



ENCYCLOPEDIA OF

# CAVES

*Edited by*

DAVID C. CULVER

WILLIAM B. WHITE

*Encyclopedia of*  
**CAVES**



*Encyclopedia of*  
**CAVES**



**Editors**

**DAVID C. CULVER**

*American University*

**WILLIAM B. WHITE**

*The Pennsylvania State University*




*Amsterdam Boston Heidelberg London New York Oxford  
Paris San Diego San Francisco Singapore Sydney Tokyo*

The chapter entitled *Nitrate Contamination in Karst Groundwater* by Brian G. Katz is in the public domain and doesn't carry the Elsevier copyright.

Alexander Klimchouk owns the copyright for his three chapters entitled *Gypsum Caves*, *Krubera (Voronja) Cave*, and *Ukrainian Giant Gypsum Caves*. Copyright © 2005 by Alexander Klimchouk.

Elsevier Academic Press  
200 Wheeler Road, 6<sup>th</sup> Floor, Burlington, MA 01803, USA  
525 B Street, Suite 1900, San Diego, California 92101-4495, USA  
84 Theobald's Road, London WC1X 8RR, UK

This book is printed on acid-free paper. 

Copyright © 2005, Elsevier Inc. All rights reserved.

No part of this publication may be reproduced or transmitted in any form or by any means, electronic or mechanical, including photocopy, recording, or any information storage and retrieval system, without permission in writing from the publisher.

Permissions may be sought directly from Elsevier's Science & Technology Rights Department in Oxford, UK: phone: (+44) 1865 843830, fax: (+44) 1865 853333, e-mail: [permissions@elsevier.com.uk](mailto:permissions@elsevier.com.uk). You may also complete your request on-line via the Elsevier homepage (<http://elsevier.com>), by selecting "Customer Support" and then "Obtaining Permissions."

#### **Library of Congress Cataloging-in-Publication Data**

Application submitted

#### **British Library Cataloguing in Publication Data**

A catalogue record for this book is available from the British Library

ISBN: 0-12-198651-9

For all information on all Elsevier Academic Press publications visit our Web site at [www.books.elsevier.com](http://www.books.elsevier.com)



*Contents by Subject Area ix*  
*Contributors xi*  
*Guide to the Encyclopedia xv*  
*Foreword xvii*  
*Preface xix*

---

**Adaptation to Darkness 1**  
*Elke Aden*

**Adaptation to Low Food 4**  
*Kathrin Hüppop*

**Adaptation to Low Oxygen 10**  
*Frédéric Hervant and Florian Malard*

**Adaptive Shifts 17**  
*Francis G. Howarth and Hannelore Hoch*

**Anchialine Caves, Biodiversity in 24**  
*Thomas M. Iliffe*

**Anchialine Caves 30**  
*Boris Sket*

---

**Bats 39**  
*Susan W. Murray and Thomas H. Kunz*

**Beetles 45**  
*Oana Teodora Moldovan*

**Behavioral Adaptations 51**  
*Jakob Parzefall*

**Breakdown 56**  
*Elizabeth L. White*

**Burnsville Cove, Virginia 60**  
*Gregg S. Clemmer*

---

**Camps 73**  
*Gregg S. Clemmer*

**Castleguard Cave, Canada 77**  
*Derek Ford*

**Cave, Definition of 81**  
*William B. White and David C. Culver*

**Cave Dwellers in the Middle East 85**  
*Paul Goldberg and Ofer Bar-Yosef*

**Chemoautotrophy 90**  
*Annette Summers Engel*

**Clastic Sediments in Caves 102**  
*Gregory S. Springer*

**Closed Depressions 108**  
*Ugo Sauro*

**Coastal Caves 122**  
*John E. Mylroie*

**Contamination of Cave Waters by Heavy Metals 127**  
*Dorothy J. Vesper*

**Contamination of Cave Waters by Nonaqueous Phase Liquids 131**  
*Caroline M. Loop*

**Cosmogenic Isotope Dating 137**  
*Darryl E. Granger and Derek Fabel*

**Crustacea 141**  
*Horton H. Hobbs III*

---

**Databases 155**  
*Keith D. Wheeland*

**Dinaric Karst, Diversity in 158**  
*Boris Sket*

**Diversity Patterns in the Tropics 166**  
*Louis Deharveng*

**Diversity Patterns in the United States 170**  
*Horton H. Hobbs III*

**Diversity Patterns in Australia 183**  
*William F. Humphreys*

**Diversity Patterns in Europe 196**  
*Janine Gibert and David C. Culver*

---

**Early Humans in the Mammoth Cave Area 203**  
*Patty Jo Watson*

- Ecotones** 206  
*David C. Culver*
- Entranceless Caves, Discovery of** 208  
*Nevin W. Davis*
- Entranceless Caves, Geophysics of** 210  
*William B. White*
- Entrances** 215  
*William B. White*
- Epikarst** 220  
*Michel Bakalowicz*
- Epikarstic Communities** 223  
*Anton Brancelj and David C. Culver*
- Evolution of Lineages** 230  
*Eleonora Trajano*
- Exploration and Light Sources** 234  
*William B. White*
- 
- Fish** 241  
*Horst Wilkens*
- Flooding** 251  
*Chris Groves and Joe Meiman*
- Food Sources** 255  
*Thomas L. Poulson*
- Friars Hole Cave System, West Virginia** 264  
*Stephen R. H. Worthington and Douglas M. Medville*
- 
- Glacier Caves** 271  
*Andrew G. Fountain*
- Guano Communities** 276  
*Pedro Gnaspini*
- Gypsum Caves** 283  
*Alexander Klimchouk*
- Gypsum Flowers and Related Speleothems** 288  
*William B. White*
- 
- Hydrogeology of Karst Aquifers** 293  
*William B. White*
- Hydrothermal Caves** 300  
*Yuri Dublyansky*
- 
- Invasion, Active versus Passive** 305  
*Dan L. Danielopol and Raymond Rouch*
- 
- Jewel Cave, South Dakota** 311  
*Mike E. Wiles*
- 
- Karren** 315  
*Joyce Lundberg*
- Karst Water Tracing** 321  
*William K. Jones*
- Kazumura Cave, Hawaii** 330  
*Kevin Allred*
- Kruber (Voronja) Cave** 335  
*Alexander Klimchouk*
- 
- Lechuguilla Cave, New Mexico** 339  
*Patricia Kambesis*
- Life History, Evolution** 346  
*David C. Culver*
- 
- Mammoth Cave System** 351  
*Roger W. Brucker*
- Mapping Subterranean Biodiversity** 355  
*Mary C. Christman*
- Marine Regressions** 361  
*Claude Boutin and Nicole Coineau*
- Maya Caves** 366  
*Andrea Stone and James E. Brady*
- Microbes** 369  
*David C. Culver*
- Minerals** 371  
*Bogdan P. Onac*
- Modeling Karst Aquifers** 378  
*Carol M. Wicks*
- Molluscs** 382  
*David C. Culver*
- Morphological Adaptations** 386  
*Kenneth Christiansen*
- Multilevel Caves and Landscape Evolution** 397  
*Darlene M. Anthony*
- Mulu Caves, Malaysia** 400  
*Joel Despain*
- Myriapods** 404  
*David C. Culver*
- Myth and Legend, Caves in** 406  
*Paul Jay Steward*
- 
- Natural Selection** 409  
*Thomas C. Kane and Robert C. Richardson*
- Neutral Mutation** 411  
*Horst Wilkens*
- Nitrate Contamination in Karst Groundwater** 415  
*Brian G. Katz*
- Nullarbor Caves, Australia** 418  
*Julia M. James, Annalisa K. Contos, and Craig M. Barnes*
- 
- Paleomagnetic Record in Cave Sediments** 427  
*Ira D. Sasowsky*
- Paleontology of Caves: Pleistocene Mammals** 431  
*Kazimierz Kowalski*
- Passages** 436  
*George Veni*
- Passage Growth and Development** 440  
*Arthur N. Palmer*
- Pits and Shafts** 444  
*John W. Hess*
- Population Structure** 447  
*Valerio Sbordon, Giuliana Allegrucci, and Donatella Cesaroni*
- Postojna-Planinska Cave System, Slovenia** 456  
*Stanka Šebela*

**Protecting Caves and Cave  
Life 458**

*William R. Elliott*

---

**Recreational Caving 469**

*John M. Wilson*

**Rescues 475**

*John C. Hempel*

**Root Communities in Lava  
Tubes 477**

*Fred D. Stone, Francis G. Howarth, Hannelore  
Hoch, and Manfred Asche*

---

**Salamanders 485**

*Jacques Pierre Durand*

**Saltpetre Mining 492**

*David A. Hubbard, Jr.*

**Show Caves 495**

*Arrigo A. Cigna*

**Siebenhengste Cave System,  
Switzerland 500**

*Pierre-Yves Jeannin and Philipp Häuselmann*

**Sinking Streams and Losing  
Systems 509**

*Joseph A. Ray*

**Sistema Huautla, Mexico 514**

*C. William Steele and James H. Smith, Jr.*

**Soil Piping and Sinkhole  
Failures 521**

*Barry Beck*

**Solution Caves in Regions of  
Moderate Relief 527**

*Arthur N. Palmer*

**Solutional Sculpturing 536**

*Phillip J. Murphy*

**Species Interactions 539**

*David C. Culver*

**Speleothem Deposition 543**

*Wolfgang Dreybrodt*

**Speleothems: Helictites and  
Related Forms 549**

*Donald G. Davis*

**Spiders and Related  
Groups 554**

*James R. Reddell*

**Springs 565**

*William B. White*

**Stalactites and Stalagmites 570**

*Silvia Frisia*

**Sulfuric Acid Caves 573**

*Arthur N. Palmer and Carol A. Hill*

---

**Ukrainian Giant Gypsum  
Caves 583**

*Alexander Klimchouk*

---

**Vertebrate Visitors—Birds and  
Mammals 589**

*Nikola Turtković*

**Vicariance and Dispersalist  
Biogeography 591**

*John R. Holsinger*

**Volcanic Caves 599**

*William B. White*

---

**Wakulla Spring Underwater Cave  
System, Florida 603**

*Barbara Anne am Ende*

**Water Chemistry in Caves 609**

*Janet S. Herman*

**Worms 614**

*Elzbieta Dumnicka*

*Glossary 619*

*Index 631*



## CONTENTS BY SUBJECT AREA

---

### TYPES OF CAVES

Anchialine Caves  
Cave, Definition of  
Coastal Caves  
Glacier Caves  
Gypsum Caves  
Hydrothermal Caves  
Solution Caves in Regions of  
Moderate Relief  
Sulfuric Acid Caves  
Volcanic Caves

---

### CAVE FEATURES

Breakdown  
Entrances  
Passages  
Pits and Shafts  
Springs

---

### HYDROLOGY AND HYDROGEOLOGY

Chemoautrophy  
Closed Depressions  
Epikarst  
Hydrogeology of Karst Aquifers

Karst Waters Tracing  
Modeling Karst Aquifers  
Passages Growth and  
Development  
Sinking Caves and Cave  
Streams  
Solutional Sculpturing  
Water Chemistry in Caves

---

### SPELEOTHEMS AND OTHER CAVE DEPOSITS

Clastic Sediments in Caves  
Gypsum Flowers and Related  
Speleothems  
Karren  
Minerals  
Speleothem Deposition  
Speleothems  
Stalactites and Stalagmites

---

### CAVE AGES AND PALEOCLIMATE

Cosmogenic Isotope Dating  
Multilevel Caves and Landscape  
Evolution

Paleomagnetic Record in Cave  
Sediments  
Paleontology of Caves: Pleistocene  
Mammals

---

### EXCEPTIONAL CAVES

Burnsville Cove, Virginia  
Castleguard Cave, Canada  
Friars Hole Cave System, West  
Virginia  
Jewel Cave, South Dakota  
Kazumura Cave, Hawaii  
Kruber (Voronja) Cave  
Lechuguilla Cave,  
New Mexico  
Mammoth Cave System  
Mulu Caves, Malaysia  
Nullarbor Caves, Australia  
Postojna-Planinska Cave System,  
Slovenia  
Siebenhengste Cave System,  
Switzerland  
Sistema Huautla, Mexico  
Ukrainian Caves  
Wakulla Spring Underwater  
Cave System, Florida



---

## BIOLOGY OF PARTICULAR ORGANISMS IN CAVES

Bats  
 Beetles  
 Crustacea  
 Fish  
 Guano Communities  
 Microbes  
 Molluscs  
 Myriapods  
 Salamanders  
 Spiders and Related Groups  
 Vertebrate Visitors—Birds and Mammals  
 Worms

---

## ECOLOGY

Ecotones  
 Epikarstic Communities  
 Food Sources  
 Population Structure  
 Root Communities in Lava Tubes  
 Species Interactions

---

## CAVE INVASION

Invasion, Active versus Passive  
 Marine Regressions  
 Vicariance and Dispersalist Biogeography

---

## BIOGEOGRAPHY AND DIVERSITY

Anchialine Caves, Biodiversity in Dinaric Karst, Diversity in Diversity in the Tropics  
 Diversity in the United States  
 Diversity Patterns in Australia  
 Diversity Patterns in Europe  
 Mapping Subterranean Biodiversity

---

## EVOLUTION AND ADAPTION IN CAVES

Adaptation to Darkness  
 Adaptation to Low Food  
 Adaptation to Low Oxygen  
 Adaptive Shifts  
 Behavioral Adaptations  
 Evolution of Lineages  
 Life History Evolution  
 Morphological Adaptations  
 Natural Selection  
 Neutral Mutation

---

## EXPLORATION OF CAVES

Camps  
 Databases  
 Entranceless Caves, Discovery of  
 Entranceless Caves, Geophysics of  
 Exploration and Light Sources  
 Rescues

---

## CONTEMPORARY USE OF CAVES

Protecting Caves and Cave Life  
 Recreational Caving  
 Show Caves

---

## HISTORICAL USE OF CAVES

Cave Dwellers in the Middle East  
 Early Humans in the Mammoth Cave Area  
 Maya Caves  
 Myths and Legends, Caves in Salpetre Mining

---

## GROUNDWATER CONTAMINATION AND LAND-USE HAZARDS IN CAVE REGIONS

Contamination of Cave Waters by Heavy Metals  
 Contamination of Cave Waters by Nonaqueous Phase Liquids  
 Flooding  
 Nitrate Contamination in Karst Groundwater  
 Soil Piping and Sinkhole Failures



**ELKE ADEN**

*Zoological Institute and Zoological Museum,  
University of Hamburg, Germany*  
Adaptation to Darkness

**GIULIANA ALLEGRUCCI**

*Tor Vergata University, Italy*  
Population Structure

**KEVIN ALLRED**

*Hawaii Speleological Survey*  
Kazumura Cave, Hawaii

**BARBARA ANNE AM ENDE**

*Wakulla Spring Underwater Cave System,  
Florida*  
Deep Caves Consulting

**DARLENE M. ANTHONY**

*Purdue University*  
Multilevel Caves and Landscape  
Evolution

**MANFRED ASCHE**

*Museum für Naturkunde*  
Root Communities in Lava Tubes

**MICHEL BAKALOWICZ**

*HydroSciences*  
Epikarst

**CRAIG M. BARNES**

*University of Sydney, Australia*  
Nullarbor Caves, Australia

**OFER BAR-YOSEF**

*Harvard University*  
Cave Dwellers in the Middle East

**BARRY BECK**

*P. E. LaMoreaux & Associates, Inc.*  
Soil Piping and Sinkhole Failures

**CLAUDE BOUTIN**

*Université Paul Sabatier, France*  
Marine Regressions

**JAMES E. BRADY**

*California State University, Los Angeles*  
Maya Caves

**ANTON BRANCELJ**

*National Institute of Biology, Slovenia*  
Epikarstic Communities

**ROGER W. BRUCKER**

*Graphtronics*  
Mammoth Cave System

**DONATELLA CESARONI**

*Tor Vergata University, Italy*  
Population Structure

**KENNETH CHRISTIANSEN**

*Grinnell College*  
Morphological Adaptations

**MARY C. CHRISTMAN**

*University of Maryland*  
Mapping Subterranean Biodiversity

**ARRIGO A. CIGNA**

*International Show Caves Association (Union  
Internationale de Spéléologie), Italy*  
Show Caves

**GREGG S. CLEMMER**

*Butler Cave Conservation Society, Inc.*  
Burnsville Cove, Virginia  
Camps

**NICOLE COINEAU**

*Laboratoire Arago, France*  
Marine Regressions

**ANNALISA K. CONTOS**

*University of Sydney, Australia*  
Nullarbor Caves, Australia

**DAVID C. CULVER**

*American University*  
Cave, Definition of  
Diversity Patterns in Europe

Ecotones

Epikarstic Communities

Life History Evolution

Microbes

Molluscs

Myriapods

Species Interactions

**DAN L. DANIELOPOL**

*Austrian Academy of Sciences, Austria*  
Invasion, Active versus Passive

**DONALD G. DAVIS**

*National Speleological Society*  
Speleothems: Helicitites and Related Forms

**NEVIN W. DAVIS**

*Butler Cave Conservation Society, Inc.*  
Entranceless Caves, Discovery of

**LOUIS DEHARVENG**

*Museum National d'Histoire Naturelle de Paris,  
France*  
Diversity in the Tropics

**JOEL DESPAIN**

*Gunung Buda Project and Sequoia and Kings  
Canyon National Park*  
Mulu Caves, Malaysia

**WOLFGANG DREYBRODT**

*University of Bremen, Germany*  
Speleothem Deposition

**YURI DUBLYANSKY**

*Institute of Mineralogy and Petrography, Russia*  
Hydrothermal Caves

**ELZBIETA DUMNICKA**

*Institute of Freshwater Biology, Polish Academy of  
Sciences, Poland*  
Worms

**JACQUES PIERRE DURAND**

*Laboratoire Souterrain, France*  
Salamanders

**WILLIAM R. ELLIOTT**

*Missouri Department of Conservation  
Protecting Caves and Cave Life*

**ANNETTE SUMMERS ENGEL**

*The University of Texas at Austin  
Chemoautotrophy*

**DEREK FABEL**

*The Australian National University  
Cosmogenic Isotope Dating*

**DEREK FORD**

*McMaster University  
Castleguard Cave, Canada*

**ANDREW G. FOUNTAIN**

*Portland State University  
Glacier Caves*

**SILVIA FRISIA**

*Museo Tridentino di Scienze Naturali, Italy  
Stalactites and Stalagmites*

**JANINE GIBERT**

*Université Lyon, France  
Diversity Patterns in Europe*

**PEDRO GNASPINI**

*University of São Paulo, Argentina  
Guano Communities*

**PAUL GOLDBERG**

*Boston University  
Cave Dwellers in the Middle East*

**DARRYL E. GRANGER**

*Purdue University  
Cosmogenic Isotope Dating*

**CHRIS GROVES**

*Western Kentucky University  
Flooding*

**PHILIPP HÄUSELMANN**

*Höhlenforschergemeinschaft Region Hohgant  
(HRH) and Swiss Institute for Speleology and  
Karst Studies (SISKA), Switzerland  
Siebenhengste Cave System, Switzerland*

**JOHN C. HEMPEL**

*EEI Geophysical  
Rescues*

**JANET S. HERMAN**

*University of Virginia  
Water Chemistry in Caves*

**FRÉDÉRIC HERVANT**

*Université Lyon, France  
Adaptation to Low Oxygen*

**JOHN W. HESS**

*Geological Society of America  
Pits and Shafts*

**CAROL A. HILL**

*University of New Mexico  
Sulfuric Acid Caves*

**HORTON H. HOBBS III**

*Wittenberg University  
Crustacea  
Diversity Patterns in the United States*

**HANNELORE HOCH**

*Museum für Naturkunde, Germany  
Adaptive Shifts  
Root Communities in Lava Tubes*

**JOHN R. HOLSINGER**

*Old Dominion University  
Vicariance and Dispersalist Biogeography*

**FRANCIS G. HOWARTH**

*Bernice P. Bishop Museum  
Adaptive Shifts  
Root Communities in Lava Tubes*

**DAVID A. HUBBARD, Jr.**

*Virginia Speleological Survey and Virginia  
Department of Mines, Minerals and Energy  
Saltpetre Mining*

**WILLIAM F. HUMPHREYS**

*Western Australian Museum, Australia  
Diversity Patterns in Australia*

**KATHRIN HÜPPOP**

*Institute of Avian Research, Germany  
Adaptation to Low Food*

**THOMAS M. ILIFFE**

*Texas A&M University at Galveston  
Anchialine Caves, Biodiversity*

**JULIA M. JAMES**

*University of Sydney, Australia  
Nullarbor Caves, Australia*

**PIERRE-YVES JEANNIN**

*Höhlenforschergemeinschaft Region Hohgant  
(HRH) and Swiss Institute for Speleology and  
Karst Studies (SISKA), Switzerland  
Siebenhengste Cave System, Switzerland*

**WILLIAM K. JONES**

*Karst Waters Institute  
Karst Water Tracing*

**PATRICIA KAMBESIS**

*Hoffman Environmental Research Institute  
Lechuguilla Cave, New Mexico*

**THOMAS C. KANE**

*University of Cincinnati  
Natural Selection*

**BRIAN G. KATZ**

*U.S. Geological Survey  
Nitrate Contamination in Karst  
Groundwater*

**ALEXANDER KLIMCHOUK**

*Institute of Geological Sciences, Ukraine  
Gypsum Caves  
Krubera (Voronja) Cave  
Ukrainian Giant Gypsum Caves*

**KAZIMIERZ KOWALSKI**

*Polish Academy of Sciences, Poland  
Paleontology of Caves: Pleistocene  
Mammals*

**THOMAS H. KUNZ**

*Boston University  
Bats*

**CAROLINE M. LOOP**

*The Pennsylvania State University  
Contamination of Cave Waters by  
Nonaqueous Phase Liquids*

**JOYCE LUNDBERG**

*Carleton University, Ottawa  
Karren*

**FLORIAN MALARD**

*Université Lyon, France  
Adaptation to Low Oxygen*

**DOUGLAS M. MEDVILLE**

*West Virginia Speleological Survey  
Friars Hole Cave System, West Virginia*

**JOE MEIMAN**

*Mammoth Cave National Park  
Flooding*

**OANA TEODORA MOLDOVAN**

*Emil Racovitza Speleological Institute, Romania  
Beetles*

**PHILLIP J. MURPHY**

*University of Leeds, United Kingdom  
Solutional Sculpturing*

**SUSAN W. MURRAY**

*Boston University  
Bats*

**JOHN E. MYLROIE**

*Mississippi State University  
Coastal Caves*

**BOGDAN P. ONAC**

*Babes-Bolyai University and Emil Racovitza  
Institute of Speleology, Romania  
Minerals*

**ARTHUR N. PALMER**

*State University of New York  
Passage Growth and Development  
Solution Caves in Regions of Moderate  
Relief  
Sulfuric Acid Caves*

**JAKOB PARZEFALL**

*Zoologisches Institut und Zoologisches der  
Universität Hamburg, Germany  
Behavioral Adaptations*

**THOMAS L. POULSON**

*University of Illinois at Chicago  
Food Sources*

**JOSEPH A. RAY**

*Kentucky Division of Water  
Sinking Streams and Loosing Streams*

**RAYMOND ROUCH**

*Laboratoire Souterrain, France (Retired)*  
Invasion, Active versus Passive

**JAMES R. REDDELL**

*The University of Texas at Austin*  
Spiders and Related Groups

**ROBERT C. RICHARDSON**

*University of Cincinnati*  
Natural Selection

**IRA D. SASOWSKY**

*University of Akron*  
Paleomagnetic Record in Cave Sediments

**UGO SAURO**

*University of Padova, Italy*  
Closed Depressions

**VALERIO SBORDONI**

*Tor Vergata University, Italy*  
Population Structure

**STANKA ŠEBELA**

*Karst Research Institute, Slovenia*  
Postojna–Planinska Cave System, Slovenia

**BORIS SKET**

*Univerza v Ljubljani, Slovenia*  
Anchialine Caves  
Dinaric Karst, Diversity in

**JAMES H. SMITH, JR.**

*Environmental Protection Agency*  
Sistema Huautla, Mexico

**GREGORY S. SPRINGER**

*Ohio University*  
Clastic Sediments in Caves

**C. WILLIAM STEELE**

*Boy Scouts of America*  
Sistema Huautla, Mexico

**PAUL JAY STEWARD**

*Cave Research Foundation*  
Myth and Legend, Caves in

**ANDREA STONE**

*University of Wisconsin–Milwaukee*  
Maya Caves

**FRED D. STONE**

*Hawai'i Community College*  
Root Communities in Lava Tubes

**ELEONORA TRAJANO**

*Universidade de São Paulo, Argentina*  
Evolution of Lineages

**NIKOLA TVRTKOVIĆ**

*Croatian Natural History Museum, Croatia*  
Vertebrate Visitors—Birds and Mammals

**GEORGE VENI**

*George Veni & Associates*  
Passages

**DOROTHY J. VESPER**

*West Virginia University*  
Contamination of Cave Waters by Heavy Metals

**PATTY JO WATSON**

*Washington University, St. Louis*  
Early Humans in the Mammoth Cave Area

**KEITH D. WHEELAND**

*The Pennsylvania State University, Retired*  
Databases

**ELIZABETH L. WHITE**

*The Pennsylvania State University*  
Breakdown

**WILLIAM B. WHITE**

*The Pennsylvania State University*  
Cave, Definition of  
Entranceless Caves, Geophysics of  
Entrances  
Exploration and Light Sources  
Gypsum Flowers and Related Speleothems  
Hydrogeology of Karst Aquifers  
Springs  
Volcanic Caves

**CAROL M. WICKS**

*University of Missouri—Columbia*  
Modeling Karst Aquifers

**MIKE WILES**

*Jewel Cave National Monument*  
Jewel Cave, South Dakota

**HORST WILKENS**

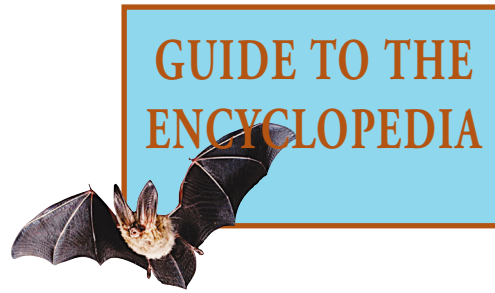
*University of Hamburg, Germany*  
Fish  
Neutral Mutation

**JOHN M. WILSON**

*Marks Products, Inc.*  
Recreational Caving

**STEPHEN R. H. WORTHINGTON**

*Worthington Groundwater*  
Friars Hole Cave System, West Virginia



The *Encyclopedia of Caves* is a complete source of information on the subject of caves and life in caves, contained within a single volume. Each article in the *Encyclopedia* provides an overview of the selected topic to inform a broad spectrum of readers, from biologists and geologists conducting research in related areas, to students and the interested general public.

In order that you, the reader, will derive the maximum benefit from the *Encyclopedia of Caves*, we have provided this Guide. It explains how the book is organized and how the information within its pages can be located.

## SUBJECT AREAS

The *Encyclopedia of Caves* presents 107 separate articles on the entire range of speleological study. Articles in the *Encyclopedia* fall within 15 general subject areas, as follows:

- Types of Caves
- Cave Features
- Hydrology and Hydrogeology
- Speleothems and Other Cave Deposits
- Cave Ages and Paleoclimate
- Exceptional Caves
- Biology of Particular Organisms in Caves
- Ecology
- Cave Invasion
- Biogeography and Diversity
- Evolution and Adaptation in Caves
- Exploration of Caves
- Contemporary Use of Caves
- Historical Use of Caves
- Ground Water Contamination and Land Use Hazards in Cave Regions

## ORGANIZATION

The *Encyclopedia of Caves* is organized to provide the maximum ease of use for its readers. All of the articles are arranged in a single alphabetical sequence by title. An alphabetical Table of Contents for the articles can be found beginning on page v of this introductory section.

So they can be more easily identified, article titles begin with the key word or phrase indicating the topic, with any descriptive terms following this. For example, “Invasion, Active versus Passive” is the title assigned to this article, rather than “Active versus Passive Invasion,” because the specific term *Invasion* is the key word.

You can use this alphabetical Table of Contents by itself to locate a topic, or you can first identify the topic in the Contents by Subject Area on page x and then go to the alphabetical Table to find the page location.

## ARTICLE FORMAT

Each article in the *Encyclopedia* begins with introductory text that defines the topic being discussed and indicates its significance. For example, the article “Behavioral Adaptations” begins as follows:

Animals living in darkness have to compete for food, mates, and space for undisturbed reproduction just as their epigeal conspecifics do in the epigeal habitats, but there is one striking difference: In light, animals can use visual signals. Thus, important aspects of their behavior driven by visual signals cannot apply in darkness. The question arises, then, of how cave dwellers compensate for this disadvantage in complete darkness. This article uses several examples to compare various behavior patterns among cave dwelling populations with epigeal ancestors.

Major headings highlight important subtopics that are discussed in the article. For example, the article “Beetles” includes these topics: Adaptations, Colonization and Geographical Distribution, Systematics of Cave Beetles, Ecology, Importance and Protection.

### CROSS-REFERENCES

Cross-references appear within the *Encyclopedia* as indications of related topics at the end of a particular article. As an example, a cross-reference at the end of an article can be found in the entry “Camps.” This article concludes with the statement:

*See Also the Following Articles*

*Recreational Caving • Exploration of Light Sources*

This reference indicates that these related articles all provide some additional information about Camps.

### BIBLIOGRAPHY

The Bibliography section appears as the last element of the article. This section lists recent secondary sources that will aid the reader in locating more detailed or technical information on the topic at hand. Review articles and research papers that are important to a more detailed understanding of the topic are also listed here. The Bibliography entries in this *Encyclopedia* are for the benefit of the reader to provide references for further reading or additional research on the given topic. Thus they typically consist of a limited number of entries. They are not intended to represent a complete listing of all the materials consulted by the author or authors in preparing the article. The Bibliography is in effect an extension of the article itself, and

it represents the author’s choice as to the best sources available for additional information.

### GLOSSARY

The *Encyclopedia of Caves* presents an additional resource for the reader, following the A–Z text. A comprehensive glossary provides definitions for more than 450 specialized terms used in the articles in this *Encyclopedia*. The terms were identified by the contributors as helpful to the understanding of their entries, and they have been defined by these authors according to their use in the actual articles.

### INDEX

The Subject Index for the *Encyclopedia of Caves* contains more than 4600 entries. Within the entry for a given topic, references to general coverage of the topic appear first, such as a complete article on the subject. References to more specific aspects of the topic then appear below this in an indented list.

### ENCYCLOPEDIA WEBSITE

The *Encyclopedia of Caves* maintains its own Web page on the Internet at:

<http://books.elsevier.com/caves>

This site provides information about the *Encyclopedia* and features links to related sites that provide information on subjects covered in the *Encyclopedia*. It also hosts sample material, published reviews, and the opportunity to purchase additional copies of the *Encyclopedia* on a secure Web site. The site will continue to evolve as more information becomes available.



Few things capture man's imagination, as do caves. Mark Twain recognized this in writing *Tom Sawyer*. Tom, Huck Finn, Becky Thatcher, and Injun Joe are well-known characters of interest to children and adults alike. Their cave exploration, for example, with candles flickering, currents of fresh air causing flames to flutter, and the discovery of Injun Joe in the dim light of a lantern with a hidden treasure was a masterpiece of literature. Twain captured it all.

Caves, stalactites, stalagmites, albino sightless fish, and underground rivers have been around for millions of years. The earliest "cave art" dates to 15,000 B.P. in the caves of Altamira in Spain and in Lascaux in France, which contain spectacular drawings of animals. Cave artifacts are the earliest evidence of cave occupation at the time of Australopithecus (3.5 m.y.b.p.). Caves provided evidence that Homo (2.4 m.y.b.p.), used caves for shelters, a water source, and safety. Caves have provided information about the evolution of mankind through their artifacts, weapons, fire, and art. Shanedar Cave, in Iraq, as an example, was the burial place for nine Neanderthal skeletons that provided knowledge about care of the sick and elderly and the ritualistic burial of their dead over 34,000 years b.p.

Approximately one-fifth of the earth's surface is underlain by carbonate rocks of a complex physical character that produced a diverse topographic expression by weathering under varied climatic conditions. Carbonate terranes in some areas are underlain by broad, rolling plains, whereas in others they are characterized by steep bluffs, canyons, sinks, and valleys. Owing to the variability of the solubility of limestone, man's inhabitation and development in limestone areas has sometimes been difficult. There are areas of limestone covered by fertile soils, whereas in others, soils are missing. In the United States, a large area in the Midwest is underlain by limestone and covered by a very rich soil that

produces large quantities of food. This area is called, literally, "the breadbasket of a nation."

Carbonate rocks are a source of abundant water supplies, minerals and oil, and gas. Even though there are many blessings associated with carbonate terranes, there are also many problems related to developing an adequate water supply, assuring proper drainage, providing stable foundation conditions, and preventing serious pollution problems. Because of this complexity, the evolution of concepts related to the movement and occurrence of ground water in karst, methods of exploration and development of water, safe engineering practices in construction of all kinds, and adequate environmental safety precautions cannot be based on one set of uniform rules.

Caves Karst areas are dynamic and environmentally sensitive. The geologic structure, solubility of the rocks involved, and the climatic conditions determine to a great degree how rapid these changes can take place. Therefore, investigations must consider the dynamic nature of karst. It is necessary to recognize the synergistic relation between circulation of water and the solution of the rock. The greater and more rapid the solution of the rock can lead to changes in and progressive lowering of water tables—base levels and cave enlargement, changes that can take place in a relatively brief period of time and can impact the hydrogeologic history of and area, and bring about major environmental problems.

During the past few years many outstanding publications illustrated by fine graphics have described caves and the science of karst. The literature on the subject is voluminous with over 50 new textbooks, approximately 1000 technical manuscripts, and over 300 field trips associated with meetings or congresses.

Because of this proliferation of scientific material and the diversification of disciplines involved—botany, biology,

chemistry, archaeology, geology, engineering, speleology, conservation and planning, history and resource exploration, and development—it is not easy to maintain a grasp of the status of karst research. *The Encyclopedia of Caves*, with 107 articles by world-wide experts on caves, is quite unique with contributions from multi-disciplines and a great variety of subject matter, academic, as well as practical, with case histories describing all types of cave-associated problems such

as: drainage, water supply, construction, environmental exploration, development, and management of water supplies in karst. This volume is a must for karst researchers, cave enthusiasts, teachers, and developers.

*Philip LaMoreaux*  
June, 2004





Throughout history, caves have always been of at least some interest to almost everyone. During the past few centuries caves have been a passionate interest to at least a few people. The number of those with a passionate interest has been continuously growing. The core of the cave enthusiasts are, of course, the cave explorers. However, scientists of various sorts, mainly geologists and biologists, have also found caves useful and fascinating subjects for scientific study.

There have always been cave explorers. Some, such as E. A. Martel in France in the late 1800s, achieved amazing feats of exploration of deep alpine caves. In the United States, the number of individuals seriously interested in the exploration of caves has grown continuously since the 1940s. Cave exploration takes many forms. Some cavers are interested in caving simply as a recreational experience, not intrinsically different from hiking, rock climbing, or mountain biking. But many pursue genuine exploration. Their objective is the discovery of new cave passages never before seen by humans. As the more obvious entrances and the more accessible caves have been explored, cave exploration in the true sense of the word, has become more elaborate and more difficult. To meet the challenge of larger, more obscure and more difficult caves, cavers have responded with the invention of new techniques, new equipment, and the training required to use it. To meet the challenge of long and difficult caves, cavers have been willing to accept the discipline of project and expedition caving and to accept the arduous tasks of surveying caves as they are explored. The result has been the accumulation of a tremendous wealth of information about caves that has been invaluable to those studying caves from a scientific point of view.

In the early years of the twentieth century, a few geologists became interested in the processes that allowed caves to form. Biologists were interested in the unique habitats and the

specialized organisms that evolved there. In both sciences and in both Europe and the United States, the interest was in the caves themselves. The study of caves was focused inward and some proposed the study of caves to be a separate science called *speleology*. In the latter decades of the twentieth century, there was a gradual change in perspective. The study of caves came to be seen as important for its illumination of other realms of science.

In the past few decades, the geological study of caves has undergone a tremendous expansion in point of view. The caves themselves are no longer seen as simply geological oddities that need to be explained. Caves are repositories and are part of something larger. As repositories, the clastic sediments in caves and the speleothems in caves have been found to be records of past climatic and hydrologic conditions. Cave passages themselves are recognized as fragments of conduit systems that are or were an intrinsic part of the groundwater system. Active caves give direct insight into the hydrology and dry caves are records that tell something of how drainage systems have evolved. Techniques for the dating of cave deposits have locked down events much more accurately in the caves than on the land surface above. Caves then become an important marker for interpreting the evolution of the landscape above. Even the original, rather prosaic, problem of explaining the origin and development of caves has required delving into the chemistry of groundwater interactions with carbonate rocks and on the fluid mechanics of groundwater flow.

Cave biology has likewise evolved from an exercise in taxonomy—discovering, describing, and classifying organisms from caves—to the use of caves as natural laboratories for ecology and evolutionary studies. The central question that has occupied the attention of biologists at least since the time of Lamarck is how did animals come to lose their eyes and pigment. The question gets answered each generation

using the scientific tools available and its most contemporary form is a question of the fate of eye genes themselves. Cave animals have also served as models for the study of adaptation because of their ability to survive in the harsh environments of caves. There are also interesting biological questions about the evolutionary history of cave animals that are being unraveled using a variety of contemporary techniques. Finally, there is increasing concern about the conservation of cave animals. Nearly all have very restricted ranges and many are found in only a single cave. The past two decades have seen a phenomenal growth in the understanding of how to manage cave and karst areas to protect the species that depend on them.

One should not suppose that caves are of interest only to geologists and biologists. Caves are repositories of archaeological and paleontological resources. Ancient art has been preserved in caves. Caves appear in folk tales, legends, mythology, and in the religions of many peoples. Caves appear frequently in literature, either as an interesting setting for the story or as a metaphor. The latter has a history extending at least to Plato.

In planning the content of the *Encyclopedia of Caves*, the editors were faced with this great variety of “clients” with their highly diverse interests in caves. Several decisions were made. One was that we would address the interests of as many “clients” as possible given the limitations of space. Thus, the *Encyclopedia*, in addition to the expected articles on biology and geology, also contains articles on exploration techniques, archaeology, and folklore. A second decision was to allow authors a reasonable page space so they could discuss

their assigned subject in some depth. As a result of this decision the *Encyclopedia* contains a smaller number of articles and thus a smaller number of subjects than might be expected. The object was to provide a good cross-section of contemporary knowledge of caves rather than attempt an entry for every possible subject.

The level of presentation was intended to be at the college level. In this way the articles would have sufficient technical depth to be useful to specialists but would still be accessible to the general reader. Some of the subjects are intrinsically more technical than others but we have attempted to keep to a minimum the specialist jargon and in particular the obnoxious acronyms that turn many technical subjects into a secret code known only to insiders.

The selection of authors was made by the editors. We attempted to select contributors who we knew were expert in the subject being requested of them. For many subjects there was certainly a choice of potential experts and our selection was to some degree arbitrary. We sincerely hope that no one is offended that some other person was selected rather than them.

We take this opportunity to thank the authors for their hard work. The *Encyclopedia* is a collective effort of many peoples in many disciplines. We are particularly appreciative of everyone’s efforts to communicate with cave enthusiasts outside of their particular discipline.

*David C. Culver*  
*William B. White*  
September 2004



## Adaptation to Darkness

Elke Aden

Zoological Institute and Zoological Museum, University of Hamburg,  
Germany

Light is the origin of all life, and primary production is the source of biodiversity; nevertheless, life also exists in darkness. Animals living in this “unreal” world have their origin in the light and have to be adapted to this environment. Probably no animals have a more intimate environmental adaptation than those inhabiting caves. What does *adaptation* mean and how dark is darkness?

### DARKNESS

The most obvious characteristic of caves is the darkness beyond the twilight zone that extends a short distance in from the entrance (Fig. 1). An experiment to characterize cave darkness as absolute darkness illustrates this point well. A photographic film developed after being exposed for a week in the depths of a cave was completely blank (Moore and Sullivan, 1978). This should be the definition for dark, and it is darker than the darkest night. This level of darkness is comparable with deep-sea ocean depths, because below 1000 to 1200 meters there is no penetration of sunlight, but sometimes bioluminescence does occur. Normally, no bioluminescence is observed in caves; only caves in New Zealand and Australia are known to have light-producing insect larvae. There are some parallels in adaptations to darkness between the deep sea and caves. The large domain on earth where life exists without light is termed *allobiosphere*, after Hutchinson (Danielopol *et al.*, 1996). Perpetual darkness is a characteristic of most rock void habitats anyway, so let us choose to define a cave as a habitat entirely without natural

illumination (Chapman, 1993). For another definition of a cave, see Culver and White (Cave, Definition of).

### ADAPTATION

To explain the origin and maintenance of patterns of organic diversity, biologists normally use two principles: phylogeny and adaptation. The term *adaptation* is applied to several different biological phenomena. Generally, three different types of responses of organisms to their environment have been termed adaptive:

*Physiological adaptation* is the ability of organisms to adjust phenotypically to short-term changes in the environment. This is somatic or phenotypic plasticity, and it is not heritable. For example, adaptation of the eye is sensitivity adjustment effected after considerable exposure to light (light adapted) or darkness (dark adapted).

*Adaptation in behavior* means fatigue in responses to a repeated, uniform stimulus.

*Evolutionary adaptation* is the long-term, hereditary change that occurs in species in response to a particular set of environmental factors.

Putting all these things together, let us say that adaptation means any morphological, physiological, or behavioral characteristics that fit an organism to the conditions under which it lives. The term *adaptation* arises from the Latin *ad* + *aptus* (“towards a fit”). Adaptive traits are those that are correlated with an aspect of the environment and are postulated to have arisen and been subsequently maintained by the same selective pressure (Northcutt, 1988). Culver *et al.* (1995) stress the predominant importance of the genetic component: Adaptation is a progress of genetic change resulting in improvement of a character with reference to a specific function or a feature of a selective advantage that has become prevalent in a population. Because most traits have

multiple functions, it is necessary to determine how a trait is actually needed by an organism in the real world—its biological role—when trying to evaluate its adaptiveness.

### TROGLOBITES

Animals that live permanently in the dark zone and are found exclusively in caves are termed *troglobites*, from *troglos* (“cave”) and *bios* (“life”). Typical troglobites are pale and blind. These genetically fixed characters evolved in all troglobites of many different systematic groups subsequent to exposure to darkness for a sufficiently long period. Usually pigmentation is necessary as protection against sunlight, especially the ultraviolet wavelengths. In caves, this protection is obsolete. The eye is a sense organ to detect light, so in caves even the most highly developed eyes are completely useless. When we recall the definition of adaptation we can say that the loss of eyes is not an adaptation to fit an animal for the dark environment, but it is a restraining condition that occurs only in the darkness as a matter of course. Nevertheless, in the field of regressive evolution, the loss of the eye has received strong attention. Another view is that the regression of ocular structures is surely an adaptive feature, because it is submitted to natural selection in order to save energy (for discussion, see Culver and Wilkens, 2000).

### TROGLOMORPHY

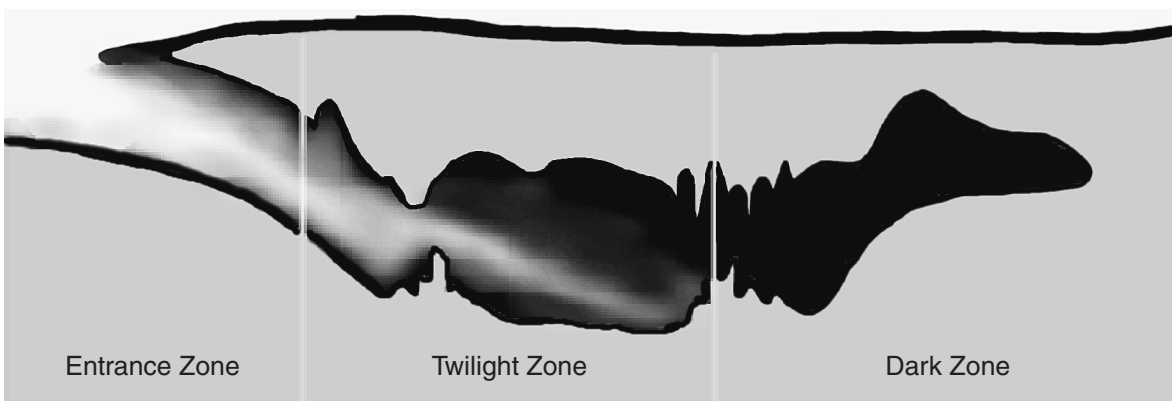
The term *troglo-morph* refers to any morphological, physiological, or behavioral feature that characterizes cave animals (Christiansen, 1992). The troglomorphic suite in cave animals exemplifies evolutionary convergence resulting from life in similar environments. Troglomorphy comprises constructive as well as regressive characteristics of the cave animals. In consequence, not every troglomorphic trait is adaptive, but on the other hand all cave adaptations result in troglomorphy. Not every cave animal displays the complete set of troglomorphic traits. Their expression depends on the

characteristics of the epigeal ancestor. A prerequisite for constructive traits is their genetic availability in epigeal forms. For example a fish that lacks barbels probably will not evolve them as a cave fish. To see the degree of adaptation, one has to search in each individual species to determine what trait could be improved. The reason for the similarities of troglomorphies in different troglobites is the process of evolution, with mechanisms underlying parallelism and convergence. The term *troglo-morphy* is restricted to cave animals; the same traits lead to the more general concept of darkness syndrome, which is comprised of morphological and biological changes of animals inhabiting the aquatic allobiosphere (Danielopol *et al.*, 1996).

The most conspicuous troglomorphic feature in troglobites is regression of their eyes. In cave fishes, the degree of eye reduction is commonly considered as a reflection of the period of cavernicolous evolution and therefore indicates the relative phylogenetic age of related cave fish species. Within the ontogeny, the eye is built up to a species-specific degree of development followed by a more or less pronounced regression (Langecker, 2000). Either a rudiment or even a total loss of any eye tissue can be found. Loss of the eyes is linked to learning how to navigate blindly. This problem is solved by cave animals in different ways. To find food and to reproduce are essential. Animals able to find food and a partner without the use of the eye are good candidates for generating a cave form. Without a need to improve the efficiency of the other nonvisual senses, there will not be a constructive evolution. Alternatively, when the nonvisual senses are not good enough for blind navigation, there will be a constructive evolution of other structures or features.

### DERIVATION OF TROGLOBITES

To begin adaptation to an environment such as a cave, a population has to pass through stages of subterranean evolution. For a critical review of the relevant theories of the evolution of subterranean animals, see Culver and Wilkens



**FIGURE 1** The darkness beyond the twilight zone that extends a short distance in from the cave entrances.

(2000). All known cave species originate from surface-dwelling species that have incidentally invaded caves. When the ancestral form has remained extant, a direct comparison can be made between the ancestral and derived cave forms. In a few cases among isopods, amphipods, and fish, the cave and epigeal form are regarded as being conspecific, but for most cave animals direct epigeal ancestors are unknown. The surface-dwelling ancestors of many cave forms have become extinct, leaving their underground derivatives as the sole representatives of the taxon.

Comparing the epigeal and hypogean forms of one species, we can identify what may be an obvious adaptation to darkness; however, both lineages are susceptible to evolutionary change, even the epigeal one, so it may be difficult to recapitulate the common ancestral state. The interpretation might be complicated by whether a structure or feature is adapted or not. Additionally, it is necessary to evaluate if a supposed troglomorphic trait is, in fact, apomorphic or merely a plesiomorphy of the group or lineage.

### ADAPTATION TO DARKNESS IN CAVE FISHES

Even though the majority of troglomorphic species live in terrestrial cave environments, some species (*e.g.*, fish) evolve in aquatic caves. Fish, in terms of numbers, are by far the most important of all vertebrate classes, probably accounting for over half of all recognized vertebrate species. In many ways, their visual systems and specifically their eyes are similar to our own. The retina is widely used as a model system for the study of the central nervous system (Douglas and Djamgoz, 1990). Much can be learned about the visual system by examining how it is reduced under such strong environmental conditions as total darkness. For further discussion of eye reduction in cave fishes, see Wilkens (Fish). Troglomorphic fishes can be found all over the world. On the other hand, a single species is often endemic; that is, it is only found in a single cave or a small karst area. About 81 species of hypogean fishes are known in 18 families (Weber, 2000; updated by G. Proudlove, pers. comm.). All of them are able to navigate in complete darkness, and several exhibit a compensatory development of extraoptic sensorial organs.

Silurids are characterized by long tactile and gustatory barbels and do not depend on sight in their feeding activities. This is, of course, a favorable requisite for successful cave colonization. Indeed, about a third of the cave fishes belong to the catfishes.

Fishes may lose their eyes, but never their auditory and lateral line systems. Some of them are more sensitive to vibration in the surrounding water than their seeing relatives—for example, by virtue of a better lateral line system. To improve orientation, the tactile sense, the olfactory sense, taste, and hearing can be advanced. This can be achieved by increasing the number of receptors, or an elongation of the neuromast cupulae may occur. A dispersion of structures can be seen in some cases. Often, elongated antennae or different appen-

dages in invertebrates or elongated barbels in cave fish have evolved to improve orientation. These modifications in sensory structures have converged in different cave animals and/or in different populations. No general way to compensate the visual system exists in all cave animals. For more information on sensory compensation in specific cave fish species, see Wilkens (Fish).

Due to compensatory improvement of extraocular senses, the signal processing structures are altered correspondingly. For example, an enhancement in taste bud number is matched by an increase in the size of the forebrain, which contains the teleost gustatory center (Jeffery, 2001). Similarly, eye regression leads to a reduced tectum opticum, which is the main center of vision processing.

In summary, adaptation to darkness means managing to live blindly, if necessary, via an improvement of nonvisual senses that may enhance the fitness of the animal to life in a dark environment like a cave. Each cave is characterized by constraints that depend on its mode of formation, location, age, size, temperature, humidity, and food supply. The adaptations of cave animals depend not only on darkness but also on the remaining cave conditions.

### See Also the Following Articles Adaptive Shifts

#### Bibliography

- Chapman, P. (1993) *Caves and Cave Life*, Harper Collins, London.
- Christiansen, K.A. (1992) Biological processes in space and time: cave life in the light of modern evolutionary theory, in *The Natural History of Biospeleology*, Camacho, A.I., Ed., Museo Nacional de Ciencias Naturales, Madrid, pp. 453–478.
- Culver, D.C., T.C., Kane, and D.W. Fong, (1995) *Adaptation and Natural Selection in Caves*, Harvard University Press, Cambridge, MA.
- Culver, D.C. and H. Wilkens (2000) Critical review of the relevant theories of the evolution of subterranean animals. In *Ecosystems of the World*, Vol. 30, *Subterranean Ecosystems* (H. Wilkens, D.C. Culver, and W.F., Humphreys, Eds.). Elsevier Press, Amsterdam, pp. 381–397.
- Danielopol, D.L., A. Baltanas, and G. Bonaduce (1996) The darkness syndrome of subsurface-shallow and deep-sea dwelling Ostracoda. In *Deep-Sea and Extreme Shallow-Water Habitats: Affinities and Adaptation* (F. Uiblein, J. Ott, and M. Stachowitsch, Eds.). Austrian Academy of Sciences, Vienna, pp. 123–143.
- Douglas, R.H. and M.B.A. Djamgoz (1990) *The Visual System of Fish*, Chapman & Hall, London.
- Jeffery, W.R. (2001) Cavefish as a model system in evolutionary developmental biology. *Dev. Biol.*, 231: 1–12.
- Langecker, T.G. (2000) The effect of continuous darkness on cave ecology and cavernicolous evolution. In *Ecosystems of the World*, Vol. 30, *Subterranean Ecosystems* (H. Wilkens, D.C. Culver, and W.F., Humphreys, Eds.). Elsevier Press, Amsterdam, pp. 135–157.
- Moore, G.W. and G.N. Sullivan (1978) *Speleology: The Study of Caves*, Zephyrus Press, Teaneck, NJ.
- Northcutt, R.G. (1988) Sensory and other neural trails and the adaptationist program: mackerels of San Marco? In: *Sensory Biology of Aquatic Animals* (J. Atema, R.R. Fay, A.N. Popper, and W.N. Tavolga, Eds.). Springer-Verlag, New York, pp. 870–883.
- Weber, A. (2000) Fish and amphibia. In: *Ecosystems of the World*, Vol. 30, *Subterranean Ecosystems* (H. Wilkens, D.C. Culver, and W.F., Humphreys, Eds.). Elsevier Press, Amsterdam, pp. 109–132.

# Adaptation to Low Food

Kathrin Hüpopp

Helgoland

Cave animals share numerous adaptations to the relative food scarcity in their habitat. A refined sensory orientation due to elongated appendages combined with enlarged or multiplied sensory areas and changes in foraging behavior improve food-finding ability in hypogean environments which are generally and/or patchily scarce in food. A reduced energy demand, realizable through reduced metabolic rates and/or changes of life history toward more K-selection, is a method to cope with the general food scarcity in caves. Higher fat accumulation ability additionally aids survival during starvation periods in caves periodically low in food. All of these and several other factors concerning adaptation to food scarcity in subterranean habitats can be illustrated in a causal network.

## INTRODUCTION

Subterranean environments are characterized not only by continuous darkness but also by a reduced variability in the number of specific abiotic conditions such as moisture, temperature, and water chemistry, as well as by isolation and restriction in space. Additionally, hypogean systems are relatively energy limited compared to photosynthetically based epigeal systems. As a response, many cave animals share numerous adaptations to the food scarcity of their environment. They not only show morphological and behavioral adaptations but also have evolved several special physiological characters. Especially *energy economy*, which is a reduction in energy consumption, has a high selective advantage in cave animals and has been observed in numerous species in a variety of phyla (Poulson, 1963; Culver, 1982; Hüpopp, 2000). All factors concerning adaptation to food scarcity in caves can be illustrated in the causal network shown in Fig. 1

On one hand, the high environmental stability in caves, including darkness and sometimes predator scarcity, *allows* the evolution of characters; on the other hand, it *requires* character changes. In fact, most characteristics of adaptation to food scarcity can only be realized in ecologically stable and, above all, predator-poor caves (Fig. 1). Food scarcity acting as a selective force in caves *requires* adaptations. Possible adaptations of cave animals to survival in caves low in food are an improved food-finding ability, an improved starvation resistance, a reduced energy demand by reduced metabolic rates, and life history characters changed toward more K-selected features (Hüpopp, 2000). Further, feeding generalism and dietary shift may be realized. Many of these characteristics have evolved coincidentally, depending on the kind of food scarcity. As a consequence, most real cave

animals show no or only minor signs of malnutrition despite the low food availability in their environment.

## TYPES OF FOOD SCARCITY

Not only the intensity but also the quality of the food scarcity and the duration of this selective force determine the degree of adaptation. Food scarcity in caves can have three facets: general food scarcity, periodic food supply, and patchy food scarcity. *General food scarcity* holds for nearly all caves and occurs especially in caves with no or low but continuous food input. Additionally, many caves are not stable throughout the year. *Periodic food supply* characterizes caves that are flooded periodically (normally several times during the rainy season) or caves with periodic food input by visiting animals. Seasonally flooded caves are subject to severe changes regarding food input, water quality, oxygen content, temperature, and competitors or predators. During the wet season, food supply can be very high and even abundant for some weeks or months. After exhaustion of these food reserves, animals in such caves suffer food scarcity like animals in generally food poor caves. Some cave animals have to cope with *patchy food scarcity*. This means that food is not necessarily limited but is difficult to find and exploit. Under such conditions, cave organisms can be observed aggregated at patchy food resources.

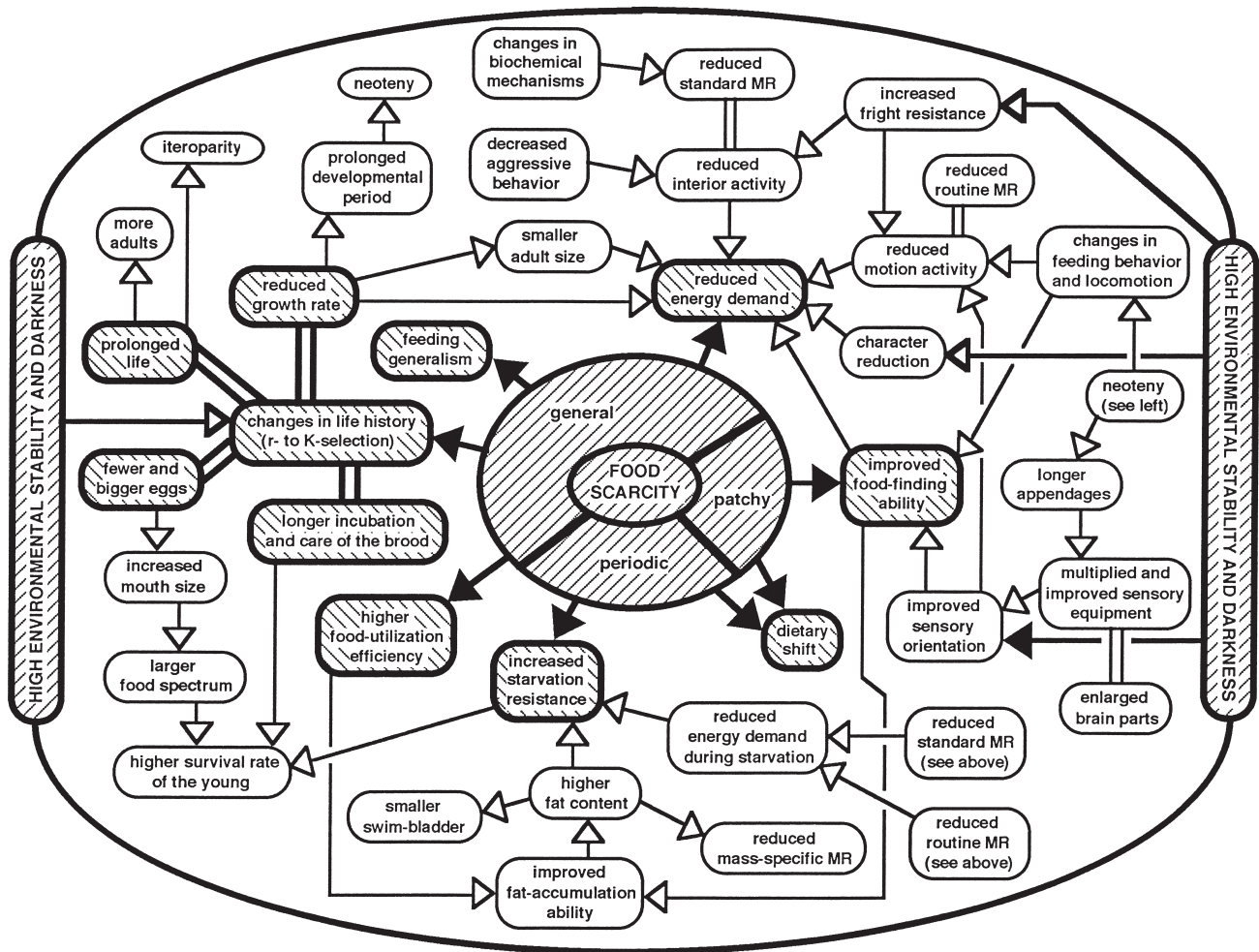
## WHAT TO FEED IN CAVES

### Food Input

The basic food resource in most caves is organic matter from external origin. Wind, percolating surface water, flooding, and streams provide input of many kinds of organic matter, such as detritus, microorganisms, feces, and accidental or dead animals. Some caves are visited actively by epigeal animals for shelter or reproduction. Such caves are much richer in food than are more isolated ones, because the visitors provide an additional food input in the form of their feces or their carcasses. Bat guano can present an immense source of food for guanobionts. Bacteria and above all microfungi decompose detritus and guano, thus building the basis for a food pyramid in caves. Lava tubes can be rich in food due to exudates from roots growing through the ceilings into the caves (Poulson and Lavoie, 2000).

### Chemoautotrophy

As the only primary producers in caves, a few species of chemoautotrophic bacteria may support the survival of cave animals, especially in caves that have no natural entrance and where the absence of water infiltration from the surface excludes the input of photosynthetic food (Sarbu, 2000). However, these chemoautotrophic systems are quantitatively important in only a few exceptional caves, the best known example being the Movile Cave in Romania.



**FIGURE 1** Network of characters observed in many cave animals and their causes, consequences, and interrelations. Closed arrowheads *require* something; open arrowheads *allow* something. (Reprinted from Hüpopp, K., in *Subterranean Ecosystems*, Wilkins, H. *et al.*, Eds., Elsevier Press, Amsterdam, pp. 159–188. With permission.)

### Influence of Cave Type

The amount of food supply in caves depends on the cave type, on surface connections, and on the geographic location. Generally, the food supply in tropical and subtropical caves is greater than in temperate ones because the biomass in the tropical epigeum is greater and its production is mostly uninterrupted (Poulson and Lavoie, 2000). As a consequence, selection pressure can be expected to be weaker, the evolutionary rate slower, and the appearance of troglobites not as fast in such caves compared to caves with low energy input such as temperate ones. In fact, troglobites are far more abundant in temperate zones than in the tropics, and species richness in caves is often correlated with the amount of available energy.

### FOOD FINDING

A variety of morphological and physiological adaptations and changes in feeding behavior are the basis for more efficient

foraging and increased food-finding ability of cave animals in darkness and under conditions of continuous or patchy food scarcity compared to surface relatives. Such alterations are only advantageous under low food conditions *and* in darkness. In the case of high prey density or in light conditions, cave species are inferior to competing epigean relatives.

### Appendages and Sensory Equipment

The most obvious morphological alterations in cave animals are longer legs, antennae, fins and barbels, or enlarged or flattened heads. If these body parts bear sensory organs, their enlarged surface can be correlated to an increased number of chemosensitive or mechanosensitive organs. As a consequence, an increased sensitivity to chemical and mechanical stimulants and changes in feeding behavior are possible. Cave animals can detect the food faster and at a greater distance from their bodies than can epigean ones and, as a side effect, spend less energy for food searching. All of these characters

have been observed in a broad variety of taxa, from amphipods over crayfish, isopods, spiders, beetles, and fish to salamanders, and more. Cave fish have been studied most intensively in this respect, above all those of the famous North American cave fish family, the Amblyopsidae, or the Mexican characid fish *Astyanax fasciatus* and cave salamanders.

In the Amblyopsidae, a positive trend in several of the specified troglomorphic features progresses from an epigeal species over four gradually more cave-adapted species (Poulson, 1963). Adaptive alterations to the cave conditions are correlated with enlarged associated brain parts, whereas smaller optic lobes reflect the reduction of eyes as a consequence of darkness and uselessness. For cave salamanders, the most likely function of the elongated limbs is to raise the body and particularly the head above the cave floor to increase efficiency of the lateral-line system. They also permit the salamanders to search a larger area per unit of energy expended and thus increase feeding efficiency. In interstitial species, the evolution of appendage length is different than in cave species. Due to the small size of the interstitial gaps, they tend to have shorter appendages and a more worm-like appearance (Coineau, 2000).

### Behavior

Changes in foraging behavior can also increase the food-finding ability. In the darkness of caves, a food-searching behavior concentrated on only the two-dimensional bottom or other surface areas can be much more economic in time and cost than a food search in a three-dimensional space, as exhibited by most surface animals in light and what they also try to do in darkness. Several cave animals have abandoned the shoaling or grouping behavior and adopted a continuous moving mode as a consequence of darkness and food scarcity in the cave habitat. They compensate for the optically orientated and spatially limited food searching mode of epigeal relatives by covering a greater area using chemo- and mechanosensors. The amblyopsid cave fish have developed a different swimming behavior, referred to as *glide-and-rest swimming*. This behavior, also enabled by the larger fins, not only conserves energy but also results in a reduction of interference noise for neuromast receptors thus improving prey detection.

### Other Factors

Most cave animals cope with food scarcity by taking a wide range of food or exhibiting a different food preference compared to surface relatives. Sometimes they show a dietary shift if one food source becomes scarce. A higher food utilization efficiency in cave animals as adaptation to the food scarcity is still not proven. Finally, the improvement of one feature sometimes may have more than one positive effect on the cave animals. The elaboration of the antennae in amphipods not only enhances food-finding ability, and thus

survivorship, but also improves the mate-finding ability in populations with often low densities. Elongated bodies presumably facilitate movement through an interstitial medium.

### Back to the Network

An improved food-finding ability is adaptive predominantly in *patchily* food-limited cave habitats and may be realized through changes in foraging behavior and improved ability for sensory orientation. The latter includes improvements not only in taste and smell senses but also in spatial orientation, as is required in the darkness of caves. A multiplied and improved sensory equipment can be causally connected with longer appendages and, by this, with neoteny. An improved food-finding ability itself can reduce the general energy demand of cave animals or improve the ability of fat accumulation.

### HOW TO SURVIVE STARVATION PERIODS

Besides a general food scarcity, many cave animals are faced with temporal periodicity of food; hence, they need an improved ability to survive long periods of starvation. Seasonality in caves, as already mentioned, is based on periodic flooding or on animals visiting the cave periodically, such as bats. Normally, this results in annual cycles.

### Fat Accumulation

The main way to improve the survival capacity in periodically food-scarce cave environments is the accumulation of large amounts of adipose tissue during food rich seasons. High lipid contents have been observed not only in cave animals but also in many surface species subjected to seasonal changes in food supply. The energy content per gram of lipids is roughly twice that of proteins or carbohydrates; therefore, fat accumulation is the best way to store energy. This may be achieved through excessive feeding, increased feeding efficiency, or improved metabolic pathways favoring lipid deposition. Cave animals build up fat reserves during the food-rich season and store them in their abdominal cavity, in subdermal layers, intra- or extracellularly in the hepatopancreas (decapods) or in the muscle mass, within the orbital sockets of the reduced eye, or in the more or less reduced swim bladder (as some fish do). They are able to survive starvation periods from several weeks to one year (as proven with fish), probably even more. Additionally, cave species cope better with starvation periods when metabolic rates are reduced, and cave animals can enable their young to resist starvation periods by producing eggs with more yolk.

### Examples

Amphipods, decapods, remipedes, collembola, beetles, and several fish species all over the world have been observed to



accumulate fat deposits, some up to huge amounts, and to be able to survive starvation periods better than their epigean relatives. For example, the different stages of various morphological adaptations in the five North American amblyopsid cave fish species are correlated with the time the species have been isolated in caves. The increasing ability to cope with food follows the same order (Poulson, 1963), which supports the high adaptive value of starvation resistance in cave animals.

Individuals of one hypogean variety of the Mexican characid fish *Astyanax fasciatus* fed *ad libitum* in the laboratory were able to accumulate fat up to 71% of dry body mass compared to only 27% in the conspecific epigean fish variety. A good measure to compare the nutritional states of animals within one species or within closely related species is calculation of the condition factor (CF):

$$CF = 100 w l^{-3}$$

where  $w$  is the wet body mass in grams, and  $l$  is the body length in centimeters. Not until after a starvation period of almost half a year did the CF of individuals of the hypogean variety of *A. fasciatus* fall below the CF of the epigean fish in an unstarved condition (Table I).

### Back to the Network

A higher fat content is highly useful in cave animals confronted with *periodic* food scarcity in that it increases their resistance to starvation. Cave animals may be able to improve their capacity of fat accumulation by an improved food-finding ability, perhaps supported by a higher food utilization efficiency. Lowered metabolic rates reduce energy demand during starvation and thus increase starvation resistance. An increased starvation resistance possibly also has an influence on the survival rate of the young.

**TABLE I Fat Content and Condition Factors of the Epigean and One Hypogean Variety of the Mexican Characid *Astyanax fasciatus* in Relation to the Number of Experimental Starvation Days**

	Days of Starvation		
	0	109	174
Fat content (% wet body mass)			
Epigean fish	9	2	—
Hypogean fish	37	28	27
Fat content (% dry body mass)			
Epigean fish	27	8	—
Hypogean fish	71	63	62
Condition factor (100 g cm <sup>-3</sup> )			
Epigean fish	2.0	1.6	—
Hypogean fish	2.9	2.5	1.9

Source: Adapted from Hüppop, K., in *Subterranean Ecosystems*, Wilkins, H. et al., Eds., Elsevier Press, Amsterdam, pp. 159–188.

## ENERGY DEMAND

A reduced energy demand is highly adaptive in the food scarcity of caves. It reflects a resistance not only to starvation during periodic food limitation or to general food scarcity but also to food patchiness, low oxygen content, or other abiotic factors in the cave environment. The energy demand of an animal usually is quantified by its metabolic rate. Meaningful information on the metabolic rate is given by the measurement of oxygen consumption of the entire organism or parts of it. In addition, indirect parameters such as respiratory frequency, resistance to anoxia, ability to survive starvation periods, body composition, growth rate, gill area, or turnover rate of adenosine triphosphate (ATP) give information on the metabolic rate. All of these methods have been used, and in most investigations the metabolic rates of the hypogean species were found to be more or less lower than that of their epigean relatives.

### Aquatic Cave Animals

Not only in caves but also in interstitial habitats, aquatic animals above all practice striking energy economy. Several cavernicolous amphipod, isopod, decapod, and fish species have been shown to live with metabolic rates much lower than those of surface relatives. The most detailed analysis of cave adaptation in fish (Poulson, 1963) demonstrates a decreasing trend in the metabolic rate from the epigean species in the Amblyopsidae over the troglomorphic to gradually more cave-adapted ones. This trend in the metabolic rate is negatively correlated with starvation resistance. High fat reserves together with low metabolic rates explain the long survival time of the most troglomorphic amblyopsid species when starved. However, high fat contents may lead to misinterpretations of metabolic rates. Studies in the Mexican cave fish *A. fasciatus* regarding metabolic rate, body composition, and starvation survival revealed lower metabolic rates in one cave form as compared to the epigean relative and very high fat contents (Hüppop, 2000) (see Table I). Because fat tissue is known to have a relatively low maintenance metabolism compared to other tissues or organs, lean body mass or bodies with comparable fat contents should be preferred as a metabolic reference to avoid misinterpretations of the metabolic rate. The recalculation of metabolic rates in *A. fasciatus* resulted in nearly identical values in both varieties of the fish species. Although obviously adapted to a periodically low energy environment, as can be seen from the high fat content, the hypogean *A. fasciatus* were not yet able to reduce their energy turnover rate in adaptation to a general food scarcity.

### Terrestrial Cave Animals

Only a few investigations on metabolic rates of terrestrial cave animals exist. Although food scarcity generally is even greater in the terrestrial than in the aquatic cave environ-

ment, only a few cave arthropod species were found to show a tendency toward energy economy.

### Activity

Every activity increases the energy consumption of animals. The standard metabolic rate (*i.e.*, the lowest oxygen consumption rate that can be measured during a test) excludes motion activity and is a measure of the physiological adaptation of cave animals to food scarcity. However, the routine metabolic rate (*i.e.*, the mean metabolic rate over 24 hours which includes spontaneous activity) is a more appropriate index of actual energy expenditures in nature; it actually may have the highest rank among other adaptations reducing energy demand in cave animals. The routine metabolic rate may be reduced in cave animals due to reduced motion activity, to changed motion patterns (temporal as well as morphological), to reduced or no longer practiced aggressive and territory behavior, or to reduced fright reactions. Actually, in most cave animals activity is reduced. Although an increase in food-finding ability in cave animals often seems to go along with an increase in food-searching activity, changed motion patterns result in a reduction of energy expenditure, sometimes to a fantastic extension. For example, in the most cave-adapted species of the amblyopsid fish in North America, over 90% of the total energy savings by adaptations are based on the reduced activity (Poulson, 1985).

### Excitement and Aggression

Metabolic rates definitely are elevated by an animal's reaction to disturbance (excitement) and by aggressive behavior. *Interior activity*, or excitement without expression in motion activity, elevates the standard metabolic rate. *External activity*, including motion activity resulting from excitement or aggression, increases the routine metabolic rate. An increased resistance to disturbance has been shown to be important for energy economy in the amblyopsid fish (Poulson, 1963). The generally low standard and routine metabolic rates of cave amblyopsids and their resistance to disturbance are interpreted not only as adaptations to the reduced food supply, by a factor of about 100 compared to the surface, but also as a by-product of relatively stable cave conditions and a general lack of predators in the amblyopsid cave environment (*c.f.*, regressive evolution).

### The Conflicts of Body Size

In addition to food scarcity, the interstitial habitat is constrained by the grain size of the substrate. Interstitial animals are constrained in size and shape due to the small size of the interstitial gaps. They often are very small and have shortened appendages excluding the posterior appendages, which tend to be elongated (Coineau, 2000). In this special subterranean habitat, the motion activity for food searching

in interstitial animals can actually be increased and can result in an elevated routine metabolic rate compared to surface forms (Danielopol *et al.*, 1994). Often, interstitial species are much smaller than their surface relatives, so their higher mass-specific routine metabolic rate corresponds to a smaller routine metabolic rate per individual. The energy reserves of larger animals last longer and are more resistant to food shortage than of small animals because the metabolic rate of animals is not directly proportional to body mass but is related to mass by the following equation:

$$\text{Metabolic rate} = aM^b$$

where  $a$  is the intercept,  $M$  is the body mass, and  $b$  is the mass exponent or slope smaller than 1 (Withers, 1992). Consequently, subterranean animals have to resolve the conflict between two advantages: (1) to be larger with a lower energy demand per unit mass but a higher one per individual, or (2) to be small, thus requiring less energy per animal and/or being able to live in crevices. Interstitial forms may have reduced their body size to fit better into the small crevices and to cope better individually with food scarcity in their special habitat (Danielopol *et al.*, 1994).

### Ectothermy and Neoteny

Troglobites are exclusively ectotherms. The generally very low metabolic rates of ectotherms (only 10 to 20% or even less that of similar sized endotherms) are the basis for their success in zones characterized by limited resource supplies, such as shortages in food, oxygen or water. Ectotherms can utilize energy for reproduction that endotherms are forced to use for thermoregulation. Finally, ectotherms are able to exploit a world of small body sizes unavailable to endotherms. Body sizes less than 2 grams are not feasible for endotherms because the curve relating metabolism to body mass becomes asymptotic to the metabolism axis at body masses lower than 2 grams (Withers, 1992).

Within the ectothermic vertebrates, only fish and amphibians evolved cave species. Because they are the largest animals in cave communities, they usually represent the highest trophic level in the cave food web and can survive in large populations only in relatively food-rich caves. Most troglobitic salamanders are aquatic and show the retention of larval characters, known as *neoteny*, which enables them to survive in the relatively less food-scarce aquatic cave habitat compared to the terrestrial cave habitat (Culver, 1982). Finally, suppression of the energetically expensive metamorphosis in hypogean salamanders can be interpreted as an adaptation to general food scarcity.

### Hypoxic Conditions

Besides food scarcity, numerous cave or interstitial species have to cope with temporary or permanent hypoxic conditions. Also, this character of some cave environments

forces reduced metabolic rates and has been proven in crustaceans and fish. In contrast to surface species, several hypogean species have no sharp break in the oxygen uptake lines under depleting oxygen concentrations. This absence of a discontinuity in the oxygen uptake line is called *oxy-regulation* and is considered to be adaptive in environments characterized by variable oxygen conditions (Danielopol *et al.*, 1994).

### Character Reduction

Many features become reduced during the evolution of cave animals. This *regressive evolution* generally is described as the reduction of “functionless” characters in cave animals and not only concerns structural but also behavioral and physiological traits. It obviously should be an advantage for cave animals to use the energy saved from not building or maintaining useless characters when living in strongly food-limited cave environments by transferring it to the development or support of other characters or to growth, reproduction, or survival during starvation periods. There exist a few hints among beetles and spiders of this possible strategy of cave animals to adapt to a food-restricted cave environment. Nevertheless, more often the reduction of characters in cave animals seems to be the result of accumulated neutral mutations.

### Back to the Network

A reduced energy demand is adaptive mainly in those caves that are *generally low in food*. A lowered interior activity, meaning a reduced standard metabolic rate, can be the result of an increased fright resistance, a lowered aggressive behavior, and possible changes in biochemical mechanisms (*e.g.*, ATP turnover rates). Reduced motion activity (*i.e.*, a lowered routine metabolic rate) can be achieved by means of reduced body movement to escape (a reduced number of) predators or for aggression, changes in feeding behavior and locomotion, and an improved sensory orientation resulting in fewer movements for food searching. In the end, reduced metabolic rates result in a higher availability of energy for growth and/or a greater resistance to starvation. Additionally, character reduction, reduced growth rates, and smaller adult body size have the ability to reduce energy demand in cave animals. The reduced energy demand in cave animals can have two effects. Under the aspect of metabolic span, a *reduction per time* is correlated with a prolonged lifetime combined with iteroparity. On the other hand, the *reduction per individual life* enables higher survival rates of individuals or even the increase of population size.

## LIFE HISTORY CHARACTERS

The extremes of the spectrum of life history adaptations are characterized as *r*- and *K*-selection. Whereas *r*-selection (*r*

being the slope of the population growth curve) means a trend toward high population growth rate under temporarily good conditions in relatively unpredictable and changing habitats, *K*-selection (*K* being the carrying capacity of the habitat) can be realized only in more predictable and stable habitats, and the appropriate fitness measure is the maximum lifetime reproduction. *K*-selected species are characterized by low or no population growth; they have reached a maximal *K*. This situation is connected with fewer but larger and more nutrient-rich eggs, increased time required for hatching, prolonged larvae stage, generally decreased growth rate, delayed and perhaps infrequent reproduction, increased longevity, and parental care. Many cave animals show a couple of these characters, demonstrating a trend toward more *K*-selection in cave species. The life history of cave animals has been the subject of some reviews; the main investigations were done on a variety of invertebrates, particularly crustaceans and arthropods, and on fish and salamanders (Hüppop, 2000).

### Egg Size

The adaptive value of fewer but bigger eggs, not only for cave fish but for all animals living in food-poor habitats, is obvious. Bigger eggs with more energy-rich yolks release bigger larvae. These larvae have a bigger head with larger mouth, so they can start external feeding on a larger spectrum of food particles and have a better chance to survive. Furthermore, bigger larvae may have a higher resistance to starvation and a higher mobility for food searching and for effective escape reactions. The reduction of the clutch size can finally result in a single larva per reproductive season that possibly never feeds, as in cave beetles.

### Growth Rate

A reduced growth rate in cave animals is adaptive to food scarcity because it means a reduced energy demand per time. More animals can live on a defined amount of food, or a defined group of animals can survive longer on it. A reduction in energy demand per unit time through a lower metabolic rate, together with a reduction of absolute and relative costs of reproduction, can make possible an increase of population density and hence an increase in the number of females actually breeding per year.

### Longevity

There is evidence that the total metabolic turnover in a lifetime not only of endotherms but also in ectotherms is the product of the energy turnover rate and the duration of life, called the *metabolic span*. Generally, lower metabolic rates and slower growth rates (that is, “slower living”) are connected with increased longevity. Because the reproductive success of an animal might be defined by the ability to

live long enough to survive the gap between good years, an increased lifetime in cave animals is advantageous in a generally food-scarce environment or in caves where relatively food-rich reproductive seasons occur irregularly. The increased longevity of cave animals connected with a delay in maturity and a trend from semelparity to iteroparity means that the population is less likely to disappear in years when food supply is too low to allow females to produce offspring.

### A Case Study

Extremely prolonged lifetimes of more than 150 years are known among North American cave crayfish; however, the amblyopsid cave fish, intensively investigated by Poulson (1963), are the best known example of how cave animals adapt their life history to food scarcity. Within this group of fish species it is obvious how cave animals with increasingly slower energy turnover rates have increasingly prolonged life cycles connected with many increasingly *K*-selected features, such as bigger and fewer eggs with prolonged developmental time, prolonged branchial incubation time (= parental care), bigger larvae at first external feeding, reduced growth rate, delayed maturity, and multiplied chances to reproduce with increasing cave adaptation (Table II). Population growth rate and population density decrease with phylogenetic age of the cave species, and the population structure shifts toward adults (Poulson, 1963).

### Back to the Network

Life history changes toward more *K*-selected characters are correlated with a prolonged lifetime (and consequently iteroparity) and/or with a shift toward more adults in the

TABLE II **Some Life History Characters of the Epigeal Amblyopsid Fish *Chologaster cornuta* Compared to the Troglotitic *Amblyopsis rosae***

	<i>C. cornuta</i>	<i>A. rosae</i>
Egg size (mm)	0.9 to 1.2	1.9 to 2.2
Developmental time	few weeks	5 to 6 months
Larval size (mm) When hatching	3	5
When leaving gill cavity	8	12
Adult size (mm)	23 to 55	36 to 48
Female body mass (g)	0.93	1.25
Adult maturity (year)	1	3
Maximal life span (years)	1	5 to 6
Number of mature ova per female	98	23
Average number of reproduction per lifetime	1	0.6
Maximum number of reproduction per lifetime	1	3

Source: Adapted from Poulson (1963, 1985) and Culver (1982).

population. Additionally, more *K*-selection may include bigger and fewer eggs and longer incubation and brood care, giving the offspring a higher chance of survival. A reduced growth rate and a smaller adult size may save energy. A prolonged developmental period may result in neoteny which in turn can have an influence on food-finding ability through appendage lengthening and changes in foraging behavior.

### See Also the Following Articles

*Food Sources • Adaptive Shifts*

### Bibliography

- Coineau, N. (2000) Adaptations to interstitial groundwater life. In *Subterranean Ecosystems* (H. Wilkens, D.C. Culver, and W.F. Humphreys, Eds.). Elsevier Press, Amsterdam, pp. 189–210.
- Culver, D.C. (1982) *Cave Life: Evolution and Ecology*, Harvard University Press, Cambridge, MA.
- Danielopol, D.L., M. Creuzé des Châtelliers, F. Mösslacher, P. Pospisil, and R. Popa (1994) Adaptation of crustacea to interstitial habitats: a practical agenda for ecological studies. In *Groundwater Ecology* (J. Gibert, D.L. Danielopol, and J.A. Stanford, Eds.). Academic Press, New York.
- Hüppop, K. (2000) How do cave animals cope with the food scarcity in caves? In *Subterranean Ecosystems* (H. Wilkens, D.C. Culver, and W.F. Humphreys, Eds.). Elsevier Press, Amsterdam, pp. 159–188.
- Poulson, T.L. (1963) Cave adaptation in amblyopsid fishes. *Am. Midl. Nat.*, 70, pp. 257–290.
- Poulson, T.L. (1985) Evolutionary reduction by neutral mutations: plausibility arguments and data from amblyopsid fishes and linyphiid spiders. *Natl. Speleol. Soc. Bull.*, 47, pp. 109–117.
- Poulson, T.L. and K.H. Lavoie (2000) The trophic basis of subsurface ecosystems. In *Subterranean Ecosystems* (H. Wilkens, D.C. Culver, and W.F. Humphreys, Eds.). Elsevier Press, Amsterdam, pp. 231–249.
- Sarbu, S.M. (2000) Mobile Cave: a chemoautotrophically based groundwater ecosystem. In *Subterranean Ecosystems* (H. Wilkens, D.C. Culver, and W.F. Humphreys, Eds.). Elsevier Press, Amsterdam, pp. 319–343.
- Withers, P.C. (1992) *Comparative Animal Physiology*, Saunders College Publishing, Fort Worth, TX.

## Adaptation to Low Oxygen

Frédéric Hervant and Florian Malard

Université Lyon

### INTRODUCTION

Before the late 1970s, ecological studies were carried out mainly in the unsaturated zone of karst aquifers, more particularly in caves. Because cave water bodies are exposed to the atmosphere, they are usually saturated with oxygen, but dissolved oxygen (DO) was not measured routinely, and oxygen availability in subterranean biotopes was rarely considered as a key ecological factor that governed the occurrence and spatiotemporal distribution of hypogean animals. Biological activity, animal density, and organic

matter content in the groundwater were assumed to be too low to induce oxygen deficiency; therefore, the possibility that hypogean organisms may have to face hypoxic stress was not considered. Physiological studies essentially concerned the adaptive responses of hypogean animals to low food supply including their higher food-finding ability, strong resistance to starvation, and reduced metabolism (Hüppop, 2000).

Since the 1970s, this view has been reevaluated by many researchers who have frequently reported low dissolved oxygen concentrations from shallow groundwater in unconsolidated sediments, more particularly in the hyporheic zone of streams (Boulton *et al.*, 1992; Strayer *et al.*, 1997); the groundwater environment has been described as being hypoxic or weakly oxygenated. Also, several authors have conducted laboratory studies to test the resistance and adaptive strategies of animals in response to low oxygen (Malard and Hervant, 1999).

The ensuing material begins by examining the oxygen status of different groundwater systems including deep- and shallow-water-table aquifers and the hyporheic zone of streams. Then, based on laboratory studies conducted by one of the authors (Hervant *et al.*, 1996–1999; Malard and Hervant, 1999), we examine the behavioral, respiratory, and metabolic responses of groundwater organisms, especially crustaceans, to low oxygen concentrations. Finally, we suggest that the selection of organic-matter-rich habitats in groundwater increases the risk of facing hypoxic stress.

### SUPPLY AND CONSUMPTION OF DISSOLVED OXYGEN IN GROUNDWATER

Because of permanent darkness, there is no photosynthesis in groundwater, thus no production of oxygen; therefore, the oxygen status of groundwater is determined by the rate of oxygen transport from the surface environment and by the rate of oxygen consumption in the subsurface. Replenishment of dissolved oxygen occurs by air diffusion from the unsaturated zone or by recharge with normoxic rainwater or river water. Fluctuations of the groundwater table enhance air entrapment, thereby increasing dissolved oxygen transfer from entrapped air. Oxygen transport within groundwater may occur as a result of oxygen diffusion, convection currents caused by heat transfer, and advection of water in response to hydraulic gradients. The diffusive movement of oxygen in water is negligible, and convective currents are limited in groundwater by sediment and weak thermal gradients (the geothermal gradient is usually about  $0.01^{\circ}\text{C m}^{-1}$ ) (Malard and Hervant, 1999); therefore, oxygen transport in groundwater is primarily due to advective movement of water in response to hydraulic gradients. Because groundwater velocity is usually low (*i.e.*,  $10^{-6}$ – $10^{-4}$   $\text{m s}^{-1}$ ), the available flux of DO in groundwater is much slower than in surface waters. On the other hand, oxygen consumption by microorganisms is limited in many aquifers by the availability of biodegradable organic carbon. Consequently, DO

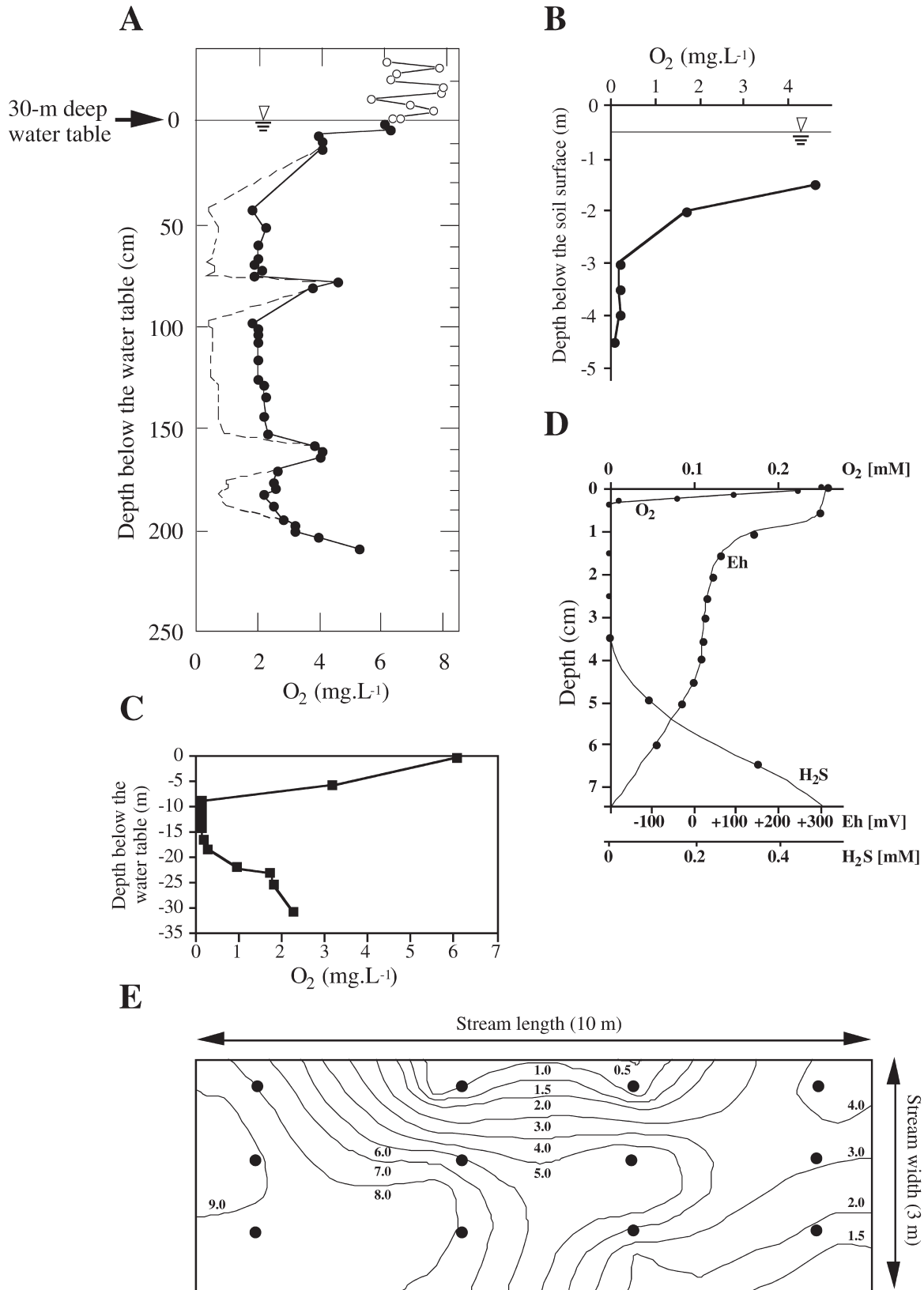
may persist at considerable distances from the recharge zone in deep-water-table aquifers where soil-generated dissolved organic carbon is completely degraded during the transit of infiltrating water in the unsaturated zone. In confined aquifers of the Ash Meadows basin (southcentral Nevada), Winograd and Robertson (1982) sampled ground water with  $2 \text{ mg L}^{-1} \text{ O}_2$  at a distance of 80 km from the recharge zone. In contrast, dissolved oxygen may be totally consumed over very short distances (*i.e.*, a few meters or even centimeters) in shallow-water-table aquifers or in the hyporheic zone of rivers because of the input of soil- or river-labile dissolved organic carbon. Malard and Hervant (1999) reported strong variability among groundwater systems in the length of underground pathways for dissolved oxygen. Based on cross-system comparison from literature data, these authors suggested that differences among hyporheic zones reflect variation in the contact time of water with sediment, whereas differences among confined aquifers are primarily a result of differences in the rate of DO consumption.

### SMALL-SCALE HETEROGENEITY IN DISSOLVED OXYGEN IN GROUNDWATER

Small-scale investigations of oxygen distributions in subsurface waters revealed strong variations over distances of a few centimeters or meters. This heterogeneity, an essential feature of the groundwater environment, was observed in a number of subsurface water habitats, including the saturated zone of karst aquifers, the water-table region of deep- and shallow-water-table porous aquifers, the halocline of anchialine caves, the hyporheic zone of rivers, and the interstitial environment of marine and freshwater beaches (Malard and Hervant, 1999) (Fig. 1). Small-scale spatial heterogeneity in DO reflects changes in sediment composition and structure, subsurface water flow velocity, strength of hydrological exchanges with the surface environment, dissolved and particulate organic matter content, and activity of microorganisms. Strong temporal changes in DO may also occur in the hyporheic zone of streams as well as in the recharge zone of aquifers, but these fluctuations are strongly damped with increasing distance from the stream and the recharge zone. Whereas diminished oxygen concentration is typically not a rule for the groundwater environment, the high spatial heterogeneity of DO at meso- (meter) and micro- (centimeter) scales is considered a peculiarity of groundwater habitats (Malard and Hervant, 1999). This implies that animals living in groundwater have to experience highly variable oxygen concentrations as they move through a mosaic of patches with contrasted DO concentrations.

### FIELD EVIDENCES OF SURVIVAL IN LOW OXYGENATED GROUNDWATER

Results of field studies reveal that most animals can be found living in a wide range of DO, even anoxia in some cases



**FIGURE 1** Mesoscale (meter) and microscale (centimeter) heterogeneity in dissolved oxygen concentrations in (A) a deep water-table aquifer (Ronen *et al.*, 1987); (B) a shallow water-table aquifer (Pospisil *et al.*, 1994); (C) an anchialine cave (Yaeger, 1994); (D) the interstitial environment of a sandy marine beach (Revsbech and Jorgensen, 1986); and (E) the hyporheic zone of a backwater (Danielopol, 1989).

(Malard and Hervant, 1999). Based on 700 faunal samples collected in the hyporheic zone of several desert streams in Arizona, Boulton *et al.* (1992) examined the field tolerance to DO of 23 common taxa. These authors showed that most taxa could be encountered in subsurface waters with less than  $1 \text{ mg L}^{-1} \text{ O}_2$ . Strayer *et al.* (1997) obtained similar results based on 167 samples of hyporheic invertebrates collected at 14 sites in the eastern United States; however, in both studies, several animal groups, particularly crustaceans and insects, occurred more frequently in well-oxygenated sediments than where oxygen was scarce. Several crustaceans (including the amphipod *Niphargus hebereri* Schellenberg, the thermosbaenacean *Monodella argentarii* Stella, and some species of remipedes) are known to develop dense populations in the sulfide zone of anchihaline caves (Malard and Hervant, 1999). It is not yet clear, however, whether these crustaceans permanently live in deoxygenated waters or if they temporarily seek shelter in a more aerated environment. A diversified aquatic fauna was also found to live in the uppermost hypoxic layer ( $\text{DO} < 0.3 \text{ mg L}^{-1} \text{ O}_2$ ) of sulfidic groundwater in Movile Cave, Romania (Malard and Hervant, 1999). On the other hand, the paucity of fauna in extensive areas of hypoxic groundwater suggests that most hypogean taxa are probably not able to survive a lack of oxygen for very long. Reports of groundwater animals among poorly oxygenated groundwaters are equivocal because their presence may be due to either tolerance to low oxygen concentrations by hypogean invertebrates or the existence of microzones of high dissolved oxygen. Recent detailed laboratory studies on the behavioral, respiratory, and metabolic responses of several subterranean crustaceans to anoxia have enabled us to define more precisely the degree of tolerance of groundwater animals to low oxygen concentrations and to elucidate some of the mechanisms responsible for extended survival under oxygen stress (Hervant *et al.*, 1996–1999).

### SURVIVAL TIMES UNDER ANOXIA

Most data available on adaptations to low oxygen in groundwater organisms arise from comparisons of the adaptive responses of three hypogean crustaceans (the amphipods *Niphargus virei* Chevreux and *Niphargus rhenorhodanensis* Schellenberg and the isopod *Stenasellus virei* Dolfus) and two epigean crustaceans (the amphipod *Gammarus fossarum* Koch and the isopod *Asellus aquaticus* L.) to anoxia (Hervant *et al.*, 1996–1999; Malard and Hervant, 1999). The responses of these five crustaceans were examined in darkness (at  $11^\circ\text{C}$ ) under three different experimental conditions: anoxia, normoxia following an anoxic stress (postanoxic recovery), and declining DO concentration (from  $10.3$  to  $0.7 \text{ mg L}^{-1} \text{ O}_2$ ). Information gained from these experiments concerned: (1) the lethal time for 50% of the population (LT 50%) in anoxia; (2) the locomotory activity (number of periods of locomotion per minute) and the ventilatory

activity (number of pleopods beats per minute) of animals; (3) the oxygen consumption rates in normoxia and under declining  $\text{Po}_2$  (in order to determine the critical partial pressure of oxygen,  $P_c$ ); and (4) changes in the concentrations of key metabolites such as high energy compounds (*e.g.*, adenosine triphosphate [ATP], phosphagen), anaerobic substrates (glucose, glycogen, amino acids), and anaerobic end products (lactate, alanine, succinate, malate, propionate).

Groundwater crustaceans show survival times (LT 50%) of about 2 to 3 days under anoxia (Table I) and several months in moderate hypoxia (Danielopol, 1989; Malard and Hervant, 1999). They are much more resistant to oxygen deprivation than morphologically closed epigean species whose LT 50% values range from a few hours to one day. Hypogean fishes, crayfishes (Huppöp, 2000), and urodele amphibians (Hervant, unpublished data) also display much higher survival times than their related epigean species.

### BEHAVIORAL ADAPTATIONS

Every spontaneous or stress-induced activity increases energetic expenditures and, therefore, oxygen consumption. Some hypogean species show a very low activity rate when compared to morphologically closed epigean animals (Table I). This reduced activity has been interpreted to be a result of (1) food scarcity, stable environmental conditions, and general lack of predators and territorial behavior; (2) cramped interstitial habitats; and/or (3) low oxygen availability (Hervant *et al.*, 1996; Hüppop, 2000). A low activity rate in groundwater animals which is often associated with an increase in food-finding ability is an efficient adaptation to low food supply because it results in a reduced energy demand.

Epigean *Gammarus fossarum* and *Asellus aquaticus* respond to experimental anoxia by a marked hyperactivity (Table I) that, in natural conditions probably corresponds to an attempt to move to more oxygenated habitats (*i.e.*, to a behavioral compensation). In contrast, all three hypogean crustaceans show a drastic reduction in locomotory activity under lack of oxygen (Table I). This adaptive behavior reduces energy expenditure during oxygen deprivation (by decreasing the oxygen consumption) and therefore increases survival time in deoxygenated groundwater. This “sit-and-wait” strategy, very advantageous under hypoxic (and/or food limited) environments, was also observed in starved stygobite crustaceans (Hervant and Renault, 2002) and cave salamanders (Hervant *et al.*, 2001). Danielopol *et al.* (1994) then Mösslacher and Creuzé des Châtelliers (1996) showed that the hypogean isopod *Proasellus slavus* actively explored its interstitial environment but slowed down exploratory movement under severe hypoxic conditions (*i.e.*,  $0.1 \text{ mg L}^{-1} \text{ O}_2$ ). The lack of an escape behavior is probably not universal for hypogean aquatic organisms, however, because active animal migration in response to fluctuating DO concentrations has already been documented in natural biotopes and in a laboratory flume (Henry and Danielopol, 1999).

**TABLE I Comparison of Locomotory and Ventilatory Activities, Oxygen Consumption (SMR), and Intermediary and Energetic Metabolism During Normoxia, Anoxia, and Postanoxic Recovery in Two Surface-Dwelling and Three Groundwater Crustaceans**

	Epigean		Hypogean		
	<i>G. fossarum</i>	<i>A. aquaticus</i>	<i>N. rhenorho.</i>	<i>N. virei</i>	<i>S. virei</i>
<b>Survival during anoxic stress</b>					
Lethal time for 50% of the population	6.3 h	19.7 h	46.7 h	52.1 h	61.7 h
<b>Activity</b>					
Number of periods of locomotion per minute (in normoxia)	19.3	6.7	12.5	1.4	4.5
Changes during anoxia	↖	↖	↘	↘	↘
<b>Ventilation</b>					
Number of pleopods beats per minutes (in normoxia)	60	43	44	48	38
Changes during anoxia	↖	↖	↘	↘	↘
<b>Respiratory metabolism</b>					
Normoxic O <sub>2</sub> consumption (SMR; $\mu\text{L } \text{O}_2/\text{g dw/h}$ )	940	1325	605	305	425
O <sub>2</sub> critical pressure ( $\text{mg}\cdot\text{L}^{-1}$ )	3.6	3.8	2.0	1.8	2.0
<b>Body energy stores (in normoxia)</b>					
Stored glycogen ( $\mu\text{mol/g dw}$ )	110	165	356	243	307
Stored arginine phosphate ( $\mu\text{mol/g dw}$ )	7.0	10.5	26.5	26.5	31.5
<b>Post-anoxic recovery</b>					
Glycogen re-synthesis rate ( $\mu\text{mol/g dw/min}$ )	0.003	0.01	0.07	0.03	0.04
% of glycogen re-synthesis	8	19	47	49	53

Source: Adapted from Hervant *et al.*, 1995–1998; Malard and Hervant, 1999.

## RESPIRATORY ADAPTATIONS

Subterranean animals generally have reduced standard metabolic rates (SMRs) and reduced routine metabolic rates (RMRs) when compared to their surface-dwelling counterparts (Hüppop, 2000). For example, the cave salamander *Proteus anguinus* Laurenti and the groundwater crustaceans *Niphargus virei*, *Niphargus rhenorhodanensis*, and *Stenasellus virei* show SMRs in normoxia from 1.6 to 4.5 times lower than their epigean relatives (Table I) (Hervant *et al.*, 1998). Low SMRs and RMRs among hypogean animals have long been interpreted only as an adaptation to low food availability (Hüppop, 2000); however, reduced SMRs in some populations of subterranean animals may also reflect an adaptation to low oxygen concentrations in the groundwater (Hervant and Renault, 2002). A reduced metabolic rate (*i.e.*, low energetic requirements) results in a lower oxygen removal rate and an increased survival time in anoxia.

The hypogean amphipods *N. virei* and *N. rhenorhodanensis* and the hypogean isopod *S. virei* reduce their ventilatory activity during anoxic stress (Table I), thereby limiting their energy expenditure. Several animals contract an oxygen debt during oxygen deprivation that is repaid upon return to normoxia (Herreid, 1980). The repayment of this debt during recovery from anaerobic stress involves a significant increase in SMR. The oxygen debt of hypogean *N. virei* and *N. rhenorhodanensis* is 2.2 to 5.3 times lower than that of epigean *G. fossarum* and *A. aquaticus* (Hervant *et al.*, 1998). This lower oxygen debt indicates a reduced energetic expenditure (*i.e.*, an energy sparing) which is probably linked to lower locomotory and ventilatory activities during anoxia.

The resistance to anoxia (and/or long-term fasting) displayed by numerous hypogean species may be explained by their ability to remain in a prolonged state of torpor. This state enables hypogean organisms to tolerate a prolonged reduction in oxygen (and/or food) availability by maximizing the time during which metabolism can be fuelled by a given energy reserve (or a given food ration). This supports the classic suggestion that difficulties in obtaining food in stressful environments may select for conservative energy use (Hervant and Renault, 2002). These adaptive responses may be considered for numerous subterranean organisms as an efficient energy-saving strategy in a harsh and unpredictable environment where hypoxic (and/or starvation) periods of variable duration alternate with normoxic periods (and/or sporadic feeding events). Hypoxia-tolerant (and/or food-limited) groundwater species appear to be good examples of animals representing a low-energy system (Hervant *et al.*, 2001; Hervant and Renault, 2002).

Theoretically, aerobic organisms can be described as metabolic conformers or regulators if their oxygen consumption varies directly with or is independent of  $\text{Po}_2$ , respectively; however, these two types are merely the two ends of a large spectrum of respiratory responses of species. Animals never fully belong to one or the other type, and below a critical  $\text{Po}_2$  ( $\text{Pc}$ ) a regulator becomes a conformer (Herreid, 1980); therefore,  $\text{Pc}$  is a good indicator of the tolerance or adaptation of an organism to low  $\text{Po}_2$ . *Gammarus fossarum*, *A. aquaticus*, *N. virei*, *S. virei* and *N. rhenorhodanensis* are able to maintain a relatively constant rate of oxygen consumption relatively constant that is independent of  $\text{Po}_2$  and between normoxia and  $\text{Pc}$  (Hervant *et al.*, 1998). However, the  $\text{Po}_2$  at which



respiratory independence is lost is significantly lower for hypogean species than for surface-dwelling ones (Table I). This implies that groundwater species are able to maintain an aerobic metabolism for a longer time in declining  $P_{O_2}$  (progressive hypoxia) instead of partly switching to a low-energy anaerobic metabolism. The maintenance of an aerobic metabolism (*i.e.*, survival at a lower energetic cost) under hypoxic conditions is partly due to the lower SMR of hypogean animals. Mösslacher and Creuzé des Châtelliers (1996) also found that the RMRs of an unpigmented and eyeless subterranean form of *A. aquaticus* decreased with decreasing environmental DO concentration. In contrast, Danielopol *et al.* (1994) showed that the hypogean isopods *Proasellus slavus*, *Proasellus strouhali*, and a blind population of *A. aquaticus* maintain a high ventilation activity independent of the external oxygen concentration (*i.e.*, from 0.1 to 9 mg L<sup>-1</sup> O<sub>2</sub>). However, the occurrence of respiratory regulation over such a wide range of DO concentrations had, until then, not been observed among epigeal crustaceans (Malard and Hervant, 1999) and had rarely been observed in other invertebrates (Herreid, 1980).

## METABOLIC ADAPTATIONS

### Metabolic Responses During Anoxia

A number of biochemical adaptations that permit extended survival under prolonged hypoxia or anoxia have been identified in various well-adapted epigeal groups, especially marine annelids and intertidal mollusks (Fields, 1983). These include the maintenance of high reserves of fermentable fuels (such as glycogen and amino acids) in some tissues under normoxic conditions, the use of anaerobic pathways to enhance ATP yield and to maintain redox balance during low oxygen conditions, and mechanisms for minimizing metabolic acidosis often associated with anaerobic metabolism. Nevertheless, epigeal crustaceans have been recognized as being of a “modest anaerobic capacity” without special and efficient mechanisms of anaerobic metabolism (Zebe, 1991).

Examination of biochemical (*i.e.*, intermediary and energy metabolism) responses of hypogean crustaceans *N. virei*, *N. rhenorhodanensis*, and *S. virei* during anoxic stress show that, similarly to epigeal crustaceans (for review, see Zebe, 1991), anaerobic metabolism does not lead to a high ATP production rate (Hervant *et al.*, 1996, 1997). The five crustaceans studied respond to severe experimental anoxia with a slight improvement of a classical anaerobic metabolism that is characterized by a decrease in ATP and phosphagen (arginine phosphate, representing an immediate source of ATP), a coupled utilization of glycogen and some amino acids (mainly glutamate), and the accumulation of lactate and alanine as end-products. The only difference is that both *Niphargus* species also accumulate a low proportion of succinate, which slightly enhances ATP yield during anaerobiosis (Fields, 1983). Lactate is largely excreted by all five

crustaceans. This excretion, which is unusual for crustaceans (Zebe, 1991), can be considered a simple way to fight against metabolic acidosis linked to anaerobic end-product (including H<sup>+</sup>) accumulations.

There is a striking difference in the respective amounts of glycogen and phosphagen stored by epigeal and hypogean crustaceans. Glycogen body reserves (Table I) are 1.5 to 3.2 times higher in the three hypogean crustaceans studied than in the epigeal *G. fossarum* and *A. aquaticus* (Hervant *et al.*, 1996, 1997) but are also higher than those reported for all surface-dwelling crustaceans, even those most tolerant of anoxia or hypoxia (Malard and Hervant, 1999). High amounts of fermentable fuels result in a more sustained supply for anaerobic metabolism, thereby increasing survival time during oxygen deprivation. Moreover, glycogen utilization rates and lactate production rates are significantly lower in hypogean crustaceans. This finding is probably linked to lower SMRs and to the reduction of locomotory and ventilatory activity during anoxia (Table I) (Hervant *et al.*, 1996, 1998).

### Metabolic Responses During a Postanoxic Recovery Phase

It is ecologically very important for organisms to recover quickly and completely from hypoxic or anoxic stress when oxygen is available once more. This recovery implies a restoration of high energy compounds (mainly ATP, phosphagen, and glycogen), as well as disposal of anaerobic end-products (mainly lactate, alanine, and succinate). End-products can be disposed of in three different ways during a postanoxic recovery phase: complete oxidation, conversion back into storage products such as glycogen (via the glyconeogenesis pathway, such as glycogen *de novo* synthesis from lactate, amino acids, and/or glycerol), and excretion into the medium (Hervant *et al.*, 1996). Excretion is an important mechanism for the disposal of lactate during aerobic recovery in the epigeal *G. fossarum* and *A. aquaticus*. This is a costly strategy because it implies a loss of energy-rich carbon chains. In contrast, hypogean crustaceans preferentially use glyconeogenesis to convert lactate into glycogen stores. The existence of glyconeogenesis has already been demonstrated in several crustaceans (Hervant *et al.*, 1999), although the organ sites for this metabolic pathway have not been identified clearly. Recent experiments using injections of labeled glucose and lactate (Hervant *et al.*, 1999) revealed that the gluconeogenesis rate in *N. virei* during postanoxic recovery was higher than any rate measured previously for epigeal crustaceans. Glycogen reserve restoration was indeed 2.5 to 6.6 times greater in hypogean species than in *G. fossarum* and *A. aquaticus* (Table I). This ability to quickly resynthesize during recovery periods the body stores depleted during lack of oxygen allows groundwater organisms to fuel successfully an ensuing hypoxic or anoxic period; therefore, groundwater species are well adapted to live in habitats show-

ing frequent and unpredictable alternations of normoxic and hypoxic/anoxic phases.

### IMBRICATION OF ADAPTIVE STRATEGIES TO LOW FOOD RESOURCES AND LOW OXYGEN SUPPLY

The occurrence of adaptive strategies in response to low oxygen among animals living in an oligotrophic environment may seem paradoxical. Notwithstanding the fact that the supply of organic matter is typically lower in groundwater than in surface water, field ecological studies carried out for the last 30 years have shown that several groundwater habitats (particularly unconsolidated sediments) have reduced DO concentrations. Although a few subterranean habitats are known to be organic-matter rich (Hüppop, 2000), low DO concentration in many groundwater habitats is most likely attributable to the lack of oxygen production and low transport rate of DO than to elevated concentrations of organic matter. If food availability drives habitat selection in groundwater, hypogean animal populations would preferentially occur in groundwater biotopes receiving higher fluxes of organic matter from the surface environment. These habitats are also more likely to exhibit reduced DO concentrations because of increased respiration rates associated with the input of organic matter. Thus, the selection of habitats having increased food supply increases the probability of facing hypoxic stress among hypogean animals. Meantime, the development of behavioral, respiratory, and metabolic strategies to low food supplies also selects for higher resistance to a low oxygen supply. Clearly, the role of food availability and the significance of low oxygen supply in determining the development of adaptive strategies and distribution patterns of animals in groundwater are overlapping aspects that can hardly be treated independently.

Some metabolic pathways, therefore, that are specifically linked to the response to long-term starvation and/or adaptation to oxygen stress are associated with energy-limited subterranean organisms. Hervant and Renault (2002) demonstrated that the groundwater crustacean *S. virei* preferentially utilizes lipids during food shortage, in order to (1) save carbohydrates and phosphagen, the two main fuels metabolized during oxygen deficiency in crustaceans (Zebe, 1991), and (2) save proteins (and therefore muscular mass) for as long as possible. Thus, this species can (1) successfully withstand a hypoxic period subsequent to (or associated with) an initial nutritional stress, and (2) rapidly resume searching for food during short-term, sporadic, nutrition events.

A general adaptation model for groundwater animals involves their ability to withstand prolonged hypoxia and/or long-term starvation (Hervant *et al.*, 2001; Hervant and Renault, 2002; Hüppop, 2000) and to utilize in a very efficient way the high-energy body stores. Because the three hypogean crustaceans studied lack a high-ATP-yielding

anaerobic pathway (such as observed in permanent anaerobic organisms) (Fields, 1983), their higher survival time in anoxia is mainly due to the combination of four mechanisms: (1) high storage of fermentable fuels (glycogen and phosphagen); (2) low SMR in normoxia; (3) further reduction in metabolic rate by lowering energetic expenditures linked to locomotion and ventilation during hypoxia; and (4) high ability to resynthesize the depleted body stores during subsequent recovery periods. The ability to maintain and rapidly restore (without feeding) high amounts of fermentable fuels for use during lack of oxygen can be considered an adaptation to life in a patchy environment. Through their efficient exploratory behavior in a moving mosaic of patches of low and high DO concentration (Malard and Hervant, 1999), numerous groundwater animals probably experience highly variable DO and/or food concentrations. The behavioral, physiological, and metabolic responses of numerous hypogean animals partly explain why they occur in groundwater systems with a wide range of DO (Malard and Hervant, 1999).

A high resistance to lack of oxygen (and/or to food deprivation) is not universally found in subterranean organisms but is probably more related to oxygen availability and/or to the energetic state of each subterranean ecosystem. Indeed, groundwater ecosystems are far more complex and diverse than earlier presumed. The aquatic amphipod *Gammarus minus* showed no significant difference in behavioral, physiological, and metabolic responses to experimental anoxia and subsequent recovery among a spring and a cave populations (see Malard and Hervant, 1999). Despite a strong tendency toward morphological convergence, subterranean organisms do not form a homogeneous group (Malard and Hervant, 1999). Further developments in the study of their physiology would highlight the diversity of adaptive responses among hypogean animals that have colonized contrasted groundwater ecosystems.

### *See Also the Following Articles* *Adaptive Shifts*

### **Bibliography**

- Boulton, A.J., H.M. Valett, and S.G. Fisher (1992) Spatial distribution and taxonomic composition of the hyporheos of several Sonoran Desert streams. *Archiv für Hydrobiol.* 125: 37–61.
- Danielopol, D.L. (1989) Groundwater fauna associated with riverine aquifers. *J. North Am. Benthol. Soc.* 8: 18–35.
- Danielopol, D.L., M. Creuzé des Châtelliers, F. Mösslacher, P. Pospisil, and R. Popa (1994) Adaptation of Crustacea to interstitial habitats: a practical agenda for ecological studies. In *Groundwater Ecology* (J. Gibert, D.L. Danielopol, and J.A. Stanford, Eds.). Academic Press, San Diego, pp. 217–243.
- Fields, J.H.A. (1983) Alternatives to lactic acid: possible advantages. *J. Exp. Zool.* 228: 445–457.
- Henry, K.S. and D.L. Danielopol (1999) Oxygen dependent habitat selection in surface and hyporheic environment by *Gammarus roeseli* Gervais (Crustacea, Amphipoda): experimental evidence. *Hydrobiologia* 390: 51–60.

- Herreid, C.F. (1980) Hypoxia in invertebrates. *Comp. Biochem. Physiol.* 67A: 311–320.
- Hervant, F. and D. Renault (2002) Long-term fasting and realimentation in hypogean and epigean isopods: a proposed adaptive strategy for groundwater organisms. *J. Exp. Biol.* 205: 2079–2087.
- Hervant, F., J. Mathieu, D. Garin, and A. Fréminet (1996) Behavioral, ventilatory, and metabolic responses of the hypogean amphipod *Niphargus virei* and the epigean isopod *Asellus aquaticus* to severe hypoxia and subsequent recovery. *Physiol. Zool.* 69: 1277–1300.
- Hervant, F., J. Mathieu, and G. Messana (1997) Locomotory, ventilatory and metabolic responses of the subterranean *Stenasellus virei* (Crustacea: Isopoda) to severe hypoxia and subsequent recovery. *C.R. Acad. Sci. Paris, Life Sci.* 320: 139–148.
- Hervant, F., J. Mathieu, and G. Messana (1998) Oxygen consumption and ventilation in declining oxygen tension and posthypoxic recovery in epigean and hypogean aquatic crustaceans. *J. Crust. Biol.* 18: 717–727.
- Hervant, F., D. Garin, J. Mathieu, and A. Fréminet (1999) Lactate metabolism and glucose turnover in the subterranean *Niphargus virei* (Crustacea: Amphipoda) during posthypoxic recovery. *J. Exp. Biol.* 202: 579–592.
- Hervant, F., J. Mathieu, and J.P. Durand (2001) Behavioural, physiological and metabolic responses to long-term starvation and refeeding in a blind cave-dwelling salamander (*Proteus anguinus*) and a facultative cave-dwelling newt (*Euproctus asper*). *J. Exp. Biol.* 204: 269–281.
- Hüppop, K. (2000) How do cave animals cope with the food scarcity in caves? In *Ecosystems of the World*, Vol. 30 (D. Wilkens, C. Culver, and W.F. Humphreys, Eds.). Elsevier Press, Amsterdam, pp. 159–188.
- Malard, F. and F. Hervant (1999) Oxygen supply and the adaptations of animals in groundwater. *Freshwater Biol.* 41: 1–30.
- Mösslacher, F. and M. Creuzé des Châtelliers (1996) Physiological and behavioural adaptations of an epigean and a hypogean dwelling population of *Asellus aquaticus* (L.) (Crustacea: Isopoda). *Archiv für Hydrobiol.* 138: 187–198.
- Revsbech, N.P. and B.B. Jørgensen (1986) Microelectrodes: their use in microbial ecology. *Adv. Microb. Ecol.* 9: 293–352.
- Ronen, D., Magaritz, M., Almon, E., and Amiel, A.J. (1987) Anthropogenic anoxicication (“eutrophication”) of the water table region of a deep phreatic aquifer. *Water Resources Res.* 23, 1554–1560.
- Strayer, D.L., S.E. May, P. Nielsen, W. Wollheim, and S. Hausam (1997) Oxygen, organic matter, and sediment granulometry as controls on hyporheic animal communities. *Archiv für Hydrobiol.* 140: 131–144.
- Winograd, I. and F. Robertson (1982) Deep oxygenated groundwater. Anomaly or common occurrence? *Science* 216: 1227–1229.
- Yaeger, J. (1994) *Speleonectes gironensis*: new species (Remipedia: Speleonectidae) from anchialine caves in Cuba, with remarks on biogeography and ecology. *J. Crust. Biol.* 14: 752–762.
- Zebe, E. (1991) Arthropods. In *Metazoan Life Without Oxygen* (C. Bryant, Ed.). Chapman & Hall, London, pp. 218–237.

## Adaptive Shifts

Francis G. Howarth  
Bishop Museum, Honolulu

Hannelore Hoch  
Museum für Naturkunde, Berlin

**A**daptive shift is an evolutionary phenomenon in which individuals from an existing population change to exploit a new habitat or food resource. If successful, the new population may diverge behaviorally, morphologically, and

physiologically to become a distinct population or species. The phenomenon is inferred from the many examples of adaptive radiation in which separate species within a lineage have adapted to occupy different habitats or food resources. We can only see the end results of the process, making it difficult to test the model except indirectly through appropriate comparative studies of the closely related species. Adaptive shifts are most recognizable on islands where pairs of closely related species overlap in distribution yet are adapted to radically different habitats. These species retain characteristics that indicate a logical progression from an immediate common ancestor, corroborating the view that they diverged from one another through the process of adaptive shift. Only in the last few decades have adaptive shifts been advanced to explain the evolution of troglobites. The generally accepted view of cave adaptation held that surface populations of facultative cave species became locally extirpated (for example, by changing climate), thus isolating the surviving populations in caves where they could evolve in isolation. Any interbreeding with its surface population was believed to be sufficient to swamp any incipient specialization. Divergence by adaptive shifts is usually envisioned as sympatric or parapatric; that is, the diverging populations remain in contact during the split. It now appears that many cave-adapted animals evolved by the process of adaptive shifts from representatives of the local surface fauna. How this occurs is the focus of this chapter.

### THEORY OF ADAPTIVE SHIFT

For over a century, the evolution of obligate cave species (troglobites) was assumed to be restricted to continental regions that had been influenced by glacial events and that the ecological effects resulting from the severe climatic fluctuations provided the isolation and necessary elements to facilitate the evolution of troglobites. Because most troglobites appear to have no surviving ancestors, it has been assumed that they evolved allopatrically (*i.e.*, as a consequence of extinction of their closely related epigean species); however, it is possible that many temperate-zone troglobites evolved parapatrically through adaptive shifts and that their current isolation occurred after cave adaptation.

In the adaptive shift model, populations of epigean species invade subterranean habitats to exploit novel resources, and the drastic change in habitat is considered to be the driving force for genetic divergence and speciation. The presence of exploitable food resources provides the evolutionary “incentive” for adaptation. Evolutionary theory predicts that adaptation and new species are more likely to arise from large, expanding populations to exploit marginal resources at the edge of their habitat and to make adaptive shifts to exploit new environments than are small populations.

Adaptive shifts proceed in a three-step process. First, a new habitat or resource becomes available for exploitation. This opening of an ecological niche can occur either by an

organism expanding its range or by geological or successional processes creating an opportunity for a resident population. Second, there is a shift in behavior to exploit the new habitat or food resource. Third, if the behavioral shift successfully establishes a new population, natural selection fosters adaptation. In a classic comparative study of cave and surface springtails, Christiansen (1965) demonstrated that a behavioral shift to exploit a new resource or survive a new environmental stress occurs first, and, if it is successful, morphological, physiological, and additional behavioral changes follow. Even if the populations remain in contact, the selection pressures imposed by the different environments and augmented by environmental stress, if strong enough, can force the two populations to diverge.

Speciation by adaptive shift is parapatric in that adaptive differentiation, accompanied by a reduction in gene flow, proceeds across a steep environmental gradient within a contiguous area. If the colonization is successful, the founding population reproduces and expands into underground habitats. Maintenance of the barrier to gene flow could be facilitated by selection against hybridization (*e.g.*, decreased hybrid viability), assortative mating, or spread of the incipient cave population away from the narrow hybrid zone, thereby reducing the effect of introgression from epigeal individuals. It has been hypothesized for cave species that selection for novel mating behaviors may be the principal origin of isolation. Many adaptive shifts undoubtedly fail; that is, the founding population dies out. Conversely, interbreeding and selection following a shift can produce a single more adaptable population capable of exploiting both environments.

### FACTORS UNDERLYING ADAPTIVE SHIFTS INTO CAVE HABITATS

The trigger for an adaptive shift into caves is the availability of suitable habitat and exploitable resources. Only a small percentage of epigeal groups have representatives inhabiting caves, and several factors appear to be involved in determining whether or not an organism can take advantage of the opportunity to exploit caves. These factors often act in concert but for clarity can be considered either *intrinsic* or *extrinsic*. Intrinsic factors are characteristics inherent in the organism that allow it to make the shift—for example, the ability to live in damp, dark habitats. Extrinsic factors are those imposed on the organism by the environment.

#### Intrinsic Factors

**PREADAPTATION** The role of preadaptation has been recognized for more than a century as one of the principal factors explaining which taxa have successfully adapted to live in caves. Most preadaptations simply result from the correspondence of an organism's preferred environment with that found in caves. That is, organisms that have character-

istics that allow them to live in damp, dark, wet-rock microhabitats on the surface have a better chance of surviving in caves than do organisms that do not possess these traits. Similarly, survival is enhanced if their normal food resource naturally occurs in caves. Nymphs of epigeal cixiid planthoppers are admirably preadapted to caves as they feed on plant roots and therefore already have a suite of behavioral, morphological, and physiological adaptations to survive and feed underground. In the cave species, these preadapted nymphal characters have been retained into adulthood so that the adults are also able to live underground.

**GENETIC REPERTOIRE** In order to adapt to caves, a population must have the ability to change. For example, if an organism is genetically hard-wired to require light, temperature change, or other environmental cues to complete its life cycle and reproduce, it is unlikely to colonize caves. In cixiids, salamanders, and a few other groups, the adaptive shift to living in caves was greatly facilitated by neoteny or the retention of nymphal characters into adulthood. Development of neoteny in salamanders is believed to involve relatively small changes in the genes that regulate development. This demonstrates that a small genetic change can have a large effect on phenotype.

**FOUNDER EVENTS AND SUBSEQUENT POPULATION FLUSH AND CRASH CYCLES** Because only a few individuals from the parent population make the initial shift, only a subset of the genetic diversity found in the parent population can be carried into the founding population. Certain alleles may be lost, while certain rare ones may become more abundant. Inbreeding, response to environmental stress, and expression of previously rare alleles may result in coevolved blocks of loci becoming destabilized, thus allowing new combinations of genes. If the new colony expands rapidly into the new habitat (*e.g.*, due to abundant food or reduced competition and predation), the relaxed selection pressure allows the survival of new mutations and unusual recombinants that ordinarily would be lost due to low fitness. Thus, the genetic variability may be quickly reestablished in the founding population; however, by this time there may be significant genetic divergence from the parent population. A subsequent population crash (as when the new colony exceeds the carrying capacity) places extreme selection pressure on the population. These cycles of expansions and crashes in founding populations are thought to facilitate adaptation to a new environment.

In parapatric divergence, occasional backcrosses with the parent population can increase genetic diversity and provide additional phenotypic variability on which natural selection can act. Mixing of the two gene pools by interbreeding becomes less likely as the new population expands its range beyond that of the parent population and adapts to the stresses of the new environment.

**RESPONSE TO STRESS** Environmental stresses in a novel habitat may facilitate adaptive shifts. Organisms living under environmental stresses often experience higher mutation rates and display greater phenotypic and genetic variation. In nature, selection and the high energetic costs of stress usually reduce this variation; however, where sufficient exploitable food energy compensates for the extra costs of survival in a novel habitat, some of the enhanced variation may survive and in time result in a new population adapted to cope with the stresses. The higher energetic costs required to cope with stress augment both natural and relaxed selection pressures to favor the loss of unused characters, such as eyes and bodily pigment of troglobites. The lower metabolic and fecundity rates possessed by troglobites may in large part be an adaptation to cope with stresses found in subterranean environments.

**MATING BEHAVIOR AND HYBRIDIZATION** An important constraint among organisms colonizing caves is the ability to locate mates and reproduce underground. The normal cues used by a species may not be present or the mate recognition signal system may be confusing in the unusual environment. For example, sex pheromones would not disperse in the same way in caves as they do on the surface. Also, an animal may have difficulty following the plume in a three-dimensional dark maze. The rarity of troglobites that use airborne sounds to locate and choose a mate attests to the difficulty of using sound underground and suggests that muteness in crickets is a preadaptation for colonizing caves. In addition, environmental stress can reduce sexual selection and disrupt mating behaviors. Founder events can exacerbate these effects and the resulting release of sexual selection pressure may allow hybridization with relatives. The maintenance of limited gene flow between the diverging populations is thought to be important in providing the additional genetic variability to accelerate adaptation; however, evolution of more appropriate mating behaviors in a newly established cave population may provide the critical factor in isolating the diverging populations.

### Extrinsic Factors

**PRESENCE OF CAVERNICOLOUS HABITATS** Obviously, there must be an opportunity for a surface population to colonize caves; that is, the surface population must live in contact with cavernous landforms. Geological processes (such as lava flows) can create new cave habitats, ecological succession or the immigration of a new organism can introduce suitable new food resources into caves, or a preadapted surface population can migrate into the cave area. The Hawaiian Islands formed sequentially in line, and the successful colonization of each island after it emerged from the sea had to proceed in an orderly fashion. Phytophagous insects had to wait for their hosts to establish and so on. Terrestrial obligate cave species are not likely to have crossed

the wide water gaps between each island. Even though suitable lava tubes and cave habitats were available from the beginning, the evolution of cave species had to wait for their surface ancestors to become established and for appropriate food resources to accumulate in caves. These circumstances provided tremendous advantages to the first organisms that could exploit a newly available resource and preempt the resource from subsequent colonists.

**PRESENCE OF EXPLOITABLE FOOD RESOURCES** An exploitable food resource is the paramount prerequisite that allows individuals of a population to shift into a new habitat or life style. In fact, in most examples of adaptive shift, both the cave and surface species feed on the same food resource. Sparse soil and organic litter with areas of barren rock on the surface are characteristic of cavernous landforms, including those created by limestone, lava, and talus. Where an interconnected system of cave and cave-like subterranean voids occur, organic material does not accumulate on the surface but is washed underground by water, falls underground by gravity, or is carried underground by living organisms. Many surface organisms will follow their food underground and attempt to exploit it. Even though their food may be abundant in caves, most organisms adapted to living in surface habitats may become lost in deep cave passages because their normal cues are reduced or absent or because they cannot cope with the harsh environment. Thus, much of this sinking material is outside the reach of most surface organisms; however, it becomes a rich reward for any organism that can adapt to exploit it.

**ENVIRONMENTAL STRESSES** The environment in deep caves and cave-like voids is highly stressful for most surface animals, and relatively few surface species can survive for long underground. Even though food may be adequate, it is much more difficult to find and exploit in the complex three-dimensional dark maze, especially because many environmental cues (*e.g.*, light/dark cycles, temperature changes, and air currents) are absent. Furthermore, the atmosphere is characteristically above the equilibrium humidity of body fluids, making respiration and water balance difficult to sustain. The substrate is moist, and the voids occasionally flood. Carbon dioxide and oxygen concentrations can reach stressful levels. In many cave regions, radiation from decaying heavy isotopes may exceed hazardous levels. Because of the mazelike space, escape to a less stressful environment is virtually impossible, and cave animals must either adapt to cope with these and other stresses *in situ* or die out.

**ANCESTRAL HABITATS** Troglobites originated from a variety of damp surface habitats. Specifically, the ancestral habitats include soil, leaf litter, mosses, and other damp microhabitats in forests; damp, wet-rock habitats (such as marine littoral, riparian, and cracks in barren lava flows); and guano-inhabiting species living in caves and animal

burrows. These source habitats corroborate the concept of preadaptation.

## CASE STUDIES

### Hawaii

Twelve taxonomic groups have independently adapted to caves on two or more islands in Hawaii, indicating that cave adaptation is a general phenomenon fostered by ecological and evolutionary factors. On the young (less than one million years) Hawaii Island, some taxa have undergone (or are undergoing) adaptive shifts into both caves and new surface habitats in a phenomenon called *adaptive radiation*.

Many of these troglobites still have extant close surface relatives living in nearby habitats. The better known among these are listed in Table I and discussed below. The number of examples will increase as more taxa are studied. Cave species on the older islands tend to be relicts today; however, they also are believed to have originally evolved by adaptive shifts.

**CIXIID PLANTHOPPERS (HEMIPTERA: FULGOROMORPHA: CIXIIDAE)** Cixiid planthoppers exemplify how adaptive shifts might occur (Fig. 1). The nymphs of nearly all species in the family live in or close to the soil and feed on the xylem sap of roots. Cixiid nymphs of surface species molt to adults (Fig. 2), emerge above ground, and live, feed,

TABLE I Parapatric Cave and Surface Species Pairs Occurring on Hawaii Island

Cave Species	Common Name	Surface Relative	Ancestral Habitat
<i>Littorophiloscia</i> sp.	Slater, wood louse	<i>Littorophiloscia hawaiiensis</i>	Marine littoral
<i>Oliarus malakiiki</i>	Cixiid planthopper	<i>Oliarus kawaii</i>	Mesic forest
<i>Oliarus polyphrenus</i> *	Cixiid planthopper	<i>Oliarus</i> spp.?	Rain forest
<i>Oliarus lovetiae</i>	Cixiid planthopper	<i>Oliarus</i> spp.?	Dry shrub land
<i>Nesidioteles ana</i> *	Thread-legged bug	<i>Nesidioteles selison</i>	Cryptic rain forest habitats
<i>Caconemobius varius</i> *	Rock cricket	<i>Caconemobius fori</i> *	Barren lava flows
		<i>C. strobilichensis</i>	Marine littoral
<i>Anisolabis howarthi</i>	Earwig	<i>Anisolabis maritima</i>	Marine littoral
		<i>A. hawaiiensis</i>	Barren lava flows?
<i>Lycosa howarthi</i>	Wolf spider	<i>Lycosa</i> sp.*	Barren lava flows

\* Represented by several distinct populations or species. Polymorphic cave populations may represent separate invasions or could result from divergence of a single lineage after cave adaptation.

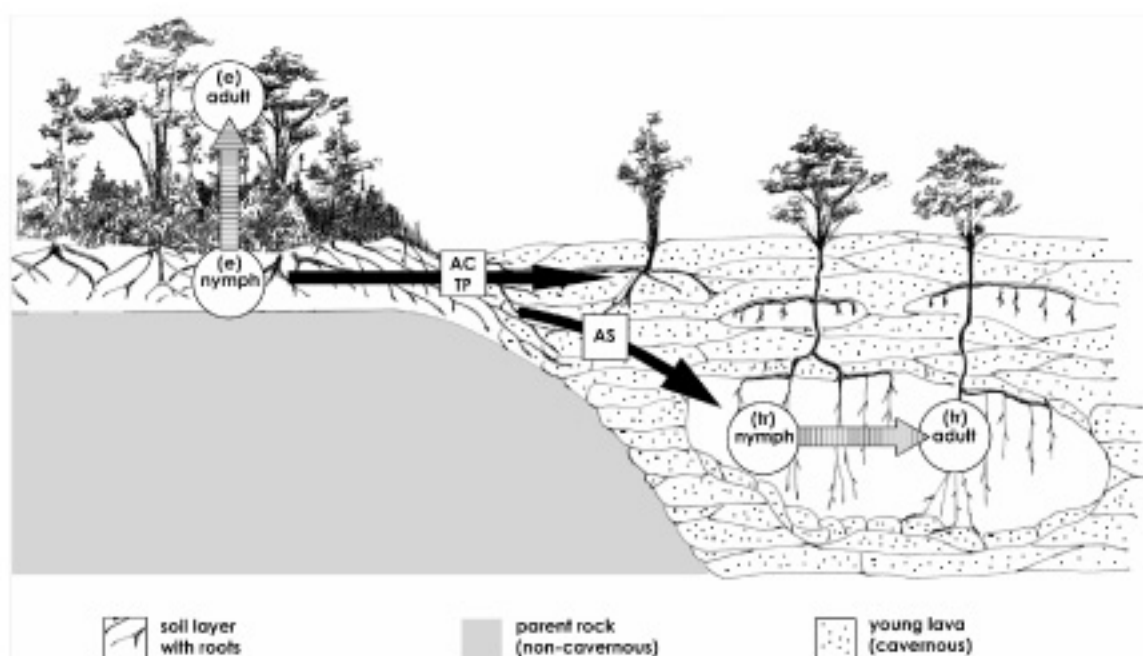


FIGURE 1 Diagrammatic view of an adaptive shift from surface to underground environments by a cixiid planthopper. AC, accidental; AS, adaptive shift; (e), epigean; TB, troglophile; (tr), troglomite.



FIGURE 2 Epigeal adult cixiid, *Oligorus* species, from Hawaii Island. (Photograph by H. Hoch.)

and mate on vegetation. Plants living on or near cavernous landforms often send their roots through the interconnected system of voids deep underground following nutrients and percolating groundwater. Thus, roots are often an important source of food energy in caves, especially in the tropics and lava tubes. Nymphs of surface species may migrate along roots deep into caves from their normal shallow habitat. These nymphs can exploit deep roots, as the deep habitat is similar to their normal one except for the perpetually saturated atmosphere, and for this stress they already have mechanisms to excrete excess water as xylem sap is very dilute. When they molt, the adults may have little chance to find their way to the surface to reproduce and would eventually die from the stressful environment; however, if host plant roots were abundant and large numbers of nymphs continually made their way underground, an adult might occasionally find a mate and reproduce fortuitously. Most of these early chance matings, if successful at all, would produce normal surface adults that would also become lost. Eventually, some offspring might acquire traits from random mutation or genetic recombination that are passed on and that allow the offspring to survive and reproduce underground more easily. If this incipient colony successfully establishes an underground population, it could more fully exploit the



FIGURE 3 Nymph of *Oligorus polyphemus* within wax filament cocoon on its host root. (Photograph by H. Hoch.)

deeper root resources. In fact, a whole new habitat and resource would be opened to the expanding population as it could move throughout the interconnected voids in the cave region and leave its surface relatives behind. The surface environment on cavernous landforms provides little suitable habitat for epigeal planthoppers, so that the subterranean population is often larger than surface populations over caves. This is especially true on volcanoes where eruptions can create vast new habitats for cave populations. In Hawaii, the principal pioneering plant on young lava flows is the endemic tree *Metrosideros polymorpha* (Myrtaceae), the roots of which are the hosts of *Oligorus polyphemus* s.l. (*sensus lato*) nymphs (Fig. 3). Even widely scattered small trees on 100-year-old flows send abundant roots deep into caves. As envisioned, adaptation can be rapid in the invasive expanding phase. Subsequently, the newly established subterranean population will acquire the troglomorphic traits characteristic for obligate cavernicoles: reduction of eyes, wings, and bodily pigment.

In Hawaii, the genus *Oligorus* has undergone extensive adaptive radiation in surface habitats after the successful colonization of a single ancestral species, and about 80 endemic species and subspecies have been described from all major islands. Eighteen surface species (e.g., Fig. 2) are known from the island of Hawaii, where at least three independent adaptive shifts into subterranean habitats have occurred (Table I). The clearest case for adaptive shift among cave cixiids involves *O. mahaiki* and *O. koanoa*. *O. mahaiki* has reduced wings, eyes, and bodily pigment and is known from a single 1500- to 3000-year-old lava tube from Hualalai Volcano. Its male genitalia (which usually provide an excellent means for distinguishing species in the group) are virtually identical to the fully winged and eyed epigeal *O. koanoa*. *O. koanoa* is widespread in mesic forests on Hawaii. Its nymphs are frequent in shallow caves and even occur near the entrance in the same cave with *O. mahaiki*. Adults of *O. koanoa* may be accidental in caves, as accumulations of body



FIGURE 4 Adult female of *Oliarus polyphemus*. (Photograph by W.P. Mull.)

parts from thousands of dead individuals have been found in dead-end passages in some caves.

The highly troglomorphic *O. polyphemus s.l.* (Fig. 4) also occurs in the same cave with *O. makaiki*, as well as in virtually every suitable cave containing its host roots, *Metrosideros polymorpha*; however, each cave system appears to harbor a unique population of this troglobite. Each population differs only slightly in morphology, but the mating calls are highly distinctive and probably sufficient to reduce hybridization if the populations were to come in contact. The ancestor of *O. polyphemus s.l.* has not been determined, although it certainly belongs in the endemic Hawaiian group of species. It is also unknown whether *O. polyphemus s.l.* represents a single colonization event in caves with subsequent divergence underground or whether some populations represent separate invasions by the same or closely related surface species.

Adult planthoppers use substrate-borne sounds to recognize and locate their mates. Among surface species, females feed on the host plant while the males fly from host to host and initiate a species-specific mating song. If a receptive female hears an appropriate song, she will answer with her own song. The male orients to the call, and the two alternately sing and listen until the male finds the female, who remains *in situ*. Studies have shown that Hawaiian cave *Oliarus* essentially use the same mate recognition system: substrate-borne vibrations, with living roots being an excellent transmitting medium. In laboratory studies on the cave cixiid *Oliarus polyphemus s.l.*, the flightless females feed on the host root and occasionally call. Males are also flightless and wander from root to root listening. When a male hears a female, he answers, and if the song is appropriate the two sing and listen alternately until the male locates the stationary female. Although the behavior has not been confirmed in natural settings in caves, it is believed that this switch in behavior occurred as an adaptation to the sub-

terranean environment. Singing is energetically costly, and males expend extra energy finding roots in the dark, three-dimensional maze. Also, predators can use these songs to locate prey, and males would be especially vulnerable if they had to sing on every root they found; therefore, males would be more likely to find a female if they did not have to initiate calling. Females conserve energy by staying in place and feeding, and they produce fine wax filaments that deter predators.

**TERRESTRIAL ISOPODS (CRUSTACEA: ISOPODA: PHILOSCIIDAE)** Species in the genus *Littorophiloscia* are marine littoral and inhabit tropical shorelines worldwide. One epigeic species, *L. hawaiiensis*, is endemic to Hawaii and is so far known only from littoral habitats on the islands of Hawaii and Laysan. Surprisingly, an undescribed troglomorphic species also lives on Hawaii Island. The cave form is remarkably similar in morphology to *L. hawaiiensis*, differing only in the troglomorphic characters (reduced eyes and pigment) displayed by the cave population. The males even share the same distinctive sexual characters. Results from a recent molecular phylogenetic study showed that *L. hawaiiensis* and the cave *Littorophiloscia* are distinct species that diverged from each other most likely by an adaptive shift. The initial adaptive shift must have been from salty marine littoral habitats to freshwater terrestrial habitats, possibly in coastal springs in young lava flows. Suitable freshwater shorelines are not well developed on Hawaii Island, but lava tubes would offer a vast new habitat. The complex three-dimensional system of anastomosing voids characteristic of young basaltic lava flows provides an immeasurably large habitat for cave animals. In contrast, *L. hawaiiensis* is restricted to a narrow band along the coast where it lives under rocks resting on soil. Thus, an adapting cave population would quickly move away from contact with its ancestral population and greatly exceed it in size.

A possible alternative explanation is the classical model of cave adaptation in which the coastal species became extinct stranding an incipient cave population; however, this model still requires that the adaptive shift to freshwater (and possibly to caves) had to occur before extinction, and that circumstance is precluded in the classical model. This scenario also requires a subsequent colonization by the halophilic littoral species that secondarily reestablished parapatry.

**CRICKETS (ORTHOPTERA: GRILLIDAE)** On the island of Hawaii, the marine littoral rock cricket *Caconemobius sandwichensis* has colonized both unvegetated lava flows and caves, both of which are barren-rock habitats like its ancestral home. Several distinct populations of rock crickets inhabit each of these inland environments, but it is unknown whether these represent multiple adaptive shifts from the marine littoral habitat or result from divergence after colonization of the new habitat, or both. A hybrid zone between the marine littoral species and the lava flow cricket



*C. fori* was found around a pool of brackish water in a deep crack where a young lava flow entered the sea, suggesting that the adaptive shift is ongoing. *C. fori* is a nocturnal scavenger on very young (*i.e.*, 1 month to about a century old) lava flows on Kilauea, disappearing when plants colonize the flow. It hides in deep cracks and caves during the day where it overlaps with several distinct cave populations or species. Additional recognizable populations of lava crickets, resembling *C. fori*, occur allopatrically on Mauna Loa and Hualalai volcanoes, also on Hawaii Island.

Up to three morphologically, behaviorally, and physiologically distinct populations of cave crickets can be found in larger caves, and individual caves may harbor a unique population of one or more of these forms. The total diversity of cave-adapted rock crickets on Hawaii is astounding, especially given the young age of the island. These multiple simultaneous adaptive shifts into such different habitats from the same ancestor further corroborate the contention that cave adaptation via adaptive shifts is a general phenomenon.

A possible scenario for the origin of troglobitic rock crickets and wolf spiders on the island of Hawaii might proceed like this. Marine littoral crickets could have been among the earliest colonists of newly emerging islands, because all that they required was already present: a rocky shoreline and ocean-derived flotsam. Barren lava was the original terrestrial habitat, and sea birds would have sought these new islands for nesting, presenting an inviting habitat for the littoral crickets to shift to the land where they could feed on wind-borne debris. Subsequent accumulation of organic material underground would have allowed the colonization of caves by either the seacoast or lava cricket preempting some resources, possibly before many plants and potential competitors arrived on the island.

**WOLF SPIDERS (ARACHNIDA: LYCOSIDAE)** The big-eyed wolf spiders (family Lycosidae) live on barren landscapes in many parts of the world and are good long-distance dispersers. They would also have been among the earliest colonists on emerging islands in Hawaii. There are several barren-ground populations of an undescribed species of *Lycosa* on Hawaii Island that differ in behavior, morphology, and color, but surprisingly they can hybridize. They occupy a range of habitats from hot, dry coastal barren lava plains to the freezing stone deserts above 4000 meters on Mauna Kea and Mauna Loa. On young lava flows, they prey on *Caconemobius* lava crickets. One member of this group followed its prey underground, becoming the anomalous small-eyed, big-eyed wolf spider (*Lycosa howarthi*).

The lycosid wolf spiders are characterized by the possession of four huge eyes (for spiders) and four smaller eyes, and they are among the better-sighted spiders. The troglobitic species has six vestigial eyes, yet differs from the lava flow species only by the characters associated with cave adaptation. As noted, both the epigeal spider and cricket were early colonists on Hawaii, and possibly the spider was able to

preempt the cave habitat because it was among the first predators to have the opportunity to exploit the young caves on the island.

### Other Islands

Adaptive shifts are best known from islands in large part because of their youth and isolation. Thus, many diverging species pairs are still extant, and their evolutionary history has not been obscured by geological or ecological events. Examples of troglobite evolution by adaptive shift are known from the Galapagos, Canary, and Greater Antilles islands. In the Galapagos, at least ten species of troglobitic terrestrial invertebrates still live parapatrically with their putative epigeal ancestors. At least seven extant parapatric pairs of troglobitic and epigeal species are known from the Canary Islands. Some of these, such as the *Dysdera* spiders and cockroaches, represent multiple invasions into caves, in parallel with Hawaii.

### Continents

Clear examples of adaptive shifts in continental caves are relatively rare, possibly because the great age of these systems has obscured the evolutionary history of the taxa involved or because the phenomenon has not generally been considered; nevertheless, there are a few cases. Perhaps the best documented is the detailed study (Culver *et al.*, 1995) done on the spring- and cave-inhabiting amphipod *Gammarus minus*, which occurs in freshwater basins in temperate eastern North America. The study demonstrated that several cave populations were derived from independent invasions from springs and that some hybridization had occurred; however, the constraints imposed by the dynamics of water flow and other factors may have isolated some populations from each other. In spite of considerable genetic and morphological diversity, these populations are all considered one species. In parallel with some Hawaiian forms, the definition of what constitutes a species is sometimes not clear. Adaptive shifts have been proposed to explain the origins of cave species in North Queensland, Australia, but the few phylogenetic analyses completed to date have not supported the contention.

### CONCLUSIONS

In cavernous regions, organic energy is continually being transported into an extensive system of subterranean voids, as evidenced by the characteristic presence of areas with a barren exposed rocky surface. Epigeal species can exploit food resources on and near the surface, but increased environmental stress levels and absent or inappropriate cues prohibit their access to this resource in the deeper voids. Animals following their normal food deeper may eventually become lost and be unable to return to the surface. Surface species continue to be frequent accidentals in caves and

provide a large proportion of the food to the cave-adapted predators and scavengers. Over time, a few of these accidentals may eventually survive and found a new population. A major initial factor facing a new cave population may be the ability to locate a mate and reproduce underground. Once a population is able to reproduce underground, a large new habitat will be opened up to it, and the population can expand rapidly. Evolution of troglobites by adaptive shift may be a common phenomenon; however, many examples of adaptive shift remain unrecognized, especially because the phenomenon is not generally considered. Other scenarios (such as allopatric evolution, which appears to be supported for many temperate troglobites) are also conceivable. The adaptive shift model and the classical theory of troglobite evolution may not be mutually exclusive.

## THE FUTURE

Adaptive shifts offer extraordinary opportunities for research. Comparative studies of closely related pairs of species adapted to such different environments as caves and surface habitats should provide better understanding not only of the processes of cave adaptation but also of selection and species formation in general. Molecular systematics will clarify the evolutionary history of taxonomic groups as well as elucidate the genetic basis of adaptive shifts. Phylogenetic analyses can elucidate the evolutionary transformation of specific morphological, behavioral, physiological, and ecological traits that occurred during the process of adaptation to novel habitats. The remarkable divergence from their epigeal relatives displayed by troglobites makes such studies especially interesting. Comparative physiological experiments can potentially dissect out for study the specific mechanisms involved in coping with a variety of environmental stresses. For example, terrestrial cave species live in an air-filled aquatic environment, while the close relatives of some live in desert-like environments. These species pairs are ideal models for studies on the physiological mechanisms involved in regulating water balance.

### See Also the Following Articles

*Adaptation to Darkness* • *Adaptation to Low Food* • *Adaptation to Low Oxygen*

### Bibliography

- Christiansen, K. (1965) Behavior and form in the evolution of cave Collembola. *Evolution* 19: 529–537.
- Culver, D.C., T.C. Kane, and D.W. Fong. (1995) *Adaptation and Natural Selection in Caves: The Evolution of Gammarus minus*, Harvard University Press, Cambridge, MA.
- Hoch, H. and F.G. Howarth (1993) Evolutionary dynamics of behavioral divergence among populations of the Hawaiian cave-dwelling planthopper *Oliarus polyphemus* (Homoptera: Fulgoroidea: Cixiidae). *Pacific Sci.* 47: 303–318.
- Hoch, H. and F.G. Howarth (1999) Multiple cave invasions by species of the planthopper genus *Oliarus* in Hawaii (Homoptera: Fulgoroidea: Cixiidae). *Zool. J. Linnean Soc.* 127(4): 453–475.

- Howard, D.J. and S.H. Berlocher, Eds. (1998) *Endless Forms: Species and Speciation*, Oxford University Press, New York.
- Howarth, F.G. (1980) The zoogeography of specialized cave animals: a bioclimatic model. *Evolution* 34: 394–406.
- Howarth, F.G. (1983) Ecology of cave arthropods. *Annu. Rev. Entomol.* 28: 365–389.
- Howarth, F.G. (1993) High-stress subterranean habitats and evolutionary change in cave-inhabiting arthropods. *Am. Naturalist* 142: S65–S77.
- Oromi, P., J.L. Martin, A.L. Medina, and I. Izquierdo (1991) The evolution of the hypogean fauna in the Canary Islands. In *The Unity of Evolutionary Biology*, Vol. 1 (E.C. Dudley, Ed.). Dioscorides, Portland, OR.
- Rivera, M.A.J., F.G. Howarth, S., Taiti, and G.K. Roderick. (2002) Evolution in Hawaiian cave-adapted isopods (Oniscidea: Philosciidae): vicariant speciation or adaptive shift? *Molec. Phylogenet. Evol.* 25: 1–9
- Peck, S.B. and T. Finston (1993) Galapagos islands troglobites: the questions of tropical troglobites, parapatric distributions with eyed-sister-species, and their origin by parapatric speciation. *Mém. Biospéol.* 20: 19–37.

# Anchialine Caves, Biodiversity in

Thomas M. Iliffe

Texas A&M University at Galveston

## DEFINITIONS

In 1973, Holthuis described several new and unusual red shrimps collected from land-locked saltwater pools in the tropical Indo-West Pacific. Because these pools shared common features, Holthuis coined the term *anchialine* (from the Greek meaning “near the sea”) and described this type of habitat as “pools with no surface connection with the sea, containing salt or brackish water, which fluctuates with the tides.” In 1966, Riedl had referred to similar habitats as *Randhoelen* (or “marginal caves”). Anchialine pools occur in uplifted reef limestone as well as irregular porous lava flows. The water in these pools varies in salinity from nearly fresh to fully marine. Dampened tidal fluctuations indicate the influence of a continuous water table extending inland from the open sea. Both salinity and the degree of connection to the sea control the nature of the biota, as pools close to the sea contain typical marine species, while those farther inland have fewer, but more unusual species.

Explorations by cave divers have resulted in the discovery of extensive, entirely submerged cave systems of which the classical anchialine pool represents only a small portion (Fig. 1). Thus, a new and ecologically more refined definition of the term *anchialine* was proposed at the 1984 International Symposium on the Biology of Marine Caves: “Anchialine habitats consist of bodies of haline waters, usually with a restricted exposure to open air, always with more or less extensive subterranean connections to the sea, and showing noticeable marine as well as terrestrial



**FIGURE 1** Diver swimming past submerged stalagmitic columns in Crystal Cave, an anchialine cave in Bermuda. (Photo by Cristian Lascu.)

influences.” An alternate spelling of anchialine is *anchihaline*, which adds an “h” to reflect international conventions on classification of salinity.

**ANCHIALINE BIODIVERSITY**

Anchialine stygobites are almost exclusively of marine origin and consist primarily of crustaceans (Table I). In addition, various freshwater stygobites including many nematodes, triclad turbellarians, polychaetes, copepods, mysids, thermosbaenaceans, isopods, amphipods, shrimp, and fish are marine relicts that may have invaded fresh groundwater by way of anchialine habitats. The reason why crustaceans make up 80 to 90% of anchialine stygobites is unclear. Perhaps crustaceans are better able to adapt to such limiting factors in the anchialine environment as lack of light, low levels of dissolved oxygen, and limited food supply.

Many new higher taxa have been discovered from anchialine caves, including the crustacean class Remipedia, the peracarid order Mictacea, and the copepod order Platycopioidea, plus 10 new families and more than 50 new genera. A diverse group of higher crustacean taxa characteristically inhabit anchialine caves. These include:

*Remipedia*: Free-swimming stygobitic crustaceans with a short head and elongate trunk composed of numerous segments, each with a pair of biramous swimming appendages (Fig. 2). This class includes 12 described species—eight from anchialine caves in the Bahamas, plus one each from the Canary Islands, Yucatan Peninsula, Cuba, and Western Australia (Fig. 3). Remipedes are considered the most primitive of living crustaceans.

*Ostracoda*: Small, free-swimming crustaceans with a calcareous bivalve shell. The ostracod orders Halocyprida, Myodocopida, Podocopida, and Platycopida include anchialine species. Of these, the halocyprids contain the most stygobitic species with

**TABLE I** Approximate Number of Strictly Anchialine Species

Sponges	4
Turbellarians	1
Gastropods	5
Annelids	10
Chaetognaths	4
Tantulocarids	1
Copepods	55–60
Ostracods	40–45
Mysids	35–40
Remipedes	12
Thermosbaenaceans	30–35
Mictaceans	1
Tanaidaceans	2
Leptostracans	1
Bochusaceans	2
Isopods	35–40
Amphipods	95–100
Decapods	45–50
Syncaerids	2
Water mites	3
Pisces	10

Source: Adapted from Pesce (2000).



**FIGURE 2** A remipede from Norman's Pond Cave in the Exuma Cays, Bahamas.

three primarily or exclusively anchialine genera.

*Danielopolina* includes 13 species with 5 species from caves in the Bahamas, 2 from the Canary Islands, and 1 each from Cuba, Jamaica, Yucatan, Galapagos, Western Australia, and deep-sea Atlantic (Fig. 4).

*Speleaoecia* has 11 species, including 6 from the Bahamas, 2 from Cuba, and 1 each from Jamaica, Yucatan, and Bermuda. *Deeveya* has the most restricted distribution, with 8 species all from the Bahamas.

*Copepoda*: Small crustaceans that are the most abundant and diverse type of animal on the planet. Copepods from the orders Calanoida, Cyclopoida, Harpacticoida, Misophrioida, and Platycopioidea

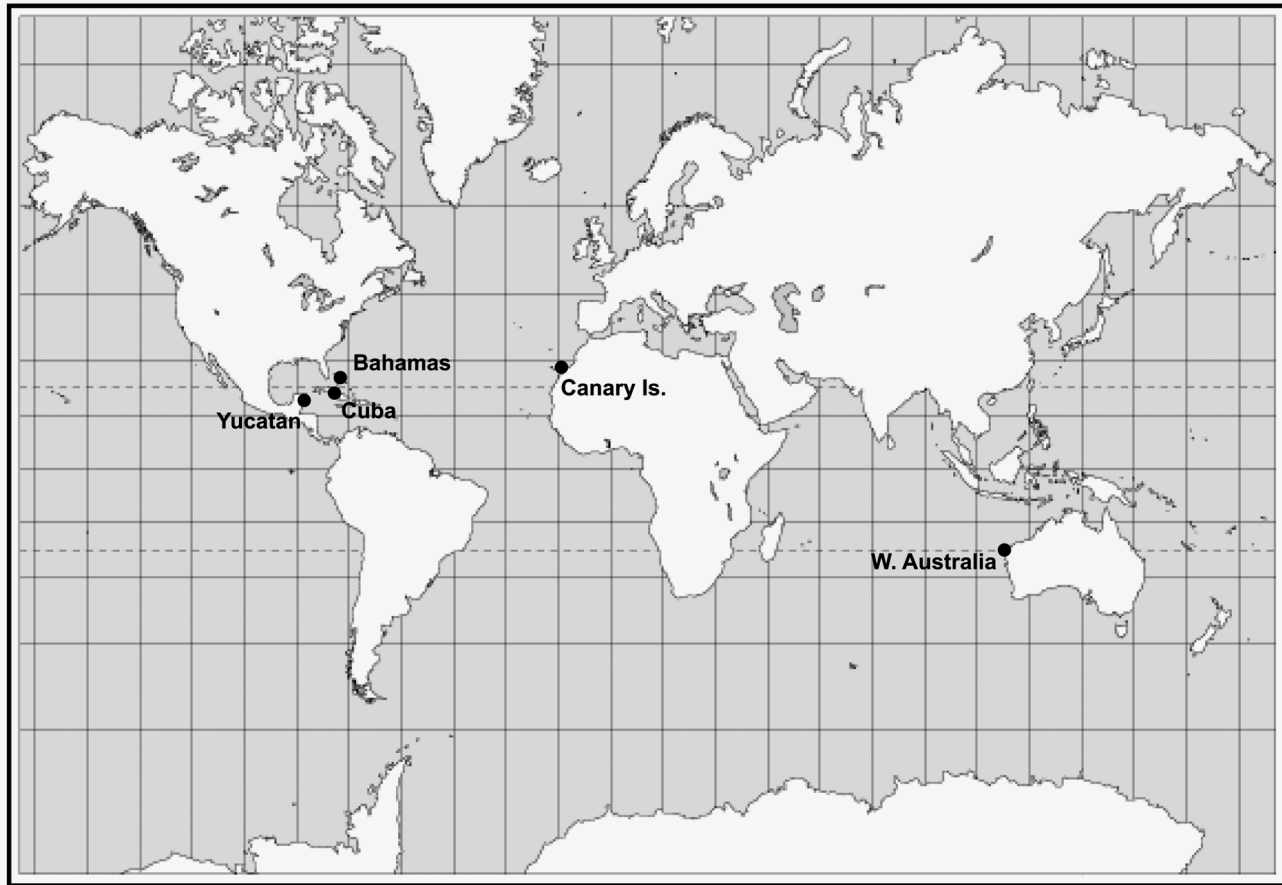


FIGURE 3 World map showing the distribution of the crustacean class Remipedia.

inhabit anchialine caves. The calanoid family Epacterciscidae, cyclopoid family Speleothonidae, and harpacticoid families Rotundiclipeidae, Superornatiremidae, and Novocriiniidae are almost exclusively anchialine. Misophrioids include both anchialine and deep-sea species. Several exclusively anchialine copepod genera are widely distributed. For example, seven species from the epacterciscid genus *Enantiosis* inhabit caves in Palau (two species), plus one species each in the Bahamas, Bermuda, Belize, Galapagos Islands, and Fiji (Fig. 5).

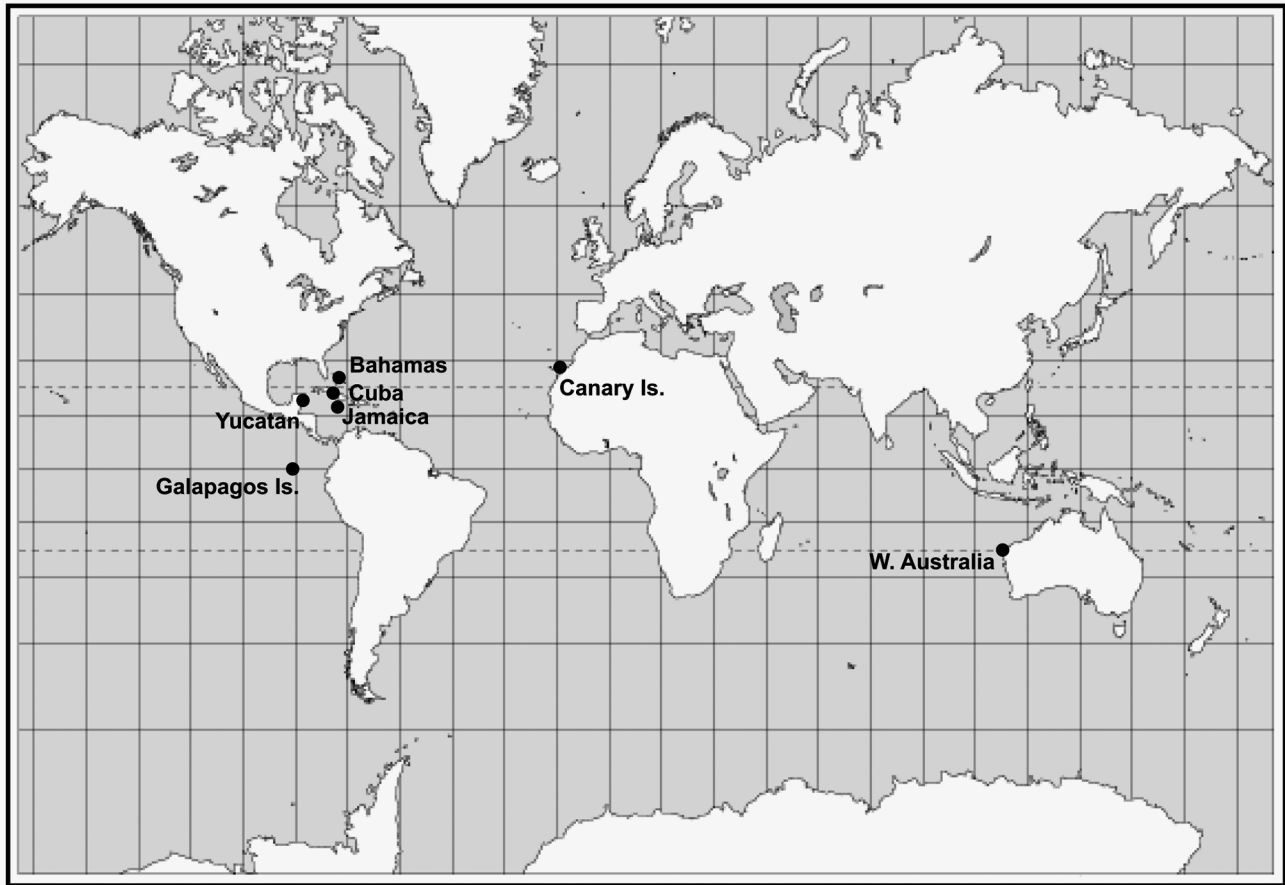
*Mysidacea*: Small, shrimp-like crustaceans with stalked eyes; embryos carried ventrally. Nineteen genera of mysids include stygobiont representatives. Most colonized groundwater during regressions of the Tethys and Mediterranean Seas.

*Mictacea*: Small crustaceans with seven pairs of pereopods (legs) (Fig. 6). The order Mictacea includes four species—one each from anchialine caves in Bermuda and the Bahamas and two from deep waters of the Equatorial Atlantic and the Indo-Pacific. A new order, Bochusacea, has been proposed to include the Bahamian species, as well as the two deep-sea species previously included within the Mictacea.

*Isopoda*: Small, sessile-eyed crustaceans inhabiting a variety of terrestrial, marine, and freshwater habitats. The isopod family Cirolanidae includes six anchialine genera. The anthurid genus *Curassanthura* consists of three anchialine species from Bermuda, the Canary Islands, and the Netherlands Antilles. The family Atlantasellidae includes only two species, which inhabit anchialine caves in Bermuda and the Dominican Republic.

*Amphipoda*: Small crustaceans with a laterally compressed body. The amphipod families Bogidiellidae, Gammaridae, Hadziidae, Hyalidae, Ingolfiellidae, Liljeborgiidae, Lysianassidae, Pardaliscidae, Phoxocephalidae, and Sebiidae include anchialine species. Of these families, the Hadziidae + Melitidae complex contains the largest number of anchialine taxa.

*Thermosbaenacea*: Small crustaceans with embryos carried dorsally (Fig. 7). Four genera of anchialine thermosbaenaceans include *Monodella* and *Tethysbaena* from the Mediterranean region; *Halosbaena* from the Canary Islands, Caribbean, and Western Australia; and *Tulumella* from the Yucatan Peninsula and the Bahamas.



**FIGURE 4** World map showing the distribution of the halocyprid ostracod genus *Danielopolina*. One additional species of *Danielopolina* inhabits deep waters in the mid-Atlantic Ocean.

*Decapoda*: Shrimps, crabs, and lobsters. Anchialine shrimps include 18 genera from four superfamilies: Alpheoidea, Oplophoroidea, Palaemonoidea, and Procaridoidea. The galatheid crab *Munidopsis polymorpha* inhabits an anchialine lava tube in the Canary Islands. Two species of brachyuran crabs occur in anchialine habitats in the Galapagos Islands, while a third brachyuran inhabits anchialine limestone caves in the Solomon Islands.

## CHARACTERISTICS OF ANCHIALINE TAXA

### Troglophobic Adaptations

Most obligate anchialine taxa exhibit typical troglomorphic adaptations to a lightless, food-poor cave environment. These include varying degrees of eye loss and depigmentation, increased tactile and chemical sensitivity, and larger but fewer eggs. Similar adaptations are also found in marine organisms inhabiting other lightless environments such as the interstitial and deep sea. Total depigmentation and loss of eyes are found in anchialine polynoid polychaetes, remipedes, halocyprid ostracods, epactericid and misoph-

roid copepods, cirrolanid isopods, leptostracans, thermosbaenaceans, chaetognaths, fishes, some shrimps, and numerous amphipods. Such pronounced troglomorphic adaptations usually occur in more primitive taxa that apparently have been restricted to caves for long time periods.

As with deep-sea shrimps, many anchialine shrimps are scarlet to blood-red in color. Ten species of insular, Indo-Pacific anchialine shrimps, representing nine genera in five families, all possess red integumentary chromatophores. However, color display is variable between individuals within a population. In contrast, continental cave shrimps of the Indo-Pacific are colorless with the exception of *Macrobrachium cavernicola*, a red palaemonid from inland caves in India. The hippolytid shrimp *Barbouria cubensis* displays an intense red coloration when found in anchialine pools open to the surface but is colorless in totally dark caves. If these shrimps are moved from darkness to light, a color transformation occurs within a matter of minutes.

Eyes are also present in many anchialine shrimps. Of 14 species within the atyid genus *Typhlatya*, pigmented eyes are found in 5 (mostly brackish or marine) species, suggesting a more recent adaptation to caves, while the remaining five (mostly freshwater) species lack eye pigment. Reduced but

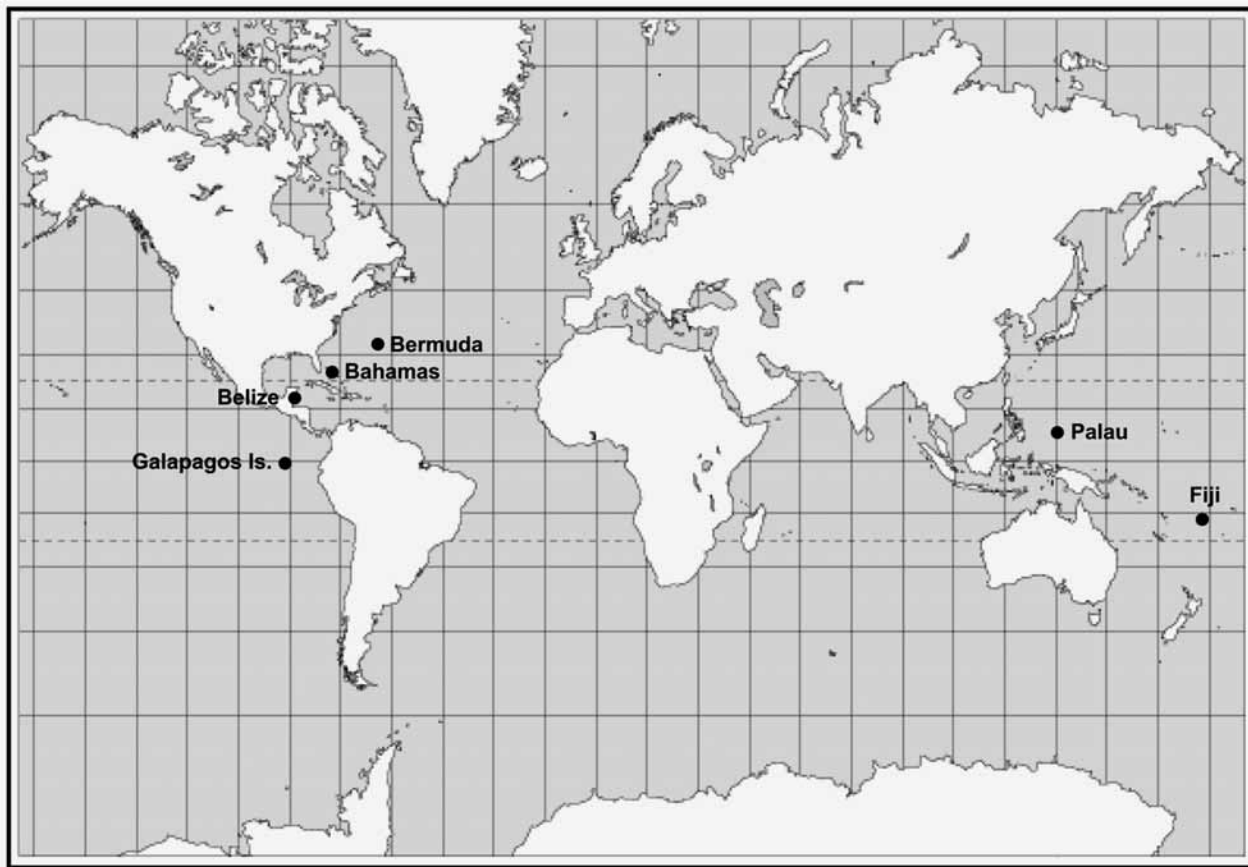


FIGURE 5 World map showing the distribution of the epacteriscid copepod genus *Enantiosis*.



FIGURE 6 The peracarid crustacean *Mictocaris halope* inhabits anchialine caves in Bermuda. The order Mictacea was erected to include both cave and deep sea species.



FIGURE 7 A thermosbaenacean from Norman's Pond Cave in the Exuma Cays, Bahamas.

pigmented eyes are present even in some of the most primitive anchialine shrimps, such as *Procaris hawaiiana*, *Procaris chacei*, *Agostocaris williamsi*, *Yagerocaris cozumel*, and *Ventrocaris chaceorum*.

### Primitive Characteristics

Living fossils are organisms that occur in low numbers, have few close relatives, inhabit small geographic areas, and evolve

at a very slow rate so that they have survived long periods of time with few changes. Anchialine stygobites such as the remipedes and the copepods *Antrisocopia* and *Erebonectes* fit these criteria and are regarded as living fossils. A number of anchialine crustaceans possess extremely primitive characteristics. Anchialine caves contain many of the most primitive known copepods in the orders Calanoida, Misophrioida, and Platycopioida. The platycopioid *Antrisocopia prehesilis* from Bermuda caves resembles in many ways with the theoretical

ancestral copepod. *Erebonectes nesioticus*, also from Bermuda, is considered one of the most primitive calanoids due to its first antennae consisting of 27 segments (the highest number ever recorded), essentially unmodified mouthparts, and primitive legs. Misophrioid copepods are of considerable phylogenetic interest because they represent the first branch to diverge from the main podoplean lineage within the Copepoda. Aside from the order Platycopioidea, copepods are divided into two superorders: Gymnoplea including the Calanoida and Podoplea with the remaining eight orders including the Misophrioida. The presence of numerous primitive and apparently ancient taxa in anchialine caves attests to the great age and long-term stability of this habitat. Thus, anchialine caves act as preserving centers for relict animals known nowhere else on Earth.

### Anomalous Biogeographical Distribution

Despite being limited to caves, many anchialine taxa have a broad and highly disjunct distribution, thus raising questions as to their origins. A variety of genera contain species inhabiting caves on opposite sides of the Atlantic Ocean. These include the remipede *Speleonectes*, the anthurid isopod *Curassanthura*, the mysid *Heteromysoides*, the ostracod

*Danielopolina*, the thermosbaenacean *Halosbaena*, the polychaete *Namanereis*, the shrimp *Typhlatya*, and the amphipods *Gevegiella*, *Pseudoniphargus*, and *Spelaeonicippe*. Such an amphiatlantic distribution suggests a Tethyan origin, with dispersal by plate-tectonic rafting.

Other anchialine genera, previously known from caves in the Caribbean and Atlantic, are found in the Galapagos Islands, located 1000 km off the South American coast in the eastern equatorial Pacific. Included in this group are the shrimp *Typhlatya*, the ostracod *Danielopolina*, and the copepods *Enantiosis* and *Expansophria*. The Caribbean-derived anchialine fauna of the Galapagos must have entered the Pacific prior to closure of the Panama land bridge about 3 to 5 million years ago.

Even more complex zoogeographic relationships exist for other anchialine taxa. The primitive shrimp *Procaris* is known only from caves and anchialine pools on Hawaii in the mid-Pacific, Ascension Island in the South Atlantic, Bermuda in the North Atlantic, and Cozumel in the Caribbean (Fig. 8). Equally perplexing is the case of the misophrioid copepod genus *Expansophria*. It is represented by cave species from Palau and the Galapagos Islands on opposite sides of the Pacific and from the Canary Islands in the Atlantic.

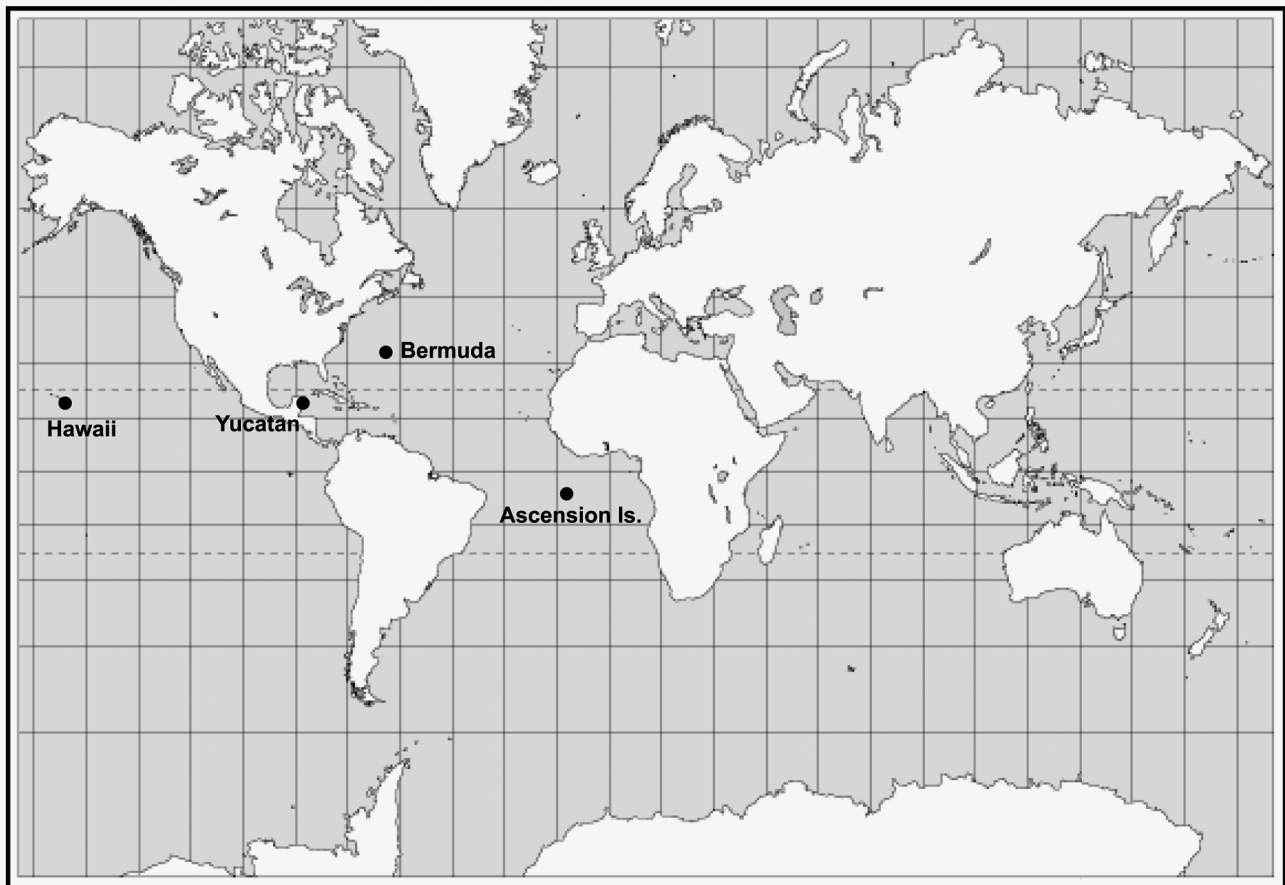
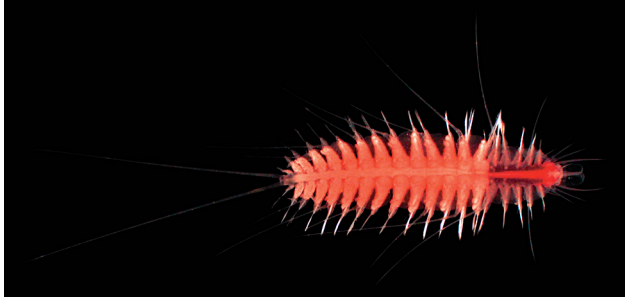


FIGURE 8 World map showing the distribution of the anchialine shrimp genus *Procaris*.



**FIGURE 9** The polychaete *Pelagomacellicephala iliffei* belongs to the family Polynoidae, which is known primarily from the deep sea, including bathyal and abyssal depths.

Anchialine taxa, originally thought to be limited to or known primarily from the Atlantic and Caribbean, have recently been discovered in caves in the Cape Range of Western Australia. These include the remipede *Lasionectes*, the isopod *Haptolana*, the thermosbaenacean *Halosbaena*, the ostracod *Danielopolina*, and the amphipod *Liagoceradocus*. The wide range and overlapping distributions of these taxa suggest considerable age coupled with similar dispersal mechanisms and simultaneous colonization of the present habitat.

### Deep-Sea Affinities

A considerable number of anchialine species have close relatives inhabiting the deep sea. Anchialine genera with affinities to present-day bathyal taxa include the galatheid crab *Munidopsis*, the polynoid polychaetes *Giesiella* and *Pelagomacellicephala* (Fig. 9), the mictacean *Mictocaris*, the ostracod *Danielopolina*, the amphipod *Speleonicippe*, and the misophrioid copepods *Boxshallia*, *Dimisophria*, *Expansophria*, *Misophria*, *Palpophria*, and *Speleophria*.

### Bibliography

- Boxshall, G.A. and D. Jaume (2000) Discoveries of cave misophrioids (Crustacea: Copepoda) shed new light on the origin of anchialine faunas. *Zoologischer Anzeiger* 239: 1–19.
- Fosshagen, A., G.A. Boxshall, and T.M. Iliffe (2001) The Epacteriscidae: a cave-living family of calanoid copepods. *Sarsia* 86: 245–318.
- Holthuis, L.B. (1973) Caridean shrimp found in land locked saltwater pools at four Indo-West Pacific localities (Sinai Peninsula, Funafuti Atoll, Maui and Hawaii Islands), with the description of one new genus and four new species. *Zoologische Verhandlungen* 128: 1–48.
- Humphreys, W.F. (2000) The hypogean fauna of the Cape Range Peninsula and Barrow Island, Northwestern Australia. In *Subterranean Ecosystems* (H. Wilkins, D.C. Culver, and W.F. Humphreys, Eds.). Elsevier Press, Amsterdam, pp. 581–601.
- Iliffe, T.M. (2000) Anchialine cave ecology. In *Subterranean Ecosystems* (H. Wilkins, D.C. Culver, and W.F. Humphreys, Eds.). Elsevier Press, Amsterdam, pp. 59–76.
- Iliffe, T.M. (2004) Anchialine caves and cave fauna of the world (<http://www.cavebiology.com>).
- Iliffe, T.M., J. Parzefall, and H. Wilkens (2000) Ecology and species distribution of the Monte Carona lava tunnel on Lanzarote (Canary

- Islands). In *Subterranean Ecosystems* (H. Wilkins, D.C. Culver, and W.F. Humphreys, Eds.). Elsevier Press, Amsterdam, pp. 633–644.
- Pesce, G.L. (2004) Anchialine waters of Italy (<http://www.geocities.com/~media/caves/anchial.html>).
- Riedl, R. (1966) *Biologie der Meereshöhlen*, Paul Parey, Hamburg, 636 pp.

## Anchialine Caves

Boris Sket

Univerza v Ljubljani, Slovenia

*Anchihaline* (or *anchialine*) *habitats* are water bodies in hollows along the sea coasts where the influence of the sea may be felt and which are inhabited by some subterranean species. This usually indicates an underground connection of the cave or a pool with the sea. Such a habitat may contain seawater, but it primarily has layers of different brackish salinities. In exceptional cases, it has freshwater but is inhabited by some animals of the recent marine provenience (Sket, 1996). We must, however, exclude genuine sea caves—“spaces ... containing a high number of speleophilous forms of the rocky littoral with exclusion of any speleobiotic species” (Riedl, 1966).

In principle, anchihaline habitats can occur everywhere along the coast, but hardly any have been noted and investigated outside the tropical or warm moderate climatic zones. Geologically, two very different types of coasts are often of interest. Some anchihaline caves are in karstified limestones, while others are in lava fields. Because the sea level along most coasts during the Ice Ages was approximately 100 meters lower than now, the coasts may be hollowed out to such a depth. They often contain dripstone formations (such as stalactites and stalagmites), indicating their own previous continental and terrestrial nature. The limestones may be of different ages; some being old and primarily compact, with others being quite recently formed and still primarily porous coral limestones or little transformed coral reefs. Similarly, anchihaline habitats are also formed in lava flows, either in systems of cracks or in the tunnel-shaped lava tubes.

### GEOGRAPHY AND SOME HISTORICAL DATA

Although well known since ancient times, the so-called *blue caves* in the Mediterranean (*e.g.*, Capri, Italy; Biševo, Croatia) were never investigated speleobiologically, as their morphology does not promise extensive anchihaline habitats in them. A number of localities with anchihaline caves have been discovered and investigated along tropical seas and in the Mediterranean. Since the middle of the 19th century, brackish habitats of some fish and shrimp species in Cuba have been known. Another historical site of this kind is



Jameo del Agua, a segment of a lava tube on the island of Lanzarote (Islas Canarias). The 20th century began with the discovery of interesting fauna in some south Italian caves. Important anchihaline caves were later sampled in Lybia, and in islands of the Caribbean.

Riedl (1966), who systematically studied sea caves of the Mediterranean, conceived the concept of the *marginal cave* ("Randhoehle" in German), which was similar to the present-day concept of the *anchi(h)aline cave*. Riedl defined the marginal cave by its position at the sea coast, the presence of brackish water, and the presence of stygobiotic species in it, but he also supposed that the origin of such caves was due to wave action and their gradual loss of connection to the sea. Thus, they should be a vector of the stygobiotic fauna originating in the sea and making it limnic.

An important study by Holthuis (1973) followed Riedl's studies and dealt with a number of shrimp species, including the now well-known red shrimps, as well as with a new concept of *anchialine pools* that was free of suppositions about the past and the future of the habitat and therefore easier to apply. However, Holthuis obtained his animals from open pools in Hawaii and on the Red Sea coast which contained some troglomorphic animals along with a very scarce selection of normal marine animals. In the period that followed, Stock and his numerous colleagues investigated a number of anchihaline caves in the Caribbean, mainly in regard to their faunistic and taxonomic features but also biogeographically. This region appeared to be particularly rich in such caves and fauna (e.g., Stock, 1994). Stock suggested and substantiated the spelling change of *anchialine* to *anchihaline*.

Sket studied the caves along the Adriatic coast and gave the first detailed quantitative data about ecological conditions in them (Sket, 1986). Later, he also specified the concept of the anchihaline cave habitat. Iliffe (2001) is noted for his sampling of a great number of caves in the Caribbean region as well as in the tropical islands of the Indopacific. His studies revealed a high number of new animal species representing an array of groups. In the meantime, a number of other field researchers and taxonomists were either sampling caves more locally or describing and studying collected animals.

Yager (1981) discovered the new crustacean group Remipedia, probably the most astonishing discovery in anchihaline waters. About the time of this discovery, research intensified into the blue holes and inland anchihaline caves in the Bahamas. Por, Fosshagen and Boxshall studied Copepoda and Tantulocarida; Kornicker and Danielopol studied Ostracoda; Stock and Holsinger studied Amphipoda; Holthuis and others studied Caridea; and Stock and Botosaneanu studied Isopoda. Jaume noted euhaline anchihaline caves in the Mediterranean (e.g., Jaume and Boxshall, 1996), and Por described hyperhaline pools in the Arabian peninsula. A number of authors discussed the models and hypotheses regarding the colonization of subterranean habitats by animals in which the anchihaline caves played a not negligible role.

## MORPHOLOGY AND HYDROLOGY

(See Por, 1985; Sket, 1986, 1996; Iliffe, 2001.) The morphology of the anchihaline caves and other cavities containing anchihaline habitats is of low importance for their fauna; however, it may be highly important for its accessibility (particularly for the time before SCUBA techniques were introduced) and to gain an understanding of its composition and distribution, as well as relations between species. Comparatively scarce are horizontal caves that either are filled with water along the entire corridor or exhibit series of pools with different connections between themselves and with the sea. Such caves can be either karst caves or lava tubes. Horizontal coastal caves may, however, be very extensive inundated cave systems, such as those being investigated along the Mexican coasts.

More common are shallow, vertical caves. They may be of small dimensions, as are the natural wells on Adriatic islands (Croatia, within the former Yugoslavia), which are sometimes artificially elaborated as watering places for sheep. Similar are *grietas* in some Caribbean islands or cracks in lava fields of the Galapagos; however, accessible vertical parts are always connected with horizontal corridors or fissures that may connect groups of caves. Of large dimensions are *cenotes*, known mainly in the Yucatan peninsula (Mexico), which again are often extended by systems of horizontal corridors. An important characteristic of such habitats is that a significant part of the aqueous body is illuminated by daylight.

Even more open are anchihaline pools in lava or in coral reefs. Such pools must be connected to the sea and may be interconnected by systems of more or less dark corridors or fissures, although the open space may prevail. Such pools are particularly well developed in Hawaii.

Due to the effect of chained vessels, in caves close to coasts under the influence of tides, the tides may also be felt underground, although with a certain delay and decline. This means that in the mild cases, such as in the Adriatic coastal caves, the entire stratified column of water moves twice a day up and down, carrying the floating organisms with itself and remarkably changing the life conditions for substratum-bound animals, particularly in the reach of the halocline. The tides in the open Adriatic are only approximately 0.5 meters, but more extreme conditions may occur elsewhere. In the Bahamian blue holes, the effects of very important tidal currents (dangerous for a diver) have not yet been studied for their influence on living conditions. In the horizontal St. Paul Underground River corridor (Palawan, Philippines), the seawater moves with the tides for some kilometers in and out along the bottom. It is difficult, however, to imagine that an anchihaline fauna exists in such a cave.

The aqueous body is seldom purely marine (euhaline) but such are present in some deeply set submarine caves that have to be very extensive to contain any stygobionts. However, extensive portions of the cave systems in the underground of the Bahamas (Porter), as well as some caves in the

Mediterranean islands (Jaume) are functionally euhaline. When influenced by freshwater, the situation may be very different for a cave on a small island than one that is on the mainland coast. In any case, the relation between the fresh and marine part of the column is governed by the Ghyben–Herzberg principle: In a porous aquifer, if the freshwater overlies seawater, the interface will be below the sea level approximately 40 times the height of the water above sea level. On an island, the freshwater body will take on the form of a lens (Ghyben–Herzberg lens), the depth of which depends on the precipitation at the site and the speed of the water outflow toward the sea. The shape of the freshwater lens and the height of the underlying layers of seawater will change slowly during the year and from year to year. Less predictable and more complex is the situation on the coast of the continent (or of a larger island), where canalized (thus concentrated) water inflow from inland may be the result of net-like systems of corridors. This may complicate the salinity distribution and will sometimes change the salinity relations very rapidly.

The transition from euhaline to limnic salinities in the column is never absolutely gradual. The depth of very gradually stratified or even homogeneous waters is regularly divided by a halocline that can be a few decimeters to a couple of meters thick. The halocline is a layer where the salinity abruptly changes (sometimes from polyhaline to nearly limnic). In genuine caves—such as in caves in general—the water temperature may be constant and equal throughout the column, approximately equal to the local yearly average. If the water body is exposed to the surface temperature influences, this may also cause a temperature stratification, changing its direction throughout the year. During the winter in moderate climates, the surface cooling in freshwater lakes causes the loss of stratification and penetration of cooler (*i.e.*, heavier) and well-aerated surface water toward the bottom. In anchihaline waters, the density changes caused by varying temperatures are much lower than the density differences caused by a small salinity difference. With cooling from 20 to 4°C, the density of pure water changes from 998 to 1000 g L<sup>-1</sup> (*i.e.*, 2 g L<sup>-1</sup>), while with the increase of salinity from 10 to 20 ppt the density changes from 1009 to 1019 g L<sup>-1</sup> (*i.e.*, 10 g L<sup>-1</sup>). This makes the water column in mixohaline anchihaline caves very stable and prevents mixing of layers, with consequences as explained below.

Although the source of organic input can appear rather obvious, some sources have been also traced by sophisticated isotope methods (Pohlman *et al.*, 2000). In caves of Mexico, the soil particles may originate from a tropical rain forest, while in the Mediterranean these particles may be from the poor remains of soil in deep karren. The use of the holes as watering places, however, may cause the introduction of very high quantities of debris which is deposited on the bottom. Another source of organic matters is production in illuminated parts of caves. Rich planktonic algal communities may

be present there, while rocky walls can also be overgrown by microscopic algae. The virtual contribution of autotrophic bacteria has only been inferred (supposed). Rich sources of oxydizable substances can be used in such a way. Some nitrate production (which may be by nitrite oxydation) has been noted within the halocline in a Mexican cave. On the other hand, remarkable hydrogen sulfide (H<sub>2</sub>S) concentrations in many anchihaline caves are a strong basis for chemoautotrophy; clouds of bacteria within the halocline and mats covering the bottom have been observed in some caves, and the sulfide-oxidizing mixotrophic bacteria of the genera *Beggiatoa* and *Thiothrix* have been identified.

Wherever the input of organic substances is remarkable, they are deposited on the bottom and putrefy, which often causes total consumption of oxygen and an accumulation of hydrogen sulfide. If communication with the open sea is feeble, a thick lower layer of the water may be infested by this gas. A 250-mmol L<sup>-1</sup> concentration was established in a Mexican cave, while such remarkable concentrations have only been organoleptically established in Adriatic caves. Such an accumulation can be identified up to the water surface in extreme cases.

The oxygen that is consumed in cave waters must be renewed from air on the surface, by an influx of precipitation water and water jets from inland, at the surface, or by mixing or diffusion from the open sea in deeper layers. Therefore, the surface layer is usually comparatively well aerated while the oxygen concentration diminishes towards the halocline; below the halocline it may rise again or decrease further. It is the rule that dissolved oxygen does not reach its saturation in anchihaline waters. Its depletion may be remarkable, probably total, although no analysis until now has been accurate enough to establish this. Such are the conditions close to the debris-covered bottom under a deep layer of hydrogen sulfide-rich water. In some other caves, the oxygen saturation is the lowest or close to zero within the halocline, the most stable water layer. Characteristically, the pH has also always been lowest in the halocline when measured.

### NON-CRUSTACEAN GROUPS IN THE ANCHIHALINE FAUNA

Sponges are represented very richly in true marine caves, sometimes with some deep-sea elements, such as the calcified *Calcarea Pharetronida*. This is particularly evident in some sack-like Mediterranean caves that capture and hold cold water throughout the year and also harbor small glass sponges (Hexactinellida) and the exceptional carnivorous Cladorhizidae (*Asbestopluma hypogea* Vacelet et Boury-Esnault) (Vacelet *et al.*, 1994). Some species are claimed to be true stygobionts of anchihaline caves, such as the haplosclerid *Pellina penicilliformis* Van Soest and Sass in marine caves in Bahamas and the axinellid *Higginsia ciccaresei* Pansini and Pesce in Southern Italy; the latter is a typical anchihaline animal living in brackish water.

Very little is known about gastropods in anchihaline caves. The presence of the tiny and mostly interstitial marine *Caecum* spp. is most probably in connection with some sand deposits within the cave. Only some of the apparently hydrobioid snails in Adriatic caves have yet been identified.

Among the few filter feeders are some tube worms occurring quite regularly at high salinities, such as *Filogranula annulata* (O.G. Costa) in Adriatic caves. Some stygobiotic errant polychaetes have been described, such as, for example, *Gesiella jameensis* (Hartmann–Schroeder) from the Canaries. Probably more sediment dependent are the tiny members of the family Nerillidae. It is remarkable that the Dinaric cave tube worm (*Marifugia cavatica* Absolon and Hrabe) has never been found in a cave within the influence of the sea. Some oligochaetes occurring in such caves do not seem to be closely related to them.

Some species of sessile chaetognaths (family Spadellidae) occur in euhaline anchihaline waters, and at least the eyeless and pigmentless *Paraspadella anops* Bowman et Bieri from the Bahamas is supposed to be stygobiotic; some other species from caves are oculated.

Fishes are among the longest known anchihaline animals; approximately 10 anchihaline species are known today. The family Ophidiidae is exapted for such habitats by their shy behavior, nocturnal habits, and/or deep-sea prevalence. The stygobiotic *Lucifuga subterraneus* Poey and *Stygicola dentatus* Poey have been recognized in Cuban *grietas* and similar localities since the middle of the 19th century. New, related species have recently been found in the region. The stygobiotic and euryhaline *Ogilbia galapagosensis* (Poll and Leleup) from underground waters of the Galapagos Islands has variably reduced eyes and a closely eyed relative in the species *O. deroyi* (Van Mol), which dwells in littoral crevasses. In Yucatan caves, the ophidiid *Ogilbia pearsei* (Hubbs) is a neighbor of *Ophisternon infernale* (Hubbs), representing another family of often cryptically living fishes, Synbranchidae. The synbranchid *Ophisternon candidum* (Mees), at up to 370 mm in length, is probably the longest cave animal. It inhabits brackish waters in northwestern Australia, accompanied by the gobiid *Mylieringa veritas* Whitley. It is remarkable that related (congeneric) species occur in anchihaline caves in mutually very remote areas.

## ANCHIHALINE CRUSTACEA

Generally, Crustacea are by far the richest and most diversely represented group in subterranean waters, and the same holds for anchihaline cave waters. The predominance of crustaceans may also be felt within a particular cave where the specimen number or the biomass relation between crustaceans and non-crustaceans may be 10:1 or higher. Among Crustacea, by far the richest in species are Amphipoda and Copepoda, although Decapoda (due to their size) are probably the most obvious. For Remipedia, the anchihaline caves are the only known habitat, and it seems to be the central one also for Thermosbaenacea.

Remipedia are crustaceans with by far the most plesiomorphic trunk and appendages but with a highly specialized (diversified) anterior end of its body, a very nice case of mosaic evolution. They have up to now only been found in anchihaline caves in euhaline salinities, or close to them, usually below the halocline in poorly aerated water (typically less than 1 mg L<sup>-1</sup> oxygen). Remipedia are hermaphrodites. Up to 45-mm-long, centipede-shaped swimmers have been found in the tropical belt connecting Mexico, the Bahamas, and the Canaries and along the northwestern Australian coast; they seem to be absent in the Mediterranean. In some Bahamian caves, a number of species may occur together; *Speleonectes lucayensis* Yager was the first found and described.

Copepods are the richest group of “Entomostraca”, which include approximately 25% of crustacean species either in the whole or in subterranean habitats, but only 14% of those in anchihaline waters. In subterranean freshwaters, Harpacticoida are several times richer than Cyclopoida, while Calanoida are negligible (approximately 440:150:10 in 1986); in anchihaline waters, the harpacticoids are not so important, while calanoids are comparatively well represented. Each of these groups has some ecologically endemic families, or nearly so, such as Superornatiremidiae in Harpacticoida, Epacteriscidae in Calanoida, and Speleoithonidae in Cyclopoida. According to existing data, a family may be also geographically extremely limited, such as the calanoid Boholinidae in the Philippines. Of particular interest is the small and relatively plesiomorphic group Misophrioida, an essentially (but not exclusively) deep-sea group discovered recently in Atlantic and Indo-Pacific tropical anchihaline caves.

Ostracods are easily recognizable as tiny crustaceans with extremely shortened body hidden between two valves. The order Halocyprida is well represented with species of very diversely shaped and sculptured valves. Among them, the genus *Danielopolina* is interesting for its presence in anchihaline waters and in deep sea.

Leptostracans are small malacostracans with a bivalved carapax on the anterior part of the body and stalked eyes. *Speonebalia cannoni* Bowman, Yager et Iliffe from a cenote-like cave in the Caicos Islands is eyeless.

Decapods are the best known crustaceans represented in anchihaline caves, primarily by different kinds of shrimps. Members of the small family Procarididae have only been found in such habitats in the tropical Atlantic and in Hawaii; Agostocarididae seem to be restricted to the Caribbean region. Atyidae are a huge family of freshwater shrimps, represented at the sea nearly exclusively by some genera in anchihaline waters. The most remarkable is the genus *Typhlatya*, which is found with some closely related genera exhibiting a range of polyhaline to limnic species distributed circumtropically; they also exhibit different degrees of troglomorphism. The atyid *Antecaridina lauensis* (Edmondson) alone is very widely distributed—Madagascar, Red Sea,

Hawaii—which is testament to the dispersion possibilities of some shrimps outside the anchihaline habitat. This has been also proven for Palaemonidae, represented by the genus *Macrobrachium*, for example, which repeats some distributional characteristics of the family Atyidae. The palaemonid *Typhlocaris lethaea* Parisi from Lybia is probably the largest cave invertebrate at all. A series of anchihaline genera belong to the essentially marine family Alpheidae. The alpheid *Barbouria cubensis* (Von Martens) in the Caribbean region has been known since the beginning of 20th century; the Indo-Pacific *Parhippolyte uweae* Borradaile, again one of the famous red shrimps, has been known from the end of the 19th century. Some Grapsidae crabs, such as *Orcovita* spp., have been found recently, although they are mostly not very troglomorphic. The only anomuran, the historical *Munidopsis polymorpha* Koelbel (family Galatheidae), from the inundated lava tube in Canary Islands, belongs to an essentially deep sea genus.

Thermosbaenaceans are small (up to 5 mm long) and delicate crustaceans with a short carapax under which the female broods her eggs; all are stygobiotic. Although the first species was found in hot (approximately 45°C) freshwater springs, and some species inhabit fresh continental waters, most are nevertheless anchihaline. The group is distributed in the Tethyan fashion, which will be described later. As an example, *Halosbaena acanthura* Stock is widely spread in the Caribbean, inhabiting interstitial and cave waters of brackish to hyperhaline salinities. Related species are known from the Canaries and northwestern Australia in almost fresh water. *Monodella halophila* S. Karaman, found in caves along the northeastern Adriatic coast, often most densely populates the least aerated water layers of a polyhaline salinity.

Mysids are small and delicate shrimp-like crustaceans with a ventral brood chamber. It is essentially a marine group that inhabits anchihaline caves circumtropically, with some exceptional species in southern Italy. Such is also the distribution of the genus *Spelaeomysis*, which resembles the atyid shrimp *Typhlatya* in its geographical and ecological distribution and the span of morphological adaptations. The widely distributed and non-troglomorphic species *S. cardisomae* Bowman seems to penetrate the entire variably brackish part of the groundwater body in the Caribbean island of San Andres, occurring even in the putrefied and probably deoxygenated waters in the land crab burrows.

Mictaceans slightly resemble the thermosbaenaceans. This is a small group of some deep-sea and two marine cavernicolous species in the Bermudas (*Mictocaris halope* Bowman and Iliffe and Bahamas).

Isopods are one of the major groups of Malacostraca, characterized mainly by their foliaceous abdominal appendages (pleopods); they are very diverse in shape and size. Since early in the 20th century, some *Typhlocirolana* spp. from the Mediterranean basin have been known; some are anchihaline while some are from freshwaters. Similarly old is

the history of *Annina lacustris* Budde-Lund from east Africa which is a very euryoecious, non-troglomorphic animal that also occurs in mixohaline anchihaline caves. All of these animals belong to the family Cirolanidae, which is essentially marine, and the great majority of freshwater species is stygobiotic. A number of genera and species have been found in anchihaline waters, particularly in the Caribbean, (such as *Babalana mayana* Bowman in Mexico and the Yucatan), but also in the Mediterranean and in Indo-Pacific areas and elsewhere, such as *Haptolana pholeta* Bruce et Humphreys in western Australia. Similar is the frame habitat selection of the genus *Cyathura* (Anthuridae), although these animals are strongly sediment bound and burrow, while cirolanids are free walkers and even occasional swimmers. The stygobiont anthurids are only present in the tropics.

The presence of tiny species of the families Microcerberidae and Microparasellidae in anchihaline waters such as artificial wells is mostly due to sand deposits as they are essentially interstitial animals. Genuine cave animals are evidently some members of the related (*i.e.*, asellote) families of Janiridae (*Trogloniroopsis lloberai* Jaume) in the Balearic Islands; Stenetriidae (*Neostenetroides schotteae* Ortiz, Lalana et Perez) in Cuba; and Gnathostenetroididae (*Stenobermuda mergens* Botosaneanu and Iliffe) in the Bahamas, which were found in Caribbean to Bermudian anchihalines, as well as in Mediterranean caves. The family Atlantasellidae seems to be endemic to anchihaline caves of the tropical Atlantic (Bermuda and the Caribbean).

Amphipoda seem to be by far the richest anchihaline group (more than twice the species number of any other crustacean group or three times all non-crustacean species), although the effect of numerous researchers cannot be excluded. The family level taxonomy of this group (counted to 6000 or even 8600 world species) is not yet settled, but it has to be used for the sake of surveying. The most characteristic group is comprised of Hadziidae and Melitidae with particularly high diversities of genera in the Caribbean region (*e.g.*, *Metaniphargus*, *Bahadzia*) and Mediterranean (*e.g.*, *Hadzia*) and with a number of scattered taxa elsewhere (*e.g.*, *Liagoceradocus* spp.); Western Australia seems to represent the third such diversity center (with the genus *Nedsia*, for example). The group as a whole, as well as some genera, are represented by species of different salinity preferences, from euhaline to limnic. On a smaller scale and limited to the Mediterranean and Atlantic, is the genus *Pseudoniphargus*; the majority of its species are freshwater but never very far from the sea. Taxonomically remote is the family Ingolfiellidae; although including some marine species, it also includes ancient freshwater species in the center of Africa, for example. This family also has some anchihaline species.

Some taxonomically and geographically isolated species seem to be more or less direct descendants of marine relatives, such as *Antronicippe serrata* Stock et Iliffe of Pardaliscidae, from anchihaline caves in Galapagos Islands.

At least most species or groups mentioned above are primarily marine, conquering continental waters with more or less success. Different are some amphipods of the Dinaric (*i.e.*, Adriatic) anchihaline caves. Some species of *Niphargus* are present there; *N. hebereri* Schellenberg is moderately widely distributed, although not obligate, while the narrowly endemic *N. pectencoronatae* Sket seems to be an obligate anchihaline species. Niphargids are a large group of essentially freshwater animals and only secondarily did they adapt to the brackish water; *N. hebereri* is very euryhaline and also in other respects a very tolerant species.

## BIOGEOGRAPHY

Different patterns of geographical distribution can be seen in anchihaline cave faunas. One of the most remarkable patterns is the so-called Tethyan distribution (Humphreys, 2001), if historical grounds are emphasized, or circum-tropical distribution, if we suppose ecological connections. The Tethys Sea encircled the globe in the Mesozoic period, when the supercontinent Pangaea split into a northern Laurasia and southern Gondwana. It was only in the Tertiary when southern and northern continents came so close to each other that they disconnected this circumtropical seaway; note that even the Mediterranean was completely dry for some period in Miocene. A number of animal groups, even genera and some species, have distribution ranges that reflect the possible circumglobal distribution within the Tethys. We may presume that particularly in the tropical belt a number of Tethyan inhabitants have survived and many of them succeeded in colonizing marginal waters, avoiding in this way competition with modern sea fauna. Such are Remipedia, Thermosbaenacea, hadziid amphipods, the *Typhlatya*-related group of shrimp genera, and even the mysid genus *Spelaeomysis*, the thermosbaenacean genus *Halosbaena*, and some others. However, it is difficult to believe that some circumtropically spread species, such as the shrimp *Antecaridina lauensis*, could conserve its morphological unity without a recent or nearly recent gene flow among populations; its genetic unity, however, has not been proven. An open question is also what occurred during the Messinian salinity crisis. Did the Tethyan elements temporarily change for freshwaters? Maybe this is connected with the existence of some freshwater populations of some elements such as *Hadzia fragilis* S. Karaman in the Adriatic region.

A certain number of those Tethyan elements characteristically skip the Mediterranean in their west–east distribution, such as Remipedia and the genus *Halosbaena*; therefore, it is also possible that some Tethyan elements disappeared from the dried-out Messinian Mediterranean, which was later colonized again by only some of them. The third possibility is their disappearance during the colder climates in place after the Tertiary.

Other distribution patterns are more locally restricted. An instructive one is the paralittoral distribution area along

the northeastern (Dinaric) coast of the Adriatic. Typical anchihaline taxa (such as *Hadzia fragilis* and *Monodella halophila*) are present along the coast, including the islands, in brackish waters. They are, however, absent in such waters within the gulf of Kvarner (Quarnero) which was not yet marine prior to the Pleistocene. These species are replaced in the Kvarner anchihaline caves by generally continental species, such as *Niphargus arbiter* G. Karaman, while *Hadzia* is represented there by freshwater populations. This is a clear evidence of a historical—not purely ecological—basis for the species distribution in anchihaline habitats.

## BIOLOGY AND ECOLOGICAL DISTRIBUTION OF INHABITANTS

Unfortunately, for most anchihaline species the ecological inclinations are virtually unknown. Some groups are evidently represented only by euhaline or at least polyhaline species which are all unquestionable immigrants from the deep sea or close relatives of deep-sea animals: the glass sponges and carnivorous sponges in the Mediterranean sea caves, the anomuran *Munidopsis polymorpha* in the Canary Islands, and the mictacean *Mictocaris halope* in the Bermudas. There are also unique representatives of some marine groups such as chaetognaths or leptostracans (*Paraspadella anops* and *Speonebalia cannoni*); however, the completely anchihaline group Remipedia also seems to be polyhaline.

The most anchihaline animals are to some degree euryhaline, with different optima more or less expressed. The distribution of shrimp species in a series of pools in Hawaii seems to depend mostly on different salinities. They are able to adapt their position in the water body to other local conditions, particularly the presence of competitors or predators. The physically delicate thermosbaenacean *Monodella halophila*, along the Adriatic coast, is limited to comparatively high salinities, although its very close relative *M. argentarii* Stella inhabits freshwaters in the Italian Monte Argentario. The Adriatic caves are inhabited by some (most of them by two) amphipod species which may be predatory on *Monodella*. This might also explain the (supposed) absence of *Monodella* in some Caribbean islands where caves were probably not investigated meters deep and where hadziid amphipods were regularly found. Some essentially limnic species, such as the copepod *Diacyclops antrincola* Kiefer or the shrimp *Troglocaris* sp. may be present at higher salinities than the supposed marine derivatives *Hadzia fragilis* and *Salentinella angelieri* Ruffo et Delamare–Deboutteville, while the limnic *Niphargus hebereri* Schellenberg reaches 30 ppt salinity, which is close to marine values.

It was observed in some Adriatic anchihaline waters that at least some absolutely troglomorphic animals do not avoid sunlit parts of the water body if they are not forced to do so by competing surface animals. The population of *Niphargus hebereri* was the most dense at the water surface in a shaft-like cave. Such a behavior (as well as similar situations in conti-

mental cave waters) teaches us that light and dark relations are not of direct importance for cave species. This also excuses us when we treat the open anchihaline pools jointly with anchihaline caves. The so-called red shrimps are very characteristic inhabitants of those pools, and they show quite different relations toward sunshine. The atyid *Halocaridina rubra* Holthuis also appears in open anchihaline pools during sunshine, while *Antecaridina lauensis* (Edmondson) is more photophobic but is able to change its color from red to white translucent and back in response to light and disturbance. The hippolytid *Parhippolyte uveae* Borradaile hides in cracks after sunset and during cloudy days, while it reappears in ponds in masses when the sun strikes the water; it is also able to rapidly change its coloration. One has to add, however, that these observations were made in single localities, and we do not know if such was the behavior of the species in any conditions.

Again, very characteristic is the sometimes apparently positive (in fact, probably neutral) relation of anchihaline animals toward low oxygen concentrations in water. These discussions have unfortunately some very serious limitations. First, due to some analysis problems at very low oxygen concentrations, we do not know if cave animals have been found in totally anoxic or just deeply suboxic water; however, the presence of  $H_2S$  in a thick layer speaks in favor of a total lack of oxygen. Second, particularly high densities of some animal colonies within the anoxic (or suboxic) water layers are most probably a result of competition (or predation) avoidance; however, this speculative conclusion has never been subjected to an experimental verification. Anyway, at extremely low oxygen concentrations and in the presence of  $H_2S$  (not quantitatively evaluated) euhaline Remipedia were found commonly or regularly; the mesohaline *Monodella halophila*, often; and the originally limnic *Niphargus hebereri*, quite so. Resistance to extremely low oxygen concentrations has been experimentally studied and verified in some freshwater cave crustaceans; it may be explained by their characteristically low metabolism.

Thus, based on the evidence available, anchihaline animals are in general very euryecious (generalist) toward a number of ecological parameters. One of the most durable among stygobionts is *Niphargus hebereri*, which has been found in limnic conditions (kilometers far inland) and in mixohaline waters of up to 30 ppt salinity; in very food poor habitats and in deposits of decaying organic debris; in well-oxygenated waters as well as in apparently anoxic layers; in waters smelling strongly of  $H_2S$ ; and in a sink polluted with mineral oil.

### TROPHIC RELATIONS

Supposedly, the richest source of food is input from the earth surface, while some food may be produced in the cave itself, as mentioned above. It is safe to say that the currents reaching into a euhaline marine cave are bringing food particles as well

as pelagic larvae. Therefore, such caves are usually populated with a depauperate marine fauna, and the stygobionts are to some degree excluded by competition. As the most modest users of organic matter and as ecological generalists (as shown above), they are able to populate the rest of the coastal underground. Some interesting studies of the organic matter transport within genuinely marine and anchihaline caves have been made but generalizations are still not possible. The sessile suspension feeders (filtrators) are nearly absent; some sponges and tube worms are on the border between the marine and anchihaline realm. Very few observations have been done about the behavior of those crustaceans that possess putative filtering structures, such as atyid shrimps and thermosbaenaceans. They seem to be predominantly on the bottom and collect organic detritus particles or bacteria from the sediment. Probably more pelagic is the rich assortment of anchihaline calanoid copepods. On the other hand, some inhabitants are proven predators, such as the procaridid shrimp *Procaris ascensionis* Chace, that feed on other shrimps. Little is known about feeding by Remipedia, but their maxillipeds are explicitly predatory. Most probably the majority of anchihaline amphipods are generalistic, feeding on detritus and carcasses as well as on live animal prey.

### THEORETICAL IMPORTANCE OF ANCHIHALINE HABITATS

The position of anchihaline habitats on the doorstep between the epigeal and hypogean realms, as well as between marine and freshwater environments, makes them very intriguing for theoretical exploitation. Several theories about the colonization of the underground include anchihaline habitats, either implicitly or explicitly. However, the first question that has to be answered regards the origin of the anchihaline fauna itself. The marine provenance of the majority is out of the question if we look at the taxonomic composition. Only one local fauna is known for which a higher percentage of members are freshwater by origin (anchihaline fauna along the Adriatic coast). The fact that the band inhabited by it was out of the sea during the last glaciation is not peculiar to that area. Probably, it was the particularly rich continental cave fauna that succeeded to rule anchihaline waters and thus prevented intrusion of other biota.

A much-discussed question has been the relation of anchihaline fauna to the deep sea. Their phylogenetic proximities have been discussed previously. At one time it was thought that anchihaline species were directly derived from deep-sea species. Later, data about deoxygenation of deeper sea layers during the geological past cast doubts on this possibility, and some researchers came to regard the deep-sea species and anchihaline species as two parallel lineages originating from littoral ancestors. However, cladistic analysis of some ostracod and some copepod groups have revealed that at least some anchihaline species in some regions may originate from deep-sea faunas (Danielopol, 1990).

The anchihaline habitat may also be regarded as a door into continental waters. The regression model and the two-step model suggest that a marine benthic animal colonizes marine cave, adapts to the cave environment and to the less saline water, and becomes isolated from the sea after the sea regresses, which results in a limnic stygobiont. These and other models differ in some details which become theoretically negligible (making all models complementary) if we consider the ecologically and genetically sound supposition of an active immigration. Active immigration into a new habitat would be furthered by a diversified gene pool and wide ecological potential of the species and would be forced to occur only by its own normally excessive reproduction and population expansion. Sea regression (stranding) in this context is not an act of repression; it implies only interruption of the gene flow (with the marine or surface part of the population) and therefore faster specialization. Of course, this is equally important for understanding the origin of the surface freshwater fauna, which may have occurred the same way on the surface, and the origin of continental cave fauna, which occurred by immigration from surface freshwater underground.

### ANCHIHALINE FAUNA AND HUMANS

It has always been a challenge to humans to enter the dark underworld; sometimes such a venture reveals the beauty of speleothems or offers the promise of a cool atmosphere in the heat of summer. So, many karst and lava caves have been exploited for tourism, and those that are close to coastal tourist resorts are particularly subject to such a possibility. Some of them contain anchihaline pools.

The Šipun cave in Cavtat (near Dubrovnik, Croatia) was adapted for such visits decades ago, with the anchihaline pool at its end being shown as a special gem. Its comparatively very rich fauna of tiny crustaceans is not particularly interesting for most non-professionals but has nonetheless been greatly endangered by pollution produced by the visitors. Anchihaline caves play an important role in tourism and the economy of Bermuda; nevertheless, a number of them have been damaged or destroyed—along with their diverse fauna—by pollution or by quarrying activities. On the other hand, the lava cave Jameo del Agua in Lanzarote (Islas Canarias, Spain) has also been exploited for tourism and its *jameito* or *cangrejo ciego* (*Munidopsis polymorpha*) is an official symbol of the island that is used in various promotional campaigns. The gorgeous hypogean estuary St. Paul Underground River (Palawan, Philippines) is the central attraction of the St. Paul Subterranean National Park; unfortunately, there are no data on an anchihaline fauna in it. Very imposing is the 7-cm long anchihaline shrimp *Typhlocaris lethaea* from the cave Giok-Kebir, close to Benghazi (Libya); this might be the world's largest troglobiotic invertebrate and

could be an interesting subject for interested tourists. Although smaller, the beautifully colored anchihaline red shrimps can be remarkable enough to be given local vernacular names such as *opaeula* (*Halocaridina rubra*) in Hawaii. They may be a subject of local taboos, such as *pulang pasayan* (*Parhippolyte uveae*) in the Philippines, or even of a kind of worship, such as *ura buta* (the same species) on the Fiji Island of Vatulele. No doubt, red shrimps might become also an attraction for ecotourists.

Apart from species protection to serve tourist needs or religious habits, modern humans have become aware of the biological importance of such habitats. A system of anchihaline pools on the Hawaiian island of Maui has been protected as a natural reserve particularly for the rich anchihaline fauna. A flooded crack in the Sinai Peninsula has (or used to have) a similar status.

### See Also the Following Articles

*Anchialine Caves, Biodiversity in*

### Bibliography

- Danielopol, D.L. (1990) The origin of the anchialine fauna: the “deep sea” versus the “shallow water” hypothesis tested against the empirical evidence of the Thaumatoocyprididae (Ostracoda). *Bijdragen tot de Dierkunde* 60(3–4): 137–143.
- Holthuis, L.B. (1973) Caridean shrimps found in land-locked saltwater pools at four Indo-west Pacific localities (Sinai Peninsula, Funafuti Atoll, Maui and Hawaii Islands), with the description of the new genus and four new species. *Zoologische Verhandlungen* 128: 1–48.
- Humphreys, W.F. (2001) Relict faunas and their derivation. In *Subterranean Ecosystems* (H. Wilkens, D.C. Culver, and W.F. Humphreys, Eds.). Elsevier Press, Amsterdam, pp. 417–428.
- Illife, T.M. (2001) Anchialine cave ecology. In *Subterranean Ecosystems* (H. Wilkens, D.C. Culver, and W.F. Humphreys, Eds.). Elsevier Press, Amsterdam, pp. 59–73.
- Jaume, D. and G.A. Boxshall (1996) The persistence of an ancient marine fauna in Mediterranean waters: new evidence from misophrioid copepods living in anchialine caves. *J. Natural History* 30, 1583–1595.
- Pohlman, J.W., L.A. Cifuentes, and T.M. Illife (2001) Food web dynamics and biogeochemistry of anchialine caves: a stable isotope approach. In *Subterranean Ecosystems* (H. Wilkens, D.C. Culver, and W.F. Humphreys, Eds.). Elsevier Press, Amsterdam, pp. 345–356.
- Por, F.D. (1985) Anchialine pools: comparative hydrobiology. In *Hypersaline Ecosystems: The Gavish Sabkha* (G.M. Friedman and W.E. Krumbein, Eds.). Ecological Studies: Analysis and Synthesis, Vol. 53, Springer, New York, pp. 136–144.
- Riedl, R. (1966) *Biologie der Meereshöhlen [Biology of Sea Caves]*. Parey, Hamburg/Berlin, 636 pp.
- Sket, B. (1986) Ecology of the mixohaline hypogean fauna along the Yugoslav coast. *Stygologia* 2(4): 317–338.
- Sket, B. (1996) The ecology of the anchihaline caves. *Trends Ecol. Evol.* 11(5): 221–225.
- Stock, J.H. (1994) Biogeographic synthesis of the insular groundwater faunas of the (sub)tropical Atlantic. *Hydrobiologia* 287, 105–117.
- Vacelet, J., N. Boury-Esnault, and J.-G. Harmelin (1994) Hexactinellid cave, a unique deep-sea habitat in the scuba zone, *Deep-Sea Res.* 1 41(7), 965–973.
- Yager, J. (1981) Remipedia, a new class of Crustacea from a marine cave in the Bahamas. *J. Crustacean Biol* 1(3), 328–333.



# B

---

## Bats

Susan W. Murray and Thomas H. Kunz  
*Boston University*

### INTRODUCTION TO BATS

Bats (order Chiroptera) are an ecologically diverse and geographically widespread mammalian group. With over 1100 species (Simmons, 2003), members of two suborders (Microchiroptera and Megachiroptera) constitute approximately one-fifth of all extant mammals. They range in size from the tiny 2-gram Kitti's hog-nosed bat (*Craseonycteris thonglongyai*) to the large, Malayan flying fox (*Pteropus vampyrus*) weighing about 1200 grams, with a wingspan of nearly 1.5 meters (Kunz and Pierson, 1994). Bats exhibit several life history traits that make them unique among mammals. Compared to small terrestrial mammals, for example, bats of similar size have very few young and long periods of pregnancy and lactation, and they may live up to 37 years. Differences in life-history traits between bats and other mammals are often attributed to the evolution of flight and echolocation (Crichton and Krutzsch, 2000; Kunz and Fenton, 2003).

Bats are the only mammals that have evolved powered flight; thus, along with echolocation, flight has made it possible for bats to seek shelter in many different types of structures (*e.g.*, foliage, tree cavities, caves, rock crevices) that are not generally used by terrestrial mammals and to exploit a wide variety of food sources. The diets of bats include fruit, nectar, pollen, leaves, invertebrates (*e.g.*, insects, spiders, crustaceans, and scorpions), small vertebrates (*e.g.*, frogs, birds, fish, and other mammals), and blood (Kunz and Pierson, 1994).

Although echolocation has evolved independently in birds and mammals, the most sophisticated and diversified form of echolocation can be found in bats. Echolocation is used for

prey detection and capture, for navigation, and in some instances for communication. Several species rely on a combination of vision, olfaction, and prey-generated sounds to locate food in addition to or instead of echolocation (Altringham, 1996).

The roosting habits of bats are often highly specialized, with different species occupying tree cavities; spaces beneath exfoliating bark; unmodified foliage; leaves modified into so called "tents;" abandoned ant, termite, and bird nests; large and small caves; rock crevices; and a wide range of manmade structures, including mines, buildings, stone ruins, and bridges (Kunz, 1982; Kunz and Fenton, 2003). Caves alone provide a variety of structural substrates for roosting, including crevices, cavities, textured walls and ceilings, expansive ceilings, rock outcrops, and rock rubble on floors. In addition, the microclimates of caves that are occupied by bats can vary enormously, depending on latitude, altitude, depth, and volume, as well as the number, size, and position of openings to the outside. These variables can influence the amount of airflow, the presence of flowing and standing water, and daily and seasonal variations in atmospheric pressure, temperature, and humidity. Thus, the environmental conditions within caves may be hot, cold, dry, humid, still, or windy.

This chapter highlights the biology of bats that typically roost in caves and cave-like structures. Specifically, we discuss why bats live in caves, where they are found, their roosting requirements, as well as conservation and management issues important to protecting cave-dwelling species.

### CAVE BATS AND THEIR DISTRIBUTION

Cave bats are defined as troglonexes, species that do not complete their entire life cycle within caves. Their ability to fly and echolocate has allowed microbats to exploit caves and similar subterranean habitats for roosts and to forage for food away from these structures. The vast majority of bats that



belong to the suborder Microchiroptera are able to echolocate and navigate in dark underground habitats and to feed in open fields or in dense forested areas. Rousette fruit bats (suborder Megachiroptera) may also roost in caves, but they rely on tongue clicks to produce audible sounds to help them navigate in the dark. The handful of other megachiropterans found roosting in caves are restricted to areas with enough light to make it possible for them to find their way in and out, as they largely rely on vision and not echolocation to navigate while in flight (Kunz and Pierson, 1994).

Bats are virtually ubiquitous. They are known from all continents, except Antarctica, and from many oceanic islands. Most bats occur in tropical regions, where they are often the most diverse and abundant mammals present. The diversity of bats generally increases as one travels from the poles toward the equator, a pattern that is largely attributable to an increase in habitat complexity as latitude decreases (Findley, 1993; Kunz and Fenton, 2003).

The distribution of cave bats not only depends on the presence of caves, but is also a consequence of specific roosting requirements (Kunz, 1982). For example, although the ghost bat (*Macroderma gigas*), the orange leaf-nosed bat (*Rhinonycteris aurantius*), and the large bent-wing bat (*Miniopterus schreibersii*) are all found in Australian caves, their roosting requirements and hence geographic distributions are quite different (Baudinette *et al.*, 2000). The orange leaf-nosed bat selects caves that are extremely hot and humid (28 to 30°C and greater than 94% relative humidity) and currently are known from only ten caves in Australia. In contrast, the large bent-wing bat can be found roosting at a broader range of temperatures and humidities and has one of the widest reported distributions of cave-roosting bats, encompassing southern Europe, Africa, southeast Asia, Japan, and Australia. The ghost bat is restricted in its distribution to the Northern Territories of Australia, but it occupies far more caves and mines than the orange leaf-nosed bat. As one might expect, the ghost bat has roosting requirements for which humidity is not such a vital condition as compared to the orange leaf-nosed bat.

Bats are found almost everywhere subterranean habitats exist. The distributions of cave-dwelling bats are determined largely by species-specific roosting requirements that vary depending on their ecology and evolutionary history. Local and global distributions and densities of bats that rely on caves for at least part of their life cycle are in turn determined largely by the distribution, quantity, and characteristics of available caves. For example, the Townsend's long-eared bat (*Corynorhinus townsendii*), known only from North America (Fig. 1), is primarily found roosting in caves and cave-like structures (Wilson and Ruff, 1999).

## FUNCTIONS OF CAVE ROOSTS

Caves are used by bats for a variety of reasons, including courtship and mating, raising young, and hibernating.



**FIGURE 1** Townsend's long-eared bat (*Corynorhinus townsendii*) is an insectivorous, cave-dwelling bat endemic to North America. (Photograph by J.S. Altenbach.)

Bats seek shelter during the day and disperse from these sites to forage for food at night. During the day, bats typically rest, groom, and often interact with their roost-mates. For example, a typical day for lactating female lesser long-nosed bats (*Leptonycteris curasoae*) involves resting quietly for up to 16 hours, interspersed with periodic grooming and nursing behavior. Although females usually roost together in caves during the day, they seldom interact with one another (Fleming *et al.*, 1998). In contrast, the common vampire bat (*Desmodus rotundus*) forms long-term social bonds, and individuals groom one another as they interact socially while occupying cave and tree roosts (Greenhall and Schmidt, 1988). In addition, many insectivorous species retreat to caves between feeding bouts, where they may cull the wings and heads of insects that were captured while foraging. Frugivorous species sometimes transport large fruits to caves where they cull soft pulp and where they can reduce the risks of predation. Some species that roost in foliage or tree cavities in the warm months hibernate in caves during the winter (Kunz, 1982; Kunz and Fenton, 2003).

## Courtship and Mating

Several types of mating systems have been described for cave-roosting bats. Mating systems of bats and other mammals are often classified into three general categories: promiscuity, polygyny, and monogamy. However, bat mating systems cannot always be easily categorized into one of these groups, as they often depict a continuous spectrum of mating behaviors (Crichton and Krutzsch, 2000).

Promiscuity is a type of mating system in which both males and females have multiple partners. Such a system is almost always highly structured, with some males siring more young than others. Promiscuity is common among temperate cave-dwelling species, possibly because of the limited time available for mating in autumn before individuals enter hibernation (Altringham, 1996). Males and females of many temperate species generally do not roost together during

warm months but instead roost alone or in small groups. Assemblages of bats that gather at caves and mines in the autumn (*referred to as swarming*) may aid individuals in finding a mate. During the swarming season, bats are active in caves and mines at night, where males can often be observed displaying and chasing females. In the United Kingdom, male and female greater horseshoe bats (*Rhinolophus ferrumequinum*) have a mating system in which males establish territorial sites inside caves and mines in early autumn. Females gather at these sites and selectively visit a series of different males on their territories (Crichton and Krutzsch, 2000).

Polygyny, a mating system thought to be the most common in bats, is characterized by one male mating with several females (Crichton and Krutzsch, 2000). An example of this type of mating system can be observed in the greater spear-nosed bat (*Phyllostomus hastatus*). In this species, females roost in caves in small stable groups, often remaining together for 10 years or more. Because the females often form discrete roosting groups in solution cavities or “pot holes” on cave ceilings, it is easy for a dominant male to defend a group of females from intrusions by other males. By defending the females, or the roost cavity, a so-called harem male is often able to mate with several females. Sometimes these harem males are accompanied by a subordinate male who has positioned himself in the harem to assume a dominant role if the harem male should become injured or die. The risks and costs associated with mate-guarding behavior can be substantial. For example, a harem male greater spear-nosed bat may incur some injuries while defending the females or roost cavity and in the final analysis may sire only 60 to 90% of the young born to those females (Crichton and Krutzsch, 2000). A similar pattern of mate guarding and courtship has been observed in the Jamaican fruit bat (*Artibeus jamaicensis*), which commonly roosts in caves on many of the islands in the West Indies and throughout Central and South America.

Monogamy occurs when males and females form long-term pair bonds. This type of mating system has been described for only a few species of bats. Two examples are the African false vampire bat (*Cardioderma cor*) and the American false vampire bat (*Vampyrum spectrum*), both of whom are carnivorous, sit-and-wait predators. An extended period of parental involvement in which males provision both females and young may have contributed to the evolution of monogamy in these and other species (Crichton and Krutzsch, 2000).

### Rearing Young

During pregnancy and lactation, females form maternity colonies, which are often located in separate places from roosts used by males. In most species of bats, the responsibility of raising young lies solely with females. Pregnancy and lactation are both energetically expensive events, thus females and their young can benefit from the heat generated

when they form clusters in the partially enclosed spaces often found in caves and cave-like structures. Roosting together in large clusters may reduce the energy expenditure of some individuals by up to 50%. When lactating females disperse from roosts in the evening to feed, they often leave their pups in a warm, incubator-like environment. Females incur high energy costs when they forage and return to the roosts one to three times each night to find and suckle their dependent young. Thus, assembling in warm places can help reduce the energy needed by small bats to remain homeothermic (Crichton and Krutzsch, 2000).

Each spring, Brazilian free-tailed bats (*Tadarida brasiliensis*) migrate from Mexico to the southwestern United States to form large maternity colonies in caves and sometimes other structures. This species is thought to form the largest aggregations of mammals known to mankind, where nightly emergences sometimes exceed several million individuals from a single cave (Fig. 2). Each time a female Brazilian free-tailed bat returns from a feeding bout to suckle her young, she faces the daunting task of finding her own pup among the millions of babies that are left on the ceilings and walls of the cave. A mother bat begins this adventure by returning to the area in the cave where she left her pups before emerging to feed. Next, she uses vocal and olfactory cues to identify her own pups among the thousands or more that are present (Crichton and Krutzsch, 2000). Hungry pups will sometimes attempt to nurse from almost any female, although lactating females usually guard against milk stealing from unrelated individuals (McCracken, 1984). The investment that a mother bat makes in her pups is substantial, requiring quantities of food intake equal to about two-thirds of her body mass each night at peak lactation (Kunz *et al.*, 1995).

Young Brazilian free-tailed bats grow rapidly from a diet of energy-rich milk. Mothers nourish their young with milk for several weeks, because young bats cannot fly and feed on



**FIGURE 2** Emerging column of Brazilian free-tailed bats (*Tadarida brasiliensis*) dispersing nightly from caves used as maternity roosts in northern Mexico and the southwestern United States during warm months. (Photograph by T.H. Kunz).

their own until their wings have almost reached adult dimensions. Within 6 weeks of birth, young free-tailed bats are able to fly and forage on their own. In contrast to most other mammals that typically wean their young at about 40% of adult size, most insectivorous bat species suckle their young until they are about 90% of adult size (Crichton and Krutzsch, 2000).

## HIBERNATION

Bats have evolved behavioral and physiological mechanisms to avoid long periods of adverse weather and low food or water availability. Some species migrate to more suitable areas, but others use daily torpor, a controlled lowering of body temperature to conserve energy. Only temperate species in the families Vespertilionidae, Rhinolophidae, and Molossidae are known to hibernate in caves and mines (Fig. 3) (Kunz and Fenton, 2003).

Hibernating bats rely on stored fat as their primary energy source during hibernation and are sustained on these reserves for upward of 6 to 8 months. Hibernation is an energy-saving strategy that is strongly influenced by the ambient conditions in a cave. When a bat is hibernating, low ambient temperatures lead to a decrease in metabolism. When the ambient temperature is too cold or too warm, bats typically arouse and move to another part of the cave. It is important for hibernating bats to occupy caves and mines that provide a variety of temperatures, because individuals often change roosting positions as the season progresses (Kunz and Fenton, 2003).

During hibernation, bats lower their body temperature to within a few degrees of the ambient temperature, but individuals arouse periodically by producing heat employing non-shivering thermogenesis. Bouts of hibernation can last anywhere from a few days to several months. In areas with moderate winters, bats such as the greater horseshoe bat (*Rhinolophus ferrumequinum*) in the United Kingdom may feed on insects on warm winter nights. Arousals from deep hibernation are energetically costly, with a single arousal expending the energy equivalent of a bat spending 68 days in



**FIGURE 3** Small hibernating cluster of the cave myotis (*Myotis velifer*), a cave-dwelling species endemic to North America. (Photograph by T.H. Kunz.)

deep torpor. Thus, if hibernating bats arouse too often, either because the microclimate is not optimal or from human disturbance, they may not have enough fat reserves to survive the winter (Kunz and Fenton, 2003).

## COSTS AND BENEFITS OF LIVING IN CAVES

The decision about where to roost is critical to the survival and reproductive success of bats. The type of roost that a bat selects is influenced by its morphology, ecology, and physiological requirements and often reflects a compromise between the costs and benefits associated with a particular type of roost (Kunz, 1982). For cave-roosting species, the benefits of living in a cave usually outweigh any costs that they may otherwise incur. In the following section, we discuss the major costs and benefits considered critical for the selection of roosts by cave-dwelling bats. It is important to note that roosting requirements and relevant costs and benefits are not uniform for all species and may vary intraspecifically, depending on geographic location, reproductive condition, and/or season (Kunz and Fenton, 2003).

### Benefits

Caves offer a wide range of benefits including a structurally and climatically stable environment, and protection from predators and adverse weather. Microclimate, specifically temperature and relative humidity, is arguably the most important factor in roost selection by cave-dwelling bats (Baudinette *et al.*, 2000). Different bat species roost in a variety of microclimates within caves and mines, and this variation is often correlated with a bat's body size, diet, phylogeny, and their ability to enter torpor (Kunz and Fenton, 2003).

Compared to non-volant mammals, bats have high rates of evaporative water and heat loss, due in part to their relatively high surface-to-volume ratio, enhanced by the large surface of their naked wing membranes. At low relative humidities (<20%), bats may lose up to 30% of their body mass per day from evaporative water loss alone. This rapid dehydration can be lethal. Many bats select caves that have high relative humidity to help conserve water during the day (Kunz and Fenton, 2003).

Bats are endothermic, meaning that they rely on the internal production of heat to maintain their body temperatures within their thermal neutral zone. Maintaining homeothermic body temperatures requires a substantial amount of energy. At ambient temperatures above and below the thermal neutral zone, bats must expend energy to cool or warm themselves, respectively. Bats use at least four different strategies for conserving energy while in their roosts (Kunz and Fenton, 2003). Some species select roosts that have an ambient temperature within their thermal neutral zone. The California leaf-nosed bat, for example, often exploits geothermally heated mines to conserve heat during the

winter. Other species form large colonies in parts of caves that have little airflow, leading to an increase in roost temperature as the metabolic heat generated by the bats becomes trapped. The lesser long-nosed bat (*Leptonycteris curasoae*) in South America, the large bent-wing bat (*Miniopterus schreibersii*) in Australia, and the Brazilian free-tailed bat (*Tadarida brasiliensis*) in the southwestern United States are examples of cave-dwelling species that form colonies large enough to substantially increase the temperature of their roost environment. Still other species select colder roost environments that allow them to reduce their body temperature and thus become torpid. Daily torpor not only reduces the amount of energy a bat expends in a day but also helps reduce water loss. Finally, some species form dense clusters that buffer individuals from changes in ambient temperature, a behavior that also reduces their energy expenditure.

In addition to the energy savings that bats may experience, they can also benefit from social interactions promoted by cave living. For example, the environmental stability of caves can facilitate social interactions such as finding, attracting, and guarding mates; information transfer; and interactions that evolve through kin selection and/or reciprocal altruism (Crichton and Krutzsch, 2000). Females that roost together sometimes share information about feeding resources, such as the location of flowering and fruiting trees. Female greater spear-nosed bats (*Phyllostomus hastatus*) typically roost in caves where they form stable groups of unrelated individuals. Information transfer, presumably facilitated by vocal contact, may help females coordinate efforts to defend food patches from other bats (Wilkinson and Boughman, 1998).

The common vampire bat (*Desmodus rotundus*), another highly social species, has evolved a system of sharing blood with both relatives and unrelated roost mates. Vampire bats must obtain a blood meal at least once every three days or they will invariably die. Females often share blood with roost-mates that are at risk of starving, but this sharing occurs only among individuals with whom they are closely associated. This is referred to as *reciprocity* (or *reciprocal altruism*) and occurs when the cost to the individual performing the altruistic act is less than the benefit to the recipient when such an act is later reciprocated (Greenhall and Schmidt, 1988).

### Costs

There are several potential costs associated with living in caves, most of which are related to living in large groups. Large numbers of bats that live in close physical contact with one another may be more prone to transmit certain diseases or increase the risk of parasitic infestations. High mite infestations on a bat, for example, may cause an increase in the amount of time an individual spends grooming, and thus increase its daily energy budget (Kunz, 1982).

That bats often emerge synchronously from a cave may increase an individual's risk of predation. Researchers have

documented birds of prey, such as owls, hawks, and falcons, swooping down into columns of bats that emerge nightly from caves and mines. As many as 14 bird species are known to feed on bats in Britain alone, with the most important predators being owls. Some birds even specialize on bats, such as the bat hawk (*Machaerhamphus alcinus*) in Africa and the bat falcon (*Falco rufigularis*) in Central and South America. Most predatory birds are territorial, so their numbers at any one cave are probably quite small, thus the impact on local populations is probably minimal. Other animals that sometimes prey on cave-roosting bats include snakes, raccoons, skunks, opossums, and other bats; even a frog has been observed preying on bats (Altringham, 1996). Few studies, however, have evaluated the impact that predators have on bat populations.

The distribution of caves in most terrestrial landscapes is highly variable, and some may not be located near abundant food resources upon which bats depend. Bats that roost alone or in small groups in tree cavities and in foliage can often take advantage of food resources located near their roosts, but cave bats, especially those that form large colonies, more often must commute considerable distances to foraging sites. Because flight is energetically expensive, bats must make compromises between colony size and the amount of energy spent commuting to feeding sites and the energy that is conserved by selecting a roost that has microclimate conducive to energy and water conservation (Kunz, 1982).

Local food resources may not be sufficient to support the energy and nutrient budgets of all individuals that form large cave colonies, thus some individuals must disperse considerable distances in order to secure their daily energy and nutrient requirements. Some maternity colonies of Brazilian free-tailed bats (*Tadarida brasiliensis*) may number in the millions, requiring some individuals to fly upwards of 50 km each night to obtain their food. This may also be the case for other species that form large colonies in caves, such as the large bent-wing bat (*Miniopterus schreibersii*) and the lesser long-nosed bat (*Leptonycteris curasoae*) (Kunz and Fenton, 2003).

## CONSERVATION AND MANAGEMENT

In recent years, reductions in the numbers of cave bat populations have increasingly concerned conservation biologists (Kunz and Racey, 1998). One of the major problems that places bat populations at risk is that they have relatively low reproductive rates and are unable to recover quickly from population declines. Cave bats face a variety of human threats that may vary in different regions of the world. Some threats reflect differences due to socioeconomic conditions, habitat types, and cultural attitudes toward bats. Notwithstanding, several successful approaches, such as habitat restoration and cave protection, have been employed to protect bats, their roosts, and food resources. Increasingly, most if not all geopolitical units (cities, states, countries) are

faced with issues related to increased mining and quarrying operations, spelunking, ecotourism, vandalism, sealing of caves and mines for safety reasons, and deliberate killing of bats. Other local issues include guano mining and over-collection of bats for scientific research which can have adverse effects on cave environments. The negative image of bats often portrayed by the media can best be overcome through better educational efforts. Lack of basic information about the natural history of most cave-roosting bats is a problem in many regions of the world. Thorough knowledge about the ecology and behavior of different species is essential if natural resource managers and politicians are to make informed decisions that affect the well-being of bats and the food and roost resources on which they depend (Kunz and Racey, 2003).

### ECOSYSTEM SERVICES PROVIDED BY CAVE BATS

Many cave-dwelling bats provide essential ecosystem services by helping to maintain forest diversity by dispersing seeds and pollinating flowers. Changes in bat diversity or abundance due to forest fragmentation or roost destruction can lead to the dysfunction of forest ecosystems. In addition to plant-visiting bats that disperse seeds and pollinate flowers, many insectivorous bats consume vast quantities of insects. Some insectivorous species feed on insects that cause significant damage to agricultural crops. The Brazilian free-tailed bat (*Tadarida brasiliensis*), for example, is known to feed on insects that cause millions of dollars in damage to corn and cotton crops in the United States each year. In addition, nearly everywhere that large quantities of guano have accumulated in caves, local communities have discovered its value as a fertilizer. In some parts of the world, guano is mined locally and sold commercially for fertilizer. Although guano mining is no longer common in most industrialized countries, it is still practiced in some underdeveloped countries (Kunz and Pierson, 1994; Kunz and Fenton, 2003).

The organic input from bat guano (feces and urine) is essential for sustaining the health of cave ecosystems. Many cave-dependent organisms (*e.g.*, fungi, arthropods, fish, salamanders) depend on bats to produce guano and thus provide critical food resources in an environment where other sources of organic nutrients are relatively scarce. Not only do bats defecate and urinate in caves, but some also discard culled wings of insects or seeds and bits of fruit and leaves as they feed, and thus supply energy and nutrients for a variety of cave organisms such as fungi, arthropods, fish, and salamanders (Kunz and Racey, 1998).

### Human Disturbance

Humans enter caves for various reasons, including scientific research—exploration, shelter, tourism, mining, and even sometimes for collecting bats to eat. Whatever the intentions

might be, these activities can have adverse consequences for bats (Kunz and Racey, 1998; Kunz and Fenton, 2003). Disturbing bats during the maternity period, whether they are handled or not, can cause pregnant females to abort their young or cause young to fall to the floor, leading to injury or certain death. Hibernating bats are particularly vulnerable to disturbances from human activities. When humans disturb hibernating bats, they often respond by arousing, which is energetically expensive. Non-tactile stimuli, such as light and noise, can also increase the activity of bats that hibernate in caves and thus lead to the depletion of valuable energy reserves (Kunz and Fenton, 2003).

### Habitat Destruction and Alteration

Mining and quarrying activities can have adverse impacts on cave-roosting bats, because such activity often modifies the physical structure and microclimate of their subterranean habitats. Because many bats have very specific roosting requirements, such changes may cause bats to abandon these sites. Just as important is the fact that mining operations often use chemicals that are highly toxic. In some regions, modern gold-mining techniques, for example, use cyanide to extract gold from ore, and such practices have killed enormous numbers of animals, including cave bats, by contaminating water sources from which bats derive their food and drinking water.

In some situations, bats have taken advantage of human technology by readily using manmade structures such as bridges and mines. Increases in the number of abandoned mines and bat-friendly bridges have also increased the abundance and distribution of some cave-dwelling species. However, reclamation of mines and the closing of others have also led to an increase in bat mortality when these structures are closed without first verifying their presence (Tuttle and Taylor, 1994).

The habitat surrounding caves can be just as important as the environment within the cave itself. Many hibernating species, such as the endangered Indiana bat (*Myotis sodalis*), typically roost beneath exfoliating bark during the warm months but hibernate in caves during the winter. To survive a prolonged period of hibernation, bats must be able to replenish their fat reserves following migration, thus productive foraging habitats located near hibernacula are essential to their success. The vegetation around a cave not only supports source populations of insect prey but also may buffer the interior of the cave from severe changes in wind flow and temperature.

### The Paradox of Vampire Bats

A source of myths and legends, vampire bats offer a valuable lesson about the need to learn more about these and other species before it is too late to protect them from extinction. Three species of vampire bats range from northern Mexico

through South America, but only the common vampire bat (*Desmodus rotundus*) is abundant enough to be considered a nuisance to humans and their livestock. All three species depend on a diet of blood, but they feed on a variety of different animals. Most of our knowledge of vampire bats comes from the common vampire bat, which specializes on mammalian blood as a source of food. Populations of vampire bats increased sharply in areas of Latin America following the introduction of livestock by European settlers over 500 years ago. Because the common vampire bat feeds on cattle and occasionally on humans, this species has become a pest in most of Central and South America. The economic loss due to cattle dying from bat-transmitted rabies alone is a major concern in many regions of Latin America (Greenhall and Schmidt, 1988).

Lack of education and misguided attempts to control vampire bat populations have led to the mass destruction of these and other non-targeted species. Nonselective killing techniques, such as fire and gas (fumigating), have been used either because local landowners are often unaware of the differences between vampire bats and other species or because they are uninformed about the value of bats in general. Poisons, such as strychnine or anticoagulants, are often applied to the wounds on livestock because vampire bats return to wounds that they made the previous night (Greenhall and Schmidt, 1988). Selective approaches that concentrate on controlling vampire bats should be used whenever possible. Recent discoveries by researchers indicate that chemicals present in the saliva of common vampire bats have important medical benefits (e.g., reducing the risks of stroke and heart attacks in humans). Thus, a bat species that is considered a nuisance or public health threat by some segments of society may also offer enormous benefits to others.

Many local, national, and international organizations have become engaged in efforts to support research on bats and have also helped to educate the public about the benefits of bats to humankind. Many cave organizations have joined this effort to protect cave bats. Television programs, newspaper articles, and other media must be used to promote the ecological value of bats and the importance of caves for sustaining many bat populations on a worldwide scale. Organizations such as Bat Conservation International ([www.batcon.org](http://www.batcon.org)), Bat Conservation Trust ([www.bats.org.uk](http://www.bats.org.uk)), the Lube Bat Conservancy ([www.lubee.com](http://www.lubee.com)), and the Organization for Bat Conservation ([www.batroost.com](http://www.batroost.com)) are among a growing number of non-government organizations that are contributing to these efforts. Notwithstanding, additional efforts are needed to help promote and protect the nearly 1100 species of bats known worldwide.

## ACKNOWLEDGMENTS

We wish to acknowledge support from the American Society of Mammalogists and Bat Conservation International

(S.W.M.), as well as the National Geographic Society, National Science Foundation, and the Lube Bat Conservancy (T.H.K) for funding our research. We also thank Tigga Kingston and Wendy Hood for making suggestions on an earlier draft of this manuscript.

## Bibliography

- Altringham, J.D. (1996) *Bats: Biology and Behaviour*, Oxford University Press, London, 262 pp.
- Baudinette, R.V., S.K. Churchill, K.A. Christian, J.E. Nelson, and P.J. Hudson (2000) Energy, water balance and the roost microenvironment in three Australian cave-dwelling bats (Microchiroptera). *J. Comp. Physiol. B* 170: 439–446.
- Crichton, E.G. and P.H. Krutzsch, Eds. (2000) *Biology of Bat Reproduction*, Academic Press, San Diego, 510 pp.
- Findley, J. S. (1993) *Bats: A Community Perspective*, Cambridge University Press, Cambridge, MA, 167 pp.
- Fleming, T.H., A.A. Nelson, and V.M. Dalton (1998) Roosting behavior of the lesser long-nosed bat, *Leptonycteris curasoae*. *J. Mammal.* 79: 147–155.
- Greenhall, A.M. and U. Schmidt, Eds. (1988) *Natural History of Vampire Bats*. CRC Press, Boca Raton, FL, 246 pp.
- Kunz, T.H., Ed. (1982) *Ecology of Bats*. Plenum Press, New York, 425 pp.
- Kunz, T.H. and E.D. Pierson (1994) *Bats of the World: An Introduction*. In *Walker's Bats of the World* (R.W. Nowak, Ed.). Johns Hopkins University Press, Baltimore, MD, pp. 1–46.
- Kunz, T.H. and M.B. Fenton, Eds. (2003) *Bat Ecology*, University of Chicago Press, Chicago, IL.
- Kunz, T.H. and P.A. Racey, Eds. (1998) *Bat Biology and Conservation*, Smithsonian Institution Press, Washington, D.C., 365 pp.
- Kunz, T.H., J.O. Whitaker, Jr., and M.D. Wadonoli (1995) Dietary energetics of the Mexican free-tailed bat (*Tadarida brasiliensis*) during pregnancy and lactation. *Oecologia* 101: 107–115.
- McCracken, G.F. (1984) Communal nursing in Mexican free-tailed bat maternity colonies. *Science* 223: 1090–1091.
- Simmons, N.B. (2003) Bats. In *Mammal Species of the World: A Taxonomic and Geographic Reference*, 3rd ed. (D.E. Wilson and D.M. Reeder, Eds.). Smithsonian Institution Press, Washington, D.C.
- Tuttle, M.D. and D. Taylor (1994) *Bats and Mines*. Resource Publication No. 3, Bat Conservation International, Austin, TX, 42 pp.
- Wilkinson, G.S. and J.W. Boughman (1998) Social calls coordinate foraging in greater spear-nosed bats. *Animal Behav.* 55: 337–350.
- Wilson, D.E. and S. Ruff, Eds. (1999) *The Smithsonian Book of North American Mammals*. Smithsonian Institution Press, Washington, D.C., 745 pp.

# Beetles

Oana Teodora Moldovan

Emil Racovitza Speleological Institute, Cluj, Romania

## INTRODUCTION

As part of the Insects class, representatives of the order of Coleoptera usually have a sclerotized body with sclerotized forewings that are leathery or horny and modified to act as rigid covers (*elytra*) over the membranous, reduced, or even absent hindwings. The mouthparts are adapted for cutting,

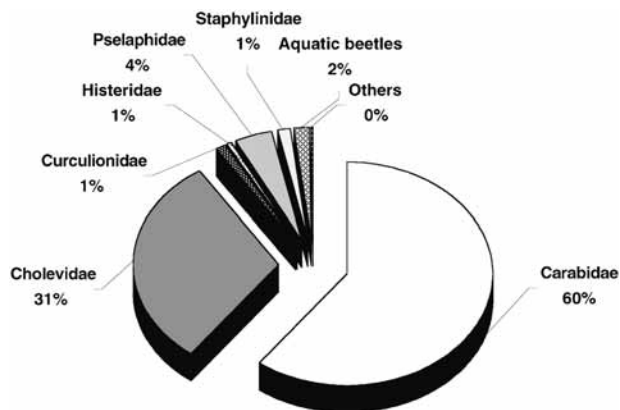
nibbling, and chewing, and the antennae have usually 8 to 11 articles. The male genitalia are retractable, and the females do not possess an ovipositor. Beetles are the most numerous of all insects, with more than 300,000 described species—almost one-third of all known animals (Brusca and Brusca, 1990). Big or small, they are everywhere, occurring in all environments, including caves, lava tubes, cracks and fissures in a massif, mesovoid shallow substratum (MSS) in limestone, or in different other rocks as schist, gneiss, granodiorites, basalts, quartzites, grits, etc.

Of the 40 families of the order, 15 have species in the underground world: the aquatic Dryopidae, Dytiscidae (predaceous diving beetles), Elmidae, Hydrophilidae (water scavenger beetles), and Noteridae, as well as the terrestrial Carabidae (ground beetles), Cholevidae, Curculionidae (weevils), Histeridae, Pselaphidae, Staphylinidae (rove beetles), Merophysidae, Ptiliidae, Scydmaenidae, and Tenebrionidae (darkling beetles) (Fig. 1). Even underground they are the best represented of all animals, with around 2000 species.

It is not surprisingly that one of the first discovered cave animals was a beetle, in Postojnska Jama (Slovenia). In 1831, Čeč observed specimens that looked very much like ants on the beautiful stalagmites. Count Franz von Hohenwart sent the material to the Austrian naturalist Schmidt, who described *Leptodirus hochenwarthi*, an amazing terrestrial species displaying high degree of adaptation to cave life (Fig. 2).

## ADAPTATIONS

Several adaptations of cave beetles to darkness, low and heterogeneous in time and space food input (at least in temperate regions, where the food is brought inside caves through the cracks network, only in some seasons and mostly by water), and a relatively constant climate are characteristic of cave life, but the degree of morphological, anatomical, behavioral, and physiological adaptation is not similar in all species. One of the first morphological changes to occur among beetles during colonization of caves is a loss of



**FIGURE 1** Proportion of cave beetle families in the group of Coleoptera. (Adapted from Juberthie and Decu, 1998.)



**FIGURE 2** *Leptodirus hochenwarthi* (Schmidt, 1832). (Photograph by Valika Kuštor, Slovenia.)

pigmentation. The cuticle becomes thinner, and the color of the cave beetles given by the benzoquinones is a red-brown. The most evident morphological change is the reduction or complete lack of eyes. The ocelles and rhabdomeres can disappear completely, and reduction can also affect the optical center, much more pronounced than for stygobitic fishes and decapod crustaceans.

Elongation of the body and antennae, which become slender and longer, is linked to their preferred habitat (the network of cracks) and serves as compensation for the lack of eyes. Longer antennae mean also longer mechanical, gustatory, olfactory, and hygrosensitive sensilla, as well as enhancement of the receptory surface. Cave beetles have larger reception surface compared with their epigeal relatives.

Life in caves makes the use of the wings impossible. Wings are completely lost in some species, and the elytrae are fused together. Moreover, in highly specialized species, under the elytrae is located a compartment containing air for humidity regulation and that causing a false physiogastry, similar to the bulging abdomen of ants and termites filled with lipid reserves.

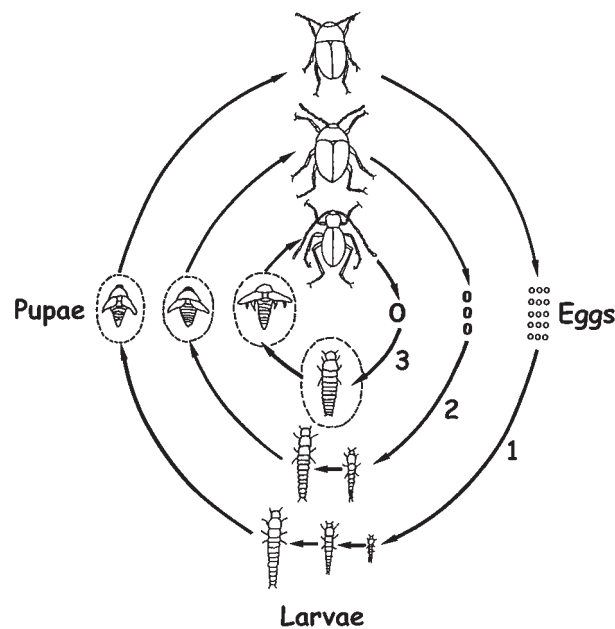
The anatomical internal modifications are especially due to the scarcity of food and its uneven distribution throughout the year; therefore, adapted species have developed a fat body containing huge vesicles filled with fat, proteins, and glycogen that allow survival during several months of fast. There is also a modification of the exocrine glands, observed on some Cholevidae. The soil species have a big sternal exocrine gland (secreting pheromones) that disappears completely in cave relatives, being replaced by smaller unicellular glands. The secreted substances switch from a mixture of

very volatile and less volatile ones for soil species to less volatile ones, perceived only at small distances (the special group of cuticular hydrocarbons), in subterranean species. In caves, the presence of food can be an attractant at long distances, while the small-distance pheromones act in place, releasing the mating behavior and even the laying of eggs. This behavior saves the energy needed for the production of offspring. Even the larvae save energy by not feeding during the development, as they are protected by small “houses” of clay.

Several breeding experiments were done in the Pyrenean Cave laboratory of Moulis (France) (Deleurance-Glaçon, 1963) on beetles with different degrees of adaptation. The most adapted have low fecundity, with a reduction in the number of ovarioles. The females lay few eggs or only one, bigger, with more vitellinic reserves; also, the time required for egg hatching is longer. The larval stages and larval life are reduced, and the time spent as a pupa increases (Fig. 3). The life cycle varies; French species spend 4 to 5 years as adults, and the American *Ptomaphagus* species spend only 2 years (Peck, 1986).

The activity of epigeal species depends very much on the day/night and seasonal alternations. For cave beetles in the absence of light and other 24-hour environmental cues, periods of activity and rest do not have a daily rhythm.

The tropical caves with important food input are inhabited by less adapted beetles, especially those caves with large deposits of guano. The process of adaptation of guanophilic and guanobitic species is slowed down. In these regions, at low altitude the species are troglomorphic, and



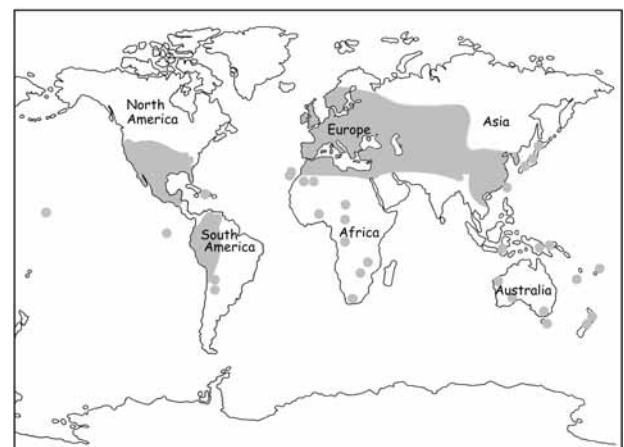
**FIGURE 3** Development cycles of underground beetles with different levels of adaptation: 1, endogean; 2, less adapted; 3, very adapted.

true troglotic beetles typically inhabit high mountain caves (Sbordoni *et al.*, 1977).

### COLONIZATION AND GEOGRAPHICAL DISTRIBUTION

The beetles that have colonized the underground world were preadapted or exapted; they were terrestrial and nocturnal, preferring moist habitats, frequently the fissures of soil, bark, or entrances to caves. The moment of cave occupation is still debated, but it is often related with the Quaternary glacial–interglacial periods or with the natural processes of empty environment colonization. Peck (1981) proposed the following scenario for colonization of caves in the Grand Canyon (between 1160- and 1580-m altitude) by *Ptomaphagus hirtus*. The first species arose during the interglacial period after the Illinois glaciation (235,000 to 185,000 BP) and dispersed underground during the next glaciation. Then, again, new cave species appeared in the next interglacial period (150,000 to 90,000 BP). Colonization with trogliphilic or troglotic species was followed by isolation during the interglacial periods which separated the populations, and new cave species appeared. This hypothesis has been tested and validated with alloenzyme paleodating and paleotemperature measurements.

The subterranean beetles spread on all continents and on some islands, not only in karstic areas (Fig. 4). The richest regions are the temperate ones. The glaciated areas usually do not have cave beetles, but some troglotic species have recolonized the underground habitats. There are parts of the world where the beetle fauna is very diversified, such as the Mediterranean karst. The reasons for the separation of different populations with wide ranges of distribution can be paleogeographical, paleoclimatical, or ecological. European and North American species are the best known, given the number of specialists and long biospeleological tradition, but



**FIGURE 4** World distribution of cave beetles (in gray). (Adapted from Juberthie and Decu, 1998.)



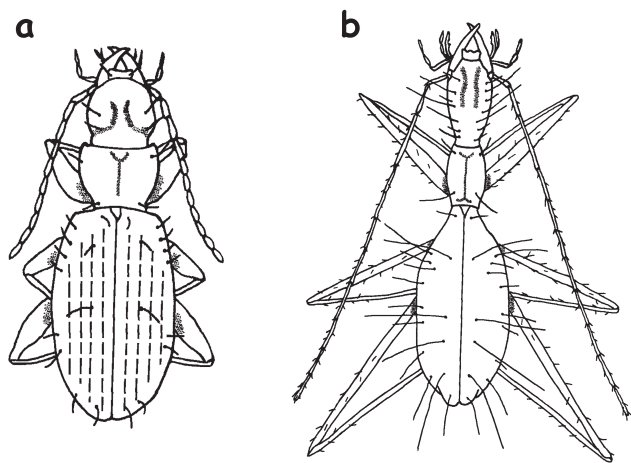
also the favorable climatic conditions. The extreme north and south areas were repeatedly covered with ice, and the limits of the glaciers are very well reflected today in the limits of the troglotic beetle distribution.

### SYSTEMATICS OF CAVE BEETLES

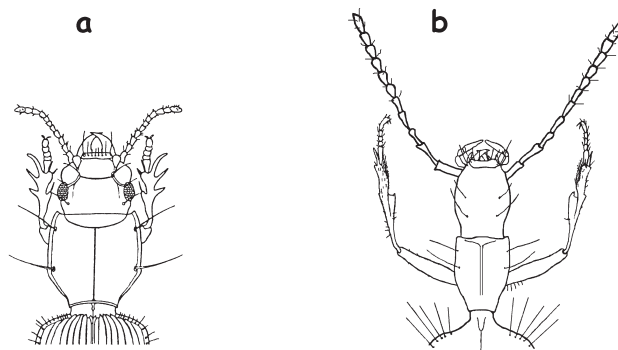
The family Carabidae includes the Trechinae, representing 1047 species in 105 genera. These have colonized all the subterranean habitats, from soil to caves. The cavernicolous species have been classified into two morphological types (anophthalm and aphenopsian), corresponding to how advanced they are in the adaptive evolutionary processes (Fig. 5). The anophthalm type characterizes the endogean and some cave species: depigmented, reduced or no eyes, anterior body and appendages slightly elongated. The other type, aphenopsian, is a very evolved species that is eyeless with a very long body, antennae, and legs and very thin cuticle. Typical for this last type are *Aphaenops* in Europe and *Neaphaenops* and *Mexaphaenops* in North America. But, one of the most amazing adaptations concerns the sensory equipment, with development of olfaction through increased numbers of antennae receptors and lengthening of the mechanical trichobotries on the elytrae. Some Trechinae are polyphagous predators, such as the French *Aphaenops*, which has a diet consisting of adults and larvae of other beetles, springtails, flies, sometimes millipedes, crickets, diplurans, etc. and which hunts in caves and MSS (Juberthie and Decu, 1998). Others are very specialized on a single prey, such as *Rhadine subterranea* from Great Onyx Cave (United States), which feeds exclusively on the eggs and young of the cricket *Hadenococcus subterranea*. The anatomy and behavior of this beetle are surprisingly adapted for locating and stealing the eggs deposited one at the time beneath the surface of silt. Chemical substances left by the cricket release the search behavior of the beetle, and when the prey is found a hole is

dug and the contents of the eggs are devoured (Mohr and Poulson, 1966). Some species can be rare in caves, only sometimes being found on the sandy banks of subterranean rivers or during flooding seasons. The Trechinae are very mobile and active in the search of the food, probably covering large areas in fissured massifs. In this group, the steps of evolution and the way in which adaptation has occurred can be observed very well thanks to the presence of many species outside, in moist or dark habitats (such as under rocks or moss) and deep in the soil. The troglomorphic features of the cave Carabidae are very diversified; some of them are explained by adaptation to different underground compartments, but others represent the original contribution of some phyletical line or the years spent as cave inhabitants (Fig. 6).

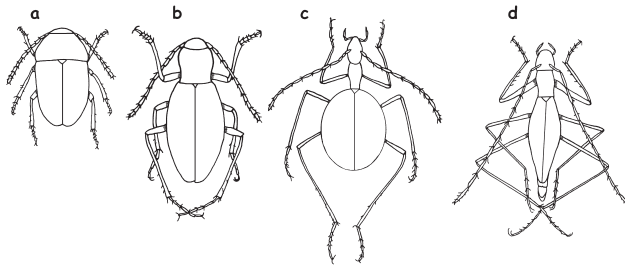
Another rich group is the Cholevidae, especially the subfamily of Leptodirinae, with 138 genera and 562 species. Leptodirinae occur only in European caves, being replaced in North America by the smaller but very interesting subfamily of Ptomaphaginae. As for the previous group, the Cholevidae have colonized all the subterranean habitats, but they consume organic or decomposed matter and are not predators. Cave clay or moonmilk that contains bacteria, fungi, and algae is important to their diet, and these beetles can sometimes be found in huge numbers on these substrates. Species of this group have different morphologies according to their degree of adaptation to cave life; four morphological types are accepted: (1) *bathyscioid*, for humicolous, endogenous, and some less specialized cave species with more or less globular forms of body and short appendages; (2) *pholeuonid*, characterizing specialized forms with longer, slender bodies and appendages and false physiogastry; (3) *leptodiroid*, for highly specialized species, such as *Leptodirus*, with extremely elongated legs and antennae and a very small anterior part of the body; (4) *scaphoid* (from *scaphe*, Greek for "boat"), which are also highly specialized and very similar to the previous group but with a different form of the body, like a boat (Fig. 7). Not enough data are available regarding predators of these beetles. It is generally accepted that they do



**FIGURE 5** Different Trechinae adaptations to caves: (a) anophthalm and (b) aphenopsian. (Adapted from Ginet and Decou, 1977.)



**FIGURE 6** Head, antennae, and first pair of legs of (a) *Clivina subterranea* and (b) *Italodytes stammeri* showing the differences, respectively, between new colonizers and old colonizers of caves.



**FIGURE 7** Different types of Leptodirinae as adaptation to caves: (a) batyscioid; (b) phleuonid; (c) leptodiroid; (d) scaphoid. (Adapted from Ginot and Decou, 1977.)

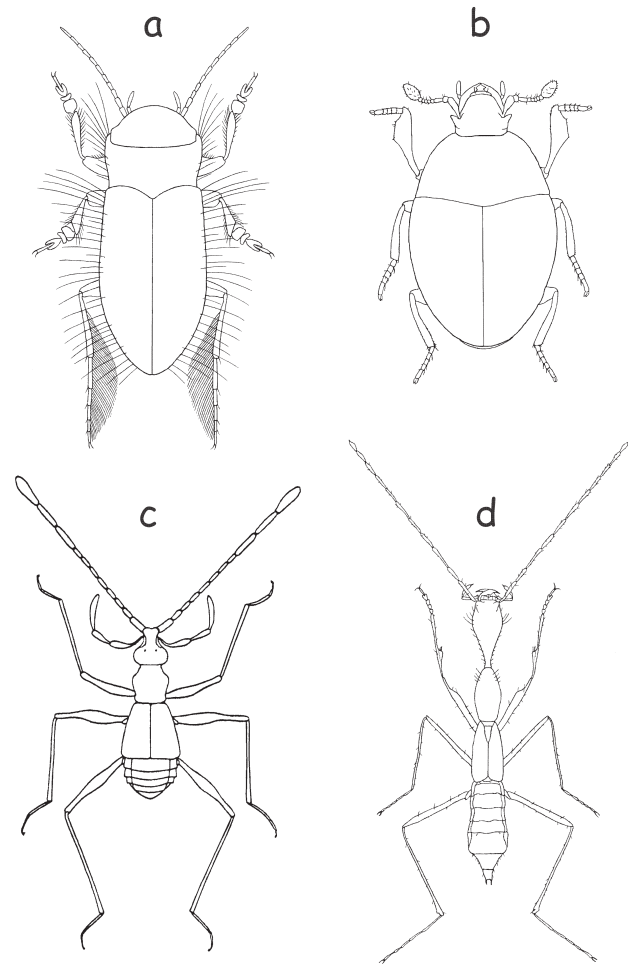
not have as many as their epigeal relatives, but some cases of predation from harvestmen and pseudoscorpions have been reported, and is probably more pronounced on the eggs and larvae than on the adults. Other Coleoptera families have few troglobitic representatives but do have interesting adaptations to subterranean life.

The aquatic beetles (Fig. 8a) were not as successful in colonizing hypogean habitats as the terrestrial ones. The first stygobiotic beetle was mentioned in France at the beginning of the 20th century. Today, 21 genera with 31 species are known to inhabit cave streams, springs, or wells, usually in warmer climates. Besides the typical adaptations of cave beetles, aquatic beetles have other adaptations, such as switching between swimmers and crawlers, different methods for obtaining air through cuticular respiration or tracheated elytral respiration, pupation at the bottom of subterranean waters, and smaller size (from 1.1 to 4.5 mm).

The Curculionidae is the best represented family of beetles on the surface, but there are few cave inhabitants, with no typical cave adaptation. These species display different degrees of specialization to a deep soil environment, as the eyeless *Trogloorhynchus monteleonii* from a cave in Central Italy (Osella, 1982). It is not a question of adaptation for cave life but rather one of a different degree of specialization to a deep soil environment (Juberthie and Decu, 1998). The cave in this case is more of a trap.

Troglophilic and guanobitic specialization (many species are myrmecophilous and termitophilous) of the Histeridae can explain the low number of cave species; the first cave specimen was discovered in Turkey (Fig. 8b). Most subterranean species are troglophilic and guanobitic. Thirty-five genera of Pselaphidae have troglobitic representatives (Fig. 8c). The origin of the temperate troglobitic pselaphids can be traced to the Tertiary, under similar conditions as in the humid and relatively cold forests of the African mountains, where forms with small eyes and no wings are largely spread in the humus.

Most Staphylinidae are from the Mediterranean region (Morocco, Algeria, Spain, Italy) or nearby (Romania and the Canary and Madeira Islands), but generally they are troglophilic (Fig. 8d).

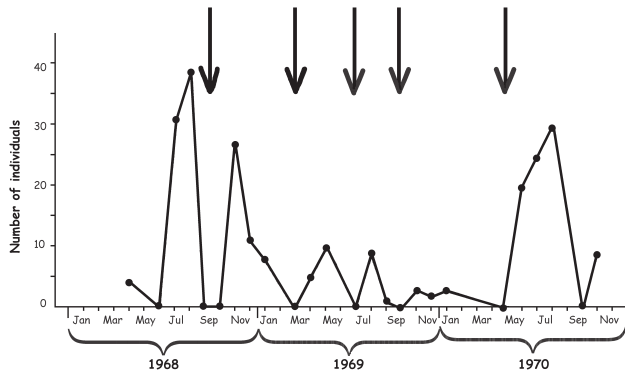


**FIGURE 8** Cave beetles: (a) aquatic *Morimotoa gigantea* (Uéno, 1957) (from Japan); (b) histerid *Spelaeabraeus agazzii* (Moro, 1957) (from Italy); (c) pselaphid *Decumarellus sarbui* (Poggi, 1994) (from Romania); (d) staphylinid *Domene vulcanica* (Oromí and Hernandez, 1986) (from Canary Islands).

Other families of cave beetles are associated with guano deposits and therefore do not share the same morphological adaptations as the cave species.

## ECOLOGY

Cave beetles generally live in relatively stable climates with constant temperature, an atmosphere saturated with water vapor, and no air currents. There is a link between the presence of beetles in caves and food input in spring and autumn (for temperate regions). It has been observed that populations migrate between the network of cracks and the caves, depending on the presence of food and on climatic parameters. The fissures and cracks offer a more stable habitat than the big passages and rooms that have large volumes of air and are more or less in direct contact with the natural entrances. Very sensitive to any change in the conditions of their environment, cave beetles quickly initiate a behavior, even if it is only to run.

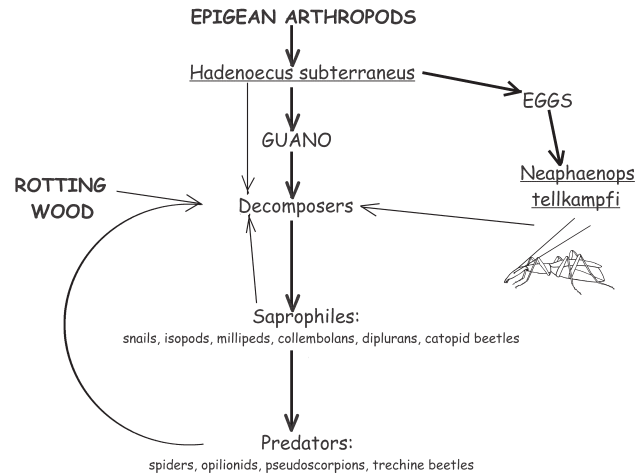


**FIGURE 9** Numerical variation of *Pholeuon moczarzi* in Vadu Crisului Cave (Romania), in the period 1968 to 1970 as a consequence of flooding periods (indicated by arrows). (Adapted from Racovita, 1971.)

Interesting examples are provided by studies from Transylvania (Romania), France, and the United States. Variations of the number of individuals at different time during a year were determined to be influenced by air temperature or the level of the subterranean stream. The example in Fig. 9 relates the increase of water level to the withdrawal of the local population of *Pholeuon* (Racovita, 1971).

Determining the size of cave beetle populations has been a concern of coleopterologists. Individuals captured at a given time have been marked and then recaptured after a period of time. Estimates can then be made by comparing the number of recaptured marked individuals with the total number of all marked ones. For example, the *Neaphaenops tellkampfi* in Mammoth Cave has been estimated to be 750,000 individuals (Barr and Kuehne, 1971). In France, the population of catopid *Speonomus* in a MSS station was estimated at 1,000,000 individuals for two species, and the population of trechine *Aphaenops* was estimated to be 100,000 individuals (Juberthie and Decu, 1998).

The presence of two or more beetle species in the same cave usually means that one of them is dominant, especially if they compete for the same food resources. The species can choose different places in the underground system and the predators different niches. In the Transylvanian caves, two genera of Leptodirinae coexist: *Pholeuon* and *Drimeotus*. With very few exceptions, *Drimeotus* is limited primarily to near the entrances and, in small numbers, in the network of cracks, while the *Pholeuon* are numerous throughout the entire cave. In Mammoth Cave, beside the numerous *Neaphaenops tellkampfi*, there are other two dominant trechine with different distributions: *Pseudoanopthalmus menetriesii*, which is found in the upper level, and *P. striatus*, which is found along the subterranean river. Mammoth Cave has one of the largest and most complex subterranean biological communities of all known caves, with no less than six trechine species, one pselaphid, and one catopid. In White Cave, the animal's entire life is dependent on crickets and to a lesser extent on a few pieces of rotten wood (Barr and Kuehne, 1971); a generalized food web for this com-



**FIGURE 10** Food web in White Cave. (Adapted from Barr and Kuehne, 1971.)

munity is shown in Fig. 10. On the partially decomposed cricket guano live saprophytic snails, isopods, millipedes, springtails, diplurans, and catopid beetles. These are eaten by spiders, harvestmen, pseudoscorpions, and trechine beetles (it has not been determined whether or not the predators are highly specialized).

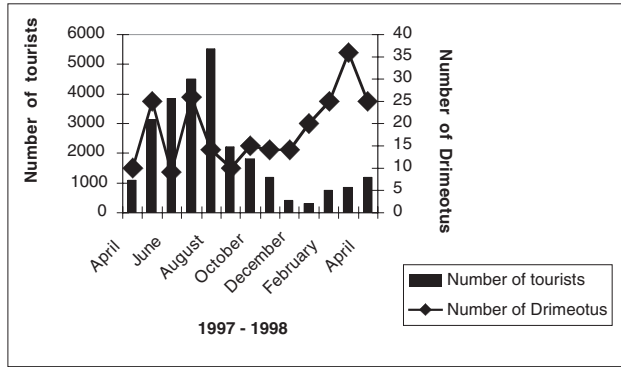
## IMPORTANCE AND PROTECTION

The diversity of species makes this group of cave invertebrates one of the best for testing many of the hypotheses concerning adaptation strategies during colonization of empty places on Earth. Cave beetles are also very precious to the natural biodiversity of the world. One species can populate one cave or one massif, so the degree of endemism is very high. On the other hand, in many regions the biospeleological explorations are only just beginning, and the task of the coleopterologist is to find and describe newly discovered species. The importance of their studies lies primarily in the development of knowledge regarding conservation management measures to be taken for more vulnerable or rare species. Experiments carried out in a Romanian show cave indicate that the presence of tourists has eliminated the troglobitic beetles from visited parts of the cave and has also influenced the yearly dynamics of the leptodirin population (Fig. 11) in the non-visited part.

Rare and having a strange morphology, cavernicolous species have attracted the attention of collectors, especially in Europe; however, laws to prevent overcollection of specimens from caves seem to have had little effect on this trade.

## Bibliography

- Barr, T.C. and R.A. Kuehne (1971) Ecological studies in the Mammoth Cave system of Kentucky. II. The Ecosystem. *Annl. Spéol.* 26(1): 47–96.
- Brusca, R.C. and G.J. Brusca (1990) *Invertebrates*. Sinauer, Sunderland, MA, 922 pp.
- Deleurance-Glaçon, S. (1963) Recherches sur les coléoptères troglobies de la sous-famille des Bathysciinae. *Annl. Sc. Nat.* 5 (1): 1–172.



**FIGURE 11** Variation in the number of *Drimeotus* in Ursilor Cave (Romania) as a function of tourist periods.

- Ginet, R. and V. Decou (1977) *Initiation à la Biologie et à l'Écologie Souterraines*, Delarge, Paris.
- Juberthie, C. and V. Decu, Eds. (1998) *Encyclopaedia Biospeologica*, Vol. II, Société de Biospéologies, Paris.
- Mohr, C.E. and T.L. Poulson (1966) *The Life of the Cave*, McGraw-Hill, New York.
- Osella, G. (1982) I Curculionidi cavernicoli italiani (Riassunto). *Lavori Soc. Ital. Biogeogr.* 7(1978); 337–338.
- Peck, S.B. (1981) Evolution of cave Cholevinae in North America (Coleoptera: Leiodidae). In *Proc. 8th Int. Congr. Speleology*, Bowling Green, KY, Vol. 2, pp. 503–505.
- Peck, S.B. (1986) Evolution of adult morphology and life-history characters in cavernicolous *Promphagus* beetles. *Evolution* 40(5): 1021–1030.
- Racovita, G. (1971) La variation numérique de la population de *Pholeuon (Parapholeuon) moczarzi* Cs. de la grotte de Vadu-Crisului. *Trav. Inst. Spéol. "E. Racovitza"* 10: 273–278.
- Sbordoni, V., R. Argano, V. Vomer, and A. Zullini. (1977) Ricerche sulla fauna cavernicola del Chiapas (Messico) e delle regioni limitrophe: grotte esplorate nel 1973 e nel 1975. Criteri per una classificazione biospeologica delle grotte. In *Subterranean fauna of Mexico*, part III, Accad. Naz. Lincei ed.
- Uéno, S.-I. (1957) Blind aquatic beetles of Japan with some accounts of the fauna of Japanese subterranean waters. *Arch. Hydrobiol.*, 53: 250–296.

## Behavioral Adaptations

Jakob Parzefall

Zoologisches Institut und Zoologisches Museum der Universität Hamburg

Animals living in darkness have to compete for food, mates, and space for undisturbed reproduction just as their epigeal conspecifics do in the epigeal habitats, but there is one striking difference: In light, animals can use visual signals. Thus, important aspects of behavior driven by visual signals cannot apply in darkness. The question arises, then, of how cave dwellers compensate for this disadvantage in complete darkness. This article uses several examples to compare various behavior patterns among cave dwelling populations with epigeal ancestors.

### COMPARISON OF BEHAVIOR PATTERNS IN CAVE DWELLING ANIMALS AND THEIR EPIGEAN RELATIVES

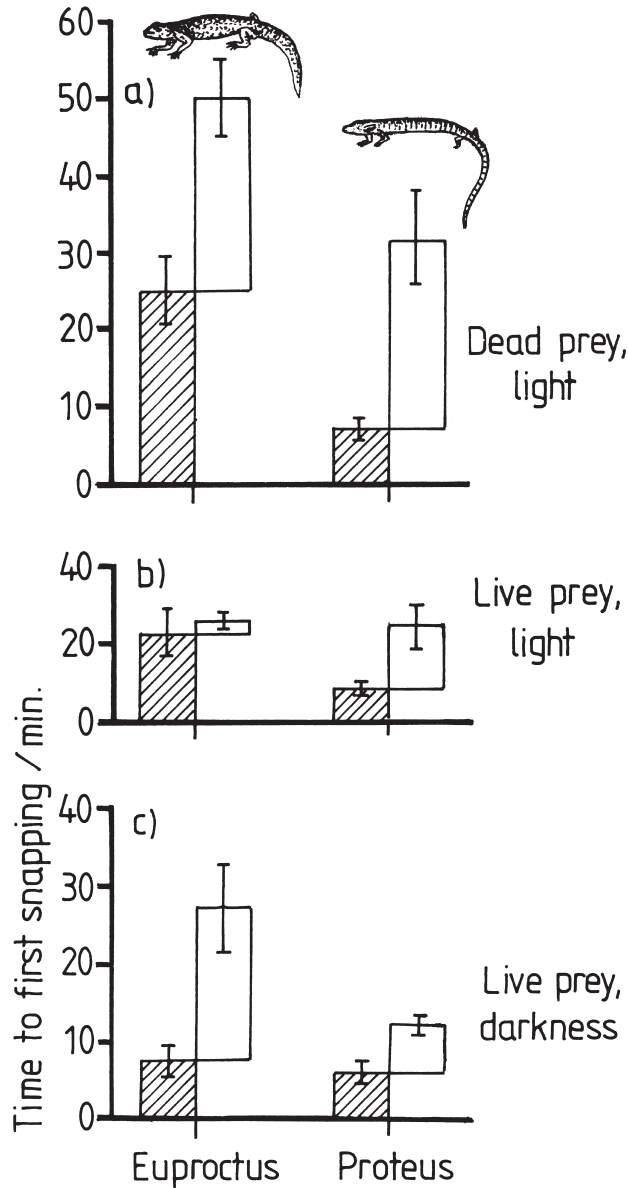
Potential cave dwellers must have the sense organs and behavior necessary to find food and to reproduce in caves. Such animals may be said to be preadapted to cave life, and in fact some of these animals can survive in the darkness without behavioral adaptations and can reduce behavioral characters not necessary in the caves. In contrast, some cave dwellers have improved sense organs and have acquired behavior adapted to their extreme habitats.

#### Food and Feeding Behavior

Suitable food sources and quantity vary from cave to cave. In general, cave animals depend upon food brought in from outside and are omnivorous. With some exceptions, most caves do not have an abundance of food compared to above-ground habitats. Food sources can be widely distributed or concentrated in patches, and their occurrence is mostly unpredictable; therefore, food-finding abilities have to be improved, and food must be stored to ensure survival during long starvation periods.

When the blind fish population of *Astyanax fasciatus* from Pachon Cave was studied in competition experiments conducted in darkness, it was found that they retrieved 80% of small pieces of meat distributed on the bottom of an aquarium, whereas the epigeal fish got only 20% (Hüppop, 1987). Among amblyopsid fish, which comprise six species in four genera, the ability to detect invertebrates at low prey densities in the dark is much better for the cave-living species *Amblyopsis spelea* than the troglophile *Chologaster agassizi*. When one *Daphnia* was introduced into a 100-L tank, the *A. spelea* found the prey hours before the *C. agassizi* did. In addition, the maximal prey detection distance is greater in cave species. *Daphnia* was detected by *Typhlichthys subterraneus* within 30 to 40 mm and by *C. agassizi* within 10 mm. (Poulson, 1963).

The reaction to prey by salamanders has been studied in the facultative cave-living Pyrenean salamander *Euproctus asper*, which has fully developed eyes, and the blind *Proteus anguinus*. Both species react to living and dead chironomids. Even in light, where *E. asper* can use their visual sense, *P. anguinus* required less time to initiate the first snapping response to dead prey. When the time between the start of an experiment and the first snap at prey was divided into pre-approach and approach phases, it turned out that the difference found could be attributed to the pre-approach phase (Fig. 1a). Living prey was detected more quickly than dead prey in both species, but *E. asper* needed more time in the darkness than did *P. anguinus* (Fig. 1b,c). These data show that *P. anguinus* is well adapted to search prey on the basis of chemical and mechanical information. In contrast, *E. asper* demonstrated a more directed, visually dominated



**FIGURE 1** Snapping response in *Euproctus asper* and *Proteus anguinus*. The mean time interval between the start of the experiments and the first snap at prey was divided into a pre-approach phase (hatched bars) and an approach phase (open bars) in three different experimental treatments. Standard errors of the mean are shown on top of the bars. (From Uiblein, F., Durand, J. P., Juberthie, C., and Parzefall, J., Behav. Proc., 28, 33–40, 1992. With permission.)

approach behavior with live prey in light and can switch to a more active, widely foraging mode with live prey in darkness and dead prey in light. This young cave colonizer seems less adapted to the dark but is capable of foraging successfully in both epigeal and hypogean habitats.

Compensating for the unpredictability of food quality and quantity also results in physiological adaptations. Cave animals are able to survive for long periods without food—nearly one year for invertebrates and up to several years for caves fishes and salamanders (Vandel, 1964). In *A. fasciatus*,

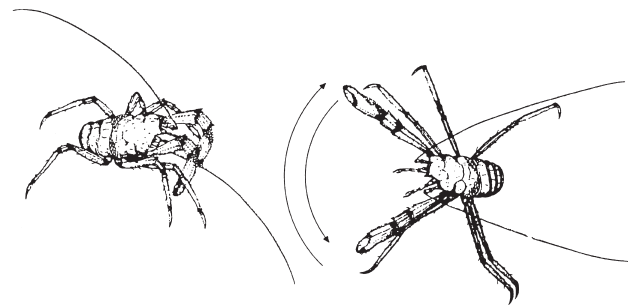
the cave fish are able to build up enormous fat reserves. A 1-year-old cave fish fed *ad libitum* had a mean fat content of 37 % fresh body mass compared to 9% in epigeal fish under the same conditions (Hüppop, 1987).

### Reproductive Behavior

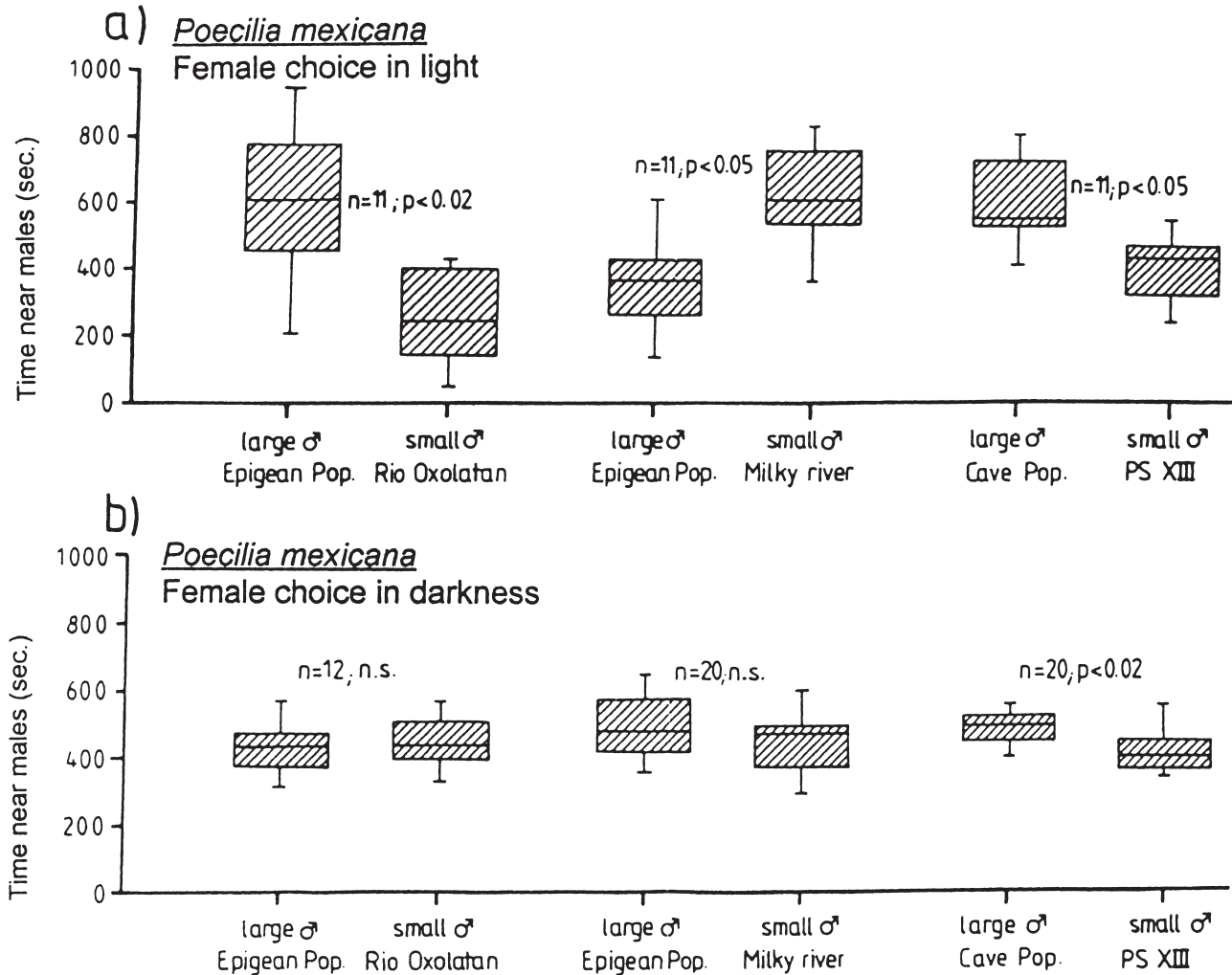
Having found enough food to reach sexual maturity, the next problem to be solved by cave dwellers is finding a sexual partner in the darkness. Subsequently, they need behavior patterns that provide effective fertilization in the absence of any visual orientation. In species with high population densities, it is easy for the male to find a female. The male of the galatheid crab *Munidopsis polymorpha* of the marine cave Jameos del Agua on Lanzarote in the Canary Islands receives a chemical signal sent by the molting female ready for reproduction (Parzefall and Wilkens, 1975).

In terrestrial invertebrates, a comparable situation has been observed: The females of the cave crickets *Hadenocerus subterraneus* and *H. cumberlandicus* that are ready to mate release an olfactory attractant. Normally, several males reach the attractive female at the same time. They can transmit information about their high reproductive fitness by sending tactile signals through the air by their elongated antennae as it is done by both of the cricket species. In *M. polymorpha* the male emits rhythmic water waves with chelipeds (Fig. 2). They must repeat these signals several times. The female eventually decides which male is good, accepts the sperm transfer (or not), and escapes.

A comparable situation has been found in the live-bearing poeciliid fish *Poecilia mexicana*, which lives in a high-population-density cave habitat. The males check conspecific females by nipping at the genital region. The females ready for reproduction produce a species-specific chemical signal and attractant for about 3 days during a cycle of about 28 days. A female accepting a male stops swimming and allows the copulation. Normally, bigger males are preferred on the basis of visual signals. Only the cave fish female is able to perform this behavior in darkness (Fig. 3); she does so by switching from the visual system to a lateral line system (the fish have one lateral line system only) (Parzefall, 2001).



**FIGURE 2** The male *Munidopsis polymorpha* (right) displays with cheliped shaking in front of a female. (From Parzefall, J. and Wilkens, H., Ann. Spéleol., 30, 325–335, 1975. With permission.)



**FIGURE 3** Female choice behavior in different populations of *Poecilia mexicana* in (a) light and (b) darkness. The female had the choice to swim to the compartment of a big or a small mature male, and the time spent in a male compartment was measured. A clear partition prevented direct contact. The middle line in the box plot represents the median; the upper end of the box, the 75% value; the lower end of the box, the 25% value. The whiskers represent the 90% and 10% values, respectively. (From Parzefall, J., *Environ. Biol. Fishes*, 62, 263–275, 2001. With permission.)

In the above-mentioned crab and cricket species, data about sexual behavior in their epigean relatives are lacking, so we cannot determine whether the reproductive behavior has changed in adaptation to the dark habitat. For *Poecilia mexicana*, comparative data on epigean conspecifics reveal that in the epigean habitat visually orientated sexual displays are lacking, in contrast to other species of the genus such as *P. velifera*, *P. latipinna*, and *P. reticulata*. So, *P. mexicana* seems to be preadapted to cave life and has improved their reproductive fitness in the dark by means of a special female choice behavior based on a lateral line system (the fish have one lateral line system only).

Species with lower population densities in cave habitats, such as the characid fish *Astyanax fasciatus* or the salamander *Proteus anguinus*, attract conspecifics from chemical signals transmitted in the water. Comparative studies with the epigean proteid *Necturus maculosus* have demonstrated that

this information is species specific (Parzefall *et al.*, 1980). The animals also constantly deposit a substance while in contact with the substrate and at communal resting places. This substance is individual specific but does not provide any detailed information about sex or reproductive state; it merely brings members of the species together. For recognition of sex and reproductive state, *Proteus* requires direct contact. When sexually motivated, a male establishes a territory that a female may enter only after direct body contact. The male sends a chemical signal by fanning his tail against the female and from time to time begins to walk away. The female follows and nips at the genital region of the male. After a short walk, they stop and the male deposits a spermatophore, which the female retrieves and places in her cloacal region. Unfortunately, comparative data in the epigean salamander *Necturus maculosus* are lacking.

### Aggressive Behavior

Aggressive behavior consists of different patterns of threatening postures and attacks followed by fights. This behavior has various functional aspects and is absolutely necessary in darkness; therefore, it has to be adapted to cave conditions.

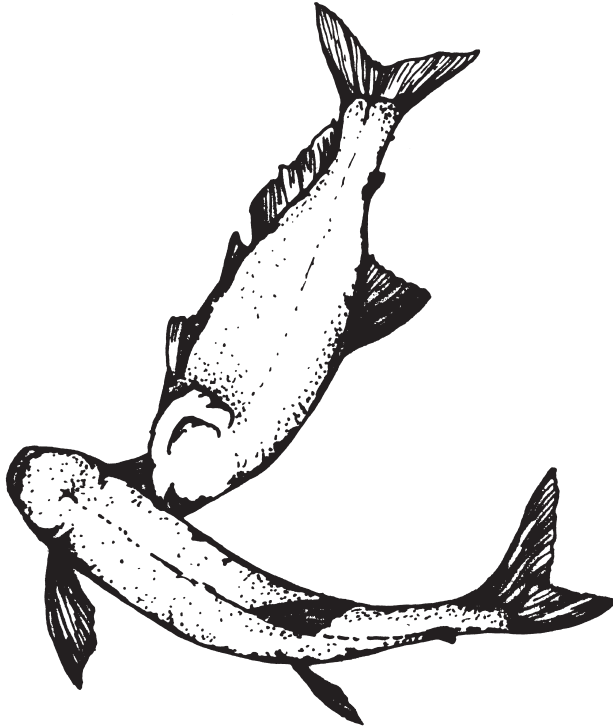
**COMPETITION FOR FOOD** Food competition results in food territories for groups, pairs, or solitary animals. Within a group, a limited food supply can lead to aggressive encounters. In general, defending food resources is only adaptive when the costs are not higher than the potential incoming energy of the food. The majority of data available regarding aggression among cave and epigeal populations is for the characid fish *Astyanax fasciatus*. The epigeal form is widely distributed in Mexico. When undisturbed, the epigeal fish defends small territories of 10 to 20 cm, depending on body size, by fin spreading, snake swimming, and Ramming (Fig. 4). In the laboratory, epigeal fish of both sexes display the entire aggressive pattern. The subordinate fish demonstrates submission by a head-up position and trying to hide or escape. The fights can be very strong; in

smaller aquaria that offer no place to hide the death of the subordinate fish can result.

Aggressive behavior depends on optical releasers. Using dummies of different types, it has been found that natural shape and locomotion are important visual signals. Tests with infrared video have shown that the epigeal fish is not able to perform aggressive patterns in complete darkness (Hausberg, 1995). They do not establish territories at all. From such data we can conclude that epigeal fish, when colonizing caves, were no longer able to perform aggressive encounters. In the blind populations of the Pachon, Piedras, and Yerbaniz caves, Hausberg (1995) noted a high percentage of fish with injuries on fins and scales. In an experiment with the Pachon population, the number of injured fish increased in the absence of food. The aggressive behavior observed within this fish includes defending small territories of a few centimeters by biting, circling, and tail beating (Fig. 5). Also in these experiments, a striking difference in swimming behavior was observed; the fish that were regularly fed glided slowly through the water of the entire aquarium without initiating aggressive encounters against conspecifics. When food was lacking, the locomotor activity decreased. The fish mostly hovered at the bottom and rhythmically flicked their fins;



**FIGURE 4** Aggressive patterns in the epigeal *Astyanax fasciatus*. (a) Aggressive fin erection; the head-down position of the fish on the right expresses a higher aggressive motivation. (b) Snake swimming is shown by the fish on the right and aggressive fin erection by the fish on the left. (c) The fish on the left is ramming against the one on the right. (d) Both fish show circling and tail beating. (From Parzefall, J. and Hausberg, C., *Mém. Spéleol.*, 28, 153–157, 2001. With permission.)



**FIGURE 5** Ramming and circling in the Pachon cave population of *Astyanax fasciatus*. (From Parzefall, J. and Hausberg, C., *Mém. Spéleol.*, 28, 153–157, 2001. With permission.)

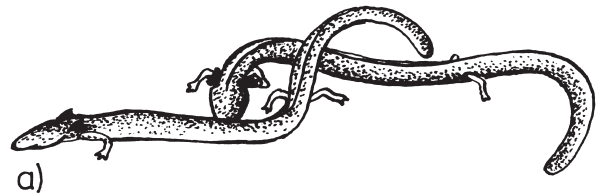
fish entering the small area of a few centimeters were attacked. The territory size was correlated with the aggressiveness of the fish, and the aggressive patterns differed from those shown in epigean fish. The cave fish has developed an aggressive behavior with signals that are only effective in close body contact.

Among cave-living invertebrates, the galatheid crab *Munidopsis polymorpha* of the marine cave Jameos del Agua on Lanzarote in the Canary Islands feeds mainly on diatoms on lava rocks. The animals keep a minimal distance from one another according to the length of their second antenna (Fig. 6). Any closer than this distance, and *Munidopsis* attacks with its extended chelipeds and by snapping its pincers. This behavior does not depend on optical releasers but on water movements (Parzefall and Wilkens, 1975). The aggressive patterns of *Munidopsis* are very similar to the one described for the deep-water, bottom-living, epigean galatheid *Munida sarsi*. The author believes that, despite their naturally dim environment, vision is still the primary sense involved in the aggressive behavior of this species, so it appears that the aggressive behavior of galatheids is effective in light and in darkness, with no striking differences.

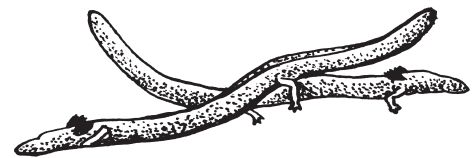
**COMPETITION FOR MATES: TERRITORIALITY AND RANK ORDER** In the blind cave salamander *Proteus anguinus*, studies in the laboratory have revealed that males show aggressive behavior and territoriality for only a very short reproductive period. Normally, the animals rest under



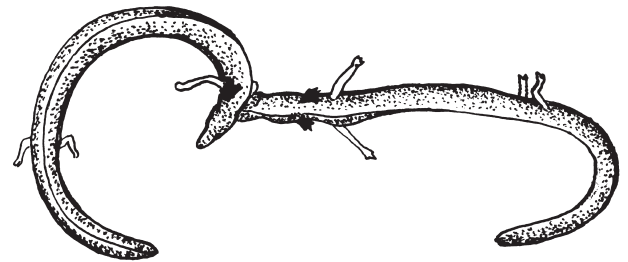
**FIGURE 6** Aggressive interactions among *Munidopsis polymorpha*. (From Parzefall, J. and Wilkens, H., *Ann. Spéleol.*, 30, 325–335, 1975. With permission.)



a)



b)



c)

**FIGURE 7** Aggressive behavior of a *Proteus anguinus* male against an intruder in his territory: (a) body contact (chemical identification); (b) tail beating; (c) biting. (From Parzefall, J. *Z. Tierpsychol.*, 42, 29–49, 1976. With permission.)

stones in groups of both sex without any aggressive reaction. When a male became sexually active, it begins to control its conspecifics by contacts with his snout and allows only females in the reproductive state to remain in the hiding place. Intruders will be attacked by tail beating, ramming, and biting in close body contact (Fig. 7). After being attacked in a particular territory, *Proteus* avoids that territory for several days on the basis of chemical cues on the substrate. In the Poeciliid fish *Poecilia mexicana*, males use aggressive behavior to establish a size-dependent rank order within a



mixed school. The females have a reproductive cycle of about 28 days and are attractive to males within the first 3 days of the cycle. The dominant male controls the females by nipping in response to an attractive female. In the field, the pair separates from the shoal and become more or less sedentary. The male nips and tries to copulate while also defending the female. During aggressive encounters with more or less equal-sized males, small males use a female-like body coloration to try to sneak copulations (Parzefall, 1979). The population of *P. mexicana* that colonized a limestone cave in Tabasco (Mexico) does not school, and the males do not fight. In laboratory studies with epigeal fish and cave fish having functional eyes, a quantitative, genetically based reduction of aggressive patterns and schooling has been demonstrated (Parzefall, 1979). The reaction are highly variable within the population. Some of the cave fishes tested seemed unable to understand the attacks and answered by nipping and copulation attempts. It seems that aggression in these cave fishes is a disadvantage, because fighting males risk losing the opportunity for contact with an attractive female in darkness.

## DISCUSSION

Studies of behavior in cave dwellers have revealed complex systems of responses to visual, chemical, and tactile stimuli. Many animals can survive in complete darkness with no visual signals. The use of weak electric signals among cave dwellers has not been detected. In some cases, an existing behavior (such as the aggression exhibited by *Astyanax fasciatus*) has changed to a more effective behavioral system. These changes are always based on existing above-ground behavior, and no completely new behavioral character has been found in cave animals.

### See Also the Following Articles

*Morphological Adaptations*

### Bibliography

- Hausberg, C. (1995) Das Aggressionsverhalten von *Astyanax fasciatus* (Characidae, Teleostei): Zur Ontogenie, Genetik und Evolution der epigäischen und hypogäischen Form [unpublished dissertation]. University of Hamburg, Germany, p. 139.
- Hüppop, K. (1987) Food finding ability in cave fish (*Astyanax fasciatus*). *Int. J. Speleol.* 16: 59–66.
- Parzefall, J. (1979) Zur Genetik und biologischen Bedeutung des Aggressionsverhaltens von *Poecilia sphenops* (Pisces, Poeciliidae): Untersuchungen an Bastarden ober- und unterirdisch lebender Populationen. *Z. Tierpsychol.* 50: 399–422.
- Parzefall, J. (1989) Sexual and aggressive behaviour in species hybrids of *Poecilia mexicana* and *Poecilia velifera* (Pisces, Poeciliidae). *Ethology* 82: 101–115.
- Parzefall, J. (2001) A review of morphological and behavioural changes in the cave molly, *Poecilia mexicana*, from Tabasco, Mexico. *Environ. Biol. Fishes* 62: 263–275.
- Parzefall, J. and C. Hausberg (2001) Ontogeny of the aggressive behaviour in epigeal and hypogean populations of *Astyanax fasciatus* (Characidae, Teleostei) and their hybrids. *Mém. Spéleol.* 28: 153–157.

- Parzefall, J. and H. Wilkens (1975) Zur Ethologie augenreduzierter Tiere: Untersuchungen an *Munidopsis polymorpha* Koelbel (Anomura, Galatheidae). *Ann. Spéleol.* 30: 325–335.
- Parzefall, J., J.P. Durand, and B. Richard (1980) Chemical communication in *Necturus maculosus* and his cave-living relative *Proteus anguinus* (Proteidae, Urodela). *Z. Tierpsychol.* 53: 133–138.
- Poulson, T.L. (1963) Cave adaptation in amblyopsid fishes. *Am. Midl. Nat.* 70: 257–290.
- Vandel, A. (1964) *Biospéologie 1964: La Biologie des Animaux Cavernicoles*. Gauthier-Villars, Paris.

# Breakdown

Elizabeth L. White

*The Pennsylvania State University*

Cave roofs and walls are rarely stable. Rockfall pieces range from small isolated blocks to complete ceiling collapse. The term *breakdown* refers to the masses of rock fragments found mostly on cave floors. Breakdown is frequently mentioned in the literature and is ubiquitous in most caves. This article considers breakdown mechanics and outlines a number of geological processes that could set the stage for breakdown. Many of the field observations were made in the Flint Ridge Section of Mammoth Cave and in the historic sections of Mammoth Cave located in south-central Kentucky. Most of the observations for folded-limestone caves were made in Appalachian Mountain caves of Pennsylvania and West Virginia. The observations for the younger Tertiary and Pleistocene limestone caves were made on Mona Island (off the coast of Puerto Rico) and on San Salvador Island in the Bahamas.

## BREAKDOWN MORPHOLOGY

Perhaps the most common breakdown feature is the breakdown-littered cave floor as shown in Fig. 1. Piles of breakdown are unsorted and highly permeable. Layering is undistinguishable or nonexistent. From this reference point one can distinguish small-scale breakdown features that are the various types of breakdown blocks themselves and large-scale features that are cavern features consisting of (or generated by) breakdown processes.

### Small-Scale Features

Breakdown can be classified by the relationship of individual blocks to the bedding of the parent bedrock:

- Block breakdown* consists of masses of rocks with more than one bed remaining as a coherent unit.
- Slab breakdown* consists of fragments of single beds.
- Chip breakdown* consists of small rock chips and shards derived from the fragmentation of individual beds.



FIGURE 1 Breakdown-littered cave floor.

This classification has the advantage that breakdown observed in the field can be properly classified without speculation as to its origin; however, it has the disadvantage of also being a function of the limestone lithology. Thus, limestone fragments of a given intermediate size might be blocks if derived from a thin-bedded limestone or slabs if derived from a massively bedded limestone. In general, however, this classification has been found useful for the areas studied.

Block breakdown can be massive; blocks measure up to tens of meters on a side and are usually bounded by bedding planes along the bedding and by joint planes across the bedding. Slab breakdown has a plate shape, with slab thickness being controlled by the thickness of the beds; the width of individual slabs varies from tens of centimeters to many meters. Chip breakdown ranges in size from centimeters to tens of centimeters; the shape of chip breakdown is variable and dependent on the process that created the breakdown. Crystal wedging, frost pry, and closely spaced joints produce very angular chunks, whereas pressure-induced spalling and mineral replacement produce flatter, more irregular shards.

In the Flint Ridge Section of Mammoth Cave, slab breakdown is the most common and is distributed through all levels of the cave. Block breakdown occurs where major roof collapse has taken place and where dividing walls have fallen between coalescing vertical shafts. An extensive breakdown has occurred in the upper gallery of the Great Salts Cave Section. This passage is floored with block and slab breakdown to a depth of 12 or more meters for a distance of more than a kilometer. The largest breakdown block so far observed in this passage is a single block 19 m long, 4.5 m wide, and 1 m thick.

### Large-Scale Features

Although breakdown blocks form a variety of features in caves ranging from a few scattered blocks to major collapsed passages, it is useful to describe two types of features: termi-

nal breakdown and breakout domes. *Terminal breakdown* occurs at the end of collapsed major cave passages. Eroding valleys on the surface have the effect of causing collapse (breakdown) in the caves below. Massive breakdown that completely occludes a cave passage is referred to as terminal breakdown. In a number of caves, artificial entrances have been created where the cave passage would have intersected the surface topographic valley. In the Central Kentucky Karst, a terminal breakdown is the most common terminator of passages. Often the terminal breakdown contains sandstone as well as limestone fragments where the collapse has extended upward to the overlying caprock. Major trunk passages beneath the sandstone-capped plateau were once continuous feeder conduits carrying groundwater from the Sinkhole Plain to the south and east of the plateau to Green River in the north. These formerly continuous passages have been truncated by ceiling collapse. Some are actual intersections of the passages with the surface; others have collapsed at depth. The present-day configuration of the cave system is due in large part to these random features of collapse. Similar terminal breakdown occurs in many other caves with and without caprock.

Breakout domes, among the most remarkable of cavern features, are the huge rooms that form as a result of major ceiling collapse. Some of these, such as Chief City in Mammoth Cave, have floor dimensions of more than 100 m and ceiling heights of 30 m. The Rumble Room in the Rumbling Falls cave system under Fall Creek Falls State Park in Tennessee has a ceiling about 20 stories tall. This breakout dome is the largest in the eastern United States and the second-largest breakout dome known in the United States. Other breakout domes include Rothrock Cathedral in Wyandotte Cave (Indiana), the entrance room in Hellhole Cave (West Virginia), the entrance room in Marvel Cave (Missouri), Devil's Sinkhole (Texas), and Salle de la Verna in Pierre Saint-Martin (France). The details of the enlargement mechanism are less clear in Devil's Sinkhole than in the others mentioned, although it also has the beehive-shaped room and the gigantic debris cone typical of all breakout domes.

Careful examination of many breakdown areas reveals a continuum of sizes, from very large breakdown rooms to small, roughly circular or elliptical breakdown areas in cave ceilings. The features at the small end of the scale are sometimes only 3 m in diameter and involve only one or two beds. The morphological term *breakout dome* describes all such features, regardless of their size.

Debris piles vary in size from dome to dome, but in those domes that are accessible the volume of debris is much smaller than the enclosing volume of the dome. Because the bulk density of the debris cone is considerably less than that of the original bedrock, it is apparent that large quantities of material must have been removed. Large breakout domes must therefore have formed at a time when water was actively circulating near their base. The dome could then enlarge by

a mechanism of solution action on fallen blocks with concurrent stoping of the sides. The dome itself is usually circular or elliptical in contour. The top is often capped by a single massive bed.

**BREAKDOWN MECHANICS**

Breakdown is generally assumed to be formed by simple mechanical bed failure due to gravitational load. Proposed failure mechanisms include brittle fracture of incompetent beams (White and White, 1969, 2000) and failure by inelastic creep (Tharp and Holdrege, 1994; Tharp, 1995). The brittle fracturing provides the simplest model for breakdown occurrence—the concept dates back to the work of Davies (1951), who based his model on the mining literature. The model assumes a rectangular passage formed in well-bedded limestone. A small amount of elastic sag of the unsupported roof beds causes these beds to separate slightly. Figure 2 shows the parameters of the fixed-beam model and the dome shape of the stress distribution. The beds act as fixed beams across the cave passage. For the ceiling to be stable, the bending strength of the beams must be greater than the gravitational force acting on the weight of the unsupported span. Thicker beds are stronger than thin beds. There will be a critical thickness ( $t_{\text{CRIT}}$ ) for any given passage width at which the strength of the bed is just sufficient to support its weight. When the mechanics are worked out, only the length of the beam ( $L$ ) and the critical bed thickness ( $t_{\text{CRIT}}$ ) remain. The width of the beam cancels out. The beam length ( $L$ ) is set equal to the passage width, while the extent of the ceiling bed along the axis of the cave passage does not enter the calculation. Figure 3 shows the roof stability according to the fixed-beam model. For a fixed beam, the critical thickness is:

$$t_{\text{CRIT}} = \frac{\rho L^2}{2S(\cos \theta)} \tag{1}$$

where  $\rho$  is the density of the bedrock (in  $\text{kg/m}^3$ ),  $\theta$  is the bedding dip (in degrees), and  $S$  is the flexural strength (in MPa). If the ceiling beds are not supported at both sides of the cave passage, they are treated as cantilever beams for which the critical thickness is:

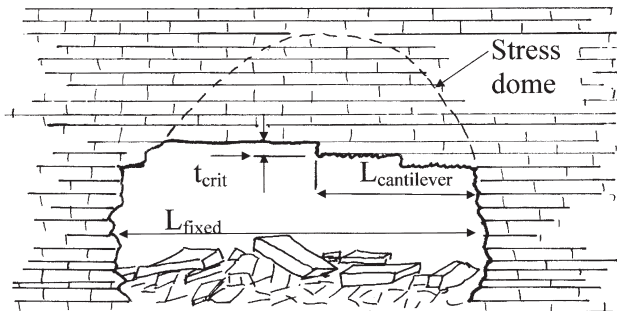


FIGURE 2 Sketch showing the parameters of the fixed-beam model.

$$t_{\text{CRIT}} = \frac{3\rho L^2}{2S(\cos \theta)} \tag{2}$$

The fixed-beam model implies a completely elastic response of the ceiling beds. It does not allow for plastic deformation and long-term creep that could lead to bed failure in the absence of any geologic triggers. It also has no time dependence; a stable ceiling would remain stable until some geologic process destabilized it. Numerous occurrences of recent breakdown have been reported. Some have occurred near entrances where freeze–thaw cycles may be responsible. Some have occurred deep in the cave but in areas of active vadose water. However, a fraction of recent breakdown occurrences are in dry passages with no obvious triggering mechanism.

There have been four documented roof failures in Mammoth Cave in the past century. Three were massive rockfalls, but the fourth involved a plastically deformed ceiling slab that had been mapped in detail. The slab displayed extensive plastic deformation in the 1960s. Sometime in the early 1970s it fell.

A more comprehensive model allows for inelastic creep (Tharp and Holdrege, 1994; Tharp, 1995). Materials break through a mechanism of crack propagation. Tharp’s model is based on the propagation of micro-cracks, which allow deformation and creep. The crack propagation velocity is given by:

$$v = c \left( \frac{K_I}{K_{Ic}} \right)^n \tag{3}$$

where  $K_I$  is the stress intensity ( $\text{MPa m}^{0.5}$ ),  $K_{Ic}$  is the fracture toughness of the bedrock, and  $c$  is a constant related to the activation energy for crack movement. The parameter  $c$  is given by:

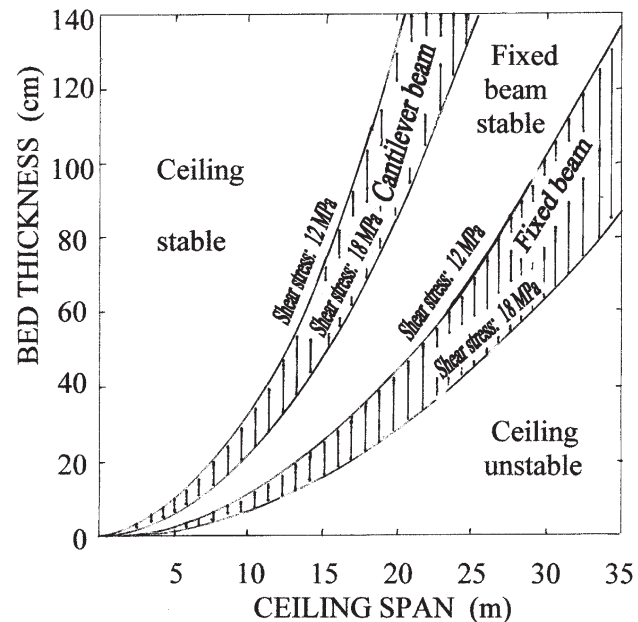


FIGURE 3 Cave roof stability according to the fixed-beam model for the special case of horizontal beds. Typical values of shear stress for Paleozoic limestones range from 12 MPa (1700 psi) to 18 MPa (2600 psi).

$$c = V_0 e^{\frac{-H}{RT}} \quad (4)$$

where  $H$  is the enthalpy of activation = 67–147 kJ/mole;  $R$  is the gas constant = 8.3145 J/K;  $V_0$  and  $n$  are fitting constants.

Propagation of micro-cracks allows inelastic deformation and also a time-to-failure. Using the Tharp model, the time-to-failure is the time scale of crack propagation through beds of nominal thickness. The time frame can range from thousands of years to as much as 1 million years. Thus, the time to failure can be in the same range as the age of the cave passage, implying that breakdown can occur at any time, even in the absence of geologic triggering processes.

The Tharp model introduces fracture toughness as another parameter in addition to the flexural strength for determining whether particular beds will collapse. The Paleozoic limestones of the eastern United States (where many of the breakdown investigations have been made) are dense, fine-grained rocks. Coarse fracturing occurs along joints and bedding plane partings. But, within the rock mass there is little to inhibit crack propagation, and these rocks break mainly by brittle fracture. It is for this reason that the fixed-beam model has worked so well.

Porous and vuggy rocks, such as the Tertiary limestone beds of the Caribbean, may have a lower flexural strength but they have higher fracture toughness, because pores and vugs inhibit crack propagation. The caves on Mona Island in Puerto Rico have large, relatively flat chambers with little breakdown because of the toughness of the porous, young limestone beds. Because of the inability of the limestone beds to propagate cracks, roof spans of 30 m or more are found throughout these caves.

## BREAKDOWN PROCESSES

### Crystal Wedging or Mineral-Activation To Initiate Breakdown

Many breakdown areas in caves with extensive sulfate minerals (primarily gypsum) suggest that crystal wedging and replacement of limestone by gypsum are important factors in this type of cavern collapse. Features that are characteristic of mineral-activated breakdown are: (1) walls and ceilings fractured in irregular patterns, often with visible veins of gypsum following the fractures; (2) breakdown consisting of thin, irregular splinters and shards of bedrock; and (3) curved plates of bedrock ranging in size from a few centimeters to more than a meter hanging from the ceiling at steep angles cemented only by a thin layer of gypsum. Microscope examination of thin sections of the bent beds shows that the sagging and bending are due to the direct replacement of limestone by gypsum. Figure 4 shows the curved breakdown slabs in Turner Avenue in Mammoth Cave. Another characteristic feature is the collapses that take the form of symmetrical mounds with coarse, irregular blocks at the base grading upward into a rock flour at the top.



**FIGURE 4** Thin plates and fragments, some held to the ceiling by gypsum, in the Upper Turner Avenue in Mammoth Cave (Kentucky). Total width of image is approximately 1 m.

Crystal wedging produces a subset of chip breakdown. Chip breakdown consists of rock fragments that are smaller than individual bedding plane slabs and can result from many processes, including purely mechanical ones. Crystal wedging breakdown appears to be of two types. Type I consists of angular rock fragments broken on sharp planes that cut the bedding planes. Type I breakdown, with fractures filled with gypsum, results from mechanical wedging due to crystallization of the gypsum. Similar rock fragments are found near cave entrances, where they result from frost action. Type II breakdown is more complex. The fragments and plates are angular and sharp and are fractured across the usual zones of weakness—bedding planes and joints. Many of the fragments, only a few centimeters on a side and less than a millimeter thick, crush like broken glass when walked upon. These irregular plates are the signature of the crystal wedging process. The limestone bedrock is shattered and intermixed with gypsum so that the passage walls become piles of rubble.

### Geologic Processes That Initiate Breakdown

Within the context of either the fixed-beam or Tharp model, any geologic processes that lengthens the beams or converts fixed beams into cantilever beams can move the ceiling beds from stable to unstable configurations. Beam thickness, flexural strength, and fracture toughness are properties of the bedrock and do not change during evolution of the cave passage. A list of triggering processes, not necessarily complete, is as follows:

- Passage enlargement below the water table.* Phreatic passages continue to enlarge as water flows through them. If the hydrologic conditions are such that the passage is not drained, it may continue to enlarge until it becomes mechanically unstable
- Removal of buoyant support.* By Archimedes' principle, the ceiling beds of a water-filled cave passage are buoyed

upward by a force proportional to the ratio of the density of water to the density of the bedrock. For limestone with a typical density of 2.65 g/cm<sup>3</sup>, 35% of the buoyant support of the ceiling is lost when the cave is drained.

*Effects of base-level back flooding.* During the time when the emergent cave passage is in the flood-water zone, rises and falls in base level alternatively fill and drain the cave passage. Additional dissolution at this time, particularly dissolution along ceiling joints, can turn fixed beams into cantilever beams and destabilize the ceiling.

*Action of vadose water.* Formation of vertical shafts, solution chimneys, and solutionally enlarged fractures by the action of undersaturated vadose water often has the effect of cutting ceiling beds, thus changing fixed beams into cantilever beams.

*Ice wedging.* Caves that draw in cold winter air can have freezing conditions some distance inside. When water moving through joints and bedding plane partings freezes, then the expansion creates enough force to fracture the bedrock.

*Crystal wedging.* Replacement of calcite in the bedrock by other minerals can exert a wedging effect. Because gypsum has a greater volume than the calcite it replaces, enough force is generated to fracture the bedrock.

### Role of Breakdown in Speleological Processes

Both geologic triggering and slow creep of beds under load assure that breakdown can occur at any time during the evolutionary history of a cave passage; however, breakdown processes are most active during the enlargement phase of cave development and during the decay phase of cave development. The role of breakdown in the enlargement phase includes the following:

Breakdown during the enlargement phase exposes more limestone surfaces and thus increases the rate of dissolution.

Upward stoping by breakdown processes can create large chambers, if actively circulating water removes the breakdown blocks at floor level.

Upward stoping along fracture zones with removal of fallen blocks results in the formation of stoping shafts; Sótano de las Golondrinas in Mexico is an outstanding example.

Breakdown in master conduits, particularly during the floodwater stage, can provide a support structure for groundwater dams. Silt and clay that deposit behind the blockage seal the dam, raise hydraulic heads upstream, and thereby generate a hydraulic gradient for the formation of new tap-off passages.

Breakdown continues to play a role during the stagnation and decay phases of cave development as follows:

Breakdown processes can stope upward to interconnect previously isolated cave levels into an integrated system of passages.

Truncation of cave passages by the formation of terminal breakdown is a dominant process in the breakup of continuous conduits into the fragments characteristic of the decay stage of cave development.

The final phase in the decay of caves is the passage collapse that takes place when the eroding land surface intersects the stress dome in the rocks of the cave ceiling.

The final residue of a cave is a rubble zone consisting largely of breakdown.

### Bibliography

- Davies, W.E. (1951) Mechanics of cavern breakdown, *Natl. Speleol. Soc. Bull.* 13: 36–43.
- Tharp, T.M. and T. J. Holdrege (1994) Fracture mechanics analysis of limestone cantilevers subject to very long term tensile stress in natural caves. In *First North American Rock Mechanics Symposium Proceedings* (P.P. Nelson and S.E. Laubach, Eds.). A.A. Balkema, Rotterdam, pp. 817–824.
- Tharp, T.M. (1995) Design against collapse of karst caverns. In *Karst Geohazards* (B.F. Beck, Ed.). A.A. Balkema, Rotterdam, pp. 397–406.
- White, E.L. and White, W.B. (1969) Processes of cavern breakdown, *Natl. Speleol. Soc. Bull.* 31: 83–96.
- White, E.L. and White, W.B. (2000) Breakdown morphology. In *Speleogenesis: Evolution of Karst Aquifers* (A.B. Klimchouk, D.C. Ford, A.N. Palmer, and W., Dreybrodt, Eds.). National Speleological Society, Huntsville, AL, pp. 427–429.

## Burnsville Cove, Virginia

Gregg S. Clemmer

*Butler Cave Conservation Society, Inc.*

### INTRODUCTION

For more than half a century, cavers have pushed, explored, and mapped the caves of Virginia's Burnsville Cove. Located near the Bath/Highland County border approximately 80 km west of Staunton, VA, this sparsely populated area is known for its rural, scenic character. The systematic study and mapping of Breathing Cave by Nittany Grotto of The Pennsylvania State University, beginning in 1954, marked the first organized effort to chart what was then the largest and best known cave in Burnsville Cove. Initial work produced an overland topographic survey, passage cross sections and longitudinal profiles, and an analysis of the cave's formation relative to stratigraphic folds and faults (see Fig. 1).

Bevin Hewitt's dramatic aqualung dive into the Mill Run spring in 1956 and his discovery of Aqua Cave beyond fueled interest in finding more caves in the Cove. Ike Nicholson's

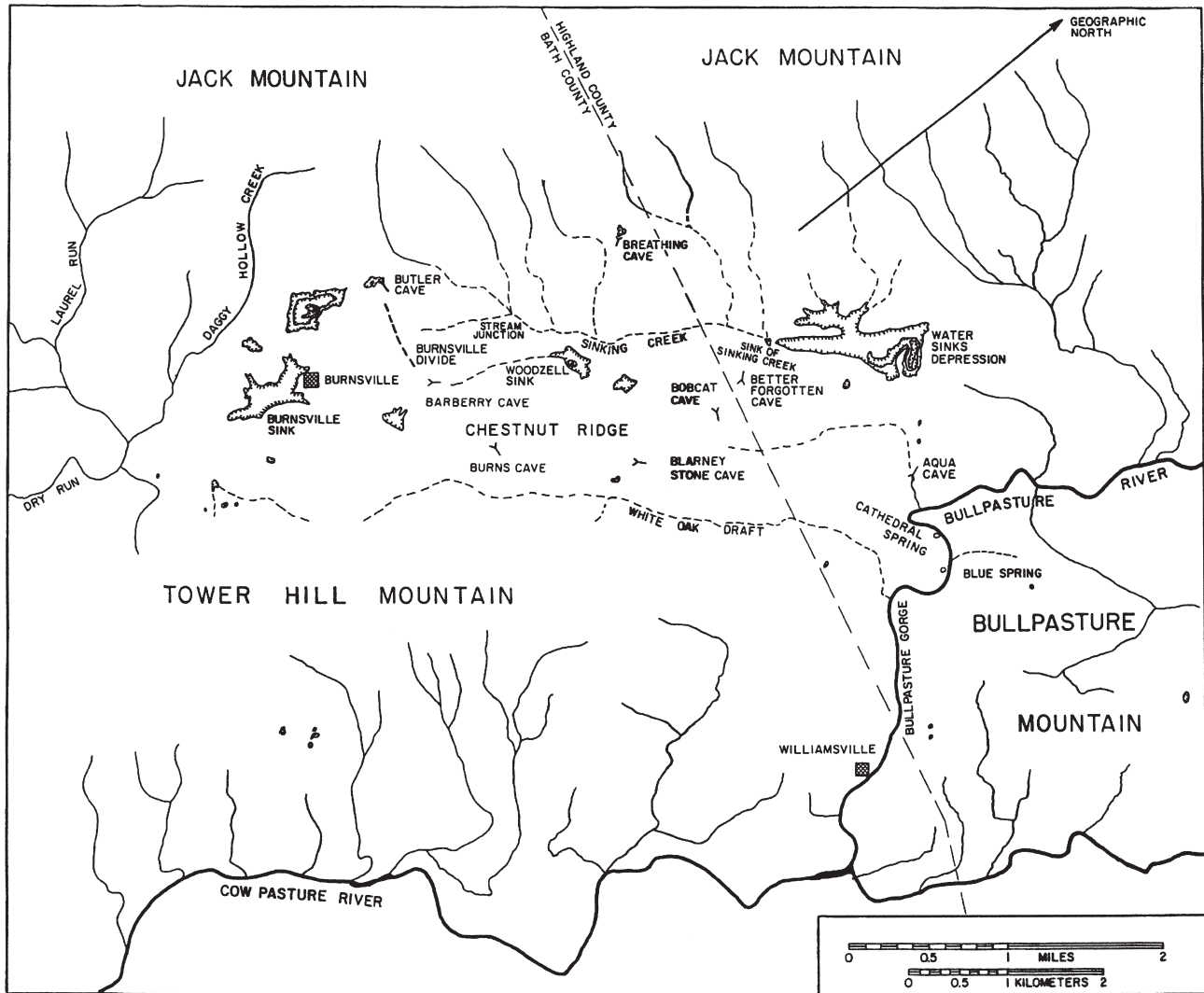


FIGURE 1 (A) Map of Burnsville Cove showing the drainage system, location of caves, and large surface depressions.

discovery of Butler Cave 2 years later (Clemmer, 2001) and the rapid discovery of more than 16 km of large cave passages there, including the Sinking Creek trunk, confirmed that Burnsville Cove possessed vast underground secrets.

The 1982 Burnsville Cove Symposium summarized the geology and cave descriptions of the Burnsville Cove reported to that date. Nicholson and Wefer (1982) described five caves—Boundless, Breathing, Butler, Better-Forgotten, and Aqua—as being part of an underground integrated karst drainage system situated between Jack Mountain to the west and Chestnut Ridge to the east. These caves, although not connected by human transit, comprised the Butler Cave–Sinking Creek Cave System, described at that time as containing approximately 35 km of mapped passages.

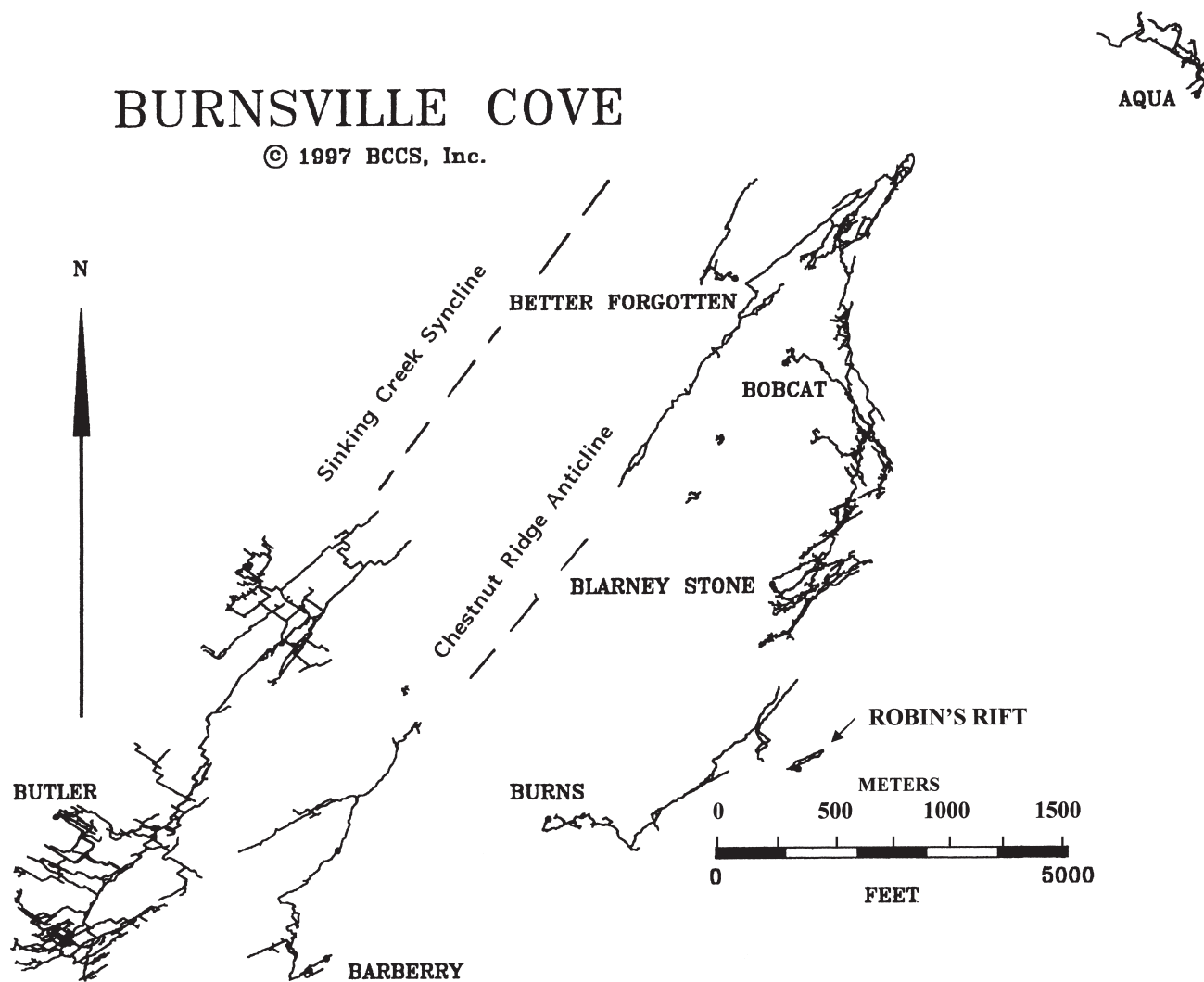
Over the past two decades, additional discoveries and mappings have greatly expanded the extent and understanding of this cave system. With more than 88 km of mapped cave passages in Burnsville Cove, this isolated corner of the

Old Dominion ranks as one of the primary karst regions in the United States.

### PHYSICAL AND GEOLOGIC SETTING

Burnsville Cove sits astride the Highland/Bath County line, 20 km southwest of the village of McDowell, VA. Bordered by Jack Mountain on the west and Tower Hill Mountain to the east, the Cove is a broad, dual-synclinal valley, split longitudinally by a folded anticlinal ridge known as Chestnut Ridge. The region measures approximately 8 km long and 5 km wide and plunges geologically to the northeast.

The Helderberg limestones of Silurian–Devonian age make up the exposed karst of the Cove. The stratigraphy of the Helderberg is not a uniform calcareous sequence, a fact that significantly impacts the speleogenesis of the area (Hess and White, 1982). The Helderberg, which sits atop the shaly Tonoloway limestone member of the Cayuga Formation, is about 150 to 160 m thick. From bottom to top, the



**FIGURE 1** (continued) (B) outline map showing principal caves in Burnsville Cove in relation to each other and to the geologic structure. (Maps courtesy of the Butler Cave Conservation Society.)

sequence consists of the Keyser limestone (100 m thick), the Coeymans (12 m), the New Scotland (5 m), and the Becraft Cherty limestone (40 m). Of these members, the Keyser contains three thin layers of insoluble sandstone (lower and upper Clifton Forge sandstones and Healing Springs sandstone) that significantly impact cave development in Burnsville Cove. With water rarely able to breach these layers, cave passages are often floored and/or roofed by these sandstones for long distances, lending a characteristic flat ceiling to many of the galleries.

The geologic structure of Burnsville Cove is not straightforward. The two synclinal valleys so separated by the folded anticline of Chestnut Ridge extend northeast from the little village of Burnsville. Sinkholes dot the pastures and woods, particularly the upper (southwest) portion of Burnsville Cove, where Burnsville Sink harbors the entrances to Butler Cave. At the Water Sinks 5.5 km to the northeast, a dramatic stream resurgence flows into small Water Sinks Cave. Water drainage in almost all other circumstances in Burnsville Cove is sub-

surface (Davis and Hess, 1982), discharging at several large springs on the Bullpasture River 8 km northeast of Burnsville.

Aqua Cave is the primary resurgence for Sinking Creek Valley, a western synclinal valley containing the Boundless, Butler, Breathing, Better Forgotten, Barberry, Buckwheat, Blind Faith, Battered Bar, and Helictite caves, as well as the Burnsville Turnpike/Black Canyon portion of the Chestnut Ridge cave system. Emory Spring, a road-covered karst spring 1.5 km upriver from the Aqua Cave resurgence contains no known cave but may be the resurgence for waters in recently discovered Helictite Cave. Cathedral Spring, located on the Bullpasture River 800 m downstream of the Aqua Cave resurgence, is the primary outflow for the caves of the eastern synclinal valley: Burns, Robins Rift, and the Bobcat–Blarney Stone portion of the Chestnut Ridge Cave System. Of key note here is the drainage divide in the Chestnut Ridge Cave System made possible by the North/South Trunk cutting transversely through the Chestnut Ridge anticline. Waters in the Burnsville Turnpike (possibly the largest contiguous

underground chamber known in Virginia, averaging 20 m wide by 15 m high and extending more than 1200 m, with the most massive segment measuring 45 m wide and 425 m long) continue into the narrow confines of Black Canyon and sump at the 622 Sump only to reappear in Aqua Cave and flow into the Bullpasture River. Waters in the Cyanide Canyon section and all of the Blarney Stone section of the system emerge at Cathedral Spring.

## HISTORY OF EXPLORATION

Well-known Breathing Cave was mined for saltpeter during the Civil War. It gained prominence after World War II as a popular sport cave with members of the National Speleological Society (NSS). Interest spread among NSS members and other cavers to investigate Mill Run Spring on the Bullpasture River. Bevin Hewitt's discovery of Aqua Cave in 1956 amply demonstrated that more cave waited to be found. Ike Nicholson's discovery of Butler in 1958 attracted a considerable number of experienced cavers to Burnsville Cove. The August 1958 Sand Canyon camp expedition (Nicholson and Wefer, 1982) "recon-mapped" 4500 m of new cave. Dozens of leads abounded. Nittany Grotto joined the survey in November 1958 and quickly mapped more than 8 km of intricate passages off the upstream and downstream trunk. Upstream discoveries in 1959 took cavers beyond Penn State Lake to the distant, joint-controlled passages of what later became known as Mbagintao Land. Far downstream, two parallel sumps—Last Hope and Rats' Doom—blocked Butler's advance to the northeast, but four years later an obscure side lead at Kutz Pit Junction revealed the muddy, remote galleries of Marlboro Country.

Overland surveys from Butler to Breathing plus the added data from both cave maps pointed to a possible connection. By 1967, a host of cavers were pushing from both caves to connect (Nicholson and Wefer, 1982). Despite new discoveries in Breathing and repeated efforts at digging in both caves, no connection has been found and the caves remain more than 150 m apart.

On Chestnut Ridge, a small pit discovered in 1959 was pushed in hopes of extending Butler downstream. It quickly degenerated into a vertical crawl of daunting proportions. Ten years later, cavers returned to this Better Forgotten Cave and hammered through the vertical crawl to find more than a 300 m of large trunk passage ending in a terminal sump. Upstream remained choked in breakdown.

As the 1960s ended, a number of cavers, hoping to protect the pristine nature of Butler Cave, formed the Butler Cave Conservation Society (BCCS), ushering in the first private cave conservation organization in the United States. In 1975, the BCCS purchased the 65-acre tract of land containing the Nicholson entrance to Butler Cave.

Exploration in Burnsville Cove slowed in the 1970s. The Robins Rift dig was a dynamic project in the relatively caveless eastern synclinal valley and eventually led to

approximately 600 m of discovery, but surface digs in the Cove yielded little significant cave. Remapping in Butler took priority and despite a kilometer of virgin cave discovered in Mbagintao Land, some began to feel that Burnsville Cove had yielded most of its secrets.

In 1979, members of the Shenandoah Valley Grotto visited an obscure blowing cave on Chestnut Ridge first located by David Nicholson in 1957. In a series of gritty, exhausting trips commencing in early 1982, they dropped deep into the heart of the ridge, following good air and a small, contorted stream passage in this cave they called Bobcat. Their discovery of the North/South Trunk in 1983 led to new, exciting discoveries of extensive, large caves. Finding day trips too short, highly fatiguing, and vastly inefficient for mapping in such remote passages, they began camping in the cave. From 1984 to 1990, 27 separate underground camps explored and surveyed more than 14.5 km of virgin cave, and ultimately Bobcat was given the distinction of being the deepest cave in Virginia.

In 1989, Ron Simmons conducted a series of cave dives into the constricted fissures of Cathedral Spring. After widening the cherty, underwater conduit, Simmons mapped a larger, descending passage to a depth of 46 m. With 290 m surveyed and the cave continuing its plunge, Simmons discontinued the exploration in the face of serious hypothermia, extended decompression times, and special gas requirements.

In March of 1991, ridge cavers dug into a small sink on the eastern flank of Chestnut Ridge and found Blarney Stone Cave. A twisting, wet passage similar to that encountered in Bobcat led to an extensive, multilevel, decorated gallery of cave passages exceeding 6 km in length. Blarney Stone and Bobcat were connected in a dual team effort in August, 1994, thus forming the 22.5-km Chestnut Ridge Cave System.

Digging for new caves continued, and in 1993 Barberry Cave (Schwartz, 1999) was discovered in an obscure pasture sinkhole 1 km east of Burnsville. A second entrance dug the following summer provided more comfortable, safer entry to a cave that had now been explored to a length of nearly 2 km. In November 1994, Ben Schwartz and Mike Ficco pushed an extremely low water crawl more than 30 m to find a large trunk passage headed to the northeast. Survey here added 3 km of cave to Barberry, but the Barberic Crawl soon had everyone considering a second series of cave camps. The first campers into Barberry, however, became temporarily trapped for several days when high water completely sealed the Crawl. Despite a media frenzy, the group engineered an intrepid self-rescue only to have the entrance later placed off-limits by the landowner.

Undeterred, cavers resumed digging once again, this time on the land of caver Nevin W. Davis. After drilling a 25-cm hole 21 m down into the ceiling of the large Barberry trunk passage beneath the Davis farm, cavers began excavating and shoring to install a large metal tank endwise. Further drilling and blasting, accompanied with a full complement of spectacular setbacks, eventually opened the Big Bucks Pit entrance



to Barberry Cave in 1996. Meanwhile, an ongoing dig on the slopes above the Water Sinks broke into virgin cave in March, 1996. Named Helictite Cave for its pretty display of such formations in the entrance area, the cave led to a rabbit warren of joint-controlled passages that are still being mapped.

Strong air also lured cavers into Burns Chestnut Ridge Cave. Extremely arduous trips to “bottom” this tight cave had exhausted and frustrated a succession of caving teams for more than three decades, but a concerted effort led by Gregg Clemmer, Nevin Davis, and Tom Shifflett finally revealed a sizeable stream passage 200 m below the entrance. Subsequent trips pushed the depth to 240 m, surpassing the Chestnut Ridge Cave System as Virginia’s deepest.

Given this success, digging for caves in Burnsville Cove accelerated. Buckwheat Cave was opened after an hour’s effort in March 1998. Pushing low crawls and following air brought mappers to within 4 m of connecting with the far downstream end of Barberry. Cave diggers found Blind Faith Cave the following March after digging down 4 m into a blind sinkhole. The cave has been mapped to more than 1 km of passage and drains toward Woodzell Sink.

A dig in April of 2000 yielded an improbable entrance to the surprisingly extensive Battered Bar Cave. Atop a narrow karst saddle on the west flank of Chestnut Ridge, the cave currently is mapped to 2072 m of passage. Two months after this discovery, a utility lineman climbed up a roadside bank 1.5 km east of Burnsville to check a telephone repeater and discovered a blowing hole. This By-the-Road Cave is now gated and managed by the BCCS in a unique agreement with the Virginia Department of Transportation, which owns the entrance.

## DESCRIPTIONS OF CAVES

### Breathing Cave

Breathing Cave is one of the best known and most visited noncommercial caves in Virginia. Until the discovery of Butler Cave, it was the largest known cave in the state (Douglas, 1964). Partially mapped several times after 1945, the cave was more completely surveyed by Nittany Grotto of The Pennsylvania State University in the late 1950s who charted it to a length of 7.3 km (Holsinger, 1975). Developed in the Keyser Limestone, Breathing was mined for saltpeter during the Civil War. A challenging, heavily joint-controlled, parallel maze cave, it divides 30 m inside the large sinkhole entrance into the Historic Section or saltpeter mine on the left and the Main Section on the right. Here, to the right, several kilometers of parallel, interconnected passages trend southeast, ending in a series of very low, narrow, wet crawls one surveyor termed *pseudopsiphons*. At the extreme terminus, the cave approaches the Good News Passage in Butler Cave (Nicholson and Wefer, 1982). Breathing Cave is currently being resurveyed by the Gangsta Cavers of the

mid-Atlantic area. The cave is a registered National Natural Landmark.

### Aqua Cave

Aqua Cave was discovered by Bevin Hewitt in July 1956 by diving 8 m horizontally into Mill Run Spring. A low airway was subsequently blasted from the left ceiling of the spring, giving cavers without dive gear a sporting access to 2 km of bracing, fairly large river cave. The recent discovery of an extensive upper level, the Big Brother section, puts the cave at over 2700 m in length.

### Butler Cave

With over 25 km of mapped passage, Butler Cave ranks as the longest cave in Burnsville Cove. Formed in the Keyser and Tonoloway limestones, extensive portions of the cave are developed between the upper and lower Clifton Forge sandstones of the Keyser, giving some passages a distinctive flat ceiling over great expanses (Hess and White, 1982). The cave underlies the western synclinal valley of the Cove, a fact that in large part determines its passage layout. Entering the spacious, central Trunk Channel at Sand Canyon, visitors follow the axis of the syncline as they walk up- or downstream. Infeeder branch passages intersect primarily from the west. A number of wet weather streams course through these side passages to the Main Trunk. All waters in Butler Cave have been dye-traced to their resurgence at Aqua Cave (Davis and Hess, 1982). Although not as spectacularly decorated as other caves in the Cove, Butler awes with its sheer volume. It remains a cave of great challenges, be they a novice’s first glimpse of the Moon Room or a veteran’s long trek to the remoteness of such exotic destinations as Djibouti or the Doom Room. Like Breathing Cave, Butler Cave is a registered National Natural Landmark. The cave is owned and managed by the BCCS. A second entrance to the system, accessed by a culvert pipe, was dug in 1998. (See Figs. 2 to 5.)

### Better Forgotten

Better Forgotten is an aptly named, tight, muddy, multidrop cave on the west flank of Chestnut Ridge near the Bath/Highland County line. Its 12-m pit entrance leads to a series of narrow vertical drops as the cave develops down dip. This eventually intersects a 580-m long section of stream trunk passage that ends downstream in a sump (Holsinger, 1975). The cave is 1200 m long and reaches a depth of 130 m. The stream has been dye-traced to its resurgence at Aqua Cave on the Bullpasture River. Better Forgotten Cave is owned by the BCCS.

### Boundless

Boundless Cave opens in a small sink 800 m southwest of the entrance to Butler Cave. Trending northeast, the passage is



**FIGURE 2** The Glop Slot is a very narrow squeeze at the bottom of the entrance pit at the Nicholson Entrance to Butler Cave. Until the opening of the SOFA entrance, all who entered the cave had to pass through it.



**FIGURE 3** This camp at Sand Canyon in Butler cave was occupied by a seven-man crew in August 1958, and most of the easily accessible passages in the cave were mapped and photographed. Notice the use of cotton clothes and provisions still in their original cardboard packaging. These practices would be frowned upon today.

characteristically very low and filled with sand and cobbles. A small stream has been traced to its resurgence in Aqua Cave more than 6 km to the northeast (Holsinger, 1975).

### Robins Rift

Opened by digging a large, air-blowing sink located at the western base of Tower Hill Mountain, Robins Rift Cave quickly developed a notorious reputation for entrance instability. At least four separate cave digs over the last 30 years have attempted to keep this cave open to visitation. With more than 600 m of passage surveyed, it stood as the



**FIGURE 4** Sometimes it is just difficult to get up in an environment of perpetual darkness. This photograph from the 1958 camp in Butler Cave shows equipment of the time. Today, the inflatable air mattress would be replaced by a Therm-a-Rest pad or equivalent and the down sleeping bag would be a synthetic fiber-filled bag which would remain warm even if it gets a bit damp.



**FIGURE 5** Ike Nicholson, the discoverer of Butler Cave, admires the crystal-filled dry pools at Crystal Craters. This photograph was taken during the 1958 camp in the cave.

largest cave in the eastern synclinal valley of the Burnsville Cove until the discovery of Blarney Stone Cave in 1991. Water in Robins Rift has been traced to the Cathedral Spring resurgence (Davis and Hess, 1982).

### Bobcat (Chestnut Ridge Cave System)

Bobcat Cave was previously known as Chestnut Ridge Blowing Cave (Douglas, 1964). The two entrances to Bobcat are situated about 10 m apart near the top of Chestnut Ridge just south of the Bath/Highland County line. The 550-m-long entrance series is a muddy, contorted, plunging slot following a small stream that has been dye-traced to Cathedral Spring. This stream is finally intersected by Tombstone Alley, a dry, paleo-overflow segment that leads to

the North/South Trunk, a passage ranging from 6 to 21 m wide and up to 12 m high (Rosenfeld and Shifflett, 1995). One of three large trunk passages in the cave, the North/South Trunk winds through large breakdown and exceptional displays of aragonite trees. To the north, pits interrupt the trunk passage, which appears to terminate at voluminous SVG Hall. A 30-m lead climb here, however, leads to the blowing Porpoise Passage, which crosses over the Chestnut Ridge anticline. Beyond, the 6-m Mud Piton Climb leads to 24-m Damart Drop and a second pitch of 11 m, Polypro Pit. This drops into the second trunk passage consisting of Sixth of July Room to the south and the highly decorated Jewel Cave/Big Bend area to the north. Maret's Lead out of Sixth of July rambles through big rooms floored in slippery mud and challenging down climbs for 600 m, ending in a sump 190 m beneath the entrance. This has been dye-traced to the Aqua Cave resurgence. A small, blowing infeasible here leads to Black Canyon, 800 m of washed, scrambling stream cave in very dark limestone. A sporting up climb through a cascade intersects the beginning of the Burnsville Turnpike, the third trunk and by far the largest. Extending more than 1200 m with widths approaching 44 m and heights up to 30 m, the Turnpike is one of the biggest and most remote underground passages in Virginia. The Turnpike ends in uptrending breakdown, with a stream entering from a lower level of breakdown. The North/South Trunk south of its intersection with Tombstone Alley is a pleasant walk of 300 m toward the Camp Room. Off the southeast side of the Camp Room, a steeply plunging down-dip lead drops into the Shamrock Dome area of the cave. A series of muddy slots and down climbs leads to Satisfaction Junction and the 722 Sump, the deepest point in the system. Southwest from the Camp Room, but on the same relative level, the North/South Trunk continues as a series of rambling, up and down climbs. A tight slot with air can be followed through collapsed breakdown to the South Lead Terminus, a comfortable room ending in more breakdown. A small, dug hole under one ledge drops into the Blarney Stone continuation of the system. The cave is considered one of the most demanding in the Old Dominion. (See Figs. 6 to 10.)

### **Blarney Stone (Chestnut Ridge Cave System)**

Blarney Stone Cave was discovered by digging open an obscure sink on the eastern slope of Chestnut Ridge in March of 1991. Its muddy fissure entrance series—four short rope drops and a series of challenging down climbs—is a shorter version of the Bobcat entrance series. After 300 m, a small overflow tube leads to larger cave. On an upper level, a 5-m aid climb across a 20-m deep shaft accesses an impressive paleotrunk named Ghost Hall. Highly decorated with stalagmites, stalactites, totem poles, and columns, Ghost Hall leads south to expansive Upper Ghost Hall. Black Diamond Crawl, a small stream crawl with black gravel, also exits the south end of Ghost Hall. Black Diamond intersects a pit that



**FIGURE 6** Anthodite formations at Bobcat Cave.



**FIGURE 7** An anthodite formation called The Elk Horn in Bobcat Cave; the white vertical piece at the bottom is about a foot long.

descends to the Pearly Gates, named for a beautiful and prolific display of cave pearls. Moon River extends upstream and downstream below this point for nearly 600 m. Numerous side passages abound here, the most notable being



**FIGURE 8** An anhydrite formation in Bobcat Cave.

the Stairway to Heaven, an extensive series of challenging upclimbs that rise more than 150 m. North of Ghost Hall, the cave winds through the totem poles of Leprechaun Forest. Extraordinary crystalline white chandeliers decorate a delicate section of the wall. A large walking passage rambles to the north, eventually finding the obscure lead beyond the Earthworks to the cave's connection with Bobcat Cave.

### Barberry

Barberry Cave has three excavated entrances, all but one closed. The entrance to Big Bucks is an excavated 21-m shaft dropping into an impressive 23-m-high trunk passage. At the bottom of the pit, this decorated, spacious stream trunk extends 670 m to the north and 550 m to the south and is aligned with the south end of the Burnsville Turnpike. The stream ends in a deep sump, but the trunk passage continues another 150 m to massive breakdown. The Woway, a sizeable side lead entering the main trunk passage from the west,



**FIGURE 9** Crystal formations found in a section of Bobcat Cave called the North/South Trunk.



**FIGURE 10** The main camp in Bobcat Cave; the crew is gathered around the cooking area.

extends via watery passages to within 120 m of Butler Cave. An air-blowing lead at the end of this very tortuous passage still holds promise of a connection with Burnsville Cove's biggest cave. Barberry Cave is 5.31 km long. (See Figs. 11 to 13.)



**FIGURE 11** Morphine Waterfalls. The main stream in Barberry Cave, Bath County Virginia, is flowing down the bedding before cascading over a 6 foot waterfall. The main passage in this area is 40 feet wide and 70 feet high and has massive flowstone decorating the walls.

### **Buckwheat**

Buckwheat Cave, another excavated entrance cave, plunges as a walking stream passage into a series of low water crawls, blocked by massive breakdown. Coming to within 4 m of portions of Barberry Cave, Buckwheat drains a small part of the western flank of Chestnut Ridge. To date, 670 m of cave have been mapped in Buckwheat to a depth of 42 m. Digging is ongoing for a connection to Barberry Cave.

### **Blind Faith**

Blind Faith was discovered the year after Buckwheat Cave by digging a 4-meter shaft in a small sink in the next wooded valley 600 m north of Buckwheat. A series of crawls and challenging down climbs eventually drop into a going stream passage. This degenerates downstream in an extremely low, downtrending passage. Upstream, the cave winds for several hundred meters along the western flank of Chestnut Ridge but stops well short of connecting to nearby Buckwheat. More than 1000 m of cave have been charted in Blind Faith to a depth of 48 m.



**FIGURE 12** Great White Wow in Barberry Cave, Bath County, Virginia. The large spacious passage in the Barberry Trunk Trends southwest until it reaches an intersection where this grand formation is suddenly encountered by the visitor. The first word spoken by its discoverers was used as part of the name.

### **Battered Bar**

Battered Bar Cave is located about 450 m north of the Blind Faith entrance on the edge of a deep sink corresponding to the terminal end of the Burnsville Turnpike in the Chestnut



**FIGURE 13** “Sidewalk superintendents” gather around Big Bucks Pit. The third entrance to Barberry Cave began as a drill hole followed by a 6-foot diameter shaft hand “dug” down to the top of the 80-foot high ceiling in the cave. In this photo, cavers are gathered around the top of the shaft, peering down to observe the “digging” activity at the bottom of the shaft.

Ridge cave system. A narrow, 18-m pit leads to an even tighter slot that slopes down 8 m to the top of a slippery 12-m-deep shaft. A steep, muddy up climb leads to a third drop of 4 m. Beyond, through massive breakdown blocks, the cave opens up dramatically. In the first big room, a fissure leads down to the Ramp, a steeply inclined 30-m-long chuteway floored with breakdown lingering at the angle of repose. Two walking passages extend to the south from the bottom of the Ramp, the left-hand passage dividing after some 125 m into left and right branches. The left branch approaches the downstream end of Blind Faith Cave, ending near an unusual folded limestone feature called the Stone Rainbow. The right-hand branch continues south 200 m, plunging dramatically to a sump in a passage covered with pure white sand. The right-hand trunk at the bottom of the Ramp climbs through breakdown, then extends for 300 m into a maze of small passages ending in breakdown. Underneath the Ramp, a stream can be followed for 150 m to massive breakdown, much of which has yet to be pushed. Any connection with the Burnsville Turnpike is approximately 250 m beyond. The cave has been surveyed to more than 2040 m of passage at a depth of 125 m.

### Helictite

Helictite Cave is formed near the top of the Helderberg limestone sequence, dissolved mainly out of the New Scotland Limestone. A vast maze cave of tubes and canyons with one major paleostream passage, Helictite possesses dramatic examples of dogtooth spar, cave pearls, helictites, and slickensides. With more than 11 km of cave mapped since its

discovery in 1996, Helictite is not a typical Cove cave. Its drainage has not been dye-traced. (See Figs. 14 to 19.)

### Burns Chestnut Ridge

Burns is the deepest cave in Burnsville Cove at 240 m. The entrance series of low, sinuous, muddy crawls; tight, body-sized cracks; and plunging slot canyons to the bottom of the cave is one of the most arduous 500 m of cave in the United States. An impressive stream canyon below the 198-m level soon sumps upstream but flows north to a series of cascades at the 213-m level. Here, a high lead some 12 m above the stream leads to nearly 2 km of walking passage, eventually giving access to the rarely visited Cathedral River. This passage was mapped downstream for 335 m to a point where



**FIGURE 14** A cluster of helictites, the signature of Helictite Cave, Highland County, Virginia. When this cave was first entered some of the first formations seen were helictites. As exploration and surveys continued it was realized that this cave was far richer in this type of formation than other Virginia caves. This photo is part of a large cluster of helictites located just a hundred feet inside the entrance. (Photograph taken by Arthur N. Palmer. With permission.)

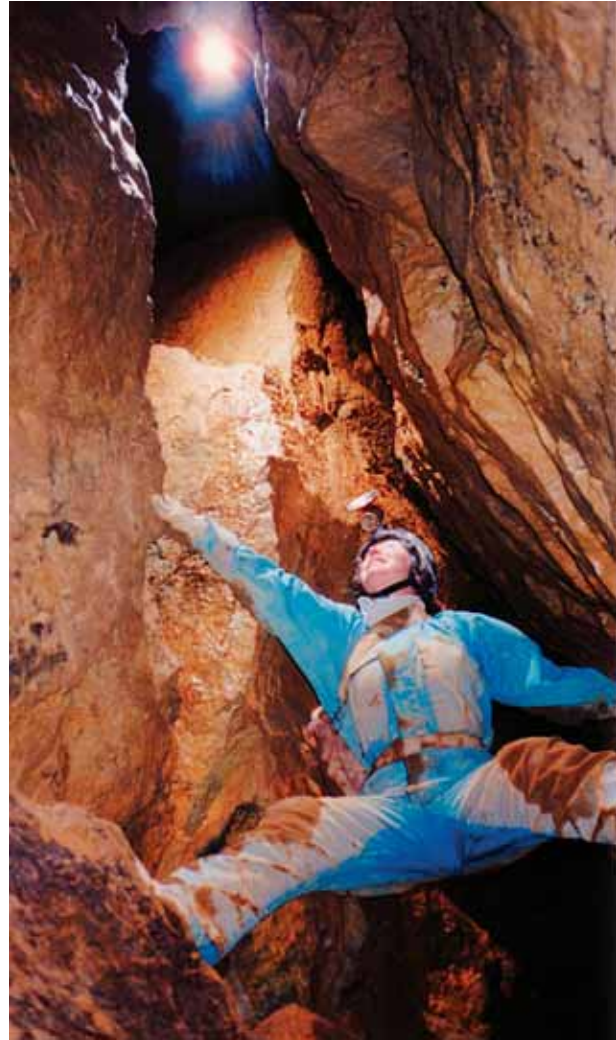


**FIGURE 15** Cave pearls, Helictite Cave, Highland County, Virginia. A clutch of cave pearls in a rimstone pool in Helictite Cave. The largest pearl is about the size of a golf ball and is with 9/1000 of an inch of being perfectly symmetrical. (Photograph taken by Arthur N. Palmer. With permission.)



**FIGURE 16** Traversing Dagger Pit, Helictite Cave, Highland County, Virginia. One of the connections to the 7-mile maze cave was found across the top of a pit named Dagger Pit for the blade-like pendants in the bottom of the pit. A traverse line enables a safe passage across the top and 40 feet above the “daggers” below.

the water came to within 10 cm of the ceiling. The downstream cave approaches Robins Rift to within 300 m. A high, dribbling in-feeder in the dry, walkable upper level holds potential for a connection to the southernmost end of Blarney Stone Cave.



**FIGURE 17** The step across, Helictite Cave, Highland County, Virginia. Maneuvering through breakdown and canyon passage in Helictite Cave requires a daring step or two. The Step Across is a seemingly simple maneuver that often causes some consternation.

### **By-the-Road Cave**

Found in June of 2000, the entrance is a recent sink collapse located in the eastern synclinal valley 800 m southwest of Robins Rift. Strategically placed to offer access to the sumped upstream portion of Burns Chestnut Ridge Cave, By-the-Road is currently mapped to an ongoing in-cave dig. Considerable air blows from the cave in hot weather. By-the-Road is gated and managed by the BCCS at the request of the Virginia Department of Transportation.

### **SPECIAL ATTRIBUTES**

A preliminary report on cave fauna of Burnsville Cove was published in the *Burnsville Cove Symposium* (Holsinger, 1982) and itemized 11 invertebrates and 8 vertebrates. Two species, the amphipod *Stygobromus conradi* and a beetle



**FIGURE 18** Pool spar, Helictite Cave, Highland County, Virginia. One of the crystals of calcite is spar sometimes called Dogtoothed Spar. In Helictite Cave, Highland County, the Dogtoothed Spar in this photo is located in a pool and is about 20 feet long and 6 feet wide. (Photograph taken by Arthur N. Palmer. With permission.)



**FIGURE 19** The Slickensides Room, Highland County, Virginia. Helictite Cave has areas where faults are intersected by passage development. Here the Slickensides of a fault has dropped into cave passage below. This makes for a dramatic passage where the scrapings or slickensides are easily recognized on the ceiling and floor of this passage. (Photograph taken by Arthur N. Palmer. With permission.)

(*Pseudanophtalmus*), are endemic to the Burnsville Cove. A more recent report (Hershler *et al.*, 1990) noted the discovery of a new species of aquatic snail, *Fontigens morrisoni*, citing Butler Cave as one of only two locations. An updated report describes the discovery of a new species of springtail (*Arrhopalites*) from Butler Cave, since found in another Virginia cave outside the Cove. The appearance of unknown animal tracks deep in the North/South Trunk of Bobcat Cave and the finding of a “raccoon-like” skeleton beneath the Camp Room proved a startling discovery. Photographs and castings were subsequently identified as belonging to *Martes pennanti*, which is a fisher unreported in Virginia for almost two centuries.

A preliminary report on cave mineralogy of the Burnsville Cove was also published in the *Burnsville Cove Symposium*

(White, 1982) and characterized the secondary mineral deposits as sparse though widely dispersed. Recent discoveries in selected areas of the Chestnut Ridge System, Barberry, and Helictite caves reveal an astounding array of helictites, aragonite trees, anthodites, cave pearls, and moon milk. Sediment studies in Butler Cave have found evidence of magnetic reversal as well as iron-fixing filamentous bacteria in a brownish-yellow layer of goethite.

After a half century of systematic investigation, it is now understood that the caves of the Burnsville Cove are hydrologically connected. Despite the physical barrier of the Chestnut Ridge anticline, the improbable presence of the North/South Trunk in the Chestnut Ridge System provides a key underground connection between the Butler Cave–Sinking Creek drainage of the western syncline and the caves of the less understood eastern syncline of the Burns–Blarney Stone–Cathedral Spring drainage. Despite the connection of Bobcat and Blarney Stone caves in 1994, connections between other caves of Burnsville Cove remain elusive. When realized, such achievements will only enhance a cave/karst region already recognized for its international prominence.

### Bibliography

- Clemmer, G.S. (2001) That cave just had to be there. In *Virginia Cavalcade* (J.A. Campbell, Ed.). The Library of Virginia, Richmond, VA.
- Davis, N.W. and J.W. Hess (1982) Hydrogeology of the drainage system, Burnsville Cove, Virginia. In *Burnsville Cove Symposium*, (W.B. White and J.W. Hess, Eds.). Adobe Press, Albuquerque, NM.
- Douglas, H.H. (1964) *Caves of Virginia*. Virginia Cave Survey, Falls Church, VA.
- Hershler, R., J.R. Holsinger, and L. Hubricht (1990) A revision of the North American freshwater snail genus *Fontigens* (Prosobranchia: Hydrobiidae). *Smithsonian Contr. Zool.* 509.
- Hess, J.W. and W.B. White (1982) Geomorphology of Burnsville Cove and the geology of the Butler Cave–Sinking Creek system. In *Burnsville Cove Symposium* (W.B. White and J.W. Hess, Eds.). Adobe Press, Albuquerque, NM.
- Holsinger, J.R. (1975) *Description of Virginia Caves*. Bull. No. 85, Division of Mineral Resources, Charlottesville, VA.
- Holsinger, J.R. (1982) A preliminary report on the cave fauna of Burnsville Cove, Virginia. In *Burnsville Cove Symposium*, (W.B. White and J.W. Hess, Eds.). Adobe Press, Albuquerque, NM.
- Nicholson, I.K. and F.W. Wefer, (1982) Exploration and mapping of the Sinking Creek system. In *Burnsville Cove Symposium*. (W.B. White and J.W. Hess, Eds.). Adobe Press, Albuquerque, NM.
- Rosenfeld, J.R. and T. E. Shifflett (1995) The Caves of Burnsville Cove, Virginia. In *Underground in the Appalachians: A Guidebook for the 1995 NSS Convention* (C. Zokaites, Ed.). National Speleological Society, Huntsville, AL.
- Schwartz, B. (1999). Exploring Barberry Cave, *NSS News* September, 268–275.
- White, W.B. (1982). Mineralogy of the Butler Cave–Sinking Creek system. In *Burnsville Cove Symposium*. (W.B. White and J.W. Hess, Eds.). Adobe Press, Albuquerque, NM.





---

## Camps

Gregg S. Clemmer  
*Butler Cave Conservation Society, Inc.*

The thorough exploration and survey of an extensive cave system demands that all participants “push the limits” of the cave to its “bitter end.” Such idealistic, oft-used phrases employed by cavers reflect a deeply held philosophy—an ethic some would say—that goal-oriented, expedition-style caving requires careful preparation, long-term dedication, and extensive stamina. “Push trips” to the bottom or to the far reaches of vast, complex cave systems challenge all three requirements. Planning entails cooperation, competency, specific goals, a mountain of gear, and the occasional kilometer of rope. Participation impacts everything from bank accounts and vacation time to jobs and marriages.

It is a given that everyone enters the cave in superb physical and mental condition. But, what happens when the mountain of gear is consumed, when the kilometer of rope is rappelled, when the strongest caver is exhausted, and the cave still goes down and down, on and on? In the years since the founding of the National Speleological Society, Inc., in 1941, U.S. cavers have continued to push the limits. In the first half century of the Society’s existence, for a variety of reasons—personal comfort, novelty and intrigue, or simply because the cave went on and on—cavers in a few instances resorted to underground camps to pursue their respective goals. Cavers in Europe confronted the same challenges. Exploration in Switzerland’s Holloch expanded to an underground camp in 1949. After four cavers were trapped by high water for 9 days in 1952, all exploration camps in Holloch became winter-time endeavors (Courbon *et al.*, 1989). The widely acclaimed 1952 descent into Pierre Saint-Martin employed a 5-day underground camp but ended tragically with the death of

Marcel Loubens (Tazieff, 1953). Gouffre Berger became the first cave to break 1000 m in depth, a feat realized in 1956 that owed much to the staged underground camps of 1954–55 at 494 m and 860 m (Cadoux, 1957). A 1955 expedition into the Cigalere also employed staged cave camps, but, instead of pushing the cave ever deeper, explorers confronted a daunting series of waterfalls as they ascended into the mountain (Casteret, 1962).

The evolving European model for underground expedition camping utilized advance supply teams to rig pits, lay phone lines, transport mountains of gear, and establish camps. Single-rope techniques being unknown, pits were negotiated by cable and rope ladders backed up by belay. The early exploration of Utah’s Neff Canyon Cave in October of 1953 followed this European model and utilized a support crew to aid four cavers on a 33-hour trip to the bottom of the cave. Engaged in a rivalry with a local climbing club, the group carried in a large amount of gear—sleeping bags, cable ladders, 150 m of rope, field phones, and coils of wire—to support their effort. But, after enduring a “fitful sleep in cold, cramped quarters” in their unsuccessful attempt to find the cave’s deepest point, the explorers emerged “completely exhausted.” One member of the support crew spent a week in the hospital suffering “utter fatigue.” They chalked up their failure to “bulky packs and unmanageable gear in the narrow, jagged passageways” (Green and Halliday, 1958).

A few months later, Floyd Collins’ Crystal Cave Expedition (C-3 Expedition) electrified the caving community with a sensational attempt in Flint Ridge to push the far reaches of Kentucky’s most extensive cave. With movie cameras rolling and backed by a full complement of sponsors, fawning reporters, and radio broadcasters, the cavers entered the cave with ambitious goals for a week underground. Metal “Gurnee cans” protected gear through tight, rocky crawlways. Field phones connected remote sections of the cave with the surface support crew. Experts in cave biology, geology, hydrology, medicine, and meteorology accompanied the

hard-charging explorers, all eager to measure the cave, the cavers, and the phenomena therein. The expedition ended with numerous official reports detailing everything from sleeplessness and mild shocks from ring voltages in the phone system to the morale-boosting effects of candy and tobacco being delivered from the surface. The festive, self-congratulatory tone at the expedition's end ignored the large amounts of trash buried or burned in the cave. Several kilometers of abandoned telephone wire would litter the passages for decades (Brucker and Lawrence, 1955). Thankfully, the "success" of the C-3 Expedition was never repeated, but in a subsequent report 2 years later one participant recommended "simplicity in all phases of trip organization" as a future goal, warning that too often "success is judged by size instead of actual accomplishment" (Smith, 1956).

In contrast, the Butler Cave Camp of August 1958 commenced as a closely held secret. Not eager to get "scooped" and exploring mostly in blue jeans and wool shirts, the seven-man crew eagerly pushed deep into this Virginia discovery without field phones, surface support crew, or scientific agenda. At the end of an exciting, tiring week, they exited with 5 km "recon-mapped" and a collection of superb color slides, but they buried their trash and spent carbide in the cave.

Youthful exuberance and naiveté characterized the August 1962 cave camp in Indiana's Sullivan cave. With lofty goals to map the cave, sample the soil for microbes, conduct psychological surveys on participants, and clean up extensive vandalism, the teenagers elected to spend 2 weeks camping in the cave despite its relatively close proximity to the entrance. Field phones connected them to the surface. Equipped with sleeping bags on cots and supplied with a double-burner Coleman stove, canned goods, rye bread, and even fresh vegetables (celery, carrots, and lettuce), the explorers endured a miserable, cold existence in wet, muddy clothes despite five complete changes of underground wardrobe. Although they mapped 2 km of passage, the young "Sullivaners" discovered only half of it to be virgin cave. One participant characterized part of their mapping as "a comedy of errors."

Vastly more significant discoveries rewarded a two-person, week-long camp in Ellison's Cave, Georgia, in 1969. Despite the dramatic failure of their only stove at base camp more than 250 m below the surface, this man and woman team stomached cold food and dank conditions to survey almost 4 km of cave without field phones and surface crew, all with minimal impact to the cave (Smith, 1977).

A bizarre example of cave camping occurred in 1972 in Midnight Cave, TX, when one man spent 6 months underground. Dismissed as nothing more than a publicity stunt by some, the venture did garner enormous attention, including a feature article in *National Geographic*. The subject entered the cave ostensibly to investigate the long-term psychological and physiological effects of solitary confinement and sensory deprivation. Amenities included a canopied sleeping area on a wooden platform, extensive incandescent lighting, field

phone, books, and record player. At the end of his time underground, the relieved cave dweller declared his trial a success as the "longest beyond time experiment in history" (Siffre, 1975).

Ongoing exploration of Wind Cave in South Dakota employed an underground camp in 1972. Situated near the Master Room, the relatively comfortable camp was supported by a surface crew, stocked by supply teams, and connected to the surface by field phones. To thwart hypothermia, participants toyed with the novel notion of running heat lamps in the camp on 480 V piped down the telephone cable. Despite the discovery of major extensions to the cave, no one favored a second underground camp the following year. "The logistics of running a base camp, although successful, were very difficult and time consuming," wrote one organizer. Henceforth, the survey reverted to "long, single-day trips from the surface" (Scheltens, 1988).

All of this experience gained was lost on organizers of Project SIMMER when 118 cavers descended on Simmons-Mingo Cave in West Virginia in October 1973. Ambitiously planned much like a military operation with a chain of command, mess tent, and administration tent, the expedition ultimately consumed 10 hours of preparation to every hour actually spent underground. Planners managed to lay more than 15 km of wire for field phones, then touted their work as the "world's largest in-cave communication network." The Gurnee can of the C-3 Expedition morphed into a "Carts can," a stovepipe and plywood contraption used to haul gear into the cave. Plagued by poor sleeping bags, wet clothes, ringing phones, and a miserable camp spot, the crews mapped less than a kilometer of cave. Project SIMMER had profited nothing from the C-3 experience of 20 years earlier and never issued a final expedition report. Participants even abandoned the phone wire in the cave. Yet, beyond these disappointments, the overall underground manager opined at the end of the experience that for deep or remote cave exploration, "the small camp-in party [would be] more efficient than the larger, more formally organized group."

American deep-caving expeditions to Mexico also began camping underground. European participants with extensive expedition experience contributed a wealth of knowledge toward maintaining a comfortable, efficient subterranean camp. Prolonged underground stays were begun in the mid-1960s and by the late 1970s had pushed the reaches of vast, deep, technically difficult caves (such as Sotano de San Agustin, La Grieta, Sumidero Yochib, Sotano del Rio Iglesia, and Sistema Purificacion) far beyond the reaches of conventional day-trip caving (Stone, 1978). (See Figs. 1 to 4.)

Outside the warmer climes of Mexico, occasional cave camping in the temperate latitudes of the United States generated little appeal for second attempts. Despite some glowing declarations of expedition success, the cave campers of Neff Canyon, C-3, Butler Cave, Sullivan Cave, Ellison Cave, Wind Cave, Project SIMMER, and even a successful,



**FIGURE 1** The chamber in which camp 3 is located in Sotano de San Agustín; this is part of the cave system Sistema Huautla in Oaxaca in southern Mexico.



**FIGURE 2** A meal is being prepared at camp 3 in Sotano de San Agustín.

comfortable camp deep in Fern Cave in Alabama brokred little enthusiasm to repeat their adventures. Pushing caves to their limits in the chillier continental 48 states went back to being brutal day-trip endeavors. Remote underground camps were best left for the warmer caves south of the border. The 1983 discovery of a large cave system under Chestnut Ridge, near Burnsville, VA, provided the impetus for yet another group to try an extended underground camp in the United States. More than 20 km of challenging, decorated, virgin galleries rewarded those who endured the cold, sloppy, tortuous entrance series of Bobcat Cave (see Figs. 5 to 7). Yet, exhaustion and the real threat of hypothermia limited all efforts to safely extend exploration via increasingly longer day trips. With no other choices, cavers with decades of grueling experience grudgingly confronted the possibility that camping underground was the only feasible way to continue the survey. Given the Spartan experiences a generation earlier at nearby Butler Cave, few relished the idea. No cave in the United States had ever been continuously pushed and mapped in such a manner. Nevertheless, over the next 10



**FIGURE 3** Cooking area of the White Lead Room in La Nita, which is part of Sistema Huautla in Oaxaca in southern Mexico.



**FIGURE 4** A caver is entering survey data into a programmable calculator, which will indicate where he is in relation to an already mapped passage in a connection attempt. This is at camp 2 in Nita Nanta, which is part of Sistema Huautla in Oaxaca in southern Mexico.

years, more than 15 km of passageways were explored and surveyed via 27 underground camps in Bobcat Cave, culminating in the 1994 connection with 7-km-long Blarney Stone Cave.



**FIGURE 5** Bobcat Cave; another view of the cooking area after several days of use.



**FIGURE 6** Bobcat Cave; one caver's area in the main camp chamber. He is using a hammock instead of a sleeping pad on the ground.

To be fair, few caves offer the isolation and daunting physical challenges that justify camping underground, but Bobcat Cave did, and once the decision to camp had been made the question became one of how to thwart hypothermia, obtain adequate nourishment, maintain endurance, and still safely and efficiently get the cave competently explored and mapped. Custom nylon coveralls were the first big difference from previous camps. Until the early 1980s, experienced American cavers—with rare exceptions—went underground clothed primarily in cotton and wool. “Farmer John” coveralls ruled the day. Wet suits were tight and uncomfortable but battled hypothermia and provided protection far better than blue jeans and corduroy jackets or the wool sweaters and flannel shirts of earlier times. Comfort counted, and the eternal cold of soggy cotton and smelly wool when still kilometers from the entrance begged for garments promising warmth, agility, and the ability to stay dry despite the wearer’s body heat.

Nylon did just that. Participants in the first Bobcat camp purchased yards of the fabric, adapted a borrowed coverall pattern, and sewed their own. Cave packs evolved the same way. The bulky, battered metal towing cans of the C-3 Expedition and Project SIMMER never even came under



**FIGURE 7** Bobcat Cave; another caver's camp area where a hammock is also used.

consideration. Instead, long, cylindrical, flexible nylon duffel bags, also self-sewn, performed admirably. With a tether on one end for upright attachment to seat harnesses when ascending or descending drops, a handle in the middle for grasping in crawls and crevices, and back straps for carrying over long distances, the “camp duff” proved invaluable for getting gear and food into camp. Double or triple thicknesses of trash bags protected food, clothes, and sleeping bags from devastating leaks. Sucking out the air from such a packed bag before tying it off provided additional space. Two decades later, nylon packs and coveralls enjoy almost universal use in caving and even exude their own fashion statements, having spawned a cottage industry in custom cave gear, vertical rigs, and personalized repair using a variety of incredibly durable fabrics. Changing into dry, warm camp clothes upon reaching camp boosted morale, especially if one’s body heat aided the process; thus, wickers and polypropylene replaced cotton and wool undergarments.

Sleeping underground, though, had always been a prolonged struggle against chill and dampness. Cotton or down sleeping bags were dismal failures, but lightweight fiberfill or synthetic bags worked nicely when laid on a foam pad (or, for example, a Therm-A-Rest pad) atop a reflective ground cloth. A stocking cap kept head and ears warm all night. Some campers even wore gloves. A dry change of socks, bound up in small plastic bags, assured dry feet even when moving about camp in wet, muddy cave boots. An extra polypropylene top and bottom, properly bagged, provided the luxury of a pillow. Hammocks, although favored by some on Mexican expeditions, were quickly abandoned after a fitful night tossing in the damp, 48° F chill of Bobcat Cave. The camp site itself needed to be relatively level, spacious enough for sleeping quarters and a community kitchen and eating area, and fairly close to reliable water. A drop of iodine per gallon of water accomplished water purification. The latrine was located in respectable proximity to camp, dug into a clay bank.

Eating revolved around breakfast and dinner, supplemented during the day by personal preferences (energy bars, Gorp™, cheese, candy, premade sandwiches, even a baked

potato). Freeze-dried food covered most menus, being far tastier than the wretched examples of the past and significantly lighter than canned goods. (*Note:* In desert caves or where water is scarce, canned goods could be a significant supply for both food and water.) Tea, coffee, sugar, salt, oatmeal, dried fruit, pepper and other spices, and even luxury condiments were easily stuffed in zip-lock bags and buried in the depths of packed sleeping bags.

Aside from ropes, climbing gear, bolt kits, and survey gear, community camp gear on the initial trip included a small white gas stove with repair kit; several full, secured fuel bottles; a cooking pot for hot water; three or four collapsible plastic gallon jugs; first-aid kit; and trowels and toilet paper, all divided among the participants. Outside of replenishment items, these were secured in the cave from camp to camp. Luxury items ranged from washcloths and personal journals to cards and a harmonica. Carbide provided 90% of the lighting, with candles around camp adding an intimate touch and saving acetylene.

Cavers know that adaptability and incentive remain a vital part of pushing the limits. Future camps may very well embrace caving LED lamps, for which rumored 50-hour burn times on one set of four D cells would surely lighten camp duffs of pounds of bulky calcium carbide on the way in and spent carbide on the way out. Every Bobcat expedition entered the cave as a small, self-contained team. Never did more than nine cavers (three teams of three) participate; six proved the average. Surface crews lounging in administration tents fielding phones attached to kilometers of wire strung through near-virgin cave were never an option and would probably violate the conservation ethic of today's cavers. Instead, with a safety contact just a few kilometers from the entrance, the expedition entered the cave with competent associates on the surface aware and available. In the years since, cave camping has remained a seldom-used tool of American cavers.

The recent multi-sump isolation of camping on a tarp suspended above water deep in Mexico's Sistema Huautla is surely the extreme (Stone *et al.*, 2002), but the continued success of camps in making new discoveries such as in Kentucky's Fisher Ridge, New Mexico's Lechuguilla, and Virginia's Omega System is a tribute to cavers' adaptability to the challenging extremes of the caves they continue to push.

### See Also the Following Articles

*Recreational Caving • Exploration and Light Sources*

### Bibliography

- Brucker, R.W. and J. Lawrence, Jr. (1955) *The Caves Beyond: The Story of Floyd Collins' Crystal Cave Exploration*, Funk & Wagnall's, New York.
- Cadoux, J. (1957) *One Thousand Meters Down*, George Allen & Unwin, London.
- Casteret, N. (1962) *More Years Under the Earth*, Neville Spearman, London.
- Courbon, P., C. Chabert, P. Bosted, and K. Lindsley (1989) *Atlas of Great Caves of the World*, Cave Books, St. Louis, MO.
- Green, D.J. and W.R. Halliday (1958) America's deepest cave. *NSS Bull.* 20, 31–37.

- Scheltens, J. (1988) Windy City Grotto at Wind Cave. *NSS News* January, 426–435.
- Siffre, M. (1975) Six months alone in a cave. *Natl. Geogr.* March.
- Smith, M.O. (1977) *The Exploration and Survey of Ellison's Cave, Georgia*, Smith Print and Copy Center, Birmingham, AL.
- Smith, P. (1956) Seven principles of effective expedition organization. *NSS Bull.* 18, 46–49.
- Stone, B. (1978) Underground camps for deep caves. *AMCS Activities Newsl.* 8, 37–45.
- Stone, B. and B. Ende, with P. Monte (2002) *Beyond the Deep: The Deadly Descent into the World's Most Treacherous Cave*. Warner Books, New York.
- Tazieff, H. (1953) *Caves of Adventure*. Harper & Brothers, New York, NY.

## Castleguard Cave, Canada

Derek Ford

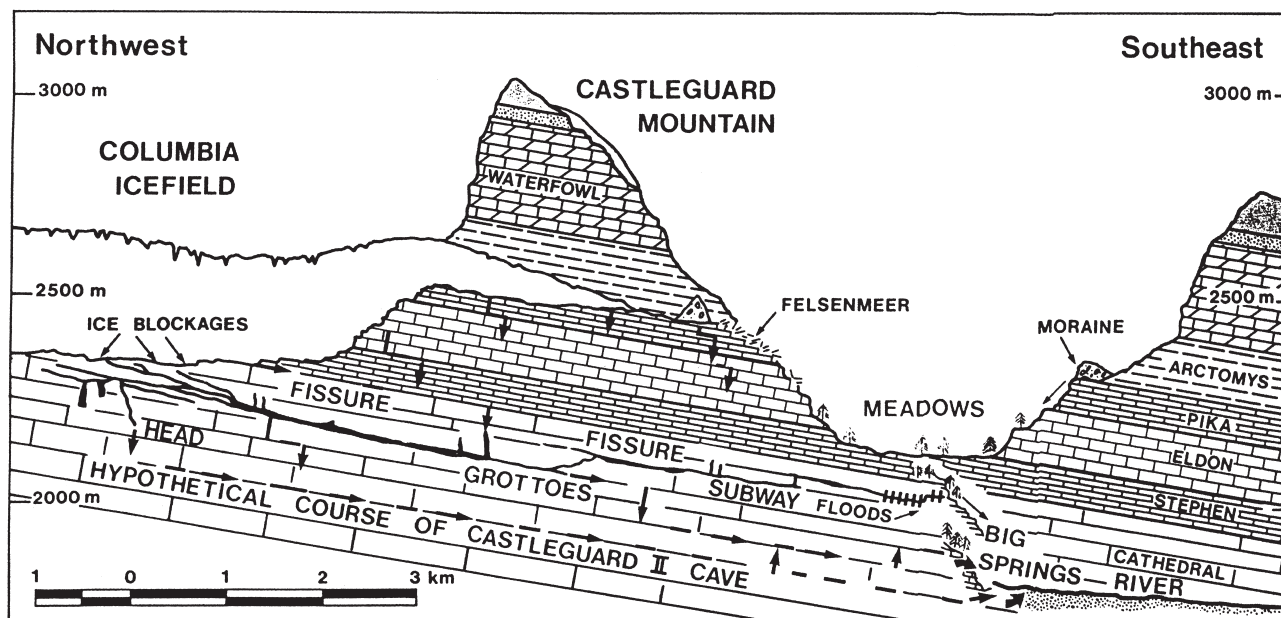
McMaster University

Castleguard Cave is the longest cave system currently known in Canada (20 km) and the foremost example anywhere of a cavern extending underneath a modern glacier (Fig. 1). It displays many striking features of interactions between glaciers and karst aquifers, a complex modern climate, rich mineralization, and a troglobitic fauna that has possibly survived one or more ice ages beneath deep ice cover in the heart of the Rocky Mountains.

### GEOGRAPHICAL SETTING

The cave is located in the northwest corner of Banff National Park, Alberta, very close to the Continental Divide. The region is one of rugged alpine mountains with many horn peaks, cirques, and U-shaped valleys typical of intensive glacial erosion, plus a few small but high plateaus. The range of elevation is from 1500 m asl in the floors of trunk valleys to summits at 3500 m. Mean annual temperatures are 0 to –14°C across this height range. Natural boreal forests extend up to ~2100 m, passing into grass and low shrub tundra and then alpine desert generally above 2400 m. The Columbia Icefield is a plateau ice cap 320 km<sup>2</sup> in area and 200 to 300 m thick, the largest remaining ice mass in the Rocky Mountains. Valley glaciers radiate up to 10 km out from it today. Ice thickness and extent were much greater during the major glaciations, when the glaciers extended 100 km or more from the icecap, with only the mountain peaks protruding as nunataks.

The karst rocks are resistant carbonates of Cambrian age. The Cathedral Formation (>560 m thick) is massively bedded, very resistant crystalline limestone that contains the cave. Above it, the Stephen Formation (80 m) is a limestone shale that can block much descending groundwater but leaks readily through some major fractures (*i.e.*, it is an aquitard). It is overlain by further thick-bedded limestones and dolostones, the Eldon and Pika Formations. The summit strata



**FIGURE 1** Schematic section through Castleguard Mountain, Alberta, Canada, showing the geological formations, the location of Castleguard Cave, Castleguard II, and the Meadows.

are mechanically weaker shales, sandstones, and dolostones. Beneath the Icefield, around the cave and north of it, these rocks dip regularly south-southeast at 4 to 6°. South of the cave and parallel to it there is a sharp downfold in the Cathedral rocks that caused some slippage of bedding planes (thrusting) to the north. A valley is excavated along the downfold, with a glacier from the Icefield at its head and the Castleguard River starting at the glacier snout. Castleguard karst groundwater drainage reaches the River via 60 or more springs.

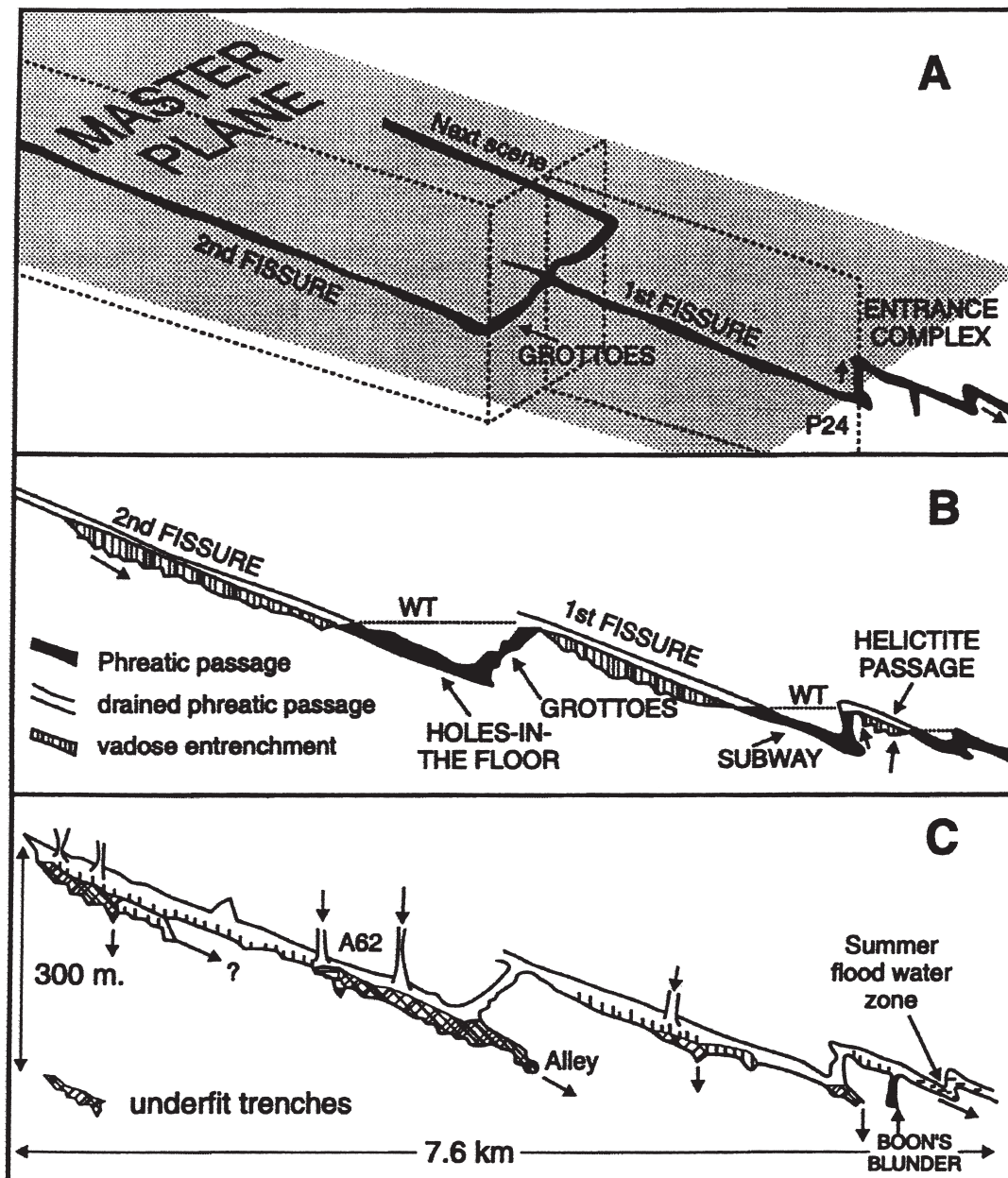
On the surface, the Cathedral limestones host a suite of small but typical alpine karst landforms such as karren, solution and suffosion dolines, and vertical shafts. They are particularly well seen in the Meadows, a broad, shallow valley north of the cave mouth (Fig. 1). Many of these features were overridden and lightly eroded by glaciers during a minor readvance—the “Little Ice Age,” which occurred during the past 500 years. The glaciers are now receding. Meltwater streams sink underground around their edges or in the Meadows. At places, streams can be heard cascading down shafts still concealed beneath the flowing ice.

### MORPHOLOGY AND GENESIS

Castleguard Cave is a textbook example of a meteoric water dissolutional cave in limestone. Cavers can enter it only at its downstream end at 2010 m asl in the north wall of Castleguard River valley, more than 300 m above the valley floor. From there, the cave ascends 386 m to terminations underneath the Icefield, where explorers are farther from their only entrance (and exit) than in any other known cave. There are three distinct morphologic sections. The *Headward*

*Complex* is comprised of inlet passages beneath the modern Icefield that were created by repeated glacial blockage and rerouting of sinking waters in the past. The passages are plugged by glacier ice or debris today. Younger vadose shafts pass down through them and become blocked by constrictions or debris below. The *Downstream or Entrance Complex* includes low tunnels in two major bedding planes and created by flooding and obstructions by glacier ice in Castleguard Valley in the past. Finally, the *Central Cave* is a sequence of remarkably long, straight conduits created where one master bedding plane is intersected by a pair of vertical joints that are linked by a sedimentary dike (Grottoes Dike) crossing them (Fig. 2A); in the bedding plane there is some evidence of crushing and shearing, indicating that differential slip opened it up a little, permitting groundwater to penetrate at its juncture with the joints and dike.

The cave possibly originated as a single phreatic loop beneath the Stephen impermeable cover rocks that descended more than 370 m below a paleowater table and then re-ascended to ancient springs just below the Meadows. More certainly, as Castleguard Valley was entrenched below the Stephen Formation, the cave became enlarged to nearly its modern dimensions, as shown in Fig. 2B. It is then comprised of two shallow, principal loops with vadose canyon entrenchments up to 20 m deep at their upstream ends, grading downstream into phreatic tubes 4 to 5 m in diameter and of beautiful circularity. The downstream loop discharged into Helictite Passage in the Entrance Complex by a vertical lift (phreatic shaft) of 24 m. Following further entrenchment of the Valley, the main cave headwaters were diverted into a lower cave (Castleguard II) and residual waters drained through constricted undercapture passages in the bottoms

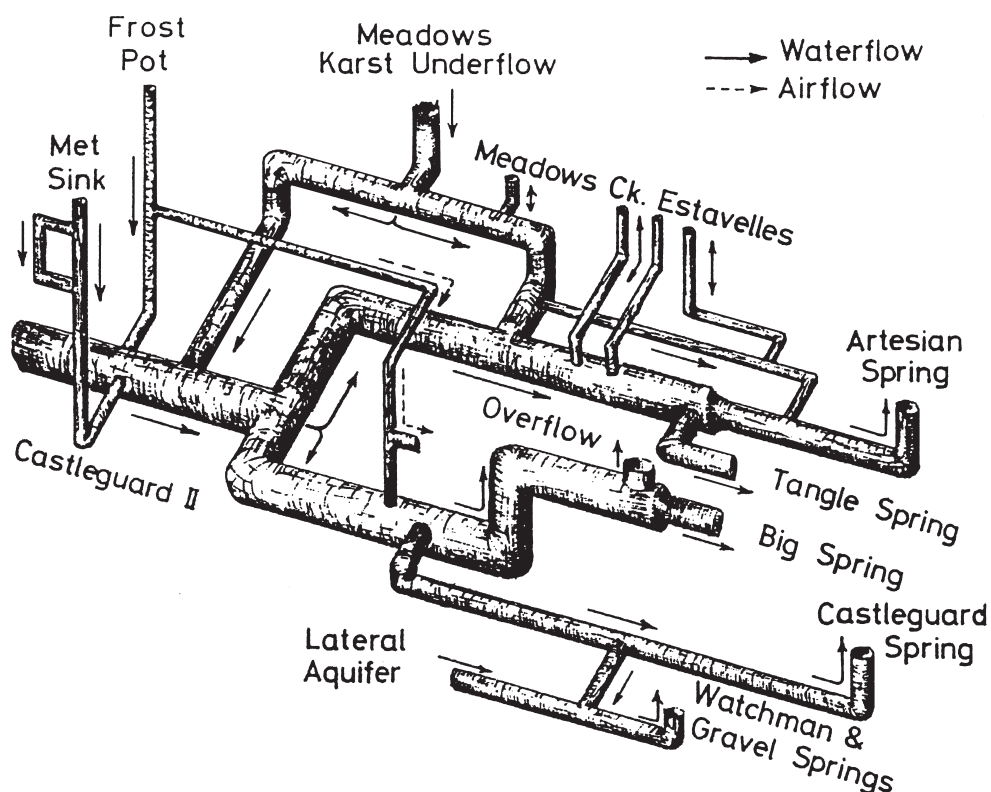


**FIGURE 2** (A) The initial phreatic passages in the Central Cave and Downstream Complex showing the master bedding plane and intersecting vertical fractures that guided them. They discharged into the Entrance Complex bedding planes via P24, a vertical shaft up a small fault. (B) The cave at the close of the principal enlargement phase. Drawdown vadose canyons supplied water to a succession of shallow phreatic loops. (C) The modern cave; small invasion vadose streams have cut shafts and underfit trenches in the drained galleries and are lost into impenetrably small, undercapture passages continuing on down into Castleguard II.

of the loops (Fig. 2C). The undercaptures channel local invasion waters passing through the leaky Stephen rocks today, but the Central Cave and Headward Complex are essentially abandoned hydrologic relicts. The Downstream Complex, however, can be flooded with terrifying rapidity when waters pour out of another, quite independent lifting shaft within it (Boon's Blunder) which fills the first kilometers of low passages entirely and discharges the waters through the explorers' entrance.

### Modern Hydrology

Modern waters drain underground from the glacier soles, alpine karst, and Meadows to a set of springs extending 3 km downstream from the Big Springs, which are a trio of dramatic overflows 15 to 40 m above the valley floor (Fig. 1). The waters flow through the putative series of inaccessible caves (Castleguard II), as illustrated in Fig. 3. Artesian Spring, the lowest in elevation, is perennial. As the annual melt season progresses, upstream springs such as Gravel and Watchman



**FIGURE 3** The proportional flow model of the inaccessible Castleguard II cave system, its feeder invasion vadose shafts, and discharge springs that Smart (1983) derived from quantitative hydrological studies. Cross-sectional areas of individual passages are proportional to their share of the total groundwater flow measured in the system, and their complicated pattern of interconnections is deduced from dye tracing and flood overflow behavior.

begin to flow. The Big Springs, 100 m higher than Artesian Spring, have a maximum discharge  $>7 \text{ m}^3 \text{ s}^{-1}$  and handle average summer floods. Their capacity is exceeded when there is very strong melting at the head of the Meadows and/or on the icefield. Groundwater then backs up in the aquifer until it floods Boon's Blunder and the Downstream Complex of the cave, 270 m above Big Springs. Cave discharges can be  $>5 \text{ m}^3 \text{ s}^{-1}$ . Tracer dye placed in glacier edge sinkholes can reach the Big Springs 4+ km distant and 750 m lower in as little as 3.5 hours. This is again a textbook example—here, of a dynamic alpine karst aquifer. The large number and great height range of its springs are attributed to repeated disruptions such as debris pluggings during the glaciations.

### Cave Sediments, Speleothems, and Dating

Subglacial boulders, gravel, and sand were swept or bulldozed into the head of the cave. Many have been partially cemented by calcite and later eroded, indicating a long history of filling and removal. Throughout the Central Cave are remnants of three partial fillings with varved silts and clays, separated by phases of erosion or calcite deposition. They are deposits of glacier flour, settled out of suspension on occasions when the cave became backflooded with subglacial waters because the Castleguard Valley was filled with flowing ice.

Despite its location beneath glaciers or alpine desert, the cave beyond the modern entrance flood zone is well decorated with speleothems, chiefly very pure, white calcite. There has been much speculation about mechanisms for its deposition in the absence of any sources of soil  $\text{CO}_2$  overhead. There is one double layer of cave pearls that are all edge-rounded cubes 5 to 7 mm in diameter, a unique deposit. In the warmer central sector (temperature of  $+2$  to  $+3^\circ\text{C}$ , relative humidity of  $\geq 95\%$ ), there are small evaporative aureoles of aragonite, huntite, hydromagnesite, gypsum, mirabilite, and epsomite; evaporation in these extreme conditions is due to strong drafts blowing through the cave when it is not in flood.

Although most speleothems appear to postdate the latest phase of varve deposition, there are many remains of older stalactites and stalagmites that suffered erosion during one or more varve floods. Uranium series dating and paleomagnetic studies of some of the oldest examples show that the cave became relict (*i.e.*, Castleguard II was already well developed) more than 780,000 years ago. The varved clays are younger. This antiquity is typical of multilevel alpine caves.

### THE CLIMATE OF THE CAVE

Castleguard Cave is a chilly place; however, because it passes through a big mountain (Fig. 1), the geothermal heat flux is



able to warm the central, most insulated parts around the Grottoes to approximately 3°C. In winter, this is much warmer than outside temperatures. The cave then functions as a chimney, with the warmer central cave air flowing upstream into the sole of the Icefield with dense, cold air pouring in through the explorers' entrance to replace it. The cold, dry air freezes residual pools of summer flood water in the Entrance Complex, giving cavers a 300-m belly crawl over dusty ice. The first liquid water is encountered only 1 km inside the cave. There is a subsidiary daily effect because the draft is strongest and coldest immediately before dawn, not a good time to be coming out through the ice crawls. In summer, the dynamic situation is reversed as cold, moist air from the interior flows down and out through the explorers' entrance into the warm exterior. Thick hoarfrost is deposited onto the chilled entrance walls until the first floods of spring arrive to remove it.

### THE FAUNA OF CASTLEGUARD

Harsh as conditions are, the cave has a small population of animals that prefer it or are entirely dependent on its protection. The first, troglaphiles, are packrats nesting above the floodwater limits in the Entrance zone. They have their own private entrances from the Meadows overhead that are too small for human cavers. Two species of blind and unpigmented (troglotitic or fully adapted) crustaceans live in pools in the Central Cave, where the water apparently never freezes. An isopod, *Salmasellus steganothrix*, is known elsewhere in the Canadian Rockies. An amphipod, *Stygobromus canadensis*, is known only in Castleguard. It is possible that the cave served as a subglacial refuge for these species during the last glaciation or longer. A packrat nest and other organic material were found in the Headward Complex in 1983 and carbon-dated to ~9000 years BP, indicating that in early postglacial times the Icefield had receded from at least part of it, thus providing some food for the troglotites downstream.

### CONCLUSIONS

Castleguard Cave has proved to be a fine laboratory for the study of dissolutional cavern genesis and of groundwater flow under glacier cover. It appears that most passages in the Cave that are large enough for humans have now been found and mapped, except perhaps in the Headward area. The Boon's Blunder flooded shaft has been dived to -10 m, where it enters a large, waterfilled tube ascending gently up the stratal dip. The underlying, very dynamic complex of Castleguard II that drains much of the Columbia Icefield today continues to defy all attempts at physical exploration. Under the Meadows and around the summit massif of the mountain more than 100 mapped sinkholes plus unmeasured subglacial streams feed water into Castleguard III, another almost entirely unknown system that may contain both extensive fossil and active galleries. There is great potential here for future generations of speleologists.

### Bibliography

- Ford, D.C., Ed. (1983) Castleguard Cave and Karst, Columbia Icefields Area, Rocky Mountains of Canada: A Symposium. *Arctic Alpine Res.* 15(4): 425-554.
- Ford, D.C., Lauritzen, S.-E., and Worthington, S. (2000) Speleogenesis of Castleguard Cave, Rocky Mountains, Alberta, Canada. In *Speleogenesis: Evolution of Karst Aquifers* (A. Klimchouk, D.C. Ford, A.N. Palmer, and W. Dreybrodt, Eds.). National Speleological Society of America, Huntsville, AL, pp. 332-337.
- Muir, R.D. and D.C. Ford (1985) *Castleguard*. Parks Canada Centennial Publication, Dept. of Supply and Services, Gatineau, Quebec, 242 pp.
- Smart C.C. (1983) The Hydrology of the Castleguard Karst, Columbia Icefields, Alberta, Canada. *Arctic Alpine Res.* 15(4): 471-486.

## Cave, Definition of

**William B. White**

*The Pennsylvania State University*

**David C. Culver**

*American University*

### DEFINITIONS AND POINTS OF VIEW

Human kind has been involved with caves for millennia. Caves were places of shelter for early humans in many parts of the world. They have served as places of worship for many societies in many times and places. Caves have been used as storehouses, as munitions factories, and as resting places for the dead. Caves play a prominent role in the myths and legends of many cultures throughout recorded history. Caves are secret places. Small children make "caves" by draping blankets over furniture. In contemporary society, caves frequently appear in movies and in cartoons. Show caves continue to draw thousands of visitors each year. Caves are also of great interest to scientists and explorers. Because caves are voids in rock, they are considered geological features, and indeed many textbooks (*e.g.*, Ford and Williams, 1989) firmly defend this point of view. However, caves are more than their geology because of their interaction with people and with organisms. One textbook (White, 1988) recognizes their human appeal by defining caves as "a natural opening in the Earth, large enough to admit a human being, and which some human beings choose to call a cave."

### CAVES AS PLACES FOR EXPLORATION

Caves are enticing, awaking an interest in many to see "where it goes." Although the first cave explorers are lost in the mists of history, cave exploration as a specialized human activity dates from the middle of the 19th century (Shaw, 1992). Earlier authors include discussions of caves in general

travelogues and descriptions of regions. The most famous of these in Valvasor's 1656 book, *The Glories of the Duchy of Carniola* (an area that is part of present-day Slovenia). In North America, Horace C. Hovey, Luella Owen, and a few others wrote popular accounts of their expeditions. The first modern speleologist is said to be Adolf Schmidl, who explored many Slovenian caves in the mid-19th century. Somewhat later came Edouard A. Martel in France who is considered the father of cave exploration. Unlike his American counterparts, Martel organized serious caving expeditions into the large caves and deep pits of the Pyrenees, the Alps, and many other places in Europe, an activity that also required inventing the technology of cave exploration as he went along.

Cave exploration by organized caving societies was well underway in Europe in the early 20th century. Organized exploration came later in the United States when several caving groups formed the National Speleological Society in 1941. During the past 50 years, cave exploration has blossomed into a recreational activity for thousands of individuals throughout the world and is organized into hundreds of caving clubs, national societies, and specialized scientific organizations. Most cavers take their explorations seriously and spend substantial time in preparing maps and writing detailed reports. Exploration and surveying of caves are among the few remaining activities where useful contributions to knowledge can be made by nonprofessionals.

Much of the allure of caves resides in their remoteness and wilderness character even beneath urban sprawl. This is, in part, because the underground landscape with its total darkness and unusual shapes of rock and mineral deposits is so alien compared with the familiar surface landscape. Caves are remote in the sense of the time and effort required to explore them. The farthest reaches of a large cave system may be only a few kilometers from the entrance as the crow flies and may be no more than 10 or 15 km as the caver crawls. And, of course, the outside world is only a few tens or hundreds of meters away, vertically, through solid rock. However, reaching the farthest corners of a large cave system, doing a bit of exploring and surveying, and returning to the entrance may require 24 to 36 hours. Or, it may require several days and an underground camp. In the same time one could have traveled comfortably across the continent on a jet plane, attended a conference on the opposite coast, returned home, and been clean and well-rested to boot. The remoteness of the cave arises not from distance but from the time needed to traverse it, from the obstacles that must be overcome, and from the sense of the strange and the bizarre in the cave landscape, a landscape duplicated nowhere on the Earth's surface. Caving, from this point of view, is truly an esthetic or wilderness experience. It requires solitude, a leisurely pace, and a sense of absorption into the environment. The emergence of the caver into the misty air under the bright stars of a summer's night is indeed the return from another world.

## CAVES AS GEOLOGICAL REPOSITORIES AND CAVES AS PARTS OF GROUND WATER FLOW PATHS

The cave environment may be described as dark, wet, neutral to mildly alkaline, and oxidizing. The variations of these parameters are much less than the variations of similar parameters on the Earth's surface. Chemical reactions under these very precisely controlled conditions permit the growth of unusual minerals and the growth of crystals of exceptional size. Mineral deposits take on the form of stalactites, stalagmites, flowstone, and other forms known collectively as *speleothems*. Because these deposits are nourished by water seeping down from the surface, changes in the climate and vegetation on the surface leave their signatures in the growth bands of the speleothems. The deposits of caves have become an important source of paleoclimatic information.

Because caves are void spaces, they tend to fill up with various materials collapsed or washed in from the surface. Debris piles near cave entrances preserve archeological and paleontological deposits. Stream-borne deposits of clays, silts, sands, and gravels record past flood conditions. Because the filling of caves takes place slowly over very long periods of time and because still older deposits are preserved in the high abandoned levels of cave systems, cave deposits are a history book for the ice ages.

Caves, of course, do not form in isolation. Every cave is related to a drainage system that now or at some time in the past carried water on its way from an inlet point to an outlet at a big spring. The underground pathways in limestones through which water moves from sinkholes and sinking streams to the outlets at springs are known as *conduits*. Conduit systems are very long but much of them is invisible. Conduits may be water filled or may have no humanly accessible entrances. Another definition of caves is that they are those conduit fragments that are accessible to human exploration. Careful inspection of the size, shape, and patterns of caves as well as details of solutional sculpturing on the cave walls provides much information on the present or past behavior of the groundwater flow system.

Much of the value of caves to the geological sciences is that they preserve records over long periods of time. Streams erode and deepen surface valleys and in so doing destroy the stream channel, flood plain, and valley shape that was there before. In contrast, caves deepen by forming new passages at lower levels, leaving the old levels high, dry, and well preserved.

## CAVES AS HABITAT

We can also look for a definition of caves by considering what animals consider caves to be dwelling places. As habitats, caves have several distinct environmental properties. In temperate zones in the summer, they tend to be cooler; conversely, they tend to be warmer in the winter. This characteristic of temperature buffering is shared not only by

what we would call true caves by any definition, but also by rock overhangs and shelters as well. Some of the fauna of true cave entrances such as phoebes and swallows are found in rock overhangs as well. If we define caves as an area of temperature buffering, then not only will rock overhangs be included but so will many manmade structures such as cellars and the underside of bridges.

A more appropriate environmental parameter to consider is darkness. Species isolated in the darkness of caves evolve a characteristic morphology, including loss of eyes and pigment. The presence of eyeless, depigmented species in a habitat would be one way to define a cave from an organism's point of view. What would be the characteristics of such a definition? First, the cavity would have to be large enough to have a zone of darkness. This would eliminate many short cavities. That is, the length of the habitat must be great enough relative to the diameter of the opening so that sunlight does not penetrate to the far reaches of the habitat. In practical terms, this length ranges from a few meters to hundreds of meters. This definition would exclude many open-air pits, which are formed the same way caves are—by dissolution of carbonate through the action of carbonic and sulfuric acid.

The second characteristic of such a habitat would be that it had been around long enough for animals either to evolve *in situ* or for animals to migrate into the habitat. It seems likely that most caves and karst areas are old enough to have an eyeless, depigmented fauna. Some of the youngest caves known are on carbonate islands such as San Salvador Island in the Bahamas. These caves, less than 125,000 years old, have an eyeless, depigmented cave fauna. In glaciated regions, the caves may be quite old but have only been ice free for perhaps 10,000 years. In this case, there are few if any terrestrial species that are either depigmented or eyeless. There are typically eyeless, depigmented aquatic species. These may have survived underneath the ice in unfrozen freshwater or have colonized from unglaciated areas. In any case, 10,000 years is almost certainly not long enough for species to evolve eyelessness *in situ*, a process that probably takes between 100,000 and 1,000,000 years (Culver *et al.*, 1995). Caves in evaporates (gypsum) and lava form much more quickly (and disappear more quickly). There are few reports of eyeless, depigmented species in gypsum caves, but lava tubes often have a rich fauna. The reasons for this are complex, but one of the factors is that the lava fields themselves are considerably older than a lava tube. Species found in lava tubes only a few thousand years old almost certainly migrated there from other lava tubes and cavities in the lava.

A third characteristic of such a habitat is that, if darkness combined with the presence of eyeless species is how it is delineated, then it will include a wide variety of aquatic habitats in darkness that have no connection with our intuitive idea of a cave. These include the underflow of rivers, marine and freshwater beaches, and any subsurface water. Many of these habitats, collectively termed *interstitial* or

alternatively *permeable and small cavities* (as opposed to permeable large cavities of caves), have a rich subterranean fauna of eyeless, depigmented species. At least in principle, we can recognize the differences between species in interstitial habitats and species in caves. While they share a lack of pigment and eyes, interstitial species tend to have shorter appendages, smaller body size, and a more worm-like appearance than do cave species (Coineau, 1999). In practice, it is difficult to distinguish species from many taxonomic groups. For example, snails occur in both habitats but there is little to distinguish the two groups morphologically. In areas with carbonate rocks, we can also distinguish the two by the size of the cavity. The simple, nonscientific definition of caves as natural cavities in a rock that can be entered by people does not help in this case. Cave animals can obviously thrive in cavities that are too small to be entered by people. Cavity diameters exist in a continuum, with a breakpoint between laminar and turbulent flow cavities of approximately 1 cm. The transition between laminar and turbulent flow is also an important biological transition, and one that in a general sense separates interstitial and cave habitats.

Thus, we can define a cave from a biological point of view as a cavity, at least part of which is in constant darkness, with turbulent water flow and with eyeless, depigmented species present.

## TYPES OF CAVES

When we define caves in terms of human access rather than in terms of geologic setting, caves can be found in many different geologic settings and have been formed by many kinds of processes (Fig. 1). Caves can be formed by purely mechanical processes. Bulk masses of rock can be fractured and shifted by tectonic processes such as faults. Likewise, rock masses can break along fractures and then pull apart by the rock masses sliding under the influence of gravity. In either case, void spaces formed between the rock masses are called *tectonic caves*. Tectonic caves tend to form in hard, massive, brittle rocks such as sandstones. They tend to be small, typically a few tens of meters, although some reach lengths of hundreds of meters.

Boulder piles, if the boulders are sufficiently large to allow humans to explore the pore spaces between the boulders, can form caves. These openings are called *talus caves*. Because talus caves are simply the interstices between a pile of boulders that may or may not be completely roofed over, talus caves really do not have a definable length. Some talus caves in the Adirondack Mountains have been claimed to be several kilometers in length, although this requires a fairly generous definition of a cave. Rocks may be differentially eroded to produce cave-sized openings. The categories of erosional caves are defined by the erosion process.

*Sea caves* are formed by wave action on sea cliffs. Fractures in the rock produce zones of weakness that focus the attack of the waves. Sea caves are formed in many kinds of resistant

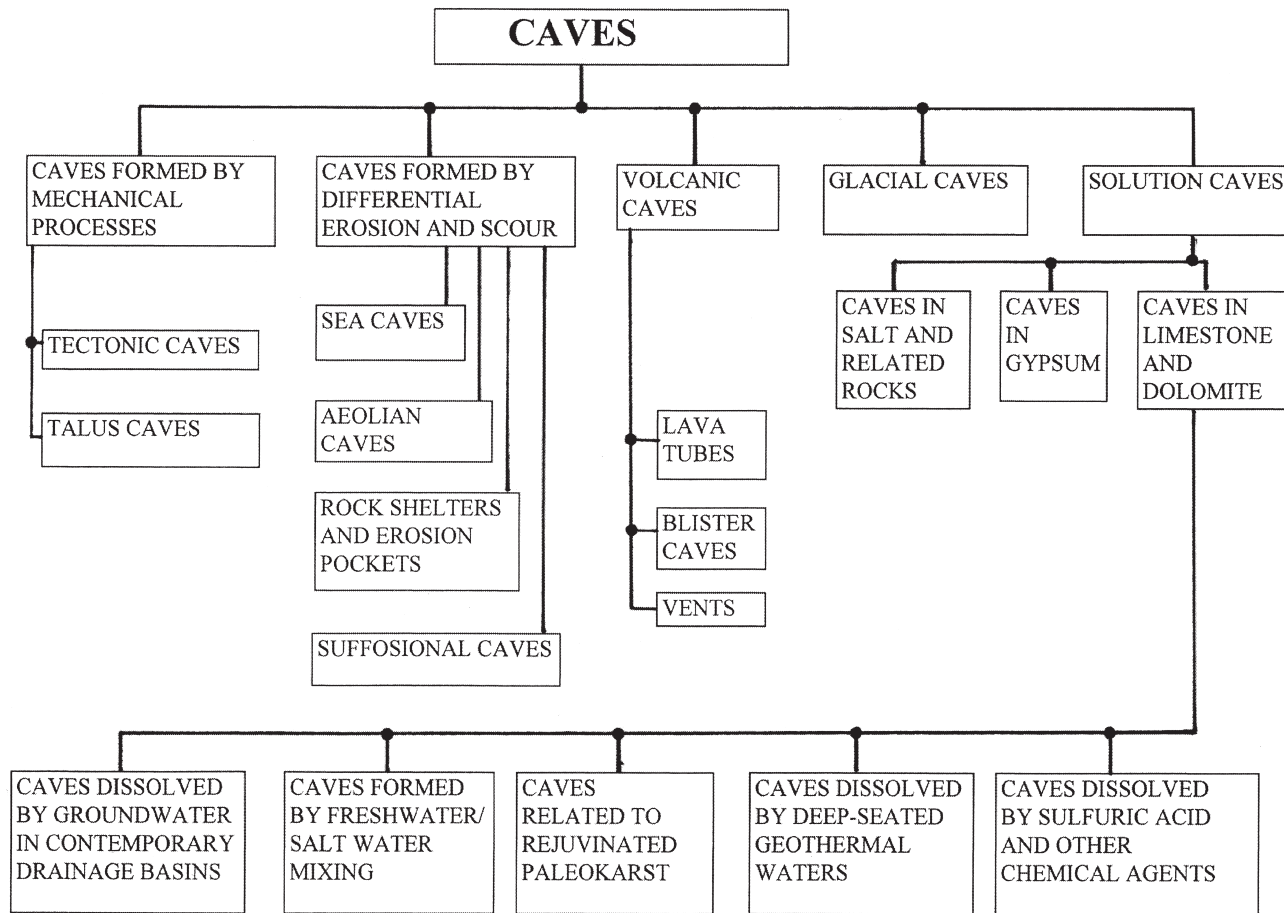


FIGURE 1 Types of caves.

rocks in many parts of the world. Fingal's Cave on the Isle of Staffa in the Scottish Hebrides (made famous by Mendelssohn in his *Hebrides Overture*) is in columnar basalt. Sea caves form in granite on the coast of Maine. Many sea caves are found on Santa Cruz and Anacapa Islands off the coast of southern California (Bunnell, 1988, 1993). Sea caves extend for distances from a few meters to a few hundred meters into the sea cliff. Frequently, the caves consist of an inner chamber that is much larger than the connection passage to the open sea. Access to a sea cave may be possible at low tide, while the cave may be flooded at high tide. Some sea caves have blow holes in the back that spurt water when tides or storm surges rush into the cave.

*Aeolian caves* are formed by wind action. These are common in the arid regions of the American Southwest. Wind-blown sand scours sandstone cliffs and sculpts out chambers a few meters to a few tens of meters in diameter. A typical aeolian cave is a bowl-shaped chamber carved in solid rock. Ceiling heights vary from 1 to 2 meters. Often the entrance is a smoothly carved hole in the cliff much smaller than the chamber inside.

Rock shelters are borderline caves. In places where a resistant bed of rock, typically sandstone, overlies weaker

beds of rock, typically shales, the weaker rock can be eroded away, leaving the resistant rock beds to form a roof. Rock shelters are usually small, a few meters to a few tens of meters in depth although they can be tens to hundreds of meters wide. As caves, rock shelters usually do not extend to total darkness; however, such shelters were habitats for early humans. They are often rich repositories of archeological material and sometimes are referred to as caves by archeologists.

Fine-grained, poorly consolidated sediment can be swept away by stormwaters. In such locations as Badlands National Monument in western South Dakota, sediments flushed by stormwaters produce small caves in the loosely consolidated silts and clays. These are known as *suffosional caves*.

Of great interest to cave explorers are lava tubes and other volcanic caves. Lava tubes form on the sides of volcanoes where streams of lava freeze over, drain, and leave behind, buried in the lava flow, open tubes with diameters of meters to tens of meters and lengths up to many kilometers. The processes that form lava tubes are entirely different from the processes that form solution caves in limestone and other rock but they are caves in the same sense that other natural openings of human size are caves. Lava tubes are also habitat for organisms. Volcanic areas that have discharged fluid

basaltic lavas usually have systems of lava tubes—for example, Hawaii, southern Oregon, and northern California. Lava Beds National Monument in northern California provides easily accessed examples (Waters *et al.*, 1990).

When glaciers melt, the meltwater drains down into the glacier through fissures. This water moves along the base of the glacier and, because it is slightly warmer than the freezing point of water, it gradually carves out long tunnels that open at the front of the glacier forming the rivers that drain the glaciers. Glacier caves are ice tunnels with floors of rock and walls and ceilings of ice. When the surface of the glacier is below freezing, the tunnels drain and become open to exploration. When the glacier is melting, the tunnels are often filled with water.

Most important are the solution caves. These form by chemical dissolution of the bedrock by circulating groundwater. They come in a great variety depending on the type of rock and the source and chemistry of the water that does the dissolving. Most solution caves are formed in limestone, a rock consisting largely of calcium carbonate, or dolomite, a rock consisting largely of calcium magnesium carbonate. These would be called limestone caves or dolomite caves. In arid regions, the more soluble rock, gypsum, calcium sulfate, is exposed at the land surface, and one finds gypsum caves, for example, in west Texas, western Oklahoma, and New Mexico, where gypsum rock occurs at the land surface. Caves easily form in salt and a few other highly soluble materials, but such caves are rare because salt does not survive at the land surface except in a few extremely arid regions.

Figure 1 shows the variety of sources for the water responsible for the development of caves. Most of the caves are dissolved by the movement of ground water in contemporary drainage basins. In coastal regions, the mixing of fresh groundwater with saltwater produces an aggressive solution that can dissolve out caves. Some caves (for example, the large caves of the Black Hills of South Dakota) are formed from hot water rising up from deep within the rock. Carlsbad Caverns in New Mexico and other caves of the Guadalupe Mountains have been formed by sulfuric acid derived from the oxidation of hydrogen sulfide migrating upward from the oil fields to the east.

In summary, caves form in a great variety of rocks by a great variety of geological and chemical processes. Each has its importance to geology. However, the common theme that binds this diverse collection of cavities together is their interest to human explorers and their use as habitat by cave-adapted organisms.

### **Bibliography**

- Bunnell, D.E. (1988) *Sea Caves of Santa Cruz Island*. McNally and Loftin, Santa Barbara, CA, 123 pp.  
 Bunnell, D.E. (1993) *Sea Caves of Anacapa Island*. McNally and Loftin, Santa Barbara, CA, 207 pp.  
 Coineau, N. (2000) Adaptations to interstitial groundwater life. In *Subterranean Ecosystems* (H. Wilkins, D.C. Culver, and W.F. Humphreys, Eds.). Elsevier Press, Amsterdam, pp. 189–210.

- Culver, D.C., T.C. Kane, and D.W. Fong (1995) *Adaptation and Natural Selection in Caves*. Harvard University Press, Cambridge, MA, 223 pp.  
 Ford, D.C. and P.W. Williams (1989) *Karst Geomorphology and Hydrology*. Unwin Hyman, London, 601 pp.  
 Shaw, T.R. (1992) *History of Cave Science*. Sydney Speleological Society, Sydney, Australia, 338 pp.  
 Waters, A.C., J.M. Donnelly-Nolan, and B.W. Rogers (1990) Selected caves and lava-tube systems in and near Lava Beds National Monument, California. *U.S. Geol. Survey Bull.* 1673, 102 pp.  
 White, W.B. (1988) *Geomorphology and Hydrology of Karst Terrains*. Oxford University Press, New York, 464 pp.

## Cave Dwellers in the Middle East

**Paul Goldberg**  
*Boston University*

**Ofer Bar-Yosef**  
*Harvard University*

This article offers information about prehistoric caves in the Middle East. Caves are a source of fascination for the public as well as many scientists. In this short entry we will attempt to briefly describe and summarize some of the discoveries in Middle Eastern caves and what those discoveries reveal about human behavior.

### INTRODUCTION

Caves figure strongly in the archeological record, through most archeological time periods and across most continents. Caves not only served as loci of habitation where daily activities such as food processing and sleeping took place but also functioned as gathering places for spiritual and religious activities.

Prehistoric caves—particularly those in the Middle East—are special sedimentary environments (Fig. 1). In essence, because of the overall low energies of the depositional processes, caves serve as excellent sedimentary traps: Whatever is brought into the cave tends to stay there. As a result, caves can preserve faithful records of past environments, as well as past human activities. Environmental information is conveyed by the presence of macro- and microfaunal remains—particularly the latter. Plant remains, an additional environmental indicator, are scarce, although microbotanical remains such as pollen and phytoliths can be found. Phytoliths tend to be better preserved and abundant and provide insights not only about past local and regional conditions but also about human activities, such as the gathering of plants for fuel, bedding, and food.



**FIGURE 1** Map of Middle East and the location of major prehistoric cave sites in the area. Only a few caves are discussed here.

In addition, anthropogenic deposits also reveal the nature of past human activities at a cave by incorporating animal bones and stone artifacts. These objects inform us about hunting and butchering practices, the manufacture and use of curated stone tools, and the use and function of space (*e.g.*, working areas, fireplaces, dumping, and sleeping zones).

The above statements are pertinent to many cave sites throughout the world. Middle Eastern caves, however, benefit from their location at the crossroads to human past and present migrations and thus offer the opportunity to monitor and document important phases in human evolution, particularly with regard to the origin of modern humans and the demise of Neanderthals.

### LOCATION AND PRESENT ENVIRONMENT

Most of the caves in the Middle East are situated either in the Mediterranean climatic zone (Fig. 1), particularly in a belt close to the present Mediterranean coastline, or in the drier, stepic and desertic region. The Mediterranean climate, which includes distinct climatic gradients from west to east and from north to south is characterized by warm, dry summers and cool, wet winters in which 500 to more than 1000 mm of precipitation can fall. Similarly, the transition from steppe to desert is marked by reductions in rainfall from 500 to less than 100 mm.

Most of the caves outlined in this section developed in limestone and formed during the late Tertiary/Quaternary period under phreatic conditions and commonly as enlargements along joints. Vadose expansion is more recent, resulting in a vaulted or domed morphology with vertical chimneys that extend to the surface above several of the caves. Many of these same caves have depressions or sinkholes that are situated beneath the chimneys. In any case, modern-day karstic activity is generally negligible, and the remains of formerly more extensive and well-developed dripstone features signify karstic conditions that were much different from what occurs today.

### CAVE DEPOSITS AND PROCESSES

Depositional and post-depositional processes operating in karstic caves are relatively well known but less so in prehistoric caves; however, recent research, particularly in Middle Eastern prehistoric caves, has begun to reveal a high degree of marked complexity. Material of geological origin may accumulate in the interior in a number of ways, including: (1) gravity-derived rockfall from the walls and roof of the cave; (2) aqueous processes associated with fluvial and phreatic deposition, or runoff; (3) colluviation of soils derived from the surfaces above and outside the cave; and (4) aeolian deposition of sand and silt.

Middle Eastern caves contain distinct biogenic contributions, such as bird and bat guano. In addition, coprolites and

organic matter remains produced by carnivores—particularly hyenas—are quite common. In many caves, the presence of millimeter-sized rounded stones indicates distinct gastrolith input by pigeons. Plant remains, such as grass and wood, can be washed and blown into the cave, or alternatively brought into the cave by past human occupants for fuel, bedding, or shelter.

Anthropogenic contributions to cave sedimentation in this region are noteworthy and tend to be unnoticed in many prehistoric cave settings throughout the world. These accumulations consist of primarily bone and shell remains, as well as the buildup of ashes, organic matter, and charcoal that are associated with fireplaces and burning activities. Additional traces of fine-grained soil and sediment that were tracked into the cave by humans and other animals are subtle but important.

Once within the cave itself, deposited material is commonly modified by a number of processes that are often penecontemporaneous with deposition. Deposits are sometimes modified by wind, runoff, and dripping water or subjected to burrowing by animals or to trampling by humans and other occupants. Mineral and organic residues are sometimes moved by human or animal activity from their original location within the cave. Bone and lithic discard evidence of activities and indications of removal, dumping, and trampling of material associated with the cleaning or maintenance of hearths are not uncommon.

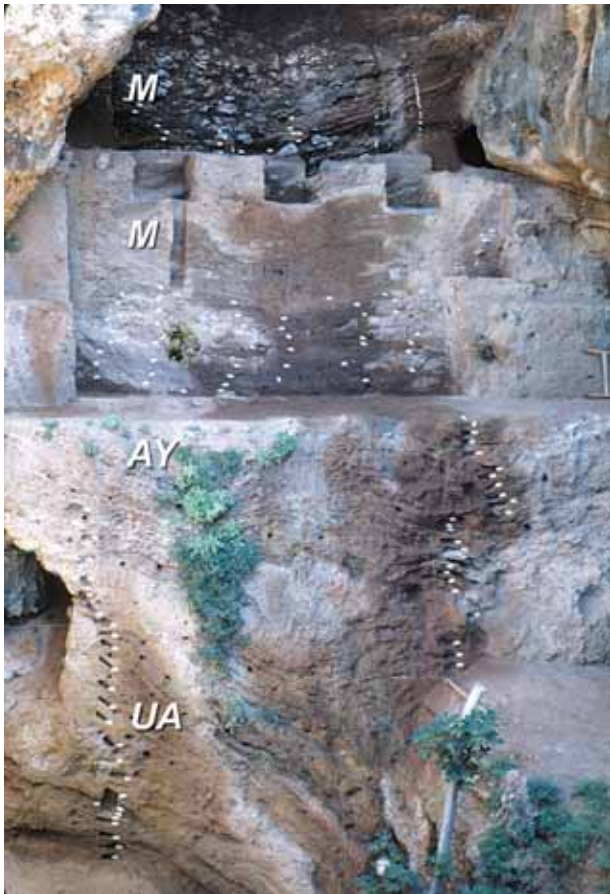
Prehistoric caves in this region are damp and act as sinks for water, organic matter, and guano and accordingly tend to act as chemical engines whereby numerous mineral transformations take place. These secondary alterations commonly include the precipitation (and dissolution) of carbonates that form speleothems, layered travertines, or the so-called cave *breccia*, which represent calcite-cemented clastic sediments typically consisting of inwashed soil material. Another characteristic type of mineral alteration involves the formation of several types of phosphate minerals, along with the formation of opal and the breakdown of clays.

Palaeoenvironmental and palaeoclimatic changes expressed in the faunal records, as well as by depositional and post-depositional accumulations and removals, are registered in a rather coarse chronology. Speleothems in Nahal Soreq Cave and a cave near Jerusalem provided detailed records of palaeoclimatic fluctuations of the last 170 thousand years. These karstic caves were rarely penetrated by humans, and these oscillations follow the pattern known from other localities of the northern hemisphere.

### THE PREHISTORIC AND HISTORICAL SEQUENCE OF CAVE OCCUPATIONS IN THE MIDDLE EAST

Prehistoric caves in the region produced the basic archaeological sequence of at least the past 400 thousand

years (Fig. 1); several examples are illustrated in the following text, with comments related to the themes discussed above. The oldest known cave deposits were exposed in Umm Qatafa, Tabun, (Fig. 2a,b), and the Yabrud IV rockshelter, where the lowermost layers—more than 400 thousand years old—contained a core-and-flake industry, a phenomenon that intersects the Acheulian sequence. The Late (or Upper) Acheulian is known from several caves. This industry is characterized by handaxes or bifaces, but these tools are not quantitatively the most dominant tool type. The Late (or Upper) Acheulian is followed by the Acheulo-Yabrudian, where the combination of bifaces and scrapers, often shaped



**FIGURE 2a** Tabun Cave, Mount Carmel. Shown in this photograph (taken during the 1969 season) are bedded sandy and silty sediments that were blown into the cave from the adjacent coastal plain. These contain Lower and Middle Palaeolithic industries, including the Upper Acheulian (UA), Acheulo-Yabrudian (AY), and Mousterian (M). Note the strong dip of the lowermost sediments that plunge into a subsurface swallow hole. This subsidence took place during the earlier phases of deposition, as the bulk of the sediments from the middle part of the photograph upwards are roughly horizontal. The uppermost part of the photograph (see Fig. 2b) is composed of interbedded clay and ashy deposits, punctuated with numerous blocks of roof fall. The dating of the deposits here is a subject of debate, but estimates using thermoluminescence (TL) dating on burned flints suggest that the deposits down to the top of the large hole on the left are close to 350 thousand years old (Mercier et al., 1995).



**FIGURE 2b** Tabun Cave, Mount Carmel. This photograph is from the upper part of the cave, above the uppermost ledge in Fig. 2a. In contrast to the lower deposits, these are largely anthropogenic in nature and consist of lighter and darker bands of ash and red clay, respectively. These anthropogenic layers are overlain by massive reddish clay that contains decimeter-sized blocks of roof fall. The latter attests to an enlargement and eventual opening of the chimney that leads up to the surface of Mount Carmel. It is through this chimney that the clayey *terra rossa* soils were washed into the cave.

on thick flakes, appear in Tabun, Hayonim, Qesem, Zuttiyeh, and the Yabrud I rockshelter, as well as in open air-sites in the El-Kowm basin (Northeast Syria). This entity occupies the Levant between the Acheulian sequence and the Mousterian or Middle Palaeolithic. Its geographic distribution indicates an origin in the northern Levant.

Cave sites with Middle Palaeolithic (250–270 thousand to 48–46 thousand calendar years BP) remains have produced a wealth of evidence, as well as a large number of human burials and isolated human bones. The earlier deposits contain skeletal remains identified as archaic Modern humans (also known as the Skhul-Qfzeh group; Fig. 3). Occurring stratigraphically above these human remains are those of southwestern Asia Neanderthals that were found in Kebara (Fig. 4), Amud, Dederiyeh, and Shanidar. Based on the evidence, both human populations demonstrated good hunting skills, the use of fire, and the ability to procure raw materials for making stone tools from a radius of 5 to 20 km around the sites. Mobility between lowland and highland areas has been easier to trace in Lebanon, South Jordan, and the Zagros because of the greater topographic relief in these areas.

Among Upper Palaeolithic and Epi-Palaeolithic (48–46 to 11.5 thousand calendar years BP) cave occupations, the best known are (1) Ksar 'Akil, with an unusual 18-m sequence of Upper Palaeolithic layers; (2) the few Levantine Aurignacian sites (*e.g.*, Yabrud II, El-Wad, Kebara, and Üçagizili); and (3) those attributed to the Natufian culture that immediately preceded the earliest farming villages. The Natufians camped in caves, built rooms inside the main chambers, and buried their dead. Their use of caves was probably more intense than that of their predecessors. During the prehistoric periods,





**FIGURE 3** Qafzeh Cave, Lower Galilee. This cave is famous for its series of Middle Palaeolithic human burials in layers XVII to XXI. The morphological analyses identified the remains as archaic Modern Humans and are therefore considered as coming out of Africa. These layers, dated by thermoluminescence (TL) from about 95 to 115 thousand calendar years BP (Valladas et al., 1988), consist of fine-grained angular rock fall that has been reworked by slope wash and colluvial processes. The darker band in layer XXI results from manganese enrichment associated with a subsurface spring that was operational during that time.



**FIGURE 4** Kebara Cave, Mount Carmel. Situated about 12 km south of Tabun, Kebara is considerably younger, dating to about 60 to 70 thousand calendar years BP. This view of the southeast corner of the cave shows mostly Upper Palaeolithic (UP) deposits in the walls on the right and left and Middle Palaeolithic (MP) sediments on the floor of the excavation. The Upper Palaeolithic deposits are comprised of finely bedded and laminated silt and sand-sized material (S) that has washed back into the cave via runoff. It commonly includes sand-sized aggregates that have been reworked from older sediments near the entrance. A large piece of limestone roof fall (Ls) in the wall to the left shows that some gravity deposition also takes place. Interestingly, the other portions of this block have been subjected to diagenesis in which the original dolomite block has been transformed into a number of phosphate minerals, including francolite, crandallite, montgomeryite, and leucophosphite (Weiner et al., 1993). Punctuating these geogenic deposits are isolated hearths (H) representing some anthropogenic material within the mostly geogenic sediments. The Middle Palaeolithic deposits, on the other hand, are mostly anthropogenic and consist of hearths and hearth products (charcoal, organic matter, and ash). Some of these hearths are revealed by a white area (see the base of the photograph).

caves were often used for camping by entire groups and rarely used as stations for performing specific tasks. One of the best examples is the use of caves at higher altitudes for short-term camps by hunters.

Since the Neolithic period (11,500 to 7500 calendar years BP) the use of caves changed dramatically. Several caves served as camps for special artisans, but in more than one case the caves became sacred and were utilized, as in Nahal Hemar and Nahal Qana caves, for storage of paraphernalia or other sacred objects. Larger caves could have served as locations for ceremonies, as indicated by a few caves in Turkey.

During the Chalcolithic and Bronze ages (7500 to 3200 calendar years BP), caves were employed for various purposes. Certain karstic caves, such as Peqi'in, served as burial grounds, while others functioned as storage facilities, animal pens, and even refugia. During the Bronze Age, caves continued to be used in similar ways, and a unique example is the warrior burial in a cave near the Jordan Valley. Finally, a common use of most caves during the last millennium BC and the first two millennia AD was by shepherds who often spent the late fall and winter months in these protected shelters.

### Bibliography

- Ayalon, A., M. Bar-Matthews, and A. Kaufman (2002) Climatic conditions during marine oxygen isotope stage in the eastern Mediterranean region from the isotopic composition of speleothems of Soreq Cave, Israel. *Geology* 30: 303–306.
- Bar-Matthews, M., A. Ayalon, and A. Kaufman (1997) Late Quaternary paleoclimate in the eastern Mediterranean region from stable isotope analysis of speleothems at Soreq Cave, Israel. *Quater. Res.* 47: 155–168.
- Bar-Matthews, M., A. Ayalon, A. Kaufman, and G.J. Wasserburg (1999) The eastern Mediterranean paleoclimate as a reflection of regional events: Soreq Cave, Israel. *Earth Planetary Sci. Lett.* 166: 85–95.
- Frumkin, A., D.C. Ford, and H.P. Schwarcz (1999) Continental oxygen isotopic record of the last 170,000 years in Jerusalem. *Quater. Res. (New York)* 51: 317–327.
- Karkanias, P., O. Bar-Yosef, P. Goldberg, and S. Weiner (2000) Diagenesis in prehistoric caves: the use of minerals that form *in situ* to assess the completeness of the archaeological record. *J. Archaeol. Sci.* 27: 915–929.
- Mercier, N., H. Valladas, G. Valladas, and J.-L. Reyss (1995) TL dates of burnt flints from Jelinek's excavations at Tabun and their implications. *J. Archaeol. Sci.* 22: 495–509.
- Schiegl, S., S. Lev-Yadun, O. Bar-Yosef, A.E. Goresy, and S. Weiner (1994) Siliceous aggregates from prehistoric wood ash: a major component of sediments in Kebara and Hayonim caves (Israel). *Israel J. Earth Sci.* 43: 267–278.
- Schiegl, S., P. Goldberg, O. Bar-Yosef, and S. Weiner (1996) Ash deposits in Hayonim and Kebara Caves, Israel: macroscopic, microscopic and mineralogical observations, and their archaeological implications. *J. Archaeol. Sci.* 23: 763–781.
- Valladas, H., J.L. Reyss, J.L. Joron, G. Valladas, O. Bar-Yosef, and B. Vandermeersch (1988) Thermoluminescence dating of Mousterian 'Proto-Cro-Magnon' remains from Israel and the origin of modern man. *Nature* 331: 614–616.
- Weiner, S., P. Goldberg, and O. Bar-Yosef (1993) Bone preservation in Kebara Cave, Israel, using on-site Fourier transform infrared spectrometry. *J. Archaeol. Sci.* 20: 613–627.
- Weiner, S., S. Schiegl, P. Goldberg, and O. Bar-Yosef (1995) Mineral assemblages in Kebara and Hayonim caves, Israel: excavation strategies, bone preservation, and wood ash remnants. *Israel J. Chem.* 35: 143–154.

# Chemoautotrophy

Annette Summers Engel  
*The University of Texas at Austin*

Nearly all life on Earth depends on sunlight and photosynthesis for organic carbon and cellular energy; however, the absence of light energy does not preclude life, as chemosynthesis provides another source of sustainable energy. Reactive rock surfaces and mineral-rich groundwater provide an assortment of potential energy sources for specialized microorganisms that gain cellular energy from the chemical oxidation of inorganic compounds and convert inorganic carbon sources into organic carbon. While chemosynthetic microorganisms are found in nearly every environment on Earth, they are most abundant in habitats where darkness prevails and competition with photosynthetic organisms is eliminated. Significant chemosynthetic populations have been reported at deep-sea hydrothermal vents (Deming and Baross, 1993), within the deep terrestrial subsurface (Stevens and McKinley, 1995), and from caves (Sarbu *et al.*, 1996).

Caves form distinctive habitats with complete darkness, relatively constant air and water temperatures, and a depleted supply of easily degradable organic matter. Because darkness precludes photosynthetic activity, most cave ecosystems are dependent on allochthonous organic material for energy. Indeed, the limited organic matter found in caves is usually derived from dead photosynthetic material, having been carried into the subsurface system via air currents, speleothem dripwaters originating from the surface, or stream drainage or occurring as guano from cave-dwelling organisms. Early (bio)speleologists demonstrated that microorganisms often colonize caves but assumed their presence was only as secondary degraders and food sources for higher organisms (Caumartin, 1963). They also suggested that chemosynthetic activity was not evident or was limited in most cave systems; however, the recent discoveries of complex cave ecosystems and chemosynthetic microorganisms encourage modifications to these original hypotheses.

Current research has shown that chemosynthetically based cave ecosystems form as a consequence of energy-rich compounds (such as hydrogen, reduced iron, or hydrogen sulfide) being present in the groundwater or cave sediments. The microorganisms utilize the available chemical energy in the cave that would otherwise be lost to the system. In this manner, chemosynthesis is a rich alternative energy source for cave organisms, resulting in higher ecosystem biodiversity compared to most non-chemosynthetically based cave ecosystems that rely on inconsistent and limited inputs of organic carbon and as such have relatively low species diversity and population densities. This article focuses on chemosynthesis and chemosynthetically based ecosystems

found in caves and summarizes current methodology and major microbial groups with respect to their evolutionary affiliations and metabolic pathways. The distribution of chemosynthetic microbial groups in several cave ecosystems is emphasized, and the article concludes with a discussion of subsurface chemosynthetically based ecosystems and suggests relevant aspects of future research.

## TERMINOLOGY EXPLAINED

The physiological mechanisms for capturing chemical energy during chemosynthesis are diverse, and there are several descriptive qualifiers that define an organism based on its carbon and energy sources. Carbon for cellular growth originates from either (1) converting inorganic carbon ( $\text{CO}_2$ ,  $\text{HCO}_3^-$ ) to organic carbon as an *autotroph* (“self-feeding”), or (2) from assimilation of organic carbon initially produced by autotrophs. The distinction between a chemosynthetic and a photosynthetic organism is based on whether the initial source of energy is from inorganic chemicals (*litho*) or light (*photo*). During chemosynthesis, microorganisms gain energy by transferring electrons from one chemical (electron donor) to another (electron acceptor). Typically, they use compounds present in groundwater or they colonize rock and mineral surfaces to mine essential nutrients. Microbes that gain energy through chemosynthesis and fix inorganic carbon are *chemolithoautotrophs* (literally, a self-feeding rock-eater). Chemical electron donors include, but are not limited to, molecular hydrogen or reduced sulfur compounds; organic molecules (*organo*), such as acetate or formate, can also be used. However, an organism is no longer classified as a chemolithoautotroph if organic compounds are used to gain energy or as a carbon source. Organisms that gain cellular energy from chemical transformations but use organic carbon compounds for their carbon source are *chemoorganotrophs*. *Heterotrophs* use organic carbon for cellular energy and carbon sources. Several studies have shown that chemolithoautotrophs can grow if organic carbon is present as *mixotrophs*, in which both chemolithotrophy and heterotrophy are expressed simultaneously. For the purposes of this article, strictly chemolithoautotrophic microbial processes will be considered from caves.

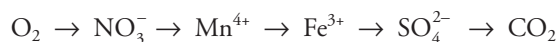
As microorganisms are classified based on the electron donors they prefer for their specific metabolic activities, they are also classified on the basis of oxygen requirements and whether they respire aerobically, anaerobically, or ferment, all of which relates to electron acceptor utilization (Table I). The majority of well-characterized microorganisms require oxygen (*aerobes*), whereby oxygen serves as the terminal electron acceptor for metabolic processes yielding energy. Common aerobic reactions include sulfur oxidation, iron oxidation, and ammonia oxidation. In more reducing environments, traditionally where organic carbon is consumed rapidly, microbes that do not require oxygen

TABLE I Examples of Chemolithoautotrophic Energy Reactions and Carbon Fixation Pathways

Energy Reaction	Metabolic Process	Major Genera	Electron Donor	Electron Acceptor	Carbon Pathway <sup>a</sup>
<b>Anaerobes</b>					
$4\text{H}_2 + \text{CO}_2 \rightarrow \text{CH}_4 + 2\text{H}_2\text{O}$	Methanogenesis	<i>Methanoseata, Methanococcus</i>	$\text{H}_2$	$\text{CO}_2$	A–CoA
$2\text{CO}_2 + 4\text{H}_2 \rightarrow \text{CH}_3\text{COOH} + 2\text{H}_2\text{O}$	Acetogenesis	<i>Acetobacterium</i>	$\text{H}_2$	$\text{CO}_2$	A–CoA
$4\text{H}_2 + \text{SO}_4^{2-} + 2\text{H}^+ \rightarrow \text{H}_2\text{S} + 4\text{H}_2\text{O}$	Sulfate reduction	<i>Archeoglobus</i>	$\text{H}_2$	$\text{SO}_4^{2-}$ ( $\text{S}_2\text{O}_3^{2-}$ )	A–CoA
$4\text{H}_2 + \text{SO}_4^{2-} + 2\text{H}^+ \rightarrow \text{H}_2\text{S} + 4\text{H}_2\text{O}$	Sulfate reduction	<i>Desulfovibrio, Desulfobacter</i>	$\text{H}_2$	$\text{SO}_4^{2-}$	A–CoA, RCA
$\text{FeOOH} + 2\text{H}^+ + \frac{1}{2}\text{H}_2 \rightarrow \text{Fe}^{2+} + 2\text{H}_2\text{O}$	Iron reduction	<i>Geobacter, Shewanella</i>	$\text{H}_2$	$\text{Fe}^{3+}$ as $\text{FeOOH}$	Calvin
$2\text{NO}_3^- + 5\text{H}_2 \rightarrow \text{N}_2 + 4\text{H}_2\text{O} + 2\text{OH}^-$	Denitrification	<i>Pyrobolus, T. denitrificans</i>	$\text{H}_2, \text{H}_2\text{S}, \text{S}^0$	$\text{NO}_3^-$	Calvin, A–CoA
<b>Aerobes</b>					
$\text{H}_2 + \frac{1}{2}\text{O}_2 \rightarrow \text{H}_2\text{O}$	Hydrogen oxidation	<i>Alcaligenes, Aquifex</i>	$\text{H}_2$	$\text{O}_2$	Calvin, RCA
$\text{H}_2\text{S} + 2\text{O}_2 \rightarrow \text{SO}_4^{2-} + 2\text{H}^+$	Sulfur oxidation	<i>Sulfolobus, Thiobacillus</i>	$\text{H}_2\text{S}, \text{S}^0$	$\text{O}_2, \text{NO}_3^-$	RCA, Calvin
$2\text{FeS}_2 + 7\text{O}_2 + 2\text{H}_2\text{O} \rightarrow 2\text{FeSO}_4 + 2\text{H}_2\text{SO}_4$	Sulfur oxidation	<i>T. ferrooxidans</i>	$\text{S}^{2-}, \text{FeS}_2$	$\text{O}_2$	Calvin
$4\text{Fe}^{2+} + \text{O}_2 + 10\text{H}_2\text{O} \rightarrow 4\text{Fe}(\text{OH})_3 + 8\text{H}^+$	Iron oxidation	<i>T. ferrooxidans</i>	$\text{Fe}^{2+}$	$\text{O}_2, \text{NO}_3^-$	Calvin
$2\text{Mn}^{2+} + \text{O}_2 + 2\text{H}_2\text{O} \rightarrow 2\text{MnO}_2 + 4\text{H}^+$	Manganese oxidation	<i>Shewanella</i>	$\text{Mn}^{2+}$	$\text{O}_2$	Calvin
$\text{NH}_4^+ + 2\text{O}_2 \rightarrow \text{NO}_3^- + 2\text{H}^+ + \text{H}_2\text{O}$	Ammonia oxidation	<i>Nitrobacter, Nitrosomonas</i>	$\text{NH}_4^+, \text{NO}_2^-$	$\text{O}_2$	Calvin
$\text{CH}_4 + 2\text{O}_2 \rightarrow \text{CO}_2 + 2\text{H}_2\text{O}$	Methane oxidation	<i>Methanomonas</i>	$\text{CH}_4$	$\text{O}_2$	RMP

<sup>a</sup> A–CoA, acetyl–coenzyme A pathway; RCA, reverse citric acid cycle; Calvin, Calvin–Benson cycle; RMP, Ribulose monophosphate cycle.

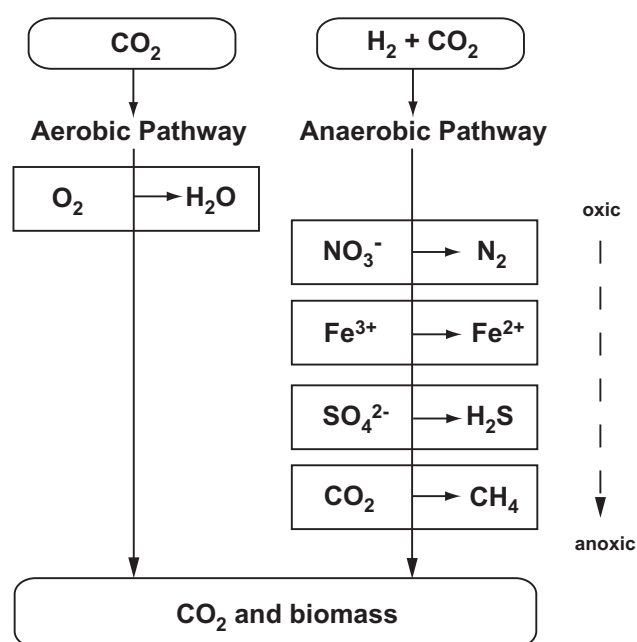
(*anaerobes*) use a variety of alternative electron acceptors for respiration in a sequence of energetic, reduction reactions that occur along thermodynamic (and redox) gradients (Fig. 1). Terminal electron acceptors are reduced in the following order:



Most anaerobic microbes are obligate anaerobes, but *microaerophilic* organisms require low concentrations of oxygen, while *facultative* organisms can grow in the presence or absence of oxygen, using different electron acceptors if necessary and if they are available. Some of the more important anaerobic redox reactions include nitrate or dissimilatory nitrogen reduction ( $\text{NO}_3^- \rightarrow \text{N}_2$ ), dissimilatory sulfate (or sulfur) reduction ( $\text{SO}_4^{2-} \rightarrow \text{H}_2\text{S}$ ), ferric iron reduction ( $\text{Fe}^{3+} \rightarrow \text{Fe}^{2+}$ ), and methanogenesis ( $\text{CO}_2 \rightarrow \text{CH}_4$ ) (Table I). Microorganisms involved in these anaerobic processes grow as chemolithoautotrophs or chemoorganotrophs.

### CHEMOLITHOAUTOTROPHY AND THE TREE OF LIFE

Today chemolithoautotrophs play important roles in global chemical and ecosystem processes. They serve as catalysts for reactions that would not otherwise occur or would proceed slowly over geological time. In addition to being primary producers in an ecosystem, chemolithoautotrophic microorganisms couple the carbon cycle to other element cycles for their metabolism and growth. As such, they are intimately involved in the carbon, nitrogen, and sulfur cycles, and some



**FIGURE 1** Schematic representation of chemolithoautotrophic, energy-yielding metabolic reactions. Aerobic microorganisms, such as iron-oxidizing bacteria, use dissolved oxygen ( $\text{O}_2$ ) to generate energy. In contrast, anaerobes use alternative terminal electron acceptors, with carbon dioxide ( $\text{CO}_2$ ) utilization during methanogenesis ( $\text{CH}_4$  production) indicating the most reducing conditions.  $\text{CO}_2$  is required for all chemolithoautotrophic metabolic reactions, and  $\text{H}_2$  is required by most anaerobes. Aerobic and anaerobic metabolism can occur simultaneously, although there is usually spatial and temporal separation of the reactions within a microbial habitat. For instance, aerobic microorganisms colonize the uppermost portions at the air–water interface, while anaerobes occupy inner regions of a mat or water–sediment interface.

are also associated with redox cycling of trace elements, such as iron, manganese, arsenic, and lead.

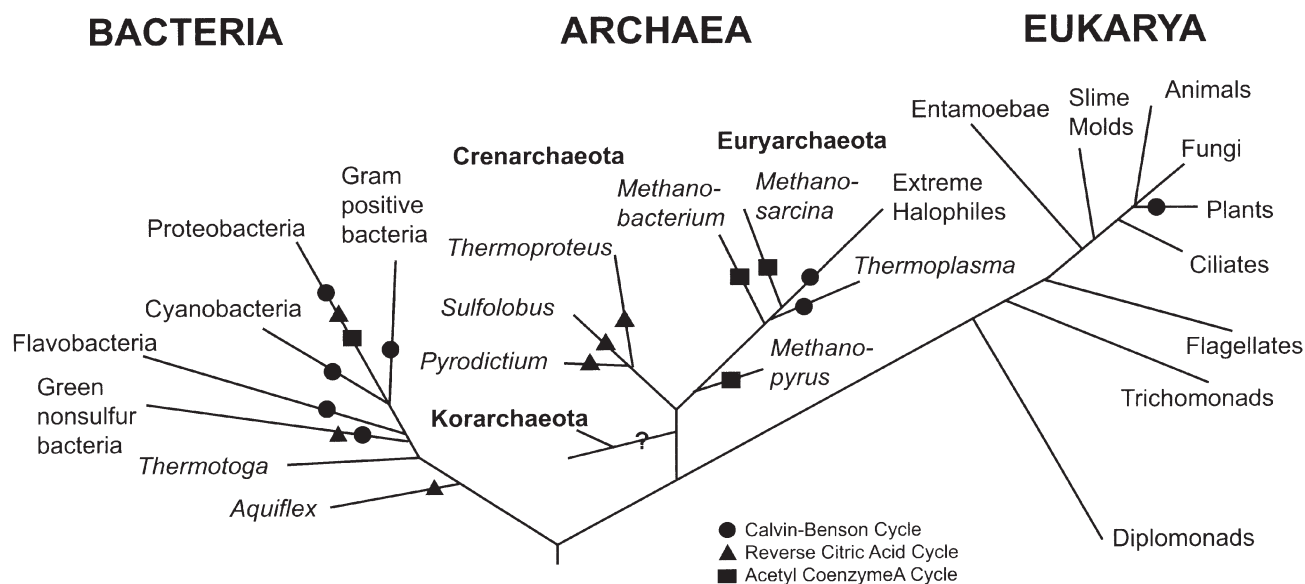
Their involvement in current biogeochemical cycling suggests that chemolithoautotrophs have been crucial in the transformation of chemical energy from one reservoir to another during Earth's history. The habitats of early Earth were virtually devoid of organic compounds, and the early atmosphere was extremely reducing. Just as today, however, early Earth would have had an assortment of electron donors, and various metabolic processes, albeit simple, could have existed. Life that first evolved would have been anaerobic and dependent on inorganic substrates for energy and growth, perfect for the evolution of chemolithoautotrophic microorganisms.

Chemolithoautotrophs use a variety of carbon fixation pathways: the Calvin–Benson cycle (also known as the reductive pentose phosphate cycle), the acetyl–coenzyme A cycle, or the reverse citric acid cycle. Based on evolutionary relationships of the 16S (small-subunit) ribosomal RNA (rRNA) gene and the subsequent “tree of life” (Woese, 1987) (Fig. 2), autotrophic carbon fixation pathways are distinctly related with the phylogenetic position of the respective organisms. Only members from the domains of Bacteria and Archaea are capable of chemolithoautotrophy (plants are photoautotrophs). Although the last common ancestor of Bacteria and Archaea has not been elucidated, none of the ancestral, deeply branching lineages are phototrophic, supporting the suggestion that chemosynthesis probably preceded photosynthesis on Earth (Schidlowski, 2001). Carbon fixation pathways among these ancient groups, however, differ and may have been one of the evolutionary factors in developing the lineages of Bacteria and Archaea

(Fig. 2). The archaeal thermophiles, such as *Thermoproteus* and *Pyrodictium*, fix organic carbon via the reverse citric acid cycle. Anaerobic chemolithoautotrophic microbes, such as some sulfate reducers and acetogenic bacteria, as well as methanogens (Archaea) fix carbon by the reductive acetyl–coenzyme A (CoA) pathway (Ljungdahl–Wood pathway). Following the evolution of photosynthesis and the buildup of oxygen in the atmosphere estimated at ~2.5 billion years ago, aerobic microorganisms evolved. Most Proteobacteria (purple bacteria) are aerobes and fix carbon via the Calvin–Benson cycle as chemolithoautotrophs, although some Proteobacteria (*e.g.*, sulfate reducers) fix carbon using the acetyl–CoA cycle or reverse citric acid cycle (Fig. 2, Table I). Other microbes that use the Calvin–Benson cycle include all photoautotrophs, some anoxygenic chemolithoautotrophic microorganisms of the domain Bacteria, and photoautotrophic eukaryotes. Ribulose biphosphate carboxylase/oxygenase (RuBisCO) is the signature enzyme in the Calvin–Benson cycle, and today RuBisCO is probably the most abundant protein in the world. As a consequence, the Calvin–Benson Cycle is the principal mechanism for biologically mediated reduction of CO<sub>2</sub> to organic carbon operating on Earth today.

### MAJOR CHEMOLITHOAUTOTROPHIC MICROBIAL GROUPS

Electron donors are essential for chemolithoautotrophic growth (Table I). For microbes other than chemolithoautotrophs (*e.g.*, heterotrophs, chemoorganotrophs), organic carbon molecules serve as electron donors used to gain cellular energy. One of the most energetic chemolitho-



**FIGURE 2** Schematic of the tree of life showing the evolutionary relationships of the domains Bacteria, Archaea, and Eukarya, as well as the carbon fixation pathways for specific lineages.

autotrophic electron donors is molecular hydrogen. Microbes that use hydrogen gas use  $\text{CO}_2$  as an electron acceptor, either to make methane (methanogenesis) or acetic acid (acetogenesis). Sulfate-reducing microbes also compete for hydrogen, but some can use small organic molecules as electron donors. Hydrogen oxidizing bacteria utilize hydrogen aerobically. Additional electron donors include reduced sulfur compounds (*e.g.*, hydrogen sulfide, elemental sulfur), ammonia ( $\text{NH}_4^+$ ), and reduced iron ( $\text{Fe}^{2+}$ ) and manganese ( $\text{Mn}^{2+}$ ). The following sections describe chemolithoautotrophic microbial groups based on required electron donors.

## Hydrogen

Hydrogen gas accumulates from the anaerobic breakdown of organic molecules by fermentative (heterotrophic) bacteria or at some locations from volcanic gases, and serves as an important energy source for aerobic and anaerobic archaeal and bacterial chemolithoautotrophs. The anaerobic microbial groups that require hydrogen as an electron donor follow predictable redox chemistry and reflect alternative terminal electron acceptor utilization (Fig. 1).

In most cases, hydrogen is rapidly consumed under anaerobic conditions by methanogens and sulfate reducers; however, if anaerobic growth is slower than production of hydrogen by heterotrophs or chemoorganotrophs, then hydrogen will diffuse into the aerobic environment, where it can be used by aerobic hydrogen-utilizing bacteria. Chemolithoautotrophic, aerobic, hydrogen-oxidizing bacteria grow with hydrogen as the electron donor and oxygen as the electron acceptor and fix  $\text{CO}_2$  via the Calvin-Benson cycle or reverse citric acid cycle. A wide variety of Gram-negative and Gram-positive bacteria are hydrogen oxidizers, including *Alcaligenes*, *Hydrogenobacter*, *Pseudomonas*, and *Aquifex*.

Iron or manganese reduction during anaerobic respiration typically occurs by chemoorganotrophs, but it is also known for some chemolithoautotrophs. Ferric iron is used as an exclusive electron acceptor by dissimilatory iron-reducing bacteria that use hydrogen as their electron donor; some iron reducers require organic carbon compounds such as acetate or formate. One of the most studied iron reducers, *Shewanella putrefaciens*, is a chemoorganotroph that can also use  $\text{MnO}_2$  as a sole electron acceptor. Iron reduction in aquatic sediments is an important anaerobic ecological process, and the formation of iron sulfides in marine and freshwater has been attributed to biological iron reduction.

Dissimilatory sulfate-reducing bacteria are obligate anaerobes that use hydrogen for the reduction of sulfate to hydrogen sulfide. Sulfate reducers are divided into two broad physiological subgroups. Group I dissimilatory sulfate reducers, including the genera *Desulfovibrio*, *Desulfomonas*, *Desulfotomaculum*, and *Desulfobulbus*, use lactate, pyruvate, ethanol, or fatty acids as carbon sources. Group II genera oxidize acetate and include *Desulfococcus*, *Desulfosarcina*,

*Desulfobacter*, and *Desulfonema*. There are also hyperthermophilic sulfate-reducing Archaea belonging to the genera *Archeoglobus*. Certain species from the bacterial groups are capable of growing chemolithoautotrophically with hydrogen as the electron donor, sulfate as the electron acceptor, and  $\text{CO}_2$  as the sole carbon source. Chemolithoautotrophs use the acetyl-CoA pathway, while the reductive citric acid cycle is used by chemoorganotrophs. If sulfate concentrations are high, sulfate-reducing bacteria completely oxidize fermentation by-products to  $\text{CO}_2$ . In low-sulfate anaerobic environments, however, sulfate-reducing bacteria compete with methanogens for hydrogen and organic compounds. The Archaea *Thermoproteus*, *Acidianus*, and *Desulfurolobus*, common in acidic hot springs, are chemolithoautotrophic sulfur reducers.

Acetogenesis results in less overall cellular energy than methanogenesis, but both metabolic groups are typically found in similar habitats. Acetogenic bacteria, such as *Clostridium* and *Acetobacterium*, are obligate anaerobes that form acetate from the oxidation of hydrogen using the acetyl-CoA pathway for  $\text{CO}_2$  fixation. Hydrogen is the common electron donor, but donors can also be from sugars, organic acids, and amino acids. Many acetogens also reduce nitrate and thiosulfate and are tolerant of low pH, making them more metabolically versatile than other anaerobes.

Methanogens are exclusively Archaea and are one of the most common anaerobic microbial groups. Methanogens oxidize hydrogen as the electron donor while reducing  $\text{CO}_2$  to methane during anaerobic respiration. Methanogenesis from  $\text{CO}_2$  reduction is done with the acetyl-CoA pathway, but formate, acetate, alcohols, carbon monoxide, and even elemental iron can serve as alternative electron donors. There are seven major groups of methanogens based on their physiology and 16S rRNA gene sequence comparisons, with the genera *Methanobacterium*, *Methanococcus*, *Methanomicrobium*, *Methanosarcina*, and *Methanobolus* having the most identified species. Chemolithoautotrophic methanogenesis occurs with hydrogen and  $\text{CO}_2$  only, although growth is less efficient than those utilizing acetate or other organic compounds. Methanogens are ubiquitous in most anaerobic environments and are usually found in close association with decomposing organic material.

## Reduced Inorganic Sulfur Compounds

High concentrations of reduced sulfur compounds are toxic to most organisms. Hydrogen sulfide gas, in particular, reacts with operational biomolecules to form nonfunctional complexes that inhibit respiration; however, hydrogen sulfide, elemental sulfur, thiosulfate, polythionates, metal sulfide, and sulfite serve as electron donors for chemolithoautotrophic sulfur-oxidizing bacteria and Archaea. (*Note:* For the purposes of this discussion, any microbe capable of oxidizing any reduced sulfur compound will be referred to

as a sulfur oxidizer). One difficulty for sulfur-oxidizing microbes is competing with chemical oxidation of reduced sulfur compounds, specifically hydrogen sulfide. As a result, most sulfur-oxidizing bacteria occupy aerobic/anaerobic interfaces where sulfide and oxygen meet and are therefore chemotactic. Interface or gradient growth is important in some ecosystems where sulfur-oxidizing bacteria form symbiotic relationships with animals, such as at deep-sea hydrothermal vent sites.

The earliest microbiological research regarding chemolithoautotrophic metabolism was done with sulfur-oxidizing bacteria (Winogradsky, 1887). Some sulfur-oxidizers thrive in low pH environments (acidophiles), while others require neutral pH conditions. Sulfur-oxidizing bacteria can form large microbial mats or thick biofilms in a range of habitats, including acid mine drainage and mine tailings, sulfidic thermal springs, marine sediments, and sewage sludge. There are several different types of sulfur oxidizers, including those belonging to the genus *Thiobacillus* and the morphologically conspicuous sulfur bacteria such as *Beggiatoa*, *Thiothrix*, *Thioplaca*, *Thiomicrospira*, and *Thiovulum*, among others. Virtually all of these colorless sulfur bacteria (as compared to the green and purple sulfur bacterial groups) are Gram-negative and some deposit intracellular elemental sulfur when grown on hydrogen sulfide. While sulfur-oxidizing bacteria are by nature chemolithoautotrophic, using the Calvin–Benson cycle for carbon fixation, some can be chemoorganotrophic, heterotrophic, or mixotrophic with respect to their carbon source. Typically, molecular oxygen is the terminal electron acceptor, although some are capable of microaerophilic growth within sulfide–oxygen gradients using nitrate.

The use of reduced sulfur compounds as electron donors and nitrate as an electron acceptor is a form of denitrification and results in the production of NO, N<sub>2</sub>O, or N<sub>2</sub>. Denitrification can also occur if nitrate is used as an alternative electron acceptor during anaerobic respiration, but with organic carbon as the carbon source. *Thiobacillus denitrificans* is a common denitrifying bacterium.

### Ammonia and Nitrite

Nitrification includes the oxidation of both ammonia and nitrite and results in the formation of nitrite and nitrate, respectively. The formation of nitrate requires a two-step process in which ammonia is first oxidized to nitrite by ammonia oxidizers, and then nitrite is oxidized to nitrate by nitrite oxidizers. The two groups of nitrifying bacteria, belonging to the family *Nitrobacteraceae*, typically work synchronously in a habitat as chemolithoautotrophs that use the ammonia or nitrite as electron donors and CO<sub>2</sub> as the sole source of carbon. In some rare instances, small organic compounds can also be used. Genera of ammonia oxidizers have the prefix *Nitroso-*, including *Nitrosomonas* and *Nitro-*

*sospira*; whereas genera of nitrite oxidizers have the prefix *Nitro-*, including *Nitrobacter* and *Nitrospira*. Nitrification occurs at the aerobic/anaerobic interface, but nitrifying bacteria have a high affinity for oxygen. Microbiological ammonia and nitrite oxidation can occur over a broad range of conditions, including in acid soils, and at low- and high-temperatures.

### Iron and Manganese

As with sulfur oxidation, bacteria can also gain energy from ferrous iron (Fe<sup>2+</sup>) or manganous manganese (Mn<sup>2+</sup>) oxidation. In the past, iron and manganese oxidation was attributed to many different bacteria based on the accumulation of iron or manganese minerals associated with cellular material; however, recent investigations have found that most of these bacteria do not gain energy from mineral buildup. Iron rapidly oxidizes to ferric (Fe<sup>3+</sup>) iron at neutral pH, so successful iron oxidizers live in low pH environments, such as acid mine drainage, acid springs, mine tailings, or acid soils containing sulfide minerals such as pyrite. Chemolithoautotrophic iron-oxidizing bacteria include the acidophilic aerobe *Thiobacillus ferrooxidans*. Despite research attempting to isolate other chemolithoautotrophs, the most common iron oxidizers, *Leptospirillum* and *Gallionella*, and some manganese oxidizers, such as *Arthrobacter* and *Hyphomicrobium* (except *H. manganoxidans*), are chemoorganotrophs. Ecologically, iron and manganese oxidizers are important for their detoxification of the environment by lowering the concentration of dissolved toxic metals.

### One-Carbon Compounds

There is some controversy over whether microbial processes requiring growth on reduced one-carbon (C-1) compounds as the sole carbon and energy source represent true chemolithoautotrophy; C-1 compounds used as electron donors are biogenic, thereby not fulfilling the *litho* component of chemolithoautotrophy. However, the theory of cycling C-1 compounds by potential chemolithoautotrophs is gaining appeal because understanding CO<sub>2</sub> and CH<sub>4</sub> dynamics is important for the study of carbon budgets of aquatic ecosystems in surface and subsurface environments.

Methanotrophs and methylotrophs utilize methane or methanol for cellular energy and growth. There are two physiological groups of methanotrophic bacteria, both obligate aerobes. Type I methanotrophs include the genera *Methylomonas*, *Methylosphaera*, and *Methylomicrobium* and fix carbon by assimilating formaldehyde in the ribulose monophosphate pathway. Type II methanotrophs fix formaldehyde in the serine pathway, and genera include *Methylocystis* and *Methylosinus*.

Growth on carbon monoxide by carboxidobacteria (carbon-monoxide-oxidizing bacteria) occurs with a range

of electron acceptors, including oxygen, elemental sulfur, sulfate, nitrate, or ferric iron. Members of the genera *Pseudomonas*, *Bacillus*, *Alcaligenes*, and *Clostridium* are known for carbon monoxide oxidation.

### SIGNATURES OF CHEMOLITHOAUTOTROPHY

Before discussing the microbial groups found in caves, a description of how chemolithoautotrophy and chemolithoautotrophic microorganisms can be characterized is warranted. Brief discussions of various methods are presented in the following sections. *A word of caution:* Virtually any method of microbial identification or characterization has some type of methodological error associated with it that should be considered when interpreting results. The techniques described are just a few of the possible microbiological, ecological, and geochemical methodologies that could be used for more thorough characterization of the diversity and distribution of chemolithoautotrophic microbial populations in caves. Without question, a combination of different techniques, while not always feasible, does provide the best possible results.

#### Traditional Methods, Including Culturing and Molecular Methodology

One of the most common microbiology techniques involves growing chemolithoautotrophic microorganisms in culture by providing cells with all the essential nutrients, including required electron donors and acceptors, required for growth. Indeed, many chemolithoautotrophic microbes have been discovered by this technique, and for many years this was the only method to obtain chemolithoautotrophic microbial strains. Even when the metabolic requirements are known, however, laboratory enrichment and pure culture isolation have proven difficult, and most microbes still remain unculturable. In fact, most microorganisms in nature have not been grown in culture, and it has been estimated that less than 1% of known microbes can be cultured with current techniques. Standard culturing often introduces a selective bias toward microorganisms that are able to grow quickly or to utilize substrates provided in the medium more efficiently (r-strategists). Culturing, although highly selective and difficult for unknown or poorly characterized microorganisms, is still a very reliable way to decipher what biogeochemical activities may be microbially mediated.

Recent advances in molecular techniques can circumvent these problems and provide culture-independent methods from which microorganisms can be identified based on the evolutionary relationships of 16S rRNA gene sequences. However, the polymerase chain reaction (PCR) used to amplify environmental 16S rRNA sequences may result in biased species diversity due to uneven extraction of DNA or PCR-amplification bias due to genome size. Although

phylogenetic affiliations are assigned for organisms in natural samples, metabolic activity must be implied, especially for novel or uncharacterized groups; therefore, additional ecological and molecular methods are required to determine if known or novel organisms in an ecosystem are capable of chemolithoautotrophic growth.

Most microbiological research conducted with cave water, sediment, or mineral samples has focused on the census of microorganisms colonizing a particular habitat. Many pure and mixed culture isolates have been obtained, including iron- and manganese-oxidizing bacteria, ammonia-oxidizing bacteria, sulfur-oxidizing bacteria, and countless heterotrophs and chemoorganotrophs (Table II). PCR-based techniques used to describe cave microbial populations demonstrate that chemolithoautotrophic systems have high biodiversity. Recent molecular research has been done in cave systems dominated by sulfur-oxidizing bacteria (Table II), even though culture-independent methodology allows for wide-ranging surveys of many different cave habitats. These molecular studies indicate that closely related microbial groups are found in geographically separated cave systems and may suggest that colonization of the subsurface, particularly sulfur-based environments, is not an isolated phenomenon.

#### Metabolic (Biochemical) Assays

If pure or mixed cultures are obtained, microorganisms can be characterized or identified based on a variety of growth-dependent assays. Biochemical assays can also be done to identify metabolic activities in natural samples without cultures. Assays include, but are not limited to, measuring the presence or absence of enzymes involved in degradation of substrates in the growth medium, the production of gases (*e.g.*, hydrogen, carbon dioxide, hydrogen sulfide), and utilization of specific carbon substrates to test for mixotrophic growth, as well as determining the ability to grow under different physicochemical conditions, such as growth over a range of pH values or temperatures or even under varying oxygen concentrations. For many organisms, a few key assays are all that is required for identification or characterization. Some more sophisticated assays include measuring enzymatic activity or membrane lipids such as phospholipid-derived fatty acids (Boschker and Middelburg, 2002). Additionally, dehydrogenase, adenosine triphosphate (ATP) or total adenylate nucleotides, and RuBisCO presence and activity are important for characterizing chemolithoautotrophic microbial populations. Most metabolic assays conducted with cave microorganisms have been done on heterotrophs or chemoorganotrophs. To date, only microbes from Movile Cave have had RuBisCO activity measured, and various populations of sulfur-oxidizing bacteria from Florida springs and Lower Kane Cave have been investigated using an assortment of biochemical assays. Future studies of cave

**TABLE II Chronological Summary of Studies Describing Chemolithoautotrophic Microorganisms Found in Various Caves**

Cave	Study Date(s) <sup>a</sup>	Chemolithoautotrophic Metabolic Processes <sup>b</sup>	Approach <sup>c</sup>
Movile Cave, Romania	1986-2003	Sulfur oxidation, methanotrophy, methanogenesis, ammonia oxidation	M, C, SI, DNA, BA, RI
Grotta Azzurra, Italy	1986-1999	Sulfur oxidation	C, M, SI
Frasassi Caves <sup>e</sup> , Italy	1995, 2000-2003	Sulfur oxidation	M, C, SI, DNA, RI
Tito Bustillo Cave, Maltravieso Cave and others, Spain	1997, 1999-2003	Ammonia oxidation, sulfur oxidation, iron and manganese oxidation	C, DNA
Zoloushka Cave, Ukraine	1994, 2001	Sulfate reduction, denitrification, sulfur oxidation, iron oxidation	C, SI
Kugitangtou caves, Turkmenistan	1994, 1997, 2001	Sulfur oxidation, sulfate reduction, iron oxidation	M, C, DNA
Anchialine caves, Mexico	1997, 2002	Ammonia oxidation, sulfur oxidation, methanotrophy	M, SI
Cueva de Villa Luz <sup>d</sup> , Mexico	1994-2002	Sulfur oxidation, sulfate reduction	M, C, DNA
Bungonia Caves, Australia	1973-1994, 2001	Iron reduction, sulfate reduction, sulfur oxidation	M, C, SI
Bundera Sinkhole, Australia	1994-1999	Sulfur oxidation, ammonium oxidation	SI
Nullarbor caves, Australia	1994, 2001	Nitrite oxidation, sulfur oxidation	M, DNA,
Caves in France, Romania, USA	1963, 1987, 2000-2002	Iron and manganese oxidation	M, C, DNA
Florida Aquifer caves	1965, 1992-2003	Sulfur oxidation	M, C, DNA, BA
Cesspool Cave, Virginia	1986, 2001	Sulfur oxidation	M, C, DNA, RI
Mammoth Cave, Kentucky	1977, 2000-2003	Ammonia and nitrite oxidation	C, DNA
Parker Cave, Kentucky	1988, 1998	Sulfur oxidation	M, DNA
Lechuguilla Cave, New Mexico	1994, 2000, 2003	Iron and manganese oxidation, nitrite oxidation	C, BA, DNA
Lower Kane Cave, Wyoming	1999-2003	Sulfur oxidation, sulfate reduction, iron reduction, methanogenesis, iron oxidation	M, C, SI, DNA, BA, RI, FISH

<sup>a</sup> Some representative years for which published results can be found in the literature.

<sup>b</sup> Listed in order of dominance, if known.

<sup>c</sup> Approach used to identify and to verify chemolithoautotrophic processes. M = microscopy; C = culture techniques; SI = stable isotopes; DNA = phylogenetic relationships based on 16S rRNA analyses; BA = biomarker assays; RI = radioisotope experiments; FISH = fluorescence in situ hybridization

<sup>d</sup> Also known as Cueva del Azuffre or Cueva de las Sardinias.

<sup>e</sup> Includes the Grotte di Frasassi and Grotta Sulfurea system

chemolithoautotrophic populations should consider the inclusion of more biochemical assay work.

### Stable Carbon Isotope Ratio Analysis

Stable isotope ratio analysis (SIRA) methods can be used to understand ecosystem energetics and carbon fixation pathways. The creation and alteration of organic compounds, reflecting carbon fluxes in an ecosystem, control the isotopic composition of organic matter (Boschker and Middelburg, 2002). The two carbon isotopes of importance in studying carbon cycling are <sup>12</sup>C and <sup>13</sup>C. Incorporation of carbon into living tissues causes significant kinetic isotope fractionation, such that the lighter isotope (<sup>12</sup>C) is preferentially assimilated, leaving behind the heavier isotope (<sup>13</sup>C). This discrimination for <sup>12</sup>C is largely due to kinetic effects caused by the irreversible enzymatic CO<sub>2</sub>-fixing reaction that assimilates CO<sub>2</sub> into the carboxyl group of an organic acid. In the Calvin-Benson Cycle, for example, RuBisCO is mostly responsible for isotope discrimination. Differences in the isotopic composition are expressed in terms of the delta

(δ)-notation of a ratio of <sup>13</sup>C/<sup>12</sup>C in a sample relative to a standard, measured in per mil (‰):

$$\delta^{13}\text{X} (\text{‰}) = \left[ \frac{^{13}\text{C}/^{12}\text{C sample}}{^{13}\text{C}/^{12}\text{C standard}} - 1 \right] \times 1000$$

The overall isotopic fractionation is determined by subtracting the isotopic composition of the carbon of an organism from the isotopic composition of the carbon reservoir, with most chemolithoautotrophic fractionation values ranging between -20 and -40‰. Excretion, respiration, and heterotrophic carbon cycling are (for the most part) considered negligible processes for carbon fractionation, and the isotopic composition of heterotrophic organic matter will be the same or slightly higher than the source organic carbon. Due to the diversity in carbon-fixation pathways, there are a wide variety of carbon isotope fractionation values that exist for microbial populations within an ecosystem. But chemolithoautotrophically fixed carbon in general has lower δ<sup>13</sup>C values than the more well-studied photoautotrophs.

Carbon stable isotope ratio analysis has been used in Movile Cave in Romania, where microbial mat δ<sup>13</sup>C values



suggest that the dominant microbes, sulfur-oxidizing bacteria, are chemolithoautotrophs (Sarbu *et al.*, 1996). These chemolithoautotrophic bacteria serve as the main energy and food base for the cave ecosystem, evident by the -26 to 30‰ fractionation between the mat and the bicarbonate, and the similar  $\delta^{13}\text{C}$  compositions of grazers (-39 to -46‰) and carnivores (-40 to -45‰) to the mats (-41 to -45‰). The similar isotopic ratios suggest that grazers consume the mats, and are in turn consumed by carnivores. The “you are what you eat” principle has been applied to ecological studies in the Frasassi Caves and Grotta Azzurra in Italy, Lower Kane Cave in Wyoming, and an anchialine cave system in Mexico. These analyses not only show microbial chemolithoautotrophic activity, but also evaluate ecosystem level dynamics and food quality for higher trophic level animals in caves. Moreover, the carbon isotope values for the Movile Cave system are distinct from surface derived organic carbon, that have  $\delta^{13}\text{C}$  values of -20 to -30‰, thereby providing a useful tool to distinguish among organic carbon sources.

### Marker Genes

While comparison of 16S rRNA gene sequences of various organisms in a community provides a phylogeny, additional molecular techniques can exploit the fact that specific operational genes are required for certain metabolic activities. Marker gene information can identify a specific metabolic activity, and, because of the potential for greater sequence variation than for 16S rRNA, marker genes provide increased phylogenetic resolution among closely related organisms. For example, a gene codes for the enzyme ammonia monooxygenase (*amoA*) used for chemolithoautotrophic ammonia oxidation; this *amoA* gene can be used as a marker gene to test if ammonia oxidation is possible in natural samples. To date, only a few studies have used marker genes to research Movile Cave microbial communities, specifically methanotrophs. Microarrays, comprised of microchips with attached nucleotide probes, can also be used to study metabolic activity and microbial diversity in complex systems (Guschin *et al.*, 1997). Probes can be designed for marker genes, as well as for species-, genera-, group-, or domain-specific 16S rRNA targets. The number of probes used in an array is limited only by the size of the microchip. Microarray methods circumvent polymerase chain reaction (PCR)-based problems involving amplification bias and molecular interactions that form chimeric sequences. The utility of microarrays is limitless, but at present no cave studies have incorporated this methodology.

### Radioisotope Experiments

Microbial activity in natural or culture samples can be measured *in situ* using radioisotope-labeled (radiolabeled) substrates, and both carbon fixation and energy pathways for chemolithoautotrophy can be quantified. These experiments provide activity rate estimates without knowing how many

organisms are in the sample and allow a sensitive, quantitative assessment of biogeochemical transformations in nature. The rate of certain metabolic processes can be determined by measuring the uptake of one or more compounds over time and the subsequent buildup of other compounds. Terminal electron acceptors are the most common radiolabeled substrates. For instance, sulfate reduction can be monitored using radiolabeled  $^{35}\text{SO}_4^{2-}$  compounds, whereby loss of  $^{35}\text{SO}_4^{2-}$  would indicate consumption and a gain of  $^{35}\text{S}^{2-}$  as the byproduct of sulfate reduction would provide sufficient evidence that sulfate reduction is occurring.

These same principles can be used to determine carbon fixation rates. Carbon molecules, such as bicarbonate or acetate, are labeled with  $^{14}\text{C}$ , and the evolved  $^{14}\text{CO}_2$  and  $^{14}\text{C}$  biomass are measured to show rates of substrate uptake and utilization among different organisms within an ecosystem. Even when multiple radiolabeled substrates are combined in an experiment, however, there are several problems with carbon radioisotope studies, with the most significant being how to decipher the results. Carbon fixation or consumption can be overestimated or underestimated due to sampling perturbation or poor understanding of the community structure. Because natural samples can be extremely sensitive to disturbance, the experiment may skew results and demonstrate that one metabolic process is dominant, when in fact it is just less sensitive to disturbance than the other processes. Usually the sensitive nature of cave habitats prevents *in situ* radiolabeled experiments. Additionally, some microbes in a sample could be capable of facultative or mixotrophic growth, acting as chemolithoautotrophs in nature, but when provided with a rich organic carbon molecule they will use it as chemoorganotrophs or heterotrophs. Detailed culturing or phylogenetic analyses of the microbial communities should be coupled to radioisotope studies to aid interpretation. Recovering the DNA from cellular biomass that incorporated radiolabeled substrates can be done to investigate the active microorganisms of interest, as well.

To date, radioisotope techniques have been used to describe microbial processes from only a few caves, including Movile Cave, the Frasassi Caves, Lower Kane Cave, and Cesspool Cave (Virginia). The measured rates of autotrophic productivity from these cave systems, based on incorporation of  $^{14}\text{C}$ -labeled bicarbonate, demonstrate that carbon fixation in Movile Cave is the highest, similar to values obtained from surface aquatic systems in open oceans, lakes, or streams. Moreover, radiolabeled acetate and leucine, organic molecules used by chemoorganotrophs and heterotrophs, suggest that Lower Kane Cave has high rates of heterotrophic productivity but an order of magnitude less than autotrophic primary production.

### Microscopy

Cell morphologies and the structural relationships between cells and inorganic substrates can be visualized directly by

light microscopy or transmission or scanning electron microscopy (TEM or SEM, respectively). But, while microscopy can provide a wealth of observational information, such as microbial mat structure and the nature of biomineralization, microscopy is not a reliable technique to identify a microbe, even with morphologically conspicuous cell types. Additionally, general microscopy does not provide any information regarding metabolic activity.

Combining microscopy with stains that highlight certain cells or metabolic activities can be a useful way to identify actively metabolizing cells, as well as to determine biomass. Acridine orange (AO) and 4',6-diamidino-2-phenylindole (DAPI) are commonly used fluorescent stains, but they bind to all nucleic acids in both alive and dead (or inactive) cells. Staining for respiring cells using 2-(*p*-iodophenyl)-3-(*p*-nitrophenyl)-5-phenyltetrazolium chloride (INT) is much more useful to estimate the number of metabolically active cells in a sample.

Much of the earlier microbiological work on cave sediments and microbial mats involved microscopy in one form or another. In particular, most studies report cell counts and morphology based on phase contrast or fluorescence microscopy using AO or DAPI. While this may prove useful to identify morphologically conspicuous bacteria, this approach is generally not adequate to characterize most microbial groups. Some interesting studies have been done using electron microscopy, showing that microbial cells can be found on nearly every surface of a cave. Unfortunately, little information about the microbial communities can be gained from these strictly observational investigations. With respect to chemolithoautotrophs in caves, the best use of traditional microscopy is to combine it with other geochemical, ecological, and microbiological methodologies.

Fluorescence *in situ* hybridization (FISH) combines fluorescence microscopy with more specific probes that can characterize a microbiological sample. FISH probes are similar to those used in microarrays, with a majority of them being based on 16S rRNA targets. FISH combined with microautoradiography (FISH-MAR) can not only identify a microbe but also reveal what the microbe may be doing in nature by combining genetic probes with radiolabeled substrate incorporation experiments (Ouverney and Fuhrman, 1999). As FISH-MAR combines the best aspects of multiple techniques, it will be an extremely useful technique for describing chemolithoautotrophy in the future.

### CAVE MICROBIAL DIVERSITY AND CHEMOLITHOAUTOTROPHY

Cave ecosystems generally reflect energy and nutrient limitations. Most caves are fed by surface streams that have had photosynthetically derived organic matter and nutrient-rich sediments washed into them. Microorganisms are also brought into a cave with surface debris and deposited with

sediments. Historically, studies have shown that most microorganisms in caves are not chemolithoautotrophic but instead are translocated soil heterotrophs, chemoorganotrophs, or fecal coliform bacteria from contaminated surface water and detritus. The roles of microorganisms in these ecosystems that receive allochthonous input are to break down complex organic material and to serve as a food source for higher trophic levels. Other bacteria washed into caves from meteoric drip waters have been associated with biomineralization processes of calcium carbonate, iron, or manganese speleothem formation.

Alternatively, caves with very little to no allochthonous input contain chemolithoautotrophic bacteria that colonize material, such as sediments, with high concentrations of inorganic chemical compounds. Moreover, groundwater rich in dissolved reduced compounds, such as CO<sub>2</sub> or hydrogen sulfide, can also discharge into caves and be used as energy sources by chemolithoautotrophs. Relatively few studies have documented the occurrence, distribution, and community composition of chemolithoautotrophic metabolic groups in these karst systems compared to higher trophic level animals, although the importance of chemolithoautotrophy in caves has recently been demonstrated. Since the mid-1990s, investigators have employed numerous microbiological, geochemical, and molecular techniques to understand specific chemolithoautotrophic groups in cave systems (Table II). To date, a few ecosystem-level studies have been initiated to describe multiple microbial groups and to attempt to integrate the activities of different microorganisms with respect to each other (Table II). It is hoped that these recent studies will serve as examples for future multidisciplinary projects. The following section discusses investigations relating to bacteria involved in sulfur, iron, and nitrogen cycling in caves.

### Sulfur Bacteria

At a glance, Table II demonstrates that sulfur oxidizers are the only group of cave chemolithoautotrophic bacteria studied rigorously. Prior to and just after the 1986 discovery of the chemolithoautotrophically based groundwater ecosystem in Movile Cave, few studies described sulfur-based microbial populations in caves. Much of the early work was simply observational or involved culturing, especially of non-chemolithoautotrophs. It was after the Movile Cave research was initiated that speleologists and microbiologists began focusing their studies on other sulfur-based cave microbial communities. Nearly all of the caves with sulfur-oxidizing bacterial populations have springs with hydrogen-sulfide-rich groundwater that discharge into them and are termed *sulfidic caves*. Because of hydrogen sulfide oxidation, sulfuric acid is generated and promotes local limestone bedrock dissolution. This cave formation process is known as *sulfuric acid speleogenesis*, first described from Lower Kane Cave by Egemeier (1981) (Fig. 3).



**FIGURE 3** Main trunk passage in Lower Kane Cave in Wyoming. White, filamentous microbial mats dominated by sulfur-oxidizing bacteria colonize shallow sulfidic water, beginning at the lower right corner (water flows from the lower right to upper left). This microbial mat extends for approximately 20 m, with an average thickness of 5 cm. Piles of gypsum surround the stream (especially on the left), formed from the replacement of limestone during sulfuric acid speleogenesis.

The first studies describing sulfur-oxidizing bacteria were driven by the need to understand the role of chemolithoautotrophs in the establishment of complex cave ecosystems in sulfidic caves. While SIRA and radioisotope studies were used initially to characterize chemolithoautotrophy, less than half of the other known sulfidic cave populations have been described using these methods (Table II).

Sulfur-oxidizing bacteria have been found in both aqueous and subaerial habitats in sulfidic caves. Filamentous bacteria form thick microbial mats or biofilms within cave spring orifices, pools, or streams (Fig. 4). One main exception is in Movile Cave, where a thin microbial mat floats at the surface of the groundwater (Fig. 5); an anaerobic microbial biofilm mixed with clay sediment also covers the submerged cave floor. Phylogenetic analyses of cave microbial mats from Lower Kane Cave, the Frasassi Caves, Cesspool Cave, Cueva de Villa Luz (Mexico), and Parker Cave (Kentucky) show sulfur-oxidizing bacteria closely related to *Thiovulum*, *Thiothrix*, *Thiobacillus*, *Thiomonas*, *Thiomicrospira*, and *Achromatium*. Based on culturing and microscopy, *Thiothrix*, *Beggiatoa*, and *Thiomicrospira* have also been reported from submarine caves in Italy. SIRA and culturing suggest that the majority of all the investigated microbial mats thus far contain chemolithoautotrophic sulfur oxidizers, although FISH-MAR experiments with radiolabeled sulfur compounds will provide more effective tests of chemolithoautotrophy in the future. Isotopic values for aqueous microbial mats from Lower Kane Cave and the Frasassi Caves range from  $-22$  to  $-39\text{‰}$ . The microbial mats from Movile Cave, however, have ratios that range from  $-41$  to  $-46\text{‰}$ , indicating that in addition to sulfur oxidation, methanogenesis and methanotrophy may also be active.

Colonization of predominately sulfur-oxidizing bacterial mats by other metabolic groups, such as anaerobic sulfate



**FIGURE 4** White, subaqueous microbial mat from Lower Kane Cave in Wyoming. A thin, white biofilm connects filaments to each other in flowing water. Endemic snails (*Physa spelunca*) graze the mats. Streambed substrate is made of chert cobbles (upper left).



**FIGURE 5** Partially flooded passage in Movile Cave in Romania. A white filamentous microbial mat floats on the surface of the water. A grid was constructed to encourage additional mat growth.

reducers or methanogens, has only recently been addressed, particularly in Movile Cave and Lower Kane Cave. Sulfate-reducing bacteria have been reported in anaerobic cave water and aqueous sediments from several sulfidic caves and springs (Table II). Sulfate reducers are important for recycling sulfur compounds by generating supplemental hydrogen sulfide that sulfur-oxidizing bacteria can use; however, more research must be conducted to differentiate between chemolithoautotrophic sulfate-reducing bacteria and the more common chemoorganotrophic sulfate reducers.

Microbial biofilms on subaerial cave-wall surfaces (*snottites*, or microbial draperies) have been described from the Frasassi Caves, Cueva de Villa Luz, Cesspool Cave, Lower Kane Cave, and Kugitangtou caves (Turkmenistan). While some of the largest snottites reportedly reach up to 10 cm in length or more, microbial biofilms typically occur as discontinuous patches of insoluble crusts with sub-centimeter-long mucus-like droplets suspended from the crusts (Fig. 6). Most



**FIGURE 6** Discontinuous cave-wall biofilms and crusts (dark patches) from Lower Kane Cave in Wyoming. Crusts form on gypsum (light areas), and condensation droplets and mucus-like drops are suspended from the crusts. Elemental sulfur is typically associated with the crusts.

of the snottites, droplets, and crusts have pH values between 0 and 3. Biofilms from the Frasassi and Kane Caves have  $\delta^{13}\text{C}$  ratios of  $-36$  to  $-39\%$ , suggesting that carbon has been produced from chemolithoautotrophy. Laboratory isolates and phylogenetic studies of subaerial surfaces in these caves demonstrate that strains are closely related to *Thiobacillus*, *Sulfobacillus*, and *Acidimicrobium*. Cultures of thiobacilli from cave-wall biofilms in Cesspool Cave have been used in dissolution experiments to determine rates of potential, microbially mediated cave modification, and enlargement. Sulfur bacteria are also associated with elemental sulfur, gypsum, and other mineral deposits in caves and may mediate precipitation of these minerals.

### Iron and Manganese Bacteria

Microorganisms associated with iron and manganese cycling are the second most studied cave bacteria to date (Table II). According to Caumartin (1963), iron plays a significant role in the microbiology of a cave, and most cave sediment contains iron bacteria. Indeed, microorganisms associated with iron and manganese cycling have been found in cave sediments based on microscopy and culturing, with chemolithoautotrophic *Gallionella* and heterotrophic *Leptothrix* and *Crenothrix* being the most common genera described. Fossil, or encrusted, sheaths and stalks of these bacteria have been observed in stalactites, sediments, and corrosion crusts from several caves, including caves from Iowa, the Black Hills in South Dakota, Lechuguilla Cave in New Mexico, Kugitangtou caves in Turkmenistan, Grand Caymen island caves, and Nullarbor Plain caves in Australia. However, it is difficult to distinguish between chemical and biological iron/manganese precipitates, and it is not evident from mineralization, fossil or active, whether an organism was chemolithoautotrophic. Therefore, the microbial ecology of these bacterial groups in caves remains speculative, and their role

in cave ecosystems, as potentially minor primary producers or detoxifiers, also remains unclear.

### Nitrogen Bacteria

Nitrification is an important chemolithoautotrophic pathway in nitrogen-limited freshwater streams and lakes, enhancing overall nitrogen availability. This process may also be important in aquatic cave ecosystems, although little work has been done. One study, for instance, based on SIRA of nitrogen compounds in anchialine caves in Mexico, indicates that nitrification may be the primary energy source for that ecosystem, in addition to sulfur and methane oxidation.

The formation of nitrate minerals in caves, such as niter and nitrocalcite (saltpeter), has been attributed to nitrification, but the process is still highly debated. Nitrate minerals are typically found in dry cave sediments, such as in the southeastern United States. Nitrogen enters the cave in various forms, including atmospheric gas, nitrates from fertilizers, organic matter in soil, and from bat and rat guano. Ammonium is produced by nitrogen-fixing bacteria in soils overlying limestone and is brought into the caves via bedrock fissures or is washed in with stream sediments. *Nitrosomonas* in cave sediments oxidizes ammonia to nitrite, and then *Nitrobacter* oxidizes nitrite to nitrate, influencing the precipitation of nitrate minerals. Isolates of *Nitrobacter* have been obtained from Mammoth Cave in Kentucky in sediments rich in saltpeter, suggesting geomicrobiological involvement, but additional investigations have been limited to date.

### Other Metabolic Groups

Methanotrophy and methanogenesis, while expected to occur in some groundwater systems with high concentrations of dissolved methane, has only been studied to a large extent from Movile Cave. Enrichment and isolation techniques,  $^{13}\text{CH}_4$ -labeling studies, and  $^{13}\text{C}$ -DNA analyses were used to detect methanotrophs from both type I and II groups, with type I dominating. Methanogens were also detected, based on 16S rRNA gene sequence analysis in Movile Cave anaerobic microbial mats.

### CHEMOLITHOAUTOTROPHICALLY BASED CAVE ECOSYSTEMS

Although Winogradsky described chemolithoautotrophic metabolism from sulfidic springs more than 100 ago, it has been estimated that chemolithoautotrophs do not produce efficient energy and therefore could not be significant primary producers for an ecosystem, especially when compared to photosynthetically produced energy. However, in environments where light does not serve as the primary energy source for life (such as at the deep-sea hydrothermal vents, the deep terrestrial subsurface, and caves), photosyn-

thesis is not possible. Chemolithoautotrophy can efficiently produce energy when competition is limited, and, as a result, chemolithoautotrophic organisms are prolific in the subsurface. Moreover, the subsurface is a refuge for organisms to escape the harsh environmental surroundings of the surface, such as ultraviolet-light bombardment and temperature and moisture fluctuations. Chemolithoautotrophic microorganisms colonizing the subsurface may serve as analogs for what life may have been like on early Earth or the type of life that may be found on other planetary bodies. In summary, estimation of the importance of chemolithoautotrophy to ecosystem level processes is being revised.

Chemolithoautotrophically based ecosystems were first described from the deep-sea hydrothermal vent ecosystems (Deming and Baross, 1993). Now, chemolithoautotrophically based ecosystems also include deep marine habitats associated with hydrocarbon cold seeps, estuarine sediments, and caves. Besides the free-living chemolithoautotrophic microorganisms from deep marine environments, primarily *Beggiatoa* and *Epsilon* Proteobacteria, animals are the most interesting constituents living at mid-ocean ridges. The vestimentiferan tubeworms (*Riftia pachypila*) and the clams *Calyptogena magnifica* have bacterial endosymbionts that oxidize hydrogen sulfide and fix CO<sub>2</sub>. Deep-sea sediments exposed to hydrocarbon seeps have mussels with methanotrophic symbionts, and some mussels (*Bathymodiolus thermophilus*) also have sulfur- and methane-oxidizing bacterial symbionts. Clams, including *Solemya* and *Thyasira*, that live in brackish water and estuarine sediments have sulfur-oxidizing symbionts. The relationships between chemolithoautotrophic microorganisms and animals are beneficial to both organisms, as the animals provide protective habitat and the bacteria supply nutrients and energy.

While reduced sulfur compounds provide a rich energy source for chemolithoautotrophic growth in hydrothermal vents, cold seeps, and marine sediments, hydrogen-based chemolithoautotrophy has been described from deep aquifers. Microbes, including sulfate-reducing bacteria, acetogens, and methanogens, live at great depths into the earth, although most are considered chemoorganotrophs living off of scant organic debris that filters in from the surface. In isolated aquifers, however, geochemical production of hydrogen supports methanogenic communities (Stevens and McKinley, 1995). No higher trophic levels, including microscopic eukaryotes, have been reported from these methanogenic microbial ecosystems.

One of the most extreme examples of a highly evolved, chemosynthetically based ecosystem is from the Movile Cave, a peculiar cave that serves as an access point to a large sulfidic aquifer in southeastern Romania (Sarbu *et al.*, 1996); 33 new cave-adapted taxa have been identified from 30 terrestrial invertebrate species (24 endemic), as well as 18 species of aquatic animals (9 endemic). Similarly, the sulfur-based ecosystems from the Frasassi Caves, Cueva de Villa Luz, and sinkholes in Florida also have many different cave-

adapted animals dependent on energy produced by chemolithoautotrophic bacteria. Although Lower Kane Cave is also sulfur based, it has a relatively simple ecosystem of few terrestrial and aquatic species, with one of them being endemic (Fig. 4). The anchialine cave ecosystem of the Yucatan Peninsula is of additional interest because recent work shows that the ecosystem may be based on chemolithoautotrophic ammonia oxidation. It is not known at present whether cave animals from any of these cave ecosystems contain sulfur-, ammonia-, or methane-oxidizing endosymbionts, and this could be a future research direction.

## CHEMOLITHOAUTOTROPHY IN THE FUTURE

Caves are important and relatively accessible habitats to study chemolithoautotrophic metabolism. In the absence of organic carbon compounds, reactive rock surfaces and mineral-rich groundwater in the subsurface provide an assortment of potential energy sources for chemolithoautotrophic microorganisms. In comparison to the research done with macroscopic organisms in caves, the distribution of chemolithoautotrophic microbial groups and associated biogeochemical processes occurring in caves have been addressed only infrequently, although the methodology exists. Of those investigations describing cave microbial communities, many have been simply observational, and the physiological capabilities of microorganisms were inferred based on the utilization of a specific substrate in cultures or from 16S rRNA gene sequence phylogenetic affiliations. To date, few stable isotope or radioisotope studies have been done to describe chemolithoautotrophy in cave ecosystems, and combined microscopy and molecular studies have only recently been initiated. Unfortunately, without future interdisciplinary investigations, understanding the true biogeochemical structure and function of chemolithoautotrophs in subsurface habitats will remain limited and the significance of chemolithoautotrophs in cave ecosystems uncertain. However, with continuing technological advances and increased understanding of microbial physiology and ecology, exciting new discoveries are being made almost daily, and undoubtedly more chemolithoautotrophically based cave ecosystems will be identified.

### See Also the Following Articles

*Microbes*

### Bibliography

- Boschker, H.T.S. and J.J. Middelburg (2002) Stable isotopes and biomarkers in microbial ecology. *FEMS Microbiol. Ecol.* 1334: 1–12.
- Caumartin, V. (1963) Review of the microbiology of underground environments. *Natl. Speleol. Soc. Bull.* 25: 1–14.
- Deming, J. and J. Baross (1993) Deep-sea smokers: windows to a subsurface biosphere? *Geochim. Cosmochim. Acta* 57: 3219–3230.
- Egemeier, S.J. (1981) Cave development from thermal waters. *Natl. Speleol. Soc. Bull.* 43: 31–51.

- Guschin, D.Y., B.K. Mobarry, D. Proudnikov, D.A. Stahl, B.E. Rittmann, and A.D. Mirzabekov (1997) Oligonucleotide microchips as biosensors for determinative and environmental studies in microbiology. *Appl. Environ. Microbiol.* 63: 2397–2402.
- Ouverney, C.C. and J.A. Fuhrman. (1999) Combined microautoradiography–16S rRNA probe technique for determination of radioisotope uptake by specific microbial cell types *in situ*. *Appl. Environ. Microbiol.* 65: 1746–1752.
- Sarbu, S.M., T.C. Kane, and B.K. Kinkle (1996) A chemoautotrophically based cave ecosystem. *Science* 272: 1953–1955.
- Schidlowski, M. (2001) Carbon isotopes as biogeochemical recorders of life over 3.8 Ga of Earth history: evolution of a concept. *Precambrian Res.* 106: 117–134.
- Stevens, T.O. and J.P. McKinley (1995) Lithotrophic microbial ecosystems in deep basalt aquifers. *Science* 270: 450–454.
- Winogradsky, S. (1887) Über Schwefelbakterien. *Botanische Zeitung* 45: 489–610.
- Woese, C.R. (1987) Bacterial evolution. *Microbiol. Rev.* 51: 221–271.

## Clastic Sediments in Caves

Gregory S. Springer  
*Ohio University*

This article examines clastic sediments in caves, including such familiar deposits as cave mud and breakdown. Clastic sediments are composed of particles that have been eroded from preexisting rocks and subsequently deposited. The origins of clastic sediments are discussed together with the processes by which they are transported and accumulated. The latter phenomena are directly related to cave sediment stratigraphy, the layering of deposits, which is discussed in relation to the interpretation of sedimentary cave deposits. Representative cave deposits are presented as examples of how clastic sediments accumulate and are interpreted.

### INTRODUCTION

#### Overview

Clastic sediments are volumetrically the most common deposits in caves. Clastic sediments are composed of rock fragments physically eroded from preexisting rocks and subsequently deposited. The majority of clastic particles in cave sediments are detrital grains eroded from land surfaces and carried into caves by streams, mass wasting, wind, wave action, and ice. The resulting cave deposits are similar to deposits created by equivalent processes on the surface. The term *allochthonous deposit* is used to identify sediments derived from outside of a cave, while *autochthonous deposits* are composed of particles eroded from cave walls and later

deposited within the same cave. The mineral compositions of sediment grains can be used to infer whether deposits are autochthonous or allochthonous when the mineral content of surface rocks and a cave differ. The processes that transported and deposited individual packages of clastic cave sediments can often be inferred from sedimentary structures, textures, stratigraphy, and facies analyses. In general, the processes that create deposits of clastic sediments in caves are strongly affected by large-scale trends in climatic, geologic, and geomorphic variables. As such, clastic sediments in caves may yield valuable information concerning cave genesis and long-term histories of earth system processes, including landscape erosion, flooding, and response of river networks to climate changes. Clastic sediments in caves are also valuable repositories of organic remains and artifacts and have attracted the concerted attention of archeologists and paleontologists since the 18th century. Clastic sediments in caves are particularly valuable to scientists because slow weathering rates in caves often allow for longer and better preservation of materials than overlying landscapes.

#### Geomorphic Perspective

Clastic sediments in caves record the processes that form cave passages and interactions of cave passages with other landforms. Stream caves are integrated components of surface drainage networks and contain sediments that record long-term transport of sediment eroded from hillsides and cave walls. As a result, cave sediments preserve a record of landscape and climate processes because stream caves are important conduits of water, solutes, and sediment that operate as substitutes for or in conjunction with surface streams. Changes in hillslope, surface stream, or climate processes cause localized sediment storage or erosion within stream passages. Changes are recorded by passage morphology and sedimentary deposits, which are analogous to surface stream morphology and terraces. As with surface streams, changes in cave stream behavior are best recorded by clastic sediments because the principle expressions of changes in earth system processes are changes in the quantity and caliber of sediment carried by streams. In contrast to the dynamic interplay of cave streams and surface landforms, hypogene caves formed by deep-seated waters operate independently of surficial processes. Passage geometries are representative of autogenic processes and clastic sediments record cave development but offer little information about contemporaneous surface or climate processes. The origin of clastic cave sediments can be deciphered because passage morphology is often related to unique physical processes and allied sedimentary processes. Thus, cave passage morphology and clastic sediments can be used to interpret cave genesis, the relationship of the cave to other landforms, and changes in earth surface processes.

Geomorphic, process-based studies that examine clastic sediments can be divided into two categories: (1) mechanistic

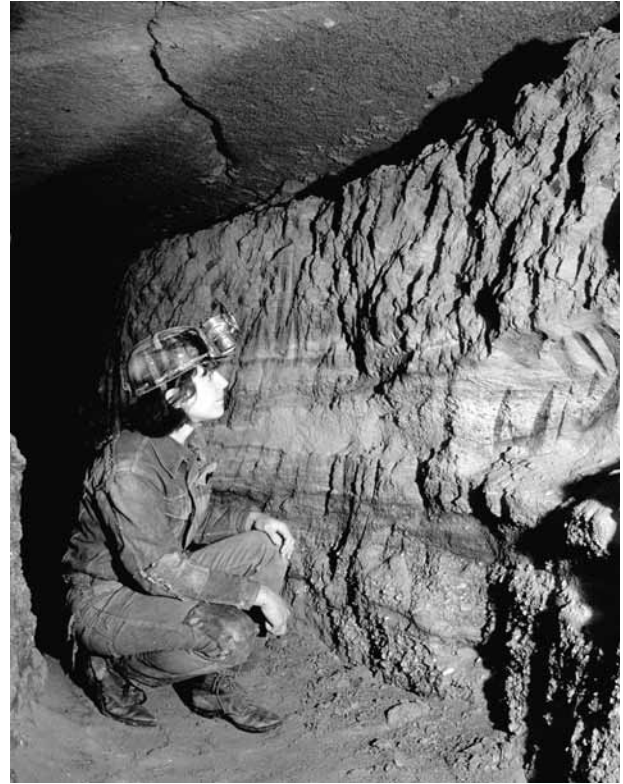
studies that seek to understand the individual mechanisms by which clastic sediments are produced, transported, and deposited, and (2) interpretive studies that infer knowledge about large-scale processes from sedimentary records. Mechanistic studies serve as the foundation for interpretive studies, because they unravel how stratigraphic packages form and their relationships to large-scale earth systems. Modern geomorphology studies pair the two study types by identifying driving and resisting forces that cause clastic sediment deposition and erosion. For example, the size of sediments carried in a stream is proportional to the water velocity and flood size. Climate processes supply these driving forces in the form of rain and snowmelt. The resisting forces are friction caused by sediment grains and channel boundaries. A decrease in precipitation and temperature will typically decrease sediment transport while increasing sediment supply. The net result is increased sediment deposition on cave streambeds, called *aggradation*, during which time the cave stream deposits more sediment than it removes from a cave. By inference, such aggradational deposits can be used to recognize past climate changes. However, cave sedimentary deposits may be extremely complex because many cave streams occupy passages that are not much bigger than the stream; deposits may be extensively reworked and eroded because of the limited space available. Thus, interpreting the significance of clastic cave sediments is impossible without first understanding the mechanisms that produce, transport, and deposit sediment as well as their overall context.

## MECHANISTIC APPROACH TO CLASTIC SEDIMENTS

### Sediment Production

Clastic sediments are made from fragments of preexisting bedrock that have been broken apart by weathering (Fig. 1). The processes that fragment source rocks are diverse and rarely unique to caves. These processes include (1) chemical, (2) kinetic, and (3) physical phenomena. Chemical processes are those phenomena associated with corrosion or precipitation. Such sediments are created when grains of quartz, clay, dolomite, and chert are liberated from bedrock by wall dissolution. For instance, streambeds of many caves contain large quantities of gravel- and cobble-sized chert, which is insoluble.

Kinetic processes are those phenomena associated with motion, such as erosion in floodwaters. Erosion mechanisms include *quarrying*, whereby bedrock is eroded by floodwaters and *corrasion*. Corrasion involves water accelerating grains of sand grains or cobbles and driving them into bedrock surfaces. Corrasion is especially effective at carving potholes in cave floors. Physical processes involve stresses that fracture rocks by tension or compression. The classic example is roof collapse caused by an increase in passage size. Shattering by ice crystals, known as *frost wedging*, is an important physical



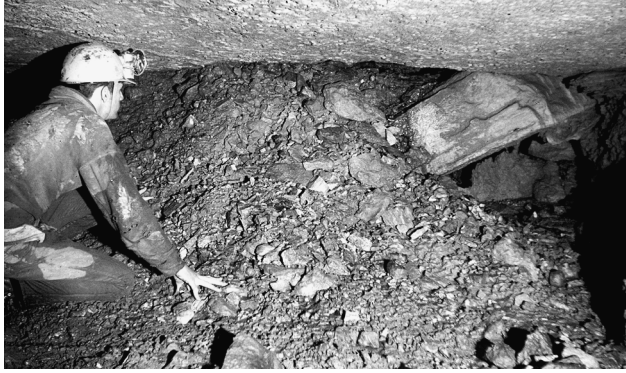
**FIGURE 1** Laminated silts overlying sorted sands and basal gravels in Mammoth Cave in Kentucky. The 1.7-million-year-old sediments accumulated as the cave stream aggraded when the Green River was choked with sediment. The river sediments accumulated because continental glaciers had fed large quantities of sediment into the proto-Ohio River, which the Green River feeds. The accumulation of sediment lowered the local channel slope, a key driving force for sediment transport. (Photograph courtesy of Art Palmer.)

process at middle and high latitudes, particularly in cave entrances.

*Breakdown* is extremely common in caves and occurs where passage widths exceed the strength of ceiling beds and where walls are undercut by erosion (Fig. 2). The process is intimately related to tension generated above voids and separation of rock beds from one another along bedding planes and subhorizontal fractures. Breakdown piles, which are clastic deposits, can easily exceed the total volume of all other deposits in a cave.

### Sediment Transport and Deposition

Allochthonous and most autochthonous sediments are repeatedly mobilized and deposited by flowing water in cave streams. Stream flow processes sort cave sediments by size because extremely small and extremely large particles are difficult to mobilize. As a result, clastic sediments deposited by streams are often composed of a narrow range of sizes. For instance, a bed of sand may lie atop a bed of gravel (Fig. 1). In contrast, sand, gravel, cobbles, and boulders are churned



**FIGURE 2** Breakdown clasts floating in gravel derived from an overlying sinkhole in Indiana. Collapses are commonly found where passages abut sinkholes or valley walls because ceiling strength is least where beds of rock are not continuous. (Photograph courtesy of Art Palmer.)

together in the deposits of creep, rockslides, and debris flows because the deposits are capable of moving virtually everything available. The controls on stream and mass wasting processes are different as are interpretations of their meanings.

Most cave streams only move significant quantities of clastic sediments during floods. The water velocity necessary to move an individual particle can be crudely estimated using the Hjulstrom diagram (Fig. 3). Examining the Hjulstrom diagram, it can be seen that fine sand is the easiest material to mobilize, while clay and boulders require substantially higher velocities. Once a particle has been mobilized it will continue to move at velocities below those required to initiate movement. Fine-grained sediments will not cease

movement until water velocities are extremely slow or chemical processes cause flocculation.

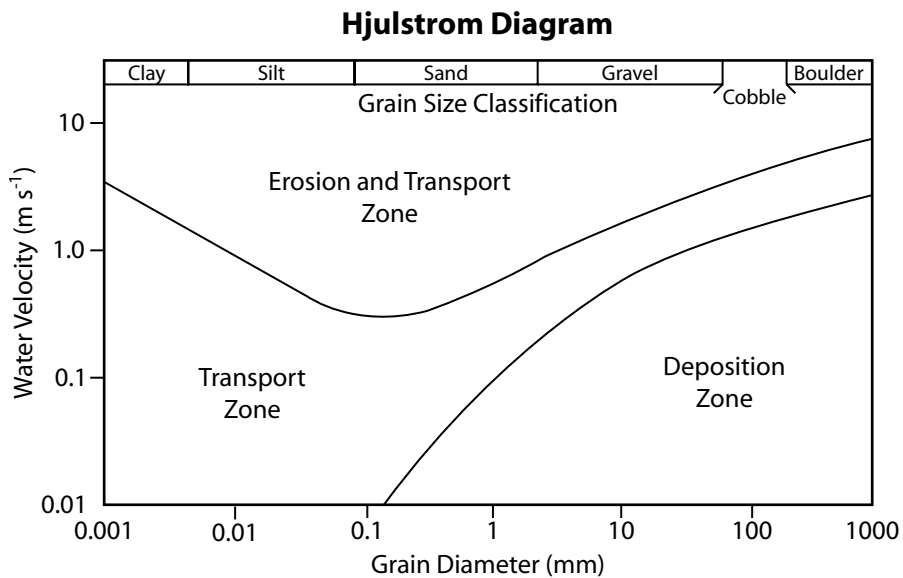
The sum of all sediment carried in a stream is called *load*. Individual grains may move as suspended load or bedload. Suspended load is particles borne within the water column by turbulence; suspended particles settle out of the water column as floods recede and typically consist of clay, silt, or sand. Bedload moves by rolling, toppling, and saltation (similar to bouncing). Most clastic sediments are carried as suspended load.

Sediment will accumulate in stream passages if driving forces are incapable of moving all sediment supplied to a channel. Long-term deposition may be recorded as banks of sediments on channel margins or thick deposits beneath streambeds. These deposits may form when climate becomes drier or excess sediment is supplied to caves or nearby rivers by tributary streams, glaciers, or landsliding (Fig. 1).

## STRATIGRAPHY OF CLASTIC CAVE SEDIMENTS

### Introduction

Deposits of clastic sediments usually contain multiple beds of unique appearances, origins, and ages. Large caves possess multiple generations of deposits scattered among passages for which the ages may differ by thousands or millions of years; therefore, long geomorphic records can be constructed by combining relatively short geomorphic records of many individual deposits. This requires placing deposits in a chronological sequence, which is typically accomplished through paleomagnetic, radiometric, cosmogenic isotope,



**FIGURE 3** Hjulstrom's diagram demonstrates the relationship between grain size and the velocity necessary to mobilize, transport, and deposit grains. Grains will remain in motion at velocities below those required to mobilize them; however, silt and clay are generally so small that they will remain suspended in water at extremely slow water velocities (left side). In contrast, coarse grains such as boulders can only be mobilized and transported under the highest velocities. The differences in mobilization and transport velocities cause sediments to be sorted by size.



and related dating techniques. Sediment ages define a narrative sequence of cave development, but substantive scientific investigations do more than reconstruct cave histories. Changes in cave sedimentation patterns and materials reflect large-scale changes in earth system processes, which are of great interest to geologists, archeologists, climatologists, and biologists. These changes are brought about by changes in regional driving forces imparted by climate and tectonics, which generate local driving forces that influence sediment production, transport, and deposition (Fig. 1).

Cave sediments generally adhere to the laws and precepts of traditional stratigraphic studies. The laws of superposition, original horizontality, and cross-cutting relationships are violated in unique ways, but not so frequently as to prevent the application of standard interpretation techniques. Key considerations are to be aware of complicating phenomena and to carefully scrutinize deposits for anomalies. Violations of the law of superposition are probably the most common problems encountered. The law of superposition states that vertically stacked sediments become younger with increasing height. The law is commonly violated in caves when cave streams carve openings beneath sediments and the opening is later filled by younger sediment.

### Sedimentary Facies

The word *facies* encompasses an incredible diversity of concepts used to correlate, differentiate, and interpret sediments and rocks. Facies are widely used tools for interpreting depositional chronologies and reconstructing geomorphic histories. A sedimentary facies is a distinctly unique body of sediment that can be identified on the basis of appearance, composition, texture, or sediment sizes. Common types of facies that are useful for clastic cave sediments include depofacies, lithofacies, and textural facies. A depofacies possesses unique sedimentary structures and stratigraphic successions for which the origins are derived from depositional processes. For instance, imbricated gravels are characteristic of bedload deposition within a streambed. Individual lithofacies possess unique mineralogy or rock fragments. For instance, granite cobbles carried from headwater streams form identifiable deposits in limestone caves. The granite-bearing deposits are different from deposits with no granite that are created by streams draining non-granitic terrain overlying the cave and can be used to identify stream provenance. Textural facies are comprised of beds with unique sedimentary structures.

Identifying unique depofacies can be difficult where multiple processes create similar deposits. A widely identified depofacies is the abandonment suite, which is comprised of stream sediments that become finer toward the top of a section. Active stream tiers commonly carry ample bedload, which accumulates to varying depths on passage floors. A passage ceases to receive bedload when lower level tiers form. Floodwater velocities and depths in the older, higher tier

gradually decrease as the lower passage incises downward or is itself abandoned. Lower velocities translate to finer sediments in suspension; hence, a typical abandonment succession from bottom to top is gravel, sand, silt, clayey silt. Abandonment depofacies have been recognized throughout the world, but they are similar to aggradational depofacies, which form by completely different processes.

A cave stream will aggrade or build up the streambed if a downstream component is obstructed by collapse or sediment accumulates in downstream channels. The driving force of stream gradient decreases when the downstream bed rises and stream velocities and sediment transport rates decrease to cause sediment accumulation. The decrease in velocities is, in turn, responsible for a decrease in mean particle size as sediment accumulates; deposits become finer upward just as they do in abandonment suites. Extensive aggradational deposits in Mammoth Cave in Kentucky have been traced to episodes of cooler climate, whereas abandonment suites are the result of normal passage abandonment. Discerning the different origins of these fining-upward sequences requires the use of secondary information. For instance, bed aggradation may cause sediment on streambeds to touch cave ceilings. If sediment shields part of a ceiling from chemical attack, the protected area will project downward into accumulating sediments as a roof pendant. Chemical attack may eventually disconnect the pendant from the ceiling and leave it intact within the surrounding sediments as convincing evidence of aggradation as opposed to abandonment. Multiple lines of evidence should be used when defining facies for use in scientific investigations.

## INTERPRETATION OF CAVE SEDIMENTS

### Introduction

Scientists examine clastic cave sediments to determine: (1) depositional environment, (2) sediment origins, (3) long-term deposition or erosion trends, (4) relationships of sediments to cave or landscape development, and (5) relationships of fossils or artifacts to cave processes. Each of these topics is interrelated with the others. Geomorphologists use knowledge of depositional histories to decipher how caves and landscapes have behaved as functions of tectonism and climate. But, archeologists and paleontologists may desire knowledge of how certain objects came to rest in a cave, whether objects have been disturbed, how objects relate to one another, and how objects have been altered since placement. The diversity of sediments and their uses means that research goals vary markedly from one study to another, but all cave studies share a commonality in that subterranean research techniques are modified versions of techniques developed for surface deposits and landforms. Analyses begin with sediment description. The investigative process can be illustrated by examining representative clastic cave sediments and their interpretation.

### Representative Clastic Sediments and Analyses

Thick deposits of sediments accumulate in cave passages when a cave stream becomes incapable of transmitting available sediment. Cave streams may experience sympathetic aggradation if the stream it drains rises or cave passages are blocked. Stream gradients decrease in both cases because raising the downstream channel elevation decreases stream gradient, which decreases stream velocity. However, sediments may also accumulate in abandoned, upper level stream passages by passive infilling during floods. The sedimentary package of clays, silts, and sands shown in Fig. 4 was deposited following emplacement of a log jam 300 m inside a cave. Initially, the channel bed was composed of coarse sandstone cobbles carried from nearby mountain slopes. The obstruction significantly decreased upstream floodwater velocities and induced deposition of fine-grained sediments throughout the 300-m-long passage. Multiple point bars of fine sand and coarse silt record channel aggradation, as opposed to passive infilling. Laminae within individual beds have variable inclinations, and inclined scour surfaces record bank erosion between episodes of point bar deposition. Deposits formed by passive infilling are typically more homogenous and lack cross-cutting, inset channels because there is no through-flowing stream to cut and fill channels.

Base-level streams are large streams fed by tributary streams such as caves. Large cave systems are often associated with base-level streams, and the most prominent example is the intimate association of 550 km of Mammoth Cave passages with the Green River of Kentucky. Incision rates of base-level streams are particularly valuable for studies of stream evolution and neotectonism. Incision rates are



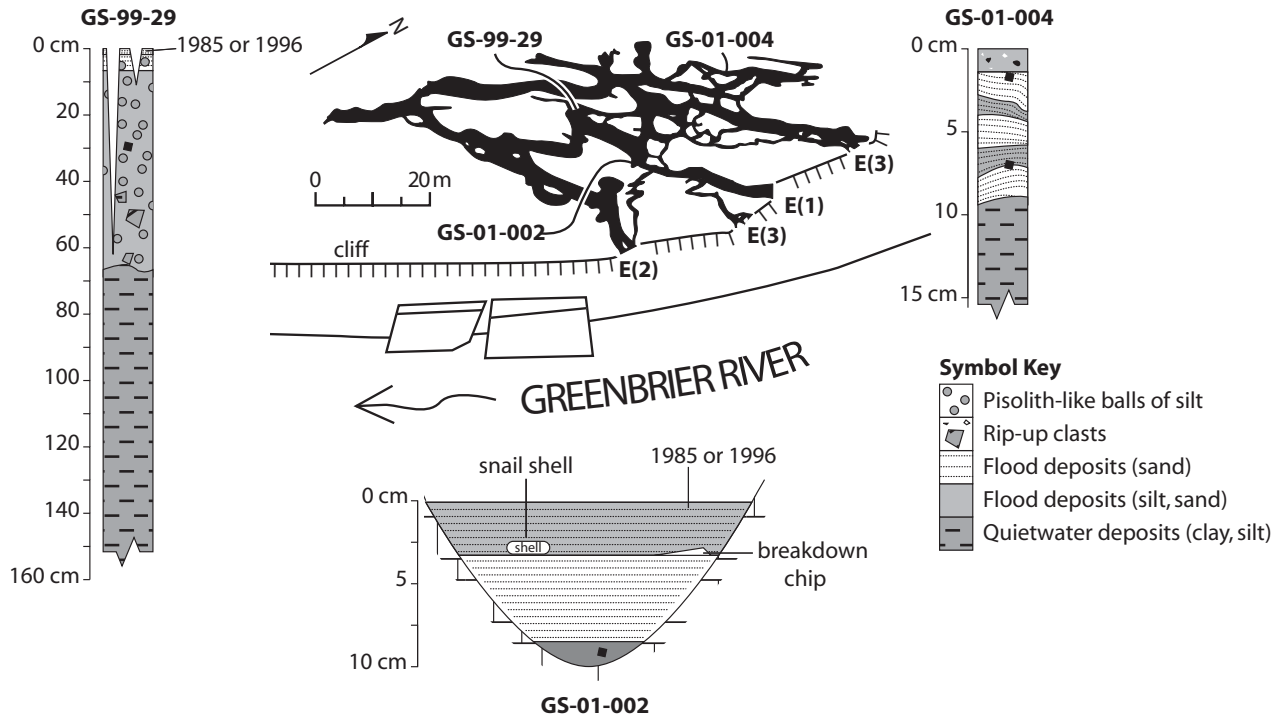
**FIGURE 4** A complex packages of silts, sand, and gravel deposited upstream of a log jam in a West Virginia cave. The stream aggraded (built up its bed) behind the log jam. Aggradation, as opposed to passive infilling, is recorded by the inset, cross-cutting sand and gravel deposits, which are typical of meandering streams. The white lines identify scour and deposition surfaces within the deposit.

calculated by dividing the height of sediments above a stream by their age. However, sediments originally deposited in caves beneath a surface stream yield only a minimum incision rate; the total amount of downcutting is greater than the height of the cave above the present stream because the surface stream had to incise some unknown distance down to the cave and then the additional vertical distance seen today. Similarly, sediments deposited above the target stream yield a maximum bound. Sediments deposited above base level, such as those shown in Fig. 4, can be recognized by sedimentary structures typical of gravity flow and intermittent exposure. Useful sedimentary evidence includes multiple generations of mud cracks, desiccation chips, and evidence of meandering with cut-and-fill structures. Sediments deposited beneath base level or in phreatic caves will not display evidence of multiple wetting and drying episodes (*e.g.*, lack mudcracks between individual beds). Phreatic sediments may be extremely coarse if the passage acted as stream conduit but may also be extremely fine grained with well-defined laminae (Fig. 5).

Flood histories and short-term changes in river behavior are recorded in some caves close to large rivers. Caves in riverbanks may fill with sediment and sympathetically aggrade if the nearby riverbed rises in response to climate changes. The small cave shown in Fig. 6 is almost entirely filled with laminated red clays deposited when the nearby river was choked with sediment produced during a glacial epoch. The clays accumulated in the cave, which was temporarily in the phreatic zone, but are now being eroded by occasional floods created by the same river that deposited them. The more recent floods have left thin deposits of silt and sand throughout the cave, which can be recognized by their brown colorations, mudcracks, cross-bedding, and



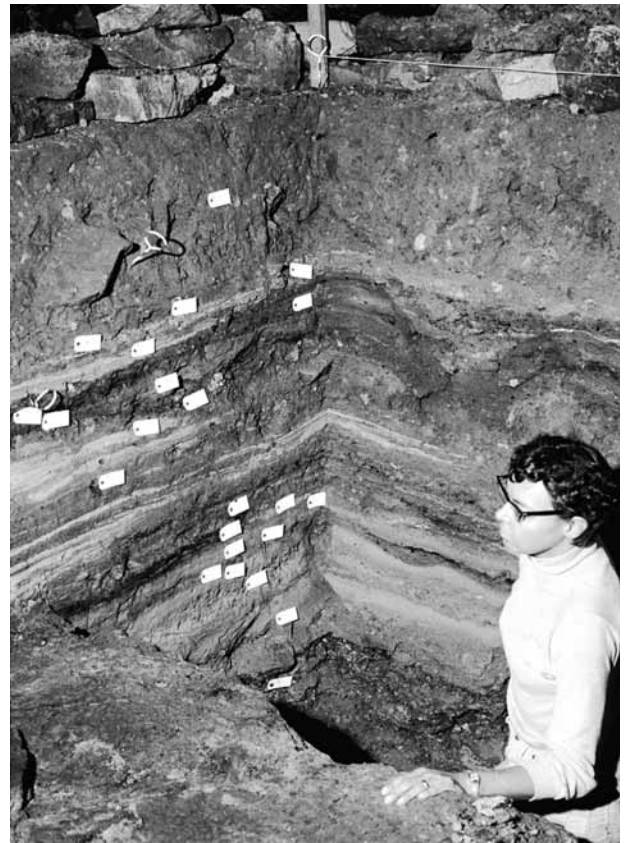
**FIGURE 5** Laminated clays deposited in a large cave that formed well below the water table in New Mexico. Cave development was aided by sulfuric acid, which altered some of the phreatic sediments to white clay known as endellite (top). (Photograph courtesy of Art Palmer.)



**FIGURE 6** Plan view of a small, riverside cave filled with sediments deposited by a West Virginia river. Stratigraphic columns include a thick deposit of red clay (partially shown in GS-99-29 and GS-01-004), interpreted to have been deposited during aggradation of the river. Floodwaters are now occasionally refilling the cave and eroding the aggradational sediments while depositing thin veneers of sand and silt. The flood sediments can be used to infer the frequency of large floods along the river.

organic deposits. Both depofacies (specifically, phreatic versus flood facies) provide useful information about the short-term history of the river.

The types of deposits being creating in cave passages will change in response to many variables. Recognizing facies differences allows inferences to be drawn about geomorphic and climatic histories. A common facies succession is the transition from traction to gravity sediments. As shown in Fig. 7, massive deposits of breakdown and collapse debris may overlie well-sorted and bedded stream sediments. Such facies successions are especially common in cave entrances wherein stream sediments may represent warm periods between cooler climates. The breakdown and collapse debris are created during cooler climates by frost wedging. Archeologists often find that artifacts are preferentially found in association with particular facies in cave entrances.



**FIGURE 7** Stream sediments beneath breakdown and frost-wedging deposits. The stream sediments reflect an episode during which streams washed sediment into the cave via a nearby entrance. Subsequently, frost wedging and collapse have covered the fluvial sediments with a deposit of unsorted sediment (top of column). The deposit contains objects of archeological significance, hence the excavation and tags. (Photograph courtesy of Art Palmer.)

**Bibliography**

- Campy, M. and J. Chaline (1993) Missing records and depositional breaks in French Late Pleistocene cave sediments. *Quater. Res.* 40: 318–331.
- Courty, M.A., P. Goldberg, and R. I., Macphail (1989) *Soil Micromorphology in Archaeology*, Cambridge University Press, London, 344 pp.
- Ford, D.C. and P.W. Williams (1989) *Karst Geomorphology and Hydrology*, Unwin Hyman, London, 601 pp.
- Granger, D.E., D. Fabel, and A.N. Palmer (2001) Pliocene–Pleistocene incision of the Green River, Kentucky, from radioactive decay of cosmogenic <sup>26</sup>Al and <sup>10</sup>Be in Mammoth Cave sediments. *Geol. Soc. Am. Bull.* 113(7): 825–836.
- Sherwood, S.C. and P. Goldberg (2001) A geoarchaeological framework for the study of karstic cave sites in the Eastern Woodlands, *Midcont. J. Archaeol.* 26(2): 145–167.
- Springer, G.S., J.S. Kite, and V.A. Schmidt (1997) Cave sedimentation, genesis, and erosional history in the Cheat River Canyon, West Virginia. *Geol. Soc. Am. Bull.* 109(5): 524–532.
- White, E.L. and W.B. White (1968) Dynamics of sediment transport in caves, *Bull. Natl. Speleol. Soc.* 30: 115–129.

---

# Closed Depressions

**Ugo Sauro**

*University of Padova*

## TYPES OF CLOSED DEPRESSIONS

Closed depressions are the dominant and most distinctive forms of the karst landscape. The following types of closed depressions can be observed in karst areas (listed according to increasing size):

1. *Rain pits* or *rain craters* (1 cm to about 3 cm in size)
2. *Solutions pans* or *kamenitza* (centimeter- to meter-scale features)
3. *Dolines*; also called *sinkholes* (diameters ranging from some meters to over 1 km)
4. *Compound depressions* (hundreds of meters to a few kilometers)
5. *Poljes* (reaching up to some tens of kilometers)

Dolines, compound depressions, and poljes link the surface and the underground fissure and cave systems.

## SOLUTION DOLINES AS THE DIAGNOSTIC FORMS OF KARST SURFACES

The solution doline (also called a sinkhole) is considered to be the diagnostic form of the karst landscape and is also defined as the index form. Dolines are the most common closed depressions in the Carso di Trieste, which is known as the classical karst because it is regarded as the most typical karst region. Dolines commonly have circular to subcircular plan geometry, and a bowl- or funnel-shaped concave profile.

Their depths range from a few decameters to a few hundred meters, and their inner slopes vary from subhorizontal to nearly vertical.

The Slav term *doline* means “depression” and in a broad sense includes channels and hollows of different types, such as fluvial valleys, dry valleys, blind valleys, poljes, and karst dolines. The name *dolina* was first applied in 1848 by Morlot to a circular, closed, karst depression. Subsequently, Cvijić, in 1895, extended use of the term to all circular, closed depressions in karst areas. Gams (2000) further suggested that the word *doline* could be replaced by the term *kraska*, to highlight its importance as a morphological marker of the karst landscapes.

Scientific investigation of dolines began in the middle of the 19th century, during construction of the Southern Railway in the Austro-Hungarian Empire through the Karst of Trieste. At that time, the most common theory was that dolines resulted from the collapse of cave roofs. If that were true, the natural hazard for a railway crossing the karst was high. The railway engineers, on the other hand, came to a different conclusion that most dolines originated through dissolution.

Dolines link the surface and the underground drainage systems. The absence of still water, such as lakes or ponds, at the bottoms of most dolines reveals that water is lost to the underground karst system, most commonly to caves. Through the sole observation of surface forms a doline seems very simple: It is a bowl- or funnel-like depression with one or a few swallowing cavities at the bottom which are covered by soil. Cross sections outcropping in road cuts and quarries, however, reveal that dolines are actually rather complex. In order to understand how dolines and, in general, all large, closed karst depressions develop, it is necessary to examine: (1) their morphology and size, (2) their locations and relationships with the topographic and geomorphologic settings, (3) their structures, (4) their hydrological behavior and related solution processes, (5) other processes that play a role in their evolution, (6) examples of evolution, and (7) peculiar morphologies that occur under specific environmental conditions. In the following sections, all of these aspects will be discussed.

## Morphology and Size of Dolines

Most dolines show a circular or slightly elliptical plan geometry (commonly, the main axis/minor axis ratio is <1.5 and the depth/width ratio is about 0.1). The three-dimensional form of dolines may be compared to a bowl (nearly hemispherical depression), a funnel (nearly conical depression), or a well (nearly cylindrical depression). In some doline populations, more complex forms, such as truncated conical depressions with flat bottoms and star shapes, are common. The bowl shape is the most typical doline shape and is four to ten times more common than funnel-shaped dolines (Cvijić, 1895). The well-shaped doline is uncommon.

Soil-covered forms show an almost circular plan geometry. Depressions that developed on bare rock are more irregular and commonly show sharp contours that follow the main fracture systems.

The dolines described by Cvijić as “holotypes” were subsequently carefully analyzed by Šušteršič (1994), who recognized that “...the dolines ... are not as regular as many simple morphometric methods presume ... some of these irregularities are probably due to the roughness of the neighbouring terrain ... the others are probably due to the greater dynamism of the whole doline which does not permit the ‘bowl’ to achieve a regular shape.” Šušteršič (1994) also identified the presence of three distinct concentric areas within each single doline: (1) a flat central area, which is generally covered by soil; (2) a ring of steep slopes; and (3) an outer belt with a more gentle slope.

A population of dolines rarely shows the entire spectrum of possible sizes attained by these karst depressions, because smaller forms are not mapped. The morphometric parameters of the dolines measured in the Carso di Trieste indicate that there is not a continuous, asymptotic size distribution; therefore, it is possible to recognize different subpopulations. The smaller forms are relatively shallow, and it is difficult to identify them through field observation alone. Within a doline population, there are a few forms that can be distinguished from the typical doline of the population because of some particular characteristics, such as elongation, asymmetry, steepness of the slopes, depth, etc. Morphometrical methods and analyses of various doline populations are illustrated in a number of papers (Bondesan *et al.*, 1992).

### Locations and Relationships with the Topographical and Geomorphological Settings

Dolines commonly occur in populations with variable numbers of individuals and with different densities, which ranging from a few to over 200 per square kilometer. Within a population, the density depends on the surface slope. On subhorizontal or gentle slopes, the density of dolines is higher than on steep slopes. Dolines are commonly lacking on very steep slopes. Two major types of karst plateaus can be distinguished on the basis of the spatial distribution of dolines: one that is characterized by isolated dolines (the classical karst type) and another that is characterized by honeycomb systems of dolines. In many karst plateaus, intermediate situations can be observed. With respect to the distribution of dolines, it is possible to recognize the influence of major fracture systems. The center of the doline is commonly set at the intersection between two or more fractures. Rows of dolines commonly follow fault lines, especially when the dislocations are linked to extensional tectonics that bring different rock units into contact. In karst plateaus where a net of dry valleys can be distinguished, dolines are aligned along the valley bottoms.

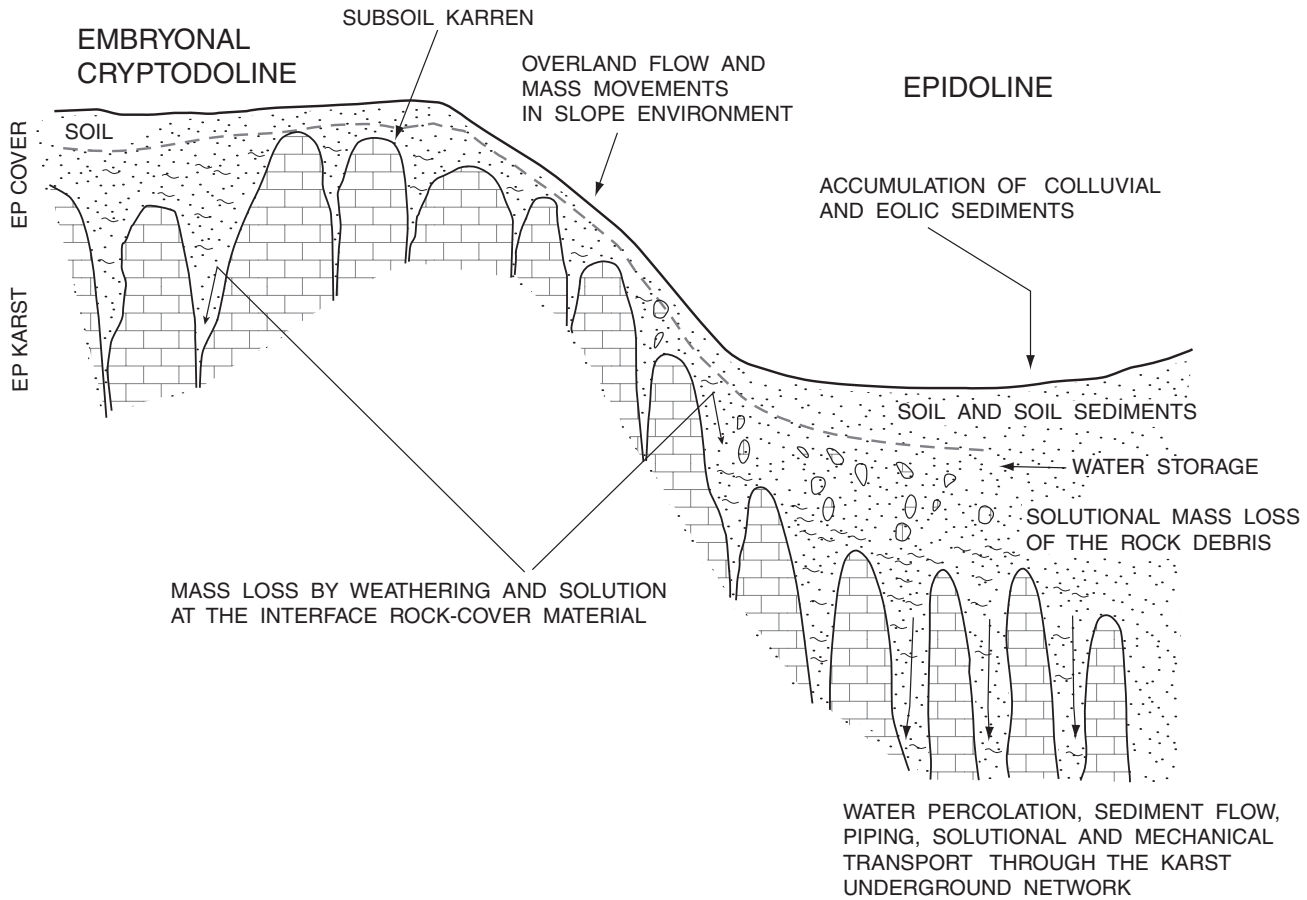
### The Structure of Dolines

In the bare karst, such as at elevations above the timberline, it has been observed that the structure of closed depressions is controlled by the macro- and microstructural properties of the soluble rocks. For example, in Monte Canin (Julian Alps, between Italy and Slovenia) the properties of the rock yield a high density of steep-sided, rocky, nival depressions, or *kotlici*. In the typical bowl- or funnel-shaped dolines, the rock is normally covered by soil and other surface deposits. The structure of the dolines in the soil-covered karst is visible only through artificial cuts. Some basic characteristics of dolines can be inferred from the analysis of many cross-sections. In particular, it can be clearly observed that the doline structure begins to develop before the onset of the surface depression. Many small depressions in the hard rock, which are completely filled by soil and surface deposits and go undetected if one looks only at the surface, are visible. These small forms have been termed *embryonic cryptodolines* or *subsoil dolines*. Some of these structures host paleosols, beside the present-day soils. The presence of paleosols in the filling sediments indicates that the development of cryptofoms took place over a long time and that cryptodolines have acted as sediment traps since the beginning of their formation. In the early phases, the trapping action was effective for soils, which show less erosion than in the surrounding area in correspondence to the cryptodepression. When the cryptodolines evolved as surface forms, the trapping action also became efficient for other materials, such as rock debris from the slopes, soil sediments, aeolian dust, volcanic ashes, etc. In the Mediterranean karst, these fillings are commonly red (*terra rossa*, or “red soil”), and the color is the result of weathering processes. In the dolines of the classical and dinaric karst, the filling commonly consists of a slightly reddish brown silt, which is primarily composed of weathered, loess-like sediment of aeolian origin. The filling may be up to 10 m thick. The profile of some dolines exhibits multilayered filling.

The sketch of the structure of an ideal middle latitude doline (Fig. 1) shows that the solid rock/filling materials interface is not a simple boundary, but rather a complex, involute surface that consists of many rounded bulges in the soluble rock separated by crevices and fissures that become narrower inward. These covered solution forms, called *rounded karren*, develop through the slow flow of the water solution at the rock/filling interface. The structures of dolines in different karst areas show large variability depending on the role that is played by different factors, such as lithology, structural conditions of the rock, topography, climate conditions, and features inherited from previous morphodynamical events.

### Hydrological Behavior and Related Solution Processes in Dolines

A simple doline is a hydrological form that can be compared to a first-order valley segment. Its concavity is an expression



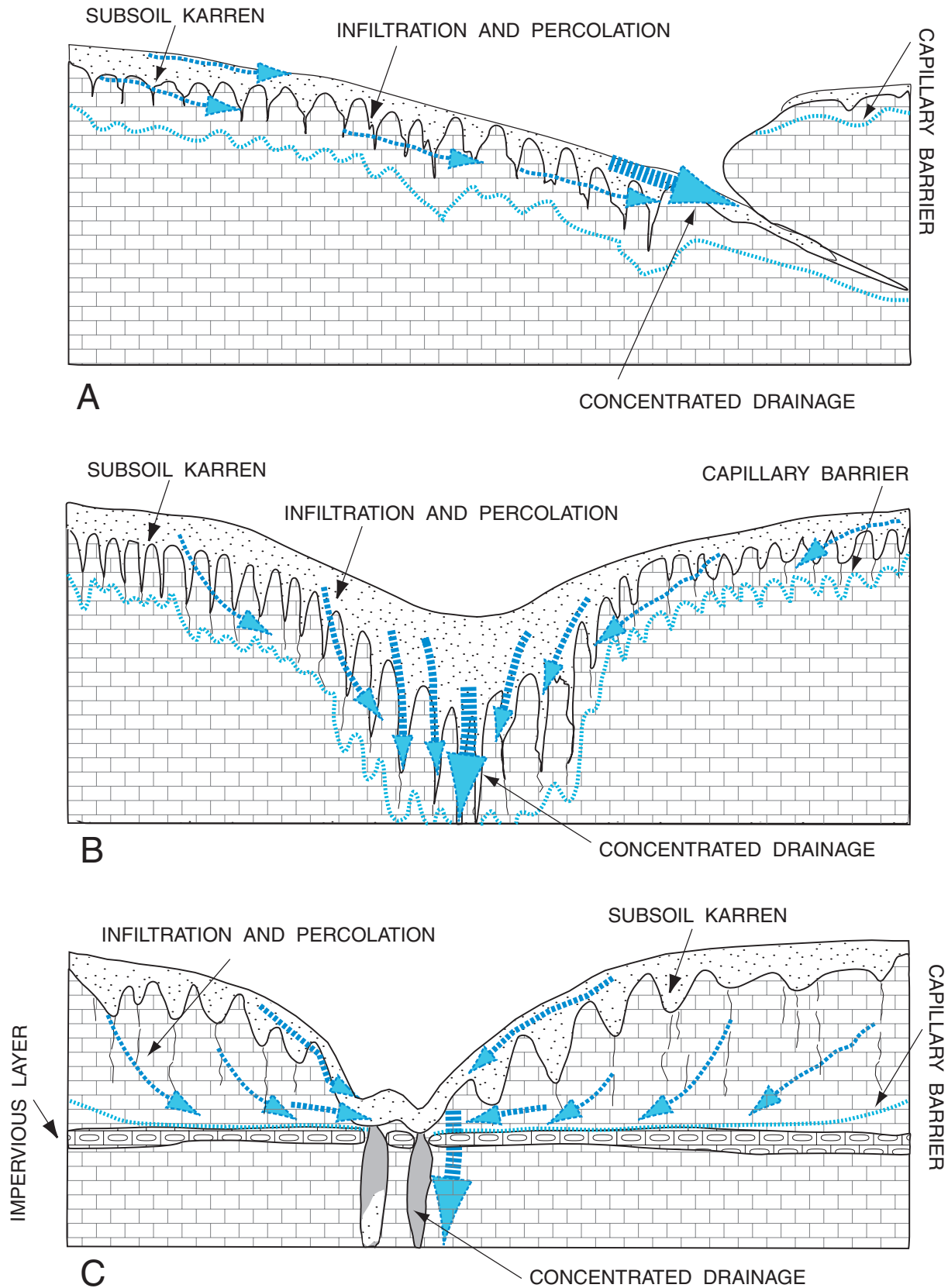
**FIGURE 1** Schematic showing the structures of a doline and a cryptodoline. The epikarst in the host rock, the fillings, and the soil are outlined. The secondary porosity of the soluble rock is greater at the bottom of the dolines. The main morphodynamic and hydrologic processes are also provided.

of the convergence of water toward the bottom which is a transitional point between surface and underground hydrologic networks. The physical structure of the doline is the framework of its hydrological functioning and, because this functioning is also related to the genesis and evolution of the form, the doline may be considered the surface expression of a peculiar three dimensional hydrostructure. The geomorphological setting and the structure of the dolines allow the distinction of three major hydrostructural types (Fig. 2): (1) *point recharge doline*, (2) *drawdown doline*, and (3) *inception doline*.

A point-recharge doline begins to form when a fluvial net loses water to the cavities of a soluble rock. It is necessary for protocaves to begin to form inside the rocky mass, connecting surface recharge points to an underground network. Once developed, a protocave focuses both drainage and solute removal at the points of transition from the surface to the underground network, thus causing the development of a surface depression. The point-recharge doline is commonly located along a rather dry hydrographic net and shows transitional features between the depression of a blind valley and a common drawdown doline (Fig. 2A). It is often elongated and skewed in the direction of the

flow, with the upstream side being gentler than the downstream side.

The drawdown doline is the most common and typical karst form. To understand the drawdown dolines it is necessary to consider the behavior of the water in the rock zone just beneath a nearly horizontal or gently sloping surface. Near the surface, the rock fractures tend to open by tensional relaxation; therefore, the soil water seeps through the fractures and enlarges them through dissolution. With time, secondary porosity develops inside the shallow rock layer near the surface which then becomes saturated in wet periods. If, in some points of this layer, the water is able to find and enlarge routes to an underground network, flow paths converging to the leakage zones are thus established. As a consequence, the water velocity increases centripetally toward each leakage point, and more water molecules are brought into contact with the rock surface near the major drain. There, the rock is dissolved more rapidly, secondary porosity increases faster than in the peripheral zone, and the hydraulic conductivity increases. Consequently, a depression tends to form at each leakage zone, the center of which deepens faster than in the surrounding areas. The drawdown doline is, therefore, the product of the resulting positive



**FIGURE 2** The three main types of solution dolines. (A) In the point-recharge doline, the strongly asymmetric hollow is linked by one main sink, fed primarily by surface and soil water. (B) In the drawdown doline, the depression results from focusing of the dissolution inside the water infiltration zone of the rock through centripetal convergence of the mainly subsurface water held inside the epikarst (*i.e.*, the upper zone of the soluble rock presents a greater secondary porosity). (C) In the inception doline, the depression also originates from a centripetal convergence of water, but this occurs inside a preexisting hydrogeological structure and is triggered by a change of hydraulic conductivity of the rocky mass, influenced by lithological and structural factors.



**FIGURE 3** A line of funnel shaped dolines in the Monti Lessini along the bottom of a dry valley (Venetian Prealps, Italy). These inception dolines develop just above a lithology change.

feedback resulting from the interrelations between the hydrological and the solute processes acting inside the outer layers of a fractured soluble rock.

Gams (2000) calls the dissolution process at the central part of a doline *accelerated corrosion*. The hydrostructure corresponding to this central part is comparable to the funnel-shaped depression created by a pumping well in the water table of a phreatic aquifer. The outer rock layer, which is characterized by high secondary porosity, is shallower in the peripheral areas and thicker in the central parts of the dolines. It hosts a hanging aquifer, which is nearly saturated during wet climate periods and nearly empty during dry periods. The existence of the epikarst with the characteristics of a water reservoir was recognized through the study of the hydrological regime of karst springs.

The inception dolines develop from the interception by the epikarst of a hydrogeological structure formed inside the rock and previously triggered by a change in hydraulic conductivity of the rocky mass. A change of lithology or the presence of an impermeable layer, such as clay or chert, may cause the formation of a hanging aquifer. If connections such as fractured zones exist and allow water to overcome an

obstacle, a hydro-structure similar to the drawdown dolines develops, yielding a focused dissolution both above and below the bottleneck. Above, the fractures of the rock are enlarged to fissures; below, small shafts develop. This type of doline differs from the drawdown doline because of the more marked lithological and structural control and because of an early evolution of the hydro-structure, which is not necessarily dependent on the epikarst. The models illustrated in Fig. 2 do not consider the role of surface deposits or filling materials. These components are important, because the water is absorbed by soil, surface materials, and filling sediments before it reaches the fissures in soluble rock. The fillings may host small aquifers nested above the epikarst and act as pads that slowly release water downward, thus influencing with their physical character both the flow velocity at the cover–rock interface and the water regime of the epikarst and the main karst springs.

### Others Processes in Doline Evolution

Even if the major process of doline formation is dissolution through a differential mass wasting of the rock, the following processes also play roles in the shaping of the depression: soil forming processes and other weathering processes, slope processes, overland flow processes, the capacity of the closed depression to trap different types of sediments, and the processes of evacuation of filling materials. The soil acts as a filter and as an insulating layer with respect to the outer environment. Soil releases solutions rich in humic acids and air with a high content of carbon dioxide. It also yields fracture-filling material.

Frost shattering of the rock is a very important weathering process. In the fillings of most mid-latitude dolines, a variable amount of angular rock debris is produced through this mechanism. During the cold phases of the Pleistocene, some dolines were completely filled with rock debris. Slope processes influenced by the gravitational force, such as creep and solifluction, are responsible for soil thinning, for the formation of a debris cover along the slopes, and for its thickening in the bottom areas. The overland flow processes are responsible for erosion, the washing of soils and loose material, and for the deposition of colluvial sediments in the bottom area of the depression. Once formed, a closed depression acts as a trap for different types of materials that are carried by wind, rain, etc.

In the mid-latitude karst, the doline filling contains variable amounts of loess-like deposits that were transported by the wind during cold Pleistocene phases, volcanic ashes, sands, and silt deposited by rain, etc. The fine-grained material is commonly deposited on the entire karst surface and then accumulates by overland flow into the central part of the depression. Many authors consider the filling material to be a residue of limestone dissolution. Even if in some karst areas this may be true, most of the mid-latitude doline fillings consist of allochthonous materials, with the exception of



angular rock debris due to *in situ* frost shattering. The filling material may be evacuated through the karst conduits through different processes, such as mass wasting of the rock debris by solution, subsurface flow, liquefaction of the loose material, or piping.

### Examples of Evolution

Some examples will help to understand the evolution of dolines. Point-recharge dolines are present in the gypsum karst of the Santa Ninfa Plateau (Sicily, Italy). There, chains of dolines follow the pattern of a fluvial network that developed on the impermeable cover and was overprinted on the gypsum. Inside some chains, the bottom of the upstream doline is at a lower altitude than that of the progressively downstream doline. The last upstream doline marks the end of a blind valley. It is clear that each closed depression became inactive after the development upstream of a new swallow hole. So, the speed of bottom deepening is strictly linked to the activity of the swallow hole.

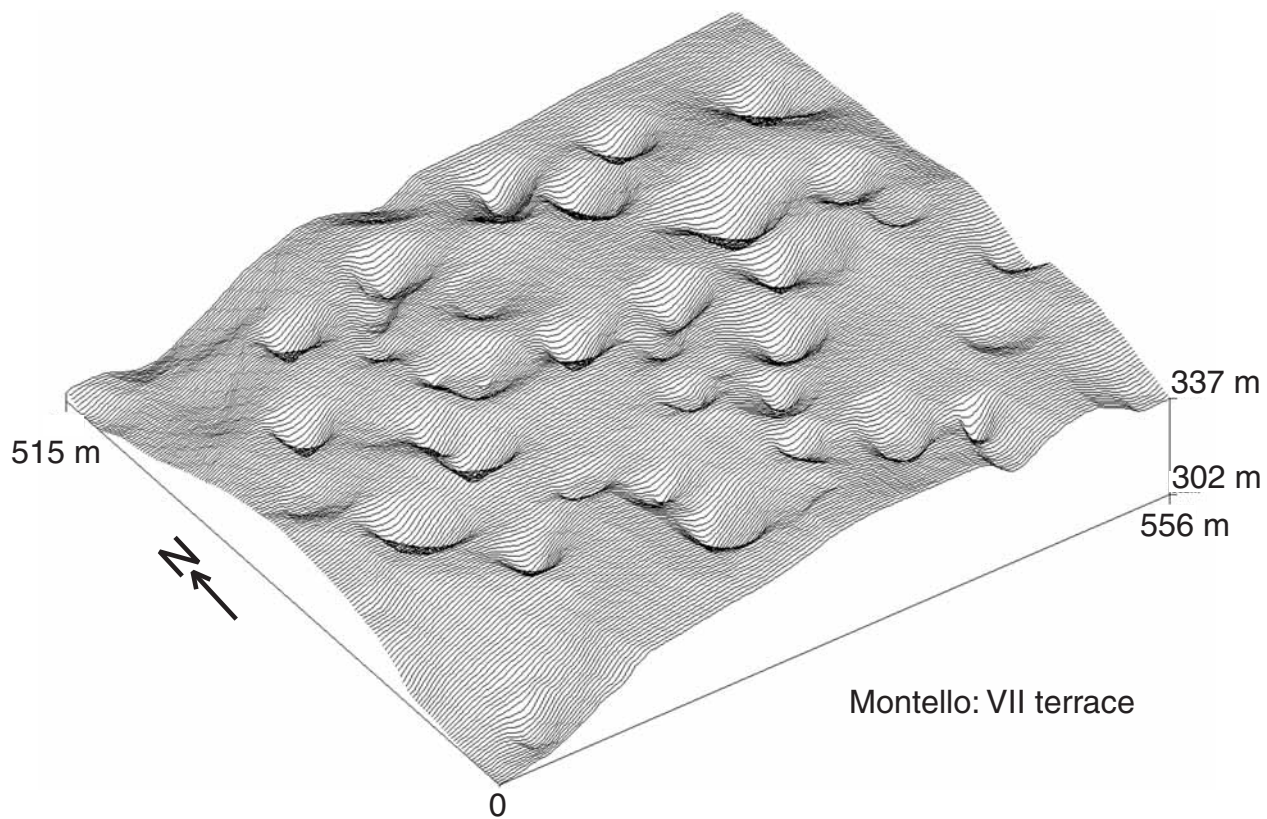
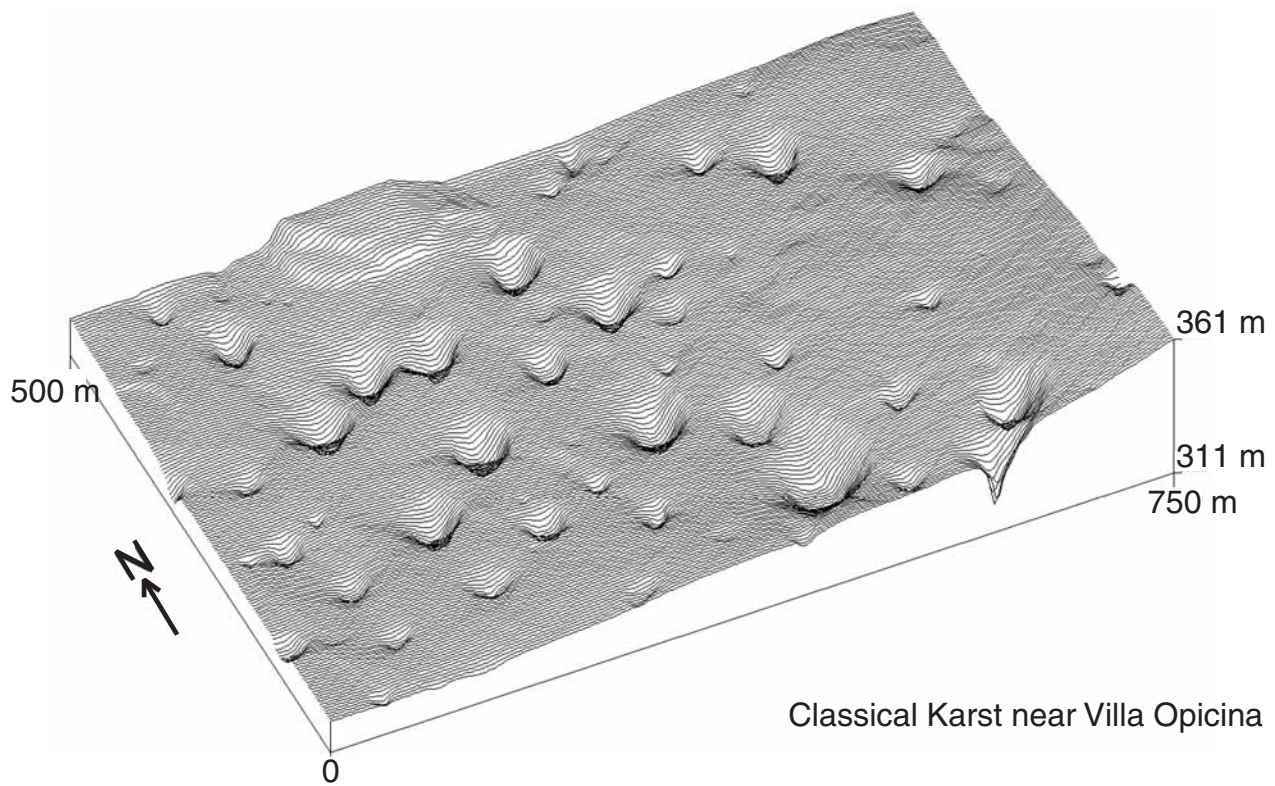
In the Waitomo district of New Zealand, populations of point-recharge dolines occur in the framework of interstratal karstification. It is possible to reconstruct the transitions from a fluvial network in an impervious rock to a honeycomb system of dolines that developed in the underlying limestone units and the subsequent recovery to fluvial network in the impervious rock unit previously overlain by the limestones, following their chemical erosion. Gunn (1986) proposed a model based on five sample areas, each representing a different stage of the transition. The model outlines the important roles played by both allogenic recharge and the location of previous subterranean drainage structures.

A small, nearly horizontal area of the classical karst, which was surveyed at very high resolution (scale 1:1000; contour interval 1 m; spot elevation, as the bottoms of some depressions, checked at the resolution of 0.1 m), is characterized by drawdown dolines, with some small and shallow forms that are difficult to see in the field (Fig. 4). Their main morphometric parameters reveal three main subpopulations: (1) small and shallow dolines less than 20 m in diameter and 0.4 to 2 m in depth, (2) medium sized dolines 12 to 50 m in diameter and 2 to 7 m in depth, and (3) large dolines, 50 to 120 m in diameter and 8 to 15 m in depth. From the ratios between the numbers of individuals of each group it is possible to infer that most of the embryonic surface dolines will probably abort prior to becoming medium-sized forms. Their hydrological functioning is at the limit between triggering or not the positive feedback that would allow them to evolve into typical dolines. The coexistence of the three subpopulations also suggests different ages for the forms, which are probably related to the starting times of their evolution during favorable morpho-climatic phases. The smaller and shallower dolines could be the result of the karst morphogenesis that began at the end of the last cold period, which was triggered by the preexistence of cryptodolines.

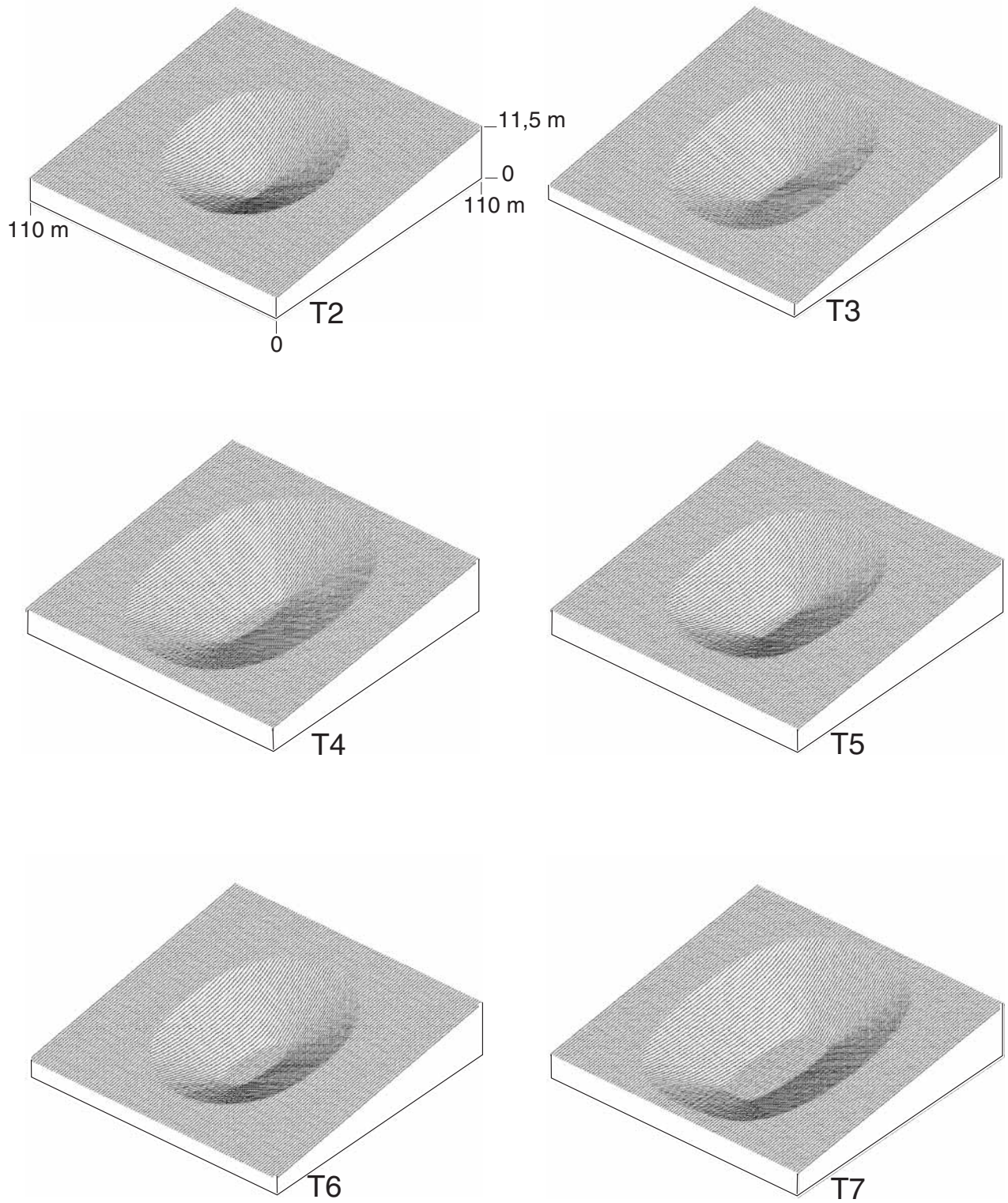
Seven rock terraces were cut in the Montello (Venetian Prealps of Italy) neotectonic anticlinal morphostructure consisting of Upper Miocene conglomerate during the tectonic uplift. The terraces subsequently became the sites of doline morphogenesis (Fig. 4). Depending on the ages of the terraces, it is possible to analyze populations of drawdown dolines that developed in very similar geomorphological environments and now represent different evolutionary stages. A “standard” doline for each paleosurface was reconstructed from morphometrical analysis of the dolines of each terrace (with the exception of the lowest one, where no recognizable dolines exist) (Fig. 5). The series show that the standard forms are not the expression of a regular and linear growth, probably because of the different influence of some local factors on each terrace. Nevertheless, there is a general trend toward increasing sizes and depths of the dolines, from the lower and younger terraces to the upper and older ones. What is clear is that deepening process was faster than the widening process. What was increasing in a perfectly linear way was the sum of the volumes of the dolines for an area unit. The depressions tended to evolve from bowl-like to dish-like forms. The flat bottoms of the older and larger depressions result from thick fillings that formed inside the hollows. In the lower terraces, the dolines are isolated spots on a nearly flat surface, but on the upper terrace their boundaries are shared and a honeycomb karst morphology is almost reached (Fig. 4).

In the Southern Monte Baldo (Venetian Prealps of Italy) are dolines that differ in size and character. Many host very thick fillings; some open dolines filled up to the rim look like amphitheatres with flat bottoms, which are open on one side. The fillings commonly consist of angular rock debris supported by a loess-like silt matrix. Some relicts of large egg-carton-like structures show that a population of big dolines, which probably developed in the late Tertiary, had been largely dismantled by the periglacial processes during the cold phases of the Pleistocene. During the Interglacials, the karst morphogenesis prevailed against other competitive processes, and so, many dolines survived up to the present day, even though their morphology has been strongly modified.

The Velebit Mountains of Croatia have different types of dolines. In the central plateau, the dolines are very large and deep and are funnel shaped, almost without covers and fillings and with open shafts on the slopes and at the bottom. In the southern plateau, the depressions are smaller and partially filled by rock debris and loess-like deposits. The main difference between the two groups is represented by the lithology of the host rocks: The larger rocky dolines developed in a massive limestone breccia characterized by low sensitivity to frost shattering, while the smaller and partially filled dolines developed in a limestone more susceptible to gelivation. The larger depressions remained, therefore, filling free, and during the winter they trapped large amounts of wind-transported snow. The large amount



**FIGURE 4** Digital elevation model of two doline areas. (Top) Classic Karst near Opicina (Triest). (Bottom) seventh terrace in Montello Hill (Venetian Prealps). Morphometric parameters and distribution of dolines are more homogeneous in the Montello area than in the Opicina example. In the latter, the dolines show a larger variability of morphometric values. (Modified from Ferrarese and Sauro, 2000.)



**FIGURE 5** Models of the standard doline for every Montello terrace, ordered from the youngest (T2) to the oldest (T7). The model is drawn using the average value of each morphometric parameter. The horizontal scale is the same for all drawings, while the vertical scale is slightly decreasing from T2 to T7.

of meltwaters accelerated the evolution of the forms, which reach huge sizes.

In the Eyre Peninsula of South Australia, clusters and lines of dolines developed on a stack of fossil coastal fore-dunes of Middle and Late Pleistocene age, now consisting of calcarenites. Some dolines occur high in the local topography and are also aligned in groups. Their distribution is influenced by the diversion of groundwaters in fractures that cut into the pre-Pleistocene basement (granites) and the predominant action of solution processes in the limestone above such zones. This is probably related to an earlier mass wasting of the sand during its diagenesis in the open fissures of the underlying rock with a local increase of porosity of the newly formed rock above. The influence of a buried surface on the development of hydrostructures and related forms is referred to as *underprinting* by Twidale and Bourne (2000).

The above examples demonstrate the important roles played by various factors and processes such as the morphostructural setting of the soluble rock, its lithology and density of discontinuities, its susceptibility to frost shattering, the qualities of the rock units above and below, the characters of the erosional surface on which the karst forms began to develop, the morpho-climatic system and its relative changes, and the occurrence of such events as falling volcanic ashes, among others.

### **Populations of Dolines Linked to Specific Environmental Conditions.**

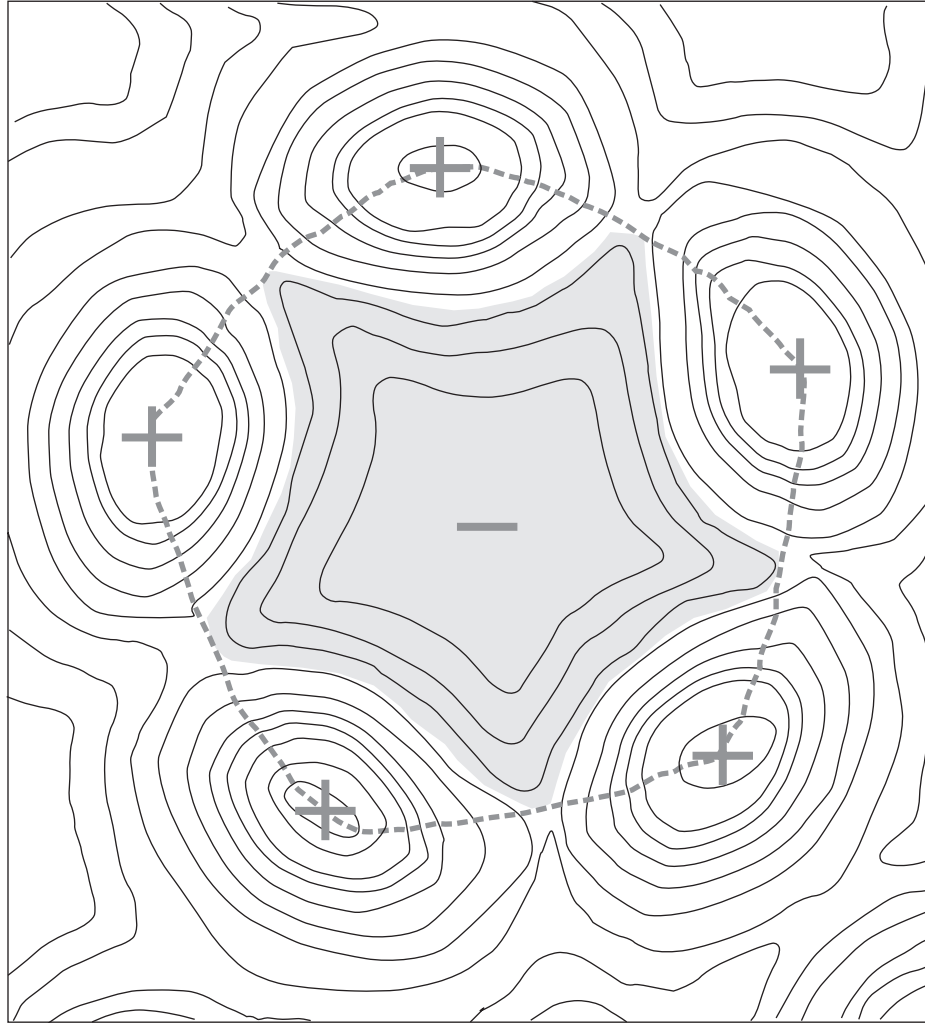
In humid tropical climates, some populations of closed depressions show peculiar characteristics that distinguish them from doline populations of the mid-latitude karst. In particular, the closed depressions are often larger than typical dolines and in the topographical maps show a star-shaped figure. The cartographic representation of a tropical karst landscape with closed depressions resembles a classic karst landscape with dolines, but with an inverted relief. In fact, most of the rounded, concentric figures drawn by the map contour lines are conical or tower-like hills encircling the concentric star-shaped contours of a closed depression (Fig. 6). The egg-carton shape of the basin is characterized by a great difference between minimum and maximum depths (differences in elevation between the bottom of the depression and the lowest and highest points of the perimeter). This type of tropical doline, called a *cockpit* from their Jamaican name, has very steep slopes, usually from 30 to 40°, and is coated by a thin soil cover. Often, the rock outcropping on the steeper slopes shows evidence of biokarstic weathering, such as honeycomb alveolar cavities, and locally of carbonate deposition. At the bottom, the fillings are shallow, and, sometimes it is possible to observe a flat, sponge-like rocky bottom, blackened by biokarstic weathering, and a sharp change of gradient at the contact with the surrounding slopes. During the wet season, the shallow holes at the bottom of some depressions behave like springs, and temporary ponds may form.

The morphological differences between the normal solution dolines and the tropical cockpits are mainly due to the presence of the valley-like depressions entrenched on the slopes of the cockpits, which determine the star-like form of these sinks. These incisions in the slopes, even if similar to some morphological types of the fluvial landscapes, are solution forms. Their presence in the tropical dolines, and not in the middle-latitude dolines, is due to such different factors as: (1) the larger dimensions of the slopes of the tropical dolines, (2) the poorer development and role of the epikarst, (3) the minor influence of limestone debris and soil cover, and (4) the more active overland flow and biokarstic weathering that act on the slopes.

Similar to tropical dolines, some populations of mid-latitude dolines, such as those of the coastal belt of Dalmatia (Croatia), may be interpreted as inherited forms, which first developed in subtropical humid conditions during the late Tertiary. The survival of inherited forms was possible where the dismantling processes competing with the solution processes, such as frost shattering, have played a secondary morphogenetic role due to both peculiar environmental conditions and a low susceptibility of the rock to gelifraction. Also similar to the tropical dolines, some very large dolines of the Central Velebit plateau can be explained as old, inherited forms that were not considerably altered by the periglacial processes of the cold Pleistocene phases because they developed in a limestone breccia resistant to frost shattering.

### **Summary of Solution Dolines**

The solution doline may be considered the most typical karst geo-ecosystem that links the surface and the underground networks. A doline is both a three-dimensional form, and a multicomponent geosystem consisting of several components of variable thickness, such as soil, surface deposits, fillings, and epikarst. If the development of a doline is triggered by a positive feedback in the synergical interactions of hydrological and solute processes, other cooperative and competitive processes may also play an important role in its evolution. In particular, the soil plays a cooperative function by enriching the water with carbon dioxide. The fillings, on the contrary, commonly act as a competitive factor by slowing water seepage into the epikarst and, if carbonates are present in their composition, by increasing the water pH, thus decreasing potential dissolution of the underlying solid rock. Without the presence of soil cover it is not possible for a doline to attain a typical bowl- or funnel-like shape, as documented by the irregular depressions of the bare high mountain karst. Soil and others surface deposits, therefore, play a fundamental role in the evolution of the forms. Dissolution is the dominant morphogenetic process in the cockpits of the tropical karst. If the soil cover is very thin on the steep slopes, it can be replaced by a rock layer that is strongly corroded by biological processes.



**FIGURE 6** Sketch of a tropical cockpit. The star-shaped depression is encircled by conical hills separated by dry valleys and gaps. The planar shape of the watershed line is polygonal.

### OTHER TYPES OF DOLINES

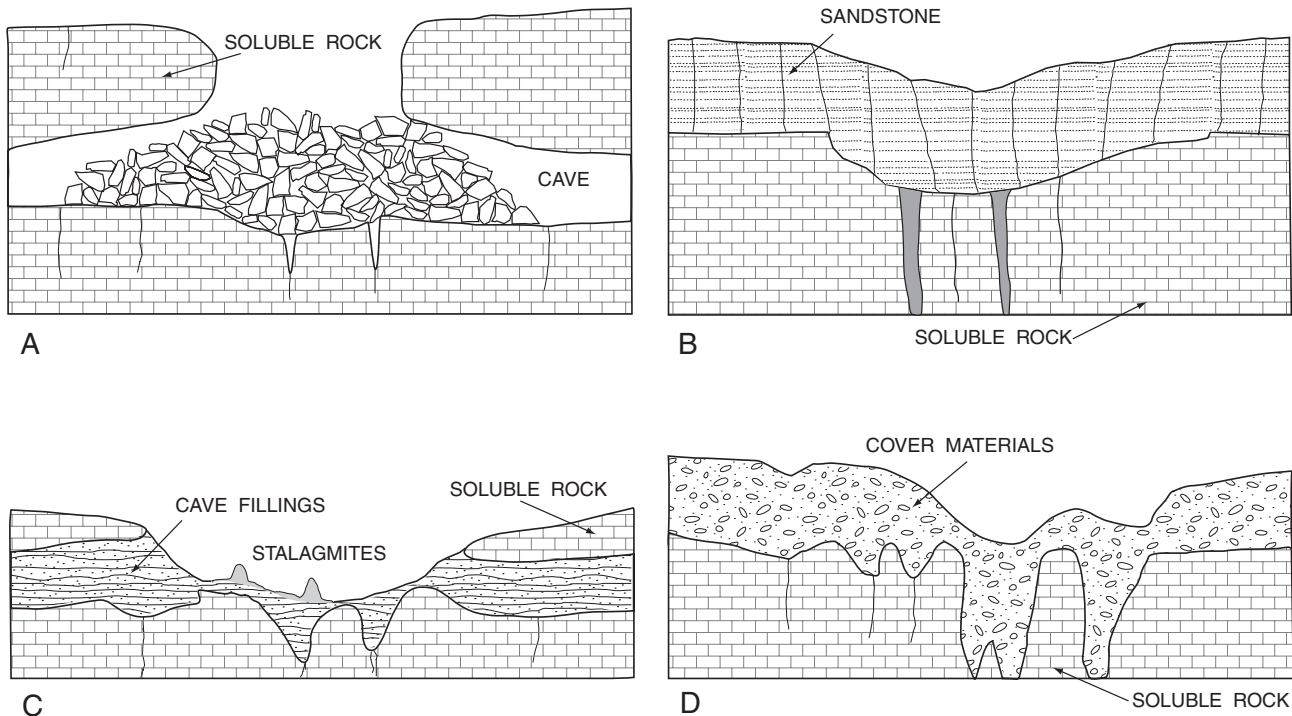
In the karst areas it is possible to find other types of dolines that do not directly originate in the solution of rock at or near the surface. The main types are (1) *collapse dolines*, (2) *subsidence dolines*, (3) *intersection dolines*, and (4) *cover dolines* (Fig. 7).

#### Collapse Dolines

Collapse dolines result from the collapse of a cave. They show different shapes, with vertical or overhanging walls. Collapse dolines that allow entry into a subterranean system are also called *karst windows*, because they open into the underground environments (Fig. 8). The best known karst windows are the dolines of Skocjanske Jame in Slovenia (Fig. 9), where the Reka River enters into a large cave feeding the aquifer of the classical karst and the spring of Timavo 40 km away.

The range of sizes of the collapse dolines varies from a few meters to hundreds of meters. The Velika dolina (large doline) of Skocjanske is about 500 m in diameter and 164 m in depth. The Blue Lake and Red Lake dolines of Imotski (Croatia) are among the most spectacular collapse dolines in the world (Fig. 10). The main axis of the Blue Lake doline is about 1.5 km; the diameter of the Red Lake doline is about 400 m at the lake surface, and its total depth, including the submerged part, is 520 m. These very large forms are not the result of a unique collapse episode, but of a number of collapses related to oscillations of the water table. Most of the collapse dolines do not provide access to a subterranean system because of collapse debris at the cavity bottom.

A particular type of collapse dolines are the *cenotes*, open depressions in the coastal karst belts giving access to the water table and resulting from the collapse of the roof of submerged cavities. The best-known cenotes are in Yucatan and in the Caribbean Islands. The evolution of cenotes and of the related cave systems is often due to both efficient



**FIGURE 7** The four main types of dolines that do not directly originate by solution of rock at or near the surface: (A) collapse doline, resulting from the collapse of the roof of a cave; (B) subsidence doline, formed by the settling of an insoluble rock following solution of the underlying soluble rock; (C) intersection doline, originating from the emptying of fillings of an old fossil cave due to intersection with the topographical surface; (D) cover doline, which has developed in incoherent rocks burying a soluble rock or partially filling a karst depression.

dissolution by the brackish waters of the coastal belts and oscillations of the water table. Some cenote populations could be interpreted to be intersection dolines.

### **Subsidence Dolines**

Subsidence dolines are closed depressions caused by the subsiding of an area. They may be due to upward propagation of an initial collapse of the roof of a deep cavity with development of a breccia-pipe structure; when this structure reaches the surface a closed depression with an unstable bottom is formed. Subsidence closed basins are also found on insoluble rocks overlying soluble rocks. If the underlying rocks are eroded by solution processes, the rocks above subside. These hollows, which may host lakes, are frequent on rocks overlying very soluble minerals, such as gypsum and salt.

### **Intersection Dolines**

Intersection dolines are depressions formed when an old cave system, partially or totally filled with sediments, is cut by the topographic surface as a consequence of the lowering of such a surface by chemical erosion. The opening of these fossil caves reactivates these old hydrostructures, leading to evacuation of the fillings and development of closed depressions. These forms are relatively common in the

classical karst, where chains of depressions or slender depressions also some hundred meters long exist. On the bottom of such a doline, it is easy to find relicts of cave fillings and stalagmites. The recent building of a highway has cut many of these forms and they have been labeled *roofless caves* by Mihevc (2001); here, the term *intersection dolines* is preferred because they are no longer underground forms.

### **Cover Dolines**

Cover dolines are the closed depressions formed in incoherent materials such as alluvial deposits, glacial drift, superficial deposits, soil sediments, etc. These forms, also commonly called *alluvial dolines*, have different characteristics according to the type, continuity, and thickness of the deposits and the presence of a well-developed karst relief under the deposits or of a still incipient karst hydrology, among other factors. The flat bottoms of large solution dolines, consisting of filling deposits, and the alluvial plains of a large river may be considered as end members of the various development environments for these dolines. The influence of buried karst hydrostructures on the formation of cover dolines is a clear example of underprinting. Various processes may play a role in the evolution of these forms, such as water infiltration, washing and piping, suffosion (in the sense of erosion from below), suction of the sediments caused by oscillations in the water table, liquefaction of the



**FIGURE 8** A karst window in the Rakov Skocijan cave system in Slovenia. In the foreground, the natural arch represents a remnant of the cave roof.



**FIGURE 9** The karst windows on the first part of the subterranean course of the Reka river in the Skočjanske Jame system (Slovenia).

sediments and the linked mud flows, and changes in volume caused by freeze–thaw cycles.

The two main models for the development of cover dolines are (1) upward migration of a cavity, and (2) subsidence, as determined by the gradual rearrangement (a sort of inner creeping) of the cover material induced by its mass wasting through the karst net. If the cover material is sufficiently cohesive, the mass wasting by the water infiltrating underground produces a cavity with an arched roof; the arch gradually migrates upward, where it reaches the surface and causes the sudden opening of an ephemeral cover doline with nearly vertical walls. The subsidence cover dolines form in less cohesive sediments.

In addition to the forms of dolines described above are other types originating by different processes, such as dolines along fault lines caused by seismotectonic movements and anthropogenic dolines. Also, craters similar to dolines were created by shelling during World War I in the chalky limestone of the Venetian Pre-Alps and are an interesting anthropogenic type. The crater-like depressions behave as drawdown dolines because of the strongly fractured rock fracturing caused by the explosions.

### COMPOUND AND POLYGENETIC SINKS

Both compound, and polygenetic closed depressions can be observed in the karst landscapes. The large closed depressions that do not show a doline morphology are also referred to as *uvula*. A compound hollow is a form that originated from the fusion of more simple forms. If more dolines coalesce together, an irregular depression develops, sometimes with a lobate perimeter. A polygenetic sink is a closed depression that clearly evolved through both the karst process and another morphogenetic process. The most frequent types are the (1) *tecto-karstic hollows*, (2) the *fluvio-karstic hollows*, and (3) the *glacio-karstic hollows*.

A tecto-karstic hollow is a closed basin that developed inside a tectonic depression that also evolved through karst processes. A fluvio-karstic hollow may be considered the closed ends of blind valleys that evolved through both fluvial and karstic processes. Glacio-karstic basins are common forms in the alpine high mountain karst. These forms were formed by both karst processes and glacial abrasion and are of two main types: (1) the high plateau type, often elongated and similar to a bathtub, and (2) the glacial cirque type,



**FIGURE 10** A huge collapse doline called Red Lake near Imotski (Croatia). The depth from the rim to the lake is over 250 m, and the depth of the lake itself is greater than 250 m.

which developed in the bottom of a glacial cirque. Larger glacio-karstic depressions can be over 1 km long. Their bottoms are often occupied by rock drumlins and till deposits.

### **POLJES: THE LARGEST CLOSED DEPRESSIONS IN KARST AREAS**

Poljes are the largest closed depressions observed in the karst terrains. In 1895, Cvijić defined a polje as a “large karst depression, with a wide, flat and nearly horizontal floor, completely enclosed between steep slopes.” This simple definition is insufficient to explain the genesis of this type of form and the role of the karst processes in its characterization. To understand this form it is necessary, as for dolines, to consider both the structure of the form and its dynamic—in other words, to consider the entire geosystem expressed by the form. Poljes present a large variability, and the development of most of them cannot be explained through

the karst process only, because they are polygenetic forms, resulting from the combination of a number of processes.

Typical of this form are the poljes of the dinaric karst, which show large, flat, and nearly horizontal floors, from one to some tens of kilometers long. The sides, usually sloping at about 30°, connect with the bottoms at a sharp angle. Closed depressions of this type are also present in others karst regions of the world and are referred to by various names, such as *campo* or *piano* in Italy, *plans* in France, and *hojos* in Cuba.

The main environmental peculiarity of this type of form is the common absence of a permanent lake inside the basin; an ephemeral lake without surface outlets may form and disappear during the seasonal cycle in relation to the precipitation regime. The lake, if present, represents the transition point between the surface and the underground hydrology and serves as a window to the underground aquifer. In other words, the polje floor is affected by the oscillations of the local water table. Although the lake may be fed by both surface runoff and underground circulation, the draining of it occurs exclusively through the subterranean karst network (Fig. 11). The dynamics of the lower part of the basin is strictly linked with the seasonal cycle of water input, throughput, and output. The temporary lake is responsible for the solution of both the floor and the base of the slopes, leading to the planation of the bottom and to its lateral enlargement by marginal corrosion. The forming, standing, and dissipation of the water body is also the cause of a redistribution and leveling of the filling materials and of their volumetric reduction by solution and erosion via the subterranean circulation system.

In the structure of the poljes it is possible to recognize a large variability in the thickness of the filling deposits, ranging from a few decimeters to more than 100 m. Swallowing cavities and springs may open at both the base of the slopes and inside the floor area. Of these, some are real caves, and others are covered dolines developed in the fillings above cavities in the underlying rock. From the hydrological point of view, some behave permanently as springs or as swallowing cavities, and others may invert their functioning from springs to swallow holes and vice versa. This last type is referred to as *estavelle* in France.

The classification of poljes may be based on both the geomorphological characters and the hydrodynamics. Gams (1994) used these two criteria to distinguish five main types of poljes: (1) *border poljes*, (2) *piedmont poljes*, (3) *peripheral poljes*, (4) *overflow poljes*, and (5) *base-level poljes*. A border polje is located at the transition between a non-karstic and a karstic area. The recharge of the basin is, therefore, mainly due to surface streams and the escape of water through stream-sinks. A piedmont polje is located downslope of a mountain area from where a large amount of debris has been received, filling the depression and hosting a local aquifer. Here, the recharge is also in the main made by surface



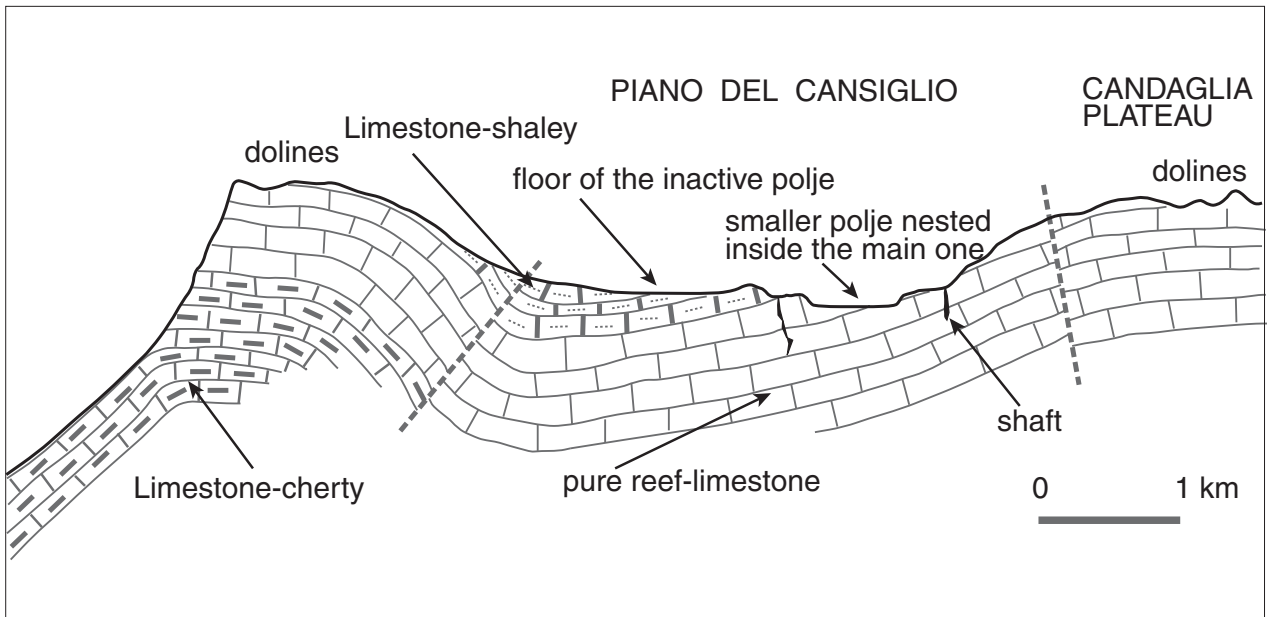


**FIGURE 11** A ponor (swallow hole) in the Cernicko polje (Slovenia). The function of the gate is to block coarse debris (in particular, tree trunks and branches) that could impede the discharge of the water.

streams. A peripheral polje is a depression fed by a large internal area of impermeable rocks with a centrifugal stream network. The sinks are located around the periphery of the inlier. An overflow polje is underlain by a belt of relatively impermeable rocks that act as a hydrological barrier to water that emerges at springs on one side of the polje floor and escapes via stream-sinks on the other side of the basin. A base-level polje is a polje with a floor cut entirely across karst rocks and is affected by the vertical oscillations of the water table; consequently, it is inundated during high-level periods.

Based on the earlier work of Ford and Williams (1989), it is possible to reduce the categories to three basic types: (1) border poljes, (2) structural poljes, and (3) base-level poljes. From the geomorphological point of view, most poljes correspond to tectonic depressions such as graben, fault-angle depressions, pull-apart basins, etc. These dislocations often lead to contact between rocks with different permeabilities, thus leading to conditions of lithological contact. Many structural poljes have also been described as lithological contact poljes (Fig. 12), a situation corresponding, at least partially, to that of the border poljes.

Some structural poljes have trapped hundreds of meters of sediments hosting local aquifers. An example is the Piano del Fucino in the Central Apennines (Italy) the bottom of which, during most of the Holocene, was occupied by a lake subject to numerous vertical variations in the level. In early Roman and modern times tunnels were excavated to drain the lake and to reclaim the floor for agriculture. Today, the intensive agriculture is supported by overexploitation of the alluvial aquifer.



**FIGURE 12** The structural polje of Piano del Cansiglio in the Venetian Prealps (Italy). The polje is now inactive and hosts smaller depressions nested inside the main floor. This form has been described as a lithological contact polje.

Some poljes have developed along typical fluvial valleys. A specific example is represented by Popovo polje in Yugoslavia, which is 40 km long and only 1 to 5 km wide. The floor slopes gently throughout its length as demonstrated by the course of the river Trebinjica. Before the construction of a draining tunnel, the bottom was occupied from October to May by a seasonal lake.

The best examples of true karst poljes can be found in tropical karst regions, such as in Southern China. Here, the floors of certain populations of large cockpits are in the vertical oscillation zone of the water table. The base-level floors of these cockpits expand by marginal corrosion, leading to the gradual dismantling of the ridges and to fusion of the floors. The resulting compound depressions represent true karst poljes, probably a unique type of polje created by karst processes only.

### *See Also the Following Articles*

*Soil Piping and Sinkhole Failures*

### *Bibliography*

- Beck, B.F. (1984) Sinkholes: Their Geology, Engineering and Environmental Impact. A.A. Balkema, Rotterdam.
- Bondesan, A., M. Meneghel, and U. Sauro (1992) Morphometric analysis of dolines. *Int. J. Speleol.* 21(1–4), 1–55.
- Cvijić, J. (1985) Karst. Geografska Monografija, Beograd.
- Ferrarese, F. and U. Sauro (2001) Le doline: aspetti evolutivi di forme carsiche emblematiche [The doline: evolution aspects of the emblematic karst form]. *Le Grotte d'Italia* V(2): 25–38.
- Ford D. and P.W. Williams (1989) Karst Geomorphology and Hydrology. Unwin Hyman, London, 601 pp.
- Gams, I. (2000) Doline morphogenetical processes from global and local viewpoints. *Acta Carsologica* 29(2): 123–138.
- Gams, I. (1994) Types of poljes in Slovenia, their inundation and land use. *Acta Carsologica* 23: 285–300.
- Gunn, J. (1986) Solute processes and karst landforms. In: *Solute Processes*. (S.T. Trudgil, Ed.) John Wiley & Sons, New York, pp. 363–437.
- Klimchouk, A., D.C. Ford, A.N. Palmer, and W. Dreybrodt, Eds. (2000) Speleogenesis and Evolution of Karst Aquifer. National Speleological Society, Huntsville, AL.
- Mihevč A. (2001) Speleogeneza divaškega Krasa [The speleogenesis of the Divaca Karst], in Slovenian. Zalozba ZRC, ZRC SAZU, Ljubljana 27: 180.
- Nicod, J. (1975) Corrosion de tipe crypto-karstique dans le karst méditerranéen. *Bull. Ass. Geogr. Fr.* 428: 284–297.
- Sauro, U. (1995) Highlights on doline evolution. In *Environmental Effects on Karst Terrains*, Vol. 34 (I. Barany-Kevei, Ed.). Universitas of Szegediensis, Szeged, pp. 107–121.
- Šušteršič, F. (1994) Classic dolines of classical sites. *Acta Carsologica* 23: 123–156.
- Twidale, C.R. and J.A. Bourne (2000) Dolines of the Pleistocene dune calcarenite terrain of western Eyre Peninsula, South Australia: a reflection of underprinting? *Geomorphology* 33: 89–105.
- White, W.B. (1988) *Geomorphology and Hydrology of Carbonate Terrains*. Oxford University Press, London, p. 464.
- Williams, P.W. (1985) Subcutaneous hydrology and the development of doline and cockpit karst. *Zeitschrift für Geomorphologie*, 29: 463–482.

## Coastal Caves

John E. Mylroie

Mississippi State University

### INTRODUCTION

Caves that form in coastal environments will be controlled by factors that separate them from caves that form in traditional inland settings. The first and most obvious factor will be the physical and chemical power of waves and saltwater acting on coastal rocks. Second, and less obvious, is the fact that sea level can change, and with that change the position of the coastline moves. Therefore, the positions of cave development by coastal processes will also move. Sea level can change in a variety of ways, but there are two ways that are of particular importance to cave formation on coasts. Sea level can change on a global scale, in which case it is referred to as a *eustatic* sea-level change. The most common way for this change to occur is by changing the amount of ice on the continents. During the last 1.6 million years, called the Pleistocene Epoch, the Earth has undergone a series of ice advances called *glaciations* (the ice ages of the popular press) and a series of retreats called *interglacials*. As ice sheets grow, evaporated seawater falling as snow on land is trapped as ice, and the sea level drops worldwide. When the ice melts as an interglacial occurs, sea level rises as the meltwater flows back into the ocean basins. A eustatic sea-level change of this type is *glacioeustatic*. Evidence indicates that the Earth has gone through at least 15 of these glacial cycles (and, hence, sea level changes) in the Pleistocene. Changes in sea level can also occur as isolated events at specific locations because the land is either subsiding or being uplifted. Such a sea-level change is considered a *local sea-level* change, as only that local area is affected, and it is commonly caused by tectonic movements of the Earth.

### SEA CAVES

The most common of the coastal caves are sea caves, and they are found the world over. The precise scientific name is *littoral cave*, meaning a cave formed within the range of tides. Sea caves are caves that form by wave erosion in coastal areas that contain exposed bedrock. They can develop in almost any type of bedrock, with wave energy utilizing fractures and other preexisting weaknesses in the rock to quarry out voids by mechanical action. The chemical action of saltwater can also exploit rock weakness. The compression of air caused by water flowing forcefully into cracks and fractures in the rock can break rock, including rock above sea level. Sea caves can vary from small voids only a few meters across to very large chambers up to 100 m deep and wide (Fig. 1). The sea caves seen on coastlines today have formed rapidly, as sea level has



**FIGURE 1** Looking out a sea cave on Eleuthera Island, Bahamas.

only been at its present elevation for perhaps 3000 to 5000 years, following melting of the large continental glaciers of the last glaciation, which ended about 10,000 to 12,000 years ago. In areas such as Norway, where the Earth's crust was depressed by large masses of ice during glaciation, the shoreline is now rising as the crust rebounds to a stable position following melting of the ice. In so doing, sea caves formed many thousands of years ago are now found high above modern sea level.

The Earth is currently in an interglacial (between glaciations), so glacial ice is at a minimum and sea level is high. The last interglacial occurred 131,000 to 119,000 years ago. During that time, the ice melted back a bit more than present conditions, and sea level was about 6 m higher than it is today. On some rocky coasts, sea caves produced at that time are still visible, 6 m above the ocean, if more recent erosion has not obliterated them.

Sea caves have had a long history of interaction with people, especially wherever sailors have used the ocean on rocky coastlines. Sea caves were particularly favored by smugglers to hide stolen goods and also to hide the small, fast sailing ships that carried such cargo out of reach of the taxman. Pirates allegedly buried treasure in sea caves, but most sea caves are in an active erosional environment, and anything buried would not survive long. Pirates who chose old sea caves above modern sea level would have had better success. When sea level was lower, sea caves that had formed before the sea level fell were left abandoned far from shore. Some sea caves in this situation contain significant archeological remains.

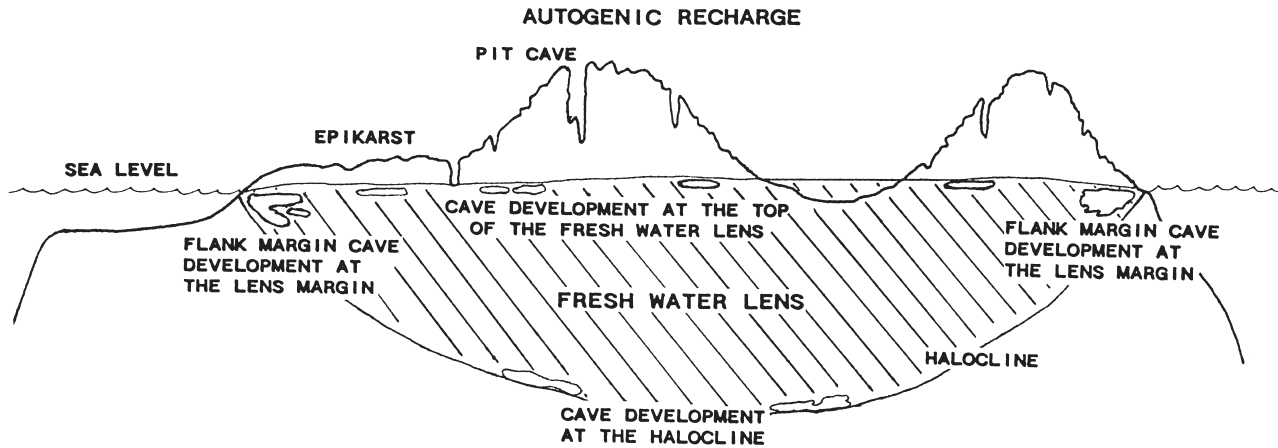
Sea caves are ubiquitous on the rocky coasts of the world. Fingal's Cave in Scotland, the Blue Grotto of Capri in the Mediterranean, Sea Lion Cave on the coast of Oregon, and Arcadia Cave on the coast of Maine are well-known sea caves visited by tourists on a regular basis. Many organisms use sea caves as a refuge, particularly seals, sea lions, and other marine mammals, as well as birds, which roost in the ceiling

ledges above the reach of waves. From the viewpoint of cave exploration, sea caves are not of major interest, primarily because they are short in length. In areas where other types of caves are rare, such as in southern California, sea caves offer the best cave exploration option. Exploration of sea caves can be very dangerous for those not experienced in handling strong waves and currents.

### FLANK MARGIN CAVES

The coastal environment creates a very unusual type of cave when limestones are present. The interaction of freshwater and seawater produces a unique geochemical situation that allows caves to form by dissolution that are very different from both sea caves (made by mechanical wave action) and limestone caves of the interior of continents (which are underground stream conduits formed by freshwater dissolution). Freshwater is slightly less dense than seawater, because of the extra salt dissolved in seawater. Average freshwater has a density of  $1.0 \text{ g/cm}^3$ ; average seawater has a density of  $1.025 \text{ g/cm}^3$ . The difference in density is only 1 part in 40, but it is sufficient such that when freshwater flows toward the ocean inside an aquifer it floats on top of the seawater that has invaded the aquifer from the ocean. If it is a sharp boundary, the boundary between the freshwater and saltwater is called the *halocline* (from *halo* meaning "salt" and *cline* meaning "boundary"). If the boundary is broad, containing water of brackish salinity, it is called a *mixing zone*. The freshwater flows toward the ocean because rainfall infiltrates the land behind the coast, piling up in the aquifer until there is sufficient slope to drive the water toward the ocean. Where the freshwater is piled up inland, because of buoyancy the halocline sinks downward into the seawater, much like a piece of wood floating in water. Because the difference in density is 1 part in 40, for each 1 m that the freshwater piles up above sea level, it sinks 40 m into the seawater. As the freshwater flows down this small 1-m-high slope toward the ocean, its elevation above sea level decreases, and in buoyant response the halocline rises up toward sea level, a 40-cm rise for each 1 cm of elevation loss of the water table. At the coast, the freshwater discharges to the sea as a thin sheet. This configuration of freshwater over seawater is called the *freshwater lens*, because when seen in cross section at an island (where the water discharges to coasts on either side), the freshwater body is seen to have the shape of a lens, similar to a lens in a magnifying glass. Figure 2 shows this relationship, with vertical exaggeration. Understanding the freshwater lens is critical to successful exploitation of fresh groundwater in island and coastal areas.

When the freshwater lens is formed within a limestone aquifer in a coastal region, a unique type of cave, called a *flank margin cave*, can develop. Seawater is usually saturated with  $\text{CaCO}_3$ , the mineral that makes up limestone ( $\text{CaCO}_3$  can be calcite or a slightly different form, or polymorph, called *aragonite*), and cannot dissolve limestone very well.



**FIGURE 2** Diagram of a freshwater lens in a limestone island. The lens is drawn with  $10\times$  vertical exaggeration. The term *epikarst* describes the dissolutional forms on the limestone land surface; *autogenic recharge* means all the water entering the limestone came as precipitation directly on the limestone, not as flow from adjacent non-limestone areas.

Freshwater that has had a long residence time in a limestone aquifer is also commonly saturated with  $\text{CaCO}_3$  and also cannot dissolve more limestone. However, because the freshwater and seawater became saturated with  $\text{CaCO}_3$  under different initial conditions, when they mix they are capable of undergoing more dissolution, a process called *mixing corrosion* or *mixing dissolution*. Where the freshwater lens meets the seawater at the halocline, it is possible to dissolve out large voids, or caves, that otherwise would not be able to form.

The top of the freshwater lens is also a place where waters can mix. In this case, the freshwater at and below the water table (in this case, the top of the lens) is called *phreatic* water, and the water descending from the ground surface above is called *vadose* water. It is common for both the phreatic and vadose waters to be saturated with respect to  $\text{CaCO}_3$ , but as with the case of mixing seawater and freshwater, the phreatic and vadose waters saturated at different initial conditions so that when they mix the water can dissolve more  $\text{CaCO}_3$ . Therefore, both the top and bottom of the freshwater lens are a favorable environment for the dissolution of  $\text{CaCO}_3$ .

The top of the lens (the water table) and the bottom of the lens (the halocline) represent density interfaces. Organic particulate material transported by the vadose water flow from the land surface commonly floats on the top of the water table. Some of this organic material may then become water logged and work its way to the bottom of the lens, where it floats on denser seawater at the halocline. The decay of the organic matter at these interfaces creates  $\text{CO}_2$ , which dissolves in the water to make carbonic acid, which promotes  $\text{CaCO}_3$  dissolution. In both situations, if the amount of organic material becomes too great, its decay will use up the local oxygen supply to create anoxic conditions. If the anoxic conditions persist, anaerobic bacteria will create  $\text{H}_2\text{S}$ , which can later encounter water with oxygen in it to create  $\text{H}_2\text{SO}_4$ ,

or sulfuric acid, a very powerful acid that can dissolve even more  $\text{CaCO}_3$ .

The mixing and possible anoxic conditions that promote dissolution can occur at the top and bottom of the lens throughout the lens area; however, these environments are superimposed on each other at the edge, or margin, of the freshwater lens where the top of the lens slopes down to sea level and the bottom of the lens rises up to sea level. Because the lens is thin at this point, its flow velocity is high because the entire lens discharge is being forced through a thinning wedge. The combination of increased flow and superposition of favorable geochemical environments for  $\text{CaCO}_3$  dissolution results in large voids forming very rapidly at the margin of the lens. As the discharge of the lens occurs at the margin of the lens, at the flank of the land, the caves thus developed are called *flank margin caves*. In addition, in tropical islands and coasts, the limestone is commonly very young. Unlike the ancient limestones of the mid-continent regions, these young limestones have not been buried, squeezed, or greatly altered. The rocks still have a high degree of primary porosity, and water moves through them easily. Such rock is said to be *eogenetic*. True conduit flow is difficult to develop, as the rock has a high degree of permeability, meaning that the water has many flow routes to choose from. So, how do caves form in this setting?

Flank margin caves are not true conduits, such as caves formed by sinking streams in continental interiors. They are instead mixing chambers. Conduit caves form by turbulent water flow, but flank margin caves develop in the laminar (nonturbulent) flow of a porous, eogenetic limestone aquifer. The freshwater enters the developing flank margin cave as diffuse flow and exits, after mixing with seawater, as diffuse flow. Flank margin caves form without human-sized entrances. As a result of their nonconduit origin, flank margin caves do not have long tunnels or the dendritic

pattern found in most conduit caves. The flank margin caves are a series of oval rooms that tend to be extensive in the horizontal direction, but limited in the vertical direction, a result of developing in the thinning margin of the freshwater lens. The chambers can connect in a somewhat random manner, creating caves that are unpredictable in their pattern. Maze-like areas are common, indicating regions where chamber development did not go to completion. As the caves were growing, the mixing zone advanced into them, such that the back wall of the cave (the wall farthest from the ocean) is the youngest. Complex cross-connections between chambers can develop, and the caves can be quite intricate despite their simple mode of development. The typical flank margin cave consists of one or more large chambers located just inside the edge of the island. The cave may trend parallel to the coast for some distance, but it rarely penetrates very far inland, as its development site was restricted to the margin of the lens (Fig. 3). The caves form entrances when the erosion of the hillside that contains them breaches into the underlying cave. Initially, this entrance may be a small opening, but through time it can enlarge as more of the outer wall of the cave erodes away. Throughout the Bahamas and other carbonate island areas, flank margin caves in all states of erosional destruction, from almost intact to almost entirely

removed, can be seen. On islands such as Bermuda, where weathering and erosion of the limestone hills is more rapid than in the Bahamas, most flank margin caves have been entirely removed.

Because they develop in the freshwater lens, flank margin caves are sensitive to sea-level change. If the sea level falls, the caves will be drained as the freshwater lens follows the sea level downward, and cave development will cease. If the sea level goes up, the lens will be pushed higher, the caves will become flooded with pure sea water from below, and dissolution and cave enlargement will stop.

The Bahama Islands are tectonically stable, meaning they are not rising or falling because of tectonic forces. The dry flank margin caves that explorers enter there today resulted from the freshwater lens being 6 m higher than today 131,000 to 119,000 years ago, during the last interglacial. That sea-level highstand lasted only about 12,000 years, but caves with individual chambers up to 14,000 m<sup>3</sup> in volume developed in that time frame, indicating how rapidly this mixing dissolution process can occur. On stable limestone coasts around the world are many flank margin caves that developed during the last interglacial sea-level highstand.

Isla de Mona, halfway between Puerto Rico and the Dominican Republic, is a small island that has been uplifted

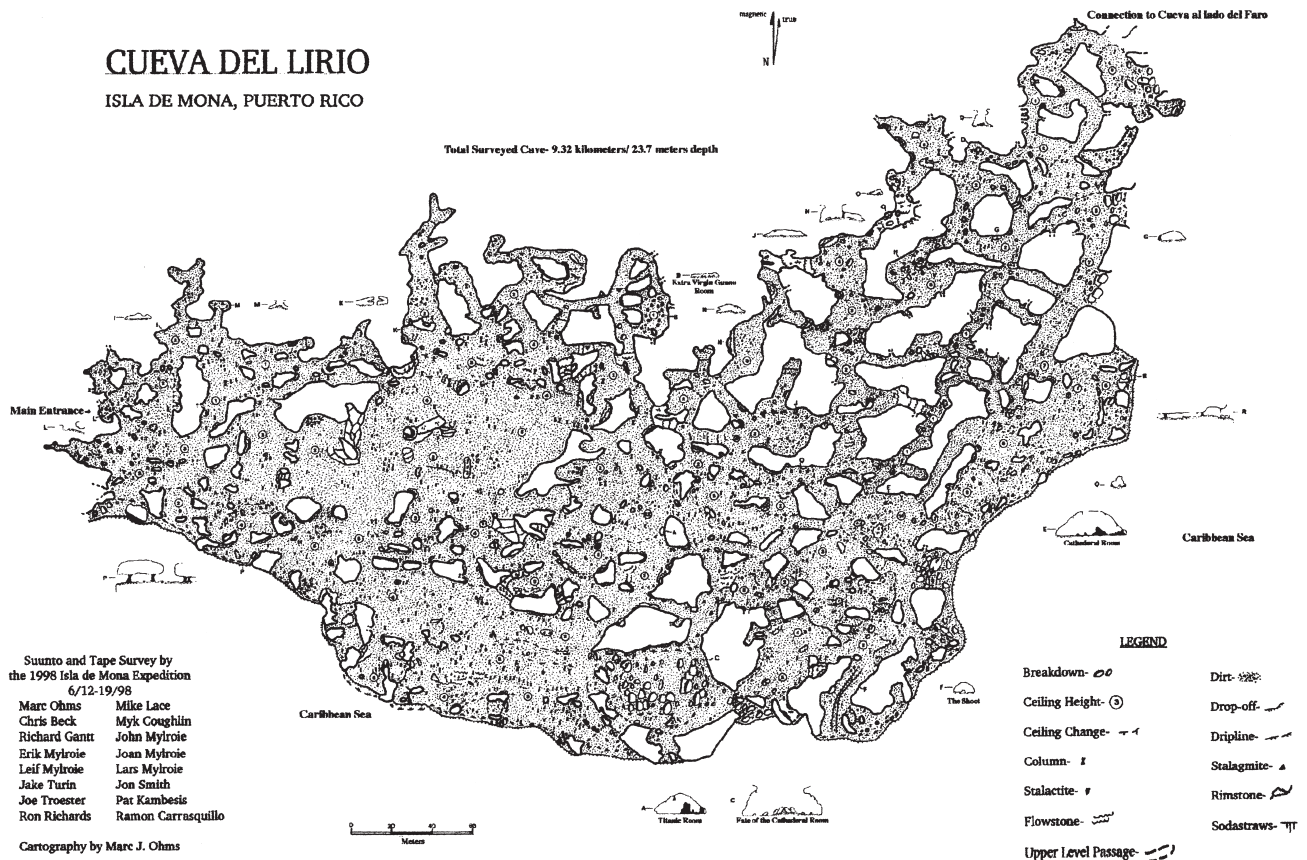


FIGURE 3 Map of Cueva del Lirio on Isla de Mona, Puerto Rico, a very large flank margin cave. (Cartography by Marc Ohms.)

by tectonics. It has huge flank margin caves that formed almost 2 million years ago (Fig. 3). These caves are very big because they developed in a freshwater lens before the Pleistocene glaciations began and so had a longer time to dissolve before sea-level fluctuation caused the freshwater lens to change position. When the initial glaciation began early in the Pleistocene, these caves were drained and speleothems (*e.g.*, stalactites and stalagmites) developed. When a subsequent interglacial sea-level highstand occurred, the sea level rose and the cave was invaded once again by the freshwater lens, partially dissolving the speleothems produced during the dry phase. The caves were then uplifted by tectonics well beyond any further glacioeustatic sea-level changes and have been preserved for exploration today. In this case, local sea-level change affected only this one island. Some of the cave chambers are over 400,000 m<sup>3</sup> in volume, much wider than they are high, but with many complex connections with adjacent chambers. The chambers have ancient speleothems that are much modified by attack from an invading freshwater lens, as well as more modern speleothems that have grown since the last uplift event and are pristine in condition. The longest flank margin cave in the world, Cueva del Lirio, is located on Isla de Mona, and has over 19 km of survey on its map (Fig. 3). Flank margin caves commonly have numerous entrances, and in tropical settings are warm and friendly. The pleasant conditions and many entrances make them easy to explore. When movies and television dramas show pirates in caves, it seems they always have enough light and they move easily through large, open passages. Flank margin caves actually do look a bit like this fictional characterization.

## BLUE HOLES

Blue holes are names for large, deep pits that form on islands and lagoons in tropical waters. They are named blue holes because their great depth gives them a very deep, dark blue color. They commonly connect to cave systems at depth. The name *blue hole* was first published in 1725 and later appeared on British Admiralty charts from the Bahama Islands in the 1840s. Blue holes became popularized in the early 1970s when cave divers began to make the first serious investigations of their depths. Since that time, blue holes have been the subject of a number of major scientific investigations, including the discovery in 1979 of a new class of Crustaceans.

Blue holes are defined as “subsurface voids that are developed in carbonate banks and islands; are open to the Earth’s surface; contain tidally influenced waters of fresh, marine, or mixed chemistry; extend below sea level for a majority of their depth; and may provide access to submerged cave passages” (Mylroie *et al.* 1995, p. 225). Blue holes can be additionally characterized as being found in two settings: (1) *ocean holes*, which open directly into the present marine environment and contain marine water, usually with

tidal flow; and (2) *inland blue holes*, which are isolated by present topography from marine conditions, open directly onto the land surface or into an isolated pond or lake, and contain tidally influenced water of a variety of chemistries from fresh to marine.

While blue holes are best known from the Bahama Islands, they are found in a wide variety of tropical coasts and islands. Their origin is tied to the coast, island, and lagoon environments where they are found, which means that their development has been influenced by glacioeustatic sea-level changes of the Pleistocene. Blue holes commonly contain many stalactites and stalagmites (known as speleothems) that are now under water, indicating that the blue holes were drained by glacioeustatic sea-level lowstands, which allowed the speleothems to form from dripping vadose water. They were then flooded by the return of a higher sea level as the ice sheets melted on the continents at the end of the last glaciation. Some of these speleothems are more than 350,000 years old, indicating that the blue holes containing them are very old and have undergone repetitive sea-level lowstands and highstands.

The four main hypotheses regarding how blue holes form are (1) drowning of surface karst features such as pits and sinkholes, (2) phreatic dissolution along a descending halocline, (3) collapse of deep-seated phreatic dissolution voids, and (4) bank margin fracturing. Blue holes come in a variety of morphologies and may represent features of polygenetic (many origins) development, in which case a combination of the above hypotheses may be correct.

Exploration of blue holes generally involves cave diving to great depths. Such exploration is at the leading edge of technology and stamina, requiring the use of mixed gases, long decompression stops, total darkness, the danger of silt-out (stirring up silt so that the way out cannot be seen), and tight passages. Cave diving in blue holes is extremely dangerous, and many cave divers and scientists have lost their lives trying to penetrate into the unknown. Unlike many other types of exploration, however, there is no substitute for direct human exploration. The blue hole depths and their caves, and the contents of those caves, cannot be viewed, measured, or sampled without someone going in them.

## CONCLUSION

Coastal caves are important to science as they contain information about present and past sea-level conditions. Their utilization as a habitat makes them important for many organisms over the breadth of the animal kingdom. The speleothems contained within blue holes and flank margin caves contain within their layers evidence of changes in the Earth’s climate over hundreds of thousands of years. While flank margin caves are generally easy to explore, sea caves can be dangerous for the unwary, and blue holes are exceptionally dangerous even for the well trained.

### Bibliography

- Bunnell, D. (1988) *Sea Caves of Santa Cruz Island*. McNally & Loftin, Santa Barbara, CA, 123 pp.
- Mylroie, J.E., J.L. Carew, and A.I. Moore (1995) *Blue Holes: Definition and Genesis. Carbonates Evaporites* 10(2): 225–233.
- Mylroie, J.E. and J.L. Carew (1995) Karst development on carbonate islands. In *Unconformities and Porosity in Carbonate Strata* (D.A. Budd, P.M. Harris, and A. Saller, Eds.). Memoir 63, American Association of Petroleum Geologists, Tulsa, OK, pp. 55–76.
- Mylroie, J.E., J.W. Jenson, D. Taborosi, J.M.U. Jocson, D.T. Vann, and C. Wexel (2001) Karst features of Guam in terms of a general model of carbonate island karst. *J. Cave Karst Stud.* 63(1): 9–22.
- Palmer, R. (1997) *Deep into Blue Holes*. Media Publishing, Nassau, Bahamas, 188 pp.
- Vacher, H.L. (1988) Dupuit–Ghyben–Herzberg analysis of strip-island lenses. *Geol. Soc. Am. Bull.* 100: 580–591.

# Contamination of Cave Waters by Heavy Metals

Dorothy J. Vesper  
West Virginia University

Heavy metals are ubiquitous throughout nature, including within caves and karst environments. Evaluating the accumulation and transport of metals in cave waters requires understanding the governing physical and chemical processes. While the presence of heavy metals in speleothems and cave deposits has been investigated in some detail, the general metal cycling through the karst system is less well known but can be inferred from analogous investigations in surface systems. The term *heavy metals* is poorly defined and has been used inconsistently through time and in the scientific literature. In the context of this discussion, the metals and metalloids discussed are those defined as potentially toxic by the U.S. Environmental Protection Agency and the World Health Organization (Table I). It should be noted that many of these metals, while toxic in large quantities, are essential nutrients in small quantities.

## NATURAL AND ANTHROPOGENIC SOURCES

Metals are omnipresent in atmospheric, marine, and terrestrial settings. In karst environments, they are most likely to be found in three primary compartments: soils, the matrix–fracture–conduit system, and springs (Fig. 1). Within conduits and caves, heavy-metal rich minerals may be found as speleothems, coatings, fillings, rinds, and other cave deposits. Additionally, both caves and springs may have metals present in water or associated with suspended and bed sediments.

TABLE I Potentially Toxic Metals and Their Abbreviations

Metal	Abbreviation	Metal	Abbreviation
Arsenic	As	Nickel	Ni
Beryllium	Be	Lead	Pb
Cadmium	Cd	Antimony	Sb
Chromium	Cr	Scandium	Sc
Cobalt	Co	Selenium	Se
Copper	Cu	Titanium	Ti
Iron	Fe	Thallium	Tl
Mercury	Hg	Vanadium	V
Molybdenum	Mo	Zinc	Zn
Manganese	Mn	Nickel	Ni

Metals may be part of the natural background or anthropogenic (Table II). Spectacular deposits of metal-rich speleothems can occur when caves exist in proximity to natural geologic sources. For example, Cupp–Coutunn Cave in Turkmenistan has speleothems rich in manganese, iron, lead, and zinc due to the presence of overlying bituminous coal and subsequent hydrothermal alternation. Mbovo Mkula Cave in South Africa also boasts unusual metal-rich speleothems thanks to the presence of overlying ore minerals and a sulfide-rich black shale. The host rock itself may contribute to the metal load. Low levels of trace metals in springs waters in Nevada and California have been attributed to the paleomarine chemistry at the time of carbonate deposition. Given that the groundwater feeding the springs was thousands of years old, the water chemistry was attributed to dissolution of the carbonates. Metals may also be also found as detrital material within the host rock. The manganese source for Jewel Cave in South Dakota has been attributed to such detritus.

Anthropogenic sources of metals are widespread (Table II). Sources may be diffuse, such as emissions from fuel combustion, or more localized, such as point-source discharges from manufacturing facilities. Acid mine drainage (AMD) is a common metal source in many karst regions (the Appalachians, Kentucky, and Tennessee in the United States and in southern China). Studies of metals in AMD in Tennessee have shown that Fe and Mn concentrations decrease in water when introduced to karst systems. The most likely explanation is that metals precipitate as alkalinity increases and the pH of the combined AMD–karst solution rises. In cave stream/spring water, the drop in metal concentrations is associated with the production of flocs of Fe and Mn hydroxides. There is some suggestion that the metals may precipitate as a metal armor on the host rock, thereby limiting the interaction between water and rock. Manufacturing sources also contribute to metal contamination. Horse Cave in Kentucky and its associated aquifer and springs have been impacted by discharge from a metal-plating factory that began operations in 1970. Although some dilution occurred,

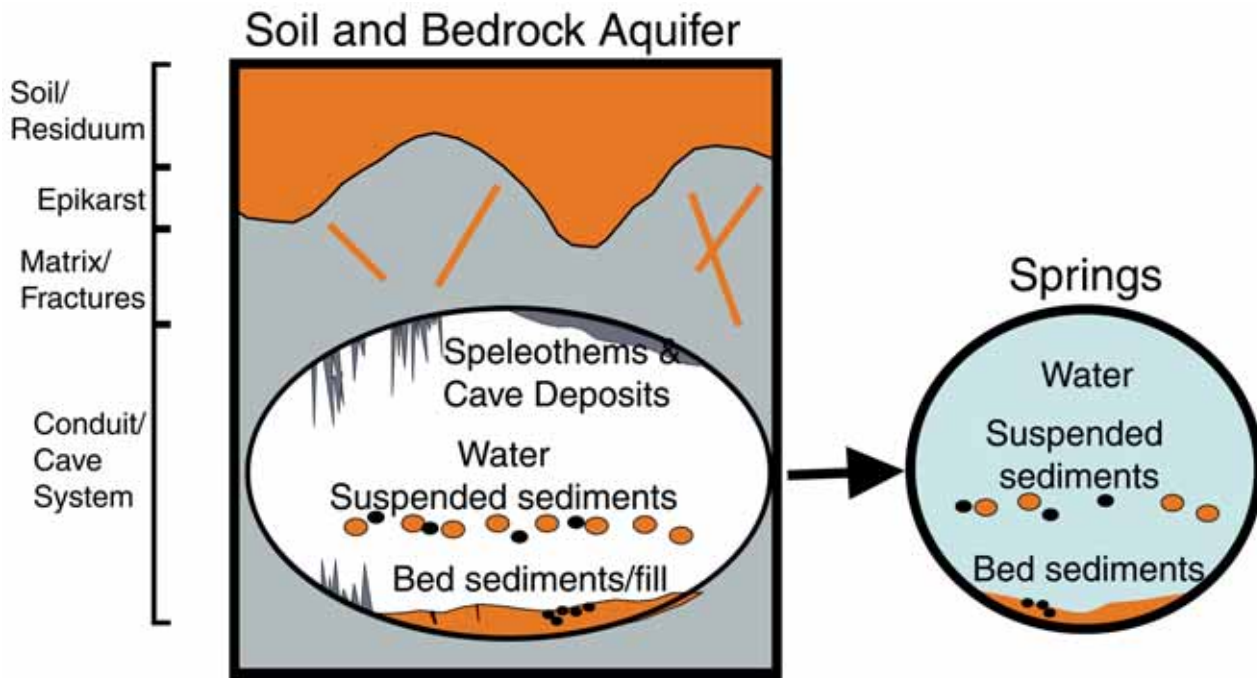


FIGURE 1 Locations for heavy metal storage in karst settings.

TABLE II Sources of Heavy Metals

Type of Source	Examples of Specific Sources
Natural	Original marine deposition; detrital materials in bedrock; ore bodies; hydrothermal deposits; black shales; coals
Anthropogenic	Mining and mineral processing; agriculture (fertilizer, pesticides, preservatives, irrigation); emissions and solid wastes from fossil fuel combustion; sewage and solid wastes; manufacturing (metallurgical, electronic, ceramic, chemical, pharmaceutical); sports and military shooting; breakdown of metal alloys and paints

elevated concentrations of Cr, Ni, and Cu were found in both cave and spring waters within the Hidden River basin.

### ENVIRONMENTAL METAL CHEMISTRY

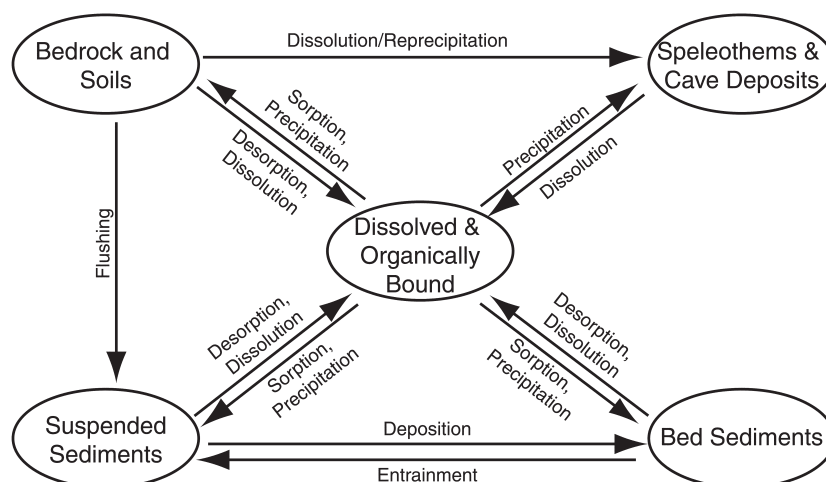
#### General Chemistry

Once metals are introduced into karst settings, their storage and transport depend on physical processes, the specific metal chemistry, and the chemistry of the surrounding environment. Metal speciation influences solubility and the likely mode of transport through the aquifer. Metal speciation also controls the bioavailability and toxicity of the metal. Metal chemistry can be complex and depends on many competing variables. Although a brief description is provided herein, the reader is referred to the bibliography, which lists a few of the excellent texts on the topic.

In general, metals are present in three forms: mineral, otherwise associated with solids, or dissolved (Fig. 2). Mineral-bound metals exist as source materials in soils in bedrock, as secondary cave deposits, and as detrital material throughout karst systems. Heavy metals may also be associated with the surfaces of solids and are often associated with suspended and bed sediments. Metal interactions at solid surfaces range in intensity from exchangeable (loosely bound) to incorporation into the near-surface mineralogy (tightly bound). Metals may also be incorporated into surface coatings (both organic and inorganic) or attached to insoluble organic matter. It is difficult to distinguish between metals that are electrostatically bound to the surface, specifically adsorbed, or coprecipitated with the surface mineral or coating; therefore, they are often loosely referred to in combination as *sorbed* metals. Dissolved metals are present in water as free metals or soluble metal complexes. Metals may also form complexes with soluble or colloidal organic compounds and thereby increase their solubility dramatically. Copper, in particular, has a strong affinity for organic compounds. Metals may move between these compartments via chemical reactions such as dissolution, sorption, or desorption or via physical processes such as deposition and entrainment (Fig. 2).

Two key variables that control metal solubility and chemical form are pH and reduction–oxidation (redox) state. Many metals are more soluble in acidic waters than in neutral waters and thus tend to precipitate in well-buffered karst waters. Redox reactions occur when electrons are transferred between metal species. For example, ferric iron ( $Fe^{3+}$ ) is





**FIGURE 2** Storage compartments for heavy metals in karst settings. Arrows indicate some of the chemical reactions and physical processes that transfer metals between compartments.

reduced to ferrous iron ( $\text{Fe}^{2+}$ ) by the addition of one negatively charged electron. In actuality, free electrons do not exist, and the reaction occurs by combination with another “half reaction” in which an electron is lost. Redox reactions are highly important because they control the solubility of many metals. While some metals are mobile in reducing conditions (As, Mn, Fe, Mo) others are mobile in oxidizing conditions and immobile in reducing environments (Zn, Cu, Hg, due to sulfide mineralization in reduced settings). For many metals, both the pH and the redox conditions must be known to predict what species should be present.

Redox states change spatially and through time. Spatial changes may occur on a microscale, and temporal changes may occur on a scale as short as hourly (*e.g.*, with storms and changing hydraulic conditions). The degree to which metal redox reactions in caves are mediated and catalyzed by microorganisms is a topic of increasing interest. Microbes can be either electron acceptors or electron donors and can therefore either oxidize or reduce metals as part of their metabolic process. Hence, both precipitation and dissolution of metals can be induced by microbial action. Much of the microbial action may occur along redox gradients, such as those found at the edges of caves.

Other factors may influence the redox state, such as introduction of oxygen during a storm and degradation of organic compounds. The breakdown of either natural organic matter or organic contaminants in the overlying soil, karst aquifer, or spring sediments can create locally reducing and acidic environments capable of solubilizing and mobilizing metals.

### Iron and Manganese

Iron and manganese can be found in many locations in caves. While oxide and hydroxide forms are the most common, heavy-metal carbonates, phosphates, nitrates, and sulfates have also been identified in caves. In general, while reduced

iron ( $\text{Fe}^{2+}$ ) is soluble in water, when it oxidizes to  $\text{Fe}^{3+}$  it forms oxide and hydroxide precipitates such as goethite ( $\text{FeOOH}$ ) and ferrihydrite ( $\text{Fe}(\text{OH})_3$ ). *Limonite* is a generic term that refers to both mineral and amorphous forms of iron oxides and hydroxides. Likewise, reduced manganese ( $\text{Mn}^{2+}$ ) is soluble, but its oxidized forms are not. Fully oxidized Mn often forms the common cave mineral birnessite, which can be poorly crystallized ( $\delta\text{-MnO}_2$ ). In reality, however, the chemistry is far more complicated than this. The reactions also depend on metal concentration, solution pH,  $\text{CO}_2$  partial pressure, and presence of organic compounds. Both reduced and oxidized metals can be mobilized by organic complexation, and reduced metals can precipitate into metal-carbonate minerals.

### Trace and Contaminant Metals

Iron and manganese oxides and solids also play a key role in trace-metal chemistry because of their ability to scavenge trace metals from solution and because—given their relative concentrations—they often control the overall redox chemistry of the solution or sediment. Iron oxides are commonly associated with As, Cu, Ni, Mn, and Zn; manganese oxides commonly contain Co, Fe, Ni, Pb, and Zn. Therefore, the transfer of Fe and Mn between mobile and immobile forms ultimately controls the trace-element chemistry, even if the trace elements are themselves not redox sensitive. For example, while precipitation of Fe and Mn oxides may remove trace and contaminant metals from solution, dissolution of the same oxides may rerelease trace metals back into solution.

Studies of soils and marine and lake sediments have shown that Fe and Mn oxides are typically the controlling factor in determining trace-metal concentrations. Trace metals may also be associated with organic compounds (both soluble and insoluble) and inorganic coatings on particulates.

## METAL STORAGE AND TRANSPORT

### Schematic Scenarios

Heavy metals are introduced into karst aquifers from surface runoff and spills, reactions in the soil zone, and dissolution of overlying geologic units and the host rock (Fig. 1). The metals can be either dissolved or associated with colloids and particulates (Fig. 2). Dissolved metals may be transported through the system or may change chemical form and precipitate as speleothems onto walls or onto sediments. The fate of the dissolved metals may depend on the type of recharge. If dissolved metals are introduced slowly from fractures in the cave ceiling they may—given the right chemical conditions—form speleothems. If the metals arrive as part of a cave stream, they may be more likely to be transported through the system or to form coatings on stream sediments. Metals introduced in particulate form either can travel through the system as suspended sediments and be discharged at a spring or can be deposited within the aquifer.

Metals deposited within the fractures and conduits of the aquifer may be stored for extended periods. It is also possible, however, that they will either be later dissolved (minerals and coatings) or reentrained (sediments) and be flushed from the system. One of the final possible storage locations on the flowpath is spring sediments. Depending on spring morphology and hydrology, it is possible for some metals to accumulate in the springbed sediments.

### Speleothems and Cave Deposits

Coatings of Fe and Mn are not uncommon in caves. Although far less common, extensive decorations incorporating Fe, Mn, and trace metals do occur. Examples of manganese deposits exist as powders and coatings in Matts Black Cave in West Virginia and Rohrer's Cave in Pennsylvania, as stream-cobble coatings in Butler Cave in Virginia, and as floor fills in Jewel Cave in South Dakota. Examples of iron-rich speleothems also exist in Rohrer's Cave, which has stalactites, stalagmites, and columns of limonite. Spectacular Fe and Mn speleothems exist in Mbobo Mkula Cave in South Africa. The metals in this cave are mobilized when acidic water, produced in the overlying shales, infiltrates through chert layers in the limestone. Trace metals are often found in association with the Fe and Mn deposits. Samples from Rohrer's Cave have been shown to contain up to 20% heavy metal oxides. Deposits of trace-metal speleothems also exist, although they are more rare. For example, malachite, a copper-carbonate, has been observed in cave crusts and speleothems.

### Suspended and Bed Sediments

Given the near-neutral pH of karst water and the input of oxygenated surface waters, neither iron nor manganese is

likely to be present in appreciable concentrations as dissolved metals in water. This is one factor that distinguishes the transport of heavy metals from the more commonly studied alkaline earth metals (*e.g.*, Ca, Mg). The alkaline earth metals, present from the dissolution of the carbonate host rock, are almost solely present in the dissolved form. If dissolved heavy metals are present, they are likely to be oxidized and precipitated as cave deposits or directly onto particulates in the sediments. Once deposited in a cave or spring, sediment Fe and Mn may be influenced by small-scale transitions in redox state. This is analogous to metal behavior in lake and marine sediments where redox gradients, and the associated Fe and Mn chemistry, change over short vertical distances.

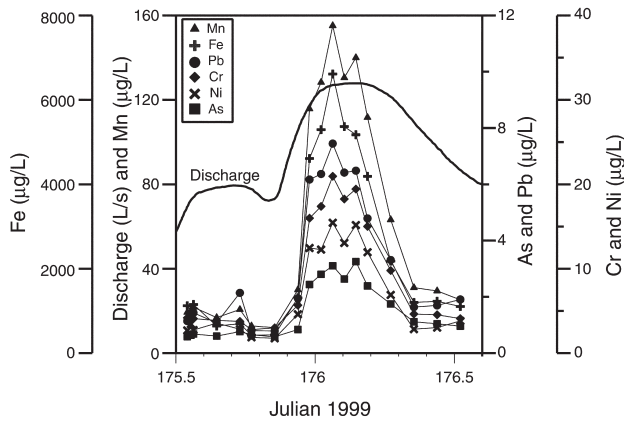
The importance of particulate metal transport has long been established in surface-water systems where it has been shown that nearly all heavy metals are transported in association with solids. Groundwater studies in the karst aquifer at the Oak Ridge National Laboratory have also shown that most of the metals are associated with colloidal or particulate matter. Metal and radionuclide transport in granular and fractured aquifers is often attributed to colloidal transport. Karst aquifers, however, are able to transport much larger sizes of particles; therefore, metal transport is not limited by the size of particulate to which the metal is adhered or incorporated. Data from springs in Kentucky and Tennessee, in which concentrations of digested and filtered samples were compared, demonstrated that Fe, Mn, and the trace elements were present in particulates larger than 0.45  $\mu\text{m}$ .

### Storm-Enhanced Transport of Sediment-Associated Metals

The ability of the aquifer to transmit sediment is largely a function of flow velocity; therefore, the flushing of particles from the overlying soil, entrainment of sediments already within the aquifer, and the deposition of suspended sediments within conduits and in springs are all key physical processes controlling metal transport and are closely linked to the groundwater velocity.

Groundwater velocity is not constant through time in karst aquifers. Systems that rapidly transmit recharge water exhibit increases in velocity during storm events. Recent work has shown that the sediment transport that occurs during storms controls the transport of heavy metals as well. Storm-event samples collected from springs in Kentucky and Tennessee demonstrated clearly that the heavy-metal concentrations increased dramatically during storm conditions (Fig. 3). Data from different-sized storms and different types of springs in the same area suggest that this relationship is consistent and that total metal transport is episodic and enhanced by storms.

While some “dissolved” (less than 0.45  $\mu\text{m}$ ) heavy metals were present throughout the storm events, their concentra-



**FIGURE 3** Concentrations of heavy metals in spring water (Beaver Spring). Symbols indicate digested sample concentrations and represent the total metal transport (both dissolved and particulate components). (1999 data from Fort Campbell Army Base, Kentucky/Tennessee.)

tions were relatively constant in comparison to the particulate metals. This suggests that “dissolved” metals transport through the aquifer occurs continuously at low concentrations while particulate metal occurs primarily during storms.

Data from Matts Black Cave indicates that the distribution of manganese coatings may also be influenced by the same physical flow processes. The coatings are much thicker on the ceilings (up to 10 mm) than on the walls (up to 2 mm) or along the stream (poorly coated), suggesting that metal deposition and stream erosion are in competition; therefore, the thickness and the distribution of metal coatings within caves may change temporally with storm events.

## SUMMARY

Heavy metals are present throughout caves and karst systems due to both natural and anthropogenic sources. The solubility and transport of iron and manganese, two of the most common heavy metals, are controlled by pH and redox conditions. Although typically soluble in water in reducing conditions, the oxidized metals tend to precipitate as cave deposits or on sediments. While speleothems of Fe and Mn are unusual, coatings of the same are not. Many metals are never present in the dissolved state and are introduced, stored, and transported through the system as colloids or larger particles. Particulate metal transport is enhanced during storms when high groundwater velocities permit the metals to be entrained and suspended. The transport and storage of trace and contaminant metals are closely linked to the iron and manganese chemistry. Although some trace metals are not sensitive to redox conditions, their behavior is governed by their association with iron and manganese so they are impacted by redox conditions.

## Bibliography

- Allard, B. (1994) Groundwater. In *Trace Elements in Natural Waters* (B. Salbu and E. Steinnes, Eds.). CRC Press, Boca Raton, FL, pp. 151–176.
- Hill, C.A. (1982) Origin of black deposits in caves. *NSS Bull.* 44: 15–19.
- Hill, C.A. and P. Forti (1997) *Cave Minerals of the World* 2nd Ed. National Speleological Society, Huntsville, AL.
- Horowitz, A.J. (1991) *A Primer on Sediment–Trace Element Chemistry*, 2nd ed. Lewis Publishers, Chelsea, MI.
- McCarthy, J.F. and L. Shevenell (1998) Processes controlling colloid composition in a fractured and karstic aquifer in eastern Tennessee, USA. *J. Hydrol.* 206: 191–218.
- Northrup, D.E. and K.H. Lavoie (2001) Geomicrobiology of caves: a review. *Geomicrobiol. J.* 18: 199–222.
- Salomons, W. and U. Förstner (1984) *Metals in the Hydrocycle*. Springer-Verlag, Berlin.
- Sasowsky, I.D. and W.B. White (1993). Geochemistry of the Obey River Basin, north-central Tennessee: a case of acid mine drainage in a karst drainage system. *J. Hydrol.* 146: 29–48.
- Siegel, F.R. (2002) *Environmental Geochemistry of Potentially Toxic Metals*. Springer-Verlag, Berlin.
- Vesper, D.J. and W. B. White (2003). Metal transport to karst springs during storm flow: an example from Fort Campbell, Kentucky/Tennessee, U.S.A.. *J. Hydrol.* 276: 20–36.

# Contamination of Cave Waters by Nonaqueous Phase Liquids

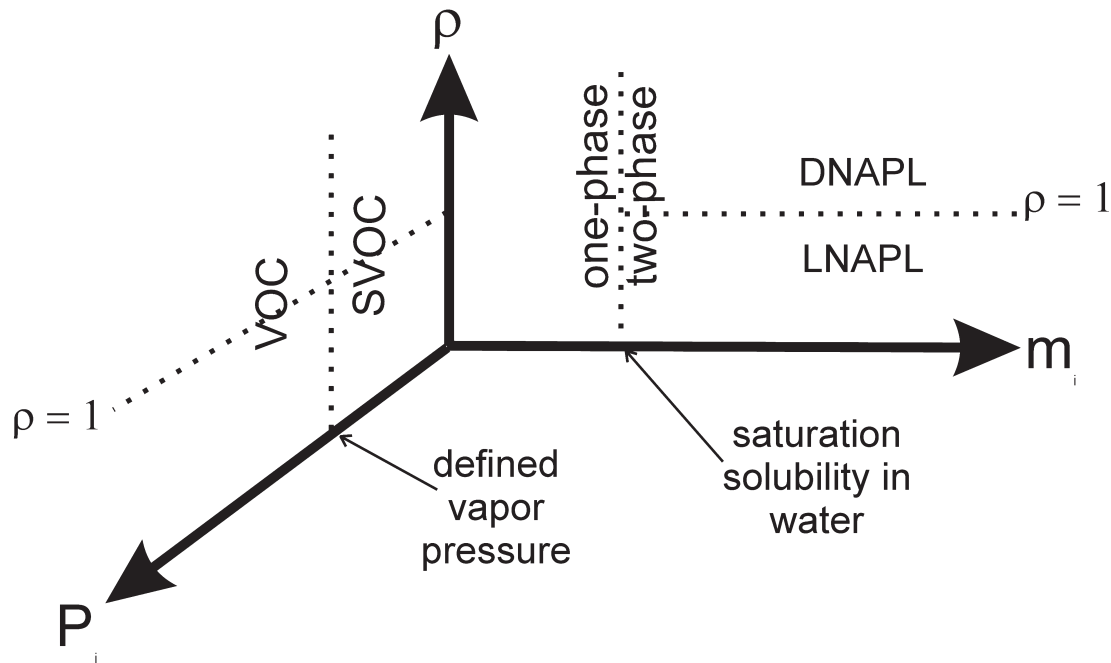
Caroline M. Loop

*The Pennsylvania State University*

Due to their unique properties, nonaqueous phase liquids (NAPLs) are widely used as solvents, insulators, and fuels. It is some of the same valuable properties, however, that make NAPLs so toxic and difficult to remove from soils and groundwater once they have been spilled. In the heterogeneous karst subsurface, the rate of movement of NAPL contamination can vary by orders of magnitude. Tailoring a conceptual model to a particular NAPL release and subsurface characterization is necessary to develop multiple working hypotheses and better guide detection and monitoring techniques.

## NAPL CHARACTERISTICS AND SOURCES

Four characteristic chemical properties that influence the behavior of NAPLs in the environment are solubility, density, vapor pressure, and viscosity. Nonaqueous phase liquids must, by definition, have limited solubility in water, allowing



**FIGURE 1** Diagram of important properties for characterizing organic contaminants.  $\rho$  = density ( $\text{g}/\text{cm}^3$ ),  $m_i$  = solubility of contaminant  $i$  in water, and  $P_i$  = vapor pressure of contaminant  $i$ .

them to remain in a separate phase (Fig. 1). Thus, the dissolved, or aqueous phase, concentration of a nonaqueous phase liquid is moderate to low. Unfortunately, even the limited aqueous phase concentration is often much higher than the maximum concentration level established by the U.S. Environmental Protection Agency (Table I). Solubilities are typically less than 5000 mg/L for chlorinated solvents, less than 2000 mg/L for gasoline compounds, and less than 1.0 mg/L for polychlorinated biphenols (PCBs).

Nonaqueous phase liquids are divided between those that are less dense than water (LNAPLs) and those that are more dense than water (DNAPLs). Hydrocarbons, including benzene and ethylbenzene, are common LNAPLs, as are vinyl chloride and styrene. LNAPLs are often used in the synthesis of plastics, and as gasoline. With a density less than water, they will be present as a separate phase on top of the water table (Fig. 2). DNAPLs include some very toxic chemicals such as perchloroethylene (PCE), PCBs, and insecticides and herbicides such as lindane and atrazine. PCE and its breakdown products were commonly used as solvents, especially in dry cleaning. (Their use, however, is decreasing due to their highly toxic nature.) PCBs, for example, the Aroclor formulations, were commonly used as liquid insulators in capacitors and transformers. DNAPLs will sink below the water table and continue to migrate deeper in an aquifer until they meet sufficient resistance (Fig. 3).

NAPLs can be characterized based on their vapor pressure, which is a measure of the tendency of the compound to evaporate from a pure liquid of the compound. NAPLs are

either volatile, with a vapor pressure greater than  $10^{-4}$  atm, or semivolatile, with a vapor pressure between  $10^{-4}$  and  $10^{-11}$  atm. Benzene has a high vapor pressure, as can be seen when gasoline fumes rise in the summer, whereas PCBs are almost wholly semivolatile. Because many NAPLs have a high vapor pressure, they had sometimes been thought to fully evaporate when poured on the ground. This belief turned out to be incorrect and, in fact, such practice significantly contaminated underlying soils and aquifers. As discussed later, vapor pressure may be helpful in locating NAPL contaminants in karst.

Viscosity influences the subsurface mobility of nonaqueous phase liquids in that the less viscous the liquid, the further it can migrate into pores and fractures. Chlorinated solvents such as trichloroethylene (TCE) and PCE have very low viscosities. Creosote wood-treatment compounds behave as DNAPLs and are characterized by a high viscosity. Fluids can increase in viscosity with time, called *weathering* in the petroleum industry, as they lose more volatile components. It is easier for flowing water, such as might be found in a cave stream, to entrain less viscous fluids, and move them further from the source.

Although petroleum compounds are formed and present in the subsurface naturally, they are rarely found in near-surface aquifers and soils unless they have been spilled. Other NAPLs, including PCBs, chlorinated solvents, and agricultural chemicals such as lindane and atrazine, have been developed in laboratories and tailored to industrial uses. Freon 11, also known as trichlorofluoromethane, is one such chemical

TABLE I Density, Vapor Pressure, and Solubility Values for Common NAPLs

Compound	Density (g/cm <sup>3</sup> )	Vapor pressure (-log atm)	Solubility (mg/L)	U.S. EPA MCL (mg/L)
Toluene	0.86	1.42	500	1
Benzene	0.88	0.9	1800	0.005
o-Xylene	0.88	2.05	175	10
Ethylbenzene	0.90	1.9	150	0.7
Vinyl chloride	0.91	-0.53	2800	0.002
Styrene	0.91	2.2	310	0.1
Aroclor 1242	1.4	6.27	0.24	0.0005
Trichloroethylene (TCE)	1.5	1.01	1100	0.005
Carbon tetrachloride	1.6	0.82	760	0.005
Tetrachloroethylene (PCE)	1.6	1.6	200	0.005
Lindane	1.9	7.08	7.5	0.0002

Note: Equilibrium aqueous phase solubility concentrations are orders of magnitude larger than the U.S. Environmental Protection Agency's maximum concentration level (MCL).

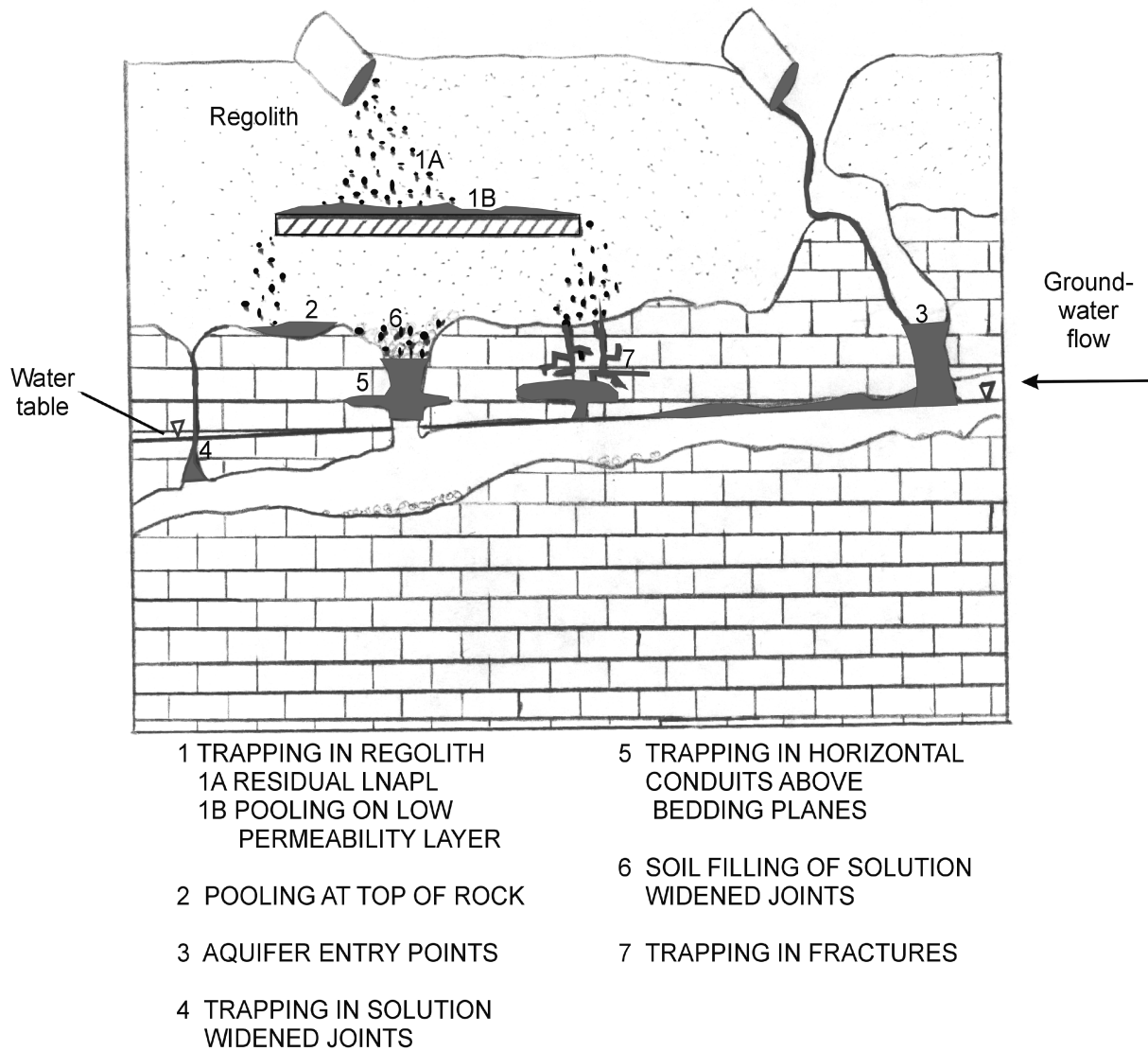


FIGURE 2 Distribution of LNAPLs in a hypothetical karst setting. (After Wolfe *et al.*, 1997.)

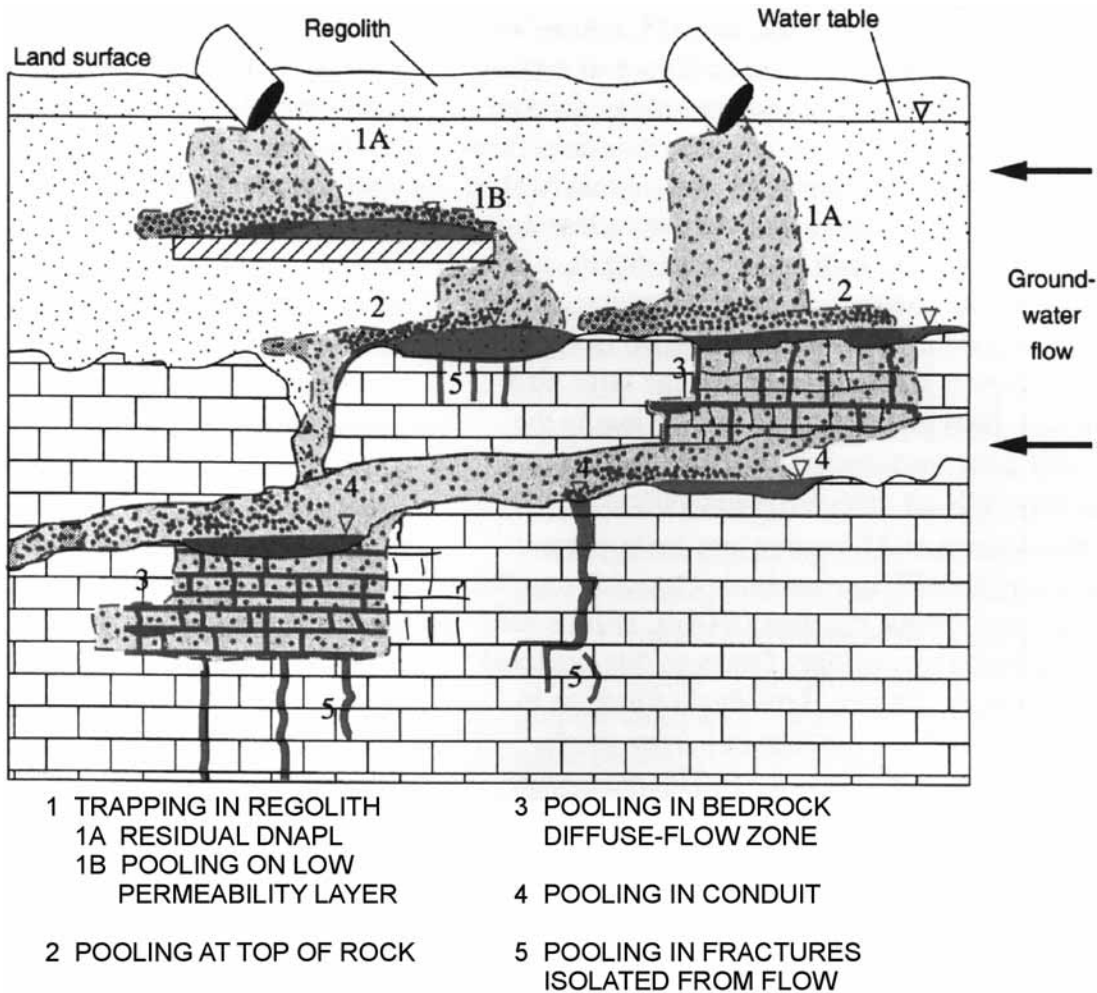


FIGURE 3 Distribution of DNAPLs in a hypothetical karst setting. (From Wolfe *et al.*, 1997.)

that was used extensively until the toxic effects of spills and leaks was found to exceed its practical use. The distribution of NAPLs in karst soils and aquifers is nearly always the result of human misuse, whether by transportation accidents, leaking tanks, or improper disposal.

**TRANSPORT INTO KARST AQUIFERS**

Both the volume and rate of release can play a key role in the movement and distribution of NAPL contaminants. For example, a gasoline spill from a 10-gal tank will move through and be sorbed to soil and regolith differently than a slow leak from a 1000-gal tank that can build up a pressure head of product, which drives it further into the surface. On the extreme end of this scale is the gasoline tanker truck that turns over and releases thousands of gallons quickly onto the ground surface, which then flows overland and into a sinkhole or sinking stream where it can more quickly be transported into a bedrock aquifer.

**Epikarst**

Climate can also impact the rate and volume of NAPL entering the karst subsurface. Karst soils are usually thin, and they overlie the regolith and irregular bedrock of the epikarst. In a wet climate three things may occur to move the NAPLs more quickly through an unsaturated soil and possibly epikarst zone. First, when water coats soil, organic, or regolith particles, if NAPL is spilled, it travels as a nonwetting fluid and will be held less securely between particle grains because it is, in a sense, lubricated by the aqueous phase.

Second, and not inconsequentially, soil and regolith pores may periodically be flushed by precipitation. In this case, pressure head builds up from the accumulation of recent precipitation, and even nonaqueous phase contaminants can be forced to migrate to deeper pores. If a less permeable layer is present in the soil, the influx of rainwater may cause a NAPL that was temporarily pooled above the layer to

migrate horizontally to an area where the less permeable layer is no longer present. At that point, the NAPL may resume its vertical flow toward the water table. While the NAPL is held in soil or regolith pores, it may dissolve into the aqueous phase, which may then potentially be flushed further through the system during precipitation events. Thus, NAPLs held in the soil or regolith can continue to dissolve and be long-term sources of aqueous phase contamination to an aquifer with which the NAPL is not in direct contact.

A third influence of climate on the transport of NAPLs into karst aquifers is the impact on sinkhole formation and collapse. Sinkholes form localized catchments for storm runoff in karst regions. Some sinkholes are plugged with soil so that NAPLs held within them may migrate downward only slightly more quickly than in nonsinkhole soils, with the only difference being a comparatively larger volume of precipitation percolating through. On the other end of the spectrum, some sinkholes have open drains so that any runoff captured will be immediately carried into the subsurface. In some cases, however, a soil plug may itself be subject to piping failure, especially during large storms. When this occurs, both the soil and the NAPL are transported into the subsurface and leave an open hole for further contaminants to more quickly enter the system.

The top of bedrock in karst is often an irregularly sculptured surface that may be undulating or may have deep crevices along joints and fractures separated by intermediate pinnacles. Water, moving downward from overlying soil into the epikarst, must often move laterally for substantial distances before finding an open fracture or shaft that will permit vertical movement into the unsaturated zone of the bedrock. Like ground water, infiltrating contaminants may be held for extended periods of time, pooling along the top of relatively impermeable bedrock. While still in the vadose zone, pools resting along the top of the bedrock can be described as *microphase pools*, which have collected in pores between regolith and other particles. The pools should be distinguished from continuous macrophase pools that may exist floating on water (LNAPLs) or below water (DNAPLs), but not distributed within pore space.

In the event that the top of the limestone or dolomite bedrock is below the water table, LNAPL pools will most likely resist resting on the bedrock; rather they will tend to remain in the soil or regolith directly above the water table. Wells intersecting a few feet of LNAPL above the water table are not uncommon in contaminated areas. DNAPLs, in contrast, are able to migrate below the water table, and may pool on less permeable layers, such as the bedrock surface. In this case, water will flow in the direction of hydraulic gradient; however, DNAPLs often flow in the direction of bedrock dip. In one specific case, an aqueous phase plume developed in one direction, whereas the DNAPL itself migrated down dip in a different direction.

### Fractures, Open Drains, and Sinking Streams

Karst bedrock is often dissected by vertical or near-vertical fractures and joints, many of which have been solutionally widened. These provide fast paths for NAPLs into the subsurface aquifer once the critical height for entry into the fracture has been exceeded. The critical height of a DNAPL pool is a function of the interfacial tension between the NAPL and water, the wetting angle between the DNAPL and the solid surface in the presence of pore water, the density difference between the NAPL and water, and the fracture aperture. Both LNAPLs and DNALs will migrate in similar ways through fractures above the water table. One exception is that the extra density of the DNAPLs will cause them to move more quickly under gravity. Viscosity will also play an important role in the ability to move through a given aperture. Storm flow can, again, add to the pressure above the nonaqueous fluid, causing it to migrate further down the fracture.

Once at the water table, LNAPLs and DNAPLs will behave very differently, with fractures acting as temporary traps for LNAPLs and preferential flowpaths for DNAPLs. In a scenario where NAPL is moving down a fracture, which further down intersects the water table, and then joins with a phreatic conduit, LNAPL will remain in the fracture above the water table, whereas DNAPL will continue to travel down the fracture into the conduit, as long as the critical DNAPL pool height is exceeded (Figs. 2 and 3). If drought conditions lowered the water table so that water flowed like a surface stream in the conduit, the same LNAPL could potentially travel down the fracture and float on the water in the free surface stream down the length of the conduit. When water level rises, the LNAPL will again get caught in a fracture or a sump and again be trapped.

In this same scenario, there will be much less difference in the transport of the DNAPL with a variation in water level. Because it is denser than water, the DNAPL, with sufficient pool height, can move through the fracture and into the conduit. An air-filled fracture would likely offer less resistance than a water-filled one, yet in both cases, the DNAPL will not be held in the fracture indefinitely. In the event that the critical pool height is not exceeded, the NAPL will diffuse into the rock matrix over time. Once the NAPL is depleted, the contaminated aqueous phase will act to reverse the concentration gradient and dissolve into fresh-water undersaturated with the NAPL, moving through the fractures.

Open drains, such as those sometimes found in sinkholes, as well as sinking streams, offer a very quick path to the underlying karst aquifer. NAPLs can be poured into the open drains. They can also either float in the case of LNAPLs, or be pushed along in the case of DNAPLs in surface streams. Sinking streams and open drains allow contaminants direct access to quick subsurface flow and can allow NAPLs to move at a rate of kilometers per hour. This can be very

important to take into consideration in an area where a spring acts as the local water supply source.

### STORAGE IN KARST AQUIFERS

Once NAPLs have entered a karst aquifer, they can be a source of contamination for thousands of years, given their low solubility values and the difficulty often encountered when attempting to retrieve them. Natural degradation is faster for hydrocarbons than chlorinated compounds such as chlorinated solvents and PCBs, but for a large spill may take many decades. Little is known about the ability of microbes present in karst systems to degrade any of the NAPL compounds. Hence, it is important to consider the locations in which NAPL might be stored in the karst aquifer.

#### Pools in Conduits

Macrophase NAPL pools—free surface pools not confined to pore spaces—can be present in conduits. DNAPL pools could be present at the bottom of a flowing subsurface stream, whereas LNAPL pools would float on top of the water. Pools such as these could also be present in dry cave passages, but in all cases require a large volume of contaminant, quickly injected to prevent either (1) seepage into sediments or (2) horizontal movement to a more permeable material. In turbulent flow, which characterizes most flow in subsurface streams, NAPL can be entrained or carried as an emulsion until the water velocity again decreases. Macrophase pools have a low surface area-to-volume ratio, so dissolution is limited. When subject to air, NAPL compounds may volatilize within the subsurface as occurs, for example, during seasonal water depressions.

#### Fractures

Fractures may intersect conduits in all directions. As discussed earlier, fractures extending from the roof of a conduit may act to indefinitely trap LNAPLs, but fractures in walls may also act to isolate NAPLs. DNAPLs are especially likely to migrate into subaqueous fractures in conduit floors (Fig. 3). Once they reach a depth where the critical pool height is no longer exceeded, they diffuse into the fracture matrix, from which they may act as a long-term source for aqueous phase contamination.

#### Matrix and Vugs

NAPLs can be stored in the bedrock matrix or in larger vugs. Diffusion of NAPLs into and out of the matrix occurs on a relatively slow scale. The quickest period of activity in the matrix may be the result of the flushing of pores during storm activity, as when the potentiometric surface changes

slope from down to the conduit during baseflow to a mound above the conduit during intense storm flow. Storage in bedrock matrix and vugs may represent the portion of a contaminant spill most resistant to short-term remediation.

#### Sediment

NAPLs may sorb to or be present in pores between sediments. In the first case, the NAPL may travel on the sediment, ready to desorb once it reaches a less concentrated environment. In the second case, once the sediment pile is disrupted, the NAPL is again free to move with the water, or down dip in the case of DNAPLs. NAPL can be held in the sediment pile by capillary forces, or it may be more similar to a microphase pool. With storm movement, a fresh flush of contaminants may be remobilized when NAPL is associated with sediment piles in karst conduits.

### DETECTION OF NAPL IN KARST

#### Springs and Caves

In an area where springs and caves are accessible, monitoring should begin by sampling these locations during storm and baseflow conditions. Springs are good monitoring sites as they are often downgradient from spills or leaks, and if previous dye traces exist, they can help to define a groundwater basin and evaluate the risk to nearby populations. Spring sediments should be observed. Conductivity and temperature are inexpensive tools for estimating the timing of a spring's response. In caves, one must be careful if NAPLs are a suspected contaminant. In one instance in the 1960s, a carbide lamp ignited a gasoline spill in a cave and killed several people, some by flames, but others by asphyxiation. Less dramatic is the instance in which a volatile NAPL produces toxic air within a cave.

#### Wells

As mentioned previously, wells can intersect feet of LNAPL product above the water table. Fracture trace analysis can help to site wells in some instances, and wells can also be used for dye trace studies. In karst, wells must be carefully considered, especially with the slow diffusion into and out of the bedrock matrix as compared to the rate at which other transport processes may be operating in the aquifer. DNAPLs are likely more difficult to find using wells, because they may have migrated into deeper fractures in the aquifer, and they are harder to direct by altering the hydraulic gradient. With either type of NAPL, but especially with DNAPLs, one must be very careful to case wells properly in a contaminated area. An open borehole is an excellent way to transmit DNAPL to an underlying, formerly uncontaminated aquifer.



## Soils

When a NAPL is spilled, it often passes through soil, which can be collected for sampling at a minimal expense. Soil sampling may be useful for verifying the type of NAPL and whether any former spills took place at the site. Soil sampling in a sinkhole is not recommended, due to possible piping failure. Soil gas sampling may be very useful, especially for LNAPLs. Contaminants can volatilize, with the resulting gas moving up through the soil. Depending on the season, the contaminant, and the subsurface configuration, soil gas sampling may be a helpful technique for identifying and locating a NAPL product.

## SUMMARY

Due to the heterogeneous nature of the karst subsurface, the rate of either water or NAPL transport through karst aquifers is highly variable. Both the quantity and timing of NAPL releases are important for understanding how the pollutant might be trapped in the aquifer. Individual NAPL characteristics such as density, solubility, vapor pressure, and viscosity are also key to recovering a contaminant from soils or groundwater. Over time, NAPL held in the epikarst or matrix can dissolve into the aqueous phase. Aqueous concentrations can be toxic and persist for many years, especially in the case of chlorinated compounds, which are naturally degraded more slowly than hydrocarbons. However, NAPL from large spills may move through a conduit on the order of kilometers per hour. All information about a specific karst system, including dye traces, spring response, depth to and shape of the bedrock surface, is important for evaluating the potential of NAPLs to be held in and transported through the subsurface. The study of NAPL contamination in karst aquifers is a relatively new aspect of karst science, and in the future will certainly be enhanced by additional case studies and research.

## Bibliography

- Black, D. F. (1966). Howard's cave disaster. *National Speleological Society News* **24**, 242–244.
- Crawford, N. C., and C. S. Ulmer (1994). Hydrogeologic investigations of contaminant movement in karst aquifers in the vicinity of a train derailment near Lewisburg, Tennessee. *Environmental Geology* **23**(1), 41–52.
- Ewers, R. O., A. J. Duda, E. K. Estes, P. J. Idstein, and K. M. Johnson (1991). The transmission of light hydrocarbon contaminants in limestone (karst) aquifers. In *Proceedings of the Third Conference on Hydrogeology, Ecology, Monitoring, and Management of Ground Water in Karst Terranes*, Association of Ground Water Scientists and Engineers. National Ground Water Association, Dublin, OH.
- Jancin, M., and W. F. Ebaugh (2002). Shallow lateral DNAPL migration within slightly dipping limestone, southwestern Kentucky. *Engineering Geology* **65**, 141–149.
- Krothe, N. C., Y. Fei, M. R. McCann, and R. P. Cepko (1999). Polychlorinated biphenyl (PCB) contamination of a karst aquifer in an urban environment, central Indiana, USA. In *Groundwater in the Urban Environment: Selected City Profiles* (J. Chilton, ed.). A. A. Balkema, Rotterdam.

- Loop, C. M., and W. B. White (2001). A conceptual model for DNAPL transport in karst ground water basins. *Ground Water* **39**(1), 119–127.
- Mercer, J. W., and R. M. Cohen (1990). A review of immiscible fluids in the subsurface: Properties, models, characterization, and remediation. *Journal of Contaminant Hydrology* **6**, 107–163.
- Pankow, J. F., and J. A. Cherry (1996). *Dense Chlorinated Solvents and Other DNAPLs in Groundwater*. Waterloo Press, Waterloo.
- Schwarzenbach, R. P., P. M. Gschwend, and D. M. Imboden (1993). *Environmental Organic Chemistry*. John Wiley and Sons, New York.
- Wolfe, W. J., C. J. Haugh, A. Webbers, and T. H. Diehl (1997). Preliminary models of the occurrence, fate, and transport of chlorinated solvents in karst regions of Tennessee, U.S. Geological Survey Water-Resources Investigations Report 97-4097. U.S. Geological Survey, Reston, Va.

# Cosmogenic Isotope Dating

Darryl E. Granger

*Purdue University*

Derek Fabel

*The Australian National University*

## INTRODUCTION

Natural curiosity prompts both cave explorers and first-time visitors to wonder “How old is this cave?” and “Why is it here?” Scientists have more specific reasons to study and date cave sediments. For example, geomorphologists use caves to learn about landscape evolution or about the sequence of events that shaped the rivers, hills, and valleys around us. Paleontologists study fossils in cave sediments to learn about animal and plant evolution and about the ecological communities that lived long ago. Paleoanthropologists study our ancestors’ bones that are found in caves—sometimes the bone are from cave dwellers, and sometimes they are from those who were eaten in the caves. These fossils and their dates help teach us about our own human origins. Archaeologists search for clues about human use of caves. Some scientists also study caves for their own sake, to learn about how water flows through rock and how the spectacular and labyrinthine underground environment is formed.

Caves are important across so many fields of science because the conditions underground are so protected and stable that minerals, rocks, and fossils can be preserved in exquisite condition for millions of years. Sediments and fossils on the ground surface are gradually but constantly weathered and eroded as rain splashes, plants root and die, animals burrow, and ice crystals grow and melt. The landscape on the surface changes slowly but surely as hillslopes are worn down, rivers incise or fill their beds with sediment, and forests grow and recede. By contrast, caves are often found nearly pristine, with delicate minerals, fossils, and sediments still intact and unmolested by the destructive forces of nature above. Although the hill or mountain that a cave is formed in may change over time, the cave itself is

contained in solid rock, so it can maintain its original shape until the entire mountain itself is eventually eroded away.

Often it is not enough to simply find interesting sediments or fossils in a cave without knowing their age as well. Because knowing the age of a cave or its sediments is critical for learning about the past, several techniques for dating cave sediments and minerals have been developed. Each dating scheme has its own advantages and limitations. Some of the dating techniques such as paleomagnetism, uranium-series disequilibrium, and radiocarbon dating have become well established and widely used. This article concerns another, relatively new, dating technique that employs radioactive nuclides to date when sediment was brought into a cave.

### RELATIVE VERSUS ABSOLUTE DATING TECHNIQUES

When attempting to date a particular cave or its contents, there are several possible techniques to consider, depending on the age and the particular fossils or minerals in question. Some of these dating techniques are relative, indicating whether one thing is older or younger than another but not the exact age of either. Other dating techniques are absolute, meaning they give a numeric age that does not depend on correlations with any other site.

Relative dating techniques are based on one-way changes that occur over time, such as mineral weathering, sediment accumulation, or plant and animal evolution. For example, some caves in South Africa contain hominid fossils and artifacts that are very important for learning about hominid evolution, but they are difficult to date. However, the cave sediments also contain fossils of ancient antelope and other animals whose ages are approximately known from other, well-dated, sites. The presence of the same suite of fossils thus indicates that two caves are the same age, but does not reveal exactly what that age is. Paleontologists and anthropologists often use such faunal correlation as a relative dating technique, so that when a fossil is dated at one site, the relative ages of the other sites can be determined.

Absolute dating techniques, on the other hand, give numeric ages. Rather than relying on irreversible changes through time, absolute ages are defined using some sort of “clock” that operates at a known and constant rate. By far the most widely used and reliable clock is radioactive decay. To understand radioactive decay, it is helpful to first review the basic structure of the atomic nucleus.

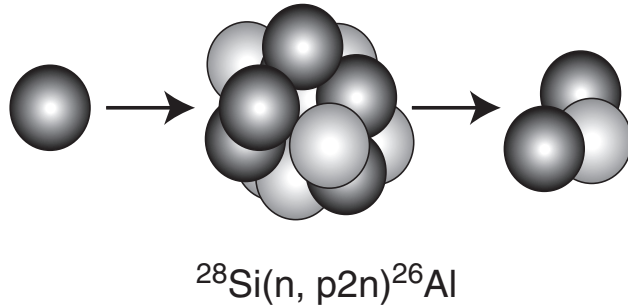
A nucleus is made of protons and neutrons. The number of protons in a nucleus determines to a large degree the way in which an atom behaves; in fact, the elements of the periodic table are defined by the number of protons they have. Sometimes two different atoms may have the same number of protons, but different numbers of neutrons. In this case, the atoms are of the same element, but they have different masses. These two atoms are called *isotopes*. For a given element, some isotopes are stable; that is, they remain

unchanged over time. Other isotopes are radioactive, in which case the nucleus spontaneously breaks apart, losing mass and energy in a radioactive decay. The radioactive decay occurs at a rate that is constant for any given nuclide. If a certain amount of a radioactive isotope is contained in a rock, for example, then half of that amount will have decayed in a characteristic time called the *half-life*. Half of the remaining half will have decayed after two half-lives, and so forth *ad infinitum*. Here is the clock that we can use for dating radioactive materials. If the original amount of a radioactive isotope is known, then the remaining amount can be measured; the difference between original and remaining radioisotopes indicates the amount of time that radioactive decay has been occurring. The trick for cave scientists is to find a material with a known initial amount of radioactive isotopes.

### BURIAL DATING WITH COSMOGENIC NUCLIDES

One way to date cave sediments is by determining the radioactive loss of so-called “cosmogenic” nuclides. (The term *nuclide* refers to atoms regardless of their element, whereas the word *isotope* always refers to atoms of the same element but different mass.) These cosmogenic nuclides are produced by cosmic rays—energetic particles coming from outer space that constantly bombard Earth. Although most of the cosmic rays are absorbed in the atmosphere, some of them reach the ground surface and cause nuclear reactions inside rocks and minerals found within a few meters of the surface. During these nuclear reactions, the nuclei inside the mineral grains are broken apart, forming lighter nuclides. By chance, some of the products of these reactions are radioactive. For example, we can consider reactions in the mineral quartz. Quartz has the chemical formula  $\text{SiO}_2$  (i.e., it is made of silicon and oxygen in a ratio of 1:2). Silicon nuclei each have 14 protons, and most of them have 14 neutrons. The common silicon nucleus thus has a mass of 28, written  $^{28}\text{Si}$ . An incoming cosmic ray particle will occasionally break apart a silicon nucleus. If a proton and a neutron are lost, then the  $^{28}\text{Si}$  is converted into  $^{26}\text{Al}$ . (*Note:* Aluminum nuclei have 13 protons.) The fortunate thing for dating is that  $^{26}\text{Al}$  is radioactive, with a half-life of 700,000 years. Another reaction that occurs in quartz is the conversion of  $^{16}\text{O}$  to  $^{10}\text{Be}$  through the loss of 4 protons and 2 neutrons. Beryllium-10 is also radioactive, with a half-life of about 1.5 million years. These two different radioactive nuclides are produced in the same quartz grain, and are the key to dating sediment burial in caves. A diagram of the reaction producing  $^{26}\text{Al}$  is shown in Fig. 1.

The cosmic rays also cause nuclear reactions inside our bodies, but very, very slowly so there is no significant health hazard to be concerned about. Rocks are exposed to cosmic rays for much longer than people, though, and over thousands of years the nuclear reactions add up to considerable quantities of the cosmogenic nuclides  $^{26}\text{Al}$  and  $^{10}\text{Be}$ . Many repeated measurements of quartz grains on the ground surface have shown that  $^{26}\text{Al}$  is produced six times faster than  $^{10}\text{Be}$ .



**FIGURE 1** An example of a spallation-type nuclear reaction, in which an incoming cosmic ray neutron (left) impacts a  $^{28}\text{Si}$  nucleus (center), to knock off two neutrons and a proton (right), making radioactive  $^{26}\text{Al}$ . Neutrons are indicated by the darker colored spheres, protons by the lighter colored spheres.

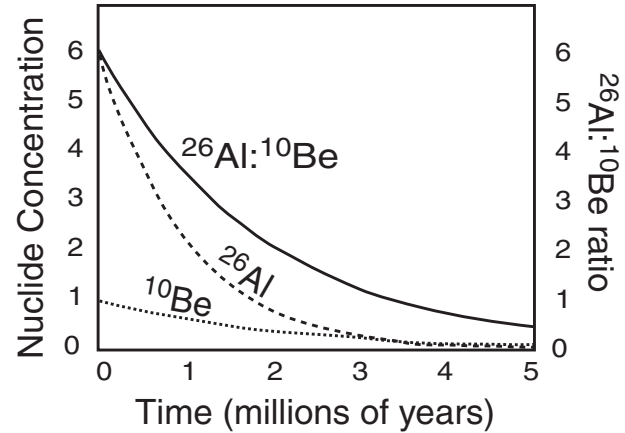
Because both the production rates and the half-lives are known, the concentrations of  $^{26}\text{Al}$  and  $^{10}\text{Be}$  in rocks exposed to cosmic rays can be calculated in a straightforward manner. For most rocks at the ground surface, the  $^{26}\text{Al}:^{10}\text{Be}$  ratio is 6:1. If quartz is brought into a cave, though, then the grains are shielded from cosmic rays and  $^{26}\text{Al}$  and  $^{10}\text{Be}$  are no longer produced.

After the quartz-bearing sediment is brought into the cave, radioactive decay gradually lowers the concentrations of both  $^{26}\text{Al}$  and  $^{10}\text{Be}$ . Aluminum-26 decays faster than  $^{10}\text{Be}$ , so the original  $^{26}\text{Al}:^{10}\text{Be}$  ratio decreases over time. After 700,000 years half of the  $^{26}\text{Al}$  is gone, but only 27% of the  $^{10}\text{Be}$  has decayed. The original ratio of 6:1 has thus been lowered to about 4.2:1. The  $^{26}\text{Al}:^{10}\text{Be}$  ratio provides the radioactive clock that we can use to date cave sediments, with an original ratio of 6:1 that decreases exponentially over time. Figure 2 shows the decay of the two nuclides, and the  $^{26}\text{Al}:^{10}\text{Be}$  ratio as a function of time. You may realize that as the concentrations of  $^{26}\text{Al}$  and  $^{10}\text{Be}$  get smaller and smaller over time, they become more difficult to measure. In fact, the practical limit to measurement usually occurs after about 5 million years of burial.

Aluminum-26 and  $^{10}\text{Be}$  in sediment can only be measured using a very sensitive technique called *accelerator mass spectrometry* (AMS). This is because the concentrations of the cosmogenic nuclides are extremely small. For example, only five atoms of  $^{10}\text{Be}$  may be produced in a gram of quartz in an entire year, and a sample may contain less than a million atoms of  $^{10}\text{Be}$ . AMS is capable of measuring an isotope ratio (e.g.,  $^{10}\text{Be}:^9\text{Be}$  or  $^{26}\text{Al}:^{27}\text{Al}$ ) as low as  $10^{-16}$ . That is, if there are  $10^{16}$  atoms of the common isotope  $^{27}\text{Al}$ , then AMS can detect a single atom of cosmogenic  $^{26}\text{Al}$ . You should realize that  $10^{16}$  is a very big number; for example  $10^{16}$  soccer balls would cover the Earth's entire surface!

### Requirements for Burial Dating

As with any dating technique, it is important to consider the circumstances for which dates will be reliable, and those



**FIGURE 2** A graph of the concentrations of  $^{26}\text{Al}$  and  $^{10}\text{Be}$  (arbitrary units) and the  $^{26}\text{Al}:^{10}\text{Be}$  ratio in quartz grains over time. The grains are washed into a cave with an original  $^{26}\text{Al}:^{10}\text{Be}$  ratio of 6. Because  $^{26}\text{Al}$  decays faster than  $^{10}\text{Be}$ , the  $^{26}\text{Al}:^{10}\text{Be}$  ratio decreases over time. The  $^{26}\text{Al}:^{10}\text{Be}$  ratio can thus be used to date when the sediment was deposited in the cave.

for which dates will be unreliable or impossible to obtain. Burial dating has several rather strict requirements. First, the sediment must have washed into the cave from outside, i.e., it must be allochthonous. Otherwise, there would be none of the cosmogenic nuclides to begin with. Second, the sediment must contain the mineral quartz, because that is the mineral for which we know the production rates of  $^{26}\text{Al}$  and  $^{10}\text{Be}$ . Quartz is not always common in cave-forming bedrock, so even if there is allochthonous sediment in the cave it may not be datable. Third, the sample must be buried underground by at least 20 m for the technique to be reliable over millions of years. It is possible to date more shallowly buried samples, but this introduces higher uncertainties. Fourth, there are limitations on the burial times. The sediment cannot have been buried more than about 5 million years, or the  $^{26}\text{Al}$  and  $^{10}\text{Be}$  will no longer be detectable. Uncertainties in measuring  $^{26}\text{Al}$  and  $^{10}\text{Be}$  are usually 3–5%, making it difficult to achieve burial dates more precise than about 100,000 years. So the sediment must have been buried for at least 100,000 years. Finally, the sediment must come into the cave without a prior history of burial. If the sediment were, for instance, buried at the bottom of a sinkhole for a million years then washed into the cave, then the burial age would account for the total time spent buried, not just that in the cave. Although these uncertainties limit the application of burial dating somewhat, there are many situations for which the technique is ideal. We describe two examples below.

### Example 1: Dating Cave Sediments at the New River, Virginia

The New River heads in the Blue Ridge Mountains of North Carolina, which are composed of igneous and metamorphic rocks that are devoid of caves. The bedrock contains abundant quartz, however, that the river washes downstream

as sand, gravel, and boulders. As the river winds westward, it passes through the Valley and Ridge province of the Appalachian Mountains in southwestern Virginia, a region where valleys are often floored by prodigiously cave-forming limestone and dolomite bedrock. These caves are formed as rainwater drains underground from the mountains, eventually reaching either the New River or its tributaries and discharging as springs.

Although on a human timescale rivers seem to be permanent and fixed features of the landscape, over geologic time rivers change quite rapidly. The mud, sand, and gravel that rivers carry downstream results from erosion, which constantly lowers the landscape upstream. If rivers are able to carry more sediment than is supplied by erosion of hills and mountains, then the rivers will flow over bare bedrock, and eventually cut gorges in valley floors. On the other hand, if rivers cannot carry all of the sediment that is supplied to them, then they will *aggrade*, or fill the valley bottoms. Geomorphologists are very interested in what determines whether rivers incise or aggrade. Sometimes climate change will alter the amount of rainfall in an area, which in turn alters both the amount of water in the river and the amount of erosion on the hillslopes. At other times, tectonic uplift will cause rivers to incise. One way to help decipher the causes of river incision and aggradation is to date river incision events to correlate them with known times of climate change or uplift.

The New River currently flows through a gorge that it has cut through the Valley and Ridge. The steep walls of the gorge are often made of cavernous limestone or dolomite. Canoeing or rafting down the river, one looks up to see caves that pock the cliffs overhead. Scuba divers find other caves submerged alongside the riverbed. It is no great leap to realize that many of the caves in the cliffs above were once submerged beneath the river, and that the caves were left high and dry as the river incised its modern gorge. In a thorough search of more than 50 caves found near the New River, Granger *et al.* (1997) found that 5 of these caves contained quartz gravel unmistakably derived from the Blue Ridge Mountains. The only way that this quartz could have entered these caves was by being washed in by the New River. This is a perfect situation for burial dating with cosmogenic nuclides. The caves are repositories of river sediment, recording the elevation of the old river level and shielding the sediment from cosmic rays.

The five quartz-bearing caves along the New River yielded burial ages ranging from  $0.29 \pm 0.18$  million years for a cave only 12 m above the river, to  $1.47 \pm 0.22$  million years for a cave found 29 m above the river. Considering all of the caves together, Granger *et al.* (1997) showed that the New River has incised its gorge through the Valley and Ridge area in the past 2 million years, and that the river has incised at a rate between 20 and 30 m per million years. Although this information does not definitively state the reason for river incision, it does show that whatever caused the river to incise

occurred recently in geologic time, at roughly the same time as the beginning of the ice ages. More work along the New River and other rivers in the area will be required to completely decipher the reasons for recent river incision.

### **Example 2: The Development of Mammoth Cave, Kentucky**

Mammoth Cave, the longest known cave in the world, has developed alongside the Green River in Kentucky. It is an example of a water table cave, or one that has developed nearly horizontal passages that are closely controlled by the level of groundwater flow. At Mammoth Cave, the water level is in turn controlled by the elevation of the Green River. Rainfall on the nearby Pennyroyal plateau quickly infiltrates the karst bedrock until it reaches cave passages that are filled or nearly filled with water. These underground streams then flow toward the Green River, passing beneath a sandstone-capped limestone plateau to discharge as springs on the Green River. In addition to the large recharge area that captures abundant rainfall, the sandstone-capped plateau is a major reason why Mammoth Cave is so long. The sandstone is a rock made of cemented quartz sand that is very resistant to erosion. Over time, as the Green River has cut through the sandstone and into the underlying limestones, cave passages have formed at successively lower levels. In most situations, the old cave passages above would be destroyed by erosion as new cave passages were formed below. However, at Mammoth Cave the sandstone is so resistant to erosion that the older passages have not eroded away. The sandstone forms ridges beneath that are preserved stacks of cave passages, with the oldest passages near the top and the youngest passages at modern river level.

The preservation of old passages at Mammoth Cave provides a wonderful opportunity to study how the cave has developed and how the Green River has incised and aggraded over time. Geologist and hydrologist Art Palmer has spent many years carefully working out the sequence of events that are encrypted within Mammoth Cave's passages. It is very difficult, though, to decipher the history of the cave without dates that can be used to tie passages together across the cave system and to match episodes of cave development with other geologic events. Burial dating with cosmogenic nuclides has provided a new set of dates that helps show how the development of the Mammoth Cave system has been strongly influenced by climate change and the growth of ice sheets across North America. Although ice sheets did not reach Mammoth Cave itself, they did impact the Green River, which alternately incised and aggraded, forming sets of passages beneath the ridges at Mammoth Cave.

Burial dating works at Mammoth Cave because quartz pebbles from conglomerates within the sandstone upland are carried into the cave through sinking streams. These streams carry the pebbles through the cave system and into the Green River. When the river incises, however, new passages are

formed at lower elevations. The old passages are no longer occupied by streams, so whatever quartz pebbles were being carried through the cave are left in place, to sit within the now-abandoned cave passages. These packages of quartz-bearing sediment can be found throughout nearly the entire cave system. It is important to realize that the sediments indicate not when the passage formed, but when the passage was abandoned. It is only through careful analysis of the cave that the abandonment of one passage can be linked to the growth of another.

Granger *et al.* (2001) dated sediments from throughout the Mammoth Cave system. These samples reach ages up to 3.5 million years old in the uppermost levels of the cave, and they tell an interesting story of how the cave developed over time. First, the dates show that the Mammoth Cave system is quite old. If the sediments that fill the cave are up to 3.5 million years old, then the cave itself must be significantly older than that! The upper levels of the cave system substantially predate the ice ages, which began roughly 2.5 million years ago. The cave, then, reveals how the landscape of central Kentucky responded to this major climate change. The initial response to climate change seems to be that the entire cave system filled up with sediment. Visitors to Mammoth Cave will notice telltale signs of sediment everywhere, even in nooks and crannies on the passage ceilings. These sediments show that much of the cave was filled up about 2.4 million years ago, which indicates that the nearby Green River must be filled up as well. The landscape response to climate change was river aggradation, perhaps due to increased hillslope erosion that would have supplied more sediment than the river could carry.

The next chapter in the story of Mammoth Cave is river incision and cave development at lower levels. Mammoth Cave is developed in levels, indicating that river incision was episodic. Granger *et al.* (2001) found that these incision pulses correlate with large glaciations that covered most of eastern Canada and the northeastern United States, advancing as far as the northern edge of Kentucky. These large ice sheets completely reorganized river systems that were either buried beneath the ice or blocked by great ice dams. In fact, the modern courses of rivers such as the Ohio River, the Missouri River, and the northern Mississippi River were shaped along the edges of ice sheets. These ice sheets caused pulses of river incision that propagated southward into Kentucky, eventually causing Mammoth Cave to form at progressively lower levels.

## SUMMARY

These two examples of burial dating with cosmogenic nuclides show only the beginning of what the dating technique can do. The caves along the New River proved ideal for burial dating because they contained quartz gravels washed in from the river outside. In this case, the caves were merely repositories of the sediment, holding it protected for

millions of years while the landscape changed outside. On the other hand, the sediments in the Mammoth Cave system were an integral part of how the cave was formed. The sediments reveal the evolution of the cave system and how cave development is tightly coupled to river incision and aggradation. In this case, Mammoth Cave was ideal because it was a water table cave that carried quartz from local bedrock. There are many more situations where geomorphologists, paleoanthropologists, and other scientists can benefit immensely from dating cave sediments over the past 5 million years.

## Bibliography

- Brain, C. K. (1981). *The Hunters or the Hunted? An Introduction to African Cave Taphonomy*. University of Chicago Press, Chicago.
- Granger, D. E., and P. F. Muzikar (2001). Dating sediment burial with cosmogenic nuclides: Theory, techniques, and limitations. *Earth and Planetary Science Letters* **188**, 269–281.
- Granger, D. E., J. W. Kirchner, and R. C. Finkel (1997). Quaternary downcutting rate of the New River, Virginia, measured from differential decay of cosmogenic  $^{26}\text{Al}$  and  $^{10}\text{Be}$  in cave-deposited alluvium. *Geology* **25**, 107–110.
- Granger, D. E., D. Fabel, and A. N. Palmer (2001). Pliocene-Pleistocene incision of the Green River, Kentucky, determined from radioactive decay of cosmogenic  $^{26}\text{Al}$  and  $^{10}\text{Be}$  in Mammoth Cave sediments. *Geological Society of America Bulletin* **113**, 825–836.
- Lal, D. (1991). Cosmic ray labeling of erosion surfaces: In situ nuclide production rates and erosion models. *Earth and Planetary Science Letters* **104**, 424–439.
- Lal, D., and B. Peters (1967). Cosmic ray produced radioactivity on the Earth. In *Handbuch der Physik* (S. Flugge, ed.), Vol. 46, pp. 551–612. Springer-Verlag, Berlin.
- Palmer, A. N. (1981). *A Geological Guide to Mammoth Cave National Park*. Zephyrus Press, Teaneck, NJ.
- Tobias, P. V. (2000). The fossil hominids. In *The Cenozoic of Southern Africa* (T. C. Partridge and R. R. Maud, eds.), Vol. 40, Oxford Monographs on Geology and Geophysics, pp. 252–276. Oxford University Press, New York.
- Vrba, E. S. (1995). The fossil record of African antelopes (Mammalia, Bovidae) in relation to human evolution and paleoclimate. In *Paleoclimate and Evolution, with Emphasis on Human Origins* (E. S. Vrba, G. H. Denton, T. C. Partridge, and L. H. Burckle, eds.), pp. 385–424. Yale University Press, New Haven, CT.

---

# Crustacea

Horton H. Hobbs III

Wittenberg University

## INTRODUCTION

Crustaceans are one of the oldest and most diverse arthropods as well as one of the most successful groups of invertebrates on earth with approximately 40,000 extant species described. They have been extremely successful in aquatic habitats, yet some species have become adapted on land as well. Their fossil record indicates that they are an

ancient group, having occupied the marine environment since the lower Cambrian period yet very early in their evolutionary history they invaded freshwater habitats. Although about 90% of the currently recognized taxa are widespread in marine systems, the remaining 10% are found in diverse inland waters and assume important roles in various ecosystem processes of many surface and subterranean lotic and lentic habitats. This article focuses on the hypogean members, specifically on those crustaceans that are highly adapted to dwelling in groundwater ecosystems and generally referred to as *stygobites* or *stygobionts* (obligate hypogean aquatic forms).

In addition to being taxonomically diverse, crustaceans are anatomically disparate, having evolved an assortment of body forms accomplished by developing highly specialized body segments and appendages as well as by fusing various segments. As a group, crustaceans are bilateral, having internal and external segmentation, and an open hemocoel. They have a rigid, chitinous exoskeleton composed of a thin proteinaceous epicuticle and a thick multilayer procuticle that in many groups is hardened by small inclusions of calcium carbonate. Their bodies are generally divided into the cephalon (head), thorax, and abdomen (with the former two sometimes combined as the cephalothorax). The many jointed appendages are biramous (or secondarily uniramous) may occur in all regions of the body, and these arthropods possess paired antennules (uniramous in all crustaceans except malacostracans), antennae, mandibles, and maxillae.

Crustaceans have invaded the hypogean realm, occupying interstitial and other groundwater habitats, including anchialine waters (inland ground water with subsurface marine connections harboring unique fauna) in karst (see article entitled Anchialine Caves in this volume) as well as in other landforms (e.g., lava). Some species of amphipod and isopod crustaceans have abandoned the groundwater and have been successful in the terrestrial hypogean environment. Most species dwelling in subterranean environments exhibit a suite of characteristic traits that are adaptive for life in such extreme ecosystems. Examples include reduction or loss of eyes and pigments, elongation of appendages, increased chemical and tactile sensitivity, degeneration of circadian rhythms, lowered fecundity and metabolic rates, and increased longevity and ovum volume. These embody behavioral, ecological, morphological, and physiological modifications that include both the reduction or loss of characters (regressive evolution) as well as the augmentation of others (constructive evolution). These various adaptations combine to generate the convergence characteristic of most obligate, cave-adapted organisms that is referred to as *trogglomorph*y.

Crustacean taxonomy continually undergoes reevaluation and revision and the classification structure used herein (generally based on Martin and Davis, 2001) reveals five classes having subterranean representatives: Branchiopoda, Remipedia, Maxillopoda, Ostracoda, and Malacostraca (see

Table I); a brief discussion of the classes and their hypogean representatives (predominantly stygobionts) is presented next.

## SYNOPSIS OF STYGOBITIC CRUSTACEAN TAXA

### Class Branchiopoda

Branchiopods are relatively small heterogeneous crustaceans that share few characteristics, including small to vestigial head appendages with similar mouthparts, flattened leaflike thoracic legs called *phyllopods* that usually decrease in size posteriorly, and a pair of spines or claws on the ultimate body segment. Classification of branchiopods has undergone numerous revisions and, of the currently recognized orders, only Diplostraca has subterranean members. There are about 100 species of the suborder Cladocera (450 total species) that occupy the subterranean environment (Table I).

They are known from subterranean waters (especially the interstitial/hyporheos) on all continents, but especially well in Bosnia and Herzegovina, France, Romania, Slovenia, and Spain. These small transparent crustaceans have a carapace that is laterally compressed and attached dorsally to the body around which it is wrapped, excluding the head. Troglomorphic adaptations are very minor except in a few species of the genera *Alona* and *Spinalona*, evident by a lack of eyes and a carapace that is translucent and sparsely pigmented. Additionally, some have conserved a suite of primitive characters (e.g., setation of valve rims), which suggests that the protected constancy of the hyporheic has allowed for the survival of some old taxa.

### Class Remipedia

The discovery of remipedes in the subterranean waters of Lucayan Cavern on Grand Bahama Island in 1979 presented a major surprise. On one hand these blind crustaceans possess characteristics that are very primitive (e.g., long homonomous body, paddle-like antennae, double ventral nerve cord), yet they have attributes that are traditionally considered advanced (e.g., maxillipeds and biramous limbs that are not platelike). These small (<1–4 cm), translucent crustaceans lack carapace but a cephalic shield covers the head, appendages of which include a pair of rodlike processes anterior to antennules and prehensile mouthparts; the head and first trunk segment comprise the cephalothorax; and they have an elongate trunk of up to 32 unfused segments each bearing a pair of similar, laterally directed biramous limbs.

They have been observed by divers primarily within submerged caves below the density interface between the overlying fresh or slightly brackish water and the underlying dense saltwater although one species, *Speleonectes epilimnius* Yager & Carpenter, is found above the density gradient. Most swim ventral side up as the result of synchronized beating of the trunk appendages and apparently stay below this

TABLE I Abbreviated Classification of Crustacea Inclusive Only of Those Groups Dwelling in Subterranean Habitats<sup>a</sup>

<b>Subphylum Crustacea</b>	<b>Class Malacostraca</b> (2211)
<b>Class Branchiopoda</b> (85)	Subclass Phyllocarida (1)
Subclass Phyllopoda (85)	Order Leptostraca (1)
Order Diplostraca (85)	Subclass Eumalacostraca (2,210)
Suborder Cladocera (79)	Superorder Syncarida (208)
Family Daphniidae (20)	Order Bathynellacea (187)
Family Moinidae (5)	Order Anaspidacea (21)
Family Bosminidae (2)	Superorder Peracarida (1829)
Family Macrothricidae (8)	Order Spelaeogriphacea (3)
Family Euryceridae [= Chydoridae] (44)	Order Thermosbaenacea (33)
Infraorder Ctenopoda (2)	Order Mysida (45)
Family Sididae (2)	Bochusacea (1)
Infraorder Haplopoda (1)	Order Bochusacea (3)
Family Leptodoridae (1)	Order Amphipoda (778)
<b>Class Remipedia</b> (12)	Suborder Gammaridea (778)
Order Nectiopoda (12)	Order Isopoda (948)
Family Godzilliidae (3)	Suborder Phreatoicoidea (11)
Family Speleonectidae (9)	Suborder Anthuridea (19)
<b>Class Maxillopoda</b> (1104+)	Suborder Microcerberidea (64)
Subclass Tantulocarida (1)	Suborder Flabellifera (141)
Subclass Mystacocarida (<20)	Superfamily Cymothoidea (Cirolanidae–90)
Subclass Copepoda (1,077+)	Superfamily Sphaeromatoidea (Sphaeromatidae–51)
Order Platycopioidea (11)	Suborder Asellota (436)
Order Calanoida (36)	Suborder Calabozoidea (1)
Order Misophrioida (17)	Suborder Oniscidea (276)
Order Cyclopoida (230)	Order Tanaidacea (6)
Order Gelyelloida (2)	Order Cumacea (12)
Order Harpacticoida (787)	Superorder Eucarida (178)
<b>Class Ostracoda</b> (976+)	Order Decapoda (178)
Subclass Myodocopa (235)	Suborder Pleocyemata (178)
Order Myodocopida (8)	Infraorder Caridea (96)
Order Halocyprida (27 strictly anchialine and approximately 200 marine interstitial species)	Infraorder Astacidea (40)
Subclass Podocopa (~365)	Infraorder Anomura (2)
Order Platycopida (1)	Infraorder Brachyura (41)
Order Podocopida (120+, of which approximately half are anchialine)	
Subclass Mystacocarida (<20 intertidal and subtidal interstices)	

<sup>a</sup> Number = approximate number of described subterranean species.

interface in the oxygen-poor (as low as 0.08 mg/L) saltwater layer. These predators likely feed in the overlying, well-oxygenated freshwater lens and locate their food by chemosensory means. Remipedes are small (up to 45 mm total length) and are commonly associated with other stygobitic crustaceans such as caridean shrimps, cirolanid isopods, haziid amphipods, mysids, ostracods, and thermosbaenaceans. Twelve species reside in two families containing six genera (Tables I and II) and are known only from anchialine caves in the Cape Range Peninsula in Western Australia, Bahamas, Canary Islands, Cuba, Turks and Caicos, and the Yucatan Peninsula (Mexico).

### Class Maxillopoda

Maxillopods are mostly small crustaceans although barnacles (Thecostraca: Cirripedia) are conspicuous deviations. They have a reduced abdomen and lack a full complement of

TABLE II Occurrence of Remipedia

Family	Genus	Species	Distribution
Godzilliidae	<i>Godzilliognomus</i>	1	Bahamas
	<i>Godzillius</i>	1	Turks and Caicos
	<i>Pleomothra</i>	1	Bahamas
Speleonectidae	<i>Cryptocorynetes</i>	1	Bahamas
	<i>Lasionectes</i>	2	Australia, Turks and Caicos
	<i>Speleonectes</i>	6	Bahamas, Canary Islands, Cuba, Mexico (Yucatan)

legs. Treated below are those subclasses having subterranean representatives: Tantulocarida, Mystacocarida, and Copepoda.

**SUBCLASS TANTULOCARIDA** These small (<0.5-mm-long), ectoparasitic crustaceans are restricted to crustacean hosts. The only stygobitic tantulocarid (*Stygotantulus stocki*

Boxshall & Huys) is known from an anchialine lava pool on Lanzarote in the Canary Islands where it is parasitic on two families of harpacticoid copepods.

**SUBCLASS MYSTACOCARIDA** This small group (most species <0.5 mm in total length; two genera with <20 described species and subspecies; Table I) of marine interstitial crustaceans is characterized by an elongate body that is divided into a head and a 10-segmented trunk. The carapace and compound eyes are lacking; the first trunk segment has maxilliped but is not fused to the head; and it has a telson bearing large, pincer-like furca. Because of the retention of primitive head segmentation, the lack of fusion of the cephalon and maxillipedal trunk segment, simplicity of mouth appendages, and absence of trunk compartmentalization, this is likely one of the most primitive of all crustaceans. (Others argue that these features may be related entirely to pedomorphosis and adaptation for interstitial habitats.)

Little is known concerning the life history of this group. Apparently eggs are laid free and likely they have up to six naupliar stages. Their small size and wormlike body are adaptations for interstitial life, using head appendages to aid in crawling among sand grains where they glean detritus and microorganisms from the surfaces of sediment particles. Although probably more widespread, they demonstrate a patchy distribution within the littoral and sublittoral sands in southern and western Africa, Australia, Brazil, Chile, southern Europe, the Gulf of Mexico, the Mediterranean Sea, and the east coast of the United States. Species of the genus *Ctenocheilocaris* are restricted to the neotropical region, whereas *Derocheilocaris* spp. inhabit the nearctic, palearctic, and ethiopian regions.

**SUBCLASS COPEPODA** The subclass Copepoda is a very large and diverse group of crustaceans (approximately 220 families, 2300 genera, and 14,000 species) and, because they can attain incredibly high densities, are considered to be the most abundant metazoans on Earth (more individuals but fewer species than the insects). Lacking compound eyes and a carapace, the basic body plan consists of a head with well-developed mouthparts and antennae; six segmented thorax bearing swimming appendages, with the first segment fused to the head with maxillipeds; and a five-segmented abdomen, lacking appendages but including a telson. Development occurs within a few days to 3 weeks from fertilized eggs that hatch into a larval stage called a *nauplius*. Six naupliar stages are followed by six copepodid stages, the last of which is the adult (no additional molts). Six of the 10 orders have subterranean representatives, most of which demonstrate varying degrees of troglomorphy, and are treated next briefly (Table I).

The Platycopioida order consists of one family (Platycopiidae), four genera, and 11 species that have retained numerous primitive characters. They are considered to be

the first order to diverge from the main lineage of copepods. The eight species of the genus *Platycopia* are known from the benthos in sea and coastal waters (Africa, Bahamas, northern Europe, Japan, United States). *Sarsicopia polaris* Martinez-Arbizu is found in muddy sediments of the Arctic Ocean, and two anchialine genera and species are endemic to a single cave in Bermuda: *Antrisocopia prehensilis* Fosshagen and *Nanocopia minuta* Fosshagen, one of the smallest known copepods.

The Calanoida order contains approximately 2400 species in about 250 genera, yet only 36 species assigned to 22 genera and seven families are described from subterranean waters (Tables I and III). Calanoids have biramous antennae and antennules that are greatly elongated, and the point of major body articulation occurs between the thorax and abdomen, which is marked by a distinct narrowing of the body. This primarily filter-feeding, planktonic group is geographically widespread, having been found in hypogean settings in Australia, Bahamas, Balearic Islands, Barbuda, Belize, Bermuda, Canary Islands, Caroline Islands, southeast China, Cuba, Dinaric Alps, Fiji, southern France, Galapagos Islands, Herzegovina, Istria, Italy, Madagascar, Mediterranean, Mexico, Philippines, and Russia.

The Misophrioida order is represented by 16 genera and 34 widely distributed copepods that are planktonic, hyperbenthic, and deep-sea, open-ocean, and hypogean water-dwellers. The subterranean species demonstrate particularly disjunct distributions, which are summarized in Table IV.

Members of the Cyclopoida order are free-living, planktonic, and associated with various substrates in benthic or littoral habitats. They detect their prey with the aid of mechanoreceptors on their first antennae and grasp their food with precision with their first maxillae or, occasionally, with their second maxillae and maxillipeds. Most are voracious predators although some are parasitic. Antennules and uniramous antennae are moderately long (never as long as antennules of harpacticoids; see below); a fifth pair of legs is highly reduced, the sixth pair vestigial. Cyclopoid copepods have not been well studied in subterranean environments. Nearly 750 species are recognized, but

**TABLE III Occurrence of Described Stygobiont Calanoid Copepods in Anchialine, Cave, or Well Habitats**

Family	Genus	Species/ Subspecies	Occurrence
Boholiniidae	2	2	Anchialine
Diaptomidae	8	11	Fresh water
Epacteriscidae	3	11	Anchialine; fresh water
Fosshageniidae	1	1	Anchialine
Pseudocyclopiidae	3	4	Anchialine; marine
Ridgewayiidae	4	4	Anchialine
Stephidae	1	2	Anchialine
Total	22	36	



TABLE IV Subterranean Misophrioid Copepod Distribution and Habitat

Genus	Species	Distribution	Habitat
<i>Boxshallia</i>	<i>bulboantennulata</i>	Canary Islands	Anchialine
<i>Dimisophria</i>	<i>cavernicola</i>	Canary Islands	Anchialine
<i>Expansophria</i>	4	Canary and Galapagos Islands, Italy, Sardinia, Palau	Anchialine
<i>Huysia</i>	<i>bahamensis</i>	Bahamas	Anchialine
<i>Misophria</i>	<i>kororiensis</i>	Atlantic	Anchialine
<i>Palpophria</i>	<i>aestheta</i>	Canary Islands	Anchialine
<i>Protospeleophria</i>	<i>lucayae</i>	Bahamas	Anchialine
<i>Speleophria</i>	4	Angaur Islands, Palau; Balearic Islands; Bermuda	Anchialine, cave
<i>Speleophriopsis</i>	2	Balearic and Canary islands	Anchialine
<i>Stygomisophria</i>	<i>kororiensis</i>	Koror Island, Palau	Anchialine

only about 170 species and subspecies are reported from freshwater caves, interstitial habitats, and wells (Table I) (e.g., *Acanthocyclops*, *Diacyclops*, *Eucyclops*, *Halicyclops*, *Idiocyclops*, *Kieferiella*, *Metacyclops*, *Speleoithona*, and *Speocyclops*) from Africa, Asia, Australia, Bahamas, Cuba, Europe, Madagascar, and North and South America. About 60 additional species and subspecies are known from marine and brackish water interstices.

The Gelyelloida order is represented by a single genus and two species inhabiting European freshwater karst systems. *Gelyella drogouei* Rouche & Lescher-Moutoué and *G. monardi* Moeschler & Rouch are restricted to karst waters in Montpellier, France, and in the Swiss Jura, respectively. This copepod order is characterized by a distinct combination of gnathostomous mouthparts and unusual derived features.

The Harpacticoida order is characterized by a body that is generally wormlike and cylindrical, with anterior segments not much larger than posterior ones; antennules and biramous antennae are quite short and the point of major body articulation occurs between the fifth and sixth thoracic segments; locomotory pereopods are reduced, consistent with loss of swimming ability and use of these appendages as levers against sand grains. This group of copepods occurs virtually in all aquatic environments; most are benthic and are well suited to move through interstices feeding on detritus and on microorganisms (e.g., bacteria, diatoms, and protozoa). The harpacticoid copepods comprise 42 families with approximately 375 genera containing about 3000 species. At least 12 families (about 445 species) are known from freshwater caves, interstitial ground waters, and wells (e.g., *Chappuisius*, *Elaphoidella*, *Parastenocaris*, *Spelaocampius*, *Stygonitocrella*). Some 342 species and subspecies in 63 genera and 13 families are found in the marine interstitial

habitat (e.g., *Leptocaris*, *Nitocra*, *Novocrinia*, *Psammotopa*, *Stygolaophonte*).

### Class Ostracoda

Ostracods are small (usually <1 mm, rarely 2 cm) crustaceans, with short, oval bodies encased within bivalved shells hinged dorsally. This is a very diverse group (5700 species) and although most are found in the marine environment (to depths of 7000 m) they are abundant worldwide in all aquatic systems. Most species are benthic, many are planktonic, some are commensal on echinoderms or various malacostracan crustacea (e.g., Sphaeromicolinae on Isopoda, Entocytherinae on cambarid Decapoda), and a few are terrestrial in moist habitats.

Although some species are known only from caves, most hypogean ostracods are found in anchialine habitats, interstitial waters, springs, and wells. Examples of ostracods occupying various subterranean waters are *Cavernocypris lindbergi* Hartman (Afghanistan cave), *Pseudocandona jeanneli* (Klie) (cave in Indiana, United States), *Mixta-candona juberthieae* Danielopol (cave in southern France), and *Pseudolimnocythere hartmanni* Danielopol (well in Greece). These stygobionts display various troglomorphic adaptations including reduction or loss of eye structure, pigments, number of setae, and some have a very elongate or trapezoidal-shaped carapace. Most of the approximately 980 subterranean species are assigned to the order Podocopida although the order Mydocopida is dominated by ostracods living in marine interstitial habitats (Bermuda, Galapagos Islands, Jamaica) and a coastal sea cave on Niue in the central Pacific (*Dantya ferox* Kornicker and Iliffe) (Table I). The order Halocyprida is represented by troglomorphic species dwelling in anchialine habitats, blue holes, and caves: *Danielopolina* (11 species in the Bahamas, Canary Islands, Cuba, Galapagos Islands, Jamaica, Yucatan Peninsula of Mexico, and the Cape Range Peninsula of Western Australia), *Deeveya* (7 species in the Bahamas and the Turk and Caicos islands), *Euconchoecia* (single species in Palau), and *Spelaeoecia* (10 anchialine species in the Bahamas, Bermuda, Cuba, Jamaica, and the Yucatan Peninsula); approximately 200 are marine interstitial species.

Of interest, the wide, irregular distribution, primitive nature, and troglomorphic adaptations of these taxa point to an extended history in a suitable cave environment. However, during the most recent period of Pleistocene glaciation, the sea level was lowered at least 100 m, resulting in coastal, anchialine caves becoming dry and then reinundated (substantiated today by the presence in these submerged caves of stalactites and stalagmites and other speleothems that were formed only in air by dripping or flowing water). This suggests that present-day anchialine ostracod fauna are recent invaders (within the past 15,000–18,000 years) and that they likely used an alternate, deeper habitat as refuge for considerable periods of time.

**Class Malacostraca**

This diverse group (23,000 species) far excels the species richness of any other crustacean and is divided into three subclasses, of which two have species dwelling in hypogean environments: Phyllocarida and Eumalacostraca. The body fundamentally comprises a five-segmented cephalon, eight-segmented thorax, six-segmented abdomen (seven in leptostracans), and telson; the carapace may be absent, reduced, or may cover part or all of the thorax and even several abdominal segments; may have none to three pairs of maxillipeds; antennules and antennae are usually biramous; the abdomen generally bears five pairs of biramous pleopods and one pair of biramous uropods; and they are mostly gonochoristic.

**SUBCLASS PHYLLOCARIDA** The Subclass Phyllocarida is represented by the single order Leptostraca, which is characterized by a head with movable, articulated rostrum; biramous antennules and uniramous antennae; absent maxillipeds; phyllopodous thoracopods; a bivalved carapace (lacking hinge) covering the thorax; and an elongate abdomen consisting of seven free pleomeres plus telson. The order is represented by fewer than 20 species assigned to six genera, most of which are small (5–15 mm long), but one species is nearly 4 cm in length. Most are epibenthic, are suspension feeders, and occur in low-oxygen marine environments. A single stygobiont, *Speonebalia cannoni* Bowman, Yager, & Iliffe (Nebaliidae), is known from two caves on Providenciales, Caicos Islands.

**SUBCLASS EUMALACOSTRACA** Members of this subclass have head, thorax, and abdomen; up to three thoracomerer are fused with the head, appendages of which are usually modified as maxillipeds; most groups have a well-developed carapace; and they possess a telson and paired uropods. There are three of four superorders with subterranean representatives.

**Superorder Syncarida** This freshwater group, derived from marine stock, demonstrates the most primitive living body architecture of any eumalacostracan and many of the rather uniform trunk segments lack appendages. They lack a carapace; telson with or without furcal lobes; some pereopods are biramous; and the pleopods are variable. They either crawl or swim and, although little is known about most species, some are likely omnivorous. Unlike most other crustaceans, which transport eggs and thus carry early embryos, syncarids lay their eggs or release them into the water subsequent to copulation. Approximately 210 species have been described that are placed into two orders (Table I): Bathynellacea and Anaspidacea; 95% of these are stygobionts.

The primitive Bathynellacea order lacks maxillipeds, is by far the more diverse group of syncarids, and is worldwide in distribution. Approximately 187 species are assigned to 56 genera that are placed within three families: Bathynellidae

(e.g., *Bathynella chappuisi* Delachaux, Switzerland; *Bathynella primaustraliensis* Schminke, Australia), Leptobathnelidae (e.g., *Acanthobathynella knoeppfleri* Coineau, Ivory Coast, Africa) and Parabathynellidae (e.g., *Notobathynella williamsi* Schminke, Australia; *Parabathynella stygia* Chappuis, Croatia, Slovakia). They typically inhabit freshwater interstitial media in epigeal, cave, and well hypogean habitats in Africa, Asia, Australia, Europe, Japan, Madagascar, Malaysia, New Zealand, and North and South America.

Order Anaspidacea (four families) has one pair of maxillipeds, is endemic to Australia, and species richness is particularly high on the island of Tasmania (numerous species awaiting formal descriptions). The Anaspididae family [e.g., *Anaspides tasmaniae* (Thomson)] inhabits various freshwater environments, including caves. However, most other syncarids are interstitial dwellers or live strictly in subsurface ground water, including caves and springs (e.g., the exclusively stygobitic family Psammaspididae—*Psammaspides* spp.—particularly diverse in New South Wales, Australia and *Eucrenonaspides* spp. in Tasmania). Family Koonungidae is found in sediment interstices, open water, and sinkholes (e.g., *Koonunga crenarum* Zeidler). Family Stygocarididae (historically considered a separate order) is represented by fewer than 10 species assigned to four genera: *Oncostygocaris*, *Parastygocaris*, *Stygocarella*, and *Stygocaris*. These tiny species inhabit interstitial waters in epigeal and hypogean environments in New Zealand and South America.

**Superorder Peracarida** Crustaceans placed into this superorder demonstrate a trend toward reduction of the carapace. They possess one (rarely two to three) maxillipeds; gills are thoracic or abdominal; unique thoracic coxal endites (oostegites) form a ventral brood pouch or marsupium in females; they lack true larval stages; the young hatch as manca, a prejuvenile stage lacking the last pair of thoracopods; pleopods lack appendix interna; and the telson is without caudal rami.

This highly successful group of malacostracans (approximately 11,000 species) is divided into 10 orders; all but the Lophogastrida have known subterranean species (Table I). Most are marine but many occupy freshwater and terrestrial habitats. Peracarids are diverse in their habits and size, ranging from a few millimeters to 44 cm in length and some are symbionts as well as stygobionts.

The Spelaeogriffacea order is limited to fresh ground-water habitats in South Africa, South America, and Western Australia (Gondwana plates). This group was initially represented by a single species, *Spelaeogriffus lepidops* Gordon, which was described from pools and a stream in Bats Cave, Table Mountain (now known from a second cave), South Africa, where it was observed swimming swiftly using rapid undulations of the body. Evidence suggested that it feeds largely on detritus. In 1987 and again in 1998 two monotypic genera were described, one from a lake in a freshwater cave in Brazil (*Poticoara brasiliensis* Pires—now known from

two other caves) and the other from the Millstream aquifer in arid northwestern Australia (*Mangkurtu mityula* Poore & Humphreys).

These small, blind, unpigmented stygobionts possess a short, saddle-like carapace fused with the first thoracomere and, anteriorly, produced into a broadly triangular rostrum; they have one pair of maxillipeds; pereopods 1 through 7 are simple, biramous, with shortened exopods; the exopods on pereopods 1, 2, and 3 are modified for producing currents, and on pereopods 4 through 7 they are modified as gills; the abdomen is elongated, often exceeding half of the total body length; and pleopods 1 through 4 are biramous and natatory and pleopod 5 is reduced.

Order Thermosbaenacea is a group of small (2- to 5-mm), aquatic crustaceans that have a short carapace fused with the first thoracic somite (remaining seven thoracic segments free) extending posteriorly over two to three additional segments. In females, the carapace provides a brood pouch; there is a single pair of maxillipeds; pereopods are biramous, simple, and lack epipods; there are two pairs of uniramous pleopods; the uropods are biramous; and the telson is free or forms a pleotelson with the last pleonite.

At least 33 stygobitic species have been assigned to seven genera and four families (one additional species of *Limnosbaena* not formally described) (Table V; see Wagner, 1994, for a revision of the order). They are known from anchialine habitats, caves, cenotes, various interstices, cold springs, thermal springs (45°C), and wells in fresh, to oligohaline, to hypersaline waters. These tethyan relicts demonstrate a very large geographic range in those areas once covered by the shallow Tethys Sea or along its former coastlines.

Order Mysida is represented by some 1000 species that are widespread over all continents where they inhabit coastal and open ocean waters as well as continental fresh waters and various groundwater habitats. Some species are intertidal and burrow into the sand during periods of low tides; most of these shrimplike crustaceans swim with the aid of thoracic exopods and are omnivorous suspension feeders that eat algae, zooplankton, and suspended detritus. They range in length from approximately 2 mm to 8 cm and display a well-developed carapace covering most of the thorax. Compound eyes are stalked, sometimes reduced; they have one to two

TABLE V Occurrence of Subterranean Thermosbaenaceans

Family	Genus	Species	Occurrence
Halosbaenidae	3	5	Caves, marine interstitial
Monodellidae	2	24	Anchialine, artesian wells, brackish wells, caves, coastal springs, interstitial, phreatic, thermal springs, wells
Thermosbaenidae	1	1	Thermal springs
Tulumellidae	1	3	Anchialine caves, caves, cenotes
Total	7	33	

TABLE VI Occurrence of Described Subterranean Mysids (Order Mysida)

Family	Genus (subgenus)	Species	Occurrence
Lepidomysidae	2	10	Anchialine, caves, crab burrows, interstitial, phreatic, prawn culture field
Mysidae	16	28	Anchialine, caves, coral reef caves, land crab burrows, marine caves
Stygiomysidae	1	7	Anchialine, caves, phreatic
Total	19	45	

pairs of maxillipeds not associated with cephalic appendages; the abdomen is elongated; pereopods are biramous although the last pair is sometimes reduced; pleopods are reduced or modified; and the statocyst is usually located in each uropodal endopod.

Of the two suborders, only the Mysida has stygobitic representatives and is divided into four families, three of which have stygobitic and stygophilic species (Table VI). At least 45 stygobitic species are recognized, most of which are endemics. The current distribution of the majority of these suggests that most colonized ground waters as a consequence of uplifting and stranding of their marine ancestors, which resulted from regressions of the Tethys and Mediterranean seas. Clearly other taxa have invaded ground waters more recently, most being stygophiles. Adaptations for subterranean existence seem to be limited to reduction or loss of body pigments (red pigments often retained) as well as reduction or loss of eyes but not eyestalks that contain endocrine organs.

Mictaceans are stygobitic crustaceans, lacking body pigmentation and without visual elements in reduced eyestalks. The head narrows anteriorly into a triangular rostrum and is fused posteriorly with the first thoracomere. The carapace is not developed but small lateral carapace folds produce a head shield laterally covering bases of mouthparts; gills are lacking; pereopods are simple; pleopods are reduced and uniramous; and uropods are biramous, with two to five segmented rami.

A recent revision of the order Mictacea has resulted in it being monotypic (Table I). The single species, *Mictocaris halope* Bowman & Iliffe, assigned to the family Mictocarididae is known from four marine caves on Bermuda. This small species (up to 3.5 mm in total length) swims, using exopods of thoracopods 2 through 6, and rarely rests or walks on the substrate. Mouthparts suggest that it is not a predator but probably procures food by scraping and/or filtering fine particulates from the water column and benthos.

Order Bocheusea is the most recently established peracarid order, which was erected to accommodate three species placed in two genera belonging to the family Hirsutiidae (initially placed in the order Mictacea; two deep-sea benthic species: *Hirsutia bathylis* Sanders, Hessler, & Garner off

Surinam in northeast South America, and *Hirsutia sandersetalia* Just & Poore from Bass Strait, Australia). With additional material it became clear that a new order, Bochusaceo, should be erected to house the hirsutiids. Additionally, a third species, *Thetispelecaris remex* Gutu & Illiffe (Table I), from three marine/anchialine caves in the Bahamas, was placed in the order. Although similar to the mictaceans, the bochusaceans possess different pereopod forms, among other features. They too are swimmers and filter feeders; pereopod 1 is specialized for feeding and not for locomotion.

The Amphipoda order is characterized by the absence of a carapace; the body is divided into head, thorax, and abdomen, each bearing appendages; the head bears two pairs of antennae; it has a single pair of maxillipeds, seven pairs of uniramous pereopods, with the first, second, and often others modified as chelae or subchelae; pereopodal coxae are expanded as lateral side plates; gills are thoracic; the abdomen consists of two regions of three segments each, an anterior pleon with pleopods, and posterior urosome with appendages modified as uropods; and the telson is free or fused with the last urosomite. This group of crustaceans is generally slender and laterally compressed although some are dorsoventrally flattened (e.g., *Heterophlias*). They range in length from 1 mm to giant deep ocean benthic forms reaching 25 cm.

Amphipod crustaceans are commonly found in numerous aquatic ecosystems around the globe where they have invaded freshwater, brackish, and marine environments, often comprising a large portion of the biomass in a habitat. A few species also dwell in various terrestrial ecosystems (Talitridae; e.g., supralittoral sandy beaches, moist forest litter) and they exhibit a great diversity of feeding strategies including carnivory, herbivory, parasitism, scavenging, and suspension feeding. Approximately 7000 species are assigned to three suborders: Gammaridea, Caprellidea, and Hyperidea. Stygobiont amphipods are known only from the very large (>5700 species) Gammaridea suborder where some 778 troglomorphic species are assigned to approximately 150 genera and 29 families (Table VII). The following families demonstrate the richest subterranean biodiversity: Bogidiellidae, Crangonyctidae, Hadziidae, Melitidae, and Niphargidae. The amphipod suborder is widespread globally with the greatest taxonomic diversity of troglomorphic species occurring in eastern and southern North America, the Caribbean/West Indian region, central and southern Europe, and the Mediterranean region. These stygobionts evolved from surface ancestors, moving into hypogean ground waters from both freshwater and marine environments involving both active and passive dispersal.

Order Isopoda is quite a diverse group with more than 11,000 described aquatic and terrestrial species. They inhabit nearly all environments where most are free living yet some are partly (Flabellifera) and others are exclusively (Epicaridea) parasitic. Their feeding habits extend from herbivores to

omnivorous scavengers, detritivores, predators, and parasites. They range in length from about 0.5 mm to 4.4 cm (the largest is the benthic *Bathynomus*). This diverse group of crustaceans is dorsoventrally flattened; they lack a carapace; the first thoracomere is fused with the head; they have a single pair of maxillipeds and seven pairs of uniramous pereopods, which are modified as ambulatory, natatory, or prehensile limbs; pleopods are biramous and modified as natatory or for gas exchange (gills in aquatic taxa, pseudotracheae in terrestrial Oniscidea); and the telson is usually fused with pleonites 1 through 6.

Representatives of subterranean isopods are known from six suborders: Phreatoicoidea, Anthuridea, Microcerberidea, Flabellifera, Asellota, Calabozoidea, and Oniscidea (Table VIII) and are global in distribution.

Suborder Phreatoicoidea is the most ancient group of isopods and is derived from marine ancestors. These isopods currently are restricted mostly to fresh waters of South Africa, Australia, India, and New Zealand. Most are epigean; however, stygobitic species (11 species in eight genera), known from caves and wells, are extant on all of these continental Gondwana fragments except South Africa.

Anthuridea is principally a marine group consisting of four families; however, at least 19 troglomorphic species assigned to two families and three genera dwell in the interstitial sediments of anchialine habitats, bays, beaches, caves, and wells in the Canary Islands, the Caribbean and Indian Ocean islands, Indonesia, Mexico, New Zealand, and South America.

The Microcerberidea consist of two families. The Atlantasellidae is represented by a single species, *Atlantasellus cavernicolous* Sket, which is restricted to anchialine caves in Bermuda. Clearly its recent origin is from marine stock. The Microcerberidae are slender, stygobionts of which approximately 63 species in six genera inhabit interstices of caves, marine beaches, and wells in the coastal regions of southern and western Africa, southeastern Asia, the Caribbean, Indian Ocean islands, Japan, the Mediterranean, and western North America.

Suborder Flabellifera is represented by 18 families, only 2 of which have subterranean members: Cirolanidae and Sphaeromatidae. The predominantly marine family Cirolanidae has species dwelling in subterranean environments ranging from fresh water to salinities near that of seawater. Approximately 92 species assigned to 29 genera are currently recognized and range from less than 3 mm in length (*Arubolana parvioculata* Notenboom) to around 33 mm [*Speocirolana bolivari* (Rioja)]. Most are blind, lack body pigments, are somewhat convex dorsally, and are opportunistic, benthic scavengers and predators. Their geographical distribution includes east Africa, the western Atlantic, and North America. (Cave and phreatic habitats are occupied by *Speocirolana* in Mexico and Texas, and by *Antrrolana* and *Cirolanides* in Virginia and West Virginia, and Texas, respectively.)

TABLE VII Occurrence of Subterranean Amphipods (Suborder Gammaridea)

Family	Genus	Species	Occurrence
Allocrangonyctidae	1	2	Caves: United States (Missouri, Oklahoma)
Aoridae	1	1	Marine interstitial: Ile de Batz (Atlantic Ocean)
Bogidiellidae (including Artesiidae)	23	110	Caves, hyporheos, interstices of sandy beaches and sublittoral sands, cold mountain springs, wells: nearly worldwide (not from continental Africa south of equator, continental Australia)
Calliopiidae	3	3	Ground water, springs: New Zealand (North and South islands)
Crangonyctidae	6	150	Caves, springs, wells: Holarctic region (mostly North America)
Gammaridae	17	37	Caves, springs, wells: Canary Islands, Eurasia, Mediterranean region, North America, Solomon Islands
Hadziidae	26	78	Caves: Australia; southern Europe; Bahamas, Caribbean, Fiji, Hawaiian islands; Mexico; United States
Hyalellidae	2	2	Caves: Australia, Brazil, Venezuela
Hyalidae	1	3	Subterranean freshwaters: Comores and Zanzibar islands (off coast of eastern Africa)
Ingofiellidae	3	37	Caves, interstitial (marine), springs, wells: Africa, Caribbean and Mediterranean regions, South America
Liljeborgiidae	1	1	Marine cave: Bermuda
Lysiannasidae	1	1	Anchialine cave: Galapagos Islands
Melitidae	23	54	Anchialine, caves, freshwater and marine interstitial and wells: Australia; Balearic, Canary, Caribbean, Galapagos, Hawaiian, Pacific, and Philippine islands
Metacrangonyctidae	2	14	Hyporheos, springs, wells: Canary Islands, Mediterranean region
Metaingolfiellidae	1	1	Well: Southern Italy
Neoniphargidae	1	1	Shallow groundwaters: Victoria and Tasmania (?), Australia
Niphargidae	8	221	Caves, hyporheos, interstitial, wells: Asia, Europe
Paracrangonyctidae	2	3	Interstices, wells: Chile, Kerguelen Island (in Indian Ocean), New Zealand
Paramelitidae	9	10	Caves, groundwater habitats: South Africa; Western Australia, southern Victoria, and Tasmania, Australia
Pardaliscidae	2	3	Anchialine caves: Bahamas, Galapagos, Lanzarote, Turks and Caicos
Perthiidae	1	1	Caves: Southwestern Australia
Phreatogammaridae	2	2	Caves, wells: South Australia, New Zealand (South Island), Spain
Pontogeneiidae	1	2	Cave: Japan
Plustidae	2	3	Freshwater caves and wells: Japan
Pseudocrangonyctidae	2	11	Caves, springs, wells: Northeastern Asia
Salentinellidae	2	14	Freshwater and brackish water caves, hyporheos, wells: Mediterranean region of northern Africa and southern Europe
Sebidae	1	2	Artesian well: Texas (Hays County)
Sternophysingidae	1	8	Caves, springs: Southern Africa
Talitridae	3	3	Caves: Corsica, Isla de la Palma (Canary Islands), Kauai (Hawaiian Islands), Sardinia
Total	148	778	

The Sphaeromatidae is mostly a marine group with four genera of stygobionts represented by 43 species inhabiting subterranean waters in southern Europe and 8 species in hot springs in the southwestern United States and north-central Mexico. The very diverse genus *Monolistra* (at least 35 species) occupies karst waters along the Dinaride and Italo-Dinaride systems.

The Asellota are divided into a number of superfamilies (not treated herein) and nine families have subterranean representatives. The family Asellidae is a large benthic group (about 18 genera and 260 species) that is found primarily in caves, springs, and wells in northwestern Africa, Europe, Japan, and Central and North America. The Stenasellidae represent an ancient group that demonstrates primitive characters and that are blind and often orange or pink in

body color. At least 67 are assigned to 10 genera and these crustaceans inhabit caves, the hyporheos, cool and thermal springs, and wells in much of Africa, southeastern Asia, eastern, southern, and western Europe, Indonesia, Malaysia, Mexico, and the Edwards Plateau in North America. The small, monotypic Stenetriidae isopod is known only from mixohaline waters in a cave on Curacao. The Janiridae is represented by 13 species assigned to five genera of marine origin. They are known from caves, springs, and wells in east Asia, western Europe, Italy, Japan, and North America (California). Microparasellidae are small, quite diverse (79 species in four genera), and widespread. They are known from eastern Asia, Australia, the Caribbean, Indian Ocean islands, Japan, and the Mediterranean. The Paramunnidae is represented by a single species inhabiting subterranean

TABLE VIII Taxonomic Treatment of Subterranean Isopods

Suborder	Family	Genus	Species/subspecies
<b>Phreatoicoidea</b>	Amphisopidae	3	5
	Nichollsidae	1	2
	Phreatoicoidea	3	4
Total	3	7	11
<b>Anthuridea</b>	Anthuridae	1	15
	Paranthuridae	2	4
Total	2	3	19
<b>Microcerberidea</b>	Atlantasellidae	1	1
	Microcerberidae	6	63
Total	2	7	64
<b>Flabellifera</b>	Cirolanidae	29	92
	Sphaeromatidae	4	51
Total	2	33	143
<b>Asellota</b>	Asellidae	18	260
	Stenasellidae	10	67
	Stenetriidae	1	1
	Janiridae	5	13
	Microparasellidae	4	79
	Paramunnidae	1	1
	Gnathostenetroididae	3	6
	Protojaniridae	4	9
Total	8	46	436
<b>Calabozoidea</b>	Calabozoidae	1	1
Total	1	1	1
<b>Oniscidea</b>	Armadillidae	–	–
	Armadillidiidae	–	–
	Berytoniscidae	–	–
	Cylistidae	–	–
	Eubelidae	–	–
	Ligiidae	–	–
	Mesoniscidae	–	–
	Oniscidae	–	–
	Philosciidae	–	–
	Plathyarthridae	–	–
	Porcellionidae	–	–
	Scleropactidae	–	–
	Scyphacidae	–	–
	Speleaeoniscidae	–	–
	Styloniscidae	–	–
	Trachelipidae	–	–
	Trichoniscidae	54	–
Total	17	99	276
GRAND TOTAL	35	196	950

waters. Although the genus *Munnogonium* currently contains seven species, only *M. somersensis* Kensley inhabits a marine cave in Bermuda and shows no obvious troglomorphic adaptations. The gnathostenetroidid isopods are small crustaceans of marine origins and the six species distributed evenly over three genera demonstrate a disjunct distribution in anchialine caves in the Caicos and Turks islands and Bermuda (the eyed *Stenobermuda*), an anchialine cave in the Bahamas (*Neostenetroides*), and the intertidal zone in Japan and a thermal spring on Ischia, a small coastal island southwest of Naples, Italy (*Caecostenetroides*). Nine species belonging to four genera are assigned to the Protojaniridae family and are quite separate

from other members of the Asellota suborder. They are found in subterranean fresh waters in South Africa, Argentina (South America), southern India, islands of the Indian Ocean, and Namibia.

The monotypic suborder Calabozoidea [Calabozoidae (*Calabozoa pellucida* Van Lieshout)] is known only from wells in the environs of the small town of Calabozo in northern Venezuela. This transparent, blind isopod appears to be restricted to phreatic waters.

The suborder Oniscidea is generally a terrestrial group (e.g., *Sinoniscus cavernicolous* Schultz, China) characterized by extreme reduction of the first pair of antennae and by biramous pleopods modified into pseudotracheae. Most members of the suborder are trogllobites yet some are stygobites; some 276 aquatic and terrestrial species assigned to 99 genera and 17 families are recognized. Examples of aquatic species are *Abebaioscia troglodytes* Vandel from the Nullarbor Plain, Australia; *Haloniscus searlei* Chilton, a scyphacid from Australia in lakes up to 159 parts per thousand; the styloniscid, *Thailandoniscus annae* Dalens, from Thailand; and the trichoniscid *Mexiconiscus laevis* (Rioja), which is terrestrial as a juvenile and aquatic as an adult.

The order Tanaidacea is known worldwide from benthic marine habitats and only a few species live in brackish or nearly fresh water. They often dwell in burrows or tubes and are known from all ocean depths. Approximately 850 species are recognized and, being small (0.5–2 cm long), many are suspension feeders, some detritivores, and others are predators. The carapace is fused with the first two thoracic segments; the first and second thoracopods are maxillipeds, with the second one being chelate; and thoracopods 3 through 7 are simple, ambulatory pereopods.

Very little is known about subterranean species, mostly due to very minimal sampling. Currently six species, assigned to the families Apeudidae and Anarthruridae, are known from anchialine/marine caves in Bermuda, Eli Malk and Koror islands (Palau), and from Niue Island (South Pacific) (Table IX).

The order Cumacea is represented by rather strange-looking crustaceans having a large, bulbous anterior end and elongated posterior, a carapace that is fused to and covers

TABLE IX Occurrence of Tanaidaceans in Subterranean Habitats

Genus	Species	Occurrence
<i>Aspeudes</i>	<i>bermudeus</i>	Anchialine: Bermuda
	<i>bowmani</i>	Marine: Koror Island (Palau)
	<i>orghidani</i>	Anchialine: Bermuda
<i>Calozodion</i>	<i>propinquus</i>	Anchialine, open ocean: Bermuda
<i>Nesotanais</i>	<i>maclaughlinae</i>	Anchialine: Eli Malk Island (Palau)
<i>Pugiodactylus</i>	<i>agartthus</i>	Marine cave: Niue Island (South Pacific)

TABLE X Subterranean Cumaceans

Family	Genus	Species	Occurrence
Bodotriidae	<i>Cyclaspis</i>	<i>simonae</i>	Submarine cave: Jamaica
Diastylidae	<i>Oxyurostylis</i>	<i>antipai</i>	Submarine cave: Jamaica
Nannastacidae	<i>Campylaspis</i>	2	Blue hole: Andros Island, Bahamas; Submarine cave: Bermuda
Nannastacidae	<i>Cumella</i>	8	Anchialine: Bermuda; blue hole: Andros Island, Bahamas; submarine cave: Jamaica

the first thoracic segments, and three pairs of maxillipeds. Pereiopods 1 through 5 are simple and ambulatory, and pleopods are present in males, but usually absent in females.

They are distributed worldwide and about 850 species are recognized. These small peracarids (0.5–2 cm in length) are mostly marine (a few brackish and freshwater species) and are generally benthic. Subterranean species are not well studied and only 12 stygobionts placed in four genera and three families are known from blue holes and submarine caves on Andros Island (Bahamas), Bermuda, and Jamaica (Table X).

**Superorder Eucarida** Eucarida is the final superorder treated herein and is characterized by crustaceans having a carapace covering and fused dorsally with the head and all thoracomeres (cephalothorax); they usually have stalked compound eyes; gills are thoracic; and the telson lacks caudal rami.

Order Decapoda is the only eucarid found in subterranean environments. This order is amazingly diverse with nearly 10,000 species known from marine, brackish, freshwater, and terrestrial habitats. Although widespread in distribution, these crustaceans are significant subterranean players in temperate and tropical regions of the world dominated by karst or volcanic terrains and are well represented in the western Atlantic, Caribbean region, Central and North America, and numerous Pacific Ocean islands. They are characterized by a well-developed carapace enclosing the branchial chamber, are unique among decapods in possessing three pairs of maxillipeds, and have five pairs of functional uniramous or weakly biramous pereopods (thus the derivation of the order name). The order is split into two suborders, the Dendrobranchiata (about 450 species, mostly penaeid and sergestid shrimps) and the Pleocyemata (all remaining decapods as well as all stygobionts). The only dendrobranchiate decapod that occupies subterranean waters is a stygoxenic penaeid shrimp, *Penaeus indicus* H. Milne Edwards, found in Mangapwani Cave in East Africa. The suborder Pleocyemata contains all of the remaining decapods and is geographically widespread globally. It is commonly divided into seven infraorders, only four of which have stygobitic representatives: Caridea, Astacidea, Anomura, and Brachyura. The three remaining pleocyemate infraorders are represented in subterranean environments by the stygophilic

TABLE XI Occurrence of Stygobitic Caridean Shrimps

Family	Genus/ subgenus	Species	Occurrence
Procarididae	1	3	Anchialine
Atyidae	15	48	Anchialine; caves; cenote; coral limestone pools; saline caves, pools, and wells; wells
Agostocarididae	1	2	Anchialine, blue hole, cenote
Palaemonidae	11	28	Anchialine, caves, coral rock pools, fissures, submarine cave, subterranean water, wells
Alpheidae	6	7	Anchialine, caves, coral rock pools, lava pools, lava tube (marine), submarine cave
Hippolytidae	6	9	Anchialine, blue holes, caves, cenote, pools in coral or lava, sea cave
Total	40	97	

*Jasus edwardsii* (Hutton) from an intertidal marine cave in southeastern New Zealand (Palinura), by the stygoxenic *Stenopus spinosus* in a lava tube in the Canary Islands, by *Odontozona addaia* from a marine cave on the island of Minorca, Spain (Stenopodidea), and by a probable stygophile *Naushonia manningi* Alvarez, Villalobos, & Iliffe from an anchialine cave on Acklins Island, Bahamas (Thalassinidea).

Approximately 2000 species of natant decapods are assigned to the infraorder Caridea. These caridean shrimps have chelate first or second pereopods (no chelation in the genus *Procaris*); first pleopods are somewhat reduced; and the pleuron of the second abdominal tergite is enlarged, overlapping that of the first and third. Global in distribution, only some 97 species in 39 genera and six families are known from anchialine habitats, blue holes, caves, cenotes, springs, and wells in some temperate but mostly tropical latitudes (Table XI).

The infraorder Astacidea, which includes about 900 species of crayfishes and chelate lobsters (>500 of those are crayfishes), is global in distribution (all continents except Africa), and the first three pairs of pereopods are chelate. Crayfishes are the only astacideans that are stygobitic and, of these, only the superfamily Astacoidea is represented in the subterranean environment. Some 40 species from a single family (Cambaridae) have been described as obligate cave-dwelling species and subspecies; about 50 additional pigmented, stygoxenic, or stygophilic crayfish commonly invade subterranean waters around the globe (Astacidae, Cambaridae, Parastacidae). The following four genera are assigned stygobitic species and subspecies from Cuba, Mexico, and North America (primarily in the Appalachian, Florida Lime Sink, Interior Low Plateau, and Ozark karst regions): *Cambarus* (11 species), *Orconectes* (8 species and subspecies), *Procambarus* (20 species and subspecies), and the monotypic *Troglocambarus* (Table XII). Most of these are troglomorphic and are opportunistic omnivores.

TABLE XII North American Stygobitic Crayfish (Astacoidea: Astacoidea: Cambaridae) in the United States, Cuba, and Mexico

Genus	Subgenus	Species/subspecies	Occurrence
<i>Cambarus</i>	<i>Aviticambarus</i>	3	United States: Alabama, Tennessee
	<i>Erebicambarus</i>	<i>hubrichti</i>	United States: Missouri
	<i>Jugicambarus</i>	6	United States: Arkansas, Florida, Georgia, Missouri, Oklahoma
	<i>Puncticambarus</i>	<i>nerterius</i>	United States: West Virginia
<i>Orconectes</i>	<i>Orconectes</i>	8	United States: Alabama, Indiana, Kentucky, Missouri, Tennessee
<i>Procambarus</i>	<i>Austrocambarus</i>	5	Cuba; Mexico: Oaxaca, Veracruz
	<i>Leonticambarus</i>	1	United States: Florida
	<i>Lonnberguis</i>	2	United States: Florida
	<i>Ortmannicus</i>	11	Mexico: San Luis Potosí; United States: Florida
	<i>Remoticambarus</i>	<i>pecki</i>	United States: Alabama
<i>Troglocambarus</i>		<i>maclanei</i>	United States: Florida

Although diverse, the infraorder Anomura has only two stygobitic species assigned to two families (Table I). They possess a variably shaped carapace; the first pair of pereopods is chelate, the third pair never, and the fifth pair reduced (never used for walking), and function as gill cleaners. The pleopods are reduced or absent. The superfamily Galatheaidea is represented by two families having subterranean species: Aeglididae and Galatheaidea. *Aegla cavernicola* Türkay is a poorly studied aeglid, known only from a cave in São Paulo, Brazil. The aggressive galatheid *Munidopsis polymorpha* Koelbel has received much attention (life history and agonistic, feeding, and reproductive behaviors) and is restricted to a single cave (lava tube) and wells (marine groundwater) on Lazarote, Canary Islands.

The cephalothorax of the infraorder Brachyura (true crabs) is dorsoventally flattened and commonly expanded laterally; the abdomen is reduced, symmetrical, and flexed beneath the thorax; uropods are usually absent; first pereopods are chelate; and the males lack third, fourth, and fifth pairs of pleopods.

Approximately 7000 species are recognized, most of which are marine; however, freshwater and tropical terrestrial species occur in epigeal and hypogean habitats. At least 41 crabs assigned to 28 genera and 11 families are categorized as stygobionts (Table XIII). Additionally, the following families are represented as facultative cavernicoles in primarily tropical subterranean settings (mostly caves and anchialine habitats; numbers are approximate): Trichodactylidae (1 genus, 2 species), Xanthidae (2, 2), Potamidae (7, 9), Potamonautidae (2, 2), Pseudothelphusidae (10, 21), Gecarcinidae (2, 2), Parathelphusidae (1, 5), Sundathelphusidae (5, 5), Hydrothelphusidae (1, 1), Gecarcinidae (3, 5), and Grapsidae (5, 12).

### Bibliography

- Bernasconi, R. (1994). Suisse (Schweiz/Svizzera). In *Encyclopaedia Biospeologica*, Vol. 1 (C. Juberthie and V. Decu, eds.), pp. 809–818. Société de Biospéologie, Moulis (France) and Bucharest.
- Botosaneanu, L., ed. (1986). *Stygofauna Mundi, A Faunistic, Distributional, and Ecological Synthesis of the World Fauna Inhabiting Subterranean Waters (Including the Marine Interstitial)*. E. J. Brill, Leiden.

TABLE XIII Occurrence of Stygobitic Brachyurans

Family	Genus	Species	Occurrence
Hymenosomatidae	1	1	Caves: Indonesia
Trichodactylidae	2	2	Cave: Chiapas and Tabasco, Mexico
Goneplacidae	1	1	Caves: New Britain, Indonesia
Xanthidae	1	1	Anchialine cave: Ecuador
Potamidae	5	6	Caves: Sarawak, Borneo; Laos; Pulau Tioman, Malaysia; Thailand
Pseudothelphusidae	5	9	Caves: Belize; Chiapas, Mexico; Columbia and Venezuela, South America; Guatemala
Gecarcinidae	5	5	Caves: Sarawak, Borneo; Thailand
Parathelphusidae	1	1	Cave: Irian Jaya, Indonesia (stygophile?)
Sundathelphusidae	4	7	Caves: New Britain, Indonesia; Papua New Guinea; Philippine Islands
Hydrothelphusidae	1	1	Cave: Madagascar
Grapsidae	2	7	Anchialine, caves: Guam; Jamaica; Java, Nusa Lain Island, Indonesia; Niue Island, Polynesia; Papua New Guinea; Solomon Islands
11	28	41	

Bowman, T. E., J. Yager, and T. M. Iliffel (1985). *Speonebalia cannoni*, n. gen., n. sp., from the Caicos Islands, the first hypogean leptostracan (Nebaliacea: Nebaliidae). *Proceedings of the Biological Society of Washington* 98(2), 439–446.

Boxshall, G. A., and R. Huys (1989). New tantulocarid, *Stygotantulus stocki*, parasitic on harpacticoid copepods, with an analysis of the phylogenetic relationships within the Maxillopoda. *Journal of Crustacean Biology* 9(1), 126–140.

Culver, D. C., and Wilkens, H. (2000). Critical review of the relevant theories of the evolution of subterranean animals. In *Ecosystems of the World 30: Subterranean Ecosystems* (H. Wilkens, D. C. Culver, and W. F. Humphreys, eds.), pp. 381–398. Elsevier Press, Amsterdam.

Gutu, M., and T. M. Iliffe (1989). Description of two new species of Tanaidacea (Crustacea) from the marine water caves of the Palau Islands



- (Pacific Ocean). *Travaux du Muséum d'Histoire Naturelle Grigore Antipa* **30**, 169–180.
- Gutu, M., and T. M. Iliffe (1998). Description of a new hirsutiid (n.g., n.sp.) and reassignment of this family from order Mictacea to the new order, Bochusacea (Crustacea, Peracarida). *Travaux du Muséum d'Histoire Naturelle Grigore Antipa* **40**, 93–120.
- Hobbs, H. H., Jr., Hobbs III, H. H., and Daniel, M. A. (1977). A review of the troglobitic decapod crustaceans of the Americas. *Smithsonian Contributions to Zoology* **244**, 1–183.
- Hobbs III, H. H. (2000). Crustacea. In *Ecosystems of the World 30: Subterranean Ecosystems* (H. Wilkens, D. C. Culver, and W. F. Humphreys, eds.), pp. 95–107. Elsevier Press, Amsterdam.
- Humphreys, W. F., and Harvey, M. S., eds. (2001). *Subterranean Biology in Australia 2000*. Records of the Western Australian Museum, Supplement No. 64.
- Juberthie, C., and Decu, V., eds. (1994–2001). *Encyclopaedia Biospeologica*, Vols. 1–3. Société de Biospéologie, Moulis (France) and Bucharest.
- Martin, J. W., and Davis, G. E. (2001). An updated classification of the recent Crustacea. *Natural History Museum of Los Angeles County, Science Series* **39**, 1–124.
- Petrescu, I, T. M. Iliffe, and S. M. Sarbu (1994). Contributions to the knowledge of cumaceans (Crustacea) from Jamaica. II. Five new species of the genus *Cumella*. *Travaux du Muséum d'Histoire Naturelle Grigore Antipa* **34**, 347–367.
- Poore, G. C. B., and W. F. Humphreys (1998). First record of Spelaeogriphacea from Australasia: A new genus and species from an aquifer in the arid Pilbara of Western Australia. *Crustaceana* **71**(1), 721–742.
- Wagner, H. P. (1994). A monographic review of the Thermosbaenacea (Crustacea: Peracarida): A study on their morphology, taxonomy, phylogeny and biogeography. *Zoologische Verhandlungen (Leiden)* **291**, 1–338.
- Zinn, D. J. (1986). Mystacocarida. In *Stygofauna Mundi, A Faunistic, Distributional, and Ecological Synthesis of the World Fauna Inhabiting Subterranean Waters (Including the Marine Interstitial)* (L. Botosaneanu, Ed.), pp. 385–388. E. J. Brill, Leiden.



---

## Databases

Keith D. Wheeland

*The Pennsylvania State University, Retired*

A cave database is a collection of bits of data that describe a cave and its environment. Modern databases have been designed to be accessed by computer. These databases can be used by the general caving community to obtain, for example, a list of caves for a particular geographical area; or cave scientists might use them to obtain answers to more complex questions. The use of computerized cave databases has improved the speed and accuracy of these answers.

### BACKGROUND AND POINTS OF VIEW

Early cave databases were published in bulletin form. One of the earliest of these publications that applied to an entire state is *Pennsylvania Caves* by Ralph W. Stone published in 1930. Stone went on to edit two additional bulletins about Pennsylvania caves in 1932 and 1953. Stone, who was a charter member of the National Speleological Society (NSS), recognized the importance of assembling cave databases. In 1942, he wrote, “One of the objects of the Society is to catalogue all known caves, whether developed or undeveloped.” In 1948, Stone became the second president of the NSS. Other early databases were published in bulletin form for caves in West Virginia by W. E. Davies in 1949 and for caves in Tennessee by T. C. Barr in 1961.

With the advent of computers, some early databases were converted to computer-readable format. In 1984 a survey conducted by Jerry D. Vineyard of the Missouri Geological Survey revealed that five statewide computerized cave databases existed in the United States: Alabama, Georgia, Missouri, Pennsylvania, and Tennessee. Some of the first

computerized cave databases were designed to be stored on Hollerith punched cards containing 80 columns of data. Some of these early databases have been converted to magnetic media that still contain the 80 columns of data. Others have been designed to take better advantage of the facilities of modern computers and database management systems. Today, cave databases throughout the world may be on paper, in a home computer, or in a larger computer. Some databases are available to the public online.

The collection of data—and their subsequent conversion to computer-readable format—has often been initiated by an interested individual. Cave databases may contain a particular type of cave, saltpeter caves, for example, but usually the databases contain caves for a particular geographical area. In some cases these smaller regional databases have been consolidated into larger geographical or geopolitical areas. In some countries (Australia, for example) this has matured to the point at which a national cave database exists. And in Austria, the cave database is a cooperative effort of 22 speleological clubs with a combined 14,000 caves. In the United States, there has been very little interest in forming a national database. Until there is the need or the will for a national cave database in the United States, serious scientific use of the databases will have to be done on a regional basis. To pursue a national project in the United States, the scientist must first find and then contact each of the stewards of the regional databases. A steward is the individual or group that maintains the database and controls access to it.

### THE INTERNATIONAL UNION OF SPELEOLOGY

The International Union of Speleology (UIS) recognizes that sharing data across cave databases can be a problem. The Informatics Commission of the UIS is working on a solution to the problem. The proposed solution is to describe a file-sharing schema. A steward who receives a request from a scientist would provide the data using this go-between

schema. In theory, each database steward would have a computer program that would export data to this standard schema. The scientist who requested data from multiple database stewards would expect to receive the data in one standard format, albeit in multiple databases.

### GENESIS OF CAVE DATABASES

Usually the database process begins with an individual collecting the data to form a database. If the database collection and maintenance process is to continue after the individual has lost interest or is no longer able to maintain the database, something else must be done. This something else generally involves forming an organization to perpetuate the database. One of the important considerations the organization faces is the determination of a set of guidelines for distributing information contained in the database. Getting individuals to contribute data to a centralized database is usually dependent on the amount of trust that the individual has toward the database steward and the policy of distribution of the information.

### CAVE DATABASE ACCESS

The caving community is protective of the information that has been collected and placed into cave databases. The most important factor that shapes this protectionism is the fact that caves are fragile environments. Most stewards of cave databases will willingly share the data when they feel that the person receiving the data will act responsibly. Even in Pennsylvania, which has a long history of publishing cave locations (all of Stone's caving publications include directions for finding the caves), the sale of certain cave publications is now being restricted to persons who are presumed to be knowledgeable about cave conservation, safety, and landowner relations. Even as these publications are restricted, so too is the access to cave databases restricted.

Access to most databases is restricted in some fashion. The stewards of the databases have devised various means of restricting access. In the simple case where a single individual controls the database, it is often that individual who determines what requests for information will be honored. If the controlling entity is an organization, this becomes more complex. Guidelines are often set, and the person who handles the requests for information uses these guidelines. If a particular request for information does not fit the guidelines, the request can be referred to the board or responsible group in the organization for resolution. Table I lists the typical criteria that are often used—alone or in combination—to determine whether a request for data will be granted. The person to whom the data will be sent must meet one or more of these criteria.

Closely related to the restriction of data access is the concept of “secret” caves. For various reasons, some persons with knowledge about a particular cave do not want the

**TABLE I Database Access Criteria**

---

An NSS member, or an organization within the NSS
A conservation-related group
A researcher
Someone who has submitted data to the database
A land owner or land manager
A member of the organized caving community
A rescue group
Someone who needs the data for engineering work for road or dam building
A subscriber to the organization that sponsors the database

---

information disseminated. Some realize, however, that their “secret” cave data may be of importance for scientific research. To acknowledge this concern, database stewards have implemented various means for addressing the problem. Some of the means employed are as follows: (1) A few stewards refuse to accept data for “secret” caves. (2) Some will accept the data with the understanding that no location data will be divulged. (3) Others have devised procedures that give veto power to the person with the “secret” cave regarding release of the data.

Some databases are accessible by the public online. This type of database generally does not include specific cave-location data. Anyone needing such data can apply to the steward of the database for extended access.

Some databases do not contain cave data per se, but are still of interest to cavers. Some examples of these are databases that include information on sinkholes, springs, mines data, mineral resources, cave biota, and cave-associated diseases.

### COMPONENTS OF CAVE DATABASES

The two components of a cave database are (1) the data itself and (2) the component that accesses and maintains the data. If the database is computerized, this component is known as the software. The software may be custom designed (the Pennsylvania Cave Database is one such system) or it may be based on off-the-shelf software as in the Tennessee Cave Survey.

### DATA STRUCTURE

The modern cave databases are designed to be composed of many separate data files all linked by some common thread. These databases are called *relational databases*. This type of arrangement allows for storage efficiency and relative ease of upgrading. A simple diagram for a relational structure is shown in Fig. 1. This structure can be altered to reflect the complexity of the caves in the database. The database is really a data model of the existing reality. If the contents of the database is a collection of simple one-entrance caves, then

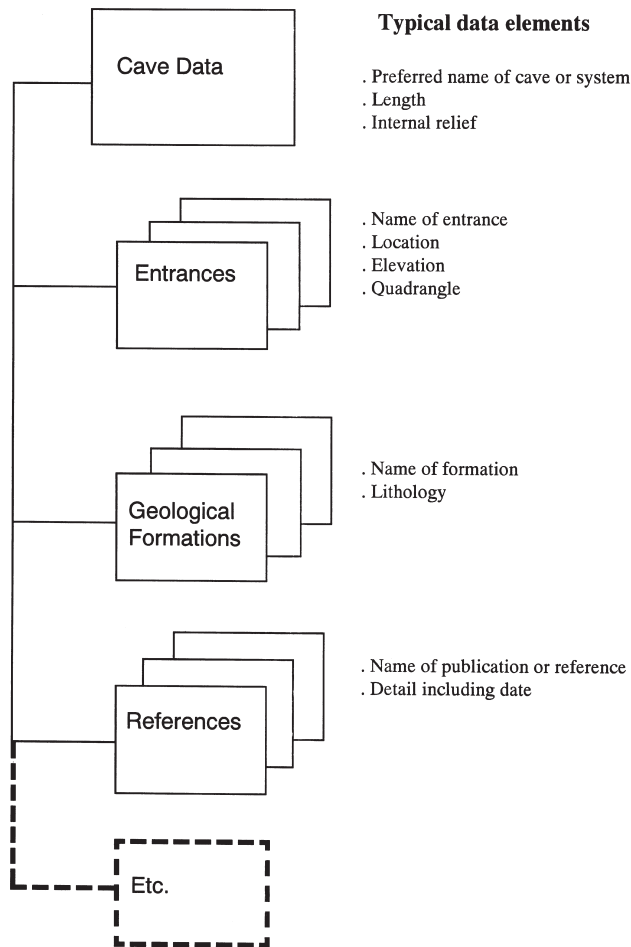


FIGURE 1 Example of a possible relational structure for a cave database.

the structure of the database would be simple. If, however, the database contains data for caves for a whole country, then chances are good that the structure of the database would be complex.

In a relational model, the various pieces of data (data elements) are usually linked by some identifier (or a group of identifiers) that is unique to the cave. This often consists of a unique number, either assigned by a person or by the computer system.

Because some caves have multiple entrances, it is desirable to associate some of the data elements with the entrance and not with the cave itself. A few databases allow for this refinement. To illustrate this point, take the example of a data element called *length*. The length is associated with the cave. The data element called *location* is associated with an entrance. There are other databases that link cave survey data with other data. In these databases it is possible to associate data elements with specific survey stations. These are but a few of the types of associations that are possible.

The inclusion of cave survey data and cave maps varies with database. Some store survey data, some store digitized

maps, while others store information describing the actual location of the map.

## CONTENTS OF CAVE DATABASES

Descriptions of cave databases are varied. There are almost as many cave database schemata as there are cave databases. One such schema is described in a publication called *Cave Inventory and Classification Systems* published by the Bureau of Land Management. More recent information regarding this schema can be found on the Internet.

Table II lists data elements that may be found in a cave database. These data elements may be associated with the entrances, with other data elements, or with the cave itself. In some cases, there may be multiple occurrences of these data elements. A particular database may contain many of these data elements; however, no known cave database has all of these data elements.

## COMPUTER SOFTWARE

Some database stewards have taken the approach of using off-the-shelf software and tailoring the software to fit their needs. Other stewards have designed systems specifically for accessing and maintaining the cave data. One such system is the Pennsylvania Cave Database. It is *menu driven*, which means that it uses extensive menus. It is also *code driven*, which means that many of the data elements have been assigned codes. For example, each county has been assigned a three-digit code to represent the name of the county. The three-digit code is stored in the database. When the county is shown on the screen or printed in a report, the county name is displayed. This approach saves storage space, is less prone to errors, and in the end is easily understood by the person reading the output. The system was designed so that new codes can be added without rewriting the software.

## STATUS AND TRENDS FOR U.S. CAVE DATABASES

Many of the states that have caves already have computerized databases, and others, like Kentucky, are in the process of organizing their regional collections into one statewide database. Many states have their own database designs, while others are using models developed by other states. For example, the states of Georgia and Alabama have adapted the Tennessee model (with some modifications) for their own databases. Some counties of Kentucky used the Pennsylvania database model. Because the Pennsylvania model has been seeded with all the state codes and county codes, and because it is code driven, it could be adapted for use in any state.

It is technically feasible to use one computer database model for every state database. This is unlikely to happen in the near future, however, because of regional preferences, politics, and the effort involved in converting the data.

TABLE II Data Elements That May Be Found in a Cave Database

Name (including alternate name/s) of the cave or entrance	Archaeology
Cave or entrance identifier	Geomorphology including sediments
Bureau of Land Management number	Mineralogy
Forest number	Cultural and historical
Monument number	Speleothems and detailed features
Specific physical location code	Air movement/barometric/chimney
County/parish	Physicochemical data
Section/range	Equipment needs to visit cave
Township	Hazards
Quadrangle	Damage assessment
Physiographic province	Potential for expansion code
Name of nearest town	Owner's name, address, phone, and e-mail
Drainage basin	Access name, address, phone, and e-mail
Open/closed status	Access policy (visitation)
Type of cave/mine	Cave-protection-sign indicator
Data restriction code	Significant list indicator
Entrance type, size, and elevation	Profile description or code
Geological formation and lithology	Passage pattern
Speleogenesis	Passage density
Cave length	Cave map
Cave length source (survey, estimate, unknown, etc.)	Cave map attributes (grade, class, quality, storage, and year)
Internal relief (vertical distance from high point to low point)	Survey data including cartographer/surveyor
Glaciated/unglaciated	Photographs
Hydrology	Dates (discovery, added to database, changed in database)
Flora and fauna	Narrative
Paleontology	References

## ADDITIONAL INFORMATION

The National Speleological Society and the Informatics Commission of the International Union of Speleology may be able to provide more details concerning the availability of cave databases for specific locations. The best way to contact the UIS is to search the Internet.

National Speleological Society  
2813 Cave Avenue  
Huntsville, AL 35810-4431 USA  
(256)852-1300; <http://www.caves.org>

### Bibliography

- Barr, T. C. (1961). *Caves of Tennessee*. Tennessee Dept. of Conservation and Commerce, Division of Geology. 64.
- Bureau of Land Management. (1983). *Cave Inventory and Classification Systems*. Bureau of Land Management, Roswell District Office, NM.
- Davies, W. E. (1949). *Caverns of West Virginia*. West Virginia Geological Survey, XIX.
- Stone, R. W. (1930). *Pennsylvania Caves*, Bulletin G3. Commonwealth of Pennsylvania Department of Internal Affairs, Topographic and Geologic Survey.

## Dinaric Karst, Diversity in

**Boris Sket**

*Univerza v Ljubljani*

### WHAT IS THE DINARIC KARST

The Dinarides or Dinaric Alps are a part of the Alpine system along the east coast of the Adriatic, the western part of the Balkan Peninsula in southern Europe (Fig. 1). In the extreme northeast of Italy and the west of Slovenia they are detached from the Southern Calcareous Alps; by a narrow belt of the so-called "isolated karst" the Dinarides cover approximately the southern halves of Slovenia and Croatia and the whole of Montenegro and western Serbia (south of Sava River). In northwestern Albania they extend to Hellenides.

The Dinaric land appeared atop the Adriatic microplate out of the sea approximately 30 million years ago as an island that separated the sea of Paratethys from the still existing

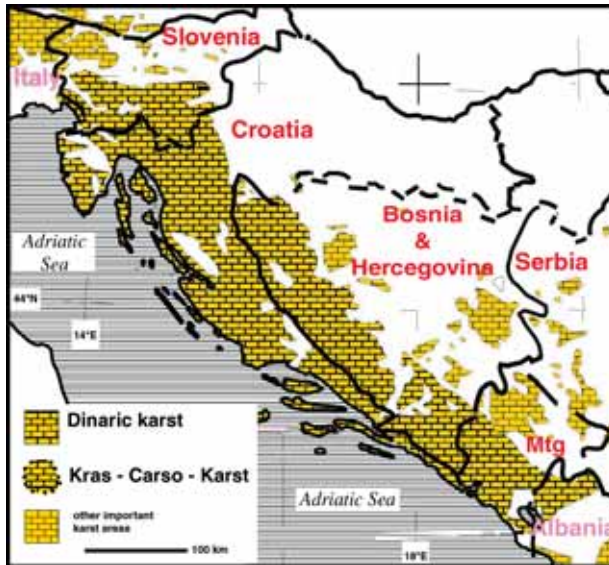


FIGURE 1 Position of the Dinaric karst. Mtg = Montenegro. (After Sket, 1997.)

narrow part of the Tethys Ocean. Its flora and fauna originated and developed in comparative isolation from the rest of Europe. After orogenic faulting and erosion of the flysch layer, karstification began—most probably at the end of the Pliocene. It caused the origin of cave habitats, hydrographic changes, and splintering of many biotic distribution areas.

Tropical or subtropical climates during the Tertiary were followed by intermittent glaciations in the Pleistocene. However, the closest extensive glacier in the region was in the Julian Alps in northwestern Slovenia, whereas in the Dinarides proper, only some of the highest peaks were glaciated. The dry land extended during the last glacials far south into today's Adriatic Sea, enabling the biota to move away from their former proximity to the coldest points. It has been supposed that after glaciations, 10,000 years ago, the whole Dinaric karst, except for its highest elevations and a narrow coastal strip, before man's impact, had been covered by extensive forests.

Man started to colonize the territory (Sket, 1997) at least by the end of the Riss glacial or 65,000 years BP. With the onset of agriculture and animal husbandry (Mesolithic, 10,000–4300 B.C.), more forest clearing occurred. Illyric tribes depended primarily on domestic animals, migratory grazing (transhumance), and storage of hay. Wintering of large herds caused higher pressure on forests' existence. The Copper to Iron Ages (3000–200 B.C.) meant additional forest devastation for mining and the primitive metallurgy. In the Halstatt period, southern Slovenia was already quite densely inhabited. Grave constructions testify to the existence of bare grounds in Lika (Croatia) in 500 B.C. and at the coast in Bronze and Roman times. Up until 60 years ago, before the reforestation started to be successful, very large parts of the Dinarides were barren rock or nearly so. The

measures that are responsible for a comparatively green karst sites nowadays were the introduction of the Austrian pine (*Pinus nigra*) for reforestation, a ban on goats, and a remarkable reduction in the human population in karst areas; the population moved to the towns and to developing industrial centers and to the fertile fields of the Pannonian Plain.

Today's Dinaric karst extends to more than 56,000 km<sup>2</sup>; it is an approximately 100-km-wide and 600-km-long belt between the Adriatic Sea and the northeast hills and plains. It includes most Adriatic islands and drowned caves below sea level, and reaches some peaks having 2000-m elevations. Mountain ridges generally run parallel to the Adriatic coast (northwest–southeast). One of the specific characteristics of this karst are *poljes*, which are large, closed, periodically flooded depressions, typically without a surface in- and outflow.

Thick carbonate layers, mainly Triassic limestones (but also dolomites and limestones of other ages), are highly porous; in the approximately 7000-km<sup>2</sup> area of the Dinaric part of Slovenia only, more than 4900 caves have been registered and investigated.

In the outer Dinarides (toward the Adriatic) the climates are Mediterranean or sub-Mediterranean. The mean yearly temperatures are between 12° and 17°C. Precipitation is about 1000–2000 mm/yr, but is unevenly distributed and more than 50% in the cold half-year; this causes regular droughts in summer and washing away of soil in winter. The climate of the inner Dinarides is more continental and cooler and there is less precipitation. The nonfluctuating temperatures of underground habitats approximately equal mean yearly temperatures of the region, which are at 8–16°C higher than winter temperatures even in subtropical regions. The floods in rainy periods cause some temperature fluctuations and enrich the underground with fresh food resources.

The comparatively isolated position of the Dinaric territory along with its tropical past and very dynamic geomorphologic changes allowed development of a very diverse flora and fauna. This is attested by the fossil molluscan faunas of Pliocene–Pleistocene lakes as well as by the diversity of survivors. The territory's position on the edge of formerly glaciated regions allowed it to be a refuge for thermophile elements during the Pleistocene. Particularly useful refuges are the thermally conditioned hypogean habitats, where animals are not exposed to unfavorable winter temperatures.

## COMPOSITION AND DIVERSITY OF SUBTERRANEAN FAUNA

### History

If we except the timely remote and isolated first mention of a cave fish in China in 1540, a series of zoological discoveries in caves started in the extreme northwest part of the Dinarides. The amphibian *Proteus anguinus* was first mentioned by Valvasor in 1689 and scientifically described

by Laurenti in 1768; however, it was first seen in a cave in 1797. The next was the most unusual cave beetle, found by the local cave worker Luka Čeč in the famous Postojna Cave, described by Schmidt in 1832 as *Leptodirus hochenwartii*. These and a great number of other discoveries in the 19th century were in the Kras (= Carso = Karst) of Slovenia, which gave its name to the geomorphologic phenomenon of the *karst*. Discoveries of cave animals in other parts of the world (first in the Caucasus, Appalachians, Pyrenees, and New Zealand) occurred in the middle of the century, and in other parts of the Dinarides even toward its end. Thanks to such a history, the “classical Karst” won the appellation of the “cradle of speleobiology (biospeleology).” Hamann’s (1896) book *Europäische Höhlenfauna*, which even at that time already cited 400 references, was still devoted mainly to the cave species from Slovenia.

The most recent census of the Dinaric obligate subterranean fauna (Sket *et al.*, 2004) revealed more than 900 species, 600 terrestrial troglobionts, and 330 aquatic stygobionts. If we compare this to 930 and 420 troglobionts and stygobionts in the whole of North America, the importance of such numbers is evident. Among regions of approximately the same size class in the world, the Dinaric karst is by far the richest in the obligate subterranean fauna. This does not seem to be a consequence of the state of investigations. To the troglobionts, one should add some regularly occurring troglaphiles and troglaxenes as well as a high number of normal surface animals (“accidentals”) that occasionally, but with a higher or lower regularity, happen to occur in caves.

### Terrestrial Cave Fauna

By far the most diverse group of troglobionts is beetles, represented by more than 200 species. This should not cause wonder, because Coleoptera are by far the richest animal group in the world; nevertheless, its representation underground is very biased; it is represented mainly by members of only two families. In addition, the other insect groups—which are still extremely diverse on surface—are hardly represented underground at all. The most important in Dinaric caves is the family Cholevidae with its subfamily Leptodirinae (known also as Catopidae: Bathysciinae). Approximately 175 species are distributed in as many as 50 genera. Although this is originally an edaphic (i.e., soil-inhabiting) group, only a few cave-inhabiting species are not specialized to the cave habitat. And only few Dinaric genera are not endemic to this region: The troglaphilous *Phaneropella lesinae* Jeannel exhibits a transadriatic distribution and its congeners occur also far in the Asia Minor. The edaphic and troglaphilous *Bathyscia montana* Schioedte may serve as an archetype of leptodirines: It is less than 2 mm long, egg shaped, with short legs and antennae. Some troglobionts are similarly built, but most of the others attained different degrees of troglomorphism. They are regularly bigger and at least slightly elongated.

The higher troglomorphic species may be *pholeuonoid*, which means that they have a spindle-shaped abdomen and a neck-shaped prothorax. Such a species include *Parapropus* spp. in the northwestern part of the Dinarides; similarly shaped cave beetles may occur also in other karst regions (such as *Pholeuon* in Romania). Only in the Dinaric karst have the beetles attained the highest, i.e., the *leptodiroid*, degree of troglomorphism. In the name-giving *Leptodirus hochenwartii* Schmidt from Slovenia and Croatia, the legs and antennae are extremely elongated, the “neck” is nearly cylindrical, and high vaulted elytrae make the abdomen egg shaped or nearly globular. Of similar shape are more than 25 member species of the genus *Antroherpon* in the southeastern part of the Dinaric karst. The high number of species probably indicates the effectiveness of such a body transformation. Nowhere else in the world has this group of beetles achieved such diversity as in the Dinaric caves.

The other beetle group in Dinaric caves is the family Carabidae with 12 genera and 80 troglaphilous species of its subfamily Trechinae. The carabid beetles in surface soil are predators; they are twice as big and longer legged than their scavenger cholevid neighbors. The northwestern *Anophthalmus* spp. or the southeastern *Neotrechus* spp. are, however, larger, more slender, and with longer appendages than the epigeal or troglaphilous *Trechus* spp. Some other troglobionts such as the *Aphaenopsis* spp. are even more troglomorphic, but this transformation never reached the degree it has in cholevids. The Dinaric Trechinae are also less exceptional; their diversity is approached by other cave faunas, such as those in North America. To the same family, but its subfamily Pterostichinae, belong also two comparatively large, approximately 10-mm-long species of *Laemostenes*; although also living outside caves, they are worth mentioning because they are present in nearly all caves in the whole Dinaric karst and far outside it.

The family Pselaphidae is represented by only 20 troglaphilous species. These are tiny beetles with very slender thoraxes and wide abdomens with shortened elytrae. They too were originally soil-dwellers. The related extensive family Staphylinidae, with a nearly tap shaped body with very short elytrae, resulted in the Dinarides in no troglaphilous species, but a number of species occur as troglaphiles or occasional guests in the entrances of the caves. Examples include some tiny species of *Atheta* and some larger *Glyptomerus* spp. Some tiny weevils (Curculionidae) are also known from Dinaric caves. Some species of the genus *Trogloorrhynchus* are often regarded as troglobionts. However, they depend on tree roots that are not as common and extensively developed in karst caves as they are in lava tubes, shallow underground. *Trogloorrhynchus* spp. are in fact, as soil inhabitants, merely guests in caves.

Most troglaphilous beetles in Dinarides are eyeless and have reduced hind wings but no one is really pigmentless; although translucent, most are dark brown, whereas some are yellowish brown in color. Although carabid beetles are more

or less evenly distributed along the Dinaric area, the specific cholevids become more diverse toward the southeast of it; the southern Herzegovina, with neighboring parts of Croatian Dalmacija and Montenegro by far being the richest.

The next richest groups of troglobionts are the spiders and false scorpions. The genus *Troglohyphantes* is very characteristic among spiders (Araneae). Its small representatives of mostly less than 4 mm in body length span their small sheet webs either in the forest litter, in micromammalian burrows (they are *microcavernicole*), in entrance parts of the caves, or deeper in them. Only the latter are mostly pigmentless and eyeless; there are approximately 25 troglobiotic species. In contrast, the always more than 5-mm-long spiders of the family Dysderidae hunt without webs. Among 25 species of seven mainly fully troglobiotic genera belongs the first scientifically described cave spider *Stalita taenaria* Schioedte. These are shiny brown to orange in the cephalothorax and legs and dirty white on the abdomen. Not less than seven families are represented by troglobiotic species in the Dinarides. The most strange might be the family Anapidae; its species *Pseudanapis relicta* Kratochvil from Montenegro measures only 1.4 mm in length and its relatives are very far away.

Similarly numerous are false scorpions (Pseudoscorpiones), which, however, are less diverse, representing only three families, which have similar body shapes. The most specialized troglobiotic species are those with extremely slender and elongated pincers on the second pair of appendages and an up to 8-mm body length. They are very different from their relatives that inhabit forest soil. *Neobisium spelaeum* Schioedte was the first species described from caves.

The other groups represented by troglobiotic species are (in descending order) millipedes (Diplopoda), woodlice (Isopoda: Oniscidea), snails (Gastropoda), centipedes (Chilopoda), harvestmen (Opiliones), and planarians (Turbellaria: Tricladida). Remarkable millipedes are species of the genus *Apfelbeckia* that are most probably troglophile or even troglaxene. At approximately 10 cm they are the largest European millipedes. During the hot and dry Mediterranean summers, they are found only at the entrances of caves, giving those rooms a sweetish scent because of their defense glands. Among snails, widely distributed are tiny species of *Zospeum*, a genus, present also in the Alps and Pyrenees; they are about 2 mm high, ovoid, and shells may be seen on wet walls or may be washed out of the earth from the bottom. In the southeastern parts of the Dinarides, bigger shells may be seen, such as those of *Aegopis spelaeus* A.J. Wagner, which can be up to 20 mm in diameter. The pigmentless species of terrestrial planarians from Slovenia has not yet been described.

Like everywhere, bats are an important troglaxene group of cave inhabitants. However, very large colonies hardly exist anymore—nowadays, a colony of 1000 specimens represents a very high number. One such year-round cave species is the long-fingered bat [*Myotis capaccinii* (Bonaparte)]. The most

often seen species, but usually only in small numbers, are the different species of horseshoe bats (*Rhinolophus* spp.). Bats are important vectors of food resources between the surface and the underground. Individuals of other mammal species may also be present deep in caves, including the rodent, the edible dormouse [*Glis glis* (Linne)], which was first scientifically described just from the beech forests of the Dinarides, and some martens [*Martes foina* (Erxleben)]. No birds enter the totally dark parts of Dinaric caves. However, the twilight areas near the entrances used to be common nesting places for large colonies of rock dove (*Columba livia* Gmelin), giving a number of caves the name Golobina, Golubinka, etc. (*golob* or *golub* is the Slovene or Croatian name for a pigeon or dove). Unfortunately, their populations have been heavily decimated or dispersed by hunters. On the other hand, groups of feral pigeons joined their wild relatives in some caves.

### Aquatic Subterranean Fauna

As is generally true throughout the world, by far the prevailing group in Dinaric hypogean waters is the crustaceans (Sket, 1999). Peculiar, however, to the Dinarides is their richness in snails (Gastropoda); therefore, we discuss them first here.

With approximately 130 species, the Dinaric aquatic gastropods represent close to half of the world's known stygobiotic snail fauna. They are also a very common appearance in Dinaric cave waters and their empty shells may accumulate in more or less pure piles some meters long (thanatocenoses). Nearly all of them belong to the group Hydrobioidea whose formal subdivision is still highly changing. These are snails of a discoid, conical, to nearly rod-shaped shell, with a simple or highly elaborated, earlike mouth and a smooth to strongly ribbed whirl. The mostly 2-to 3-mm-high shells are approximately twice as big as those of their North American relatives, which is a difficult to explain curiosity. The shells of *Hadziella* species (from the northwest Dinarides) are flat; *Hauffenia* are mostly widely conical, *Iglica* are very slender (*iglica* in Slavonic languages means "small needle"); the *Lanzaia* and *Plagigeyeria* spp. from the southeast exhibit very diversely ornamented, ribbed shells with elaborate mouths. A member of pulmonate snails (Pulmonata: Ancyliidae) is the generalist, genetically/cytologically diverse and therefore widely distributed species *Ancylus fluviatilis* O.F. Mueller with a cap-shaped shell without a spiral. It may be present also in caves and such a cave population might be clinaly (gradually) troglomorphized: Skin pigmentation gradually disappears and eyes become more and more reduced along the sinking stream in the Postojna-Planina Cave System. *Acroloxus tetensi* (Kuščer), with a similarly cap-shaped shell, is a stygobiotic species of Acroloxidae.

Among crustaceans, the most numerous are copepods and amphipods, with approximately 60 species each. Of



amphipods (Amphipoda), not less than 45 species are of the genus *Niphargus*. This is one of the most diverse genera of the group, spread over almost all of Europe (and in Iran and Arabian Peninsula in Asia). It inhabits all freshwater habitats, including forest ditches, brooks, caves, and interstitial waters. Specimens of different species may be 2 to 30 mm long and extremely diverse in their body shapes. However, all of these species are absolutely without eyes. The same variability span is achieved in the *Niphargus* species of the Dinarides. One of the smallest species, *N. transitivus* Sket, inhabits interstitial and karst waters in the extreme northwest. The slender and up to 20-mm-long *N. stygius* (Schioedte), the type species of its genus, inhabits mainly percolation waters in Slovenia; the very stout and large *N. orcinus* Joseph and its relatives are spread throughout larger cave water bodies along the Dinaric karst. Particularly interesting is the particularly long-legged *N. balcanicus* (Absolon) with a densely spiny neck, from Herzegovina. The related *Niphargobates orophobata* Sket from the epikarst zone in Slovenia has the only close relative in the Greek island of Kriti (Crete). Another relative of *Niphargus*, *Carinurella paradoxa* (Sket), which inhabits interstitial waters within the northwest Dinaric karst, is able to roll into a ball. The up to 25-mm-long and stout *Typhlogammarus mrazeki* Schaeferna is an omnipotent raptor that can catch a shrimp swimming or climb up a vertical wall with a thin layer of water. The extremely fragile *Hadzia fragilis* S. Karaman has particularly numerous relatives in the Mediterranean and in the Caribbean. It is a mainly anchihaline species but a few populations are present in continental freshwaters.

Copepods (Copepoda) are represented by some generalist and a number of specialized species, with a particularly numerous number coming from the genera *Diacyclops* and *Acanthocyclops*. Cyclopoids are particularly richly represented in larger bodies of water, where they may even be accompanied by the explicitly planctonic diaptomids (Calanoida: Diaptomidae); four Dinaric cave species is an enormous number for freshwater Calanoida. Harpacticoids are particularly well represented in the epikarstic percolation waters. Their genera *Elaphoidella* with 20 and *Parastenocaris* with 15 species are the leading groups and numbers are still growing.

Isopoda are not numerous, but are very diversely represented. The asellids (family Asellidae) are represented by the troglomorphic races of *Asellus aquaticus* (Linne) and by some troglomorphic *Proasellus* species. Very characteristic is the rich group of aquatic pill-bugs *Monolistra* (family Sphaeromatidae), some of them with long spines on their backs. The largest isopods are cirolanids (Cirolanidae) *Sphaeromides*, distributed close to the Adriatic coast but without any known ecological or historical connection to the sea. The water fleas (Cladocera), with only three tiny (less than 0.5-mm-long) stygobiotic *Alona* species, again are relatively very richly represented.

Thermosbaenacea are represented by an anchihaline coastal species, *Monodella halophila* S. Karaman, and a

freshwater species *Limnosbaena finki* Meštrov & Lattinger. The decapod shrimp belong to the family Atyidae; they are very common in Dinaric caves, the most widely distributed "species" *Troglocaris anophthalmus* (Kollar) is likely to be split into a number of independent species.

Also worth mentioning are 13 epizoic to parasitic species of Turbellaria Temnocephalida, living mainly on atyid cave shrimp. Besides these stygobiotic species, only one epigeic species has been known from Europe, again from the same region.

Three species of true filter feeders should be mentioned, because these types of animals are very rare in caves. Besides some troglophilic species the only stygobiotic freshwater sponge (Porifera: Spongillidae), *Eunapius subterraneus* Sket & Velikonja, inhabits Dinaric caves near Ogulin (Croatia); it is of a softer consistency than the surface species and forms only few gemmulae. The only stygobiotic clam (Bivalvia: Dreissenidae), *Congeria kusceri* Bole, is similar to and related to the well-known zebra clam; it fastens itself to rocks by means of byssal threads. The only stygobiotic tube worm (Polychaeta: Serpulidae), *Marifugia cavatica* Absolon et Hrabe, fastens itself to rocks with its less than 1 mm wide calcareous tubes. Particularly interesting is that generations of tubes may accumulate to build meter-thick tufa-like layers. Ecologically similar is also the only stygobiotic cnidarian (Hydrozoa: Bougainvilliidae), *Velkovrhia enigmatica* Matjašič et Sket. A colonial species, it attaches to the substratum by means of stolons, with sessile medusoids still distinctly developed.

The only stygobiotic vertebrate in Europe is the usually approximately 20-cm-long cave salamander *Proteus anguinus* Laurenti. Its distribution area is holodinaric with some localities in the small Italian part of the Dinaric karst and with the extreme southeastern locality reportedly in Montenegro. At present, two subspecies are formally described, although this does not match its whole diversity. All proteus populations exhibit outer gills, only three toes on the first legs, and two on the hind legs. The holodinarically distributed troglomorphic race *P. a. anguinus* has a more or less colorless skin and an elongated head with reduced eyes, hidden below the skin. The nontroglomorphic *P. a. parkelj* Sket & Arntzen is limited to a tiny area in the extreme southeastern part of Slovenia. It is very darkly (sometimes black) pigmented, has normally developed eyes, and varying body proportions. However, both races are obligate cave-dwellers and both come out of springs on some nights.

In the central and southern parts of the Dinaric karst, a number of endemic cyprinid fishes (Pisces: Cyprinidae) with small distribution areas are present. Most of them are known as regular periodical colonizers of caves, leaving the open waters of poljes before the retreat of the water and appearing again soon after a flood. They were observed to do both directions of migrations actively, not because they were directly forced to do so by hydrological events. In ancient times some species were economically important; special

constructions were placed in caves to catch them in masses since they were a highly prized export article of the otherwise poor karst regions. A number of species belong to the genus *Phoxinellus* that exhibit different degrees of scale reduction; *P. alepidotus* (Heckel) possesses only a few scales along the lateral line. The others are *Leuciscus* and small *Chondrostoma* spp.; taxonomically the most diverse species is *Aulopyge huegelii* Heckel.

## BIOGEOGRAPHICAL PATTERNS IN THE DINARIC UNDERGROUND

### Widely Spread Taxa

Species or species groups may inhabit very different, wide areas within the Dinaric karst or—in a few cases—beyond it. The latter may be particularly instructive, possibly explaining to us the noncontiguous distribution areas of even highly specialized cave species. Such is the case with the isopod *Asellus aquaticus* (Linne), amphipod *Synurella ambulans* (F. Mueller), and the gastropod *Ancylus fluviatilis*. They are highly generalist species of approximately European distribution that penetrate underground particularly along sinking rivers. In the Dinaric karst, some cave populations of these species became troglomorphic and stygobiotic. Similar but less well known is the situation with some generalist cyclopoid copepods.

Probably a result of a similar situation in the past is the recent distribution of the cave shrimp *Troglocaris*; relatives of a handful of Dinaric species are present in France in the West and in Georgia (Gruzija) in the East. Among terrestrial animals, such are the gastropods *Zospeum*, a genus reaching from the southeastern Dinarides far into the Pyrenees.

### Holodinaric Distribution

Also the holodinaric distribution of some taxa may be a consequence of multiple (i.e., polytopic and/or polychronous) immigration with subsequent extinction of surface populations. In some cases, the immigration was followed by speciation; in other cases, the whole Dinaric area seems to be inhabited by a homogeneous species (or a group of still unrecognized sibling species). In all such cases, the species (or genus) is never contiguously spread over the Dinaric area; it is instead split into groups of populations in hydrographically isolated karst areas. Such a distribution exhibits the most unique cavernicolous representatives of their higher groups: the amphibian *Proteus anguinus*, the clam *Congeria kusceri*, the tubeworm *Marifugia cavatica*, and the cnidarian *Velkourhia enigmatica*. Other cases are particular representatives of bigger groups, e.g., one gastropod species, *Zospeum amoenum* (Frauenfeld), the spider *Parastalita stygia* (Joseph), and most probably some *Niphargus* species whose taxonomy has not yet been well studied.

### Merodinaric Distribution Pattern

The northwestern elements are, e.g., the monotypic beetle genus *Leptodirus*, the flat hydrobioid snails *Hadziella*, and the monolistrine (Isopoda) subgenus *Microlistra*. Their approximate counterparts in the southeastern Dinaric area are numerous leptodiroid species of the genus *Antroherpon*, hydrobioid snail genera *Lanzaia* and *Plagigeyeria*, and the isopod subgenus *Pseudomonolistrina*. No explanation for this bipolarity of the continental Dinaric cave fauna has been presented until now.

A paralittoral distribution is exhibited by the anchihaline amphipod *Hadzia fragilis* S. Karaman, the thermosbaenacean *Monodella halophila*, and in a big part of the belt also the amphipod *Niphargus hebereri* Schellenberg. These predominantly anchihaline species are not present in the brackish subterranean waters of the Kvarner Gulf, which was inundated by the sea only during the Pleistocene times; this shows us clearly that the paralittoral distribution pattern has a historic—not purely ecological—background.

### Smaller Distribution Areas

Most species and subspecies, but also some genera, exhibit smaller distribution areas within one of the merodinaric areas. The most interesting fact is that these areas do not for the most part follow the recent hydrological divides. One species (or subspecies) may either cross the borders of a divide or may be limited to a part of the drainage area. This has been more properly studied for species of the isopod genus *Monolistrina* and of some hydrobioid snails. It has been supposed that such distribution areas had been achieved in geologically past drainage areas (sometimes still prekarstic, on the surface) and maintained by competition between related species today. Most small distribution areas are not specifically explainable; they may be either relics of a formerly wider area or results of locally limited immigrations underground. A number of animal species is known from only one locality, either a cave or a spring; the most striking is the mysid *Troglomysis hercegovinensis* Stammer from only one “lake” in the vast cave system of Vjetrenica in Herzegovina, in the well-investigated area of Popovo Polje.

### Endemism

Only a negligible number of obligate subterranean species cross the borders of the Dinaric region. Such is the case of some amphipods, snails and beetles crossing the slightly indistinct border between the Dinaric and South Alpine regions, and such is the case of some copepod species, which may even exhibit wider distribution areas. On the other hand, also comparatively high is the endemism between regions within the Dinarides. At the moment, the only distribution data for administrative regions (states) that are at hand, definitely do not reflect the natural biogeographical

units. Nevertheless, the number of endemic species is mostly 40–60%, sometimes even much higher. Consideration of nominal subspecies would increase the endemism remarkably as has been studied in some large genera, while even a number of endemic genera exists, scattered to different taxonomic groupings; they are particularly numerous in the cholevid beetles. Only 5 of the 44 present cholevid genera are not endemic for the Dinaric karst and at least 23 genera seem to be endemic for one of the states (Slovenia, Croatia, or Bosnia and Herzegovina). Because political borders are crossing regions with homogeneous faunistic assemblages, the endemism degree would certainly be much higher in natural biogeographic provinces.

### HOT SPOTS WITHIN THE HOT SPOT

In this highly biodiverse area, some systems have particularly rich cave faunas. When searching for caves with more than 20 obligate cave inhabitants, 20 such caves or cave systems were traced and as many as 6 of them were in the Dinaric karst (Culver and Sket, 2000). The Postojna-Planina Cave System is, with 84 such species, the richest among them. The system consists of 17- and 6-km of passages connected by 2 km of flooded corridors not yet mastered by cavers. The dry parts of the Postojnska jama is one of the oldest (since 1818) and most famous tourist caves in the World, with a small railway in it; some parts of the system are used extensively by tourists, but there are still many “wild” parts that are rich in fauna. This is the type locality for a number of “first cave” animals, including the first described troglobiont, the beetle *Leptodirus hochenwartii*, the first cave spider *Stalita taenaria* Schioedte, and many others. Altogether nearly 60 animal species or subspecies were first found and described from this system, and the European cave salamander, *Proteus anguinus*, was first seen in its natural habitat in Črna jama in 1797. It is also a site of long-term ecological studies. Dry parts of the system are inhabited by 35 species, 9 of which are beetles. There are 49 stygobiotic species; particularly numerous are crustaceans, snails, and oligochaetes. The main artery of the system is the sinking river Pivka, which sinks at the Postojnska jama and resurges in the Planinska jama; there is approximately 10 km of underground bed in between. A mixed fauna of stygobiotic, stygophile, and stygoxene species inhabits it. The last ones are mainly insects; aquatic larvae of some of them are present along the course. Populations of some stygophile species exhibit a clinal (gradually) increased troglomorphy along the stream. These caves are in Slovenia, which is the richest in the world for aquatic subterranean fauna. The next four richest caves are also in Slovenia: Križna jama, Logarček, Šica-Krka System, and Grad.

In Herzegovina, which is the richest area in the world for terrestrial fauna, evidence is growing that a number of additional caves will be catapulted to the status of the richest ones. Until now, only Vjetrenica in Popovo Polje, with more

than 70 species was registered. This complex cave system has 7.6 km of passages, which include a number of small streams, pools, and trickles of water. The surface animals are very few here. There is no sinking stream, but water jets after rains import organic debris through crevices and shafts by which the rich fauna is being fed. The most recent census shows 40 species of stygobionts and 35 terrestrial troglobionts. Among stygobionts there are 10 species of amphipods, some of which are very large, and three species of decapod shrimps. There are nine species of beetles. Particularly noteworthy are the amphibious catopid beetle *Hadesia vasiceki* (J. Mueller) and the amphipod *Typhlogammarus mrazeki* Schaeferna, which occupy the hygropetric (described below).

### SPECIAL ASSEMBLAGES

In an area with such a high number of faunal elements and, therefore, comparatively high pressure for interspecific competition, one can expect further ecological specialization of species. Therefore, besides a number of more or less “trivial” communities and synusiae, composed of species that sometimes merely by chance are locally combined, a small number of characteristic groupings with particular ecological demands or abilities exist.

*Ice caves* are scattered all over the area. They are usually sack shaped and surrounded by forest in moderately higher elevations and may bear ice deposits during the whole year. Particularly wet soil with close to zero temperature is the ecological characteristic of the proximity of such a subterranean glacier in summer. This environment is usually particularly rich in troglobiotic and troglophilic Coleoptera (e.g., *Nebria* spp.). However, the highly troglomorphic leptodirine beetles of the genus *Astagobius* seem to have specialized to such an environment.

The *cave hygropetric* is a rocky wall, usually sintered, overflowed by a thin layer of slipping water. A number of leptodirine beetles seem to be specialized for climbing in such a semiaquatic environment and collecting organic particles brought by water. All of them—although not closely related—have a pholeuonoid body shape, with very strong claws, and with a particularly hairy mouth apparatus. The best known representative of such beetles is *Hadesia vasiceki* J. Muller. These obligate inhabitants may join some nonspecialized semiterrestrial or semiaquatic guests using such environments as hunting grounds or simply as distribution paths.

A number of aquatic and probably some terrestrial species are nearly limited to the percolation-water-filled, *crevice systems*, also known as *epikarsts*; however, such species are primarily found in percolation-water-fed rimestone pools or puddles on cave walls or bottoms. Morphologically adapted to such narrow places seem to be the harpacticoid copepods of the genera *Parastenocaris* and *Elaphoidella* in particular, while the tiny amphipod *Niphargobates* exhibits strong and curved legs and claws appropriate for climbing in less narrow crevices.

*Thermal waters* are a trophically particularly inhospitable environment. They force higher metabolism intensities and, because they are purified as they make their way through greater earth depths, they offer little food and little oxygen. In hypothermal waters of 15–28°C on the northwestern edges of the Dinaric karst, some stenasellid isopods, like a thermophile race of *Protelsonia hungarica* Mehely and tiny gastro-pods *Hadziella thermalis* Bole, are present. In Slovenia, close to the Pleistocene Alpine glacier, stenasellids are present only in such an environment. It seems, in fact, that biota are limited to trophically less inhospitable springs, because the filtration of huge quantities of water from depths gave no results.

*Sinking streams* are streams that, after some course on the surface, flow underground. The subterranean bed of a sinking stream is in fact an ecotone environment. Ecological conditions in them are more fluctuating, are food resources richer and more diverse than in “autogenous” waters. Some surface species may penetrate along such streams for shorter or longer stretches underground. Among them are adaptation-prone stygophile species such as *Asellus aquaticus*. Along such a subterranean bed, a rich assemblage of selected surface and subterranean animals is formed; the fauna changes its quantitative and qualitative composition with gradual ecological changes leaving the sinking point and the surface influences. Although some stygobionts, e.g., *Troglocaris* shrimp and even *Proteus* and some *Niphargus* spp., find such a rich environment particularly inviting, others strictly avoid it. On the other hand, this is the only cave environment where a number of insect larvae (of Ephemeroptera, Plecoptera, and Trichoptera) may be present.

## POLLUTION AND PROTECTION

A number of threats face the Dinaric cave fauna. In the 19th and early 20th centuries, some animals had been caught in large numbers for trading purposes. The amphibian *Proteus anguinus* was reportedly a popular pet in parlor aquaria, while the rare cave beetles won high prices among amateur entomologists-collectors. Some dealers organized genuine chains of collectors all along the Dinaric karst. Because they were using baited traps they were potentially able to affect some populations.

In the decades of economic development of the traditionally poor and economically passive Dinaric karst after the Second World War, a number of hydrotechnical projects have been accomplished. Surface and underground dams and artificial tunnels changed the hydrology of some parts of the Dinaric karst remarkably. We may expect that some previously isolated populations-races might come in contact and fuse again or at least that some populations were “polluted” by repeated input of foreign genes. New competition assemblages may have formed, threatening the existence of some species. The hydrological regime of the underground in wide surroundings of those constructions definitely changed, changing also the living conditions (and

sometimes threatening the existence) of cave populations and species. For example, the live deposits of the *Marifugia*-tufa with its builder and many interstitial guests are now dead, due to the lack of regular floods in Popovo Polje and the sinkcave Crnulja. This unique phenomenon will be—or already has been—destroyed.

Of course, the most serious threat to the cave biota is the omnipresent and diverse pollution. The net-shaped underground hydrological connections make the direction of pollutant outflows unpredictable and their effect very wide reaching. In the case of the sinking river Pivka, a moderate amount of organic pollution may enable surface animals to increase their success in competitive situations to the detriment of stygobionts. In this way, pollution may indirectly extinguish cave faunas. However, spills of generally poisonous materials are not a rare event in the karst and only the fact that such spills are also detrimental to the precious resource of potable water allows us to efficiently protect the subterranean fauna.

However, as early as 1920, the Section for Nature and Natural Monuments Conservation of the Slovene Museum Society wrote and published a memorandum that outlined a very complete and detailed nature conservation plan. Beside the Alpine sites and biota, one of its main subjects was specifically karst caves as a whole as well as the particularly interesting cave fauna. A paragraph about a total ban on the commercial exploitation of cave fauna was included, saying that it should only be exploited for scientific and educational purposes. This was—very generally—realized in 1922. This early attempt at nature protection, initiated in a high degree by cave fauna, has been now followed by a number of species protection acts and other environmental legislation in all Dinaric countries. So, the legal background for the many-sided protection of this hot spot exists—but so do many practical hindrances for its practical implementation.

## Bibliography

- Culver, D. C., and B. Sket (2000). Hotspots of subterranean biodiversity in caves and wells. *J. Cave Karst Studies* 62(1), 11–17.
- Gottstein-Matočec, S., T. Bakran-Petricioli, J. Bedek, D. Bukovec, S. Buzjak, M. Franičević, B. Jalžic, M. Kerovec, E. Kletečki, J. Kralj, P. Kružić, M. Kučinić, M. Kuhta, N. Matočec, R. Ozimec, T. Radja, V. Štamol, I. Ternjaj, and N. Tvrković (2001). Croatia. In *Encyclopaedia Biospeologica*, Vol. 3 (C. Juberthie and V. Decu, eds.), pp. 2237–2287. Moulis, Bucharest.
- Sket, B. (1997). Biotic diversity of the Dinaric karst, particularly in Slovenia: History of its richness, destruction, and protection, Special Publication 3, pp. 84–98. Conserv. Prot. Biota of Karst, Karst Water Institute.
- Sket, B. (1999). High biodiversity in hypogean waters and its endangerment—the situation in Slovenia, Dinaric karst, and Europe. *Crustaceana* 72(8), 767–779.
- Sket, B., K. Paragamian, and P. Trontelj (2004). A census of the obligate subterranean fauna in the Balkan Peninsula, In: H. I. Griffiths and B. Krystufek (eds.). *Balkan Biodiversity. Pattern and Process in Europe's Biodiversity Hotspot*. Kluwer Academic Publishers B.V. (in print).
- Naše Jame—Our Caves* 35(1).
- Valvasor, J. W. (1689). *Die Ehre des Herzogthums Crain*. W. M. Endtner, Nuerinberg.

# Diversity Patterns in the Tropics

Louis Deharveng

*Museum National d'Histoire Naturelle de Paris*

## HISTORICAL CONTEXT

Until the 1980s all authors who worked on cave fauna stressed that true subterranean animals were rare or absent in the tropics (Leleup, 1956). Why would animals develop adaptations to an environment that is, at least in the humid tropics, so similar to the outside environment in its weak thermal amplitude and high humidity? This idea was actually based on data collected in a few tropical caves, mainly from Malaysia (Batu Caves) and India (Siju Caves), where sampling strongly focused on the widespread guano habitats. As early as 1914, however, Jeannel and Racovitza mentioned that troglobites were rare but diversified in tropical caves. The first unambiguous evidence that a rich troglobitic community might exist in the tropics was drawn by Howarth (1973) from the study of Hawaiian subterranean fauna. Since then, the richness of troglobites in tropical caves has been largely confirmed in other parts of the world (Chapman, 1980; Humphreys, 1993; Gnaschini and Trajano, 1994; Deharveng and Bedos, 2000).

## TROPICAL SUBTERRANEAN HABITATS

The intertropical belt has an ecological definition that roughly matches its geodesic limits (i.e., between 23°27'N and 23°27'S; Fig. 1). Tropical climates, ranging from desert to hyperhumid areas, and from lowland to nival belt, can be characterized by a low thermal amplitude across seasons. This characteristic is also, along with darkness, the most

prominent feature of a cave climate. Caves appear, therefore, as azonal habitats, and this may account for the frequent “deconnection” between their fauna and outside fauna.

The subterranean environment encompasses various habitats which can be grouped in six categories according to the size of the voids available for the fauna and the presence of either freshwater, brackish water, or air in these voids: interstitial freshwater, interstitial anchialine, interstitial terrestrial (traditionally not dealt with in subterranean habitats, but with soil habitats), cave freshwater, cave anchialine, and cave terrestrial. Guano represents a special high-energy terrestrial habitat that is widespread in tropical caves and well characterized faunistically.

All of these habitats host characteristic assemblages, but only limestone caves and lava tubes have been significantly sampled worldwide. The spectacular landscape and the huge caverns of tropical karsts have attracted cavers and biologists during the last two decades; the large amount of data they accumulated constitute the core of our present-day knowledge on subterranean tropical fauna.

## STATE OF OUR KNOWLEDGE—AND GAPS

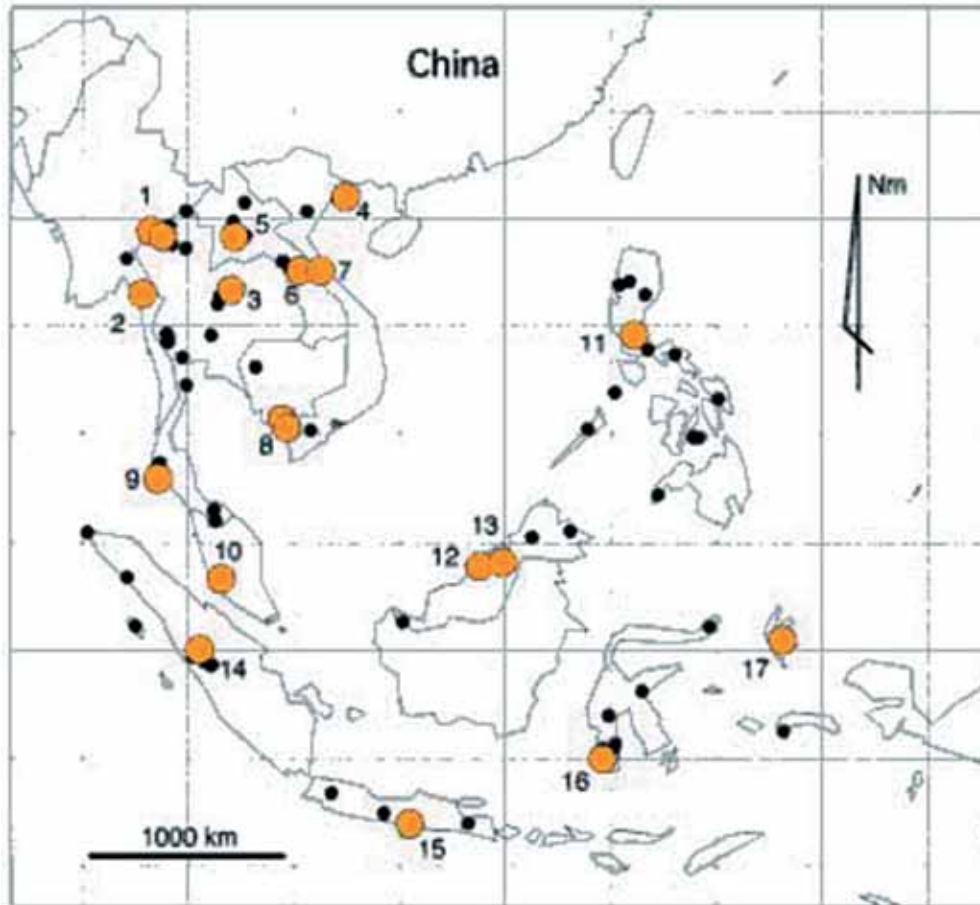
During the last two decades, a number of troglobites and stygobites have been discovered in most sampled tropical areas. In addition, evidence is growing that many guanobitic species, though not or poorly troglomorphic, might be restricted to subterranean habitats as well. Data, however, remain scarce and uneven. For instance, among the many caves sampled in Southeast Asia, very few have been investigated in detail (Fig. 2).

Freshwater and anchialine interstitial habitats have been rather extensively sampled in the Neotropics (Iliffe, 1994), but poorly investigated in Southeast Asia, where only 11 interstitial species are described compared to about 50 cave-restricted aquatic species.

Noninterstitial freshwater stygobites are more easily caught and have been relatively well studied in several



**FIGURE 1** Main documented hot spots (in orange, more than 10 obligate subterranean species) and cold spots (in blue, less than 10 obligate subterranean species) of tropical subterranean biodiversity. Anchialine and interstitial habitats excluded. Gray lines: limits of the tropical regions; red line: equator. Cave systems cited in Tables I and II as circles; others as triangles. (After Juberthie and Decu, 1994, 2001.)



**FIGURE 2** Main records of obligate subterranean species in Southeast Asia. Large yellow spots: best studied localities, with usually more than four obligate subterranean species; small black spots: isolated records, usually one or two species. 1: Tham Chiang Dao and Mae Hong Son karsts; 2: Farm caves; 3: Tham Phulu; 4: Ha Long Bay; 5: Vang Vieng; 6: Khammouan; 7: Ke Bang; 8: Hon Chong-Kompong Trach; 9: Phangnga; 10: Batu caves; 11: Montalban; 12: Niah cave; 13: Mulu; 14: Gunung Seribu; 15: Gunung Sewu; 16: Maros; 17: Batu Lubang. (After Deharveng and Bedos, 2000, updated.)

tropical regions, such as Cuba and Thailand. Conversely, data are lacking for many of the major karsts of the tropics, such as those of central and northern Vietnam.

A number of anchialine stygobitic species have been described from tropical America. In contrast, only two or three species are known in Southeast Asia, though several groups frequent in neotropical caves have been recently discovered there (Juberthie and Decu, 1994, 2001).

Our knowledge of troglobites is also geographically and taxonomically uneven. Sarawak caves probably have the largest number of named troglobites, but no Collembola or microarthropod has ever been described from there. In contrast, Collembola are among the best studied troglobites in Thailand, with 16 described species. Guanobites, especially small Arthropods, are poorly known, and their ecological status often pending. Even the giant Rhaphidophrid crickets of Southeast Asia, at the base of cave food webs, remain unnamed in most cases.

More generally, most of the species listed in the literature are still undescribed. For instance, of the 21 troglobites cited

from the SKT system (Sulawesi) by Deharveng and Bedos (2000), only 4 are described species.

### EMERGING BIODIVERSITY PATTERNS

The unbalanced sampling of tropical caves and the uneven identification level of their fauna result in an immensely heterogeneous amount of data being available for deriving biodiversity patterns. Trends begin nevertheless to emerge:

1. Species richness of tropical subterranean habitats varies from place to place, but is never very low or null as in northern temperate regions affected by glaciations. All large caves investigated so far in Southeast Asia hosted, for instance, at least a few cave-restricted species.

2. At a continental scale, diversity appears higher for terrestrial fauna in the Oriental and Australian regions than in the Neotropics or Africa (Table I). This puzzling observation seems to be confirmed by recent works on Brazilian cave fauna, though the work might be biased by the

TABLE I Biodiversity and faunistic composition of some well-studied tropical caves, including the main regional hot-spots (more than 10 troglobites and stygobites).

	SKT System (SUL)	Ngalau Surat (SUM)	Gua Air Jernih (MAL)	Tham Chiang Dao (THA)	Batu Lubang (HAL)	Areias system (BRA)	Tham Non (LAO)	Tham Thon de Caguanes (LAO)	Cueva Grande de Cima cave (CUBA)	Alambari de Cima cave (BRA)	Kulumuzi cave (TAN)	Siju caves (ASS)	Batu Caves (MAL)	Olhos d'Agua cave (BRA)	Farm caves (MYA)	Niah Cave (SAR)	Great Cave (SAR)
Mollusca		1									1						
Hirudinea		1															
Arachnida		1															
Acari		1		1	1	1	1	1	1	1	1	1	1	1	1	1	1
Araneae	3	2	4	2	4	1	2	2	1	1	1	1	1	1	1	1	1
Opilionida	1	1	1	1	1	1	1	1	1	1	1	1	1	1	1	1	1
Palpigradida	1	1	1	1	1	1	1	1	1	1	1	1	1	1	1	1	1
Pseudoscorpionida	1	1	1	1	1	1	1	1	1	1	1	1	1	1	1	1	1
Schizomida	1	1	1	1	1	1	1	1	1	1	1	1	1	1	1	1	1
Scorpionida																	
Myriapoda																	
Chilopoda																	
Diplopoda Glomerida																	
Diplopoda Julida	1	1	1	1	1	1	1	1	1	1	1	1	1	1	1	1	1
Diplopoda Polydesmida	2	2	2	1	2	3	2	2	2	2	1	1	1	1	1	1	1
Diplopoda Stermiulida																	
Crustacea	3	3	1	2	3	2	2	1	1	1	1	2	1	1	2	2	2
Isopoda Oniscidea	2	2	1	2	2	3	1	2	1	1	1	1	1	1	1	1	1
Entomobryomorpha	1	1	1	1	1	1	1	1	1	1	1	1	1	1	1	1	1
Poduromorpha																	
Symphyleona	1	1	1	1	1	1	1	1	1	1	1	1	1	1	1	1	1
Campodeidae	1	1	1	1	1	1	1	1	1	1	1	1	1	1	1	1	1
Nicoletiidae																	
Blattodea	1	1	1	1	1	1	1	1	1	1	1	1	1	1	1	1	1
Coleoptera Catopidae																	
Coleoptera Carabidae	1	1	1	1	1	1	2	1	1	1	1	1	1	1	1	1	1
Coleoptera Pselaphidae																	
Dermaptera																	
Hemiptera																	
Hymenoptera Formicidae																	
Orthoptera	21	17	13	15	15	13	6	6	6	6	10	7	4	4	4	1	1
Troglobites	1	1	1	1	1	1	1	1	1	1	1	1	1	1	1	1	1
Turbellaria																	
Mollusca																	
Crustacea																	
Amphipoda (Bogidiellidae)	1	1	1	1	1	1	1	1	1	1	1	1	1	1	1	1	1
Copepoda																	
Decapoda Anomura (Aeglidae)																	
Decapoda Brachyura	1	1	1	1	1	1	1	1	1	1	1	1	1	1	1	1	1
Decapoda Nantia	3	3	1	1	1	1	1	1	1	1	1	1	1	1	1	1	1
Isopoda Anthuridae																	
Isopoda Oniscidea																	
Isopoda Stenasellidae	1	1	1	1	1	1	1	1	1	1	1	1	1	1	1	1	1
Ostracoda																	
Syncairida																	
Pisces	1	1	1	1	1	1	1	1	1	1	1	1	1	1	1	1	1
Stygobites	7	3	5	1	1	3	0	1	5	4	0	1	3	3	0	2	2
Troglobites + stygobites	28	20	18	16	16	16	16	16	11	10	10	8	7	7	4	3	3

ASS: Assam; BRA: Brasil; HAL: Halmahera; LAO: Laos; MAL: Malaya; MYA: Myanmar; SAR: Sarawak; SUL: Sulawesi; SUM: Sumatra; TAN: Tanzania; THA: Thailand.

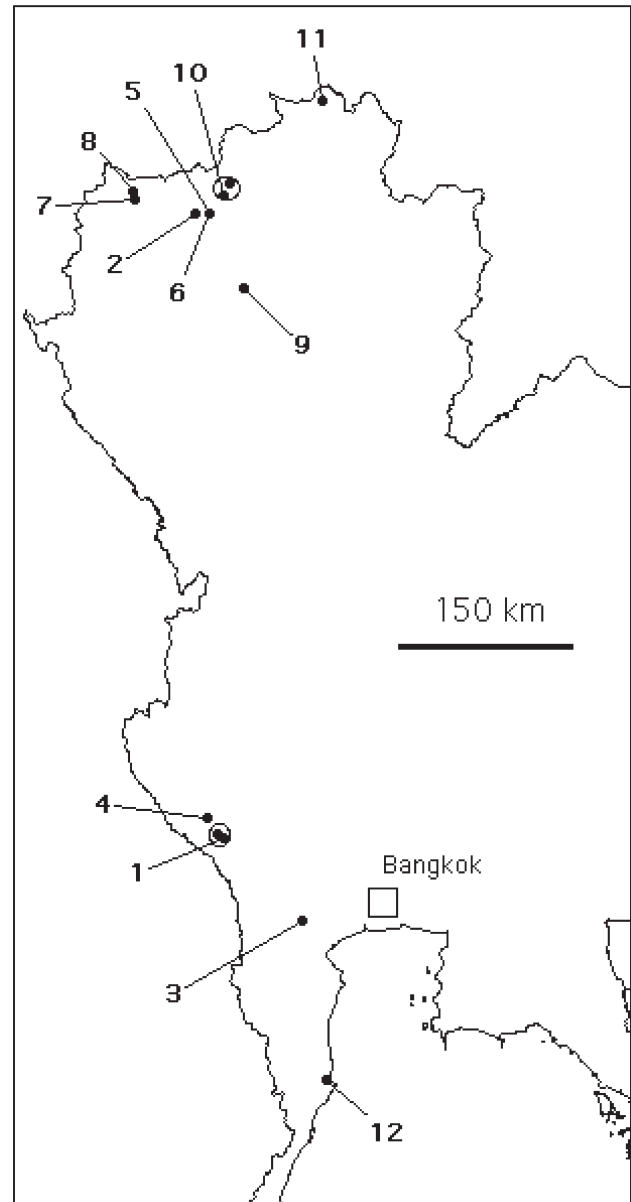
size of the sampled karst units. A different pattern emerges for stygobites, with highest richness in anchialine caves of tropical America and Australia, but here the sampling effort might explain much of the difference.

3. Large karsts tend to be richer in troglobites than smaller karsts. Statistically, they should have a wider diversity of habitats for a comparable spatial configuration. Thus in Sarawak, Gua Air Jernih in the Mulu karst has much more cave-restricted species than the Niah cave in the small isolated hill of Gunung Subis (Table I).

4. "Most diversity in caves is expressed regionally rather than locally" (Culver and Sket, 2000, p. 16). This point is directly linked to the impact of habitat fragmentation on speciation. The few available data suggest that this impact might be stronger in tropical than in temperate regions, for a similar spatiohistorical fragmentation of the habitat. This is illustrated by the example of the Paronellid Collembola of western Thailand (Fig. 3). Spiders seem to exhibit a similar pattern, with each karst unit having its endemic species (Deeleman-Reinhold, 1995).

5. As a rule, troglomorphy appears to increase (a) with seasonality, (b) with decreasing mean annual temperature (i.e., with altitude and latitude), and (c) with increasing drought. The more seasonal the area, the more troglomorphic traits and more troglomorphic taxa are seen in its fauna. Thus, obligate subterranean beetles are few and weakly modified morphologically in Indonesia (two species), Malaysia (none), or Cuba (none). They are more numerous or more troglomorphic in eastern and northern Thailand (four or five species), or southern Brasil (two species); they finally reach levels of troglomorphy and diversity comparable to temperate Trechidae in southern China, just north of the tropical belt. Cave fish are mostly known in the northern part of the tropics and in the subtropics; they are very rare in the humid tropics. Similarly, New Guinea's high-altitude caves host several highly modified beetles, which are absent in low-altitude caves of the same region. It is doubtful, however, that such patterns apply to all taxa. Araneae in particular may have similar richness in troglomorphic taxa at different altitudes.

6. Howarth (1973) considered the cave species of Hawaii to be derived from surface fauna present on the island. He hypothesized that the absence of relicts might be characteristic of tropical caves. Hawaii, however, as a young archipelago, did not experience drastic ecological changes that would have eliminated surface fauna, hence, making cave species relicts. Actually, evidence is accumulating that climatic relicts are present in many tropical caves, for instance, in the Cape Range of western Australia (Humphreys, 1993) as well as in dry or strongly seasonal tropical regions (Laos, South Sulawesi). Several stygobites, on the other hand, are probable marine relicts secondarily adapted to freshwater, like the crab *Cancrocaeca xenomorpha* of Maros (South Sulawesi) or the isopod *Cyathura (Stygocyathura) chapmani* of the Mulu caves. More generally, the numerous monospecific genera described from tropical caves are indicative of phyletic



**FIGURE 3** The *Troglapedetes* (Collembola: Paronellidae) of western Thailand. 1: *calvus*; 2: *centralis*; 3: *convergens*; 4: *dispersus*; 5: *fredstonei*; 6: *leclerci*; 7: *longicornis*; 8: *maffrei*; 9: *maungonensis*; 10: *microps*; 11: *multispinosus*; 12: *paucisetosus*.

isolation and often relictness. Relicts come in addition to the regional pools of nonrelictual taxa, contributing therefore to a local increase in cave species richness.

### TROPICAL VERSUS TEMPERATE SUBTERRANEAN BIODIVERSITY

The tropics are known to have the highest biodiversity on earth for surface ecosystems, but trends might be reversed for subterranean habitats. Culver and Sket (2000) compared the specific richness of 20 caves and wells worldwide having 20 or more obligate subterranean species and came to the



conclusion that “the scarcity of high diversity caves in the tropics is still a puzzle” (p. 16). Their study included two tropical caves, the SKT system in South Sulawesi, which is the richest spot of tropical subterranean biodiversity, and Bayliss lava tube in northern Australia. These caves ranked 12 and 15 of 20 for total species richness, far behind the temperate cave systems of the Dinaric karst. However, aquatic microinvertebrates (Copepoda, Oligochaeta), which contribute the most to biodiversity in temperate caves, have not been studied in SKT nor in most tropical caves. A more relevant comparison based on terrestrial fauna only places these two caves much closer to the richest temperate caves (ranks 4 and 5 of 22 in Table II). They would rank even higher if the obligate subterranean guanobitic species, probably considerably more diverse in the tropics than in temperate areas, were considered.

**TABLE II Tropical versus temperate cave biodiversity with at least 10 (troglonites + stygobites) species**

	Aquatic	Terrestrial	Total	Ranked on Terrestrial
Europe Pyrenees				
Baget (FR)*	24	9	33	17
Goueil di Herr (FR)*	14	12	26	14
Europe: Italy				
Busso del Rana*	15	5	20	21
Grotta dell' Arena*	6	14	20	11
Europe: Dinaric karst				
Grad (SLO)*	17	3	20	22
Jama Logarcec (SLO)*	28	15	43	10
Krisna Jama (SLO)*	29	16	45	8
Sica-Krka system (SLO)*	27	7	34	18
Sistem Postojna-Planina (SLO)*	48	36	84	1
Vjetrenica Jama (Bosnia)	39	21	60	5
Europe: Romania				
Pestera de Movile*	18	29	47	2
USA				
Mammoth cave*	15	26	41	3
Shelta cave USA*	12	12	24	14
China: Hunan (subtropical-temperate)				
Feihu Dong	4	16	20	8
Tropical Australia				
Bayliss Cave*	0	24	24	4
Southeast Asia				
Gua Air Jernih (SAR)	5	13	18	12
Ngalau Surat (SUM)	3	17	20	7
SKT system (SUL)	7	21	28	5
Africa				
Kulumuzi cave (TAN)	0	10	10	16
Tropical America				
Alambari de Cima cave (BRA)	4	6	10	19
Areias System (BRA)	3	13	16	12
Cueva Grande de Caguanes (CUBA)	5	6	11	19

Abbreviations like table I. FR: France; SLO: Slovenia; \* Culver and Sket (2000)

Tropical cave fauna, therefore, differ from the richest temperate cave fauna by a different contribution of species from high- versus low-energy habitats and a different representation of the main taxonomic groups, more than by their absolute richness in obligate subterranean species.

## ACKNOWLEDGMENT

Eleonora Trajano and Abel Perez Gonzalez provided important information about the biodiversity of tropical American caves.

## Bibliography

- Chapman, P. (1980). The biology of caves in the Gunung Mulu National Park, Sarawak. *Trans. Brit. Cave Res. Assoc.* 7(3), 141–149.
- Culver, D. C., and B. Sket (2000). Hotspots of subterranean biodiversity in caves and wells. *J. Cave Karst Studies* 62(1), 11–17.
- Deeleman-Reinhold, C. L. (1995). The Ochyroceratidae of the Indo-Pacific region (Araneae). *Raffles Bull. Zoology Suppl.* 2, 1–103.
- Deharveng, L., and A. Bedos (2000). The cave fauna of Southeast Asia. Origin, evolution and ecology. In *Ecosystems of the World: 30 Subterranean Ecosystems* (H. Wilkens, D. C. Culver, and W. F. Humphreys, eds.), pp. 603–632. Elsevier, Amsterdam.
- Gnaspini, P., and E. Trajano (1994). Brazilian cave invertebrates, with a checklist of troglomorphic taxa. *Revista Brasileira Entomologia* 38(3/4), 549–584.
- Howarth, F. G. (1973). The cavernicolous fauna of Hawaiian lava tubes. I. Introduction. *Pacific Insects* 15, 139–151.
- Humphreys, W. F. (1993). Cave fauna in semi-arid tropical western Australia: A diverse relict wet forest-litter fauna. *Mémoires de Biospéologie* 20, 105–110.
- Iliffe, T. M. (2000). Anchialine cave ecology. In *Ecosystems of the World: 30 Subterranean Ecosystems* (H. Wilkens, D. C. Culver, and W. F. Humphreys, eds.), pp. 59–76. Elsevier, Amsterdam.
- Jeannel, R., and E. G. Racovitza (1914). Biospeologica XXXIII. Énumération des grottes visitées 1911–1913 (5<sup>ème</sup> série). *Arch. Zoologie Expérimentale et Générale* 53, 325–558.
- Juberthie, C., and V. Decu, eds. (1994). *Encyclopaedia Biospeologica*, Vol. I, pp. 1–834. Société de Biospéologie, Moulis, France.
- Juberthie, C., and V. Decu, eds. (2001). *Encyclopaedia Biospeologica*, Vol. III, pp. 1375–2294. Société de Biospéologie, Moulis, France.
- Leleup, N. (1956). La faune cavernicole du Congo belge et considérations sur les coléoptères reliques d'Afrique intertropicale. *Ann. Mus. R. Congo Belge Sci. Zoologiques* 46, 1–170.

# Diversity Patterns in the United States

Horton H. Hobbs III  
Wittenberg University

## INTRODUCTION

The scientific study of cave fauna (cavernicoles) in the United States had its inception in 1842 with the description by DeKay of the blind amblyopsid cave fish, *Amblyopsis*

*spelaea*, from Mammoth Cave, Kentucky. By 1888 the number of obligate cave-dwellers, i.e., troglobites (terrestrial) and stygobites (aquatic species), had increased to more than 50, as reported by Alpheus Packard in his compendium of North American cave fauna; numerous additional descriptions of cave-restricted organisms occurred through the 1940s and 1950s. By 1960 Brother Nicholas listed 334 species, in 1998 Stewart Peck estimated 1353 cave species (including interstitial and undescribed species and subspecies), and in 2000 Culver *et al.* reported that a total of 973 species and subspecies were described from caves in the 48 contiguous states. Currently, 1121 species and subspecies are described (inclusive of Alaska and Hawaii) and are assigned to 238 genera and 112 families (Table I). Nearly all have evolved from the independent invasion of surface organisms

**TABLE I Summary of the Obligate Subterranean Phyla/Classes/Orders, Families, Genera, and Species/Subspecies Described from U.S. Caves**

Phylum/class/order	Family	Genus	Species/subspecies
Turbellaria	4	6	28
Oligochaeta	4	6	13
Mollusca	5	16	29
Arachnida			
Acari	7	13	22
Aranea	8	22	98
Opiliones	6	13	44
Pseudoscorpiones	9	29	152
Schizomida	1	1	1
Scorpiones	1	1	1
Crustacea			
Copepoda	2	3	7
Ostracoda	2	5	14
Bathynellacea	1	1	1
Thermosbaenacea	1	1	1
Amphipoda	11	18	135
Isopoda	6	15	97
Decapoda			
Shrimps	2	2	5
Crayfishes	1	4	34
Crabs	1	1	1
Chilopoda	3	4	4
Diplopoda	12	20	60
Hexapoda			
Thysanura	1	1	1
Diplura	2	3	8
Collembola	6	12	75
Insecta			
Orthoptera	1	2	3
Dermaptera	1	1	1
Hemiptera	2	2	2
Homoptera	1	1	7
Coleoptera	7	24	261
Diptera	1	1	1
Osteichthyes	2	5	6
Amphibia	1	5	9
Totals	112	238	1,121

into the subterranean realm and there, physical isolation and thus cessation of gene flow with surface congeners has led to speciation. In the stressed subterranean environment where there is perpetual darkness and extremely limited food, selective pressures have led to the evolution of parallel and convergent regressive forms (profound morphological alterations) that are characteristic of troglobites and stygobites worldwide. This combination of characteristics, which includes reduction or loss of eyes and pigments, gracilization and elongation of appendages, increased chemical and tactile sensitivity, degeneration of circadian rhythms, lowered fecundity and metabolic rates, and increased longevity, is postulated to be adaptive to life in such extreme ecosystems and is termed *troglo-morphy*.

This article summarizes the ecological, taxonomic, and geographic patterns of biodiversity of cave-inhabiting fauna in the 50 United States, focusing on troglobites and stygobites (separated because the two environments have completely different environmental characteristics and faunas), but not ignoring cave visitors (trogloxenes/stygoxenes) and “cave lovers” (troglophiles/stygo-philes). Specific numbers of organisms known from various cave areas (see below) are derived mostly from a cave biota database that is available on the World Wide Web at [www.karstwaters.org/troglist](http://www.karstwaters.org/troglist). No attempt is made herein to summarize the protozoans or other microbial communities of caves although clearly these are incredibly important in cave ecosystems as sources of food (primary and secondary production), in the deposition of minerals, and in the process of speleogenesis. Additionally, attention is directed toward the vulnerability as well as to the challenges of conservation of this fauna and associated habitats.

## CAVE ECOLOGY

The obvious feature of caves (see article in this volume on “What Are Caves?” and Hobbs, 1992) is perpetual darkness that results in the absence of green plants (producers of carbon-based molecules and thus “food” for organisms). Other characteristics of these food-poor cavities are low variances in temperature and humidity (usually near saturation), which make for a predictable, less variable environment. Evolutionarily, as an organism makes the transition to troglobite or stygobite, isolation is another key feature of that environment. These are unique combinations of characteristics that set caves apart from other ecosystems and that make this extreme environment inhospitable to most organisms.

The zonal variation in biological, chemical, and physical properties influences the distribution and abundance of fauna occurring in caves. The *entrance* area of caves is the ecotone between the epigeal and hypogean worlds and has received only minimal study. Clearly, here there is more diversity and greater environmental variability than in any other cave zone. On both horizontal and vertical scales,

entrances provide a transition of characteristics (e.g., temperature, humidity, light) that may provide conditions for entry or survival for preadapted species or for relictual species that otherwise are rare or have become extinct on the surface due to climatic changes. They are important windows into the subterranean realm through which pass migrating troglonexes (e.g., bats, crickets) and can be the point of entry of important organic material. Further into the cave but still within the limits of light penetration (the *twilight zone*), the influence of surface conditions is apparent and variation of meteorological conditions is significantly less than at the surface and entrance areas. The *dark zone* initially demonstrates considerable influence of surface conditions but as distance increases from the entrance, it grades into a much less variable environment that is far from “constant” but significantly reduced in fluctuations of such parameters as atmospheric and water temperatures. In the dark, deep interior of caves that is characterized by more environmental constancy, virtually no food is produced and organisms are thus dependent on input of carbon from the surface that energetically supports most cave ecosystems (plant debris, bat and cricket guano). Exceptions to these generalizations about food occur in caves where chemoautotrophic production by sulfur-oxidizing microbial organisms (e.g., sulfur bacteria: *Achromatium*, *Beggiatoa*, *Thiothrix*) occurs, resulting in sufficient energy to support and sustain complex cave ecosystems. These types of caves are dominated geochemically by reduced sulfur compounds and are rare occurrences (e.g., Cesspool Cave in Allegheny County, Virginia, and Lower Kane Cave, Big Horn County, Wyoming).

Cave organisms can be separated on the basis of habitat and/or resource base: *terrestrial riparian communities* found on stream banks with a resource base of allochthonous particulate organic matter deposited by stream fluctuations; *terrestrial transitory organic matter (dung) communities* usually

living within a few hundred meters of the surface with a resource base of organic matter (often fecal material) that is derived from the activities of animals (e.g., bats, crickets) moving in and out of caves; *terrestrial epikarst communities* living primarily in the network of small, air-filled cavities above the cave but below the surface; *aquatic stream communities* living primarily in cave streams ultimately dependent on dissolved and particulate organic matter derived from the surface; *aquatic phreatic communities* found in the permanent groundwater at or below the cave itself, including the hyporheos; and *aquatic epikarst communities* living primarily in the network of small flooded or partially flooded cavities above the cave but below the surface and most easily sampled within the cave in drip pools.

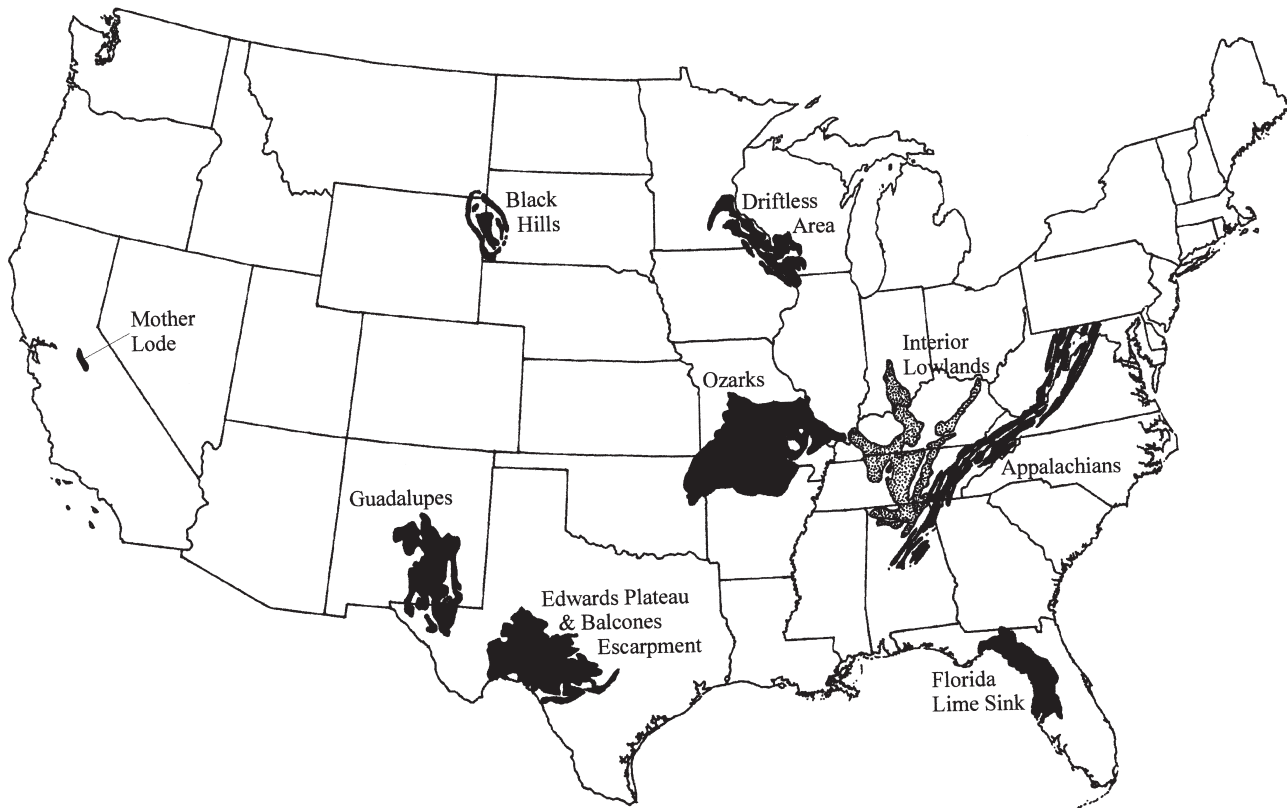
### DISTRIBUTION OF KARST, CAVES, AND CAVERNICOLES

Within the continental United States, available and appropriate habitat for subterranean fauna is not continuous, thus cave-inhabiting organisms are found in distinct areas (mostly karst), some being widely distributed and isolated (Table II, Figs. 1 and 2). Due to these separations and a unique geology, history, and climate, it should not be surprising that there are distinct differences in regional fauna, variances expressed in diversity, population densities, as well as taxonomic groups. Isolation, due in part to folding of strata, has resulted in high species richness (particularly of troglobitic beetles) in the Appalachians, whereas in the Interior Lowlands this is not the case, likely due to cave connectivity. Most cave-adapted species are found south of the southern limits of the Pleistocene glacial ice sheet, yet some were able to survive subglacial conditions in the northern states (e.g., New York, Wisconsin) as well as in Canada (e.g., Alberta, British Columbia) and are represented

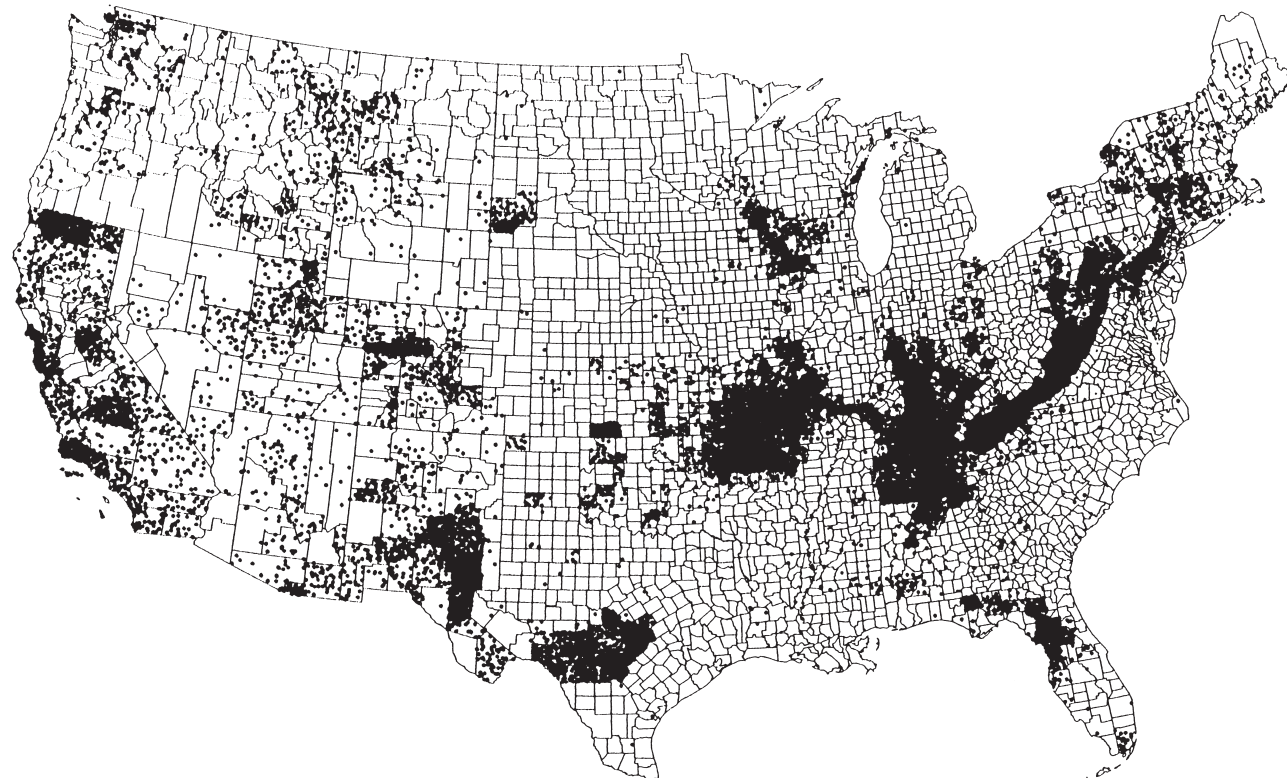
**TABLE II Comparison of Species Richness and Characteristics of 10 U.S. Karst Regions<sup>a</sup>**

Major karst regions of United States	Number of troglobites		Number of stygobites		Total species	Number of caves		Area of karst (km <sup>2</sup> )		
Appalachians	178	(02)	85	(01)	263	(02)	7,441	(2)	37,268	(5)
Black Hills	2	(09)	0	(10)	2	(10)	160	(9)	7,272	(8)
Driftless Area	11	(08)	2	(08)	13	(09)	615	(7)	25,222	(7)
Edwards/Balcones	105	(03)	56	(03)	161	(03)	2,011	(4)	65,586	(2)
Florida Lime Sinks	0	(10)	24	(05)	24	(06)	627	(6)	27,338	(6)
Guadalupes	13	(07)	1	(09)	14	(08)	1,379	(5)	43,522	(4)
Hawaii (lava)	35	(04)	6	(06)	41	(05)	?		?	
Interior Lowland Plateau	256	(01)	62	(02)	318	(01)	11,928	(1)	60,612	(3)
Mother Lode	20	(06)	3	(07)	23	(07)	179	(8)	390	(9)
Ozarks	31	(05)	51	(04)	82	(04)	6,964	(3)	110,125	(1)
Total	651		290		941		31,304		377,335	

<sup>a</sup>Ranks from highest to lowest are presented in parentheses (modified from Culver and Hobbs, 2002). An additional 179 species are from other cave and karst regions throughout the contiguous United States and one described stygobitic amphipod occurs in Alaska, bringing the total number of described obligate cavernicoles in the United States to 1121.



**FIGURE 1** Map of major karst regions treated in this article (excluding the Hawaiian Islands, which are lava). The Interior Lowland Plateau is stippled in order to differentiate it from the Appalachians (extend into Canada; truncated herein at Maryland–Pennsylvania border) and the Ozarks. (Modified from Culver *et al.*, 2003.)



**FIGURE 2** Dot map of the distribution of caves in the United States. Each dot represents one cave. (Modified from Culver *et al.*, 1999.)

primarily by groundwater amphipods and isopods. In the Driftless Area (parts of Illinois, Iowa, Minnesota, and Wisconsin) and other smaller karst regions above the glacial boundary, low biodiversity in caves is attributed to the lack of time for colonization and isolation due to the effects of glaciers. Also, the Guadalupe Mountains of New Mexico demonstrate depauperate cave fauna likely resulting from the aridity of the region. Although high densities of lava tubes occur in the western United States and limestone caves have developed in numerous smaller karst areas, this article focuses primarily on caves formed in soluble rock, particularly limestone and follows the nine geologically defined cave regions discussed by Culver and Hobbs (2002) (Fig. 1). These are the Appalachians, Black Hills, Driftless Area, Edwards Plateau & Balcones Escarpment, Florida Lime Sinks, Guadalupe Mountains, Interior Lowland Plateaus, Mother Lode, and the Ozarks. Also, a tenth, the Hawaiian region and one of volcanic origin (thus many islands are “young” ecologically), is treated.

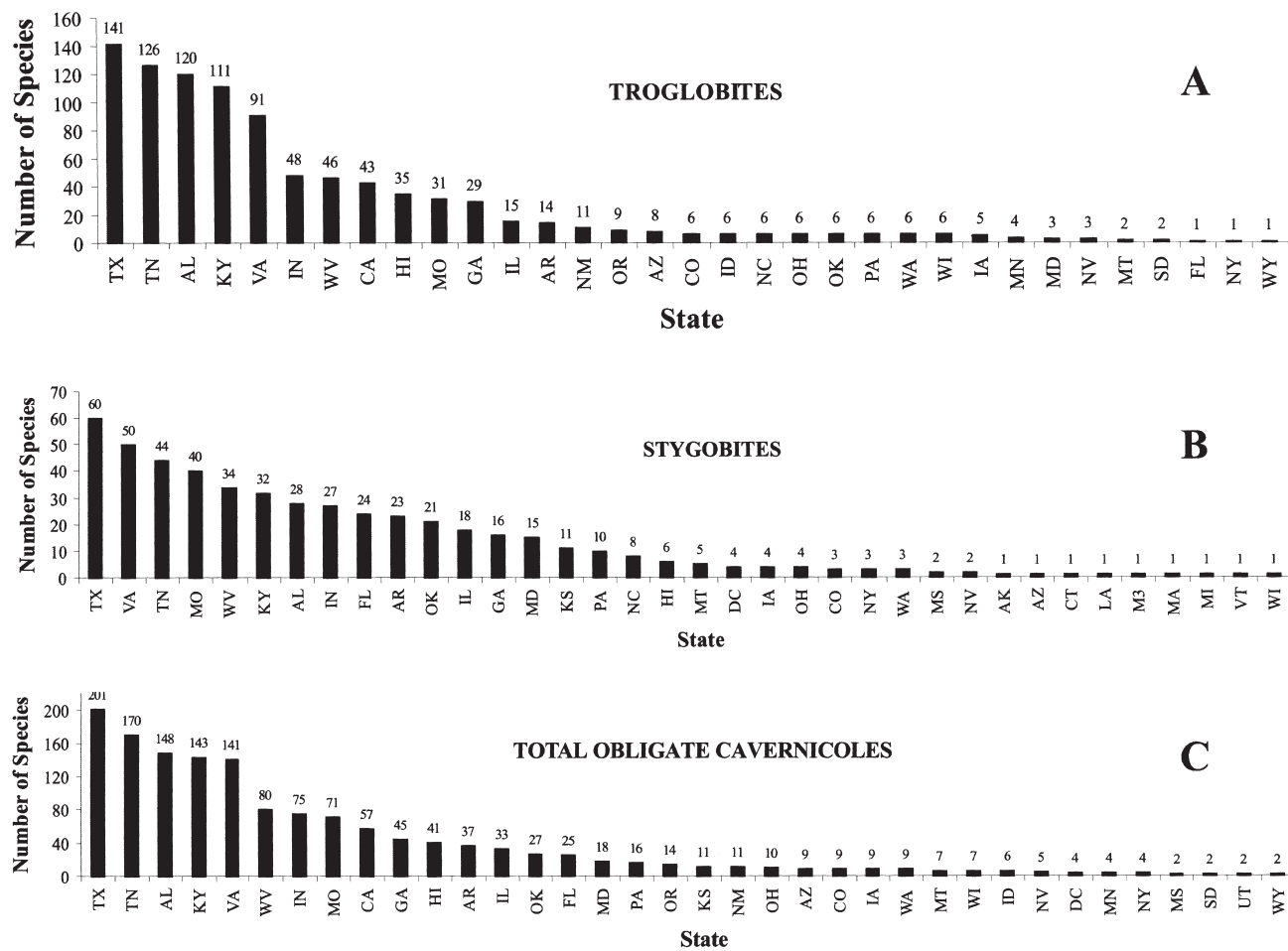
Caves of the coterminous United States are shown in Fig. 2 resulting from a plot of nearly 45,000 caves. Clearly the distribution of cavernicoles is influenced by the distribu-

tion and abundance of cavities available for habitation. Indeed, although it is useful to examine the number of cavernicoles in states (Fig. 3) or within various karst areas (Fig. 4), Christman and Culver (2001) and Culver et al. (2003) demonstrated that the availability of habitat expressed by the number of caves in a region (Table II) is the best predictor of the biodiversity of cave-dwelling organisms. Also, the distribution of cavernicoles within caves is patchy and nonrandom and usually is associated with concentrations of food sources. Whereas troglobite diversity within caves is likely affected not only by resource availability but also by variety (organic plant debris, bat or cricket guano, mammalian scat), stygobites tend to be less diverse in part due to the preponderance of feeding generalists and the lack of specialization on food type.

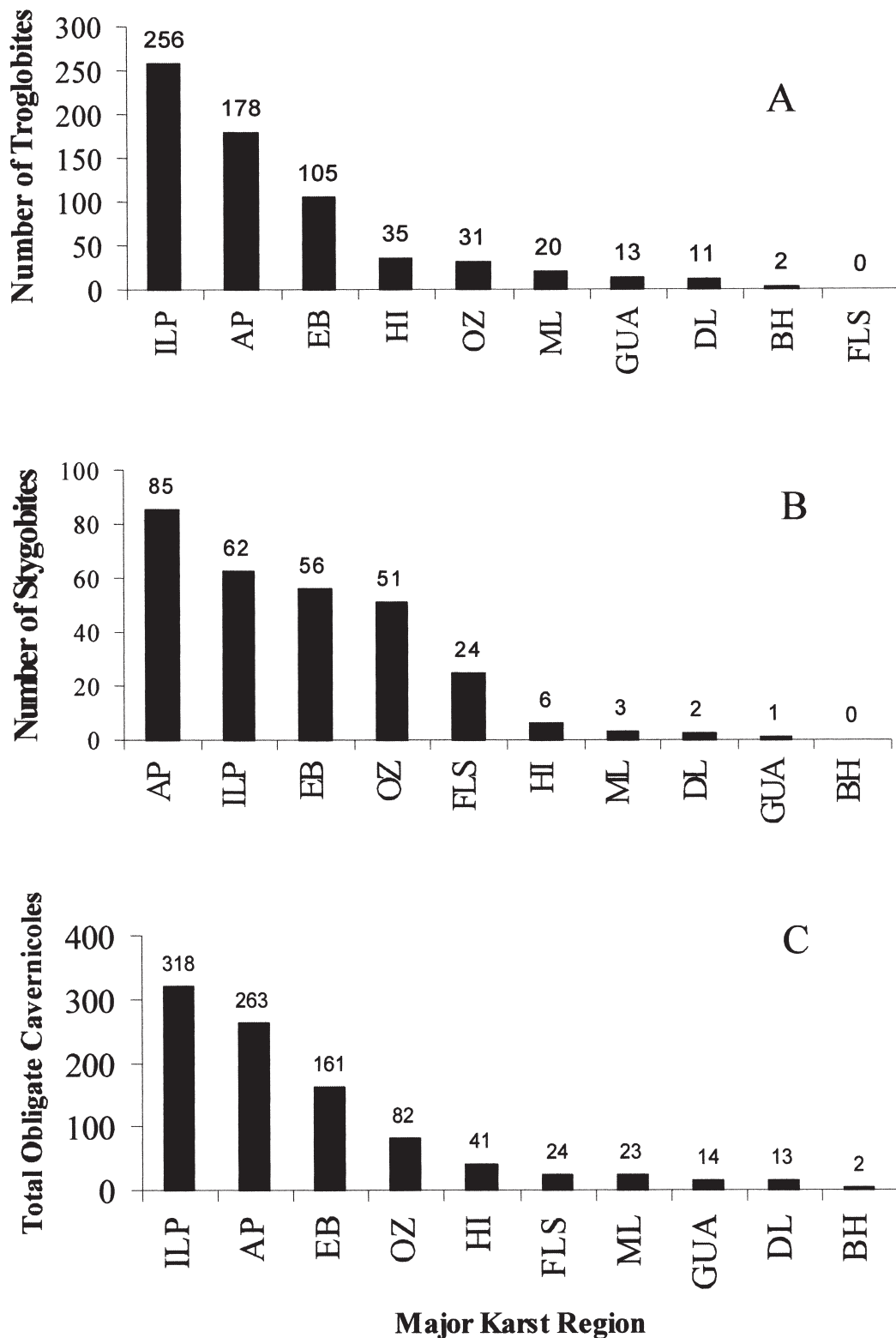
**TREATMENT OF THE FAUNA: INVERTEBRATES**

**Class Turbellaria**

This diverse group of stygobitic flatworms (28 species) is assigned to four families and six genera. The largest genus, *Sphalloplana*, is represented by 16 species found in subterra-



**FIGURE 3** Frequency histograms by state of number of described obligate subterranean species. (A) Troglobite biodiversity by state, (B) stygobite biodiversity by state, and (C) combined cavernicolous biodiversity by state.



**FIGURE 4** Frequency histograms by major karst region of described obligate cavernicoles. (A) Troglobites, (B) stygobites, and (C) total. AP, Appalachians; BH, Black Hills; DL, Driftless Area; EB, Edwards Plateau & Balcones Escarpment; FLS, Florida Lime Sink; GUA, Guadalupe; HI, Hawaii; ILP, Interior Lowland Plateau; ML, Mother Lode, OZ, Ozarks.

nean settings primarily in the Appalachians and Interior Lowlands major karst regions.

### Class Oligochaeta

This group of aquatic worms is represented by 13 species belonging to six genera and four families mostly from the Appalachians and Interior Lowlands. They are poorly known from cave soils and streams as well as from interstitial waters, the latter habitat only rarely sampled. Of interest, 7 species of the genus *Cambarincola* (Branchiobdellidae) are restricted as ectosymbionts to cambarid crayfishes occupying subterranean waters. Tubificid worms are common to subterranean streams containing much organic material (or that are receiving sewage effluent!), but no stygobitic forms are known.

### Class Mollusca

Both aquatic and terrestrial snails inhabit caves, the diversity of stygobites being nearly six times greater than that of troglobites. Twenty-four stygobionts are placed in 12 genera in two families and three families contain four genera and five species of generally small, translucent troglobitic gastropods. Numerous species of terrestrial epigeal snails are deposited in caves on debris transported in by floods but apparently are not able to maintain populations for many generations. Yet a few species are troglobitic (mostly from the Appalachians and Interior Lowlands karst regions, e.g., *Helicodiscus barri* Hubricht), feeding on guano and decaying allochthonous material (mainly plant) and associated microbes. Hydrobiid snails have been particularly successful in subterranean waters with 23 stygobites described primarily from the Appalachians, Edwards Plateau & Balcones Escarpment, Interior Lowlands, and Ozarks. Some of these snails are site endemics (e.g., *Antrobia culveri* Hubricht, known from a stream in a single cave in Taney County, Missouri) or are restricted to a single drainage (e.g., *Fontigens turritella* Hubricht, from two caves in the Greenbrier River drainage in Greenbrier County, West Virginia). *Physa spelunca* Turner & Clench is unique in that it is a site-endemic species restricted to a thermal cave stream (Lower Kane Cave; see above) draining into Big Horn River, Wyoming.

### Class Arachnida

The cave-adapted arachnids are represented by a very diverse group of mostly terrestrial arthropods that are widely distributed throughout karst terrains of the United States. Mites (Order Acari) are small arachnids that are dominated by terrestrial species (11 genera and 19 species) with only three stygobites placed in two genera. Mites are undoubtedly underrepresented in these totals due primarily to inadequate sampling. Seven families are represented, with the rhagidiids being the most diverse. Although most of the known mites are predaceous and commonly observed moving rapidly

among organic debris in moist areas of caves, some species are parasites on bats and harvestmen. Stygobites are known only from the Interior Lowlands (Indiana), and the greatest diversity of troglobites resides in the Appalachians and Interior Lowlands; at least one species is endemic to lava tubes on Hawaii. No troglobitic ticks are known but in some localities ticks are common, particularly in bat caves.

Spiders (Araneae) have been quite successful in the terrestrial cave environment with 98 species in 22 genera and 8 families. These troglobites are known from all the major karst areas except the Black Hills and the Florida Lime Sinks. The genus *Cicurina* is particularly diverse in Texas (49 species) and *Phanetta subterranea* (Emerton) and *Porhomma cavernicola* (Keyserling) are widely dispersed throughout the Appalachians and Interior Lowlands, and less widely within the Ozarks. Five species assigned to five genera and three families are known from lava tubes in Hawaii. In addition to the troglobites, a significant number of facultative species [e.g., *Gaucelmus augustinus* Keyserling, troglophile; *Meta ovalis* (Latreille), troglaxene; *Nesticus carteri* Emerton, troglophile] are common inhabitants of caves in the major karst regions.

The Order Opiliones (harvestmen or “daddy longlegs”) are widely distributed throughout the karst regions of the United States but are not overly diverse except in the Mother Lode (13 species) and Edwards Plateau & Balcones Escarpment (13 species). A total of 44 species has been assigned to 13 genera and six families that are scattered over the Appalachians, Interior Lowlands, and other lesser karst areas, as well as those mentioned above. The genus *Banksula* is diverse in the Mother Lode and environs (nine species) and *Texella* is represented by 11 species in the Edwards Plateau & Balcones Escarpment region as well as an additional three species in California and the Guadalupe. Large populations of troglaxenic harvestmen are often encountered in ceiling pockets or beneath ledges, out of the desiccating effects of air movements where they form dense, undulating mats (e.g., *Leiobunum townsendii* Weeds in caves in the Edwards Plateau, Texas, and *L. bicolor* Wood in southern Ohio caves). These troglaxenic species are typically scavengers often associated with organic matter washed into caves while the troglobitic forms are more commonly predators feeding on microarthropods, such as collembola.

Pseudoscorpions (Order Pseudoscorpiones) are minute predators that have pincer-like pedipalps (as do scorpions), but lack the tail and sting characteristic of scorpions. Some are troglaxenic/trogliphilic and often are associated with bat guano communities, whereas others are highly specialized troglobites. This highly diverse group of small arachnids (152 species within 29 genera and nine families) is particularly abundant in Alabama caves (41 species) and also demonstrates high diversity in Texas (25 species), and California and Virginia (13 species each). They are found in all major karst regions except the Florida Lime Sinks, the Black Hills, and the Driftless Area. Two families are particularly widespread,

Chernetidae and Chthoniidae, with the latter being incredibly diverse (95 species). The chernetids are dominated by the extensive genus *Hesperochnes*, which is found in the Appalachians, the Edwards Plateau & Balcones Escarpment, Interior Lowlands, Mother Lode, and the Ozarks. The chthoniids are heavily influenced by the genera *Apochnonius* (15 species), *Kleptochthonius* (31 species), and *Tyrannochthonius* (37 species) and are found in all the major karst regions except the Black Hills, Florida Lime Sinks, and the Driftless Area. Two species of the genus *Tyrannochthonius* are found in lava tubes on the Hawaiian Islands (Hawaii and Oahu).

The Order Schizomida is represented by a single terrestrial species, *Hubbardia shoshonensis* Briigs & Hom, from a cave in Inyo County, California. Although similar to true whip scorpions, they have a much shorter telson as well as other anatomical features that separate the two orders. They reside in leaf litter and under stones and are predators on small invertebrates.

Scorpions (Order Scorpiones) are believed to be one of the most ancient terrestrial arthropods and the most primitive arachnid. All are terrestrial predators characterized by two large pedipaps terminating in chelae as well as by the stinging apparatus derived from the telson and bearing a sharp barb called the *aculeus*. Although numerous pigmented species are found in U.S. caves, only one species is troglobitic: *Uroctonus grahami* Gertsch & Soleglad, known only from Shasta County, California. At least 11 species are troglobitic to the south in Mexican caves.

### Subphylum Crustacea

**CLASS MAXILLOPODA** The Subclass Copepoda (see Crustacea article, this volume) is not well sampled in the cave environment in the United States and this is reflected in the low species richness reported. Currently two families containing three genera and seven species and subspecies of these crustaceans are known from the Edwards Plateau & Balcones Escarpment in Texas, the Interior Lowlands in Illinois, Indiana, Kentucky, and Tennessee, and from Orange County, North Carolina. One obligate parasitic copepod, *Cauloxenus stygius* Cope, is associated with the Northern Cavefish, *Amblyopsis spelaea*, in southern Indiana caves.

Like the copepods, the Class Ostracoda has not been studied thoroughly in U.S. caves. Even so, 14 species belonging to five genera and two families are stygobites in the Appalachians, Edwards Plateau & Balcones Escarpment, Florida Lime Sinks, Interior Lowlands, and the Ozarks. Twelve species of the family Entocytheridae are commensal on cambarid crayfishes inhabiting caves and two species of Cyprididae are free living in cave streams and lakes.

**CLASS MALACOSTRACA** The Order Bathynellacea (see Crustacea article, this volume) is characterized by lacking maxillipeds and a carapace. These small crustaceans are not well studied, particularly in the United States, where only

one species, *Iberobathynella bowmani* (Delamare Deboutteville, Coineau, & Serban), is known from two localities in Dickens and San Saba counties, Texas. These reclusive organisms are interstitial or reside in groundwater, those habitats not having been adequately sampled.

The Order Thermosbaenacea (see Crustacea article, this volume) is represented by a single species, *Monodella texana* Maguire, which is known from a cave and wells in Bexar, Hays, and Uvalde counties, Texas. This is the sole North American representative of the Thermosbaenacea and is endemic to the Edwards Aquifer.

The Order Amphipoda (see Crustacea article, this volume) is quite diverse with 134 stygobitic species and subspecies in 18 genera and 10 families. An additional species is a talitrid troglobite, *Spelaeorchestia koloana* Bousfield & Howarth, which is a rare endemic that feeds on plant roots and organic debris in a few caves on the island of Kauai, Hawaiian Islands. Most amphipods are scavenger/predators and are laterally compressed, giving them a shrimplike appearance. Amphipods occur in all major karst regions except the Black Hills, Driftless Area, and Guadalupe. Crangonyctidae is the most diverse and widely distributed family, with the genera *Bactrurus* and *Crangonyx* housing 7 and 12 stygobites, respectively, yet the genus *Stygobromus* (98 species) is approximately five times as diverse as those two genera combined. In addition to most of these being found in unglaciated regions, *S. quatsinensis* Holsinger & Shaw is endemic to caves and springs north of the southern limits of Pleistocene glaciation in British Columbia, Canada, and southeastern Alaska. Also, eyed and pigmented stygophilic amphipods commonly inhabit cave and karst spring waters of the contiguous states and are major players in the trophic dynamics of some systems [e.g., *Gammarus* spp. and *Hyalella azteca* (Saussure)].

The Order Isopoda (see Crustacea article, this volume) is represented in caves by 78 stygobites in 11 genera and four families. The family Asellidae is immense with all but eight species of the order assigned to this family of dorsoventrally flattened crustaceans. Geographically, these stygobites are widespread, absent only from the Black Hills, Driftless Area, Guadalupe, and the Mother Lode major karst regions. The genus *Caecidotea* (Fig. 5) is represented by 56 species and subspecies and widely dispersed over these regions, whereas other species are much more restricted [e.g., *Remasellus parvus* (Steeves) in Florida and *Salmasellus howarthi* Lewis in Washington]. The genus *Lirceus* (also an asellid) has two stygobitic species from southwestern Virginia (*L. culveri* Estes & Holsinger and *L. usdagalun* Holsinger & Bowman from Scott and Lee counties, respectively) and numerous stygophilic species (e.g., *L. fontinalis* Rafinesque) that occupy springs and caves. The predominantly marine family Cirolanidae is represented in the United States by three dome-shaped and elliptical stygobitic species, *Cirolanides texensis* Benedict and *Speocirolana hardeni* Bowman, both from Texas, and the widely disjunct *Antrolana lira* Bowman from Virginia and West Virginia (Appalachians).





**FIGURE 5** The aquatic isopod, *Caecidotea stygia* Packard, from Mammoth Cave, Edmonson County, Kentucky.

The troglobitic isopods are represented by 19 species and subspecies in four genera. The 15 species in the contiguous United States belong to three genera (*Amergoniscus*, *Brackenridgia*, *Miktoniscus*) within the Trichoniscidae and these “pillbugs” are found in the Appalachians and Interior Lowlands as well as in Oklahoma, Oregon, and Texas. Four species of the genus *Hawaiiioscia* are endemic to the Hawaiian Islands of Kauai, Maui, Molokai, and Oahu.

Stygobitic members of the Order Decapoda (see Crustacea article, this volume) are limited to 34 crayfishes, five shrimps, and one crab. Crayfishes belong to the family Cambaridae: 11 species of *Cambarus* in the Appalachians, Interior Lowlands, and the Ozarks; 8 species and subspecies of *Orconectes* (Fig. 6) in the Interior Lowlands and Ozarks; 14 species and subspecies of *Procambarus* in the Florida Lime Sinks and Interior Lowlands; and a single species of *Troglocambarus* in the Florida Lime Sinks. Shrimps belong to two families: Atyidae, 2 species of *Palaemonias* in the Interior Lowlands, and Palaemonidae, three species of *Palaemonetes* in the Florida Lime Sinks and Edwards Plateau & Balcones Escarpment. The single crab (Grapsidae; *Hemigrapsus oregonensis* (Dana) (formerly *Hemigrapsus estellinensis* Creed) is endemic, and probably extinct, to a deep artesian salt spring in Hall County, Texas. Approximately 50 stygophilic/



**FIGURE 6** *Orconectes (Orconectes) inermis testii* (Hay) from Mayfield's Cave, Monroe County, Indiana (internal mark on second abdominal segment is used in population studies).

stygoxenic crayfishes utilize caves and, of special note and concern, is the impact of introduced epigeal species that utilize cave streams [e.g., *Procambarus (Scapulicambarus) clarkii* (Girard) in a cave in San Diego County, California, and likely introduced into the area from the southern Gulf states].

Troglobitic centipedes, Class Chilopoda, are rare in caves, fast moving, usually small, slender, and are voracious predators. They are found in organic debris, on clay, and burrowing in silt. Four genera and species from three families are known from the Guadalupe and the Appalachians as well as from northcentral California and the Edwards Plateau & Balcones Escarpment.

Troglobitic millipedes, Class Diplopoda, are slow-moving grazers, feeding on organic detritus and associated microbes. Typically found in food-poor caves, some 60 species and subspecies in 20 genera are known primarily from the Appalachians, Driftless Area, Guadalupe, Interior Lowlands, and Edwards Plateau & Balcones Escarpment. The largest genus, *Pseudotremia*, a member of the Cleidogonidae, has 29 troglobitic species in Appalachian and Interior Lowland caves. Numerous troglaphiles are noted in these karst regions as well (Fig. 7).

**CLASS HEXAPODA** The Class Hexapoda is restricted to the primitive orders of insects lacking wings (apterygote) and, in caves, is represented by three orders: Thysanura, Diplura, and Collembola.

Troglobitic *thysanurans* (bristletails) are unusual in caves and only a single species, *Texoreddellia texensis* (Ulrich), a member of the Nicoletiidae family, is known from caves in 18 counties in Texas. Troglloxenic species (e.g., *Pedetontus* sp.) are not uncommon in entrance areas.

Troglobitic *diplurans* are small and lack a median caudal filament but possess two cerci (“tails”). Eight species are assigned to three genera and two families, with the campodeid *Litocampa* being the most diverse genus with six species. This poorly studied group is known only from the



**FIGURE 7** Unidentified trogliphilic, polydesmid diplopod from Bat Cave, Alachua County, Florida.

Appalachians, Interior Lowlands, the Edwards Plateau & Balcones Escarpment, and a single species from Lincoln County, Nevada (*Condeicampa langei* Ferguson). These are observed on wet flowstone, cricket guano, and on silty substrata.

Troglobitic springtails (Order Collembola) are small, jumping insects that can occur in very high densities, particularly where organic matter has accumulated. Often they are observed moving about on the surface of small drip pools as well as on larger stream pools. Not only do they provide food for many small predators but they also graze on bacteria and fungi. They are a diverse group with 75 troglobitic species assigned to 12 genera and are known from all the major karst regions, except the Florida Lime Sinks, as well as other minor karst areas. Entomobryidae is the largest family, with the greatest diversity in the genus *Pseudosinella* (25 species); *Sinella* has 13 species. Fifteen species make up the widely distributed genus *Arrhopalites* (Sminthuridae). Numerous trogliphilic species [e.g., *Sinella cavernarum* (Packard)] contribute to the terrestrial communities of many caves. Six troglobitic species assigned to three genera and two families are found in lava tubes on the islands of Hawaii, Maui, and Oahu.

**CLASS INSECTA** The Class Insecta is characterized by those insects possessing wings (pterygote) or secondarily with reduced wings and is represented in caves by troglobitic/stygbotic members of five orders. Troglobitic members of the Order Orthoptera are known only from Hawaiian lava tubes. Three species of flightless, mute crickets are assigned to two genera and belong to the family Gryllidae. *Caconemobius varius* Gurney & Rentz is known from five caves on Hawaii Island and displays small eyes, reduced body pigment, and a translucent exoskeleton. It is omnivorous or perhaps a scavenger and appears to be most abundant in low, wet caves. *C. howarthi* Gurney & Rentz has been collected from four

caves on the island of Maui. It has been observed only in the dark zone of caves and appears to be more cave adapted than *C. varius*. *Thaumatogryllus cavicola* Gurney & Rentz is known from approximately 10 small, generally shallow caves on the island of Hawaii. In some of these lava tubes it has been observed on dangling roots of grasses and trees that have penetrated the ceilings in characteristically wet areas. In the contiguous states, pigmented rhabdophorid crickets often are very numerous in caves, particularly within the first 100 to 200 m of the entrance, and these troglonexes are represented by species of the genera *Ceuthophilus*, *Hadennoecus*, and *Euhadennoecus*. These crickets not only migrate to the surface to forage for food during spring, summer, and fall (and thus provide food in the form of guano to caves), but they also use caves as refugia during cold periods. Some crickets (e.g., *Ceuthophilus silvestris* Bruner in small caves in glaciated Wyandot County, Ohio) interact with caves only seasonally, entering them solely during the winter months.

A single endemic, troglobite (*Anisolabis howarthi* Brindley) from Hawaii is the only known member of the Order Dermaptera (earwigs) to inhabit caves. Characterized by the heavily sclerotized posterior forceps (cerci), they use these for predation and are considered to be scavenging omnivores as well.

Only two troglobitic “bugs” (Order Hemiptera–Heteroptera) are known, both endemic to lava tubes on the island of Hawaii. The thread-legged bug, *Nesidiolestes ana* Gagne & Howarth (Reduviidae), is a predator of arthropods, and the lava tube water-treader, *Speleovelia aaa* Gagne & Howarth, sucks on rotting fluids of deceased arthropods.

The Order Homoptera is represented by seven troglobitic planthoppers endemic to the islands of Hawaii, Maui, and Molokai. All belong to the Cixiidae family and are placed in the genus *Oliarus*. Often they are observed on roots that have penetrated ceiling cracks of lava tubes.

The Order Coleoptera has been incredibly successful in caves with 261 species in 21 genera and five families. Only three species are aquatic, two of which are dryopids (Oregon and Texas) and one a dytiscidae from Texas (*Haideoporus texanus* Young and Longley, the only stygbotic predaceous diving beetle known in the United States). Beetles are major components of cave communities particularly in the Appalachians and Interior Lowlands. Troglobites are dominated by the carabids, particularly the genus *Pseudanophthalmus* that is inordinately abundant in Kentucky and Texas caves, 62 and 67 species, respectively. Two carabids are endemic to lava tubes on the Hawaiian island of Maui. Troglobitic ground beetles are represented by the genus *Rhadine* (17 species), which is restricted to Texas, particularly dense in the Edwards Plateau & Balcones Escarpment karst region. In certain Texas caves, *Rhadine s. subterraneanea* (Van Dyke) and *R. noctivaga* Barr feed exclusively on cave cricket eggs (*Ceuthophilus* spp.) that have been buried in fine-grained, calcareous deposits. This feeding behavior also has been demonstrated in Mammoth and other caves in the

Pennyroyal Plateau of western Kentucky (Interior Lowlands) for the carabid *Neaphaenops tellkampfi* (Erichson) preying on eggs of the cricket *Hadenoecus subterraneus*, and on the Cumberland Plateau of eastern Kentucky the cricket is *Hadenoecus cumberlandicus* and its predator is *Darlingtonia kentuckensis* Valentine. Leiodids (*Ptomaphagous* spp.) and pselaphids (predominantly *Batrisodes* spp.) make up the remaining troglobites. Numerous troglonophiles (e.g., Carabidae, Leiodidae, Leptodiridae, Ptinidae, Staphylinidae, Tenebrionidae) also are common members of cave communities. In addition to predators, the cavernicolous beetles are scavengers and opportunistic saprophiles.

A single, widely distributed troglobitic fly (Order Diptera) is known from caves in the Appalachians, the Interior Lowlands, and the Ozarks: *Spelobia tenebrarum* (Aldrich), Sphaeroceridae. A variety of flies utilize caves periodically and include various culicids (e.g., *Culex pipiens* Linnaeus), heleomyzids [e.g., *Amoebalaria defessa* (Osten-Sacken)], mycetophilids (e.g., *Macrocera nobilis*), phorids [e.g., *Megaselia cavernicola* (Brues)], and sphaerocerids [e.g., *Leptocera tenebrarum* (Aldrich)].

Additional insects are observed in caves but are either troglo/stygoxenes or troglo/stygophiles and include lepidopterans [e.g., *Scoliopteryx libatrix* (Linnaeus)], psocopterans (e.g., *Psyllipsocus ramburi* Sélys-Longchamps), and siphonapterans [e.g., *Myodopsylla insignis* (Rothschild)]. A particularly disturbing example of surface insects entering the subterranean world is the invasion of central Texas caves during the summer months by the troglonenic, exotic red fire ant, *Solenopsis invicta* (Hymenoptera).

### TREATMENT OF THE FAUNA: VERTEBRATES

A number of vertebrates spend varying times of their life in subterranean environments but most are not considered cavernicoles (e.g., some snakes and mammals are adapted to a fossorial mode of life in the soil). Other vertebrates visit caves for shelter during times of unfavorable surface environmental conditions (e.g., amphibians, snakes), to avoid predation (e.g., pack rats, birds), or for breeding purposes (e.g., birds, bats). Generally these cave-dwellers are classified as accidentals or as troglonenes/stygoxenes; fishes and salamanders are the only vertebrates in which troglonophilic/stygonophilic or troglobitic/stygoitic species have evolved.

#### Class Osteichthyes

Approximately 85 stygoitic fishes are known worldwide, however only six cave-obligate species are recognized from North American subterranean waters and belong to one of two families, Amblyopsidae and Ictaluridae. The amblyopsid cave fishes are stygoitic except for one stygonophilic species, *Chologaster agassizii* Putnam, which inhabits caves and springs of Illinois, Kentucky, and Tennessee yet migrates to the surface at night to exploit food resources. Four additional



FIGURE 8 The blind cave fish *Amblyopsis spelaea* DeKay from Mammoth Cave, Edmonson County, Kentucky.

species are confined to subterranean waters: *Amblyopsis rosae* (Eigenmann) from the Ozarks, *Amblyopsis spelaea* (Fig. 8) from the Interior Lowlands, *Speoplatyrhinus poulsoni* Cooper & Kuehne from a single cave in the Interior Lowlands, and *Typhlichthys subterraneus* Girard from the Interior Lowlands and the Ozarks. The ictalurid subterranean representatives, *Satan eurystomus* Hubbs & Bailey and *Trogloglanis pattersoni* Eigenmann, are known only from deep phreatic waters of the Edwards Aquifer in Bexar County, southwest Texas, and have never been observed in accessible caves. Members of both of these families are predatory feeders primarily of crustaceans except the toothless *T. pattersoni*, which is likely a grazer taking up detritus.

Other fishes occupy subterranean waters (some regularly demonstrate migratory patterns) and some of the families represented are the following: Anguillidae [e.g., *Anguilla rostrata* (LeSueur)], Centrarchidae (*Lepomis* spp.), Cottidae (*Cottus* spp.), Cyprinidae (*Notropis* spp.), Ictaluridae [*Ictalurus catus* (Linnaeus)], Mugilidae (*Mugil cephalus* Linnaeus), and except for *Cottus* sp., show no troglomorphic adaptations for living in this environment.

#### Class Amphibia

Oddly, no stygonophilic or stygoitic frogs are known from caves (possibly because they cannot complete their life history in the subterranean environment), but they certainly utilize caves (e.g., *Rana palustris* LeConte), primarily to retreat from surface climatic extremes. Globally, only 11 stygoitic salamanders are known from hypogean waters and are assigned to two families, Proteidae and Plethodontidae, the former restricted to limestone caves and karst springs in Bosnia-Herzegovina, Croatia, Italy, and Slovenia. The plethodontids are represented by nine species and subspecies in North America (Fig. 9) and are known from the Appalachians, Edwards Plateau & Balcones Escarpment, Interior Lowlands Plateau, and the Ozarks as well as from caves in the Dougherty Plain of southwestern Georgia and adjacent panhandle of Florida (Tables II and III). Numerous additional species of plethodontid salamanders are stygo-



FIGURE 9 Adult *Typhlotriton spelaeus* Stejneger from Copperhead Cave, Newton County, Arkansas. (Photograph courtesy of Rob Payn.)

TABLE III Stygobitic Salamanders of the United States

Genus	Species/ subspecies	State	Major karst region
<i>Eurycea</i>	<i>tridentifera</i>	Texas	Edwards Plateau & Balcones Escarpment
<i>Gyrinophilus</i>	<i>gulolineatus</i>	Tennessee	Appalachians
	<i>palleucus</i>	Tennessee	Interior Lowland Plateau
	<i>necturoides</i>		
	<i>palleucus</i>	Alabama,	Appalachians, Interior
	<i>palleucus</i>	Georgia	Lowland Plateau
		Tennessee	
	<i>subterraneus</i>	West Virginia	Appalachians
<i>Haideotriton</i>	<i>wallacei</i>	Georgia,	Dougherty Plain, NE
		Florida	Florida Panhandle
<i>Typhlomolge</i>	<i>nathbuni</i>	Texas	Edwards Plateau & Balcones Escarpment
	<i>robusta</i>	Texas	Edwards Plateau & Balcones Escarpment
<i>Typhlotriton</i>	<i>spelaeus</i> (Fig. 9)	Arkansas, Kansas Missouri Oklahoma	Ozarks

philic [e.g., *Pseudotriton ruber* (Latreille)] and troglomorphic [e.g., *Eurycea lucifuga* (Rafinesque)].

### Class Reptilia

Although there are no known obligate reptiles from caves in the United States, these habitats are used often by snakes for short durations or even significant amounts of time. Most tend to remain near entrances and use the cave as a refuge from extreme surface conditions. Some snakes prey on bats during their flights out of the cave [e.g., the colubrid *Elaphe obsoleta* (Say)] and certain lizards are observed in the entrance areas of caves as well [e.g., the geckonid *Coleonyx variegatus brevis* (Stejneger) in Texas]. In Florida the American alligator [*Alligator mississippiensis* (Daudin)] and the cooter turtle [*Pseudemys floridana* (LeConte)] are seen in the entrances to many submerged caves and will venture short distances into these cavities that serve often as the source of large karst springs.

### Class Aves

The most noted of all birds that utilize caves is probably the troglomorphic oilbird of Cueva del Guacharo in Venezuela, South America (*Steatornis caripensis* Humboldt), for centuries prized by locals as a source of cooking and lighting oil. Although the eyes of this bird are large and well developed for use in dim light, they utilize echolocation (as do bats) when in the complete darkness of caves. In the United States, no such highly specialized species occur in caves yet swallows (e.g., *Hirundo* spp.), the canyon wren [*Catherpes mexicanus* (Swainson)], and the eastern phoebe [*Sayornis phoebe* (Latham)] are common inhabitants of cave entrances. Various species inhabit the twilight zone of caves, including the eastern (common) screech-owl [*Otus asio* (Linnaeus)] and the turkey vulture [*Cathartes aura* (Linnaeus)] nests in this semidark zone of caves.

### Class Mammalia

The occurrence of mammals in caves is quite common although none are obligate and most are temporary residents/visitors, including numerous rodents such as pack rats (*Neotoma* spp.), mice (*Peromyscus* spp.), beaver (*Castor canadensis* Kuhl), the wood chuck, *Marmota monax* (Linnaeus), as well as carnivores such as bears (*Ursus* spp.) and raccoons [*Procyon lotor* (Linnaeus)]. Clearly no bats are obligate cave-dwellers yet 30 of the 53 species and subspecies found in the United States occupy caves at least occasionally. They are assigned to four families (Table IV) and most are insectivorous (e.g., the endangered Indiana Bat, *Myotis sodalis* Miller and Allen), but some feed on fruits, pollen, and nectar (e.g., Mexican long-tongued bat, *Choeronycteris mexicana* Tschudi). During the winter most hibernate in caves (or mines) often in large, dense clusters of up to several

TABLE IV Cave-Dwelling Bats of the United States

Family	Genus	Species/subspecies	Common name	Status <sup>a</sup>
Molossidae	<i>Tadarida</i>	<i>brasiliensis</i>	Brazilian free-tailed bat	NT
Mormoopidae	<i>Mormoops</i>	<i>megalophylla</i>	Ghost-faced bat	NT
Phyllostomidae	<i>Choeronycteris</i>	<i>mexicana</i>	Mexican long-tongued Bat	OSC
	<i>Leptonycteris</i>	<i>curasoae yerbabuenae</i>	Lesser long-nosed bat	E
	<i>Leptonycteris</i>	<i>nivalis</i>	Greater long-nosed bat	E
Vespertilionidae	<i>Antrozous</i>	<i>pallidus</i>	Pallid bat	NT
	<i>Eptesicus</i>	<i>fuscus</i>	Big brown bat	NT
	<i>Idionycteris</i>	<i>phyllostis</i>	Allen's big-eared bat	OSC
	<i>Lasiurus</i>	<i>borealis</i>	Eastern red bat	NT
	<i>Lasiurus</i>	<i>cinereus</i>	Hoary bat	NT
	<i>Lasiurus</i>	<i>seminolus</i>	Seminole bat	NT
	<i>Myotis</i>	<i>auriculus</i>	Southwestern bat	NT
	<i>Myotis</i>	<i>austroriparius</i>	Southeastern bat	OSC
	<i>Myotis</i>	<i>evotis</i>	Western long-eared bat	OSC
	<i>Myotis</i>	<i>grisescens</i>	Gray bat	E
	<i>Myotis</i>	<i>leibii</i>	Eastern small-footed bat	OSC
	<i>Myotis</i>	<i>lucifugus</i>	Little brown bat	NT
	<i>Myotis</i>	<i>septentrionalis</i>	Northern long-eared bat	NT
	<i>Myotis</i>	<i>sodalis</i>	Indiana bat	E
	<i>Myotis</i>	<i>thysanodes</i>	Fringed bat	OSC
	<i>Myotis</i>	<i>velifer</i>	Cave bat	OSC
	<i>Myotis</i>	<i>volans</i>	Long-legged bat	OSC
	<i>Myotis</i>	<i>yumanensis</i>	Yuma bat	OSC
	<i>Pipistrellus</i>	<i>hesperus</i>	Western pipistrelle bat	NT
	<i>Pipistrellus</i>	<i>subflavus</i>	Eastern pipistrelle bat	NT
	<i>Corynorhinus</i>	<i>rafinesquii</i>	Rafinesque's big-eared bat	OSC
	<i>Corynorhinus</i>	<i>townsendii ingens</i>	Ozark big-eared bat	E
	<i>Corynorhinus</i>	<i>t. pallescens</i>	Western big-eared bat	OSC
	<i>Corynorhinus</i>	<i>t. townsendii</i>	Townsend's Big-eared Bat	OSC
	<i>Corynorhinus</i>	<i>t. virginianus</i>	Virginia Big-eared Bat	E

<sup>a</sup> E, endangered; NT, no threat; OSC, of special concern.

thousand individuals and the summers are spent in trees or buildings. A few species (e.g., gray bat, *Myotis grisescens* Howell) may live in caves throughout the year, although different ones are utilized in winter and summer. Some species, like the Brazilian free-tailed bat [*Tadarida brasiliensis* (Saussure)], occupy caves in very large numbers and contribute an immense amount of organic material (guano, i.e., bat droppings) to the cave ecosystem. During the summer approximately 20,000,000 individuals of this particular species occupy a single cave near San Antonio, Texas, and, at that time, the population represents the largest concentration of mammals in the world. Guano produced by bats living in caves not only supports immense communities of guano-philic (e.g., bat fleas, dermestid beetle larvae, gnats, and pseudoscorpions), but also this nitrogen-rich material has been mined for use as fertilizer as well as for producing saltpeter (potassium nitrate), which is an ingredient of gunpowder.

## DISCUSSION

The biodiversity of cavernicoles in the United States is summarized in Table I and their distribution patterns are demonstrated in Tables II and III and Figs. 3 and 4. Clearly

the more mobile troglobites have been very successful, with more than twice their numbers invading subterranean habitats when compared to stygobites. Also, insects (359 species and subspecies including apterygous and pterygous forms; 32% of all obligate species), arachnids (319; 28%), and crustaceans (294; 26%) dominate the species richness summaries, with terrestrial arachnids making up nearly one-third of all subterranean species. Much variation is shown among major karst regions, with those to the north (Black Hills and Driftless Area) having few obligate species. The number of stygobites ranged from zero (Black Hills) to 85 (Appalachians), and the number of troglobites varied from zero (Florida Lime Sinks) to 256 (Interior Lowlands), and even at the generic level, overlap among regions is low. Karst regions with the greatest total biodiversity are the Interior Lowlands, Appalachians, and the Edwards Plateau & Balcones Escarpment (Fig. 4C), although troglobites show somewhat different patterns than do stygobites (Figs. 4A and B). States with the highest total species richness are Texas, Tennessee, Alabama, Kentucky, and Virginia. Stygobites show a different pattern: Texas, Virginia, Tennessee, Missouri, and West Virginia (Fig. 3). Most assuredly "hot spots" do exist where concentrations of fauna occur and northeastern

Alabama is one of these centers of biodiversity for troglobites and stygobites. Of particular note, Jackson County has 1526 caves and 66 obligate cavernicoles, which translates into more than three times the number of caves and nearly twice as many species as any other Alabama county. This shows the strong relationship between the number of caves observed and the number of species reported ( $r^2 = 0.81$ ).

Troglobites and stygobites make up slightly more than 50% of the imperiled U.S. fauna that is tracked in the central databases of the Natural Heritage Program. There are far too many potential (and realized) disturbances to discuss herein that threaten these out-of-sight organisms and the reader is referred to Elliott (2000) for an excellent review of them. Suffice it to say that the ultimate long-term survival of subterranean karst communities depends on appropriate management and protection of the cave, the groundwater, and the entire catchment area.

It becomes clear that these subterranean species are geographically concentrated in a small percentage of the landscape, with more than 50% of cave-inhabiting species occurring in less than 1% of the land. Hence, it is much easier to preserve a large percentage of at-risk species by focusing habitat conservation efforts in those areas of high concentrations of obligate cave fauna, or “hot spots.” Protecting and conserving karst habitats and their biodiversity is a challenging but most important task for modern and future speleologists. The subterranean biodiversity of the United States is globally significant but highly vulnerable.

### Bibliography

- Christman, M. C., and D. C. Culver (2001). The relationship between cave biodiversity and available habitat. *J. Biogeography* **28**, 367–380.
- Culver, D. C., M. C. Christman, W. R. Elliott, H. H. Hobbs III, and J. R. Reddell (2003). The North American obligate cave fauna: Regional patterns. *Biodivers. Conser.* **12**(3) 441–448.
- Culver, D. C., and H. H. Hobbs III (2002). Patterns of species richness in the Florida stygobitic fauna. In *Hydrogeology and Biology of Post-Paleozoic Carbonate Aquifers* (J. B. Martin, C. M. Wicks, and I. D. Sasowsky, eds.), Special Publication 7, pp. 60–63. Karst Waters Institute.
- Culver, D. C., H. H. Hobbs III, M. C. Christman, and L. L. Master (1999). Distribution map of caves and cave animals in the United States. *J. Cave Karst Studies* **61**(3), 139–140.
- Culver, D. C., H. H. Hobbs III, and J. E. Myroie (1999). Alabama: A subterranean biodiversity hotspot. *J. Alabama Acad. Sci.* **70**(3), 97–104.
- Culver, D. C., L. L. Master, M. C. Christman, and H. H. Hobbs III (2000). Obligate cave fauna of the 48 contiguous United States. *Conserv. Biol.* **14**(2), 386–401.
- Elliott, W. R. (2000). Conservation of the North American cave and karst biota. In *Ecosystems of the World 30: Subterranean Ecosystems* (H. Wilkins, D. C. Culver, and W. F. Humphreys, eds.), pp. 665–689. Elsevier Press, Amsterdam.
- Harvey, M. J., J. S. Altenbach, and T. L. Best (1999). Bats of the United States. Arkansas Game & Fish Commission, U.S. Fish and Wildlife Service, Asheville.
- Hobbs III, H. H. (1992). Caves and springs. Chap. 3 in *Biodiversity of the Southeastern United States: Aquatic Communities* (C. T. Hackney, S. M. Adams, and W. H. Martin, eds.), pp. 59–131. John Wiley and Sons, New York.
- Nicholas, Bro. G. (1960). Checklist of macroscopic troglobitic organisms of the United States. *Amer. Midl. Nat.* **64**, 123–160.

- Packard, A. S. (1888). The cave fauna of North America, with remarks on the anatomy of the brain and the origin of the blind species. *Mem. Nat. Acad. Sci.* **4**, 1–156.
- Peck, S. B. (1998). A summary of diversity and distribution of the obligate cave-inhabiting faunas of the United States and Canada. *J. Cave Karst Studies* **60**(1), 18–26.

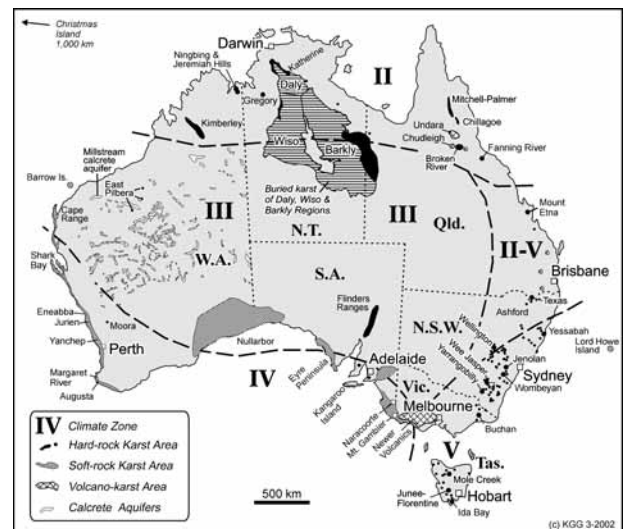
## Diversity Patterns in Australia

William F. Humphreys

Western Australian Museum, Australia

### INTRODUCTION

That Australia, and tropical areas worldwide, have diverse subterranean fauna has not been long recognized. Until recent decades, Australia was thought to be deficient in overtly cave-adapted (troglomorphic) animals. This circumstance was considered to have resulted from a number of causes: (1) the relative sparsity of carbonate rocks in Australia, as found in other Gondwanan fragments, compared with the world average (Fig. 1); (2) the general aridity of the continent—it is the most arid inhabited continent, two-thirds of which receives less than 500 mm of rain annually—generally resulting in both dry caves and the low input of food energy into the underground voids; (3) the global lack of cave-adapted



**FIGURE 1** Karst areas of Australia and the bioclimatic zones: II, tropical; III, subtropical dry; IV, transitional zone with winter rain; V, warm temperate; II–IV warm temperate/tropical transition zone. (After Hamilton-Smith and Eberhard, 2000. Graphic by K. G. Grimes.)

animals in tropical areas; and (4) the lack of widespread glaciation, which was perceived to be the main driving force driving the evolution of troglobites in the Northern Hemisphere, then the focus of biospeleological research. Concomitantly, there was perceived to be a high proportion of animals found only in caves but not specialized for cave life, that is, lacking overt troglomorphisms. Although not articulated, these arguments would have applied also to stygofauna, the inhabitants of underground waters in both karstic and alluvial aquifers.

Understanding the biogeography of an area is reliant on having a broad spatial and taxonomic sample of the biota, a comprehensive taxonomy, a well-developed systematic and paleoclimate framework, and a fully developed geographical understanding (especially of paleodrainage and plate tectonics). There are serious deficiencies in information on most of these fields of endeavor in Australia. The taxonomic and systematic framework is very patchy and many groups of interest to hypogean questions remain largely unstudied (e.g., Thysanura, Collembola, Diplura, Oligochaeta) or are just beginning to be studied so it is still too early for them to contribute in detail to biogeographical understanding (e.g., many higher taxa in Oligochaeta, Copepoda, Ostracoda, Amphipoda, Diplura, Gastropoda). Hence, the focus here will be on some higher taxa for which there is more adequate information, and on some systems, such as the groundwater inhabitants of the smaller voids (mesovoids), for which there is a useful body of data.

During the last two decades of the 20th century, more focused, as well as more widespread, exploration of caves and later groundwater has shown that the Australian tropics and arid zones contain especially rich subterranean fauna. However, no area of Australia has been well studied for its hypogean life, the distribution of the effort has been very uneven across the country, and many areas remain effectively unexplored for cave fauna. Detailed examination of subterranean biology in Australia is sparse and studies have been largely restricted to faunal surveys. Prominent karst areas, such as the Barkley and Wiso regions, have barely been examined because of their remoteness from population centers. Other remote areas, such as the Nullarbor, in which there has been a long history of cave research, have proved to have sparse hypogean assemblages, especially among the stygofauna. Even within those relatively well surveyed areas, the taxonomic effort is seriously underdeveloped. For example, in one compilation, 63% of the stygofauna from New South Wales was undescribed. Where species have been described, there are many oddities, not yet well placed within their lineage and thus contributing poorly to understanding the biogeography of the Australian hypogean biota.

## GEOGRAPHIC FACTORS

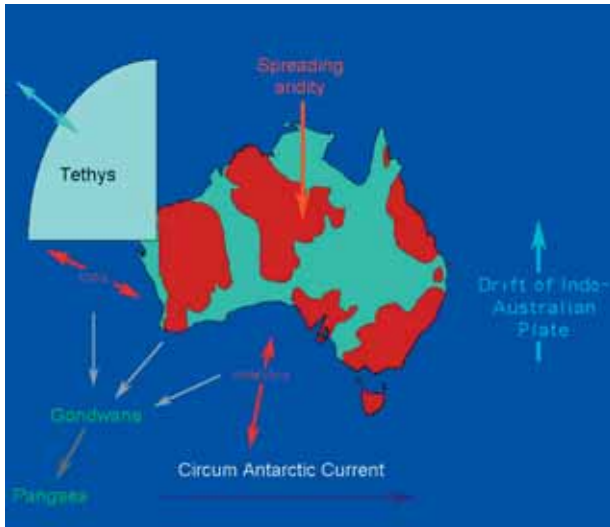
In contrast to the widespread glaciation that directly influenced many of the classical karst areas in the Northern

Hemisphere, Australia has not been subjected to continent-wide glaciation since the Permian. The biogeography of the hypogean fauna of Australia has been influenced by the continent's past connections with Pangaea and Gondwana, as well as having formed the eastern seaboard of the Tethys Ocean during the Mesozoic. Australia is a fragment of Gondwana together with Africa, India, Madagascar, South America, and Antarctica. Gondwana itself fragmented and Eastern Gondwana (India, Antarctica and Australasia) became isolated from South America and Africa by 133 million years ago. By the Upper Cretaceous (ca. 80 million years ago), Australia was joined only to Antarctica and it formed the eastern seaboard of Tethys. These lands shared a Gondwanan flora and fauna, and when the final separation between them occurred (45 million years ago), both lands were well watered and supported cool temperate and subtropical forests.

The separation of Australia from Antarctica, and its resulting rapid northward drift toward southeast Asia, has been the most significant factor that has shaped the Australian subterranean fauna in the Tertiary. It resulted in the formation of the Southern Ocean seaway and the development of the circum-Antarctic ocean currents and winds that markedly altered the climate of the Southern Hemisphere, causing Australia to become much drier. The formation of the Antarctic ice cap 15 million years ago saw the beginning of a series of marked climatic fluctuations that have greatly stressed the Australian (and other Gondwanan) flora and fauna. Warm and wet interglacial periods alternated with very dry, cool, and windy glacial stages, but only a small area of the Eastern Highlands and Tasmania were subject to extensive ice cover. These cyclic fluctuations, superimposed on a generally increasing and spreading aridity, provided conditions under which subterranean refugia played an important role.

## Shield Regions and the Cretaceous Marine Transgressions

Australia has several major shield regions—parts of the Earth's crust little deformed for a prolonged period—that have been emergent since the Paleozoic. The largest is the *Western Shield*, which includes the Pilbara and Yigarn cratons. These stable, truly continental areas of Australia have a nonmarine, presumably freshwater history extending through several geological eras. The Cretaceous marine inundation, at ca. 120 Ma, would have eliminated nonmarine life in the submerged areas (Fig. 2) and only 56% of the current land area of the continent remained above sea level. This has important implications for lineages with poor dispersal ability, as is typical of subterranean fauna. The distribution of ancient lineages, both epigeal and subterranean, may be expected to reflect this marine incursion in two ways. First, ancient terrestrial and freshwater lineages may have survived on these continually emergent landmasses. Second, marine ancestors may have become stranded along the shores as the



**FIGURE 2** Deep history events that have influenced the biogeography of Australian subterranean faunas (see text). The shaded continental areas have not been covered by the oceans since the Paleozoic.

Cretaceous seas retreated and today may be represented as relictual marine lineages now far inland.

Caves and other subterranean habitats can remain as relatively stable environments over long periods of time because they are well insulated from the climatic perturbations that profoundly affect surface environments and surface animals. There, a number of ancient geographical and phylogenetic relictual groups have survived (*Spelaeogriphacea*, *Remipedia*, *Thermosbaenacea*, etc.) (Fig. 3). Owing to their limited potential for dispersal, their present distributions may contain a great deal of information about past geography and climates. The ghost of Cretaceous and earlier marine transgressions is probably reflected in the distribution of phreatoicideans, an ancient group of isopods, in both their epigeal and subterranean forms, the latter being restricted to the tropics, and it has been well documented in the crangonyctoid amphipods (see Box 1).

In this respect aquatic subterranean fauna hold a special significance because, unlike terrestrial troglobites, the aquatic troglobite fauna (*stylobites*) contain many relict species that are only distantly related to surface forms. These lineages provide the most compelling evidence that the distribution of some relict fauna occurred through rafting on tectonic plates moved by seafloor spreading. Recently a number of notable discoveries of such relict fauna have been made in Australia whose geographical distribution and lifestyles suggest origins variously in Pangaea, Gondwana, Eastern Gondwana, and Tethys.

### Cave Atmosphere

The latitudinal position and general aridity of Australia make cave atmosphere a significant biogeographic determinant in Australia. Cave environments have traditionally been

separated into different zones—the entrance, twilight, transition, and deep zones—with characteristics related to the remoteness from the surface environment, such as more stable temperature and humidity and reduced light and food energy input. On the basis of research in the Undara lava tube, Howarth and colleagues developed the concept of a fifth zone, the *stagnant-air zone*, which is characterized by elevated carbon dioxide and depressed oxygen levels. Only in such areas were highly troglomorphic species found in cave passages. However, in other tropical areas, such as arid Cape Range, highly troglomorphic species occur in caves that have unremarkable concentrations of oxygen and carbon dioxide, some even occurring in sunlight near cave entrances, but only where the air is saturated, or nearly saturated, with water vapor.

Howarth also addressed the importance of water content in the cave atmosphere, largely from his Australian studies. Both tropical and temperate cave systems lose water when the outside air temperature (strictly, the outside water vapor pressure) drops below that in the cave. In the tropics, where average seasonal temperature differences are less than in temperate regions, caves tend to be warmer than the surface air at night and cooler during the day. Even if both air masses are saturated with water, the cave will tend to dry out as water vapor leaves the cave along the vapor pressure gradient—the so-called “tropical winter effect.”

Owing to widespread aridity, this concept has particular relevance to Australia and also in tropical areas where the general form of many caves (giant grikes, small and shallow caves) and low subterranean water supply make them vulnerable to drying. Within this context the extent of the deeper cave zones (transition and deep) will fluctuate as the boundary of threshold humidity levels migrates with the changing atmospheric conditions further into or out of the cave. Such changes occur in ecological time, associated with daily and seasonal fluctuations in air density and humidity, and through evolutionary time, in response to climatic cycles and long-term climatic trends. Such changes should have little effect on groundwater or on troglobites in deep caves, which are extensive enough to contain the entire change. But, in the shallow caves common in the Australian tropics, such changes are likely to cause large areas of cave systems to dry out. Such processes may lead to the extinction of certain cave fauna, or impede movement through the epikarst and thus could promote speciation between different karst areas. The high diversity of *Schizomida* and of the paradoxosomatid millipede *Stygiochiropus* in arid Cape Range are candidates for such analysis.

Humid caves within the arid zone have permitted the survival of a diverse troglobitic fauna in arid Cape Range, the affinities of which lie with the inhabitants on the floor of the rainforest, both temperate and tropical, habitats now thousands of kilometers distant. While the fauna is now geographically relict, the driving force resulting in the initial invasion of the caves is unknown—species may have estab-





**FIGURE 3** Subterranean animals, clockwise from upper left: 1, *Tjirtudessus eberhardi* (Dytiscidae), one of 50 species of blind diving beetles from calcretes aquifers in the Australian arid zone; 2, unnamed blind philosciid isopod; 3, head of *Ophisternon candidum* (Symbranchiformes), one of two Australian cave fish; 4, the phreatoicidean isopod *Phreatoicooides gracilis*; 5, *Pygolabis humphreysi*, from Ethel Gorge calcrete belongs to a family of flabelliferan isopods, the Tainisopidae, known only from groundwater in Kimberley and Pilbara regions of Western Australia; 6, *Mangkurtu mityula* (Spelaeogriphacea), a subterranean family that is known from only two locations in each of Australia, Africa, and Brazil; 7, *Draculoides vinei* (Schizomida), one of seven species of micro-whipscorpions known from Cape Range; 8, *Ngamarlanguia luisae* (Gryllidae: Nemobiinae) from Cape Range, the only troglobitic cricket in Australia. (Photographs by Douglas Elford, Western Australian Museum, except 1, W. F. Humphreys from a painting by Elyse O'Grady; and 4, from GDF Wilson Australian Museum.)

### Amphipods

Australia is a major center of amphipod diversity and much of this diversity is represented by stygal species. Unexpectedly, they are diverse in the tropic areas and in the arid center of Australia, in typical karst and in groundwater calcrete aquifers. They belong to a number of higher taxa including the crangonyctoids (Paramelitidae, Perthiidae, Neoniphargidae), hadzioids (Fig. 6) (Melitidae, Hadziidae), Ceinidae, Bogidiellidae, and Eusiridae, but there is scant knowledge of their distribution and diversity. About 65 described species occur in these eight families, with much of the diversity occurring in groundwaters of the arid region (Bradbury and Williams, 1997). Whereas some families appear to be restricted to the moist temperate southeast and southwest of the continent (Eusiridae and Neoniphargidae), others are much more widespread and encompass parts of the arid zone and tropical areas (Melitidae, Paramelitidae). Other families are more restricted and Bogidiellidae are known only from the northwest, whereas Perthidae and Ceinidae occur in the southwest and south, respectively. Bogidiellid, melitids, and hadziids are known from the anchialine waters of the northwest, especially Cape Range and Barrow Island. Notably, while taxa in southern areas comprise both stygal and epigeal species, northern taxa, in the arid tropic and subtropics, comprise only stygal taxa.

A clear relationship can be seen between the Cretaceous marine transgressions and the distribution of amphipods. Melitoid taxa occur near the shorelines of areas that have been transgressed, while in those areas that have not been transgressed, crangonyctoid taxa and niphargiids are found. Paramelitids are diverse and abundant in Tasmania but seemingly sparse in New South Wales, where neoniphargids are diverse. More comprehensive collecting in Western Australia suggests that family distributions may be circumscribed (Fig. 4).

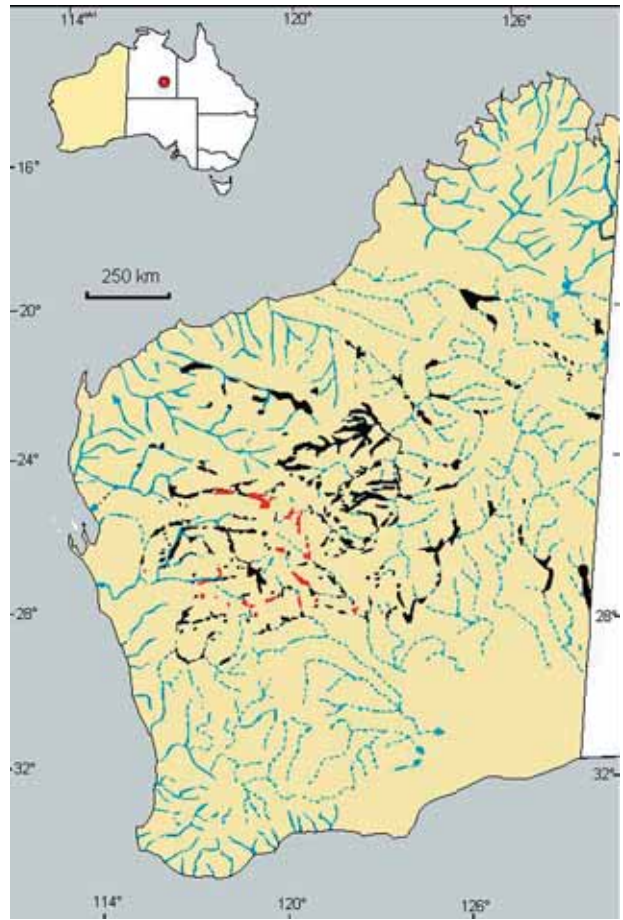


FIGURE 4 The distribution of groundwater calcretes in Western Australia, which occur throughout the arid land north of 29°S. Most occur immediately upstream of salt lakes (playas) within paleodrainage channels (dotted lines).

lished in caves coincident with the onset of aridity to escape the surface drying, or they may have established in caves seeking resources unrelated to the onset of aridity. This question cannot be resolved for Cape Range because the aridity has been sufficiently intense to extirpate entirely close relatives at the surface. Other tropical areas, such as North Queensland, offer greater prospect of resolving such issues because contemporary lineages occur with surface and cavernicolous species exhibiting various degrees of troglomorphy.

Another area where a resolution of the causes of colonization of the hypogean environment may be resolved is in the groundwater calcrete deposits (see Box 2) in the arid

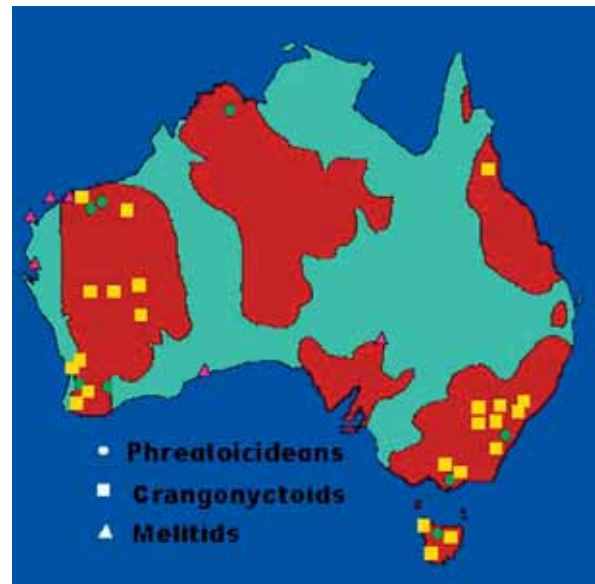
zone. There, many different lineages of diving beetles (Dytiscidae) have invaded the groundwater and become eyeless and flightless (Fig. 3). Each calcrete body has a unique dytiscid assemblage, there is almost no overlap in species between different calcretes, and speciation appeared to have taken place *in situ* because species pairs (one large and one small) are common among the 50 stygal species in the arid zone. Molecular studies suggest that numerous lineages invaded the calcrete aquifers during the constrained time period, which suggests that it occurred in response to a widespread factor, such as might be expected from spreading aridity.

### Groundwater Calcretes

The long period of emergence and the ensuing erosion down to the Archaean basement has resulted in classical karst terrain being absent from the Western Shield. However, thin carbonate deposits are widespread throughout the arid zone and are well developed as groundwater (valley) calcretes (hereafter termed calcrete) which occur widely in Australia but in isolated, though sometimes extensive, pockets usually associated with palaeodrainage lines (Fig. 5). Calcretes are carbonate deposits forming from groundwater near the water table in arid lands as a result of concentration processes by near-surface evaporation. They occur forming immediately upstream of salt lakes (playas), chains of which form such a prominent part of the landscape in the more arid parts of Australia. The playas are the surface manifestation of palaeodrainage channels incised into Precambrian basement rocks by rivers that largely stopped flowing when the climate changed from humid to arid in the Palaeocene. Hence, the palaeovalleys predate the fragmentation of Gondwana.

Calcretes are especially important in the Australian context as they form in arid climates (annual rainfall <200 mm) with high potential evaporation (>3000 mm per year). Although quite thin (10–20 m thick) the groundwater calcretes often develop typical karst features and within them. Groundwater salinity may vary markedly owing the episodic recharge characteristic of the arid zone.

Because they are deposited at intervals from the groundwater flow, the calcrete masses are separated by habitat—Tertiary valley-fills, largely clays, and saltlakes—that is unsuitable for stygofauna. Consequently, they form isolated karst areas along the numerous major palaeovalleys, some of which date from the Permian. The sediments filling the palaeochannels are mostly Eocene



**FIGURE 5** The distribution of subterranean amphipod and isopod taxa in relation to long emergent land areas in Australia. The phreatoicidean isopods and crangonyctoid amphipods are ancient continental lineages, whereas the melitid amphipods have a more recent marine ancestry.

or later but the age of the calcretes is unknown. The extensive alluvial fan calcretes and some of the river valley calcretes formed in the Oligocene ((37–30 Ma) may have following the onset of the continental aridity. Many of the calcrete areas, especially those north of 31°S, are being actively deposited and the others have probably been remobilized and redeposited, attributes that make the dating of calcrete deposits using standard radiometric methods problematic. However, a molecular phylogeny of the diverse diving beetle fauna, the numerous species of which are each restricted to a single major calcrete area (Leys *et al.*, in press), indicate that the calcretes have been present for at least 5–8 million years.

### Energy Supply

Energy enters subterranean systems largely mediated by water, animals, and plants. Because these elements themselves are not uniformly distributed across Australia they have the potential to influence Australian cave biogeography. The carriage of organic matter in surface water is strongly affected by seasonal rainfall and plant growth. The episodic rainfall, characteristic of the arid zone, means that some areas potentially have unpredictable energy supplies.

Plants provide the raw material that is transported by water into the subterranean realm, but they also directly transport energy into hypogean habitats by means of sap transport within the roots and by root growth. Roots, especially tree roots, were identified as an important and

reliable source of energy for troglobitic cixiid and meenoplid fulgoroid Homoptera. These occur in the lava tubes of tropical North Queensland and similar fauna are found in karst across the tropics, into the Kimberley and down the arid west coast, to the south of Cape Range. Tree roots are also utilized by cockroaches throughout the country (e.g., in the Nullarbor, *Trogloblatella nullarborensis*).

Tree rootmats also represent a reliable food supply for elements of the rich communities of aquatic invertebrates, including some exhibiting troglomorphisms, occurring in some shallow stream caves of western Australia. They provide habitat, and probably food, for stygofauna in the Nullarbor, in calcrete aquifers of the Western Shield, and in anchialine caves in Cape Range and Christmas Island where they

are associated with a diverse fauna largely comprising crustaceans.

Roots, like guano, often provide copious quantities of energy to cave communities, which may be quite diverse. Roots in both the Undara lava tube, Queensland, and the Tamala Limestone of western Australia, support diverse cave communities. However, whereas the former contain numerous highly troglomorphic species, the latter has few stygomorphic species, many being indistinguishable for surface species.

Animals may transport energy into cave systems and deposit it there as excreta, exuvia, carcasses, and eggs. In Australia such troloxenic agents exhibit marked latitudinal differences. In the south rhabdophorid crickets are the most conspicuous troloxenic agents, whereas bats, while not diverse, are locally abundant where they form breeding colonies. In the tropics bats are widespread, diverse, and important producers of guano, as, to a lesser degree, are swiftlets in more humid areas.

Guano is usually intermittently distributed in both space and time because it is dependent on the biology of the birds and bats. In consequence, the cave communities associated with guano are highly specialized and differ markedly from the cave fauna not dependent on guano. Markedly troglomorphic species are not commonly found in the energy-rich, but temporally unstable, guano communities.

### STYGOFAUNA AND CRUSTACEA

Stygofauna are discussed in the context of Crustacea, which comprise the overwhelmingly majority of stygofauna, but the Dytiscidae example above introduced the insect component.

The magnitude of the biodiversity present in subterranean waters globally has only recently been given prominence. Australia, especially the northwestern and southeastern parts, has unexpectedly come to the attention of stygobiologists and systematists on account of its diverse regional groundwater fauna (stygofauna). Recently, these have been determined to include a number of higher order taxa variously new to science (for instance, an undescribed family of flabelliferan isopod), new to the Southern Hemisphere (Thermosbaenacea, Remipedia, Epacteriscidae), or new to Australia (Spelaeogriphacea, Pseudocyclopiidae). Many of these taxa occur near coastal and anchialine waters and are interpreted as comprising a relictual tethyan fauna. Several of these lineages have congeneric species, which are known elsewhere only from subterranean waters on either side of the North Atlantic—the northern Caribbean region and the Balearic and Canary archipelagos (see Box 3).

### Syncarida

The Syncarida are crustaceans now entirely of inland waters. The Anaspidacea are confined to Australia, New Zealand, and southern South America. In southeastern Australia they

are often large and mostly surface living, although several stygomorphic species occur in caves streams and groundwater, and an undescribed family has been reported that is restricted to caves. In contrast, both families of Bathynellacea have a global distribution, often even at the generic level, and are widespread in Australia. *Bathynella* (Bathynellidae) is found from Victoria to the Kimberley and elsewhere the genus occurs globally. Genera within the Parabathynellidae known from Australia exhibit different regional affinities. *Chilobathynella* and *Atopobathynella* are known from Chile and southeastern Australia, while the latter is also found throughout northwestern Australia, including Barrow Island and Cape Range, and the arid paleodrainage channels of the arid center. *Notobathynella* is found across Australia and New Zealand, while *Hexabathynella*, from the eastern Australian seaboard, has a more global distribution, being found in New Zealand, southern Europe, Madagascar, and South America. Bathynellacea are small stygobites, mostly inhabitants of interstitial freshwater environments, although an undescribed genus of large, free-swimming parabathynellid occurs in brackish water (<6000 mg L<sup>-1</sup> TDS) in the Carey paleodrainage systems of the arid zone, where it is associated with a number of maritime copepods lineages such as Ameiridae (Harpacticoida) and *Halicyclops* (Cyclopoida).

### Copepoda

Remarkably little work has been conducted on nonmarine copepods in Australia. Recent work on groundwater copepods, largely from groundwater calcretes of the Western Shield, and the near coastal, especially anchialine systems of the northwest, has revealed higher taxa not previously described from Australia, in some cases even from the Southern Hemisphere.

Numerous new species of copepods are being described from Australian groundwaters, largely from the Yilgarn area of the Western Shield including five new genera of Cyclopoida and Harpacticoida, and several genera are reported for the first time from Australia [*Nitocrella* Ameiridae (Eurasia), *Parapseudoleptomesochra* (global), *Haifameira* Ameiridae (depth of Mediterranean Sea), and the family Parastenocarididae (Pangaea, freshwater)]. The broader distribution of these lineages within Australia awaits investigation.

The occurrence of near-marine lineages (e.g., *Halicyclops*) in the center of the Western Shield alongside lineages considered to be ancient freshwater lineages (*Parastenocaridis*: Parastenocarididae) is notable. It may reflect both the salinity stratified, often hypersaline groundwater in these paleodrainage systems, as well as the ancient origins of the fauna. *Mesocyclops* has a mostly tropical distribution; *Metacyclops* (*trispinosus* group) and *Goniocyclops* have an Eastern Gondwanan distribution; and the limits to the distributions of newly described genera of Ameiridae, Canthocamptidae, and Cyclopiinae await confirmation.

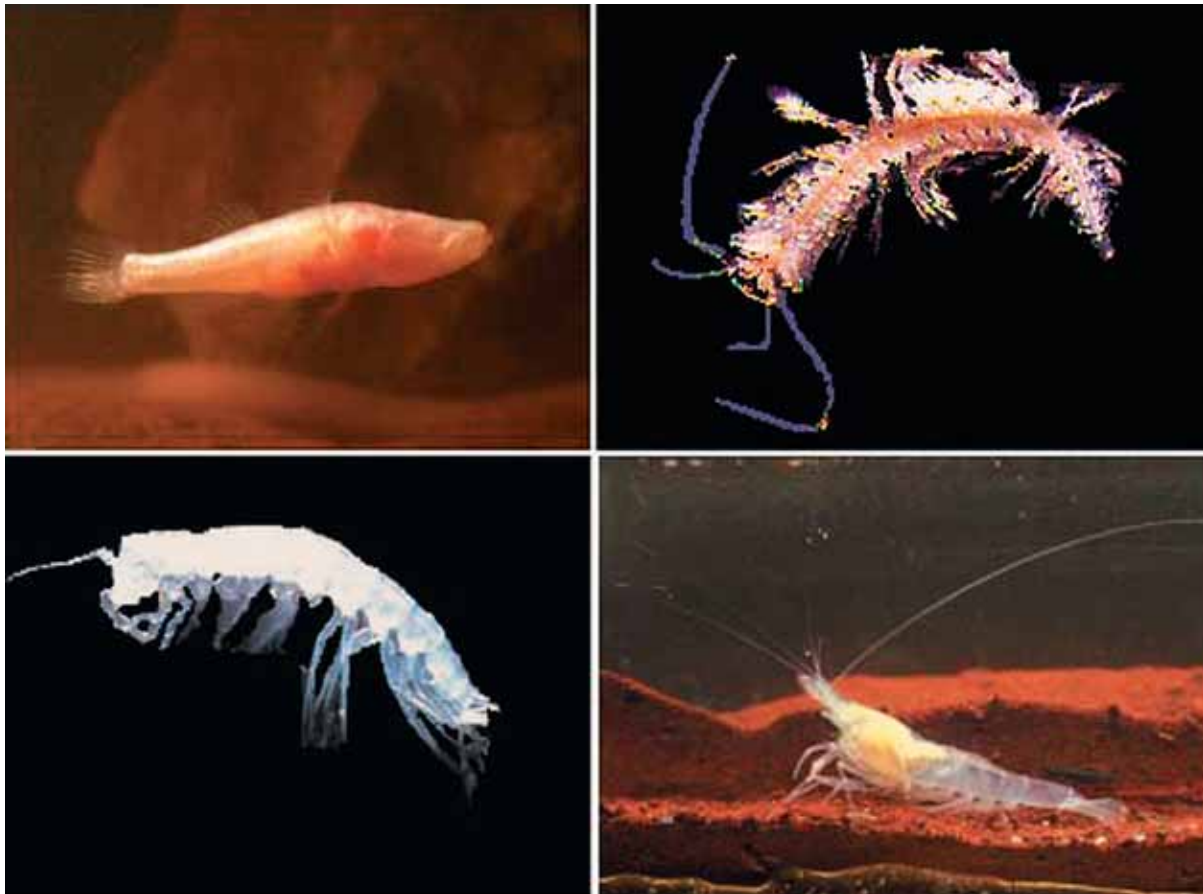
**Anchialine Habitats—Tethyan Relicts**

*Anchialine* (or *anchihaline*) habitats comprise near-coastal mixohaline waters, usually with little or no exposure to open air and always with more or less extensive subterranean connections to the sea. They typically show salinity stratification and may usefully be considered to be groundwater estuaries. They typically occur in volcanic or limestone bedrock and show noticeable marine as well as terrestrial influences. The water column is permanently stratified with a sharp thermohalocline separating a surface layer of fresh or brackish water from a warmer marine, oligoxic water mass occupying the deeper reaches. They have a significant amount of autochthonous primary production, via a sulfide-based chemoautotrophic bacterial flora, as well as receiving advected organic matter from adjacent marine or terrestrial epigean ecosystems. Anchialine habitats are mostly found in arid coastal areas and are circum-globally distributed in tropical/subtropical latitudes.

Anchialine habitats support specialized subterranean fauna (Fig. 6), predominantly crustaceans representing biogeographic and/or phylogenetic relicts. These specialized anchialine endemics are largely restricted to the oligoxic reaches of the water column below the thermohalocline. The structure of these assemblages is highly predictable and, remarkably, however remote an anchialine habitat, this predictability frequently extends to the generic composition.

In continental Australia anchialine systems occur adjacent to the North West Shelf (Cape Range and Barrow Island), and on Christmas Island (Indian Ocean), an isolated seamount 360 km south of Java but separated from it by the Java Trench.

Cape Range supports such a fauna comprising atyids, thermosbaenaceans, hadziid amphipods, cirrolanid isopods, remipeds, thamatocypridid ostracods, and an array of copepods such as epacteriscid and pseudocyclopiid calanoids, and speleophriid misophrioids. Some are the



**FIGURE 6** Stygal animals from Australian anchialine waters. Clockwise from upper left: *Milyeringa veritas* (Eleotridae); *Lasionectes exleyi* (class Remipedia); *Stygiocaris stylifera* (Decapoda: Atyidae); *Liagoceradocus branchialis* (Hadziidae).

**Anchialine Habitats—Tethyan Relicts—cont'd**

only known representatives of higher taxa in the Southern Hemisphere (Class Remipedia; Orders Thermosbaenacea, Misophrioida), and several genera are known elsewhere from anchialine systems on either side of the North Atlantic (*Lasionectes*, *Halosbaena*, *Speleophria*). The poor dispersal abilities of these stygal lineages and their close fit with the areas covered by the sea in the late Mesozoic suggests that their present distributions could have resulted from vicariance by plate tectonics (Fig. 2).

Anchialine systems on oceanic islands support a different group of fauna, but the structure of these assemblages is similarly predictable, even between oceans. Christmas Island is a seamount and supports an anchialine fauna characterized by the stygobitic shrimp

*Procaris* (Decapoda), which belongs to the primitive, highly aberrant, family Procarididae that appears globally to be restricted to anchialine caves. This family has been reported elsewhere only from other isolated seamounts, Bermuda and Ascension Island in the Atlantic Ocean, and Hawaii in the Pacific. In each case, as with Christmas Island, the procaridids are associated with alpheid, hippolytid, and atyid shrimp. These cooccurrences of two primitive and presumably ancient caridean families support the contention that crevicular habitats have served as faunal refuges for long periods of time. There is no coherent theory as to their distribution to remote seamounts such as Christmas Island.

**Ostracoda**

Ostracods recorded from Australian inland waters are mainly from the families Limnocytheridae, Ilyocypridae, and Cyprididae. In the Murchison, ostracods from the families Candonidae, Cyprididae, and Limnocytheridae have been recorded in open groundwater but stygophilic species occur only in the Limnocytheridae and Candonidae, the latter including the globally widespread genus *Candonopsis* (subfamily Candoninae), which occurs widely and in a wide variety and age of substrates. Species are known from Pleistocene syngenetic dune karst (Tamala Limestone), several species from Tertiary (probably Miocene) groundwater calcretes on the Western Shield, and from the Kimberley (Devonian Reef Limestone). In Europe there are only a few, mostly hypogean species that are considered to be Tertiary relicts with surface relatives today occurring in tropical and subtropical surface waters; they are especially diverse in Africa. The subfamily Candoninae (family) Candonidae are common elements of stygofauna globally but recent finds from the Pilbara describe about 25% of the world's genera but these are more closely related to the South American and African Candoninae than to European ones.

The thaumatocypridid genus *Danielopolina*, previously unreported in the Southern Hemisphere, occurs as a tethyan element in the anchialine system at Cape Range. Fossils in marine cave facies in the Czech Republic suggest that this lineage was already inhabiting marine caves in the Jurassic.

**Isopoda**

Phreatoicidan isopods (Fig. 3) have a Gondwanan distribution and occur widely across southern Australia (and in tropical Arnhemland) in surface habitats that have permanent water—generally surface expressions of groundwater—usually as cryptic epigean species. Their distribution is

strongly associated with the areas of the continent not submerged by Cretaceous seas. About 59 species in 23 genera are described from Australia, of which 10 species in eight genera are hypogean (cavernicolous or spring emergents). They are under active revision and numerous taxa are being described. Five hypogean species occur on the Precambrian “western shield” and the family Hypsimetopodidae is represented with a genus each on the Pilbara (*Pilbarophreatoicus*) and the Yilgarn (*Hyperoedesipus*) regions (separate cratons of the western shield). These are closely related to the hypogean genus *Nichollisia* found in the Ganges Valley of India, suggesting they were hypogean prior to the separation of Greater Northern India from the western shore of Australia. *Crenisopus*, a stygobitic genus occurring in sandstone aquifer in the Kimberley, is the link between African and Australasian lineages of phreatoicideans. The genus is basal to the Phreatoicidae, suggesting divergence after they entered freshwater but prior to the fragmentation of East Gondwana during the Mesozoic era.

The flabelliferan isopod family, Tainisopidae, endemic to northwestern Australia, occurs in the exposed and greatly fragmented Devonian Reef system throughout the western Kimberley as well as in remote outcrops of this fossil reef in northeastern Kimberley. A second clade of this family (Fig. 3) inhabits groundwater calcretes in the Pilbara, from which the Kimberley was separated by the Cretaceous marine incursions. The location and distribution of this family is indicative of ancient origins but its sister relationship has yet to be established. Cladistic analysis suggests that this family is related to the cosmopolitan marine Limnoriidae and Sphaeromatidae, but at a basal level, suggesting it is much older than the more derived families like the Cirolanidae. Among Asellota, the Janiridae occur widely across southern Australia and Tasmania and the genus *Heterias*, which also occurs in New Zealand, is likely to be great; Protojaniridae are known from the Northern Territory.

Terrestrial isopods (Oniscidea) are a prominent component of cave fauna throughout Australia, as elsewhere in the world, yet there are few described highly troglomorphic Oniscidea (Fig. 3). Their distribution seems to reflect the general aridity that developed following the separation of Australia from Antarctica, rather than to suggest more ancient relictual distributions. So, in humid Tasmania the Styloniscidae are a prominent component of cave fauna, as they are in the wet forest of the surface, but only one species is troglomorphic. Armadillidae, Ligiidae, and Scyphacidae are also common in Tasmanian caves but none is troglomorphic. On the mainland Olibrinidae, Philosciidae, and Armadillidae are prominent among cave fauna. In the drier areas of Australia, where armadillidians are such a prominent part of the surface fauna, they appear in caves more frequently, and a few have overt troglomorphies. These troglobites are known from the Nullarbor, North Queensland (Chillagoe), Cape Range, and Kimberley. The troglobitic Philosciidae and Oniscidae from Cape Range and the troglaxene Platyarthridae remain undescribed.

A single species of *Haloniscus*, an aquatic oniscidean isopod, is known from salt lakes (playas) across southern Australia. Numerous stygobitic species occur in groundwater calcrete deposits of the Yilgarn region of the Western Shield, a long emergent landmass in arid Australia, sometimes in saline waters. The occurrence of a congeneric species in anchialine waters in New Caledonia suggests a considerable age for the genus and remarkable morphological conservation—New Caledonia separated from the Australian plate in the Late Cretaceous, about 74 Ma. Other stygobitic oniscideans, belonging to the Philosciidae and probably other families, are widespread in Australia but are largely unknown.

### Spelaeogriphacea

This order of stygal crustaceans has populations known only from two species in separate lacustrine calcrete deposits in the Fortescue Valley, a major ancient paleovalley of the northern Pilbara region of Australia. All extant spelaeogriphaceans occur with very circumscribed distributions in subterranean freshwater habitats on Gondwanan fragments known from two locations in each of Africa (Table Mountain, South Africa), South America (western Mato Grosso, Brazil), and Australia. The supposition of a Gondwanan origin is refuted by the fossil record. A marine fossil from a shallow marine sediment of a Laurentian plate was of Carboniferous age in Canada, while modern-looking fossil spelaeogriphaceans occur in lacustrine deposits of the Jurassic of China and from lower Cretaceous freshwater deposits in Spain. All living spelaeogriphaceans occur in or above geological contexts that are earliest Cretaceous or older. Their broad occurrence suggests a Pangaeian origin. The colonization of Gondwanan freshwater is likely to have occurred after the retreat of the Gondwanan ice sheet (after 320 Ma) and prior to the dissolution of Gondwana (142–127 Ma).

### Decapoda

Atyid shrimps (Decapoda) are widespread in surface waters throughout the tropics and they appear as stygobitic species in caves and groundwaters where they are represented by four short-range endemic genera. Stygal species occur widely across northern Australia, into the arid zone (Canning Basin), and in anchialine and freshwater systems of northwestern Australia (*Stygiocaris*; Fig. 6) and Christmas Island. They may have colonized Australia from Asia via the Indonesian archipelago, but their presence in caves of the Canning Basin and the apparent Madagascan affinities of some genera suggest a more ancient origin.

### CHELICERATA

The chelicerates globally comprise a biodiverse component of cave communities and they are represented in the Australian cave fauna by the orders Acarina, Amblypygida, Opiliones, Pseudoscorpionida, Schizomida, Scorpionida, and Araneae.

#### Acarina

The mite family Pediculochelidae (Acariformes) was first recorded in Australia from a dry cave in Cape Range where a specimen was attributed to *Paralycus lavoipierrei* that is described from California. *Tiramideopsis* (Mideopsidae) occurs in the Millstream aquifer, a genus previously known from similar habitats of India and suggesting ancient links (cf. Phreatoicoidea). Generally, the poorly known mesostigmatid mite fauna of Australian caves does not appear to constitute a distinctive cave fauna or exhibit any of the morphological characteristics of deep-cave arthropods.

#### Amblypygi

Trogliphilic species of *Charon* are found on Christmas Island and in the Northern Territory.

#### Opiliones

Cavernicolous species of Triaenonychidae in Tasmania and New South Wales species often show depigmentation, attenuation of pedipalps and legs, a reduction in (but not loss of) eye size, reduced sclerotization, and other troglomorphic features. The cave fauna of Tasmania, unlike continental Australia, have distribution patterns more like those of the other periglacial areas of the world in which profound environmental changes were associated with Cainozoic glacial cycles. The distribution of the opilionid genus *Hickmanoxyomma*, which is exclusively cavernicolous, appears to have resulted from the ablation of surface forms—in the south and east of Tasmania, where the effect of glaciation was most intense, and the occurrence of some

sympatric species suggests that there may have been multiple phases of cave invasion. In contrast, in the coastal lowlands, to the north and northeast, where periglacial conditions were less extreme, surface-dwelling species of *Hickmanoxyomma* are present. A cavernicolous assamid with reduced eyes, but not strongly troglomorphic, and the strongly troglomorphic *Glennhuntia glennhunti* ("Phalangodidae") from arid Cape Range are both probably rainforest relicts although the wider affinities of both families are unknown.

### Pseudoscorpiones

The worldwide family Chthoniidae is most commonly represented among troglomorphic species in Australia. The genera *Tyrannochthonius*, *Pseudotyranochthonius*, and *Austrochthonius* are widespread with cave populations in eastern and western parts of the continent. Syarinidae, which occur in the rainforests of Africa, Asia, and the Americas, occur widely in Australia and as a troglophile in Cape Range. The Hyidae, known from India, Madagascar, and southeast Australia, are represented in Australia in the Kimberley and by the markedly troglomorphic *Hyella* from arid Cape Range.

### Schizomida

Schizomids are essentially a tropical forest element that occur across the top of the continent, as far south as the humid caves in the arid Cape Range. The latter contains six troglobitic species in the genera *Draculoides* (Fig. 3) and *Bamazomus*. (Only five other troglobitic species, in the genera *Bamazomus* and *Apozomus*, are known from the rest of Australia.) *Draculoides* is endemic to Cape Range and Barrow Island.

### Scorpiones

A troglobitic scorpion (*Liocheles*: Liochelidae) occurs on rainforest-covered Christmas Island, Indian Ocean. An unknown species in a new genus of troglobitic scorpion occurs on the arid Barrow Island and shares morphological features of the families Urodacidae (species in the genus *Urodacus* and endemic to Australia) and Heteroscorpionidae (species in the genus *Heteroscorpion*, endemic to Madagascar). Only one other troglobitic scorpion is known outside the Americas, from Sarawak (Malaysia).

### Araneae

*Troglo diplura*, which has South American affinities, is the only troglobitic mygalomorph spider in Australia, and occurs in caves in the arid Nullarbor region. Like the cockroach *Trogloblatella*, it is heavily sclerotized, suggesting a more drying atmosphere than generally associated with troglomorphic animals found elsewhere, such as in the arid zone caves of Cape Range, which have affinities with rainforest floor communities. The primitive araneomorph (true) spider

*Hickmania troglodytes* from Tasmania is a troglophilic Austrochilidae, a family that also occurs in Chile and Argentina.

Large lycosoid spiders occurs widely in the arid areas, one of which, *Bengalla bertmaini* (Tengellidae), is highly troglomorphic in Cape Range, lacking eyes and pigment.

Symphytognathidae occur as troglitic elements in the tropical caves of Cape Range and Northern Territory (Katherine) as *Anapistula*, found as epigeal elements in the wet tropics of Australia, Malaysia, and Indonesia.

Filistatidae occur throughout Australia (*Wandella*) but the monotypic *Yardiella* from Cape Range has relatives in northeast India and the family has a generally Gondwanan distribution.

Among the Pholcidae *Wugigarra* occurs along the eastern seaboard and the southeast of the continent while the western three-quarters of the continent contains old elements of the pholcid fauna. If the distribution of the genus were restricted by current ecological conditions, then the genus would be expected to be found in the west and other refugia, but this apparently is not the case. This distribution may be due to the marine subdivision of the continent by the Cretaceous marine transgression. The genus *Trichocyclus* occurs as a cavernicolous element throughout much of the rest of the continent from the Nullarbor to the tropics.

## INSECTS

### Zygentoma

Among the Nicoletiidae, *Trinemura* is represented in caves in the west, while *Metrinura* is found in the caves of the northeast.

### Collembola

The composition of collembolan fauna changes between the south and north of Australia. Caves in the south of the continent contain up to five genera of troglobitic collembola, while those in tropical areas have only two genera. The genera *Adelphoderia* and *Arrhopalites* are not recorded as troglobites in tropical caves, but because the former is known from both temperate and tropical rainforest litter (Greenslade, personal communication), it seems likely to occur in tropical caves. This apparent trend in diversity may well reflect the greater sampling effort in southeast Australia. *Oncopodura* occurs in southeast Australia and in the northern hemisphere.

### Planthoppers: Relicts or Invaders?

There is continuing debate as to whether cave fauna result from active colonization or occur as relicts as a result of the extirpation of surface populations by adverse conditions (e.g., glaciation, aridity). The cave fauna on arid Cape Range are clearly relictual in that they are now remote from the humid



forest from which the fauna were sourced. However, the aridity is sufficiently intense to have obliterated all close surface relatives and so the process by which it became relictual cannot be resolved. By contrast, in a grossly similar fauna in Far North Queensland, the troglobitic cixiid and meenoplid planthoppers have some members with surface relative and many intermediate forms. These lineages show many reductive, but no progressive trends, and this has been interpreted as support for the active colonization of the subterranean realm, rather than as a process of relictualization (Hoch and Howarth, 1989).

In North Queensland seven evolutionary lines of planthoppers (Fulgoroidea) of the families Cixiidae (genera *Solonaima*, *Undarana*, *Oliarus*) and Meenoplidae (*Phaconeura*, a continent wide genus) are found. *Solonaima* (Cixiidae) exhibits four independent invasions of the caves and shows a full range of adaptations to cave life, from epigeal to troglobitic, together with intermediate stages. This lineage provides an excellent model for the stepwise evolution of cave forms and the reconstruction of the historic process of cave adaptation—the loss of eyes and pigmentation, reduction of wings and tegmina, and increased phenotypic variation, such as wing venation, even within same species, suggesting a relaxation of selection pressure. To Hoch and Howarth (1989) this suggested that there had been fragmentation of the rainforest owing to the drying climate during the Miocene. This model, argued on other evidence, has also been suggested for the arid Cape Range region on the west coast of the continent.

### Blattodea

Cockroaches represent a widespread and common element of many Australian caves, particularly those where the predominant energy source is guano from bats or swiftlets where *Paratemnopteryx* and related genera (*Gislenia*, *Shawella*) are prominent. *Paratemnopteryx stonoi* exhibits significant morphological variation in seven tropical caves spread over a 150-km distance in North Queensland, such variation being consistent with molecular variation (Slaney and Weinstein, 1997). The genus *Neotemnopteryx* is widespread on the east coast and is represented by 14 species, of which five species are cavernicolous, but troglobitic species occur in the Nullarbor and the southwest coast represented by the troglobitic, respectively *N. wynnei* and *N. douglasi*. In the Nullarbor, where caves are relatively dry, the large, eyeless but highly sclerotized *Trogloblatella nullarborensis* is found. In contrast, the Nocticolidae occur widely in the Old World tropics and a number of cave species occur throughout the Australian tropics, down to arid Cape Range where *Nocticola flabella* is found, the world's most troglomorphic cockroach, which is distinguished by its pale, fragile, translucent appearance. In contrast, a more robust monotypic troglobite, *Metanocticola*, is found on Christmas Island. The genus *Nocticola* also occurs in the Philippines, Vietnam, Ethiopia, South Africa, and Madagascar.

### Orthoptera

Many cave crickets (Rhopidophoridae), which occur in cave and bush habitats across southern Australia, are troglonexes, like some bats. During the day these moisture-loving insects tend to congregate in relatively cool, moist, and still air to avoid desiccation. In the evening, part of the cricket population moves outside the cave entrance to feed but they return underground before dawn and so transport organic matter into the cave. Rhaphidophoridae have a disjunct global distribution in the temperate zones of both hemispheres. The Macropathinae are considered to be the basal group and these have a circum-Antarctic distribution, suggesting a Gondwanan origin. Generic diversity is much greater in Australia and New Zealand than elsewhere. Four genera are restricted to Australian temperate zones and a further three genera to Tasmania itself. The remaining three subfamilies inhabit the Boreal zone, suggesting vicariance owing to the Mesozoic dissolution of Pangaea.

In contrast, the only truly troglobitic cricket in Australia is the pigmy cricket *Ngamalanguia* (Nemobiinae: Grylliidae) (Fig. 3), a genus endemic to Cape Range that lacks eyes, ocelli, tegmina, wings and auditory tympana, is pale, and has exceptionally long antennae.

### Coleoptera

Globally, beetles are by far the most intensively studied cave animals. Chief among them are the trechine carabid beetles, of which more than 2000 species have been described. Of these, more than 1000 species are troglomorphic, inhabiting caves from periglacial areas of Australia and New Zealand (25 species), eastern Palearctic (ca. 250 species), western Palearctic (ca. 600 species), and Nearctic and Neotropical (ca. 200 species).

Unlike mainland Australia, Tasmanian caves support a distinctive cave fauna of carabid beetles from the tribes Trechini (a strongly hydrophilous group forming a dominant element of cave fauna of the periglacial areas of Europe, North America, New Zealand, and Japan) and Zolini (confined to Australasia) each containing two genera with troglobitic species. In the periglacial areas of Tasmania, vicariant patterns similar to those for opilionids may be deduced for the trechine and zoline carabid beetles, which form such a prominent part of the Tasmanian cave fauna. Harpalinae, a globally widespread and predominantly phytophagous group, typical of dry country, are considered unsuitable for cave colonization, and yet many genera are represented in caves in Australia. Two genera of the Calleidini occur in guano caves in Australia, which suggests, because these beetles are typically arboreal, the possibility of a reversal from the arboreal habit typical of this tribe, to an edaphic or subterranean life.

Although the Cholevidae is well represented in the more humid parts of Australia, the tribe Leptodirinae

(Bathysciinae), which comprises the predominant component of the rich cholevid beetle fauna of the Northern Hemisphere, is entirely missing from Australia and the rest of the Southern Hemisphere. In the Snowy Mountains area of the mainland, where periglacial conditions also persisted, is found the only troglomorphic psydrid beetle known globally. Numerous other families of beetles occur in caves throughout Australia, in both the humid and arid areas, but most seem to be accidentals. The Australian troglotic fauna, especially those that associate with periglacial areas, differ from those in the Northern Hemisphere, owing to the composition of the surface fauna, rather than due to different evolutionary trends.

## VERTEBRATES

Caves in the wet-dry (monsoonal) tropics commonly provide refuge to vertebrates during the dry season and clearly this temporary habitation has an impact on the trophic relations of these caves. Among them are tree frogs (e.g., *Litoria caerulea*), which are also abundant in uncapped boreholes, and fish, such as the common eel-tail catfish, *Neosilurus hyrtlii* and the spangled perch or grunter, *Leiopotherapon unicolor*. In the dry season, the fish may survive in caves and underground water systems and from there they would contribute to the repopulation of the seasonally inundated floodplains.

Australia has only two highly troglomorphic fishes which are sympatric where they occur at Cape Range. The blind gudgeon, *Milyeringa veritas* (Eleotridae) (Fig. 6), is of unknown affinity but inhabits water ranging from seawater to freshwater in a largely anchialine system in Cape Range. Swamp eels (Synbranchidae) are represented in Australia by two species of *Ophisternon*, of which *O. candidum* is a highly troglomorphic species (Fig. 3). The genus occurs widely in the coastal wetlands of the Indo-Malayan region, with one other troglomorphic species inhabiting caves in Quintana Roo, Mexico, a distribution suggesting a tethyan origin.

Snakes are commonly seen in caves, especially in the tropical regions where they predate bats (e.g., the banded cat-snake *Boiga fusca ornata*). The blindsnake, *Ramphotyphlops longissimus*, from the Barrow Island karst has apparent troglomorphies and may represent the first troglotic reptile.

Birds are rarely represented in Australian caves other than as superficial components inhabiting cave openings. The exceptions are swiftlets (*Collocalia* species) that build their nests in the dark zone, on smooth concave walls high above the cave floor in some tropical caves in Far North Queensland and Christmas Island (Indian Ocean). The nests of some species are intensively harvested for the gourmet delicacy "birds' nest soup" in Southeast Asia and India. The Christmas Island glossy swiftlet (*Collocalia esculenta natalis*) is endemic to Christmas Island where, in the absence of cave bats, they are the prime source of guano in caves. A number of other species of *Collocalia* occur in the Indian Ocean,

Southeast Asia, and Queensland, mostly nesting in caves. The nests detach from the cave walls in dry air, a factor that may account for their absence from the drier tropical areas, such as the Kimberley. The various subspecies inhabit few of the caves available, being known from only five caves on Christmas Island, whereas the white-rumped swiftlet (*Collocalia spodiopygus chillagoensis*) occurs in less than 10% of approximately 400 caves at Chillagoe in Queensland.

Bats comprise nearly a third of the Australian mammalian fauna. Seven families of bats, comprising about 30% of the Australian bat fauna, are found in caves. The 17 species of cave-dwelling bats in Australia are largely restricted to the tropics and encompass insectivorous and vertebrate predators (ghost bats, *Macroderma gigas*) and frugivorous bats. Six species are restricted to the Cape York peninsula and 11 species occur across the northern part of the continent, 2 of them extending in the west coast to the arid Pilbara region. Only 4 species are restricted largely to the center of the continent, two being restricted to the western plains of Queensland and New South Wales.

## CONCLUSIONS

In a global context, the most striking features of the subterranean fauna of Australia are (1) the apparent age of the lineages present in subterranean environments and (2) the high proportion of geographic relicts present in the subterranean systems that are widely separated from their near relatives. Although much remains to be done to establish consistent patterns, numerous independent examples suggest similar processes but at a range of spatial and temporal scales.

In the southeast there is evidence that Pleistocene glaciation influenced the cave fauna. But, over most of mainland Australia, the overwhelming influence seems to have been relict distributions resulting from increasing aridity during the Tertiary, particularly in the Miocene. Numerous terrestrial and aquatic lineages have affinities with Gondwana, or with Western Gondwana, often at the generic level. In terrestrial lineages, these are commonly associated with rainforests. Numerous crustaceans, often lineages entirely comprising stygal species, and even a fish lineage, have distributions throughout the area of the former Tethys ocean. Many lineages from northwestern Australian anchialine waters comprise species congeneric with those inhabiting caves on either side of the North Atlantic.

## Acknowledgment

I thank M. S. Harvey, I. Karanovic, T. Karanovic, and G. D. F. Wilson for their comments and unpublished information.

## Bibliography

- Bradbury, J. H., and W. D. Williams. (1997). Amphipod (Crustacea) diversity in underground waters in Australia: an Aladdin's Cave. *Memoirs of the Museum of Victoria*, 56: 513–519.

- Hamilton-Smith, E., and S. Eberhard (2000). Conservation of cave communities in Australia. In *Ecosystems of the World, Vol. 30. Subterranean Ecosystems* (H. Wilkens, D. C. Culver, and W. F. Humphreys, eds.), pp. 647–664. Elsevier, Amsterdam.
- Hoch, H., and F. G. Howarth. (1989). The evolution of cave-adapted cixiid planthoppers in volcanic and limestone caves in North Queensland, Australia (Homoptera: Fulgoroidea). *Memoires de Biospéologie*, 16:17–24.
- Howarth, F. G. (1987). The evolution of non-relictual tropical troglobites. *International Journal of Speleology*, 16: 1–16.
- Howarth, F. G., and F. D. Stone. (1990). Elevated carbon dioxide levels in Bayliss Cave, Australia: implications for the evolution of obligate cave species. *Pacific Science*, 44: 207–218.
- Humphreys, W. F. (1999). Relict stygofaunas living in sea salt, karst and calcrete habitats in arid northwestern Australia contain many ancient lineages. In *The Other 99%. The Conservation and Biodiversity of Invertebrates* (W. Ponder and D. Lunney, eds.), pp. 219–227. Transactions of the Royal Zoological Society of New South Wales, Mosman 2088.
- Humphreys, W. F. (2000). The hypogean fauna of the Cape Range peninsula and Barrow Island, northwestern Australia. In *Ecosystems of the World, Vol. 30. Subterranean Ecosystems* (H. Wilkens, D. C. Culver, and W. F. Humphreys, eds.), pp. 581–601. Elsevier, Amsterdam.
- Humphreys, W. F., and M. S. Harvey, eds. (2001). Subterranean biology in Australia 2000. *Records of the Western Australian Museum*, Suppl. No. 64.
- Leys, R., C. H. S. Watts, S. J. B. Cooper, and W. F. Humphreys. (In press). Evolution of subterranean diving beetles (Coleoptera: Dytiscidae: Hydroporini, Bidessini) in the arid zone of Australia. *Evolution*.
- Slaney, D. P., and P. Weinstein. (1997). Geographical variation in the tropical cave cockroach *Paratemnopteryx stonei* Roth (Blattellidae) in North Queensland, Australia. *International Journal of Speleology*, 25: 1–14.

## Diversity Patterns in Europe

Janine Gibert  
*Université Lyon, I*

David C. Culver  
*American University*

### INTRODUCTION

To an extent that is unusual in most branches of zoology systematics, Europe is a both a hot spot of subterranean biodiversity and a hot spot of research into subterranean biology, both historically and at present.

The scientific study of cave life can be traced back to Johann von Valvasor's comments in 1689 on the European cave salamander *Proteus anguinus*. The only stygobitic salamander in European, *Proteus* reaches a length of more than 25 cm, making perhaps the largest stygobiont known anywhere. It occurs throughout the Dinaric Mountains in northeast Italy, Slovenia, Croatia, Bosnia, and Herzegovina. During the late 18th century and much of the 19th century, living *Proteus* were collected and delivered to many scientists throughout Europe. It was this animal more than any other cave animal that played a formative role in the emerging theories of evolution of Lamarck and Darwin. The first

invertebrate was described in 1832, also from Slovenia, as *Leptodirus hochenwartii*, a bizarre appearing beetle with an enlarged abdomen and long spindly appendages.

Besides the caves of the Dinaric region, the cave fauna of the French and Spanish Pyrenees began to attract attention, and the Pyrenean fauna began to be described by the mid-19th century. In 1907, the Romanian zoologist E. G. Racovitza published the enormously influential "Essai sur les problèmes biospéologiques," which set the agenda for biospeological research in the coming decades. Together with the French entomologist René Jeannel, as well as Pierre-Alfred Chappuis and Louis Fage, he established in 1907, an association named *Biospeologica*. This association had three objectives: (1) to explore caves and look for subterranean species, (2) to obtain identifications and descriptions from specialists for all material sampled, and (3) to publish results in the *Mémoires de Biospeologica*. Ultimately, *Biospeologica* was responsible for the inventory of the fauna of more than 1500 caves, mostly in Europe. More than 50 monographic treatments of the taxonomy and distribution of European cave fauna were published between 1907 and 1962.

Even with more than a century and a half of description and cataloging of the European subterranean fauna, both species descriptions and inventories are far from complete. At present, several large-scale inventory projects of European fauna are ongoing. The most important of these is PASCALIS (Protocol for the Assessment and Conservation of Aquatic Life in the Subsurface), which has developed common protocols for the comparison of subterranean aquatic species diversity at six sites in five countries (France, Spain, Belgium, Italy, and Slovenia). Individual country assessments of subterranean biodiversity are active as well, and at the beginning of the project the most advanced of these was in Italy, where there were more than 6000 records for 899 subterranean species.

### DIVERSITY COMPARISONS TO OTHER CONTINENTS

As of 2000, approximately 5000 obligate subterranean aquatic (stygobitic) and terrestrial (troglobitic) species from Europe had been described. By contrast, 1200 have been described from Asia, 500 from Africa, and 1000 from North America. The dominance of Europe in known subterranean species is the result of several factors. First, Europe has been better studied than the other continents. This is particularly evident in the status of biodiversity assessment in noncave subterranean habitats. About half of the stygobitic species known from Europe are not primarily cave-dwellers, but rather live in other subterranean habitats such as the underflow of streams. In North America, these habitats are little studied and account for less than a fifth of the known stygobionts. The terrestrial equivalent, the M.S.S. (*milieu superficiel souterrain*), accounts for half of the subterranean species richness in Italy and this habitat is unsampled in

North America. In the cases of Asia and Africa, large geographic areas have been little studied with respect to subterranean species, both cave and noncave.

Second, subterranean biodiversity in Europe is actually higher than on other continents. There is some empirical evidence to support this. On a worldwide basis, there are 20 caves and wells that are known to have a total of 20 or more stygobionts and troglobionts. Of these, 13 are in Europe, 3 are in North America, and the rest are scattered elsewhere. In several regions, especially the western Balkans (northeast Italy, Slovenia, Croatia, Bosnia, Herzegovina, and Yugoslavia) and the Pyrenees (France and Spain), even the casual observer can note the large number of stygobionts and troglobionts present, relative to caves in other continents. A possible explanation for the increased diversity of stygobionts in the western Balkans is the complex biological and geological history of the Dinaric mountains. The amount of available subterranean habitat in these mountains is large and has had a long history of cave development and evolution. In addition, the complex history of the Mediterranean Sea, including the fact that it dried up about 6 million years ago (the Messinian crisis), may have resulted in a greater invasion rate of the subterranean realm from marine waters. Moreover, multiple invasions may have occurred from surface continental waters. In the case of terrestrial species, it is possible that invasion of European caves was enhanced during interglacials of the Pleistocene relative to North America. This is because mountain ranges in Europe are largely east–west oriented, whereas mountain ranges in North America are largely north–south oriented. Thus, in North America, species could escape hot summers either by migrating north or by invading caves. In Europe, the orientation of the mountains reduced the migration potential, perhaps resulting in increased invasion rates of caves and other subterranean habitats.

### TAXONOMIC RICHNESS OF THE EUROPEAN SUBTERRANEAN CAVE FAUNA

Subterranean diversity patterns in Europe are diverse, complex, and not always well documented. The distribution of the biota is certainly controlled by a combination of factors, including geological history, physicochemical variables, aquifer structure, connectivity between regions, and biological interactions. Moreover, biodiversity patterns have to be considered hierarchically. Local ( $\alpha$ ) and regional ( $\gamma$ ) diversity is better known than the increases in diversity over spatial scales ( $\beta$ ), although it is likely that  $\beta$ -diversity is likely to be much more important numerically. Put another way, the diversity in a single cave is almost always much less than the overall diversity of caves even within a small area as a result of reduced opportunities for migration and invasion.

The taxonomic diversity of the European fauna, with more than 5000 stygobionts and troglobionts, is too extensive and complex to be reviewed here, but several

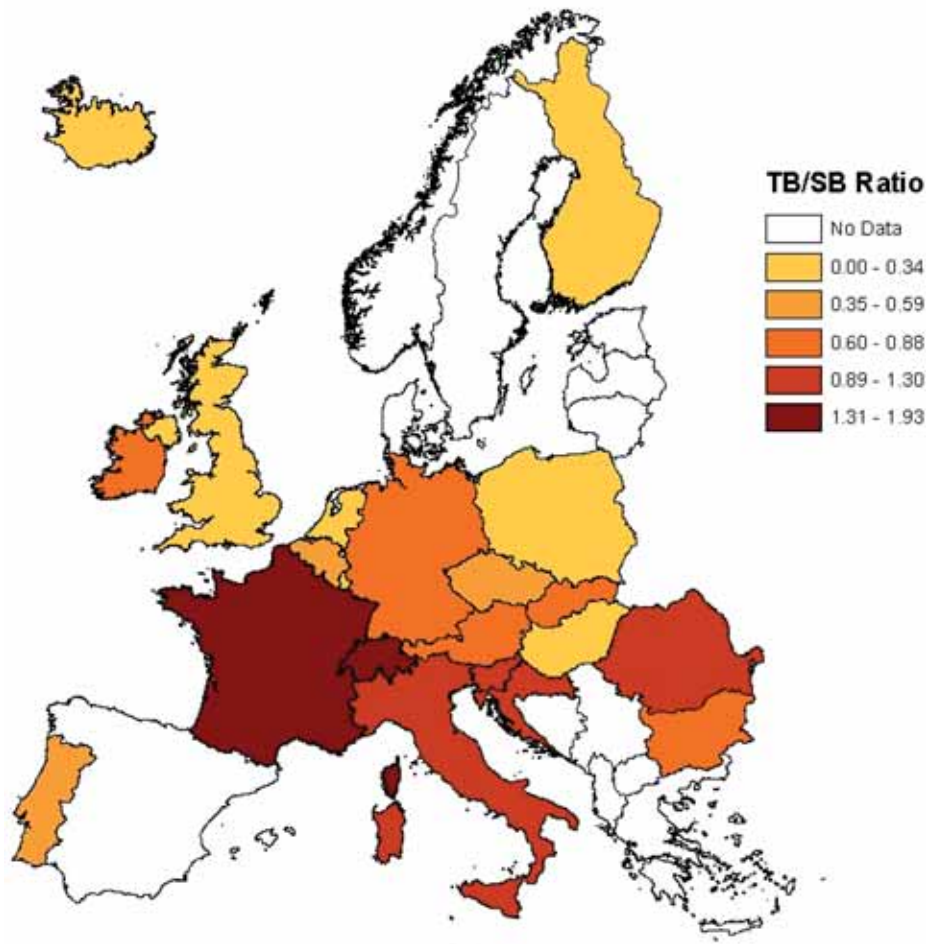
highlights are especially noteworthy. The first of these are the beetles in the terrestrial habitats. Two families of beetles dominate in temperate zone caves: the Carabidae and the Cholevidae. Both of these families reach their zenith of subterranean species richness in Europe. Among the Carabidae, there are seven genera with 20 or more species: *Anophthalmus*, *Aphaenops*, *Duvalius*, *Geotrechus*, *Hydraphaenops*, *Neotrechus*, and *Orotrechus*. The genus *Duvalius* is especially speciose, with more than 250 species. In contrast, there is only one carabid genus in North America with more than 20 species—*Pseudanophthalmus*—although it has more than 200 species. Among the Cholevidae, a total of 23 genera are known from the Pyrenees alone, two of which (*Speocharis* and *Speonomus*) contain more than 35 species. For example, the number of species and the distribution patterns of the two closely allied genera *Bathysciola* and *Speonomus* are very different (Fig. 1). Only 11 species of *Bathysciola* inhabit soil layers in large areas, whereas 39 species of *Speonomus* have strikingly restricted distributions. In the Pyrenees, a total of 41 genera are known, with *Antroherpon* containing 26 species. Once again the contrast with North America is instructive. There are only two genera and *Ptomaphagus* has 19 species.

Among aquatic species, two groups are especially noteworthy. One is the amphipod family Niphargidae. There are four genera and *Niphargus* alone has more than 200 species. Taxonomically, the diversity of the Niphargidae is rivaled by that of the Crangonyctidae in North America. Especially speciose is the genus *Stygobromus*, with nearly 200 species. However, the crangonyctids seem to be less diverse ecologically than the niphargids, both in terms of morphological variation and habitat variation. The final group worthy of special note are the mollusks in the Dinaric Mountains. In the Slovenian part of the Dinaric Mountains, for example, there are 37 aquatic obligate cave snails, one aquatic cave clam, and 11 species of terrestrial obligate cave snails. The entire Dinaric Mountain region has several times that many species. Surface freshwater in this region is also extraordinarily rich in mollusk diversity, especially among aquatic species.

### GEOGRAPHIC PATTERNS WITHIN EUROPE

While the inventory of known subterranean species is far from complete, and the summary of this information even less so, existing data provide some important information of about diversity patterns. The first general pattern is that there is a gradient in species richness with diversity dropping off to the north. A comparison of Italy and the United Kingdom, the two European countries with the most thorough inventory, shows this in a striking manner. In the United Kingdom, a total of 10 troglobionts and 16 stygobionts have been described. In Italy, a total of 265 stygobionts, 321 troglobionts, and an additional 317 troglobionts from the M.S.S. have been described. Of course, part of this difference is a result of the covering of the United Kingdom by Pleistocene

## Ratio of Troglobites to Stygobites



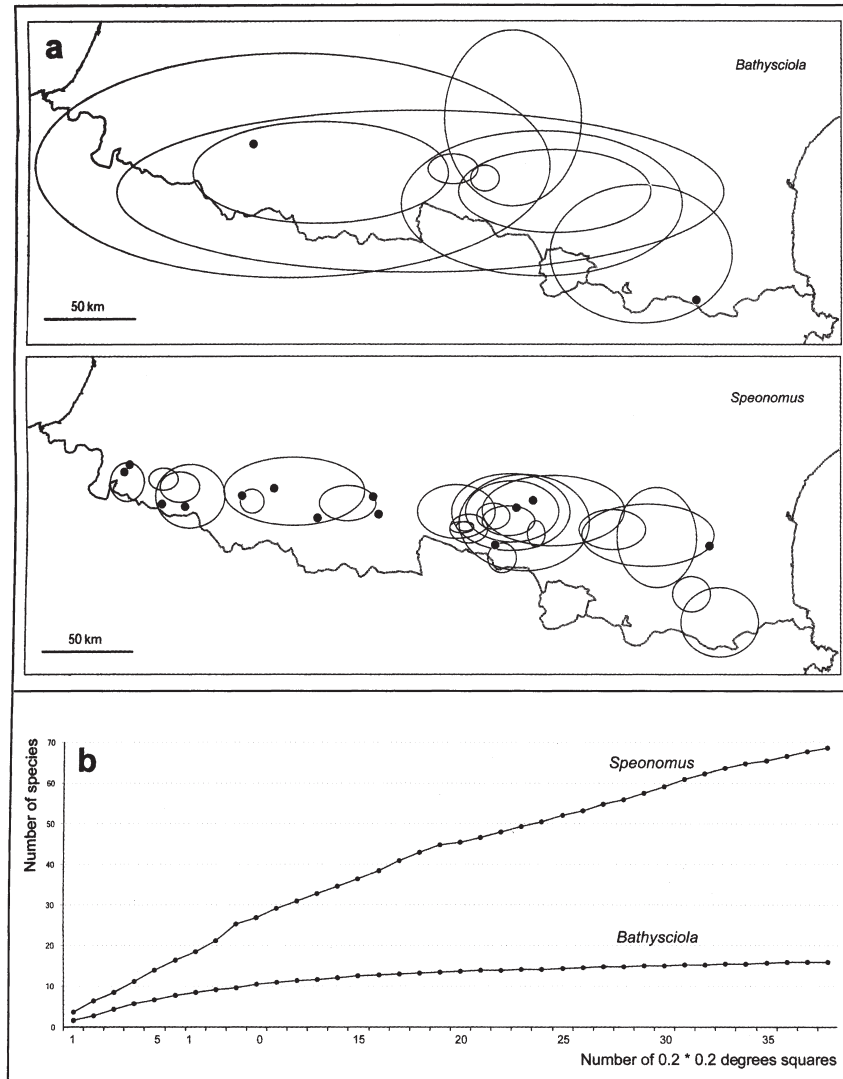
**FIGURE 1** Ratio of troglobionts (TB) to stygobionts (SB) for European countries for which data are available.

ice sheets, but undoubtedly other factors are at work to produce this diversity gradient. As one moves north, mean annual temperature declines and, all other things being equal, so does net primary productivity. While little or no primary production occurs in subterranean habitats, they are dependent on surface primary production for food. Thus, food availability declines with increasing latitude.

The central and southern European–Mediterranean region presents a taxonomic diversity and species richness higher than other parts of Europe. In addition to the Coleoptera, Amphipoda, and Gastropoda mentioned earlier, many other groups reach their highest diversity in this region, including isopods, spiders, and springtails. The distribution of species largely reflects the effect of historical circumstances on processes such as colonization, extinction, and species. As pointed out by Holsinger, this region is characterized by extensive karst areas, temperate to Mediterranean climates, extensive shallow embayments in the Tertiary (with the

Mediterranean salinity crisis in the Miocene), absence of Pleistocene glaciation, marine interstitial and anchihaline habitats (see article on anchihaline communities) common in coastal areas of the Mediterranean, and abundant freshwater subterranean habitats.

The second pattern that is evident is that the ratio of troglobionts to stygobionts declines with increasing latitude (Fig. 2). The reduction in troglobionts may be largely the result of Pleistocene effects. No subterranean terrestrial habitats existed, as far as we know, within the ice sheets. On the other hand, some subterranean aquatic species may have survived the Pleistocene in running water habitats underneath the glacial ice. Additionally, it may be that recolonization has been more rapid among aquatic species (for example, through fluvial corridors and due to the hydrological continuum and the connectivity between aquifers). Stygobionts can be found in almost all parts of Europe with suitable groundwater habitats, even though these habitats are



**FIGURE 2** (a) Schematic distribution patterns of species in two closely allied genera of Cholevidae (Coleoptera) in the Pyrenees. The 11 species of *Bathysciola* inhabit soil layers, and the 39 species of *Speonomus* are troglodionts. Known sites of occurrence are encircled by ovals; single-site species are indicated by black points. (b) Cumulative plot of species and subspecies richness of *Bathysciola* and *Speonomus* in the Pyrenees.

often not cave habitats, but rather other subterranean habitats such as the underflow of streams. The pattern in Fig. 2 includes these noncave stygobionts.

The third pattern is that of the subterranean fauna that result from habitat differences on a more local scale. This is particularly evident in the differences between the aquatic cave fauna (karstic aquifers) and the subterranean fauna of gravel and sand aquifers. The obvious physical difference is in the size of the available space for fauna. For example, comparison of subterranean communities of the Vidourle karst (south of France) and the neighboring alluvial aquifer bordering the surface stream of the Vidourle, some hundreds meters downstream of the resurgences, reveals important differences (Table I). Karstic communities are more diverse (49 species with 20 stygobionts) than interstitial communities (19 species with 12 stygobionts). The large voids in

karstic channels enable a large size range of organisms to occur while very tiny spaces in sandy aquifers represent a barrier to larger animals such as the amphipod *Niphargus virei* and the decapod atyid *Troglocaris inermis*, which are limited to the karstic aquifer. A similar pattern may exist in subterranean terrestrial communities. There are noncave subterranean habitats in superficial subsurface layers such as scree slopes and collectively termed the *milieu souterrain superficiel* that may also harbor small species, but this pattern has not been investigated.

### PROSPECTS FOR ASSESSING EUROPEAN BIODIVERSITY PATTERNS

The current incomplete state of knowledge of groundwater biodiversity is a major constraint on successful implementa-

TABLE I Comparison of Vidourle karst communities and neighbouring alluvial aquifer communities (Juberthie and Juberthie-Jupeau 1975)

	Karstic aquifer Vidourle karst	Porous aquifer Neighbouring alluvial aquifer
Nematoda	<i>Monhystrella plectides</i> <i>Tripyla tenuis</i> <i>Tripyla filicaudata</i> <i>Anatonchus</i> sp. <i>Mononchus mylanchulus</i> <i>Mononchus iotonchus</i> <i>Mononchus anatonchus</i> <i>Nygolaimus stagnalis</i> <i>Dorylaimus</i> sp. <i>Thornenema loevicapitatum</i> <i>Labronema</i> sp. <i>Pugentus</i> sp. <i>Oxydirus oxycephaloïdes</i>	<i>Iotonchus acutus</i> <i>Cephalobus</i> sp.
Oligochaeta	<i>Enchytraeidae</i>	
Mollusca	<i>Moitessieria rollandiana rhodani</i> <i>Hauffenia minuta globulina</i> <i>Bythynella reyniesi</i> <i>Bythiospeum diaphanum</i> <i>Theodoxius fluviatilis</i>	<i>Moitessieria rollandiana rollandiana</i>
		<i>Physa acuta</i>
Crustacea: Ostracoda	<i>Mixocandona</i> n.sp. <i>Pseudocandona</i> n.sp.	
Crustacea: Calanoida	<i>Spelaodiaptomus rouchi</i>	
Crustacea: Cyclopoida	<i>Eucyclops serrulatus</i> <i>Acanthocyclops venustus</i> <i>Acanthocyclops viridis</i> <i>Paracyclops fimbriatus</i> <i>Diacyclops languidoïdes</i> <i>Mesocyclops delamarei</i> <i>Mesocyclops albidus</i>	<i>Acanthocyclops venustus</i> <i>Paracyclops fimbriatus</i>
		<i>Tropocyclops prrasinus</i>
Crustacea: Harpacticoida	<i>Ceuthonectes</i> sp. <i>Elaphoidella gracilis</i> <i>Elaphoidella leruthi meridionalis</i> <i>Nitocrella</i> sp. <i>Attheyella crassa</i> <i>Attheyella wulmeri</i> <i>Bryocamptus pygmaeus</i> <i>Limocamptus echinatus</i>	<i>Elapoidella gracilis</i> <i>Nitocrella</i> sp. <i>Bryocamptus pygmaeus</i>
		<i>Nitocra hibernica</i>
Crustacea: Syncardia	<i>Bathynella</i> sp.	<i>Bathynella</i> sp. <i>Parabathynella</i> sp.
Crustacea: Isopoda	<i>Proasellus cavaticus</i>  <i>Microcharon</i> sp. <i>Faucheria faucheria</i>	<i>Proasellus coxalis</i> <i>Microcharon</i> sp. <i>Faucheria faucheria</i>
Crustacea: Amphipoda	<i>Niphargus virei</i> <i>Niphargus kochianus</i>	<i>Niphargus gallicus</i> <i>Niphargus pachypus</i> <i>Niphargopsis legeri</i> <i>Salentinella juberthieae</i>
Crustacea: Decapoda	<i>Troglocaris inermis</i>	
Total species	45	19
Total Stygobionts	20	12

tion of its conservation. The PASCALIS project (2002–2004) aims at improving the scientific knowledge of groundwater biodiversity in Europe. The main goal of this project is to establish a rigorous and detailed protocol for assessing groundwater biodiversity and to develop operational tools for its conservation.

The PASCALIS project will provide a toolbox that includes several validated methods for (1) determining the reliability of patterns of regional biodiversity revealed by mapping of existing data, (2) obtaining by means of a standardized field sampling method an unbiased estimate of groundwater biodiversity in regions for which no data exist, and (3) predicting overall species richness based on biodiversity indicators in regions with incomplete data sets.

These considerations should lead to the development of a common database and mapping process that allows researchers to zoom in on subterranean landscapes in order to consider groundwater biodiversity at different spatial scales (European, country, region, and local scales). For example, zooming on a particular region could reveal a distribution pattern of biodiversity at the regional scale and emphasize differences between different groundwater systems and ecological units. The ultimate goal of the project is to propose a specific action plan for the conservation of groundwater biodiversity at a European level by identifying priority regions for conservation, by identifying the spatial scale of relevance for conserving biodiversity within these regions, and by formulating a series of appropriate measures for maintaining their biodiversity.

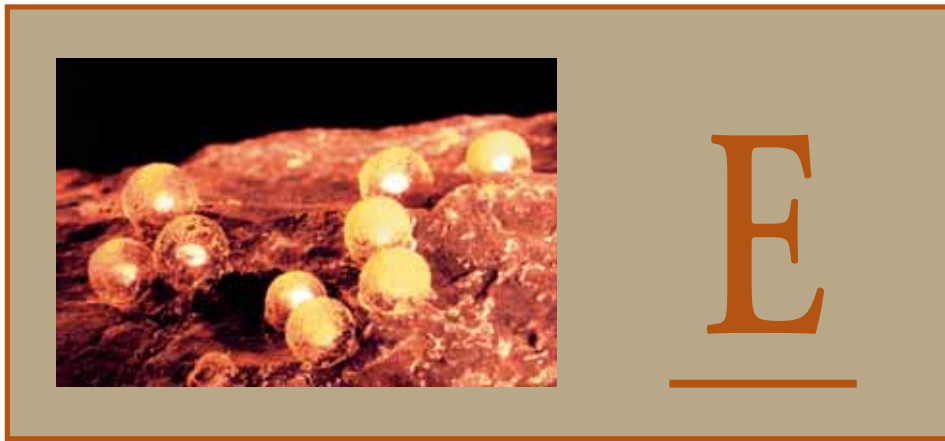
### Acknowledgment

This work was supported in part by the European project PASCALIS No. EVK2-CT-2001-002121.

### Bibliography

- Culver, D. C., L. Deharveng, J. Gibert, and I. D. Sasowsky (eds.). (2001). *Mapping Subterranean Biodiversity. Cartographie de la Biodiversité Souterraine*, Special Publication 6. Karst Waters Institute, Charles Town, WV.
- Culver, D. C., and B. Sket (2000). Hotspots of subterranean biodiversity in caves and wells. *J. Cave Karst Studies* **62**, 11–17.
- Deharveng, L., H. Dalens, D. Drugmand, J.C. Simon-Benito, M.M. Gama, P. de Sousa, C. Gers, and A. Bedors (2000). Endemism mapping and biodiversity conservation in western Europe: An arthropod perspective. *Belgian J. Entomology* **3**, 59–75.
- Gibert, J. (2001). Protocols for the assessment and conservation of aquatic life in the subsurface (PASCALIS): A European project. In *Mapping Subterranean Biodiversity. Cartographie de la Biodiversité Souterraine* (D. C. Culver, L. Deharveng, J. Gibert, and I. D. Sasowsky, eds.), Special Publication 6, pp. 19–21. Karst Waters Institute, Charles Town, WV.
- Gibert, J., and L. Deharveng (2002). Subterranean ecosystems: A truncated function biodiversity. *Bioscience* **52**, 473–481.
- Holsinger, J. R. (1993). Biodiversity of subterranean amphipod crustaceans: Global patterns and zoogeographical implications. *J. Natural History* **27**, 821–835.
- Juberthie, C., and V. Decu (1994–2002). *Encyclopaedia Biospeologica*, Vols. 1–3. Societé de Biospeologie, Moulis, France.
- Juberthie, C., and L. Juberthie-Jupeau (1975). La réserve biologique du laboratoire souterrain du C.N.R.S. à Sauve (Gard). *Annales Spéléologie* **30**, 539–551.
- Sket, B. (1999). High biodiversity ion hypogean waters and its endangerment—the situation in Slovenia, Dinaric Karst, and Europe. *Crustaceana* **15**, 125–139.
- Stoch, F. (2001). Mapping subterranean biodiversity: Structure of the database and mapping software SKMAP and report of status for Italy. In *Mapping Subterranean Biodiversity. Cartographie de la Biodiversité Souterraine* (D. C. Culver, L. Deharveng, J. Gibert, and I. D. Sasowsky, eds.), Special Publication 6, pp. 29–35. Karst Waters Institute, Charles Town, WV.





---

## Early Humans in the Mammoth Cave Area

**Patty Jo Watson**

*Washington University, St. Louis*

### INTRODUCTION

The longest cave in the world (more than 560 km, and still being explored and mapped) is the Mammoth Cave System in west central Kentucky in the United States. Beginning about 4000 years ago, the people living in the Mammoth Cave region began exploring some portions of this immense subterranean labyrinth. Use by indigenous peoples of parts of the Mammoth Cave System continued until about 2000 years ago. The materials discarded or lost underground many millennia in the past preserve detailed information, not only about prehistoric activities in the cave, but also about subsistence practices and other lifeways above ground.

### ANCIENT CAVERS IN EASTERN NORTH AMERICA

The Mammoth Cave System was not the only cave entered by aboriginal inhabitants of the Americas. To the contrary, any cave opening large enough for a person to squeeze into was probably explored and well known. The earliest trip yet documented into the dark zone of any cave in the Western Hemisphere is that of a 45-year-old man whose skeletal remains were found in Hourglass Cave, high in the Southern Rocky Mountains (Mosch and Watson, 1997). In Eastern North America, the oldest archaeological record of dark zone cave exploration dates to 4500 years ago when eight or nine people made one or two trips far back inside a 11-km-long

cave in what is now northern Tennessee. They left a thin trail of charcoal from their cane torches, and—in the damp clay floor of one passageway—the impressions of their feet (Crothers *et al.*, 2002).

For more than 4000 years, from 4500 years ago to the time of European contact, indigenous peoples of the Americas entered caves, explored them, and used them for a variety of purposes: as storage places, as sources of valuable minerals or of magical powers, as shrines, as cemeteries, or as places to contact the spirit world. The archaeology of the Mammoth Cave System illustrates several of those cultural activities for the two millennia between 4000 and 2000 years ago.

### ARCHAEOLOGY OF THE MAMMOTH CAVE AREA

Like many other regions of the eastern United States, west central Kentucky was first inhabited by Paleoindian hunter-gatherers, who arrived approximately 11,000 years ago. Archaeological evidence for this time period (ca. 11,000 to 10,000 years before present) is sparse, but data from here and elsewhere in the midcontinent indicates to archaeologists that Paleoindian communities were small and were dispersed fairly widely across the landscape.

In archaeological terminology, the Paleoindian period in Eastern North America is followed by the Archaic period (ca. 10,000 to 3000 years ago), which is succeeded by the Woodland period (3000 to 1100 years ago), and—in some places—the Mississippian period (1100 to 500 years ago). The explorers who left their footprints in that Tennessee cave 4500 years ago are spoken of by archaeologists as Archaic people, and so are the earliest explorers of the Mammoth Cave System. There is also archaeological evidence of Archaic cavers in Fisher Ridge Cave just east of Mammoth Cave National Park, as well as Lee Cave and Bluff Cave (both within Mammoth Cave National Park but not known to be

connected to the Mammoth Cave System) and Adair Glyph Cave (some distance north of Mammoth Cave).

During most of the Archaic period, archaeobotanical evidence shows that all societies in the Eastern Woodlands of North America hunted, fished, and gathered the abundant resources of the forests where they lived. About 3000 years ago, however, at the end of the Archaic and beginning of the Early Woodland period, some local groups had become farmers growing several species of small-seeded plants: sunflower, a relative of sunflower called sumpweed or marshelder, goosefoot (also called lambsquarters), maygrass (also known as canary grass), bottle gourd, and a gourdlike form of squash (Smith, 2002). These Early Woodland folk were among the first agriculturists in Eastern North America, and some of them were also highly skilled cavers who confidently made their way through many kilometers of passages in what is now known to be the world's longest cave, the Mammoth Cave System. Beginning in the 1950s, archaeologists and speleologists have studied the remains left by these early cavers to discover where they went and what they did underground and also to investigate the evidence they left of their early farming economy.

### PREHISTORIC ARCHAEOLOGY IN THE WORLD'S LONGEST CAVE

Dry cave passages are excellent repositories of archaeological and paleontological remains because they lack factors of weathering and decay that quite rapidly alter or destroy all perishable materials aboveground. Some of the earliest Euroamerican explorers of the Mammoth Cave System noted well-preserved traces of prior human presence there. When the National Park Service acquired the land above Mammoth Cave, Salts Cave, and a series of other caves (known since 1972 to form a single cave system; see Brucker and Watson, 1987), archaeologist Douglas Schwartz at the University of Kentucky was asked to prepare a series of reports on Mammoth Cave area archaeology. Subsequently, other investigators affiliated with the Cave Research Foundation and the National Park Service took up this work, which is still continuing (Crothers, 2001; Crothers *et al.*, 2002; Watson, 1969, 1997). Results of this research are summarized next.

### Chronology

Several dozen radiocarbon dates have been obtained on a wide variety of material from various parts of the prehistoric archaeological record in the Mammoth Cave System (Crothers *et al.*, 2002, and Table 1 and Fig. 1 therein). As already noted, the dates span some 2000 years, from a little before 4000 years ago to a little after 2000 years ago. Most of them, however, cluster around 2500 years before present,

plus or minus a few hundred years. Thus, two archaeological periods are represented: Late Archaic and Early Woodland. Both Archaic and Early Woodland cavers explored several kilometers of passages in both the upper and lower levels of Mammoth Cave and Salts Cave, but the Early Woodland record is much more abundant and much more extensive than is the Archaic one.

### Archaeological Evidence

The most prominent and pervasive category of prehistoric material in dark zone cave passages is torch and campfire debris. Everywhere the ancient cavers traveled, they left a scatter of cane and dried weed stalks, as well as charred fragments of torch materials. Charcoal smudges left by torches on cave walls, ceilings, and breakdown boulders are also commonly visible. River cane seems to have been the preferred torch material, but dried stems of goldenrod and false foxglove were also used. In addition to the torch remains, fragmentary bindings and cordage made from the inner bark of certain trees are strewn along the passage floors. Less abundant items include wooden and gourd containers, mussel shell scrapers or spoons, basketry and vegetal fiber artifacts (including remains of bags, cordage, and moccasin-like footwear), digging sticks, scaling or climbing poles, imprints of human feet in dust or damp clay floored passages, dried human excrement (paleofeces), and the physical remains ("mummies," actually simply desiccated bodies) of two of the ancient cavers themselves.

In most places within the dry cave passages entered by the Early Woodland people there is evidence that they removed cave minerals from the walls, breakdown boulders, ceilings, and cave sediments. These minerals consist of various sulfate compounds, most prominently gypsum (hydrous calcium sulfate) and mirabilite (hydrous sodium sulfate), with epsomite (hydrous magnesium sulfate) probably also included, although it is much less abundant in the cave than are gypsum and mirabilite.

Archaeological excavation in the entrance areas of both Mammoth Cave and Salts Cave yielded a considerable quantity of charred plant material and animal bone (deer, turkey, raccoon, opossum, squirrel, rabbit, turtle, fish, rodents), as well as tools made of bone, chipped stone, and ground stone. The Salts Cave excavations also recovered a surprising quantity of human bone (Robbins, 1997).

Physical remains of prehistoric people are known from a few cave sites where they died by accident (e.g., an adult man in Mammoth Cave and a young boy in Salts Cave) or were purposely buried (Crothers *et al.*, 2002). Use of sinkholes and vertical shafts as mortuary facilities, into which the dead were lowered or dropped, was much more common than cave interments across the Midwest, Midsouth, and Southeast.

## Interpretations

The somewhat scant evidence dating to the earliest human presence in Mammoth Cave, Salts Cave, and Lee Cave, as well as the Tennessee footprint cave, indicates that Archaic people who ventured into these underground locales seem to have been exploring rather than working or spending long periods of time there. Adair Glyph cave is quite different, however (DiBlasi, 1996). Here the ancient people used sticks or their fingers on a mud-floored passage to make a dense series of curvilinear and rectilinear markings whose meanings are unknown to us, but whose creation must have taken considerable time and thought, and probably more than one trip into the cave. At any rate, it is obvious that those responsible for the markings were not simply exploring this room, which is about a kilometer from the entrance. At Fisher Ridge Cave, the archaeological evidence primarily indicates exploration, but there is a lattice or checkerboard design (scratched onto a large breakdown boulder) that was present when the first Euroamerican cavers entered that passage during the early 1980s. Finally, a few geometric and representational figures (some scratched, some drawn with charcoal) documented in both Salts Cave and Mammoth Cave are probably prehistoric, either late Archaic or Early Woodland, or both (Crothers, 2001; DiBlasi, 1996).

In Wyandotte Cave, Indiana, and 3rd Unnamed Cave, Tennessee, late to terminal Archaic people quarried and worked chert derived from underground sources. At 3rd Unnamed Cave they also engraved rectilinear, curvilinear, and representational figures onto the limestone ceilings, walls, and breakdown boulders. Some are reminiscent of the mud images in Adair Glyph Cave.

Thus, it now appears that the first people to enter dark zones of several big caves in Eastern North America were indeed exploring these complexes, but they were also obtaining chert from some of them, and in several they were also probably carrying out ritual activities.

During the subsequent Woodland period (3000 to 1200 years ago), caves were important features for many communities across the Midsouth and Southeast as ceremonial and mortuary foci (Crothers *et al.*, 2002). Dozens of examples are known in Kentucky, Tennessee, the Virginias, Alabama, Georgia, Florida, and Texas, but the prehistoric archaeological record in the Mammoth Cave System ceases 2000 years ago for reasons not yet clearly understood. For the centuries between about 2800 and 2300 years before present, however, Early Woodland cavers spent considerable amounts of time in both Salts Cave and Mammoth Cave mining sulfate minerals. They were obviously very familiar with several kilometers of complicated passage systems in each of these caves and were quite capable of navigating their way through multiple levels of walking passages, crouchways, and crawlways. They battered the gypsum crust off interior cave surfaces; they dug gypsum crystals (satinspar and

selenite) from crevices in cave walls and/or from sediment on cave floors and ledges; they scooped up mirabilite from those areas where it forms so abundantly that it piles up in and on the breakdown and on passage floors; they brushed mirabilite crystals off cave walls into gourd, wood, or basketry containers; and they removed mirabilite-bearing cave sediments, presumably so that the salty, medicinal sulfate deposits could be leached from them outside the cave.

The technology used for all of this work was simple but effective, consisting of cane and weed stalk torches; twigs and small branches for campfire fuel; digging sticks, climbing poles, and ladders; baskets, fiber bags, and gourd and wood containers. The minerals removed from the cave were probably sought for their medicinal (mirabilite and perhaps epsomite as well) or magical attributes. Battering the gypsum crust off cave walls produced gypsum powder, which can be mixed with water or grease to make white paint, known ethnographically to be important in ritual contexts. Gypsum crystals may have been thought to have special powers that would enable curers and wisdom keepers to diagnose and treat illness, to foretell the future, or to exercise other magical abilities. (All of these activities are attested ethnographically among indigenous North American populations.) Early Woodland mining of cave sulfates is most extensive and best known in Salts Cave and Mammoth Cave, but evidence of gypsum mining has also been documented recently in Hubbards Cave, Tennessee, and probably took place in Big Bone Cave, Tennessee, as well (Crothers *et al.*, 2002).

The pictographs and mud glyphs created in some caves as early as the late Archaic period, and found in many subterranean locales up to the time of European contact, are clear evidence that many if not all activities underground took place within a setting that was special for the ancient cavers. We cannot know exactly what they thought about the world underground, but there is information from ethnographic and ethnohistorical information indicating some general concepts that help us speculate about prehistoric belief systems with regard to caves in Eastern North America (Hudson, 1976). Many North American Indians believed in a multilayered universe, wherein there was another world (or several; the details differ from group to group) below the surface world and another (or several) above the surface world. Each layer was inhabited by an array of creatures specific to it. The ancestors of humankind, having originated in the underground world, had climbed onto the surface world and established themselves there in the primordial past. Sky beings (e.g., falcon or owl spirits) and subterranean beings (the most powerful and fearsome being a kind of griffin, or dragon-like, creature known variously as the Uktena, Michibichi, the Water Panther, the Long Tailed Beast) could be contacted and engaged in human enterprises by specially gifted individuals (e.g., shamans) who knew how to carry out the dangerous procedures required; in

particular, how to journey to those realms, negotiate with their inhabitants, obtain magical substances and objects, and return safely to the surface world. It seems likely that the enigmatic cave pictographs, petroglyphs, and mud glyphs were created by specialists in the esoteric knowledge necessary to ensure safe journeys to and from portions of the world underground.

## CONCLUSION

The first human inhabitants of North America were also the first North American cavers. They found and explored hundreds of caves, especially in the midcontinental karst region that extends from the Midwest through the Midsouth to the Southeastern United States and including what is now known to be the longest cave in the world. Archaeologists and speleologists have investigated only a small sample of indigenously utilized caves, but the resulting information makes it clear that subterranean landscapes were well known to aboriginal communities who lived in these karstic areas. As was the case with other features of their surroundings, prehistoric people were familiar with the physical and spiritual aspects of the world underground, knew how to get there, and once there how to travel to their objectives. They also knew how to negotiate with the supernatural beings that inhabited these realms of darkness and what to do to ensure safe return to the surface world. Because of the size and complexity of the caves they conquered, it can quite justifiably be claimed that they were the best cavers in the world, a distinction held by Archaic and Woodland peoples of Eastern North America until less than a century ago.

## Bibliography

- Brucker, R. W., and R. A. Watson (1987). *The Longest Cave*, 2nd ed. Southern Illinois University Press, Carbondale.
- Crothers, G. M. (2001). Early Woodland mineral mining and perishable remains in Mammoth Cave, Kentucky. In *Fleeting Identities: Perishable Material Culture in Archaeological Research* (P. Drooker, ed.), pp. 314–334. Southern Illinois University Press, Carbondale.
- Crothers, G. M., C. H. Faulkner, J. Simek, P. J. Watson, and P. Willey (2002). Woodland cave archaeology. In *The Woodland Southeast* (D. Anderson and R. Mainfort, eds.), pp. 502–504. The University of Alabama Press, Tuscaloosa.
- DiBlasi, P. J. (1996). Prehistoric expressions from the central Kentucky karst. In *Of Caves and Shell Mounds* (K. C. Carstens and P. J. Watson, eds.), pp. 40–47. The University of Alabama Press, Tuscaloosa.
- Hudson, C. (1976). *The Southeastern Indians*. The University of Tennessee Press, Knoxville.
- Mosch, C., and P. J. Watson (1997). An ancient Rocky Mountain caver. *J. Cave Karst Studies (National Speleological Society Bulletin)* 59, 10–14.
- Robbins, L. M. (1997). Prehistoric people of the Mammoth Cave area. In *Archeology of the Mammoth Cave Area* (P. J. Watson, ed.), 2nd ed., pp. 137–162. Cave Books, St. Louis, MO.
- Smith, B. D. (2002). *Rivers of Change: Essays on Agriculture in Eastern North America*, 2nd ed., Smithsonian Institution Press, Washington, DC.
- Watson, P. J., ed. (1969). *The Prehistory of Salts Cave, Kentucky*. Illinois State Museum, Springfield, IL.
- Watson, P. J., ed. (1997). *Archeology of the Mammoth Cave Area*, 2nd ed. Cave Books, St. Louis, MO.

# Ecotones

David C. Culver  
*American University*

## INTRODUCTION

An *ecotone* is a zone of interaction and exchange between ecological systems that influences nutrient cycling and community dynamics of the adjacent systems. Ecotones are now regarded as one of the biosphere's most complex ecological systems but also one of the most important for maintaining the vitality of landscapes. Ecotones are more than an edge or a boundary; they involve active interactions. Two essential components of understanding an ecotone is that it is dynamic and it is not isolated from landscape-level processes. The importance and understanding of ecotones between caves and surface environments has largely resulted from the research of J. Gibert and her colleagues. She identified four important processes occurring in surface/subsurface ecotones. They are *elasticity*, the variation in spatial limits of the ecotone; *permeability*, the filtering effect, i.e., mesh size, of the ecotone; *biodiversity*, species richness and other measures of biological diversity; and *connectivity*, the connection with other systems and other ecotones. The two main types of cave/surface ecotones are terrestrial and aquatic. There may also be ecotones at different scales within the karstic ecosystems (for example, at the confluence of two streams or two galleries), but the most obvious possibility—a terrestrial/aquatic ecotone—is usually not important because there are a few interactions between the terrestrial/aquatic boundary with flows of energy being very reduced between them.

## TERRESTRIAL ECOTONES

Energy flow and faunistic distribution inside karst depend on the modules of openness: size and distribution of penetrable spaces, transport of food, and mobility of organisms. A cave entrance is a transition zone between surface and subsurface environments. There is a distinct gradient of several abiotic factors, especially light, temperature, and humidity. Ecotone elasticity depends to a great extent on the size and orientation of the entrance. Obviously, large cave entrances have larger ecotones. The orientation of the entrance can also be important. Open-air vertical pits have a larger ecotone because not only does sunlight penetrate farther, but food from the surface, such as leaves or dead animals, goes farther into the cave because of the action of gravity. The fauna of pits is also more skewed toward nonobligate cave-dwellers—troglaphiles and troglonexes compared to obligate cave-dwellers—trogloblions.

The extent of the ecotone may also vary with season. For example, in caves that “breathe” out in the winter, the ecotone shortens. Some species tend to be found only in the ecotone. Perhaps the most obvious examples are orb-weaving spiders in the genus *Meta*, which are common in entrance zones in many north temperate caves. *Meta* and some beetles such as *Quedius* are attracted to the entrance because of the availability of suitable prey. Other arachnids, beetles, flies, moths, and caddis flies are also often found in entrance zones. They usually do not feed in the cave but benefit from the environmental conditions of the entrance zone.

Because of these ecotonal species, it is at least possible in theory that species richness would be higher in the ecotone than in the cave or on the surface. However, species richness in surface habitats is always much higher than in the caves, and richness of the ecotone is typically intermediate. For example, in Cathedral Cave in Mammoth Cave National Park in Kentucky, mean invertebrate species diversity at pitfall traps in the surrounding woods was 11.6 and that of the cave was only 5.6. The entrance zone was intermediate, with an average of 8.5 species per pitfall trap.

The terrestrial ecotone is also important because it is a transit point for much of the organic matter that forms the base of the detritivorous terrestrial cave community. Most cave entrances, at least ones that can be entered by humans, are quite permeable to the movement of organic matter. Several vectors transport organic matter, including gravity, precipitation, and some animals. Animal vectors of food include cave crickets and other troglomen that routinely leave the cave and cave entrance to forage, and surface animals that penetrate into the cave and leave organic matter such as feces. There is one situation where human activity alters the permeability of the entrance. This occurs when gates are installed. Gates are typically installed to protect rare bat populations or cave formations and minerals. However, gates may reduce the access of some of the biological vectors and other food into the cave. For example, an improperly designed gate on Shelta Cave in Alabama both caused a bat population to abandon the cave and prevented the movement of leaf detritus by the action of gravity into the cave.

### Aquatic Ecotones

Water is the most frequently exchanged component between caves and the surface. The permeability (mesh size) of aquatic cave/surface ecotones varies enormously from large cave entrances with either sinking streams or springs to partly clogged fissures in the epikarst (see articles on epikarst and epikarst communities). These constitute the two main sources of water seen in most caves. In other subterranean habitats, the situation can be more complicated. This is especially true of the underflow of streams (the hyporheic) and its connection to surface water and groundwater. Typically, the aquatic fauna is used to delineate the boundary of the surface water/groundwater ecotone, but chemical

measures can be used as well. For example, the bicarbonate-to-calcium ratio is low in surface waters but high in cave waters. However it is measured, the ecotone may extend several kilometers, especially in river caves.

Karst springs are convergence points for the dispersion of surface fauna into the cave and *vice versa*. During floods, tens of thousands of groundwater crustaceans may be washed out of their habitat and in some cases may colonize gravels in the underflow of streams in the process. Movement in the reverse direction also occurs, perhaps in response to unfavorable surface conditions. The amphipod *Gammarus minus* colonized caves in Virginia and West Virginia via this route.

In general, percolating water and often sinking streams are not especially permeable to larger pieces of organic matter, and the mesh size of inputs is often small. Particulate organic matter that does enter the cave is mostly processed by aquatic detritivores before the water exits at a spring. A striking example of this was a study in the French karst basin at Baget in the Pyrenees. Particulate organic matter was 300 more times more concentrated in the inputs than in the spring. By contrast, dissolved organic matter was at roughly the same concentration in the inputs and outputs.

As is the case with terrestrial cave/surface ecotones, there rarely seems to be enhanced species richness at the ecotone boundary. In a detailed study of the spatial distribution of aquatic invertebrate species around the entrance of the karstic spring Le Château in the French Juras, a total of 28 invertebrate species were recorded. Of these, 3 were found only in the cave and 2 of these were obligate cave-dwellers. Seven species were found both inside and outside the cave, and 18 were found only in surface waters. None of the species were limited to the ecotonal boundary itself.

For both aquatic and terrestrial environments, the concept of the ecotone is a powerful and useful way of looking at subterranean karstic environments.

### See Also the Following Articles

#### Entrances

#### Bibliography

- Culver, D. C., and T. L. Poulson (1970). Community boundaries: Faunal diversity around a cave entrance. *Annales Spéléologie* **25**, 853–860.
- Di Castri F., A. J. Hansen, and M. M. Holland (1988). A new look at ecotones. *Biology International* special issue no. 17.
- Gibert, J. (1997). The importance of ecotones in karstlands. In *Conservation and Protection of the Biota of Karst* (I. D. Sasowsky, D. W. Fong, and E. L. White, eds.), pp. 17–19. Karst Waters Institute, Charles Town, WV.
- Gibert, J., F. Malard, M. J. Turquin, and R. Laurent (2000). Karst ecosystems in the Rhône River basin. In *Subterranean Ecosystems* (H. Wilkens, D. C. Culver, and W. F. Humphreys, eds.), pp. 533–558. Elsevier, Amsterdam.
- Gibert, J., M. J. Dole-Olivier, P. Marmonier, and P. Vervier (1990). Surface water—Groundwater ecotones. In *Ecology and Management of Aquatic-Terrestrial Ecotones* (R. J. Naiman and H. Décamps, eds.), pp. 199–225. Parthenon, London.
- Gibert J., J. Mathieu, and F. Fournier, eds. (1997). *Groundwater/Surface Water Ecotones: Biological and Hydrological Interactions and Management Options*. Cambridge University Press, Cambridge, England.

Plénet, S., and J. Gibert (1995). Comparison of surface water/groundwater interface zones in fluvial and karstic systems. *Compte Rendus Acad. Sci. Paris* **318**, 499–509.

Turquin, M.-J., and Y. Bouvet (1977). Energy flow and faunistic distribution inside karst: The influence of module of openness. In *Proceedings of the 7th International Congress of Speleology*. Sheffield, UK, pp. 406–407.

## Entranceless Caves, Discovery of

Nevin W. Davis

*Butler Cave Conservation Society, Inc.*

### INTRODUCTION: HUMANKIND'S NEED FOR EXPLORATION AND DISCOVERY

Humankind has always had the need to explore and use caves. Early Americans entered caves in the Virginias, Kentucky, and elsewhere. Polynesian Hawaiians have explored lava tubes on the Big Island of Hawaii from early times to the present. The Hawaiians used the tubes for ceremonial purposes, collecting water, and burials, but from the evidence left by charcoal from cane torches in remote places, they also must have enjoyed exploration for its own sake. Today there is a large group of cavers whose exploration instinct is satisfied with the traversing of known passages and the mapping or remapping of passages that are already “in the book” or “previously enjoyed” (slang terms for cave passages that are well known by the caving public), but there is also a select group of cavers who are satisfied only with exploration and mapping of “virgin” passages. So the question arises “What is a virgin cave passage?” Purists would say that a virgin cave passage is a passage that has never been seen by humans. A looser definition would be a passage that has never been recorded or described even though it may have been viewed years before or by aboriginal man. In this article we use the first definition.

A virgin cave passage can be found in known caves. Many times exploration will yield a passage that appears to have never before been entered. A passage that has no footprints or scrape marks is a good candidate for being virgin but there is no assurance in today's world of well-explored caves unless some obstacle is passed that would preclude others from having been there. These include but are not limited to

1. Water-filled sumps that have no written or oral record of being dived
2. Very remote passages in a project cave that no casual explorer would have gotten to

3. Passages that are blocked by breakdown or dirt fill that, when removed, reveals extensions
4. Deep pits.

Virgin cave passages can also be found in another interesting way. Suppose the cave is totally unknown and has no entrance. (An entrance is an opening large enough for a human to enter.) Absent an entrance a cave is very likely to be virgin. In Virginia the number of entrances per cave varies widely. One cave has 16 entrances, Clark's Cave has 8 entrances, most caves have 1 entrance, but some of the best known caves originally had no passable entrance. They were dug open. One of the best known of these is Butler Cave–Sinking Creek System with 25.41 km of passage that was dug open in May 1958. Coincidentally, in the same year Rane Curl published a paper in the *Bulletin of the National Speleological Society* entitled “A Statistical Theory of Cave Entrance Evolution.” In it he came up with a statistical way to predict the number of entranceless caves in a region with a distribution of caves with 0 through 4 entrances. For example, in West Virginia at that time, out of a population of 257 caves with lengths greater than 30 m, 228 caves had 1 entrance. His theory gave the number of entranceless caves in this situation as 2405. This is an impressive number, but the theory also leads to a distribution function of lengths of caves within this set with 0 through 4 entrances. Unfortunately, 50% or 1200 of the entranceless caves would have passage lengths of less than 55 m (1200 would also have lengths greater than 55 m), while 200 of the single-entrance caves would have a length greater than 55 m. This means that any successful effort to dig open a cave would be met with a large number of short caves!

Fortunately, the search for entranceless caves in the real world is quite different from the theoretical approach. In the real world, some intelligence can be applied to the effort to better the odds of finding something significant. Here are some recent numbers from the Virginia Speleological Survey database. In Virginia there are 2601 caves with a length greater than 9 m. Of this population, 2066 caves have one entrance and 251 caves were dug open. The average length of the single-entrance caves is 239 m, while the average length of the formerly entranceless caves is 809 m. Clearly something is happening here! Cavers are not digging for short caves or are only reporting their successes.

### ENVIRONMENTAL SETTINGS OF ENTRANCELESS CAVES

The discussion that follows is based on experience in the Appalachians in limestone terrains. Insight that applies to the Appalachian Mountains in the Eastern United States should also apply to many other limestone terrains with even rainfall. The environmental variables that produce significant long and deep known caves obviously likewise apply to entranceless caves. These include the following:

1. Large upland catchment areas directing the runoff into sinkholes and losing streams. Catchment areas can vary from under 260 hectares to more than 26,000 hectares.
2. Entrenched rivers with large karst springs.
3. Thick, contiguous beds of limestone.
4. Insoluble caprock that overlies some portion of the limestone, protecting it from surface solution. This condition occurs only in small areas in the folded Valley and Ridge Province of the Appalachians but is found over large areas in the Cumberland Plateau and in Central Kentucky near Mammoth Cave.
5. High relief. Relief of 30–60 m, as is found in the valleys of central Pennsylvania, leads to much shorter caves than are found in the Burnsville Cove in West Central Virginia, where the relief from the highest cave entrance to the spring exceeds 244 m.

All of these environmental variables need not be in their most desirable range to produce long and deep caves. Hosterman Pit in central Pennsylvania sits under a hill in the center of Penns Valley. Nearby Pine Creek is only entrenched 60 m below the hilltop, the karst springs run at less than 30 liters/sec, and there is no caprock or large catchment area; however, the cave has more than 1.6 km of passage and is 59 m deep.

Another consideration in searching for caves is entrance lifetime. Caves are long-term features under the landscape with lifetimes measured in millions of years, whereas entrances to them are fleeting features with lifetimes measured in millennia. One factor affecting entrance lifetime in a temperate climate is air flow. Bedrock in any climate will assume the mean temperature of the region. This of course means that the air temperature in the depths of the caves surrounded by that bedrock also has this temperature. In the winter outside air temperatures are often below freezing in the Appalachians while the cave temperatures are near 10°C. Almost all air movement in caves is driven by the chimney effect, i.e., warm air rises. This means that warmed cave air exits the upper entrances of caves to draw the cold outside air into lower entrances. Eventually, the temperature of the rock at lower entrances drops below freezing causing any water in the rock to freeze, expand, and fracture the rock. This can also occur in caves with only one entrance because significant quantities of air can penetrate the soil, covering potential high entrances including domes and high ceiling fissures. The large surface area over a cave means that air velocities through the soil can be insignificant, while the velocities in the smaller cave passages can be meters per second. The upshot of all of this is that lower entrances to caves have very short lifetimes.

Another consideration in the Appalachians where most of the ridges are covered with deciduous trees is that leaves and twigs will soon cover and block small vertical entrances. Pits 2 feet in diameter can be totally blocked in one season.

Leaves blocking a small entrance are soon followed by roots and more leaves and it is not long before all traces of an entrance are gone. Humankind does not help this condition much since it seems that a natural instinct is to cover holes with poles (for safety?) and the cycle of covering is repeated in an unnatural way, unless of course someone steps on the hidden, rotten poles in a few years and falls into the pit.

Humankind also has had his effect on valley and ridge margin sinks, all potential cave entrances. Any depression extends an invitation to be filled with trash. Many cave entrances have been lost this way. In a sinkhole dig in Burnsville Cove, Virginia, a domestic pig skull was found under 2 m of soil with some 50- to 70-year-old domestic trash near the surface. Because this sinkhole receives no drainage from nearby fields, the 2 m of compacted soil covering the skull took no more than 200 years to accumulate from the hill above. This gives an idea of rates of infilling of small sinks.

### STALKING THE ELUSIVE ENTRANCELESS CAVE

The same moving air that can destroy a lower entrance to a cave can help find an upper entrance. In the winter when the ground is covered with snow, potential cave entrances can be found by looking for melted spots. Remember that air does not necessarily need an opening to move through. It can move through a soil covering as well as loose rocks. The most sensitivity to this effect can be had with early season snows before the ground freezes. This will also lead to more false positives because rotting stumps and other such sources of heat can also melt the snow. The best conditions to search for snow melt is with a new snowfall in midwinter with an overcast sky, since sunlight can also give false positives by shining through shallow snow cover onto rocks and melting the snow. This is a tried-and-true method that has led to countless new caves.

Stick to looking in smaller sinks. The smaller the better because larger sinkholes have more material blocking a potential entrance and will require a more protracted dig. Give preference to sinks with a bedrock outcrop. These are more likely to lead to a cave if for no other reason than that there is at least one solid wall to follow when digging!

A straight 1.5-m digging bar can be a helpful tool to probe suspected sites. In a small sinkhole if the bar sinks easily into loose, organic material this is a potential dig site. Many times a 1.5-m bar will punch through into space at the top of a dome pit or fissure. If the bar indicates that the fill in a sink is consolidated material without organic content, it is probably a sign to look elsewhere.

The topography in the Valley and Ridge Province of the Appalachians features major parallel ridges of clastic rocks and oftentimes karstic valleys. This means that the clastic ridges serve as the catchment areas to direct recharge into the valley margin sinkholes. These sinks, although they are potential entrances to the caves that underlie the valleys, are poor choices for dig sites unless they are known to have been

entrances in the past. The reason for this is that the bed load in the sinking streams tends to choke any entrances. An effort to open entrances in these locations may require equipment like a trackhoe to get anywhere. At the base of Jack Mountain near Burnsville Cove in Virginia, Cycle Sink provides an example of this. This sink was a collapse in the bed of a sinking stream that reached 6 m depth without digging. Digging efforts there resulted in very little progress until a storm completely removed the collapse, filling it and leaving no sign that it ever existed. The stream now flows past this area before it sinks.

In a similar situation where the surface is composed of limestone outcrops, cavers did not dig at the stream sink. Instead at a Giles County site in Virginia the dig was 9 m from the stream sink and above it. This was a place where some air exited. The dig is now the entrance to a significant Virginia cave.

Traditionally, the way to find caves is to talk to land owners, hunters, ginseng hunters, and other outdoor people. The problem often is asking the right questions, particularly when trying to find entranceless caves. Ask about snow melt spots or places that may have entrances which are now covered over. If all else fails in the search for the elusive entranceless cave, go where there are already known long and/or deep caves. Search nearby or in an adjacent drainage and success will surely follow.

### EXAMPLES

The Burnsville Cove in West Central Virginia consists of a synclinal valley surrounded by ridges composed of clastic rocks. The valley is bisected by Chestnut Ridge, an anticlinal structure. Butler Cave–Sinking Creek System and its drainage lie on the western side of this ridge. The entrance to Bobcat Cave, a significant cave at 15 km in length, lies high on the western side of the ridge but the cave has passage on both sides of the ridge. Of special interest to cavers is the drainage on the eastern side of the ridge, especially to the southwest where the recharge area and the majority of cave passage must be. Bobcat Cave ends in breakdown and tight fissures to the southwest. Ridge walking by the author over the years has led to innumerable snow melt spots on Chestnut Ridge. In March 1991 a crew dug at one of these, a 1.2-m-diameter sink high on the eastern side. In 20 minutes a narrow fissure had been opened. Below was a 9-m drop followed by a second drop into a room. Two more drops lead to Strychnine Canyon, a tight, crawly passage over 274 m long that eventually ends in a large phreatic passage at Ghost Hall. This is the beginning of 7.5 km of passage that eventually connects to Bobcat Cave. The ultimate goal of finding a series of passages upstream to the recharge area has not been met, but 20 minutes of work to open access to more than 7.5 km of cave passage isn't bad!

Buckwheat Cave is a small, pleasant, 670-m-long cave in a ravine on the western side at the base of Chestnut Ridge.

The entrance is 4.6 m above the base of the ravine on the north side. An ephemeral stream collects in the ravine and only flows past the entrance in the wettest of times. This cave is part of the population of entranceless caves that were opened by digging. With this knowledge cavers looked at the next ravine to the north. Topographically, it is very similar and even has a small sink 1.5 m above the bottom of the ravine on the north side. Stratigraphically, the sink is located in the same limestone unit as Buckwheat Cave. The sink is 2.4 m in diameter and only 0.6 m deep. It had no snow melt and the fill was rather tight and inorganic. Optimistic cavers spent one day digging there in March 1999 and after sinking a shaft 4 m opened aptly named Blind Faith Cave. The cave is now 1019 m long and 48 m deep and comes very close to connecting to another excavated cave, Battered Bar Cave.

The first example described here is an illustration of the benefits of following the air. The use of snow melt in finding new caves is a powerful tool that can lead to minimum effort in opening them. The second example shows that intimate knowledge of a particular area can lead to discovery even if the signs are not otherwise favorable.

*See Also the Following Articles*  
*Entranceless Caves, Geophysics of*

### Bibliography

- Curl, Rane L. (1958). A statistical theory of cave entrance evolution. *Bull. National Speleological Society* **20**, 9–21.
- Curl, Rane L. (1964) On the definition of a cave. *Bull. National Speleological Society* **26**, 1–6.

---

## Entranceless Caves, Geophysics of

William B. White

*The Pennsylvania State University*

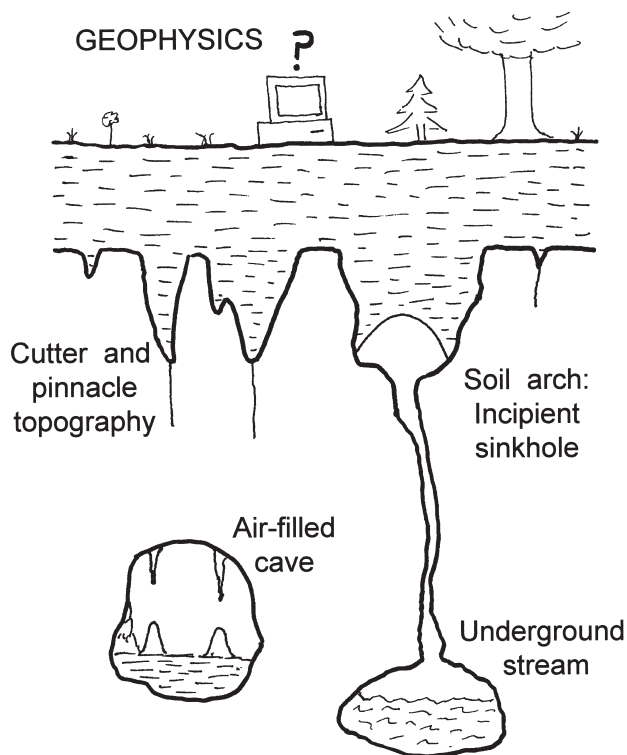
We begin with a tract of land. Maybe it is a small tract, say, one or two hectares, suitable for construction of a building. Maybe it is a large tract, a few hundred hectares such as might be used for a housing development, an industrial park, a shopping mall, or perhaps a landfill. Maybe last year it was a corn field, or a wood lot, or a pasture. Or maybe the land is covered with rundown houses and an abandoned warehouse, now scheduled for urban renewal. Regardless, suppose that beneath the land surface is karstic carbonate rock. The questions in the minds of the consulting company, the developer, or the zoning board concern the nature of the subsurface. Is the land suitable for whatever project they have in mind, or are there potential dangers of



sinkhole collapse, of irregular cutter and pinnacle topography on the bedrock beneath the soil, or of cave roof collapse down in the bedrock? There is an assortment of geophysical probes that will reveal at least some of the karst features that lurk beneath the soil or deep in the limestone bedrock. They are not all equally effective and some work better for one target than another.

### WHAT ARE WE LOOKING FOR?

There are two interrelated problems that we must deal with in determining the nature of the subsurface. One is to devise instruments that will detect the presence of karst features both beneath the soil and deep in the bedrock. The other is to devise methods that will distinguish between the various targets. Some of these are indicated schematically in Fig. 1. Beneath the soil is the bedrock surface. Within the bedrock surface are filled sinkhole structures and solutionally widened crevices that together make a very complex pinnacled surface. This zone is generally called the *epikarst*. The exact nature of the epikarst has a great deal to do with establishing stable foundations for buildings, for the emplacement of storage tanks or pipelines underground, and with the hiding places of contaminants spilled onto the land surface. Within the bedrock are solution cavities of various sorts. Some may be filled with water, some with clay and silt, and some with air (cave passages). In general, any given solution cavity may



**FIGURE 1** Various subsurface targets to be detected and distinguished by geophysical methods.

have some clay and silt, some water, and some air with the proportions varying depending on the season of the year and the amount of rainfall. The cavities may be above the water table, below the water table, or some of each.

The parameters that must be considered are the thickness, mineralogy and moisture content of the soil, the size and depth of the solution cavities, the nature of the cavity fillings, and the depth to the water table. A small cavity at shallow depth may very well give the same signal as a large cavity at great depth. One must also distinguish between soil-filled cavities at the top of the bedrock from cavities at some depth within the bedrock. The signals that these various targets provide arise from differences in density and electrical conductivity between the cavity, the cavity filling, and the surrounding bedrock. None of the signals is highly distinctive so that all of the technologies described below require a great deal of subjective interpretation.

### GROUND-PENETRATING RADAR

Radar consists of a transmitter and a receiver. An outgoing pulse of electromagnetic radiation from the transmitter reflects from a target object and returns to the receiver. The transmitting antenna is rotated so the outgoing beam is swept in all directions. Only when there is an object in the beam path does the beam get reflected back to the receiver. System electronics convert the collected reflected pulses from different directions into a two-dimensional image, which is displayed as a map. Measured delay times between the outgoing pulse and the arrival time of the reflected pulse give the distance to the object. Military radar, police radar, and civilian radar for such purposes such as airport traffic control all operate on the same basic principles.

*Ground-penetrating radar* (GPR) also works on the same principles except that the antenna is focused downward into the earth. Transmitted pulses and received reflections must penetrate the soil and bedrock. Usually there are two antennas, one for transmitting and one for receiving. Instead of sweeping the field of view, a profile of the subsurface is obtained by dragging the antenna structure and other electronics along a specified traverse path. A typical radar frequency is 120 MHz or about 2.5 m. The radar will resolve objects of a size equal to the wavelength and larger. There will be reflections from interfaces where there is a change in electrical conductivity, the soil/bedrock interface, or the water table, for example.

GPR is particularly useful for characterizing the soil/bedrock interface, thus locating cutter and pinnacle topography on the bedrock and locating sinkholes that have been buried under overlying soils. Because the electromagnetic waves are absorbed by rock and soil, there is a limit to the depth to which the radar will penetrate. Penetration depth is greater in dry sandy soils than in wet clay-rich soils. Useful ranges of 10–20 m are typical. Good results have been obtained in Florida where ground-penetrating radar has been

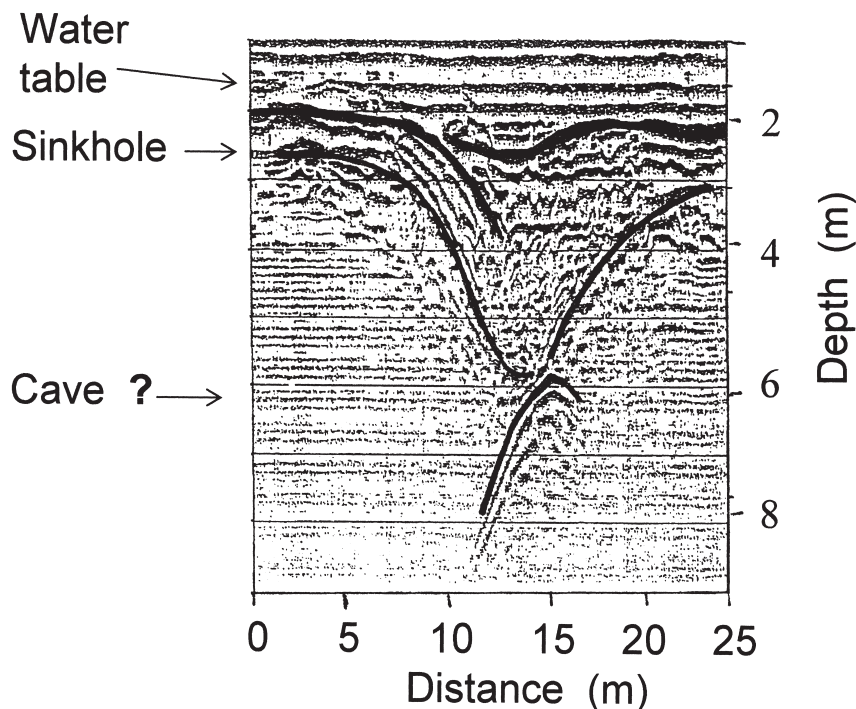


FIGURE 2 Ground-penetrating radar images of cutter and pinnacle topography at a site in central Florida.

helpful in mapping the distribution of sinkholes (Fig. 2). GPR is less useful for locating cave passages deep in the bedrock.

### MICROGRAVITY

The weight of any object is determined by the force with which the object is pulled downward by the Earth's gravity. The force can be measured with an ordinary spring balance. To measure weight, it is assumed that the gravitational acceleration is constant,  $9.806 \text{ m}\cdot\text{sec}^{-2}$ , and that differences in the measured force are due to differences in the weights of objects hung on the balance. However, the acceleration due to gravity is not exactly constant. A very sensitive spring balance, on which is hung a constant standard mass, will give different readings from place to place. The earth is not precisely spherical; therefore, gravity varies with longitude and latitude according to what is called the *international ellipsoid*. Gravity is less at higher elevations than it is at sea level. Finally, gravity varies depending on local topography and the exact nature of the rock beneath the measurement site. These factors are combined in what is called the *Bouguer anomaly*, defined as follows:

$$B = g - (g_0 - c z - T)$$

where  $g$  is measured gravity,  $g_0$  is the reference gravity from the international ellipsoid,  $cz$  is an elevation (also called *free-air*) correction, and  $T$  is a terrain correction. All of these parameters are measured in units of *gals* where one gal =  $0.01 \text{ m}\cdot\text{sec}^{-2}$ . Gravity anomalies are very small, on the order

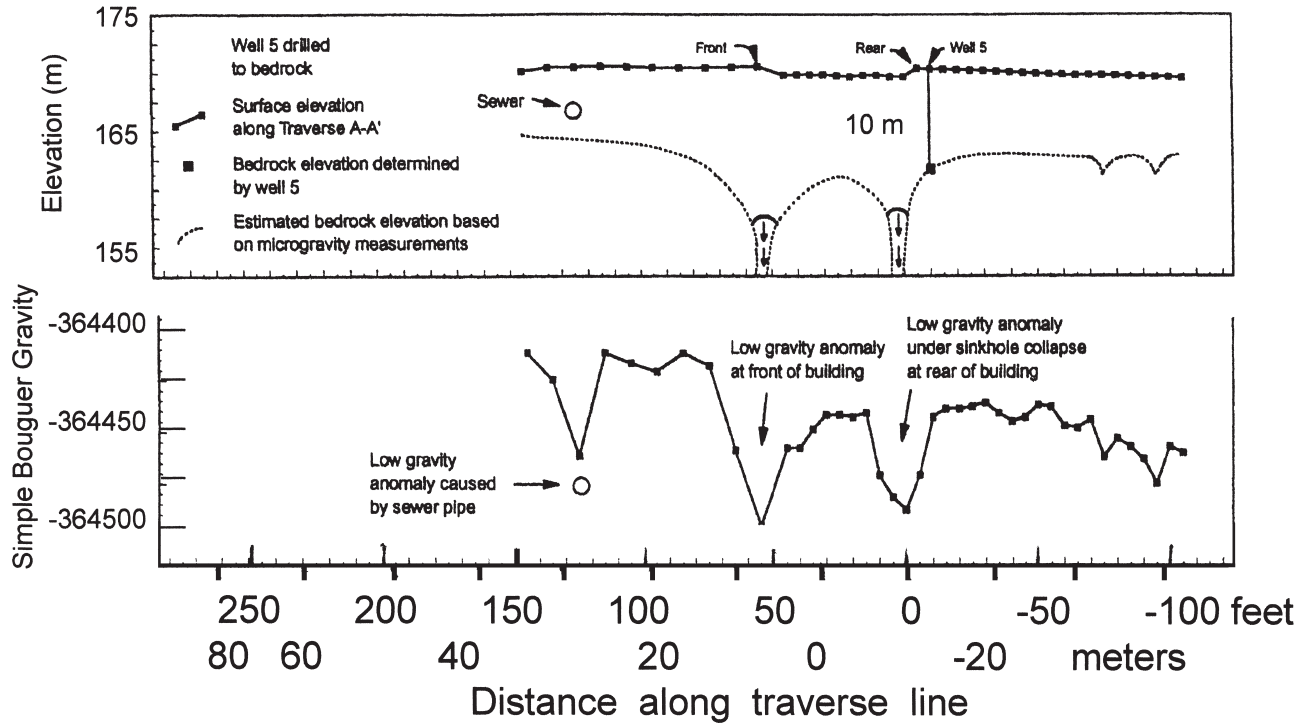
of 1–100  $\mu\text{gal}$  ( $1 \mu\text{gal} = 10^{-8} \text{ m}\cdot\text{sec}^{-2}$ ), but are measurable with highly sensitive equipment.

Microgravity measurements are useful in locating caves and other shallow voids because the gravitational force is less over a void than it is over the solid rock on either side. In practice, one runs a very precise survey across the suspected void and measures the gravitational anomaly at intervals along the survey. A dip in the measured gravity suggests that the traverse has crossed a void. The location of a cave passage is determined by connecting the anomalies from a series of parallel traverses (Fig. 3).

The advantages of microgravity measurements are that they are not affected by power lines, buried pipes, or other sources of electrical interference. The equipment is small so that traverses can be set up under buildings and in other restricted spaces. Because each measurement requires a tedious nulling of the instrument, gravity surveys are best when confined to small areas. High-sensitivity gravity measurements are not suitable for regional scale surveys. Gravity anomalies are somewhat ambiguous. Large cavities at great depths give signals that are similar to those for smaller cavities at shallower depth. Air-filled, water-filled, and sediment-filled cavities give different magnitudes of anomalies that are difficult to distinguish from size/depth effects.

### SHALLOW SEISMIC EXPLORATION

An assortment of geophysical measurements called *seismic* measurements have in common the use of sound waves to probe the internal structure of the Earth. At the scale of



**FIGURE 3** A microgravity traverse beneath a building showing the anomalies due to an underlying cavities. (Traverse conducted by the Center for Cave and Karst Studies, Western Kentucky University, Bowling Green, KY.)

the entire planet, natural vibrations created in the Earth by moving faults (earthquakes) are picked up by seismic recording stations. This information is used both to locate and characterize the earthquakes and also the echoes as the waves pass through the Earth and bounce back. These echoes are the main source of information on the deep structures of the Earth such as the mantle and the core. On smaller scales, sound waves generated by detonating explosives in boreholes are used to probe deep in the crust to locate petroleum reservoirs. On a still smaller scale, sound waves generated by thumping the ground can be used to probe for caves and irregularities in the bedrock surface. Such measurements are sometimes called *shallow seismic* rather than *deep seismic*.

Sound waves are introduced into the ground by striking a metal plate with a sledge hammer, by a mechanical thumper, or by a small charge of explosives. The sound waves propagate downward and are reflected by the soil/bedrock interface and by discontinuities within the bedrock such as open fractures, bedding plane partings, and solution cavities. The reflected waves are detected by an array of microphones (usually called *geophones*) laid out on the land surface. Because the wavelength of the sound waves is large compared to the spatial dimensions of the targets, the seismic data do not form direct images. Instead, the data are computer processed to reveal anomalies, which must in turn be interpreted. Shallow seismic measurements have been helpful in mapping bedrock surfaces but less effective in locating caves deep within the bedrock.

## RESISTIVITY SURVEYS

Soil and rock are weak conductors of electricity. A current injected into the ground through a metal stake electrode will flow through the ground to a second electrode, which completes the circuit. The voltage drop along the flow path of the current can be measured by a second set of electrodes driven between the current-carrying ones (Fig. 4). If the material between the electrodes is homogeneous, the current will flow in a set of uniform paths extending deep beneath the ground surface. If, however, there are discontinuities in the subsurface, the current path will be disrupted and this will appear in the voltage drop measured at the surface. A complete resistivity survey requires moving the electrodes in a systematic pattern across the area being investigated. Because the current flow paths curve deeply between the electrodes but the voltages are measured only at the surface, considerable interpretation is needed to identify anomalies that might represent solution cavities at depth. A recent innovation is that of the electrode array, where up to 56 electrode stakes are set in a regular two-dimensional array. The current signals of voltage drop measurements are inserted and measured between various pairs of electrodes by a computer program and the computer software then generates a resistivity profile.

Soils are generally better conductors than rocks. Wet media are better conductors than dry media. Water-filled or wet sediment-filled cave passages may have a better conductance

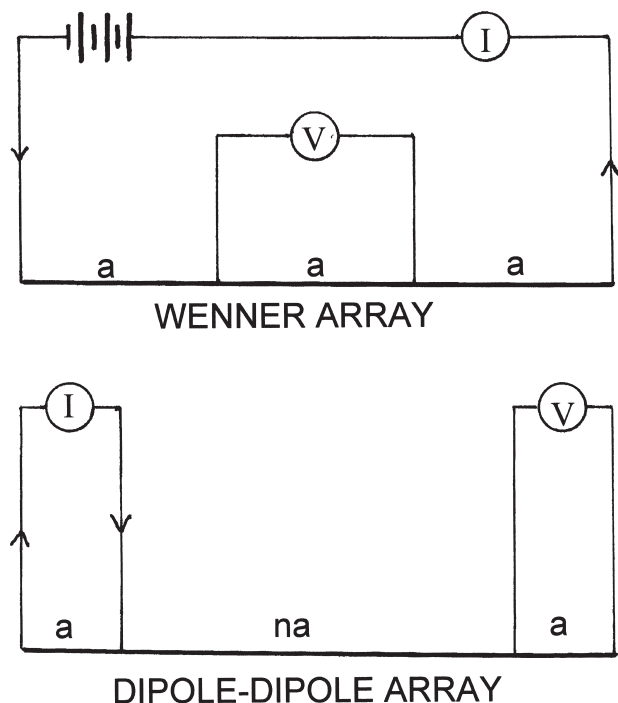


FIGURE 4 Electrode arrays for resistivity measurements.

than the surrounding rock. Air-filled cave passages have an extremely low conductance. Resistivity is the inverse of conductivity. It is the contrasts in conductivity or resistivity that allow the identification of caves (Fig. 5). Because solution cavities can only be identified by their disruption of the flow lines of electric current through the ground, the spatial resolution is not very high. Large cave passages at shallow depths such as the one illustrated in Fig. 5 are easy to recognize. Smaller passages and greater depths become harder to detect.

### THERMAL IMAGING AND RELATED TECHNIQUES

The Earth's surface can be regarded as a warm object with a temperature in the range of  $-30$  to  $+30^{\circ}\text{C}$  ( $243$ – $303\text{K}$ ) depending on latitude and season. Warm objects emit infrared radiation just as extremely hot objects emit visible radiation. Cave air normally remains constant at the mean annual temperature of the region, whereas surface temperatures fluctuate over a wide range through winter and summer. Warm air tends to rise not only through entrances and open pits, but also along fractures and broken rock zones so that warm cave air may migrate to the surface in the absence of any obvious opening. This is the basis for the cave hunter's trick of looking in the winter for places where the snow has melted.

A more quantitative approach is to make use of the thermal contrast between cave temperature and surface temperature. A warm body near  $300\text{K}$  emits infrared radiation with a wavelength of about  $10\ \mu\text{m}$ . Thermal imaging

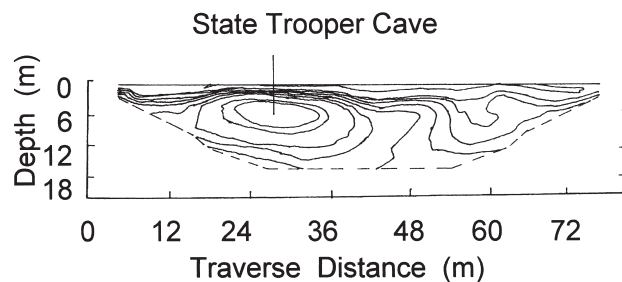


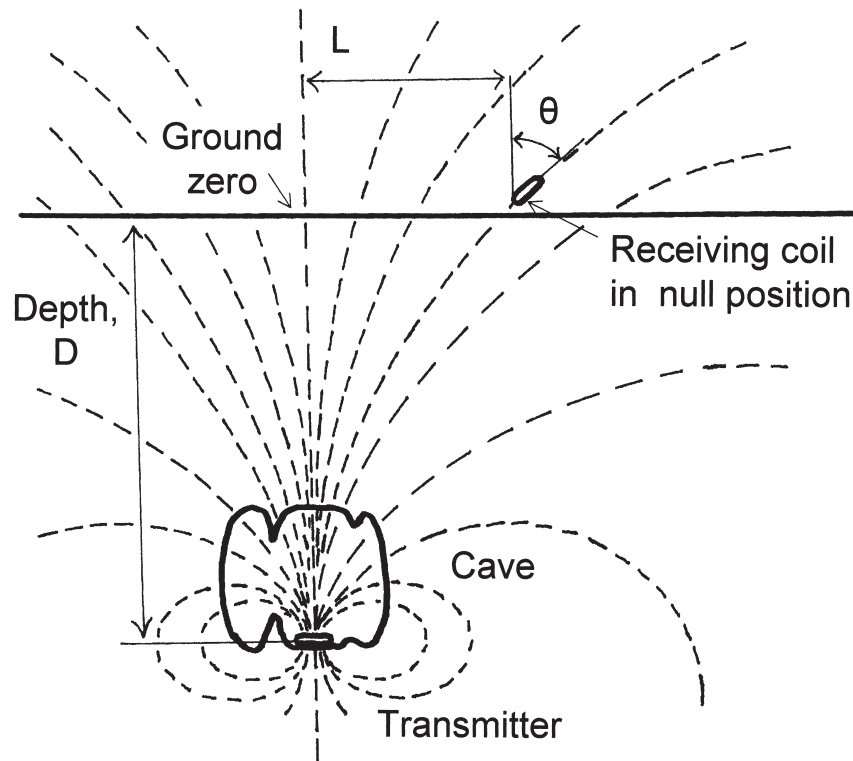
FIGURE 5 Resistivity profile over State Trooper Cave, Bowling Green, Kentucky. (Traverse constructed by the Center for Cave and Karst Studies, Western Kentucky University, Bowling Green, KY.)

devices exist that allow the thermal mapping of a region from aircraft. Places where cave air is escaping show up as warm spots on the thermal map. Once identified these temperature anomalies can be further investigated on the ground. Some success has been obtained with locating springs that have been drowned in impoundments by locating the plume of warm spring water rising to the surface of the cold winter lake. Unfortunately, high-resolution infrared imaging equipment was developed mainly for the military and is not readily accessible to cave and karst investigators.

### CAVE RADIO

Cave radio is a technique for precisely locating a point in a cave on the land surface above, providing that one can access the cave to install a transmitter. Cave radio can be used to tie underground surveys to surface locations and to pinpoint the locations for digging entrances into underlying caves or drilling wells to intersect underground streams.

The technologies described previously allow looking into the karst aquifer from the outside. Cave radio is a technique for looking out from the inside. Further, a cave radio is not really a radio. It depends on magnetic induction rather than the transmission of radio waves. The essentials are sketched in Fig. 6. The transmitter is a flat coil of wire that must be very precisely leveled in the cave. The coil is fed with a pulsed AC signal, typically  $1000\ \text{Hz}$ . The magnetic field lines spread upward from the coils as sketched in Fig. 6. On the surface, the receiver is another coil of wire mounted on a flat support that can be tilted and rotated. The receiver coil picks up the signal from the transmitter, amplifies it, and sends it to the operator who listens to the signal in headphones. When the receiver coil is perpendicular to the field lines, the signal is at a maximum and when it is parallel to the field lines, the signal is zero. The null point is much sharper than the maximum. The observer tilts the receiver coil until the signal vanishes. This means that the receiver is tilted directly along the field lines. Several such measurements from different directions establish ground zero, the point on the land surface that is directly above the transmitter, often with an accuracy on the order of  $10\ \text{cm}$ . The depth of the transmitter



**FIGURE 6** The essentials of the cave radio. The dashed lines are the magnetic field lines emanating from the transmitter coil.

below the land surface can be determined by measuring the dip of the receiver coil at a known distance from ground zero:

$$D = \frac{L (3 \pm \sqrt{9 + 8 \tan^2 \theta})}{4 \tan \theta}$$

Where  $D$  is the depth in meters,  $L$  is the distance from measurement point to ground zero, and  $\theta$  is the angle of the receiver coil with respect to vertical at the point of measurement. The equation takes the plus sign for dip angles up to  $90^\circ$  and the minus sign for dip angles from  $90$  to  $180^\circ$ .

### CAN GEOPHYSICS FIND CAVES?

The techniques described briefly above are some of the commonly used methods for locating cave passages and for characterizing the topography of the bedrock in karst regions. Several other techniques, such as natural potentials and electromagnetic induction, have also been applied. Originally, the main problem with nearly all of the techniques was that they were operating at about the limit of their sensitivities. It was difficult to determine if an observed anomaly was real or only an instrumental artifact. However, substantial improvements in the devices were made during the 1980s and 1990s. The improvements were in the form of more sensitive measurements and better computer processing abilities. Anomalies can now be detected reliably in many situations. The question of exactly what the anomaly represents must still be answered by excavations or drilling test holes.

*See Also the Following Articles*  
*Entranceless Caves, Discovery of*

### Bibliography

- Barr, G. L. (1993). Application of ground-penetrating radar methods in determining hydrogeologic conditions in a karst area, west-central Florida, Water Resources Invest. Report 92-4141. U.S. Geological Survey.
- Crawford, N. C., M. A. Lewis, S. A. Winter, and J. A. Webster (1999). Microgravity techniques for subsurface investigations of sinkhole collapses and for detection of groundwater flow paths through karst aquifers. In *Hydrogeology and Engineering Geology of Sinkholes and Karst* (B. F. Beck, A. J. Pettit, and J. G. Herring, eds.), pp. 203–218. A.A. Balkema, Rotterdam.
- Reynolds, J. M. (1997). *Introduction to Applied and Environmental Geophysics*. John Wiley, New York.

## Entrances

William B. White

*The Pennsylvania State University*

If a cave is to be accessible to human exploration it must have an entrance. Entrances, however, are more rare than might be expected. For the most part, the processes that form caves do not demand that they have entrances. If a cave

entrance was created as part of the original cave-forming process, the entrance can easily be destroyed by later collapse and slumping. Most entrances are formed late in the history of caves by random processes of erosion and collapse. Some caves may have no entrances at all.

### LOCATIONS OF ENTRANCES

The search for caves by cave explorers is a search for entrances. Some entrances, of course, are obvious—the storybook picture of a gaping hole in the hillside. These caves have generally been known about for centuries. Other entrances are small, obscure, and often go unrecognized until the systematic combing of an area is undertaken. Still other entrances have been opened by human activities. They are found in road cuts, rock quarries, and other excavations. The search for cave entrances has become more intense as the more obvious openings have been discovered and the caves explored, surveyed, and described. Much exploration is now focused on finding concealed entrances. These are places where cave passages intersect the Earth's surface but where collapses, slumping, and other occlusions have erased all traces on the land surface. At such locations, a relatively modest amount of excavation may expose the cave passage.

### TYPES OF CAVE ENTRANCES

Cave entrances come in three broad categories: (1) those that are an intrinsic part of the cave-forming process so they are the same age as the cave, (2) those that formed by later processes of truncation and collapse and thus are younger than the cave, and (3) those that formed by human activities such as quarrying and road building so that these entrances are the youngest of all.

1. *Entrances formed as an intrinsic part of the cave-forming process:*  
Entrances at sinking streams  
Entrances at springs  
Pit and fissure entrances
2. *Entrances formed by later processes of truncation and collapse:*  
Cave passages truncated by valley deepening  
Entrances formed by sinkhole collapse
3. *Entrances created by human activity:*  
Entrances in quarries and road cuts  
Excavated entrances.

Whether or not a sinking stream results in a cave entrance depends to some extent on the magnitude of the sinking stream. Large streams tend to produce large entrances (Fig. 1). However, large streams can also close up cave entrances. Many stream entrances are blocked with stream sediment as well as logs and debris that have been washed into the entrance by floods. The stream flows through the permeable debris pile but explorers cannot follow. Stream



**FIGURE 1** Little Brush Creek Cave, Uinta Mountains, Utah. The large entrance is due to flood waters from spring snowmelt, not the small stream visible in this midsummer photograph.



**FIGURE 2** Cave Mountain Cave, West Virginia. The entrance is high on the walls of the Smoke Hole Gorge. It may have been opened by the downcutting of the South Branch of the Potomac River or it may be an old spring mouth.

sinks are often regarded as possible sites for digging but there may be tens of meters of flood debris between the surface stream and the underlying cave passage. Of the very large number of sinking streams, only a few are open cave entrances.

Some springs issue from open cave mouths, providing an entrance that is easy to enter. Other springs are flooded but may be penetrated by divers. Often the passage flooding occurs only near the spring and a short distance upstream is open cave passage. Other springs are blocked with rubble, permeable to the water but not to would-be explorers. Some dry entrances to caves are, in fact, abandoned spring mouths. The entrance shown in Fig. 2 may be an example.

Pits and shafts are sometimes an integral part of the underlying cave system and sometimes are younger features that formed from infiltrating surface water more recently than the primary portion of the cave. Pits and shafts are dissolved by seepage water clinging to the walls of the shaft



**FIGURE 3** Tytoona Cave, central Pennsylvania. The entrance is formed by the collapse of the roof of a large passage carrying an underground stream.

and do not require streams of water for their development. Some shafts are open to the surface and some are not. Open shafts can provide a natural entrance to the underlying cave system. However, because the development of the shaft is by independent water sources, the shaft may be connected to the underlying cave only by a small and sometimes impenetrable drain. Other drains may be blocked by loose rock and other debris that have fallen down the shaft.

Caves tend to form as near-horizontal passages directed toward major surface valleys. As the valleys deepen and widen, the caves are gradually shortened as valley walls retreat. With time, tributary valleys deepen and may cut directly through underlying cave passages (Fig. 2). Rubble associated with the collapse of the tributary valley floor will cut the cave into two segments and may completely block both ends. Continuing downcutting of the tributary valley can remove some or all of the rubble so that one or both of the cave passage segments become exposed on the valley wall.

Once cave passages are formed, they remain in place beneath the landscape. The landscape does not remain in place. Continuous erosion and valley deepening lowers the land surface so that the amount of rock above the cave passage gradually decreases. The roof of the cave loses the ability to support its own weight. Descending water from the land surface can enlarge joints and further weaken the roof until the cave ceiling collapses. The collapse also truncates the underlying passage. One or both ends may remain open on the sides of the sinkhole (Figs. 3 and 4).

Many cave passages are blocked, and thus do not provide entrances, because of the soil slumping and collapse that is a normal part of the weathering and retreat of valley walls. Such blockages are often quite shallow. Human activities that scrape away the weathered zone are, therefore, quite likely to produce entrances and expose the underlying cave passages. It is for this reason that so many cave entrances occur in quarries, road cuts, and other excavations. Figure 5 shows an entrance in the ditch of a country road that was opened by building the road. This innocuous opening is the top of a



**FIGURE 4** The entrance to Smallin Cave, Missouri viewed from the inside. The present location of the entrance represents the point of retreat of the surface valley seen in the background.

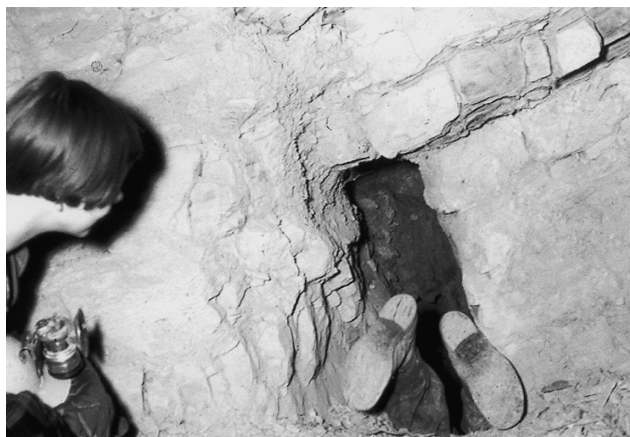


**FIGURE 5** Roadside Pit, West Virginia. A small crevice in a road ditch opens into the top of a 20-m pit, which in turn opens into a large cave.

20-meter pit that opens into a cave of substantial size. There is no relationship between the size of the entrance and the size of the cave. For this reason it is necessary to check out every opening with a size sufficient to admit a human being (Fig. 6).

### STATISTICS OF CAVE ENTRANCES

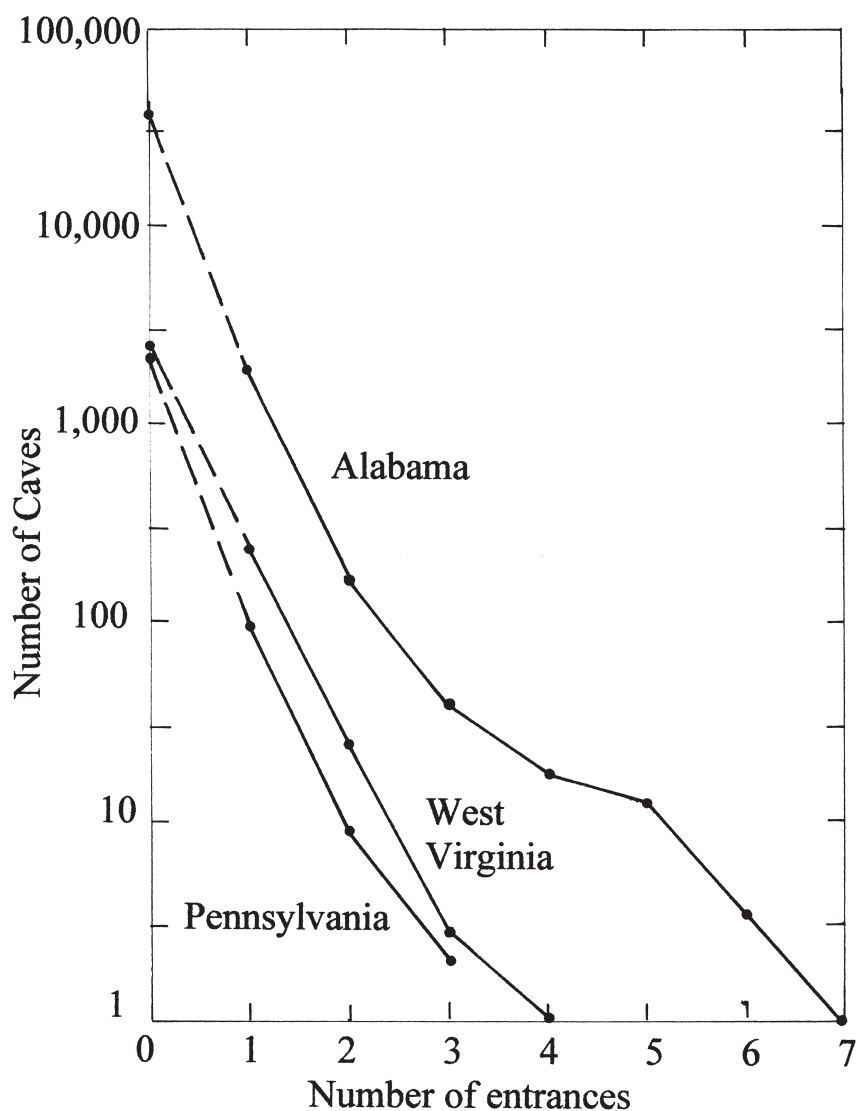
Most caves have only one entrance but some have two entrances and a few have more than two entrances. Because entrance formation is primarily a stochastic process, one might expect a statistical relationship between the number of caves with a given number of entrances and the number of entrances and, indeed, this is the case (Fig. 7). For three populations of caves in Pennsylvania, West Virginia, and Alabama, the number of caves falls off systematically with the



**FIGURE 6** Solution conduit in a quarry wall. Every opening must be checked.

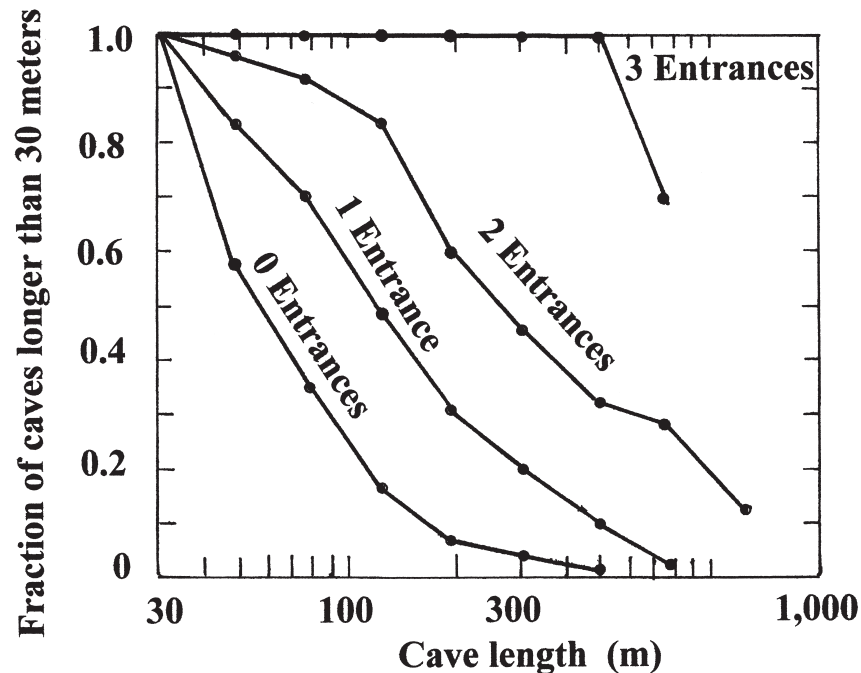
number of entrances. This leads to very interesting speculation. Because the number of caves with one entrance is much larger than the number of caves with more than one entrance, the curves can be extrapolated to predict the number of caves that have zero entrances. There is predicted to exist a very large number of caves with no human access from the surface. A few of the previously entranceless caves have been exposed by human excavations. Examination of the large distances between stream sinks and their resurgent springs shows that many caves must exist that do not have entrances.

Because the most important mechanism for the formation of entrances is random truncation and collapse of cave passages, larger caves are more likely to have entrances than smaller caves. This hypothesis is supported by the distribution of caves by length (Fig. 8). Caves with larger numbers



**FIGURE 7** Number of caves as a function of the number of entrances. Data for Alabama are based on 1973 data of the Alabama Cave Survey. Data for Pennsylvania and West Virginia are from Curl (1958). The curves are extrapolated to predict the number of caves with zero entrances.





**FIGURE 8** Distribution of caves in West Virginia as a function of number of entrances and cave length. The number of all caves decreases as their length increases (that is, there are many more small caves than there are large caves, regardless of number of entrances). Overall, caves with multiple entrances tend to be longer. Caves with zero entrances are predicted to be, on the average, smaller but also with fewer and fewer caves of greater length.

of entrances tend to be the larger caves. The hypothetical population of entranceless caves is likely to consist mostly of small caves.

### ENTRANCES AS HABITAT

Although entrances might appear to be a sharp boundary between the outside surface environment and the inside cave environment, they are, in fact, transitional. Ecologists call such transitions *ecotones*. Outside is the surface environment—a sun-drenched hillside, a forest, a deep sheltered valley, or a desert. Inside is the cave environment—complete darkness, high humidity, and constant temperature. The boundary between inside and outside is often taken by cave surveyors as the *drip line*, that is, the line marking the last spot where rainfall reaches the ground. In the outer transitional zone, cool, moist cave air creates a microclimate that is cooler in the summer and warmer in the winter than the surrounding terrain. Ferns, mosses, and flowering plants, some of them rare, grow in these sheltered locations. The inner transitional zone is a *twilight zone* where enough daylight penetrates to permit the growth of some plants. The width of the transitional zone depends on the local setting. It may vary from a meter or less for a crawlway entrance on a cliff face to hundreds of meters for a large cave entrance at the head of a narrow valley.

The cave entrance zone is, in effect, a continuous sequence of microclimates each segment of which can provide habitat

for organisms. Organisms can migrate from the surface environment through the outer and inner transitional zones into the deep cave environment.

### ENTRANCES AS PALEONTOLOGICAL AND ARCHAEOLOGICAL SITES

Cave entrance areas provide shelter for animals and for early humans. Humans made their camps, either migratory or semipermanent, in appropriately shaped entrances. The best sites were entrances on south-facing slopes that were large enough for easy movement. Early humans typically left their debris—remnants of meals, scraps of clothing and tools, campfires, and sometimes burials. Predatory animals often dragged their prey into cave entrances. The bones remained behind.

Cave entrances are not stable. Because of freeze/thaw cycles and other hillside erosion, there is a continuous, if sparse, rain of soil and rock fragments into the sheltered area of the cave entrance. This pile of weathered material is known as *entrance talus*. Because of movement of material downslope, the entrance not only migrates deeper into the hill but also migrates upward as rocks break away above to contribute to the talus pile below. Entrance talus piles can vary from very small to depths approaching 100 m. The continuous accumulation of entrance talus buries animal remains and human debris, which are entombed in rough stratigraphic sequence as the talus pile enlarges.

The sediments in cave entrance areas are, therefore, often excellent sites for paleontological and archaeological investigations.

### See Also the Following Articles

*Ecotones*

### Bibliography

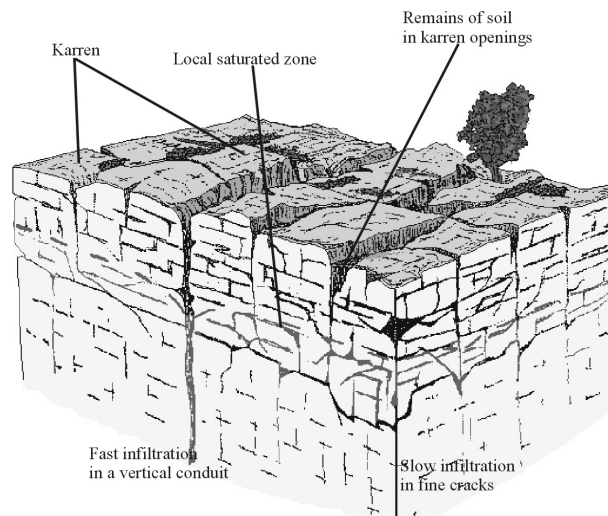
- Curl, R. L. (1958). Statistical theory of cave entrance evolution. *Natl. Speleol. Soc. Bull.* **20**, 9–22.
- White, W. B. (1988). *Geomorphology and Hydrology of Karst Terrains*. Oxford University Press, New York.

## Epikarst

Michel Bakalowicz  
*HydroSciences*

The word *epikarst* (in French: *épikars*) gradually came into use during the 1990s following the definition by Mangin (1973) of the *epikarstic aquifer* (in French: *aquifère épikarstique*). According to Mangin, the epikarstic aquifer is the perched saturated zone within the superficial part of the karst that stores a part of the infiltrated water. The term *epikarst* is a generalization of the concept of the epikarstic aquifer. It is the shallow, superficial part of karst areas in which climate, tree roots, and karst processes fracture and enlarge rock joints and cracks, creating a more permeable and porous zone over the massive carbonate rock in which only few open vertical joints and fine cracks occur (Fig. 1). The epikarst overlies the infiltration zone itself, which is intersected by occasional enlarged vertical fractures and karst conduits, so that the base of the epikarst acts as an aquitard and may contain a local perched water table, the so-called *epikarstic aquifer*. *Epikarst* generally corresponds to the *karren* (or *lapiaz*) zone of geomorphologists and speleologists (White, 1988); according to Williams (1983), dolines should be considered as part of it.

Instead of epikarst, Williams (1983) preferred the term *subcutaneous karst*, which, according to him, was an expression translated from the French *karst sous-cutané* and proposed by Birot to describe the shallow part of karst morphology in tropical regions. However, Birot did not use that expression, but instead used either superficial, sub-superficial, or subepidermic. Prior to this, Ciry employed the term *karst cutané* (cutaneous karst), referring specifically to the shallow caves and karst features of Burgundy, supposedly developed during glacial periods, when the permafrost limited karst processes during summer melting. It is now known that no karst processes occurred during glacial periods



**FIGURE 1** The epikarst, represented without a significant soil cover, showing a karren at its surface. The local saturated zone is shown. Arrows indicate the infiltration flow, slow and dispersed in the fine cracks, rapid and concentrated in enlarged fractures and vertical conduits. (Modified from Mangin, 1975.)

and that the *karst cutané* in Burgundy is what remains of ancient karst phases after the reduction of thickness through surface erosion.

The expression *subcutaneous karst* is no longer used, and *epikarstic zone*, *epikarstic aquifer*, and *epikarst* are now widely referred to.

### EPIKARST, A NECESSARY CONCEPT

#### In Ecology

The concept of epikarst was first proposed by groundwater ecologists (Rouch, 1968), who believed that perched saturated zones must exist within the temporary percolation zone, i.e., the infiltration zone. They observed aquatic microfauna, mainly Copepoda, in water dripping from stalactites, in shallow caves. According to Rouch, the observed diversity and abundance of the fauna imply the existence of a local and permanent perched phreatic zone, a few meters below ground surface. In nonkarstic rocks, ecologists had already described such a zone, rich in groundwater fauna, which was named by Mestrov the *hypotelminorheic zone*. The concept was applied to most rock types and was considered to refer to the “skin” of the subsurface.

Later, Juberthie *et al.* (1980) extended the concept to terrestrial underground fauna by defining the *underground shallow medium* (in French: *milieu souterrain superficiel* or MSS). The shallow zone of the karst is expressed as the “reservoir” of life, the place where exchanges occur between surface and subsurface, where surface animals discover and colonize the underground environment. A general paradigm (Rouch, 1986) explains the existence of fauna adapted to living in the karst and the underground environment by a

permanent and active colonization from the ground surface of the epikarst, that essential medium for life, which is distinct from the cavernous environment.

### In Hydrogeology

Drogue, in his unpublished doctoral thesis, mentions for the first time the hydrogeological role played by the epikarst and named it the *superficial karst*. He observed a perched, discontinuous, and temporary water table in the karstified limestones of Languedoc (Southern France), drained by a fracture network to the saturated zone.

To explain the observed homogenization of isotopic characteristics in three karst aquifers of the French Pyrenees, Bakalowicz *et al.* (1974) invoked the existence of shallow storage in karst aquifers and suggested its generalization to all karst aquifers. The role of the epikarst is also shown in the process of *evapotranspiration*, i.e., the consumption of groundwater by plants. Numerous karst scientists, mainly in France, were to show through hydrodynamic and hydrogeochemical studies that the epikarst is necessary to explain the functioning of the karst aquifer.

Moreover, in one of the earliest attempts to model a karst aquifer by a grid approach, Kiraly (1975) showed that the successful simulation of karst spring hydrographs is dependent on the introduction of a shallow layer of elevated porosity and permeability representing the epikarst.

### In Karstology

The epikarst represents the vertical extension of the soil, and as such can act as a reservoir for the accumulation of organic matter. The decomposition of organic matter within this layer produces carbon dioxide, CO<sub>2</sub>, which is the main agent of carbonate rock solution, and of karst processes, when dissolved in groundwater. The epikarst is the key site for carbonate rock solution. Karst depressions (dolines) are initiated by drainage of epikarst storage via vertical conduits. Karren areas develop in poorly drained areas of the epikarst.

### HOW DOES THE EPIKARST WORK?

The first approaches to studying the epikarst were indirect, in that its behavior was deduced from that of the whole karst aquifer. It soon became evident that a more direct approach to investigating the shallow zone of the karst aquifer was required. Several field test sites were designed for analyzing the epikarst. The use of tracer tests and artificial rainfall complemented the classical hydrodynamic, chemical, and isotopic investigations (Bakalowicz, 1995). According to the first interpretations by Mangin and by Bakalowicz, these investigations showed the existence of various infiltration modes through the shallow part of karst. The rainwater recharges the karst aquifer and emerges at its springs by the following pathways:

1. A part of the water infiltrates directly and quickly through wide fractures and vertical conduits, from dispersed infiltration at the karst surface, or from point infiltration through sinkholes.
2. The other part is stored in the epikarst where it contributes to different processes: a part is consumed by plants (evapotranspiration), another part percolates slowly through the fine cracks and rock porosity (slow infiltration), and the last part is flushed away into the vertical conduits of the infiltration zone, which during the heavy rains recharges the epikarst (delayed infiltration).

Point and direct fast infiltration waters do not flow through the epikarst. Figure 2 describes how infiltration water is distributed in karst aquifers according to the different types of underground flows.

### PLACE OF EPIKARST IN KARST EVOLUTION AND MORPHOLOGY

The epikarst is also the site for the accumulation of organic matter in soil. Here the organic matter is transformed in carbon dioxide, CO<sub>2</sub>, which, when dissolved in groundwater, is the main solvent of carbonate rocks. The epikarst is the main site for carbonate rock solution.

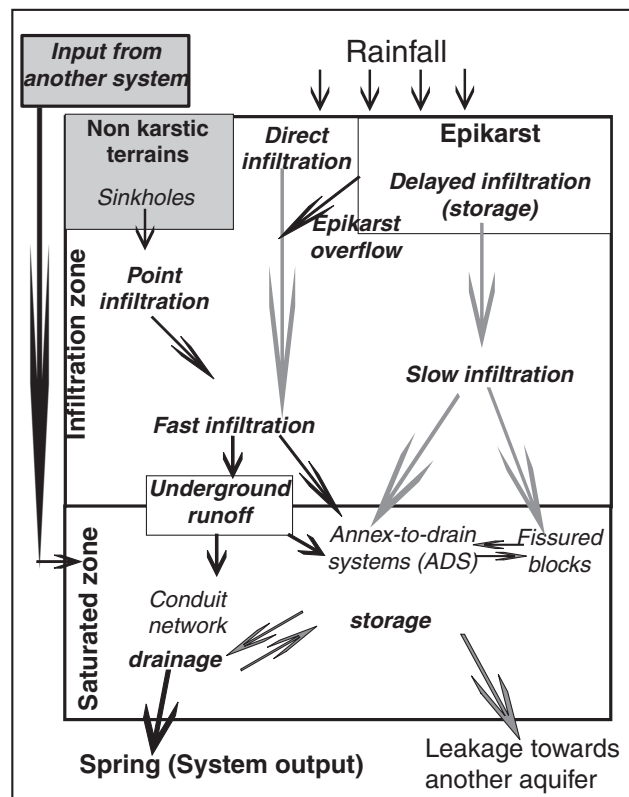


FIGURE 2 Functional scheme of a karstic aquifer showing the distribution of infiltration water according to the different types of underground flows.

The epikarst works as a CO<sub>2</sub> reservoir, gently recharging the infiltration zone by means of the slow infiltration. As a matter of fact, this slow infiltration induces mixing of air and water during the slow percolation in fine cracks and pores. This process drives the CO<sub>2</sub>-rich air present in soil down into the system and disperses it through the whole infiltration zone. In that way, the fast infiltration water, from direct dispersed and point recharge, may dissolve CO<sub>2</sub> and consequently carbonate rock in the depth of the karst, at the top of the phreatic zone. Consequently, storage in the epikarst is an essential mechanism for karst development, at the surface as well as at depth.

The functioning of epikarst determines the spatial distribution of carbonate rock solution, not only at the ground surface, but also between the surface and the karst at depth. Vertical conduits, which are discharge points for the epikarst, are enlarged near the surface as closed depressions. They allow for the introduction at depth of fast-infiltrated aggressive waters, which dissolve the rock at various depths in such a way that fractures may be enlarged into conduits, which is a prerequisite for the development of caves.

At the top of the system, waters stored in the epikarst gently dissolve the rock in the few meters below the soil, deepening fractures and cracks. The enlarged fractures can stock detritic sediments, residue of the dissolution of carbonate rocks or resulting from displacement by rain, wind, and surface runoff—this is the karren field, which may or may not be covered with soil and plants. When climate and plant cover conditions are stable for a long time, karren, and then epikarst, may develop into spectacular landforms, such as in the Stone Forest in Yunnan, China, or the tsingy in Madagascar.

Recent developments in geophysics have unveiled the existence of the epikarst at depth. Two methods are particularly effective: ground-penetrating radar (GPR), which shows the vertical structure of epikarst (Al-Fares *et al.*, 2002), and magnetic resonance sounding, which demonstrates the presence of water stored in the epikarst. GPR has shown the existence of an extensive fractured zone within the first 10 m below the ground surface of a Mediterranean karst. The zone approximately follows the ground surface, independently of strata dipping. Occasional major vertical fractures are the origin of vertical conduits, which are in turn the origin of the conduit network that characterizes the karst aquifer.

### THE EPIKARST, THE SKIN OF THE KARST

Finally, epikarst is an essential interface between the biosphere and the karst itself. Karst develops and evolves as a result of the epikarst, which distributes the infiltrated water and the rock solvent (CO<sub>2</sub> + water) in such a way that a characteristic landscape is created at the surface (closed depressions, karren) as well as at depth (the conduit network and caves). Therefore, epikarst can be compared to the skin of a living being.

In the same way, epikarst is a very fragile, sensitive medium. It may easily be eroded. During glacial periods of the Quaternary, the periods of freeze/thaw alternation and the ice and snow cover movements totally destroyed the epikarst of cold regions of Europe and North America. Most of the slope debris that has accumulated at the foot of limestone cliffs originated from such a process. In Mediterranean areas, the heavy rains and flash floods act in the same way, but the erosion is limited to steep slopes and the accumulation occurs in dejection cones.

Humans are also an efficient erosive agent. We deforest and cultivate the rich but generally thin soils. Some well-known examples in Ireland and England show preserved soil and epikarst under dolmen in areas otherwise devoid of such features. As observed in Mediterranean karst areas and in Southern China, even when soils were once thick, they have progressively disappeared, revealing karrens with rounded shapes, typical of formations more normally found under soil or a sediment cover. These examples show how much the epikarst is fragile and may be easily eroded. Moreover, during the construction of highways or ski stations, the epikarst is systematically destroyed, either because from a geotechnical point of view it provides too fragile of a foundation for buildings or because it provides a useful source of rubble.

Once the epikarst is eroded, a uniform rock surface, the pavement, may be observed, interspersed with only a few cracks and occasional large vertical conduits. To re-create the necessary conditions for karst evolution, soil and a plant cover must develop, but the process requires several thousand years in a temperate, humid climate.

### See Also the Following Articles

#### *Epikarstic Communities*

#### **Bibliography**

- Al-Fares, W., M. Bakalowicz, R. Guérin, and M. Dukhan (2002). Analysis of the karst aquifer structure by means of a ground penetrating radar (GPR). Example of the Lamalou area (Hérault, France). *J. Appl. Geophys.* **51**, 97–106.
- Bakalowicz, M. (1995). La zone d'infiltration des aquifères karstiques. Méthodes d'étude. Structure et fonctionnement. *Hydrogéologie* **4**, 3–21.
- Bakalowicz, M., B. Blavoux, and A. Mangin (1974). Apports du traçage isotopique naturel à la connaissance du fonctionnement d'un système karstique. Teneurs en oxygène 18 de trois systèmes des Pyrénées, France. *J. Hydrol.* **23**, 141–158.
- Juberthie, C., B. Delay, and M. Bouillon (1980). Extension du milieu souterrain en zone non calcaire: Description d'un nouveau milieu et de son peuplement par les Coléoptères troglodytes. *Mém. Biospéol.* **7**, 19–52.
- Kiraly, L. (1975). Rapport sur l'état actuel des connaissances dans le domaine des caractères physiques des roches karstiques. In *Hydrogeology of Karstic Terrains* (A. B. L. D. Eds, ed.), pp. 53–67. International Union of Geological Sciences, Heise, Hannover.
- Mangin, A. (1973). Sur la dynamique des transferts en aquifère karstique. In *Proceedings 6th International Congress on Speleology, Olomouc*, pp. 157–162, Academia, Prague.
- Rouch, R. (1968). Contribution à la connaissance des Harpacticides hypogés (Crustacés, Copépodes). *Ann. Spéléol.* **23**(1), 5–167.
- Rouch, R. (1986). Sur l'écologie des eaux souterraines dans le karst. *Syngologia* **24**, 352–398.

- White, W. B. (1988). *Geomorphology and Hydrology of Karst Terrains*. Oxford University Press, New York.
- Williams, P. W. (1983). The role of subcutaneous zone in karst hydrology. *J. Hydrol.* **61**(1), 45–67.

## Epikarstic Communities

Anton Brancelj

*National Institute of Biology, Slovenia*

David C. Culver

*American University*

The *epikarst*, or subcutaneous zone, is the uppermost part of karstified rock. It has been variously defined but in general it is the boundary between soil and rock in karst, honeycombed with small fractures and solution pockets. Its vertical extent varies from nearly zero to a few tens of meters. The cavities and cracks in the rock in the epikarst zone may or may not be well integrated in the horizontal direction. Sometimes water percolating through the epikarst moves laterally at the base of the crevices for substantial distances before finding a pathway deeper into the vadose zone. At other places water may drain from the base of the crevices through joints and fractures. The habitat consists of a series of small cavities and crevices, some of which are water filled, some of which are filled with organic material, humus, and insoluble material, and some of which are air filled. Whereas hydrogeologists often stress the water storage capacity of the epikarst zone, biologists usually stress the vertical movement of water in the zone, and the term *percolating water* is often used in this connection. Water bodies in the epikarst zone are small and most of them represent capillary water or thin film, and only during rain and snowmelt does vertical discharge increase.

The habitat has rarely if ever been sampled directly. Instead, biologists have had to rely on indirect samples—ones taken by sampling the water that drips out of epikarst into caves, into trickles or small pools on the floor. Furthermore, with a few exceptions that we elaborate below, most of our knowledge of the organisms of epikarst comes from observations of natural collection areas of percolating water, such as rimstone or clay pools in the upper levels of a cave. For the most part, rimstone pools and other areas where percolating water collect are not where epikarstic populations can exist in the long term. These habitats are often temporary, too small to support a viable population, or too vulnerable to predation to allow a long-term population. They are sink populations in the ecological terminology of source–sink populations. Nonetheless, they are important collection sites for a very poorly known fauna.

### ENVIRONMENTAL CONDITIONS

Epikarstic water is highly heterogeneous in fluxes. In a study of epikarstic water in Mammoth Cave, Kentucky, USA, Thrailkill and Robl (1981) distinguished between vadose seeps and vadose flows. *Vadose flows* transit the epikarst zone rapidly and have a mean discharge of greater than  $10^{-6}$  m<sup>3</sup>/s with calcium ion and carbon dioxide concentration slightly elevated from surface water. One-year systematic measurements of discharge of flows in six caves in Slovenia revealed that fluxes are highly dependent on precipitation. They range from less than a milliliter to more than 20 mL/s. *Vadose seeps* were themselves heterogeneous, with some with supersaturated levels of calcium ion and carbon dioxide that result in calcite deposition. Water supersaturated with respect to calcium ion is likely a very challenging one for animals due to the risk of the animal acting as a site for CaCO<sub>3</sub> deposition!

Temperature of water in epikarst is relatively constant with some oscillations related to seasons and weather events. In principle, the water temperature in epikarst equals the mean air temperature of the location. Heavy rain or sudden snowmelt can influence the temperature in the uppermost zone of epikarst or in zones with high water permeability, but normally oscillations are in the range of a few degrees centigrade and they decrease with depth.

Chemically, water from the epikarst is highly enriched in calcium ion with a concentration 10 to 50 times that of rainwater, indicating that it is actively dissolving calcium carbonate. Measurements of calcium concentrations in percolation water from six caves in Slovenia indicate high values. On average the concentration of Ca was about 72 mg·L<sup>-1</sup> (ranging from 10 to 100 mg·L<sup>-1</sup>), resulting also in high conductivity—the average value was 480 μS·cm<sup>-1</sup> (ranging from 170 to 730 μS·cm<sup>-1</sup>). Calcium carbonate concentration increases during water movement downward. Measured values of oxygen concentration are usually between 60 and 100% of saturation. However, this may be misleading since these measurements were based on epikarst water exposed to the air, usually measured in galleries accessible to humans. Due to biological activity and the absence of any way to replenish oxygen, its concentrations may actually be considerably lower. Epikarstic water may be relatively rich in fine particulate organic matter and dissolved organic carbon as a result of feeding and metabolic activities in the soil and epikarst itself. In a study of dripping epikarstic water in Cormoran Cave in France, Gibert (1986) found organic matter densities of up to 168.1 mg·m<sup>-3</sup>, several times higher than that found in an adjacent cave stream and about eight times lower than a nearby surface stream.

Because by definition the epikarst is not a zone of permanent water, it is subject to period drying. The same is true for the collecting sites of epikarstic water—rimstone pools and other temporary pools. Some epikarstic species of amphipods in the genera *Crangonyx* and *Niphargus* have evolved the ability to withstand drying and desiccation by

burrowing in clay and the same is probably also true for some Copepoda. The clay itself may also have an important nutritional role as well.

### TAXONOMIC COMPOSITION

A wide variety of invertebrate species are known primarily or exclusively from epikarstic habitats. In the compendium of subsurface aquatic species, *Stygofauna Mundi*, over 10 species of oligochaetes, 280 species of crustaceans, 2 species of beetles, and 30 species of flatworms are reported from percolating waters of caves. Seven genera of crustaceans have 10 or more species that are found in the epikarst (Table I). In North America, the amphipod *Stygobromus* and the isopod *Caecidotea* are common epikarstic species, whereas in Europe the isopod *Proasellus*, the cyclopoid copepods *Speocyclops* and *Diacyclops*, and the harpacticoid copepods *Elaphoidella* and *Parastenocaris* predominate. The apparent absence of harpacticoids and cyclopoids from North America is simply because they have not been studied at all in North America. Until recently, this was also the case for South America. A very recent sampling by Brancelj (2002) of epikarst fauna in five caves in eastern Brazil revealed at least seven taxa of Copepoda and one of Ostracoda, all probably new to science. Five genera are found only in the epikarst (Table II). They include the harpacticoid genus *Morariopsis* from the Dinaric Mountains, the amphipod *Niphargobates* from the Balkans, the syncarid crustacean *Batobathynella* from Malaysia, the beetle *Trogloguignotus* from Venezuela, and the beetle *Troglelmis* from the Republic of Congo. Several of these

**TABLE I** Genera of Crustaceans with 10 or More Epikarstic Species

Order	Genus	Total number of subterranean species	Number of epikarstic species
Cyclopoida	<i>Speocyclops</i>	41	28
	<i>Diacyclops</i>	34	10
Harpacticoida	<i>Elaphoidella</i>	91	34
	<i>Parastenocaris</i>	167	15
Isopoda	<i>Caecidotea</i>	57	13
	<i>Proasellus</i>	115	29
Amphipoda	<i>Stygobromus</i>	100	45

Data from Botosaneanu (1986).

**TABLE II** Genera Found Only in Epikarst

Class	Order	Genus	Number of species
Crustacea	Harpacticoida	<i>Morariopsis</i>	3
	Syncarida	<i>Batobathynella</i>	1
	Amphipoda	<i>Niphargobates</i>	1
Insecta	Coleoptera	<i>Trogloguignotus</i>	1
	Coleoptera	<i>Troglelmis</i>	1

Data from Botosaneanu (1986).

species are shown in Fig. 1. Since the publication of *Stygofauna Mundi* in 1986, many more epikarstic species have been described but they have not been summarized. Among these, most are copepods, which is probably the most common stygobitic group in epikarst.

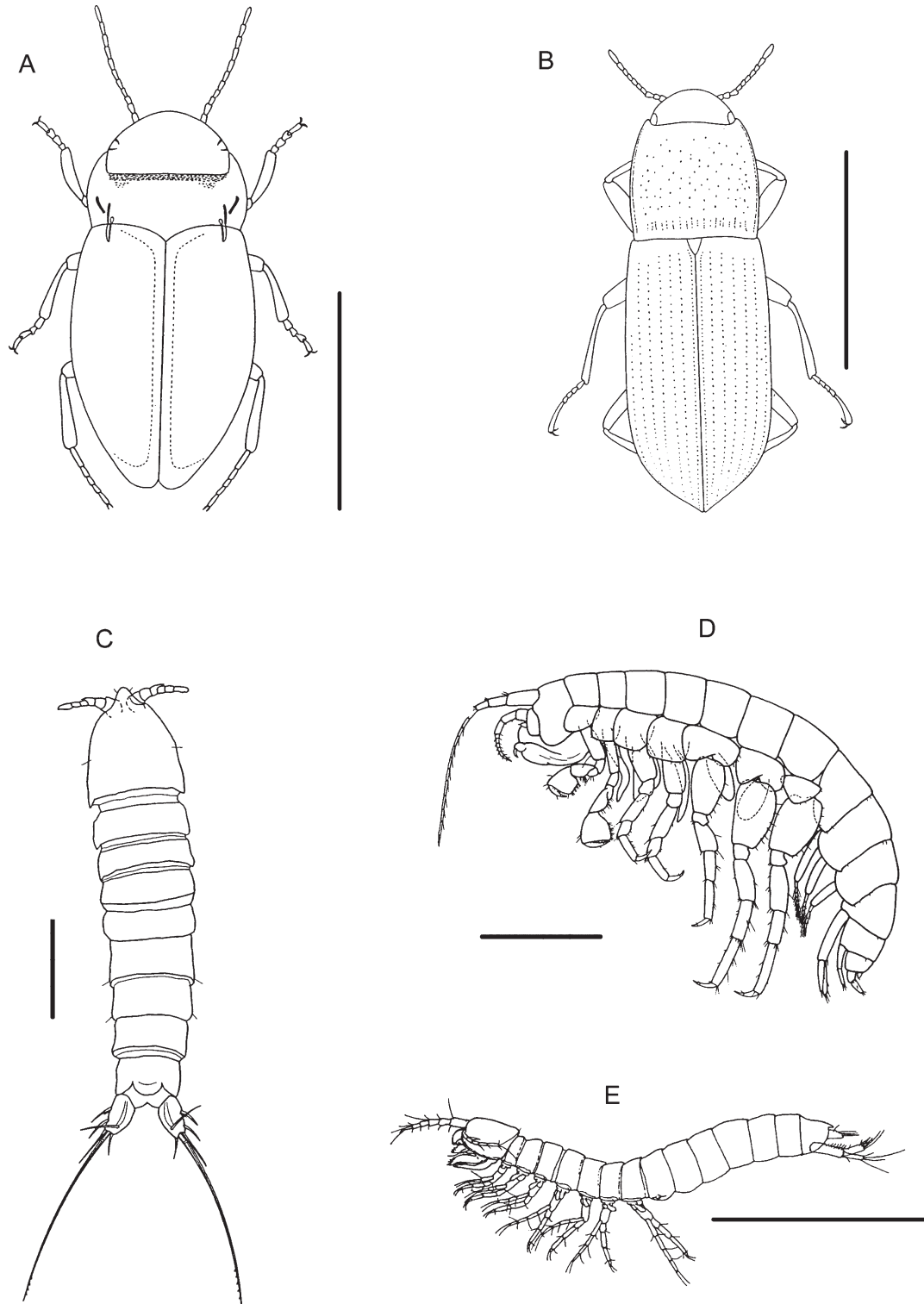
Many epikarstic species are found in genera where most of the other species are from interstitial habitats such as shallow alluvial aquifers and the underflow of streams (i.e., hyporheic zone). Examples include the amphipod genus *Bogidiella*, and isopod genus *Microcharon*, and the Syncarida in general. More rarely are the epikarst species found in genera where the other subterranean species are cave stream species. One possible example is the amphipod genus *Crangonyx* where three of eight subterranean species are epikarstic. These taxonomic distribution patterns suggest an affinity between interstitial and epikarstic habitats.

Because part of the epikarst is air filled, one would expect terrestrial species as well. To our knowledge, no one has sampled these species directly, but Gibert (1986) did collect considerable numbers of terrestrial species in nets under ceiling drips. She found a total of 12 species, including one collembolan and one dipluran known only from caves. It is interesting that the most common terrestrial species she found was the collembolan *Arrhopalites secundarius*, a globular-shaped species with a morphology typical of deep soil species. Indeed, it would be surprising if the terrestrial epikarst fauna did not share affinities with the deep soil fauna. Little else is known about terrestrial epikarst species except for tantalizing hints scattered in the literature. For example, there is a very unusual carabid beetle, in its own genus (*Horologion*), found only once in 1938 in a small, shallow cave in West Virginia. In spite of repeated visits to the cave and nearby caves, it has never been collected again. Given that it was found in a very shallow cave and that it has not been seen since, it seems likely that this species and others collected in similar circumstances are in fact epikarstic species.

In addition to Copepoda in trickles and puddles, we can collect some other groups that drift from the epikarst (Table III), but the number of specimens is lower in comparison with Copepoda. Apart from Copepoda, the most common groups are Nematoda and Oligochaeta. Fauna collected from trickles and puddles can be divided into three categories. In the first category are taxa, which are not members of epikarstic fauna and they were sampled accidentally (Aranea, Diplopoda, some Collembola, Coleoptera, Diptera). The second category represent taxa from terrestrial or semiterrestrial epikarstic habitats or from soil (Turbellaria, Nematoda, Gastropoda, Oligochaeta, Acarina, Isopoda, Collembola). In the third category are stygobitic taxa (Rotatoria, Ostracoda, Copepoda, Bathynellaceae, Amphipoda).

### MORPHOLOGICAL FEATURES

Compared to obligate cave-dwelling species, epikarst species tend to be smaller in size. Groups with larger sized species



**FIGURE 1** Examples of species from five genera endemic to epikarst (see Table II). (A) *Trogloguignotus concii*; (B) *Troglelmis leleupi*; (C) *Morariopsis dumonti* (scale bar: 100  $\mu$ m); (D) *Niphargobate orophobata*, ♀ 3.3 mm, and (E) *Allobathynella malaya* (scale bar: 1 mm for figures A, B, D, and E; 0.1 mm for figure C).

TABLE III Fauna Found During a 1-Year Period in Trickles and Puddles in Six Caves in South and Southwest Slovenia

	Postojnska jama		Pivka jama		Črna jama		Škocjanske jame		Dimnice		Županova jama	
	Trickle	Puddle	Trickle	Puddle	Trickle	Puddle	Trickle	Puddle	Trickle	Puddle	Trickle	Puddle
Turbellaria	3		3	2			12		2			
Nematoda	2	9	158	28	32	30	194	26	29	2	120	17
Rotatoria				2								
Gastropoda		1		12	1	2		1			2	3
Oligochaeta	4	17	21	36	5	25	26	72	34	150	8	26
Aranea*			1		1							
Acarina	2	4	8		10	1	6	4	3	2	3	1
Ostracoda		106	5	3		2	5	15	1	3	8	
Copepoda	11	504	601	1013	291	217	238	418	61	1024	315	248
Bathynellaceae		1	2									
Isopoda					1			1			6	3
Amphipoda		1	2			1		3			2	
Diplopoda*		1	1		3							
Collembola*	9	3			2		2		5	1	3	
Coleoptera*		2										
Diptera-larvae*	7	1	3		5		50	1	31		1	

Note: *jama* means "cave"; an asterisk (\*) indicates terrestrial taxa. After Pipan and Brancelj (2001).

that are absent in the epikarst include fish, salamanders, crayfish, and shrimp. On the other hand, groups with very small species, usually less than 2 mm, predominate, both in terms of abundance and number of species. Primarily, these are cyclopoid and harpacticoid copepods. Even within a genus, epikarstic species tend to be smaller (Fig. 2). The North American amphipod genus *Stygobromus* is exclusively subterranean. In the eastern United States, 43 species primarily occur in only one of the following three habitats: cave streams, epikarst, and other interstitial habitats. Median size of the largest reported females for the 23 epikarst species was 4.8 mm, whereas that of 10 cave stream species was 8.0 mm. There are some curious exceptions to the patterns such as the epikarstic *Stygobromus gracilis*, which reaches a size of 18 mm.

### BIOGEOGRAPHY OF EPIKARSTIC SPECIES

Local species richness in the epikarst can be quite high compared to other subterranean environments. Gibert (1986) lists 12 species as occurring in the percolating waters of Cormoran Cave in France, among them four obligate subterranean species, including two harpacticoid and one cyclopoid crustacean species. In another cave in France, Delay (1968) found five harpacticoid and one cyclopoid crustaceans species. In one small cave in Slovenia (Velika Pasjica, 2002) Brancelj found an amazingly rich epikarstic copepod fauna: 11 harpacticoids and 1 cyclopoid. Of these, all but one are obligate subterranean species, and three were new to science. In addition, intensive sampling in the epikarst zone in six more caves in Slovenia revealed a total of 37 taxa of Copepoda. Ten of them are ubiquitous, the rest are

stygobitic, and 14 of these are endemic to Slovenia. The high species richness in Slovenian epikarst is in accord with the high richness of other subterranean habitats.

Epikarstic species have been found in caves throughout the world, but have not been thoroughly studied in any region. This is largely because of the special techniques required to adequately sample the species present (see below). Most records are from collections from water in drip pools. The best studied karst region is the Karst region of Slovenia where seven caves have been intensively sampled by Pipan and Brancelj (2001). Each cave had between 10 and 18 sampling points, to collect material from a variety of microlocations (from actual pools or directly from the trickles). Trickles and pools that had been filled with water from the trickles were sampled several times during a 1-year period. The caves are situated in a rectangle of about 2400 km<sup>2</sup> and the distance between caves varied from about 1 km to approximately 60 km. Several patterns characteristic of epikarst species emerged. First, endemism is high. Among 37 taxa collected in the seven caves, 14 taxa are endemic to Slovenia. Second, within the seven caves studied, distribution of species was patchy. Only one species, *Speocyclops infernus*, a cyclopoid copepod, was collected in all seven caves. In contrast, two-thirds of taxa (24 out of 37) were present only in two caves (11 taxa) or in one cave (13 taxa). Only *S. infernus* was repeatedly collected by Stoch (1997) from trickles and pools in most caves in Slovenia and northeastern Italy. This indicates that the majority of stygofauna in epikarstic zone are (1) very localized on a microscale and (2) very diverse on a macroscale. This supports the hypothesis that communications between voids in the horizontal direction is limited and thus distribution/migration of individuals, including



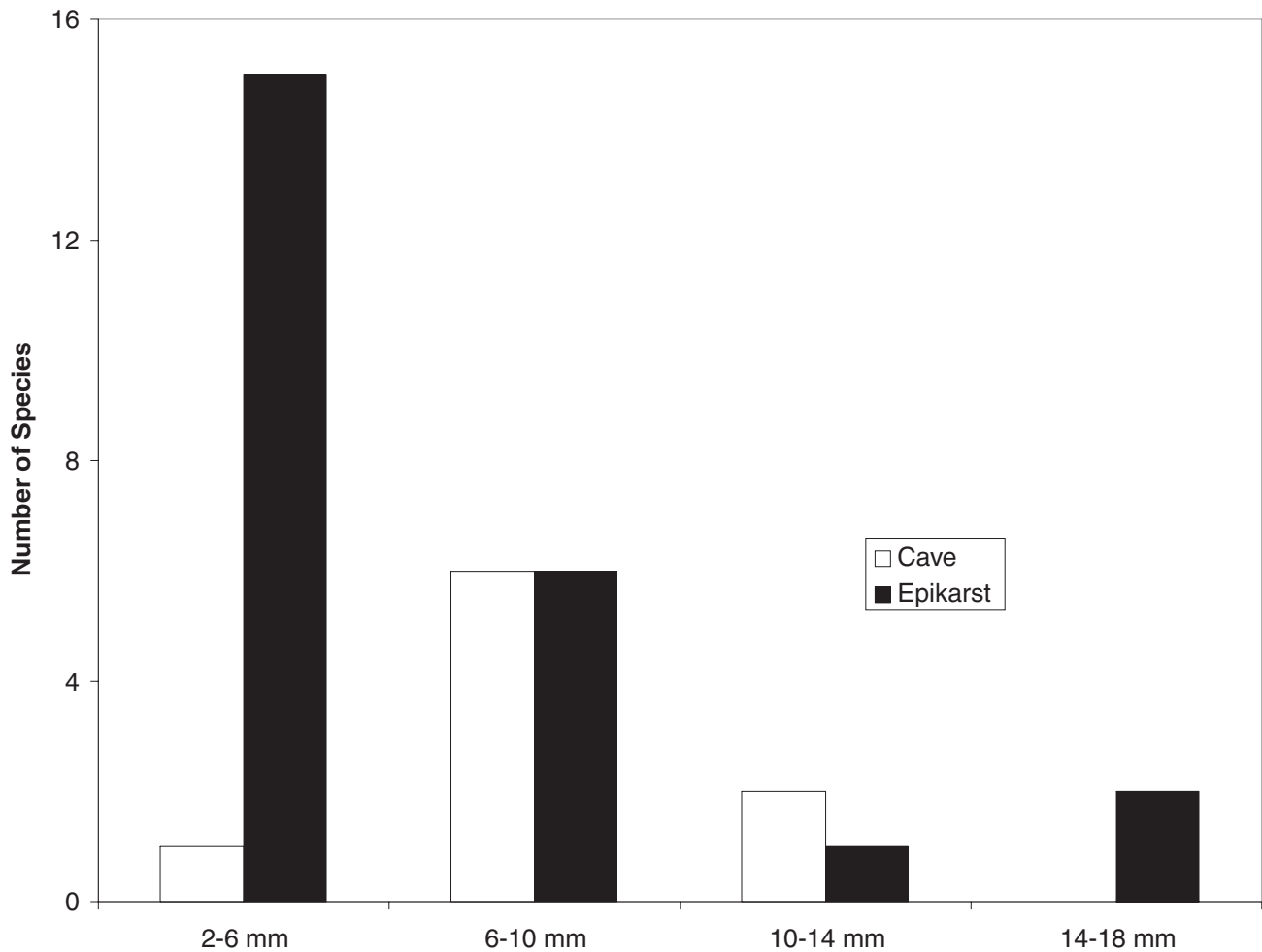


FIGURE 2 Size distribution of largest known females for stygobitic *Stygobromus* from cave streams and epikarst.

genetic material, is limited. Each hydrological unit within a certain geological block (an equivalent to watershed) thus functions as an island with its own fauna. Even in systems where long-distance horizontal migration should be possible, several taxa are known to have very restricted distribution, for example, *Velkourbia enigmatica*, *Alona hercegovinae*, *A. sketi*, and *A. stochi* (taxa known from Herzegovina or Slovenia and each from one or few locations only).

The distribution of Copepoda within caves is even more complex and blurred. In general, the pattern of distribution of different taxa within a cave follows the same pattern as for distribution between the caves. Some taxa are very common in all locations and on all sampling dates, while others are restricted only to a few or one location. Direct sampling from the drips (see Techniques for Sampling Epikarst, below) in short-term intervals (weekly or monthly) results in a relatively low number of taxa between two successive samplings. But over a longer period (about 1 year), this number becomes relatively high and can be compared with a number of taxa collected from the pools. Pools in most of the caves act as “concentrators” of fauna; also, the fauna could be decimated by some predators (like the amphipod

*Niphargus*). Because of very restricted information on time series, we cannot make any conclusions about the relationship between fauna composition and seasonality or the relationship to a breeding season.

The combination of thickness of strata above cave galleries and hydrology seems to have some influence on the distribution of taxa/specimens. In contrast, depth of strata above the galleries seems relatively unimportant, because the same species of copepod were present in the pools in galleries only a few meters below the surface as well as almost 100 m below the surface. If the concept of accidental drift in the vertical direction is accepted and population collected from the trickles being concerned as sink populations, the distance traversed in the vertical direction is irrelevant. So at least some animals can be expected in trickles or pools deep below the surface all over the world.

### ECOLOGY OF EPIKARSTIC SPECIES

As mentioned earlier, fauna of Copepoda in trickles and pools in “fossil” galleries (and probably all stygofauna collected there) are a result of accidental downward drift. The

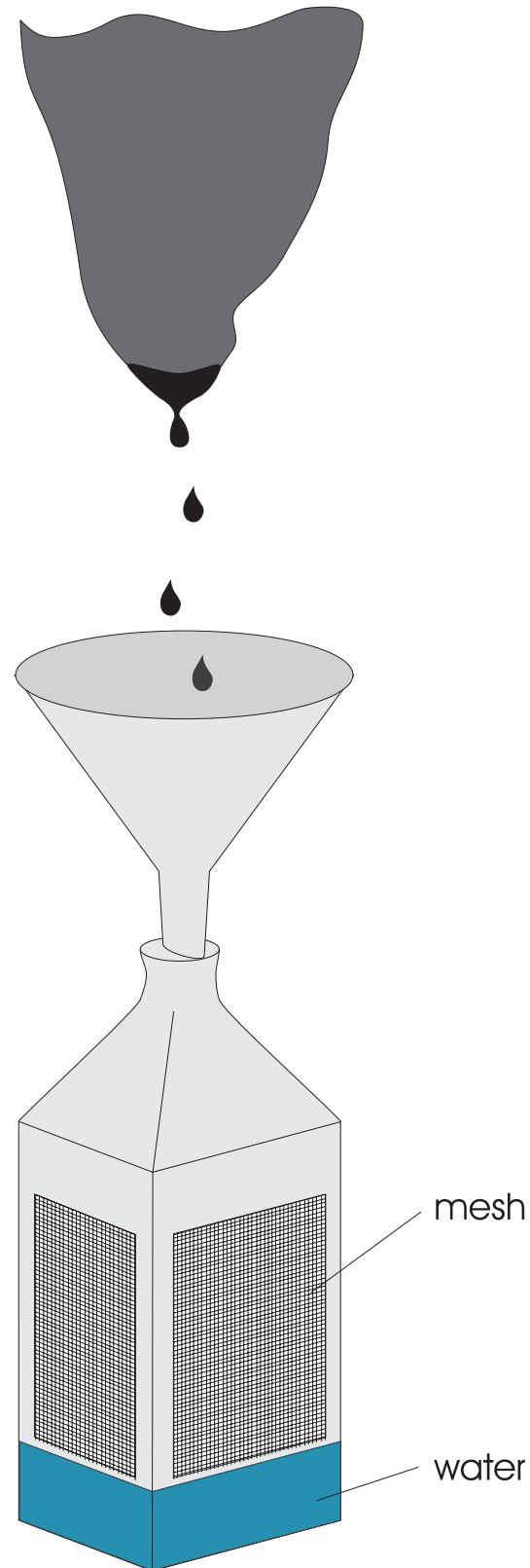
fact was confirmed on several occasions. In water filtered directly from the trickles in different caves, nauplia were at least as common as adults of cyclopoida or harpacticoida. This is the most evident demonstration that the natural habitat of species are small voids in the epikarst zone. In samples of fauna, collected in pools filled with water from trickles, a very small proportion of females of Copepoda with attached spermatophores on the genital segments or copulas were collected, a sign that seems to indicate mating activities in the pools (Brancelj, 2002). The presence or absence of the eggs or egg sacks is not a good indicator of proliferation habitat, because Borutskii (1964) suggests that females of some genera (*Moraria* and *Speocyclops*) deposit eggs directly on the substratum.

Considering the high number of specimens of *S. infernus* collected in all of the caves, particularly in the pools, that were systematically sampled for 1 year (as well as being the most common taxon in random samplings in some other caves in Slovenia), it appears that the species is (1) a very ubiquitous species or (2) a very widespread species, or (3) very prone to drifting. Because it commonly appears as the only species in some pools, particularly in pools with clay bottoms, and because it frequently coexists with *Niphargus*, the first possibility, possibly combined with other two, seems the most probable.

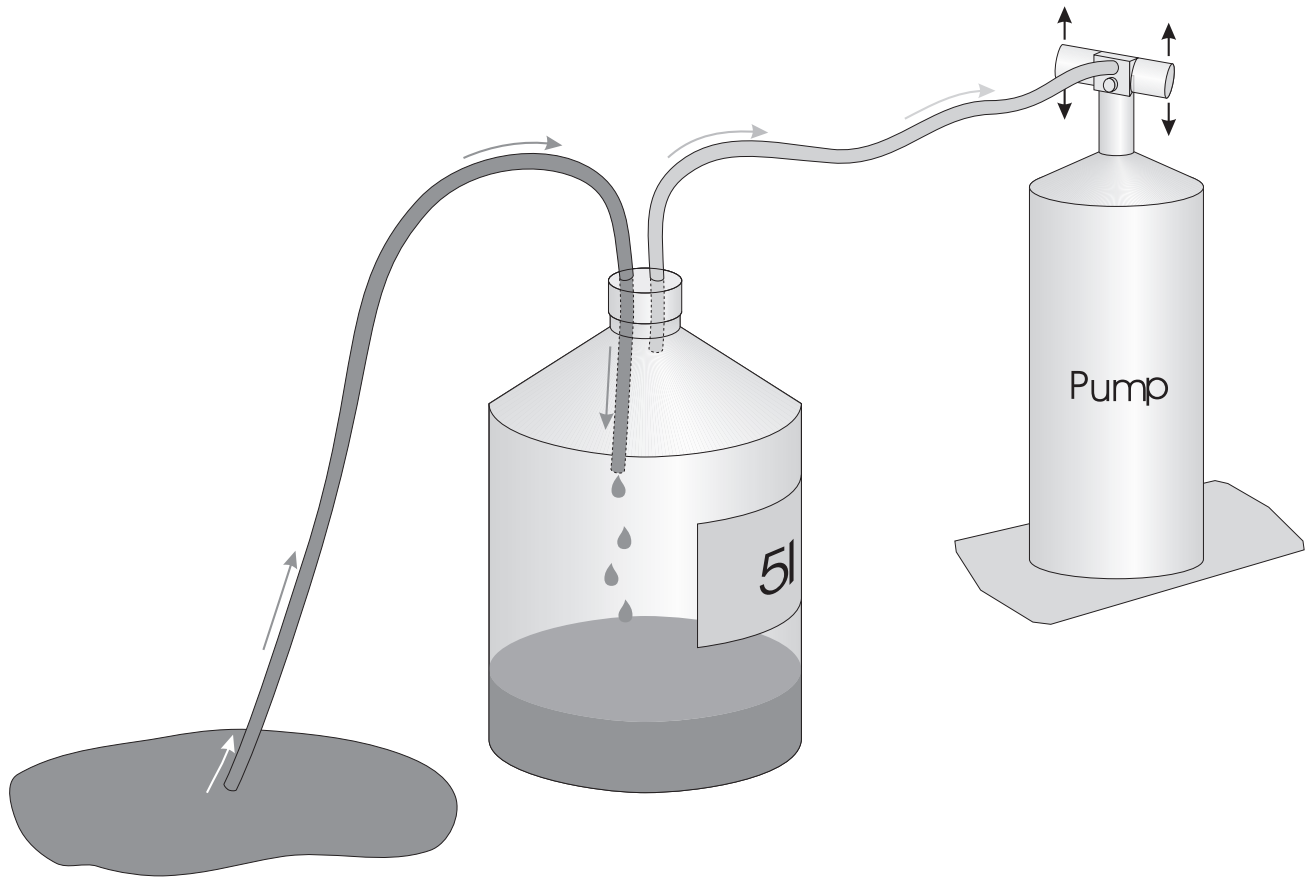
As one could expect, epikarstic zones have no planktonic species. In narrow fissures, relatively small pools of stagnant water, specimens with elongated and very flexible bodies that are able to crawl along a solid surface are likely favored by natural selection. Rather limited information exists on the relationship between the abundance of a particular taxon and water flow. In general, we could expect the number of specimens collected in trickles and pools to be positively related to the amount of precipitation and consequently to water fluxes in trickles. Measurements of fluxes and the number of specimens of Copepoda in some caves in Slovenia revealed that most harpacticoid species are quite resistant to water fluxes and the only cyclopoid (*Speocyclops infernus*) is positively correlated with the water flux.

### TECHNIQUES FOR SAMPLING EPIKARST

Direct methods for sampling fauna in epikarst are still being developed. In theory, drilling vertically into the epikarst zone and collecting water from voids there is possible but rather inefficient. In principle, a metal or plastic tube, closed at the bottom and with a series of holes some centimeters above the sealed end, that is left in position for some time should act as a pitfall trap for stygobitic fauna there—but that's in theory! In practice, there are two possibilities for sampling the fauna. The most direct is to sample percolating water from the trickles, especially in permanent trickles. By means of a funnel, water from a trickle is diverted into a plastic container with one or several holes on the sides. The container is covered with a mesh (mesh size of 60–100  $\mu\text{m}$ ; Fig. 3). If the



**FIGURE 3** Device for collecting fauna from percolating water. By means of a funnel, water is collected in a container with mesh-covered sides. The lower rim of the holes in the side of the container are positioned some centimeters above the bottom, allowing a small pool of water to form in the bottom of the container.



**FIGURE 4** Device for collecting fauna from small amounts of percolating water in pools and cracks.

area of trickles is dispersed over a wide area, collecting water from several drips is recommended. The methods get good results if containers are emptied at least once per week, although the interval can be extended to about 1 month.

The second method is to collect and filter water from small pools on calcareous slopes or on the bottom of galleries, which are filled with water from the trickles. The volume of the pools can vary from a few milliliters to several tenths of liters. Water from the pools can be collected by means of different types of pipettes or pumps (see Fig. 4), which is very efficient in small rimstone pools or in the deep and narrow cracks on stalagmites that fill with water. Hand-net methods can be used in some bigger pools. From some pools water can be collected by means of plastic containers. The most efficient is a collector that is made out of a plastic bottle having a volume between 0.2 to about 1 liter. During all samplings, vigorous agitation of the water is recommended to collect particles from the bottom of the pools where most animals are attached.

**See Also the Following Articles**  
*Epikarst*

### **Bibliography**

- Borutskii, E. V. (1964). Fauna of U.S.S.R. In *Crustacea*, Vol. III, No. 4, *Freshwater Harpacticoida*. Israel Program for Scientific Translations, Jerusalem.
- Botosaneanu, L., ed. (1986). *Stygofauna mundi*. E. J. Brill, Leiden, The Netherlands.
- Brancelj, A. (2001). Male of *Moraria radovnae* Brancelj, 1988 (Copepoda: Crustacea), and notes on endemic and rare copepod species from Slovenia and neighbouring countries. *Hydrobiologia* **453/454**, 513–524.
- Brancelj, A. (2002). Microdistribution and diversity of Copepoda (Crustacea) in a small karstic cave in central Slovenia. *Hydrobiologia* **477**, 59–72.
- Delay, B. (1968). Recherches sur les eaux souterraines—2—Données sur le peuplement de la zone de percolation temporaire. *Ann. Spéléologie* **23**, 705–716.
- Gibert, J. (1986). Ecologie d'un système karstique Jurassien. Hydrogéologie, derive animale, transits de matières, dynamique de la population de *Niphargus* (Crustacé). *Mémoires Biospéologie* **12**, 1–376.
- Holsinger, J. R. (1978). Systematics of the subterranean amphipod genus *Stygobromus* (Crangonyctidae), Part II: Species of the eastern United States. *Smithsonian Contributions to Zoology* **266**, 1–144.
- Pipan, T., and A. Brancelj (2001). Ratio of copepods (Crustacea: Copepoda) in fauna of percolation water in six karst caves in Slovenia. *Acta Carsologica* **30**, 257–265.
- Stoch, F. (1997). La fauna delle acque carsiche sotterranee delle valli del Natisoni. *Memoire Istituto Italiano di Speleologia* **9**, 89–100.
- Thraillkill, J., and T. L. Robl (1981). Carbonate geochemistry of vadose water recharging limestone aquifers. *J. Hydrol.* **54**, 195–208.

# Evolution of Lineages

Eleonora Trajano

*Universidade de São Paulo, Argentina*

Subterranean ecosystems are distinguished by the presence of species that may considerably differ from their epigeal (surface) relatives in terms of morphology, physiology, behavior, and ecology. To investigate which organisms colonize the subterranean realm to establish more or less self-sustained populations (and why others do not succeed in this), how some of these lineages differentiate, and what mechanisms are causing this evolutionary change are the main challenges and sources of debate for biospeleologists throughout the world.

## SUBTERRANEAN ENVIRONMENT AND ITS INHABITANTS

The hypogean (subterranean) domain contrasts greatly with the epigeal one because of its permanent absence of light and, thus, of both photoperiodicity and primary production, tending toward food scarcity and environmental stability. Two different processes representing distinct steps in the evolution of subterranean lineages are *colonization*, which leads to the establishment of hypogean populations that spend at least part of their life cycles in this habitat, and *genetic isolation*, which may give rise to exclusively subterranean taxa. These two processes may be concurrent, but more often isolation postdates colonization and derives from independent events. A minimum requirement for successful colonization of the hypogean habitat is that colonizers not be dependent on light as a primary source of energy or for orientation cues. If the energy sources available in the hypogean habitat are sufficient for the physiological requirements of the species and the individuals are able to find food and mates for reproduction nonvisually, then they can complete their life cycle without leaving the subterranean habitat.

Subterranean populations are subject to selective forces more or less distinct from those in the epigeal environment, including the cessation of typically epigeal selective pressures such as those related to light. If genetically isolated, such populations may differentiate due to the interruption of genetic flow from epigeal individuals, causing cessation of indirect influence from surface conditions.

Subterranean organisms are herein defined as organisms regularly found in the subterranean biotope and for which this is part of or the whole natural habitat, where they are able to orient themselves, at least topographically. In contrast, “accidentals” may be introduced into caves by mishap (by being washed into caves or falling through upper openings, for instance) or when entering in search of a mild climate; although accidentals can survive temporarily, their inability

to properly orient and to find food leads to their eventual demise.

Subterranean organisms are traditionally classified into three ecological-evolutionary categories originally proposed in the mid-1800s: (1) *trogloxenes* are regularly found in the subterranean habitat, but must leave it during some period(s) in order to complete their life cycles (usually because hypogean food sources are insufficient for the species requirements); (2) *troglophiles* are able to complete their life cycles both in the hypogean and in the epigeal environment, forming populations in both habitats, with individuals commuting between them and maintaining genetic flow between these populations; and (3) *troglobites* are species restricted to the subterranean domain and are usually characterized by apomorphic character states related to the hypogean life (“troglophisms”) such as reduction until loss of eyes and dark pigmentation.

## COLONIZATION OF SUBTERRANEAN HABITATS

Subterranean organisms illustrate well the importance that preadaptations may have for the adoption of a new way of life. (*Preadaptations*, as defined here are character states conferring performance advantage in a given selective regime, but which have been selected in another, independent previous regime.) Classical preadaptations to the subterranean life include nocturnal activity, selecting for development of mechanosensory and/or chemosensory traits, and opportunistic, generalist feeding, allowing survival in a food-poor environment that has scattered, variable, and frequently unpredictable food sources. Therefore, subterranean communities represent a subsample of the epigeal ones that is strongly biased toward nocturnal, ecologically generalist taxa, including those currently living in the area as well as those that had lived there, colonized the hypogean habitat, and then become extinct in the surface (see discussion of relicts below).

Several colonization routes to hypogean habitats may be distinguished. In the case of aquatic organisms, marine fauna are a source of colonizers for both marine and freshwater hypogean habitats. The latter may be reached through active invasion of aquifers along interstitial and other pathways (e.g., anchialine habitats, submarine karst springs) by marine organisms progressively adapting to freshwater conditions. Subterranean freshwater species may also evolve directly from marine ancestors by stranding of founder populations in gradually freshening groundwaters during marine regressions. Among hypogean populations derived directly from epigeal freshwater ancestors, stream-dwellers dependent on lotic conditions (fast-flowing, well-oxygenated waters) may access the subterranean environment mainly through stream sinkholes and resurgences. Those adapted or at least tolerant to lentic conditions (slow-moving, low-oxygen waters), and especially small-sized organisms, may also penetrate deep into the water table, colonizing phreatic habitats both

laterally and vertically (for instance, through hyporheic zones), and reaching caves through this route. In the first case, the boundary between epigeal and hypogean habitats is clearer and, due to the fragmented nature of streams, disruption of populations is easier to achieve. Phreatic habitats, on the other hand, may be continuous throughout wide areas and encompass different kinds of subterranean habitats where troglomorphic taxa may be found.

Routes of colonization of the subterranean realm by terrestrial organisms are basically limited by their size. A vertical colonization of caves through deep soil and spaces (cracks, crevices) in the overlying bedrock is probable for small organisms; large animals require larger contacts between the subterranean habitat and the surface, and large cave entrances may be a frequently used route. The importance of forest-floor litter fauna as a source of colonizers for hypogean habitats has long been noted for many karst areas in the world.

The colonization of subterranean habitats by preadapted taxa forming troglomorphic populations could occur at any time, but it is predicted that it happens mainly during the periods most favorable to these preadapted species in the epigeal environment, when reproductive success and survival rates are at their highest. Therefore, the generality of the notion of colonization constrained by unfavorable climatic conditions and immediately followed by speciation resulting in troglobites, which is central to the paleoclimatic model (see below) according to several modern authors, is highly questionable. Dispersion is a natural tendency of all organisms, which tend to occupy all suitable and ecologically accessible habitats. The gradient between epigeal and hypogean environments is generally restricted to the proximity of their contacts. Thus, except perhaps for organisms living deep in a progressively drying soil or sediment over karst bedrock, epigeal animals cannot be “forced” to enter subterranean habitats during stressful periods because they would not know in which direction to move in order to find access to the sheltered hypogean environment. Animals do not present purpose-oriented behaviors—they just survive where they are already living, to which they are adopted. On the other hand, organisms may be washed or dragged into the subterranean habitat at any time (by floods, for instance, in a case of *passive colonization*) and survive or not depending on the presence of preadaptations or simply by chance.

### MODELS OF GENETIC DIFFERENTIATION AND ORIGIN OF TROGLOBITES

As for epigeal taxa, genetic differentiation is probably more frequently achieved by geographic isolation leading to allopatric speciation of troglobitic species. In view of the vertical spatial continuity, which allows permeability between the epigeal and the hypogean compartments of the biosphere and which is higher for smaller organisms, the most

plausible mechanism of geographic isolation for most subterranean populations is through local extinction of related epigeal populations. A classical model for temperate regions, which also applies to the tropical ones, is based on local extinction due to paleoclimatic fluctuations, rendering the epigeal environment unsuitable for many taxa. Because the buffered condition of the subterranean environment results in the maintenance of environmental variables within the tolerance range of several species, troglomorphic populations in their hypogean habitats could survive periods of climatic stress above and could differentiate in the absence of genetic flow from their (locally extinct) epigeal conspecifics.

The majority of hypogean terrestrial populations belong to hydrophilic taxa that are preadapted to life in the generally damp subterranean environment. Thus, the colonization of hypogean habitats and establishment of troglomorphic populations would take place mainly during humid periods (glacial or interglacial, depending on the region), and the geographic isolation in drier periods, when humid vegetation types are replaced by drier ones and the epigeal drainage may be disrupted. During these drier periods, which are climatically stressful for hydrophilic and aquatic taxa, a decrease in food input is expected, causing a decline in subterranean population sizes. This would result in bottleneck effects and favor genetic drift leading to rapid differentiation. Under such conditions, one can predict strong selection for improved efficiency in finding food and mates (as indeed is observed in many troglobites), which, in turn, could allow a new increase in population sizes.

On the other hand, geological and hydrological barriers, such as the presence of insoluble, nonpermeable rocks interposed between the surface and habitable subterranean habitats, obliteration of subterranean conduits by collapse, siltation or chemical deposition, karst drainage divides, and stream capture, could also provide isolation events for specific areas and taxa without extinction of epigeal populations.

In addition to the derivation of troglobitic species directly from marine ancestors through active invasion or stranding in freshwater subterranean habitats (see above), a possible instance of concomitant colonization and isolation is a consequence of stream capture. This is a noncyclic, geomorphologic model proposed for the intensively studied Mexican tetra characin fishes, genus *Astyanax*. Stream capture occurs when a surface stream running on an impervious stratum beneath which there is soluble rock (usually limestone) meets at an intersection with a vertical joint in the latter, which is gradually enlarged by dissolution and erosion to the point that all of the stream water sinks into the capturing pit. At this point, the stream reach downstream of the sinkhole and its fauna would be completely subterranean, isolated from the reach upstream by waterfalls. Nevertheless, it has been observed that surface fish have constant access to the caves from both above and below, thus the applicability of this model to the origin of the cave *Astyanax* species is questionable.

Models of parapatric and sympatric speciation have also been proposed and may account for the origin of some troglobitic species. These models postulate the occurrence of genetic differentiation without geographic isolation, dependent on intrinsic biological properties of the taxa. A particular explanation proposed initially for tropical terrestrial troglobites is the adaptive-shift model, which is based on the notion that the hypogean habitat is so stressful for epigean organisms that those managing to colonize it are prone to rapid genetic reorganization and differentiation. The adaptive-shift model is not in accordance with the observation that most troglobites belong to preadapted taxa, for which the subterranean life would not represent such a new, highly stressful ecological challenge. As a matter of fact, troglomorphic populations, especially in tropical areas, are far more frequent than predicted by this model, according to which every subterranean terrestrial population would tend to become troglobitic with time.

It is important to note that troglomorphs, which by definition are as well adapted to the subterranean as to the epigean way of life, are not merely an “intermediate” or “preparatory” step in the evolution of troglobites. Only when extrinsic (climatic, geological, hydrological) or intrinsic (genetic) barriers interrupt or greatly decrease the gene flow between hypogean and epigean individuals does a troglomorphic population have the potential to originate troglobitic species. Otherwise, troglomorphic populations may remain as such forever, and the high proportion of troglomorphs, at least in tropical caves, indicates that this is frequently the case.

### SINGLE VERSUS MULTIPLE ORIGIN OF TROGLOBITES

By definition, troglobites cannot survive long or complete their life cycles in the epigean environment, either because conditions in the latter became unsuitable for the species (first step in the climatic model) or, further on, because they acquired specializations that preclude the epigean life, even when the original environmental conditions are restored.

Therefore, their dispersion is basically subterranean, and most troglobitic species have small geographic distributions, restricted to limited areas or even to a single cave or cave system. Nevertheless, troglobites have been assigned to single species that present wide distributions and that may encompass superficially discontinuous karst areas.

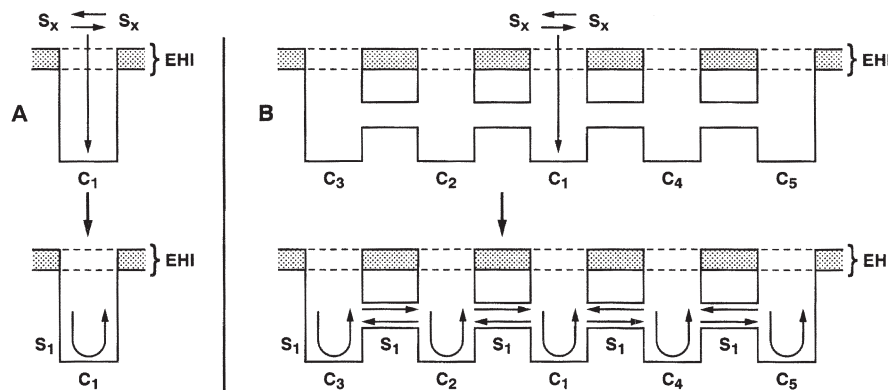
In any case, but especially for the latter, the question arises of whether these species originated after a single (Fig. 1) or multiple (Fig. 2) independent colonization events by the same epigean ancestor, followed or not followed by subterranean dispersion. Because selective forces and constraints are generally similar throughout the subterranean environment, different populations of the same ancestral species isolated independently in the hypogean habitat tend to evolve in the same direction, acquiring similar apomorphic traits (e.g., reduced eyes and pigmentation) and frequently resulting in very similar, morphologically indistinguishable taxa—a classical case of parallel evolution. In many cases, such cryptic species resulting from independent speciation events can only be recognized by genetic methods.

Troglobitic species distributed in superficially discontinuous karst areas are strong candidates to represent examples of multiple colonization and independent speciation. However, keep in mind the possibility of a continuity through deep karst or that a previously continuous karst area (for instance, limestone on top of an anticlinal structure), harboring a single troglobitic species, was fragmented by erosion and karst denudation. This illustrates well the need for integration of morphological, ecological, genetic, and geological data for the elucidation of this and many other relevant questions in biospeleology.

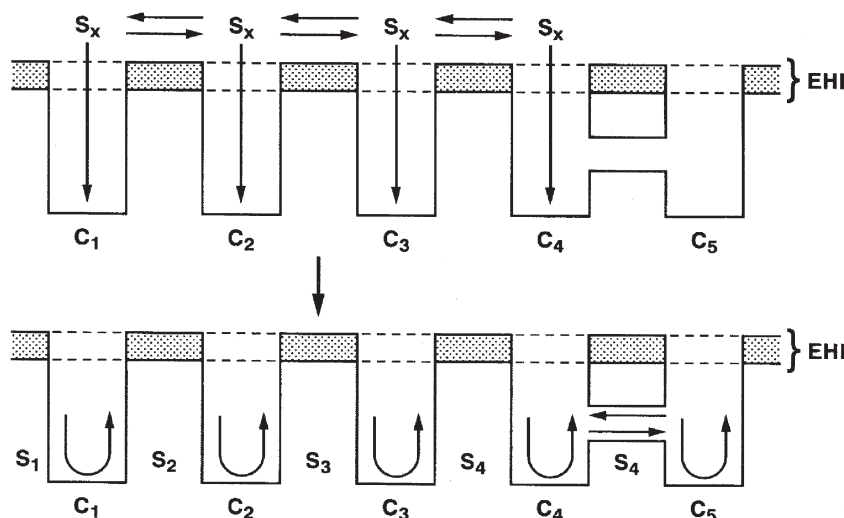
### TROGLOMORPHIC TRAITS

#### Variation and Time of Isolation: “Recent” versus “Ancient” Troglobites

The many known cases of troglobitic species showing intrapopulation variation in troglomorphic characters such as eyes and pigmentation, observed for taxa such as several



**FIGURE 1** Generalized scheme for a single colonization event of cave system C<sub>1</sub> by an epigean ancestor (S<sub>x</sub>), resulting, after genetic isolation, in a troglobitic species (S<sub>1</sub>) restricted to that cave system (as shown in part A) or also occurring in other cave systems (S<sub>2-5</sub>) due to subterranean dispersal of S<sub>1</sub> (as shown in part B). EHI, epigean/hypogean interface. Arrows indicate gene flow between populations. (Extracted from Holsinger, 2000.)



**FIGURE 2** Generalized scheme for multiple colonization events by a single, widespread epigean ancestor ( $S_x$ ), establishing independent populations in cave systems  $C_{1-4}$ , each one originating a troglotitic species ( $S_{1-4}$ ) after genetic isolation; subsequently,  $S_4$  expanded its range to cave system  $C_5$  by subterranean dispersal. EHI, epigean/hypogean interface. Arrows indicate gene flow between populations. (Extracted from Holsinger, 2000.)

fishes and crustaceans, may correspond to “recent” troglotites, for which isolation time was not enough for fixation of transformed character states throughout the whole population or may be a result of secondary introgression between fully differentiated troglotites and closely related epigean, eyed and pigmented populations (as in the well-known case of the Mexican tetra characin population from La Cueva Chica).

On the other hand, species isolated for a long time and/or subject to fast differentiation conditions may differ considerably from epigean-related taxa, to the point that such relatives are not recognized anymore, either because the subterranean taxon has diverged too much or because the surface ones had become extinct. Subterranean taxa belonging to lineages extinct in the epigean environment are referred as *phylogenetic relicts* (e.g., the crustacean order Spelaeogriphacea, with only three extant species, all troglotites showing a Gondwanic distribution). Those belonging to epigean groups that have disappeared from a particular area but which still exist somewhere else are *geographic* or *distributional relicts*.

### Constructive versus Regressive Traits: Definitions and Mechanisms

Two kinds of apomorphic traits of troglotites related to the hypogean life (troglomorphisms) can be distinguished: constructive and regressive traits. Constructive character states correspond to developed traits in relation to those observed in epigean relatives (e.g., elongation of antennae in arthropods), for which natural selection, usually related to feeding and reproductive efficiency, may be evoked. Classical examples are the developed mechanosensory and chemo-

sensory organs of many troglotites. Regressive characters are transformation series in which derived states correspond to a decrease until loss (character reversal) of structures, physiological, and behavioral components selected in the epigean environment occurs. Regressive traits, particularly reduced eyes and pigmentation, are the most conspicuous and distinguishing features of troglotites. These were understandably the first aspects of subterranean biology to attract the attention of researchers and are the central focus of most studies on hypogean organisms.

One of the most debated questions about subterranean evolution refers to the mechanisms underlying character regression, and dozens of hypotheses, more or less distinct, have been proposed since the 19th century, which included neo-Lamarckian (role of disuse) and orthogenetic (age of phyletic lines) theories. The main models elaborated within the neo-Darwinian paradigm fall into two groups: those directly or indirectly involving natural selection (adaptationists) and those involving adaptively neutral mutations. All of them, however, are based on the observation that regressing structures and behaviors are generally those that become useless in the subterranean habitat, i.e., those directly or indirectly related to light.

Because nutrient scarcity is one of the most striking features of subterranean ecosystems and seems to be the logical explanation for development of many structures in troglotites, it is not surprising that economy of energy was one of the first Darwinian explanations evoked for character regression as well. According to this adaptationist model, mutant individuals for underdeveloped eyes and pigmentation, normally excluded from epigean populations by stabilizing selection, would have an advantage over normally eyed and pigmented individuals in the subterranean habitat

because they could save extra energy (otherwise spent in useless structures) for survival and reproduction. Although appealing, this model finds no good support from empirical data and lacks generality—not every troglobite showing regressive traits lives in a food-poor environment, and some caves may be quite rich in nutrients, especially those harboring large populations of troglonexes such as bats. Moreover, regression of eyes and pigmentation is also observed in some epigeal organisms such as those living in deep soil, turbid large rivers, and also endoparasites, for which food is not a limiting factor. On the other hand, at least in theory, economy of energy could be in some cases associated with other genetic models, accelerating differentiation.

Currently, two main theories are of interest that are based on different genetic mechanisms: neutralism and pleiotropy. Pleiotropic effects of development of antennae (a constructive character) causing regression of eyes due to competition for neural centers has been hypothesized for the North American freshwater amphipods *Gammarus minus*. Evidence of similar mechanisms in a larger number of subterranean taxa is lacking. The neutralism theory postulates the accumulation of mutations that become neutral after a change in way of life as a major cause of regression of any trait that loses its function under the new selective regime. There is genetic evidence that such mutations, excluded by stabilizing selection under the previous selective regime, would no longer be eliminated and, because mutations are more frequently deleterious than constructive, would accumulate and cause disorganization of structures and loss of physiological and behavioral components. This is a very general model that applies to any character regression affecting traits that had lost their function in any hypogean or epigeal taxa.

Whatever the mechanism(s) leading to character regression, it does not operate in the same way and rate for all characters in each troglobitic species or population. As a matter of fact, even closely related species may present different mosaics of characters, with more or less regressed states. For instance, some cave populations of the Brazilian armored catfish, genus *Ancistrus*, show very reduced eyes but are more pigmented than other populations with less reduced, highly variable eyes.

It is noteworthy that autapomorphies of troglobites do not necessarily encompass reproductive isolation. Reproductive characters are conservative and it is predicted that several other traits may change before isolation reproductive mechanisms are fixed throughout the population. Such is the case with the Mexican tetra characins, genus *Astyanax*, which encompass at least 19 cave troglomorphic populations, some of which have been shown to introgress with epigeal, eyed and pigmented tetras to produce fertile hybrids.

### **Bibliography**

Camacho, A. I., ed. (1992). *The Natural History of Biospeleology*. Monografías, Museo Nacional de Ciencias Naturales, Madrid.

Culver, D. C. (1982). *Cave Life: Evolution and Ecology*. Harvard University Press, Cambridge, MA.

Culver, D. C., T. C. Kane, and D. W. Fong (1995). *Adaptation and Natural Selection in Caves*. Harvard University Press, Cambridge, MA.

Holsinger, J. R. (2000). Ecological derivation, colonization, and speciation. In *Ecosystems of the World*, Vol. 30, *Subterranean Ecosystems* (H. Wilkens, D. C. Culver, and W. F. Humphreys, eds.). Elsevier, Amsterdam.

Howarth, F. G. (1993). High-stress subterranean habitats and evolutionary change in cave-inhabiting arthropods. *American Naturalist* **142**(suppl.), 65–77.

Romero, A., ed. (2001). *The Biology of Hypogean Fishes*. Kluwer, Dordrecht. [Reprinted from *Environmental Biology of Fishes* **62**(1–3), 2001.]

Trajano, E. (1995). Evolution of tropical troglobites: Applicability of the model of Quaternary climatic fluctuations. *Mémoires de Biospéologie* **22**, 203–209.

Wilkens, H., D. C. Culver, and W. F. Humphreys, eds. (2000). *Ecosystems of the World*, Vol. 30, *Subterranean Ecosystems*. Elsevier, Amsterdam.

## Exploration and Light Sources

**William B. White**

*The Pennsylvania State University*

The skills, training, and equipment necessary to explore caves vary tremendously with the size and complexity of the cave. In common, however, are the environmental realities that caves are dark, usually wet and muddy, and have temperatures that are close to the regional average. The terrain is rugged with piles of loose rocks, low crawls, narrow fissures, pits, and puddles, pools, and flowing streams. The equipment needed by the explorer includes reliable light sources, clothing that provides protection from the environment, and any additional equipment needed for vertical and water-containing parts of the cave system. This article is a summary, not a technique manual. Those who are contemplating becoming cave explorers are urged to join experienced explorers and learn from their experience.

### **SKILL LEVELS IN CAVE EXPLORATION**

#### **Small, Near-Horizontal Caves**

In regions of low to moderate relief, caves tend to form as near-horizontal passages although there may be many small-scale irregularities in the form of short climbs, drops, and piles of broken rock. Exploration of these caves requires a certain amount of equipment and a certain skill level, but generally nothing that requires extensive training. Even in small, near-horizontal caves, there are certain minimum requirements for exploration.



Above all, caves are dark. Beyond the twilight zone at the entrance, darkness is absolute. Failure of light sources is the single most common risk in caving. Maneuvering one's way through even a small cave by touch alone is exceedingly difficult and for a cave of even moderate complexity, probably impossible. *Requirement 1:* The explorer must understand the necessity of reliable light sources, backup sources, and the expected lifetime of light sources.

Cave temperatures are usually constant and near the mean annual temperature of the region. Caves in temperate climates are in the range of 8–12°C. Caves at high latitudes and/or high altitudes are colder, often in the range of 0–4°C. Caves tend to be wet and humid. The combination of low temperature and high humidity accelerates heat loss with risk of hypothermia. Tropical caves may pose the opposite problem. High temperatures, 20–25°C, combined with high humidity restricts heat loss with the resultant risk of overheating and possibly heat exhaustion. Some caves contain ponded water and/or flowing streams, which require crawling, wading, or swimming in water that is also at or close to cave temperature. *Requirement 2:* The explorer must dress appropriately both for the expected environmental conditions and also for the expected activity. A fast moving exploration team has different heat management requirements than a team engaged in survey or photography.

The cave terrain is rugged. Passages are irregular often scaling from dimensions of tens of meters to crawlways at the limit of human penetration. Ceilings are irregular and protruding ledges are common. Passage floors are often muddy. Loose rocks (breakdown) occur as isolated fragments and as piles tens of meters high. Passages may be discontinuous with vertical offsets that require climbing up or down. Some passages are traversed on ledges or by hopping along canyons that have been incised into the main passage floor. *Requirement 3:* The explorer must be prepared with foot, head, and body protection against the abuse required for traversing cave passages.

### Vertical Caves

Vertical caves are those that have substantial elevation differences between the lowest and highest points in the cave. To be considered a vertical cave, the elevation difference should occur over a relatively short horizontal distance. There exist caves, some volcanic caves, for example, with elevation differences between the top and bottom of more than 1000 m but with only gently sloping passages. The vertical component of caves may consist of pits, sequences of pits sometimes interconnected by small passages, and vertical crevices of various sizes, depths, and shapes. Pits are often pathways for descending water ranging from trickles down walls to large waterfalls.

Vertical caves may be entered from the top, from the bottom, or from various points between. The requirements for exploring vertical caves are more rigorous than those for

small horizontal caves and usually involve special training on the rigging and use of ropes and on techniques for descending and ascending ropes.

### Large Cave Systems

What constitutes a “large” cave as distinguished from a “small” cave is to some extent in the eye of the beholder. As used in this article, a large cave is one that cannot be explored in its entirety in a single day. Exploration of large caves requires developing techniques for push caving, for expedition caving, and for cave camps. Push caving is done by a team that simply drives itself to continue exploration for 20- to 30-hr stretches. Requirements are mainly superb physical conditioning and the mental stamina to keep going to exhaustion and beyond. Expedition caving has an organizational structure. Teams return to the same cave over and over. Some type of organizational structure must be assembled. Records must be kept. The advances in exploration and survey are recorded so that each exploratory push adds to the previously explored cave in a systematic way. In addition to the standard caving skills, the requirement for an expedition caver is a willingness to accept a measure of discipline and control.

### Underwater Caves

It has, of course, been known for a long time that caves exist below regional base levels or below sea level. Until the past 20–30 years, the exploration of these caves was very limited because they were full of water and the necessary equipment did not exist. Although a few heroic explorations were made going back into the 19th century using pressurized suits and air compressors, it was the invention of self-contained underwater breathing apparatus (SCUBA) that allowed explorations to be extended to underwater caves.

Requirements for underwater exploration are the most formal and the most extensive. Formal training on the equipment is needed along with formal certification of cave-diving qualifications. A distinction can also be made between clear water diving like that found in many of the large spring caves in Florida and what may be called northern sump diving. The water-filled passages of many temperate and northern climate caves are lined with silt, such that movement of a diver's body quickly stirs up the silt and reduces visibility to near zero.

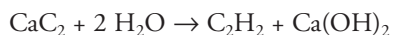
## BASIC EQUIPMENT

### Light Sources

The most basic items of equipment are the light sources. Without light, no exploration is possible and if all lights of an exploration party are lost, the party can expect to wait in the dark for rescue. Cavers are advised to each carry three sources of light, which are called the primary, secondary, and

tertiary sources. New technology, particularly the development of white light-emitting diodes (LEDs), has greatly enlarged the caver's choices of light sources.

For many years the primary light source was the miner's carbide lamp. Most American cavers used a helmet-mounted lamp that consisted of a lower chamber containing lumps of calcium carbide, an upper chamber containing water, and an adjustable valve that allowed water to drip into the carbide producing acetylene gas. The acetylene produced in the lower chamber was ejected through a nozzle where it was burned to produce a bright yellow flame. A version more popular in Europe uses a belt-mounted carbide and water chamber connected by a hose to the helmet-mounted nozzle and reflector. The chemical reaction is



Carbide lamps have many advantages. They are nearly indestructible. A small repair kit with spare nozzles, filters, gaskets, and other parts allow replacement of failed parts in the cave. A waterproof bottle holding 500 g of carbide will keep the lamp going for tens of hours. The large flame makes a great deal of light. The lamp can also be used to warm a meal. A carbide lamp combined with a plastic garbage bag tent can offer some protection against hypothermia. The downside of carbide lamps is that the spent carbide is a white, pasty solid consisting mostly of calcium hydroxide but also containing all of the impurities that were present in the carbide. Spent carbide must be carried out of the cave because it is strongly alkaline and toxic to cave organisms.

Carbide lamps have been to a large extent replaced by electric lamps. These are available in a great variety of forms. The miner's Wheat lamp features a helmet-mounted fixture that holds the bulb and reflector with power provided by a belt-mounted lead-acid battery. Other belt-mounted lamps are used. Other primary light sources are helmet-mounted lamps with a small battery pack attached to the back of the helmet. These use disposable alkaline batteries, typically the AA size. They are much lighter than other lamps but require the caver to carry a sufficient supply of spare batteries. A new development, rapidly coming into use, is to replace filament-type bulbs with arrays of white LEDs. LEDs are more rugged than filament bulbs and are much more efficient, producing light for a longer time on a set of batteries.

The secondary source is often a flashlight of some kind. Small, rugged, waterproof flashlights such as the aluminum-bodied Maglites are widely used. Secondary sources are needed to provide light when it is necessary to refuel or repair the primary source. However, it should be remembered that the secondary will become the primary source if the original primary fails completely. For this reason the secondary source is often a second lamp similar to the primary source.

The tertiary source is the backup to the backup. In the early days, candles and a waterproof container of matches were often used. Escaping from a cave with a candle is not easily done. The present-day choices are the small LED

devices, which are available in a variety of forms, some of which are even designed for key rings. The single LED will provide marginally enough light to find one's way through the cave and it will work for 30 hr or more on a single battery.

### Hard Hats

The most important item in the caver's outfit is the hard hat. Caves have low and irregular ceilings; there are projecting ledges and other objects on which to bang one's head. Loose rocks get knocked down pits. Hard hats are essential. Two styles are in common use: miners' hats with a snout, and rock-climbers' helmets, which are rounded. In either style, there is an outer shell of tough polymer that provides the actual protection and an inner harness that keeps the shell from coming into contact with the head. Hard hats should have chin straps with safety release features. Hard hats without straps can be easily knocked off during climbing. However, cavers have been known to become trapped by their hard hats when the caver slid down a narrow fissure only to discover that the hard hat would not fit. Thus the necessity for a release feature on the chin strap.

Hard hats should have mounting brackets for lamps, whether carbide or electric. Helmet-mounted light sources leave the hands free for climbing or other activities. Some cavers mount both an electric lamp and the burner of a belt-mounted carbide lamp on their helmets and can switch from one to the other as needed.

### Clothing

Beginning cavers in small caves may wear any clothing that is rugged and that they don't mind getting dirty. More advantageous is a coverall type of outfit that protects the entire body, keeps mud off the inner clothing, and can be peeled off after exiting the cave. Specialty coveralls of tough nylon are available in a variety of bright colors.

Underclothing should be selected to preserve heat, particularly if the cave is wet. Wool has this property. Cotton does not. Special clothing of polypropylene has become available for serious cave exploration.

Footwear should provide ankle support and have a good gripping sole. In the United States, ankle-high boots with cleated soles are often favored. European cavers have a preference for high-topped rubber boots ("Wellingtons"). These have the advantage of allowing the caver to wade calf-deep water with dry feet. Wool or polypropylene socks are recommended.

### Cave Packs

Because of climbing, crawling, and the frequent necessity for squeezing through tight places, it is unwise for the caver to carry very much in his or her pockets. Most cavers carry

packs in which to transport food, water, spare batteries or spare carbide for their lights, a first aid kit, repair kits for lights, surveying equipment, and anything else that might be needed underground. Most needed personal gear can be carried in a small side pack, but if the trip involves vertical caving, larger packs for ropes, ladders, and other climbing equipment will be needed. Packs must be made of tough material that will not tear as the pack is pushed, dragged, or rolled through the cave. It must remain tightly closed so that the contents are not lost. Straps work, whereas zippers tend to become clogged with mud.

## VERTICAL CAVING

Vertical caves range in depth from a drop of just a few meters into a cave entrance to deep alpine and high plateau systems where sequences of pits have reached depths of 1500 m and more. The techniques for descending and ascending vertical caves have evolved and improved greatly during the past several decades. Specialized equipment is well established. The use of it requires training and practice, which is best accomplished under the guidance of experienced vertical cavers.

### Going Down

Older techniques for descending pits involved winches and lowering lines and rope and cable ladders of various types. The only surviving technique is the cable ladder. The ladder consists of two strands of woven cable as the legs of the ladder. The rungs are short (typically 15 cm) lengths of aluminum tubing, crimped to the cable a convenient distance apart. Thirty meters of cable ladder can be rolled to a diameter of 30 cm or less and stuffed in a pack. Sections of ladder can be strung together but today ladders are mainly used for short drops and for tight crevices where single-rope techniques are awkward. Ladder climbs should be belayed because of the possibility of slipping off the ladder.

Nearly all descents of vertical caves are made with what are known as *single-rope techniques*. The ropes themselves have undergone substantial innovation with older woven (laid) ropes being replaced by sheaf ropes. Sheaf ropes have a core of twisted polymer to provide strength surrounded by a braided sheaf. The sheaf allows the rope to slide smoothly through descending devices without the twisting experienced on the older laid ropes. Caving ropes are strong but are sensitive to abrasion. They must be rigged where they do not rub against the rock. This often requires that the rope be attached to a set of secondary anchors bolted to the wall along the drop. These are known as *rebelays* and require the caver to learn how to pass them, both descending and ascending.

Descending a pit is a question of connecting oneself to the rope and sliding down it in a controlled manner, a procedure known as a *rappel*. Many rappelling devices have been devised. One of the most popular is the rappel rack, a U-

shaped steel rod. Across the U are placed a series of brake bars, usually of aluminum. These have holes at one end for threading over the U while the other ends are notched so that the brake bars can be hinged away from the rack, thus allowing bars to be added or removed according to the weight of rope hanging below. The rope is threaded through the brake bars in such a way that the bars are locked against the U-rod of the rack and friction between the rope and the brake bars controls the speed of descent. The caver wears a harness of nylon webbing that is attached to the rack by a carabiner.

### Going Up

Pits can be ascended by cable ladder, which works equally well going up or going down. However, ascending a pit or sequence of pits using single-rope techniques requires some means for climbing the rope. Prussik knots are a form of slip knot that will clamp around the main rope when tension is put on them and release when the tension is released. A set of three Prussik knots, two connected to the climber's feet and the third attached to the chest harness, provides a slow and tedious method of rope climbing but is useful as an emergency measure. Most cavers use ascenders of some type. There are several designs but all are based on a moving toothed cam that presses against the main rope when the climber's weight is on it. It releases and can be moved upward when the climber's weight is released. A number of ways have been devised for arranging the ascenders, each with their adherents. The overall result is that the caver essentially walks up the rope.

Some caves are explored from the bottom, which means that explorers need to ascend drops or pits without benefit of a rope. Standard rock-climbing techniques are used but are more limited because of poor lighting, wet and muddy surfaces, and the presence of weak or rotten rock. Most vertical ascents require drilling holes in the rock, setting bolts, and attaching anchors that support the climber while a new and higher bolt is set.

## LARGE SYSTEMS: EXPEDITION CAVING AND PROJECT CAVING

It is useful to make a distinction between "caving" and "cave exploring." *Caving* is simply traversing the cave, whether for recreation, scientific observations, photography, or other objectives. *Cave exploring* is the systematic checking of all passages to obtain a complete description of the cave. For present-generation explorers, this implies that the passages will be surveyed and a map produced. Systematic exploration and survey is much more time consuming than a casual trip through the cave and, for caves of even modest size, may require multiple trips or even multiple years of effort; thus, the terms *expedition caving* or *project caving*.

The approach to expedition caving depends on whether or not the frontier of exploration can be reached from some

entrance in a reasonable period of time. If so, the expeditions can be based at the surface. Exploration parties enter the cave, proceed quickly to the point at which exploration is to begin, explore and survey, and then return to the surface to eat and sleep. The alternative is a cave in which reaching the frontier of exploration requires so much time that there is no time left for exploration, much less returning to the surface. Such caves require setting up underground camps.

With either type of large cave, complete exploration and survey requires a sustained effort and thus an organizational structure. The structure may take the form of a formal organization or a loosely knit “project.” In either case, some leadership is necessary to coordinate expeditions, data collection, and data storage. Survey results need to be deposited in central files and between-expedition activity is necessary to plot draft maps and prepare objectives for the next expedition.

Lengths and organization of expeditions also depend on the accessibility of the cave. Many caves in the United States and Europe are within easy access of roads. The style is to conduct frequent weekend or weeklong expeditions. Expeditions to caves in inaccessible regions or that require extensive travel often extend for periods of months. For these expeditions, arrangement for supplies and their transport to the expedition site becomes an important part of expedition management.

Although it has greatly expanded its original objectives, the Cave Research Foundation was organized to explore and survey the complex Mammoth Cave System in Kentucky. It has been at the task for nearly 50 years and the end is not yet in sight. In the course of this 50-year effort, the length of the system was expanded from something like 40 km to 550 km.

## **WATER AND UNDERWATER CAVING**

### **Water Caves**

Most caves are wet and many contain pools and flowing streams. Most of these caves can be traversed only by getting wet. However, some caves exist that contain ponded water too deep for wading and a few caves exist that contain rivers not different in kind from whitewater rivers on the surface. Exploration of such caves requires techniques beyond those of basic caving.

Cave exploration that requires total immersion in water requires protective clothing beyond the usual warm underclothes and coveralls. Wet suits are tight-fitting full-body outfits made of polymer foam with a protective smooth outer polymer layer. As the name implies, the wet suit allows water to soak through but provides an insulating layer to preserve body heat. Wet suits are widely used in any cave exploration that requires extensive exposure to water. They are often worn under coveralls for protection against snags and abrasion. Less common are dry suits, which are full-body outfits of water-impermeable polymer. They keep water out, but they

also keep perspiration in. Dry suits work best for waterfalls and whitewater streams where the caver may be immersed for only short periods. Once out of the stream, the suit can be opened to allow perspiration and waste heat to escape.

Exploration of deep water caves requires, in addition to wet suits, some sort of flotation device. Automobile inner tubes have been used as have standard life jackets. Small inflatable rubber rafts are the vessel of choice. There is the additional hazard that rafts may snag, rip, and leave the explorers stranded somewhere deep in the cave so appropriate precautions and backup are needed.

Exploration of river caves is one of the most hazardous types of cave exploration. The distinction between a stream cave and a river cave can perhaps be made on the basis of whether or not a caver can wade the stream and not be swept away. Big river caves pose a distinct threat to cavers of being swept away. Exploration of river caves requires much the same techniques as exploring vertical caves. Anchors must be placed and ropes played out to prevent the explorers from being washed away. Waterfalls must be rigged with ropes. Deep pools may require swimming. Great care must be taken to avoid being pinned by the force of flowing water.

### **Underwater Caves**

Many caves end in sumps. Sumps are places where the ceiling of the passage dips below the surface of standing water. Some sumps are short and shallow. A dive of a few meters or a few tens of meters brings the explorer back up into an air-filled passage. Some sumps are longer and deeper. Some caves are completely underwater. Cave systems in Florida, the Yucatan Peninsula, and the Bahamas have been drowned by the sea-level rise that took place at the end of the ice ages. Underwater caves can be quite long. Six caves are known in Florida with lengths in excess of 5 km. The underwater cave Ox Bel Ha in the Mexican state of Quintana Roo has a surveyed length of 70.65 km and a dozen other underwater caves are known in the Yucatan with lengths exceeding 5 km.

It is inappropriate to discuss details of the techniques of cave diving in an article on basic caving techniques. Both sump diving and underwater cave exploration require complex SCUBA equipment, extensive training, and, above all, experience. Formal training and certification is offered by the Cave Diving Section of the National Speleological Society. Underwater caving is far less forgiving of mistakes and equipment failures than any other type of caving. Rescues are rare. Body recoveries are all too common.

The horizontal limits of underwater exploration are dictated by air supply. The distance a diver can travel before one-third of the air supply is consumed was for a long time limited by how far the diver could swim. A new development is the use of underwater propulsion systems—scooters—allows divers to go much farther with the same air supply. Most of the air in SCUBA tanks is wasted; it is breathed once and then exhaled as a stream of bubbles. Another develop-

ment, however, is the invention of the rebreather, a device that recycles the air by extracting carbon dioxide. This ability greatly extends the diver's range.

The depth limits of underwater exploration are limited by the need for decompression. Pressure increases with depth, causing an increased solubility of gases, particularly nitrogen, in the diver's blood. Ascent from an underwater cave must be done slowly, lest nitrogen form bubbles in the blood, bringing on a painful condition known as the *bends*. Special gas mixtures have been devised to partially alleviate the problem.

### SAFETY

Whether recreational caving in relatively small, near-horizontal caves or exploring deep vertical caves, caving parties must take responsibility for their own safety. Rescue of disabled persons from caves is an extremely complex and expensive operation. Most rescue teams are volunteers. Their services should be reserved for serious accidents and not wasted on people who simply forgot to take extra batteries for their flashlights.

For beginning cavers in relatively small, near-horizontal caves, the rules are simple: (1) Never cave alone. A party of three works well. If one caver has accident, another can go for help while the third remains with the injured caver. (2) Carry the necessary light sources and know how many hours of service they will provide. Be out of the cave before the lights go out. (3) Always notify someone about where you are going and when you expect to return. If the entire party does not return, there is someone to call for help. (4) Be careful. Any

injury that incapacitates a caver will require a massive rescue effort.

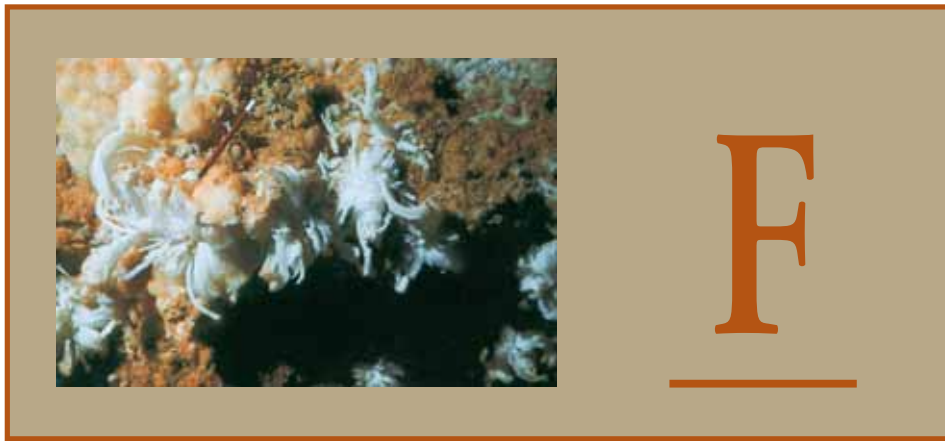
### CONSERVATION

Caves are fragile. Time moves slowly underground. Any damage done to a cave—broken speleothems, graffiti, litter—will take a very long time for natural processes to repair. Organisms that live in caves are also easily disrupted. There is an ethic among cavers to do their explorations with the minimum possible impact on the cave and its inhabitants. Anyone who visits caves, no matter how casually, should make the maximum effort to preserve the underground environment.

### *See Also the Following Articles* *Recreational Caving*

#### *Bibliography*

- Brucker, R. W., and R. A. Watson (1976). *The Longest Cave*. Alfred A. Knopf, New York.
- Damon, P. H., Sr. (1991). *Caving in America*. National Speleological Society, Huntsville, AL.
- Exley, S. (1994). *Caverns Measureless to Man*. Cave Books, St. Louis, MO.
- Farr, M. (1991). *The Darkness Beckons*. Diadem Books, London.
- Judson, D. (1984). *Caving Practice and Equipment*. David and Charles, Newton Abbot, UK.
- NSS Caver Training Committee (1992). *Caving Basics*. National Speleological Society, Huntsville, AL.
- Padgett, A., and B. Smith (1987). *On Rope*. National Speleological Society, Huntsville, AL.
- Steele, C. W. (1985). *Yochib: The River Cave*. Cave Books, St. Louis, MO.
- Stone, W., and B. Am Ende (2002). *Beyond the Deep*. Warner Books, New York.



# Fish

**Horst Wilkens**

*University of Hamburg, Germany*

## INTRODUCTION

Besides salamanders, fish are the only vertebrates that have been able to colonize habitats characterized by constant darkness. At present, more than 80 species, subspecies, or populations have been described and the number is still growing. The troglotic taxa comprise only about 0.27% of all teleost fish. They are distributed among eight orders (21%), 18 families (4%), and more than 55 genera (1%). The comparatively high number of orders indicates the remarkably extensive systematic diversity. The high number of genera in comparison to species is explained by the large proportion of genera consisting of only one species. Despite their systematic diversity, most of the cave fish species are Ostariophysi, which comprise the majority of the primary freshwater fish. Only representatives of two families are of marine origin. Higher teleost taxa, especially the Perciformes,

are poorly represented among the cave fish (Weber, 2000) (Table I).

Cave fish are distributed across all continents except Antarctica, but find higher densities in the neotropic (South America), Ethiopian (Africa, Madagascar, Southern Arabia), Oriental (India, Southeast Asia, Southern China), and Australian (Australia, New Guinea) biogeographic regions. The palearctic (Europe, Northern Asia) and the nearctic (North America) biogeographic regions comprise many fewer species.

Generally, cave fish derive from groups already adapted to the conditions that result from a reduced amount of light. They display a nocturnal way of life or have already entered caves as troglaphiles. Examples include loaches, catfish, or gobies. A few species, however, such as the troglotic populations of the characid *Astyanax fasciatus* and the live-bearing tooth carp *Poecilia mexicana*, descend from primarily light-dependent forms.

The complete absence of light as an information-transmitting medium has caused a series of morphological, behavioral, and physiological structures to lose their biological function. Such structures are subjected to regressive evolution. Eyelessness and pale body color in particular are

**TABLE I Biogeographic Distribution of the Number of Genera, Species, and Families of Cave Fish**

Biogeographic Region	Genus	Species	Family
Nearctic	7	9	3 (Characidae, Amblyopsidae, Ictaluridae)
Neotropis	13	29	9 (Characidae, Pimelodidae, Trichomycteridae, Astroblepidae, Loricariidae, Sternopygidae, Poeciliidae, Synbranchidae, Bythitidae)
Orientalis	18	26	7 (Cyprinidae, Cobitidae, Balitoridae, Siluridae, Clariidae, Synbranchidae, Gobiidae)
Ethiopian	8	10	4 (Cyprinidae, Clariidae, Eleotridae, Gobiidae)
Palearctis	4	6	3 (Cyprinidae, Balitoridae, Gobiidae)
Australis	3	3	2 (Eleotridae, Synbranchidae)

generally considered to be a hallmark of obligatorily cave-living animals. At second glance, the question arises “In what manner do these species cope with darkness and which constructive adaptations to these conditions evolve secondarily?” A further issue is that the lack of primary production in darkness may cause a food limitation and thus require an improvement in food-finding and energy storage capabilities.

For several cave-dwelling fish species, surface-dwelling sister populations (their correct taxonomical status is often under dispute) are still extant. This fact makes cave fish an important tool of biological research. Comparison of divergent traits in surface and cave forms provides general insight into the process of evolution. In particular, the interfertile cave and surface populations of *Astyanax fasciatus* (Characidae) provide a model system of exceptional importance (Wilkens, 1988; Culver and Wilkens, 2000).

## REGRESSIVE TRAITS

### Eyes

**GENERAL MORPHOLOGY AND REGRESSION PATTERNS OF CAVE FISH EYES** Eye regression in cave fish has been a keen interest of cave biologists since Eigenmann’s studies on blind North American amblyopsid and Cuban bythitid cave fish. Since then many more cave forms have been analyzed. In these, all degrees of eye reduction—from just a slight decrease in size on the one hand to extreme structural rudimentation on the other—have been found (Fig. 1). Morphologically, the regressive process is at its phylogenetically initial stages just a qualitative one. At such less regressive stages, cave fish eyes will just be smaller in the adult fish in comparison to the surface sister forms, but are still externally visible (*Poecilia mexicana*). At later stages the size of eye single structures are diminished, the overall eye sizes are smaller, and the eyes sunk beneath the body surface are no longer externally visible. In such cases the epidermis may still have contact with the cornea and due to this a connection may exist between eyeball rudiment and body surface (e.g., *A. fasciatus*). In others the cornea is disjunct from the epithelial corneal part with the rudiment lying isolated in the eye cavity (e.g., *Ophisternon infernale*, *Lucifuga spelaeotes*, *Amblyopsis spelaea*). Strongly reduced eyes are characterized by the loss of single structures. Such rudiments contain a rudimentary retina, which has lost the visual cells. Also, the lenses may be completely reduced or are only represented by the rudimentary lens capsule. In such cases the anterior eye chamber is filled with a specific tissue, the spongiosum, and the pupil is closed. In extremely reduced eye rudiments, the correct identification of single structures is difficult, because they have lost their histological characteristics. In such cases a sclera encloses undifferentiated tissue remnants. Only in two species, *Phreatichthys andruzzii* and *Uetgitglanis zammaroni*, both from Somalia, has the whole eye rudiment completely vanished in adult specimens.

## RUDIMENTATION DURING ONTOGENETIC GROWTH

It is characteristic of all cave fish eyes that they are subjected to a process of regression during growth. At the earliest embryonic stages, the nearly complete eye, equipped with all of the typical single structures, develops. The eyes are insignificantly smaller in size when compared with the surface sister forms. During further ontogeny, however, normal eye development is disturbed. The final state of eye rudimentation characteristic of a specific cave fish species is achieved by structural diminution or loss. During this process the high variability of rudimentary eyes develops, which is not exhibited during early ontogeny. This process of ontogenetic regression observed in cave fish eyes is due to the developmental physiological function of the eye during the formation of the bony head. This internal selection force makes necessary the full development of the embryonic eye and explains its low variability during this phase. At later stages, however, selection no longer acts, eye regression proceeds, and variability continuously increases.

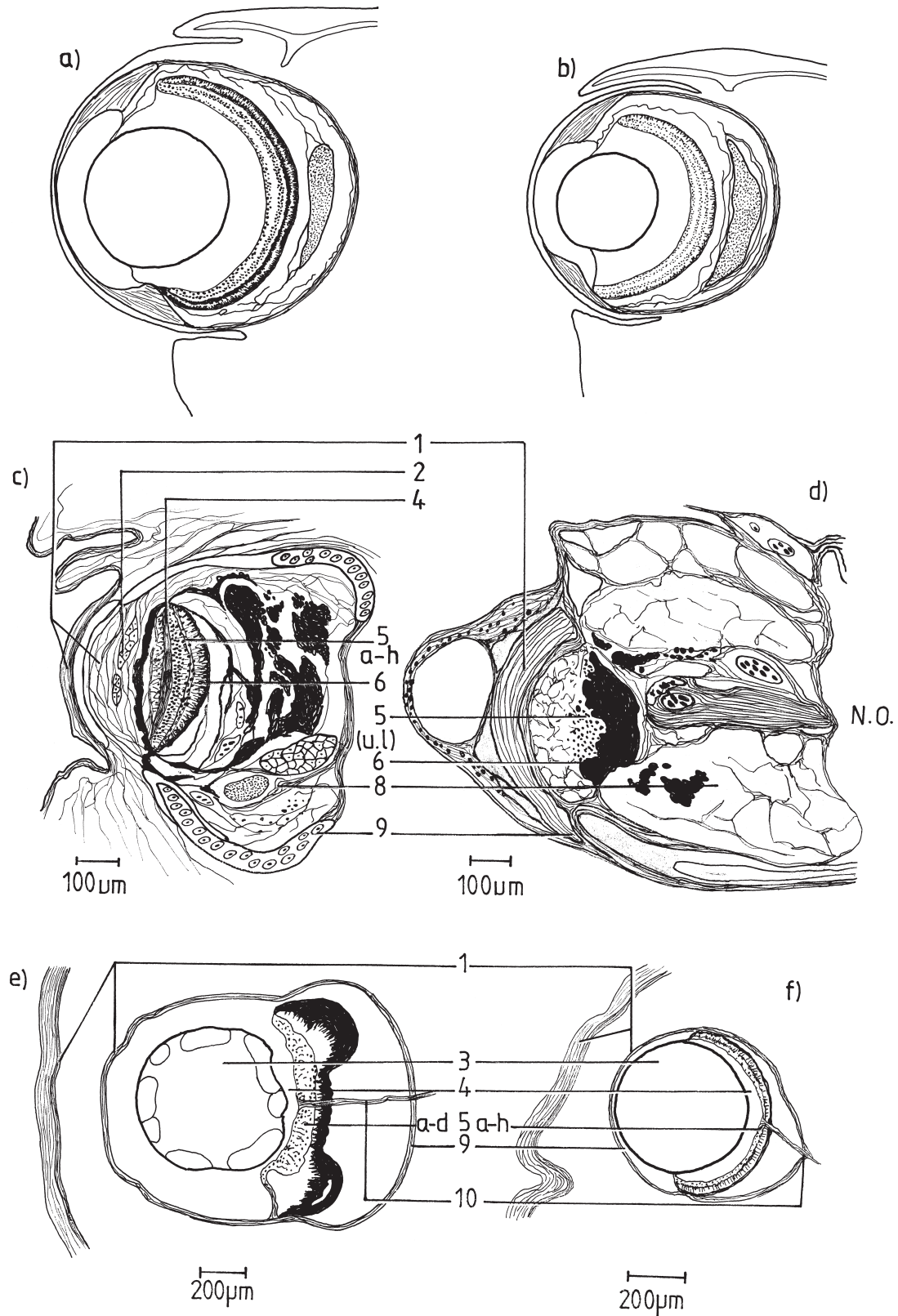
## DEVELOPMENTAL PRINCIPLES OF EYE REGRESSION

At the beginning of eye development, the eye cup induces the formation of a lens. Both structures seem to have inductive influence on different eye structures: The lens is closely correlated to the formation of the pupil, anterior eye chamber, and cornea, whereas the retina primarily induces structures such as pigmentary epithelium and lens muscle. Between these two subunits of eye differentiation, a varying more or less close correlation exists in different species. This developmental pattern is verified by histology. For example, large lenses may be combined with a poorly developed retina (*Rhamdia* spp., *L. speleotes*, or *A. fasciatus*). Rather well-developed retinæ in some cases with an attached lens muscle may occur in combination with missing lenses (*Garra barreimiae*) (Fig. 1).

**GENETICS OF EYE REGRESSION** Eye regression is genetically based. Usually keeping or breeding cave fish in daylight has no or only a faint influence on eye size and differentiation. The most intensive studies on the genetics of eye reduction have been performed on cave and surface populations of the characid *A. fasciatus* (for details, see the article titled Neutral Mutation). It has been found that developmental control genes such as *pax6*, *sox1*, and *sonic hedgehog* as well as structural genes are responsible for eye reduction. As yet, only in opsin genes, which are responsible for color vision, have several mutations and one deletion been detected (Yokoyama *et al.*, 1995). In correlation with this, the occurrence of multiple photopigments was reported. Photopigment variability has probably evolved, because there is no longer selection pressure on color vision in darkness.

## Body Pigmentation

Besides eyelessness, pale or pink body coloration is another conspicuous feature of many cave species. This is brought



**FIGURE 1** At the beginning, cave fish eye reduction is just a diminution of overall eyeball size and that of all single structures (a: *P. mexicana*, surface; b: *P. mexicana*, cave). Only at later stages do certain structures get lost completely and considerable variability develops. In cave *G. barreimiae* the lens may be reduced, whereas the retina still contains all characteristic layers of a functional eye (c) or the retina is no longer layered at all (d). In *L. spelaeotes* from the Grand Bahamas, lens and retina are merely reduced in size (f), whereas in specimens from Abaco (Bahamas) both show structural reduction (e). Cornea (1), anterior eye chamber/spongiosum (2), lens/lens capsule (3), vitreous body (4), retina rudiment (5; a = inner limiting membrane, b = ganglionic layer, c = inner plexiform layer, d = inner nuclear layer, e = outer plexiform layer, f = outer nuclear layer, g = outer segments of visual cells, h = pigmentary epithelium, ul. = unlayered), pigmentary epithelium (6), chorioid (8), sclera (9), optic nerve (10, n.o.).



about by the reduction of the amount of dark melanin pigment. It may be caused by the reduction of the number of melanophore color cells. In such a case, the characteristic pattern of color cells is not disturbed. Furthermore, the melanin content within the melanophores may be partially or totally diminished. The pink coloration is a consequence of the skin now being translucent and the red color of the blood. Additionally, to the melanin coloration cave fish may also reduce the amount of silvery guanin deposited in scales and skin. This increases the translucent appearance of cave fish (some populations of *A. fasciatus*, *P. andruzzii*). In some cave species, a color not existing in the surface sister form may even be developed. They can show a bright yellow appearance caused by carotinoids (as seen in, e.g., one population of *A. fasciatus*, *P. sphenops*, *R. zongolicensis*).

As shown for the *Astyanax* cave forms, pigment reduction is genetically based. The genetic basis of the reduction of the number of melanophores is polygenic. The color mutants responsible for total (albino gene) or partial reduction of melanin (brown gene), guanin (guaninless gene), and carotinoid deposition (yellow gene) rely in each case on a recessive gene. In contrast to eye reduction, however, a strong environmental influence can be observed. In several, but not all, species the melanin coloration darkens when specimens are kept at daylight, because the number of melanophores and the amount of melanin increase. Whereas the guanin deficit remains uninfluenced by environment, the yellow coloration is dependent on ingestion of carotinoids with the food.

### Pineal Organ

The pineal photoreceptors in fish not only perceive light, but are also neuroendocrine cells. They synthesize and release the hormone melatonin under the control of light. The rhythmic secretion of melatonin is likely to play a key role in the synchronization of internal rhythms through external time-keepers such as light. Concerning the pineal in cave fish, the situation is still contradictory. Whereas in the *Astyanax* cave populations the photoreceptive visual cells are completely reduced in the eye, only minor disorganization and reduction of outer segments of the visual cells in the pineal were observed. Similar results were found in Mexican cave *Rhamdia*. Contrary to this, the amblyopsid *Typhlichthys subterraneus* shows complete reduction of the outer segments in both eyes and pineal (Langecker, 2000). It has been posited that due to the presumably still existing biological function for the synchronization of internal rhythms, a complete regression in *Astyanax* and *Rhamdia* cave fish is not possible, whereas such correlation does not exist in *T. subterraneus*. One might speculate that in *Astyanax* cave fish the circadian rhythm is genetically correlated with the circannual rhythm: Whereas there is no longer an external time-keeper for the

circadian rhythm in the *Astyanax* caves, the periodic seasonal rainfall may have such a function for the circannual rhythm, the persistence of which might be important for an appropriate timing of reproduction.

### Light Reaction

Every surface fish species is adapted to a specific light intensity of its environment. In many but not all cases, cave fish derive from species such as catfish that already show nocturnal activity. Studies have revealed that under the conditions of continuous darkness the behavioral trait of preference for the species-specific light intensity is reduced. This could be demonstrated in the *Astyanax* cave forms as well as in cave-living *Rhamdia zongolicensis* and *R. reddelli* (Langecker, 2000).

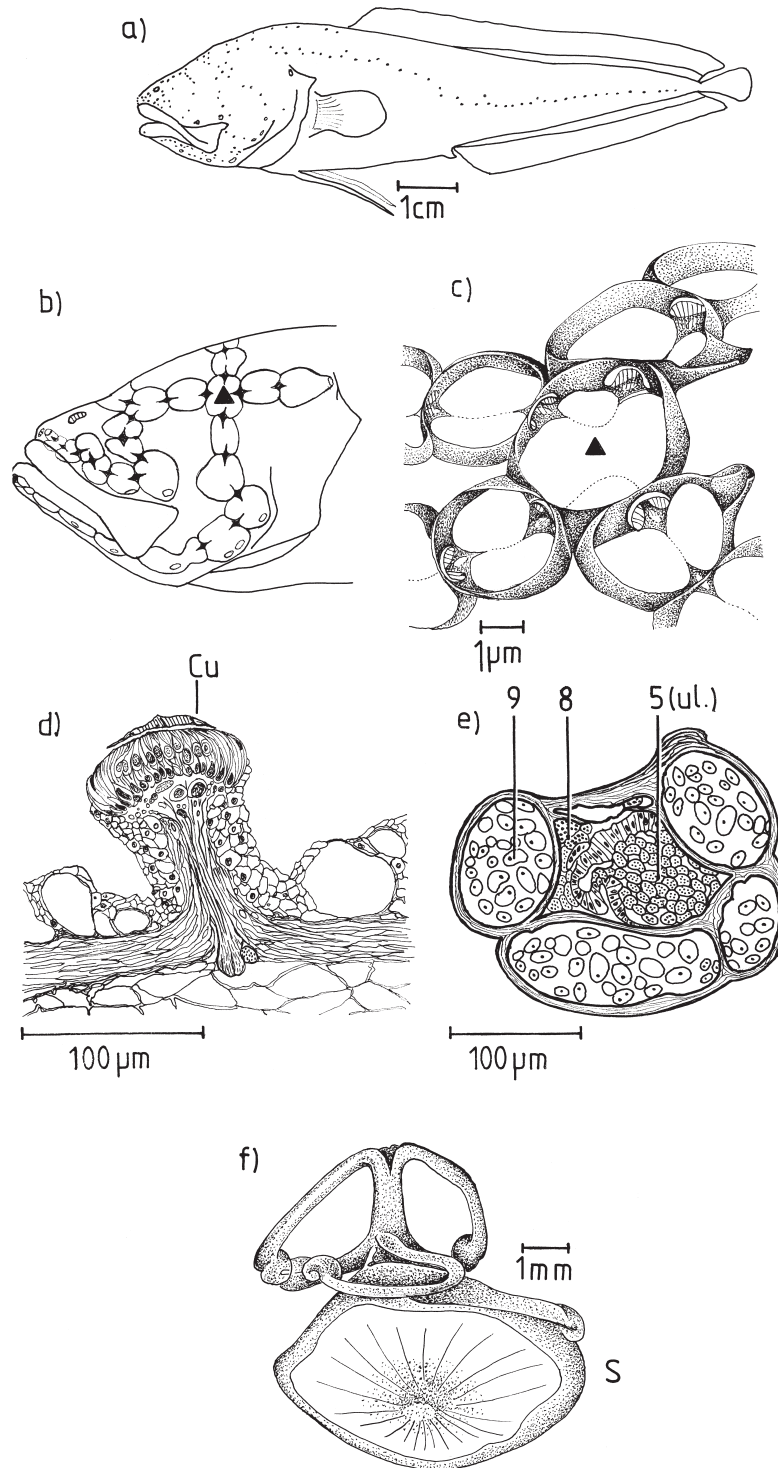
## CONSTRUCTIVE TRAITS

### Sensory Compensation and Adaptation

In cave-living fish sensory compensation of eyelessness concerns all other senses such as olfaction, taste, lateral line, and that of touch as well as electrosense. Many of them are already highly developed under surface environments so that improvement under completely lightless conditions is unnecessary. It is characteristic, however, that depending on which species is being referred to, not all senses in total but different ones may alone be improved and accentuated.

*Ogilbia pearsei* The Yucatan live-bearing cave brotula *O. pearsei* (Bythitidae) (Fig. 2) is characterized by a very specialized adaptation of part of the lateral line sense, the head channel system (Schemmel, 1977). These channels are enlarged to a series of widened chambers between which tiny openings exist. Within every opening sensory cells are positioned. The chambers lie directly beneath the body surface. They are not enclosed by bones, but merely separated from the outer environment by a thin layer of skin and are therefore superficially recognizable. This part acts like an eardrum, transmitting the slightest pressure differences into the interior chamber. As a consequence, the sensory cells are subjected to the movement of the channel fluid from one chamber to the next. This process is intensified by a relatively large amount of fluid within one chamber in combination with a tiny connecting opening to the next. Free neuromast sensory organs are positioned on protruding papillae on the body surface, but are only found in low numbers restricted to the head and along the lateral line.

The inner ear contains a relatively large otolith. One can conclude from the massive enlargement of the otolith (sagitta) that *O. pearsei* is able to perceive low-frequency sounds. The fixation of the distal ends of the morphologically specialized third and fourth vertebrae ribs at the swim bladder may indicate that in *O. pearsei*, as in other species in this group, sound production is possible (Schemmel, 1977).



**FIGURE 2** In the live-bearing brotula *O. pearsei*, the head channel system of the lateral line is specialized to locate small prey (b = total view of head, c = single channel chambers under larger magnification; triangles indicate identical chambers). Free neuromasts are positioned on epidermal elevations (d, cu = cupula) but are low in number (a, dots = free neuromasts; a,b, circles = channel pores). The eyes are extremely reduced (e). The greatly enlarged sacculus (s) with huge otolith and extensive sensory area (macula sacculi) indicate auditory capacities (f). For abbreviations, see Fig. 1. (After Schemmel, 1977; Wilkens, 1982.)

In contrast to the highly specialized mechanosensitive head channel system of *O. pearsei*, taste has not or only to a very low extent been improved. Few taste buds are found in low density exclusively within the mouth cavity and along the frontal lip margins. Even the threadlike ventral fins are not equipped with taste buds. The development of the morphological structures of olfaction also does not indicate adaptive improvement.

*O. pearsei* as a cave fish is specialized to capturing moving planctonic and nectonic prey, which is detected exclusively by the mechanosensitive sense. The locomotion of this fish is by soft undulation of the long dorsal and anal fins; only rapid escape is achieved by the typical fishlike movement of the whole body. The huge mouth is a trap that opens suddenly, at the moment *O. pearsei* has approached a piece of prey close enough to suck it in and swallow it.

**OPHISTERNON INFERNALE** The eel-like synbranchid fish *O. infernale* from the Yucatan is closely related to the surface sister species *O. enigmaticum*. Food finding in the cave form is improved by enhancement of the number of taste buds on the head surface and outer jaws (Fig. 3). The sensory morphology of the nose is not constructively developed. Concerning the lateral line, the morphology of the head channel system is unaltered when compared with sister surface fish. However, the number of free neuromasts is increased in the head region. The sizes of these organs have not been enhanced nor are they situated on epidermal elevations (Parzefall and Wilkens, 1972).

*O. infernale* occurs syntopically with *O. pearsei* (Wilkens, 1982). It occupies the niche of a bottom-living species feeding on invertebrates. Specimens can be observed lying exposed on the ground searching for living animals on and probably also in muddy bottom substrate. The prey is ingested by a sucking movement of the mouth. Larger individuals were observed to stay in limestone crevices.

**ASTYANAX FASCIATUS** Improvement of senses in the Mexican cave characids is not restricted to one sense, but includes taste, lateral line sense, and olfaction (Fig. 4). The most conspicuous improvement is observed in taste. In the surface sister form, the taste buds are mainly concentrated on the lips, whereas their number rapidly decreases in the transition zone to the head. The density as well as the distributional area have changed in the cave forms. The number on the lips is the same as in the surface fish. However, the distributional area is considerably extended on the head and particularly in the ventral region. Between different cave populations, differences in the number of taste buds as well as of the extension of the area covered by them were found. This character has a polygenic basis.

In contrast to taste, which seems to play a subordinate role in the surface fish, the lateral line sense is well developed in

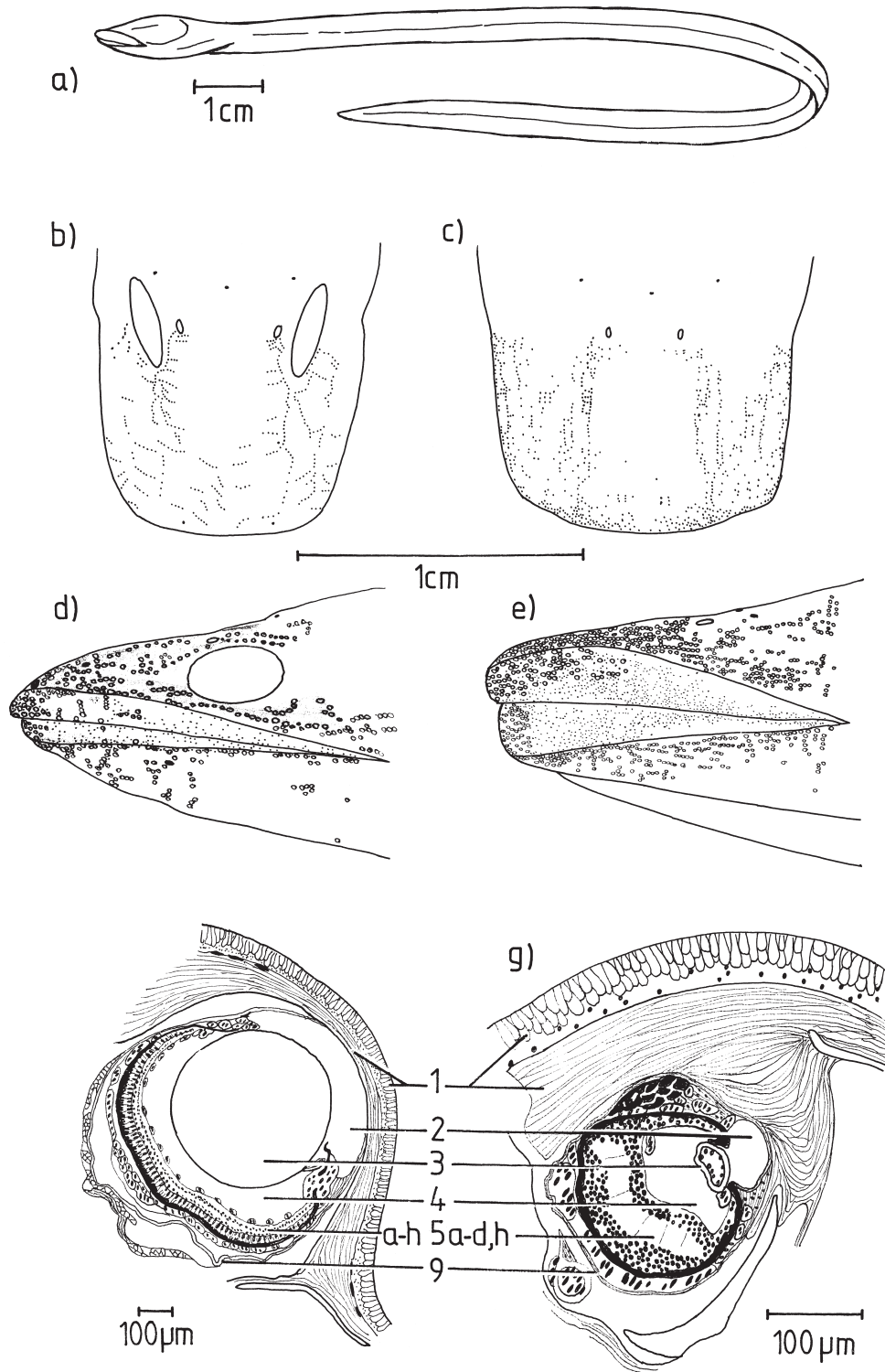
this form. The whole body is covered with numerous external sense organs. Their number has not been increased in the cave forms. It was found, though, that their size has changed. In the head region in particular they are twice as long in the cave fish (Teyke, 1990).

The noses of *A. fasciatus* are pitlike structures that contain folds covered by olfactory epithelia. The number of folds varies and differs between male and female specimens. The only cave fish population studied was revealed to have a lower number than the surface fish. No histological differences were found concerning the olfactory epithelia. These results are in contrast with the enlargement found in a cave population of that part of the brain in which the sensory input of the nose finds its neural projection. From this it could be concluded that olfaction is also improved in the *Astyanax* cave fish.

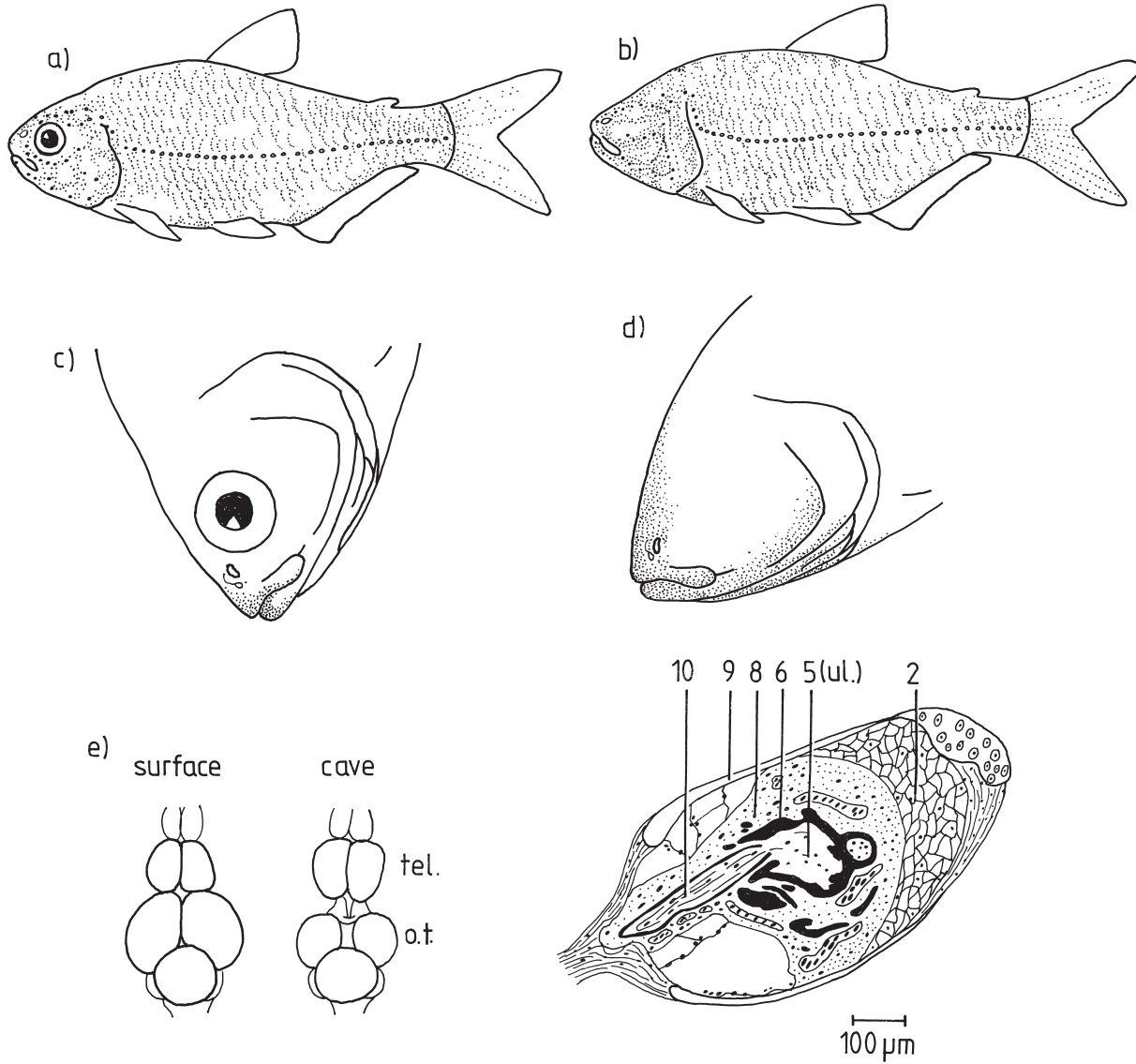
As a cave fish the originally optically oriented surface *Astyanax* has become a bottom feeder. After olfactorial information is transmitted over a longer distance, food finding and final localization are achieved with the help of the enlarged taste bud area covering the ventral head surface. To increase the efficiency, a specific food uptake behavior is developed: By lowering the angle between body and bottom surface locomotion, searching and feeding simultaneously are possible (Wilkens, 1988).

**RHAMDIA ZONGOLICENSIS** Within the *Rhamdia laticauda* catfish group (Pimelodidae) several cave forms have evolved in Mexico. The one best studied is *R. zongolicensis*, which was discovered in a cave in the Sierra de Zongolica in Veracruz. All cave *Rhamdia* are closely related to the sister surface species *R. laticauda*, which is characterized by a comparably high degree of adaptation to life in darkness. The only morphologically detectable sensory improvement to be observed in *R. zongolicensis* and the other *Rhamdia* cave species (*R. reddelli*, *R. macuspanensis*) studied is that of taste and tactile senses achieved by the prolongation of barbels. In contrast to this, neither number and structure of free neuromasts nor that of the head channel system shows quantitative or qualitative differences among the surface and cave forms. The *Rhamdia* catfish are able to perceive weak electric fields. However, neither the morphological structure nor distribution pattern of the electrosensitive ampullary organs has been constructively improved in the cave fish (Fig. 5) (Weber, 2000; Wilkens, 2001).

**CAVE AMBLYOPSIDS** The North American troglomorphic species genus *Chologaster* and their cave-limited sister species *T. subterraneus*, *A. spelaea*, *A. rosae*, and *Speoplatyrhinus poulsoni* deliver a unique example of a phylogenetic line of increasing adaptation to cave life (Poulson, 1963). Whereas in the cave-living species the eyes are extremely rudimentary, sensory compensation occurs in all other senses: The free neuromasts are large and exposed on heads and body surface



**FIGURE 3** In comparison to the closely related eyed surface synbranchid eel *O. enigmaticum*, the numbers of free neuromasts and taste buds (b, d) are enhanced and the head is broadened in the Yucatan cave fish *O. infernale* (c,e; a = total view). The eyes are reduced (g; f = eye of *O. enigmaticum*). For abbreviations, see Fig. 1. (After Parzefall and Wilkens, 1972.)



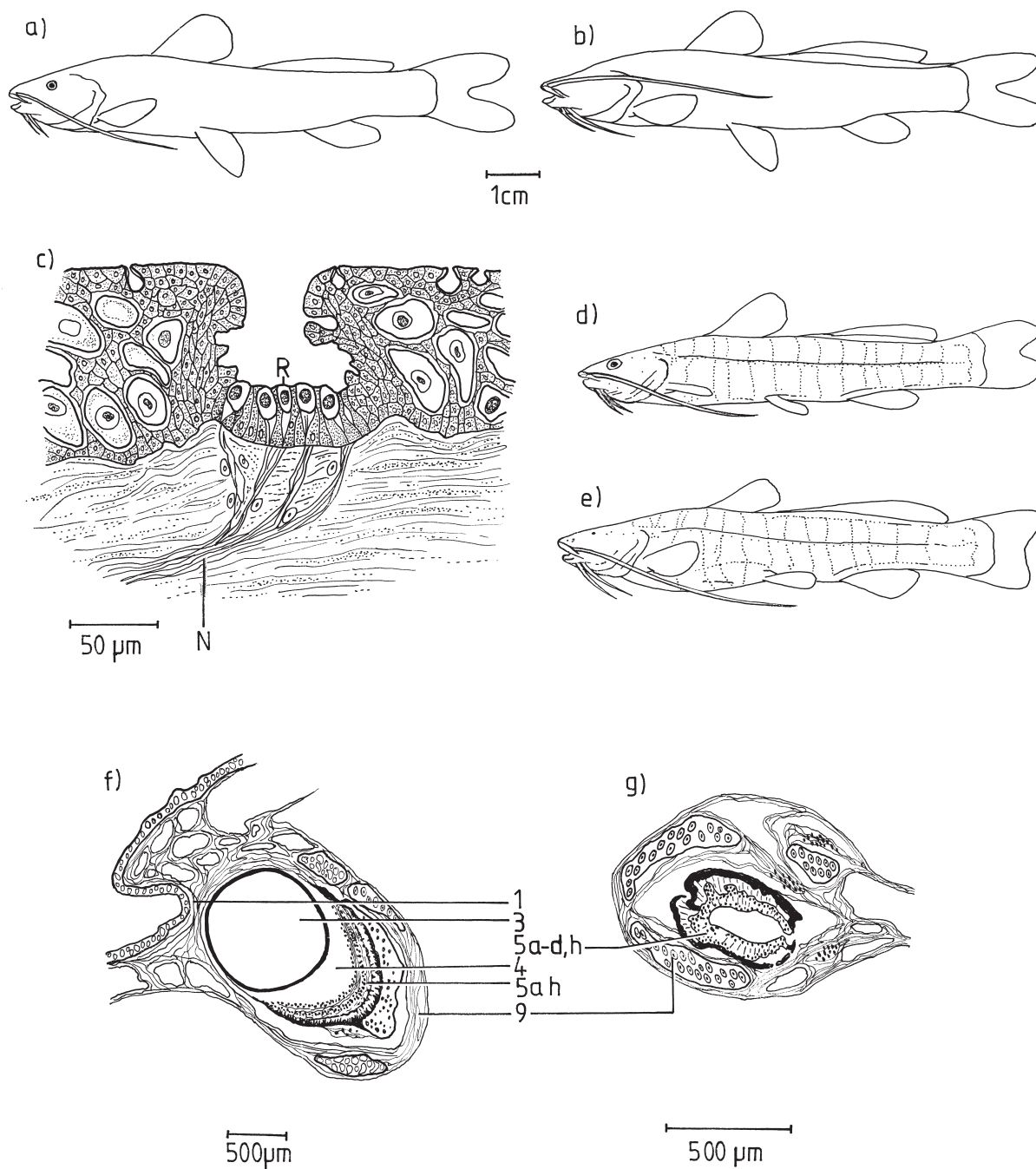
**FIGURE 4** The lateral line sense of (a) the surface characid *A. fasciatus* is as well developed as that of (b) the cave sister form in terms of the number of neuromasts (dots = free neuromasts; circles = pores of lateral canals). Food finding and location on the ground is improved in the cave fish by a larger number of taste buds on the head and a lower angle between its body and the bottom (d vs. c). Comparison of surface and cave fish brains reflects the improvement of olfaction by enlargement of the forebrain (tel.), respectively, eye rudimentation: 0 by diminution of midbrain optic tectum (o.t.). For abbreviations see Fig. 1 (From Wilkens, 1988.)

on protruding epidermal ridges. The olfactory rosettes are more developed and tactile receptors are more numerous. There is increasing development of the inner ear. In correlation with this, the corresponding parts of the brain are enlarged (Fig. 6).

**EIGENMANNIA VICENTESPELAEA** Whereas electro-sensitive organs and electro-sensitivity have been described for catfish, electrogenic potential can only be supposed for one cave fish species, the sternopygid *E. vicentespelaea*. Unfortunately, this has as yet not been studied in this moderately eye reduced cave fish (Triques, 1996).

**Adaptations to Food Limitations and Food Finding**

**HEAD ENLARGEMENT** In several cave fish, the occurrence of laterally broadened heads in comparison to their epigean relatives is characteristic. This can be observed in the cave populations of *A. fasciatus*, in *A. spelaea*, *S. poulsoni*, and *O. infernale*, and in catfish such as the Mexican cave *Rhamdia* or *Satan eurystomus* (Ictaluridae) from Texas. The adaptive value of this feature is still disputed. The enhanced hydrodynamic effects in front of the head while swimming and the more spacious distribution of the neuromasts may possibly increase the sensitivity and ability for spatial resolution of the lateral line system. Furthermore, it may be possible that prey

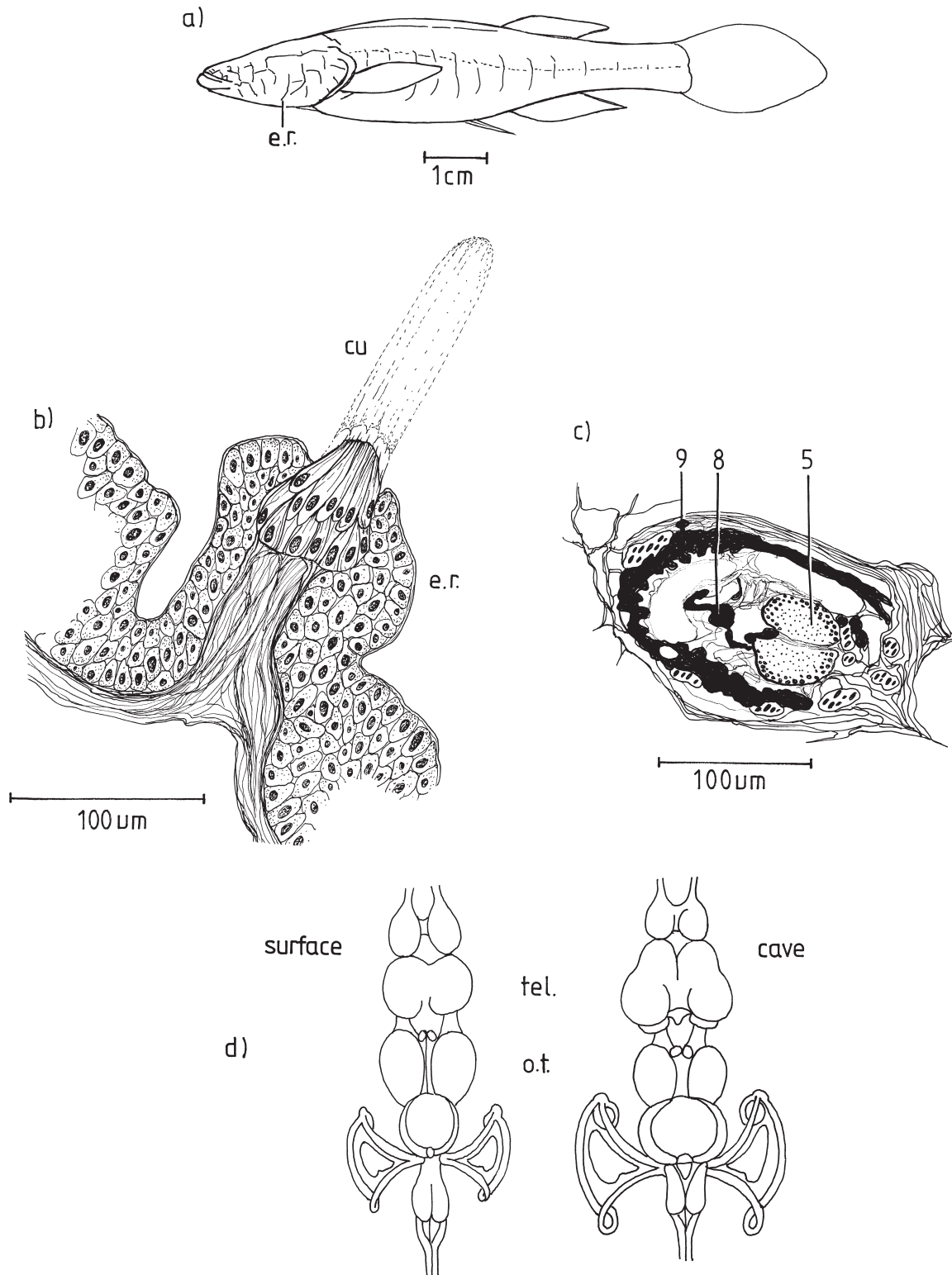


**FIGURE 5** In comparison to the pimelodid (a) surface catfish *R. laticauda*, the (b) cave *R. zongolicensis* shows only little sensory improvement. Whereas taste and touch are intensified by barbel elongation (b vs. a), the morphology of the electric sense (c = ampullary organ with receptor cells (R); d, e = distribution of ampullary organs in both forms) is unchanged. The eye rudiments are highly variable (f, g). For abbreviations, see Fig. 1. (After Weber, 2000; Wilkens, 2001.)

capturing is improved by the development of a broader mouth (Poulson, 1963; Weber, 2000). In cave amblyopsids, head broadening may additionally be associated with branchial incubation.

**FAT STORAGE AND METABOLISM** Because of the lack of light-dependent primary production, many caves are

characterized by food limitation. The cave fish have adapted to this. As a first step, fat is stored. In cave *Rhamdia* the body cavity is filled with huge amounts of fat deposited in the mesenteria of the gut. A similar situation can be observed in the *Astyanax* cave fish. It has been shown that cave fish specimens of either species are able to survive after long starvation periods (Wilkens, 1988, 2001). Cave amblyopsid



**FIGURE 6** In the (a) cave amblyopsis *A. spelaea*, the (b) free neuromasts wear elongated cupulae (cu). They are exposed on elevated epidermal ridges (e.r. in a and b). Comparison of the brain with a surface sister species (d) shows that reduced sensory organs like the eye (c) correspond with size diminution of the midbrain optic tecta (o.t.), respectively, and enlargement for constructively developed ones such as olfaction (tel.). For abbreviations, see Fig. 1. (After Poulson, 1963.)

fish lower their metabolic rates and intensity of reaction to disturbing stimuli (Poulson, 1963).

**REPRODUCTION** Reproduction in cave fish is usually by eggs, from which free-living larvae develop. Only a few species such as the bythitids from Cuba and the Bahamas (*Lucifuga* spp.) and from the Yucatan (*O. pearsei*) or the poeciliid *P. mexicana* are live bearing. Female *O. pearsei* will be pregnant with one to three embryos, which when born have about 3-cm body lengths and seem to be able to survive after birth on their own. Eigenmann was the first to observe that the North American cave amblyopsids practice brood care by branchial incubation. Eggs and yolk sac-fry are kept in the gill cavity of these species. In cave amblyopsids a correlation between a lower number of eggs, increased yolk content, and an advancing degree of cave adaptation can be observed (Poulson, 1963). However, there is no general rule: Whereas in *Astyanax* cave populations egg yolk content is enhanced, no differences were found between *Rhamdia* cave fish (*R. zongolicensis* and *R. reddelli*) and the surface sister species *R. laticauda* (Wilkens, 1988, 2001).

### Bibliography

- Culver, D. C., and H. Wilkens (2000). Critical review of the relevant theories of the evolution of subterranean animals. In *Ecosystems of the World*, Vol. 30, *Subterranean Ecosystems* (H. Wilkens, D. C. Culver, and W. F. Humphreys, eds.), pp. 381–389. Elsevier Amsterdam.
- Langecker, T. G. (2000). The effects of continuous darkness on cave ecology and cavernicolous evolution. In *Ecosystems of the World*, Vol. 30, *Subterranean Ecosystems* (H. Wilkens, D. C. Culver, and W. F. Humphreys, eds.), pp. 135–158. Elsevier Amsterdam.
- Parzefall, J., and Wilkens, H. (1972). Artbildung bei Höhlenfischen. Untersuchungen an zwei amerikanischen Synbranchiden. *Z. Morphol. Tiere* **73**, 63–79.
- Poulson, T. L. (1963). Cave adaptation in amblyopsid fish. *Am. Midi. Nat.* **70**, 257–290.
- Schemmel, C. (1977). Zur Morphologic und Funktion der Sinnesorgane von *Typhliasina pearsei* (Hubbs) (Ophidioidea, Teleostei). *Zoomorphologie* **87**, 191–202.
- Teyke, T. (1990). Morphological differences in neuromasts of the blind cave fish *Astyanax hubbsi* and the sighted river fish *Astyanax mexicanus*. *Brain Behav. Evol.* **35**, 3–30.
- Triques, M. L. (1996). *Eigenmannia videntespelaea*, a new species of cave dwelling electrogenic neotropical fish (Ostariophysi: Gymnotiformes: Stenopogonidae). *Rev. Aquariol.* **23**, 1–2.
- Weber, A. (2000). Fish and amphibia. In *Ecosystems of the World*, Vol. 30, *Subterranean Ecosystems* (H. Wilkens, D. C. Culver, and W. F. Humphreys, eds.), pp. 109–132. Elsevier Amsterdam.
- Wilkens, H. (1982). Regressive evolution and phylogenetic age: The history of colonization of freshwaters of Yucatan by fish and crustacea. *Texas Mem. Mus. Bull.* **28**, 237–243.
- Wilkens, H. (1988). Evolution and genetics of epigeal and cave *Astyanax fasciatus* (Characidae, Pisces). Support for the neutral mutation theory. In *Evolutionary Biology* (M. K. Hecht and B. Wallace, eds.), 271–367, Plenum Publishing, New York.
- Wilkens, H. (2001). Convergent adaptations to cave life in the *Rhamdia laticauda* catfish group (Pimelodidae, Teleostei). *Environ. Biol. Fish* **62**, 251–261.
- Yokoyama, S., Meany, A., Wilkens, H., and Yokoyama, R. (1992). Initial mutational steps toward loss of opsin gene function in cavefish. *Molec. Biol. Evolution*, **12**, 527–532.

## Flooding

Chris Groves

Western Kentucky University

Joe Meiman

Mammoth Cave National Park

### INTRODUCTION

A major way in which groundwater within karst aquifers differs from that in porous and fractured rocks is associated with the way in which these aquifers respond to flood-producing rainfall. Whereas groundwater levels and changing chemical conditions in many types of aquifers respond slowly to these rainfall inputs, as water often moves slowly through these systems over long timescales, such changes within karst systems can be profound and rapid. The purpose of this article is to describe impacts and consequences of flooding, and in particular storm-scale changes in conditions, within karst flow systems, concentrating on spatial and temporal changes in flow and water quality changes typical of the karst aquifer flood water zone.

Another purpose is to draw attention to the fact that flooding can create an extremely hazardous condition to those who venture underground. As described below, water tables in karst aquifers have been measured to rise many meters in a short period of time, flooding passages at times to the ceiling, sometime within minutes. Numerous cavers have stories of close escapes from these conditions and, indeed, some have not been as lucky. Those who travel through caves should have a good understanding of these processes and take care to use good judgment when planning their underground ventures.

Throughout the early to mid-20th century, much debate in karst hydrogeology centered on the question of whether cave development is focused at, above, or below the water table. Eventually, as experience accumulated from direct observation, cave survey, and fluorescent dye tracing, it became clear that all three are possible and, in many karst aquifers, are occurring simultaneously. While many kilometers of water table conduits can be followed throughout the gently dipping Paleozoic limestones of the southeastern United States, for example, one can also see waterfalls cascading down (and forming) great vertical shafts within the vadose zones of these aquifers. At the same time, divers have explored and surveyed many additional kilometers of flooded passages, where pipe-full conduits carry water through saturated regions of the rock, beneath the water table.

In turn, it has become clear that aquifer evolution is influenced by the fact that the position of the water table is subject to fluctuations over a variety of timescales and, thus, dictating regions within an aquifer where conditions are



either saturated or unsaturated. These changes can occur over long timescales (say,  $10^3$  to  $10^7$  years), as regional landscape and hydrologic changes influence base-level elevations, for example, river incision, glacially influenced sediment aggradation, tectonic motions, and sea-level changes. Over much shorter scales (minutes to months) the flood water zone is defined by significant fluctuations that occur over seasonally changing weather conditions—and even individual storms. Indeed, such variation and “flashiness” of flow and chemical condition changes within well-developed karst aquifers have long been considered typical and characteristic features that make these systems different from flow in porous and fractured media. Flood characteristics and impacts within karst aquifers have been studied in a variety of climatic and hydrogeological settings and over a range of timescales.

Within karst systems the distinction between surface water and groundwater can become blurred because surface streams often sink into the aquifer and then resurge as springs after flowing through the subsurface. The focus here is on the events happening during and following a storm event within the aquifer, rather than within the surface components of these systems. The flood behavior of surface rivers fed by karst drainage basins can be different than for the underground rivers within the same flow systems. Karst water tables can respond exceedingly quickly to flood recharge events, because flow routes are bound to fixed cross-sectional areas. Typical flood responses may result in the conduit rapidly achieving pipe-full conditions without attenuation effects of the flood plains of their surface counterparts.

### CHANGING HYDROLOGIC CONDITIONS DURING FLOODS

Within most karst aquifers at any time, the positions of various parts of the water table comprise a fundamental element of aquifer evolution, because these surfaces create the three-dimensional distribution of hydraulic heads and gradients that drive movement of fluids into, through, and out of the system. In a series of interrelated feedback loops, the flow and chemical conditions of these fluids control locations and rates of aquifer framework dissolution.

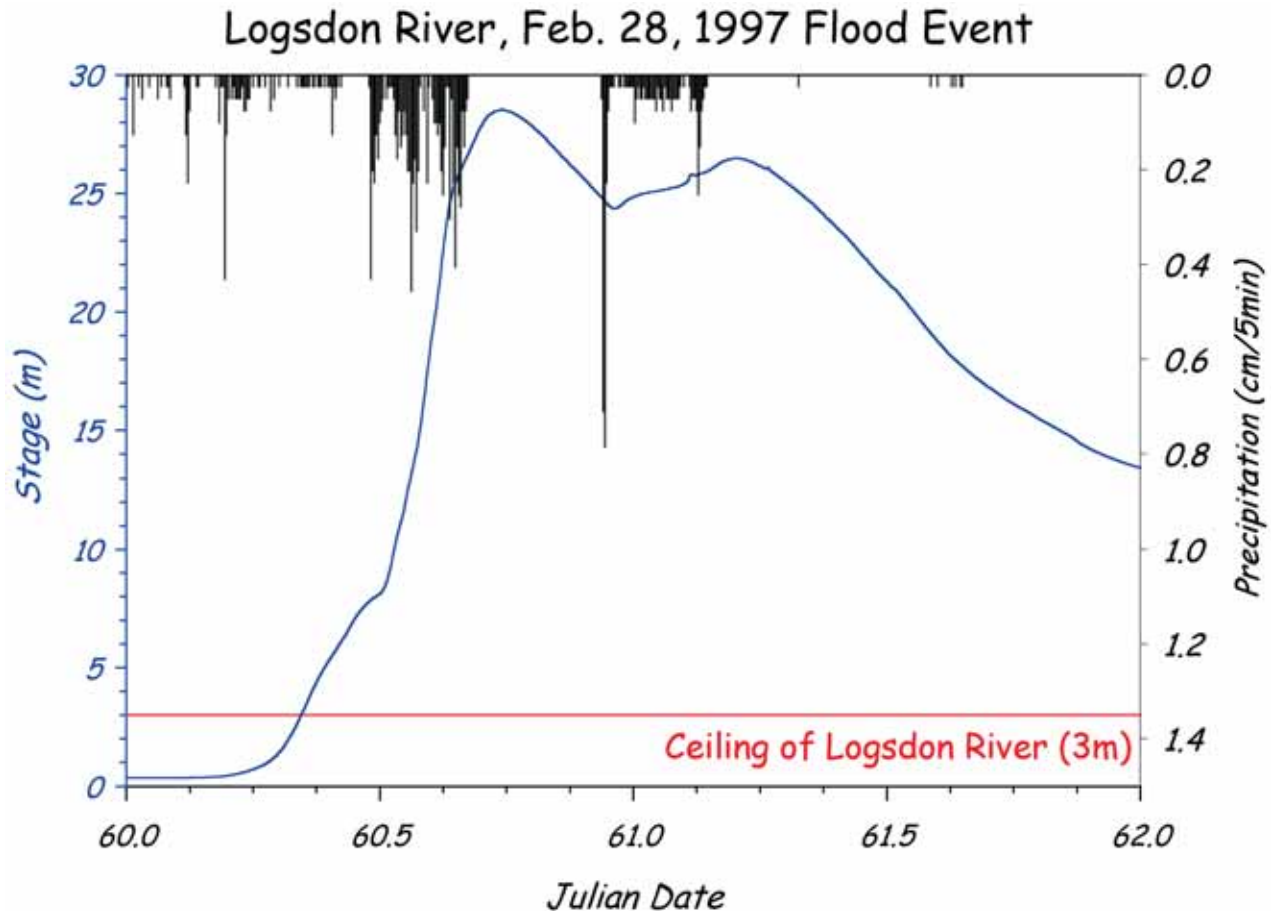
Compared to porous media aquifers, changes in the water table elevations can be quite rapid following significant storm recharge to karst aquifers and, indeed, flooding cave passages can present one of the most significant dangers associated with cave exploration. As an example, the Logsdon River (Fig. 1) is one of the major underground streams of Kentucky's Mammoth Cave System. Its flow has been monitored continuously since 1994 as part of a long-term program designed to understand flow, carbonate chemistry, and water quality changes. Data loggers record the river's stage ( $\pm 0.0001$  m), which is the water table elevation at the monitoring site, with 2-min temporal resolution using probes installed through a set of two 145-m-deep wells. On February 28–March 1, 1997, about 28 cm of rain fell in the area over a 20-hr period.



**FIGURE 1** In the flood water zone. Logsdon River of Mammoth Cave, 150 m beneath the surface, under winter base flow conditions, prior to the February 28, 1997, flood. Note the monitoring well in the center of the photograph.

The stage height of Logsdon River (Fig. 2) rose about 28 m in about 12 hr, not only filling the river passage to the ceiling, but rising upward through the aquifer above the passage, filling all fractures and conduits on the way. At the peak stage height the passage ceiling was under about 25 m of water. A remarkable feature of this flood was the rate at which the water rose, as indicated by the slope of the hydrograph shown in Fig. 2. The water started rising, slowly, with the onset of precipitation, but as the storm progressed, the rate at which the water rose accelerated. At its peak rate, water was rising at about 8 m per hour, rapidly flooding passages and fractures in the part of the aquifer 28.6 m above the base flow elevation of the river. The conduit remained fully filled for the next 8 days.

The analysis of this flood made interesting news for the cave explorers and scientists who frequent this part of the cave system. While it was obvious that the river itself would not be a good place to be during a flood event, the maximum rates of flooding (rising of the water table) did not occur until the stage had reached a level of 8 m above the river's base stage level, coincidental with a second band of heavy precipitation. These higher passages were long ago abandoned by the river as it continued to cut downward into the aquifer and are now generally dry. During the 20 or so years since their discovery that cavers have been visiting those dry upper level passages, which provide an important route to deeper areas of the cave that are still being actively explored and studied, nobody had ever seen water flowing in them. Thus, in the minds of those who had always seen these as dry passages there was thought to be little reason for a person in those areas to feel threatened for their safety, even under reasonably wet conditions. However, if anyone had been in that “rapidly rising” zone of the aquifer at the wrong moment during this flood, from the moment that water was first seen rising from the floor of the passage the water would have been 2 m deep (and over most people's heads)



**FIGURE 2** Logsdon River stage response to February 28, 1997, rainfall event. Note how each series of rainfalls (three) produce separate stage rises. This portion of the river remained pipe-full for 8 days. February 28 is Julian day 60.

within about 15 minutes, and to the ceiling of even the large passages in that part of the cave in less than an hour. While fortunately nobody was, there has been tragic loss of life under similar circumstances, including three deaths in Indiana's Salamander Cave in 1975 and another six in a single flood of a Missouri cave during the historically wet Midwest summer of 1993.

Back in the area of the Mammoth Cave System discussed above, a team including one of the authors (Meiman) traveled through the normally dry overflow passages above Logsdon River, heading into the cave for water quality sampling in a higher level area, on October 10, 2002. In the waning moments of a rainfall event, 9 cm in a 24-hr period, the investigators directly witnessed the dramatic rising limb of the karst hydrograph. En route to Logsdon River via an upper, normally abandoned conduit, flowing water was encountered. The flooding stream filled the 12-m-wide passage, and a fountain of water (0.5 m high and 0.25 m wide) was jetting upward from a hole in the floor. With the experience of having studied the earlier flood, as fascinating as the scene was, the group quickly left the area and climbed safely back upward to the cave's entrance. Numerous other similar stories

are told by cavers who have observed rapid flooding events within caves and survived—some just barely.

### WHAT CAN THE STUDY OF FLOODING TEACH US ABOUT KARST AQUIFERS?

While observations of storm-scale changes of water quality and flow conditions during floods at karst springs have surely been made for thousands of years by those using the springs as water supplies, quantitative analysis of physical and chemical responses became well developed beginning in the 1960s, primarily by observations of spring and surface component behavior and more recently by the development of increasingly sophisticated methods by which storm pulses can be studied to provide information on aquifer structure and behavior. Although much attention has been given to the analysis of the lag times of karst floods using methods altered from the traditional techniques used to study storm pulses in nonkarst surface flow systems, it has also been noted that other properties of flood hydrographs, including lag times following the onset of precipitation, return times to prestorm conditions, and overall hydrograph shapes are related both to

the physical geometry of the interior of the karst aquifer as well as to the distributions of various autogenic and allogenic recharge inputs. Thus, comparing quantitative data of storm inputs and outputs in conjunction can shed light on the aquifer “black box” through which the storm flows are modified as they pass. Complex mathematical analyses of karst spring and stream hydrographs have been developed for data from variety of settings.

Due to the inherent inaccessibility of flooding aquifers, relatively little quantitative data on floods have come from within the underground conduits themselves, although application of automated electronic data gathering using computer data loggers have made this increasingly feasible and as time goes on should revolutionize capabilities to directly measure and understand flood behavior within the interiors of karst aquifers.

Another important observation that has been utilized to glean information on karst aquifer behavior from flood pulse observations is related to the moderate solubility of limestone and the complex biogeochemical interactions with carbon dioxide that take place within karst systems. Various studies show that there is often a significant geochemical evolution of karst waters within residence times required for flow through an aquifer. Thus, observation of chemical conditions in conjunction with hydrologic responses can provide additional tools for probing aquifers. By the combined observation of hydrologic and chemical behavior of a karst spring in Hungary, for example, it was concluded that the variations in water chemistry accompanying storm pulses could be related to the relative contributions of allogenic and autogenic recharge, and methods have been developed to identify the relative contributions to observed flood pulses of storm water recharge and stored water already present within the aquifer prior to the onset of the event. Especially powerful analyses of storm pulses have been made by combining naturally occurring hydrographs along with simultaneous chemical changes, in some cases with floodwaters tagged by artificial tracers including salt and fluorescent dyes.

In the last few decades karst hydrology, which had in previous years been considered by many to be a relatively esoteric branch of the earth sciences, has received increasingly close attention from mainstream hydrologists, as well as planners and developers, because of increasing populations on karst landscapes and the associated environmental challenges that accompany development in karst. Karst flooding is related to two of the most significant: sinkhole flooding and water supply. Many towns on the extensive sinkhole plains of the southeastern United States and other similar areas have flooding problems, even in cases where homes and businesses are distant from surface streams and their floodplains, with urban development in closed depressions. Flooding within such sinkholes, which happens naturally, can be exacerbated by development, which can cause enhanced runoff due to the increase in impermeable surfaces such as buildings and parking lots, as well as

decreased drainage capacity resulting from siltation associated with construction. In some cases, storm water management in such areas has utilized “drainage wells” drilled into the lowest point of a sinkhole, with the hope of hitting a cave or solutionally enlarged joint or bedding plane into which the floodwaters can be injected. Study of such features in Bowling Green, Kentucky, where several hundred such wells have been drilled, shows that while many (but not all) are effective in ameliorating sinkhole flooding problems, they are also associated with problems including aquifer contamination from polluted runoff and increased probability of sinkhole collapse.

## CONCLUSION

Many well-developed karst aquifers, and the cave systems that they contain, are characterized by the rapidity with which changes can occur to flow and chemical changes in response to storm recharge. These changes, in turn, can have a significant impact on the behavior of such flow systems, including the ways in which they allow the movement of water from one place to another, the rates and patterns with which the aquifers evolve, and the movement of other materials, including sediment and contaminants. The analysis of flood hydrographs, along with natural chemical changes and the movement of artificially injected water tracers, has led to the development of sophisticated and powerful tools for the study of karst aquifers.

## Bibliography

- Ashton, K. (1966). The analysis of flow data from karst drainage systems. *Trans. Cave Res. Group Great Britain* **7**, 161–203.
- Crawford, N. C. (1984). Sinkhole flooding associated with urban development upon karst terrain; Bowling Green, Kentucky. In *Sinkholes: Their Geology, Engineering and Environmental Impact* (B. F. Beck, ed.), pp. 283–292. A. A. Balkema, Rotterdam.
- Currens, J. C., and C. D. R. Graham (1993) Flooding of Sinking Creek, Garretts Spring karst drainage basin, Jessamine and Woodford counties, Kentucky, USA. *Environmental Geology* **22**, 337–344.
- Halihan, T., and C. M. Wicks (1998). Modeling of storm responses in conduit flow aquifers with reservoirs. *J. Hydrol.* **208**, 82–91.
- Halihan, T., C. M. Wicks, and J. F. Engeln (1998). Physical response of a karst drainage basin to flood pulses; example of the Devil’s Icebox cave system (Missouri, USA). *J. Hydrol.* **204**, 24–36.
- Jones, G., and J. Gunn (1982). Flood alleviation in the lowland karst area of Mullinahone, County Tipperary, Ireland. *J. Earth Sci. (Dublin)* **5**, 37–42.
- Ryan, M., and J. Meiman (1996). An examination of short-term variations in water quality at a karst spring in Kentucky. *Ground Water* **34**, 23–30.
- White, E. L. (1989). Flood hydrology. In *Karst Hydrology: Concepts from the Mammoth Cave Area* (W. B. and E. L. Whites, eds.), pp. 127–143. Van Nostrand Reinhold, New York.
- White, E. L., and B. M. Reich (1970). Behavior of annual floods in limestone basins in Pennsylvania. *J. Hydrol.* **10**, 193–198.
- Wilcock, J. D. (1968). Some developments in pulse-train analysis. *Trans. Cave Res. Group Great Britain* **10**, 73–98.

# Food Sources

Thomas L. Poulson  
*University of Illinois at Chicago*

## USE OF THE SCIENTIFIC METHOD, CAVEATS, AND TRADE-OFFS

I will use the scientific method to hypothesize that organisms in caves are food-limited and I will use the adaptations of different species to test predictions about the degree of their limitation by food supply. There are a few cave species where organisms which are not so food-limited are exceptions that prove the rule. The species in these food-rich caves show few or no adaptations to food scarcity. At one extreme are caves with abundant food from organic pollution, sulfur-based chemoautotrophy, natural deposits of fossil fuel, or extensive bat guano. At an intermediate scale are areas with nonsoluble ridges above limestone valleys where streams sink at the contact and can carry large amounts of decomposing plant material into caves. At the other extreme are caves in glaciated areas where food supply is variable, but there are few or no cave-adapted species. If they had been present, most became extinct when glaciers covered the caves.

I will explain the trade-offs for supply and kinds of food in caves. These include quantity versus quality, quantity versus risk of injury, and quality versus unpredictability. In addition predictability of food influences whether a species can be a specialist or generalist, and in terrestrial habitats the usability of a food type depends on the moisture of the substrate.

## LIMITED FOOD SUPPLY IN MOST CAVES

### Observations and First Principles

The observed absence of light in caves leads to the hypothesis of food limitation; no light means no photosynthesis. During growing seasons the aboveground world is overwhelmingly green; the amount of all animal life combined is only about 20% of live and dead plant material plus dead plant parts. This is because animals that eat plants or dead plant parts are only about 15% efficient, and animals that eat plant eaters are on average only 20% efficient. This inefficient transfer of energy along a food chain is due to costs of doing business. Costs can include hunting, pursuit, capture, killing, eating, digestion, assimilation, making specific proteins and fats and carbohydrates, and reproduction. Organ system costs are circulation, respiration, excretion, neural processing, and metabolism. Then there are losses of feces and urine. Because the sum of costs go up with steps in the food chain, it should be no surprise that the mass of

organisms must be progressively reduced from plants to herbivores to first order carnivores. In addition, no second or third order predators that live exclusively in caves, especially not endothermic birds and mammals that have very high costs due to heat production and high metabolic rates.

Actually the food limitation in caves is even greater than the above plant-based food chain argument suggests, because food chains in caves mainly start with losses from the above-ground food chains. These losses include death, feces, and urine with additions of the fungi bacteria that decompose them. Even though fungi and bacteria have relatively low costs of doing business, there is, still further energy lost with each species along a food chain of decomposers.

The food limitation in caves should be still greater because the amount, and especially sizes, of organic matter that gets into caves is progressively reduced with depth below the surface. This is because most caves do not have entrances of greater than 1 cm dimension, and those that have bigger entrances have very few of them relative to cave length. Why is this true? Even without the usual soil filter over the limestone the soil moving downward with water tends to plug most of the openings (look at a road cut in limestone). The very small vertical joint cracks in the limestone layers and horizontal bedding plane cracks do not change much in size with depth, except in the rare greater than 1-cm pathways that may enlarge and become a cave.

The restriction on entry of organic matter is even greater because the pathways of greater than 1 cm are convoluted. It is more like a series of pinball machines than a vertical series of sieves of decreasing pore size. Thus we should expect mostly millimeter sized particulate organic matter and mostly dissolved organic matter to be brought into caves by percolating water.

The small amounts of tiny particulate and dissolved organic matter that percolate into most caves are likely to be low in food quality and very slowly used by microorganisms that are the main base of cave food chains. The logic is that the easily decomposed organic matter is eaten, lost by leaching, and used by microorganisms as it moves from the surface through the soil and through decreasing sizes and numbers of openings in the limestone. Soil detritivores, like earthworms, and decomposers, like fungi, “eat” the particulate organic matter. Bacteria use the easily metabolized sugars and other simple organic molecules leached out of particulate organic matter by water. Thus most dissolved organic matter to reach caves without entrances are large and complex molecules like fulvic and humic acids that are metabolized very slowly. The colonies of actinomycete bacteria, which use complex organic molecules and give caves their characteristic musty smell, grow less than 1 mm over decades. As is often true for slow-growing microorganisms, actinomycetes are known to produce antibiotics like streptomycin, which protect them from being eaten.

Even the rare particulate organic matter that is washed or percolates into caves, with the usual centimeter to decimeter

scale entrances, is so thoroughly leached that it is of low food quality and only slowly used. In Mammoth Cave streams, I observed that leached and black particulate organic matter does not disappear over decades between rare 25- to 100-year floods that wash in new organic matter. However, fresh leaf and wood litter entering caves via sinking streams decomposes just as fast as in a surface desert stream. Even in caves with very small entrances fresh sawdust or newly broken pieces of lumber are decomposed so rapidly by fungi and bacteria that they use up dissolved oxygen in the water and can kill even specialized cave organisms with low metabolic rates.

### Species Adaptations Predicted from Hypotheses of Limited Food

If hypotheses about extreme food limitation in caves are correct then one prediction is that cave species with the highest costs of doing business should be both relatively rare and should have many adaptations to cope with a shortage of food. Table I lays out predictions of decreasing adaptations to scarce food with decreasing costs of doing business, decreasing size, and decreasing complexity of organization of organ systems and nervous systems from fish and salamanders to protozoa and bacteria. For each cost bacteria are given a score of 1 and estimates of the increasing costs are given. The least increases are for cellular functions, which should be the same, plus anabolism, where the number of proteins, fats, and carbohydrates increase from bacteria to fish and salamanders. The greatest increases are for locomotion and foraging where the costs increase dramatically with increasing size and complexity. Summing estimated costs gives a range from 4 to 68 for predictions of increased specializations to cope with limited food supply.

Table II shows that predicted specializations from Table I are matched by observed increased specializations to food limitation from bacteria to fish and salamanders in caves. Among species that have evolved from troglolithes to troglo-

bites, from snails and flatworms to fish and salamanders, all appear white and eyeless, but they are increasingly different than their troglolithic relatives and ancestors in their external morphology. Their body builds are less robust with lower weight per length and lower metabolic cost per length, their legs and sensory appendages are longer, and their macroscopically visible sense organs on body and appendages are larger, fancier, more numerous, and more dense. Their internal anatomy, where we can assess it macroscopically, also indicates greater ability to find food from arthropods. Refer to Mohr and Poulson (1966) or to Poulson and White (1969) for drawings of sense organs, such as smell and movement and touch and taste, and primary and secondary processing parts of the brain that process sensory information in troglolithes versus troglobites of amblyopsid cave fish and of crayfish. Their foraging behavior is also more efficient at finding and utilizing scarce food that is patchily distributed in space. Where we have data, troglobites that are hungry move long distances between turns and so increase their chances of encountering an area with food. Once they find a food item their rate of movement slows, their rate of turning increases, and they remain in the area even after they eat a food item because there are likely to be more food items in the same area.

Once troglobites encounter a food item their efficiency at ingesting it and using it also increases from flatworms to fish. Bacteria simply absorb molecules across a cell membrane, and flatworms may catch live prey using their mucus and ingest it by extruding a pharynx. Among arthropods, spiders use a series of webs like a trap line to increase chances of capturing some prey. I suggest that they will have especially potent poisons to subdue the largest possible prey. Among fishes, amblyopsids use many motion sensors on a very large head to detect prey, different touch receptors to contact prey, huge mouths to suck in especially large prey items, and extremely efficient digestion with very fast growth in the rare cases where large prey items are captured and eaten.

**TABLE I** Based on Energetic Costs of Doing Business I Hypothesize that Fish and Salamanders should be Most Limited by Scarce Food in Caves and Bacteria should be Least Limited

Organisms	Locomotion foraging	"Capture" ingestion digestion	Cell circulation costs	Respiration excretion	Sum of costs
Fish & salamanders	30	20	3	15	68
Arthropod predators	20	20	3	10	53
Arthropod detritivores	15	15	3	8	41
Snails & flatworms	6	5	2	4	17
Protozoa	3	2	1	2	8
Bacteria	1	1	1	1	4

Note. Costs are estimated and relative to bacteria that are given a score of 1. Organisms are listed in order of decreasing size and decreasing complexity of organization. The sum of costs is a predictor of degree of food limitation and the adaptations listed in Table II support these predictions.

**TABLE II Troglomorphic Specializations of Kinds of Organisms to Food Scarcity in Caves Support the Predictions from Table I Based on Complexity of Organization and Costs of Doing Business**

Efficiency Specializations	Fish / sal	Arth pred	Arth det	Snail/fw	Prot/bact
<b>Foraging</b>					
Search pattern	++++	+++	++	+	0
Cost of transport	+++	++	++	0	0
Sense append lgth	+++	++	++	+	0
Sense density	+++	++	++	+?	0
Sense kinds	+++	++	++	+?	0 NA
Brain center 1	++++	++	++	+?	0 NA
Brain centers 2/3	++++	+?	+?	0?	0 NA
Assimilation & growth	+++	++	+	0?	0
<b>Metabolic</b>					
Routine	+++	++	++	+	0
Starvation	++++	+++	++	++	0?
<b>Reproduction</b>					
Egg size	++++	++++	+++	++?	0 NA
Parental care	+++	0	0	0	0
Many repetitions	++++	++	+	+?	0
<b>Sum adaptation</b>	45	27	22	11	0
<b>Sum cost (Table I)</b>	68	53	41	17	0

Note. Kind of organisms listed across the table are the same as those down Table I. “Specializations” are adaptations both in terms of efficiency and metabolic economy, and increasing chances of successful reproduction.

**Aquatic and Terrestrial Differences in Food Supply**

Because water flows and dissolves, there are major differences in the variability and predictability of food, in time and space, in terrestrial and aquatic habitats in caves. This is true whether the food input is by abiotic agents such as washing, falling, or blowing into a large entrance or by biotic agents such as commuting by bats or cave crickets. The main difference is in whether the food is diluted and dispersed widely or remains concentrated in a local area. In terms of relative food limitation this means that aquatic cave species will be more limited and more specialized for energy economy than terrestrial species.

A corollary prediction is that aquatic detritivore species should be slower growing and live longer than terrestrial species. Indeed the data show that the differences in longevity are incredibly large with the maximum life span of terrestrial detritivore troglobites (millipedes) on the order of a decade and the maximum life span of aquatic species (crayfish) on the order of a century. The selection for long life is that renewal of the detritus at the base of the aquatic food chain can be rare in time, on the order of decades (e.g., statistically 10-, 20-, or even 50-year floods). With the same food base of plant detritus terrestrial species also get rare pulses of food, but it is left by floods on stream banks and ceilings, so is not progressively leached. Thus it will remain approximately the same relatively high food quality for many years. This means that the most food-limited terrestrial species, like millipedes and bristletails, can grow and complete their life cycles in less than a decade.

**Exceptions that Prove the Rule of Food Limitation in Caves**

There are past and present situations that are both much less food-limited and much more food-limited than most of the limestone caves in today’s temperate zones of the Earth. I consider these at decreasing scales in time and space. The corollary, from earlier logic, is that this should affect the degree of species specialization to food limitation.

Scale across space and over the evolutionary time of glacial cycles there were probably times when less food washed into caves than at present, especially for aquatic species that may have been isolated in caves for tens of millions of years. During both cold–wet periods with glacial advances and during dry–warm periods with glacial retreats, there would have been less food input into caves would have been less. Because the more specialized troglobites are presumed to date from pre-glacial times, present adaptations to food scarcity are some complex result of fluctuating food supplies, with times of greatest food supply “crunches” being most important.

At an intermediate scale across space and over time are contrasts between caves in flatbedded limestones in temperate and tropical regions, caves in flatbedded and steeply folded limestones in temperate regions, and limestone caves and lava tube caves. I have argued that wet tropical caves should be less food-limited than temperate zone caves based on less seasonality, greater rainfall, year-round occupancy by bats in a higher percentage of caves, and faster rates of cave development (with more entrances) in the wet tropics. I still believe that this is a strong hypothesis, but a

Brazilian scientist has argued that the tropics are not uniform. For example, glacial cycles that have had great effects in the tropics and there and both wet and more arid zones are present within the tropics. I concur that data on degree of adaptation to food limitation within a taxonomic group are not yet adequate to support or reject my predictions based on less food limitation in the wet tropics than in temperate zone caves.

The caves in steeply folded and thin strata of the Appalachian Valley and Ridge Province of the United States should be less food-limited than caves in the flatbedded and thick limestones of the Interior Low Plateau Province. This prediction is supported mainly by aquatic species with a greater number of species, greater density of individuals, and higher proportion of troglophile to troglobite species in caves of the Appalachian Valley and Ridge Province. The logic for my hypothesis is that the geology results in more large cave entrances and more regular and greater input of particulate organic matter to valley and ridge caves where the ridge tops are insoluble rocks, like sandstone and shale, and the valley sides and bottoms are soluble limestone with caves. Water flowing off the insoluble ridge tops dissolves entrances where it encounters the limestone, so large amounts of unleached plant organic matter are washed into the caves almost every year. The trade-offs for cave species are that the food supply is reliable (+) and plentiful (+), but that the risk of being dislodged from rock refuges in streams and killed by abrasion or predators is high (-). Under these circumstances short-lived troglophiles, which can take fast advantage of good times and recover quickly after bad times, coexist with more energy-efficient troglobites that have longer life cycles (especially isopod and amphipod species).

The contrast of caves in flatbedded limestones vs. lava tube caves is even more striking and even more strongly supports my overarching hypothesis of the selective influence of low food supplies in caves. Over geological time the changes in food input and limitation are reversed in limestone caves and in lava tubes. As erosion continues over thousands to hundreds of thousands of years, limestone caves become more open to food input and so less food-limited. But unlike lava tubes, we cannot readily date the time of initial formation. The long times prevent us from assessing how adaptations to food scarcity change. In contrast we can exactly date the time of lava tube formation and follow what happens in lava tubes of different ages. Lava tubes are most open to food input soon after sudden formation when they are colonized both by troglophiles and troglobites and population densities are at the highest. Over only tens to hundreds of years both windborne and waterborne sediments fill the larger voids above the lava tubes and abiotic agents introduce less food. Population densities decline and only those species adapted to food scarcity persist.

On a short timescale of one to tens of years organic matter in the form of green “plants” (including blue-green bacteria)

and lint in terrestrial parts of commercialized caves can greatly increase. None of the human-caused input of organic matter like lint, which can be widespread, or algae and moss, which is localized around lights, seems to be eaten by specialized cave species or above-ground native species but alien millipedes occasionally invade and graze algae and mosses around lights even when dense congregations of camel crickets are nearby. Why? I have seen neither outside species, like mice, or any cave species on the plant growth or on lint-covered surfaces, even when there are dense roosts of camel crickets nearby. Why not? One hypothesis is that these kinds of organic matter are of poor food quality. Certainly blue-green bacteria and mosses are heavily defended because few or no herbivores eat them above ground, and much of lint is synthetic fibers that are complex and either not decomposed or slowly decomposed. A weaker hypothesis is that extensive modern human visitation of caves is only about 100 years old, so no species have had time to evolve to utilize either lint or green photosynthesizers associated with extensive human visitation. Still another, not mutually exclusive hypothesis, is that long-lived troglobites avoid areas because their predators are also attracted. Long-lived terrestrial troglobites must spread their risk of reproductive failure over many years and so anything that might lower the chances of successful reproduction, such as increased predation risk, is avoided.

Pollution of aquatic habitats by decomposable organic matter can occur across a large spatial scale, everything downstream of the input point, and its effects of decreasing the diversity of cave species occur on a short timescale, often within weeks or months. This is the same pattern seen outside of caves where a huge abundance of only a few species of short-lived and low-oxygen-tolerant species replaces a much lower abundance and much higher diversity of species that are not tolerant of low oxygen. Whether above or below ground, the food base with pollution is colonial sewage bacteria and the only animal may be tubificid worms. Oxygen is low because the biological oxygen demand is high when bacteria and fungi rapidly decompose of large quantities of organic matter by bacteria and fungi. This may not explain why energy-efficient troglobites do not still occur, because they have very low metabolic rates and so should be able to live where oxygen is low though probably not at the extremely low oxygen concentrations where sewage bacteria survive. Other relevant observations are of the path of community recovery when input of excess decomposable organic matter, like human or animal wastes, is stopped. First the sewage bacteria and worms are replaced by somewhat longer lived and more energy-efficient troglophiles like crayfish and isopods. Then, after sewage bacteria and worms disappear. Then the area is recolonized by long-lived and energy-efficient troglobites, the troglophiles become rare, and the original diversity of species is restored. The temporary dominance of troglophiles suggests that either the demographic pressure of faster reproducing species or interference

competition by the troglaphiles (low-metabolic-rate troglobites should win with competition based on energy efficiency) may explain the dominance of troglaphiles when oxygen is not limiting. Still, another hypothesis is that pollution by decomposable organic matter is often associated with pollution by toxins and that, compared to troglaphiles, troglobites are especially compromised by bioaccumulation of toxins over their much longer life spans. Whatever the explanation, the changes with organic pollution underscore the usual food limitation in caves and the needs for adaptation to scarce food by troglobites.

**FOOD SOURCES AND FOOD TYPES, ESPECIALLY IN TERRESTRIAL HABITATS**

In this section I deal with the differences between input by abiotic agents and biotic agents and the more striking results of different kinds of biotic agents of input in terrestrial than in aquatic habitats. I start with aquatic versus terrestrial contrasts for the same food sources and types, proceed to terrestrial extremes of food types, and end with a detailed look at different fecal types of biotic input in terrestrial habitats.

**Aquatic versus Terrestrial Contrasts for Extremes of Food Quality**

As Table III shows, hypothesized differences in variability and predictability of food on land versus in water depend on whether there is abiotic input by water or biotic input by troglaxenes. There are opposite in common trade-offs for land and water for quantity versus quality of abiotic and biotic inputs. On the minus side for plant detritus a combination of surface decomposers and leaching by water usually removes all but the compounds most recalcitrant to digestion, so bacterial and fungal decomposers are also much reduced. On the plus side with 10- to 100-year floods, espe-

cially in a few places near cave entrances, renewal of unleached detritus may “feed” the cave communities for another 10 to 100 years. Even leached wood, twigs, and leaves decompose slowly in caves because they are mostly lignins and cellulose that only some bacteria and fungi can digest, and very slowly at that. Once the detrital pieces get small enough to be eaten by worms, amphipods, and isopods, the rate of decomposition is enhanced. The reason is cycles of bacteria-fungi-protozoa biofilm buildup, ingestion of pieces and digestion of the biofilm by animals, egestion of now smaller particles, and recolonization of pieces by biofilm organisms. As the size of pieces decreases in this cycle the surface area to volume increases and decomposition slowly accelerates.

For biotic input by troglaxenes the quantity of food is less (-) but the quality of food is much greater (+). In addition biotic input is much more predictable (+) both in time, every year and every month, and in space, usually near entrances and in the same spots. However, these advantages are much less when inputs are over water, as seen in column two of Table III.

In water, leached feces of troglaxenes are not much higher quality than leached plant debris, and both become diluted and dispersed over wide areas. The only advantage of this reduction in quality is that a little food occurs everywhere and is easy to find. Consumers of this low-quality food must be very efficient digesters and are thus slow-growing and are probably long-lived. They also must be opportunistic omnivores. Species that have predatory ancestors, especially fish and salamanders, will get some benefit from eating detritus with a biofilm if their preferred food of copepods, isopods, and amphipods is especially scarce. Species that have herbivorous or detritivorous ancestors, such as crayfish and isopods, will greatly benefit from eating occasional live prey. All of this yields little opportunity for specialization of relatively few species.

**TABLE III Trade-offs (+ and -) of Food Variability and Predictability in Caves: How Quantity and Quality Vary in Space and Time**

In common trade-offs water and land	Water trade-offs for food	Land trade-offs for food
Abiotic input (mostly water)	Abiotic input	Abiotic input
+/- Occurrence	+ Gets everywhere	- Localized
+ Moderate quantity	- Low densities	+ Locally high
- Low quality (leached)	- Continued leaching	+ May avoid
+/- Renewal predictability	+/- Not every year	- Rare
+/- Successional communities	- None	+ Some
Biotic input (troglaxenes)	Biotic input	Biotic input
- Occurrence regionally	+/- Not everywhere	+ Localized
+/- Occurrence in a cave	+/- Not everywhere	+ Localized
+/- Mostly low quantity	- Dilution	+ Stays in place
+/- Quality	- Only leached feces	+ Feces + others
+ Renewal predictability in cave	+/- Moderate	+ Yearly

Note. Abiotic input is by flowing water, wind and gravity whereas biotic input is by troglaxenes like bats, pack rats, and cave crickets. The kinds of biotic input are feces > dead bodies > eggs. Match columns 2 and 3 to descriptors in column 1.



### Terrestrial Extremes of Food Types: Leaves, Feces, Dead Bodies and Cricket Eggs

Many more species are on land because they have opportunities for specialization and almost no minus trade-offs (Table III, last column). With less leaching, food quality is higher. Food quality varies from partly leached litter, to feces, to dead bodies, to eggs. With no dilution, input stays where it is deposited, and this makes the food input more predictable in time and space. I will explore the consequences of these on-land advantages in the next section, but suffice it to summarize here that a high diversity of terrestrial cave species occurs for four reasons (Table IV): (1) There are many food types with a wide range of quality and quantity; (2) within many food types there is a heterogeneity of digestibility for different components and so successional replacement of species during decomposition; (3) predictability in time and/or space at, within, and among cave scales allows some species to specialize (with narrower niches more species can coexist); and (4) there is different usability of the same food types because of interactions among microhabitat and moisture.

**EXTREME FOOD TYPES IN TERRESTRIAL CAVE HABITATS** In Table IV I contrast aspects of food type and aspects of the species that are expected to use each type. Quality of food includes both caloric density and digestibility as indexed by carbon to nitrogen ratio. Predictability of food

**TABLE IV Extreme Food Types in Caves on Land: How Food Traits Influence the Ecology and Life History of Species that Eat Each Type and How this Influences Species Diversity**

Traits/Hypotheses/ Diversity	Twigs & leaves	Feces	Dead bodies	Cricket eggs
<b>Food type</b>				
Caloric density	Low → very low	Moderate	High	Very high
Digestibility	Low → very low	Moderate	High	Very high
<b>Occurrence</b>				
Among caves	High	Moderate	Low	Very low
Within a cave	High	Variable	Low	High
Amount per area <sup>b</sup>	Very high	Variable	Low	High
Renewal rate	Very low	High	Low	High
Monopolized?	No	Variable	If small	Yes
<b>Species hypotheses</b>				
Specialization?	No	Variable	No	Yes
Life span	Long	Variable	Short	Short
<b>Species diversity</b>	High	Variable	Low	Very low

Note. Digestibility is largely determined by the nitrogen to carbon ratio: If there is a range of digestibility then there can be a range of species that use it, a food type so these will replace one another during successional decomposition.

<sup>a</sup>As shown in Table V there are many kinds of feces, so the traits are variable.

<sup>b</sup>Amount per area is at locations within a cave where the food type is present.

type includes both frequency of occurrence within and among caves and amounts where it occurs. These food type traits lead to hypotheses about the likelihood that species will specialize to use each type. At one extreme are variably leached leaves and twigs that are low in quality but high in amount; for this type I predict consumers with little specialization and long life spans. At the other extreme are cricket eggs that are high in quality but low in amount; for this type I predict consumers with great specialization and short life spans. Corollaries of my primary predictions are secondary predictions about the diversity of species likely to use each food type. I predict the highest diversity of consumer species for litter because it is most heterogeneous, can undergo very slow decompositional succession by different species, and has a low renewal rate. Its lowest quality components can last for many years, often decades, and cannot be monopolized by one or a few species. I predict the lowest diversity of species for cricket eggs because they are homogeneous, have no successional use, have a yearly renewal rate, and can be monopolized by one species. This is a more specific case of the generalizations discussed above for cave species in general. Thus if food is of low quality and low renewal rate, in our example litter, we expect species generalization with the plus and minus trade-offs of a jack-of-all-trades but a master of none. We expect the opposite trade-offs for a specialist that is favored by food of high quality and regular renewal, like our example of cricket eggs. These predictions are best supported by extensive data on the most specialized cave species I know, namely carabid beetles that specialize in eating cave cricket eggs.

A cricket egg is a real prize that can be quickly eaten by one beetle of about the same size as the egg, the ultimate in monopolization of and energy return from a single food item. A beetle spend only 10% of its time digging up 0 eggs, but 90% of its energy digging, so it is not surprising that a beetle defends its ongoing investment of digging and the egg prize to be. In fact the deeper the hole, and the closer the hole depth the more aggressively a beetle defends the hole. Once a beetle digs up an egg it runs with it until it is in a place safe — under a rock, up the wall or on the ceiling — from other beetles that will try to steal the egg because this is much less expensive than digging up its own egg.

Given the payoff it is not surprising that beetle predators of cricket eggs have sophisticated searching behaviors. First, they slow their rate of walking and increase their rate of turning when on the silt or sand substrates where cave crickets lay the overwhelming majority of their eggs. Second, beetles dig in spots where crickets have raked silt or sand into tiny mounds over the egg-laying site and avoid the holes that a cricket makes to test the suitability of a site by inserting its ovipositor. The beetles may recognize an egg mound not only by texture but also by the raking removing beetle scents left as they forage for eggs. Third, the beetle digs only to a depth equal to that of the cricket's ovipositor, because if there is no egg at that depth there will be none deeper.

An even stronger support for my predictions of specialization to eat cave cricket eggs is the convergent evolution of this habit among at least five different species of carabid beetles that eat eggs of at least three different species of cave crickets. In each case the cricket egg is 8 mg and in most cases closely matched to the weight of the beetle. Also, each beetle species chooses a substrate habitat of silt or sand closely matched in moisture content to that best for cricket egg development. In each case the beetle's life history is closely matched to the seasonal cycle of cricket egg laying. As predicted in each case, the egg can be monopolized by one individual beetle in only one species of egg eater.

As with cricket eggs, another food item that is high in quality and can potentially be monopolized is dead bodies. Corpses that are too large to be carried away by scavengers are usually at the bottom of deep pits where surface species can blunder in and fall to their deaths. This is rare within and among caves, and we have no data to suggest that any cave species even has this food item as part of its regular diet. On the other hand, under maternity colonies of bats that number in the thousands (e.g., gray bats) to millions (free-tailed bats), baby bats regularly fall from the ceiling and are quickly eaten by hordes of small scavengers, especially dermestid beetles and camel crickets. Tiny corpses that can be carried away, are rarely seen in caves because we predict that they are carried away by scavengers. In fact, if we incapacitate or kill a small beetle or cricket and watch, we see that either beetles or crickets of the same species as the food item almost immediately find it and carry it away. Thus in this case the dying or dead species does not support any more species to the cave community; it merely enlarges the feeding niche of existing cave species that we predicted should be opportunistic feeders.

At the opposite extreme are food types that cannot be monopolized and have a high diversity of consumers, especially leaf and twig litter of very low quality and large piece size. Recall that I predicted (Table IV) that the low quality and low predictability of renewal with very long times for decomposition, often decades, would prevent monopolization or specialization and might support a relatively high diversity of cave species. Also, relatively undecomposed litter is carried into caves only by infrequent floods (e.g., 20- to 50-year events) and avoids continued leaching only if deposited at the extreme high watermark on ceilings or high on stream banks. Only there is it available as a moderately high quality food source every year for terrestrial cave species. In such situations many generalist species make up the cave community. Among eaters of fungi and bacteria, either grazed on or digested off of as a biofilm, are primary consumers such as springtails, bristletails, and millipedes. Predator generalists that eat the primary consumers include daddy longlegs, spiders, pseudo-scorpions, carabid beetles, and various mites. All of the following species have relatively long lives for terrestrial species. Springtails live for several years and millipedes like for a decade. Primary and secondary

consumer predators live carabid beetles live for several years and Linyphiid spiders for more than a decade.

So we see that my predictions for the extremes of terrestrial food types (Tables III and IV) are upheld, but the real test of the generality of my predictions is to look at an intermediate food type that has a wide range of food qualities and quantities, i.e., feces.

**A PLETHORA OF FECAL TYPES** In terrestrial habitats, of all the biotic inputs of food to caves by troglodytes their feces and the usability of their feces are most different and offer the greatest number of feeding niches for cave animals. It can be said that you are what you eat and your feces reflect even more what you eat. Consider, as a human omnivore, your own feces when you eat hot spicy food compared to salad compared to meat and potatoes (the cave community would be incredibly richer if humans lived in caves). In addition, the usability of any one fecal type can vary with its predictability in time and space and with the moisture of the substrate where it is deposited. Is it, as in Goldilocks, too wet, too dry, or just right? Thus if, like Doctor Doolittle, we could question cave species about food they would tell us that cave species have an incredibly rich vocabulary for feces. Their vocabulary for feces is every bit as rich as the vocabulary of Inuit Eskimos for frozen water, which includes words for different forms and amounts of snow and ice. As for Eskimo survival as related to snow and ice, cave animals would tell us how different forms and amounts of feces are critical for niche separation of cave species that feed on the feces of raccoon, pack rat, bat, cave cricket, and cave sand beetle (Table V).

In Table V, I consider how quality, quantity, and predictability of feces lead to hypotheses and predictions about whether cave species specialize on one fecal type and whether distinct communities of species are associated with each fecal type. For quality the most important component is ease of digestibility and the heterogeneity of the fecal producer's diet. For quantity, where feces occur, turd size, numbers of turds per day, and spatial dispersion (e.g., random or clumped) are important. Predictability includes spatial and temporal occurrence within and between caves as well as abiotic constraints on whether the feces are dried or leached making them less useable. Quality, quantity, and predictability of feces together lead to opposite predictions for whether a species will specialize on a single fecal type and whether a diverse community of species will be associated with a single fecal type. The best predictors of species specialization are high quality, homogeneity of quality, and high predictability in time and space, e.g., fresh bat feces at the top of a pile of guano under maternity roosts. The best predictors of species diversity are heterogeneity of quality, which leads to successional replacement of species, and large quantities, which leads to different species using different densities of feces, e.g., from the top of to areas beyond the periphery of a pile of bat guano under a maternity roost.

**TABLE V** On Land in Caves there can be a Diversity of Fecal Types and so there should be a Diversity of Species Eating Feces.

	Raccoon	Pack rat	Bat <sup>a</sup>	Cave cricket	Sand beetle
<b>Fecal traits</b>					
Quality					
Caloric density	High	Moderate	Low	Very low	High
% Easily digestible	50	30	20	60	70
low digestibility	Hair, seeds	Hair, wood	Chitin	Little	None
Diet heterogeneity	High	Moderate	Low	Low	Very low
Quantity where it occurs					
Turd size mg	13,700	60	20	5	0.1
Turds per day	10	20	50	5	5
Spatial dispersion	Random	Latrine	Roost → fly-by	roost → walk-by	Under rocks
Predictability					
Among caves	20%	30%	10%	90%	70%
Area within cave	10%	5%	30%	40%	15%
Seasonality	Moderate	Little	Great	Little	Little
Drying risk	Winter	Usually	Little	Rarely	None
Leaching risk	None	None	None	Moderate	None
<b>Predictions / tests</b>					
Species specialization					
To fecal type	No	A little	Yes	Yes	Yes
To microhabitat	No	Rocks, dirt	No	Rocks, dirt	Sand, dirt
Species succession					
	Yes	Yes	Yes	A little	No
	a lot	depth	depth		
Species diversity	++	+++	++++	+++	++

Note. For each fecal type there should be increasing specialization of feeding with increasing predictability and quality of the feces but decreasing diversity of species. These data, predictions, and tests are from the Interior Low Plateau of east central United States and for Texas and New Mexico.

<sup>a</sup>Bats are insectivorous species.

Because maternity colonies of bats are rare, the overall specialization of species to using bat feces is relatively low. What of other fecal types? We will now consider each type in summary. For details about communities associated with each fecal type, especially bats with completely different diets (fruit and blood in the tropics in addition to insects in the temperate zone) see Poulson and Lavoie (2000).

Raccoon feces should not support specialist feeders but its heterogeneity in quality and low predictability should allow use by a wide variety of species at the community scale. Raccoons rarely wander into caves and are only rarely found far from entrances. On this basis we should predict only generalist opportunistic feeders on feces. In fact, in early stages of decomposition in summer there can be domination of the most easily digestible components by dense squirming masses of maggots of sphaeroцерid flies that usually have a wide feeding niche and are not abundant. With fresh raccoon feces the large size of individual turds and a tangling of turds in piles allows maggots to best do their collective facilitative behavior with an abundance of external digestive enzymes and increasing the rate of development allowed by generation of body heat. As successional decomposition proceeds, with less and less digestible components available, larvae of scavenger and fungal-eating species become the most common. At the end of decomposition, when the only major components are nearly undigestible raccoon hair and seeds, there is an even larger variety but a very low density of very

small generalist feeders. These can use tiny and scattered amounts of remaining digestible components and include springtails, mites, and scavenger beetle adults.

In winter the community using raccoon feces has few if any animal species but all major size classes of fungi. Low temperatures and dry conditions just inside cave entrances preclude use by most animals that in summer eat fungal hyphae or disrupted hyphal networks in the process of feeding so that fungi could not accumulate enough energy to produce increasingly large fruiting bodies from phycmycetes to ascomycetes to the mushrooms of basidiomycetes.

In contrast to the random deposition of raccoon feces in place and time, pack rats have fecal latrines that can be in the same spot for decades, centuries, and even millennia. Consequently we might predict that many cave species could specialize on this fecal resource; however, they do not. Let us consider why not. The problem is that pack rats occur in few caves, regionally and locally, and where they do occur their latrines are usually in very dry entrances where, at best, only fungi can do well as users of feces. Because pack rats urinate elsewhere, e.g., as one way of scent marking trails in and out of the cave, there is no mitigation by urination of dry conditions as can occur with bats that almost always urinate over their fecal piles in caves.

In cave entrances that have moist microclimates pack rat fecal latrines have a rich community of fecal users. The piling of pellets helps to create a stable microclimate which buffers

variation in the cave microclimate and collectively creates a resource with low surface area to volume. The largest latrines have a spatial zonation, from pile top where fresh feces are deposited daily to pile edges where both fresh and old feces are scattered as a mosaic. A large species of fungus gnat grazes fungi on the freshest feces and a smaller species of fungus gnat eats a combination of fungi and bits of feces deeper in the pile and toward the periphery. Still deeper in the pile the feces are only powder consisting of mostly hard to decompose lignin and cellulose. Use of partially intact feces at the periphery depends on whether the substrate is rock, mud, or sand. On rock there is a smelly slurry of soluble nutrients with domination by saprophytic mites that can tolerate the low oxygen. On mud there can be large numbers of two species of springtail and a few predatory pseudo-scorpions. On sand most nutrients are leached and there are more species with no dominance. Thus the overall diversity of species using piles of rat pellets depends on depth in the center and the substrate at the periphery of the piles.

As with rat feces, sand beetle feces are localized and their use depends on the substrate; the difference is that sand beetle feces are much more predictable because there are so many areas where cave crickets lay eggs eaten by sand beetles. Thus we might predict some specialization in use of their feces. As I explained previously, a 5-mg cricket egg is a huge meal for a 7-mg sand beetle, and the successful beetle usually retreats under a rock to prevent another beetle from stealing the egg. Under the rock the beetle ingests the egg and urinates and defecates as it digests the egg over a 1- to 2-week period. Which community of consumers and their predators that use the feces depends on whether the rock is on a sand or silt–mud substrate. On silt the main consumers are scavenger beetles and springtails and both mites and pseudo-scorpions are predators. On sand the main consumers are bristletails, springtails, and mites and spiders are the main predators.

The feces of insectivorous bats can be like rat feces in occurring in piles, unlike rat feces in having no substrate constraints, and like raccoon feces in having rare places in which piles occur. In the rare caves with heat traps and adequate moisture where free-tailed or gray bat maternity colonies exist, the piles are so large that they create their own microclimate and the substrate is not an important constraint on use by cave animals. The microclimate requirements are so exacting that maternity colonies occur in fewer caves than rare hibernating roosts or transient colonies. The maternity colonies have stayed in the same caves for decades and probably centuries, and so it has been possible for some cave animals to specialize on this locally superabundant food resource. When mother bats are nursing in a maternity colony the input of feces and urine is prodigious, and the surface of the guano pile can be a seething mass of varying combinations of mites, springtails, and camel crickets. These feed both directly on feces and urea from urine and also indirectly on the bacteria and fungi that metabolize feces and

urine. As detailed in Poulson and Lavoie (2000), the animals using feces in huge piles of bat guano vary with depth in the pile and with decreasing density of feces from the center of the pile to the periphery. This zone blends into a fly-by scattering of fecal pellets analogous to the walk-by scattering of fecal splotches of cave crickets away from their entrance roosts.

Cave cricket and bat feces share a huge spatial variation in local density from areas under roosts to walk- and fly-by scatterings of turds on the way to and from near-entrance roosts. In both cases the higher diversity and more adaptation to food scarcity occurs from the periphery of roosts to the much less dense feces and lower renewal rates in fly- and walk-by areas. The difference is that cave crickets occur in almost every cave within their geographic range so a more predictable community is associated with the cricket's scattering of feces.

Unlike the huge piles of bat feces under maternity roosts, the veneers of feces under cave cricket roosts are another example of the Goldilocks principle for substrate moisture; it should be not too wet or too dry to be used by the highest diversity of cave animals. If the substrate is steeply sloped with lots of drip water from speleothems then leaching removes what little nutrients are in the feces. If the substrate is too dry, e.g., due to air movement in cold and dry winter microclimates, then only fungi can use the feces. The most diverse communities with highest densities of each species are found on flat rocky areas with the locally deepest veneers of fresh feces such as under protected ceiling microhabitats of mini domes. In these areas a common and rare specialist cave snail is found as well as other specialists including a millipede and two mites as consumers and a pselaphid beetle and web worm as predators. On both mud and rock substrates oligochaete worms may preempt the feces, and on sand the feces can be used only if there are incredible if rates of fecal input are high enough to create crusts that buffer the local moisture microclimate.

### Cave Crickets as Key Industry Species

Cave crickets are key species by virtue of their high frequency of occurrence, high densities where they occur, and high impact per individual as the largest terrestrial cave invertebrate. Within their geographic range they are found in virtually every cave with high densities in roosts just inside cave entrances. They are the basis for three separate cave communities. At entrances they go outside to feed about every 10 days and return to their roosts where they digest crop contents that may be 100–200% of their body weight. As they digest they defecate and one community depends on this fecal input. Adults crickets walk from entrance roosts to reproductive areas deep in the caves and defecate along the way. The walk-by feces they deposit, at very low densities with infrequent renewal, are the most important and reliable energy source for the most energy-efficient terrestrial species

in the cave. The eggs they lay in sand and silt areas are eaten by carabid sand beetles, and beetle feces are the basis for the third cave community that depends on cave crickets. Cave crickets are not only key species in several of the karst areas of the United States but also in parts of Europe and perhaps in Asia and South Africa.

### *See Also the Following Articles*

*Adaptation to Low Food • Guano Communities*

### **Bibliography**

- Culver, D. C. (1982). *Cave Life: Evolution and Ecology*. Harvard University Press, Cambridge, MA.
- Culver, D. C., T. C. Kane, and D. W. Fong (1995). *Adaptation and Natural Selection in Caves: The Evolution of Gammarus minus*. Harvard University Press, Cambridge, MA.
- Griffith, D. M., and T. L. Poulson (1993). Mechanisms and consequences of intraspecific competition in a carabid cave beetle. *Ecology* 74(5), 1373–1383.
- Mohr, C. E., and T. L. Poulson (1966). The Life of the Cave. *Living World of Nature Series*. McGraw-Hill, NY.
- Palmer, A., and K. Lavoie (2004). *Introduction to Speleology. Cave Books*. Cave Research Foundation, Yellow Springs, OH.
- Poulson, T. L. (1992). The Mammoth Cave ecosystem. In *The Natural History of Biospeleology*, (A. Camacho, ed.), pp. 569–611. Museo Nacional de Ciencias Naturales, Madrid, Spain.
- Poulson, T. L., and K. H. Lavoie (2000). The trophic basis of subsurface ecosystems. In *Ecosystems of the World 30: Subterranean Ecosystems*, (H. Wilkens, D. Culver, and W. Humphreys, eds.), pp. 231–250. Elsevier, Amsterdam.
- Poulson, T. L., and W. B. White (1969). The cave environment. *Science* 165, 971–981.

## Friars Hole Cave System, West Virginia

**Stephen R. H. Worthington**

*Worthington Groundwater*

**Douglas M. Medville**

*West Virginia Speleological Survey*

The Friars Hole System, in Greenbrier and Pocahontas Counties, West Virginia, is the largest cave, in terms of surveyed passage (72.7 km, or 45.2 miles), in both the Valley and Ridge and Appalachian Plateaus Provinces in the eastern United States. The cave's geological setting, in moderately faulted and gently dipping Mississippian limestones, is in the midpoint of a range of Appalachian cave settings, from those found in flatbedded unfaulted carbonates to the west, in the Cumberland Plateau, for example, to those in the more highly faulted and folded limestones in the Valley and

Ridge Province to the east; for example, Burnsville Cove in Virginia.

As such, Friars Hole Cave System is an excellent example of a large cave, the development of which has been influenced by minor structures such as low angle thrust faults and the availability of competing flow paths to two regional base level springs 20 km apart. As a result, this system has a complex hydrological history and a plan view that reflects both abandoned flow paths and currently active internal drainages within the cave system.

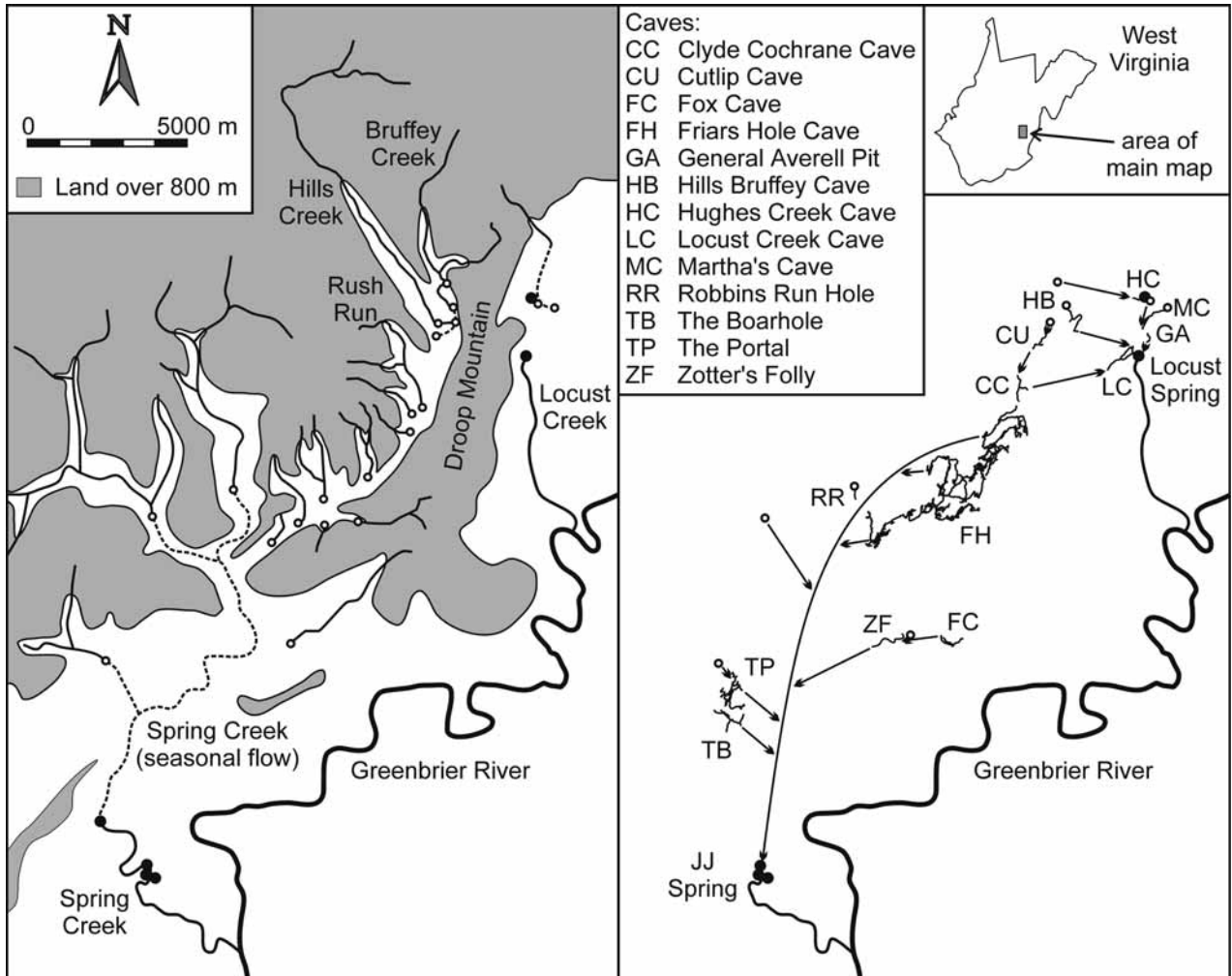
### **SETTING OF THE CAVE**

#### **Location**

Friars Hole Cave System is located close to the boundary between the Valley and Ridge and Plateaus Provinces of the Appalachian mountains. Friars Hole itself is a 150 m deep, dry valley between the summits of Droop Mountain and Jacox Knob, which are 850 m asl. Friars Hole extends for 13 km from the sinks of Bruffey Creek and Hills Creek in a southerly and southwesterly direction to Spring Creek (Fig. 1a). Sandstones, shales, and minor limestones of the Mississippian Mauch Chunk Series underlie these summits and the valley sides, but there is a series of inliers of Union Limestone along the valley bottom (Fig. 2). Streams flowing onto the limestone sink soon after reaching it, and the entrances to Friars Hole Cave System are found there. A number of these sinking streams feed active stream passages within the cave, which underlies a 6-km length of Friars Hole. Much of the cave lies under the nonkarstic flanks of the valley, with passages lying up to 185 m below the surface.

#### **Hydrology and Hydrogeology**

Hills Creek is the largest sinking stream along Friars Hole and its hydrology is complicated. At low flow it sinks completely in its gravel bed and is seen in succession in Cutlip Cave, Clyde Cochrane Cave, and Friars Hole Cave System where it forms Rocky River, the largest stream in the cave (Fig. 2). At high flow that part of Hills Creek which does not sink in its bed continues on the surface for 500 m beyond the main sink and enters Hills-Bruffey Cave. This also takes the high flow discharge from Bruffey Creek. Hills-Bruffey Cave drains to the east to Upper Hughes Cave, Lower Hughes Cave, Martha's Cave, General Averell Pit, and finally Locust Creek Cave, which is the cave at Locust Spring on the east side of Droop Mountain. In very high flow conditions the water backs up at the entrances of Hills-Bruffey Cave and overflows on the surface to its final sinkpoint at Cutlip Cave. From here it flows south through Clyde Cochrane Cave and then through the Friars Hole Cave System via Rocky River and rises at JJ Spring on Spring Creek, 19 km to the southwest of the Cutlip Cave entrance (Fig. 1b). The next sinking stream to the south of Hills Creek is Rush Run, and like Hills



**FIGURE 1** Topography and hydrology of the Friars Hole area. Friars Hole is the dry valley between the sinks of Hills Creek and Spring Creek (a). Mapped caves in the drainage area of Friars Hole. Arrows represent traced flow paths of cave streams (b).

Creek and Bruffey Creek, it has part of its discharge flowing to Locust Spring and part to JJ Spring.

The streams that sink directly into Friars Hole Cave System all drain to the southwest to JJ Spring. This spring drains some or all of the flow from an area of 265 km<sup>2</sup>, and the streams draining via the known cave in Friars Hole Cave System account for only a third of this discharge (Fig. 1). JJ Spring is located on Spring Creek, which flows across the Union and Pickaway limestones for several kilometers. At low flow both Spring Creek and its tributaries sink in their beds on reaching the Union Limestone, and the bed of Spring Creek is dry for 13 km. At high flow the sinks are overwhelmed and there is flow along the length of Spring Creek (dashed line in Fig. 1A). There must be an extensive cave system underlying Spring Creek and its tributaries. One fragment of this is seen in Robbins Run Hole, most of which lies 25 m below the bed of Robbins Run. A second, flooded, fragment has been explored at Circulating Cenote, one of the

springs for the Friars Hole Cave System. Several other caves have been explored between Friars Hole Cave System and JJ Spring including Fox Cave, Zotter's Folly, the Portal, and the Boarhole, but these are all located on the flanks of Spring Creek rather than directly under the creek. (Fig. 1b).

Although JJ Spring is the perennial spring for Friars Hole, there are also three nearby overflow springs, the Cannon Hole, the Circulating Cenote, and Dale's Spring. The Cannon Hole is, in fact, called an estavelle because at low flow it absorbs the surface flow of Spring Creek. The complexity seen at the springs of the Friars Hole Cave System is common in karst aquifers; here distributaries are common where conduit systems discharge to the surface. Furthermore, the pattern of one perennial spring plus several intermittent overflow springs is also common. It is likely that the drainage to JJ Spring and the associated springs follows a single large conduit for most of the distance between Friars Hole and the springs, as shown in Fig. 1b.

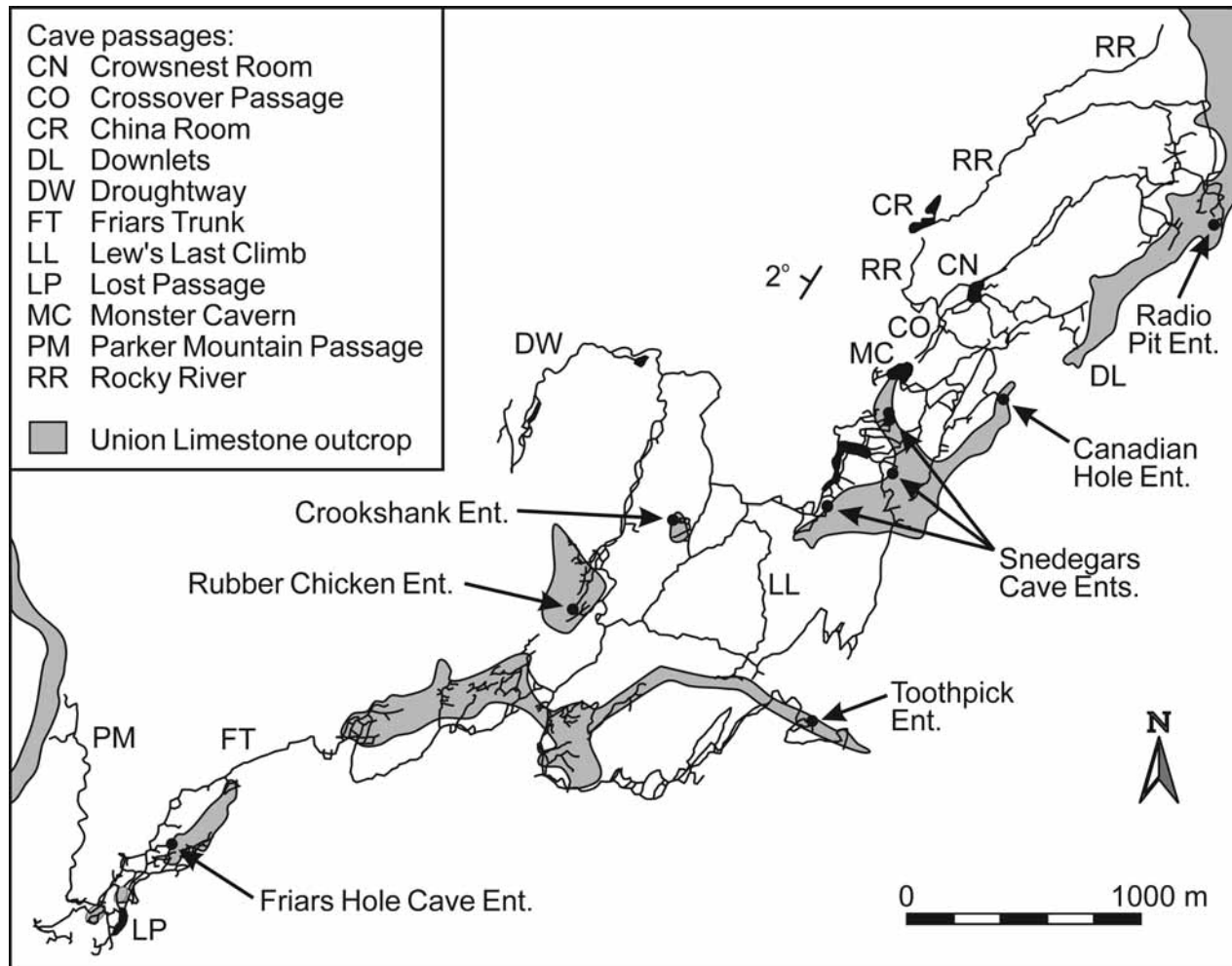


FIGURE 2 Cave passages of Friars Hole Cave System showing the relationship to surface outcrops of limestone.

### Geology

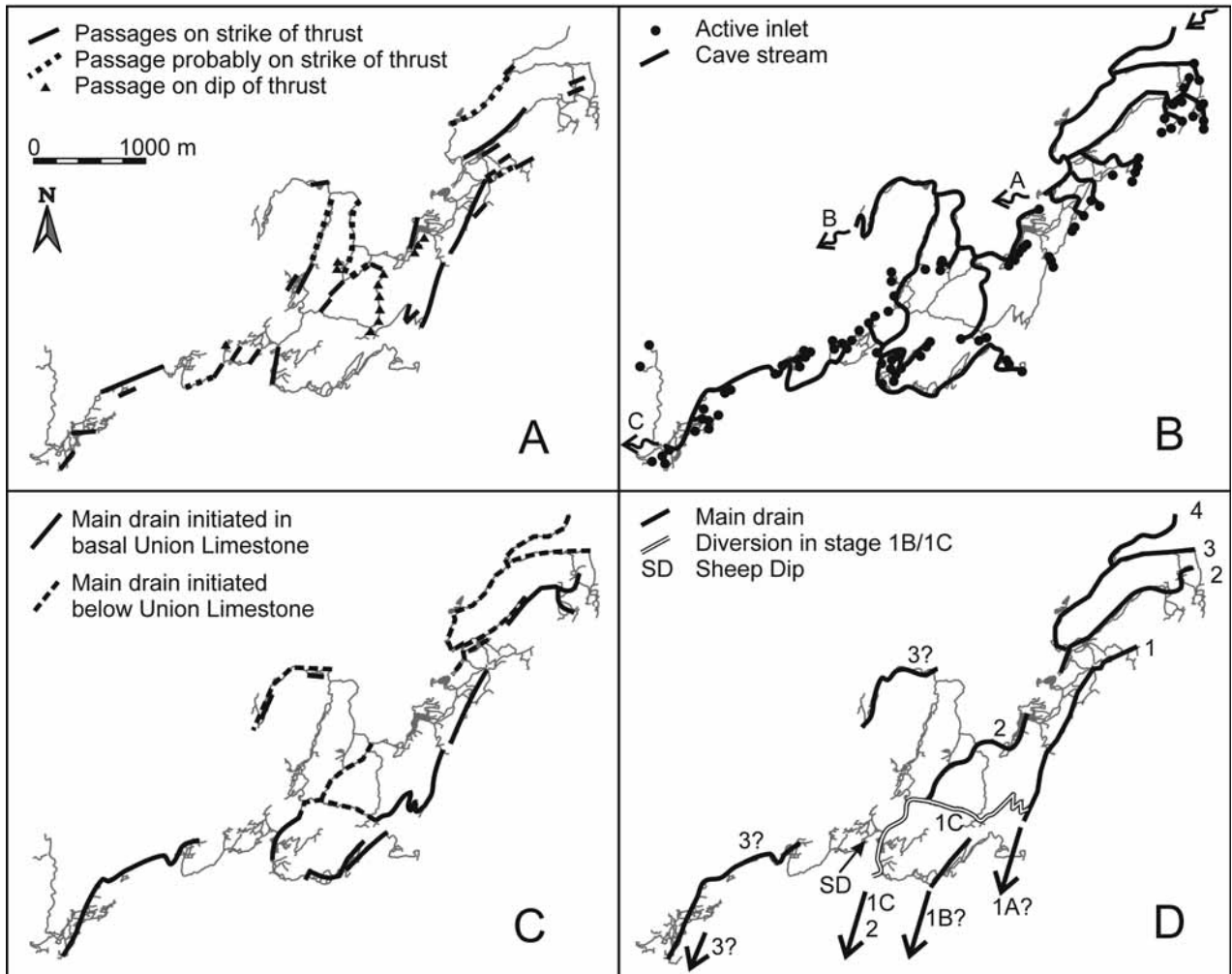
Almost all of Friars Hole Cave System is formed in the 48-m thick Union Limestone and the underlying 30-m thick Pickaway Limestone, which both belong to the Mississippian Greenbrier Group. The Union Limestone is primarily a pure limestone with 91% of the section at Friars Hole being composed of oosparites and biosparites. However, there are four calcilitites ranging in thickness from 50 cm to 3 m with insoluble fractions ranging from 47 to 63%. The Pickaway Limestone is much less pure than the Union Limestone and consists of a regular alternation of calcilitites and calcarenites of up to 3 m in thickness. The underlying Taggard Formation is 7 m thick and is composed predominantly of shale. It is only seen in the cave in the passages underlying Crowsnest Room (Fig. 2), and JJ Spring is perched on the Taggard Shale.

The strata dip to the northwest at 2 degrees within Friars Hole Cave System and the dip is similar along the flow path to the springs. However, to the east of the cave underneath

Droop Mountain there is a monocline which probably has thrust faulting associated with it. Thrust faulting is also seen at many locations within the cave (Fig. 3a). Many thrust faults in the cave have a strike of around N25°E and dip to the west, though there is much variability. The major joint set in the cave strikes at N60°E to N70°E. Although a majority of passages in Friars Hole Cave System are developed along joint sets and solutionally enlarged bedding plane partings that are parallel or subparallel to the strike, several substantial passage segments follow joints and bedding partings downdip to the northwest (Fig. 2).

### HISTORY OF EXPLORATION

Although the Snedegar entrance to the Friars Hole Cave System was used for saltpeter mining during the U.S. Civil War, contemporary exploration of the cave began in the early 1950s with the descent of the 30-m Crookshank Pit, followed by its connection to Snedegars Cave in June 1964.



**FIGURE 3** Cave passages of Friars Hole Cave System showing passages following thrust faults (a), active inlets and cave streams (b), stratigraphic control of main drains (c), and a possible sequence of development of the cave (D).

The entrance to Friars Hole Cave, 4 km to the southwest of Snedegars Cave, was dug open in August 1964 and led to over 6 km of passage in a separate cave.

In March 1976, following excavation of a doline containing a sinking stream 1800 m to the northeast of the Friars Hole entrance, 7 km of passage was surveyed in Rubber Chicken Cave. Within two months, connections between it and the nearby Friars Hole and Snedegar-Crookshank caves were established, resulting in a single cave (the Friars Hole Cave System) with a combined length of 24 km of surveyed passage.

In the summer of 1976, a major extension was found in Canadian Hole, a short, multipitch cave 600 m to the north of the Snedegar Salt peter entrance. Over the next year, over 8 km of passage was surveyed culminating in November 1977 with a connection to the Friars Hole complex to the south. A final connection to another nearby cave (Toothpick Cave) was made in November 1978, resulting in over 42 km of surveyed passages in the entire complex.

Continued work in the Friars Hole Cave System since then has increased the total surveyed length of the cave to 72.7 km by the summer of 2002. A significant extension to the cave took place between 1995 and 2000 where an upper passage (Fig. 2, PM) entering the Friars Hole trunk was followed for 2.2 km to the west and northwest, ending beneath the Robbins Run valley 600 m to the west of the Friars Hole valley and establishing Robbins Run as a paleo in feeder to the Friars Hole Cave System.

### HYDROLOGY OF THE CAVE

Seven of the entrances of Friars Hole Cave System (Friars Hole Cave, Rubber Chicken Cave, Toothpick Cave, Crookshank Cave, Canadian Hole, and the Staircase and North Entrances to Snedegars Cave) are active stream sinks (Figs. 2 and 3B). The remaining three entrances, Radio Pit and the Salt peter and Maze entrances to Snedegars Cave, are



abandoned stream sinks. In addition to the active stream sink entrances to the cave there are more than one hundred other inlet passages where streams currently enter the cave ranging from small flows to large sinking streams.

In the cave many of the inlet passages can be followed upstream to sediment blockages quite close to the surface, and thus these locations are clustered underneath the surface inliers of the limestone (Figs. 2 and 3b). These passages are typically tall vadose canyons that range from less than 50 cm up to several meters in width. They usually descend joints through the Union Limestone, but also often flow down dip for short distances when they reach one of the impure limestone beds. Most inlet passages descend through the Union Limestone within a few tens of meters, through a few are longer. The longest passage in the Union Limestone is Lew's Last Climb, which was initiated along a low-angle fault, descending over a distance of 600 m before reaching the Pickaway Limestone; subsequently a tall, narrow canyon passage has downcut below the fault (Figs. 2 and 3a).

There is some integration of stream passages in the Union Limestone, but most takes place in the Pickaway Limestone, where the stream passages have much lower gradients. Within the known cave the major streams integrate into three major drainages (Fig. 3b). The eastern drainage has the largest cave stream, Rocky River, and drains some or all of the flow from a catchment area of 45 km<sup>2</sup>. Rocky River is a large strike-oriented cave stream that can be followed in the cave for more than 2 km to a boulder blockage (Fig. 3b, point A). There are several long tributaries to Rocky River, such as the one sinking at the Canadian Hole entrance. This descends through the Union Limestone with three major drops (11, 15, and 9 m), and then flows down dip in the upper Pickaway Limestone until it joins the strike-oriented Rocky River.

The central drainage in the cave includes the streams sinking at the Toothpick, Snedegar Staircase, Crookshank, and Rubber Chicken entrances to the cave. The longest stream is the Toothpick stream, which can be followed almost continuously for 5.5 km, ending at a sump, which is the lowest point in the cave (Fig. 3b, point B). The path of the Toothpick stream is sinuous. After dropping rapidly through the Union Limestone by two 10 m drops, most of the passage is in the basal Union Limestone or uppermost Pickaway Limestone, and much of it probably formed at the intersection of major bedding planes and thrust faults (Figs. 3a and c).

The western drainage in the cave is aligned along the strike and closely follows the base of the Friars Hole valley. Consequently, only short tributaries join the main stream. The cave stream is last seen in a boulder blockage along a northeast striking fault (Fig. 3b, point C). Along most of its path the stream follows Friars Trunk, which is one of the largest passages in the cave, averaging 15 m in width and 8 m in height.

The three separate cave streams seen in the cave join together before reaching JJ Spring (Fig. 1b). The gradient

from the lowest point in the cave to the spring is only 0.002, and it seems likely that most this strike-aligned pathway is along a perennially flooded conduit below the level of Spring Creek.

## PALEOHYDROLOGY

### Surface Paleohydrology

Friars Hole Cave System has a long and complex history, and the evolution of the cave is intimately related to the evolution of the surface overlying it. The progressive capture of the surface creek along Friars Hole has left the valley in a largely relict situation, allowing the evolution of the surface drainage to be inferred.

Hills Creek and its tributaries originally flowed along the length of the Friars Hole valley and formed a tributary to Spring Creek. As the creek eroded downward it eventually reached the Union Limestone and was captured underground. With continued surface erosion the sinkpoint for Hills Creek has retreated upstream a distance of more than 4 km, and is now 40 m lower than the original sinkpoint. This has formed a long inlier of Union Limestone along the eastern part of Friars Hole, which terminates at the original sinkpoint that fed the Downlets in the Friars Hole Cave System (Fig. 2). The elevation of the top of the Union Limestone at the Downlets is 780 m asl, which is the highest elevation of this contact along Friars Hole; this is the reason that the original sinkpoint was at this location.

Flow from the original sinkpoint of Hills Creek was to the southwest through Friars Hole Cave System, but Locust Spring is a much closer spring than JJ Spring, and offers a much steeper hydraulic gradient. As the sinkpoint of Hills Creek retreated to the north its location became closer to Locust Spring (Fig. 1b), and east-flowing cave streams such as the one in Locust Creek Cave must have captured at least some of the flow. At present much of the flood discharge from Hills Creek drains into Hills-Bruffey Cave and then east under Droop Mountain to Locust Spring, but the low-flow sinkpoint of Hills Creek 500 m to the west of the flood sink is gradually capturing the flow back toward Friars Hole Cave System and to JJ Spring on Spring Creek.

The underground capture of Hills Creek at the Downlets bisected the drainage along Friars Hole. Upstream, the 54 km<sup>2</sup> Hills Creek watershed fed this large sinking stream. Downstream, the catchment area of 20 km<sup>2</sup> along the remainder of Friars Hole fed a much smaller creek, which eventually eroded down to the limestone contact, and was captured underground. The process of fragmentation of the surface drainage by capture underground has continued to the present day, resulting in Friars Hole now being a dry valley. However, small creeks continue to flow off the clastic rocks on the flanks of Friars Hole, but now sink soon after reaching the Union Limestone, which outcrops along the axis of Friars Hole (Figs. 1 and 2).

### Cave Paleohydrology

Friars Hole Cave System has a long and complex history, which is not yet fully understood. Despite the survey of almost 75 km of passages, the exploration of many has been stopped by sediment fill, boulder blockages, or water-filled passages. Furthermore, the currently explored cave only spans one-third of the distance between the major sink at Hills Creek and the springs for the cave (Fig. 1). Clearly, there are many tens of kilometers of unexplored cave, including both currently active stream passages and relict passages.

Despite only partial knowledge of the underground drainage in the area, a number of factors are helpful in deducing the paleohydrology of the cave. We assume that the fossil drainage was guided by the same principles that determine present flow patterns. Determining factors include stratigraphy, structure, and the water table elevation. Modern cave streams descend rapidly through the pure Union Limestone and have much lower gradients as they follow impure horizons subhorizontally in the basal Union or upper Pickaway. Low-angle thrust faults are common in the cave (Fig. 3a), with at least 5 km of major passages being initiated along the intersection of a thrust fault with a prominent bedding plane.

The water table elevation is important in determining flow direction, with generally downdip flow in the vadose zone and strike-oriented flow in the phreatic zone. Detailed analysis of cave streams has shown that some were initiated solely on bedding planes and followed a downdip course, and others were initiated along joints or along the intersection of a bedding plane and a joint or fault. The currently-known cave is all above the present water table, but the low gradient between the lowest point in the cave and the springs indicates that most of the intervening conduit, which closely follows the stratal strike, is below the water table.

The largest passages in the cave tend to follow the strike of the strata. These main drains are inferred to be the principal passages at each stage in the history of Friars Hole Cave System, and are presumed to have connected the major sink into the cave (Hills Creek) with the spring or springs. A number of these main drains can be identified in the cave and are usually found in the lower Union Limestone or upper Pickaway Limestone (Fig. 3c). These main drains range in elevation over 80 m, with the higher ones being found in an updip location in the southeast part of the cave, and lower ones parallel and downdip to the northwest. This pattern is most clearly seen in the easternmost part of the cave, where four major, parallel main drains can be identified; these are numbered 1–4 in Fig. 3d. The first three of these are abandoned, and the fourth is Rocky River, the present underground course of Hills Creek.

Solutional scallops on passage walls are commonly used to infer flow direction and discharge, but they are rarely preserved in the major passages of Friars Hole Cave System,

where exfoliation has been common in the impure limestones of many passage walls. However, scallops are well preserved in the critical Sheep Dip area (Fig. 3d, SD), where there are a series of round, phreatic tubes in the Union Limestone. These are unique in the cave because all other passages in the cave in the Union Limestone are vadose canyons. Scallop measurements in the Sheep Dip area showed that the paleoflow was to the east, rather than to the southwest, which is the current flow direction. The paleo water table at this time can be identified from the transition from vadose to phreatic passages and was at 702 m. This eastward flow descended to at least 22 m below the water table.

Scuba diving in flooded cave passages in the area surrounding Friars Hole has shown that most sumps descend just a few meters below the water table. The interpretation of paleoflow shown in Fig. 3d assumes that most conduits were initiated below the water table and within a few meters of it. Undulating profiles along some of the main drains confirm that some sections must have been below the water table. Conversely, tall canyons have developed along some main drains, indicating these carried vadose streams at one time.

The initial sinkpoint of Hills Creek was at the Downlets, and the underground course of that creek was a large strike-oriented conduit (Fig. 3d, main drain 1). The subsequent main drains are further downdip, have an average vertical spacing of 17 m, and are associated with later sinkpoints of Hills Creek. The parallel courses of the main drains in the eastern part of the cave make interpretation there straightforward. However, the interpretation is only tentative for the remainder of the cave. For instance, in Fig. 3d flow to the south at 1A and 1B is less well-supported than at 1C, and any of these three paths imply a major unexplored passage to the south, underneath the clastic caprock, and leading to a spring on Greenbrier River, where the Union Limestone would have been exposed earlier than on Spring Creek. The relationships shown for main drains 2 and 3 in Fig. 3d are even less certain, but are consistent with passage sizes, orientations, and elevations. What is certain is that there are unexplored continuations to many passages, though many are undoubtedly blocked by sediment or are water-filled

### Age of the Cave

An indication of the age of the cave can be inferred from speleothem samples taken from it. The ages of forty speleothems from the cave have been determined by uranium series dating, and ten of these gave ages beyond the 350,000 year limit of the dating method. A sample from the Crossover Passage, a stage 2 passage (Figs. 2 and 3d) was paleomagnetically reversed, and thus is more than 700,000 years old. A sample from the Lost Passage, a stage 3 passage at the cave's southwest end (Figs. 2 and 3d), was more than 350,000 years old and was magnetically normal, but had a  $^{234}\text{U}/^{238}\text{U}$  ratio in secular equilibrium, a process which takes more than 1

million years. This sample probably dates from the Olduvai subchron between 1.72 and 1.88 million years ago. If this is true, and assuming a steady rate of base-level lowering, then the oldest passages in the cave are 4.1 million years old.

### **Bibliography**

Dougherty, P. H., P. A. Jameson, S. R. H. Worthington, G. N. Huppert, B. J. Wheeler, and J. W. Hess (1998). Karst regions of the eastern United States, with special emphasis on the Friars Hole Cave System, West Virginia. In *Global Karst Correlation*, (Yuan Doaxian and Liu Zaihua, eds.), pp. 137–155. Science Press, Beijing, China.

Medville, D. M. (1981). Geography of the Friars Hole Cave System, U.S.A. In *Proceedings of the 8th International Congress of Speleology, Bowling*

*Green, Kentucky*, (B.F. Beck, ed.), p. 412–413. National Speleological Society, Huntsville, AL.

Medville, D. M., and H. E. Medville (1991). Structural controls on drainage beneath Droop Mountain, West Virginia. In *Appalachian Karst*, (E. H. Kastning and K. M. Kastning, eds.), pp. 11–18. National Speleological Society, Huntsville, AL.

Sasowsky, I. D., W. B. White, and D. M. Medville (1989). The remarkably constant longitudinal profile of Toothpick Stream, Friars Hole Cave System, West Virginia, U.S.A. In *Proceedings of the Tenth International Congress of Speleology*, pp. 284–286. Hungarian Speleological Society, Budapest.

Storrick, G. D. (1992). The caves and karst hydrology of southern Pocahontas County and Upper Spring Creek valley. West Virginia Speleological Survey, p. 215.



# G

---

## Glacier Caves

Andrew G. Fountain  
*Portland State University*

### INTRODUCTION

Caves in glaciers are common and range from vertical shafts descending from the glacier surface to near horizontal passages along the bottom of a glacier. Caves can also form from large cracks in the ice known as crevasses or bergshrund, if located at the head of the glacier where the ice pulls away from the valley wall. There are a variety of ways to classify openings in ice, including the morphology of the opening or by the process of formation. The latter classification will be used here, because it provides a more robust explanation of these features. The focus of this article will be on caves formed by water, since they are the typical caves of interest.

Caves formed by crevasses are near the surface and have lateral extents of a few tens of meters at most. In contrast, water-generated caves can extend many tens to hundreds of meters vertically or laterally. Such caves are typically first encountered at the glacier's edge where streams emerge from the glacier bottom. These marginal caves are only a surface expression of a complex network of passages in and under the ice that is still not well understood.

By definition, a glacier is a perennial snow or ice patch that moves. Glaciers are a sedimentary formation with seasonal snow accumulation on the upper parts of the glacier that buries the previous season's accumulation. As any individual layer becomes buried it densifies and eventually metamorphoses into ice. Ice itself can be considered a crystalline mineral. Because of the rheological properties of ice, it does not deform until a critical force is achieved, which is controlled by glacier thickness and the slope angle on which it rests. People unfamiliar with alpine glaciers assume that

glaciers are very cold, freezing any water that touches them. In fact, most alpine glaciers in the world are considered "warm," or "temperate," meaning the ice temperature is at the melting point. These glaciers exist in the temperate and tropical zones of the Earth, including Europe, North America, (exclusive of the Canadian Arctic and the Brooks Range), and the glaciers of Africa, South America, New Zealand, New Guinea, and most in central Asia including the Hindu Kush-Himalaya region. Polar, or "cold," glaciers are well below freezing throughout the body of the ice. These glaciers are restricted to the polar regions or to very high altitudes. This difference in temperature is important for many glaciological reasons, but for our purposes here it is important for the formation of caves.

In cold ice no water is present and openings in the ice are caused exclusively by ice fracture. In warm ice, water coexists with ice because the two phases are close to thermodynamic equilibrium. The friction of water movement slightly heats the water and any heat generated in warm ice causes melt. Therefore, to understand cave formation one has to understand how water moves through the glacier. The following discussion will be limited to temperate glaciers and references to "glacier" will imply a temperate glacier.

Water movement through temperate glaciers is much like that in karst terrain. The surface is covered with a porous medium, soils over karst and snow over ice. Vertical shafts, called moulins, are analogous to sink holes. In the absence of sinkholes or moulins surface water takes advantage of crevasses in ice or fractures in karst to move from the surface into the interior. Within the body of a glacier, conduits exist like they do in karst. Much of this information has been gained from the analysis of tracer injections, a common technique also used in the investigation of karst. In addition, boreholes are drilled into ice using jets of high-pressure hot water. This is a much cheaper and faster method than anything available for rock. Borehole cameras and groundwater style tests have been conducted. The major difference

between a temperate glacier and karst terrain is that a glacier is constantly deforming and the internal hydrologic pathways, for the most part, are probably recreated seasonally.

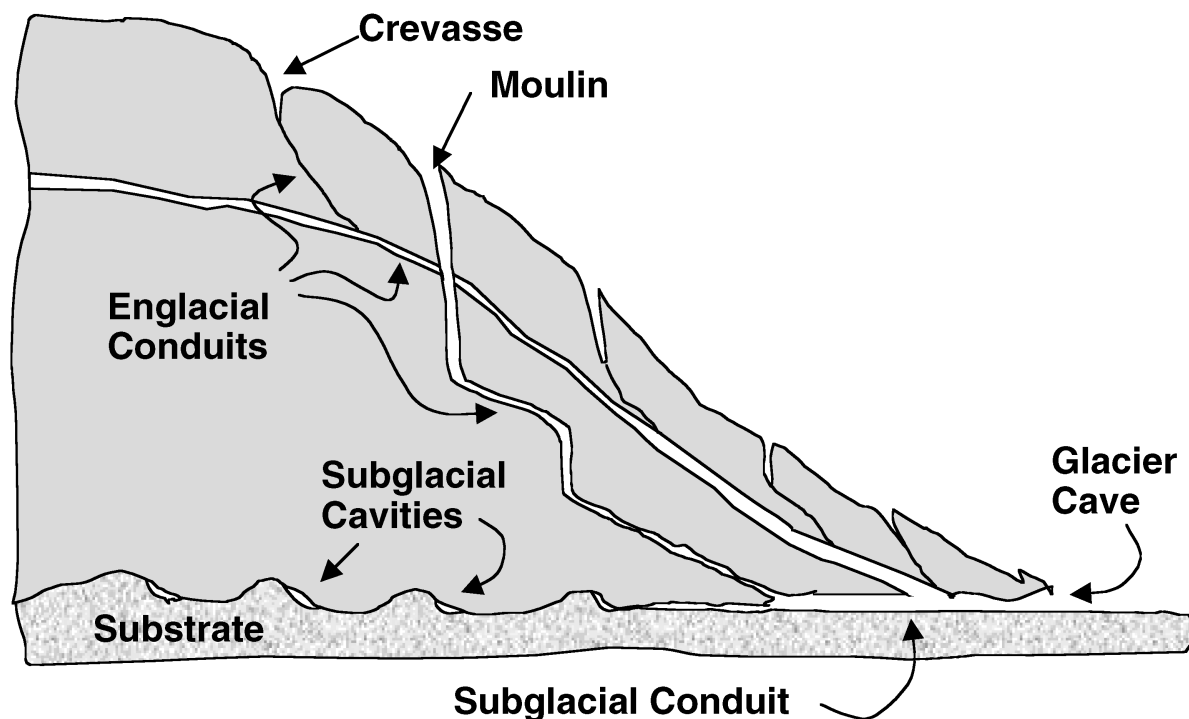
Simple observations show that water from the surface melt of snow and ice and from rainwater enters the glacier over the entire surface and exits the glacier in discrete locations like streams. Therefore, a self-organizing hydraulic system exists in the glacier. Little water is observed running off the surface of the glacier and it is clear that it enters the body of the ice. Although some have suggested that water may flow through the ice along crystalline boundaries, subsequent models and field evidence have shown that these microscopic passages cannot transmit the large flux of water generated by surface melt. For example, in the maritime climate of the North Cascade Range of Washington, five or more meters of snow can accumulate on the glaciers. Not only does all this snow melt in summer, but also an additional 3–5 m of ice melts. Consequently, a point on the lower glacier can experience, correcting for density, a flux of 6.5 m of water in a 5-month period from May through September. A more efficient method of evacuating water from the surface is necessary (Fig. 1).

### ENGLACIAL CONDUIT SYSTEMS

Flowing water forms englacial (in the body of the glacier) conduits, which subsequently turn into ice caves. Because the ice is at its melting point, any heat generated by friction caused by flowing water enlarges the water passage.

Compensating for this melt-enlargement is the pressure of the ice above the conduit, which squeezes the passage closed. Ice is a visco-plastic medium meaning that once the pressure (or stress) reaches a critical threshold it starts to deform. Once the ice begins to deform its rate of deformation is proportional to the applied pressure, the viscous behavior. Another component of the process is the pressure of the water itself, which may compensate to some degree, the pressure of the weight of the ice above. Therefore, the diameter of conduits in ice is a balance of two processes, the effective pressure on the conduit that tends to squeeze the conduit closed (the ice pressure due to depth in the ice minus the water pressure in the conduit) and the discharge of water flowing through the conduit that melts the walls and enlarges the passage. These processes were modeled mathematically for the steady-state case with some important results.

First, the theory suggests that conduits form an arborescent, or “tree-like” network with smaller branches feeding into larger branches. Instead of being a two-dimensional network like stream channels on the Earth’s surface, a glacier’s conduit system is three-dimensional through the body of the ice. The reason for this configuration is curious. Unlike typical water flow in pipes where higher water pressure drives greater water discharge, in ice-walled conduits higher water discharge flows at lower pressures. Everything else being equal, a greater water discharge increases frictional heat, which creates a conduit with a larger diameter and hence, a lower water pressure. The reason for this counterintuitive



**FIGURE 1** Simplified cross section of the lower part of a temperate glacier. The smooth shading represents the glacier and the textured shading indicates the substrate (rock or debris) under the glacier.

process is that for water pipes, the pipe diameter is constant, but in glaciers the conduit diameter enlarges due to the melt caused by flowing water. Certainly, transient high discharges create high pressures that mimic regular pipe flow, but over the long term (weeks to months) the inverse relation between discharge and pressure holds. One main implication of this result, pertinent to glacier caves, is that larger caves will be formed in the ice by larger water flows at shallow depths in the ice. Conversely, smaller caves result from smaller discharge at greater depths.

Secondly, theory suggests that conduits are a seasonal phenomenon. The conduits enlarge in summer when melt water influx is the greatest and the water discharge in the conduits is the largest. In winter, the surface of the glacier is typically covered with a cold blanket of snow and the conduit network is starved of water. Without the melt-enlargement of the flowing water and its pressure the conduits squeeze closed. The rate of closure depends on the radius of the conduit cross section and the depth in the ice. Consequently, a large radius conduit deep in the ice will close faster than a small shallow conduit. In fact, conduits less than 11 m deep should not close at all, because the ice pressure does not reach the critical pressure required for ice deformation. For an ice thickness of 150 m or more, a conduit that has survived the summer melt season would be less than 0.1% of its original radius.

The rapid closure of glacial conduits, compared to rock-walled conduits in karst, may be the most distinguishing characteristic. Glacial conduits, to a large degree, have to be regenerated each spring. Conduits near the surface probably survive the winter largely intact, whereas deeper conduits close. In addition, glaciers are constantly deforming as they move down slope. Like stream flow, ice moves slowest at the bottom due to basal drag and faster at the top. Because of this, conduits that descend through the glacier must also be deformed becoming oversteepened as the upper part of the conduit moves faster than the lower part. How the conduit system regenerates each spring and how it withstands the deformation imposed by glacier movement is one of the many questions in this field.

A variety of strategies have been employed to test the theories. Field investigations have injected tracers into the glacier and monitoring the tracer return at the outlet stream. Results show that the system is generally arborescent (tree-like network of smaller conduits feeding larger ones) with slow water flow, compared to “normal” streams. This suggests conduits of low slope. Hot water drills have been used to penetrate the glacier and directly intersect conduits. Roughly 50% of the holes drilled intersect an englacial conduit suggesting their abundance in glaciers. Few direct observations of active englacial conduits exist. Borehole cameras show conduits around 10 cm in diameter and no large (meters) conduits have been observed. Some of the so-called conduits appear to be cracks in the ice that conduct water. A few brave souls have descended from the surface via natural

openings (see the next section, Surface Features) and encountered large cave-like conduits that run for several hundred meters. The relatively gently sloping passages are interrupted by vertical passages that descend, via a series of plunge pools, to another passage at depth. Unfortunately, these efforts are generally restricted to the lay-enthusiast and have not made their way into the scientific literature.

## SURFACE FEATURES

An obvious surface feature is a moulin, a sinkhole-like feature that can be 10 m or more in diameter on the Greenland Ice Sheet, but more commonly is a couple of meters at most. This vertical shaft can drop straight down for tens of meters. Moulins have provided access to the glacier interior by spelunkers willing to brave the cold, wet interior and dangers of rapid water level fluctuations. Early winter, after melting ceases and before much snow accumulates, can be an advantageous time to explore the moulins.

Moulin is a French word meaning “mill.” Moulins are vertical drainage shafts that route surface water directly to the interior of the glacier. Exploration of a moulin and subsequent reconstruction shows that they are indeed vertical shafts with plunge pools. In thinner ice (less than 50 m) they may intersect the bed directly; in thicker ice they terminate in a gently sloping conduit. Moulins originate from crevasses and two are commonly associated together. Crevasses open in zones of tension on the glacier and close in zones of compression. If water flow to a crevasse can be maintained during the transition from tension to compression, the opening where the water enters the crevasse will be maintained. If the crevasse closes entirely, the moulin exists alone as a near circular opening in the glacier. Tracer tests in the moulins exhibit relatively short transit times, compared to other glacial features, indicating very efficient flow paths. Pressure sensors lowered into moulins have shown rapid variations in water level indicating that they are connected to the glacial water system.



**FIGURE 2** A moulin on the surface of South Cascade Glacier, Washington. The frame pack next to the moulin is included for scale.

Moulins do not drain the water from the entire glacier surface. They are only found in the ice-covered zone of the lower glacier where water flow is common and plentiful. They are not typically found in the upper snow-covered zones of the glacier. Other pathways must be present. As previously mentioned, the percolation of water through the ice grains is insufficient to route the water from the surface. By all appearances, the principal drainage features are crevasses. Surface streams are commonly observed to flow into crevasses and water-filled crevasses are not particularly common on any given glacier. In the absence of crevasses, surface streams will flow for long distances over the ice surface.

### SUBGLACIAL FEATURES

The most explored part of the glacier interior is through ice caves found along the glacier margin. These caves are only one example of the variety of openings under the glacier. At the base of glaciers, the ice contacts a rocky substrate, either bedrock or sandy gravel debris called till. Water flows from the body of the glacier (englacial) to the bed and can flow in



**FIGURE 3** Englacial conduit taken from inside the conduit looking out. John Firestone is standing at the entrance of South Cascade Glacier, Washington.

several different kinds of water systems. Because of our ignorance of how the water flows exactly, we classify the flow into two broad categories, “fast” and “slow” systems. This classification is based on the travel time of artificial tracers injected into the glacier. Fast systems have relatively low surface-to-volume ratios, cover only a small fraction of the glacier bed, and are most likely composed of arborescent conduits. Travel time of tracers may only be hours to a day and the tracer exits the glacier with relatively little dispersion. Slow systems cover much of the bed, are characterized by a high surface-to-volume ratio, and involve a variety of flow processes. Travel time of tracers injected into a slow system can be a day to weeks and exhibits a high degree of dispersion with multiple peaks suggesting multiple flow paths.

Numerous flow processes are included within the slow system. The subglacial debris acts like a confined aquifer transmitting water under a pressure gradient imposed by the glacier and water system. Water may flow in eroded bedrock channels, which would provide a favorable water path from year to year. These channels are commonly displayed at parks featuring glacially carved features. However, these channels tend to be relatively short in length and connected to other subglacial hydraulic features such as cavities. Cavities are formed as the ice slides over abrupt changes in the bedrock surface. In the lee of a downward step in the bedrock, the ice separates from the bedrock and eventually contact the bedrock down slope. The size of the cavity is related to the height of the step, speed of glacier movement, and water pressure in the cavity. Unlike conduits, however, the melt-enlargement of the cavities is a small contribution to the size of the cavity because of the slow moving water. This is a consequence of many cavities linked together with most of the cavities oriented parallel to the step in the bedrock, and



**FIGURE 4** A subglacial conduit looking from the opening inward toward the center of the glacier. The illuminated ice is transmitted sunlight and indicates a thin ice roof. This “conduit” has been naturally enlarged by the advection of warm air into the cave and we expect most subglacial conduits to be smaller. Note the figure in the distance. This is South Cascade Glacier, Washington.

therefore, perpendicular to the ice flow. This creates a large surface-to-volume ratio with a low-pressure gradient resulting in a slow water flow speed.

Near the margin of the glacier both conduits and cavities can be air-filled, and under some circumstances they can be entered. The caves are typically bathed in a blue or greenish light where the ice is thin. Deep access is usually limited, because as the ice thickens toward the interior of the glacier it exerts more pressure squeezing the passages to a much smaller size. Near the margin, the caves can be quite large, perhaps 10 meters in some cases, due to warm air circulating from the outside into the cave. These caves are quite dangerous, because the constant movement of the ice stresses the cave roof causing it to collapse.

It is unclear how the fast and slow systems interact, although evidence suggests that the two systems may coexist under the same glacier and under certain conditions may evolve from one system to another. For example, it is thought that slow systems dominate the subglacial hydraulics in winter, which explains the solute rich content of winter water flow from glaciers. A system with a high surface-to-volume ratio and slow-moving water provides a relatively long residence time for solute acquisition. Conversely, in summer the water is rapidly evacuated via low surface-to-volume features, subglacial conduits, as indicated by solute dilute waters.

## ICE SHEETS

As previously mentioned, polar glaciers do not have englacial or subglacial water systems, because the ice is well below freezing and any water flow at the glacier surface refreezes when it enters the body of the ice. For these glaciers, melt water runs off the surface and ice caves are entirely absent. However, for the large ice sheets, such as Greenland and Antarctica, the situation is a bit different. Due to the great thickness of ice (kilometers) ice pressure at the bottom is quite high. Thermodynamics dictates that as the pressure increases, the melting point of the ice becomes colder. Due to the thermal insulation of the overlying ice, the depressed melting point, and the geothermal heat from the Earth itself, the bottom of the ice sheet can melt.

In places in Antarctica and in Greenland, a layer of water can develop with a thickness of a meter or more. These locations coincide with unusually rapid ice flow called “ice streams,” and this thick layer of water is thought to play a part in its rapid motion. Boreholes drilled to this water layer and cameras lowered down have confirmed its thickness in a couple of sites. This water is eventually discharged into the ocean under the ice where the ice sheet flows out on to the ocean. Little is known about this layer of water and investigations are currently underway to better define their origin, evolution, and effect on rapid glacier flow.

Another topic of great current interest is the large subglacial lakes under the Antarctic Ice Sheet. Although

numerous lakes exist, the largest is Lake Vostok, about the size of Lake Erie, with a depth of several hundred meters existing under approximately 3.6 km of ice. Its presence is known via ground-penetrating radar, and its existence is reflected on the surface of the ice sheet by an unusually flat terrain. One of the most intriguing questions about the lake is whether it supports life, which may have been out of contact with the rest of the Earth for millions of years. Preliminary evidence based on ice cores drilled near the lake shows that viable life probably exists in the lake.

## SUMMARY

Caves in glaciers are generally a consequence of water flow, which enlarges passages by melting via the frictional heat as it flows. Some caves also form where the glacier flows over a rock ledge. Unlike the stability of conduits in karst terrain, conduits in glaciers have strong annual cycles of enlargement and shrinkage. The fraction of conduits accessible to humans is small and there should be many small conduits (10 cm in diameter) throughout the body of the glacier. The channel systems mapped by enthusiasts tend to be relatively shallow compared to the depth of the glacier. The large caves seen at the glacier's margin are most likely the result of warm air enlarging a conduit formed by stream water. Such caves close to a much smaller dimension a short distance into the ice as the glacier rapidly thickens. Many questions remain as to the origin and evolution of the conduit system and other hydraulic features found in and under glaciers. Answers to these questions will help us better understand glacier movement and potential dangers posed by glacier-generated floods.

## Bibliography

- Fountain, A. G., and J. S. Walder (1998). Water flow through temperate glaciers. *Reviews of Geophysics* **36**, 299–328.
- Holmlund, P. (1988). Internal geometry and evolution of moulins, Storglaciären, Sweden. *Journal of Glaciology* **34**, 242–248.
- Kohler, J. (1995). Determining the extent of pressurized flow beneath Storglaciären, Sweden using results of tracer experiments and measurements of input and output discharge. *Journal of Glaciology* **41**, 217–241.
- Paterson, W. S. B. (1994). *The Physics of Glaciers*, 3rd ed., p. 480. Pergamon Press, Tarrytown, New York.
- Pohjola, V. A. (1994). TV-video observations of englacial voids in Storglaciären, Sweden. *Journal of Glaciology* **40**, 231–240.
- Raymond, C. F., and W. D. Harrison (1975). Some observations on the behavior of the liquid and gas phases in temperate glacier ice. *Journal of Glaciology* **71**, 213–234.
- Röthlisberger, H. (1972). Water pressure in intra- and subglacial channels. *Journal of Glaciology*, **11**, 177–203.
- Siegert, M. J., J. C. Ellis-Evans, M. Granter, C. Mayer, J.-R. Petit, A. Salamatin, and J. C. Priscu (2001). Physical, chemical and biological processes in Lake Vostok and other Antarctic subglacial lakes. *Nature* **414**, 603–609.
- Stenborg, T. (1969). Some viewpoints on the internal drainage of glaciers. *International Association of Hydrological Sciences* **95**, 117–129.
- Walder, J. S., and B. Hallet (1979). Geometry of former subglacial water channels and cavities. *Journal of Glaciology* **23**, 335–346.



# Guano Communities

Pedro Gnaschini

*University of São Paulo, Argentina*

## GUANO AND ITS IMPORTANCE TO CAVE COMMUNITIES AND TO SCIENCE

Guano is the accumulation of feces of particular animals in time and space. A commonly known example is seabird guano, which is the accumulation of droppings of large colonies of seabirds. This has been exploited for many years as a source of nitrogen compounds. In caves, guano also occurs, and it comes from three different animal sources — birds, bats, and crickets. It should be stressed that the animals that add guano into caves are always recognized as trogloneic animals. Bat guano has also been exploited in the past, especially for the production of gunpowder.

As discussed in other chapters, the cave ecosystem lacks primary producers and completely depends on the energy that comes from the outside, hence, it is a food-poor environment. Actually, the food supply in caves tends to be low or sporadic in quantity and poor or variable in quality. It is also clear that any accumulation of food inside caves (as is a guano pile) is of great attraction to detritivorous scavenger animals. Other common examples of energy sources in caves include dead animals and debris washed in from the surface (by water, gravity, etc.).

There are some caves where the accumulation of guano is so large that the caves are considered to be food-rich places, the so-called eutrophic caves. These caves are more common in tropical countries but they occur in all continents. For example, many caves in Mexico and Brazil are also eutrophic, although in these countries there are many more caves that are food-poor (poecilotrophic). In some of these food-poor caves bat guano deposits are scattered and do not constitute the main or only base of the trophic chain. Nevertheless, it is a very important food source. Eutrophic caves tend to occur where there is an enlarged chance of bat aggregation due to the biology of the bats or to physical characteristics of the cave areas. For instance, in Brazil, limestone caves tend not to be eutrophic, because they are generally larger and occur in a large number in particular areas, offering more shelters for bats. In turn, sandstone caves are smaller and occur in smaller numbers leading to the concentration of bats in the same shelters, and, therefore, to the concentration of bat guano. Nevertheless, Poulson and Lavoie (2000) also considered that bat and cricket guano provide the most important biotic input of energy to hypogean environments in temperate zones.

Scattered feces (even of other vertebrates, such as cats, pumas, dingoes, foxes, otters, rats, agoutis, and didelphids) may also be used as food by cave animals. In some cases it

may be preferred because such animals would avoid the high predation risk that they would be subjected to in guano deposits, where large communities may be established. An interesting example of association to feces of other vertebrates was provided by Calder and Bleakney (1965), who noticed that in Nova Scotia bats are not important, and the cave fauna depends mainly on porcupine dung.

In addition to the availability of food, bats may also play a large influence on the cave climate. In many caves with a higher concentration of bats, especially considering large chambers connected to other points of the cave by narrow/low conduits, temperature tends to be very high, reaching (and sometimes surpassing) 40°C. Concentration of ammonia is also very high, making these places very difficult for human exploration. These are considered as bat caves.

Because guano communities are somewhat isolated and, in general, present a simple structure, they are an important field for ecological studies. Moreover, the physical and nutritional properties of the guano vary according to the kind of animals producing the piles; namely, insects, birds, or bats (in turn with several kinds of feeding preferences) providing an additional field for comparison of community structures.

Guano has been studied in different places and with different foci, including mineral and chemical analysis of bat guano, mathematical simulation of community dynamics, and extensive faunistic surveys. Guano communities have been the subject for ecological studies in several caves around the world, but more commonly in tropical than in temperate caves, contrary to what would be expected from the higher development of temperate speleobiology. Theoretical definitions about guano inhabitants are based mainly on papers by Decu and colleagues (focusing on eastern European caves) and Poulson and colleagues (relative to North American caves). Both of these groups started their research on guano fauna in the 1960s while Gnaschini and colleagues (focusing on South American caves) start their research in the 1980s. Their ideas are summarized in papers by Poulson (1972), Decu (1986), and Gnaschini (1992), and a general review can be found in Gnaschini and Trajano (2000).

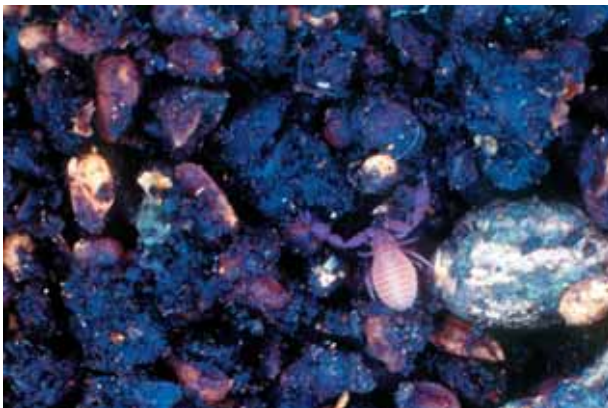
## TYPES OF GUANO

Guano in caves comes from three main different animal sources: birds, bats, and crickets. Guano of rhabdophorid crickets represents a large amount of food input for cave animals in temperate caves, especially those in the United States. Some trogloneic crickets (*Hadenocetus subterraneus*) leave the caves for food periodically, and when they come back they deposit a large amount of feces based mainly on vegetal matter. Cricket guano may also be found in Asian caves, but, in this case, it should be considered to be a by-product of bat guano because these crickets feed mainly inside caves on guano of other animals (Deharveng & Bedos, 2000).

Several birds, such as doves, owls, parakeets, swallows, swiftlets, and vultures, may nest near cave entrances, and their droppings may be used as a food supply in the twilight zone. In some tropical caves, however, bird droppings such as those from oilbirds (guacharos, *Steatornis caripensis*) (northern South America and Caribbean) and swiftlets (*Aerodramus* sp.; tropical oriental caves) may be an important food source. They colonize the dark zones, and their droppings may form large piles. Swiftlets feed on insects and are common in Southeast Asia where their nests are exploited for a traditional dish in human cuisine. Oilbirds are common in northern South American caves, occurring in northern Bolivia, Colombia, Guyana, Peru, Venezuela, and in the island of Trinidad. They are known to navigate based on sound, like bats, but their clicks can be heard by humans, unlike those of bats. Therefore, they can be found deep inside caves. They feed mainly on palm fruits, which they carry inside the caves. Consequently their guano is comprised of both rejected seeds (with some pulp adhering) and droppings.

The most important source of animal droppings in caves throughout the world, however, is bat guano. In the northern temperate regions and other parts of the old world, most cave-dwelling bats have an insectivorous diet. This type of guano is generally finely granulated and consists of small pieces of insect cuticle, sometimes with some material still adherent.

In some places in the old world, for instance in African caves, frugivorous bats also deposit guano. This kind of guano is generally granulated and consists of seeds and decaying plant matter (Fig. 1). It is similar to oilbird guano regarding physical and nutritional characteristics. It is in the neotropics, however, that the feeding habits of bats (especially within the Phyllostomidae) are very diversified. Frugivorous and insectivorous bats also occur. The most common in inhabited areas may be the vampire, or hematophagous, bats (especially *Desmodus rotundus*). Owing to the high availability of prey in the form of domestic



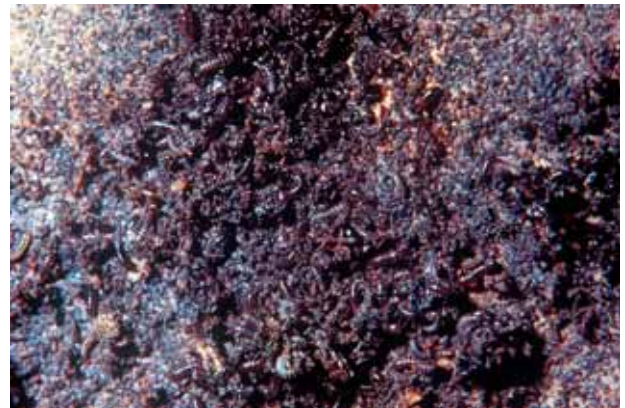
**FIGURE 1** Close up of a frugivorous bat guano pile showing a *Maxcheres* pseudo-scorpion and the large amount of seeds with adherent digested material. Photo by P. Gnaspini.

animals, and roosts not being a limiting factor in cave areas, the populations of these bats are very high (Trajano, 1985). Their guano is a very dark and smelly paste (Fig. 2). Although they form small colonies (up to ten individuals), large carnivorous bats may also deposit large amounts of guano. These animals feed on birds and small mammals and occasionally on large insects, and their guano is formed of large somewhat compact droppings full of digested animal material mixed with feathers and/or hairs (Fig. 3). Although nectarivorous bats (Glossophaginae) are relatively frequent in caves, guano piles from these bats have not been identified thus far, probably because the colonies are generally small and, on account of its liquid nature, the guano would mix with the substrate.

Sometimes in the same cave one can find more than one kind of bat guano pile with some maybe even mixed with each other. The texture and nutritional characteristics differ among the various types of bat guano and these different characteristics will influence the associated communities.



**FIGURE 2** Overview of a somewhat old and dry hematophagous bat guano pile. White patches (including the one pointed by the observer) are concentrations of *Acherontides* collembolans (see Fig. 4). Photo by P. Gnaspini.



**FIGURE 3** Close up of a carnivorous bat guano pile showing a large concentration of cholevid larvae (at least two species of the genus *Dissochaetus*). Photo by P. Gnaspini.

Other important characteristics influencing the establishment of associated fauna are the substrate and the place where guano is deposited, because they would influence the availability of the organic matter (see Poulson & Lavoie, 2000). For instance, if guano is deposited on sandy substrates and/or under dripping water, nutrients may be washed away more rapidly.

### THE FAUNA ASSOCIATED WITH GUANO DEPOSITS — DEFINITIONS

Considering that guano is an important source of food in caves, there are many animals that directly feed on this substrate and/or on microorganisms (e.g., bacteria and fungi) that grow on guano. These animals are called guanophages. To complete the guano communities, there are also several predators that feed on the guanophages. Deharveng and Bedos (2000) also recognize two types of associated communities: the giant arthropod community (GAC) and the meso- and microinvertebrate community (MIC). The latter is always on or close to guano deposits and formed by large number of species of guanophages and their predators, and the former consists mainly on one species of guanophages and mostly on predators, which may live far from the guano piles and come closer to feed.

Due to the specificity of these communities to the guano, some authors (see, e.g., Decu, 1986) have argued that these animals should not be considered as cavernicoles, because they occur in caves just after this specific source of food, and not because of the cave environment. Therefore, these would not depend on caves from an ecological point of view. Because this would mean that (1) guano inhabitants colonize caves only because of guano, and would not be there if that food supply was missing, and (2) they do not depend on the cave ecosystem nor are they subjected to cave environmental constraints, Gnaschini (1992) discussed that, in order to reach and colonize the guano piles frequently deposited far from known cave entrances, organisms should be able to orient themselves and also survive inside the cave. In other words, they must have an ecological relationship with the caves and should be considered cavernicoles. In addition, if true, the same argument to exclude guano dwellers should have been used to exclude other communities associated with specific sources of food in caves. This would be the case, for instance, of the animals that feed specifically on roots in caves, which are an important part of the troglobitic fauna of Hawaii. Therefore, guano piles should simply be treated as a substrate, and, as any substrate inside a cave, it would be colonized by cavernicoles.

Because guano is an important source of food, and, sometimes, the only source of specific types of food (such as digested blood or vegetal matter, especially fruits and seeds), there are some cave-dwelling animals that are restricted to guano piles, and some that occasionally visit this substrate to feed directly on guano or to prey on guano dwellers. Therefore,

following the same rationale of “affinity to the environment” used to classify cave animals into troglobites, trogliphiles, and troglonexes, cavernicolous guano dwellers can be classified into guanobites, guanophiles, and guanoxenes. It should be reinforced that this classification should be used only for animals inhabiting guano deposits inside caves.

Guanobites are organisms that, when in caves, exclusively inhabit guano deposits, and whose entire biological cycle takes place in this substrate. It should be noted that guano deposits are discontinuous in caves, and hence guanobites may be found on any cave substrate as they move through the cave environment to colonize guano piles. Guanobites, however, do not reproduce or feed in these substrates. Guanophiles may inhabit and reproduce both in guano piles and in other substrates of the cave environment. Guanoxenes may be found feeding and/or reproducing on guano deposits but depend on other substrate(s) in the caves to complete their biological cycle. Although theoretically possible, this third type seems to be unlikely in practice.

It should be noted that the relationships with the cave and with the guano are not necessarily interdependent. The degree of fidelity to, or dependence on, the cave environment is neither influenced by nor influences the relationships of the cavernicoles to the guano (i.e., their degree of fidelity to the guano environment). For example, an animal restricted, in caves, to guano piles (thus, a guanobite) may occur in the epigeal environment as well, in this case not being a troglobite, as expected if the two classifications were correlated. Therefore, the guano inhabitants should be classified independently according to their cave and guano relationships. When analyzing the cave relationships of an organism, one must take into account its possible occurrence in the epigeal environment, as well as the possible modifications acquired during colonization and isolation in the hypogean environment, in order to classify it as a troglonexe, a trogliphile, or a troglobite. Independently, one may also consider whether or not an organism inhabits substrates other than guano inside the cave.

The entire biological cycle of a guanobite takes place in the guano piles inside caves, and, therefore, entirely in the cave environment. Thus, a guanobite may be either a troglobite or a trogliphile, because both can complete their entire cycle inside caves. It can never be classified as a troglonexe, because this group must leave the caves (and therefore any substrate inside the caves) to complete its life cycle. This applies also to guanophiles, because at least the populations observed in the guano piles complete their life cycles inside the cave. Finally, guanoxenes can be troglonexes, trogliphiles, or troglobites. It is noteworthy that a classification combining troglo- and guano-related classifications is very useful because it gives a precise notion of the ecological–evolutionary relationships of the organisms studied.

As discussed in other chapters, troglomorphisms generally are adaptive responses to the general low predictability and availability of food in the subterranean environment.

Therefore, it would not be expected to find troglomorpha in species associated to guano piles (especially not among guanobites), because these animals would be living under a large food availability. However, some cases seem to occur.

### COMMUNITY STRUCTURE AND SUCCESSION IN BAT-GUANO PILES

Like all communities associated with the cave environment, guano communities are simple and composed of only a few trophic levels. Two levels can be recognized: the guanophages and their predators. In turn, the relationships between the animal components are very complex, because most predators would feed on any of the items in the guanophage level, and maybe even within the predator level. Therefore, the trophic relationship within this community should be viewed as a food web instead of a food chain.

In temperate regions, the seasonal activity of cave bats leads to seasonal changes in the structure of guano piles and, consequently, in the associated fauna (Poulson, 1972; Decu, 1986; Poulson & Lavoie, 2000). In general, these bats are active during the summer and hibernate (in the same or in other caves) in winter. When bats are present and active, fresh guano accumulates continuously. As bats reduce their activity or leave the sites, there is a progressive desiccation of the deposits, promoting chemical and microclimatic changes. The microclimatic properties of the guano depend on the depth and the distance from the center of the deposit. Because several taxa show microclimatic preferences, a faunistic succession is observed in the guano deposits. Guano piles are initially alkaline owing to the concentration of ammonia in the feces. They subsequently become acid as a result of the decomposition of alkaline compounds and fermentation of the piles.

On the other hand, Decu (1986), based on the literature and his own observations in Cuba, stated that bats are permanently active in tropical caves. As the guano input is continuous, there would be no seasonal differences in the structure and composition of the guano deposits and the associated fauna. In both cases guano deposition is predictable; but, whereas in temperate bat caves deposition is seasonal, in tropical bat caves such deposition is continuous. This led Decu and Tufescu (1976) to characterize caves as belonging to a temperate type when there is seasonal succession and to a tropical type when there is not, irrespective of their geographic location. However, Poulson and Lavoie (2000) considered that the predictability of bat guano availability in temperate caves is much smaller than in tropical caves.

In the Brazilian karstic areas thus far studied, continuous guano deposition usually does not occur because roost availability is high and the bats form itinerant colonies, frequently moving between and inside caves. Therefore, guano piles show temporal changes in these caves, passing through the same phases of deposition, and subsequent desiccation after

the bat colony leaves the sites. In contrast to temperate caves, succession in Brazilian caves is not necessarily (if at all) seasonal. In fact, the temporal and spatial deposition of guano may be highly unpredictable. Neotropical bats show regular activity throughout the year, but can leave a specific roost at any time, causing the interruption of guano deposition and consequent succession. Therefore, from whichever cave region, piles of bat guano are “qualitatively and microclimatically non-uniform... [and]... look like a mosaic of microhabitats that shelter a mosaic of zoological communities in various evolutionary stages” (Decu, 1986).

### THE ASSOCIATED FAUNA — EXAMPLES

As expected, a large variety of animals inhabit guano piles. A huge list of papers citing communities associated to bat guano can be found in the literature, but it is not the goal of this chapter to present an extensive review of the available data. For a review and discussion of guano dwellers in tropical caves, please refer to Gnaspini and Trajano (2000) and Deharveng and Bedos (2000). For temperate caves, see Calder and Bleakney (1965), Negrea and Negrea (1971), Decu and Tufescu (1976), and the review by Poulson and Lavoie (2000). When a broad overview on the guano communities is made, we could recognize that some taxa occur almost everywhere in the world constituting the basis of most guano communities. This is especially the case, of course, when the family level is analyzed — generic and specific levels would give more differences and would allow a better biogeographic comparison. These are the “basic” taxa (*sensu*, i.e., Negrea & Negrea, 1971). In addition, there are some less common but still frequent groups, which could be called “accessory” taxa (also *sensu* Negrea and Negrea, 1971). Of course, faunal regionalism would also interfere with the taxa observed in the different places. For instance, although crickets are commonly associated to guano, raphidophorid crickets occur in North American, European, and Australian caves, whereas phalangopsid crickets occur in African and South American caves.

Good examples of basic taxa are laelapid, macrochelid, oribatid, and uropodid mites; chernetid pseudo-scorpions; entomobriid, hypogastrurid, and isotomid springtails; tineid moths, carabid, cholevid, histerid, and staphylinid beetles; and drosophilid, fanniid, milichiid, and phorid flies. Examples of accessory taxa are planarians, earthworms, other pseudo-scorpion families (Cheliferidae, Ideoroncidae, Neobisiidae), harvestmen, spiders, schizomids, isopods, millipedes, chilopods, psocopterans, cockroaches, crickets, several other beetle families (e.g., Aderidae, Curculionidae, Dermestidae, Elateridae, Hydrophilidae, Nitidulidae, Ptiliidae, Tenebrionidae, Trogidae), and several other dipteran families (e.g., Ceratopogonidae, Dolichopodidae, Empididae, Muscidae, Sciaridae, Sphaeroceridae, Stratiomyiidae).

As expected, mites (Acari) are by far the most diversified group of guano inhabitants. Guano-inhabiting mites include



**FIGURE 4** Close up from the pointed region of Fig. 2 showing a large concentration of *Acherontides eleonorae* collembolans. Photo by P. Gnaspini

guanophages and predators. Argasid ticks may occasionally be found on guano, but they should not be considered to be true guano inhabitants because they drop from their hosts (bats) when well-fed, and stay there for a while before starting to look for new hosts. Springtails (Collembola) are, together with mites, the most speciose invertebrates in guano piles, and may form extremely large populations of guanophages. The Brazilian species *Acherontides eleonorae* (Fig. 4) is a good example of guanobite and is noteworthy in view of the extremely large populations (hundreds of individuals  $\text{cm}^{-2}$ ) found on old, dry piles of hematophagous bat guano from São Paulo caves (therefore concentrating on the borders of the guano piles through succession), and because they survive and breed when kept in closed vials with this substrate.

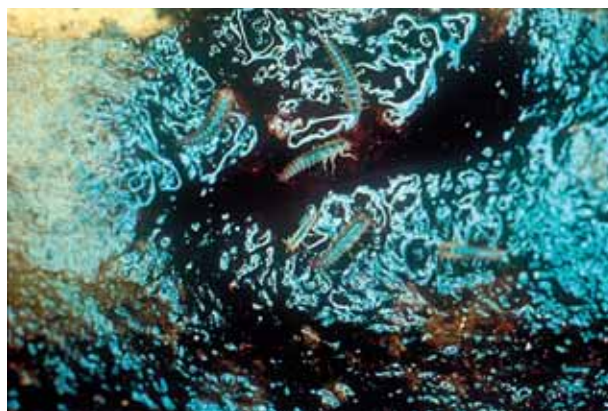
After Collembola and Acari, larvae of tineid Lepidoptera are among the most ubiquitous guanophages in many caves where they make their cases. Pyralid moths were also frequently recorded. Beetles (Coleoptera) of the families Dermestidae, Histeridae, Hydrophilidae, Pselaphidae, Scarabaeidae, Staphylinidae, and Tenebrionidae are occasionally found associated with guano piles, sometimes in large populations. However, cholevids (= cholevine leiodids) may be considered to be the most common guano-inhabiting beetles (Figs. 3, 5, and 6). Aderid beetles were frequently found on swiftlet guano in Southeast Asia, where they form guanobitic populations (Deharveng & Bedos, 2000).

The most important guanophage flies (Diptera) belong to the families Drosophilidae, Fanniidae, Milichiidae, Muscidae and Phoridae, many of which are probably guanobites (Figs. 7 and 8). In Brazil, they show a preference for piles of hematophagous guano; faniids and muscids are occasionally found associated with guano from carnivorous bats in Southern Brazilian caves (Gnaspini & Trajano, 2000). A striking example of a troglobite-guanobite is the African mormotomyiid *Mormotomyia hirsuta*, which is a highly modified species whose larvae live on guano.

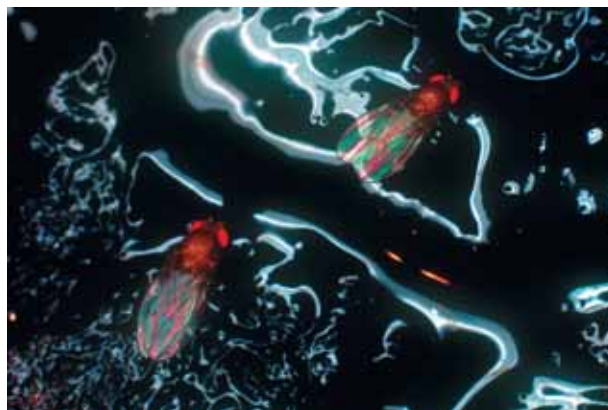
In tropical America, bugs (Heteroptera) of the families Cydnidae and Lygaeidae are associated exclusively with



**FIGURE 5** Adult *Adelopsis leo* (Cholevidae) feeding on carnivorous bat droppings. Photo by P. Gnaspini.

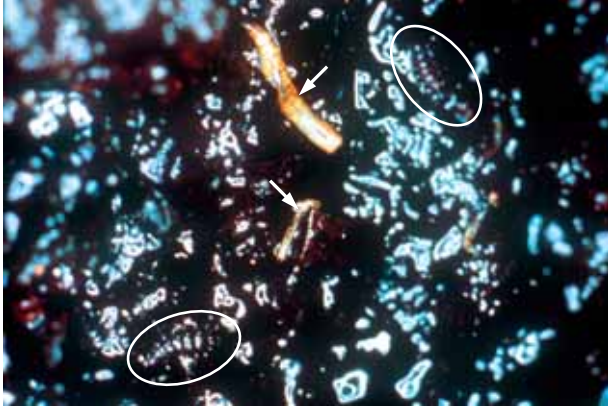


**FIGURE 6** Larvae of *Adelopsis leo* (Cholevidae) feeding on hematophagous bat guano. Photo by P. Gnaspini.



**FIGURE 7** *Drosophila eleonorae* (Drosophilidae) feeding on a recent and very pasty hematophagous bat guano pile. Photo by P. Gnaspini.

guano from frugivorous bats or from oilbirds (due to the similar physical and nutritional characteristics), where they may establish very large breeding populations (see Gnaspini & Trajano, 2000). Lygaeids were also recorded in frugivorous bat guano from Asia and New Guinea. In caves these insects



**FIGURE 8** Larvae of muscid (arrows) and faniid (ovals) flies feeding on a recent and very pasty hematophagous bat guano pile. Photo by J. Allievi.

are restricted to guano and thus should be considered to be guanobites. Representatives of these families are generally plant eaters (and some are detritivores). This may explain why the cave species occur only in guano from frugivorous animals.

Cockroaches (Blattaria) are typical tropical cave dwellers. These highly opportunistic insects are, as expected, found in several substrates, including different types of guano, and may establish huge populations. For instance, Braack (1989) recorded several species in a single cave, with the population of one species reaching 75,000 individuals and of two other species each reaching 40–50,000 individuals. Crickets (Ensifera) are omnivorous cavernicoles observed throughout the world and may concentrate near and on guano piles. Isopods are also commonly recorded on guano, sometimes forming large populations. In Brazil, for instance, some groups show preference to particular kinds of guano — philosciids in guano of frugivorous bats from São Paulo caves, scleropactids in guano of insectivorous bats from one Pará cave, and armadillids in guano of carnivorous bats from Mato Grosso do Sul (Gnaspini & Trajano, 2000). Diplopods may also be found associated with guano, and some species may be considered troglobite–guanobites, because they are troglomorphic.

In addition, other higher taxa were occasionally collected in or near guano piles. Earthworms (Oligochaeta) may use guano as an extension of their endogean habitat; they need a moist and nutrient-rich substrate, such as that found in guano from hematophagous and frugivorous species (where large populations of enchytraeid worms were found in Brazil; Gnaspini & Trajano, 2000). Psocoptera feed on fungi and may be found in guano. Subulinid gastropods were recorded in some tropical American caves (see Gnaspini & Trajano, 2000), and may form guanobitic populations in Asia (Chapman, 1984). Harvestmen (Opiliones) may also be found near the piles and are observed occasionally feeding on guano.

Among the predators, pseudo-scorpions may be found in any kind of guano, preying on the abundant springtails and mites. A few cases of large populations were recorded, for example, the Brazilian chernetid (*Maxcheres iporangae*; Fig. 1), which seems to be restricted to a single cave where it exclusively inhabits frugivorous bat guano piles (see Gnaspini & Trajano, 2000). Spiders (Araneae) such as Pholcidae and *Loxosceles* spp. (Sicariidae) sometimes make their webs over or near guano piles, opportunistically preying on guanophages. Barychelid trapdoor spiders were observed associated to swiftlet guano in Asia (Chapman, 1984). Whip spiders (Amblypygi) were frequently recorded in guano from swiftlets in Southeast Asia (Deharveng & Bedos, 2000). Guanobitic geophilomorph chilopods were recorded in Asia (Chapman, 1984). Reduviid bugs (Heteroptera) are not generally directly associated to guano but occasionally feed on guanophages.

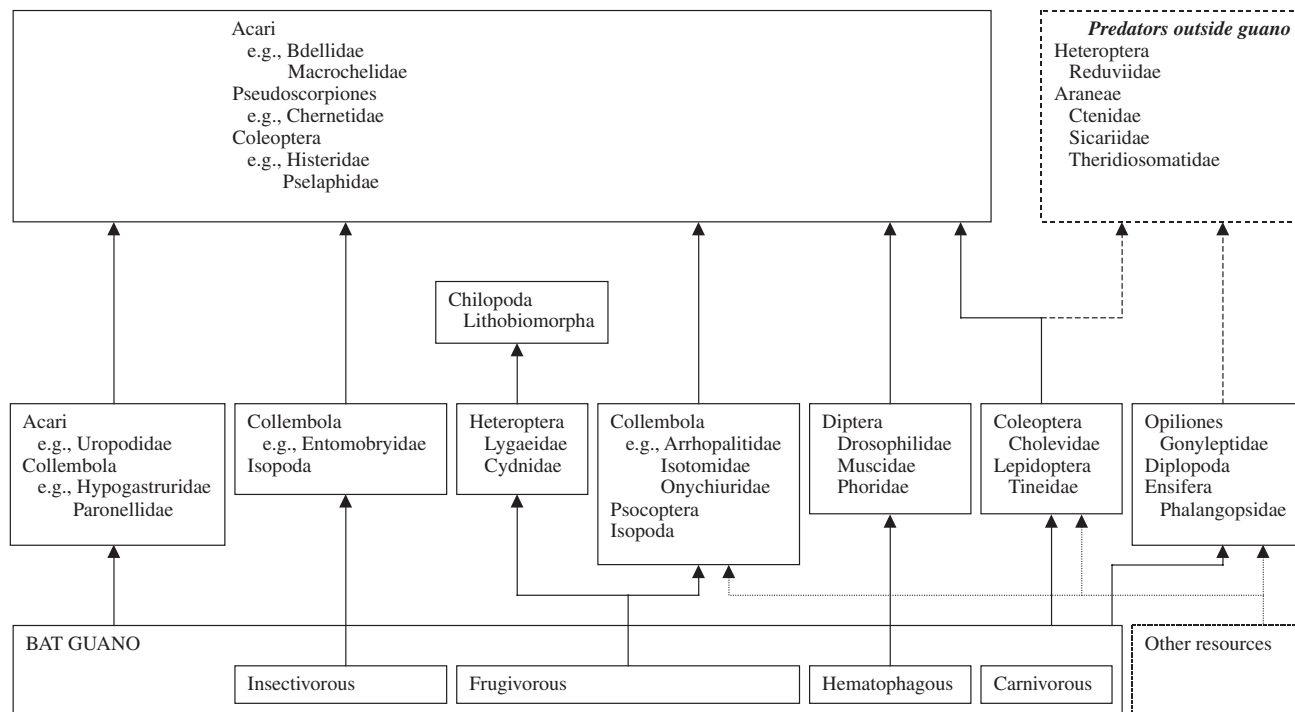
It is important to stress that aquatic communities may also use guano as food. For instance, veliid bugs were recorded on floating guano particles from Namibia, aquatic guanophages that feed on hematophagous bat guano seem to be the main food item of a troglobitic catfish from Northeastern Brazil, and even whole aquatic communities may depend on bat guano.

### THE FOOD WEB — EXAMPLES

As mentioned before, animals inhabiting guano piles may be guanophages and their predators and may also inhabit other substrates. Figure 9 shows an example of a Brazilian food web, where a large variety of types of guano may be found. Note that some taxa may be found in any kind of guano (e.g., tineid larvae), whereas some are restricted to one kind (e.g., flies in guano from hematophagous bats, and heteropterans and lithobiomorphans in guano from frugivorous species).

### CONSERVATION

Guano mining causes an impact on the bat population, which can move away from the mining site, resulting in the interruption of guano deposition. This, in turn, would lead to the abandonment and/or death of guano inhabitants, especially when guanobites are considered. This also includes aquatic environments. It is also clear that any important change in the epigeal environment may lead to the death and/or abandonment of bats (and/or birds and crickets), and, consequently, the guano inhabitants. Again, guanobites are important targets, and guanobites–troglobites may be even extinguished. For instance, logging or forest cutting may locally extinguish frugivorous bats and birds, interrupting the deposition of guano inside the local caves. One important example is the popular use of poisonous pastes against hematophagous bats in neotropical countries because of their menace to cattle. The bats lick the paste and due to their social behavior, they lick each other and die in large groups.



**FIGURE 9** Hypothetical food web for bat guano communities from São Paulo caves in southeastern Brazil. Arrows indicate direction of energy flow.

In the following days and months there is a large increase in energy input due to the large amount of cadavers deposited in the caves. However, afterward, energy input drastically decreases. Pollution from metals may also represent a threat to bats.

## CONCLUSIONS

In summary, guano is an important source of food in caves all around the world. There are some basic taxa that are almost always present in guano communities in caves, and accessory taxa, which are somewhat less common but still frequent groups. In addition, the composition of guano communities shows some differences related to the kind of guano (e.g., bird vs. bat guano, guano of frugivorous vs. insectivorous vs. hematophagous bats, etc.). Although there are large number of papers about guano communities in caves, there is still much to be done as many important findings have occurred in the last decade.

## ACKNOWLEDGMENTS

Sonia Hoenen (IBUSP) and David Culver provided helpful criticisms to the manuscript. The author has a research grant from FAPESP (Fundação de Amparo à Pesquisa do Estado de São Paulo) # 00/04686-4 and a research fellowship from CNPq (Conselho Nacional de Desenvolvimento Científico e Tecnológico) # 300326/1994-7. Figures 1, 3, and 8 are reprinted or modified from *Ecosystems of the World*, Vol.

30, *Subterranean Ecosystems*, Chapter 13, Gnasplini & Trajano, *Guano communities in tropical caves*. pp. 251–268, Copyright (2000), with permission from Elsevier Science.

## See Also the Following Articles

### Food Sources

### Bibliography

- Braack, L. E. O. (1989). Arthropod inhabitants of a Tropical cave "island" environment provisioned by bats. *Biological Conservation* **48**, 77–84.
- Calder, D. R., and J. S. Bleakney (1965). Microarthropod ecology of a porcupine-inhabited cave in Nova Scotia. *Ecology* **46**, 895–899.
- Chapman, P. (1984). The invertebrate fauna of the caves of Gunung Mulu National Park. *Sarawak Museum Journal* **51**, 1–22.
- Decu, V. (1986). Some considerations on the bat guano synusia. *Travaux de l'Institut de Spéologie "Émile Racovitza"* **25**, 41–51.
- Decu, V., and M. V. Tufescu (1976). Sur l'organisation d'une biocénose extrême: la biocénose du guano de la grotte "Pestera lui Adam" de Baile Herculane (Carpates Méridionales, Roumanie). *Travaux de l'Institut de Spéologie "Émile Racovitza"* **15**, 113–132.
- Deharveng, L., and A. Bedos (2000). The cave fauna of Southeast Asia. Origin, evolution and ecology. In *Subterranean Ecosystems*, (H. Wilkins, D. C. Culver, and W. F. Humphreys, eds.), pp. 603–632. Elsevier Press, Amsterdam.
- Gnasplini, P. (1992). Bat guano ecosystems. A new classification and some considerations, with special references to Neotropical data. *Mémoires de Biospéologie* **19**, 135–138.
- Gnasplini, P., and E. Trajano. (2000). Guano communities in tropical caves. In *Subterranean Ecosystems*, (H. Wilkins, D. C. Culver, and W. F. Humphreys, eds.), pp. 251–268. Elsevier Press, Amsterdam.
- Negrea, A., and S. Negrea (1971). Sur la synusie du guano des grottes du Banat (Roumanie). *Travaux de l'Institut de Spéologie "Émile Racovitza"* **10**, 81–122.
- Poulson, T. L. (1972). Bat guano ecosystems. *Bulletin of the National Speleological Society* **34**, 55–59.

- Poulson, T. L., and K. H. Lavoie (2000). The trophic basis of subsurface ecosystems. In *Subterranean Ecosystems*, (H. Wilkins, D. C. Culver, and W. F. Humphreys, eds.), pp. 231–249. Elsevier Press, Amsterdam.
- Trajano, E. (1985). Ecologia de populações de morcegos cavernícolas em uma região cárstica do sudeste do Brasil. *Revista Brasileira de Zoologia* 2, 255–320.

## Gypsum Caves

Alexander Klimchouk

National Academy of Science, Ukraine

After limestone, the second most common rock in which solution caves develop is gypsum. Gypsum rocks support karst in a variety of geological settings and host some of the longest caves in the world. This article describes particular features of caves and their origin in gypsum rocks and relates these to different types of karst.

### DISTRIBUTION AND TYPES OF GYPSUM KARST

Gypsum ( $\text{CaSO}_4 \cdot 2\text{H}_2\text{O}$ ) is one of the most common evaporite rocks, i.e., inorganic rocks formed by chemical precipitation in a concentrated solution. As gypsum is much more soluble than limestone, it is much less common in outcrops. This is one of the reasons why gypsum karst has received relatively little appreciation in the past in the mainstream of karstology, and has commonly been considered of limited significance. However, since the 1970s it has been increasingly realized that karst processes in gypsum operate extensively when they occur below various types of cover beds within the upper few hundred meters of sedimentary sequences, with this type of setting being widely distributed over cratonic regions.

The variety of depositional settings in which gypsum can form range from deep-water, to subaerial, to lacustrine, thus the mode of occurrence of gypsum and the associations of lithofacies are quite diverse. The picture is further complicated by the fact that gypsum is very susceptible to recrystallization, dissolution, and replacement. Gypsum deposited in the shallow subsurface is converted to anhydrite after burial, and back to gypsum as the sulfate reenters the meteoric realm and is washed in cooler and fresher fluids. Gypsum and anhydrite occur widely as rare to frequent interbeds in sequences containing halite, carbonates, and siliciclastic sediments, but also as massive beds. Individual beds of gypsum with thicknesses of 10–40 m are fairly common, although sequences of them may exceed 200–300 m.

The karst which develops in gypsum has many features in common with carbonate karst, but it also has significant peculiarities imposed by the specific features of evaporite geology and dissolution processes. In characterizing gypsum karst and caves, it is particularly important to refer to the

overall settings of karst development, which are conveniently generalized by the evolutionary typology of karst types. Types of karst are viewed as successive stages in geological/hydrogeological evolution, from deposition through burial to reemergence, between which the major boundary conditions, the overall circulation pattern, and extrinsic factors and intrinsic mechanisms of karst development appear to change considerably. The different types of karst are marked by characteristic styles of cave development, which are particularly distinct in gypsum.

*Syngenetic karst*, which commences in freshly deposited gypsum, is limited in extension and does not present any significant caves. *Intrastratal karst* is considered to develop within rocks already buried by younger strata, where karstification is later than deposition of the cover rocks; it is by far the predominant karst type in gypsum. As a consequence of standard denudation and uplift on the continents, the buried rocks are shifted with time into progressively shallower positions. Karstification may be initiated at any of the stages of intrastratal development en route back to the surface. The entire sequence of intrastratal karst types includes *deep-seated karst*, *subjacent karst*, and *entrenched karst*. The respective settings differ by the degree of separation of soluble units from the surface and by structural and hydrogeological conditions for karstification. In terms of groundwater dynamics, deep-seated karst is always confined. In subjacent karst the hydrogeological confinement is locally breached by erosion of the cover rocks so that hydrodynamics change through to semiconfined and eventually to vadose and water table. Further erosional incision leads to the establishment of entrenched karst, where major valleys largely or entirely drain subhorizontal gypsum beds that remain capped with protective insoluble beds. Where poorly permeable clays or shales surround gypsum in a stratified sequence, intrastratal karst may not develop at all, and any considerable karstification will not commence until the gypsum bed is exposed to the surface.

*Denuded* and *open karst* types (soluble rocks are exposed to the surface through the most of their area) are characterized by similarly exposed geomorphic settings but differ in their previous karstification history. Although denuded karst is former intrastratal karst, which has considerable karstification inherited from the deep-seated stage, open karst represents the “pure line” of exposed development, that is karst evolved solely when the soluble rock has been exposed to the surface, with limited or no inheritance.

### IMPLICATION OF EQUILIBRIUM CHEMISTRY AND DISSOLUTION KINETICS TO SPELEOGENESIS IN GYPSUM

Chemical equilibrium and reaction kinetics for gypsum dissolution differs from that of calcite, imposing some important consequences for speleogenesis and evolution of karst. The solubility of gypsum is generally much greater



than that of calcite, the ratio being dependent on various factors different for each mineral. Although the solubility difference may be as great as three orders of magnitude under certain conditions, it is more commonly of one order, or even less than ten times, under typical CO<sub>2</sub> pressures found in karst. There are several chemical and physical factors, especially important in deep-seated settings, which can considerably enhance or renew gypsum solubility (e.g., presence of other salts in groundwaters, anaerobic reduction of sulfates in the presence of organic matter, dedolomitization of intercalated dolomite layers, pressure applied to the rock).

From the perspective of speleogenesis, the main difference of dissolution processes between carbonates and evaporates lies in kinetics. The process of dissolution in carbonate rocks is controlled mainly by the reaction at the rock surface. Experimental studies of dissolution rates for limestones suggest that relatively high rates drop rapidly when a solution reaches about 70–90% of saturation, because kinetic reaction changes its order in this region. This kinetic switch is of the ultimate importance for speleogenesis in carbonates as dissolution can continue, although at slow rates, along entire flow paths. A positive feedback loop between discharge and the rate of fissure growth makes the mechanism self-accelerating. The rapid enlargement stage begins when the water is able to pass through the entire conduit while preserving considerable undersaturation. This represents the breakthrough event resulting in a boost of the growth rate, provided that hydrogeological settings permit increasing discharge.

In contrast to limestone, dissolution of gypsum is controlled mainly by diffusion across a boundary layer. It is commonly assumed that the dissolution reactions of gypsum follow a linear rate law and no switch to nonlinear kinetics occurs with an increase in concentration. Hence, slow but uniform enlargement throughout long, initial flow paths cannot occur to open them up. Enlargement of initial flow paths in gypsum within reasonable geological times seems to be impossible in many settings common for limestone caves. Caves may form only where gradients are high enough, or initial widths of openings are large enough, and/or where flow distances are short enough to enable establishment of the breakthrough conditions (when solution remains undersaturated all the way through an initial flow path) within a feasible time.

Because the early conduit development in gypsum is extremely sensitive to variations of boundary conditions such as fissure aperture widths and hydraulic gradient, the range of variations, within which speleogenetic initiation of conduits occurs either almost immediately or virtually never, is very narrow. This explains why, on one extreme, gypsum formations may remain virtually untouched by karstification in many cases, and on the other extreme gypsum may support some of the most heavily karstified terrains where the process occurs at very high rates.

Another peculiar feature of speleogenesis in gypsum is that, because of the diffusion control of dissolution rates, it

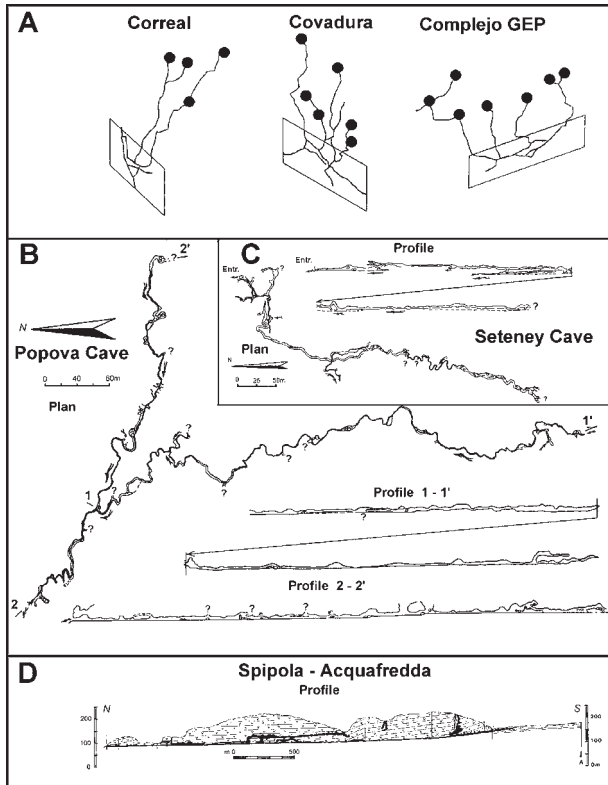
is highly dependent on hydrodynamic conditions. Unlike in limestone, dissolution rates in gypsum are proportional to flow velocity. Before the breakthrough event, disparity of dissolution rates between alternative flow paths in gypsum seems to be greater than in limestone. After breakthrough, enlargement rates increase more dramatically in gypsum than in limestone. These differences determine that speleogenetic competition between alternative flow paths is much stronger in gypsum than in limestone, and that a “runaway” development of the favorable paths is even more pronounced.

### SPELEOGENESIS IN GYPSUM AND TYPES OF CAVES

There are important distinctions in speleogenetic mechanisms and resultant cave patterns between phreatic unconfined and confined settings. Under unconfined phreatic conditions the above-described self-accelerating mechanism driven by the positive feedback loop between discharge and the rate of fissure growth is operative. Caves develop when initial widths of flow paths are large enough to permit quick breakthrough under given hydraulic gradient. Because of extremely competitive speleogenesis, linear or crudely branching caves form in gypsum. Passages rapidly adjust to the contemporary geomorphic setting and available recharge. In the unsaturated vadose zone, percolation and free-flowing waters quickly reach near-saturation, so that most of the dissolution occurs where water first enters the gypsum or is focused along streambeds during high-flow events. Where wide fissures in the vadose zone are fed from the surface or a perched aquifer, vertical pitches readily form in gypsum caves. No deep phreatic karstification develops in unconfined gypsum aquifers because of kinetic constraints.

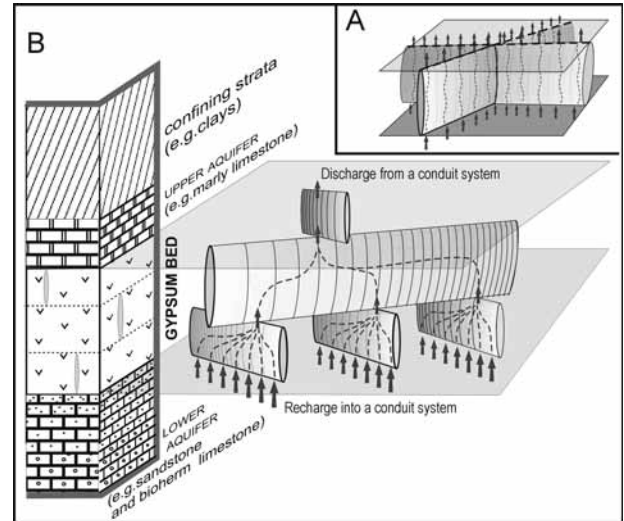
This style of cave development is best represented by open karst type, i.e., where karstification in gypsum commenced only after the unit has been exposed to the surface. Open gypsum karsts are found mainly in arid and semi-arid environments and where the gypsum units are fairly thick. Examples include Sorbas in southern Spain, the Central Apennines and Sicily in Italy, the Diebel Nador and Oranis areas in eastern and western Algeria, the Ar Rabitat/Bir area in northwest Libya, central and northern Somalia, some mountain areas in the northern Caucasus in Russia and in Central Asia, and gypsum karst areas in the southwestern United States. The longest gypsum caves of this type are Kulogorskaja-Troja in the Pinega region of Russia (14.3 km), Jester Cave in Oklahoma, U.S. (11.8 km), and Spipola-Aquafredda Cave in Central Apennines, Italy (10.5 km).

Confined (artesian) settings had been long viewed as unfavorable for speleogenesis in general, and even more so in gypsum. This is because commonly implied lateral artesian flow through a soluble unit can hardly support any considerable conduit development along inherently long flow paths. The recognition of the importance of cross-formational hydraulic communication between aquifers

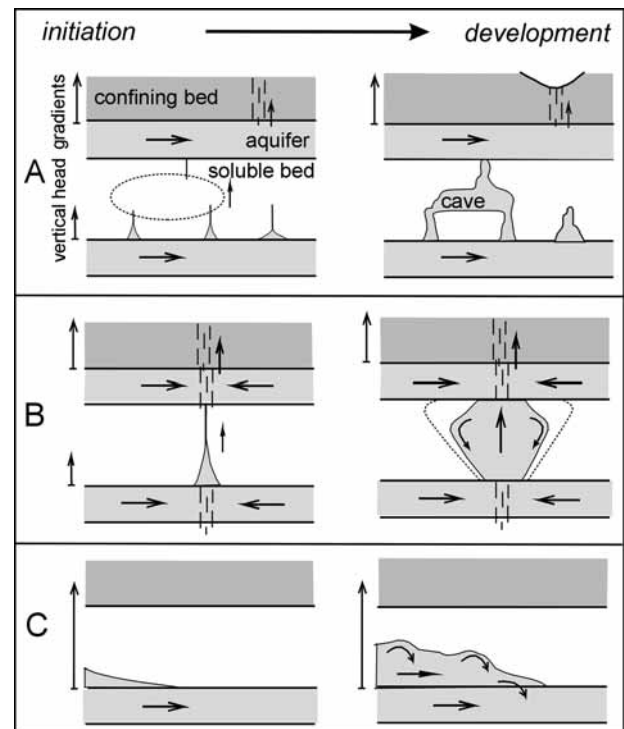


**FIGURE 1** Typical sketches, plans and profiles of gypsum caves formed in unconfined settings. A = in the open karst of Sorbas, Spain, feeding dolines are indicated by dots (from Calaforra, 1998); B and C = in the open karst of the Ekeptze-Gadyk massif, North Caucasus, Russia (from Ostapenko, 2001); D = the Spipola-Acquafredda system in the open karst of the Emilia Romagna, Italy (from Grimandi, 1987).

in multistory artesian systems gave a new impetus to the artesian speleogenetic theory, which allowed the adequate explanation of the formation of maze caves in gypsum. Figures 1 and 2a illustrates transverse speleogenesis, where conduit development is driven by the vertical hydraulic gradient across the layered sequence so that flow is directed transversely relative to bedding and the long dimensions of intrastratal fissures. Of primary importance is that distances of cave-forming flow are short, enabling reasonably quick breakthrough, and that discharge through the conduit after breakthrough is controlled by the hydraulic conductivity of the adjacent aquifers rather than by the resistance of the conduit itself. In the above conditions a specific hydro-geologic mechanism operates which suppresses the positive feedback loop and speleogenetic competition in the early development of transverse conduits. It favors the formation of maze patterns provided proper structural prerequisites exist. Outstanding examples are the giant gypsum maze caves in the western Ukraine, which are presently relict where they were entrenched. Five of them occupy the top ranks in the list of the longest gypsum caves in the world with passages totaling about 500 km. The longest gypsum cave, Optimistychna, is currently mapped for 223 km (see Table I) and is



**FIGURE 2** Diagrams illustrating initial conditions for transverse speleogenesis and fissure arrangement and cross-formation flow in a multistory artesian system. (a) A simple case of joints crossing a bed for the whole thickness; (b) fissure networks in multiple levels, the case of the Western Ukraine.



**FIGURE 3** Initiation and development of conduits and cavities under artesian conditions (from Klimchouk, 2000a): (a) Transverse speleogenesis along uniformly distributed common fissures, (b) transverse speleogenesis along a single prominent fissure across an otherwise low-fissured bed, and (c) lateral contact speleogenesis in the case of a massive impermeable bed driven by natural convection.

TABLE I The Longest (&gt;2000 m) and Deepest (&gt;100 m) Gypsum Caves of the World

Longest gypsum caves of the world			
Name	Length (m)	Country	Rock age
Optimistychna	223,000	Ukraine	Neogene
Ozerna	117,000	Ukraine	Neogene
Zoloushka	92,000	Ukraine	Neogene
Mlynki	27,000	Ukraine	Neogene
Kristal'na	22,000	Ukraine	Neogene
Kulogorskaja - Troja	14,300	Russia	Permian
Jester	11,800	U.S.	Permian
Spipola-Aquafredda	10,500	Italy	Neogene
Olimpijskaja-Lomonosovskaya	9,110	Russia	Permian
Slavka	9,100	Ukraine	Neogene
Agua, cueva de	8,350	Spain	Neogene
Verteba	7,820	Ukraine	Neogene
Cater Magara	7,300	Syria	Neogene
Park's Ranch	6,269	U.S.	Permian
Konstituzionnaja	6,130	Russia	Permian
Kungurskaja Ledjanaja	5,600	Russia	Permian
Kumichevskaja	4,520	Russia	Permian
Zolotoj Kljuchik	4,380	Russia	Permian
Covadura	4,245	Spain	Neogene
Crystal Caverns	3,807	U.S.	Permian
Double Barrel	3,724	U.S.	Permian
Scrooge	3,700	U.S.	Permian
Umm al Masabih	3,593	Libya	Jurassic
Simfonia	3,240	Russia	Permian
Pedro Fernandes	3,204	Spain	Neogene
Pekhorovskaja	3,200	Russia	Permian
Martin	3,150	U.S.	Permian
Leningradskaja	2,950	Russia	Permian
Carcass	2,920	U.S.	Permian
Pshashe-Setenay	2,690	Russia	Jurassic
Vodnaja	2,600	Russia	Permian
Pinezskaja Terechenko	2,600	Russia	Permian
Atlantida	2,525	Ukraine	Neogene
Ingh. Ca' Siere	2,500	Italy	Neogene
Wimmelburger Schlotte	2,840	Germany	Permian
Eras'kina 1-2	2,500	Russia	Permian
10-years LSS	2,450	Russia	Permian
Bukovinka	2,408	Ukraine	Neogene
Hyaenlabyrinth	2,310	Somalia	Paleogene
Pekhorovskij Proval	2,262	Russia	Permian
Geograficheskogo obshchestva	2,150	Russia	Permian
Ugryn'	2,120	Ukraine	Neogene
Re Tiberio	2,110	Italy	Neogene
Kulogorskaja-5	2,035	Russia	Permian
Michele Gortani	2,015	Italy	Neogene
Gostry Govdy	2,000	Ukraine	Neogene

TABLE I The World's Longest (&gt;2000 m) and Deepest (&gt;100 m) Gypsum Caves—cont'd

The deepest gypsum caves of the world			
Name	Depth (m)	Country	Rock age
Tunel dels Sumidors	210	Spain	Triassic
Pozzo A	>200	Italy	Triassic?
Corall, sima del	130	Spain	Neogene
Triple Engle Pit	130	U.S.	Permian
Covadura	126	Spain	Neogene
Campamento, sima del	122	Spain	Neogene
Aguila, sima del	112	Spain	Triassic
Rio Stella-Rio Basino	100	Italy	Neogene
AB 6	100	Russia	Jurassic

the second longest cave in the world after the Mammoth-Flint-Ridge system in Kentucky, U.S. Other prominent examples include network caves encountered by mines in the Paleogene gypsum of the Paris basin, France, and the maze of Pedro Fernandez Cave in the Neogene gypsum of Estremera, Madrid basin, Spain.

Another mechanism of deep-seated karstification can operate where the major aquifer underlies the gypsum and where lateral contact circulation occurs along the bottom of the gypsum unit (Figure 2c). Fissures or other irregularities at the base of the gypsum induce cave development even if no transverse flow across the unit is allowed due to large thickness of massive gypsum or presence of an impervious overlying bed. Once saturated, the water becomes heavier and returns to the aquifer replaced by less dense water. Such a system of natural convection may create vast isolated cavities in gypsum. Outstanding examples of this kind of speleogenesis include numerous giant Schlotten-type caves in the Zechstein (the Upper Permian) gypsum encountered by mines in the South Harz region of Germany at depths up to 400 m.

In unconfined settings that evolve after deep-seated karst in the course of uplift and denudation (subjacent, entrenched, and denuded karst types), the presence of inherited artesian conduits and newly formed wide fissures allows further cave development to occur readily in both vadose and phreatic zones. Rapid widening of preexisting caves occurs at the water table, particularly if periodic backflooding takes place from the adjacent river. In more stable conditions, such as in the interiors of massifs, extensive horizontal notching may develop at the level of the water table, promoted by chemical stratification in the water. Contemporary cave development under unconfined settings generates single-conduit or crudely branching caves that stretch from swallow holes on the interfluvial toward outlets on the valley slopes often superimposing on relict artesian maze patterns. Characteristic features of many entrenched gypsum karsts are vertical solution pipes (also known as

TABLE II Genetic Classification of Caves in Gypsum, with Relation to Karst Types and Speleogenetic Settings

Type of karst	Speleogenetic settings			Characteristics of solution caves
	Hydro-geological conditions principal complementary	Initial permeability (before speleo-genesis)	Flow pattern through gypsum and type of recharge	
Intrastratal deep-seated	Confined (artesian)	Fairly homogeneous generally low Very hetero-geneous, generally low to negligible, locally high	Ascending transverse flow across gypsum unit sandwiched between aquiferous beds, with possible lateral component; dispersed basal recharge Ascending transverse flow; localized basal recharge Lateral flow in the underlying aquifer, natural convection "cells" in gypsum	1. Rectilinear 2-D or 3-D (multistory) mazes 2. Discrete voids, commonly large and isometric -Discrete voids; commonly large and isometric
Intrastratal subjacent	Confined, phreatic, water table, vadose	Heterogeneous: low to high	Ascending flow with possible considerable lateral component; localized or dispersed basal recharge Descending flow with considerable lateral component; localized recharge from coverbeds and via superficial sinkpoints; possible backflooding from nearby rivers	Continuing development of types 1 and 2 3. "Through caves": linear or crudely dendritic in plan, horizontal, inclined, or step-like in profile Lateral enlargement of inherited artesian caves at the water table
Intrastratal entrenched	Phreatic, water table, vadose	Heterogeneous: low to high	Descending flow with possible considerable lateral component; localized recharge from coverbeds and via superficial sinkpoints; possible backflooding from nearby rivers	Continuing or newly started development of type 3 caves 4. Vertical pipes developing downward from the top of the gypsum Lateral enlargement of inherited artesian caves at the water table
Exposed denuded	Phreatic, water table vadose	Heterogeneous: generally high	Descending flow with possible considerable lateral component; localized recharge via superficial sinkpoints; possible backflooding from nearby rivers	Continuing or newly started development of type 3 caves Vertical pits at sinkpoints Lateral enlargement of all cavities at the water table
Exposed open	Phreatic water table vadose	Heterogeneous: generally low	Descending flow with possible considerable lateral component; localized recharge via superficial sinkpoints; possible backflooding from nearby rivers	Development of type 3 caves Vertical pits at sinkpoints Lateral enlargement of all cavities at the water table

"organ pipes" and "chimneys") that perforate gypsum sequences formed by aggressive waters leaking through the vadose zone from perched aquifers above. Their density may be as high as 300 per square km.

Evolutionary stages of intrastratal karst development which include subjacent, entrenched, and denuded karst types are often present adjacent to each other and to deep-seated karst within the same aquifer in monoclinical tectonic settings, although one of them commonly predominates. Remarkable examples include the Pinega and Pre-Ural regions in Russia, the Western Ukraine, the South Harz in Germany, and the Gypsum Plain in New Mexico, U.

In highly soluble aquifers such as gypsum, natural convection circulation and gravitational separation of water due to density differences plays an important role in speleo-

genesis. As shown previously, dissolution due to natural convection is important in cave initiation and development under deep-seated confined settings where recharge to gypsum by low-density fresh water occurs from below. The natural convection effects account for the development of cavities along the lower contact of gypsum, as well as for the formation of keyhole sections, ceiling half-tubes, and domes in "transverse" artesian maze caves. Under shallow phreatic conditions, characteristic tipdown triangular cross sections develop, with flat ceilings ("Laugdecke" in German), combined with inclined wall facets.

Mechanisms and preferential styles of speleogenesis change during the course of karst evolution. This is illustrated by Table II, which relates genetic types of gypsum caves to the stages of karst evolution.

**Bibliography**

- Klimchouk, A. (2002). Evolution of karst in evaporites. In *Evolution of Karst: From Prekarst to Cessation*, (F. Gabrovsek, ed.), pp. 61–96. Postojna-Ljubljana, Založba ZRC.
- Klimchouk, A. B., D. C. Ford, A. N. Palmer, and W. Dreybrodt, eds. (2000). *Speleogenesis: Evolution of Karst Aquifers*, p. 527. National Speleological Society, Huntsville, AL.
- Klimchouk, A., D. Lowe, A. Cooper, and U. Sauro, eds. (1996). Gypsum karst of the world. *International Journal of Speleology, theme issue*, 25(3–4), 307.
- Palmer, A. N. (1991). Origin and morphology of limestone caves. *Geological Society of America Bulletin*, 103, 1–21.

# Gypsum Flowers and Related Speleothems

**William B. White**

*The Pennsylvania State University*

Caves provide excellent environments for the growth of mineral crystals. Cave conditions of temperature and moisture remain constant for long periods of time. Some 256 different minerals have been identified from caves, although most are quite rare. Most of the speleothems found in caves are composed of calcium carbonate. However, minerals composed of sulfates of various kinds are found in dry caves. The crystal growth habits of the sulfate minerals are quite different than the habits of carbonate minerals, and the resulting speleothems have a quite different appearance. Sulfate mineral crystals tend to grow as large, curved fibrous bundles having the appearance of flower petals as well as other shapes. The most common of the sulfate minerals is gypsum,  $\text{CaSO}_4 \cdot 2\text{H}_2\text{O}$ , and the commonly appearing speleothems are known as gypsum flowers.

## EVAPORITE MINERALS IN CAVES

Calcium sulfate occurs in three degrees of hydration. Anhydrite is  $\text{CaSO}_4$ , the anhydrous salt. It is stable at temperatures above  $35^\circ\text{C}$  and at high salinities. Anhydrite is common in sedimentary deposits where the high ionic strength of seawater lowers the activity of water and stabilizes anhydrite structure. Anhydrite is not stable in the cave environment because of the lower temperature and the presence of fresh water.  $\text{CaSO}_4 \cdot 1/2\text{H}_2\text{O}$  is ordinary plaster but occurs only rarely in nature as the mineral bassanite. Gypsum,  $\text{CaSO}_4 \cdot 2\text{H}_2\text{O}$ , is the fully hydrated form. Gypsum is monoclinic with unit cell parameters:  $a = 5.679 \text{ \AA}$ ,  $b = 15.202 \text{ \AA}$ ,  $c = 6.522 \text{ \AA}$ , and  $\beta = 118.4^\circ$ . Single crystals of gypsum are water-clear. These transparent masses are called selenite. Selenite can be easily cleaved into plates and slabs

perpendicular to the b-crystallographic axis, the {010} cleavage plane.

Most crystals grow at different rates in different crystallographic directions. The fast growth direction in gypsum is along the crystallographic c-direction. Because of the differences in growth rate, gypsum often takes the form of long acicular crystals and fibers.

In addition to gypsum, two other sulfate minerals have similar crystal structures and also form crusts and “flowers”: mirabilite,  $\text{Na}_2\text{SO}_4 \cdot 10\text{H}_2\text{O}$ , and epsomite,  $\text{MgSO}_4 \cdot 7\text{H}_2\text{O}$ . These minerals are highly water soluble, so appear only in very dry caves. Mirabilite is unstable in the outside atmosphere. If mirabilite crystals are removed from the cave, the mineral loses its water of crystallization to become thenardite,  $\text{Na}_2\text{SO}_4$ . The large water-clear crystals of mirabilite collapse into a white powder. The behavior of epsomite is unusual. Unlike mirabilite which loses all ten water molecules at once, epsomite loses water step-wise where the first step is  $\text{MgSO}_4 \cdot 7\text{H}_2\text{O}$  (epsomite)  $\rightarrow$   $\text{MgSO}_4 \cdot 6\text{H}_2\text{O}$  (hexahydrate) +  $\text{H}_2\text{O}$ . The conditions of temperature and water vapor pressure for this reaction are very close to cave conditions, so small shifts in the local environment will cause the mineral to hydrate or dehydrate according to the season.

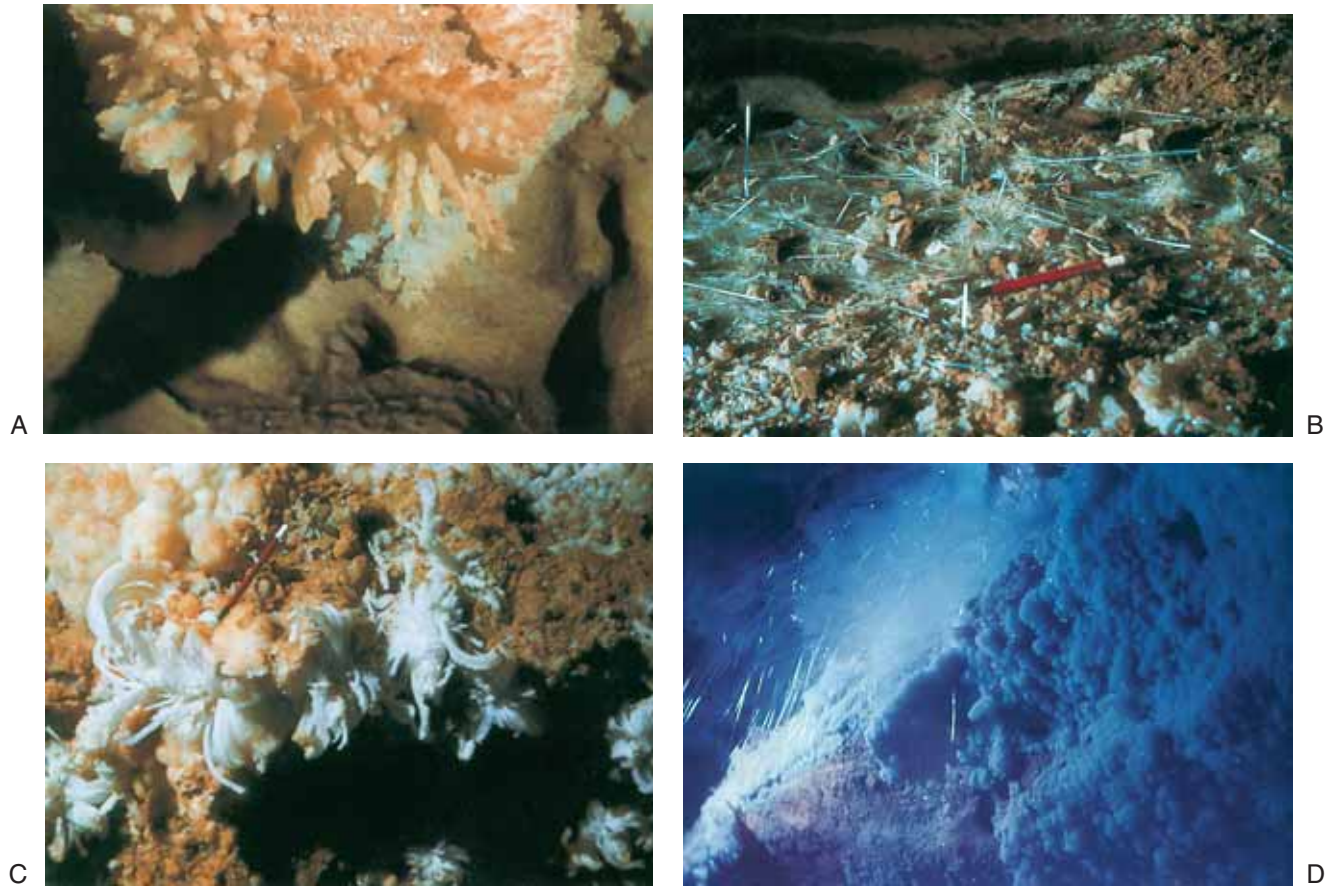
Other sulfate minerals that occur in caves include the double salts bloedite,  $\text{MgSO}_4 \cdot \text{Na}_2\text{SO}_4 \cdot 4\text{H}_2\text{O}$  and eugsterite,  $\text{CaSO}_4 \cdot \text{Na}_2\text{SO}_4 \cdot 2\text{H}_2\text{O}$ . Celestine,  $\text{SrSO}_4$ , occurs as a minor mineral associated with gypsum deposits where seepage waters are rich in  $\text{Sr}^{2+}$ . Typically celestine appears as pale-blue crystals embedded in a white gypsum crust. In caves where the sulfate ion is derived from oxidation of sulfide minerals or from the oxidation of  $\text{H}_2\text{S}$ , there may occur aluminum-containing sulfate minerals such as alunite,  $\text{KAl}_3(\text{SO}_4)_2(\text{OH})_6$ . Some caves are associated with ore deposits. The oxidation and hydration of the metal sulfides of the ore deposits by reaction with cave waters produces a complex suite of iron, copper, and other metal sulfate minerals.

## SPELEOTHEMS

Gypsum and the other sulfate mineral speleothems exhibit a great variety of shapes depending on growth rate and the source of water.

- A. Bulk crystals
  1. Soil gypsum
  2. Dentate gypsum
  3. Gypsum needles
- B. Gypsum crusts
  1. Granular crusts
  2. Fibrous crusts
- C. Fibrous gypsum
  1. Gypsum flowers
  2. Angel hair
  3. Cave cotton

Gypsum can grow in the clastic sediments to form a variety of crystals which can reach dimensions of many



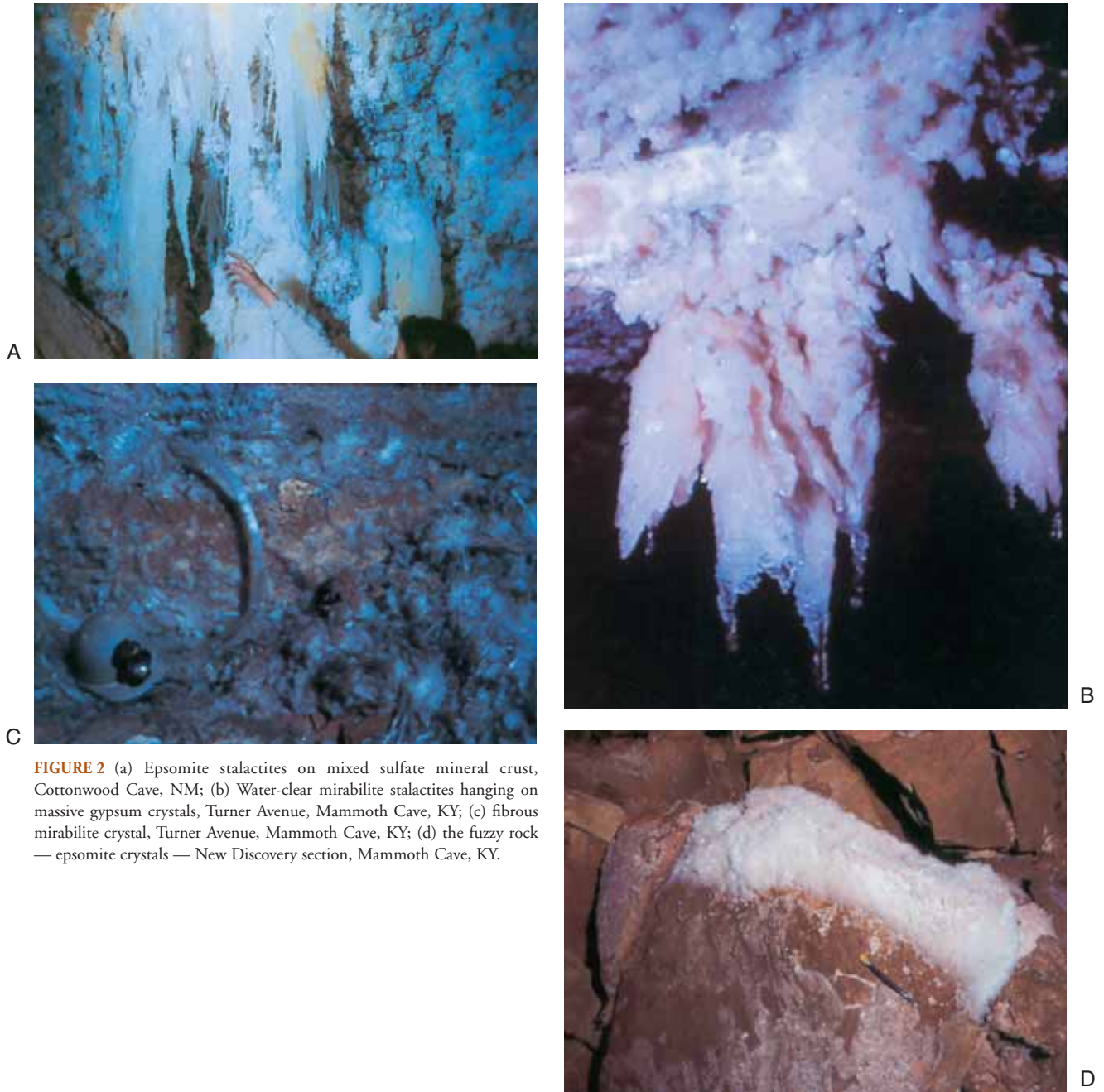
**FIGURE 1** (a) Dentate gypsum on bedrock pendant, Cumberland Caverns, TN; (b) gypsum needles, Cumberland Caverns, TN; (c) gypsum flowers, Cumberland Caverns, TN; (d) angel hair gypsum, Cumberland Caverns, TN.

centimeters. These are sometimes elongated and other times irregular masses. The surfaces are rough and rarely display crystal faces, although the interior may be clear selenite. The presence of some moisture films on gypsum in air-filled cave passages can result in large faceted crystals such as the dentate crystals shown in Fig. 1a. Another habit of bulk gypsum crystals is shown in association with mirabilite stalactites in Fig. 2b. Crystals of this sort can reach dimensions of meters and have been termed “gypsum chandeliers.” Gypsum needles are straight, clear crystals that grow by extrusion from the soil in some caves (Fig. 1b). At the base of each needle, where it is inserted into the soil, is a V-shaped notch. Polarized light microscopy shows that the needles are twins, with the {100} twin plane emerging from the tip of the V and forming the central plane of the needle. The V-notch, termed a “reentrant twin,” provides an optimum site for the deposition of new crystal from moisture in the soil. Thus, the gypsum needles grow from the base and are extruded from the soil as the crystals grow. Gypsum needles have been observed with lengths of more than one meter.

Gypsum crusts are formed on cave walls from minute amounts of moisture seeping through the limestone rock. Some crusts have a sugary appearance and are composed of

sand-sized grains of gypsum. Others have a satin appearance in cross section and are composed of fibrous crystals arranged perpendicular to the crust. Crusts have been observed to grow over historical names that had been scratched on the cave walls. They grow irregularly because of the variation in the permeability of the bedrock. Locations where growth is faster produce blister-like bulges in the crusts, and these may erupt to form gypsum flowers. As crusts continue to grow, they often break free of the wall and peel away exposing bare bedrock and later new crusts.

Most spectacular of the gypsum speleothems are the gypsum flowers (Fig. 1c). Gypsum flowers range in size from a few centimeters to tens of centimeters, often with the “petals” elaborately curved. Under the optical microscope, the petals of the gypsum flowers are seen to be bundles of fibers, each fiber a separate gypsum crystal. Gypsum flowers grow from the same seepage waters that form gypsum crusts. The solutions move faster in more porous zones and thus the crystals grow faster near the center of the zone. The faster growing crystals tend to push past the slower growing fibers at the side, thus causing the overall mass of fibers to curve outward producing the curved flower petals. The fibers that make up gypsum flowers are



**FIGURE 2** (a) Epsomite stalactites on mixed sulfate mineral crust, Cottonwood Cave, NM; (b) Water-clear mirabilite stalactites hanging on massive gypsum crystals, Turner Avenue, Mammoth Cave, KY; (c) fibrous mirabilite crystal, Turner Avenue, Mammoth Cave, KY; (d) the fuzzy rock — epsomite crystals — New Discovery section, Mammoth Cave, KY.

relatively coarse, perhaps fractions of a millimeter to a millimeter in diameter. Much smaller and longer fibers occur as the form known as “angel hair” (Fig. 1d). The fibers that make up angel hair appear to be single crystals with lengths of a meter or more with a cross section of a millimeter or less. Still smaller fibers occur in a speleothem called “cave cotton.” As the name implies, cave cotton is a mass of tangled fibers generally with lengths of a few tens of centimeters but with a diameter of fractions of a millimeter. The thin crystals flex easily so that the mass appears much like a ball of cotton.

Mirabilite, epsomite, and other sulfate minerals have similar crystal habits although different crystal structures on the atomic scale. As a result, “flowers” of mirabilite and epsomite are also found in extremely dry cave passages. However, the high solubility of these minerals means that they dissolve easily in any available seepage. Stalactites of epsomite (Fig. 2a) and mirabilite (Fig. 2b) occur when there is sufficient seepage to form liquid droplets. Otherwise, the minerals occur as curved bundles of fibers (Fig. 2c) or fibrous crystals (Fig. 2d). It is difficult to distinguish the water soluble minerals from gypsum by visual inspection only.

## SOURCES AND DEPOSITIONAL MECHANISMS OF EVAPORITE MINERALS

There are multiple sources for the gypsum and other sulfate minerals which occur in limestone caves.

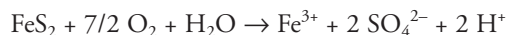
1. Gypsum beds that occur within the limestone
2. Gypsum derived from the oxidation of pyrite that occurs within the limestone
3. Gypsum derived from oxidation of pyrite in overlying rock formations
4. Gypsum derived from oxidation of H<sub>2</sub>S
5. Gypsum derived from the hydration of anhydrite pods within the limestone

The chemistry of gypsum deposition is exceedingly simple. Evaporation of solution containing Ca<sup>2+</sup> and SO<sub>4</sub><sup>2-</sup> causes them to combine to form gypsum.



The solubility of gypsum is approximately 2600 mg/L at 10°C making it relatively easy for gypsum to dissolve in one part of the groundwater flow system and be transported to the site of deposition elsewhere. Beds of primary gypsum occur in many limestone sequences thus they can provide a source of gypsum that requires only transport to its final site of deposition.

Pyrite, FeS<sub>2</sub>, occurs widely distributed in many sedimentary rocks. It is unstable in wet, oxidizing environments. Although the details are complicated the overall reaction is



Ferric iron is very insoluble in mildly alkaline karstic waters and precipitates as Fe(OH)<sub>3</sub> so that iron rarely migrates far from the site of the original pyrite. The reaction can be more complicated because Fe<sup>3+</sup> can also break down more pyrite with the release of additional acidity. Microorganisms often

catalyze these reactions. The sulfuric acid produced by pyrite oxidation can either react with limestone directly to produce gypsum which is then transported in solution, or the reaction can be delayed until the reactants reach the walls of the cave passage where gypsum is deposited *in situ*. In either case the combined reaction is



Some limestones contain nodules of anhydrite incorporated within the limestone. When these are exposed by the formation of cave passages, the anhydrite reacts with water to form gypsum.

Some caves, particularly those in the Carlsbad area of New Mexico, have been formed by the dissolving action of sulfuric acid rather than by carbonic acid, which is the usual mechanism in shallow ground water caves. The source of sulfuric is the oxidation of hydrogen sulfide, H<sub>2</sub>S, which seeps upward from nearby petroleum fields until it encounters oxygen-rich groundwater. The sulfuric acid dissolves the limestone and also can deposit quantities of gypsum which can then be redistributed to form gypsum speleothems.

### See Also the Following Articles

*Speleothems: Helictites and Related Forms • Minerals*

### Bibliography

- Alpers, C. N., J. L. Jambor, and D. K. Nordstrom (2000). *Sulfate Minerals: Crystallography, Geochemistry and Environmental Significance*. Reviews of Mineralogy and Geochemistry, Vol. 40. Mineralogical Society of America, Washington, DC.
- Hill, C. A. (1987). *Geology of Carlsbad Cavern and Other Caves in the Guadalupe Mountains, New Mexico and Texas*. New Mexico Bureau of Mines and Mineral Resources, Bull. 117, Socorro, NM.
- Hill, C. and P. Forti (1997). *Cave Minerals of the World*. 2nd ed. National Speleological Society, Huntsville, AL.





## Hydrogeology of Karst Aquifers

William B. White

*The Pennsylvania State University*

An *aquifer*, according to standard definitions, is a rock unit capable of storing and transmitting water. Both properties are necessary. The open spaces within the rock mass provide the storage space. These open spaces — pores, fractures and, in the case of karst aquifers, pipe-like conduits — must be interconnected so that water can flow through. In order to appreciate the special complications of aquifers that contain cave-size openings, it is necessary to first describe what are here called “normal” aquifers. We then proceed to the special properties of karst aquifers. These are presented as a “conceptual model,” that is a picture or cartoon of the parts and pieces of a karst aquifer, how they interrelate, and how they function. The purpose of a conceptual model is to set a foundation on which more precise and quantitative descriptions of aquifer behavior can be built.

### NORMAL AQUIFERS

In normal aquifers, pores between mineral grains are the open spaces available for the storage of water. *Porosity* is defined as the ratio of the volume of pores to the volume of bulk rock and is usually expressed as a percentage. Pore space by itself is insufficient. There must also exist pathways for the water to move through the pores so that overall the rock will transmit water. The ability of a rock to transmit water is referred to as its *permeability*. It is possible to have a rock, for example, a volcanic pumice, that has a high porosity but an

almost zero permeability. Many types of rocks can be effective aquifers, but not all of them. Shales typically have both low porosity and low permeability. Rocks that do not transmit water are called *aquicludes*. They frequently serve as barriers or confining layers in the movement of groundwater.

In addition to the pore spaces between mineral grains, many rock units have been fractured so that the bulk rock is laced with cracks, known as joints, and more sparsely with clusters of joints, known as fractures or joint swarms. In addition, there may be partings where the rock has separated along bedding planes. The term fracture is used loosely for all of these mechanical openings. Fractures also act as pathways for groundwater movement so that one can speak of matrix permeability referring to the interconnected pores and fracture permeability referring to joints, larger fractures, and bedding plane partings. In some rocks, for example, fractured granites and fractured massive basalts, fracture permeability completely dominates matrix permeability.

Aquifers are usually named with the name of the rock formation in which they occur. Rock formations extend indefinitely along the beds but the beds have a definite thickness. The aquifer thickness enters into various calculations but the lateral extent does not. Some aquifers are local; others extend over hundreds of kilometers. Descriptions of the principal aquifers in the United States have been compiled into a *Ground Water Atlas* by the U.S. Geological Survey (United States Geological Survey, 1992–1998).

Groundwater in normal aquifers moves very slowly, typically a few meters per year. The velocity is proportional to the hydraulic gradient according to Darcy’s law

$$v = -K \frac{dh}{dl}$$

The proportionality constant,  $K$ , has units of velocity and is called the hydraulic conductivity. The hydraulic conductivity is related to properties of the rock, properties of the fluid, and the strength of gravity which provides the ultimate

driving force moving the water. If the cross-sectional area,  $A$ , of the bit of aquifer being examined is specified, Darcy's law also describes the volume of water moving across the specified area per unit time. Combining these ideas

$$Q = Av = -A \frac{Nd^2 \rho g}{\eta} \frac{dh}{d\ell}$$

The parameter  $d$  is the mean diameter of the mineral grains and  $N$  is a geometric factor to take account of the irregular shape of the grains.  $Nd^2$  is the permeability, a property of the rock. Permeability and hydraulic conductivity are often confused. Because both measure the ability of the rock to transmit water, they are sometimes used — incorrectly — interchangeably. Hydraulic conductivity has units of velocity; permeability has units of area. Darcy's law is valid for other fluids (such as petroleum) as well as water. The properties of the fluids are described by their density,  $\rho$ , and viscosity,  $\eta$ , both functions of temperature. The gravitational force is described by  $g$ , the acceleration due to gravity.

Darcy's law is one of the most powerful statements in all of hydrology. It underlies most of the theory of groundwater flow. When combined with statements of the conservation of water within a unit volume of the aquifer, the result is a differential equation that describes the groundwater flow field. Many pages of standard textbooks on groundwater hydrology deal with the boundary conditions and solutions of these equations. The results take the form of flow fields, techniques for testing water wells, prediction of contaminant plumes, and many others. One of the most fundamental distinctions between karst aquifers and most normal aquifers is that in important parts of the karst aquifer, Darcy's law does not work.

Another aspect of karst aquifers that differs remarkably from normal aquifers is in the relationship between groundwater and surface water. In normal aquifers, groundwater and surface water are mostly disconnected. In a rainstorm, some water soaks into the ground as infiltration,  $I$ . Some water runs off over the land surface to enter creeks and rivers which quickly drain the water away as runoff,  $R$ . Some water is lost back to the atmosphere by evaporation and by the transpiration through the leaves of plants. Generally, these factors are taken together as evapotranspiration,  $E$ . Over long time periods, these factors must balance

$$P - E = I + R$$

Surface water flows in streams and rivers at velocities of fractions of a meter per second whereas groundwater moves at velocities of meters per year. The two can be treated as almost separate entities. The same is not true in karst aquifers.

## KARST AQUIFERS

### The Triple Porosity Model

The internal structure of a karst aquifer contains three types of permeability and is thus sometimes described by what is called the triple porosity or triple permeability model.

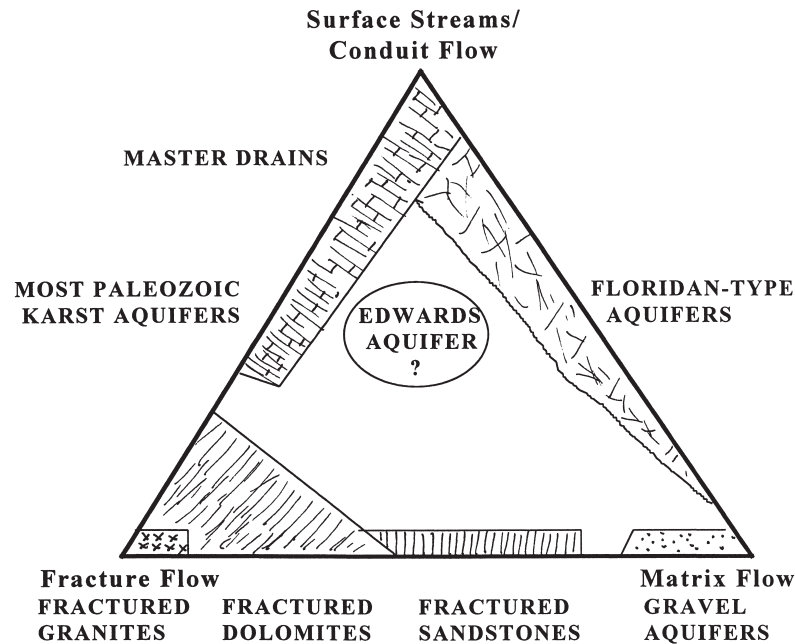
1. Matrix permeability is due to the pore spaces within the bedrock. Matrix permeability in karstic aquifers is not intrinsically different from the matrix permeability in normal aquifers.
2. Fracture permeability is due to joints, joint swarms, and bedding plane partings. Again, these are not intrinsically different from fractures in normal aquifers except for their tendency to be enlarged by dissolution of the bedrock.
3. In conduit permeability conduits are solutionally generated pathways in the aquifer bedrock. Flow of water in conduits is similar to flow in pipes. The flow regime may be turbulent. The flow velocities are in the range of centimeters per second compared with meters per year in normal aquifers. Water is confined to the conduits with little dispersion. As a result, contaminants are not dispersed to form a plume. Instead, they are carried down the conduit to a spring with little dilution except for incoming tributary passages.

The properties of each component of the permeability are summarized in Table I. Many Paleozoic limestones and dolomites have very little matrix porosity, while young limestones that have not been subject to the heat and pressure of deep burial are quite porous. Limestones and dolomites tend to be hard, brittle rocks and are often highly fractured.

Aquifers can be described by the triple porosity model as illustrated in Fig. 1. Various normal aquifers such as fractured sandstones, fractured granites, and gravel aquifers

TABLE I Characteristics of the Three Types of Aquifer Permeability

Permeability	Aperture	Travel time	Flow mechanism	Guiding equation	Distribution
Matrix	$\mu$ m–mm	Long	Darcian flow field: laminar	$h_f = \frac{\eta \nu L}{\rho g (Nd^2)}$	Continuous medium
Fracture	10 $\mu$ m–10 mm	Intermediate	Cube law: mostly laminar, may be nonlinear components	$\frac{Q}{h} = \frac{C}{f} B^3$	Localized but statistically distributed
Conduit	10 mm–10 m	Short	Darcy-Weisbach: open channel and pipe flow, turbulent	$h_f = \frac{f L v^2}{4 g r}$	Localized



**FIGURE 1** The three types of aquifer permeability expressed as a triangular diagram. Normal aquifers would lie along the bottom of the triangle. Karst aquifers are those in which conduit permeability is an important component.

lie along the base of the triangle where there is little or no contribution from dissolution processes in the development of the aquifer. Dense, brittle carbonate rocks form aquifers that lie along the side of the triangle between conduit flow and fracture flow. Aquifers in young carbonates such as the Floridan aquifer contain flow systems that are a mix of matrix and conduit flow. There are aquifers, such as the important Edwards Aquifer in central Texas, that contain contributions from all three types of permeability.

### Conduit Permeability

The feature of karst aquifers that makes them distinct from other aquifers is the presence of conduits, which act as networks of pipes carrying water rapidly through the aquifer. The degree of conduit development is highly variable. The connection of the conduits to the other types of permeability is also highly variable. As a result, there is a range of aquifer types as illustrated in Fig. 2 with very different roles played by the conduit system.

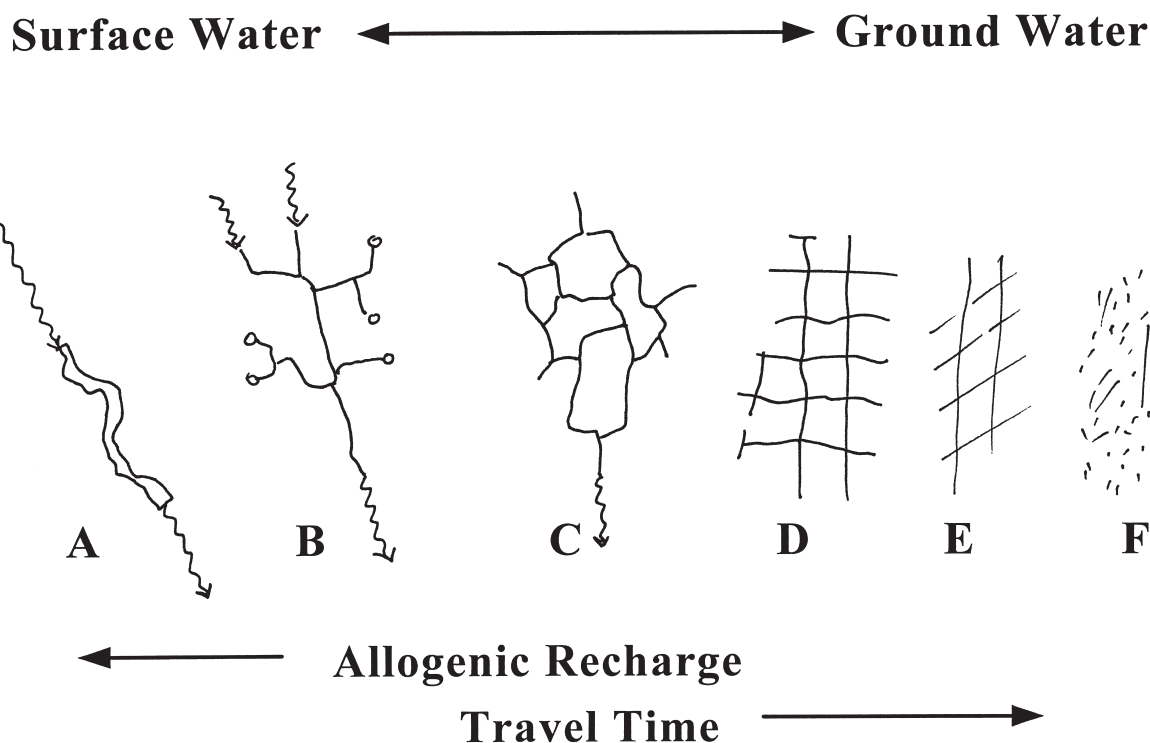
At one end of the sequence is the downstream reach of a sinking stream with its catchment mostly as surface streams on noncarbonate rock. In this case the conduits take the form of a drainage tunnel. Water moves through the tunnel at normal surface flow velocities, in one end and out the other. There are few connections between the water flowing in the conduit and the fracture and pore water in the surrounding rock. When a larger fraction of the drainage basin is karstic, sinkhole drains and smaller conduits converge to form master trunk systems. Master trunk and branchwork conduits form where the flow of water is under a moderate to

high hydraulic gradient. These conduit systems behave hydraulically much like surface streams except that they happen to be underground.

When gradients are low and where the free flow of the conduit system is impeded, water circulates along multiple pathways, gradually dissolving out either networks of joints or multiple loop openings along bedding plane partings. Dissolution along fractures leads to network mazes; circulation along bedding plane partings leads to anastomotic mazes. If master trunk and branchwork conduit systems can be likened to surface streams, network and anastomotic mazes can be likened to swamps. Like swamps, much water can move through these multiple pathways but at very low velocities.

The flow through conduits is generally turbulent whereas the flow in fractures and pores is generally laminar. Flow velocity increases with conduit size. Under usual hydraulic gradients, the onset of turbulence occurs when conduit apertures reach about one centimeter. We may take one centimeter — either the width of a solutionally widened fracture or the diameter of a tubular conduit — as the threshold for conduits. Continuous flow paths through the rock with an effective width of one centimeter or greater would be considered conduit permeability. Smaller openings would be fracture or matrix permeability.

Caves are not exactly equal to conduits. Caves are explored by humans, which give them a minimum dimension of 0.5 m, whereas with a minimum aperture of one centimeter there are many conduits that are too small to be called caves. Conduits provide continuous flow paths because for them to function as permeability in the aquifer, water must be able to



**FIGURE 2** Sketches showing various types of conduit permeability: (A) Single conduit with mainly surface water input; (B) branchwork conduits with sinkhole and sinking stream inputs; (C) anastomotic maze of interconnected tubes developed along bedding plane partings; (D) network maze developed along vertical fractures; (E) permeability consisting of solutionally widened fractures; and (F) matrix permeability only. Flow is most localized at (A) and most diffuse at (F). Travel times increase left to right. The sequence moves from a surface stream with a roof at (A) to a normal groundwater aquifer at (F).

move continuously from input to output. Caves are often occluded and are discontinuous; caves are fragments of conduits. Many active conduits are located below the water table. Many caves lie above the active zone of groundwater circulation and are abandoned conduits.

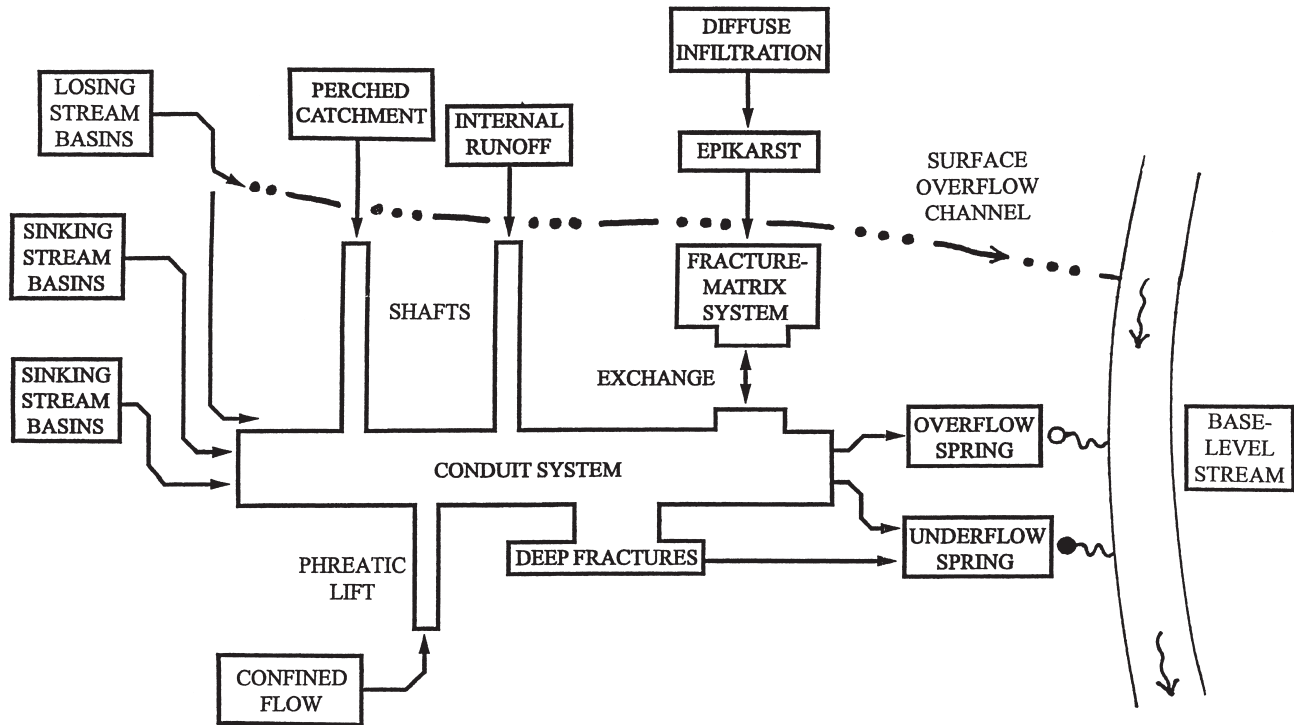
Water flows through conduits either as open channel flow (a stream with a free air surface), or as pipe flow (a completely water-filled tunnel). A single conduit may have sections with open stream passage and sections that are water filled. Exploration of cave sumps by scuba divers has shown that conduits frequently undulate in the vertical plane with alternating free surface streams and sumped passages.

### Karst Groundwater Basins and Groundwater Flow Systems

Because of the rapid transmission of water through conduits and because of the rapid drainage of surface water into the aquifer through sinkholes and surface streams, it is necessary to combine both surface water and groundwater characteristics. The result is the concept of a groundwater basin which includes both surface and subsurface components. Combining water sources with the internal characteristics of the aquifer and with the discharge of water back to surface routes produces the “standard model” of karstic aquifers illustrated in Fig. 3.

The standard model contains the following sources of recharge:

1. *Dispersed (or diffuse) infiltration.* Rainfall onto the karst surface infiltrates through the soils into underlying fractures. Dispersed recharge supports a water table in the karst aquifer. This component is not intrinsically different from infiltration in any aquifer.
2. *Allogenic recharge from surface streams.* Mostly, these drain from nearby drainage basins on noncarbonate rocks. Allogenic recharge enters the aquifer at well-defined swallow holes. Sometimes these are cave entrances, pits, or debris piles in blind valleys, and sometimes they are just sections of streambed where water is gradually lost. Flood flow in allogenic basins injects large pulses of water into the aquifer on short timescales. There is little or no filtration where surface streams become groundwater. Dissolved contaminants, suspended contaminants, and even massive objects such as cans, old tires, household garbage, and dead animals can be swept into the aquifer during periods of high flow.
3. *Internal runoff.* The land surface above karst aquifers is characterized by closed depressions of various sizes. Some of these are soil mantled, some have exposed bedrock, and a few expose an underlying underground stream. The latter are often called “karst windows.”



**FIGURE 3** A conceptual model for a carbonate aquifer showing various inputs and flow paths. Any particular groundwater basin may or may not contain all of these features.

Some closed depressions have collapses in the bottom where soil piping has occurred. During moderate storms, the rainfall infiltrates through the soils into the underlying aquifer through fractures and bedding plane partings. However, there is no surface runoff in sinkhole topography. Overland flow during storms drains to the bottoms of the closed depressions to make its way into sinkhole drains and thus directly into the underlying aquifer. Storm runoff can pond in the closed depressions and the seepage pressure can induce soil piping failures. Soil piping failures inject volumes of clastic sediment into the aquifer along with any contaminants that may have accumulated in the sinkhole.

### Piracies and Spillover Routes

Unlike surface water basins, groundwater basins may not have rigorously fixed boundaries. Escape routes along conduits that cross the basin boundaries into adjacent drainage basins are common. These are known as piracy routes and are most common in locations where the groundwater basin seems to be defined by the overlying surface water basin. Overflow routes on the land surface converge to a master stream that is often the location of the spring from which the groundwater discharges. However, certain surface streams that sink underground within the surface water basin may cross surface divides, sometimes

under ridges or mountains, and appear in springs far outside the original basin. Such piracies can be identified by tracer studies, but these must be conducted with great care because dyes injected into swallow holes may reappear in completely unexpected places.

Karst aquifers evolve over time. New conduits are formed at depth and old conduits are drained and abandoned. The old conduits may have converged on a spring in a particular surface water basin. The new conduits may have shifted the flow path so that the present system drains to a new spring which may be in a different surface water basin. Under low flow conditions, the present day basin may be well behaved with all recharge draining to the active spring. During flood flow, however, rising water levels within the conduit system may activate some of the abandoned conduits. The result is that floodwaters are diverted into the old drainage system. Such spillover routes are also a common feature of karst aquifers.

### The Karst Water Table

In a normal aquifer, rainfall infiltrates through the soil into the underlying bedrock. It moves vertically through the pore spaces in the rock, displacing the air that occupied the pores. This portion of the aquifer is known as the *vadose* or unsaturated zone. The infiltrating water continues to move vertically until it reaches a portion of the aquifer where all pore spaces are water filled. This portion of the aquifer

is known as the *phreatic* or saturated zone. The interface between the vadose and phreatic zones is the *water table*. In a normal aquifer, the water table is a surface that stands higher under topographic highs and lower under topographic lows. The water table slopes from topographic highs to surface streams which are the locations of ground water discharge. The slope of the water table is supported by the hydraulic resistance for groundwater moving through the pore spaces of the rock.

In a karst aquifer, the open pipes of the conduit system have a very low hydraulic resistance. The presence of conduits creates a trough in the water table. The water table in the fracture and matrix permeability in the bedrock slopes toward the conduits rather than to the surface streams. The conduit system acts as a drain for the entire aquifer. Sinkholes and sinking streams allow very rapid input of storm water into the aquifer. The groundwater trough fills quickly, often flooding the conduit systems.

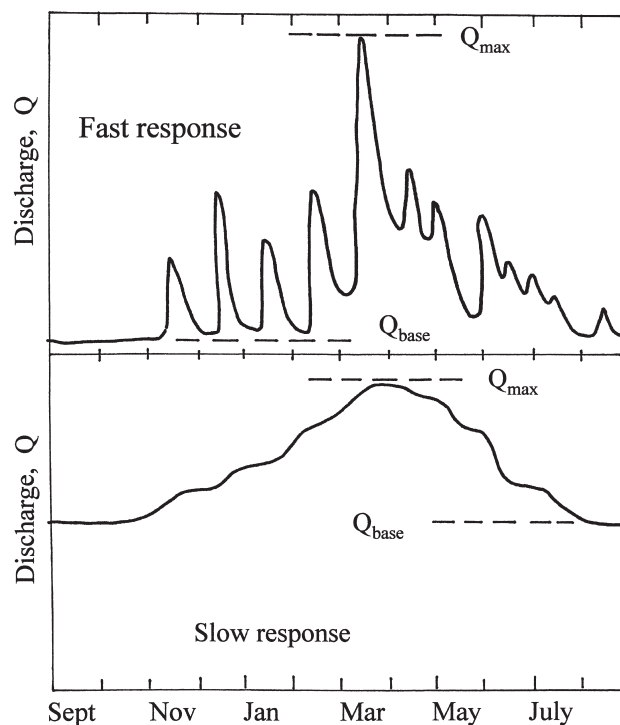
In terrain with low to medium relief, the karst water table is well defined. The location of the water table can be determined by measuring the elevation of standing water in wells. If there is a sufficient density of wells, the standing water elevations can be contoured to construct a map of the water table surface. In high relief terrain, the position and even the existence of the water table is more difficult to define. Recharge water from rainfall and snow melt in mountainous regions often descends through the vadose zone as waterfalls in shafts and steep gradient free surface streams which may cross over each other. The presence of even a large free surface stream does not necessarily mark the location of the water table. Furthermore, sumped passages may occur that are perched above regional base levels, and these also do not necessarily indicate the location of the water table.

## CHARACTERISTICS OF KARST AQUIFERS

### Discharge Characteristics: Hydrographs

Karst aquifers usually discharge through a relatively small number of large springs. The discharge, turbidity, and chemistry of water from karst springs provide information on the generally inaccessible processes upstream in the groundwater basin.

Surface drainage basins respond very rapidly to storms. A sudden intense storm will send a flood down the valley of the surface stream. Depending on the degree of development of the conduit system, groundwater basins may respond much the same way. If there is a well-developed conduit system, storm inputs through sinking streams and internal runoff into sinkholes will move rapidly through the system. The discharge at the spring will increase rapidly and the water may become muddy. Other springs, draining groundwater basins with more poorly developed conduit systems, will have a more subdued response. These responses can be described by measuring discharge at the spring and constructing spring hydrographs (Fig. 4). Fast response springs



**FIGURE 4** Sketches of (a) a fast response hydrograph showing individual storm peaks and (b) a slow response hydrograph showing only seasonal wet and dry periods. The horizontal scale is the water year which begins in September in the eastern United States.

are those with open conduit systems so that the rise and fall of the storm hydrograph is short compared with the average spacing between storms. The storm flow from the spring rises, peaks, and falls back close to base flow before the next storm arrives. The discharge from slow response springs may increase during wet seasons and decrease during dry seasons, but the system responds too slowly for the spring to be impacted by individual storms. There are, of course, intermediate response springs with some storm response but with the hydrographs of individual storms smeared together.

Spring hydrographs provide several parameters for characterizing the aquifers that feed the spring. The ratio of peak discharge to base flow discharge,  $Q_{\max}/Q_{\text{base}}$ , is a measure of the “flashiness” of the aquifer. The recession of the hydrograph often has an exponential form. It can be fitted to a function of the form

$$Q = Q_0 e^{-t/\tau}$$

$Q$  is spring discharge in volume per unit time,  $t$  is time, and  $\tau$  is the response time of the aquifer. Plots of hydrograph recession curves for many highly karstic groundwater basins show two (or more) segments, a fast response time on the order a few days and a slow response time on the order of 20–30 days. One interpretation is that the fast response represents the draining of the conduits while the slow response is the draining of fractures and small openings that feed into the conduits.

### Carrying Capacity of Conduit Systems

When surface streams flowing on noncarbonate rocks reach the contact with the carbonates, the amount of surface stream flow lost to the carbonate aquifer depends on the carrying capacity of the conduit system. If the conduit system is poorly developed so that it can carry only a portion of the base flow, the stream will remain on the surface across the carbonate rock. The flow in the surface stream will be smaller than expected for the area of the basin because part of the flow will be lost into the carbonate aquifer. At the next stage, the conduit system can carry base flow but not storm flow. At this stage, the surface stream will go dry during the dry season. With further enlargement of the conduit system, small storms can also be accommodated. At this stage, the surface stream will be dry most of the time and will carry water only during flood flow. Because of disuse, the streambed will become overgrown with vegetation, banks will cave in, and sinkholes may develop along the stream channel. At the final stage, when the conduit system can carry the most extreme flood flows, the surface channel will eventually disappear. Upstream from the swallow hole, surface flow on noncarbonate rocks will continue to deepen the channel resulting in a blind valley.

### Base Flow/Area Relationships

The boundaries of the groundwater basins that subdivide karst aquifers are determined by a variety of evidence — geological constraints, tracer tests from sinkholes and sinking streams to springs, and explored cave passages — but the basin boundaries cannot be measured directly. In most regions, the base flow emerging from the spring that drains a groundwater basin is proportional to the basin area.

$$Q = kA$$

The proportionality constant,  $k$ , varies depending on the hydrogeology of the basin, particularly the development of the conduit system. Basins with well-developed conduit systems will drain effectively between storms so that base flows will be small. Basins with poorly developed conduit systems will store water more effectively so that base flows are maintained. A serious disagreement between basin area calculated from base flow and basin area determined from the interpreted boundaries is an indication of the presence of piracy routes or of serious error in interpreting the boundaries.

### Clastic Sediments

The solutionally widened fractures and conduits in karst aquifers are sufficiently wide to permit the transport of clay, silt, sand, and gravel and even materials up to the size of cobbles and boulders. More importantly, the velocity of moving water is sufficient to drag solid particles through the aquifer.

Clastic sediments are transported mainly during flood flow episodes. Very small particles, mainly clay, are transported in suspension in the water making the water turbid or muddy. When water velocities decrease following a storm event, the sediments in suspension settle out, leaving a layer of mud. Coarser particles, sand and gravel, are transported as bedload. That is, the particles are rolled along the bottom of the conduit by the tractive force of the water flowing over them. Bedload transport requires a minimum velocity that depends on particle size to place the particles in motion. Banks of silt, sand, and gravel are frequently found in caves. Streambeds in caves are often armored with a layer of gravel and cobbles that move only during flood flows.

Transport of clastic sediment is an essential part of the functioning of the karst aquifer. In completely developed aquifers where all surface streams sink underground, the insoluble material carried by the sinking surface streams must be carried through the conduit system and washed out through the springs. If this did not happen, the conduit system would eventually become completely clogged with sediment and drainage would be forced to return to the surface.

## WATER SUPPLY AND WATER QUALITY

### Water Wells in Karst

Groundwater for domestic or industrial use is extracted by drilling wells. Pumping water from the wells lowers the water level in the well (a quantity known as “drawdown”) thus creating a local hydraulic gradient that forces water from the surrounding rock to flow toward the well. For any given aquifer, there will be a maximum quantity of water that can be pumped from the well determined by the balance between the pumping rate and the drawdown. Water supply wells are located to provide the maximum quantity of water.

The optimum placement of wells in karst aquifer is difficult to determine. A well drilled into a flooded conduit would provide large quantities of water with negligible drawdown, but the water might be of questionable quality. In contrast, wells drilled into unfractured carbonate rock are often dry holes or at best provide only small quantities of water. For those aquifers with fracture permeability consisting of vertical fractures, wells drilled on fractures or on fracture intersections provide the best yields. For those aquifers with fracture permeability consisting of bedding plane partings, these partings provide high permeability zones that will be tapped regardless of the detailed location of the well.

### Water Quality

In the highly populated and developed countryside of today, one learns quickly not to drink from creeks and rivers. Municipal water companies draw water from surface sources, but these supplies are filtered, treated, and chlorinated before being released into public water supplies. Water from wells

and springs, on the other hand, is often thought to be “pure.” This statement is not true in general and it is exceptionally untrue when applied to karst aquifers. Karst springs are the outlets draining open conduit systems. Conduits receive portions of their water from sinkholes and sinking streams. There is little or no filtration. Any surface contaminants that enter the conduit system are flushed through to the springs with little dilution. Karst springs should be regarded with the same suspicion as surface streams.

Groundwater in carbonate aquifers tends to contain high concentrations of magnesium and calcium. These ions,  $Mg^{2+}$  and  $Ca^{2+}$ , make the water “hard.” Hard water is not a health risk, but it does require more soap for washing and laundry. It tends to precipitate calcium and magnesium carbonates in hot water heaters and other plumbing fixtures and may require water softeners for many uses. Wells drilled into fractured carbonate aquifers are also at risk. Open fractures can allow contaminants to migrate down from the land surface. Groundwater in the fractures generally flows down gradient to the conduit system. Pumping on wells in fractures may reverse the hydraulic gradients and cause water to flow from the conduits to the wells bringing contaminants to the wells.

### Contaminant Transport

Because of high velocity flow restricted to the conduit system, contaminants in karst aquifers generally do not spread out into a plume as they do in normal aquifers. Different categories of contaminants have different modes of transport within karst aquifers. Types of contaminants are listed below:

1. *Water-soluble compounds.* Inorganic salts and some organic compounds are soluble in water. These move with the water in the aquifer and appear at the springs possibly in a somewhat diluted form. In the case of a spill, water-soluble compounds will reach the spring in about the same time as the travel time of the water, often a matter of hours or at most a few day.
2. *Light nonaqueous phase liquids (LNAPLs).* Gasoline, fuel oil, home heating oil, and related hydrocarbons are less dense than water and are only slightly soluble. These compounds will float on the water table and will float on free-surface underground streams. However, they tend to pond behind sumps and tend to be trapped in pockets in the ceilings of water-filled conduits. Rising water levels can force LNAPLs upward along fractures where fumes can enter homes and other buildings.
3. *Heavy nonaqueous phase liquids (DNAPLs).* Chlorinated hydrocarbons such as trichloroethylene (TCE) and perchloroethylene (PCE) — both used as solvents, degreasers, and dry cleaning agents — as well as polychlorinated biphenyls (PCB) and many other compounds are more dense than water and are only slightly soluble. These materials are sometimes trapped in the epikarst but when they enter the aquifer, they tend to sink to the lowest water-filled

passages or become trapped in the clastic sediments that occur in the conduits. As a result, spills of DNAPLs often never reappear at springs and remain trapped in the karst aquifer for long periods of time.

4. *Metals.* Metallic elements such as chromium, cadmium, lead, and mercury are highly toxic, while others such as copper and zinc are less so, and these can be carried into karst aquifers either as ionic species in solution or as solid particles of various sorts. Because of the alkaline chemistry of karst waters, some metals are precipitated, some are adsorbed on clay particles, and some are incorporated into the oxide manganese which forms the black coatings of cave stream sediments. Metal transport in karst aquifer, therefore, involves a very complex chemistry that is not easily generalized.
5. *Pathogens.* Viruses, bacteria, protozoa, and larger organisms are easily transported into karst aquifers because of the large solution openings and the absence of filtering. Most common of these are the fecal coliform family of organisms and fecal streptococci. These organisms are indications of contamination by sewage or animal waste. *Giardia lamblia* is of most concern among protozoa. It is released in a cyst form in animal feces and is present in many surface waters. Sinking streams carry the stable cysts into the subsurface. Die-off is slow underground so that karst waters remain contaminated far from surface inputs.

### See Also the Following Articles

*Karst Water Tracing • Modeling Karst Aquifers*

### Bibliography

- Ford, D. C. and P. W. Williams (1989). *Karst Geomorphology and Hydrology*. Unwin Hyman, London.
- Milanovich, P. (1981). *Karst Hydrogeology*. Water Resources Publications, Littleton, CO.
- Palmer, A. N. (1991). Origin and morphology of limestone caves. *Geol. Soc. Am. Bull.* **103**, 1–21.
- United States Geological Survey (1992–1998). Ground Water Atlas of the United States. Hydrologic Investigations Atlas 730-B-M, 12 folio volumes.
- White, W. B. (1988). *Geomorphology and Hydrology of Karst Terrains*. Oxford University Press, New York.
- White, W. B. (1998). Groundwater flow in karstic aquifers. In *The Handbook of Groundwater Engineering*, Chap. 18 (J. W. Delleur, ed.), pp. 18.1–18.36. CRC Press, Boca Raton, FL.

## Hydrothermal Caves

Yuri Dublyansky

*Institute of Mineralogy and Petrography, Russia*

### DEFINITION

The term *hydrothermal karst* defines a process of dissolution and filling of cavities in the rocks under the action of hot



waters. This definition, though quite simple, is sometimes difficult to apply, because it requires another definition of which water should be called hot or thermal. In hydrological studies any water that is appreciably warmer (5°C or more) than the surrounding environment is called thermal. This type of definition is fairly satisfactory when it is applied to a still-active process in areas with a moderate climate. It is difficult to apply, however, to those settings where neither resurgence temperatures nor annual climatic averages are applicable (i.e., to deep-seated waters tapped by boreholes or to fossil karst processes). Conventionally, the temperature of 20°C is considered to be the lower limit of the hydrothermal environment. Although some meteoric karst systems in hot arid climates may exceed this without any thermal input, most hydrothermal cave systems relate to hypogenic sources of energy (i.e., internal heat of the Earth).

Formed due to the action of rising waters, hydrothermal systems typically lack any genetic relationships to recharge from overlying or directly adjacent surfaces. Caves must be uplifted with the rock and intersected by surface erosion, common karst, or by drilling, mining, or quarrying to be discovered and studied.

### SETTINGS OF HYDROTHERMAL KARST

It is convenient to subdivide hydrothermal karst settings into the following three categories: endokarst, deep-seated hydrothermal karst, and shallow hydrothermal karst.

#### Endokarst

It is a well-known fact that the rate of karst development decreases with increasing depth. However, deep drilling for oil and gas reveals that solutional porosity of carbonate rocks at a depth of 4–5 km may be as great as 18–28%, and the porosity of aluminosilicate rocks may be as great as 25–30%. The pressures of fluids at these depths are typically greater than the hydrostatic ones and may approach lithostatic values. At those levels, where the pressure exceeds the strength of the rock, pores and cavities may exist only if they are filled with high-pressured fluid (water), which prevents them from failure. The process of formation of such cavities is termed endokarst. The size of endokarstic cavities does not normally exceed several centimeters. Though this type of karst apparently does not produce traversable caves, it may play a significant role in creation of deep-seated reservoirs for hydrocarbons.

#### Deep-Seated Hydrothermal Karst

This covers a range of depths (approximately 0.3–4.0 km) where the temperature gradients are relatively small, pressures are close to hydrostatic, and the influence of the temperature changes at the Earth's surface is practically absent. Processes of cave excavation and cave infilling occur in response to

the change of physicochemical parameters of fluids moving toward the Earth's surface, such as a decrease in temperature and pressure. It is thought that dissolution related to the elevated content of carbonic acid is the leading factor in initiation and enlargement of caves in the deep setting. Recent studies, however, revealed the important role of dissolution processes involving sulfuric acid. At certain specific combinations of bedrock solubility and frequency of fractures, dissolution is accompanied by collapse. Characteristic collapse breccias are known in many fossil hydrothermal systems related to Pb–Zn ore deposits in dolomitic rocks (e.g., in Silesia, Poland).

#### Shallow Hydrothermal Karst

The shallow setting describes processes developing near the free surface of the thermal water — both below and above it. In this zone the pressures are low (down to atmospheric) and temperatures may range from boiling to just slightly exceeding the ambient ones. The temperature gradients may be significant, which lead to the appearance of some specific and powerful processes, like thermal convection and condensation corrosion. Also, this is a zone where upwelling thermal waters meet colder oxidized meteoric waters. This may induce specific reactions and processes like H<sub>2</sub>S oxidation, mixing corrosion, and cooling corrosion. The caves formed in such a setting commonly exhibit extremely diverse morphologies. Characteristic dimensions of individual caves are appreciably greater than those of the deep-seated hydrothermal caves. Also, shallow hydrothermal karst speleothem types are much more varied than those of the deep-seated karst.

All enterable active hydrothermal caves (those containing hot waters) are examples of shallow hydrothermal karst. Examples of such caves are known in many places including Turkmenistan (Bakharden Cave, with a lake with temperature of 35–37°C), Italy (Grotta Giusti, 32–34°C), and Hungary (Molnár János Cave, 18–24°C).

### CHEMISTRY OF FLUIDS AND PROCESSES OF CAVE EXCAVATION

Hydrothermal caves associated with the CO<sub>2</sub> and caves formed by waters containing H<sub>2</sub>S are considered to represent two major classes of hydrothermal (hypogenic) caves.

#### Dissolution by Rising Thermal Water (CO<sub>2</sub>)

Thermal waters rising from significant depth are commonly saturated with CO<sub>2</sub>, which may originate from metamorphism of carbonate rocks and igneous activity. Solubility of CO<sub>2</sub> in water depends on both temperature and pressure. Water saturated with respect to CO<sub>2</sub> at deep levels (e.g., 2–3 km) becomes supersaturated as it rises toward the surface. Hence, CO<sub>2</sub> must exsolve in the gaseous phase and

leave the system. Rising carbonic thermal waters also cool down. Due to the inverse relationship between carbonate solubility and temperature, they may acquire and maintain aggressiveness — even at decreasing CO<sub>2</sub> levels. The solubility of CaCO<sub>3</sub> increases evenly along the ascending fluid path, but near the land surface (or water table) it drops drastically. Such nonlinear behavior leads to the appearance of two geochemical zones: a zone of carbonate dissolution at depth and a zone of carbonate precipitation closer to the surface.

### Oxidation of Sulfides (H<sub>2</sub>S)

Sulfuric waters become aggressive when their dissolved H<sub>2</sub>S oxidizes upon contact with oxygen-rich waters or air to form sulfuric acid. Conversion of H<sub>2</sub>S to H<sub>2</sub>SO<sub>4</sub> produces a sharp increase in dissolution. The effect is attenuated when CO<sub>2</sub> generated by the H<sub>2</sub>SO<sub>4</sub>-CaCO<sub>3</sub> reaction is degassed. In two settings hydrogen sulfide oxidation is an important speleogenetic process. The first is subaqueous dissolution of carbonates near the water table. Large rooms of Carlsbad Cavern in New Mexico are believed to be formed this way. The second setting is dissolution and subsequent replacement of calcite by gypsum and its consequent removal above the water table. This mechanism, termed *replacement corrosion*, was suggested for caves of the Big Horn Basin in Wyoming.

### Dissolution Due to Mixing of Waters (CO<sub>2</sub> and H<sub>2</sub>S)

Solutional aggressiveness can be renewed or enhanced by mixing of waters of contrasting chemistry, particularly those differing in CO<sub>2</sub> and H<sub>2</sub>S content or salinity. Mixing of waters having different temperatures produces similar effect, due to contrasts in CO<sub>2</sub> contents. This effect, known as *mixing corrosion*, is thought to be responsible for the development of network maze cave systems in Budapest, Hungary, e.g., Pál-völgy, Szemlo-hegy, and Ferenc-hegy.

### Hydrothermal Karst in Noncarbonate Rocks

The mechanisms described above pertain to the most common variety of hydrothermal karst developing in carbonate rocks. Besides, hydrothermal caves have been reported from silicate rocks (quartzite, skarn, jasperoids, quartz veins), sulfate rocks (gypsum, anhydrite), rock salt, and even from massive sulfide ores.

### Hydrothermal Karst Related to Oxidation of Sulfide Ores

A Substantial amount of heat can be released when infiltrating oxygen-rich waters react with sulfide ores. This may lead to both increased temperatures and enhanced carbonate aggressiveness of waters passing through ore

bodies. These thermally and chemically modified waters may then attack carbonate rocks to produce a specific type of hydrothermal karst. This type of hydrothermal karst is commonly triggered by mining activities that may facilitate access of waters to the ore bodies.

## MORPHOLOGY OF HYDROTHERMAL CAVES

Hydrothermal karst produces a large variety of cave morphologies with cave sizes ranging from solutionally enlarged pores to extensive cave systems with total mapped passage length exceeding 100 km. The most common morphologic types of hydrothermal caves are discussed below.

### Solution Porosity

Solutionally enlarged pores are commonly observed in borehole cores from depths up to 4–5 km in geothermal areas and oil fields. They may form extensive layers of rock in which solutional voids account for as much as 5–15% of the entire rock volume. In places such horizons become parts of oil and gas reservoirs. Layers of solutionally enhanced transmissivity appear where the movement of the fluids is slow, of the order of a few millimeters per year or less, and where hydraulic structures which could concentrate the flow (faults and fissures) are absent. Such zones of enhanced porosity may become the inception horizons for future caves.

### Isometric Rooms

Roughly spherical pockets or rooms with diameters ranging from 0.5 to 8.0 m were reported from Khod Koniom Cave in the Crimea. The cavities, lined with crystals of hydrothermal calcite (temperature of formation 40–85°C) and filled with red clay are truncated by later vertical vadose cave at a depth of 80–200 m. Similar caves occur in Kirghizstan, where medieval excavations in the Birksu mercury mine (Turkestan Range) uncovered a series of near-spherical rooms 3–8 m in diameter. The rooms coalesce in two- and three-dimensional clusters following the bedding planes and minor faults. Originally, the rooms were entirely filled by massive hydrothermal calcite containing veinlets of cinnabar, but the ore was removed by medieval miners.

### Individual Chambers

Caves of this type are composed of one or several large individual chambers. The latter commonly have a length of 100–200 m, a width of 30–60 m, and a height of 80 m. Examples of caves belonging to this type are: Bakharden Cave in Turkmenistan (Kopet-Dag Range), Novoafonskaya Cave in Abkhazia (Caucasus), Karani Cave in the Crimea, Ukraine, and Champignons Cave in Provence, France.

### Single-Conduit Caves

Single-conduit caves are exemplified by the hydrothermal Hellespont, Spence, and Kane Caves in Wyoming. The caves are nearly horizontal, tube-shaped conduits 60–600 m long. They have developed in a vadose setting, where ascending  $H_2S$ -bearing fluid comes in contact with the air, which induces replacement corrosion. Thermal springs discharge through the three above-mentioned caves, and several inactive caves having similar morphology are known in the region.

### Bush-Like Caves or Caves with Cupolas

Such caves typically consist of a basal chamber from which a branching pattern of rising passages develops (Fig. 1). The branches are composed of coalesced spherical cupolas whose typical size is 0.5–1.5 m, and cupolas terminate most of the branches. Such caves are known in Hungary (e.g., Sátorkő-pusztá Cave in the Pilis Mountains) and in the Azérous Mountains in northern Algeria. This type of cave is an example of monogenic hydrothermal karst, although the

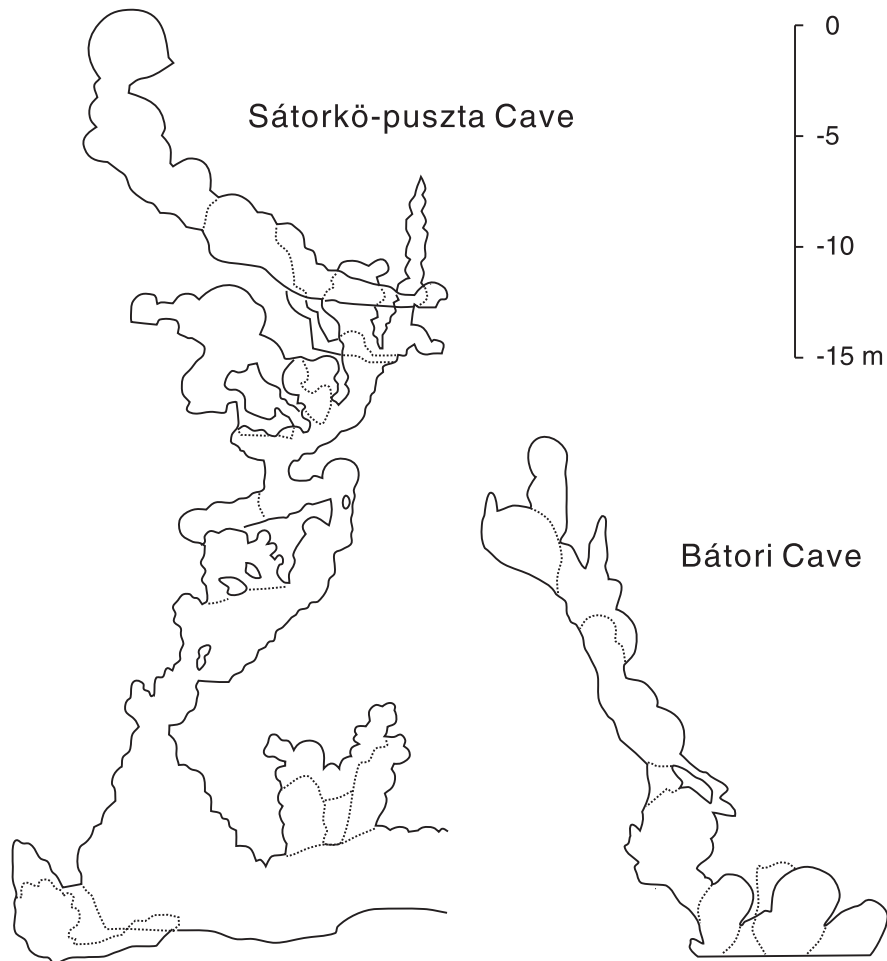
exact mode of formation for such caves is not yet understood. One hypothesis ascribes their formation to the convective movement of hot water in the phreatic zone, whereas another model invokes the convective movement of moist air above the hot water table coupled with condensation corrosion.

### Phreatic Maze Caves

Maze caves are the most common type of hydrothermal cave systems. Among them network caves, anastomotic caves, spongework caves, and ramiform caves are distinguished.

*Network caves* are angular grids of intersecting passages formed by the widening of nearly all major fractures within favorable areas of soluble rocks. Two-dimensional rectilinear maze systems are created where rising water is trapped in densely jointed carbonate rock below a relatively impervious bed. Examples of such a pattern are Cserszegtomaji-kut and Acheron-kut caves in Hungary, developed in Triassic dolomite under the cover of Miocene sandstone.

Multistory rectilinear network caves are more common. Examples are caves of the Buda Hills, Hungary (Pál-völgy,



**FIGURE 1** Examples of the presumably monogenic hydrothermal bush-like caves with cupolas: Sátorkő-pusztá Cave in the Pilis Mountains and Bátori Cave in Buda Hills, Hungary (by M. Juhász, P. Borke, and J. Kárpat).

Szemlo-hegy, Ferenc-hegy) and caves of the Black Hills in South Dakota (Wind Cave, Jewel Cave). Many of the carbonate-hosted lead-zinc ore deposits (the so-called Mississippi Valley type) exhibit a network pattern of solutionally widened fractures later filled — partly or entirely — with sulfides (Jefferson City Mine in Tennessee and Devil's Hole Mine in the UK).

*Anastomotic caves* consist of curvilinear tubes that intersect in a braided pattern. They usually form a two-dimensional array along a single favorable parting or low-angle fracture. Less common three-dimensional variants follow more than one geologic structure. An example of a supposedly hydrothermal three-dimensional anastomotic cave is the Pobednaya Cave in southern Kirghizstan, with its 1.5 km of very narrow, tube-shaped crawlways.

*Spongework caves* consist of interconnected cavities of varied size in a seemingly random three-dimensional pattern. Such caves appear to form by the coalescing of intergranular pores and minor interstices. *Ramiform caves* consist of irregular rooms and galleries wandering three-dimensionally with branches extending outward from the main areas of development. Passage interconnections are common, producing a continuous gradation with spongework and network caves. Jósef-hegy Cave in the Buda Hills, Hungary, is a good example of the ramiform pattern.

## CAVE DEPOSITS

### Mineralogy

Calcite is the most common mineral of hydrothermal caves developed in carbonate rocks. In addition, such minerals as quartz, barite, fluorite, and sulfides are commonly reported from the deep-seated hydrothermal caves. (Ore-related hydrothermal karst, where the list of minerals can be quite large, is not considered here.) Shallow hydrothermal karst caves rarely contain any “exotic” minerals.

### Character of Cave Deposits

Large euhedral calcite crystals, palisade aggregates, thick crusts, and sediments reflecting stable hydrodynamic conditions are common in deep-seated hydrothermal caves. The size of individual crystals can be as large as 10–30 and even 100 cm. The crystal morphology is normally simple, dominated by scalenohedra (dogtooth spar). In contrast, the deposits of shallow karst caves commonly reflect a more

dynamic environment. Crusts are typically less thick and euhedral crystals are rare. The size of crystals in aggregates ranges from several millimeters to a few centimeters. The dominant crystal morphology is a combination of scalenohedra and prisms with the crystal tip blunted by flat rhombohedra (nailhead spar). Minerals might be contaminated by significant amounts of clay, which indicate that the paleo waters were dynamic enough to carry the particles. Besides mineral crusts composed of relatively large crystalline aggregates, such morphologically complex deposits as subaqueous coralloids may also develop in the shallow hydrothermal karst setting. In addition to subaqueous deposits, two more types of speleothems occur in shallow hydrothermal karst: waterline deposits (rafts, folia, cave cones), and subaerial deposits (e.g., cave popcorn). These two types are also common in cold karst.

## REGIONAL EXTENT

Hydrothermal origin was established for many large cave systems of the world: e.g., caves in the United States (South Dakota and Wyoming), England, France, Poland, Czech Republic, Hungary, Ukraine (Crimea), Caucasus, Kirghizstan, Israel, Iran, Algeria, Namibia, and South Africa.

### Bibliography

- Collignon, B. (1983). Spéléogénese hydrothermale dans les Bibans (Atlas Tellien - Nord de l'Algérie). *Karstologia* **2**, 45–54.
- Dublyansky, Y. (1997). Hydrothermal cave minerals. In *Cave Minerals of the World*, 2nd ed. (C. Hill and P. Forti, eds.) pp. 252–255. National Speleological Society, Huntsville, AL.
- Dublyansky, Y. (2000). Hydrothermal speleogenesis: Its settings and peculiar features. In *Speleogenesis: Evolution of Karst Aquifers*, (A. Klimchouk, A. Palmer, D. Ford, and W. Dreybrodt, eds.), pp. 292–297. National Speleological Society, Huntsville, AL.
- Dzulynsky, S., and M. Sass-Gustkiewicz (1985). Hydrothermal karst phenomena as a factor in the formation of the Mississippi Valley-type deposits. In *Handbook of Strata-Bound and Stratiform Ore Deposits*, Part 4, Vol. 13, Chap. 5, pp. 391–439.
- Egemeier, S. J. (1981). Cavern development by thermal waters. *Natl. Speleol. Soc. Bull.* **43**, 31–51.
- Ford, D. C., and P. W. Williams (1989). *Karst Geomorphology and Hydrology*, p. 601. Unwin Hyman, London.
- Ford, T. D. (1995). Some thoughts on hydrothermal caves. *Cave Karst Sci.* **22**, 107–118.
- Palmer, A. N. (1991). Origin and morphology of limestone caves. *Geol. Soc. Am. Bull.* **103**, 1–21.
- Takács-Bolner, K., and S. Kraus. (1989). The results of research into caves of thermal water origin. *Karszt és Barlang* (Hungary), Special Issue, 31–38.



---

## Invasion, Active versus Passive

**Dan L. Danielopol**  
*Austrian Academy of Sciences*

**Raymond Rouch**  
*Laboratoire Souterrain, France (Retired)*

Why and how subterranean habitats were invaded by surface-dwelling animals is one of the themes which has fascinated generations of speleologists. The subterranean realm is colonized actively and/or passively by aquatic and terrestrial fauna. Ecological evidence and arguments for evolutionary scenarios which support various models of colonization are provided in this article. Modern evolutionary-ecological research offers new perspectives to better understand the invasibility of subterranean systems by both terrestrial and aquatic fauna.

### INTRODUCTION

The topic of subterranean life is closely related to the question of why and how organisms penetrate and further settle, sometimes in large numbers, in an apparently inimical environment, i.e., where space and energy can be very constraining for the development of flourishing organismic populations. Caves accessible to humans were one of the first habitats to be intensively explored over the past 200 years. This led to the discovery of a diverse aquatic and terrestrial troglobitic fauna, sometimes without direct relationship to the living surface-dwelling animals. This discovery stimulated naturalists to propose various explanations for the subsurface habitat colonization by surface-dwelling animals.

Students working on subterranean animals used the term invasion to stress that the subsurface realm is extensively and, in many cases, massively colonized by surface-dwelling animals which later adapt to subterranean life conditions. The invasion modalities are grouped in two major categories: (1) active colonization which is mainly related to the environmental cues as perceived by the surface-dwelling organisms and (2) passive colonization where animals arrive into and settle within the subsurface environment either by the force of or by the chance of the environmental dynamics.

Scenarios explaining the active and/or passive invasion of subterranean animals were proposed during the late 19th century as well as during a large part of the 20th century by naturalists interested in the evolutionary processes that generated the troglobitic and/or stygobitic fauna. At the beginning of the 20th century Neo-Lamarckians, like E.G. Racovitza and R. Jeannel in Europe and A.M. Banta in North America, favored the view of an active invasion of the subterranean realm by animals that could not survive at the Earth's surface either because of climatic changes or because of strong predator pressures. These animals retreated into subterranean habitats which offered them a kind of stable refugium against epigeal environmental constraints. A similar view is shared by A. Vandel who is an exponent of the organicist view of subterranean evolution, which considers that old species, like senescent individuals unable to live in an epigeal dynamic environment, retire into subterranean habitats. An origin of troglobites due to passive invasion was proposed at the end of the 19th century by E. R. Lankester who considered that the troglobitic evolution could start with the organisms that accidentally colonized cave habitats. Most of these kinds of hypotheses were not followed by rigorous scientific tests.

During the second part of the 20th century the authors assisted in an increased interest in the ecology of subterranean animals. Biologists proposed various scenarios explaining the origin of the diverse hypogean fauna. As compared to

the previous generation of scenarios, these are more carefully documented and offer better possibilities to test their plausibility. In this article, a brief review of this information is subsequently presented within its evolutionary and ecological context.

## EVOLUTIONARY SCENARIOS

### Models Based on Active Dispersal

**The Climatic-Relict Model** — This assumes that surface-dwelling animals actively colonize subterranean habitats during periods when the environment changes drastically. Such events happened during the Pleistocene period in the Northern Hemisphere. Dry and/or cold climate at the soil surface, especially in karstified areas, is considered an important climatic stressor that constrained various animal groups to invade underground systems. The fraction of organisms which could not adapt to subterranean environment became extinct while the new troglobionts or stygobionts built a relictual fauna. Various terrestrial and aquatic hypogean animals from Europe, North America, Africa, and Australia are considered to fit this model.

**The Adaptive-Shift Model** — Preadapted surface-dwelling organisms are able to colonize unconstrained subsurface habitats where they progressively adapt to the new environment. The invasion of terrestrial fauna and their subsequent evolution in caves formed in volcanic regions like the Hawaiian Islands is an example proposed by F. G. Howarth. For marine anchialine caves a similar scenario called the zonation model was proposed by T. M. Iliffe.

**The Active Colonization Model** — This scenario, well documented by R. Rouch and D. L. Danielopol, considers the possibility of colonization of subterranean environment by preadapted and/or generalist organisms. This is an active process which does not occur during periods of environmental stress. The authors consider this model as having a wide generality for the subterranean invasion. The process of invasibility following the scenario of Rouch and Danielopol is decoupled from the speciation process, while in the adaptive-shift model both processes play an additive role.

**Colonization through Marine Shallow-Water Ecotones** — The penetration route within the subterranean aquatic caves follows either directly through the entrance of the caves or through submarine karstic springs or porous clastic sediments along coastal areas.

**Transit of Marine Fauna through Epigeal Limnic Systems** — An alternative for the colonization of caves and/or interstitial habitats by marine benthic animals occurs through the adaptation of euryhaline animals in a first step to surface inland waters and further by the invasion of subterranean waters. The latter scenario applies to crustaceans that colonized the Dinaric Karst.

**Colonization from the Deep Sea** — Bathyal and/or abyssal fauna displaying biological convergent traits with

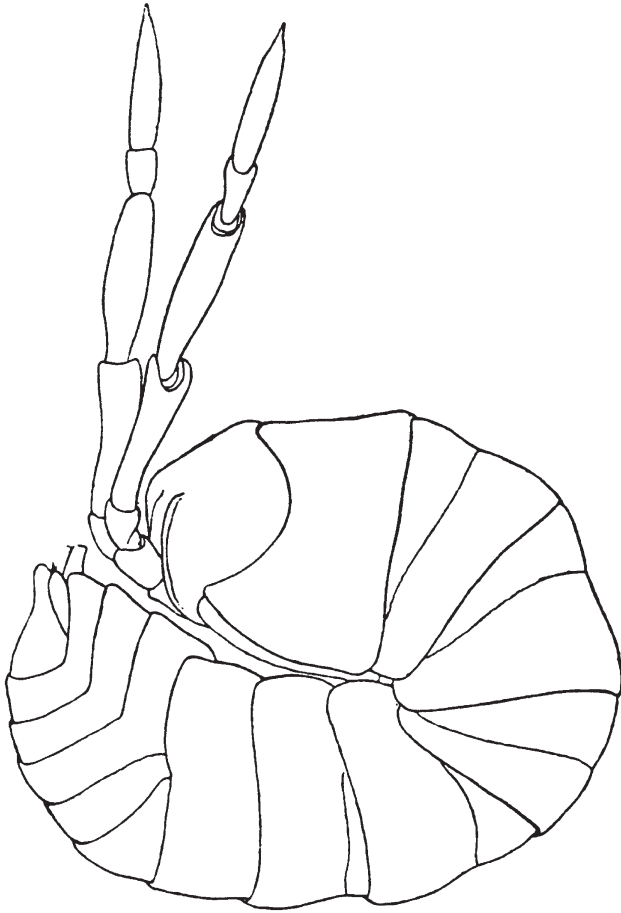
troglobitic fauna could colonize shallow marine caves, especially on volcanic islands. It was proposed that deep-sea animals — sponges, crustaceans, or fishes — could, during that time, penetrate through the crevices of volcanic or karstic rocks up to the anchialine shallow caves.

**Escape from Epigeal Predators and/or Strong Competitive Pressure** — The invasion of subterranean habitats by animals, especially small invertebrates that tried to escape to stronger predation and/or competition, is a scenario envisaged by generations of biospeleologists. It is hypothesized that many crustaceans invaded subterranean aquatic habitats in order to escape the predation and/or competition pressure of other animal groups, like insects. For instance, E.G. Racovitza, at beginning of the 20th century, suggested that the troglobitic isopod *Spelaeoniscus debrugei* took refuge in caves because of the incomplete capacity to protect itself by rolling up into a ball when predators attack. Because the isopod's antennae are left out during the rolling up of the body (Fig. 1), it was assumed that these crustaceans were easily preyed upon by epigeal invertebrates.

### Models Based on Passive Dispersal

**Passage of Epigeal Animals during Massive Surface Water Infiltration into Subterranean Systems** — There are a whole series of possibilities for passive migration of fauna into the subsurface. In alluvial plains along river channels during floods, epigeal animals are transported by surface water which later infiltrates into the subsurface taking animals with it. One example is the periodical invasion of crustacean Cladocera from the backwaters of the Danube wetlands (in Austria) into the aquifer existing below the floodplain. Surface streams which flow into karstic systems, e.g., through sinkholes or infiltrates through macro- and micro-channels, allow the invasion of subterranean karst by a diverse fauna. The dispersal of this fauna can continue underground into large karstic systems through the complex drainage systems. It is hypothesized that the highly diverse stygobitic crayfish fauna of Florida originated through this process.

**The Regression Model** — Dutch biologist J. Stock developed a general model for the invasion of marine benthic fauna into inland subterranean waters based on the eustatic regressive sea level movements. Stock noticed that various crustacean groups with stygobitic representatives, like the amphipod Ingolfiellidea, are presently known from sites located on ancient marine paleo coasts. He assumed also that once animals colonized subsurface coastal marine habitats such animals become thalassostygobionts that minimally dispersed into other geographic areas. During marine regressive phases, the coastal thalassostygobionts, instead of following the regression of the marine water, remained in place and progressively adapted to inland non-marine subterranean water (brackish and later freshwater) which replaced the marine water. Such animals become limno-



**FIGURE 1** *Spelaeoniscus debrugei*, a troglobiont isopod from North Africa. (From E. G. Racovitza, (1907). *Arch. Zool. Exper. Gen.* 7, 69–77. With permission.)

stygobionts. In this way the invasion of subterranean waters happens through a so-called passive regression process and by vicariant events, i.e., the inland originally marine form is stranded and respectively isolated from the marine population. Stock's model has since been extended to more detailed scenarios, like the two-step evolutionary model of J. Notenboom, C. Boutin, and N. Coineau (Fig. 2) and the three-step model of J. R. Holsinger. They combine the active migration process of preadapted animals with a second passive process during marine regressions, and they include a third phase of ecological isolation in the new inland subterranean habitats. It is assumed that the three-step evolutionary model is able to explain also the invasion of both marine and non-marine benthic animals into the subsurface environment. Despite the opinion that the passive regression models have a wide generality, they were never carefully tested for their basic ecological and biogeographical assumptions that the animals cannot follow the marine water during the regressive periods and do not further disperse inland far away from the original site (see next section for additional arguments).

**Rafting and Resettlement of the Fauna in New Subterranean Habitats** — Interstitial marine animals can be

transported passively on various objects with the whole sediment over various distances. Harpacticoids and ostracods could spread in this way.

**Erosion of Sediment and the Drift of Subsurface Fauna with the Surface Water Flow** — Surficial interstitial marine and even freshwater fauna are especially exposed during storms and floods to the resuspension of the sediment and the passive transport through the surface water column to other places. After the resettlement they are able to recolonize shallow subsurface habitats.

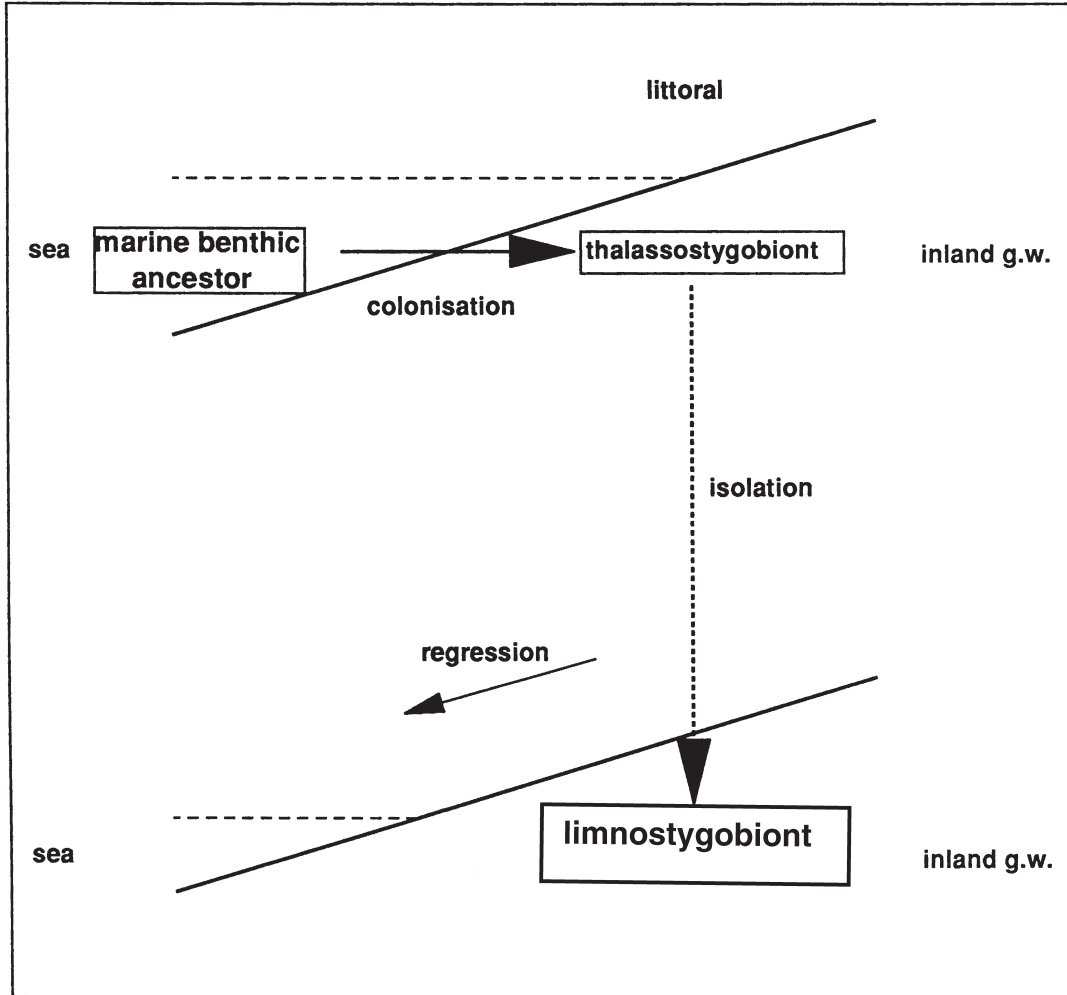
### Unique versus Multiple Invasions

Various biospeleologists assumed that important invasions of a subterranean habitat, e.g., a cave, followed by the adaptation of the originally epigeic animals to the hypogean life and the expansion of their geographic range, which occurred during unique historical events like the strong climate deterioration on the Northern Hemisphere during the Pleistocene era. Today this view is challenged by the evidence of multiple invasions of subterranean environment by epigeic animals preadapted over a wide geographic range. For instance, R. Rouch and D. L. Danielopol consider this a basic aspect of their active colonization model. Multiple colonization occurs either simultaneously or independent in time. The amphipod *Gammarus minus* independently invaded various caves of West Virginia at different times taking advantage of the suitable subterranean habitats.

Ward and Palmer coined the term “interstitial highway” to describe the long-term dispersal routes below the soil surface. It applies especially to interstitial habitats along river channels and alluvial plains. Hypogean dwelling animals, like the amphipods *Bogidiella albertimagni* and *Niphargopsis casparyi* known from western to eastern Europe, expanded their geographic range along large river systems like the Rhône, the Rhine, and the Danube.

### THE ECOLOGICAL EVIDENCE

Evolutionary and/or historical scenarios can be checked for their plausibility by examining recent field ecological situations and/or by laboratory experimental observations. Active migration of animals is commonly observed for thigmotactic animals living on the bottom of running waters from where they penetrate the hyporheic interstitial systems without being constrained by some environmental stress. There are hundreds of species, insect larvae, crustaceans, water mites, and various worms observed to invade shallow subsurface habitats and adopt the hyporheal as their common life place. The colonization and further adaptation to groundwater habitats by crustaceans, e.g., representatives of the harpacticoid genus *Elaphoidella*, with wide ecological valence in tropical, subtropical, and temperate zones, is in accordance with the active colonization scenario of R. Rouch and D. L. Danielopol.



**FIGURE 2** Schematic presentation of the two-step evolutionary model, which explains the invasion of inland subterranean habitats by marine fauna; g.w.—groundwater. (Adapted from J. Notenboom (1991). *J. Biogeogr.* **18**, 437–454. With permission.)

Laboratory experiments with the amphipod *Gammarus roeseli* demonstrated that this species actively migrates through the porous space of gravel sediments when exposed to oxygen gradients, respectively, they avoid hypoxic zones and look for normoxic water. New volcanic islands which allow the development of sandy beaches are rapidly colonized by marine epigean animals that settle into the interstitial habitats, for instance, the interstitial habitats of a sandy beach of the Long Island near the New Guinea. This is an island which emerged through a volcanic eruption and was colonized by two species of crustacean harpacticoids within the first 20 months of its existence.

Observation in the field and/or laboratory of the penetration of epigean animals in subsurface habitats because of predator pressure pointed to a more complex behavior than previously known. This behavior was used in the colonization under the constraint scenario mentioned above. For instance, observation of *Gammarus roeseli* exposed to fish predation shows that a fraction of the surface-dwelling

animals migrate into the sediment, while others reduce their movement at the sediment surface. However, because animals are very thigmotactic, they penetrate into the sediment anyway provided there is the necessary vital porous space.

Passive invasion of karstic systems by diverse epigean animals, both insect larvae and crustaceans, was thoroughly studied during long-term filtration of exurgencies by the ecologists working in France. Studies done on the Baget, Moulis, and Dorvan karstic drainage basins documented that a surprisingly high number of animals penetrate during the rainy period into the subsurface. Much of this fauna is further released outside at the exurgencies following the water which flows through the subsurface voids. In the experimental area Rhitrodat at the Biological Station Lunz am See, Austria, it was documented that the hyporheic zone of a gravel stream can be recolonized within hours by various meio- and macrofauna like rotifers, cyclopoids, and chironomids. A significant relationship between the volume of the entrapment of



sediment and the number of animals caught pointed to the passive invasion of this environment by various animals.

The view that aquatic animals take refuge in subsurface habitats, mainly in the riverbed sediments, under the pressure of climatic drought was checked in the field and laboratory. Observation of two northern California streams, intermittent and perennial, did not show an increase of the hyporheic fauna in either type of stream during the dry period. The reaction is more complex in a stream flowing through the Sonoran Desert in Arizona, where during the dry period the shallow interstitial habitats accumulate epigeal benthic invertebrates which later disappear with the increasing sediment dryness. Also, observation in the laboratory using oligochaetes in sediment columns pointed out that the progressive dryness of the sediment determines a low fraction of the worms to follow the water into the depth of the column. Most of the animals remain entrapped in the unsaturated zone of the sediment. Marine interstitial fauna, especially in tidal littoral zones, are able to migrate tenths of centimeters during the seasons.

### BRIDGING THE GAP — EVOLUTIONARY- ECOLOGY AT WORK

Evolutionary biologists, like R. Lewontin, point out that organisms are active subjects which are able to choose (or select) their habitat; in this way organisms define their niche. Of course organisms are also objects of the selective pressures imposed by the environment that they experience. Hence, the fact that organisms represent the subject and the object of selection forms an important biological principle which gives support to the active invasion scenarios. The success of invasibility as the penetration and the settlement of an organism in the explored environment depends on the level of resources available for its survival and reproduction. Organisms with low energetic requirements and unspecialized for their resource acquisition (the so-called generalists) have an advantage over more specialized organisms or those needing high energetic resources. At a premium are also those surface organisms already predisposed to colonize subsurface habitats. There are general ecological principles which apply to the colonization of the subterranean environment too.

Both population geneticists and ecologists dealing with metapopulation studies of plants and insects recognized that the success of invading new environments depends on the selective capacity of organisms for progressive adaptation during their dispersion paths. The process, called “adaptive infiltration,” supports some of the models which explain the active subterranean invasion, e.g., the zonation model of T. M. Iliffe. However, in environments that deteriorate rapidly animals can become extinct before significant evolutionary changes have time to occur. This latter argument weakens the credibility of scenarios based on the principle of refugium under constraints, e.g., the climatic-relict hypothesis. The

generality of invasion by surface-dwelling organisms of subterranean habitats is a well-documented phenomenon which cannot be explained by local processes like the predation and/or competition pressure of epigeal animals (remember the scenario of the refugium of animals underground under the pressure of voracious surface predators).

The passive invasion scenario of J. Stock and its modern variants of bi- and triphase evolutionary models have a weakness; they do not explain why marine animals which colonize marine interstitial habitats should remain in place or migrate minimally during the regression phase of the sea. As mentioned above, marine interstitial animals display the capacity to migrate vertically or horizontally depending on the environmental conditions. Marine regressions proceed at a low rate theoretically allowing animals to track the receding sea and to keep their marine ecological requirements. Obviously we need more ecophysiological information about the way marine littoral fauna adapt to inland subterranean habitats.

### CONCLUSIONS

1. The examination of alternative hypotheses which could illuminate the problem of subterranean invasion, as advocated by L. Botosaneanu and J. R. Holsinger, proved to be a successful scientific strategy during the last 10–20 years. It stimulated active research where the quality of information for various models could be compared.
2. The scenarios regarding which animals repeatedly colonized the subsurface realm during geologic time could be tested with field and laboratory data.
3. The evolutionary models following which epigeal animals migrated into the subterranean realm under external environmental pressures like climatic deterioration, predation, and competition pressure seems to have limited generality, applying (if real) more to local situations.
4. The passive invasion of marine animals as described by the scenario that considers migration in inland groundwater occurs during marine regressive phases (widely favored by biospeleologists) needs additional ecological research in order to keep it as a robust explanatory model.
5. The scenario describing which deep-sea animals were able to actively colonize anchialine caves was seldom corroborated by recent research and various students who supported this hypothesis were converted to an alternative explanation — the migration of shallow marine organisms into submarine caves.

### ACKNOWLEDGMENTS

Our research was financially supported during the years mainly by the F.W.F. Austria and the Austrian Academy of

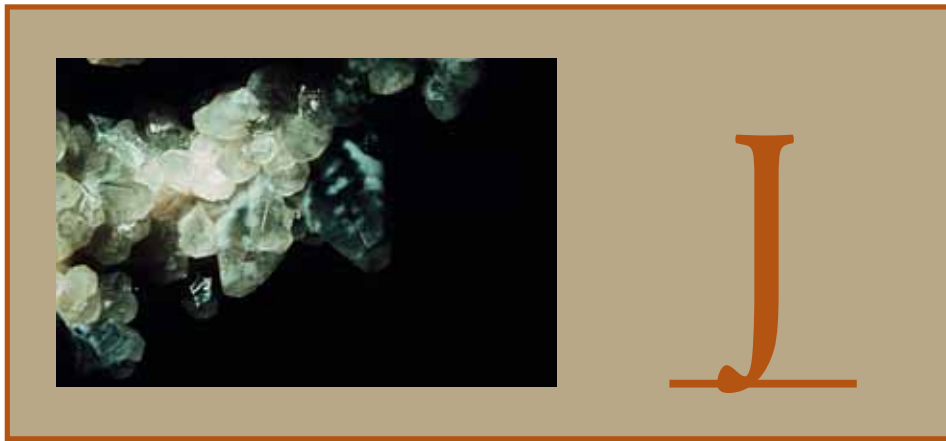
Sciences, (grants attributed to D. L. Danielopol.) and by the C.N.R.S., France (for R. Rouch). We thank D. C. Culver (American University, Washington DC) for critical review of the manuscript.

### *See Also the Following Articles*

*Marine Regressions • Vicariance and Dispersalist Biogeography*

### *Bibliography*

- Bodergat, A.-M., and P. Marmonier, eds. (1997). Contraintes et instabilité de l'environnement: Stratégies adaptatives des organismes Récents et fossiles. *Geobios* **MS 21**, Editions Univ. Claude-Bernard, Lyon.
- Botosaneanu, L., and J. R. Holsinger (1991). Some aspects concerning colonization of the subterranean realm — especially of subterranean waters: A response to Rouch and Danielopol, 1987. *Stygologia* **6**, 11–39.
- Culver, D. C. and J. R. Holsinger, eds. (1994). *Biogeography of Subterranean Crustaceans: The Effects of Different Scales*. *Hydrobiologia*, **287**, 1. Kluwer Academic, Dordrecht.
- Culver, D. C., T. C. Kane, and D. W. Fong (1995). *Adaptation and Natural Selection in Caves. The Evolution of Gammarus minus*. Harvard University Press, Cambridge, MA.
- Danielopol, D. L., K. Martens, and J. C. von Vaupel Klein, eds. (1999). *Crustacean Biodiversity in Subterranean, Ancient Lake and Deep-Sea Habitats*. *Crustaceana*, **72**, 8, Brill, Leiden.
- Gibert, J., D. L. Danielopol, and J. Stanford, eds. (1994). *Groundwater Ecology*. Academic Press, San Diego, CA.
- Giere, O. (1993). *Meiobenthology. The Microscopic Fauna in Aquatic Sediments*. Springer-Verlag, Berlin.
- Howarth, F. G. (1983). Ecology of cave arthropods. *Annu. Rev. Entomol.* **28**, 365–389.
- Illiffe, T. M. (1986). The zonation model for the evolution of aquatic faunas in anchialine caves. *Stygologia* **2**, 2–9.
- Notenboom, J. (1991). Marine regressions and the evolution of groundwater dwelling amphipods (Crustacea). *J. Biogeogr.* **18**, 437–454.
- Racovitza, E. G. (1907). *Spelaoniscus debrugei* n.g., n.sp., isopode terrestre cavernicole d'Algerie. *Arch. Zool. Expér. Gén.* **7**, 69–77.
- Rouch, R., and Danielopol, D. L. (1987). L'origine de la faune aquatique souterraine. Entre le paradigme du refuge et le modèle de la colonisation active. *Stygologia* **3**, 345–372.
- Uiblein, F., J. Ott, and M. Stachowitsch, eds. (1996). *Deep sea and extreme shallow-water habitats: Affinities and adaptations*. *Biosystematics and Ecology Series 11*, Austrian Academy of Sciences Press, Vienna.
- Vandel, A. (1965). *Biospeleology. The Biology of Cavernicolous Animals*. Pergamon Press, Oxford, England.
- Wilkens, H., D. C. Culver, and W. F. Humphreys, eds. (2000). *Subterranean Ecosystems*. Elsevier, Amsterdam.



---

## Jewel Cave, South Dakota

Mike Wiles

*Jewel Cave National Monument*

### HISTORY

#### Early History

The first written record of Jewel Cave is a 1900 mining claim, the Jewel Tunnel lode, filed by Frank and Albert Michaud and Charles Bush. The “jewels” of Jewel Cave are the calcite crystals (Fig. 1) that line most of the cave’s walls, ceilings, and floors. The cave’s entrance was originally a blowing hole that was too small for human entry. It had to be enlarged to facilitate mining and to provide easy entrance for tourists. Little mining was actually done, however, and the cave failed as a major tourist attraction in the early years, because it was too far off the beaten track. In 1908 Jewel Cave was the first cave set aside as a national monument, and in 1933 it became part of the National Park Service.

#### Early Exploration

Until the late 1950s, little was known of the cave and only about two miles of passages had been mapped. The situation changed dramatically when Dwight Deal, a young geologist and caver from Wyoming, obtained permission to explore Jewel Cave. He invited Herb and Jan Conn — climbing friends in their late 30s — to accompany him in surveying and mapping the cave. They quickly discovered many more miles of cave passages, and soon became certain that Jewel Cave was not the small cave it had been assumed to be for so many years.

#### Later Exploration

Dwight later wrote a master’s thesis on the geology of Jewel Cave (Deal, 1962). After he completed his work and moved on in pursuit of his career, the Conns continued exploring the cave for over twenty years. Through the careful and systematic documentation of a survey, they discovered over 62 miles of cave passages before turning the effort over to younger explorers (Conn, 1981). They demonstrated that Jewel Cave was not a small cave; rather, it was one of the world’s longest cave systems.



**FIGURE 1** Calcite crystals. The largest crystal shown here is about 2 inches long.

## BAROMETRIC AIRFLOW

Additionally, it was recognized that the cave's pronounced airflow responded very closely to changes in the outside air pressure. In 1965, Herb Conn measured the airflow resulting from known barometric pressure changes, and developed a mathematical model that predicts the total volume necessary to account for the behavior of the airflow at the entrance. Although no one can know for sure just how big the discoverable cave may some day be, four billion cubic feet is an astoundingly large number, and is strong evidence that the vast majority of the cave system is yet to be found. The wind has been known to blow barometrically at speeds over 35 miles per hour through crawlways that are thousands of feet from the entrance. There are strong breezes even at the farthest known extents of the cave — an irresistible lure for any cave explorer.

## PHYSICAL CHARACTERISTICS

### Three-Dimensional Cave System

Exploration has shown that the cave is a complex three-dimensional maze with passages occurring in at least four different levels: All of the 130 miles of currently known passages crisscross beneath about three square miles of surface area. The entire cave appears to have formed phreatically, primary along joints and also along bedding planes.

### Loft Level

The uppermost “loft” level typically has smooth, domed ceilings and powdery weathered limestone covering flat floors. Passage development appears to have been controlled more by horizontal bedding planes than by joints, and is less likely to follow the parallel trends commonly exhibited by most of the other levels of the cave. The calcite-crystal coating common throughout most of the cave is generally absent, but there are remnants suggesting it once coated the surfaces of the loft level passages and was later redissolved. These remnants often contain some of the largest calcite crystals found in the cave.

### Chert Level

Chert level passages are found just below the loft level in a 30-foot zone of alternating beds of chert and limestone. These passages often have flat ceilings and angular pieces of broken chert littering the floor.

### Main Level

Main level passages lie beneath the chert level. They are often large, strongly joint-oriented, and usually breakdown-modified. The ubiquitous deposits of manganese minerals are often found beneath the breakdown collapse. These

manganese deposits are composed of a variety of manganese oxides and hydroxides, mostly unidentified, and are often referred to simply as “manganese.”

### Lower Levels

Lower levels occur in bedded dolomitic limestone, and often exhibit some development along bedding planes. It is common to find the crystal coating separated from the underlying bedrock, presumably because it had been deposited phreatically onto a surface that had previously weathered to a punky consistency, and thus was not as firmly attached to the walls and ceilings as elsewhere in the cave. Manganese deposits tend to be thickest in the lower levels. One deposit near the scenic tour route is almost 4 ft thick.

### Breakdown Modification

Breakdown collapse is common throughout the cave system, and many of the larger rooms have resulted from the joining of two or more levels by collapse of the intervening rock. What would have been flat floors are now covered in piles of breakdown. This makes moving through the cave a constant up-and-down experience. Even without the breakdown, no one level of cave passages is very continuous. Often the caver must cross large passages via small holes and crawlways, and must constantly change levels to go from one end of the cave to the other.

### Passage Sizes

Jewel Cave passages average 10 ft wide and 15 ft high, but range from 7 in. to 110 ft in height, and 1–180 ft in width. Most of the crawls are relatively short, but one area, named the Miseries, consists of nearly 1800 ft of hands-and-knees to belly-crawls. On the other hand, the Volksmarch is about half a mile of uninterrupted walking.

## HYDROLOGY

No part of the cave is presently known to intercept the water table, as is the case with the famous Lakes region of nearby Wind Cave. Water arrives only in the form of vadose dripping in areas that are near surface drainages where erosion has cut through the overlying Minnelusa Formation to within 100 ft of the upper surface of the Pahasapa Limestone; the lower subunits of the Minnelusa are quite permeable. Most of the cave is capped with stratigraphically higher subunits that restrict water flow. Areas of the cave below these subunits show virtually no evidence of dripping water, present or past. Only about 5% of the cave shows signs of dripping, and about half of that is presently active.

Dripstone and occasional small pools can be found in the hydrologically active areas, but Jewel Cave shows no evidence of streams or rivers. Apparently, a higher water table had at

one time supported surface flow, and then both the ground-water level and the surface flow had decreased significantly, soon after the cave had formed. Thus, there was little opportunity for mechanical enlargement due to vadose flow.

## BIOLOGY

### Cave Life

Jewel Cave is largely devoid of life, except near the historic entrance. This is most likely because of the relative lack of moisture, or a mechanism to carry organic material deep into the cave where it could serve as a food source for subterranean life. Animals that feed outdoors do use the entrance area for shelter, however. These are mostly bats and packrats, and the parasites and other organisms that feed on these mammals and their excretions.

### Bats

Though they almost certainly did not inhabit the cave prior to the enlargement of the long windy constriction that was the natural entrance of the cave, several species of bats now make the cave their home. Many *Myotis* use the cave as a day roost during the spring, summer, and fall, and can be found as far as 1000 feet from the entrance. They are joined in the winter by several hundred male *Corynorhinus townsendii* (Townsend's big-eared bats). Jewel Cave is presently the world's largest-known hibernaculum for this species. Interestingly, the *C. townsendii* prefer to hibernate closer to the entrance, in the path of airflow, which varies widely in temperature and humidity when the cave blows in. When the temperature is coldest, they will hang in clusters of a hundred or more. When the air is warmer, many individuals will break out of the cluster and form smaller clusters nearby. The *C. townsendii* appear to frequently be active throughout the winter. On the other hand, the *Myotis* move around less, and seem to prefer the warmer and more constant temperatures of rooms deeper in the cave and away from the airflow. They commonly roost singly or in pairs, and are occasionally found in clusters of up to a dozen individuals.

### Microbiology

Microbes are known to inhabit caves, even when there is little or no organic food source. A single preliminary study at Jewel Cave has identified such microbial life, but more research is needed to build a base of knowledge from this meager starting point.

## SPELEOTHEMS

Some of the speleothems found in Jewel Cave include dripstone (stalactites, stalagmites, flowstone, draperies); helictites; gypsum formations (flowers, needles, and beards);

aragonite; calcite crystals, coatings, and rafts; boxwork; helictite branches; pool fingers; popcorn; popcorn stalagmites (many of which are hollow); and hydromagnesite balloons.

### Popcorn Stalagmites

The popcorn stalagmites are particularly curious. They range in size from 2 in. high and 2 in. in diameter, to 18 ft high and 4 ft in diameter, and many have holes down their center axis. Sometimes the hole is off-center, forming a slot along the side of the stalagmite. In some cases the hole is even deeper than the stalagmite is high. Though almost certainly formed by the action of dripping water, none of these formations is found in areas where water is dripping today, nor do they occur where there is any sign of travertine (the popcorn stalagmites are themselves made up of calcite deposits) from past dripping. Clearly, they were formed under significantly different circumstances than are observed today, and the nature of their origin remains a mystery.

### Hydromagnesite Balloons

Hydromagnesite balloons (Fig. 2) were first discovered in Jewel Cave, and have since been found in half a dozen other caves throughout the world. These delicate bubbles of hydromagnesite typically have a pearly white luster and come



FIGURE 2 Hydromagnesite balloon. The balloon is about 1 inch high.

in a variety of irregular shapes. They are no more than one and a half inches across, and the shell is made up of layers of hexagonal plates with a total thickness of only a thousandth of an inch. The balloons appear to have been inflated. Both biological and chemical mechanisms have been proposed, but no firm conclusions have yet been reached. Several hundred of the balloons occur in two widely separated locations in the cave, both in passages that experience significant airflow.

### OTHER BLACK HILLS CAVES

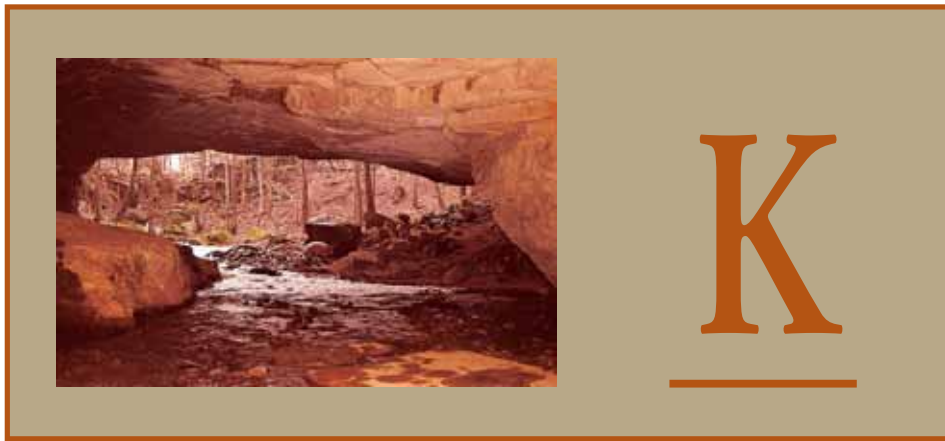
Jewel Cave is one of over 200 caves known in the Black Hills. Most are dry caves with joint-oriented passages, and many have a calcite crystal coating — though most often thinner and less extensive than that found at Jewel. Thick manganese deposits are only found in one other local cave. The majority of these caves are less than 500 ft long. Four of them are 1–5 miles long, and only a few have a barometric wind. One notable exception is Wind Cave, with a prominent barometric wind and over 111 miles of surveyed passages. It has the same “feel” as most Black Hills caves, but has extensive boxwork development, and little in the way of a calcite crystal coating.

### CONCLUSION

Jewel Cave is a unique cave system of immense proportions. Thus far, only a small part of it has been found, and there is much to be learned about its extent and speleogenesis. It has a great potential for future discovery, particularly in the areas of exploration, geology, and biological science.

### Bibliography

- Alexander, E. C., Jr., M. A. Davis, and S. C. Alexander (1989). Hydrogeological study of Jewel Cave/Wind Cave: Final Report. University of Minnesota.
- Conn, H. (1966). Barometric Wind in Wind and Jewel Caves, South Dakota. *Natl. Speleol. Soc. Bull.*, **28**, 55–69.
- Conn, H. and J. Conn (1981). *The Jewel Cave Adventure*. Revised printing. Cave Books, St. Louis, MO.
- Deal, D. E., (1962). *Geology of Jewel Cave National Monument, Custer County, South Dakota, with special reference to cavern formation in the Black Hills*. Master's thesis, University of Wyoming.
- Olson, R. (1977). *The hypogean ecology of Jewel Cave National Monument, Custer County, South Dakota*. Master's thesis, University of Illinois.
- Palmer, A. N., (1999). *Jewel Cave, A Gift from the Past*. Second printing. Black Hills Parks and Forests Association, Hot Springs, SD.
- Wiles, M. E., (1992). *Infiltration at Wind and Jewel Caves, Black Hills, South Dakota*. Master's thesis, South Dakota School of Mines and Technology.



---

## Karren

Joyce Lundberg  
Carleton University, Ottawa

The term *karren* indicates small-scale dissolutional features of rock surfaces; they are of the order of millimeter to meter scale with an upper size limit of 5 m. Cave karren are generally understood to be minor modifications to the main passage form and generally smaller than the passage, although some may dominate the passage form or even comprise the whole passage. Although some are inherent to the initial speleogenetic process, many are subsequently superimposed upon passage walls.

### INTRODUCTION

Cave karren develop where soluble rocks interact with solvent fluid (typically water, but it can be water vapor or aerosol) and typically where that fluid is moving. Flow may be in phreatic (pressure flow), vadose (free flow), or alternating (floodwater) conditions. Karren usually develop on bare rock but occasionally they can form under sediments or guano. The karren features are diverse and almost impossible to fit into any meaningful classification system such as one based on genesis. Many similar forms are produced by dissimilar processes; e.g., circular ceiling cavities may be produced by eddies in phreatic flow when the whole cave is water-filled, or they may be produced under vadose conditions where water trickles from the soil above into an air-filled cave, or where water vapor condenses on the walls and ceilings.

### CONTROLS ON KARREN FORM

In most cases the shape of the karren feature relates to the properties of the flow, e.g., free fall drips produce *pits*; film flow produces *rills* and *longitudinal flutes*; channel flow with turbulent eddies and rollers produces *dissolutional potholes*, *scallops* (probably the most ubiquitous cave karren feature), *transverse flutes*, *anastomoses*, *pendants*, and *half-tubes*; and floor/wall/ceiling *pockets*. If flow is slow enough that turbulence does not dominate flow, then density and convection currents may govern the form, producing *facets*, *notches*, *bevels*, and convection *cupolas*. Condensation of vapor on surfaces produces corrosion *cusps/hollows* and *bellholes*.

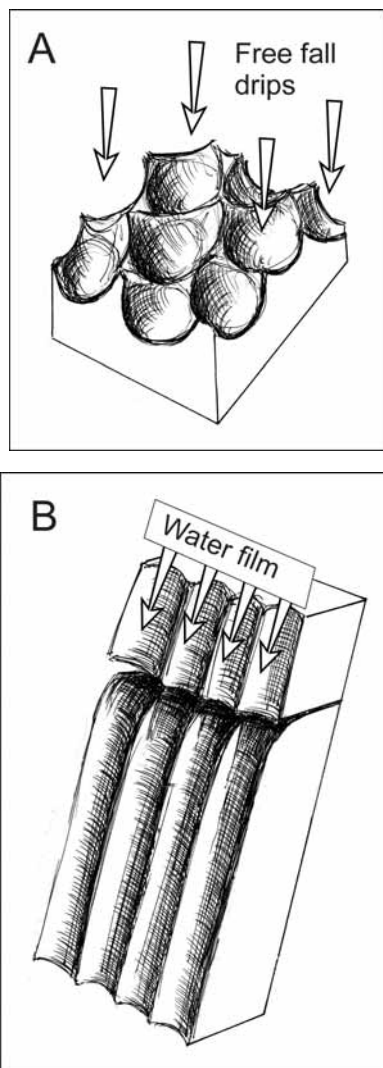
In some cases the dissolutional features are modified strongly by the rock properties. Karren are best developed (i.e., have the smoothest, most regular shape) in homogeneous, fine-grained, pure rock. Rock heterogeneity results in differential dissolution: Impure beds resist dissolution and protrude, as do less soluble shell fragments or pebbles in the rock. The rock surface may become so rough that the basic karren form is completely obscured. Rock texture and composition (grain size, shape, chemistry), sedimentary facies (ripple units, bedding planes), and fracture characteristics (joint/fault frequency and orientation) can constrain karren form. There is no standard term for the forms produced from this type of differential dissolution because there is no standard morphology; each shape is unique to the rock properties that govern it. At times, they may resemble true karren forms that are not governed by rock properties, e.g., the passage cross section shown in Fig. 10A is notched from water level corrosion (see below) while the passage shown in Fig. 10B is notched from alternating more-or-less soluble beds. Finally, karren form may be affected by clastic material carried in the water. Abrasion features (*scour marks*) are at

the edge of the karren category, because they are not strictly dissolutional.

### DESCRIPTIONS OF FEATURES

*Drip pits* occur where water drips freely (e.g., into cave entrances, or from small vadose inlets), producing a suite of simple circular cavities, of semicircular to parabolic cross section, typically 1–5 cm in diameter and depth (Fig. 1A).

*Longitudinal rills and flutes* are suites of vertical grooves on walls (Fig. 1B). They are usually best developed in vertical shafts. They vary in size from ~1 cm (rills) up to ~30 cm (flutes) in width and many meters in length, often extending the whole length of the shaft. They develop where a water film flows down a high-angle rock face; the discharge and velocity must remain low enough that the flow maintains

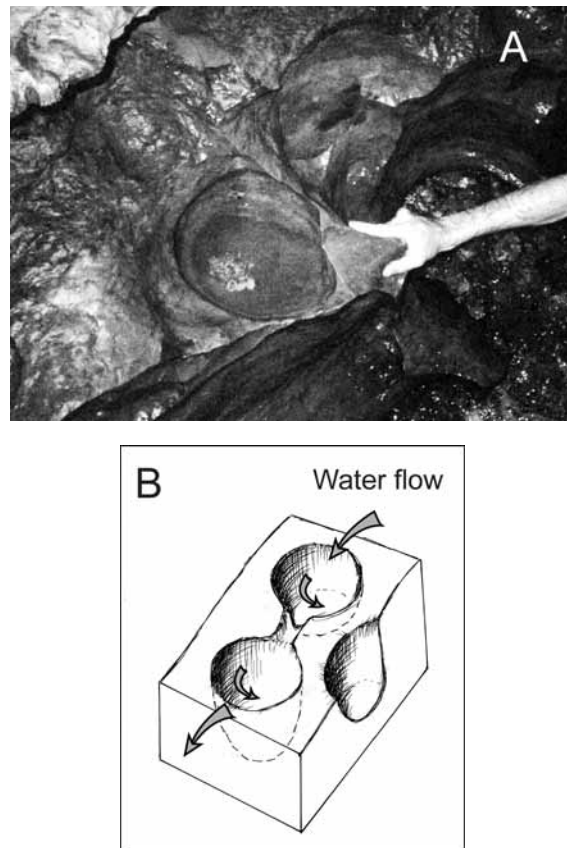


**FIGURE 1** (A) Drip pits that develop in caves under free-falling drops are very similar to those that develop subaerially from raindrops. (B) Flutes develop on steep to overhanging walls from films of water.

attachment to the face and remains as a film, rather than becoming focused into a channel. Although the bigger flutes may be somewhat interrupted or influenced by bedding planes and joints, the basic form is not governed by rock properties. Sometimes the flute wall itself may be made up of smaller scale rills.

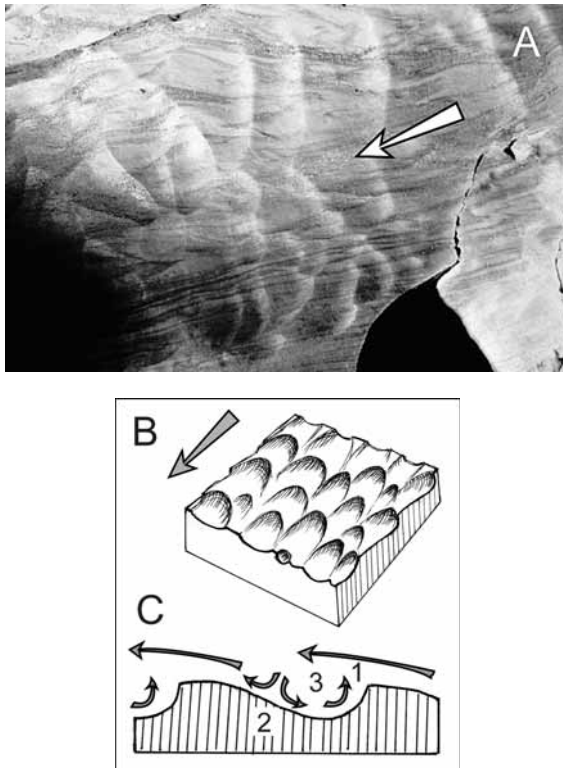
*Dissolutional potholes* are sharp-edged, rounded-interior basins in streambeds (Fig. 2). The scale is typically 20–200 cm in diameter and depth. They usually have an almost perfectly round circumference and are often deeper than they are wide. The potholes develop in channels of steep gradient where flow is strongly turbulent and velocity is high. They may be entirely dissolutional or modified by abrasion when clastic particles are introduced; if a pebble or boulder is trapped in the pothole it can rapidly enlarge. Some become abandoned when a drainage channel develops in the pothole wall. Then a new pothole develops below, leading to a suite of potholes lining channel walls and floor.

*Scallops* are spoon-shaped scoops (Fig. 3A, B) that occur in suites, overlapping and intersecting each other, covering the entire wetted surface. In width they are typically 1–20 cm but may reach 2 m; their length is usually twice their width. Their wavelength decreases with increasing velocity



**FIGURE 2** (A) Potholes in streambed, Lagarta Cave, Ecuador. (B) Block diagram showing typical regular cross sections and upper pothole with breached wall. Arrows indicate turbulent eddies.





**FIGURE 3** (A) Scallops in marble, north Norway. Flow indicated by arrow from right, light source from left. These scallops are almost wide enough to be called transverse flutes. (B) Block diagram shows typical packing pattern of scallops. (C) Longitudinal profile of scallop or flute showing separation of flow at 1, reattachment of flow at 2, and eddy at 3.

(a log-normal length distribution), and they are markedly asymmetrical, especially in vadose situations with the steep side facing downstream, as shown in Fig. 3A, B. Thus, in a fossil cave the former water velocity and direction can be calculated by measuring the scallops. They develop where water flows regularly, with subcritical turbulent flow. They usually line all surfaces in phreatic caves, and most surfaces in vadose caves. The scallop shape is cut where flow has separated from the rock surface, then becomes reattached (Fig. 3C), allowing aggressive water direct access to the rock face rather than the more usual indirect diffusion through the saturated boundary layer. The initial eddy may be caused by an initial inhomogeneity; one eddy then triggers others, so that the process becomes self-propagating. The frequency of detachment increases as velocity increases, thus wavelength is smaller. For any one section of passage, the scallops of characteristic wavelength are formed by the dominant discharge. In vadose passages, only the higher velocity flows reach the higher parts of the passage; thus the upper level scallops, formed only by flood flows, are smaller.

*Transverse flutes* are essentially scallops of infinite width; they have the same cross section as scallops, but are laterally more extensive. They are produced in almost exactly the same way as scallops, but require a laterally continuous



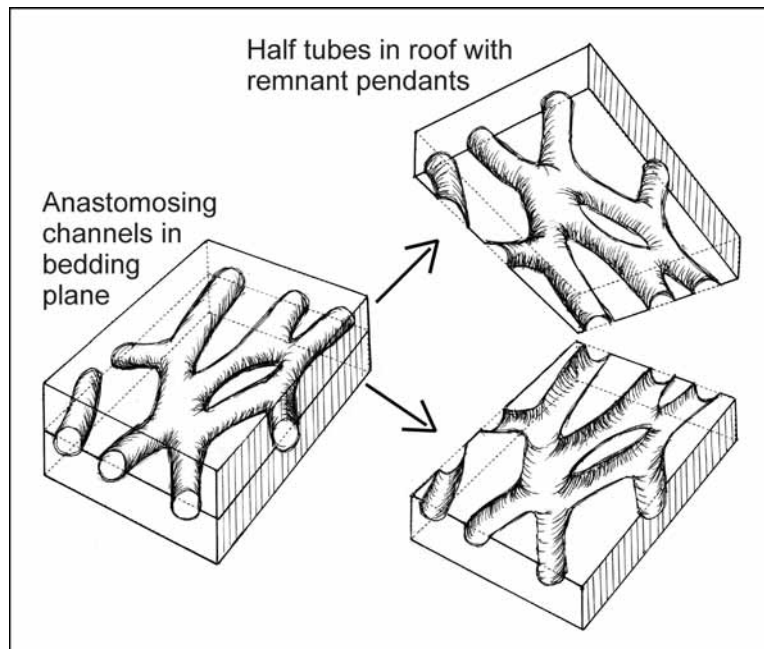
**FIGURE 4** Scour marks in fine-grained limestone, vadose stream passage, Lagarta Cave, Ecuador.

separation of flow, i.e., a transverse, roller eddy. Thus, they are rare.

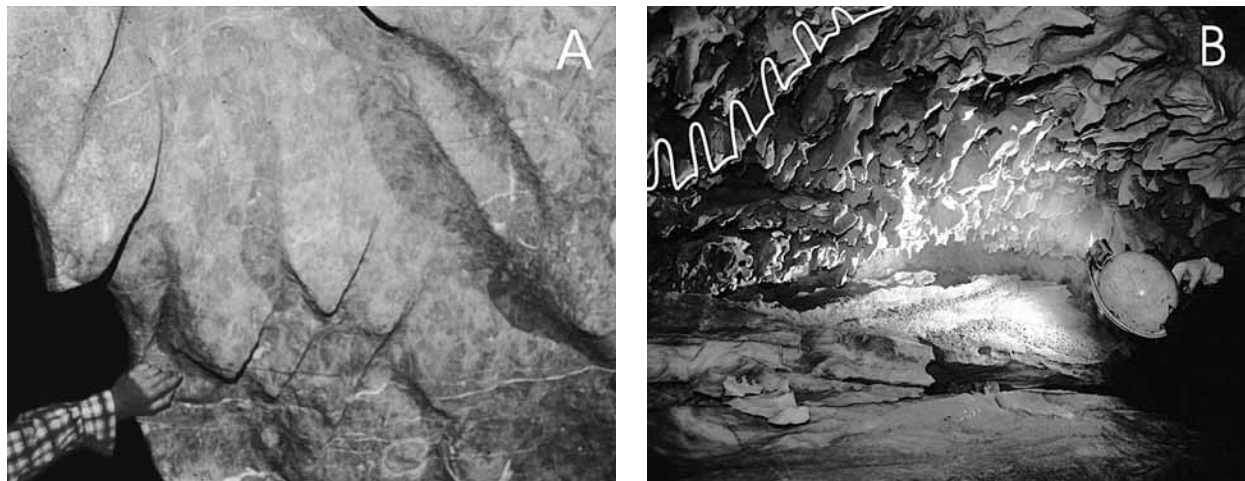
*Scour marks* develop where clastic particles are carried at high velocities; the scallop form becomes elongated and polished (Fig. 4). These are standard fluvial forms, but relatively rare in caves because they need both very high velocities and silica sand.

*Anastomoses*, *pendants*, and *half-tubes* may form separately or may be part of a continuum of forms. They are associated either with normal phreatic flow or with *paragenesis*. Paragenesis, or antigravitational erosion, occurs where a passage has been filled with sediment and flow is confined against the ceiling, thus exposing the ceiling to pressurized flow and enhanced dissolutional activity. Paragenetic features therefore develop upward.

The term *anastomose* refers to a reticulate pattern (such as in the veins of a leaf); in caves it applies to a pattern of interweaving channels (Fig. 5) cut into a fissure of low dip that is penetrated by water, often under pressure. The fissure may exist between two rock surfaces (i.e., a bedding plane or joint), or between sediment fill and cave roof (i.e., paragenesis). Anastomosing channels (typically a few centimeters up to a meter in width) are usually exposed to view only when the lower confining bed or fill is removed (i.e., when a passage opens and relict anastomoses can be seen in the roof). Floodwater can sometimes be forced into a complex three-dimensional, reticulate route through the rock; this creates a form of *spongework* (but spongework is more commonly formed by almost static flow, see the next section).



**FIGURE 5** Block diagram of bedding plane anastomosing channels; when the lower block is removed the upper bedding plane half-tubes with intervening remnant pendants are exposed.

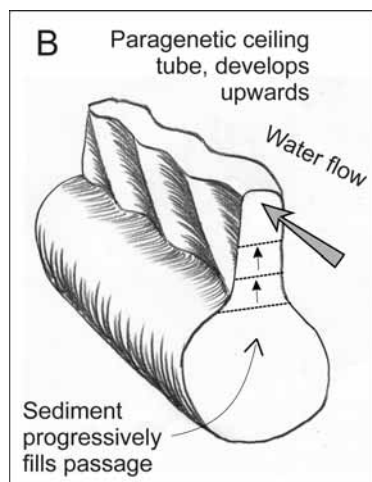


**FIGURE 6** (A) Pendants from phreatic eddies, Royal Arch Cave, Queensland, Australia. (B) Paragenetic pendants in marble, Stordekkgrota, north Norway (the roof cross section has been highlighted with the white line to show the complexity).

The term *pendant* refers to positive forms hanging from passage ceilings, typically ~10–100 cm in dimension. They are remnant from removal of intervening rock through eddy dissolution (in which case the pendants often have sinusoidal cross sections and look like egg boxes; Fig. 6A) or remnant from anastomosing channels (in which case the pendant cross section resembles an inverted flat-topped mesa, Fig. 5). Paragenetic pendants can be complex and very attractive (Fig. 6B). Positive forms can also be left on walls and floors, but, because they do not hang down, are not termed pendants; e.g., *echinolites* are remnant forms that protrude

upward from the floor. These are often of complex shape, and multifaceted with concave surfaces.

A *half-tube* is a channel of semicircular cross section usually cut upward into a ceiling but sometimes in walls. The half-tube may develop in the same way as paragenetic anastomoses, where flow is confined against the roof but under less pressure so that only one channel forms; here the tube cuts upward and meanders (Fig. 7). Another possibility is that the half-tube forms where water trickling through a joint intersects the main phreatic passage causing enhanced dissolution through mixing corrosion; in this case the half-



**FIGURE 7** (A) Paragenetic ceiling tube in Abdiget Cave, Hungary. (B) Progressive upward entrenchment of meandering half-tube.

tube follows the joint and is straight with the passage cross section then resembling a gothic arch (ogive). A third suggested mode of origin is that  $\text{CO}_2$  is trapped against the ceiling during flooding, enhancing aggressiveness.

*Bypass tubes* and *corkscrews* develop by paragenesis where a sediment fill forces drainage to adopt new routes through the bedrock above the blocked section. The blockage causes locally very high hydraulic potential and the water is forced to exploit every available fracture often in a tortuous route.

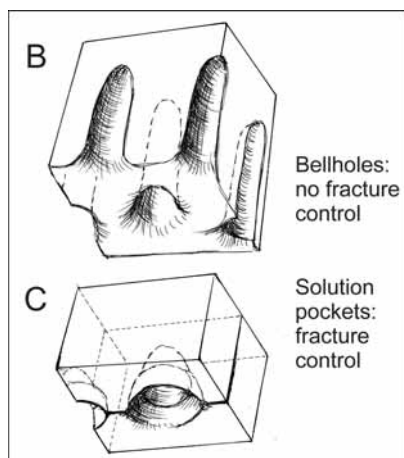
*Solution pockets* are closely related to half-tubes and pendants. These are negative forms most often apparent in ceilings but also developed in walls and floors. They are blind

pockets of rounded cross section, often circular to elliptical in plan, sometimes multicusped, and usually related to joint or lithological control (Fig. 8C). On walls they may have asymmetrical cross sections. They range in size from ~10 cm to many meters. If they are markedly taller than wide they are called *chimneys* and sometimes *avens*. They may form through mixing corrosion where a joint introduces foreign water into a phreatic cave passage. Alternatively, they may form in vadose caves where water seeping from a joint renews its aggressiveness by absorbing  $\text{CO}_2$  from the cave atmosphere.

*Bell holes* resemble solution pockets in that they are also blind pockets developed in ceilings; however, they are never associated with guiding joints or lithological control. The form has been called “negative stalagmite”-shaped. They are parabolic at top, flared at base, usually much deeper than wide, and with a usually perfectly vertical long axis (Fig. 8A, B). Typically they are ~1 m deep and 20–30 cm wide. They occur in suites, apparently randomly spaced but probably roughly polygonal as a response to competition for space. They are most often reported from humid tropics. Theories of formation have ranged from phreatic eddying to bat urine corrosion, but, because many are currently active without phreatic conditions, recent research suggests that they may form by condensation corrosion.

Another blind pocket feature is the *cupola*. These are complex multicusped alveolar pockets, often in hierarchical suites (Fig. 9A). They can range from small to passage-sized scale (at which size they would not be classified as karren). Cupolas are characteristic features of thermal caves. Thermal waters rising upward through rock are often very aggressive (from dissolved  $\text{CO}_2$  or  $\text{H}_2\text{S}$ ). Below water level, thermal convectional cells may be established in quasi-static water and carve out rounded, spherical cupolas. Alternatively, the aggressive medium may be steam from the warm waters condensing on cooler passage roofs, again circulating in a thermal convection cell and thus producing cupola forms. Cupolas may form part of a complex three-dimensional network similar to a spongework, or they may be part of a branching dendritic network. Most cupolas have no guiding fractures.

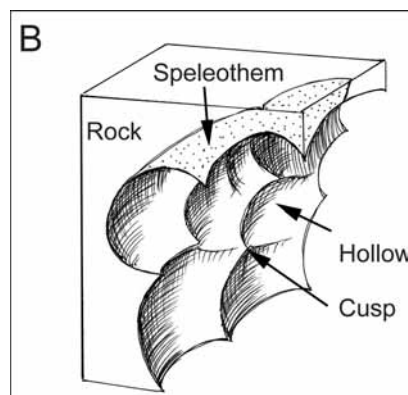
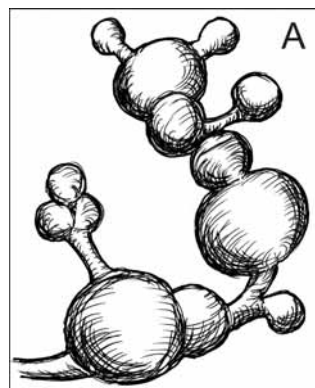
Condensation from vapor also produces *condensation corrosion hollows and cusps*. These forms can be quite complex, but are typically large, shallow, scallop-like hollows, with somewhat sharp cusps where the hollows intersect. These are usually cut smoothly through all material regardless of geological structure and texture (Fig. 9B); e.g., a single hollow may be cut through bedrock and speleothem without any obvious impact of the change in properties. Reprecipitation of calcite sometimes occurs downwind of the dissolution, on the lee side of the hollows. Sometimes condensation rills/flutes are produced. Condensation corrosion has long been known from  $\text{H}_2\text{S}$ -rich vapor in hydrothermal caves. Although condensation rates are much greater in hydrothermal caves, recent research suggests that condensation may be important in many nonthermal caves, mainly during



**FIGURE 8** (A) Bell holes in cave roof, Dominican Republic. (B) Block diagram of bell hole form showing no relationship with lithological controls. (C) Block diagram of solution pocket showing obvious relationship with fissure and often lithological variations in the bedding.

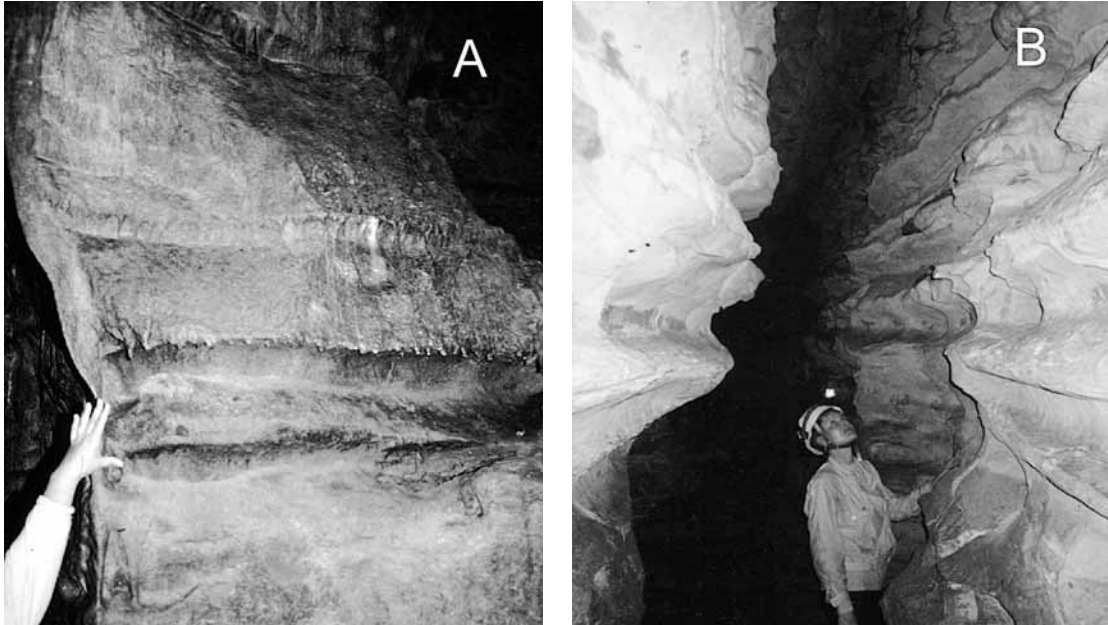
summer afternoons, often in tropical regions. Condensation requires significant changes in relative humidity, and corrosion requires dissolved gases such as  $\text{CO}_2$  and  $\text{H}_2\text{S}$ . Condensation may be caused just by climatic effects or by establishment of bat colonies. Corrosion is most obvious in entrance areas of caves, in narrow passages where an increase in air-flow velocity causes a decrease in pressure and temperature, and in thermal caves directly above steam vents.

The final examples of cave karren occur where water (either meteoric or thermal) is almost static. Where open, vadose standing water becomes aggressive by absorbing  $\text{CO}_2$



**FIGURE 9** (A) Cupolas. (B) Condensation corrosion hollows and cusps cutting equally through rock and speleothem (stippled).

from the atmosphere, and a sharp horizontal *waterline notch* develops exactly at the water level and exactly horizontally. The notch often cuts straight across geological structure. The scale is typically tens of centimeters, but, where water level is stable over long periods, it may penetrate the rock face quite deeply, e.g., up to a meter in normal meteoric water caves. Shallow notches often occur in suites corresponding to changing water levels (Fig. 10A). Horizontal *corrosion notches* can also form where density gradients are set up by the production of heavy ion pairs and solute ions; these sink, setting up cellular flows that carry fresh solute or  $\text{H}^+$  to the water surface and to the rock wall. In this case notches are formed that taper off steeply below the waterline. Maximum dissolution is focused on the point of first contact but the cellular flow carries some  $\text{H}^+$  ions downward, resulting in declining dissolution with depth (with a linear or exponential decay). The form may then be an inclined face at about  $45^\circ$ , or *facet*, that meets the flat ceiling of the notch to produce an inverted triangular cross section (the *laughöhle*). The best studied examples are developed in gypsum, where 1- to 3-mm thick density currents have been measured against the rock surface. Continued retreat of the inclined face under stable water conditions leaves a horizontal ceiling, termed a *laugdecke* or *corrosion bevel*. These are relatively rare because conditions are not often stable enough for long enough periods of time.



**FIGURE 10** (A) Water level notch in Istvan Cave, Hungary, caused by absorption of  $\text{CO}_2$  from cave air. (B) Notches caused by differential dissolution of beds, Jumandi Cave, Ecuador.

*Spongework*, a complicated three-dimensional network of interconnecting pockets and tubes at various scales from a few tens of centimeters up to tens of meters, may be produced where phreatic water is very slow moving. The very slow dissolution kinetics close to saturation allow differential dissolution to enhance subtle differences in rock properties. The spongework is often concentrated roughly into levels.

### See Also the Following Articles

*Epikarst*

### Bibliography

- Bogli, A. (1980). *Karst Hydrology and Physical Speleology*, (especially pages 158–164). Springer-Verlag, Berlin.
- Ford, D. C., and P. Williams (1989). *Karst Geomorphology and Hydrology*, p. 601 (especially pp. 294–309). Unwin Hyman, London.
- Klimchouk, A. B., D. C. Ford, A. N. Palmer, and A. Dreybrodt (2000). *Speleogenesis Evolution of Karst Aquifers*, pp. 527 (especially pp. 100–111; 407–426). National Speleological Society, Huntsville, AL.
- White, W. B. (1988). *Geomorphology and Hydrology of Karst Terrains*, pp. 464. Oxford University Press, NY.

## Karst Water Tracing

William K. Jones  
*Karst Waters Institute*

### DEFINITIONS AND OBJECTIVES OF TRACER TESTS IN KARST

Water tracer tests are usually conducted to establish the hydrologic connections between two or more points. The

tracer is an identifiable label or marker added to flowing water that establishes the links between the injection point of the tracer and the monitoring points where the tracer reappears. Fluorescent dyes are the most commonly used tracers in karst aquifers, but a wide range of substances has been used successfully. The experimental design of a tracer test may be qualitative to simply establish if a hydrologic connection exists between two points, or quantitative to measure the time-concentration series (*breakthrough curve*) generated by the recovery of the tracer. Water tracer tests usually work well in karst areas because of the fast groundwater flow rates and the prevalence of flow paths restricted to discrete conduits.

The level of effort and the cost of conducting a tracer test is a function of the question being asked. Many tracer tests are an extension of cave exploration and are conducted to “see where the water goes.” The tracer test may have the relatively simple objective of establishing a connection between two cave passages separated by an impassable reach. Tracer tests may be used to determine the destination of water flowing into a sinkhole or blind valley. The karst drainage basin contributing water to a spring or resurgence may be estimated based on the results of tracer experiments. The interbasin transfer of water is frequently demonstrated by tracer tests. The travel rate of a tracer may be used to establish some of the hydrologic properties of an aquifer. Examination of the breakthrough curve of a tracer test can aid in the interpretations of some of the internal flow characteristics of the aquifer. The movement of a tracer may mimic the subsurface behavior of a pollutant introduced into the aquifer at the same point. Tracers may be used to identify

the source of pollution at a spring. Tracer tests are sometimes used to demonstrate the “vulnerability” of karst aquifers to chemical spills and pollution associated with inappropriate land use practices and to establish “wellhead protection areas” for public water supplies.

Naturally occurring chemicals or isotopes may be used to determine the age or residence time of water at sampling points within the aquifer. The sources of the water in terms of percentages contributed by conduit flow versus drainage from the overlying epikarst or deeper fracture zones may be studied. These chemical markers are considered tracers, but they identify the various components or storage areas of the aquifer rather than establish direct hydrologic connections or paths between specific points in the aquifer.

### HISTORY OF WATER TRACING IN KARST AQUIFERS

A considerable amount of folklore concerning underground water connections has accumulated throughout the world’s cave areas. Tests have been reported using tracers such as wheat chaff, duck feathers, marked logs, tagged eels, and muddy water from storm events. A 2000-year-old tracer test is attributed to tetrarch Philippus who supposedly established the source of the springhead of the Jordan River in 10 AD. Chaff was thrown into Phialo Pond (Berekhat Ram Crater Lake) and reemerged from the cave spring Panium, the head of the Jordan River. Although the results of this test have been questioned, it does establish that the basic idea of tracing underground water is quite old.

A scientifically planned tracer test was conducted in 1872 by A. Hagler to determine the origin of a typhoid fever outbreak in the village of Lausen in Switzerland. About 800 kg of salt (NaCl) was injected in a sinking stream on a farm south of the village and the water supply spring for the village showed a strong reaction for chloride the following day (Käss, 1998).

The start of modern water tracing studies followed the discovery of fluorescein by A. V. Baeyer in 1871. The sodium salt of fluorescein, called uranine in Europe, rapidly became the most used and probably the most successful groundwater tracer for cave and karst studies to this day. The first reported use of sodium fluorescein as a tracer was an experiment conducted in southwestern Germany on October 9, 1877, by Professor Albert Knop. Then 10 kg of sodium fluorescein supplied by C. Ten Brink was injected at infiltration points in the bed of the Danube River and reappeared two days later and 12 km away at the Aach Spring, a tributary of the Rhine River. A test conducted a couple of weeks earlier from the same location used almost 10,000 kg of salt and may have been the first quantitative tracer test with hourly sampling at the Aach Spring.

Work on the development of methods for tracing underground waters continued in Europe. Many of the early tracer tests used large quantities of dye, because detection

depended on visual coloring of the water at the resurgence. An interesting example of an accidental tracer experiment occurred in the French Franche-Comte in 1901. As the result of a fire at the Pernod distillery at Pontarlier, a quantity of absinthe poured into the Doubs River. A significant amount of the alcohol seeped through the bed of the river and reemerged the following day 10 km away at the source spring of the Loue River. The test of the connection between the Doubs and the Loue was repeated by E. A. Martel in 1910 using 100 kg of sodium fluorescein. The Loue was brightly colored two days later for a distance of 100 km downstream. The source of the Garonne River in southern France was determined by a tracer test in 1931 by Norbert Casteret. He injected 60 kg of sodium fluorescein at the Trou du Toro on the Spanish side of the Pyrenees and it emerged 3.7 km away and 10 hr later at the Goueil de Joueou on the French side. The Garonne River was colored a bright green for over 50 km downstream. Quantitative tests at the same site in the early 1990s used less than 2 kg of sodium fluorescein and yielded travel times for the tracers of about 11 hr during high-flow conditions in the summer and 180 hr for a low-flow test in the winter (Freixes, Monterde, and Ramoneda, 1997).

Various tracer techniques were tried in Europe through the 1920s. A “fluoroscope” was developed which allowed a rough estimation of dye concentrations in water samples by visual comparison with prepared laboratory standards. A number of different salts, dyes, and even radioactive compounds were tried. Bacteria were tried as a particulate drift tracer as early as 1896. Spores from the club moss *Lycopodium calvatum* were suggested as a possible tracer in 1910, and the first reported tracer test using spores is from Europe in 1940 (Käss, 1998). Spores became a popular tracer in Europe in the 1950s because they could be dyed different colors and several sinkpoints could be traced simultaneously. Plankton nets were suspended at the springs to passively collect the spores, so constant surveillance of a number of springs was no longer required. Spores dyed with fluorescent dyes proved to be easier to identify under a microscope. Drifting tracers such as spores and bacteria are still used to a certain extent in Europe but have never been popular in North America.

One novel tracing experiment in Slovenia in 1929 used marked eels. The dorsal fins of 494 eels were notched and the eels were released in the Reka River that sinks into Skocjanske Cave and resurges 34 km to the west at the Timavo Springs in Trieste Bay (Italy). Twenty-nine of the eels were caught in eel pots at the Timavo Springs during the one-year observation period.

The Yorkshire Geological Society carried out a series of tracer tests in the Ingleborough area of Great Britain in 1904. One principle from this work has been to test “key sinks” and to guess the remainder in lieu of testing everything. This approach is still practiced in many karst areas, but more intensive studies at later dates sometimes produce surprising results. Much of the subsequent work on tracing under-

ground drainage in the British Isles has been conducted by caving groups associated with various universities. A study of the caves of northwest County Clare, Ireland, in the early 1960s by E. K. Tratman and the University of Bristol Speleological Society, involved a number of tracer tests using sodium fluorescein and passive carbon detectors to monitor the resurgences.

Just as professional cave and karst studies in North America lagged behind Europe in general, so did the interest in tracing underground water. The first description of tracer tests from North America was a U. S. Geological Survey water supply paper by R. B. Dole in 1906. This paper discussed the use of sodium fluorescein as a tracer, but few tracer tests are reported from North America before the late 1950s. Whereas most of the water tracing studies in Europe were conducted by professional hydrologists or speleologists, often at considerable expense, the real beginning of karst water tracing studies in North America was the contribution of unpaid cavers as an extension of cave exploration. A brief description of a method to recover sodium fluorescein sorbed onto activated coconut charcoal granules was published by J. R. Dunn in a cave club newsletter in 1957. This discovery offered an inexpensive technique to monitor different resurgences without the necessity of constant surveillance. The researchers could place carbon packets (called "Dunn Bugs") in the springs, inject the dye in a sinking stream or cave, and return in a few weeks to collect and test the carbon packets. The concentration of the dye on the carbon increases with the exposure time to the dye, so recovery concentrations of sodium fluorescein below the normal visual threshold could be detected. The testing relied on visual identification of the dye as a fluorescent yellow-green sheen floating on top of the carbon in an elutant. Apparently a very similar technique was described by Mayrhofer in 1904 (Kass, 1998), but the activated carbon system was used in Europe more as a technique for enriching the dye concentration in a sample than as an unattended monitoring system. The first field test of the passive detector system in North America was described by T. D. Turner in 1958. Turner reported a tracer test using carbon detectors and 4 g of sodium fluorescein over a distance of 4.8 km near Pine Grove Mills, PA.

Water tracing in North American cave studies really began in the early 1960s using sodium fluorescein and passive detectors of activated carbon. Hermine Zotter began a dye tracer study in Pocahontas County in east central West Virginia in 1960. Thomas Aley conducted a tracer test for a court case in California in 1963. This was probably the first use of underground water tracing to resolve litigation in the United States. Aley worked on a study for the U. S. Forest Service in the Ozarks in Missouri in 1966 and conducted a 64-km long trace from the Eleven Point River Basin to Big Spring on the Current River Basin. William Jones conducted a study for the U. S. Geological Survey in Greenbrier County, West Virginia, in 1966. The results of the tracing

tests were coupled with the positions of surveyed cave streams and topographic divides to delineate karst drainage basins. Charles Brown was conducting tracer tests in the Maligne basin in Alberta, Canada, by 1969. James Quinlan became the park geologist for Mammoth Cave National Park in Kentucky in 1973 and started an intensive series of water tracing tests. The results of the tracing tests were combined with data from cave surveys and potentiometric contours to produce a detailed map of drainage basins and sub-basins around Mammoth Cave (Ford and Williams, 1989).

The development in the early 1960s of *fluorometers* that control or measure light emissions in both the excitation and emission wavelengths of different fluorescent compounds enabled dye analytical methods to become much more quantitative. Quantitative water tracing using fluorometers dates from the early 1960s. Much of the early quantitative tracer work was for surface water time-of-travel studies. Fluorometers also allowed several different fluorescent compounds to be used simultaneously because the instruments could be set to narrow specific wavelengths.

Much of the development of quantitative tracer techniques was presented in a series of conferences in Europe beginning with the Specialists Conference on Tracing of Subterranean Waters in Graz, Austria, in 1966. This conference series has continued at about four-year intervals as the Symposium on Underground Water Tracing (SUWT) conferences. The published proceedings from the series contain a wealth of information on various tracer techniques for both karst and porous media water tracing. Much of the material from these conferences is distilled in the book by Käss (1998). A U. S. Geological Survey paper by Wilson (1968) and a paper on the evaluation of fluorescent tracers by Smart and Laidlaw (1977) were probably the most influential papers on quantitative water tracing published in North America.

## TRACERS

Groundwater tracers are generally classified as: (1) naturally occurring (often accidental in their addition to the water), (2) artificial tracers deliberately introduced into the aquifer, and (3) pulses. Naturally occurring tracers include the chemical constituents and isotopes naturally found in water or present due to the activities of man. Tritium, fluorocarbons, pollutants from waste sites, and thermal waters may all serve as tracers in some circumstances. Isolated thunderstorms may generate a distinctive flow response at springs some distance from the storm. Organisms unique to a particular subsurface drainage basin may be considered a tracer if their distribution can be used to define the boundaries of the basin. Naturally occurring tracers are often used to "date" the water, artificial tracers are used to label a specific sink or cave, and pulses send an identifiable signal through the conduit or sometimes a large part of the aquifer.

Most tracer tests in karst areas are conducted using artificially injected tracers. These tracers may be broadly classified

as: (1) water-soluble tracers (dyes, salts), (2) particulate or drift material tracers (club moss spores), and (3) physical pulses (flood waves). The ideal tracer should be:

1. Nontoxic
2. Not normally present in the study area (low background)
3. Detectable at very low concentrations
4. Conservative (minimal sorptive and decay losses)
5. Have the same density of water (or be neutrally buoyant)
6. Relatively inexpensive
7. Easy to sample using passive collectors
8. Easy to analyze and quantify in the laboratory

The vast majority of tracer tests in cave and karst areas are conducted using fluorescent dyes. All fluorescent dyes have some tendency to adsorb to clay minerals and some have high photochemical decay rates. The relative fluorescent intensity of many dyes is pH- and temperature-dependent. These considerations are usually not a problem for underground tracing in cavernous aquifers with high flow rates. Tracer tests in diffuse-flow aquifers often involve the use of more conservative isotopes where the longer residence times make fluorescent dyes less suitable. A list of the principle fluorescent tracer dyes commonly used in North American karst studies is presented in Table I.

Tracer tests from Europe have largely been conducted quantitatively and required direct sampling of the resurgences. Studies in the British Isles and North America through 1990 have mostly been qualitative and used passive collectors to monitor the resurgences. Qualitative tracing is still used for reconnaissance type studies and work in remote

areas, but quantitative tracing techniques are now the norm for most scientific studies throughout the world.

The fluorescent dyes commonly used as tracers are believed to be quite harmless to people and the environment. A review of the toxicity data for tracer dyes was presented by Smart (1984). The only tracer dye not recommended is Rhodamine B, but the high sorptive tendency for this dye makes it a poor choice for groundwater tracing under any circumstances.

A lot of confusion exists over the names of many of the tracers. Sodium fluorescein is known as uranine in Europe and commonly called fluorescein in the North American literature. Only the sodium salt of fluorescein is soluble enough to make it an efficient tracer. When describing a dye, the Color Index name should be cited at least once. Sodium fluorescein has a Color Index constitution number CI 45350 and a generic name of acid yellow 73. Also, all dye shipments should be checked when they are received to make certain the correct product is being used.

Note that a few words of caution are in order for anyone planning on conducting tracer tests. Specialists now do most dye tracing, and water tracing by untrained people may be very damaging. In the United States, some states require a permit for conducting a tracer test, and the local water inspectors should always be notified in advance of any test so a hazardous materials team is not called out at great expense. A few states do not allow any water tracing tests. Care should be taken to avoid coloration at water intakes. All work in a given area should have one coordinator so various tests cannot cross tracers. Some epikarst aquifers may take several years to clear a given dye from an injection point, so careful planning is needed to avoid confounding future tests

**TABLE I Principal Fluorescent Tracers Used in North American Karst Studies**

Tracer Color index name Color	Excitation emission maximum	Passive detector	Remarks
<b>Phorwite AR Solution</b> FB #28 UV blue	349 nm 430 nm	Unbleached cotton	Invisible in solution. High photochemical decay rate. Often high background fluorescence. May be present due to household detergents.
<b>Solophenyl</b> Direct yellow 96 UV yellow	≈397 nm ≈490 nm (pH sens.)	Unbleached cotton	Sensitive to pH. No coloring of water. Usually low background.
<b>Sodium fluorescein</b> Acid yellow 73 Yellow-green	491 nm 512 nm	Activated carbon 6-14 mesh	High photochemical decay and sensitive to pH. Probably the most frequently used tracer for karst studies. Low sorption.
<b>Eosin</b> Acid Red 87 Red	516 nm 538 nm	Activated carbon 6-14 mesh	High photochemical decay. Can overlap with sodium fluorescein if both are present in the same sample.
<b>Rhodamine WT</b> CI acid red 388 Red	554 nm 580 nm	Activated carbon 6-14 mesh	Low background. Good stability in sunlight. Moderate sorption. Generally requires a fluorometer for detection.



using the same tracer. The following description of the basic procedures for conducting tracer tests in karst area is not intended to serve as a training manual. Tracers, like antibiotics, will lose their usefulness if overused or improperly used through time.

### QUALITATIVE TRACING USING PASSIVE DETECTORS

Passive collectors such as packets of activated carbon or unbleached cotton are placed in the monitoring points and collected at regular intervals. The dye, if present, is then eluted from the carbon or exposed by examining the cotton under ultraviolet light. The use of a fluorometer to analyze the elutant increases the minimum detectable concentration of the tracer by several orders of magnitude. It is not possible to reliably obtain the dye concentrations at the resurgences from this technique, because exposure time of the detector to the dye and other variables affect the elutant dye concentration. Time of travel for the tracer can only be approximated based on the changing interval for the detectors. Detailed instructions for conducting qualitative tracer tests are presented in Aley and Fletcher (1976), Jones (1984), and Alexander and Quinlan (1996).

The principal groups of passive detectors and tracers are

1. Activated carbon (activated charcoal)
  - a. Sodium fluorescein
  - b. Eosin
  - c. Rhodamine WT
2. Cotton
  - a. Tinopal CBS-X (FB 351)
  - b. Phorwite
  - c. Calcophor white (FB number 28)
  - d. Direct yellow 96
3. Plankton netting (about 25-micron mesh openings)
  - a. Colored spores of *Lycopodium calvatum*

The fluorescent dyes have been used extensively in North America and Europe while tracing using spores has been primarily a European technique. The following discussion outlines the basic procedure for conducting a qualitative tracer test using sodium fluorescein and carbon detectors.

The execution of a tracer test should involve an initial survey of the study area to identify the hydrologic boundaries and all possible springs and resurgences. Any previous tracer tests from the area and all cave survey data should be studied. All land owners potentially affected by the test should be contacted and access secured to injection and monitoring points. Local and state agencies should be notified about the study and any required permits obtained. Measurements of background fluorescence from the springs should be used to help determine the most suitable tracers. Initial tests in an area should be conducted during average flow conditions; tests under minimal discharge should generally be avoided.

The amount of dye to use for any given test is an educated guess at best. The quantity of tracer to be injected is a function the hydrologic conditions of the study area and the characteristics of the tracer and the analytical procedure. The possible travel distances and discharges of the resurgences may be used to help estimate the travel time and tracer quantity required for the test. Several formulae to estimate dye quantities are presented in Käss (1998), but these provide only rough guidelines. Tests in conduit aquifers involving distances less than 1 km and discharges less than 30 L/sec should require less than 200 g of sodium fluorescein. Most of the other commonly used tracer dyes probably require two to four times the mass used for a sodium fluorescein test. Less dye is usually needed for qualitative tests than for quantitative tests. If the possible coloration of the resurgences is not objectionable, the estimated amount of dye should be increased. Care must be taken to keep maximum tracer recovery concentrations below the visible threshold (about 30 µg/L for sodium fluorescein) if the tracer could affect a water supply. The U.S. Geological Survey suggested a maximum dye concentration of 10 µg/L at water intakes, but this is a conservative number and is not based on toxicological considerations (Alexander and Quinlan, 1996).

The monitoring locations should include all possible resurgences and one or two “impossible” ones to serve as controls for the test. Carbon detectors are usually made of envelopes of plastic screening material containing a few grams of activated carbon granules (about 6–14 mesh). The construction of a carbon detector is shown in Fig. 1. Cotton detectors are usually balls of unbleached cotton. The passive detectors should be changed at regular intervals, usually between 2 and 14 days. The detectors should be in place for at least one changing interval prior to dye injection to establish background information. They should be placed to remain submerged with changing water levels, be readily recoverable, and remain out of sight to casual observers. An interesting “hanger” for detectors in deeper water was developed by James Quinlan and is shown in Fig. 2. The detectors should be placed so medium velocity current flows through them and they are not exposed to direct sunlight. Detectors lose their ability to adsorb the tracers through time, but they will retain the dye for periods of at least one year following exposure when kept in total darkness. Caution must be used to prevent contamination of the detectors and they should be placed before the dye is injected.

Injection points for the tracer are ideally flowing streams at surface sinkpoints or upstream of impassible reaches in a cave. Powered dyes are often mixed with water prior to injection to avoid unwanted spread of the dye. The injection points should be chosen to minimize the surface exposure of the tracers to sunlight.

Tests involving injection points without rapid continuous flow such as a dry sinkhole or water well are much more difficult and more prone to failure. Tracer tests from sinkholes or wells are usually only conducted by professional

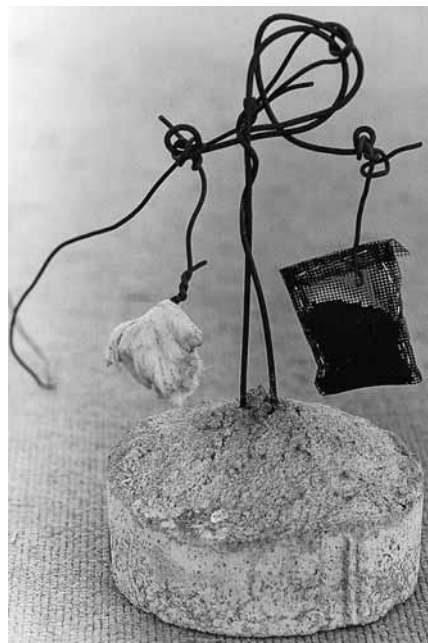


**FIGURE 1** Photo showing construction of a passive carbon detector (Dunn Bug). Plastic window screen material is cut into strips, folded, and stapled. The envelope is filled with activated carbon and the top is folded and stapled. An old railroad spike makes a convenient anchor which is attached with copper wire. Another envelope material suggested by Calvin Alexander is cut from a “milk sock” available from farm supply stores (lower right).

hydrologists. The basic procedure is to use a tank truck to deliver water to the site. Several thousand liters of water are run into the sinkhole before the dye is added. The dye is then flushed into the aquifer system with about an additional ten thousand liters of water. Injection sites that use water wells often provide unsuccessful tests, which means that the dye injected as the tracer will not be usable in the area for a number of years. Caution and careful planning are needed for this type of test.

Another dye injection involves leaving the dye in a safe storage area in a presently dry sink or streambed and letting the next storm wash the tracer into the flow system. This “dry set” system works best in remote areas where people or animals are unlikely to encounter the tracer before it is removed by precipitation. The analysis of the carbon for the presence of sodium fluorescein involves the following steps:

1. Rinse the carbon in clean water to remove sediment
2. Fill a test tube about half full with the carbon
3. Pour in the test solution, called the eluent, to cover the carbon about 3 cm deep (5–10 ml)
4. Let the samples sit undisturbed in the dark for between 30 min and 24 hr
5. Shine a concentrated white light source such as a focusable flashlight through the test tube and look for the characteristic fluorescent green sheen on top the carbon granules (do not shake or disturb the solution for a visual examination)



**FIGURE 2** Photo showing a “Quinlan Gumdrop” anchor used to suspend dye detectors off the bottom of deeper springs or streams. The base is concrete molded in a coffee can. The left arm holds a cotton detector and the right arm holds a carbon detector. Vinyl-clad copper wire is used to attach the detectors and to retrieve the anchor.

Some workers prefer to use a larger diameter vial to increase the length of the light path through the elutant. The most commonly used eluent for sodium fluorescein is 5% potassium hydroxide (KOH) in 70% isopropyl alcohol. Many other eluents have been used including the Smart Solution (50% 1-propanol, 20%  $\text{NH}_4\text{OH}$ , and 30% distilled water by volume). It takes some practice to distinguish weakly positive sodium fluorescein tests from some naturally occurring background. Numerous trials at varying dye concentrations should be run under controlled conditions before moving on to actual field tests. One of the advantages of the passive collector system is that the samples are time integrated for the exposure period of the detectors at each monitoring point.

### QUANTITATIVE WATER TRACING IN KARST AREAS

Many of the professionally conducted water tracing tests are quantitative. Resurgences are sampled at short discrete time intervals and the water is analyzed using a calibrated fluorometer to determine the concentration of the dye in each sample. Several different dyes may be injected simultaneously so multiple sinkpoints may be tested at the same time and under the same flow conditions. The results are plotted on a graph showing the concentration of the dye through time (breakthrough curve). The expense and complexity of quantitative tests are much higher, but

considerably more information is obtained about the nature of the subsurface flow systems. The combination of quantitative dye tracing results with discharge measurements allows a more certain delineation of karst drainage basins and the calculation of the percentage of discharge from different sources at a given resurgence. Good results are dependent on using an appropriate tracer, adequate sampling frequency, and accurate analysis of the samples.

The planning and dye injection procedure is essentially the same as described for qualitative traces. Qualitative tests are often conducted first to identify which resurgences to monitor and to estimate the travel time for the tracer. Fluctuations in background fluorescence are often a problem in the blue and green wavelengths, so the red dye Rhodamine WT is the most commonly used fluorescent dye for quantitative studies. Quantitative tests generally require about twice as much dye as qualitative tests. The much greater sampling effort required for quantitative testing is the major reason for the increase in cost.

The instrument used to determine fluorescent dye concentrations is a fluorometer. Fluorometers pass light through the sample at a controlled *excitation wavelength* and measure the relative fluorescent intensity of the output signal at the *emission wavelength*. Laboratory standards at different dye concentrations must be prepared for each batch of dye to calibrate the fluorometer to determine dye concentrations. *Filter fluorometers* may be laboratory or field instruments and use various filters to set the excitation and emission wavelengths, while *scanning spectrofluorophotometers* are laboratory instruments that are better suited to analyzing samples containing multiple dyes or having high fluorescent backgrounds. A continuous scan through the wavelengths of interest with about a 20-nm separation between the excitation and emission settings allows a single scan to be analyzed for several different dyes. Some workers use computer enhancement of the instrument output signal to help identify and separate overlapping fluorescent peaks. Spectrofluorophotometers are more selective in their ability to isolate specific fluorescent compounds, but both types of fluorometers are highly sensitive to low concentrations of dye.

Filter fluorometers may be fitted with a *flow-through door* which circulates water past the instruments' light source. This provides a continuous record of fluorescent intensity in one set of wavelengths, but this is usually only practical for tests with travel times of less than 24 hr. Advances in developing fluorometric probes compatible with data loggers may make continuous fluorometric measurements more cost-effective for many field studies. Most quantitative tracer studies at present involve the use of automatic water samplers at several resurgences over a period of days to weeks. The sampling interval is dependent on the expected travel time of the tracer and may range from 15 min to one per day. Some resolution in the shape of the dye recovery curve may be lost if the sampling interval is too long. Sampling should continue for a time sufficient to ensure that most of the dye

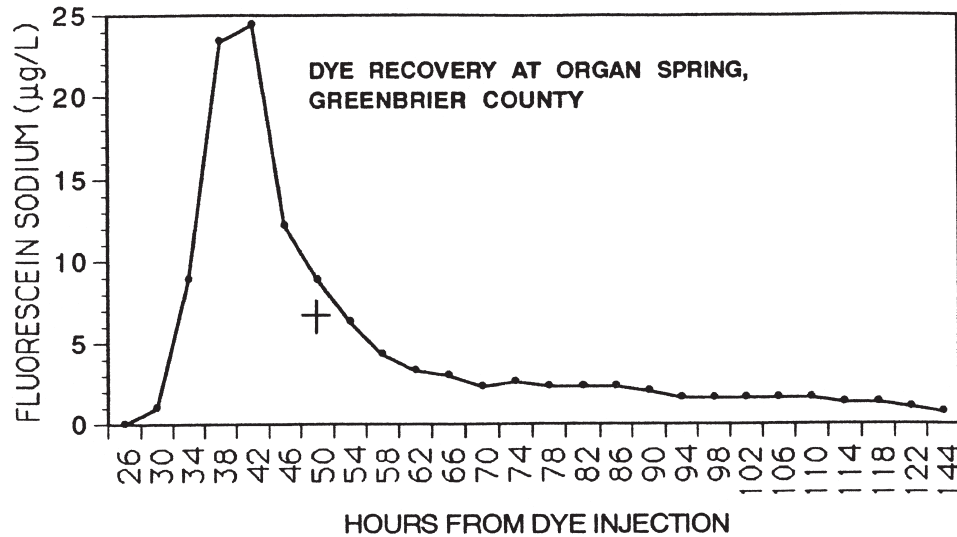
pulse has been recovered. Samples should be stored in the dark in glass containers to minimize photochemical decay and sorption of the dye to the sample bottles.

## INTERPRETATION OF WATER TRACING TESTS

Qualitative tracer tests are positive if the dye is detected at one or more monitoring points. A successful tracer test may prove a hydrologic connection between the injection point and recovery point(s) of the tracer, but the exact flow path(s) will remain unknown. Depending on the changing interval for the detectors, some information of the travel time for the tracer may be available. If the tracer is not detected at a monitoring station, it is listed as "none detected" rather than "negative." Negative tests do not prove that a connection does not exist and the percentage of the injected tracer actually recovered can only be determined by quantitative measurements of the dye concentration and discharge at the resurgences during the recovery period of the dye pulse.

Tracer tests are representative of the karst flow system for the hydrologic conditions prevailing at the time of the test. Overflow routes may exist that function only during high-flow conditions, so a thorough study of a karst region will require multiple tests at different water levels. Some resurgences may only function during high-flow conditions. The travel times for the tracers will be less at high water levels, and the dye will move much faster if the conduits are completely flooded. Quantitative tests between the same injection and recovery sites under a range of flow conditions may be used to develop the relationship between travel time and groundwater discharge and to predict solute transport characteristics. Discharge-dependent thresholds may be identified.

The graph of dye recovery concentration plotted through time is called a dye recovery or breakthrough curve (Fig. 3). This curve presents a picture of the passage of the dye "cloud" or pulse through time at the stationary sampling point. Breakthrough curves are typically skewed to the right with rapid rise to peak (maximum) dye concentration and a long trailing edge of declining dye concentrations. The shape or form of the breakthrough curve is a function of the characteristics of the tracer, the flow conditions during the test, and the characteristics of the aquifer or conduit system. The mean flow velocity is usually computed using the straight-line distance between sink and resurgence and the time between dye injection and recovery of half of the tracer. This is the "*centroid*" or center of recovered mass on the breakthrough curve. Some workers use the time to peak concentration if the resurgences are not completely sampled through the long trailing period of declining tracer concentrations. If discharge is steady throughout the dye recovery period, the amount of dye recovered can be calculated by integrating the area under the breakthrough curve and multiply by the discharge:



**FIGURE 3** Graph showing a simple breakthrough curve from a tracer test in Organ Cave, Greenbrier County, West Virginia. The principal components of the curve are (1) first arrival of the dye at 30 hr; (2) peak (maximum) recovery concentration at 42 hr; (3) Dye centroid (center of mass and median recovery point) at 50 hr; and (4) total time of dye cloud passage from 30 through 144 hr (114+ hr).

$$M = Q \int_0^{\infty} C dt$$

where

$M$  = mass of dye recovered

$Q$  = discharge

$C$  = dye concentration at time  $t$ .

Discharge is usually based on current-meter measurements during the test. If the tracer is *conservative* (not subject to decay or sorptive losses) and all of the water from the injection point is accounted for, the mass of dye recovered should be equal to the mass injected. This is the *dye budget* for the test. None of the fluorescent tracers are completely conservative, but tracer tests with travel times of less than a few days should balance reasonably well if all of the resurgences have been monitored. Assuming complete mixing and a conservative tracer, the area under the time-concentration breakthrough curve should be constant even as the shape of the curve changes in the downstream direction. A significant loss of the tracer from the system suggests that additional resurgences are present or some of the tracer has moved into storage areas along the flow route. Less conservative tracers usually produce a longer travel time estimate due to *retardation* caused by sorption and desorption along the flow route.

Breakthrough curves for many tracer tests in karst areas exhibit multiple peaks, and the time between the peaks may be dependent on discharge. The interpretation of these tests is somewhat subjective, but much insight into the internal flow characteristics of the karst aquifer and the conduit system can be gained from these tests. The best breakthrough curve data is obtained using continuous flow fluorometry during the passage of the dye pulse. The shape or form of the

dye cloud is dependent on the interaction of dispersion, dilution, divergence and convergence, and storage (Smart, 1988).

Traces involving longer distances and longer travel times show lower peak concentrations and longer persistence of the dye pulse as the tracer becomes increasingly more dispersed with time and distance. The shape of the tracer cloud becomes more asymmetrical as dispersion is influenced by the tracer moving in and out of pockets of “dead zone storage” along the flow route. Dispersion is also affected by the retardation factor for tracers that are less than completely conservative.

Divergence occurs where the underground flow routes divide or break away from the main conduit. Convergence is where the routes rejoin the main conduits. The divergent routes generally are longer flow paths than the main conduit, so the portion of the flow and tracer diverted may reappear as second or multiple pulses at the sampling station.

Dilution is caused by unlabeled tributary water mixing with the water containing the original tracer injection. This will cause a lower concentration of dye in the downstream water samples.

Storage of the tracer in the conduit system may be very complex. Storage may just represent very low velocity flow through one section of a branching conduit, called *in-line storage*. A test done under conditions of diminishing flow may leave some of the dye abandoned in upper level pockets to be remobilized when the flow increases at a later date. Some dye may become stored off-line in lateral areas along the route such as small voids or in pores in the sediments. In-line storage tends to create dye pulses that correlate with flushing due to storm events. Dye from off-line storage tends to drain slowly during groundwater recessions. Some

conceptual models of breakthrough curves for different flow levels and conduit geometries are presented in Fig. 4 (adapted from Smart and Ford, 1982).

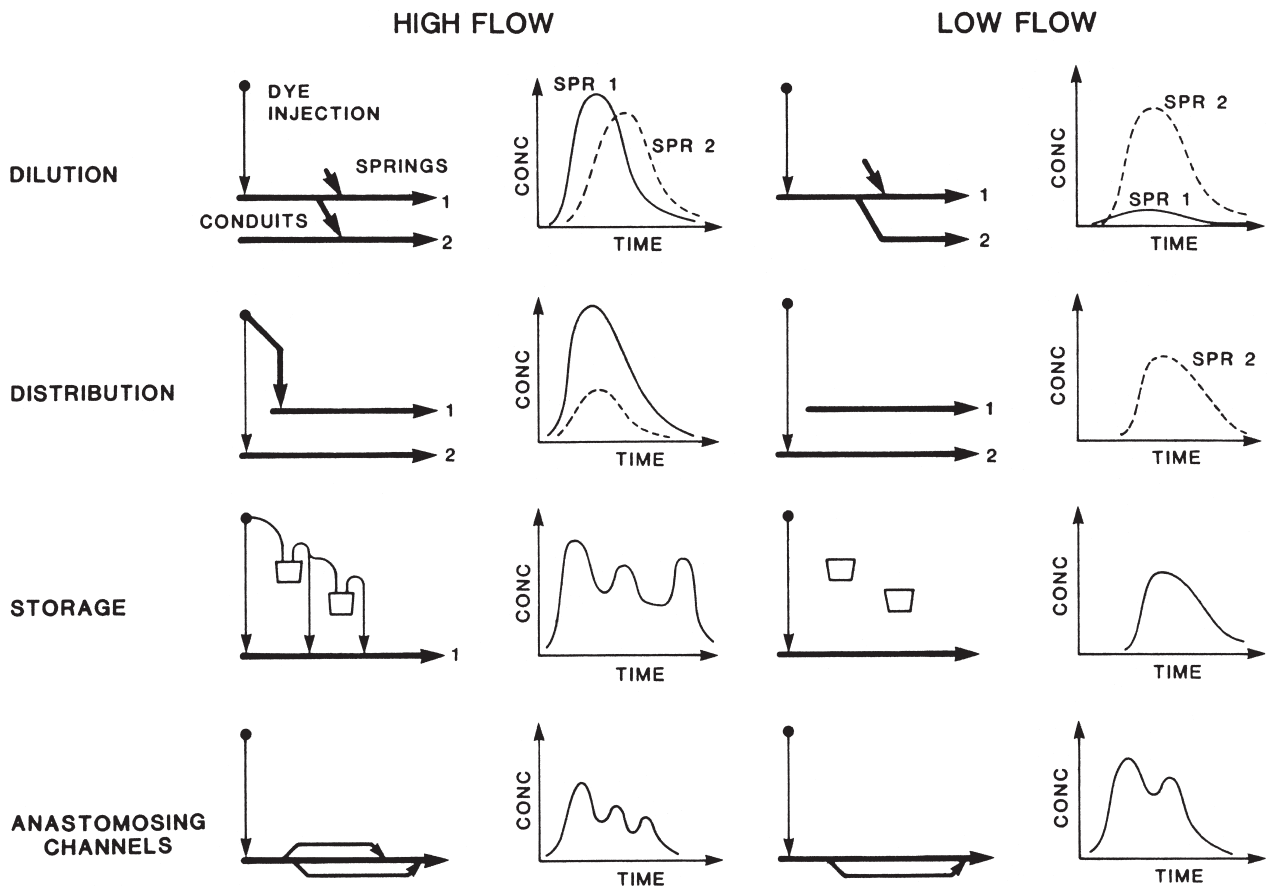
The best picture of the conduit aquifer system for any karst area is from the actual surveying of the cave passages. Tracer tests, interpreted in the context of the regional geology and hydrologic setting, can be used to fill in the blank place on the map where actual exploration of the caves is not possible. The rather unusual mixture of quantitative techniques and subjective interpretation of the unseen part of the aquifer makes water tracing a fascinating endeavor.

**See Also the Following Articles**  
*Hydrogeology of Karst Aquifers*

**Bibliography**

Alexander, E. C., Jr., and J. F. Quinlan (1996). Practical tracing of groundwater with emphasis on karst terranes. In *Guidelines for Wellhead and Springhead Protection Area Delineation in Carbonate Rocks*, (prepared by Eckenfelder Inc.). EPA 904-B-97-003, Appendix B, pp. 1–38.

Aley, T., and M. W. Fletcher (1976). The Water Tracers Cookbook, *Missouri Speleology*, **16** (3), 1–32.  
 Ford, D. C., and P. W. Williams (1989). *Karst Geomorphology and Hydrology*, p. 601. Unwin Hyman, London.  
 Freixes, A., M. Monterde, and J. Ramoneda (1997). Tracer tests in the Joek karstic system (Aran Valley, Central Pyrenees, NE Spain). In *Tracer Hydrology 97*, (A. Kranjc, ed.), pp. 219–225. A. A. Balkema, Rotterdam, The Netherlands.  
 Jones, W. K. (1984). Analysis and interpretation of data from tracer tests in karst areas. *Natl. Speolol. Soc. Bull.*, **46** (2), 41–47.  
 Käss, W. (1998). *Tracing Technique in Geohydrology*, p. 581. A. A. Balkema, Rotterdam, The Netherlands.  
 Smart, C. C. (1988). Artificial tracer techniques for the determination of the structure of conduit aquifers. *Ground Water*, **26** (4), 445–453.  
 Smart, C. C., and D. C. Ford (1982). Quantitative dye tracing in a glaciated alpine karst. *Beitr. Geol. Schweiz-Hydrrol.*, **28**(1), 191–200.  
 Smart, P. L. (1984). A review of the toxicity of twelve fluorescent dyes used for water tracing. *Natl. Speolol. Soc. Bull.* **46** (2), 21–33.  
 Smart, P. L., and I. M. S. Laidlaw (1977). An evaluation of some fluorescent dyes for water tracers. *Water Resources Res.* **13**, 15–33.  
 Wilson, J. F. (1968). *Fluorometric Procedures for Dye Tracing*. Techniques of Water-Resources Investigations of the U. S. Geological Survey, Book 3, Chapter A12 (Revised), pp. 1–34.



**FIGURE 4** Graphs showing conceptual models of possible dye breakthrough curves. The pattern of the recovery curve is a function of prevailing water levels at the time of the test and geometry of the conduit system (From W. K. Jones (1984). *Natl. Speolol. Bull.* 46(2), 41–47; after C.C. Smart and D.C. Ford (1982). *Beitr. Geol. Schweiz-Hydrrol.* 28(1), 191–200. With permission.)

# Kazumura Cave, Hawaii

Kevin Allred

*Hawaii Speleological Survey*

## INTRODUCTION

Among the many known lava tube caves presently explored throughout the world, Kazumura Cave, on the big island of Hawaii, stands foremost in length and vertical extent. It is also the longest linear cave in the world, extending further over a straight-line distance more than any other. This cave contains a wide range of speleothems and morphology with populations of cave-adapted invertebrates. Because much of the cave is located under rural subdivisions, it is a popular place to visit for locals and out-of-state cavers.

## PHYSICAL SETTING

### Location and Surface Relationships

Kazumura Cave was formed, along with many other nearby caves, approximately 300–500 years BP in a large tholeiitic lava flow complex known as the Ai-laaui Shield Flow on the eastern side of the Island of Hawaii (Holcomb, 1987). It is thought that the Kazumura Cave flow was one of the last in the Ai-laaui flow complex, however, black glassy-skinned lava has intruded into the cave in several places, showing that later flows occurred after the cave had cooled significantly. The flow originated from the summit of Kilauea Volcano at about 1189 m. The upper end of the cave was collapsed and filled from highway construction at the 1130-m elevation, but continuous passage can be traversed downslope for 41.8 km to the lower end at an elevation of 28 m (Fig. 1). It is, by far, the longest linear cave in the world, covering a straight-line distance of 32.2 km. The cave has an average slope of less than two degrees. It has a temperature range from 15°C near the Kilauea caldera to 22°C at the lower end.

The surface slopes of the Ai-laaui flows are presently undergoing dramatic transformation from a barren lava wasteland to lush tropical old growth jungle atop ever-thickening soils. In many cave passages, delicate tree roots penetrate the thin soils and then cracks of the roof supply an energy source for cave-adapted crickets, fantails (Fig. 2), and spiders (Howarth, 1973). Lava tube slime, a little known about organic growth, sometimes coats ceilings and walls with gold, white, or red.

### Human Impacts

Because much of the cave is beneath developing rural subdivisions, it is being negatively impacted. Sometimes with a roof less than 10 ft thick, it is prone to collapse from bulldozing, and is sometimes used for domestic sewage,

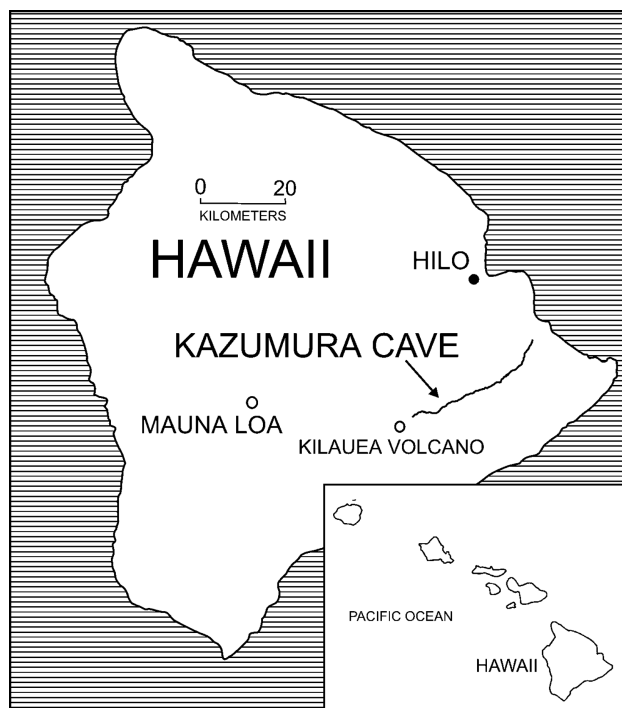


FIGURE 1 The location of Kazumura Cave on the Island of Hawaii.

graywater, and trash disposal. Recently, its increased notoriety has resulted in some industrial tourism resulting in many thousands of feet of passage modification. In these areas, it no longer retains its virgin natural appeal.

## HISTORY OF EXPLORATION

### Local Visitation

Not much is known of the earliest exploration of Kazumura Cave. There is some evidence of use by prehistoric Hawaiians. Many parts of the cave also contain modern paraphernalia such as rotten rope, string, trash, and bits of worn-out shoes. In one section, someone used an innovative approach by placing pages of a *Reader's Digest* magazine along the floor to mark their way back to the nearest entrance.

### Survey and Systematic Exploration

An entrance of Kazumura Cave was a designated civil defense shelter in the early 1960s, and its name originated from this. In August 1979, acting on reports of a major lava tube, the UK speleological expedition explored and surveyed 11.7 km of the cave with a vertical range of 261 m, making Kazumura Cave one of the three longest lava tube caves in the world. It was also visited and partially surveyed by Japanese cavers. Finally, 14 years later, members of the Hawaii Speleological Survey of the National Speleological Society began a more determined survey using profile views. The original British



**FIGURE 2** A fantail clings to a tree root which has penetrated the roof of the cave. Photo by Mike Shambaugh.

portion was extended to 12.5 km and various plugs and collapses were dug through to eventually extend the cave to 65.4 km with a vertical extent of 1101.8 m. The cave presently has 101 known entrances (Fig. 3).

## DESCRIPTION OF KAZUMURA CAVE

### Speleogenesis

Kazumura Cave is a well-developed “master tube,” formed from the crusting over of a highly liquid pahoehoe lava flow

issuing steadily for a long period from Kilauea Volcano. Because of the insulative nature of the lava tube, the Kazumura flow extended 39 km to the Pacific Ocean and significantly extended the coastline there. But the cave itself becomes low and pinches off in pooled lava 3.5 km from the beach. Although some portions of the cave developed by the crusting over of the main open lava stream, evidence indicates that generally, the cave passage first formed as a braided, interweaving delta-like pattern near the growing snout of the flow. The cave roof was thickened through accretion against the cool ceilings. Overflow or “Abreakouts” further built up the roof. Kazumura Cave passages vary widely in shape from wide and low typical of the embryonic braided passages (Fig. 4) to deep and canyon-like which indicates significant downcutting (Fig. 5).

### Thermal Erosion

As the flow extended, one or two braids pirated the flow and downcutting occurred through a process known as thermal erosion (Hulme, 1973). This is a partial melting of the underlying substrate with an accompanied mechanical plucking away of unmelted crystals. Deepened canyon-like passages, lavafalls, and exposed beds of old pahoehoe and aa flows exposed behind ruptured wall linings are all evidence of this thermal erosion. More turbulent flow eroding aggressively into the substrate on the outside of bends created cutbanks (Fig. 6). The early formed braided passages not lava filled are commonly found at the ceiling level off of the main passage (Fig. 7). As thermal erosion progressed, portions of the now unsupported ceiling collapsed into the free-flowing lava and this breakdown was carried away or wedged into upper areas during temporary flooding (Fig. 8).



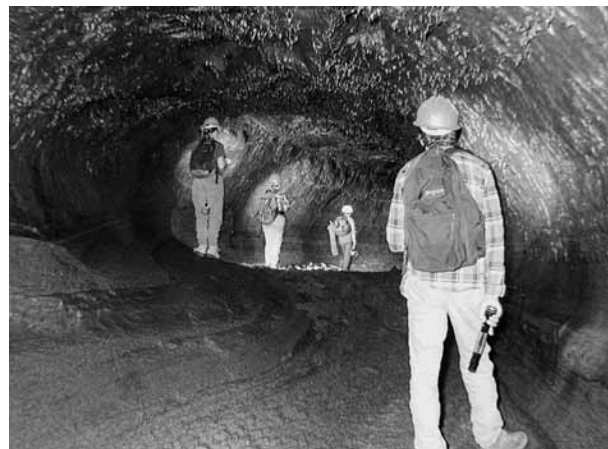
**FIGURE 3** One of many entrances to Kazumura Cave. Photo by Mike Shambaugh.



**FIGURE 4** Low, wide passages are typical of early formed embryonic passages. Photo by Kevin Allred.



**FIGURE 5** Over time, the flowing lava cut down the floor of Kazumura Cave creating deep canyon-like passages. Here, near an entrance, (upper center) an intermediate roof formed, reinsulating the lava. Photo by Mike Shambaugh.



**FIGURE 6** During the thermal erosion of Kazumura Cave, increased turbulence at the outside of bends has formed cutbanks (right). Slipbanks result on the inside of the bends (left) where there is less thermal erosion. Photo by Mike Shambaugh.

### Extraneous Tubes

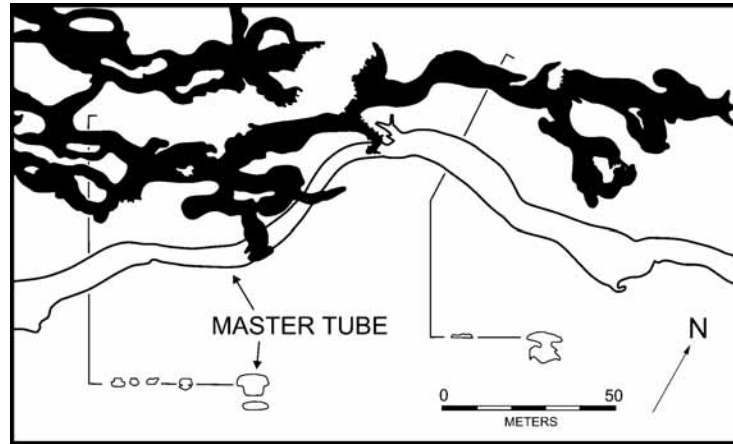
The most outstanding proof of thermal erosion is found where the downcutting lava stream encountered older lava tubes or large bubbles. Here, melting of the substrate was not possible due to the air-cooled voids. The stream was not able to cut into and invade these spaces unless the thin separating rind eventually collapsed. These rinds are as little as 10 cm thick (Allred & Allred, 1997). Several extraneous tubes have been identified in the cave. They are recognized as large, egg-shaped bulges protruding from walls (Fig. 9). Most tubes ruptured from the contraction of hot walls during the cooling of the cave, but some of them remain unbroken, thus the extent of the voids within are unknown. The longest

extraneous tube found in Kazumura Cave is nearly one kilometer long under an extraordinary large hump in the floor which diverted the stream to the side. The thin separation finally collapsed during the cooling of Kazumura Cave allowing access into a master tube which crosses nearly perpendicular to the Kazumura passage. This passage contains lava formations unlike any found in Kazumura Cave proper. Heligmites and miniature volcanoes erupted out of the floors.

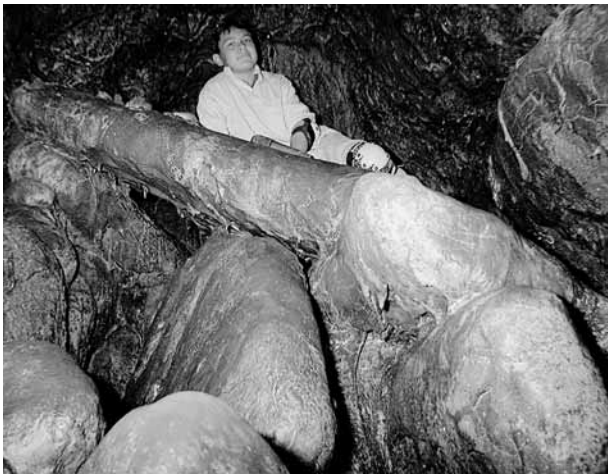
### Multilevel and Lavafall Development

Intermediate roofs are formed in some spacious passages and below entrances which were open during the eruption





**FIGURE 7** Early formed braided tubes are in black. The developed master tube is in white. One or two braids pirated the Kazumura lava flow and were deepened by thermal erosion (note cross sections).



**FIGURE 8** Flooding lava carried some breakdown into upper level passages. Photo by Mike Shambaugh.



**FIGURE 9** An older air-cooled extraneous lava tube was resistant to the thermal erosion of Kazumura Cave lava. The protective rind on this one finally ruptured from contraction during the cooling of the cave. Photo by Mike Shambaugh.

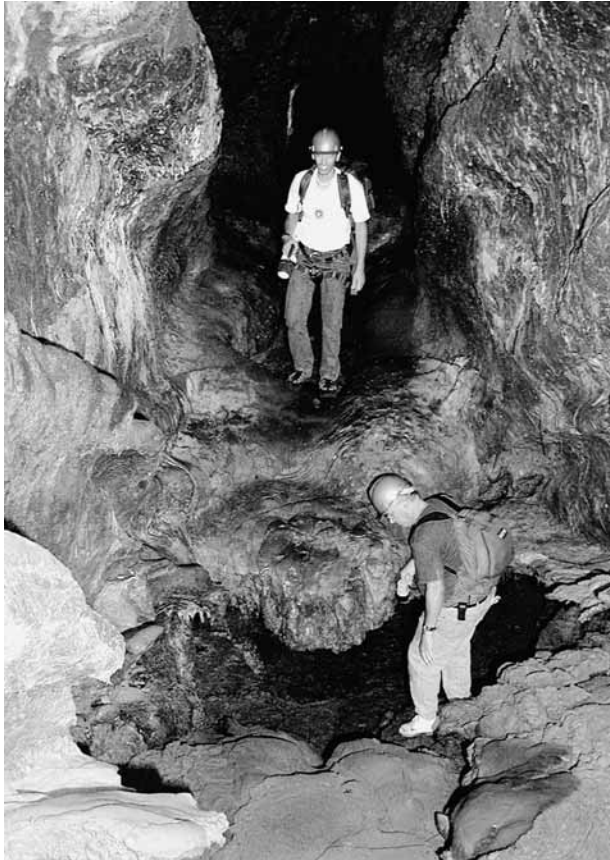
(Fig. 10). Cooling formed crusts which reinsulated the lava stream. Because of these secondary roofs, entrances in the cave system have not completely bisected the underground continuity of the cave. Up to four stacked levels are found in some places. Breakout overflows through skylights probably also occurred, but they probably did not leave much connected passage unless they happened during the early braiding stage. Lavafalls are well developed in the cave closer to the caldera where steeper slopes contributed to greater turbulence. It is thought that some headward backcutting occurred on many of the lavafalls until they reached a level, nonturbulent upstream floor (Allred & Allred, 1997). Lavafalls can be up to 12.9 m high and their solidified plunge pools up to 15.5 m in diameter (Fig. 11). By calculating the amount of crystallization contraction in the sunken plunge

pools, some of these are estimated to have eroded 20–30 m in depth (Allred & Allred, 1999).

## LAVA SPELEOTHEMS

### Primary Speleothems

In many parts of the cave fluctuations in the flowing stream against a ceiling have formed sharktooth stalactites composed of many layers of linings. Other primary speleothems are splashed stalactites, stretched lava, Pele’s Hair, squeeze-ups, and lava blades which sometimes resemble rillenkarren on a bare carbonate karst (Fig. 12). Boiling within partially solidified lava linings has resulted in extruded forms such as tubular lava stalactites above globular stalagmites, helicites, and blisters (Fig. 13) (Allred & Allred, 1998).



**FIGURE 10** Near entrances or in spacious passages, later formed intermediate roofs insulated the lava stream.

### Secondary Speleothems

Secondary deposits of white crusts and crystals appear to be gypsum. They occur in dry places in the cave away from rain seepage through the porous ceilings.

### Bibliography

- Allred K., and C. Allred (1997). Development and morphology of Kazumura Cave, Hawaii. *J. Cave Karst Stud.* **59** (2), 67–80.
- Allred K., and C. Allred (1998). Tubular lava stalactites and other related segregations. *J. Cave Karst Stud.* **60** (3), 131–140.
- Allred K., and C. Allred (1999). Estimating Depths and Volumes of Lava Tube Plunge Pools — An Ongoing Study. Convention vulcanospeleological session of the geology and geography section. National Speleological Society, Huntsville, AL.
- Holcomb, R. T. (1987). Eruptive history and long-term behavior of Kilauea Volcano. U.S. Geological Survey Professional Paper 1350, pp. 261–350.
- Howarth, R. T. (1973). The cavernicolous fauna of Hawaiian lava tubes. 1. Introduction. *Pacific Insects* **15** (1), 139–151.
- Hulme, G. (1973). Turbulent lava flow and the formation of lunar sinuous rilles. *Mod. Geol.* **4**, 107–117.



**FIGURE 11** With increased turbulence in steeper slopes, the lava flow in Kazumura Cave cut back into the substrate creating lavafalls and plunge pools. This lavafall is 30 ft (9.1 m) high. Its molten 45-ft (13.7 m) wide plunge pool is estimated to have been 90 ft (27.4 m) deep. Photo by Mike Shambaugh and Kevin Allred.

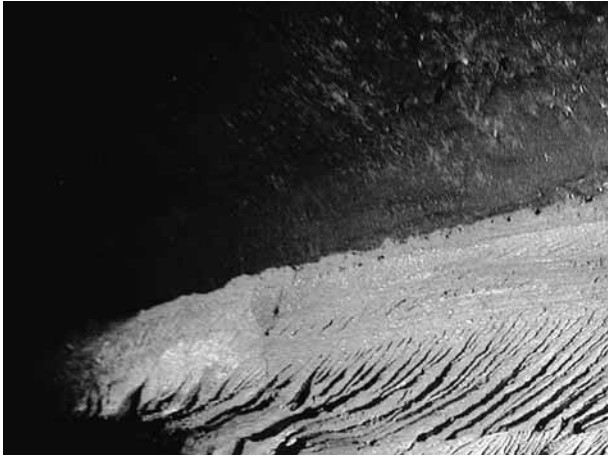


FIGURE 12 Lava blades



FIGURE 13 When Kazumura Cave was still red hot, tubular lava stalactites boiled from partially solidified lava linings. These stalactites dripped to the floor to form stalagmites.

## Krubera (Voronja) Cave

Alexander Klimchouk

*National Academy of Science, Ukraine*

At the dawn of the new millennium, Krubera (Voronja) Cave in the Arabika Massif, Western Caucasus, became the deepest known cave in the world, with a depth of

1710 m. For the first time, the deepest known cave was found to be outside western Europe.

The Arabika Massif is one of the largest limestone massifs of the Western Caucasus. It is located in Abkhazia, a republic currently within Georgia. The massif, with its strongly pronounced glaciokarstic landscape at elevations ranging between 1900 and 2500 m (the highest peak, the Peak of Speleologists, rises to an altitude of 2705 m), is composed of Lower Cretaceous and Upper Jurassic limestones. In the central part of Arabika the cretaceous beds are retained only in a few ridges and peaks as well as in small outcrops along the synclinal cores. The core part of the massif is composed of Upper Jurassic strata that dip continuously to and beneath the Black Sea shore (Fig. 1). Geologically, Arabika corresponds to the large anticline of the sub-Caucasian (northwest–southeast) direction, with the gently dipping southwestern mega-flank (complicated by several low-order folds in the same direction) and steeply dipping northeastern flank. The massif is highly tectonized, with a fault-block structure strongly controlling both cave development and groundwater flow systems. To the northwest, northeast, and east, Arabika is bordered by the deeply incised canyons of the Sandripsh, Gega, and Bzyb rivers. The latter separates Arabika from the adjacent Bzyb'sky Massif, another area with major speleological prospects in the Western Caucasus, including Snezhnaja-Mezhonogo (-1370 m) and Pantjukhina (-1508 m), among many other significant caves.

Among the several hundred caves known in the Arabika Massif, some deep caves explored during the 1980s stand out, including the Iljukhina System (-1240 m), the Arabikskaja System (Kujbyshevskaja-Genrikhova Bezdna; -1110 m), Dzou Cave (-1080 m), Moskovskaja Cave (-970 m), and Cherepash'ja Cave (-650 m). In 2001 Sarma Cave, previously explored to -700 m, was pushed to a depth of 1530 m. The deepest cave, Krubera (Voronja), is located in the Ortobalagan glaciated trough valley, about 300 m to the southeast and 60 m above Kujbyshevskaja Cave, the main entrance to the Arabikskaja System (Figs. 2 and 3). Although Krubera Cave is not connected directly with the Arabikskaja System, it is most probably part of a single linked hydrological system.

An open-mouthed 60-m shaft was first documented by Georgian researchers in the early 1960s, who named it after Alexander Kruber, a founder of karst science in Russia. The early exploration was stalled by an impassable squeeze in a meandering passage, which led off from the foot of the entrance shaft. During the 1980s, the speleological club of Kiev pushed the cave to -340 m by breaking through several critically tight meanders between the pots. During this time the cave received its alternative name Voronja (Crow's Cave), owing to the number of crows nesting in the entrance shaft. Meanwhile, other deeper caves of the Ortobalagan Valley diverted the main effort, and the exploration of Krubera Cave was suspended. In August 1999, the Ukrainian Speleological Association expedition, led by Yury Kasjan,

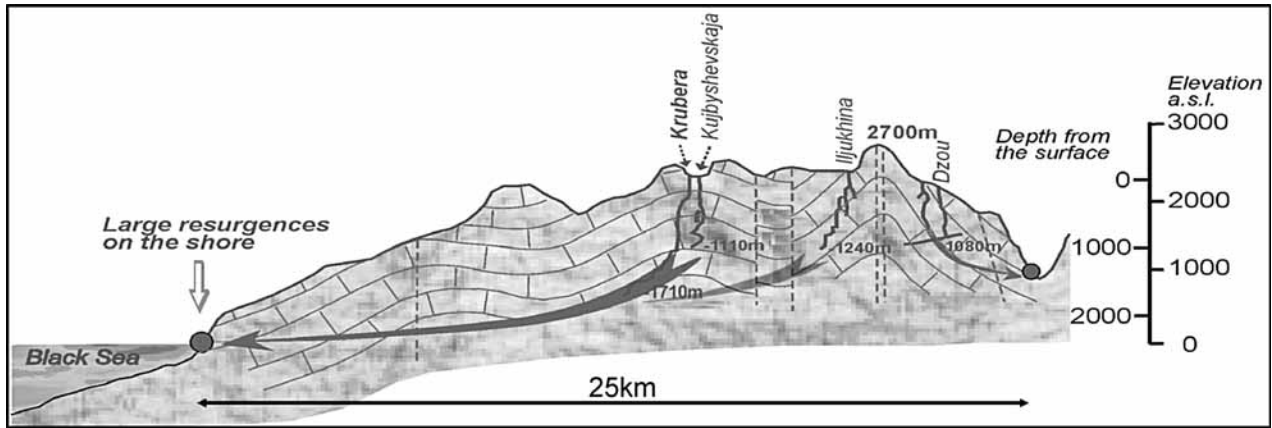


FIGURE 1 Schematic geological profile across the Arabika Massif, showing the main hydrological connections established by dye tracing.

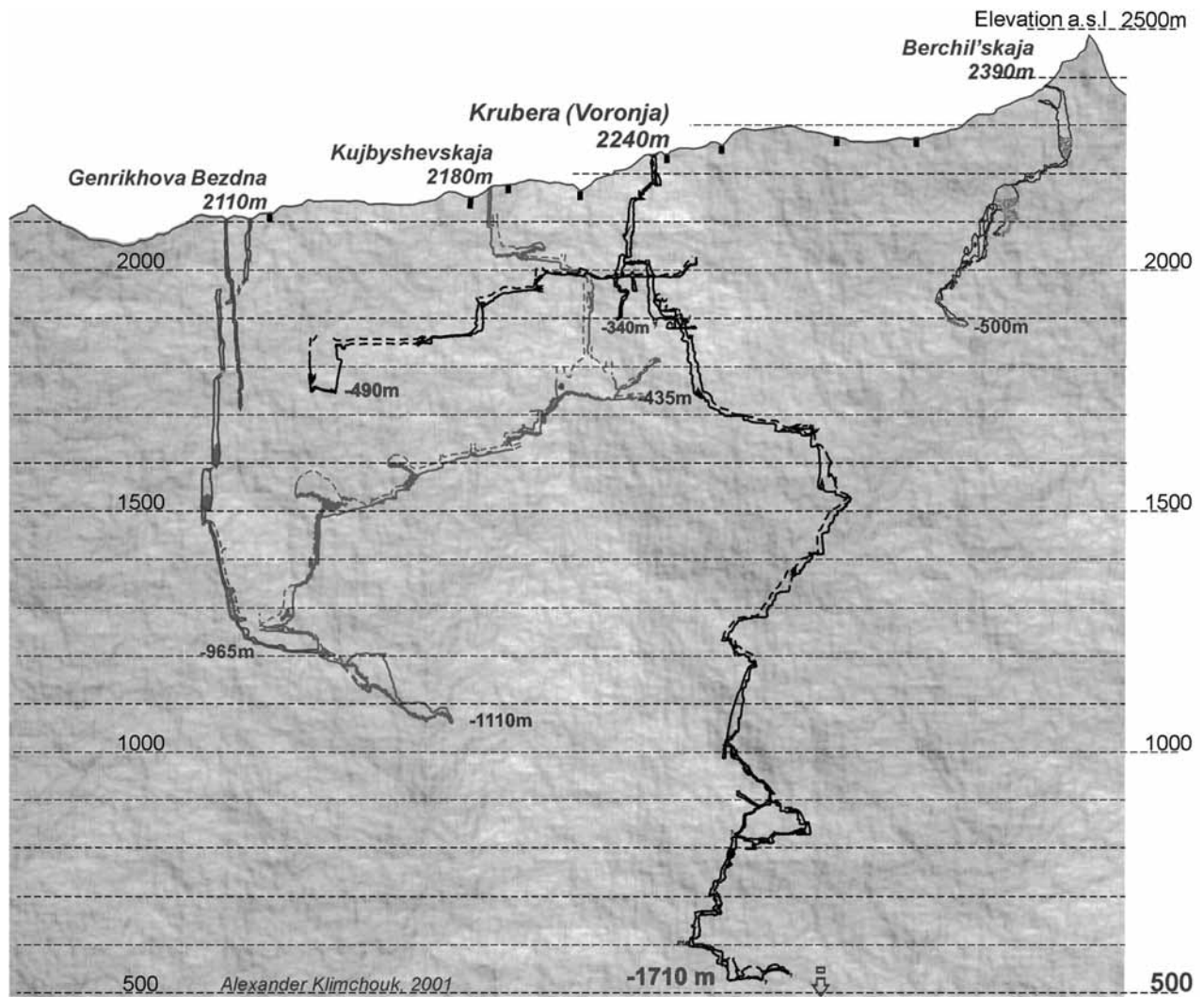


FIGURE 2 Combined profile along the Ortobalagan trough valley, showing the elevations of the main caves.

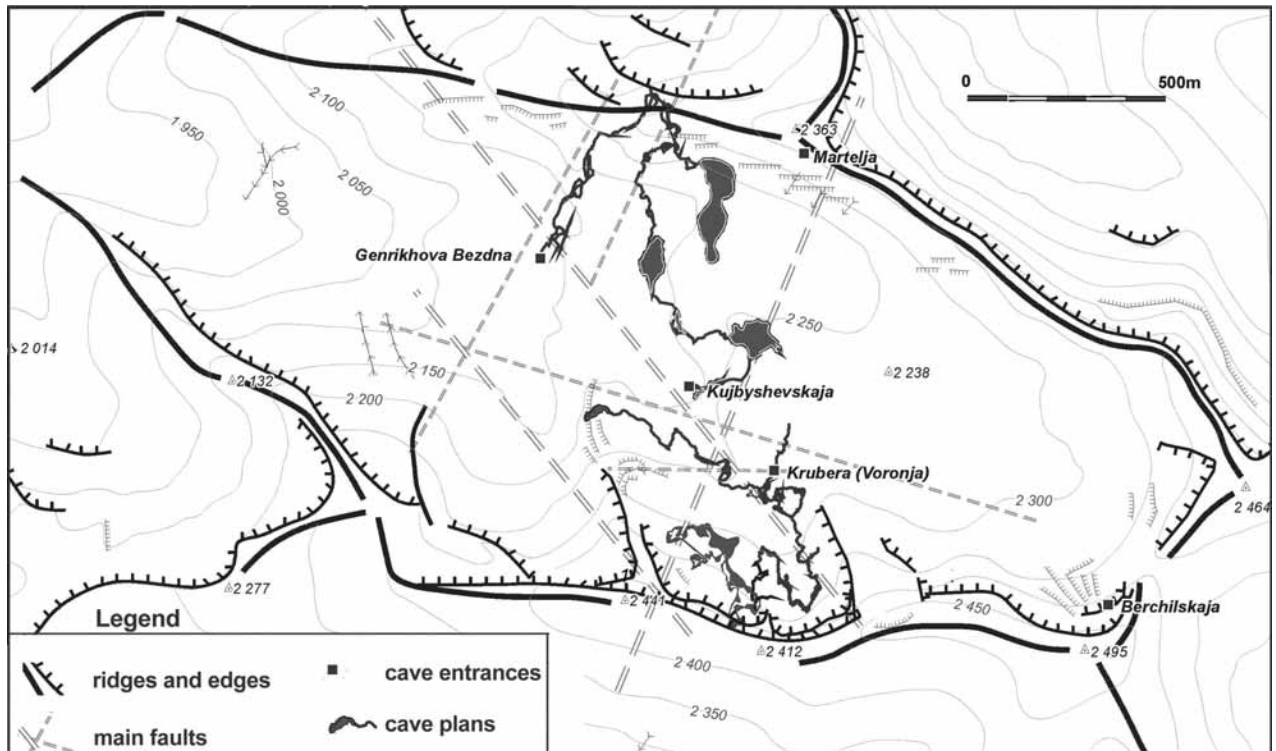


FIGURE 3 Main caves in the Ortobalagan trough valley.

recommended work in Krubera Cave. They made a major breakthrough by finding a deep continuation, explored to -750 m, from a window in the wall of a pitch at -220 m. Further expeditions explored the new branch to -1410 m in 2000 and to -1710 m in 2001.

Krubera Cave is developed in the thickly bedded and massive Upper Jurassic limestones in the fold zone of the Berchil'sky anticline by the Ortobalagan trough valley. The main branch descends steeply in vertical pitches, separated by short meanders, while shifting slightly toward the southern slope of the anticline. Apart from the "non-Kujbyshevskaja" branch, which stretches for almost 500 m to the northwest, the cave develops within quite a small area ( $400 \times 400$  m), remaining within a small tectonic block and not extending beyond the southern margin of the trough valley (Fig. 2).

There is a strong tectonic control of cave development in plain view. Some segments of the major caves stretch along faults, other sections twist within major tectonic blocks and reflect back inside the blocks when intercepted by a fault. The main branch of the Krubera Cave turns many times and drops steeply via vertical pits, separated by short meanders. Through both the degree of morphological development and its hydrological system, the cave seems to be a tributary to the adjacent Kujbyshevskaja Cave. A small water flow (up to  $1 \text{ L s}^{-1}$ ) appears in the cave at a depth of about 340 m. This flow disappears and reappears at various levels, but never increases significantly.

Major karst springs with individual average discharges of  $1\text{--}4 \text{ m}^3 \text{ s}^{-1}$  are located along the fringes of the massif at altitudes above sea level ranging from 1 m (Reproa Spring) to 540 m (Gegsky Vodopad). Submarine springs are also known, emerging from the floor of the Black Sea at depths of 20–40 m (and probably greater). Some boreholes located along the shore of the Black Sea yield karstic groundwater from depths of 40–280 m below sea level. An outline of the hydrogeological structure of the massif and its true speleological potential were revealed in the 1980s, when spectacular progress was made in deep cave exploration. Two dye-tracing tests during 1984 and 1985 proved connections between the major caves and springs. In particular, tracers injected in the Kujbyshevskaja Cave were detected in Kholodnaja Rechka ( $1.5 \text{ m}^3 \text{ s}^{-1}$ , 50 m above sea-level) and Reproa ( $2.5 \text{ m}^3 \text{ s}^{-1}$ ; 1 m above sea level) springs along the seashore. Tracer was also detected in a borehole which yields groundwater at a depth of 40 m below sea level, located between these two springs. This gave a reason to identify the major karst hydrogeological system as being potentially the deepest in the world at that time, with a vertical range greater than 2300 m. The system comprises the majority of the southeastern flank of the major Arabika anticline.

At its present lowest explored point of -1710 m (530 m above sea level), Krubera Cave neither enters a master river passage nor shows any signs of major flooding (which could indicate close proximity to the base level of a main collector).

These features, together with the proven connection of the Arabikskaja caves to large springs on the shore of the Black Sea, suggest a good potential for further deepening the cave system of the Ortobalagan Valley. Equally realistic is the possibility of connecting caves with entrances at higher elevations into the Krubera or Kujbyshevskaja caves. The best prospects can be found in the nearby Berchil'skaja Cave (-500 m), the entrance of which is about 150 m above, and

Martel's Cave, located about 80 m higher. Hence, the future possibility of locating a 2000 m+ system in the area is exceptionally good.

#### ***Bibliography***

Klimchouk, A., and J. Kasjan (2001). Krubera (Voronja): In a search for the route to 2000 meters depth: The deepest cave in the World. in the Arabika Massif, Western Caucasus. *NSS News*, 59(9), 252–57.



## Lechuguilla Cave, New Mexico

Patricia Kambesis

*Hoffman Environmental Research Institute*

In May of 1986, after two years of digging efforts, a team of explorers broke through into the major cave passages in Lechuguilla Cave, which at that time had been known only as a small guano cave. This began one of the most remarkable chapters in American cave exploration and speleology. The cave quickly grew in length and depth and became known as the deepest limestone cavern in the United States and ultimately, third in length for U.S. caves. It is the fifth longest cave in the world.

Lechuguilla Cave has been called the “jewel of the underground,” and rightfully so with its incredible variety of spectacular speleothems which decorate many of the cave’s massive chambers, circuitous tunnels, and confounding mazes. However, it is not just the cave’s aesthetic beauty and explorer’s appeal that define Lechuguilla as a world class cave. Due in large part to the stewardship of the National Park Service and the foresight of the American caving community, science has been a part of the exploration efforts in the cave since the very beginning. Consequently, important studies in geology, cave microbiology, microclimatology, mineralogy, geomicrobiology, and geochemistry have been conducted in the cave. Scientific discoveries have gone hand in hand with cave exploration and survey.

Geologically, Lechuguilla Cave is unusual in that its speleogenesis involves sulfuric acid and the degassing of hydrogen sulfide,  $H_2S$ , from a hydrocarbon-rich basin. The concept of basinal degassing is significant not just for cave

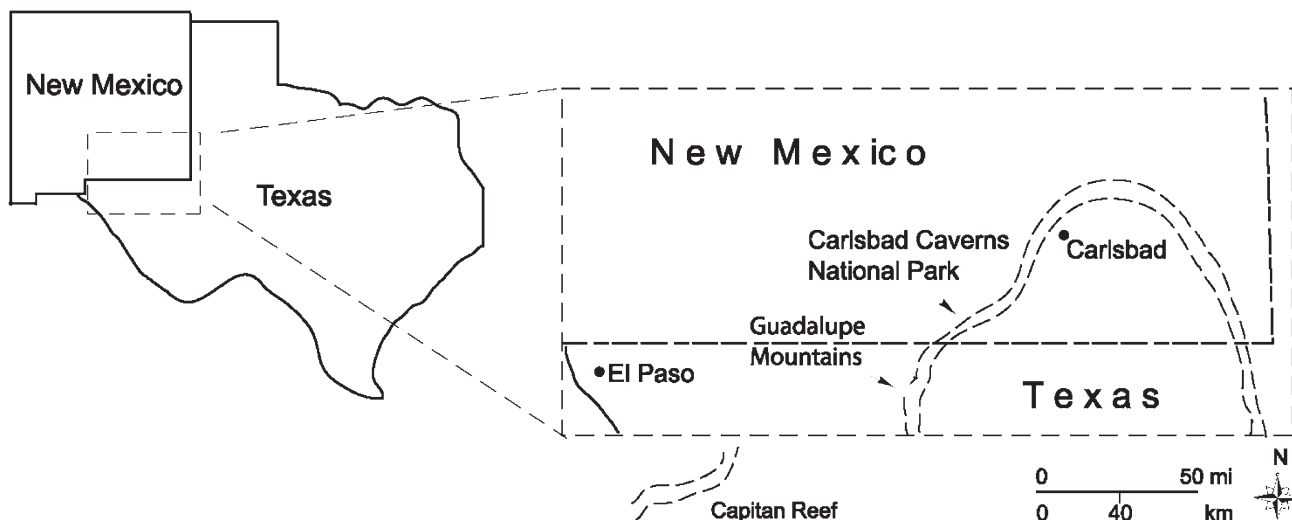
formation in this area but also to the understanding of migration of hydrocarbons, the formation of petroleum reservoirs, the deposition of uranium ore, and the origin of Mississippi Valley type lead–zinc deposits. Lechuguilla Cave is one of the world’s best documented examples of a cave formed by sulfuric acid in a hypogene setting.

Mineral residues and some of the more unusual speleothems in Lechuguilla Cave show indications of microbial influence. The significance of these geomicrobiological interactions is providing insight into the basic mechanisms of dissolution and precipitation by microorganisms and on the origin of specific types of speleothems. The microbe environment in Lechuguilla Cave is also being studied by NASA scientists who believe that it may be an analog to similar environments on other planets.

The exploration and concurrent survey of Lechuguilla Cave have influenced the modes and methods of cave mapping in the United States. The abundance and delicacy of formations, unusual sediments, and microbiology within the cave have caused both explorers and resource managers to reevaluate human impact on all caves in general, and it has raised the profile of cave conservation and restoration efforts.

### PHYSICAL SETTING

Lechuguilla Cave is located within Carlsbad Caverns National Park, which is part of the Guadalupe Mountains of southeastern New Mexico. (Fig. 1). These mountains are situated on the northern margin of the Chihuahan Desert. The area climate is semiarid to arid with average winter temperatures of  $7^{\circ}C$  and summer temperatures of  $27^{\circ}C$ . The annual rainfall ranges from 20 to 50 cm with more than half of the precipitation coming during the summer months. Vegetation of the area includes cacti, succulents, and desert shrubs. The cave’s name comes from one of the local flora, the lechuguilla plant. This plant is of the Agaves family and tequila is made from it. Lechuguilla plants grow in large



**FIGURE 1** Lechuguilla Cave is located within Carlsbad Caverns National Park in Carlsbad, New Mexico.

clumps on limestone ledges and slopes, and are a common plant in Lechuguilla Canyon and at the entrance of the cave.

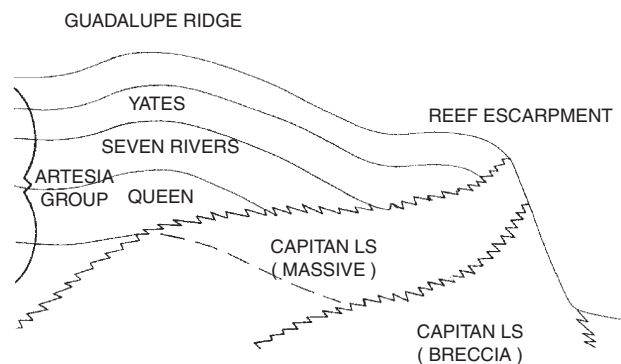
### GEOLOGIC SETTING

Lechuguilla Cave is developed within the Capitan reef complex that forms a belt of Permian-aged carbonates 8 km wide and 650 km long that defines the northwest perimeter of the Delaware Basin, a major hydrocarbon basin in the southwest United States. The Delaware Basin lies between the structurally active Basin and Range Province and the nonstructurally active Great Plains. The Guadalupe Mountains are a fault block that has been exhumed by erosion and evaporite solution–subsidence within the Delaware Basin.

Though the Guadalupe Mountains are considered a karst area, there are few surface karst features in these mountains. Though there are some sinkholes, paleo karst, and a variety of springs both small and large, there is no direct correlation between the surface topography and geomorphology and the extensive caves that lie within the mountains. This is a reflection of the cave's development in a hypogene setting. Cave entrances are not past or present points of hydrologic recharge or discharge. Rather, they are fortuitous collapses that have exposed the caves to the surface. In all of its great length, Lechuguilla Cave has only one entrance.

### STRATIGRAPHY AND STRUCTURE

Paleontologic and stratigraphic data from rock exposures within Lechuguilla Cave indicate that most of the cave is developed either in the back reef facies of the Permian reef or within the reef and fore reef slope facies. The cave spans four stratigraphic units including (in descending order) the Yates Formation, Seven Rivers Formation, Queen Formation, and



**FIGURE 2** Lechuguilla Cave is developed in rocks that were formed by a Permian-aged reef. The cave spans four stratigraphic units which include the Yates, Seven Rivers, Queen, and Capitan Formations. (From Jagnow, D. H. (1989). The geology of Lechuguilla Cave, New Mexico. In *Subsurface and Outcrop Examination of the Capitan Shelf Margin, Northern Delaware Basin*, Core Workshop 13, (Harris, P.M. and Grover, G. A. eds.), pp. 459–466. Society of Economic Paleontologists and Mineralogists, Tulsa, OK. With Permission).

the Capitan Formation (Fig. 2). Backreef facies include the Yates, Seven Rivers, and Queen Formations. The reef and fore reef units encompass the Capitan Formation.

Rock units exposed in the cave include the Yates Formation, which is composed of dolomites, calcareous siltstones, quartz siltstones, and fine-grained sandstones. This unit is exposed at the entrance of Lechuguilla Cave, in the upper levels of the Chandelier Graveyard, in Tower Place, and in many of the other upper level passages. The Seven Rivers Formation consists of dolomites and occasionally, quartz siltstones. This formation is evident throughout most of the upper parts of the cave from the entrance through The Rift. The Queen Formation is made up of dolomites interbedded with siltstones and fine sandstones. Within the cave this



formation is exposed in Windy City, Sugarlands, and in the north and south ends of The Rift.

The Capitan Formation is divided into massive and breccia members. The massive member lacks bedding and consists of fossiliferous and dolomitic limestones. The breccia member is made up of reef limestone fragments mixed with lenses of siliciclastic material. The massive Capitan outcrops at depths of 175–275 m within the cave. The breccia member outcrops at depths below 250 m throughout the cave.

The major folds within the vicinity of Lechuguilla Cave include the Guadalupe Ridge anticline and the Walnut Canyon syncline. The cave lies within the structural limb shared by these two folds. Joint sets trend either parallel or perpendicular to these major folds. Cave passage orientations are controlled by these two major joint sets. Lechuguilla Cave is located within a structural trap for natural gas located just off the Guadalupe Ridge anticline. The cave is also located beneath the Yates Formation, which functions as a stratigraphic trap for H<sub>2</sub>S.

The development of Lechuguilla Cave was influenced by the arrangement of stratigraphic units, differential dolomitization of these units, joint patterns, and folds. All four controls first appeared in the Late Permian with some modification by later tectonic and diagenetic events. However, the overall layout and geometry of the cave is a function of regional groundwater flow and sulfuric acid production.

**REGIONAL/LOCAL HYDROGEOLOGY**

The permeable Capitan Limestone is the aquifer for the region and the upland surface of the Guadalupe Mountains is the recharge area. Water moves through the shelf rocks of the Artesia Group and drains downdip into the Capitan Limestone aquifer. Water moves slowly through the caves of the Guadalupe Mountains, including Lechuguilla Cave, and shows a combination of deep phreatic and water table characteristics. Water table conditions are responsible for

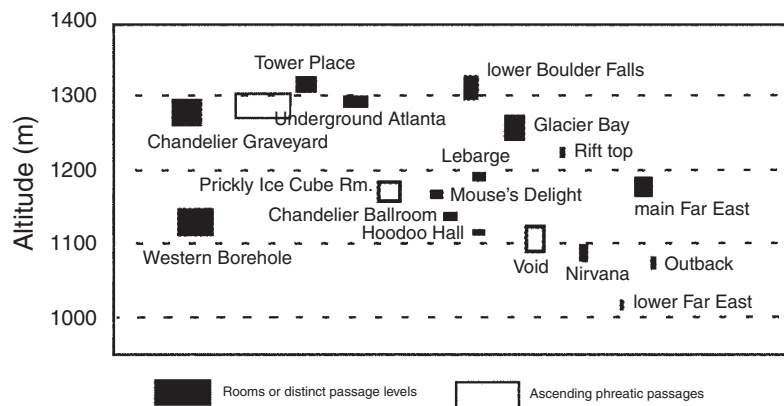
horizontal level development of cave passages. In these areas, cave passages cut across bedding planes. The vertical development of the system is a function of deep phreatic conditions. Lechuguilla Cave was formed in a diffuse-flow aquifer regime. The cave may have functioned as a mixing chamber for hypogene-derived H<sub>2</sub>S and meteoric-derived freshwater.

The Artesia Group (Yates, Seven Rivers, and Queen Formations) was probably the original reservoir where water containing H<sub>2</sub>S was stored prior to and during sulfuric acid speleogenesis. The aquifer also functioned as the avenue for eastward migration of H<sub>2</sub>S water with oxygenated meteoric water. The aquifer possibly also served as the site where the mixing of H<sub>2</sub>S water with oxygenated water occurred, which ultimately formed the passages of Lechuguilla Cave. Hydrogen sulfide speleogenesis took place at or near the water table.

Over time, as the water table dropped, cave passage development occurred where H<sub>2</sub>S was ascending to the water table in significant quantities. As the water table lowered during uplift and deformation, H<sub>2</sub>S was episodically released forming major rooms and passages. When H<sub>2</sub>S occurred during times when the water table was stable, horizontal levels of cave passages developed. The massive rooms and long passage trends within Lechuguilla Cave reflect these events (Fig. 3).

The relationship of the ages of the mineral alunite with respect to elevations within the cave suggests that there was a 1100-m decline in the water table from 12 million years ago to the present. This suggests that the Capitan aquifer water table was relatively flat during the late Miocene and Pliocene. It is speculated that the paleo spring that would have been associated with Lechuguilla Cave has not been preserved, because it has been truncated or obliterated by valley downcutting and erosion of the ancient Pecos River Valley.

Flowing water is relatively rare in caves of the Guadalupe Mountains. There is only one area in Lechuguilla Cave that has flowing water. This is the Lost Pecos River in the Far East section of the cave. A small stream issues from a crack in



**FIGURE 3** Elevation of the various rooms and passages within Lechuguilla Cave. The width of each block is proportional to the width of the room or passage. (Adapted from Palmer, A. N. and Palmer, M. V. (2000). *J. Cave and Karst Stud.*, 62(2), 91–108.)

the wall and feeds a series of pools in the area. This water probably originates from a small perched aquifer that the cave passage has intersected.

Drip and pool water is fairly common throughout the cave and is sourced from vadose meteoric water that has seeped down from the surface along joints, bedding planes, and interconnected pores in the rock. The geochemistry of Lechuguilla Cave's pool waters is quite diverse. The water chemistry is a function of precipitation chemistry, bedrock, and the gypsum deposits that occur in close proximity. The water is further modified by evaporation, speleothem deposition, and microbial activity.

## BIOLOGY

The megascopic biology of Lechuguilla Cave is somewhat limited. Cave crickets and arachnids are present in the entrance passages and to some extent past Boulder Falls, the first significant pit in the cave. Bat bones have been found throughout the system but no bats currently inhabit the cave, except at the entrance.

However, the microscopic biology is quite a different story. It is speculated that because the microbial systems within Lechuguilla Cave have no multicellular grazers or predators, no meteoric influences, and have been in existence for long spans of time, then the evolution of these microbial communities is independent of surface organisms. Kim Cunningham (1995) was the first to recognize microbial evidence in corrosion residues and in some speleothems. Based on initial microbial work in the cave, it appears that some of the microbe communities are chemolithotrophs. The work of researchers has shown that some of the microbes in Lechuguilla show considerable anticancer potential.

Lechuguilla Cave contains remnants of what could be past and perhaps present geomicrobiological interactions. These features include corrosion residues, moonmilk, pool fingers, webulites, and U-loops. Microorganisms of today have been found in association with carbonate and silicate speleothems, sulfur compounds, and iron and manganese oxides.

## MINERALOGY

Lechuguilla Cave is well known for its unusual mineralogy and for the spectacular nature of its speleothems. Most of the caves of the Guadalupe Mountains display many of the same features as Lechuguilla. However, the Lech displays most features as large-scale textbook examples. Lechuguilla Cave contains some of the most spectacular examples and varieties of gypsum speleothems including massive selenite chandeliers, delicate clear gypsum crystals, gypsum needles, gypsum cotton, and crusts. Calcite speleothems, though less abundant, are also spectacular in their shape and configuration and occur in places throughout the cave where meteoric waters seep into the underground. Large stalagmites have formed in Tower Place. Stunning arrays of soda straws,

stalactites, and draperies festoon such places as Deep Secrets, the Oasis Pool, and the Pearlsian Gulf.

Large amounts of massive or laminated gypsum are common within the cave. These deposits accumulated where groundwater flow was not strong enough to carry away the sulfate produced by the sulfuric acid reaction with the limestone when the cave was enlarging. Some of the gypsum beds have been dissolved away by meteoric water that percolates into cave or from freshwater reflooding. Many of these gypsum remnants occur in dry sections of the cave and in places resembling small glaciers. (Glacier Bay, Prickly Ice Cube Room, Land of Fire and Ice, Blanca Navidad).

Elemental sulfur deposits occur as yellow masses or as stringers within larger masses of gypsum. The sulfur, which can be massive, granular, or platy, is exposed by dissolution of the surrounding gypsum. Locations where sulfur deposits have been observed include the Void, Ghosttown, Ghostbusters Balcony, and near Blanca Navidad.

Caves formed by sulfuric-acid-bearing waters contain direct by-products of their origin including gypsum, hydrated halloysite, and alunite. Lechuguilla contains many of these minerals. The alunite is important because it contains potassium, which gives it the potential to be dated by the K-Ar or  $^{40}\text{Ar}/^{39}\text{Ar}$  dating methods. Polyak et al. (1998) used  $^{40}\text{Ar}/^{39}\text{Ar}$ -dated alunite to determine that Lechuguilla Cave is at least 5 million years old.

Lechuguilla Cave is rich in corrosion residues which contain bacterial and fungal communities indicating that microbes could be active participants in limestone dissolution in conjunction with abiological processes. Gypsum and sulfur in the Guadalupe Mountains are significantly enriched in the light isotope of sulfur. The enrichment of light sulfur implies that hydrocarbons and sulfur bacteria were involved in speleogenesis.

Endellite and Montmorillonite fill solution pockets in many places in the cave. The minerals celestite and barite have also been found in many of the maze areas of the cave (Chandelier Maze).

Some speleothems have a biologic origin. Rusticles, which are observed in only two locations within the cave, are composed of iron oxide minerals which contain fossil microbial casts. Pool fingers, which grow underwater, are calcite in composition but seem to have a microbial origin.

Helictites are one of the "signature" speleothems of Lechuguilla Cave. These are vermiform in shape and contain a central canal. These formations developed as a result of the common ion effect.

Other unusual mineralogies include folia, hydromagnesite balloons and fronds, raft accumulations and cones, splash rings, and silticles.

Though the wide variety of mineralogies and speleothems seem randomly diverse, they are related to each other by the unusual origin of the cave and/or from convective airflow loops that are driven by temperature gradients resulting from the cave's great vertical relief.

**PALEONTOLOGY**

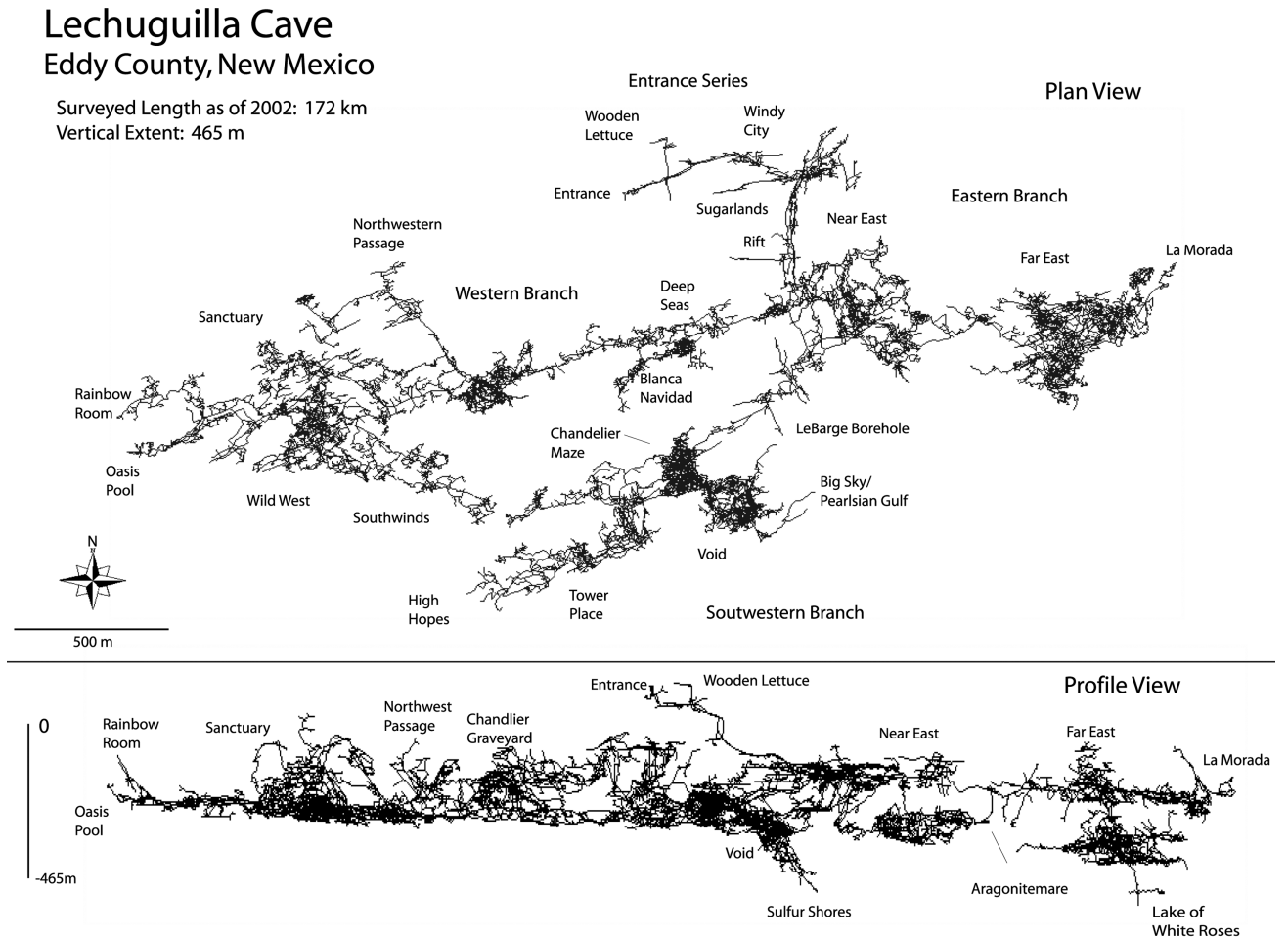
Vertebrate paleontologic remains are very rare. Pleistocene fossil remains have been found in fills near the Lechuguilla Cave entrance area. It is speculated that the fill is from an ancient sinkhole that may have trapped some local mammals. There are bat remains scattered throughout the system, some of them of paleontologic significance. There is only one other locality within Lechuguilla Cave that contains vertebrate fossil remains. A fully articulated ringtail cat skeleton has been found in the Land of Awes, an area that is far removed from the current entrance and the surface. This specimen indicates the possibility of an ancient entrance that is no longer accessible.

Lechuguilla Cave has formed within the Capitan reef complex. The primary frame-building organisms of the reef include calcareous sponges, calcareous algae, and bryozoans. These fossils are very common within the bedrock of Lechuguilla Cave. Many of the fossils found within the cave have been broken into sandstone size fragments that accumulated in voids in the Capitan reef and in the backreef lagoon.

Fossils are also exposed in the bedrock walls which are not covered with mineral crusts and coatings. The most abundant fossil remains are those of invertebrate reef organisms including bivalves, brachiopods, bryozoans, crinoids, porifera, gastropods, urchin spines, corals, and cephalopods. These occur throughout all areas of the cave.

**DESCRIPTION OF LECHUGUILLA CAVE**

The overall pattern of the chambers and passages of Lechuguilla Cave is characteristic of caves formed by sulfuric acid speleogenesis. These types of caves are characterized by ramiform passage morphology, large passage size, and horizontal passages connected by deep shafts and fissures. Irregular passage shapes are common, as are dead-end rooms and galleries and blind alcoves. The ramified shape and layout of Lechuguilla Cave (Fig. 4) is formed by the oxidation of rising H<sub>2</sub>S, where the main passages and large domed rooms correspond to favored paths of H<sub>2</sub>S movement. The large passage sizes are a function either of large H<sub>2</sub>S inputs or H<sub>2</sub>S inputs over longer periods of time.



**FIGURE 4** Map showing Lechuguilla Cave at 182 km in surveyed length with a vertical extent of 473 m. Lechuguilla Cave is the third longest and deepest limestone cave in the United States. It is the fifth longest cave in the world.

Lechuguilla Cave contains a number of fissures (or rifts) which descend from the floors of large rooms or passages and pinch downward with bottoms that are clogged with calcite crust, carbonate sediment, or terminate in water (Fig. 5). These rifts extend below the level of major cave rooms and may be inflow routes along which oxygenated and H<sub>2</sub>S-rich water first began to mix. Such areas include the routes from



**FIGURE 5** Large, slanting fissure passage descends into the LeBarge Borehole within the Southwestern Branch of the cave. Fissures are a common passage morphology in Lechuguilla Cave and in other caves of the Guadalupe Mountains. (Photographer: Dave Bunnell.)

the Chandelier Graveyard to Sulfur Shores and from the Outback to Lake of the White Roses.

Different levels within Lechuguilla Cave are connected via ascending passages such as the Great White Way which connects the south Rift to Deep Secrets, and the Gulf of California fissure which connects the mazes of Snow White's Passage to the LeBarge Borehole.

Ascending tubes with large cross sections and great vertical extent may also be the result of the mixing of two major water sources (groundwater and meteoric water). Such an ascending tube rises 200 m from The Rift to the cave's entrance. The Wooden Lettuce Passage (whose highest point is located approximately 6 m above the current entrance) may have been a paleo entrance.

Horizontal passages may represent former water table levels (Fig. 6). The Western Borehole is a mile-long linear trend of horizontal passage with areas of elliptical passage cross section, which may have served as an outlet for water from zones of maximum cave origin. The Western Borehole ends abruptly without breakdown collapse or major passage extensions.

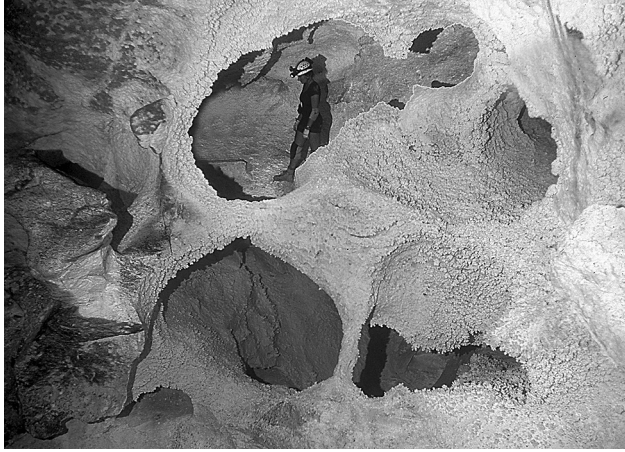
The walls of many of the large passages in Lechuguilla Cave are honeycombed with interconnected, nontubular, solution cavities of various sizes and geometry forming three-dimensional mazes of spongework-type morphology (Fig. 7). These passages, called boneyards, are ubiquitous throughout Lechuguilla Cave and in other caves in the Guadalupe Mountains. They develop where many interconnected openings are solutionally enlarged at comparable rates. Mazes originate in mixing zones where the aggressiveness of the water is high.

## HISTORY OF EXPLORATION

Prior to May of 1986, the known extent of Lechuguilla Cave consisted of a 27-m entrance pit which dropped into a large three-level chamber containing several insignificant side passages. Surveyed passage length was 121 m. Covering the floor was a thick veneer of guano which coated a large rubble pile. Of note was the fact that a tremendous volume of air issued from the rubble pile, sometimes strong enough to



**FIGURE 6** The Great Western Borehole, located in the Western Branch of the system, is one of the largest passages in Lechuguilla Cave. The passage extends in an east-west direction for over a mile. (Photographer: Dave Bunnell.)



**FIGURE 7** A boneyard maze in Lechuguilla Cave. These three-dimensional mazes are very common throughout the system and originate in mixing zones where the aggressiveness of the water is high. (Photographer: Dave Bunnel.)

blow sediment up the entrance pit. Later, other visitors to the cave suggested it be named Misery Hole because of the great amount of dust that blew out of the entrance pit.

Lechuguilla Cave has been known at least since the early part of the twentieth century. The name and date of the cave's original discoverer is unknown, but it is possible that guano miners may have made the first entrance into the cave. In 1914, John Ogle, Cad Ogle, and C. Whitfield filed a placer mining claim to mine bat guano from the cave. At that time guano mining was a major industry in the Guadalupe Mountains. Only a small amount of guano was actually removed from the cave, and it appears that the project was abandoned after only preliminary mining efforts. After the initial mining activities, the cave saw a minimal amount of activity. Park rangers visited the cave in the early 1940s, and in the early 1950s Colorado Grotto members mapped the cave and published a descriptive report.

In the 1970s the Cave Research Foundation (CRF) and park personnel made several trips to the cave. CRF remapped the cave and the map was published in January of 1979 in D. J. Jagnow's *Cavern Development in the Guadalupe Mountains*. CRF digging crews began working the lowest levels of the blowing rubble pile, having to shore it up as they went. Progress on the unstable rock pile was minimal and CRF abandoned the dig project.

In 1984, digging activities led by cavers from Colorado took a new approach to the breakdown pile by using the wind and bedrock walls as their guide. Over the course of four digging expeditions, significant progress was made on the rubble pile. On May 25, 1986, the dig broke out on the side of a talus slope into a low, wide room. Continuing through a squeeze and following the wind, the diggers/explorers broke into large going passage. This marked the beginning of one of the greatest North American cave discoveries of the twentieth century. Between 1986 and 1998,

over 166 km of cave passages were discovered, explored, and documented.

After the breakthrough, exploration moved at breakneck speed with 5–8 km of passages documented with each expedition. The first 48 months of exploration and survey work delineated the main framework of the cave and established its vertical extent. Explorers pushed and mapped the east-west trending entrance passages to a 140-ft pit named Boulder Falls. The cave continued at the base of the pit and through a series of large, gypsum-floored corridors and rooms (Colorado Room, Windy City, Glacier Bay, Sugarlands). The east-west trend terminated at The Rift, a large fissure with a vertical extent of over 30 m in places. At the south end of The Rift the cave split into three separate east-west trending branches.

Explorers pushed a small hole in The Rift which leads to a tall, slanting gypsum fissure named the Great White Way. Deep Secrets was the first significant room at the base of the fissure, and it contained not only an abundance of gypsum coatings and assorted calcite speleothems, but also some of the longest soda straws ever observed in the Guadalupe Mountains. A series of mazy rooms and climb ups eventually broke into the Great Western Borehole, a mile-long, gypsum-coated trunk passage that branched to two terminations. The southern terminus ended at the calcite-encrusted Oasis Pool located at the base of a sheer wall. The northern terminus was pushed to the Rainbow Room, an ascending bedding plane passage. In other places in the Western Borehole lofty avens led to upper level segments including the Chandelier Graveyard, Pelucidar, and Barsoom.

A major junction in The Rift (the EF Junction) led to more gypsum-coated mazes and yet another descending, gypsum-coated fissure. This proved to be the gateway to the Southwest Branch, one of the most spectacularly decorated sections of the cave. Exploration and survey documented lakes and pools in areas containing both flowstone, dripstone, and gypsum formations (Lake LeBarge, Lake Chandalar, Yellow Brick Road, Lake Castrovalva). Long, tubular passages and convoluted boneyard mazes coated with all manner of gypsum minerals were discovered and mapped (LeBarge Borehole, Land of Awes, Chandelier Ballroom, Prickly Ice Cube Room, Chandelier Maze, Hoodoo Hall).

Passages trending to the southwest of the Chandelier Maze opened into more boneyard mazes (Land of the Lost), large austere chambers floored with breakdown (The Voids), and high vaulted rooms floored with pools, flowstone, and cave pearls (Big Sky and Pearlsian Gulf). Thick deposits of rock flour coat the floors of many of the rooms and passages. Another steeply descending fissure leads to Sulfur Shores and what may be the top of the water table. High level fissures trending north from the Prickly Ice Cube Room lead to large shafts, upper level rooms containing some of the largest flowstone formations in the cave (Underground Atlanta and Tower Place), and more perched lakes and boneyard mazes (High Hopes).

At the far end of the The Rift is a pit leading to a series of ramps and fissures that are coated with dark corrosion residues which drop into the Eastern Branch of Lechuguilla Cave. This branch of the cave proved to be the most technically challenging requiring the rigging of multiple pitches and traverses. More perched lakes and large-scale mazes and rooms characterized this branch of the system (Lake of the Blue Giants, Nirvana, Megamaze, Moby Dick Room). Explorers were temporarily stopped by a tall, aragonite-coated fissure named the Aragonitemare. A series of climbing attempts finally reached the top of the fissure (which was measured at 60 m) and led to a continuation of the Eastern Branch called the Far East Maze. Cavers documented east-trending maze passages, some with corrosion residues or massive aragonite trees covering the floors, and other areas with perched pools coated with calcite rafts (Grand Guadalupe Junction, Silver Bullet Passage, Land of Enchantment, Boundary Waters). At the Grand Guadalupe Junction upward-trending passages were explored in a series of complex upper mazes (La Morada Maze, Firefall Hall). Pits in the floor of Grand Guadalupe Junction dropped into The Outback, a sparsely decorated section of lower level cave defined by more slanting fissures and long, low pancake crawlways. In the middle of The Outback the bottom of the passage literally dropped out to the deepest point of the cave known as Lake of the White Roses at 465 m, which may also be the water table. By 1990, over 83 km of passages had been discovered, explored, and documented.

Between 1991 and 1998 another 83 or more kilometers of discoveries had been documented. The slowdown in pace of exploration was a function of the remoteness of many of the leads, the necessity of technical climbing in some areas, and because the National Park Service (NPS) had, at various times, closed the cave for management purposes.

Exploration and survey work continued to fill in more maze passages that surround all major branches of the cave. New discoveries identified significant northern and southern extensions in the Western Branch of the cave. From the central Western Borehole, a technical climb led to the discovery of another one of the cave's major chambers, Hudson Bay. Northwest trending passages led to the northernmost extent of Lechuguilla Cave. At the known limits of the Western Borehole, explorers extended the perimeters of the cave via breakouts to the Wild West, South Winds, and The Sanctuary. The latter contained passages that headed back toward the High Hopes block suggesting a possible connection between the southwest and western branches of the cave. In October 1998, after 12 years of dedicated exploration/survey trips, Lechuguilla Cave surpassed the 166 km mark.

The potential for more discoveries in Lechuguilla is still very good. During the mid to late 1990s, exploration did focus on the Western Branch of the cave. With equal focus on the other branches, the cave is certain to yield more significant extensions.

## Bibliography

- Cunningham, K., D. Northup, R. M. Pollastro, R. Wright, and E. LaRock (1995). Bacteria, fungi and biokarst in Lechuguilla Cave, Carlsbad Caverns National Park, New Mexico. *Environ. Geol.* **25**, 2–8.
- Hill, C. A. (1987). Geology of Carlsbad Cavern and other caves in the Guadalupe Mountains, New Mexico and Texas. New Mexico Bureau of Mines and Mineral Res. *Bull.* **117**, 150.
- Hill, C. A. (1996). Geology of the Delaware Basin, Guadalupe, Apache, and Glass Mountains, New Mexico and west Texas. Society of Economic Paleontologists and Mineralogists — Permian Basin Section. Publication 96-39, p. 480.
- Hill, C. A. (2000). Sulfuric acid, hypogene karst in the Guadalupe Mountains of New Mexico and west Texas, U.S.A. In *Speleogenesis, Evolution of Karst Aquifers*, (A. Klimchouk, D. Ford, A. Palmer, and W. Dreybrodt, eds.), pp 309–316. National Speleological Society, Huntsville, AL.
- Jagnow, D. H. (1979). Cavern development in the Guadalupe Mountains Research Foundation, Columbus, OH, 55 p.
- Jagnow, D. H. (1989). The geology of Lechuguilla Cave, New Mexico. In *Subsurface Adoutcrop Examination of the Capitan Shelf Margin, Northern Delaware Basin*, Core Workshop 13, (Harris, P. M., and Grover, G. A., eds.), pp. 459–466. Society of Economic Paleontologists and Mineralogists, Tulsa, OK.
- Palmer, A. N. and Palmer, M. V. (2000). Hydrochemical interpretation of cave patterns in the Guadalupe Mountains, New Mexico. *J. Caves Karst Stud.* **62** (2), 91–108.
- Polyak, V., J., W. C. McIntosh, N. Guven, and P. Provencio (1998). Age and origin of Carlsbad Cavern and related caves from <sup>40</sup>Ar/<sup>39</sup>Ar of alunite. *Science* **275**, 1919–1922.
- Reames, S., P. Burger, L. Fish, and P. Kambesis (1999). *Deep Secrets: The Discovery and Exploration of Lechuguilla Cave*. Cave Books, St. Louis, MO.
- Widmer, U., ed. (1998). *Lechuguilla: Jewel of the Underground, 2nd edition*, Caving Publications International, Allschwil, Switzerland.

# Life History Evolution

David C. Culver  
*American University*

## INTRODUCTION

The concept that life history characteristics, e.g., age at first reproduction, number of offspring, and longevity, were not just a passive reflection of what the environment would allow, but rather that they were molded by natural selection gained great currency in the 1960s and 1970s. Since then a variety of models of life history evolution have been put forward to explain the multifaceted differences in life history characteristics of species. The subterranean environment in general and the cave environment in particular have characteristics that act as strong selective agents in the evolution of life histories. Foremost among these are extreme food scarcity and the reduction in seasonal cues for reproduction. Nearly all cave animals are characterized by increased longevity, greatly diminished reproductive rates, and increased investment in the offspring that are produced, often in the form of increased egg size.

There is perhaps no aspect of the biology of cave animals that is both more interesting and more difficult to study. Many undergraduate and graduate students have set out to study life history and population growth of cave animals, but given longevities that often measure in the decades and reproductive rates that are exceptionally low, very little change is often observed in populations over the course of a normal research project. This is further complicated in many cases by the inability to sample the subterranean habitat in times of high water, often the critical time in demography of subterranean populations. What we know about the evolution of life history of cave animals is based on a few long-term studies with bits and pieces of information from many shorter term studies.

### LIFE HISTORY EVOLUTION OF AMBLYOPSID FISH

The fish in the family Amblyopsidae are a small lineage of fish comprising six species, four of which are stygobionts in North American caves and one of which is a stygophile in North American caves. The extensive work of Thomas Poulson (1963) on life history characteristics of these species is both the most extensive comparative study of cave and noncave species in the same lineage and the most influential study of any cave organisms. Poulson was the first cave biologist to look at the life history of cave animals as an adaptation to the cave environment.

One species, *Chologaster cornuta*, lives in freshwater swamps in the Coastal Plain of the southeastern United States. There are other species associated with caves. The stygophilic *Chologaster agassizi* is found in springs and caves in the central United States, especially Kentucky. The other four species, all obligate cave dwellers, are in two lineages that probably diverged about 10 million years ago. One sublineage is the genus *Amblyopsis* with two species, *A. rosae* in the Ozarks and *A. spelaea* in the Interior Low Plateaus. The other sublineage has two monotypic genera, *Typhlichthys subterraneus* and *Speoplatyrhinus poulsoni*. The last species is one of the rarest vertebrates in North America, known from only a single cave. Little is known about its life history and it will not be considered further.

When the stygobitic species are compared to the other two species, they differ in a set of characteristics which represent

a reduction in reproductive effort on the part of the cave species (Table I). Compared to the two *Chologaster* species, all the obligate cave-dwelling species show at least a 20% reduction in the number of caves, at least a 100% increase in the age of first reproduction, at least a 50% reduction in the proportion of the population breeding at any given time, and at least a 40% reduction in growth rate. Poulson (1963) argues that all of these characteristics are an adaptation to a food-poor environment, and there is little doubt that he is correct in this assertion. It is important to note that all of the characteristics listed in Table I could also be the result of food stress on a population. The response of almost any population to food stress is an increase in the age at first reproduction, a reduction in the number of eggs, a reduction in the number of breeding females, and a reduction in growth rate. In a sense, these are imposed by the environment. However, in the case of cave fish, there is strong evidence that this is not just an environmental response, but rather it is a genetically programmed response to the cave environment which is the result of selection for a set of life history characteristics.

The strongest evidence for the adaptive nature of cave fish life histories comes from an additional set of life history characteristics that cannot be the simple result of the environmental pressure of starvation (Table II). These include at least a doubling of life span, at least a 40% increase in egg size, and at least a 50% increase in the maximum number of broods as a result of increased longevity. One stygobitic species, *T. subterraneus*, shows an increase in reproductive effort per brood as measured by total egg volume per gram of female. All stygobitic species show an increase in maximum lifetime reproductive effort compared to the swamp-dwelling *C. cornuta* and the same or greater effort than the stygophilic *C. agassizi*. The maintenance and even a possible increase in lifetime reproductive effort is somewhat surprising, and may not simply be the result of increased longevity. This apparent anomaly will be addressed in a later section.

Differences in life history characteristics among the stygobitic fish have two general explanations. One is that the species have had different amounts of evolutionary time in caves. Thus, the more "extreme" life histories of *A. rosae* and *A. spelaea* compared to *T. subterraneus* may be

TABLE I Life History Characteristics of Amblyopsid Fish that are Consistent with a Response to Starvation, as Well as an Adaptation to a Food-Poor Environment

Species	Age at first reproduction (months)	Number of eggs	Maximum proportion of females with eggs	Growth rate (mm per year)
<i>Chologaster cornuta</i>	12	93	1.00	2.4–3.8
<i>Chologaster agassizi</i>	12	150	1.00	1.7–2.2
<i>Typhlichthys subterraneus</i>	24	50	0.50	1.0
<i>Amblyopsis spelaea</i>	40	70	0.10	1.0
<i>Amblyopsis rosae</i>	37	23	0.20	0.9

TABLE II Life History Characteristics of Amblyopsid Fish that are an Adaptation to a Food-Poor Environment

Species	Longevity (years)	Egg diameter (mm)	Average no. of broods	Maximum no. of broods	Reproductive effort per brood (mm <sup>3</sup> /gm of female)	Maximum lifetime reproductive effort (mm <sup>3</sup> /gm female)
<i>Chologaster cornuta</i>	1.3	0.9–1.2	1.0	1	64	64
<i>Chologaster agassizi</i>	2.3	1.5–2.0	2.0	2	148	297
<i>Typhlichthys subterraneus</i>	4.2	2–2.3	1.5	3	452	903
<i>Amblyopsis spelaea</i>	7.0	2–2.3	0.5	5	52	260
<i>Amblyopsis rosae</i>	4.8	1.9–2.2	0.6	3	83	249

because the *Amblyopsis* species have been isolated in caves longer. There is no direct evidence for this and a second explanation seems more likely: The different species occupy different subterranean habitats which result in different selective pressures. For example, *A. rosae* occurs in areas near the surface while *T. subterraneus* occurs deeper in the groundwater.

### GENERALITY OF LIFE HISTORY CHARACTERISTICS

While there is no other comparative study within a lineage of both cave- and surface-dwelling species that is as complete as that of the amblyopsid fish, available evidence from other groups indicates that the patterns observed in amblyopsid fish are widespread. Only a few cases will be mentioned here.

Longevity in cave animals, at least aquatic species, seems to be greatly increased relative to surface species. The French cave-dwelling amphipod *Niphargus virei* has a maximum age of 35 years and routinely reaches the age of 10 years, based on annual growth rates. There are several reports of cave fish living for more than ten years in a laboratory setting, including *Pimelodella kronei* (Brazil), *Phreatichthys andruzzii* (Somalia), and *Caecobarbus geertsii* (Congo). Cave springtails (collembola) often have double the life span of soil- and litter-dwelling species, and harpacticoid crustaceans living in the interstices of gravel aquifers also have double the life span of surface-dwelling species. In these and many other cases of reported longevity, it is impossible to determine if increased longevity was a direct result of selection in the subterranean environment or whether only those lineages with great longevity can successfully invade caves. The reason these causes cannot be separated is that it is often impossible to find a closely related surface-dwelling ancestor to compare to the subterranean species and thus lineage and selection effects are confounded.

The epitome of longevity in cave animals is from the study of the crayfish *Orconectes australis australis* in Shelta Cave, Alabama, by John Cooper. Based on growth rates of marked individuals over a period of several years, the minimum age at sexual maturity was 15 years, and the best estimate, based on average growth rates rather than maximum growth rates, was 35 years. Furthermore, this was the estimated age of sexual maturity. The estimated age at first reproduction was

over 100 years. Since Cooper's study was completed, the population of crayfish in Shelta Cave crashed to less than 10% of its former size. This was probably the result of an ill-advised gate to the cave that kept out bats, which probably were an important food supply to the crayfish in the form of guano or the organisms that fed on guano. Nevertheless, it is an impressive example of the ability of cave animals to survive for extended periods of time.

Increased egg size and reduced numbers of eggs is widely reported among subterranean animals, including harpacticoid copepods living in interstitial habitats and cave amphipods. One especially clear-cut example without the confounding effects of lineage differences is the amphipod, *Gammarus minus*. Populations of this species (actually a species complex) have invaded subterranean drainages in extensive karst areas in Virginia and West Virginia. The average egg number in a cave population was 50% less than in a spring population less than 5 km away, for females of the same size. In contrast, the volume of an individual egg is about 40% larger for the cave population. Many other subterranean animals have very small numbers of eggs, but usually comparison with the appropriate surface species is unavailable.

One remarkable life history adaptation to cave life is shown by some leiodid beetles in the genus *Iserius*. Two species, *I. colasi* and *I. serullazi*, have a nonfeeding larval stage that lasts nearly 100 days followed by a pupal stage lasting more than 115 days. The evolutionary advantage of the suppression of larval feeding is not entirely clear, but it is probably related to escaping predation, a factor whose importance is suggested by the length of the pupal period as well. If prey available to the prey are scarce, the loss from lack of feeding might be quite small.

One feature of the life history of subterranean organisms shows a great deal of variability, the seasonality or lack of seasonality of reproduction. For predators such as the carabid beetle, *Neaphaenops tellkampfi*, which feeds on the cricket eggs (see article on species interactions), reproduction is timed to the availability of cricket eggs. Because the crickets forage in surface habitats at night, their reproduction is seasonal. For most subterranean species, seasonality is much less clear-cut. It is a common (and frustrating) observation that a cave population that shows a clear seasonality one year fails to show the same pattern the next year. Work by the



French biologist Marie-José Turquin (1985) provides the basis for this variation. She points out that species living in cave streams are subject to floods year round. For the populations of the amphipod *Niphargus* that she studied in southern France, flood frequency reached a maximum in the summer. The impact of these floods was large: It caused significant mortality and it brought in significant amounts of food. Both mortality and reproduction were keyed to these events, which of course do not occur at the same time or intensity each year. Other populations that live in cave pools or live in the interstices of gravels in streams are not faced with the same hydrological regime. In these environments, floods do not occur. Instead their habitat can shrink due to drying. In these populations, ovigerous females and egg laying follows several months after the onset of the wet season. Of course, terrestrial populations would be subject to different temporal patterns, but Turquin's point that reproduction is keyed to events of high mortality and/or food input is likely to be a general one.

### THE PARADOX OF HIGH REPRODUCTIVE EFFORT IN CAVE ANIMALS

Except for Turquin, few investigators have noted what seems to be a paradoxical aspect of the life history of stygobionts and troglobionts. Even though the number of eggs produced in any one brood is small and the possibility of enough resources to allow for reproduction is small, the potential for reproduction of cave animals is often quite large. This is even the case for the amblyopsid cave fish. The reproductive effort per brood is highest in the stygobiont, *T. subterraneus*, and the lifetime maximum reproductive effort of the other two stygobionts, *A. rosae* and *A. spelaea*, is much greater than that of the swamp-dwelling *C. cornuta* and nearly that of the spring-dwelling *C. agassizi*. How can we account for this paradox of long life span and a potentially high reproductive rate even in the amblyopsid cave fish, which are so exquisitely adapted to subterranean life? Turquin suggests that this paradox is in fact essential to life in caves. Although there are situations where there is a low but constant source of food such as production by chemoautotrophic bacteria, the more usual situation in caves is that food comes into the

subterranean realm in pulses or spurts, which may be more or less predictable. Turquin suggests that the combination of a life span and the ability to expend significant reproductive effort make life in food-poor subterranean environments possible. If this idea is indeed correct, then it goes toward explaining some otherwise perplexing features of the life history of subterranean organisms. The high variability of reproduction between years makes sense because the animals are responding to opportunities for reproduction when there is food input that are not necessarily predictable from year to year. The increased longevity of cave animals allows them to "wait" for opportunities. It also fits in nicely with the idea that for most of the time, the growth rate ( $r$  of the standard growth equations) is slightly negative for cave animals. This was certainly the case for *O. australis australis* in Shelta Cave and was likely true for many of the fish populations studied by Poulson. Occasionally, growth rates must be positive or these populations would become extinct. The long life span and relatively high potential investment in reproduction allows stygobionts and troglobionts to take advantage of these opportunities for growth.

### See Also the Following Articles Population Structure

#### Bibliography

- Cooper, J. E. (1975). Ecological and behavioral studies in Shelta Cave, Alabama, with emphasis on decapod crustaceans. Ph.D. Dissertation, University of Kentucky, Lexington, Ky.
- Culver, D. C. (1982). *Cave Life. Evolution and Ecology*. Harvard University Press, Cambridge, MA.
- Ginet, R., and V. Decou (1977). *Initiation à la biologie et à l'écologie souterraines*. J.-P. Delarge, Paris.
- Mathieu, J., and M. J. Turquin (1992). Biological processes at the population level. II. Aquatic populations: *Niphargus* (stygobiont amphipod) case. In *The Natural History of Biospeleology*, (A. I. Camacho, ed.), pp. 263–293. Monografías, Museo Nacional de Ciencias Naturales, Madrid.
- Poulson, T. L. (1963). Cave adaptation in amblyopsid fishes. *Am. Midl. Nat.* **70**, 257–290.
- Trajano, E. (2001). Ecology of subterranean fishes: an overview. *Environ. Biol. Fishes* **62**, 133–160.
- Turquin, M. J., and D. Barthelemy (1985). The dynamics of a population of the troglobitic amphipod *Niphargus virei* Chevreux. *Stygologia* **1**, 109–117.



---

## Mammoth Cave System

**Roger W. Brucker**

*Karst Environmental Education and Protection, Inc.*

**M**ammoth Cave System is located about 160 km (100 miles) south of Louisville, KY, and about 16 km (10 miles) northeast of Bowling Green, KY. Most of the cave lies within Mammoth Cave National Park, a World Heritage Site and a part of the United Nations program of International Biosphere Reserves. It is the longest cave in the world by a factor of three, with about 580 km (365 miles) of surveyed passages (Fig. 1). Between its historical discovery in the late 1700s and 1957, it was considered a single cave 37 km (23 miles) long surrounded by several long caves.

### RECENT AND ONGOING EXPLORATION

In 1957, the discovery of a connection between Floyd Collins' Crystal Cave and Unknown Cave in nearby Flint Ridge revealed the likelihood that additional discoveries of natural connections between these long caves would increase Mammoth Cave's length. In 1972, a team of explorers led by John Wilcox found a natural passage connection between the integrated Flint Ridge Cave System (combining Colossal Cave, Salts Cave, Unknown-Crystal Cave) and Mammoth Cave, a system then totaling 144 km (90 miles) in length. Between 1972 and 1983 connections were found between Proctor Cave, Mammoth Cave, and Roppel Cave, extending the underground labyrinth outside the boundaries of Mammoth Cave National Park.

Exploration continues and Mammoth Cave, as of 2004, is separated from the 160-km (100-mile) Fisher Ridge Cave System by only 90 m (300 ft). Explorers familiar with the caves of the Central Kentucky Karst region have predicted

that the Mammoth Cave System may eventually reach 1600 km (1000 miles) in length, although it might require underwater cave diving to realize this potential. The park is visited by one million annually. About half of the park visitors go on guided cave trips under the leadership of the National Park Service.

### PREHISTORIC EXPLORERS AND MINERS

The first explorers of Mammoth Cave were indigenous inhabitants of eastern North America. Radiocarbon dating of organic materials they discarded or lost underground indicates an activity span of about 2400 years, starting in 2250 BC. They entered the caves for seasonal shelter and to mine selenite, mirabilite, and gypsum minerals. These inhabitants penetrated several miles into the cave using cane and dry weed-stock torches for light. Extensive archeological investigations have led to a reconstruction of the eastern aborigine diet, based primarily on plant materials recovered from human paleo feces preserved in the cave. Several desiccated aboriginal corpses (mummies) have been found, one of a prehistoric miner crushed when a heavy rock shifted.

### HISTORY OF MAMMOTH CAVE

The oral history of Mammoth Cave begins with long hunters, solitary woodsmen who roamed the forested Midwest in search of game. The first recorded event is a traditional account of a hunter named Houchins, who is said to have chased a bear into the cave around 1795. The cave was mined for saltpeter (one ingredient of gunpowder) by a succession of owners, culminating in a commercial saltpeter mining operation with 70 slaves during the War of 1812. Wagonloads of saltpeter were shipped to Philadelphia and made into black powder by E. I DuPont. With the spread of population westward into Kentucky between 1795 and 1840, a road network and stagecoaches brought tourists to

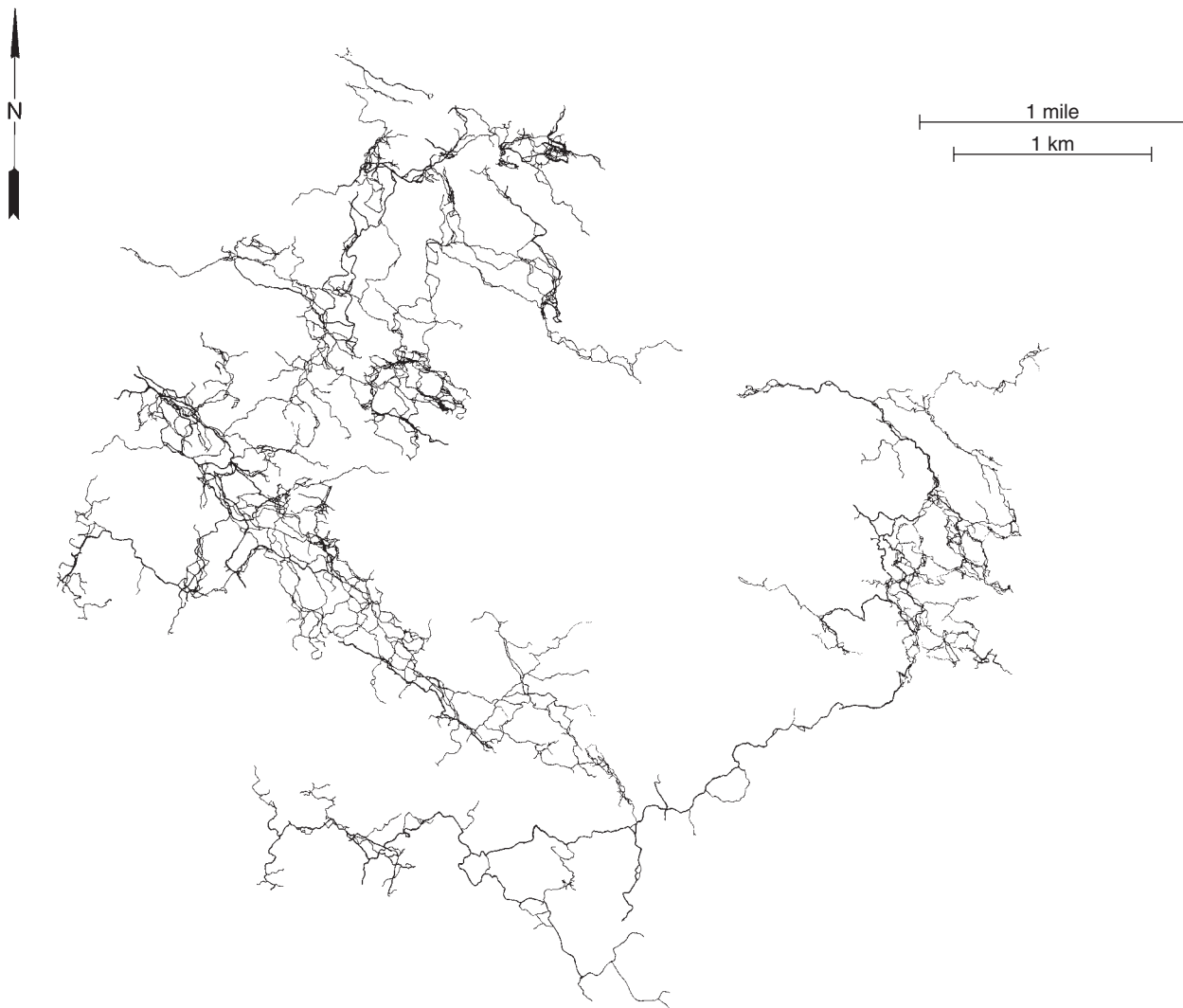
visit Mammoth Cave. Mammoth Cave was part of the “grand tour” by international visitors, along with Niagara Falls, NY. In 1838 an owner of the cave, Franklin Gorin, brought his slave, Stephen Bishop, to guide visitors through the cave. He proved to be one of the most personable and celebrated explorers and guides in a tradition of African-American guides that extended unbroken until 1941.

The building of the Louisville & Nashville Railroad in 1858 swelled tourism and created opportunities for entrepreneurs to exhibit nearby smaller caves. Commercial rivalry intensified as the fiercely competitive “cave wars” characterized the struggle for tourist dollars. The cave wars, fueled by the highly publicized entrapment and death of cave explorer Floyd Collins in Sand Cave in 1925, gradually ebbed as marginal caves went bust and the movement to create Mammoth Cave National Park gained momentum. The park was formally established in 1941 and dedicated in 1946.

## GEOGRAPHIC AND GEOLOGIC SETTING

The Mammoth Cave System is developed in Mississippian limestone rocks on the west side of the Cincinnati Arch, primarily the Girkin limestone, Ste. Genevieve limestone, and St. Louis limestone. The Mammoth Cave Plateau, or Chester Cuesta, is separated from the Pennyroyal Plateau by the Chester Escarpment, which rises 60 m (200 ft) above the Sinkhole Plain to the Mammoth Cave Plateau. The Sinkhole Plain and Mammoth Cave Plateau contain the Mammoth Cave System, which is drained by the deeply incised and meandering Green River. The rocks dip gently northwest.

The Central Kentucky Karst is an area of about 390 km<sup>2</sup> (150 square miles), consisting of 30 or more overlapping karst drainage basins. Sinkholes and sinking creeks funnel runoff and groundwater to caves. Rolling farmland with hundreds of closed depression sinkholes characterizes most



**FIGURE 1** The Mammoth Cave System. Map by Patricia Kambesis, Cave Research Foundation.

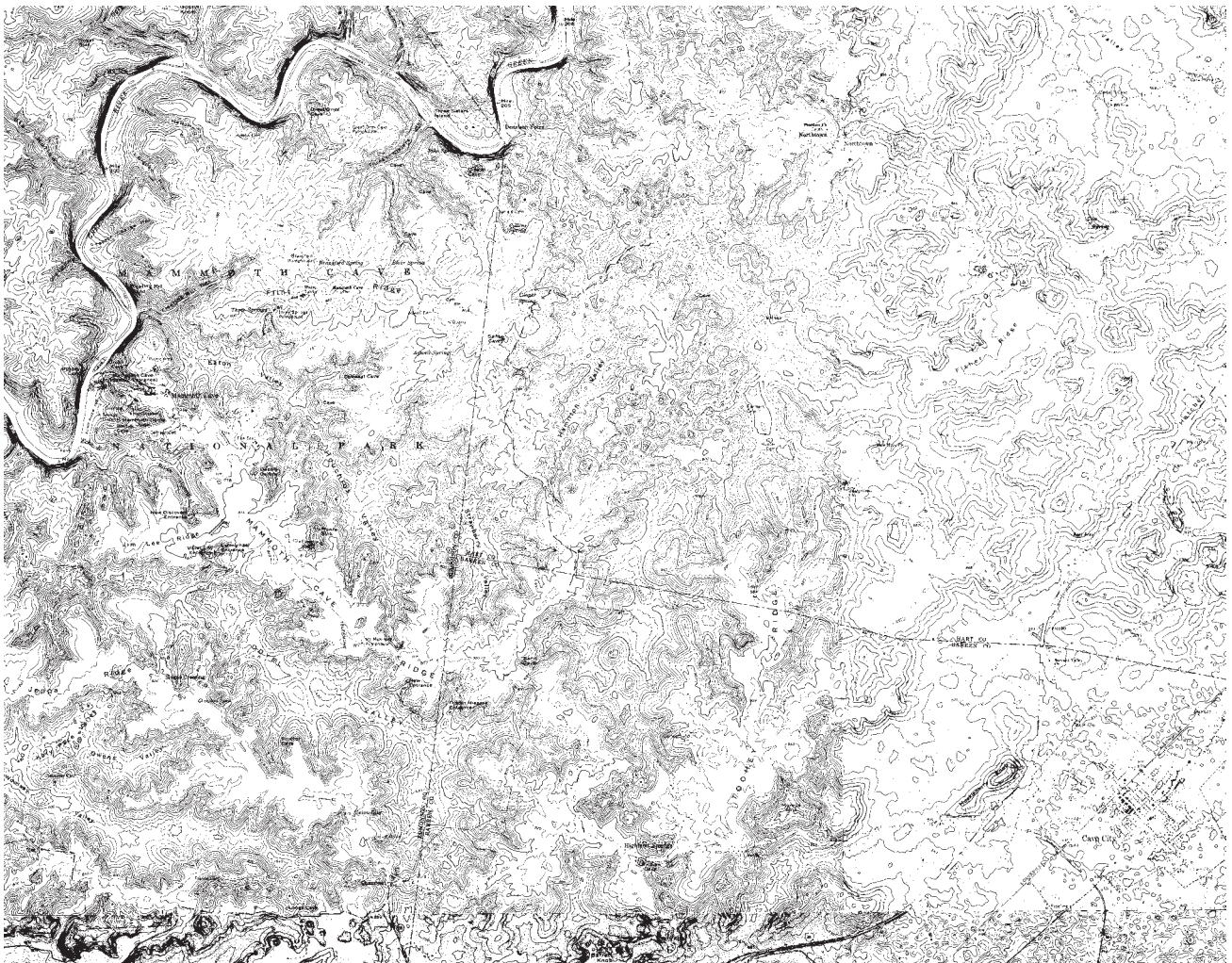
of the area topography. The Mammoth Cave Plateau topography is developed in a dendritic pattern of valleys and ridges oriented generally perpendicular to Green River. The upland represents a fluvial surface on the flat-lying Big Clifty Sandstone, with remnants of Upper Missippian bedrock on the highest ridges. The valley drainage breached the resistant sandstone and was diverted into sinkholes, creating karst valleys below the base of the sandstone.

Unlike fluvial topographic drainage basins where watershed divides can be delineated in the field, these karst basins and valleys are dynamic. The subsurface consists of a three-dimensional network of integrated conduits which preserve the underground former flow paths or paleo drainage routes, cave passages that have migrated downward through time. Basin low-water boundaries in the area have been determined by dye tracing, but heavy rains overwhelm the constricted conduit system and back up cave water stages to more than twice the base level river stage. Under these conditions, water may be pirated through earlier drains to adjacent basins. The interconnected conduits not only create spillover routes, but

also serve as migration corridors for cave-dwelling animals and leads for explorers.

### MAMMOTH CAVE PASSAGE PATTERNS

Passages in Mammoth Cave are arranged in a tree-like dendritic pattern on several levels. The smallest branches are vertical shafts, cylindrical voids that resemble the interior of grain storage silos up to 12 m (40 ft) in diameter and 60 m (200 ft) deep. Vertical shafts are often found at the edges of upland reentrants where their catchment areas may be hundreds of square meters. High volumes of fast moving water descend the shaft walls to produce a rapid rate of enlargement and material removal. Slower moving films of water descend the walls continuously. Vertically flowing groundwater in the shafts represents a karst “chain saw” in comparison to the dissolving capacity of slow moving water flowing horizontally. Slope retreat gradually isolates the larger shafts from their catchment areas. Shaft drains and sinkhole drains join to form downcutting canyons



**FIGURE 2** Topography near Mammoth Cave drawn from the U.S. Geological Survey Mammoth Cave and Horse Cave 7.5 minute quadrangles.

that change to elliptical tubes as they reach a temporary base level.

In their downstream extremities, the lowest level trunk passages sump at the Green River level. An artificial pool of the Green River at 106 m (421 ft) mean sea level (MSL) is behind Dam No. 6 located at Brownsville, KY. Built in 1893, the pool backflooded to raise the normal pool stage in the cave about 1 m. Cave divers have reported submerged elliptical tubes from 2 to 10 m deep at the resurgences of Turnhole Spring, Echo River Spring, and Pike Spring on Green River. Additionally, water discharges through root-like distributary systems below the pool stage into the river.

Upper levels of the flat-lying cave were once continuous drains from the karst valleys and Sinkhole Plain. Some of these levels have been associated with temporary pauses of the Green River as it lowered its bed below the base of the capping bedrock. The highest elevation passages are cut into segments by surface valleys that break down passage ceilings and by vertical shafts that short circuit surface runoff and groundwater to the lowest active levels of the cave.

An examination of a related set of these passage segments shows how segmentation takes place. A short segment of a once connected trunk passage, Kentucky Avenue, extends from Frozen Niagara about 1.1 km (0.7 mile) northwest to a terminal breakdown at Mt. McKinley. About 1200 m (4000 ft) is missing, destroyed by the encroachment of Doyle Valley to the east. The trunk passage then continues 0.3 km (0.2 mile) as Sandstone Avenue which terminates in a massive collapsed sinkhole where Carmichael Entrance and Violet City Entrance are located. This trunk continues on the other side of the sinkhole as Broadway 3.5 km (2.2 miles) to the Historic Entrance, a terminal breakdown. Northwest of the entrance steps is Dixon Cave, a 0.3-km (0.2-mile) trunk segment which terminates at its entrance, a former big spring outlet.

The primary reason why so many hundreds of miles of passages are present in Mammoth Cave is that the capping bed of clastic rock acts as a “roof” to the cave system. The resistant Big Clifty Sandstone and a thin bed of impermeable shale at its base have protected much of the cave system from erosion. A mapping program has revealed how protected passage fragments were part of a set of evolving drainage patterns, which show how subterranean watercourses have developed through time. As can be seen in the lowest water-filled passages as well as upper levels, drainage diversion or piracy is a ubiquitous occurrence. Diversion routes often develop as trenches cut in the bedrock floor of a tube or canyon. Their gradient deepens and they may depart from the original passage to become tubes or canyons leading to lower reaches of the system.

### MAMMOTH CAVE MINERALS

Mammoth Cave is not noted for extensive displays of speleothems, such as stalactites, stalagmites, columns, and flowstone. These depositional formations are confined to

parts of the cave system where the clastic capping bedrock has been removed and carbonate saturated groundwater can descend. The Frozen Niagara section shown to visitors contains the best display of these speleothems.

Gypsum minerals can be seen in parts of the cave where the clastic bedrock above remains intact. These sulfate minerals form as crystals, needles, gypsum cotton, flowers, and massive crusts resembling drifted snow. Less common are mirabilite and selenite crystals. The origin of the sulfate is pyrite beds overlying the cave. Investigators believe that aborigines gathered and used mirabilite as a laxative and perhaps as food seasoning, gypsum as a paint ingredient, and selenite crystals as ritual or ceremonial objects.

### MAMMOTH CAVE ORIGIN

As a significant and complex cave, Mammoth Cave’s origin in process terms has been studied since the 1920s. Early studies of the cave were mainly descriptive and based on only about 10% of the cave system known today. Inadequate cave maps also hampered early investigations. A. C. Swinnerton (1932) observed that horizontal passages in Mammoth Cave were formed in the “zone of discharge,” a 30-m (100-ft) band located between the highest stage of the base level Green River and its lowest cave resurgence. At Mammoth Cave this “shallow phreatic zone” extends from 9 m (30 ft) below pool stage to 21 m (70 ft) above pool stage. Leveling surveys confirm that these cave passages conform in profile to the trend of this zone. Many such passages are oriented downdip, but passages cut across beds indicating that dip is not the structural control. (On the north side of Green River cave passages are oriented generally updip toward their discharge points.)

### BIOLOGY OF MAMMOTH CAVE

Although cave environments harbor a low diversity of animal life relative to surface habitats, for underground habitats Mammoth Cave has a very wide diversity of aquatic and terrestrial life. Prominent among observable animals are cave guests like bats and pack rats, cave lovers like salamanders and cave crickets, and permanent cave dwellers like blindfish and beetles. Endangered species include the Kentucky cave shrimp (*Palaemonias ganteri* Hay) and both the gray bat and Indiana bat. Several species of obligate cave-dwelling fish and crayfish are threatened.

With no light and thus no green plants, cave organisms must rely on food brought in from above ground. Food chains in aquatic habitats start with dead plant material washed into the cave from cracks, sinkholes, and sinking streams. Decomposer bacteria and molds do the initial breakdown and animals eat the decomposers. The most important food chains in terrestrial habitats start with the feces and eggs of cave crickets. Cave crickets roost inside cave entrances and at night venture out to forage for bits of dead and decomposing matter. One community of organisms

depends on the veneers of guano under the dense roosts of cave crickets. Another community depends on the feces of cave beetles that eat eggs that crickets lay in the sand away from the cave entrance. Cave beetles search vigorously for cricket eggs, using touch and smell to locate the sand that crickets rake over their eggs.

As with any aquatic life, the organisms of Mammoth Cave are vulnerable to pollution. Several disastrous petroleum and chemical spills have confirmed the sensitivity of species in large streams, especially long-lived shrimp, crayfish, and fish at the end of food chains. An emerging area for research is bioaccumulation and biomagnification of toxins, such as mercury, that migrate up the food chain. These toxins affect the reproduction of long-lived animals and are remobilized by floods. Another area of concern is incompletely treated human waste. This excess organic matter favors fast reproducing species whose numbers overwhelm the usual cave species and thus reduce species diversity. Awareness of pollution threats is focusing keen attention on violations of the Clean Air Act and Clean Water Act, and the effects of development on the Tier III protected waters of Mammoth Cave.

### A MAGNET FOR INTERNATIONAL CAVE RESEARCH

The modern era of cave investigation at Mammoth Cave started in 1954 and continued with the organization of the Cave Research Foundation (CRF) in 1957. The CRF undertook a systematic exploration and mapping program as the basis for a scientific program in archeology, biology, and hydrogeology. More than 10 books, dozens of theses, and hundreds of scientific papers and cave maps have resulted from a cooperative partnership between the National Park Service and CRF scientists. University research and educational activities associated with Mammoth Cave include two organizations from Western Kentucky University, Bowling Green, KY; the Center for Cave and Karst Studies; and the Hoffman Institute.

#### Bibliography

- Brucker, R. W., J. W. Hess, and W. B. White. (1972). Role of vertical shafts in the movement of ground water in carbonate aquifers. *Ground Water* 10 (6), 5–13.
- Borden, J. D., and R. W. Brucker (2000). *Beyond Mammoth Cave*, pp. 316. Southern Illinois University Press, Carbondale, IL.
- Brucker, R. W., and R. A. Watson (1987). *The Longest Cave*, pp. 316. Southern Illinois University Press, Carbondale, IL.
- Granger, D. E., D. Fabel, and A. N. Palmer (2001). Pliocene–Pleistocene incision of the Green River, Kentucky, determined from radioactive decay of cosmogenic <sup>26</sup>Al and <sup>10</sup>Be in Mammoth Cave sediments. *Geol. Soc. Am. Bull.* 113, pp 825–836.
- Lawrence, J., Jr., and R. Brucker (1975). *The Caves Beyond: The Story of the Floyd Collins' Crystal Cave Exploration*; (reprint of the 1955 edition), p. 283. Zephyrus Press, Teaneck, NJ.
- Murray, R., and R. Brucker (1982). *Trapped! The Story of Floyd Collins*, p. 347. University Press of Kentucky, Lexington, KY.
- Palmer, A. N. (1981). *A Geological Guide to Mammoth Cave National Park*, p. 210. Zephyrus Press, Teaneck, NJ.

- Swinerton, A. C. (1932). Origin of limestone caverns. *Bull. Geol. Soc. Am.* 43, 663–694.
- Watson, P. J., ed. (1987). *Archeology of the Mammoth Cave Area*, p. 255. Cave Books, St. Louis, MO.
- White, W. B., R. A. Watson, E. R. Pohl, and R. W. Brucker (1970). The Central Kentucky Karst. *Geogr. Rev.* 160 (1), 88–115.
- White, W. B., and E. L. White, eds. (1989). *Karst Hydrology, Concepts from the Mammoth Cave Area*, p. 346. Van Nostrand Reinhold, NY.

## Mapping Subterranean Biodiversity

Mary C. Christman  
University of Maryland

### INTRODUCTION

The ability to describe and explain the spatial distribution of cave fauna is becoming increasingly more important as man continues to expand his reach and encroaches on traditionally inaccessible areas. Knowing where and under what conditions various fauna are found can help immensely in developing conservation plans (Adams, Stein, & Kutner, 2000). Hence, an increasingly urgent need is the ability to accurately map the geographic distribution of various species and ecosystems (and often as critical, the distribution of the required habitat). Mapping includes the graphical presentation in which species densities are mapped over a region but, more importantly, it includes the statistical spatial modeling that provides not only the map but also the means of assessing the accuracy of the map. This article emphasizes the statistical approaches that provide such information and which can be used in interpretation, hypothesis testing, and decision making. Statistical modeling provides the means for studying the spatial process that generates the observed geographic distribution of species and hence, it is useful both for research into the generating process as well as for identifying areas in which high species richness might be expected, although not yet reported. Throughout this article the terms model and map are used interchangeably (unless otherwise noted). The following discussion is based on mapping species richness, but the ideas are the same whether one is mapping biodiversity or abundances of individual species or species assemblages.

### DECOMPOSITION OF THE SPATIAL PROCESS

The spatial process that generates the observed spatial distribution of species richness can be decomposed into several components (Cressie, 1993). First, there is the large-scale trend that usually can be explained using environmental or geophysical data. These data might include such attributes

as cave length or depth, cave type, surface climate features, altitude, latitude, distance from certain features such as the maximal extent of an ancient ice sheet or embayment, and others. For example, large-scale patterns of precipitation might help explain the spatial arrangement of caves in karst areas and hence, of cave species.

Next is meso-scale or small scale variation that is not explainable by the large-scale trend. Such variation might arise because of unknown factors that operate at smaller scales, i.e., elevation or slope aspect. It might also be due to even finer spatial features such as connectivity of caves. The variations at this scale are often observed to have covariability, i.e., adjacent areas often have similar numbers of species, possibly due to connectivity. As a result, this variation is often modeled as having spatial autocorrelation among neighboring areas.

The final component is random error or the unexplained variability that is unaccounted for after the fitting of the other components. This variability could be due to sampling intensity to factors not present in the model, such as size of the cave entrance opening. It is usually assumed that these variations are independent of one another, i.e., the value at one site neither influences nor is influenced by a value at a neighboring site.

Using this decomposition of the spatial variability, it can be written that  $Y(s)$ , the number of species at site  $s$ , is a linear combination of the components:

$$Y(s) = \mu(s) + \delta(s) + \varepsilon(s)$$

where  $\mu(s)$  is the large-scale trend at site  $s$ ,  $\delta(s)$  is the spatial correlation component describing the meso-scale variability, and  $\varepsilon(s)$  is the random noise or unexplained variability. In order to do statistical analyses, it is assumed that the three components are independent of each other. When this assumption holds (i.e., is true), the modeler can estimate the precision of each estimated model component.

An example of the decomposition of actual data is given in Fig. 1. In this instance, Christman and Culver (2001 a, b) modeled the number of species found in counties in the southeastern United States as a function of the number of caves in that county (large-scale trend), the autocorrelation between adjoining counties (meso-scale variability), and random error (unexplained variability). Counties without caves were constrained by the model to have zero species; hence, the flat regions on the graphs.

## MAPPING BIODIVERSITY

### Interpolators

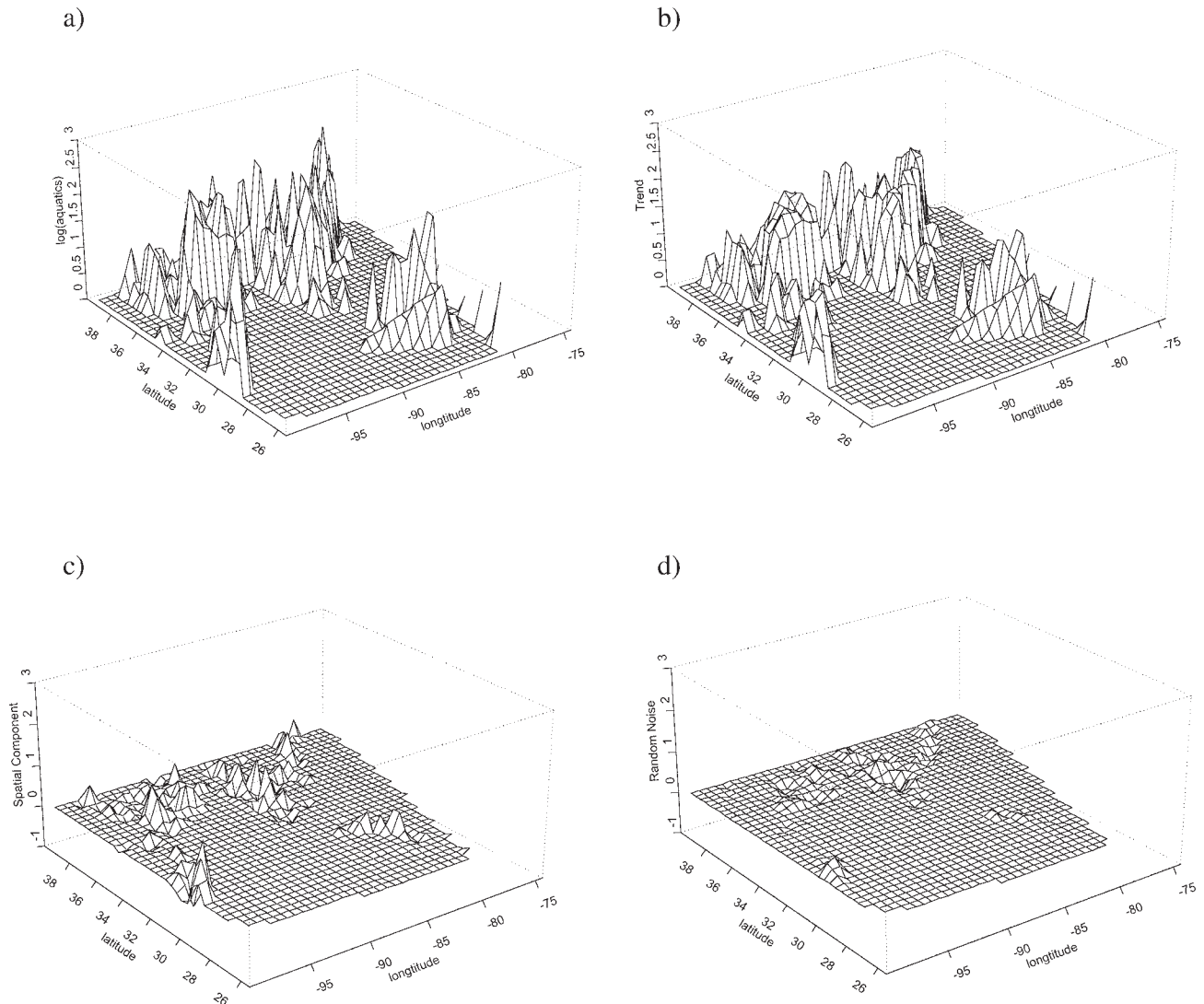
There are many software packages that provide graphical routines for displaying spatial data. Some examples include S-Plus (Insightful Corp., Seattle, WA), SAS (SAS, Inc. Cary, NC), and ArcView and ArcGIS (ESRI, Inc., CA). Numerical interpolators are usually used to construct graphical presen-

tations of these data (Fig. 1) such as contour plots or three-dimensional perspective plots. Several kinds of interpolators are available, each providing a slightly different method for smoothing these data so that a continuous surface is displayed. Smoothing techniques include simple methods such as moving averages, locally weighted smoothing, smoothing splines, and others. Moving average smoothing involves estimating the mean for a location using the set of observed points within a given radius of the location to be predicted. Locally weighted smoothing uses a weighted mean instead of the arithmetic mean where the weights are usually some function of the distances of the observed points to the location to be predicted. A smoothing spline replaces the weighted mean with the value predicted by a local regression over the points within the region.

Smoothers provide different types of surfaces depending on the parameters that are used in the smoothing algorithm. For example, at each point in the vertices of a grid overlying the study region, a moving average smoother uses the average of the  $p\%$  data points closest to the point being estimated where  $p$  is given. When  $p$  is small, only data that are very close in space to the prediction site are used and hence, the surface appears spiky and very similar to the original data. If  $p$  is large then more of these data are used and the result is a much smoother surface. The choice of smoother and parameter values influences the final map display and thus, like any graphic, can be manipulated to emphasize or de-emphasize features of these data (Fig. 2). These routines are nonstatistical in the sense that they are not models of the spatial process which generates these data and cannot provide any means of assessing the bias, precision, or accuracy of the map.

### KRIGING

These data are point data in the sense that the observed values (in this case, number of species in a single cave) are associated with a single site and are not summary values over a region. The usual spatial method for analyzing such data is kriging (Cressie, 1993; Haining, 1990). In kriging, the predicted value of  $Y(s_0)$ , the number of species at a prediction site,  $s_0$ , is the sum of the estimated large-scale trend plus the estimated autocorrelation component. In kriging, the optimal (in the sense of smallest variance) predictor for the autocorrelated component is a linear combination of values of  $Y$  at sampled sites ( $s_1, s_2, \dots, s_n$ )  $Y(s_0) = \sum_{i=1}^n \lambda_i Y(s_i)$ . The coefficients,  $\lambda_i$ , are functions of the covariability of the observations at sampled sites with the prediction site,  $s_0$ . Kriging provides a means of studying the fine-scale spatial structure of subterranean biodiversity, because autocorrelation among sites can be ascribed to processes occurring at the spatial level of individual caves. In addition, it can be used to interpolate values at intervening sites between observed caves and hence, to map biodiversity over the study region. In fact, that is its



**FIGURE 1** Perspective plots showing (a) the geographic distribution of the observed counts of stygobites (log-transformed) in counties in the southeastern part of the United States; (b) the fitted regression plane for the large-scale component of the model in which the log-transformed number of stygobites is related to the number of caves (log-transformed); (c) the spatial autocorrelation meso-scale component in which the logged number of stygobites is predicted conditionally using the logged counts in surrounding counties; and (d) the residuals or unaccounted for variation in these data. (From Christman, M. C., and Culver, D. C. (2001b). With permission.)

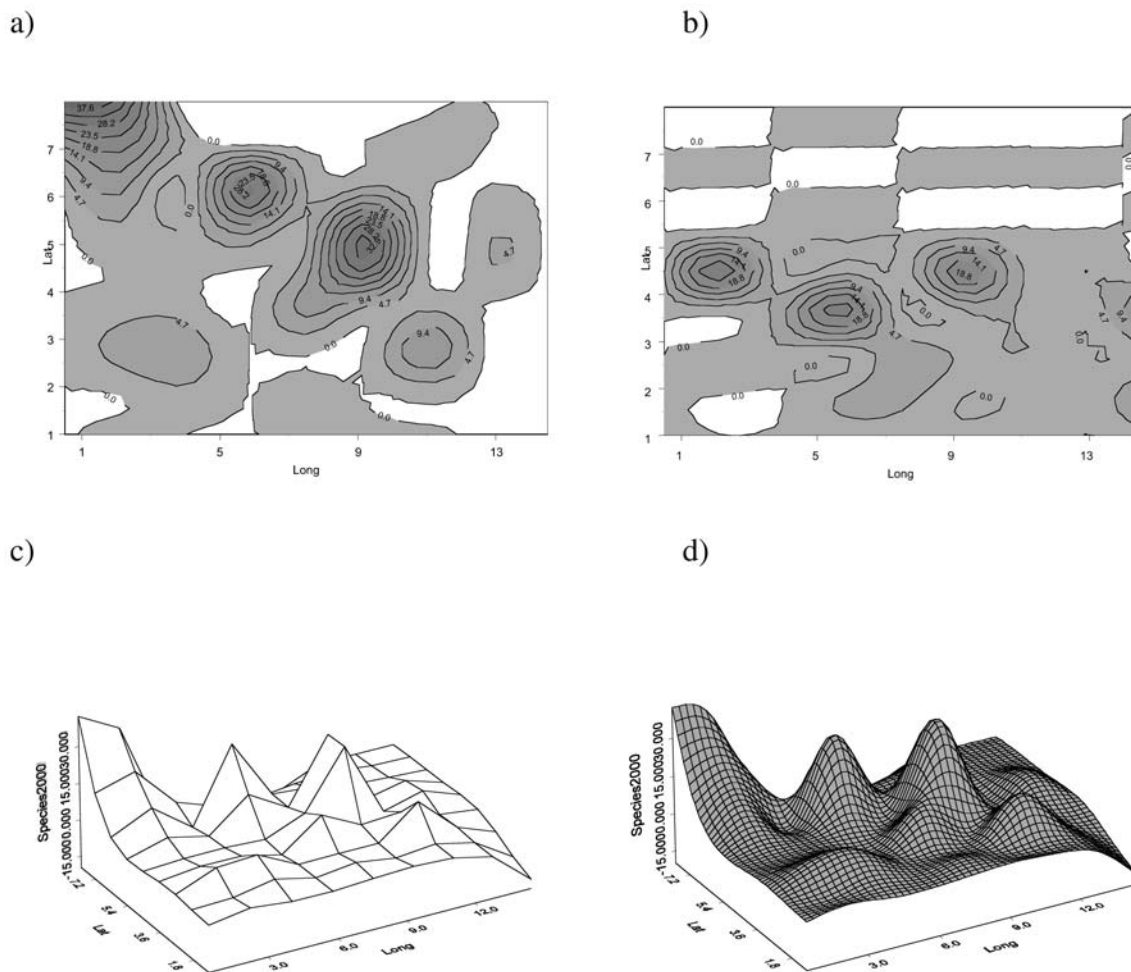
most common use, because the kriging procedure will give a predicted value at an observed site equal to the observed value at that site.

One can also map the standard errors associated with the predicted values in order to gain some sense of the precision of the predictions. However, kriging requires some stringent assumptions be met in order to be a valid method for modeling the spatial distribution. These include stationarity and isotropy. A process is said to be second-order stationary if the following is true: (1) the trend is constant over the region, i.e.,  $\mu(s) = \mu$  for every site  $s$  in the region; and (2) the covariability between two sites may depend on the distance and direction between them but not on the location of the sites within the study region. A process is said to be isotropic if the covariability between two sites does not

depend on the direction between them. When large-scale trend does exist (i.e.,  $\mu(s) \neq \mu$ ), one approach is to model the large-scale trend separately and obtain estimates of  $\mu(s)$ ,  $\hat{\mu}(s)$ , for example. Then the differences between the observed values and the estimated large-scale trend ( $Y(s) - \hat{\mu}(s)$ , called the residuals) are modeled using kriging. The results of kriging the residuals are estimates of the other two components of  $Y$ ,  $\delta(s)$  and  $\varepsilon(s)$ . The estimates  $\hat{\mu}(s)$  and  $\hat{\delta}(s)$  are then added together to obtain estimates for the original variable of interest. Hypothesis testing can proceed as long as these data are from a spatial process which generates Normally distributed observations.

A cautionary note concerning the use of kriging for mapping subterranean biodiversity is required. The geologic conditions necessary for caves and other subterranean





**FIGURE 2** Four graphical representations of the same data, the number of stygobites per 100 km<sup>2</sup> hexagon in the Dinaric Karst region of Slovenia: (a) a contour plot based on a simple linear interpolator between sites; (b) a contour plot based on a weighted average interpolator; (c) a three-dimensional perspective plot using a linear interpolator; and (d) a three-dimensional perspective plot using a smoothing spline. The X and Y axes are the coordinates of the centroids of the hexagons using a unit of 1 to indicate that the hexagons are adjacent.

features needed by obligate subterranean species are not normally uniform over the study region. Kriging assumes that the study region is a convex polygon within which the sites at which data are taken represent a sample from the continuous spatial field and hence, assumes that the conditions are continuous. As a result, it will predict nonzero estimates of species richness at sites near caves, even if the sites do not have any appropriate habitat for cave fauna. In some instances, this is easily resolved by masking, which is the process of removing those locations from possible interpolation. This is effective only if the inappropriate area is small relative to the study region. When habitable areas are more patchy, the correct modification to the modeling is not so clear. More research is required to determine the best method of resolving the spatial relationships under such situations. One technique that has been used is to aggregate the point data to another scale, for example, to sum up the number of caves and total number of species found in a given area.

## MODELING ISSUES

### Aggregation and Scale

One of the first issues that must be resolved when performing spatial modeling is the scale at which the analysis is to be done. When data are available at scales other than the original scale of measurement, then these data are said to be aggregated. For example, localities may only record (or make available to the public) the county in which a cave is located but not the latitude–longitude coordinates of the individual cave. In that case, data have been aggregated to the level of county and any fine-scale processes cannot be analyzed. Scaling has both a positive and a negative impact on ecological studies. First, it may be that different processes are acting at different scales and the researcher should attempt to partition the effects of the different scales. For example, similarities between adjacent caves could be due to cave connectivity (a micro-scale process), altitude, or aspect of the hillside on which the cave is located (a meso-scale process)

or the latitude at which the cave is found (a macro-scale process). On the other hand, if data are aggregated in such a way that the aggregation scale does not mimic the scale at which a process is occurring, then it is not possible to study the relationships at the appropriate scales.

The shape of the aggregation units can influence the analyses as well (Openshaw & Taylor, 1979). A possible solution to this problem would be to use a regularly gridded aggregation method and at as many different scales as possible. One should then be able to capture most of the interesting features of these data. For example, one such system is the hexagon covering developed by White, Kimerling, and Overton (1992) at the U. S. EPA Environmental Research Laboratory in Corvallis, OR. Briefly, hexagons have the advantage of retaining equal shape and equal area over the globe (White et al., 1992) and regions can be covered in hexagon grids at any of many different scales. They have been widely used in mapping biodiversity in the United States (Adams et al. 2000).

The problem of relationships between variables changing as the scale of data aggregation is changed is a well-studied phenomenon. It has been called the Ecological Fallacy or the Modifiable Areal Unit Problem: The tendency of the correlation between X and Y to change as the scale changes (cf. Openshaw & Taylor, 1979). A good review of the issues can be found in Gotway and Young (2002).

When data are aggregated into blocks, the statistical models used to analyze them and estimate the spatial relationships differ as well. Now, the model is based on analyzing relationships among discrete units rather than within a continuous surface as is done in kriging. The decomposition remains the same but the model for predicting  $Y(s)$  is given by

$$Y(s) = \mu(s) + \sum_t \eta(s,t)[Y(t) - \mu(t)] + \varepsilon(s)$$

where  $s$  (or  $t$ ) are the site identifiers,  $\mu(\cdot)$  and  $\varepsilon(s)$  and the same as before, and the  $\eta(s,t)$  are the parameters describing the spatial correlations between the observations at sampling sites  $s$  and  $t$  (Cressie, 1993; Haining, 1990). The site identifiers are usually spatially indexed as the centroids of the blocks. Such models are sometimes referred to as lattice models because these data are arranged in either a regular or irregular lattice. In order to make the model tractable, it is sometimes assumed that the spatial correlation is independent of direction between sites and location within the study region. Other simplifying assumptions include constraining the autocorrelation to exist only if the two sites are within  $K$  miles (or kilometers) of each other or setting the autocorrelation to be an inverse function of the distance between two sites, for example, setting  $\eta(s,t) = \eta D(s,t)^{-p}$  where  $D(s,t)$  is a distance metric and  $p$  is the decay factor, indicating how fast the autocorrelation drops off as two sites are further apart. Note that in this model, one does not attempt to estimate species richness at sites in between aggregated locations because by definition, there are no such sites between

aggregated blocks. As with kriging, hypothesis testing is based on the assumption that these data are random observations from a Normal distribution.

Fig. 1 was generated using a lattice model with the mean number of species in any county being a function of the number of caves in that county and of the number of species in surrounding counties whose centroids were within 56 km of the county being estimated (Christman & Culver, 2001a). The spatial correlation parameterization used was

$$\eta(s,t) = \begin{cases} 0, & \text{if } \|s - t\| > 56 \text{ km} \\ \eta \left[ \frac{\max_{i,j}(\|s_i - s_j\|)}{\|s - t\|} \right], & \text{if } \|s - t\| \leq 56 \text{ km} \end{cases}$$

where  $\max_{i,j}(\|s_i - s_j\|)$  is the greatest distance between any two counties in the dataset. The ratio of the maximum distance to the local distance constrains the parameter  $\eta$  to fall within the interval  $(-1, +1)$  and hence, is interpretable as a correlation coefficient.

An example of using the lattice model at different scales is shown in Fig. 3. These data were collected in the Dinaric Karst region of Slovenia and are modeled at different spatial scales based on hexagons of equal size. A parameterization of autocorrelation referred to as the power variogram (cf. Proc Mixed in SAS; SAS, Inc. Cary, NC) where the autocorrelation parameter is modeled as  $\eta(s,t) = \eta^{\|s - t\|}$  was used. The estimated autocorrelation coefficients are 0.729 for the 100-km<sup>2</sup> hexagons and 0.805 for the 200-km<sup>2</sup> hexagons. Not surprisingly, the larger hexagons have a higher autocorrelation than the smaller hexagons; this is likely due to the smoother spatial distribution pattern exhibited in the larger hexagons.

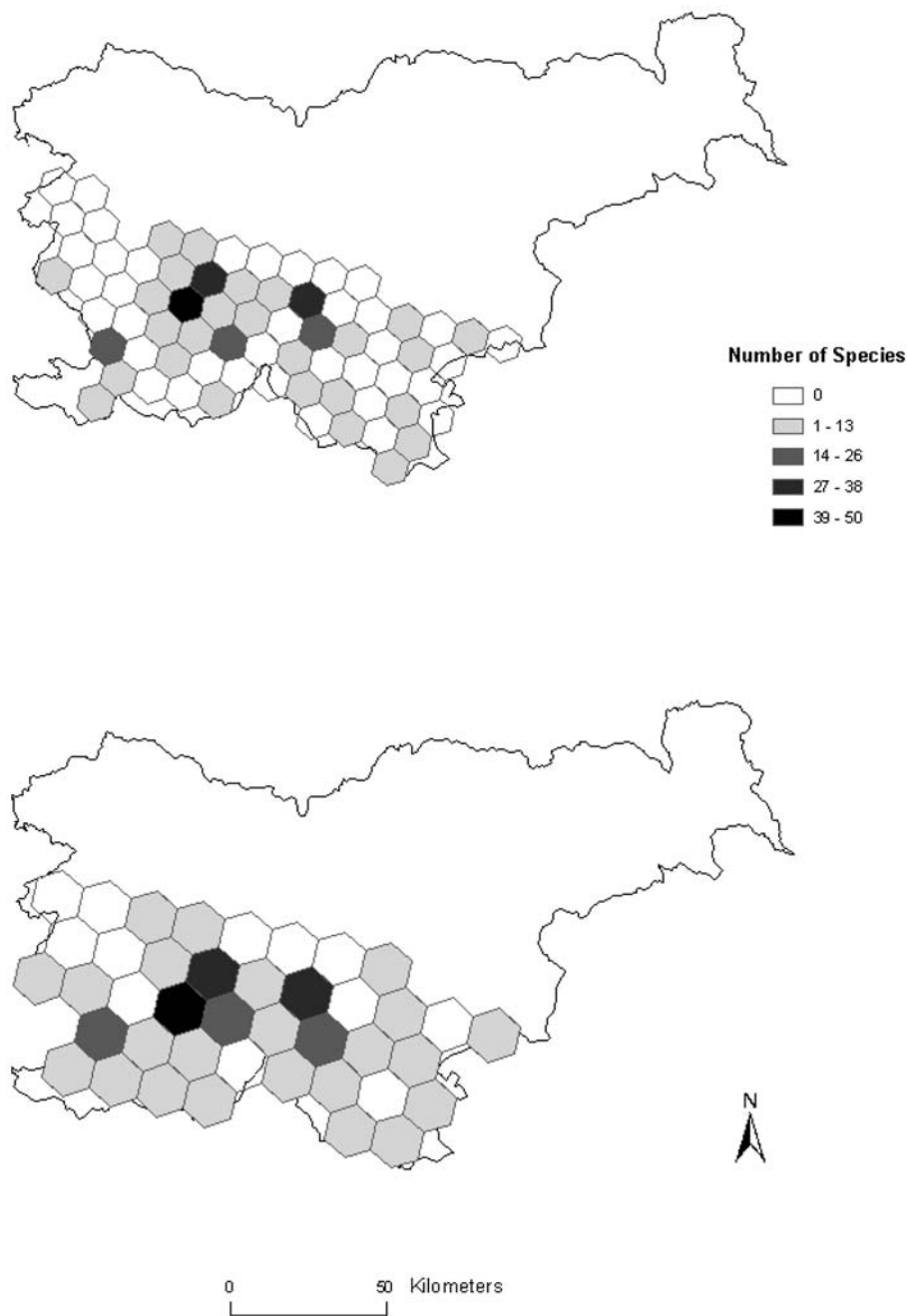
### Excess Zeroes

Although the above models work well when the assumptions are met and there are few zeroes, a common problem with obligate subterranean data is the excess number of zeroes. This occurs either because there is no habitat available for cave species or because there are no records of species within individual caves. The second case usually does not arise when these data are aggregated, but can be a problem when these data are analyzed at the original scale of individual caves. In the case of lack of habitat, the lattice model can be adapted to require that any prediction be predicated on the existence of karst (or caves or whatever other variable might be appropriate). This adaptation when applied to the lattice model is given as

$$Y(s) = \begin{cases} 0, & Y(s) = 0 \\ \mu(s) + \sum_t \eta(s,t)[Y(t) - \mu(t)] + \varepsilon(s), & Y(s) > 0 \end{cases}$$

as long as  $Y(s) = 0$  only when  $X(s)$ , the habitat defining variable, equals 0.

Other models have also been used which allow for the fact that a zero may be either due to lack of available habitat or



**FIGURE 3** Hexagonal covering of the Dinaric Karst region of Slovenia: (a) 100 km<sup>2</sup> and (b) 200 km<sup>2</sup> hexagons. Shading indicates the number of distinct species found in the area covered by the hexagon.

simply no data have been observed (cf. Ridout, Hinde, & Demetrio, 2001). In the latter case, this could be that the cave (or county or hexagon) either has not been explored or has been explored but no organisms were found. These models have been developed under the assumption that there is no spatial autocorrelation among sites and hence, are applicable only if the assumption holds. Some work has been done to incorporate excess zeroes in a kriging model (cf. Warren, 1997), but research is still ongoing with respect to lattice models.

#### *See Also the Following Articles* *Databases*

#### *Bibliography*

- Adams, J. S., B. A. Stein, and L. S. Kutner (2000). Biodiversity: Our precious heritage. In *Precious Heritage: The Status of Biodiversity in the United States* (B. A. Stein, L. S. Kutner, and J. S. Adams, eds.). Oxford University Press, New York.
- Christman, M. C., and D. C. Culver (2001a). The relationship between cave biodiversity and available habitat. *J. Biogeogr.* **28**, 367–380.
- Christman, M. C., and D. C. Culver (2001b). Spatial models for predicting

- cave biodiversity: An example from the southeastern United States. In *Mapping Subterranean Biodiversity: Proceedings of an international workshop held March 18 through 20, 2001, Laboratoire Souterrain du CNRS, Moulis, Ariège, France* (D. C. Culver, L. DeHarveng, J. Gibert, and I. D. Sasowsky, eds.). Karst Waters Institute, Charles Town, WV.
- Cressie, N. A. C. (1993). *Statistics For Spatial Data*, revised edition. Wiley & Sons, New York.
- Gotway, C., and L. Young (2002). Combining incompatible spatial data. *J. Am. Stat. Assoc.* **97**, 632–648.
- Haining, R. (1990). *Spatial Data Analysis in the Social and Environmental Sciences*. Wiley & Sons, New York.
- Openshaw, S., and P. J. Taylor (1979). A million correlation coefficients: Three experiments on the modifiable areal unit problem. In *Statistical Methods in the Spatial Sciences* (N. Wrigley, ed.). Pion, London.
- Ridout, M., J. Hinde, and C. G. B. Demetrio (2001). A score test for testing a zero-inflated Poisson regression model against zero-inflated negative binomial alternatives. *Biometrics* **57**, 219–223.
- Warren, W. G. (1997). Changes in the within-survey spatio-temporal structure of the northern cod (*Gadus morhua*) population, 1985–1992. *Can. J. Fish. Aquat. Sci.* **54** (Supplement), 139–148.
- White, D., A. J. Kimerling, and W. S. Overton (1992). Cartographic and geometric components of a global sampling design for environmental monitoring. *Cartogr. Geogr. Inf. Syst.* **19**, 5–22.

## Marine Regressions

Claude Boutin

Université Paul Sabatier, France

Nicole Coineau

Laboratoire Arago, France

The ocean milieu not only covers more than two-thirds of the Earth's surface, but very likely has played a major role in the appearance, the evolution, and diversification of the life on the whole planet, including the different terrestrial and aquatic habitats existing on the continents. Even caves and other subterranean aquatic biotopes were often colonized by animal species directly coming from marine habitats during the periods of marine regressions. Because of this, the present geographic distribution of some aquatic cave inhabitants is closely related with the past position of shorelines before a recession of the sea. In some cases cave or groundwater animal species are the sole evidence of past ocean presence, and could be used to date the marine regression period.

### FROM THE SEA TO FRESHWATER AND LAND

Most biologists and paleontologists have long agreed that life appeared first in marine environments, and that all animal phyla (all the different lineages of the animal kingdom) which later colonized continents first existed and evolved in the sea. A good number of phyla are still exclusively marine; some of them are well known, such as the Echinodermata (sea urchins, starfishes) or the Cephalocordata (the amphioxus), while other phyla such as the Ctenophora or the

Chaetognatha are known only by zoologists. In contrast, a great number of phyla have both marine branches and other branches living in continental freshwaters or in terrestrial habitats. This is the case of Arthropoda and Vertebrata, which include many marine species and many other species presently living in river and lake freshwaters or in terrestrial habitats of continents. When colonizing the freshwater habitats long ago, many groups still continued to live in the sea; they are therefore represented both by marine and freshwater species belonging to the same order, often to the same family, and sometimes to the same genus. Such situations may be observed in many crustacean groups such as Decapoda, Isopoda, and Amphipoda. In these groups the colonization of continental freshwaters by marine ancestral populations may have occurred repeatedly at different periods, originating groups of continental species that were different from their distant marine ancestors.

### ADAPTABILITY TO DIVERSE HABITATS

Since the 1970s, biologists interested in the development of life on Earth and in the diversity of living organisms have made significant advances in the field of historical biogeography and evolutionary ecology. Now we better understand why species are the way they are. These researchers have also displayed the surprising ability of many living organisms to colonize a great variety of habitats, including the extreme environment of every type. Such habitats occur in polar regions covered by ice caps; in deep parts of oceanic plains; around the hydrothermal vents which form sea bottom oases; in the deep part of continental caves; and in all subterranean waters present in continental caves, marine caves, and anchialine caves (a kind of coastal caves related to the sea but filled with water also subjected to continental freshwater influences), as well as in continental groundwaters.

There is general agreement for considering that the ancestral populations of troglobionts (species presently living in caves and other terrestrial subterranean habitats) lived first in soils, humus, litter, or moss strata of forest ecosystems. They lived mainly during the Cenozoic and Pleistocene periods, in temperate regions, and probably at any period from the Mesozoic to the Present in tropical regions. Thus it is shown that terrestrial subterranean species or populations are derived from surface ancestral species.

For the limnostygobionts, the subterranean freshwater species presently living in caves or in continental groundwaters, the question is less simple because their origin is double. Some species clearly belong to groups which presently live in surface freshwaters and appear to be derived from surface freshwater ancestral populations. Many other species of limnostygobionts are representatives of marine groups, totally absent in surface freshwaters, and showing evident phylogenetic affinities with marine species or groups belonging to the marine planctonic, benthic, or interstitial communities. With reference to their origin, the first group

of limnocybionts was called limnicoid and the second group thalassoid.

### MARINE REGRESSIONS AND THE BIOGEOGRAPHY OF THALASSOID STYGOBIONTS

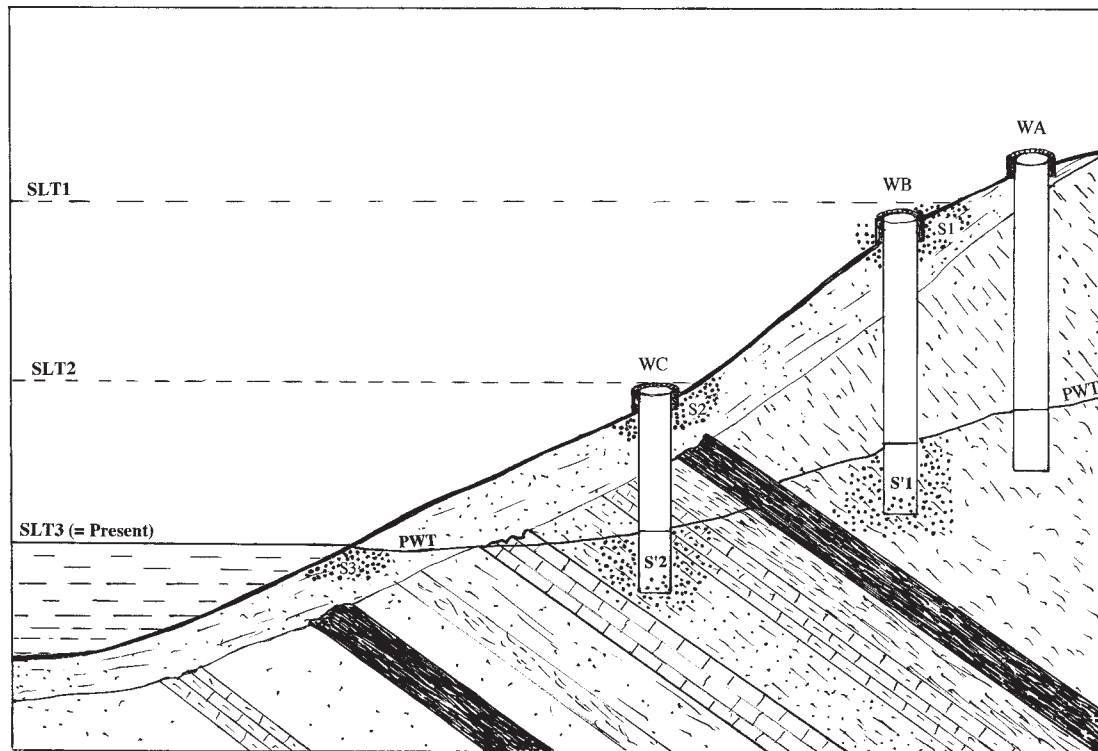
The direct marine origin of the thalassoid limnocybionts has been postulated and acknowledged for a long time by many stygobiologists who came first from France and then from many different countries in the world.

Among the thalassoid limnocybionts occurring in continental subterranean habitats around the Present marine shores, it is possible to mention some Protista such as the Foraminifera known from groundwaters of Central Asia, the Sahara, and Morocco and a high number of Metazoa (or Animalia phyla). Subterranean Porifera and Cnidaria are thalassostygobionts still living in littoral caves, but Platyhelminthes, Nematoda, Annelida (Oligochaeta and Polychaeta) and Gastrotricha, Mollusca, and Arthropoda (mainly representatives of many Crustacea orders but also Hydracarina) often occur within the freshwater thalassoid stygofauna.

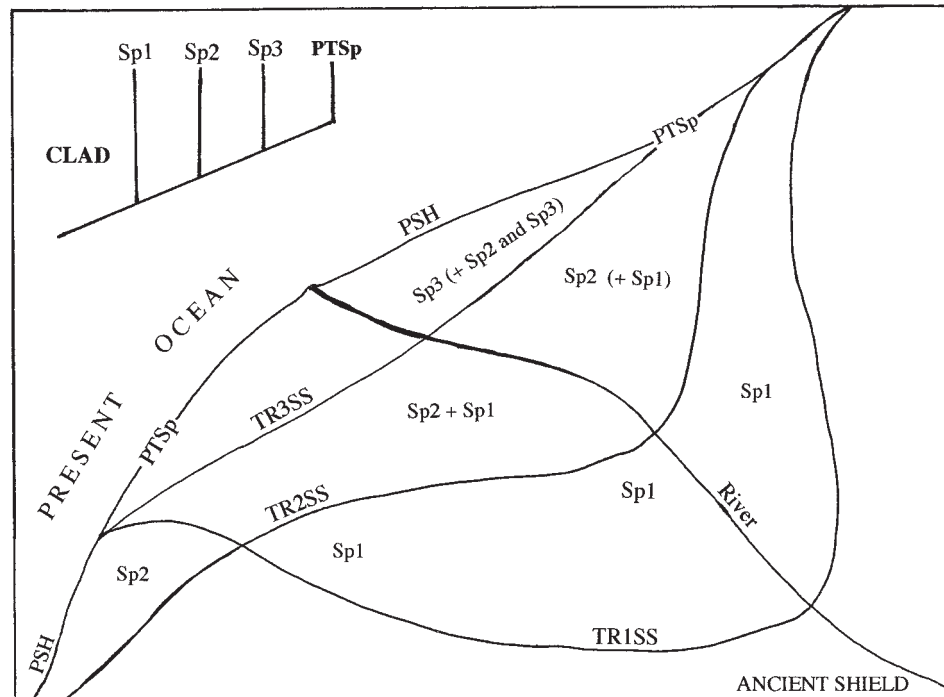
The ecological and evolutionary processes that changed the habitats of some ancestral marine populations which

originated the thalassoid limnocybionts have interested stygobiologists for the last 25 years. J. Stock (1980) was the first to propose a *regression model evolution* which provided an understanding of the occurrence and distribution of subterranean amphipods in caves of the West Indies. The marine regression was considered the event responsible for the origin of subterranean thalassoid crustaceans. These species were simply viewed as descendants from marine populations “stranded” by the receding sea. Then several authors independently described a *two-step model of evolution and colonization* emphasizing the succession of two very different ecological changes. The first one, occurring in marine coastal habitats, is called the “vertical transition.” It is the colonization of subterranean milieu, either in marine caves or more often in interstitial and crevicular environments, correlated with an adaptation to the life in darkness and in the last habitats, in small size interstices. The second step, sometimes called a “horizontal transition,” is an adaptation to life in brackish water and progressively in freshwater. This may have occurred first in the intertidal zone and continued on the spot in groundwater during and after the sea receding (Fig. 1).

This way of viewing the origin of thalassoid limnocybionts occurring in caves or in groundwaters, and the feeble



**FIGURE 1** Origin of two present thalassoid limnocybiontic species, S'1 and S'2, in relation with two successive marine transgression–regression cycles, from time T1 to the Present, T3. The sea level first reached SLT1 at time T1 and then the sea receded. Later a new transgression reached SLT2 in time T2 and receded until the Present sea level, SLT3. S1 is a marine species which colonized the coastal sediments at time T1 (vertical transition), S2 is a thalassostygobiont living during T2 period, and S3 is a present thalassostygobiontic species. The present limnocybionts, S'1 and S'2, are derived from S1 and S2 during the sinking of the water table up to the present water table (PWT). WA, WB, and WC are three present wells. Two different thalassoid stygobiontic species S'1 and S'2 occur in WB and WC as their origin is related to the two different regressions which occur after T1 and T2 (and as an impermeable black layer reducing the possible genetic fluxes between the groundwater populations of WB and WC).



**FIGURE 2** Schematic map showing the geographic distribution of three species of thalassoid limnocybionts, Sp1 to Sp3, in relation to three successive marine regressions. TR1SS to TR3SS are the seashore lines during the maximum of transgressions at the periods T1, T2, and T3. Each transgression was followed by a marine regression as far as the present shore, (PSH). PTSp is a present thalassostygobiontic species still living in a coastal interstitial or cave environment. CLAD is a simplified cladogram showing the phylogenetic relationships within the group of stygobiontic species.

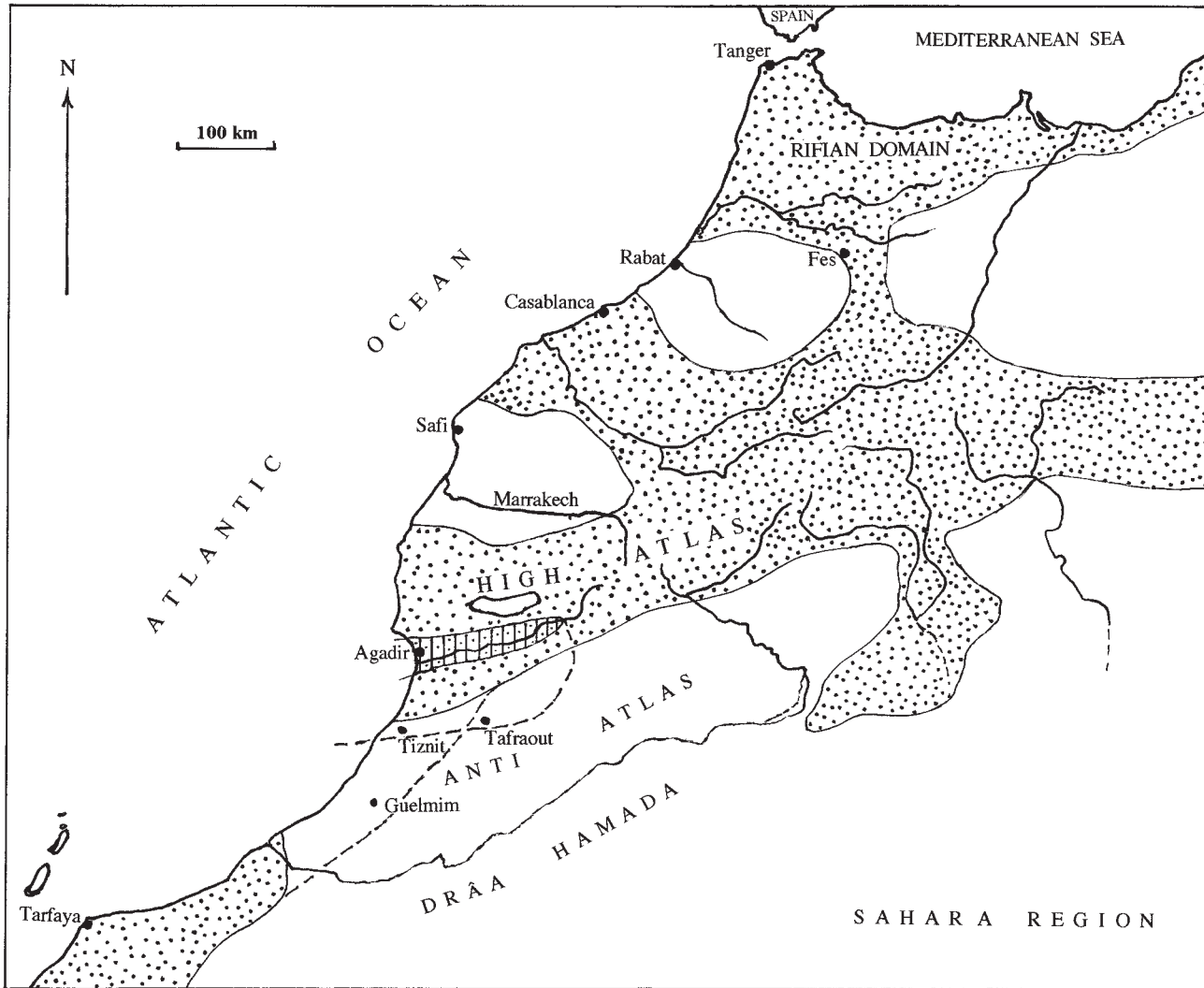
aptitude for active dispersal observed in interstitial and subterranean biota, allow us to understand the correlation which may be observed between the extent of past marine gulfs and the present distribution area of continental thalassoid stygobionts (Fig. 2). Notenboom (1991) emphasized such correlations between the place of past marine gulfs and the distribution of present stygobiontic amphipods from Spain. Boutin (1994b) explained similar correlations occurring with the metacrangonyctid amphipods from Morocco. Many other distribution patterns of limnocybiontic peracarid crustaceans including a number of thalassoid amphipods, isopods, and Thermosbaenacea could probably be well understood in the same way, when considering the two-step model of evolution and colonization.

#### WHEN THALASSOID LIMNOSTYGOBIONTS ARE THE SOLE EVIDENCE OF A MARINE TRANSGRESSION-REGRESSION CYCLE

Usually subterranean biologists use the data provided by the studies of regional historical geology and paleogeography for the reconstruction of biogeographic scenarios which explain the observed species distribution pattern. However, an exactly opposite approach, using biological and paleogeographical data, is sometimes possible. Furthermore, it may happen that some thalassoid limnocybionts, belonging to a well-known group of species, occur in a region character-

ized by an incompletely known paleogeographic history. This can occur when all the Mesozoic and Cenozoic rocks have been removed by recent erosion.

Such a situation occurs in southwestern Morocco where two locations of the amphipod *Longipodacrangonyx* are known in the groundwaters of the Tiznit region, about 40 km south of the known southern limit of the Eocene marine gulf of the Souss valley (Fig. 3). Further south, near the city of Guelmim, another amphipod belonging to the most primitive lineage of the genus *Metacrangonyx* occurs in many sites. Other amphipod species of *Longipodacrangonyx* and species of the primitive lineage of *Metacrangonyx* are well known in many other regions of Morocco where they clearly exhibit a distribution respectively related with the past marine embayments of the Lutetian (mid-Eocene) sea and with those of the Cenomano-Turonian (mid-Cretaceous). Therefore they are considered as the descendants of coastal ancestral populations which colonized the continental sediments during the regressions of the late Lutetian (about 40 m.y. BP) for *Longipodacrangonyx* and during the Turonian (about 90 m.y. BP) for one group of *Metacrangonyx* species. The geological history of the provinces of Tiznit and Guelmim is far from well known because of a recent uplift of the region resulting in the erosion of all marine sediments of Mesozoic and Cenozoic age. There are no data or marks of possible marine deposits in the region that are more than 400 m.y. The occurrence and location of *Longipodacrangonyx*



**FIGURE 3** Schematic and synthetic paleogeographic map of Morocco with present shorelines and rivers. Dotted areas were covered by the Cenomanian–Turonian seas in the late Cretaceous. One of the known Eocene marine gulfs is also figured as a vertically hatched area in the Souss region. (From Choubert and Faure-Muret, 1962 and Andreu-Boussut, 1991 with modification and additional data). Broken lines represent new limits proposed for the southern shore of the Souss Eocene gulf and for the Atlantic Ocean shore of Morocco during the Turonian.

is an indication of an Eocene gulf more southerly extended than supposed from observation of preserved sediments, and the occurrence of *Metacrangonyx* east of the present shoreline is evidence of the presence of the Cretaceous sea during a period which ended with the Turonian marine regression. The presence of this ancient sea near Gelmim and Tiznit is not really surprising to geologists, as the Tarfaya Cretaceous Basin is well known about 200 km in the south, and the High Atlas Cretaceous Basin immediately north of the Souss valley, near Agadir, where marine sediments are preserved. However, the continuity of the Turonian Sea from the Tarfaya Basin to the High Atlas was only a possibility before the discovery in this region of a species of *Metacrangonyx*, which clearly belongs to a group of species that settled in groundwaters during the regression of the Turonian shorelines.

Generally, after a past marine regression, the presence of the sea is usually marked on the continent by the presence of sedimentary rocks containing classic fossils used for dating

the transgression. But if a subsequent erosion occurs, all sediments with their fossils may be removed. In contrast, the thalassoid crustaceans, often called “living fossils,”—settled during the marine regression and later dwelt in subterranean groundwaters. They may survive such erosive destruction, as they are able to change habitat when groundwaters, first embedded in superficial sedimentary rocks, shift into deeper and older rocks during a regional uplift.

#### **DATING MARINE REGRESSIONS OR LAND EMERSIONS FROM THE STYGOFAUNA**

It is noteworthy that the thalassoid limnostygobionts may provide not only the evidence of an ancient sea in the region where they occur, but that they can also, if they belong to a well-known monophyletic group of species, provide an indication about the date of the marine regression which allowed the colonization of subterranean waters by their

ancestral populations. The above example in southwestern Morocco allows the dating of two different marine regressions: one during the Eocene, south of the Present Souss valley, and the other during the late Turonian in the Guelmim province.

The date of the most ancient emerged lands of Israel and Palestine certainly is not Cenozoic, as generally proposed. A species of *Metacrangonyx* belonging to a lineage settled in continental subterranean waters during the marine regression of the Senonian (late Cretaceous) occurs near the Dead Sea, as well as in the eastern Egyptian Sinai near the Eilat Gulf. Some geologists considered the possible emergence of isolated lands in this region during the late Cretaceous from indirect evidence, but these emerged lands or islands are difficult to localize with precision, and in many parts of Israel marine sediments indicate the presence of the sea during the beginning of the Cenozoic. The characteristics of the two species of *Metacrangonyx* known in the region indicate that they are part of a derived group of species which accomplished the transition from marine to continental environment during the Senonian. The suggested conclusion is that late Cretaceous is the age of the most ancient parts of the Levant.

The emergence and the growing of an island, when marine sediments are uplifted above the sea surface, is an ecological event very similar to a marine regression occurring on the margin of a continent. During the closure of the eastern Mediterranean, all the lands of the Levant (eastern Mediterranean countries) formed a continuous emerged land. This was marked on its margins by recent cycles of marine transgressions and regressions. It appeared first as islands, and the greatest age of the land in these countries is that of the most ancient emerged island.

Similarly, the age of the most ancient part of the Canary Archipelago has been dated from Senonian, based on the study of the thalassoid amphipods occurring in wells of Fuerteventura Island (Boutin, 1994b). A part of Fuerteventura is not volcanic, unlike the remainder of the Archipelago, instead it is made of Cretaceous sedimentary marine rocks forming a first emerged island before the Cenozoic, while all studied volcanic rocks are Cenozoic. This island emergence is quite similar to a marine regression discovering lands above sea level and at the same time developing available groundwater habitats for marine crustaceans that are candidates for originating the thalassoid limnocybiontic fauna. It is noteworthy that all the wells housing the Fuerteventura metacrangonyctid amphipod are dug in the "basal complex" and never in the Cenozoic volcanic rocks. *Metacrangonyx* is the sole evidence of the Senonian age of the most ancient part of the island of Fuerteventura.

### EVALUATING THE RATE OF EVOLUTIONARY CHANGES FROM THE MARINE REGRESSION CALENDAR

Many observations made by paleontologists as well as by neontologists suggest that the morphological change in animal lineages is rather low in habitats ecologically stable for

millions of years, and rather important and rapid in unstable habitats subjected to repeated disturbances. As for the molecular evolution, it is generally described following the molecular clock model with the molecular changes occurring regularly and proportionally to the duration. But the average rate of molecular changes fixed in generations forming a lineage is different according to the considered gene, or molecule. Moreover, it is difficult to be sure that, during a long period, the fixation of occurring mutations is always constant. This rate could be dependent on a repeated "bottle neck" occurring in animal populations of a lineage living in unstable habitats. Therefore it has been suggested that it would be especially interesting and informative to study comparatively, both at a molecular level and from a morphological point of view, some thalassoid limnocybionts belonging to different lineages of a group which settled in continental groundwaters during different marine regressions. As a matter of fact, after the vertical transition the different lineages of limnocybionts lived for a long period in the changing and unstable coastal biotopes before the horizontal transition to the more stable continental groundwaters, which resulted from the marine regressions. Probably such comparisons will permit the testing of molecular clocks and the respective value of molecular and morphological characters for the reconstruction of phylogenies. These studies would be possible when the dates of the successive marine regressions, which originated the different lineages within a thalassoid group of limnocybionts, are well known. The first studies with this aim have just been performed and the results are awaited by stygobiologists.

Finally, the biogeography and the history of the thalassoid stygobiontic fauna are closely related with the shifts of the shorelines, and the origin and some evolutionary aspects of these stygobionts result from marine regressions.

### See Also the Following Articles

*Invasion, Active versus Passive • Vicariance and Dispersalist Biogeography*

### Bibliography

- Andreu-Boussut, B. (1991). Les Ostracodes du Crétacé-moyen (Barrémien à Turonien) le long d'une transversale Agadir-Nador (Maroc). *Strata, Série 2 Mémoires*, **14** (1), 1–405.
- Boutin, C. (1994a). Phylogeny and biogeography of metacrangonyctid amphipods in North Africa. In *Biogeography of Subterranean Crustaceans: The Effects of Different Scales* (D. C. Culver and J. R. Holsinger, eds.). *Hydrobiologia*, **287** (1), 49–64.
- Boutin, C. (1994b). Stygobiology and historical geology: The age of Fuerteventura (Canary Island), as inferred from its present stygofauna. *Bull. Soc. Géol. Fr.*, Paris **165** (3), 273–285.
- Boutin, C. (1997). Stygobiologie et géologie historique: l'émergence des terres de Méditerranée orientale datée à partir des Amphipodes Metacrangonyctidae (Micro-Crustacés souterrains). *Geobios M.S.* 21, 67–74.
- Boutin C., and N. Coineau (1990). "Regression model," "Modèle biphasé" d'évolution et origine des micro-organismes stygobies interstitiels continentaux. *Rev. Micropal.* **33** (3–4), 303–322.
- Boutin C., and N. Coineau (1991). Instability of the environmental conditions and evolution rate. Examples of thalassic hypogean microcrustaceans in Mediterranean areas. *Bull. Inst. Géol. Bassin d'Aquitaine*, Bordeaux **50**, 63–69.



- Boutin C., and N. Coineau (2000). Evolutionary rates and phylogenetic age in some stygobiontic species. In *Ecosystems of the World, 30: Subterranean Ecosystems* (H. Wilkens, D. C. Culver, and W. F. Humphreys, eds.), pp. 433–451. Elsevier, Amsterdam.
- Choubert, G. and A. Faure-Muret (1962). Évolution du domaine atlasique marocain depuis les temps paléozoïques. In *Livre à la mémoire du Professeur Paul Fallot*, 1, 447–527. *Mém. h.s. Soc. géol. France*, Paris.
- Coineau, N., and C. Boutin (1992). Biological processes in space and time: colonization, evolution and speciation in interstitial stygobionts. In *The Natural History of Biospeleology* (A. I. Camacho, ed.), pp. 423–451. Monografias 7, C.S.I.C., Madrid.
- Danielopol, D. L. (1980). An essay to assess the age of the freshwater interstitial ostracods of Europe. *Bijdr. Dierk.* **50**, 243–291.
- Holsinger, J. H. (2000). Ecological derivation, colonization, and speciation. In *Ecosystems of the World, 30: Subterranean Ecosystems*. (H. Wilkens, D. C. Culver, and W. F. Humphreys, eds.), pp. 399–415. Elsevier, Amsterdam.
- Notenboom, J. (1991). Marine regressions and the evolution of groundwater dwelling amphipods (Crustacea). *J. Biogeogr.* **18**, 437–454.
- Holsinger, J. R. (1994). Pattern and process in the biogeography of subterranean amphipods. In *Biogeography of subterranean Crustaceans: The Effects of Different Scales* (D. C. Culver and J. R. Holsinger, eds.). *Hydrobiologia*, **287**(1), 131–145.
- Stock, J. H. (1980). Regression Model evolution as exemplified by the genus *Pseudoniphargus* (Amphipoda). *Bijdr. Dierk.* **50** (1), 105–144.

## Maya Caves

**Andrea Stone**

*University of Wisconsin-Milwaukee*

**James E. Brady**

*California State University, Los Angeles*

Ancient Maya civilization extended across southern Mexico, Guatemala, Belize, and western Honduras (Fig. 1). Although this zone has a highland component, it is the limestone-covered Maya Lowlands that saw the rise of the great Classic cities, which are famous for their hieroglyphic inscriptions, fine architecture, and sculpture. The Lowland Maya offer an unusual case study of one of the world's great civilizations emerging in a tropical karst landscape. Moreover, the prevalence of caves in the environment shaped the development of the Classic Maya civilization. Although caves served some practical ends, for instance, sources of water in Yucatan, they principally provided religious sanctuaries and theaters of ritual activity. They also figured prominently in the Maya's mental world of myth and symbol. In their highly stratified society, the Maya's ritual use of caves was an institution that cut across class boundaries. This widespread cultural practice also had great antiquity, accompanying the rise of sedentary villages, beginning in the Early Preclassic Period (ca. 1200 BC). Cave rituals became more elaborate during the Late Classic florescence (600–900 AD) and continued in northern Yucatan and the Maya Highlands through the Postclassic Period



**FIGURE 1** Map of the Maya area with some important archaeological cave sites.

(900–1550 AD). The fact that cave ceremonialism continues today in the Maya area, despite a legacy of colonial persecution, shows the centrality of caves in indigenous religion at the time of the conquest.

### GENERAL CHARACTERISTICS OF ANCIENT MAYA CAVE UTILIZATION

The ancient Maya explored caves with the aid of wooden torches. Bundles of split pine torches have been recovered in cave entrances and burnt remains recovered in deeper passages. Charcoal torch strikes on cave walls are also common. One of the few cave-specific tools developed by the Maya is a ceramic tube that served as a torch holder. Unlike Paleolithic cave explorers who penetrated equal depths by firelight, the ancient Maya never used oil lamps. Light appears to have been a limiting factor in their speleological exploits. Their record for penetration of a cave is 3 km, set at Actun Chek, Belize. The longest caves in the Maya area are the Chiquibul and Cave's Branch cave systems of Belize, where individual caves reach 15 km in length. Most caves explored by the ancient Maya are more modest; however, small size did not preclude their designation as sacred sites. Even the smallest caves, cenotes, and rockshelters were ritually utilized. Although the Maya generally explored the deepest parts of caves, the heaviest concentration of artifacts is usually found in the light to twilight zones near entrances. Forays into the dark zone may have been restricted to ritual specialists.

### ANTIQUITY OF MAYA CAVE USE

Evidence for cave utilization in the Maya area prior to the advent of sedentary villages, ca. 1200 BC, is extremely limited. The discovery at Loltun Cave, Yucatan, of stone tools associated with extinct megafauna offers some evidence for use during the late Pleistocene. Charcoal from a hearth in Carwash Cenote, Quintana Roo, yielded a radiocarbon date of  $8250 \pm 80$  years BP. The picture is equally dim during the Archaic period but begins to clarify during the Preclassic. At Copan, Honduras, ceramic evidence from Gordon's Cave #3 indicates its use as an ossuary as early as 1000 BC. Major architectural modifications at the Cueva de las Pinturas, Guatemala, have been dated to the end of the Middle Preclassic (300 BC), and stone masonry at Naj Tunich, Guatemala, dates to the Late Preclassic. An elaborate figure carved at an entrance to Loltun Cave suggests that the site was appropriated for elite use by the late Preclassic.

### CAVE BURIAL

Human skeletal material in caves reflects both the disposal of sacrificial victims and the burial of loved ones. Rockshelters were often used as cemeteries in the southern Maya Lowlands from at least the Late Preclassic (300 BC to 300 AD) to the end of the Classic Period (900 AD). Important individuals were buried in cave alcoves that were closed off with crude stone walls. This practice appears to be confined to the Preclassic except at Naj Tunich, which is unique in having elaborate masonry tombs dating to the Classic period.

A number of cave ossuaries have been reported, generally in the Highlands, although the data are sketchy. On the eastern edge of the Maya area, Gordon's Cave #3 near Copan contains hundreds of cremated remains from roughly 1000 BC that appear to have been brought to the cave in cloth bags. On the western edge of the Maya area in Chiapas, small, walled-up caves yielded sealed ceramic vessels that contained cremated human remains dating to the Postclassic (900–1550 AD). Ethnohistorical sources from Chiapas mention the worship of bundles in caves containing the remains of ancestors, and ethnographic sources suggest that important males were interred in lineage caves up until the close of the 19th century. If, as these sources suggest, the ossuaries are associated with ancestor worship, it is interesting to note that many Maya still believe that ancestors live within the earth.

### CAVE MODIFICATIONS

Almost all Maya caves show extensive breakage of speleothems. Often broken formations have been moved or taken from the cave, and speleothems are frequently reported in cultural deposits at surface sites. Modern indigenous terms for speleothems identify them as congealed water or dripping water turned to stone. Because water is so essential to



**FIGURE 2** Altar-like construction from Actun Kabal, Belize. (Photograph by Andrea Stone.)

agriculture, speleothems are directly related to fertility, and today they are placed on household altars. Similar ideas were probably held by the Classic Maya.

The Maya deployed various types of architectural constructions to modify space within caves. Among the most common are stone walls defining enclosures. Walls with low doorways intentionally impede access by forcing visitors to enter on hands and knees. Retaining walls and dirt fill were used to create level spaces. Plaster floors and stone pavements also demarcated special areas. Altars, often nothing more than a crude stack of stones, are frequently reported (Fig. 2). Stairways leading down into caves appear most frequently in Yucatan and Quintana Roo. Dams have been reported in several caves with seasonal flooding. Finally, small architectural structures, probably reserved for the most private rituals, were occasionally built inside caves.

### CAVE ART

With about sixty known decorated caves, the Maya Lowlands have one of the most important cave art traditions in the world. Pigment-based art consists of paintings, drawings, and both positive and negative hand- and footprints, often utilizing charcoal and clays available in the cave. However, prepared mineral pigments, such as red — from hematite — blue, and yellow occur in rare instances. The most typical carvings, mainly found in Yucatan, Quintana Roo, and Belize, are deeply engraved petroglyphs showing frontal faces, meanders, and geometric elements. Another category of sculpted art is the modified speleothem, typically shaft-shaped speleothems with crudely carved faces (Fig. 3). These may represent spirit beings embodied in stone. Artistic modification of speleothems was widely practiced among the Classic Maya. Rare examples of painted petroglyphs and sculptures modeled from clay are also known.

Although the sculpted art tends to be crude, some of the painted art is refined and resembles elite art. This is epitomized by the paintings of Naj Tunich, Guatemala, dating to the 7th and 8th centuries. Both hieroglyphic



**FIGURE 3** Modified speleothem from a cave in Guatemala. (Drawing by Anne Chojnacki.)

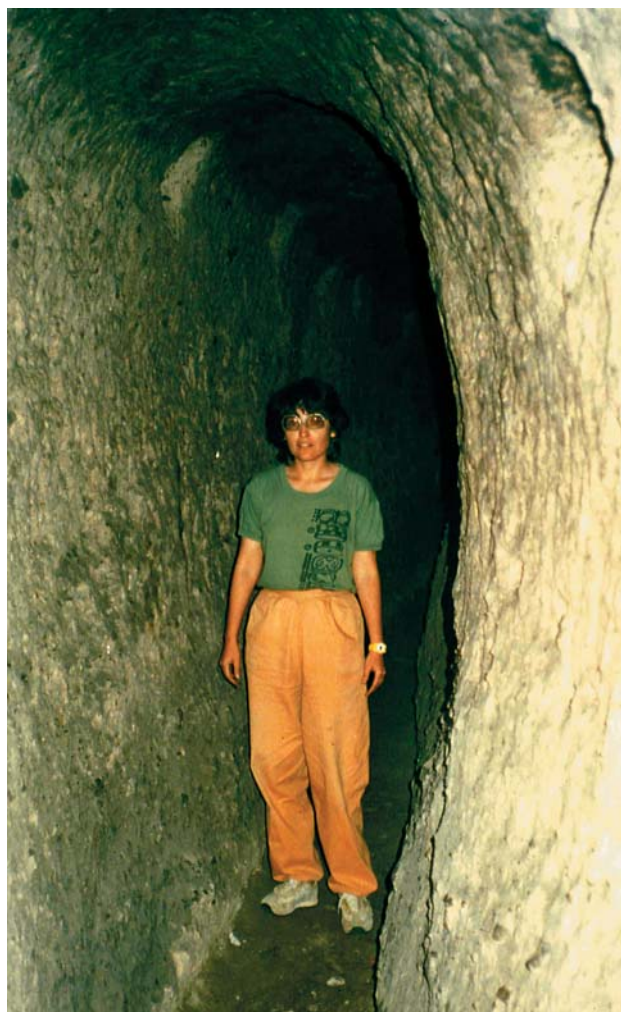
inscriptions and depictions of human figures which evince elite cave utilization are present. The hieroglyphs reveal that political relations among regional sites were mediated by ritual cave use and that some caves, such as Naj Tunich, held higher status than others as regional pilgrimage destinations. The painted cave art has been the subject of technical analysis including AMS radiocarbon dating and multispectral imaging.

### ETHNOHISTORY AND ETHNOGRAPHY

Colonial documents and modern ethnographic studies of the Maya aid in the reconstruction of Classic Maya cave use. An important colonial source is the *Popol Vuh*, a K'iche' Maya text recounting the adventures of supernatural twins in an underworld realm called Xibalba, "place of fright," a thinly-veiled allusion to a cave. The *Popol Vuh* reveals thematic associations of caves with danger, regeneration, and the ballgame.

In indigenous cosmology the first appearance of humans on the face of the Earth is from a cave, the womb of the Earth. Thus, caves are the primary symbol of human and world creation. Not surprisingly, caves play an important role in conceptions of sacred geography, definitions of territorial boundaries, and pilgrimage routes in today's Maya communities and probably did so in the past.

As penetrations into the sacred Earth, caves are the residences of ancestors and supernatural beings. The most important indigenous deity in the Maya Highlands today is known by a name that translates as "Hill-Valley." He/she controls the fruits of the Earth and is petitioned in caves. The cave's association with water is equally important among contemporary groups, many of whom believe that storms emanate from caves. In dry areas, such as Yucatan, the presence of a cave or cenote influenced the location of settlements. Cave water was ritually pure and in Yucatan was called *subuy ha* or "virgin water." Archaeological evidence of ritual activity near pools of water in caves and the placement of ceramic vessels and stone troughs under drips, often in remote areas, are testimony to the antiquity of this belief.



**FIGURE 4** Artificial cave dug in volcanic ash under the central plaza of the Pre-Columbian settlement of Utatlan, Guatemala. This cave is an important religious site among contemporary highland Maya. (Photograph by James Brady.)

## CAVES AND COMMUNITY

The identity of Maya communities with caves is so close that the cave often gives its name to the community. In colonial rituals at the foundation of a new community, the presence of a cave was considered essential and lent authority to settlers' claims to occupy and govern a territory. Because the cave symbolized political legitimacy in Mesoamerica, it is not surprising that the pre-Hispanic Maya elite incorporated caves into their ritual activity and their elaborate architecture. Caves have been found to underlie building complexes, including pyramids, at such sites as Chichen Itza, Mayapan, Tulum, Polol, and Dos Pilas.

Caves were so important that, in the nonkarstic area of the Maya Highlands where caverns do not occur naturally, artificial caves were excavated, often beneath pyramids or other architecture. Such tunnels have been found at the sites of Utatlan, Mixco Viejo, Zaculeu, Iximche, and La Lagunita in Guatemala (Fig. 4). The fact that artificial caves have also been reported at the Central Mexican sites of Teotihuacan, Xochicalco, and Acatzingo Viejo suggests that caves were a fundamental concern throughout Mesoamerica.

### Bibliography

- Brady, J. E. (1997). Settlement configuration and cosmology: The role of caves at Dos Pilas. *Am. Anthropol.* **99** (3), 602–618.
- Brady, J. E. (1999). *Sources for the Study of Mesoamerican Ritual Cave Use, 2nd ed.* Studies in Mesoamerican Cave Use, Publication 1. California State University, Los Angeles, Los Angeles.
- García-Zambrano, A. J. (1994). Early colonial evidence of Pre-Columbian rituals of foundation. In *Seventh Palenque Round Table, 1989*, (M. G. Robertson and V. Field, eds.), pp. 217–227. Pre-Columbian Art Research Institute, San Francisco, CA.
- McNatt, L. (1996). Cave archaeology of Belize. *J. Cave Karst Sci.* **58** (2), 81–99.
- Stone, A. J. (1995). *Images from the Underworld: Naj Tunich and the Tradition of Maya Cave Painting*. University of Texas Press, Austin.
- Stone, A. J. (1997). Pre-Columbian cave utilization in the Maya area. In *The Human Use of Caves*, (C. Bonsall and C. Tolan-Smith, eds.), pp. 201–206. BAR International Series 667. Archaeopress, Oxford, England.
- Thompson, J. E. S. (1975). Introduction to the reprint edition. In *The Hill-Caves of Yucatan*, (by H. C. Mercer). University of Oklahoma Press, Norman.
- Vogt, E. Z. (1981). Some aspects of the sacred geography of Highland Chiapas. In *Mesoamerican Sites and World Views*, (E. P. Benson, ed.), pp. 119–142. Dumbarton Oaks Research Library and Collection, Washington, DC.

# Microbes

David C. Culver  
American University

**B**acteria, Fungi, and Archaea are nearly ubiquitous in caves. They range from common, surface-dwelling bacteria to some of the most metabolically exotic organisms known.

They have a critical part to play in (1) the processing and breakdown of organic matter, (2) the production of organic matter (chemolithoautotrophy), and (3) dissolution of rock and the deposition of minerals. Because of the presence of unusual Bacteria and Archaea in caves, the isolation of these strains has potential in the development of new anticancer and other drugs. Some caves may be useful models for the study of the origin of life and extraterrestrial life.

## INTRODUCTION

The early study of microbes in caves was largely limited to culturing bacteria and fungi collected in the “typical” well-oxygenated, aphotic environment of caves. These microbes are for the most part identical to surface strains. These strains are active only under favorable conditions, especially the presence of organic matter. In an early (1963) but remarkably prescient review, the French microbiologist Victor Caumartin noted that a list of all microorganisms that have been encountered in caves could never be complete and would be of little interest. Indeed, he spoke of caves as being “contaminated” with surface bacteria. This is somewhat misleading, as “contamination” with surface bacteria is a natural process and, with certain extremely rare exceptions (caves with natural entrances and isolated from all surface waters), is present in all caves. Further, these “contaminants” play a key role in the processing and breakdown of organic matter. The reason that Caumartin used the phrase was because what was especially interesting about caves from a microbiological point of view was the possibility of chemolithoautotrophy, the process of obtaining energy and synthesizing organic compounds from inorganic chemical compounds and the energy from chemical bonds. In the more than 40 years since Caumartin’s review, several technological and conceptual changes have resulted in an enormous increase in knowledge about cave microbes. The first of these changes has been the use of molecular techniques, especially the ability to sequence 16sRNA gene sequences, that have expanded the microbiological tool box well beyond culturing of strains. The range of techniques also includes stable carbon isotope ratio analysis (SIRA), marker genes, radioisotope experiments, electron microscopy, and fluorescence *in situ* hybridization (FISH). The second of these changes is the recognition that redox environments occur in caves and that these reduced-oxygen environments are especially interesting places to look for unusual microbes. This was coupled with an improved ability to sample these environments as a result of development of better techniques for cave diving and for measuring water chemistry in real time. The third change came from studies of deep-groundwater habitats that were sampled from deep wells. The discovery of bacteria at depths of more than a kilometer and that these Bacteria and Archaea have played a major role in geochemical processes helped cave microbiologists realize that cave microbes might play a major geochemical role as well. Finally, the discovery of

several caves with highly unusual chemical environments made the study of both chemolithoautotrophy and geomicrobiology possible. These caves include Movile Cave in Romania, Frassasi Caves in Italy, Cesspool Cave in Virginia, and Lower Kane Cave in Wyoming.

## PROCESSING AND BREAKDOWN OF ORGANIC MATTER

For the most part, organic matter in caves is not produced in caves by chemolithoautotrophy but rather enters from the surface. It comes in through entrances as a result of gravity, water movement, and the movement of animals. It comes with water whenever and however water enters the cave. This organic matter forms the basis of the detritivore animal communities of caves. Bacteria and fungi are key to the breakdown of this organic matter, just as they are in surface environments. Examples of such “contaminant” microbes, to use Caumartin’s phrase, are shown in Table I. It is no surprise that the density of microorganisms is lower in the cave than in surface habitats—there is much less organic matter in caves. However, in their study of Old Mill Cave in Virginia, Dickson and Kirk found two samples in the cave that were as high or higher than the averages shown in Table I. At least in Old Mill Cave, bacteria, actinomycetes, and fungi are very patchily distributed in the cave. They also found that terrestrial invertebrate populations in the cave were positively correlated with fungal, but not bacterial density, suggesting that fungi may have particular importance in the detritivore food web.

Caumartin suggested that, as organic matter is broken down, chemoautotrophs would predominate. Based on what is currently known, this does not seem to be the case. Rather, chemolithoautotrophy in caves often seems to involve redox environments, typically with the involvement of sulfur compounds. Caumartin’s conjecture remains unproven.

## CHEMOLITHOAUTOTROPHY

The first well-documented case of chemolithoautotrophy in caves is that of Movile Cave along the Romanian Black Sea coast. The evidence put forward in support of chemolithoautotrophy in this cave includes:

**TABLE I Plate Counts of Microorganisms in and Near Old Mill Cave in Virginia**

Sample Description	Number of Samples	Average Plate Count ( $\times 10^{-3}$ per gram)		
		Bacteria	Actinomycetes	Fungi
Forest soil above cave	3	11,700	3600	500
Floor, dark passages	7	2607	104	49
Mud, creek outside cave	3	1000	20	3
Mud, creek inside cave	6	348	63	15

Source: Data from Dickson and Kirk (1976).

- Identification of the autotrophic bacteria *Thiobacillus thioparus* LV43
- Demonstration of RuBisCO presence and activity, indicating autotrophy
- Elucidation of the pathway of carbon using stable isotope ratios
- Radioisotope studies of  $^{14}\text{C}$ -labeled bicarbonate fixation

The chemoautolithotrophic processes identified in caves include iron oxidation, sulfur oxidation, sulfate reduction, iron reduction, ammonia oxidation, methanogenesis, and methanotrophy. Of these, only sulfur oxidation has been at all well studied. Filamentous sulfur-oxidizing bacteria form microbial mats or biofilms in some caves. Among the genera of sulfur oxidizers are *Achromatium*, *Beggiatoa*, *Thiobacillus*, *Thiomicrospira*, *Thiomonas*, and *Thiothrix*. Rates of chemoautotrophic fixation can be quite high—a rate of 30.4 ng C per mg dry wet per hr was reported for Cesspool Cave in Virginia. Based on sequence analysis of the ribosomal RNA of the microbial mat in this cave, there were at least five species in the microbial mat. Several of the *Thiobacillus* strains demonstrated the ability to corrode calcium carbonate, suggesting that they may also be involved in cave formation and enlargement.

## DISSOLUTION OF ROCK AND DEPOSITION OF MINERALS

In the lifespan of a solution cave, the process of dissolution of rock predominates at first, but as time passes the process of deposition (the production of calcium-carbonate speleothems and other cave minerals) assumes greater importance. Perhaps the most exciting development in cave science that occurred toward the end of the 20th century was the realization that microbes might well play a key role in both of these processes. Iron, manganese, and sulfur-oxidizing bacteria generate acidity that can in turn dissolve  $\text{CaCO}_3$ . For example, sulfur oxidizers such as *Thiobacillus* gain energy from the oxidation of sulfide and thiosulfate to sulfuric acid. Of course, sulfuric acid and other acids are produced abiotically, and the question, largely unanswered, is the extent of microbial involvement in these processes. There is evidence that microbial involvement may be very important. This includes the presence of iron and manganese oxidizing bacteria in “corrosion residues” in Lechuguilla Cave in New Mexico. The presence of acid biofilms in Cueva de Villa Luz in Mexico also points to a role for bacteria in cave formation.

Evidence for the key role of microbes in precipitation of some minerals is very strong. Microbes can act as centers of precipitation of minerals, and a wide variety of microbes, including fungi and heterotrophic bacteria, have been implicated. More generally, numerous observations have been made of bacteria (including the minute “nannobacteria”, purported to be bacteria 50–200 nm in diameter) on and in mineral precipitates in caves. In only a few cases have these

observations been backed up by more detailed studies. This is especially true for “moonmilk,” a calcium-carbonate mineral aggregate ranging in appearance from talcum powder to cottage cheese. Both abiotic and biotic mechanisms may be important.

Iron oxide crusts may be microbiological in origin. At a minimum, iron- and manganese-oxidizing bacteria such as *Gallionella ferruginea* and *Leptothrix* are present in caves with iron and manganese wall crusts. The relative enrichment of gypsum in the light stable isotope of sulfur points to the likely microbial involvement of sulfur-oxidizing bacteria in gypsum deposition.

One of the most interesting cases of likely microbial involvement in mineral deposition in caves is that of calcium nitrate (saltpeter), which was extensively mined in the United States during the Civil War. An interesting feature of these mines was that saltpeter earth regenerates itself. Although still the subject of debate, many studies support the role of nitrifying bacteria in this process, especially *Nitrosomonas*, which converts ammonia to nitrite, and *Nitrobacter*, which converts nitrite to nitrate. The source of the ammonia is unclear, but it is likely to be from water dripping into the cave.

In general, microbiological studies to date have shown that there is a microbiological mechanism that can account for many cave minerals as well as cave corrosion. Microbiological mechanisms include: (1) microbial cells functioning as centers of precipitation, (2) secretions and waste products that change the chemistry of the microenvironments, (3) modification of activated complexes, and (4) possible (but unlikely) modification of the thermodynamic equilibrium. W.B. White has pointed out that what microbes cannot do is break the second law of thermodynamics so that energetically unfavorable reactions can proceed. What remains is to demonstrate its quantitative importance.

### CAVE MICROBES AS NEW DRUG AGENTS

There has been growing interest in the potential of cave microbes as drug agents, especially anticancer drugs. Several features of cave microbes increase the likelihood of their usefulness. First, because they are in food-poor environments, they may have strong chemical defense mechanisms against other microbes such as antimetabolites. Second, simply because they are unknown, they are worth considering. While some promising discoveries have been made by Mallory and others, no drug has yet been brought to market.

### ORIGIN OF LIFE AND EXTRATERRESTRIAL LIFE

In the evolution of life on Earth, chemoautotrophy likely evolved before photoautotrophy. Among the evidence for this is that chemoautotrophs are more basal on the tree of life than photoautotrophs and that free oxygen is a metabolic poison to many anaerobic organisms. Furthermore, climatic conditions both in the early history of Earth and for other

planets in the solar system were such that it was either too hot (early Earth) or too cold (present-day Mars) for liquid water to be stable on the surface of the planet. In this case, liquid water may have been present underground, offering potentially favorable conditions for the evolution of life. Several speleologists have suggested that caves such as Lechuguilla Cave in New Mexico and Movile Cave in Romania may be models of the kinds of environments where extraterrestrial life might occur and may even represent the kind of environment where life on Earth evolved.

### See Also the Following Articles

*Chemoautotrophy* • *Lechuguilla Cave, New Mexico* • *Saltpetre Mining* • *Speleothem Deposition* • *Speleothems: Helictites and Related Forms*

### Bibliography

- Caumartin, V. (1963) Review of the microbiology of underground environments. *Bull. Natl. Speleol. Soc.* 25: 1–14.
- Dickson, G.W. and Kirk, P.W., Jr. (1976) Distribution of heterotrophic microorganisms in relation to detritivores in Virginia caves (with supplemental bibliography on cave mycology and microbiology) In *The Distributional History of the Biota of the Southern Appalachians*. Part IV. *Algae and Fungi* (B.C. Parker and M.K. Roane, Eds.), University Press of Virginia, Charlottesville, pp. 205–226.
- Northup, D.E., Dahm, C.N., Melim, L.A., Spilde, M.N., Crossey, L.J., Lavoie, K.H., Mallory, L.M., Boston, P.J., Cunningham, K.J., and Barns, S.M. (2000) Evidence for geomicrobiological interactions in Guadeloupe caves. *J. Cave Karst Studies* 62: 80–90.
- Northup, D.E. and Lavoie, K.H. (2001) Geomicrobiology of caves: a review. *Geomicrobiol. J.* 18: 199–222.
- Sasowsky, I.D. and Palmer, M.V., Eds. (1994) *Breakthroughs in Karst Geomicrobiology and Redox Geochemistry*. Special Publ. 1, Karst Waters Institute, Charles Town, WV.
- Summers, E.A., Porter, M.L., Kinkle, B.K., and Kane, T.C. (2001) Ecological assessment and geological significance of microbial communities from Cesspool Cave, Virginia. *Geomicrobiol. J.* 18: 259–274.
- Taylor, M. R. (1999). *Dark Life: Martian Nanobacteria, Rock-Eating Bugs, and Other Extreme Organisms of Inner Earth and Outer Space*, Scribners, New York.
- Vlasceanu, L., Popa, R., and Kinkle, B.K. (1997) Characterization of *Thiobacillus thiooparus* LV43 and its distribution in a chemoautotrophically based groundwater ecosystem. *Appl. Environ. Microbiol.* 63: 3123–3127.

## Minerals

**Bogdan P. Onac**

*Babes-Bolyai University and Emil Racovita Institute of Speleology, Romania*

This chapter presents a short review of the physical, chemical, and crystallographic properties of cave minerals. In addition, their general modes of occurrence and genesis under various cave settings are discussed. To suit the needs of any particular reader, nearly 30 of the most common cave mineral species are described in this chapter. This provides the necessary backdrop for anyone eager to know about cave mineralogy.

## INTRODUCTION

Caves are natural subterranean cavities, fissures, and fragments of conduit systems that are accessible to human exploration. The cave environment typically maintains constant temperature, water vapor pressure, and carbon dioxide pressure over long periods. Solutions entering the caves, according to their primarily chemical composition or following the reaction with different cave deposits (i.e., limestone, clay minerals, detritus), will precipitate a variety of interesting, sometimes unique, cave minerals. Only secondary mineral species (i.e., formed within the cave from a physical process or a chemical reaction) are considered true cave minerals.

Although several types of reactions may take place in the cave environment, those that are ultimately responsible for the deposition of cave minerals fall into one of the following categories: (1) dissolution/precipitation (e.g., calcite, gypsum), (2) hetero- or homogeneous acid/base reactions (the  $MgO-CO_2-H_2O$  system, carbonic acid), (3) phase transitions (aragonite/calcite inversion), (4) hydration/dehydration (e.g., mirabilite/thenardite, brushite/monetite, etc.), and (5) redox reactions involving mainly manganese and sulfur.

Moore (1970) published the first checklist of cave minerals. He included 68 cave minerals formed within and outside of the United States. Six years later, another comprehensive compilation of nearly 80 minerals, primarily a review of United States cave mineralogy, had been undertaken (Hill, 1976). The first book to provide worldwide coverage on this topic was the first edition of *Cave Minerals of the World* (Hill & Forti, 1986). This edition summed up 173 minerals, 86 of which were either ore-related or miscellaneous, uncommon cave minerals. In the second edition of the same book 255 cave minerals were reported, 125 of which were precipitated under special cave settings. In the last 6 years, 23 new cave minerals have been added. Apart from these two books specifically dedicated to cave minerals, other reviews on this topic can be found in White (1976, 1988), Bögli (1980), Ford and Williams (1989), Gillieson (1996), and Onac (2000).

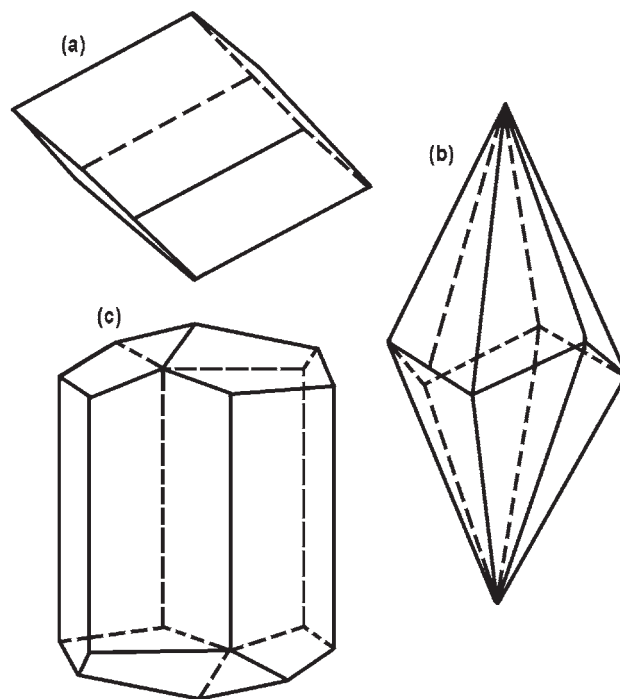
This exponential increase in the number of cave minerals over the last 30 years is due to (1) advancements in analytical facilities (X-ray powder diffraction, X-ray fluorescence spectrometry, scanning electron microscopy, electron microprobe, etc.); (2) discovery of many new cavities carved by either  $H_2S$ -rich or hydrothermal ore-forming solutions, skarn-hosted caves, etc. (all displaying a diverse and fascinating mineralogy); and (3) the increasing interest for nondescript weathering crusts and various earthy masses existing within caves.

Minerals most likely to be encountered in a “normal” cave environment (i.e., limestone, gypsum, or salt caves) belong to eight chemical classes. Our approach will emphasize only the chief minerals of each class that are represented in the cave environment following *Dana’s New Mineralogy* scheme

(Gaines, Skinner, Mason, Foord, & Rosenzweig, 1997). Less attention will be given to species, which are rare, or which do not ordinarily appear in caves except in a unique set of conditions (ore-related and other miscellaneous minerals). Within each of *Dana’s* classes, physical and chemical properties of the more common cave minerals are discussed, along with their general modes of occurrence, genesis, and stability under various cave settings. The crystallographic data for the common cave mineral species are listed in Table I. Organic minerals are given a brief overview. The presentation is arranged according to the abundance of each chemical subclass in the cave environment.

## CARBONATES

Approximately 27 carbonate species are reported from caves worldwide. Of these, calcite and aragonite are the two most common and abundant (Table I). Calcite is the thermodynamically stable form of calcium carbonate under temperature, pressure, and  $CO_2$  partial pressure found in caves. Crystal habits include rhombohedrons, scalenohedrons (dogtooth), prismatic (nailhead), or combinations of these (Fig. 1). Aragonite is the metastable, orthorhombic polymorph of calcite and occurs as short-to-long prismatic (along  $c$ ), acicular or tabular (chisel-shaped) crystals, often twinned. With time (i.e., geologic time scales) aragonite will internally change its crystal structure to the stable calcite; however, the external habit of aragonite will remain preserved. Both calcite



**FIGURE 1** Common crystal habits of calcite: (a) rhombohedron; (b) scalenohedron (dogtooth); and (c) prismatic (nailhead). (Adapted from Onac, B. P. (2000). *Geology of Karst Terrains*. Editura Didactica si Pedagogica, Bucuresti, Romania.)

TABLE I Crystallographic Data for Common Cave Minerals

Mineral	Crystal system	Unit cell parameters		Observations
		$a_0$ (Å)	$\alpha$ (°)	
<b>Chemical formula</b>		$b_0$ (Å)	$\beta$ (°)	
		$c_0$ (Å)	$\gamma$ (°)	
<b>Carbonates</b>				
Calcite CaCO <sub>3</sub>	Trigonal	4.99		Vigorous effervescence in cold dilute HCl, perfect rhombohedral cleavage; exhibits double refraction; rhombohedral, prismatic (nailhead), scalenohedrons (dogtooth) or twinned crystals
Aragonite CaCO <sub>3</sub>	Rhombic	17.061 4.959 7.964 5.737		Acicular; sinks in bromoform; columnar aragonite has cleavage parallel to elongation; twins are common
Hydromagnesite Mg <sub>5</sub> (CO <sub>3</sub> ) <sub>4</sub> (OH) <sub>2</sub> ·4H <sub>2</sub> O	Monoclinic	10.11 8.94 8.38	114.5°	Common in moonmilk, nodules, earthy masses; feels like cream cheese when rubbed between the fingers
Malachite Cu <sub>2</sub> <sup>2+</sup> (CO <sub>3</sub> )(OH) <sub>2</sub>	Monoclinic	9.48 12.03 3.21	98°	Green color and streak; botryoidal habit; typically banded
<b>Sulfates</b>				
Gypsum CaSO <sub>4</sub> ·2H <sub>2</sub> O	Monoclinic	5.678 15.20 6.52	118.43°	Low hardness; perfect cleavage after (010); swallow-tail twins; flexible; soluble in hot dilute HCl
Epsomite MgSO <sub>4</sub> ·7H <sub>2</sub> O	Rhombic	11.86 11.99 6.85		Acicular crystals elongated parallel to <i>c</i> , powdery crusts; bitter taste; very soluble in water; vitreous, fibrous, silky luster; frequently associated with gypsum
Mirabilite Na <sub>2</sub> SO <sub>4</sub> ·10H <sub>2</sub> O	Monoclinic	11.51 10.37 12.85	107.80°	Bitter and salty taste, very soluble
Celestine SrSO <sub>4</sub>	Rhombic	8.37 5.35 6.87		Tabular and fibrous crystals; characteristic pale blue color; brilliant red flame coloration
Barite BaSO <sub>4</sub>	Rhombic	8.88 5.45 7.15		Tabular and prismatic crystals; high specific gravity; green flame coloration
<b>Phosphates</b>				
Brushite CaHPO <sub>4</sub> ·2H <sub>2</sub> O	Monoclinic	6.36 15.19 5.18	118.45°	Colorless to ivory yellow; needle-like or prismatic crystals; earthy or powdery
Carbonate-hydroxylapatite Ca <sub>5</sub> (PO <sub>4</sub> CO <sub>3</sub> ) <sub>3</sub> (OH)	Hexagonal	9.30 6.92		Slight effervescence with HCl; widely referred to as <i>dahlite</i>
Hydroxylapatite Ca <sub>5</sub> (PO <sub>4</sub> ) <sub>3</sub> (OH)	Hexagonal	9.41 6.87		Compact to coarse granular in crusts; various shades of brown and red; indistinct cleavage
Taranakite K <sub>2</sub> Al <sub>5</sub> H <sub>6</sub> (PO <sub>4</sub> ) <sub>8</sub> ·18H <sub>2</sub> O	Trigonal	8.71 95.1		Nodules, flour-like masses; white, gray, yellowish; acidic environment indicator; first reported as <i>minervite</i>
Ardealite Ca <sub>2</sub> (SO <sub>4</sub> )(HPO <sub>4</sub> )·4H <sub>2</sub> O	Monoclinic	5.72 30.95 6.26	117.29°	Fine-grained powdery masses; white to pale yellow; associated with gypsum and brushite; described from Cioclovina Cave, Romania
<b>Oxides &amp; Hydroxides</b>				
Goethite FeO(OH)	Rhombic	4.62 9.95 3.01		Blackish brown to yellow or reddish; typically massive, botryoidal, with internal radiating fibrous or concentric structure; pseudomorphs after pyrite
Ice H <sub>2</sub> O	Hexagonal	4.52 7.36		Melts at 0°C; form sublimation crystals
Birnessite (Na,Ca,K) <sub>x</sub> (Mn <sup>4+</sup> ,Mn <sup>3+</sup> ) <sub>2</sub> O <sub>4</sub> ·1.5H <sub>2</sub> O	Monoclinic	5.174 2.85 7.33	103.18°	Red-brown streak; soluble in concentrate HCl; commonly earthy and admixed with other Fe and Mn oxides and hydrates



TABLE I Crystallographic Data for Common Cave Minerals—cont'd

Mineral	Crystal system	Unit cell parameters	Observations
<b>Silicates</b>			
Opal	Amorphous		Botryoidal crusts, banded; conchoidal fracture; brittle
SiO <sub>2</sub> ·nH <sub>2</sub> O			
Quartz	Trigonal	4.91	Prismatic crystals terminated by hexagonal dipyrmaid or rhombohedra faces; practically any color; high hardness; soluble only in HF; no cleavage
SiO <sub>2</sub>		5.40	
Allophane	Amorphous		Earthy masses, moonmilk-like deposits; white, pale-cream, yellow
mAl <sub>2</sub> O <sub>3</sub> ·nSiO <sub>2</sub> ·pH <sub>2</sub> O			
<b>Halides</b>			
Halite	Cubic	5.64	Salty taste, perfect cubic cleavage, low hardness
NaCl			
Fluorite	Cubic	5.46	Isometric; fluorescent in UV, no effervescence in HCl
CaF <sub>2</sub>			
<b>Nitrates</b>			
Niter	Rhombic	5.41	Cooling taste, soluble in water, violet flame
KNO <sub>3</sub>		9.16	
		6.43	

and aragonite may appear as monocrystals. More commonly these crystals are associated in polycrystalline aggregates shaped into a countless number of speleothem types (i.e., soda straws, stalactites, and stalagmites).

Although dolomite (a mineral containing magnesium) is very common as a rock, it is extremely rare as a secondary cave mineral. Except for huntite, CaMg<sub>3</sub>(CO<sub>3</sub>)<sub>4</sub>; dolomite, CaMg(CO<sub>3</sub>)<sub>2</sub>; and hydromagnesite, the Mg-rich cave minerals are quite uncommon. These minerals, along with magnesite, MgCO<sub>3</sub>; monohydrocalcite, CaCO<sub>3</sub>·H<sub>2</sub>O; and nesquehonite, Mg(HCO<sub>3</sub>)(OH)·2H<sub>2</sub>O, are the chief constituents of moonmilk deposits appearing as microcrystalline aggregates of various habits and shapes. They are also identified in crusts and nodules. The Mg/Ca ratio of the solutions governs the deposition of Ca–Mg carbonate species in caves. As the ratio increases, a polymineral sequence precipitates along the pathway. This is best illustrated by corralloid multiaggregates (Fig. 2).

Some secondary carbonates containing copper and/or zinc, such as malachite; azurite, Cu<sub>3</sub><sup>2+</sup>(CO<sub>3</sub>)<sub>2</sub>(OH)<sub>2</sub>; rosasite, (Cu<sup>2+</sup>,Zn)<sub>2</sub>(CO<sub>3</sub>)(OH)<sub>2</sub>; etc., are extremely colorful. The whole range of speleothems they form or stain have great aesthetic value. These minerals, as well as the relatively rare cerussite, PbCO<sub>3</sub>; rhodochrosite, Mn<sup>2+</sup>CO<sub>3</sub>; and smithsonite, ZnCO<sub>3</sub>, are the oxidation products of sulfides (chalcopyrite, bornite, sphalerite, etc.) dispersed in the bedrock.

Carbonate mineral deposition in caves is dictated by the availability of supersaturated percolation water entering the cave galleries. Figure 3 summarizes the chemical pathway of percolating waters passing through the vertical sequence of an air-soil-limestone-cave. The meteoric water is already acidified by atmospheric carbon dioxide — CO<sub>2(atm)</sub>. As these waters percolate through decaying organic soil matter, dissolved CO<sub>2(bio)</sub> increases further. Upon entering the cave, degassing of CO<sub>2</sub> occurs, causing the water to become

supersaturated with calcium, resulting in the precipitation of the various speleothems of calcite and/or other carbonate minerals. The simple linked series of reactions shown in Fig. 3 is far more complex in reality; the chemical kinetics are discussed in detail by Dreybrodt (1988), White (1988), and Ford and Williams (1989).

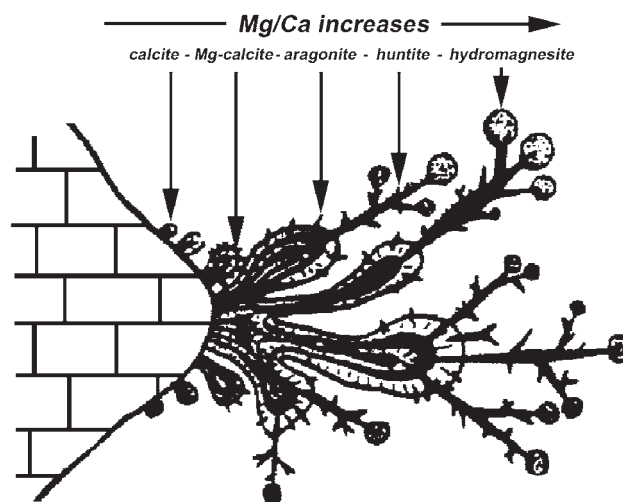


FIGURE 2 Sequence of polymineral precipitation in corralloid multi-aggregates (Adapted from Maltsev, unpublished manuscript.)

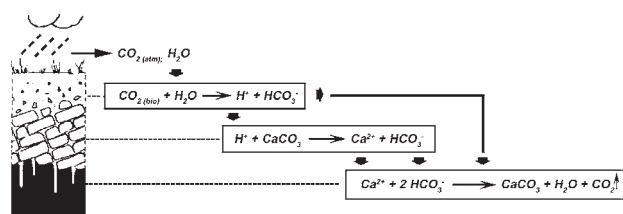


FIGURE 3 Reactions in the air-soil-rock-cave system and carbonates deposition (Modified from Onac, B. P. (2000). *Geology of Karst Terrains*. Editura Didactica si Pedagogica, Bucuresti, Romania.)

## SULFATES

$\text{Ca}^{2+}$ ,  $\text{Mg}^{2+}$ , and  $\text{Na}^{+}$  ions, with lesser amounts of  $\text{K}^{+}$ , dominate the circulating groundwater. As a result, gypsum, epsomite, and mirabilite are the usual sulfate minerals found in caves (Table I). By far the most representative of this group and perhaps the second most common cave mineral is gypsum. It forms a huge variety of speleothem types ranging from the less spectacular white, soft moonmilk deposits composed of microcrystals, to curving clusters, to prismatic crystals up to 2 m long (Cave of the Swords, Mexico). It also forms the enormous and spectacular stalactites (the so-called chandeliers) exposed in Lechuguilla (New Mexico) and Cupp-Coutunn (Turkmenistan) caves.

Two other common cave sulfates that usually occur as colorless white fibrous efflorescences on cave walls and sediments are mirabilite and epsomite. Both minerals are highly sensitive to variations in relative humidity and temperature. As the relative humidity drops below ~70%, the two sulfates will dehydrate to thenardite ( $\text{Na}_2\text{SO}_4$ ), hexahydrate ( $\text{MgSO}_4 \cdot 6\text{H}_2\text{O}$ ), and kieserite ( $\text{MgSO}_4 \cdot \text{H}_2\text{O}$ ), respectively. Samples of mirabilite and epsomite removed from the cave environment will decompose within minutes into a white milky powder. Caves with low relative humidity, high temperatures, or those well ventilated appear to be ideal locations for the deposition of bassanite ( $2\text{CaSO}_4 \cdot \text{H}_2\text{O}$ ) and anhydrite ( $\text{CaSO}_4$ ).

Barite and celestine (Table I) are relatively insoluble in comparison to other sulfates. Only under special conditions does direct precipitation of these minerals in caves from meteoric waters take place. Both sulfates commonly occur as millimeter- to centimeter-size crystals, crusts, and speleothems in caves invaded by thermal waters or hydrothermal solutions. Famous occurrences of celestine are known from Crystal Cave (Ohio), Lechuguilla Cave (New Mexico), Cango Cave (South Africa), and Valea Rea Cave (Romania). Barite is known from caves in England, Italy, Hungary, France, Russia, etc.

The other 60 sulfates described from caves (e.g., alunite, chalcantite, halotrichite, jarosite, melanterite, etc.) are much less common and are known only from warmer caves where Al, Fe, Cu, and Pb were supplied by ore bodies or hydrothermal solutions.

Four mechanisms are ultimately responsible for the deposition of sulfates in caves. Most commonly cited are simple precipitation by evaporation and sulfuric acid reaction with the carbonate bedrock. With respect to the origin of sulfates in caves, when these minerals do not occur in the overlying limestone, the following sources have been proposed: oxidation of sulfides (e.g., pyrite or marcasite), presence of bat guano, or postvolcanic activities (i.e., fumaroles).

## PHOSPHATES

Phosphates are the largest group of cave minerals. The  $\text{PO}_4$  radical combines with some 30 elements to form over 300

phosphate minerals, out of which 56 have been found in different cave settings. Brushite, hydroxylapatite, carbonate-hydroxylapatite, taranakite, and ardealite are the most abundant (Table I); all of the other phosphates are rare. Phosphates occur whenever a cave contains fresh or fossil bat guano or significant accumulations of bone breccia. Concentrations of bat guano are found primarily in caves situated in low-latitude humid areas. The most diverse phosphate assemblages are to be found there. Many of the rare phosphate minerals were identified in caves from South Africa, Australia, Namibia, and Romania. Unlike other cave minerals, the phosphates do not form spectacular speleothems, but occur as crusts, nodules, lenses, and earthy or powdery masses.

Depending on whether the percolating water passing through guano reacts with carbonate rocks or clay minerals, Ca-rich or Mg- and Al-rich phosphates will be deposited. Less commonly, the reaction of guano with ore-derived metals or spontaneous combustion of guano can produce some rare phosphate minerals (Fig. 4).

Many cave phosphate minerals include the  $\text{NH}_4^+$  ammonium ion [e.g., biphosphammite,  $(\text{NH}_4, \text{K})\text{H}_2\text{PO}_4$ ; struvite,  $(\text{NH}_4)\text{MgPO}_4 \cdot 6\text{H}_2\text{O}$ ; taranakite, etc.] that is derived from decomposition of bat urea. After leaching of alkali ions, the more stable minerals (e.g., brushite or hydroxylapatite) persist. Members of the apatite group,  $\text{Ca}_5(\text{PO}_4)_3(\text{OH}, \text{F}, \text{Cl})$ , are common cave minerals. Fluorine, chlorine, and the hydroxyl ion can mutually replace each other to form almost pure end members: fluorapatite, chlorapatite, hydroxylapatite, and carbonate-hydroxylapatite. Of these, the last two are the most thermodynamically stable phosphate minerals under ordinary cave conditions, occurring on almost all coatings and crusts. Brushite is stable under acidic ( $\text{pH} < 6$ ) and damp conditions, occurring as

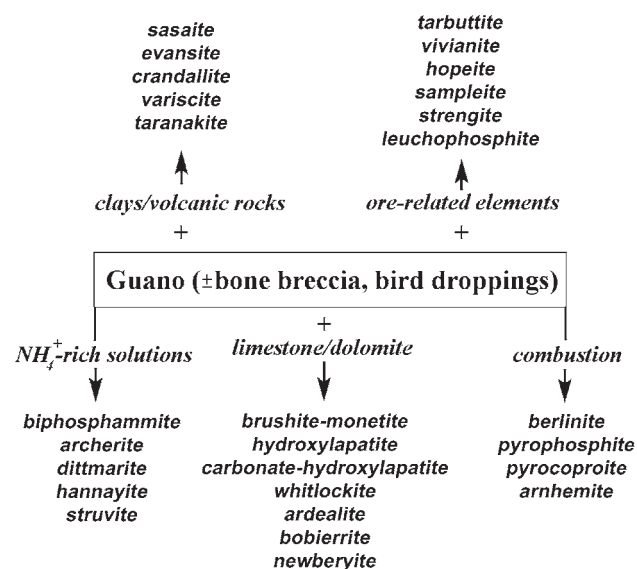


FIGURE 4 Phosphate minerals formed along different pathways in caves.

nodular masses or prismatic crystals. It loses water readily, converting to monetite ( $\text{CaHPO}_4$ ). Brushite is isostructural with gypsum, so it is not surprising that ardealite,  $\text{Ca}_2(\text{SO}_4)(\text{HPO}_4) \cdot 4\text{H}_2\text{O}$ , should exist, particularly in the view of their frequent association. A decrease of organic content and an increase of the Ca/P ratio characterize the mineral sequence brushite–whitlockite–hydroxylapatite. Like brushite, taranakite is stable in acidic environments and precipitates near contacts between guano and clays under poorly drained conditions. It usually occurs as white-yellowish soft nodules or as flour-like masses. Other products with the interaction of bat guano with various rocks and loose sediments in the cave environment are illustrated in Fig. 4.

### OXIDES AND HYDROXIDES

Among the most common oxide and hydroxide minerals frequently precipitated in caves are those containing iron [e.g., goethite; hematite,  $\text{Fe}_2\text{O}_3$ ; lepidocrocite,  $\text{Fe}^{3+}\text{O}(\text{OH})$ ] and manganese [e.g., birnessite; pyrolusite,  $\text{MnO}_2$ ; and romanechite,  $(\text{Ba},\text{H}_2\text{O})(\text{Mn}^{4+}, \text{Mn}^{3+})_5\text{O}_{10}$ ; Table 1]. Of these, goethite occurs in caves worldwide under a variety of reddish-brown speleothems. Dark-brown to black fine-grained mixtures (chiefly birnessite, romanechite, and todorokite) have been reported covering cave walls, stream clasts, and other speleothems in caves like Vântului (Romania), Jewel and Jasper (United States), Zbrasov (Czech Republic), etc. The term “wad” is frequently used as a field term for composite mixtures consisting mainly of manganese oxides, in much the same sense as *limonite* is used for hydrous iron oxides. All minerals mentioned previously are formed under oxidizing conditions.

Pyrite ( $\text{FeS}_2$ ) and other sulfides are the primary source for iron oxide and hydroxide minerals in caves. Manganese may be released from impure limestone or from within the soil weathering zone by simple accumulation and decay of plants. Some bacterial species are known to catalyze the oxidation and precipitation of Fe and Mn in the cave environment. Furthermore, pH and/or Eh conditions within the aqueous solution control this biologically mediated process.

The crystalline forms of solid water (ice) also belong to this group of cave minerals. Ephemeral ice speleothems form in the entrance passages of caves during cold seasons, whereas perennial ice deposits accumulate when special airflow conditions maintain low temperatures, even during the warm season. Freezing of dripping or flowing water creates speleothems similar to those of calcite. Spectacular hexagonal platy ice crystals and hoarfrost may sublime on the cave walls and ceiling from moist, warm air entering the cave.

### SILICATES

The silicates comprise about one-third of all mineral species. Although many of these minerals are uncommon in caves, others make up some particular cave deposits (e.g., opal,

quartz, and allophane; Table I). The solidified colloidal silica, opal, is the most common mineral among the cave silicates. It occurs mostly in lava tubes and cavities within volcanic or metamorphic rock, but may also be found in limestone caves. Opal typically forms botryoidal crusts, coralloids, and can be intermixed with calcite in different speleothems. In time it can gradually transform to chalcedony or even quartz. The most abundant opal speleothems are found in lava tubes (e.g., Algar do Carvao, Azores). The presence of quartz in caves, usually as euhedral crystals lining the walls, indicates at least one hydrothermal episode in the cave’s history. Spectacular quartz crystals are displayed in the Wind and Jewel caves (South Dakota), Chiricahua Crystal Cave (Arizona), and Kristallkluff Cave (Swiss Alps). The third most frequent silicate mineral in caves is allophane, an amorphous hydrous aluminum silicate. It has been reported mostly as white-pale cream to yellow-orange moonmilk like deposits, and also in the form of different speleothems. Most allophane occurrences are related to the action of acidic waters upon cave sediments.

Most clay minerals (hydrated silicates) in caves are thought to be derived from the bedrock or were transported in along with other clastic sediments by the cave streams or percolating waters. Others, however, are definitely of authigenic origin. Among these are dickite, halloysite, illite, and montmorillonite.

In addition, a long list of other cave silicates can be compiled (e.g., benitoite, clinocllore, epidote, fraipontite, ilvaite, etc.); however, their secondary origin is questionable. All of these minerals were deposited either as crystals, granular aggregates, or earthy masses mostly under particular settings (i.e., hydrothermal and ore-related environs, lava tubes, etc.).

### HALIDES

The list of halides, compounds in which a halogen element is the sole or principal anion, comprises some 100 species. Only 11 of these minerals were documented from different cave environments. The more common members are simple in composition and fall into either the anhydrous (halite,  $\text{NaCl}$ ; sylvite,  $\text{KCl}$ ; fluorite,  $\text{CaF}_2$ ; bromargyrite,  $\text{AgBr}$ , etc.) or hydrous [carnallite,  $\text{KMgCl}_3 \cdot 6\text{H}_2\text{O}$ ; atacamite; and paratacamite,  $\text{Cu}_2^{2+}\text{Cl}(\text{OH})_3$ , etc.] halide group. They form mostly in caves located within extensive salt beds (Mount Sedom, Israel; Meledic Plateau, Romania) or in lava tubes from Iceland, Italy, the United States, and Australia.

Halite is by far the most common water-soluble halide mineral (Table I), displaying an overwhelming variety of speleothem types, especially when precipitated in salt caves. Typically, halite may appear as massive, coarsely granular or compact aggregates, or as cubic crystals, often with cavernous and stepped faces (hopper crystals). It is colorless, white, gray, yellowish (colored by discrete impurities), blue, or purplish (color due to lattice imperfections).

Fluorite is another secondary halide mineral forming various sized euhedral cubic crystals (sometimes twinned) and coarse-to-fine granular aggregates of blue, purple, green, or violet color (Table I). Fluorite has been described from a number of ore-related cavities such as Cupp-Coutunn (Turkmenistan), Treak Cliffs (UK), Kootnay (British Columbia, Canada), Glori, and Blanchard (New Mexico). In all these locations fluorite was interpreted as precipitated from hydrothermal solutions circulating along fissures or channels. Fluorite precipitated from low-temperature percolating waters rarely occurs (caves in Arizona and Wyoming) (Hill & Forti, 1997).

Except for the halides occurring in caves within or near ore bodies (fluorite and bromargyrite) or those precipitated from fumarole vapors (e.g., galeite and kainite), all are rather soluble salts leached by percolating waters from the overburdened rocks and redeposited in caves during evaporation of the solvent. Therefore, these minerals form mainly in caves in dry climate areas that experience little precipitation.

### NITRATES

Minerals of this group are structurally similar to the carbonates with plane triangular  $(\text{NO}_3)^-$  groups in place of  $(\text{CO}_3)^{2-}$ . Because N is more electronegative than C, the anionic group,  $(\text{NO}_3)^-$ , is less stable, restricting the nitrate cave minerals much more than the carbonates. Nitrates are highly soluble, forming only in warm, dry (low humidity), and well-ventilated caves. They commonly appear along with gypsum, epsomite, halite, and other salts as efflorescence, tiny crystals impregnated in the cave soil, dry guano deposits, or in those deposits overlying the guano.

There are 11 nitrate minerals found in caves, with 5 of these known *only* from particular cave environs (sveite, mbobomkulite, hydrombobomkulite, nickelalumite, and gwihabaite). Although niter; nitratine ( $\text{NaNO}_3$ ); nitrocalcite,  $\text{Ca}(\text{NO}_3)_2 \cdot 4\text{H}_2\text{O}$ ; and nitromagnesite,  $\text{Mg}(\text{NO}_3)_2 \cdot 6\text{H}_2\text{O}$  were documented in several caves worldwide, none of these can be considered common for the cave environment.

Most of the nitrate minerals are concentrated in cave soils after being carried inside by water percolating through rich organic soils. The deposition of nitrates was aided by the action of various nitrogen bacteria. Alternatively, bat and rat guano or basic volcanic rocks can also supply nitrates in caves.

### NATIVE ELEMENTS

Although several chemical elements occur as minerals in the Earth's crust, thus far only sulfur has been found in a number of caves from the United States, Italy, Mexico, Iceland, Russia, etc. Sulfur occurs as canary-yellow powder in granular to massive aggregates, or it can take a variety of speleothem types (crusts, stalactites, euhedral crystals, cave rafts, etc.). The origin of sulfur in most of the caves is related to either hydrogen sulfide oxidation (caves from the Guadalupe

Mountains, New Mexico; Cueva de Villa Luz, Mexico; Sant Cesarea and Grotta dello Zolfo, Italy) or reduction of sulfate ion in the presence of sulfur bacteria (Frasassi, Grotta di Cala Fetente, Italy).

### ARSENATES AND VANADATES

The arsenates and vanadates are oxysalts characterized structurally by independent  $(\text{AsO}_4)^{3-}$  or  $(\text{VO}_4)^{3-}$  anionic groups linked through intermediate cations. The majority are mostly low-temperature, hydrous minerals. Only six arsenate and eight vanadate minerals were identified in caves known to have sulfuric acid or hydrothermal speleogenesis. Typically, they form at the expense of primary arsenic- or vanadium-rich minerals by weathering and oxidation processes. Some are precipitated in reducing  $\text{H}_2\text{S}$  environments. None of these minerals are common for normal cave settings; however, it is worth mentioning a few members of each of these two subclasses: conicalcite and talmessite of the arsenate group and tyuyamunite, carnotite, and calcivolborthite among the vanadates. Most of these minerals were identified in caves from Tyuya-Muyun region (Kirghizstan), Valea Rea Cave (Romania), Sonora Caverns (Texas), Lechuguilla, Carlsbad, Spider, and other caves in the Guadalupe Mountains (New Mexico).

### SULFIDES

This group of cave minerals comprises compounds in which the large atoms S, As, and Bi are combined to one or more of the metals (Fe, Zn, Pb, Cu, Hg, and Sb). Thirteen minerals (e.g., marcasite, cinnabar, metacinnabar, pyrite, stibnite, etc.) were described from skarn-hosted and hydrothermal-related caves. Most of the hydrothermal-related caves are associated with Mississippi Valley type lead-zinc ore deposits (Ford & Williams, 1989; Hill & Forti, 1997). The usual occurrences of sulfides consist of crusts, inclusions, druses, or crystals. With few exceptions, all sulfides were precipitated in preexisting meteoric karst channels from low-temperature hydrothermal solutions.

### ORGANIC MINERALS

The presence of large bat or bird colonies in some caves is ultimately responsible for the deposition of nine organic minerals from arid and semiarid regions in Western Australia, Namibia, Israel, and the United States. These minerals include oxalates, mellates, and purines. Almost all were derived from the reaction of urine or animal excreta with carbonate bedrock, clays, or cave detritus.

### WHY STUDY CAVE MINERALS?

There has always been an aura of mystery in writing about cave minerals, especially those rare species that have

stimulated complex investigations. However, cave minerals occur either as major or minor components in speleothems and thus, summarized in the following list are a few reasons why cave minerals are of interest.

1. Caves are natural underground laboratories where crystal growth processes can be observed.
2. Studies of crystallography and mineralogy of cave minerals provide invaluable insight into the chemical and physical conditions existing within various cave environments.
3. Many caves provide a unique set of conditions that allow the deposition of a suite of exotic minerals; many of them are restricted to only such particular cave settings and are never found in the outside world.
4. The mineral assemblage present in a given cave can sometimes be used as diagnostic criterion of the cave speleogenetic pathway.
5. Calcite speleothems in caves are well suited for uranium-series dating based on which an absolute chronology can be derived. Furthermore, carbon and oxygen isotopic variations in speleothems combined with changes in calcite crystal fabric and luminescence of growth lamina are potentially powerful tracers of changes in Quaternary climate and possibly vegetation.
6. Oxygen isotope analyses and fluid inclusions of hydrothermal-related cave minerals (e.g., quartz, barite, malachite, etc.) provide solution temperature at the time of deposition.
7. Studying the variations of  $^{34}\text{S}/^{32}\text{S}$  ( $\delta^{34}\text{S}$ ) in cave sulfates (e.g., gypsum, barite, celestine, etc.) allows the discrimination between vadose, bacteriogenic, or hydrothermal origins.
8. Some cave minerals play an important role in reconstructing landscape evolution (e.g., calcite, alunite, etc.).
9. Supporting evidence shows some mineral assemblages were precipitated in caves with the aid of various microorganisms. Deciphering the geomicrobiological processes involved on their deposition may help our understanding of the caves as life environments.

#### *See Also the Following Articles*

*Gypsum Flowers and Related Speleothems* • *Speleothems: Helictites and Related Forms* • *Stalactites and Stalagmites*

#### **Bibliography**

- Bögli, A. (1980). *Karst Hydrology and Physical Speleology*. Springer-Verlag, Berlin.
- Dreybrodt, W. (1988). *Processes in Karst Systems*. Springer-Verlag, Berlin.
- Ford, D. C., and P. W. Williams (1989). *Karst Geomorphology and Hydrology*. Chapman & Hall, London.
- Gaines, R. V., C. Skinner, E. E. Foord, B. Mason, and A. Rosenzweig (1997). *Dana's New Mineralogy*. Wiley & Sons, New York.

- Gillieson, D. (1996). *Caves. Processes, Development, Management*. Blackwell, Oxford, England.
- Hill, C. A. (1976). *Cave Minerals*. National Speleological Society, Huntsville, AL.
- Hill, C. A., and P. Forti (1986). *Cave Minerals of the World*. National Speleological Society, Huntsville, AL.
- Hill, C. A., and P. Forti (1997). *Cave Minerals of the World*, 2nd Ed. National Speleological Society, Huntsville, AL.
- Moore, G. W. (1970). Checklist of cave minerals. *Natl. Speleol. Soc. News* 28(1), 9–10.
- Onac, B. P. (2000). *Geology of Karst Terrains*. Editura Didactica si Pedagogica, Bucuresti, Romania
- White, W. B. (1976). Cave minerals and speleothems. In *The Science of Speleology*. (T. D. Ford and C. H. D. Cullingford, eds.). Academic Press, London.
- White, W. B. (1988). *Geomorphology and Hydrology of Karst Terrains*. Oxford University Press, New York.
- White, W. B. (1997). Thermodynamic equilibrium, kinetics, activation barriers, and reaction mechanisms for chemical reactions in karst terrains. *Environ. Geol.* 30 (1/2), 46–58.

## Modeling Karst Aquifers

**Carol M. Wicks**

*University of Missouri — Columbia*

There are two major categories within the field of modeling karstic aquifers. One category is modeling the evolution of a karstic aquifer over time. It seeks to answer the question “How does a karstic aquifer form?” The other category is modeling the flow of water through karstic aquifers that are fully formed. It explores how water, solutes, and sediment are carried into, through, and out of a karstic aquifer. This article reviews and summarizes the second category of modeling karstic aquifers.

### THE PURPOSE OF MODELING

For a modeling effort to result in useful predictions or meaningful insight, the purpose of the modeling effort has to be clearly stated as the first step. Many modeling efforts are aimed at predicting consequences of proposed actions. For example, what is the decrease, in cubic meters per day, in the discharge from a spring if the pumping rate at a well, which is 10 kilometers away, increases by 5 cubic meters per day. Some modeling efforts are aimed at gaining insight into controlling parameters in generic settings. For example, over what time scales, decades or hundreds of years, is the dissolution of wallrock, with associated increases in the diameter of the conduits, an important parameter in controlling groundwater flow through karstic aquifers. Thus, a critical first step in all modeling efforts is to clearly state the question that needs to be answered. Defining the purpose of the modeling effort will determine which governing equations

should be solved and which computer code (mathematical model) should be used.

## CONCEPTUAL MODELS OF KARSTIC AQUIFERS

Once the purpose of the modeling effort is clearly stated, a conceptual model of the karstic aquifer (either site-specific or generic) has to be built. A conceptual model provides a qualitative visualization of the way in which water (chemicals and sediment) is added to, stored in, transmitted through, and discharged from a karstic aquifer. The conceptual model is based on an understanding of the geological setting of the karstic aquifer, the area of the groundwater basin, the area of allogenic recharge basin, the geomorphologic characteristics of the conduits (for instance, branchwork pattern), the relative importance of fractures in the aquifer, and the relative permeability of the surrounding bedrock (matrix). All field data available should be assembled at this point.

Often a conceptual model is best represented through a complicated drawing. The drawing of a karstic aquifer needs to be simplified so that only the salient features of the aquifer necessary to provide an answer to the posed question (the purpose of the model) are included within the conceptual model. Often the resultant drawing can be reduced to a box and arrow diagram.

## MODEL SELECTION

There are several computer codes (mathematical models) available for solving the governing equations for groundwater flow and transport of chemicals and sediment through karstic basins. Each of the models offers advantages and disadvantages to the modeler, and understanding what those advantages and disadvantages is important. Selection of an inappropriate mathematical model will result in a generation of incorrect results and a failure to answer the posed question (failure to achieve the purpose of the modeling effort). The next sections describe the commonly used mathematical models, the advantages and disadvantages of each, and examples of situations in which the models have been used.

## MATHEMATICAL MODELS

### The Equivalent Porous Media Approach

The equivalent porous medium approach has proven useful in modeling groundwater flow and the potentiometric surface in regional-scale studies in which little site-specific information is available. In this approach, drain cells or cells with a high hydraulic conductivity are inserted in the numerical flow model as analogs for preferential flow paths or conduits in karstic aquifers. The approach is based on a Darcian approach and Darcy's Law (Eq. 1):

$$q = -K \, db/dl \quad (1)$$

where  $q$  is the specific discharge ( $L^3 L^{-2} \tau^{-1}$ ),  $K$  is the hydraulic conductivity ( $L \tau^{-1}$ ), and  $db/dl$  is the hydraulic gradient ( $L L^{-1}$ ). The hydraulic conductivity is a function of the properties of the fluid (groundwater in this case) and of the geologic medium:

$$K = (\rho g / \mu) k \quad (2)$$

where  $\rho$  and  $\mu$  are the density and viscosity of the fluid, respectively,  $g$  is the gravitational constant, and  $k$  is the permeability ( $L^2$ ) of the geologic medium often as expressed as a function of typical grain size of the particles,  $d$ , comprising the geologic medium ( $k = C d^2$ , where  $C$  is a shape factor).

The assumptions inherent in Darcy's Law are that flow is laminar (Reynolds number is less than 10) and that there is a linear relation between hydraulic gradient ( $db/dl$  in Eq. 1) and specific discharge ( $q$  in Eq. 1). In addition, often the hydraulic head ( $b$  in Eq. 1) is limited to the sum of energy available from changes in elevation (potential energy) and in pressure and the energy available from changes in velocity of the moving water is neglected (kinetic energy). These assumptions are often valid for flow through a typical porous medium where the pores are small and the velocity of the water is on the order of  $10^{-6}$  m/sec.

The main difficulty in using the equivalent porous medium approach is the assumption that the karstic aquifer behaves like a Darcian aquifer. This is often not the case as the velocity of the water flowing through a karstic aquifer can greatly exceed  $10^{-6}$  m/sec. The Darcian approach involves selecting a unit volume of aquifer in which the properties within that volume are representative of the properties of the entire aquifer (a representative elementary volume). In a porous medium aquifer, selection of the size of the representative elementary volume and specification (determination) of the properties in that volume, while not easy, can be accomplished.

In a karstic aquifer, the selection of an appropriately sized representative elementary volume and specification of the properties within that volume are problematic. The properties that differentiate karstic aquifers from porous medium aquifers are tributary flow to springs, turbulent flow in conduits, troughs in the potentiometric surface, downgradient decreases in hydraulic gradient, downgradient increases in hydraulic conductivity, and substantial scaling effects in hydraulic conductivity. The values of these properties in karstic aquifers are highly scale-dependent. Selecting one size for a representative elementary volume is difficult. In addition, a limitation to using this approach to model groundwater flow through karstic aquifers is that conduits can be represented as regions of high hydraulic conductivity or leakage, but they are not represented as open (completely water-filled) conduits. The selected represented elementary volume must be large enough to include a conduit and enough of the surrounding bedrock for that volume to be accurately represented as an equivalent high conductivity zone.

Data and information needed for an equivalent porous medium model of a specific karstic aquifer are the same as the data and information needed for a Darcian aquifer. For each and every cell within the numerical model, values of the parameters (hydraulic conductivity, porosity, etc.) must be specified. In addition, boundary conditions must be specified, and if transient conditions are important then initial conditions (an initial head value must be specified for each and every cell in the numerical model). The amount of data that is needed is quite large. If the purpose of the model is to ask generic questions, then approximate values can be used and the data requirements are reduced.

The equivalent porous media approach has been used to understand the role of high conductivity zones on the shape of potentiometric surface (a map of the values of the hydraulic head), the location of wedges of saline water in coastal karstic aquifers, and the transport of contaminants through karstic basins. In all of these studies, a regional scale perspective was used. The purpose of the modeling effort was to gain a general understanding and not solve a specific problem.

### The Fracture Flow Approach

The fracture flow approach has shown to be useful in predicting groundwater flow and solute transport through karstic aquifers. The fracture flow models are based on either a discrete or continuous representation of the fracture flow system, together with equations describing the exchange between the fractures and the rock matrix. The equations that describe the flow are based on Darcy's Law (Eq. 1), but the formulation of the hydraulic conductivity involves the width of the fractures and the number of fractures per unit length (Eq. 3):

$$k = Nb^3/12 \quad (3)$$

where  $k$  is the permeability of the medium expressed as ( $L^2$ ),  $N$  is the number of fractures per unit distance across the medium ( $L^{-1}$ ), and  $b$  is the width of the aperture ( $L$ ). In addition, equations linking flow into and out the fractures and out of and into the matrix must be included. Fracture flow models, including double-porosity models, are commonly used within the oil industry.

An assumption used in some (but not all) fracture flow models is that the matrix (the bedrock surrounding the conduits) is impermeable. In a fracture flow approach, the location and the geometry of the fractures are assumed to be either exactly known or at least describable through a statistical method. Early work with fracture flow systems emphasized flow through granite and other rocks with a low hydraulic conductivity. Further, all the flow was thought to be along the fracture planes. In some karstic basins, the assumption of the surrounding bedrock being impermeable (incapable of allowing flow to occur) is not valid. Thus researchers have modified the original models to account for flow through the matrix and through the

fracture and exchange between the two systems (the double-porosity fracture flow models). The major limitation of this approach, and the greatest data need, is to be able to specify the location, size, and geometry of the fracture system. The fracture system in a karstic aquifer consists of the sizes, locations, orientations, and connections among all the conduits within the aquifer, and knowing these is extremely difficult.

Uses of fracture flow models are often limited to regional scale studies in which knowledge of the details of the fracture locations, sizes, orientations, and connections is not critical to addressing the purpose of the model. For instance, a fracture flow model was used to demonstrate how difficult it is to remove a contaminant from a generic karstic basin. The purpose of the modeling study was not to determine how to clean up a specific aquifer but to determine whether pumping groundwater out of a generic karstic basin could be used as an effective clean-up strategy.

### The Linear Systems Approach

The linear systems approach has proven useful in modeling some hydrologic processes which occur within karst basins, because knowledge of the internal structure of the basin is not required and assumptions about laminar flow are not made. The linear systems technique has been used to characterize the response of karst aquifers to recharge events, to identify the recharge area of large karst springs, and to predict contaminant breakthrough at a spring. The linear systems technique treats the basin like a "black box," which characteristically operates on input series to produce an output series. The lumped, time-invariant linear system for hydrologic modeling provides a basin-scale perspective and is expressed using a form of the Duhamel or convolution integral:

$$o(t) = \int_0^{\infty} h(t-\tau) i(\tau) d\tau \quad (4)$$

where  $o(t)$  is the observed output response from the system,  $i(t)$  is the impulsive input into the system,  $\tau$  is the variable of integration, and  $h(t-\tau)$  is the kernel function.

Assumptions are made and there are limitations to the linear systems approach. One assumption is that the karstic aquifer operates on each and every input according to the calculated kernel function. Another assumption is that one time series input and output couple are sufficient to characterize a kernel function.

There are two main difficulties when using this type of model. In many large karstic basins definition of the size of the basin is difficult, making estimating the water budget difficult. In order to have a predictive model, the water and solutes budgets for the karstic aquifer must be known. The other difficulty is obtaining representative kernel functions. Three kernel functions can be described. One relates the areally distributed excess precipitation (precipitation minus losses to soil moisture and evapotranspiration) to changes in

discharge. Another kernel function relates the mass of solute introduced in the excess precipitation as a nonpoint source to mass of that solute in the spring water. The third function relates the mass of a solute introduced as a point source to mass of that solute in the spring water. Derivation of the kernel function by deconvolution — solving Eq. 4 for  $h(t-\tau)$  — is an ill-posed problem that can result in an unstable kernel function. Recently, methods other than solving Eq. 4 have been used to calculate the stable kernel functions that relate (1) excess precipitation to discharge, (2) the introduction of an areally distributed solute to changes in chemistry of the spring, and (3) a point source to changes in chemistry of a spring. Thus, some of the difficulties in using the linear systems approach have been reduced.

Data and information that are required in the linear system approach are at least one input time series and its resultant output time series (having more than one series is preferred). These are needed to calculate each type of kernel function and the area of recharge to the karstic aquifer (the land surface that contributes water, surface, and subsurface, to the point of interest, usually a spring). For predictions of contaminant breakthrough based on a point source introduction, a kernel function is required for each and every point of introduction. Thus, hundreds of quantitative dye traces might be needed to adequately characterize the movement from possible input locations to the outlet location. For predictions to be made, the input series must be known or at least be estimated with a high degree of reliability.

Using the linear systems approach, predictions of changes in discharge due to isolated recharge events and due to multiple day recharge events is possible. In addition, predicting breakthrough of contaminants is possible given *a priori* knowledge about quantitative dye tracing results. This approach seems most useful for predicting the physical and chemical response of a karstic basin to recharge events and in some cases, breakthrough of contaminant pulses at a spring. This approach is not useful for gaining insight into controlling parameters or governing processes as the basin is treated as a black box.

### The Pipe Network Approach

The pipe network approach has been used to predict discharge of groundwater from a karstic aquifer for which detailed information about the sizes, locations, positions, and orientations of individual conduits are known. In this approach, the conduits are thought of as storm water or sewage water tunnels and the surrounding bedrock is assumed to be impermeable (no water flows through it). Therefore all water flows through the conduits. This approach is based on the solution of one of the many forms of the Hagen-Poiseuille law:

$$Q = \pi (h_0 - h_L) R^4 / 8 \mu l \quad (5)$$

where  $Q$  is the discharge ( $L^3 \tau^{-1}$ ),  $h_0 - h_L$  is the change in hydraulic head ( $L$ ) over a length,  $l$ , and  $R$  is the radius of the

conduit ( $L$ ). The change in hydraulic head over a length is related to energy losses due to frictional resistances along the wetted perimeter of the conduit. Thus friction factors,  $f$ , must be known or estimated.

One assumption used in a pipe network approach is that the matrix (bedrock surrounding the conduit) is impermeable. In many cases this is not an unreasonable assumption. None of these mathematical models accounts for dissolution of the bedrock with an associated increase in the diameter of the conduit. Dissolution of wallrock and increases in conduit diameters over geologic time are primary characteristics of karstic systems. Thus, neglect of this important process would seem to completely rule out the use of pipe network models for modeling karstic aquifers. However, if the purpose of the model is to predict the discharge of water and transport of chemicals through a karstic aquifer over relatively short (human-time scale) amounts of the time, then the amount of dissolution that could occur and the resultant increase in the diameter of the conduits is likely negligible.

As water can flow only through the conduits in pipe network models, the location, size (diameter), and connections between each and every conduit must be known. Research suggests that the geometry of the conduits must be known to within about 10%. The conduits are the locations along which flow occurs. Another important parameter that must be known or estimated is the friction factor. Energy lost due to frictional losses along the conduits must be calculated and the amount of energy lost depends on how much friction there is between the water and walls of the conduit. Determining the value of the friction factor is difficult and depends on whether the conduit is exposed bedrock or if the bottom of a conduit is covered with cobbles. In most cases, conduits have cobbles or at least sediment covering the bottom of the conduit and exposed bedrock along the walls of the conduit. The friction factors between water and exposed bedrock and between water and cobbles are different. However, the model allows specification of only one friction factor.

Further limitations of at least one of the pipe network models are that the cross-sectional area of the conduits are limited to commonly engineered shapes, and that the mixing cell equations are solved for movement of the chemicals through a karstic aquifer and not the advection–dispersion equation. The first limitation forces the modeler to select the conduit cross-sectional area that best represents the actual cross-sectional area. A problem arises when a stream has cut a small channel into the bottom of the conduit. In this situation there is no comparable cross-sectional area to select. This might seem to be a minor point, but as the model fills the conduit from the lowest to the highest elevation and always fills the conduit from edge to edge, a situation can arise in which a stream in a real conduit might be deep and narrow and in the modeled conduit, the stream would be shallow and wide, yet contain the same amount of water. The



second limitation forces situations in which the concentration of a chemical will be diluted as it is transported from one pipe into another if the second pipe contains a larger volume of water than the first pipe.

Even with all the limitations described previously, a pipe network model can be used to simulate flow and transport. Pipe network models provide a simple, yet accurate way of modeling flow through a karst aquifer. Results from previous studies suggest that the similarities in geometries between a cave system and a sewer or storm water system make a pipe network model an appropriate model for some karstic basins.

### MODEL DESIGN, CALIBRATION, VERIFICATION, AND PREDICTION

Model design is the step in which the conceptual model is put in the mathematical model. Depending on the mathematical model selected, either the grid or the conduit locations need to be specified. In all cases, the time step and initial and boundary conditions need to be specified. Values of the parameters (friction factors, hydraulic conductivities, etc.) are also specified during this step.

Calibration of the model requires a set of field data (distribution of hydraulic head or discharge and concentration as a function of time). The output from the model is compared to the real data. The values of the parameters are adjusted until a good match is obtained between the model output and the real data. Acceptable values of the parameters are constrained by geologic and hydrologic observations and field data. Once the model is calibrated, the values of the parameters are not changed.

Verification of the model requires a second and independent set of field data. Once the model is calibrated, a second set of simulations is run. The output from the model is compared to the second set of field data. A good match between the model output and the second set of field data helps establish that the calibrated parameter values have been appropriately specified.

Finally, the model can be used to answer the question that the modeling effort posed. This is the prediction step. The output from the model is an indication of how a karstic aquifer might respond to imposed stresses, such as pumping or dissolution. The output is only an indication because of uncertainties in knowing the values of parameters, such as friction factors or hydraulic conductivities. Investigating the range of outputs for a given range of parameter inputs will help bound the uncertainty of the model prediction.

### SUMMARY

In all cases, the application of an appropriate mathematical model depends on the question that has to be addressed. There are at least four mathematical approaches that have been used successfully to model groundwater flow and solute transport through karstic aquifers. Not all approaches are

appropriate for all situations. The person who is conducting the modeling study must make informed decisions and understand the limitations of each approach and the assumptions made. However, there are mathematical models that are capable of simulating flow and transport through karstic aquifers.

### See Also the Following Articles

*Hydrogeology of Karst Aquifers*

### Bibliography

- Anderson, M. P., and W. W. Woessner (1992). *Applied Groundwater Modeling: Simulation of Flow and Advective Transport*. Academic Press, San Diego, CA.
- Bird, R. B., W. E. Stewart, and E. N. Lightfoot (1960). *Transport Phenomena*. John Wiley & Sons, New York.
- Huber, W. C., and R. E. Dickinson (1992). Storm Water Management Model, version, Vol. 4. U.S. Environmental Protection Agency, Athens, GA.
- Klimchouck, A. B., D. C. Ford, A. N. Palmer, and W. Dreybrodt (2000). *Speleogenesis: Evolution of Karst Aquifers*. National Speleological Society, Huntsville, AL.
- Loop, C. M., and W. B. White (2001). A conceptual model for DNAPL transport in a karst groundwater basin. *Ground Water*, **39**, 119–127.
- McDonald, M. G., and A. W. Harbaugh (1988). A modular three-dimensional finite-difference ground-water flow model. U.S. Geologic Survey, Washington DC.
- Palmer, A.N., M. V. Palmer, and I. D. Sasowsky (1999). *Karst Modeling*. Karst Waters Institute, University of Akron, Ohio.
- Sasowsky, I. D., and C. M. Wicks (2000). *Groundwater Flow and Contaminant Transport in Carbonate Aquifers*. A. A. Balkema, Rotterdam, The Netherlands.
- Teutsch, G. (1993). An extended double-porosity concept as a practical modeling approach for a karstified terrain. Hydrogeological processes in karst terrains, international association of hydrogeologist. Publication no. 207, pp. 281–292.
- Wicks, C. M., and J. A. Hoke (2000). Prediction of the quantity and quality of Maramec Spring water. *Ground Water*, **38**, 218–225.

## Molluscs

David C. Culver  
*American University*

### INTRODUCTION

Clams, snails, and their relatives comprise the phylum Mollusca. They occur in subterranean habitats and are sometimes common in aquatic habitats, including caves and springs, and more occasionally in terrestrial habitats. Nearly all obligate cave-dwelling molluscs are gastropods. All gastropods have a muscular foot, visceral mass, and distinct head region. A fleshy mantle covers the viscera and secretes a calcium carbonate shell. Bivalves have hinged calcium carbonate shells. They are represented by a tiny handful of species in caves, and there is but one undoubted cave-limited clam — *Congeria kusceri*. Morphological characteristics of

TABLE I Subterranean families and genera, from Bernasconi and Riedel (1994).

Higher Classification	Family	Genera
Bivalvia: Lamellibranches	Dreisseniidae	<i>Congeria</i>
	Sphaeriidae	<i>Pisidium</i>
Gastropoda: Prosobranchia: Archaeogastropoda	Hydrocenidae	<i>Georissa</i>
Gastropoda: Prosobranchia: Mesogastropoda	Hydrobiidae	over 50 genera
	Pomatiopsidae	<i>Akiyoshia, Moria, Saganoa</i>
	Assimindeidae	<i>Cavernacmella</i>
	Cyclophoridae	<i>Pholeoteras, Opisthostoma</i>
Gastropoda: Pulmonata: Basommatophora	Acroloxidae	<i>Acroloxus</i>
	Ellobiidae	<i>Zospeum, Carychium</i>
Gastropoda: Pulmonata: Stylommatophora	Pupullidae	<i>Argna, Speleodiscus, Klemmia, Virpazaria</i>
	Orculidae	<i>Speleodentorcula</i>
	Enidae	<i>Speleoconcha</i>
	Clausiliidae	<i>Sciocochlea</i>
	Ferussaciidae	<i>Ceciloides, Cryptareca</i>
	Subulinidae	<i>Opea</i>
	Helicosididae	<i>Helicodiscus</i>
	Zonitidae	15 genera
	Trigonochlamyidae	<i>Troglolestes</i>
	Polygyridae	<i>Mesodon, Polygyra</i>

obligate subterranean species include a thin, often translucent shell that is usually white with a depigmented body and depigmented and reduced eyes. The aquatic species of gastropods are usually very tiny. This is true not only for species in small cavity habitats such as the underflow of streams, but also for large cavity habitats such as caves. Features associated with the miniaturization of cave snails include complex coiling of the intestine, loss or reduction of gills, simplification of gonadal morphology, and loss of sperm sacs. Although these characteristics represent an interesting case of convergent evolution, they also pose a difficult challenge for any attempt to reconstruct the phylogenetic history of cave snails. In contrast, some terrestrial cave species can be quite large. The largest reported terrestrial snail is that of *Paraegopsis oberwimmeri*, a pulmonate snail whose shell reaches a diameter of nearly 3 cm.

Almost nothing is known about the ecology of cave molluscs. Because their shells remain long after the death, many collections of cave molluscs consist of dead shells only. This has resulted in a great deal of biogeographic information but a lack of ecological information.

Most gastropods in surface waters are either detritus feeders or algal feeders. Presumably, aquatic subterranean gastropods are detritus feeders. Most bivalves are deposit or filter feeders, and the few cave bivalves are likely also deposit or filter feeders. An amphibious habitat seems especially common among cave snails. Nowhere is this more apparent than in the genus *Zospeum* found in Dinaric caves. Most species appear to be primarily terrestrial but *Z. exiguum*, which is common in Križna Jama in Slovenia, appears to be primarily aquatic.

## TAXONOMIC PATTERNS OF CAVE MOLLUSCS

Nearly all subterranean molluscs are gastropods. The only undoubted obligate cave bivalve is the “living fossil” *Congeria kusceri* from the Dinaric karst. Minute clams in the genus *Pisidium* may also be cave-limited species. In this genus it is very difficult to distinguish between stygobites and surface-dwelling species that occasionally enter caves. Four species have only been found in caves: three from caves in the Caucasus Mountains and one from Turkey. The rarity of bivalves in caves may be the result of the greatly reduced motility of bivalves and their general inability to withstand conditions of reduced oxygen. It seems unlikely that the absence of bivalves in caves is due to the absence of potential surface ancestors. For example, clams in the family Unionidae are highly diverse in the southeastern United States, which is also an area of extensive cave development, yet no clams are found in these caves.

Nearly all aquatic subterranean gastropods are prosobranchs. The major morphological difference between prosobranchs and pulmonates is that prosobranchs possess a gill and a horny or calcareous operculum. Pulmonates use a modified portion of the mantle cavity as a lung and lack an operculum. *Acroloxus* from the Dinaric Mountains and *Hydrophrea* from New Zealand are pulmonates. Conversely, all troglobites are pulmonates, except for the prosobranch *Pholeoteras euthrix*. By far the most common aquatic subterranean species are in the family Hydrobiidae, comprising 97% of all species. There are over 350 described species of aquatic obligate subterranean molluscs. The number of terrestrial cave-limited species is much less, probably less

TABLE II Obligate snails from caves of the United States. State distribution is shown in the final column. From Hershler and Holsinger (1990).

	Order	Family	Species	State
Aquatic	Mesogastropoda	Hydrobiidae	<i>Ammicola cola</i>	AR
	Mesogastropoda	Hydrobiidae	<i>Ammicola stygia</i>	MO
	Mesogastropoda	Hydrobiidae	<i>Antrobia culveri</i>	MO
	Mesogastropoda	Hydrobiidae	<i>Antrorbis breweri</i>	AL
	Mesogastropoda	Hydrobiidae	<i>Antroselates spiralis</i>	KY, IN
	Mesogastropoda	Hydrobiidae	<i>Balconorbis uvaldensis</i>	TX
	Mesogastropoda	Hydrobiidae	<i>Dasyscias franzi</i>	FL
	Mesogastropoda	Hydrobiidae	<i>Fontogens antroecetes</i>	IL, MO
	Mesogastropoda	Hydrobiidae	<i>Fontigens proserpina</i>	MO
	Mesogastropoda	Hydrobiidae	<i>Fontigens tartarea</i>	WV
	Mesogastropoda	Hydrobiidae	<i>Fontigens turritella</i>	WV
	Mesogastropoda	Hydrobiidae	<i>Holsingeria unthanksensis</i>	VA
	Mesogastropoda	Hydrobiidae	<i>Phreatoceras conica</i>	TX
	Mesogastropoda	Hydrobiidae	<i>Phreatoceras imitata</i>	TX
	Mesogastropoda	Hydrobiidae	<i>Phreatoceras taylora</i>	TX
	Mesogastropoda	Hydrobiidae	<i>Phreatodrobia coronae</i>	TX
	Mesogastropoda	Hydrobiidae	<i>Phreatodrobia micra</i>	TX
	Mesogastropoda	Hydrobiidae	<i>Phreatodrobia nugax</i>	TX
	Mesogastropoda	Hydrobiidae	<i>Phreatodrobia plana</i>	TX
	Mesogastropoda	Hydrobiidae	<i>Phreatodrobia punctata</i>	TX
	Mesogastropoda	Hydrobiidae	<i>Phreatodrobia rotunda</i>	TX
	Mesogastropoda	Hydrobiidae	<i>Stygopyrus bartonensis</i>	TX
	Mesogastropoda	Physidae	<i>Physa spelunca</i>	WY
Terrestrial	Stylommatophora	Carychiidae	<i>Carychium stygium</i>	KY, TN
	Stylommatophora	Endodontidae	<i>Helicodiscus barri</i>	AL, GA, TN
	Stylommatophora	Zonitidae	<i>Glyphyalinia pecki</i>	AL
	Stylommatophora	Zonitidae	<i>Glyphyalinia specus</i>	AL, GA, KY, TN, WV
	Stylommatophora	Zonitidae	<i>Pristiloma cavato</i>	CA

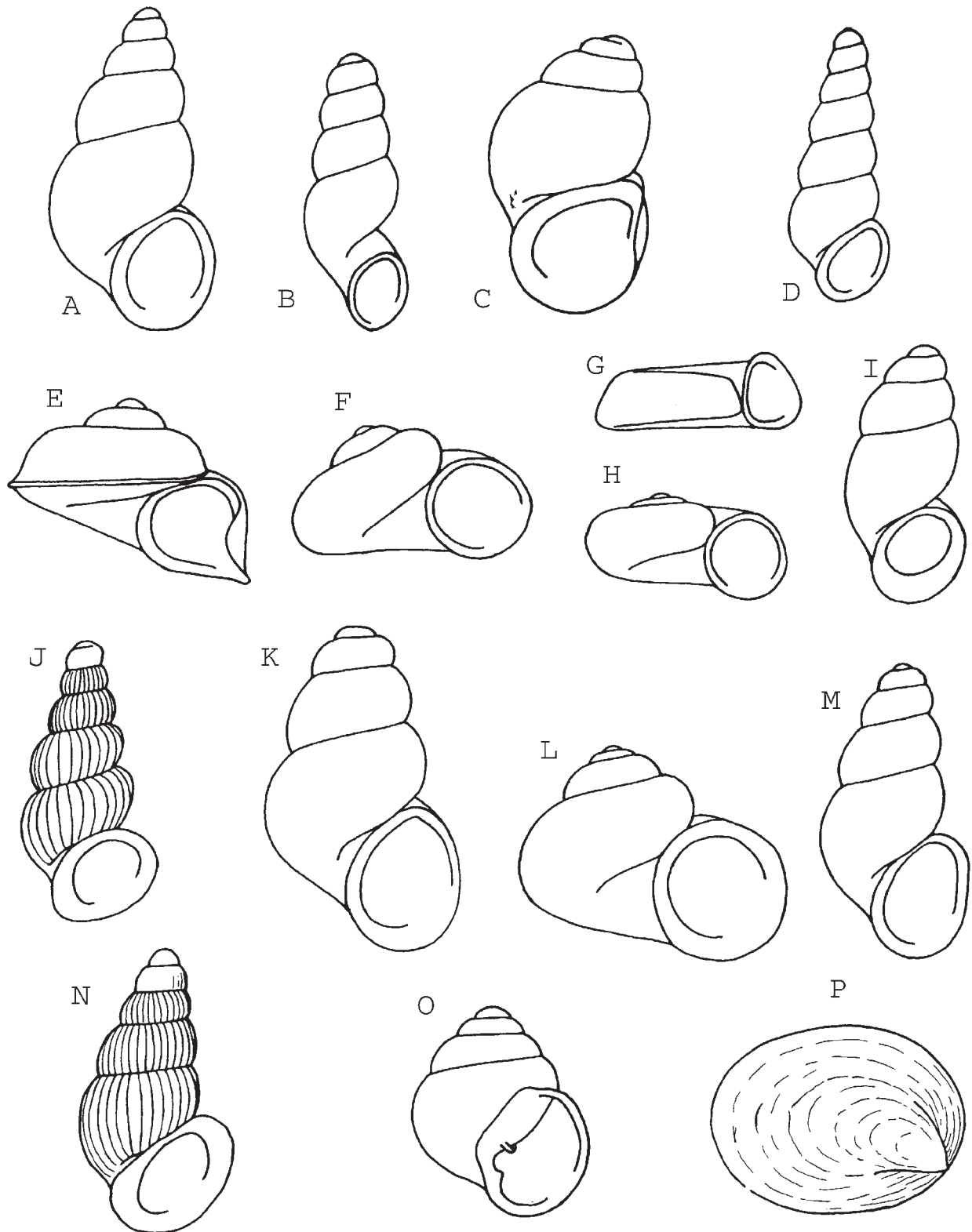
than 50. A summary of molluscan troglobites and stygobites is given in Table I. What is noteworthy is the extraordinarily high diversity of hydrobiid gastropods at both the generic and species levels.

### BIOGEOGRAPHIC PATTERNS OF CAVE MOLLUSCS

In the United States, there are 23 described species of aquatic obligate cave snails and 5 species of terrestrial obligate cave snails (Table II). Within the United States, a hot spot of biodiversity is the Edwards Aquifer in Texas. This deep karst aquifer, which is intersected by numerous wells and caves, includes two endemic genera — *Phreatodrobia* and *Stygopyrus*. Of the 23 described aquatic cave snails, 11 are from the Edwards Aquifer. The reasons for this high diversity are unclear, especially which ecological conditions allow the coexistence of this many snail species. It is known that unlike other U.S. cave areas (but similar to some regions of northern Mexico), snails in the Edwards Aquifer arose not only from old freshwater groups as did other U.S. cave snails, but they also arose from marine ancestors of groups during the late Cretaceous ocean embayments. These species appear to be stranded relicts that resulted from the regression of the Cretaceous seas. The Edwards Aquifer is also a hot spot of subterranean biodiversity for other groups, especially the amphipods.

On a worldwide basis, two areas are likely to be hot spots of subterranean snail biodiversity. One is the Dinaric Mountains, ranging along the Adriatic Coast from extreme northeast Italy to Montenegro. In the Slovenian part of the Dinaric Mountains, for example, there are 37 aquatic obligate cave snails, 1 aquatic cave clam, and 11 species of terrestrial obligate cave snails. The entire Dinaric Mountain region has several times that many species. Surface fresh water in this region is also extraordinarily rich in mollusc diversity, especially among aquatic species. A possible explanation for the richness of surface species is the long freshwater history combined with the highly fragmented nature of surface waters. This fragmentation occurs because of the high frequency of surface streams sinking into subterranean watercourses, resulting in increased chances for speciation. In addition, diversity of molluscs may be higher in regions of carbonate rocks, because this greatly increases the availability of calcium carbonate for the construction of shells. The high diversity of subsurface species in the region may be explained by the same factors, as well as the high density of caves and the development of extensive subterranean streams and rivers. A sampling of the diversity of Dinaric cave snails is shown in Figs. 1 and 2.

The second hot spot of subterranean snail diversity is East Asia, although this region has been studied less than the Dinaric Mountains. In East Asia it is the terrestrial cave snail



**FIGURE 1** A sampling of stygobitic mollusks from caves in the Dinaric mountains. (A) *Akiyoshia uenoi*, 2 mm; (B) *Baglivia karamani*, 1.7 mm; (C) *Belgrandiella kusceri*, 2.4 mm; (D) *Cilgia dalmatica*, 1.8 mm; (E) *Dalmatella sketi*, 2.2 mm; (F) *Erythropomatiana erythropomatia*, 1.5 mm; (G) *Hadziella ephippiostoma*, 1.6 mm; (H) *Hauffenia tellinii*, 1.8 mm; (I) *Istriana mirnae*, 2 mm; (J): *Lanzaia vjetrenicae*, 1.8 mm; (K) *Marstoniopsis croatica*, 3 mm; (L) *Neoboratia subpiscinalis*, 2.4 mm; (M) *Paladilhiopsis robiciana*, 4 mm; (N) *Plagigeyeria mostarensis*, 3.3 mm, (O) *Zospeum exiguum*, 1.6 mm, (P) *Acroloxus tetensi*, 4.5 mm. (Adapted from Bernasconi, R., and A. Reidel (1994). Mollusca. In *Encyclopedia Biospeologica I*, (C. Juberthie and V. Decu, eds.), pp. 54–61. Societe de Biospeologie, Moulis, France.)



**FIGURE 2** The hydrobiid snail *Marstoniopsis croatica*. (Photograph by Boris Sket.)

fauna that is especially rich in species. The surface terrestrial fauna in karst areas is especially rich as well. A single karst hill in East Asia may contain between 60 and 100 species. A single cave on an island in HaLong Bay in Vietnam yielded 17 terrestrial cave snails, 15 of which belong to a single family.

### COMMENTS ON SELECTED SPECIES

The hydrobiid cave snail, *Fontigens tartarea*, occurs in a dozen or so caves in West Virginia. As far as we know, its habits are typical, at least for the genus. The maximum linear extent of its range is 200 km, and there is considerable variation among populations, enough so that the northern species were at one time considered to be a separate species. Variation includes both size and shape of the shell, and indeed this may be a complex of species. Shell length ranges from 1 to 2.3 mm, so even large *F. tartarea* are tiny. In place in a cave stream, they look like large sand grains. It is very sporadic in its occurrence, occupying less than 10% of the cave streams within its range. Within cave streams it is also very sporadic in occurrence; it is very common in a few spots and absent in most of the stream. Some of this patchiness may be the result of inadequate collecting, but *Fontigens* has a reputation among cave biologists as being patchily distributed in the extreme. A possible explanation for this patchiness is that they may be associated with patchily distributed biofilms. Concentrations of *F. tartarea* are often on vertical faces of rocks in streams, yet another puzzle in its distribution.

The most unusual and unique cave mollusc is certainly the Dinaric cave clam, *Congeria kusceri*. It is related to the well-known zebra mollusc. The genus *Congeria* was common in the countries of the western Balkans, Hungary, and Romania in the late Miocene, and its near demise occurred when the ancestral Mediterranean Sea dried up (the Messinian salinity crisis). *C. kusceri* escaped extinction by colonizing the subterranean waters that exited into the Mediterranean Sea. Living specimens are only known from Hercegovina and Croatia (shells are known from Slovenia). It attaches to cave walls typically in terminal lakes deep underground. Shell length reaches over 12 mm, and the mollusc often occurs in clusters. Shells are often covered by precipitated calcium carbonate and the tubes of the unique cave polychaete, *Marifugia cavatica*. It appears to be able to emerge from the water, probably kept moist by water dripping from above. This seasonal drying is the probable cause of the growth rings observed on the shells of *C. kusceri*. Based on this inference, *C. kusceri* lives to an age of 25 years, compared to 1 or 2 years for surface-dwelling species in the same family. It also shows other demographic adaptations to cave life, possibly including internal fertilization and brooding of eggs.

### Bibliography

- Bernasconi, R., and A. Riedel (1994). Mollusca. In *Encyclopedia Biospeologica I*. (C. Juberthie and V. Decu, eds.), pp. 54–61. Société de Biospéologie, Moulis, France.
- Bole, J., and F. Velkovrh (1986). Mollusca from continental subterranean aquatic habitats. In *Stygofauna Mundi*, (L. Botosaneanu, ed.), pp. 177–206. E. J. Brill, Leiden, The Netherlands.
- Hershler, R., and J. R. Holsinger (1990). Zoogeography of North American hydrobiid snails. *Stygologia* 5, 5–16.
- Morton, B., F. Velkovrh, and B. Sket (1998). Biology and anatomy of the “living fossil” *Congeria kusceri* (Bivalvia: Dreissenidae) from subterranean rivers and caves in the Dinaric karst of former Yugoslavia. *J. Zool. Lond.* 245, 147–174.
- Vermeulen, J., and T. Whitten (1999). *Biodiversity and Cultural Property in the Management of Limestone Resources. Lessons from East Asia*. The World Bank, Washington, DC.

## Morphological Adaptations

Kenneth Christiansen

Grinnell College

### INTRODUCTION

Morphological adaptation is any evolutionary modification of the morphology of lineages of organisms associated, in this case, with their existence in caves. Stewart Peck (1998) usefully divided these changes into two groups, regressive and progressive. Regressive adaptations involve reduction or loss of systems that occur in surface-dwelling organisms. Progressive adaptations involve enlargement, modification, or development of systems not seen in most surface-dwelling organisms

## TROGLOMORPHY

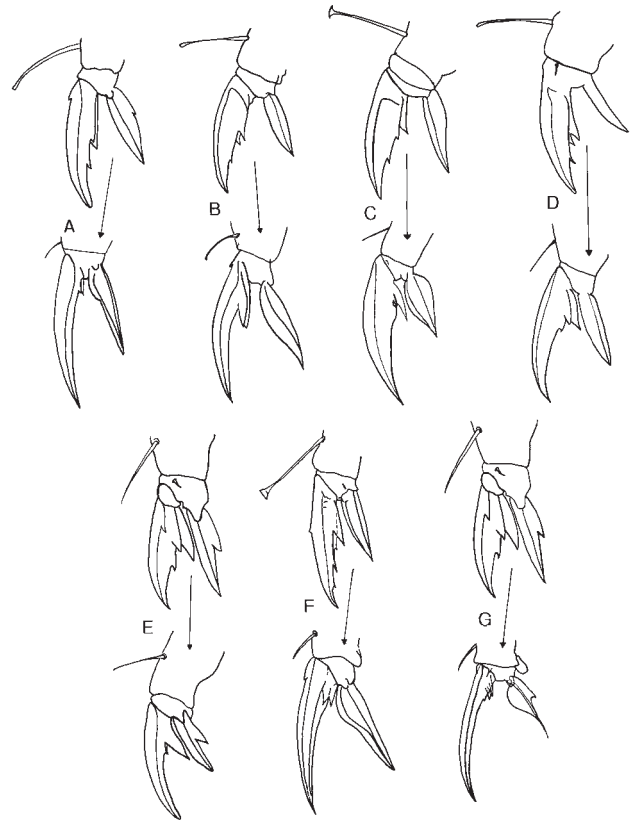
The term troglomorphy (Christiansen, 1962) designates both regressive and progressive evolutionary features associated with cave life. Though the term was originally used only for morphological features, subsequent study has shown that it applies equally well to behavioral and physiological features. In aquatic forms, where underground waters are frequently not associated with caves, the equivalent term stygomorph is sometimes used. These two terms serve to identify cave-adapted organisms without the unprovable, and sometimes erroneous, designation of troglobite. Troglomorphic features are essentially the same as those discussed under the rubric *Le Facies Cavernicole* (Vandel, 1964). Though characteristic of cave animals, they are by no means limited to cave animals. Many of the regressive features associated with the absence of light are seen in other environments where light is absent or greatly reduced, such as soil and the abyssal benthos. Some environments, such as soil and micro-caverns, serve as recruiting grounds for cave organisms. Because of the lack of light, organisms in these environments rely on nonvisual methods of food location that, combined with the common habit of feeding on dead vegetable matter or fungi, preadapt them to survival in caves.

Not all cave organisms display characteristics of troglomorphy. Organisms with troglomorphic characteristics have been called cave-dependent, and those organisms without troglomorphic features are called cave-independent. The existence of these two types of characteristics facilitates the study of evolution within cave organisms. Cave-independent features enable the determination of the lineages to which different species belong, and the cave-dependent features, which always display polarity, enable the determination of their relative evolutionary position within a lineage.

## EVOLUTION OF TROGLOMORPHY

Where troglomorphy does occur, it involves parallel or convergent evolution of different lineages. This convergence can be seen clearly in the Collembolan genera *Sinella* and *Pseudosinella* of the family Entomobryidae, where similar foot modifications occur in many European, North American, and Japanese lineages (Fig. 1). Convergence can also be seen in the head flattening in different fish and amphibian families (Fig. 2) and in physogastry and pseudophysogastry, which occur in beetles (Fig. 3) and at least one Hemipteran.

Troglomorphic changes vary in their generality. Many troglomorphic changes are limited to one order or even to one or a few families, including the foot modifications seen in Collembola (Fig. 1) and in Hawaiian cave planthoppers. Another taxonomically limited troglomorphy is the development of a ridge on the ventral surface of the thorax in the tribe Leptodirini of the beetle family Leiodidae. The clear pedomorphosis seen in the Urodele amphibia and the

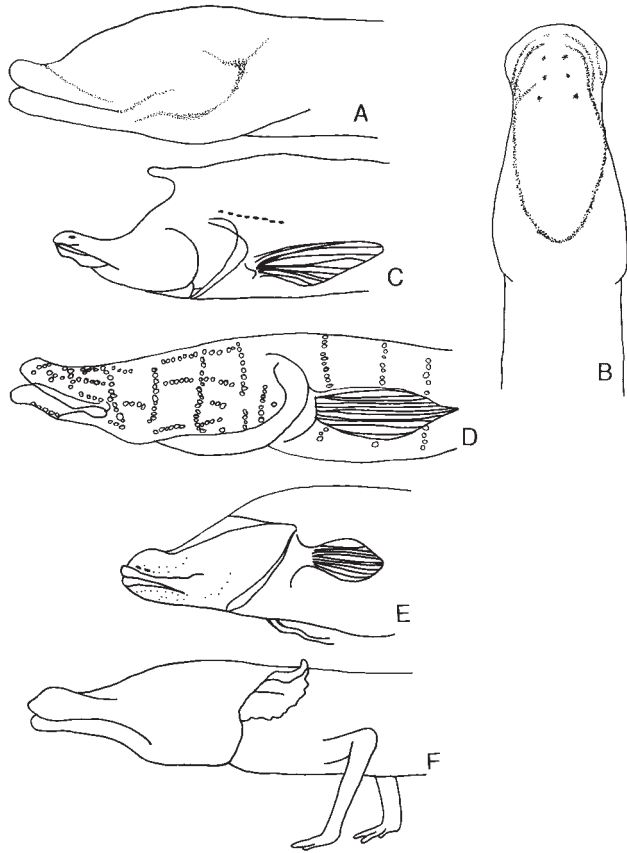


**FIGURE 1** Parallel evolution in caves of the foot complex of cave Collembola. (A) *Pseudosinella* in the United States; (B, C, and D) different lineages of *Pseudosinella* in Europe; (E and F) different lineages of *Sinella* in the United States; and (G) *Sinella* in Japan. Least troglomorphic foot above and most troglomorphic species foot below.

pseudophysogastry of beetles of the subfamilies Catopcerinae and Cholevinae of the family Leiodidae and the subfamily Trechinae of the family Carabidae (Fig. 3) are other examples.

Somewhat more widespread is scale loss in some species of four families of teleost fish. The reduction of the swim bladder is more widespread, reduced in some members of three families and totally lost in two families.

Some troglomorphic features are very widespread. Table I summarizes some of the major morphological troglomorphic features. These features include head flattening in vertebrates (Fig. 2); thinning of the cuticle in terrestrial arthropods; and the elongation of appendages and body form seen in some fish, amphibia, and arthropods. Size increase is a troglomorphic characteristic in several orders of small arthropods, as is the reduction or loss of wings in most troglobitic pterygote insects. Some troglomorphic characteristics appear to be almost taxonomically unlimited, occurring in virtually all species that show significant troglomorphy. This category includes pigment loss and eye reduction, which are the most common regressive adaptations. An increase in putative nonvisual sensory systems is also virtually universal.



**FIGURE 2** Extreme convergent troglomorphic head flattening in cave vertebrates. (A and B) lateral and dorsal view of head of *Ophisternon infernale* (Synbranchidae); (C) *Synoclocheilus hyalinus* (Cyprinidae); (D) *Speoplatyrhinus poulsoni* (Amblyopsidae); (E) *Lucifuga subterraneus* (Bythitidae); and (F) *Typhlomolge rathbuni* (Plethodontidae). (Adapted from Christiansen, K. (2002). *Evolution* **19** (4), 529–537; and Weber, A. (2000). Subterranean organisms — fish and amphibia. In *Ecosystems of the World — Subterranean Ecosystems*, (H. Wilkins, D. C. Culver, and W. F. Humphreys, eds.), pp. 109–113. Elsevier Press, Amsterdam.)

## REGRESSIVE EVOLUTION

Much of the controversy surrounding the study of morphological change in caves has been about regressive modifications. Only a few results of evolution have created a wealth of theories and hypotheses comparable to that devoted to explaining the effects of regressive evolution. The exponents of these theories often use cave organisms as primary model systems to support their arguments. At least 14 hypotheses have been advanced to explain the mechanisms of regressive changes. Most of these hypotheses are discussed in more detail in Barr (1968; pp. 69–80). Ten such hypotheses that are of historical or current interest will be dealt with in this article.

Five of these hypotheses are primarily of historical interest. Three of them rely on theories that directly oppose the now well-established core tenets of the Neo-Darwinian thesis. These theories are (1) Lamarckism and Neo-Lamarckism, which rely on the inheritance of acquired characteristics, (2)

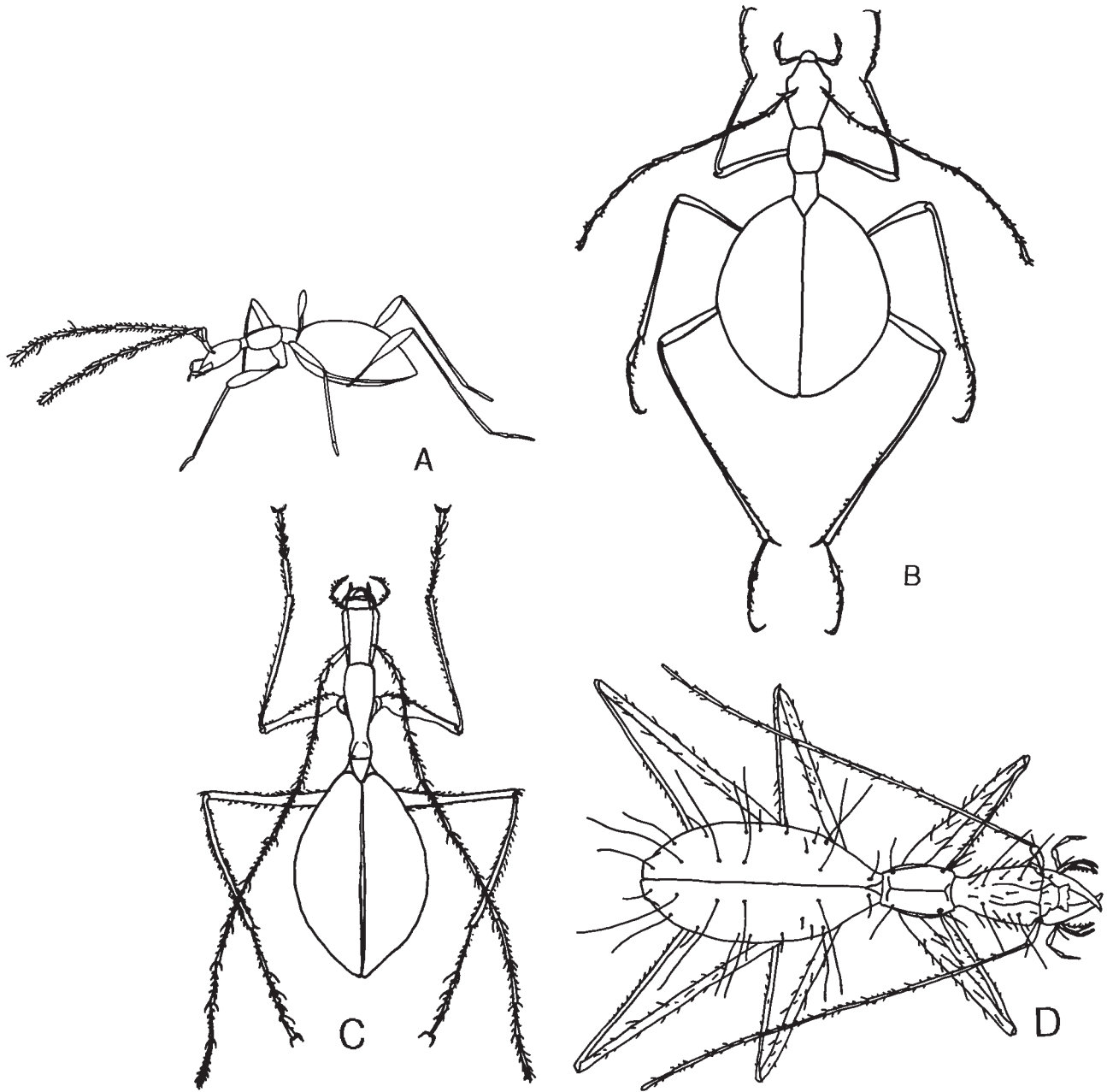
orthogenesis, and (3) Vandel's organicism. Organicism states that lineages go through three stages: birth, specialization, and senescence. Under this model, degenerative changes are characteristic of lineage senescence. Thus, Vandel hypothesizes that all cave species are in the senescent evolutionary stage. They show regressive evolution, not because of environment or selection, but because of their age status in the lineage. No recent evidence has been presented to support Vandel's theory.

Two other hypotheses of historical interest are Lankester's escape hypothesis and Ludwig's trap hypothesis. The escape hypothesis states that weak-eyed organisms falling into caves were unable to escape. The trap hypothesis holds that weakly pigmented surface forms would be sensitive to light and thus would concentrate in caves. These two hypotheses were never widely supported, instead they were dealt a deathblow by the work of Fong and Culver (1985) which showed large-eyed individuals of a highly variable amphipod population were actually more rather than less photophobic than small-eyed individuals. None of these five hypotheses are extensively studied today, but a few are being pursued.

Two explanations still being considered, have received no recent support. The first of these is material compensation. This hypothesis comes in many forms but all of them presuppose that, in the food-poor cave environment, selection will favor the most economical use of the energy furnished by food and thus will favor reduction of useless structures or processes. This hypothesis has run into difficulties. Recent discoveries show that regressive evolution can occur in cave environments where there is an abundant supply of food. These environments include some tropical caves and caves where chemoautotrophic bacteria furnish ample food supply. Even in caves with limited food, the evidence to support a theory of material compensation is weak. As Poulson (1963) noted in his detailed study of this problem, the calculations do not clearly support or disprove the idea of selective reduction of "useless" traits as having a positive effect on energy economy. In the cavefish *Astynax* the reduction of the eyes does not appear to result in energy savings as measured by egg yolk consumption in embryos. Moreover, the caves where blind fish are found are reported to be food-rich. More data on the genetics of cave organisms are needed to settle this debate.

Another explanation is Heuts' (1951) negative allometry hypothesis, in which he posits that organs appearing early in development and growing rapidly at first, such as eyes, are more likely to be negatively affected by lowering growth rates. This thesis is supported by some data but is generally more descriptive than explanatory.

Most recent studies have involved either the increase in the number of neutral genes having a disruptive and/or reductive effect on functionless organs, associative selection with adaptive structures, or some combination of the two. Poulson (1986) and others have strongly supported the disruptive effect of the accumulation of neutral mutations as the most



**FIGURE 3** Convergent pseudophysogastry in different lineages of cave beetles: (A) Trechinae, *Aphaenops pluto* (after Vandel 1964); (B) Cholevinae, *Glaciocavicola bathysciodes* (courtesy Stewart Peck); (C) Bathyscinae *Antroherpon scutulatum* (courtesy of PierMauro.Giachino); and (D) Bathyscinae, *Leptodirus hohewarti* (after Vandel).

plausible explanation for regressive evolution. The fact that, in the course of increasing troglomorphy, progressive features tend to show less variability than regressive ones would tend to support the accumulation of genes in regressive structures. Sket (1985) challenges the generality of this increase in variability. Culver and Wilkens (2000), in their recent work on the topic, suggested that the accumulation of mutated genes and associative selection reinforce each other in regressive evolution. Hypotheses of this sort afford the best available explanation for regressive evolution.

There are still problems. First, it is questionable whether any single hypothesis can explain all of the aspects of regressive evolution. Moreover, a number of ideas exist concerning regressive evolution that has not been tested in cave animals. One such idea is Regal's (1977) noise suppression hypothesis. This hypothesis posits, on a basis of cybernetic theory, that natural selection is constantly acting to squelch nonessential messages within developing organisms. This action reduces metabolic noise and hence improves evolutionary fitness. In addition, a few earlier hypotheses, such as orthogenesis,



TABLE I Common Troglomorphic Characteristics

Morphological characteristic	Ref.
Specialization of sensory organs (touch, chemoreceptor, hygroreceptor, thermoreceptor, pressure receptors)	Vandel, 1964; Sbordoni, 1980; Weber; 2000
Elongation of appendages	Sbordoni, 1980; Coineau & Boutin, 1992; Weber, 2000; Christiansen, 1961 Harvey, Shear, & Hoch, 2000; Vandel 1964
Pseudophysogastry	Vandel 1964, Sbordoni 1980; Accordi et al., 1980
Reduction of eyes, pigment, wings	Vandel 1964, Sbordoni 1980, Coineau & Boutin, 1992; Weber, 2000
Compressed or depressed body form (hexapods)	Harvey, Shear, & Hoch, 2000
Increased egg volume	Vandel, 1964; Sbordoni, 1980; Poulson, 1963
Increased size (Collembola, Arachnida)	Christiansen, 1961; Harvey, Shear, & Hoch, 2000
Unguis elongation (Collembola)	Christiansen, 1961
Foot modification (Collembola, planthoppers)	Christiansen, 1961; Howarth et al., 1990
Scale reduction or loss (Fish)	Wilkins, 1988; Weber, 2000; Ercolini et al., 1982
Loss of pigment cells and deposits	Numerous
Cuticle thinning (terrestrial arthropods)	Numerous
Elongate body form (Teleost fishes, Arachnids)	Weber, 2000; Coineau & Boutin, 1992.
Depressed, shovellike heads (Teleost fishes, salamanders)	Weber, 2000
Reduction or loss of swim bladder	Romero & Paulson, 2001
Decreasing Hind femur length/crop empty	Studier, E., Lavoie, K., & Howarth, F., 2002
Live weight, ratio (crickets)	

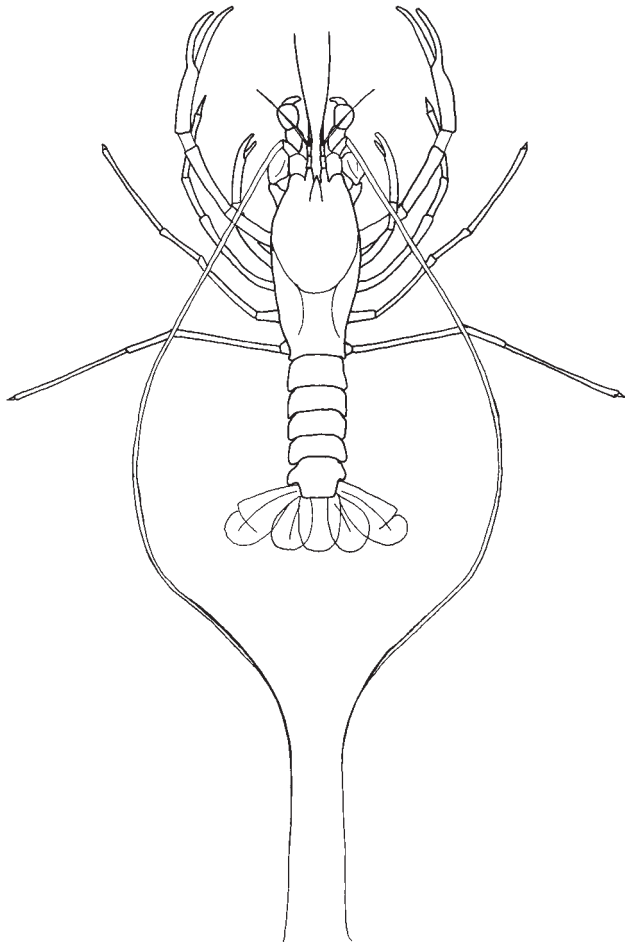
have recently been revisited and revised. Several students of evolution suggest that this concept is misunderstood and actually denotes that there is a limited array of variations, which can occur and be functional in any group of organisms. This results in the fact that very similar characteristics occur under different ecological conditions and independently of selection. Regressive evolution remains a fruitful field for future research. The study of progressive modifications in cave life has produced less controversy.

### PROGRESSIVE TROGLOMORPHY AND ADAPTATION

Though some progressive evolutionary modifications may be nonadaptive, they most putatively increase their owner's chances of survival or competitiveness in caves. There have been a number of works dealing with such adaptations in specific groups (Christiansen, 1965; Poulson, 1963; Hobbs, 2000; Weber, 2000). The general topic of cave adaptation has also received a number of reviews (Vandel, 1964; Barr, 1968; Culver, 1982; and Culver et al., 1995). External morphological adaptation has been studied far more than internal.

Regressive troglomorphy is commonly found in troglophile forms, but progressive troglomorphy is usually limited to troglobitic or nearly troglobitic forms (those very rarely found outside caves). Progressive troglomorphy is, however, not universal among such cave organisms. In order for it to occur, three factors have to be present: (1) selection pressure for the development of a particular characteristic, (2) the genetic and physiological or behavioral ability of the

organism to respond to this pressure, and (3) sufficient time evolving in caves to develop the adaptations. Many cave organisms lack one or more of these factors. Indeed, the majority of trogliphiles and some troglobites show little or no progressive troglomorphy, probably because one or more of the factors necessary to morphological adaptation is absent. Thus, there are many species of fish and crayfish found in caves that show no troglomorphy. Many extremely edaphic Collembola, such as the members of the family Onychiuridae, already unpigmented and eyeless in all surface habitats, rarely show further troglomorphy, although they have many troglobitic species. In many other groups, troglomorphy is questionable or inconsistent (Culver, 1982). Troglomorphy is also usually absent in some cave environments, such as localized guano piles or large masses of organic debris that are extremely energy-rich. Peck (1973) pointed out that troglomorphy should not be normal in these cases, because strong troglomorphy only occurs when organisms are exploiting large-volume spaces such as cave wall or floor surfaces or large bodies of water. The cases where troglomorphy occurs in food-rich regions (some tropical caves and chemoautotrophic caves) most commonly involve only the regressive features of eye and pigment reduction. This fact supports the hypothesis that the mechanisms of regression differ from those of progressive adaptation. It is interesting that Boutin and Coineau (1990) have found something similar to troglomorphy in phreatobites, which live in narrow spaces, where small size and elongate body form are developed convergently.

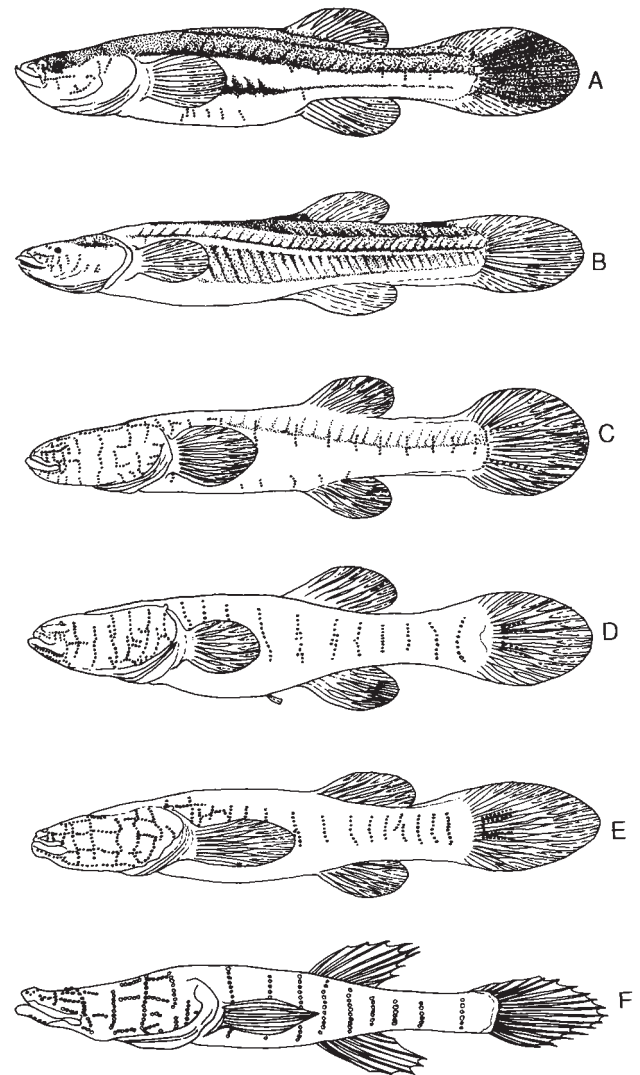


**FIGURE 4** Extreme troglomorphy seen in the crayfish *Troglacambarus maclanei* (Adapted from Hobbs, H. (2000). Subterranean organisms — Crustacea. In *Ecosystems of the World — Subterranean Ecosystems*, (H. Wilkins, D. C. Culver, and W. F. Humphreys, eds.), pp. 95–108. Elsevier Press, Amsterdam.)

### EFFECTS OF ENVIRONMENTAL FACTORS ON ADAPTATION

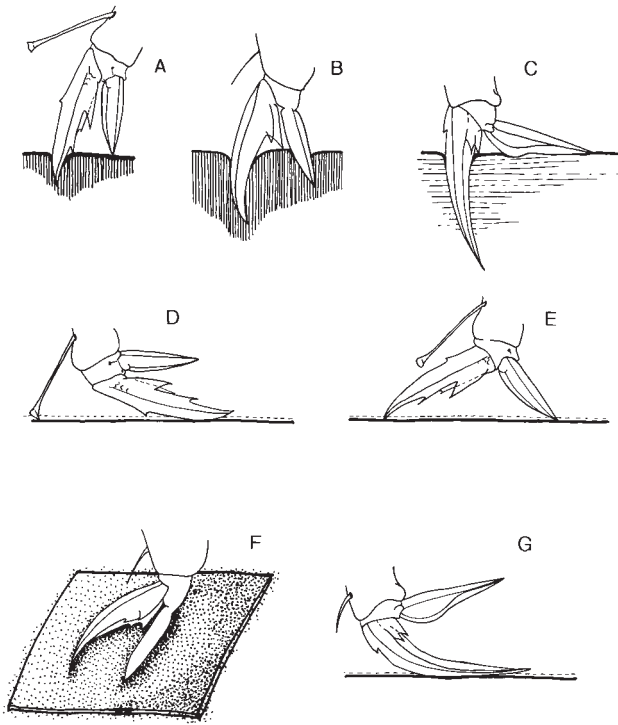
There is a strong correlation between the environmental factors found in caves and the development of progressive troglomorphy. While earlier works suggested non Neo-Darwinian explanations for adaptation in cave animals (Vandel, 1964), almost all recent work has been done with the clear assumption of the applicability of the Darwinian core tenets. A possible recurrence of a view similar to that held by Vandel can be seen in the emphasis on phenotypic plasticity espoused by Romero (2002); however, the fact that similar positive troglomorphic features evolve in many different cave regions and lineages implies an adaptive control over their genetic development.

The nature of this adaptive value is sometimes completely unknown, as with the mesosternal carina development in beetles and the flattening of heads in fish and salamanders. In some cases, various untested hypotheses for these adaptive values have been advanced. For example, the large air space



**FIGURE 5** The species of Amblyopsidae showing increase in the neuromast number: (A) *Chologaster cornutus*, (B) *Chologaster agassizi*, (C) *Typhlichthys subterraneus*, (D) *Amblyopsis spelaea*, (E) *Amblyopsis rosae*, and (F) *Speoplatyrhinus poulsoni*. (Adapted from Weber, A. (2000). Subterranean organisms — fish and amphibia. In *Ecosystems of the World — Subterranean Ecosystems*, (H. Wilkins, D. C. Culver, and W. F. Humphreys, eds.), pp. 109–113. Elsevier Press, Amsterdam.)

under the elytra in pseudophysogastry has been theorized to serve a respiratory function by increasing the air exposure of the thin abdominal membrane and by serving as a bubble lung during flooding. It has also been explained as a flotation device. In other cases the adaptive value appears to be self-evident, as with the increase in motion sensory organs in fish and elongation or hypertrophy of tactile organs generally. In some cases these apparently adaptive functions are associated with specific habits and/or habitats. Thus, the extremely delicate or gracile body form and elongate antennae of the cave crayfish (Fig. 4) *Troglacambarus maclanei* is associated with its normal habitat on walls or ceilings of flooded cave passages.



**FIGURE 6** Morphological and behavioral changes seen in the process of adaptation of the foot complex of cave Collembola of the genus *Pseudosinella*: (A) typical weak penetration of clay seen in nontroglophic species; (B) intermediate troglomorphy showing increased penetration of clay; (C) extreme troglomorphy capable of walking on water surfaces; (D and E) nontroglophic positions on smooth, hard, wet surfaces; (F) sideways position seen in forms having intermediate troglomorphy; and (G) typical foot position on hard, wet surfaces in highly troglomorphic species.

There is general agreement that cave habitats are very specialized and, in some respects, very demanding. The normal scarcity and sporadic availability of food, the absence of light, and the difficulty of long-range dispersal pose problems. On the other hand, the relatively high and constant humidity, absence of wind currents, and limited predation and parasitism represent considerable advantages. All of these lead to selection pressures, which do not occur in surface habitats, and release from some selection pressures, which do occur there. These changes are consistent among caves all over the world.

### EVIDENCE OF TROGLOMORPHIC ADAPTATION

Many recent studies have furnished direct evidence to support the adaptive value of troglomorphic changes (Christiansen, 1965; Culver et al., 1995; and Poulson, 1963). These works indicate that those troglomorphic features that have been studied are subject to selection and are, in fact, adaptive.

In spite of all this, few studies have produced data to support the precise adaptive functions of specific troglomorphic developments. One of the best-studied examples of the adaptive function of troglomorphic change is that of the

cavefish of the family Amblyopsidae. Here the great increase in neuromast motion sensory organs (Fig. 5) is associated with an increased ability to locate prey and with greater success in capturing it. This adaptations, combined with a variety of behavioral, physiological, and developmental changes, increase the chances of survival in cave waters. A second example occurs in the beetles of the subfamily Trechinae. Here the cave species that are crevice feeders tend to be small and flattened, whereas the cursorial feeders tend to be larger pseudophysogastric types (Fig. 3). Still another example is in the family Entomobryidae of the Collembola, where laboratory studies have shown that the foot adaptations seen in increasing troglomorphy are associated with behavioral changes that first allow for better movement over wet stone surface, then make for increased efficiency in moving over wet clay, finally resulting in an ability to walk on water surfaces (Fig. 6). In the course of this evolution, each change in behavior (the need to walk on wet stone, wet clay, or water) precedes a change in the direction of the development of the foot structure. Thus every troglomorphic characteristic in these cases is associated with the ability to deal with the particular environmental conditions found in caves.

The function of troglomorphic modification is also shown by analogous modifications in other habitats. For example, the extremely troglomorphic form of Collembola is most closely approached in two very different surface habitats. The foot structure is closest to that seen in aquatic Collembola, but the body shape and size are most similar to those seen in forms (largely tropical) that live in trees above the litter or soil. The foot structure is clearly related to the widespread occurrence of wet clay in caves, which makes movement difficult, and to the rimstone or other water pools, which act as traps for many Collembola. The body shape and size changes are probably associated with a method of predator escape. The freedom of movement furnished by open cave surfaces is more similar to conditions found in the arboreal habitat than to the normal surface habitat in soil or leaf litter where cave forms are recruited. Another example of analogous modification is the hypertrophy of organs for nonvisual location of food in both deep-sea and cave-dwelling fish. Wing reduction or loss, which is characteristic of cave insects, is also seen in environments such as soil and high alpine areas where wings are nonadaptive. The reduction of eyes and pigment in cave forms occurs also in dark edaphic and microcavernicole habitats. The loss of the epicuticular wax layers seen in caves is also seen in edaphic habitats where humidity is consistently high, as it is in habitable caves.

### OCCURRENCE OF MORPHOLOGICAL TROGLOMORPHY

One of the mysteries of the evolution of cave organisms is the fact that only certain groups of any major taxon evolve morphologically within caves. In some cases the opportunity

to evolve is simply lacking due to dietary restrictions or lack of entrance to caves. Yet there are many instances where neither restriction applies. In Collembola, most genera do not reproduce in cave depths, but many occasionally do in entryways where large amounts of organic debris have accumulated. Members of the families Isotomidae and Sminthuridae are often found in deeper reaches of caves where piles of organic debris have accumulated, yet no genus of the Isotomidae and only one genus of Sminthuridae (*Arrhopalites*) have evolved a lineage of cave species. Similarly, the order Psocoptera, with more than 3800 species, has only 8 cavernicole species, none of which are clearly troglomorphic. In beetles, the highly variable families Scarabidae, Ptiliidae, and Tenebrionidae have no troglomorphic species; there is no *a priori* reason to expect this circumstance. In the widely varied family Carabidae, only 4 or 5 of the 40 tribes have developed troglomorphic forms.

The majority of the troglomorphic species of the beetle family Carabidae belong to a single tribe, the Trechini. Similarly, in the 17 tribes of the beetle family Leiodidae, only 3 tribes harbor troglobitic species and most of these belong to the tribe Leptodirini (Bathyscini). In freshwater teleost fish, about half the families found in caves show no species with troglomorphic features or any evidence of derivative forms with them. Similarly, in the crustacean order Amphipoda, the large, Holarctic family Gammaridae, with over 50 genera and over 300 species, has only 14 genera and 33 species that are troglobitic or stygobitic. In contrast, the family Crangonyctidae, with only 6 extant genera and about 145 species, has 5 troglomorphic genera and 116 such species. Even more striking is the Palearctic family Niphargidae with 8 genera and 207 species, all troglobitic or stygobionts.

One possible explanation of these cases of failure in the evolutionary exploitation of caves is the absence of necessary exaptations or preadaptations. It has been generally agreed that preadaptation or exaptation is required for successful passage from troglaxene to troglophile. This idea is largely based on inference; little strong evidence to support it has been produced. It is true that many terrestrial troglobite lineages are recruited from habitats such as soil and micro-cavernicole cavities where suggested preadaptations or exaptations are developed. For example, soil organisms have to deal with survival in the absence of light and, and for most groups, poor food sources. Both of these conditions could serve as preadaptations for cave life. In addition, soil habitats usually have high humidity, as do most biologically active cave habitats.

Four facts argue against this idea as a major explanation. First, each of these environments is significantly different from that of caves. For example, food supply in soil is generally widely and continuously available but also very dispersed. In caves, the supply is usually concentrated and locally available but sporadic or periodic. Second, movement in soil is severely limited, where it is virtually unlimited for

small organisms in caves. Third, there are many cases where the most primitive troglobite members of a cave lineage do not show morphological evidence of these preadaptations or exaptations. Fourth and finally, even if these exaptations or preadaptations are adequate to explain the successful invasion of caves, there are many cases of groups with similar potential preadaptations that are not successful. Examples exist in the Carabid beetles and in the Collembola. In the Carabidae, members of the tribe Anillini are eyeless and depigmented. Although most are edaphic, only one species in Alabama appears to be a true troglobite. This contrasts with the tribe Trechini, which has hundreds (if not thousands) of troglobitic species. In the Collembola, the family Entomobryidae has hundreds of troglobites, some showing the highest degree of troglomorphy. In contrast, the Isotomidae, with hundreds of depigmented, reduced-eye, or eyeless edaphobites, has only two troglobitic species, neither of which is strongly troglomorphic.

A possible explanation for these two cases is that physiological and/or behavioral preadaptations rather than morphological changes are crucial for survival in caves. The best evidence to support this explanation comes from the fish families with a large percentage of stygiobiont forms. In the family Amblyopsidae, where five of the six species are found in caves, the single noncave species lives in stable habitats, shows low activity level, is nocturnal, and has the ability to feed and orient itself in the dark. All these features could be adaptive in a cave environment. The surface-living forms of the family Synbranchidae include about 17 species, 4 of which are found in underground waters and show similar probable preadaptations. They are mostly light-avoiding species feeding at night and able to move through small spaces. Another piece of evidence to support the idea of non-morphological preadaptation is the widespread existence of opportunistic troglophile species that lack morphological troglomorphy and are able to survive in caves. These species thrive where they do not face competition from troglomorphic species and where food resources are abundant.

More definitive evidence concerning the role of preadaptation or exaptation in the development of troglomorphy could be obtained by comparing groups successful in exploiting caves with those that are not successful. For instance, compare the behavior and physiology of surface species of the highly troglomorphic fish family Amblyopsidae and Synbranchidae with those of the family Centrarchidae that has 18 species, 11 of which are found in caves, none showing any troglomorphy. In the family Cichlidae, with over 900 species with only 2 reported in caves, there are no troglomorphic species. For a terrestrial example, compare the following: The collembolan genus *Folsomia*, with 190 *primarily* soil species, many with reduced eyes and pigment, has no troglomorphic cave species, and the genus *Pseudosinella* contains 280 species, the majority of which are troglomorphic troglobites.

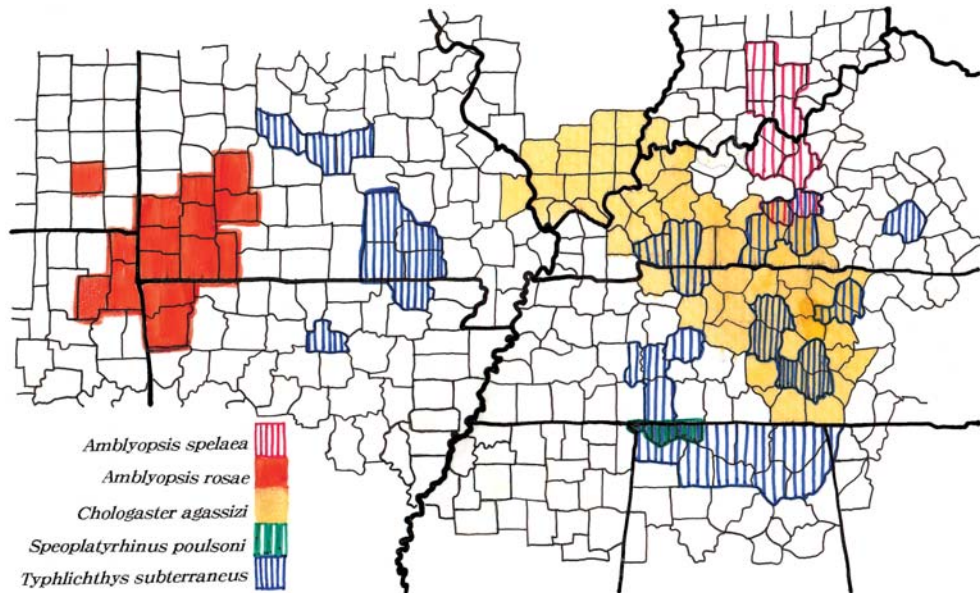


FIGURE 7 Distribution of cave inhabiting Amblyopsidae, assembled and modified from various sources.

Where troglomorphy does occur, it allows for a separate analysis of those features clearly affected by the cave environment (cave-dependent) and those that are unaffected by it (cave-independent). The cave-dependent features show a great deal of convergence and parallelism, giving clear polarity for phylogenetic analysis. This permits a measure, or at least an indication, of the degree of cave adaptation of different groups of organisms. An unfortunate corollary is that the large amount of resultant homoplasy makes cladistic analyses of cave animals difficult. Nevertheless, the existence of these two types of features makes caves an excellent natural laboratory for studying evolutionary processes.

The Superficial Underground Environment (MSS) is a specialized microcavernicole habitat that is frequently in direct contact with caves. Here we find many, but by no means all, of the fauna of caves. In a sense, this can be looked on as an extension of the cave habitat but with an absence of bodies of water or large open spaces. Because this environment is not well studied, it furnishes a good field for future research.

### EXAMPLES OF DETAILED ANALYSIS OF TROGLOMORPHIC EVOLUTION

Wherever progressive troglomorphy occurs, it is clear that understanding the factors that produce it requires detailed study of the organisms involved. In the next section, two such studies will be considered and what they tell us about the development of these adaptations will be discussed.

The first study deals with interspecific troglomorphic changes among the members of the North American teleost fish family Amblyopsidae. This small family has six known species (Fig. 5), all limited to the Southeast quadrant of the United States: one surface species (*Chologaster cornuta*), one

troglophile (*Chologaster agassizi*), and four troglobite species (*Typhlichthys subterraneus*, *Amblyopsis spelaea*, *Amblyopsis rosae*, and *Speoplatyrhinus poulsoni*). The single surface species is not found near any region occupied by the troglophile or troglobite species of the family, but it is found in slow streams and swamps on the coastal plain from southern Virginia to southern Georgia. The other species have either overlapping or nearly adjunct ranges (Fig. 7). Although many have studied these fish, Thomas Poulson did the definitive work. There is a clear gradient of increasing troglomorphy as we move from *C. cornuta* to *S. poulsoni*. The troglomorphic changes involve eye, pigment, and optic lobe reduction; increase in neuromast number, size, and exposure; hypertrophy of tactile, olfactory, and equilibrium receptors and their associated brain centers; and enlargement and flattening of the head. The single genetic study of the members of this family points to a multiple origin for different populations of the least troglomorphic of the troglobite species, *T. subterraneus*. This conclusion is reinforced by the wide and disjunctive distribution of this species. Thus, the evidence is strong that troglomorphic features seen in *T. subterraneus* were developed by parallel evolutionary changes. Whether the increasingly troglomorphic features of the remaining troglobite species were developed from some *Typhlichthys* like ancestor or from now extinct troglophilic forms remains in doubt. The existence of clines in *A. spelaea* from south to north with the most troglomorphic condition occurring in the southern populations would seem to support the former hypothesis. In addition, the extreme troglomorphy of *S. poulsoni* argues for ancestry from some already troglomorphic form. In any case, the widely disjunctive distributions of the highly troglomorphic *A. rosae* and *A. spelaea* strongly support the parallel evolution of their troglomorphic features.

A second notable feature is the lack of congruent develop-

ment of troglomorphic features. The overall gradient for troglomorphy is clear but only one feature, olfactory rosette size, follows this gradient strictly. Eye size shows a sharp reduction from *C. cornuta* to *S. poulsoni*, but the eyes of *T. subterraneus* are smaller than those of the generally more troglomorphic *A. spelaea*. Similarly, although there is a striking increase in neuromast number from *C. cornuta* to *S. poulsoni*, the number in *Amblyopsis* is smaller than that of *Typhlichthys*. A third notable feature is the increasingly limited distribution with increasing troglomorphy in the troglobitic species (Fig. 7). *Typhlichthys subterraneus*, the least troglomorphic of these, is scattered over five states. In contrast, *S. poulsoni*, the most troglomorphic, is found in only one cave system.

The second study involves the troglobitic collembolan *Pseudosinella hirsuta*, studied in great detail by Christiansen

and Culver (1968). This study involved the geographic variation of 25 populations of *P. hirsuta* using 12 cave-dependent and 3 cave-independent morphological features as well as one behavioral feature. This species belongs to a lineage of three species (Fig. 8) including *P. dubia* and *P. christianseni*. *P. dubia* shows little progressive troglomorphy and has a widely disjunctive distribution of three caves in Washington County, Arkansas, and one cave in Dent County, Missouri. *Pseudosinella hirsuta* is common and widespread in caves of central Kentucky and Tennessee. It has some populations in caves of northeast Alabama and two in adjacent northwest Georgia. In addition, there are populations in eastern Tennessee and the westernmost part of Virginia (Fig. 9). Assuming that the troglophile ancestor of *P. hirsuta* resembled *P. dubia*, *P. hirsuta* already shows significant increase in troglomorphy. In some other features,

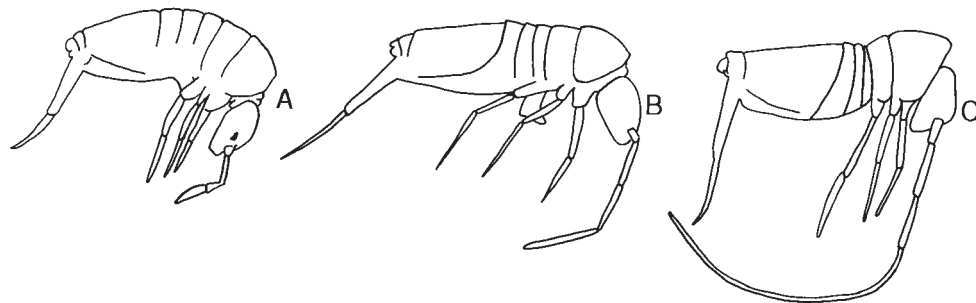


FIGURE 8 Members of the *Pseudosinella hirsuta* lineage: (A) *P. dubia*, (B) *P. hirsuta*, and (C) *P. christianseni*.

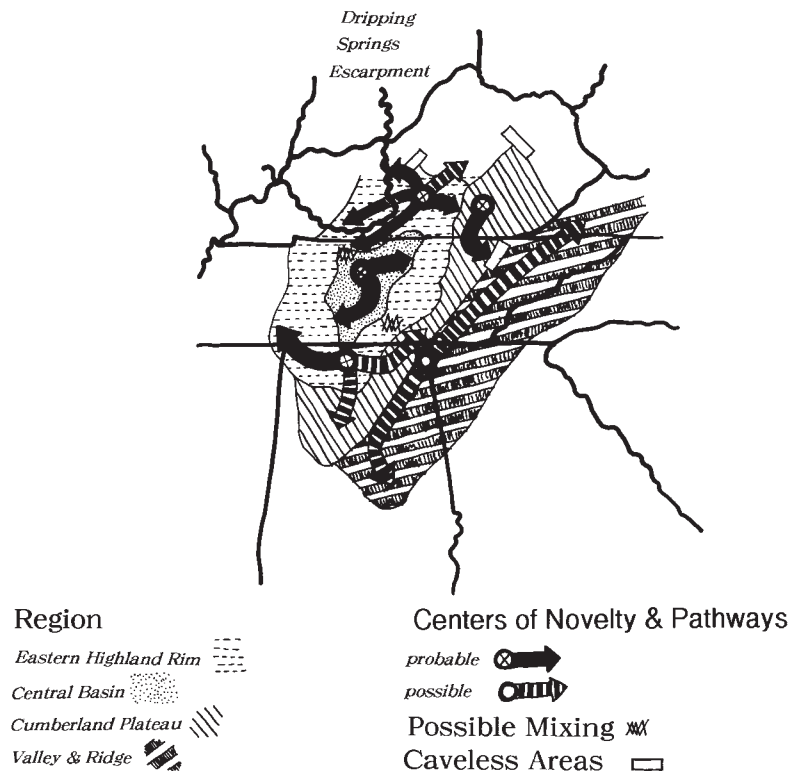


FIGURE 9 Centers of novelty and pathways of evolutionary distribution of *Pseudosinella hirsuta*.

such as the foot structure, *P. hirsuta* shows a wide range, varying from one similar to *P. dubia* to one similar to *P. christianseni*. The most troglomorphic of the species, *P. christianseni*, occurs in small, scattered locations in the eastern part of the range of *P. hirsuta*.

All cave-dependent features of each cave population show similar states of advanced or primitive cave adaptation, with the exception of the extremely phenotypically plastic mesothorax. On this basis, each population can be placed in one of several sequences of advanced to primitive conditions. Each sequence is largely or entirely limited to a single geological region with a single evolutionarily advanced region and one to five primitive regions, generally marginal (Fig. 9). The populations' cave-independent features do not follow the same pattern, but do give some indication of decreasing variability from advanced to primitive populations. Each sequence of caves contains most or all of the variations seen within the species.

The main conclusions from this study regarding troglomorphy are

1. The characteristics of *P. hirsuta* have evolved independently in at least four different places.
2. *Pseudosinella christianseni* represents a continuation of the evolutionary trends seen in *P. hirsuta*. The two species have never been found in the same cave, but where they exist in caves near each other, the populations of *P. hirsuta* are usually among the most highly troglomorphic seen in the species.
3. Dispersal of *P. hirsuta* occurs primarily via underground routes. There is no indication of morphological discontinuity between populations in a given cave sequence.
4. There is morphological evidence for genetic discontinuity between different cave sequences.
5. Most importantly, it appears that the extremely troglomorphic *P. christianseni* evolved at four different times from *P. hirsuta* like ancestors.
6. The ranges of the troglobitic species tend to reduce with increased troglomorphy.
7. The putative ancestral species is no longer found near the ranges of the more troglomorphic species.

These patterns are all seen in many other groups of cave organisms but seldom with the detail and clarity seen in these two examples.

## CONCLUSIONS

1. Morphological cave adaptation or troglomorphy is seen in many, but not all, troglobitic animals.
2. The development of troglomorphy requires a number of conditions and is still not clearly understood.
3. Troglomorphy can be either regressive, involving the reduction or loss of features, or progressive,

involving alteration or expansion of preexisting features or the development of new features.

4. Progressive and regressive troglomorphy probably involve different combinations of mechanisms.
5. All troglomorphic development involves extensive parallelism and convergent evolution.
6. The occurrence of these troglomorphic (cave-dependent) features alongside nontroglomorphic (cave-independent) features, which show no parallelism or convergence, makes caves an ideal environment in which to study evolution.
7. These trends are associated with the unusual, and often demanding, environmental conditions of caves, which are very different from those in surface habitats but similar in the great majority of caves throughout the world.
8. The common result of these environmental conditions is that the initial development of troglobitic forms results in equivalent levels of troglomorphy evolving in many different places.
9. The higher the level of troglomorphy within troglobitic groups, the more restricted the distribution of the species and the more limited their geographic range.
10. Forms showing low levels of troglomorphy are often troglophilic, whereas those showing high levels are almost always troglobitic.
11. Although it appears likely that development of troglomorphy is facilitated by preadaptations or exaptations for cave life, the reasons why only a few groups of organisms develop this remain unclear.

## Bibliography

- Barr, T. C. (1968). Cave ecology and the evolution of troglobites. *Evol. Biol.*, 35–102.
- Boutin, C. and N. Coineau (1990). "Regression model" "model biphasé" d'évolution et d'origine des micro-organismes stygobies interstitiels continentaux. *Rev. Micropaléontol.* 33, 303–322.
- Christiansen, K. (1962). Proposition pour la classification des animaux cavernicoles. *Spelunca* 2, 76–78.
- Christiansen, K. (1965). Behavior and form in the evolution of cave Collembola. *Evolution* 19 (4), 529–537.
- Christiansen, K., and D. Culver (1968). Geographical variation and evolution in *Pseudosinella hirsuta*. *Evolution* (2), 237–255.
- Christiansen, K. (2002). Adaptation: External morphology. In *Encyclopedia of Cave and Karst Science*, (John Gunn, ed.). Fitzroy Dearborn, London.
- Culver, D. C. (1982) *Cave Life*, p. 189. Harvard University Press, Cambridge, MA.
- Culver, D. C., T. C. Kane, and D. W. Fong (1995). *Adaptation and Natural Selection in Caves*. Harvard University Press, Cambridge, MA, 223 pp.
- Culver, D. and H. Wilkens (2000). Critical review of relevant theories of the evolution subterranean animals. In *Ecosystems of the World—Subterranean Ecosystems*. (H. Wilkens, D. Culver, and W. Humphreys Eds.). Elsevier, Amsterdam.
- Fong, D. W., and D. Culver (1985). A reconsideration of Ludwig's differential migration theory of regression evolution. *N.S.S. Bull.* 47 (23), 123–127.

- Heuts, M. J. (1951). Ecology, variation, and adaptation of the blind African cave fish *Caecobarbus geertsii*. *Ann. Soc. Roy. Zool. Belgique* **82**, 155–230.
- Hobbs, H. H. (2000). Subterranean organisms — Crustacea. In *Ecosystems of the World — Subterranean Ecosystems* (H. Wilkins, D. C. Culver, and W.F. Humphreys, Eds.). Elsevier, Amsterdam, pp. 95–108.
- Peck, S. B. (1973). A systematic revision and the evolutionary biology of the *Ptomaphagus (Adelops)* beetles of North America (Coleoptera, Leiodidae, Catopinae), with Emphasis on Cave-inhabiting Species. *Bull. Museum of Comparative Zool.* **45** (2), 29–162.
- Peck, S. B. (1998). Cladistic biogeography of cavernicolous *Ptomaphagus* beetles (Leiodidae, Cholevinae: *Ptomaphagini*) in the United States. *Proceedings 20th International Congress of Entomology*, pp. 235–260. *Museo Regionale di Scienze Naturali*, Torino, Italy.
- Poulson, T. (1963). Cave adaptation in Amblyopsid fishes. *Am. Mid. Nat.* **70**, 257–290.
- Poulson, T. L. (1986). Evolutionary reduction by neutral mutations: plausibility arguments and data from Amblyopsid fishes and Linyphiid spiders. *Nat. Speleol. Soc. Bull.* **47** (2), 109–117.
- Regal, P. J. (1977). Evolutionary loss of useless features: is it molecular noise suppression? *Am. Naturalist* **111** (977), 123–133.
- Romero, A. (2002). Hypogean evolution. In *Encyclopedia of Cave and Karst Science*, (John Gunn, ed.). Fitzroy Dearborn, London.
- Sbordoni, V. (1980). Strategie adattative negli animali cavernicoli: uno studio di genetica ed ecologia di popolazione. *Procedimento di Acad. Natl. de Lincei*, **51**, 60–100.
- Sket, B. (1985). Why all cave animals do not look alike: A discussion of the adaptive value of reduction processes. *N.S.S. Bull.* **47** (2), 78–85.
- Vandel, A. (1964). *Biospeleologie — la biologie des animaux cavernicoles*, p. 619. Gauthier Villars Press, Paris.
- Weber, A. (2000). Subterranean organisms — fish and amphibia. In *Ecosystems of the World — Subterranean Ecosystems*, (H. Wilkins, D. C. Culver, and W. F. Humphreys, eds.), pp. 109–113. Elsevier Press, Amsterdam.

## Multilevel Caves and Landscape Evolution

Darlene M. Anthony  
Purdue University

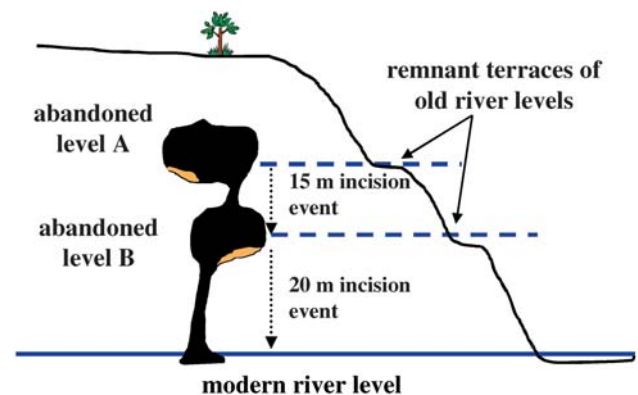
### MULTILEVEL CAVES

Cave explorers were among the first to note that some caves were found at different levels within a hillside or valley wall. The opportunity to enter a cave via one entrance, journey through extensive horizontal passageways connected to each other by narrow canyons, and exit via a second, lower entrance was considered by many to be the ultimate trip in sport caving. The notoriety of multilevel (or tiered) caves increased with the overall depth of the entire system, or with the number of levels or entrances that could be traversed during a single trip underground. When multilevel cave passages were surveyed and drafted by cartographers, the map often resembled a jumble of ribbon in plan view. However, when viewed from the side, or in vertical profile,

the passages fell neatly into narrow zones of horizontal development connected in a few key places by vertical passages. This particular pattern of cave development is found in many of the world's karst landscapes, where scientists are interpreting the role of multilevel caves in landscape evolution.

### CAVES AND THE WATER TABLE

Why do some caves develop levels, whereas others do not? What characteristics do multilevel caves share? How many years does it take to form a level as large as a subway tunnel? A basic understanding of the relationship between horizontal conduits and the regional hydrologic system is vital to answering these questions. In a karst terrain, caves typically form where slightly acidic water finds flow paths (such as joints, bedding planes, or faults) in carbonate rocks, directing surface water downward to the regional water table. Caves often provide the fastest (and sometimes shortest) path for surface water to reach the regional base level, which is represented by major regional rivers. Because caves are formed by flowing water, cave development is strongly controlled by base level elevation. In the *vadose zone* (above base level), underground streams carve narrow canyons that lead downward in the fastest manner possible until the *phreatic zone* (at or below base level) is reached. At the phreatic zone, cave streams form nearly horizontal tubes as water flows to a discharge outlet, which in many cases is a spring at or near the regional river. When surface rivers remain at the same elevation for long periods of time, called *stillstands*, cave streams develop large, horizontal passages at grade with the rivers (Fig. 1). When any event causes the regional rivers to suddenly lower, or incise, the sudden difference in elevation creates disequilibria between the cave stream and the newly lowered base level. The increased hydraulic gradient causes the cave stream (now in the vadose



**FIGURE 1** Generalized representation of a multilevel cave and its relationship with the regional base level shows the extensive horizontal conduits that form during long periods of base-level stability. These large passages are quickly abandoned in favor of lower levels during periods of accelerated river incision.



zone) to preferentially downcut narrow canyons in the floor of the horizontal conduit, abandoning the upper level to keep grade with the new base level. Differences between phreatic tubes and vadose canyons are often striking when exploring multilevel caves, and the vadose–phreatic transition clearly indicates a previous position of the regional base level.

### RIVER INCISION AND THE RECORD IN CAVES

Karst geomorphologists examining the relationship between cave levels and the landscape recognized that as surface rivers incised, the regional base level lowered, leaving formerly active cave passages dry and forming new cave passages beneath the older. Abandoned cave levels were often found to coincide with the scars of ancient terraces and remnants of gravel deposits found on the surface of the river valley. But when did the river incise, abandoning the cave levels? Rivers are by nature a destructive force in the landscape, removing many of the depositional features that mark their passage. Reconstructing the position of a surface river over geologic time is made even more difficult by the weathering and erosion of remnant fluvial deposits and by the lack of appropriate methods (such as carbon-14) for determining the absolute age of unconsolidated gravel and sand.

In sharp contrast to surface streams, multilevel caves contain vast piles of undisturbed sediments deposited by underground streams (Fig. 2). Subterranean capture of surface streams at sink points directs gravel, sand, and silt from surface highlands into caves, where sediment is transported along developing horizontal conduits to output springs. Banks of sediment are deposited in conduits in the same manner as sediments in surface streams, complete with flood deposits, channel cut-and-fill deposits, and other

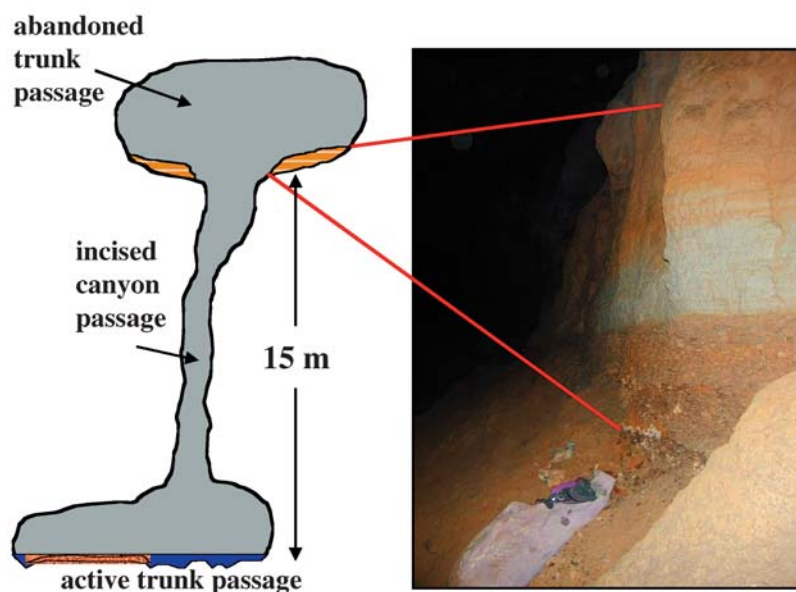
fluvial features. When an underground stream abandons a conduit in favor of a lower level, sediments left behind may remain undisturbed for millions of years, unaffected by either erosion or weathering. Because sediments in abandoned conduits were deposited by moving water, they represent the last time the conduit was an active part of the local hydrologic system. Conduit elevation and the timing of sediment burial serve as proxy for the paleoelevation of the water table over geologic time.

But how long ago was the sediment washed into the cave? This important question may now be answered with a new method of absolute age dating that compares the radioactive decay of atoms called *cosmogenic nuclides*. (The theory and application of cosmogenic nuclides and burial dating is the subject of a separate *Encyclopedia of Caves* entry.) The following examples illustrate how karst geomorphologists are using burial dates from cave sediments to interpret the history of river incision in North America.

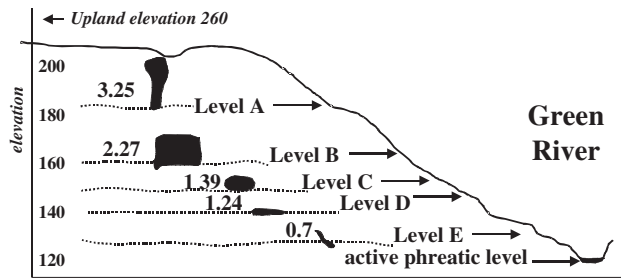
### EXAMPLES OF MULTILEVEL CAVES AND RIVER INCISION

#### Water Table Positions at Mammoth Cave, Kentucky

The development of large, horizontal cave passages at several different levels in the Mammoth Cave System of Kentucky is now firmly linked to changes in the elevation of the Green River, with passage morphology and sediment age permitting a reconstruction of regional base level during the past 3 million years (Fig. 3). Several periods of river stability allowed the formation of extensive horizontal passages at levels A and B, followed by brief periods of accelerated river incision that abandoned the higher levels. The most recent



**FIGURE 2** In-place fluvial sediments (right) preserve the record of a stream once occupying the abandoned conduit. Cosmogenic nuclides are measured to determine how long ago the cave stream was active and to constrain the timing of the incision event that abandoned the conduit.



Elevation in meters above sea level; no horizontal scale

**FIGURE 3** Generalized elevations of cave levels in Mammoth Cave, Kentucky, and the age of sediments deposited in each level. Cave levels correlate with remnant terraces and fluvial deposits along the Green River valley walls. Passage morphology and the age of sediments in Mammoth Cave constrain river stillstands and incision events during the past 3 million years.

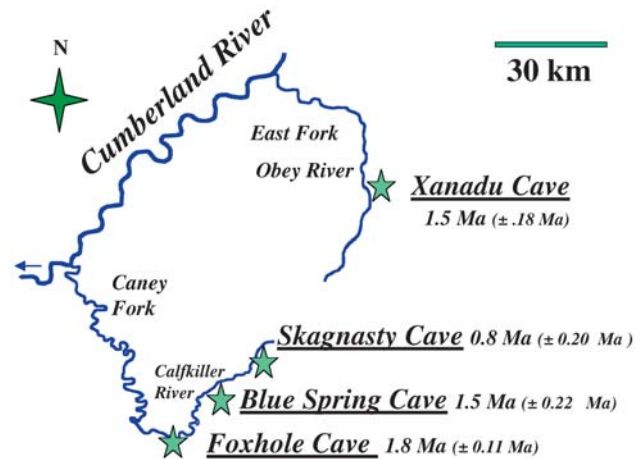
river stillstand ended 1.39 million years ago (Ma), with the abandonment of level C. Remnant terraces in the Green River gorge corresponding with cave levels may now be assigned ages, which correlate with major ice advances in the Ohio River basin during the Plio-Pleistocene.

#### Incision Pulses on the Cumberland River, Tennessee

Whereas Mammoth Cave preserved a record of changes in the water table at one location, abandonment of multilevel caves along the valley walls of tributaries to the Cumberland River in Tennessee tracks the migration of incision pulses, or *knickpoints*, along this major North American river. Knickpoints are sudden changes in the gradient of a river's long profile, such as rapids or waterfalls, and may form as a response to a sudden drop in the water table. A knickpoint will migrate in the upstream direction at a rate directly related to the size of the river's total drainage area, with pulses moving faster on a larger river than its tributaries. As a knickpoint migrates up a larger river, knickpoints are initiated on the smaller tributaries (much like dominoes). The ages of sediments found in large, abandoned passages at similar elevations above the modern river level show that caves were abandoned sequentially beginning around 1.8 Ma as a knickpoint generated by incision of the Cumberland River moved up the Caney Fork and beyond the cave outlets (Fig. 4). The simultaneous abandonment of passages on two tributaries of different lengths and drainage areas (Caney Fork and East Fork-Obey River) illustrates how the same incision event may initiate knickpoints that migrate up streams of varying stream power, affecting two different caves at the same time.

#### LANDSCAPE INTERPRETATION USING MULTILEVEL CAVES

Dating sediments in cave passages allows scientists to correlate the development and abandonment of multilevel



**FIGURE 4** Abandonment of multilevel caves along tributaries of the Cumberland River, Tennessee, track the migration of knickpoints triggered by an incision event originating on the Cumberland River more than 2 million years ago. Incision of the Caney Fork reached Foxhole Cave at 1.8 Ma, causing successive abandonment of caves as the pulse moved upstream. Differences in stream power account for the simultaneous abandonment of caves on separate tributaries.

caves with regional and global events. For example, the abandonment of Mammoth Cave's level C at  $\sim 1.4$  Ma was initiated by the blocking of major north-flowing rivers by an ice sheet that forced a reorganization of North American drainage east of the Mississippi River, creating the modern Ohio River at  $\sim 1.5$  Ma. The dates of abandonment at Mammoth Cave generate a Pleistocene incision rate of  $\sim 30$  m/million years (m.y.) for the Green River.

Along tributaries to the Cumberland River, abandonment of cave passages was linked to a pulse of river incision even older than the reorganization of the Ohio River basin. Sea-level lowstands at either 2.5 or 2.1 Ma are likely candidates for triggering this earlier incision event recorded in caves along the Cumberland River. Pleistocene incision rates for tributaries of the Cumberland River are also  $\sim 30$  m/m.y., corroborating those found at the Green River.

Cosmogenic nuclides in cave sediments may also be used to determine rates of surface processes during the time sediments were deposited underground. Erosion rates indicate that the sandstone-capped uplands surrounding the Green River gorge and the Cumberland River have maintained a steady rate of 2–7 m/m.y., despite accelerated river incision rates of  $\sim 30$  m/m.y. Although surface valleys have deepened considerably, landscape features of the Appalachian Plateaus would have been recognizable more than 3 million years ago.

For speleologists, the ages of levels B and C abandonment demonstrate that level C passages needed at least 500,000 years to form, defining a minimum number of years for extensive conduits to develop in that particular limestone unit.

Thanks to a new method for dating sediments in caves, the relationship between multilevel caves and the surrounding landscape may be used to infer the timing of many geomorphic processes. Multilevel caves are being used in alpine settings to constrain previous positions of glaciers. In tectonically active areas, they are helping to determine uplift rates. Geomorphologists are presently examining multilevel caves in every type of karst terrain, uncovering clues as to how the landscape changed over geologic time.

### **Bibliography**

- Ford, D. C., and P. W. Williams (1989). *Karst Geomorphology and Hydrology*. Unwin Hyman, London.
- Granger, D. E., D. Fabel, and A. N. Palmer (2001). Pliocene-Pleistocene incision of the Green River, Kentucky, determined from radioactive decay of cosmogenic <sup>26</sup>Al and <sup>10</sup>Be in Mammoth Cave sediments, *Geol. Soc. Am. Bull.* 113, No. 7, pp. 825–836.
- Miotke, F.-D., and A. N. Palmer (1972). *Genetic Relationship between Caves and Landforms in the Mammoth Cave National Park Area*. Bohler, Wurzburg.
- Palmer, A. N. (1987). Cave levels and their interpretation. *Natl. Speleol. Soc. Bull.* 49, pp. 50–66.
- Whipple, K. X., and G. E. Tucker (1999). Dynamics of the stream-power incision model: Implications for height limits of mountain ranges, landscape response timescales, and research needs. *J. Geophys. Res.* **104**, No. B-8, 17,661–17,674.
- White, W. B. (1988). *Geomorphology and Hydrology of Karst Terrains*. Oxford University Press, New York.

## Mulu Caves, Malaysia

### **Joel Despain**

*Gunung Buda Project and Sequoia and Kings Canyon National Park Service*

One of the world's great tropical karst regions lies below Gunung Mulu (Mount Mulu) in the Malaysian state of Sarawak on the island of Borneo (Fig. 1). Here, the Melinau limestone is exposed in a range of precipitous massifs, low mountains and hills, and in the floodplains of the Senap, Buda, Medalam, Terikan, Melinau, Melinau Paku, and Tutoh Rivers in a northeast-oriented outcrop 10 km wide and 35 km long. Within the rock have formed the largest cave rooms in the world, the Sarawak Chamber, the 10th longest cave in the world; Clearwater, with 109 km of surveyed passage; and the one of the world's largest cave passages, Deer Cave. The karst also includes numerous large springs, towering limestone pinnacles 50 m tall, dolines a kilometer across, and huge karst windows.

The region around Gunung Mulu is spectacular and dramatic due to the precipitous rise of the mountains above

the coastal plain, the 200-m tall, white limestone cliffs that ring the lower mountains, the prolific dense vegetation, and the persistence of low clouds and mist. The three mountains of the Melinau limestone, Gunung Api, Gunung Benerat, and Gunung Buda, lie 75 km from the South China Sea at the edge of the Sarawak's interior highlands. This area of Southeast Asia lies 4 degrees north of the equator and receives year-round rainfall totaling an average of 3295 mm per year.

British geologists Webb and Waltham studied the rocks of the area and their structure. They are Tertiary in age and are associated with subduction of the South China Sea floor, which ended 1 million years ago. The Melinau limestone is overlain conformably by the Setap Shale, which is 4000–5000 m thick and is underlain by the Mulu Formation, 4000–5000 m of shale, sandstone, and local quartzite. The Melinau limestone, itself, is a lenticular body, and the rock is very massive and white or gray with generally less than 1% insoluble material. The limestone is lagoonal in origin and was deposited within a reef complex. Fossils are locally common and include corals, bryozoans, bivalves, gastropods, and algal balls. The massive beds of the Melinau limestone dip to the northwest perpendicular to the trend of the range and are folded with minor faulting. The folds formed basins and domes. Synclines in the basins are associated with zones of recrystallization, creating marble that acts as a parallel barrier to groundwater flow. Joints and fractures are found in four areas: They occur near the folds, as a vertical set parallel to the folding and the crest of the mountains, as another vertical set that trends east–west, and at right angles to the bedding along strike.

Overall drainage in the area is from highlands near Gunung Mulu on the east through the Melinau limestone to the coastal plains and rivers to the west. The cave systems currently divert streams south in Gunung Api to the Melinau River, south and west in Gunung Buda to the Medalam and Buda Rivers, and north and west in Gunung Benerat to the Medalam and Terikan Rivers. Dye tracing by both British and American expeditions has revealed rapid and apparent direct connections between sinking streams, dolines, and losing rivers and resurgences. Hydrologic inputs into the caves respond rapidly to rainfall, which can lead to both floods and a rapid decline in flow following rain, although significant storage in Clearwater Cave was documented by British researchers Freiderich and Smart. Heavy rain on the surface is usually apparent underground. Even in upper-level fossil passages, rain creates prominent waterfalls that appear and disappear from small holes, fractures, and openings as aggressive, meteoric water descends to the base level.

The caves of the area are characterized by large passages and breakdown rooms, streams at lower levels that often sump, narrow unstable rifts with breakdown, and dramatic erosional features that create towering pinnacles, natural bridges, and large, irregular speleogens. All of the larger caves are formed on multiple levels with many kilometers of

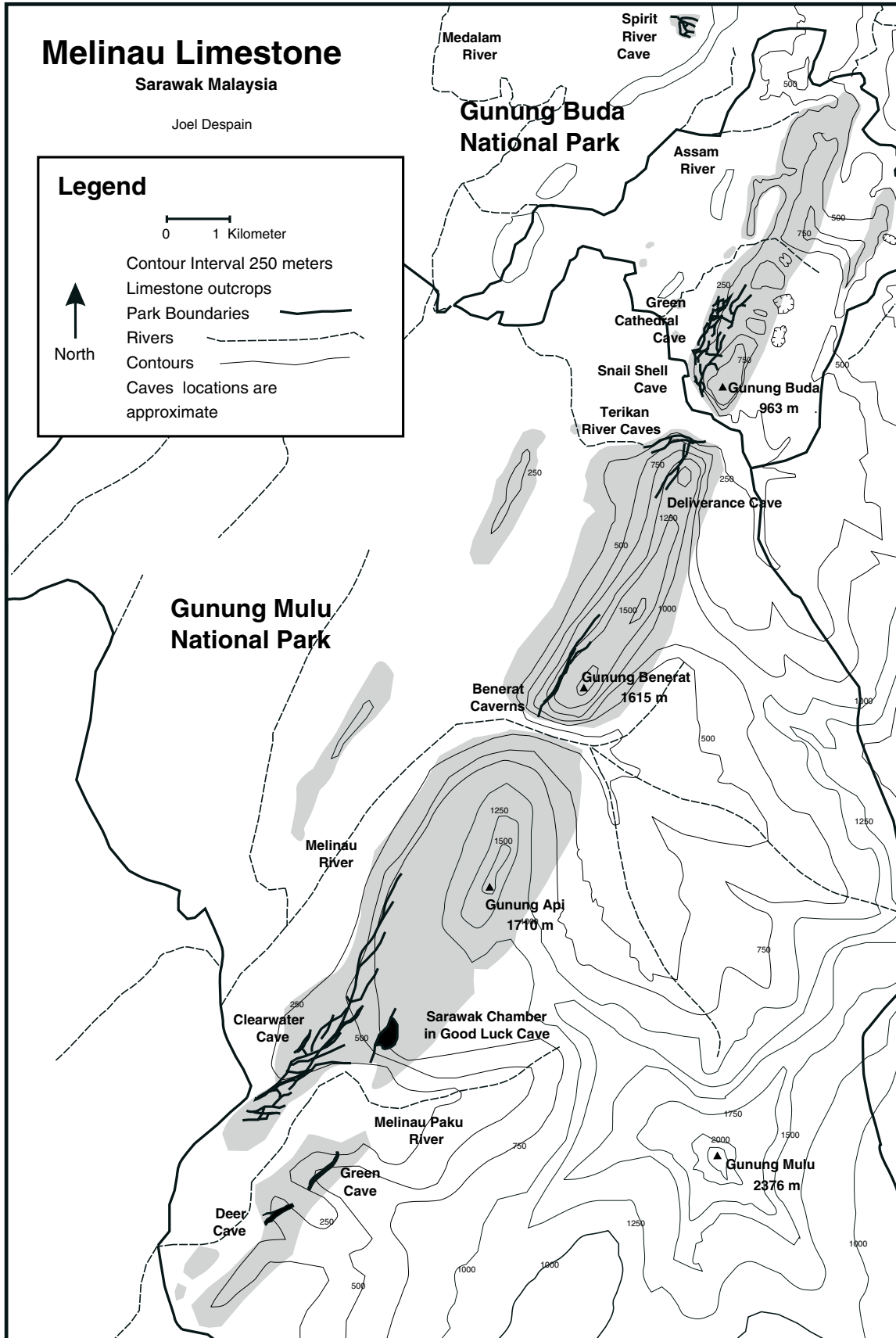


FIGURE 1 Selected caves, bedrock outcrops, and national park boundaries for the Mulu caves and Melinau Limestone region of Malaysian Borneo.

abandoned fossil passage. Most passages appear to be phreatic with secondary vadose erosion sometimes associated with an influx of sediment. Sediments in the caves include unsorted gravels, which is likely to have been deposited during floods, and finer sediments and muds. Although breakdown and mud are common, large floor areas are limestone bedrock. Most cave development is generally along strike and parallel to the folding and the crest of the range with a few passages following joint sets at other orientations. Passages on dip are often steep ramps following the inclined beds. Speleothems include all common varieties, such as helictites, stalagmites, stalactites, curtains, and occasional aragonite. The Mulu caves are also known for *showerheads*, calcite heads up to a meter in diameter that discharge large volumes of water, and *bathtubs*, circular raised pools that often lie near or below showerheads. A classic example of a showerhead can be seen from the tourist trail on the east side of Deer Cave just before the Garden of Eden entrance.

As in many parts of the world, local people were the first explorers of these caves. The Berawan, Tabuan, and Penan currently make use of the caves as have other groups in the area. Many caves contain burials and other evidence of human visits. The caves also house several species of swiftlets whose nests are used to make Chinese bird's nest soup—a high-priced Asian delicacy. Unfortunately, unsustainable harvesting of nests at Mulu and across Southeast Asia have led to a steep decline in the numbers of these birds.

The first Western reference to the karst of the area was made by Raja Brooke's secretary and author, Spencer St. John, in 1856, who described the potential of the region to contain caves. In 1961, G. E. Wilford of the Malaysian Geological Survey undertook the first cave exploration in the rugged, remote area. He mapped Deer Cave and sections of Cave of the Winds (later connected to Clearwater Cave), and Tiger Foot and the Terikan River Caves of Gunung Benerat. Wilford also referenced other known caves at Mulu and alluded to the great potential for further cave discoveries in the early 1960s in the *Borneo Geological Survey Memoir*, the *Borneo Region Geological Survey Bulletin*, and *The Journal of Tropical Geography*.

However, British cavers did not reach Gunung Mulu until the 1978 Royal Geographic Society/Sarawak Government expedition. This project sought to survey the flora and fauna of the region and to study the area's geology and hydrology in consideration of making Gunung Mulu a Malaysian national park. Cavers entered openings along the Melinau River in the limestone cliffs of the southeast corner of Gunung Api to find 50-m-diameter, clean-washed stream passages, vast breakdown rooms, and multiple levels of cave development in Clearwater Cave. They surveyed a total of 24.2 km in 1978. The expedition also resurveyed Deer Cave, a 1-km-long tunnel of enormous proportions. The western entrance leads into a passage 200 m wide and 120 m tall. Intermittent waterfalls emerge from the ceiling of the passage

to fall the 120 m to the floor. The smaller back entrance leads into the jungle-cloaked karst window, the Garden of Eden. The huge passage continues as Green Cave, across the collapse. To the north, the team surveyed the Terikan River caves on the northwest tip of Gunung Benerat, first reported by Wilford.

The 1980 expedition added 13.4 km to the length of Clearwater Cave, mostly in upper-level passages. Kilometers were also surveyed in nearby Cave of the Winds, and significant discoveries were made in Gunung Benerat at Benerat Caverns and Blue Moonlight Bay Cave. A group of four surveyed caves at Gunung Buda for the first time and made significant discoveries in several caves including Beachcomber, which would later be connected to the Green Cathedral System, Buda's longest cave. However, the height of the expedition was the discovery of the Sarawak Chamber in Nasib Bagus, Good Luck Cave. The cave resurgence was initially shown to be hydrologically connected to Hidden Valley, to the north. A survey and film team returned after the dye trace to document the unexplored cave. The team found a challenging and exciting river passage that after 700 m led upward and greatly enlarged. After a few survey shots into the void, the cavers could no longer see any walls. A turn due south led the group 70 m to the one edge of the passage. This wall was followed and surveyed using 77 survey legs, each 30 m in length. Team members began to suspect that they were not following one wall of a large passage, but rather that one side of a huge room had been traversed. Using a compass the cavers set out to see if a room did lie between the end of their survey and the river passage. After a half-kilometer of clambering across gigantic rocks, the team realized the vast size of their discovery. At 700 by 400 m the Sarawak Chamber is the largest cave room in the world!

Another large British expedition traveled to Mulu in 1984. This group extended Clearwater Cave by another 14 km and surveyed in Benerat Caverns, Sarang, Laba-Laba, Angin, Labang, Harimau, and Lipah Sileh Caves. Numerous other British expeditions have also returned to the area, resulting in Clearwater's present length of 109 km and in surveys in dozens of the other caves in Api and Benerat. Much of this work has been documented in a series of reports titled *Caves of Mulu*, *Caves of Mulu '80*, and *Caves of Mulu '84* and in the book *Giant Caves of Borneo*. The British reports included extensive sections on local geology, hydrology, geomorphology, and cave biology.

The 1995 American expedition to Malaysia traveled to Gunung Buda. The group was able to use logging roads that penetrated the area in the early 1990s for easy access. Buda proved to be as rich in caves as the limestone mountains to the south, although passages are often smaller. The expedition surveyed 30 km of cave passage, including 11.8 km in Green Cathedral Cave, which was connected to Beachcomber Cave, 5.8 km in Snail Shell Cave, and 3.8 km in Upper Turtle Cave. The 1996 expedition focused largely on surface work, but surveyed several kilometers in Snail

Shell and also mapped several smaller caves in outlying blocks of the limestone. The 1997 expedition discovered 3.6 km of spectacular Deliverance Cave in Gunung Benerat and mapped Hornbill and Babylon Caves within Buda. Upper Turtle Cave was connected to Green Cathedral, bringing that cave (with new surveys) to 21.2 km. The 2000 American expedition continued work in Hornbill, Deliverance, Green Cathedral, and Snail Shell Caves. The group finally rediscovered Compendium Cave, originally surveyed by the 1984 British expedition. New discoveries included Spirit River Cave, with 5.2 km of passage, and Buda River Cave near base camp. Both of these caves developed in outlying blocks of limestone. Bukit Assam Cave north of Compendium was surveyed to a length of 1.6 km at the end of the expedition. An expedition sponsored by the California Institute of Technology in September 2003 added 1240 m of survey to Green Cathedral Cave for a total length of 26,971 m and connected Bukit Assam and Compendium caves to create a cave system in northern Gunung Buda 8051 m in length. This work has been compiled in another series of reports: *Caves of Gunung Buda*, *Caves of Gunung Buda 1997*, and *Caves of Gunung Buda 2000*.

The caves are not the only outstanding feature of the Gunung Mulu area. The British Royal Geographic Society and other researchers before and since have also documented an amazing diversity of plants and animals in the area. The large range in elevations, various soil and rock substrates, and tropical climate have produced what may be the world's most diverse assemblage of tree species, an amazing variety of herbaceous plants, and 109 species of palms for a total of 3500 vascular plants in 17 vegetation zones. More than 270 bird species including all Bornean hornbills, broadbills, and barbets are known from Mulu, and primates found in the area include monkeys, prosimians, and the ape, the Bornean gibbon. Other important wildlife includes dozens of snakes, civets, many bats, and more than 200 species of cave-adapted invertebrates.

Cave biology work was undertaken by both British and American expeditions. British efforts recognized four dominant terrestrial habitats and communities within the Mulu caves: bat guano, bird guano, the entrance transition zone, and the deep cave community. Each has unique species of crickets, spiders, beetles, cockroaches, and in some communities isopods and millipedes. Some species were found to occur throughout the caves, whereas others were restricted to specific habitats. An American team used various traps to examine invertebrates and fish during the 1997 expedition in Ulat Cincin Cave and collected many cave specimens from a number of caves during the 2000 trip. Characteristically tropical members of the Mulu cave community include snakes found deep within the caves that predate primarily on birds but also bats, several species of crabs including some that lack pigment and are white, and at least two species of large centipedes.

The spectacular caves and wonderful array of plants and animals found at Gunung Mulu led the Sarawak state government to designate Gunung Mulu as a 52,864-hectare national park in 1974. The park includes the 2377-m-high sandstone, shale, and quartzite Gunung Mulu, the limestone mountains, Gunung Api and Gunung Benerat, and terraced floodplains as low as 28 m above sea level. It was opened to the public in 1985. Unfortunately, Gunung Buda, the northernmost mountain of Melinau limestone, was excluded from the park boundaries. Following the successful American expeditions to Gunung Buda, this changed in 2001, when the Sarawak government created a new national park, Gunung Buda. It lies adjacent to Gunung Mulu National Park and protects 6235 hectares of limestone uplands, swampy floodplains, forested low hills, and rivers. In addition, Mulu National Park was made a World Heritage Site by the United Nations in 2000.

The Gunung Buda area and all areas around Gunung Mulu Park have been selectively logged in the last decade. This has led to significant erosion within the watersheds of many Gunung Mulu and Gunung Buda national parks caves. The worst erosion appears to be large landslides into the dolines on the eastern side of Gunung Buda. These dolines cause water and sediment incursion into Green Cathedral Cave. Gunung Buda's new status as a national park should prevent future extractive intrusions into the watersheds of the dolines, allowing natural vegetation to return and stabilize the highly weathered soils of the area. In addition, the International Union for the Conservation of Nature through the World Heritage Site process has encouraged the Sarawak government to add areas with limestone and within the watersheds of Mulu's caves to the park. Such additions are being considered by the Sarawak government.

### Bibliography

- Brook, D., and A. C. Waltham, eds. (1978). *Caves of Mulu*. The Royal Geographic Society, London.
- Eavis, A. J., ed. (1981). *Caves of Mulu '80*. The Royal Geographic Society, London.
- Eavis, A. J., ed. (1985). *Caves of Mulu '84*. The Royal Geographic Society, London.
- Hacker, Bradley, ed. (1997). *Caves of Gunung Buda*, Gunung Buda Project. National Speleological Society, Huntsville, AL.
- Hacker, Bradley, ed. (2000). *Caves of Gunung Buda 1997*, Gunung Buda Project. National Speleological Society, Huntsville, AL.
- Hazebroek, Hans P., and A. K. Morshidi (2000). *National Parks of Sarawak*. Natural History Publications Borneo, Kota Kinabalu, Sabah, Malaysia.
- MacKinnon, John, and Karen Phillipps (1993). *A Field Guide to the Birds of Borneo, Sumatra, Java and Bali*, Oxford University Press, Oxford.
- Meredith, M., J. Wooldridge, and B. Lyon (1992). *Giant Caves of Borneo*. Tropical Press Sdn. Bhd., Kuala Lumpur.
- Payne, Junaidi, Charles M. Francis, and Karen Phillipps, *A Field Guide to the Mammals of Borneo*, The Sabah Society, Kota Kinabalu, Sabah.
- Proffitt, M., and Jed L. Mosenfelder, eds. (2003). *Caves of Gunung Buda 2000*, Gunung Buda Project. National Speleological Society, Huntsville, AL.
- Waltham, Anthony C., and Barry Webb (1982). Gunung Mulu National Park, Sarawak. *Sarawak Museum Journal*, Special Issue No. 2.

# Myriapods

David C. Culver  
American University

## INTRODUCTION

*Myriapods* are wingless terrestrial arthropods with at least nine pairs of walking legs and a body not distinctly divided into a thorax and abdomen. In spite of these shared features, most zoologists hold that the myriapods are polyphyletic, and their relationships to other arthropods and to each other are obscure. The most familiar myriapods are centipedes and millipedes. Of the four classes of myriapods, three have troglobiotic species. Only the Pauropoda have no troglobionts. A variety of cave myriapods is shown in Fig. 1. Millipedes are often the most abundant component of terrestrial cave communities at least in terms of biomass. Generally speaking, the myriapods have been less thoroughly studied than other arthropod groups (insects and arachnids), with the exception of the mites.

## PAUROPODA

Pauropods are the smallest myriapods, rarely more than 1 mm long, eyeless, generally lacking in pigment, and they have a unique branched antennal structure. Their mouth parts are usually modified for the sucking of fluids, probably from dead organisms and leaf molds. They generally occur in

very humid, cool spots, in leaf litter and soil fissures. Given their general habits, habitats, and morphology, it would seem likely that they should occur in caves. The absence of troglomorphic species may be attributed to the general troglomorphic appearance of the group, especially eyelessness and general lack of pigment. Large numbers of pauropods have been reported from a few caves, such as Höllöch in Switzerland and several caves in southern France. Pauropods have also been found in mines. It is somewhat surprising that they are not more widespread and common in caves. This may be due to the fact that they have often been overlooked or that they have food or habitat requirements that are rarely met in caves.

## SYMPHYLA

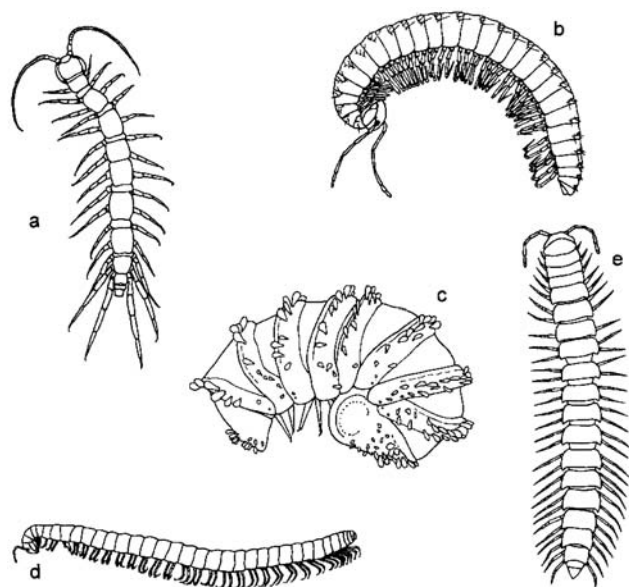
Symphylans are small myriapods, usually less than 1 cm long. All species are eyeless, generally lack pigment, and have one pair of elongate multisegmented antennae, 12 pairs of legs, and a pair of posterior unsegmented appendages called *spinnerets*. Most symphylans feed on dead and decaying vegetation. They are widespread throughout the world in litter and soil. Many symphylans are troglophilic, such as the cosmopolitan species *Scutigera immaculata*. Only three troglobiotic species have been described, two of which—*Scolopendrellopsis pretneri* Juberthie-Jupeau and *Scutigera hauseri* Scheller—are from the Planinska-Postojna system in Slovenia, the world's most diverse cave community in general. The third species is from a Mexican cave. However, all three of these species might also be found in soil habitats as well if these habitats were to be carefully searched.

## CHILOPODA

Chilopoda exhibit a great range of body lengths from a few millimeters to 30 cm. The first trunk segment bears a pair of specialized claws that contain a poison gland; the claws are used in the capture of prey. One curiosity of the centipedes is that the number of leg-bearing segments is always odd, ranging from 15 to 191. Centipedes are typically forest litter-dwelling predators although they have also colonized desert habitats. There are five orders of centipedes with about 3300 described species and several times that number of undescribed species. Worldwide, there are slightly more than 50 described troglobiotic species.

The smallest order is the Craterstigmatomorpha with 15 pairs of legs and a posterior end shaped like a clam shell. There are only two species known from the soil in Tasmania and New Zealand. Neither have been found in caves.

Scutigeraomorpha is a primarily tropical order characterized by 15 pairs of extremely long legs and large compound eyes, the only centipede order with compound eyes. They are found in caves in Asia, Africa, Australia, and South America. Some of the Asian troglophiles are extraordinarily large with leg spans up to 15 cm. None of the



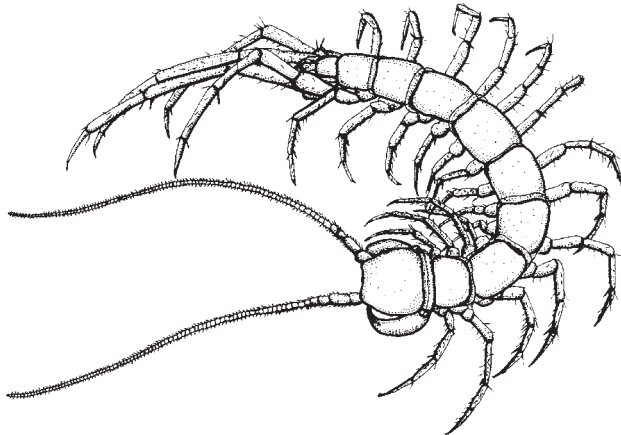
**FIGURE 1** Illustrations of troglobiotic myriapods: (a) centipede—Lithobiomorpha, *Lithobius anophthalmus*; (b) millipede—Chordeumatida, undescribed species from China; (c) millipede—Glomerida, *Trachysphaera orientalis*; (d) millipede—Julida, *Antrocoreana arcuata*; (e) millipede—Polydesmida, *Epanerchodus fontium*.

species are troglolobiotic.

Scolopendromorpha is a widespread order characterized by 21 or 23 pairs of legs. Members of this order are either eyeless or with a few simple ocelli. Two troglolobiotic species (*Thalkeithops grallatrix* Crabill from New Mexico and *Newportia leptotarsis* Negrea, Matic, and Fundora from Cuba) show morphological modifications for cave life—depigmentation and elongation of appendages. A handful of other species from the Mediterranean and Cuba are known only from caves (troglolobions) but show no morphological modifications for cave life (troglomorphy). Species such as these may also occur in noncave habitats but have not yet been found there, or they may be recently isolated in caves.

Geophilomorpha is the largest centipede order with species common on all continents excepts Antarctica and in nearly all climates. They are long, thin centipedes with between 35 and 191 pairs of appendages and without eyes. Nearly all of these species are found in moist habitats in leaf litter and in soil. In spite of the similarities of this habitat to caves, geophilomorphs are quite uncommon in caves. This is probably because geophilomorphs are adapted to small rather than large cavities, are strongly thigmotactic, and have rarely made the transition to large cavities (caves). This explanation is, of course, incomplete because many other groups have made this transition. Although several troglolophilic species have been reported in Cuba, there are no known troglolobites.

It is with the Lithobiomorpha that one finds the greatest number of chilopod troglolobions. They have 15 pairs of stout legs, usually short antennae, and at most a few ocelli. Of the 850 or so described species, nearly 50 are troglolobions. Some troglolobiotic species, such as *Lithobius matulicii* from caves in the Popovo Polje of Bosnia and Herzegovina have more than 100 segments in their antennae (Fig. 2)! Caves in the Pyrenees mountains of France and Spain are a hot spot of lithobiomorph diversity with more than 20 species. Europe as a whole has approximately 40 species. By contrast in the United States, only one lithobiomorph has been formally described (*Nampabus turbator* Crabill) and two undescribed



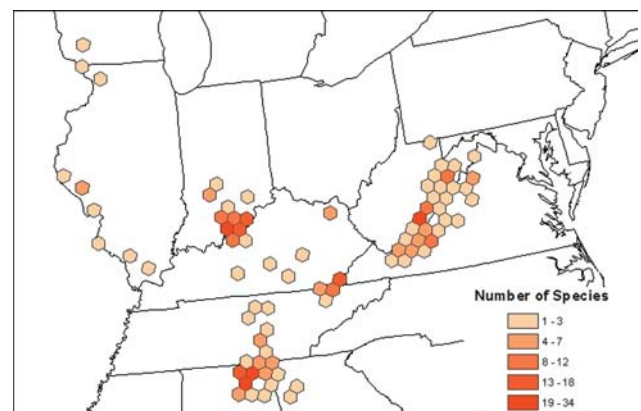
**FIGURE 2** Illustration of the cave centipede *Lithobius matulicii* from Vjetrenica Jama in Bosnia and Herzegovina. (Drawing by Slavko Polak.)

troglolobions have been found in Texas caves. The reasons for the difference are not understood. A scattering of troglolobions have been described from elsewhere, including the Near East, Japan, and Korea.

## DIPLOPODA

The millipedes range in size from a few millimeters to 35 cm, and are by far the most common of the myriapod orders. The first trunk segment is legless, followed by three or four segments with one pair of appendages. The remaining segments have two pairs of legs. They are generally elongate, and the body may or not be flattened. The exoskeleton is often hardened due to the presence of calcium salts. They typically have groups of simple eyes, but all millipedes in the order Polydesmida lack eyes. The mouth parts of many millipedes are adapted for cutting and chewing hard material, such as wood or dead leaves. This may explain in part the remarkable numerical dominance of millipedes in many terrestrial cave communities both in the temperate zone and in the tropics. They are often the dominant detritivores in a cave. It is not unusual to see dozens of millipedes, both troglolophilic and troglolobiotic, in caves. A single bait with cheese or rotten meat will often attract 100 or more millipedes.

The taxonomic situation with millipedes has been likened to that occurring in entomology at the middle of the 19th century. About 11,000 species have been described and probably 70,000 species await description. At least several hundred troglolobions have been described. Centers of cave millipede richness are in the Dinaric region of Bosnia and Herzegovina, Croatia, and Slovenia, as well as in the Pyrenees of France and Spain. In North America, centers of cave millipede richness are in northeast Alabama, southern Indiana, and central West Virginia (Fig. 3). Currently, 15 orders of millipedes are recognized. The Glomerida, or pill millipedes, can roll up into an almost perfect sphere. They are common troglolobions in Europe, Mexico, and central



**FIGURE 3** Map of troglolobiotic millipede species richness in caves in the eastern United States. Each hexagon is 1000 km<sup>2</sup> in area.



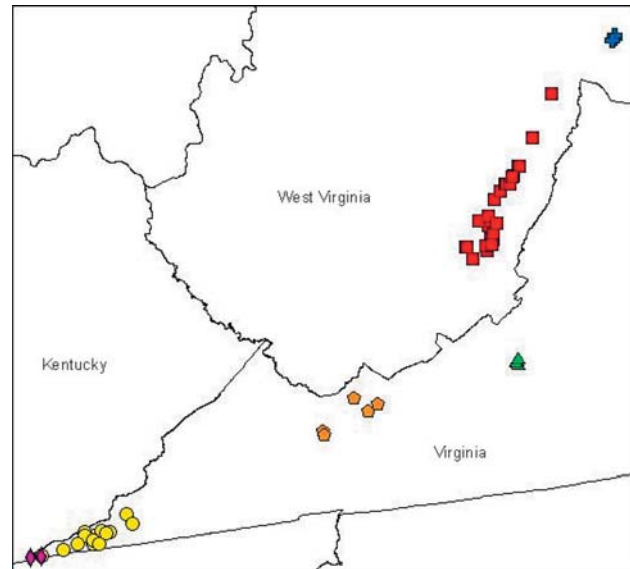
**TABLE I** Number of Species of Troglobiotic Millipedes in U.S. Caves

Order	Number of families	Number of genera	Number of species
Callipodida	2	2	3
Chordeumatida	5	13	49
Julida	1	2	2
Polydesmida	1	2	5
Spirostreptida	1	1	1

America. Polydesmida is the larger millipede order with nearly 30 families. They are easily recognized by the winglike lateral extensions on the dorsal side of the animal. All species in the order are eyeless. Many troglobitic species have been described from Europe, Japan, and Mexico, and they are the dominant invertebrate detritivores in many Mexican caves. Five troglobitic polydesmids have been described from U.S. caves, mostly in the southwest (Table I). The order Julida is restricted to the Northern Hemisphere. They are the dominant millipede order in Europe and there are two troglobitic species in North America as well. Several troglobitic julids in the genus *Trogloiuulus* have mouth parts modified to comb bacteria from surfaces and to filter food particles from water. As a result, they are amphibious, and often collected in pools and streams. The most important millipede order in north temperate caves is the Chordeumatida. Most surface-dwelling species are adapted to high humidity and cool temperatures and are found in leaf litter and in the soil. Given similarities of these habitats to the cave environment, it is not at all surprising that there are so many species. In the United States alone, there are 49 species (Table I). Most of the ranges of these troglobionts is very small (Fig. 4), and most described species may actually be a complex of genetically distinct but morphologically identical species.

### Bibliography

- Harvey, M. S., W. A. Shear, and H. Hoch (2000). Onychophora, Arachnida, Myriapods and Insecta. In *Subterranean Ecosystems* (H. Wilkens, D.C. Culver, and W. F. Humphreys, eds.), pp. 79–94. Elsevier, Amsterdam.
- Hoffman, R. L. (1979). *Classification of the Diplopoda*. Museum d'Histoire Naturelle, Geneva.
- Lamarck, J. B. (1809). *Zoological Philosophy: An Exposition with Regard to the Natural History of Animals*. Trans. H. Elliot (1984). University of Chicago Press, Chicago.
- Mauries, J-P. (1994). Diplopoda. In *Encyclopaedia Biospeologica* (C. Juberthie and V. Decu, eds.), pp. 255–262. Société de Biospéologie, Moulis, France.
- Minelli, A., and S. I. Golovatch (2001). Myriapods. In *Encyclopedia of Biodiversity*, Vol. 4 (S. A. Levin, ed.), pp. 291–303. Academic Press, San Diego.
- Negrea, S., and A. Minelli (1994). Chilopoda. In *Encyclopaedia Biospeologica* (C. Juberthie and V. Decu, eds.), pp. 249–254. Société de Biospéologie, Moulis, France.
- Shear, W. A. (1969). A synopsis of the cave millipedes of the United States, with an illustrated key to genera. *Psyche* 76, 126–143.



### Diplopoda Pseudotremia

#### Species Name

- ▲ *Pseudotremia cavernarum* Cope, 1869
- *Pseudotremia fulgida* Loomis, 1943
- ⊕ *Pseudotremia lusciosa* (Loomis, 1939)
- *Pseudotremia nodosa* Loomis, 1939
- ⬠ *Pseudotremia tuberculata* Loomis, 1939
- ◆ *Pseudotremia valga* Loomis, 1943

**FIGURE 4** Map of troglobiotic *Pseudotremia* species in Virginia and West Virginia caves.

## Myth and Legend, Caves in

Paul Jay Steward

*Cave Research Foundation*

Since the beginning of time man has fantasized about caves and the mysteries they hold. They are a doorway to the Underworld and have played a vital role in the narrative of cultures throughout the globe. Many of the stories associated with caves conjure up images of a dark and mysterious place inhabited by gods and demons and associated with everything from resurrection, fertility, worship, sacrifices, the beginning of life, to a resting place for the dead. Others envision the earth as hollow, teeming with lost worlds and civilizations.

The most popular of these stories are the ones handed down from ancient mythology. The Greeks believed the Underworld to be the kingdom of the dead ruled by Hades, a greedy god whose only concern was increasing the number

of souls in his dark world. In Northern Ireland there is a cave called Saint Patrick's Purgatory. It is used as a place of worship and is believed to be the entrance to Hell.

Although it was a one-way trip for most, getting to the Underworld was not an easy chore. Between the world of the living and the dead, five rivers must be crossed: the Acheron (river of woe), the Cocytus (river of lamentation), the Phlegethon (river of fire), the Styx (river of hate, which surrounds the Underworld with nine loops), and the Lethe (river of forgetfulness).

Hermes, the god of travelers, was born in a cave on Mount Cyllene. He was quite familiar with the trail and would lead the souls of the dead through the darkness. Erebus was the god of darkness in the Underworld. The last river to cross was the Acheron. Charon would lead you across Acheron in a ferry, provided you were buried with a coin placed under your tongue for payment. Those who could not pay were trapped between the two worlds forever.

Across the river loomed the gates to the Underworld. Cerberus, a three-headed dog with a dragon tail, guarded the gates and would allow the souls to enter but never leave. Once through the gates, the souls appeared before a tribunal consisting of Hades, Aeacus, Minos, and Rhadamanthys. Souls who had committed crimes against the gods were sent to Tartarus, while the souls of the just were sent to Elysium Fields.

Many of the caves located on the island of Crete are associated with mythology. Zeus, the king of the gods, and brother to Hades, was born in a cave located on Mount Aegaeum. Today it is called the Cave of Psychro. Amnisos Cave is also located on Crete and is believed to be the sanctuary of Artemis, the goddess of fertility. Aeolus, the god of wind and air, kept his winds locked in a cave and only let them out as instructed by the gods of Olympus. Somnus, the god of sleep, resided in a cave. The twins, Romulus and Remus, were found in a basket along the banks of a river and brought to the Cave of Lupercal where they were suckled and raised by a she-wolf. Many of the gods from the oceans lived in caves and grottoes. Even the goddess of music loved to play her instruments in a cave.

The Underworld was not just reserved for gods and souls of the dead. Cunning little elves and dwarfs spent much of their time living and hiding in caves. Harpies were filthy, winged monsters, with the faces of women and the bodies of vultures, that lived in caves. Hydra, the many-headed serpent, and Cacus, a fire-breathing troll, lived in caves. Polyphemus, a Cyclops, lived in a cave near Mount Aetna and survived on meals of human flesh. The serpent Python dwelt in a cave. Typhon, the scourge of mankind, lived in Kilikian Cave, and the famed Medusa lived in the secret Cave of the Gorgons.

Sibyls Cave is located in the ancient town of Cumae, near Naples, and was the home of Sibyl, a famous female prophet. Many of her prophecies were written on leaves, which she placed at the mouth of her cave for people to find. These

"Sibylline Leaves" were bound into books and consulted by the Romans in times of crisis. It is also through this cave that Sibyl was said to have led Aeneas to the Underworld.

Makua Cave, also known as Kaneana Cave, is located on the western shore of the Hawaiian Island of Oahu. The cave is named after the Hawaiian god Kane, the god of creation. It is believed that the cave is the womb from which mankind emerged and spread throughout the Waianae Coast. In ancient times Kahunas were forbidden to enter the cave for they believed it was the home of Nanaue, the shark man of Kaneana. It was said this half-man, half-shark beast would drag his victims to the back of the cave and devour them.

Located on the high slopes of Mount Amarnath, deep in the Himalayan Mountains, lies Amarnath Cave. This is one of the holiest sites in the Hindu religion. The cave contains several ice stalagmites that grow from a natural spring. The largest of these is believed to be a representation of the Hindu god Shiva. The smaller ones represent the Hindu gods Ganesha, Parvati, and Bharirava.

Every year during the months of July and August, tens of thousands of pilgrims bear the harsh climate and rugged terrain to trek to the cave to worship these phallus-shaped formations. According to the legend, in the cave Shiva disclosed the secrets of creation and immortality to his companion, Parvati, and those who make the difficult journey to the cave are promised salvation. Also in the cave with Parvati was a pair of mating doves that overheard the conversation and learned the secrets. The doves made the cave their eternal home and have been reborn every year since. Many pilgrims report seeing a lone pair of doves during their trek.

To the Maya, caves and cenotes were sacred places used for rituals and sacrifice. They called their Lowerworld Xibalba, or Place of Phantoms. Many of their temples were built over cave openings, and much of their water came from the caves. The Maya believed they were born from the earth goddess and originated out of seven caves.

Caves are mentioned throughout the bible. They are used for shelters, as tombs to bury the dead, as places to hide from one's enemies, and a place for quiet worship.

Lot and his two daughters left the city of Zoar and found shelter in a mountain cave. Abraham purchased Machpelah Cave, also called Cave of the Patriarchs, from Ephron and used it as a family tomb. This cave is one of the holiest sites known in the Jewish religion. The Patriarchs Abraham, Isaac, and Jacob, along with the Matriarchs Sarah, Rebecca, and Leah, are buried in the cave. It is also believed the cave is a passageway to the Garden of Eden.

Seeing their armies defeated by Joshua, the five kings of the Amorites fled to Makke'dah Cave. After being captured and killed, their bodies were returned to the cave and the cave sealed with large stones. David found refuge in Adullam Cave after fleeing from Saul. David wrote many of the Psalms in this cave. Also in this immense cavern, David trained his outlaw army of 400 men. In Engedi Cave, David found Saul

asleep and cut off a part of his robe. Obadiah hid Elijah and 100 prophets in caves on Mount Carmel.

Caves were frequently used as stables that also contained rooms for people to sleep. Many believe that Jesus was born in one of these caves. After dying on the cross, Jesus was brought to a cave and buried.

Several historical books written by Egyptians several hundred years before the birth of Christ contain stories about the lives of Adam and Eve. It is believed that after being banned from the Garden of Eden, God sent Adam and Eve to live in a strange broad land, covered in sand, strewn with stones, and void of all vegetation. Here, God commanded them to live in the Cave of Treasures. The cave became a family shrine and many generations would live, die, and be buried in there.

Another cave associated with Adam and Eve is Lilith Cave. According to Jewish folklore, Adam's first wife was Lilith, not Eve, as commonly accepted. Unfortunately, it was not a match made in heaven. Adam and Lilith fought and argued constantly. Any attempts by Adam to mate with Lilith were met with rejection. Lilith refused to lie under Adam in the standard missionary position. She felt they were equal and therefor wanted to make love in equal positions. Adam wanted no part of this arrangement. In a rage, Lilith left the Garden and took up residence in a cave along the shores of the Red Sea in an area fraught with demons. In the cave, she made love to many demons and populated the world with thousands of demon children. She became known as the Mother of Demons, and is said to still reside in her cave.

Ti-Tsang Wang is the Chinese god of mercy. He wanders through the caverns of Hell searching for souls to save and help escape from the Underworld.

Amaterasu is the Japanese sun goddess. One day her mischievous brother, Susanoo, destroyed her beautiful garden. Amaterasu was so mad she hid herself in a cave and covered the entrance with a large rock. This made the world dark and cold. For many weeks she hid in the cave. One day she heard laughter, music, and singing coming from outside

her cave. Amaterasu was curious as to how all the other gods could sound so happy with the world so dark and cold. They told Amaterasu another god more beautiful than her had come and brought light to the world. As she peered out from the cave she saw her reflection in a mirror. Quickly, she was pulled out from the cave and told that the light was her own reflection. Amaterasu had never seen herself before and was amazed at her own beauty. Afterward she returned to her throne in the heavens to warm and light the earth.

No talk of caves would be complete without a few ghost stories. The quiet, isolation, and absolute darkness found underground create the perfect setting for imaginations to run wild. Many of the caves across the world have horrible tales of ghosts tormenting unsuspecting visitors. One of the oldest and most documented cases in the annals of American haunted places is the Bell Witch Cave.

The cave is along the south side of the Red River, in the rural farming town of Adams, Tennessee. Above the cave is a known burial ground for the Choctaw Indians. While many believe it is Indian ghosts that haunt the cave, others believe it is a troubled spirit known as the Bell Witch.

Numerous stories abound of unusual happenings in the cave. Researchers have discovered high energy levels and evidence of paranormal activity in and around the cave. Visitors have reported strange sounds, eerie feelings, and even sightings of apparitions. In the cave, camera equipment is known to jam, stop working, and rewind for no apparent reason. Photographs taken in the cave sometimes contain white or orange glowing orbs floating about. Orbs are a common occurrence in locations associated with paranormal activity. Others have reported seeing a dark-haired woman drifting throughout the cave.

The current owners of Bell Witch Cave allow tours from May 1 to October 31. They, too, tell of strange sounds and happenings in the cave. It is not unusual for a tour to be cut short by a disturbed guest wanting to return to the surface and vowing never to return.



---

## Natural Selection

Thomas C. Kane

Robert C. Richardson

*University of Cincinnati*

Charles Darwin (1859) proposed that natural selection leading to adaptation was the primary mechanism of evolution. Caves supporting biological communities can generally be described as food poor relative to surface habitats, and with constant temperature, humidity, and darkness in zones away from the entrance. These characteristics are both obstacles and advantages to cave-dwelling organisms and they provide some of the selection pressures to which these species must adapt. Currently it is estimated that 50,000 to 100,000 species of animals are obligate cave dwellers. Various evolutionary scenarios have been suggested for the origin of cave-limited species. One view suggests that colonization of caves may have been a passive process driven by climate changes in the surface habitats of the ancestors of present-day troglobites. Glacial advances and retreats have been posited as one such climatic change, whereby species that had adapted to the cool, moist surface environments of glacial maxima were extirpated during warm, dry interglacials, leaving only remnant populations living in cave entrances and deep sinkholes, which were still cool and moist. These populations subsequently underwent further adaptation to the cave environment producing many of the current troglobitic taxa. Such a scenario has been suggested for the more than 250 species of cave-limited trechine carabid beetles in the United States, for example. Yet another scenario suggests that caves may have been actively colonized by ancestral stocks due to the advantages that caves afforded, especially the constancy of temperature and the relative lack of predators. The passive colonization view implicitly

emphasizes the problems that incipient cave dwelling must solve, whereas the active colonization view explicitly emphasizes the advantages of cave habitats.

Regardless of how ancestral forms first came to be in caves, a remarkably similar suite of characteristics can be observed in modern-day troglobites. Most species exhibit enlargement or elaboration of certain structures such as antennae in the case of many invertebrates, the lateral line system in the case of some fishes, and taste buds in the case of one species of cave fish from Mexico. Even more spectacular are the reduced or lost features, in particular, eyes and pigment. This suite of morphological features has been termed *trogomorphy* by Christiansen (see this volume). However, historically different evolutionary explanations have been afforded to the elaborated as opposed to the reduced traits. Elaborated features appear “more obviously” adaptive, in that they presumably increase the organism’s ability to survive and reproduce in the cave habitat. They often involve nonvisual (nonoptic) sensory structures such as those involved in chemosense (antennae, taste buds) or tactile sense (lateral line) and can be argued to provide sensory compensation in an environment in which the visual sense cannot function. The reduction or loss of features, often referred to as *regressive evolution*, is less obviously adaptive.

The quandary over the origin of regressive features in cave animals dates back to the earliest theorizing on evolution. In one of the first works on evolutionary biology, Jean Baptiste de Lamarck (1744–1829) took note of a strange salamander living in caves. It was colorless and blind.

The *Proteus*, an aquatic reptile allied to the salamanders, and living in deep dark caves under the water, has . . . only vestiges of the organ of sight. . . . Light does not penetrate everywhere; consequently animals which habitually live in places where it does not penetrate have no opportunity of exercising their organ of sight. . . . Now animals belonging to a plan of organization of which eyes were a necessary part, must have originally had them. Since, however, there

are found among them some which have lost the use of this organ . . . it becomes clear that the shrinkage and even disappearance of the organ in question are the results of permanent disuse of that organ. (1809, p. 116)

Lamarck explained the reduced eyes of *Proteus* as a consequence of their lack of use, as he did the reduced eyes of moles. He surmised that in a creature that has fully developed eyes, complete lack of use will cause their eyes to be underdeveloped or to degenerate. If these losses due to disuse and degeneration are then passed on to offspring, those offspring will likewise have reduced vision. Over time, Lamarck thought a repeated cycle of disuse, degeneration, and inheritance would lead to species such as *Proteus*, with only vestigial organs where their ancestors had eyes.

Darwin similarly took note of cave dwellers 50 years later in his *Origin of Species* (1859/1985). By this time, a number of different cave species were known. Nearly all were blind and white. One of the most famous was described by J. E. de Kay in 1842. This is the blind fish of Mammoth Cave, *Amblyopsis spelaea*. Like *Proteus*, *Amblyopsis* is blind. And like Lamarck, Darwin attributed the loss of eyes in the fish to disuse. He says, "It is well known that several animals, which inhabit the caves of Carniola and Kentucky, are blind . . . As it is difficult to imagine that eyes, though useless, could be in any way injurious to animals living in darkness, their loss may be attributed to disuse" (1859/1985, p. 135). Nonetheless, Darwin readily resorted to selectionist explanations (e.g., sensory compensation) for the elaborated traits of cave animals.

Although the view that acquired characteristics can be inherited is no longer tenable, the evolutionary explanation for regressive features remains controversial. One theory invokes neutral evolution; that is, evolution not favored either directly or indirectly by natural selection. In this view features such as eyes and pigmentation would be of no selective value. That is to say that neither their maintenance nor loss will affect the fitness of a cave-dwelling organism. Therefore, mutations affecting these features will not be removed by natural selection. Because complex organs such as eyes require many genes to maintain them, mutations on average tend to be degenerative and, therefore, the net effect over time will be the reduction or loss of these characteristics. This type of explanation has been offered to explain eye and pigment reduction in the Mexican cave fish. Alternative explanations for regressed features have invoked natural selection, usually indirectly, in the form of evolutionary trade-offs. For example, because caves are food poor environments, many biologists have suggested that natural selection would favor energy economy. Thus, individuals that put less energy into the development and maintenance of "useless" structures such as eyes and pigmentation may survive better and produce more offspring than those that maintain such features. This suggests that regressive evolution can have an effect on fitness.

Studies on a shrimplike crustacean, *Gammarus minus*, suggest that the reduction and elaboration of features may act in concert to produce adaptation to the cave environment. *Gammarus minus* is distributed in the central United States from southern Pennsylvania to eastern Oklahoma, usually in surface springs and spring runs. In two karst areas, one in West Virginia and the other in southwestern Virginia, populations of *G. minus* also occur in caves. Genetic data suggest that there is little or no interbreeding between the cave-dwelling and spring-dwelling populations within these two areas. They are distinct populations. Interestingly, individuals from cave and spring populations often differ from each other morphologically, with cave-dwelling individuals having smaller eyes, longer antennae, and larger body size than their spring-dwelling counterparts from the surface. Thus, populations from caves are often troglomorphic, whereas spring-dwelling forms are not. Laboratory studies have shown that these morphological differences have a genetic basis and are therefore passed on from parents to offspring; that is, they are heritable. Field studies on several populations from caves have demonstrated that individuals with smaller eyes, larger antennae, and larger body size mate more frequently and produce more offspring than those in the same population with larger eyes and smaller antennae and body size. Therefore, with regard to eye size and antennal length, the more troglomorphic individuals in the population are more fit. Adaptation appears to occur at the level of the brain. Chemosensory (taste) and optic (visual) inputs are integrated in the olfactory and optic lobes of the brain, respectively. The brains of troglomorphic cave-dwelling individuals have greatly reduced optic lobes and greatly increased olfactory lobes relative to the optic and olfactory lobes of surface dwelling individuals. The evolutionary trade-off to improve chemosensory function is to co-opt portions of the brain previously involved in the now useless visual function. This is consistent with Darwin's view of sensory compensation but, unlike Darwin himself, supports the view that both antennal enlargement and eye reduction are the result of natural selection, producing adaptation to the cave environment.

In our discussion of adaptation and natural selection, we have chosen to concentrate on a single species, *Gammarus minus*, because of the wealth of data available. A fair question is whether the *G. minus* "story" is unique to this species or can be generalized to account for the evolution of many of the tens of thousands of other cave-limited species. Indirect support for the latter view comes from the fact that cave animals tend to "look alike." The troglomorphic pattern can be observed in cave animals of widely divergent taxa (e.g., invertebrates and vertebrates), and among similar taxa from different geographic areas (e.g., cave beetles from North America and Europe). Finally, regressive evolution is a common phenomenon and is not restricted to the evolution of cave animals. The horse's hoof, a frequently touted example of adaptation, involves the loss of toes. Even our

own species bears the marks of regressive evolution in the form of the vestigial vermiform appendix and the coccyx.

### See Also the Following Articles

*Neutral Mutation*

### Bibliography

- Culver, D. C. (1982). *Cave Life: Evolution and Ecology*. Harvard University Press, Cambridge, MA.
- Culver, D. C., T. C. Kane, and D. W. Fong. (1995). *Adaptation and Natural Selection in Caves: The Evolution of *Gammarus minus**. Harvard University Press, Cambridge, MA.
- Darwin, C. (1985). *The Origin of Species*. Penguin Books, New York. (Originally published 1859)
- Lamarck, J. B. (1809). *Zoological Philosophy: An Exposition with Regard to the Natural History of Animals*. Translated by Hugh Elliot (1984). University of Chicago Press, Chicago, IL.
- Stearns, S. C., and R. F. Hoekstra. (2000). *Evolution: An Introduction*. Oxford University Press, New York.
- Williams, G. C. (1966). *Adaptation and Natural Selection*. Princeton University Press, Princeton, NJ.

## Neutral Mutation

**Horst Wilkens**

*University of Hamburg, Germany*

The neo-Darwinian paradigm of selection quite generally dominates all modern interpretations of evolutionary processes. This is in contrast with the conditions characteristic of the basal process of molecular evolution. Selection involved at this level is so weak that mutation pressure and drift play the major role (Kimura, 1983). The question is whether these basic principles of molecular evolution are also manifested in phenotypic evolution—and how closely they are correlated. Knowing this, interpretations of certain specific processes of structural evolution can be provided.

The reduction and rudimentation of structures is extremely common throughout nature. The most conspicuous and spectacular examples are provided by cave-dwelling animals. The eyelessness and lack of body pigmentation of troglobites have stimulated the thinking of scientists from the beginning of research. In contrast to features like teeth in whales or wings in wingless birds and beetles, the loss of biological function of light-dependent structures in cave animals occurs abruptly when subterranean life is started. Due to this, cave animals are extremely useful for the study of the causes of regressive evolutionary processes without being influenced by persisting biological functions.

As a unique model system in research of regressive evolution, the characid *Astyanax fasciatus* (Cuvier, 1819) [= *A. mexicanus* (Filippi, 1853)] was discovered by Curt Kosswig and has served since the middle of the 20th century (Wilkens, 1988). This widely distributed surface fish is the sister form of more than 20 troglobitic populations

distributed in different caves within 150 km of each other in northeast Mexico (Mitchell *et al.*, 1977). Unlike the majority of surface species entering the hypogean realm, the large-eyed epigeal *Astyanax* is no true troglophile, which are characterized by extremely negative scotophilia as is seen in, for example, catfish (Langecker, 2000). Specimens of *A. fasciatus* got trapped in the underground without the possibility of escape. They were able to survive in darkness because of preadaptations like chemically oriented spawning behavior and a well-developed lateral line sense. Whereas traits such as olfaction, taste, lateral line, yolk content, and energy storage were constructively improved by directional selection in darkness, those that became biologically functionless (dorsal light reaction, circadian rhythmicity, schooling, optically triggered aggressive behavior, pigmentation, eyes) were subjected to reduction (Langecker, 2000; Wilkens, 1988).

Surface and cave forms of *Astyanax* are interfertile (Strecker *et al.*, 2003). Thus it was possible to perform a genetic analysis of structural reduction. The material examined was derived from seven cave populations: Sótano de la Molina, Cueva de El Pachon, Sótano de la Tinaja, Cueva de los Sabinos, Sótano de Yerbaniz, Sótano de las Piedras, and Cueva de la Curva.

Albinism was detected in three of seven populations (Molino, Pachon, Yerbaniz). It is based on one recessive allelic gene. All three populations are homozygous for the albino gene. With the exception of the Molino form, all populations mentioned above are homozygous for a recessive allelic gene (“brown gene”), which is responsible for a partially reduced melanin content in the melanophores. Similarly, scale guanin is slightly reduced in all cave populations. However, in two of them different recessive genes are found, which reduce the guanin content of the scales partially (Molino) or completely (Piedras). The Piedras population is heterozygous for this gene. Another regressive mutation (“yellow gene”) causes bright yellow body color. This probably results from the mutatively disturbed ability to decompose carotenoids ingested with the food. For this a recessive gene is responsible, which is heterozygous and only found in the Piedras population (Culver and Wilkens, 2000).

Besides the mere color mutationism, reduction of the melanin pigmentation of *Astyanax* cave fish is additionally caused by a decrease in the number of melanophores of which only about 20% are left. Crossings have revealed that two or three genetic factors are responsible for this (Wilkens, 1988; Culver and Wilkens, 2000).

The eyes of the cave fish populations just mentioned are sunk below the body surface and no longer externally visible. They are reduced in size and structural differentiation. In adult cave fish, lenses are no longer developed and the retinas do not contain visual cells. Only the layers not involved in their formation can be found in the eyes that are best differentiated. In the worst developed ones, the sclera just encloses undifferentiated remnants of nervous, pigmentary, and chorioid tissue (Wilkens, 1988).

Crossings between surface and cave fish have not revealed genes responsible for specific eye structures such as lens or retinas. Size and degree of structural differentiation of eyes are correlated. The larger an eye is, the better it is developed. The genetic factors influencing eye size were called *eye genes*. At least six of them were calculated to be responsible for eye reduction in the cave fish (Wilkins, 1988). These eye genes are defective and the different cave populations are at least partially heterozygous for them. They are randomly distributed in the different populations, providing a partially diverging genetic basis, which can be concluded from the fact that their hybrid offspring may develop larger and better developed eyes than the parental generation (Wilkins, 1988).

“It is an important fact that rudimentary organs, such as teeth in the upper jaws of whales and ruminants, can often be detected in the embryo, but afterward wholly disappear. It is also a universal rule that a rudimentary part or organ is of greater size relative to the adjoining parts in the embryo than in the adult” (Darwin, 1859, p. 430).

As in these structures, this process of ontogenetic regression is also valid for the cave fish eye. It can be

explained in the cave fish eyeball by its important function during early ontogeny: It provides by induction the correct formation of the head. It is this internal selective force that will eliminate all regressive eye structural mutations, which might heavily disturb eye—and as a consequence—head building. Disruptions in the formation and evagination of the optic primordia can result in defects in both ocular and craniofacial development (Mathers and Jamrich, 2000). Only those mutations that do not totally disturb eye formation or are even lethal [e.g., many of those artificially induced in the zebrafish (*Danio rerio*) or the medaka (*Oryzias latipes*)] are not subjected to elimination by selection in cave fish in which regression proceeds under natural conditions. The existence of internal selection is clarified during early cave fish ontogeny by eye variability not being higher than in the *Astyanax* surface fish until a body length of 10 mm is reached. Only during the subsequent growth stages does the characteristic variability of cave fish eye size develop and become enhanced, because internal selection has ceased now (Fig. 1). Generally similar observations were made in *Rhamdia* (Pimelodidae) and *Garra* (Cyprinidae) cave fish ontogeny.

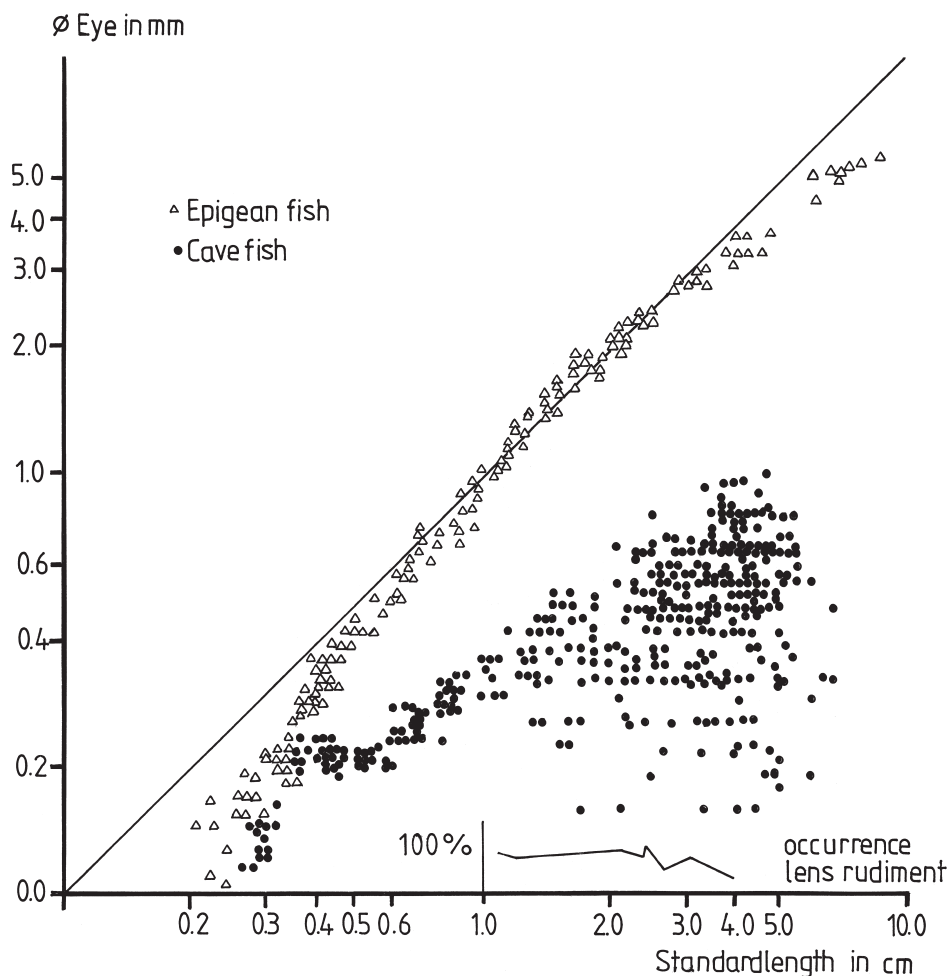


FIGURE 1 Growth of eyes in *Astyanax* surface and cave forms.

The genetic character of the eye genes is still being studied. It seems, however, that relatively few genes are involved in cave fish eye reduction. This can be concluded from several observations that corroborate this view: (1) the development of nearly all eye structures during early ontogeny (ontogenetic regression), (2) the occurrence of larger and better differentiated eyes containing structures never observed in the parental generation in crossings between different cave populations (Wilkens and Strecker, 2003), and (3) surface lens transplantations into the cave fish embryonic eye that induced development of better differentiated eyes (Jeffery, 2001).

Molecular studies provided evidence, too. The genes for structural proteins of the lens, *gamma-s* as well as *alpha-A-crystalline*, are not active in cave specimens, although at least the *alpha-A-crystalline* does not show any mutations. Furthermore, the messenger ribonucleic acid (mRNA) for a redlike opsin could even be detected as being expressed for a short time during the development of photoreceptor cells in the retina of the larval blind form. However, initial mutational steps toward loss of opsin gene function were found by sequencing the entire coding regions of one red and two green opsin genes with a deletion of 12 consecutive nucleotides in the Pachon population (Yokoyama *et al.*, 1995). Studies in cave fish have revealed the existence of multiple photopigments (Parry *et al.*, 2003). This shows that due to the loss of their biological function in cave vision, variability may develop. However, total reduction may not be possible due to the developmental formation of the visual cone photosensitive membranes as inductive elements of the larval eye being closely correlated with the formation of opsins.

Like most structural genes, which seem to be unaffected by regressive mutations, the study of developmental control genes provided similar results. The transcription factor *Pax6* is not disturbed by regressive mutations in the cave fish (Culver and Wilkens, 2000). The same was shown for the homeobox gene *Prox1* expression regulating the building of lens fibers during cave fish ontogeny (Jeffery, 2001). In the frog *Xenopus*, transcription factors *Rx* and *Pax6* are more spatially restricted to distinct domains within the anterior neural plate during development and both are downregulated along the midline through the actions of the *Hedgehog* gene (*Shh*), transforming growth factor- $\beta$ , and epidermal growth factor family members. The result of this regulation at the midline is bilaterally symmetric optic vesicles (Mathers and Jamrich, 2000). It was shown that cave fish eye development can in fact be influenced by application of *Shh* mRNA (*Sonic hedgehog* gene), regulating *Pax6* expression at the anterior midline during early cave and surface fish embryogenesis (Jeffery, 2001).

In a blueprint of how eye development might have changed during cave fish evolution presented by Jeffery (2001) the lens is attributed a central role in eye development, because it undergoes apoptosis instead of differentiation, and in the absence of lens signaling the cornea, iris,

pupil, and retinal photoreceptor cells are believed to fail to develop. Earlier studies not considered in this blueprint show the retina to be subjected to apoptotic processes simultaneously (Wilkens, 1988). The lens and future retina function as two developmentally correlated units of equal importance. This is shown by histological studies of hybrid eyes between surface and cave fish revealing that the eye structures are developmentally correlated. Equivalence of the lens and retina is exemplified by the fact that in spite of the general correlation there are two relatively independent systems of induction within the eye existing from the earliest embryogenesis: lens, pupil, and anterior eye chamber on the one hand, and retina, pigmentary epithelium, vitreous body, and lens muscle on the other. The lens muscle may even be found without a lens existing (Wilkens, 1988). In F<sub>2</sub> hybrids between surface and cave *Astyanax*, eyes with large and fully developed lenses are found in combination with entirely undifferentiated retinas or vice versa.

Eye ontogeny in *Astyanax* cave fish is not just the linear prolongation of embryonic growth. Until a surface or cave fish reaches 4 mm in body length, the allometric correlation between eye size and body length of surface and cave fish is the same; eye growth stops between 4- and 6-mm body lengths completely. At this time apoptotic processes develop in both lens and retina. From a 6-mm to about a 10-mm body length, cave fish eye growth starts again and in some specimens at almost the same rate as in the surface fish. At the moment we cannot exclude the possibility that additional genes are responsible for this, part of which might have become defective and thus caused cave fish eye variability (Fig. 1) (Wilkens, 1988).

Even today the influence of selection on the reduction of functionless traits is under dispute (Culver and Wilkens, 2000). Darwin himself was keenly aware of the bizarre phenotypic appearance of cave animals. It is usually overlooked that, when discriminating between regressive and constructive evolution in troglomorphic structures, he considered natural selection to be responsible only for the improvement of structures. Different causes were assumed for the evolution of regressive structures: "By the time that an animal had reached, after numberless generations, the deepest recesses, *disuse* [emphasis added] will on this view have more or less perfectly obliterated its eyes, and *natural selection* [emphasis added] will often have effected other changes, such as an increase in the length of the antennae or palpi, as a compensation for blindness" (Darwin 1859, p. 179).

Darwin (1859, p. 432) also observed that "An organ when rendered useless, may well be variable, for its variations cannot be checked by natural selection." The loss of the biological function of structures for which light is a transport of information in cave animals is the key event of their future development. It was pointed out by the German biologist Curt Kosswig that because of this, stabilizing selection would no longer act on such features; that regressive mutations



became neutral and were no longer eliminated but accumulated randomly. In the initial phase, variability between the normal (wild) and mutative structures is characteristic. By further accumulation of the large number of regressive mutations, the rudimentary state is achieved in time (Wilkens, 1988). In accordance with the generally unquestioned preponderance of selection in evolution this *neutral mutation theory* is still being attacked—in one case (Romero, 2001, p. 66) with peculiar arguments arising from not realizing the difference that exists between constructive troglomorphic traits driven by selection and regressive ones explained by the above-mentioned theory.

Among the selective forces promoting eye and pigment reduction in cave animals, energy economy was very often made responsible (Culver and Wilkens, 2000). This seems questionable because such reductions not only occur in food-limited caves, but are also observed in food-rich underground environments. Furthermore, energy economy does not explain the reduction of optically triggered behavioral traits such as the specific surface aggressive behavior, dorsal light reaction, and circadian rhythm in the *Astyanax* cave fish. They are not manifested in darkness by the ancestral surface form and thus could not be subjected to any selective influence. It has also been speculated that neural compensation may provide a selective advantage (Culver and Wilkens, 2000). However, as revealed in *Astyanax* and amblyopsid cave fish brains, those parts correlated with regressive structures like the optic tectum are reduced, and those parts correlated with senses constructively developed like olfaction are improved (Poulson, 1963; Peters *et al.*, 1993).

Jeffery (2001) defined enhanced midline signaling activity as constructive and deduced from this that cave fish eye reduction was a process driven by selection. This is not necessarily the correct interpretation, because other genes are active in early eye development; for example, the *eyeless* gene uncouples patterning and morphogenesis of the medaka (*D. rerio*) eye. The earliest expression of *Rx* and *pax6* in the anterior neural tube is a direct response to anterior neural inducers, such as chordin, follistatin, and/or cerberus (Mathers and Jamrich, 2000). It may well be that these genes are in disorder and the origin of cave fish eye regression even starts at an ontogenetically earlier stage. Note that mutating genes—like the yellow gene in the Piedras fish—may appear constructive but result from negative mutations.

The evolutionary process of eye and pigment reduction in cave animal species is not subjected to external selective forces. It is based on mutations that have a defective character. All color mutations in *Astyanax* are characterized by the loss of their biological function as adaptations to the environment of the ancestral surface form. The same can be shown for the regressive development of eyes: From the observation that hybrid eyes between specimens from different *Astyanax* cave fish populations are larger and develop eye structures never found in comparable stages of the parental generations, it must be concluded that different

defective gene rudiments having originated at random exist in the various cave populations that may get functional again after recombination in laboratory crossings.

As pointed out earlier, it was Darwin who stated that loss of function and lack of selection are the cause of variability. The defective color genes are in part heterozygous in specific cave populations. Furthermore, the distribution of these genes between the different populations is subject to variability. The same was shown for the genes responsible for eye regression. The defective eye genes show variability within the different populations (heterozygosity) as well as between the different cave populations, in which they are randomly distributed providing a partially diverging genetic basis. As described earlier, this is the reason for the fact that F<sub>1</sub> hybrids may develop larger and better developed eyes than the parental generation and some F<sub>2</sub> specimens even better ones—and worse, too—than F<sub>1</sub> hybrids (Wilkens, 1988) or that multiple photopigments are existing (Parry *et al.*, 2003).

The comparative studies of polygenic constructive traits, such as gustatory equipment or feeding behavior, and regressive traits, such as eyes and the melanophore system, in *Astyanax* surface and cave fish have shown that their phenotypic manifestation is subjected to identical genetic principles (Wilkens and Strecker, 2003). It can be hypothesized that expressional fluctuations of one or a few developmental control genes, which are responsible for the early anlage driven by random mutations, deliver the material, which is either positively seized by external selection in the case of biological significance in constructive features or, in the case of missing selection, subjected to mutation pressure and rudimentation in regressive ones. Thus the evolution of constructive and regressive traits basically starts at the same random mutation source. Only in regressive traits is this fundamental principle of molecular evolution phenotypically kept manifest at later stages. Thus at its primary basis, evolution proceeds without selection and the latter will only secondarily get involved.

### *See Also the Following Articles*

*Natural Selection*

### *Bibliography*

- Culver, D. C., and H. Wilkens (2000). Critical review of the relevant theories of the evolution of subterranean animals. In *Ecosystems of the World: Subterranean Ecosystems* (H. Wilkens, D. C. Culver, and W. F. Humphreys, eds.), pp. 328–389. Elsevier, Amsterdam.
- Darwin, C. (1859). *On the origin of species*. Reprint by Gramercy Books (1979). New York, Avenel, 459 pp.
- Jeffery, R. J. (2001). Cave fish as a model system in evolutionary developmental biology. In *Developmental Biology*, pp. 1–12. Academic Press, San Diego.
- Kimura, M. (1983). *The Neutral Theory of Evolution*. Cambridge University Press, Cambridge, MA.
- Langecker, T. G. (2000). The effects of continuous darkness on cave ecology and cavernicolous evolution. In *Ecosystems of the World: Subterranean Ecosystems* (H. Wilkens, D. C. Culver, and W. F. Humphreys, eds.), pp. 135–138. Elsevier, Amsterdam.

- Mathers, P. H., and M. Jamrich (2000). Regulation of eye formation by the *Rx* and *pax6* homeobox genes. In *Cellular and Life Sciences*, Vol. 57, pp. 186–194. Birkhäuser Verlag, Basel.
- Mitchell, R. W., W. H. Russell, and W. R. Elliott (1977). Mexican eyeless characin fishes, genus *Astyanax*: Environment, distribution and evolution, special publication Mus. Texas Tech. Univ. 12. Texas Tech Press, Lubbock.
- Parry, J. W. L., S. N. Peirson, H. Wilkens, and K. Bowmaker (2003). Multiple photopigments from the Mexican blind cave fish, *Astyanax fasciatus*: A microspectrophotometric study. *Vision Research* **43**, 31–41.
- Peters, N., V. Schacht, W. Schmidt, and H. Wilkens (1993). Gehirnproportionen und Ausprägungsgrad der Sinnesorgane von *Astyanax mexicanus* (Pisces, Characidae). In *Zeitschrift für Zoologische Systematik und Evolutionsforschung* pp. 144–159. Paul Parey, Hamburg and Berlin.
- Poulson, T. L. (1963). Cave adaptation in amblyopsid fishes. *Am. Midl. Nat.* **70**, 257–290.
- Romero, A. (2001). Scientists prefer them blind: The history of hypogean fish research. *Envir. Biol. Fishes*, **62**, 43–71.
- Strecker, U., L. Bernatchez, and H. Wilkens (2003). Genetic divergence between cave and surface populations of *Astyanax* in Mexico (Characidae, Teleostei). *Mol. Ecol.* **12**, 699–710.
- Wilkens, H. (1988). Evolution and genetics of epigean and cave *Astyanax fasciatus* (Characidae, Pisces). Support for the neutral mutation theory. In *Evolutionary Biology* (M. K. Hecht and B. Wallace, eds.), pp. 271–367. Plenum Publishing, New York.
- Wilkens, H., and U. Strecker (2003). Convergent evolution of the cavefish *Astyanax* (Characidae, Teleostei): genetic evidence from reduced eye-size and pigmentation. *Biol. J. Linnean Soc.* **80**, 545–554.
- Yokoyama, S., A. Meany, H. Wilkens, and R. Yokoyama (1995). Initial mutational steps toward loss of opsin gene function in cave fish. *Mol. Biol. Evol.* **12**, 527–532.

# Nitrate Contamination in Karst Groundwater

Brian G. Katz  
U.S. Geological Survey

Nitrate contamination of groundwater has been reported throughout the world in many diverse hydrogeologic settings. Karst aquifer systems, though, are particularly vulnerable to contamination due to numerous solution features that allow for direct hydraulic connections between the surface and subsurface. Concentrated groundwater recharge and flow through conduits and solution-enlarged fractures allow rapid movement of water through the aquifer, with little opportunity for chemical transformation or microbial degradation reactions. This chapter discusses environmental concerns associated with nitrate in groundwater, land use and hydrogeologic factors controlling nitrate contamination in karst groundwater, the temporal variability of nitrate in karst aquifers, processes that result in losses of nitrate in groundwater, and protection of groundwater resources in karst areas.

## BACKGROUND INFORMATION

In karst terrain, as well as in other hydrogeologic systems, numerous interrelated factors account for nitrate contamination of groundwater. These factors can be grouped into two main categories: land use (including nitrate sources, land application rates and timing of fertilizers and manure, and waste disposal practices) and hydrogeologic characteristics (such as the degree of connectivity between the aquifer and surface solution features, soil drainage characteristics, the timing and amount of recharge, degree of aquifer confinement, shallow and deep flow patterns, and type of water supply well). Other conditions that further promote nitrate contamination in karst aquifer systems are the typically oxygenated groundwaters, which contribute to the stability of nitrate (preventing its transformation to reduced nitrogen species), the thin soil cover overlying many karst aquifers, and often careless waste disposal practices. Also, in many areas, an epikarst zone directly above the aquifer can provide temporary storage for nitrate and other contaminants, which can be released from this zone into the aquifer by recharge from storm events. Losses or decreases in nitrate concentrations within a karst aquifer system can result from naturally occurring processes, such as denitrification (microbially mediated transformation of nitrate to reduced nitrogen species) and dilution (e.g., resulting from interactions between surface water and groundwater).

## ENVIRONMENTAL CONCERNS AND NITROGEN CYCLING IN GROUNDWATER

Several human and ecological health concerns are associated with elevated nitrate concentrations in groundwater. Infants under 6 months of age who ingest nitrate in drinking water are susceptible to methemoglobinemia, which can lead to reduced blood oxygen levels and can result in death. For these health concerns, the U.S. Environmental Protection Agency established a maximum contaminant level (MCL) for nitrate of 10 mg/L, as nitrogen (N), for drinking water. Another study found an increased risk of non-Hodgkins lymphoma associated with nitrate concentrations of 4 mg/L or more in rural drinking water supplies. Groundwater contributes to base flow in many streams and rivers and elevated nitrate concentrations from groundwater can stimulate the growth of nuisance aquatic vegetation in surface waters. As of this writing (2003), there were no guidelines for nitrate concentrations in streams to limit the growth of nuisance aquatic vegetation.

Nitrate is one of several species of nitrogen (N) that can exist in the subsurface. The presence of other N species in a karst aquifer depends on oxidation–reduction conditions and microbial reactions in the subsurface. N-cycling processes are complex. For example, oxidation of reduced N species (ammonium, organic N, nitrite) to nitrate or transformation of nitrate to reduced N species generally takes place in the

soil or unsaturated zone where organic material and microbial communities are present. These processes are controlled by the presence or absence of oxygen and other terminal electron acceptors (e.g., sulfate, ferric iron, organic carbon). These processes need to be understood to properly assess the fate of nitrate in karst aquifers. It is beyond the scope of this chapter to discuss these processes in detail. Numerous reviews, texts, and other publications have described biologically mediated transformations, storage pools, and nitrate removal.

### LAND-USE FACTORS

Activities associated with various land uses can dramatically affect nitrate concentrations in groundwater in karst systems. Most cases of elevated nitrate concentrations in karst aquifers are related to agricultural activities. Numerous studies have demonstrated that nitrate concentrations in groundwater are higher beneath agricultural areas compared to forested areas and are related to the percentage of agricultural land used near wells or springs.

Nonpoint or diffuse sources account for nitrate contamination of groundwater on a regional scale in many agricultural areas throughout the world. Elevated nitrate concentrations in many of these areas often are associated with contamination from other agricultural chemicals, such as herbicides and other pesticides. Although several retrospective studies have reported lower nitrate concentrations in groundwater from the southeastern United States compared to other regions, elevated nitrate concentrations exceed the nitrate MCL for drinking water in many parts of the karstic Upper Floridan aquifer in areas of extensive agricultural land use. The application of manure also has contributed to nitrate contamination of groundwater as indicated by statistically significant relations between nitrate concentration in groundwater and the amount of manure applied to soils overlying carbonate aquifers.

Nitrate contamination of groundwater can also originate from localized agricultural point sources, such as concentrated animal feeding areas, poorly designed waste storage areas, and disposal of dead animals in sinkholes. Also, other documented cases of nitrate contamination of groundwater are related to the spreading of organic wastes over agricultural lands, irrigation of pasture land with cheese factory effluent, and spray irrigation of wastewater from a vegetable- and meat-canning facility.

Several cases have been documented of nitrate contamination of groundwater in karst areas associated with land uses other than agriculture. In rural areas, contamination from septic tanks and cesspools is fairly common. Effluent from these systems can reach the water table undergoing little filtration or attenuation due to the typically thin soil cover in many karst areas. Also, nitrate contamination of groundwater has resulted from diversion of untreated sewage into nearby sinkholes or swallow holes. Leaky sewers have contributed

to nitrate contamination in some urban areas. In many rural landscapes, the dumping of household refuse, construction materials, and dead livestock have resulted in groundwater contamination problems. Landfills and open dumps in limestone outcrops in the recharge area of a well field have contributed to nitrate contamination of groundwater in China. In an Indiana karst system, nitrate contamination of groundwater was attributed to by-products from ordnance manufacturing and demolition processes at a military institution.

Atmospheric deposition (wetfall and dryfall) is potentially another source for elevated nitrate concentrations in karst groundwater, although very few studies have addressed this issue. Seasonal variability of nitrogen (ammonium and nitrate) in precipitation most likely is related to the application of fertilizers in the spring, but other potential atmospheric sources of nitrate, including industrial waste gases and fossil-fuel combustion, could be responsible. The influence of atmospheric sources has been inferred from isotopically enriched values of  $\delta^{18}\text{O}$  of nitrate found in winter and summer spring-water samples, when nitrate in groundwater was relatively low and its concentration in precipitation was high.

Most studies have focused on the collection of water from wells or springs in karst aquifers; however, a few studies have collected samples of cave drip water as a novel way of characterizing the chemistry of recharge water moving through the vadose zone into caves and groundwater. Caves near and below agricultural land had higher nitrate concentrations in drip water than did groundwater in forested areas. Concentrations of nitrate were about an order of magnitude higher in autogenic recharge waters at a cave located beneath an agriculturally intensive landscape than in recharge at caves beneath less intensive land uses. This study also found that nitrate showed a temporal variation with a flush of nutrients during late summer and autumn that corresponded to trends in surface rivers and streams.

### HYDROGEOLOGIC FACTORS

Based on an analysis of retrospective data from 1972 to 1992 from sites around the United States, the U.S. Geological Survey (USGS) reported that nitrate concentrations were highest in karst bedrock areas compared to other hydrogeologic settings, such as sand and gravel, alluvium, and other bedrock types. Differences reflected the intensive agricultural activity on land overlying the carbonate settings, but were also related to the hydraulic connections to the surface and solution features typical of fractured carbonate rocks.

Similar findings were reported for other karst areas in the midwestern United States. Based on data from 6039 water samples collected during 1977 to 1980 from 22 counties in Iowa, nitrate-N concentrations from all well depths were higher in a karst region compared to samples from shallow and deep bedrock. Even though nitrate concentrations decreased with depth in all regions, elevated nitrate concen-

trations in the karst region extended to 30 m greater depth than in the confined deep bedrock region.

The degree of confinement of the aquifer also can affect nitrate concentrations in groundwater. Several studies have shown that nitrate concentrations in limestone aquifers are substantially higher in water from unconfined aquifers than from confined aquifers. However, in some areas, a rapid response of groundwater to elevated nitrate concentrations after fertilizer applications was attributed to the rapid movement of fertilizer-derived nitrate into macropores.

The type and depth of a sampled well type also are related to nitrate concentrations in groundwater, although very few studies have specifically addressed this issue in karst areas. Based on more than 5600 samples collected throughout the United States in both karst and nonkarst settings, the USGS reported that median nitrate-N concentrations ranged from 0.2 mg/L in public supply wells to 2.4 mg/L for irrigation and stock wells. Water samples from about 16% of the generally shallow irrigation and stock wells exceeded the nitrate MCL, compared to only about 1% of samples from public supply wells, which are typically open to much deeper parts of an aquifer.

### NITRATE CONTAMINATION OF SPRINGS

Springs represent discharge points of groundwater basins and are typically the dominant source of water for surface streams in karst areas. Because springs integrate water temporally, spatially, and vertically from an aquifer, they offer an effective way of assessing sources and timescales of nitrate contamination of groundwater in karst areas. In many areas, nitrate concentrations in spring waters have increased substantially during the past 40 to 50 years and, in most cases, the increasing trends were related to increased amounts of fertilizer application. Nitrate concentrations in spring waters (and nitrate flux) are related to the extent of cultivated zones at the surface.

In several studies, nitrate concentrations were found to be higher in springs than in water from nearby wells. For example, in the Ozarks, higher nitrate concentrations in springs were attributed to groundwater that generally follows shallow flow paths and issues from conduits and, therefore, is more susceptible to contamination from the surface. Elevated nitrate concentrations are found in shallow systems, as well as in springs draining deep groundwater systems (up to 100-m depths) in areas of intensive water exploitation and fertilizer use.

Stable nitrogen isotopes ( $\delta^{15}\text{N}$ ) in hydrologic studies have been particularly effective in assessing sources and fate of nitrate. In studies of karst springs, these and other naturally occurring tracers have been used effectively to test hypotheses about flow-system characteristics and dominant geochemical processes. For example, based on measurements of  $\delta^{18}\text{O}$  and  $\delta^{15}\text{N}$  of nitrate in spring waters in the southwest Illinois sinkhole plain, significant denitrification occurred within the

soil zone, epikarst, and shallow karst hydrogeologic system and accounted for the loss of nitrate in spring waters from spring to winter. A multitracer approach that included isotopic and other chemical tracers was used to show that nitrate concentrations in Florida spring waters were related to average groundwater residence times determined from age-dating techniques. Springs with lower flow rates had short residence times (around 10 years) and relatively high nitrate-N concentrations (20–35 mg/L), whereas those with higher flow rates had longer residence times (20–30 years) and lower nitrate concentrations (0.2–5 mg/L). These differences were attributed to the higher contribution of young water (recharged less than 7 years) from shallow parts of the Upper Floridan aquifer in spring waters with low flows (0.028–0.28  $\text{m}^3/\text{s}$ ), compared to a higher contribution of deep older water (recharged two to three decades ago) that accounted for lower nitrate concentrations in spring waters with high flow rates ( $>2.8 \text{ m}^3/\text{s}$ ).

### TEMPORAL VARIABILITY OF NITRATE

Temporal variations in nitrate concentrations in groundwater and springs reflect the interrelation of several important hydrogeologic, land-use, and climatic factors. The degree of temporal variation is related to the degree of karstification, mantle thickness, and the proportion of conduit to diffuse flow. For example, nitrate concentrations in groundwater generally increase following seasonal applications of fertilizers. Large fluctuations in nitrate concentrations in springs have been observed during high-discharge events related to annual variations in rainfall.

### PROCESSES THAT RESULT IN LOSSES OF NITRATE IN KARST GROUNDWATER

Although many karst aquifers tend to be oxic, nitrification–denitrification processes can occur within the overlying soil zone, epikarst, and aquifer (rock) matrix. In the relatively immobile pore waters in the rock matrix of the Chalk aquifer in Britain, denitrification accounted for the decrease in nitrate concentrations downgradient in the direction of flow. Other studies have documented nitrate losses in karst groundwater as a result of denitrification.

Dilution of nitrate can result from mixing of surface water and groundwater following periods of high rainfall in karstic systems. Dilution by runoff transported through fast-flow conduits has also accounted for large decreases in nitrate concentrations in spring waters during high-rainfall periods. In the karstic aquifer systems of Greece, the high volume of groundwater has kept the concentration of nitrate low even in areas of intense agricultural land use. In a study in Iowa, wetter than average conditions following a drought period resulted in a substantial increase in nitrate concentrations as a result of the increased water volume moving through the soils and the leaching of nitrate left over from the drought.

## PROTECTING GROUNDWATER RESOURCES

Understanding the factors and processes that affect the occurrence, movement, and fate of nitrate is essential for protecting groundwater quality and preventing further nitrate contamination in karst areas. Although the delineation of groundwater contributing areas and/or protection zones for springs and wells in karst areas remains difficult and challenging, recharge areas are protected in many locales, especially springs or wells used for water supply. Considerable work is being done to evaluate management strategies for reducing nitrate contamination from point and nonpoint sources in karst systems. The time lag between a reduction in land application of fertilizer or manure spreading can vary greatly, depending on site-specific soil characteristics, climatic conditions, and recharge rates. Given the large year-to-year variations in nitrate concentrations at Big Spring, in Iowa, it has been difficult to identify any improvements in water quality resulting from reductions in nitrogen that have occurred incrementally during the past decade. In about one-third of the studied basin, decreases in nitrogen inputs have been overshadowed by large variations in annual recharge. As the worldwide demand for water increases, much work remains to be done to characterize both the residence time of groundwater in varied and complex karst systems, and the travel time from a recharge area to a point of spring discharge or withdrawal for public consumption.

### Bibliography

- DiGnazio, F. J., N. C. Krothe, S. J. Baedke, and R. F. Spalding, (1998)  $\Delta^{15}\text{N}$  of nitrate derived from explosive sources in a karst aquifer beneath the Ammunition Burning Ground, Crane Naval Surface Warfare Center, Indiana, USA. *J. Hydrol.* **206**, 164–175.
- Drew, D., and H. Hötzl, eds. (1993). *Karst Hydrogeology and Human Activities: Impacts, Consequences, and Implications. International Contributions to Hydrogeology*, Vol. 20. A. A. Balkema, Rotterdam, Netherlands.
- Hallberg, G. R., and D. R. Keeney (1993) Nitrate. In *Regional Ground-Water Quality* (W. M. Alley, ed.), pp. 297–322. Van Nostrand Reinhold, New York.
- Johnson, C. J., P. A. Bonrud, T. L. Dosch, A. W. Kilness, K. A. Senger, D. C. Busch, and M. R. Meyer (1987). Fatal outcome of methemoglobinemia in an infant. *J. Am. Med. Assoc.* **257**, 2796–2797.
- Katz, B. G., J. K. Böhlke, and H. D. Hornsby (2001). Timescales for nitrate contamination of spring waters, northern Florida, USA. *Chem. Geol.* **179**, 167–186.
- Kendall, C., and R. Aravena (2000). Nitrate isotopes in groundwater systems. In *Environmental Tracers in Subsurface Hydrology* (P. G. Cook and A. L. Herczeg, eds.), pp. 261–298. Kluwer Academic Press, Boston.
- Mueller, D. K., P. A. Hamilton, D. R. Helsel, K. J. Hitt, and B. C. Ruddy (1995). Nutrients in groundwater of the United States—An analysis of data through 1992. U.S. Geological Survey Water-Resources Investigations Report 95-4031.
- Panno, S. V., K. C. Hackley, H. H. Hwang, and W. R. Kelly (2001). Determination of the sources of nitrate contamination in karst springs using isotopic and chemical indicators. *Chem. Geol.* **179**, 113–128.
- Peterson, E. W., R. K. Davis, J. V. Brahana, and H. A. Orndorff (2002). Movement of nitrate through regolith covered karst terrane, northwest Arkansas. *J. Hydrol.* **256**, 35–47.
- Plagnes, V., and M. Bakalowicz (2001). The protection of karst water

- resources: The example of the Larzac karst plateau (south of France). *Environ. Geol.* **40**, 349–358.
- Scanlon, B. R. (1990). Relationships between groundwater contamination and major-ion chemistry in a karst aquifer. *J. Hydrol.* **119**, 271–291.
- Spalding, R. F., and M. E. Exner (1993). Occurrence of nitrate in groundwater—A review. *J. Environ. Quality* **22**, 392–402.
- Stournaras, G. (1998). Groundwater and nitrates in Greece—An overview. *J. Environ. Hydrol.* **6**, 1–8.
- Wells, E. R., and N. C. Krothe (1989). Seasonal fluctuation in  $\Delta^{15}\text{N}$  of groundwater nitrate in a mantled karst aquifer due to macropore transport of fertilizer nitrate. *J. Hydrol.* **112**, 191–201.
- Zhu, X. Y., S. H. Xu, J. J. Zhu, N. Q. Zhou, and C. Y. Wu (1997). Study on the contamination of fracture-karst water in Boshan district, China. *Groundwater* **35**, 538–545.

## Nullarbor Caves, Australia

Julia M. James

Annalisa K. Contos

Craig M. Barnes

University of Sydney, Australia

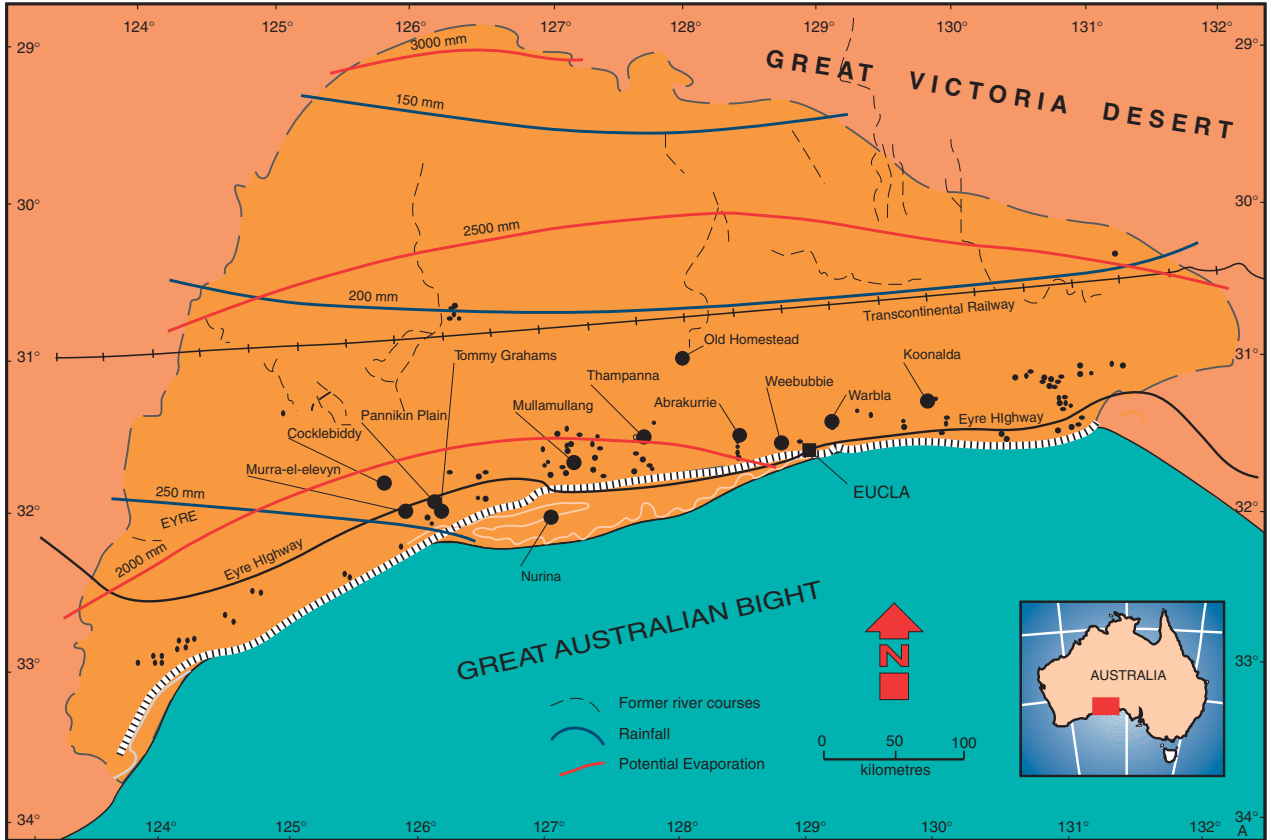
### INTRODUCTION

In Australia, the karst land referred to as the Nullarbor covers an area in excess of 200,000 km<sup>2</sup>, although in proportion to its area the karst is poor in known caves. Despite being referred to by their collective name, the Nullarbor Caves, many of the individual caves are world class in their own right. They have played an important role in elucidating Australian prehistory and they have been the focus of many intrepid expeditions—first to find the caves and then to explore them both in the dry waterless passages and in the extensive flooded passages.

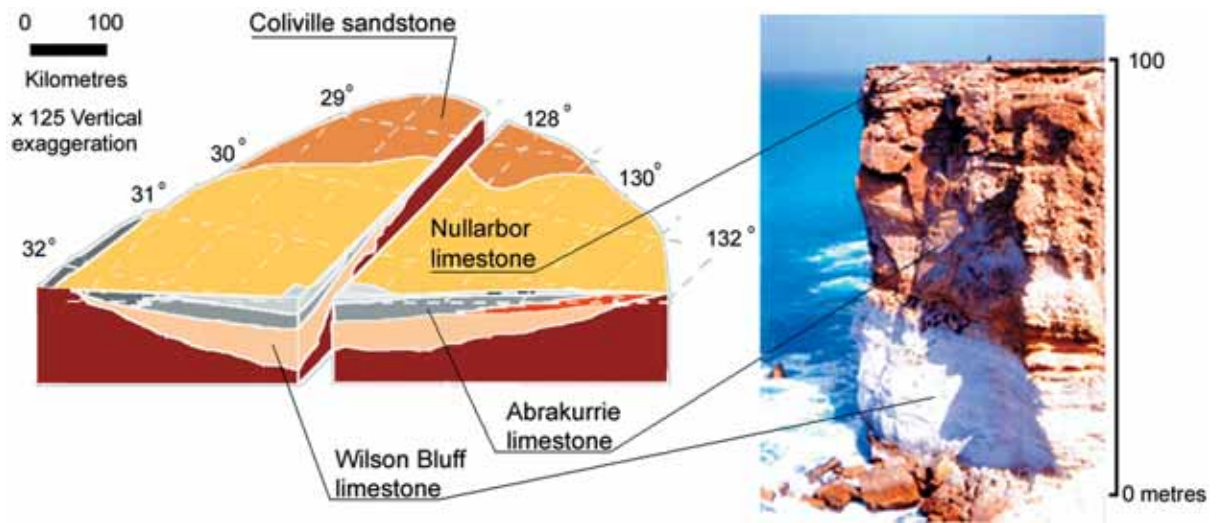
The very existence of caves beneath a desert is remarkable and because of this they have individually and as a group contributed significantly to the understanding of speleogenesis in arid environments. These caves are renowned for their rare secondary minerals, and the great variety of novel cave decorations has provided valuable insight into past surface and climatic conditions. The desiccating environment in these caves has also preserved biological materials in such pristine condition that they are considered outstanding repositories of paleoenvironmental information. Despite being nutrient poor, the dry passages of the Nullarbor Caves host a range of terrestrial invertebrates including several unique troglobitic species. Colonies of microbes have produced abundant biofilms in the saline cave waters and these contain many new species of bacteria.

### PHYSICAL SETTING

The Nullarbor Caves are found on one of the largest continuous exposed karst lands in the world in the southwest



**FIGURE 1** Location map for the Nullarbor Caves. The golden yellow color depicts the limestone area. (After Lowry and Jennings, 1974.)



**FIGURE 2** The geology of the Nullarbor (after Lowry and Jennings, 1974), the Mullaullang strata are not shown for clarity, together with a plate showing an outcrop of the limestone strata exposed in the cliffs bordering the Great Australian Bight. (Photograph courtesy of Annalisa Contos.)

part of the Australian continent (Fig. 1). These caves are developed in four limestone strata: the Nullarbor (early–middle Miocene), the Mullaullang member of the Nullarbor limestone, Abrakurrie, and Wilson Bluff (middle–late Eocene). Banded to the north by the Colville Sandstone, the

limestone strata are unconformable, almost horizontally bedded and dip to the south-southeast (Fig. 2). Uplift of the limestones probably occurred at the end of the Lower Miocene. Relatively weak jointing and the absence of folding or major tilting suggest that the region has remained

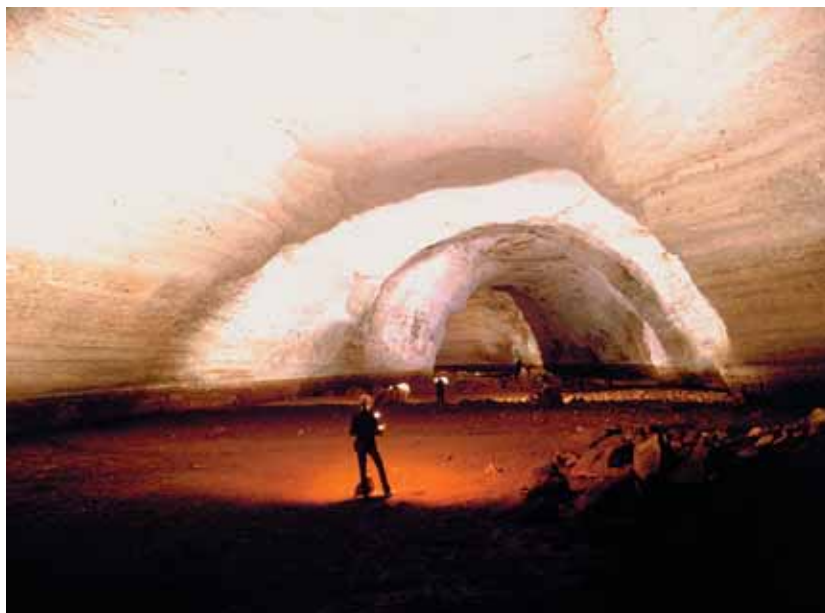
relatively stable since uplift. Particularly important to cave development is that all limestone strata are both porous and permeable.

The Nullarbor is a plain that is almost completely flat. The plain in the south is sparsely vegetated and in the north it is treeless. At present, the tree line that delineates the edge of the treeless plain is approximately 80 km north of Eucla (Fig. 1). Pollen studies of sediments and gut contents of extinct fauna have shown that the “tree line” extended to Eucla during the last glacial, a time when the coastline was 160 km further south. These studies have also shown that the vegetation has remained similar throughout and since the last cold period.

The major surface karst features are ridges and corridors, with relief of 3 to 5 m amplitude, and large but extremely shallow circular depressions called *dongas*. Set into the plain and distributed throughout the Nullarbor are thousands of blowholes, holes in the ground through which air blows in and out strongly. More frequent in the southern part of the plain are hundreds of abrupt, sharp-edged collapse dolines (Fig. 3). Typical of semiarid to arid karst, the Nullarbor has poorly developed karren features, although there are extensive calcretes and the surface of the limestone is case hardened. Immediately below the indurated surface the rock mass is extensively weathered with many small cavities.



**FIGURE 3** The mouth of Pannikin Plain cave set in the flat plain. The cave entrance is 10 m in diameter and after 8 m leads down through collapse to the main passage. (Photograph courtesy of Dirk Stoffles.)



**FIGURE 4** The main chamber in Abrakurrie. The chamber is in the white Wilson Bluff limestone. The flat floor consists of fluvial sediments mixed with the products of crystal weathering. The volume of the chamber is  $\sim 135,000 \text{ m}^3$ . (Photograph courtesy of Julia James.)



**FIGURE 5** Weebubbie lake has an area of  $\sim 7500 \text{ m}^2$ . From the end of the lake a series of large flooded passages continue, reaching a depth of 45 m. (Photograph courtesy of Alan Warild.)

The caves can be entered from either blowholes or dolines that often descend over breakdown to large passages that are tens of meters in width and height. The passages enlarge to form huge chambers (Fig. 4) with domed ceilings and arch entrances. The most striking feature of these caves is the spectacular lakes (Fig. 5) of considerable depth and clarity. These lakes have helped establish the international reputation of the Nullarbor Caves. In a few of the known caves, kilometers of flooded passage have been discovered leading from the lakes.

Although open to debate, some evidence suggests that the Nullarbor has been semiarid to arid for some 6 million years. At present, the Nullarbor has a warm semiarid climate in the south, but it is hot and arid in the north. Surface temperatures range widely both seasonally and diurnally as a result of continentality, although winters are short and cool to mild. The average temperature of the caves is  $18^\circ\text{C}$ . An important meteorological feature is that for the entire region potential evaporation exceeds precipitation (Fig. 1). The rainfall pattern is unreliable; along the coast most precipitation falls in winter as light rain and mist, whereas inland, irregular summer thunderstorms distribute the rainfall. This annual pattern is interrupted every few summers by intense rain-bearing cyclonic depressions. These events can drop hundreds of millimeters of rain in an hour, causing considerable local flooding.

There are no permanent streams on the Nullarbor, but there are numerous intermittently active watercourses. During intense rainfall, water flows into depressions or collapse dolines and rapidly disappears underground. In the caves, the streams flow only short distances before entering lakes or sinking in sediment. Lakes are encountered at similar depths in the Nullarbor Caves and they form part of a

regional water table known as the Nullarbor aquifer. The surface of the aquifer slopes gently toward the Great Australian Bight and is close to sea level in height. It has both conduit and diffuse flow characteristics, with the flow of water in the caves being from north to south. The caves act as conduits within the unconfined aquifer whose surface marks the top of the phreatic zone. The ultimate destination of the cave waters remains an enigma as there are no large springs issuing from the coastal cliffs and dunes, and no known submarine springs in the Great Australian Bight.

### PREHISTORY, HISTORY, AND SPELEOLOGICAL HISTORY

On the Nullarbor, the nomadic Aborigines inhabited the fringes of the plain from the earliest times and entered the caves in a search for flint. Indeed, several of the caves, such as Koonalda (Fig. 1), have been mined for flint. Archaeological excavations 80 m below the surface, on the edge of the twilight zone in Koonalda, the only cave containing a constant supply of potable water, have provided evidence of a period of uninterrupted human "occupation" spanning approximately 30,000 years. The stone artifacts found there show discernible changes in stone implement technology but there are no grinding stones, indicating a lack of grasses and cereals and a purely hunting lifestyle. Several caves are decorated with hand stencils or primitive engravings similar to artwork found in Paleolithic caves in Europe and dating to Late Glacial times.

The presence of caves on the Nullarbor was first recorded in 1866 just prior to European settlement at Eucla in 1867. The local Aboriginal tribe was the Mirning, which at its



peak numbered 200 persons but by 1867 numbered only 30. Anthropologists have established that at this time the Mirning no longer used the Nullarbor Caves. Even after European settlement, the population density of the area remained very low on a world scale, thus until the early 20th century, many of the Nullarbor Caves formed a pristine underground wilderness, preserved by their remoteness in an inhospitable landscape. However, the change of land use from wilderness to sheep and cattle grazing, coupled with the introduction of other feral animals, especially the rabbit, has subsequently caused considerable damage to many of the caves.

The first expeditions specifically to locate and explore caves took place during the 1930s. On some of these early expeditions, a light aircraft was used to locate the caves. With the formation of Australian speleological societies in the 1950s, major caving expeditions commenced. These benefited from the newly available air photographs, which proved invaluable in locating caves with large dolines and entrances. The highlight of the 1950s exploration was the discovery and survey of Mullamullang, which at 10.8 km was the longest cave in Australia at that time. The flooded passages in many of the caves attracted cave divers, with the first major attempt at underwater exploration occurring in 1972. The 1980s saw cave exploration intensify once more and the use of ultralight aircraft for prospecting. This systematic searching of the surface and depressions led to many new caves being found and explored. In the known caves, passages were extended by dedicated cavers who were prepared to continue even when the way became constricted or required excavation. Improvements in cave diving equipment saw flooded caves explored to world record lengths. This attack on the Nullarbor

underground has continued into the new millennium; even in 2002 new caves and flooded maze passages coated in crystal were discovered. Since the 1950s, speleological investigations in the Nullarbor Caves have taken place in parallel with exploration, leading to them being among the most studied arid caves in the world.

### ORIGIN AND ENLARGEMENT OF THE CAVES

At first it was anticipated that the number and size of the Nullarbor Caves would be limited by a lack of surface water and biogenic carbon dioxide. This hypothesis was supported by an apparently immature karst surface, lacking in richness and diversity of landforms. In contrast, the enormous caves found indicated that below ground the karst was mature, while the large number of blowholes showed that cavities are numerous beneath the surface, the latter supported by extensive drilling records. In fact, the Nullarbor is not lacking in caves but in entrances to them. Old Homestead (Fig. 1) illustrates this; it has a single entrance, yet on the surface above the cave at least 30 blowholes too narrow for human passage have been identified as having an air connection with the voids below. Within the cave there is evidence of additional entrances that are now blocked with aeolian surface materials.

As early as the 1970s, scientists hypothesized that the caves had shallow phreatic origins, developing in zones of fluctuating water tables. This hypothesis was readily accepted as an explanation for the smaller, shallow Nullarbor Caves. For the huge caves, other investigators invoked more pluvial times in the past to supply copious aggressive waters for dynamic phreatic development. The existence of the paleo-



**FIGURE 6** Tafoni in Cocklebiddy entrance passage. The tafoni are in lines separated by harder layers in the limestone. Gypsum and halite efflorescence can be seen on the curved surfaces and a fine powdered deposit of gypsum and calcite sand can be seen on the ledges below the tafoni. Above the surface of the lake is a deeply cut corrosion notch. (Photograph courtesy of Julia James.)

drainage channels found in the north of the plain (Fig. 1) was regarded as support for this argument. At present, runoff generated by intense rainfall is the only aggressive water to enter the caves. Lenses of this freshwater form on top of the brackish waters in the cave lakes allowing corrosion notches (Fig. 6) to develop on the walls around the lake.

The brackish waters in the lakes, flooded passages, and the Nullarbor aquifer are saturated with respect to calcite, evidence that they are dissolving limestone and have a role in the development of the caves. They have large amounts of total dissolved solids, with sodium ions and chloride dominating. The highest levels of total dissolved solids in caves are found in Nurina, where the water is hypersaline, and the lowest in Mullamullang (Fig. 1). The generalization that salinity in the cave waters decreased with distance from the ocean led to the hypothesis that seawater was back flooding into the caves. Stable isotope analysis has shown that the source of the salt is actually sea spray and that it is the salt content of the meteoric waters that decreases with distance from the ocean.

The aggressive meteoric waters are implicated in many aspects of karst and cave development on the Nullarbor. The light rain dissolves some limestone on the surface and in the soil profile but when it evaporates calcium carbonate (calcite), sodium chloride (halite), and calcium sulfate-2-water (gypsum) crystallize out on the surface. Subsequent cycles of light rain and evaporation increase the surface and soil salt content. This concentration of calcium carbonate, where potential evaporation exceeds rainfall, is a recognized mechanism for the formation of calcretes and the case hardening of limestone. On the arid Nullarbor, halite and gypsum are also concentrated in this manner. During periods of intense rain, the soluble salts concentrated through the above mechanism dissolve. The resulting vadose waters are aggressive because they have increased ionic strength and are thus able to create cavities immediately below the indurated surface. These cavities, called the *zone of intense phreatic preparation*, were previously interpreted as resulting from shallow phreatic solution at times of past high water tables. However, using the concept of renewed aggressivity from increased soluble salt content it is possible to propose that the zone is recent, not ancient, and vadose not phreatic, in origin.

The vadose waters continue through the limestone, now saturated with respect to calcite and with a high ionic strength, until they reach the water table. The brackish waters of the cave conduits and lakes and of the Nullarbor aquifer are also saturated with respect to calcite. When these two waters mix, the mixed water is aggressive and mixing corrosion takes place at the mixing surface. The location of the mixing surface in the karst has varied over time as sea levels were lowered during periods of glacial advance. It is likely that this process has been active throughout the history of cave development beneath the Nullarbor, creating shallow phreatic caves.

Whatever the process creating the first caves, when they drain due to the lowering of the water tables, the major process of enlargement is considered by all to be crystal weathering. It is the scale and intensity of crystal weathering in the Nullarbor Caves that makes them the foremost example in the world of this process of cavern enlargement. The agents of crystal weathering are the meteoric salts in the vadose waters. The Nullarbor Caves are barometric breathers, thus air flow in the caves reverses in response to pressure change. This breathing removes moisture from the caves and replaces it with desiccating desert air. If the humidity in the caves is sufficiently reduced, the vadose waters will start to evaporate until they become so concentrated that salts they are carrying crystallize in the surface layers of the limestone. Calcite, the first mineral to crystallize, can be observed in thin sections of the wall rock. Following calcite, gypsum and then halite crystallize causing granular disintegration of the wall rock. Gypsum is the more effective weathering agent because it has greater expansion on crystallization. This process produces upward stopping domes and highly fretted walls. The caves enlarge, stopping upward due to crystal weathering and subsequent collapse, ultimately penetrating to the surface. These collapse entrances allow aggressive runoff to reach the caves and contribute to their enlargement.

The collapse and crystal weathering products would fill a cave if they were not removed. Beneath the Nullarbor there are a number ways for their removal. Mixing corrosion at the vadose and phreatic interface will dissolve them. In Murra-elleyn, aggressive runoff waters are contributing to their removal. Solution within the freshwater lens has etched fallen boulders, leaving fossil corals standing up to 3 cm proud of their surface. Aeolian processes are the only way the products of crystal weathering can be removed from the dry cave passages. In Mullamullang, crystal weathering has reduced the bedrock to sand below a dome (Fig. 7). The sand shifts through the cave carried by the strong cave winds.

Crystal weathering masks, modifies, and mimics other geomorphic forms in the caves. *Pseudocorrosion notches* form around lakes that never receive runoff. These are a result of the brackish waters rising through the surrounding porous rock by capillary action and evaporation. This produces a band of halite and gypsum flowers and causes granular disintegration of the wall rock. Figure 6 shows the multiple rows of tafoni in the entrance chamber of Cocklebidly. To the advocates of dynamic phreatic solution, tafoni were solution scallops but are actually a product of crystal weathering. They have formed in bands separated by harder indurated limestones. These harder layers were generated when the parent coral reefs that produced the limestones emerged briefly above water.

Crystal weathering is also responsible for the novel "coffee and cream" sediments found in many of the caves. The weathering products are made up of two forms, which appear to flow over one another. Both the light- and dark-colored



**FIGURE 7** The dune in Mullamullang has been produced by the crystal weathering of the dome above it. It also accumulates sand transported by the strong cave winds from deeper in the cave. (Photograph courtesy of Alan Warild.)

materials are made up of high magnesium calcite with different impurities. The “cream” contains goethite-dominated iron minerals and some kaolin. The strikingly contrasting dark brown coffee has more gypsum, hematite, and manganese dioxide.

It has been proved that crystal weathering is occurring at observable rates in the caves under the present climatic conditions. Thus it is easy to accept that these enormous caves could have enlarged continuously over millions of years at a slow but variable pace dominated by this geomorphic process.

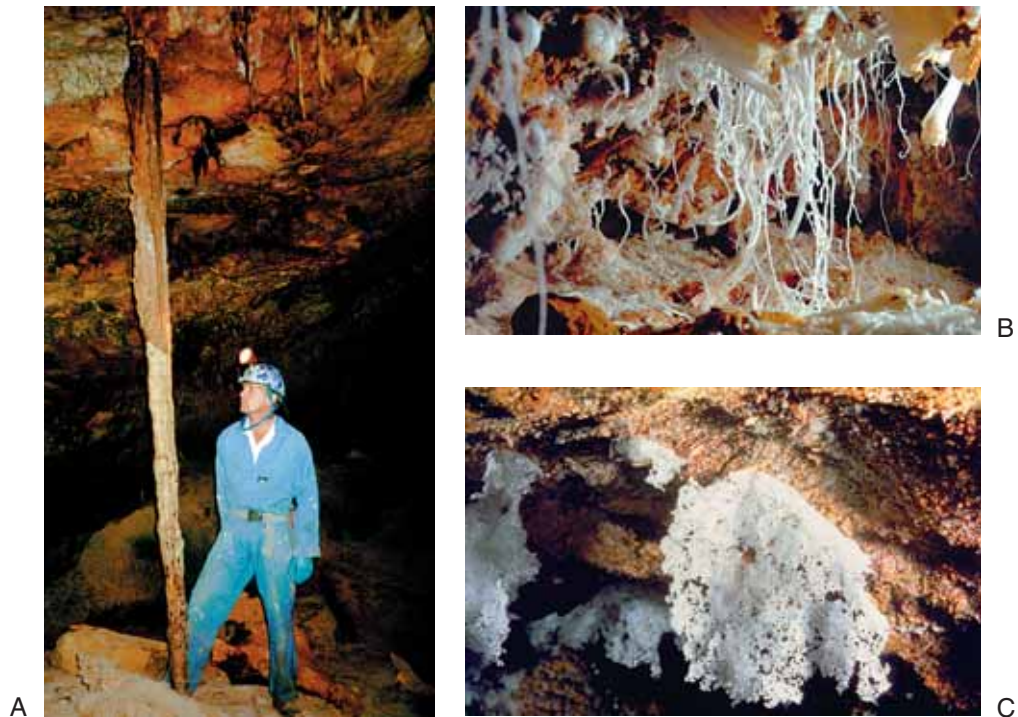
Throughout this *Encyclopedia of Caves* entry the words *large*, *enormous*, and *huge* are used. Yet none of the Nullarbor Caves would rate a mention in lists of the deepest and longest caves of the world. Old Homestead is the longest of the Nullarbor Caves at 25 km. Mullamullang is 135 m deep and is the second longest cave (>13 km). Weebubbie is equally deep but its large passage (Fig. 5) is submerged for 45 m of its overall depth. It is the flooded passages of the Nullarbor Caves that have attracted international expeditions in search of world records. Cocklebiddy has the longest underwater section, 6.5 km through large passages with only two modest air spaces to the limit of exploration and has held world records. Pannikin Plain has the largest flooded passages; they are the size of the Abrakurrie main chamber, the largest air chamber in Australia (Fig. 4). Another feature of the Nullarbor Caves that is internationally recognized is the strength of the cave winds. These have been measured at  $70 \text{ km h}^{-1}$  issuing from the blowhole entrance of Thampanna.

## MINERALS

The Nullarbor Caves are renowned for their secondary minerals. The most unusual are the very rare organic minerals produced within bat guano. These are exceptionally soluble and are thus found only in the driest of caves. Only nine organic minerals have been reported from caves worldwide; of these, five were first collected from the Nullarbor Caves.

Halite is rare in limestone caves around the world, yet beneath the Nullarbor it is abundant and occurs in all the known forms of halite speleothems. Of exceptional beauty are the wide variety of delicate and erratically shaped halite flowers (Fig. 8). The source of the halite is the meteoric salt in the vadose water. It persists only in places in the caves where there is continuously low relative humidity. One of the most exciting halite speleothems found is a 2.7-m-long fallen column. For its protection this giant, christened Big Salty, was removed to the Western Australian Museum. A number of uranium series dates were obtained from it for growth rate studies and it was concluded that there had been two previous periods on the Nullarbor dry enough for massive halite deposition. The same cave has five other halite columns (Fig. 8), disguised from collectors by their unattractive appearance.

Gypsum is even more widespread and is found in many speleothem shapes. Halite is substantially more soluble than gypsum. This differential solubility is demonstrated when slow-dripping gypsum straws develop halite tips that are lost after subsequent rain increases flow through the straws.



**FIGURE 8** (a) A halite column. (Photograph courtesy of Julia James.) (b) A halite curtain ~100 mm high. (Photograph courtesy of Norm Poulter.) (c) Halite flowers ~500 mm long. (Photograph courtesy of Julia James.)

In the Nullarbor Caves calcite speleothems once regarded as rare are widespread, although under the current arid conditions subaerial calcite deposition is rare. Conventional calcite deposition by CO<sub>2</sub> degassing is to be found in Nurina where pools are covered with calcite rafts that have coalesced to form fragile floors and have stacked into piles against the cave walls.

Ancient “black” calcite is found in all of the common speleothem shapes. This black calcite, which has a humic compound as the chromophore, is seen both on the surface and throughout the caves to the water table. Uranium series dating has shown that its deposition ceased more than 350,000 years BP. Flowstones of black calcite over a meter thick suggest that its deposition extended over a long period of time. The black calcite must have been deposited when the climate was wetter or at a time when there was a much lower potential evaporation in order to allow the calcite-saturated waters to reach the caves. A more extensive vegetation cover would also have been necessary to provide both the carbon dioxide and the humic chromophore. Some of the massive speleothems of black calcite have been reduced to shards by the relentless attack of the agents of crystal weathering.

Mixing-zone calcites lie submerged in the flooded passages of the Nullarbor Caves. In Tommy Grahams (Fig. 1), these speleothems are being deposited below a halocline at a depth of 22 m. Above the halocline, the limestone wall rock is being eroded, while below it calcite is precipitating as a result of “mixing crystallization.” Similar calcite deposits are found

in many of the water-filled Nullarbor Caves. Particularly significant is a calcite flowstone over a kilometer in length and covering many meters of the lower passage walls and floor in the flooded passage of Cocklebidy. It is the nature of their deposition that makes these a valuable source of past environmental data.

Calcite biominerals encapsulated within biofilms have formed speleothems that have been named *microbial mantles*. Six different mantle morphologies have been observed: icicles (Fig. 9), U-loops, bulbs, feathers, and thin roof and thick floor sheets. Biofilms are implicated in both the nucleation and habit modification of the spindle-shaped microcrystals found within them. The floors below the mantles are either snow fields of loosely packed white crystalline detritus or pavements of cemented calcite.

### BIOLOGY PAST AND PRESENT

The Nullarbor Caves contain repositories of biological materials of outstanding paleoenvironmental value preserved in the desiccated sediments. The bone and subfossil material found covers a range of faunal elements, including extinct mega-fauna, many modern species now extinct on the Australian mainland and species whose range has markedly contracted. The most exciting finds have been the complete skeleton of a marsupial lion *Thylacaleo* and mummified *Thylacines*. The latter species is known as the Tasmanian tiger and is now extinct, although at the time of European

settlement it was found in Tasmania and the southeastern mainland. Desiccation resulted in mummies being found with soft tissues intact; one carcass has been dated at 4600 BP.

The entrance is the only source of nutrients and energy for the cave ecosystems, excepting those caves inhabited by the bat species *Chalinolobus morio* where modest guano piles add additional nutrients. This limited supply of nutrients restricts the numbers and types of invertebrates. Despite this, the Nullarbor Caves host a range of terrestrial invertebrates, which includes several remarkable and unique troglobitic species that are survivors of local evolutionary, environmental processes. These troglobites have preserved a tiny sample of late Tertiary/Pleistocene surface fauna, now absent from the region, and give the systems their zoogeographic importance. The caves also contain a larger number of trogliphilic insects (mainly cockroaches, beetles, and crickets) and accidental species.

The almost total absence of aquatic fauna in the cave waters of the aquifer is surprising. Salinity is not the cause of this absence as there is one known aquatic troglobitic species, an amphipod crustacean, in the hypersaline waters of Nurina. Neither is a lack of nutrients responsible, for biofilms are abundant in the cave waters and, like the invertebrate fauna, are remarkable. So far microbiological studies have been restricted to the calcite precipitating microbial mantles (Fig. 9). They are communities of microorganisms consisting primarily of *Pseudomonas* spp. and *Pseudoalteromonas* spp. as well as nitrite oxidizers. Of the 36 phylotypes, 12 could not be identified to a subdivision level and only two showed any relationship to previously described environmental clones.

The presence of chemotrophic bacteria in the Nullarbor introduces another variable into the understanding of the cave origins and their enlargement. They can add and remove carbon dioxide or hydrogen carbonate from the cave waters, thus dissolving limestone or precipitating calcite. They are widespread in the flooded cave passages and thus they may have a considerable impact.

## CONCLUSION

In the world of caves, where in most cases biogenic carbon dioxide and surface waters provide the essential ingredients for the solution of limestone and the precipitation of decora-



**FIGURE 9** Microbial mantles, icicle morphology. The gelatinous biofilm can be seen with its encapsulated calcite crystals reflecting light from the flash gun. In the top right corner, above the mantles, the limestone bedrock is etched. (Photograph courtesy of Peter Rogers.)

tions, the more of both, the bigger and more spectacular the caves. The Nullarbor Caves provide an example of how caves can originate, enlarge, and become decorated with speleothems at times when there is a shortage of both.

## Bibliography

- Contos, A. K., J. M. James, B. R. Heywood, and P. A. W. Rogers. (2001). Morphoanalysis of bacterially precipitated subaqueous calcium carbonate from Weebubbe Cave, Australia. *Geomicrobiology J.* **18**, 331–343.
- Davey, A. G., M. R. Gray, K. G. Grimes, E. Hamilton-Smith, J. M. James, and A. P. Spate (1992). World Heritage significance of karst and other landforms in the Nullarbor region. Applied Ecology Research Group, University of Canberra, ACT, Australia.
- Ford, D. C., and P. W. Williams (1989). *Karst Geomorphology and Hydrology*. Chapman & Hall, London.
- Gillieson, D. (1996). *Caves Processes, Development, Management*. Blackwell Publishers, Malden, MA.
- Hill, C. A., and P. Forti (1997). *Cave Minerals of the World*, 2nd ed. National Speleological Society, Huntsville, AL.
- Holmes A. J., N. A. Tujula, N. Holley, A. K. Contos, J. M. James, P. A. W. Rogers, and M. R. Gillings (2001). Phylogenetic structure of unusual aquatic microbial formations in Nullarbor Caves, Australia. *Environ. Microbiol.* **3**, 256–264.
- James, J. M. (1992). Corrosion par melange des eaux dans les grottes de la Plaine de Nullarbor, Australie. In *Karst et Evolutions Climatiques* (J. N. Salomon and R. Marie, eds.). Presses Universitaires de Bordeaux.
- Long, J., M. Archer, T. Flannery, and S. Hand (2002). *Prehistoric Mammals of Australia and New Guinea: One Hundred Million Years of Evolution*. University of New South Wales Press, Sydney, Australia.
- Lowry, D. C., and J. N. Jennings (1974). The Nullarbor Karst, Australia. *Zeitschrift Geomorphologie* **18**, 35–81.



---

## Paleomagnetic Record in Cave Sediments

Ira D. Sasowsky  
*University of Akron*

### INTRODUCTION

The paleomagnetic record in cave sediments allows us to answer one of the fundamental questions about caves: “How old are they?” This is a hard question because caves are essentially empty space created in rock (see section on speleogenesis) and, therefore, we are trying to determine the age of something that is no longer there. Hence, we must constrain the age of the cave by other strategies. We know of two conditions that must always apply.

First, the cave must be younger (more recent) than the rock in which it has formed. The only exception is the case of lava tubes, where the cave is the same age as the rock in which it was formed. However, the majority of caves are formed in limestone, a long time after the limestone rock was originally deposited. For example, Mammoth Cave in Kentucky is about 4 million years old, but the rocks in which it is found are more than 300 million years of age. Because of this large difference, dating a cave by the age of the rocks that host it is not very satisfactory.

A second, and more useful, method to determine the age of a cave is to date materials that we find within it. This can include things that have been carried in by natural processes such as sediments and speleothems. This provides a minimum age, because the cave must have existed before the material could have been placed in it. The paleomagnetism of cave sediments is one such way to determine age. Other methods (not addressed here) are uranium-thorium

radiometric dating of speleothems and cosmogenic isotope dating of quartz particles washed in to a cave.

### EARTH MAGNETISM AND PALEOMAGNETISM

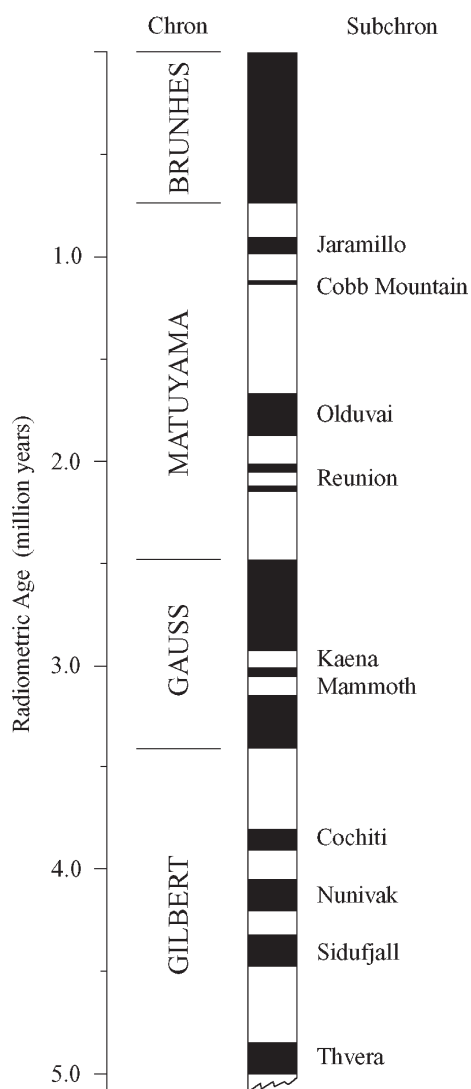
To understand the paleomagnetism of cave sediments, an understanding of Earth’s magnetism and paleomagnetism is required. It has long been known that the Earth has a magnetic field. The field has several sources, but it is mainly generated in the core of the Earth by rotation of the planet. Early natural scientists and explorers used magnetic minerals (lodestones) to measure the direction of the field or to guide them in their travels. This led to the development of compasses, which are precision devices with a narrow magnetic needle that points toward magnetic North ( $N_m$ ). The Earth also has geographic, or true, North (N) and South Poles that are defined by the axis of rotation of the Earth. The magnetic North and South Poles are in the general region of the geographic poles and are the areas to which a compass needle will point. In addition to a north–south orientation (which is called *declination*), the magnetic field has an up–down component (called *inclination*). At the North magnetic pole, the inclination is plus 90 degrees (straight down). At the magnetic equator, the inclination is 0 degrees (flat), and at the South Pole it is minus 90 degrees (straight up).

Measurements of the position of the magnetic poles have been made since the early 1600s, and it has been found that the magnetic pole position varies (drifts) with time—a process called *geomagnetic secular variation*, or simply *polar drift*. This drift is on the order of 0.05 degree per year. Then, in the 1900s, it was discovered that the magnetic field had reversed many times throughout geologic history. In these instances, rather than gently drifting through time, the poles had actually (and quite rapidly) flipped: The magnetic North Pole moved to the geographic South Pole and vice versa. These changes are called *field reversals*. When the magnetic North Pole is in the Southern (geographic) Hemisphere, the

condition is considered to be one of reverse polarity. When the North Pole is in the Northern Hemisphere, as it is today, it is considered a time of normal polarity.

Many rocks and sediments hold a weak magnetic signal that is “locked in.” The signal that they hold points in the direction of magnetic North from the time that they were deposited. Rocks deposited during a time of reversed polarity have a magnetic signal that points to the Southern Hemisphere. Through the study of rocks worldwide, a chronology of the magnetic field has now been constructed. This magnetostratigraphic timescale (Fig. 1) shows the orientation of the magnetic field during different portions of Earth’s history. Those times when the fields were reversed are indicated in white.

As a result of the creation of this worldwide timescale, it is now possible to determine the age of other rocks and sedi-



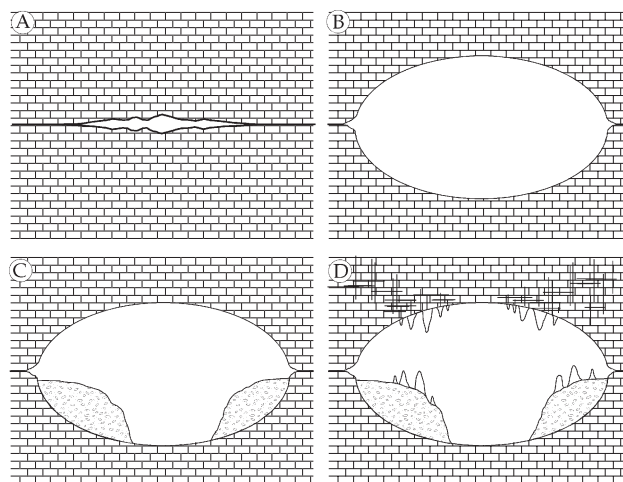
**FIGURE 1** Magnetostratigraphic timescale. The polarity of the Earth’s magnetic field has switched through time, with the North magnetic pole alternating position near the North geographic and South geographic poles. (Courtesy of U.S. Geological Survey.)

ments by measuring their magnetic properties and placing them in their proper position in the magnetostratigraphic timescale.

### PALEOMAGNETISM OF CLASTIC CAVE SEDIMENTS

All streams carry small, broken up bits of rock (*clastic sediment*) that come from the weathering of the surrounding landscape. This includes fine materials such as clay and coarser materials such as sand and gravel. When water flow decreases, or stops all together, these materials are dropped (deposited) from the stream. As the particles slowly settle from the water, tiny magnetic mineral grains (primarily magnetite and hematite) orient themselves with the magnetic field. The process is similar to a compass needle becoming oriented. When the particle reaches the stream bottom, it is buried by additional particles, and the magnetic orientation of the grains is locked in. This is called *detrital remanent magnetism* (DRM). If a sample of this material is analyzed, the direction of the magnetic field during the time of deposition can be determined.

Caves typically have a period of their existence during which a stream is flowing through them (Fig. 2) If this stream comes from the surface of the Earth, it will carry clastic sediments that can then be left in the cave. Such deposits (Fig. 3) can range in thickness from millimeters to tens of meters and can consist of all grain sizes. Virtually all caves have some clastic sediment. To measure the paleomagnetism, researchers collect a small, oriented sample of the material. Duplicate samples and samples from many locations and levels are usually obtained. Clays are the most desirable material to sample, because they represent a still-water environment, which allows for good orientation of the



**FIGURE 2** Typical stages in the evolution of a cave: (A) Initial rock mass with open bedding plane. (B) Enlargement of bedding plane by groundwater circulation. (C) Deposition of clastic sediments. (D) Deposition of speleothems (chemical sediments).

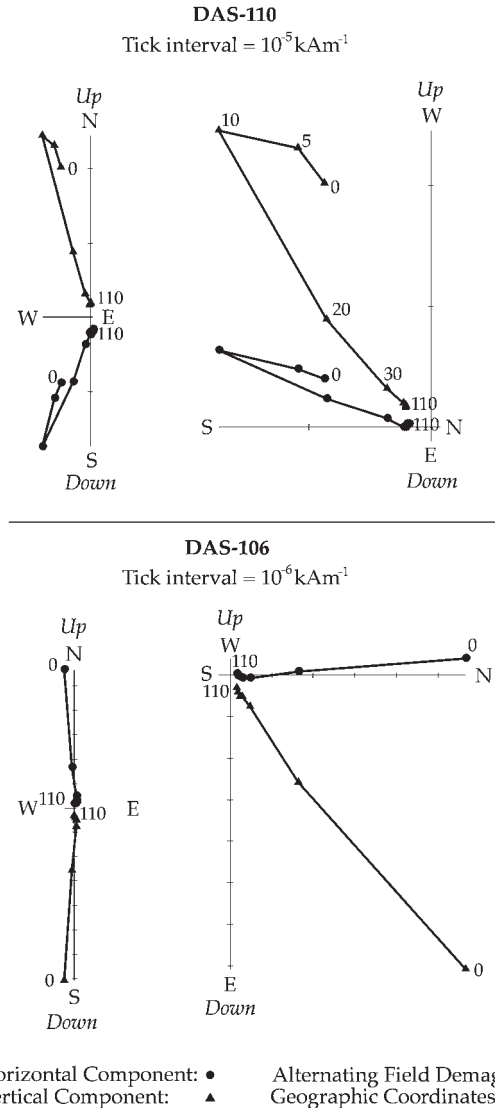


**FIGURE 3** Clastic sedimentary deposit in Windy Mouth Cave, West Virginia, USA. A stream that once flowed through the cave deposited these sediments.

magnetic particles. But good results have also been obtained from coarse, cross-bedded sands. The samples are then taken to a laboratory and measured in a magnetometer. This instrument determines both the direction and strength (magnetic intensity) of the sample. Oftentimes several steps of magnetic cleaning, or *demagnetization*, are needed to reveal the DRM. On an automated system, such measurement takes about 30 minutes. The resulting plots, which show magnetic direction and intensity (Fig. 4), tell whether the sample has a normal or reverse polarity.

Now comes the tricky part: interpretation. The magnetostratigraphic timescale is a binary one—it only shows normal or reverse. If we have an isolated sample of cave sediment that is normal, how can we know which normal interval (*chron*) it is from? The short answer is that we cannot—at least not with absolute certainty. But we can make educated guesses with an isolated sample. For example, if we find a reversed polarity sample, we know that it must be at least 780,000 years old (the end of the last reversed interval; also called the Matuyama chron). Likewise, if we find an isolated deposit of normal polarity sediment, we infer that it must be either less than 780,000 years old or more than 990,000 years old. Using these constraints, in context with other information such as U-Th dates of speleothems or position in the landscape, we can narrow down the age range of a cave. The work of Victor Schmidt at Mammoth Cave, Kentucky, USA, was some of the first to date a cave using this technique.

In many caves, deposits of clastic sediments are discontinuous or complex to decipher. In these cases, interpretation may be limited to that mentioned above. However, in other cases, one or more “stacks” of sediment may be found, and a fairly complete stratigraphy may be constructed. When this occurs, the resulting local magnetostratigraphy may be directly matched with the global column (Fig. 5), and the age range of the method is greater.



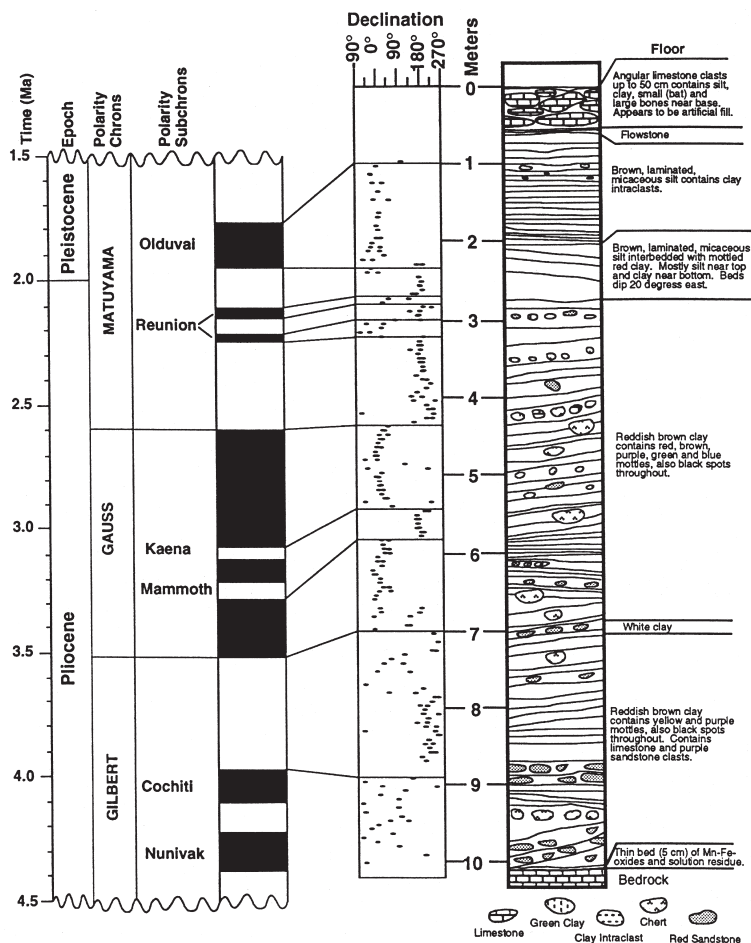
**FIGURE 4** Orthogonal vector plot (Zijderveld diagram) of two clastic sediment samples from caves. Each sample has two plots. The lower sample has normal polarity, showing a northward declination and downward inclination. The upper sample is reversed, and shows a characteristic hooking, with southward declination and upward inclination.

### PALEOMAGNETISM OF SPELEOTHEMS

Speleothems are deposits of secondary minerals (such as calcite) that form on the ceilings, walls, and floors of caves. Stalactites and stalagmites are the most frequently studied of these features. As with the clastic sediments discussed earlier, speleothems can retain a record of the magnetic field from the time of their formation. In this case, however, the magnetism is a *chemical remanent magnetism* (CRM) rather than a DRM, and the sampling and processing are slightly different.

Because speleothems are hard, drilling is required to collect the oriented sample. This is done using a gasoline-





**FIGURE 5** Correlation of the magnetostratigraphic column from Cave of the Winds, Colorado, with the global record (by Luiszer, 1994). An apparently continuous record of deposition from 4.5 to 1.5 million years ago is shown. (Courtesy of Fred Luiszer and the Karst Waters Institute.)

powered drill with a hollow, diamond-tipped bit. Water is pumped on the bit to cool it and remove the rock cuttings. It is a rather onerous procedure to carry out in the difficult setting of a cave, and this may be one reason why there have been relatively few such studies. However, small cores have been taken, and a project conducted by B. Ellwood collected very long cores from large speleothems in Carlsbad Caverns, New Mexico, USA.

### IMPORTANCE OF THE PALEOMAGNETIC RECORD IN CAVES

In the preceding sections, the importance of the magnetic record in caves with regard to determining cave age has been discussed. Paleomagnetism provides a relatively quick and inexpensive method for estimating such ages. However, the method relies on establishing a complete record of polarity changes. Therefore, difficulties arise due to discontinuous deposition or erosion of the sediments.

The main advantage of paleomagnetism is that it has a

greater range than U-Th disequilibrium dating. The former has been applied back to 4.5 million years, whereas the latter has a range of about 450,000 years. Paleomagnetism also requires less laboratory work. Therefore, both methods have utility for the study of caves.

Through age determination of caves, it is also possible to relate the caves and other features to landscape evolution, such as the incision of rivers. Therefore, the study of caves, which may seem rather esoteric, serves a purpose that is much broader.

The relatively new study of “environmental magnetism” may provide an additional utility for cave sediments. Rather than simply looking at reversals, environmental magnetism examines the magnetic properties of sediments to understand the environmental conditions under which the materials were produced. For example, Ellwood et al. (1998) identified glacial effects on cave sediments. These methods, along with continued development of our understanding of cave processes, suggest that the magnetism of cave sediments will continue to be an important research tool.

### Bibliography

- Butler, R. F. (1992). *Paleomagnetism: Magnetic Domains to Geologic Terranes*. Blackwell Scientific Publications, Boston.
- Ellwood, B. B., J. Zilhão, F. B. Harrold, W. Balsam, B. Burkhart, G. J. Long, A. Debénath, and A. Bouzouggar (1998). Identification of the last glacial maximum in the Upper Paleolithic of Portugal using magnetic susceptibility measurements in Caldeirão Cave sediments. *Geoarchaeology* **13**, 55–71.
- Luiszer, F. G. (1994). Speleogenesis of Cave of the Winds, Manitou Springs, Colorado. In *Breakthroughs in Karst Geomicrobiology and Redox Geochemistry*, Special Publication 1 (I. D. Sasowsky and M. V. Palmer, eds.), pp. 91–109. Karst Waters Institute, Charles Town, WV.
- Schmidt, V. A. (1982). Magnetostratigraphy of sediments in Mammoth Cave, Kentucky. *Science* **217**, 827–829.
- Stern, D. P. (2002). The great magnet, the Earth. <http://www.phy6.org/earthmag/demagint.htm>.

## Paleontology of Caves: Pleistocene Mammals

Kazimierz Kowalski

*Polish Academy of Sciences, Poland*

Sediments of many caves contain bones of mammals accumulated during the Pleistocene, the last geological period before the Recent. They originate from animals that used the caves as seasonal shelters and from those that perished accidentally in vertical caves or were brought to the caves as prey of mammalian predators and owls.

Mammalian fossils in cave sediments are of great importance to the reconstruction of the history of the recent animal world during the Pleistocene and of the paleo-environmental changes during consecutive cold and mild phases of this period. They are also important to the study of the background of the earliest stages of human evolution.

### INTRODUCTION

Cave sediments are of great importance to the knowledge of the evolution of the animal world in the last periods of the history of the Earth because they contain particularly numerous bones of vertebrates, chiefly mammals. Animals that perish on the surface of the soil soon become disintegrated by scavengers. The remaining bones are successively destroyed by plant roots and humic acids. In caves green plants are lacking and the bones of mammals dying there or the bones of prey brought into caves by carnivores sheltering in them remain preserved for long period of time, covered eventually by successively accumulating sediments. As a rule, the caves develop in limestone and their sediments are rich in calcium carbonate, which protect bones from the destruction of their mineral substances.

### ORIGIN OF MAMMALIAN BONE ACCUMULATIONS IN CAVES

#### Vertical Caves as Natural Traps

Caves in the form of vertical pits or shafts are natural traps for animals. Carnivorous and plant-eating mammals, large and small, with the unique exception of bats, can fall accidentally into the openings of such vertical caves and die at the bottom. Generally, young individuals prevail among them and all skeletal bones are present, sometimes scattered on inclined bottoms of such caves.

#### Bats

Of all groups of mammals the bats are the most connected with caves. Many of their species, particularly those in the colder regions of the Earth, find shelter in the caves during the day and during times of hibernation. They leave them only in the night during the warmer season of the year. Their orientation to the total darkness of caves is possible due to the phenomenon of echolocation, that is, the use of echoes of ultrasounds emitted by a majority of bats. Some individuals perish in caves, mainly during hibernation, and their skeletons, sometimes in great number, accumulate on the bottom below their colonies (Fig. 1). Bat bones in cave sediments, particularly near the entrances of caves, may also originate from owl pellets. Some owls “specialize” in hunting bats, which they capture in the air during the flight from or to their resting places (Kowalski, 1995).



**FIGURE 1** Accumulation of bones of bats under their colony sorted by dripping water in quaternary sediments of the cave in Podlesice, Poland. (Original photograph by Wojciech Woloszyn.)

**Mammalian Carnivores**

Many carnivorous mammals seasonally or incidentally use caves as their shelters. In Europe the cave bear was dependent on caves, but such places were also often retreats of the cave hyena, cave lion, panther, and other carnivores (Kurtén, 1968). Outside Europe the cave bear is absent and is replaced by local species of carnivores. All of them contributed to the accumulation of bones after their deaths or as a result of the bones of their prey being left in caves (Fig. 2). For some smaller carnivores, caves were also hunting grounds, mainly for hibernating bats and rodents. So, for example, in the Tatra Mountains on the border between Poland and Slovakia, skeletons of martens (*Martes martes*) are rather commonly found deep in caves, where they perished during the hunt for hibernating bats. In Slovenian caves, the prey of martens in caves are dormice (*Myoxus glis*).

**CAVE BEAR** Among the representatives of the mammalian order of Carnivora the cave bear (*Ursus spelaeus*) was probably the most strongly connected with caves (Kurtén, 1976). It appeared about 300,000 years ago, survived numerous changes of climate during the cold and mild phases of the late Pleistocene, and became extinct about 17,000 years before the present. Its ancestor was *Ursus deningeri*, known from fossil localities of the early Pleistocene fauna of Europe.

The distribution of the cave bear was limited to Europe; it reached from southern England and Spain to the west to the

Black Sea, Caucasus Mountains, and Caspian Sea in the east, and from sea level to the Alpine caves at 2800 m above sea level (Rabeder, 1991). Data regarding its presence in the Ural mountains need confirmation.

The cave bear was the largest representative of the order Carnivora in the Pleistocene of Europe. It was similar to the living brown bear (*Ursus arctos*), now broadly distributed in the Holarctic, but its body was more barrel-like and its extremities shorter. It was also larger than the brown bear. Males, much larger than females, reached 400–450 kg, whereas females weighed from 225–250 kg. It differed also from the brown bear in that it had larger teeth, which were broad, blunt, and evidently adapted for consumption of vegetarian food.

Remains of *Ursus spelaeus* are known mainly from caves, which sometimes contain enormous numbers of their bones. In the Drachenhöhle near Mixnitz in Austria, where cave sediments were exploited as fertilizer, about 200,000 kg of bones belonging to cave bears were obtained. This does not mean that a great number of bears were simultaneously present in that cave, but rather that their remains accumulated during many thousands years.

Undoubtedly, caves were the most important or unique places of hibernation for cave bears. Here the young were born and here their milk teeth were replaced by permanent ones. An analysis of the age of cave bears at the moment of their death based on the grade of wear of their teeth indicates that they appeared in caves during several winter seasons.



**FIGURE 2** Mandibles of carnivores common in the Pleistocene cave sediments of Europe: (1) cave hyena (*Crocota crocuta spelaea*) and (2) cave bear (*Ursus spelaeus*), from Komarowa Cave in central Poland. (Original photograph by Piotr Wojtal.)

The choice of caves as places of hibernation differentiates cave bears from brown bears, which shelter in caves only as an exception. The finding of cave bear bones outside of caves is very rare. The activity of cave bears underground is also documented by the polished walls of caves (*Bärenschliffe*) left by them during their wandering in the dark interior of the caves. Footprints of these carnivores on the claylike bottoms of the caves and traces of their claws on the walls testify to the presence of bears in the caves.

The role of caves in the lives of cave bears is a subject of many arguments but their dependence on caves is evident. Caves were probably unique places suitable for these large animals as shelters during hibernation. The temperature in deep caves remains above the freezing point during the entire year even in high mountains and in the cold climate of glacial phases of the Pleistocene.

In the collections of cave bear bones from particular caves, the ratio of females to males is very different. This difference is partly a result of selective collecting of the larger, most spectacular skulls during earlier excavations. It is certain, however, that the length of life of the two sexes and their representation in populations were different in different caves (Weinstock, 2000).

Because of their large size, it is rather difficult to imagine that the cave bear was hunted by any animal predators. Some earlier scientists attributed the extinction of cave bears to Paleolithic hunters, but the interpretation of the presence of bear bones in caves as remains of human meals or as raw material for implements is not convincing. In recent tribes of bear hunters in Asia (e.g., Ainu on Hokkaido Island), brown bears were the object of worship. Some archaeologists were also convinced that a similar cult existed among cave bear hunters, but its presence in the Paleolithic tribes has not been documented.

A relatively high number of cave bear bones with traces of diseases or degeneration was interpreted by some scientists as the beginning of the species' extinction. It is, however, more likely that it was connected with the selection of unusual specimens during the excavations. A convincing explanation of the cause of the extinction of the cave bear at the end of the Pleistocene is still sought.

#### REMAINS OF OTHER MAMMALIAN CARNIVORES PRESERVED IN CAVES

Nearly all groups of carnivorous mammals occasionally utilized caves as retreats, feeding places, and breeding sites. Among them, the spotted hyena (*Crocuta crocuta*) in Africa is generally acknowledged as a common visitor to caves (Behrensmeyer and Hill, 1980), and the same is true of its extinct population known under the name of the cave hyena (*Crocuta crocuta spelaea*) and widespread in the Old World in the Pleistocene. Its remains are common in cave sediments and in some of them, e.g., in the Tornewton Cave and Kirkdale Cave in Britain, they are a dominant element of the fossil fauna. Hyena dens in recent Africa, however, are mainly situated within flat grounds in

the form of burrows dug by these carnivores. Hyenas bring fragments of carcasses of their prey to their dens. The bones of hyena prey can be recognized by characteristic traces of gnawing.

Additional carnivores that could contribute to the accumulation of big bones in the caves are representatives of the cat family (Felidae), in particular, the panther (*Panthera pardus*) and the lion (*Panthera leo*). The fossil lion of the Pleistocene, known as the cave lion, was probably a subspecies of the recent lion of the tropics. Both of these species, the panther and the lion, now limited to the tropical zone of the Old World, also inhabited the cold part of Eurasia. The panther stores its prey in trees, and the dimensions of its prey are smaller than in the case of the lion (Brain, 1981).

In North America the Florida cave bear (*Tremarctos floridanus*) is in many ways similar to the cave bear of Europe (Kurtén and Anderson, 1980). It is known from cave sediments in the southern part of North America and survived in Florida until the Holocene. It was probably an herbivore; its direct ancestor is unknown.

Extinct dire wolf (*Canis dirus*) is known mainly from caves and was the most widespread carnivore in the late Pleistocene of America reaching from Peru to most of the United States. Its dentition indicates a scavenging mode of life, and in the New World it probably occupied the ecological niche of hyena absent in the late Pleistocene of America. The mountain lion (*Felis concolor*) still living in America also left numerous remains in caves. In its mode of life, it resembled that of the cheetah in the Old World.

#### Traces of Other Large Mammals in Caves

In Africa and in warmer parts of Asia, many caves contain accumulations of bones brought there by porcupines (*Hystrix*). These herbivorous rodents collect bones on the ground's surface, store them in their burrows or in caves, and then probably use them as a source of calcium or for wearing their permanently growing incisors. In southern China in a cave that contained remains of the Pleistocene primate *Gigantopithecus* nearly all skeletons were destroyed and only isolated teeth and, seldom, some bones were preserved. Traces of gnawing by porcupines are very characteristic as series of parallel furrows on the surface of bones.

Bones of large herbivorous mammals, mainly ungulates, in cave sediments were, as mentioned earlier, brought usually by carnivores and deposited near the entrances. Sporadically, however, other large mammals, mainly ungulates, actively entered the initial part of caves to search for protection from bad weather or in search of water, which is rare on the surface of karst regions. Occasionally, they fell down into vertical wells and their skeletons were preserved intact on the bottom.

The land connections with Eurasia and South America during several periods of the Pleistocene brought many new species of mammals to North America. Particularly charac-

teristic is the presence in many caves of representatives of edentates. One of them, shasta ground sloth (*Nothrotheriops shastensis*), inhabited caves in the dry part of the southwest United States and became extinct about 11,000 years ago. Its coprolites indicate that its food contained roots, stems, and seeds of desert plants.

The end of the Pleistocene was the time of extinction of many species of large mammals in North America. Probably at the same time the first great wave of human migration from Asia across the Bering bridge took place. The factor responsible for this extinction is still the subject of argument: the changing climate or the overkill by Paleoindians. The study of the fossil bones in cave sediments may contribute to the solution of this problem.

### Role of Paleolithic Man in Accumulation of Bones in Caves

The presence of animal remains in caves may be also connected with the activity of Paleolithic hunters, who occasionally used them as temporary shelters since the beginning of their evolution. Animal bones that are the remains of human meals are recognized by characteristic traces of cleaning that was done with stone implements as well as by traces of fire. Usually they are accompanied by stone implements and in the late Paleolithic also by tools made from bones. Human bones are rare in caves.

Drawings and paintings on the walls of caves, mainly representing game animals, trace the presence of Stone Age man and his artistic activity; at the same time they are a source of information about the fauna of the Pleistocene. They represent mainly large mammals probably because the

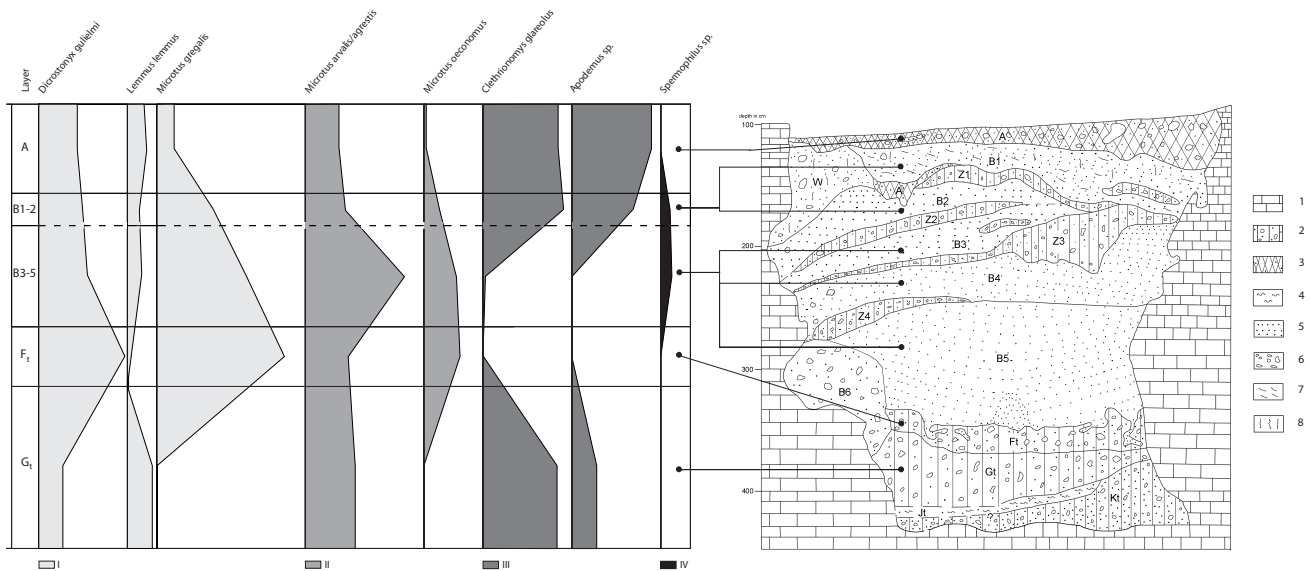
game animals played a central role in the economy of societies based on hunting and gathering. The pictures of game animals probably had some magic meaning connected with hunting.

### Owls and Diurnal Birds of Prey

The diet of the majority of owls and of many diurnal birds of prey is composed mainly of small vertebrates, especially rodents (Fig. 3) Undigested remains of the food of owls, bones and hair, form in their stomachs so-called “pellets,” which are cast up through the beak. The digestion in owls takes place in an alkaline environment and bones of small vertebrates are well preserved in them. In diurnal birds of prey, digestion usually takes place in an acid environment and elements of the skeleton of their prey disappear or are damaged and rare.

Owls often occupy protected places in the vicinity of cave entrances. Underneath diurnal resting places, some of which are also used for nesting, the pellets accumulate on the ground where they disintegrate after some time. Bones and teeth contained in them are incorporated in slowly growing sediments. Usually cave sediments are composed of layers differing in mechanical and chemical composition. Commonly the layers also differ in the composition of the small mammal remains they contain (Andrews, 1990).

The bones of small vertebrates, originating from owl pellets, are of great importance to the study of stratigraphy, the paleoenvironment, and the evolution of fauna. The changes of the composition of vertebrate remains in successive layers of sediments are a result of changes of the environment in the vicinity of the cave: Some species became



**FIGURE 3** Section of late Pleistocene sediments of Komarowa Cave in Central Poland and the share of remains of particular rodent species in successive layers. Samples have been collected in layers Gt, Ft, B, and A (black dots). Layer B (sand) was interrupted by intercalations of loams (Z). Latin numerals signify environmental preference of rodent species: I, tundra; II, meadow; III, forest; IV, steppe. Arabic numerals signify type of sediments: 1, limestone; 2, loam; 3, humus horizon; 4, silt; 5, sand; 6, limestone blocks; 7, humus; 8, roots. (Original drawing prepared by Marcin Zarski and Barbara Miekina.

extinct totally or disappeared from the vicinity of the cave, whereas others appeared as a result of the evolution or change of the area of their distribution. Sometimes the faunal lists of successive layers are the same, but the share of different elements is different, enabling the reconstruction of changes in the paleoenvironment.

Here bones of rodents from owl pellets play a particularly important role, because rodents are usually strictly connected with the type of vegetation (forest, steppe, desert, etc.). Keep in mind, however, that the composition of rodent remains present in cave sediments may differ sometimes from that in the environment of the cave. Owls hunt, dependent on species, in the vicinity of their caves or fly far in the search of their prey. Sylvan and subterranean rodents or those active by day are underrepresented as fossils. The digestion can also destroy some bones, changing their composition. The interpretation of the data obtained from the field work needs the knowledge of factors influencing the bones from the moment of death of an animal to the time of their study in the laboratory. In addition, the selectivity of owls during hunting, different susceptibilities to digestion, and, later, the chemical and mechanical factors in the long period of presence in the sediments influence the composition of the fossil fauna. The value of bones found in the strata of cave sediments depends on the knowledge of taphonomy, the branch of paleontology devoted to the study of factors influencing the accumulation of animal remains (Kowalski, 2001).

### IMPORTANCE OF PLEISTOCENE FAUNAL REMAINS TO SCIENCE

Today, the scientific collecting of mammalian fossils in the sediments of caves is always connected with the study of small bones. The sediments are washed on sieves, and material from each layer is kept separately. The location of individual bones of large mammals is noted. Correctly excavated sediments allow researchers to determine the age of successive sediment layers and to reconstruct the prevailing type of paleoenvironment during the sedimentation, the evolution of lineages of particular groups of animals, the paleogeography, and, finally, the development of the culture of man during the Stone Age.

### Dating of Sediments

The determination of the age of cave sediments is sometimes made possible by the application of physical methods, mainly based on radioactive isotopes. For the period of the last several thousand years, the most exact data can be obtained by using the content of radioactive carbon  $^{14}\text{C}$ . Other isotopes may be used for dating sediments from older periods. Other physical methods can also be used—with differing degrees of exactitude—for dating of cave sediments and their components.

Independent of absolute dating, which is not always possible, there is relative dating based on the study of animal remains. The results of the analysis of fauna, particularly of rodents, which evolved rapidly during the Pleistocene, can be compared with data from faunal assemblages of a known geological age. In many evolutionary lineages of rodents (e.g., voles), the teeth develop high crowns, sometimes permanently growing, that are well adapted for grinding the tissues of plants. The crowns of teeth are covered by enamel, the hardest tissue in the animal body, and remain well preserved during fossilization. The time of extinction or local disappearance of particular species, e.g., mammoth, or the time of immigration of others is also useful for relative dating. The replacement of faunal assemblages of different climates can be linked to known periods of glaciations and interglacials and may be important to the correlation of fossils from different periods of the Pleistocene.

### Mammals in Cave Sediments and the Paleoenvironments of the Pleistocene

The mammalian species are usually linked to different types of environments, especially with types of vegetation. The mammalian assemblages of the Pleistocene contain many still living species, the presence of which indicates the type of the environment. So, for example, beavers indicate the presence of water, horses and antelopes need open landscape and steppe vegetation, and lemmings are tundra animals. The ecological niche of extinct mammals is more difficult to reconstruct. The recent elephants are connected with equatorial forests and savannas, but mammoths, a fossil member of the same family as African and Indian elephants, lived in the cold steppe-tundra of the Pleistocene. Generally, however, the composition of the local fossil fauna permits the reconstruction of the climate and vegetation in the neighborhood of the place when bones have accumulated.

### Bibliography

- Andrews, P. (1990). *Owls, Caves and Fossils*. Natural History Museum Publications, London.
- Behrensmeier, A. K., and A. P. Hill, eds. (1980). *Fossils in the Making*. University of Chicago Press, Chicago.
- Brain, C. K. (1981). *The Hunters or the Hunted. An Introduction to African Cave Taphonomy*. University of Chicago Press, Chicago.
- Kowalski, K. (1995). *Taphonomy of Bats (Chiroptera)*, Vol. 18, pp. 251–256. Geobios, Lyon.
- Kowalski, K. (2001). *Pleistocene Rodents of Europe*, Vol. 7. Folia Quaternaria, Cracow.
- Kurtén, B. (1968). *Pleistocene Mammals of Europe*. Weidenfeld and Nicolson, London.
- Kurtén, B. (1976). *The Cave Bear Story*. Columbia University Press, New York.
- Kurtén, B., and E. Anderson (1980). *Pleistocene Mammals of North America*. Columbia University Press, New York.
- Rabeder, G. (1991). *Die Höhlenbären der Conturines*. Verlagsgesellschaft Athesia, Bozen.
- Weinstock, J. (2000). Cave bears from southern Germany: Sex ratios and age structure. A contribution towards a better understanding of the palaeobiology of *Ursus spelaeus*. *Archaeofauna* 9, 165–182.

# Passages

George Veni  
George Veni & Associates

Voids that transmit or have the capacity to transmit turbulently flowing water in karst are called *conduits*, a term that is used generically to describe all segments of karst drainage networks or to refer specifically to segments too small for human entry. Turbulent flow, a key factor that distinguishes conduits from smaller openings in the rock, occurs when an opening achieves a width of about 1 cm. Conduits large enough for human entry are called *caves*. Passages, rooms, pits, and domes are types of conduits within caves that have certain physical characteristics. *Passages* are horizontal to moderately sloping and narrow relative to their lengths. A *room* is a type of passage that is wide relative to its length; rooms often form where passages intersect and are circular, oval, or irregular in shape. Pits and domes are steeply sloping to vertical passages. When encountered from the top, they are called *pits*, and from below, they are called *domes*.

## DEFINITIONS AND CONCEPTS

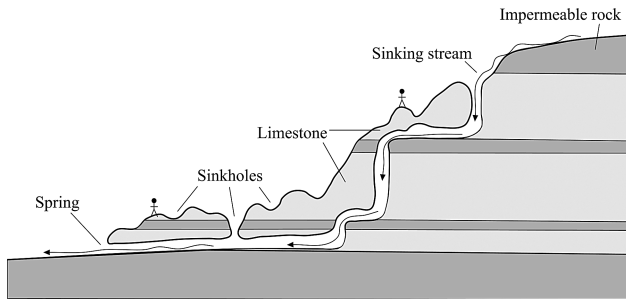
Several factors affect the location, size, and shape of cave passages. Because limestone, dolomite, and other karstic rocks are poorly permeable, passages develop along fractures and bedding planes where permeability is higher. Initially,

groundwater will flow through a variety of these structurally guided conduits until a preferential path is developed that enlarges to form a passage. The pattern that the passages form, the morphology or shape that they take, and the sediments and features that they contain reflect the lithologic, structural, and hydrologic conditions within the karst aquifer. Many of the factors and conditions discussed in this article are shown and summarized in Fig. 1. This discussion describes typical conditions; local hydrogeologic factors may produce variations and exceptions. For in-depth discussions of cave and passage development, see Bögli (1980), White (1988), Ford and Williams (1989), Gillieson (1996), and Klimchouk *et al.* (2000).

Passages can be classified into three general types according to their position in the karst aquifer. Vadose passages occur at the upgradient ends of the aquifer, and they transmit water through the vadose zone from the surface to the water table. They tend to have high gradients and, depending on the gradient and volume of flow, contain small or large accumulations of sediment. Phreatic passages occur at and below the water table (the phreatic zone) and transmit groundwater from the vadose to the discharge ends of the aquifer. They have relatively low gradients and usually contain significant accumulations of sediment where intersected by vadose passages. Tributary passages feed groundwater into the main vadose and phreatic passages. They decrease in numbers down the hydraulic gradient while generally increasing in size and volume of flow. Discharge passages occur near springs where groundwater flows to the surface. They often form a “distributary” pattern that

		TYPE OF RECHARGE				
		VIA KARST DEPRESSIONS		DIFFUSE		HYPOGENIC
		SINKHOLES (LIMITED DISCHARGE FLUCTUATION)	SINKING STREAMS (GREAT DISCHARGE FLUCTUATION)	THROUGH SANDSTONE	INTO POROUS SOLUBLE ROCK	DISSOLUTION BY ACIDS OF DEEP-SEATED SOURCE OR BY COOLING OF THERMAL WATER
		BRANCHWORKS (USUALLY SEVERAL LEVELS) & SINGLE PASSAGES	SINGLE PASSAGES AND CRUDE BRANCHWORKS, USUALLY WITH THE FOLLOWING FEATURES SUPERIMPOSED:	MOST CAVES ENLARGED FURTHER BY RECHARGE FROM OTHER SOURCES	MOST CAVES FORMED BY MIXING AT DEPTH	
DOMINANT TYPE OF POROSITY	FRACTURES	ANGULAR PASSAGES	FISSURES, IRREGULAR NETWORKS	FISSURES, NETWORKS	ISOLATED FISSURES AND RUDIMENTARY NETWORKS	NETWORKS, SINGLE PASSAGES, FISSURES
	BEDDING PARTINGS	CURVILINEAR PASSAGES	ANASTOMOSES, ANASTOMOTIC MAZES	PROFILE: SHAFT AND CANYON COMPLEXES, INTERSTRATAL SOLUTION	SPONGEWORK	RAMIFORM CAVES, RARE SINGLE PASSAGE AND ANASTOMOTIC CAVES
	INTERGRANULAR	RUDIMENTARY BRANCHWORKS	SPONGEWORK	PROFILE: sandstone RUDIMENTARY SPONGEWORK	SPONGEWORK	RAMIFORM & SPONGEWORK CAVES

FIGURE 1 Summary of cave patterns and their relationship to types of recharge and porosity. (From Palmer, A.N., *Geol. Soc. Am. Bull.*, 103(1), 1–21, 1991. With permission.)



**FIGURE 2** Schematic model of stairstep cave development. (Adapted from Crawford, 1996.)

divides the water into multiple outlets that form in response to changing conditions on the surface, such as downcutting of valleys below the springs. Some of these passage types may be hydrologically inactive or active only during flood events, having formed when groundwater levels were higher.

### PATTERNS OF CAVE PASSAGES

The distribution and geometry of passages within a cave are dictated by a combination of local lithologic, structural, and hydrologic factors. Variations in the solubility of the strata may determine the particular bed in which a passage forms. Interbedded rocks of very low solubility, such as shales, clays, or chert, may perch groundwater and produce passages at the base of a group of soluble rocks. Fractures that breach those poorly soluble units allow pits to form that may extend to make contact with the next poorly soluble unit, creating a stairstep pattern (Fig. 2).

Passages formed along fractures tend to be narrow and linear, with sharp, often right-angle turns and intersections with other passages (Fig. 1, angular passages). Passages guided by bedding planes are usually wide and meandering, with low-angle passage intersections (Fig. 1, curvilinear passages). When the structural grain of the rock, such as the primary fracture direction or dip of the beds, significantly differs from the hydrologic gradient, cave passages may form closely spaced meanders or zig-zags as competing factors alternately control the development of different short segments of passages.

Vadose tributary passages in caves formed in horizontal or nearly level beds join the main passages from both sides in a roughly equal number; however, where beds are dipping, the tributaries enter the main passages from predominantly the updip direction, and distributary passages branch off in the downdip direction. This is most noticeable in steeply dipping strata but has also been observed in beds with  $<1^\circ$  of dip. Phreatically formed passages, usually the main passages within a cave, tend to follow the strike of dipping strata (Fig. 3).

The pattern of cave passages will vary depending on the number of sources that contribute most of the groundwater within the cave. Caves recharged by multiple sites of roughly equal contribution will tend to form the tributary systems

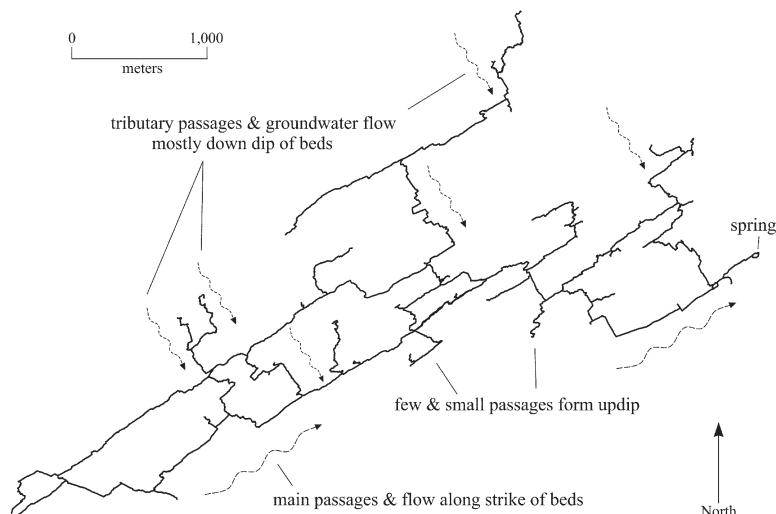
described previously. Numerous small passages will join and enlarge as they flow downgradient, and their combined flow will form the main drainage passage that leads to a spring (Fig. 1, sinkhole type of caves). In contrast, caves formed by capturing a single large source of water, such as a surface stream, quickly grow into single large passages that maintain a relatively constant size between their source and spring. Tributaries are few and provide relatively little water, and due to their lesser flows those passages are smaller and more recently formed. Occasionally, they will form floodwater mazes next to the main passage (Fig. 1, sinking stream type of caves).

Passages that form down steep hydraulic gradients are more linear than those formed on low gradients. Nearly level gradients will produce anastomotic patterns, where passages divide their flow as they branch, rejoin, and vary in size. Pondered water may dissolve low wide rooms along bedding planes or a criss-crossing network of passages along fractures. Ponding is often the result of a geologically short-lived phenomenon, such as collapse along a cave stream or inundation of the spring. Normal conditions are restored when, for example, groundwater cuts a path through or around the collapse. Flooding may also inject water episodically into fractures and bedding planes, temporarily creating ponded conditions until the floodwaters subside. Flooding from chemically aggressive surface streams is especially effective in creating floodwater mazes. Some maze passages form by vadose water moving down through poorly soluble but permeable strata, such as sandstone, and enlarging fractures in underlying soluble rocks so that they interconnect linearly (Fig. 1, fissure networks).

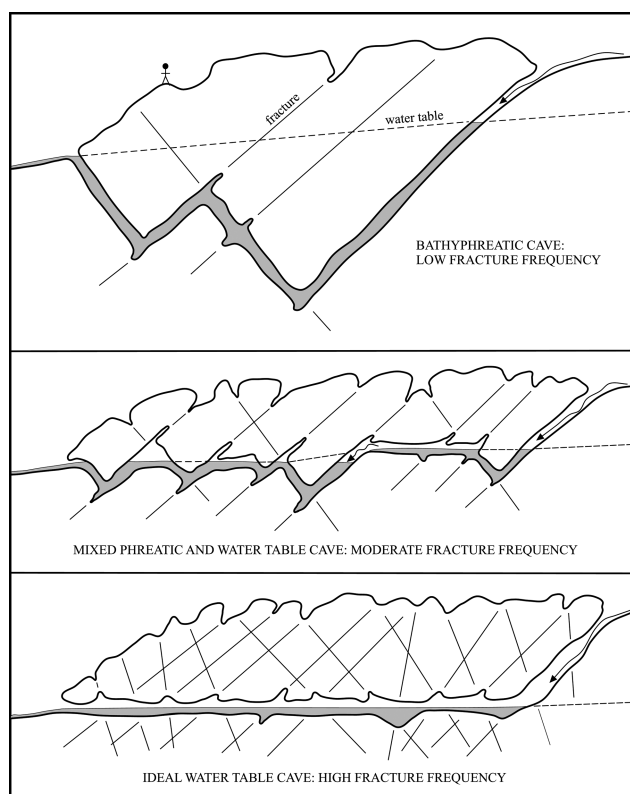
Passage patterns also reflect their development in shallow to deep portions of the aquifer. Roughly horizontal passages form in the shallow portion of the phreatic zone. They may result from closely underlying poorly permeable strata but also develop without a poorly permeable base in highly fractured rock. In aquifers where the rock is less fractured, fewer permeable zones are available to develop passages between the vadose passages and the springs. Consequently, groundwater pressure will move water through deeper fractures, forming deeper passages. These passages will ascend and descend en route along the more permeable fractures. The greater the distance to the springs, the greater the potential depth of the conduits (Fig. 4). Springs that discharge from such systems in Mexico have been measured to depths of more than 300 m.

While most passages form from the top down by water entering the ground and discharging back to the surface at a lower elevation, ramiform passages form from the bottom up. Rising gases, typically hydrogen sulfide, flow into groundwater to form an acidic solution that dissolves the rock. These passages are characterized by the absence of features that would reflect vadose flow from the surface; by decreased passage development with increased elevation; by abrupt terminations of rooms and passage (often with maze





**FIGURE 3** Map of Honey Creek Cave, TX, illustrating passage development and groundwater flow relative to dip of the beds. (From Elliot, W. R., and Veni, G., eds. (1994). *Convention Guidebook*, National Speleological Society, Huntsville, AL. With permission.)



**FIGURE 4** Model of cave development below the water table relative to fracture frequency. (Adapted from Ford and Ewers, 1978, and Ford and Williams, 1989.)

passages or honeycombed walls); by the occurrence of irregularly shaped rooms and passages with little apparent relationship to convergent, tributary flow patterns; and, where exposed, by deep, narrow fissures in the floors marking where the gases probably rose (Fig. 1, hypogenic caves). Several mineralogical indicators will also be present, such as gypsum deposits, where hydrogen sulfide produced sulfuric

acid which dissolved the limestone. Carlsbad Caverns (New Mexico) is the best known example of a cave formed by this process.

### PASSAGE MORPHOLOGY AND EVOLUTION

Phreatically formed passages have circular to elliptical cross sections. The ellipses will be vertical, horizontal, or diagonal, depending on whether the passage is enlarged along a fracture or bedding plane and the orientation of those features (Fig. 5). Phreatic walls are relatively smooth. The symmetry of phreatic passages results from their development below the water table where roughly equal water pressure is present on all walls.

Vadose passages are relatively tall and narrow in cross section, especially where the hydraulic gradient is steep and/or the bedding is thick. They form by vadose water downcutting the floor to reach the water table in as short a distance as possible. Water pressure and dissolution are concentrated at their floors and lowermost walls. Pits are the ultimate form of vadose passage. The walls of vadose passages are rough and irregular due to greater turbulence and differences in water pressure and dissolution, as well as from greater mechanical erosion by rocks and other sediments carried by the streams. Passages formed along vertical fractures tend to be narrow while those formed along horizontal or dipping fractures and beds are wider because they can more easily undercut, collapse, dissolve, and wash away the strata (Fig. 5).

Water levels in an aquifer naturally decline over time as the land surface erodes, allowing groundwater to discharge from progressively lower elevations. Consequently, phreatic passages will often be drained and become modified by the new vadose hydrologic conditions. The most common change is the incision of passage floors to drain water to the

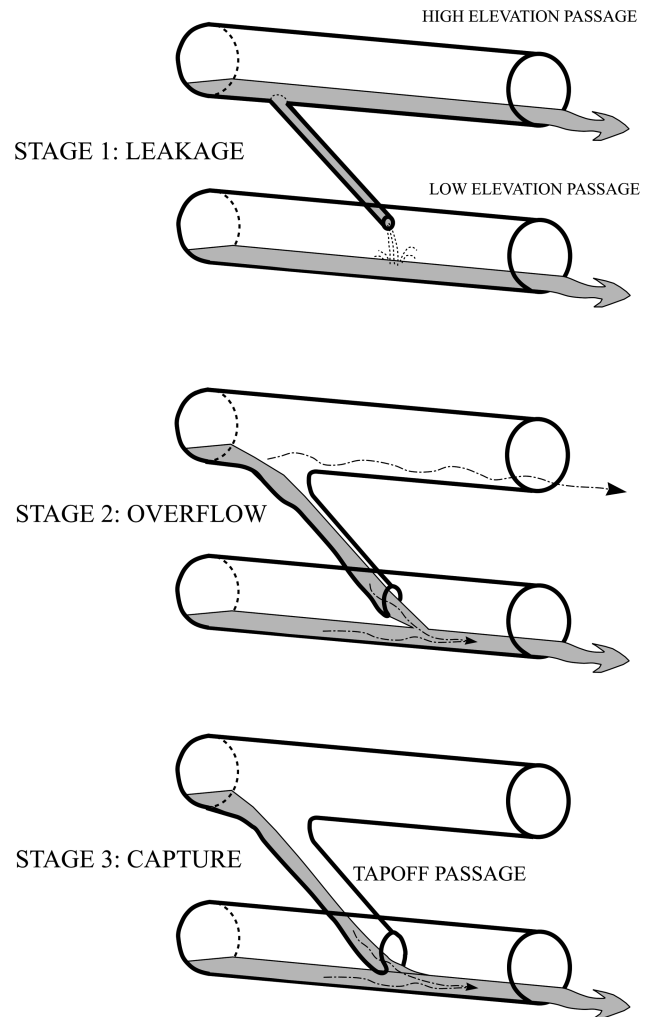
	HORIZONTAL	VERTICAL	DIAGONAL
PHREATIC			
VADOSE			
INCISED			

**FIGURE 5** Cross-sectional patterns of phreatic, vadose, and incised passages relative to bedding and fractures.

descending water table. Keyhole passage shapes are typical, where a broad, smooth-walled phreatic tube sits over a narrow, rough-walled vadose canyon that is cut into its floor (Fig. 5). In caves where phreatic water moved up and down pits, newly vadose passages at the tops of pits will form waterfalls that lengthen the pit by cutting headward, toward the water source, into the wall below the passage.

During phreatic conditions, the buoyancy of the water can support up to 42% of the weight of the passage ceiling. In broad rooms and passages, especially in thin- to medium-bedded limestone of low structural strength, the change to vadose conditions can result in ceiling instability and collapse. The influx of chemically aggressive vadose groundwater may accelerate the collapse. The result after the collapse is a more structurally sound dome shape in the passage's ceiling and a large mound of breakdown on its floor. Because the collapsed rock will fill more space than when it was intact, it could extend to the ceiling and prevent further collapse. In some caves, where jagged walls demonstrate extensive collapse but there is no underlying mound of breakdown, groundwater on or under the rubble is dissolving and removing the pile faster than it is accumulating.

Some of the passage patterns, shapes, and modifications described in this article can be hidden by sediments and speleothems. Pits seemingly without passages are the most common example. The passages exist but are buried by sediments deposited on the pit floors where the water that carries them changes from high-energy vertical flow to low-energy horizontal flow conditions. Another somewhat common example is where large passages end in low crawlways that can barely be entered. These often reflect where the once sediment-free phreatic conduit dipped down and up in



**FIGURE 6** Three-stage evolutionary model of tapoff passage development. (Adapted from Veni, 1997.)

a V-shaped pattern (Fig. 4); during vadose conditions, the bottom of the “V” was filled by sediments. In some cases, dense deposits of chert, clay, or other poorly soluble materials may armor a passage floor to prevent downward erosion. As more of this material is deposited, groundwater will dissolve the walls and ceiling to enlarge the passage upward by a process called *paragenesis*.

Karst aquifers evolve at different rates according to the geologic factors described in this article, but especially in response to erosion of the overall landscape. The down-cutting of surface streams will drain old aquifer levels, create new ones, and change groundwater gradients toward new springs. These changes will be reflected in cave passages. In many cases, water from one passage will be captured or pirated into another passage with a steeper hydraulic gradient. These passages are known as *tapoff passages*. Originally meant to describe a newly formed passage that transmits water from a cave to a newly formed spring, its definition has been expanded to describe a relatively short, high-gradient cave stream passage that pirates flow from a

high elevation stream to a lower elevation stream (Fig. 6). Tapoffs can form between any combination of surface and subsurface streams, are usually small relative to the surrounding passages, and have few or no tributaries. With sufficient time, they may enlarge to the point where they may be difficult or impossible to recognize.

## CONCLUSIONS

Cave passages form the framework of karst aquifers. Their proper interpretation provides insights into the evolution of the aquifer and land surface, groundwater flow behavior, potential fate and transport of contaminants that might enter the aquifer, and the definition and distribution of habitat for terrestrial and aquatic species living in the cave and aquifer, as well as providing key information on the portion of the conduit system that remains humanly inaccessible.

*See Also the Following Articles*  
*Passage, Growth and Development*

### Bibliography

- Bögli, A. (1980) *Karst Hydrology and Physical Speleology*. Springer-Verlag, Berlin, 220 pp.
- Crawford, N.C. (1996) *The Karst Hydrogeology of the Cumberland Plateau Escarpment of Tennessee*, Report of Investigations No. 44, Part IV, Tennessee Department of Environment and Conservation, Nashville, 451 pp.
- Ford, D.C. and Ewers, R.O. (1978) The development of limestone caves systems in the dimensions of length and depth. *Can. J. Earth Sci.*, 15(11), 1783–1798.
- Ford, D.C. and Williams, P.W. (1989) *Karst Geomorphology and Hydrology*. Unwin Hyman, London, 601 pp.
- Gillieson, D. (1996) *Caves: Processes, Development, Management*. Blackwell Publishers, Cambridge, 324 pp.
- Klimchouk, A.B., Ford, D.C., Palmer, A.N., and Dreybrodt, W., Eds. (2000) *Speleogenesis: Evolution of Karst Aquifers*. National Speleological Society, Huntsville, AL, 527 pp.
- Palmer, A.N. (1991) Origin and morphology of limestone caves. *Geol. Soc. Am. Bull.*, 103(1), 1–21.
- Veni, G. (1997) *Geomorphology, Hydrogeology, Geochemistry, and Evolution of the Karstic Lower Glen Rose Aquifer, South-Central Texas*, Vol. 1. Texas Speleological Survey Monographs, Austin, TX, xi + 409 pp.
- White, W.B. (1988) *Geomorphology and Hydrology of Karst Terrains*. Oxford University Press, New York, 464 pp.

# Passage Growth and Development

Arthur N. Palmer  
*State University of New York*

Of all cave types, solution caves have the most complex developmental histories. They are formed by the

dissolving action of underground water as it flows through fractures, partings, and pores in bedrock. Such caves must grow rapidly enough to reach traversable size before the rock material that contains them is destroyed by surface erosion. Because of their sensitivity to local landscapes and patterns of water flow, solution caves contain clues to the entire geomorphic, hydrologic, and climatic history of the region in which they are located. At the land surface, most of this evidence is rapidly lost to weathering and erosion, but in caves these clues can remain intact for millions of years.

## STAGES OF CAVE DEVELOPMENT

Solution caves develop in several stages that grade smoothly from one to the next: (1) For the rock to transmit enough water to form caves, it must first contain a network of pre-solutional openings, such as fractures, partings, and primary pores. (2) Because these openings are narrow, the initial groundwater moves very slowly and becomes nearly saturated after only a short distance of travel. Solutional widening of the openings is likewise very slow. Nevertheless, among the many alternate routes that the water follows, great variation is seen in the amount of flow because of differences in widths and lengths of openings. Those paths with the greatest flow enlarge the fastest. (3) These favored routes eventually become wide enough that groundwater is able to pass all the way to the spring while still retaining much of its solutional capacity. (4) Flow along these preferred routes increases rapidly, enlarging them into cave passages rather uniformly over their entire length. (5) The cave acquires a distinct passage pattern that depends on the nature of groundwater recharge, geologic setting, and the erosional history of the region. (6) Most caves evolve by diversion of water to new and lower routes as surface rivers deepen their valleys and lower the elevations of springs. (7) Caves are eventually destroyed by roof collapse and by intersection of passages by surface erosion. At any given time, different parts of the same cave may be experiencing different stages in this sequence.

## THE EARLIEST STAGES

At great depth beneath the surface there is very little groundwater flow because openings in the rock are narrow and few, and hydraulic gradients are feeble. As rocks are gradually exposed at the surface by uplift and erosion, increasing amounts of groundwater pass through them. At first, the rate at which these openings enlarge by dissolution depends almost entirely on the amount of flow through them. In turn, the most important controls over the amount of flow are how much water is available to supply the upstream end of the growing caves and how wide the initial openings are. The overall hydraulic gradient, length of flow, and water chemistry are also important, but less so.

When the openings along a particular flow path enlarge enough that water can pass through all the way to the spring

while still retaining much of its solutional capacity, this flow path begins to enlarge much more rapidly than that of its neighbors. From then on, water chemistry becomes the main factor in controlling growth rate, and the entire path enlarges rapidly at about 0.001–0.01 cm/yr. Openings that have not reached this stage continue to enlarge only slowly, often at diminishing rates with time. The typical result is a cave with only a few negotiable passages surrounded by openings that have hardly enlarged at all.

The time needed to reach this stage of rapid cave enlargement can be considered the “gestation time” through which an incipient cave must pass in order to grow into a true cave. It is difficult to specify exactly when this time begins. Some researchers argue that it should include the entire age of the soluble rock, including early chemical changes, compaction, and burial by other rocks, as well as later uplift and perhaps folding and faulting. But before cave growth can truly begin, there must be a substantial hydraulic gradient through the rock. This usually requires that the soluble rock be exposed at or near the surface, when zones of groundwater recharge and discharge are well defined. Most people date the age of a cave to the onset of these conditions.

Field evidence and computer modeling show that short fissures in limestone that begin at 0.01–0.1 cm wide would require no more than a few thousand or tens of thousands of years to reach their maximum enlargement rates. Longer and narrower paths require much longer times, typically on the order of hundreds of thousands of years.

**DEVELOPMENT OF CAVE PATTERNS**

**Competition between Initial Flow Routes**

Most groundwater enters the ground in upland recharge areas and emerges at lower elevations such as river valleys. Patterns of solution caves typically reflect these trends. Such caves can form only along paths that gain discharge with time, which requires one of the following conditions:

Where water leaks from a stream and drains to a lower outlet, the underground flow increases dramatically as the initial openings enlarge by dissolution. When the incipient cave enlarges enough to carry all of the flow, the surface stream becomes a sinking stream. From then on the average flow rate remains about the same, but the water level in the cave drops as the passages enlarge. The cave reaches its maximum enlargement rate long before that point, so the leveling out of the flow rate does not interfere with the growth of the cave.

Water that seeps through soil into underlying soluble rock can gain discharge only by increasing its catchment area. Because the upstream ends of the major flow paths enlarge most rapidly, soil subsides into these growing voids to form sinkholes. As sinkholes grow they increase their catchment area, delivering progressively more water to the passages they feed. Water input to the caves by this mechanism increases in

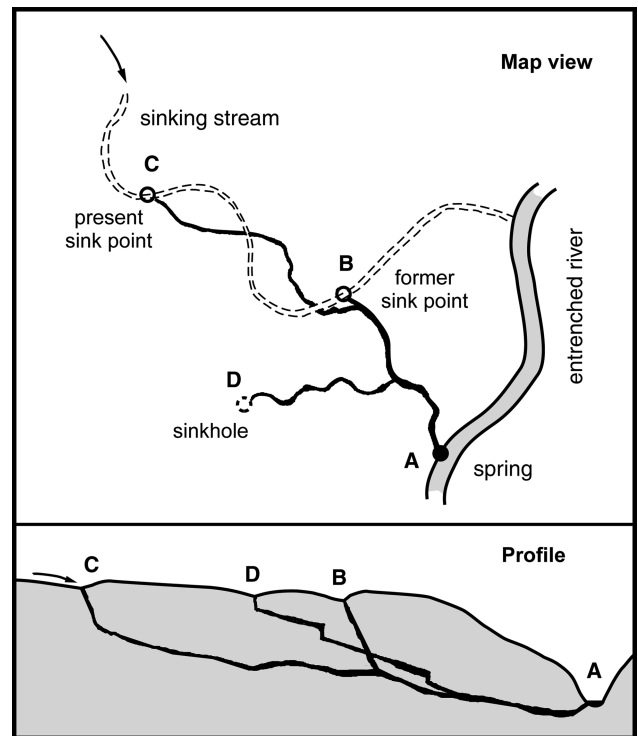
an irregular manner, and much less rapidly than in routes fed by leaking streambeds.

The routes fed by leaky streams increase their flow much more rapidly, so they are usually the first to form traversable cave passages. Passages fed by sinkholes have a limited catchment area and require more time to form. They usually join the earlier passages as tributaries of a branching cave system.

The first passages to form are usually short and direct. With time, as their water levels drop, these early passages serve as targets for later passages that drain more remote areas. Although the growth of any single passage propagates in the downstream direction, the overall system grows in the upstream direction, away from the springs, by the addition of new tributaries. A typical sequence is shown in Fig. 1.

**Vertical Organization of Cave Passages**

Because their flow is gravitational, most vadose passages tend to have a strong component down the dip of the rock strata. This is especially true in well-bedded rocks. Phreatic passages show no consistent relation to the dip, except where that is the only direction to potential outlets or where prominent fractures also extend in that direction. In well-bedded rocks, the intersections between the dipping beds and low-gradient



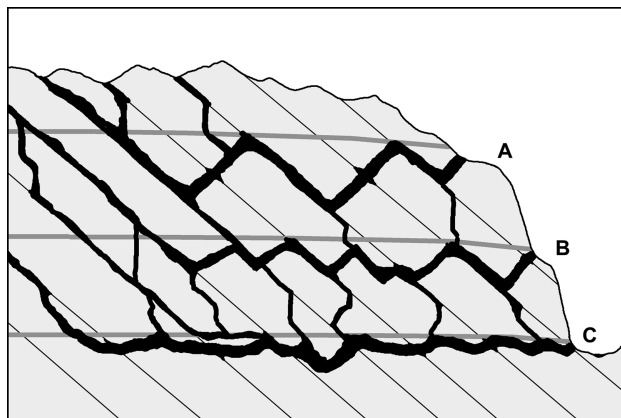
**FIGURE 1** Typical stages in the early development of a solution cave. Segment B–A forms first as a short, high-gradient path from a sink point in the upland stream to the entrenched river. Segment C–B forms next, aided by the decrease in head in the previous segment. The passage fed by the sinkhole at D is slower to form because of its smaller catchment and less rapid increase in flow with time.

water table encourage many phreatic passages to develop roughly along the strike of the beds. These relationships tend to be obscure where the geologic structure is complex.

The vertical arrangement of underground water flow is strongly controlled by the deepening of surface valleys by river erosion, and the vertical arrangement of cave passages reflects this control. In general, the largest passages form when the erosional base level is relatively static. At such times, rivers develop floodplains, and springs remain at fairly constant elevations for lengthy periods of time. Meanwhile the passages that drain to those springs are able to grow large. In contrast, most passages that form during rapid river entrenchment are small because the cave-forming water undergoes more frequent diversion to lower routes. The major passages may be arranged in several different levels that decrease in age downward. Partial filling of river valleys with sediment tends to block nearby cave passages, causing them to fill with sediment as well, or at least to become ponded with water.

This conceptual model has been well validated at Mammoth Cave, Kentucky. But several complications can disrupt this simple interpretation. Vadose passages may hang up on insoluble strata and grow to large size well above the local levels of surface rivers. In addition, most phreatic passages contain vertical loops that descend far below river levels. Even the ideal cave levels controlled by pauses in river entrenchment are not perfectly “level.” For this reason, many people prefer to call them *stories* or *tiers*. Either of these terms is preferred in general applications. However, the term *cave level* is still appropriate where there is a clear relation to erosional base level. The critical measurement is not the average elevations of phreatic passages, but instead the elevations where passages change from vadose to phreatic types (for example, from a canyon to a tube). This transition may not be clear where the geologic structure is complex or in caves that experience severe fluctuations in water level due to flooding.

Figure 2 shows an idealized profile through a multistoried cave. Three main stages of cave development are shown, with decreasing loop amplitudes from the highest story to the lowest. This is a conceptual ideal, but it is not characteristic of all multistoried caves. Ford ascribed the decrease in amplitude to increasing fissure frequency in the host rock with time. Fissures are sparse at first, and passages are constrained to only a few deeply descending loops. As erosional unloading and cave development persist, fissures become more numerous until eventually the passages are able to form more or less along the water table, with minimal phreatic looping. However, in some caves the greater amplitude of loops in upper passages is instead caused by floodwaters, which superpose ungraded, looping bypass routes around low-flow routes that have more uniform gradients. Furthermore, the depth of phreatic loops also tends to be greatest in highly deformed or massive rocks and in broad regional flow systems.



**FIGURE 2** Idealized profile through a complex, multistory cave system showing decreased loop amplitude with time as fissure frequency increases from stage A to B to C.

### Origin of Branching Systems

Branching (branchwork) caves are roughly the underground equivalents of surface drainage. Many small passages join in the downstream direction to form larger but fewer passages. Of all solution caves, branchwork caves are by far the most common. There are several reasons for the branching pattern:

- As phreatic passages enlarge, the local hydraulic head within them decreases. Groundwater flows from surrounding smaller openings, where the water table is higher, toward the low heads in the passages.
- Vadose passages have no inherent tendency to converge, because their streams are independent of one another. However, the structures that they follow often intersect, forcing their streams to converge as tributaries. Examples of convergent structures include intersecting fractures and trough-like structures in bedding-plane partings.
- Water from broad recharge areas converges toward outlets of limited extent, generally stream valleys. Thus there is a natural tendency for conduits to join each other simply by competition for space. After two streams have converged, there is little opportunity for water to diverge farther downstream. The exception is in the vicinity of spring outlets, where local distributary systems may develop because of collapse, flooding, and widening of fissures by erosional stress release. In those areas a tangle of diversion passages may develop similar to the channels on a river delta.

### Development of Maze Caves

Most nonbranchwork caves are mazes in which all of the passages form more or less simultaneously. A maze cave can form only if the growth rate is similar along many alternate flow paths. This requires the ratio of discharge to flow

distance to be large along many alternate flow routes. This condition can be met in any of the following ways:

1. *Floodwater recharge.* A rapid influx of water into caves during floods will fill the caves with high-pressure water and force solutionally aggressive water into all fissures in the surrounding rock. Floodwaters combine steep gradient, high discharge, and short flow paths. As a result, these openings enlarge at approximately the maximum possible rate. This process is most active in the vicinity of constrictions in major stream passages, which result from collapse, sediment chokes, or poorly soluble strata.

2. *Short flow paths.* Mazes can also form where many alternate flow paths are short (i.e. from where the water first enters the soluble rock). In this case, all openings except for the narrowest enlarge simultaneously at similar rates. The epikarst is an example. This is a network of enlarged openings, all of which have enlarged simultaneously at comparable rates. The tendency for uniform growth diminishes with flow distance, so only a few major drains lead downward into the aquifer below.

3. *Uniform recharge through a permeable insoluble rock.* Where water enters a soluble rock by first seeping through an insoluble but permeable rock, all fissures in the soluble rock receive roughly comparable amounts of flow, regardless of how wide they are. For example, mazes can be formed by recharge through a permeable but insoluble material such as quartz sandstone. Their uniform enlargement is also aided by the short flow paths.

4. *Local boosts in aggressiveness.* Where the groundwater gains solutional capacity by mixing of waters of contrasting CO<sub>2</sub> content or salinity, or by oxidation of sulfide-rich water, many alternate routes are enlarged at roughly comparable

rates. Mazes are formed along short paths of flow in and around the mixing zone.

The differences in maze patterns depend partly on geologic structure. *Network mazes* consist of intersecting fissures arranged in a pattern like that of city streets. They require many intersecting fractures (joints or faults), which are typical of massive or thick-bedded rock. They can be formed by all four processes above. *Anastomotic mazes* have a braided pattern of intersecting tubes, usually arranged two dimensionally along a single parting or fault. They are nearly all formed by process 1 above. *Spongework mazes* form where primary (matrix) porosity is dominant. In pattern they resemble the intersecting holes in a sponge. Most of them form by process 4, and less commonly by process 1. A two-dimensional variety can form along bedding-plane partings. *Ramiform mazes* consist of rooms with offshoots extending outward from them at various elevations. They usually include areas of network or spongework maze development and are formed mainly by process 4. Many network and anastomotic mazes, and a few spongework mazes, are merely superimposed on a basic branchwork pattern and represent only part of the entire cave development.

Figure 3 summarizes typical cave patterns and their relation to source of aggressive water and to dominant structural characteristics.

**Adjustment of Caves to Changing Conditions**

When an incipient cave finally reaches its maximum growth rate, several other changes take place more or less simultaneously. The cave water changes from laminar to turbulent, which increases the solution rate slightly. The flow also







CAVE PATTERN		curvilinear branchwork	rectilinear branchwork	anastomotic maze	network maze	spongework maze	ramiform pattern
							
SOURCE OF AGGRESSIVE WATER	sinkholes	●	●	●	●		
	sinking streams	●	●	●	●	●	
	uniform seepage				●	●	
	mixing of 2 sources				●	●	●
	sulfuric acid			●	●	●	●
DOMINANT STRUCTURES	bedding-plane partings	●		●		●	●
	fractures		●		●		●
	intergranular pores					●	●

FIGURE 3 Relation of cave patterns to mode of groundwater recharge and geologic structure. Dot sizes show the relative abundance of each pattern within the various recharge and structural categories. Single-passage caves are rudimentary or fragmentary versions of those shown here.

becomes able to transport sediment. For example, it can carry away the soil that subsides into caves through karst depressions, allowing the depressions to grow more rapidly. The sediment load can also help to enlarge caves by mechanical abrasion. But in places, sediment accumulates in thick beds that retard dissolution and erosion.

When a cave is able to transmit the entire flow from its recharge area, the average flow can increase no further. Instead the head within the passage decreases as the cross section continues to enlarge. Much of the upstream part of the cave becomes vadose, and streams may entrench canyons in the passage floors.

As caves acquire entrances that allow air exchange with the surface, many cave streams lose part of their solutional capacity. Where water first enters caves, it is fairly rich in soil-derived CO<sub>2</sub> and may acquire even more by oxidation of organic materials within the caves. Loss of CO<sub>2</sub> through entrances and other openings can drive the stream water to supersaturation with dissolved calcite or dolomite. As a result, many vadose cave streams are aggressive only during high flow.

As the land surface becomes dissected by erosion, patterns of groundwater recharge change. Initial water sources are usually few and large, but with time they may become divided into many smaller ones. Vadose water must travel increasingly greater distances to reach the water table, and extensive complexes of vadose canyons and shafts can form. The resulting pattern of active cave streams tends to become denser with time, and it eventually becomes much denser than that of the original surface drainage. Growing dolines eventually merge to form a continuous karst surface. Eventually the only surface streams that retain their flow are the main entrenched rivers and the ephemeral upstream ends of sinking streams.

### CAVE DEGENERATION

As the land erodes, the surface intersects underlying cave passages, segmenting them and eventually destroying them entirely. Evidence for the cave may persist for a while as a canyon-like feature or a rubbly zone of collapsed blocks. This final chapter in the life of a cave passage usually occupies tens of thousands or even hundreds of thousands of years. However, newer passages continue to develop where the soluble rock extends to lower elevations. In dipping strata, new areas of rock are uncovered by erosion at about the same rate as they are eroded away in the up-dip areas. Thus some of the caves we see today are the descendants of earlier caves that once occupied parts of the soluble rock that are now gone. This process ends when the entire soluble rock in the cave region is eroded away.

### CONCLUSION

Patterns of solution caves are very sensitive to their physical setting. Aided by dating of cave deposits, cave patterns

can shed considerable light on the history of landscape development, groundwater flow, and climate changes in the surrounding region.

### See Also the Following Articles

#### Passages

#### Bibliography

- Dreybrodt, W. (1990). The role of dissolution kinetics in the development of karst aquifers in limestone: A model simulation of karst evolution. *Journal of Geology* **98**(5), 639–655.
- Ford, D. C., and R. O. Ewers (1978). The development of limestone cave systems in the dimensions of length and depth. *Canadian Journal of Earth Sciences* **15**, 1783–1798.
- Granger, D. E., D. Fabel, and A. N. Palmer (2001). Pliocene-Pleistocene incision of the Green River, Kentucky, determined from radioactive decay of <sup>26</sup>Al and <sup>10</sup>Be in Mammoth Cave sediments. *Geological Society of America Bulletin* **113**(7), 825–836.
- Palmer, A. N. (1975). The origin of maze caves. *National Speleological Society Bulletin* **37**, 56–76.
- Palmer, A. N. (1991). Origin and morphology of limestone caves. *Geological Society of America Bulletin* **103**, 1–21.
- White, W. B. (1969). Conceptual models of carbonate aquifers. *Ground Water* **7**(3), 15–21.
- White, W. B. (1977). Role of solution kinetics in the development of karst aquifers. In *Karst Hydrogeology* (J. S. Tolson and F. L. Doyle, eds.), 12th Memoirs, pp. 503–517. International Association of Hydrogeologists, Huntsville, AL.
- Worthington, S. R. H. (2001). Depth of conduit flow in unconfined carbonate aquifers. *Geology* **29**(4), 335–338.

## Pits and Shafts

John W. Hess

*Geological Society of America*

The passages that make up limestone caves tend to be of two types, those that are more or less horizontal and those that are more or less vertical. This article is concerned with the vertical passages, passages that are variously known as pits and shafts. To explore these passages requires becoming adept at “vertical caving,” an activity that requires knowledge of rope rigging as the use of specialized gear for descending and ascending the ropes. The processes responsible for the development of pits and shafts are complex but mainly involve water descending by near vertical routes through the vadose zone.

### INTRODUCTION

The vertical passages found in many caves and in karst landscapes generally have much greater vertical than horizontal dimensions. They are variously known as pits,

shafts, “drops,” chimneys, natural wells, potholes (UK), sotanos or cenotes (Mexico), abimes or gouffres (France), Schnact (Germany), and jamas (Slovenia) as well as many other names. Pit and shaft are used interchangeably in this article. Some pits are open to the land surface where they may form vertical entrances to underlying cave systems or they may be isolated “dead bottom” pits with no human connection to underlying cave systems. Pits and shafts are also found inside caves where they may provide connections between horizontal cave levels. In the Mammoth Cave area these features are called “domepits.” It is a pit if one is at the top looking down and a dome if one is at the bottom looking up.

Pits and shafts are formed by the dissolution of bedrock by water guided along some initial pathway of structural weakness. The dissolution process may be aided by mechanical processes of breakdown and stoping. Although there is a continuum of intermediate forms, pits and shafts can be roughly cataloged into:

solution chimneys, vertical shafts, waterfall shafts, and stoping shafts.

The pits and shafts described in this article are all formed by downward movement of water. Some shafts are known that formed by the upwelling of water; one example is the orifice that feeds an artesian spring. Some of these are very deep. In eastern Mexico there are water-filled shafts hundreds of meters deep.

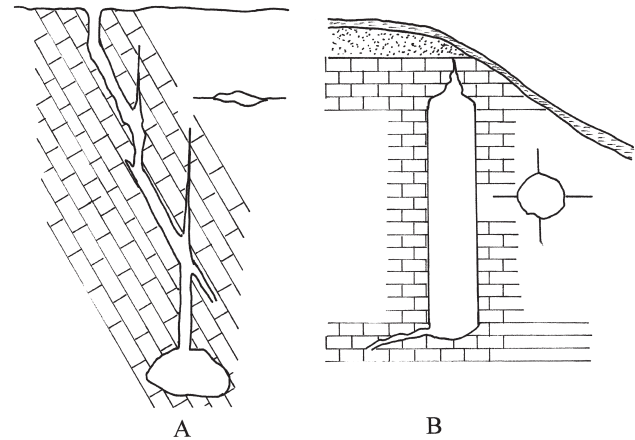
## DESCRIPTIONS OF PITS AND SHAFTS

### Solution Chimneys

Both vertical and horizontal cave passages are initiated along some initial selection of fractures and bedding plane partings, which provide pathways for water descending vertically from the land surface to the underlying aquifer. These waters contain carbon dioxide derived from the overlying soils and thus are acidic and dissolve limestone to gradually enlarge the fractures and bedding plane partings. When the fractures have enlarged, the result is an irregular chimney that follows the original fracture pattern (Fig. 1A). The cross sections of the chimneys tend to be narrow in one dimension and elongate along the fracture. Solution chimneys may be vertical or may zigzag downward following multiple fractures or a combination of fractures and bedding plane partings. Solution chimneys range from cross sections too small to admit human explorers to many meters. Depths also vary greatly. One of the deepest solution chimneys is Sotanito de Ahuacatlán in the Sierra Madre Oriental, Mexico, which is a single solution-widened fracture 320 m deep leading nowhere.

### Vertical Shafts

Vertical shafts are a special form of vertical cave found widely in the karst of the Allegheny and Cumberland Plateaus, the



**FIGURE 1** Profile sketch of (A) a solution chimney and (B) a vertical shaft. The geometry of the solution chimney is determined by the preexisting pattern of fractures and bedding plane partings. The geometry of the vertical shaft is created by the hydraulics of fast-moving films of water on the walls of the shaft.

Mammoth Cave area, the Indiana Karst, and the karst of the Ozark Dome of Missouri and Arkansas. In their ideal form vertical shafts are cylindrical voids with perfectly vertical walls (Figs. 1B and 2). They range in diameter from less than one meter to tens of meters and in depth from a few meters to hundreds of meters. The tops of vertical shafts are typically a domed bedrock ceiling cut with ceiling channels that provide infeeders for the water forming the shaft. The base of the shaft is typically a bedrock floor. Water that flows down the shaft drains through small passageways much smaller than the shaft itself. Shaft drains are often too small for human exploration and form dendritic networks that eventually carry the vadose water from the shaft to the near horizontal master drains that make up the conduit network. The key feature of vertical shafts is the absolutely vertical walls that cut beds of diverse lithology and ignore bedding plane dip. The walls of vertical shafts are often fluted where descending water has grooved the wall with small parallel channels.

Vertical shafts are usually associated with an impervious caprock. Unsaturated water draining from the caprock creates and uses the shafts as direct connections to the drainage system at depth. Some shafts have irregular shapes because they coalesce as they enlarge. Other shafts form retreating canyons. Undersaturated water flows down only one side of the shaft which then gradually saws its way into the plateau as the caprock retreats. Shafts are found with active dissolution and smooth wet limestone walls on the inward side while abandoned portions of the shaft, now beneath the hillside slopes of the dissected plateau, receive seepage water from the overlying limestone soils and deposit calcite speleothems. Vertical shafts are typically much younger than the horizontal cave passages and often slice through the upper level horizontal passages.



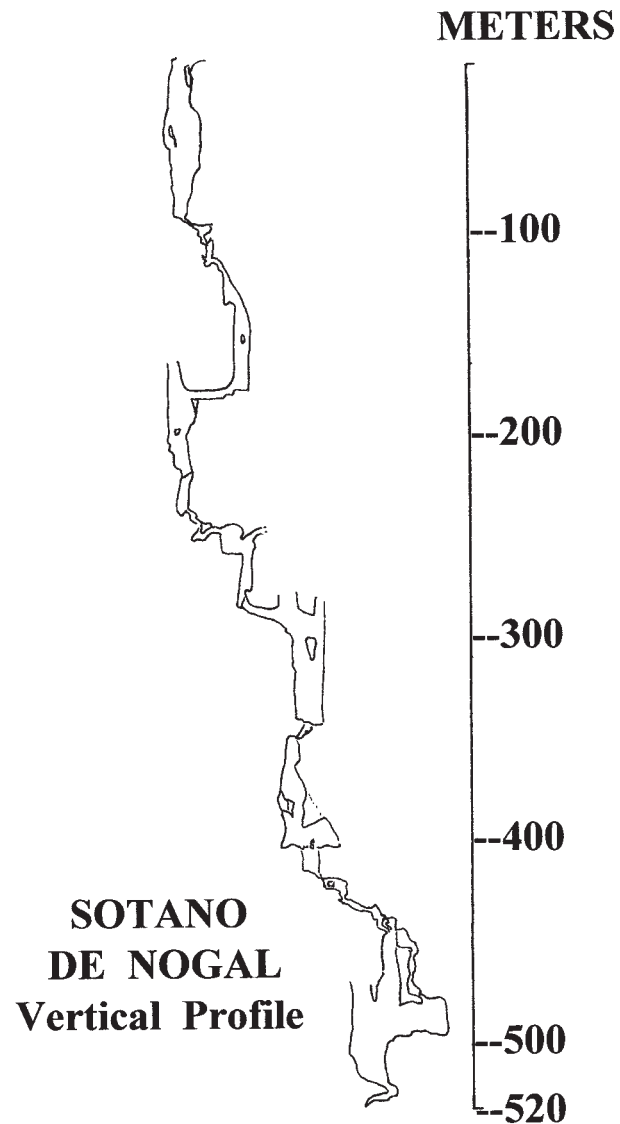


**FIGURE 2** View vertically downward in Keller Well, a geometrically ideal vertical shaft in the Mammoth Cave System, KY. The meterstick is 8 m below the observer. Depth to water is 17 m. (Photograph by Roger Brucker, Cave Research Foundation.)

Solution chimneys and vertical shafts represent end-member morphologies derived from the same underlying process; dissolution of carbonate rocks by thin, fast-moving moisture films. As they enlarge, solution chimneys or segments of solution chimneys often transform into vertical shafts as the geometry required by the hydraulics of moving water dominates over the original geometry of the fractures and bedding plane partings.

### Waterfall Shafts

Shafts take on the ideal vertical cylinder geometry when carved by films of water streaming uniformly down the walls. At higher flow rates, the water becomes a cascade. Storm flow from limestone mountains or limestone plateaus creates deep shaft complexes. The term waterfall shaft is used to describe these vertical caves cut by flowing water. Some waterfall shafts actually have perennial waterfalls, some take water only



**FIGURE 3** Profile map of a vertical cave consisting of a sequence of shafts and short connecting passages. Adapted from a map of Sotano de Nogal, Queretaro, Mexico, published by the Association for Mexican Cave Studies in 1976.

during storms or snowmelt, and some are abandoned shafts that no longer take significant water at any time. Like solution chimneys and vertical shafts, waterfall shafts are initiated along fractures and bedding plane partings. Because waterfalls shift depending on magnitude of flow and with time as rock is removed and new pathways open up, waterfall shafts have rugged, complex forms that are not easily characterized. Many vertical caves consist of a sequence of shafts, sometimes offset by short segments of horizontal passage or by steep chutes (Fig. 3). The vertical shaft and the waterfall shaft are end members along a continuum, depending on the relative importance of dissolution by water films clinging to the walls and dissolution by water in flowing streams.

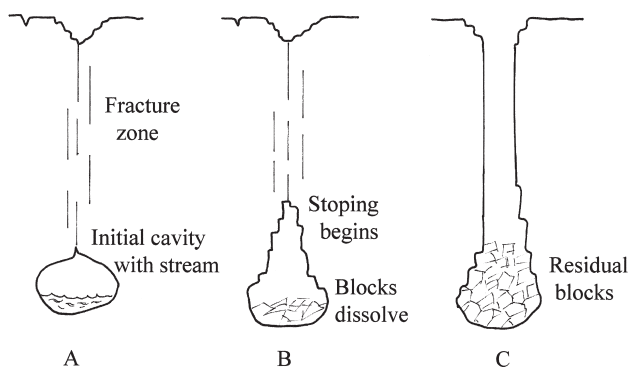
## Stoping Shafts

Solution chimneys, vertical shafts, and waterfall shafts are all formed by the same mechanism — water draining vertically through the vadose zone along fractures of various sorts. In contrast, stoping shafts form primarily by the mechanical processes of rock failure and breakdown. The initiation point is a preexisting void at depth. Ceiling collapse drops rocks into the void, partially filling it, and creates new void where the rocks were removed. As this process continues, the void migrates upward as rock fall continues. Because the rubble created by the falling blocks takes up more volume than the solid rock from which it came, the initiating void space can be filled and the process brought to a halt. If, however, the initial void contains flowing water that dissolves the fallen blocks and removes them, the void volume grows and the upward stoping process continues until it breaks through at the land surface (Fig. 4).

Because stoping shafts form primarily by mechanical rather than chemical processes, their development is not limited to carbonate rocks. Although the cavity that initiates the stoping process is usually formed by dissolution of carbonate rock, shafts are known that have stoped upward through sandstone, shale, and even overlying lava flows. Thus on the Coconino Plateau of Arizona there occur shafts and breccia pipes that have stoped through clastic rocks far above the cavities in the Redwall and Muav Limestones that were the initiation centers. It might be noted that mine tunnels can also serve as the initial void spaces so that mine subsidence is not an intrinsically different process.

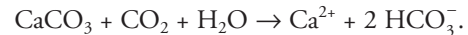
## MECHANISMS FOR THE DEVELOPMENT OF PITS AND SHAFTS

The chemistry involved when carbonate rocks are dissolved to form solution chimneys, vertical shafts, and waterfall shafts is not intrinsically different from the chemistry



**FIGURE 4** Sketches showing the evolution of a stoping shaft. (A) Fracture system and preexisting large chamber, (B) beginning of upward stoping process where fallen blocks are removed by dissolution in the large chamber, and (C) the shaft after it has broken through to the land surface. Incomplete dissolution of the fallen blocks may result in a completely obscured original chamber.

involved in the formation of horizontal caves. It may be summarized by a single reaction



However, there is a significant difference in the approach of the reaction to chemical equilibrium. Much of the dissolution of horizontal caves takes place in water that is close to saturation with calcium carbonate. Close to equilibrium, reaction rates are slow and the dissolutional enlargement of cave passages takes a long time. Once the vertical fractures have become enlarged even to a few millimeters, water drains through them very quickly. As a result, the fresh, unsaturated water that enters from the land surface or from the edge of a caprock descends through the vadose zone much more rapidly than the time required for chemical reactions to come to equilibrium. The result is that most shaft waters are highly undersaturated and are dissolving limestone at the fastest rate possible. A vertical shaft, a few meters in diameter, can form in a few thousand years.

## Bibliography

- Brucker, R. W., J. W. Hess, and W. B. White (1972). Role of vertical shafts in the movement of ground water in carbonate aquifers. *Ground Water* **10** (6), 5–13.
- Courbon, P., C. Chabert, P. Bosted, and K. Lindsley (1989). *Atlas of the Great Caves of the World*. Cave Books, St. Louis, MO.
- Ford, D. C., and P. W. Williams (1989). *Karst Geomorphology and Hydrology*. Unwin Hyman, London.
- White, W. B. (1988). *Geomorphology and Hydrology of Karst Terrains*. Oxford University Press, New York.

## Population Structure

Valerio Sbordoni, Giuliana Allegrucci, and Donatella Cesaroni

Tor Vergata University, Italy

Population structure is an important guideline to understanding the evolution of cave-dwelling animals, because it represents the outcome of their history and adaptation as well as the groundwork for speciation in the cave environment. However, despite its potential value, population structure is still a poorly studied feature of cave life.

Population structure can be viewed from two different perspectives. Ecologists usually view the composition of a population according to age and sex of individuals, and population geneticists keep in mind the organization of genetic variation within and between populations, with special emphasis on their spatial arrangement. In this article we address the latter aspect.

The advent of molecular techniques, from allozyme electrophoresis to microsatellite DNA analysis, led to significant improvements in understanding the genetics of natural

populations. Particularly, the feasibility to estimate parameters such as the amount of genetic variation, gene flow, time since isolation, etc., provides important evidence to test alternative hypotheses on patterns of colonization and evolution of cave populations.

The most obvious cause of structuring in cave populations is habitat fragmentation. However, as we will discuss, habitat fragmentation may not include the unique factor of population structuring. Generally speaking, caves reflect the historical process of habitat fragmentation quite well. Cave regions in temperate countries have been subjected to profound and repeated changes in climate and vegetation, which are particularly well documented in the Pleistocene. Cold and dry phases corresponding to glacial periods have repeatedly led to changes from mesophyllous forest to mountain steppe. Consequently, previously widespread ancestral populations of several cave-dwelling species became confined to small refugial habitats, leaving relictual populations at different steps of isolation, depending upon the biological properties and/or the history (i.e., time) of the organisms involved. Extrinsic causes for fragmentation can also be detected in other circumstances such as the structure and history of drainage systems, tectonic changes, or lava flow events in volcanic cave areas. In many cases these phenomena can be dated to a reasonable extent.

Other evolutionary processes can also account for population structuring, especially where population structure is perceived at much smaller scales, even within a single cave. Double or multiple invasion of a cave habitat at different times by different populations of a given species represents a feasible mechanism. Alternatively, extrinsic factors such as habitat and resource patchiness may interact with the intrinsic biological properties of organisms, like fecundity, dispersal ability, and behavioral characters, leading to a population structure maintained by different forms of natural selection.

In the following article, a series of study cases will be discussed to underscore the role of different factors in shaping population structure in a limited sample of cave organisms that have been the object of appropriate population genetic studies.

## ESTIMATING GENETIC STRUCTURE

The genetic parameters relevant to investigate population structure are effective population size ( $N_e$ ), observed and expected heterozygosity ( $H_o$  and  $H_e$ , respectively), genetic distance ( $D$ ), amount of structuring between subpopulations ( $F_{ST}$ ), and gene flow ( $N_e m$ , where  $m$  is the migration rate).

### Effective Population Size ( $N_e$ )

The number of individuals that effectively participate in producing the next generation is named effective population size. Generally, the effective size of a population is consid-

erably less than the census size. Evolutionary processes are greatly influenced by the size of populations.

### Heterozygosity

Mean heterozygosity, calculated across a number of loci, is a valuable parameter used to estimate the degree of genetic variation within a population. Population structuring occurs when genotype frequencies deviate from Hardy-Weinberg expected proportions, or panmixia is unfulfilled. If inbreeding or selection occurs, then populations can be considered "structured" in some way.

### Genetic Distance

When two populations are genetically isolated, both mutation and genetic drift lead to differentiation in the allele frequencies at selectively neutral loci. As the amount of time that two populations are separated increases, the difference in allele frequencies between them should also increase, until each population is completely fixed for separate alleles. Therefore, calculation of genetic distance ( $D$ ) between two populations provides a relative estimate of the time elapsed since these populations have existed as a single panmictic unit. Small estimations of distance among completely isolated populations indicate that they have only been separated for a short period of time. Alternatively, in the absence of isolation, small values of genetic distance may indicate population structure (i.e., subpopulations in which there is random mating, but between which there is a reduced amount of gene flow).

### F-Statistics

F-statistics, developed by Wright (1965), represent the basic method to measure the amount of subdivision in populations. F-statistics can be viewed as a measure of the correlation of alleles within individuals, and they are related to inbreeding coefficients. An inbreeding coefficient is really a measure of the nonrandom association of alleles within an individual. As such, F-statistics describe the amount of inbreeding-like effects within subpopulations, among subpopulations, and within the entire population. In particular, the  $F_{ST}$  index is an estimator of the amount of structuring of a population into subpopulations.

### Migration

If there is no migration (gene flow) occurring between two populations or demes, eventually alternate alleles will become fixed and will reach 1. Alternatively, it has long been known that if migration, measured in terms of  $N_e m$ , is  $>1$  (where  $N_e$  is the effective population size and  $m$  is the proportion of migrants per generation, or migration rate), the allele frequencies in the subpopulations remain homogenized

(Wright, 1931). If, however, migration is present but  $N_e m < 1$ , an equilibrium based on the rate of mutation, migration, and genetic drift will be established.

### POPULATION STRUCTURE AT REGIONAL SCALE: TERRESTRIAL CAVERNICOLES

It is well known that troglobitic species (i.e., obligate cave dwellers) occupy very reduced distribution ranges, sometimes limited to a given karst region or even to a single cave system. Troglomorphic species (i.e., species able to live and reproduce in the cave habitat as well as in surface habitats) comparatively show much wider distribution ranges.

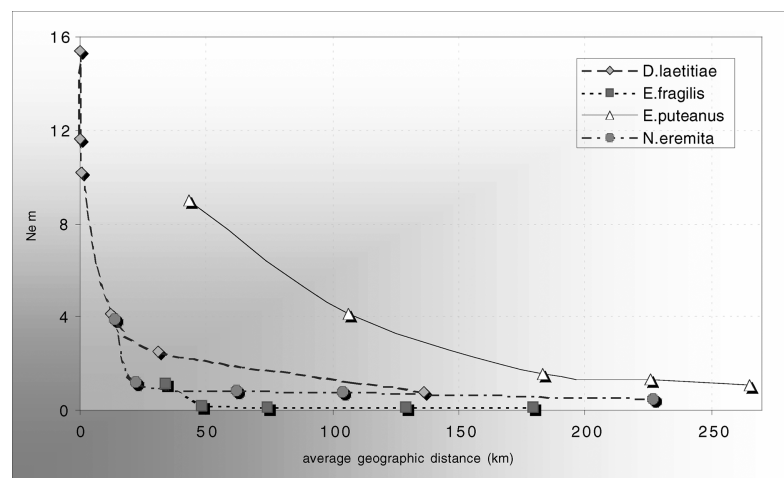
Related troglobitic species within a genus are often geographically vicariant in different karst areas or cave systems. A huge number of taxa in terrestrial and aquatic organisms, such as carabid and leiodid beetles, spiders, pseudo-scorpions, millipedes, isopods, amphipods, etc., exemplify this situation, particularly in limestone areas of temperate regions. These vicariant species represent the outcome of a geographical speciation process that was initiated with the population genetic structuring of an ancestral troglomorphic species at the regional scale.

As already outlined, the amount of population structure is strictly dependent on intrinsic factors, such as dispersal ability of the organism implied and extrinsic factors limiting gene flow between populations, such as geographic distance and the extent of ecological and geographical barriers to migration. Therefore we cannot automatically expect that different organisms experiencing similar evolutionary pathways show the same geographical pattern of population structure. Careful genetic analyses are required to reveal the occurrence of actual or potential gene exchange between populations. In turn these analyses represent a tool to disclose historical relationships between populations and to

test hypotheses on processes generating spatially structured population systems.

Potential or actual gene exchange between cave populations, and their resultant structuring at a regional scale, can be understood by illustrating study cases involving rhabdiphorid crickets and nesticid spiders living in Italy and the eastern United States. By means of allozyme polymorphisms, levels of gene flow between populations were evaluated for *Nesticus* cave spiders and cricket populations belonging to *Dolichopoda laetitiae* from the Italian peninsula, and to *Euhadenoecus puteanus* and *E. fragilis* from the eastern United States. The enhanced degree of population fragmentation in these organisms is chiefly the result of a gradual reduction of gene flow between populations caused by bioclimatic changes that occurred in the Pleistocene. Hence, levels of gene flow ( $N_e m$ ), as measured on the basis of the present patterns of genetic differentiation (Wright's  $F_{ST}$ ), are supposed to reflect historical gene flow occurring between cave and surface populations living in a continuum of wet or mesophyllous woody environments.

The amount of genetic structuring was estimated for multiple combinations of populations at different geographic scales.  $F_{ST}$  and  $N_e m$  values were calculated for different groups of populations by considering increasingly wider geographic windows. The size of the geographic window for the population sampling was progressively enlarged from a minimum average population distance of 12–14 km for Italian caves and 30–40 km for American caves, to a maximum average distance of larger than 200 km (Fig. 1). Moreover, in *D. laetitiae*, estimates of  $F_{ST}$  and  $N_e m$  have also been performed at smaller geographic windows by means of samples caught in sites 50–500 m apart. At the same geographic scale the extent of gene flow among *E. puteanus* populations was higher than among *Dolichopoda* populations, whereas the degree of population structuring in *E. fragilis* is undoubtedly



**FIGURE 1** The amount of gene flow ( $N_e m$ ), as measured on the basis of the present patterns of genetic differentiation (Wright's  $F_{ST}$ ), was estimated for multiple combinations of populations at different geographic scales, by considering geographic windows increasingly wider. The four curves outline the trends in *Dolichopoda laetitiae*, *Euhadenoecus fragilis*, *Euhadenoecus puteanus* and *Nesticus eremita*.

more than in both *D. laetitia* and *E. puteanus*. Population fragmentation and geographical isolation in *E. fragilis* have already proceeded to a very large extent, because almost irrelevant gene flow is detectable at any scale.

This outcome is in agreement with the well-known features of these three species. Both American species are found in caves, but *E. puteanus* also commonly occurs outside caves in forest habitats, whereas *E. fragilis* is a strictly cavernicolous species inhabiting a patchy limestone area. *Dolichopoda laetitia* shows halfway troglomorphic habits with respect to the two American species. Moreover, troglomorphic features are more advanced in *E. fragilis* than in *E. puteanus*, with *D. laetitia* intermediate both in the degree of leg elongation and in the rate of pigment reduction. The general emerging picture corroborates the idea that gene flow with epigeal populations prevents or retards adaptation to the cave habitat, and that isolation is an important prerequisite for the evolution of troglomorphic adaptations.

In the European spider species, *N. eremita*, the relation between  $N_e m$  estimates and geographic distance was similar to that observed for *D. laetitia*. *Nesticus eremita* is a widespread troglomorphic species, colonizing not only natural limestone caves, but also artificial caves, cellars, and some epigeal habitats, just like *D. laetitia*. Moreover, this spider can move outside caves and disperse to some extent by means of ballooning at juvenile stages. Therefore both present and past gene flow can explain the pattern of genetic differentiation between populations, which typically reflects a pattern of isolation by distance.

The comparison to the examined cricket species indicates that the dispersal ability for *N. eremita* is lower than that for *E. puteanus*, perhaps lesser than for *D. laetitia*, but undoubtedly higher than for *E. fragilis*. The study cases examined here proved that different cave species, even if closely related, could show different levels of isolation, fragmentation, and dispersal, depending on both extrinsic obstacles to gene flow and intrinsic properties of organisms (Fig. 1).

In some cases, different molecular markers, used to investigate population genetic structures, or technical procedure of data analysis may lead to slightly different conclusions or may make the comparison of patterns of structuring difficult. An example is provided by a species group of Appalachian cave spiders, *N. tennesseensis* "complex," where population genetic structure was investigated using mtDNA sequence data (*ND1* gene). Hedin, in a 1997 paper, described high sequence homogeneity within populations with large divergences between populations for all species analyzed. The revealed pattern was consistent with an ancestral interbreeding population, which, at some time in the past, was fragmented into several habitat-limited subpopulations. Subsequent to fragmentation, the exchange of migrants among subpopulations became extremely restricted to nonexistent. The conclusion was that Appalachian *Nesticus* species are characterized by similar and essentially complete population subdivision regardless of difference in species

habitat preference (surface, cave-dwelling, troglomorphic). However, this outcome is in disagreement with many other studies on cave animals, essentially based on allozyme data, where troglomorphic species showed lower rates of gene flow than troglomorphic or epigeal species. Hedin underlined that mtDNA, which is maternally inherited, could reveal a reduced amount of gene flow with respect to estimates based on nuclear loci. This would explain the discrepancy between levels of gene flow estimated in the American species of *N. tennesseensis* complex and the European *N. eremita*. In addition, Hedin suggested that studies on population structure based on allozymes have to take into account that populations currently exchanging no genes can still share ancestral allozyme polymorphisms, i.e., the calculated extent of gene flow could be actually interpreted as the trace of historical gene flow between populations, as already outlined.

### SURFACE VS. UNDERGROUND DISPERSAL ROUTES

How can extrinsic and intrinsic factors interact to influence patterns of structuring populations? An additional example is useful. The genetic structures of populations were compared in two pairs of prey-predator species in two regions of Kentucky: (1) the cave cricket, *Hadenoeus subterraneus*, and the carabid beetle *Neaphaenops tellkampfi*, which is a predator of *Hadenoeus* eggs and (2) the cave cricket, *H. cumberlandicus*, and its egg predator *Darlingtonia kentuckensis*. The two regions where the species occur show different extents of fragmentation in the karst cover, with the latter much more dissected into relatively smaller limestone fragments. This difference is expected to affect migration via underground routes more than surface routes, because substantial forest cover was almost continuous in both regions, at least in historical times. This is why population fragmentation and divergence could be strongly affected by extrinsic barriers. Results from allozymic analyses showed a similar overall degree of genetic structuring in the two cave cricket species (average  $F_{ST}$  were 0.58 and 0.46 in *H. subterraneus* and *H. cumberlandicus*, respectively). On the other hand, although *N. tellkampfi* populations showed a degree of genetic structuring ( $F_{ST} = 0.56$ ) similar to cricket species, *D. kentuckensis* populations displayed much higher values of genetic structuring ( $F_{ST} = 0.96$ ,  $Nm = 0.01$ ), suggesting that some of them are already evolving into reproductively isolated species.

### POPULATION STRUCTURE IN AQUATIC TROGLOBITES: HYDROLOGICAL ROUTES VS. ADAPTIVE DIVERSITY

In aquatic organisms, hydrologic relationships appear to reflect population connectivity and gene flow much better than geographic distance. In some cases populations from different caves exposed to the same groundwater aquifer may show no trace of genetic differentiation, suggesting a single panmictic gene pool, as reported in several crustaceans and

fish. In other cases, strong population subdivisions occur even over very short geographic distances.

The crustacean, *Gammarus minus*, has been the object of several detailed investigations by D. Culver, T. Kane, and D. Fong (1995). This freshwater and cave-dwelling amphipod species is found in caves throughout its range, but morphologically highly modified cave populations are found only in two relatively small regions of Virginia and West Virginia in the United States. Populations of *G. minus* reside in resurgences and related subsurface basins; both in cave stream habitats and occasional openings to the surface (karst windows).

Genetic analysis of allozyme polymorphisms pointed out that the hydrological relationships among populations have largely determined the levels of genetic differentiation. Actually, cave and karst-window populations within a given basin are similar to each other. Different resurgence populations show similar genetic characters as well; genetic similarity between populations is by basin, and not by habitat. As a consequence, F-statistics suggest little if any gene flow between basin and resurgence, and little if any gene flow among populations of different basins.

On the other hand, the analysis of morphological variation in *G. minus* generated a different pattern. In this case, populations are similar by habitat rather than by basin. Populations from cave and resurgence are markedly different, and karst-window populations exhibit a wide range of eye sizes, from very small (a troglomorphic character) to the sizes seen in resurgence populations. Both troglomorphic feature variations and genetic structure of populations suggest independent invasion of subsurface basins, and the overall similarity of eyes in cave populations relative to resurgence populations identify a role for natural selection.

A significant correlation between allozyme and morphological distances was also found, suggesting that morphological variation among populations is largely influenced by evolutionary history. However, there is no significant path linking habitat and genetic distances, indicating that selection has little influence on genetic structure. The significant path linking habitat distances and morphological distances does indicate that selection has a strong effect on morphological variation among populations. A series of several interrelated analyses led to the conclusion that *G. minus* is actually a species complex; populations in resurgence habitats constitute one species, and populations in different basins may be as many troglomorphic species as independent isolations occurred in different basins.

### POPULATION STRUCTURE IN AQUATIC TROGLOBITES: HISTORICAL DETERMINANTS AND SECONDARY CONTACT

In several instances an apparent population structuring can be determined to some extent by a genetic admixture between already differentiated gene pools. In tropical karst

areas rapid evolution of drainage basins combined with tectonic events may alter connections of surface and cave streams, thus producing either isolation or secondary contact between biota adapted to different conditions. The Cueva de Los Camarones in Chiapas, Mexico, offers an excellent example of such situations. Two undescribed species of *Procambarus* crayfish belonging to the *P. mirandai* species group inhabit the subterranean stream. They were roughly distinguishable only by comparing extreme phenotypes, ranging from dark, thick, eyed, surface-dwelling-like individuals to light, elongate, micro-ophthalmic, cave-dwelling-like individuals. Analyses of allozyme polymorphisms and morphometry were performed to enlighten evolutionary relationships among individual crayfish and to explain patterns of microgeographic variation previously revealed along the cave stream. Results from multivariate morphometric analyses showed a real discontinuity between the two species mainly determined by the shape of the rostrum, chelae, and telson. Moreover, these same characteristics exhibited clinal variation within the less cavernicolous species. The genetic structure of the two species was investigated at 23 enzyme loci, revealing unusually high levels of heterozygosity in both species. Results of analyses on individual allozymic profiles corroborated morphometric results, yielding a genetic distance between the two gene pools of  $D = 0.26$ . Due to the occurrence of alternative alleles, we could quantify patterns of introgression revealing absence of F1 individuals and asymmetric gene flow between the two species. In the light of these data, the observed microgeographic variation in morphology within one of the two species, as well as the occurrence of aberrant phenotypes, could be interpreted as the outcome of introgression.

### POPULATION STRUCTURE WITHIN A SINGLE CAVE

A study was carried out on a *Dolichopoda* population within Grotta delle Piane located in Central Italy, in the Umbria region, at altitudes between 200 and 275 m. It is a karst system developing according to three main tectonic fractures, following different directions — north south, east west, and northwest-southeast. The subterranean karst mainly follows the direction of the faults, originating an entangled labyrinth constituted by overlapping horizontal planes. The cave presents four main entrances and, along with other organisms, it is inhabited by *D. laetitiae*, located near the entrances.

To test the hypothesis of a nonrandom distribution of *Dolichopoda* genotypes, the population has been sampled in six near but distinguishable sections where significant aggregates of crickets had been detected. Sectors 1, 2, and 3 are located in the upper level, while sectors 4, 5, and 6 are in the lower one. Population size was evaluated seasonally by mark-recapture. Study samples were classified according to their location and age as juveniles, adolescents, and adults.

Adults were mostly present during the summer season and overall population size ranged between 1766 (autumn estimates) and 2095 (summer estimates).

Trophic niche was also characterized by means of fecal content analysis. Seven categories of items were determined: arthropod remains, moth scales, bat hairs, rodent hairs, green plant remains, vegetable fibers, and fungi. Correspondence analysis, carried out on the item proportions scored for the six sectors of the cave, showed a differentiation of sector 1 sample with respect to all the others. The subpopulation inhabiting sector 1 was characterized by the dominance of plant matter and fungi in diet. Genetic structure was analyzed at seven polymorphic allozyme loci (i.e., *Aph-1*, *Est-1*, *Est-2*, *Gpi*, *Me-3*, *Np*, and *Pgm*). Allele frequencies and heterozygosity estimates were calculated for each of the six considered subpopulations. Multivariate analyses carried out on allele frequencies suggested a clear differentiation of subpopulations inhabiting sectors 4 and 5 between each other and from all the others. *Aph-1* and *Pgm* loci appeared to be chiefly responsible for this ordination. Interestingly, these loci also showed significant deviation from Hardy-Weinberg expectations. The amount of genetic structuring as evaluated by the  $F_{ST}$  index was equal to 0.056 if all loci were considered.

In order to estimate levels of gene flow among different subpopulations,  $F_{ST}$  pairwise comparisons were considered, excluding from the analysis *Aph-1* and *Pgm* as potential loci under selection. To compare results from mark-recapture experiments and from genetic analysis, the different sectors of the cave were grouped as follows: group A, including sector 4; group B, including sectors 5 and 6; and group C, including sectors 1, 2, and 3. In Fig. 2 such indirect estimates of gene flow between the different sectors of the cave are illustrated. Values were of the same order of magnitude as direct estimates resulting from mark-recapture experiments

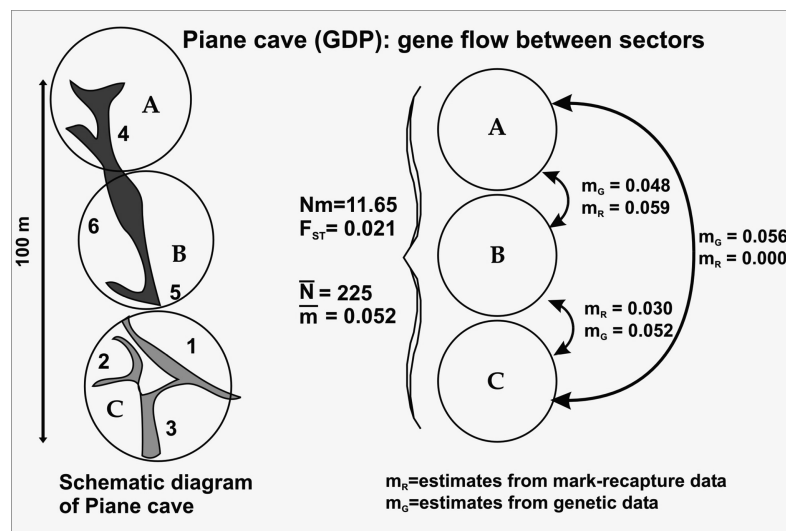
performed ad hoc for comparative purposes. Similarly to the following example, it seems that natural selection, by means of nonrandom distribution of different genotypes, is the process implied in shaping population structure in the Piane Cave.

## POPULATION STRUCTURE AND HABITAT HETEROGENEITY

The hypothesis that habitat heterogeneity affects population structure was investigated in the *D. laetitia* population inhabiting the Cerveteri's Etruscan necropolis near Rome, Italy. This is a well-known necropolis extending throughout a roughly elliptical area of 70 hectares. The necropolis includes approximately 300 tombs of different sizes and location. Small colonies of *Dolichopoda* inhabit most of these tombs raising the following questions: How many *Dolichopoda* populations inhabit the necropolis? Is there a case for a metapopulation (i.e., a population of populations) or, alternatively, for a unique population? To what extent does this peculiar habitat structure affect the population genetic structure?

A. Sansotta, in his thesis and the authors of this article faced these questions by means of a long-term series of ecological and genetic investigations to measure the dispersal ability of crickets across tombs, to estimate the effective population size, to determine the amount of heterozygosity of the population, and to assess whether *Dolichopoda* genotypes are randomly distributed throughout the necropolis (Sbordoni *et al.*, 1991).

Extensive fieldwork was carried out by means of mark-recapture techniques based on individual tagging. Both allozyme polymorphisms and RAPD-DNA markers were employed to carry out genetic analysis.



**FIGURE 2** Estimates of gene flow ( $Nm$ ) between different sectors of the Piane cave calculated from  $F_{ST}$  values (F-statistics, Wright 1965).  $N$  = population size;  $m$  = migration rate.

As a first result from this study, crickets revealed remarkable dispersal ability as they proved to move significantly across tombs to such an extent that the necropolis can be considered as the home range for a panmictic population as a whole. Second, a population sample collected across the necropolis exhibited relatively high values of heterozygosity ( $H_o = 0.218$ ;  $H_e = 0.244$ ) compared to other *Dolichopoda*. Third, individuals carrying definite allele combinations (genotypes) were located preferentially in some tombs within the necropolis to such an extent that genotypes in different partitions of the necropolis were not randomly distributed, but were significantly associated to some cave ecological descriptors, namely temperature.

In summary, these crickets appeared to respond to the necropolis spatial and environmental heterogeneity by means of habitat choice expressed by different genotypes. Therefore, multiple niche selection associated to habitat choice appears to be the most probable selective process to explain the observed high level of genetic polymorphism.

### POPULATION STRUCTURE AND FOOD RESOURCE HETEROGENEITY

The Frasassi Cave System is located in Central Italy, on the Adriatic side of the Apennine Mountains. This karst system is developed in at least four main horizontal levels. Each level shows a complex pattern, strongly influenced by faults and by a hydrogeological setting. The system is characterized by the occurrence of sulfide streams in some sections and by deposits of guano in others. The oniscidean isopod, *Androniscus dentiger*, is the most abundant species in different habitats in the Frasassi caves. G. Gentile and S. Sarbu (2000) studied the possible occurrence of genetic structuring in this species in population samples collected at different sites by means of  $F_{ST}$  analyses based on 18 allozyme loci. Among other samples collected throughout different caves in this system, three neighbor samples were collected within Grotta del Fiume (i.e., Guano room, Green Lake room and along a lateral sulfide section).

Results indicated departures from Hardy-Weinberg equilibrium at several loci, generally due to heterozygote deficiencies. The  $F_{ST}$  value was 0.180, indicating a level of genetic structuring comparable to values found among geographically distant populations of the same species. However, even by removing the Grotta del Mezzogiorno sample from the analysis, the amount of population subdivision remained unexpectedly high ( $F_{ST} = 0.180$ ), especially considering the neighborhood of sampling locations within the same cave. Such an extent of population structure implies very low levels of gene flow, as shown between the Green Lake room and the lateral sulfide section, although each of these demes shows a limited gene exchange with the subpopulation from the Guano room. Interestingly enough, compared to other samples, individuals collected in the sulfide section were proved to feed on different types of resources such as chemo-

autotrophically synthesized food, as established by stable isotope ratio analysis. Again we are facing a situation where natural selection could be involved in promoting and maintaining population structuring in *A. dentiger* in the Grotta del Fiume.

Caves are often expected to be very homogeneous environments as a result of their physical parameters and habitat stability. This may not necessarily be true, at least in instances where localized trophic resources may convert a cave into a patchy habitat, constraining colonies to set around resources, in spite of the potential dispersal capability of individuals. If trophic resource heterogeneity remains stable over time, we could expect that genetic polymorphism is maintained by natural selection. This interpretation explains why several cave-dwelling organisms show relatively high heterozygosity levels notwithstanding their reduced population sizes.

### GENETIC VARIABILITY, POPULATION SIZE, AND NATURAL SELECTION

The amount of genetic variability expressed by troglitic populations is a controversial issue. In fish, for example, a recent study based on RAPD markers suggests that hypogean populations of balitorid fish have lower genetic variability than related surface populations. Similar results were obtained from allozymic studies in the Mexican cavefish *Astyanax fasciatus*, amblyopsid fishes from North America, and a trichomycterid species from Venezuela. The decreased genetic variation observed was reputedly consistent with the expectation that the troglitic fish have smaller population sizes than the epigeic species. Limited to single caves and cave systems, they supposedly have small population sizes. However, a study of hypogean cyprinid fish from Somalia showed that populations of *Phreatichthys andruzzii*, a troglomorphic stygobiont species, are more heterozygous than most epigeic cyprinid species studied thus far. In addition, when comparing this species with its closest relative, *Barbopsis devecehii*, a micro-ophthalmic, less specialized fish also occurring in the groundwaters of Somalia, statistically significant higher heterozygosity values were revealed ( $H_e$  ranging from 0.046 to 0.062 in *Phreatichthys* and from 0.014 to 0.020 in *Barbopsis*). Due to the lack of appropriate population estimates, we cannot test the hypothesis that these differences are related to population sizes. In *Phreatichthys* it has been hypothesized that selective advantage for individuals with high heterozygosity could be involved. Negative correlations have been found in various organisms between individual heterozygosity levels and fitness components such as rate of oxygen consumption, energy requirements for maintenance, etc. These and other metabolic features may represent adaptations to low-energy-input conditions in troglitic and susceptibility to affect selective advantage to a considerable extent. Comparing population structures of *Phreatichthys* to *Barbopsis*, it was revealed that the former is strongly structured into



**TABLE I** Estimates of Heterozygosity in Troglomorphic and Nontroglomorphic Cave Crickets

Orthoptera	No. species	No. pops	Average He	Range of He
<i>Noctivox</i>	1	1	0.180	—
<i>Longuripes</i>	1	1	0.253	—
<i>Hadenoecus</i>	5	18	0.078	0.020–0.130
<i>Euhadenoecus</i>	4	24	0.064	0.030–0.110
<i>Ceuthophilus</i>	1	7	0.026	—
<i>Dolichopoda</i>	10	52	0.144	0.056–0.209
<i>Troglophilus</i>	9	19	0.060	0.000–0.178

genetically isolated populations while consistent gene flow maintains genetically homogeneous in even geographically distant populations of *Barbopsis*, indicating an earlier cave isolation of *Phreatichthys* populations. On the contrary, *Barbopsis* could have experienced a longer direct contact with their epigeal relatives. Because isolation in the cave habitat by means of breakdown of gene flow with epigeal populations is a prerequisite to enhance adaptation of cave populations, it could be speculated that old established cave populations have a higher probability of expressing fitness-related features in their gene pools such as increased heterozygosity.

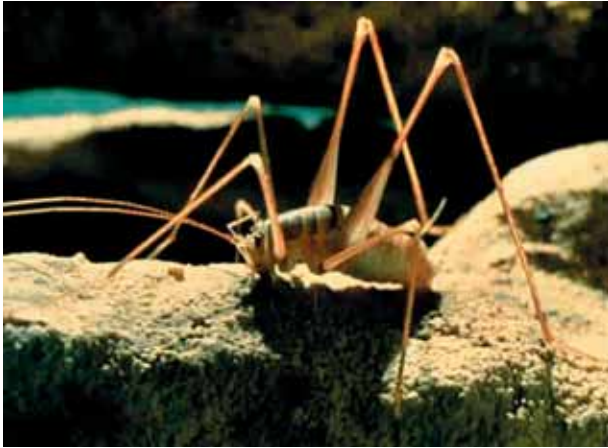
The tenet that troglobites or troglomorphic cave dwellers have low genetic variability may not be generally applicable. A comparison between troglomorphic and nontroglomorphic cave crickets like *Dolichopoda* vs. *Troglophilus*, *Hadenoecus* vs. *Ceuthophilus*, and *Longuripes* vs. *Noctivox* leads to the invariable result that the former have higher heterozygosity than the latter (Table I).

Moreover it can be seen that, among other taxa, several stygobiotic crustaceans such as amphipods and isopods as well as troglobitic beetles show evidence for very high levels of heterozygosity (Table II).

*Niphargus longicaudatus*. Photo by V. Sbordoni*Leptodirus hobenwarthi*. Photo by V. Sbordoni**TABLE I** Estimates of Heterozygosity in Different Troglotic Taxa

Crustacea	No. species	No. pops	Average He	Range of He
<b>Amphipoda</b>				
<i>Crangonyx</i>	1	6	0.118	—
<i>Gammarus</i>	1+	8	0.108	0.075–0.130
<i>Niphargus</i>	4	9	0.274	0.104–0.347
<b>Isopoda</b>				
<i>Androniscus</i>	5+	34	0.102	0.027–0.178
<i>Trichoniscus</i>	2+	12	0.089	0.034–0.218
<i>Stenasellus</i>	4	13	0.079	0.000–0.196
<i>Proasellus</i>	1+	3	0.084	0.037–0.148
<i>Typhlocyrolana</i>	2	3	0.040	0.029–0.061
<i>Monolistra</i>	3	3	0.280	0.261–0.316
<b>Coleoptera</b>				
<b>Carabidae</b>				
<i>Duvalius</i>	2	3	0.114	0.100–0.141
<i>Neapbaenops</i>	1	8	0.192	0.173–0.222
<i>Darlingtonia</i>	1	10	0.009	0.000–0.040
<i>Pseudanophthalmus</i>	3	13	0.094	0.053–0.170
<b>Cholevidae</b>				
<i>Bathysciola</i>	1	1	0.121	—
<i>Speonomus</i>	5	44	0.113	0.060–0.192
<i>Orostygia</i>	2	2	0.165	0.133–0.198
<i>Leptodirus</i>	1	1	0.168	—
<i>Ptomaphagus</i>	1	6	0.056	0.012–0.099

These findings can hardly be explained by large population sizes, but they could reflect the existence of genetic polymorphisms maintained by balancing selection. Interestingly, high heterozygosity levels have been revealed mainly in small arthropods, which appear to perceive the



One *Dolichopoda* specimen. Photo by V. Sbordoni



*Androniscus dentiger*. Photo by G. Gentile

environmental patchiness as coarse grained and therefore favorable in which to adapt to habitat and/or resource heterogeneity by means of a multiple niche polymorphism strategy.

**See Also the Following Articles**  
*Life History, Evolution*

### Bibliography

- Caccone, A., and V. Sbordoni (1987). Molecular evolutionary divergence among North American cave crickets. I. Allozyme variation. *Evolution* **41**, 1198–1214.
- Cesaroni, D., G. Allegrucci, and V. Sbordoni (1992). A narrow hybrid zone between two crayfish species from a Mexican cave. *J. Evol. Biol.* **5**, 643–659.



Somali cave fish:

*Barbopsis devechii*

*Phreatichthys andruzzii*

Photos from Ercolini, Berti, Chelazzi & Messina. 1982. "Researches on the phreatobitic fishes of Somalia: achievements and prospects" *Monitore Zoologico Italiano, N.S. Suppl.*, **17**, 9: 219–241.

- Cesaroni, D., G. Allegrucci, A. Caccone, M. Cobolli Sbordoni, E. De Matthaëis, M. Di Rao, and V. Sbordoni (1981). Genetic variability and divergence between populations and species of *Nesticus* cave spiders. *Genetica* **56**, 81–92.
- Culver, D. C., T. C. Kane, and D. W. Fong (1995). *Adaptation and Natural Selection in Caves*. Harvard University Press, Cambridge, MA.
- Gentile, G., and V. Sbordoni (1998). Indirect methods to estimate gene flow in cave and surface populations of *Androniscus dentiger* (Crustacea, Isopoda). *Evolution* **52**, 432–442.
- Hedin, M. C. (1997). Molecular phylogenetics at the population/species interface in cave spiders of the Southern Appalachians (Araneae: Nesticidae: *Nesticus*). *Mol. Biol. Evol.* **14**, 309–324.
- Sarbu, S. M., S. Galdenzi, M. Menichetti, and G. Gentile (2000). Geology and biology of the Frasassi caves in Central Italy: An ecological multidisciplinary study of a hypogenic underground karst system.. In *Subterranean Ecosystems, Ecosystems of the World 30*, Chap. 19 (H. Wilkens, D. C. Culver, and W. F. Humphreys, eds.), pp. 359–378. Elsevier, Amsterdam.
- Sbordoni, V., G. Allegrucci, and D. Cesaroni (1991). A multidimensional approach to the evolution and systematics of Dolichopoda cave crickets. In *Molecular Techniques in Taxonomy*, NATO ASI Series, Vol. H 57 (G. M. Hewitt et al., eds), pp. 171–199. Springer-Verlag, Berlin.
- Sbordoni, V., G. Allegrucci, and D. Cesaroni (2000). Population genetic structure, speciation and evolutionary rates in cave dwelling organisms. In *Subterranean Ecosystems, Ecosystems of the World 30*, Chap. 24 (H. Wilkens, D. C. Culver, and W. F. Humphreys, eds.), pp. 453–477. Elsevier, Amsterdam.
- Sbordoni, V., G. Allegrucci, A. Caccone, G. Carchini, and D. Cesaroni (1987). Microevolutionary studies in Dolichopodinae cave crickets. In *Evolutionary Biology of Orthopteroid Insects*, (B. Baccetti, ed.), pp. 514–540. Horwood, Chichester, UK.
- Wright, S. (1931). *Genetics*, **16**, 94.
- Wright, S. (1965). *Evolution*, **19**, 355–420.

# Postojna–Planinska Cave System, Slovenia

Stanka Šebela

*Karst Research Institute, Slovenia*

The Postojna Cave System is the longest (19.555 km long, 115 m deep) known cave in the classic karst of Slovenia. The term karst is derived from this region. The Postojna–Planinska system is located 25 km northeast from the classic karst area. The Postojna Cave is connected to the Planinska Cave (6.656 km long, 65 m deep) by unknown passages. There remains a 500-m unexplored separation, although an underground water connection has been known since the explorations of Gruber in 1781. The Postojna Cave system has a lengthy history of tourism. The first printed guidebook was written by Agapito in 1823, but the oldest inscriptions on the cave walls date from the 13th and 14th centuries. Records indicate that since 1819 (more than) 28 million tourists had visited the Postojna Cave. The cave system is also very important for the development of biospeleology.

## PHYSICAL SETTING

### Hydrology and Topographic Setting

The Pivka River flows on impermeable Flysch and sinks into the underground system of Postojnska Cave at an elevation of 511 m. At a point 7 km downstream, the underground Pivka joins the Rak River in the Planinska Cave system and emerges from the Planinska entrance to form the Unica River at an elevation of 453 m. The average flow of the Pivka at the swallow point is 5.26 m<sup>3</sup>/sec. At Postojna, the average annual precipitation (from 1982 to 2000) is 1565 mm. Dye-tracing experiments in 1988 provided evidence for the bifurcation of the Pivka, for the surficial river also drains toward the sources of the Vipava River and thus forms part of both the Adriatic and the Black Sea drainage basins. The portion of the Pivka that enters the Postojna–Planinska Cave systems belongs to the Black Sea drainage basin.

The land surface above the Postojna–Planinska Cave system can be divided into two erosional levels. The lower level is above the Postojna Cave system and reaches 632 m. The upper surface is more than 630 m above Planinska Cave and can reach 753 m.

### Geologic Setting

The Postojna–Planinska Cave system is developed in Cretaceous carbonate rocks. The passages of Postojna Cave

are developed in upper Cretaceous (Cenomanian, Turonian, and Senonian), mostly bedded limestones. The Cenomanian and Turonian limestones are more thin bedded and can include chert lenses. The Senonian limestones range from thick bedded to massive. The cave passages are developed in about an 800-m-thick lithological column. The Planinska Cave system is developed in lower and upper Cretaceous limestone and calcarenite with inliers of limestone, which in the northeast part traverse into lower Cretaceous dolomite.

The area is part of the Javorniki–Snežnik thrust unit, which has overthrust the Eocene Flysch. The Hrušica thrust unit, which is upper Triassic dolomite in the southern part of the area, overthrusts the Javorniki–Snežnik thrust unit. Overthrusting took place after the deposition of the Eocene Flysch. During the Miocene and Pliocene, the overthrusting was accompanied by folding. The principal folding deformation in Postojna Cave is the Postojna Anticline (Fig. 1). Between the Postojna and Planinska Caves is the Studeno Syncline.

It is important to distinguish older overthrusting and folding deformations from younger faulting deformations. The Postojna–Planinska Cave system is situated between two regionally important faults with a northwest–southeast Dinaric orientation. These faults are the Idrija Fault on the north and the Predjama Fault on the south (Fig. 1). The tectonic structure of the area between those two faults has all the characteristics of the intermediate zone between two dextral strike-slip faults. The cave passages follow the strike and dip of the bedding planes, especially those with interbedded slips. They also follow Dinaric- and cross-Dinaric-oriented (northeast–southwest) fault zones and mostly north–south-oriented fissures.

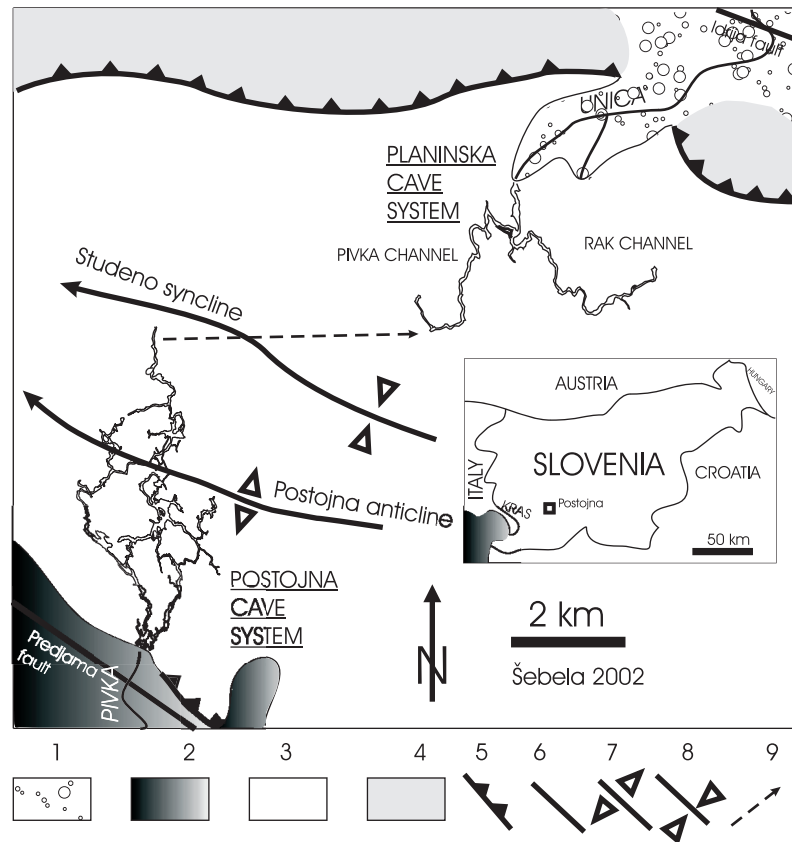
Most of the structural elements were already in place at the beginning of cave development. Later, some of the structures were reactivated and appear to be responsible for the collapse chambers. The structural elements were used as pathways for cave development. In the same fault zone in the Postojna Cave system, horizontal and vertical movements occur with four different reactivations.

Neotectonic faults that were active after cave development can be found in Postojna Cave, where they cut older cave sediments that are 0.78 to 0.99 Ma in age.

## HISTORY OF EXPLORATION

The oldest inscription on a cave wall is from 1213. In 1818, Luka Čeč discovered new parts of the cave, and this is regarded as the official year of discovery of this tourist section of the Postojna Cave system. The train for visitors was installed in 1872, and the cave has had electricity since 1884.

In 1689, Valvasor described the cave as one of the most remarkable caves in the world. Hacquet provided a description of the cave in his work *Oryctographia Carniolica*, written from 1778 to 1779. Nagel produced the first cave map in 1748. The first guidebook was written by Agapito in 1823,



**FIGURE 1** Geological position of Postojna–Planinska cave system, Slovenia: 1, alluvium (Holocene) covering the karst polje of Panina; 2, Eocene flysch; 3, Cretaceous limestone (Javorniki–Snežnik thrust unit); 4, upper Triassic dolomite (Hrušica thrust unit); 5, thrust; 6, fault; 7, anticline; 8, syncline; 9, direction of underground water flow.

and Hochenwart also explained the geology of the cave in his 1830/32 guidebook. Schaffenrath provided cave illustrations in Hochenwart’s book. In 1854, Schmidl described the importance of the discovery of new cave passages by Čeč. Schmidl is also the author of the first monograph on the Postojna Cave system, written in 1854. He was one of the first explorers of some parts of the underground Pivka River in the Postojna Cave system. In the Planinska Cave system, he explored the Pivka Passage to the sump and also part of the Rak Passage in 1850. In 1889, the first Slovene caving club (Anthon) was established in Postojna.

The French speleologist Martel, in his book *Les Abîmes*, included descriptions of many explorations and studies of the Postojna Cave system. At the beginning of the 20th century, Perko was one of the leading names connected with the Postojna Cave system. He was a manager of the cave from 1909 to 1941.

The Speleological Institute was established in Postojna in 1926. Its first task was to find new natural caves and passages between the Postojna and Planinska Cave systems and to connect the caves. Gallino and Petrini surveyed the Postojna Cave system by theodolite in 1933/34. In 1947, the Karst

Research Institute of the Slovene Academy of Sciences and Arts was established. Systematic speleological, geological, morphological, and hydrological studies of the Postojna Cave systems and other caves were carried out.

### DESCRIPTION OF THE CAVE

Postojna Cave is developed in two principal levels. The higher level begins at an altitude of 529.5 m and is represented by dry passages (Fig. 2) that are filled with cave sediments, flowstone, and collapse blocks. The lower level contains the underground channels of the Pivka River and are shifted more to the southwest and northwest with respect to the higher levels. Both levels are connected by side passages. The river channels of Postojna Cave are 10 to 15 m lower than the older dry passages. In some parts, the phreatic passages are still preserved. Paragenetic passages and collapse chambers are also present. The largest collapse chambers are aligned to principal fault zones and developed in thick-bedded limestone.

Studies of the cave sediments show that there were 10 principal development stages of the cave system between the



**FIGURE 2** The tourist railway runs under fallen stalagmite in the Postojna Cave system, Slovenia.

first sedimentary deposits and the present. The stages have been determined by absolute dating of flowstone and the relative ages of the cave sediments. The Postojna Cave system was active at least 0.99 Ma ago. Samples from a small natural passage accessible from an artificial passage showed reverse polarity and are at least 0.78 to 0.99 million years old, belonging to the Matuyama Reversed Epoch.

Most of the passages in the Planinska Cave system are active water channels, with some higher elevation dry passages. Paleomagnetic analyses of sediment in smaller passages indicate that the cave sediments were deposited during the Brunhes Normal Epoch (younger than 0.78 Ma).

## SPECIAL ATTRIBUTES

### Biology

In 1831, one of the first guides in the Postojna Cave system, Luka Čeč, found the first beetle in the cave. The author Hochenwart gave it to Schmidt, who described it as a new species *Leptodirus hochenwarti*. Because the first specimens of cave animals were described from Postojna Cave, the cave is called the birthplace of biospeleology. In 1979, the first specimen of the cave amphibian *Proteus anguinus* was found in Črna Jama Cave, which is part of the Postojna Cave system, by Josip Jeršinič Löwengreif. The only known cave vertebrate in Europe was otherwise first described in 1768 by Laurenti from another cave in southeast Slovenia. The Postojna Cave system is the first described location for 37 species.

### Mineralogy

The Postojna–Planinska Cave system is richly decorated with flowstone (Fig. 2), which is the most common form of calcite in Slovene caves. Allochthonous mechanical sediments, composed of cave sands and loams, were transported to the cave from elsewhere. These minerals reflect the composition of the original noncarbonate rock, mostly Eocene Flysch.

### Paleontology/Archaeology

The first traces of human settlement (e.g., remains of the cave bear *Ursus spelaeus*, cave lion, wolf, deer) in the valley of the Pivka River derive from the Postojna Cave system. Cultural layers from Postojna Cave belong to the last half of the Middle Paleolithic, which is the end of the Mousterian. In the beginning of the Würm glacial period, the presence of Paleolithic man in the cave can be proved reliably.

### Bibliography

- Čar, J. and Gospodarič, R. (1984) About geology of karst between Postojna, Planina and Cerknica. *Acta Carsologica SAZU*, 12, 93–106
- Gospodarič, R. (1976) The Quaternary caves development between the Pivka basin and polje of Planina. *Acta Carsologica SAZU*, 7, 7–139.
- Habič, P. (1989) Pivka karst bifurcation on Adriatic–Black Sea watershed. *Acta Carsologica SAZU*, 18, 233–264.
- Šebela, S. (1998) *Tectonic Structure of Postojnska Jama Cave System*. Založba ZRC, Ljubljana, 112 pp.
- Šebela, S. and Sasowsky, I.D. (1999) Age and magnetism of cave sediments from Postojnska jama cave system and Planinska jama cave, Slovenia. *Acta Carsologica SAZU*, 28, 293–305.
- Shaw, T.R. (2000) *Foreign Travellers in the Slovene Karst 1537–1900*. Založba ZRC, Ljubljana, 244 pp.

# Protecting Caves and Cave Life

William R. Elliott

Missouri Department of Conservation

Human activities and disrespect for caves threaten many caves and cave life, leading to habitat loss, declines in populations, or even extinction. Protection of these resources involves management of the landscape above the cave as well as the minute details of providing proper security systems for caves. Cave restoration can improve conditions for cave life but can also cause problems if not properly done. Public education about cave and karst conservation is essential because many people are not aware of the gradual degradation of cave resources.

## PROTECTING CAVE LIFE

### Threats to Cave Life

Caves are often thought of as unchanging environments, but even in the farthest reaches of large caves there are detectable, annual changes in air and water. Some caves are naturally perturbed by flooding or temperature shifts, and these events influence the types of communities found there.

Caves that flood violently usually lack troglobites, the truly cave-adapted species, but may have troglaphiles (cave-loving species) and troglonexes (animals, such as bats, that roost in caves but exit to feed or migrate). Indiana bats (*Myotis sodalis*) and gray bats (*Myotis grisescens*) hibernate in the near-freezing zone of certain cold-air-trap caves, which are caves with deep or large entrances. Such entrances allow cold air to flow inward during strong cold fronts. In contrast, Mexican free-tailed bats (*Tadarida brasiliensis mexicana*) prefer warm caves with high ceiling domes, which, combined with bat body heat, help to create an incubator effect (over 40°C) for young bats in the summer.

Different animals are adapted to the natural extremes of caves and other habitats. Human-caused threats, however, can severely tax the ability of wildlife to adjust. Some of the most destructive changes to caves were brought about by quarrying and water projects that completely destroyed, or flooded caves. Human disturbance of bat roosts has caused severe declines in numerous bat species (Elliott, 2000). Bats will be discussed in more detail below.

Other pressures on cave life act over long time spans and are more difficult to measure. They include hydrological changes caused by land development, which can alter the normal hydrological cycle and increase sedimentation. For example, residential developments may cause an increase in nitrogenous wastes and sediments washed into caves. Sediments can be harmful to aquatic creatures with gills and/or soft body tissues, such as cavefishes, salamanders and cavenails (eyeless, subterranean snails).

The enrichment of caves by wastes, such as ammonia and other nitrogen-based compounds, in infiltrating waters can lead to an increase in bacterial growth. Bacteria in groundwater are not killed by sunlight, and they can be transmitted for many miles. Residential developments may also bring exotic species, such as the aggressive red imported fire ant, which has caused many problems in caves in Texas (Elliott, 2000).

Regional overpumping of karst groundwater can lower groundwater to the point where important springs and wells run dry, endangering species that live there and threatening water sources. In Texas, endangered species of salamanders, amphipods, and wild rice have been affected by such trends.

Dramatic chemical spills can harm caves if the contaminants seep into streams or other routes into the cave. Once chemicals are in the groundwater, they are difficult to remove. Nutrient loss seems to happen less frequently than nutrient enrichment but can cause severe problems (see later example of Shelta Cave).

### Extinct and Endangered Species

Although about six North American troglobitic species are thought to be extinct, it is likely that others became extinct before they could be discovered or described. Local populations of invertebrates, fishes, salamanders, and bats have been extirpated. Because some troglobitic species are endemic to a

single cave or a small cluster of caves, and because many caves have been disturbed, filled, quarried, mined, or polluted, it is possible that some species have disappeared recently without our knowledge.

### Bats

Bats are important contributors to the world's ecological health. Caves harbor numerous bat species that consume night-flying insects, some of which are pests (McCracken *et al.*, 2002). In the tropics, bats that eat fruit and pollinate plants often roost in caves. So, even though some bats do not use caves, the bat-cave connection is still important.

Declines in North American cave bats became noticeable in the 1950s. Six of the 42 continental U.S. bats are currently on the U.S. endangered species list. The six are dependent on caves for part of their life cycle, and human disturbance has been the major factor in their decline. For example, Indiana bats (*M. sodalis*) have lost significant numbers through disturbance of their hibernacula and improper gating, but also perhaps through warming of their roosts caused by global warming. If such bats cannot hibernate deeply, they use up their body fat too quickly, which results in starvation or death before spring.

Large water projects can drown caves under reservoirs or use them as recharge wells. A recharge project caused violent flooding of the Valdina Farms Sinkhole, a large cave near San Antonio, TX. In 1987, a large flood pulse cleaned out the cave. The cave lost a colony of four million Mexican free-tailed bats (*Tadarida brasiliensis mexicana*) and a rare colony of the leaf-chinned bat (*Moormoops megalophylla*). A salamander (*Eurycea troglodytes*) that lived only in that cave is probably extinct as a result.

The mining of caves for saltpeter, bat guano, or other minerals can have a drastic effect on bat colonies and other fauna. Mexican free-tailed bats have been disturbed by some guano mining in Texas, while some miners may have aided the colonies by mining out rooms that otherwise would have filled with guano. The better operations mine only in the winter when the bats are gone. The opening of large second entrances can severely alter the meteorology of a cave, causing bats to vacate. Marshall Bat Cave in Texas lost its free-tail colony after 1945, when a large, 40-m-deep shaft was dug into the rear of the cave to hoist out guano. The shaft caused too much ventilation and cooling of the cave.

Mammoth Cave once harbored Indiana bats before the entrance was modified to block incursions of cold winter air. The National Park Service is currently trying to reinstate the natural temperature profile of the cave.

Nutrient loss resulting from the loss of gray bats apparently caused a domino effect in Shelta Cave, in Huntsville, AL. Shelta had the most diverse cave community known in the southeastern United States, but land development encroached on the cave in the 1960s, and local residents were concerned about youths entering the cave,

which harbored a large colony of gray bats. The National Speleological Society purchased the cave in 1967, and they moved their headquarters to a building nearby. They gated the cave in 1968 with a strong, cross-barred gate that had been taken from an old jail. This gate, in hindsight, was inappropriate for bats, which abandoned the cave within two years. Urbanization of the area probably also affected the colony. In 1981, a horizontal-bar, bat-friendly door was put on the gate, but no bats returned to the cave. The loss of bat guano to the lake in the cave probably contributed to the decline of cave crayfishes there (Elliott, 2000).

### Cave Preserve Design

Cave conservation encompasses many techniques that can be applied to developed show caves as well as to wild, or unmodified, caves. Show caves, however, have special problems, such as the growth of cyanobacteria and plants near trail lights, accumulation of cave lint and trash, and general disruption of the ecology of the cave. Trail lights are not used at some show caves; instead, visitors are provided with electric hand lanterns, and viewing native wildlife along the trail is a goal of the tour. Such show caves usually provide a more educational experience for the public.

Good cave management includes developing rules for access to the cave. Many publicly owned caves can be left open to the public as long as visitors do not vandalize or disturb cave life. Educational signs at cave entrances are used to inform the public of etiquette and safety rules (Fig. 1). Some caves may require a permit system for entry, based on bat seasons, flooding hazards, or other considerations of safety or sensitivity. Usually, such a cave would be gated to control access, but appropriate signs are needed to inform people of the availability of permits. Certain caves may be considered closed for recreation but not for monitoring and research. Examples include a few caves that are especially pristine and rich in multiple resources or which have overlapping seasons for endangered bats. For example, a few eastern American caves harbor gray bats in the summer and Indiana bats in the winter, and must be closed to entry except perhaps between seasons in May and September.

Cave preserves have been set aside for the protection of endangered species. Too often, however, such preserves surround only the entrance area and do not take in the entire extent of the cave, much less the recharge area to the cave (often referred to as the *watershed*). It is essential to have good scientific information about the cave, including an accurate map, a detailed description, inventories of resources of the cave, and a hydrogeologic assessment. The last item may require a dye-tracing study, in which tracer dyes are put into streams, sinkholes, and other input points. The dyes are recaptured with charcoal traps placed in cave streams, springs, or wells. Maps can then be drawn that delineate the water sources of the cave, which makes it possible to manage the land around the cave intelligently.



FIGURE 1 An informative cave sign.

Lack of detailed information should not stall conservation planning, however. For example, foresters in Missouri try to maintain water quality to ensure a pesticide-free food supply for gray bats. They maintain a continuous forest canopy 60 m wide along streams, in the 8 ha around and above gray bat cave openings, and as travel corridors 60 m wide from gray bat caves to riparian foraging areas. This canopy provides protection from predators and a substrate for insect production.

Buffer zones around small caves that lack streams may include one or more hectares for the protection of terrestrial invertebrates in the cave. It is important to maintain native vegetation and drainage patterns on the epigeum (surface). Even intermittent cave streams may have sources beyond a few hectares, so the preserve would necessarily be larger in such cases. If the cave preserve is adjacent to undeveloped lands, then occasional visits to the cave by raccoons and other nonresident species may continue to provide necessary nutrient inputs in the form of droppings. If the preserve is isolated by developed lands, then the preserve area probably should be larger to maintain native flora and fauna. Camel crickets and harvestmen may exit the cave at dusk and forage for carrion and feces in the surrounding area, but these arthropods may not travel more than 50 to 100 m from the

cave entrance. Pesticide use is banned or limited in cave preserves to avoid poisoning the cave fauna directly or indirectly. Even a small cave may have to be protected with a strong cave gate to prevent heavy visitation and vandalism, which can alter the cave habitat. Such cave gates should be designed to freely allow bats and small animals to pass back and forth. Preserve designs are discussed in various species recovery plans and in guidelines issued by the U.S. Fish and Wildlife Service and other agencies.

Buffer zones around large caves may be more difficult to achieve. For example, Tumbling Creek Cave in Missouri has high biodiversity and a recharge area of 9 mi<sup>2</sup> (2331 ha). Since 1967, the cave was protected under two private properties with extensive forest cover, losing streams, and light farming and cattle production. Even though the cave was protected by the Ozark Underground Laboratory, gray bats gradually declined for unknown reasons. Recently, sedimentation from poor land usage by a neighbor contributed to the decline of a cavenail unique to the cave. A drought of several years probably also contributed to the decline. Today, more of the recharge area of the cave is under careful land use, but it remains to be seen if the cavenail will increase again.

In Southeast Alaska's Tongass National Forest, studies found that some old-growth forest areas had to be protected on intensely karsted terrain. The limestone was so pure that little mineral soil had developed, and trees grew out of a thin moss blanket. When the area was clear-cut, the thin soils washed off into the numerous sinkholes, which fed cave streams, which fed salmon streams. In a sense, the karst served as three-dimensional stream banks feeding the local streams; they could also be considered as stream buffers removed at a distance, and were protected under existing laws and forestry standards. Some cave entrances and sinkholes received slash and runoff from logging and roads, in violation of the Federal Cave Resources Protection Act. Many of these areas are now protected from road building and timber harvest.

Some states have published karst best management practice (BMP) sheets for construction projects on karst. Different types of karst may require different BMPs. Missouri's 2000 karst BMP is reproduced below, with some modifications, by permission of the Missouri Department of Conservation.

## MANAGEMENT RECOMMENDATIONS FOR CONSTRUCTION PROJECTS AFFECTING KARST HABITAT

### Introduction

Karst features range from sinkholes, vertical shafts, losing streams, and springs to complex underground drainage systems and caves. These features are the result of the dissolving action of water on carbonate bedrock. Under-

ground drainage systems can be extensive; as a result, specific karst features can be impacted by disturbances occurring miles from the affected area.

Associated with karst features are unique plants and animals that have at least part, if not all, of their life cycle dependent upon the unique environment of these systems. Even slight alterations or disturbances can have significant impacts upon these plants and animals. It is of utmost importance that construction projects in known karst topography be extremely sensitive to the potential impacts that may occur and that all possible precautions be taken to prevent or reduce those impacts.

### Karst Identification

It is often difficult to clearly delineate the type and extent of karst features present due to the complex and varied processes involved in their formation; however, it is important to correctly identify and delineate karst features so that these areas are managed properly for the resident species (e.g., a bat hibernaculum or a bat maternity cave).

- Initial investigation should include the use of state, federal, and private geotechnical data. Observation by speleologists or geotechnical consultants should be considered if existing data indicate the presence of karst features in the vicinity. Initial geological investigation of the immediate and surrounding area of the proposed project site should be conducted to determine the presence and type of karst features.
- The identification and delineation of karst features should include the following: location, distribution, and dimensions of rock cavities; location, distribution, and dimensions of soil voids; depth and configuration of the rock surface; variation in the physical characteristics of the subsurface soils and rock; groundwater quality and flow patterns.

### Access and Staging Area Management Recommendations

Staging areas are those short- or long-term sites within a construction or development area where most equipment and materials are stored. These areas are often accessed frequently, and when fuel and oil are stored here the potential for run-off and erosion in these areas may be high.

- Erosion and sediment controls should be installed and maintained to prevent discharge from the site.
- Staging areas for crew, equipment, and materials should be established well away from karst features such as caves, sinkholes, springs, and highly erodible soils when practical.
- Stationary fuel and oil storage containers should remain within a staging area or another confined area to avoid accidental introduction into the groundwater.



- Excess concrete and washwater from trucks and other concrete mixing equipment should be disposed of in an area well away from karst features, streams, and wetlands.
- If temporary roadways must be built, ensure that roadways are of low gradient with sufficient roadbed and stormwater runoff drains and outlets. Appropriate containment basins, silt fences, filter strips, etc. should be included for retention of storm water run-off as a means for reducing sedimentation introduction into karst features and groundwater.

### Buffer Zone Management Recommendations

The buffer zone is the vegetated area immediately surrounding the karst feature, which helps slow runoff and filter out pollutants that might enter karst systems. A buffer zone of at least a 100-foot radius should be maintained on all sides around caves, sinkholes, and springs.

- Buffer zones located down slope of construction areas should be physically screened with sediment controls, such as silt fences or filter strips. Sediment controls should be monitored after rain and maintained for the duration of the project.
- General application of pesticides, herbicides, or fertilizers within the buffer zone should be prohibited to avoid contamination due to overspray or runoff. Fertilizer use or spot-application of pesticides and herbicides may be acceptable if appropriate nonrestricted chemicals are used.
- All buffer zones disturbed by the project should be revegetated immediately following or concurrent with project implementation. Native trees, shrubs, and grasses should be planted to ensure long-term stability in areas where the soil erosion threat is not critical. Annual non-native grasses such as rye or wheat may be planted in conjunction with native species to provide short-term erosion control. Areas judged to be subject to immediate soil loss due to steep slopes or other factors causing critical erosion conditions may be planted with non-native mixtures to ensure rapid establishment and erosion control.
- Post-construction evaluation of vegetation establishment should be conducted at 1-month intervals for at least 3 months after completion of the project. Any recommended sediment controls should be inspected at these times. If determined beneficial to soil stability and not adversely impacting site function and/or aesthetics, recommended sediment controls should remain permanent.

### Karst Area Management Recommendations

Karst areas provide habitat for a diversity of highly specialized and sensitive vertebrate and invertebrate animals. These

areas also provide an important filtration system for the underground water humans use and drink. For this reason, it is important to avoid rerouting waterways and drainage patterns in karst areas.

- All construction debris, refuse, discarded containers, and any other waste materials should be stored away from karst areas. Take care to contain this material to prevent its accidental introduction into caves, sinkholes, or springs as a result of cleanup activities, runoff, flooding, wind, or other natural forces.
- Sedimentation and erosion controls appropriate to soil type, water flows, exposure, and other site-specific factors should be implemented during all phases of construction.
- Sediment and erosion controls should be monitored periodically. Clean, repair, and replace controls as necessary.
- Final revegetation of disturbed areas should use native plant species. Grasses, such as rye or wheat, may be used with non-native mixtures initially to maintain soil stability until establishment of native vegetation can be completed. A monitoring program should be included in the project proposal to ensure successful revegetation efforts.
- All temporary erosion and sediment controls should be removed (unless removal would cause further disturbance) and disposed of within 30 days after final site stabilization is achieved or after temporary practices are no longer needed.
- All debris and excess materials should be removed and properly disposed of upon completion of project.

### Cave Gating Criteria

Cave gates are steel structures built to protect cave resources by keeping out human intruders while allowing air, water, and wildlife to pass freely in and out. Cave gates have locking doors or removable bars so that authorized persons can gain access during appropriate seasons for necessary work. Poorly designed cave gates can harm wildlife and cave resources. Cave gating is not an automatic solution to cave conservation problems, and there are many reasons for not gating a cave. Technical knowledge and experience are required to gate a cave; for example, installing a gate cannot be done properly by a general welding contractor without the proper specifications, design, and on-site supervision by an experienced cave gater. Knowledge of cave ecology, especially bats, is necessary before a gate can be considered. Similar techniques are used for gating abandoned mines, which often harbor bats of great value. Some governmental agencies assist cave owners in cave gating, but first a decision guide must be followed, as discussed later.

A few rules of thumb can be followed for cave gates. Natural entrances should not be sealed, but opening a long-sealed cave also can cause problems for the cave unless some

means of protection is devised. Gates should not be made of reinforcing bar (or *rebar*), as it is much too weak. Chain-link fences are easily breached but can be used around sinkholes if necessary. Do not construct any raised footings, stone work, or concrete walls on the floor or around a gate because they can hinder air exchange and change the temperature at the bats' favorite roosts. Gates should be tailored for the wildlife inhabiting the cave. A cave gate is not a substitute for good land management but is a last resort.

Limited space does not allow a full discussion here of the many construction techniques that have been developed for cave gating. Cave gate designs and specifications by the American Cave Conservation Association (ACCA), Bat Conservation International (BCI), and National Speleological Society (NSS) are available on the World Wide Web and in publications.

### Cave Gate Styles

Depending on the requirements of the cave, the type of entrance, and the presence of bats and other wildlife, the design could specify a full gate, a half gate or fly-over gate (Fig. 2), a chute gate (particularly for maternal gray bats), a cupola or cage gate (Fig. 3), an enclosure, a fence, or no gate at all. For example, due to certain physical restraints, it may

not be feasible to gate some bat caves that require the protection of a gate. Also, many caves that could be gated do not have to be gated because other modes of protection may work better.

It is important to rely on an experienced cave-gating expert. Leading organizations are ACCA, BCI, NSS, U.S. Forest Service, U.S. Fish and Wildlife Service, and the Missouri Department of Conservation, among others. ACCA's designs were adopted by BCI and many government agencies and have become the industry standard. These organizations conduct regional cave-gating workshops to demonstrate the proper decision-making process, design, and construction techniques for ecologically sound cave gates (Fig. 4). Construction of such gates has provided significant protection of colonies of endangered bats, such as grays, Indianas, and others, which has resulted in increases in their populations. Protection of other irreplaceable cave resources is another benefit of properly built gates. These cave-gating workshops may also lead to the formation of regional cave-gating groups made up of representatives from local organizations. The workshops include lectures supplemented by construction of actual cave gates under the direct supervision of cave-gating experts. Each gate is somewhat different, and various problems in funding, logistics, design, teamwork, safety, and construction must be solved.



**FIGURE 2** The half gate at Great Spirit Cave, Missouri, is 31 m wide and weighs 16 metric tons. It protects gray bats (*Myotis grisescens*) in the summer, Indian bats (*M. sodalis*) in the winter, and many other resources.



**FIGURE 3** A cupola or cage style of cave gate allows bats to gain altitude and exit laterally, which is easier than flying up through a horizontal grate.



**FIGURE 4** A cave-gating class builds a bat-friendly cave gate at McDowell Cave in Missouri. Note the T-bar stiffeners inside the end of the top horizontal bar which provide greater strength and an airfoil design for lower wind resistance. Proper spacing of the bars is essential.

Gates are now made stronger than in the past, but it is important to check and repair them regularly because any cave gate can be breached by determined vandals. Designs have evolved to foil attempts to tunnel under a gate or to destroy the door or lock. Specifications vary for different gate styles. Gates are usually made of mild steel angle iron. Stainless and Manganal steels may be used in corrosive environments, but they are more expensive, more difficult to cut and weld, and unnecessary in most applications. The design life of most mild steel gates may be 30 years.

### **Cave Gating Decision Guide**

#### **ARE THERE POOR REASONS NOT TO GATE THE CAVE?**

For example,

- Purely aesthetic objections to a gate while the cave's resources are being degraded anyway.
- It may "start a trend" towards too much gating.
- Because a few people consider themselves above the rules and may threaten the gate.

Score no points for any poor reasons not to gate.

**ARE THERE POOR REASONS FOR GATING THE CAVE?**

For example,

- For fear of liability, which may be nonexistent; cave owners are protected by law in some states.
- For administrative convenience (instead of having a comprehensive conservation program).
- To keep wild animals or competing explorers out.

Score no points for any poor reasons to gate.

**ARE THERE GOOD REASONS NOT TO GATE THE CAVE?**

For example,

- The gate, as designed, will not comply with current ACCA and BCI standards.
- A vigilant owner or manager lives nearby.
- Other controls can be used—road gates, signs, surveillance.
- Visitors probably will comply with a good permit system.
- Cave management experts are opposed to the gate.
- The cave gaters are inexperienced and overconfident.
- No one will commit to checking and maintaining the gate.
- The entrance is too small for a proper gate (e.g., a half-gate for gray bat maternity colony), or the environment or budget will not allow a good design.

Score one point each *against* gating for any good reason against gating that holds true.

**ARE THERE GOOD REASONS TO GATE THE CAVE?** For

example,

- The cave is hazardous to casual visitors, and no other controls (permits and signs) are adequate.
- Endangered species inhabit the cave and can be bolstered by protection.
- The cave is a target for vandals, looters, and trespassers; a better clientele is desired.
- The cave has high value, is threatened, and can best be studied and appreciated with a good permit system combined with a gate.

Score one point each *for* gating for any good reason to gate that holds true.

**FINAL RESULTS** Add up the points for and against gating, and determine which seems more important. Other criteria may have to be considered.

**Security Systems**

In the near future, technology will allow cave conservationists to deploy electronic alarms and surveillance equipment in lieu of cave gates or to supplement gates that are frequently attacked. New sensors are becoming available that can distinguish human-sized intruders from bats and

other small animals. The major option for a cave manager would be an audible alarm versus a silent alarm. The former may frighten off intruders or anger them, possibly leading to an attack on the equipment. A silent alarm would alert an authority, who could apprehend or warn the intruders. In the latter case, the key question would be “Who will respond, and how quickly?”

A few of the many options for these security systems are outlined below:

- Sensors for detecting humans could include light detectors, infrared light beams, motion detectors, pressure mats, and seismic detectors.
- Light detectors are available as data loggers, which record the time and date that a light illuminated the detector in the dark zone of the cave. Such data loggers may be used to measure the amount of traffic in well-traveled caves or to detect if anyone has trespassed into a closed cave, but the data are downloaded later and cannot determine anyone’s identity. Similar light sensors can be linked to an alarm system that would alert a manager or law officer; however, it is usually necessary to install such sensors in the dark zone, which would leave the entrance and twilight zones unprotected.
- Invisible infrared light beams can be positioned at a certain height so that bats and wildlife are unlikely to trip them, and they can be deployed in the entrance, but false alarms may occur. They require continuous electrical power, as do motion detectors. The latter might be tuned to ignore small animals, and they can be placed in the entrance.
- Pressure mats can be buried just below the surface and can be linked together to create a security zone. Such a mat uses no electrical power until it is triggered by someone stepping on it.
- Seismic detectors can be concealed and tuned to respond only to the seismic shaking caused by a human walking or by earthquakes.

All of the above sensors must be linked to a system that conveys information out of the cave, either via a cable that must be concealed or by wireless relays. The system can then trigger an automated message or radio call to an authority.

Concealed video and still cameras are routinely used by law officers to obtain evidence leading to the arrest and conviction of law breakers. They are somewhat labor intensive and vulnerable to attack if noticed by culprits, but they are easily deployed to new sites as needed.

**MANAGEMENT AND EDUCATION****Cave Management**

A general goal of land management over a cave is not to alter the landscape very much or build infrastructure such as sewer lines, pipelines, roads, and the like, especially if the cave

contains streams and species of concern. Paving over the top of a cave cuts off much of its water supply. Emplacing septic systems may relegate the cave to a sewer. For prescribed burns, smoke must not be allowed to enter caves, especially those occupied by endangered species such as bats. For example, if a hillside is burned under certain meteorological conditions, a cold front could carry the smoke down the slope and into a cave, especially if it is a cold-air trap. This smoke could be harmful for hibernating bats. Conversely, smoke could rise up a hill and into a cave that serves as a summer roost and is a warm-air trap.

### Cave Restoration

Many cavers and cave managers favor cave cleanup and restoration projects for multiple reasons. Graffiti removal may seem to be only an aesthetic pursuit, and it usually does not directly help restore wildlife in the cave unless toxic materials are removed. However, one has to consider how some caves become targets for vandalism. If a government agency or cave owner allows people to vandalize and litter a cave, then many visitors may assume that it is all right and will continue to do so. Inaction could be considered as condoning the bad behavior. Vandalism sometimes extends to harassment or killing of bats and other wildlife. Trashy caves give rise to ignorant behavior and serve as places to misbehave; this behavior then spreads to other caves. The same behavior is seen in illegal dumping grounds, where a few leave some household trash on public or vacant land. If no one objects, others then opportunistically dump there, and the problem escalates. Signage does not seem to help at that point.

Volunteers can be enlisted to photograph, document, and then carefully remove graffiti. Such a conservation project helps to restore public respect for a cave, especially when the work is publicized and the effort explained. An important public education need is filled in this way and it is an important opportunity to educate volunteers about cave wildlife.

Significant signatures and markings usually are left in place or documented in a file or database before removal. Various rules and laws define the type and age of markings that must be preserved in place, so it is best to check with the appropriate state historical program office about such requirements. More stringent requirements may be practiced by conservationists on their own initiative.

An example of effective restoration is Little Scott Cave in Missouri, managed by the Missouri Department of Conservation (MDC). This cave is near a highway, and it became a target for repeated vandalism, including extensive graffiti, breakage, the death of two bats by spray painting, the littering of hundreds of beer cans from underground parties, and occult ceremonies. Cavers repeatedly tried to clean up the mess and notified the MDC. Finally, the MDC gated the cave in April 2000 and simultaneously instituted a easy

procedure for getting access to the cave. Those interested in entering the cave can call or e-mail the agency to get the combination to the lock on the cave gate, as long as they can answer some basic questions about caving etiquette, gear, and safety. MDC awarded grants to two grottos (caving clubs) to clean up the cave with low-impact techniques in which no chemicals were used. This work was noted in local newspapers and in Elliott and Beard (2000).

Before restoring a cave to a more natural state, it is important to consider how altered the cave is and define realistic goals for the restoration project. Is it a show cave with many years of accumulated change and little hope of complete restoration, or is it a wild cave that is not so ecologically disturbed? In a show cave, nuisance species may be present, such as cyanobacteria near electric lights, exotic species in cave lint along trails, or epigeal (surface) wildlife that is attracted to artificial food sources in the cave. The following questions should be asked before planning projects:

- Do we know what native species should be in the cave?
- How can we restore the cave to a more normal aesthetic and ecological state without harming the native species?
- To what historic period should we restore the cave?

The historic period is an important aspect of ecological restoration for the benefit of bats, the populations of which have declined drastically within the last few decades. Some species of bat can be protected by bat-friendly structures (e.g., a fly-over gate or fence for some species or a properly designed gate for species that will fly through). Some roosts may return to the maximum past population, as measured by ceiling stains, but most colonies do not fully recover. Some bat species (e.g., Mexican free-tails) will not tolerate a gate at all. No cave is ever completely restored to its former aesthetic or ecological state, but a proper biological inventory and careful project planning will increase the success of restoration efforts.

It is important not to remove decayed wood and organic matter from a cave without first checking it for cave life, which may have colonized it over many years. An NSS handbook now exists to aid in proper cave restoration and conservation.

### Prioritizing Caves

Cave protection usually involves crisis management: Caves and cave life that are under the greatest threat receive the most attention. Rarely do we look at caves over a large region and consider which ones are most deserving of protection before they become degraded. Caves can vary greatly, and comparing and ranking them would seem to be a daunting task. In some states, adequate records exist that would allow cavers, managers, and scientists to evaluate and prioritize

caves for protection. Ideally, a cave would receive a numerical score for each of its resources. A composite score could then be derived for the entire cave and could be used for ranking and prioritizing caves or karst regions. A cave could be scored for its length, depth, hydrology, biology, geology, paleontology, archaeology, history, speleothems, aesthetics, recreational value, and threats against it. Each aspect could be scored in various ways; for instance, for biology, we could consider the total number of species present, how rare or endemic the troglobitic species of the cave are, the importance of the cave to endangered species, and its overall biodiversity. Small numerical differences between caves would not be important, as the rankings would be used as a general guide.

Most states have a natural heritage database, usually within a state agency, and many states have a state cave database, usually managed by a nonprofit cave survey organization. Increasingly, these databases are being voluntarily shared by the two types of organizations for the purpose of protecting significant caves from road and land development and other threats. The precise locations of caves, especially those on private lands, are protected in each system so as not to draw the attention of potential intruders.

### Public Education

Cave conservation includes publications, videos, and educational programs for the public. The Missouri Department of Conservation and other organizations offer workshops on cave ecology for biologists and teachers (Elliott, 2002). It is not necessary for the public to become experienced cavers to achieve conservation goals, but it is

helpful to inform the public about all the resources offered by caves. Two concepts are important to convey to the public: (1) caves operate on a much longer time scale than surface landscapes and are essentially nonrenewable resources, and (2) our caves have already lost so much that when we visit a cave we should give something back to it. For example, we can pick up trash, teach others about cave conservation, or be advocates of the cave in regard to those who have authority over it.

### Bibliography

- Links and references with an asterisk are available at the Biospeleology web site: <http://www.utexas.edu/depts/tnhc/.www/biospeleology>
- Elliott, W.R. (2000) Conservation of the North American cave and karst biota, in Wilkens, H., Culver, D.C., and Humphreys, W.F., Eds., *Subterranean Ecosystems*, Vol. 30, Ecosystems of the World Series, Elsevier, Amsterdam, pp. 665–689.\*
- Elliott, W.R. (2002) Where to learn about caves, in *Conserving Missouri's Caves and Karst*, Missouri Department of Conservation, Jefferson City, MO, pp. 29–33.\*
- Elliott, W.R. (2004) Biological do's and don'ts of cave restoration and conservation, in Hildreth-Werker, V. and Werker, J., Eds., *Cave Conservation and Restoration*, National Speleological Society, Huntsville, AL, pp. 33–44\*
- Elliott, W.R. and Beard, J.B. (2000) Cave restoration. *Missouri Conservationist*, 61(10), 14–16. (Also available at <http://www.conservation.state.mo.us/conmag/2000/10/>.)
- McCracken, G.F. and Westbrook, J.K. (2002) Bat patrol. *Natl. Geographic Mag.*, April.
- MDC (2000) *Management Recommendations for Construction Projects Affecting Missouri Karst Habitat*, Missouri Department of Conservation, Jefferson City, MO, 2 pp.
- Nieland, J. (2003) Bat gate construction on-site coordination and work, in *Proc. of the Bat Gate Design Forum*, Austin, TX (available at <http://www.mcrcc.osmre.gov/bats/>.)



---

## Recreational Caving

**John M. Wilson**  
*Marks Products, Inc.*

### RECREATIONAL CAVING DEFINITION

*Recreational caving* may be defined as the activity of entering a void, such as a cave, for the pure joy of the activity. When entering a cave, cavers would expect it to be totally dark, even during normal daylight, for the experience to be truly considered as caving. Most cavers generally agree that the definition of *cave* is “an underground void large enough for a person to get into.” But, even though some measure of fun can be had checking out small cave-like openings, true recreational caving involves exploring longer cave passages, which also might include manmade voids such as mines and tunnels. A few deep pits and caves have long, relatively straight entrances that allow daylight to penetrate the entire cave, but cavers still consider these to be valid caving caves; Deer Cave in Malaysia and Neversink Pit in Alabama are examples of exceptions to the total darkness rule. The information in this section is based on caving in true recreational caves or voids.

Recreational caving as defined here includes sport caving as well as relatively easy cave recreation that might involve only walking passages and visiting caves by large groups. Recreational caving may overlap with more avocational or professional caving purposes when recreational cavers add speleological activities to their cave visits or vice versa. These avocational and professional activities may include photography, mapping, and various cave-related scientific specialties. Cave activities or caving have become a subordinate occupation for avocational cavers, who give many volunteer hours for the joy of it, as material compensation for caving is rare.

### TYPES OF CAVES USED

The following five types of natural caves used in recreational caving are ranked by popularity, based on information obtained from cave publications and other sources. There are significant differences in cave popularity in some geographic areas, depending on the type of caves available for caving.

#### Solution Caves

Limestone and other solution caves are by far used the most by cavers for recreation. They are formed by several types of solution processes described elsewhere in this book. Availability is the most important factor in determining the popularity of types of recreational caves in a given geographic area. This is why limestone caves top the list of popular caves. This group also includes caves formed in marble, dolomite, and gypsum. These three types make up a small part of the recreational caving in solution caves.

#### Lava Caves

Lava caves, which are often referred to as lava tubes, are the second most common type of cave used for recreational purposes. Cavers cave in lava tubes as well as lava voids that are not in tube form. These caves result from flowing lava and other processes described elsewhere in this book. Many lava caves have relatively flat floors and multiple entrances, making them suitable for those with limited caving skills. Lava caves do have their own special risks. They often have dark, very rough-textured surfaces with sharp edges that absorb light, reducing the effectiveness of caving light systems. Many novices have been amazed to discover the extent of torn clothing after traversing small passages in lava caves, in contrast to an equivalent-sized passage in a limestone cave.

### Sea Caves

Sea caves are formed primarily by wave action at the shores of oceans and large lakes. They are the most common type of erosion caves. These caves are less common than limestone or lava caves and are always located at past or present sea levels. The relative predictability and attractiveness of their locations make sea caves the third most popular type of cave for recreational caving. Some sea caves have considerable incidental visitation by people primarily doing other forms of recreation. Many sea caves have no totally dark areas; however, this apparent deficiency is more than made up for by other factors. The interaction of tides and waves and the often abundant variety of life forms in and near sea caves are appealing to cavers who would not normally visit these comparatively small caves if they were not next to the ocean. Some partially flooded caves at sea level were formed primarily by solution processes or flowing lava. Technically, these are not sea caves but are solution or lava caves. Recreational cavers may not be able to make this distinction, and visitation information in some reports indicates visits to sea caves when it was in fact the caving occurred in solution or lava caves.

### Talus and Tectonic Caves

Talus caves are formed when very large rocks fall from mountains or cliffs. The spaces between the rocks are sometimes large enough to allow a person to enter. Tectonic caves are formed by tectonic processes along faults near the Earth's surface. Few people use talus and tectonic caves for recreation, as they are usually small and have few caving features of interest to most recreational cavers, making these the fourth most popular type of cave. Little documented caving occurs in these types of caves; therefore, ranking them separately is not statistically meaningful.

### Ice or Glacier Caves

Ice caves are formed in glaciers and are the least popular type of the five natural voids used for recreational purposes. These caves are cold, wet, and unstable. Specialized skill and equipment are necessary to explore ice caves successfully. These caves are located only in glaciers and ice fields; thus, they are rare and remote from population centers. Sometimes lava caves with permanent ice deposits are referred to as ice caves, but these ice deposit caves are still considered lava caves, despite the common mistake of referring to them as ice caves.

### OTHER VOIDS USED

Some man-made voids are occasionally used by people for caving. They might even use some of the same type of equipment, but in most places it is not recommended by

caving organizations due to safety and legal considerations. As with all caving, the permission of the property owner should be obtained before entering. Most owners of abandoned mines and buildings will not grant permission for recreational purposes.

### Mines and Tunnels

These and other voids in the Earth created by people are rarely used for recreational caving purposes because of their instability. In terms of absolute visitation, mines are used by mine workers far more intensively than caves are used by recreational cavers. Miners use some of the same equipment as cavers. Once abandoned, mines tend to become unstable, and owners are often obligated to construct gates or other barriers and post entrance restrictions. Among the few interesting exceptions to these generalizations about mines is the Wieliczka Salt Mine near Cracow, Poland. Part of the mine is developed as a show cave, but cavers should not expect to go caving in the mine, as visitors are limited to the show cave area.

### ACTIVITIES NOT CONSIDERED CAVING

Some activities that appear to be caving are usually not considered recreational caving by cavers. Visiting a show cave and show caving are activities done by many more people than recreational caving. Some surface activities, such as looking for caves (which cavers call *ridge walking*), are not considered caving in this section, which presents a more precise description of traditional recreational caving by not including data from show caving and cave-related surface activities

### Shelter Caves

Shelter caves are small, naturally occurring voids that may be formed by any of the previously described cave formation processes. In addition, aeolian caves formed by wind are usually considered shelter caves. Many people visit shelter caves as an incidental part of other surface recreational activities, so there is little documentation of their visits. Because shelter caves are penetrated by daylight and require no caving equipment, visiting them is usually not considered recreational caving.

### Show Caves

Show caves have manmade improvements that allow for easier passage; thus, almost anyone can go into one of these caves without any special skills or equipment. Show caves are managed as a commercial business that charges an admission fee or are maintained by a governmental agency, often as part of a park system, and may also require a user fee. Show caving is not considered caving by most cavers because of the cave



improvements. The major disqualifying improvement is the artificial light provided, usually as a permanently installed electric light system or as a communal light carried by a tour guide. Some show caves have supplemental offerings and are referred to as *wild caving*. These cave trips may or may not be led by a guide. In either case, wild caving in show caves is considered recreational caving.

### Manmade Show Caves

Manmade show caves are usually built to provide a hands-on educational experience for the public. The historic cave paintings in Lascaux, France, are shown to the public in a manmade cave that was created because the originals were being threatened due to changes in environmental conditions associated with visitation. Some such manmade structures do include the kinds of caving challenges that appeal to some recreational cavers and provide an opportunity to practice caving skills. Visiting these manmade show caves might be considered recreational caving, depending on the specific caving conditions.

### Abandoned Buildings

Little information is available on the recreational exploration of these types of structures, perhaps because it is often illegal. Manmade surface enclosures usually do not appeal to the traditional caver, although some of the same caving skills and equipment are used by the few people who do enter these structures. Most cave organizations do not recommend caving in abandoned buildings because of structural instability and legal considerations.

## FACTORS CONTRIBUTING TO RECREATIONAL CAVE VISITATION

Some caves become very popular, with visitation averaging several hundred people a week; however, most caves rarely see humans, and the few who do enter have other purposes, such as mapping or research. Cave popularity can be affected by word of mouth, the media, availability of other recreational options, and cultural changes. Recent increases in the popularity of other forms of recreation and extreme sports may have provided alternatives for potential cavers; thus, the number of recreational cavers is most likely lower than it might otherwise could be. Cave visitation can be influenced by the following six criteria, listed in a plausible order of importance:

- *Known existence.* The cave must be known to exist, and such knowledge is often spread by those taken to caves by previous visitors. The location of a cave location can also be spread by word of mouth and by various print and electronic media. Keeping the location of a cave secret, at least in the short run, has

significantly delayed the advent of recreational caving to these caves.

- *Physical access.* For visitation, a cave must have physical access. Factors affecting physical access to a cave might include gates, barriers, or proactive access control, as well as caves being difficult to find or requiring long hikes from the nearest road to reach the entrance. Other physical factors include vertical entrances, which reduce visitation of non-vertically equipped cavers to near zero but attract those with vertical caving capabilities. Water barriers or in-cave sumps usually keep all but properly equipped cave divers from entering.
- *Distance to cave.* With all other factors being equal, the farther a cave is from a given starting point, the less likely it is to be visited. The percentage of the population who have caved is higher in communities located in karst areas than in areas more distant from suitable caves; however, even moderate distances may change the nature of how people organize in order to cave. It appears that cavers living in urban areas tend to organize more effectively, perhaps to accommodate their transportation needs; thus, these organized cavers may continue to remain actively involved longer than those people who live close to caves but are not organized into a cave group. It is true that many very experienced cavers travel all over the world to go caving; however, most recreational cavers are not experienced and will go on only a few cave trips in their lives. Recreational cave trips tend to be to caves that are relatively nearby. It is reasonable to assume that a higher percentage of existing caves have been discovered in areas that are easy to access.
- *Caver appeal.* Popular caves have one or more interesting features that appeal to the caver, such as significant size and complexity, aesthetics, unique or unusual geologic features, interesting biota, fun caving features, caving challenges, or cultural mystique. The attractiveness of a cave to cavers often depends on the degree to which cavers can do the things they like to do in a cave, such as a climbing through complex passageways, crawling into different parts of the cave, and exploring and seeing interesting cave features.
- *Suitability for group caving.* Almost all recreational caving is done in groups of 3 to 30 people. Caves without places where people can stop and socialize or at least communicate are noticeably visited less often by recreational cavers.
- *Legal access.* Anarchy exists in a few places in the world, and social deviance occurs to some degree in all cultures. These factors partially account for the fact that the single act of legal posting or closing of a cave is not always effective. Cave owners usually take additional actions if they intend to achieve total compliance with their cave restrictions. Some posted

caves with little or no enforcement may continue to have cave visitation; the extent of the trespassing depends on the respect for property rights among the area's cave visitors. All respected cave organizations recommend that cavers should never trespass in a cave that has been gated or posted. Serious consequences of ignoring such postings include lawsuits, serious injuries, and human fatalities, partially due to spelunkers disregarding cave closings.

### WHY PEOPLE BEGIN CAVING

There is no single reason why people enter caves. Attempts to sum up caving using a short, catchy phrase have resulted in oversimplified explanations. People who cave do so for many different reasons. Non-cavers may find it difficult to imagine why anyone would crawl in the mud, climb in the dark, and go into tight places. Most people start caving to have an enjoyable experience. The most common reasons why people cave are listed below. They apply to novice as well as avocational cavers.

- *To enjoy the company of others in a fun group activity.* The social aspect is a significant factor for novice recreational cavers. Schools, youth groups, and community groups often sponsor cave trips.
- *To explore or have an adventure.* Maze exploration is considered great fun by many. The excitement of cave exploration can be compared to exploring a complex maze. The curiosity to see what is around the bend in the passage or beyond the extent of one's light leads the caver on. The increased adrenaline and other hormone production in the stimulating cave environment provides a pleasurable sensation. Some people enjoy this experience and will return for more. Psychologists have provided strong evidence from studies of animals and people that exploratory behavior is an innate characteristic. If so, this behavior may explain why people cave; however, it does not explain why they cave as opposed to choosing other forms of exploration. It is unlikely that an innate exploratory need completely accounts for caving behavior, as most people explore other things and never see the inside of a cave.
- *To accomplish something unique, to see things that most people have not seen or done, or to learn something about caves and nature.* For example, some cavers have the goal of discovering a "virgin" cave, a cave passage thought to have had no prior entry by humans.
- *To engage in a physical or sporting activity for the personal challenge or just for the exercise.*

### THE OCCASIONAL DOWN SIDE

Sometimes a person goes on a cave trip with mistaken assumptions, believing that it will be an exciting adventure

full of glamorous achievements and revealing a hidden world of wondrous vistas, not to mention the possibility of finding something of value such as a hidden treasure. It is a considerable disappointment when the new caver discovers reality. It is often hard work getting to and through caves. Much of the time is spent traversing passages that are anything but glamorous, and the wondrous sites are few and far between. No crowds are cheering the caver on. Actually, only a few other people care about these exploits. On top of all that, there is no buried pirate or other kind of treasure in caves, and in most places laws prohibit the removal of mineral formations and artifacts. In fact, most cavers help enforce these laws, and the National Speleological Society (NSS) even offers a reward of up to \$1000 for the arrest and conviction of anyone guilty of cave vandalism (check with the NSS about the current status of this award). It is not unusual for a new caver to emerge from a cave wet, muddy, bruised, and tired with sore muscles he did not know he had and nothing much to show for his efforts, with memories being mostly of mud and rock seen from a distance of 20 cm while crawling. He has probably decided this will be his first and last cave trip. In fact, he has a lot of company, as between one fourth and one half of the people who have gone caving once will never go on another cave trip. This figure does vary, depending on the type of cave trip in which the person participated and the type of future cave trips available. Cave trips that are competently led in caves appropriate for the first-time caver will lead to higher repeat caving rates.

### NOVICE CAVERS

Since the founding of the National Speleological Society in 1941, there have been significant improvements in caving techniques, equipment, and safety procedures. Many recreational cavers are among the best-equipped and most experienced cavers. As a result, recreational cavers have penetrated farther into caves and coped with more challenging situations.

Inexperienced cavers sometimes try to emulate competent recreational cavers with bad results when they exceed their skill level and have inadequate equipment for the situation. Novice cavers make up a significant portion of all recreational cavers and sometimes can be identified by their inappropriate equipment, misdirected motivation, or lack of cave knowledge. Some novices who have not had a good orientation and/or have had no contact with the mainstream of the organized caving community may do strange and sometimes dangerous things in caves. For example, while there may be some instances when the following items might be appropriate in a cave, the possession of some of these items in a cave and the kinds of reasons given for having them usually identify the person as being either unprepared for cave trips or someone who has plans to vandalize the cave. In general, one should not take any of the following into a cave on a recreational trip:

- Large knives for killing snakes, bats, or other wildlife
- Guns for shooting bears or outlaws
- Handheld flashlight or candle as the primary or only light source
- No auxiliary light sources, or unreliable light sources
- Clothesline or other light-duty rope for rappelling down a drop or pit
- Hemp rope for climbing hand over hand out of a pit
- Balls of string to unwind and mark one's route in order not to get lost
- Hand-carried coolers for beverages, especially alcoholic beverages
- Alcoholic beverages or mind-altering drugs
- Paint, especially a can of spray paint
- Equipment for collecting cave mineral formations

Except when it is clear that such equipment has been brought along for certain professional or ceremonial activities, observing someone with any of this equipment should cause enough concern to take appropriate action. Some cavers might try to advise such a person of the inappropriateness of the items and recommend corrective action before going caving. Cave conservation and appropriate equipment and techniques are discussed in other chapters of this book.

Unfortunately, a few recreational cavers have engaged in destructive activities such as painting graffiti in a cave, breaking cave formations, stealing mineral formations and artifacts, and harming cave life. Many states and some countries have cave protection acts that provide for punishment under the law for harming caves or their natural inhabitants. Cavers will sometimes refer to cave vandals as spelunkers.

The term *spelunkers* is often applied to recreational cavers. The word is derived from the Latin word *spelunca* ("cave") or the even earlier Greek word, *spelaiion*. However, in the organized caving community today, comprised of those who have learned proper techniques for cave exploration and developed an awareness of the fragile nature of this underground resource, the term *spelunker* has become a derogatory term. The majority of English-speaking cavers would not refer to another caver as a spelunker, although there are a few exceptions to this rule. Two cave clubs in Missouri are composed of competent cavers with an independent spirit who refer to themselves as spelunkers.

### WHY DOESN'T EVERYONE CAVE?

Some avocational cavers have wondered why everyone does not go caving, while other cavers are glad everyone doesn't. Millions of people living in North America have caved at least once. Professional and avocational cavers number in the tens of thousands. For these thousands, caving is the epitome of experiences life has to offer. The stereotypical cave trip involves crawling or wiggling through tight places, sometimes no more than 20 cm high, where mobility is severely restricted. Sometimes cavers must crawl through a

stream or slide through a passage on their back, with only a few inches of air space between the water and ceiling. Some cavers thrive on these challenges; others do not. Anyone with even mild claustrophobia will be unlikely to return to this type of activity. The same is true of people with acrophobia, as many caves have floors that are little more than a series of rocks, boulders, crevices, and pits. Bats and a variety of invertebrates do not appeal to everyone. Erroneous beliefs and imaginary threats stop others from even considering going into a cave. The vast majority of the population does not enjoy these types of experiences. They either avoid exposure to such situations or accept them as a one-time experience in life. Some people enjoy a more sedentary life style that is incompatible with sport caving. Most caving requires effort, sometimes strenuous effort, to participate.

Other limiting factors include vertical caves with entrance drops or pits. These entrance drops may be anywhere from a few meters to more than a 300 meters deep. Special skills and equipment are needed for this type of caving. Many difficult cave rescues have been a result of poorly informed and inadequately equipped recreational cavers attempting to descend into vertical caves.

### A CAVING LEVEL FOR ALMOST EVERYONE

People interested in caving are pleased to discover that they can choose caving activities appropriate to their training and interests. Caving varies widely in its intensity, required skills, and equipment. Exploring some caves requires little more effort than taking a short hike; such caving requires no special equipment beyond a good light system. Diversity is the very nature of caves, and cavers can pursue their interests in many different cave environments. Caves present a continuum of difficulty requiring more organization, planning, and stamina. Cave divers require special training and underwater breathing equipment.

Someone seeking an athletic challenge or someone who is an extreme sports aficionado can find caves suited to their goals. Cavers who search for new caves, draft cave maps, or take cave photographs have a seemingly endless opportunity to find and record nature's handiwork. A cave is usually a low-energy environment that is often isolated from outside environments and hence spawns many different life forms. Caves are a natural attraction for geologists and biologists. This variety of activities attracts people with widely varying interests, nowhere more pronounced than at a National Speleological Society annual convention, where the program includes numerous special-interest sessions, contests, and workshops stressing various cave-related skills, as well as hundreds of different presentations.

### WHY DO PEOPLE CONTINUE TO CAVE?

The transition from recreational caving status to being an avocational caver or speleologist often occurs as these cavers

find that caving is more interesting if it has a purpose. Caving merely to do informal exploration of a cave that many others have seen and studied before may no longer satisfy the needs of the more adventurous. A few cavers have adopted caving as a life-long avocation. The careers of most speleologists were preceded by some recreational caving. Others who were recreational cavers at one time may have stopped caving for various reasons but maintained their support of cave organizations and goals, and involvement in other cave-related activities.

The hierarchy of human needs model proposed by Maslow in 1954 describes the sequence in which people focus their efforts on meeting their various needs—physiological, safety, belonging and love, esteem, self-actualization, cognitive, and aesthetic. People meet their more basic needs first and then proceed to address their higher needs. Considering the characteristics of large, complex, and scientifically interesting caves, it can be easily understood how caving meets the self-actualization, cognitive, and aesthetic needs of an avocational caver. Participation in cave-related organizations may also meet some belonging and esteem needs. A person mainly focused on basic needs and trying to survive is unlikely to participate in caving.

### DEMOGRAPHIC FACTORS

Contemporary studies conducted by members of the National Speleological Society have discovered several significant differences between cavers and the general population. None of these studies has been published outside local caving newsletters, but the results are intriguing:

- *Age.* The mean age of recreational cavers, as determined by information gathered from cave registers between 1975 and 1985, was 21 years (mode, 18 years). The frequency of caving decreases significantly with increasing age. Anecdotal information obtained recently indicates that the mean age of cavers may be greater by several years.
- *Sex.* Males make up 75% of cavers and make up an even higher percentage of cavers on cave trips, which suggests that males have taken a greater average number of cave trips. There does not appear to be any component of recreational caving that would favor one sex over the other. Most people say that cultural factors account for this difference. While this may be true, it is not an adequate explanation. A more explicit hypothesis suggests that caving activity is closer to traditional male activities such as outdoor physical activity, exploratory behavior, and risk taking. These activities, plus being covered with mud and dirt when caving, are not those normally associated with traditional feminine activities. A test of this hypothesis would occur in a society where the roles of women have veered away from the traditional feminine roles;

if caving is primarily a culturally linked phenomenon, then one would expect the percentages of female cavers in such a society to increase.

- *Race.* In North America, Caucasians are the most numerous ethnic group, representing at least 95% and probably more of all cavers. There are far fewer African-American cavers than would be expected, given their percent of the population. There is anecdotal information that caving activity among Hispanic populations is lower than for non-Hispanic Caucasians. Recreational caving exists in most parts of the world, but data indicate that the percentage of the population engaging in recreational caving is highest in Europe and North America, although no definitive studies on this issue have been conducted. One plausible explanation that may account for some of these differences could be that recreational caving is similar to other forms of recreation that require significant leisure time and equipment. While the cost of basic caving equipment is not considered expensive by Western standards, it might be beyond the reach of many. Maslow's hierarchy of needs may also help explain this difference, as people will focus most of their attention on meeting basic needs before acting on higher needs. The hypothesis is most plausible if one assumes that in Europe and North America a greater percentage of the population is focused on meeting their higher needs, and recreational caving fulfills these needs for people who are active cavers. While Maslow's hierarchy of needs may account for some caving frequency, other factors are at work here that have not been studied in relation to recreational caving.
- *Length of cave trips.* The length of cave trips can last from a few minutes to several days. Most recreational cave trips fall within 2 to 8 hours, and the average is about 4 hours. The length of cave trips is mostly a factor of the size of the cave, difficulty traversing a particular cave, and the interest and ability of each caver.
- *Cycles in cave visitation.* Cycles in the frequency of caving do occur (e.g., seasonal variations), with the warmer months being more popular than the colder ones. Because most caves have a relatively constant temperature year-round, it appears that factors other than temperature are more important in determining when to go caving. Also, weekends are generally significantly the most popular time to visit caves.

### SUMMARY

While recreational caving has parallels with other forms of recreation, its diverse nature allows people to enjoy an activity in the same places and sometimes in the same organizations as professionals with similar interests. People

cave for many different reasons, at many different skill levels, and in a several different types of caves requiring a variety of equipment and techniques. While young males are the most common cavers, all types of people can be found caving. People have clear preferences in the features and types of caves they choose and in the distances they choose to travel to cave. Recreational caving can be a risk to both the cave environment and the caver. The effort required to navigate through restricted passageways filled with water and mud, drops, rough terrain, and assorted other obstacles is enough to keep most people from trying it or discourage them from returning. These same features are part of the appeal of a cave and contribute to the cognitive challenges, diverse types of participation, and spectacular aesthetics associated with caves.

### See Also the Following Articles

*Exploration and Light Sources • Rescues*

### Bibliography

- Archer, J. and Birke, L. (1983) *Exploration in Animals and Humans*. Van Nostrand-Reinhold, New York.
- Maslow, A. H. (1954) *Motivation and Personality*. Harper, New York.
- Zuckerman, M. (1994) *Behavioral Expressions and Biosocial Bases of Sensation Seeking*. Cambridge University Press, New York.

## Rescues

**John C. Hempel**

*EEL Geophysical*

From time to time those who explore caves do not return to the surface under their own power. Trained teams of cavers take it upon themselves to rescue cavers who are in trouble. Rescues are required for many reasons: there may have been an accident and a caver is injured, cavers may be trapped by rising water, and cavers may simply have lost their lights and are unable to move or become lost. Cave rescue is a highly organized activity in the United States.

### INTRODUCTION

Since humans began using caves for habitat, recreation, or religious reasons, accidents have been a real threat to those exploring the netherworld. Prior to electronic communication, cave rescues went almost unnoticed outside of the community in which they occurred. Since the 1920s media coverage of cave rescues has turned unfortunate ordeals into public entertainment. Cave rescues first attracted national attention when Floyd Collins, a young caver and explorer from Kentucky, became trapped in Sand Cave, KY, in 1925.

His attempted rescue and death has been the subject of records, movies, books, and documentaries. During the attempt to free Floyd, hourly radio news reports held the nation captive for days. Newspaper articles documenting the efforts of his rescuers won a young journalist, Skeets Miller, a Pulitzer Prize.

In 1925 few individuals practiced caving as a sport and recreation in caves was a novel idea. As a fairly new sport, experienced cavers were rare and few could be found to help at Sand Cave. No one at the rescue had been trained for cave rescue emergencies and they lacked the specialized equipment to save Floyd's life. The rescue team had no idea how to help Floyd remove the rock that pinned him. Miners, farmers, relatives, and hundreds of other people came to the scene and tried to help. Eventually there were so many bystanders that the rescue took on a circus-like appearance, complete with hot dog stands and vendors selling souvenirs. After days of entrapment and bitter cold, Floyd died, imprisoned by a 14-pound rock.

### HISTORY OF RESCUE

Since 1925, cave exploration has increased in popularity and frequency. Caving has become one of the "new outdoor sports." With this increase, people of many backgrounds have become attracted to caves. They come for adventure, for recreation, and for science. Unfortunately, not all visitors come with the proper equipment or training. It is often these poorly prepared "spelunkers" that rescuers are called to help. Currently almost 90% of cave rescue emergencies result from poorly prepared or inexperienced people entering caves. As the number of people entering caves has increased, so has the need for rescue.

Like any sport, people can be injured in various ways while exploring caves, and many rescues require rescuers to possess special skills to reach and treat the caver. However, most missions are initiated for simple problems, such as a light failing or the group lost in an unfamiliar area of the cave.

Cave rescues take many forms. The simplest rescue mission might involve locating a lost person, and a more complex rescue could involve negotiating multiple vertical drops or water problems while carrying an injured patient. These missions may involve as many as 200 rescuers.

The National Speleological Society (NSS) first began recording cave rescue information around 1950 and each year since has published the rescue information gathered. Currently, these accident reports are collected in a single yearly publication entitled *American Caving Accidents*.

Additional record keeping is done by the National Cave Rescue Commission (NCRC) and by individual regions of the NSS. One example is the eastern region of the NCRC, which has maintained their regional mission reports on file, on the Web, and available for research. These are available on the eastern region Web site or by accessing their files. The NCRC records are compiled each year as part of the publi-

cation *American Caving Accidents*. These data banks have made it possible to take a comprehensive look at the growth of cave rescue in America. By studying mission reports compiled over the past 30 years, rescuers can better prepare for future rescue situations and determine training needs for an area.

## DEVELOPMENT OF RESCUE TEAMS

In order to better understand the growth of cave rescue in the United States, the historical records were categorized and divided into several time periods. The mission types, frequency, and occurrence showed that there was an almost proportional increase in the number of rescue callouts and the growth of the caving population as determined by increases in NSS membership. From this, one can infer that the growth of the NSS reflects an overall increase in total hours people spend sport caving each year. As more people take up caving, more accidents occur.

The increase in total accidents graphs as a parallel linear trend when compared to NSS growth but when accidents are graphed by type, the growth trend shows several sudden peaks followed by a gradual return to a more linear trend. An example of this was the sharp increase in the vertical and water rescue accident rates when new equipment and skills were introduced in the 1970s. It is theorized that this surge in vertical and water missions reflects a lack of training or experience in using the new equipment resulting in higher accident rates. As training and experience were gained, the rate declined and eventually returned to a more normal growth line.

As accidents increased over the 50 years of study, more rescuers were needed to help on rescue missions. This resulted in the formation of local cave rescue teams. During the 1960s and 1970s, teams such as the National Capital Cave Rescue Team and the Hondo Underground Rescue Team (HURT) responded to rescues all over the country. These teams were soon featured in men's magazines such as *Saga*, which ran an article entitled "Get the Heroes from HURT." The backlash from all of this publicity set cave rescue team training back a decade.

## IN THE BEGINNING

Cave rescue teams were a relatively new concept in the United States during the 1950s. Organized training in cave rescue was done informally by local clubs but not on a national scale. Before 1976, no structured rescue classes were available to cavers. Because of this, cavers learned rescue skills by doing rescues.

From training done by early clubs, the first true American cave rescue teams emerged. The earliest teams were formed in response to accidents occurring on club trips or when club members were nearby. During the early years an injured caver often waited for hours as one of the established cave

rescue teams was summoned to the site. This often took many hours resulting in a number of body recoveries instead of rescues.

Cavers recognized the need for more formal training. Grottos (local NSS chapters) began training and new teams were formed around experienced leaders. As these teams gained in mission experience, they began to amass information on which techniques worked and which did not.

In the 1960s, the NSS formed the first Cave Rescue Commission and began planning for a national policy on cave rescue. The first commissioners met at NSS conventions and began the first formal exchange of information between teams. This effort continued with several false starts and slowdowns until 1976 when the first formal certification in cave rescue was offered by the West Virginia Fire Extension Service. This class, taught by NSS instructors, was the beginning of the society's first organized effort to train cave rescuers.

Since 1977, the NCRC of the NSS has taken the lead in cave rescue training throughout the United States and the Caribbean. Standards for cave rescue developed by the NCRC are derived from mission experiences, mission data analysis, and current rescue training standards.

## LEARNING FROM THE PAST

Mission records reveal some interesting facts about the types of mission each decade spawned, including how training and experience influence the outcome of many missions. As the years progressed, better trained teams succeeded in saving lives more often than untrained teams and experienced fewer injuries to team members.

### Accident Frequency Rate during the 1950s

National Speleological Society cavers in the United States spent a maximum of 1,440,000 hours caving per year. There were 13 rescue missions or incidents reported during those 1,440,000 hours of caving in the decade of the 1950s. For NSS caving this translates to one accident per roughly 111,000 hours underground during the decade.

### Accident Frequency Rate during the 1960s

Caving in the 1960s started off with a bang. New rappelling systems, such as brake bars and carabiners, replaced the body rappel for descending. Prusik knots were replaced by new and faster Jumars. Ascending devices and improved cable ladders opened previously unexplored passages to a new generation of cavers. All over the country cavers were off to push greater depths and longer drops. With this quest to push the limits, rescues became harder and more frequent.

By the beginning of the 1960s, the NSS was recording several rescues per year. As a result the NSS became more interested in defining its rescue capabilities. In 1960 the NSS

polled its members to determine who had rescue experience. The survey found that only 81 members nationwide had cave rescue experience, about 8% of the active members of the NSS at that time.

### Accident Frequency Rate during the 1970s

From 1970 to 1980 there were 198 incidents reported. Caving was getting safer but people were pushing harder and accidents were increasing. The NSS had about 3200 members and cavers had one accident per 23,272 hours underground. For the first time chronic medical problems became a factor and rockfall turned up as a cause of 8% of the rescue missions.

The 1970s saw additional improvements in equipment and technique. Descending devices now included racks and figure eights in addition to brake bars and carabiners. The introduction of better equipment was not complete until braided nylon ropes appeared and Charlie Gibbs introduced his Gibbs ascent system at the 1969 NSS Convention. During this period southeastern cavers were experimenting with racks for descending long drops and with new abrasion-resistant rope designs. Vertical caving took a giant leap forward and vertical incidents took a leap upward. The percentage of vertical missions dropped back from 42% in the 1960s, but the number of vertical problems increased.

### Accident Frequency Rate during the 1980s

The 1980s found cavers well equipped to push the hardest caves and “world class caving” was introduced. Cavers took the new equipment, mastered it, redesigned it, and even manufactured it in order to explore the world’s largest caves. With equipment mastery and vertical skills training a part of every caver gathering, the vertical accident rate started to trend back toward the linear caver population growth curve.

From 1980 to 1990, accidents continued to increase as did membership in the NSS. However, vertical accident rates began to drop. This decade saw 300 incidents with an NSS membership of 5200. The calculated rate of accidents per hour underground remained near that of the previous decade with one accident occurring per every 24,960 hours of caving. Analysis of incidents indicated that for the first time vertical accidents were not the leading type. Water-related accidents surpassed vertical accidents this decade because sport diving became more popular and the great cave springs claimed many lives. Chronic medical problems doubled in response to the aging of the caving populations and the availability of treatments that allowed persons with chronic medical problems to become more active.

## THE PRESENT

The years from the 1990s and into the twenty first century were ones of consolidation. The NCRC sponsored cave

rescue training courses at beginner and advanced levels in most parts of the country at regular intervals. Rescue certification was well established. Many involved with rescue had advanced from basic first aid to emergency medical technician (EMT) and paramedic status. Most caving groups have a local cave rescue committee and relations with other search and rescue organizations such as police and fire departments have greatly improved. For the unfortunate victim of a caving accident this means a shorter wait for rescue personnel to arrive, better medical training when they do arrive, and an effective organizational structure that deals with everything from proper packaging and transport of the victim from the cave to news conferences with the media.

Most countries with active caving groups have found it necessary to organize formal rescue teams. These groups have interacted and exchanged information through the International Congresses of Speleology which are held every four years.

### See Also the Following Articles

*Recreational Caving*

### Bibliography

Hempel, J. C., and A. Fregeau-Conover (2001). *On Call*. National Speleological Society, Huntsville, AL.

---

# Root Communities in Lava Tubes

**Fred D. Stone**

*Hawai'i Community College*

**Francis G. Howarth**

*Bernice P. Bishop Museum*

**Hannelore Hoch**

*Museum fur Naturkunde, Germany*

**Manfred Asche**

*Museum fur Naturkunde, Germany*

Plant roots were not considered an important food resource in cave ecosystems until the discovery of a planthopper and other cave-adapted animals on tree roots in a lava tube in Hawai'i Volcanoes National Park in 1971 by Francis Howarth. Furthermore, very few troglobites (obligate cave dwellers) had been reported from lava tubes or from tropical caves. In the subsequent three decades, cave-adapted species have been discovered in many areas of the tropics in lava tubes as well as in other suitable subterranean habitats. Advances in knowledge of tropical cave communities and of the Adaptive Shift hypothesis for cave species evolution are

described by Howarth and Hoch elsewhere in this encyclopedia. The potential for discovery of new cave species in the tropics is great, as only a tiny part of the potential underground habitat has been studied to date (Fig. 1).

### HABITAT AVAILABLE FOR TROGLOBITE EVOLUTION

Lava tubes are a small subset of the total habitat available to troglobites; other habitats include:

- *Mesocaverns*, which are small voids, about 0.5 to 25 cm in width, beneath the surface in many kinds of substrate. These mesocaverns include fractures, cracks, and vesicles in many kinds of rock; cracks, animal burrows, and tree root holes in soil; spaces between rocks in talus slopes or other types of rock piles; spaces in rocks and gravel from alluvial deposits or along stream beds; and solution cavities. The mesocavernous environment is most likely the predominant habitat for cave species because it has such a large potential area and is near enough to the surface to contain abundant energy resources from root penetration, migrating surface organisms, and water-transported organic matter.
- *Caves in limestone or other soluble rock*, which are generally the best-studied cave communities because of their attraction to cavers and their accessibility, but they may not be the most widespread habitat for cave species.
- *Tree root habitats*, which are also much larger than those found in lava tubes. Roots can penetrate through soil layers and porous or fractured rock deposits in many

kinds of surface materials. Lava tube root areas are particularly important because they allow access to the underground habitat by scientists, who otherwise have a difficult time gaining access to the cave species. Lava tubes have the additional advantage that they form in lava flows that flow along the surface of the ground, so they generally tend to be fairly shallow throughout their length. Limestone caves may also contain important root communities, particularly in areas near the surface or with ready access to the water table.

Species that live on and around tree roots include many surface species, such as ants, that venture underground but are not necessarily adapted to survive entirely in the deep cave zone. Other species spend a portion of their life cycle underground on or near tree roots, such as immature stages of planthoppers (Hemiptera: Fulgoromorpha; *e.g.*, Cixiidae) and cicadas (Hemiptera: Cicadidae). Cicada nymphs spend up to 17 years underground feeding on tree roots until they crawl up the tree trunk and emerge as surface-dwelling adults. In spite of their long sojourn underground, no cicada species have yet been discovered that spend their entire life cycle in the subterranean environment. This adaptive shift has been made in many areas by planthopper species, however.

### THE CAVE ENVIRONMENT IN RELATION TO CAVE SPECIES

#### Energy Sources

Tree root communities gain their energy from photosynthesis on the ground surface and therefore have the same trophic structure as surface communities with primary producers,



FIGURE 1 Lava tube passage with tree roots.



herbivores, carnivores, detritivores, decomposers, and fungivores. Sugar produced in the tree leaves is transported downward through the trunk and into the roots, where it becomes the energy source for root growth and for the species that feed on the roots (Fig. 2).

### Moisture/Humidity

Troglobites live in air saturated with water vapor and have a number of adaptations to cope with high humidity, such as loss of pigments and thinning of their skin or cuticle. Species that feed directly on sap or water in tree roots can survive in somewhat drier areas due to the constant supply of moisture through the tree roots. Examples include cave planthoppers in the family Cixiidae.

### Air Flow

Restricted airflow is essential to survival of cave-adapted species, as airflow is desiccating. Certain types of air motion may actually introduce moisture into caves in dry areas. For example, the interaction of surface air with cave air often causes moisture to condense in the zone of contact. This results in a drip zone just inside the entrance of caves. Cave-adapted species may be found living under rocks, in cracks, or on roots in this zone. Lava tubes in dry areas of Hawai'i sometimes act to remove moisture from air flowing through them, if they are sufficiently deep and have restrictions to prevent the loss of water vapor. Hawaiians took advantage of these water traps as sources of water for drinking and agriculture. Tree roots follow the moisture, so often on dry lava flows on the leeward side of Hawai'i, *Metrosideros polymorpha* ('ōhi'a) trees survive by sending roots into these water-trap caves.

### O<sub>2</sub> and CO<sub>2</sub>

In the root zone deep in the soil, or in mesocaverns, oxygen is depleted and carbon dioxide increased by respiration of the roots and of soil organisms. Air exchange with the surface is restricted in these zones by the small, labyrinthine nature of the spaces, allowing the oxygen/carbon dioxide imbalance to be maintained. Species living in this zone need to adapt to the low oxygen and high carbon dioxide levels. In deep caves with restricted airflow, a similar oxygen/carbon dioxide imbalance can occur for the same reasons. Areas with animal guano or washed-in organic matter can have enhanced carbon dioxide and lowered oxygen due to respiration by bacteria and other decomposers. Carbon dioxide is heavier than air, so it moves downward and accumulates in lower areas of caves.

### Influence of Cave Geomorphology on Ecological Conditions

The shape of caves and lava tubes is critical for the occurrence of habitat suitable for cave-adapted species. The

most important elements are the following: (1) restriction of airflow to reduce the impact of surface air, which can cool and dry the cave; (2) passages that trap water vapor, such as low ceiling segments followed by higher ceiling areas, upsloping, or upper-level, dead-end passages; and (3) passages that serve as carbon dioxide sumps (for example, low floor areas or downsloping dead end passages).

## CAVE ZONES IN RELATION TO ROOT GROWTH

### Tree Roots

Tree roots penetrate the substrate to obtain water and nutrients for growth. In lava flows and limestone areas with fractured or cavernous substrate, surface water rapidly percolates to the water table at some depth below the surface. Some tree species are adapted to send their roots deep beneath the surface to reach the water table. Areas with fractured or cavernous rock often have little or no surface soil, due to its erosion into the underground habitat, or, in the case of lava tubes, due to the recent lava flows. Trees may also have adaptations that allow them to survive on nutrients that leach from the cave rocks. Where the water table is too far below the surface for roots to penetrate, the voids in the substrate may accumulate water vapor that the roots can utilize. In Hawai'i, troglonexes such as bats and crickets do not occur and therefore do not contribute nutrients in guano to the cave community. In mainland areas, such as the Undara lava tubes in Queensland, Australia, bats bring significant amounts of guano into the lava tubes that provides nutrients for the tree roots as well as the scavengers (guanobites).

Trees that can grow on bare rock have adaptations for sending roots deep to a water source and may penetrate into caves more than 30 m below ground. This is especially true in the tropics, where the high evapotranspiration rate imposes a severe stress on trees. In the wet/dry tropics, these trees often stay green while those growing in soil often lose their leaves in the dry season. In Hawai'i, varieties of 'ōhi'a are adapted to colonize bare rock in new lava flows. Roots appear to have special adaptations for growing on bare rock. The 'ōhi'a tree is one of the first colonists on new lava flows, and it also grows in wet soil areas in the rainforest. Research in lava tubes in Hawai'i Volcanoes National Park showed that trees in wetter areas had roots with thinner outer layers and larger vessels in the xylem. This adaptation would make the roots easier to penetrate by the piercing mouthparts of the cave planthoppers. In Australia, *Brachychiton* species and some *Eucalyptus* species send roots into caves, and *Ficus* species do this where they occur throughout the tropics (Fig. 3).

### Entrance

Entrance zones of lava tubes are often more densely vegetated than surrounding areas. This is partly because the entrance pits accumulate dust and debris from the surface, providing

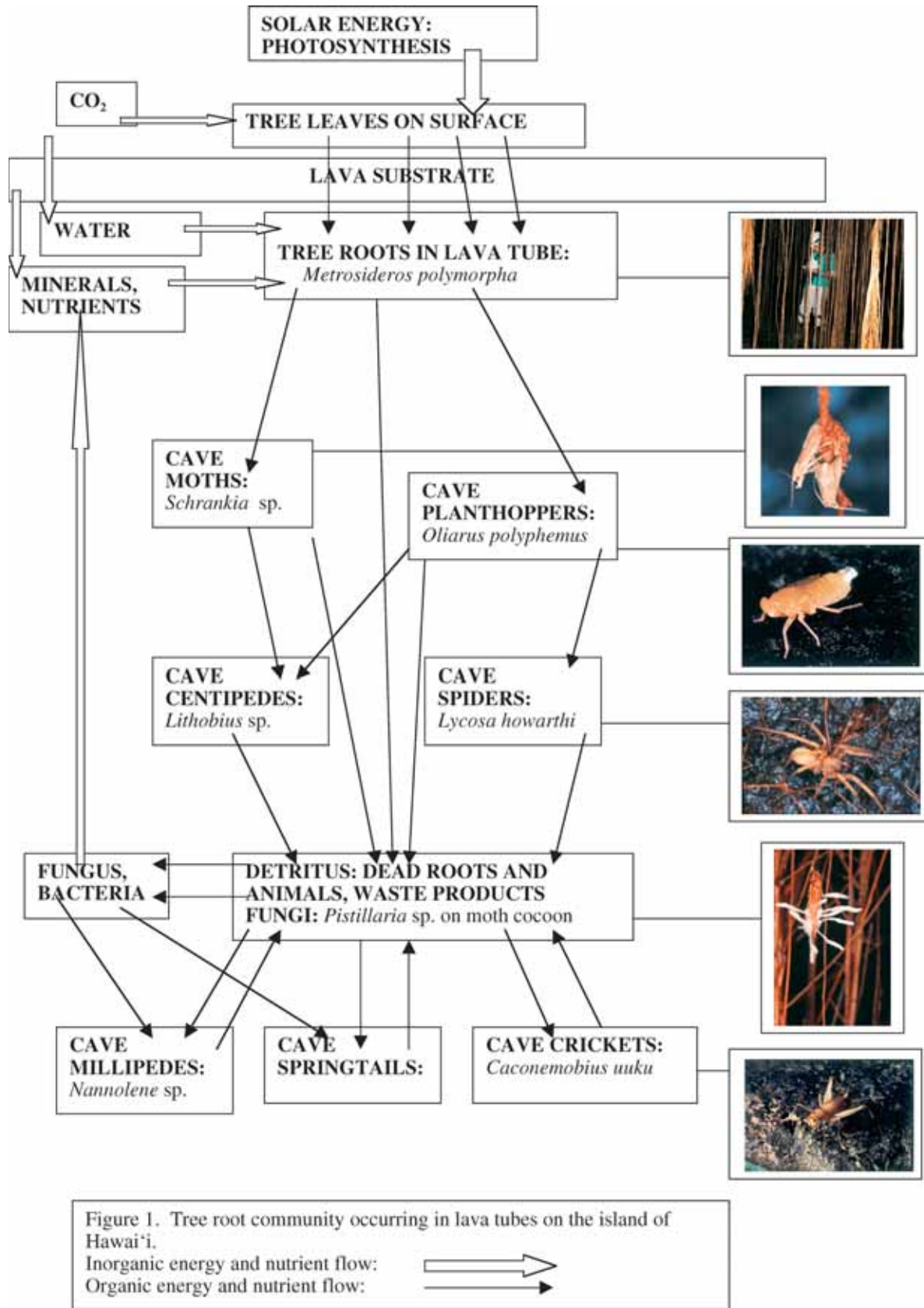


FIGURE 2 Cave root food web.

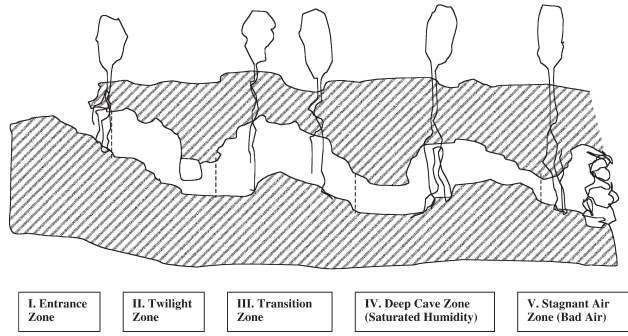


FIGURE 3 Cave bioclimatic zones.

nutrients, and partly due to the ready access to moisture. A drip zone often occurs just inside cave entrances, due to the mixing of surface and cave air that results in condensation of water vapor. This can often be seen as a fog zone when conditions are right. Cave-adapted species that generally occur in the deep cave zone can sometimes be found under rocks, in cracks, or on roots due to the constant moisture in this zone. Tree roots that hang from the ceiling in the entrance zone may be more similar to aerial roots that occur on the surface, due to their exposure to desiccating surface air. They tend to be bushier and have a thicker cortex than roots in the deep cave environment.

**Twilight**

This is the zone just inside the entrance where some light penetrates. It is strongly impacted by surface air, so it is generally not suitable for cave-adapted species. In cases where there is a restricted entrance or an upsloping dead-end passage, the twilight zone may be small or absent, and cave-adapted species can then be present very near the entrance.

**Transition/Mixing Zone**

Beyond the zone of light penetration is an area that still receives some impact from surface air. This zone is generally drier than the deeper cave and has a more variable temperature. In the tropics, there is a diurnal *winter effect* due to cool surface air moving into the cave at night, where it is warmed by the cave air. The warming process causes the air to evaporate moisture from the cave surface, desiccating the cave environment. This zone often has trogliphilic and troglonexic species that are resistant to the drier conditions and more variable temperature and thus are able to out-compete or prey on the deep cave species. However, this zone is critical for trogliphilic species with preadaptations that allow them to survive in the dark zone, allowing them to make the adaptive shifts for survival in the deeper true-cave zones. A zone of mixing occurs between the transition zone and the deep cave air, which can sometimes be seen as a foggy area due to condensation of water vapor into droplets.

**Deep Cave (Saturated Humidity) Zone**

This zone is beyond the effects of surface air. Humidity remains near 100%, and the temperature remains relatively constant. Air motion is reduced. Due to the constant moisture and lack of desiccation, tree roots proliferate in this zone and provide the basis for some of the most diverse communities of cave-adapted species (Fig. 4).

**Bad Air (Saturated Humidity Plus High Carbon Dioxide/Low Oxygen) Zone**

In areas with low dead-end passages, virtually no air motion, and an energy source for respiration, carbon dioxide can increase and oxygen decrease. Carbon dioxide readily mixes with the air, so there is no build-up where there is air exchange with other zones; however, where air is stagnant, carbon dioxide, being heavier than air, settles into low areas. If these areas also have high humidity and energy sources, they are home to the most highly cave-adapted species. Bayliss Cave is a lava tube in Australia with a large bad air zone, high humidity, and abundant tree roots penetrating the cave ceiling and growing through the soil on the floor. It is home to 24 highly cave-adapted species, among the highest diversity of any cave community.

**MORPHOLOGY AND ADAPTATIONS OF CAVE SPECIES**

Obligate cave species respond to cave conditions of total lack of light, high humidity, constantly wet substrate, and potentially high carbon dioxide and low oxygen by adaptive alteration of their morphology, physiology, and behavior. Morphological changes include loss of eyes and pigment; flightlessness; enhanced senses of smell, hearing, and touch and ability to detect air motion; elongation of appendages such as legs and antennae; loss of pulvilli and lengthening of claws; and rotation of legs to keep the body upright. Physiologically, cave species lose their circadian rhythms and diurnal activity patterns; they often have fewer but larger offspring and a slower metabolic rate than surface species. Though energy sources may be abundant in caves, they are often more dispersed than on the surface and more difficult to find in the dark, three-dimensional maze, so cave species have adapted to survive long periods without feeding (Figs. 5 and 6).

Behaviorally, cave species must develop special adaptations for finding food, finding a mate, and avoiding predators. In the labyrinthine spaces of caves and mesocaverns, cave species may resort to a constant random search for food. Tree roots can assist the search by providing a pathway that cave species can follow. Because the roots are also an energy source, predators and scavengers may use the root pathways to assist in locating prey. Tree roots also provide hiding places for predators such as the small-eyed big-eyed hunting spiders (Fig. 7).



FIGURE 4 Roots in deep cave zone.



FIGURE 5 Hawaiian sea coast cricket *Caconemobius sandwichensis*.



FIGURE 7 Hawaiian cave spider *Lycosa howarthi*.



FIGURE 6 Hawaiian cave cricket *Caconemobius uuku*.

Cave planthoppers use tree roots for their food source as well as to assist them in finding mates. Female planthoppers sit on the roots and produce a substrate-borne sound that travels readily along the roots. Male planthoppers move randomly over the cave walls until they find a root. If they detect a signal from the female, they return the call and follow the root until they locate the female. The female lays its eggs on the roots, and the nymphs insert their mouthparts into the xylem to feed. The planthopper nymphs produce wax filaments from a gland on their abdomen and make a loose wax “cocoon” that protects them from predators while they feed.

Cave moths use a different strategy for finding their mates. Female moths sit on the roots and often have reduced wings and are flightless. Male moths fly erratically through the cave



FIGURE 8 Hawaiian cave moths mating (*Schranksia*).

with their legs held out in front. They have extremely sensitive touch and can feel a small root and even alight on a strand of spider web without alerting the spider. The female moth releases a pheromone, and when the male detects the chemical it flies upwind until it reaches the female. The female lays its eggs on the root, and the inchworm caterpillar feeds on the small tree roots. It also uses the roots to build a hanging cocoon to protect it from predators while it pupates (Fig. 8).

Male cave crickets and cockroaches have tergal glands that release pheromones to attract the females, as do their surface relatives. The female crawls onto the male to the tergal gland, and the male attaches to her with a special genital hook. In Thai species of the cockroach family Nocticolidae, the tergal glands are highly modified into large horn-like structures, whose function has not been studied.

**See Also the Following Articles**

Food Sources • Volcanic Caves

**Bibliography**

- Atkinson, A, Griffin, J.J., and Stephenson, P.J. (1976) A major lava tube system from Undara Volcano, North Queensland. *Bull. Volcanol.*, 39(2), 1–28.
- Cordell, S., Goldstein, G., Mueller-Dombois, D., Webb, D., Vitousek, P.M. (1998) Physiological and morphological variation in *Metrosideros polymorpha*, a dominant Hawaiian tree species, along an altitudinal gradient: the role of phenotypic plasticity. *Oecologia*, 113, 118–196.

TABLE I Cave tree root communities in Hawai‘i and Australia

	Hawai‘i Lava Tubes	Australia: Bayliss Lava Tube
<b>Producers</b>		
	<i>Metrosideros polymorpha</i> (‘Ōhi‘a tree)	<i>Brachychiton</i> spp., <i>Eucalyptus</i> spp., <i>Ficus</i> spp.
<b>Primary consumers</b>		
Insecta, Hemiptera: Cixiidae (cave planthoppers)	<i>Oliarus polyphemus</i> and other <i>Oliarus</i> species	<i>Solanaima baylissa</i>
Insecta, Lepidoptera: Noctuidae (cave moths)	<i>Schranksia</i> spp.	—
Insecta: Coleoptera (beetles)	—	Curculionidae: Rhytirhininae
<b>Secondary consumers</b>		
Aranea (spiders)	Lycosidae: <i>Lycosa howarthi</i> ; Linyphiidae; Theridiidae	Pholcidae; <i>Spermophora</i> sp.; Nesticidae; <i>Nesticella</i> sp.; Zodariidae; <i>Storena</i> sp.
Acari (mites)	Rhagidiidae: <i>Foveacheles</i> sp.	—
Chilopoda (centipedes)	Lithodiidae: <i>Lithobius</i> sp.	Scuterigidae
Hemiptera	Reduviidae: <i>Nesidolestes ana</i>	Reduviidae: <i>Micropolytoxus</i>
<b>Scavengers, detritivores, fungivores</b>		
Insecta, Dermaptera: Anisolabidae	<i>Anisolabis howarthi</i>	—
Insecta, Orthoptera: (crickets)	Gryllidae: <i>Caconemobius varius</i> , <i>C. uuku</i> , <i>Thaumatogryllus cavicola</i> (cave tree cricket)	—
Insecta, Blattodea, Nocticolidae, Blatellidae (cave cockroaches)	—	Nocticolidae: <i>Nocticola</i> sp.; Blatellidae: <i>Paratemnopteryx</i> sp.
Insecta: Hemiptera: Mesoveliidae	<i>Cavaticovelina aaa</i>	—
Diplopoda (Millipedes)	Cambalidae: <i>Nannolene</i> sp.	Polyxenidae; Polydesmidae; Cambalidae (all undetermined species)
Crustacea: Isopoda	<i>Littorophiloscia</i> sp.	Oniscomorpha: undetermined species
Insecta: Collembola (springtails)	<i>Sinella yoshia</i> ; <i>Protanura hawaiiensis</i>	Entomobryidae; <i>Pseudosinella</i> sp.
<b>Decomposers</b>		
Fungi	<i>Pistillaria</i> sp.	

- Deharveng, L. and Bedos, A. (1986) Gaz carbonique, in *Thai-Maros 85: Rapport Speleologique et Scientifique to Thailand and Sulawesi*. Association Pyreneenne de Speleologie, Toulouse, France, pp. 144–152.
- Hoch, H. and Howarth, F.G. (1989) Six new cavernicolous cixiid planthoppers in the genus *Solonaima* from Australia (Homoptera: Fulgoroidea). *Syst. Entomol.*, 14, 377–402.
- Hoch, H. and Howarth F.G. (1993) Evolutionary dynamics of behavioral divergence among populations of the Hawaiian cave-dwelling plant-hopper *Oliarus polyphemus* (Homoptera: Fulgoroidea: Cixiidae). *Pacific Sci.*, 47(4), 303–318.
- Howarth, F.G. (1973) The cavernicolous fauna of Hawaiian lava tubes. 1. Introduction. *Pacific Insects*, 15(1), 139–151.
- Howarth, F.G. (1981) Community structure and niche differentiation in Hawaiian lava tubes, in Mueller-Dombois, D., Bridges, K.W., and Carson, H.L., Eds., *Island Ecosystems: Biological Organization in Selected Hawaiian Communities*, Vol. 15, US/IBP Synthesis Series. Hutchinson Ross Publishing, Stroudsburg, PA, pp. 318–336.
- Howarth, F.G. (1991) Hawaiian cave faunas: macroevolution on young islands, in Dudley, E.C., Ed., *The Unity of Evolutionary Biology*, Vol. 1. Dioscorides Press, Portland, OR, pp. 285–295.
- Howarth, F.G. and Stone, F.D. (1990) Elevated carbon dioxide levels in Bayliss Cave, Australia: implications for the evolution of obligate cave species. *Pacific Sci.*, 44(3), 207–218.
- Jackson, R.B., Moore, L.A., Hoffman, W.A., Pockman, W.T., and Linder, C.R. (1999) Ecosystem rooting depth determined with caves and DNA. *Proc. Natl. Acad. Sci. USA*, 96, 11387–11392.
- McDowell, W.M. (2002) An Ecological Study of *Metrosideros polymorpha* Gaud. (Myrtaceae) roots in lava tubes. Masters thesis, University of Hawai'i, 91 pp.



## Salamanders

Jacques Pierre Durand  
*Laboratoire Souterrain, France*

Several lineages of salamanders have evolved to become obligate inhabitants of caves. These independently evolved lineages possess characteristics similar to those of other animals that have become adapted for life inside caves or within underground waterways. For example, cave salamanders lack or have much reduced pigmentation, have reduced or absent eyes and associated structures, possess elongated and flattened bodies with longer and more gracile limbs, and possess several physiological and reproductive specializations — all related to a subterranean lifestyle. These observations underscore that salamanders are excellent models for studying common morphological and physiological specializations for underground life.

There are several different life cycles that are played out in subterranean ecosystems. Those animals that spend their entire lives within caves are referred to as troglobionts or troglobites. There are also animals that spend only a part of their lives in caves, either intentionally or accidentally, and these organisms are called troglaphiles or troglaphilic. The prefix troglo- refers to the Greek “troglodytes” — one who creeps in holes. There are also organisms that live in underground waterways (some of these waterways are not caves) called stygobionts or stygobites. The prefix stygo- refers to the mythological River Styx, which must be crossed to reach the world of the dead.

Not all of the eight common families of salamanders include underground-adapted taxa. Salamanders restricted to caves, i.e., those that live their entire lives in caves, belong to the Plethodontidae and Proteidae families. Salamanders that spend only part of their lives in caves are plethodontids, but there are also some Salamandridae.

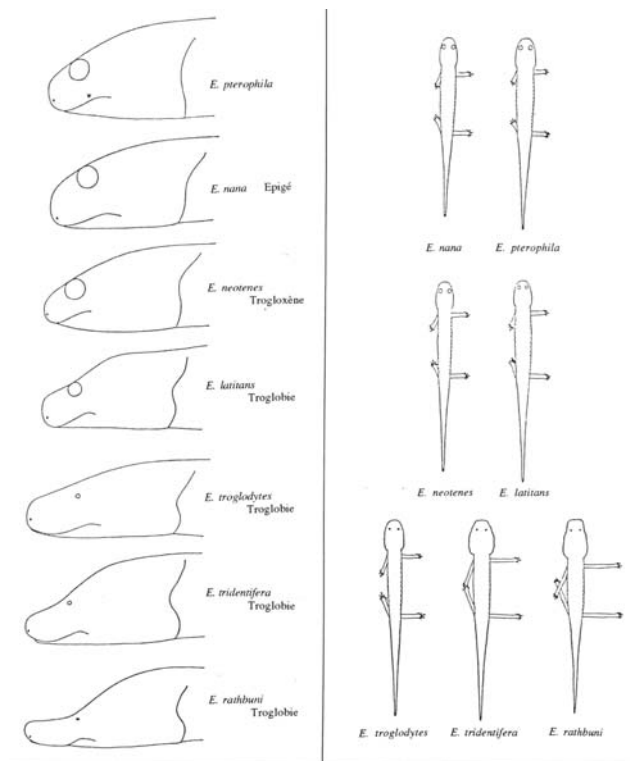
### NORTH AMERICAN SALAMANDERS FOUND ONLY IN CAVES

There are ten species of Plethodontidae found only in caves. These species seem to be glacial relicts. The majority of North American troglaphilic Plethodontidae are members of the Boletoglossinae. In Europe, subterranean plethodontids are represented only by *Hydromantes* (see the following section).

### Eurycea

Several stygobitic *Eurycea* are restricted to Edward’s Plateau, TX. They are characterized by small size, elongated shape, a long tail, a mobile lower mandible, the absence of lungs, a nasolabial furrow, and internal fertilization. There is a morphological continuum from the neotenic epigeic forms (*E. pterophila* and *E. nana*) to the troglaphilic forms (*E. neotenes*), then troglobitic forms (*E. latitans*, *E. troglodytes*, *E. tridentifera*) to the most highly evolved, *E. rathbuni* (Fig. 1). All *Eurycea* seem to have a common *Proeurycea* ancestor (Wake, 1966). The existing continuum between various *Eurycea* of Edward’s Plateau is related to their morphological, physiological, and behavioral preadaptations and adaptations to aphotic underground life.

*Eurycea latitans*, the Cascade Cavern salamander, is the least specialized of the stygobitic species observed in four caves in Kendall County, Texas (Cascade Cavern, Cascade Sinkhole, Dead Man’s Cave, and Century Cavern). Its characteristics include a length of 64–105 mm, a grooved trunk with short legs, four fingers and five toes, and it is four to five times longer than it is wide. This species of salamander has clear coloring with delimited pigmented patches. The head is less globulous than that of *E. neotenes*, with a flattened snout and a truncated brow followed by a marked expansion of the face, 14–15 costal grooves, and 17–18 presacral vertebrae. There are three gills on each side of the head; with the reduction in size of the eyes, the orbital



**FIGURE 1** The *Eurycea* salamander series. Note the progressive widening of the head, the lengthening of the body and limbs, and the sinking of the orbit related to the reduction in size of the eyes. These modifications are progressive from species living on the surface to the most specialized stygobiont, and finally to neotenic or perennibranchiate forms. This adaptive pattern is convergent with that of troglóbionts from very different families such as the Proteidae (Modified from Mitchell and Reddel, (1965)).

depression becomes increasingly visible. The eyes are under the skin but are not more than 1 mm in diameter.

*Eurycea troglodytes*, Valdinia Farm salamander populations, are isolated in the deep wells and the brooks of an underground water system of the Edward's Plateau. Their characteristics include an average body length of 78 mm and reduced eyes (0.7–0.9 mm) covered by skin. They have a broader head with head-body limits more clearly defined than in *E. tridentifera* and *E. rathbuni*, 13–14 rib grooves, and 18 presacral vertebrae. Their legs measure 5–11 times more in length than in width with almost white coloring and translucent skin on the belly. These animals live in cave pools whose banks are rich in guano and invertebrates, submerged at the time of high waters of the underground streams.

*Typhlomolge* is a species synonymous with *Eurycea tridentifera*. *Eurycea tridentifera* lives in caves of the Edward's Plateau, such as Honey Creek Cave in the Comal Counties of Texas. Its characteristics include depigmentation and blindness, persistent red external gills, and fused premaxillae. Nasals and prefrontals are absent. It has 11–12 costal grooves and 13–14 vertebrae. *Eurycea tridentifera* has a finned tail with basal constriction. Its limbs are 8–13 times longer than wide. Its eyes are small (0.6 mm) but visible. The head is



**FIGURE 2** *Eurycea rathbuni*. This North American stygobiont is one of the most specialized. Note the angular head, the orbit and the eyes, which have disappeared, the permanent gills reddened by blood, and very elongated thin limbs. (Photo by R. W. Mitchell. Magnification  $\times 2.5$ .)

wider than the body (40%), but not as much as in *E. rathbuni*. The muzzle is abrupt and truncated at the level of the nostrils. The body is white with a little gray and orange pigment.

*Eurycea rathbuni* (Fig. 2), the Texas blind salamander, lives in underground brooks and phreatic groundwater. Sometimes ejected from artesian wells, populations are isolated in the aquifers and the underground rivers (artesian well in San Marcos, Ezell's Cave, Frank Johnson's well, and Wonder Cave in Edward's Plateau, TX). They live in water where food is scarce. Their characteristics include a longer body, a very depressed orbit, and a more angular head than in other *Eurycea*. The adults are blind, unpigmented, and neotenic, with long thin members. The skin-covered eye is vestigial. The lens, the vitreous body, and the ocular muscles are absent and the retina is disorganized. They are 30–120 mm long. Sexual maturity for these oviparous animals is reached around 40–50 mm. Their metamorphosis obtained in experiments is partial. The females have 17–22 eggs per ovary. The larvae and the young (10–30 mm length) show gray dorsal pigmentation. The apparent eyes are black and covered by a transparent cornea (Fig. 3). *Eurycea rathbuni* has a developed lateral line, long thin legs, an extremely flat muzzle, and white body, except for the gills, which are colored by blood. The tail attains 50% of the total length and the head 16%.

*Eurycea robusta*, the Blanco blind salamander, lives in the Balcones aquifer north and east of the Blanco River in Hays County, TX.

### Typhlotriton

The Grotto salamander or Ozark blind salamander, lives in the caves of the Southwestern Ozark Plateau (Rock House Cave and Marble Cave), Missouri, Kansas, Oklahoma, and Arkansas where it is rather common. Some larvae occur

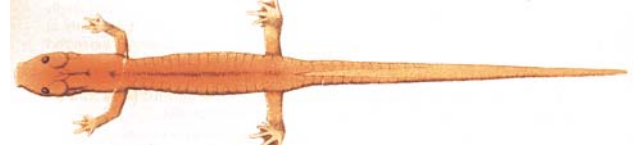




**FIGURE 3** Larva of *E. rathbuni*, length 17 mm. Note the existence (as in *Proteus* larva) of some dorsal pigmentation and eyes whose pigmentary epithelium of the retina is black. Above the eye, the cutaneocorneal epithelium is semitransparent. In troglobionts, ocular decay is irreversible. (Photo by Maruska. Magnification  $\times 6.5$ .)

in springs. *Typhlotriton braggi* and *T. nereus* are synonyms for *T. spelaeus*. Only one species, *T. spelaeus*, is blind and unpigmented. *Typhlotriton spelaeus* differs from *Eurycea* in that it metamorphoses. Characteristics include 18–19 costal furrows instead of 14–15 and 17–20 vertebrae instead of 15–16. The tongue is attached to the oral floor. Its length is 72–120 mm with a broad head and tail 42–47% of its total length. The adult (Fig. 4) is pale yellow; the belly skin is lighter. Like all plethodontids lungs are absent. This salamander is terrestrial and is able to use cutaneous and buccal respiration only in very wet environments. Consequently, it is observed only inside cavities where moisture and food are abundant.

*Typhlotriton* reproduction takes place between March and August. The females isolate themselves, and the whole cycle takes place in caves where guano is present and where amphipods and flatworms are abundant. Generally the young larvae (17 mm) migrate toward the twilight of the cave entrance or outside where food is more abundant. In springs, the larvae are pigmented (Fig. 5). In the old larvae (from 80 to 110 mm length) the dorsal and side pigmentation varies from light gray to dark gray with yellow spots on the base of the back and the tail. The branchiae are colored pink by blood. The functional eyes measure 3 mm in diameter; the head is 25% wider than the trunk. The tail comprises 50% of body length with a corrugated caudal membrane. After 3–5 years of aquatic life, the animals metamorphose and gills regress. *Typhlotriton spelaeus* becomes aerial and enters caves. The upper eyelid covers the lower eyelid and an ocular cyst is inserted. In *Typhlotriton* as in *Proteus*, the ocular degeneration is genetic. It is one of the rare examples where an animal, during its existence, passes from surface life to cavernicolous life, and from aquatic life to air-breathing life, a process related to the thyroxinian climax, which is accompanied by morphological, physio-



**FIGURE 4** Adult *T. spelaeus*, at the time when it metamorphoses, comes out of water and loses its gills. No lungs are present; respiration occurs through the skin and within the buccal cavity, which must remain wet. To make this possible, *T. spelaeus* seeks moisture, entering caves and becoming a true troglobiont whose eyes and pigmentation degenerate. This is a unique example of morphological and physiological adaptive modifications occurring during the life of one individual. This has been correlated with the presence of thyroxin in the blood. (Photo by J. Durand. Magnification  $\times 2.5$ .)



**FIGURE 5** Larva of *T. spelaeus*. Before metamorphosis (from 3 to 7 years) the larva of *Typhlotriton* is often observed in springs, exposed to light where it forages. Its eyes are large and functional at this time. (Photo by J. Durand. Magnification  $\times 4.5$ .)

logical, behavioral, and sensory transformations. The rarity of food accompanied by underground darkness result in an increase of the larval life span and an increase in the size of the larvae. So the penetration to the moist underground is obligatory for the adult for respiratory and reproductive reasons.

### Haideotriton

For a long time only one specimen of *Haideotriton wallacei*, the Georgia blind salamander, had been collected — an oviparous female, ejected from a water pump in Albany, in south Georgia. Now specimens have also been found in several caves and the groundwater in Jackson County in northern Florida.

This salamander is a Plethodontidae perennibranch (28–76 mm, from the nose to the cloaca). *Haideotriton* has external gills and, like all plethodontids, no lungs. The

broad head is rectangular but not flattened. The eyes are not functional. *Haideotriton* lacks a dorsal fin, but does possess a caudal fin. Dorsolateral coloring is whitish with some scattered pigments. The body comprises 11–13 costal grooves and 13–14 vertebrae.

### Gyrinophilus

*Gyrinophilus* includes three caves species. *Gyrinophilus porphyriticus*, the spring salamander, is an off-pink color, mottled with dark patches. *Gyrinophilus subterraneus*, the West Virginia spring salamander, occurs in General Davis Cave near Alderson in Greenbrier County, TX. Like *Typhlotriton*, *G. subterraneus* can metamorphose. *Gyrinophilus palleucus*, the Tennessee cave salamander, is restricted to the northeast of Alabama (Cumberland Plateau) and the east of Tennessee (Jackson County). There are two subspecies. *Gyrinophilus palleucus palleucus* (Fig. 6), the pale salamander, is a white color with a slightly grayer back. This distinguishes it from *G. palleucus necturoïdes*, the Big Mouth Cave salamander, (up to 220 mm) which possesses salmon-colored to pink flesh.

All *Gyrinophilus* possess a caudal fin but lack a dorsal fin. Other characteristics include 17–19 costal furrows and 18–20 vertebrae. The tongue is free. *Gyrinophilus palleucus* does not normally metamorphose, but can be forced to do so with an injection of thyroxin. Artificially transformed, the eyelids then come to cover micro-ophthalmic eyes. The colonization of the caves by *Gyrinophilus* dates from Pliocene or Pleistocene.

### NORTH AMERICAN SALAMANDERS SOMETIMES FOUND IN CAVES

#### Hydromantes

Vernacular names include Speleomantes, Spelerpes, Geotriton, Web-toed salamanders, and Höhlensalamanders. The upper jaw is raised and there are neither gills nor lungs in the adult. Other characteristics include a depressed head and bulge under each nostril, with a short tentacle in the young animal. There are large protuberant eyes with 9–13 costal furrows. A round section tail is used for movement. This salamander has robust members with four rounded fingers and five toes with interdigital palmaria at the base. The skin is very fragile, smooth, shiny, and glossy. The length is 60–140 mm.

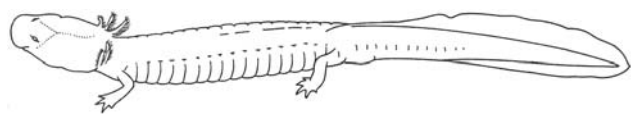


FIGURE 6 *Gyrinophilus palleucus* (magnification x1).—(Modified according to MacCready 1954).

Three species live in the mountains of California in caves as well as in wet biotopes. They are *H. platycephalus*, the Mount Lyell salamander; *H. shastae*; and *H. brunus*, the Limestone salamander.

### Plethodon

Some species of *Plethodon* that are terrestrial and live under the forest leafings or moss also are found in caves. *Plethodon glutinosus glutinosus*, the Slimy salamander of the eastern and northern United States, is blue-black with tiny silver spots. Normally this species inhabits moist woodlands. Sometimes it lays eggs in caves.

### Eurycea

These troglophiles undergo a complete metamorphosis. *Eurycea lucifuga* lives in the caves of Virginia, Tennessee, Illinois, and Alabama and is common in the twilight zone of cave entrances. *Eurycea longicauda* is abundant in caves and mines where they reproduce. Their activity is nocturnal and they migrate regularly toward the exterior. *Eurycea bislineata*, the Northern Two-lined salamander, is observed in the underground rivers of Pennsylvania in winter, but in April it migrates to the surface. The group of neotenic *Eurycea* of the underground water of Edward's Plateau in Texas includes, beside the troglotic forms described earlier, the troglitic forms: *E. nana*, the San Marcos salamander; *E. pterophila*, the Fern Bank salamander; and *E. neotenes*, the Texas salamander, which is the most commonly found.

### Gyrinophilus

The subspecies of *Gyrinophilus porphyriticus* include *G. p. porphyriticus*, the Northern Spring salamander, *G. p. duryi*, the Kentucky Spring salamander, *G. p. dunni*, the Carolina Spring salamander, and *G. p. danielsi*, the Blue Ridge Spring salamander. These are all common at cave entrances. The cavernicolous populations are not modified and the eyes are large.

### EUROPEAN SALAMANDERS FOUND ONLY IN CAVES

#### Hydromantes

Mertens and Wermuth (1940) recognized only one species. More recently the Sarde form has been considered distinct from the continental form: *Hydromantes genei* (*H. g. genei* and *H. g. imperialis*) and *H. italicus* (*H. i. italicus*, *H. i. gormani*, *H. i. ambrosii*, *H. i. Strinati*; Fig. 11). Formerly thought to be viviparous, these salamanders are now believed to be oviparous. Eggs are laid in cracks and very wet interstices in the ground. Embryonic development and cutaneous and buccal respiration require constant moisture of eggs and animal skin envelopes.

## Proteidae

This group includes *Necturus*, which is North American and lives on the surface in rivers and lakes, and *Proteus*, represented by a single species in subterranean waters in Slovenia, Italy, Croatia, and Bosnia. These salamanders are perennibranchiates with three gills on each side of the head, characterized by an internal fertilization with spermatophore. The vertebrae are amphicoelous. The lungs and the members are rudimentary. *Proteus* salamanders are characterized by the absence of eyelids and eyes hidden under the skin, vomeropalatine teeth in two longitudinal series, prefrontal, nasal, and jawbones. The premaxillae are not fused. Eggs are laid under stones. *Necturus* are pigmented. Cranium and bodies are squat. The eyes are developed. There are five species of *Necturus*. The most widespread species, *N. maculosus*, reaches 40 cm and 1 kg. The two genera evolved independently. They have a common gene pool and chromosomal formula ( $2N = 38$ ).

European *Proteus* (Fig. 7) have many names: Olm, Grottenolm, human fish, Hypochton, blind salamander, Protée, Proteo, and Cloveske ribice. *Proteus anguinus* is a blind eel-like animal whose size can reach 40 cm and weighs a few tens of grams at 40 years. Its general aspect is spindly with a cranium and an elongated body with many costal furrows and more than 38 vertebrae (up to the sacrum). Neither the pectoral girdles nor the pelvis are fused. The legs are slender with only three fingers and two toes. *Proteus* salamanders move on land only with difficulty but swim very well. They are adapted to darkness. They are exclusively oviparous animals and reproduce underground. Coloring varies from whitish to pinkish with some spots. The gills are pink. The eyes are reduced (300–700  $\mu\text{m}$ ) and covered by skin in the adult. The lengthened muzzle has no orbit and is therefore flattened, but it is also wide and truncated at the level of the nostrils. These animals possess true choanae.



**FIGURE 7** *Proteus anguinus*. The adults may reach a 35– to 40-cm length and live 80 years. The head is rounder than that of *E. rathbuni*. The orbit remains depressed and the eye is no longer visible. The gills are permanent. The members, shorter in length, have only three fingers and two toes. (Photo by J. Durand. Magnification  $\times 1.5$ .)

They are true perennibranchiates without visible metamorphosis, although several experiments show a discrete sensitivity (especially of the skin) to some thyroxine-like hormones. External gills persist, the branchial arcs are more or less ossified, the arc of the aortic is retained, and a lateral line system and developed caudal fin are present.

*Proteus* species are the quintessential cave salamanders. They were first described by Laurenti in 1768 in *Synopsis Reptilium*, after being mentioned in the work of J. W. Valvasor, *Die Ehre of Herzogthums Crain* in 1689. Seven subspecies of *Proteus* were described then invalidated. Some *Proteus* captured in the Dobicica sources, Bela Krajina in Slovenia, were described as *Proteus anguinus parkelj*. They were characterized by a black pigmentation, by eyes which were still more developed than degenerative, by a shorter and widened cranium, by fewer teeth, and by more developed musculature of the mandibles. This gave a more massive aspect to the head of *P. a. parkelj*. The longer body included a higher number of vertebrae whereas the legs and the caudal fin were shorter.

## Ecology

*Proteus* salamanders live in fresh oxygenated water (4–14°C), frequenting small-drowned argillaceous beaches bordering underground rivers. They slip with ease between blocks of rock fallen from the vault and the walls of the cave. Where the current is less violent, *Proteus* salamanders hunt out their prey, especially cavernicolous shellfish (isopodes and amphipodes), but also the larvae and various prey from the surface.

## Sensory and Behavioral Adaptations

In addition to the above characteristics, *Proteus* also possess a lateral line mechanoreceptor apparatus and other olfactory and chemoreceptor capacities. Individuals are able to distinguish, from a distance, the presence and gender of conspecific individuals within their laying territory, as well as active prey.

## Marking of Territory, Aggression, and Social Life

*Proteus* secrete and can detect particular chemicals. Markings are mucus, of cutaneous or cloacal origin, and impregnate the substrate. *Proteus* recognize and show a strong attachment for their usual shelter refuge (below a rock, crack, etc.). Unlike *Necturus*, *Proteus* are social and seasonally gregarious; meetings are tolerated. Only at the time of reproduction do males become isolated, mark their territory, and become aggressive, accepting only reproductive females. Laying territories are established by reproductive females.

## Reproduction and Development

Sexual maturity occurs between 11 and 14 years for the male, 15 to 18 years for the females. Environmental temperatures

during breeding are 11–12°C. Fertilization employs a spermatophore that the male deposits on the substrate followed by storage of spermatozooids in the spermathecae of the female. Reproduction is oviparous. The females lay from 20 to 80 eggs, which they fix under stones (Fig. 8). Oviposition takes place from October to March at the Moulis Cave Laboratory. Hatching takes place after 100 days  $\pm$ 5 with 12°C, and 110 days  $\pm$ 10 with 9–10°C. In the Moulis Cave, 50% of the eggs hatch, yielding larvae that live three months on yolk reserves before becoming predatory (Fig. 9).

### Regressions Related to the Underground Life

At hatching the skin of the larvae is mottled by small melanophores. The melanic pigment disappears little by little with

the total darkness. Raised under a light (temperature of color 4500 K, and 400 lux/m<sup>2</sup>), melanic pigment is secreted, melanoblasts multiply, and the *Proteus* young become black (Fig. 10). On the other hand, marked photophobia induces *Proteus* to flee lighted habitats.

### Regression of the Eyes

Adults possess a rudimentary ocular cyst inserted in the orbit. The cornea and lens are lacking and skin covers the whole area. Eyes develop normally at the embryo stage. Larvae are born with a cornea and lens and a retina with the usual layers of neurons: visual, bipolar, multipolar, and amacrine cells. Internal and external plexiform layers containing synaptic vesicles, as well as tyrosin hydroxylase, precursor of



**FIGURE 8** The eggs of cave salamanders are very few (6–80), but large (8–9 mm diameter for *Proteus*). They are laid and fastened under a stone. In some species, the female protects her eggs. (Photo by J. Durand. Magnification  $\times$ 2.)



**FIGURE 9** *Proteus anguinus* larva at the hatching stage, 30 mm long, 120 days after fertilization from the Moulis Cave Laboratory. The eyes are normally differentiated with cornea, lens, and retina. The larvae can swim, but generally remain on their side; the limbs are not completely formed. The abdomen is filled by yolk that enables the individual to be independent of the surrounding biotope. (Photo by J. Durand. Magnification  $\times$ 4.5.)



**FIGURE 10** Young *Proteus anguinus*. This whitish *Proteus* has been maintained in the darkness 24/24 hours and the black colored *Proteus* exposed to 12/24 hours in 400 lux, 3600 Klight. The depigmentation is thus a physiological reversible process. This is not the case for eye degeneration. (Photo by J. Durand. Magnification  $\times$ 0.6.)



**FIGURE 11** The eyes of *H. italicus* are large and capable of twilight vision. This species lives in surge-wet ground, caves, mine galleries, etc.; the surface in these regions are dry climatic areas of Mediterranean or Californian type. At night or in rainy weather the *Hydromantes* can migrate outside of the cave and forage, retreating underground at dawn. (Photo by J. Durand. Magnification  $\times$ 2.)

the dopamine, dehydrorhodopsin, and antigen S, interstitial-retinal-binding-protein (IRBP) are also present. Later, in ontogeny, the eye, the optic nerve, and the tectum opticum nerve center degenerate. Despite the very young *Proteus* larvae's exposure to light for several years, the visual apparatus does not regenerate. More than 110 experiments of cross xenoplastic eye embryonic anlage grafts between *Proteus* and surface big-eyed salamanders *Euproctus asper* and *Pleurodeles waltlii* reveal that the *Proteus* eye differentiation followed by an ocular degeneration is genetically programmed.

In conclusion, *Proteus* are typical representatives of aphotic life. Their characteristics (e.g., cells of very big size, the low speed of cellular mitosis, reduced activity and metabolism, longevity, adaptations, and regressions) testify to a single phylogenetic origin. Because of the uniqueness of *Proteus* and the sensitivity of suitable habitat, these salamanders should be protected from human activity.

### Salamandridae

Salamandridae are characterized by vomero-palatine extending toward the back of the mouth and furnished with teeth; vertebrae that are opisthocelous, and eyes developed with mobile eyelids. Only one salamandrid is stygobitic.

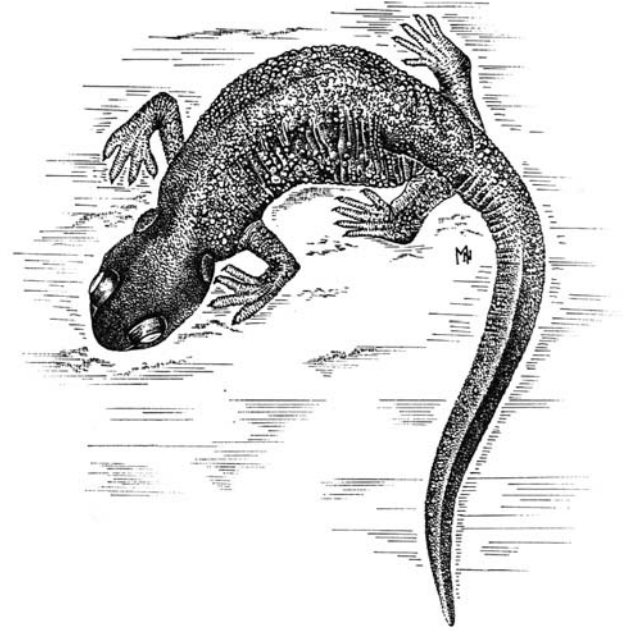
*Euproctus asper*, or Pyrenean Triton, Molge, Gebirgsmolch, lives in torrents and lakes between 700 and 2600 m, and presents, at lower altitude with some residual populations isolated in underground water from caves of the Northern Pyrenean slope (Fig. 12). The hypogean life does not induce morphological modification, but it exerts a marked influence on the physiology and behavior of the *Euproctus asper*. Its characteristics include a cylindrical trunk, a length from 6 to 16 cm, and a robust prehensile tail, oval in cross section. Other characteristics include short robust limbs with four fingers and five toes with cornified claws, a round head, flat truncated muzzle, rough skin, lacking or indistinct parotid gland, and a marked gular fold.

### CONCLUSIONS

Salamanders adapt well to life in caves; they often lack lungs, retain branchial, or employ cutaneous respiration. All are aquatic throughout their life or at an early stage of their development. They also need water or moisture for respiration and reproduction. Their passage from aquatic living to terrestrial living is often physiologically and morphologically influenced. Additional cave-dwelling amphibians may be discovered when the caves of Asia, Indonesia, and South America are explored.

### Bibliography

Brandon R. A. (1971). North American troglotic salamanders: Some aspects of modification in cave habitats, with special reference to *Gyrinophilus palleucus*. *Bull. NSS* 33 (1), 1–22.



**FIGURE 12** *Euproctus asper* (magnification x1). Small populations of cave salamanders at low Pyrenean altitudes.

- Conant, R. (1975). *A Field Guide to Reptiles and Amphibians of Eastern and Central North America*, p. 429. Houghton Mifflin, Boston, MA.
- Conant, R., and J. T. Collins (1991–1998). *Reptiles and Amphibians, Eastern/Central North America. Peterson Field Guides Collection*. Houghton Mifflin, Boston, MA.
- Crother B. I. (2001). *Scientific and Standard English Names of Amphibians and Reptiles of North America North of Mexico, with comments regarding confidence in our understanding*. SSAR Herpetological Circular 29, III, p. 82.
- Culver, D. C. (1982). *Cave Life. Evolution and Ecology*, p. 189. Harvard University Press, Cambridge, MA.
- Durand, J. (1998). *Amphibia in Encyclopaedia Biospeologica*, Vol. 2, (C. Juberthie and V. Decu, eds.), pp.1215–1243, Soc. Inter. de Biospeologie, Moulis.
- McCrary, E. (1954). A new species of *Gyrinophilus* (Plethodontidae) from Tennessee caves. *Copeia*, 1954, 200–206.
- Mitchell, R. W. and Reddell, J. R. (1965). *Eurycea tridentifera*, a new species of troglotic salamander from Texas and a reclassification of *Typhlomolge rathbuni*, Texas. *J. Sci.*, 17, 12–27.
- Riemera, W. J. ed. (0000). *Catalogue of American Amphibians and Reptiles*. American Society of Ichthyology and Herpetology, Kensington, MD.
- Stebbins, R. C. (1985) *Western Reptiles and Amphibians. Peterson Field Guides*. Houghton Mifflin, Boston, MA.
- Thorn, R. (1968). Les Salamandres d'Europe, d'Asie et d'Afrique du Nord. (P. Lechevalier, ed.), p. 3611. Paris.
- Vandel, A. (1965). *Biospeology. The Biology of Cavernicolous Animals*, p. 524. Pergamon Press, Oxford, England.
- Wake, D. B. (1966). Comparative osteology and evolution of the lungless salamanders, family Plethodontidae. *Memoirs S. Calif. Acad. Sci.*, 4, 1–11.

# Saltpetre Mining

David A. Hubbard, Jr.

*Virginia Speleological Survey and Virginia Department of Mines,  
Minerals and Energy*

## DEFINITIONS AND IMPORTANCE

Historically, saltpetre is one of the most strategic of commodities. It occurs naturally in caves and rock shelters, but it is rare. A suite of related nitrates occurs in many caves. The mining and processing of cave nitrate-enriched sediments is a relatively simple endeavor, although labor intensive. The tendency of these sediments to contain a suite of nitrates rather than just potassium nitrate is one reason the archaic spelling *saltpetre* is used in reference to the mining of cave nitrates and the caves in which they occur. This convention is followed throughout this article.

The invention of gunpowder revolutionized weaponry and warfare. Gunpowder, also referred to as black powder, consisted of a mixture of saltpetre, sulfur, and charcoal. Although saltpetre was used in the preservation of meats, the greatest historic demand for saltpetre was during times of insurrection and war. Nowhere has the quest for saltpetre contributed to historic events more than in the United States of America, where this commodity contributed to both the formation of a country and almost its destruction.

The mineral *niter* (synonym, *saltpeter*) is potassium nitrate ( $\text{KNO}_3$ ). Like many other nitrate compounds, niter is *deliquescent*; that is, it has a natural tendency to draw water to itself and dissolve into a solution. Although deliquescent minerals can absorb moisture from humid air, they occur naturally in sheltered locations under conditions of low humidity or during periods of reduced humidity. The deliquescent nature of saltpetre is the reason for the old warning of soldiers and frontiersmen, who depended upon their firearms for survival, to “keep your powder dry!”

Caves and rock shelters, also termed *rockcastles*, are locations where nitrates may accumulate. Analyses of cave sediments, which were mined historically for saltpetre, commonly reveal no nitrate minerals. The reason is that most of the classical saltpetre caves are in regions where the humidity typically is too high for niter and the even more deliquescent minerals *nitromagnesite*,  $\text{Mg}(\text{NO}_3)_2 \cdot 6\text{H}_2\text{O}$ , and *nitrocalcite*,  $\text{Ca}(\text{NO}_3)_2 \cdot 4\text{H}_2\text{O}$ , to crystallize into their solid mineral forms. Instead, the saltpetre-rich sediments, historically termed *petre dirt*, contain concentrated viscose nitrate solutions in the form of sediment moisture.

Because nitrate minerals rarely crystallize in most of the known saltpetre caves, other clues to the accumulation of nitrates in cave sediments are important. In the absence of niter, the foremost evidence of significant nitrate concentrations in cave sediment is the presence of *efflorescent crusts*.

These white or light-colored, powdery crusts commonly are composed of a mixture of soluble salts and minerals, such as gypsum and calcite, that accumulate on cave sediment and rock surfaces as a result of evaporation. Efflorescent incrustations signify locations where periodic atmospheric conditions allow evaporation and the concentration of the minute amounts of dissolved solids in interstitial soil and rock moisture. Precipitation and concentration drive the wicking action of the dissolved solids through soil and rock pores from their respective remote sources. The sources of most saltpetre cave nitrates are the surface ecosystems overlying saltpetre caves.

Recent microbiological work in caves and karst has shown that bacteria are important in cave development (*speleogenesis*) and in the development of the secondary cave mineral forms (*speleothems*) that were thought to be the result of physiochemical reactions (Taylor, 1999). The importance of nitrifying and other bacteria in the accumulation of efflorescent crusts and nitrate accumulations in sediments (petre dirt) is unknown but probably is not trivial.

## SALTPETRE MINING

The mineral niter ( $\text{KNO}_3$ ) rarely is found in caves, but when observed it occurs as clear to white lint-like fibers, acicular (needle-like) crystals, powder, crusts, coralloid, or flowstone forms. The most extensive form observed in saltpetre caves is the lint-like fibers that occur in dense carpets on bedrock walls (Fig. 1) and sediment-covered walls and floors. These niter fiber occurrences can be harvested with the use of a thin wooden spatula or paddle-like scraper, leaving little or no evidence of extraction. Such a wooden scraper was observed high on a Virginia saltpetre cave ledge before this author had observed an efflorescent niter occurrence.

The majority of the documented saltpetre caves normally do not contain crystalline niter. At the humidities typically found in these caves, the deliquescent nitrate accumulations occur as viscose nitrate solutions in efflorescent crusts on rock and sediment surfaces and within sediments and bedrock proximal to the cave.

The earliest mining of saltpetre may have been in China, dating from the development of gunpowder approximately a thousand years ago. Although the discovery of the effects of niter in the preservation of meat may predate gunpowder, no evidence is known that niter was extracted from caves for preservation of meat remote from caves. The importance of gunpowder in revolutionizing armed conflict resulted in intense periods of demand for niter. In addition to mining in rock shelters and caves, saltpetre was obtained from artificial niter beds and from soils collected under buildings. In western societies, the earliest documented search for niter is the 1490 quest of Hans Breu for saltpetre in Sophienhöhle (Sophie's Cave) in Germany. The French Revolution and Napoleonic Wars of Europe (1792–1815) and the



**FIGURE 1** (A) Fibrous form of the mineral saltpeter carpeting cave walls in a Virginia saltpetre cave (photograph by John C. Taylor; image width approximately 12 cm). (B) Fibrous form of the mineral saltpeter carpeting cave surfaces in a Virginia saltpetre cave; scale is in centimeters.

Revolutionary (1775–1783), 1812 (1812–1815), and Civil (1861–1865) Wars of North America were periods of intense demand for saltpetre. The written record of actual saltpetre mining processes is sparse, as is typical for many mundane tasks. The most extensive known distribution of saltpetre caves and the best preserved evidence of mining can be found in the southeastern United States. Although the mining

evidence in each saltpetre cave is as different as caves are from one another, similar patterns of marks, disturbances, and artifacts convey some information about basic mining and processing methodologies.

Tangible evidence of saltpetre mining includes the principal physical evidence of wall and floor sediment removal, the secondary evidence of lighting and names and artifacts used in mining or as bracing that date to the mining era, evidence of simple sediment processing and separation of rocks and clay balls, and modified pathways and conveyances of miners and mined sediment. Nitrate processing evidence is important in distinguishing saltpetre mining from sediment extraction for other purposes and is discussed in the section on saltpetre processing.

### Principal Physical Evidence of Mining

Physical evidence of sediment removal includes tool marks, wall discolor marks of former sediment levels, and tunnels and pits within sediments. Tool marks on worked sediment faces are of wide and narrow bladed tools. Sediment mining tool marks predating the 1860s typically are hoe like and wide bladed (10 to 13 cm), while many of those of the American Civil War era are narrow bladed (5 to 7 cm) and attributed to mattocks. The blades of these tools were metal, and rarely were such tools left in caves, while pointed digging and prying sticks and paddle-like spatulas more commonly are found. Pick and mattock impact marks on rock walls may relate to efflorescent wall crust or sediment removal. The discoloration marks of old sediment levels on bedrock walls provide an indication of the thickness of mined nitrate-rich sediment. An important distinction is that not all sediment in a saltpetre cave is equally enriched or desirable. Slightly worked deposits of difficult to process clay sediments with well-preserved mattock marks and well-developed white efflorescent crusts are evidence that the difficulty in extracting nitrates from clay outweighs the effort. Similarly, pits and tunnels through thick sediments may indicate low yield deposits, which were partially exploited, but such excavations may have had more utility as passage and haulage routes.

### Secondary Evidence of Mining

Indirect evidence of mining includes soot stains above torch perches and the stubs of pine faggots (torches) at worked sediment faces and along well-traveled routes between entrance and mining areas. Rock piles in wall niches or backfilled in small passages are evidence of hand sorting of rock from the sediment. Less common are piles of small rocks and clay balls from sieving near the site of sediment mining or near locations where sediment was transported in cloth or burlap sacks. The combination of old sediment level stains and names dating to the mining era stranded high on walls, as well as remote clusters of tally and torch marks, may differentiate periods of mining. Mining artifacts include

pointed wooden digging and prying sticks, wooden scrapers, and wood hoops for holding sacks open during filling. Stone and wood bracing stabilize undermined large rocks in some saltpetre caves. In breakdown mazes, the use of rock for slab and ceiling stabilization may not be obvious. The breakup of rock slabs to access the underlying sediment has resulted in labor-intensive passage enlargement and rock walls and fills that may appear as having other significance. Other modified pathways and conveyances include cut steps in steep sediment banks, stone steps, wooden stairs, boardwalks, and plank ramps across chasms and canyons; various types of ladders; and windlasses.

Perhaps the most rewarding evidence of saltpetre mining is the correlation of names etched into cave walls with written mine-era records of payrolls, equipment receipts, or saltpetre production or sales receipts. Such corroboration sometimes allows the matching of different historic cave names with present-day names as well as verification of the nature of the sediment mining.

### SALTPETRE PROCESSING

In some saltpetre caves, evidence of the processing is intermingled with the mining evidence. Large hoppers or smaller vats were commonly used in saltpetre processing, but barrels and sections of hollow logs also were employed. Two of the best preserved examples of sediment processing equipment are displayed on cave tours: rectangular hoppers in Mammoth Cave in Kentucky and V- or wedge-shaped vats in Organ Cave in West Virginia. Intact hoppers and vats are rare in most present-day saltpetre caves. All that remains in many saltpetre caves are the internal casts of nitrate-depleted mine spoils. Surrounding such casts occur the discarded piles of leached cave sediments, discarded from the vats prior to their last loads of sediment. The wooden remains of many hoppers and vats have rotted or been destroyed by vandals.

Processing requires a source of water, which usually is not located close to the nitrate-rich cave sediments that require at least a periodic reduction in the humidity to accumulate. Processing of the majority of saltpetre cave sediment has entailed the puddling of the nitrate-rich sediments in a hopper or vat. After the nitrates are leached from the cave sediments, the liquid, termed *beer*, is decanted. To this beer another leachate, from wood ashes (potash), is added until a white precipitate ceases to form from the mixing of the two solutions. This process exchanges the potassium cation of the potash solution for the calcium and magnesium cations of the cave nitrate solution. The resulting potassium-rich nitrate solution is transported to large iron kettles for further processing and eventual fractional crystallization of the niter crystals. The kettles are usually hemispherical and without legs or other attachment points that would serve as heat sinks, resulting in differential heating within the kettle. Most kettles have a wide lip or rim by which they are supported over a heat source. The fractional crystallization process

enables workers to selectively crystallize specific soluble salts, while leaving less soluble salts in solution.

The processing of sediment, especially for smaller caves, occurred outside of many saltpetre caves for lack of a suitable water source. Some small caves were worked as satellite locations to a nearby major saltpetre works. No evidence of kettle processing is known from within any saltpetre cave, although kettles are known to have been hidden in and recovered from caves.

Perhaps the most impressive examples of evidence of in-cave saltpetre processing are preserved at Mammoth Cave in Kentucky. Some of these War of 1812 era workings may be observed on tours and include large hoppers and a complex system of hollow log plumbing, whereby fresh water was pumped into and saltpetre leachate was pumped out of the cave.

The processing of the nitrate deposits of the sandstone rockcastles of eastern Kentucky is abbreviated. The nitrates from these shelter caves typically are potassium nitrate and do not require the ionic exchange step required for the calcium- and magnesium-rich nitrates of the carbonate solutional caves.

Evidence of saltpetre processing in caves is important in establishing that the mining evidence is of saltpetre mining. Cave sediments have been excavated from caves worldwide for uses other than saltpetre extraction.

### CONTRASTING SALTPETRE MINING WITH OTHER CAVE SEDIMENT EXTRACTION

The cave sediments of many European caves are enriched not only in nitrates but also phosphate as a result of the bones of mega fauna, which used these caves during the Ice Ages of the Pleistocene. Locally, nitrate- and phosphate-enriched sediments have been extracted from European caves for fertilizing gardens. In China, cave sediments historically have been worked for fertilizer and for bones to be used in the apothecary trade. Marketed as “dragon bones,” these fossil remains have been processed for use in folk remedies and as aphrodisiacs. Bat guano has been utilized as fertilizer in numerous areas within the United States, but the extraction of other nitrate-rich cave sediments for garden use also is known from at least one U.S. locality. It is likely that European immigrants to the United States continued the time-honored traditional exploitation of enriched cave sediments as garden fertilizer at other southeastern U.S. sites. Evidence of the extraction of cave sediments without associated saltpetre processing evidence, written historic records of saltpetre mining, or local saltpetre mining lore may represent other uses of cave sediments, such as for garden fertilizer, chinking for a log home, ceramics, fossil or artifact pilferage, or other usage.

In summary, saltpetre mining is a historic extractive industry tied to the development and usage of black-powder-charged firearms. The archaic spelling of the mineral,



saltpetre, is retained as a descriptor because, in most cases, this mineral has only rarely been encountered in saltpetre caves; rather, a suite of the deliquescent nitrates typically occurs as viscous solutions within cave sediments, which were mined and the nitrates extracted by leaching and chemically converted to the crystalline commodity, potassium nitrate (saltpeter), the major constituent of black powder.

### Bibliography

- DePaeppe, D. (1985) *Gunpowder from Mammoth Cave: The Saga of Saltpetre Mining Before and During the War of 1812*. Cave Pearl Press, Hayes, KS, 38 pp.
- Duncan, M.S. (1997) Examining early nineteenth century saltpetre caves: an archaeological perspective. *J. Cave Karst Studies*, 59(2), 91–94.
- Faust, B. (1964) Saltpetre caves and Virginia history, in Douglas, H.H., Ed., *Caves of Virginia*. Virginia Cave Survey, Falls Church, VA, pp. 31–56.
- Hill, C., Ed. (1981) Saltpetre. *NSS Bull.*, 43(4), 83–133.
- Hill, C. and Forti, P. (1997) *Cave Minerals of the World*, 2nd ed. National Speleological Society, Huntsville, AL, 463 pp.
- Shaw, T.R. (1992) *History of Cave Science*. Sydney Speleological Society, Sydney, Australia, 338 pp.
- Smith, M.O. (1990) *Saltpetre Mining in East Tennessee*. Byron's Graphic Arts, Maryville, TN, 32 pp.
- Taylor, M.R. (1999) *Dark Life*. Scribner, New York, 287 pp.

## Show Caves

### Arrigo A. Cigna

*International Show Caves Association (Union Internationale de Spéléologie), Italy*

### A SHORT HISTORY OF SHOW CAVES

Caves have always attracted the attention of humans. Initially, the interest was primarily quite practical (*i.e.*, to provide shelter, a sanctuary, or a burial place). Later, and until the Middle Ages, caves were associated with the devil or hell in general, and people avoided entering caves. For this reason, bandits could use caves as hiding places safe from undesired visitors.

Some historical show caves were known in ancient times. About 2000 year ago, Plinius, a Roman writer, described “Dog’s Cave” near Naples, Italy, being visited by people because of the peculiar release of carbon dioxide close to the floor that killed small animals (hence, its name), while standing people were not affected. Other caves were visited not for tourism but mainly for religious purposes; such shrines may be found everywhere.

In Postojna Cave (Slovenia), on the walls of the so-called Passage of the Ancient Names are old signatures left by occasional visitors, with the most ancient ones dating back to 1213, 1323, and 1393, according to some authors of the 19th century. By 1920, such signatures were scarcely visible due to seepage; currently, the oldest signature that can be

read easily is dated 1412. From the 16th century onward, the signatures become rather abundant. Because the cave was visited frequently beginning in the 16th century by many persons attracted to this underground world, this period can be considered the start of cave tourism.

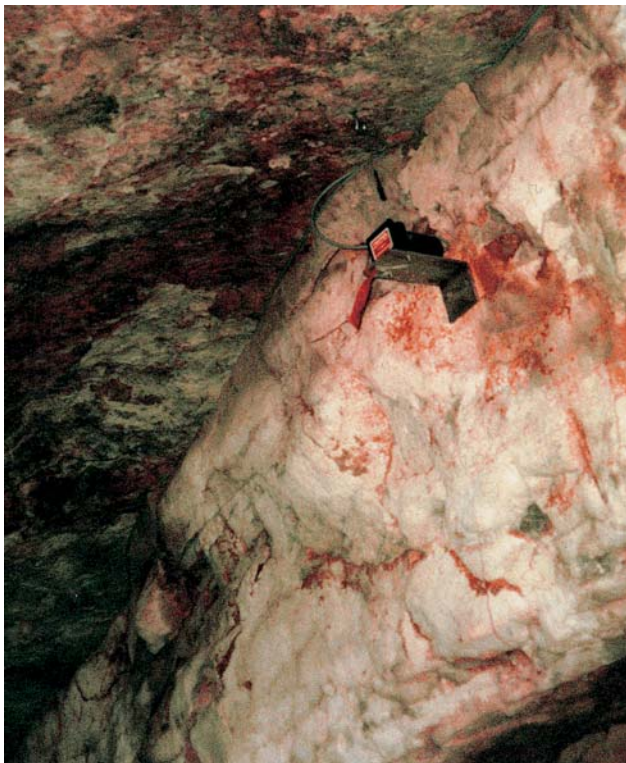
In more recent times, the Cave of Antiparos in Cyclades, Greece, became a great attraction in the 17th century, as indicated by the many prints of that time that reproduced images of the cave. The Kungur Cave, 100 km southeast of Perm, near Kungur (Urals), Russia, is an ice show cave visited as early as the 18th century. It is probably the largest gypsum show cave. On August 13, 1772, the scientist Joseph Banks landed on Staffa Island, and in November he wrote in the *Scots Magazine* that “there is a cave in this island which the natives call the Cave of Fingal.” Since that time, this cave has become one of the best known caves of the world, inspiring countless poets and musicians. At one time its fame was so great that it became the natural cave most frequently represented in paintings and engravings all over the world.

The Cango Cave (Oudtshoorn, South Africa) was discovered around 1780, and the first recorded visit was made in 1806. A few years later, a farmer bought the land around the cave with the exclusion of the entrance. The governor included in the deed the condition that the farmer was obliged to leave the entrance of the cave perfectly free and undisturbed and that it was to be considered as public property, with a road being located on his land to reach the cave. This document has historical importance because it is probably the first attempt in the world to legislate for cave protection.

In the United States, Mammoth Cave, Kentucky, was defined the “stellar attraction of the Mammoth Cave National Park” by R. Gurnee and J. Gurnee (1990). Already known by prehistoric Indians 3000–4000 years ago, in the late 18th century the cave was mined for saltpetre to make gunpowder, but only at the beginning of the following century did Mammoth Cave become a tourist attraction.



**FIGURE 1** Kartchner Caverns (Arizona, USA) are probably the show caves managed according to the most up-to-date criteria in the world. An electric train transports visitors from the office building to the cave, thus avoiding both acoustic and environmental pollution. (Photograph courtesy of Arrigo A. Cigna.)

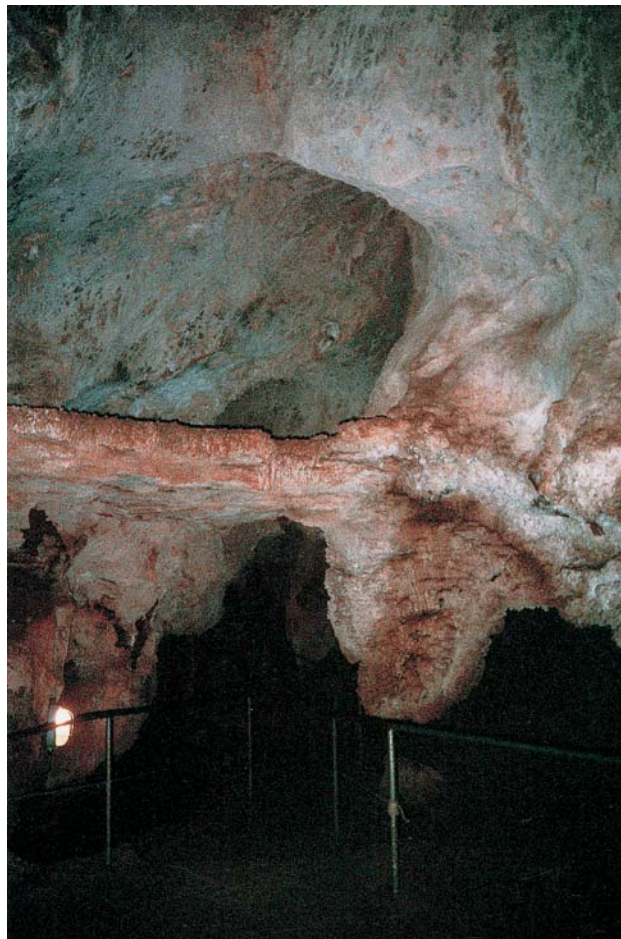


**FIGURE 2** Sometimes joints in a cave indicate the possibility of future rock falls. In order to ensure the safest conditions in a show cave, it is necessary to detect well in advance any minor movement. A detector that monitors possible displacement of a limestone layer can be seen in this photograph of Kartchner Caverns in Arizona. (Photograph courtesy of Arrigo A. Cigna.)



**FIGURE 3** A monitoring network should always be installed in a show cave in order to avoid making significant changes in the cave environment. In the case of Kartchner Caverns in Arizona, such monitoring is particularly important because the relative humidity within the cave is close to 100% while outside the climate is very dry. During construction of the pathway, many pipes were laid down and covered by concrete. These pipes contain circuits that connect monitoring sensors within the cave with a computer in the main building. (Photograph courtesy of Arrigo A. Cigna.)

If a show cave is defined as a cave where a fee is paid in order to have access to visit it, then the oldest one would be the Vilenica Cave in Slovenia. The cave is close to the village of Sezana, just a few kilometers from the Italian border. At the beginning of the 17th century, the Count of Petac began

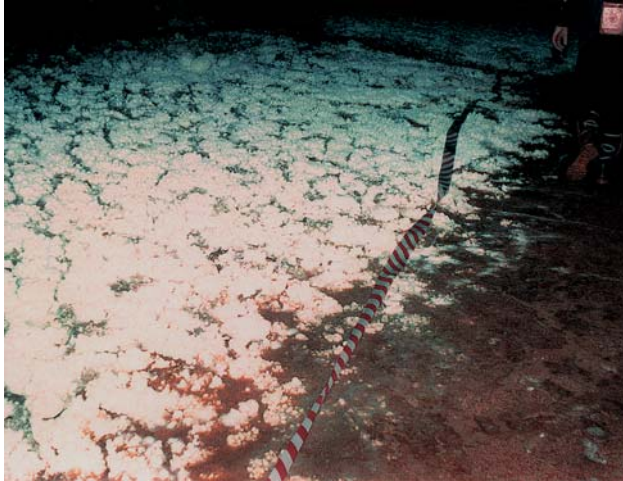


**FIGURE 4** Congo Caves (Oudtshoorn, South Africa) were discovered around 1780, and the first recorded visit was made in 1806. These are now the most important show caves in Africa. Here, flowstone was deposited over a clay filling was washed away leaving the flowstone in place. Iron handrails can be seen along the pathway; today, such handrails are generally replaced with stainless steel or plastic handrails to avoid iron contamination of the cave environment. (Photograph courtesy of Arrigo A. Cigna.)

to invite the people of Trieste and some noble friends to visit the cave. On certain holidays, an area for the orchestra and a dance floor were set up a hundred meters or so from the entrance, and the entire dripstone passage was illuminated with torches and candles. Probably already in 1633 the Count Benvenut Petac was charging admission to visit the cave. Part of the money was donated to the local church of Lokev, where masses were dedicated to “greater safety” of the people in the cave.

### THE ENVIRONMENTAL PROTECTION OF SHOW CAVES

A cave is an environment with little contact with the outside. For this reason, its equilibrium may be easily changed when additional energy is introduced (Cigna, 1993). Obviously such changes may occur more frequently when the whole energy budget of the cave is small, but in the case of show



**FIGURE 5** In one of the most innermost parts of Cango Caves (Cango 3, Oudtshoorn, South Africa), the floor is covered by calcite crystals. A plastic ribbon marks the boundaries of the trail to prevent destruction of the crystals. (Photograph courtesy of Arrigo A. Cigna.)

caves the energy budgets are often not very small, because of the generally large size of the caves. Rivers or subterranean lakes play an important role in keeping the natural equilibrium because they may absorb any further input of energy more easily than rock.

In a show cave, both the visitors and the electric lighting system release energy into the environment. A person who is walking releases nearly as much energy as a 200-watt bulb at a temperature of about 37°C; therefore, the total energy released by hundreds or thousands of visitors in a day is not negligible. The heat released by the electric lighting system has the same order of magnitude.

Various methods are available to keep the additional energy input into the cave as low as possible, such as limiting the number of visitors to the so-called *visitors' capacity*, which is defined as the maximum number of visitors acceptable in a specific time period such that no environmental parameters are permanently modified. Also, instead of reducing the number of visitors allowed in the cave, the time that people spend into the cave may be reduced. This result may be easily achieved when people enter the cave through one entrance and exit along another passage, instead of returning along the same pathway that took them in. Using high-efficiency lamps can reduce the contribution by the electric lighting system, and a further reduction can be obtained if the lamps are switched on only when visitors are in the vicinity.

Another perturbation of the cave environment is due to the lint (hair, flakes of skin, dust from shoes, and lint from clothing) left by visitors. In caves visited by a large number of people the accumulation of lint becomes a real problem to be solved only by thorough removal. In fact, such lint can cause deterioration of formations and reduce their pristine white beauty to a blackened mess. Lint released into a cave might be reduced by means of air curtains at the entrance. Such a solution would wash people entering the cave and, at the

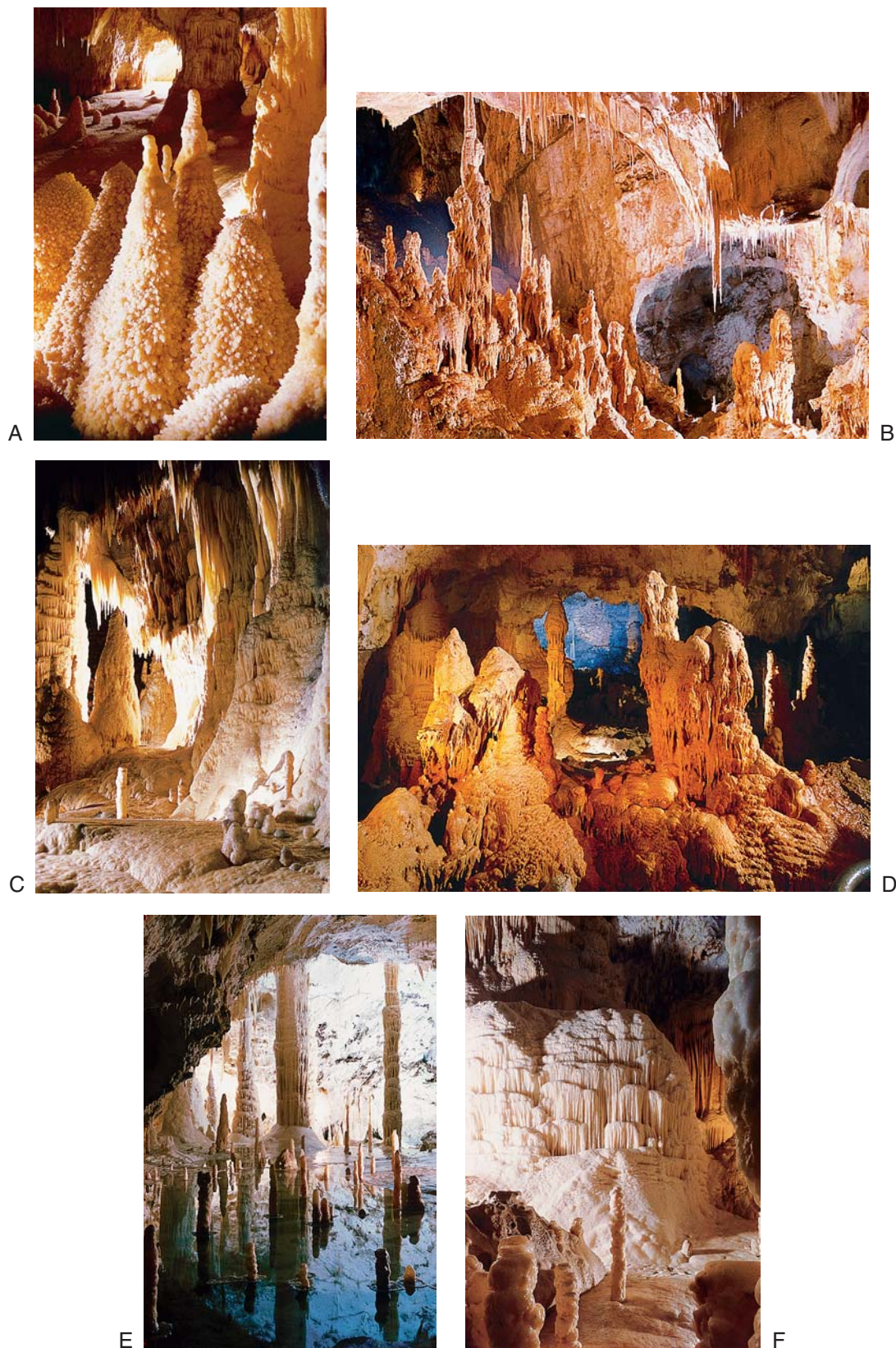


**FIGURE 6** Hwanseon Cave (Daei, South Korea) is a very important show cave of Korea. Tourists reach the vicinity of the cave by car or bus and then climb a slope of a couple kilometers to reach the cave entrance, shown here. (Photograph courtesy of Arrigo A. Cigna.)

same time, isolate the cave environment from outside, as an air curtain acts as an invisible door and prevents airflow through it.

Protecting the environment of a show cave is fundamental both from the point of view of avoiding any damage to a not-renewable resource and conservation of the source of income for cave management. Therefore such a common interest may have an important role in the implementation of any action aiming to the safeguard of the cave environment.

Visitors also release carbon dioxide as a result of their breathing. Until a few years ago, such carbon dioxide was considered to be a threat to cave formations as it could increase water acidity and lead, consequently, to corrosion instead of deposition of new formations. Further studies (Bourges *et al.*, 1998) have shown that, in many instances, more carbon dioxide is produced by natural processes (e.g., oxidization of organic matter in the soil above a cave) and introduced into caves by water percolating into them than is released by visitors. When water that has a relatively high concentration of carbon dioxide reaches the cave environment, it immediately releases part of this carbon dioxide,



**FIGURE 7** Frasassi Caves (Ancona, Italy) developed mainly in the shallow, phreatic zone, where rising hydrogen-sulfide-rich groundwater mixed with oxygenated seepage water. Today, these are the most important show caves in Italy (for details, see [www.frasassi.com](http://www.frasassi.com)). (A) Treasure's room: some stalagmites become covered by calcite crystals have been flooded; (B) Witches Castle; (C) crystallized lake: the soil is covered by a layer of calcite crystals; (D) camel and dromedary: two groups of stalagmites suggest the form of these animals; (E) Candles' room: it is so named because when stalagmites grew and became flooded, a calcite rim deposited around them in the form of a candlestick; (F) Niagra Fall: a large group of stalagmites is covered by stalactites. (Photographs courtesy of Ente Consorzio Frasassi.)

which is not in equilibrium with the carbon dioxide in the air. The resulting chemical reaction moves toward deposition of calcium carbonate, and the cave formations continue to grow; however, in rather small caves with a high visitor flux and without any input of natural carbon dioxide, the formations might indeed corrode because the chemical reactions would then be the reverse. The carbon dioxide in the air dissolves into the water, particularly when water vapor condenses on the cave walls.

Another form of environmental pollution may occur through a joint contribution by visitors and light. Visitors release into the cave spores or seeds of plants that may grow in the vicinity of lamps if the light flux is high enough. The result is the so-called *lampenflora*—the growth of green plants (generally algae, fern, moss) on cave walls or formations close to a light source. When this layer of green plants becomes included in the calcite deposition it is no longer removable; however, the *lampenflora* may be washed away by bleach or hydrogen peroxide if it is not covered by any calcite. Special care must be taken to prevent harming the cave fauna. The growth of *lampenflora* can be avoided by employing lamps with a very low emission of light useful for the chlorophyllian process and low light flux at the rock surface.

### THE DEVELOPMENT OF A SHOW CAVE

Correct development of a show cave must take into account both the protection of the environment and the safety of the visitors. As already pointed out, the physical and chemical equilibria of the environment should not be modified outside the range of natural variations, but any potential sources of harm to visitors must be minimized. This means that the pathways must be strong enough to withstand the very high humidity and occasional floods. In the past, wooden structures were often used, but they had to be replaced frequently. Today, some environmentalists still prefer the use of wood because it is a natural material. Nevertheless, the rather short life of a wooden structure in the cave environment implies an additional cost that is not justified by any advantage. On the contrary, rotting wood supplies large amounts of food, thus modifying the equilibrium of the cave life.

At present, the preference is to use only structures that can be easily decommissioned, but this approach is not without problems, because once it is no longer convenient to manage a show cave it is unlikely that anyone will spend the money to remove such structures from the cave. Only when show cave managers are obliged to deposit a given amount of money to ensure future decommissioning of any structures will it be feasible to routinely use such structures.

In the meantime, it is preferable to use a material that is compatible with the cave environment and will not release pollutants in the long run. A material with these characteristics and which is not expensive is concrete. It may be conveniently used for pathways in general. Stainless steel handrails are also a convenient solution, particularly when

they are also used as pipes to provide water in different parts of the cave to wash out the pathways. In fact, the higher cost of stainless steel is justified by the minimal maintenance required over many years of operation. Sometimes plastic may be used under the condition that it does not contain any contaminant (*e.g.*, heavy metals or organic compounds) that could be released.

When an artificial entrance is needed in order to provide easy access to the cave or to establish a circuit that prevents the return of visitors along the same pathway, it is absolutely necessary to install a system of doors to stop any additional airflow into the cave. Normally, doors operated mechanically or manually are used, but it would be most preferable to install air curtains. This solution (suggested many years ago by Russell and Jeanne Gurnee, 1990) is less expensive and quite safe and offers the great advantage of reducing any sense of claustrophobia among visitors. In addition, it also decreases the release of lint.

A system to monitor such parameters as temperature, humidity, carbon dioxide, and radon should always be installed in any show cave. Currently, it is possible to install networks at a very reasonable cost that are reliable and require little care; for example, data loggers can be discharged every month and the data transferred into a computer for any further evaluation. Automatic networks directly connected to a computer are operated more easily, but, of course, their cost is higher. In any case, it must be stressed that any kind of monitoring network requires some calibration and regular maintenance to prevent malfunctioning.

Such monitoring networks offer another important advantage in that they contribute significant amounts of interesting data, greatly enlarging our knowledge regarding the behavior of cave environments. A rather widespread feeling among speleologists, and people in general, is that a cave is “lost” to science when it is developed as a tourist attraction, but this perception is not at all supported by the important scientific results obtained from many show caves. Sometimes the line between use and abuse may be difficult to define; nevertheless, a careful development continuously monitored may be the most effective way to protect a cave.

It is evident that the economy of a region around a potential show cave can be radically modified by development of the cave; therefore, strenuous opposition to any tourist visitation appears to be rather unfair to the local residents, particularly when a suitable compromise between strict conservation and sound development can be found. In any case, as previously noted, a cave development is not acceptable if it is not supported by appropriate preliminary research.

A recent evaluation of show cave visitors (Cigna and Burri, 2000), based on data obtained for about 20% of all show caves internationally, indicates that more than 150 million people visit show caves each year. By assuming a budget per person as reported in Table I, the total amount of money spent to visit show caves is around \$2.3 billion annually. The number of local people directly involved in the show cave

**TABLE I** Rough Estimation of the Annual Direct and Local Budget of a Show Cave per Visitor

Source	Amount (US\$)
Direct income	5
Other local income	
Souvenirs and snacks	1.5
Meals	5
Transportation	2
Travel agency	2
Total	15.5

business (management and local services) can be estimated to be several hundred per cave, or some hundreds of thousands of individuals worldwide. By taking into account that several hundred other people are working indirectly for each person directly connected with a show cave (Forti and Cigna, 1989), a gross global figure of about 100 million people receive salaries tied to the show cave business; therefore, about one employee is directly or indirectly connected to each tourist in a show cave. There are many other human activities that involve a larger number of people; nevertheless, these figures are not negligible and give an indication of the role that show caves play in the global economy.

In addition to show caves, one must also consider the existence of karst parks that include a cave within their boundaries. As reported by Halliday (1981), the number of visitors to the three top karst national parks in the United States (Mammoth Cave, Carlsbad Caverns, and Wind Cave) amounts to about 2,500,000 tourists each year; therefore, karst parks add to the number of people involved in the whole “karst” business.

### INFORMATION ON SHOW CAVES IN THE WORLD

Many books have been published to be used as guides to local caves. On the one hand, they report a rather large amount of information; on the other hand, however, they are fully reliable for only a short time after their publication. In fact, show caves experience a certain turnover of characteristics that visitors might expect to see, and even the very status of a show cave can change. Recently, a rather useful way to obtain up-to-date information has become available; Showcaves of the World is a website (<http://www.showcaves.com>) that changes and grows continually to provide the latest information regarding show caves.

#### *Bibliography*

- Bourges, F., D'Huils, D., and Mangin, A. (1998) *Étude de l'Aven d'Orgnac*, Rapport final, Lab. Souterrain de Moulis-C.N.R.S.-Géologie Environnement Conseil, pp. 1–84.
- Cigna, A.A. (1993) Environmental management of tourist caves. *Environ. Geol.*, 21, 173–180.
- Cigna, A.A. and Burri, E. (2000) Development, management and economy of show caves. *Int. J. Speleol.*, 29B(1-4), 1–27.

Forti, P. and Cigna, A.A. (1989) Cave tourism in Italy: an overview. *Cave Tourism*. Proc. Int. Symp. 170th Anniv. Postojnska Jama, Postojna, Nov. 10–12, 1988. Centre Scient. Res. SAZU & Postojnska Jama Tourist and Hotel Organiz.: 46–53.

Duckeck, J. (2000) Showcaves of the World, <http://www.showcaves.com>.

Gurnee, R. and Gurnee, J. (1990) *Gurnee Guide to American Caves*. R.H. Gurnee, Closter, NJ, 288 pp.

Halliday, W.R. (1981) Karstic national parks: international economic and cultural significance. *Proc. Int. Symp. Utilization of Karst Areas*, Trieste March 29–30, 1980. Ist. Geol. e Paleont. – Commissione Grotte Boegan, CAI Trieste: 135–144.

## Siebenhengste Cave System, Switzerland

**Pierre-Yves Jeannin and Philipp Häuselmann**

*Höhlenforschungsgemeinschaft Region Hohgant (HRH) and Swiss Institute for Speleology and Karst Studies (SISKA), Switzerland*

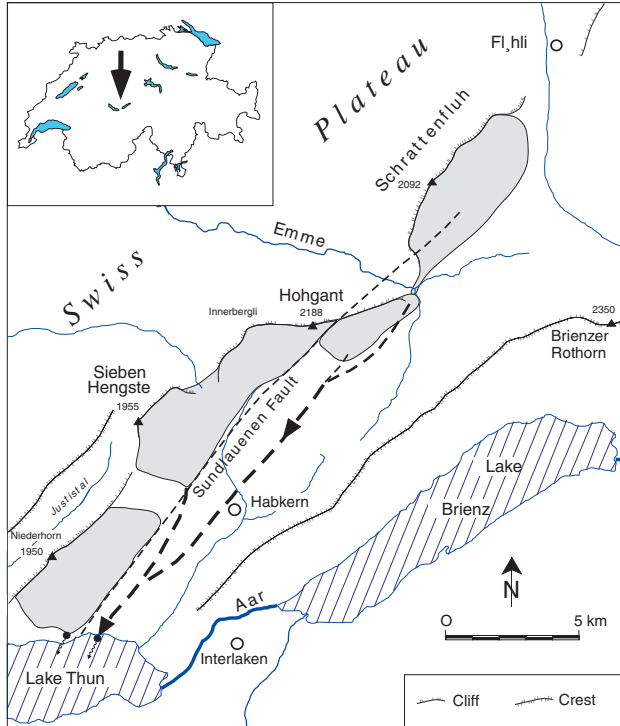
This article presents the main results of 50 years of caving exploration in the Siebenhengste region. An overview of the regional context (geographical, geological, and hydrological setting) is followed by discussion of the main caves and the history of their exploration, genesis of the cave system, several aspects of the minerals and speleothemes to be found here, and findings on cave biology (recent and past fauna).

### GEOGRAPHICAL AND GEOLOGICAL SETTING

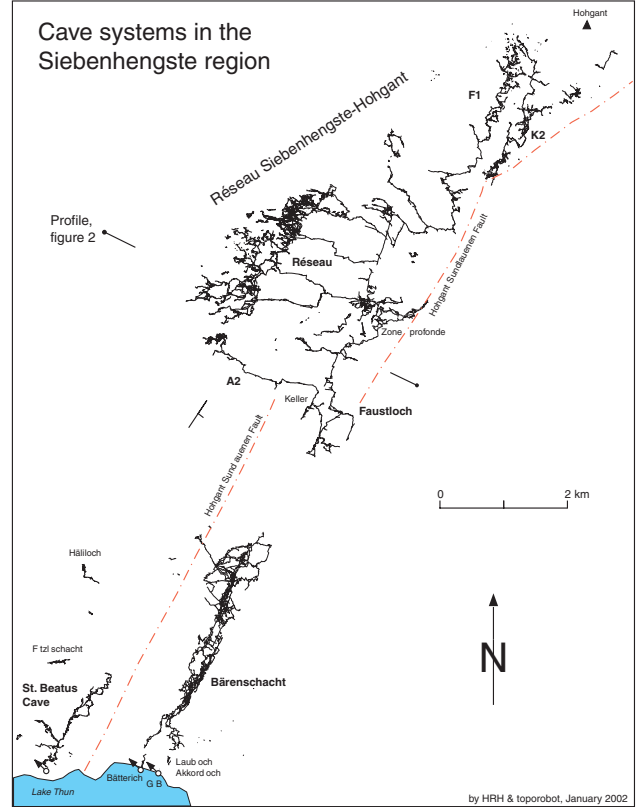
With a length of more than 150 km and a depth of up to 1340 m, the Réseau Siebenhengste–Hohgant cave system is one of the most important on Earth. Close to this network, several other large caves have been found, but they remain unconnected to the main system so far. The total length of explored conduits within the area is about 280 km, and this ensemble is referred to as the *Siebenhengste cave system* in this report.

The system is located in the frontal Alpine range (Helvetic Nappe), directly facing the Swiss Plateau (Fig. 1). From the edge of Lake Thun, where the main spring of the system (Bätterich) is located, it extends more than 20 km northeastwards to the Schrattenfluh, crossing the deep Emme Valley (Bitterli, 1988).

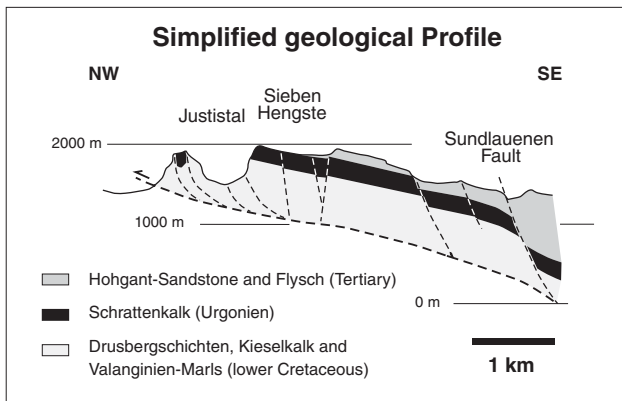
The mountain range enclosing the caves is the southeast-dipping limb of an anticline. Its northwestern limit is formed by high cliffs. Elevations of the summits located along the cliffs range between 1950 and 2190 m above sea level (a.s.l.). Patches of denuded karren fields occur at 1700 m a.s.l., where limestone is exposed. Below this limit, sandstone mainly crops out; therefore, forest, meadow, and swamp covers most of the area. The climate is humid and temperate,



**FIGURE 1** Location of the Siebenhengste region with the water catchments of the St. Beatus spring (bottom left) and of the Bätterich/Gelber Brunnen springs (Sieben Hengste–Hohgant–Schrattenfluh). (Adapted from Jeannin *et al.*, 2000.)



**FIGURE 3** Plan view of the cave systems; G.B. stands for Gelberbrünnen spring.



**FIGURE 2** Geological cross section of the Sieben Hengste range; see Fig. 3 for profile location.

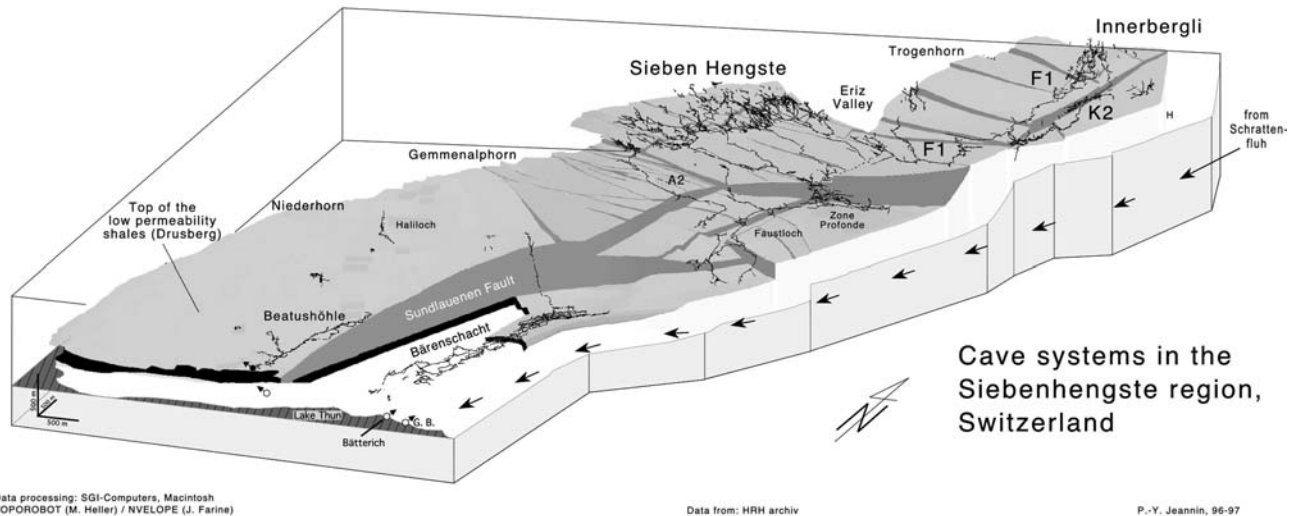
dominated by a western wind. The average annual temperature is about 2°C at 1800 m a.s.l., and annual precipitation ranges between 1500 and 2000 mm. Southeastwards, the limestone/sandstone series disappears below the thick flysch deposits of the Pennine Nappes (Fig. 2).

Karst features are developed predominantly within the Schrattenkalk formation (Barremian to Aptian, Cretaceous, Urgonian facies), which is usually 150 to 200 m thick. Detailed geological studies identified six different formations within the Schrattenkalk, which is underlain by the Drusberg

Marls (lower Barremian). These marls are 30 to 50 m thick. Most of the underground rivers follow the dip on the top of this impervious layer, often along the main faults. The Hohgant sandstones (Eocene), which are locally up to 200 m thick, overlie the Schrattenkalk (Fig. 2). In most of the region, faults enable the surface waters to flow through the sandstones down into the Urgonian limestone.

An important longitudinal normal fault, stretching from Lake Thun to Schrattenfluh (the Hohgant–Sundlauenen Fault), disrupts the continuity of the southeastward dipping monocline of the Siebenhengste range (Figs. 2 and 3). The offset on the fault is 200 to 1000 m, depending on the location. Several parallel normal faults are also present. The normal faults in the Siebenhengste region mainly developed during the Lower Cretaceous to the Eocene. Another set of faults is extensively developed in the area: the dextral strike-slip faults and, to a lesser degree, the related sinistral strike-slip faults. These faults are related to alpine tectonics and are of Miocene age. They appear to have been partly reactivated very recently.

West of the Sieben Hengste, the frontal folds of the Helvetic Nappe are observed in the Sigriswilergrat Range, west of Justistal (Figs. 1 and 2), allowing placement of the original crest of the anticline between 1 and 2 km in front of (northwest of) the Sieben Hengste cliffs.



**FIGURE 4** Three-dimensional view of the cave system. (From Jeannin, P.-Y. *et al.*, in *Speleogenesis, Evolution of Karst Aquifers*, Klimchouk, A.B. *et al.*, Eds., National Speleological Society, Huntsville, AL, 2000, pp. 338–347. With permission.)

## HYDROLOGY

Most of the region is drained by underground karst systems emerging at two main locations: the St. Beatus spring and the Bätterich/Gelberbrunnen springs. The St. Beatus spring, with a discharge ranging between 10 l/s and 2 to 3 m<sup>3</sup>/s (average, 72 l/s), has a catchment area of about 10.5 km<sup>2</sup> that lies in the southeast part of the region. The Bätterich/Gelberbrunnen spring catchment extends at least 21 km to the northeast, reaching the Schratzenfluh massif, as proven by a tracing experiment (Fig. 1). As the main spring (Bätterich) lies below Lake Thun, the discharge of the system is very difficult to measure. It probably exceeds 20 m<sup>3</sup>/s during floods. The catchment area is around 32 km<sup>2</sup> and is largely covered by sandstone where surface flow may occur locally. Recharge rates are therefore difficult to assess.

## OVERVIEW OF THE CAVE SYSTEMS AND HISTORY OF THEIR EXPLORATION

The different caves known at present sum to a total length of more than 280 km of passage, lying between 480 and 2000 m a.s.l. The system has a distinct labyrinth character, whose complex geometry can only be explained by the development of several superimposed cave systems that correspond to different and more or less independent times and conditions. Seven large caves enclose most of the known passages in the area (Figs. 3 and 4). All passages of the caves are surveyed and mapped in detail as shown in Fig. 5.

### The St. Beatus Cave

St. Beatus Cave is a spring cave that can be followed from the spring upstream for approximately 2 km as a crow flies. The explored length of the cave is 12 km with a height of +353 m

with respect to the entrance. Most of the cave is of phreatic origin (elliptic passage), although canyons are found in many places (keyhole cross section). Most of the passages lie on the top of the Drusberg marls. A detailed study of the morphology of this cave and its sediments was conducted (Häuselmann, 2002), allowing the identification of several speleogenetic phases (see later discussion). Some smaller caves are known in the vicinity of St. Beatus Cave.

The entrance of the cave has been known since prehistoric times and seems to have been inhabited by the hermit called St. Beatus in the early middle ages. The first caving explorations were made in the 19th century, and already in 1904 the entrance part of the cave had become a show cave. Maybe one third of today's known passages were explored before World War II. The evolution of caving techniques (especially cave diving) allowed the exploration of the other two thirds of the cave over the last 50 years. A complete and systematic resurvey of the cave was conducted in the 1990s, allowing the exploration of about 1 km of new passages. Exploration of this cave is almost complete by today's standards.

### The Bärenschaft (“Bear’s Shaft”)

Bear's Shaft is the second largest cave in the region with a length of 60 km and a depth of –946 m. The name of the cave comes from three bear skeletons found at the bottom of the first shaft, some hundreds of meters from the entrance. The entrance part presents a series of shafts leading to the bottom of the limestone (Schrattenkalk) at a depth of 150 m (Bitterli *et al.*, 1991). From this point down to –550 m, the passage is steep with small shafts, and the cross-section is on the order of 5 m<sup>2</sup>. Most of this section has developed along a thin calcareous bed within the Eocene sandstone series (Hohgant series). Due to large faults, deep shafts make it



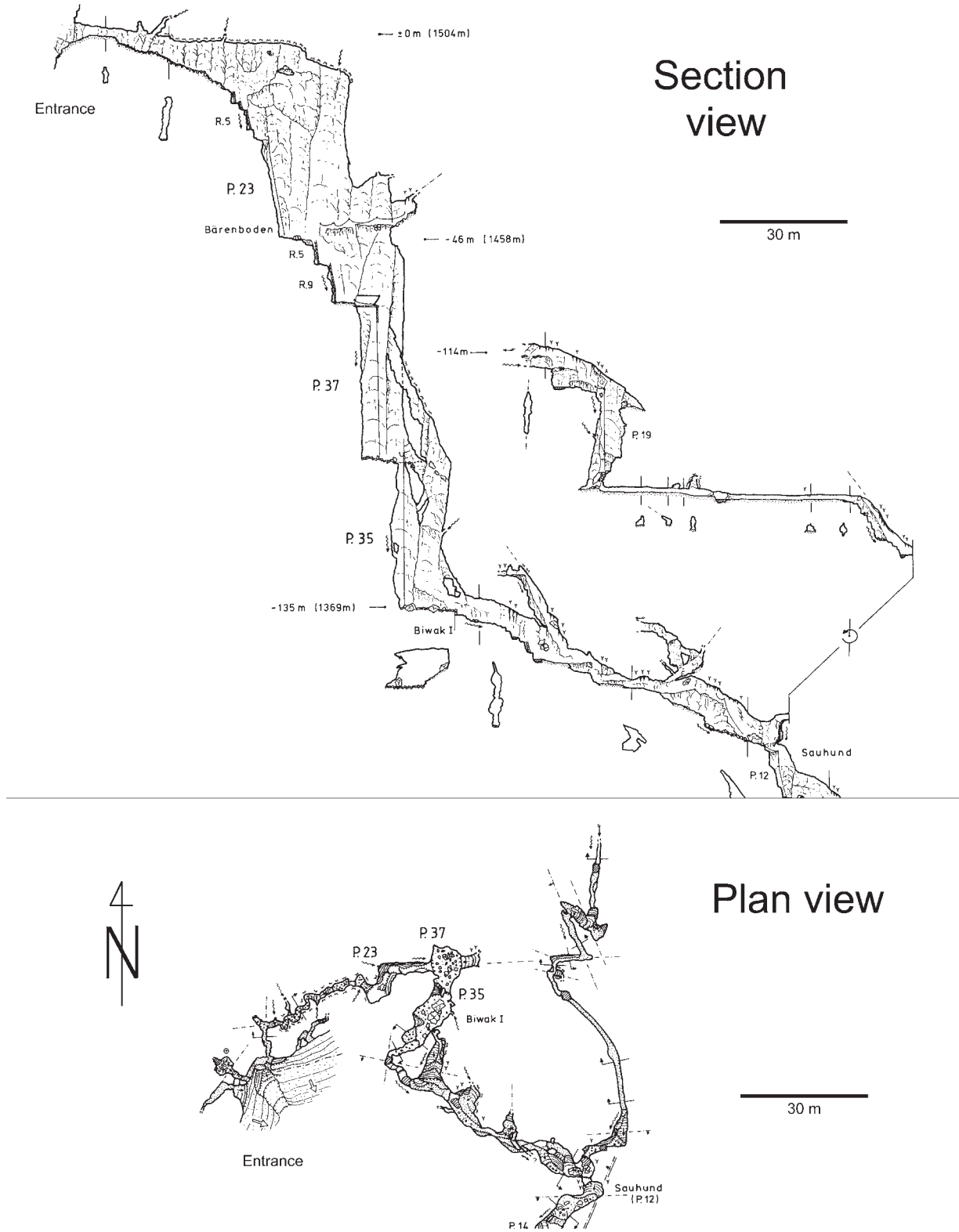


FIGURE 5 Example of a detailed map of the cave system. (Adapted from Bitterli *et al.*, 1991.)

possible to reach an incredible labyrinth of large elliptical conduits at a depth of –900 m. This labyrinth is quite similar to Hölloch (Muotathal, Switzerland). The bottom part of the cave floods, as it is located at the level of Lake Thun (Bätterich spring). Higher levels remain dry and are richly decorated by dripstones and flowstones, gypsum crystals, and some aragonite formations.

With the exception of 2 km in the entrance part, Bärenschacht is almost exclusively of phreatic origin. Direct infiltration into the cave is prevented by a thick cover of marls and flyschs. In some places, the depth of the conduits below the land surface reaches as much as 800 m; therefore, the large cross sections found in the labyrinth (between 12 and 25 m<sup>2</sup>) clearly indicate that Bärenschacht is the downstream collector of the Bätterich/Gelberbrunnen catchment area (i.e., the downstream part of most of the caves of the Siebenhengste region).

Bärenschacht was first discovered in 1965 and explored in 1973 and 1974 down to a sump at –565 m. Explorations were conducted by large teams recalling the conquest of the Himalayan summits in the 1950s. The sump was dived and considered too tight. In 1986, an audacious caver dug underwater and was able to squeeze through a very narrow flooded conduit for about 40 m. A steep and large passage ended in the darkness of very large shafts. This was the key to the labyrinth at –900 m and the beginning of incredible explorations by a very restricted group of cavers able to cope with a dive featuring both a nasty siphon and difficult vertical caving. Nearly 40 km were explored at that time (Funcken, 1994). In 1995, a tunnel was dug on top of the sump, making it possible for non-divers to reach the deep part of the cave (Funcken et al., 2001). Today's exploration is driven forward by the Coordination Group of Bärenschacht which is part of the body of HRH.

### **The Réseau Siebenhengste–Hohgant**

The Réseau Siebenhengste–Hohgant cave system is located below the Siebenhengste karren field. In the international scene of speleology, it is the best known system of the region, because its exploration was quite spectacular. This is also the reason why its name has been used for the entire cave region. This cave network was connected to F1 and Faustloch in the 1980s, giving today a system of 150 km of connected passages with a depth of 1340 m. The Siebenhengste labyrinth itself is nearly 106 km long.

Schematically, most of the entrances to the Réseau start with a series of shafts and short meanders down to a depth of 150 to 250 m. The Réseau (“network” in French) itself is reached at that depth, where a labyrinth of elliptic or keyhole passages can be followed for kilometers, upstream, downstream, or horizontally. This labyrinth is clearly visible on the map of the caves (Fig. 3). Similar to antennas, underground streams have been explored downstream along large and straight canyons that follow some of the main

strike-slip faults of the region. These all reach a perpendicular major conduit coming from F1. Due to geological complications (crossing a normal fault), the major conduit splits into three-dimensional anastomoses in the so-called *Zone Profonde*.

Exploration of the Siebenhengste massif started in 1966, but it was in 1972 and 1973 that the existence of such a large cave system was revealed. Exploration was then quick, with a length of 20 km being reached in 1976, 32 km (–800 m) in 1978, and 45 km in 1982. It was at that time that the F1 (Innerbergli area) was connected, giving a length of 60 km to the Réseau. This quick exploration was not systematic at all and left many unexplored passages. A more systematic exploration of these side passages was begun in 1982 and is still ongoing today. As a consequence, the overall aspect of the Réseau Siebenhengste–Hohgant did not change much during this period, but the density of the conduits has more than doubled. The exploration of this incredible cave system is still far from finished, and new kilometers of passage are found every year. Exploration and survey are achieved in a very systematic way in the Réseau as well as at the surface. Hundreds of small caves have been explored in the Siebenhengste karren field, some of them reaching a length of 1 or 2 km; however, only a restricted subset of them could be connected to the Réseau.

### **The Faustloch**

The Faustloch is a 14-km long cave (–930 m) that was connected to the Réseau Siebenhengste–Hohgant in 1987. The entrance part, down to –200 m, developed in the sandstone overlying the Urgonian limestone and is followed by two huge shafts (80 m and 60 m) crossing the limestone down to its bottom. From here onward, an underground stream can be followed along a canyon. At –450 m, the stream crosses the Drusberg marls and goes deeper into a series of small and wet shafts, and meanders developed in a cherty limestone (Hauterivian). At the top of the descent across the Drusberg marls, a major elliptic conduit is found (cross section of 10 to 20 m<sup>2</sup>). This conduit is the continuation of the F1–Siebenhengste major collector (fossil phreatic conduit). It can be followed downstream over several kilometers toward the Bärenschacht and divides into several branches. Two of them end on deep siphons (one of them has been dived down to –38 m for a length of 300 m), which lie slightly higher than those of the Bärenschacht. The other branches are clogged by thick sediments. Despite strong digging efforts, the continuation has not yet been opened.

The Faustloch was discovered in 1970, the entrance being as large as a fist (“Faust” in German). It took several years to descend the shaft series down to –350 m—first, because of large water quantities cascading down the shafts, and, second, because it was very difficult to set anchors in the sandstone. The first third of the cave was explored between 1971 and 1978. In 1987, a large flood event occurred in the

Siebenhengste region, and the fossil passage coming from the Réseau Siebenhengste–Hohgant was reactivated by a stream of several cubic meters per second. This opened the passage upstream of Faustloch, allowing the Réseau to be connected. It also opened the downstream end of the cave (Funcken and Moens, 2000). After a long digging effort, almost 10 km of passage could be found toward the Bärenschacht. In 1997, a new flood clogged this passage again, and the most remote part of the cave is not accessible anymore.

Due to strong, cold-water cascades, the entrance shaft of Faustloch is a dangerous section of the cave, where three cavers have lost their lives (one in 1976 and two in 1998).

### The F1 (Innerbergli Area)

The F1 cave has a typical dendritic pattern. Its length is nearly 29 km, and its depth is 650 m. It was connected in 1982 with the Réseau Siebenhengste–Hohgant. The entrance shaft is comprised of small pits and meanders, with some tight passages. At a depth of 150 m, the Drusberg marls are found, and the passage gets larger, thanks to the presence of some tributaries converging at that point and to the collapse of the conduit wall where it contacts the Drusberg marl. A large active canyon can be followed for about 3 km before disappearing into a large collapse room. From this room onward, a phreatic fossil conduit continues for another 3 km. It is joined by four main tributaries but ends (clogged) very close to the Réseau. The connection could be managed only through tight and wet passages. The cave entrance was found in the summer of 1981, and the main conduit grew over 15 km in the 18 months prior to connection to the Réseau in Christmas 1982. A systematic exploration of the tributaries has been undertaken over the last 20 years, but the complete exploration of F1 will require many more years.

### The K2

The K2 cave is parallel and quite similar to F1. Its length is 14 km and its depth is –750 m. The entrance shaft series, found in 1980, is followed by a severe squeeze and a long and narrow meander down to a room at –300 m. The passage out of this room is very tight, and many cavers have had to turn back at this point. After a short maze of small phreatic conduits, a large canyon passage is reached and can be followed for several kilometers. This section is very dark and slippery. At a depth of –600 m, the main passage splits into a complex three-dimensional labyrinth of elliptical conduits (fossil phreatic passages) reaching a siphon at its lowermost point. In 1991, a dive of the siphon led to a deeper point of the cave (–750 m), where any continuation does not seem possible. At that time, this point was probably one of the most remote parts of Switzerland. In 1992, a lower entrance was found, giving access to the lower part of the cave and reactivating exploration in this region. Many tributaries were explored, but no major continuation could be found. The

intermediate section of K2 is still being explored with the hope of being able to connect it to F1 or to the Hagglätsch cave (5 km), which develops about 80 m straight above K2.

### The A2 (Hohlaub Area)

This 11-km long cave (–690 m) can be considered as the southwestern continuation of the Siebenhengste labyrinth, but no connection has been achieved. The entrance was found in 1973 and explored down to a depth of 30 meters. There, a very tight meander was found. At least four groups have tried to squeeze through the meander, where a strong draft indicated a continuation. Only in 1986 was the 35-m-long passage traversed. A mining action was organized in order to be able to explore the galleries found beyond. A series of shafts and meanders was explored down to a depth of 220 m. A labyrinth of horizontal elliptic passages (fossil phreatic conduits), corresponding to the Siebenhengste labyrinth, crosscuts the shaft zone. Downstream, an active canyon stretches toward the East to a collapse room, where the water disappears. A fossil phreatic conduit continues on toward Faustloch but turns abruptly to the right some hundreds of meters before reaching it. This region, called Keller (“cellar”), develops along a fault and gives access to the lowermost point of the cave (–690 m). It is still nearly a hundred meters above the nearby Faustloch. Most of the cave has been explored between 1986 and 1994; however, a lot of passages remain to be discovered (Gerber, 1994).

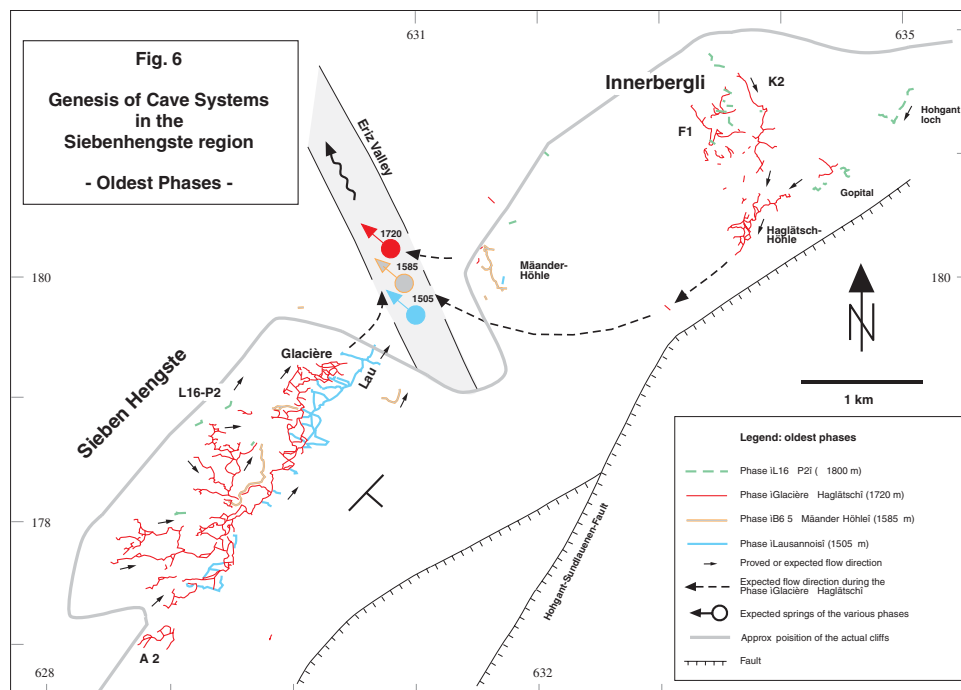
## GENESIS AND AGE OF THE CAVE SYSTEMS

Theories regarding the genesis of the Siebenhengste cave system began to be developed immediately upon exploration of the cave, as a result of the exceptional density of conduits. Various contradicting hypotheses were discussed. In the middle of the 1980s, Hof laid the groundwork for the current ideas. Jeannin *et al.* (2000) and Häuselmann *et al.* (2002) refined this model. The ideas are based on the observation of the conduit morphology that allows recognition of paleowater tables.

Two major observations help to identify the position of paleowater tables:

1. The change of a vadose conduit morphology (canyon or meander) into a phreatic morphology (elliptic tube) gives the exact height of the paleowater table.
2. In looping passages, the position of the paleowater table can be inferred to be higher than the top of the loops, if they do not present any indication of free-surface flow morphology (entrenchment).

By applying this concept, several phases (or levels) of conduits have been recognized. The inferred paleowater tables are considered to be linked to the position of paleosprings (*i.e.*, of paleovalley bottoms; regional base level). Phases are labeled with elevations inferred for the



**FIGURE 6** Older phases of the cave system genesis. (From Jeannin, P.-Y. *et al.*, in *Speleogenesis, Evolution of Karst Aquifers*, Klimchouk, A.B. *et al.*, Eds., National Speleological Society, Huntsville, AL, 2000, pp. 338–347. With permission.)

paleosprings. Due to the Alpine uplift, real elevations may have been different when the systems were active.

The oldest speleogenetic phases are found in the uppermost caves. Five phases could be identified, at 1950, 1800, 1720, 1585, and 1505 m a.s.l., respectively. The conduit morphology (scallops) indicates that the springs of those hydrological systems were located in the Eriz valley (Fig. 6). Based on additional data, we hypothesize that the Aare Valley (today's main valley) did not exist at that time and that the inferred paleosprings were located along the (mostly disappeared) Eriz paleovalley. Glacial deposits found in some of the caves, as well as dating of younger phases, indicate that these high and old cave systems clearly developed before 450,000 years B.P. An age of several million years is probably more correct.

The next series of speleogenetic phases had springs located in the Aare valley (Fig. 7), meaning that a significant geomorphic event happened between phases 1505 and 1440, capable of turning the flow direction 180° within the karst system. Evidence for springs at 1440, 890, 805, 760, 700, 660, and 558 m a.s.l. has been found so far. Investigations of cave sediments in conduits of the last six phases gave the following ages:

- Phases 890 and 805: older than 350 ky
- Phase 760: active phreatic system between 350 ky and 207 ( $\pm 27$ ) ky
- Phase 700: active phreatic system between 207 ( $\pm 27$ ) and 146 ( $\pm 11$ ) ky

- Phase 660: active phreatic system between 146 ( $\pm 11$ ) and 28 ( $\pm 11$ ) ky
- Phase 558: active phreatic system from 28 ( $\pm 11$ ) ky until today.

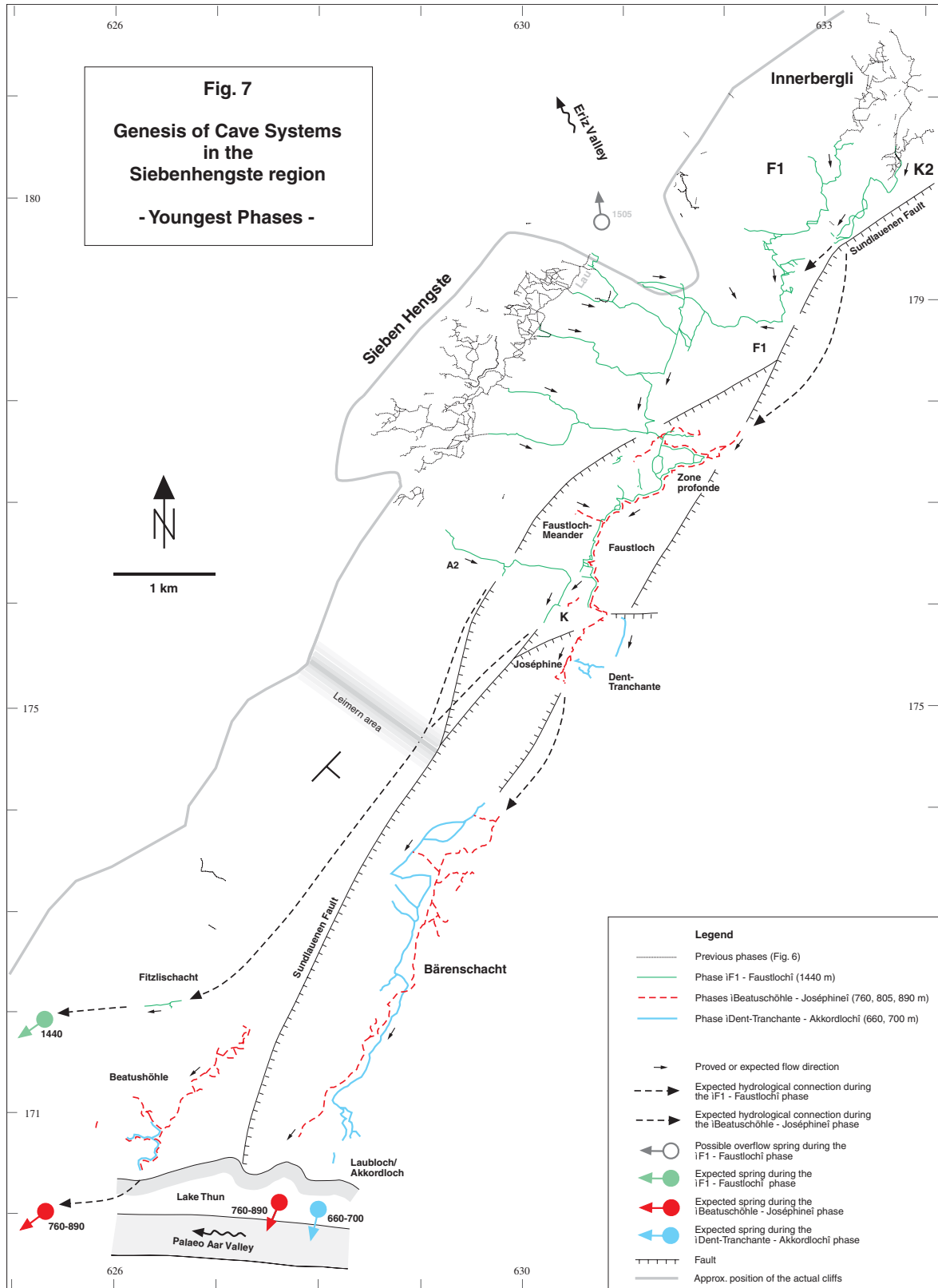
The main reason for the deepening of the Aare valley was the presence of large glaciers during the cold periods of the Quaternary.

## CAVE MINERALS

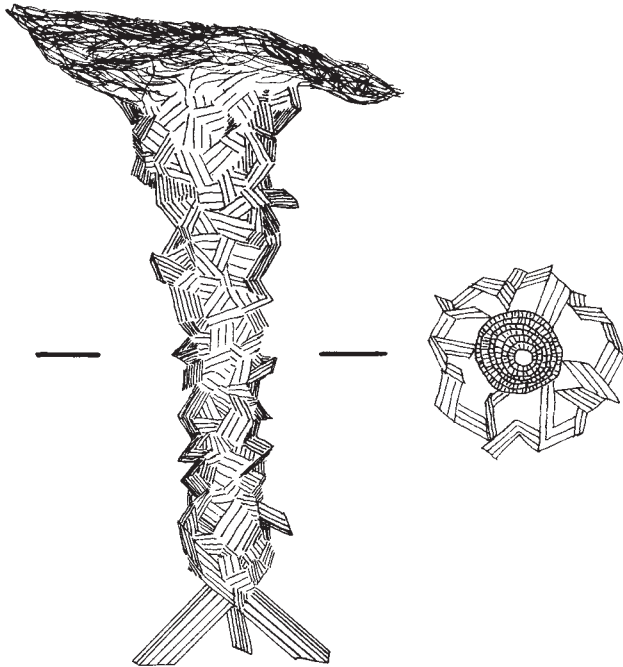
Many sections of the caves in the Siebenhengste region are nicely decorated. White to yellowish flowstones are present in many passages, producing a strong contrast with the dark limestone walls. Some of the flowstones can be followed over hundreds of meters, up to almost 1 km. Stalactites and stalagmites are common features, but they are never very large and are usually quite dispersed. Some particular speleothemes are calcite stalactites mantled in a gypsum crust that remain at a few centimeters from the calcite core (Fig. 8). Larger gypsum crystals are sometimes present at the tip of the stalactite.

Soda straws are found in many places, some of them reaching more than 3 m in length. Helictites, draperies, cave pearls, rimstone dams, cave shields, moonmilk, and some spars are found in all parts of the cave system, but mainly in the lower levels. Although frequent, speleothemes are generally not set in a very dense pattern in the Siebenhengste caves, but really decorate the conduit walls, roof, and floor.

Beside these very classical calcite formations, aragonite is observed as frostwork or is interbedded in stalagmites or



**FIGURE 7** Younger phases of the cave system genesis. (From Jeannin, P.-Y. *et al.*, in *Speleogenesis, Evolution of Karst Aquifers*, Klimchouk, A.B. *et al.*, Eds., National Speleological Society, Huntsville, AL, 2000, pp. 338–347. With permission.)



**FIGURE 8** Sketch of a gypsum mantle covering and stalactite. (Illustration by A. Hof.)

stalactites. Rarely, soft fibrous aragonite aggregates looking similar to asbest has also be found. Gypsum is very frequently found in the caves of the Siebenhengste region. Gypsum stars and needles (up to 15 cm long) are the most common formations. Gypsum crusts, snow, and “mantles” (Fig. 8) are also quite common. Gypsum hair up to 30 cm is quite rare, but can be seen in some cave parts. In Faustloch, a floor is covered by a 20-cm thick carpet of mirabilite crystals, probably coated by some thenardite white crust.

In fact, very few data have been collected on minerals and speleothems of the Siebenhengste region. More systematic investigations would probably reveal many other types of minerals and formations.

### PRESENT AND PAST FAUNA DISCOVERED IN THE CAVES

Many investigations of cave biology have been undertaken in the Siebenhengste region, mainly by R. Bernasconi, but have never been brought to the attention of a wider public. Investigations in the St. Beatus Cave and other caves revealed the existence of 26 mosses, 4 ferns, and 3 algae, as well as 4 mushroom species; also, 11 bat species have been observed, sometimes quite far from the cave entrances. Many invertebrates have been collected and determined. The current number of species follow: Collembola (11), Niphargus (3), Dytiscides (1), Asellus (2), Diptera (4), Turbellaria (2), Ostracoda (1), Gasteropoda (8), Copepoda (1), Diplopoda (1), Opiliones (1), Arachnia (2), Acaria (2), Trichoptera (4), Coleoptera (4), Thysanura (1), Lepidoptera (3), Oligochaeta

(1), and rainworms (2), giving a total count of 54 species (24 of which are described from St. Beatus Cave). *Bythiospeum alpinum* (Mollusca Gasteropoda Prosobranchia Hydrobiidae), found in Bärenschacht, is a new animal species for science. The same is true for *Onychiurus dunarius*, a collembol first described from the St. Beatus Cave.

Attention has also been paid to remains of past fauna. Bone fragments of a cave bear (*Ursus spelaeus*) have been found in one cave, but these are the only remains of Pleistocene fauna. A large spectrum of Holocene animals (46 species total) have been found, usually at the bottom of entrance shafts, which acted as natural traps. The brown bear (*Ursus arctos*), which was extinct in Switzerland by around 1850, was present in many caves. Bear nests have been found in two caves. Moreover, a moose (*Alces alces*) found in the Innerbergli area dated back to 424 to 633 years A.D. Many species of small mammals and small bovines common to the region were found in the caves as well and also provide some interesting information. For instance, the presence of domestic animals and of species typical for forest environment is surprising in caves that open in a denuded limestone pavement. In fact, these animals are relicts of warmer periods, when forest still covered much of the Siebenhengste region almost to the top of the mountains.

The same type of observation has been made from bat bones found in the caves. The presence of species living today at least 500 m below their finding location indicates relicts of a warmer climate (Morel, 1989). Today, bats are still present but scarce. The very large number of skeletons found in the caves seems to indicate that the bat population was much higher in the past. Most of these bones probably date from a period extending between 4000 B.C. and 1500 A.D. as confirmed by <sup>14</sup>C dating of bat bones from a nearby karst area. Although still poorly investigated, bones found in caves provide a rich record of the past fauna and climate of Central Europe.

### ACKNOWLEDGMENTS

The English was reviewed by Monique Hobbs. We also thank all the cavers who explored this huge system and provide a very valuable work of exploration and cave mapping.

### Bibliography

- Bitterli, Th. (1988) Das Karstsystem Sieben Hengste–Hohgant–Schratzenfluh: Versuch einer Synthese. *Stalactite, Journal de la Société Suisse de Spéléologie*, 38(1+2), 10–22 (in French and German).
- Bitterli, Th., Funcken, L., and Jeannin, P.-Y. (1991) Le Bärenschacht: un vieux rêve de 950 mètres de profondeur. *Stalactite, Journal de la Société Suisse de Spéléologie*, 41(2), 71–92 (in French and German).
- Funcken L. (1994) Bärenschacht: plus de 36 km post-siphon. Une exploration hors du commun. *Stalactite, Journal de la Société Suisse de Spéléologie*, 44(2), 55–82 (in French and German).
- Funcken, L. and Moens, M. (2000) Synthèse des explorations au Faustloch depuis 1987. *Stalactite, Journal de la Société Suisse de Spéléologie*, 50(1), 3–22 (in French and German).
- Funcken, L., Moens, M., and Gillet, R. (2001) *Bärenschacht: l'interminable*

- exploration. *Stalactite, Journal de la Société Suisse de Spéléologie*, 51(1), 9–22 (in French and German).
- Gerber, M. (1994) Le A2-Loubenegg (région des Sieben Hengste). *Stalactite, Journal de la Société Suisse de Spéléologie*, 44(1), 3–8 (in French and German).
- Häuselmann, Ph., Jeannin, P.-Y., and Monbaron, M. (2003) Role of epiphreatic flow and soutirages in conduit morphogenesis: the Bärenschacht example (BE, Switzerland), *Zeitschrift für Geomorphologie* 47, 171–190.
- Jeannin, P.-Y., Bitterli, Th., and Häuselmann Ph. (2000) Genesis of a large cave system: the case study of the North of Lake Thun system (Canton Bern, Switzerland), in Klimchouk, A.B., Ford, D.C., Palmer, A.N., and Dreybrodt, W., Eds., *Speleogenesis, Evolution of Karst Aquifers*. National Speleological Society, Huntsville, AL, pp. 338–347.
- Morel, Ph. (1989) Ossements de chauves-souris et climatologie: Collecte systématique de squelettes de chiroptères dans des systèmes karstiques des Préalpes et Alpes suisses – premiers résultats. *Stalactite, Journal de la Société Suisse de Spéléologie*, 39(2), 59–72 (in French and German).

## Sinking Streams and Losing Streams

Joseph A. Ray  
Kentucky Division of Water

The purpose of this chapter is to discuss the characteristics and significance of influent streams, creeks, and rivers that drain underground and to evaluate their integral function in karst hydrology. Losing streams are sometimes observed recharging sand and gravel aquifers and volcanic material such as basalt. This chapter, however, will restrict discussion to the more common karst phenomena developed within soluble rocks such as limestone. Many of the terms associated with influent streams are often interchanged depending on the practice of the user.

### INFLUENT RIVERS AND STREAMS

The unique nature of losing and sinking influent streams is their development and evolution of conduit flow routes and caves through soluble rocks. Large volumes of concentrated recharge from losing and sinking rivers are central to the evolution of most of the world's largest and most significant caves and springs in karst. Caves formed by influent streams may contain a major stream or active floodwater route or may be long abandoned high above active base level. Abandoned flood routes often retain fluvial sediment and features left by the former stream (Fig. 1).

Where major rivers cross soluble rocks they generally carve a low-gradient, continuous surface valley through the region and usually function as the master drainage or base level for local tributaries and springs; however, certain rivers and most smaller streams become influent and lose water where they

traverse soluble rocks. For example, influent water from the upper Danube River resurfaces at Germany's largest resurgence, Aach Spring. Because of early conflicts over water rights, this subsurface river was the site of the first quantitative water trace to prove the spring's source. The pioneering 2-day study, conducted by Knop in 1877, used hourly salt content measurements of Aach Spring to calculate a concentration curve totaling nearly 10,000 kg of salt, about half of the quantity deliberately injected at the Danube River sinks (Kass, 1998).

The Takaka River in New Zealand begins losing base flow into sediment-covered marble 20 km from its resurgence at Waikoropupu Spring. This large spring maintains a low-flow discharge of  $>5 \text{ m}^3/\text{s}$ . The Reka River in Slovenia sinks into Skocjanska Cave and resurges 30 km south near Trieste, Italy, forming a group of 16 springs with a mean discharge of  $>26 \text{ m}^3/\text{s}$ . The Trebinjica River in the Dinaric karst is one of the largest rivers in the world to sink into limestones and contributes to the Ombla River Spring near Dubrovnik. One of the largest springs in the world, the Ombla has a discharge ranging from 4 to  $140 \text{ m}^3/\text{s}$ .

River rises, supplied primarily by nearby losing rivers, are a common type of large spring in Florida. The typical losing river reach is less than 5 km in length. The Santa Fe River, a major tributary of the Suwannee River in north-central Florida, may be the largest losing stream in the United States. The losing reach has developed where the Santa Fe River incises a regional escarpment or linear bluff. The influent conduit capacity ranges from about 5 to  $16 \text{ m}^3/\text{s}$  at O'Leno State Park, 4.8 km northeast of its resurgence at Santa Fe Rise. Subsurface flow is locally visible in a karst window about 3 km from the sink area, and when river stage exceeds 14 m the dry river channel is reoccupied by flood waters (Martin and Dean, 1999).

Big Spring, Missouri's largest spring with a discharge ranging from 6 to  $36 \text{ m}^3/\text{s}$ , receives water from several losing tributaries of the Eleven Point River. This regional-scale recharge was demonstrated by groundwater tracer tests conducted by Aley over distances of 60 km. Elk River is possibly the largest losing stream in West Virginia, with 8 km of dry river channel, under-drained by caves and conduits feeding Elk River Springs.

The Edwards Aquifer in southcentral Texas is one of the largest, most important karst aquifer systems in the United States. It contains a 5- to 25-km-wide, 350-km-long recharge zone that is traversed by numerous losing rivers and creeks. The Blanco, Medina, Frio/Dry Frio, and Nueces/West Nueces rivers are four of the larger losing-stream systems that contribute to the karst aquifer with a combined average recharge of  $20 \text{ m}^3/\text{s}$ . Large springs, including Comal, San Marcos, and Leona springs, and high-volume artesian wells, yielding groundwater flow under hydrostatic pressure, are supplemented by this extensive network of losing streams.

With more than half of the state covered by soluble rocks, Kentucky contains many losing and sinking streams.



**FIGURE 1** Steep-gradient stream sinking into a large-capacity cave opening in southeastern Kentucky. The flood capacity of this cave may exceed  $20 \text{ m}^3/\text{s}$ . (Photograph courtesy of James C. Currens.)

Figure 2 shows stream patterns in the region surrounding Mammoth Cave National Park. The light-shaded diagonal band showing an absence of streams corresponds with the sinkhole plain. This gently rolling landscape was an early settlement-transportation corridor because of the streamless, prairie terrain. The main portion of the sinkhole plain, between the Green and Barren rivers, is flanked to the southeast by dozens of sinking streams. These influent streams comprise the headwaters of the three largest karst drainage basins in Kentucky, including groundwater in the National Park. Blue Spring Creek, with a watershed of  $37 \text{ km}^2$ , is the largest of these sinking streams. Its basin comprises nearly 10% of the  $390 \text{ km}^2$  watershed of Gorin Mill Spring, Kentucky's largest spring. Figure 3 shows the sequence of multiple stream swallets that are activated over a 5-km reach of Blue Spring Creek as discharge increases from low flow to moderate and high flow.

Losing streams and meander cutoff caves and springs are common in southwestern Kentucky. These features frequently occur along the West Fork of Red River and Sinking Fork of Little River. The most significant losing stream is probably the Sinking Creek/Boiling Spring system in northcentral Kentucky. Although 19 km of Sinking Creek

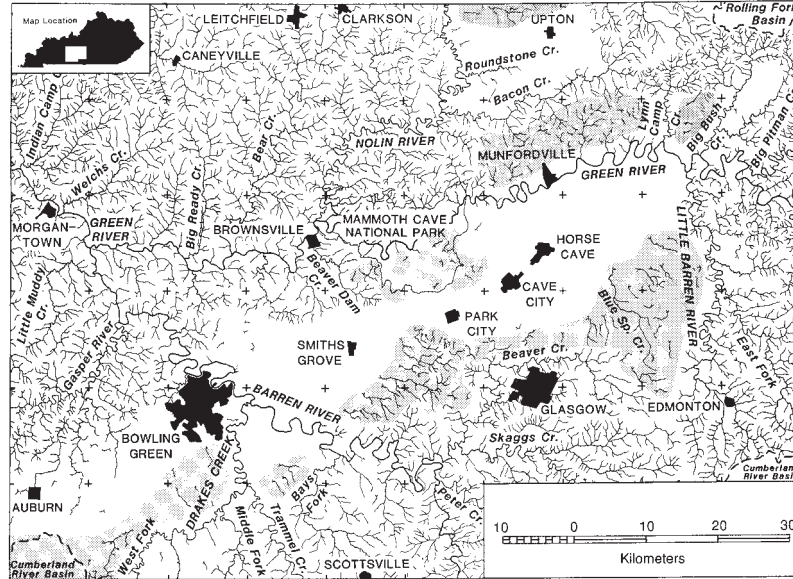
is shown on topographic maps upstream of Boiling Springs, this 20- to 30-m-wide stream is actually a dry channel for most of the year.

### FUNCTION OF INFLUENT STREAMS

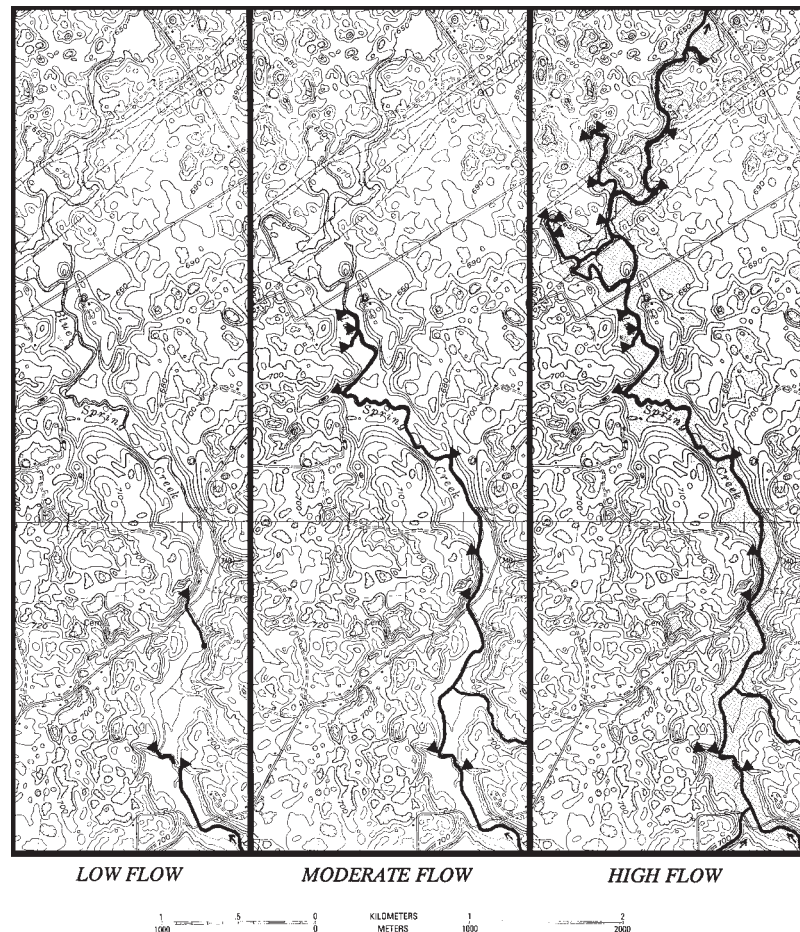
In order to comprehend the hydrology of influent streams, one must also understand the structure of a normal stream. An idealized stream basin may be viewed as having three basic components: The *headwaters*, or allogenic source; the *main stem*, or zone of transfer; and the *mouth*, or discharge point. *Allogenic* waters are defined as stream flow derived from non-local sources. In karst drainage, influent allogenic streams may be derived from adjacent nonsoluble rock terranes\* or soluble rocks that include perching units such as shale, chert, or sandstone. This allogenic flow comprises the headwaters of most losing and sinking streams. Karst watersheds that contain a significant amount of stream or fluvial recharge are often termed *fluviokarst*.

\*In this article, the term *terrane* is used in karst where both surface and subsurface physical features, including groundwater, are relevant to the discussion; when only surface features are addressed, the term *terrain* is used (Hansen, 1991).





**FIGURE 2** Stream patterns and urban centers in an 8250-km<sup>2</sup> region surrounding Mammoth Cave National Park in Kentucky. A consistent stream density occurs over most of the region except for the streamless karst plain, oriented southwest to northeast. Numerous sinking streams drain beneath this sinkhole plain and contribute to large springs on the Green and Barren rivers. These sinking stream watersheds are identified with a gray tone.



**FIGURE 3** The sinking-stream complex of Blue Spring Creek in central Kentucky. Flow variations are compared during low-, moderate-, and high-flow conditions on three images of the same topographic map segment. Active swallets or stream sinks are identified with black triangles tangent to the flowing stream. The influent capacity of successive swallets are exceeded as stream discharge increases. Stream flooding and intermittent lakes are identified by a gray tone in the high-flow map. More than 40 additional sink-points are located up to 2 km beyond the map border.

Likewise, the concept of base level is important in the understanding of influent streams. *Base level* refers to sea level or the lowest level of master stream erosion. Influent streams develop when they cross soluble rocks along their transfer route to base-level rivers or seas. As potential groundwater discharge locations (down-valley or along master rivers) deepen over time, tributary headwaters tend to keep pace by developing advantageous subsurface flow routes. Enlarging conduits typically follow preferential pathways along bedrock fractures and bedding planes and function as shortcuts to base level. Because karst conduit development can occur some depth below base level, losing reaches may locally occur along base-level streams.

As incipient conduit flow routes are established, convergent recharge from losing and sinking streams tends to rapidly accelerate conduit enlargement. This preferential and aggressive conduit erosion controls the location of main flow routes and caves within the developing karst drainage basin. Similar in function to local headwater stream networks, diffuse percolation from the shallow weathered zone (epikarst) continually feeds the under-draining trunk-flow routes created by losing and sinking streams. This integrating process often creates an efficient subsurface network, generally dendritic or trellised in pattern, that functions as a unified karst drainage basin or watershed.

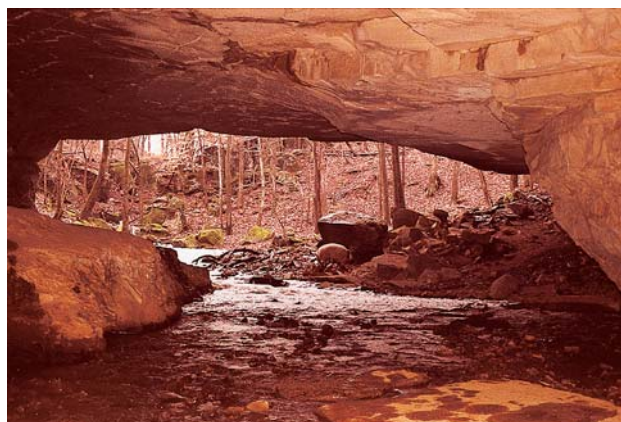
Jakucs (1977) pointed out that much classic theory on the development of karst ignored the erosional and hydrologic influence of through-flowing and losing streams derived from adjacent non-karst terrane. He described several varieties of erosion within karst terrane by allogenic or “alien” streams and illustrated the evolution of a chain of swallow-holes formed as these streams incise soluble rocks.

In many cases, the largest karst caverns are created in the zones where allogenic rivers pass through the subsurface. Because gravel, cobbles, boulders, and other debris can be swept underground by sinking streams, features resembling normal surface landforms such as floodplains, alluvial bars, and stream meanders can be formed within flood-route caves. This transported sedimentary load contributes to mechanical abrasion (corrasion) along with the solutional enlargement (corrosion) of passages by aggressive flood waters. Exceptional flood-route caves and mazes are often formed where influent tributaries converge, where flood-water routes diverge around obstacles, and within effluent distributaries. Accordingly, sinkhole collapse and karst-window development tend to focus along the trunk route and near the boundary zones of subsurface rivers.

Losing and sinking streams can concentrate large amounts of floodwater runoff and contaminants into a karst aquifer at specific points. Obviously, this type of rapid recharge makes karst groundwater extremely vulnerable to pollution. Figure 4 shows muddy stream runoff free-falling into an open cave in southcentral Texas. The aquifer and receiving spring are obviously degraded by this rapid influx of unfiltered stormwater runoff. Figure 5 is a view showing lateral stream



**FIGURE 4** Muddy stormwater runoff falling into an open cave in southcentral Texas. This flow of unfiltered recharge into the karst aquifer can easily flush contaminants into the community water supply. (Photograph courtesy of George Veni.)



**FIGURE 5** Cave inflow from a karst window in southcentral Kentucky showing direct livestock access to the sensitive groundwater system. Exclusion of farm animals from influent streams would help improve groundwater and spring quality. (Photograph courtesy of George Veni.)

flow in a karst window taken from inside the receiving cave. This site in southcentral Kentucky illustrates agricultural pollution by livestock having direct access to the sensitive groundwater system. Education of the agricultural industry, urban developers, and the public about the dynamics of karst drainage is vital if we are to protect and restore these important groundwater resources.

### EVOLUTIONARY SEQUENCE OF LOSING AND SINKING STREAMS

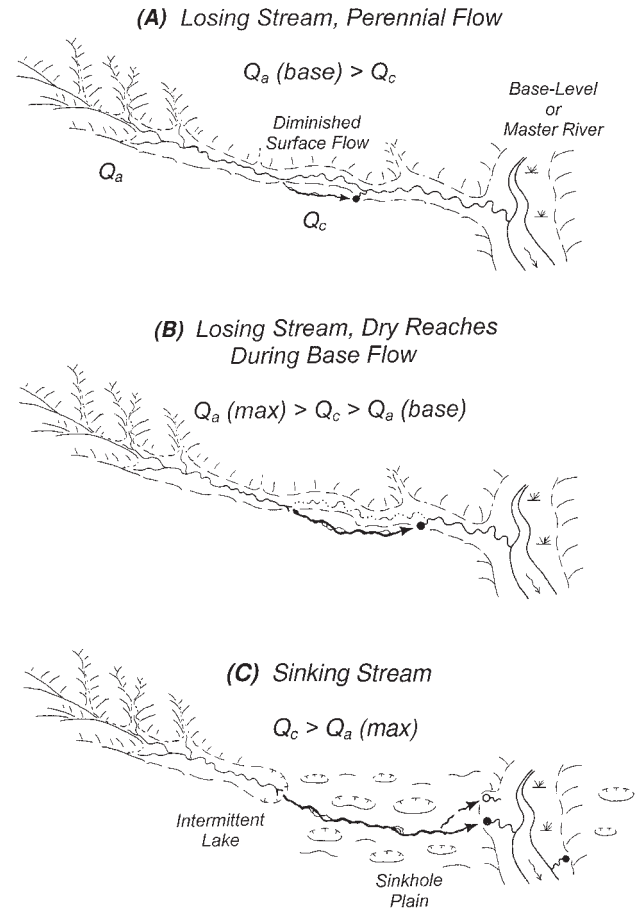
The subsurface flow route of influent streams may range from minor cutoffs to regional trunk conduits. As an evolving surface drainage network initially incises soluble rocks, meander cutoffs and short-distance detours of flow into the subsurface may begin to develop. Where the exposure of soluble rocks is limited, the depth and extent of conduit flow is accordingly minimized. Such watercourses usually regain lost conduit flow at downstream springs.

This intra-valley losing and gaining karst flow is probably the most common type of tributary stream behavior in soluble rocks. In addition to flow in highly soluble rocks, losing and gaining hydrology can occur in thin or interbedded limestone/shale units that lack the potential for deep conduit flow. Likewise, less soluble rocks such as dolomite locally develop this type of interrupted stream flow. Often, normal stream morphology remains largely unaffected by the stream loss, and many topographic maps do not reveal the subsurface diversions.

The idealized diagrams in Fig. 6 illustrate a reasonable evolutionary sequence in the development of losing and sinking streams. Three types of influent streams tributary to a base-level river are shown and are compared by means of a generalized water-balance. Evapotranspiration and artificial withdrawals are ignored in these simplified relationships.

Case (A) illustrates karst flow in a losing stream where influent conduit capacity is exceeded during all conditions. The base flow from the allogenic watershed,  $Q_a$  (base), is greater than the conduit-flow capacity ( $Q_c$ ); consequently, surface flow is only diminished within reach of the losing-stream reach. Due to subtle flow variations, some losing reaches can be difficult to identify. This less common (and less recognized) situation may occur during incipient karst development, because of persistent conduit clogging, or along broad rivers with large base flows. Streams with abundant loads of coarse sediment often lose a portion of surface flow entirely through its alluvium. This type of intergranular flow may be locally indistinguishable from karst diversions.

Case (B) shows a losing stream that develops a dry reach during base flow. Maximum allogenic discharge during flood,  $Q_a$  (max), is greater than the conduit-flow capacity ( $Q_c$ ), causing a continuous overflow channel to be fluvially eroded and maintained. However, the conduit-flow capacity ( $Q_c$ ) is greater than the allogenic base flow,  $Q_a$  (base), which causes a dry reach below the losing point. This is probably



**FIGURE 6** Three basic types of influent streams draining to a base-level or master river. These generalized illustrations utilize the terms  $Q_a$  for allogenic discharge or headwater source and  $Q_c$  for conduit-flow capacity in the subsurface transfer zone. Arrows show flow direction from under-draining conduits to springs in the discharge zone. Case (A) shows a losing stream with perennial flow, where base-flow allogenic discharge is greater than conduit-flow capacity. Case (B) shows a losing stream where maximum allogenic discharge is greater than conduit-flow capacity, but base-flow allogenic discharge is less than conduit-flow capacity; therefore, a dry reach occurs during base flow. Case (C) shows a terminal sinking stream where conduit-flow capacity is greater than maximum allogenic discharge. (Adapted from White, 1999.)

the most common type of influent stream. Conduit flow may return to the surface at a down-valley spring within the same watershed (intra-basin flow) or it may divert beneath a surface divide into a neighboring watershed (inter-basin flow). Because of their frequency and significance in karst hydrology, groundwater systems or spring basins dominated by losing streams may be classified as type I or overflow allogenic karst basins.

Case (C) illustrates a sinking stream that is pirated or diverted entirely underground. Conduit-flow capacity  $Q_c$  is greater than the maximum allogenic discharge,  $Q_a$  (max). Because of the exceptional conduit-flow capacity, a surface escape route or overflow channel is not maintained. An abandoned karst valley or sinkhole-dominated plain often separates the stream sink and its resurgence. Groundwater

systems dominated by sinking streams in blind valleys may be classified as type II or underflow allogenic karst basins.

These three cases are simplified. Actual influent streams are usually more complex, as they may exhibit overlap or transitional situations based on weather trends or unique conditions. For example, case (A) may resemble case (B) during severe drought, whereas case (B) may resemble case (A) in wet years. Also, during extreme flood events some sinking streams, case (C), may yield overland flow through degraded gaps or hanging valleys that are progressively being abandoned.

Some karst areas contain relatively thick surficial deposits of soil or sediment. Streams that lose water through appreciable bedrock cover tend to maintain surface overflow routes. Influent soil pipes or channels formed in sediment frequently collapse, partially clogging flow routes. Cobbles and gravel concentrated from the cover material tend to collect within these unstable conduits and may help to maintain a limited capacity of leakage into the under-drain system.

Depending on season or flow condition, losing and sinking stream flow may advance to, or retreat from, a series of sink points along a considerable stream reach. The 32-km-long dry channel of Lost River in southern Indiana is an exceptional example. Such streams have a tendency of adjustment between the influent capacity of under-draining conduits and loss of base flow within a stream reach. Because winter base flow exceeds summer low flow, the influent front tends to migrate between the two conditions. Figure 3 shows a channel reach of 3 km over which flow migrates between low and moderate conditions, which generally corresponds to the two base-flow conditions. Also, excessive runoff from developed or agricultural areas increases the magnitude of peak runoff and may alter the expected base flow discharge. Knowledge of these potential flow dynamics is important during hydrogeologic mapping and karst inventories for dye tracing studies.

In summary, many rivers drain through the karst regions of the world and are altered by interaction with underlying conduit flow developed within soluble rocks. Countless allogenic tributary streams lose water or sink entirely and contribute to the primary groundwater circulation routes through karst watersheds and drainage basins. These main conduit flow routes function as transfer paths from headwater influent streams to discharge points at springs. Many of the largest and most important caves in the world were developed by influent recharge. The active trunk flow routes serve as master groundwater collectors of diffuse recharge from infiltration and runoff into sinkholes. Due to limited filtration of influent stream recharge and rapid groundwater velocities, most karst aquifers are extremely vulnerable to pollution from surface activities. Knowledge of the recharge sources and variability inherent to karst drainage is vital for protecting and restoring threatened cave resources, water supplies, and many perennial spring-fed streams.

### *See Also the Following Articles*

*Hydrology of Karst Aquifers • Karst Water Tracing*

### **Bibliography**

- Ford, D.C. and Williams, P.W. (1989) *Karst Geomorphology and Hydrology*. Unwin Hyman, London, 601 pp.
- Hansen, W.R. (1991) *Suggestions to Authors of Reports of the United States Geological Survey*, 7th ed. U.S. Government Printing Office, Washington, D.C., 289 pp.
- Jakucs, L. (1977) *Morphogenetics of Karst Regions*. John Wiley & Sons, New York, 284 pp.
- Jennings, J.N. (1985) *Karst Geomorphology*. Basil Blackwell, Oxford, 293 pp.
- Jones, W.K. (1997) *Karst Hydrology Atlas of West Virginia*. Special Publication 4, Karst Waters Institute, Charles Town, WV, 111 pp.
- Kass, W. (1998) *Tracing Technique in Geohydrology*. A.A. Balkema, Rotterdam, 581 pp.
- Martin, J.B. and Dean R.W. (1999) Temperature as a natural tracer of short residence times for groundwater in karst aquifers, in Palmer, A.N., Palmer, M.V., and Sasowsky, L.D., Eds., *Karst Modeling*. Special Publication 5, Karst Waters Institute, Charles Town, WV, pp. 236–242.
- Mylroie, J.E. and Mylroie, J.R. (1991) Meander cutoff caves and self piracy: the consequences of meander incision into soluble rocks. *Natl. Speleol. Soc. Bull.*, 52, 33–44.
- Palmer, A.N. (1975) The origin of maze caves. *Natl. Speleol. Soc. Bull.*, 37, 56–76.
- Schumm, S.A. (1977) *The Fluvial System*. John Wiley & Sons, New York, 338 pp.
- White, W.B. (1988) *Geomorphology and Hydrology of Karst Terrains*. Oxford University Press, New York, 464 pp.
- White, W.B. (1999) Conceptual models for karstic aquifers, in Palmer, A.N., Palmer, M.V., and Sasowsky, L.D., Eds., *Karst Modeling*. Special Publication 5, Karst Waters Institute, Charles Town, WV, pp. 11–16.

## **Sistema Huautla, Mexico**

**C. William Steele**

*Boy Scouts of America*

**James H. Smith, Jr.**

*Environmental Protection Agency*

**S**istema Huautla, the deepest cave in the Western Hemisphere, is located in the southern Mexican state of Oaxaca. It is among the ten deepest caves in the world, and one of the longest of the world's deep caves. The exploration of the Huautla caves is still ongoing, nearly forty years since cavers first discovered them. The stories connected to the exploration are well documented in magazines, books, caving publications, photography, maps, and film. Sistema Huautla was the first cave outside of Europe to be explored deeper than 1000 m.

### **CAVE DESCRIPTION**

The integrated Sistema Huautla is comprised of 17 entrances and 55,953 m of passage to a depth of 1475 m. This most complex vertical system has more independent deep routes



FIGURE 1 Sistema Huautla is located in the northeast corner of the state of Oaxaca, Mexico. (Map by Jim Smith.)

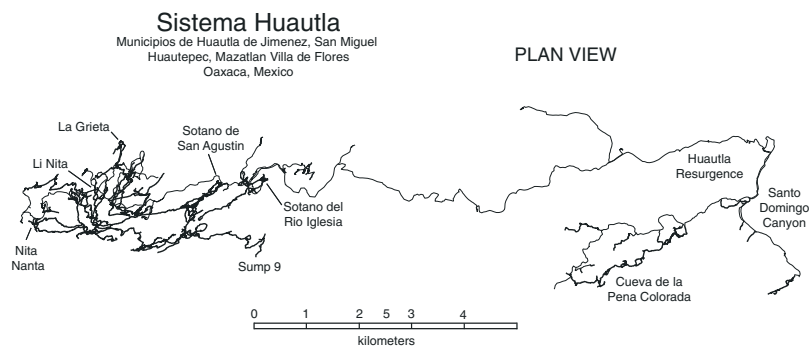


FIGURE 2 Sistema Huautla is a complex network of cave streams with 17 known entrances. The pattern of stream flow is determined by the structural geology of the karst groundwater basin. (Map by Bill Stone, 2003.)

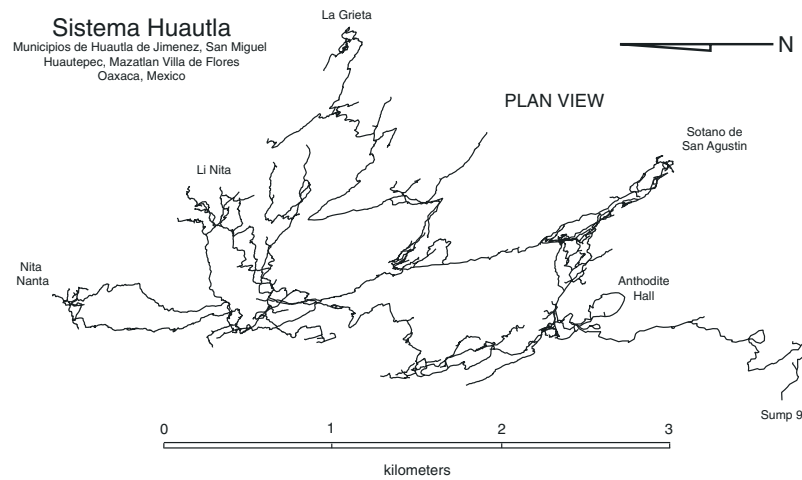
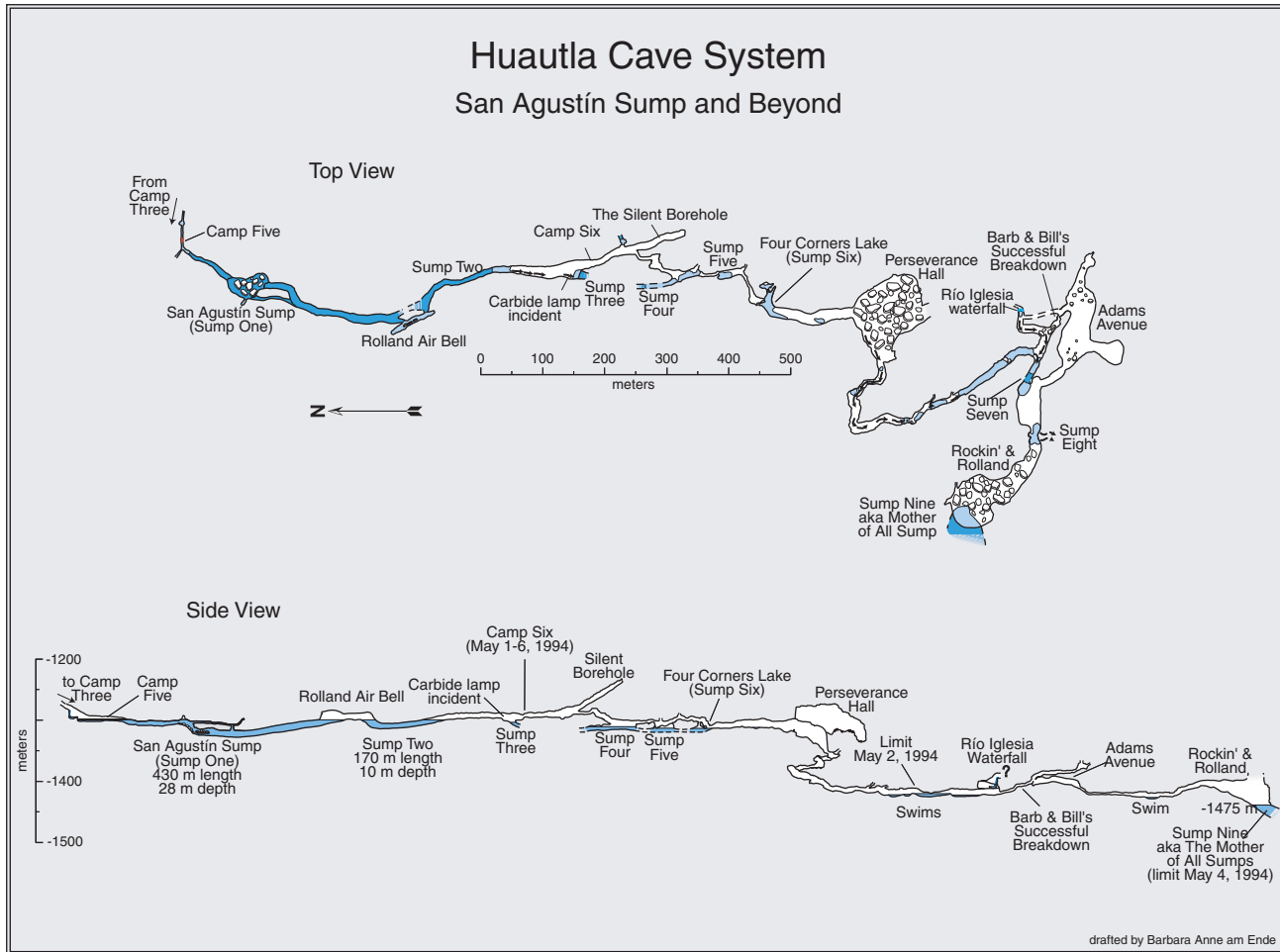


FIGURE 3 Sistema Huautla is a cave composed of many separate streams that descend vertically to a base level then converge to form one large stream before discharging out a spring entrance. (Map by Bill Stone, 2003.)



**FIGURE 4** Exploration beyond the 840 Sump to Sump 9 in Sotano de San Agustín is the greatest single feat of U.S. deep cave exploration ever accomplished. (Map by Barbara Anne Am Ende.)

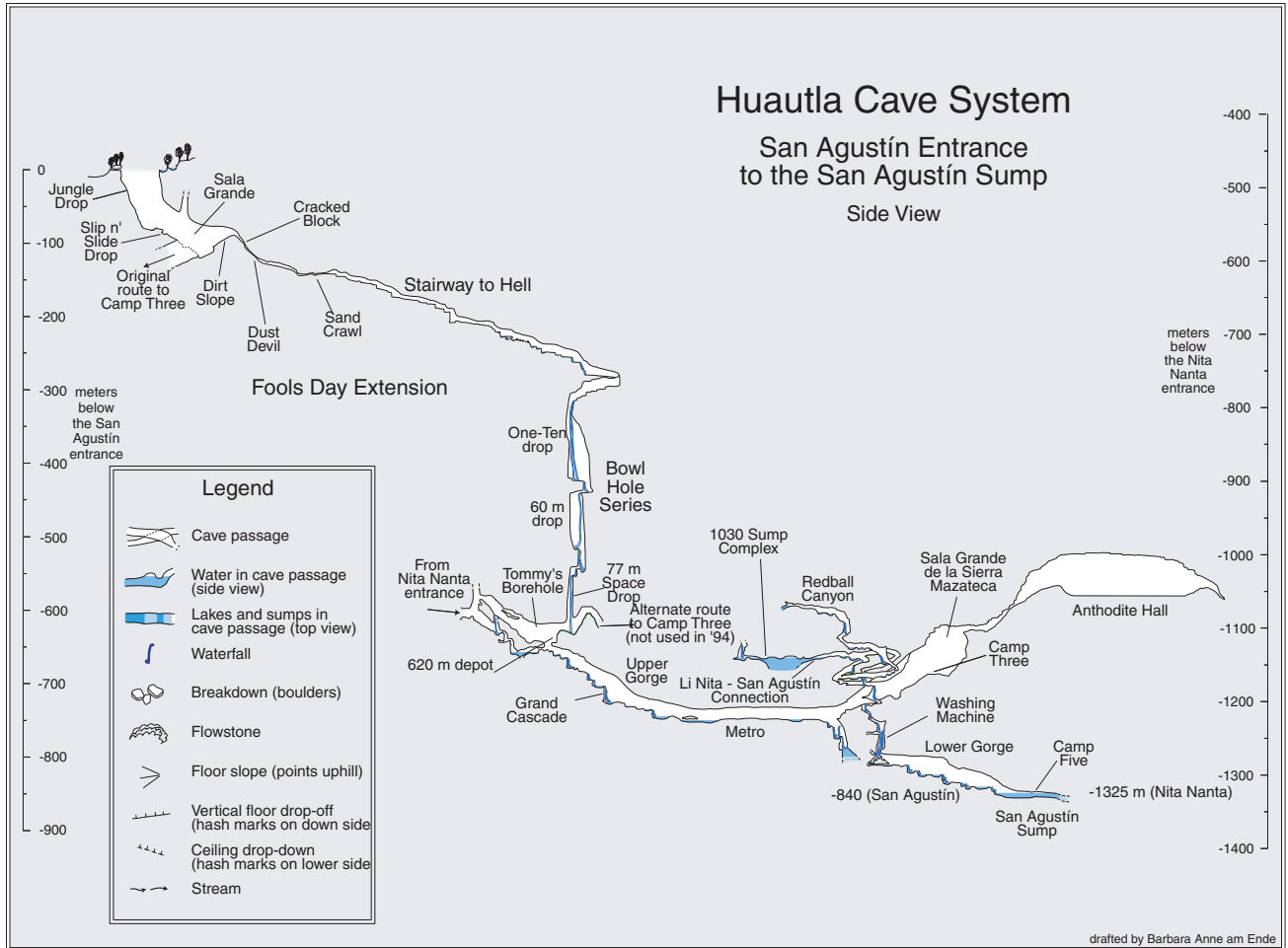
than any other cave in the world: three routes over 1000 m deep, one over 900 m, two over 800 m, one over 700 m, and two over 600 m. The connection of Nita Nanta with the rest of the system in 1987 marked the first, and thus far, the only time two caves each over 1000 m deep have been joined together. The world's deepest down and up traverse, a spectacular crossover trip, can be made: 1225 m down via Nita Nanta's highest entrance, through spectacular stream galleries of San Agustín, and 1107 m back up Li Nita, all without retracing a single footstep. This down and up traverse would be 11 km in traverse length, although the two entrances are less than a kilometer apart on the surface. Such a trip is likely never to be done due to the logistics of rigging well over 100 pitches and diving two widely separated sumps at the bottom.

The most remote recess of Sistema Huautla is beyond a series of water-filled tunnels at -840 m in San Agustín. Sump dives of 450 and 170 m in length reach air-filled tunnels that measure 20 m wide and 20 m tall that ultimately lead to Perseverance Hall, the second largest chamber in Sistema

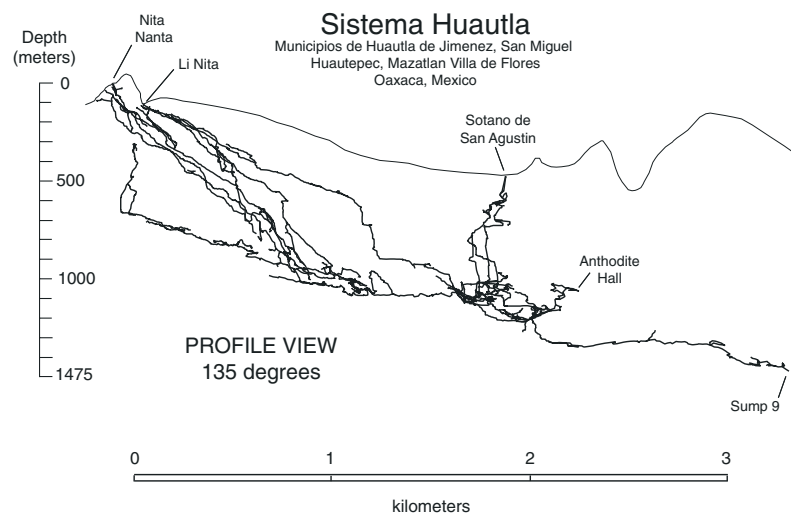
Huautla. From Perseverance Hall, measuring at 120 m wide and 120 m long and 30 m tall, the passage dips steeply to galleries that lead to the deepest level and final sump of Sistema Huautla, 1475 m below the highest entrance. The final sump and furthest exploration is located 2.5 km from the 840-m sump or 6.6 km from the San Agustín entrance.

Hidden in the depths of the Sierra Mazatecas, 640 m below the entrance of San Agustín, is the jewel of Sistema Huautla, Anthodite Hall. Anthodite Hall, at 300 m long and 200 m wide and 70 m high, is one of the largest chambers in the region. The ceiling and walls are covered with milky white to clear speleothems, the majority of which are large anthodites. These radiating pin cushions are half a meter in length.

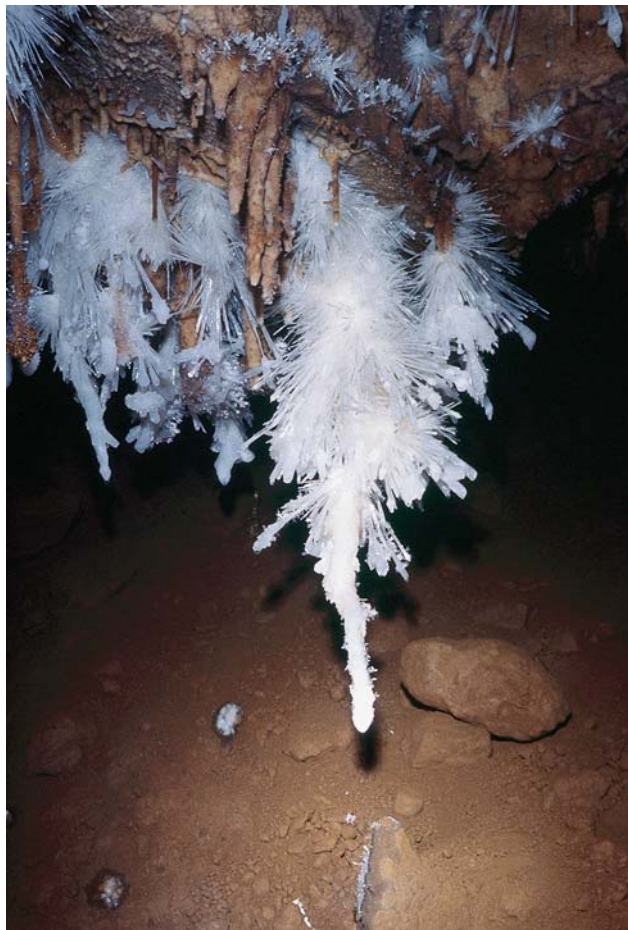
The caves of Huautla were first discovered in 1965 by cavers from Austin, TX. The caves were initially explored through the rest of the 1960s by Canadian cavers and cavers from assorted American states such as Texas, Georgia, Indiana, and Tennessee. In 1967 the distinction of having the deepest cave in the Western Hemisphere came to the Huautla



**FIGURE 5** Anthodite Hall, the jewel box of Sistema Huautla contains the most spectacular anthodite speleothems found in the cave system. Anthodite Hall is the largest chamber in Sistema Huautla. (Map by Barbara Anne Am Ende.)



**FIGURE 6** Sistema Huautla is a vertical drainage system composed of separate streams that descend through the mountain down steeply descending passages and a multitude of vertical shafts. More than 50 kilometers of cave passages are represented with 1475 meters of vertical relief. (Map by Bill Stone.)



**FIGURE 7** Anthodites are speleothems that are characterized by radiating clusters of needles or quills generally are composed of aragonite, one of the crystalline forms of calcium carbonate ( $\text{CaCO}_3$ ). Anthodites may grow from the ceiling, walls, and floor. They may form single clusters, huge busters or chandeliers. This anthodite was found in Anthodite Hall, Sistema Huautla. (Photographs taken by James H. Smith.)

area caves with the exploration of Sotano del Río Iglesia at 531 m deep. This was surpassed the following year when Sotano de San Agustín was explored to a depth of 612 m.

Following a hiatus from 1970 to 1976, expeditions to Huautla began again in 1976 and carried on steadily until the late 1990s. These were organized and led by Richard Schrieber, Bill Stone, Jim Smith, Mark Minton, and Bill Steele. These expeditions are well documented in the newsletters of the Association for Mexican Cave Studies.

## GEOLOGY

Sistema Huautla is located in the Sierra Mazateca of the Sierra Madre Oriental del Sur. The Sierra Mazateca, a northwest-southeast trending mountain range which attains altitudes of up to 2200 m, contains the easternmost mountains to the Gulf of Mexico. The Sierra Mazateca is



**FIGURE 8** Laura Smith is descending a waterfall on a rope during the exploration of Cueva Agua Carlota, Huautla. In order to follow the stream cave explorers must use rope techniques perfected specifically for cave exploration. (Photographs taken by James H. Smith.)

flanked to the east by the foothills and coastal plain of the Veracruz Basin and to the west by the intermountain basin of the Cañada de Oaxaqueña (a.k.a. Tehuacan Valley). The Cañada de Oaxaqueña is drained to the east by the Río Tomellín and Río Salado, which converge to form the Río Santo Domingo. The Río Santo Domingo cuts across the Sierra Madre Oriental del Sur and converges with the Río Papaloapan in the Veracruz Basin.

The Sierra Mazateca range receives orographic precipitation that decreases in amount from the east to the west. Annual rainfall averages range from 6 m along the eastern front of the Sierra Mazateca at Tenango to 400 mm at Teotitlán del Camino in the arid Cañada de Oaxaqueña. The Sistema Huautla area, located at an altitude of 2100 m, receives approximately 2.5 m of annual rainfall. The abundant rainfall is one of the essential factors to the formation of deep vertical drainage systems.





**FIGURE 9** Jeb Blakely traverse the Upper Gorge of Sorano de San Agustín, Sistema Huautla, at 700 meters. The Upper Gorge is a series of potholes punctuated by waterfalls some requiring ropes to descend. The stream that flows through the Upper Gorge is swift requiring guarded movement to avoid being swept downstream. (Photographs taken by James H. Smith.)

## HYDROGEOLOGY

The Sistema Huautla karst groundwater basin is an elongate basin 4 km wide and 14.5 km long oriented north-south, and is defined by its structural geology. The basin is bordered on the west by allochthonous sandstones and shale of Jurassic Age and to the north and east by cretaceous limestones. The drainage of the basin is characterized as subterranean with more than 100 km of active and paleo conduits that have been explored and surveyed. The drainage outlet or spring for the Sistema Huautla cave is to the south in the Rio Santo Domingo Canyon at an elevation of 300 m above sea level. Subterranean groundwater flow is determined by regional strike and plunge of dipping limestone strata. The vertical extent of the subterranean drainage was verified by dye tracing. From the highest mapped entrance of Sistema Huautla, Nita Nanta, to the Sistema Huautla Resurgence, the vertical extent of 1760 m, is second only to Sistema Cheve, which dye traced to 2525 m.



**FIGURE 10** Anthodite observed in Anthodite Hall, Sistema Huautla. (Photographs taken by James H. Smith.)

## BIOLOGY

The cave life in the Huautla System is highly diverse and rich in cave-adapted animals. Of the 48 species of invertebrates known from the caves of Huautla, 10 are highly adapted troglotic forms. Many groups of tropical arachnid have been found inhabiting the caves. The most striking animal is the scorpion *Alacran tartarus*. Found deep in the system, it is usually found near or in the water. One of the rarest troglotic tarantula spiders, *Schizopelma grieta* is also found deep in the caves. Another, as yet unnamed, spider of the genus *Pholocophora* has also been found in the caves. An amblypid with very reduced eyes, *Paraphrynus grubbsi*, is known to be in four of the caves. An undescribed schizomid of the genus *Schizomus* has also been found. Two cave-adapted millipedes, *Cleidogona baroqua* and *Mexicanbala fishi*, have been found. Among the insect groups the collembola *Pseudosinella bonita* and the beetle *Platynus urqui* have been described, while a large nicoletiid thysanuran, common on the mudbanks of the streams, remains undescribed. Closer examination of the caves will no doubt reveal more species of cave-adapted life. A new species of the



**FIGURE 11** Anthodite observed in Anthodite Hall, Sistema Huautla. (Photographs taken by James H. Smith.)



**FIGURE 12** Anthodite observed in Anthodite Hall, Sistema Huautla. (Photographs taken by James H. Smith.)

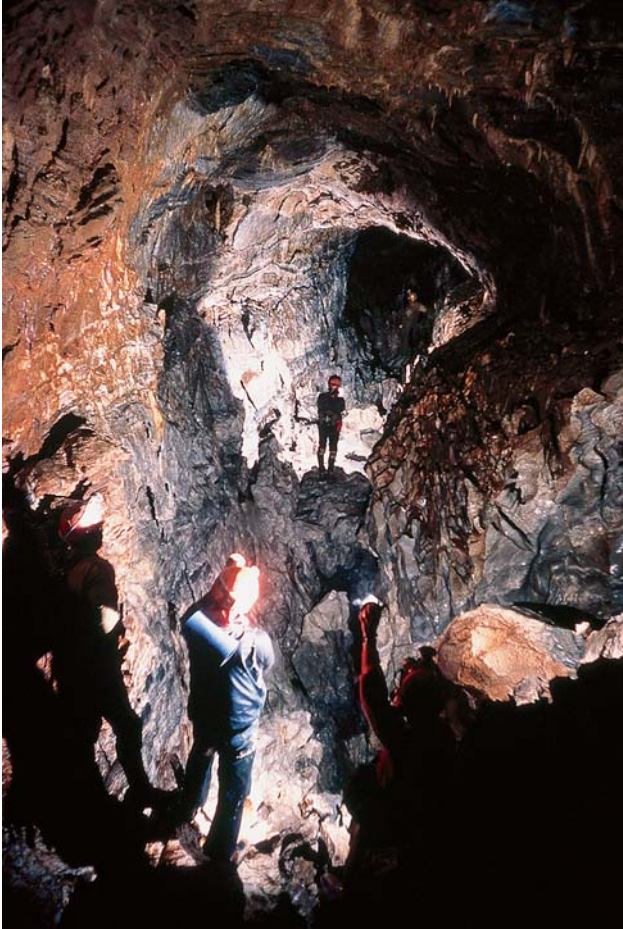
spider genera, *Ctenus*, *Maymena*, *Coryssocnemis*, *Metagonia*, and *Modismus* await description, as do opilionids of the genera *Hoplobunus* and *Karos*, millipedes of the genus *Sphaeriodesmus*, and campodeid diplurans.



**FIGURE 13** Anthodite Hall is a 300 meter long by 200 meter wide chamber with a 70 meter high ceiling. The chamber is located at 600 meters below the Sotano San Agustín entrance. The chamber is illuminated by more than 20 flash bulbs. (Photographs taken by James H. Smith.)



**FIGURE 14** The AFracture of the Deep at 760 meters in La Grieta, Sistema Huautla. The AFracture of the Deep is the connection area between the Sotano San Agustín and La Grieta branches of Sistema Huautla. The connection was made from the San Agustín side by tunneling through the floor. (Photographs taken by James H. Smith.)



**FIGURE 15** At –740 meters deep in Lower La Grieta, Sistema Huautla, explorers search for a potential connection to Sotano de Agua Carrizo an 848 meter deep cave the bottom of which is located only a few meters from La Grietas stream passage. This photograph was taken near the Triple Connection between Sotano San Agustin, La Grieta, and Nita Nanta (the highest entrance). (Photographs taken by James H. Smith.)

## ARCHAEOLOGY

No archaeological remains have been discovered in the passages integrated into the Sistema Huautla; however, a site in an area cave, named Blade Cave, suggests use by ancient Mazatecs. Evidence from the cave includes 60 ceramic vessels that date from the Early Urban stage (1–300 AD) through the Early City-State stage (750–1250 AD). Many of the vessels appear to have held perishable offerings. Frequently, wealth items such as beads and pendants of jade, stone, shell, and coral were included in these offerings or added to the vessels later. Evidence of blood sacrifice is present in the form of remains of animals, in particular dog mandibles. Four bifacially chipped blades, one 18 cm in length, were likely used as knives for such sacrifices. Autosacrificial bloodletting was possibly occurring as smaller prismatic obsidian blades were found. Human skeletal material is abundant in the Blade Cave assemblage. It is not certain what these individuals

represent. The investigations have amassed an abundance of detailed contextual information on ancient Mazatec cave ritual. Ethnographic research leads to the belief that the ceremonies conducted in Blade Cave were primarily petitions for rain.

## Bibliography

- Smith, J. H. (2002). *Hydrogeology of the Sistema Huautla Karst Groundwater Basin*, p. 154, Bulletin 9. Association For Mexican Cave Studies, Austin, TX.
- Steele, C. W. (1979). Huautla to the Eighties, *Caving International*. Number 5. Edmonton.
- Steele, J. F. ( ) *Blade Cave: An Archaeological Preservation Study in the Mazatec Region, Oaxaca, Mexico*. Master's thesis, University of Texas, San Antonio.
- Stone, W. C., B. Am Ende, and M. Paulsen (2002). *Beyond the Deep: The Deadly Descent Into the World's Most Treacherous Cave*. Warner Books, New York.

# Soil Piping and Sinkhole Failures

Barry Beck

*P. E. LaMoreaux & Associates, Inc.*

If you visit Mammoth Cave National Park in Kentucky, you may hike down into huge forested sinkholes like Cedar Sink. These low areas are completely enclosed by steep rock walls, and they are many acres in size and hundreds of feet deep, possibly with a stream flowing out of a cave on one side and into a cave on the other. If you live in Central Florida you may have seen a house or a road that collapsed into a sinkhole—one that is smaller than those mentioned in Kentucky, but significantly more devastating. If you are a farmer in some areas of Slovenia, the only land with sufficient soil to grow crops is at the bottom of the numerous bowl-shaped basins that dot the landscape, thousands of feet across and tens of feet deep; these are locally termed *dolinas*, the original term for sinkholes. If you visit West Texas, you may go to see the Devil's Sinkhole, a gaping collapse in the ground surface more than 100 feet in diameter that drops vertically into an even larger cave room extending down to 300 feet below the ground surface; whatever cave lies below is completely plugged with the debris from the upward stopping roof collapse. All of these different features have been termed *sinkholes*, and they are part of the same overall process, even though each one is a little bit different.

Sinkholes are generally thought of as “natural enclosed depressions found in karst landscapes.” In European terminology they are generally called *dolines*, an Anglicized form of

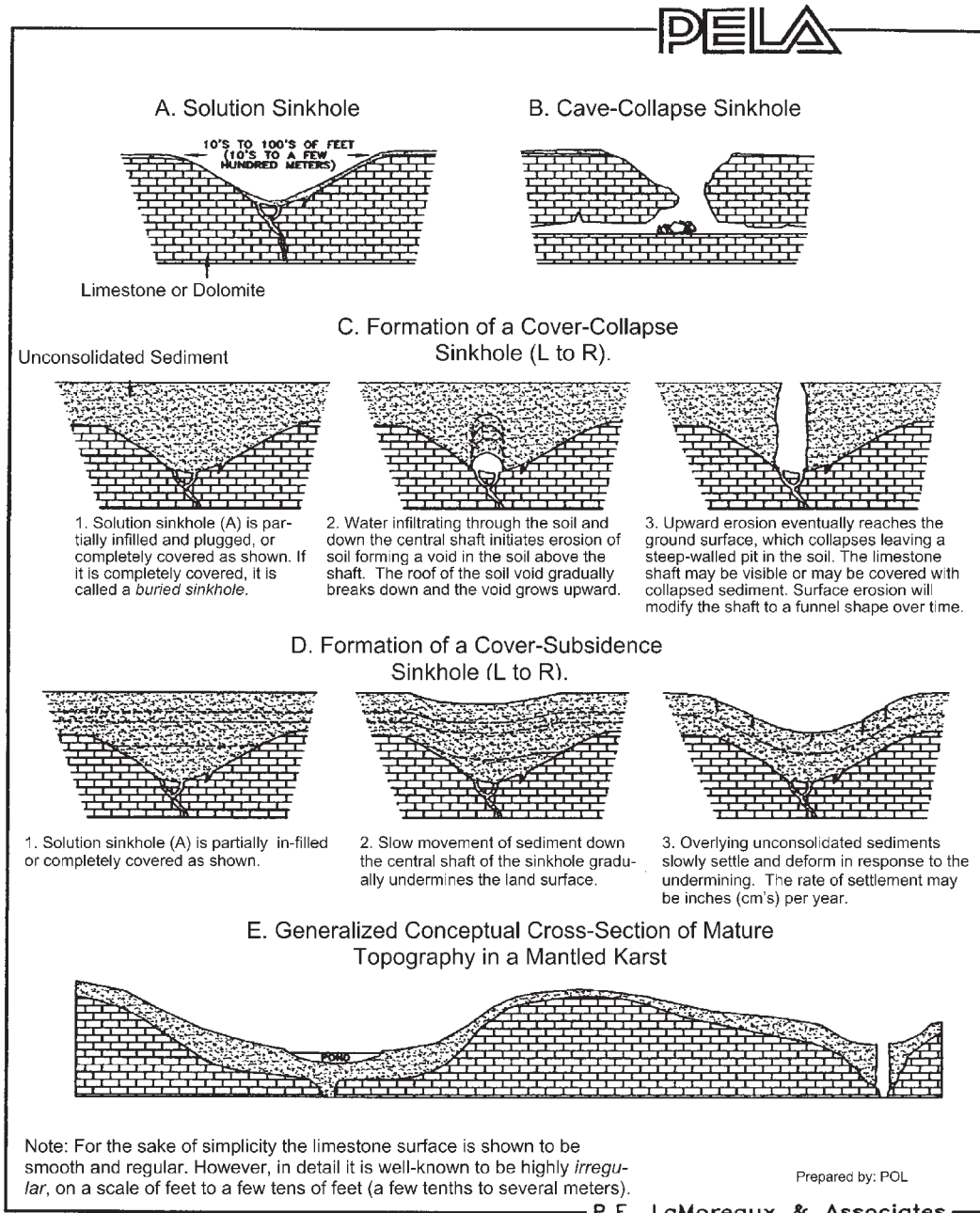


FIGURE 1 Sinkhole formation. (Prepared by P.E. LaMoreaux & Associates, Inc. Used with permission.)

the Serbo-Croatian word *dolina*. Although they vary over a wide range of sizes and shapes, they are generally subcircular in plan, and they vary in cross section from saucer shaped through bowl shaped to cylinder shaped. Depending on the “type” of sinkhole under discussion, they may vary from 0.3 m in diameter and 1 m deep for small cover collapses, to a kilometer or more in diameter and hundreds of meters deep for the polygenetic sinkholes of mature karst landscapes. In the following description of the origin and types of sinkholes, it is assumed that the reader is generally familiar with karst processes and terminology. Moreover, this discussion

generally refers to traditional karst developed on limestones or dolostones (dolomites).

Although five different types of sinkholes are generally identified by geologists,<sup>1</sup> these are the result of only two different processes: the transport of surficial material downward along solutionally enlarged channels, or collapse of the rock roof over large bedrock cavities (Fig. 1). The

<sup>1</sup>The somewhat different European terminology is explained briefly later in this article.

natural solution process dissolves the limestone most rapidly at its surface. If the limestone is bare, or almost bare (that is, exposed at the ground surface), water flows over the top of the limestone toward the points of easiest infiltration, usually at joint intersections, and then downward. As water converges toward these points of infiltration, vertical solution pathways develop, and the converging flow dissolves and lowers the limestone surface forming a bowl-shaped depression. This is the classic *solution sinkhole* (Fig. 1A).

Because the solution process is imperceptibly slow, solution sinkholes are not generally hazards to the engineering of human's structures. Their role is to act as drainage inlets into a conduit drainage network. They are environmental hazards in that they are a direct input to the deeper karstic groundwater. Contaminants introduced into an open sinkhole (of any type) will flow rapidly into the karst drainage network with little or no degradation or filtering of the contaminants.

If the limestone is mantled (covered) by an accumulation of residual soil (insoluble residue from the dissolution of the limestone), the terrane is termed a *subsoil karst*. If the limestone is mantled by sediments of an outside origin (for example, marine sands or glacial sediments) the terrane is termed a *mantled karst*. In terms of the processes that will form sinkholes, the two settings are generally the same. The overlying unconsolidated sediments may simply be termed *cover*. Water infiltrates through the cover to the limestone surface, then downslope to the vertical drains and downward. In the process the cover sediment is eroded down the vertical conduits. This process, internal erosion of the cover sediment, forms what have been termed *subsidence sinkholes*. Jennings (1971) describes them as follows: "Where superficial deposits or thick residual soils overlie karst rocks, dolines [sinkholes] can develop through spasmodic subsidence and more continuous piping of these materials into widened joints and solution pipes in the bedrock beneath. They vary very much in size and shape. A quick movement of subsidence may temporarily produce a cylindrical hole which rapidly weathers into a gentler, conical or bowl-shaped depression" (p. 126). The process is diagrammatically shown in Figs. 1C and 1E. These have also been called *alluvial dolines*. However, that term is somewhat misleading and has not been generally accepted.

If the covering sediment is somewhat cohesive, an arched void may form in the sediment immediately above the limestone drain, as the sediment is eroded down the drainage conduit. As upward erosion of the cover sediment continues, the void may grow larger over time while the eroded sediment is removed down the conduit or shaft. Or, if collapse of the soil is relatively rapid, the void may simply migrate vertically upward, as the crumbling sediment from the arched roof accumulates on the floor (Fig. 1C, parts 1–3). More cohesive strata within the cover, such as a clay layer, may impede the upward erosion and cause the cavity to widen, rather than grow upward for a period of time.



**FIGURE 2** A cover-collapse sinkhole that developed rapidly (overnight) near Orlando, Florida. It is approximately 30 feet in diameter and 15 feet deep. Note that only surficial sand (cover) is exposed in the hole. The limestone is approximately 100 feet below the surface in this area. (Photograph courtesy of Barry F. Beck.)

Eventually the upward growth of the void may leave only a thin roof of soil that is not strong enough to support its own weight, resulting in ground collapse. At that moment a hole suddenly appears in the ground surface; this is termed a *cover-collapse sinkhole* (Fig. 2). If the limestone is not too far below ground, and if the previously collapsed sediment was removed down the drain as the collapse grew upward, then the limestone and drain may be visible in the hole. More often, all that is visible in the hole is collapsed sediment. A cover-collapse sinkhole is a subtype of a subsidence sinkhole.

The process of localized internal erosion of the soil is often called *soil piping* by geologists, in this case caused by subsurface karstic erosion.<sup>2</sup> Soil piping was described by William B. White (1988): "Concentrated runoff ... can form channelized paths through the soil to a solution opening in the underlying bedrock. The increased hydraulic gradient and increased flow velocities speed the removal of soil from the subsurface. Because the pavement or the building itself [*or even the root-bound soil zone*] acts as a supporting structure, the loss of soil may not be noticed until a substantial cavity has formed. At some point structural support is lost and the building collapses into the hole" (p. 357; italicized text added). This downward erosion of unconsolidated sediment has been termed *ravelling* by engineers; it is the same process.

When the earth suddenly collapses beneath a building, a roadway, or a railroad, this is an obvious disruption to human's infrastructure (Fig. 3). Such unexpected damages

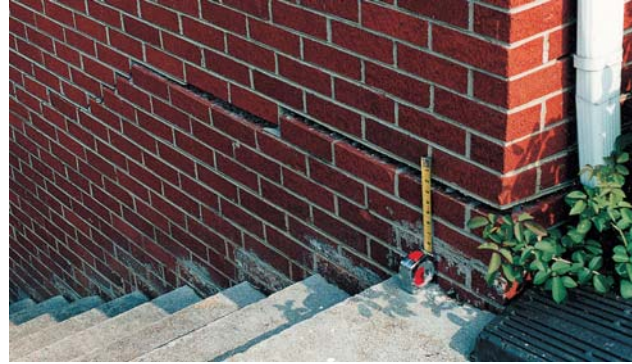
<sup>2</sup>The erosion of unconsolidated sediments along fractures or bedding plane surfaces near a steep hillslope or cliff, where the eroded material is removed laterally, may also produce horizontal soil caves and vertical soil pipes. Such features may produce cover-collapse pits and soil caves, which create a pseudokarst terrain, because it is not due to solution of the underlying bedrock.



**FIGURE 3** The remnants of a home engulfed as a large cover-collapse sinkhole developed over several hours, Keystone Heights, Florida (east of Gainesville). The occupants were able to evacuate safely, although their Christmas tree and presents were lost. The surficial sediment is clayey sand, which spans the upward eroding subsurface void allowing it to grow to a significant size before it collapsed. The limestone at this location is approximately 100 feet below the land surface. (Photograph courtesy of Barry F. Beck.)

due to cover-collapse sinkholes are common in karst areas, although the actual rate of incidence is not high. Where detailed records have been compiled and averaged, a corrected incidence of 1.7 sinkholes per square mile per year is the highest reported. Rates of less than one sinkhole per square mile per year are commonly reported in high incidence areas. Inasmuch as most sinkholes are less than 200 feet in diameter, the actual risk of a sinkhole damaging an individual 2000-square-foot home in Pinellas County, Florida, has been calculated as on the order of one chance in five thousand.

The incidence of cover-collapse sinkholes is often increased by the ponding or damming of surface water flow due to human construction and drainage. Storm water retention basins or waste treatment lagoons have frequently

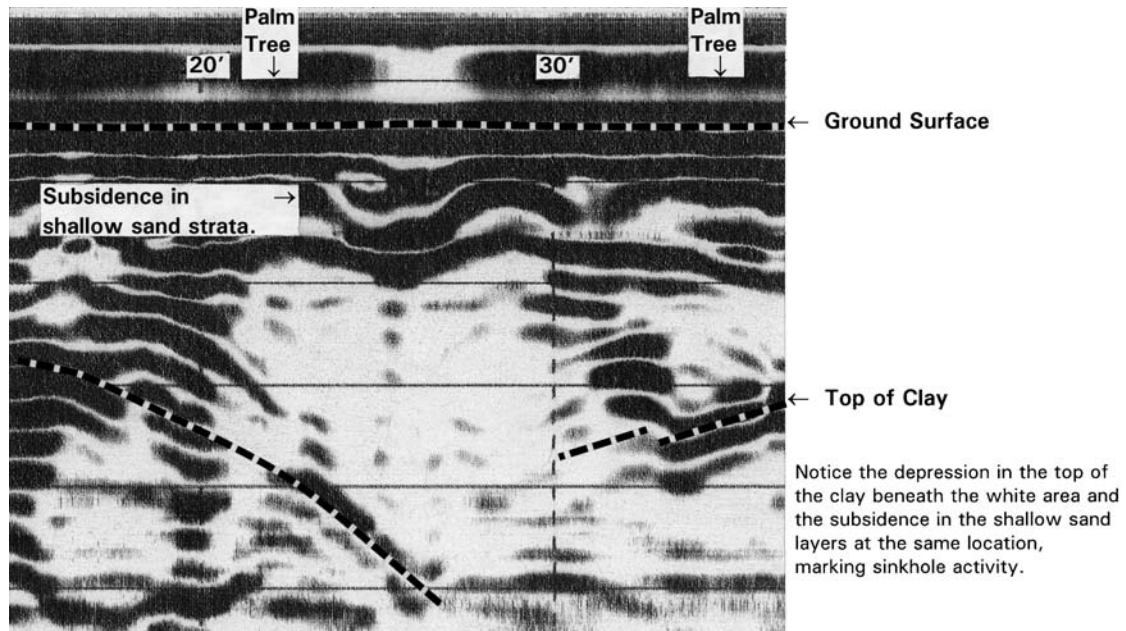


**FIGURE 4** Damage to a home in East Tennessee caused by a cover-subsidence sinkhole. This damage developed slowly over several years. However, the area is underlain by limestone and has other characteristics of karst topography. Drilling showed a depression in the limestone surface in the area of the damage, and a slight depression in the ground surface could also be seen. (Photograph by Arthur J. Pettit, P.E. LaMoreaux & Associates, Inc. Used with permission.)

emptied rapidly into sinkholes formed in the bottom. This is obviously a source of groundwater contamination. Large reservoirs also cause sinkholes to collapse in their bed, often causing unacceptable leakage and costing hundreds of thousands of dollars to repair. In some cases episodes of intense groundwater withdrawal due to well pumping also trigger the collapse of cover-collapse sinkholes. This is particularly true in Florida where high-intensity irrigation for freeze protection of crops often causes tens of sinkholes to form overnight, some highly damaging.

The surface expression of a sinkhole may also develop imperceptibly slowly. In karst terrain a generally circular area of the ground may slowly subside—at the rate of inches to feet per year—due to subsurface karstic erosion, not local compaction. These features have been termed *cover-subsidence sinkholes*. The downward erosion may take place slowly, grain by grain, if the sediment is loose and granular, or it may take place by plastic flow into cavernous voids. It is also possible that the surface sediment is gradually “sagging” downward as the area below it is undermined by karstic erosion removing the structural support. The time frame involved is years. Cover-subsidence sinkholes have been documented due to their damage to human’s rigid structures (Figs. 4 and 5). Whereas an inch of settlement spread out over a year is unnoticeable, after 10 years a 10-inch deep depression has formed. If this is beneath a foundation, significant damage may occur. We do not yet have a complete understanding of the mechanisms by which cover subsidence occurs. Both cover-collapse and cover-subsidence sinkholes are subtypes of subsidence sinkholes.

Sinkholes are generally thought of as bowl-shaped, funnel-shaped, or cylindrical depressions in the ground surface. However, during and after the development of these basins, depending on their origin, natural processes will begin to fill



**FIGURE 5** Ground penetrating radar graph showing a cross section of shallow sediment layers that have settled due to a cover-subsidence sinkhole in Tampa, Florida. The surficial sediment is loose sand and a clay layer occurs approximately 8 to 10 feet below ground surface. Note that the clay stratum has subsided as it has been undermined by deeper karstic erosion. Note the small, but obvious, area of settlement in the surface sands directly over the clay subsidence. The limestone is approximately 20 feet below ground surface and cannot be seen on this graph. This cover-subsidence sinkhole developed slowly over several years, partially beneath a home, damaging it to such an extent that it was uninhabitable. (Radar graph by P. E. LaMoreaux & Associates, Inc. Used with permission.)

them. The sides will erode outward and the eroded sediment will accumulate in the basin, creating a broader, shallower depression. This low area will also collect runoff and sediment from the surrounding area. It may be wet and swampy, possibly even forming a small lake, where organic growth will fill the basin over time. These processes, and others, may fill the sinkhole completely, eventually leaving no sign of its previous existence. Such a feature is now termed a *buried sinkhole* (Fig. 1C, part 1).

It is also possible for external sedimentation processes, which operate more rapidly than the rate at which karst develops, to completely cover a karst terrane and fill all the surface depressions. In the northern United States and Europe, many karst areas have been blanketed by a thick mantle of glacial debris. In some areas of Florida, the limestone is covered by a blanket of marine or coastal sands, obscuring the underlying karst until the moment when the ground surface collapses due to ongoing karstic erosion. Figure 1C, part 1, shows a buried solution sinkhole. It is also possible to have cover-collapse or cover-subsidence sinkholes buried. As A. C. Waltham (1989) points out, "... these phenomena develop either by pre-burial subaerial erosion or subsequent subsoil erosion ..." (p. 35). That is, the karstic erosion process will continue to operate while the terrane is covered, creating modifications to the unconsolidated strata overlying the limestone.

All four of the aforementioned types of sinkholes—solution, cover-collapse, cover-subsidence, and buried—are the result of the downward movement of material along solutionally enlarged channels through the limestone. However, the dissolution of the limestone by laterally flowing groundwater at depth may also produce conduit drainage systems—caves. These caves continue to grow as the groundwater flowing through them continually dissolves the limestone, over time making the passages larger and larger. Simultaneously, the upper surface of the limestone is also being lowered by solutional attack. These processes may eventually result in a situation where a large cave is close to the limestone surface with only a thin rock roof over the void. If this rock roof suddenly collapses into the cave, a *bedrock-collapse* or *cave-collapse sinkhole* is formed (Fig. 1B).

Bedrock-collapse sinkholes are generally very steep walled, or even overhung. They are often deeper than they are wide and relatively cylindrical. Because the walls are in solid rock, they will maintain this profile for a long time, in terms of a human life span. Thus, examples of bedrock-collapse sinkholes are not difficult to find. Karst geologists generally agree that bedrock-collapse sinkholes are rarely observed in the act of collapsing because the rate of surface down-wasting is extremely slow on a human timescale. That is, bedrock-collapse sinkholes are rare, except on a geologic timescale. The Florida Sinkhole Research Institute collected data on

more than 1700 sinkholes that developed in Florida, and not one of these was definitely a bedrock-collapse sinkhole.

The Mitchell Plain of southern Indiana is an example of the long-term product of karstic erosion. It is pockmarked with sinkholes. The largest and deepest of them are generally formed over major, active cave passages due to roof collapse. One of the rare examples of the formation of a cave-collapse or bedrock-collapse sinkhole within historic time occurred at the Colglazier entrance to Blue Spring Cave, on the Mitchell Plain southwest of Bedford, Indiana. What had formerly been a shallow marshy depression grew into a cave-collapse sinkhole nearly 100,000 cubic feet in volume during a heavy rainstorm in 1941. Although other cave-collapse sinkholes occur across the Mitchell Plain over large cave passages, the incidence of collapse in the human time frame is extremely rare, as mentioned above.

Europeans favor a different terminology. They favor using the Anglicized Serbo-Croatian term *doline*, and they include all collapse (a rapid process) dolines in one subgroup, within which they differentiate cave or rock collapse from overburden collapse. Sinkholes due to the slow karstic erosion of cover (herein cover subsidence) are called *suffosion dolines*. The suffosion process is defined as the gradual winnowing and downwashing of fines by a combination of physical and chemical processes. According to European usage, suffosion dolines are small depressions usually only a few meters in diameter and depth. This specific example does not match the features herein called cover-subsidence sinkholes, although it could describe one possible example. The term *suffosion* is little used in the United States, and the process of winnowing and downwashing of fines leaving coarser materials in place does not accurately describe the processes occurring in the development of cover-subsidence sinkholes. Therefore, we will eschew the European terminology in favor of the American nomenclature, which appears to more correctly characterize the erosion process.

Subtypes of sinkholes (dolines) are routinely defined as if they occurred in isolation, but, in fact, *in the evolution of a complex karst landscape these features are stages in time rather than subtypes*. Most sinkholes in a mature, mantled karst landscape are polygenetic, and most karst landscapes will eventually be mantled, at least by residual soil, except for those few cases where the area is underlain by hundreds of meters of very pure limestone.

Solution and internal drainage are the basic paradigm underlying karst landscape development. As the landscape evolves and cover sediments are deposited (either as residuum from the insoluble residue in the limestone or transported into the area from outside sources), other erosional processes will also play a role, integrated with the underlying paradigm. As the cover sediments are eroded downward through the internal drainage network, the solution process continues accompanied by episodes of cover collapse, infilling of karstic depressions, and possible cover subsidence under the appro-

priate conditions. Where enlarging subsurface karst features approach the top of solid rock, cavern roof collapse can also impact the landscape. The Mitchell Plain of southern Indiana is a good example of such a complex karst landscape.

According to this concept, a sinkhole is part of a long-term process and it may have different forms and surface expressions at different times. When the sinkhole is completely filled, there is no surface indication of its presence, but the epikarstic drainage feature still exists and continues to function below ground. This has been termed a *buried sinkhole*, which is a valid and appropriate concept despite the fact that no depression exists during this stage of sinkhole development. In recognition of the complex evolutionary process that characterizes the development of karstic drainage and subsurface erosion, and in view of the varying surface expressions that this process may have as it evolves and the landscape matures, and considering that under some conditions there may be no ground surface expression of the underlying karst drainage, the traditional definition of a sinkhole as “a depression” appears inappropriate. The following is a functional, process-oriented definition of a sinkhole, or doline:

Sinkholes (dolines) are the surface (and near-surface) expressions of the internal drainage and erosion process in karst terrane, usually characterized by depressions in the land surface. Formative processes include bedrock solution, downward transport of overburden sediment, and/or bedrock collapse. Most large, mature sinkholes have a complex origin involving all three processes. At some stages in sinkhole development, a surface depression may not be present.<sup>3</sup>

### *See Also the Following Articles*

*Closed Depressions*

### *Bibliography*

- Beck, B. F. (1988). Environmental and engineering effects of sinkholes—the processes behind the problems. *Environ. Geol. Water Sci.* **12**(2), 71–78.
- Beck, B. F. (1991). On calculating the risk of sinkhole collapse. In *Appalachian Karst* (E. H. Kastning and K. M. Kastning, eds.), pp. 231–236. National Speleological Society, Huntsville, AL.
- Ford, D., and P. W. Williams (1989). *Karst Geomorphology and Hydrology*. Chapman & Hall, London.
- Jennings, J. N. (1971). *Karst*. The MIT Press, Cambridge, MA.
- Sowers, G. F. (1996) *Building on Sinkholes*. ASCE Press, New York.
- Sweeting, M. M. (1973) *Karst Landforms*. Columbia University Press, New York.
- Waltham, A. C. (1989). *Ground Subsidence*. Blackie & Sons, Glasgow.
- White, W. B. (1988). *Geomorphology and Hydrology of Karst Terrains*. Oxford University Press, New York.
- Williams, P. W. (2003). Dolines. In *Encyclopedia of Caves and Karst Science* (J. Gunn, ed.), pp. 304–310. Fitzroy Dearborn, New York.

<sup>3</sup>This definition was first proposed by Beck in an oral presentation to an Italian sinkhole conference held in Grosseto, Tuscany, in 2000.



# Solution Caves in Regions of Moderate Relief

Arthur N. Palmer  
State University of New York

Caves in regions of moderate relief are widely regarded as the standard to which all others are compared. Tectonic stability is their most significant characteristic. The presence of moderate relief implies that uplift of the land is slow and erosional processes are able to keep pace. As a result, rivers easily erode to their local base levels, and base-level control is reflected in cave passages. The relation between caves and surface features is stronger than in any other setting.

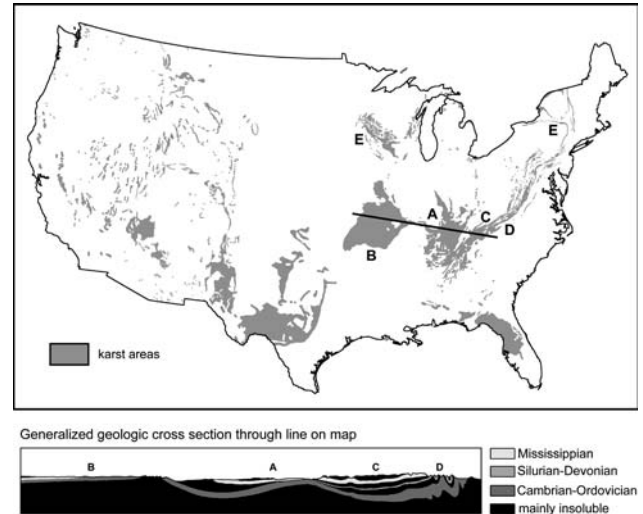
## CHARACTERISTICS OF KARST REGIONS OF MODERATE RELIEF

Landscapes that contain solution caves and related features are called *karst*, the German name for a vast cave-rich area of western Slovenia. Karst develops wherever soluble rocks are exposed at or near the surface and have abundant through-flow of water. The following discussion is limited to solution caves in carbonate rocks (limestone or dolomite) within regions of moderate relief. Relief by itself has little influence on cave origin. For example, alpine caves form by the same mechanisms as those in moderate relief, but they show different relationships to the landscape and to the geologic structure. Tectonic stability is what distinguishes regions of moderate relief from alpine settings.

In this chapter, the standard cave-forming process is considered to be dissolution of carbonate rocks by groundwater rich in carbonic acid derived from the soil. Some solution caves in moderate-relief karst are the product of quite different mechanisms (*e.g.*, by sulfuric acid or by gypsum dissolution), which are discussed in other chapters. Nearly all regions of moderate relief have a well-developed soil cover, except where it has been lost through glacial scour, deforestation, or overgrazing. Soil is the source for most of the carbonic acid that allows groundwater to dissolve caves, and it enhances the deposition of carbonate speleothems where groundwater seeps into aerated caves. It also affects the nature of groundwater recharge and therefore cave patterns.

## GEOGRAPHIC DISTRIBUTION

Regions of moderate relief include plateaus of relatively undeformed rock, as well as deformed mountains that uplifted hundreds of millions of years ago and which are tectonically nearly stable today. These landscapes are well illustrated by the low karst plateaus of the eastcentral United



**FIGURE 1** Map of karst regions of the 48 contiguous United States, showing areas discussed in the text. A = margins of the Illinois Basin (Indiana and Kentucky); B = Ozark Plateaus of Missouri and Arkansas; C = Appalachian Plateaus; D = Ridge and Valley Province (folded Appalachians); E = karst areas modified by continental glaciation. The cross section shows the distribution, structure, and ages of the three major cave-bearing rock sequences.

States and by the Appalachian Mountains (Fig. 1). Together, these represent the birthplace of the classic American karst studies of the late 19th century through the mid-20th century. Base-level and water-table control of cave development weighed heavily with American karst scientists, but these were far less conspicuous topics in European studies. Many of these differences can be traced to the large percentage of European karst studies that focused on alpine regions. Nevertheless, many important karst areas throughout the world are in plateaus and ancient mountains of moderate relief.

The most cavernous states in the United States, ranked by number of known caves, are Tennessee, Missouri, Virginia, Alabama, Kentucky, West Virginia, Arkansas, and Indiana. Each has more than 3000 significant caves, and all are in the moderate-relief interior plateaus or Appalachian Mountains. The extensive Florida karst shares many of the same cave-forming processes, although it has much lower relief and is influenced by the unusually high porosity of its carbonate rock and in local areas by the mixing of freshwater and seawater. In the mountainous and semiarid western United States, most caves are of alpine, thermal, sulfuric acid, and volcanic origin or have formed in gypsum.

## ORIGIN OF SOLUTION CAVES

Most solution caves in carbonate rocks are formed by the circulation of groundwater from upland land surfaces through a network of fractures, partings, and intergranular pores to springs at lower elevations. The paths of greatest

flow are the ones that develop into cave passages. Groundwater recharge takes place in several ways, including diffuse seepage through soil, small trickles delivered by sinkholes, and concentrated inflow as sinking streams.

As water passes through the atmosphere and soil, it absorbs carbon dioxide, which combines with the water to form carbonic acid. This acid, though weak, is abundant and is the main agent of carbonate-rock dissolution. Where the water first enters limestone or dolomite, it dissolves all available openings in the rock at nearly uniform rates, producing a maze of widened fissures and pores (the epikarst). In areas of moderate relief, most of these openings are soil filled. Water drains from the base of the epikarst through a relatively small number of major conduits, which deliver solutionally aggressive water deep into the soluble rock. It is along these paths that caves form. As the openings enlarge, soil subsides into them, forming sinkholes at the surface that funnel increasing amounts of water into the ground as their catchment areas expand.

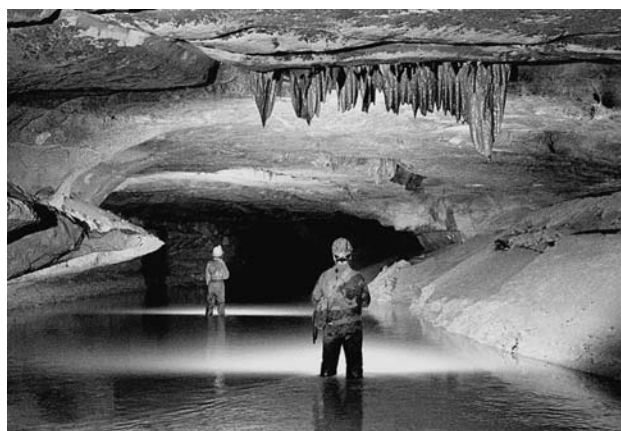
Water descends by gravity along the steepest available openings until it reaches the zone where all openings are filled with water. The top of this zone is the *water table*. Above the water table is the *vadose zone*, and below it is the *phreatic zone*. (Most groundwater specialists prefer to call them the *unsaturated* and *saturated* zones, but these terms blur the distinction between hydrologic and chemical saturation.) Cave passages that form in the vadose zone have continuously descending profiles that typically consist of canyon-like passages interrupted by vertical shafts, so that the resulting pattern is step-like. Canyons develop mainly along the partings between rock strata and grow by entrenchment of their floors by flowing streams (Fig. 2). Shafts form where the descending water follows steeply inclined or vertical openings, mainly joints or faults.

Below the water table, gravity is offset to varying degrees by the downward increase in hydrostatic pressure. Phreatic water follows the paths of least resistance to the nearest available outlets, usually river valleys. Passages of phreatic origin are tubular or fissure-like conduits with low overall gradients, and most have looping profiles that fall and rise erratically along their length (Fig. 3). Because fractures and partings tend to become narrower with depth, most phreatic passages follow rather shallow paths at, or not far below, the water table.

As surface rivers entrench their valleys, groundwater seeks progressively lower outlets, and new cave passages form below the earlier ones. Much of this entrenchment is caused by uplift of the Earth's crust, while stream erosion tries to keep pace; therefore, younger passages are not necessarily lower in absolute elevation above sea level. Changes in the rate of river entrenchment leave their mark on both valleys and caves. Steep-walled valleys are produced by rapid entrenchment, whereas wide flat-floored valley bottoms (or their remnant terraces) indicate slow entrenchment, static conditions, or even rising river levels. Major cave passages



**FIGURE 2** A typical canyon passage in McFail's Cave (New York) formed by vadose flow.



**FIGURE 3** A typical tubular passage in the Lost River Cave System (Indiana) formed by phreatic flow (*i.e.*, at or below the water table). Although the water level in this passage has dropped since the passage began to form, the water still fills the entire passage during high flow.

tend to form at those elevations. Sediment accumulates in valleys and caves when river levels rise.

The erosional-depositional history of stream valleys is controlled by significant events such as climate changes, sea-level fluctuations, rearrangement of river patterns, changes in sediment supply, changes in uplift rate, or depression of the continent by the weight of glaciers. At the surface, much of the evidence for this history is destroyed by later erosion. A great deal more evidence is preserved in caves.

Cave origin is not as thoroughly understood as the above paragraphs might imply. There is still debate on many topics, such as: When does cave development actually begin? Of all the original openings in soluble rock, which ones evolve into caves? How deep can caves form below the surface? How does the local setting affect cave patterns? What do caves tell us about past geologic history and climates? Each question is best examined in karst regions of moderate relief, because they not only show the greatest geologic and hydrologic variety, but also are tectonically stable enough that cave features can be preserved for lengthy periods of time.

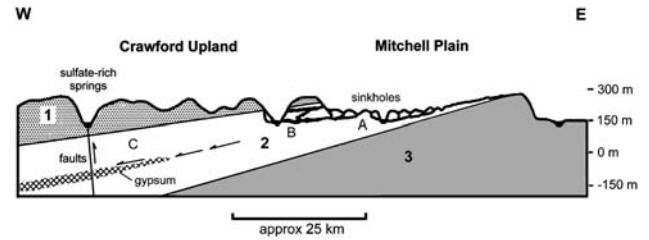
### FIELD EXAMPLES

Several well-documented karst areas are briefly described here, with emphasis on the details that help to answer the questions posed in the paragraph above. These areas are located in the low plateaus of the eastcentral United States and in the Appalachian Mountains. These areas have three major karst-bearing sequences in common: limestones and dolomites of Cambrian–Ordovician, Silurian–Devonian, and Mississippian age. The same strata, arranged in different settings, produce a great variety of cave types.

#### Dissected Plateaus of Southern Indiana and Western Kentucky

Perhaps no other karst area in the world shows the relation between river erosion and cave development so clearly as the karst plateaus of westcentral Kentucky and southern Indiana. Carbonate rocks are exposed at the surface around the perimeter of the Illinois structural basin. In general, the rocks dip gently at less than half a degree toward the center of the basin in southern Illinois (Fig. 4). The main cavernous units are carbonate rocks of Mississippian age with a thickness of 100 to 200 m. Most of them exhibit prominent bedding. At considerable depth below the surface, gypsum is interbedded with limestone and dolomite in the middle part of the sequence. At depths of less than about 100 m, dissolution by groundwater has removed virtually all the gypsum.

Where the carbonate rocks are exposed at the surface they form a vast sinkhole plain covering thousands of square kilometers (*e.g.*, the Pennyroyal Plateau of Kentucky and Mitchell Plain of Indiana). Many river caves are located in this region, including some of the longest caves in the United



**FIGURE 4** Cross section through the karst area of southern Indiana. 1 = mainly insoluble sandstones and shales; 2 = Mississippian limestones; 3 = insoluble siltstones; A = caves in exposed limestones in the Mitchell Plain; B = caves beneath insoluble caprock along the eastern edge of the Crawford Upland; C = deep flow routes guided by interbeds of gypsum, with outlets through the caprock along faults.

States. Binkley's Cave, Blue Spring Cave, and the Lost River Cave System (all in Indiana) and Hidden River Cave (Kentucky) all have mapped lengths of 33 to 35 km. (A *cave system* is a group of several interconnected caves explored separately and later joined by the discovery of interconnecting passages.) The erosional relief of the sinkhole plain is generally less than 50 m, so the caves rarely contain more than one or two distinct levels of passage development. In river valleys, post-glacial sediment has accumulated to depths as much as 25 m thick, flooding and choking some cave passages that lie below the current base level.

Farther in the down-dip direction, the carbonate rocks are capped by insoluble sandstone and shale, forming a dissected upland of irregular limestone ridges capped by the more resistant insoluble rocks (*e.g.*, the Chester Upland of Kentucky and Crawford Upland of Indiana). Multilevel caves are numerous, thanks to the protective caprock, which inhibits erosional destruction of the underlying caves. The most extensive caves are the Mammoth Cave System (557 km of surveyed length), the Fisher Ridge Cave System (161 km), and the Martin Ridge Cave System (52 km), all of which are close neighbors at the southeastern edge of the Illinois Basin in Kentucky. Mammoth is the world's longest cave, more than twice as long as any other, and it is likely that future exploration will connect it with one or both of the neighboring caves.

Still farther down-dip, the insoluble caprock is continuous. Movement of groundwater through the confined underlying carbonate rocks is able to escape upward through the caprock only along sparse high-angle faults. Springs fed by this water have high sulfate contents, suggesting that the interbedded gypsum is hosting deep groundwater flow through the carbonates. Hydrogen sulfide in the spring water indicates that sulfate reduction is also taking place at depth.

By scanning these three regions from their down-dip to up-dip ends, it is possible to envision how the karst landscape must have evolved with time. Presumably, the deep gypsum dissolution in the confined part of the karst aquifer has prepared the way for later cave development at shallower depths. In places, the exposed carbonate rocks are frag-

mented and contorted and contain veins of calcite and quartz, all of which are indicators of former gypsum bodies. However, extensive geologic mapping of caves in the capped ridges and sinkhole plain shows that the cave patterns are closely adjusted to present-day shallow groundwater flow and must have had very little (if any) inheritance from earlier deep-seated dissolution.

The clues that indicate passage development by shallow groundwater flow are fairly clear. In the prominently bedded rocks of this region, most vadose water preferentially follows the dip of the strata, except where it jogs downward along joint-controlled shafts. Where it reaches the water table, the water loses its dip tendency, and much of the water follows paths that show no dip trend. Many phreatic passages closely parallel the strike of the beds, which is approximated by the intersection between the dipping beds and the less steeply sloping water table. Most passages consist of a vadose upstream section and a phreatic downstream section. At the present or former vadose-phreatic transition point, the passages change from down-dip canyons to low-gradient tubes with irregular profiles. In Indiana, the lower parts of the carbonate sequence are massive and prominently jointed, producing high, fissure-like passages in which the vadose-phreatic transition is not so clear.

Mapping of these transition points in any part of the region shows a tight clustering at a few consistent altitudes. At Mammoth Cave these are 200 to 210 m, 180 to 190 m, 168 m, and 152 m (Fig. 5). These same levels of development can be traced through much of the region, although their altitudes and spacing vary. In each of the lowest two levels in Mammoth Cave, the vadose-phreatic transitions in different passages fall within a meter of each other. If deep-seated dissolution had prepared the way for later cave

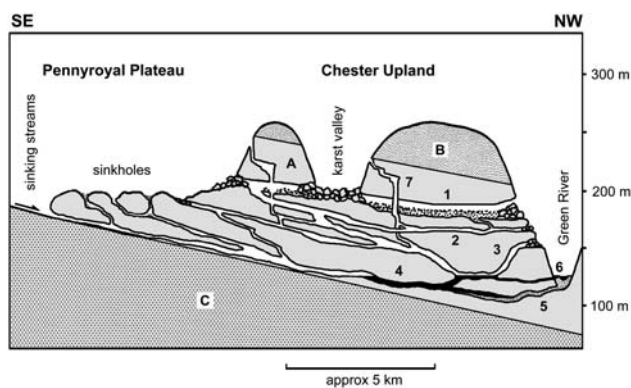
development, this tight correlation would be absent. No good example of control of cave development by ancient, deep-seated dissolution has yet been demonstrated in either Kentucky or Indiana, although it is likely that a few such examples may yet be revealed.

The drainage history of the region has been greatly clarified by cave evidence. The uppermost passages are large canyons partly or completely filled with sand and gravel. They represent slow dissection by surface rivers, alternating with periods when river valleys and cave passages were partly filled with sediment. This alternating sequence may reflect climate changes from humid (entrenchment) to relatively dry (sediment accumulation), but it may also have been the result of sea-level changes. Throughout this period, the Pennyroyal Plateau and Mitchell Plain formed a low-relief surface near base level with little or no karst development. The largest cave passages in the Chester and Crawford Uplands are located at roughly the same elevations, and many of them appear to have formed by water draining through the upland ridges and fed by runoff from the adjacent plains. A widespread episode of sediment accumulation followed, covering the plains and filling the caves to depths of up to 30 m. Soon afterward, rivers began to entrench rapidly, allowing the Pennyroyal Plateau and Mitchell Plain to develop many sinkholes and caves. This rapid entrenchment was apparently triggered by rerouting of rivers by glacial advances, which led to the development of the Ohio River. The large canyon passages and sediment fill in the upper levels of the caves date from the late Tertiary Period, which predates the first significant continental glaciation. Rapid entrenchment and development of the sinkhole plain took place during the Quaternary Period, when glacial ice masses periodically covered much of high-latitude North America. Glaciers fell short of the present karst areas, but their effects on the caves was strongly felt in the form of changes in river entrenchment and valley filling.

Dating of the passages in Mammoth Cave has recently been accomplished with aluminum and beryllium isotopes in quartz-rich sediment. The oldest cave sediments in the large upper-level canyons are up to 3.4 million years old, and the canyons themselves are presumably much older. The period of widespread sedimentation took place about 2.3 million years ago, just before the onset of extensive worldwide glaciation. The 168-m and 152-m passage levels date from roughly 1.5 and 1.0 million years ago and correlate with adjustments of the Ohio River drainage pattern. Some of these changes were caused by diversion of surface rivers to more southerly routes. The contribution of caves to the interpretation and timing of the regional geomorphic and climatic history is clearly demonstrated.

### The Ozark Plateaus

Karst of the Ozark Plateaus of Missouri and Arkansas resembles that of the sinkhole plains of Indiana and

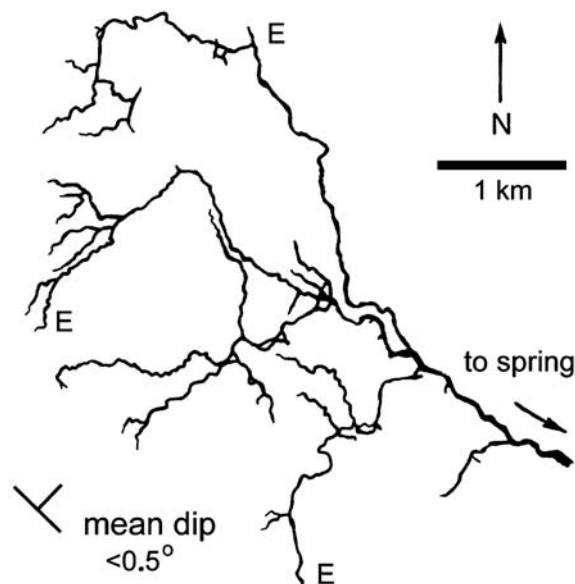


**FIGURE 5** Idealized profile through the Mammoth Cave System in Kentucky and its relation to the surrounding landscape. A = cavernous limestones (from bottom to top, St. Louis Limestone, Ste. Genevieve Limestone, and Girkin Formation); B = resistant caprock mainly of sandstones and shales; C = impure, poorly cavernous limestone; 1 = large Tertiary-age canyons, with thick sediment fill, at 180 to 200 m above sea level; 2, 3 = major cave levels with vadose-phreatic transitions at 168 and 152 m above sea level; 4 = late Pleistocene passages; 5 = sediment fill from a post-glacial rise in base level; 6 = springs fed by active cave streams; 7 = vadose passages (canyons and shafts).

Kentucky, except that most of its caves are in dolomite. This rock type is widely considered to be inferior to limestone in cave-forming potential, but the caves seem not to have noticed. Ordovician and Mississippian carbonates are the main cavernous units. In general, they dip gently away from the St. François Mountains of southeastern Missouri at less than half a degree, but with local broad, gentle warps in the regional structure. Chert is so abundant in some of the carbonate rocks that residual chert fragments have accumulated to depths as great as 40 m, subduing the surface karst topography. The chert fragments also retard flood runoff into caves, and some surface rivers fed by karst springs have relatively low flood peaks as a result.

Caves are numerous and widespread in the Ozark Plateaus. The longest are sprawling branchworks composed of sinuous, low-gradient passages guided by bedding. Vertical shafts are sparse, and the low topographic relief prevents them from being very deep. Crevice Cave is the largest cave in the region, with 46 km of mapped passages (Fig. 6). The Ozarks are also well known for large karst springs. Many of these appear to drain water from considerable depth beneath topographic divides.

In the 1930s through the 1950s the well-known geologist J Harlan Bretz used qualitative field observations in this region to support his view that caves originate deep in the phreatic zone and are invaded by vadose streams only late in their history. This hypothesis has gone out of favor in the past half century; however, the geomorphic history of Ozark caves has yet to be studied in detail using quantitative methods.



**FIGURE 6** Map of Crevice Cave in Missouri showing an ideal branching passage pattern guided by prominent bedding. The relation between dip-oriented canyons and the strike-oriented main tubular passage is shown. E = entrance. (Map by Paul Hauck.)

### Appalachian Plateaus

This region stretches all the way from central New York to northern Alabama. Its karst is developed mainly in Mississippian carbonates, with maximum thicknesses of about 500 m. At the northeastern end the cavernous rocks are much thinner and of Silurian–Devonian age. The Appalachian Plateaus contain the largest caves of the east, including the Friar’s Hole Cave System, Organ Cave System, and Scott Hollow Cave (West Virginia), Blue Spring Cave and Cumberland Caverns (Tennessee), and Sloan’s Valley Cave (Kentucky), all of which have surveyed lengths between 40 and 70 km.

In many ways, the geology and caves of this region resemble those of the Mammoth Cave area of Kentucky, but the Appalachian Plateaus have greater relief and more obvious control by faults and insoluble beds. The strata have been warped into broad folds, typically with dips of only a few degrees. In many places the cave-bearing rocks are overlain by a thick impermeable cap and are exposed only in narrow bands along escarpments and entrenched river valleys. Perhaps the most dramatic example is the Obey River Gorge of northeastern Tennessee, where a broad, nearly flat plateau of sandstone and shale has been breached by an abrupt V-shaped canyon 300 m deep, in which carbonate rocks are exposed only in the lower 25 to 30%. Many complex caves have developed along the valley bottom parallel to the river and extending into embayments formed by tributary valleys. These cave patterns reflect the widening of joints and partings by stress release from erosional unloading along valleys. Many caves in northern West Virginia have a similar setting. A conspicuous exception in the latter area is Simmons-Mingo Cave, which crosses beneath a prominent surface divide along a linear fault zone for a distance of 3.2 km.

In parts of southeastern West Virginia, the insoluble caprock is of irregular thickness and forms only the tops of hilly plateaus. It has been breached by small surface streams high above base level, producing caves that extend from these points of focused recharge to remote springs along the plateau edges. Caves do not follow the valley bottoms as faithfully as they do in the examples cited above. The Friar’s Hole Cave System is the best example.

Along the plateau edges, many caves are perched on insoluble underlying beds. In southeastern West Virginia, hundreds of kilometers of vadose passages have formed at the contact between limestones of the Greenbrier Group and underlying shale of the Maccrady Formation (Fig. 7). Erosion by vadose flow has entrenched canyons into the shale as much as 15 m deep. Flow along the contact is mainly in the dip direction but is locally deflected from that direction by intersecting fractures. As a result, vadose passages are not oriented as relentlessly down the dip as in the Mammoth Cave area. The vadose passages feed conduits of phreatic origin that follow the strike of the beds, often along synclinal



**FIGURE 7** Cave development at the contact between limestones of the Greenbrier Group (ceiling) and shales of the Maccrady Formation (walls and floor) in Ludington Cave in southeastern West Virginia.

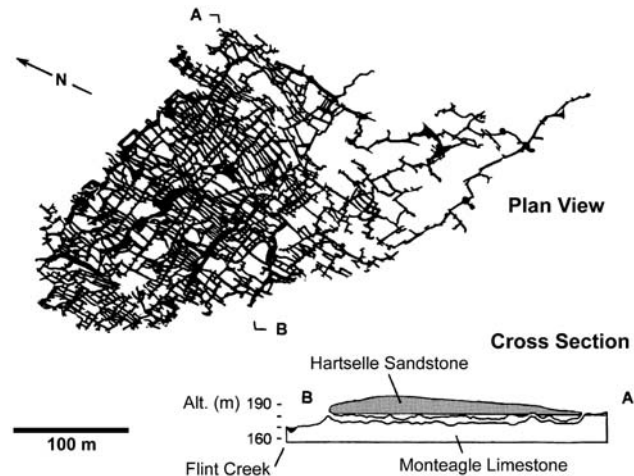
troughs. Dye tracing shows that some of these conduits extend up to 20 km.

Faults exert a strong effect on some caves in the Appalachian Plateaus. The deepest vertical shaft in any cave of the eastern United States is in Ellison's Cave in northwestern Georgia and is located along a large strike-slip fault. The fault zone features slickensides, pulverized rock, displacement of solutional rock surfaces, and occasional mild earthquakes. Upper-level stream passages in the cave are perched on shaly beds hundreds of meters above the local valley floors, but where they intersect the fault the water plunges down shafts up to 180 m deep.

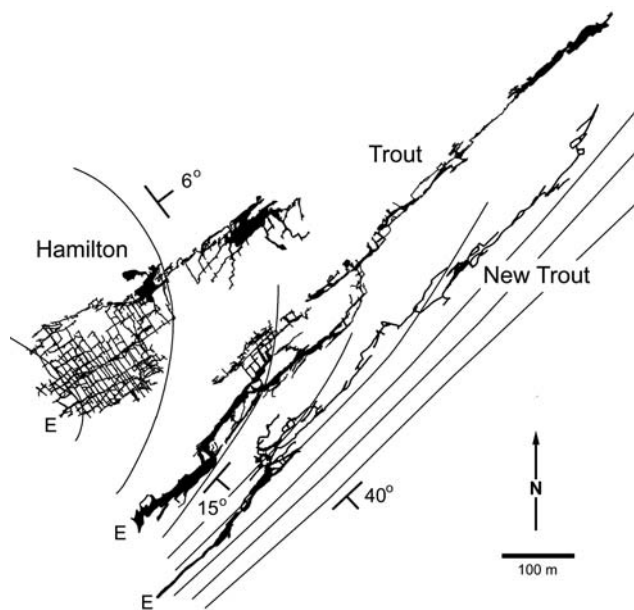
Some caves in the region consist of extensive networks of intersecting fissures, in which all major fractures over a large area of soluble rock have enlarged more or less simultaneously by dissolution. Network caves of this type can form in a variety of ways, but, in the areas described here, the largest are located where seepage takes place through a thin overlying cap of quartz sandstone. Water infiltrates through the sandstone as if through a sponge and enlarges each fracture at or near the top of the underlying carbonate rock at fairly uniform rates. This process can take place in either phreatic or vadose conditions, and often both in sequence. The best example of a sandstone-capped network in the Appalachian Plateaus is Anvil Cave in Alabama (Fig. 8). Twenty kilometers of tightly labyrinthine fissure passages are constrained to the top of the Monteagle Limestone beneath a thin caprock of Hartselle Sandstone no more than 10 m thick. This and some other caves like it have undergone some enlargement by backflooding from nearby rivers.

### Ridge and Valley Province in the Appalachian Mountains

The intensely folded and faulted eastern region of the Appalachian Mountains (Ridge and Valley Province) consists of numerous subparallel ridges and valleys that follow the trends of the folds (see Fig. 1). Resistant quartz sandstones and conglomerates are the main ridge formers. Carbonate



**FIGURE 8** Map of Anvil Cave in Alabama, a joint-controlled network cave beneath a thin permeable sandstone cap. (From map by William Varnedoe.)



**FIGURE 9** Composite map of caves at Trout Rock in West Virginia showing their relation to the geologic structure. Hamilton Cave is a network maze along the crest of a local anticlinal flexure. Trout and New Trout Caves are located along the anticlinal flank. Structural contours are drawn at intervals of 10 m. The local dip of the strata is shown in degrees. E = entrance. (Cave maps by David West; geology by A. and M. Palmer.)

rocks are exposed in linear bands over much of the region, mostly in valleys and in the flanks of ridges. Caves in this region contain the same general passage types as those in the plateaus farther west, but the overall cave patterns show some differences. Because the average dips are much steeper than in the plateaus, vadose water tends to follow short, steep paths interrupted by many shafts and fissures along discordant fractures. Major phreatic passages usually have elongate patterns extending along the strike of the beds.

A good example is the group of caves at Trout Rock, in northeastern West Virginia (Figs. 9 and 10). These include



**FIGURE 10** Strike-oriented passage in steeply dipping Devonian limestone (New Trout Cave in West Virginia).

several levels of strike-oriented passages in steeply dipping limestone, with a network maze at the crest of a small anticline. Nearby Rexrode Cave and Smoke Hole Caverns have linear patterns tightly constrained along the strike of beds that are almost perfectly vertical.

The Burnsville Cove System of Virginia illustrates a variant of the tendency for strike orientation. The main passage drains approximately along the axis of a syncline, with many joint-controlled tributaries, overflow routes, and local networks superimposed on the main trend. Gravel and large boulders carried through the cave during peak flow suggest that part of the cave's complexity is due to enlargement by periodic floodwaters.

In the western part of the Ridge and Valley Province most of the caves are in Silurian–Devonian limestones only about 100 to 200 m thick. The thinness of these rocks helps to constrain so many of the caves to strike-oriented trends. In contrast, along the eastern margin of the region, the Cambrian–Ordovician carbonate rocks are up to 4 km thick in a nearly continuous sequence. Prolonged weathering has reduced them to a broad, rolling lowland that extends through western Virginia and southeastern Pennsylvania. Caves in this area are not as large as might be expected from the thickness of soluble rock. The largest accessible caves tend to be in small residual knobs (*e.g.*, Luray Caverns in Virginia). Elongation of caves along the strike of the beds is less prominent than in the thinner rocks to the west, as the massive nature of the carbonates and the intense structural deformation allow groundwater to flow in a variety of somewhat unpredictable directions along complex fractures.

Caves in the folded Appalachians have been used to validate some of the most widely accepted views on cave origin. The idea that levels of cave development correlate with periods of rather static base level in nearby river valleys

had been proposed by various European geologists in the first half of the 20th century. Many of these studies were not entirely convincing because some “levels” were caused simply by perching of water on insoluble beds, and correlations between caves in mountain ranges were clouded in places by irregular rates of tectonic uplift. The elevations of major cave passages in the Appalachians correlate well with river terraces, which are remnants of former floodplains produced when rivers pause in their downward entrenchment and widen their valleys. The caves are not perched on insoluble beds, because most of them are oriented along the strike of steeply dipping beds or cut across geologic structures. Most caves in the region could be attributed to dissolution at the top of the phreatic zone, because those in dipping beds concentrate in narrow horizontal bands that terminate abruptly in both the up-dip and down-dip directions. Although these observations do not hold true for every cave in the region, this general view is still valid for the majority.

Caves in the Potomac River basin cluster vertically in a few groups for which the elevations decrease in the downstream direction at roughly the same rate as the current river gradients. This suggests that the caves, while forming, were adjusted to river patterns not much different from those of today. The various cave levels become more distinct in the downstream direction, apparently because base-level control is better defined in the mature lower parts of the river valley.

Several excellent examples of sandstone-capped mazes are located in the Ridge and Valley Province where a thin cap of Oriskany Sandstone overlies jointed limestones of the Devonian Helderberg Group and where the dip is locally rather low. Some of these mazes have also been enlarged partly by periodic flooding from nearby rivers, so the zone of maximum passage development is not necessarily at the very top of the limestone. In fact, flooding has produced local mazes superimposed on the branching pattern of many Appalachian caves, even where a sandstone cap is absent. Mazes are especially common along the crests of anticlines where fractures have been enlarged by tension.

Yet, the importance of the permeable sandstone in producing extensive network mazes is well illustrated in this region. These caves are located only where the sandstone is thinnest and die out where the sandstone becomes thicker. Farther north, where the same limestone is overlain by relatively impermeable shale, network caves of this type are absent. Diffuse seepage from underlying strata can also form network mazes, but in carbonate rocks most such water is already saturated with dissolved carbonate minerals, and the caves formed in this way are few and small.

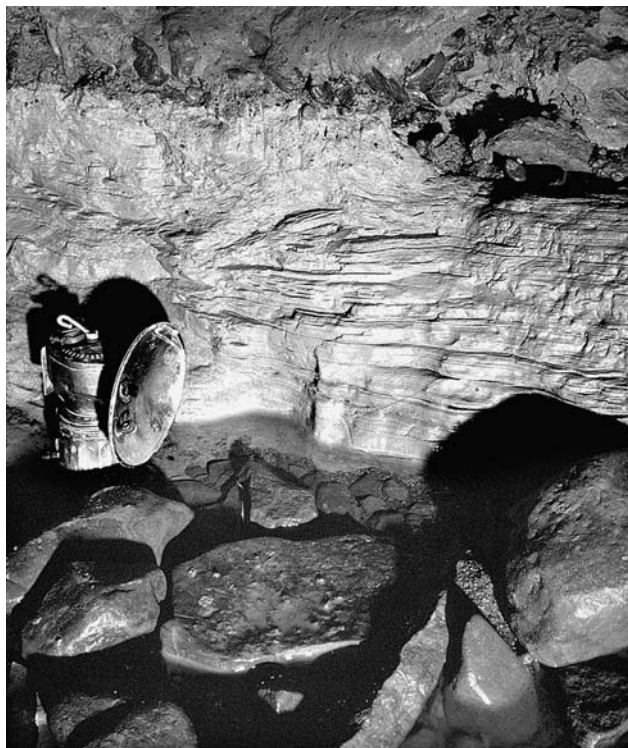
### Glaciated Plateaus of Northeastern and Northcentral United States

Extensive caps of glacial ice covered the northcentral and northeastern states several times during the past 2 million years. Where glacial deposits are thick (as in northern Illinois,

Indiana, and Ohio), preexisting karst surfaces were completely buried, and there is no substantial field evidence about caves in these areas. However, where the glacial deposits are thin or absent, preglacial caves have survived with only minor disturbance.

Howe Caverns and related caves in New York, in gently dipping Silurian–Devonian carbonates, are examples of preglacial caves that have survived at least one phase of continental glaciation. Ice sheets were more than 1 km thick over the region, yet the caves remain more or less intact. Some of the overlying surface karst was partly or completely masked by glacial sediments, and patterns of groundwater flow were altered slightly by blockage of inputs and springs by these deposits.

During the waning phases of the latest glaciation, about 14,000 years ago, the local north-flowing river (Schoharie Creek) was blocked by ice, forming a pro-glacial lake up to 150 m deep. Thinly laminated clays were deposited on the surface during this lake event, and they are also present in every major cave in the Schoharie Valley (Fig. 11). They are absent in caves in surrounding drainage basins. In Howe Caverns and nearby caves the clays occupy the lowest passage levels, and post-glacial entrenchment has extended at most only 10 to 20 cm below their base. Radiometric dating of speleothems in these caves indicates ages of more than



**FIGURE 11** Laminated glacial lake clays in Caboose Cave in New York, deposited in pro-glacial Lake Schoharie roughly 14,000 years ago. Miner's lamp for scale is 15 cm high.

350,000 years, showing that the caves had reached their present state of maturity well before the onset of the latest (Wisconsinan) glaciation about 70,000 years ago. Only a few minor passages can be demonstrated to have formed in the 14,000 years since the last glacial retreat. Some are diversions from upper levels, and others are floodwater passages formed under the most favorable conditions of aggressive water, short flow path, and steep hydraulic gradient. In a few caves in the Schoharie valley, narrow passages up to 0.5 m<sup>2</sup> in cross-sectional area have been formed by water diverted around passages that are blocked by glacial deposits.

Sinking streams are most common in moderate-relief karst, where runoff from large areas of insoluble material feeds swallow holes in adjacent cavernous rock. Like most surface streams, they tend to exhibit severe flooding. Floods have their greatest effect on caves that are at least partly air filled. Cave enlargement is rapid during floods because the incoming water tends to have a low concentration of dissolved solids. Solutional growth is aided by abrasion by streamborne solid particles. Caves that have been influenced greatly by floodwater show complex patterns, with diversion mazes, dead-end fissures, and solution pockets superimposed on the basic pattern of stream passages. Such caves occur in all the regions described above, but they are fairly sparse, accounting for an average of about 10% of all caves. The percentage is much higher in glaciated regions because of diversion of surface water into caves by low-permeability glacial deposits, which also block many springs.

An example is Mystery Cave in southeastern Minnesota, which is located in a low-relief plateau of highly fractured Ordovician dolomites and limestones. It developed as a subterranean cutoff of several meanders in a surface river, across a reach of particularly steep gradient. The entire cave consists of a fissure network with 21 km of mapped passages. The local dip is 0.3 to 0.8° to the west, and the groundwater flow is to the east, against the dip, along fractures discordant to the bedding. The maze pattern is a result of periodically aggressive water following steep hydraulic gradients through a network of fairly wide initial fissures. The stresses of glacial loading and unloading may have aided the mechanical widening of joints, although much of the cave predates the latest glaciation. Uranium/thorium radiometric dates for calcite speleothems cluster at 100,000 to 150,000 and 10,000 to 15,000 years, periods that are pre-Wisconsinan and post-Wisconsinan, respectively. Flowstone in a high-level passage dates to more than 350,000 years. Its close relation to the current river pattern is intriguing, because the cave probably began to form at least half a million years ago.

Isotopic analysis of calcite speleothems in this mid-continental region has provided paleoclimatic evidence that is both more precise and geographically more specific than that of other methods such as marine sediment cores. The fact that these speleothems can be dated fairly accurately to ages of at least 350,000 years makes them doubly useful



for paleoclimatic studies. Variations in oxygen isotopes are temperature-related, and although there are difficulties in translating them directly into former temperatures, they are useful in detecting paleoclimatic trends. Variations in carbon isotopes help to determine the type of vegetation in the area at any time.

## SUMMARY

The examples described here represent the typical range of caves found in karst regions of moderate relief. Even with such a brief overview it is possible to answer the questions posed earlier:

- *When does cave development begin?* This depends on the definition of terms as much as on geologic setting. Slow flow far below river levels can dissolve primitive routes, but highly soluble materials such as gypsum are usually involved (as in Indiana). But, even where such early flow is well documented, there is little evidence that this process has determined the patterns of currently traversable caves. The close association between caves and the current cycle of landscape development argues against a widespread influence by older deep-seated processes. This conclusion is supported by the correlation of vadose-phreatic transition points between cave passages and with surface features such as river terraces.
- *Which of the original fractures and pores in a soluble rock evolve into caves?* Those that are widest, have the steepest hydraulic gradients, and shortest paths are favored. Mystery Cave in Minnesota illustrates rapid development in such a setting, even though the cave cuts diagonally across the strata in a direction opposite that of the stratal dip. The limited depth of phreatic loops in most caves and the tendency for phreatic tubes to follow the strike of the strata show that shallow paths are the most favorable, due to a decrease in fissure width with depth. Concentrations of caves in zones of stress release in deep canyons also show the importance of initial fracture width, as well as the close association with river levels.
- *How far below the surface can caves form?* The minimum value is the height to which soluble rocks extend continuously above the local river level. The deepest flow systems below river levels appear to be those that follow major faults (even in relatively undisturbed strata such as those of Indiana and Kentucky). Although the depth of cave development is limited in the moderate-relief regions described here, phreatic caves at least 100 m below the present base level are known from geochemical studies, water tracing, diving in water-filled caves, and measurement

of high-amplitude phreatic loops in currently air-filled caves.

- *What is the effect of local geologic setting on cave development?* The nature of groundwater recharge controls the overall cave pattern. Most caves fed by typical karst recharge are branchworks (e.g., Figure 6), whereas network mazes are formed either by uniform seepage through overlying or underlying permeable but insoluble rock or by severe discharge fluctuations during floods. Thick, overlying, insoluble rocks restrict recharge to a few points, which makes the cave pattern deviate from the ideal branchwork pattern. Perching of vadose water along partings in well-bedded rocks, or on insoluble beds, produces dominantly down-dip passages (e.g., Figure 2). Most phreatic passages are oriented roughly parallel to the strike, except where the host rocks are massive and prominently fractured. All areas discussed above exhibit these trends, especially the Ridge and Valley Province.
- *What information do caves provide about past climates and geologic history?* Their close association with fluvial erosion relates them to the developmental history of the entire surrounding region. Dating of sediments and speleothems provides a reliable time scale, and isotopic analysis of speleothems provides information on former climates.

Although this section is limited to karst areas of moderate relief and describes only caves formed by the carbonic acid reaction, the conclusions drawn from it are valid for the majority of karst regions throughout the world.

## Bibliography

- Bretz, J.H. (1956) *Caves of Missouri*. State of Missouri, Division of Geological Survey and Water Resources, Rolla, MO, 490 pp.
- Davies, W.E. (1960) Origin of caves in folded limestone. *Natl. Speleol. Soc. Bull.*, 22(1), 5–18.
- Granger, D.E., Fabel, D., and Palmer, A.N. (2001) Pliocene–Pleistocene incision of the Green River, Kentucky, determined from radioactive decay of <sup>26</sup>Al and <sup>10</sup>Be in Mammoth Cave sediments. *Geol. Soc. Am. Bull.*, 113(7), 825–836.
- Jones, W.K. (1997) *Karst Hydrology Atlas of West Virginia*. Special Publication 4, Karst Waters Institute, Charles Town, WV, 111 pp.
- Kastning, E.H. and Kastning, K.M., Eds. (1991) *Appalachian Karst*. Proc. of Appalachian Karst Symp., Radford, VA, National Speleological Society, Huntsville, AL, 239 pp.
- Palmer, A.N. (1975) The origin of maze caves. *Natl. Speleol. Soc. Bull.* 37, 56–76.
- Sasowsky, I.D. and White, W.B. (1994) The role of stress release fracturing in the development of cavernous porosity in carbonate aquifers. *Water Resources Res.*, 30(12), 3523–3530.
- Stone, R.W. (1953) Caves of Pennsylvania. *Natl. Speleol. Soc. Bull.*, 15, 143.
- White, W.B. (1960) Terminations of passages in Appalachian caves as evidence for a shallow phreatic origin. *Natl. Speleol. Soc. Bull.*, 22(1), 43–53.
- White, W.B. and White, E.L., Eds. (1989) *Karst Hydrology: Concepts from the Mammoth Cave Area*. Van Nostrand-Reinhold, New York, 346 pp.

# Solutional Sculpturing

Phillip J. Murphy  
University of Leeds, United Kingdom

## INTRODUCTION

Studies of the solutional sculpturing of cave walls can provide information on both the direction and discharge of water flow in a cave passage. Scallop-like features are the most well-studied type of solutional sculpturing. Their asymmetry indicates the direction of groundwater flow and their wavelength is inversely proportional to the flow velocity. Laboratory and field investigations have enabled the calculation of mean flow velocity from scallop wavelength data and thus the calculation of discharge at the time of scallop formation.

## SCALLOPS AND FLUTES

Scallops are asymmetrical, cusped, oyster-shell-shaped dissolution depressions in cave walls (Fig. 1). The term *scallop* was first proposed by Coleman (1949) to replace the term *flute* used prior to this. The term *flute* has been used for the elongate, nearly parallel crested forms seen in some cave passages. They are scallops of infinite width and are much rarer than true scallops. Vertical grooves seen in vadose shafts formed by water streaming down in thin sheets have also been called flutes.

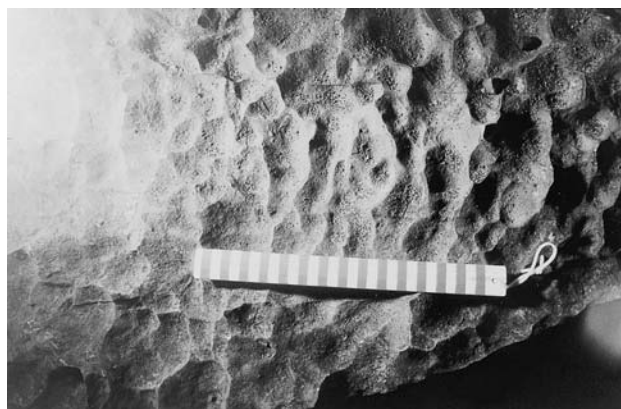
## GROUNDWATER FLOW DIRECTION

Scallops are asymmetrical in the direction of flow, with a smooth slope on the downstream side of the scallop and a steep cusp on the upstream side. Coleman (1949) realized they could be used as a quick and simple indicator of the direction of flow in a conduit. They occur in packed patterns on cave floors, walls, and ceilings. They are measured from cusp to cusp and can vary from 1 cm to several meters in length (where they become difficult to distinguish from bends in the passage walls).

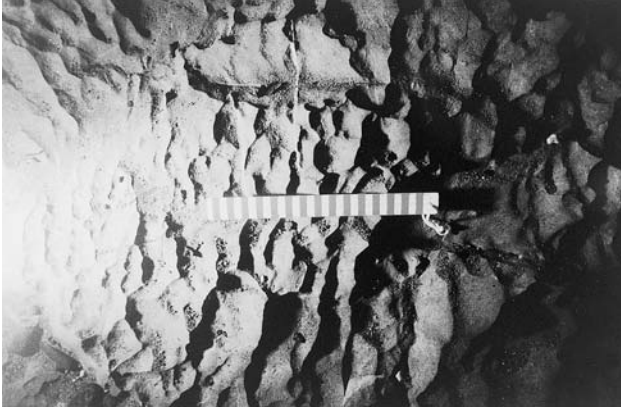
The simplest way to ascertain the direction of asymmetry in a scallop population is to shine a light along the scalloped surface and then to position yourself so you are looking directly toward the scallops. If the light is shining upstream, the steep slopes of the scallops are brightly illuminated and the shallow slopes are in darkness, resulting in the majority of each scallop not being illuminated (Fig. 2). If the light is shining downstream, the steep slopes are in darkness and the shallow slopes are brightly illuminated, resulting in the majority of each scallop being illuminated (Fig. 3). If the scallop asymmetry is not sufficiently distinct, their profiles may be transferred to paper using a profile template and analyzed graphically. A large sample of scallops can then be analyzed statistically for asymmetry.



**FIGURE 1** Scallops on the roof of Joint Hole, North Yorkshire, UK. (Photography courtesy of P. Murphy.)



**FIGURE 2** Scallops illuminated with the light source pointing upstream, Joint Hole, North Yorkshire, UK. (Photography courtesy of P. Murphy.)



**FIGURE 3** Scallops illuminated with the light source pointing downstream, Joint Hole, North Yorkshire, UK. (Photography courtesy of P. Murphy.)

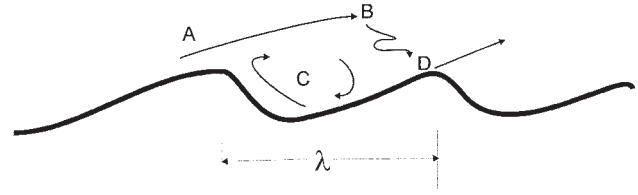
### GROUNDWATER FLOW VELOCITIES

The size of the scallops is inversely proportional to the flow velocity of the water that formed them. Scallop populations usually form unimodal well-sorted log-normal distributions. In the right conditions, patterns of scallops of characteristic length cover all available surfaces. They are the stable form of these surfaces in the prevailing conditions and can be considered as solutional analogs to current ripples in unconsolidated sediments.

Curl (1974) studied the process of scallop and flute formation and was able to show that they are a hydraulic phenomenon. Curl proposed that scallops are formed where there is detachment of the saturated boundary layer at a specified Reynolds number, occurring in the subcritical turbulent flow regime. Where the main flow separates, it passes above an area of slower, recirculating flow. Within a short distance the fast flow becomes irregular and turbulent. Because the turbulence produced causes mixing between the fast stream and the lee eddy, fluid is entrained out of the lee eddy, causing the jet to turn toward the surface and reattach (Fig. 4). Detachment allows aggressive waters to come into contact with the bedrock, increasing the rate of direct erosion. The rate of solution is the highest in the area of reattachment where the turbulent flow impinged the most on the surface. This means scallops migrate downstream. The frequency of detachment increases as flow velocity increases, hence reducing the erosion length available to each individual scallop.

Being a hydraulic phenomenon, scallop formation and the conduit flow conditions that gave rise to them are described by fluid dynamic equations. Previous work has shown that scallops form at a stable scallop Reynolds number ( $Re^*$ ) of  $\sim 2200$  where  $Re^*$  is related to the mean boundary shear velocity  $\bar{u}^*$ , the mean scallop wavelength  $\bar{\lambda}$ , fluid density  $\rho_f$ ; and fluid dynamic viscosity  $\mu$  by

$$Re^* = \bar{u}^* \bar{\lambda} \rho_f / \mu \quad (1)$$



**FIGURE 4** Fluid motion in the vicinity of a scallop: (A) detachment of the laminar boundary, (B) transition to turbulence, (C) the lee eddy, and (D) flow reattachment. (After Curl, 1974.)

Measuring a statistically viable sample allows  $\bar{\lambda}$  to be calculated, and thus an estimate of  $\bar{u}^*$  to be made using Eq. (1). A water temperature appropriate for the study area needs to be chosen. Then a modified Prandtl's universal velocity distribution equation for a parallel-sided conduit [Eq. (2)] or a circular conduit [Eq. (3)] can be used to calculate the mean flow velocity at the time of creation of the scallops:

$$\bar{u} = \bar{u}^* [2.5 \{ \ln(d / 2\bar{\lambda}) - 1 \} + B_L] \quad (2)$$

$$\bar{u} = \bar{u}^* [2.5 \{ \ln(d / 2\bar{\lambda}) - 1.5 \} + B_L] \quad (3)$$

where  $d$  is the hydraulic diameter of the conduit and  $B_L$  is Prandtl's bed roughness constant. Blumberg and Curl (1974) showed through experimental flume work on scallops that  $B_L = 9.4$ .

An approximation to the groundwater flow velocity (in meters per second) indicated by a scallop population can be calculated by dividing 3.5 by the mean length of the scallops in centimeters.

### CALCULATION OF DISCHARGE AND OTHER PARAMETERS

Following the approach of Gale (1984) further hydraulic parameters can be estimated from the values obtained above and the following equations:

$$f = 8 / (\bar{u} / \bar{u}^*)^2$$

$$Q = \bar{u} a$$

$$Re = \bar{u} d \rho_f / \mu$$

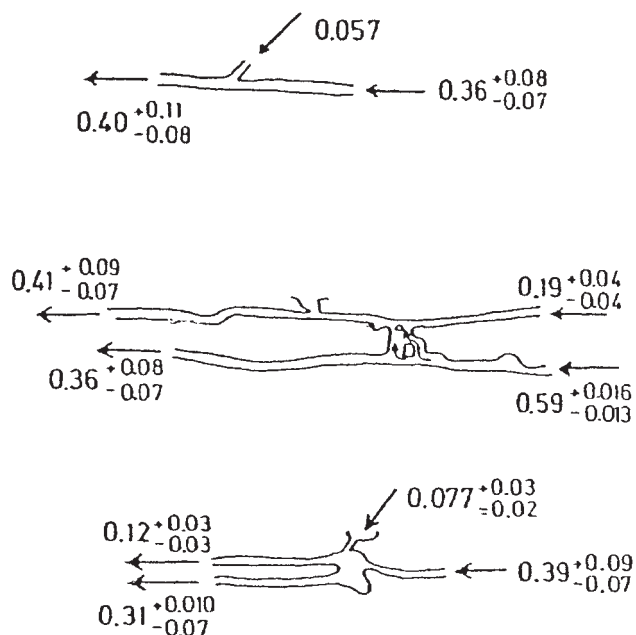
$$F = \bar{u} / (gd)^{0.5}$$

$$\bar{\tau} = (\bar{u}^*)^2 \rho_f$$

$$P = \bar{u} \bar{\tau}$$

$$\omega_{\max} \approx 0.96 \bar{u}^*$$

where  $f$  is the Darcy-Weisbach friction factor,  $Q$  the discharge,  $a$  the cross-sectional area of the conduit,  $Re$  the conduit Reynolds number,  $F$  the Froude number,  $g$  the gravitational acceleration,  $\bar{\tau}$  the mean boundary shear stress,  $P$  the power of flow per unit area of boundary, and  $\omega_{\max}$  the maximum settling velocity of material in suspension.



**FIGURE 5** Flow through the junctions ( $\text{m}^3\text{s}^{-1}$ ) with estimates of errors of flow. (From Lauritzen, 1982.)

### USES AND PITFALLS OF SCALLOP DISCHARGE DATA

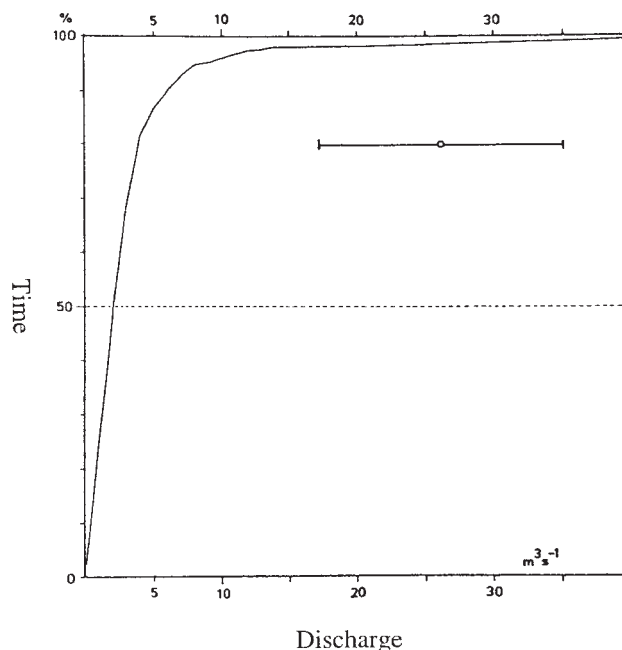
Curl's theory of scallop formation has been tested both in laboratory studies and in the field both in vadose and phreatic conduits. Studies in network cave systems have shown that paleodischarges calculated from scallop data fit the requirements of the continuity equation, whereby the same amount of incompressible liquid has to pass through each cross section of a tube or tube system (Fig. 5).

Working in relict conduits where enough scallop lengths can be measured, the paleovelocity and paleodischarge of the conduit can be calculated by assuming a temperature of the water and measuring the conduit dimensions. A number of other factors, however, have to be considered. One problem is under what flow conditions in the conduit does scallop formation occur? Field studies have shown that the velocities indicated by the mean scallop length (the *scallop dominant discharge*) correspond to the upper 5% of the flow regime (Fig. 6).

Scalloped surfaces exhibit a number of small depressions, which appear to be related to the intersection of the rims of the scallops and therefore not related to the flow velocity. The use of the *Sauter mean* ( $\lambda_{32}$ ) rather than the arithmetic mean is used by some workers to suppress

$$\lambda_{32} = \frac{\sum_{i=1}^n \lambda_i^3}{\sum_{i=1}^n \lambda_i^2}$$

the importance of these smaller features.



**FIGURE 6** Flow duration curve for the period from September 1983 to April 1985 with the flow rate deduced from scallops for the underground outlet for Lake Glomdal, Norway. The flow rate deduced from scallops represents only 2% or less of the time of flow. (From Lauritzen *et al.*, 1985.)

Being hydraulic phenomena, the process of scallop formation is independent of substrate; however, field observation has shown that bedrock variation does exert some control on scallop size. Studies of scallop distributions in an active phreatic conduit have shown that distinct and adjacent scallop distributions indicative of very different flow regimes can coexist (Murphy *et al.*, 2000). Contrast in size between ceiling and lower wall scallop populations in relict conduits have been explained by a partial draining of the conduit with a corresponding change in discharge. Such a situation could occur in the epiphreatic zone. Workers in relict conduits have often assumed that the presence of small scallops on the floor contrasting with large scallops on the walls and ceiling is due to invasion of the relict conduit by a vadose stream. This may not be the case and the contrasting scallop sizes could be a product of the phreatic phase of the conduit's history.

The occurrence of scalloping superimposed on speleothems means the scallops must postdate initial draining of the conduit and initiation of speleothem growth. Such occurrences allow for the possibility of constraining the timing of paleohydraulic events by dating the speleothems. This approach has been used by Murphy *et al.* (2001) to date the occurrence of a second phreatic event in a conduit's history.

### OTHER PHENOMENA

Pockets resemble hollow, bisected hemispheres or hemi-ellipses (Springer and Wohl, 2002). They are readily distinguishable from scallops by their lack of oversteepened upstream faces. The flow field in pockets can be forward,



**FIGURE 7** A lateral pothole on Buckeye Creek Cave, West Virginia. (Photograph courtesy of G. Springer.)

reversed, upward or downward. All four flow fields were recorded in Buckeye Creek Cave in West Virginia, USA. In contrast to scallops, pockets do not migrate but are developed on defects such as joints and stylolites, the morphology of the pocket being dependent on the nature and orientation of the defect. The presence of pockets within fields of scallops suggests some pockets may have originated as preferentially enlarged scallops.

Lateral potholes may resemble hollow bisected cylinders, hemispheres, hemiellipses, or upright teardrops in vertical channel walls (Fig. 7). They are eroded by sediment-laden vortical flow near the air-water interface and are potential indicators of paleoflow depths and velocities. They are described from a vadose canyon passage in Buckeye Creek Cave, West Virginia, by Springer and Wohl (2002) where scallops within lateral potholes record recirculating flow with flows descending at an angle of 10–30 degrees from the horizontal.

The preferential development of small-scale solutional etching on one set of passage walls in gull rifts in southwest England has been used by Self (1995) to infer paleoground-water flow.

**TABLE I** Classification of Interspecific Interactions

	Effect of species 2 on species 1		
	0	+	?
Effect of species 1 on species 2	0 None	Commensalism	Amensalism
	+	Commensalism	Mutualism
	?	Amensalism	Predation
			Competition

### Bibliography

- Blumberg, P. N., and R. L. Curl (1974). Experimental and theoretical studies of dissolution roughness. *J. Fluid Mechanics* **75**, 735–742.
- Coleman, J. C. (1949). An indicator of water flow in caves. *Proc. Univ. Bristol Speleological Soc.* **6**(1), 57–67.
- Curl, R. L. (1974). Deducing flow velocity in cave conduits from scallops. *Natl. Speleological Soc. Bull.* **36**, 1–5.
- Gale, S. J. (1984). The hydraulics of conduit flow in carbonate aquifers. *J. Hydrol.* **70**, 309–327.
- Lauritzen, S.-E. (1982). The paleocurrents and morphology of Pikhaggrottene, Svartisen, North Norway. *Norsk. Geogr. Tidsskr.* **36**, 183–209.
- Lauritzen, S.-E., J. Abbot, R. Arnessen, G. Crossley, D. Grepperud, A. Ive, and S. Johnson (1985). Morphology and hydraulics of an active phreatic conduit. *Cave Sci.* **12**, 139–146.
- Murphy, P. J., A. M. Hall, and J. N. Cordingley (2000). Anomalous scallop distributions in Joint Hole, Chapel-le-Dale, North Yorkshire, UK. *Cave Karst Sci.* **27**(1), 29–32.
- Murphy, P. J., R. Smallshire, and C. Midgley (2001). The sediments of Illusion Pot, Kingsdale, North Yorkshire, UK: Evidence for sub-glacial utilisation of a karst conduit in the Yorkshire Dales. *Cave Karst Sci.* **28**(1), 29–34.
- Self, C. A. (1995). The relationship between the gull cave Sallys Rift and the development of the River Avon east of Bath. *Proc. Univ. Bristol Speleological Soc.* **20**(2), 91–108.
- Springer, G. S., and E. E. Wohl (2002). Empirical and theoretical investigations of sculpted forms in Buckeye Creek Cave, West Virginia. *J. Geol.* **110**, 469–481.

## Species Interactions

David C. Culver

American University

### INTRODUCTION

Species can affect each other in a variety of ways. They can be predator and prey, they can be competitors, or they can be mutualists in which case each species has a beneficial impact on the other. A complete classification of the population effects of interspecific interactions is given in Table I. In addition to these population impacts, i.e., the impact of one species on the growth rate of another, the interactions can occur between two free-living species, or between individuals, one of which is permanently attached to or embedded in another—symbioses. Symbiotic (literally “living together”) organisms can have mutualistic, commensal, or

parasitic population interactions. The entire array of interspecific interactions occurs among cave organisms. Many symbiotic associations have been noted. These include mites parasitic on bats, ostracodan crustaceans commensal on crayfish, and flatworm-like temnocephalans parasitic on cave amphipods and shrimp. Cave symbionts have been little studied ecologically, and in many cases the nature of the interaction is not known. Among free-living species the most common interactions are competition and predation.

Caves have proved to be useful ecological laboratories for the study of interspecific interactions. The number of species in any one cave is quite small compared to most surface communities. This makes analysis much simpler because the number of pairwise interactions is much smaller in smaller communities. In a community of 4 species there are 6 pairs of possible interactions, whereas in a community of 10 species there are 45 such pairs. [In general, for a community of  $S$  species there are  $\{S(S - 1)/2\}$  interaction pairs.] Many cave streams have only two or three macroscopic invertebrates compared to dozens in surface streams. This makes the job of determining major competitors, predators, and prey much simpler. Secondly, cave communities typically have a simple trophic structure with only two or three trophic levels. Food webs are simpler and easier to analyze. Third, because of the patchy nature of the habitat and the resulting patchy distribution of most species, nearby caves often have different species present. This allows these “natural experiments” to be used to study the effects of species additions and removals. Because of the relatively large number of caves in cave-bearing areas (there are more than 45,000 known caves in the United States), the number of such natural experiments can be quite large.

Although many interactions have been remarked on in the literature, and complete food webs have been constructed for a few communities, two sets of species have been studied extensively. One is the predator–prey system of carabid beetles and their cricket egg prey, which occurs extensively through the Interior Low Plateaus of Kentucky, Tennessee, and Alabama and in the Balcones Escarpment of Texas. The other are the amphipods and isopods that compete in cave streams in Virginia and West Virginia.

### BEETLE PREDATORS AND THEIR CRICKET EGG PREY

Because of the scarcity of food in caves, especially for predators, the great Romanian biospeleologist Emil Racovitza pointed out that many cave animals are “carnivores by predilection but saprovores by necessity.” This has the effect of both shortening food webs and making predatory behavior difficult to observe because predatory events themselves are usually quite rare. An exception to both the rarity of observation and tendency of predators toward omnivory is the predator–prey pair of cave crickets (in particular their eggs) and beetles found in many caves in

North America. The best studied pair is that of the beetle *Neaphaenops tellkampfi* and the cave cricket *Hadenoeus subterraneus* in Mammoth Cave, Kentucky, and other nearby caves. Very similar predator–prey interactions occur with other beetles (e.g., *Rhadine subterranea*) and cave crickets in Texas (e.g., *Ceuthophilus cunicularis*) and with other beetles and crickets in other parts of Kentucky.

The key to this predator–prey interaction begins with the cave crickets. Species like *Hadenoeus subterraneus* are often quite common in caves, typically reaching numbers into the hundreds and even thousands. Their pale pigmentation and long antennae give an initial impression of being limited to caves. In point of fact, they are quite cave adapted. Aside from elongated antennae, they have a thinned cuticle that allows them to survive in the saturated relative humidity of caves. They are also resistant to starvation and have lower metabolic rates compared to surface-inhabiting relatives. Presumably the advantage they gain from cave life is avoidance of most predators and some relief from high daytime temperatures in the summer. However, they leave the cave periodically to forage for food. Some species may leave every night during the summer months but *H. subterraneus* probably leaves the cave to feed at 10- to 20-day intervals.

Whatever the frequency of outside feeding, it represents an important food source entering the cave. Many species feed on the splattering of cricket guano present in the caves and a few beetles have specialized on the eggs crickets bury in the cave. In caves with sand or uncompacted silt, crickets bury their eggs in this soft substrate. Cricket eggs, rich in protein and lipids, and nearly one-third the size of an adult *N. tellkampfi* (Fig. 1), are a bonanza to the beetles if they can find them. Successful cricket egg predation behavior has evolved several times among cave beetles. Most of these beetle species are 6.5 to 8 mm long and actively forage for eggs, locating the holes where the eggs were laid by a combination of chemoreception and mechanoreception. Beetles dig a hole to find an egg, and when they are successful, they remove the egg, pierce it with their mandibles, and the egg contents are pumped into the gut. In caves without soft substrates, beetles are unable to locate and dig up the

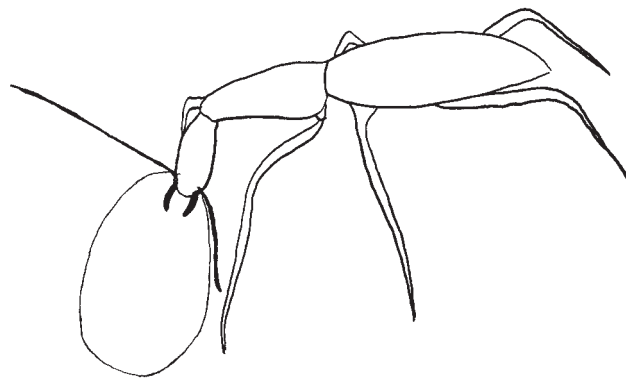


FIGURE 1 Sketch of *Rhadine subterranea* eating cricket egg. (Adapted from photograph by Dr. Robert W. Mitchell.)

eggs. An evolved response on the part of *H. subterraneus* has been to increase the ovipositor length in populations experiencing egg predation by cave beetles. The increase in ovipositor length from 12 to 13 mm is sufficient to reduce egg predation. Beetles often do not dig deep enough. Reproduction in the beetles is timed to follow periods of maximum egg deposition by crickets (Fig. 2). However, most if not all populations of cricket-egg-eating beetles must switch to other prey because cricket eggs are not available year-round. In periods of cricket egg scarcity, *N. tellkampfi* and other species become “ordinary” predators, feeding on a variety of prey. They also must switch habitats since the sandy substrates and uncompacted silt where cricket eggs are laid have few other species. Interestingly, they are apparently not very efficient general predators, much less so than related species in the genus *Pseudanophthalmus* as well as conspecific populations that do not prey on cricket eggs.

**COMPETITION AND OTHER INTERACTIONS IN APPALACHIAN CAVE STREAMS**

A thoroughly studied case of interaction within a trophic level is that of the amphipod and isopod species that occupy many gravel-bottomed streams in Appalachian caves. In these streams, there is an alternation between deeps (pools) and shallows (riffles). The amphipods and isopods are highly concentrated in riffles as a result of the concentration of food (especially leaf detritus), increased oxygen, and the absence of salamander predators, which live in pools. In this habitat, the three obvious kinds of interactions are as follows: (1) Species may compete for food, (2) species may compete for space (the underside of gravels), and (3) species may serve as food for other species. All can and do occur in particular situations, but the most universal (and easiest to analyze) is competition for space on the underside of riffles.

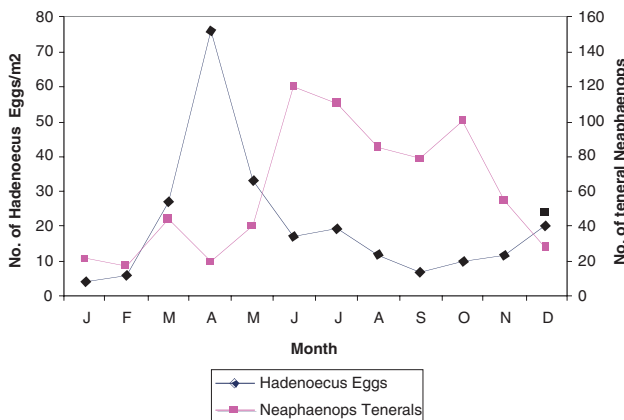
The basis for competition for space on the underside of riffles is that when any two individuals meet in a riffle, space

is in short supply. It is very easy to observe the behavioral response to most encounters even in a small dish in the lab—one or both individuals rapidly move away. More realistic laboratory experiments were done in a small artificial riffle, where the washout rate of individuals put in the riffle in various combinations could be measured. The next step was to construct a model of competition relating relative washout rate to the interaction coefficients of the standard competition equations:

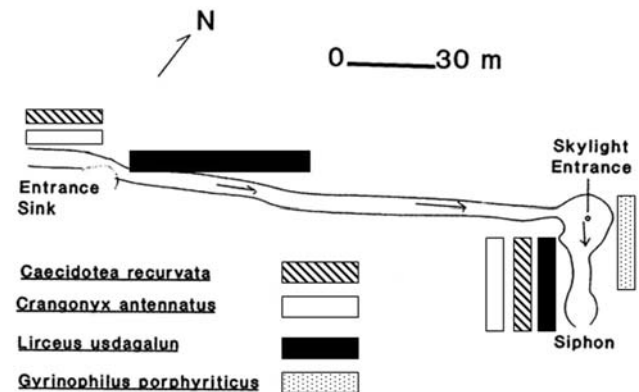
$$\begin{aligned} dN_1/dt &= r_1N_1(K_1 - N_1 - \alpha_{12}N_2) \\ dN_2/dt &= r_2N_2(K_2 - N_2 - \alpha_{21}N_1) \end{aligned}$$

where *r* is the intrinsic rate of increase of species 1 and 2, *N* is population size, *K* is carrying capacity, and  $\alpha_{ij}$  represents the effect of species *j* on species *i*. For competition for space in a riffle  $\alpha_{ij}$  is approximately equal to the ratio of the washout rate of species *i* when species *j* is present to the washout rate of species *i* when species *j* is not present. The resulting estimates of competition can then be compared with field data on the amount of overlap among species in caves and within riffles within a cave. The greater the amount of overlap in the field, the less the intensity of competition for space because otherwise the species would not be in proximity.

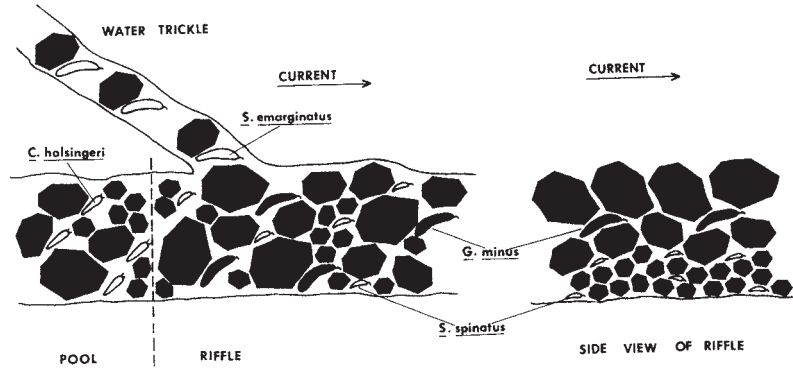
Three different cave stream communities show the range of interactions. The first involves a trio of species found in Thompson Cedar Cave and other nearby caves in Lee County, Virginia: the amphipod *Crangonyx antennatus* and the isopods *Caecidotea recurvata* and *Lirceus usdagalun*. The intensities of competition measured in the laboratory were such that, if they accurately reflect the situation in the field, only one of the three pairs (*Crangonyx antennatus* and *Caecidotea recurvata*) should be able to persist in the same stream, as well as the triad of species itself. In a survey of seven cave streams, no “unstable” species pairs were found, suggesting that laboratory measurements reflected the situation in the field. This was further supported by the distribution within Thompson Cedar Cave (Fig. 3). In various parts



**FIGURE 2** Seasonal changes in number of eggs per square millimeter of the cave cricket *Hadenoeus subterraneus* and a visual census of newly emerging adults (teneral) of the beetle *Neaphaenops tellkampfi* in Edwards Avenue, Great Onyx Cave, Kentucky.



**FIGURE 3** Map of distribution of *Crangonyx antennatus*, *Caecidotea recurvata*, *Gyronophilus porphyriticus*, and *Lirceus usdagalun* in Thompson Cedar Cave, Lee County, Virginia.



**FIGURE 4** Diagrammatic view of niche separation of *Caecidotea holsingeri* (open oblong shapes), *Gammarus minus* (large solid crescents), *Stygobromus emarginatus* (large open crescents), and *Stygobromus spinatus* (small open crescents) in caves of Greenbrier County, West Virginia. No more than three of the species actually occur together in a single cave stream.

of this small cave stream, all three species occurred together, *Lirceus usdagalun* occurred by itself, and *Crangonyx antennatus* and *Caecidotea recurvata* occurred together, but in no place did the pair *Lirceus usdagalun* and *Caecidotea recurvata* or the pair *Lirceus usdagalun* and *Crangonyx antennatus* occur. The final wrinkle is the occurrence of predaceous larvae of the spring salamander *Gyrinophilus porphyriticus*. Its preferred prey, *Caecidotea recurvata*, is reduced in abundance, and very few amphipods and isopods occur in pools. When *Gyrinophilus porphyriticus* finds isolated rimstone pools, it decimates any amphipod or isopod population that might be there.

Superficially, the pattern of distribution of amphipods and isopods in Organ Cave, Greenbrier County, West Virginia, resembles that of Thompson Cedar Cave. Four species are known from Organ Cave (Fig. 4): the amphipods *Gammarus minus*, *Stygobromus emarginatus*, and *Stygobromus spinatus* and the isopod *Caecidotea holsingeri*. When together, they occupy different sized rocks within a riffle, different riffles, or different streams. In this study laboratory stream studies were combined with perturbation (addition and removal) experiments in the field. Three species pairs were studied:

*Stygobromus spinatus* and *Caecidotea holsingeri*  
*Gammarus minus* and *Caecidotea holsingeri*  
*Gammarus minus* and *Stygobromus emarginatus*

Laboratory stream results were similar to those found for the species in Thompson Cedar Cave except that the competition between *Caecidotea holsingeri* and *Stygobromus spinatus* was one sided—the isopod always seemed to dislodge the amphipod. Technically, this was a case of amensalism (Table I). Superficially, the *Gammarus minus*–*Caecidotea holsingeri* pair seemed to compete for space: Fewer individuals remained in the artificial riffle when the other species was present. However, it turned out that *Gammarus minus* was eating, rather than dislodging, *Caecidotea recurvata*. Thus, this was predation rather than competition. In the field, a new interaction appeared. The presence of *Gammarus minus* had a positive effect on the abundance of *Stygobromus*

*emarginatus*, rather than the negative effect predicted from the artificial riffle experiments. Subsequent investigation showed that *Stygobromus emarginatus* was feeding on the fecal material of *Gammarus minus*. Thus, the two species compete at the microscale (a single rock), but have a commensal relationship (Table I) at the scale of a riffle.

The final cave community that has been intensively studied is the isopod community in Alpena Cave, Randolph County, West Virginia. Two species occur in the same stream—*Caecidotea cannulus* and *Caecidotea holsingeri*. Superficially, they would seem to be competitors. Typically, *Caecidotea cannulus* is larger than *Caecidotea holsingeri* and this difference is enhanced in Alpena Cave when the two species occur together. However, the size of the isopods is strongly correlated with the size of the gravels in the streams and it turns out that Alpena Cave has a bimodal distribution of gravel sizes. Neither laboratory stream studies nor field perturbation experiments detected any evidence of competition between these two species.

## CONCLUSION

Because of the highly replicated nature of caves, they can be important ecological laboratories for the study of species interactions. The above studies indicate some of the potential for such work. Many more cave communities await such an analysis.

## Bibliography

- Culver, D. C. (1982). *Cave Life: Evolution and Ecology*. Harvard University Press, Cambridge, MA.
- Culver, D. C. (1994). Species interactions. In *Groundwater Ecology* (G. Gibert, D. L. Danielopol, and J. A. Stanford, eds.), pp. 271–281. Academic Press, San Diego.
- Griffith, D. M. (1990). Laboratory studies of predatory behaviour in two subspecies of the carabid cave beetle: *Neaphaenops tellkampfi*. *Int. J. Speleology* **19**, 29–38.
- Kane, T. C., and T. L. Poulson (1976). Foraging by cave beetles: Spatial and temporal heterogeneity of prey. *Ecology* **57**, 793–800.
- Mitchell, R. W. (1968). Food and feeding habits of the troglotic carabid beetle *Rhadine subterranea*. *Int. J. Speleology* **3**, 249–270.



Studier, E. H., K. H. Lavoie, W. E. Wares II, and J. A.-M. Linn. (1987). Bioenergetics of the cave cricket, *Hadenoeus subterraneus*. *Comparative Biochem. Physiol.* **84A**, 431–436.

# Speleothem Deposition

Wolfgang Dreybrodt  
University of Bremen, Germany

## INTRODUCTION

Precipitation of calcite from supersaturated  $\text{H}_2\text{O}-\text{CO}_2-\text{CaCO}_3$  solutions sculpts fascinating cave decorations of stalagmites, stalactites, and other speleothems and also creates flowstone and sinter terraces. Rainwater seeping through vegetated soils on its way down to the limestone bedrock can absorb large amounts of carbon dioxide, which is present in the soil in much higher concentrations than in the atmosphere. When this water moves down, it dissolves limestone in the soil and in the fissures of the bedrock and comes very close to saturation with respect to calcite. If such a solution enters a cave, outgassing of  $\text{CO}_2$  creates a supersaturated solution from which calcite is deposited. This causes the growth of calcite speleothems in their various shapes (White, 1976). The chemical composition of this solution depends on the  $\text{CO}_2$  content of the soil atmosphere, but also on the conditions under which  $\text{CO}_2$  is absorbed.

Two extremes can be envisaged. If the soil is free of calcite, only  $\text{CO}_2$  is absorbed there, and dissolution of limestone later proceeds exclusively in the fractures of the rock under conditions closed to carbon dioxide. For each  $\text{CaCO}_3$  unit dissolved, one  $\text{CO}_2$  molecule is consumed. When this solution enters a cave, its  $\text{CO}_2$  concentration may have become so low that carbon dioxide is taken up from the cave atmosphere and the solution becomes aggressive. This can be seen by Rinnenkarren extending below bedding planes in many caves. If, however, the partial pressure of carbon dioxide in the soil atmosphere is above 0.01 atm, a supersaturated solution will precipitate calcite. The other extreme occurs when the soil contains limestone particles, and rainwater seeping down dissolves limestone under conditions open to the atmosphere such that for each  $\text{CaCO}_3$  unit dissolved, one molecule of  $\text{CO}_2$  is absorbed from the soil air. If such a solution reaches equilibrium with respect to calcite and later on encounters a cave, it will deposit calcite, provided the  $\text{PCO}_2$  of the cave atmosphere is smaller than that in the soil above. Intermediate cases, e.g. when dissolution first proceeds in the soil under open conditions and then continues in the fissures of the rock under closed conditions, are also possible. Supersaturation and consequently growth rates are minimal for the first extreme, maximal for the second, and in between for intermediate cases provided  $\text{PCO}_2$

in the soil air is unaltered (Dreybrodt, 1999). These considerations show that growth rates of speleothems are not simply related to soil  $\text{PCO}_2$ , but also in a complex way to the chemical pathway of the water on its way down to the cave.

## PRECIPITATION RATES

Calcite ( $\text{CaCO}_3$ ) is precipitated from a supersaturated solution by three elementary reactions, which proceed in parallel (Plummer *et al.*, 1978):

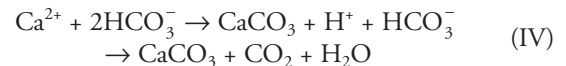


These cause precipitation rates given by the Plummer-Wigley-Parkhurst (PWP) equation:

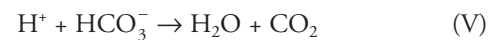
$$R = k_4(\text{Ca}^{2+})_s (\text{HCO}_3^-)_s - k_3 - k_2(\text{H}_2\text{CO}_3^*)_s - k_1(\text{H}^*)_s \quad (1)$$

The rate  $R$  is given in  $\text{mmol cm}^{-2}\text{s}^{-1}$ . The parentheses denote the activities of the species at the surface of the mineral. The rate constants  $k_1, k_2, k_3$  depend on temperature, but  $k_4$  also on the  $\text{CO}_2$  concentration in the solution (Plummer *et al.*, 1978).

Reactions (I) through (III) can be summarized as follows:



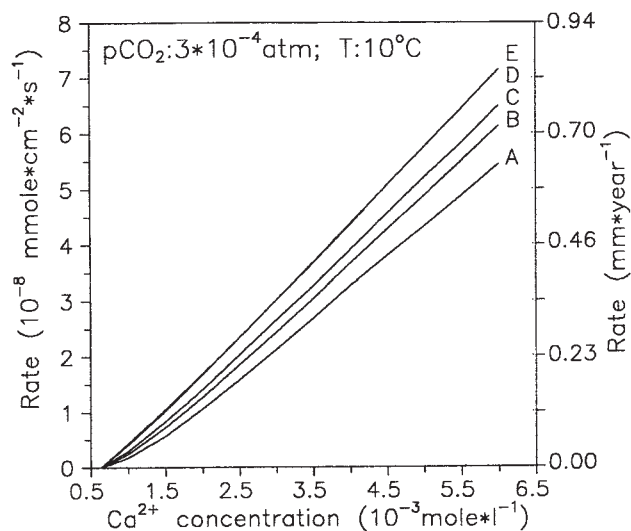
Thus, one molecule of  $\text{CO}_2$  is produced by each  $\text{CaCO}_3$  deposited, and during deposition of calcite,  $\text{H}^+$  and  $\text{HCO}_3^-$  must react by



This reaction is slow and it takes, depending on the pH of the solution, several seconds up to minutes to come to equilibrium (Usdowski, 1982). Therefore, conversion of  $\text{H}^+ + \text{HCO}_3^-$  into  $\text{CO}_2$  plays an important role. When calcite is deposited to a surface area  $A$  from a solution with volume  $V$ , according to (IV) and (V), the number of  $\text{CO}_2$  molecules produced must be equal to the number of  $\text{CaCO}_3$  units deposited, which is expressed by

$$V \frac{d[\text{CO}_2]}{dt} = AR \quad (2)$$

where  $[\text{CO}_2]$  is the concentration of  $\text{CO}_2$ . The reaction rate  $d[\text{CO}_2]/dt$  is slow. Therefore, when the ratio  $V/A$  becomes sufficiently small, the deposition rate  $R$  is limited by the slow reactions (IV) and (V). A further mechanism controlling deposition rates is diffusional mass transport by which  $\text{Ca}^{2+}$  and  $\text{HCO}_3^-$  are transferred from the bulk of the solution to the surface, where they react. Due to this diffusional mass transport concentration, gradients build up such that the concentrations of all species in the bulk are higher than those at the surface. Therefore, calculating deposition rates by use of the PWP equation and employing concentrations



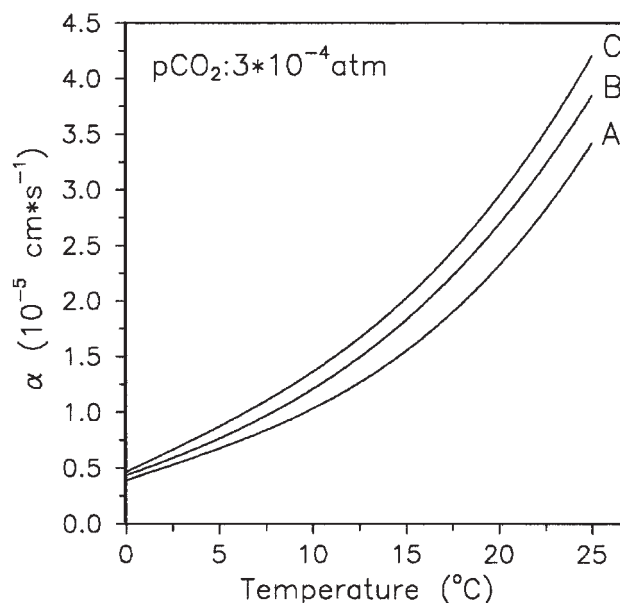
**FIGURE 1** Precipitation rates of calcite from thin films of supersaturated solutions on dependence of calcium concentration. Film thickness  $\delta$  is (A) 0.005 cm, (B) 0.0075 cm, (C) 0.01 cm, and (D, E) 0.02 cm up to 0.04 cm. The right-hand scale gives the growth rates in millimeters per year. (From Baker *et al.*, 1998.)

measured from the bulk solution can lead to significant overestimations of the rates.

The correct rates have been obtained by involved models (Buhmann and Dreybrodt, 1985; Dreybrodt and Buhmann, 1991; Liu and Dreybrodt, 1997), which have also been verified by experiment (Dreybrodt *et al.*, 1997). In this context we discuss only situations relevant to speleothems.

### Precipitation from Thin Water Layers

Many speleothems, e.g., stalagmites and stalactites, grow by precipitation of calcite from thin water layers with depth  $\delta$  on the order of tenths of a millimeter. These thin films covering the speleothem are either in slow laminar flow or stagnant. To predict the precipitation rate and its dependence on the chemical composition of the solution, temperature, and thickness of the water film, Buhmann and Dreybrodt (1985) have solved the transport reaction equations numerically. In their numerical model they assumed that a planar calcite surface is covered by a stagnant water layer of thickness  $\delta$ . The free surface of this layer is in contact with an atmosphere with known partial pressure,  $P_{CO_2}$ , of carbon dioxide, and equilibrium between the  $CO_2$  concentration in the water and its surrounding atmosphere is established. Figure 1 shows the precipitation rates for various thicknesses of the water film as a function of the Ca concentration in the solution at a temperature of  $T = 10^\circ C$  and in equilibrium with a cave atmosphere of  $3 \cdot 10^{-4}$  atm. The rates are controlled by diffusional mass transport and by the slow conversion of  $HCO_3^-$  to  $CO_2$ . Therefore, they drop with decreasing thickness of the water film. All the curves in Fig. 1 can be approximated within an error of less than 10% by the following equation:



**FIGURE 2** Values of  $\alpha$  as taken from the curves in Fig. 1 for various film thicknesses  $\delta$  as a function of temperature, where  $\delta =$  (A) 0.005 cm, (B) 0.0075 cm, and (C) 0.01 cm. (From Baker *et al.*, 1998.)

$$R = \alpha(c - c_{eq}) \quad (3)$$

where  $\alpha$  ( $cm \ s^{-1}$ ) is a reaction constant,  $c$  is the calcium concentration ( $mmol \ cm^{-3}$ ) in the solution, and  $c_{eq}$  its equilibrium concentration with respect to the partial pressure of  $CO_2$  in the cave atmosphere. Values of  $\alpha$  have been obtained numerically (Buhmann and Dreybrodt, 1985; Baker *et al.*, 1998). They are presented in Fig. 2 as a function of temperature for various thicknesses of the water film. Note the strong increase in  $\alpha$  by about one order of magnitude from 5 to  $25^\circ C$ . It turns out that  $\alpha$  is practically independent of the  $P_{CO_2}$  in the cave in the range from  $3 \cdot 10^{-4}$  atm up to  $5 \cdot 10^{-3}$  atm, which covers most of the natural conditions.

The equilibrium concentration  $c_{eq}$  of Ca is given (Dreybrodt, 1988) by

$$c_{eq} = 10.75 (1 - 0.0139T)^3 \quad (4)$$

$P_{CO_2} \text{ mmole/cm}^{-3}$

where  $T$  is the temperature in degrees Celsius.

Rates can now be obtained by use of Eqs. (3) and (4) in units of  $mmole \ cm^{-2} \ s^{-1}$ . This can be converted to growth rates in centimeters per year by multiplication by the factor  $1.17 \cdot 10^6$ . These growth rates are given on the right-hand side ordinate in Fig. 1.

**Precipitation Rates on Stalagmites** When stalagmites grow under constant water supply and temperature, they attain final equilibrium shapes independent of the initial surface on which they grow. Once this equilibrium is established, the stalagmite grows by vertically shifting its present shape. The growth rate at its apex is therefore representative of that for the whole stalagmite (Dreybrodt 1988, 1999; Franke, 1965).

When water drips to the stalagmite, a thin film of about 0.1 mm is established at the apex that remains there until it is replaced by a new drop after time  $t$ . During this time, due to precipitation of calcite, the supersaturation of the solution decreases exponentially with decay time  $\tau$  and the total amount of calcite deposited is the average of the declining rates (Curl, 1973; Dreybrodt, 1988). Therefore, the growth rate  $R$  on stalagmites becomes dependent on the time interval  $t$  between two drips by

$$R = 1.17 \cdot 10^6 \cdot (c - c_{eq}) \cdot \frac{\delta}{t} \left( 1 - \exp\left[-\frac{\alpha t}{\delta}\right] \right) = \text{cm/year} \quad (5)$$

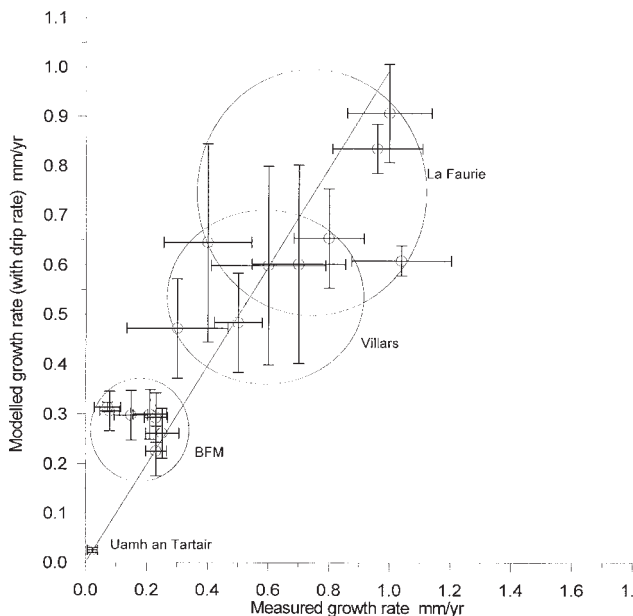
For  $t \leq 0.2 \delta/\alpha$ , the rates are close to the maximal rates as given by Eq. (3). The reason is that the time  $\tau = \delta/\alpha$  is much larger than the time  $T$  between two drops and therefore the precipitation rates remain practically unaltered.

On the other hand, if  $T \geq 5\tau$ , then the rates are given by

$$R = 1.17 \cdot 10^6 (c - c_{eq}) \cdot \delta/t \quad (6)$$

They become independent on  $\alpha$ , since after the time  $5\tau$  the solution has attained equilibrium and therefore deposition has stopped. The rates are now determined by the total calcite available for deposition,  $\delta(c - c_{eq})$ , divided by the time  $t$ .

Equation (5) has been tested in the field by observing drip rates, temperature, and calcium concentration (Baker *et al.*, 1998; Genty *et al.*, 2001) and measuring recent growth rates of specific stalagmite. Figure 3 depicts the results. It shows the modeled growth rates from Eq. (5) versus measured growth rates for various caves throughout Europe. The thin solid line represents the theoretical prediction. The measured values are reasonably close to this theoretical line.



**FIGURE 3** Comparison of measured and modeled growth rates of stalagmites. The straight line depicts modeled growth rates. (From Genty *et al.*, 2001.)

Growth rates have also been measured in the laboratory by dripping supersaturated solutions to small plates cut from stalagmites and determining weight increase (Buhmann and Dreybrodt, 1985; Huang and Fairchild, 2001) and close agreement to theoretical rates has been found.

A final remark must be made. For thin films  $\delta < 0.04$  cm, the precipitation rates are controlled by the reaction of  $\text{HCO}_3^-$  to  $\text{CO}_2$ , and when the film is stagnant or in laminar flow also by molecular diffusion. Therefore, the rates are one order of magnitude below the maximal rates, which one finds from the PWP equation, Eq. 1.

### Precipitation from Water Films in Turbulent Flow

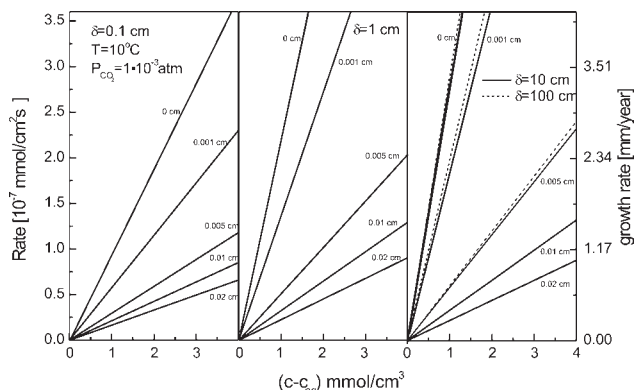
In many cases deposition of cave sinter occurs from turbulently flowing water. Relatively thin films of a few millimeters flow down from stalactites or stalagmites when water supply from drip points is sufficiently high. Supersaturated water flowing down cave walls precipitates flowstone. Finally cave rivers can shape sinter terraces and rimstone dams.

When water flows turbulent mass transport is enhanced by eddies in its bulk. This turbulent bulk, however, is separated from the mineral surface by a laminar diffusion boundary layer (DBL) with thickness  $\epsilon$ , which depends on the hydrodynamic conditions, e.g., flow velocity, surface roughness, and depth of the flowing fluid. In this layer mass transport proceeds by molecular diffusion solely. Because diffusional mass transport increases with decreasing  $\epsilon$ , deposition rates are strongly dependent on the hydrodynamics of flow. In all the cases of interest here  $\epsilon$  is about a tenth of a millimeter.

Rates also depend on the depth  $\delta$  of the flowing water, because  $\delta = V/A$  determines the influence of  $\text{HCO}_3^-$  on the  $\text{CO}_2$  reaction. For small  $\delta \leq 0.2$  cm this reaction becomes rate limiting. As in laminar flow, the rates exhibit a linear relation of the Ca concentration as given by Eq. (3). Values of  $\alpha$  have been listed by Liu and Dreybrodt (1997) for various values of  $\epsilon$ ,  $\delta$ ,  $\text{PCO}_2$ , and temperature.

Figure 4 depicts precipitation rates calculated by use of these values and Eq. (3) for various thicknesses  $\delta$  and  $\epsilon$  as listed on the curves for a partial pressure  $\text{PCO}_2 = 1 \cdot 10^{-3}$  atm and  $10^\circ\text{C}$ . These conditions apply to many cave rivers, from which flowstone is deposited.

In all cases one visualizes a strong decrease of the rates with increasing  $\epsilon$ . The uppermost curves show the rates for  $\epsilon = 0$ , which in this case, due to the complete mixing concentrations at the mineral surface, equal those in the bulk. These rates are the maximal rates possible in that particular case. Due to the limiting action of  $\text{HCO}_3^-$ -conversion, the rates increase with increasing  $\delta$ . There is a limiting thickness  $\delta$  (10 cm in Fig. 4) above which the rates become independent of  $\delta$ . At that thickness the  $V/A$  ratio is sufficiently large and  $\text{HCO}_3^-$ -conversion is not controlling the rates anymore. This limiting thickness increases with decreasing  $\text{PCO}_2$  in the solution. Its value is about 1 cm at  $5 \cdot 10^{-3}$  atm, 10 cm at  $1 \cdot 10^{-3}$  atm, and 100 cm at  $3 \cdot 10^{-4}$  atm. For  $\epsilon = 0$  and



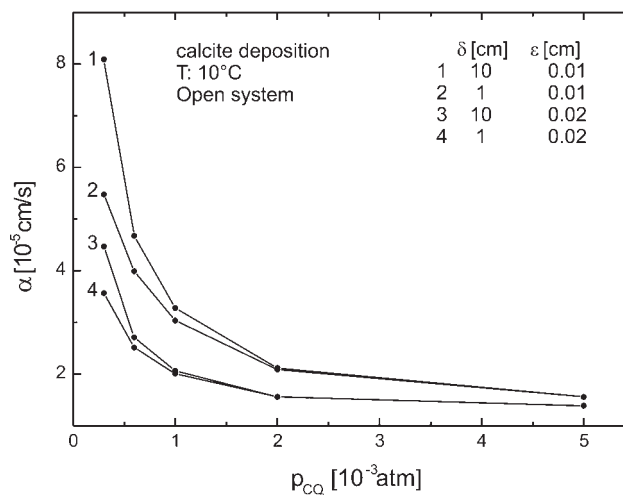
**FIGURE 4** Dependence of precipitation rates on calcium concentration for water layers in turbulent flow with  $\delta = 0.1, 1, \text{ and } 10 \text{ and } 100 \text{ cm}$ , respectively. The numbers on the lines give the values of the thickness  $\epsilon$  of the DBL.

$\delta > 10 \text{ cm}$ , neither mass transport nor  $\text{HCO}_3^-$  conversion are rate limiting and the rates can be obtained from the PWP equation, Eq. (1). These are the maximal possible rates for a given chemical composition of the solution.

The values of  $\alpha$  depend on the  $\text{PCO}_2$  in the solution in particular for  $\text{PCO}_2 < 1 \cdot 10^{-3} \text{ atm}$ . Figure 5 depicts as an example values of  $\alpha$  in their dependence on  $\text{PCO}_2$  for  $\delta = 1 \text{ and } 10 \text{ cm}$ , and  $\epsilon = 0.01 \text{ and } 0.02 \text{ cm}$ . The temperature dependence of  $\alpha$  is roughly linear, with  $\alpha$  increasing by about a factor of 3, from  $5^\circ\text{C}$  to  $20^\circ\text{C}$ . Details can be found in Liu and Dreybrodt (1997).

In summary, rates from turbulently flowing water can be significantly higher than those from thin laminar films. This is the case when flow is highly turbulent and DBL thickness is less than  $0.005 \text{ cm}$ . When a DBL with  $\epsilon \approx 0.01 \text{ cm}$  is present rates drop, and for water films less than  $1 \text{ mm}$  deep they are close to rates from laminar or stagnant films of about  $0.01 \text{ cm}$ . The reason is that in both cases diffusion proceeds through a layer (DBL) or a laminar film of comparable thickness, and also  $\text{HCO}_3^-$ – $\text{CO}_2$  conversion occurs mainly in the DBL. For water deeper than  $1 \text{ cm}$  conversion of  $\text{HCO}_3^-$  in the bulk ceases to be rate limiting and rates increase further.

**Field Observations of Growth Rates in Turbulent Flow** Up to the present time, no quantitative observations relating growth rates of flowstone to water chemistry and flow parameters in caves have been reported. Reports on growth rates solely, without further information, exist, but in this context they are not very valuable. Little quantitative work, however, has been performed on calcite-depositing surface streams. Liu *et al.* (1995) have measured *in situ* deposition rates to marble tablets fixed to the stream of Huanglong Ravine, a large tufa-depositing stream system on the northwestern Plateau of Sichuan Province, China. This stream originates from springs, which contain about  $6 \text{ mmol/L}$  of calcium at a high  $\text{PCO}_2$  of about  $0.2 \text{ atm}$  and



**FIGURE 5** Values of  $\alpha$  in a turbulent flowing solution as function of  $\text{PCO}_2$ , for  $\text{PCO}_2 < 2 \cdot 10^{-3} \text{ atm}$ .

exhibit an almost pure carbonate chemistry with some magnesium present. Due to outgassing of  $\text{CO}_2$ ,  $\text{PCO}_2$  in the stream water drops to  $10^{-3} \text{ atm}$  after  $1000 \text{ m}$  downstream and maintains this pressure. Rates between  $5 \text{ and } 1 \text{ mm/year}$  were observed. They showed a satisfying correlation to the theoretically predicted rates for high flow velocities between  $0.5 \text{ to } 2 \text{ m/s}$ , where a boundary layer thickness  $\epsilon$  of about  $10^{-2} \text{ cm}$  is estimated. Rates calculated from the bulk water chemistry by use of the PWP equation turned out to be higher by a factor of 10 than the observed data. The influence of  $\epsilon$  was convincingly demonstrated by locating marble tablets on top of rimstone dams with fast flow of water and comparing them to those of marble tablets located a distance of less than  $1 \text{ m}$  in the pool behind, where the water was calm but its chemistry identical to that flowing across the dam. In all cases the rates measured in the pool were significantly lower than those on the dams. Such observations are expected to be valid also for streams in caves.

## MORPHOLOGY OF STALAGMITES

The variety of shapes formed as speleothems by dripping or flowing water is overwhelming. Regular stalagmites, however, show a simple shape when they grow from a punctiform source of water supply. In this case the morphology of stalagmites can be derived from simple principles analytically (Dreybrodt, 1988) and by computer simulations (Dreybrodt, 1999). These principles are illustrated by Fig. 6, which shows an arbitrary surface of a stalagmite in a given direction. This surface is approximated by a polygon. Water drips to the center at point  $P_1$  from where it spreads radially outside. Now two principles govern the growth:

1. Water spreading outside loses Ca concentration by precipitation of calcite. Therefore the deposition rates of calcite decrease accordingly.

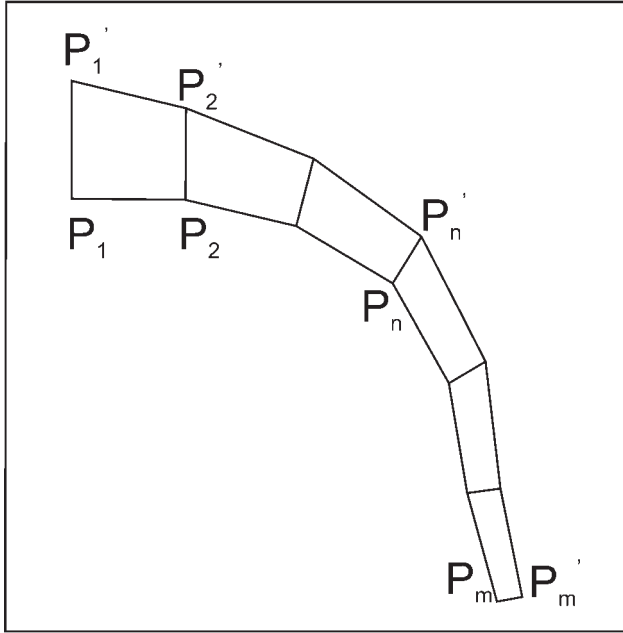


FIGURE 6 Geometrical construction of the growth of a stalagmite.

2. Growth of the calcite layer is always perpendicular to the surface to which it is deposited locally.

Therefore, to obtain the new surface of the growing stalagmite after a time step  $\Delta t$ , lines are drawn perpendicular to the secant at points  $P_1$  to  $P_m$ . The new surface is obtained by taking the lengths  $P_n P_n'$  (i.e., the growth at point  $P_n$ ) such that they decrease continuously with increasing distance from point  $P_1$ . In this way, the new surface after time  $\Delta t$  can be constructed. By repeating this procedure, the growth of a stalagmite on any arbitrary surface can be found layer by layer. The shape of the stalagmite can then be obtained by rotation of the constructed lines around the axis  $P_1 - P_1'$ . Such constructions have been performed by computer, using the expression

$$R_m = R \exp\left(-\frac{\overline{P_1 P_m}}{\rho}\right) \quad (7)$$

to simulate the rates decreasing with flow distance  $\overline{P_1 P_m}$ . Note that  $R$  is the rate given by Eq. (5) and  $\rho$  is the distance water must flow until the rates have dropped to about one-third of the value at  $P_1$ . Figure 7 shows the result for a stalagmite growing on a plane surface (A) and on a declined plane (B), with  $\rho = 10$  cm and  $R_1 = 0.01$  cm/year. The time between two layers is 500 years. From Fig. 7 three principles of stalagmite growth can envisaged:

1. All stalagmites develop to a final equilibrium shape, which depends only on the rates given by Eq. (7). If another rate law is assumed this is also valid, although the final shape will be somewhat different.
2. Once the final shape is reached, the stalagmite grows by shifting its surface parallel upward. In other words,

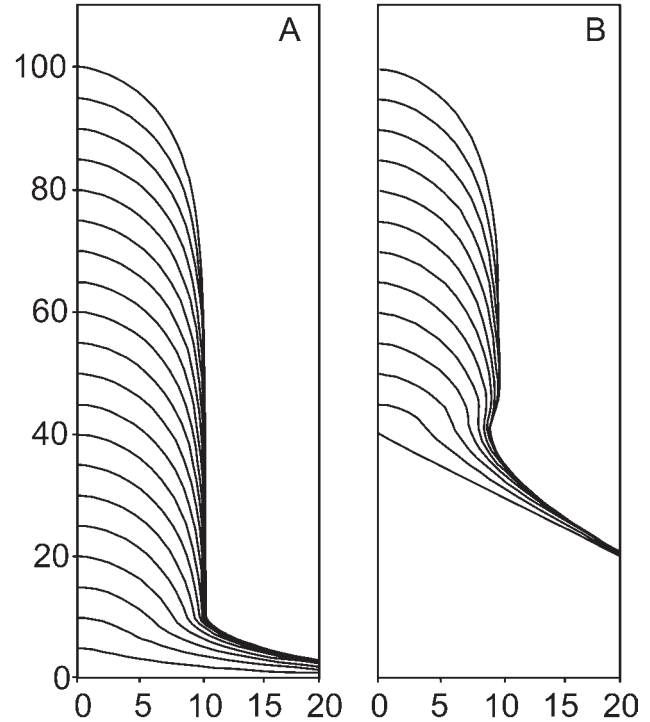


FIGURE 7 Growth of a stalagmite (A) on a horizontal plane surface and (B) on a plane inclined by 45°. The numbers are in centimeters and  $R = 0.01$  cm/year. Time between neighboring layers is 500 years.

the vertical growth rate is the same everywhere on the surface.

3. The final shape is independent of the initial surface, onto which the stalagmite started to grow.

These principles shown here by inspection of computer runs can be also derived by strict mathematics (Dreybrodt, 1988).

The radius  $\rho$  of the stalagmite used in Eq. (7) must be estimated from conservation of mass, i.e., the amount of calcite deposited on the final surface during the time  $\Delta t$  between two drips must be equal to the amount of calcite lost from the water supplied during this time. From this one obtains (Dreybrodt, 1988)

$$\rho = \sqrt{\frac{V}{\pi\delta(1 - \exp(-\alpha\Delta t/\delta))}} \quad (8)$$

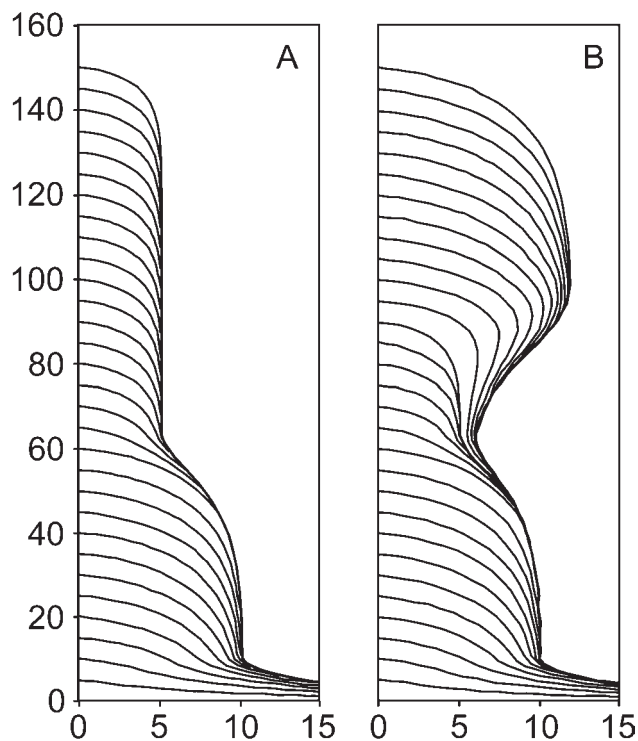
where  $V$  is the volume of the drop,  $\Delta t$  the time between two drips,  $\delta$  the depth of the water film covering the stalagmite, and  $\alpha$  the rate constant of deposition [cf. Eq. (3)].

If the time between two drips is large compared to  $\delta/\alpha$ , one finds a minimum radius (Curl, 1973) given by

$$\rho_{\min} = \sqrt{V/(\pi\delta)} \quad (9)$$

which under natural conditions is about  $\rho_{\min} = 1.5$  cm. For high water supply, i.e.,  $\Delta t \ll \delta/\alpha$ , one obtains

$$\rho = \sqrt{\frac{V}{\pi\alpha\Delta t}} \quad (10)$$



**FIGURE 8** Growth of a stalagmite (A) with  $\rho = 10$  cm during the first 6,000 years; then  $\rho$  is changed to 5 cm; (B) with  $\rho = 10$  cm and a sudden change to  $\rho = 12$  cm after 6,000 years.  $R = 0.01$  cm/year. Time between adjacent lines is 500 years.

Equations (8) and (10) relate the diameter of the stalagmite to climatic conditions. The important variables are  $\alpha$ , dependent on temperature, and the supply of water  $V/\Delta t$ .

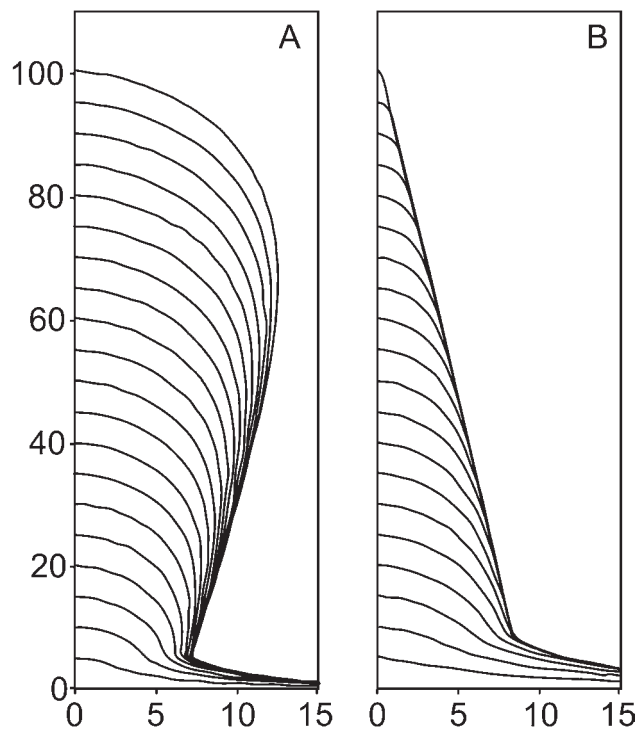
Figure 8A shows an example of a stalagmite that first grew under a value of  $\rho = 10$  cm and attained its equilibrium shape. Then by a sudden climatic change of precipitation the radius dropped to a value of 5 cm. Growth continues into a new equilibrium shape of smaller diameter. Figure 8B shows the shape when the radius increases from 10 to 12 cm by increasing water supply.

When  $\rho$  increases linearly in time, we find a clublike shape as illustrated by Fig. 9A. In contrast, if  $\rho$  decreases linearly in time, conelike shapes form (Fig. 9B). The examples in Figs. 7 through 9 have been simulated with constant growth rates. If this is no longer the case, the layers will no longer be equidistant for equal time steps.

Taken together we state that the morphology and the stratigraphy of ideal stalagmites can be understood from simple principles. Only four parameters,  $\alpha$ , the deposition constant,  $c_{\text{eq}}$ , the equilibrium concentration of the supersaturated solution, and the water supply rate,  $V/\Delta t$ , all dependent on climatic variables are needed.

## CONCLUSION

Precipitation rates of calcite from supersaturated solutions depend not only on the calcium concentration of the solu-



**FIGURE 9** Growth of stalagmites under continuous linear change of  $\rho$ : (A)  $\rho = 5 + 0.001t$ , (B)  $\rho = 10 - 0.001t$ , where  $t$  is time in years,  $R = 0.01$  cm/year, and the time between adjacent lines is 500 years.

tion and its temperature, but also on many other conditions. If calcite is deposited from thin films of several tenths of a millimeter in thickness, the precipitation rates are on the order of tenths of millimeters per year. With increasing film thickness, flow becomes turbulent and deposition rates are enhanced. Depending on the degree of turbulence and the depth of the flowing water, up to 1 cm/year of calcite can be deposited. These variations are the reason why calcite deposition can model so many fascinating shapes, as speleothems, but also tufa dams and sinter terraces. For regular stalagmites the morphology and the stratigraphy can be understood from the chemistry of the precipitation kinetics and from simple principles of crystal growth.

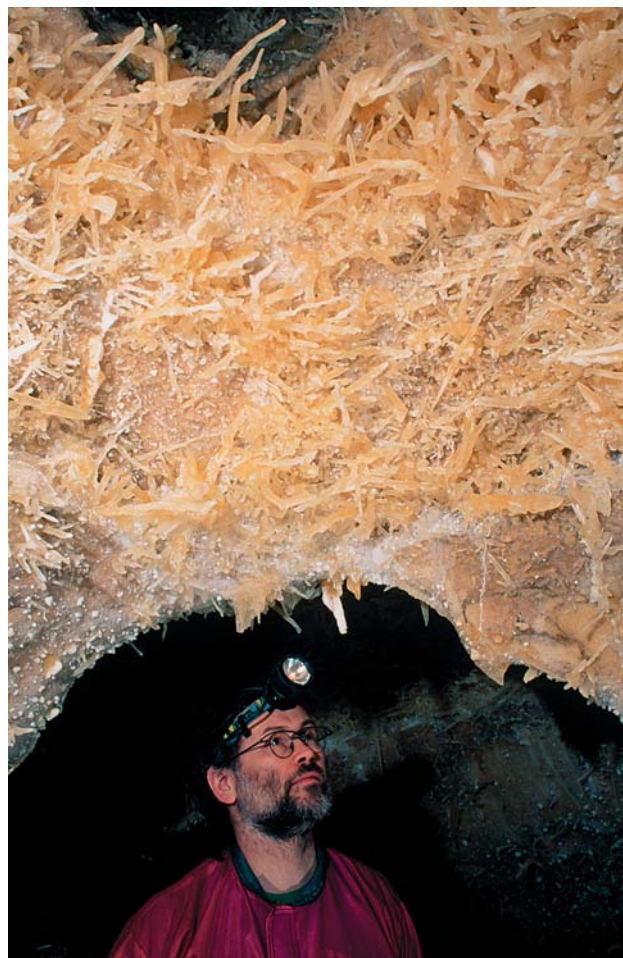
## See Also the Following Articles

*Speleothems: Helictites and Related Forms*

## Bibliography

- Baker, A., D. Genty, W. Dreybrodt, W. L. Barnes, N. J. Mockler, and J. Grapes (1998). Testing theoretically predicted stalagmite growth rate with recent annually laminated samples: Implications for past stalagmite deposition. *Geochim. Cosmochim. Acta* **62**, 393–404.
- Baumann, J., D. Buhmann, W. Dreybrodt, and H. D. Schulz (1985). Calcite dissolution kinetics in porous media. *Chem. Geol.* **53**, 219–228.
- Buhmann, D., and W. Dreybrodt (1985). The kinetics of calcite dissolution and precipitation in geologically relevant situations of karst areas. 1. Open systems. *Chem. Geol.* **48**, 189–211.
- Curl, R. L. (1973). Minimum diameter stalagmites. *Natl. Speleological Soc. Bull.* **35**, 1–9.

- Dreybrodt, W. (1988). Processes in karst systems. In *Physics, Chemistry and Geology: Environments*, Springer Series in Physical Environments, Vol. 4. Springer, Berlin.
- Dreybrodt, W. (1999). Chemical kinetics, speleothem growth and climate. *Boreas* **28**, 347–356.
- Dreybrodt, W., and D. Buhmann (1991). A mass transfer model for dissolution and precipitation of calcite from solutions in turbulent motion. *Chem. Geol.* **90**, 107–122.
- Dreybrodt, W., L. Eisenlohr, B. Madry, and S. Ringer (1997). Precipitation kinetics of calcite in the system  $\text{CaCO}_3\text{-H}_2\text{O-CO}_2$ : The conversion to  $\text{CO}_2$  by the slow process  $\text{H}^+ + \text{HCO}_3^- \rightarrow \text{CO}_2 + \text{H}_2\text{O}$  as a rate limiting step. *Geochim. Cosmochim. Acta* **61**(18), 3897–3904.
- Franke, H. W. (1965). The theory behind stalagmite shapes. *Studies Speleology* **1**, 89–95.
- Genty, D., A. Baker, and B. Vokal (2001). Intra- and inter-annual growth rate of modern stalagmites. *Chem. Geol.* **176**, 191–212.
- Huang, Y., and I. J. Fairchild (2001). Partitioning of  $\text{Sr}^{2+}$  and  $\text{Mg}^{++}$  into calcite under karst-analogue experimental conditions. *Geochim. Cosmochim. Acta* **65**(1), 47–62.
- Liu, Z., and W. Dreybrodt (1997). Dissolution kinetics of calcium carbonate minerals in  $\text{H}_2\text{O-CO}_2$  solutions in turbulent flow: The role of the diffusion boundary layer and the slow reaction  $\text{H}_2\text{O} + \text{CO}_2 \rightleftharpoons \text{H}^+ + \text{HCO}_3^-$ . *Geochim. Cosmochim. Acta* **61**, 2879–2889.
- Liu, Z., U. Svensson, W. Dreybrodt, Y. Daoxian, and D. Buhmann (1995). Hydrodynamic control of inorganic calcite precipitation in Huanglong Ravine, China: Field measurements and theoretical prediction of deposition rates. *Geochim. Cosmochim. Acta* **59**(15), 3087–3097.
- Plummer, L. N., T. L. M. Wigley, and D. L. Parkhurst (1978). The kinetics of calcite dissolution in  $\text{CO}_2$ -water systems at  $5^\circ\text{C}$  to  $60^\circ\text{C}$  and 0.0 to 1.0 atm  $\text{CO}_2$ . *Am. J. Sci.* **278**, 537–573.
- Uzdowski, E. (1982). Reactions and equilibria in the systems  $\text{CO}_2\text{-H}_2\text{O}$  and  $\text{CaCO}_3\text{-CO}_2\text{-H}_2\text{O}$ . A review. *Neues Jahrbuch für Mineralogie, Abhandlungen* **144**, 148–171.
- White, W. B. (1976). Cave minerals and speleothems. In *The Science of Speleology* (T. D. Ford and C. H. D. Cullingford, eds.), pp. 27–327. Academic Press, London.



**FIGURE 1** Dense growth of helictites on cave ceiling (Photograph courtesy of Kevin Downey.)

## Speleothems: Helictites and Related Forms

Donald G. Davis  
National Speleological Society

### SUBAERIAL HELICTITES

*Helictites* are elongated speleothems that, unlike stalactites, may grow in any direction (Fig. 1). Upward-growing helictites have sometimes been called *heligmities*, but there is little logical basis for this distinction, because helictites do not occur as separate “up” and “down” forms. Helictites may be straight, smoothly curving, or even spiral (helical, the root meaning of *helictite*), but in most cases they twist and turn erratically. Accordingly, the alternative names *erratics*, *eccentric*, or *eccentric stalactites* have been used by some authors. Helictites are usually composed of calcite or aragonite, more rarely other materials. They occur in a great

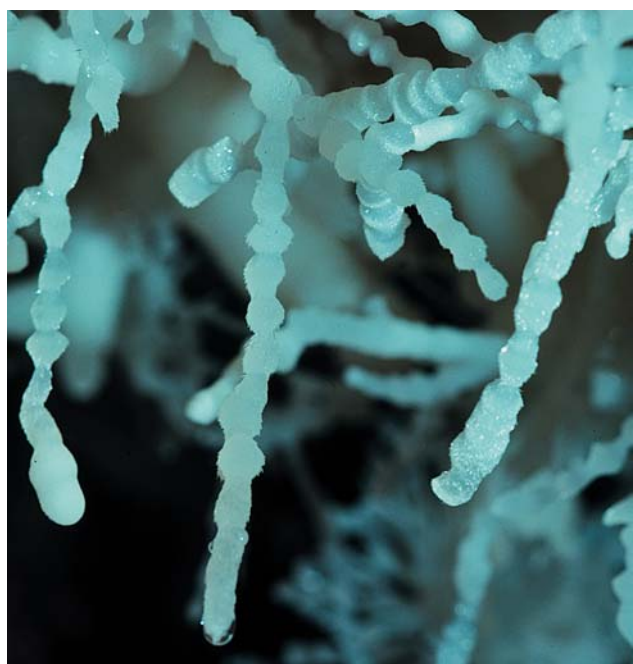
range of sizes, from hair-thin and a fraction of a centimeter long to several centimeters wide and more than a meter in length. All share the common characteristic of a narrow central canal of capillary size.

Because helictites are so conspicuous and unusual in appearance, many (often fanciful) theories have been proposed for their origin. By growing artificial helictites of sodium thiosulfate, Huff (1940) demonstrated that hydrostatic pressure feeding capillary flow was the true mechanism. In natural carbonate helictites, the tip is extended by deposition of calcium carbonate around the central pore as the outflowing moisture evaporates or loses carbon dioxide. Moore (1954) subsequently explained helictite curvature by a combination of effects of impurities, crystallographic-axis rotation, and stacking of wedge-shaped crystals. These factors take precedence over gravity because the rate of flow is too slow to form a hanging drop at the tip. Increased flow can cause helictites to convert to soda-straw stalactites, and decreased flow, vice versa.

Varieties including *filiiform* (hairlike), *vermiform* (wormlike), and *antler* (forking) helictites have been defined on the basis



A



B

**FIGURE 2** (A) Spectacular display of beaded helictites. (B) Detail of beaded helictites. (Photographs courtesy of Kevin Downey.)

of shape and size. Aragonite helictites may be beaded (Fig. 2), consisting of a string of conical beads of radiating fibrous crystals. The larger ends of the cones may face either the attached end of the helictite or the free end, but the orientation is usually consistent within each chain. This bizarre-



**FIGURE 3** Anthodites in Skyline Caverns, Warren County, Virginia. (Photograph courtesy of William B. White.)

looking beaded structure is relatively rare and has never been explained.

### ANTHODITES

*Anthodites* (Fig. 3) were defined by Henderson (1949) from Skyline Caverns, Virginia, as “clusters of slender, branching, tubular formations originating near a common point and radiating outward and downward.” The term *anthodite*, which simply means “flower rock,” has come to be used in conflicting ways, with many writers applying it to branching aragonite sprays that lack central canals. For the latter speleothem, the term *frostwork*, which was used in the Black Hills (South Dakota, USA) before 1900, has much earlier priority. The first edition of *Cave Minerals of the World* called frostwork “acicular anthodites” and speleothems of the Skyline Caverns type “quill anthodites.” The second edition (Hill and Fortik, 1997) treated anthodites and frostwork as separate speleothem types (following a discussion exchange in the *National Speleological Society Bulletin*).

Anthodites, in Henderson’s original sense, are not very clearly distinct from helictites. Occurrence in clusters in which they radiate or curve away from a common base seems to be the only distinct morphological trait characterizing “anthodites.” Typical helictites are usually more independent and less smoothly curvilinear. These macroscopic differences reflect the growth habit of the original primary mineral. Anthoditic morphology is generally seen in examples that originated as aragonite; helictitic morphology in those originating as calcite. Alternation between mineralogies, causing overgrowth of one mineral by the other, as well as conversion of aragonite to calcite, result in intermediate or transitional forms that are difficult to classify and interpret.

### FROSTWORK

*Frostwork* (Fig. 4) consists of sprays of acicular aragonite needles, often intricately branching. Like helictites, these





**FIGURE 4** Aragonite frostwork tree in Lechuguilla Cave, New Mexico. (Photograph courtesy of Ballman/Downey/Widmer.)

needles are not gravitationally oriented and may grow in any direction. However, because it lacks internal feeder channels, frostwork is genetically distinct from helictites and from Henderson's anthodites, although all of these may be found in proximity to each other.

Frostwork apparently grows from seepage of a thin film of carbonate-bearing moisture over the crystal surfaces, although growth from aerosols has also been suggested. It is usually found in sections of caves below dolomitic bedrock and where evaporation prevails. These conditions encourage enrichment of magnesium in wall moisture, facilitating aragonite growth. Relatively high cave temperature is also favorable but not essential. When evaporation has concentrated the solution sufficiently that magnesium minerals can also precipitate, the aragonite needles may be tipped with blobs of hydromagnesite moonmilk. Individual frostwork "trees" may grow up to half a meter long. Composite masses can form even larger conical stalagmitic growths of intertwined aragonite, which are often hollow where drips have passed through the center. Such hollow aragonite stalagmites have been called *logomites* in the Black Hills caves. Where not soiled, frostwork is almost always snowy white, rarely incorporating colored contaminants. It is among the most aesthetically impressive cave decorations.



**FIGURE 5** Large composite shield, showing drapery growth from margin of medial crack. (Photograph courtesy of Kevin Downey.)

### CAVE SHIELDS

*Shields* (Fig. 5), also called *palettes*, are disk-shaped speleothems consisting of paired circular or oval plates separated by a medial crack, which is an extension of a fracture in the rock substrate. Like helictites, they may be oriented in any direction. The largest are more than 3 m wide. Shields and helictites, though different in appearance, are closely related genetically. From a geometric viewpoint, shields can be regarded as flattened, biaxial "helictites" in which growth occurs along the margin of a plane rather than the end of a line. Shields and helictites are similar in being fed by seepage under hydrostatic pressure; an active shield in France was observed jetting five arcs of water from its edge. To sustain flow from a shield's extended margin requires a higher rate of discharge than in a helictite. Shields often grow helictites from their upper plates, and draperies from overflow from the lips of the lower plates.

The medial crack in a shield is usually of capillary size along the edge, but may be wider, up to several millimeters, internally. This may be caused by crystal-growth wedging along the active edge pushing the plates slightly apart. Some have suggested that flexing by earth tides prevents the cracks from closing up; however, self-generated wedging may be all that is really required. Shields that have split open, showing the internal surfaces, display concentric growth rings, and in some cases, also closely spaced horizontal ribs, 2 mm or so wide, that presumably reflect former fluctuating water levels inside the shield.

Shields are sometimes confused with flowstone canopies undermined by sediment removal; canopies usually curve and have no medial crack. Shields are found in fewer caves than helictites, but are often abundant where they do exist. They are probably favored by low primary permeability in the substrate rock, forcing seepage to be localized along



**FIGURE 6** Active subaqueous helictites in pool in Lechuguilla Cave, New Mexico. (Photograph courtesy of Kevin Downey.)

fractures; highly permeable walls are more likely to grow helictites. *Welts* are incipient shields—linear excrescences along cracks where flow has not become confined to particular sections.

### SUBAQUEOUS HELICTITES

Until 1987, all helictites were assumed to grow surrounded by air. In that year, spectacular displays of spaghetti-like helictites were discovered in Lechuguilla Cave, New Mexico, USA, growing from the undersides of shelfstone and from subaqueous calcite crust in pools (Fig. 6). They are usually 2–5 mm wide, but sometimes more than 1 cm, and up to 30 or more centimeters long. By the year 2000, more than 30 sites with active or “dead” *subaqueous helictites* had been recorded in Lechuguilla Cave, which remains almost the only cave in which they are known (a few small ones have been found in Virgin Cave in the same area).

Like subaerial helictites, subaqueous helictites have tiny central canals, but the mechanism of capillary seepage under hydrostatic pressure, with CO<sub>2</sub> degassing or evaporation at the tip, does not apply in the pool environment. Instead, subaqueous helictites have invariably been found where blocks or crusts of gypsum are in contact with flowstone upflow from the pool basins. It is now generally accepted that the subaqueous helictites were produced by the *common-ion effect*, in which stringers of gypsum-enriched water flowed into pools already saturated with calcium bicarbonate, triggering deposition of the less soluble calcium-mineral species (calcite) where the calcium-rich solutions mixed. Water analyses at the type locality were consistent with this mechanism (Davis *et al.*, 1990). The initial result is development of shelfstone and crust barriers between the incoming and ambient waters, with further inflow being restricted to small pores around which rings of calcite grow. Extension of these rings into the pool creates the helictites. Subaqueous



**FIGURE 7** Helictite bush of subaqueous origin in Wind Cave, South Dakota. Calcite rafts demonstrate former submergence. (Photograph courtesy of Kevin Downey.)

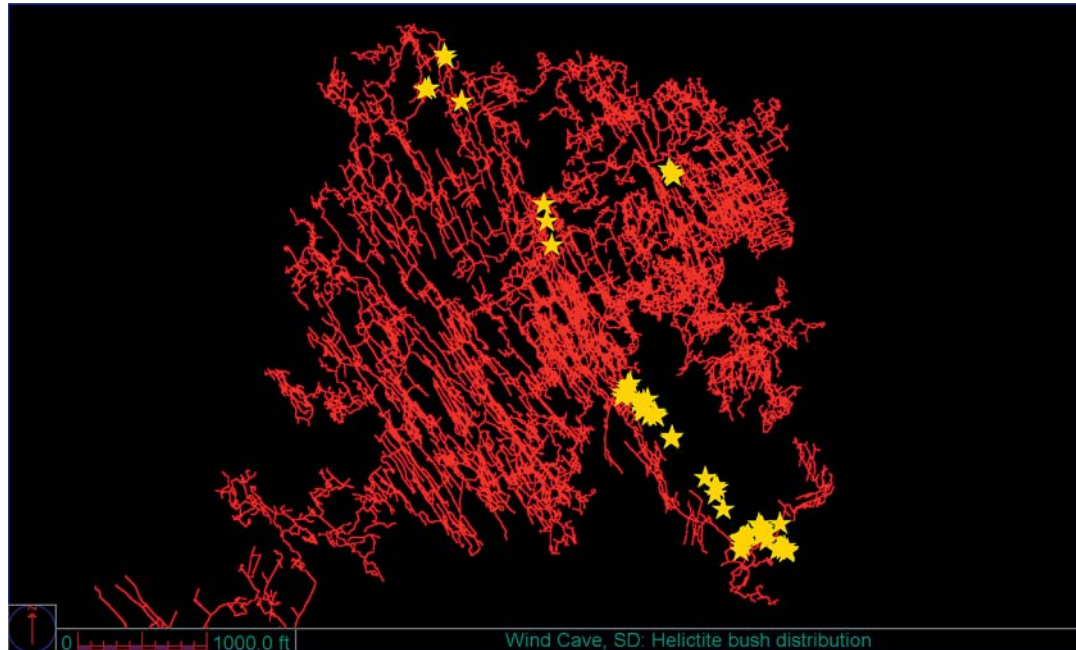
helictites grow generally downward, as is appropriate to the greater density of the entering gypsum-rich solution, though some turn upward toward the ends.

Lechuguilla Cave is almost the only known subaqueous-helictite site because it is exceptionally well supplied with gypsum left over from its sulfuric-acid speleogenesis, some of it in contact with flowstone-growing seepage. This is a rare and unstable situation.

### SUBAQUEOUS “HELICTITE BUSHES”

In certain passages of Wind Cave, South Dakota, USA, there are clusters of intertangled helictitic calcite speleothems (Fig. 7), typically about 0.5 m or less long, but a maximum of 2 m. They almost always extend upward from discontinuities in floor crust, though the largest clump grows downward from a passage-end pinch. All yet observed appear to be inactive. These were informally called *helictite bushes* by the cavers who observed them, and were assumed for many years to be subaerial helictites of unusual form.

After the discovery of Lechuguilla Cave’s subaqueous helictites, Davis (1989) examined the Wind Cave bushes and concluded, from several kinds of evidence, that they represent another type of subaqueous speleothem, developed below the water table at a time between the end of speleogenesis and the drainage of the passages. They are quite distinct from all other helictites, either subaerial or sub-



**FIGURE 8** Line plot of Wind Cave showing preferential distribution of helictite bushes in passages along fracture zone bisecting the cave. (Data courtesy of Wind Cave National Park; plot from Compass Cave Survey Program by Larry Fish.)

aqueous. They are frequently strap-shaped and irregularly flattened in cross section (in contrast to the cylindrical outline typical of helictites), and often branch dendritically. Their internal canals are not capillary tubes, but relatively large, irregular conduits that may be more than 1 cm wide and that more or less mirror the convolutions of the speleothem's cross section. It is unlikely that such structures grew upward in a subaerial environment.

The distribution of helictite bushes shows no correlation with sources of downward-seeping water. They are largely confined to a prominent dip-oriented passage trend that bisects the main part of the maze cave (map, Fig. 8) and are always near the lowest level in any particular section. The typical upward growth suggests that the incoming fluid was less dense than the surrounding ambient water (in contrast to the Lechuguillan case). Davis (1989, 1991) proposed that helictite bushes grew by interaction of near-surface groundwater, possibly via the common-ion effect, with thermal fluid rising from depth along a fracture set. In this scenario, helictite bushes would be more closely related to geysermite and submarine "white smokers" than to other helictite types.

Chemical and isotopic analyses of helictite-bush fragments by LaRock and Cunningham (1995) failed to confirm a deep-seated origin of the helictite-growing fluid, but did indicate growth in a cooling thermal environment at 33–42°C, approximately 200,000 years ago. Their specimens showed a multiple-layered structure: an inner tube of crystals with C-axes parallel to the speleothem's axis, an outer coating of "palisade" crystals at right angles, and a transitional layer

between. The transition and palisade layers were repeated a number of times in some examples, perhaps recording cycles of emergence/submergence. Fossil microbial filaments, most abundant in the inner layer, suggest a microbiological role in bush growth.

LaRock and Cunningham (1995) found no analytic evidence for common-ion-effect involvement, and suggested that the calcite was deposited via CO<sub>2</sub> degassing at the overlying water surface. They proposed that the flow inside the bush branches was driven not by fluid rising from depth, but by water table fluctuations, causing a pressure gradient toward the passage to develop in water trapped behind the passage-lining crust when the water level in the open passage dropped faster than that behind the crust. Their interpretation does not explain why the bushes are largely confined to a narrow passage trend, whereas the crust lining is much more extensive in the cave, or why the phenomenon has not been seen in other caves with subaqueous crust linings. These unique speleothems need further study.

#### *See Also the Following Articles*

*Gypsum Flowers and Related Speleothems* • *Minerals* • *Speleothem Deposition* • *Stalactites and Stalagmites*

#### *Bibliography*

- Davis, D. G. (1989). Helictite bushes: A subaqueous speleothem? *Natl. Speleological Soc. Bull.* **51**(2), 120–124.
- Davis, D. G. (1991). Wind Cave helictite bushes as a subaqueous speleothem: Further observations. *Geo<sup>2</sup>* (Geology & Geography Section, National Speleological Society), **19**(1), 13–15.

- Davis, D. G., A. N. Palmer, and M. W. Palmer (1990). Extraordinary subaqueous speleothems in Lechuguilla Cave. *Natl. Speleological Soc. Bull.* **52**(2), 70–86.
- Henderson, E. P. (1949). Some unusual formations in Skyline Caverns, Virginia. *Natl. Speleological Soc. Bull.* **11**, 31–34.
- Hill, C. A., and P. Forti (1997). *Cave Minerals of the World*, 2nd ed. National Speleological Society, Huntsville, AL.
- Huff, L. C. (1940). Artificial helictites and gypsum flowers. *J. Geol.* **48**(6), 648–659.
- LaRock, E. J., and K. I. Cunningham (1995). Helictite bush formation and aquifer cooling in Wind Cave, Wind Cave National Park, South Dakota. *Natl. Speleological Soc. Bull.* **57**(1), 43–51.
- Moore, G. W. (1954). *The Origin of Helictites*, Occasional Paper No. 1. National Speleological Society, Huntsville, AL.

## Spiders and Related Groups

James R. Reddell

*The University of Texas at Austin*

### INTRODUCTION

The class Arachnida is second only to the Insecta in number of species and diversity. It is also among the more important groups of invertebrates occurring in caves with 9 of the 11 extant orders containing troglobites. The windscorpions (order Solifugae) do not occur in caves except as accidentals. The whipscorpions (order Uropygi) rarely occur as troglonexes in tropical caves.

### DISTRIBUTION

The class Arachnida is distributed worldwide and, with the exception of many Acarina, is entirely terrestrial. Of the orders containing troglobites, three (Schizomida, Amblypygi, and Ricinulei) are predominantly tropical and subtropical in distribution. Troglobitic Ricinulei occur only in the New World tropics and subtropics and troglobitic Schizomida are known only from North America, South America, and Australia. With the exception of one species from Sarawak, unquestionably troglobitic Scorpiones occur only in Mexico and Ecuador. The remaining orders include troglobites in both Old and New Worlds and in tropical and temperate regions.

With some exceptions, genera containing troglobites belong to families also known from the surface. The spider family Holarchaeidae is known only from two troglobitic species in New Zealand. Several families of aquatic mites are apparently restricted to subterranean waters. Although some genera contain only troglobites, they typically are closely related to other genera occurring on the surface in the same area. Relict species are known in several groups. The troglobitic telemid spider *Telema tenella* from Europe is the

only species in the family occurring in temperate regions. Other isolated species now inhabit caves in areas outside the general range of the genus or family. These include species that have survived in the moist habitat of caves in desert regions. Examples of this type of distribution include several species of Schizomida, Ricinulei, and Opiliones in northern Mexico and the southern United States.

Early studies of the distribution of troglobites in general indicated that troglobites were extremely rare in tropical lowlands. In recent years extensive studies in the tropics have demonstrated a rich troglobitic fauna. Troglobitic arachnids are especially abundant in areas previously thought to contain a depauperate fauna. It is typical of most tropical areas for the insect fauna to include few troglobites. For example, in the Yucatan Peninsula of Mexico, only one true insect (a phalangopsid orthopteran) is considered to be troglobitic, whereas about 18 species of arachnids are troglobites. Arachnids to a large extent appear to occupy the predatory positions held by beetles and other insects in temperate caves.

Most species of troglobitic Arachnida have very limited distributions, with many occurring in a single cave. A few widely distributed species may represent newly evolved troglobites that have not been isolated long enough for morphological differentiation to have occurred. In some cases, more detailed analyses of populations have revealed the existence of cryptic species.

### BIOLOGY

The biology of few species of troglobitic arachnids has been studied. In numerous cases only a single sex or even specimen is known and the rarity of most troglobites precludes anything more than cursory observations. Except for many mites that may feed on living or decaying organic matter or are parasites, most arachnids are predators. Some Opiliones are known to feed on organic material and a few minute spiders may feed on fungi.

Most troglobitic arachnids are preadapted for life in caves. All species of Ricinulei and Palpigradi are eyeless and in the Schizomida the ocular structures consist of one small eyespot on each side of the head. Arachnid families containing troglobites typically live in leaf litter, soil, or other sheltered habitats. Scorpions of the genus *Typhlochactas* are all blind, but the troglobitic species have longer appendages than the litter-dwelling surface species.

Adaptations for the cave environment include loss or reduction of eyes and pigment, elongation of appendages, and an increase in sensory structures. For the few species where data are available, fewer and larger eggs are produced and metabolic rates are lower. They may also have longer life spans. Troglobitic species of the dictynid spider genus *Cicurina* have been maintained in the laboratory for as much as 2 years before reaching sexual maturity.

Epigeal Amblypygi are nocturnal, spending the day under rocks, ground debris, and crevices. Many cavernicolous

species have extremely elongate pedipalps and exhibit various degrees of eye reduction. A few species are totally eyeless.

A study of the Hawaiian troglobitic spider *Lycosa howarthi* revealed greater water loss and a lower metabolic rate than a related epigeal species. Oxygen consumption in the troglobitic species remained constant over a 12-hour period, whereas it increased in the epigeal species during darkness.

The biology and environment of the Australian troglobite *Draculoidea vinei* (Harvey) have been studied in detail. The troglomorphic species *Stenochrus portoricensis* Chamberlin of southern Mexico and the West Indies is of special interest in that it is facultatively parthenogenetic. With only a few exceptions, all insular populations are parthenogenetic. In the Yucatan Peninsula of Mexico there is an equal ratio of males and females from the surface, but essentially all specimens from deep within caves are females. This presumably explains the extreme abundance of this species in the caves of the peninsula.

Epigeal Ricinulei inhabit leaf litter and the underside of rocks. They are primarily predators, but cavernicole species have been found feeding on dead arthropods and the feces of bats and millipedes.

Endogean Palpigradi are found under rocks and in leaf litter. All are eyeless, depigmented, and with slender appendages. Troglobitic species are distinguished by longer appendages and larger numbers of trichobothria and other sensory structures.

## CONSERVATION

Troglobitic Arachnida, as in all groups of cave organisms, are particularly susceptible to loss of populations and even extinction. Small population sizes, long life span, slow reproductive rates, and a high degree of endemism all place troglobitic arachnids at risk. Deforestation in many parts of the world has resulted in the loss of habitat for many species of invertebrates and bats that provide essential nutrients into the cave ecosystem. The loss of vegetation may result in environmental degradation, especially of small, shallow caves. Modifications of natural vegetation in the vicinity of the cave may result in invasion of introduced species. Urbanization in many areas has resulted in the destruction of many caves and impacted many others.

The actual number of species threatened by extinction is unknown but it must be a very high number. The U.S. Fish and Wildlife Service has placed 11 species of troglobitic arachnid on the official list of endangered species. Ten of these are from two limited areas of Central Texas where active urbanization threatens essentially every cave with destruction. Furthermore, the red imported fire ant *Solenopsis (Solenopsis) invicta* Buren has invaded hundreds of caves with devastating effect on the cavernicole fauna. The listed species are the neobisiid pseudoscorpion *Tartarocreagra texana* (Muchmore); the phalangid harvestmen *Texella cokendolphi* Ubick and Briggs, *T. reddelli* Goodnight and Goodnight, and *T. reyesi*

Ubick and Briggs; and the dictynid spiders *Cicurina (Cicurella) baronia* Gertsch, *C. (C.) madla* Gertsch, *C. (C.) venii* Gertsch, and *C. (C.) vespera* Gertsch; and the leptonetid spiders *Neoleptoneta microps* (Gertsch) and *N. myopica* (Gertsch). In addition to these species, the Hawaiian lycosid spider *Adelocosa anops* Gertsch is also considered endangered.

The listing of these species has slowed destruction of caves in these very limited areas, but only an aggressive program of conservation throughout the world can preserve the remarkable diversity of troglobitic arachnids.

## SYSTEMATICS

The classification of the Arachnida is far from settled, especially with respect to the phylogenetic relationships of the orders. Many specialists now consider the Acari to constitute a separate subclass of arachnids, with some placing the order Ricinulei within that subclass. Others consider the Acari to be polyphyletic and provide a different arrangement for arachnid orders and suborders. For convenience the Acari is considered here as an order and the classic suborders maintained.

### Order Scorpiones (Scorpions)

This order of about 1300 species in nine families is worldwide in distribution (Fig. 1). Scorpions where they occur in caves are the top predator in the system. There are now 14 troglobites known worldwide, all but 2 of which are from Mexico. There have been no studies, however, on the biology or ecology of any of the species. All of the troglobitic species are extremely rare, most known only from a few specimens.

**Family Chaerilidae** The only Old World troglobite, *Chaerilus chapmani* Vachon and Lourenço, is from Sarawak.



FIGURE 1 *Alacran tartarus* from Sótano de San Agustín, Oaxaca, Mexico. (Photography courtesy of Robert and Linda Mitchell.)

Two other species of the genus have been found in caves in Sumatra.

**Family Diplocentridae** The genus *Diplocentrus* includes four species from caves in southern Mexico, of which three are troglobites (*D. anophthalmus* Francke, *D. cueva* Francke, and *D. mitchelli* Francke).

**Family Euscorpidae** Two species of the genus *Troglocormus* (*T. willis* Francke and *T. ciego* Francke) have been described from caves in Mexico.

**Family Superstitionidae** This family includes seven troglobites. *Troglotayosicus vachoni* Lourenço was described from Ecuador. The Mexican genus *Typhlochactas* includes four troglobites (*T. cavicola* Francke, *T. poncho* Sissom, *T. reddelli* Mitchell, and *T. rhodesi* Mitchell) from the Mexican states of Tamaulipas and Veracruz. This genus also contains two eyeless species from leaf litter in southern Mexico. *Sotanochactas elliotti* (Mitchell) is known only from San Luis Potosi and *Alacran tartarus* Francke is found only in Oaxaca. The European *Belisarius xambeui* Simon was once considered troglobitic because of its reduced eyes. It is now known to be a soil-dwelling form occasionally found in caves.

**Family Vaejovidae** The only unquestioned troglobite in the family Vaejovidae is *Vaejovis gracilis* Gertsch and Sologlad from Veracruz, Mexico. Many other species of *Vaejovis* have been found in caves but most are at best considered troglaphiles. *Uroctonus grahami* Gertsch and Sologlad with reduced eyes is known only from caves in California, USA, and may be a neotroglobite. One species, *Pseudouroctonus reddelli* (Gertsch and Sologlad), is an extremely abundant troglaphile in the caves of Texas, USA.

### Order Schizomida (Short-Tailed Whipscorpions)

This small order contains about 200 species in two families (Fig. 2). About 80 species, some awaiting description, have been recorded from caves. They range in size from 2 to 12.4 mm in total length. Epigeal species are found under



**FIGURE 2** *Agastochizomus lucifer* from Sótano de Yerbaniz, San Luis Potosí, Mexico. (Photography courtesy of Robert and Linda Mitchell.)

rocks, in leaf litter, and some species are associated with termites and ants.

**Family Hubbardiidae** This family occurs worldwide in the tropics and subtropics. A large number of species of Hubbardiidae have been recorded from caves, but unquestioned troglobites are known only from caves in Cuba, Jamaica, Belize, Mexico, California (USA), Ecuador, and Australia. Two monotypic genera, *Cokendolpherius* and *Reddellzomus*, have recently been described from caves in Cuba. Two species of *Draculooides* have been found in Western Australia. *Hubbardia* from California and Arizona is a genus most closely related to the Asian fauna. The only troglobite is *H. shoshonensis* (Briggs and Hom) from a single cave surrounded by desert. The genus *Rowlandius* includes numerous species, including several troglaphiles. Troglobites are known from caves in Cuba and Jamaica. The genus *Sotanochenochrus* contains only two troglaphitic species from Mexico. The large genus *Stenochrus* contains eight described and several undescribed troglaphites from caves in Mexico. The genus *Stewartpeckius* contains only the troglaphite *S. troglaphius* (Rowland and Reddell) from Jamaica. The genus *Tayos* contains only the troglaphite *T. ashmolei* (Reddell and Cokendolpher) from Ecuador.

**Family Protoschizomidae** Eleven species have been described from Mexico. *Protoschizomus* includes four species of troglaphite from the states of San Luis Potosí and Tamaulipas. *Agastochizomus* with four species from caves in Hidalgo, San Luis Potosí, and Tamaulipas includes *A. lucifer* Rowland, at 12.4 mm in length the largest species in the order.

### Order Amblypygi (Tailless Whipscorpions)

This order of about 100 species in three families is distributed worldwide in tropical and subtropical habitats. Many species are large (up to 4.5 cm in body length) with extremely elongate pedipalps and antenniform first legs (Fig. 3). Cavernicolous species occur in all families and



**FIGURE 3** *Paraphrynus chacmool* from Actun Ziz, Yucatán, Mexico. (Photography courtesy of Robert and Linda Mitchell.)

virtually every species found in karst regions also inhabits caves. About 40 species have been recorded from caves.

**Family Charontidae** This family is largely Asian in distribution but the genus *Charinides* includes three troglobitic species in Cuba. Five or six species of the genus *Stygophrynus* inhabit caves in Malaysia, Burma, Borneo, and Java. An undescribed eyeless *Charinus* is known from caves in Belize. Other genera containing cavernicolous species include *Phrynichosaurus* and *Sarax* from Malaysia, *Tricharinus* from Jamaica and Surinam, and *Charinus* from Africa, Venezuela, and Cuba.

**Family Phrynichidae** This tropical family contains cavernicolous species in the genera *Phrynichus* (Africa), *Damon* (Africa), and *Trichodamon* (Brazil). All are probably trogliphiles.

**Family Phrynidae** The family Phrynidae is the dominant family in the New World tropics and subtropics and is well represented in caves. All genera contain cavernicolous species, but the genus *Paraphrynus* is notable for containing six troglobites and several trogliphiles in Mexico. The large trogliphilic *Paraphrynus raptator* (Pocock) is sympatric with the troglobitic *P. chacmool* (Rowland) from Yucatan, Mexico. Both species are found on cave walls, but *P. chacmool* has been found only in total darkness far from the cave entrance. Both species of the genus *Acanthophrynus* from southern Mexico have been reported from caves. One species of *Heterophrynus* has been found in Colombian caves, but other species of the genus may occur in caves.

## Order Araneae (Spiders)

This is the largest order of Arachnida with more than 50,000 described species (Fig. 4). Thousands of species, including large numbers of troglobites and trogliphiles, have probably been recorded from caves. The diversity of troglobitic spiders



**FIGURE 4** *Cicurina (Cicurella) cueva* from Cave X, Travis County, Texas, USA. (Photography courtesy of Robert and Linda Mitchell.)

is great with numerous families being recorded in essentially every karst region worldwide.

### SUBORDER MESOTHELAE

**Family Liphistiidae** This primitive family is tropical in distribution. Troglobitic species of the genus *Liphistius* are known from Malaysia and Thailand.

### SUBORDER MYGALOMORPHAE

**Family Barychelidae** The only troglobite in this family is *Troglotele coeca* Fage from Cuba.

**Family Cyrtaucheniidae** The only troglobitic species in this family is *Acontius stercoricola* (Denis) from Guinea.

**Family Dipluridae** Troglobitic and trogliphilic species in the genus *Euagrus* have been found in Mexico. The genus *Masteria* includes troglobites in Jamaica and the Philippines. *Troglodiplura lowryi* Main is a troglobite in Australia.

**Family Hexatelidae** The only troglobite in this family is *Hexathele cavernicola* Forster from New Zealand.

**Family Microstigmatidae** The only troglobite in this family is *Spelocteniza ashmolei* Gertsch from Ecuador.

**Family Theraphosidae** This family of tarantulas includes six troglobites in the genus *Spelopelma* in Mexico. One species is eyeless while the others have reduced eyes and pigment.

**SUBORDER ARANEOMORPHAE** At least 25 families of Araneomorphae are considered to contain troglobites, although some are better represented in caves than others.

**Family Agelenidae** The genus *Tegenaria* includes troglobitic and trogliphilic species in Europe and the United States.

**Family Anapidae** This largely tropical family includes troglobites in the genera *Cruzetulus* in South Africa and *Conculus* from Korea.

**Family Austrochilidae** This primitive tropical family contains only one troglobite, *Hickmania troglodytes* (Higgins and Peters) from Tasmania.

**Family Cybaeidae** This family includes troglobitic species of the genus *Cybaeus* from Japan and Korea.

**Family Cycloctenidae** This family includes troglobitic species in the genera *Cycloctenus* and *Toxopsiella* from Australia and Tasmania.

**Family Dictynidae** The genera *Blabomma* and *Chorizomma* contain troglobitic species in Europe. The genus *Cicurina* includes troglobites in the United States, Mexico, and Japan. The radiation of this genus in the caves of Texas (USA) is especially remarkable with more than 50 eyeless species known.

**Family Dysderidae** This family includes a large number of troglobitic species from caves in the Mediterranean basin. The most abundant genus is *Dysdera* with numerous species recorded. Other significant genera include *Folkia*, *Harpactea*, *Harpactocrates*, *Minotauria*, *Rhode*, *Rhoderia*, *Speleoharpactea*, and *Stalita*.

**Family Gnaphosidae** Troglotic species in this family include two species of *Lygromma* from the Galapagos Islands and one of *Herpsyllus* from Cuba.

**Family Hahniidae** This family of small spiders includes troglotic in the genera *Hahnia* and *Iberina* from Europe.

**Family Holarchaeidae** This family includes only two troglotic species, *Holarchaea globosa* (Hickman) from Tasmania and *H. novaeseelandiae* (Forster) from New Zealand.

**Family Leptonetidae** This family is primarily holarctic in distribution with a few species in southern Mexico. It is well represented in caves, with numerous troglotic and trogliphilic species in many genera having been described. About 60 species of troglotic in several genera, including *Falcileptoneta*, *Leptoneta*, *Marisana*, and *Sataurana*, have been described from caves in China, Korea, and Japan. The fauna of Europe and northern Africa include many troglotic in the genera *Barusia*, *Leptoneta*, *Leptonetela*, *Paralptoneta*, *Protoleptoneta*, *Sulcia*, and *Teloleptoneta*. Cave-associated species in the United States include representatives of the genera *Appaleptoneta*, *Archoleptoneta*, *Callileptoneta*, and *Neoleptoneta*. Two species of *Archoleptoneta* and eight of *Neoleptoneta* are known from caves in Mexico, but only five of the latter genus are considered troglotic.

**Family Linyphiidae** This large family contains numerous troglotic and trogliphilic species in caves throughout the northern hemisphere. The European fauna include many troglotic in the genera *Caviphantes*, *Centromerus*, *Icariella*, *Leptyphantes*, *Porrhomma*, *Thyphlonyphia*, and *Troglohyphantes*. Species of *Leptyphantes* have also been found in caves in Korea and South Africa. Other genera represented by troglotic include *Anthrobia* in the United States and *Phanetta* in the United States and Mexico, *Erigone* and *Meioneta* in the Hawaiian Islands, *Allomengea* and *Jacksonella* in Korea, *Dunedinia* in Australia, and *Metopobactrus* and *Walckenaeria* in the Canary Islands.

**Family Liocranidae** Genera represented by troglotic include *Brachyanillus* from Algeria and Spain, *Liocranum* from Spain, and *Agraecina* from the Canary Islands and Romania.

**Family Lycosidae** This family of wolf spiders is represented in caves only by accidentals, with the exception of two remarkable species, *Lycosa howarthi* Gertsch and *Adelocosa anops* Gertsch from the Hawaiian Islands.

**Family Mimetidae** The only troglotic species in this family is *Mimetus strinatii* Birgnoli from Ceylon.

**Family Mysmenidae** This family is represented from caves by trogliphiles in the genus *Maymena* in Mexico and troglotic in the genus *Trogloneta* in Tasmania.

**Family Nesticidae** The family Nesticidae is closely associated with caves, with numerous species of troglotic and trogliphile having been described. The genus *Nesticus* includes troglotic and trogliphiles in the United States, Mexico, China, Korea, Ceylon, Japan, and Europe. *Eidmannella* includes several troglotic from Texas

(USA). Other genera containing troglotic include *Canario-nesticus* and *Typhlonesticus* from Europe. The genus *Nesticiella* is abundant in caves in Asia, central Africa, Hawaii, and Fiji.

**Family Ochyroceratidae** This is a tropical family of small spiders that contains cavernicolous species in North and South America, the Antilles, Asia, and Africa. The genus *Ochyrocerata* includes troglotic and trogliphiles in Mexico, Guatemala, Peru, and Cuba. Troglotic and trogliphilic species of *Theotima* are known from Mexico, Belize, Hawaii, Jamaica, and Cuba. Two other genera, *Fageicera* and *Speocera*, include trogliphiles in Cuba. Trogliphilic species in the genera *Athepus*, *Psiloderces*, *Simonicerca*, *Speocera*, and *Theotima* have been recorded from caves in Asia. The genus *Speloderces* includes a trogliphile in South Africa.

**Family Oonopidae** This tropical family of small spiders includes several cave-associated species, including several troglotic. Troglotic species include species of *Wanops* in Mexico, *Oonopsides* in Cuba, *Gamasomorpha* in Ecuador and Ceylon, and *Dysderoides* in India.

**Family Pholcidae** This cosmopolitan family is well represented in caves, especially in the New World tropics. More than 90 trogliphiles and troglotic in the genera *Anopsicus*, *Corysoccnemis*, *Ixchela*, *Metagonia*, *Modisimus*, *Physocyclus*, and *Psilochorus* have been collected from caves in Mexico. Troglotic species of *Metagonia* have been described from caves in Belize, Cuba, Jamaica, and the Galapagos Islands. Other genera containing cave-associated species include *Artema*, *Pholcus*, and *Spermophora* in New Guinea; *Aymaria* in the Galapagos Islands; *Blancoa*, *Chebchea*, and *Mesabolivar* in Venezuela; *Priscula* in Peru; *Spermophora* in Tasmania; and *Spermophoroides* in the Canary Islands.

**Family Prodidomidae** This small family includes only two troglotic, *Lygromma anops* Peck and Shear from the Galapagos Islands and *L. gertschi* Platnick and Shadab from Jamaica.

**Family Stiphidiidae** This small African and Australasian family includes troglotic and trogliphiles in the genera *Baiami*, *Stiphidion*, and *Tartarus* from caves in Australia and Tasmania.

**Family Synotaxidae** Three species of the genus *Tupua*, one trogliphile and two troglotic, have been described from caves in Tasmania.

**Family Telemidae** Cave-associated species, including some troglotic, of this family include species of *Telema* in Japan, and Guatemala; of *Telemofila* in New Caledonia, *Usofila* in the United States, *Cangoderces* in South Africa; and *Apneumonella* in Tanganyika. Of special interest is the troglotic *Telema tenella* Simon from Europe. This is considered a "living fossil," and is the only representative of the family from temperate regions.

**Family Tetrablemmidae** This small tropical family includes cave-associated species in the genus *Tetrablemma* from Mexico, *Caraimatta* from Mexico, and *Ablemma* from Okinawa and Sumatra.





**FIGURE 5** *Eukoenenia hanseni* from Sótano del Tigre, San Luis Potosí, Mexico. (Photography courtesy of Robert and Linda Mitchell.)

**Family Tetragnathidae** Genera in this family containing cave-associated species include *Meta* in Canada, the United States, Europe, Russia, and Tasmania; *Metellina* in Europe; and *Orsinome* in Tasmania.

**Family Theridiidae** This large family includes numerous troglophiles in caves in many parts of the world. Troglotic species include representatives of the genera *Achaearana*, *Coscinidia*, and *Stemops* in New Guinea; *Pholeomma* and *Steatoda* in Australia; *Icona* in Australia and Tasmania; *Robertus* in Europe; *Theridion* in the Azores and Galapagos Islands; and *Thymoites* in the United States.

**Family Theridiosomatidae** Cave-associated species in this family include representatives of the genera *Plato* in Venezuela, *Wendilgarda* in Guadeloupe and Ceylon, and *Andasta* in Ceylon.

#### Order Palpigradi (Micro Whipscorpions)

This is a small order containing 78 species arranged in two families (Fig. 5). It is remarkable that 27 described species are known only from caves. Several others have also been reported from caves but also occur on the surface. Palpigrades range in body length from about 1.9 to 2.8 mm.

**Family Eukoeneniidae.** The genus *Koenenides* is represented in caves only by *K. leclerci* Condé from Thailand. Troglotic species of *Eukoenenia* have been found in Europe (22 species), Cuba (1 species), Thailand (3 species), and Indonesia (1 species). Additional troglotic species in the genera *Allokoenenia*, *Eukoenenia*, and *Koenenides* have been found in India, Sulawesi, and Thailand.

**Family Prokoeneniidae** The only described troglotic species of this family is *Prokoenenia celebica* Condé from Sulawesi, Indonesia. Two additional species of the genus from Southeast Asia and one from California await description.

#### Order Pseudoscorpiones (Pseudoscorpions)

This order of about 3000 species in 20 families is worldwide



**FIGURE 6** *Tartarocreagris infernalis* from Electro-Mag Cave, Williamson County, Texas, USA. (Photography courtesy of Robert and Linda Mitchell.)

in distribution and is extremely well represented in caves (Fig. 6). More than 400 species in 15 families have been described from caves.

**Family Atemnidae** Cave-associated species have been described from the genera *Atemnus* in the Philippines, *Oratemnus* in Australia, and *Catatemnus* and *Titanatemnus* from Africa.

**Family Bochicidae** This family is primarily restricted to the neotropics. The northernmost populations are apparent relicts in the caves of Texas (USA) and northern Mexico. Most species are troglotic. Five genera that contain only troglotites are *Antillobisium* with two species in Cuba, *Troglobochica* with two species in Jamaica, *Troglohya* with two species in southern Mexico, *Paravachonium* with five species in Mexico, and *Vachonium* with seven species in southern Mexico and one in Belize. The genus *Leucohya* includes two troglotites in northern Mexico and one in Texas. The genus *Mexobisium* includes one troglotite from Guatemala, two from Belize, one from the Dominican Republic, and two from southern Mexico.

**Family Cheiridiidae** This family contains few species associated with caves but species of *Cheiridium* from Namibia and Cuba; *Cryptocheiridium* from Australia, Malaysia, Philippines, and Cuba; and *Neocheiridium* from Curaçao are probably troglotiles.

**Family Cheliferidae** Genera containing cave-associated species in this family include *Lissochelifer* in Kenya, *Mexichelifer* in Mexico, *Protochelifer* in Australia, and *Stygochelifer* in Java.

**Family Chernetidae** Many species of this family have been recorded from caves where they are frequently present in bat guano in very large numbers. The ecological status of these species is unknown but most are probably troglotiles. Genera recorded from caves include *Bitulochernes* and *Epactiochernes* from Cuba; *Neoallochernes* from Antigua in the Lesser Antilles; *Hesperochernes*, *Neoallochernes*, *Tejachernes*, and *Dinocheirus* from the United States; *Chernes*, *Lasiochernes*, and *Pselaphochernes* from Europe; *Chelanops*, *Dinocheirus*,

*Lustrochernes*, *Parachernes*, and *Tejachernes* from South America; *Dinocheirus* and *Megachernes* in Asia; *Caffrowithius* and *Nudochernes* from Africa; and *Sundochernes* and *Troglochernes* from Australia.

**Family Chthoniidae** This is one of the more important families of pseudoscorpions inhabiting caves worldwide. An estimated 200 species of the family have been described from caves, of which a large number in many genera are troglobites. The European fauna include about 80 species of *Chthonius*, as well as species of the genera *Microchthonius*, *Paraliochthonius*, *Spelyngochthonius*, *Troglochthonius*, and *Tyrannochthonius*. The Asian fauna include representatives of the genera *Allochthonius*, *Lagynochthonius*, *Mundochthonius*, and *Pseudotyrannochthonius*. *Austrochthonius*, *Lagynochthonius*, *Pseudotyrannochthonius*, *Sathrochthonius*, and *Tyrannochthonius* have been recorded from Australia. *Chthonius* has been recorded from northern Africa, *Selachthonius* from South Africa, and *Tyrannochthonius* from Kenya. The South American fauna include species of *Lechytia* from Trinidad, *Pseudochthonius* from Brazil, and *Tyrannochthonius* from Peru. *Tyrannochthonius* and *Kleptochthonius* are especially abundant in the caves of the United States, with other genera including species of *Aphrastochthonius*, *Apochthonius*, *Mexichthonius*, *Mundochthonius*, and *Neochthonius*. The fauna of Mexico and Central America include species of *Aphrastochthonius*, *Lechytia*, *Mexichthonius*, *Pseudochthonius*, and *Tyrannochthonius*. *Lagynochthonius* and *Tyrannochthonius* have been recorded from caves in Jamaica. Species of *Tyrannochthonius* and *Vulcanochthonius* are troglobites in Hawaiian lava tubes.

**Family Garypidae** The family Garypidae includes species of *Archeolarca* and *Larca* in the United States and of *Larca* in Europe.

**Family Ideoroncidae** The genus *Typhloroncus* includes several species of troglobite in Mexico. *Albiorix* includes three troglobites in Mexico and one in Arizona (USA). Species of *Dhanus* have been described from caves in Malaysia and one of *Negroroncus* from the Congo.

**Family Neobisiidae** This is a dominant family of pseudoscorpions in the caves of the Holarctic region, with particular radiation in the United States and Europe. Species in the genera *Microcreagris*, *Pararoncus*, and *Parobisium* are troglobites in Japan. The genera *Neobisium* with more than 70 species and *Roncus* with more than 40 species are the dominant genera in Europe and northern Africa. Other genera with troglobites in Europe include *Acanthocreagris*, *Balkanoroncus*, *Insulocreagris*, and *Roncobisium*. The fauna of the United States include species in the genera *Alabamocreagris*, *Austrolinocreagris*, *Lissocreagris*, *Minicreagris*, *Novobisium*, *Parobisium*, *Tartarocreagris*, and *Trisetobisium*.

**Family Pseudochiridiidae** This small tropical family includes cave-associated species in the genera *Pseudochiridium* from Malaysia and *Paracheiridium* from Madagascar.

**Family Pseudogarypidae** This small family includes three troglobitic species of *Pseudogarypus* in California and Arizona (USA).



**FIGURE 7** *Pseudocellus osorioi* from Sótano del Tigre, San Luis Potosí, Mexico. (Photography courtesy of Robert and Linda Mitchell.)

**Family Sternophoridae** This small family includes a species of *Afrosterphorus* described from a cave in Papua New Guinea.

**Family Syarinidae** This family contains cave-associated species in the caves of Europe, North America, South America, and the West Indies. The genus *Chitrella* contains several species, including possible troglobites, from caves in the United States. *Chitrellina chircabuae* Muchmore, the only member of the genus, is an eyeless species from a cave in Arizona (USA). *Ideoblothrus* includes cave-associated species from caves in Mexico and Australia. The genus *Ideobisium* contains species in Ecuador, Venezuela, and Puerto Rico. The genera *Hadoblothrus*, *Pseudoblothrus*, and *Troglobisium* include troglobites from Europe.

**Family Tridenchthoniidae** The only cave-associated species of this family is *Tridenchthonius juxtaluaca* Chamberlin and Chamberlin from a cave in Guerrero, Mexico.

**Family Withidae** Cave-associated species of this family have been recorded for the genera *Parawithius* in Venezuela and *Pycnowithius* in Kenya.

### Order Ricinulei (Hooded Tickspiders)

This is the smallest order of arachnids with about 50 extant species in one family and three genera (Fig. 7). One genus, *Ricinoides*, is exclusively African and contains no cave-associated species. Three species from northern Mexico

inhabit caves at higher elevations of isolated mountain ranges surrounded by desert and are apparent relicts. Once thought to be extremely rare, populations of both troglaphiles and troglobites may be present in vast numbers.

**Family Ricinoididae** *Cryptocellus* is known from South and Central America, whereas the genus *Pseudocellus* occurs in Texas (USA), Mexico, Central America, and Cuba. The only described troglobitic species of *Cryptocellus* is *C. bordoni* (Dumetresco and Juvara-Bals) from Venezuela. Cave-associated species of *Pseudocellus* occur in Cuba, Guatemala, and Mexico. The troglobitic *P. silvai* (Armas) and the troglaphilic *P. paradoxus* (Cooke) have been described from Cuba. An undescribed troglobite is known from Belize. The Mexican cavernicole fauna include the following troglobitic species: *P. osorioi* (Bolívar y Pieltain) from Tamaulipas and San Luis Potosí, *P. reddelli* (Gertsch) from Durango, and *P. sbordonii* (Brignoli) from Chiapas. Two additional undescribed troglobites are also known from Mexico.

### Order Acari (Mites and Ticks)

This order of about 40,000 described species is probably represented in subterranean habitats by thousands of species, but comparatively few are terrestrial troglobites. Numerous species of mites found in the interstitial habitat below streams and in cave waters exhibit adaptations to subterranean conditions.

#### SUBORDER NOTOSTIGMATA

**Family Opilioacaridae** This rare primitive group includes two troglaphilic species of *Opilioacarus* from caves in Cuba. The genus *Siamacarus* includes two species, one of which is troglomorphic, from caves in Thailand.

**SUBORDER MESOSTIGMATA** Large numbers of species, both free living and parasitic, in this suborder have been recorded from caves. Numerous species in the families Macronyssidae and Spinturnicidae are parasites of bats and have been recorded from caves. The free-living members of the suborder inhabit a wide variety of biotopes, including litter and soil, and they easily colonize caves. Many species have been recorded from caves in all parts of the world, but only a few exhibit troglomorphic adaptations.

**Family Macrochelidae** This family contains a large number of cavernicolous species; some are known only from caves but all are probably troglaphiles. Among the more significant genera that inhabit caves are *Macrocheles* in Japan, Europe, Mexico, Venezuela, and the West Indies; *Holostaspis* in Europe and Algeria; and *Geholaspis* in Europe. Most of these have been taken from bat guano.

**Family Parasitidae** This family includes a large number of cave-associated species, many abundant in bat guano. Many species of *Eugamasus* have been recorded from caves in Afghanistan, Japan, and Europe. One European species is considered a probable troglobite. Other important

cave-associated genera include *Pergamasus* and *Parasitus* in Europe and Mexico; *Paracarpais* in Europe and the United States; and *Vulgarogamasus* in Europe and the United States.

**Family Uropodidae** This family contains a large number of cave-associated species. They are frequently present in bat guano with populations in the millions. Troglobitic species are known in the following genera: *Chiropturopoda* (3 species from Rumania, South Africa, and Zaire), *Nenteria* (5 species from Europe and Trinidad), *Oplitis* (2 species from Cuba, Venezuela, and Trinidad), *Trichouropoda* (5 species from Cuba, Java, Afghanistan, and Europe), *Uroobovella* (12 species from Europe, Java, Cuba, and Trinidad), *Uropoda* (2 species from Mexico, the Antilles, and Austria), and *Uroseius* (3 species from Japan, Italy, and Bosnia-Herzegovina).

**Family Zerconidae** This family of predatory mites includes cave-associated species of the genera *Dithnozercon* from the United States, *Prozercon* from Japan, and *Zercon* from Europe. *Paleozercon cavernicolus* Blaszak *et al.* is a late Pleistocene fossil recovered from calcite in Hidden Cave, New Mexico (USA).

**SUBORDER METASTIGMATA** This suborder includes the ticks, many species of which have been found as parasites of bats.

**Family Argasidae** Many species of this family are parasites of bats. Species of the genera *Antricola* and *Parantricola* occur in vast numbers in bat guano in the caves of Cuba and Mexico and apparently feed on the guano. A few species of the genus *Argas* have unusually long legs and sensory organs that indicate a degree of adaptation to cave life. Numerous species of *Ornithodoros* have been taken from caves. Some are parasites of bats but others have been taken from a variety of ground-dwelling mammals. *Ornithodoros (Pavlovskiella) turicata* (Dugès) in the caves of the southwestern United States is a known vector of relapsing fever and many cases of this disease have been documented in cave explorers following visits to caves inhabited by it.

**Family Ixodidae** Few species of this family have been recorded from caves except as accidentals. Several species of the genus *Ixodes* in Europe are parasites of bats and frequently found in caves. One species, *Ixodes conepati* Cooley and Kohls, a parasite of small mammals, is frequently taken from caves in Texas and New Mexico (USA).

**SUBORDER PROSTIGMATA (TERRESTRIAL)** This suborder includes the majority of mites considered troglobitic. The families Myobiidae and Psorergatidae include numerous bat parasites that have been recorded from caves. The majority of aquatic mites recorded from subterranean habitats also belong in the suborder.

**Family Cunaxidae** The family includes one troglobitic species of *Bonzia* in England. Troglaphiles in the genera *Cunaxa* and *Cunaxoides* are known from Spain and Mexico, respectively.

**Family Ereyinetidae** This family includes, in addition to bat parasites in the genera *Neospeleognathopis* and *Speleocheir*, a troglobitic species of *Ereynetes* from lava tubes in Japan. Other cave-associated species include representatives of the genera *Ereynetes* from Mexico and *Riccardoella* from Europe.

**Family Leeuwenhoeckiidae** Four species of troglobite belonging to the genera *Heterotectum*, *Ischnothrombium*, *Pentagonotectum*, and *Tectumpilosum* have been described from bat guano in Cuban caves.

**Family Proterorhagiidae** This family was described for the troglomorphic species *Proterorhagia oztolica* Lindquist and Palacios-Vargas from caves in Colima, Mexico.

**Family Rhagidiidae** This is the most important family of mites inhabiting caves. A large number of species have been recorded as troglaphiles and troglobites. The ecological status of some species is uncertain, but many are doubtless troglobitic. Troglobites and troglaphiles have been described in the genera *Coccorhagidia* from Cuba; *Flabellorhagidia* from the United States; *Foveacheles* from Europe, Mexico, United States, and Hawaii; *Poecilophysis* from Europe, Mexico, and United States; *Rhagidia* from Europe, Mexico, United States, South Korea, and Japan; *Robustocheles* from Canada, United States, and Mexico; *Traegardhia* from Italy; and *Troglocheles* from Europe.

**Family Trombiculidae** This family includes numerous species of bat parasites that have been recorded from caves. Species in the genera *Cubanothrombium* and *Heterothrombium* from caves in Cuba appear to be troglobitic. Two species of the genus *Trombicula* from Afghanistan, Java, and Morocco are considered troglobites. Species of *Microtrombicula* and *Nycterinastes* have been collected from caves in Mexico.

**Family Trombidiidae** This family includes parasites of bats, but others are predators of insects. Many species have been recorded from caves. Cave-associated species, including some probable troglobites, are known in the genera *Anomalothrombium* from Madagascar; *Hannemania* from Mexico; *Leptothrombium* and *Neotrombicula* from Rumania; *Spelaeothrombium* from Europe and Africa; *Speothrombium*, *Dolichotrombicula*, and *Discotrombidium* from Cuba; and *Typhlothrombium* from Belgium.

**SUBORDER PROSTIGMATA (AQUATIC)** An estimated 4000 species in 100 families and more than 300 genera have been recorded from aquatic habitats. A large percentage of these are known only from subterranean habitats that include caves and phreatic and interstitial habitats. Subterranean species show reduction or loss of eyes and pigment and many species possess elongated bodies and short legs. Only a few of the more important families are discussed here. Other families containing subterranean species include the Anisitellidae, Arenohydracaridae, Arrenuridae, Athienemanniidae, Bogatiidae, Chappuisididae, Feltridae, Halacaridae, Hungarohydracaridae, Hydrovolziidae, Kantacaridae, Lebertiidae, Mideopsidae, Momoniidae, Neocaridae, Nipponacaridae,

Omartacaridae, Piersigiidae, Pionidae, Sperchontidae, Torrenticolidae, Trombidiidae, and Unionicolidae.

**Family Aturidae** This family contains a large number of species adapted for subterranean existence. Among the more important genera are *Aturus* from Europe, Mexico, and Japan; *Axonopsella* from Cuba, South America, Australia, and Tasmania; *Axonopsis* from Europe, North America, Asia, North Africa, and Cuba; and *Frontipodopsis* from Europe, Asia, North America, Central America, and South America. Numerous genera are known only from subterranean waters.

**Family Hydryphantidae** This is an abundant family in underground waters, with a large number of described species. Genera containing subterranean species include *Clathrosperchon* from the southern United States, Mexico, and South America; *Cowichiana* from Canada; *Cyclothys* from the United States; *Euwandesia* from Chile and New Zealand; *Thyasella* from Europe; and *Wandesia* from Europe, North America, South America, Cuba, India, Australia, Tasmania, and Siberia.

**Family Hygrobatidae** This family contains numerous species recorded from subterranean waters. Among the more important genera are *Atractides* from Europe, South America, and Asia; *Australiobates*, *Callumobates*, *Camposea*, and *Decussobates* from Chile; *Corticacarus* from South America; *Gondwanobates* from Australia and New Zealand; and *Hygrobates* from India.

**Family Limnesiidae** This family includes a large number of subterranean species, including many depigmented, eyeless species. Among the more important genera are *Kuwamuraarus* from North America, Mexico, India, Indonesia, and Japan and *Neomamersa* with many species in North America, Central America, South America, and the West Indies.

**Family Limnohalacaridae** Two genera, *Lobohalacarus* and *Soldanellonyx*, contain species recorded from caves in Japan. Other genera with species recorded from caves include *Troglohalacarus* and *Parasoldanellonyx* from Europe and *Homohalacarus* from the United States. Numerous other genera have been recorded from other subterranean habitats.

**Family Stygotrombidiidae** This family is extremely abundant in subterranean waters of Europe with numerous species of *Stygotrombidium* having been described. Other genera associated with underground waters include *Cerberotrombidium*, *Charonotrombium*, *Hydrotrombium*, and *Victatrombium*.

**SUBORDER ASTIGMATA** Most of the species in this suborder are parasites of bats and other mammals. Representatives of the families Acaridae, Chirodiscidae, Chirotrichobidiidae, Rosensteiniidae, Sarcoptidae, Teinocoptidae, and Gastronyssidae have been taken from bats in caves.

**Family Acaridae** Species of this family feed on dead insects and other organic material. The ecological status of cave-associated species is generally unknown. Genera recorded from caves include *Aellenella* from Kenya,

*Acotyledon* from Puerto Rico, *Caloglyphus* from Mexico and Trinidad, *Sancassania* from Mexico, and *Schwiebea* from Europe and Kenya.

**SUBORDER CRYPTOSTIGMATA** This large group contains more than 7000 species arranged into 140 families and 700 genera. Epigeal species are taken from soil, litter, and other endogean habitats. They are extremely abundant in caves, but remain poorly studied. A few of the more important families recorded from caves are discussed below.

**Family Damaeidae** The genus *Belba* includes one troglobite from Europe and one apparent troglophile from Mexico. Other genera with cave-associated species include *Damaeus* from Algeria, Europe, and Korea; *Dameosoma* from Europe; *Epidamaeus* from the United States and Korea; and *Hypodamaeus* from Scandinavia.

**Family Galumnidae** Species of the genus *Galumna* occur in the caves of Yucatán, Mexico, and other neotropical areas. Populations in the millions may be present in some caves.

**Family Haplozetidae** The frugivorous species *Rostrozetes foveolatus* Sellnick has been taken from caves in Cuba and Trinidad, where it is extremely abundant on bat guano.

**Family Hypochthoniidae** Genera with cave-associated species include *Eohypochthonius* from Cuba and Trinidad, *Hypochthonius* from Europe, and *Malacoangelia* from Cuba.

**Family Microzetidae** The cave-associated species of this family have been found in the guano of birds and bats. Genera taken from caves include *Acaroceras* from Cuba and Mexico, *Gymnozetes* from Cuba, and *Microzetes* from Trinidad.

**Family Oppiidae** This is one of the more important families of cryptostigmatid mites found in caves. Most species are probably trogliphiles. Many genera have been recorded from caves, including *Amerioppia* and *Multioppia* from Fiji; *Brachioppia* from Puerto Rico; *Hypogeoppia*, *Kunoppia*, *Leuroppia*, *Medioppia*, *Microppia*, *Oppia*, and *Serratoppia* from Europe; *Lasiobella* from the Canary Islands; *Amerrioppia* and *Oppia* from Mexico; and *Oppia* from Cuba.

**Family Scheloribatidae** This important family includes cave-associated species in the genera *Monoschelorbates* from Mexico; *Poroschelorbates* from the Canary Islands; and *Schelorbates* from Mexico, Cuba, Puerto Rico, and Fiji.

**Family Sphaerochthoniidae** The genus *Sphaerochthonius* is frequently found in caves with species having been recorded from Fiji, Cuba, Puerto Rico, and Mexico.

### Order Opiliones (Harvestmen)

This order contains an estimated 5500 species divided into four suborders (Fig. 8).

**SUBORDER CYPHOPHTHALMI** The Cyphophthalmi is a small group of about 100 species. These mitelike harvestmen are considered the most primitive members of the order. Many epigeal species are blind, but the cave



**FIGURE 8** *Texella reyesi* from Electro-Mag Cave, Williamson County, Texas, USA. (Photography courtesy of Robert and Linda Mitchell.)

species possess longer legs and other adaptations for a subterranean existence.

**Family Neogoveidae** The only troglobitic species in this small family is *Neogovea mexasca* Shear from Mexico.

**Family Pettalidae** Although all species of this family are blind, the only troglobite is *Speleosiro argasiformis* from South Africa.

**Family Sironidae** Eight troglobitic and one trogliphilic species of *Siro* have been described from caves in Europe. The most highly troglomorphic species is *Tranteeva paradoxa* from Bulgaria. The only species recorded from tropical caves is *Marwe coarctata* from Kenya.

**Family Stylocellidae** Two species in the genus *Stylocellus* have been described from caves in Sarawak.

**Family Troglosironidae** This family was created for the troglobitic species *Troglosiro aelleni* Juberthie in New Caledonia.

**SUBORDER EUPNOI** This suborder includes the delicate long-legged harvestmen commonly found in cave entrances. Most cavernicolous species belong to the family Sclerosomatidae with numerous species of *Leiobunum* having been recorded as troglonexes in the caves of Europe, Canada, Mexico, and the United States.

**SUBORDER DYSNOI** This small suborder includes troglobites in three families.

**Family Ischryopsalidae** This monotypic family from Europe includes a large number of trogliphiles and troglobites in the genus *Ischryopsalis*. Ten species are troglobitic. Some species are notable in occurring in caves with a temperature as low as 1.5°C.

**Family Nemastomatidae** Troglobitic species in the following genera have been described: *Buresiola* (four species from Europe and Tunisia), *Nemaspela* (two species from Europe), *Mitostoma* (two species from Europe), *Nemastoma* (three species from Europe and the United States). *Ortholasma sbordonii* Brignoli is a possible troglobite in Mexico.

**Family Sabaconidae** The only troglobite is *Sabacon picosantrum* Martens from caves at high altitude in Spain. A second species is a troglophile in the caves of France.

**SUBORDER LANIATORES** This suborder occurs worldwide but is particularly abundant in the tropics and subtropics. The taxonomy of the group is still poorly known with the limitations of some families not yet settled. Many species from the tropics are large and heavily spinose.

**Family Agoristenidae** Two cavernicole species of the family Agoristenidae have been described from caves in Venezuela. *Phalangozea bordoni* Munoz-Cuevas is a troglobite.

**Family Assamiidae** This family is restricted to tropical Africa and Asia. Blind, depigmented species have been described from forest litter and termite nests, but some from caves appear to be troglobitic and trogliphilic. The following genera include species of troglobite: *Typhlobunellus* from Tanzania, *Sijucavernicus* and *Metassamia* from Assam, and *Calloristus* from India.

**Family Biantidae** The only troglobite in this family is *Decuella cubaorientalis* Avram from Cuba. Other species from Cuba and Ceylon are probably trogliphiles.

**Family Cladonychiidae** This Holarctic family contains a few trogliphiles in Europe. *Speleomaster lexi* Briggs and *S. pecki* Briggs are troglobites from lava tubes in the northwestern United States. *Erebomaster flavescens* Cope includes two subspecies of trogliphile and one of troglobite from caves in the eastern United States.

**Family Gonyleptidae** This neotropical family includes numerous cavernicolous species, but the only apparent troglobite is *Vima chapmani* Rambla from Venezuela. Genera containing trogliphiles or troglonexes include *Pachyloides* from Uruguay and Venezuela; *Rhopalocranaus*, *Mendellina*, *Vima*, and *Santinezia* from Venezuela; *Ancistrotellus* from Brazil; and *Aucayacuella* from Peru.

**Family Phalangodidae** This family is especially abundant in the caves of North America and Europe. The genus *Banksula* occurs in the caves of California (USA). The genus *Texella* includes troglobitic and trogliphilic species in California and Texas (USA). Other troglobites from caves in the United States belong to the genera *Bishopella*, *Calicina*, *Crosbyella*, *Goodnightiella*, *Phalangodes*, and *Phalangomma*. Two troglobites in the genus *Guerrobunus* are known from Mexico. The genus *Jimeneziella* includes two troglobitic species in Cuba. *Panopiliops inops* Goodnight and Goodnight is a troglobite in Costa Rica. The genus *Scotolemon* includes several troglobites from caves in Europe. Other troglobitic species in Europe include representatives of the genera *Lola* and *Paralola*. The only troglobitic member of the family from Africa is *Conomma troglodytes*.

**Family Stygnommatidae** The genus *Stygnomma* includes troglobites and trogliphiles from Mexico, Belize, and the Galapagos Islands.

**Family Stygnopsidae** This family includes numerous cavernicolous species, many undescribed, in the caves of

Mexico. Troglobites include representatives of the genera *Hoplobunus*, *Mexotroglinus*, and *Troglostygnopsis*. Trogliphiles are found in the genera *Hoplobunus*, *Karos*, *Sbordonia*, and *Stygnopsis*. Two species of *Hoplobunus* are troglobites in Texas (USA). South American troglobites include *Pachyspeleus strinatii* from Brazil and *Galanomma microphthalmum* Juberthie from the Galapagos Islands.

**Family Travuniidae** This family includes troglobites from caves in Europe, the United States, and Japan. The genus *Peltonychia* includes numerous species with troglomorphic adaptations ranging from eyed to totally eyeless from caves in Europe. Other troglobitic European species occur in the genera *Dinaria* and *Travunia*. The remaining troglobitic travuniid species are *Speleonychia sengeri* Briggs from lava tubes in Washington (USA) and *Yuria pulchra* Suzuki from Japan.

**Family Triaenonychidae** This family is largely tropical but a few species are known from the United States. The genus *Hendea* includes several species of troglobite and trogliphile in New Zealand. The Australian troglobite fauna include species of the genera *Calliuncus* and *Holonuncia*. The cavernicole fauna of Tasmania include species of troglobitic *Hickmanoxyomma*, *Lomanella*, and *Picunchenops*. Other troglobitic genera containing troglobites include *Speleomontia* in South Africa, *Picunchenops* in Argentina, and *Cryptobunus* in the northwestern United States.

**Family Zalmoxidae** The genus *Ethobunus* includes troglobites from Belize and Jamaica.

### Bibliography

- Condé, B. (1998). Palpigradida. In *Encyclopaedia Biospeologica*, Vol. II (C. Juberthie and V. Decu, eds.), pp. 913–920. Société de Biospéologie, Moulis, France.
- Dusbabek, F. (1998). Acari parasiti. In *Encyclopaedia Biospeologica*, Vol. II (C. Juberthie and V. Decu, eds.), pp. 921–928. Société de Biospéologie, Moulis, France.
- Heurtaut, J. (1994). Pseudoscorpions. In *Encyclopaedia Biospeologica*, Vol. I (C. Juberthie and V. Decu, eds.), pp. 185–196. Société de Biospéologie, Moulis, France.
- Juberthie, C. (1994). Ricinulei. In *Encyclopaedia Biospeologica*, Vol. I (C. Juberthie and V. Decu, eds.), pp. 231–235. Société de Biospéologie, Moulis, France.
- Palacios-Vargas, J. G., V. Decu, V. Iavorski, M. Hutz, and C. Juberthie (1998). In *Encyclopaedia Biospeologica*, Vol. II (C. Juberthie and V. Decu, eds.), pp. 929–952. Société de Biospéologie, Moulis, France.
- Rambla, M., and C. Juberthie (1994). Opiliones. In *Encyclopaedia Biospeologica*, Vol. I (C. Juberthie and V. Decu, eds.), pp. 215–230. Société de Biospéologie, Moulis, France.
- Reddell, J. R., and J. C. Cokendolpher (1995). *Catalogue, Bibliography, and Generic Revision of the Order Schizomida (Arachnida)*, Speleological Monograph No. 4. Texas Memorial Museum, Austin.
- Ribera, C., and C. Juberthie (1994). Araneae. In *Encyclopaedia Biospeologica*, Vol. I (C. Juberthie and V. Decu, eds.), pp. 197–214. Société de Biospéologie, Moulis, France.
- Savory, T. (1977). *Arachnida*, 2nd ed. Academic Press, New York.
- Schwarz, A. E., J. Schwoerbel, and M. Gruia (1998). Hydracarina. In *Encyclopaedia Biospeologica*, Vol. II (C. Juberthie and V. Decu, eds.), pp. 953–976. Société de Biospéologie, Moulis, France.
- Weygoldt, P. (1994). Amblypygi. In *Encyclopaedia Biospeologica*, Vol. I (C. Juberthie and V. Decu, eds.), pp. 241–247. Société de Biospéologie, Moulis, France.

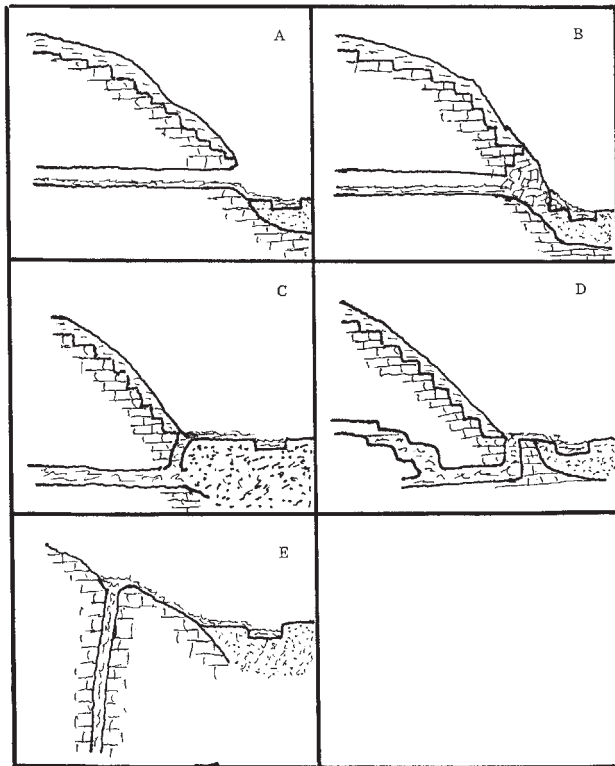
# Springs

William B. White

The Pennsylvania State University

## INTRODUCTION

A spring is a place where groundwater returns to the surface. All aquifers must ultimately drain somewhere. If the drainage occurs at a single location, as distinguished from a line of seeps, a wetland, or discharge into the bed of a surface stream, the place where the groundwater appears is called a *spring*. The sizes of springs vary greatly from barely perceptible trickles to full-sized rivers gushing forth from the earth. Springs have been of immense importance to humankind throughout history. Most have been used as water supplies. Indeed, in arid regions, springs may have been the only water supply. Hot springs and mineral springs have been valued for their curative properties with many health resorts constructed around springs. Many of the largest springs come from cave passages or from fractures in carbonate rock and are known as *karst springs*. Large springs are also found in volcanic rocks and springs of various sizes



**FIGURE 1** Sketches of various types of springs: (A) Gravity spring draining from an open cave mouth. (B) Gravity spring draining through rubble. (C) Alluviated spring. (D) Shallow artesian spring. Water rises from flooded cave passages at depths of a few meters to a few tens of meters. (E) Deep artesian spring. Water rises along a deep channel in the bedrock. Depths may be hundreds of meters.

in nearly all rocks. This article is concerned only with karst springs.

## TYPES OF SPRINGS

Springs can be categorized and described in terms of the nature of the spring orifice and by the characteristics of the discharge (Fig. 1).

### Conduit and Diffuse Flow Springs

Springs that drain from cave passages—conduits—have distinctive characteristics. They tend to be flashy; that is, flow increases rapidly in response to storms in the watershed. The springs often become turbid, sometimes muddy, in response to storms. The chemistry of the spring water also varies with seasons and in response to storms. These springs are known as *conduit springs* even if the conduit that feeds the spring is not visible at the spring orifice. Other springs, *diffuse flow springs*, drain from faults, networks of fractures, or other localized zones of high permeability. These springs tend to flow at a constant rate with at most only sluggish response to storms, although the flow may rise and fall with wet and dry seasons. The water usually remains clear. The temperature and chemical composition of the water remain constant throughout the year. Some very large springs, those in Florida, for example, do drain from conduits but show little storm response.

### Gravity Springs

In a sense, all springs are gravity springs because it is the action of gravity that causes water to drain from storage in the aquifer. However, the term *gravity spring* is reserved for springs that represent the emergence of an underground stream within the cave system that feeds the spring. Some gravity springs are open cave mouths (Fig. 2). One can enter



**FIGURE 2** Locust Spring forming the head of Locust Creek, Pocohantas County, West Virginia, a gravity spring draining from an open cave conduit.

the cave by simply walking (or crawling) into the spring mouth. In a few of these springs, one can follow the cave stream upstream for considerable distances. In other cases the spring mouth is obscured by surface debris that has slumped across the passage. In these cases, the spring water emerges from hillside rubble with no obvious cave passage.

### Alluviated Springs

Spring mouths are frequently located on the banks of rivers or large creeks. Over time, the beds of the rivers and creeks accumulate thick deposits of sand, silt and clay, a material known as *alluvium*. The sediments may block the spring mouths, thus forcing the water to rise through a channel between the hillside and the alluvial river sediments (Fig. 3). Such blockages have occurred in the Mammoth Cave, Kentucky, area caused by changes in the Ohio River and its tributaries during glacial and postglacial periods. Similar springs are found in New York where spring mouths have been choked with glacial drift. The spring orifices of



**FIGURE 3** An alluviated spring in Mammoth Cave National Park, Kentucky.

*alluviated springs* are rise pools, sometimes called *blue holes*, where water wells upward and then flows out to the surface stream. Divers have explored some alluviated springs and found the flooded cave passage feeding the spring at depths of 5–10 m.

### Offshore Springs

During periods when the glaciers of the Pleistocene ice ages had their maximum advance, so much water was stored in the glaciers that sea levels were lowered by as much as 100 m. Caves systems discharged their water through springs located near the shoreline. When the glaciers retreated and sea levels rose again, these springs were drowned but continued to discharge freshwater. Freshwater is less dense than seawater. As a result, the location of drowned *offshore springs* is marked by a plume of freshwater rising to the surface, sometimes with a pronounced boil (Fig. 4). Offshore springs are found in many coastal areas where carbonate rocks extend below sea level.

### Artesian Springs

*Artesian springs* are those in which the water is forced upward under pressure from channels in the bedrock. Some artesian springs are shallow, fed by cave passages below the water table. Shallow artesian springs sometimes well up with a pronounced boil (Fig. 5), but with water coming from depths of only a few tens of meters. Many cave streams end in sumps from which the connection to the spring is through flooded passages.

Deep artesian springs are fed by channels that extend to depths of hundreds of meters. Usually these channels are guided by geological structures such as major fracture systems or faults. These springs are sometimes known as *Vauclisian springs*, named after the Fontaine de Vaucluse in southern France. Exploration by divers and remote sensing equipment has established the depth of the Fontaine de Vaucluse at 308 m. Deep artesian springs are found along the Sierra de El Abra in Tamaulipas, Mexico. The Nacimiento del Rio Mante was explored to 252 m without reaching



**FIGURE 4** An offshore spring in the Adriatic Sea near Opatija, Slovenia.





**FIGURE 5** Boil in Big Spring, Obey River gorge, Fentress County, Tennessee.

bottom. A recent discovery is Cenote de Zacatón, also in Tamaulipas, Mexico, with an explored depth of 329 m. Exploration of these deep underwater systems is at (or beyond) the limits of diving techniques and as a result little is known about the feeder system of these springs.

### Overflow, Underflow, and Distributary Springs

Springs may have more than one orifice. During dry season, only the orifice at the lowest elevation, the underflow spring, may be flowing. *Underflow springs* are often low on the banks of surface streams or in the channel itself and may not be obvious to observers. When flow through the aquifer increases during wet seasons or in response to storms, other orifices at higher elevation may become active. *Overflow springs* may appear as dry cave entrances during dry seasons and may discharge a large volume of water during wet seasons.

Cave systems sometimes reach the surface as a single conduit leading to a single spring. However, it is common to find downstream distributaries where the passages split into multiple branches each of which may reach the surface to produce a spring. *Distributary springs* have been observed scattered along several kilometers of surface stream, all discharging water from the same karst groundwater basin. Distributary springs are usually not at exactly the same elevation. As a result, only one or a few springs may be flowing during the dry season but many more become active during storm flow or during the wet season.

### Thermal Springs

The water temperature in springs draining shallow groundwater basins is typically the same as the mean annual temperature of the region. Water temperature from some open and fast-flowing conduit systems fluctuates with the seasons. The water is warmer than average in the summer and

colder than average in the winter. The transit of water from inlet to spring in these very open systems takes place faster than the water can come into thermal equilibrium with the surrounding rock. The seasonal average, however, is close to the mean annual temperature.

There exist limestone springs that discharge water at temperatures higher than the local average temperature. These *thermal springs* are called *warm springs* or *hot springs* depending on the temperature. Not all thermal springs are limestone springs. Hot springs are common in volcanic areas where groundwater is heated by volcanic activity. In karstic regions, the source of heat is usually geothermal. The temperature of the earth increases with depth at rates ranging from 15–40°C/km. If the groundwater circulation path takes the water to great depths before reaching the spring, the water temperature will be increased. Thermal springs draining from karst aquifers have observed temperatures from just above ambient to as high as 50°C, although most are somewhat cooler.

### Mineral Springs

Springs can also be categorized by the chemical composition of their waters. Water from a typical karst spring will contain mainly  $\text{Ca}^{2+}$ ,  $\text{Mg}^{2+}$ , and  $\text{HCO}_3^-$  with minor concentrations of  $\text{Na}^+$ ,  $\text{K}^+$ ,  $\text{SO}_4^{2-}$ ,  $\text{Cl}^-$ ,  $\text{NO}_3^-$ , and possibly a few other ions. Total ion concentrations are typically in the range of a few hundred milligrams per liter. Mineral springs are those that contain much higher concentrations of dissolved substances, sufficient to give the water a strong taste and possibly an odor. Mineral springs have a great range of both chemical composition and concentrations of dissolved substances. Broadly, they may be subdivided into *saline springs*, which contain dissolved salts of magnesium, calcium, and sodium with magnesium sulfate often a dominant constituent. Sulfur springs contain dissolved hydrogen sulfide,  $\text{H}_2\text{S}$ , which gives the water a rotten egg odor. *Iron springs*, also called *chalybeate springs*, have high iron concentrations. Mineral springs may or may not also be thermal springs. Mineral springs were prized for their medicinal properties, particularly in the 19th century. Resort hotels and baths were built on the sites of many of these springs, although only a few remain in operation.

### Seeps and Wetlands

Marshy areas often result from the discharge of groundwater from any type of aquifers. Karst aquifers in which the movement of water is through networks of fractures may return water to the surface through an extended wetland region rather than through a single large spring. Other karst regions may be mantled with glacial drift, volcanic ash, or other recent permeable cover, thus spreading and diffusing the groundwater discharge. *Seeps* and *wetlands* are found where the karstic carbonate rocks are underlain by impen-

**TABLE I** Some Representative Large Karst Springs Excluding the United States

Spring	Location	Maximum flow	Mean flow	Minimum flow
Tobio	New Guinea	—	85–115	—
Matali	New Guinea	>240	90	20
Dumanli	Turkey	—	50	25
Buna	Bosnia	440	40	2
Ljubljana	Slovenia	132	39	4.2
Ras el Ain	Syria	—	39	—
Chingshui	China	390	33	4
Vaucluse	France	200	29	4.5
Frio	Mexico	515	28	6
Coy	Mexico	200	24	13
Timava	Italy	138	17.4	9
Niangziguan	China	15.8	12.1	8.1
Aachquelle	Germany	24.1	8.2	1.3
Blautopf	Germany	26.1	2.2	0.35

Note: Data from various sources, especially Ford and Williams (1989). All flow measurements in cubic meters per second.

erable layers. Water may emerge from the bottom of the aquifer along the line of contact with the impermeable layer as a continuous zone of small seeps and springs rather than as one large spring.

## SPRING DISCHARGES

### Magnitudes of Spring Discharges

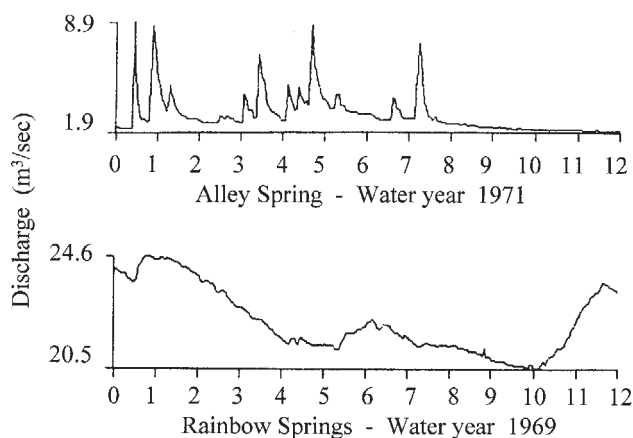
The volume of water discharged from karst springs varies by many orders of magnitude. Table I lists a selection of some of the largest karst springs of the world. Where data were available, maximum, minimum, and mean discharges are listed. Some spring discharges vary only slightly about the mean; others vary by several orders of magnitude between base flow and peak flow. None of the largest karst springs are in the United States. The largest reported springs are in Papua New Guinea where several large rivers flow directly from caves. For the United States, large springs occur in Florida, Missouri, and Texas. Although there are hundreds (perhaps thousands) of karst springs in eastern United States, many of the Appalachian groundwater basins are relatively small. They provide spring discharges typically an order of magnitude smaller than the large springs listed in Table II.

A plot of discharge as a function of time is known as a *hydrograph*. Hydrographs are routinely measured for surface streams and provide a graphic picture of the variations in stream discharge. Hydrographs can also be measured for springs and provide some insight into the characteristics of the groundwater basin and the conduit system that feeds the spring. Figure 6 shows two examples. The hydrograph of Alley Spring contains many sharp peaks, which represent

**TABLE II** A Selection of Large Karst Springs in the United States

Spring	Location	Maximum flow	Mean flow	Minimum flow
Silver Spring	Florida	36.3	23.0	15.3
Rainbow Spring	Florida	28.9	19.8	13.8
Wakulla Spring	Florida	54.1	11.1	0.71
Comal Springs	Texas	15.1	9.2	—
San Marcos Spring	Texas	8.5	4.2	2.3
Big Spring	Missouri	36.8	12.1	6.7
Greer Spring	Missouri	25.5	9.4	2.9
Maramec Spring	Missouri	18.4	4.2	1.6
Alley Spring	Missouri	—	3.6	1.5
Davis Spring	West Virginia	28.3	3.1	0.6

Note: Data from various sources. All flow measurements in cubic meters per second.

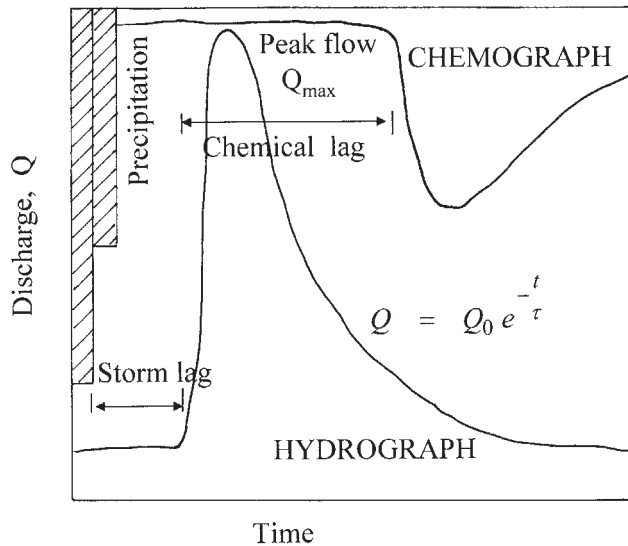


**FIGURE 6** Hydrographs, each drawn for a single water year from U.S. Geological Survey water records for Alley Spring, Missouri, and Rainbow Spring, Florida.

the spring response to individual storms. The hydrograph of Rainbow Spring is smooth. The contributions of individual storms have been averaged out and only the rise and fall of discharge with seasonal wet and dry periods is reflected in the hydrograph. Aquifers with well-developed conduit systems drain rapidly. Little water is retained in storage. Spring discharge has time to fall to base flow before the next storm arrives. The ratio of peak flow to base flow gives a measure of the “flashiness” of storm response. For Alley Spring, this parameter is 4.7. For Rainbow Spring it is 1.2. Ratios as high as 100 have been observed for Davis Spring, West Virginia.

### Ebb-and-Flow Springs

*Ebb-and-flow springs* are those in which the discharge varies in a cyclical fashion. Discharge drops to some minimum value, then rises rapidly to a peak, and then decreases again. Usually this flow-and-flush cycle occurs on a timescale of



**FIGURE 7** Sketch of a single storm peak on a spring hydrograph showing the rapid rising limb and the more drawn out recession limb.

minutes to hours. Ebb-and-flow behavior has been ascribed to a siphon action in the conduit system that feeds the spring. The deeper part of the conduit slowly fills with water until the level reaches a spillover route or the pressure head become sufficient to force water out of the system. Draining through the spillover route triggers a siphon action so that the lower, flooded parts of the conduit are also drained. Once the conduit system has been drained, siphon action ceases and the system slowly fills to begin the next cycle. One of the best studied examples is Big Spring, draining the Lilburn Cave System in Kings Canyon National Park, California, USA. Detailed analyses of hydrographs measured at the spring and in the lowest levels of the cave substantiate a forced siphon mechanism.

### Analysis of Spring Hydrographs

Some information concerning the groundwater basin that provides the spring discharge can be obtained from a more careful analysis of the spring hydrograph. Figure 7 shows a schematic hydrograph of a single storm to illustrate the various features. If there has been no rain in the watershed for a long time, the flow from the spring will decrease to a minimum value called the *base flow*,  $Q_B$ , (of course, if the spring completely dries up during droughts, the base flow is zero). The storm precipitation is represented by the bars on the left side of the diagram (drawn upside down). After a period of time, the storm lag, the flow of the spring will begin to increase and quickly rise to a *peak value*,  $Q_{max}$ . The rising limb of the hydrograph is generally very steep. After the storm passes, the flow from the spring will begin to decrease, but the rate of decrease is slower than the rate of rise. Often the recession limb of the hydrograph can be represented by an exponential function with two adjustable

parameters,  $Q_0$  and  $\tau$ . The parameter  $\tau$  has units of time and is a measure of the response time of the aquifer. Exponential fits to karst spring recession curves often produce two or more segments. The fast response segment, with  $\tau$  on the order of 3–10 days, may represent the draining of the open conduits, while the slow response segment, with  $\tau$  on the order of 20–50 days, may represent the draining of fractures and other small tributaries. Sometimes spring hydrographs have multiple segments or do not fit exponential equations at all. These responses do not lend themselves to straightforward hydrologic interpretation.

### Turbidity and Chemical Variability

Flow velocities in the conduit system of karst aquifers, especially during storm flow, are often sufficient to take clays, silts, and other small particles into suspension and carry the suspended particles to the spring. As a result, some springs become turbid or muddy following storms with the water gradually becoming clear as the discharge decreases back toward base flow conditions. The presence of muddy water during storm flow is often an indication that the groundwater basin is recharged by sinking streams or open sinkholes that can carry muddy water into the system.

The chemical composition of springs draining from fracture systems (diffuse flow springs) tends to remain constant throughout the year regardless of storms and wet and dry periods. The chemical composition of springs draining from conduit systems tends to be much more variable. The variability in such components as  $Ca^{2+}$ ,  $Mg^{2+}$  and  $HCO_3^-$  is due to dilution of groundwater by storm water, and by changes in recharge chemistry due to winter/summer changes in vegetation. The bulk chemistry of the spring water can be easily monitored by measuring the electrical conductivity. This produces a curve called a *chemograph*, which can be superimposed on the hydrograph as indicated in Fig. 7. The dip in the chemograph indicates the dilution due to the input of storm water. In Fig. 7, the dip in the chemograph is shown offset from the peak in the hydrograph by a time period called the *chemical lag*. If the chemical lag is zero, that is, if the dip in the chemograph is directly superimposed on the peak of the hydrograph, it indicates that the storm water has moved directly to the spring. In this case, the storm lag is a rough measure of the travel time between the storm water input points and the spring. If the dip in the chemograph is offset, it indicates that the conduit system is at least partially flooded. Rising water levels at the upstream end of the system force water out of the flooded conduits to produce the peak in the hydrograph and it is only later that the actual storm water reaches the spring.

Chemographs can be constructed for individual chemical constituents if enough samples are collected and analyzed during the storm flow. These may also be interpreted in terms of the movement of various constituents through the system.

## SPRINGS AS WATER SUPPLIES

Water gushing from the earth has seemed an obvious source of freshwater for human consumption for millennia. Villages and towns have grown up around springs because of the convenient supply of high-quality water. As a result, there is a popular myth that spring water is intrinsically “pure.” Indeed, spring water is often chosen by water bottling companies. In the case of karst springs, the myth of “pure spring water” is exceedingly dangerous.

Karst springs frequently receive their water from cave passages, which in turn receive their water from surface streams that sink underground or from storm flow into sinkholes. Sinkholes are often repositories for household garbage, farm waste such as empty pesticide cans, other trash, and dead animals. Sinking surface streams and sinkholes may admit spilled petroleum hydrocarbons (gasoline, diesel fuel, and home heating oil) as well as industrial solvents such as perchloroethylene (PCE) and trichloroethylene (TCE) and many others. Any spring that becomes turbid after storms or which shows a high degree of chemical variability should be immediately suspect. Even fracture flow springs with clear water and constant chemistry may require extensive testing as well as filtration before being approved as public water supplies. Regulations now often require an elaborate test for surface water influence. Minor debris such as bits of plant material or insect parts are sufficient to require a filter plant.

## SPRINGS AS HABITAT

Springs provide a stable habitat for a variety of aquatic organisms. Spring waters, with their nearly constant temperature, remain warm and ice-free during winters. Springs are a transitional environment between true cave conditions upstream and normal surface stream conditions downstream. The temperature and water chemistry of springs are comparable to cave stream conditions, but springs are also under the influence of sunlight. Aquatic plants can grow in springs and provide sources of nutrient that are not available in the cave system. However, springs are generally more sheltered and subject to smaller swings in microclimate that are completely open surface streams.

### *See Also the Following Articles*

*Hydrogeology of Karst Aquifers*

### **Bibliography**

- Alfaro, C., and M. Wallace (1994). Origin and classification of springs and historical review with current applications. *Environ. Geol.* **24**, 112–124.
- Ford, D. C., and P. W. Williams (1989). *Karst Geomorphology and Hydrology*. Unwin Hyman, London.
- LaMoreaux, P. E., and J. T. Tanner (2001). *Springs and Bottled Waters of the World*. Springer-Verlag, Berlin.
- Vineyard, J. D., and G. L. Feder (1974). *Springs of Missouri*. Missouri Geological Survey and Water Resources, WR 29, Rolla, MO.

# Stalactites and Stalagmites

Silvia Frisia

*Museo Tridentino di Scienze Naturali, Italy*

## INTRODUCTION

Stalactites and stalagmites are the most common speleothem types, the morphology of which is basically controlled by dripping; therefore, both speleothems can be considered as gravitational forms. Stalactites are centimeters to meters in scale and they hang from the ceiling and grow toward the floor. Stalagmites are convex cave deposits (decimeters to meters in scale) that grow from the floor upward and are commonly fed by water dripping from an overhead stalactite. The genesis and internal structure of carbonate stalactites and stalagmites are the focus of the following sections.

## COMPOSITION

Stalactites and stalagmites (Fig. 1) are commonly composed of calcite, the calcium carbonate phase that is stable at surface temperature and pressure. They may be also composed, wholly or partially, of aragonite (Fig. 2), the high-pressure polymorph of  $\text{CaCO}_3$  and, rarely, of noncarbonate minerals, such as halides, phosphates, sulfates, oxides, and silicates. The mineralogical composition of a stalagmite is not necessarily the same as that of the feeding stalactite. Calcite stalactites feeding aragonite stalagmites have been observed in many caves. The mineralogical composition, in fact, depends on the combination of drip-water chemistry, drip rate, the presence of ions and complexes in solution that may inhibit nucleation and growth of any phase, and the physical parameters of the cave atmosphere.

The precipitation of calcite crystals that commonly compose stalactites and stalagmites mostly occurs through the loss of drip-water  $\text{CO}_2$  to the cave atmosphere. This mechanism decreases the activity of the hydrogen ion ( $\text{aH}^+$ ) and shifts the pH to higher values, thus increasing the activity of the  $\text{CO}_3^{2-}$  ion in solution and favoring calcium carbonate precipitation. Surface area and timing for  $\text{CO}_2$  degassing to occur vary for stalactites and stalagmites.

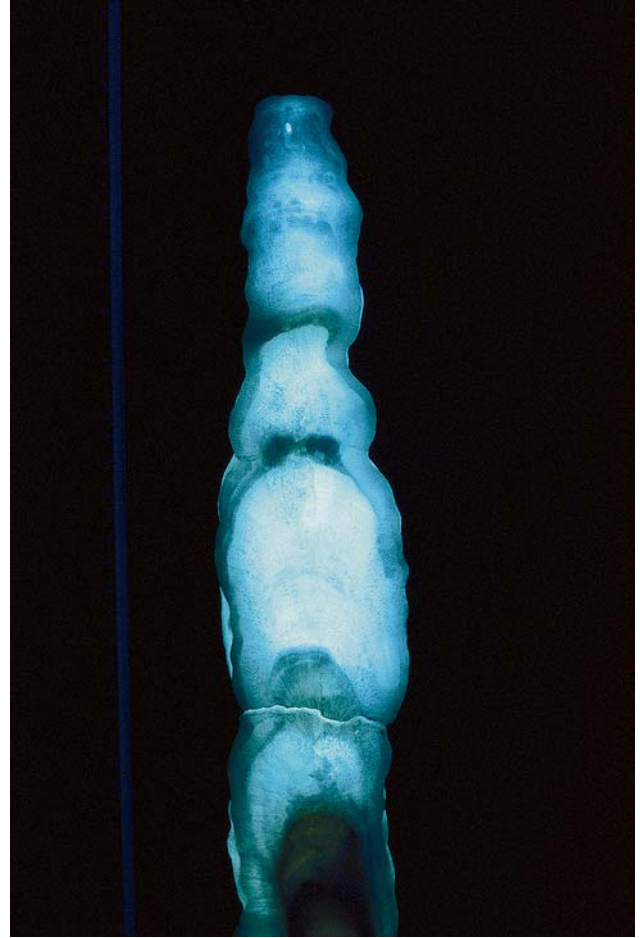
## STALACTITES

The most common variety of stalactites is the tubular soda straw, consisting of thin, translucent, tubular layers of crystals surrounding a central canal. Soda straws are speleothems generated by sole axial feeding, characterized by constant central canal diameter, and by a wall structure that is controlled by geometric selection during growth on the meniscus of a drip. The term *soda straw*, therefore, is not applied to any stalactite with a central tube.



**FIGURE 1** Stalactites and stalagmites. Grotte de Clamouse. (Photograph courtesy of A. Borsato.)

Commonly, the outer diameter of a soda straw varies from 5 to 10 mm, and the inner diameter ranges from 2 to 6 mm. Scanning electron microscopy observations demonstrate that soda straws grow by linear, downward accretion of coalescent rhombohedral crystallites (Fig. 3), with their C-axes (the upward direction from the origin of the crystal unit cell; in calcite, which has threefold symmetry, the threefold symmetry is around the C-axis) dimension nearly vertically oriented. Crystal deposition commences when a droplet of water flows out of the host rock and degasses. A small rim of calcite, of the diameter of the droplet, forms. Once this rim of calcite has grown, successive layers of crystals are deposited by nucleation and growth on the previous layer. Soda straws commonly show growth bands, which can be visible by the naked eye, typically 0.05–0.5 mm thick, which is the linear annual extension rate expected for these speleothems. These bands identify a periodic thickening of the straw walls toward the inner channel, resulting in macrosteps. Field observations and sampling revealed that the dimension of the inner diameter of the straws is a function of the drip rate. In some cases, degassing within the straw causes



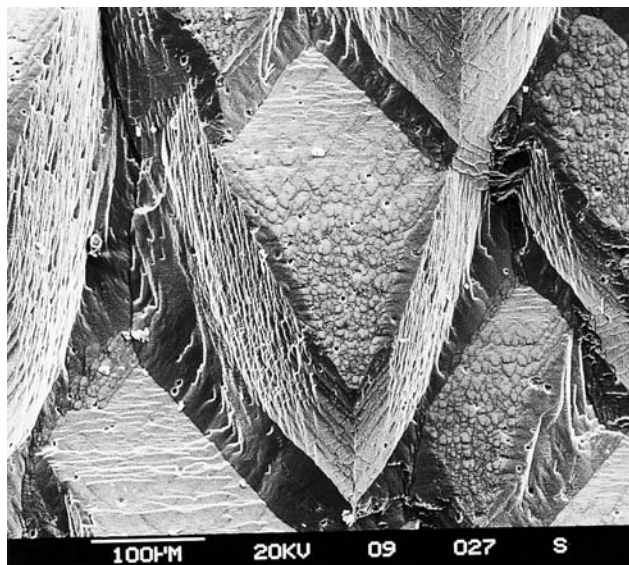
**FIGURE 2** Stalagmite consisting of columnar calcite (the white, translucent part) and aragonite (gray sectors). Note that the elongated, translucent, columnar crystals are elongated perpendicular to the substrate. The individuals that are most peripheral, however, are bent and their orientation becomes perpendicular to the growth surface of the stalagmite. Grotte de Clamouse, France. (Photograph courtesy of A. Borsato.)

precipitation of calcite, inner thickening of the wall, and, in the end, the complete obstruction of the channel.

A conical stalactite grows through deposition of crystals along the sides of the drop in the central canal and through simultaneous deposition of crystals by a thin film of fluid that flows along the tubular wall of the central canal (straw). The crystals deposited by the external flow have the C-axis perpendicular to the straw and, therefore, exhibit a radial arrangement around the central canal. Consequently, growth of a cone stalactite occurs both in vertical and lateral directions.

### STALAGMITES

Stalagmites do not show a central canal. Calcite and aragonite stalagmites commonly form through carbonate deposition from a thin film of supersaturated fluid, having a thickness estimated on the order of 0.1 mm, which remains stable and

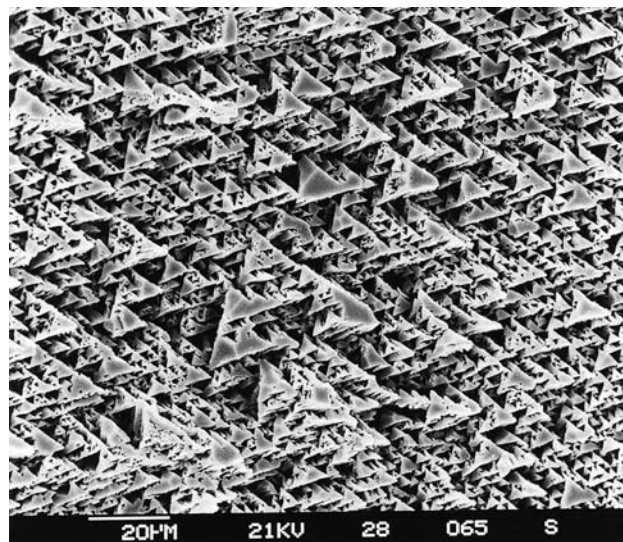


**FIGURE 3** Coalescing rhombohedral crystallites in a soda straw. Crystal tips point toward the direction of flow. Grotta Pere Noel, Belgium. (Photograph courtesy of S. Frisia.)

slowly moves down from the stalagmite tip to the flanks. The morphology of stalagmites is mostly determined by the drip rate, the distance from the tip of the feeding stalactite, and the supersaturation of the thin film of fluid that forms at the tip of the speleothems after the splashing of each drop. Very fast, constant dripping yields pillar-like stalagmites, whereas slow dripping results in a thin, candle-shaped morphology. A diminution of drip rate with time results in the tapering of stalagmites. The spray produced by fragmentation of a drop at the impact point (common when the fall is high) forms stalagmites that resemble pile of plates.

Buhmann and Dreybrodt (1985) achieved a theoretical understanding of the rate of stalagmite growth, based on the chemical and hydrological properties of the drip water feeding the stalagmites and the composition of cave air. The growth of both stalagmites and soda straw stalactites has been subsequently simulated by laboratory experiments designed to reproduce natural cave conditions. Given the solution composition used, the rates of crystal growth in these studies were  $0.72$  to  $1.83 \text{ nmol min}^{-1} \text{ cm}^{-2}$  comparable with rates of  $0.9$  to  $2.1 \text{ nmol min}^{-1} \text{ cm}^{-2}$  calculated using the theoretical treatment of Buhmann and Dreybrodt with a water film thickness of  $50 \text{ }\mu\text{m}$  regarded as representative for speleothems.

Successive stalagmite layers are formed by composite crystals consisting of crystallites (Fig. 4), which can be considered as the smallest unit of which composite crystals are built. The stacking pattern of these crystallites yields different fabrics. When the stacking is ordered, the resulting fabric is *columnar* (length-to-width ratio of the composite crystals  $< 6:1$ ) or *acicular* (length-to-width ratio  $> 6:1$ ). Stalagmites composed of columnar and fibrous fabrics are



**FIGURE 4** Coalescing crystallites on the growth surface of a stalagmite. Grotta di Ernesto, Italy. (Photograph courtesy of S. Frisia.)

translucent. In a stalagmite cut along the vertical growth axis, columnar and fibrous crystals appear as long individuals, with straight boundaries, and elongation perpendicular to the substrate (see Fig. 2). The peripheral composite crystals bend toward the flanks of the speleothem, as their growth is prompted by the cations and anions transported by the thin film of fluid that flows along the flanks of the stalagmite. Under the optical microscope, columnar fabric shows uniform extinction, a C-axis perpendicular to the substrate, and elongation along the C-axis. In columnar and fibrous fabrics, each composite crystal consists of crystallites typically  $100 \text{ }\mu\text{m}$  wide and  $\geq 100 \text{ }\mu\text{m}$  long, with flat F-faces, which are smooth crystal faces produced by spiral growth mechanism, and few crystal defects.

Columnar and fibrous fabric may show visible alternation of brown and white laminae, which is caused by seasonal variations in drip-water flow and chemistry. The development of layering in columnar calcite has been studied through scanning electron microscopy observation of seasonal precipitates in an alpine cave. Crystallites show relatively large sizes (up to  $150 \text{ }\mu\text{m}$  wide) and rugged crystal surface morphology in the season when water supersaturation with respect to calcium carbonate is higher. Crystallites have a relatively small size (about  $50 \text{ }\mu\text{m}$  wide) and show smooth (flat) faces when drip waters are barely at saturation for calcium carbonate and when growth inhibitors, such as phosphate, are present in solution.

When crystallite stacking is disordered and few crystallites grow in optical continuity with the substrate, the fabric is microcrystalline. Unlike columnar and fibrous fabric, microcrystalline calcite forms composite crystals with irregular crystal boundaries. On a stalagmite cut along the vertical growth axis one sees crystals that are shaped like flames. Stalagmites composed of microcrystalline fabric



**FIGURE 5** Slab of stalagmite characterized by porous, milky, microcrystalline calcite. Grotta Spia, Italy. (Photograph courtesy of A. Borsato.)

are milky, very porous, and laminated (Fig. 5). Crystallites that compose microcrystalline fabric are rich in defects and characterized by multiple twinning, lamellae, and dislocations. Microcrystalline fabrics form under fluctuating discharge rates and seasonal input of calcite growth inhibitors, such as phosphate, or organic matter particles. A peculiar stacking of crystallites forms scaffold-like composite crystals, which have been observed in stalagmites from caves where air currents or underground rivers allow for CO<sub>2</sub> exchange with the outer atmosphere.

Changes in physical and chemical characteristics of stalagmites are used to extract information on past climate and environment evolution at very high resolution, because stalagmites can be dated precisely with the uranium series method and the counting of annual growth laminae. Stalagmites are particularly important in those areas where speleothems are the only archives of paleodata that cover long time spans, such as arid or high mountain regions. In coastal zones and submerged caves, stalagmites showing interlayered marine deposits (such as colonies of marine Serpulids) can be used to reconstruct timing and duration of sea-level fall.

### See Also the Following Articles

*Minerals • Speleothems: Helictites and Related Forms*

### Bibliography

- Buhmann, D., and W. Dreybrodt (1985). The kinetics of calcite dissolution and precipitation in geologically relevant situations of karst areas: I Open-system. *Chem. Geol.* **48**, 189–211.
- Burns, S. J., D. Fleitmann, A. Matterer, U. Neff, and A. Mangini, A. (2001). Speleothem evidence from Oman for continental pluvial events during interglacial periods. *Geology* **29**, 623–626.
- Dreybrodt, W. (1988). *Processes in Karst Systems*. Springer Verlag, Berlin.
- Frisia, S., A. Borsato, I. Fairchild, and F. McDermott (2000). Calcite fabrics, growth mechanisms, and environments of formation in speleothems from the Italian Alps and southwestern Ireland. *J. Sedimentary Res.* **70**, 1183–1196.
- Hill, C., and P. Forti, eds. (1997). *Cave Minerals of the World*, 2nd ed. National Speleological Society, Huntsville, AL.
- Huang, Y., and I. J. Fairchild (2001). Partitioning of Sr<sup>2+</sup> and Mg<sup>2+</sup> into calcite under karst-analogue experimental conditions. *Geochim. Cosmochim. Acta* **65**, 47–62.
- Morse, J. W., and F. T. Mackenzie (1990). *Geochemistry of Sedimentary Carbonates*. Elsevier, Amsterdam.

## Sulfuric Acid Caves

Arthur N. Palmer

*State University of New York*

Carol A. Hill

*University of New Mexico*

### INTRODUCTION

Most caves owe their origin to carbonic acid generated in the soil. In contrast, sulfuric acid caves are produced by the oxidation of sulfides beneath the surface. Although sulfuric acid caves are relatively few, they include some large and well-known examples, such as Carlsbad Cavern, New Mexico, USA. They also provide evidence for a variety of deep-seated processes that are important to petroleum geology, ore geology, and the nascent field of geomicrobiology.

### GEOLOGIC SETTING

Cave origin by sulfuric acid requires the reaction of oxygen with either solid or aqueous phase sulfides. The most common sulfide source is hydrogen sulfide (H<sub>2</sub>S), which originates in reducing environments such as petroleum-rich sedimentary basins. Sulfuric acid is generated when rising H<sub>2</sub>S-rich water encounters oxygen-rich water at or near the water table (Fig. 1). The resulting caves are often included under the broad umbrella of *thermal caves*, but since elevated temperature is not required for their origin, and known sulfuric acid caves contain no clear evidence for it, this label

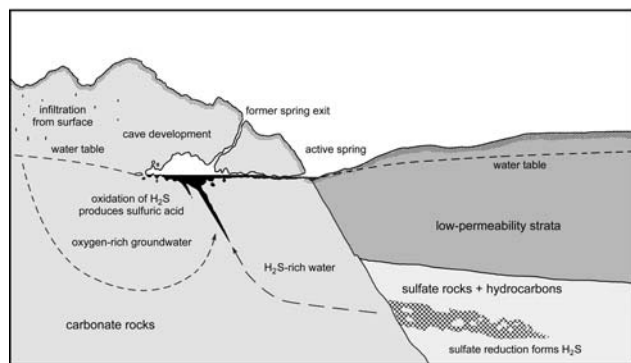


FIGURE 1 General setting for sulfuric acid cave origin.

should not be indiscriminately applied to them. The term *hypogenic caves* is more appropriate.

Oxidation of metallic sulfides (e.g., pyrite) accounts for only a few minor caves and generally produces only scattered solutional pores. This chapter focuses only on caves produced by  $H_2S$  oxidation.

The source of cave-forming  $H_2S$  is usually a sedimentary basin bordering a carbonate upland, or deep sulfate deposits interbedded within the carbonate rock itself. Water from basinal sediments can be expelled by compaction, by overpressuring as a result of rapid sediment accumulation, and by flow down a regional hydraulic gradient. Because of their higher permeability, carbonate rocks often have lower hydraulic heads than surrounding materials and serve as the zones of groundwater discharge to the surface.

Caves form only where the  $H_2S$  can be oxidized beneath the surface in carbonate rocks. This requires either convergence with oxygenated groundwater fed by infiltration or liberal exchange of air through openings to the surface. Either way, oxidation is greatest at and near the water table. Most  $H_2S$ -rich groundwater simply discharges at springs without encountering enough oxygen below the surface to form caves.

### DIAGNOSTIC FEATURES OF SULFURIC ACID CAVES

The typical sulfuric acid cave consists of a central area of irregular rooms, with local mazes of intersecting fissures or spongelike solution pockets and sparse outlet passages that lead to active or relict springs. Some caves consist of only a single passage. From these main zones of cave development, narrow fissures commonly descend and pinch out downward. In active examples these fissures are the main inlets for  $H_2S$ -rich water.

Much of the solutional enlargement of a sulfuric acid cave takes place above the water table.  $H_2S$  escapes from the rising water into the cave air and is absorbed by moisture droplets and films, along with oxygen from the cave atmosphere. The moisture can be supplied by infiltration and/or condensation. Production of sulfuric acid within this water dissolves the adjacent carbonate rock and typically produces a rind of

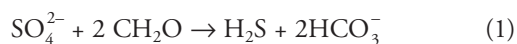
replacive gypsum. Fractionation during the redox reactions makes the sulfur isotopes in the secondary gypsum relatively “light” compared to those of primary gypsum. Sulfuric acid can also alter clays, yielding several by-products including alunite ( $KAl_3(SO_4)_2(OH)_6$ ) and hydrated halloysite (or endellite,  $Al_2Si_2O_5(OH)_4 \cdot 2H_2O$ ), while liberating silica, which precipitates as intergranular cements and irregular chert beds. Native sulfur can accumulate by incomplete oxidation of  $H_2S$  at low pH, especially where acids are locally shielded from the carbonate rock by gypsum or siliciclastic rock. Also, the presence of  $H_2S$  can ultimately cause precipitation of uranium-vanadium minerals such as tyuyamunite [ $Ca(UO_2)_2(VO_4)_2 \cdot 5-8H_2O$ ] and metatyuyamunite [ $Ca(UO_2)_2(VO_4)_2 \cdot 3-5H_2O$ ].

Cave enlargement can continue even after sulfuric acid activity has ceased. Through-flowing meteoric water easily removes the secondary gypsum. Condensation of moisture in cool upper levels and on cave ceilings is also prominent, owing to circulation of warm humid air from lower levels. Because it absorbs  $CO_2$  from the cave air, condensation moisture readily dissolves carbonate rocks. This moisture consists mainly of capillary films, which produce smooth, rounded surfaces and cupolas. The dissolved material is carried downward by seepage along the walls and within pores, and it often reprecipitates as cave popcorn and needlelike speleothems where the water descends into evaporative regions. This process is more noticeable than in most other caves, because sulfuric acid caves rarely contain through-flowing streams, and their entrances tend to be small and few, thus enhancing thermally driven convection within the cave atmosphere.

Many of the diagnostic features of sulfuric acid cave origin can be removed by near-surface processes after the caves cease to be active. This is especially true in humid climates, where the evidence of former sulfuric acid cave development is often effaced by shallow meteoric groundwater. Cave patterns and their relation to the geologic setting may be the only remaining genetic clues.

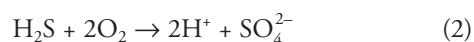
### CHEMICAL REACTIONS

Most  $H_2S$  is generated by reduction of sulfates by organic carbon compounds. Gypsum and anhydrite are the typical sulfate sources involved in sulfuric acid speleogenesis. The simplest form of the reduction reaction is



where  $CH_2O$  represents a generic organic compound.

$H_2S$  is highly soluble in water and, except at depths of only a few meters below the water table, it rarely reaches concentrations high enough to produce gaseous bubbles. Where  $H_2S$  is carried by groundwater into an oxidizing environment, sulfuric acid is produced:

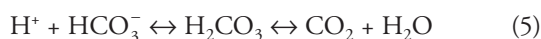
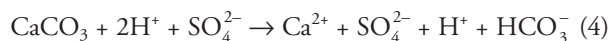




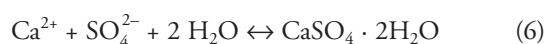
usually with other sulfur species as intermediate products. At low pH, the following equilibrium becomes important:



Within carbonate rocks, sulfuric acid is a potent cave-former. For limestone, the dissolution reaction can be stated as follows:



Dolomite dissolves in a similar manner. As reaction (5) proceeds, the partial pressure of carbon dioxide ( $\text{PCO}_2$ ) rises, and if  $\text{CO}_2$  does not escape, carbonic acid aids in cave development. Where groundwater flow rates are small, gypsum can be deposited, often as a direct replacement of carbonate rock:



Buffering of the acids by dissolution of carbonate rock generally keeps the pH moderate (ca. 6–7). Low pH can develop if the acids are shielded from the carbonate rock by a nonreactive material. Gypsum crusts tend to shield the carbonate rock from the acid, so that above the water table the pH of water films and droplets on gypsum can decrease considerably. Buildup of acid in contact with gypsum is limited by reaction (3), which usually holds pH to values of about 1.5 (depending on temperature and other dissolved species). Gypsum is dissolved and consumes  $\text{H}^+$  to produce  $\text{HSO}_4^-$ . However, droplets and films of moisture on relatively nonreactive materials such as chert, quartz, and microbial filaments can reach extremely low (sometimes negative) pH values, as in Cueva de Villa Luz (described below).

## MICROBIAL INTERACTIONS

Reduction of sulfate in the presence of organic carbon can take place spontaneously at temperatures above about  $85^\circ\text{C}$ . At lower temperatures the process depends on bacterial sulfate reduction. Thus in many cases (perhaps most),  $\text{H}_2\text{S}$  production requires microbial mediation. Sulfate reducers include the bacterium *Desulfovibrio*, which ingests sulfate and excretes  $\text{H}_2\text{S}$ .

In the oxidizing zone, where the caves are formed, sulfur-oxidizing bacteria (e.g., *Thiothrix*) can speed reactions by several orders of magnitude. Also, certain species are able to facilitate the conversion of sulfides directly to sulfuric acid without intermediate by-products. The oxidation reactions are strongly exothermic, providing an energy source for microbial growth. Bundles of bacterial filaments are common in active sulfuric acid caves, and their mineral-coated fossilized forms have also been observed in relict caves. Microbes are also active mediators of redox reactions in the deeply weathered walls of certain sulfuric acid caves.



**FIGURE 2** Fissure inlet midway in Lower Kane Cave, Wyoming. Note the mat of white bacterial filaments in foreground. (Photograph courtesy of A. N. Palmer.)

## FIELD EXAMPLES

Some of the best documented examples of sulfuric acid caves are described here.

### Kane Caves, Wyoming

Lower Kane Cave, in north-central Wyoming, is where sulfuric acid cave development was first described in detail. The cave consists of a single linear stream passage in the Madison Limestone of Mississippian age, where the limestone is breached by the Bighorn River along the Sheep Mountain Anticline. The cave spring is located at the present river level, and the passage extends at a low gradient for approximately 350 m. The cave stream is fed by  $\text{H}_2\text{S}$ -rich water that discharges from floor fissures at several places along the passage, including the upstream terminus (Fig. 2). Bundles of filaments of sulfur-oxidizing bacteria form conspicuous tendrils in and around the fissures. A gypsum rind coats most of the walls and ceilings around the inlets as the result of oxidation of  $\text{H}_2\text{S}$  within moisture films. The gypsum flakes off the limestone bedrock and drops to the floor, where it either falls into the stream or builds mounds adjacent to it. The stream is undersaturated with gypsum, and any gypsum that comes in contact with it is carried away in solution. Thus the cave enlarges by a process that Egemeier (1981) called *replacement solution*.

About 30 m directly above is Upper Kane Cave, a relict precursor of the active lower cave. The upper cave is a dry passage similar in pattern and length to the lower one, but with a larger cross section and a breakdown-strewn floor. Breakdown and dissolution by vadose seepage have obscured

or removed much of the gypsum crust that must have once lined most of its surfaces. Discharging along both banks of the Bighorn River are other similar caves that contain H<sub>2</sub>S-rich water, but they are smaller than the Kane Caves and present more difficult access.

The water that feeds these caves belongs to two large regional groundwater systems with infiltration as much as 150 km away. The apparent source of the H<sub>2</sub>S is reduction of sulfates interbedded within the Madison in the presence of basinal hydrocarbons. Sulfates have been removed by shallow meteoric groundwater in most exposed areas of the Madison, but it is still abundant within intermountain basins.

### Cueva de Villa Luz, Mexico

Of all of the well-studied sulfuric acid caves, Cueva de Villa Luz in Mexico has the most intense H<sub>2</sub>S-H<sub>2</sub>SO<sub>4</sub> activity. It is located in the semitropical jungle of southern Tabasco, in a low upland of folded and faulted Cretaceous limestone (Fig. 3). It lies several tens of kilometers south of a basinal oil field and 50 km east of the active El Chichón volcano. The cave atmosphere is highly toxic, with fluctuating H<sub>2</sub>S concentrations that at times exceed 200 ppm. (The OSHA safety standard for H<sub>2</sub>S was once 10 ppm but has recently

been decreased to 0 ppm.) Levels of carbon monoxide and carbon dioxide in the air are also dangerously high at times. Gas masks are mandatory for safe entry, although visitors often unwisely explore the near-entrance regions without protection.

The cave consists of braided stream passages that discharge to a single spring, which is the head of the surface stream Rio Azufre (“Sulfur River”). Total discharge is a rather uniform 200–300 L/s and shows little response to rainfall variation. The cave water is a sulfate-chloride-bicarbonate brine compatible with a basinal origin, presumably from the oil field to the north. Light sulfur isotopes in the H<sub>2</sub>S support this hypothesis. Water flows into the cave through approximately 26 inlets, all too small for human entry. Most are located at the upstream end of the cave, with a few about midway along the cave stream. The cave streams have moderate and rather uniform gradients, with a few scattered deep pools up to several meters deep. The ceiling rises and falls abruptly, with many skylights to the surface.

The stream inlets deliver two types of water. Some are anoxic and high in H<sub>2</sub>S, while others are oxygenated, with no detectable H<sub>2</sub>S, and have apparently encountered aerated conditions farther upstream (Table I). Otherwise the two water types are chemically rather similar. The anoxic water

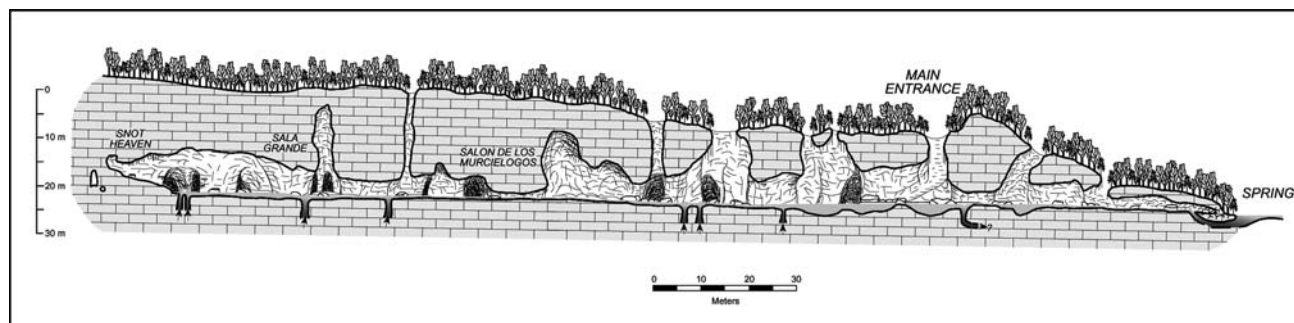


FIGURE 3 Profile of Cueva de Villa Luz. (From map by Bob Richards and Louise D. Hose.)

TABLE I Water Chemistry in Lower Kane Cave, July 1970, and Cueva de Villa Luz, January 1998<sup>a</sup>

	Lower Kane inlets	Villa Luz H <sub>2</sub> S-rich inlet	Villa Luz O <sub>2</sub> -rich inlet	Villa Luz spring
Temperature (°C)	23.5	27.5	28.3	28.0
pH	7.0	6.61	7.23	7.14
Ca (mg/L)	97	396	383	393
Mg	31	81	97	88
Na	11	484	477	—
HCO <sub>3</sub>	218	498	451	477
SO <sub>4</sub>	189	940	980	910
Cl	12.5	814	792	803
H <sub>2</sub> S (aq)	6 ± 1.5	500 ± 50	N.D. (<0.1) <sup>b</sup>	17.5 ± 3
O <sub>2</sub> (aq)	0	N.D. (<0.1) <sup>b</sup>	4.3 ± 0.7	1.3 ± 0.2
PCO <sub>2</sub> (atm)	0.0005–0.0014	0.11	0.023	0.030

<sup>a</sup> Data for Lower Kane Cave from Egemeier (1981) and for Cueva de Villa Luz from Hose *et al.* (2002).

<sup>b</sup> N.D. = not detected (below detected limit stated in parentheses).

Data for A. Palmer; see Hose *et al.*, 2002 for additional data.

releases  $\text{H}_2\text{S}$  to the cave atmosphere, and white filaments of sulfur-fixing bacteria coat the floors over which it flows. The water is roughly at equilibrium with dissolved limestone and dolomite. The oxic water precipitates iron hydroxide, which coats filaments of iron-fixing bacteria that grow on the floors of these streams. This water is slightly supersaturated with respect to limestone and dolomite, and in a few places it deposits calcite travertine. The two waters mix to produce streams that are white with colloidal sulfur and have a nearly neutral pH.

Infiltration moisture on the cave walls and ceilings absorbs  $\text{H}_2\text{S}$  and oxygen from the cave atmosphere, and the resulting sulfuric acid has produced a thick coating of crystalline gypsum over most limestone surfaces, especially in the vicinity of anoxic inlets. Sulfur accumulates on the gypsum-coated walls above sulfide-rich inlets. The gypsum and sulfur are highly depleted in  $^{34}\text{S}$  relative to  $^{32}\text{S}$ , with  $\delta^{34}\text{S}$  ranging from -26 to -22‰ CDT, showing the influence of microbial mediation. Droplets of water suspended from gypsum crystals have pH values as low as 1.5, but weathered gypsum paste that accumulates on the walls and floors can have an even lower pH, despite the tendency for reaction (3) to buffer the acid.

The cave walls are coated in many places by organic slime intermixed within the gypsum. Bacterial filaments hang from many of the gypsum surfaces, and drops that accumulate on them have an average pH of 1.4 (Fig. 4). However, the drops that linger longest before falling have measured pH values as low as zero. They can burn skin and eat holes in clothing.



**FIGURE 4** Bundles of bacterial filaments in Cueva de Villa Luz. The droplets are sulfuric acid with pH as low as zero. Height of photo is ~15 cm. (Photograph courtesy of A. N. Palmer.)

The filaments form white, gelatinous, elastic bundles. Their mucouslike texture has inspired a vivid informal name, but the terms *microbial veils* and *biofilms* are gaining favor. The bacteria form the base of a complex food chain, including midges, spiders, gastropods, and fish (*Poecilia mexicana*). In an annual spring ceremony, the local Soque Indians harvest the fish just inside the cave entrance to provide food for a traditional feast.

Although it is compelling to think of the entire cave community as based solely on the energy from sulfide oxidation, the system is complicated by an influx of organic material and light from the many openings to the surface. A more likely candidate for pure chemoautotrophy is the less diverse underground community of Movile Cave in southeastern Romania, which occupies an air-filled  $\text{H}_2\text{S}$ -rich room that is almost totally isolated from external nutrients. However, the cave has an  $\text{H}_2\text{S}$  activity far lower than that of Cueva de Villa Luz.

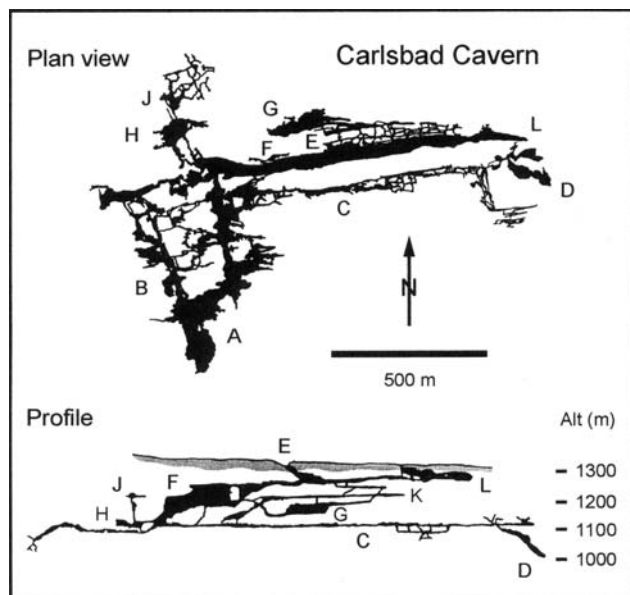
Much of the sediment on the floor of the main stream of Cueva de Villa Luz is an organic-rich muck in which sulfate reduction and iron sulfide precipitation are actively taking place. A large percentage of the sediment consists of tiny gastropod shells a few millimeters in diameter, as well as fragments of metamorphic rock.

The cave enlarges in several ways. The most vigorous enlargement is by the replacement-solution mechanism described above for the Kane Caves. It also accounts for the irregular ceiling profile. The skylights apparently originated as narrow fissures communicating with the surface and have enlarged as escaping  $\text{H}_2\text{S}$  is absorbed by moisture on their walls. Although the main streams are slightly supersaturated with both calcite and dolomite during dry periods, they are able to dissolve the bedrock during periods of high infiltration, when the dripping of  $\text{H}_2\text{SO}_4$ -rich water is most abundant. Beneath skylights, drips from the surface form cylindrical holes in the gypsum piles. Where acidic water drains through the porous gypsum of the cave walls, it forms solutional rills in the limestone near stream level, where the gypsum is absent.

### Caves of the Guadalupe Mountains, New Mexico

The Guadalupe Mountains of southeastern New Mexico contain some of the world's most spectacular caves, of which Carlsbad Cavern and Lechuguilla Cave are the largest and best known (Figs. 5 and 6). Although the caves are currently inactive, they have been the focus of extensive studies of sulfuric acid cave origin. Many of the processes recently observed in Cueva de Villa Luz were anticipated by studies of now-inactive caves in the Guadalupe.

The Guadalupe are composed of a Permian reef complex, which today rises to altitudes up to 2600 m as the result of Cretaceous and late Cenozoic uplift. The Capitan Reef, which forms the southeastern escarpment, grades northward into bedded back-reef limestones and dolomites. An



**FIGURE 5** Map and profile of Carlsbad Cavern, New Mexico. E = entrance. Other letters show correspondence between locations on map and cross section. (From map by Cave Research Foundation.)



**FIGURE 6** Western Borehole, Lechuguilla Cave, showing rind and floor accumulations of speleogenetic gypsum. (Photograph courtesy of A. N. Palmer.)

apron of fore-reef talus extends to the southeast and forms the boundary with the Delaware Basin, which consists of Permian carbonates and quartz-rich sandstones capped by sulfates and halides. Hydrocarbons are abundant at depth within the Delaware Basin and in smaller concentrations beneath the Guadalupe Mountains.

The typical Guadalupe cave has a ramifying pattern consisting of irregular rooms and mazes with passages branching outward from them (Fig. 5). The map of a typical large cave resembles an ink blot, with many overlapping tiers. Branches do not converge as tributaries, but instead serve as distributary outlets at successively lower elevations. Some

caves involve simple widening of only a few fractures. Many caves, or parts of caves, have complex network or spongelike patterns. Because of the large primary porosity in the reef, spongework is most abundant in caves in that rock unit.

Unlike most other caves described in this chapter, caves of the Guadalupe Mountains have considerable vertical relief as the result of mixing between  $H_2S$ -rich water and oxygenated water deep beneath the water table.  $H_2S$ -rich water rising from the Delaware Basin along prominent fractures and partings converged with fresh groundwater that infiltrated at higher elevations to the west and southwest. From the great relief of certain passages, it is apparent that sulfuric acid production began as much as 200 m below the contemporary water table when the caves were actively forming. Nevertheless, the greatest burst of oxidation took place at and just above the water table, producing some of the largest cave rooms in North America. The Big Room of Carlsbad Cavern is up to 80 m high and covers an area of 33,200 m<sup>2</sup>.

Large rooms have irregular outlines rimmed by dead-end galleries and blind alcoves. Some rooms and adjacent passages have nearly horizontal floors that disregard stratigraphic boundaries, indicating dissolution at former water tables. The oxygen demand in producing a large room requires plentiful air exchange with the surface. Most rooms connect to the surface via older ascending phreatic passages. In the absence of an open cave passage, air can also be exchanged in limited quantities through narrow fissures in the overlying bedrock. The ceilings of major cave rooms are typically smooth and arched, and they show evidence of gypsum replacement. Many are still lined by gypsum rinds (Fig. 6). Some rooms are floored by thick gypsum up to 10 m thick, which accumulated in pools by a combination of subaqueous precipitation and accumulation of fallen material from the ceiling. As at Cueva de Villa Luz, the  $\delta^{34}S$  of the cave gypsum is highly negative, with a mean of -16.8‰ CDT, compared to +10.3‰ for the primary gypsum and anhydrite of the Delaware Basin.

Many passages have steep gradients that connect different levels or serve as entrance galleries. Although entrances of this type give the impression that they were originally surface-water inlets, closer inspection shows that they were instead groundwater outlets while the caves were forming. The entrance passages contain no stream entrenchment, and almost no vertical shafts or coarse sediment. Instead, the passage ceilings rise in a series of smooth convex-upward arcs quite distinct from the abrupt stair-step pattern typical of vadose passages in humid climates. Local confinement of rising water by resistant beds forced some passages to follow an up-dip course. Dissolution above the water table has been limited to rills formed by dripping sulfuric acid, ceiling and wall corrosion by condensation moisture, and drip holes in gypsum blocks.

The caves also contain a wide variety of carbonate speleothems. Besides the common dripstone, flowstone, and pool deposits, there are several rare forms. Underwater

helictites, produced by the common-ion effect between dissolved calcite and gypsum, were first discovered in Lechuguilla Cave (see article on helictites for this volume). They are among the very few known in the world. Finger-like “pool fingers” and “U-loops” are calcite-coated bacterial filaments. The filaments are now fossilized, but the resulting forms are remarkably like the bundles of bacterial filaments in Cueva de Villa Luz (Fig. 4).

Other cave deposits include residual silt (insoluble residue from limestone dissolution) and clay alteration products such as alunite and hydrated halloysite (endellite). Argon dating can be applied to the potassium-bearing alunite, which is generated by sulfuric acid attack of montmorillonite. This procedure therefore gives the dates of active sulfuric acid cave enlargement. The highest caves in the Guadalupe are about 12 million years old, and the lowest caves, apparently representing the latest phase of sulfuric acid cave development, are about 4 million years old. This was the first application of this procedure to cave dating (Polyak *et al.*, 1998).

Bedrock weathering produces a corrosion residue up to several centimeters thick in places. It is most conspicuous on silty carbonates where condensation takes place from moist air currents. The weathered surface becomes brightly colored by a corrosion residue of iron and manganese oxides and altered clay minerals. The corrosion residue includes filaments of microorganisms that derive energy from the weathering reactions.

Because of the close association of major cave development with former water tables, the vertical arrangement of Guadalupe caves must be related to the erosional history of nearby rivers. One might expect major passages and rooms to correlate with pauses in base-level lowering and, therefore, to cluster at similar elevations. On the contrary, there is very little correlation between major levels of development from one cave to another, and even within different sections of the same cave.

The actual picture is more chaotic. As the water table dropped, bursts of cave enlargement occurred at those times and places where H<sub>2</sub>S happened to rise to the water table in significant quantity. Major rooms and passages were produced by episodic release of H<sub>2</sub>S from the Delaware Basin, probably during periods of uplift and faulting. When these releases coincided with periods of rather static water tables, distinct horizontal levels resulted. Under this scheme of cave enlargement, it was possible for neighboring caves to develop with virtually no correlation between passage elevations.

The largest Guadalupe caves were fed simultaneously by two or more different H<sub>2</sub>S sources. During H<sub>2</sub>S influxes, a given pathway would be active for a time, only to become inactive as the route of H<sub>2</sub>S escape shifted. Some sites were active for long times, others only briefly. Some paths were occupied repeatedly, others abandoned after a single wave of activity. Alunite dating suggests that the main episodes lasted at least 10<sup>5</sup> years.

## Caves of the Grand Canyon

Grand Canyon National Park (Arizona, USA), while not primarily a “cave park,” does contain a widespread karst system. Most of the caves in this region are located in the uppermost unit (Mooney Falls Member) of the late Mississippian Redwall Limestone. Minor cave development also occurs in the Permian Kaibab Limestone and Cambrian Muav Limestone. There are two types of caves in the canyon: (1) older paleocaves in the Redwall that drained across the Colorado Plateau before the downcutting of the Grand Canyon and (2) younger vadose caves that drained (or are still draining) to the Colorado River during or after the downcutting of the Grand Canyon. The older paleocaves contain a number of deposits that can be dated with respect to the paleo-water table. This information can then be used to help determine the age of downcutting of the Grand Canyon itself.

Various analyses relate the cave deposits to the evolution of the Grand Canyon: <sup>40</sup>Ar/<sup>39</sup>Ar dating of the minerals alunite and jarosite; U-series and U-Pb dating of cave spar, cave mammillaries, and speleothems such as stalactites and stalagmites; various types of stable isotope analyses on several kinds of cave deposits; and X-ray diffraction, electron microscopy, and multielement chemical analyses on various mineral samples.

From the results of these analyses, and from the relative sequence of deposits observed in these caves, the following sequence of events has been established for the Redwall paleocaves: (1) Mississippian Redwall Limestone/Stage 1 karst episode, which is represented by paleokarst breccias; (2) Stage 2 (Laramide?) phreatic karst and iron oxide episode represented by hematite-goethite cave deposits formed in a redox zone; (3) a calcite spar episode characterized by spar crystal linings overlying the hematite-goethite; (4) a shallow-phreatic-water table Stage 3 sulfuric acid episode characterized by solution domes, alunite, mammillaries, and replacement gypsum; and (5) a subaerial speleothem episode.

The sulfuric acid karst episode in Grand Canyon caves probably represents renewed dissolution at or near the water table in the Pliocene–Pleistocene, with the source of H<sub>2</sub>S possibly derived from hydrocarbons in the underlying Precambrian Chuar Group. In the Grandview mine, which is at the same level as the Cave of the Domes on Horseshoe Mesa, an <sup>40</sup>Ar/<sup>39</sup>Ar date of ~700,000 YBP for the mineral alunite suggests that water table cave development in that part of the canyon occurred around this time period (Fig. 7A). Mammillaries collected from Tse’an Bida Cave, Mother Cave, and Grand Canyon Caverns gave U-series dates of >600,000 YBP. One stalactite from Bat Cave, western Grand Canyon, gave a U-series date of ~460,000 YBP indicating that the level of the water table (river level) must have been somewhere below the level of Bat Cave ~0.5 Ma, and that the rate of downcutting for that part of the western Grand Canyon must have been < 0.67 mm/yr (Fig. 7B).

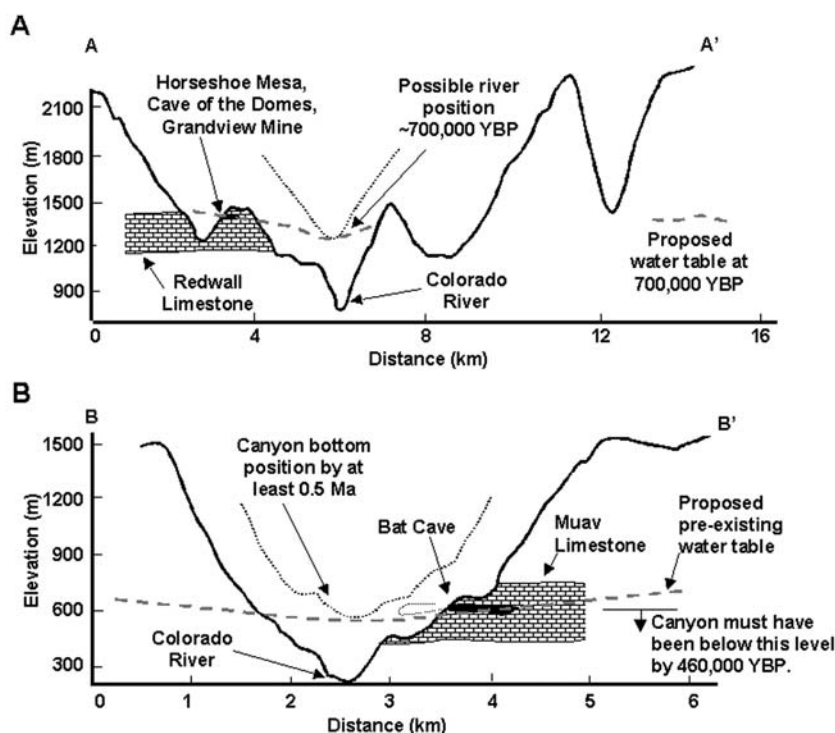


FIGURE 7 Tentative relationship of dated cave and mine deposits in the Grand Canyon to the history of downcutting of the canyon. (From Hill *et al.*, 2004).

### RELATION OF SULFURIC ACID CAVES TO MISSISSIPPI VALLEY-TYPE ORE DEPOSITS, URANIUM DEPOSITS, HYDROCARBONS, AND RESERVOIR POROSITY

Sulfuric acid caves are not only important because they represent a mode of speleogenesis recognized only recently, but also because they can be genetically related to native sulfur deposits, Mississippi Valley-type (MVT) ore deposits, uranium deposits, and to hydrocarbons and reservoir porosity. All of these deposits and features are interconnected via the generation and migration of hydrogen sulfide within and around intracratonic basins. The general model is that  $H_2S$  is generated within a basin by the reaction of hydrocarbons with evaporite (sulfate) rock according to reaction (1). The  $H_2S$  can then either stay within the basin or it can move into a carbonate margin around the basin (Hill, 1995).

Within a basin,  $H_2S$  in aqueous form (dissolved in water) can react with oxygen to form native sulfur deposits. Examples include the massive economic sulfur deposits at the Culberson sulfur mine, Delaware Basin, southeastern New Mexico and west Texas (located just south of Carlsbad Cavern). Also within a basin, porosity can be created within an  $H_2S$  system where dissolution is produced by the mixing of waters of different  $H_2S$  content or by the oxidation of  $H_2S$ . *Sulfuric acid oil field karst* refers to a specific kind of  $H_2S$ -related porosity where carbonate reservoirs of cavernous size have been dissolved by a sulfuric acid mechanism. In an  $H_2S$  system, porosity can be produced entirely in the deep subsurface and does not have to represent

a paleokarst surface of dissolution in the shallow-phreatic or vadose zone.

MVT ore deposits commonly occur in carbonate rock around the edges or margins of intracratonic basins. This is due to the migration of  $H_2S$  from hydrocarbon basins into structural and stratigraphic traps along the basin margins. As groundwater moves through these traps, metal ions such as lead, zinc, and copper precipitate readily in the  $H_2S$ -rich environment (Hill, 1995). The  $H_2S$  migration mechanism has not only been applied to the small MVT deposits around the Delaware Basin, but also to huge lead-zinc deposits such as those of the Viburnum Trend, Missouri.

Uranium is another metal that precipitates readily in the presence of  $H_2S$ . Such precipitation is typical of “roll-front” deposits where groundwater encounters and percolates through a reducing ( $H_2S$ -rich) environment, allowing uranium to precipitate preferentially at the redox interface. In the case of the Grand Canyon, it is possible not only that the isotopically light cave gypsum was ultimately derived from hydrocarbons in the subsurface, but also that  $H_2S$  from hydrocarbons was the source of reduced sulfur for the copper and uranium mineralization in the mines of the Grand Canyon. Some of the highest grade uranium deposits in North America are located in the breccia pipes of the Grand Canyon, and these breccia pipes (and also the paleokarst breccia described earlier) may have acted as stratigraphic and structural traps for the  $H_2S$ .

Sulfuric acid caves are an integral part of this “intra-cratonic basin” model of  $H_2S$  generation and migration. Where  $H_2S$  migrates from a basin into carbonate rock

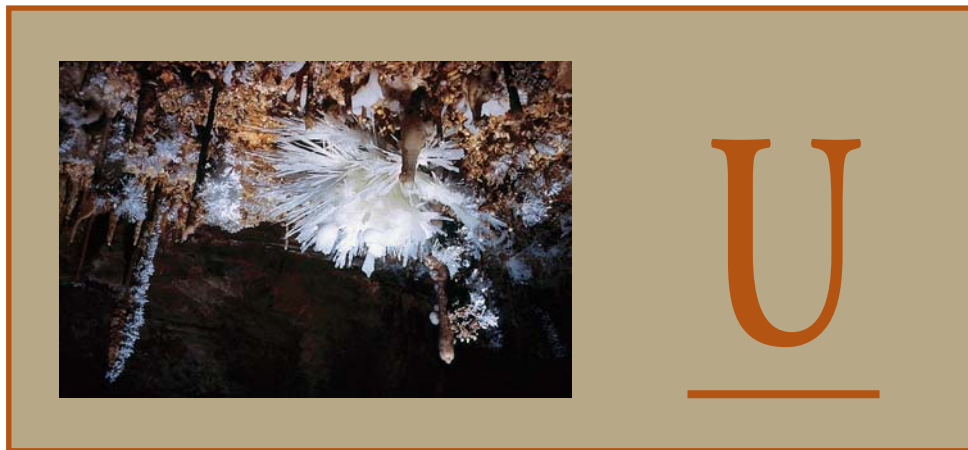
surrounding the basin, and where this H<sub>2</sub>S encounters oxygenated groundwater, then sulfuric acid forms via reactions (2) and (3), and cave dissolution occurs via reactions (4) and (5). As a by-product of these reactions, gypsum and native sulfur form within these caves, hydrated halloysite (endellite) and alunite are produced under low-pH sulfuric acid solutions, and the uranium-vanadium minerals tyuyamunite and metatyuyamunite precipitate in an H<sub>2</sub>S-rich environment.

## CONCLUSIONS

The role of sulfuric acid in cave origin, which was virtually unrecognized only a few decades ago, is now recognized as one of the most significant cave-forming processes. It also provides a view of deep-seated processes that integrates cave studies with other fields, such as petroleum geology, economic geology and microbiology.

## Bibliography

- DuChene, H. R., and C. A. Hill, eds. (2000). The caves of the Guadalupe Mountains. *J. Cave Karst Studies* **62**(2), 51–158.
- Egemeier, S. J. (1981). Cavern development by thermal waters. *Natl. Speleological Soc. Bull.* **43**, 31–51.
- Hill, C. A. (1987). *Geology of Carlsbad Cavern and Other Caves in the Guadalupe Mountains, New Mexico and Texas*, Bulletin 117. New Mexico Bureau of Mines and Mineral Resources, Socorro, NM, p. 150.
- Hill, C. A. (1995). Sulfur redox reactions: Hydrocarbons, native sulfur, Mississippi Valley-type deposits and sulfuric acid karst in the Delaware Basin, New Mexico and Texas. *Environ. Geol.* **25**, 16–23.
- Hill, C. A., V. J. Polyak, W. C. McIntosh, and P. P. Provencio (2004). Preliminary evidence from Grand Canyon caves and mines for the evolution of the Grand Canyon and Colorado River System. In *The Colorado River: Origin and Evolution* (R. A. Young and E. E. Spamer, eds.), Monograph 12. Grand Canyon Association, Grand Canyon, AZ, pp. 141–145.
- Hose, L. D., A. N. Palmer, M. V. Palmer, D. E. Northup, P. J. Boston, and H. R. DuChene (2000). Microbiology and geochemistry in a hydrogen-sulphide-rich karst environment. *Chem. Geol.* **169**, 399–423.
- Northup, D. E., C. N. Dahm, L. A. Melim, M. N. Spilde, L. J. Crossey, K. H. Lavoie, L. M. Mallory, P. J. Boston, K. I. Cunningham, and S. M. Barns (2000). Evidence for geomicrobiological interactions in Guadalupe caves. *J. Cave Karst Studies* **62**(2), 30–40.
- Palmer, A. N., and M. V. Palmer (2000). Hydrochemical interpretation of cave patterns in the Guadalupe Mountains, New Mexico. *J. Cave Karst Studies* **62**(2), 91–108.
- Polyak, V. J., and P. Provencio (2001). By-product materials related to H<sub>2</sub>S-H<sub>2</sub>SO<sub>4</sub> influenced speleogenesis of Carlsbad, Lechuguilla, and other caves of the Guadalupe Mountains, New Mexico. *J. Cave Karst Studies* **63**(1), 23–32.
- Polyak, V. J., W. C. McIntosh, N. Güven, and P. Provencio (1998). Age and origin of Carlsbad Cavern and related caves from <sup>40</sup>Ar/<sup>39</sup>Ar of alunite. *Science* **279**, 1919–1922.



## Ukrainian Giant Gypsum Caves

Alexander Klimchouk

National Academy of Science, Ukraine

The extensive gypsum karst in the Western Ukraine is renowned for its giant maze caves. It is internationally important as a model example of artesian speleogenesis. The region contains the five longest gypsum caves in the world, accounting for well over half of the total known length of gypsum caves on the earth. The host gypsum bed, ranging from few meters to more than 40 m in thickness, is the main component of the Miocene evaporite formation that girdles the Carpathians to the northeast, from the Nida river basin in Poland across the Western Ukraine and Moldova to the Tazleu river basin in Romania. The gypsum occurs on the southwestern edge of the Eastern European platform, where it extends along the Carpathian Foredeep for over 300 km in a belt ranging from several kilometers to 40–80 km wide (Fig. 1). It occupies more than 20 000 km<sup>2</sup>, together with some separated areas that occur to the northeast of the unbroken belt.

Most Miocene rocks along the platform margin rest on the eroded terrigenous and carbonate Cretaceous sediments. The Miocene succession comprises deposits of Badenian (Tortonian) and Sarmatian age. The Lower Badenian unit, beneath the gypsum, includes mainly carbonaceous, argillaceous, and sandy beds (30–90 m thick) adjacent to the foredeep, and these grade into rocks of calcareous biohermal and sandy facies (10–30 m thick) toward the platform interior. The Miocene gypsum bed is variable in structure and texture. Most commonly it grades from microcrystalline massive gypsum in the lower part through to variably grained

bedded gypsum in the middle, to giant crystalline rock in the upper horizon. A layer of evaporitic and epigenetic limestone, locally called *Ratynsky*, commonly overlies the gypsum. This layer ranges from half a meter to more than 25 m in thickness. The gypsum and the *Ratynsky* limestone comprise the Tyrassky Formation, which is overlain by the Upper Badenian unit, represented either by argillaceous and marly limestones and sandstone or, adjacent to the foredeep, by marls and clays of the Kosovsky Formation. The total thickness of the capping marls and clays ranges from 40 to 60 m in the platform interior to 80 to 100 m or more in the

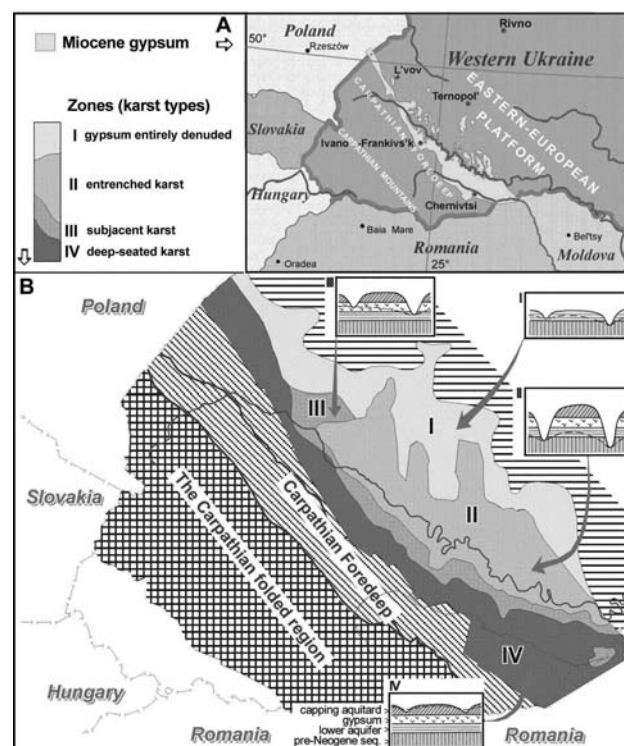


FIGURE 1 Location of the gypsum karst of the Western Ukraine.



areas adjacent to the regional faults that separate the platform edge from the foredeep.

The present distribution of Miocene formations and the levels of their denudation exposure vary in a regular manner from the platform interior toward the foredeep. The Tyrassky Formation dips 1–3° toward the foredeep and is disrupted by block faults in the transition zone. To the south and southwest of the major Dniester Valley, large tectonic blocks drop down as a series of steps, the thickness of the clay overburden increases, and the depth of erosional entrenchment decreases. Along the tectonic boundary with the foredeep the Tyrassky Formation drops to a depth of 1000 m or more. This variation—the result of differential neotectonic movement—played an important role in the hydrogeological evolution of the Miocene aquifer system and resulted in the differentiation of the platform edge into four zones (Fig. 1B). The gypsum was entirely removed by denudation within the first zone, but the other three zones represent distinct types of karst: entrenched, subjacent, and deep seated. The gypsum bed is largely drained in the entrenched karst zone, is partly inundated in the subjacent karst zone, and remains under artesian confinement in the deep-seated karst zone.

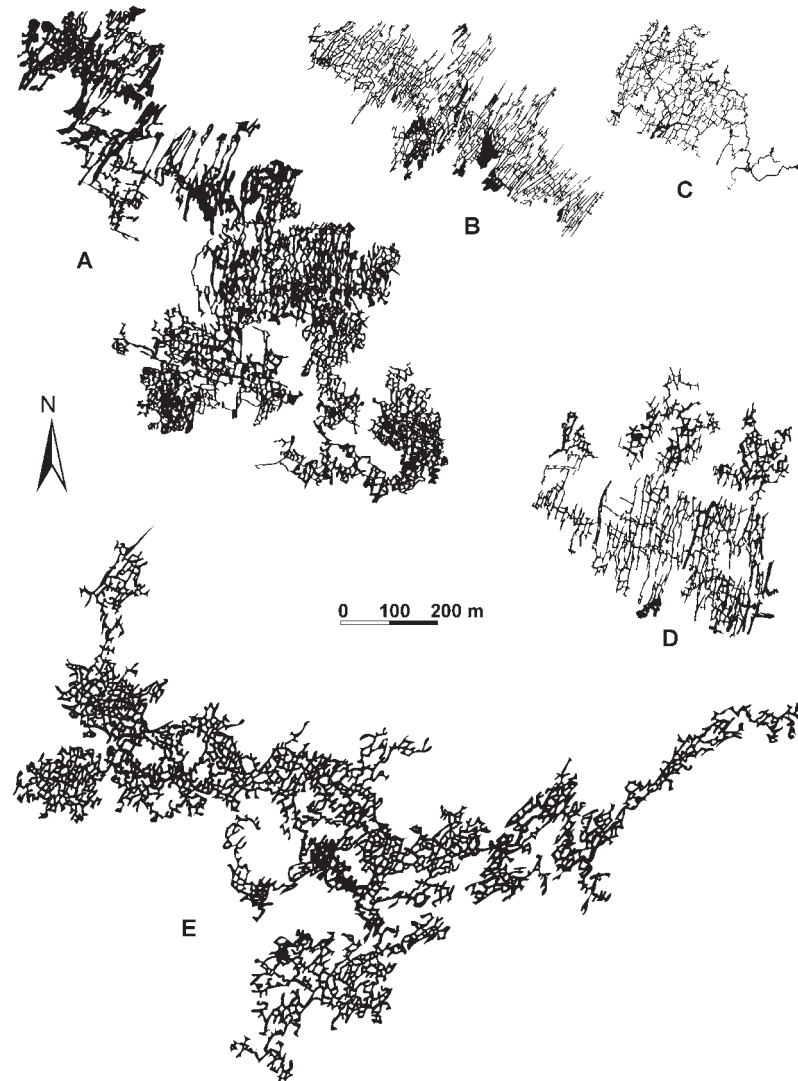
In hydrogeological terms the region represents the southwestern portion of the Volyno-Podolsky artesian basin. The Sarmatian and Kosovskey clays and marls serve as an upper confining sequence. The lower part of the Kosovskey Formation and the limestone bed of the Tyrassky Formation form the original upper aquifer (above the gypsum), and the Lower Badenian sandy carbonate beds, in places together with Cretaceous sediments, form the lower aquifer (below the gypsum), the latter being the major regional one. The hydrogeologic role of the gypsum unit has changed with time, from initially being an aquiclude, intervening between two aquifers, to a karstified aquifer with well-developed conduit permeability. The regional flow is from the platform

interior, where confining clays and the gypsum are largely denuded, toward the large and deep Dniester Valley and the Carpathian foredeep. In the northwest section of the gypsum belt, the confined conditions prevail across its entire width. In its wide southeast section the deeply incised valleys of Dniester and its left-hand tributaries divide the Miocene sequence into a number of isolated, deeply drained interfluvial valleys capped with the clays (Podol'sky area). This is the entrenched karst zone where most of the explored, presently relict, maze caves are located. To the south-southeast of the Dniester (Bukovinsky area) the gypsum remains largely intact and is partly inundated (the subjacent karst zone). Further in this direction, as the depth of the gypsum below the clays increases and entrenchment decreases, the Miocene aquifer system becomes confined (the deep-seated karst zone). In this zone the groundwater flow pattern includes a lateral component in the lower aquifer (and in the upper aquifer, but to a lesser extent) and an upward component through the gypsum in areas of potentiometric lows, where extensive cave systems develop, as evidenced by numerous data from exploratory drilling.

Fourteen large caves over 1 km in length are known in the region (Table I). Most of these caves are located north of the Dniester River. Two other large caves, Zoloushka and Bukovinka, occur in the Bukovinsky region, near the Prut River and the border with Moldova and Romania, generally in the area of artesian flow within the Miocene aquifer system but within local, particularly uplifted blocks, where entrenchment into the upper part of the gypsum caused unconfined (water table) conditions to be established in the Holocene. Most of the caves have only one entrance, either through swallow holes at the interfluvial valleys or from gypsum outcrops in the slopes of the major valleys. Some caves and their entrance series have been known to local people since long ago (e.g., Ozerna, Kristal'na, Mlynki, Vertebe), but others

**TABLE I Morphometric Parameters of Large Gypsum Caves of the Western Ukraine**

No.	Cave	Length (km)	Average cross-sectional area (m <sup>2</sup> )	Density of passages (km · km <sup>-2</sup> )	Areal coverage (%)	Cave porosity (%)
1	Optimistychna	223.0	2.8	147	17.6	2.0
2	Ozerna	117.0	6.0	150	44.6	5.0
3	Zoloushka	92.0	8.0	142	48.4	3.8
4	Mlynki	27.0	3.3	141	37.6	3.4
5	Kristal'na	22.0	5.0	169	29.2	6.0
6	Slavka	9.1	3.7	139	27.6	3.4
7	Verteba	7.8	6.0	118	34.7	12.0
8	Atlantida	2.52	4.5	168	30.0	4.0
9	Bukovinka	2.4	2.5	120	21.5	4.4
10	Ugryn	2.12	3.8	177	33.3	5.7
11	Gostry Govdy	2.0	1.7	270	17.5	4.0
12	Jubilejna	1.5	2.3	278	37.0	4.0
13	Komsomol'ska	1.24	2.1	177	24.3	3.0
14	Dzhurinska	1.13	2.4	126	17.8	2.0



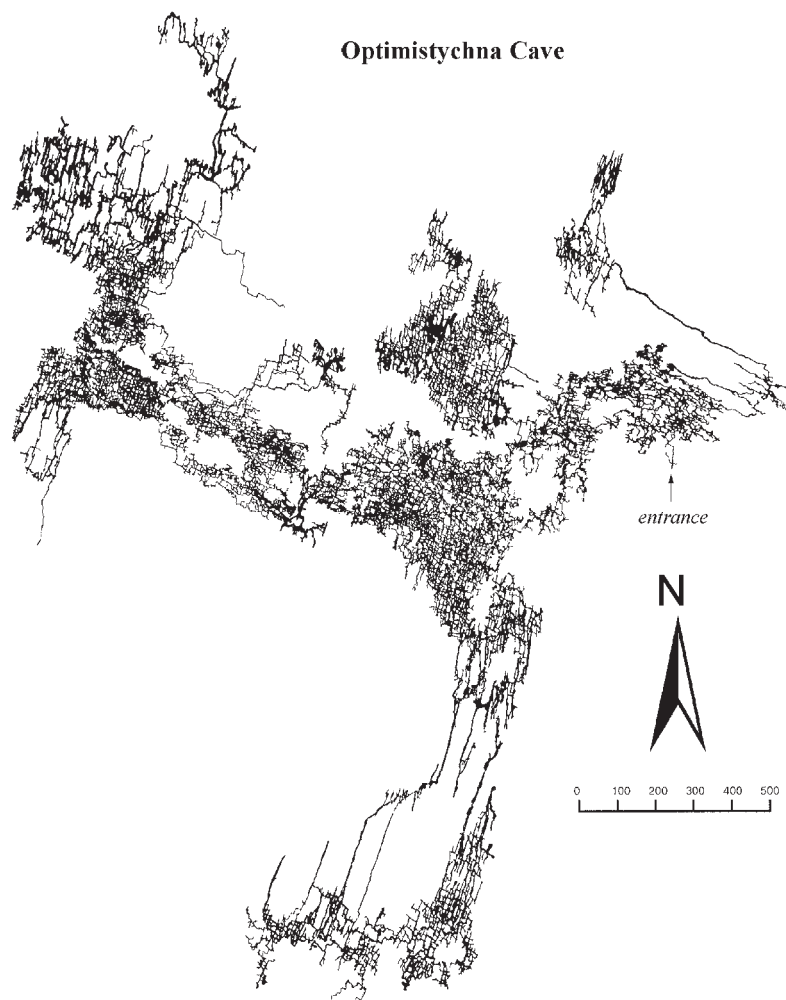
**FIGURE 2** Maps of some of the main maze caves in the gypsum of the Western Ukraine: A = Ozerna Cave, B = Kristal'na Cave, C = Slavka Cave, D = Mlynki Cave, E = Zoloushka Cave. (Courtesy of the speleological clubs of Ternopil, Chernivtsy, and Kiev.)

were discovered by cavers via digs (e.g., Optimistychna, Slavka, Atlantida). Two caves (Zoloushka and Bukovinka) became accessible when opened as a result of excavation at gypsum quarries. Systematic cave exploration and mapping in the region began in the 1960s.

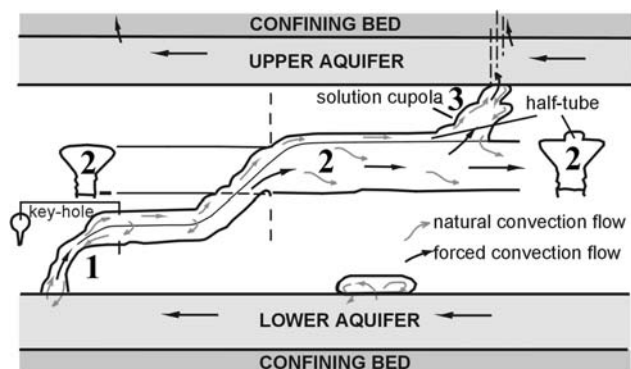
All of the large gypsum caves in the region are mazes developed along vertical and steeply inclined fissures arranged into multistory, laterally extensive networks. Aggregating passages form lateral two- to four-story systems that extend over areas of up to 1.5 km<sup>2</sup> (Fig. 2). A notable feature of the mazes is the exceptionally high passage network density, which is characterized conveniently by using the ratio of a cave length to an area occupied by a cave system. This parameter varies from 118 (Verteba Cave) to 270 (Gostry Eovdy Cave) km · km<sup>-2</sup>, with the average value for the region being 164 km · km<sup>-2</sup>. Values of areal coverage and cave porosity (fractions of the total area and volume of the rock within a cave field, occupied by passages) vary for individual

caves from 17.5 to 48.4% (average 29.5%) and from 2 to 12% (average 4.5%) respectively, being roughly an order of magnitude greater than these characteristics for typical unconfined caves. Optimistychna Cave (Optimisticheskaya in Russian spelling) is the longest gypsum cave, and the second longest cave of any type known in the world, with more than 223 km of passages surveyed (Fig. 3). By area and volume the largest caves are Ozernaja (330,000 m<sup>2</sup> and 665,000 m<sup>3</sup>) and Zoloushka (305,000 m<sup>2</sup> and 712,000 m<sup>3</sup>), followed by Optimistychna Cave (260,000 m<sup>2</sup> and 520,000 m<sup>3</sup>).

Maze caves in the region were developed under confined conditions, due to upward transverse groundwater circulation between aquifers below and above the gypsum beds. According to the morphology, arrangement, and hydrologic function of the cave mesoforms during the main (artesian) speleogenetic stage, three major components can be distinguished in the cave systems (Fig. 4):



**FIGURE 3** Map of the Optimistychna Cave, the largest gypsum cave in the world. (Courtesy of the speleological club of Lviv.)



**FIGURE 4** Main morphogenetic features of maze cave systems in the Western Ukraine shown according to their hydrologic functionality. 1 = feeding channels, 2 = master passages, 3 = outlet features.

1. *Feeding channels.* These are the lowermost components in a system: vertical or subvertical conduits through which water rises from the subgypsum aquifer to the master passage networks. Such conduits are commonly separate but sometimes

they form small networks at the lowermost part of the gypsum. The feeding channels join master passages located at the next upper level and scatter uniformly through their networks.

2. *Master passages.* These are horizontal passages that form laterally extensive networks within certain horizons in the middle part of the gypsum bed. They receive dispersed recharge from numerous feeding channels and conduct flow laterally to the nearest outlet feature.
3. *Outlet features.* These include domes, cupolas, and vertical channels (dome pits) that rise from the ceiling of the master passages to the bottom of the overlying bed. They discharge water from cave systems to the overlying aquifer.

The predominant sediments in the maze caves of the region are successions of fine clays, with minor beds of silty clays. These fill passages to a variable extent and can reach 5–7 m in thickness. Breakdown deposits are also common. They include chip, slab, and block breakdown material from

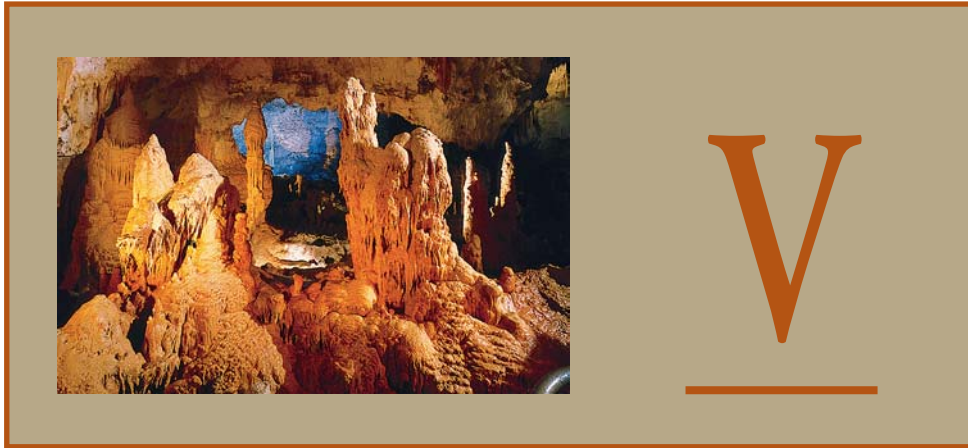
the gypsum, as well as more massive breakdown from the overlying formations. Calcite speleothems (stalactites, stalagmites, flowstones, and helictites) occur locally in zones of vertical water percolation from overlying formations. Gypsum crystals of different habits and sizes are the most common cave decorations. They are of largely subaerial origin. Hydroxides of Fe and Mn occur as powdery layers within the clay fill of many caves, indicating repeated transitional cycles from a reducing to an oxidizing geochemical environment. Massive deposition of Fe/Mn compounds in the form of powdery masses, coatings, stalactites, and stalagmites has occurred in Zoloushka Cave, where a rapid dewatering caused by groundwater abstraction during the last 50 years gave rise to a number of transitional geochemical processes, some of which appear to show considerable microbial involvement.

The Western Ukrainian maze caves provide the most outstanding and unambiguous evidence for the transverse artesian speleogenetic model. The artesian speleogenesis in the Podol'sky region took place mainly during the late Pliocene through to the middle Pleistocene. It was induced by incision of the Dniester Valley and its left-hand tributaries

into the confining clays, and respective activation of the upward transverse groundwater flow within the underlying artesian system. Breaching of artesian confinement and further incision of the valleys during the middle Pleistocene caused substantial acceleration of groundwater circulation within the Miocene artesian system. The majority of passage growth probably occurred during this transitional period. Where the water table was established in the gypsum for a prolonged time, further widening of passages occurred due to horizontal notching at the water table. Eventually, with the water table dropping below the lower gypsum contact, cave systems in the entrenched karst zone became largely relict. Cave development under confined or semiconfined conditions continues today within the zones of deep-seated and subjacent karst.

#### **Bibliography**

- Klimchouk, A., D. Lowe, A. Cooper, and U. Sauro, eds. (1996). Gypsum karst of the world. *Int. J. Speleology* 25(3–4) (special issue).
- Klimchouk, A. B., D. C. Ford, A. N. Palmer, and W. Dreybrodt, eds. (2000). *Speleogenesis: Evolution of Karst Aquifers*. National Speleological Society, Huntsville, AL.



## Vertebrate Visitors—Birds and Mammals

Nikola Tvrtković

Croatian Natural History Museum, Croatia

### CAVE-DWELLING SPECIES

There are no troglobites, permanent inhabitants of caves, in the group of warm-blooded animals. Most birds and mammals documented in connection with caves are random guests, although some species are not accidental visitors. They prefer to stay in the cave for a shorter or longer period of time and have adapted in some way to cave habitats, such as in the case of mammals that have developed special pads for climbing, long vibrissae, partial heterothermy, and certain types of echolocation. Like troglobites, these types of cave visitors are referred to as *cave-dwelling animals* or *cavernicola* (Vandel, 1965), with different levels of troglophilia. Most of them originate from the scansorial type of animal, especially from rock-dwellers (*petricola*). According to the official ecological classification of *cavernicola* adopted from the first scheme of Schiner-Racovitza, cavernicolous birds and mammals are habitual troglonexes after the Hazelton and Glennie system (Ford and Cullingford, 1976), or trogliphiles (*eutrogliphiles* and only partly *subtrogliphiles*) after the Pavani system (Vandel, 1965)—*cavernicola* by choice, not by chance.

In the first group of cavernicolous birds and mammals are facultative visitors only: They roost or feed in caves, but they are also common in different surface habitats. Facultative cave visitors by choice are the pack rat (*Neotoma* spp.) in America, the edible dormouse (*Myoxus glis*) in Europe, the Egyptian fruit bat (*Rousettus aegyptiacus*) in North Africa and

western Asia, and the bird *Origma* (*Origma* spp.) in Australia. Their nests or roost sites have been found many hundreds of meters from the entrances, but they are common in other habitats too, such as in tree holes or shallow depressions in cliffs.

The second group are regional *cavernicola*—they are permanent cave-dwellers only in some parts of their range. The cave swallow (*Hirundo*=*Petrochelidon/fulva*) is the first example: It breeds in caves in southern parts of its range, in the border area between the United States and Mexico and in Cuba. The monk seal (*Monachus monachus*) rears its young on beaches along the North African coast, but most of their breeding sites along the northern Mediterranean coast were (before extinction) in the sea caves. Two types of choughs (*Pyrrhocorax graculus* and *P. pyrrhocorax*) are high mountain birds of Euroasia nesting in crevices in cliffs, but in the Mediterranean karst they nest only in deep cold potholes (pits). The Geoffroy bat (*Myotis emarginatus*), as a primarily Mediterranean species, has large nursery colonies in sea caves or hot caves together with the greater horseshoe bat (*Rhinolophus ferrumequinum*). In Central Europe both species are spread in the nonkarst areas. Their small roost colonies can be found in attics, and they migrate in fall to karst areas with their traditional hibernacula.

The last group are regular *cavernicola*. According to Brosset (1998) and some other sources, the birds among these regular cave visitors include the guacharo or oilbird (*Steatornis caripensis*) in Central and South America, the Guinean cock of the rock (*Rupicola rupicola*) in South America, the waterfall swift (*Hydrochous gigas*) in Southeast Asia, the swiftlets (*Aerodramus* spp. and *Collocalia* spp.) in Southeast Asia and the neighboring islands from the Seychelles to West Oceania, and two rockfowls from central Africa (*Picathartes oreas* and *P. gymnocephalus*). Regular cave visitors in mammals include the Dinaric vole (*Dinaromys bogdanovi*), restricted only to the karst area of the western Balkans (Petrov and Todorović, 1982), and the dawn bat

(*Eonycteris spelea*) from the group of fruit bats of Southeast Asia. The largest group of regular cavernicola are microchiropteran bats restricted to caves, like the gray bat (*Myotis grisescens*) in North America, the long-fingered bat (*Myotis capaccinii*) from Mediterranean karst habitats with waters, and Schreiber's bat (*Miniopterus schreibersi*) from Europe, North Africa, Asia, and Australia.

### CAVES AS SHELTER

Caves offer a wide spectrum of microhabitats (Ginet and Decou, 1977), because they are always a suitable shelter from rain, sun, and wind and from most predators. Darkness and a stable temperature, humidity, and airflow regime are important characteristics for resting, mating, nesting, and wintering. Caves provide daytime shelter for owls, hyraxes, wild boars, peccaries, porcupines, and various species of rock-dwelling rodents, or nighttime shelter suitable for digesting food in the case of owls and bats. Most bats mate in cave wintering places before and after hibernation. Schreiber's bat forms small harems in different parts of caves in August and September. Males of the lesser mouse-eared bat (*Myotis blythii*) in Europe and Asia position themselves on the ceiling and walls of caves from spring to fall in isolated solitary places marked with urine, waiting for females. Most cave birds breed colonially. It has been documented that the nests of some rodents like the edible dormouse have been found deep in the caves (Polak, 1997).

Hot chambers in caves with temperatures greater than 25°C and high humidity are the summer home for nursery colonies of a great number of bats. The world's largest extant nursing bat colony is that of the guano bat (*Tadarida brasiliensis*) in Bracken Cave in Texas with about 20 million specimens (Hutson *et al.*, 2001). In the temperate region or in the upper extremes of the subtropical regions, caves are suitable wintering places for many bats. They hibernate alone or in colonies. Schreiber's bat forms thick clusters in several layers, with an average of 2000 specimens per square meter of roof surface. The lesser mouse-eared bat prefers sites at only 2–3°C, and the gray bat prefers sites with temperatures between 10 and 15°C. The long-fingered bat forms wintering clusters only above cave waters.

### CAVES AS FORAGING HABITATS

Owls like the barn owl (*Tyto alba*) and mammals like the ringtail (*Bassariscus astutus*), the red fox (*Vulpes vulpes*), the coyote (*Canis latrans*), the badger (*Meles meles*), and the striped skunk (*Mephitis mephitis*) visit temperate caves too, but mostly for eating young bats or birds that fall to the floor of the roosting site, or to eat bats during their hibernation (Juberthie *et al.*, 1998). Throughout the year predators in tropical caves include carnivores such as *Herpestes*, *Viverra*, and *Felis*, and shrews such as *Crocidura malayana* and *C. cinerea*. *Desmodus rotundus* and other vampire bats are a

special case of bat predacy preying on other bats in some South American caves. The most dangerous cave predator of swiftlets and bats is man (*Homo sapiens*). Native hunters from Papua New Guinea collect fruit bats in caves for food, and modern hunters in Asia collect nests made of swiftlets' saliva to make a special soup.

### GAPS IN KNOWLEDGE

Lists of cave-dwelling birds and mammals are incomplete. Most of the data have been documented accidentally and we have not yet had the ability to compare the numbers of cave-dwelling species in different karst regions of the world. The ecology and behavior of cavernicolous birds and mammals are also poorly known. Some species have been documented with only one specimen, like the shrew *Soriculus salenskii* in Sichuan (China) inside a cave with water (Kengay and Zheng, 2002), or the fruit bat *Aproteles bulmerae* from only one cave in Western Papua (Nowak, 1991). From more than 20 species of the Asian genus *Aerodrama*, until now echolocation is known of in only three species (del Hoyo *et al.*, 1999). How successful is the first flight of nestlings of the Alpine chough from a 70-m-deep nest site in the darkness of a pothole? Many similar questions about cavernicolous birds and mammals are even today without answers.

### IMPACT OF BIRDS AND MAMMALS ON CAVE ECOLOGY

Birds and mammals have an important impact on cave ecology. Juberthie *et al.* (1998) noted that the feces of porcupines in two caves in Africa are an important food for endemic stygobitic isopods. The input of the droppings of birds and bats is sometimes extremely high. Invertebrate guano fauna is formed in guano piles, an important food resource for cave-dwelling invertebrate predators. Rodents like the Dinaric vole take green plants and seeds inside caves for storage, whereas rodents and birds build subterranean nests of plant particles. The remains and carcasses of cave visitors are an energy source for troglobites, although in tropical caves an abundance of food input attracts more surface competitors (Mohr and Poulson, 1966). In cases of colonial breeding in relatively small cave chambers, bats have changed habitat factors like temperature and humidity. In extreme situations, millions of specimens of decomposing guano produce a high concentration of ammonia and/or carbon dioxide, which is dangerous for man (Hill and Smith, 1984).

### MAN AND CAVERNICOLOUS BIRDS AND MAMMALS

In the past, ancient man and his relatives had to compete hard for caves with big carnivores like the cave bear *Ursus spelaeus*. In time, *Homo sapiens* created artificial caves: houses,

mines, and other human-made shelters, which are suitable habitats for some cave birds and mammals. Tin roofs provide a microclimate that is very similar to that of hot caves, which proves to be a good place for nursery colonies of bats or the rock dove (*Columba livia*). There has, therefore, been a co-evolution of man and sinanthropic formerly cave-dwelling species.

Some cave-dwelling birds and mammals are of direct economic importance (Nowak, 1994). Local people in Southeast Asia collect bats for food. Swiftlet nests, mostly of the black-nest swiftlets (*Aerodrama maximus*) and the edible-nest swiftlets (*A. fucifugus*), are high-priced export goods to some Southeast Asia countries. Cave guano harvesting was important in the past for the gunpowder industry (Hutson *et al.*, 2001), while today it is an important source of nitrates for the fertilizer industry. Cave-dwelling birds and bats are consumers of pest insects or insect vectors of different diseases. The role of cave bats as pollinators of some fruits and their role in tree seed dispersion in subtropical areas are important. On the other hand, in some cases, cave bats are problematic for public health as potential vectors of rabies. In South America vampire bats are vectors of some zoonoses. Dry caves with guano piles are dangerous places because they can act as reservoirs of different kind of histoplasmosis. Fruit bats are pests in orchards.

The tendency of some species of birds and bats to aggregate in large numbers only in caves makes them very vulnerable. Some species are restricted to a few caves only. For example, 75% of the whole population of the gray bat in the United States lives in only three caves. There is a long list of threats in caves for cave-dwelling birds and mammals today. In combination with threats outside the caves, formerly high regional populations of bats are in drastic decline. In Eagle Creek Cave in Arizona, the population has declined from more than 25 millions guano bats in 1963 to 30,000 in 1969. Some formerly large colonies of this species in Mexico are now extinct. On the IUCN Red Data List of Threatened Animals there are 11 species of cave birds (Stattersfield and Capper, 2000) and many more cave bats, which make up the vast majority of the 370 threatened species of bats altogether (Hutson *et al.*, 2001).

### See Also the Following Articles

Bats • Paleontology of Caves: Pleistocene Mammals

### Bibliography

- Brosset, A. (1998). *Aves*. In *Encyclopaedia Biospeologica*, Vol. II (C. Juberthie and V. Decu, eds.), pp. 1249–1256. Société de Biospéologie, Moulis, France (in French).
- del Hoyo, J. E., A. Elliot, and J. Sargatal (1999). *Handbook of the Birds of the World*, Vol. 5, *Barn-Owls to Hummingbirds*. Lynx Edicions, Barcelona.
- Ford, T. D., and C. H. D. Cullingford (1976). *The Science of Speleology*. Academic Press, London.
- Ginet, R., and V. Decou (1977). *Initiation a la Biologie et a L'écologie Souterraines*. Jean-Piere Delarge, Paris (in French).
- Hill, J. E., and J. D. Smith (1984). *Bats, a Natural History*. British Museum of Natural History, London.

- Hutson, A. M., S. P. Mickleburgh, and P. A. Racey (Comp.). (2001). *Microchiropteran Bats: Global Status Survey and Conservation Action Plan*. IUCN/SSC Chiroptera Specialist Group, IUCN, Gland, Switzerland.
- Juberthie, C., V. Decu, and C. Radulescu (1998). *Mammalia (Marsupialia, Insectivora, Artiodactyla, Rodentia et Fissipedia)*. In *Encyclopaedia Biospeologica*, Vol. II (C. Juberthie and V. Decu, eds), pp. 1257–1261. Societe de Biospeologie, Moulis, France.
- Kengay, J., and X. Zheng (2002). *Mammals of Sichuan*. Burke Museum, University of Washington, Seattle.
- Mohr, C. E., and T. L. Poulson (1969). *The Life of the Cave*. McGraw-Hill, New York.
- Nowak, R. (1994). *Walker's Bats of the World*. The Johns Hopkins University Press, Baltimore, MD.
- Petrov, B., and M. Todorović (1982). *Dinaromys bogdanovi* (V. et E. Martino, 1922)—*Bergmaus*. In *Handbuch der Säugetiere Europas*, Band 2/I, Nagetiere II (J. Niethammer and F. Krapp, eds.), pp. 193–208. Akademische Verlagsgesellschaft, Wiesbaden (in German).
- Polak, S. (1997). The use of caves by the edible dormouse (*Myoxus glis*) in the Slovenian karst. *Natura Croatica* 6(3), 313–321.
- Stattersfield, A. J., and D. R. Capper (2000). *Threatened Birds of the World*. Lynx Edicions and Bird Life International, Barcelona and Cambridge, UK.
- Vandel, A. (1965). *Biospeology, the Biology of Cavernicolous Animals*. Pergamon Press, Oxford (English translation of volume published 1964).

## Vicariance and Dispersalist Biogeography

John R. Holsinger  
Old Dominion University

### OVERVIEW OF BIOGEOGRAPHY

Biogeography is a subdiscipline of biological systematics briefly defined as the science that documents and attempts to explain the geographic distribution of organisms. Two conceptually different approaches have developed over the years. They include historical or large-scale biogeography and ecological or small-scale biogeography. *Historical biogeography* is the oldest and most commonly practiced approach and explains distributional patterns of organisms on the basis of their dispersal and/or vicariance over evolutionary time. It is essentially large scale, inasmuch as it examines the distribution of biotas from a regional, continental, or global perspective. In comparison, *ecological biogeography*, sometime called *deterministic biogeography*, explains distribution patterns on the basis of relatively short-term, ecological effects. It is generally regarded as small-scale biogeography because it focuses on the effects of environmental differences that have developed over ecological time. An example of the latter would be the Case and Cody (1987) application of island biogeography theory to explain distributional patterns on islands in the Sea of Cortez in Mexico.

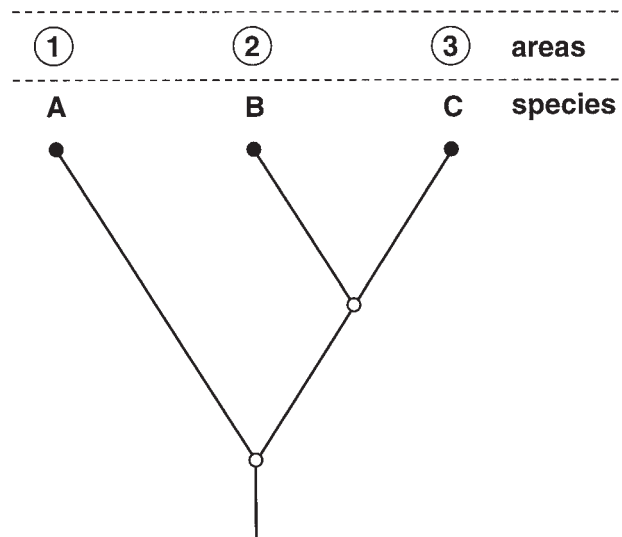
Historical biogeography had its beginnings in Europe in the 18th century, with the early, largely botanical, works of Linnaeus, Buffon, Forster, Humboldt, and Candolle (Brown and Lomolino, 1998). Modern historical biogeography began in the following century and owes many of its basic principles to Alfred Russel Wallace, a colleague of Charles Darwin, who is often called the “father of biogeography.”

As a science, historical biogeography is very different now than it was in the 1800s or, for that matter, in the first six or seven decades of the 20th century. Significant changes came in the 1960s and 1970s with wide acceptance of the theory of plate tectonics and continental drift, coupled with the rapidly developing popularity of phylogenetic analysis or cladistics. With subsequent application of these exciting new theories and concepts to the interpretation of distribution patterns, historical biogeography has become more focused and analytical. Some workers now refer to it as *cladistic biogeography* (Humphries and Parenti, 1999). Prior to the 1960s, biogeographic discussions consisted largely of lengthy narratives and scenarios, sometimes highly subjective, to explain distribution patterns in terms of centers of origin and outward dispersal. Dispersalist models identified centers of origin and then speculated on the subsequent peripheral movement of organisms across potential dispersal barriers, such as over imaginary land bridges. In retrospect, many of these barriers appear to have been insurmountable.

The application of cladistics to biogeography has placed significant emphasis on construction of biological-area cladograms, combined with subsequent examination of relationships between terminal taxa and areas of endemism (Fig. 1). In these analyses, congruence between area cladograms of different monophyletic taxa suggests that these organisms share a common evolutionary history. This procedure has led ultimately to the acceptance of vicariance as an alternative hypothesis to explain heretofore many otherwise inexplicable distribution patterns. However, this is not to say that dispersalist models have diminished in importance. On the contrary dispersal is still considered very important in explaining distributions. But in recent studies, centers of origin are rarely evoked, and dispersal often provides an alternative hypothesis rather than the sole explanation for a given pattern of distribution (see Wiley, 1988). Another analytical method called *panbiogeography* (Craw *et al.*, 1999), which places greater emphasis on congruent distribution tracks (i. e., generalized tracts) than area cladograms, is also gaining popularity as an analytical methodology. When used in combination with phylogenetics, panbiogeography has proven effective for explaining distribution patterns of subterranean animals (Christiansen and Culver, 1987).

### BIOGEOGRAPHY OF CAVE ANIMALS

To date, between 10,000 and 15,000 species of animals have been described from caves and similar subterranean habitats



**FIGURE 1** Example of a biological or taxon area cladogram for a hypothetical genus composed of species A, B, and C that occur in discontinuous areas 1, 2, and 3, respectively. These cladograms are produced by combining the name of a species with the area(s) it inhabits. In this simple example, each species is endemic (restricted) to a different geographic area, suggesting a strong relationship between species distribution and geographic isolation. Open circles are internal nodes, which indicate splits in lineages leading to terminal species. Internal nodes can also correspond to vicariant events.

throughout the world. However, an exact count is not available and would be meaningless nevertheless, because new species from subterranean environments are being discovered and described on a regular basis and the number continues to increase. A majority of these species are troglomorphic forms, typically without eyes or pigmentation and adapted for and restricted to life in subterranean environments. From a biogeographic perspective, subterranean environments typically include cave passages in limestones and other soluble carbonate rocks, lava tubes in basalt, and interstitial spaces in a variety of unconsolidated sediments. However, virtually any habitable space beneath the surface of the earth can be a subterranean environment.

Troglomorphic animals make excellent candidates for biogeographic studies and are increasingly studied in this research for five reasons. First, they are taxonomically diverse and widespread geographically. Second, they are becoming well known taxonomically, largely through the diligent collecting efforts and taxonomic research of the last 50 years, coupled in the last decade with phylogenetic analyses. Third, dispersal abilities, although undoubtedly variable, are generally limited because these organisms are adapted to the restricted confines of subterranean habitats. Fourth, ranges are commonly, but not invariably, narrowly circumscribed, resulting in numerous locally endemic species. Fifth, many taxa apparently represent old phylogenetic lineages that have persisted in subterranean refugia for long periods of time. However, both distributional and phylogenetic relicts seem



to be more common among stygobites than troglobites, and apparently both groups are represented by more relict species in temperate climate karst regions than tropical karst regions.

What roles have vicariance and dispersal played in shaping the distribution patterns of subterranean fauna? Is one of these processes more important than the other in explaining distributions, or are they approximately equal in explanatory value? Dispersal is defined as the movement of an organism from one area to another, which changes the natural distribution of that organism, whereas vicariance is defined as the occurrence of closely related taxa in disjunct areas, which have been separated by the development of a natural barrier (Humphries and Parenti, 1999). The formation of a natural barrier that results in splitting a formerly continuous range is a vicariant event. As I will point out, both dispersal and vicariance have played significant roles in the development of cave faunal distribution patterns, and constructing both dispersalist and vicariance models is necessary for deeper insight into the complexity of these patterns. Therefore, because most present-day ranges probably reflect aspects of both dispersal and vicariance, teasing out these two components and delineating their contribution to the formation of distribution patterns is one of the principal tasks of large-scale cave biogeography.

Dispersal and vicariance biogeography of terrestrial troglobites and aquatic stygobites are considered separately below, primarily because of important differences between the two with respect to origins, habitats, and dispersal potentials. Although most of the examples used here to illustrate various distribution patterns are species from North America with which I am most familiar, many comparable examples could be cited from Europe and other parts of the world where subterranean fauna have also been studied in detail.

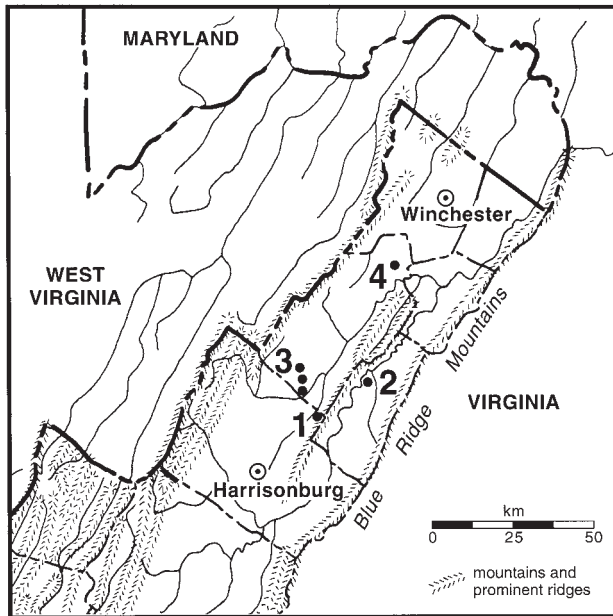
### TERRESTRIAL TROGLOBITES

Two levels of dispersal have played roles in shaping the distribution patterns of troglobites. The first level involves the actual invasion of caves from the surface by putative preadapted founder populations. This may occur under constraint when climatic changes precipitate invasion, which apparently occurred in temperate karst during climatic vicissitudes of the Pleistocene. It may also occur when founders invade newly developing subterranean food niches, which is apparently common and ongoing in tropic karst. These two models for invasion and colonization are termed *climatic relict* and *adaptive shift*, respectively. They were reviewed recently in detail (Holsinger, 2000) and both are largely dispersalist in character because they involve the active movement of an organism from one environment to another, effectively changing its natural distribution. However, because climatic change envisioned under the climatic relict model would likely preclude re-invasion of surface habitats and isolate founders in caves, it might arguably be regarded as a vicariant event.

The second level of dispersal involves movement of troglobitic organisms within the subterranean realm, typically, but not invariably, between caves in karst areas or lava flows. Both the extent of a given karst area or lava flow and the dispersal vagility (mobility) and niche breadth of a given species determine potential limits of dispersal. For many troglobites this potential is greatly limited and species ranges are often determined by the extent of interconnected cave passages and solution channels within a contiguous karst area. In a biogeographic sense, contiguous karst areas are analogous to islands, inasmuch as they are physically isolated from each other by noncavernous rocks and often contain locally endemic cave species.

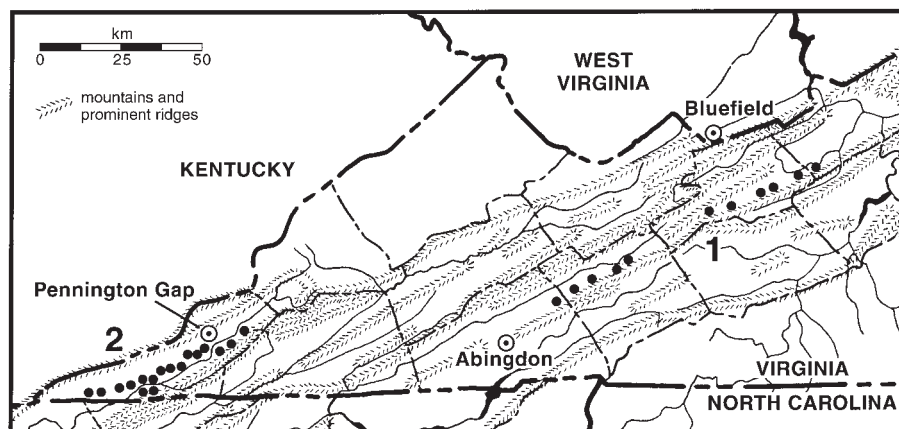
Dispersal of terrestrial troglobites includes movement through larger cave passages (>20 cm) and numerous smaller mesocaverns (<20 cm) within karstic limestone or other soluble carbonate rocks or basaltic lava. It may also include movement through shallow underground compartments (= *milieu souterrain superficiel* or MSS), which occur in some areas in loose rocks at the base of scree slopes or in cracks and fissures in mantle rock just beneath the lower layer of soil, both within and outside karst areas (Juberthie and Decu, 1994). Moreover, it is likely that some of the more widely distributed troglobites, such as species of linyphiid spiders and certain collembolan and dipluran insects in eastern North America, commonly disperse through cracks and crevices in epikarstic habitats above caves and even occasionally through damp leaf litter or deep soil outside karst areas. At the opposite end of this spectrum are troglobitic pseudoscorpions of the genus *Kleptochthonius* and pselaphid beetles, of which a majority of species are highly localized endemics restricted to single caves (Barr and Holsinger, 1985). Presumably the low vagility and limited niche breadth of these species prevent them from dispersing far from very small areas or even a single cave habitat.

Trechine beetle species of the genus *Pseudanophthalmus* (family Carabidae) in eastern North America are a classic example of well-studied troglobites, whose ranges are often largely determined by the dispersal limits of contiguous karst (Barr and Holsinger, 1985). Many species appear to be limited in their distribution to areas that typically encompass only interconnected caves in a contiguous karst area. The effect on dispersal by the extent of contiguous karst is nicely illustrated by the distribution of species of *Pseudanophthalmus* in the Appalachian Valley and Ridge physiographic province, where ranges vary in extent from a single cave to many caves that occur over a linear distance of approximately 95 km. In the Shenandoah Valley of northwestern Virginia, where belts of cavernous limestones are strongly folded, discontinuous and separated from each other by insoluble sandstones and shales, four closely similar species of the monophyletic *hubbardi* group occur in caves within relatively short distances of each other (Fig. 2). Extensive searching in caves of this region over the years suggests that the range of each species is restricted to an



**FIGURE 2** Distribution of four troglobitic beetle species (numbers 1–4) of the *hubbardi* group of *Pseudanophthalmus* in caves of the northern Shenandoah Valley of Virginia. Cave localities are indicated by solid circles. Each species inhabits a cave or a small cluster of caves in a physically isolated limestone belt (contiguous karst).

isolated belt of cavernous limestone, which for all intents and purposes constitutes a small contiguous karst area. Further evidence of the extreme isolation of these species is that three of the four species are recorded from single caves. Elsewhere in the Appalachian Valley and Ridge, belts of cavernous limestone are more extensive and continuous over large areas, and several species of *Pseudanophthalmus* have much larger ranges that cover linear distances of 50–95 km and include many caves (Fig. 3). In the Mississippian plateaus of Indiana, Kentucky, and Tennessee, where limestone outcrops are



**FIGURE 3** Distributions of the troglobitic beetles *Pseudanophthalmus hoffmani* (1) and *P. delicatus* (2) in southwestern Virginia karst areas. Cave localities are indicated by solid circles. Both species occur in continuous belts of cavernous middle Ordovician limestone. The former is recorded from caves developed in a long, relatively narrow belt of moderately dipping limestone along the northwestern flank of Big Walker Mountain. The latter is recorded from caves that are developed in a relatively broad exposure of low-dipping limestone, which extends throughout much of the Powell Valley in central Lee County, Virginia.

typically broader and less disturbed by folding than in the Appalachian Valley and Ridge to the east, ranges of trechine beetles are often more extensive (Barr and Holsinger, 1985) and provide further evidence that ranges of these troglobites are generally defined by the limits of contiguous karst.

The effect of vicariance on the distribution patterns of troglobites is more difficult to document than that of dispersal, primarily because barriers to subterranean dispersal develop gradually over extended periods of time, making it difficult to assess their impact. However, vicariant events are probably relatively common in the subterranean realm and thus are significant factors in isolating cave populations and promoting speciation. Physical barriers to dispersal may develop externally from the surface though sinkhole collapse into underlying cave passages or by deep erosional gorges that eventually completely bisect subterranean channels. Physical barriers may also develop internally and destroy or close off subterranean dispersal corridors by filling them with silt, flowstone deposits, or rubble from a ceiling collapse. Moreover, physical barriers may develop vertically as well as laterally, inasmuch as new generations of caves are actively forming beneath old ones. Thus, it is assumed that animals will move downward to colonize newly developing living space and available niches, and that the progressive isolation of populations in newly developing, lower level passages may result from this activity.

#### AQUATIC STYGOBITES (STYGOFAUNA)

The subterranean aquatic environment in general is more diverse and interconnected than its terrestrial counterpart, and the extent to which groundwaters are continuous over wide areas plays a significant role in the dispersal of stygobites. It is generally accepted that the pervasive nature of subterranean groundwaters provides stygobites, on average, greater dispersal potential and therefore wider ranges than

their terrestrial troglobite counterparts. Available groundwater habitats occur both within and outside karst regions, and many areas far beyond the boundaries of karst terranes are inhabited by an interesting diversity of stygobites (Ward *et al.*, 2000). However, it is not uncommon to find the same species, or closely related species, simultaneously living in caves of a karst area and adjacent subterranean aquifers in a noncavernous area. As pointed out below, dispersal between karst areas is often facilitated by movement through the interstitial spaces of shallow groundwater aquifers that are not directly associated with the caves in karst.

Subterranean groundwater habitats in karst caves typically include streams, drip and seep-fed pools, and phreatic lakes. They are often more accessible and easier to observe than those outside karst areas. In addition to typical karst caves with freshwater habitats, anchialine caves are a special cave subset that develop in limestones or basalt in coastal areas near the sea and are connected to nearby marine waters by subterranean channels (see Iliffe, 2000). As one might expect, the water in anchialine caves varies from nearly fresh to fully marine and, depending on depth, may be horizontally partitioned by a halocline. With some notable exceptions, anchialine caves are inhabited by stygofaunas having morphological affinities with marine faunas living in the nearby sea.

Outside karst areas, the more common subterranean groundwater habitats include the saturated interstitial spaces of gravels and coarse sands situated beneath stream beds (hyporheic) or in coral rubble, coarse sand, etc., in littoral and sublittoral zones (macroporous sediments), unconsolidated sediments beneath the water table (*nappes phréatiques*), and the outflow of small springs and seeps (through fine sediments or leaf litter) from perched water tables (hypotelminorheic). The movement of stygobites through the saturated media of unconsolidated sediments is often termed *interstitial dispersal* and is apparently the principal reason why many species that live in the shallow groundwater aquifers of unconsolidated sediments are typically widely distributed. For many species interstitial dispersal appears to be a highly successful mechanism for range expansion, and probably accounts for the relatively extensive ranges of some of the common and widespread stygobite amphipods in the genus *Stygobromus* that live in shallow groundwater aquifers along the outer margin of the Piedmont and on the Coastal Plain of eastern North America. These species, along with those in other crustacean groups (e.g., bathynellids, copepods, isopods), are excellent samples of stygobites that apparently rely exclusively on interstitial dispersal to maintain their distributions.

The distribution patterns of stygofaunas suggest that dispersal is often not limited to a single type of groundwater habitat but more frequently involves two or more such habitats. For example, an important aspect of cave drip pools is their close relationship with epikarstic habitats that occur in open spaces and bedrock fractures between cave passages and the earth's surface. Aquatic epikarstic habitats are in the

form of perched aquifers or perched water tables situated well above the true groundwater table. A number of studies have demonstrated passive dispersal of small (<10 mm in length) stygobite species (e.g., planarians, amphipods, and isopods) from epikarstic aquifers via ceiling drips into shallow cave pools on the floor below. Passive dispersal may also occur when the water in ceiling drips or wall seeps passes into a cave stream. There is little doubt that epikarstic aquifers facilitate dispersal of small stygobite crustaceans both within and between caves.

A second example of dispersal involving more than one cave habitat is illustrated by species that move actively or passively between pools and small streams. Studies on Appalachian cave amphipods in the genus *Stygobromus* indicate that, in general, the larger, more widely distributed species are recorded from both pools and streams, whereas in contrast, smaller species with greatly delimited ranges are generally found only in tiny drip pools. Finally, note that some species living in cave streams may be passively washed downstream and into springs at the surface, where a few can apparently survive for long periods of time with adequate cover. It is conceivable that the outwash from springs might occasionally facilitate limited passive dispersal through surface water between caves.

Larger stygobites, such as crayfish, shrimps, salamanders, and fishes, and amphipods and isopods exceeding 20 mm in length, are rarely if ever encountered in cave drip pools but are commonly found in cave streams or lakes. In the relatively shallow, wet caves of the Florida lime sink region, decapods (primarily crayfish) also commonly inhabit submerged cave passages. Because of the larger size of cave crayfish, which excludes them from interstitial dispersal, their distribution patterns are usually defined by the limits of contiguous karst.

Dispersal over relatively great distances through deep phreatic water in karst areas is another dispersalist mechanism available to some stygobites, although it is probably utilized primarily by taxa that inhabit deep groundwater aquifers. Recent investigations suggest that deep phreatic water habitats are more common and interconnected than previously believed, but they remain relatively poorly known because of limited accessibility to cave biologists. Most observations have been made where lower level cave passages allow access to bodies of phreatic water or through water wells in limestone bedrock that access deep groundwater aquifers. Recent observations on amblyopsid cave fishes in the Ozarks and cirolanid isopod crustaceans in the Appalachians provide us with strong evidence that deep phreatic aquifers can serve as important avenues for dispersal. According to a study in southern Missouri by Noltie and Wicks (2001), the principal habitats of the cave fishes *Amblyopsis rosae* in the Springfield Plateau and *Typhlichthys subterraneus* in the Salem Plateau are numerous small channels, solution tubes, and vugs beneath the groundwater table in these karst regions. Interestingly, because a majority of these organisms live in areas that are

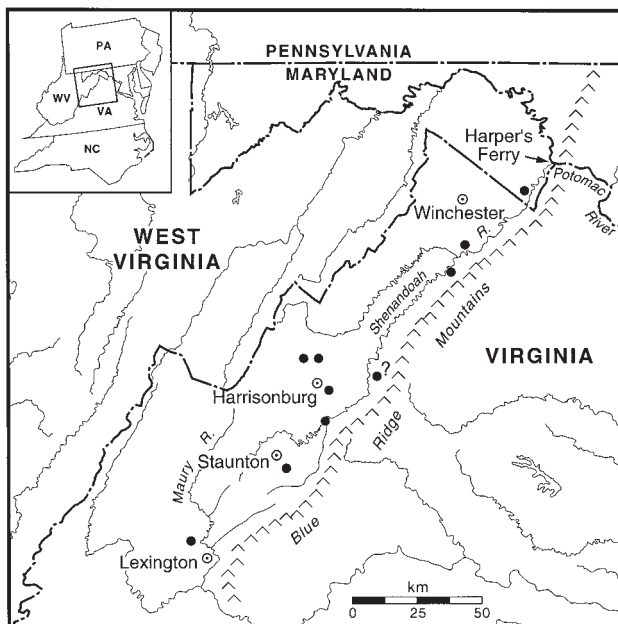
inaccessible to cave biologists, their population sizes have been underestimated by biologists. Lateral movements in the phreatic zone beneath the water table facilitate dispersal of the fishes over a relatively wide range. However, further observations on *A. rosae* indicate the existence of four semi-isolated genetic groupings within its overall range, suggesting a limited degree of physical impediment to dispersal and gene flow. Dispersal through deep phreatic water is probably also responsible for the extensive distribution of *Typhlichthys subterraneus* east of the Mississippi River in caves of the Interior Low Plateaus in southern Kentucky, central Tennessee, and northern Alabama. However, there is some evidence in this region for differentiation into several local "biological species" separated by extrinsic dispersal barriers (Barr and Holsinger, 1985).

Biogeographic studies on the stygobitic cirolanid isopod *Antrolana lira* (Holsinger *et al.*, 1994), currently recorded from the phreatic water in 10 caves in the Shenandoah Valley karst region of northwestern Virginia and eastern West Virginia (Fig. 4), suggest that this species, which may reach 21 mm in length, also utilizes deep phreatic water for dispersal. But unlike the near flat-lying strata in the Missouri plateaus, the limestone layers in this region are steeply folded and separated from each other by nonsoluble layers of sandstone and shale. However, fracturing of the sandstones and shales makes it likely that the limestone beds are not fully isolated from each other at variable depths below the water table, and minimal lateral movement of water and isopods

across the insoluble beds is possible. Therefore, although tenuous gene flow is conceivable throughout the range of this species and probably accounts for morphologically identical populations, genetic studies are needed to determine how much dispersal is actually taking place and whether differentiable genetic groupings have developed in different parts of the aquifer as they have for some of the amblyopsid cave fishes.

Dispersal through deep phreatic water also appears to be utilized by some of the species that inhabit the Edwards Aquifer in south-central Texas. This deep, extensive aquifer is associated with the Balcones Fault Zone and forms a biological mixing zone where karst groundwater of the Edwards Plateau comes into contact with interstitial groundwater of the Coastal Plain. The intense faulting and fracturing of the bedrock in this region has also resulted in compartmentalization and development of phreatic sub-aquifers within the main aquifer. Thus, although dispersal obviously occurs freely in some parts of the aquifer, barriers prevent it in other parts, and it is probable that a combination of these two effects has contributed significantly to the evolution of the highly diverse stygofauna of the region. More than 31 stygobitic species have been sampled from the artesian well in San Marcos, where specimens are coming from a depth of approximately 60 m. Sampling has also been carried out from very deep artesian wells located approximately 90 km southwest of San Marcos near San Antonio. Deep springs and caves have also been carefully investigated in this region. That part of the aquifer extending from San Marcos southwest to San Antonio appears to be a viable dispersal corridor for a number of stygobites. Four of the 10 stygobitic amphipod species recorded from the artesian well in San Marcos have also been flushed out of two of the artesian wells near San Antonio, and a fifth species has been found in phreatic waters of two nearby caves and possibly additional caves west of San Marcos. The cirolanid isopod *Cirolanides texensis* is also recorded from the San Marcos artesian well and, like the amphipods, it has been sampled from deep artesian wells near San Antonio, as well as from caves to the north and west on the Edwards Plateau.

As mentioned above, dispersal between karst areas or even between caves is often facilitated by movement through shallow groundwater aquifers that may or may not be developed in limestone terranes. Thus, dispersal through these aquifers, which can occur in a variety of terranes, appears to be a very common means of range expansion for relatively widely distributed stygobites. Studies on stenassellid isopod crustaceans in groundwaters on the Arabian Peninsula by Magniez and Stock (1999) illustrate how interstitial groundwater in the gravel sediments of a hyporheic zone and the "free" water in nearby limestone cavities can be linked through an ecotone, which is cohabited by representatives of species from the different habitats. Many species of isopods and amphipods occur in caves and to a lesser extent in springs and seeps at the surface and they apparently utilize



**FIGURE 4** Distribution of the stygobitic cirolanid isopod *Antrolana lira* in the Shenandoah Valley of the Virginias. The solid circles represent 1 or 2 closely proximate cave localities. Note that the range of this species extends beneath a major surface drainage divide between Staunton and Lexington, Virginia. The question mark indicates a sight record for specimens pumped from a water well.

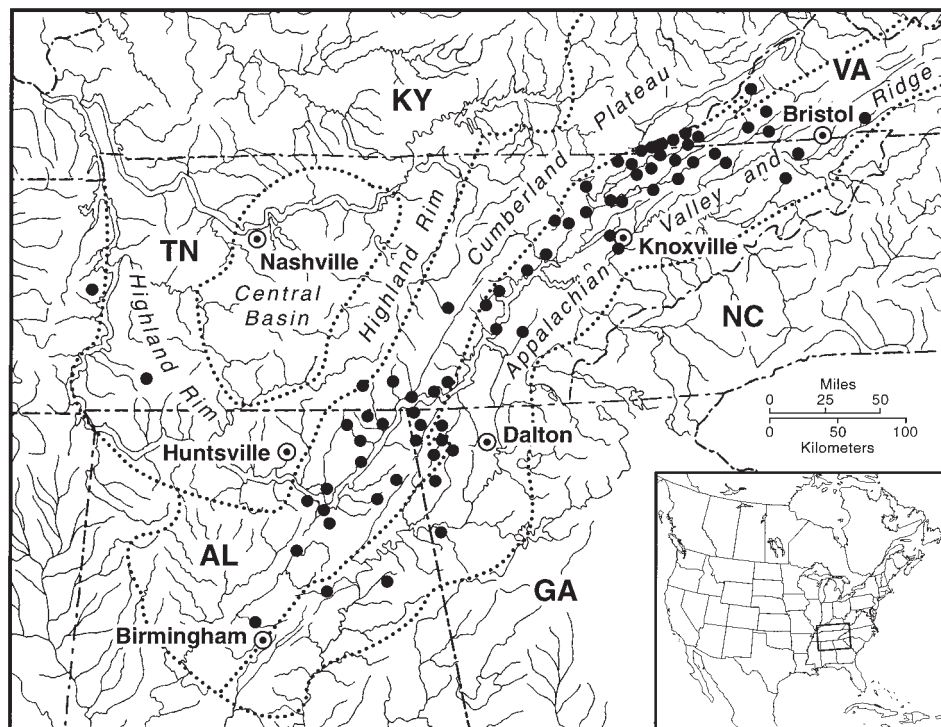
interstitial dispersal to broaden their ranges. The amphipod crustaceans *Crangonyx antennatus* and *C. packardi* and the isopod *Caecidoetea pricei* are three good examples of North America stygobitic crustaceans that frequently inhabit drip pools and small streams in caves but utilize dispersal through epikarstic aquifers and hypotelminorheic habitats (seeps) outside karst terranes to maintain extensive ranges. The geographic distribution of *C. antennatus*, which extends for approximately 700 km through a number of different karst areas in parts of several states in the Appalachians, is shown on the map in Fig. 5. The range of *Crangonyx packardi* extends from southern Indiana and central Kentucky west to eastern Kansas over a linear distance of approximately 1000 km, whereas that of *Caecidoetea pricei* extends from Rockbridge County, Virginia, northeast to Montgomery County, Pennsylvania, covering a linear distance of approximately 450 km.

Most of the same vicariant events that form physical barriers to dispersal of troglobites mentioned above apply equally to stygobites. For example, sinkhole collapse into underlying cave passages and bisection of subterranean channels by deep erosional surface gorges would both serve to effectively block potential stygofaunal dispersal corridors. Moreover, siltation, flowstone deposition, and ceiling collapse can also destroy or close off aquatic dispersal corridors.

However, three vicariant phenomena are unique to the geographic distribution of stygofaunas: stranding, stream

capture, and spring failure. In a cladistic biogeographic analysis, any one of these events might coincide with the nodes on the area cladogram of the taxon being investigated (Fig. 1). The nodes, in turn, reflect splits in the lineages that gave rise to terminal taxa. The possibilities for applying this kind of analysis to the interpretation of biogeographic patterns of various groups of stygobites is exciting and will increase as more phylogenies of these organisms become available.

*Stranding* involves the isolation of marine or brackish water organisms in gradually freshening subterranean groundwaters following marine regressions. Founding populations adapt to freshwater conditions as the salinity gradually decreases in concert with regression of marine waters. This process is gradual, but it is vicariant because ultimately the stranded populations become isolated from their marine ancestors when ecological conditions are changed and genetic continuity is eliminated. The evidence for stranding comes from the large number of freshwater stygobitic crustaceans that inhabit subterranean groundwaters in parts of the world that once bordered on or were covered by the putative warm, shallow waters of the Tethys Sea. Most of these taxa have obvious taxonomic affinities with modern marine species and are apparently relicts of former marine embayments and island emergence that occurred in different parts of the Tethyan realm at different times between the Cretaceous and middle to late Tertiary. Marine relict stygobites are especially common in Texas,



**FIGURE 5** Distribution of the stygobitic amphipod crustacean *Crangonyx antennatus* in the southern Appalachians. The solid circles represent 1 to 10 closely proximate localities. Although most of these localities are caves, the species has been observed to enter cave pools through ceiling drips from epikarstic zones and occasionally has been found in seeps and small springs at the surface.

Mexico, and the West Indies in southern North America and the Mediterranean region of southern Europe and northern Africa. They are also recorded from eastern Africa, the Arabian Peninsula, and parts of the western Pacific region including Australia.

*Stream capture* involves the piracy or capture of one stream by another, and in karst areas it includes diversion of surface streams through sinkholes into subterranean channels. Initially, preadapted freshwater organisms enter subterranean waters passively when their surface habitat stream is diverted into a subterranean channel. Founder populations become permanently established in caves only after they are isolated in underground streams and contact is cut off with surface ancestors. The capture of surface streams by sinkholes is a relatively common phenomenon in karst areas and is vicariant when remnant surface streams recede up gorge or dry up completely. In accordance with this model, ancestors of cave-adapted populations of the widely distributed characid fish *Astyanax fasciatus* invaded caves in east-central Mexico when surface streams were captured by sinkholes in karst areas and were unable to reestablish contact with epigeal forms. Similarly, stygobitic crayfish in north-central Florida are apparently derived from surface ancestors that gained entry into subterranean waters via stream capture in karst areas, presumably becoming isolated underground by the same processes.

*Spring failure* involves the retreat of preadapted surface populations into cave streams from surface springs during episodic droughts. Subsequent isolation of founder populations in underground streams is vicariant when the springs are eliminated by erosional processes or when stream flow to the surface ceases due to lowering of the groundwater table. Spring failure is a fairly common phenomenon in karst areas where the climate is becoming progressively more arid. Apparently, it has been a significant factor in the evolution of troglomorphic salamanders in central Texas, which are derived from spring-dwelling ancestors that migrated into cave streams to survive severe surface droughts since the Pleistocene. Spring failure may also be implicated in the evolution of cave-adapted hydrobiid snails in parts of North America.

A final note regarding vicariance includes a brief discussion of groundwater calcrete aquifers, which constitute a unique subterranean environment recently identified from the Western Australian arid zone by Humphreys (2001). Calcretes are isolated subterranean carbonate deposits with cavelike, freshwater habitats. They have developed under arid conditions by evaporation and became isolated in the upper tributaries of paleodrainage systems by the progressive upstream movement of salinity, perhaps beginning in the Eocene. Calcretes are numerous and inhabited by a stygofauna consisting predominantly of locally endemic crustaceans, many of which are relict species. The intervals of hypersalinity/calcrete discontinuities have acted as barriers to the dispersal of the stygofauna, and long-term isolation

of crustacean populations in upstream pockets of freshwater has resulted in the evolution of a remarkably diverse regional stygofauna. In a biogeographic sense, calcretes are discontinuous groundwater habitats, which, like isolated belts of contiguous karst, are analogous to islands.

## SUMMARY

The biogeography of organisms living in subterranean environments is primarily concerned with explanation and interpretation of the distribution patterns of troglomorphic species. Both vicariance and dispersal have played important roles in shaping the distribution patterns of troglomorphs, which include terrestrial troglobites and aquatic stygobites. Whereas vicariance delimits ranges through the development of dispersal barriers, dispersal increases ranges by movement of organisms into new areas. The effect of these processes has been different for troglobites and stygobites, largely because the two groups inhabit ecologically different subterranean habitats and have different dispersal potentials. In general, subterranean aquatic environments are more pervasive and diversified than their terrestrial counterparts and, as a result, stygobites typically inhabit a wider variety of habitats and have more extensive ranges. Stygobites not only exploit karst groundwaters but also inhabit the extensive interstitial groundwater media that extends far beyond the boundaries of karst terranes. Some karst species apparently also use deep phreatic aquifers for dispersal. Troglobites may also exploit terrestrial habitats outside karst, such as "shallow underground compartments," but these are generally limited in scope, and the ranges of a majority of terrestrial species are restricted to caves in karst or basaltic lava.

Although several forms of vicariance, such as the destructive geomorphic processes that close subterranean passages, are similar for both troglobites and stygobites and often establish the outer limits of distribution in karst areas, several important vicariant events are unique to stygobites. They include stranding, stream capture, and spring failure, and each has played a significant role in the distribution of stygobites. The newly discovered groundwater calcretes in western Australia are also vicariant in character, inasmuch as they restrict the distribution of stygobite crustaceans in this arid region.

## ACKNOWLEDGMENTS

I am grateful to David C. Culver, David A. Hubbard, Jr., Glenn Longley, and Wil Orndorff for providing useful information during the preparation of this article, and Donald K. Emminger in the Graphics Office at Old Dominion University for assistance with preparation of the figures.

## *See Also the Following Articles*

*Invasion, Active versus Passive • Marine Regressions*

### Bibliography

- Barr, T. C., Jr., and J. R. Holsinger (1985). Speciation in cave faunas. *Annu. Rev. Ecol. Systematics* **16**, 313–337.
- Brown, J. H., and M. V. Lomolino (1998). *Biogeography*. Sinauer Associates, Sunderland, MA.
- Case, T. J., and M. L. Cody (1987). Testing theories of island biogeography. *Am. Scientist* **75**(4), 402–411.
- Christiansen, K. A., and D. C. Culver (1987). Biogeography and the distribution of cave collembola. *J. Biogeography* **14**, 459–477.
- Craw, R. C., J. R. Grehan, and M. J. Heads (1999). *Panbiogeography: Tracking the History of Life*, Oxford Biogeography Series No. 11. Oxford University Press, Oxford, UK.
- Holsinger, J. R. (2000). Ecological derivation, colonization, and speciation. In *Subterranean Ecosystems* (H. Wilkins, D. C. Culver, and W. F. Humphreys, eds.), pp. 399–415. Elsevier, Amsterdam.
- Holsinger, J. R., T. W. Bowman, and D. A. Hubbard, Jr. (1994). Biogeographic and ecological implications of newly discovered populations of the stygobiont isopod crustacean *Antrrolana lira* Bowman (Cirolanidae). *J. Natural History* **28**, 1047–1058.
- Humphreys, W. F. (2001). Groundwater calcrete aquifers in the Australian arid zone: The context to an unfolding plethora of stygol biodiversity. *Records West. Austral. Museum* Supplement No. 64, 63–83.
- Humphreys, C. J., and L. R. Parenti (1999). *Cladistic Biogeography*, Oxford Biogeography Series No. 12. Oxford University Press, Oxford, UK.
- Illiffe, T. M. (2000). Anchialine cave ecology. In *Subterranean Ecosystems* (H. Wilkins, D. C. Culver, and W. F. Humphreys, eds.), pp. 59–76. Elsevier, Amsterdam.
- Juberthie, C., and V. Decu (1994). Structure et diversité du domaine souterrain; particularités des habitats et adaptations des espèces. In *Encyclopaedia Biospeologica*, Vol. I (C. Juberthie and V. Decu, eds.), pp. 5–22. Société de Biospéologie, Moulis, France.
- Magniez, G., and J. H. Stock (1999). Consequence of the discovery of *Stenasellus* (Crustacea, Isopoda, Asellota) in the underground waters of Oman (Arabian Peninsula). *Contrib. Zool.* **68**(3), 173–179.
- Nolte, D. B., and C. M. Wicks (2001). How hydrology has shaped the ecology of Missouri's Ozark cavefish, *Amblyopsis rosae*, and southern cavefish, *Typhlichthys subterraneus*: Insights on the sightless from understanding the underground. In *Environmental Biology of Fishes* (A. Romero, ed.), 62, pp. 171–194. Kluwer Academic Publishers, Dordrecht.
- Ward, J. V., F. Malard, J. A. Stanford, and T. Gonser (2000). Interstitial aquatic fauna of shallow unconsolidated sediments, particularly hyporheic biotopes. In *Subterranean Ecosystems* (H. Wilkins, D. C. Culver, and W. F. Humphreys, eds.), pp. 41–58. Elsevier, Amsterdam.
- Wiley, E. O. (1988). Vicariance biogeography. *Annu. Rev. Ecol. Systematics* **19**, 513–542.

## Volcanic Caves

William B. White

The Pennsylvania State University

### INTRODUCTION

Much of the human interest in caves revolves around caves as places of exploration. Very long caves occur in volcanic areas, formed by processes quite different from the bedrock dissolution process that is responsible for limestone and gypsum caves. Volcanic caves divide broadly into blister caves,

fissure caves, volcanic throats, and lava tubes. Lava tubes are the most common and also the largest of the volcanic caves. They occur in many parts of the world where there has been recent volcanism. In form, lava tubes tend to be rounded conduits with diameters measured in meters and lengths varying from a few meters to tens of kilometers. These caves are interesting both for the challenge of exploration and for the geological and biological features of the caves.

### SMALLER VOLCANIC CAVES

#### Blister Caves

Partly solidified lavas are pasty. A rising bubble of hot gases from the interior of the lava flow can push up the nearly solidified crust at the top of the flow creating a chamber. As the lava cools and solidifies, the chambers will sometimes be left behind as an open cavity (Fig. 1). Typical *blister caves* are roughly circular, ranging from a few meters to a few tens of meters in diameter and with ceiling heights from less than a meter to several meters.

#### Fissure Caves

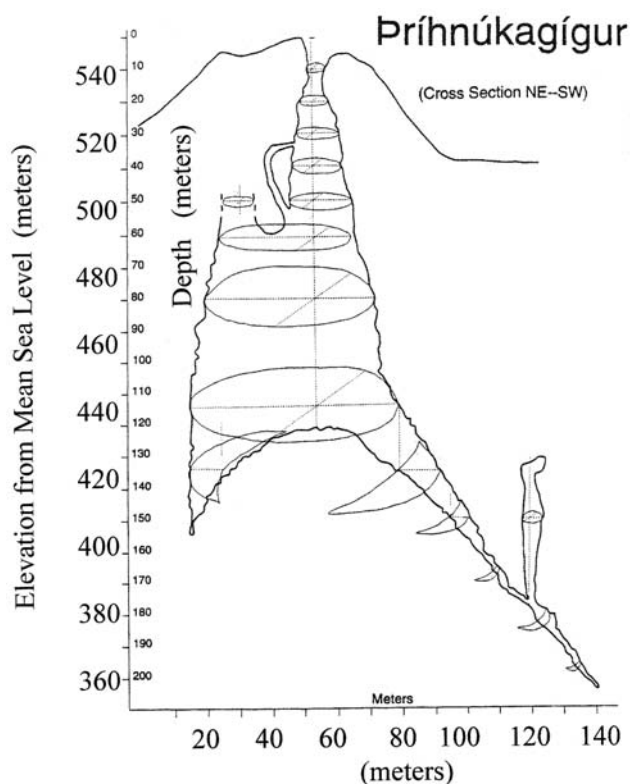
Volcanic terrains are not always stable. Collapse of magma chambers at depth, filling of magma chambers preparatory to further eruptions, earthquakes, and other movements of the crust cause cracks of various sizes, lengths, and depths. If these happen to be roofed over, they become caves. *Fissure caves* in volcanic areas are not intrinsically different from tectonic caves in other types of rocks. In both cases, the caves are created by mechanical fracturing and parting of solid bedrock.

#### Volcanic Throats

If the lava pouring from an erupting volcano has a chance to drain back into the magma chamber after an eruption ceases, the throat of the volcano can be left open. Open *volcanic*



FIGURE 1 Blister cave, Krafla volcanic area, northern Iceland.



**FIGURE 2** Profile map of Thrihnúkkagigur, Iceland. (Original survey by Árni B. Stefánsson in 1991. Illustration adapted from Butler Cave Conservation Society expedition report.)

*throats* are rare because collapse in the crater usually blocks them. In active volcanoes, the throat will be filled with volcanic gases, making exploration difficult. The Thrihnúkkagigur pit in Iceland (Fig. 2) appears to be an example of a volcanic throat that opens into a collapsed magma chamber.

### Lava Tubes

The largest and most interesting of the volcanic caves are *lava tubes*. Lava tubes are long pipelike conduits that form in lava flows. They typically have circular or elliptical cross sections and reach diameters of 10 m or more. They form at the same time as the lava flow and so are generally very young features. Ages of lava tubes can be dated by historic records or by radioisotope dating of the lava flow. Typically, lava tubes are no older than a few centuries. Lava tubes occur in great numbers in the lava flows of the Pacific Northwest in northern California, Oregon, and Washington, in Hawaii, in Iceland, in the African rift valley, and in the Canary Islands among others. The longest lava tube in the continental United States is Ape Cave on Mount St. Helens in Washington with a length of 3.9 km. The exploration of lava tubes has expanded greatly in recent years, particularly in Hawaii where exceptionally long caves have been found. These have lengths of many kilometers including Kazamura Cave with an integrated length of 41.8 km.

## DEVELOPMENT OF LAVA TUBES

### Volcanic Rocks That Will Host Lava Tubes

The main constituents of igneous rocks in general are the oxides  $\text{SiO}_2$ ,  $\text{Al}_2\text{O}_3$ ,  $\text{MgO}$ ,  $\text{FeO}$  (or  $\text{Fe}_2\text{O}_3$ ),  $\text{CaO}$ ,  $\text{Na}_2\text{O}$ , and  $\text{K}_2\text{O}$ . The melting points of the rocks and the viscosity of the lavas that form when the rocks are melted depend on the details of the chemical composition and also on the presence of volatile components, particularly  $\text{H}_2\text{O}$ . Melts with high  $\text{SiO}_2$  (70–75 wt %) and  $\text{Al}_2\text{O}_3$  content are highly viscous and form a fine-grained rock called *rhyolite* that is chemically very similar to granite. Rhyolite lavas are not common, are associated with explosive eruptions, and do not form lava tubes. Intermediate compositions, with somewhat less  $\text{SiO}_2$  and more  $\text{MgO} + \text{FeO}$  produces rocks called *andesite* (low  $\text{Na}_2\text{O}$ ) or *dacite* (higher  $\text{Na}_2\text{O}$ ). Andesite and dacite lavas form volcanic peaks and lava flows but are generally too viscous to produce lava tubes.

Rocks that contain about 50%  $\text{SiO}_2$ , are rich in  $\text{MgO} + \text{FeO}$ , and have lower concentrations of  $\text{Al}_2\text{O}_3$  and  $\text{Na}_2\text{O} + \text{K}_2\text{O}$  form rocks called *basalts*. Basalts form highly fluid lavas with viscosities orders of magnitude smaller than the viscosities of rhyolite, andesite, or dacite lavas. Basaltic lava flows on large shield volcanos such as those in Hawaii pour down the mountain side and extend for tens of kilometers beyond the summit crater. Basaltic lava flows require only small gradients so that in many lava tube regions, the landscape is nearly flat.

### Volcanic Eruptions

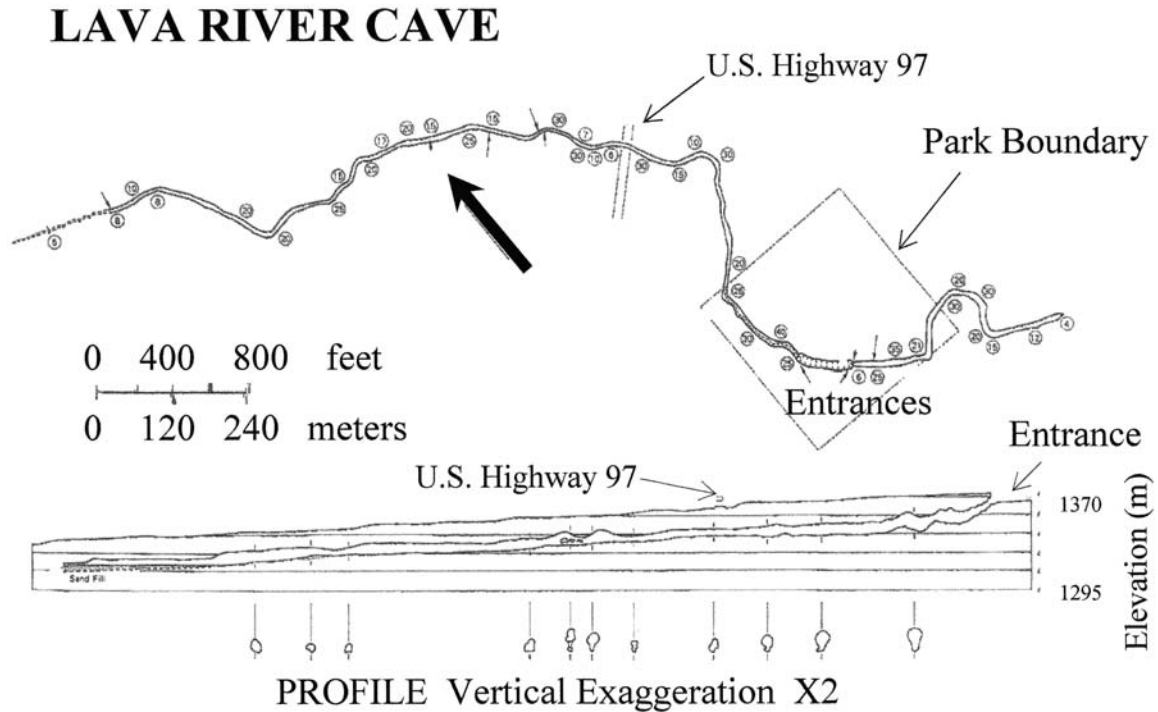
Volcanic eruptions occur in a great variety of modes depending on the composition of the lava, the presence (or absence) of volatile compounds, and the presence (or absence) of groundwater. Most favorable for the development of lava tubes are highly fluid lavas that solidify into rocks with smooth, ropey surfaces called *pahoehoe*.

### Passage Patterns

The simplest pattern for lava tubes is a single uniform tunnel. These may have lengths from a few tens of meters to many kilometers. Lava tubes often have rectangular or elliptical cross sections, which may remain constant or may vary along the length of the tube (Fig. 3). Braided and distributary patterns are also common. In terrain with low relief, the lava rivers can diverge and rejoin to form complicated braided patterns, which are inherited by the lava tubes. Flows may diverge in the downstream direction, forming distributary patterns with the lava emerging a multiple points along the toe of the flow.

Two modes for the development of lava tubes have been discussed. The simplest model is that of a lava river developing within the lava flow. The overall lava flow gradually cools, stiffens, and slows down but more concentrated flow in the





**FIGURE 3** Map of Lava River Cave, south of Bend, Oregon, a simple tube. (Map adapted from guidebook to 1983 National Speleological Society convention.)

river remains fluid. Gradually, through splashing and cooling, a levee is built up along the sides of the river and still later, as the overall flow becomes thicker, the lava river becomes roofed over. The process of roofing over the lava river is irregular so that there may be sections that are completely roofed over while in other places there are skylights. It is possible for the surface of the flow to chill sufficiently to allow observers to walk on it. Observers have seen and photographed rivers of molten rock flowing at depths of a few tens of meters below the surface of the solidified flow. In order for a lava tube to remain behind, it is necessary for eruption to cease while the downstream end of the lava river remains open. This allows the lava to drain after the eruption ceases and leaves an open tube.

The alternative hypothesis is that the lava tube forms after the main part of the flow has become stationary. Lava is thought to force its way along planes within the flow with local remelting enlarging the tube. The incipient lava tube then serves to carry fresh lava to the advancing front of the flow, which is still moving. Thus the flow can continue to advance after the upslope body of the flow has become stationary. Again, it is necessary for the eruption to cease so that the tube can drain. The mechanisms are not mutually exclusive and it is possible that the roofing-over mechanism is dominant in the part of the flow nearest the vent, while the other mechanism becomes more important as the flow advances.

Lava tubes form at shallow distances below the surface of the lava flow. As a result, the roofs of the tubes are thin and



**FIGURE 4** Skylight into a lava tube associated with the Newberry Volcano, central Oregon.

collapses are common. Many long tubes are broken into multiple segments. Tube entrances are in the sinkholes formed by roof collapses. Sometimes the collapses result in blockages of the tubes, but often one can simply walk under the skylight and continue (Fig. 4). The horizontal extent of lava tubes is limited by breakdown and by lava plugs, the latter formed either by incomplete draining of the tube or by intrusion of new lava.

In profile, the simple tubes usually have a very gentle slope reflecting the slope of the lava surface above. Many are nearly horizontal. There do occur lava tubes with canyons cut in

the floor of the original tube and other modifications due to reactivation of the tubes by fresh intrusions of lava. More complex profiles occur with some tubes stacked in levels. These can occur where new eruptions build a new lava flow over a previous one and when the lava rivers follow more or less the same pathway. In some lava falls, a lava river from a younger flow has poured into an underlying older tube. The geometry of lava tubes reflects the complex eruptive history of their parent volcano.

### **Speleothems and Other Features**

Lava tubes contain some features with a superficial resemblance to features in solution caves. Among these are lava stalactites and stalagmites. After the main flow of lava has drained from the tube, hot gases boiling from the remaining lava remelt the rock that makes up the ceiling of the tube. Molten lava dripping from the ceiling produces lava stalactites. If the floor is free of flowing lava, drippings onto the floor produce lava stalagmites. These features have the

same chemical composition as the lava that makes up the walls of the tube.

Groundwater seeping through the lava flow long after the flow has solidified causes some chemical weathering of volcanic rock. Groundwater seeping into the lava tubes can evaporate and deposit crusts of various minerals on the walls of the tube. These minerals are generally white and stand out in sharp contrast to the dark-colored walls of the tube. Gypsum,  $\text{CaSO}_4 \cdot 2\text{H}_2\text{O}$ , is a common mineral. Some carbonate and phosphate minerals have also been reported.

### **Bibliography**

- Greeley, R., and J. H. Hyde (1971). Lava tubes of the cave basalt, Mount St. Helens, Washington. *Geol. Soc. Am. Bull.* **83**, 2397–2418.
- Sigurdsson, H. (2000). *Encyclopedia of Volcanoes*. Academic Press, New York.
- Waters, A. C., J. M. Donnelly-Nolan, and B. W. Rogers (1990). Selected caves and lava-tube systems in and near Lava Beds National Monument, California. *U.S. Geol. Survey Bull.* 1673.
- Wood, C. (1974). Caves in rocks of volcanic origin. Chap. 4 in *The Science of Speleology* (T. D. Ford and C. H. D. Cullingford, eds.), pp. 127–150. Academic Press, London.



## Wakulla Spring Underwater Cave System, Florida

**Barbara Anne am Ende**  
*Deep Caves Consulting*

*The source of the Waculla forms a large circular basin of great depth, in which the water appears to be boiling up from a fathomless abyss, as colorless as the air itself.*

*Charles Latrobe, 1833*

### INTRODUCTION

Wakulla Spring, located 30 km south of Tallahassee, Florida, is a compelling source of freshwater. An average of nearly 1 million cubic meters of water discharges every day—enough to fill a thousand olympic-sized swimming pools! A multi-kilometer-long cave system, with passages up to 30 m in diameter at an average depth of nearly 90 m, provides water to the spring vent. However, during the Pleistocene, sea level was lower and mastodons and other terrestrial animals found their way deep into the passage that currently feeds the spring.

The earliest evidence of human visitation to Wakulla Spring comes from Paleo-Indian artifacts dated from 9500 to 12,000 years BP. The first European explorer in the area was Panfilo de Navarez, who in 1528 was searching for the province of Apalachen with its purported gold and riches. He and his Spanish crew ran out of provisions, diverting to the village of Aute for resupply. The exact location of Aute is not certain, though it was probably at or near Wakulla Spring. A recent archeological investigation at the spring found red, unglazed earthenware olive jar fragments, suggesting

Hernando de Soto (retracing Navarez's route) visited Wakulla Spring in 1539. The beauty of this spring has caused much speculation that it might have been the Fountain of Youth sought by Ponce de Leon, though there is no evidence that he visited Wakulla.

The spring's name is a European language bastardization of the Muskogean *Wacara* (pronounced "wakala") where *cara* meant "spring of water," which is similar to the Creek word *wahkola* meaning "loon." Over the years, the name has been published variously as *Wackhulla*, *Wakully*, *Waculla*, *Wahkula*, and *Wakulila*. In 1843, the name *Wakulla* (pronounced "Wah-cuh-lah") was officially given to the county. This large spring, and the nearby smaller one, Sally Ward, are grouped together and termed the *Wakulla Springs*.

Beginning in the early 19th century, American settlers started moving into the Tallahassee area. The Wakulla River, which suddenly appears in the midst of a pine, live oak, and cypress forest, was a draw for local tourists. Its remote location with poor roads helped protect the natural environment. The trip from Tallahassee through the pines was long and monotonous, prompting the rumor that "young people never went to Wakulla Springs without coming back engaged." Enterprising inhabitants provided boat tours for visitors. Several published reports commented on the vertigo induced in visitors who boated over the spring basin because of the clarity of the water. The county held an annual picnic on the site on the first Saturday in May for many years. Several plans and attempts were devised to commercialize the spring given the success of other Florida springs such as Weeki Wachee and Silver Springs, but none of these plans materialized.

In 1934, Edward Ball, while working for his brother-in-law, Alfred I. du Pont, began purchasing land around Wakulla Springs. A year later, he began constructing a hotel next to the spring basin. Though rumored it was to become a private lodge, the hotel was always a commercial operation. However, local hunters were excluded from the land. A fence

built across the river denied access to the spring and caused much contention. The county could no longer hold its annual picnic. Nevertheless, Ball resisted the notion of expanding the commercial operation to a gaudy, highly developed tourist trap. Over the years, a number of movies were filmed at Wakulla including two Tarzan movies, the *Creature from the Black Lagoon*, and *Airport '77*, in which a 70-foot model of a 747 was perched on the ledge over the cave entrance in the spring basin. Edward Ball died in 1981 and the land went to the Nemours Foundation. It was realized that Wakulla Springs would never make a profit, and the operation was sold to Florida, in 1986 becoming the Edward Ball Wakulla Springs State Park.

Today, the park continues its boat tours of the river where wildlife such as alligators, turtles, deer, and squirrels can be seen at close proximity. Birds abound, including anhingas, which are frequently seen perched, holding their wings out to dry after diving for fish. Glass bottom boats circle the spring basin when the visibility of the water is good. Swimming from a white sand beach is encouraged, though scuba diving is generally not allowed except by special permit.

## GEOLOGY

### Geologic Framework

Wakulla Spring lies within the Woodville Karst Plain, a low-lying area underlain by Oligocene and Miocene aged limestone overlain by a thin blanket of unconsolidated sands (Fig. 1). The Eocene Ocala Group is a widespread unit that is an important part of Florida's aquifer system. However, near Wakulla Spring it lies well below all known cave passages; the top of the Ocala was encountered between 120 and 180 m below the land surface in oil test wells near Wakulla. The Lower Oligocene Suwannee Limestone unconformably overlies the Ocala Group. The Suwannee

Limestone is a calcarenite containing miliolid foraminifera, mollusks, bryozoans, echinoids, and corals. Chert is common and was used by Paleo-Indians for tools and weapons. The passages in Wakulla Cave are developed in the Suwannee Limestone. The Lower Miocene St. Marks Formation unconformably overlies the Suwannee and is the uppermost bedrock unit at Wakulla Spring. The ledge above the Wakulla Spring vent is St. Marks Formation. The unit is primarily a calcilutite containing quartz sand, clay stringers, and mollusks. The lower contact of the St. Marks Formation lies at an approximately 27-m water depth.

Samples collected during exploration in 1987, as well as visual descriptions and video footage from within Wakulla Cave, indicate a distinct lithologic and color change within the Suwannee Limestone at a depth of about 65 m. Above lies a soft biocalcarene, whereas below the contact is a less soluble, recrystallized dolomitic calcarenite. The dolomitic rock may have retarded additional downward dissolution in the conduits. The 3D map produced during the 1998–1999 diving project shows that the floor level for much of the cave is uniform at a depth of about 90 m (Fig. 2).

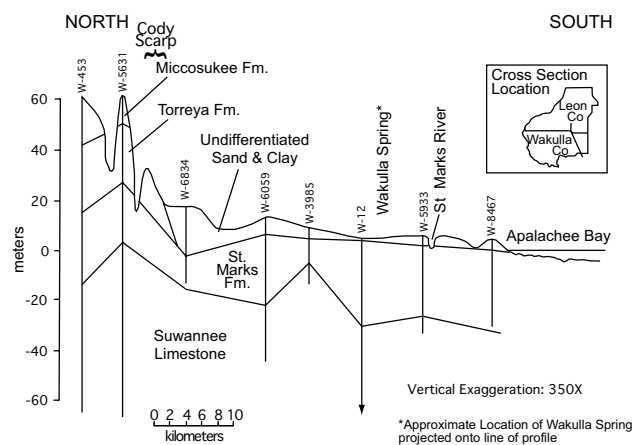
During the Pleistocene, the shoreline transgressed across this area, reworking sands from older formations and depositing the sediment over the limestone. Five marine terraces are recognized in Wakulla County, and Wakulla Spring lies within the Pamlico Terrace, ranging from 3 to 8 m above sea level. The Cody Scarp (Fig. 1) is an escarpment marking the boundary between the northern Tallahassee Hills and the Coastal Lowlands to the south. The boundary represents the ancient shoreline location.

### Paleontology

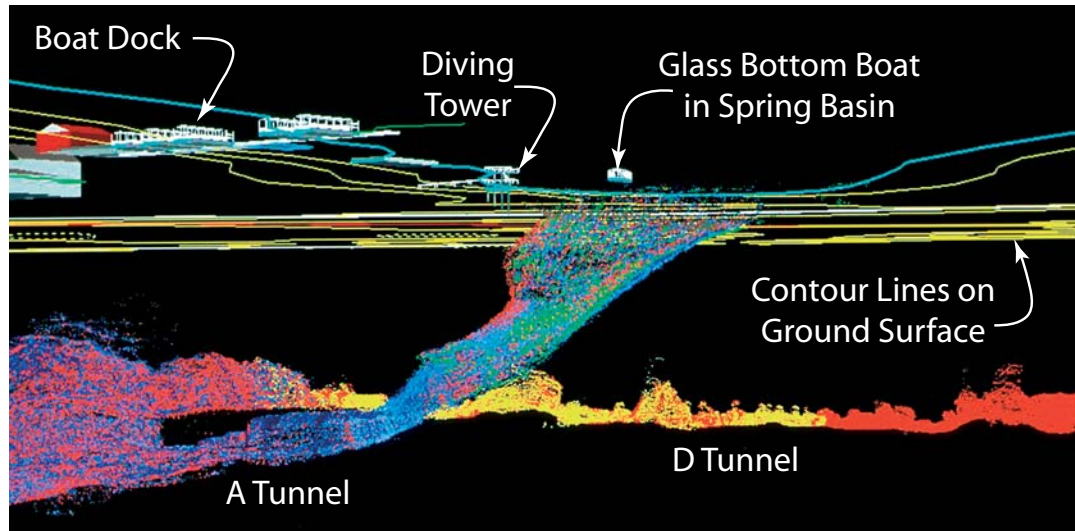
The first correct identification of the enormous bones seen through the clear water on the bottom of the Wakulla Spring basin was made by Sarah A. Smith for the *Tallahassee Floridian and Journal* in 1850. This publication prompted a local professor to collect a significant portion of a mastodon skeleton, but the bones were lost in a shipwreck on their way to a museum on the Atlantic coast.

Additional bones were collected during the next decades. In 1930, more mastodon bones were discovered in shallow water during construction of a swimming area at Wakulla Spring. The Geological Survey was enlisted in its collection and the skeleton remains on display today in the Museum of Natural History in Tallahassee (Fig. 3).

Dives by Wally Jenkins, Garry Salsman, and their buddies in 1955 and 1956 (see exploration section below) resulted in the discovery of mastodons, mammoths, deer, camels, giant ground sloths, and bears, along with many spear points from Paleo-Indians. The divers used pillowcases lined with plastic bags inflated by air from their tanks to lift the heavy bones to the surface from depths as great as 60 m. During later exploration Pleistocene mammal bones were discovered as far back as 366 m from the entrance.



**FIGURE 1** Geologic cross section from the Tallahassee Hills through the Woodville Karst Plain. The approximate location of Wakulla Spring has been projected onto the cross-section line. (After Rupert, 1993.)



**FIGURE 2** Perspective view of the entrance area to Wakulla Spring Cave. Each colored dot represents a wall point surveyed with the digital wall mapper. Different colors of dots are from different data files. Topographic contours of the ground surface are shown in yellow, and the boundary of the Wakulla River is shown in blue.



**FIGURE 3** Mastodon skeleton in the Museum of Natural History, Tallahassee, assembled with bones found at Wakulla Spring, Florida. (Photograph courtesy of Barbara Anne am Ende.)

### Hydrology

Wakulla Spring is one of 33 first magnitude springs in Florida. Average discharge from 1907 to 1974 was  $11 \text{ m}^3/\text{s}$ . Wakulla Spring displays the greatest range of discharge of any Florida spring. A minimum flow of  $0.7 \text{ m}^3/\text{s}$  was recorded on June 18, 1931, whereas a maximum flow  $54 \text{ m}^3/\text{s}$  was reported on April 11, 1973.

The presence of fossil mammal bones located deep within the cave (Fig. 4), coupled with lower Pleistocene sea level



**FIGURE 4** Mastadon bone lying nearly 200 m inside Wakulla Spring Cave at a water depth of about 80 m. (Photograph courtesy of Wes Skiles.)

(and by extension, base level on land), constrains hydrologic models. It has been suggested that mammals wandered into the dry cave entrance looking for water. Further, it was hypothesized that the Wakulla Spring may have been a sink where water entered the aquifer at the time. Indeed, a report from another Florida spring noted the presence of an extinct land tortoise with a wooden stake stuck in its shell at 26 m below the current water level. A less likely explanation published for the presence of mastadon bones in Wakulla spring was that “In winter, mastodons crossing frozen pools broke through the ice and drowned.”

Directly north of the Wakulla area, an unconfined surficial aquifer system is found in the unconsolidated sands and gravels of the Tallahassee Hills. Recharge occurs by direct precipitation. An intermediate aquifer system lies below the surficial sediments ranging from about 15 to 46 m thick. The

bedrock contains interlayered clayey sediments, limestone, and dolomite resulting in discontinuous water-bearing zones. Water recharges into the intermediate aquifer by leakage from the surficial aquifer and from sinkhole-drained lakes. A dramatic example of flow into the aquifer from a lake in the Tallahassee Hills occurred on September 16, 1999. Much of the 1620-hectare Lake Jackson in the Tallahassee Hills suddenly drained down Porter Hole, a 5-m-deep sinkhole in the lake bed. The pit leading down from the sink swallowed the lake's southern half in a single day. Similar drainage events have occurred in the past as well.

Below the surficial and intermediate aquifers lies the Floridan aquifer system, which is a major carrier of water and extends through much of the northern part of the state. In the Woodville Karst Plain, the Floridan aquifer is comprised of the St. Marks Formation, Suwannee Limestone, and Ocala Group. Transmissivities are high and range from 465 to 11,613 m<sup>2</sup>/day. Recharge comes from downward leakage from the intermediate aquifer in the Tallahassee Hills and through sinkholes. The Woodville Karst Plain also forms a recharge area via direct rainfall and through sinkholes. Four streams sink underground, also contributing to recharge, though one re-emerges.

Regional groundwater flow of the Upper Floridan aquifer is to the southeast across Wakulla County (Fig. 5). In the Woodville Karst Plain the Floridan aquifer is unconfined and no low-permeability units lie between the surface and carbonate aquifer units.

The primary source of Wakulla Springs was determined, through the use of uranium isotopes, to be southward-flowing Floridan aquifer water. Further, strontium isotopic ratios were used to conclude that the spring water has not come solely from local recharge, but rather comes from water having been in contact with Floridan aquifer bedrock for considerable time. Conversely, tritium age dating for shallow and deep groundwater gave recharge times of less than 30 years.

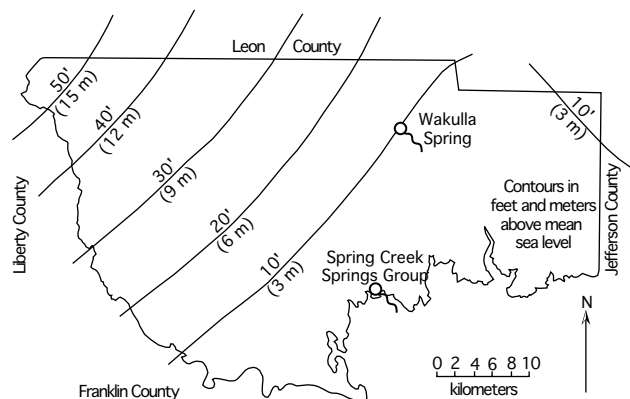
The conduit flow of groundwater in the Wakulla Spring cave and the Woodville Karst Plain is remarkably complex

considering the relatively uniform piezometric surface of the area (Fig. 5). A groundwater divide has been reported 1 to 2 km inside the main tunnel of Wakulla Spring. The divide marks a divergence between water flowing north to the Wakulla Spring vent and water flowing approximately along the regional groundwater gradient south, presumably to the Spring Creek Springs Group of 13 submarine springs. This flow divergence is perplexing because one would not expect diffuse aquifer percolation to supply water to a tunnel approximately 30 m in diameter.

The Spring Creek Springs Group has pulsating changes in flow where the surface of the water alternates between flat quiescence and boiling surface turbulence. The alternating surges generally last for several minutes and are thought to be a result of flushing through complex, tortuous passages. Since the Spring Creek Springs Group is likely to be connected, at least indirectly, with the nearby Wakulla Spring, much remains to be learned about the flow within the Woodville Karst Plain.

The importance of understanding the sources of water for Wakulla Spring is apparent when considering the clarity of water discharging from the spring. The vertigo-inducing clarity of the water in the 19th and early 20th centuries has diminished during the last few decades. One of the first reports of low visibility came in 1894: "The water has been stirred up by the heavy rains, and we could only see down 80 feet [24 m]," less than the maximum of 38 m. Reports in 1945 and 1946 by the commercial operation run by Ed Ball noted that visibility was affecting the ability to run glass bottom boat tours and turn a profit. The visibility is diminished primarily from tannic and humic acids in surficial swamp or river waters that enter the karst. Particulate matter may also contribute to lower visibility, but the dark color of the tannic water is a bigger problem. Boat guides at Wakulla report that dark water has become a more frequent, longer duration problem. Records of dark water indicated water visibility was poor for 58% of the time during the last 12 years and that the poor visibility is correlated to rainfall events. The best chance for crystal clear water is during the dry months of May and June.

Another significant problem with water quality at Wakulla Springs is the increase in nitrates, presumably the result of runoff from fertilizers used on lawns and agriculture. Simultaneous has been the introduction of exotic algae, particularly hydrilla. A virtual explosion of algae growth has choked much of the Wakulla Spring basin and river in recent years, probably enhanced by the high nitrate levels. The state park has attempted to manage the hydrilla using mowers and divers to remove as much as they can, but it has been a losing battle. Recently, the park applied a herbicide to the spring basin to improve visibility of the spring by glass bottom boat tours and to regain a healthy ecologic balance in the river system. It is hoped that native plants will reestablish themselves and that the hydrilla will not be reintroduced.



**FIGURE 5** Potentiometric surface map of the Upper Floridan aquifer in Wakulla County. (After Meadows, 1991.)

## Speleogenesis

Little work has been conducted on the speleogenesis of Wakulla Spring cave system considering its magnitude. The reason is probably because the cave system is entirely flooded and averages a nearly 90-m water depth.

One study suggested that karstification began approximately 9000 years BP based on the regional structural geology, sea-level fluctuations, climatic change, and groundwater flow of the Woodville Karst Plain and its offshore extension. A model for the origin of Wakulla Spring described the tunnels as a branching, flow-dominated, saturated cave. A four-stage sequence of development started through self-initiation. Small, random variations in permeability created positive feedback loops. The up-gradient process was based on geochemical feedback. Down-gradient, hydrodynamic processes governed the feedback loop and was enhanced by corrosion from mixing of waters. The largest conduits were developed in the cave when sea level was lower during the Pleistocene. Discharge occurred in springs that are presently submarine, while recharge entered through a sinkhole that now is the current Wakulla Spring.

## EXPLORATION AND MAPPING OF WAKULLA SPRING CAVE

A filming crew arrived at Wakulla Spring in 1955 for one of the many movies that needed a clear water setting. The movie company hired Garry Salsman, a Florida State University (FSU) student, to assist because he owned an air compressor to fill diving tanks. He and a buddy, Wally Jenkins, made their initial dive into the cave after completing the first day's filming. On their second dive into the cave, the two explorers discovered a mastodon long bone some 60 m inside and carried it out of the cave. The manager of the spring was so excited about the find that he permitted Salsman and his FSU buddies to continue diving in Wakulla.

Equipment at that time was quite primitive and techniques for diving at such depths (55 m and heading down) were not well established. Early dives in the 69°F water were made in nothing more than swimming trunks. Hardware-store flashlights wrapped in plastic bags were used for lighting. The scuba tanks did not have pressure gauges, so the students would venture in on each dive just a little bit farther than the previous one, to ensure an adequate air supply. The team of divers diligently created safety plans and avoided decompression sickness. However, by 1957 their diving ended having reached nearly 300 m into the cave at a water depth of 73 m. In part because of limitations in technology, in part because of the students graduating and moving on, and because of liability concerns by the springs manager, diving in Wakulla Springs ended in 1961 for two decades. In 1981 three Florida cave divers used diver propulsion vehicles and stage bottles to penetrate 335 m into

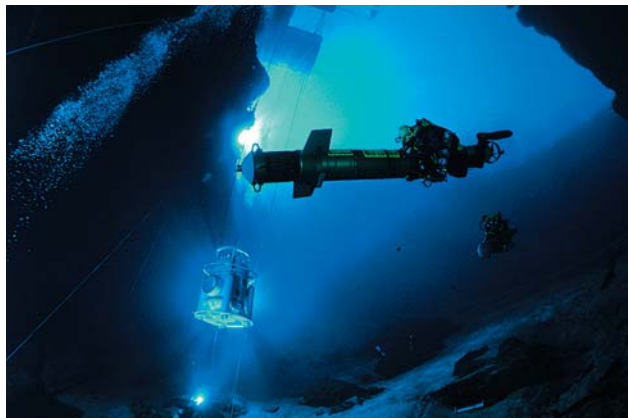
the cave at 79 m depth. Nitrogen narcosis was a significant impairment factor, as it had been for the FSU students.

When Wakulla Springs was sold to the state of Florida, cave divers hoped to obtain access to the underground tunnels once again. In 1987 the U.S. Deep Caving Team, Inc. (USDCT), received a permit to dive in the cave for a 2-month period in the fall. State officials were particularly interested in obtaining a map of the cave, as well as geologic, hydrologic, and biologic sampling and studies. Bill Stone, leader of the project, was in the process of designing a mixed-gas rebreather, the MK-1, and wanted the opportunity to test the device. During this project, the rebreather was successfully tested to a depth of 43 m and Stone was able to remain underwater continuously for 24 hours. However, the rebreather was not used for missions into the cave. For this, the divers used clusters of scuba tanks filled with mixed gas attached to the diver propulsion vehicles, as well as tanks on the divers' backs. Dives were made using dry suits, and a specially designed habitat was built to allow divers to decompress in a "bubble" of air. The total surveyed length of the cave was 3310 m at a maximum depth of 110 m. The culmination of diving was due to time and technology constraints. The intention was to return to explore the tunnels that beckoned onward into the darkness.

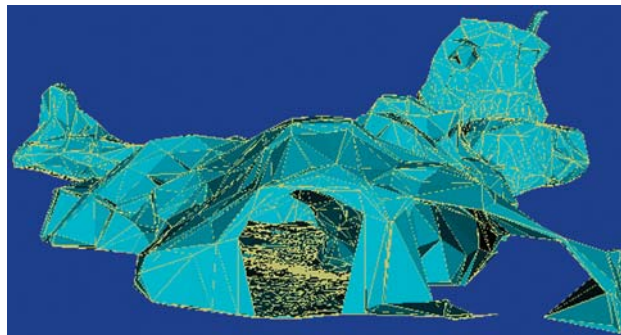
A group of cave divers known as the Woodville Karst Plain Project (WKPP) that had been diving in various sinks and springs in the area began diving in Wakulla Spring in 1991. During the next few years, the team explored and surveyed extensively, culminating in an impressive dive with a reported maximum penetration in Wakulla Spring of 5488 m using semiclosed rebreathers. The most recent maps published by the WKPP extend in maximum distance from the entrance to about 3000 m.

In December 1998, the USDCT returned to Wakulla Springs for the Wakulla 2 project. Stone's rebreather was no longer a prototype and the MK-5 was commercially available. Diver propulsion vehicles were powered by electric automobile batteries. Decompression was conducted in a rented decompression chamber deployed in the spring basin. The purpose of the expedition was not exploration (although 1.1 km of new passage was discovered), but rather mapping. A special device, the digital wall mapper (DWM) was designed and built for the project. Also powered by electric auto batteries, the DWM kept track of its location and measured distances to the walls of the cave using sonar (Fig. 6). A total of about 10 million points on the walls of the cave were surveyed during the 3-month expedition. A total of 6.4 km of tunnels were imaged this way (Fig. 7). The point cloud generated during the project shows exquisite detail of passage morphology that had not heretofore been measured in caves. Current efforts are aimed at meshing the point cloud into solid polygons (Fig. 8) to render a more realistic cave.

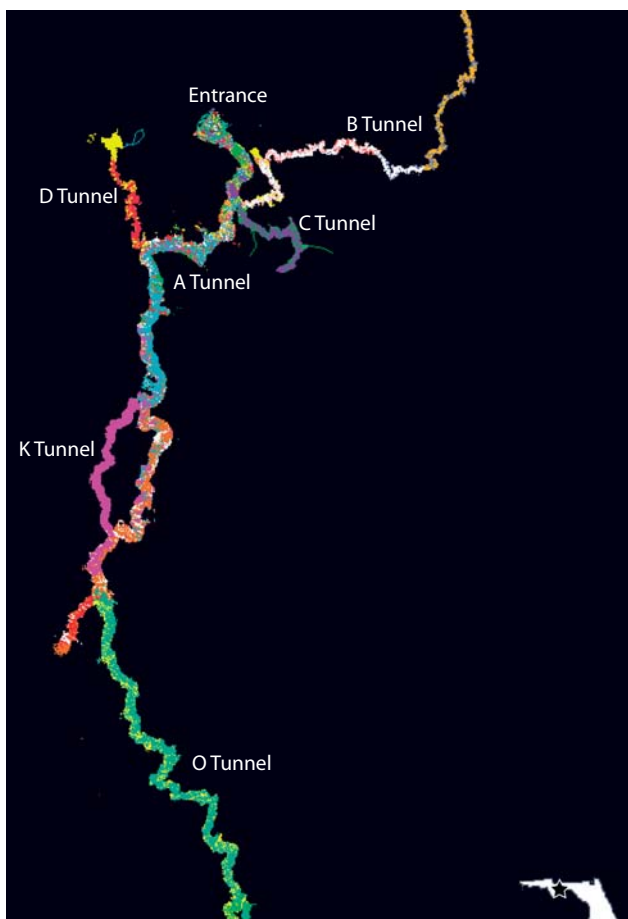
In a separate effort, a 3D map of the Wakulla Spring cave was built based on a traditional survey by the WKPP. Solid



**FIGURE 6** Divers entering the tunnel with DWM equipment. (Photograph courtesy of Wes Skiles.)



**FIGURE 8** Image of a meshed portion of the Wakulla point cloud. The points are connected by cream-colored lines to form solid blue triangles. This section of cave is at the junction of A and C Tunnels.



**FIGURE 7** Map of Wakulla Spring Cave showing 3 million wall points. In B, C, and D Tunnels, segments of passage mapped by hand are shown by lines.

walls were created from survey station data of four wall distance estimates taken about 10 to 100 m apart (269 stations and 1076 estimated wall points). Although this map lacks the detail of the USDCT map, the sparseness of data makes it more easily viewable on the average personal computer.

### FUTURE OF WAKULLA SPRING CAVE

The end of Wakulla Spring Cave is nowhere in sight and exploration will probably continue. However, even with the best technical diving equipment available, the current frontier is extremely remote. It may require yet greater advances in diving technology to make significant additions to the exploration of Wakulla Spring.

Long periods of time with poor visibility of the water also hampers exploration. The source of low-quality water in terms of clarity and nitrates has not been directly identified. It is probably from nonpoint source pollution such as excessive runoff from cleared and/or paved areas and residential and agricultural contaminants. The state of Florida is currently taking many positive steps to preserve and restore the quality of water in its many springs. Time will tell if the state can overcome the ecological pressure created by the modern lifestyle of a large population in the area around Wakulla Spring.

### Bibliography

- am Ende, B. (2000). Wakulla 2—Building the first fully 3D cave map. *NSS News*, 58, 244–260, 270.
- Burgess, R. F. (1999). *The Cave Divers*. Aqua Quest Publications, New York.
- Kincaid, T. R. (1999). Morphologic and fractal characterization of saturated karstic caves. Ph.D. dissertation, University of Wyoming, Laramie.
- Lane, E. (2001). *The Spring Creek Submarine Springs Group, Wakulla County, Florida*. FGS Special Publication No. 47. Florida Geological Survey, Tallahassee, FL.
- Meadows, P. E. (1991). Potentiometric surface of the Upper Floridan aquifer system in the Northwest Florida Water Management District, Florida, May, 1990. U.S. Geological Survey Open File Report 90–586.
- Revel, T. J. (2002). *Watery Eden: A History of Wakulla Springs*, Sentry Press, Tallahassee, FL.
- Rupert, F. R. (1988). *The Geology of Wakulla Springs*, FGS Open File Report No. 22. Florida Geological Survey, Tallahassee, FL.
- Rupert, F. R. (1993). Karst features of northern Florida. In *Geologic Field Studies of the Coastal Plain in Alabama, Georgia, and Florida: Southeastern Section* (S. A. Kish, ed.), Meeting Guidebook, Tallahassee, FL, April 1998, pp. 49–61. Geological Society of America, Boulder, CO. Florida Geological Survey, Tallahassee, FL.



- Rupert, F., and Spencer, S. (1988). *Geology of Wakulla County, Florida*. Florida Geological Survey Bulletin No. 60, Tallahassee, FL.
- Schmidt, W. (2000). *The Wakulla Springs Woodville Karst Plain Symposium Transactions*, pp. 160–171. FGS Special Publication No. 46. Florida Geological Survey, Tallahassee, FL.
- Stone, W. C. (1989). *The Wakulla Springs Project*. The U.S. Deep Caving Team, Derwood, MD.

## Water Chemistry in Caves

Janet S. Herman  
University of Virginia

### INTRODUCTION

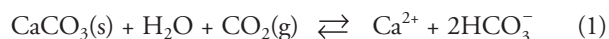
Caves would not exist in limestone bedrock if it were not for water. Interestingly, water is not only the agent of formation of the natural openings in the earth that we call caves, but it is also the agent of cave decoration. The duality of water's role in bedrock dissolution to form the cave and in mineral precipitation to decorate the cave can be understood through an examination of the chemistry of cave waters. Just as any natural water acquires its chemical composition, cave waters acquire solutes from many different sources, including gases from the atmosphere, weathering and dissolution of the minerals of soils and bedrock, and from human activities.

### LIMESTONE DISSOLUTION AND THE CHEMICAL EVOLUTION OF CAVE WATERS

Calcite,  $\text{CaCO}_3$ , is the principal component of limestone. The solubility of calcite in natural waters is established by chemical equilibria among the solid calcite, the dissolved calcium and carbonate-bearing species in aqueous solution, and the carbon dioxide in the gas phase in contact with the solution. Indeed, the pH of most natural waters is controlled by reactions involving the carbonate system, calcium is the predominant cation in most freshwaters, and most groundwater in contact with limestone is near equilibrium with respect to calcite solubility. These facts allow us to understand the chemical evolution of cave waters using the tools of chemical thermodynamics.

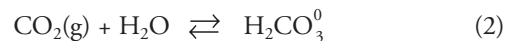
#### Role of $\text{CO}_2$ Gas in Calcite Solubility

We can describe the dissolution of calcite in natural waters by



where the role of carbon dioxide is to generate acid. Dissolved carbon dioxide is the most common acid in natural

waters, and the reactions that give rise to free acid are the formation of carbonic acid from the hydration of  $\text{CO}_2$  gas:



and the subsequent dissociation of carbonic acid according to



A natural water in contact with a gas phase containing  $\text{CO}_2$ , therefore, has the dissolved carbonate-bearing species (i.e.,  $\text{H}_2\text{CO}_3^0$ ,  $\text{HCO}_3^-$ , and  $\text{CO}_3^{2-}$ ) in solution regardless of contact with a solid carbonate phase such as calcite.

The first fact of the chemistry of caves waters is therefore evident. The extent to which  $\text{CO}_2$  gas is dissolved in infiltrating waters determines the extent to which acid is available to carry out limestone dissolution to form caves out of previously solid bedrock. Caves in limestone bedrock in continental settings are typically formed by the circulation of shallow groundwater. These waters derive from the infiltration of dilute, fresh rainfall into soil. Microbial respiration in the soil biodegrades natural organic matter (presented simply here as  $\text{CH}_2\text{O}$  from dead vegetation) and generates  $\text{CO}_2$  gas according to



Infiltrating water dissolves the  $\text{CO}_2$  gas available in the soil environment, thereby generating the acidity for dissolution of limestone bedrock as the water continues along its flow path.

The measure of the amount of  $\text{CO}_2$  gas in the atmosphere is its partial pressure ( $P_{\text{CO}_2}$ ), where the total atmospheric pressure is 1 bar. The value of the partial pressure of  $\text{CO}_2$  ranges from the low value of  $10^{-3.5}$  bar in the open atmosphere at the earth's surface, to the higher values of  $10^{-2.2}$  to  $10^{-2.0}$  bar in the typical soil atmosphere of a humid, temperate climate, to a high value of  $10^{-1.5}$  bar in a notably  $\text{CO}_2$ -rich cave. This range in partial pressure of  $\text{CO}_2$  gas is an important factor in the starting point for calcite dissolution. A pure water in equilibrium with  $10^{-3.5}$  bar  $\text{CO}_2$  has a pH of 5.7, whereas a water in equilibrium with  $10^{-1.5}$  bar  $\text{CO}_2$  has a pH of 4.7 at 25°C. The greater amount of  $\text{CO}_2$  generates a distinctly more acidic solution.

The greater the amount of  $\text{CO}_2$  dissolved in the groundwater, the greater extent of dissolution of calcite at equilibrium [see Eq. (1)]. The solubility of a mineral is the mass of mineral that can dissolve in a volume of aqueous solution. At equilibrium between solution and mineral, no further dissolution occurs nor does mineral precipitate from solution. An idealized calculation of pure water in equilibrium with respect to calcite at each of two different partial pressures of  $\text{CO}_2$  and two different temperatures illustrates the impact these two variables have on solution composition (Table I). The availability of  $\text{CO}_2$  gas is clearly an important factor in determining the extent of calcite

**TABLE I Chemical Composition for Water in Equilibrium with Respect to Both Calcite and CO<sub>2</sub> Gas at Two Different Pco<sub>2</sub> Values and at Two Different Temperatures<sup>a</sup>**

Pco <sub>2</sub> (bar)	Temperature (°C)	pH	Ca <sup>2+</sup> (mg/L)	HCO <sub>3</sub> <sup>-</sup> (mg/L)
10 <sup>-3.5</sup>	12	8.3	24	72
10 <sup>-3.5</sup>	25	8.3	19	58
10 <sup>-1.5</sup>	12	7.0	120	372
10 <sup>-1.5</sup>	25	7.0	96	298

<sup>a</sup>These values for Ca<sup>2+</sup> and HCO<sub>3</sub><sup>-</sup> concentration were obtained in a hypothetical calculation of simultaneous equilibria.

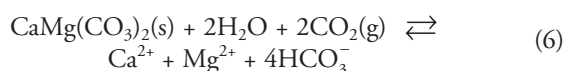
dissolution. Temperature is the other. Like all gases, CO<sub>2</sub> solubility is greater at lower temperatures than at higher temperatures. The greater CO<sub>2</sub> gas solubility that is possible at 12°C in groundwater compared to a warm 25°C surface water further promotes calcite dissolution.

### Chemical Composition of Groundwater in Limestone Terrain

The resulting chemical character of the groundwater in caves is one rich in dissolved calcium (Ca<sup>2+</sup>) and bicarbonate (HCO<sub>3</sub><sup>-</sup>). The pH of cave waters tends to be relatively high because the protons released from carbonic acid are consumed in the dissolution of calcite. Equation (1) demonstrates the molar relationships of Ca<sup>2+</sup> and HCO<sub>3</sub><sup>-</sup> in this system: 2 mol HCO<sub>3</sub><sup>-</sup> are generated for every mole of Ca<sup>2+</sup>. The typical groundwater collected from limestone terrain, then, has very large concentrations of dissolved HCO<sub>3</sub><sup>-</sup> compared to groundwater in other geological settings (Table II).

Unlike the hypothetical case of pure water in contact with pure calcite and a CO<sub>2</sub>-containing atmosphere (e.g., Table I), Ca<sup>2+</sup> and HCO<sub>3</sub><sup>-</sup> are not the only dissolved chemicals in a natural water. Limestone bedrock, although predominantly made up of calcite, ordinarily has some other minerals present. Rainwater infiltrating through soil and groundwater migrating to greater depths come in contact with these various solid phases.

A mineral commonly associated with calcite is dolomite, CaMg(CO<sub>3</sub>)<sub>2</sub>, whose dissolution is described by



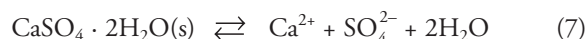
In addition to the common occurrence of dolomite in limestone bedrock, some caves are developed in dolostone, bedrock made up primarily of the mineral dolomite. Dissolved Mg<sup>2+</sup> is, therefore, a major constituent in many cave waters (e.g., Table II). Gypsum, CaSO<sub>4</sub> · 2H<sub>2</sub>O, may be associated with calcite and dolomite in some sequences of sedimentary rock. If present, this highly soluble sulfate

**TABLE II Chemical Composition of Groundwater Collected in Limestone Terrain<sup>a</sup>**

Sample location	pH	Ca <sup>2+</sup>	Mg <sup>2+</sup>	Na <sup>+</sup>	K <sup>+</sup>	HCO <sub>3</sub> <sup>-</sup>	SO <sub>4</sub> <sup>2-</sup>	Cl <sup>-</sup>	NO <sub>3</sub> <sup>-</sup>
State College, PA, USA	7.36	54.9	23	6	1.4	238	16.5	13.5	22
Mallorca, Spain	7.25	119	25	31	2.9	334	99	58	4.7
Warm River Cave, VA, USA	6.72	180	32.7	4.3	18.2	335	341	3.6	ND
Huntsville, AL, USA	7.5	48	3.6	2.1	ND	152	3.2	8.0	ND
Manatee County, FL, USA	7.59	93.3	48.9	47.0	8.1	159	352	1.8	47.0
Yucatan Peninsula, Mexico	7.23	94	28	16	0.6	382	5.9	34	14

<sup>a</sup>Some samples were collected in caves; some samples were collected in wells drilled in limestone bedrock. All chemical concentrations are reported in units of milligrams per liter. ND = not determined.

mineral can have a big impact on the chemical composition of cave waters



For instance, in the sample from Manatee County, Florida, USA (Table II), the groundwater circulation put it in contact with a gypsum layer at depth, and the resultant groundwater had higher dissolved SO<sub>4</sub><sup>2-</sup> concentrations than HCO<sub>3</sub><sup>-</sup> concentrations.

The other common rock-forming elements of Na<sup>+</sup> and K<sup>+</sup> may enter solution from dissolution of minerals or from ion-exchange reactions whereby the base cations occupying the surface sites of clay minerals in the limestone bedrock or in the sediments of the cave stream can exchange by



This mass action expression illustrates the shift in the composition of the ion-exchange complex on the clay mineral surface with shifting concentrations of dissolved cations. When more dissolved Ca<sup>2+</sup> is present from calcite dissolution, it tends to shift toward sorption onto the clay [i.e., Eq. (8) shifts to the right]; however, when more dissolved Na<sup>+</sup> is present from saltwater intrusion, Na<sup>+</sup> will move toward occupying more surface sites [i.e., Eq. (8) shifts to the left].

The anions commonly present in cave waters may derive from any of several sources. Neither Cl<sup>-</sup> nor NO<sub>3</sub><sup>-</sup> are major rock-forming elements. Both chemicals have atmospheric sources, especially in regions where the atmospheric chemistry is impacted by industrial emissions, and, thus, they may enter with rainfall. Cl<sup>-</sup> may be introduced to the groundwater of near-coastal limestone terrain by the dissolution of sea spray or marine aerosols into rainfall or by saltwater intrusion in limestone aquifers. Several samples in Table II have been influenced by the proximity of marine waters (Mallorca, Spain; Manatee County, Florida, USA;

Yucatan Peninsula, Mexico). Furthermore, both chemicals may also come in as contaminants in waters influenced by animal fecal wastes, road salts, and agricultural chemicals.

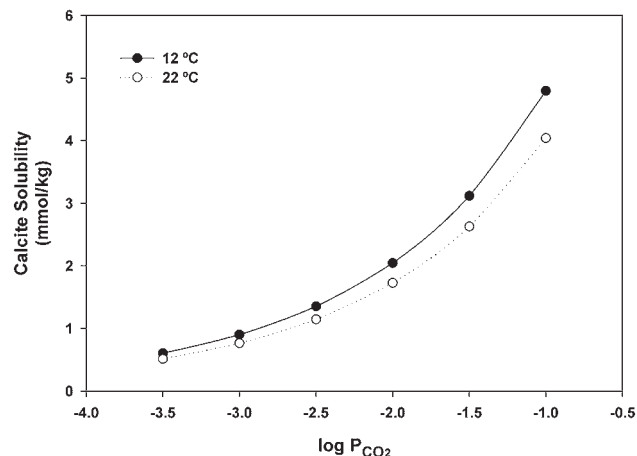
### Saturation State of the Aqueous Solution

The chemical status of a water capable of dissolving calcite is termed *undersaturated*. That is, the solution is undersaturated with respect to calcite and will dissolve calcite until equilibrium solubility is obtained [i.e., Eq. (1) will shift toward the right]. An undersaturated solution has less dissolved  $\text{Ca}^{2+}$  and  $\text{HCO}_3^-$  in it than it would have at equilibrium. Such a solution is also described as being aggressive toward calcite in that it is capable of dissolving more calcite in the cave-forming process. A water initially at equilibrium with respect to calcite can be shifted toward undersaturation by changes in the two important factors discussed above:  $\text{PCO}_2$  and temperature. An increase in  $\text{PCO}_2$  or a decrease in temperature will cause a water to again become undersaturated with respect to calcite and to further the dissolution of limestone bedrock. Conversely, an equilibrium solution can be shifted toward being *supersaturated* and capable of precipitating calcite [i.e., Eq. (1) will shift toward the left] with a loss of  $\text{CO}_2$  gas or an increase in temperature. A supersaturated solution has more dissolved  $\text{Ca}^{2+}$  and  $\text{HCO}_3^-$  in it than it would have at equilibrium. An adjustment toward equilibrium is achieved by precipitating calcite from solution.

A summary of the influences of  $\text{PCO}_2$  and temperature is illustrated in a solubility diagram (Fig. 1). Along each solid curve, the dissolved  $\text{Ca}^{2+}$  concentration and the pH are the equilibrium values for the  $\text{PCO}_2$  and temperature indicated. A groundwater with lower dissolved  $\text{Ca}^{2+}$  concentration or with lower pH than the values on the curve is undersaturated and capable of calcite dissolution. A groundwater with higher dissolved  $\text{Ca}^{2+}$  concentration or with higher pH than the values on the curve is supersaturated and capable of calcite precipitation.

The saturation state of a solution is usually quantified through the calculation of the saturation index. The saturation index is the logarithm of the ratio of the actual dissolved  $\text{Ca}^{2+}$ ,  $\text{HCO}_3^-$ , and  $\text{H}^+$  concentrations to those expected at equilibrium. The log of that ratio is greater than 0 for a supersaturated solution, less than 0 for an undersaturated solution, and equal to 0 at equilibrium.

The process of  $\text{CO}_2$  gas exchange in cave waters often controls the saturation state of the solution. Groundwater rich in dissolved  $\text{CO}_2$  picked up during infiltration through an organic-rich soil and circulation in the confined subsurface will have a high  $\text{PCO}_2$ . When such a groundwater enters a cave, the water begins to equilibrate with the cave atmosphere that is usually less rich in  $\text{CO}_2$  by virtue of circulation and exchange with the open atmosphere on the earth's surface. The outgassing of  $\text{CO}_2$  from a water entering the cave can drive the pH up and the saturation state of the

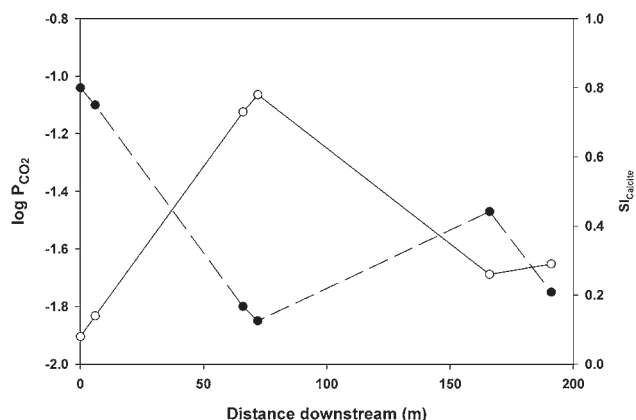


**FIGURE 1** Solubility of calcite as a function of  $\text{PCO}_2$  at two different common groundwater temperatures, 12 and 22°C, for 1 bar total pressure. For a given  $\text{PCO}_2$  value (in bars), water samples with total dissolved calcium concentrations (in mmol/kg) plotting below the line are undersaturated with respect to calcite and capable of dissolving calcite; solution compositions on the curves are in equilibrium with respect to calcite and no further reaction can occur without a change in environmental conditions; solution compositions plotting above the line are supersaturated with respect to calcite and capable of precipitating calcite. The retrograde solubility of calcite can also be observed by noting that at a given  $\text{PCO}_2$  value, the equilibrium solution at 12°C is capable of holding more total dissolved calcium (greater calcite solubility) than is the 22°C solution.

water from being near equilibrium with respect to calcite to being significantly supersaturated with respect to calcite. In essence, the loss of  $\text{CO}_2$  to the atmosphere acts to drive Eq. (1) back to the left. If calcite does not immediately precipitate, the result is a supersaturated solution capable of precipitating calcite. A longitudinal sampling of a cave stream in Virginia showed just such a trend in saturation state of the solution along the flow path (Fig. 2). Until the solution can reach equilibrium by precipitating calcite, it remains supersaturated with saturation indices significantly greater than 0.

### Environmental Factors Influencing Calcite Dissolution

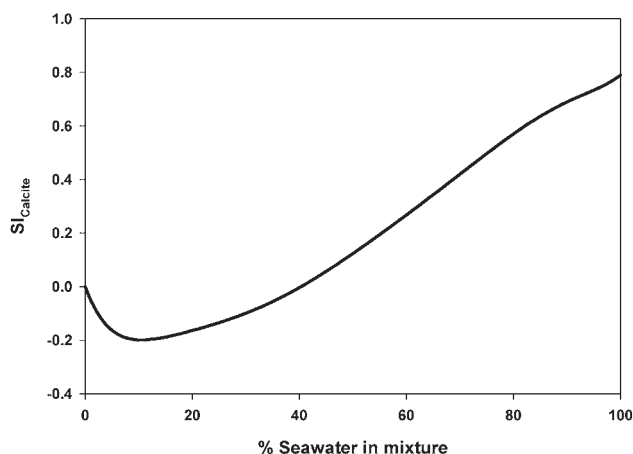
The critical role of  $\text{CO}_2$  gas in shifting the chemical equilibria toward more calcite dissolution in the presence of more  $\text{CO}_2$  gas or toward less calcite dissolution in the presence of less  $\text{CO}_2$  gas is the basis for understanding some of the climatic effects on cave development. In a moist, warm environment, the growth and decay of terrestrial vegetation occurs to greater extents and at greater rates than in cool, dry environments. The overall result is greater availability of  $\text{CO}_2$  gas to generate carbonic acid in a warm, organic-rich environment. Cave development in tropical settings, therefore, is recognized to be far greater than in arctic or desert settings. Some of the most dramatic caves we know from locations such as Puerto Rico, Mexico, and Belize developed under tropical climatic conditions.



**FIGURE 2** Plot of the log partial pressure of  $\text{CO}_2$  ( $\text{PCO}_2$ ; ---●---) and saturation index with respect to calcite ( $\text{SI}_{\text{Calcite}}$ ; —○—) as a function of distance along the flow path for a cave stream, Warm River Cave, Virginia. From the point of entry into the cave room, the streamwater is outgassing  $\text{CO}_2$  from an initial high concentration in the groundwater toward a lower value in equilibrium with the cave atmosphere. The decreased  $\text{PCO}_2$  thereby drives the solution from an initial condition near equilibrium with respect to calcite toward greater and greater supersaturation. Precipitation of calcite begins at some greater distance (delayed time) from the point of water entry into the cave. As calcite precipitation proceeds, the solution approaches equilibrium with respect to calcite at a new, lower  $\text{PCO}_2$  level.

There are other hydrogeological and geochemical settings that generate waters undersaturated with respect to calcite and capable of dissolving limestone to form caves. The mixing of freshwater and saline water in coastal regions gives rise to an aggressive solution that can dissolve more calcite than either individual type of water can. The chemical characteristics of groundwater in coastal regions are those of a mixture of two solutions: (1) a dilute, fresh groundwater such as might be generated by the infiltration of rain into a soil and into an underlying limestone where calcite dissolution occurs and (2) seawater that is intruding into the limestone aquifer. The dense saline water that encroaches into coastal aquifers forms the downgradient boundary of the fresh groundwater circulation system where discharging freshwater mixes with intruding seawater to form a zone of brackish groundwater.

The chemical reactivity of the brackish-water mixture results from the nonlinearity of mineral solubility as a function of the relative concentrations of dissolved constituents in the mixture. The great contrasts in solute concentrations between the mixing endmembers make it possible to generate a mixture that is capable of further dissolution of calcite from two solutions that were individually in equilibrium with, or even supersaturated with, respect to calcite (Fig. 3). This renewed potential for calcite dissolution in the coastal mixing zone has been recognized as an important contribution to the formation of caves in the near-coastal setting. Caves developed along the coasts of Florida, Mexico, Spain, Greece, and the Bahamas have been influenced by calcite dissolution in the freshwater–saline water mixing zone. The chemical compo-



**FIGURE 3** Saturation state of a solution derived from mixing fresh and saline waters. The mixing curve was generated for a fresh groundwater in equilibrium with respect to calcite at  $\text{PCO}_2 = 10^{-2.2}$  bar and  $22^\circ\text{C}$ . The freshwater was mixed with a standard composition of surface seawater for which  $\text{PCO}_2 = 10^{-3.3}$  bar. The mixture is undersaturated where the mixing curve plots below value  $\text{SI}_{\text{Calcite}} = 0$ ; the mixture is supersaturated where it plots above the value  $\text{SI}_{\text{Calcite}} = 0$ . Starting with a saturated freshwater and a supersaturated saline water, mixing produces an undersaturated brackish water that is capable of calcite dissolution that contributes to the formation of caves in coastal limestone.

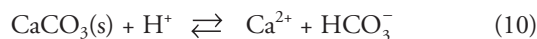
sition of water in the resulting coastal caves once again has  $\text{Ca}^{2+}$  and  $\text{HCO}_3^-$  as major constituents, but the overall character of the water could be described as diluted seawater with sodium ( $\text{Na}^+$ ), chloride ( $\text{Cl}^-$ ), and sulfate ( $\text{SO}_4^{2-}$ ) concentrations also being high, however, the source of these solutes is not in the local bedrock.

### Role of Strong Acids in Limestone Dissolution

Although the abundant natural acid in hydrogeological systems is carbonic acid, there are settings in which other natural acids are important. The migration of hydrogen sulfide into shallow, oxygenated groundwater environments from greater depths where reducing conditions prevailed sets up the potential for the generation of strong acid in the subsurface environment. For instance, caves of the Guadalupe Mountains of New Mexico have been formed by sulfuric acid derived from the oxidation of hydrogen sulfide migrating from underlying oil and natural gas reservoirs. As dissolved  $\text{H}_2\text{S}$  gas comes in contact with dissolved  $\text{O}_2$ , oxidation generates acid in the groundwater:



Once acid is present, the dissolution of calcite looks just as it did for the carbonic acid source:



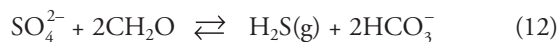
but the chemical composition of the cave water has a high concentration of  $\text{SO}_4^{2-}$  that is not seen in the more typical solution caves.

The oxidation of other sulfide phases may also generate sulfuric acid for limestone dissolution. Iron sulfide minerals, mainly pyrite ( $\text{FeS}_2$ ), and other base-metal sulfide minerals are common in the rocks of the earth's crust. Although stable under reducing conditions, with exposure to  $\text{O}_2$ -containing air and water, the sulfide minerals undergo oxidation as in this reaction with pyrite:



Just as in the oxidation of hydrogen sulfide gas, acidity is released to solution that can further react with limestone bedrock according to Eq. (10). Although natural weathering of bedrock containing sulfide minerals does occur, the acceleration of this reaction due to the human activity of mining and processing minerals far outstrips the natural occurrence of acidity from such reactions. Today, the contact of acid mine drainage with limestone bedrock in active or abandoned mining districts may be contributing to the formation of new conduits and caves in the regional bedrock.

One environment fosters both reduction and oxidation reactions involving sulfur. In the saline waters of coastal caves and blue holes, density stratification of the groundwater in the cave or aquifer may limit the mixing of shallow oxygenated waters to greater depth. At depth, modest concentrations of dissolved and suspended organic matter can result in reduction of  $\text{SO}_4^{2-}$  as the organic matter undergoes microbially mediated oxidation in the absence of dissolved  $\text{O}_2$ . The use of  $\text{SO}_4^{2-}$  as an alternate electron acceptor results in the formation of dissolved sulfide:



where the organic matter,  $\text{CH}_2\text{O}$ , may be dissolved or particulate. Further migration of  $\text{H}_2\text{S}$  along a groundwater flow path may bring the water into contact with  $\text{O}_2$  where the  $\text{H}_2\text{S}$  oxidizes to sulfate generating acidity [Eq. (9)]. The increased capacity to dissolve limestone has contributed to the formation of caves and blue holes on the islands of the Caribbean.

### PRECIPITATION OF MINERALS AND THE FORMATION OF SPELEOTHEMS FROM CAVE WATERS

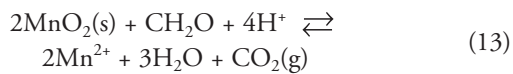
Not all cave waters derive their final composition from the process of calcite dissolution. Just as the increased abundance of  $\text{CO}_2$  gas was a factor in shifting the extent of calcite dissolution in undersaturated subsurface waters, the same factor in reverse can shift cave water to being supersaturated and capable of mineral precipitation. Carbonate minerals precipitate as a result of Eq. (1) shifting toward the left due to  $\text{CO}_2$  outgassing when soil water or groundwater with elevated  $\text{PCO}_2$  enters the open room of a cave. Although  $\text{CO}_2$

levels were increased in the restricted environment of the soils, when soil water or groundwater with high  $\text{PCO}_2$  comes in contact with a cave atmosphere with lower  $\text{PCO}_2$ , sudden outgassing can occur. Precipitation of calcite from drip waters forms dripstone and flowstone on cave ceilings, walls, or floors, and precipitation from stream waters forms travertine. In each case, the resulting chemical composition of the cave water is somewhat reduced in dissolved  $\text{Ca}^{2+}$  and  $\text{HCO}_3^-$  concentrations and the pH of the solution is slightly lower; that is, the solution composition shifts down to the left on Fig. 1 as the supersaturated solution (saturation index greater than 0) establishes equilibrium (saturation index equal to 0).

Although  $\text{CO}_2$  outgassing can drive the cave water to high levels of supersaturation from which calcite precipitation ensues, the rate of calcite precipitation may be slow enough to maintain a supersaturated solution for some time. In the example from a cave stream in Virginia, for instance, the solution reaches a high degree of supersaturation before beginning to adjust toward equilibrium through calcite precipitation as the stream moves through the cave (Fig. 2). The principles of thermodynamics are useful in determining the ultimate equilibrium composition of the calcite–water– $\text{CO}_2$  system, but the rates at which the reactions occur are less poorly known and fall under the purview of geochemical kinetics.

All cave water is not confined to a stream channel in which travertine or rimstone dams may be the product of calcite precipitation. Diffuse infiltration waters commonly emerge from the ceiling or walls of caves where rapid outgassing of  $\text{CO}_2$  from small water droplets with large surface area drives the solution to become supersaturated. Generally, the precipitated mineral is calcite, although in some instances the polymorph aragonite is formed. Being formed from a solution with a variety of dissolved chemicals present, some trace incorporation of cations other than  $\text{Ca}^{2+}$  contributes to some chemical impurity of the carbonate speleothems. The chemical and morphological variety of the precipitated carbonates makes the study of cave speleothems an endlessly fascinating endeavor.

In addition to the transport and reaction of  $\text{Ca}^{2+}$  and  $\text{HCO}_3^-$  in the cave environment, chemical reactions in the soil water and groundwater environment can mobilize iron and manganese. Ordinarily found in their oxidized form in insoluble oxide minerals, iron and manganese can be reduced in much the same way that  $\text{O}_2$  is reduced coupled to the oxidation of organic matter. In the water-saturated subsurface, when biodegradation of organic matter consumes all of the available  $\text{O}_2$ , bacteria will turn to the use of alternate electron acceptors. Oxidized iron (Fe(III)) and manganese (Mn(IV)) may be present in the form of goethite ( $\text{FeOOH}$ ) and birnessite ( $\text{MnO}_2$ ) as grain coatings in the soil. Here shown for birnessite, an oxidized manganese mineral is reduced when coupled to microbially mediated oxidation of organic matter to  $\text{CO}_2$ :



When these elements are used as electron acceptors, they are reduced to Fe(II) and Mn(II), respectively, and are then soluble in groundwater. Dissolved  $\text{Fe}^{2+}$  and  $\text{Mn}^{2+}$  enter the cave in flowing groundwater where they may remain dissolved in cave waters or they may be reoxidized to precipitate Fe(III) and Mn(IV) oxide and carbonate minerals. The presence of oxidized iron and manganese minerals can be recognized as coatings on cave walls or on speleothems as black or reddish brown coatings. For instance, birnessite can be a black, dendritic deposit on the surface of calcite speleothems.

### HUMAN IMPACT ON CAVE WATERS

Just as the activities of crop and animal farming, industrial production, and fecal, municipal, and hazardous waste disposal have had deleterious effects on the quality of surface water and groundwater in many regions of the world, some cave waters have been negatively impacted. The variety of chemical contaminants is too numerous to elucidate in detail, but everything from fertilizers, pesticides, metals, bacteria, petroleum hydrocarbons, and chlorinated solvents to exotic synthetic organic compounds and pharmaceuticals have been reported to contaminate cave waters. In these situations, cave waters are not unique but rather are like other groundwater. Human activities, sometimes immediate and sometimes at remote times and places, can impact the chemical composition of groundwater along its flow path.

There are, however, some dramatic examples in which the physical characteristics of limestone aquifers have distinguished the resulting groundwater contamination from that typical in other types of bedrock. The large conduits and caves in the subsurface of karst terrains are openings many orders of magnitude larger than are present in the subsurface in other geological settings. These relatively huge openings lend themselves to rapid transmission of high concentrations of contaminants and allow the migration of large particles of contaminants without the benefit of filtration by the porous media of the subsurface environment. Some examples of the dramatic contamination of cave waters include the presence of free-phase gasoline floating on cave streams and the fecal coliform bacterial contamination of rural drinking water supplies. Once introduced to groundwater, the rapid flow through limestone aquifers makes it particularly difficult to limit the spread of contamination. The hard lessons learned about the contamination of water supplies in karst regions drive home the need to avoid contamination of groundwater in the first place rather than try to remediate contamination after it occurs.

### Bibliography

- Back, W., B. B. Hanshaw, T. E. Pyle, L. N. Plummer, and A. E. Weidie (1979). Geochemical significance of groundwater discharge and carbonate solution to the formation of Caleta Xel Ha, Quintana Roo, Mexico. *Water Resources Res.* **15**, 1521–1535.
- Butler, J. N. (1982). *Carbon Dioxide Equilibria and Their Applications*. Addison-Wesley, Reading, MA.
- Drever, J. I. (1997). *The Geochemistry of Natural Waters*, 3rd ed. Prentice Hall, Upper Saddle River, NJ.
- Garrels, R. M., and C. L. Christ (1965). *Solution, Minerals, and Equilibria*. Freeman, Cooper & Co., San Francisco.
- Hem, J. D. (1989). Study and interpretation of the chemical characteristics of natural water. *U.S. Geol. Survey Water-Supply Paper* 2254.
- Krauskopf, K. B., and D. K. Bird (1995). *Introduction to Geochemistry*, 3rd ed. McGraw-Hill, New York.
- Langmuir, D. (1971). The geochemistry of some carbonate groundwaters in central Pennsylvania. *Geochim. Cosmochim. Acta* **35**, 1023–1045.
- White, W. B. (1988). *Geomorphology and Hydrology of Karst Terrains*. Oxford University Press, New York.
- White, W. B., D. C. Culver, J. S. Herman, T. C. Kane, and J. E. Mylroie (1995). Karst lands. *Am. Scientist* **83**, 450–459.
- Wigley, T. M. L., and L. N. Plummer (1976). Mixing of carbonate waters. *Geochim. Cosmochim. Acta* **40**, 989–995.

## Worms

Elzbieta Dumnicka

*Institute of Freshwater Biology, Polish Academy of Sciences, Poland*

### GENERAL CHARACTERISTICS

*Worms*—several types (phyla) of small invertebrates hide under this name: flatworms (Turbellaria), roundworms (Nematoda), ribbon worms (Nemertina), and annelids (Annelida). Sometimes the wormlike Onychophora are also included. The shape of worms is rather simple: flat, filiform, or tubelike. The body is usually small (from half a millimeter to 2–3 cm, exceptionally more). The majority of worm species do not show morphological changes connected with life in the cave environment, because they are usually unpigmented and blind in any case. Only in flatworms, leeches, and a few ribbon worms, which are normally oculated and pigmented, did these changes occur. The body coloration is determined principally by the contents of the digestive tube and by blood pigments (as in annelids). Features characteristic of typical cave fauna other than morphological ones have been described, including slowing down of the metabolism or prolongation of all stages of the life cycle (Dumnicka, 1984).

The majority of worms living in caves are the same species that live in the soil or on the bottom of surface water bodies. Nevertheless, in all phyla there are also species found exclusively in various kinds of underground habitats (including caves), and they are classified as troglobionts or stygobionts. The distribution of stygobionts is often wider

than that of strictly cave fauna, since they can live in various types of underground waters (e.g., interstitial waters, hyporheic waters of rivers, and so on).

### HISTORY OF STUDIES

Though studies on cave worms started many years ago (Jeannel, 1926; Hyman, 1937; Cernosvitov, 1939) they are still poorly known. Data on the distribution, biology, and ecology of various systematic groups were summarized in *Encyclopaedia Biospéologica* (Juberthie and Decu, 1994, 1998) and *Stygofauna Mundi* (Botosaneanu, 1986) (for water fauna). Since the publication of those books, many new species or even higher taxa have been described. For example, 66 stygobiontic oligochaete species were cited in *Stygofauna Mundi* (1986), but that number is now 110. Thus the majority of information on the number and distribution of troglobiontic and stygobiontic species is incomplete. According to our present knowledge, troglobiontic and stygobiontic worms are most numerous in Europe and North America, but these are the continents with the most intensive biospeleological studies and the longest history of them. Studies of worms in karstic regions of Australia, Malaysia, and South America started only recently, and their results should enlarge our knowledge about this group.

### BRIEF CHARACTERIZATION OF INVERTEBRATE TYPES CONSIDERED WORMS

#### Phylum: Turbellaria (Flatworms)

The body of flatworms is elongated with a delicately ciliated surface, with only one opening (no anal opening). Representatives of two orders have been found in caves, as discussed next.

**CLASS: TRICLADIDA** The Tricladida are almost exclusively aquatic forms feeding on living or dead animals. The triclad engulfs food particles, extruding a long and muscular pharynx through its mouth (Fig. 1), and sucks up the food into the gastrovascular cavity. Adaptations to cave life are very visible in this group of worms, expressed in depigmentation of the body and disappearance or reduction of the eyes. Of the approximately 350 triclad species currently known, 150 are stygobionts. They have been found mainly in Europe and North America, but recent discoveries have been made Tahiti, Mexico, and Australia.

**CLASS: TEMNOCEPHALIDA** The Temnocephalida are external parasites of crustacea (Decapoda and Amphipoda), attaching to the host's gills, antennae, or legs (Fig. 2). The body is simple, with one or more (up to six) accetabula allowing for attachment to the host animal (Fig. 3). They produce a viscous substance to better attach and glue their eggs, from which small specimens (similar to adult forms)

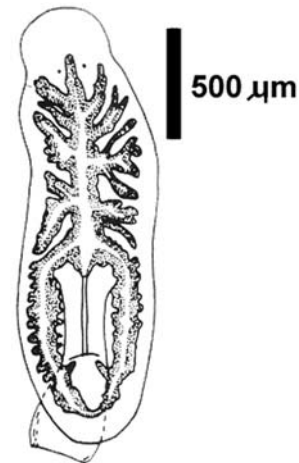


FIGURE 1 *Dinizia sanctaehelenae* (Tricladida). (From Botosaneanu, 1986.)



FIGURE 2 The Temnocephalida is an external parasite of crustacea.

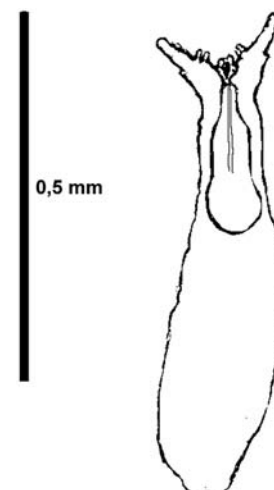


FIGURE 3 *Troglodicaridicola capreolaria* (Temnocephalida). (Redrawn from Juberthie and Decu, 1994.)

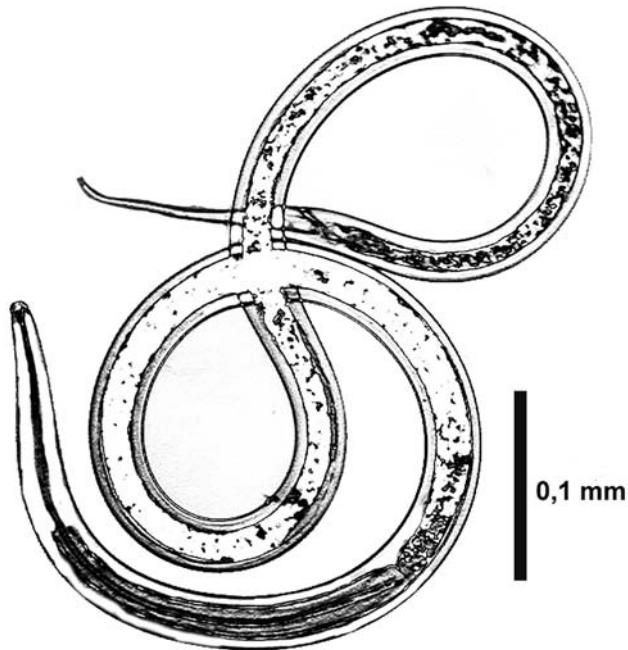


FIGURE 4 *Dorylaimus* sp. (Nematoda).

hatch. Those worms feed mainly on secretions or body fluids of the host; only the predatory genus *Bubalocerus* uses crustacea as a means of transport. So far only 15 species of these highly specialized worms are known from caves in southern Europe, but one undetermined species was found on a cave crab in Papua New Guinea.

#### Phylum: Nematoda (Roundworms)

Roundworms show high homogeneity in their morphology and anatomy. The body is filiform, usually small in free-living forms (length 0.2–3 mm), pointed at one or both ends, covered by smooth chitin cuticle, and without appendages (Fig. 5). A very large group (about 100,000 known species), this species lives in all habitats: terrestrial and aquatic (sea bottom and all kinds of freshwater), and as parasites in plants, animals, and people. The same species can be found in different environments (terrestrial or aquatic) and different climatic zones.

Their high resistance to unfavorable life conditions (the eggs are resistant to desiccation and temperature extremes) and ability to form cysts means they can be easily transported long distances by wind or water. That is why common species of nematodes are abundant in cave environments. They feed on bacteria, vegetal debris, and bat guano; some of them are predators. Among nematodes the troglonitic species are extremely rare; only about 20 are known.

#### Phylum: Nemertina (Ribbon and Proboscis Worms)

In Nemertina, the body is unsegmented, strongly elongated, and usually without appendages (Fig. 5). A retractable

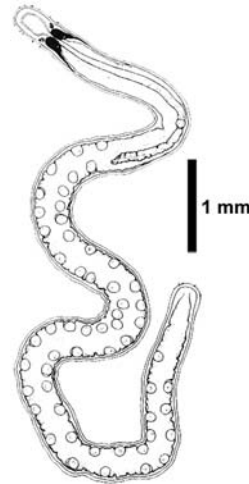


FIGURE 5 *Ototyphonemertes* sp. (Nemertina). (From Botosaneanu, 1986.)

proboscis apparatus at the anterior end is characteristic of these worms only. Almost all known species (about 800) live in marine environments, but there are a few exceptions: 3 or 4 blind, depigmented species live in subterranean European waters and one species has been described from New Zealand.

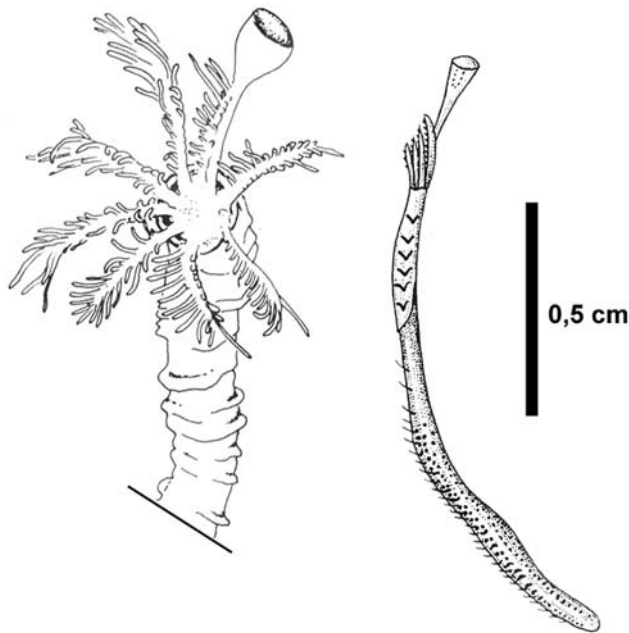
#### Phylum: Annelida

The Annelida are tubelike invertebrates with a regularly segmented body. Usually they are bilaterally symmetrical, elongated, mainly hermaphroditic (bisexual) with gonads situated in some segments only.

**CLASS: POLYCHAETA** Segments have muscular, paired, laterally situated “pseudo-legs” (parapodia) with setae on their ends. Polychaeta are almost exclusively marine forms (about 850 species), of which 230 species live in conditions similar to cave conditions (inside the bottom material, between grains of sand) or in submarine (anchihaline) caves. Some curious stygobionts are known from freshwater as well. The most famous one is *Marifugia cavatica* (Fig. 6), known from caves situated east of the Adriatic Sea (Slovenia and Croatia). Living in tubes, individuals form big colonies on the bottom, walls, and roofs of water-filled corridors.

**CLASS: OLIGOCHAETA** All segments (except for the first and last ones) of Oligochaeta have four bundles of setae (Fig. 6). They live in both aquatic and terrestrial (earthworms) environments. About 1500 species have been described, with 130 from caves and subterranean waters. The smallest ones (Fig. 7A) (representing the class Aphanoneura, separated from Oligochaeta about 20 years ago) live among the grains of sand and gravel saturated with water (interstitial waters) at the seashore as well as along cave streams and stagnant water.



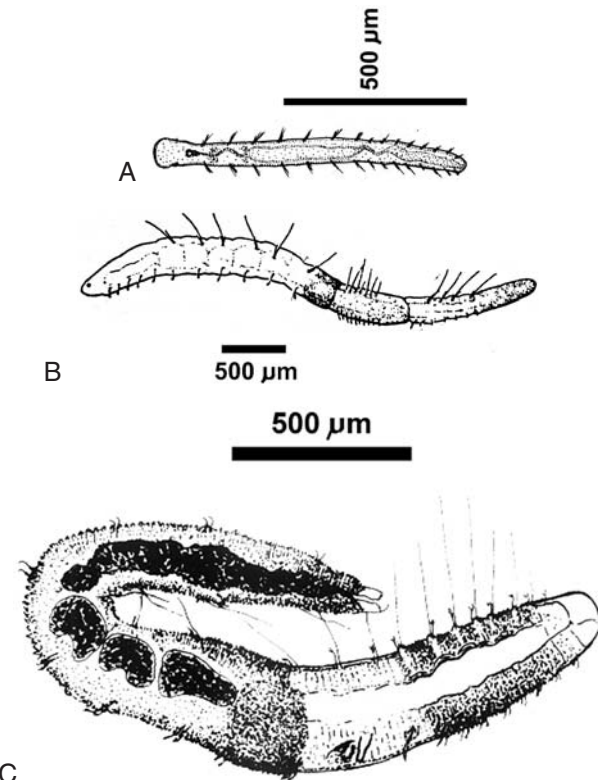


**FIGURE 6** *Marifugia cavatica* (Polychaeta): (A) Anterior part of the body. (From Botosaneanu, 1986.) (B) Habitus of female individual (From Juberthie and Decu, 1998.)

The bigger ones (Fig. 7B) “walk” on the bottom surface or swim using the setae as locomotory organs. The representatives of tubificids (Fig. 7C) and lumbriculids generally are “anchored” inside the sediments with the anterior part of the body, waving the posterior end for better oxygenation of the surrounding water. They move slowly when the food is used up or environmental conditions deteriorate, that is, when oxygenation decreases or products of metabolism accumulate. Like nematodes, some stygobiontic oligochaete species can form cysts, which help them to survive in small, periodically desiccated cave pools. These invertebrates are bisexual. Normally cross-fertilization occurs but self-fertilization is also known.

The majority of oligochaetes feed on organic matter from sediments or soil. In the cave environment, organic matter usually forms only a small part of the sediment, so oligochaetes ingest big amounts of substrate but utilize only a small part of it. Some species feeding on algae in surface waters can change their food preference in subterranean waters and eat small particles of organic matter. Only a few stygobiontic species are predators. Trogllobiontic and stygobiontic oligochaetes are known from the caves of all continents (except the Antarctic), but the most diversified fauna have been found in the Mediterranean region.

**CLASS: HIRUDINEA (LEECHES)** The Hirudinea have segments without parapodia and setae. All leeches have two suckers: a small one around the mouth and a big one at the end of the body. Usually the species from surface waters are found in caves, but they can form separated cave

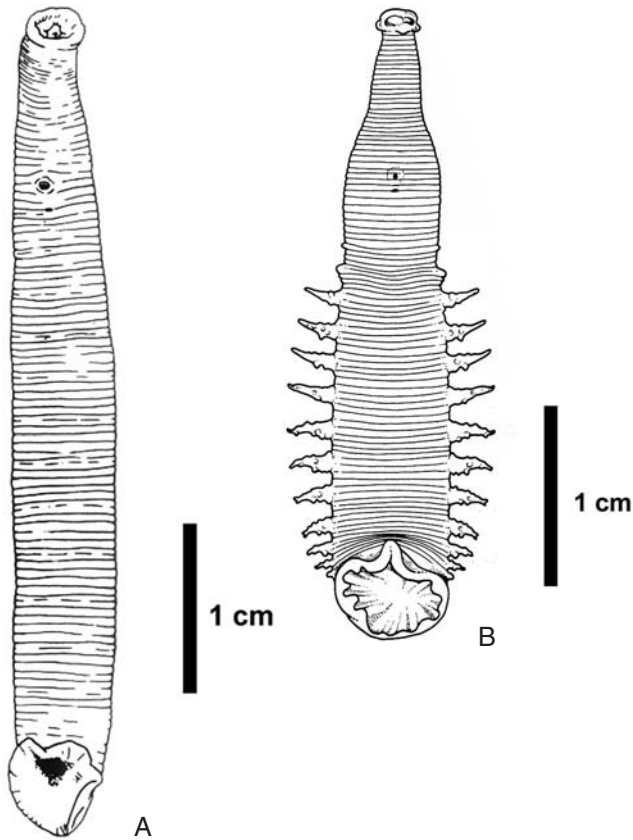


**FIGURE 7** Representatives of caves oligochaetes: (A) *Aeolosoma* sp. (B) *Nais* sp. (C) *Haber turquini*. (Part C from Botosaneanu, 1986.)

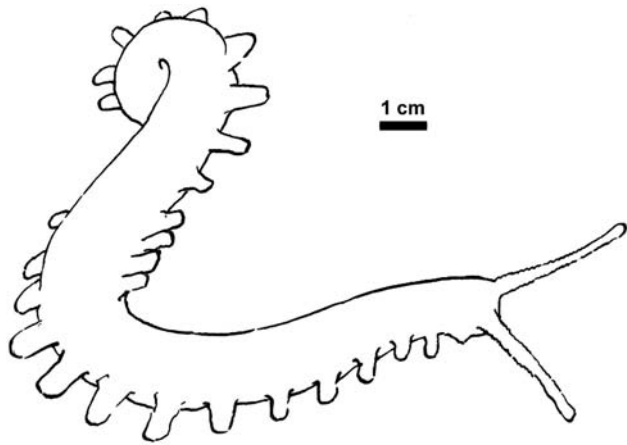
populations, depigmented to various degrees, and with eyes partially or totally reduced (Figs. 8A and B). An unusual species of leech, *Croatobranchnus mestrovi*, was found recently (Sket *et al.*, 2001) in Croatian deep caves. This species has head morphology not found in other Hirudinea. The rim surrounding the oral sucker forms four pairs of conical lobes, with five finger-shaped papillae on each lobe. Their role is not known yet. Moreover, the posterior half of the body has 10 or more pairs of lateral processes (Fig. 8B) not serving as locomotory organs, but most probably as respiratory organs. This species lives in deep vertical caves, usually near the bottom, where low constant temperature (4–6°C) was recorded. Most leeches were seen on the rocky walls in a thin layer of flowing water; rarely were they found on the bottom of pools. All cave leeches are predators, feeding on other small invertebrates; bloodsuckers are not found in subterranean waters. Leeches are known from the caves of the northern hemisphere.

#### Phylum: Onychophora

Onychophora are wormlike, predatory invertebrates with one pair of antennae and 13–43 pairs of locomotory appendages (Fig. 9). This is a small group (about 100 species) of “living fossil” terrestrial invertebrates, very interesting from the systematic and phylogenetic points of view. They



**FIGURE 8** Representatives of caves leeches: (A) *Dina* sp. (From Botosaneanu, 1986.). (B) *Croatobranchus mestrovi*, ventral side. (From Sket *et al.*, 2001.)



**FIGURE 9** *Speleoperipatus speleus* (Onychophora). (Redrawn from Juberthie and Decu, 1994.)

are found in tropical and subtropical regions but in a very restricted area. Cave species are known from the Southern Hemisphere except for *Speleoperipatus speleus*, which was found in caves in Jamaica.

## ECOLOGICAL AND PHYLOGENETIC REMARKS

As mentioned, among the worms living in caves there are both common, widely distributed species and highly specialized forms known exclusively from a few localities. This first group is not very interesting to biologists working on the systematics and evolution of cave fauna, but their role in the functioning of cave biocenoses is usually important; in caves these species occur at a high density and sometimes their biomass is also high.

Troglobiontic and stygobiontic worms species originated from soil, freshwater, and marine forms. Their ancestors colonized the underground environment in various geological epochs and in various places. Some of them are very old; for example, Onychophora formed in the Paleozoic. Among the oligochaetes there are cave forms at various systematic levels, from the exclusively troglobiontic or stygobiontic families [Oncerodrilidae in South America, Dorydrilidae in a restricted area of Europe, and Parvidrilidae, recently described from North America, found also in European caves (Martinez-Ansemil *et al.*, 2002)] and genera (*Delaya*, *Krenedrilus*), to genera with mainly subterranean species (*Rhyacodrilus*, *Trichodrilus*), to genera with only a few or single stygobiontic species. Troglobiontic or stygobiontic species belong to almost all oligochaete families of various origin (marine and freshwater) and of various age—both old and recent cave forms are encountered. This tells us that migration to the cave environment took place at various times and places.

## Bibliography

- Botosaneanu, L. (ed.) (1986). *Stygofauna Mundi. A Faunistic, Distributional, and Ecological Synthesis of the World Fauna Inhabiting Subterranean Waters (Including the Marine Interstitial)*. E. J. Brill, Leiden, The Netherlands.
- Cernosvitov, L. (1939). Etudes biospéologiques X (1). Catalogue des Oligochètes hypogés. *Bull. Museum Roy. Hist. Nat. Belgium* **15**, 22.
- Dumnicka, E. (1984). Laboratory studies on biology of cave-dwelling Enchytraeidae: *Enchytraeus dominicae* Dumnicka and *Fridericia bulbosa* (Rosa). *Mém. Biospéol.* **11**, 199–205.
- Hyman, L. H. (1937). Studies on triclad Turbellaria, VIII. Some cave planarians of the United States. *Trans. Am. Micros. Soc.* **44**, 51–89.
- Jeannel, R. (1926). *Faune Cavernicole de la France, avec une Etude des Conditions d'Existence dans le Domain Souterrain*. Lechevallier, Paris.
- Juberthie, C., and Decu V. (eds.) (1994). *Encyclopaedia Biospéologica*, Vol. I. Société de Biospéologie, Moulis, France.
- Juberthie, C., and Decu V. (eds.) (1998). *Encyclopaedia Biospéologica*, Vol. II. Société de Biospéologie, Moulis, France.
- Martinez-Ansemil, E., B. Sambugar, and N. Gianni (2002). First record of Parvidrilidae (Annelida, Oligochaeta) in Europe with a description of a new species (*Parvidrilus speleus* sp. nov.) and comments on the family and its phyletic relationships. *J. Zool. Lond.* **256**, 495–503.
- Sket, B., P. Dovec, B. Jalzic, M. Kerovec, M. Kucinic, and P. Trontelj (2001). A cave leech (Hirudinea, Erpobdellidae) from Croatia with unique morphological features. *Zoologica Scripta* **30**, 223–229.



The following glossary defines specialized terms that are found in the articles in the *Encyclopedia of Caves*. The authors of the Encyclopedia have defined these words as they are used in their articles, for the benefit of readers who may not be familiar with the technical vocabulary of cave study. As the name indicates, the Glossary is a compendium of the terminology of this particular encyclopedia. It is not a general dictionary and therefore does not include all possible terms that a reader might encounter in other publications.

## A

- aa** Jagged irregular volcanic rock formed from the solidification of highly viscous lavas.
- accidental** Surface dwelling species that get into caves by mistake and cannot survive in the underground environment.
- acheulian** The acheulian is a term that designates a particular lithic industry during the Lower Paleolithic period that was characterized by the production of bifacial tools, also known as hand axes.
- acicular** Refers to crystals that have grown in a long, narrow, needle-like habit.
- acrophobia** The abnormal fear of being in high places.
- active invasion** A process related to the capacity of organisms to select their habitats depending on their direct perception of the surrounding environment. Pertains also to the colonization of a new environment due to the gradual adaptation of the organisms to new habitats.
- adaptation** Any trait that evolves by natural selection to increase an individual's chances of surviving and leaving offspring; for cave animals we call these troglomorphic adaptations.
- Adriatic microplate** A small continental plate which broke off the African plate, crossed the present-day Mediterranean, and joined the European continental plate.
- Aeolian** Windblown or wind-driven.
- aggrade** To fill up with sediment.
- aggressive behavior** A physical act or threat of action by one individual that reduces the freedom or genetic fitness of another.
- aggressive water** This refers to water that has the potential to be corrosive to the material under discussion. Typically it may be water that is not yet saturated with a chemical/rock (such as gypsum) and can thus dissolve more of that chemical. In the case of dissolution of carbonate rock, the water must be slightly acidified. If the water is aggressive then it still has enough acidity left to continue to corrode the carbonate rock.
- air curtain** A controlled screen of air moves across a passage that isolates one environment from the another.
- allele** Any of the different forms of a gene occupying the same locus on homologous chromosomes.
- allochthonous** A mass of rock that has been moved from its origin by tectonic processes, as in thrust sheet. Alternatively, sediment that has been carried into a cave from outside.
- alloenzymes** Enzymatic variation whose synthesis is controlled by the same gene.
- allopatric** Relating to populations, species, or taxa whose geographical ranges are separated from one another.
- allopatric speciation** Speciation after geographic isolation of a population.
- allozymes** Different forms of an enzyme, differing slightly in amino acid sequence, which are the products of alternative alleles at a given locus.
- amphicelous vertebrae** Vertebrae whose centrae are concave both posteriorly and anteriorly.
- anastomoses** Small interconnecting conduits that fork and rejoin, usually along bedding planes.
- anastomotic maze** A maze of interconnected, curving, tubular passages, analogous to a braided pattern in river channels.
- anchihaline (anchialine)** Subterranean bodies along sea coasts with underground connections to the sea and containing layers of water of different salinities.
- anhydrite** Mineral, the anhydrous form of calcium sulfate,  $\text{CaSO}_4$ . The conversions of gypsum to anhydrite and back to gypsum are common due to changes in the physical and chemical parameters of geological environments.

**anophthalmic** Animal lacking eyes.

**anoxic** Literally, without oxygen. In practice it refers to environments in which the oxygen content is too low to allow a specified oxidation reaction to occur (e.g., the oxidation of hydrogen sulfide).

**anthodites** A speleothem composed of clusters of needle or quill-like crystals.

**anticline** A fold that is convex upward. Antonym: syncline)

**apomorphic** The derivation (advancement) of two homologous character states in a transformation series, which has been modified in the common ancestor of one or more taxa.

**aquifer** A rock unit capable of storing and transmitting water. Both properties are necessary. The open spaces within the rock mass provide the storage space. These open spaces — pores, fractures, and, in the case of karst aquifers, pipe-like conduits — must be interconnected so that water can flow through.

**aquitard** Geological formation of a rather impervious and semi-confining nature that transmits water at a very slow rate compared with an aquifer.

**arborescent** Converging network, tree-like.

**archaea (archaeobacteria)** One of the domains of life that includes a group of prokaryotes with a unique cell envelope and plasma membrane structure, and a unique type of ribosomal RNA that distinguishes them from bacteria.

**autocorrelation, spatial** When observations of the same variable taken at different locations in space are correlated then the spatial process from which observations of the variable arise is said to be spatially autocorrelated.

**autotrophic** Organisms which may produce organic substances (food) using light or inorganic substances as an energy source.

**avocational caver** A caver for whom caves or caving has become a subordinate occupation without material compensation. A caver who gives many volunteer hours to cave-related activities for the joy of it. A caver who has adopted caving as a lifelong avocation.

## B

**base flow** For either a surface stream or a spring, base flow represents the lowest discharge achieved during the driest parts of the year.

**base level** The position of the water table

(and associated surface and cave streams) during dry periods. Alternatively, the elevation of the master surface stream to which tributaries and cave streams are discharged.

**base level** The lowest level to which a river is able to erode its channel. A river is at its base level if it has ceased to deepen its channel and has developed a floodplain.

**basinal sediments** Sediments that accumulate in a region of low (and usually subsiding) topography.

**bergshrund** Crevasse located at the head of the glacier where the ice separates from the mountain side as it flows down hill.

**bifurcation** Surficial or underground river that belongs to two different drainage basins.

**bioaccumulation** Occurs for any chemical that accumulates in an individual's body over its lifespan because ingestion is greater than egestion, detoxification, and excretion.

**biodiversity** Any measure of the taxonomical diversity of organisms.

**biofilm** A thin layer, about 1 mm, of living bacteria, fungi, and protozoa on a hard substrate such as a rock or piece of dead organic matter like a leaf or fecal pellet.

**biogenic** Means derived from biological sources.

**bio-luminescence** Light produced by biochemical reactions in animals or plants.

**biosparite** A coarse-grained limestone with abundant fossils.

**biotope** The type of habitat of a species, the place where it occurs, with all abiotic characteristics.

**bivalves** Molluscs with two shells, commonly called clams.

**blowhole** A generally round hole in the ground ranging in diameter from a few tens of centimeters to one or two meters, connecting with a generally smooth-walled vertical tube of similar diameter, which may or may not descend into an accessible cave chamber. A blowhole is so named because it almost always connects with numerous small voids into which or from which atmospheric pressure changes induce air-flow (wind), sometimes of considerable strength.

**boletoid tongue** A tongue attached by a central pedicle and thus resembling a mushroom. It can be projected several centimeters outside of the mouth to capture a prey.

**boneyard** A type of cave passage consisting of multiple chambers interconnected by smaller openings forming a three-dimensional, swiss-cheese-like maze.

**boundary layer** The finite zone near a cave wall or stream bed in which the movement of fluid is affected by friction. The fluid is substantially slowed down with respect to fluid further away from the boundary.

**branchwork cave** A cave formed by underground streams that converge in a branching pattern, with tributaries joining downstream to form progressively fewer but (usually) larger passages.

**breakdown** Rubble and boulders in a cave resulting from collapse of the cave ceiling.

**breakthrough curve** A graphical plot of tracer concentration versus time. Also called a dye-recovery curve.

## C

**calcarenite** A type of limestone composed of sand-sized calcite particles.

**calclutite** A type of limestone composed of mud-sized calcite.

**cantilever** Beams suspended only at one end; a rigid structural member projecting from a vertical support so that the upper part is in tension and the lower part is in compression.

**caprock** An insoluble rock unit overlying soluble, cave-bearing strata. A typical caprock consists of sandstone or shale.

**carabiner** An oval metal ring with a hinged gate on one side. Used to link ladders, harnesses, and other equipment in rock climbing, caving, and mountaineering.

**cave entrance** An opening from the cave to the surface large enough for a human to enter.

**caver** A person who enters caves using caving equipment.

**caving equipment** Hardhat and primary light system with backup light sources used by cavers. This equipment may include many other items depending on the specific characteristics of the cave, such as additional light sources, boots, gloves, kneepads, coveralls, special clothing, cave pack, water, food, first aid supplies, rope, vertical equipment, cave diving equipment, mapping equipment, and photography equipment.

**cenote** From the Yucatec Maya word *t's'onot*, refers to places where bedrock solution has led to the collapse of surface

limestone, giving access to the water table.

**Cenozoic** One of the great geological periods extending from 65 to 1.7 My before the Present, just after the Mesozoic.

**Chalcolithic** The Chalcolithic period in the Levant is characterized by the emergence of craft specialization and metallurgy (copper), and the spatial organization of villages related to specific activities such as religion. The Chalcolithic period lasted from about 7500 calendar years before Present to 5500 calendar years before Present.

**chemoautotrophy** Ability of an organism to obtain nourishment from chemical reactions involving inorganic substances, such as the oxidation of sulfides to sulfates as contrasted to using the sun's energy as with green plant photoautotrophs.

**chemolithoautotroph** An organism that grows exclusively using inorganic compounds, obtaining carbon from inorganic carbon compounds ( $\text{CO}_2$ ,  $\text{HCO}_3^-$ ) and energy from chemical transformations.

**chemolithotrophs** Microorganisms that use inorganic material.

**chemotrophic bacteria** Bacteria that use the energy derived from chemical reactions for the same processes that phototrophic bacteria use light energy.

**chimney effect** The effect that air warmer than the surrounding air is less dense and rises. Conversely air cooler than the surrounding air descends.

**Chiroptera** The order name for bats, meaning "hand wing."

**choanae** Internal posterior nares.

**choice behavior** Normally females are choosy whereas males accept every female for reproduction. The reason for this is that the eggs a females produces are limited.

**cladogram** A branching diagram depicting the hierarchical relationships among taxa based upon shared derived characters.

**clastic** Refers to a broken up object/material. In geology, clastic refers to a particle from a pre-existing rock. Here it refers to the type of material carried in a flow of water, which can be particulate load or dissolved load; the clastic materials are the rock particles that can scrape the surfaces of the caves.

**clastic sediments** Broken pieces of previously existing rocks. Silt, sand, gravel, and cobbles are usually clastic sediments.

**claustrophobia** The abnormal fear of being in tight places.

**collapse chamber** Large chambers in the cave formed by breakdown of the bedding followed by removal of some collapse material by the underground river.

**imbricated gravel** Grains are shingled, such that all grains dip in a similar direction.

**collapse doline** A crater or well-like surface depression or hollow, ranging in size from a few to many hundreds of meters in dimension. A collapse doline is formed by collapse from below.

**colloids** Small particles ranging in size from approximately 0.01 to 10  $\mu\text{m}$ .

**common-ion effect** When solutions of different chemistries mix, if they have one ion in common, the precipitation of the less soluble species may be initiated.

**conceptual model** Provides a visualization of the way in which water is added to, stored in, transmitted through, and discharged from an aquifer.

**conduit** A subsurface bedrock channel formed by groundwater solution to transmit groundwater; often synonymous with cave passage but also used to refer to channels too small for human entry. Conduits can also form in glaciers.

**conduit flow (of water)** Flow through a void or channel, or as in this case, a cave.

**confined (artesian) aquifer** An aquifer where groundwater is under pressure in a bed or stratum confined by less permeable rocks or sediment above it. A head in such an aquifer lies above the bottom of the confining bed.

**conspecific** Belonging to the same species.

**convergence** Independent evolution of similar characters in distinct taxa.

**convergence** The independent evolution of similar traits in two or more lineages.

**calcrete** A deposit, often nodular, of calcium carbonate formed in the soil.

**corrosion** The breakdown of a material by chemical action. It usually causes a visible eating away of the surface but may simply cause a chemical change.

**covariability or covariation** Two variables are said to covary when they are either negatively or positively correlated.

**creep** Slow movement of material downslope under the force of gravity.

**crevasse** Gaping crack in glacial ice caused by tensional forces.

**crystal weathering** The detachment of

particles of various sizes from rock surfaces by the growth of crystals from percolating salt solutions.

**cusp** The high point formed at the intersection of two scallops.

**cut and fill** To scour a channel in sediments and subsequently in-fill with younger material.

**cutter and pinnacle topography** An irregular bedrock surface developed on carbonate rocks consisting of deep trenches (cutters) dissolved along fractures with intermediate pinnacles of limestone. Cutter and pinnacle topography is often buried in soil and has no expression at the land surface.

## D

**dark zone** Dark area of a cave, without natural illumination.

**darkness** Without natural illumination. After exposing a photographic film in darkness for one week it has to be blank.

**debris flow** A rapidly moving mixture of rock and water.

**decomposer** Species that feed on dead plants and animals. Generally refers to bacteria and fungus, as opposed to larger detritivores and scavengers.

**decompression** The requirement for a diver to ascend slowly or make stops on his/her way to the surface to allow gas, such as nitrogen, dissolved in the blood to be released and exhaled instead of forming bubbles in the blood.

**dedolomitization** Replacement of Mg ions by ions of Ca in dolomites during the course of some chemical reactions that may occur during diagenesis and weathering.

**denitrification** A process by which oxidized forms of nitrogen, such as nitrate ( $\text{NO}_3^-$ ), are transformed by denitrifying bacteria to form nitrites ( $\text{NO}_2^-$ ), nitrogen oxides ( $\text{NO}_x$ ), ammonia ( $\text{NH}_3$ ), or nitrogen ( $\text{N}_2$ ).

**detectability** The extent to which a dye may be identified and quantified in a water sample. In the case of fluorescent dyes it depends on the spectral characteristics of the dye, the potential interference from background materials, and the sensitivity and selectivity of the fluorometer. The lowest reliably measured and identified concentration of a substance in solution is called its *limit of detection*.

**detrital** Physically detached from pre-existing rock.

**detritivore** Species that feed on dead plants and animals and their waste products. Generally refers to insects, millipedes, or other members of the animal kingdom.

**diffuse flow (of water)** Flow through the minute voids and cracks present in limestone rock.

**Dinaric Mountains** A range of mountains, largely limestone, ranging along the Adriatic Coast from extreme northeast Italy to Montenegro.

**dip** The inclination of beds in a deformed sedimentary rock, or of any geologic structure (e.g., a fault). It refers both to the direction of tilt as well as the angle of tilt to the horizontal (e.g., 25° to the west). *Stratal dip* refers specifically to the dip of sedimentary beds.

**dispersal** Movement of an organism from one area to another, thereby changing its natural distribution.

**dissimilatory** Metabolic process that does not incorporate elements into the cell (assimilation), but instead the elements are used to gain energy.

**dissolution kinetics** Kinetics refers to the speed at which a reaction, in this case dissolution, can proceed. Typically a reaction may be rapid at the start but gets slower as the system approaches its final equilibrium state.

**donga** A shallow, generally circular, closed depression several meters deep and hundreds of meters across, with a flat clay-loam floor and very gently sloping sides.

**dripstone** Any formation resulting from the deposition of calcite, generally by percolating water.

**dye tracing** A method by which the locations of underground rivers can be identified, using injection and later recovery of nontoxic, fluorescent dyes.

## E

**echolocation** The production of high-frequency vocalizations and the reception of echoes from these sounds provide animals with an acoustic image of their environment; used for prey detection and capture and navigation.

**ecotone** A zone of transition between adjacent ecological systems, having a set of characteristics uniquely defined by space and time scales, and by the strength of the interactions between adjacent ecological systems.

**ectotherm** An animal whose body temperature is determined primarily by passive heat exchange with its environment.

**edaphic** Organisms living in the soil.

**effluent** streams that exit from the ground or a water body.

**eluent** Liquid used to release dye from charcoal or other adsorbent material.

**elutant** Solution of eluent containing dye. Elution is a verb referring to the process of releasing adsorbed dye.

**elytrae** The sclerotized first wings of beetles.

**emission** The discharge of energy from an excited fluorescent substance. The emission spectrum is the characteristic relationship of the intensity of emitted energy (light) to the wavelength of the emitted energy.

**endemic** Geographical restriction in the distribution of a species.

**endogean** Animal living in soil.

**endotherm** An animal whose body temperature is substantially elevated above the ambient temperature by internal, metabolic heat production.

**englacial** In the body of the glacier.

**entrance zone** Area of cave where outside influences dominate, with natural illumination.

**eogenetic** Means young or youthful. Eogenetic rock is rock that has not been greatly altered since its deposition; eogenetic karst is the karst developed on such rock.

**epigean** Surface environment as opposed to subterranean (hypogean) environment, encompassing vegetation and superficial water bodies.

**epikarst** The boundary region between soil and rock in karst, usually honeycombed with small fractures, solution pockets, and solutionally widened trenches (cutters or grikes).

**Epi-Paleolithic** The Epi-Paleolithic is a Levantine interval that spans roughly 20,000–10,200 calendar years before Present. Groups of foragers at this time manufactured small stone tools (known as microliths) of various forms. Some of the microliths are geometric in shape and resemble trapezoids, rectangles, and crescents (called lunates). During this period there is an increased occurrence of marine mollusc ornaments. The late Epi-Paleolithic included the Natufian culture.

**epizoic** Living on the surface of (another) animal without harming it.

**estavelle** A conduit opening to the surface that functions as a spring in

high-flow conditions and as a stream sink in low-flow conditions.

**euhaline** Marine water.

**euohedral** A crystal with well-formed faces (as opposed to anhedral crystal with no faces).

**eury-** With a wide ecological potential; e.g., eurytherm is an animal which may live at very different temperatures, etc. Euryecous organisms are also called generalists.

**euryhaline (euryhaline organisms)** Pertains to organisms that are tolerant of a wide range of salinity.

**eustatic sea level change** The change in sea level that happens worldwide as a result of: (1) change in the amount of water, as occurs in glacial/interglacial cycles; (2) change in the volume of the ocean basins, as occurs when the sea floor collects sediment; and (3) change in the character of the water, such as occurs by thermal expansion of the water when the oceans are warmed.

**eutrophic cave** Cave with a large amount of available organic matter/energy, especially that provided by guano or debris taken by water (especially during floodings).

**evaporite** A rock consisting of minerals that have deposited because of the evaporation of sea or lake water. Salt beds and gypsum are common examples.

**exaptation** An apparent morphological or physiological adaptation of an organism to a habitat with which it has not (yet) been in contact; also called “pre-adaptation.”

**excitation** For fluorescent substances, certain electrons are raised temporarily to higher orbits by absorption of energy (light) from an external source. The excitation wavelength is the characteristic relationship of the intensity of emitted light to the wavelength of the absorbed light.

**exudation** See **crystal weathering**.

## F

**filiform** Thread-like, long and slender.

**first magnitude spring** A spring having an average flow of 100 cubic feet per second (2.83 m<sup>3</sup>/s) or greater.

**fitness** The genetic contribution of an individual to succeeding generations.

**flank margin cave** A cave developed in a limestone coast by mixing dissolution, in the margin of the fresh-water lens, just inside the flank of the land mass.

**flashiness** The rapidity with which a water table position (and related flow and chemical conditions) changes within a karst aquifer in response to an input of water from a storm.

**floodwater zone** The region between the lowest position (during dry periods) and highest position (during floods) of the water table within a karst aquifer.

**fluorescence** Non-thermal emission of light from a substance that has been excited from some energy source (ultraviolet light, x-rays, electrons, ions, etc.). Fluorescence implies that the emission ceases when its excitation sources are removed as distinguished from phosphorescence which implies an afterglow.

**fluorescent intensity** The relative detectability or strength of the fluorescence of a compound. The fluorescent signal may be weakened or altered due to the presence of other compounds, the pH of the solution, or exposure to sunlight (photochemical decay). This loss of fluorescent intensity is also called *quenching*.

**fluorometer** An instrument containing a lamp and a means of controlling the excitation wavelengths and a detector set at specific emission wavelengths to measure the relative fluorescent intensities caused by variations in concentration of the substance. The wavelengths may be set by specific filter combinations in a *filter fluorometer*, or scanned through a broad range of wavelengths using a *spectrofluorophotometer*.

**flutes** Elongate, nearly parallel dissolution runnels in cave walls orientated transverse to the direction of flow.

**fluvial** Describes processes and landforms related to rivers or streams. Because of the development of turbulent flow within conduits and caves, karst hydrology often deals with fluvial action, both on the surface and in the subsurface.

**flysch** Thick sequence of interbedded marine shales and sandstones. Flyschs cannot be karstified and are therefore quite impervious.

**fungivore** Species that are adapted to feed on fungus. Examples: collembola, millipedes.

## G

**Gastropoda** Molluscs with a muscular foot, visceral mass, and distinct head region, and typically a spiral shell.

**genus** A category in the hierarchy of plant and animal classification inter-

mediate in rank between family and species.

**geographic North Pole** Also called the True North Pole, this is the point where the Earth's axis of spin coincides with the Earth surface.

**glacial drift** An unsorted mixture of ground-up rock debris—silt, sand, pebbles, and boulders—left behind when glaciers melted.

**glacioeustatic sea level change** The change in sea level worldwide that occurs when ice sheets grow during a glacial cycle (sea level falls) or ice sheets melt during an interglacial cycle (sea level rises).

**Gondwana** The southern supercontinent formed following the fragmentation of Pangaea in the Mesozoic era, about 150 million years ago, largely comprising the present South America, Africa, India, Madagascar, Australia, New Zealand, and Antarctica.

**groundwater** That portion of the Earth's water that is held within the pore spaces (openings) in geologic formations including water in the saturated (the pores are completely filled with water) and in the unsaturated (the pores are only partially filled with water) zones.

**guano** A mixture of feces and urine deposited by bats that serves as an important food resource for other cave organisms, or accumulation of feces of particular animals in time and space, especially of bats, birds (oilbirds and swiftlets), and crickets.

**guanobite** Species that, when in caves, exclusively inhabit guano deposits, and whose entire biological cycle takes place in this substrate.

**guanophage** Animal that feeds directly on guano and/or on microorganisms (bacteria and fungi, for instance) that grow on it.

**guanophile** Species that, when in caves, may inhabit and reproduce both in guano piles and in other substrates in the cave environment.

**guanoxene** Species that, when in caves, may be found feeding and/or reproducing on guano deposits but depend on other substrate(s) in the caves to complete their biological cycle.

## H

**halocline** A zone, present in anchialine caves, in which there are rapid vertical changes in the salinity.

**Hardy-Weinberg equilibrium** The maintenance of constant allele and genotype frequencies in a population through successive generations.

**heterotrophs** Organisms that need organic substances as food.

**heterozygosity** The observed or expected proportion of individuals of the same population whose homologous chromosomes carry different alleles.

**high energy habitats** Habitats with abundant food resources.

**Holarctic** The biogeographic region that includes the northern parts of the Old and New Worlds.

**humicolous** Animal living in humus.

**hydraulic gradient** The drop in hydraulic head divided by the distance of water flow. It is equivalent to the rate of energy loss within a hydrologic system.

**hydraulic head** The sum of energy that a given volume of fluid has resulting from various combinations of pressure, motion, and elevation, which provides the basis for understanding fluid movement. Fluids move from areas of large hydraulic head to areas of lower hydraulic head.

**hydraulic potential** This refers to the pressure of groundwater flow and usually relates directly to the gradient of the water table, a higher water table gives a higher hydraulic potential.

**hydrograph** A plot of the flow volume (discharge) as a function of time. The time scale of a hydrograph varies. It can be a single storm, a water year, or many years of record.

**hydrograph recession limb** The later part of a flood hydrograph that shows the rate at which water level is dropping back toward the pre-storm level.

**hydrology** The study of the circulation, properties, and distribution of water on or under the Earth's surface.

**hydrophilic** Organisms adapted to humid climates, showing low or no tolerance to dry conditions.

**hydrostatic pressure** The pressure exerted on a rock or fluid by a column of water from topographic surface to a given depth within the Earth's crust.

**hygroptic, madicolous habitat** A steep or vertical rocky surface, covered by a thin layer of moving water; if outside caves, it is inhabited mostly by algae, mosses, and some aquatic insect larvae.

**hypogean environment** Environment in the network of interconnected sub-

terranean spaces, with variable sizes from microvoids to large spaces accessible to humans (caves), filled with water or air as opposed to the surface (epigean) environment.

**hypogenic** Refers to an origin deep beneath the Earth's surface.

**hypogenic caves** Formed by acids generated partly or entirely at depths below the surface.

**hyperheic zone** Interstitial spaces within sediment deposits beneath and along stream channels, constituting a transition zone between surface and groundwater.

**hyperheos** An ecotonal assemblage of epigean and hypogean organisms living within the interstitial space of superficial layers of riverbed sediments.

**hypoxia** Reduced oxygen partial pressure (in practice, from 0 to 15 kPa).

## I

**in the book** A slang term for a passage that has been surveyed.

**incompetent beams** Beams that would break under their own weight.

**indurated limestone** Rock at or near the surface which has been case-hardened and made relatively impervious to water by weathering and precipitation of calcite.

**inelastic creep** The slow permanent deformation of a beam.

**infiltration** Flow of water through the soil surface into a porous medium.

**influent** Streams that flow into the ground or a water body.

**interbedded slip** Tectonically deformed bedding, normally due to deformation during folding of the beds.

**international ellipsoid** The distribution of gravity due to the Earth's shape and is used as a reference for measurement of other gravitational anomalies. If the Earth were a homogeneous sphere, its surface gravity would be equal everywhere. The Earth, however, is an ellipsoid rather than a sphere so that gravity varies with latitude.

**interstitial** Water-filled interconnected spaces within unconsolidated, granular sediments such as gravel, sand, and clay, which lie along and below rivers and streams in their floodplains, lakes, and shores.

**interstitial** Subsurface habitats with small spaces, such as gravel aquifers, compared to the large spaces of caves.

**intracratonic basin** A broad structural subsidence of part of the Earth's conti-

ental crust. Such basins are the sites of considerable sediment accumulation (see **basinal sediments**).

**invisibility** The capacity of immigration from one area into another followed by its settlement into the new environment, e.g., a new habitat or community.

**invasion** Massive dispersal of organisms from one area into another.

**isostructural** Two or more crystalline substances that have the same crystallographic structure, but different chemical composition.

**isotopes** Two or more species of the same chemical element that differ in mass because of differences in the number of neutrons. For example,  $^{34}\text{S}$  and  $^{32}\text{S}$  are the most common isotopes of sulfur. Their ratio gives information about the origin of the sulfur-bearing material.

**iteroparity** Repeated reproduction within the organisms life.

## J

**jumars** Devices for climbing rope. Jumars have a toothed cam that grips the rope when the device is under tension and releases when the tension is released, allowing the jumar to be slid up the rope. The device is attached to the climber by a foot stirrup.

## K

**karren** Minor forms of karst, due to solutional sculpturing of rock surfaces or underground.

**karren fields** Rock surface (generally limestone) sculptured by dissolution (flutes, gorge, holes, etc.).

**karst** A landscape in which the dominant features owe their origin mainly to dissolution of bedrock.

**karstic aquifer** An aquifer in which the dominant porosity consists of open conduits and solutionally widened fractures.

**keyhole passage** When a phreatic (elliptic) conduit has been incised by a free surface stream cutting a canyon, the cross-section of the passage is very similar to a large keyhole.

**kriging** A method for calculating a predicted value for a site in the study region that has not been sampled. The method uses a weighted mean of the nearby observed values to interpolate a value at the unobserved site. The weights are functions of the covariances between the observed sites and the unobserved site.

## L

**lacustrine (deposits)** Deposits formed in lakes.

**Lamarckism** Theory of evolution through inheritance of acquired characteristics.

**level (cave level)** A level at which cave passages tend to cluster as the result of a pause in the downward erosion of local river valleys. In comparison, *stories* or *tiers* refer to the vertical arrangement of cave passages regardless of their relation to erosional history.

**laminae** Extremely fine layers of sediment.

**laminar** Smooth streamline flow. Water moves in streamlines which slide past each other with no mixing other than by molecular diffusion. A drop of dye injected into laminar flow will persist as a single colored streamer for a long way down stream.

**lampenflora** Plants growing in the vicinity of artificial light sources in caves.

**lava** (1) the molten rock discharged from a volcano, and (2) the solid rock that forms when lava cools and solidifies.

**lava tubes** Spaces in lava flows formed when flowing lava solidifies on the surface, insulating the molten lava beneath which continues to flow, eventually emptying the tube. Many other voids occur in lava flows including air bubbles or vesicles, spaces between lava flow units, compression cracks and ridges, and cooling cracks and rift-zone cracks. Lava tubes are a type of cave, and the terms are used interchangeably in this volume.

**limnic** Non-purely marine water with salinities of 30–18 ppt, 18–5 ppt, 5–0.5 ppt, and less than 0.5 ppt.

**limnicoid** From freshwater origin. A limnicoid stygobiontic species is derived from surface freshwater ancestor. (Antonym: thalassoid)

**lithology** The physical character of the rocks; the description of the rocks on the basis of such characteristics as color, mineralogic composition, and grain size.

**lithostatic pressure** The pressure exerted on a rock or fluid buried deep within the Earth by overlying rocks.

**littoral cave** A sea cave formed within the range of tides.

**looping passage (or phreatic loops)** Phreatic conduit going up and down. In many cases, several generations of conduits cross each other and form a network of "looping" conduits.

**low energy habitats** Habitats with rare food resources.



## M

**M.S.S.** Mesovoid shallow substratum or superficial underground compartment (milieu superficial souterrain in French), represented by the interconnected microvoids and cracks under the soil.

**magma** Molten rock created deep in the Earth's crust or upper mantle.

**magma chamber** Voids either directly beneath a volcano or deep in the Earth's crust below the volcano which serves as storage reservoir for magma prior to an eruption.

**magnetic North Pole** The point in the northern hemisphere where magnetic inclination is  $-90$  degrees (straight down). The point shifts with time, but over thousands of years it averages near the position of True North.

**mathematical model** The set of equations and appropriate boundary and initial conditions that quantitatively describe the conceptual model.

**Maya Lowlands** A geologic-cultural zone largely equivalent to the massive limestone platform of the Yucatan Peninsula. It is contrasted with the volcanic Maya Highlands lying to the south.

**maze cave** A cave composed of a complex grid of intersecting passages, usually with many closed loops.

**meander** In caves, high, narrow, and sinuous conduits. Their size ranges between a few tens of centimeters up to tens of meters.

**meandering** Sinuous winding pattern of a stream bed across a valley or cave floor.

**megafauna** Extinct marsupials of the Pleistocene which, although often closely related to modern species or genera, were relatively much larger and more heavily built.

**melanophore** Color cell containing melanin.

**Mesoamerica** A geographic-cultural region of the New World, extending from Central Mexico to upper Central America, where pre-Hispanic civilizations, such as those of the Olmec, Maya, Teotihuacan, and Aztec were located.

**mesocaverns** Any small spaces beneath the ground, from 0.5 to 25 cm in diameter.

**mesohaline** Non-purely marine water with salinities of 30–18 ppt, 18–5 ppt, 5–0.5 ppt, and less than 0.5 ppt.

**Mesozoic** One of the great geological periods extending from 245 to 65 My before the Present. Dinosaurs and ammonites were living during the Mesozoic.

**metahaline anchihaline pools** Pools with salinities elevated above the euhaline values.

**metal speciation** The distribution of a metal between its specific chemical forms.

**metamorphosis** A complex process of transformation from larva to adult. Intrinsic factors and extrinsic environmental factors affect the timing and rate of transformation. Such factors cause morphological, physiological, and behavioral changes. Coincident with this transformation is a shift from an aquatic lifestyle to a terrestrial lifestyle. Metamorphosis is a common evolutionary theme, especially among amphibians.

**meteoric water** Meteoric means relating to the weather, so meteoric water is water derived from rain. Meteoric water may then percolate into the ground. Meteoric groundwater is thus distinguished from other types of groundwater, such as those of thermal origin or volcanic origin.

**methemoglobinemia** Often referred to as “blue-baby” syndrome. This serious medical condition is found mostly in infants under six months of age and results from reactions with nitrite ions ( $\text{NO}_2^-$ ). Until infants reach about 6 months of age, their digestive system secretes lower amounts of gastric acid and the pH level in their digestive system is higher than most adults. In these higher pH conditions, bacteria can proliferate and increase the transformation of nitrate to nitrite. Once in the blood, nitrite oxidizes iron in the hemoglobin of red blood cells to form methemoglobin, which lacks the oxygen-carrying capacity of hemoglobin.

**micromammalian burrows** Burrows of small rodents or insectivores (mice and shrews).

**microsatellite DNA** Tandemly repeated DNA sequences of 1–10 bases flanking a core region, used as co-dominant genetic markers in population genetic analyses.

**mixed gas** A mixture of oxygen and at least one inert gas, such as helium, that is used on technical dives instead of air to avoid nitrogen narcosis or reduce decompression times.

**mixing zone** The boundary between fresh and sea water in an aquifer when there is a gradual change from one to the other.

**mixohaline** Brackish water.

**mixotrophs** Organisms that combine two kinds of energy acquisition, the autotroph and the heterotroph.

**modified speleothem** Sculptural modification of flowstone formations.

**monoclinic** One of the seven axis systems used to describe crystals. In the monoclinic system, two axes, usually called a and c, intersect at an angle that must be determined by experiment. The third axis, b, is at right angles to the plane of the other two.

**Monogamy** A mating system in which a single male and female pair for some period of time and share in the rearing of offspring.

**moulin** A vertical shaft or passage in the ice that intersects the glacier surface.

**Mousterian and Middle Paleolithic** The Mousterian and the Middle Paleolithic are a part of the Paleolithic period that lasted from about 250,000–40,000 calendar years before Present. This period corresponds roughly to the time during which the Neanderthals prevailed in Europe and Western Asia, but also to the first appearances of Modern Humans. Both Neanderthals and modern humans made lithic tools such as points, flakes, and blades, and in Europe these people made bifacial tools defined as hand axes or leaf points.

## N

**Naj Tunich** Located in southeastern Peten, Guatemala, it is the most archaeologically elaborate cave in the Maya Lowlands, with large-scale architectural modifications, masonry tombs, and Late Classic paintings.

**nappe** In mountainous ranges, a pile of terranes, which have been displaced by tectonic movements for kilometers on top of other terranes.

**Natufian** Refers to a Levantine society of foragers—with a more complex social structure than their predecessors—just predating the Neolithic period that showed the initial stages of sedentism evident in the construction of stone structures and villages. It lasted from about 14,500 to 11,600 calendar years before Present.

**natural selection** The process by which organisms with different characteristics experience differential reproductive success (differential fitness).

**Neolithic** An Old World chronological interval marked by the development of agriculture and sedentism. In the Middle East, this period lasted from about 11,600 until 7500 calendar years before Present.

**neoteny** The presence of juvenile features in an adult animal.

**neotroglobite** A species recently isolated in caves and that does not include extreme adaptations to the cave environment.

**network maze** A maze cave formed by intersecting fissure-like passages. Network caves follow the trends of joints or faults, and most have patterns resembling the layout of city streets.

**neuromast cupulae** Boost in the skin with sensory hair cells inside, found in the lateral line system of lower vertebrates to detect vibration in water.

**neutral mutation** A genetic mutation that has no advantage or disadvantage for the organism.

**nitrogen and oxygen isotopes of nitrate** Various sources of nitrate (such as fertilizers, animal wastes, sewage, atmospheric deposition) can have different nitrogen ( $^{15}\text{N}/^{14}\text{N}$ ) and oxygen ( $^{18}\text{O}/^{16}\text{O}$ ) isotopic signatures that leave distinct “fingerprints” in ground and surface water. These unique isotopic signatures can provide useful information about the origin of nitrate in contaminated waters. Isotopic signatures of nitrogen and oxygen are commonly expressed using the delta notation ( $^{15}\text{N}$  and  $^{18}\text{O}$ ), which expresses the ratio of the heavier isotope to the lighter isotope ( $^{15}\text{d}/^{14}\text{d}$  and  $^{18}\text{O}/^{16}\text{O}$ ), relative to a designated standard.

**nitrogen cycle** An important system that involves the flow of nitrogen and nitrogen-containing species through terrestrial ecosystems and includes the processes of nitrogen fixation, ammonification, nitrification, and denitrification. Nitrogen is a vital nutrient for all living matter, both plant and animal, and is used by organisms to produce a number of complex organic molecules, such as amino acids, proteins, and nucleic acids.

**nitrogen narcosis** A drunken-like condition progressively induced in divers at depths greater than about 30 m by the nitrogen content of air or other breathing gas.

**normoxia** Normal oxygen partial pressure (i.e., 15–21 kPa).

**novice cavers** Cavers with little caving experience, few caving skills, or only superficial knowledge of caves and karst.

**Nullarbor** Literally means “no trees” and is derived from the Latin *nulla arbor*. A region of Australia.

## O

**oligohaline** Non-purely marine water with salinities of 30–18 ppt, 18–5 ppt, 5–0.5 ppt, and less than 0.5 ppt.

**omnivore** A species feeding on more than one trophic level.

**oosparite** A coarse-grained limestone with accretionary particles (ooliths).

**opisthocelous vertebrae** Vertebrae whose centrae are concave posteriorly and convex anteriorly.

**optic tectum** Roof of the midbrain.

**orographic** Precipitation that results when moisture-laden air encounters a high barrier and is forced to rise over it.

**orthogenesis** Theory of evolution toward a preordained form determined by inherent features of the initial ancestral organism.

**oxic** Well-oxygenated aquatic environments with 2 mg/L<sup>-1</sup> oxygen or more; dysoxic with 2.0–0.2 mg/L<sup>-1</sup>; suboxic with 0.2–0.0 mg/L<sup>-1</sup>; anoxic with no oxygen and presence of H<sub>2</sub>S.

## P

**pahoehoe** Volcanic rock with smooth ropy surface formed from the solidification of fluid lavas.

**Paleolithic** A chronological period in Old World archaeology characterized by the production and use of predominately stone tools and a hunter-gatherer economy. It is usually subdivided into Lower, Middle, and Upper Paleolithic periods and lasted from at least two million to about 40,000 calendar years before Present.

**paleo-drainage** The no longer active network of definable channels formerly occupied by a river or stream which, under less arid conditions, constituted the active surface catchment of the region.

**paleomagnetism** The study of changes in the Earth's magnetic field.

**Paleozoic** An area of geologic time, from the end of the Precambrian to the beginning of the Mesozoic (from about 570 to about 225 million years ago).

**panmixia** The free interchange of genes within an interbreeding population.

**parapatric** Relating to populations whose geographical ranges are contiguous but not overlapping, so that gene flow between them is possible.

**parapatric speciation** Speciation without geographic isolation, as a result of genetic differentiation affecting adjacent

populations and resulting in species with contiguous (but not overlapping) distributions.

**passive detectors** Packets of adsorbent material that can remove or collect dye (or other tracers) from solution and concentrate it on the material over time. Most fluorescent dyes are collected on activated carbon (charcoal) or unbleached cotton. The carbon detectors are also known as *bugs*, *Dunn bugs*, and *dye traps*.

**passive invasion** The involuntary penetration into a new habitat due to external environmental pressures.

**Pedomorphosis** Retention of juvenile characteristics in the adult.

**percolation** Flow of a liquid through an unsaturated porous medium, e.g., of water in soil, under the action of gravity.

**permafrost** Layer of soil or rock in which the temperature has been continuously below 0°C for at least some years. Consequently, groundwater present in a permafrost is frozen.

**permeability (or intrinsic permeability)**

Property of a porous medium which allows for the movement of liquids and gases through it under the combined action of gravity and pressure.

**petroglyph** Rock art formed by any number of sculpting techniques.

**pH** A measure of the acidity of a solution. It is the negative logarithm of the hydrogen-ion activity; therefore, a low value indicates a high acidity, and each pH unit represents a tenfold change in H<sup>+</sup>. A pH of 7 is considered neutral (neither basic nor acidic). Most karst water has a pH between 7 and 8.

**pholeuonoid** One of the shapes of troglobiotic beetles with spindle-shaped trunk and elongated antennae and legs.

**phreatic passages** Cave passages formed below the water table.

**phreatic zone** The environment below the top of the water table where the rock is saturated with water. The words “saturated zone” are a common synonym, but because the word saturated has chemical implications that are critical in karst systems, the term phreatic is preferred for karst areas.

**phreatobite** An organism found only in groundwater.

**phyletical line** Related species with same origin.

**phylogenetic** Pertaining to evolutionary relationships within and between taxonomic groups.

**phylogeny** Evolutionary history of a taxon.

**pit** A near-vertical cave passage. Pits may open to the surface or may be located completely inside the cave.

**Pleistocene** The ice ages. A period of time extending from 1.65 million years ago to 11,500 years ago. The past 11,500 years are referred to as the Holocene.

**plesiomorphic** A phylogenetically primitive organism or its character state (trait).

**polar glacier** A glacier whose internal temperature is well-below freezing.

**polarity** The relation of the Earth's magnetic North Pole to its True North Pole. When the magnetic North Pole is in the northern hemisphere, polarity is considered "normal." During times when the magnetic North Pole is in the southern hemisphere, polarity is considered to be "reversed."

**polygyny** A mating system in which single males mate with several females, and females provide most of the care of offspring.

**polyhaline** Non-purely marine water with salinities of 30–18 ppt, 18–5 ppt, 5–0.5 ppt, and less than 0.5 ppt.

**polymorph** Two or more crystalline substances having the same chemical composition, but different crystal structures.

**porosity** The measure of the volume of voids per unit volume of geologic material. The pores can be irregularly shaped (porous media), can be a set of intersecting fractures (fractured media), or can be riddled with tubes (cavernous media).

**porous media aquifers** Non-karst aquifers in which water generally moves slowly through small spaces between grains, as in sandstone, for example, in contrast to the rapid conduit flow common to well-developed karst aquifers.

**potentiometric surface** A surface representing the level to which underground water confined in pores and conduits would rise if intersected by a borehole. See **water table**.

**preadaptation** The possession of a morphological, behavioral, or physiological character that enhances an organism's ability to survive or exploit a novel situation.

**precipitation** Formation of a mineral or amorphous solid from solution; also rainfall.

**previously enjoyed** A slang term for cave passage that is well known by the caving public.

**primary consumer, herbivore** Species that feed on plants or other primary pro-

ducers. Examples include planthoppers and *Schrankia* moth larvae.

**primary pores** The initial openings between grains or crystals in a rock. Their volume is considerably reduced by compaction or mineral deposition after the rock forms.

**primary producer** Species that obtain their energy and nutrients from non-organic sources. Includes photosynthesizers such as plants and algae, and chemoautotrophs such as iron- and sulfur-oxidizing bacteria.

**primary production** The conversion of inorganic carbon (CO<sub>2</sub> or HCO<sub>3</sub><sup>-</sup>) to organic carbon, as done by chemolithoautotrophs or photoautotrophs.

**project cave** A cave (usually a long cave) which is the site of an extended sometimes multiyear effort to map and explore. A feature of a project cave is that without the use of the maps produced, an outsider to the project has little chance of penetrating to the front of exploration.

**promiscuity** A mating system in which there is no prolonged association between the sexes involving multiple mating by both sexes.

**prusik knot** A slip knot that pulls tight under tension and releases when the tension is released. As a climbing device, two short secondary ropes are attached to the climbers feet and tied around the main rope in a prusik knot. By alternately standing on one knot while the other is slid up the rope, the climber is able to ascend.

**pseudophysogastry** A condition in beetles where the abdomen appears to be greatly enlarged, but where most of the enlargement is just empty space.

## R

**ramiform maze** A maze cave consisting of interconnected rooms and sponge-work, with passages extending outward as present or former outlet routes.

**random error** The noise or unexplained variation in the data that is left after a model has been fit to the data. For example, it might be that on average four species are found in caves in a particular study region. In reality, each cave may have either more or less than four species. Any difference is due to random or unexplained error. The use of the word random is to indicate that, in a statistical sense, the values of the errors do not covary in any systematic way.

**rank order** Each member of social groups determines his position by aggressive encounters. In a stable rank order very little fighting occurs.

**rappelling** Any one of several techniques for sliding down a rope with a controlled descent.

**rebreather** A device containing scuba tanks that recirculates a diver's exhaled breath, adding just enough oxygen to make up for what the body metabolizes, while scrubbing out the exhaled carbon dioxide.

**recharge** Water infiltrating from the surface to the ground into an aquifer. In karst areas recharge can be autogenic, falling directly onto the karst surface and infiltrating quickly, or allogenic, where streams flowing on the surface of adjacent non-karst rocks sink into the aquifer at discrete points as the stream reaches the limestone bedrock of the aquifer.

**recharge area** The catchment area of a drainage basin.

**redox reactions** "Redox," an abbreviated form of reduction and oxidation, refers to reactions that involve the transfer of electrons. Examples include the oxidation of sulfide to sulfate and the reduction of sulfate to sulfide.

**refuge (refugium)** A region in which certain types of organisms are able to persist during a period in which most of their original geographic range becomes unsuited for their existence, e.g., because of climatic change.

**resurgence** The re-emergence of karst groundwater or the reappearance of a sinking stream. A spring for which the source of the water has been determined by tracing tests.

**rhyolite** A fine-grained igneous rock containing high concentrations of aluminum. The chemical composition of rhyolite is similar to that of granite.

**rimstone** A secondary deposition of calcium carbonate in the form of a basin or dam that often holds percolating water.

**rockshelter** Although classified under the same term as caves by the Maya, rockshelters are pockets of space at the base of rock walls that are relatively open and lack dark zones.

## S

**saprophilic** Animal obtaining organic matter from dead and decaying organisms.

**saprovore** A species feeding on dead or decaying organic matter.

**saturated boundary layer** See **turbulent saturation**

**saturation** Applied to the reaction of calcium carbonate with carbonic acid, a water is said to be saturated when the reaction has reached equilibrium. The reaction to the right is exactly balanced by reaction to the left, and the net reaction is at steady state.

**scalenoedron (scalenoedra)** A pyramidal crystal form, enclosed by twelve faces, each a scalene triangle.

**scallop dominant discharge** The part of the hydrological regime represented by a scallop population.

**scallops** Asymmetrical, cusped oyster-shell shaped dissolution depressions in cave walls.

**scotophilia** Avoidance of bright light (negative phototaxis).

**SCUBA** Self-contained underwater breathing apparatus. Divers carry tanks of compressed air along with necessary valves, regulators, and a mouthpiece to travel long distances underwater.

**secondary consumer, carnivore** Predatory or parasitic species that feed on primary consumers.

**sediment aggradation** An event whereby a river channel receives more sediment than it can carry away, resulting in an upward-moving position of the river's bed, and in turn, the water table.

**seepage** Water percolating into a cave that may deposit a film of calcite.

**semelparity** Only one reproduction within the organism's life.

**sexual display** Males show a courtship behavior with impressive visual signals to attract females for reproduction.

**shaft** Often used synonymously with pit. Shafts are generally more nearly vertical and some, known as vertical shafts, have smooth, perfectly vertical walls.

**shear stress** Intrinsic strength of the rocks with respect to bending; that component of stress which acts tangential to a plane through any given point in a body; any of the tangential components of the stress tensor.

**show caves** Caves which have man-made improvements that allow a person to tour the cave without caving equipment. The cave is managed and fees are often charged.

**show caving** Entering a show cave without caving equipment.

**siliciclastic** Composed of sedimentary silicate minerals such as quartz and clay.

**sink (sinking stream)** A point where a surface stream disappears underground.

Also called *lost rivers, ponors, swallets*, and *swallow holes*.

**sorption** The process of removing from solution and holding, either by absorption (physical assimilation) or adsorption (adhesion to the surface). Some compounds and dyes are much more susceptible to sorption losses than others.

**species richness** Number of species.

**speleogenesis** The process of the origin of solution caves, and the branch of knowledge about it. In a wider sense this term means not only the very origin but also the entire life history of caves from gestation to obliteration (complete filling or decay).

**speleogens** Eroded bedrock features in caves such as scallops, ceiling and floor channels, and bedrock projections and protrusions.

**speleothem** A general term for secondary deposits formed in caves, e.g., stalactites, stalagmites, helictites, and gypsum flowers.

**spelunker** A derogatory term used in the caving community to describe a person characterized as one or more of the following: inexperienced in caving, poorly equipped, exhibiting foolish behavior in a cave, a cave vandal, or poorly informed about the cave environment or speleology.

**spongework maze** A maze cave consisting of interconnected voids like those in a sponge, usually formed by the solution enlargement of intergranular pores.

**sport caving** A subset of recreational caving. This caving requires more organization, planning, or stamina than most other recreational caving.

**spring** Discrete point or opening from which groundwater flows to the surface; strictly speaking, a return to the surface of water that had gone underground.

**stage bottles** Stashes of scuba tanks that are placed in the cave ahead of a major mission to provide additional supplies of breathing gas for the return trip of a long dive.

**stage height** Water level of a stream or river at any moment.

**steno** With a narrow ecological potential; e.g., stenohaline is an animal bound to a strongly defined salinity value, etc.

**stopping** Upward enlargement of a cave passage by sequential ceiling collapse.

**strike** The direction perpendicular to the dip of a bed or geologic structure. For example, if a sedimentary rock contains

beds that dip to the south, the strike is east–west. (The same would be true for beds dipping to the north.)

**strike-oriented** Aligned in the direction of a horizontal line along a sloping plane of sedimentary strata.

**stygobiont (stygobite)** Animal species inhabiting subterranean waters and occurring only in subterranean waters, either in interstitial habitats or in free water of caves or other karstic habitats. Limnostygobionts live in fresh groundwater, and thalassostygobionts live in marine ground waters or marine caves.

**stygophile** A species that completes its entire life cycle in subterranean waters but can also complete its entire life cycle in surface waters.

**stygophile** Refers to species that can reproduce in both underground and surface waters.

**Stygo-troglobiont** A species that completes its entire life cycle only in aquatic-terrestrial subterranean environments.

**Stygo-troglophile** An aquatic-terrestrial species able to complete its life cycle in caves but also found in surface habitats.

**succession** The directional change in species composition over short periods of time. In caves this is months to a few years and is based on use of large sizes of complex organic matter; hence successional decomposition.

**sump** With respect to caves, a sump is a place where the ceiling of a cave passage descends below water level.

**survey a cave** Action of measuring and sketching a cave in order to produce a map of the cave.

**symbiosis** Two organisms permanently attached or embedded in one another.

**sympatric** Relating to populations, species, or taxa that occur together within the same geographical area.

**sympatric speciation** Speciation without geographic isolation, as a result of genetic differentiation within a population and resulting in species with overlapping distributions.

**T**

**tafoni** Roughly hemispherical hollows weathered in rock either at the surface or in caves.

**talus** Piles of loose boulders that accumulate at the bottoms of cliffs and other steep slopes.

**taxon (taxa)** A formally recognized category in the hierarchical classification of

organisms; e.g., phylum, order, family, genus, and species.

**tectonic** Related to the forces that form the Earth's major structural features, such as mountain chains.

**tectonic movements** Landscape movements associated with interactions between segments of the Earth's crust, often resulting in mountain building.

**temperate glacier** A glacier whose internal temperature is at the melting point.

**terrace** A deposit above a stream, typically flat-topped, composed of floodplain or stream sediments.

**territoriality** A defended territory, usually by males.

**Tertiary** The first period of the Cenozoic era between 65 and 2 million years ago.

**Tethys** The past circumglobal sea between the southern continent Gondwana and the northern Laurasia. Paratethys was its branch in present-day southeast Europe in the Tertiary. Before drying out it was split and diluted to a series of great lakes, which were very important for the formation of the local aquatic fauna.

**thalassoid** From marine origin. A thalassoid stygobiont, even living in continental groundwaters, is related to marine groups and derived from marine ancestor and not closely related to surface freshwater fauna. (Antonym: limnicoid)

**thermal neutral zone** Range of ambient temperatures in which the metabolic rate of a homeothermic animal is at its lowest level (basal metabolic rate).

**thyroxinian climax** The values of the plasmatic concentration in thyroxine (T3 and T4) significantly rise during the development of the larvae until the efficacy maximum level — the metamorphose climax.

**torpor** Reduced body temperature and metabolic rate used to conserve energy.

**total darkness** The area in a cave in which no natural light enters.

**tracer** In hydrology any dissolved, suspended, or floating material used to determine the path and (or) rate of movement and dispersion of similar materials in water.

**troglobiont (troglobite)** Terrestrial animal species living in caves or karstic habitats

(from the Greek word *trogli* meaning hole, cavity, cave). May include aquatic species living in cave waters.

**troglo-morphic** Morphological adaptations of obligatory subterranean organisms that commonly include loss or severe reduction of eyes and pigments, often accompanied by attenuation of the body and/or appendages.

**troglo-philic** A species that can complete its life cycle in caves but may also be found on the surface.

**troglo-xene** Species that spend part of their life underground (hibernation, shelter) and part on the surface (feeding, reproduction). Example: cave bats and some cave crickets.

**turbulent** Rough, well-mixed flow. In turbulent flow, the drag against the walls of the channel and the drag of flowing water against itself breaks up the streamlines and produces swirls and eddies in the flow. A drop of dye injected into turbulent flow will quickly mix and the water downstream will be a uniform color.

**twilight zone** Area of cave extending from the limit of green plants to darkness, where the light gradually attenuates.

**twins** Two or more crystals of a single mineral exhibiting symmetrical intergrowths. The individual parts are related to one another in a definite crystallographic manner.

## U

**Upper Paleolithic** The final phase of the Paleolithic period. In the Levant it continued from 40,000 to about 20,000 calendar years before present. It is marked by lithic technology that includes blades, points, endscrapers, and burins. Non-lithic objects include bone tools, ochre, and shell.

## V

**vadose** Pertaining to the zone above the water table where all cavities are generally air-filled, except during temporary flooding.

**vadose water** Water migrating vertically through the unsaturated zone above the water table.

**vadose zone** The environment above the water table, where the rock has air-filled voids. The words "unsaturated zone" are a common synonym, but because the word unsaturated has chemical implications that are critical in karst systems, the term vadose is preferred for karst areas.

**valley margin sinkholes** Sinkholes on the boundary between the clastic ridges and karstic valleys found in the Valley and Ridge province of the Appalachians. Streams draining the ridges often sink at these locations.

**vent** The opening to the Earth's surface where an underground conduit discharges water to form a spring.

**vertical shafts** Vertically oriented cave passages.

**vicariance** The occurrence of closely related taxa in disjunct areas that have been separated by the development of a natural barrier (vicariant event).

**vicariant** Members of a former continuously distributed species or taxon that became separated by a geographical barrier.

**virgin passage** Cave passage that has never before been seen by humans.

**volant** Mode of locomotion that involves powered flight.

**vug** Small cavity in the rock.

## W

**water table** The surface within an aquifer below which all pore spaces are filled with water. The water table is marked by the level of standing water in unpumped wells.

**watershed (also groundwater basin)**

The land area from which rainfall ultimately drains to the spring in question.

**wavelength (scallop)** The width of a scallop measured from cusp to cusp in the direction of flow.

## X

**xibalba** The Kiche' Maya term for the underworld in the *Popol Vuh*. It is generally understood to have been reached through a cave.



## A

- A2, *see* Hohlaub Area
- Abandoned buildings, 471
- Abebaioscia troglodytes*, 150
- Ablemma*, 558
- Acanthobathynella knoepffleri*, 146
- Acanthocreagris*, 560
- Acanthocyclops*, 145, 162
- Acari, 561–563
- Acaridae, 562
- Acarina, 192
- Acaroceras*, 563
- Accelerated corrosion, dolines, 112
- Acetobacterium*, 93
- Achaearanea*, 558
- Acheulian sequence, Middle East cave dwellers, 88
- Achromatium*  
cave ecology, 172  
chemolithoautotrophy, 99, 370
- Acidianus*, 93
- Acidimicrobium*, 100
- Acidophilic aerobe, iron, 94
- Acids, in limestone dissolution, 612–613
- Acontinus stercoricola*, 557
- Acotyledon*, 562
- Acridine orange, chemolithoautotrophy, 98
- Acroloxus*, 383
- Acroloxus tetensi*, 161
- Active colonization model, active dispersal, 306
- Active dispersal, invasion models, 306
- Adaptations  
as adaptive shift factor, 18  
aquatic troglobites, 450–451  
*Astyanax fasciatus*, 246  
beetles, 46–47  
behavioral, *see* Behavioral adaptations  
cave amblyopsids, 246, 248  
to darkness, 1–3  
definition, 1  
derivation, 1  
to dissolved oxygen in groundwater, 11  
diverse marine habitats, 361  
*Eigenmannia vicentespelaea*, 248  
fish, 244, 248–251  
and food limitations, 256  
to low food  
basic food resource, 4–5  
cave type effects, 5  
energy demand, 7–9  
fat accumulation, 6–7  
food finding, 5–6  
food scarcity types, 4  
life history characters, 9–10  
overview, 4  
to low oxygen  
behavioral adaptations, 13  
in groundwater, 11, 13  
metabolic responses, 15–16  
overview, 10–11  
respiratory adaptations, 14–15  
marine regression, 365  
*Ophisternon infernale*, 246  
*Rhamdia zongolicensis*, 246  
salamanders, 489  
subterranean ecosystems, 230  
troglomorphic, anchialine taxa, 27–28  
types, 1
- Adaptive shift  
ancestral habitats, 19–20  
basic theory, 17–18  
biogeography, 593  
cavernicolous habitats, 19  
continents, 23  
crickets, 22–23  
definition, 17  
environmental stresses, 19  
exploitable food resources, 19  
founder events, 18  
future research, 24  
genetic repertoire, 18  
Hawaii case study, 20–23  
hybridization, 19  
on islands, 23  
mating behavior, 19  
population flush and crash cycles, 18  
preadaptation, 18  
stress responses, 19  
wolf spiders, 23
- Adaptive-shift model, active dispersal, 306
- Adelocosa anops*, 555, 558
- Adelphoderia*, 193
- Aegla cavernicola*, 152
- Aegopsis spelaeus*, 161
- Aellenella*, 562
- Aeolian caves, 84
- Aerobe definition, 91
- Aerodrama fucifugus*, 591
- Aerodrama maximus*, 591
- Aerodrama* spp., 277, 589–590
- African false vampire bat, courtship and mating, 41
- Afrostermophorus*, 560
- Agastoschizomus*, 556
- Agelendiae, 557
- Aggregation, mapping subterranean biodiversity, 358–359
- Aggression, energy demand, 8
- Agoristenidae, 563
- Agraecina*, 558
- Air flow, cave environment and species, 479
- Alabamocreagris*, 560
- Alacran tartarus*, 519, 556
- Albinism, neutral mutation, 411
- Albiorix*, 560
- Alcaligenes*, 93, 95
- Alces alces*, 508
- Alligator, U.S. diversity, 181
- Alligator mississippiensis*, 181
- Allochthonius*, 559
- Allogenic recharge, dispersed, karst aquifers, 296
- Allogenic waters, influent streams, 510
- Allokoenia*, 559
- Allomengea*, 558

- Alluvial dolines  
 characteristics, 118  
 definition, 523
- Alluviated springs, 566
- Alona*, 142
- Alona hercegovinae*, 227
- Alona sketi*, 227
- Alona stochi*, 227
- Alpha-A-crystalline, neutral mutation, 413
- Amarnath Cave, myths and legends, 406
- Amblyopsidae  
 behavior, 6  
 food finding, 6
- Amblyopsids  
 adaptation, 248  
 life history evolution, 347–348  
 sensory compensation, 246, 248
- Amblyopsis rosae*  
 biogeography, 595  
 evolution, 393–394  
 life history characters, 8  
 life history evolution, 347  
 reproductive effort, 349  
 U.S. diversity, 180
- Amblyopsis spelaea*  
 evolution, 393–394  
 feeding behavior, 51  
 fish eye regression, 242  
 life history evolution, 347–348  
 and natural selection, 410  
 reproductive effort, 349  
 U.S. diversity, 170–171, 177
- Amblypygi, 192, 556–557
- Ameobaleria defessa*, 180
- Amergoniscus*, 178
- American false vampire bat, courtship and mating, 41
- Amerioppia*, 563
- Ammonia, chemolithoautotrophic microbial groups, 94
- Amphibia, U.S. diversity, 180–181
- Amphipoda*, 26
- Amphipods, Australian diversity patterns, 188
- Anaerobes, 91
- Anapidae, 557
- Anapistula*, 193
- Anaspides tasmaniae*, 146
- Anastomoses  
 characteristics, 317  
 as karren form, 315
- Anastomotic caves, 304, 443
- Ancestral habitats, as adaptive shift factor, 19–20
- Anchialine caves  
 biodiversity definitions, 24–25  
 biogeography, 35  
 crustacean biodiversity, 25–27  
 crustacean types, 33–35  
 fauna and humans, 37–38  
 geography and historical data, 30–31  
 inhabitant distribution, 36  
 morphology and hydrology, 31–33  
 non-crustacean groups, 33  
 overview, 30  
 pools concept, 31
- taxa characteristics  
 anomalous biogeographical distribution, 29–30  
 deep-sea affinities, 30  
 primitive characteristics, 28–29  
 troglomorphic adaptations, 27–28
- Tethyan relicts, 190–191
- theoretical importance, 37
- trophic relations, 36–37
- Ancistrotellus*, 564
- Ancistrus*, 234
- Ancylus fluviatilis*, 161, 163
- Andasta*, 558
- Androniscus dentiger*, 453
- Angel hair, 290
- Anhydrite, as evaporite mineral, 288
- Animals  
 biogeography, 592–593  
 cave-dwelling, definition, 589  
 energy demand, 7–8  
 Pachon Cave, feeding behavior, 51  
 reproductive efforts, 349–350
- Anisolabis howarthi*, 179
- Annelida, 616–617
- Annina lacustris*, 34
- Anomalothrombium*, 562
- Anophthalmus* spp.  
 characteristics, 160  
 European diversity patterns, 197
- Anopsicus*, 558
- Anoxia  
 metabolic responses during, 15  
 survival times, 13
- Antarctica, ice sheets, 275
- Antecaridina lauensis*  
 anchialine caves, 34  
 biogeography, 35  
 distribution in anchialine caves, 36
- Anthodites, 550–551
- Anthrobia*, 558
- Antillobisium*, 559
- Antler, 550
- Antricola*, 561
- Antriscopia prehensilis*, 28, 144
- Antrobia culveri*, 176
- Antroherpon*  
 characteristics, 163  
 European diversity patterns, 197
- Antrolana lira*  
 biogeography, 596  
 U.S. diversity, 177
- Antronicippe serrata*, 35
- AO, *see* Acridine orange
- Apfelbeckia*, 161
- Aph-1*, 452
- Aphaenops*  
 ecology, 50  
 European diversity patterns, 197  
 systematics, 48
- Aphaenopsis* spp., 160
- Aphrastochthonius*, 560
- Apneumonella*, 558
- Apochthonius*  
 classification, 560  
 U.S. diversity, 177
- Apozomus*, 193
- Appalachian Mountains  
 entranceless caves, 208–210  
 karst examples, 533–534  
 streams, species interactions, 541–542
- Appalachian Plateaus, karst example, 531–533
- Appaleptoneta*, 558
- Appendages, in food finding, 5–6
- Aproteles bulmerae*, 590
- Aqua Cave  
 and Burnsville Cove, 62–63  
 description, 64
- Aquatic cave animals, energy demand, 7
- Aquatic ecotones, 207
- Aquatic epikarst communities, 172
- Aquatic phreatic communities, 172
- Aquatic snail, Burnsville Cove, 70
- Aquatic stream communities, 172
- Aquicludes, normal karst aquifers, 293
- Aquifers  
 definition, 293  
 Edwards Aquifer, 509  
 epikarstic aquifer, 220  
 karst, *see* Karst aquifers
- Aquiflex*  
 chemolithoautotrophs, 92  
 hydrogen, 93
- Arabika Massif, 335
- Arachnida  
 Acari, 561–563  
 Amblypygi, 556–557  
 Araneae, 557–558  
 biology, 554–555  
 conservation, 555  
 distribution, 554  
 Opiliones, 563–564  
 overview, 554  
 Palpigradi, 559  
 Ricinulei, 560–561  
 Schizomida, 556  
 Scorpions, 555–556  
 in U.S., 176–177
- Aragonite  
 characteristics, 372  
 flank margin caves, 124
- Araneae, 193, 557–558
- Araneomorphae, 557–558
- Archaeology  
 Mammoth Cave area, 203–204  
 Postojna–Planinska Cave System, 458  
 Sistema Huautla, 520–521
- Archeolarca*, 560
- Archoleptoneta*, 558
- Argas*, 561
- Argasidae, 561
- Arrhopalites*  
 Australian diversity patterns, 193  
 Burnsville Cove, 70  
 U.S. diversity, 179
- Arrhopalites secundarius*, 224
- Arsenates, 377
- Artema*, 558
- Artesia Group, Lechuguilla Cave, 341
- Artesian springs, 566–567
- Arthrobacter*, 94
- Artibeus jamaicensis*, 41
- Arubolana parvioculata*, 148

- Asbestopluma hypogea*, 33  
*Asellus aquaticus*  
 behavioral adaptations, 13  
 characteristics, 162–163  
 dinaric karst, 165  
 metabolic responses during anoxia, 15  
 metabolic responses during postanoxic recovery phase, 15  
 respiratory adaptations, 14–15  
 survival under anoxia, 13  
 Assamiidae, 563  
*Astagobius*, 164  
 Astigmata, 562  
*Astyanax*  
 fat storage and metabolism, 249  
 troglobite origins, 231  
 troglomorphic traits, 234  
*Astyanax fasciatus*  
 adaptation, 246  
 biogeography, 598  
 body pigmentation, 244  
 color mutations, 414  
 energy demand, 7  
 eye ontogeny, 413  
 fat accumulation, 7  
 fat content and condition factors, 7  
 feeding behavior, 51  
 fish eye regression, 242  
 food competition, 54  
 food finding, 6  
 head enlargement, 248  
 light reaction, 244  
 neutral mutation, 411  
 overview, 241–242  
 pineal organ, 244  
 and population structure, 453  
 reproductive behavior, 53  
 sensory compensation, 246  
*Astyanax rosae*, 246  
*Astyanax spelaea*  
 head enlargement, 248  
 sensory compensation, 246  
*Astyanax* spp.  
 regressive evolution, 389  
 reproduction, 251  
 Atemnidae, 559  
*Atemnus*, 559  
*Athepus*, 558  
*Atheta*, 160  
*Atlantasellus cavernicolous*, 148  
*Atopobathynella*, 189  
 ATP, and anoxia, 15  
*Atractides*, 562  
 Atruidae, 562  
*Aturus*, 562  
*Aucayacuella*, 564  
*Aulopyge huegelii*, 163  
 Australia, diversity patterns  
 Acarina, 192  
 Amblypygi, 192  
 amphipods, 188  
 anchialine habitats, 190–191  
 Blattodea, 194  
 calcretes, 187  
 cave atmosphere, 185–187  
 Coleoptera, 194–195  
 Copepoda, 189  
 Cretaceous marine transgressions, 184–185  
 Decapoda, 192  
 energy supply, 188–189  
 geographic factors, 184  
 Isopoda, 191–192  
 Opiliones, 192–193  
 Orthoptera, 194  
 Ostracoda, 191  
 overview, 183–184  
 shield regions, 184–185  
 Spelaeogriphacea, 192  
 Syncarida, 189  
 vertebrates, 195  
*Australiobates*, 562  
 Austrochilidae, 557  
*Austrochthonius*  
 Australian diversity patterns, 193  
 classification, 559  
*Austrolinoceae*, 560  
 Autotroph, 90  
 Avens, 319  
 Aves, U.S. diversity, 181  
*Axonopsella*, 562  
*Axonopsis*, 562  
*Aymaria*, 558  
 Azurite, 374
- B**  
*Bacillus*, 95  
 Back flooding, breakdown initiation, 60  
 Bacteria  
 and anchialine caves, 32  
 cave ecology, 172  
 chemolithoautotrophy, 99, 370  
 hydrogen, 93  
 mineral deposition, 371  
 sulfuric acid caves, 575  
*Bactrurus*, 177  
 Bad air zones, lava tubes, 481  
 Badger, foraging, 590  
*Bahadzia*, 35  
*Bahalana mayana*, 34  
 Bahama Islands, flank margin caves, 125–126  
*Baiami*, 558  
*Balkanoroncus*, 560  
*Bamazomus*, 193  
*Banksula*, 564  
 Barberry Cave  
 Burnsville Cove exploration, 63  
 description, 67  
*Barbopsis devecchii*, 453–454  
*Barbouria cubensis*  
 anchialine caves, 34  
 troglomorphic adaptations, 27  
 Bärenschacht, Siebenhengste Cave System,  
 502–503  
 Barite, 374–375  
 Barn owl, foraging, 590  
 Barometric airflow, Jewel Cave, 312  
*Barusia*, 558  
 Barychelidae, 557  
 Base level, influent streams, 510  
*Bassariscus astutus*, 590  
 Bat falcon, cave dwelling costs, 43  
 Bat hawk, cave dwelling costs, 43  
*Bathymodiolus thermophilus*, 101  
*Bathynella*, 189  
*Bathynella chappuisi*, 146  
*Bathynella primaustraliensis*, 146  
*Bathynomus*, 148  
*Bathyscia montana*, 160  
 Bathyscioid, cave beetles, 48  
*Bathysciola*, 197  
*Batrissodes* spp., 180  
 Bats  
 African false vampire bat, 41  
 American false vampire bat, 41  
 Australian diversity patterns, 194  
 bone accumulation in caves, 431–432  
 Brazilian free-tailed bat, 41, 43–44, 182  
 cave dwelling benefits, 42–43  
 cave dwelling costs, 43  
 cave life, 459–460  
 cave roost functions, 40  
 conservation and management, 43–44  
 courtship and mating, 40–41  
 dawn bat, 589–590  
 distribution, 39–40  
 ecosystem services, 44  
 Egyptian fruit bat, 589  
 feces, 263  
 fruit bat, 590  
 Geoffroy bat, 589  
 ghost bat, 40, 195  
 gray bat, 182, 459, 590  
 greater horseshoe bat, 41–42, 589  
 greater spear-nosed bat, 41, 43  
 guano bat, 277, 590  
 guano piles, 279  
 habitat destruction and alteration, 44  
 hibernation, 42  
 horseshoe bat, 161  
 human disturbance, 44  
 Indiana bat, 44, 181, 459  
 Jamaican fruit bat, 41  
 Jewel Cave, 313  
 Kitti's hog-nosed bat, 39  
 large bent-wing bat, 40, 43  
 leaf-chinned bat, 459  
 lesser long-nosed bat, 40, 43  
 long-fingered bat, 161  
 Mexican free-tailed bat, 459  
 Mexican long-tongued bat, 181  
 Nullarbor Caves, 426  
 orange leaf-nosed bat, 40  
 overview, 39  
 parasite classifications, 562  
 rearing young, 41–42  
 Schreiber's bat, 590  
 Townsend's long-eared bat, 40  
 vampire bats, 40, 43–45, 590  
 Battered Bar Cave, description, 68–69  
*Batubathynella*, 224  
 BCCS, *see* Butler Cave Conservation Society  
 Bear  
 foraging habitats, 590  
 paleontology, 432–433  
 Siebenhengste Cave System, 508  
 Beaver, U.S. diversity, 181  
 Bedrock-collapse sinkhole, formation, 525



- Beetles  
 adaptations, 46–47  
 biogeography, 593  
 colonization, 47–48  
 cricket interactions, 540–541  
 dinaric karst, 164  
 ecology, 49–50  
 epikarst, 224  
 feces, 263  
 geographical distribution, 47–48  
 importance and protection, 50  
 life history characteristics, 349  
 overview, 45–46  
 population structure, 450  
 Sistema Huautla, 519  
 species interactions, 540–541  
 systematics, 48–49  
 terrestrial ecotones, 207  
 U.S. diversity, 179
- Beggiatoa*  
 and anchialine caves, 32  
 cave ecology, 172  
 chemolithoautotrophy, 99, 370  
 reduced inorganic sulfur compounds, 94
- Behavioral adaptations  
 definition, 1  
 feeding, 51–52  
 food competition, 54–55  
 food finding, 6  
 mate competition, 55–56  
 overview, 51  
 reproduction, 52–53
- Belba*, 562
- Belisarius xambeui*, 556
- Bell holes  
 characteristics, 319  
 as karren form, 315
- Bell Witch Cave, myths and legends, 407
- Bends, underwater cave exploration, 239
- Bengalla bermaini*, 193
- Best management practice, cave preserve design, 461
- Better Forgotten Cave, description, 64–65
- Bevels  
 definition, 320  
 as karren form, 315
- Biantidae, 564
- Big-eyed wolf spider, adaptive shift, 23
- Big Mouth Cave salamander, 488
- Biodiversity  
 anchialine caves, 24–27  
 crustaceans, 25–27  
 ecotones, 206  
 subterranean mapping  
 interpolators, 356  
 kriging, 356–358  
 modeling issues, 358–360  
 overview, 355  
 spatial process decomposition, 355–356  
 tropics, 167–170
- Biofilms, 577
- Biogeography  
 anchialine caves, 29–30, 35  
 aquatic stygobites, 594–598  
 cave animals, 592–593  
 cladistic, definition, 592  
 epikarstic communities, 226–227  
 limnology, 362–363  
 molluscs, 383–384  
 overview, 591–592  
 terrestrial troglobites, 593–594
- Birds  
 cave-dwelling species, 589–590  
 and cave ecology, 590  
 caves as shelter, 590  
 foraging habitats, 590  
 overview, 590–591
- Birds of prey, diurnal, paleontology, 434
- Bishopella*, 564
- Bitulobernes*, 559
- Blabomma*, 557
- Black Hills caves, 314
- Black-nest swiftlets, 591
- Blanco*, 558
- Blanco blind salamander, 486
- Blarney Stone Cave  
 Burnsville Cove exploration, 63  
 description, 66–67
- Blattaria, as guano inhabitants, 281
- Blattodea, Australian diversity patterns, 194
- Blind Faith Cave, description, 68
- Blindsnake, Australian diversity patterns, 195
- Blister caves, 599
- Block breakdown, 56
- Blue holes  
 characteristics, 126  
 definition, 566
- Blue Ridge Spring salamander, 488
- Blue Spring Creek, as influent river, 509–510
- BMP, *see* Best management practice
- Bobcat Cave  
 camp, 75–76  
 description, 65–66  
 as entranceless cave, 210
- Bochicidae, 559
- Body pigmentation, and fish eyes, 242, 244
- Body size, energy demand, 8
- Bogidiella*, 224
- Bosxshallia*, 30
- Boulder piles, as cave type, 83
- Boundless Cave, description, 65
- Brachioppa*, 563
- Brachyanillus*, 558
- Brackenridgia*, 178
- Branching caves, origin, 442
- Branchiopoda, 142
- Brazil, karst, bat-guano piles, 279
- Brazilian free-tailed bat  
 cave dwelling benefits, 43  
 cave dwelling costs, 43  
 ecosystem services, 44  
 rearing young, 41  
 U.S. diversity, 182
- Breakdown  
 clastic sediment production, 103  
 crystal wedging, 59  
 definition, 56  
 initiating processes, 59–60  
 mechanics, 58–59  
 mineral activation, 59  
 morphology, 56–58  
 in speleological processes, 60
- Breakout domes, 57
- Breakthrough curve, karst waters tracing, 321
- Breathing Cave  
 Burnsville Cove exploration, 63  
 description, 64
- Breccia, Middle East caves, 87
- Bronze age, Middle East cave dwellers, 89
- Brown bear  
 paleontology, 432  
 Siebenhengste Cave System, 508
- Bubalocerus*, 615
- Buckwheat Cave  
 description, 67  
 as entranceless cave, 210
- Buffer zones  
 cave preserve design, 460–461  
 cave protection management, 462
- Buresiola*, 563
- Burial, Maya Caves, 367
- Burial dating, with cosmogenic nuclides  
 Mammoth Cave, Kentucky development, 140–141  
 New River, Virginia, 139–140  
 overview, 138–139  
 requirements, 139
- Buried sinkhole, 524, 526
- Burns Chestnut Ridge Cave  
 Burnsville Cove exploration, 64  
 description, 69–70
- Burnsville Cove, Virginia  
 Aqua Cave, 64  
 Barberry Cave, 67  
 Battered Bar Cave, 68–69  
 Better Forgotten Cave, 64–65  
 Blarney Stone Cave, 66–67  
 Blind Faith Cave, 68  
 Bobcat Cave, 65–66  
 Boundless Cave, 65  
 Breathing Cave, 64  
 Buckwheat Cave, 67  
 Burns Chestnut Ridge Cave, 69–70  
 Butler Cave, 64  
 By-the-Road Cave, 70  
 camp, 75  
 entranceless caves, 210  
 exploration history, 63–64  
 Helictite Cave, 69  
 overview, 60–61  
 physical and geologic setting, 61–63  
 Robins Rift Cave, 65  
 special attributes, 70–71
- Burnsville Cove Symposium*, 70–71
- Butler Cave  
 camp, 74  
 description, 64  
 as entranceless cave, 210
- Butler Cave Conservation Society, Burnsville Cove exploration, 63
- Bypass tubes, 319
- By-the-Road Cave, description, 70
- Bythiospeum alpinum*, 508

## C

C-3 Expedition, *see* Crystal Cave Expedition  
*Caconemobius fori*, 23

- Caconemobius howarthi*, 179  
*Caconemobius sandwichensis*, 22  
*Caconemobius varius*, 179  
*Caecidotea*  
 epikarst, 224  
 U.S. diversity, 177  
*Caecidotea cannulus*, 542  
*Caecidotea holsingeri*, 542  
*Caecidotea pricei*, 597  
*Caecidotea recurvata*, 541  
*Caecobarbus geertsii*, 348  
*Caecosteneroides*, 150  
*Caffrowithius*, 559  
*Calabozoa pellucida*, 150  
 Calcite  
 characteristics, 372  
 dissolution, 611–612  
 hydrothermal karst, 304  
 Nullarbor Caves, 424–425  
 precipitation rates, 544  
 solubility, CO<sub>2</sub> role, 609–610  
 Calcium sulfate, as evaporite mineral, 288  
 Calcretes, Australia, 187  
*Calicina*, 564  
*Callileptoneta*, 558  
*Calliuncus*, 564  
*Calloristus*, 564  
*Callumobates*, 562  
*Caloglyphus*, 562  
 Calvin–Benson cycle, chemolithoautotrophs, 92  
*Calyptogenia magnifica*, 101  
*Cambarincola*, 176  
*Cambarus*  
 characteristics, 151  
 U.S. diversity, 178  
*Camposea*, 562  
 Camps  
 adaptability and incentive, 77  
 Bobcat Cave, 75–76  
 Burnsville Cave, Virginia, 75  
 Butler Cave, 74  
 Crystal Cave Expedition, 73–74  
 eating, 76–77  
 Ellison's Cave, 74  
 European model, 73  
 Fern Cave, 75  
 Mexico, 74–75  
 Midnight Cave, 74  
 nylon, 76  
 overview, 73  
 Project SIMMER, 74  
 Simmons–Mingo Cave, 74  
 sleeping, 76  
 Sullivan Cave, 74  
 Wind Cave, 74  
*Canarionesticus*, 558  
*Cancrocaeca xenomorpha*, 169  
 Cango Cave, as show cave history, 495  
*Cangodermes*, 558  
*Canis latrans*, 590  
 Canyon wren, U.S. diversity, 181  
 Capitan Formation, Lechuguilla Cave, 341  
*Caraimatta*, 558  
 Carbonates, 372, 374  
 Carbon dioxide  
 in calcite solubility, 609–610  
 cave environment and species, 479  
 show caves, 497–499  
 Carbon fixation pathways,  
 chemolithoautotrophs, 92  
*Cardioderma cor*, 41  
*Carinurella paradoxa*, 162  
 Carlsbad Cavern, sulfuric acid caves, 577  
 Carnivores, mammalian, paleontology, 432  
 Carolina Spring salamander, 488  
 Castleguard Cave, Canada  
 cave sediments, 80  
 climate, 80–81  
 dating, 80  
 fauna, 81  
 geographical setting, 77–78  
 modern hydrology, 79–80  
 morphology and genesis, 78–79  
 overview, 77  
 speleothems, 80  
*Castor canadensis*, 181  
*Catatemnus*, 559  
 Catfish  
 adaptation, 246  
 head enlargement, 248  
 sensory compensation, 246  
 troglomorphic traits, 234  
*Cathartes aura*, 181  
 Cathedral limestones, Castleguard Cave, 78  
*Catherpis maxicanus*, 181  
*Cauloxenus stygius*, 177  
 Cave of Antiparos, as show cave history, 495  
 Cave art, Maya Caves, 367–368  
 Cave-collapse sinkhole, 525  
 Cave concepts  
 cave types, 83–85  
 darkness, 83  
 definitions, 81  
 geological repositories, 82  
 groundwater flow paths, 82  
 habitats, 82–83  
 Cave conservation  
 preservation design, 460–461  
 public education, 467  
 Cave degeneration, 444  
 Cave dwellers  
 bats, 459–460  
 benefits, 42–43  
 costs, 43  
 definition, 589  
 extinct and endangered species, 459  
 Middle East, 85, 87–89  
 overview, 458  
 threats to, 458–459  
 various species, 589–590  
 Cave exploration  
 basic concept, 81–82  
 Burns Chestnut Ridge Cave, 64  
 Burnsville Cove, Virginia, 63–64  
 clothing, 236  
 conservation, 239  
 entranceless caves, 208, 212–213  
 expedition and project, 237–238  
 Friars Hole Cave System, 266–267  
 hard hats, 236  
 Jewel Cave, 311  
 Kazumura Cave, 330–331  
 Krubera Cave, 337–338  
 large cave system skills, 235  
 Lechuguilla Cave, 344–347  
 light sources, 235–236  
 Mammoth Cave System, 351  
 overview, 234  
 packs, 236–237  
 Postojna–Planinska Cave System, 456–457  
 safety, 239  
 small near-horizontal cave skills, 234–235  
 underwater caves, 238–239  
 underwater cave skills, 235  
 vertical caves, 237  
 vertical cave skills, 235  
 Wakulla Spring Underwater Cave System,  
 607–608  
 water caves, 238  
 Cave gating  
 criteria, 462–463  
 decision guide, 464–465  
 styles, 463–464  
 Cave hypogetric, 164  
 Cave level, 442  
 Cave management, 465  
 Cave of the Patriarchs, myths and legends,  
 407  
 Cave protection  
 cave prioritization, 466–467  
 construction projects  
 buffer zone management, 462  
 cave gate styles, 463–464  
 cave gating criteria, 462–463  
 cave gating decision guide, 464–465  
 karst area management, 462  
 karst identification, 461  
 overview, 461  
 staging area management, 461–462  
 security systems, 465  
 Cave of Psycho, myths and legends, 406  
 Cave radio, entranceless caves, 214–215  
 Cave Research Foundation, Lechuguilla Cave,  
 345  
 Cave restoration, 465–466  
 Cavernicoles  
 as adaptive shift factor, 19  
 classification, 563  
 definition, 589  
 U.S. distribution, 172–174  
 Cavernicolous birds, 590–591  
*Cavernocypris*, 145  
*Caviphantes*, 558  
 Celestine, 374–375  
 Cenotes, collapse dolines, 117  
 Central Cave, Castleguard Cave, 78  
 Centroid, karst water tracing, 328  
*Centromerus*, 558  
*Cerberotrombidium*, 562  
*Ceuthophilus cunicularis*, 540–541  
*Ceuthophilus silvestris*, 179  
*Ceuthophilus* spp.  
 and population structure, 454  
 U.S. diversity, 179  
 CF, *see* Condition factor  
 Chaerilidae, 555  
*Chaerilus chapmani*, 555  
 Chalcolithic age, Middle East cave dwellers, 89

- Chalinolobus morio*, 426  
 Chalybeate springs, 567  
 Chandelier Maze, Lechuguilla Cave, 346  
*Chappuisius*, 145  
 Characid fish  
   color mutations, 414  
   eye ontogeny, 413  
   fat storage and metabolism, 249  
   fish eye regression, 242  
   neutral mutation, 411  
   overview, 241–242  
   regressive evolution, 389  
   troglomite origins, 231  
   troglomorphic traits, 234  
*Charinides*, 556  
*Charinus*, 556  
*Charon*, 192  
*Charonotrombium*, 562  
 Charontidae, 556  
*Chebchea*, 558  
 Cheiridiidae, 559  
*Cheiridium*, 559  
*Chelanops*, 559  
 Chelicerata, Australian diversity patterns,  
   192–193  
 Cheliferidae, 559  
 Chemical equilibrium, gypsum speleogenesis,  
   283–284  
 Chemical remanent magnetism, speleothems,  
   429  
 Chemoautotrophy  
   low food adaptation, 4  
   overview, 90  
   terminology, 90–91  
 Chemolithoautotrophic microbial groups  
   ammonia, 94  
   diversity, 98  
   hydrogen, 93  
   iron, 94  
   manganese, 94  
   nitrite, 94  
   one-carbon compounds, 94–95  
   overview, 93  
   reduced inorganic sulfur compounds, 93–94  
 Chemolithoautotrophy  
   cave ecosystems, 100–101  
   definition, 90  
   future research, 101  
   iron bacteria, 100  
   manganese bacteria, 100  
   marker genes, 97  
   metabolic assays, 95–96  
   metabolic groups, 100  
   microbes, 370  
   microscopy, 97–98  
   nitrogen bacteria, 100  
   radioisotope experiments, 97  
   signatures, 95  
   SIRA methods, 96–97  
   sulfur bacteria, 98–100  
   traditional methods, 95  
   and tree of life, 91–92  
 Chemoorganotrophs, 90  
*Chernes*, 559  
 Chernetidae, 559  
 Chert level, Jewel Cave, 312  
 Chestnut Ridge Cave System  
   Blarney Stone description, 66–67  
   Bobcat Cave description, 65–66  
*Chiliobathynella*, 189  
 Chilopoda, 404–405  
 Chimneys, 319  
 Chip breakdown, 56  
*Chiropturopoda*, 561  
*Chitrella*, 560  
*Chitrellina chiricahuae*, 560  
*Choeronycteris mexicana*, 181  
*Chologaster*  
   adaptation, 246  
   sensory compensation, 246  
*Chologaster agassizi*  
   evolution, 393  
   feeding behavior, 51  
   life history evolution, 347–348  
   reproductive effort, 349  
   U.S. diversity, 180  
*Chologaster cornuta*  
   evolution, 393–394  
   life history characters, 8  
   life history evolution, 347–348  
   reproductive effort, 349  
*Chondrostoma* spp., 163  
*Chorizomma*, 557  
 Choughs, 589  
 Christmas Island glossy swiftlet, Australian  
   diversity patterns, 195  
 Chthoniidae, 559–560  
*Chthonius*, 559–560  
*Cicurina*  
   biology, 554  
   classification, 557  
*Cicurina (Cicurina) baronia*, 555  
*Cicurina (Cicurina) madla*, 555  
*Cicurina (Cicurina) vespera*, 555  
*Cirolanides*, 148  
*Cirolanides texensis*, 177  
 Cixiids, adaptive shift, 20–22  
 Cladistic biogeography, 592  
 Cladonychiidae, 564  
 Clam  
   characteristics, 384  
   chemolithoautotrophy, 101  
 Clastic sediments  
   aggradation *vs.* abandonment, 106  
   base-level position, 106  
   base-level stream behavior, 106–107  
   facies, 105  
   facies successions, 107  
   geomorphic perspective, 102–103  
   interpretation, overview, 105–106  
   karst aquifers, 299  
   overview, 102  
   paleomagnetism, 428–429  
   production, 103  
   stratigraphy, 104–105  
   transport and deposition, 103–104  
*Clathrosperchon*, 562  
*Cleidogona*, 519  
 Climate, Castleguard Cave, 80–81  
 Climatic–Relict model  
   active dispersal, 306  
   biogeography, 593  
 Closed depressions, *see also* Dolines  
   compound sinks, 119–120  
   poljes, 120–122  
   polygenetic sinks, 119–120  
   types, 108  
*Clostridium*  
   hydrogen, 93  
   one-carbon compounds, 95  
 Coastal caves  
   blue holes, 126  
   flank margin caves, 123–126  
   overview, 122  
   sea caves, 122–123  
*Coccorhagidia*, 562  
 Cockroaches, as guano inhabitants, 281  
*Cokendolpherius*, 556  
*Coleonyx variegatus brevis*, 181  
 Coleoptera, Australian diversity patterns, 194–195  
*Collocalia* spp., 589  
 Collapse dolines, 117–118  
 Collembola  
   adaptation evidence, 391  
   Australian diversity patterns, 193  
   morphological troglomorphy, 392  
*Collocalia esculenta natalis*, 195  
*Collocalia spodiopygus chillagoensis*, 195  
 Colonization, beetles, 47–48  
*Columba livia*, 161, 591  
 Common-ion effect, subaqueous helictites, 552  
 Compound sinks, 119–120  
 Computer software  
   cave databases, 157  
   mapping subterranean diversity, 356  
*Conculus*, 557  
*Condeicampa langei*, 179  
 Condition factor  
   *Astyanax fasciatus*, 7  
   calculation, 7  
 Conduit springs, 565  
 Conduit systems  
   definition, 436  
   karst aquifers, 295–296, 299  
*Congeria kusceri*, 162–163, 382, 384–385  
*Conomma troglodytes*, 564  
 Contaminant metals, in cave waters, 129–130  
 Contaminant transport, karst aquifers, 300  
 Cooter turtle, U.S. diversity, 181  
 Copepoda, 25–26, 34, 144, 189  
 Corkscrews, 319  
 Corrosion  
   accelerated, dolines, 112  
   clastic sediment production, 103  
   flank margin caves, 124  
   hydrothermal karst, 302  
   Nullarbor Caves, 423  
 Corrosion bevel, 320  
*Corticacarus*, 562  
*Corynorhinus townsendii*, 40  
*Coryssocnemis*  
   classification, 558  
   Sistema Huautla, 520  
*Coscimidia*, 558  
 Cosmogenic isotope dating  
   burial dating, 138–141  
   overview, 137–138  
   relative *vs.* absolute techniques, 138

- Courtship, bats, 40–41  
 Cover-collapse sinkhole, 523  
 Cover dolines, 118–119  
 Cover-subsideance sinkholes, 524  
*Cowichiana*, 562  
 Coyote, foraging, 590  
 Crab  
   food competition, 55  
   reproductive behavior, 52  
   tropics, 169  
*Crangonyx*, 177  
*Crangonyx antennatus*  
   biogeography, 597  
   species interactions, 541  
*Crangonyx packardii*, 597  
*Craseonycteris thonglogyai*, 39  
 Crayfish  
   environmental effects, 390  
   life history characteristics, 349  
   North American cave crayfish, 10  
*Crenisopus*, 191  
 Crevice systems, 164  
 CRF, *see* Cave Research Foundation  
 Crickets  
   adaptive shift, 22–23  
   Australian diversity patterns, 194  
   beetle interactions, 540–541  
   eggs, food types, 260–261  
   feces, 263  
   food types, 263–264  
   guano, 276  
   population structure, 450, 454  
   reproductive behavior, 52  
   species interactions, 540–541  
   systematics, 48  
   U.S. diversity, 179–180  
 CRM, *see* Chemical remanent magnetism  
*Crocidura cinerea*, 590  
*Crocidura malayana*, 590  
*Crocota crocuta*, 433  
*Crocota crocuta spelaea*, 433  
*Crosbyella*, 564  
 Crustaceans  
   Australian diversity patterns, 189  
   Branchiopoda, 142  
   Copepoda, 144  
   Malacostraca, 146–152  
   Maxillopoda, 143–145  
   Mystacocarida, 144  
   Ostracoda, 145  
   overview, 141–142  
   Remipedia, 142–143  
*Cruzetulus*, 557  
*Cryptobunus*, 564  
*Cryptocellus bordoni*, 560  
*Cryptocheiridium*, 559  
 Cryptostigmata, 562–563  
 Crystal Cave Expedition, and camps, 73–74  
 Crystal weathering, Nullarbor Caves, 423  
 Crystal wedging, breakdown initiation, 59–60  
*Crenocheilocaris*, 144  
*Ctenus*, 520  
*Cubanothrombium*, 562  
 Cueva de Villa Luz, Mexico, sulfuric acid caves, 575–577  
*Culex pipiens*, 180  
 Cumberland River, Tennessee, incision pulses, 399  
*Cunaxa*, 561  
 Cunaxidae, 561  
*Cunaxoides*, 561  
 Cupolas  
   characteristics, 319  
   hydrothermal karst, 303  
   as karren form, 315  
*Curassanthura*, 29  
 Cusps  
   characteristics, 319–320  
   as karren form, 315  
*Cyathura*, 35  
*Cyathura chapmani*, 169  
 Cybaeidae, 557  
*Cybaeus*, 557  
 Cycloctenidae, 557  
*Cyclotenus*, 557  
*Cyclothyas*, 562  
 Cyphphthalmi, 563  
 Cyrtacheeniidae, 557  
**D**  
 Damaeidae, 562  
*Damaeus*, 562  
*Dameosoma*, 562  
*Damon*, 556  
*Danielopolina*  
   anchialine caves, 34  
   and anchialine taxa, 30  
   characteristics, 29, 145  
*Danio rerio*, 412  
*Dantya ferox*, 145  
*Daphnia*, 51  
 DAPI, *see* 4',6-Diamidino-2-phenylindole  
 Darcy's law, and normal karst aquifers, 293  
 Darkness  
   adaptation, 1–3  
   cave concepts, 83  
*Darlingtonia kentuckensis*, 450  
 Databases  
   access, 156  
   background, 155  
   components, 156  
   computer software, 157  
   contents, 157  
   data structure, 156–157  
   genesis, 156  
   International Union of Speleology, 155–156  
   National Speleological Society, 158  
   U.S. status and trends, 157  
 Dating  
   Castleguard Cave, 80  
   pleistocene sediments, 435  
 Dawn bat, 589–590  
 Decapoda, 27, 34, 192  
 Declination, earth magnetism, 427  
*Decuella cubaorientalis*, 564  
*Decussobates*, 562  
 Deep cave zone, lava tubes, 481  
 Deep sea, colonization, active dispersal, 306  
 Deep-seated hydrothermal karst, 301  
 Deep-seated karst  
   characteristics, 283  
   mechanisms, 286  
 Deep seismic exploration, entranceless caves, 213  
*Deeveya*, 145  
 Demagnetization, clastic sediments, 429  
 Denuded karst, 283  
*Derocheilocaris* spp., 144  
*Desmodus rotundus*  
   cave dwelling benefits, 43  
   cave roosts, 40  
   foraging habitats, 590  
   guano, 277  
   paradox, 44–45  
*Desulfococcus*, 93  
*Desulfonema*, 93  
*Desulfovibrio*, 575  
*Desulfurolobus*, 93  
 Deterministic biogeography, 591  
 Detrital remanent magnetism, clastic sediments, 428  
*Dhanus*, 560  
*Diacyclops*  
   characteristics, 145, 162  
   epikarst, 224  
*Diacyclops antrincola* in anchialine caves, 36  
 4',6-Diamidino-2-phenylindole,  
   chemolithoautotrophy, 98  
 Diffuse flow springs, 565  
 Digital wall mapper, Wakulla Spring  
   Underwater Cave System, 607  
*Dimisophria*, 30  
*Dinaria*, 564  
 Dinaric karst  
   aquatic subterranean fauna, 161–163  
   definition, 158–159  
   distribution size, 163  
   endemism, 163  
   fauna history, 159–160  
   holodinaric distribution, 163  
   hot spots, 164  
   pollution and protection, 165  
   special assemblages, 164–165  
   taxa distribution, 163  
   terrestrial cave fauna, 160–161  
 Dinaric vole, 589  
*Dinaromys bogdanovi*, 589  
*Dinocheirus*, 559  
 Diplocentridae, 555  
*Diplocentrus anophthalmus*, 555  
*Diplocentrus mitchelli*, 555  
 Diplopoda, 405–406  
 Dipluridae, 557  
*Discotrombidium*, 562  
 Dissolutional potholes, as karren form, 315  
 Dissolved oxygen, adaptation  
   in groundwater, 11, 13  
   overview, 10–11  
 Distributional relicts, 233  
 Distributory springs, 567  
*Dithnozercon*, 561  
 Ditynidae, 557  
 DNAPLs, *see* More dense than water  
   nonaqueous phase liquids  
 DO, *see* Dissolved oxygen  
*Dolichopoda*  
   habitat heterogeneity, 452–453  
   and population structure, 454

- Dolichopoda laetitiae*, 449–451  
*Dolichotrombicula*, 562  
Dolines, *see also* Closed depressions  
collapse dolines, 117–118  
cover dolines, 118–119  
definitions, 521, 523, 525  
environmental condition links, 116  
evolutionary processes, 112–113  
evolution examples, 113, 116  
hydrological behavior, 109–112  
intersection dolines, 118  
morphology and size, 108–109  
solution, and karst surfaces, 108  
solution processes, 109–112  
structure, 109  
subsidence dolines, 118  
topographical and geomorphological settings, 109  
Dolomite  
characteristics, 374  
chemical reactions, 574  
Domes, 436  
Dormouse, 161, 589  
Downstream Complex, Castleguard Cave, 78  
*Draculoides*  
Australian diversity patterns, 193  
classification, 556  
*Draculoides vinei*, 554  
Drawdown doline, 110  
*Drimeotus*, 50  
Drip line, entrances, 219  
Drip pits, 316  
DRM, *see* Detrital remanent magnetism  
Drug agents, microbes as, 371  
*Dunedinia*, 558  
*Duvalius*, 197  
DWM, *see* Digital wall mapper  
Dye budget, karst water tracing, 328  
*Dysdera*, 557  
Dysderidae, 557  
*Dysderoides*, 558  
Dyspnoi, 563
- E**
- Earth magnetism, and paleomagnetism, 427–428  
Earthworms, as guano inhabitants, 281  
Eastern phoebe, U.S. diversity, 181  
Ebb-and-flow springs, 568–569  
Eccentric stalactites, 549  
Echinoliths, 318  
Ecological biogeography, 591  
Ecotones  
aquatic ecotones, 207  
marine shallow-water ecotones, 306  
overview, 206  
terrestrial ecotones, 206–207  
Ectothermy, energy demand, 8  
Edible-nest swiftlets, 591  
Edwards Aquifer, as influent river, 509  
Eel-tail catfish, Australian diversity patterns, 195  
Effective population size, genetic structure estimation, 448  
Efflorescent crusts, saltpetre mining, 492  
Egg size, low food adaptation, 9  
Egyptian fruit bat, 589  
*Eidmannella*, 558  
*Eigenmannia vicentespelaea*, 248  
*Elaphe obsoleta*, 181  
*Elaphoidella*  
characteristics, 145, 162  
dinaric karst, 164  
ecological evidence of invasion, 309  
epikarst, 224  
Elasticity, ecotones, 206  
Ellison's Cave, camp, 74  
Embryonic cryptodolines, doline structure, 109  
Emission wavelength, karst water tracing, 327  
*Enantiosis*, 29  
Endelleite, Lechuguilla Cave, 342  
Endokarst, and hydrothermal karst, 301  
Energy demand  
activity, 8  
aquatic cave animals, 7  
back to network, 9  
body size conflicts, 8  
character reduction, 9  
ectothermy, 8  
excitement and aggression, 8  
hypoxic conditions, 9  
neoteny, 9  
overview, 7  
terrestrial cave animals, 7–8  
Energy economy, subterranean environments, 4  
Energy sources, cave environment and species, 478–479  
Energy supply, Australian diversity patterns, 188–189  
Englacial conduit systems, glacier caves, 272–273  
Entranceless caves  
cave radio, 214–215  
environmental settings, 208–209  
examples, 210  
exploration overview, 208  
geophysics overview, 210–211  
geophysics potential, 215  
ground-penetrating radar, 211–212  
microgravity, 212  
parameters, 211  
resistivity surveys, 213–214  
searching for, 209–210  
thermal imaging, 214  
Entrances  
as archaeological sites, 219–220  
Castleguard Cave, 78  
cave ecology, 171  
as habitat, 219  
lava tubes, 479, 481  
locations, 216  
overview, 215–216  
as paleontological sites, 219–220  
statistics, 218–219  
talus, 219  
types, 216–217  
Entrenched karst, 283  
Environment  
adaptation effects, 390  
as adaptive shift factor, 19  
in calcite dissolution, 611–612  
Eogenetic, flank margin caves, 124  
*Eohypochthonius*, 563  
*Eonycteris spelea*, 590  
*Epactiochernes*, 559  
*Epidamaeus*, 562  
Epigeal limnic systems, active dispersal, 306  
Epigeal predators, active dispersal, 306  
Epikarstic communities  
aquatic, characteristics, 172  
biogeography, 226–227  
ecology, 227–228  
environmental conditions, 223–224  
morphological features, 224–226  
overview, 223  
sampling techniques, 228–229  
taxonomic composition, 224  
terrestrial epikarst communities, 172  
Epikarst  
aquifer, 220  
definition, 164  
in ecology, 220–221  
epikarstic zone, 220  
hydrogeology, 221  
in karst evolution, 221–222  
and karst skin, 222  
NAPL transport, 134–135  
overview, 220  
pathways, 221  
Epi-Palaeolithic period, Middle East cave dwellers, 88–89  
Epsomite  
characteristics, 374  
crystal habits, 290  
as evaporite mineral, 288  
Equivalent porous media approach, karst models, 379  
*Erebomaster flavescens*, 564  
*Erebonectes nesioticus*, 28–29  
*Ereynetes*, 561  
Ereynetidae, 561  
*Erigone*, 558  
Erosion, Kazumura Cave, 331–332  
Erratics, 549  
Etching, solutional sculpturing, 539  
Ethnography, Maya Caves, 368  
Ethnohistory, Maya Caves, 368  
*Ethobunus*, 564  
*Euagrus*, 557  
Eucarida, 151–152  
*Euconchoecia*, 145  
*Eucrenoaspides* spp., 146  
*Eucyllops*, 145  
*Eugamasus*, 561  
*Euhadenoecus*, 179  
*Euhadenoecus fragilis*, 449–450  
*Euhadenoecus puteanus*, 449–450  
*Eukoenenia*, 559  
Eukoeneniidae, 559  
Eumalacostraca, 146–152  
*Eunapius subterraneus*, 162  
Eupnoi, 563  
*Euproctus asper*  
characteristics, 491  
eye regression, 491  
feeding behavior, 51

- Europe, diversity patterns  
 assessment, 199–201  
 continent comparison, 196–197  
 geographic patterns, 197–199  
 overview, 196
- Eurycea bislineata*, 488  
*Eurycea latitans*, 485  
*Eurycea longicauda*, 488  
*Eurycea lucifuga*, 488  
*Eurycea nana*, 485, 488  
*Eurycea neotenes*, 485, 488  
*Eurycea pterophila*, 485, 488  
*Eurycea rathbuni*, 485  
*Eurycea robusta*, 486  
*Eurycea tridentifera*, 485  
*Eurycea troglodytes*  
 cave life, 459  
 characteristics, 485
- Euscorpiidae, 555  
*Euwandesia*, 562
- Evaporite minerals  
 sources and deposition, 291  
 types, 288
- Evapotranspiration, 221
- Evolution  
 cave water chemistry, 609  
 sinking streams, 512–514  
 troglobite habitats, 478  
 troglomorphic examples, 393–395  
 troglomorphy, 386–387
- Evolutionary adaptation  
 definition, 1  
 marine regression, 365
- Exaptations, subterranean ecosystems, 230
- Excitation wavelength, karst water tracing, 327
- Excitement, energy demand, 8
- Expansophria*  
 and anchialine taxa, 30  
 characteristics, 29
- Expedition caving, techniques, 237–238
- Exploitable food resources, as adaptive shift factor, 19
- External activity, energy demand, 8
- Extraocular senses, darkness adaptation, 3
- Extraterrestrial life, microbes, 371  
*eyeless*, 414
- Eyes  
 neutral mutation, 411–413  
 salamanders, 490–491
- F**
- F1, *see* Innerbergli Area
- Facets, as karren form, 315
- Facies, clastic sediment, 105, 107
- Facultative organisms, 91
- Faicesteria*, 558  
*Falcileptoneta*, 557  
*Falco rufigularis*, 43
- Fat  
 accumulation examples, 6–7  
 accumulation overview, 6  
*Astyanax fasciatus*, 7  
 back to network, 7  
 storage and metabolism in fish, 249
- Faustloch, Siebenhengste Cave System, Switzerland, 503
- Feces, food types, 261–263
- Feeding channels, Ukrainian Caves, 586
- Felis*, 590  
*Felis concolor*, 433
- Fern Cave, camp, 75
- Ferric iron, sources and deposition, 291
- Field reversals, earth magnetism, 427
- Filiform, 550
- Filigranula annulata*, 33
- Filter fluorometers, karst water tracing, 327
- Fire ant, conservation, 555
- FISH, *see* Fluorescence *in situ* hybridization
- Fish  
 adaptation, 244, 246  
 biogeography, 595  
 body pigmentation, 242  
 Cueva de Villa Luz, 577  
 darkness adaptation, 3  
 eye ontogenic growth, 242  
 eye regression developmental principles, 242  
 eye regression genetics, 242  
 eye regression patterns, 242  
 eyes and body pigmentation, 244  
 fat storage and metabolism, 249  
 food finding, 6  
 head enlargement, 248–249  
 light reaction, 244  
 mate competition, 55–56  
 and natural selection, 410  
 neutral mutation, 412  
 overview, 241–242  
 pineal organ, 244  
 and population structure, 453  
 reproduction, 251  
 reproductive behavior, 52  
 sensory compensation, 244, 246  
 U.S. diversity, 170–171
- Fissure caves, 599
- Flabellorhagidia*, 562
- Flank margin caves, 123–126
- Flatworms, 615
- Flooding  
 hydrologic conditions, 252–253  
 and karst aquifers, 253–254  
 overview, 251–252
- Floodwater, maze cave development, 443
- Florida cave bear, 433
- Flow paths, maze cave development, 443
- Flow-through door, karst water tracing, 327
- Fluorescence *in situ* hybridization, 98
- Fluorescent dyes, karst water tracing, 324–325
- Fluorescope, karst water tracing, 322
- Fluorite, 376
- Flutes, 316–317, 536
- Fluvio-karstic hollows, 119, 510
- Folkia*, 557  
*Folsomia*, 393  
*Fontignis morrisoni*, 70  
*Fontignis tartarea*, 384–385  
*Fontignis turritella*, 176
- Food finding  
 appendages, 5–6  
 back to network, 6  
 behavior, 6  
 competition, 54–55  
 examples, 6  
 factors, 6  
 fish adaptation, 248–251  
 overview, 5  
 sensory equipment, 5–6  
 starvation survival, 6
- Food input, low food adaptation, 4
- Food limitations  
 exceptions, 257–259  
 fish adaptation, 248–251  
 observations and first principles, 255–256  
 species adaptations, 256
- Food quality, aquatic *vs.* terrestrial contrasts, 259
- Food scarcity, types, 4
- Food sources  
 heterogeneity, and population structure, 453  
 scientific method application, 255
- Food supply, aquatic and terrestrial differences, 257
- Food types  
 crickets, 263–264  
 feces, 261–263  
 terrestrial extremes, 260–261
- Food web, guano examples, 281
- Foveacheles*, 562
- Fracture flow approach, karst models, 379–380
- Fractures, karst aquifers, 135–136
- Free-air, entranceless caves and microgravity, 212
- Freshwater lens, flank margin caves, 123
- Friars Hole Cave System, West Virginia  
 age, 269–270  
 cave paleohydrology, 269  
 exploration history, 266–267  
 geology, 266  
 hydrogeology, 264–265  
 hydrology, 264–265, 267–268  
 location, 264  
 overview, 264  
 surface paleohydrology, 268–269
- Frontipodopsis*, 562
- Frostwork, 550–551
- Fruit bat, 590
- F-statistics, genetic structure estimation, 448
- G**
- Galanomma microphthalmia*, 564  
*Gallionella*, 94  
*Gallionella ferruginea*, 371  
*Galumna*, 563  
 Galumnidae, 563  
*Gamasomorpha*, 558  
*Gammarus*, 177  
*Gammarus fossarum*  
 behavioral adaptations, 13  
 metabolic responses, 15  
 respiratory adaptations, 14  
 survival under anoxia, 13
- Gammarus minus*  
 life history characteristics, 349  
 and natural selection, 410  
 population structure, 451  
 species interactions, 542

- Gammarus roseli*, 309  
 Gamma-s-crystalline, neutral mutation, 413  
*Garra*, 412  
*Garra barreimiae*, 242  
 Garypidae, 560  
*Gaucelmus augustinus*, 176  
*Geholaspis*, 561  
*Gelyella droguei*, 145  
*Gelyella monardi*, 145  
 General food scarcity, 4  
 Genetic distance, genetic structure estimation, 448  
 Genetics, as adaptive shift factor, 18  
 Genetic structures, 448–449, 452  
 Genetic variation, and population structure, 453–455  
 Geoffroy bat, 589  
 Geographic relicts, 233  
 Geomagnetic secular variation, earth magnetism, 427  
 Geophysics, entranceless caves, 210–211, 215  
 Georgia blind salamander, 487  
*Geotrechus*, 197  
*Gesiella jameensis*, 33  
*Gevegiella*, 29  
 Ghost bat, 40, 195  
*Giesiella*, 30  
*Gigantopithecus*, 433  
 Glaciations, 122  
 Glacier caves  
   characteristics, 85  
   englacial conduit systems, 272–273  
   ice sheets, 275  
   overview, 271–272  
   recreational caving, 470  
   subglacial features, 274–275  
   surface features, 273–274  
 Glacioeustatic, 122  
 Glacio-karstic hollows, 119  
*Glennbuntia glennbunti*, 193  
 Glide-and-rest swimming, amblyopsid cave fish, 6  
*Glis glis*, 161  
*Glyptomerus* spp., 160  
 Gnaphosidae, 557  
*Gondwanobates*, 562  
*Goniocyclops*, 189  
 Gonyleptidae, 564  
*Goodnightiella*, 564  
 GPR, *see* Ground-penetrating radar  
 Grand Canyon, Arizona, sulfuric acid caves, 579  
 Gravity springs, 565–566  
 Gray bat, 182, 459, 590  
 Greater horseshoe bat  
   characteristics, 589  
   courtship and mating, 41  
   hibernation, 42  
 Greater spear-nosed bat  
   cave dwelling benefits, 43  
   courtship and mating, 41  
 Greenland, ice sheets, 275  
 Grietas, 32  
 Ground-penetrating radar  
   entranceless caves, 211–212  
   epikarst, 222  
 Groundwater, *see also* Water  
   calcretes, Australia, 187  
   composition in limestone, 610–611  
   dissolved oxygen, 11, 13  
   flow paths in caves, 82  
   karst aquifers flow systems, 296–297  
   karst basins, 296–297  
   nitrate contamination, 415–418  
   in normal karst aquifers, 293–294  
   solutional sculpturing, 536–537  
 Growth rate, low food adaptation, 10  
 Grunter, Australian diversity patterns, 195  
 Guadalupe Mountains, New Mexico, sulfuric acid caves, 577–579  
 Guano  
   associated fauna definitions, 278–279  
   associated fauna examples, 279–281  
   bat community structure, 279  
   in cave communities, 276  
   conservation, 281–282  
   food web examples, 281  
   types, 276–278  
 Guano bat, 590  
 Guanobites, 278  
 Guanophage flies, as guano inhabitants, 280  
*Guerrobunus*, 564  
 Guinean cock, 589  
*Gymnozetes*, 563  
 Gypsum  
   characteristics, 374  
   as evaporite mineral, 288  
   Lechuguilla Cave, 342  
   Nullarbor Caves, 424  
   sources and deposition, 291  
   speleogenesis, 284–287  
 Gypsum crusts, 289  
 Gypsum flowers  
   as evaporite mineral, 288  
   sizes, 289–290  
 Gypsum karst  
   distribution and types, 283  
   speleogenesis, 283–284  
*Gyrinophilus palleucus necturoides*, 488  
*Gyrinophilus palleucus palleucus*, 488  
*Gyrinophilus porphyriticus*, 488  
*Gyrinophilus porphyriticus danielsi*, 488  
*Gyrinophilus porphyriticus dunni*, 488  
*Gyrinophilus porphyriticus duryi*, 488  
*Gyrinophilus porphyriticus porphyriticus*, 488  
*Gyrinophilus subterraneus*, 488
- ## H
- Hadenoecus*  
   and population structure, 454  
   U.S. diversity, 179  
*Hadenoecus cumberlandicus*  
   population structure, 450  
   reproductive behavior, 52  
   U.S. diversity, 180  
*Hadenoecus subterraneus*  
   guano, 276  
   population structure, 450  
   reproductive behavior, 52  
   species interactions, 540–541  
   systematics, 48  
   U.S. diversity, 180  
*Hadesia vasiceki*, 164  
*Hadoblothrus*, 560  
*Hadzia*, 35  
*Hadzia fragilis*  
   biogeography, 35  
   characteristics, 162–163  
*Hadziella*, 161, 163  
*Hadziella thermalis*, 165  
*Habnia*, 557  
 Hahniidae, 557  
*Haideoporus texanus*, 179  
*Haideotriton wallacei*, 487  
*Haifemeira*, 189  
 Half-tubes  
   characteristics, 317–319  
   as karren form, 315  
*Halicyclops*  
   Australian diversity patterns, 189  
   characteristics, 145  
 Halides, 376  
 Halite  
   characteristics, 376  
   Nullarbor Caves, 424  
*Halocaridina rubra*  
   distribution in anchialine caves, 36  
   and humans, 37  
 Halocline, flank margin caves, 123  
*Haloniscus*, 192  
*Haloniscus searlei*, 150  
*Halosbaena*  
   Australian anchialine habitats, 191  
   biogeography, 35  
   characteristics, 29  
*Halosbaena acanthura* Stock, 34  
*Hannemania*, 562  
 Haplozetidae, 563  
*Haptolana pholeta*, 34  
*Harpactea*, 557  
*Harpatorates*, 557  
 Harvestmen  
   classification, 563  
   conservation, 555  
*Hauffenia*, 161  
*Hawaiioscia*, 178  
 Head enlargement, fish adaptations, 248–249  
 Headward Complex, Castleguard Cave, 78  
 Headwaters, influent streams, 510  
 Heavy metals  
   contaminant metals, 129–130  
   general chemistry, 128–129  
   iron and manganese, 129  
   metal storage and transport, 130  
   natural and anthropogenic sources, 127–128  
   speleothems, 130  
   storm-enhanced transport, 130–131  
   suspended and bed sediments, 130  
   trace metals, 129–130  
 Heavy nonaqueous phase liquids, karst aquifer transport, 300  
*Hedgehog*, 413  
*Helicodiscus barri*, 176  
 Helictite bushes, subaqueous types, 552–553  
 Helictite cave, description, 69

- Helictites  
 characteristics, 549  
 Lechuguilla Cave, 342  
 subaqueous types, 552
- Heligmites, 549
- Hemigrapsis estellinensis*, 178
- Hendea*, 564
- Herpestes*, 590
- Herpsyllus*, 557
- Hesperocheernes*  
 classification, 559  
 U.S. diversity, 177
- Heterias*, 191
- Heteromysoides*, 29
- Heterophilias*, 148
- Heteroptera, as guano inhabitants, 280–281
- Heteroscorpion*, 193
- Heterotectum*, 561
- Heterothrombium*, 562
- Heterotrophs, 90
- Heterozygosity, genetic structure estimation, 448
- Hexabathynella*, 189
- Hexactinellida*, 33
- Hexapoda, U.S. diversity, 178–179
- Hexatelidae, 557
- Hexathele cavernicola*, 557
- Hibernation, bats, 42
- Hickmania troglodytes*, 193, 557
- Hickmanoxyomma*, 192–193, 564
- Higginsia ciccaresei*, 33
- Hirsutia bathyilis*, 147
- Hirsutia sandersetalia*, 148
- Hirudinea, 617
- Historical biogeography, 591
- Hohlaub Area, Siebenhengste Cave System, 504
- Holarchaea*, 557
- Holarchaea novaezealandiae*, 557
- Holarchaeidae, 557
- Hollows  
 characteristics, 319–320  
 as karren form, 315
- Holonuncia*, 564
- Holostaspis*, 561
- Homohalacarus*, 562
- Homo sapiens*  
 and anchialine fauna, 37–38  
 disturbance of bats, 44  
 foraging habitats, 590  
 impact on cave waters, 614  
 impact on Kazumura Cave, 330  
 Mammoth Cave area, 203–205  
 overview, 590–591
- Hooded tickspiders, *see* Ricinulei
- Hoplobunus*  
 classification, 564  
 Sistema Huautla, 520
- Horizontal caves, exploration, 234–235
- Horlogion*, 224
- Horseshoe bat, 161
- Hothrotheriops shastensis*, 433
- Hot springs, 567
- Howe Caverns, karst examples, 534
- Hubbardia shoshonensis*  
 classification, 556  
 U.S. diversity, 177
- Humans, *see* *Homo sapiens*
- Humidity, cave environment and species, 479
- Hyalella azteca*, 177
- Hybridization, as adaptive shift factor, 19
- Hydrapnaops*, 197
- Hydrocarbons, sulfuric acid caves, 579–580
- Hydrochous gigas*, 589
- Hydrogen, chemolithoautotrophic microbial groups, 93
- Hydrogenobacteria*, 92–93
- Hydrogeology  
 epikarst, 221  
 Friars Hole Cave System, 264–265  
 groundwater nitrate contamination, 416–417  
 Lechuguilla Cave, 341–342  
 Sistema Huautla, 519  
 Ukrainian Caves, 584
- Hydrographs  
 analysis, 569  
 karst aquifers, 298  
 spring discharges, 568
- Hydrology  
 anchialine caves, 31–33  
 aquatic troglobites, 450–451  
 Castleguard Cave, 79–80  
 conditions in flooding, 252–253  
 dolines, 109–112  
 Friars Hole Cave System, 264–265, 267–268  
 Jewel Cave, 313  
 Postojna–Planinska Cave System, 456  
 Siebenhengste Cave System, 501–502  
 Wakulla Spring Underwater Cave System, 605–606
- Hydromagnesite balloons, Jewel Cave, 314
- Hydromantes*, 485
- Hydromantes brunus*, 488
- Hydromantes genei genei*, 488
- Hydromantes genei imperialis*, 488
- Hydromantes italicus ambrosii*, 488
- Hydromantes italicus gormani*, 488
- Hydromantes italicus italicus*, 488
- Hydromantes italicus strinatii*, 488
- Hydromantes platycephalus*, 488
- Hydromantes shastae*, 488
- Hydrophrea*, 383
- Hydrothermal karst  
 bush-like caves, 303  
 with cupolas, 303  
 definition, 300–301  
 deposit character, 304  
 deposit mineralogy, 304  
 fluid chemistry and processes, 301–302  
 individual chambers, 302  
 isometric rooms, 302  
 phreatic maze caves, 303–304  
 regional extent, 304  
 settings, 301  
 single-conduit caves, 303  
 solution porosity, 302
- Hydrotrombium*, 562
- Hydroxides, 375–376
- Hydryphantidae, 562
- Hyena, paleontology, 433
- Hygrobatas*, 562
- Hygrobatidae, 562
- Hyperoedesipus*, 191
- Hyphomicrobium manganoxidans*, 94
- Hypochthoniidae, 563
- Hypochthonius*, 563
- Hypodamaeus*, 562
- Hypogenic caves, sulfuric acid caves, 573
- Hypogeoppia*, 563
- Hystrix*, 433
- I**
- Iberina*, 557
- Iberobathynella bowmani*, 177
- Icariella*, 558
- Ice caves, recreational caving, 470
- Ice sheets, glacier caves, 275
- Ice wedging, breakdown initiation, 60
- Icona*, 558
- Ideobisium*, 560
- Ideoblothrus*, 560
- Ideoroncidae, 560
- Idiocyclops*, 145
- Inception doline, 110
- Inclination, earth magnetism, 427
- Indiana bat  
 cave life, 459  
 habitat destruction, 44  
 U.S. diversity, 181
- Indiana Plateaus, karst example, 529–531
- Infiltration  
 dispersed, karst aquifers, 296  
 water, passive dispersal, 306
- Influent rivers, 509–510
- Influent streams  
 function, 510–512  
 overview, 509–510
- Inland blue holes, 126
- In-line storage, karst water tracing, 329
- Innerbergli Area, Siebenhengste Cave System, 504
- Insecta, 179–180, 193–195
- Insulocreagris*, 560
- Interglacials, 122
- Interior activity, energy demand, 8
- Internal runoff, dispersed, karst aquifers, 296–297
- International ellipsoid, entranceless caves and microgravity, 212
- International Union of Speleology, 155–156
- Interpolators, mapping subterranean diversity, 356
- Intersection dolines, 118
- Interstitial dispersal, 595
- Intrastratal karst  
 characteristics, 283  
 evolutionary stages, 287
- Invasions  
 active dispersal models, 306  
 ecological evidence, 309  
 evolutionary ecology, 309–310  
 overview, 305–306  
 passive dispersal models, 306–308  
 unique *vs.* multiple, 308–309
- Invertebrates, U.S., treatment, 174–180
- Iron  
 in cave waters, 129  
 chemolithoautotrophic microbial groups, 94



Iron bacteria, chemolithoautotrophy, 100  
 Iron springs, 567  
*Ischnothrombium*, 561  
*Ischryopsalis*, 563  
 Ischyropsalidae, 563  
*Isereus colasi*, 349  
*Isereus serullazi*, 349  
 Isla de Mona, flank margin caves, 126  
 Isopoda, 22, 26, 34, 191–192  
*Ixchela*, 558  
*Ixodes conepati*, 561  
 Ixodidae, 561

**J**

*Jacksonella*, 558  
 Jamaican fruit bat, courtship and mating, 41  
*Jasus edwardsii*, 151  
 Jewel Cave, South Dakota  
   barometric airflow, 312  
   biology, 313  
   early exploration, 311  
   early history, 311  
   hydrology, 313  
   later exploration, 311  
   physical characteristics, 312–313  
   speleothems, 314  
*Jimenezziella*, 564

**K**

K2, Siebenhengste Cave System, 504  
 Kane Caves, Wyoming, sulfuric acid caves, 575  
*Karos*  
   classification, 564  
   Sistema Huautla, 520  
 Karrens  
   definition, 220, 315  
   feature descriptions, 316–321  
   form controls, 315–316  
   overview, 315  
 Karst aquifers  
   base blow/area relationships, 299  
   clastic sediments, 299  
   conduit permeability, 295–296  
   conduit system carrying capacity, 299  
   contaminant transport, 300  
   and flooding, 253–254  
   fractures, 135–136  
   groundwater basins, 296–297  
   hydrographs, 298  
   models, 378–382  
   NAPL detection, 136–137  
   NAPL transport, 134  
   normal types, 293–294  
   passage morphology, 439  
   pen drains, 135–136  
   piracies, 297  
   sinking systems, 135–136  
   spillover routes, 297  
   storage, 136  
   triple porosity model, 294–295  
   water quality, 299–300  
   water table, 297–298  
   water tracing  
     definitions and objectives, 321–322

    history, 322–323  
     with passive detectors, 325–327  
     quantitative tracing, 327  
     test interpretations, 327–329  
     tracers, 323–325  
   water wells, 299  
 Karst  
   bat-guano piles, 279  
   Castleguard Cave rocks, 77–78  
   deep-seated hydrothermal karst, 301  
   deep-seated karst, 283, 286  
   denuded karst, 283  
   dinaric, *see* Dinaric karst  
   endokarst, 301  
   entrenched karst, 283  
   epikarst in evolution, 221–222  
   fluvio-karstic hollows, 119, 510  
   glacio-karstic hollows, 119  
   gypsum karst, 283–284  
   hydrothermal, *see* Hydrothermal karst  
   intrastratal karst, 283, 287  
   karst cutané, 220  
   mantled karst, 522  
   moderate relief  
     Appalachian Mountains, 533–534  
     Appalachian Plateaus, 531–533  
     characteristics, 527–528  
     geographic distribution, 528  
     Ozark Plateaus, 531  
     Southern Indiana Plateaus, 529–531  
     Western Kentucky Plateaus, 529–531  
   open karst, 283  
   shallow hydrothermal karst, 301  
   skin, and epikarst, 222  
   subcutaneous karst, 220  
   subjacent karst, 283  
   subsoil karst, 522  
   sulfuric acid oil field karst, 580  
   superficial karst, 221  
   surfaces, and solution dolines, 108  
   syngenetic karst, 283  
   tecto-karstic hollows, 119  
   U.S. distribution, 172–174  
   U.S. glaciated plateaus, 534–535  
   windows, collapse dolines, 117  
   Woodville Karst Plain Project, 607  
 Kazumura Cave, Hawaii  
   exploration history, 330–331  
   extraneous tubes, 332–333  
   multilevel and lavafall development, 333  
   overview, 330  
   physical setting, 330  
   primary speleothems, 333–334  
   speleogenesis, 331  
   thermal erosion, 331–332  
 Kentucky Plateaus, karst example, 529–531  
 Kentucky Spring salamander, 488  
*Kieferiella*, 145  
 Kitti's hog-nosed bat, 39  
*Kleptochthonius*  
   biogeography, 593  
   classification, 560  
   U.S. diversity, 177  
*Koelenides*, 559  
*Koelenides leclerci*, 559  
*Koonunga crenarum*, 146

Kotlici, doline structure, 109  
*Krenedrilus*, 618  
 Krubera Cave  
   Arabika Massif overview, 335  
   development, 337  
   exploration points, 337–338  
   history, 335  
*K-selection*, 9  
*Kunoppia*, 563  
*Kuwamuraarus*, 562

**L**

*Lagymochthonius*, 559–560  
 Lampenflora, show caves, 499  
 Land emersions, dating from stygofauna,  
   364–365  
 Laniatores, 563–564  
*Lanzaia*, 161, 163  
*Larca*, 560  
 Large bent-wing bat  
   cave dwelling benefits, 43  
   cave dwelling costs, 43  
   distribution, 40  
 Large cave systems, exploration skills, 235  
*Lasiobella*, 563  
*Lasiochernes*, 559  
*Lasionectes*, 191  
 Laugdecke, 320  
 Lava caves, recreational caving, 469–470  
 Lavafall, Kazumura Cave, 333  
 Lava flow cricket, adaptive shift, 23  
 Lava speleothems, Kazumura Cave, 333–334  
 Lava tubes  
   characteristics, 84–85, 600  
   development, 600–602  
   root communities  
     air flow, 479  
     bad air zone, 481  
     deep cave zone, 481  
     energy sources, 478–479  
     entrance, 479, 481  
     geomorphology effects, 479  
     moisture/humidity, 478–479  
     morphological adaptations, 481–483  
     O<sub>2</sub> and CO<sub>2</sub>, 479  
     overview, 477–478  
     transition/mixing zone, 481  
     tree roots, 479  
     troglomite habitat, 478  
     twilight, 481  
 Leaf-chinned bat, cave life, 459  
 Lechuguilla Cave, New Mexico  
   biology, 342  
   description, 343–344  
   exploration history, 344–347  
   geological setting, 340  
   hydrogeology, 341–342  
   mineralogy, 342  
   overview, 339  
   paleontology, 343  
   physical setting, 339–340  
   stratigraphy and structure, 340–341  
   sulfuric acid caves, 577  
*Lechytia*, 560  
 LEDs, *see* Light-emitting diodes

- Lee Cave, Mammoth Cave area archaeology, 204  
 Leeches, 617  
 Leeuwenhoeckiidae, 561  
*Leiobunum*, 563  
*Leiobunum townsendii*, 176  
*Leipotherapon unicolor*, 195  
 Length, cave database structure, 157  
 Lepidoptera, as guano inhabitants, 280  
*Leptophantes*, 558  
*Leptocera tenebrarum*, 180  
 Leptodiroid, cave beetles, 48  
*Leptodirus*  
   characteristics, 163  
   systematics, 48  
*Leptodirus hohenwartii*  
   characteristics, 160  
   dinaric karst, 164  
   European diversity patterns, 196  
   overview, 46  
*Leptoneta*, 557–558  
 Leptonetidae, 557–558  
*Leptonycteris curasoae*  
   cave dwelling benefits, 43  
   cave dwelling costs, 43  
   cave roosts, 40  
*Leptospirillum*, 94  
 Leptostracans, anchialine caves, 34  
*Leptotrix*, 371  
*Leptothrombium*, 562  
 Less dense than water nonaqueous phase liquids  
   characteristics, 132  
   epikarst, 135  
   fractures, 135–136  
   pools in conduits, 136  
   in soils, 137  
   in wells, 136  
 Lesser long-nosed bat  
   cave dwelling benefits, 43  
   cave dwelling costs, 43  
   cave roosts, 40  
*Leuciscus*, 163  
*Leucobya*, 559  
*Leuopopia*, 563  
*Liagoceradocus* spp., 35  
 Life history characters  
   amblyopsid fish, 347–348  
   *Amblyopsis rosae*, 8  
   back to network, 10  
   case study, 10  
   cave animal reproductive efforts, 349–350  
   *Chologaster cornuta*, 8  
   egg size, 9  
   generality of characteristics, 348–349  
   growth rate, 10  
   longevity, 10  
   overview, 9, 347  
 Light-emitting diodes, for exploration, 236  
 Light nonaqueous phase liquids, karst aquifer  
   transport, 300  
 Light sources, for cave exploration, 235–236  
 Lillah Cave, myths and legends, 407  
 Limestones  
   dissolution, 609  
   groundwater composition, 610–611  
   sources and deposition, 291  
   strong acids in dissolution, 612–613  
 Limnesiidae, 562  
 Limnohalacaridae, 562  
*Limnosbaena*, 147  
*Limnosbaena finki*, 162  
 Limnology, *see also* Thalassoid  
   limnologybionts  
     adaptability, 361  
     biogeography, 362–363  
 Limonite, in cave waters, 129  
 Linear systems approach, karst models, 380  
 Linyphiidae, 558  
*Liocheles*, 193  
 Liocranidae, 558  
*Liocranum*, 558  
 Lion, paleontology, 433  
 Liphistiidae, 557  
*Lirceus usdagalum*  
   species interactions, 541  
   U.S. diversity, 177  
*Lissochelififer*, 559  
*Lisocreaegris*, 560  
 Litho, 90  
*Lithobius matulicii*, 405  
*Litocampa*, 178  
*Litoria caerulea*, 195  
 Littoral cave, 122  
 Littoral rock cricket, adaptive shift, 22  
*Littorophiloscia hawaiiensis*, 22  
 LNAPLs, *see* Less dense than water nonaqueous  
   phase liquids  
*Lobohalacarus*, 562  
 Location, cave database structure, 157  
 Loft level, Jewel Cave, 312  
*Lola*, 564  
*Lomanella*, 564  
 Longevity, low food adaptation, 10  
 Long-fingered bat, 161  
*Longipodacrangonyx*, 363  
 Longitudinal flutes, as karren form, 315  
 Longitudinal rills, 316  
*Longuripes*, 454  
 Low food adaptation  
   basic food resource, 4–5  
   cave type effects, 5  
   energy demand, 7–9  
   fat accumulation, 6–7  
   food finding, 5–6  
   food scarcity types, 4  
   life history characters, 9–10  
   overview, 4  
   strategies, 16  
 Low oxygen adaptation  
   behavioral adaptations, 13  
   in groundwater, survival, 11, 13  
   metabolic responses during anoxia, 15  
   metabolic responses during postanoxic  
     recovery phase, 15–16  
   overview, 10–11  
   respiratory adaptations, 14–15  
   strategies, 16  
*Lucifuga speleotes*, 242  
*Lucifuga* spp., 251  
*Lucifuga subterraneus*, 33  
*Lustrochernes*, 559  
*Lycosa howarthi*  
   adaptive shift, 23  
   biology, 554  
   classification, 558  
 Lycosidae, 558  
*Lygromma*, 557  
*Lygromma anops*, 558  
*Lygromma gertschi*, 558  
**M**  
*Machaerhamphus alcinus*, 43  
 Machpelah Cave, *see* Cave of the Patriarchs  
*Macrobrachium*, 34  
*Macrobrachium cavernicola*, 27  
*Macrocera nobilis*, 180  
*Macrocheles*, 561  
 Macrochelidae, 561  
*Macroderma gigas*  
   Australian diversity patterns, 195  
   distribution, 40  
 Main stem, influent streams, 510  
 Makke'dah Cave, myths and legends, 407  
 Maku Cave, myths and legends, 406  
 Malachite, 374  
*Malacoangelia*, 563  
 Malacostraca  
   characteristics, 146–152  
   U.S. diversity, 177–178  
 Malayan flying fox, *see* *Pteropus vampyrus*  
 Malayan flying fox, 39  
 Mammals  
   cave-dwelling species, 589–590  
   and cave ecology, 590  
   caves as shelter, 590  
   foraging habitats, 590  
   overview, 590–591  
   U.S. diversity, 181–182  
 Mammoth Cave System  
   biology, 354–355  
   breakdown mechanics, 58  
   breakdown morphology, 57  
   burial dating, 140–141  
   early humans, 203–205  
   exploration, 351  
   flooding hydrology, 252–253  
   geographic and geologic setting, 352–353  
   history, 351–352  
   international research, 355  
   minerals, 354  
   origin, 354  
   overview, 351  
   passage patterns, 353–354  
   prehistoric explorers and miners, 351  
   saltpetre processing, 494  
   as show cave history, 495  
   water table positions, 399  
 Manganese  
   in cave waters, 129  
   chemolithoautotrophic microbial groups, 94  
 Manganese bacteria, chemolithoautotrophy, 100  
*Mangkurty mityula*, 147  
 Manmade show caves, 471  
 Mantled karst, 522  
 Marginal cave, basic concept, 31  
*Marifugia cavatica*, 616  
   anchialine fauna, 33  
   characteristics, 162–163, 384

- Marine regressions  
 adaptability, 361  
 dating from stygofauna, 364–365  
 evolutionary change rate, 365  
 overview, 361  
 sea–freshwater–land, 361  
 thalassoid stygobionts, 362–363
- Marine shallow-water ecotones, active dispersal, 306
- Marine transgression–regression cycle, 363–364
- Marisana*, 557
- Marker genes, chemolithoautotrophy, 97
- Marmota monax*, 181
- Martens, 161
- Martes foina*, 161
- Martes pennanti*, 71
- Marwe coarctata*, 563
- Master passages, Ukrainian Caves, 586
- Mating  
 as adaptive shift factor, 19  
 bats, 40–41
- Matrix, nonaqueous phase liquids, 136
- Matts Black Cave, heavy metals, 131
- Maxillopoda  
 characteristics, 143–145  
 U.S. diversity, 177
- Maya Caves  
 ancient utilization, 366  
 antiquity, 366–367  
 art, 367–368  
 burial, 367  
 and community, 368–369  
 ethnography, 368  
 ethnohistory, 368  
 modifications, 367  
 overview, 366
- Maymena*  
 classification, 558  
 Sistema Huautla, 520
- Maze caves  
 development, 442–443  
 Ukrainian Caves, 585–587
- Medaka, neutral mutation, 412
- Medioppia*, 563
- Megachernes*, 559
- Megaselia cavernicola*, 180
- Meles meles*, 590
- Mendellina*, 564
- Mephitis mephitis*, 590
- Mesabolivar*, 558
- Mesocaverns, troglobite evolution, 478
- Mesocyclops*, 189
- Mesostigmata, 561
- Mesothelae, 557
- Meta*  
 classification, 558  
 terrestrial ecotones, 207
- Metabolic span, low food adaptation, 10
- Metacrangonyx*  
 marine regression dating, 365  
 marine transgression–regression cycle, 363–364
- Metacyclops*  
 Australian diversity patterns, 189  
 characteristics, 145
- Metagonia*  
 classification, 558  
 Sistema Huautla, 520
- Metals, karst aquifer transport, 300
- Metaniphargus*, 35
- Metanocticola*, 194
- Meta ovalis*, 176
- Metassamia*, 564
- Metastigmata, 561
- Metellina*, 558
- Methanobacterium*, 93
- Methanococcus*, 93
- Methanogenesis, 100
- Methanolobus*, 93
- Methanomicrobium*, 93
- Methanosarcina*, 93
- Methanotrophy, chemolithoautotrophy, 100
- Methylocystis*, 95
- Methylomicrobium*, 94
- Methylomonas*, 94
- Methylosinus*, 95
- Methylosphera*, 94
- Metopobacterus*, 558
- Metrosideros polymorpha*  
 adaptive shift, 21–22  
 in lava tubes, 479
- Mexaphaenops*, 48
- Mexicambala fishi*, 519
- Mexican characid fish  
 adaptation, 246  
 biogeography, 598  
 body pigmentation, 244  
 color mutations, 414  
 energy demand, 7  
 eye ontogeny, 413  
 fat accumulation, 7  
 fat content and condition factors, 7  
 feeding behavior, 51  
 fish eye regression, 242  
 food competition, 54  
 food finding, 6  
 head enlargement, 248  
 light reaction, 244  
 neutral mutation, 411  
 overview, 241–242  
 pineal organ, 244  
 and population structure, 453  
 reproductive behavior, 52–53  
 sensory compensation, 246
- Mexican free-tailed bat, cave life, 459
- Mexican long-tongued bat, U.S. diversity, 181
- Mexichelifer*, 559
- Mexichthonius*, 560
- Mexico, camps, 74–75
- Mexiconiscus laevis*, 150
- Mexobisium*, 559
- Mexotroglinus*, 564
- Microaerophilic organisms, 91
- Microbes  
 chemolithoautotrophy, 93–95, 98, 370  
 as drug agents, 371  
 extraterrestrial life, 371  
 mineral deposition, 370–371  
 organic matter breakdown, 370  
 origin of life, 371  
 overview, 369  
 rock dissolution, 370–371  
 sulfuric acid caves, 575
- Microbial veils, 577
- Microbiology, Jewel Cave, 313
- Microcharon*, 224
- Microchthonius*, 559
- Microcreagris*, 560
- Microgravity, entranceless caves, 212
- Microorganisms, chemoautotrophy, 90–91
- Microphase pools, 135
- Micropia*, 563
- Microscopy, chemolithoautotrophy, 97–98
- Microstigmatidae, 557
- Microtrombicula*, 562
- Micro whipscorpions, *see* Palpigradi
- Microzetes*, 563
- Microzetidae, 563
- Mictacea*, 26
- Mictaceans, anchialine caves, 34
- Mictocaris*, 30
- Mictocaris halope*  
 characteristics, 147  
 distribution in anchialine caves, 36
- Middle East, cave dwellers  
 deposits and processes, 87  
 location and present environment, 87  
 overview, 85, 87  
 prehistoric and historical occupations, 88–89
- Middle Palaeolithic period, Middle East cave dwellers, 88
- Midges, Cueva de Villa Luz, 577
- Midnight Cave, camp, 74
- Migration, genetic structure estimation, 448–449
- Miktoniscus*, 178
- Milieu souterrain superficial  
 epikarst ecology, 220  
 European diversity patterns, 199  
 morphological troglomorphy, 393  
 terrestrial troglobites, 593
- Millipede  
 Australian diversity pattern, 185  
 Sistema Huautla, 519–520
- Milyeringa veritas*, 195
- Mimetidae, 558
- Mimetus strinatii*, 558
- Minerals  
 arsenates, 377  
 breakdown initiation, 59  
 carbonates, 372, 374  
 halides, 376  
 hydroxides, 375–376  
 Lechuguilla Cave, 342  
 Mammoth Cave System, 354  
 microbe effects, 370–371  
 native elements, 377  
 nitrates, 376–377  
 Nullarbor Caves, 424–425  
 organic minerals, 377  
 overview, 372  
 oxides, 375–376  
 phosphates, 375  
 Postojna–Planinska Cave System, 458  
 precipitation, 613–614  
 Siebenhengste Cave System, 506  
 silicates, 376

- Minerals (*continued*)  
 sulfates, 374–375  
 sulfides, 377  
 vanadates, 377
- Mineral springs, 567
- Mines  
 bat habitat destruction, 44  
 recreational caving, 470
- Minicreagris*, 560
- Miniopterus schreibersii*, 40, 43, 590
- Minotauria*, 557
- Miocene rocks, Ukrainian Caves, 583–584
- Mirabilite  
 characteristics, 374  
 crystal habits, 290  
 as evaporite mineral, 288
- Mirolistra*, 163
- Misophria*, 30
- Mississippi Valley-type deposits, sulfuric acid caves, 579–580
- Mitchell Plain, sinkholes, 525–526
- Mites, *see also* Acari  
 classification, 561, 563  
 as guano inhabitants, 279–280
- Mitocaris halope*, 34
- Mitostoma*, 563
- Mixing corrosion  
 flank margin caves, 124  
 hydrothermal karst, 302
- Mixing dissolution, flank margin caves, 124
- Mixotrophs, 90
- Models  
 active dispersal, 306  
 climatic-relict model, 593  
 European camps, 73  
 karst aquifers, 378–382  
 passive dispersal, 306–308  
 subterranean biodiversity mapping, 358–360  
 subterranean ecosystems, 231–232  
 Tharp model of breakdown, 59  
 triple porosity karst aquifers, 294–295
- Modisimus*  
 classification, 558  
 Sistema Huautla, 520
- Moisture, cave environment and species, 479
- Mollusca  
 biogeographic patterns, 383–384  
 overview, 382  
 species comments, 384–385  
 taxonomic patterns, 382–383  
 in U.S., 176
- Monachus monachus*, 589
- Mondella halophila*, 162
- Monk seal, 589
- Monodella argentarii*  
 distribution in anchialine caves, 36  
 survival in low oxygen groundwater, 13
- Monodella halophila*  
 anchialine caves, 34  
 biogeography, 35  
 characteristics, 163  
 distribution in anchialine caves, 36
- Monolitra*, 162–163
- Monoschelorbates*, 563
- Monte Baldo, doline evolution, 113
- Montmorillonite, Lechuguilla Cave, 342
- Moormoops megalophylla*, 459
- Moose, Siebenhengste Cave System, 508
- Moraria*, 228
- Moraripsis*, 224
- More dense than water nonaqueous phase  
 liquids  
 characteristics, 132  
 epikarst, 135  
 fractures, 135–136  
 pools in conduits, 136  
 sediment, 136  
 in wells, 136
- Mormotomyia hirsuta*, 280
- Morphological adaptations  
 cave species, 481–483  
 environmental effects, 390  
 evolution examples, 393–395  
 overview, 386  
 progressive troglomorphy, 389–390  
 regressive evolution, 387–389  
 troglomorphic evidence, 390–392  
 troglomorphy evolution, 386–387  
 troglomorphy occurrence, 392–393
- Moths, morphological adaptations, 482–483
- Moulin, glacier caves, 273–274
- Mountain lion, paleontology, 433
- Mouse, U.S. diversity, 181
- Mouth, influent streams, 510
- MSS, *see* Milieu souterrain superficiel
- Multilevel caves  
 landscape interpretations, 399–400  
 overview, 397  
 river incisions, 398–399  
 water table, 397–398
- Multioppia*, 563
- Mulu Caves, Malaysia  
 biology, 403  
 characterization, 402  
 drainage area, 402  
 expeditions, 402–403  
 overview, 400  
 rock studies, 400
- Mundochthonius*, 559–560
- Munidopsis*, 30
- Munidopsis polymorpha*  
 anchialine caves, 34  
 characteristics, 152  
 distribution in anchialine caves, 36  
 food competition, 55  
 and humans, 37  
 reproductive behavior, 52
- Munidopsis sarsi*, 55
- Munnogonium somersensis*, 150
- Mussel, chemolithoautotrophy, 101
- MVT deposits, *see* Mississippi Valley-type deposits
- Mygalomorphae, 557
- Mylieringa veritas*, 33
- Myodopsylla insignis*, 180
- Myotis capaccinii*, 161, 590
- Myotis emarginatus*, 589
- Myotis grisescens*  
 cave life, 459  
 U.S. diversity, 182
- Myotis griseps*, 590
- Myotis sodalis*  
 cave life, 459  
 habitat destruction, 44  
 U.S. diversity, 181
- Myoxus glis*, 589
- Myriapods  
 Chilopoda, 404–405  
 diplopoda, 405–406  
 overview, 404  
 Pauropoda, 404  
 Symphyla, 404
- Mysidacea*, 26
- Mysids, anchialine caves, 34
- Mysmenidae, 558
- Mystacocarida, 144
- Mystery Cave, karst examples, 535
- Myths and legends, 406–407
- ## N
- $N_e$ , *see* Effective population size
- Namanereis*, 29
- Nampabus turbator*, 405
- Nanocopia minuta*, 144
- NAPLs, *see* Nonaqueous phase liquids
- National Cave Rescue Commission, record keeping, 476
- National Speleological Society  
 contact information, 158  
 and recreational caving, 472  
 rescue history, 475
- Natural selection  
 neutral mutation, 413  
 overview, 409–411  
 and population structure, 453–455
- Nauplius, Copepoda, 144
- Naushonia manningi*, 151
- NCRC, *see* National Cave Rescue Commission
- Neaphaenops tellkampfi*  
 ecology, 50  
 life history characteristics, 349  
 population structure, 450  
 species interactions, 540–541  
 systematics, 48  
 U.S. diversity, 180
- Nebria* spp., 164
- Necturus*, 489
- Necturus maculosus*, 53
- Nedsia*, 35
- Negroroncus*, 560
- Nemaspela*, 563
- Nemastoma*, 563
- Nemastomatidae, 563
- Nematoda, 615–616
- Nemertina, 616
- Nenteria*, 561
- Neoallochernes*, 559
- Neobisiidae, 560
- Neobisium*, 560
- Neobisium spelaeum*, 161
- Neocheiridium*, 559
- Neochthonius*, 560
- Neogovea mexasca*, 563
- Neogoveidae, 563
- Neoleptoneta*, 558
- Neoleptoneta microps*, 555

- Neoleptoneta myopica*, 555  
 Neolithic period, Middle East cave dwellers, 89  
*Neomamersa*, 562  
*Neosilurus hyrtilii*, 195  
*Neospeleognathopis*, 561  
*Neostenetroides*, 150  
*Neostenetroides schotteae*, 35  
*Neotemnopteryx douglasi*, 194  
*Neotemnopteryx wynnei*, 194  
 Neoteny, energy demand, 9  
*Neotoma* spp.  
   characteristics, 589  
   U.S. diversity, 181  
*Neotrechus* spp.  
   characteristics, 160  
   European diversity patterns, 197  
*Neotrombicula*, 562  
*Nesidiolestes ana*, 179  
 Nesticidae, 558  
*Nesticiella*, 558  
*Nesticus*  
   classification, 558  
   population structure, 449  
*Nesticus carteri*, 176  
*Nesticus eremita*, 450  
*Nesticus tennesseensis*, 450  
 Network caves, 303–304  
 Network mazes, development, 443  
 Neutral mutation  
   albinism, 411  
   *Astyanax fasciatus*, 411  
   eye genes, 411–413  
   natural selection, 413  
   overview, 411  
   structural genes, 413  
*Newportia leptotarsis*, 405  
 New River, Virginia, cave sediment dating,  
   139–140  
*Ngamalanguia*, 194  
*Nicholsia*, 191  
*Niphargobates*  
   dinaric karst, 164  
   epikarst, 224  
*Niphargobates orophobata*, 162  
*Niphargus*  
   dinaric karst, 165  
   epikarst, 227  
   European diversity patterns, 197  
*Niphargus arbiter*, 35  
*Niphargus balcanicus*, 162  
*Niphargus hebereri*  
   anchialine caves, 35  
   characteristics, 163  
   distribution in anchialine caves, 36  
   survival in low oxygen groundwater, 13  
*Niphargus orcinus*, 162  
*Niphargus pectencoronatae*, 35  
*Niphargus rhenorhodanensis*  
   metabolic responses during anoxia, 15  
   respiratory adaptations, 14  
   survival under anoxia, 13  
*Niphargus stygius*, 162  
*Niphargus transilivius*, 162  
*Niphargus virei*  
   life history characteristics, 348  
   metabolic responses, 15  
   respiratory adaptations, 14  
   survival under anoxia, 13  
 Niter, saltpetre mining, 492  
*Nitocrella*, 189  
 Nitrates  
   characteristics, 376–377  
   groundwater contamination, 415–418  
 Nitrite, chemolithoautotrophic microbial  
   groups, 94  
*Nitrobacter*, 371  
 Nitrocalcite, saltpetre mining, 492  
 Nitrogen bacteria, chemolithoautotrophy, 100  
 Nitromagnesite, saltpetre mining, 492  
*Nitrosomonas*  
   ammonia, 94  
   mineral deposition, 371  
*Nitrosospira*, 94  
*Nocticola*, 194  
*Nocticola flabella*, 194  
*Noctivox*, 454  
 Nonaqueous phase liquids  
   characteristics and sources, 132–134  
   epikarst transport, 134  
   fractures, 136  
   matrix, 136  
   overview, 131  
   pools in conduits, 136  
   sediment, 136  
   in soils, 137  
   in springs and caves, 136  
   transport into karst aquifers, 134  
   vugs, 136  
   in wells, 136  
 Noncarbonate rocks, hydrothermal karst, 302  
 North America, eastern, ancient cavers, 203  
 North American cave crayfish, life history  
   characters, 10  
 Northern Spring salamander, 488  
 Northern two-lined salamander, 488  
 Notches, as karren form, 315  
*Notobathynella*, 189  
*Notobathynella williamsi*, 146  
 Notostigmata, 561  
*Novobisium*, 560  
 NSS, *see* National Speleological Society  
*Nudochernis*, 559  
 Nullarbor Caves, Australia  
   biology, 425–426  
   minerals, 424–425  
   origin and enlargement, 422–424  
   overview, 418  
   physical setting, 418–421  
   prehistory and history, 421–422  
   speleological history, 421–422  
*Nycterinastes*, 562  
 Nylon, camps, 76
- O**  
 Ocean holes, 126  
*Ochyrocerca*, 558  
 Ochyroceratidae, 558  
*Odontozona addaia*, 151  
 Offshore springs, 566  
*Ogilbia deroyi*, 33  
*Ogilbia galapagosensis*, 33  
*Ogilbia pearsei*  
   anchialine fauna, 33  
   reproduction, 251  
   sensory compensation, 244, 246  
 Oilbird  
   characteristics, 589  
   guano, 277  
*Oliarius*  
   Australian diversity patterns, 194  
   U.S. diversity, 179  
*Oliarius koanoa*, 21  
*Oliarius makaiki*, 21–22  
*Oliarius polyphemus sensus latus*, 21–22  
 Oligochaeta  
   characterization, 616–617  
   as guano inhabitants, 281  
   in U.S., 176  
*Oncopodura*, 193  
*Oncostygocaris*, 146  
 Oncyphophora, 618  
*Onychiurus dunarius*, 508  
 Oonopidae, 558  
*Oonopsides*, 558  
 Open karst, 283  
*Ophisternon candidum*  
   anchialine fauna, 33  
   Australian diversity patterns, 195  
*Ophisternon infernale*  
   adaptation, 246  
   anchialine fauna, 33  
   fish eye regression, 242  
   head enlargement, 248  
   sensory compensation, 246  
 Opilioacaridae, 561  
 Opiliones, 192–193, 563  
*Oplitis*, 561  
*Oppia*, 563  
 Oppiidae, 563  
 Orange leaf-nosed bat, distribution, 40  
*Oratemnus*, 559  
*Orconectes*  
   characteristics, 151  
   U.S. diversity, 178  
*Orconectes australis australis*  
   life history characteristics, 349  
   reproductive efforts, 350  
 Ore deposits, sulfuric acid caves, 579–580  
 Organo, 90  
 Origma, 589  
*Origma* spp., 589  
*Ornithodoros*, 561  
*Ornithodoros (Pavlovskiella) turicata*, 561  
*Orotrechus*, 197  
*Orsinome*, 558  
*Ortholasma sbordonii*, 563  
 Orthoptera, 194  
*Oryzia latipes*, 412  
 Osteichthyes, U.S. diversity, 180  
 Ostracoda, 25, 34, 145, 191  
*Otus asio*, 181  
 Outlets, Ukrainian Caves, 586  
 Overflow springs, 567  
 Owls, paleontology, 434  
 Oxies, 375–376  
 Oxygen, cave environment and species, 479  
 Ozark Plateaus, karst example, 531

## P

- Pachon Cave, animal feeding behavior, 51  
*Pachyloides*, 564  
*Pachyspeleus strinatii*, 564  
 Pack rat  
   characteristics, 589  
   U.S. diversity, 181  
*Palaemonetes*, 178  
*Palaemonias*, 178  
*Palaemonias ganteri*, 354  
*Palaemonias mirandai*, 451  
 Paleohydrology, Friars Hole Cave System, 268–269  
 Paleolithic man, bone accumulation in caves, 434  
 Paleomagnetic record  
   importance, 430  
   sediments, 427–429  
   speleothems, 429–430  
 Paleontology  
   bats, 431–432  
   carnivores, 432–433  
   diurnal birds of prey, 434  
   large mammals, 433–434  
   Lechuguilla Cave, 343  
   mammals, 433  
   overview, 431  
   owls, 434  
   paleolithic man, 434  
   Postojna–Planinska Cave System, 458  
   sediment dating, 435  
   sediments and paleoenvironment, 435  
   Wakulla Spring Underwater Cave System, 604  
*Paleozercon cavernicolus*, 561  
 Pale salamander, 488  
 Palettes, *see* Shields  
 Palpigradi, 559  
*Palpophria*, 30  
 Panbiogeography, 592  
*Panopiliops inops*, 564  
*Pantera leo*, 433  
 Panther, paleontology, 433  
*Panthera pardus*, 433  
*Parabathynella stygia*, 146  
*Paracarpais*, 561  
*Paracheiridium*, 560  
*Parachernes*, 559  
*Paraegopsis oberwimmeri*, 382  
 Paragenesis  
   characteristics, 317  
   passage morphology, 439  
*Paraliochthonius*, 559  
*Paralola*, 564  
*Paraloptoneta*, 558  
*Paralycus lavoipierrei*, 192  
*Parantricola*, 561  
 Parapatric divergence, and adaptive shift, 18  
*Paraphrynus grubbsi*, 519  
*Parapropus* spp., 160  
*Parapseudoleptomeresochra*, 189  
*Pararoncus*, 560  
 Parasitidae, 561  
*Parasitus*, 561  
*Parasoldanellonyx*, 562  
*Paraspadella anops*  
   anchialine fauna, 33  
   distribution in anchialine caves, 36  
*Parastalita stygia*, 163  
*Parastenocaris*  
   Australian diversity patterns, 189  
   characteristics, 145, 162  
   dinaric karst, 164  
   epikarst, 224  
*Parastygocaris*, 146  
*Paratemnopteryx*, 194  
*Paravachonium*, 559  
*Parawithius*, 560  
*Parhippolyte uveae*  
   anchialine caves, 34  
   distribution in anchialine caves, 36  
   and humans, 37  
*Parobisium*, 560  
 PASCALIS project, European diversity patterns, 199, 201  
 Passage development  
   adjustment to conditions, 443–444  
   branching system origins, 442  
   earliest stages, 440–441  
   initial flow route competition, 441  
   maze caves, 442–443  
   overview, 440  
   stages, 440  
   vertical organization, 441–442  
 Passages  
   definitions and concepts, 436–437  
   lava tube patterns, 600–602  
   morphology and evolution, 438–440  
   overview, 436  
   patterns, 437–438  
 Passive dispersal, invasion models, 306–308  
 Patchy food scarcity  
   definition, 4  
   and food finding, 6  
 Pathogens, karst aquifer transport, 300  
 Pauropoda, 404  
*Pax6*, 413–414  
 PCBs, *see* Polychlorinated biphenyls  
 PCE, *see* Perchloroethylene  
 PCR, *see* Polymerase chain reaction  
*Pelagomacellicephala*, 30  
*Pellina penicilliformis*, 33  
*Peltonychia*, 564  
*Penaes indicus*, 151  
 Pendants  
   characteristics, 317–318  
   as karren form, 315  
 Pen drains, karst aquifers, 135–136  
*Pentagonotectum*, 561  
 Peracarida, 146–151  
 Perchloroethylene  
   cave waters, 132  
   karst aquifer transport, 300  
*Pergamasus*, 561  
 Periodic food scarcity, and fat content, 7  
 Periodic food supply, 4  
 Permeability  
   ecotones, 206  
   karst aquifers, 295–296  
   normal karst aquifers, 293  
*Peromyscus* spp., 181  
 Petre dirt, saltpetre mining, 492  
 Pettalidae, 563  
*Pgm*, 452  
*Phaconeura*, 194  
*Phalangodes*, 564  
 Phalangodidae, 564  
*Phalangozea bordoni*, 563  
*Phaneropella lesinae*, 160  
*Phanetta*, 558  
*Phanetta subterranea*, 176  
 Pholcidae, 558  
*Pholcus*, 558  
*Pholeomma*, 558  
*Pholeteras euthrix*, 383  
*Pholeuon*, 50  
 Pholeuonid, cave beetles, 48  
*Pholocophora*, 519  
 Phosphates, 375  
 Photo, 90  
*Phoxinellus alepidotus*, 163  
*Phreatichthys andruzzii*  
   body pigmentation, 244  
   fish eye regression, 242  
   life history characteristics, 348  
   and population structure, 453–454  
*Phreatichthys sphenops*, 244  
 Phreatic zone  
   cave water table, 397  
   flank margin caves, 124  
   hydrothermal karst, 303–304  
   karst water table, 298  
   Nullarbor Caves, 423  
   passage morphology, 438–439  
   solution caves, 528  
*Phreatodrobia*, 383  
 Phrynichidae, 556  
*Phrynichosaurus*, 556  
*Phrynichus*, 556  
 Phrynidae, 557  
 Phyllocarida, 146  
 Phyllopods, 142  
*Phyllostomus hastatus*  
   cave dwelling benefits, 43  
   courtship and mating, 41  
 Phylogenetic relicts, 233  
 Phylogeny, worms, 618  
*Physa spelunca*, 176  
 Physiological adaptation, 1  
*Physocyclus*, 558  
*Picathartes gymnocephalus*, 589  
*Picathartes oreas*, 589  
*Picunchenops*, 564  
 Pigmentation, and fish eyes, 242  
*Pilbarophreatoicus*, 191  
*Pimelodella kronei*, 348  
 Pipe network approach, karst models, 380–381  
*Pisidium*, 382  
 Pits  
   definition, 436  
   descriptions, 445–447  
   development mechanisms, 447  
   entrances, 216–217  
   overview, 444–445  
*Plagigeyeria* spp., 161, 163  
 Planthoppers  
   adaptive shift, 20–22  
   Australian diversity patterns, 193–194  
   morphological adaptations, 482  
*Plato*, 558

- Platytopia*, 144  
*Platymys urqui*, 519  
Pleistocene mammals  
  bats, 431–432  
  bone accumulation, vertical caves, 431  
  carnivores, 432–433  
  diurnal birds of prey, 434  
  large mammals, 433–434  
  overview, 431  
  owls, 434  
  paleolithic man, 434  
  sediment dating, 435  
  sediments and paleoenvironment, 435  
*Plethodon glutinosus glutinosus*, 488  
*Pleurodeles walilii*, 491  
Pockets  
  characteristics, 319  
  as karren form, 315  
  solutional sculpturing, 538–539  
*Poecilia latipinna*, 53  
*Poecilia mexicana*  
  Cueva de Villa Luz, 577  
  fish eye regression, 242  
  mate competition, 55–56  
  overview, 241  
  reproductive behavior, 52–53  
*Poecilia reticulata*, 53  
*Poecilia velifera*, 53  
*Poecilophysis*, 562  
Point-recharge doline, 110  
Polar drift, earth magnetism, 427  
Poljes, 120–122  
Pollution, dinaric karst, 165  
Polychaeta, 616  
Polychlorinated biphenyls  
  cave waters, 132  
  karst aquifer transport, 300  
Polygenetic sinks, 119–120  
Polymerase chain reaction,  
  chemolithoautotrophy, 95  
Pools in conduits, nonaqueous phase liquids,  
  136  
Popcorn stalagmites, Jewel Cave, 314  
Population size, and population structure,  
  453–455  
Population structure  
  aquatic troglobites, 450–451  
  food resource heterogeneity, 453  
  and genetic variability, 453–455  
  and habitat heterogeneity, 452–453  
  and natural selection, 453–455  
  overview, 447–448  
  and population size, 453–455  
  at regional scale, 449–450  
  single cave, 451–452  
  surface *vs.* underground dispersal, 450  
Porcupines, paleontology, 433  
*Porhomma cavernicola*, 176  
*Poroschelorbates*, 563  
Porous rocks, breakdown mechanics, 59  
*Porrhomma*, 558  
Postanoxic recovery phase, metabolic responses  
  during, 15–16  
Postojna–Planinska Cave System, Slovenia  
  archaeology, 458  
  biology, 458  
  description, 457–458  
  exploration history, 456–457  
  mineralogy, 458  
  overview, 456  
  paleontology, 458  
  physical setting, 456  
  as show cave history, 495  
Potholes  
  characteristics, 316  
  as karren form, 315  
  solutional sculpturing, 539  
*Potiicoara brasiliensis*, 146  
Preadaptations  
  as adaptive shift factor, 18  
  subterranean ecosystems, 230  
*Priscula*, 558  
*Proasellus*  
  characteristics, 162  
  epikarst, 224  
*Proasellus slavus*, 15  
*Proasellus stroubali*, 15  
Proboscis worms, 616  
*Procambarus*, 151, 178  
*Procaris ascensionis*, 37  
Prodidomidae, 558  
Progressive troglomorphy, and adaptation,  
  389–390  
Project caving, techniques, 237–238  
Project SIMMER, camp, 74  
*Prokoenia celebica*, 559  
Prokoeniidae, 559  
*Prosellus slavus*, 13  
Prostigmata, 561–562  
*Protelsonia hungarica*, 165  
*Proterorhagia oztotlica*, 561  
Proterorhagiidae, 561  
*Proteus*  
  ecology, 489  
  eye regression, 491  
  and natural selection, 410  
*Proteus anguinus*  
  characteristics, 14, 162–163, 489  
  dinaric karst, 164–165  
  European diversity patterns, 196  
  feeding behavior, 51  
  mate competition, 55  
  reproductive behavior, 53  
*Protochelifer*, 559  
*Protoleoneta*, 558  
*Protoschizomus*, 556  
*Prox1*, 413  
*Prozercon*, 561  
*Psammaspides* spp., 146  
*Pselaphochernes*, 559  
*Pseudanapsis relicta*, 161  
*Pseudanophthalmus*  
  biogeography, 593–594  
  European diversity patterns, 197  
  species interactions, 540–541  
  U.S. diversity, 179  
*Pseudemys floridana*, 181  
*Pseudoalteromonas* spp., 426  
*Pseudoanophthalmus menetriesii*, 50  
*Pseudoanophthalmus striatus*, 50  
*Pseudoblothrus*, 560  
*Pseudocandona*, 145  
*Pseudocellus osorioi*, 561  
*Pseudocellus paradoxus*, 560  
*Pseudocellus reddelli*, 561  
*Pseudocellus sbordonii*, 561  
Pseudochiridiidae, 560  
*Pseudochiridium*, 560  
*Pseudochthonius*, 560  
Pseudocorrosion notches, Nullarbor Caves, 423  
Pseudogarypidae, 560  
*Pseudogarypus*, 560  
*Pseudolimnocythere hartmanni*, 145  
*Pseudomonas* spp.  
  hydrogen, 93  
  Nullarbor Caves, 426  
*Pseudomonolista*, 163  
*Pseudoniphargus*  
  anchialine caves, 35  
  characteristics, 29  
Pseudoscorpions  
  Australian diversity patterns, 193  
  biogeography, 593  
  classification, 559–560  
  conservation, 555  
*Pseudosinella*, 179, 393  
*Pseudosinella bonita*, 519  
*Pseudosinella christianseni*, 394–395  
*Pseudosinella dubia*, 394  
*Pseudosinella hirsuta*, 394–395  
*Pseudotremia*, 178  
*Pseudotyranochthonius*, 193, 559–560  
*Pseudouroctonus reddelli*, 556  
*Psilodermes*, 558  
*Psilochorus*, 558  
*Psyllipsocus ramburi*, 180  
*Pteropus vampyrus*, 39  
*Ptomaphagus hirtus*, 47  
*Ptomaphagus* spp., 180, 197  
*Pycnowithius*, 560  
Pyrenean salamander, feeding behavior, 51  
Pyrite, 291, 375–376  
*Pyrodictium*, 92  
*Pyrrhocorax graculus*, 589  
*Pyrrhocorax pyrrhocorax*, 589
- ## Q
- Quarrying  
  bat habitat destruction, 44  
  clastic sediment production, 103  
*Quedius*, 207
- ## R
- Racoon, feces, 262  
Radioisotope experiments,  
  chemolithoautotrophy, 97  
Rahgidiidae, 561–562  
Ramiform caves  
  characteristics, 304  
  development, 443  
*Ramphotyphlops longissimus*, 195  
*Rana palustris*, 180  
Randhoelen, 24  
Rank order, behavioral adaptations, 55–56  
Rappel, vertical caving, 237  
Rat, feces, 263

- Ratynsky, Ukrainian Caves, 583  
 Ravelling, 523  
 Reaction kinetics, gypsum speleogenesis, 283–284  
 Rebelays, vertical caving, 237  
 Reciprocity, 43  
 Recreational caving  
   cave types, 469–470  
   continuance, 473–474  
   definition, 469  
   demographic factors, 474  
   down sides, 472  
   levels, 473  
   non-caving activities, 470–471  
   novice cavers, 472–473  
   reasons, 472–473  
   visitation factors, 471–472  
   voids, 470  
*Reddellzomus*, 556  
 Red fox, foraging, 590  
 Reduced inorganic sulfur compounds, 93–94  
 Regression model, passive dispersal, 306–308  
 Regressive evolution  
   definition, 9  
   morphological adaptation, 387–389  
   and natural selection, 409  
*Remasellus parvus*, 177  
 Remipedia, 25, 33–34, 142–143  
 Replacement solution, Kane Caves, 575  
 Reproduction  
   behavioral adaptations, 52–53  
   cave animal efforts, 349–350  
   fish adaptations, 251  
   salamanders, 489–490  
 Reptilia, U.S. diversity, 181  
 Rescues  
   accident frequency rates, 476–477  
   current status, 477  
   early teams, 476  
   history, 475–476  
   overview, 475  
   team development, 476  
 Réseau Siebenhengste–Hohgant, Siebenhengste Cave System, Switzerland, 503  
 Reservoir porosity, sulfuric acid caves, 579–580  
 Resistivity surveys, entranceless caves, 213–214  
*Rhadine noctivaga*, 179  
*Rhadine subterranea*  
   species interactions, 540–541  
   U.S. diversity, 179  
*Rhagidia*, 562  
*Rhamdia laticauda*, 251  
*Rhamdia macuspanensis*, 246  
*Rhamdia reddelli*  
   light reaction, 244  
   reproduction, 251  
   sensory compensation, 246  
*Rhamdia* spp.  
   fat storage and metabolism, 249  
   fish eye regression, 242  
   head enlargement, 248  
   neutral mutation, 412  
   pineal organ, 244  
*Rhamdia zongolicensis*  
   adaptation, 246  
   body pigmentation, 244  
   light reaction, 244  
   reproduction, 251  
   sensory compensation, 246  
*Rhinolophus ferrumequinum*  
   characteristics, 589  
   courtship and mating, 41  
   hibernation, 42  
*Rhinolophus* spp., 161  
*Rhinonycteris aurantius*, 40  
*Rhode*, 557  
*Rhodera*, 557  
*Rhopalocranaus*, 564  
*Rhyacodrilus*, 618  
 Ribbon worms, 616  
 Ribulose biphosphate carboxylase/oxygenase, 92, 95  
*Riccardoella*, 561  
*Ricinoidea*, 560  
 Ricinoididae, 560–561  
 Ricinulei, 560–561  
 Ridge walking, 470  
 The Rift, Lechuguilla Cave, 346  
*Riftia pachypila*, 101  
 Rills  
   characteristics, 316  
   as karren form, 315  
 Ringtail, foraging, 590  
 River incisions, multilevel caves  
   Cumberland River, 399  
   Mammoth Cave, 399  
   overview, 398–399  
 Rivers, *see* Inflow rivers  
 RMRs, *see* Routine metabolic rates  
*Robertus*, 558  
 Robins Rift Cave, description, 65  
*Robustocheles*, 562  
 Rock dove, 161, 591  
 Rock shelters, 84  
*Roncobisium*, 560  
*Roncus*, 560  
 Roofless caves, intersection dolines, 118  
 Room, 436  
 Root communities, in lava tubes  
   air flow, 479  
   bad air zone, 481  
   deep cave zone, 481  
   energy sources, 478–479  
   entrance, 479, 481  
   geomorphology effects, 479  
   moisture/humidity, 479  
   morphological adaptations, 481–483  
   O<sub>2</sub> and CO<sub>2</sub>, 479  
   overview, 477–478  
   transition/mixing zone, 481  
   tree roots, 479  
   troglobite habitat, 478  
   twilight, 481  
 Rosasite, 374  
*Rostrozetes foveolatus*, 563  
 Rounded karren, doline structure, 109  
 Roundworms, 615–616  
*Rousettus aegyptiacus*, 589  
 Routine metabolic rates, and respiratory adaptations, 14  
*Rowlandius*, 556  
*r*-selection, 9  
 RuBisCO, *see* Ribulose biphosphate carboxylase/oxygenase  
*Rupicola rupicola*, 589  
*Rx*, 413–414  
**S**  
 Sabaconidae, 563  
*Sabacon picosantrum*, 563  
 Salamanders  
   aggression, 489  
   cave life, 459  
   characteristics, 487  
   dinaric karst, 164  
   ecology, 489  
   European diversity patterns, 196  
   *Eurycea*, 485–486, 488  
   eye regression, 490–491  
   feeding behavior, 51  
   food finding, 6  
   *Gyrinophilus*, 488  
   *Haideotriton*, 487–488  
   *Hydromantes*, 488  
   mate competition, 55–56  
   overview, 485  
   *Plethodon*, 488  
   *Proteidae*, 489  
   reproduction and development, 489–490  
   respiratory adaptations, 14  
   sensory and behavioral adaptations, 489  
   social life, 489  
   species interactions, 542  
   territory marking, 489  
   *Typhlotriton*, 486–487  
   underground life regressions, 490  
*Salamandridae*, 491  
*Salentinella angelieri* in anchialine caves, 36  
 Saline springs, 567  
*Salmasellus howarthi*, 177  
*Salmasellus steganothrix*, 81  
 Saltpetre mining  
   definitions, 492  
   overview, 492–493  
   principal physical evidence, 493  
   secondary evidence, 493–494  
   sediment extraction comparison, 494–495  
 Salts Cave, Mammoth Cave area archaeology, 204  
*Sancassania*, 562  
 Santa Ninfa Plateau, doline evolution, 113  
*Santinezia*, 564  
*Sarax*, 556  
*Sarsicopia polaris*, 144  
*Satan eurystomus*, 180, 248  
*Sataurana*, 557  
*Sathrochthonius*, 560  
 Saturated zone, solution caves, 528  
 Sauter mean, scallop dominant discharge, 537  
*Sayornis phoebe*, 181  
*Sbordonia*, 564  
 Scale, mapping subterranean biodiversity, 358–359  
 Scallop dominant discharge, solution caves, 537



- Scallops  
 characteristics, 316–317  
 definition, 536  
 as karren form, 315
- Scanning spectrofluorophotometers, karst water tracing, 327
- Scaphoid, cave beetles, 48
- Scheloribates*, 563
- Scheloribatidae, 563
- Schizomida, 193, 556
- Schizomus*, 519
- Schizopelma grieta*, 519
- Schreiber's bat, 590
- Schwiebea*, 562
- Scoliopteryx libatrix*, 180
- Scolopendrellopsis pretneri*, 404
- Scorpions, 193, 519, 554–556
- Scotolemon*, 564
- Screech-owl, U.S. diversity, 181
- SCUBA equipment, underwater cave exploration, 238–239
- Scutigera hauseri*, 404
- Scutigera immaculata*, 404
- Sea caves  
 characteristics, 84, 122–123  
 recreational caving, 470
- Security systems, cave protection, 465
- Sediments  
 Castleguard Cave, 80  
 clastic, *see* Clastic sediments  
 extraction, saltpetre mining comparison, 494–495  
 nonaqueous phase liquids, 136  
 and paleoenvironments, 435  
 paleomagnetic record, 427–429  
 pleistocene dating, 435  
 Ukrainian Caves, 586–587
- Seeps, 567–568
- Seismic measurements, entranceless caves, 212–213
- Selachthonius*, 560
- Sensory compensation  
*Astyanax fasciatus*, 246  
*Eigenmannia vicentespelaea*, 248  
 fish, 244, 246  
*Ophisternon infernale*, 246  
*Rhamdia zongolicensis*, 246
- Sensory equipment, in food finding, 5–6
- Serratoppia*, 563
- Shafts  
 descriptions, 445–447  
 development mechanisms, 447  
 entrances, 216–217  
 overview, 444–445
- Shallow hydrothermal karst, 301
- Shallow seismic exploration, entranceless caves, 212–213
- Shasta ground sloth, paleontology, 433
- Shelter caves, 470
- Shewanella putrefaciens*, 93
- Shields, 551–552
- Short-tailed whipscorpions, *see* Schizomida
- Show caves  
 characteristics, 470–471  
 development, 499–500  
 environmental protection, 496–499  
 history, 495–496  
 world information, 500
- Shrews, 590
- Shrimp  
 anchialine caves, 34  
 biogeography, 35  
 characteristics, 29, 151, 163  
 dinaric karst, 165  
 distribution in anchialine caves, 36  
 and humans, 37  
 Mammoth Cave System, 354  
 troglomorphic adaptations, 27  
 trophic relations, 37
- Siamacarus*, 561
- Sibyls Cave, myths and legends, 406
- Siebenhengste Cave System, Switzerland  
 Bärenschacht, 502–503  
 fauna, 508  
 Faustloch, 503  
 genesis and age, 504, 506  
 geographical and geological setting, 500–501  
 Hohlaub Area, 504  
 hydrology, 501–502  
 Innerbergli Area, 504  
 K2, 504  
 minerals, 506  
 Réseau Siebenhengste–Hohgant, 503  
 St. Beatus Cave, 502
- Sijucavernicus*, 564
- Silicates, 376
- Silurids, darkness adaptation, 3
- Simmons–Mingo Cave, camp, 74
- Simonocera*, 558
- Single-rope techniques, vertical caving, 237
- Sinkholes  
 definition, 521, 523  
 formation, 524–525  
 shapes, 524  
 subtypes, 526  
 surface expression, 523–524  
 types, 521–523
- Sinking streams, *see also* Influent streams  
 definition, 165  
 entrances, 216  
 evolutionary sequence, 512–514
- Sinking systems, karst aquifers, 135–136
- Sinoniscus cavernicolous*, 150
- SIRA, *see* Stable Carbon Isotope Ratio Analysis
- Sironidae, 563
- Sistema Huautla, Mexico  
 archaeology, 520–521  
 biology, 519–520  
 description, 514, 516, 518  
 geology, 518  
 hydrogeology, 519  
 overview, 514
- Slab breakdown, 56
- Slimy salamander, 488
- Small spiders, 558
- Smoothers, mapping subterranean diversity, 356
- SMRs, *see* Standard metabolic rates
- Snails, 70, 382, 384
- Snottites, chemolithoautotrophy, 99
- Sodium fluorescein, karst water tracing, 324–325
- Software packages, 157, 356
- Soil piping, 523
- Soils, NAPL, 137
- Soldanellonyx*, 562
- Solemya*, 101
- Solenopsis (Solenopsis) invicta*, 555
- Solonaima*, 194
- Solutional sculpturing  
 discharge calculation, 537  
 etching, 539  
 groundwater flow direction, 536–537  
 groundwater flow velocities, 537  
 overview, 536  
 pockets, 538–539  
 potholes, 539  
 scallop discharge data, 538  
 scallops and flutes, 536
- Solution caves  
 characteristics, 85  
 origin, 528–529  
 recreational caving, 469
- Solution chimneys, description, 445
- Solution dolines  
 and karst surfaces, 108  
 overview, 116
- Solution pockets, 319
- Solution sinkhole, 521–522
- Soriculus salenskii*, 590
- Sotanochoctas ellioti*, 556
- Sotanostenochrus*, 556
- Spangled perch, Australian diversity patterns, 195
- Speciation, and adaptive shift, 18
- Species interactions  
 Appalachian cave streams, 541–542  
 beetles–crickets, 540–541  
 overview, 539–540
- Spelaegriphus lepidops*, 146
- Spelaenicippe*, 30
- Spelaecampus*, 145
- Spelaeoecia*, 145
- Spelaegriphacea, Australian diversity patterns, 192
- Spelaeomontia*, 564
- Spelaeomysis*, 34–35
- Spelaenicippe*, 29
- Spelaeorchestia koloana*, 177
- Spelaeothrombium*, 562
- Speleochir*, 561
- Speleocteniza ashmolei*, 557
- Speleogenesis  
 gypsum, 283–287  
 Kazumura Cave, 331  
 sulfur bacteria, 98  
 Wakulla Spring Underwater Cave System, 607
- Speleoharpactea*, 557
- Speleoithona*, 145
- Speleological processes, breakdown role, 60
- Speleology, Nullarbor Caves, 421–422
- Speleomaster lexi*, 564
- Speleonectes*, 29
- Speleonectes epilimnius*, 142
- Speleonychia sengeri*, 564
- Speleoperipatus speleus*, 618
- Speleophria*, 30, 191
- Speleosiro argasiformis*, 563

- Speleothem deposition  
 overview, 543–544  
 precipitation rate overview, 544  
 stalagmite morphology, 547–548  
 stalagmites, 545–546  
 from thin water layers, 544–545  
 from water films, 546–547
- Speleothems  
 anthodites, 550–551  
 Castleguard Cave, 80  
 caves as geological repositories, 82  
 and cave waters, 613–614  
 frostwork, 551  
 heavy metals, 130  
 Jewel Cave, 314  
 Kazumura Cave, 333–334  
 lava tube development, 602  
 Lechuguilla Cave, 342  
 paleomagnetism, 429–430  
 shapes and types, 288–290  
 shields, 551–552  
 subaerial helictites, 549–550  
 subaqueous helictite, 552  
 subaqueous helictite bushes, 552–553
- Speleovelia aaa*, 179  
*Spelobia tenebrarum*, 180  
*Spelodermes*, 558  
*Spelopelma*, 557  
 Spelunkers, 473  
*Spelyngochthonius*, 559  
*Speocera*, 558  
*Speocharis*, 197  
*Speocirolana bolivari*, 148  
*Speocirolana hardeni*, 177  
*Speocyclops*, 145, 224  
*Speocyclops infernus*, 226, 228  
*Speonebalia cannoni*, 34, 36, 146  
*Speonebalia cardisomae*, 34  
*Speonomus*, 50, 197  
*Speoplatyrhinus pousoni*, 180, 246, 248, 347, 393–394  
*Speothrombium*, 562  
*Spermophora*, 558  
*Spermophoroides*, 558  
*Sphaeriodesmus*, 520  
 Sphaerochthoniidae, 563  
*Sphaerochthonius*, 563  
*Sphaeromides*, 162  
*Sphalloplana*, 174
- Spiders, *see also* Arachnida  
 Australian diversity patterns, 193  
 biology, 554  
 characteristics, 161, 163  
 classification, 557  
 conservation, 555  
 Cueva de Villa Luz, 577  
 dinaric karst, 164  
 population structure, 450  
 Sistema Huautla, 519–520  
 terrestrial ecotones, 207
- Spinalona*, 142  
 Spinnerets, Symphyla, 404  
 Sponges, anchialine fauna, 33  
 Spongework, 304, 317, 321, 443  
 Spotted hyena, paleontology, 433  
 Spring discharges, magnitudes, 568  
 Spring failure, 598  
 Springs  
 as habitat, 570  
 nitrate contamination, 417  
 nonaqueous phase liquids, 136  
 overview, 565  
 types, 565–568  
 as water supplies, 570
- Spring salamander, 488  
 Springtail, Burnsville Cove, 70  
 St. Beatus Cave, Siebenhengste Cave System, 502  
 Stable Carbon Isotope Ratio Analysis, chemolithoautotrophy, 96–97  
 Stagnant-air zone, Australian diversity pattern, 185  
 Stalactites  
 characteristics, 571  
 composition, 570  
 eccentric stalactites, 549  
 epsomite composition, 290  
 overview, 570
- Stalagmites  
 characteristics, 572–573  
 composition, 570  
 morphology, 547–548  
 overview, 570  
 precipitation rates, 545–546
- Stalita*, 557  
*Stalita taenaria*, 161, 164  
 Standard metabolic rates, 14  
 Starvation periods, survival methods, 6  
*Steatoda*, 558  
*Steatornis caripensis*, 181, 277, 589  
*Stemops*, 558  
*Stenasellus virei*, 13–15  
*Stenobermuda*, 150  
*Stenobermuda mergens*, 35  
*Stenochrus*, 556  
*Stenocrus portoricensis*, 554  
*Stenopus spinosus*, 151  
 Sternophoridae, 560  
*Stewartpeckius troglobius*, 556  
 Stillstands, cave water table, 397  
 Stiphidiidae, 558  
*Stiphidion*, 558  
 Stopping shafts, description, 447  
 Stories, 442  
 Stratigraphy, Lechuguilla Cave, 340–341  
 Stream captures, 598  
 Streams, Appalachian, species interactions, 541–542  
 Stress response, as adaptive shift factor, 19  
 Striped skunk, foraging, 590  
*Stygicola dentatus*, 33  
*Stygiocaris*, 192  
*Stygiochirapus*, 185  
*Stygnomma*, 564  
 Stygnommatidae, 564  
 Stygnopsidae, 564  
 Stygobionts, 142  
 Stygobites, 142, 166–167, 594–598  
*Stygbromus*, 197, 224, 595  
*Stygbromus canadensis*, 81  
*Stygbromus conradi*, 70  
*Stygbromus emarginatus*, 542  
*Stygbromus gracilis*, 226  
*Stygbromus quatsinensis*, 177  
*Stygbromus spinatus*, 542  
*Stygocarella*, 146  
*Stygocaris*, 146  
*Stygochelifer*, 559  
 Stygofauna  
 Australian diversity patterns, 189  
 biogeography, 594–598  
 marine regression dating, 364–365  
*Stygofauna Mundi*, 224  
*Stygonitrocrella*, 145  
*Stygothrymus*, 556  
*Stygotpyrus*, 383  
*Stygotantulus stocki*, 143–144  
 Stygotrombidiidae, 562  
*Stygotrombidium*, 562  
 Stylocellidae, 563  
*Stylocellus*, 563  
 Subaerial helictites, 549–550  
 Subaqueous helictites, 552–553  
 Subcutaneous karst, 220  
 Subjacent karst, 283  
 Subphylum Crustacea, U.S. diversity, 177–180  
 Subsidence dolines, 118  
 Subsidence sinkholes, 523  
 Subsoil karst, 522  
 Subterranean ecosystems  
 biodiversity mapping  
 interpolators, 356  
 kriging, 356–358  
 modeling issues, 358–360  
 overview, 355  
 spatial process decomposition, 355–356  
 characteristics, 4  
 colonization, 230–231  
 constructive *vs.* regressive traits, 233–234  
 fauna rafting and resettlement, 308  
 inhabitants, 230  
 overview, 230  
 recent *vs.* ancient troglobites, 232–233  
 troglobite genetic and origin models, 231–232  
 troglobite origin, 232  
 troglobites, 230
- Suffosion, 525  
 Suffosional caves, 84  
 Suffosion dolines, 525  
*Sulcia*, 558  
 Sulfates, 374–375  
 Sulfides  
 characteristics, 377  
 hydrothermal karst, 302  
 Sulfidic caves, sulfur bacteria, 98  
*Sulfobacillus*, 100  
 Sulfur bacteria, 98–100, 172  
 Sulfuric acid caves  
 chemical reactions, 574–575  
 Cueva de Villa Luz, 575–577  
 diagnostic features, 574  
 formation, 291  
 geologic setting, 573–574  
 Grand Canyon, 579  
 Guadalupe Mountains, 577–579  
 Kane Caves, 575  
 Lechuguilla Cave, 342

- Sulfuric acid caves (*continued*)  
 microbial interactions, 575  
 MVT deposits, 579–580  
 overview, 573
- Sulfuric acid oil field karst, 580
- Sulfuric acid speleogenesis, sulfur bacteria, 98
- Sullivan Cave, camp, 74
- Sundochnes*, 559
- Superficial karst, 221
- Superstitionidae, 555–556
- Surface big-eyed salamander, 491
- Surface paleohydrology, Friars Hole Cave System, 268–269
- Swiftlets, 194, 277, 589, 591
- Syarinidae, 560
- Symphyla, 404
- Synarida, 146, 189
- Syngenic karst, 283
- Synotaxidae, 558
- Synurella ambulans*, 163
- T**
- Tadarida brasiliensis*  
 cave dwelling benefits, 43  
 cave dwelling costs, 43  
 cave shelter, 590  
 ecosystem services, 44  
 rearing young, 41  
 U.S. diversity, 182
- Tadarida brasiliensis mexicana*, 459
- Tailless whipscorpion, *see* Amblypygi
- Takaka River, as influent river, 509
- Talus caves  
 characteristics, 83  
 recreational caving, 470
- Tantularia, 143–144
- Tapoff passages, morphology, 439
- Tarantula spider, Sistema Huautla, 519
- Tartarocreagris*, 560
- Tartarocreagris texana*, 555
- Tartarus*, 558
- Tayos ashmolei*, 556
- TCE, *see* Trichloroethylene
- Tecto–karstic hollows, 119
- Tectonic caves  
 characteristics, 83  
 recreational caving, 470
- Tectumpilosum*, 561
- Tegenaria*, 557
- Tejachernes*, 559
- Telema*, 558
- Telema tenella*  
 classification, 558  
 distribution, 554
- Telemidae, 558
- Telemofila*, 558
- Teloleptoneta*, 558
- Temnocephalida, 615
- Tennessee cave salamander, 488
- Terminal breakdown, occurrence, 57
- Terrestrial cave animals, energy demand, 7–8
- Terrestrial cavernicoles, population structure, 449–450
- Terrestrial ecotones, 206–207
- Terrestrial epikarst communities, 172
- Terrestrial isopods, adaptive shift, 22
- Terrestrial riparian communities, 172
- Terrestrial transitory organic matter communities, 172
- Territoriality, behavioral adaptations, 55–56
- Tetramblemma*, 558
- Tetramblemmidae, 558
- Tetragnathidae, 558
- Texas blind salamander, 486
- Texella*, 564
- Texella cokendolpheri*, 555
- Texella reddelli*, 555
- Texella reyesi*, 555
- Texoreddellia texensis*, 178
- Thailandoniscus annae*, 150
- Thalassoid limnocybionts, 363–364
- Thalassoid stygobionts, marine regressions, 362–363
- Thalkechops grallatrix*, 405
- Tharp model, breakdown mechanics, 59
- Thaumatogryllus cavicola*, 179
- Theotima*, 558
- Theraphosidae, 557
- Theridiidae, 558
- Theridion*, 558
- Theridiosomatidae, 558
- Thermal caves, sulfuric acid caves, 573
- Thermal erosion, Kazumura Cave, 331–332
- Thermal imaging, entranceless caves, 214
- Thermal springs, 567
- Thermal waters  
 dinaric karst, 165  
 dissolution, 301–302
- Thermoproteus*, 92–93
- Thermosbaenaceans  
 anchialine biodiversity, 26  
 anchialine caves, 34
- Thetispelecaris remex*, 148
- Thiobacillus*, 99, 370
- Thiobacillus denitrificans*, 94
- Thiobacillus ferrooxidans*, 94
- Thiobacillus thioparus*, 370
- Thiomicrospira*, 94, 99, 370
- Thiomonas*, 99, 370
- Thioploca*, 94
- Thiothrix*  
 and anchialine caves, 32  
 cave ecology, 172  
 chemolithoautotrophy, 99, 370  
 reduced inorganic sulfur compounds, 94  
 sulfuric acid caves, 575
- Thiovulum*, 94, 99
- Thread-legged bug, U.S. diversity, 179
- Thyasella*, 562
- Thyasira*, 101
- Thymoites*, 558
- Thyphloniphia*, 558
- Ticks, *see* Acari
- Tiers, 442
- Tiramideopsis*, 192
- Titanatemnus*, 559
- Tooth carp, 241
- Townsend's long-eared bat, distribution, 40
- Toxopsiella*, 557
- Trace metals, in cave waters, 129–130
- Tracers, karst water tracing, 323–325
- Traegardhia*, 562
- Transverse flutes, 315, 317
- Tranteeva paradoxa*, 563
- Travunia*, 564
- Trechus* spp., 160
- Tree frog, Australian diversity patterns, 195
- Tree roots, in lava tubes, 479
- Tremarctos floridanus*, 433
- Triaenonychidae, 564
- Tricharinus*, 556
- Trichloroethylene  
 cave waters, 132  
 karst aquifer transport, 300
- Trichocyclops*, 193
- Trichodamon*, 556
- Trichodrilus*, 618
- Trichouropoda*, 561
- Tricladida, 615
- Tridenchthoniidae, 560
- Tridenchthonius juxtalaucua*, 560
- Triple porosity model, karst aquifers, 294–295
- Trisetobisium*, 560
- Troglelmis*, 224
- Troglobionts, adaptability, 361
- Troglobisium*, 560
- Troglobites, *see also specific troglobites*  
 adaptation to darkness, 2  
 aquatic, population structure, 450–451  
 biogeography, 593–594  
 classification, 556  
 darkness adaptation, 3  
 derivation, 2–3  
 as ectotherms, 8–9  
 evolution habitats, 478  
 and food limitations, 256  
 genetic and origin models, 231–232  
 population structure, 449  
 recent *vs.* ancient, 232–233  
 single *vs.* multiple origin, 232  
 subterranean ecosystems, 230  
 tropics, 167  
 U.S. diversity, 179
- Trogloblatella*, 193–194
- Trogloblatella nullarborensis*, 188
- Troglobochica*, 559
- Troglocambarus*, 151, 178
- Troglocambarus maclanei*, 390
- Troglocaris anophthalmus*, 162
- Troglocaris* sp., 36, 163, 165
- Troglochernes*, 559
- Troglochthonius*, 559
- Troglocormus ciego*, 555
- Troglocormus willis*, 555
- Trogloidiplura*, 193
- Trogloidiplura lowryi*, 557
- Trogloglanis pattersoni*, 180
- Trogloguignotus*, 224
- Troglohalacarus*, 562
- Troglohya*, 559
- Troglohyphantes*, 161, 558
- Trogloianiropsis lloberai*, 35
- Trogloiulus*, 406
- Trogomorphy  
 and adaptation, 389–390  
 adaptation evidence, 390–392

- Trogomorphy (*continued*)  
 and biogeography, 592–593  
 characteristics, 2, 278–279  
 constructive *vs.* regressive traits, 233–234  
 definition, 142, 171  
 evolution, 386–387  
 and natural selection, 409  
 occurrence, 392–393  
 overview, 386  
 recent *vs.* ancient troglobites, 232–233  
*Trogomysis hercegovinensis*, 163  
*Trogloneta*, 558  
 Troglomorphs, subterranean ecosystems, 230  
*Troglophilus*, 454  
*Troglophynchus monteleanii*, 49  
*Troglophynchus*, 160  
*Troglosiro aelleni*, 563  
 Trogloniridae, 563  
*Troglotynopsis*, 564  
*Troglotayosicus cavicola*, 555  
*Troglotayosicus poncho*, 555  
*Troglotayosicus reddelli*, 555  
*Troglotayosicus rhodesi*, 555  
*Troglotayosicus vachoni*, 555  
*Troglotohele coeca*, 557  
 Troglonexes  
 food quality, 259  
 subterranean ecosystems, 230  
*Trombicula*, 562  
 Tropics  
 biodiversity patterns, 167–169  
 diversity, historical context, 166  
 state of knowledge, 166–167  
 subterranean habitats, 166  
 temperate subterranean biodiversity  
 comparison, 169–170  
 Tubes, Kazumura Cave, 332–333  
 Tubeworms  
 anchialine fauna, 33  
 characteristics, 163  
 chemolithoautotrophy, 101  
 Tunnels, recreational caving, 470  
*Tupua*, 558  
 Turbellaria, 174, 176, 615  
 Turbidity, spring discharges, 569  
 Turkey vulture, U.S. diversity, 181  
 Twilight zone, entrances, 219  
*Typhlatya*  
 anchialine caves, 34  
 biogeography, 35  
 characteristics, 29  
 troglomorphic adaptations, 27  
*Typhlichthys subterraneus*  
 biogeography, 595–596  
 evolution, 393–394  
 feeding behavior, 51  
 life history evolution, 347–348  
 pineal organ, 244  
 reproductive effort, 349  
 sensory compensation, 246  
 U.S. diversity, 180  
*Typhlocaris lethaea*, 34, 37  
*Typhlochactas*, 554  
*Typhlocirolana* spp., 34  
*Typhlogammarus mrazeki*, 162, 164  
*Typhlonesticus*, 558  
*Typhloroncus*, 560  
*Typhlothrombium*, 562  
*Typhlotriton braggi*, 487  
*Typhlotriton nereus*, 487  
*Typhlotriton spelaeus*, 487  
*Typhobunellus*, 564  
*Tyrannochthonius*  
 Australian diversity patterns, 193  
 classification, 559–560  
 U.S. diversity, 177  
*Tyto alba*, 590
- U**  
*Uetigiglanis zammaroni*, 242  
 UIS, *see* International Union of Speleology  
 Ukrainian Caves  
 hydrogeology, 584  
 large caves, 584–585  
 maze caves, 585–587  
 Miocene rocks, 583–584  
 overview, 583  
 sediments, 586–587  
*Undarana*, 194  
 Underflow springs, 567  
 Underground shallow medium, 220  
 Underprinting, 116  
 Underwater cave exploration, 235, 238–239  
 Underworld, myths and legends, 406  
 United States  
 Amphibia, 180–181  
 Arachnida, 176–177  
 Aves, 181  
 cave distribution, 172–174  
 cave ecology, 171–172  
 cavernicole distribution, 172–174  
 diversity, overview, 170–171  
 glaciated plateaus, 534–535  
 Hexapoda, 178–179  
 Insecta, 179–180  
 karst distribution, 172–174  
 Malacostraca, 177–178  
 Mammalia, 181–182  
 Maxillopoda, 177  
 Mollusca, 176  
 Oligochaeta, 176  
 Osteichthyes, 180  
 Reptilia, 181  
 Turbellaria, 174, 176  
 Unsaturated zone, solution caves, 528  
 Upper Palaeolithic period, Middle East cave  
 dwellers, 88–89  
 Uranium deposits, sulfuric acid caves,  
 579–580  
*Uroctonus grahami*, 177, 556  
*Urodacus*, 193  
*Uroobovella*, 561  
*Uropoda*, 561  
 Uropodidae, 561  
*Uroseius*, 561  
*Ursus arctos*, 432, 508  
*Ursus deningeri*, 432  
*Ursus spelaeus*, 432, 508  
 U.S. Deep Caving Team, 607–608  
 USDCT, *see* U.S. Deep Caving Team  
*Usofila*, 558
- V**  
*Vachonium*, 559  
 Vadose passages, morphology, 438  
 Vadose water  
 breakdown initiation, 60  
 flank margin caves, 124  
 Nullarbor Caves, 423  
 Vadose zone  
 cave water table, 397  
 solution caves, 528  
*Vaejovis gracilis*, 556  
 Vampire bats  
 cave dwelling benefits, 43  
 cave roosts, 40  
 foraging, 590  
 paradox, 44–45  
*Vamyrum spectrum*, 41  
 Vanadates, 377  
 Vaucluisian springs, 566  
 Velebit Mountains, doline evolution, 113, 116  
*Velkovrhia enigmatica*, 162–163, 227  
 Venetian Fore-Alps, doline evolution, 113  
 Vermiform, 550  
 Vertebrate visitors  
 Australian diversity patterns, 195  
 cave-dwelling species, 589–590  
 and cave ecology, 590  
 caves as shelter, 590  
 foraging habitats, 590  
 U.S., treatment, 180–182  
 Vertical caves  
 exploration skills, 235  
 going down, 237  
 going up, 237  
 as natural traps for bone, 431  
 Vertical shafts, description, 445–446  
*Victatrombium*, 562  
*Vima*, 564  
*Vima chapmani*, 564  
 Visitors' capacity, show caves, 497  
*Viverra*, 590  
 Voids, recreational caving, 470  
 Volcanic caves  
 lava tube development, 600–602  
 overview, 599  
 smaller caves, 599–600  
 Volcanic eruptions, in lava tube development, 600  
 Volcanic throats, 599–600  
 Vole, 589  
 Voronja Cave, *see* Krubera Cave  
 Vuggy rocks, breakdown mechanics, 59  
 Vugs, nonaqueous phase liquids, 136  
*Vulcanochthonius*, 560  
*Vulgarogamasus*, 561  
*Vulpes vulpes*, 590
- W**  
 Wakulla Spring Underwater Cave System,  
 Florida  
 exploration and mapping, 607–608  
 future, 608  
 geologic framework, 604  
 hydrology, 605–606  
 overview, 603–604  
 paleontology, 604

- Walckenaeria*, 558  
*Wandella*, 193  
*Wandesia*, 562  
*Wanops*, 558  
 Warm springs, 567  
 Water, *see also* Groundwater  
   allogenic, influent streams, 510  
   breakdown initiation, 60  
   dinaric karst, 165  
   dissolution, 301–302  
   flank margin caves, 124  
   heavy metals  
     contaminant metals, 129–130  
     general chemistry, 128–129  
     iron and manganese, 129  
     metal storage and transport, 130  
     natural and anthropogenic sources, 127–128  
     speleothems, 130  
     storm-enhanced transport, 130–131  
     suspended and bed sediments, 130  
     trace metals, 129–130  
   human impact, 614  
   mineral precipitation, 613–614  
   NAPLs  
     characteristics and sources, 132–134  
     epikarst transport, 134  
     overview, 131  
     transport into karst aquifers, 134  
   Nullarbor Caves, 423  
   speleothem formation, 613–614  
 Water caves, exploration, 238  
 Water chemistry  
   aqueous solution saturation state, 611  
   calcite dissolution, 611–612  
   CO<sub>2</sub> in calcite solubility, 609–610  
   groundwater in limestone, 610–611  
   limestone dissolution, 609, 612–613  
   mineral precipitation, 613–614  
   overview, 609  
   speleothem formation, 613–614  
 Waterfall shafts, description, 446  
 Water flow, passive dispersal, 308  
 Water movement, glacier caves, 271–272  
 Water quality, karst aquifers, 299–300  
 Watershed, cave preserve design, 460  
 Water-soluble compounds, karst aquifer transport, 300  
 Water table  
   and caves, 397–398  
   karst aquifers, 297–298  
   Mammoth Cave, 399  
   solution caves, 528  
 Water tracing, karst aquifers  
   definitions and objectives, 321–322  
   history, 322–323  
   with passive detectors, 325–327  
   quantitative tracing, 327  
   test interpretations, 327–329  
   tracers, 323–325  
 Water-treader, U.S. diversity, 179  
 Water wells, karst aquifers, 299  
 Weathering, 132  
 Wells, nonaqueous phase liquids, 136  
*Wendilgarda*, 558  
 Western Shield, Australian diversity patterns, 184–185  
 West Virginia spring salamander, 488  
 Wetlands, 567–568  
 White-rumped swiftlet, Australian diversity patterns, 195  
 Wind Cave  
   camp, 74  
   characteristics, 314  
 Withidae, 560  
 WKPP, *see* Woodville Karst Plain Project  
 Wolf spiders  
   adaptive shift, 23  
   classification, 558  
 Wood chuck, U.S. diversity, 181  
 Woodville Karst Plain Project, Wakulla Spring Underwater Cave System, 607  
 Worms  
   Annelida, 616–617  
   characteristics, 614–615  
   ecological overview, 618  
   flatworms, 615  
   Oncychophora, 618  
   phylogenetic overview, 618  
   proboscis worms, 616  
   research history, 615  
   ribbon worms, 616  
   roundworms, 615–616  
*Wugigarra*, 193
- X**  
*Xibalba*, 406–407
- Y**  
*Yardiella*, 193  
 Yates Formation, Lechuguilla Cave, 340  
*Yuria pulcra*, 564
- Z**  
 Zalmoxidae, 564  
 Zebrafish, neutral mutation, 412  
*Zercon*, 561  
 Zerconidae, 561  
*Zospeum*, 163  
*Zospeum amoenum*, 163  
*Zospeum exiguum*, 382  
 Zygentoma, Australian diversity patterns, 193