



guide

shecco publications

GUIDE 2014: NATURAL REFRIGERANTS
CONTINUED GROWTH & INNOVATION IN EUROPE



The information in this report, or upon which this report is based, has been obtained from sources the authors believe to be reliable and accurate. While reasonable efforts have been made to ensure that the contents of this publication are factually correct, shecco does not accept responsibility for the accuracy or completeness of the contents, and shall not be liable for any loss or damage that may be occasioned directly or indirectly through the use of, or reliance on, the contents of this publication.

GUIDE 2014: NATURAL REFRIGERANTS

CONTINUED GROWTH AND INNOVATION IN EUROPE

This project was supported by



TABLE OF CONTENTS

| | |
|---|----|
| WELCOME MESSAGE BY THE PUBLISHER | 6 |
| ABOUT THIS GUIDE..... | 7 |
| ABOUT NATURAL REFRIGERANTS..... | 10 |
| APPLICATIONS OF NATURAL REFRIGERANTS IN EUROPE..... | 14 |
| CITY, BUILDINGS & TRANSPORT..... | 15 |
| INDUSTRY..... | 23 |
| SPORTS..... | 25 |
| NATURAL REFRIGERANTS IN THE EUROPEAN FOOD CHAIN: APPLICATION AREAS & END-USER VIEWS | 28 |
| APPLICATION AREAS | 29 |
| Food Storage & Distribution..... | 29 |
| Food Processing..... | 30 |
| Beverages: Breweries & Wineries..... | 36 |
| Fishing: Processing Plants, Vessels & Container Ships..... | 37 |
| END-USER VIEWS ON NATURAL REFRIGERANTS IN COMMERCIAL REFRIGERATION..... | 39 |
| NATURAL REFRIGERANTS IN THE EUROPEAN FOOD CHAIN: MARKET & TECHNOLOGY MAPS..... | 40 |
| CO ₂ TRANSCRITICAL STORES IN EUROPE..... | 41 |
| CO ₂ CASCADE STORES IN EUROPE | 48 |
| CO ₂ TRANSCRITICAL AND CO ₂ /HFC STORES IN EUROPE < 2006 - 2013 | 54 |
| HC PLUG-IN AND INDIRECT NH ₃ AND HC SUPERMARKETS IN EUROPE..... | 56 |
| CO ₂ AND HC LIGHT-COMMERCIAL REFRIGERATION IN EUROPE | 60 |
| NATURAL REFRIGERANTS IN STORES AROUND THE WORLD..... | 63 |
| THE EUROPEAN MARKET TODAY & TOMORROW..... | 70 |
| NATURAL REFRIGERANT SUPPLIER MAP | 71 |
| NATURAL REFRIGERANT TECHNOLOGY - COMMERCIAL AVAILABILITY 2013-2025..... | 74 |
| POLICY | 74 |
| EUROPEAN UNION POLICIES..... | 77 |
| Natural Refrigerants, Vision & Enforceability..... | 77 |
| MAC Directive & F-Gas Regulation Review..... | 78 |
| HCFC Phase-out, Ecodesign & Ecolabel..... | 82 |

| | |
|--|-----|
| NATIONAL POLICIES..... | 85 |
| CASE STUDIES | 87 |
| ADVANSOR | 88 |
| ALFA LAVAL | 90 |
| CARRIER | 92 |
| DANFOSS | 94 |
| DSI | 96 |
| DANISH TECHNOLOGICAL INSTITUTE | 98 |
| EMERSON, GREEN & COOL | 100 |
| GEA..... | 102 |
| JOHNSON CONTROLS | 104 |
| MAYEKAWA | 106 |
| SINTEF | 108 |
| EUROPEAN INDUSTRY SURVEY..... | 110 |
| RESPONDENTS PROFILE..... | 111 |
| NATURAL REFRIGERANTS USE & GEOGRAPHIC MARKETS..... | 115 |
| USE OF REFRIGERANTS PER APPLICATION | 116 |
| CURRENT NATURAL REFRIGERANTS PRODUCTS & SERVICES..... | 117 |
| NATURAL REFRIGERANTS STAFF TODAY AND BY 2020..... | 119 |
| NATURAL REFRIGERANTS R&D ACTIVITIES TODAY AND BY 2020..... | 120 |
| PURCHASING CRITERIA FOR HVAC&R TECHNOLOGY & WILLINGNESS TO PAY FOR NATURAL REFRIGERANTS..... | 122 |
| NATURAL REFRIGERANTS: NEW PRODUCTS & SERVICES..... | 123 |
| NATURAL REFRIGERANTS: OUTLOOK 2020 BY APPLICATION | 124 |
| EUROPEAN NATURAL REFRIGERANT BUSINESS DIRECTORY..... | 129 |
| SUPPORTERS DIRECTORY..... | 130 |
| DIRECTORY..... | 133 |
| REFERENCES..... | 182 |
| ABOUT THE AUTHORS..... | 194 |

WELCOME MESSAGE BY THE PUBLISHER



MARC CHASSEROT

Publisher /
Managing Director of shecco

SO WHY A 2ND EDITION FOR GUIDE EUROPE?

Europe is market leader for natural refrigerant based HVAC&R technologies and things are moving fast. It's been two years since we launched our first GUIDE Europe and we felt that it was time to provide an update.

You will see some exciting data including super-markets (including, CO₂ transcritical, cascades and plug-in units for hydrocarbons) as well as a supplier map and directory with over 400 companies working with natural refrigerants. You will see case studies of these technologies being implemented as well as "market expectations" of

where natural refrigerants will come next. Our industry survey is full of exciting insights that can help you to plan better for the coming years.

In all nearly 200 pages of valuable information about this fast growing trend.

Happy Reading

ABOUT THIS GUIDE

A SHORT OVERVIEW



NINA MASSON

Lead Author /
Head of Market Research of
shecco

At least 420 companies are currently active in providing natural refrigerant-based solutions, products and services, across Europe. This is a strongly conservative estimation and the starting point for the most comprehensive specialised business directory currently available - a listing that concludes this "GUIDE 2014: Natural Refrigerants - Continued Growth and Innovation in Europe".

The growing number of organisations involved in driving the market for technology free of fluorinated gases also testifies to the leadership role Europe has taken in the adoption of natural refrigerants. This GUIDE, as a completely updated version to the very first in the GUIDE publication series launched in 2011, has as its ultimate objective to track dynamic market developments over the last two years, such as visualising the fast-growing evolution of food retail stores using carbon dioxide as a refrigerant in their refrigeration systems, or the likely emergence of HFC-free solutions in sectors not yet among the mainstream markets.

It also comes at a point in time when proposed European-level rules on the restricted or banned use of f-gases are expected to take effect this year. They will determine the direction that HVAC&R system and component suppliers, contractors and training institutes, but more importantly commercial and industrial end-users, will be taking in their refrigerant choice until 2020 and beyond.

And solutions are already there. According to an industry survey conducted by shecco among 376

European heating, refrigeration and air conditioning experts exclusively for this GUIDE, products and services to replace HFCs or HCFCs have become mainstream solutions in some areas while moving quickly forward to take this role within the next decade. The role of natural refrigerant solutions in terms of an organisation's products and services offered, staff numbers involved, research & development activities dedicated, and new geographic markets opened, is expected to significantly grow in importance over the following years - up from solid levels already today among those early adopters acknowledging the commercial and other benefits of natural refrigerant solutions. More importantly, both respondents using and not yet using natural refrigerants believe that new applications are on the horizon for HFC-free solutions, such as in Mobile Air Conditioning or transport refrigeration.

Chapter 1 - About Natural Refrigerants - briefly summarises the characteristics of the "natural five" ammonia, carbon dioxide, hydrocarbons, water, and air. All substances have distinct characteristics that make them viable options for a wide application range. The chapter talks about the most commonly used natural working fluids and their chemical, physical, technical and environmental properties, as well as existing challenges.

Chapter 2 - Applications of Natural Refrigerants in Europe - depicts their use in three "ecosystems": City, Buildings & Transport; Industry; and Sports. The purpose of the "ecosystems" is to highlight the

variety of examples of natural refrigerant products and technologies in Europe, especially over the last two years (2011-2013). Real-life cases in public & commercial buildings, private residential housing district heating and cooling, data centres, buses, trucks, trains, and passenger (electric) vehicles are highlighted. Adoption in the chemical, petrochemical, pharmaceutical or agricultural sectors are mentioned, as well as the use of natural refrigerants in large sports venues.

Chapter 3 - Natural Refrigerants in the European Food Chain / Application Areas & End-User Views - is this GUIDE's focus section dedicated to a 4th ecosystem that has shown highly dynamic developments in the last years. Graphics depict the use of HFC-free systems from "field to fork", throughout the whole food chain, to show their application throughout food sourcing, production & processing, transport, food retail and restaurants. The chapter concludes with public statements from leading food retailers and consumer goods brands on natural refrigerants in light-commercial refrigeration, as well as commercial refrigeration generally, in warm climates and in convenience stores.

Chapter 4 - Natural Refrigerants in the European Food Chain / Market & Technology Maps - examines and depicts first the market for commercial CO₂ transcritical refrigeration systems, a market that is quickly gaining further momentum in Europe. shecco's completely updated supermarket map shows an increase of 117% in the number of

CO₂ transcritical supermarkets within two years. For the first time, a new map provides figures on the European market with CO₂ cascade systems. In a 2nd section on other natural refrigerant solutions in stores and in light-commercial applications, new market maps visualise that a growing number of retailers rely on central ammonia and hydrocarbon systems. More than 480,000 hydrocarbon plug-in supermarket cabinets in operation prove that other natural solutions are ready for the market. With consumer good brands committed to environmental stewardship, the number of CO₂ and HC freezers and coolers is growing in Europe. A 3rd section depicts that while Europe still leads in the adoption of CO₂ refrigeration technology in supermarkets, other world regions are gaining momentum. A world map shows where more than 5,000 stores using CO₂ transcritical and cascade/secondary refrigeration systems are located.

Chapter 5 - The European Market Today & Tomorrow - visualises for the first time in a "Natural Refrigerant Suppliers Map" in which countries the over 400 system manufacturers, component suppliers, contractors, consultancies and engineering businesses offering natural refrigeration solutions are headquartered. A 2nd section investigates the commercial availability of natural refrigerant solutions in the following decade. To provide suppliers, end-users and policy-makers with an indication about the commercial availability of refrigeration and air-conditioning equipment using natural refrigerants, a table indicates their production capac-

ity for a variety of sectors across the European Union, between today and 2025.

Chapter 6 - Policy - describes how laws, standards and rules are among the decisive factors for building a prosperous business around natural refrigerants within a framework of investment security and joint leadership. This chapter provides an analysis of selected policy initiatives in Europe, among them the new proposed changes to the F-Gas Regulation, that have an impact on the HVAC&R industry in general and the uptake of natural refrigerants in particular. A next section discusses best practice policy initiatives at the national level in selected European countries, and provides an example of one national regulation restricting the use of natural refrigerants.

Chapter 7 - Case Studies - presents a selection of outstanding real-life cases, covering commercial and industrial heating, air-conditioning and refrigeration solutions. Such examples of successfully working technologies are the strongest arguments for spreading innovative solutions, engaging legislators and convincing end-users. Examples cover cases from suppliers based and/or active in Europe.

Chapter 8 - European Industry Survey - summarises the results from 367 HVAC&R industry experts responding to an open survey running until November 2013. After a summary of respondents profiles, the chapter presents findings in three sections: 1) Current refrigerant use, share of products

& geographic markets: This first section provides an overview of refrigerant use by application sector and response group. It highlights current leading European markets for NR, the present share of products & services from an organisation's total HVAC&R activities, and the expected change in such activities in the next 7 years. 2) Staff and R&D, purchasing factors & willingness-to-pay: This section investigates the percentage of staff involved in NR-related activities, as well as the share of R&D activities dedicated to natural refrigerants currently and by 2020. Moreover, drivers for NR-related R&D and priority partners for such activities are identified. End-users' general purchasing criteria and their willingness to pay for NR technology are evaluated. 3) Outlook 2020: Natural refrigerant applications in Europe: The final section explores respondents' plans to provide new natural refrigerant products and services in the next 7 years. The expected total market share of NR solutions across Europe in 2020, by refrigerant and application, is shown.

The "GUIDE 2014: Natural Refrigerants - Continued Growth and Innovation in Europe" concludes with a **European Natural Refrigerant Business Directory**, presented in two parts: firstly, a directory listing the supporters for this GUIDE edition; and secondly a directory of other European-based companies involved in the natural refrigerants business. Sorted by country, the directory indicates the type of activities, main HVAC&R industry sectors covered, as well as the natural refrigerants used in products and services. It lists and categorises sys-

tem manufacturers, component suppliers, contractors & installers, as well as marketing and consulting firms in the sector in European countries.

In a nutshell, this GUIDE summarises state-of-the-art technology, captures industry's and end-users' views, tracks market trends in the period 2011-2013, and highlights areas of use potential today and by 2020. It puts forth evidence that "Continued Growth and Innovation in Europe" can solidify the region's world-leading position in many sectors using natural refrigerants, but it also unveils that even stronger commitment is needed to overcome remaining challenges.

By informing end-users, suppliers and legislators about today's and future market realities it is hoped that this GUIDE can facilitate this important process.



ABOUT NATURAL REFRIGERANTS

As a general differentiation, “natural refrigerants” are substances that exist naturally in the environment, while “non-natural refrigerants” or “synthetic refrigerants” are man-made chemicals, not naturally occurring in the environment.

The following section provides a short overview of the “Natural Five”. Air, ammonia, carbon dioxide, hydrocarbons and water have distinct characteris-

tics that make them viable options for a wide application range today and tomorrow. The following section about the most commonly used natural working fluids and their chemical, physical, techni-

cal and environmental properties, as well as existing challenges, shall serve as a brief introduction.

ABOUT NATURAL REFRIGERANTS

AN OVERVIEW

As a general differentiation, “natural refrigerants” are substances that exist naturally in the environment, while “non-natural refrigerants” or “synthetic refrigerants” are man-made chemicals, not naturally occurring in the environment. The precision of the term “natural refrigerants” is sometimes debated, given that, to be used as refrigerants, ammonia, carbon dioxide, and hydrocarbons also undergo an industrial purification and manufacturing process.

However, today there is a well-established distinction between substances whose chemical properties and safety aspects have been studied in their entirety, and those fluorinated gases which, given their chemical complexity and comparatively short period of usage, have confirmed and/or have unknown negative effects on ozone depletion, global warming and ecological safety, and therefore, are subject to continued debate.

The most commonly used natural refrigerants today are ammonia (NH₃, R717), carbon dioxide (CO₂, R744), and hydrocarbons (HCs), such as propane (R290), iso-butane (R600a), and propylene, also known as propene (R1270).

Mixtures of ammonia and dimethyl ether (R723) have been developed, as well as various hydrocarbon blends with optimised performance and safety properties (isobutane/ propane; R441 etc.). Water and air are also used, to a lesser extent, for example in adsorption chillers and deep-freezing applications.

In addition to their wide availability, their non-toxicity, non-flammability, and their unbeatable environmental credentials have, once again, shifted water and air into the focus of R&D activities. Natural refrigerants no longer in use are sulphur dioxide (SO₂) and methyl chloride (CH₃Cl).

CARBON DIOXIDE (ODP= 0; GWP= 1)



Carbon dioxide (chemical symbol CO₂, refrigerant designation R744) is colourless, odourless, and heavier than air. With a Global Warming Potential (GWP) = 1, CO₂ is the reference value for comparing a refrigerant’s direct impact on global warming.

Carbon dioxide carries an A1 safety classification (the same as most fluorocarbon refrigerants), indicating that it has low toxicity and is nonflammable. CO₂ as a refrigerant is sourced as a by-product from a number of production methods. Although it is nontoxic, if enough carbon dioxide builds up in an enclosed space, it will begin to displace oxygen. Over a certain period of time, this can cause asphyxiation of those present. With a long atmospheric lifetime, CO₂ does not lead to any by-product formation or decay products with serious environmental impact.

When used as a refrigerant, carbon dioxide typically operates at a higher pressure than fluorocarbons and other refrigerants. While this presents some design challenges, it can be overcome in systems designed specifically to use carbon dioxide. Carbon dioxide is compatible with some, but not all, commonly used refrigeration system lubricants. In particular, it is not suited for use with polyol es-

ter (POE) and poly vinyl ether (PVE) lubricants, and it only has limited applications with poly alkylene glycol (PAG) lubricants. It is generally regarded as a cheap and easily available refrigerant.

AMMONIA (ODP= 0; GWP= 0)



Ammonia (chemical symbol NH₃, refrigerant designation R717) is a colourless gas at atmospheric pressure. With zero ozone-depletion and global warming potential, as well as a short atmospheric lifetime, it does not form any by-products or decomposition products with negative environmental impact. It is compatible with some, but not all, commonly used refrigeration system lubricants. In particular, it is not suited for use with polyol ester (POE) and poly vinyl ether (PVE) lubricants, and it only has limited applications with poly alkylene glycol (PAG) lubricants.

Despite its undisputed energy efficiency benefits, the use of ammonia is restricted in certain applications and geographic regions, due to its toxicity and flammability. As a result, R717 is effectively prohibited from use inside occupied spaces but can be used in unoccupied areas or outside.

However, many advances have been made in recent years to minimise risks for human health, particularly for ammonia installations in populated areas. These advances include using ammonia in conjunction with other refrigerants, such as in secondary systems, in order to reduce and isolate an ammonia charge, using advanced safety equipment, deploying containment casings, or using ammonia absorption systems.

It is important to note that ammonia has a strong odour, making leaks easy to detect. The additional safety equipment required will obviously increase costs; however, manufacturers claim that operational energy and maintenance savings potentially outweigh the higher initial outlay in the long run.

HYDROCARBONS (ODP= 0; GWP< 4)

HC With zero ozone-depleting characteristics and an ultra-low global warming impact, the group of hydrocarbons (HCs) does not form any by-products or decomposition products in the atmosphere.

HC refrigerants can be applied either in systems designed specifically for their use, or as replacements in a system designed for a fluorocarbon refrigerant.

This makes them a cost-competitive solution, and optimal for developing countries. If a hydrocarbon refrigerant is to be used in a system designed for a different refrigerant, it should be noted that modifications are probably be required to ensure compatibility. Lubricant compatibility and the issues associated with hydrocarbons' flammability have to be addressed. However, the greatest potential for hydrocarbon refrigerants lies in new systems.

Hydrocarbon refrigerants are flammable and, as a result, carry an A3 safety classification, which means they have a low toxicity but are in the higher range of flammability. HCs are often subject to stricter safety requirements concerning the quantities permitted in occupied spaces.

Hydrocarbon refrigerants are fully compatible with almost all lubricants commonly used in refrigeration and air conditioning systems. One major ex-

ception to this rule is lubricants containing silicone and silicate (additives which are commonly used as antifoaming agents).

WATER (ODP= 0; GWP= 0)

H₂O Water (chemical symbol H₂O, refrigerant designation R718) is one of the oldest refrigerants used for refrigeration applications. Also known as dihydrogen monoxide, water or water vapour is one of the Earth's most abundant elements. Water has been extensively used as a process fluid (distillation, drying processes), as a heat transfer or energy storage medium (central heating, system cooling, ice storage systems) and as a working fluid in the Rankine power generation cycle. R718 is an environmentally safe refrigerant with zero ozone depletion potential and zero global warming potential. It is odourless, colourless, nontoxic, non-flammable, non-explosive, easily available, and it is the cheapest refrigerant.

In refrigeration applications, water requires state-of-the-art technology. Its use as a refrigerant has been mostly limited to compression chillers with steam injection compressors, absorption systems built around a binary fluid comprised of lithium bromide as the absorbent, and adsorption systems using water as the refrigerant and the mineral zeolite as the adsorber.

From an environmental and thermodynamic point of view, water is an ideal refrigerant for applications above 0°C. R718 has a higher latent heat of evaporation (2,270kJ/ kg) than other natural refrigerants. R718 absorbs significantly larger amounts of energy, in the form of heat, during a change of phase from liquid to gas, without a change in temperature.

An obvious limitation is the high freezing rate at atmospheric pressure. Water leads to corrosion and oxidation of many metals. Water is more reactive than other refrigerants and choosing the right materials for the R718 system during the design phase requires special attention.

AIR (ODP= 0; GWP= 0)

AIR Air (refrigerant designation R729) is a refrigerant that is environmentally benign, cheap, totally safe, and nontoxic. Environmental concerns about ozone depletion, global warming, and increasingly stringent legislation have renewed the interest in alternative refrigeration technology globally. However, the use of air cycle refrigeration systems is not new. It was used on refrigerated cargo ships around the turn of the last century.

Air cycle refrigeration works on the reverse Brayton or Joule cycle. Air as a refrigerant does not undergo phase change (condensation/evaporation) at the temperature levels encountered in conventional refrigeration applications. The COP value of air is low because of its light weight, but air cycle cooling systems can provide relatively high temperature heat recovery without the efficiency set back experienced by vapour compression systems. Air cycle units, compared to vapour-compression units, can also produce a much higher temperature difference between the hot and cold sides. As a result, very cold air can be produced for near-cryogenic processes. The performance of an air cycle unit does not deteriorate as much as that of a vapour-compression unit when operating away from its design point.

When operating in a refrigeration cycle, an air cycle unit can also produce heat at a useful temperature.

Air has been used commercially for aircraft cooling for a long time. In spite of the low COP, air is used because of the specific operating conditions of aircraft (e.g., availability of compressed air and ram effect) and stringent specifications (e.g., low weight, small size, absolute safety, zero toxicity, etc.). Air has also been used as a refrigerant for residential and automobile air conditioning and cooling. In some refrigeration plants, air is used in the quick freezing of food products.

| REFRIGERANT | REFRIGERANT NUMBER | CHEMICAL FORMULA | GWP (100 YEARS) | ODP | NORMAL BOILING POINT (°C) | CRITICAL TEMPERATURE (°C) | CRITICAL PRESSURE (BAR) | SAFETY GROUP | MOLECULAR WEIGHT (G/MOL) |
|----------------|--------------------|--------------------------------|-----------------|-----|---------------------------|---------------------------|-------------------------|--------------|--------------------------|
| Ammonia | R717 | NH ₃ | 0 | 0 | -33.3 | 132.4 | 114.2 | B2 | 17.03 |
| Carbon dioxide | R744 | CO ₂ | 1 | 0 | -78 | 31.4 | 73.8 | A1 | 44.0 |
| Propane | R290 | C ₃ H ₈ | 3.3 | 0 | -42.1 | 96.7 | 42.5 | A3 | 44.10 |
| Isobutane | R600a | C ₄ H ₁₀ | 4 | 0 | -11.8 | 134.7 | 36.48 | A3 | 58.12 |
| Propylene | R1270 | C ₃ H ₆ | 1.8 | 0 | -48 | 91 | 46.1 | A3 | 42.08 |
| Water | R718 | H ₂ O | 0 | 0 | 100 | 373.9 | 217.7 | A1 | 18.0 |
| Air | R729 | - | 0 | 0 | -192.97 | - | - | - | 28.97 |

APPLICATIONS OF NATURAL REFRIGERANTS IN EUROPE

AN ECOSYSTEM APPROACH



CITY, BUILDINGS & TRANSPORT

Natural refrigerants can be used in a variety of applications in public & commercial buildings, private residential housing, district heating & cooling and data centres. In the European public transport sector, natural refrigerants are also used in buses, trucks, trains, electric vehicles & fuel stations. The section provides an overview of latest developments in both areas.

PAGE 15



INDUSTRY

For industrial processes in the chemical, petrochemical, pharmaceutical and construction sectors, as well as in agriculture, natural refrigerant-based systems are more and more used to provide effective and stable cooling and heating solutions.

PAGE 23



SPORTS

Today, the natural refrigerants ammonia and CO₂ are already used in the construction of ice rinks, ski slopes, and swimming stadiums in many European countries. This chapter highlights the main applications of natural refrigerants in large sport facilities in Europe.

PAGE 25

CITY, BUILDINGS & TRANSPORT

INTRODUCTION

Following the 1st edition of the GUIDE Europe published in 2012, this chapter provides updated information on installations and successful applications of natural refrigerants in Europe today. For previous case studies, please refer to the "GUIDE 2012: Natural Refrigerants - Market Growth for Europe."¹

The purpose of the "ecosystems" is to highlight the current development of a variety of examples of natural refrigerant products and technologies in Europe. The examples mentioned aim to provide insights into the experiences of a range of European manufacturers, suppliers and contractors, as well as end users that drive the adoption of natural refrigerant-based technology. The cases highlighted also allow for a deeper analysis of the different business models currently used in various industrial sectors in Europe:

- **FOOD CHAIN:** Food & beverage storage, distribution, production & processing, food transport refrigeration and food retail
- **INDUSTRY:** Industry processing, construction and agriculture
- **SPORTS:** Ice rinks, ski slopes, and swimming stadiums
- **CITY, BUILDING & TRANSPORT:** Public & commercial buildings, data centres, district heating & cooling, private residential housing, and transport facilities

The GUIDE Europe 2014 has dedicated an entire focus section to the Food Chain, following this chapter about various applications in Europe.

CITY, BUILDINGS & TRANSPORT

PUBLIC & COMMERCIAL BUILDINGS: AIRPORTS, OFFICE & GOVERNMENT BUILDINGS, HOSPITALS, UNIVERSITIES, LABORATORIES, HOTELS, SHOPPING MALLS & MARKETS

CO₂: With a high demand for hot water, O'Donovan's Hotel in Clonakilty town, West Cork, Ireland, installed a 25kW CO₂ heat pump. The CO₂ heat pump can operate at a seasonal performance factor of 3.2 when generating hot water at 75°C in ambient conditions of 9.4°C air temperature and 10°C water inlet temperature. The Cúil Dídin Residential and Nursing Care Facility in Ireland also opted for a CO₂ heat pump to ensure a more energy efficient and secure hot water supply. The new CO₂ heat pump is capable of producing 2,500 litres of hot water per night at 90°C. Overall, cost savings are around 70-80%.

The recently renovated Café Royal in London installed a CO₂ refrigeration system, making this iconic hotel the first to use a CO₂ refrigeration system in London. The CO₂ system is used to cover the refrigeration demand for both coldrooms and kitchen refrigeration, which provides complete flexibility in terms of delivered temperature and is also highly efficient with the capability of providing 100% heat recovery. A CO₂ refrigeration system was also installed to provide the on-site catering refrigeration requirements for patients and hospital staff at the Homerton University Hospital in London. This CO₂ system takes advantage of the existing 2 x 500 kW ammonia chillers to supply the con-

denser cooling, which eliminated the need for any additional remote coils. The complete system now operates on natural refrigerants, with the ammonia system providing the condenser cooling and the CO₂ system providing the critical cooling via the evaporators. Harrods store in Knightsbridge in London, installed a new refrigeration system using CO₂ as refrigerant. This is one of the first installations in a store in London that aims to transition to a totally environmentally friendly refrigeration system by not using synthetic gases used for the last 100 years. To date, the Pan Chai, Mango Tree and the brand new Georgian Restaurant in London have all chosen to use CO₂ refrigeration.

A large furniture store located in Haparanda/Tornio, on the border between Sweden and Finland in northern Scandinavia, has utilised a CO₂ refrigeration system for its refitted bistro shop. The refrigeration supplies two glass door freezers, a freezer gondola, a refrigerated gondola and six-shelf refrigerated cabinets.

NH₃: The Directorate for Public Construction and Property in Norway (Statsbygg) installed several ammonia heat pumps because ammonia is an environmentally friendly working fluid with excellent thermophysical properties. A 900 kW ammonia heat pump system for space heating, space cooling and hot water heating was installed at the StatoilHydro Research Centre in Trondheim, Norway. The heating and cooling demands at design condi-

¹ Please download the GUIDE 2012: Natural Refrigerants - Market Growth for Europe" at <http://publications.shecco.com/publications/view/23>

tions for the 28,000 m² building are 1.50 and 1.35 MW, respectively. Sea water from 60 metres depth is used as a heat source. A large ammonia chiller and heat pump system (CHPS) were installed at Oslo Airport Gardermoen, Norway. The maximum heating and cooling capacity of the CHPS is 7.5 MW and 6.0 MW, respectively, and the system utilises the vast groundwater aquifer in the area as a thermal energy storage.

In Switzerland, Energieverbund Schlieren (Schlieren energy consortium) in Zurich installed two large ammonia heat pumps, which is one of the largest projects of its kind in Europe. In the Mülligen letter sorting centre and Rietbach central energy installation, ammonia heat pumps with a heating capacity of around 5.5 MW each are used. By using ammonia as refrigerant, it is possible to achieve the necessary high flow temperatures of around 80°C. The energy consortium can produce annual savings of around 48,700 megawatt hours worth of fossil fuels, corresponding to a reduction of 8,100 tonnes in carbon emissions per year.

HC: Eight 650 kW water-cooled water chillers using hydrocarbon refrigerant R290 were installed at the Co-operative Group's new headquarters in Manchester, the largest ever propane chiller project in a commercial building in the UK. The building has achieved the highest BREEAM rating, receiving the 'Outstanding' accreditation for a large, commercial building in the UK.

H₂O: At Salford Quays in Manchester, UK, the MediaCityUK project that features a combined heat and power unit (CHP) in conjunction with an absorption chiller to provide electricity, heat and cooling, has recently won the award for 'Sustainability and Environmental Impact' at the British Institute of Facilities Management (BIFM). The tri-

generation CHP plant has cut carbon emissions by 29% compared to traditional energy services. The sustainable redevelopment of the German Parliament building provides an example of how absorption chillers can contribute to sustainable architecture projects. The Reichstag building's incorporation of solar panels, combined heat and power units that run on biodiesel, a waste heat reservoir and absorption chillers has resulted in a 94% reduction in carbon dioxide emissions. At IBM Zurich Research Laboratory, an adsorption chiller was used in a high-concentration PV thermal (HCPVT) system to provide cooling. In Corsica, an absorption chiller was installed to provide cooling for the Casino store in Corte. The absorption chiller has reduced emissions by 240 CO₂ eq. for the casino. An 18 kW solar heating and cooling system featuring an absorption chiller was installed in a research centre in Italy to replace an old air conditioning system.

CO₂/H₂O: At a Prodega Cash & Carry market run by transGourmet Schweiz AG in Switzerland, an adsorption chiller that is integrated into the overall design allows for the conversion of waste heat from the transcritical CO₂ system into useful energy for cooling. Such use of adsorption cooling leads to an improvement in the overall electrical energy consumption by approximately 5%.

DATA CENTRE

Cooling of data centres is estimated to have an annual electricity cost of €2.7 billion worldwide. The intense heat loads produced by computer blade servers require cooling to maintain optimal operating temperatures. Their large power consumption, combined with rising costs of energy and the drive to be green, are resulting in ever-greater demand

for environmentally sound server-cooling solutions such as CO₂, H₂O and hydrocarbons cooling.

CO₂: A CO₂ cooling system extension was installed in the ICT Data Centre on Level 4 of the Mechanical Engineering Building of Imperial College London in the UK. The provision of additional high density cooling has allowed ICT to increase the capacity for the central High Performance Computing (HPC) installation in the Data Centre. This CO₂ cooling system is more efficient than conventional cooling; therefore, a higher density of computing equipment can be installed in the same area with other cooling systems. The use of this centralised CO₂ cooling permits high density computing that is space saving, energy efficient and meets the need for short connectivity distances between computer systems within the HPC cluster. This achieves very high bandwidth connectivity, which in turn boosts overall system performance.

H₂O: In the iDataCool project, jointly developed by the University of Regensburg and the IBM Research and Development Lab Böblingen, an innovative adsorption chiller driven by waste heat was installed in the computing centre of Regensburg University, Germany.

HC: A cooling unit using propane was installed in the Lübbecke public utilities in Germany. The R290 system supplies the cooling demand for the building air-conditioning and for the server room cooling. The R290 unit helps reduce operating costs and, in light of current discussions about a possible ban on certain HFC refrigerants, guarantees a high level of investment security.



For high performance
Alfa Laval Optigo™ CC254 & CC403



Plug and play cooling
Alfa Laval Optigo™ CS200 & CS300



Double airflow
Alfa Laval Optigo™ CD304



Alfa Laval Optigo™

5 models, 3 families, 1 brand



Experience the Alfa Laval advantage

With the Alfa Laval Optigo range you get a higher and more effective cooling capacity with lower power consumption. One range for all commercial cold room storage, from supermarkets to restaurants and groceries. All products are simple and straightforward to install and exchange. And they are also available for high-pressure CO₂.



Visit www.alfalaval.com/refrigeration to learn more.



www.alfalaval.com

CITY, BUILDINGS & TRANSPORT

CITY & BUILDINGS



NH₃ Ammonia |
 CO₂ Carbon Dioxide |
 HC Hydrocarbons |
 H₂O Water |
 ||||| Refrigeration |
 Heating |
 Air Conditioning

CITY, BUILDINGS & TRANSPORT

TRANSPORT

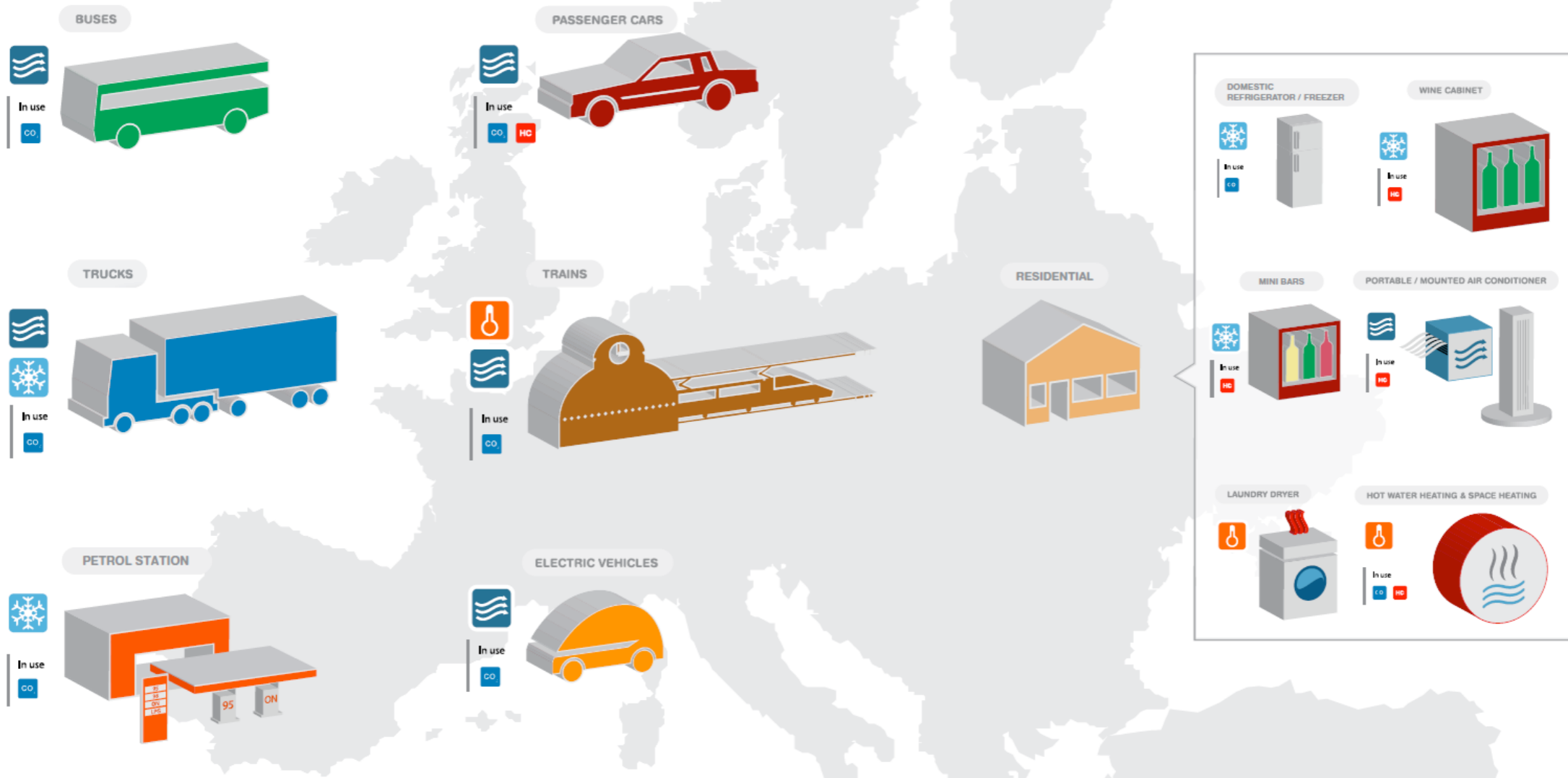

NH₃ Ammonia |
 CO₂ Carbon Dioxide |
 HC Hydrocarbons |
 H₂O Water |
 |||| Refrigeration |
 Lightbulb Heating |
 Waves Air Conditioning

DISTRICT HEATING & COOLING

NH₃: Ammonia heat pumps represent an energy efficient alternative for district heating and cooling systems. Several hundred ammonia heat pumps have been installed in Norway since the early 1990s. Most installations are in larger buildings (200 kW to 2 MW) and in district heating and cooling systems (700 kW to 8 MW). In the world's largest district-wide natural heat pump system in Drammen Fjord near Oslo, Norway, an ammonia heat pump is used to provide over 13 MW of heat for a community of 60,000 people. The system passed its efficiency trials in December 2012, and it will now supply hot water through underground pipes for heating several thousand homes and businesses. In the past, heat pumps were often limited to producing water temperatures of 60 °C.

At Glasgow University in the UK, ammonia heat pumps are used to meet the University's heating needs. The ammonia heat pump delivers 14 MW of heat at over 90°C and saves 15% in terms of energy consumption. In recent years, high temperature heat pumps for various applications that can extract heat from a wide variety of sources and produce hot water up to 90°C are more and more widely used in Europe.

A 2 MW ammonia heat pump was used by the energy provider Bio Varma Sarpsborg AS in Norway to heat water up to 82°C for the municipal district heating network. In Switzerland, an ammonia heat pump system was installed in the Swiss town Rheinfelden to supply hot water for more than 1,000 residential dwellings in Augarten and Weiherfeld, as well as a nearby commercial estate. The system consists of two ammonia heat pumps with an output of 1,250 kW each. It achieves even greater energy efficiency by using treated wastewater

from the Abwasserreinigungsanlage Rheinfelden (ARA – Rheinfelden sewage plant) as the heat source.

CO₂: Heat pumps using CO₂ as the working fluid are ideal for use in situations where there is a small temperature difference on the cold side and a large temperature difference on the warm side. In Denmark, CO₂ compressor heat pumps were installed in Frederikshavn and Marstal for district heating. At Frederikshavn, 1 MWth CO₂ heat pump (16 units) at the town's waste water treatment plant uses 2 GWh a year to extract 4 GWh of heat from the waste water. It produces 6 GWh of heat for the district heating supply. The German municipality Lauterecken installed a new district heating system working with a new high temperature CO₂ heat pump. The project qualifies as investment in sustainable infrastructure and is, therefore, eligible to subsidies from the German government stimulus package II. The CO₂ heat pump covers 77% of the heating needs and saves 53 tonnes of carbon emissions per year.

H₂O: In the Mediterranean city of Montpellier, France, a district solar cooling project with an absorption chiller was built in 2012 for the Arche Jacques Coeur building, which includes 11.000 m² of office space, 170 residences and 3000 m² of commercial space. The solar cooling and absorption chiller installation is estimated to reduce CO₂ emissions by 40 tonnes per year, the equivalent of 25 cars driving 10,000 km per year.

An absorption chiller integrated into a district cooling network in Denmark uses surplus heat from the district heating network during the summer months to provide close to 3.5 MW of cooling energy for the city of Copenhagen. The new cooling network complements the city's existing heating

system, covering 98% of Copenhagen. The new project of 15 MW capacity is expected to save 14,000 tonnes of carbon dioxide per year. Copenhagen's district cooling system reduces carbon emissions by nearly 70% and electricity consumption by 80% compared to conventional cooling.

PRIVATE RESIDENTIAL HOUSING: REFRIGERATOR, HOT WATER & AIR CONDITIONING

CO₂: CO₂ heat pumps have been successfully used for domestic water heating (DWH) mainly in Japan. Today, CO₂ heat pumps have a 98% share in the domestic water heater sales market in Japan. This year brought a new development to this environmentally friendly technology in Europe: the first combi-type CO₂ heat pump for residential space heating and domestic hot water production with a COP of 3.64 was introduced to the European market. Today, already 16 manufacturers offer R744 heat pumps for varying applications in Europe. Based on the Japanese EcoCute technology, some manufacturers have re-engineered CO₂ heat pumps to suit European conditions in terms of hot water temperature, water storage volume, control logic and installation (indoor vs. outdoor).

Some 130 CO₂ heat pump units have been installed at a pioneering housing project in Dublin, Ireland, to provide low cost, low carbon heating and hot water for the social housing apartments. The CO₂ units can deliver hot water up to 65°C. The use of CO₂ heat pumps enables that the project meet the building regulation requirements pertaining to the use of energy (Part L of the Building Regulations covering the Conservation of Fuel and Energy in Dwellings). The Tveita housing cooperative in Norway installed three 100 kW heat pumps in three 13-storey buildings for domestic hot water.



SANDEN

Delivering Excellence

LEADER IN CO₂ TECHNOLOGY - EXPERT IN THERMAL COMFORT

SANDEN CO₂ SOLUTIONS

the best combination of service, quality and ecology



aquaeco₂ - HEAT PUMP WATER HEATER

Residential domestic hot water production

- Developed and manufactured in France for the European market
- COP = 3.42 (certified EN16147)



ECOCUTE - HEAT PUMP WATER HEATER

Residential domestic hot water production

- High performance - APF = 3.0 (JIS C9220:2011)
- Cold area option for energy efficient operation by -20°C



SPACE HEATING HEAT PUMP

Residential space heating

- Patented technology
- Hot water output temperature adjustable from 40°C to 70°C
- COP = 4.0



CO₂ COOLING MODULE

Retail refrigeration

- Product range under extension
- 20 to 40% energy savings vs. HFC technology



aquaeco₂ - COMBI-TYPE HEAT PUMP

Residential space heating & domestic hot water production

- The first combi-type CO₂ heat pump in Europe for households
- The best COP for domestic hot water production - COP = 3.64 (EN16147)



G-DRINK & G-SNACK VENDING MACHINES

Commercial refrigeration

- Energy class A++ according to EVA EMP 3.0b standard
- Indoor and outdoor versions available



aquaeco₂ - HEAT PUMP WATER HEATER, LARGE CAPACITY

Hot water production - residential & professional

- Indoor distance installation: up to 12 meter distance allowed between heat pump unit and DHW tank
- Tank capacities available from 200 to 750L



V21 - BOTTLE & CAN VENDING MACHINE

Commercial refrigeration

- International certifications: UL, CE, TUV/GS, RoHS and Energy Star
- Chosen by the most renowned brands in food & beverage



HEAT PUMP WATER HEATER

Residential domestic hot water production

- Based on Ecocute
- Quietest and most efficient heat pump water heater in Australia
- COP = 4.5



CO₂ TECHNOLOGY COMPONENTS

Various applications of CO₂

- Exchangers, compressors...

These heat pumps can raise the temperature from around 8°C to 70°C in a single stage. The company won the Varmepumpeprisen 2013 (heat pump prize) for its use of eco-friendly CO₂ units.

HC: Worldwide, over 50 million domestic refrigerators each year are produced with R600a. R600a is the standard refrigerant in European domestic refrigerators and freezers today. Increased energy efficiency and the use of R600a refrigerant have drastically reduced the climate impact of household refrigerators, due to the mitigation of direct (refrigerant) and indirect (CO₂ associated with electricity consumption) GHG emissions. HCs, particularly R290, are used in Europe for small (domestic) heat pumps.

TRANSPORT: BUSES, TRUCKS, TRAINS, ELECTRIC VEHICLES & FUEL STATIONS

CO₂: Following uncertainties brought about in the last two years about the safety of an alternative synthetic refrigerant complying with the European “MAC Directive”, CO₂ air conditioning in cars is again considered by automotive manufacturers as a European or even global solution in mobile air conditioning (MAC) in passenger cars. CO₂-based systems outperform current systems in over 95% of driving conditions worldwide. Extensive analysis showed that a vehicle running with CO₂ air conditioning in Athens, Greece, compared to another vehicle using HFC-134a, can save up to 26% of additional fuel consumption. Calculations performed a few years ago for Bombay, India, and Shanghai, China, showed that CO₂ can save up to 28% and 26% on fuel consumption respectively.

The technology for CO₂ compressors for mobile air conditioning, although not currently commercialised, have been further developed and refined

thanks, in part, to advances made in stationary applications such as light commercial refrigeration. A heat pump system using CO₂ for a car’s thermal management system has been optimised for battery electric vehicles. The CO₂ compressor with a gas cooler in the heating / cooling unit with a heating power of 3.2kW at -7°C ambient temperature achieved a COP of about 3.0.

The Berlin Public Transport Company (BVG), the Jena Local Transport Limited Company (JeNah), the Niederrheinische Transport Company Corporation (NIAG) and four other public transport companies in Germany are already using CO₂ (R744) in some of their bus air conditioners. A total of seven public transport companies in Germany and Luxembourg have equipped a fleet of 22 buses with CO₂ MAC systems. The German NIAG Group has equipped three new buses with mobile air conditioning units that use CO₂ as a refrigerant. The new systems help to save two thirds of the service costs for systems using conventional refrigerants. Germany’s main train operator Deutsche Bahn (DB) has installed a CO₂ mobile air-conditioning unit in one of their diesel multiple unit (DMU) trains operated by the DB subsidiary Westfrankenbahn. In Europe, CO₂ refrigeration technology using CO₂ recovered from recycled waste for refrigeration in trucks is increasingly applied. The system provides cooling with reduced environmental impact and is being chosen for transport refrigeration. At the same time, infrastructure for the technology has expanded. The first commercial CO₂ filling station was opened in Munich-Garching in June 2012. Retailer Spar in the Netherlands has already converted 100% of its fleet to a CO₂ refrigeration system, achieving a 27% lower logistic carbon footprint and a total of 13% lower logistic costs per year.

In 2012, fuel company OKQ8 installed a compact CO₂ refrigeration unit at its first sustainable filling station outside Stockholm, Sweden. The refrigerators, freezers and fast food fridges of the filling station’s shop are all kept cool with CO₂. The waste heat from the shop’s cooling equipment is used for heating the air in the station’s carwash. The overall energy consumption at the fuel station in the city Häggvik is expected to be 50% lower than that of a conventional filling station.

HC: Hydrocarbon refrigerants have been used in millions of vehicles since around 1993, particularly in the USA and Australia, and there have been no documented reports of fires arising from the operation of hydrocarbon refrigerants in existing systems. Hydrocarbons and liquid CO₂ are under limited use or are being explored for use in road vehicles.

For earlier applications, please refer to the GUIDE 2012: Natural Refrigerants - Market Growth for Europe” at <http://publications.shecco.com/publications/view/23>

INDUSTRY

INDUSTRIAL PROCESSING

NH₃: For cooling industrial processes, such as in the chemical, petrochemical, and pharmaceutical sectors, ammonia refrigeration systems are used to provide effective and stable cooling performance. In Europe, Neste Oil in Finland replaced its R22 refrigeration system with an ammonia system. In Belgium, a 500 kW ammonia heat pump was installed in Emerson's factory in Welkenraedt, where waste heat from the factory is reused.

CO₂/HC: A CO₂/propylene cascade refrigeration system was installed in a German chemical plant. The evaporator (propylene) in the high cascade stage is simultaneously the condenser of the lower cascade stage (CO₂). The liquid CO₂ evaporator cools the chemical process down to -50°C.

HC: Operations in the chemical industry and the pharmaceutical business require high technical quality for the production plants. In some new plants built in Europe, hydrocarbon refrigerants have already been used to guarantee the highest cooling precision. For example, in an explosion-hazardous area of a chemical plant in Germany, a refrigeration system is set up for industrial, non-stop running, using the refrigerant propylene (R-1270) to the HCl-liquefaction. In a plastic production plant of Borealis, a Belgian manufacturer of polyethylene and polypropylene in Belgium, the original R22 refrigeration unit was replaced by an R1270-based refrigeration system. R-1270 has the same thermodynamic characteristics as the HCFC refrigerant R22. Thanks to the conversion, Borealis now saves approximately 33% on its energy bill. In the gas processing plant of NAM in Den Helder,

the largest natural gas producer in the Netherlands adopted a new refrigeration unit with R290 as a refrigerant and a cooling capacity of 2 x 2110 kW to replace its old R22 units. The system consists of two R290 compressor skids, 2 chiller packages and 2 condenser packages, a stand-by propane compressor skid and a R290 drain vessel. The new unit can chill 20 million m³ of natural gas each day.

CONSTRUCTION

NH₃: In underground building sites, there is a frequent problem with ground water, which impedes underground works. Freezing the soil around the construction site is an effective method against penetration by ground water and ensures static safety. Nowadays, NH₃ soil freezing units are widely utilised in the construction of underground tunnels, stations or building shaft projects, as well as to safeguard excavations. In a building construction project in Germany, an ammonia soil freezing unit cooled brine down to approximately -30°C, enabling construction work to proceed without risk of structural damage.

CO₂/NH₃: CO₂/NH₃ cascade refrigeration systems are widely used where low temperatures must be attained economically and within compressor application ranges. A CO₂/NH₃ soil-freezing containerised refrigeration unit was used in the underground construction works of a building in Germany. The CO₂/NH₃ cascade refrigeration system was selected to enable lower cooling temperatures down to -50°C.

AGRICULTURE

NH₃: In the Netherlands, in a 15.000 m² greenhouse of Maurice van der Hoorn, a Dutch Phalaenopsis (Orchid) grower, an ammonia heat pump was installed, which made this the first greenhouse that runs entirely without natural gas.

For earlier applications, please refer to the GUIDE 2012: Natural Refrigerants - Market Growth for Europe" at <http://publications.shecco.com/publications/view/23>



SWEP, Box 105, SE-261 22 Landskrona, Sweden
Tel: +46 (0)418 40 04 00, Fax: +46 (0)418 292 95
info@swep.net www.swep.net

Economy and ecology in refrigeration

SWEP offers Brazed Plate Heat Exchangers for supermarkets of all sizes and in all climatic conditions. They are designed to operate with the highest efficiency, safety, and reliability. Low hold-up volumes and quick response times save investment and operating costs as well as valuable retail space.

Natural refrigerants enhance sustainability, and our BPHEs are the ideal choice. We have built up expertise in CO₂ from thousands of installations worldwide, and offer solutions for subcritical and transcritical operation as well as energy recovery to boost efficiency.

Contact us to see how you can keep costs low – and reliability high.

SWEP
A DOVER COMPANY

SPORTS

ICE RINKS, SKI SLOPES & SWIMMING STADIUMS

NH₃: At the 2012 Summer Olympic Games, the Aquatic Centre and the Olympic Energy Centre in London both adopted ammonia-based technologies. The cooling system of the Aquatic Centre was converted to an NH₃ system. The large-scale Olympic Energy Centre also features ammonia chillers. The new Energy Centre and network built on the site provide efficient and low-carbon power by using biomass boilers and a combined Cooling, Heat & Power (CHP) plant to capture the heat generated as a by-product of electricity production. The primary Olympic Park Energy Centre makes claim to being one of the largest combined cooling, heating and power generating facilities built in the UK.

In 2012, Oxford's popular ice rink was refurbished with an ammonia refrigerant cooling system. A 360 kW ammonia chiller, which requires less electricity to run and reduces running costs by up to 20%, was installed. Ammonia is the primary refrigerant of choice for the new Olympic ice rink in the Belgian city of Liège. The ammonia refrigeration system in the sports facility has a total capacity of 1,000 kW. A central refrigeration plant with ammonia reciprocating compressors was installed to provide a constant ice quality, even under differing framework conditions and heat loads, for the elevated ice track and the ice rink at the Lentpark in Cologne, Germany.

In Russia, a large-scale ammonia based refrigeration plant was built in 2012 to cater to the cooling needs of a sports facility: the 1814 metre bobsleigh track in Krasnaya Polyana, which will host the 2014

Winter Olympics competition. At the heart of the new refrigeration plant are four ammonia screw compressors. The ammonia refrigerant plays a key role in ensuring superior efficiency in the project.

CO₂: CO₂ refrigeration systems have been proven as one of the most promising alternatives in ice rink refrigeration. In the ice rink industry today, mainly in Europe, there are more than twenty rinks that have adopted CO₂ in the second-cycle of the refrigeration system and several in Canada that have applied a system with CO₂ in the first-cycle as well as in the distribution system.

The first application of CO₂ in ice rinks was in Austria in 1999, when, instead of brine, CO₂ was used in the secondary cycle and NH₃ in the primary cycle. In Sweden, similar technology was applied in the Backvallen ice rink in 2006, and similarly, the other two ice rinks (Tingvalla Ice Stadium, Göransson Arena) were built on this technology. In the ice rink Waltershausen and the SAP Arena Mannheim in Germany, as well as the Messe Stadium Dornbirn in Austria, CO₂ as a coolant has made it possible to use the advantages of the evaporating refrigerant in ice rinks and also in refrigeration plants with indirect cooling.

For earlier applications, please refer to the GUIDE 2012: Natural Refrigerants - Market Growth for Europe" at <http://publications.shecco.com/publications/view/23>

INDUSTRY & SPORTS

INDUSTRY, SPECIAL APPLICATIONS & SPORTS

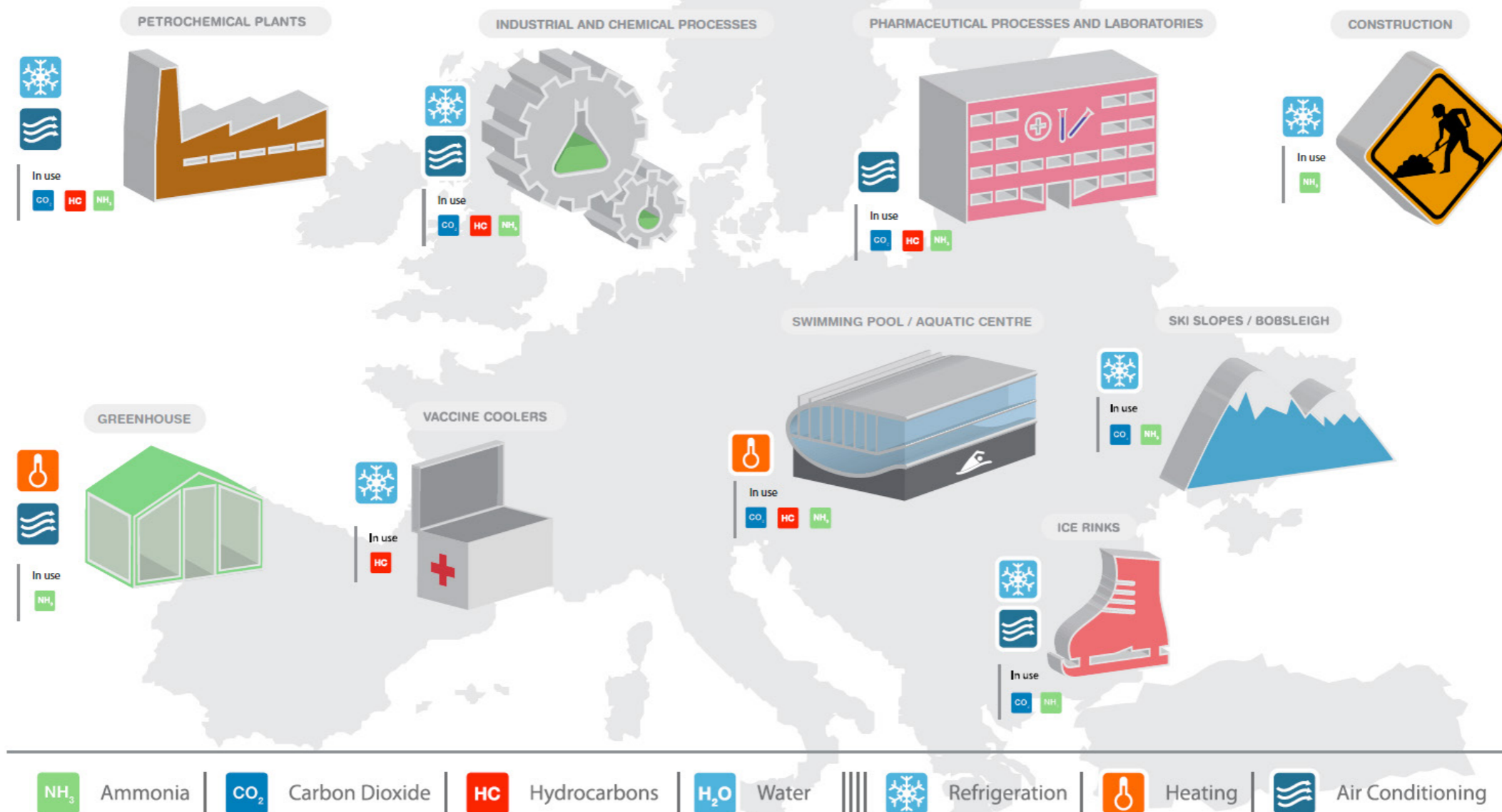

Refrigeration Plants with CO₂ and NH₃ Training Courses and Hands-on experience



DANISH
TECHNOLOGICAL
INSTITUTE

Training courses at Danish Technological Institute provide you with an understanding of refrigeration technology and CO₂ and NH₃ as refrigerants. Moreover, you will be introduced to safety conditions and advantages of natural refrigerants as well as how to operate and maintain different refrigeration systems and more.

The education consists of basic theory, discussion and exchange of experience combined with demonstrations and hands-on training.

See all training programmes at:
www.dti.dk/refrigeration/c641

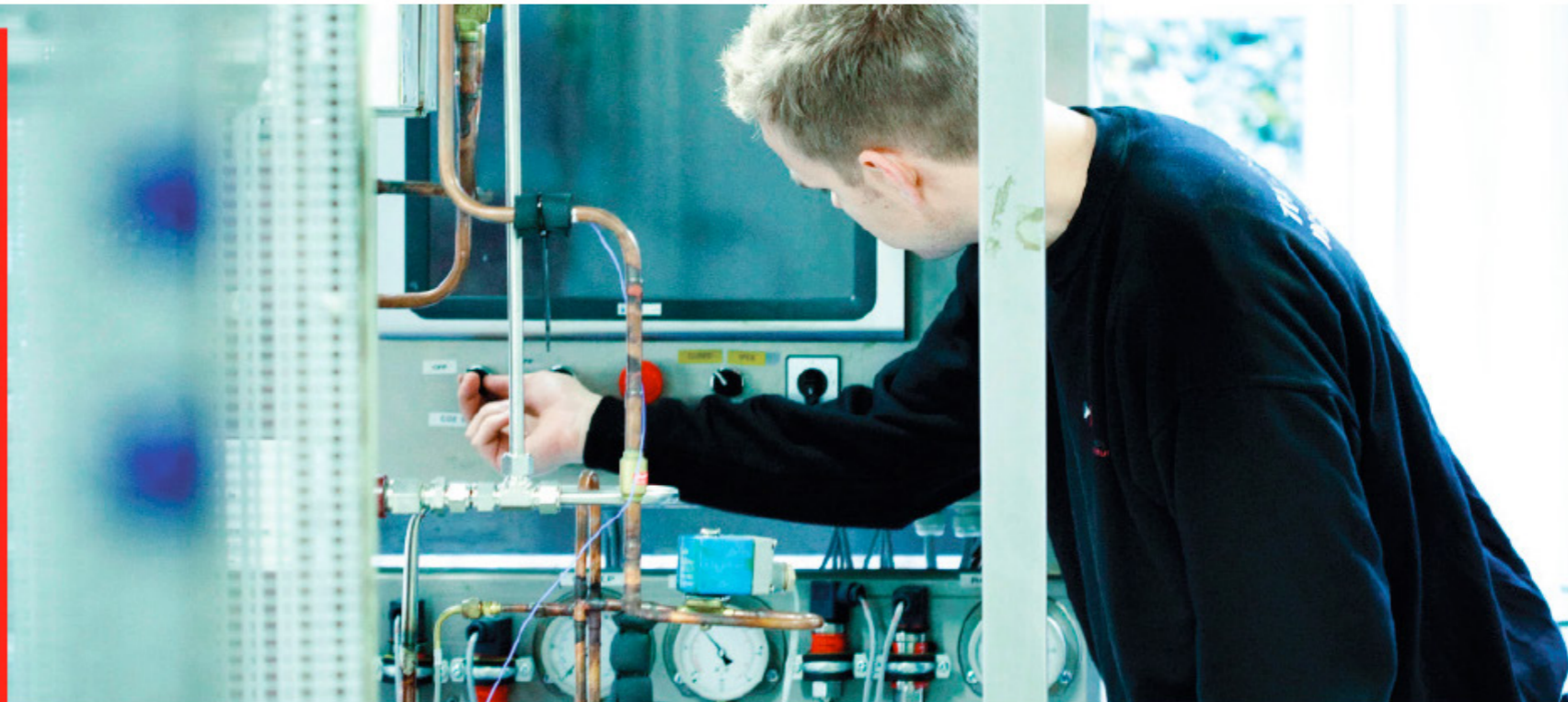

Refrigeration Plant with CO₂ – Theory and Hands-on 29-30 April 2014, Aarhus, Denmark

- System design and components
- Overview of CO₂ systems:
 - Industrial plants
 - Supermarket plants
 - Transcritical plants
- EU directive on pressure equipment and assembly methods related to CO₂.

Read more: www.dti.dk/k27561

Refrigeration Plant with NH₃ – Theory and Hands-on 20-21 March 2014, Aarhus, Denmark

- Plant design and components
- Overview of NH₃ applications:
 - Cold storage, food processing, chillers
- Operation, service and maintenance procedures
- Hands-on training on one and two stage training plants.

Read more: www.dti.dk/k27560

10 % discount - Register three or more participants to the training courses in Denmark

The courses are held at Danish Technological Institute's advanced purpose-built teaching and training facilities in Aarhus, Denmark, or as a workshop on your company premises.

We also offer special tailored courses that fit your particular needs.

Read more: www.dti.dk/services/33261

Contacts for further information CO₂ courses

- Mr. Christian Heerup
- phone: +45 7220 2528
- e-mail: chp@dti.dk
- www.dti.dk/k27561

NH₃ courses

- Mr. Sverre Hansen
- phone: + 45 7220 1267
- e-mail: sha@dti.dk
- www.dti.dk/k27560

NATURAL REFRIGERANTS IN THE EUROPEAN FOOD CHAIN

APPLICATION AREAS & END-USER VIEWS



APPLICATION AREAS: ECOSYSTEMS

“From the field to the fork”, already today natural refrigerants are used in industrial, commercial, residential and transport applications throughout the whole food chain. In food sourcing, production & processing, transport, food retail and restaurants they offer a natural solution for heating, air-conditioning and refrigeration. This chapter comprises the main areas in which natural refrigerants are used in the food chain and provides best practice examples from Europe.



END-USERS VIEWS

Leading commercial end-users share their thoughts on the latest natural refrigeration trends and requirements of their business. Retailers across Europe are asking the industry for natural refrigeration solutions for small convenience stores and warm climates. Global consumer brands confirm their commitment towards a natural (refrigeration) future.

NATURAL REFRIGERANTS IN THE EUROPEAN FOOD CHAIN

INTRODUCTION

The food and beverage industry is the largest manufacturing sector in terms of turnover and value added in Europe. 75% of all European industrial refrigeration capacity is installed in the food industry. Starting from a basis of 60-70 million cubic meters of cold storage for food, the need for more chilled and frozen food promises continued investments in refrigeration systems. In the food industrial and commercial refrigeration sectors, the move towards a broader adoption of natural refrigerants is continuing throughout Europe. Ammonia maintains its market-leading position while CO₂, CO₂ cascade solutions, as well as hydrocarbons are becoming increasingly competitive in the market. Among European food retailers, there is a clear shift towards CO₂ refrigeration in large-format stores and convenience stores. Transcritical CO₂ systems and subcritical cascade systems have been the preferred choice by supermarkets in Europe. R290 is regarded as one of the best refrigerants for use in ice cream cabinets, bottle coolers and commercial freezers.

In the food and beverage industry, a clear trend towards a stronger adoption of refrigerants with less environmental impact; an increased focus on refrigerant charge reductions and leakage tightness; a continued strong focus on a system's capital cost but also its cost of ownership; and an even stronger emphasis on reliability, safety and legislative compliance of the system are all factors encouraging the use of natural refrigerants in Europe.

The Food Chain Ecosystem captures a broad range of innovative and successful examples for natural refrigerant utilisation in the following sectors:

- **Food storage & distribution:** factories, cold storage and warehouses
- **Food processing:** dairies, bakeries, slaughterhouses, ice cream & chocolate production, coffee plants
- **Beverages:** breweries and wineries
- **Fishing industry:** processing plants, vessels, and container ships
- **Food retail:** supermarkets, hypermarkets & convenience stores, and fast food restaurants

APPLICATION AREAS

FOOD STORAGE & DISTRIBUTION

NH₃: In 2012, UK logistics provider Kuehne+Nagel installed an ammonia refrigeration plant for a multi-temperature chill store to its existing distribution centre at Brinklow, UK. The cooling capacity of each unit accounts for 400 kW and operates with an ammonia charge of less than 0.45 kg/kW. One of McDonald's suppliers in the UK, Keystone Distribution, has installed a 2,000 kW two-stage ammonia refrigeration plant for its state-of-the-art Hemel distribution facility. The ammonia refrigeration system incorporates several energy saving features that contribute to 15 MW of yearly energy savings. A logistics provider converted an existing empty warehouse in Hertfordshire into a temperature controlled food and beverage storage and distribution facility with a two-stage pumped circulation ammonia refrigeration plant. The system has an overall capacity of 2,224 kW including cooling for the cold

store, chill store and loading bay areas. Bonduelle Group, supplier of canned or deep-frozen vegetables, and processed salads upgraded its existing cold storage with an ammonia refrigeration system in its site in Estrées, France. The facility lowers energy consumption by 25% compared to a conventional cold room and saves a total of 500 tons CO₂ eq. per year. Agri-Norcold's newly expanded facility in Denmark uses ammonia refrigeration in its site in Vejen to supply cooling to the 8,400 m² cold storage. Multifrozen, a subsidiary of Unilever, also chose to use ammonia in its new cold storage facility in Veszprem, North-Western Hungary. The building of the largest Ukrainian refrigeration complex for storage of fruits and vegetables in Kherson, incorporates an ammonia refrigeration system with a cooling capacity of 10,000 tons.

Drillieux, a Belgian fruit company, expanded its cold storage by installing a 963 kW NH₃-based refrigeration system to eighteen new cold rooms with a total storage capacity of 5 million kilogrammes in 2013. A 3,300 kW ammonia refrigeration unit was installed in the brand new warehouse of the Belgian New Fruit Wharf (BNFW) in the Port of Antwerp, Belgium, in 2013. Thanks to the ammonia system, the warehouses are climatized throughout the year, at a low energy cost.

CO₂: An eco-friendly CO₂ refrigeration plant for S-Market was built in Finland in 2012. CO₂ unit coolers were used in the refrigeration plant that cools

For earlier applications, please refer to the GUIDE 2012: Natural Refrigerants - Market Growth for Europe" at <http://publications.shecco.com/publications/view/23>

different cold rooms and a freezing room. The refrigeration plant operates at -20°C to -18°C in the freezing room and at different temperatures in the diverse cold rooms for fish, chicken, ready-food, fruit and vegetables.

NH₃/CO₂: The German discounter Lidl has committed to the use of natural refrigerants in all newly built logistic centres. In its site in Hüfingen, Baden-Württemberg, 6,000 m³ of deep freezing and refrigerated space are cooled with a CO₂/NH₃ system. The waste heat from the refrigeration is recovered to heat other parts of the building. In the expansion project of Kloosterboer's Delta Terminal in Netherlands, ammonia and CO₂ are used in the cooling and freezing rooms for smaller batches. With three large freezers and 5 large cooling and freezing cells, all with a temperature range between $-/-25^{\circ}\text{C}$ and $+ / +12^{\circ}\text{C}$, Kloosterboer can respond more flexibly to the customers' wishes.

A distribution centre in the Netherlands built by fruits, vegetables and exotics importer Hillfresh International, features a NH₃/CO₂ cascade refrigeration system serving 21 cold storage units and 7,500 pallet spaces. The system's ammonia charge has been reduced by almost 90%. In an 80,000 m³ food store plant in France, an NH₃/CO₂ secondary brine equipment is used for the freezing portion. In Harnes, a NH₃/CO₂ cooling and freezing installation has been selected for a French establishment used for storage by a producer of potato products. In 2012, a new refrigeration plant based on a cascade system that employs ammonia (NH₃) in the first step and CO₂ in the second, was installed to the plant of SAS Lubrano et Fils for freezing of bake-off bread located at Sète, France.

HC: R1270 (propylene) chillers have a proven economic track record in terms of lower capital costs

and reduced energy consumption, making them one of the preferred technologies for food and drug cold storage. In recent years, Roche Pharmaceuticals in Germany and Ireland, Mansfield's Fruit Farms, Grimsby Fish Market, Peake Fruits - Suffolk UK, Liverpool Fruit Terminal, and Nestlé in the UK, as well as a fish processing plant in Romania have installed R1270 chillers in their facilities.

FOOD PROCESSING: DAIRIES, BAKERIES, SLAUGHTERHOUSES, ICE CREAM & CHOCOLATE PRODUCTION & COFFEE PLANTS

NH₃: In 2013, the dairy product company Arla built Europe's largest and most environmentally friendly dairy production facility outside Aylesbury, Buckinghamshire, on the outskirts of London. The facility features a sophisticated ammonia refrigeration system, which delivers more than 7.5MW of cooling capacity. Ammonia chillers, installed in the energy centre, supply the plant's large cooling load. In two plants of Mlekpól, the largest Polish dairy producer in Grajewo and Mrągowo, Poland, ammonia compressors have demonstrated their notable energy efficiency: around 25% less energy than the solutions previously in operation has been used.

A Welsh bakery combined an in-line spiral freezer and its associated low volume ammonia plant, in one complete package in 2012. The combined system reduces the refrigerant load and ensures the greatest possible heat transfer, resulting in 15-20% energy savings compared to a separate spiral freezer and refrigeration plant installation.

The Dutch biscuit manufacturer Verkade installed an ammonia chiller, which is filled with only 100g of ammonia per kW. The new refrigeration system

helps Verkade reach the company goal of reducing energy consumption and carbon dioxide emissions. Producer of Alpine milk chocolate, Milka, achieved an efficiency increase of more than 30% with their new refrigeration system employing ammonia chillers in a Lörrach, Germany, factory. This was achieved by grouping the former cooling centers into four units connected with each other, supplemented by free cooling which employed outside air. At the heart of the system are three ammonia chiller units using variable-speed compressors with a power rating of 3.8 MW.

A new ammonia-based refrigeration unit was installed in Vlevico, Colruyt's renewed meat plant in Halle, Belgium. The heat released from the refrigeration unit is recuperated for the production of hot water. Vlevico now saves 371,000 Euros each year on its energy bill. The plant also reduced its CO₂ emissions by 1602 tonnes per year. The BESS study (Benchmarking and Energy management Schemes in SMEs) has declared Vlevico one of the most efficient and ecological meat processing companies in Europe. A 600kW NH₃ refrigeration unit with direct expansion (at -10°C) was installed in the beef processing plant of Verbist in Izegem, Belgium. This system transfers liquid ammonia to the evaporators in the cold rooms. Inside the evaporator, the NH₃ dissipates completely. The advantages over a pump circulation system are the limited amount of refrigerant (as low as 25%) and the avoided need to install pumps or a separator. In practice, this means less safety risks and a lower investment cost.

The expanding applications for ammonia in commercial and industrial refrigeration are being demonstrated in several recent projects involving heat pumps. Ammonia heat pumps constitute one possibility for the efficient management of heat energy. In the UK, a Nestlé chocolate factory replaced

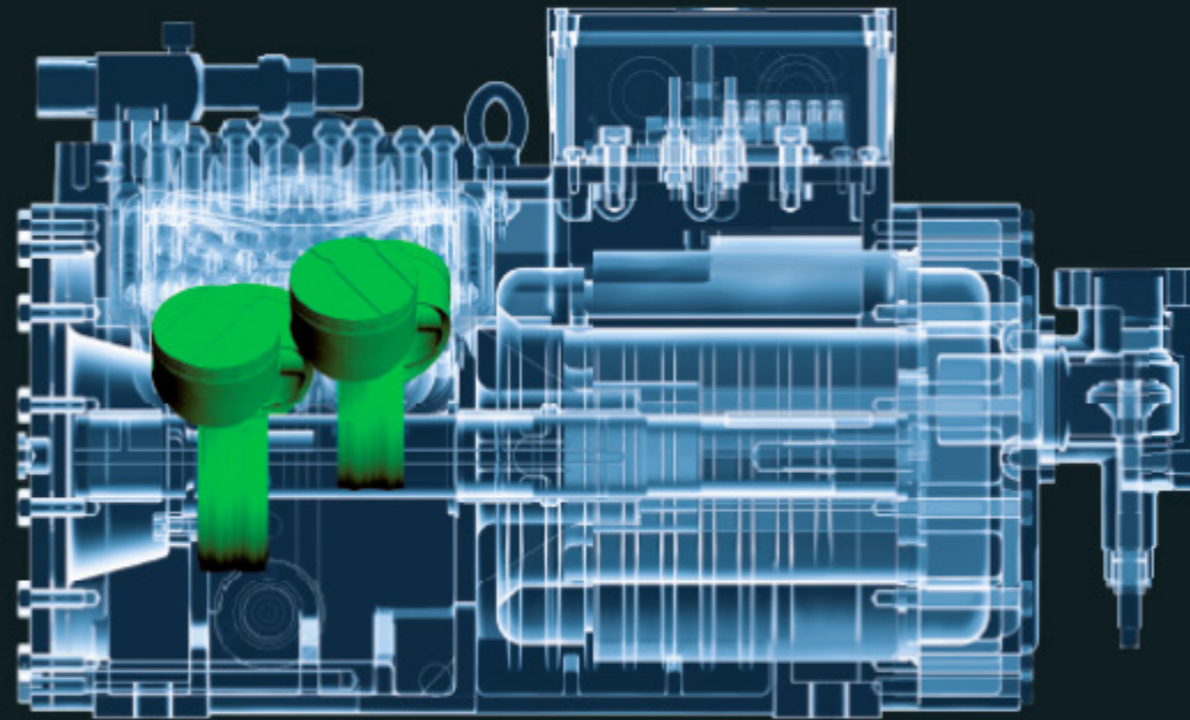

OCTAGON CO₂

CO₂ AS A REFRIGERANT?
ABSOLUTELY!



The compressor is the heart of every refrigeration system. This heart now beats for the environment – with CO₂. At these high pressure levels you need a product you can rely on. As the market leader in CO₂ reciprocating compressors, BITZER offers quality and peace of mind – plus a broad product portfolio and services to match. When you turn to BITZER, a strong heart ensures a better life. Learn more about our products at www.bitzer.de



THE HEART OF FRESHNESS

FOOD CHAIN

FOOD SOURCING, PRODUCTION & PROCESSING

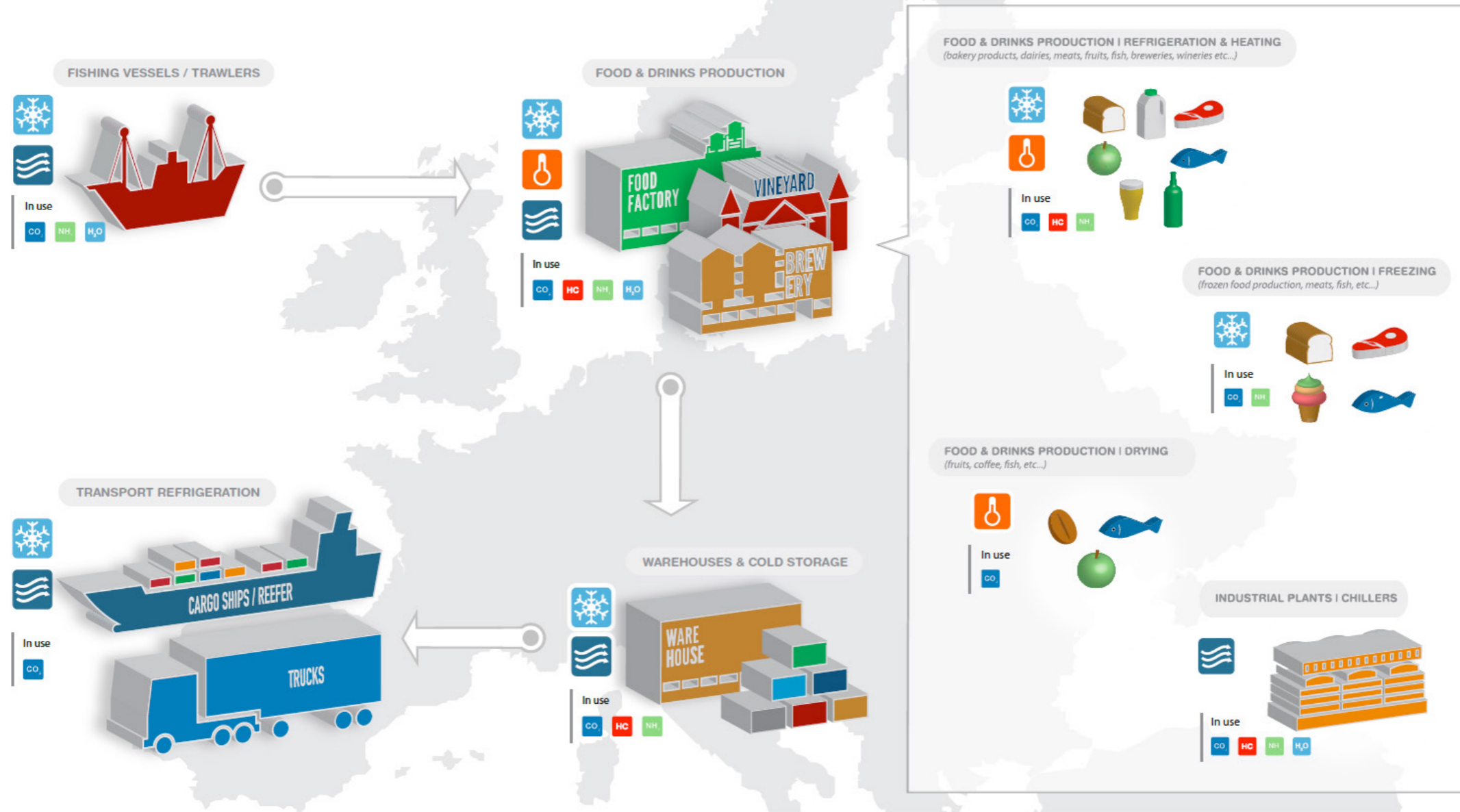

NH₃ Ammonia |
 CO₂ Carbon Dioxide |
 HC Hydrocarbons |
 H₂O Water |
 ||||
 Refrigeration |
 Heating |
 Air Conditioning

FOOD CHAIN

TRANSPORT, FOOD RETAIL & RESTAURANTS

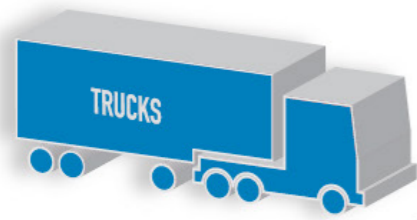

| | | | | |
|---|---|--|---|---|
| <p>CENTRAL REFRIGERATION PLANTS</p> <p>In use CO₂ HC NH₃</p> | <p>MEDIUM-SIZED REFRIGERATION CABINETS</p> <p>In use CO₂ HC</p> | <p>ICE FLAKE MACHINES</p> <p>In use CO₂</p> | <p>PLUG-IN DISPLAY CABINETS</p> <p>In use CO₂ HC</p> | <p>OPEN DISPLAY CABINETS / ISLANDS</p> <p>In use CO₂ HC</p> |
| <p>ICE CREAM FREEZERS</p> <p>In use HC</p> | <p>REFRIGERATION & FREEZING ROOMS</p> <p>In use CO₂ HC</p> | <p>VENDING MACHINES</p> <p>In use CO₂ HC</p> | <p>WATER HEATING, SPACE HEATING & COOLING</p> <p>In use CO₂ HC NH₃</p> | <p>GLASS-DOOR BOTTLE COOLERS</p> <p>In use CO₂ HC</p> |

| |
|---|
| <p>COLD DRINK DISPENSERS & ICE CUBE MACHINES</p> <p>In use HC</p> |
| <p>SODA MACHINES, MILKSHAKE & ICE-CREAM MACHINES</p> <p>In use HC</p> |
| <p>REFRIGERATED BUFFET UNITS</p> <p>In use HC</p> |
| <p>MEAT FREEZER</p> <p>In use HC</p> |
| <p>WATER HEATING, SPACE HEATING & COOLING</p> <p>In use CO₂</p> |
| <p>SALAD REFRIGERATORS</p> <p>In use HC</p> |
| <p>REFRIGERATION & FREEZING ROOMS</p> <p>In use CO₂ HC</p> |

NH₃ Ammonia |
 CO₂ Carbon Dioxide |
 HC Hydrocarbons |
 H₂O Water |
 ||||
 Refrigeration |
 Heating |
 Air Conditioning

FOOD CHAIN

OVERVIEW OF APPLICATION FIELDS

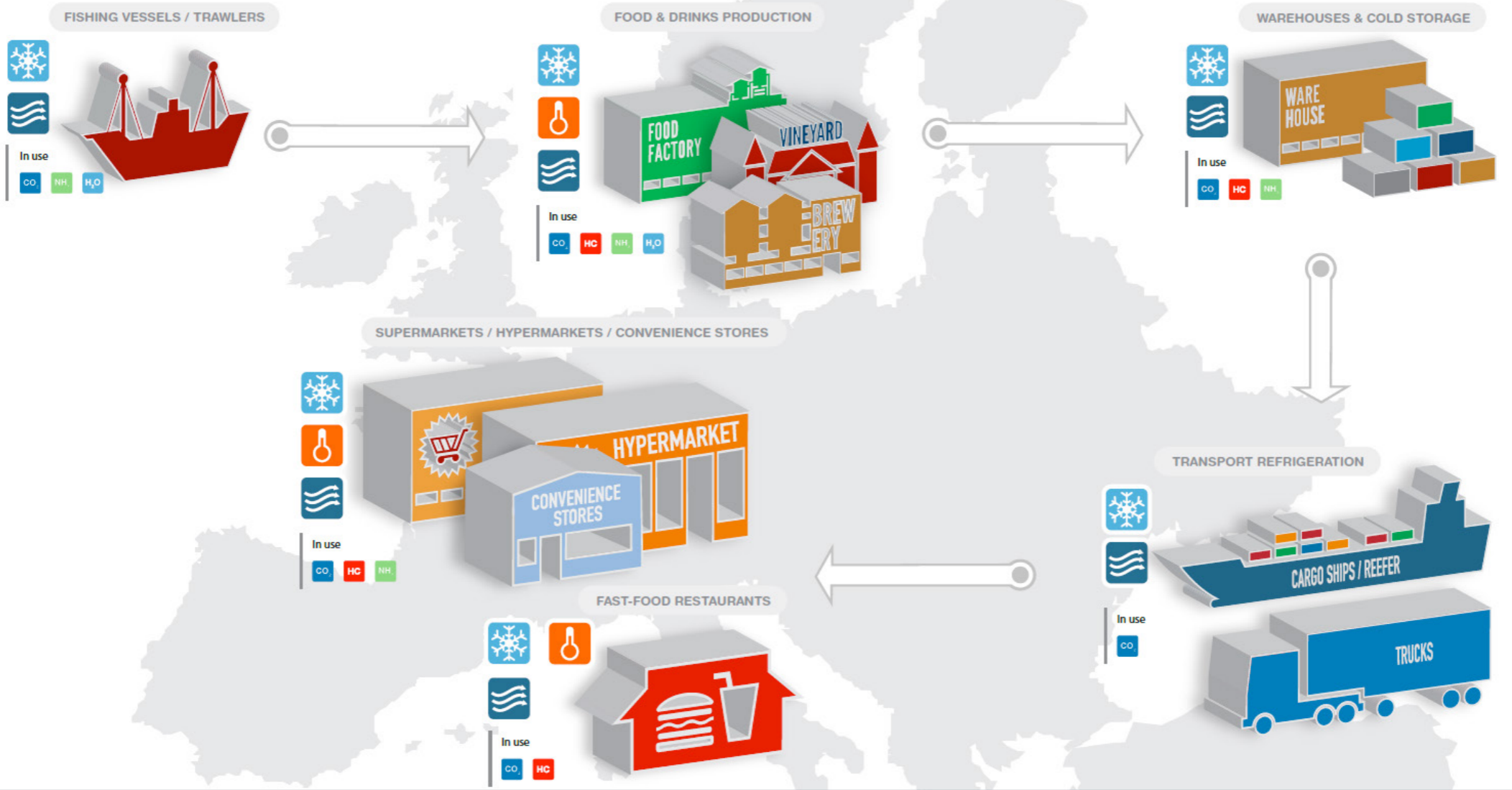

NH₃ Ammonia |
 CO₂ Carbon Dioxide |
 HC Hydrocarbons |
 H₂O Water |
 |||| ❄️ Refrigeration |
 🔥 Heating |
 🌊 Air Conditioning



Apply Danfoss expertise within natural refrigerants to your business

Dealing with Danfoss you will not only benefit from our global know-how available as local support, but we also offer different tools that can support you in your daily business working with natural refrigerants and industrial refrigeration.

We have developed an Industrial Refrigeration Application Tool and handbook making it easy to apply Danfoss knowledge. Furthermore, our mobile app, calculation software DIRcalc™ and 3D CAD symbols are free to download from our website.

One

supplier

Danfoss is your one-stop shop for everything in industrial refrigeration and natural refrigerants.

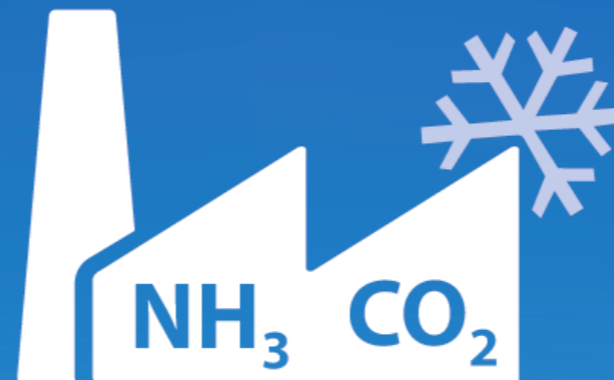

Free

tools

available to make your work with natural refrigerants easy.

www.danfoss.com/IR

existing HCFC-22 packaged chillers and a central coal-operated steam generation unit with a high-pressure heat pump solution that uses ammonia with screw compressors to reach a temperature of 90°C. The system extracts the waste heat at -5°C from the glycol as the secondary refrigerant from the refrigeration process and raises it to the main heating demand of 60°C. A plant of Robert Wiseman Dairies in Manchester, UK, won the Innovation Prize presented by trade magazine Food Processing by incorporating ammonia reciprocating compressors. Simultaneous and energy efficient provisions of refrigeration and heat have slashed the dairy producer's gas bill by 52%, its electricity bill by 20% and water bill by 50%. In a slaughterhouse of Norway, two sets of ammonia heat pump screw compressors were installed to supply additional 2400kW of 52°C hot water. The heat pumps save 1.6 GW of fuel per year (approximately 210,000 litres) and are met by high satisfaction reports from its customers.

CO₂: In a Norwegian ice cream plant, a transcritical CO₂ cooling and freezing system was installed. The 220 kW (at -38°C) CO₂ system with 150 kW of heat recovery and hot gas defrost achieves reductions of 1,000 tonnes of CO₂ equivalent per year (direct and indirect emissions) in comparison with a similar R404a system.

Schlachtbetrieb Zürich AG installed the largest CO₂ heat pump system with 800 kW in Switzerland. The three CO₂ heat pumps are used to produce high temperature hot water (90°C) for the slaughterhouse based on waste heat from refrigeration systems. As a result, about 260,000 m³ of natural gas has been saved per year and the annual CO₂ emissions have been reduced by around 30%, or 510 tonnes per year.

NH₃/CO₂: An NH₃/CO₂ cascade system was installed in a German bakery plant, where the CO₂ cycle was used for direct cooling in the freezers applied in the system, with limited NH₃ quantity. When calculated over one year of operation, 870,000 kWh of energy could be saved per year. At 70 cents per kW, this would result in savings of more than €600,000 per year.

In Russia, Nestlé invested in an NH₃/CO₂ cascade refrigeration system at its coffee processing plant in Timashvesk. The 4 MW refrigeration system is one of the largest of its kind in Europe. The system greatly reduces the ammonia charge, increasing system safety and facilitating system supervision. The use of screw compressors in the CO₂ stage reduces the number of compressors required by half and triples the time needed between maintenance operations.

In Switzerland, a food company producing organic quality meat products installed a sustainable heating and cooling system for its meat processing centre in Landquart, using heat pumps and refrigerating machines that run on ammonia and carbon dioxide. A two-stage ammonia heat pump is used for heating purposes according to the different temperature levels. Two ammonia refrigeration machines are responsible for refrigeration and are cooled with groundwater. CO₂ is used in the deep-freeze storage rooms. In France, an NH₃/CO₂ cooling and freezing installation has been selected for a French establishment used for storage by a producer of potato products in Harnes.

HC/CO₂: A meat processing plant in Osnabrück, Germany, uses a propane-CO₂ cascade system for refrigeration and deep-freezing, in processing and cold storage applications. The system uses propane as a refrigerant in the plant room and propyl-

ene glycol to distribute the cold in temperatures ranging between 3°C to -8°C. The refrigeration supply in the deep-freezing unit features CO₂ direct evaporation at -32°C. The cooling capacity is 80 kW for refrigeration and 8 kW for deep-freezing. The newly integrated CO₂/propane system reduces the required space and assembly efforts, leading to reduced investment costs.

BEVERAGES: BREWERIES & WINERIES

NH₃: Refrigeration plays an important role in beer processing. Refrigeration equipment is the major user of electricity, accounting for approximately 50% of total consumption. Ammonia refrigeration can reduce energy use in beer brewing process plants. In the plant of brewer Brauhaus Tegernsee in Germany, an ammonia system was installed as the indirect refrigeration system capable of chilling 190 hl brewing water from +16°C to +2°C in 2.5 hours. An ammonia heat pump in the system also supplies heat to the adjoining buildings. Carlsberg also uses ammonia for process cooling in all Carlsberg breweries. Nearly all Scandinavian brewing companies have ammonia refrigeration systems. The Daniel Thwaites brewery in Northern England installed a new reciprocating compressor using ammonia as the working fluid. The ammonia system has resulted in an increased output of 400 kW compared to the 310 kW supplied by the previous installation. In addition, the energy efficiency has improved, saving the owners approximately £2,000 (around €2,500) per week in electricity costs, which means that the investment will be paid back in less than 18 months.

CO₂: The Norwegian brewery Mack is moving towards a more modern plant by installing two CO₂ transcritical chillers with a total cooling capacity of 500 kW. The system satisfies Mack's requirements

for performance, safety and reduced environmental impact. In a plant of brewery Anheuser-Busch InBev in Leuven, Belgium, a 670 kW CO₂-based refrigeration unit is used for process cooling. The system uses heat released during the refrigeration process to evaporate CO₂, which is essential to carbonate beer. Thanks to this heat recuperation, InBev Belgium consumes no extra energy, limiting the impact on the environment and lowering the energy bill substantially.

H₂O: A solar cooling system in the cellar of the GICB winery (Groupement Interproducteurs du Cru de Banyuls) in the south of France installed an absorption chiller. The project is the first in France in the private food sector and one of the first in Europe. The average thermal Coefficient of Performance (COP) is 0.55. Energy consumption is 2,800 kWh which corresponds to a cost of only €280/year. The energy savings are estimated at €950/year (on the basis of an average increase of energy price of 5%/year).

FISHING: PROCESSING PLANTS, VESSELS & CONTAINER SHIPS

In recent years, natural refrigerants have begun to enter the fishing and maritime refrigeration market. The transition to ammonia, carbon dioxide, and water has begun among transport refrigeration end-users in Europe. According to a leading manufacturer of plate freezers for fishing vessels, the company has already delivered more than 500 CO₂ plate freezers to European fishing companies. Today, 80% of its maritime plate freezers use ammonia and CO₂.

Ammonia and CO₂ are used in refrigerated ships, accounting for nearly 5% of the installed global market in 2010. Today, fishing companies increas-

ingly voice their interest for the use of ammonia (NH₃) as refrigerant for on-board refrigeration. CO₂ is also being considered as an alternative for intermodal containers. CO₂ containers are commercially available today for marine shipping. CO₂ plate freezers in fishing vessels have been widely used by European fishing companies.

NH₃: Today, ammonia is the refrigerant of choice for modern environmentally friendly refrigeration systems across the fishery cold chain in Europe. From catch to consumer, ammonia refrigeration is used in the production of ice, to refrigerate seawater, refrigerate compartments and to cool cold stores, ensuring food safety, shelf life and appearance.

In the fish processing industry, fast and continuous deep freezing and storage play an important role, as marine food is very prone to spoiling or losing quality. In Greenland, a 10,000 m³ cold fish store was installed at Qasiannhuit (Christianshab) including an ammonia refrigeration system equipped with a two-stage system for an air blast freezer, a plate freezer & cold store, and one-stage systems for air conditioning, ice production, and two chill stores. An ammonia refrigeration system with a 630 kW ice production and freezer capacity and 1555 kW cold room capacity was installed in a fish processing factory in Spain. In Iceland and the Faroe Islands, two new fish processing installations in Faskruosfjorour and Vestmanna have a 1150 kW and 1,000 kW ammonia refrigeration capacity respectively.

CO₂: Marine container refrigeration systems based on CO₂ refrigerant can reduce the carbon footprint by 35% compared to its predecessor, primarily due to its higher energy efficiency. Its carbon footprint also shrinks due to the fact that CO₂

is a far less potent greenhouse gas (GHG) compared to its CFC-based predecessor, Freon. Several companies have announced production of high-efficiency CO₂ refrigerated marine containers, and demonstration units are being tested in various locations worldwide, including the United States and Singapore. Sea trials of a refrigerated CO₂ reefer container that is now available in the market indicate that the CO₂ transcritical system achieves an average energy usage equal to R134a, tested over more than 23,000 operating hours. Moreover, a 28% reduction of emissions as compared to the HFC equivalent units was realised.

NH₃: Ammonia is also applied in indirect and cascade systems on new refrigerated ships. In ships that carry professional crew only (no passengers) and those with relatively high refrigeration capacity like fishing ships, ammonia is more commonly used.

H₂O: In 2012, on the new AIDA 6 cruise ship, a tri-generation system with absorption chiller, was installed. The system achieves a cooling capacity of up to 1,300 kW and produces up to 100 m³ of fresh water per day. Waste heat from the cooling water of its diesel engines is used to operate the cascade heat consumption in an absorption chiller connected to a Multiple Effect Distillation (MED) desalination unit for the production of cooled water and drinking water on board the ship.



HOW IMPORTANT ARE DURABILITY & BEST-IN-CLASS PERFORMANCE TO YOU?

Finding the right balance between performance and environmental impact is a constant battle for retailers. Emerson's range of 4-cylinder Copeland Stream compressors for CO₂ (R744) transcritical applications offers the ideal, durable solution for R744 medium temperature cascade and booster systems. The high pressure design, optimized refrigerant flow, heat transfer and CoreSense™ for advanced protection as well as individual power consumption monitoring are just some of the features which give the new CO₂ Stream range best-in-class for performance and

underline its uniqueness. Combined with the R744 subcritical Copeland Scroll™ for low temperature operation, Emerson are able to offer the most energy efficient package on the market.

And of course all Stream compressors are equipped with CoreSense Diagnostics so that potential problems can be diagnosed and fixed quickly, improving operational efficiency and extending the system's durability further. Emerson Stream compressors — the new benchmark for semi-hermetic compressors.

Emerson Climate Technologies - European Headquarters - Pascalstrasse 65 - 52076 Aachen, Germany
Tel. +49 2408 929 0 - Fax +49 (0) 2408 929 570 - Internet: www.emersonclimate.eu
The Emerson Climate Technologies logo is a trademark and service mark of Emerson Electric Co. Emerson Climate Technologies Inc. is a subsidiary of Emerson Electric Co. Copeland is a registered trademark of Emerson Climate Technologies Inc.



EMERSON. CONSIDER IT SOLVED.™

END-USER VIEWS ON NATURAL REFRIGERANTS IN COMMERCIAL REFRIGERATION

COMMERCIAL REFRIGERATION

Delhaize Group is committed to increasing the number of natural refrigerant systems where they are feasible and cost-effective.

Georgios Patkos, Delhaize Group

The big motivator for us [Delhaize Group] is our overall CO₂ emissions goal, which we have had since 2008, and which is a 20% reduction in emissions per m² by 2020.

Megan Hellstedt, Delhaize Group

We rose to the challenge of CFCs, HCFCs, HFCs. My business can't believe that we can come up with so many different refrigerants that cost so much money. But hopefully CO₂ is going to put us in a place where we will have some future proofing.

John Skelton, Sainsbury's Supermarkets

COMMERCIAL REFRIGERATION IN WARM CLIMATES

We know there are companies testing their solutions for warmer climates, and they are testing effective systems, and they will share their learnings quickly, and we will be able to adopt it. So we believe there is a momentum on that issue and that we have some solutions that are emerging. The question is how to quickly make them cost effective for the industry.

Megan Hellstedt, Delhaize Group

COMMERCIAL REFRIGERATION FOR CONVENIENCE STORES

Probably the reason we only have the one convenience store using CO₂ is because at the moment we are finding it easier to get to the right cost point with supermarkets and more difficult in convenience store applications. That is something that we need to change, and something that we need to change pretty quickly. Whether it is CO₂ or another natural, we made a commitment back in November 2009 that all of our refrigeration systems would be natural by 2030, and the piece that is holding me up delivering that, at the moment, is our convenience estate.

John Skelton, Sainsbury's

I want the support to do more stores, I want the support to do the right thing with convenience stores. I want to know what are the technologies that are coming round the corner? I want people advising me and helping me to make sure that we have the best refrigeration system in our stores. The Sainsbury's door is always open.

John Skelton, Sainsbury's

LIGHT COMMERCIAL REFRIGERATION

Cost still drives business decisions today, but cost is coming down, and I can assure you that in three years time, in our case, this issue changed for us from us thinking that we could not do this, to thinking instead yes, let's go!

Antoine Azar, The Coca-Cola Company

It is not a legend, HFC-free systems perform well, their price is going down and there is more and more natural refrigerant training available, so I think with time we are addressing all those elements that posed an initial concern.

Antoine Azar, The Coca-Cola Company

As of 2015, we [Refrigerants Naturally!] will not buy any more HFCs.

Antoine Azar, on behalf of "Refrigerants, Naturally!"

Our strategy is 100% HC procurement, starting from the last year already. One exception for us is Japan where we are facing issue to get components, and to get the right sized compressor with hydrocarbons available.

Jürgen Brenneis, Red Bull

NATURAL REFRIGERANTS IN THE EUROPEAN FOOD CHAIN

MARKET & TECHNOLOGY MAPS



CO₂ TRANSCRITICAL & CASCADE STORES IN EUROPE 2011-2013

Driven by retailers' growing environmental commitment, the market for commercial CO₂ transcritical refrigeration systems is gaining further momentum in Europe. shecco's updated commercial supermarket map shows an increase of 117% in the number of CO₂ TC supermarkets within two years. For the first time, a new map provides figures on the European market with CO₂ cascade systems.

PAGES 41 & 48



OTHER NATURAL REFRIGERANTS IN STORES & LIGHT-COMMERCIAL REFRIGERATION IN EUROPE 2013

A growing number of retailers rely on central ammonia and hydrocarbon (HC) systems, and more than 480,000 hydrocarbon plug-in supermarket cabinets in operation prove that other natural solutions are ready for the market. With consumer good brands committed to environmental stewardship, the number of CO₂ and HC freezers and coolers is growing in Europe.

PAGES 56 & 60



NATURAL REFRIGERANT TECHNOLOGY IN STORES AROUND THE WORLD 2013

Worldwide, the number of retailers using CO₂ refrigeration technology is constantly growing. Europe still leads in the adoption of CO₂ refrigeration technology in supermarkets, but other world regions are gaining momentum. See a world map showing where more than 5,000 stores using CO₂ transcritical and cascade/secondary refrigeration systems are located.

PAGE 63

CO₂ TRANSCRITICAL STORES IN EUROPE

INTRODUCTION

In 2012, shecco published the first detailed figures on the number of supermarkets using CO₂ transcritical refrigeration systems in the European Union. shecco's pioneering CO₂ transcritical commercial refrigeration map for the first time provided industry with precise figures, which were urgently needed by both technology leaders and legislators to quantify the future market potential of non-fluorinated gases. In order to respond to the fast moving adoption of natural refrigeration in European supermarkets, shecco conducted a 2nd research study in 2013. Building on the first study, shecco extended its research activities to determine the updated number of CO₂ transcritical (TC) supermarkets by covering all major European supermarket chains, refrigeration system manufacturers, component suppliers, contractors and associations. Over 100 supermarket chains, more than 30 system suppliers and 4 associations were contacted. The numbers reflected in the 2013 maps refer to the number of supermarkets using natural refrigeration systems and not the number of packs, which might be even higher as, for example, some large supermarkets use more than one CO₂ TC unit.

Furthermore the geographical scope of the research was extended to all European countries (Europe 50+). The natural refrigeration systems and refrigerant types examined were extended from CO₂-only systems to NH₃-only and HC-only systems as well as cascade systems using CO₂, NH₃ and hydrocarbons, and lastly, hydrocarbon plug-in supermarket cabinets.

CO₂ TRANSCRITICAL STORES IN EUROPE 2013

The data collected between July and October 2013 revealed a great increase of CO₂ TC supermarkets in Europe within less than two years. From the end of 2011 up until October 2013 an additional 1,555 CO₂ TC supermarkets appeared on the market, bringing the total number of CO₂ TC stores to 2,885. And the number is constantly growing. Thanks to new technologies, CO₂ TC systems are being used in new market segments such as smaller convenience stores, and are also being applied to southern regions with higher ambient temperatures.

SCANDINAVIAN COUNTRIES FOLLOW DANISH LEADERSHIP

shecco's latest CO₂ transcritical supermarket map shows that Denmark is still a leader in the adoption of CO₂ refrigeration technology with 712 stores, the highest number of CO₂ TC stores in Europe. Denmark is considered a pioneer and role model when it comes to legislating high global warming potential (GWP) refrigerants. Danish policy is stricter than EU policy and largely explains the flourishing CO₂ TC commercial refrigeration market. Danish regulations by and large prohibit the use of HFC gases and ozone depleting substances as refrigerants. Complementing the HFC ban, in 2001 Denmark introduced a tax on the imports of bulk HFCs. Moreover, to promote the spread of natural refrigerants, the Danish Environmental Protection Agency has set up a Knowledge Centre for HFC-free Refrigeration. Denmark's success in mak-

ing the use of f-gases financially and technically prohibitive in food retailing within the shortest timeframe is lauded overseas in discussions on restricting the use of hydrofluorocarbons. Danish retailer Fakta for example already has around 150 CO₂ TC stores in operation today.

The latest figures provided by shecco reveal that other Nordic countries are catching up to the leader. In Norway, 310 CO₂ TC supermarkets were in operation in July 2013, reflecting an increase of 131% compared to the end of 2011. Retailers like COOP Norway already have more than 40 CO₂ TC stores in operation and have set CO₂ TC systems as a standard. A REMA1000 supermarket in Trondheim, Norway, is expected to reach 30% energy savings using an integrated CO₂ system and heat recovery. Retailer Royal Ahold is rolling out CO₂-only technology as the standard in Scandinavia.

Sweden and Finland are also following Danish and Norwegian leadership. In Sweden, the number of CO₂ TC stores has increased by almost 200%, reaching a total number of 266. COOP Sweden has recently installed a new CO₂ system, which combines cooling, frost, heat recovery and air conditioning in one single plant. Swedish retailer ICA has been using CO₂ TC systems in new installations since 2010. In 2013 alone, CO₂ systems have been implemented in over 50 ICA stores in Sweden. One of the largest supermarkets in Scandinavia, the Nordby Supermarket in Strömstad, Sweden, has cut energy consumption by up to 20-30% using a transcritical CO₂ booster refrigeration system. The CO₂ solution provides cooling for the freezers, refrigerators and cold rooms; in addition heat is reclaimed to heat the supermarket during the winter.

In Finland, the number of CO₂ TC operations has almost quadrupled in the last two years to 86 stores. In recent years, Finnish retailer Kesco has been rolling out CO₂ refrigeration in its stores in Northern Europe. About half of all new Kesco food stores use CO₂. The retailer has reported that its stores using carbon dioxide as a refrigerant consume 30% less heat energy compared to stores using other refrigerants.

The high number of commercial CO₂ TC installations in the Northern countries highlights the availability and the maturity of CO₂ technology for these climate zones.

UK'S RETAILERS COMMITTED TO CO₂

The number of CO₂ TC stores in the UK has steadily increased in the last two years. Even though the UK does not tax high-GWP refrigerants, CO₂ TC refrigeration in supermarkets is gaining momentum. The first UK system was installed in 2006 in Swansea in a Tesco supermarket. Since then the number of installations has grown steadily. UK retailers like Tesco, Marks & Spencer, Waitrose, Boots and Sainsbury's have committed to ambitious targets in order to eliminate climate-warming f-gases from their stores. In 2013, the number of CO₂ TC stores in the UK had already reached more than 441 stores.

In April 2013, Tesco was operating 65 CO₂ TC stores in the UK and is looking to at least double that number to 130 stores by end of 2013. Following the retailers 20x20 sustainability plan, Sainsbury's has made heavy investments in climate friendly refrigeration technology. Sainsbury's is considered a pioneer in CO₂ TC refrigeration, and today has 167 stores, including 166 supermarkets and 1 convenience store, using R744 technology. Recently

Sainsbury's opened its second zero emissions store in Leicester. Several measures including natural CO₂ refrigeration units for the chillers and freezers reduce the stores carbon footprint by 33%. British retailer Booths expects all of its new refrigeration systems to be CO₂-based. UK retailer Marks & Spencer (M&S) has more than 80 pumped CO₂ cascade systems in operation today. But as the retailer's goal is to become HFC-free and to integrate heat reclaim, the question M&S is facing today is whether to develop an HFC-free front end for the current base of CO₂ pumped systems installed, or alternatively transition to CO₂ TC. Therefore, M&S is currently trialing CO₂ TC refrigeration as an alternative to their pumped systems.

Two pieces of legislation have helped to encourage investment in climate friendly, energy saving refrigeration technology: the UK climate change legislation, which includes the 2001 Climate Change Levy (CCL) aimed at encouraging energy efficiency and reduced greenhouse gas (GHG) emissions; and the 2008 Climate Change Act, which sets a target for the UK to reduce carbon emissions to 80% below 1990 levels by 2050.

CO₂ TRANSCRITICAL SYSTEMS ARE GAINING MOMENTUM IN GERMAN SUPERMARKETS

German retailers are also pushing forward with the adoption of CO₂ technology in their stores. In 2012, shecco counted 149 German supermarkets using CO₂ TC refrigeration systems. The latest figures reveal an increase of 158%, bringing the total number of CO₂ TC stores in Germany to 429.

The German retailer Aldi Süd has adopted CO₂ as its standard refrigerant for all new stores in Germany. In 2013, Aldi Süd already had 151 CO₂ TC

stores in operation. At Edeka Südwest (South-West) CO₂ TC systems and subcritical hybrid cascade systems have been the preferred choice since 2009. As a result, today the company has 106 CO₂ TC systems in operation. Retail giant Metro is also adopting CO₂ transcritical systems at its Metro Cash & Carry and Real stores. In 2010, German food retailer tegut signed a contract to implement 50 sustainable and energy efficient refrigeration systems using CO₂. So far the company has 20 stores running on CO₂. Three stores of the Kaufland retail chain use CO₂-only refrigeration systems.

The strong German market for CO₂ TC supermarket installations is largely thanks to an incentive scheme for commercial refrigeration using natural refrigerants run by the Federal Ministry for Environment (BMU). As part of the "Integrated Energy and Climate Protection Programme", at the end of 2008 the German Government instituted a "Climate Protection Incentive Programme for commercial refrigeration plants".

SWISS RETAILERS SUCCESSFULLY ROLL OUT CO₂ TRANSCRITICAL SYSTEMS

Since the first CO₂ direct expansion refrigeration system was installed in a Swiss hypermarket in November 2004, several supermarket chains have made the switch to CO₂ refrigeration systems. Leading retail chains Migros and Coop are paving the way for CO₂ TC systems. In 2008, Coop launched the first tests with CO₂ as the only refrigerant. Today, around 200 stores operated by the Swiss retailer Coop use natural refrigerants, representing almost 25% of Coop's supermarkets in Switzerland. In fact all of the stores use CO₂ TC refrigeration systems. Migros has also committed to using CO₂ as a standard refrigerant in all new stores since 2010. Migros already operates some 300 carbon dioxide



CO₂
 For energy and eco-friendly refrigerant solutions, trust the Parker Sporlan Leaf.

Together, we can perform best under pressure all day, every day.



Supermarket Customers take for granted that product will be fresh, milk and meats at the proper temperature and frozen foods maintained perfectly frozen.

With Parker Sporlan CO₂ flow control products, be assured your refrigeration systems operate reliably and efficiently while being constantly monitored by state of the art digital controls.

High pressure CO₂ systems need heavy duty, ultra reliable components, and supermarket owners demand dependable, trouble free systems with economical life-cycle costs and the lowest possible carbon footprint. The green performance delivered by our products fit both transcritical and subcritical modes. Have the confidence that your CO₂ refrigeration requirements are secure with Parker Sporlan systems, spare parts, and integrated facilities management a name whose reputation has been built on quiet success.

aerospace
 climate control
 electromechanical
 filtration
 fluid & gas handling
 hydraulics
 pneumatics
 process control
 sealing & shielding



ENGINEERING YOUR SUCCESS.

www.parker.com/race
racecustomerservice@parker.com

MAP OF CO₂ TRANSCRITICAL STORES IN EUROPE 2011/2013

DATA BY COUNTRY

TOTAL
2011



TOTAL
2013

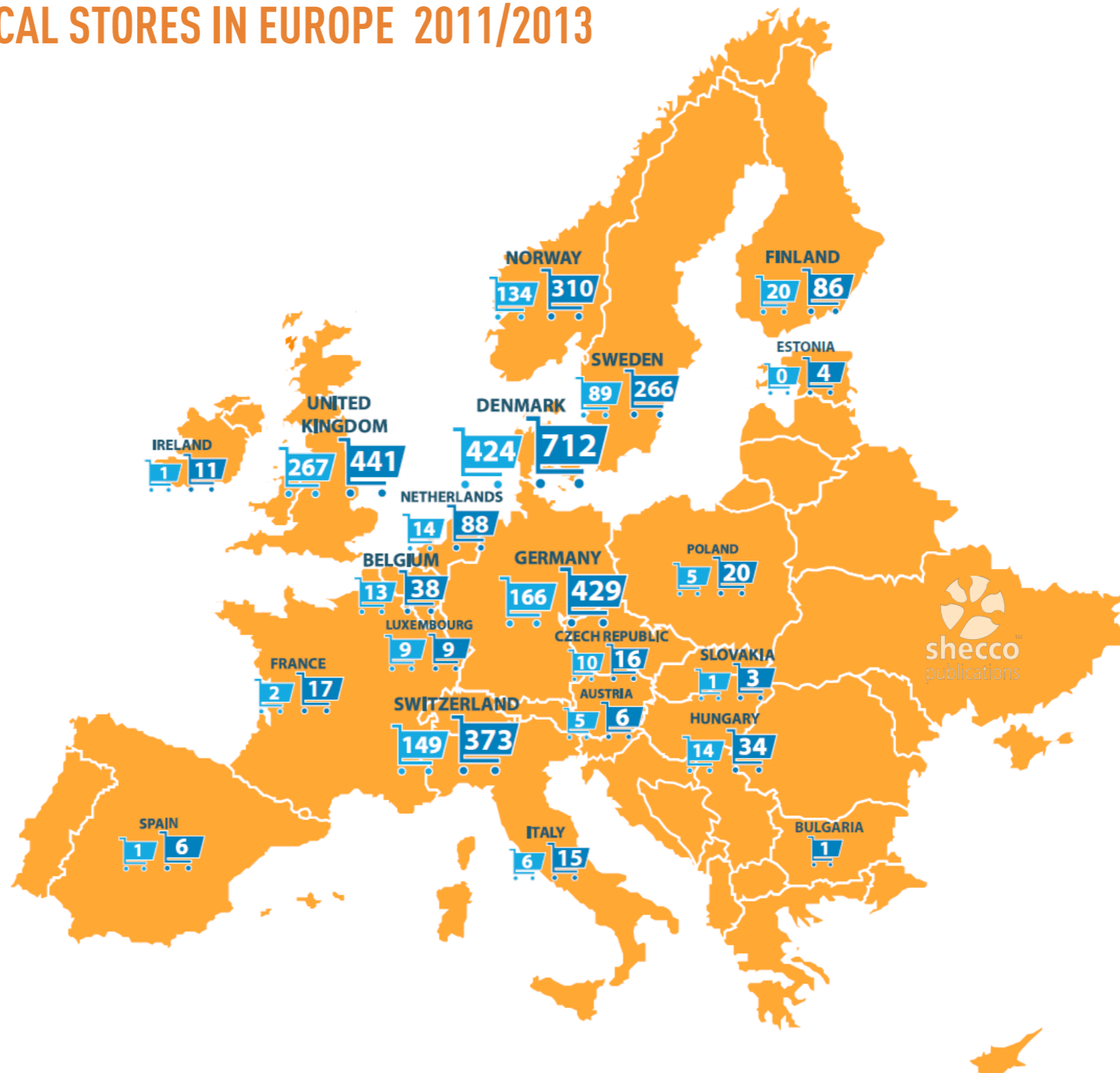

These figures are based on a 2013 survey of leading system suppliers and commercial end-users. Feel free to contact us to add your data to the map. Send an email to research@shecco.com

MAP OF CO₂ TRANSCRITICAL STORES IN EUROPE 2011/2013

| COUNTRY | CO ₂ TC SUPERMARKETS 2013 | CO ₂ TC SUPERMARKETS 2011 | GROWTH 2011 TO 2013 TOTAL | GROWTH 2011 TO 2013 PERCENT |
|----------------|--------------------------------------|--------------------------------------|---------------------------|-----------------------------|
| Austria | 6 | 5 | 1 | 20% |
| Belgium | 38 | 13 | 25 | 192% |
| Bulgaria | 1 | 0 | 1 | 100% |
| Czech Republic | 16 | 10 | 6 | 60% |
| Denmark | 712 | 424 | 288 | 68% |
| Estonia | 4 | 0 | 4 | 0% |
| Finland | 86 | 20 | 66 | 330% |
| France | 17 | 2 | 15 | 750% |
| Germany | 429 | 166 | 263 | 158% |
| Hungary | 34 | 14 | 20 | 143% |
| Ireland | 11 | 1 | 10 | 1000% |
| Italy | 15 | 6 | 9 | 150% |
| Luxembourg | 9 | 9 | 0 | 0% |
| Netherlands | 88 | 14 | 74 | 529% |
| Norway | 310 | 134 | 176 | 131% |
| Poland | 20 | 5 | 15 | 300% |
| Slovakia | 3 | 1 | 2 | 200% |
| Spain | 6 | 1 | 5 | 500% |
| Sweden | 266 | 89 | 177 | 199% |
| Switzerland | 373 | 149 | 224 | 150% |
| UK | 441 | 267 | 174 | 65% |
| TOTAL | 2.885 | 1.330 | 1.555 | 117% |

Data taken into account for drafting the market maps is based on shecco's continuous global research activities. While the below lists only indicate those companies that gave direct input, the total figures cover a significantly higher number of food retailers and suppliers.

SUPERMARKETS

Ahold Europe
 Carrefour
 Coop Switzerland
 Coop Norway
 Delhaize Group
 FegroSelgros
 Metro AG
 Migros AG
 Prodega/Growa Cash+Carry
 Tesco

SUPPLIERS

Advansor A/S
 Carrier Kältetechnik Deutschland GmbH
 compact Kältetechnik GmbH
 Epta s.p.a.
 Frigo-Consulting AG
 Green&Cool
 Hafner-Muschler, Kälte- u. Klimatechnik GmbH & Co. KG
 Hauser GmbH
 Kältering AG
 Knudsen Køling A/S
 SSP Kälteplaner AG
 Space Engineering Services Ltd
 SCM Frigo
 Veld Koeltechnik BV

FOOD INDUSTRY | LOGISTICS COMPANIES | CATERING | RETAIL TRADE | CHEMICAL INDUSTRY

WE LOVE IT WHEN IT'S CHILLY!

We are committed to providing environmentally compatible, efficient refrigeration.



SSP | KÄLTEPLANER.CH |

SSP Kälteplaner AG | CH-4702 Oensingen | CH-6004 Lucerne | CH-1800 Vevey
Phone +41 62 388 03 50 | www.kaelteplaner.ch | mail@kaelteplaner.ch

SSP Kälteplaner AG | D-87787 Wolfertschwenden
Phone +49 8334 259708 0 | www.kaelteplaner.ch | mail@kaelteplaner.ch

cooling systems in its branches, many of them with CO₂ TC systems. Migros aims to replace all HFC stores by the end of 2014. The refilling of HCFC refrigerants will be banned as of January 2015.

SPAR supermarket also uses CO₂ TC refrigeration systems in Switzerland. A SPAR store in Schüpfen has recently installed a fully integrated system to satisfy the store's refrigeration, space heating and cooling, ventilation and lighting needs. The total number of 373 Swiss CO₂ TC supermarkets in 2013 reflects an increase of 150% compared to the end of 2011.

The adoption of CO₂ TC installations in Switzerland has been incentivised by a mix of the voluntary "Minergie-Label" and the HFC regulation. Since 2004 "substances stable in the air", such as HFCs have been tightly regulated in Switzerland, making alternative refrigerants such as CO₂ attractive as cooling solutions.

BENELUX COUNTRIES SHOW IMPRES- SIVE GROWTH OF CO₂ TRANSCRITICAL STORES

In Belgium, the number of CO₂ TC stores has increased by 192% within less than two years, bringing the total number to 38 stores. Retailers like Delhaize and Ahold are undertaking significant efforts to adopt CO₂ technology in their stores. Overall, Delhaize Group has invested in natural refrigerants in 56 stores in Belgium and Luxembourg, including 15 CO₂ TC stores. In Luxembourg, 9 CO₂ TC systems are currently in operation (2013).

Compared to the previous research conducted by shecco, the number of CO₂ TC stores in the Netherlands has increased by 529% to 88 stores. Dutch retailer Royal Ahold already has hundreds of CO₂

cascade systems in operation. In the Netherlands, Royal Ahold has 850 stores and rebuilds about 150 stores a year. The retailer is a member of the Consumer Goods Forum (CGF) and supports the CGF resolution to phase-out HFCs in new stores from 2015. It has therefore been piloting 3 CO₂-only systems since 2012. If the CO₂ pilots are successful, Royal Ahold will include them in the roll-out, and in five years time CO₂ TC systems should have reached half of the stores and in ten years could be implemented in almost all Royal Ahold stores. The Jumbo supermarket chain, the 2nd largest retail chain in the Netherlands, equipped a store in Deventer with a CO₂ booster system in 2012.

SHIFTING EFFICIENCY EQUATOR ALLOWS CO₂ REFRIGERATION TO BECOME AN OPTION FOR SOUTHERN COUNTRIES

With suppliers starting to offer CO₂ solutions for higher ambient temperatures, this technology will experience rapid growth rates in the future, in all southern countries. To date, 6 supermarkets in Spain use CO₂ TC systems and further tests are being conducted to improve efficiency in warm climates. A field trial of a CO₂ TC booster and rooftop mounted hydrocarbon mechanical subcooler installation in Spain shows that energy consumption is equal to HFC systems in southern European climates. The trialed system is more energy efficient than HFC coolants and allows energy savings of more than 25%.

In Italy, the number of CO₂ TC stores increased by 150% to 15 stores compared to 2012. Since the first CO₂ TC store was installed in a Coop supermarket in Lestans in 2011, several retailers have opted for the advanced refrigeration technology. Amongst

some of the most recent is Carrefour's installation of its first CO₂ TC at its hypermarket in Barulo, which has reduced the overall energy bill of the hypermarket by 7%. Retailer "Il Kanguro's" first CO₂ TC store was in Belluno, in the North-East of Italy, in operation since 2012.

In France the number of CO₂ TC supermarkets has already reached 17 stores, compare to 2012 when only two CO₂ TC stores were in operation. Since February 2012 the Carrefour market of Beaurains-les-Arras, in the North of France, has been using a Booster TC CO₂ system for both positive and negative temperature levels. This first-ever CO₂ TC system in a French supermarket has been followed by a second one in Lyon in 2012. Since November 2012, another French retailer Leclerc, has had a supermarket in Nantes refrigerated using CO₂ as a refrigerant.

CO₂ CASCADE STORES IN EUROPE

Building on its initial study on the number of CO₂ TC supermarkets in the EU, shecco extended its research activity for the 2013 edition to include CO₂ cascade refrigeration systems. The focus of the research was on supermarkets using CO₂ for low temperature (LT) and HFCs, NH₃ or HCs for the medium temperature (MT). The latest figures reveal 1,639 stores using CO₂/HFC cascade systems in Europe. In addition, 19 stores use CO₂/NH₃ cascade systems. The highest number of CO₂ cascade stores, 314, has been recorded in Germany. In Switzerland, 243 CO₂/HFC and 4 CO₂/NH₃ supermarkets were in operation in 2013. The Netherlands (242 supermarkets) and Italy (199 supermarkets) are also countries with high numbers of CO₂/HFC cascade stores.

GERMANY

It was back in 2004 that the German retailer real,-, part of the METRO group, operated its first test store with a R404A/CO₂ refrigeration system. The successful trial led the retailer to decide in 2009 that all new stores would use R134a for the MT and CO₂ for the LT. With the R134a/CO₂ cascade systems, real,- has achieved reductions in energy consumption of up to 35% compared to the previously used R404 only systems. Since 2009, CO₂ TC systems and subcritical hybrid cascade systems have been the preferred choice at Edeka Südwest. As a result, today the company has 59 subcritical CO₂ cascade systems in operation. Aldi Süd is committed to CO₂ as the preferred refrigerant. In addition to more than 150 CO₂ TC stores Aldi operates 49 CO₂/HFC cascade stores. In 2013, Kaufland operated 40 stores using CO₂/HFC cascade systems. In

total, shecco counted 314 German supermarkets using CO₂/HFC cascade systems in 2013.

SWITZERLAND

After starting up its first LT CO₂ plant in Switzerland in 2002, today Migros operates almost 200 stores with CO₂ cascade systems. Coop started to test CO₂ as a refrigerant back in 2003. Since 2010, CO₂-only refrigeration systems have been the standard in all new and retrofitted stores. But some CO₂ cascade supermarkets are still in operation today. In addition to the 243 CO₂/HFC cascade systems in operation, 4 supermarkets are using CO₂ cascade systems with NH₃ for the MT.

BENELUX

Today, Albert Heijn, a supermarket chain owned and operated by Ahold, already has 257 CO₂ cascade stores in operation in Europe. The majority of Ahold's CO₂/R134a stores are located in the Netherlands. The total number of CO₂/HFC stores in the Netherlands to be 242. Besides 15 CO₂ TC systems, Delhaize Group has invested in natural refrigerants in 56 stores in Belgium and Luxembourg. Adding these figures to those of the other retailers in those two countries brings the total number of cascade stores to 50 in Belgium and 17 in Luxembourg.

ITALY

Carrefour Group has adopted several CO₂ cascade systems in Italy. In total, 199 CO₂ cascade stores, operated by several Italian retailers, were counted in mid 2013.

FRANCE

In France, 120 supermarkets using CO₂/HFC refrigeration systems were counted in 2013. Carrefour operates 70 CO₂/HFC cascade supermarkets, more than half of them located in France. Besides France, the Carrefour Group has adopted several CO₂ cascade systems in Italy, Spain and Turkey. Super U is another French retailer relying on CO₂/HFC systems, in operation, for example, in a supermarket in Lanvallay.

Among the 3 CO₂ cascade supermarkets using ammonia is a Carrefour hypermarket in La Chapelle Saint-Luc in the Aube department, in North-Eastern France. The hypermarket, which opened in November 2012, uses an NH₃/CO₂ refrigeration system. A Leclerc hypermarket in Ploufragan has been using a NH₃/CO₂ system since 2010.

UNITED KINGDOM

UK retailer Marks & Spencer (M&S) has 82 food halls operating with a pumped CO₂ cascade system, out of a total of 542. In addition, the retailer has trialed several different CO₂ cascade systems, including systems using CO₂/HC, CO₂/R404a and CO₂/R134a. Supermarket chains Morrison and Iceland also operate CO₂/HFC stores, bringing the total number to 87 stores in the UK.

PORTUGAL

The Portuguese retailer Sonae is trialing its first CO₂/R134a cascade system and is looking for all-natural refrigeration systems. Suppliers of refrigeration systems have made huge progress in develop-

REDEFINING REFRIGERATION SYSTEMS



Frigo-Consulting Ltd.
Refrigeration Consulting & Engineering
Feldstrasse 30
P.O. Box
CH-3073 Guemligen Bern / Switzerland
Phone +41 31 996 48 48
info@frigoconsulting.ch

Office Zurich:
Lerzenstrasse 8
P.O. Box
CH-8953 Dietikon 1
Phone +41 44 732 46 46
info.zh@frigoconsulting.ch

Office Lausanne:
Chemin de la Colice 4
P.O. Box
CH-1023 Crissier
Phone +41 21 633 44 66
info.sr@frigoconsulting.ch

MAP OF CO₂ CASCADE STORES IN EUROPE 2013

DATA BY COUNTRY

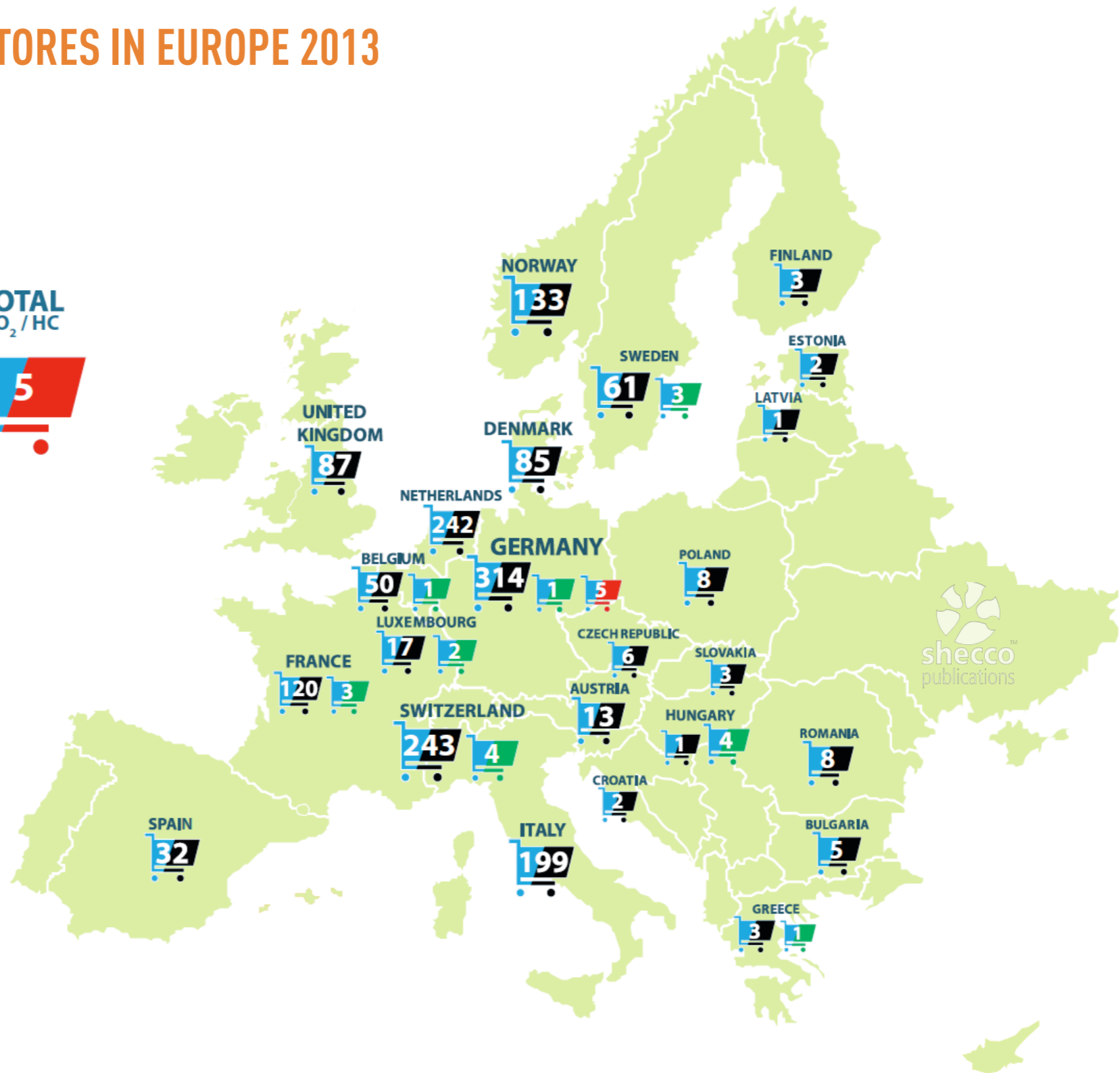

These figures are based on a 2013 survey of leading system suppliers and commercial end-users. Feel free to contact us to add your data to the map. Send an email to research@shecco.com

MAP OF CO₂ CASCADE STORES IN EUROPE 2013

| COUNTRY | CO ₂ /HFC CASCADE SUPERMARKETS | CO ₂ /NH ₃ CASCADE SUPERMARKETS | CO ₂ /HC CASCADE SUPERMARKETS |
|----------------|---|---|--|
| Austria | 13 | | |
| Belgium | 50 | 1 | |
| Bulgaria | 5 | | |
| Czech Republic | 2 | | |
| Denmark | 6 | | |
| Estonia | 85 | | |
| Finland | 2 | | |
| France | 3 | | |
| Germany | 120 | 3 | |
| Hungary | 314 | 1 | 5 |
| Ireland | 3 | 1 | |
| Italy | 1 | 4 | |
| Luxembourg | 199 | | |
| Netherlands | 1 | | |
| Norway | 17 | 2 | |
| Poland | 242 | | |
| Slovakia | 133 | | |
| Spain | 8 | | |
| Sweden | 8 | | |
| Switzerland | 3 | | |
| UK | 32 | | |
| TOTAL | 1.638 | 19 | 5 |

Data taken into account for drafting the market maps is based on shecco's continuous global research activities. While the below lists only indicate those companies that gave direct input, the total figures cover a significantly higher number of food retailers and suppliers.

SUPERMARKETS

Ahold Europe
 Carrefour
 Coop Switzerland
 Coop Norway
 Delhaize Group
 FegroSelgros
 Metro AG
 Migros AG
 Prodega/Growa Cash+Carry
 Tesco

SUPPLIERS

Arneg s.p.a
 Carrier Kältetechnik Deutschland GmbH
 compact Kältetechnik GmbH
 Enex srl
 Epta s.p.a.
 Frigo-Consulting AG
 Hafner-Muschler, Kälte- u. Klimatechnik GmbH & Co. KG
 Kältering AG
 SSP Kälteplaner AG
 Space Engineering Services Ltd
 SCM Frigo
 QPLAN Ltd. (2011)

ing technologies that can make all-natural systems efficient even in high ambient climates.

SPAIN

32 CO₂/HFC stores in Spain prove that CO₂ technology is making its way to the south. Eroski supermarket has equipped several stores with R134a/CO₂ systems. After piloting two eco-efficient stores in 2010 and 2011, the retailer Eroski decided to go a step further in the field of sustainable construction and established the zero-emission store in Oñate. Carrefour Spain has installed a CO₂/R134a cascade system in its Tarrasa and Barcelona-Sants supermarkets, with CO₂ used for the frozen facilities and R134a for the chilled facilities. Supermarket chain DinoSol, that operates 195 stores in the Canary Islands, has opened its first cascade CO₂ store in Las Palmas de Gran Canaria, located at the commercial centre 'El Tablero', in San Bartolomé de Tirajana. In 2011, the Spanish supermarket chain "Supermercados Hiber" was one of the pioneers of climate-friendly technology with two shops opening in Barajas and Móstoles using CO₂. In Spain, after several tests of CO₂/R134a cascade systems, Carrefour is planning to adopt CO₂ cascade technology for all new projects and renewals of complete refrigeration plants.

AUSTRIA

REWE International AG - the Austrian subsidiary of the German REWE Group -introduced the eco-store concept with CO₂ cascade systems in 2012. The new stores are in line with REWE's commitment to reduce carbon emissions by 30% by 2015. In their mid-term view, REWE considers CO₂ cascade system as the best solution available on the market to help achieve their target. In total, 13

CO₂/HFC cascade stores were in operation in Austria in 2013.

HUNGARY

In Hungary, 4 CO₂/NH₃ supermarkets were already in operation in 2012. The Tesco stores in Balassagyarmat and Miskolc as well as two Auchan stores in Maglód and Miskolc also rely on this technology, saving up to 40% energy compared to stores using R404A refrigeration plants.



We're making it easy to choose what's best for the environment and your company

Green & Cool is the market's leading supplier of refrigeration systems that use environmentally friendly carbon dioxide as a refrigerant.



Green & Cool chillers, refrigerators, heat pumps and air conditioning units for supermarkets, restaurants, caterers, the food industry, hospitals, the pharmaceutical industry, computer rooms and process industry, etc., are available in over 100 different configurations – from small and compact integrated units to large and complex systems.

www.greenandcool.com

**GREEN[®]
& COOL**
Green Refrigeration Systems

CO₂ TRANSCRITICAL AND CO₂/HFC STORES IN EUROPE < 2006 - 2013

TOTAL NUMBER OF STORES BY YEAR

TOTAL
CO₂ TC
2885

TOTAL
CO₂ / HFC
1568

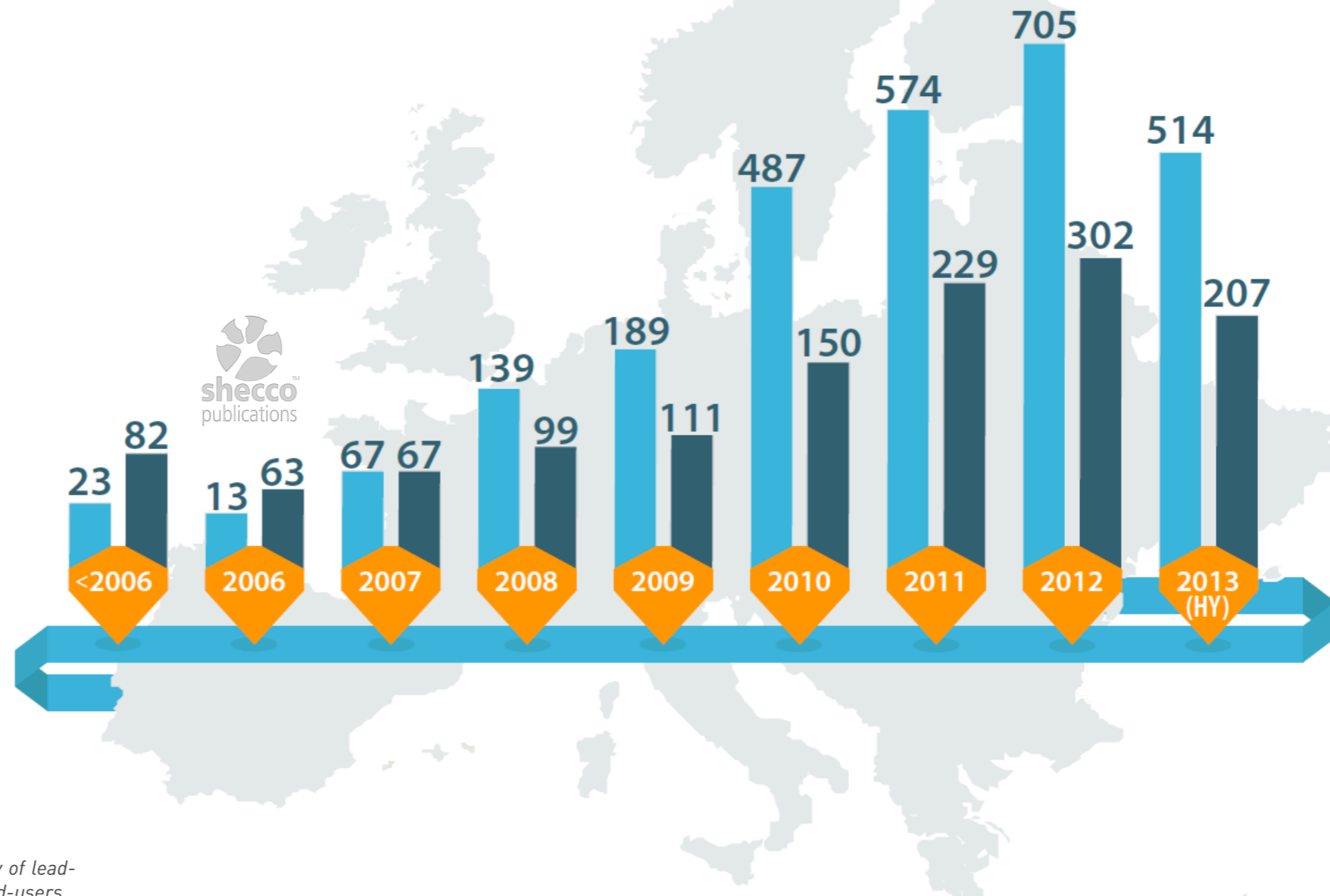

These figures are based on a 2013 survey of leading system suppliers and commercial end-users. Feel free to contact us to add your data to the map. Send an email to research@shecco.com

CO₂ TRANSCRITICAL AND CO₂/HFC STORES IN EUROPE < 2006 - 2013

| | BEFORE 2006 | 2006 | 2007 | 2008 | 2009 | 2010 | 2011 | 2012 | 2013 (Half) | TOTAL |
|--------------------------------------|-------------|------|------|------|------|------|------|------|-------------|-------|
| CO ₂ TRANSCRITICAL STORES | 23 | 13 | 67 | 139 | 189 | 487 | 574 | 705 | 514 | 2.885 |
| CO ₂ / HFC CASCADE STORES | 82 | 63 | 67 | 99 | 111 | 150 | 229 | 302 | 207 | 1.638 |

Data taken into account for drafting the market maps is based on shecco's continuous global research activities. While the below lists only indicate those companies that gave direct input, the total figures cover a significantly higher number of food retailers and suppliers.

SUPERMARKETS

Ahold Europe
 Carrefour
 Coop Switzerland
 Coop Norway
 Delhaize Group
 FegroSelgros
 Metro AG
 Migros AG
 Prodega/Growa Cash+Carry
 Tesco

SUPPLIERS

Advansor
 Arneg
 Carrier Kältetechnik Deutschland
 compact Kältetechnik
 Enex
 Epta
 Frigo-Consulting
 Green & Cool
 Hauser GmbH
 Hafner-Muschler, Kälte- u. Klimatechnik
 Kältering
 Knudsen Køling
 SSP Kälteplaner
 Space Engineering
 SCM Frigo
 Veld Koeltechnik

OTHER NATURAL REFRIGERANT STORES IN EUROPE

HC PLUG-IN AND INDIRECT NH₃ AND HC SUPERMARKETS IN EUROPE

HYDROCARBON PLUG-IN UNITS IN EUROPE

For the first time, shecco conducted research on the number of plug-in supermarket cabinets using hydrocarbons, mostly propane, as a refrigerant. In addition, supermarkets using indirect ammonia or hydrocarbon based (centralised) refrigeration systems were part of shecco's research. In total, around 480,000 R290 plug-in supermarket cabinets have been counted in Europe. This number might be even higher, as some suppliers of supermarket cabinets did not provide data. However, this figure already serves as a very good indicator, as it captures input from market leaders.

In Europe, thousands of stores use plug-and-play hydrocarbon units as their frozen food integrals. In the UK, German retailer Lidl increased the number of HFC-free freezer cabinets using hydrocarbons by over 20% in 2013, bringing the total number to around 9,000. In Germany, Lidl is using propane in 60-70% of its low and medium temperature (MT) chest freezers. Rewe Group has already 15,000 cabinets using natural refrigerants in Germany. German discount retailer Aldi Süd (South) uses propane in four out of five (about 32,000) of its low temperature (LT) chest freezers. At Aldi Nord (North), propane has a share of 49% in LT chest freezers. German-based wholesaler Lekkerland uses isobutane for cooling (MT) in 71% of the company's chest freezers. For LT refrigeration, Lekkerland uses isobutane in 66% of the chest refrigerators and propane in another 18%.

Delhaize uses hydrocarbon plug-in freezers in 66 stores in Romania.

INDIRECT HC AND NH₃ REFRIGERATION SYSTEMS

Even if CO₂ TC and CO₂ cascade refrigeration systems are the predominant solution for centralised natural refrigeration in Europe, several retailers have opted to use hydrocarbon refrigerants.

In the UK, Musgrave trialed a combined hydrocarbon-air hybrid system in its Budgens stores. Waitrose, part of the John Lewis partnership, had over 74 stores running on hydrocarbons in 2012. The latest figures indicate that the retailer has reached 98 HFC-free installations, accounting for almost 1/3 of Waitrose shops.

New stores as well as refurbished stores are equipped with low carbon hydrocarbon water-cooled refrigeration systems with cold air retrieval and integration with heating systems. The Cooperative Group UK is also developing hydrocarbon-based secondary refrigeration, which is expected to be its primary future technology. British retailer Marks and Spencer has invested in R290 low-pressure receiver systems at its sustainable learning stores. Iceland UK is trialing a hydrocarbon chilled water refrigeration system.

Since 2009, German retailer Lidl has relied on compact refrigeration units using propane for normal refrigeration, a heat pump for heating and CO₂ for deep-freezing. More than 200 units are in operation today, showing that propane is already suitable for series production. The compact refrigera-

tion unit is designed to be cost efficient and environmentally friendly, producing the refrigeration needed to cool shelves, refrigerate counters, cold rooms, cold storage cells and for air-conditioning. It also generates floor heating and integrates the electro-technical equipment for the whole store.



Natural refrigerants for a cleaner tomorrow.

Cool by nature.

We are committed to the responsible use of natural resources, the development of clean technologies and the replacement of harmful substances with eco-friendly alternatives. As a global leader in providing refrigerant gases and services, Linde is proud to support the introduction of natural refrigerants in many countries around the world.

Linde provides a range of high quality ammonia, carbon dioxide and hydrocarbon based natural refrigerants that meet the exacting purity requirements of air conditioning and refrigeration applications. Combined with extensive technical support we ensure responsible and safe usability.

Linde AG

Linde Gases Division, Seitnerstrasse 70, 82049 Pullach, Germany

Phone +49.89.7446-2399, refrigerants@linde-gas.com, www.linde-gas.com/refrigerants

MAP OF HC PLUG-IN UNITS & INDIRECT NH₃ AND HC STORES IN EUROPE 2013

DATA BY COUNTRY

TOTAL
Hydrocarbon
Plug-in UNITS



TOTAL
Indirect Ammonia
SUPERMARKETS



TOTAL
Indirect Hydrocarbon
SUPERMARKETS

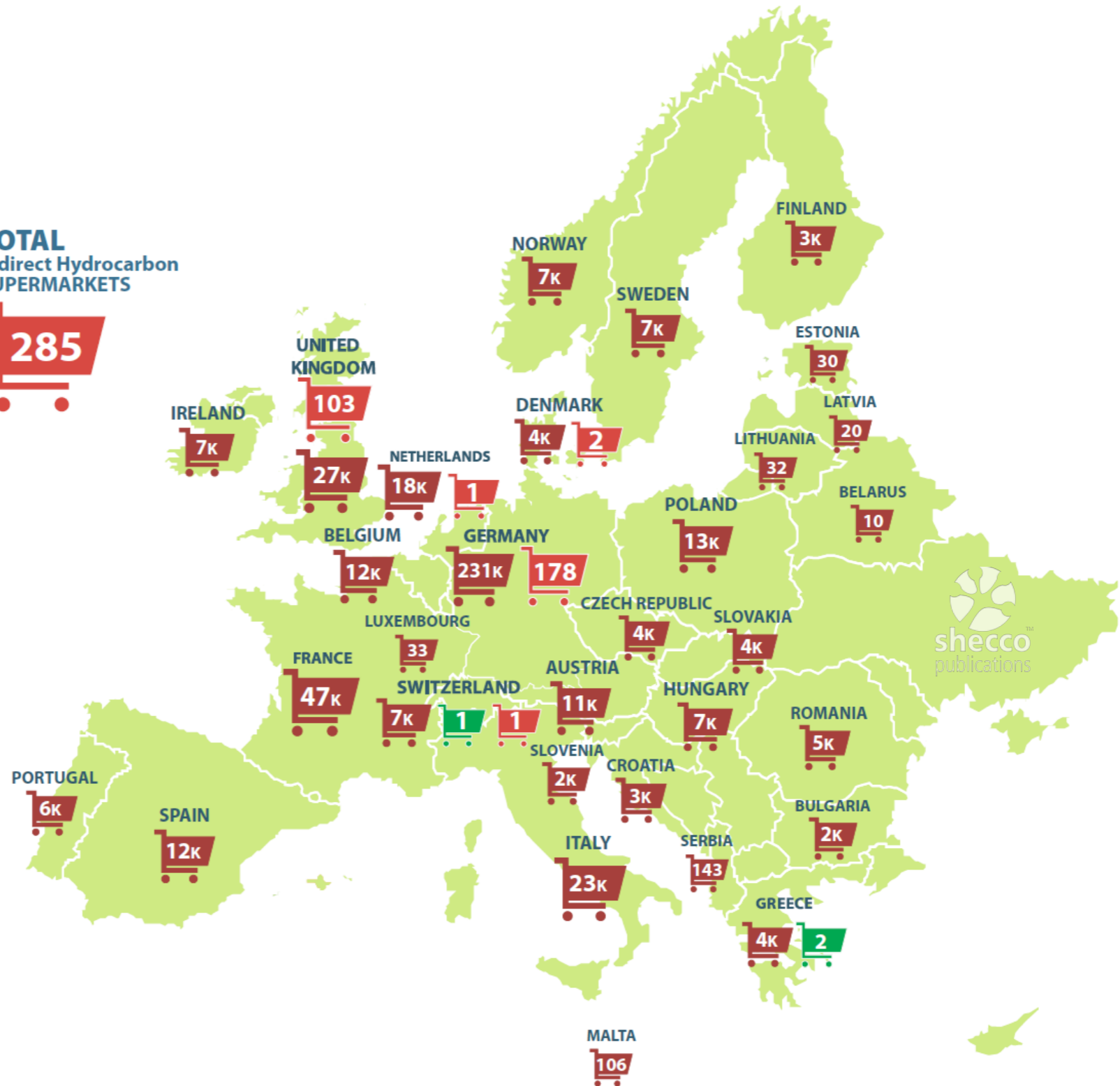

These figures are based on a 2013 survey of leading system suppliers and commercial end-users. Feel free to contact us to add your data to the map. Send an email to research@shecco.com



MAP OF HC PLUG-IN UNITS & INDIRECT NH₃ AND HC STORES IN EUROPE 2013

| COUNTRY | HC PLUG-IN SUPERMARKETS | INDIRECT HC SUPERMARKETS | INDIRECT NH ₃ SUPERMARKETS |
|----------------|-------------------------|--------------------------|---------------------------------------|
| Austria | 11.097 | | |
| Belarus | 10 | | |
| Belgium | 12.261 | | |
| Bulgaria | 2.472 | | |
| Croatia | 3.143 | | |
| Czech Republic | 4.154 | | |
| Denmark | 4.036 | 2 | |
| Estonia | 30 | | |
| Finland | 3.964 | | |
| France | 47.389 | | |
| Germany | 231.251 | 178 | |
| Greece | 4.731 | | 2 |
| Hungary | 7.748 | | |
| Ireland | 7.028 | | |
| Italy | 23.135 | | |
| Latvia | 20 | | |
| Lithuania | 32 | | |
| Luxembourg | 33 | | |
| Malta | 106 | | |
| Netherlands | 18.473 | 1 | |
| Norway | 7.506 | | |

| COUNTRY | HC PLUG-IN SUPERMARKETS | INDIRECT HC SUPERMARKETS | INDIRECT NH ₃ SUPERMARKETS |
|--------------|-------------------------|--------------------------|---------------------------------------|
| Poland | 13.199 | | |
| Portugal | 6.450 | | |
| Romania | 5.505 | | |
| Russia | 765 | | |
| Serbia | 143 | | |
| Slovakia | 4.954 | | |
| Slovenia | 2.326 | | |
| Spain | 12.769 | | |
| Sweden | 7.483 | | |
| Switzerland | 7.666 | 1 | 1 |
| UK | 27.320 | 103 | |
| TOTAL | 480.000+ | 285 | 3 |

Data taken into account for drafting the market maps is based on shecco's continuous global research activities. While the below lists only indicate those companies that gave direct input, the total figures cover a significantly higher number of food retailers and suppliers.

SUPERMARKETS

Delhaize Group

Futron GmbH

Iarp S.r.l.

SSP Kälteplaner AG

SUPPLIERS

AHT Cooling Systems GmbH

Epta s.p.a.

CO₂ AND HC LIGHT-COMMERCIAL REFRIGERATION IN EUROPE

The global number of light-commercial systems using CO₂ or hydrocarbons, such as ice cream freezers and bottle coolers, is estimated to be above 2,7 million units. The majority of these HFC-free units are installed in Europe.

The Coca-Cola Company has decided to phase out HFCs by adopting CO₂ technology as the main solution. In October 2013, it had already installed 986,000 HFC-free units globally.

Red Bull has around 457,000 "ECO Coolers," that use hydrocarbons as the refrigerant, half of its total cooler fleet. These coolers use R600a as a refrigerant and contribute to energy savings of 20%. Furthermore, Red Bull has a clear commitment to purchase hydrocarbon-based equipment wherever it is legally possible and technically feasible.

PepsiCo has installed over 200,000 HFC-free units in 30 different countries. The HFC-free systems use R290, R600a and CO₂. Today, PepsiCo's coolers consume 48% less energy and its vending machines use 47% less energy than 2004 models with HFC refrigerants. The company established 100% HC use in Turkey in 2009 and integrated Russia into the use of 100% HCs in 2011.

One of Heineken's priorities is to embed and integrate environmental sustainability into its corporate strategy and to reduce its carbon footprint, 28% of which is linked to cooling. As a result, Heineken has set itself the target of reducing the CO₂ emissions from fridges by 42% by 2015 and by 50% by 2020. This has led to a "Global Fridge" policy, whereby Heineken "Green Fridges" have to meet five key criteria including the use of hydrocarbons (R290 or R600a) as the refrigerant when le-

gally or technically possible. As a result of its Green Fridge policy, Heineken purchased 130,000 fridges in 2012, about 65% of which were equipped with hydrocarbons.

Hydrocarbon bottle coolers are a standard for Carlsberg Breweries and are deployed whenever it is possible. Carlsberg installs bottle coolers in the Nordic countries (Denmark, Finland, Norway and Sweden) and has also started to install them in several countries in Southern Europe. At the end of 2011, Carlsberg Breweries had already installed 9,000 HC coolers.

Unilever, the world's largest producer of ice cream, is rolling-out freezer cabinets that use hydrocarbons as refrigerants. The company has already purchased over 1 million units with hydrocarbons and the target is to purchase 1,3 million by 2015.

Nestlé is reducing the carbon footprint of smaller refrigeration systems, such as the freezers for their Häagen-Dazs, Mövenpick, Oreo, Schöller and other ice cream brands. Over 11,000 ice cream freezers in seven countries operate with hydrocarbon refrigerants, such as propane and butane, which Nestlé has identified as the best currently available alternatives to synthetic refrigerants. In Switzerland, all new ice cream freezers now use HCs. Another 2,300 HC freezers are operating in Australia, Spain, Malaysia, Chile and the USA. The new HC freezers are equipped with high-efficiency fans, improving the energy efficiency by 80%. For 2013, Nestlé announced that it will further expand the number of freezers to 13,500, covering Brazil, Bulgaria, Greece, Mexico and Romania.

Danone has 1,000 coolers using hydrocarbon technology in a number of countries, including Mexico.

MAP OF CO₂ & HC LIGHT-COMMERCIAL REFRIGERATION IN EUROPE AND GLOBALLY IN 2013

EUROPEAN & GLOBAL COMPARISON



**GLOBAL
2013
Bottle Cooler**
1,650.000+

CO₂

HC



**GLOBAL
2013
Ice Cream Freezer**
1,050.000+

CO₂

HC



**EUROPE
2013
Bottle Cooler**
1,250.000+

CO₂

HC



**EUROPE
2013
Ice Cream Freezer**
800.000+

CO₂

HC



These figures are based on a 2013 survey of leading system suppliers and commercial end-users. Feel free to contact us to add your data to the map. Send an email to research@shecco.com

Embraco is a Global Market and Technological Leader in hermetic compressors for refrigeration.

As one of the pioneers in the development of environmental friendly products, **Embraco** reinforces its commitment to global sustainability by offering a full range of high efficiency compressors and condensing units using hydrocarbons.

www.embraco.com



propane
solutions

IT IS EFFICIENT

UP TO 2,05 W/W @
RATED POINT EN12900 50 Hz



IT SAVES MONEY

LESS CONSUMPTION THAN R404A



IT IS SUSTAINABLE

VERY LIMITED GREENHOUSE EFFECT POTENTIAL
NO IMPACT ON THE OZON LAYER
R290 CHARGE IS 40%-50% LESS THAN R404A

CHANGES

**ARE MADE
FOR THE**

BETTER

embraco

POWER IN.
CHANGE ON.

NATURAL REFRIGERANTS IN STORES AROUND THE WORLD

According to shecco's research among leading supermarket chains, refrigeration system manufacturers, component suppliers, contractors and associations worldwide, the number of supermarkets using CO₂ refrigeration technology is constantly growing. The total number of CO₂ transcritical (TC) supermarkets is above 3,060 globally. CO₂ cascade and secondary refrigeration systems are found in more than 2,020 stores worldwide. Europe is still leading in the adoption of CO₂ refrigeration technology in supermarkets, but other world regions are gaining momentum.

NORTH AMERICA

In North America, CO₂ TC stores are also entering the market. In Canada, several regional initiatives have helped to incentivise investment in CO₂ refrigeration by offering rebates and financing to offset the cost of new, energy efficient commercial refrigeration installations. These initiatives include the Refrigeration Optimization Programme (OPTER) administered by Québec's Ministry of Natural Resources and Wildlife, the Power Sense Programs in British Columbia, the Manitoba Commercial Refrigeration Program and Efficiency Nova Scotia. In Canada, Sobeys has taken the lead in implementing CO₂ TC refrigeration systems. In addition to more than 30 CO₂ TC systems, Sobeys operates several CO₂ cascade stores. CO₂ is a core part of Sobeys' goal to reduce GHG emissions by 15% by the end of 2013. Overwaitea Food Group is one of the most recent Canadian retailers to have invested in CO₂ TC refrigeration. The Urban Fare Express store, which had already established aggressive goals for green operations in every area of its business, began experimenting with CO₂ refrigeration systems

in 2010 and installed a CO₂-only system, joining the ever-growing list of HFC-free grocery stores in Canada. In mid-2013, more than 65 stores in Canada were already equipped with CO₂ TC refrigeration systems and several more stores were under construction.

Hannaford, part of the Delhaize Group opened its first 100% CO₂ TC store in the US in July 2013. In the Hannaford supermarket in Turner, Maine, a CO₂ TC booster system for low and medium temperatures was installed and supplemented with a glycol heat reclaim system and a warm gas defrost system.

Walgreens, the largest US drugstore, opened its first net-zero energy store in South Evanston, Chicago in November 2013. The CO₂ transcritical system for heating and cooling saves 60% energy compared to traditional technology. Another CO₂ TC store has opened on the East Coast by Whole Foods. The store in Brooklyn, NY opened in December 2013. Angelo Caputo's Fresh Market currently has a store with a CO₂ TC refrigeration system under construction. The store in Carol Stream, Illinois will open beginning of 2014. In mid 2013, 102 CO₂ cascade and secondary stores were counted in the USA. Supervalu Inc. opened its first all-natural refrigerant grocery store in 2012 in Carpinteria, CA. The new NH₃/CO₂ system achieved a 29% TEWI reduction compared to a R407A/CO₂ system. In 2012, Delhaize was operating 3 stores with low temperature CO₂ or as cascade. Whole Foods' first CO₂ store was completed in 2009, consisting of a low temperature CO₂ secondary system. In 2010, the company installed two CO₂ cascade systems in California and Massachusetts.

SOUTH AMERICA

In South America, CO₂ cascade refrigeration systems are in operation in stores in Colombia (3), Venezuela (2) and Argentina (1). In Brazil, there are 40 CO₂ cascade installations across the country. Brazilian retailer Verdemar is adopting CO₂ cascade refrigeration systems as a standard in new stores. It was the first retailer in South America to implement CO₂, with the first store starting operation in 2010. Today, 3 out of a total of 8 stores by the small retailer operate with CO₂. Verdemar expected to have 50% of its stores equipped with CO₂ by the end of 2013. Recently, a new Compre Max store opened in Northeastern Brazil using a CO₂/R134a refrigeration system. The refrigeration system uses CO₂ in the low-pressure stage of the system, providing both refrigeration and freezing.

ASIA

In Japan, the number of CO₂ TC stores has exceeded 120 and is expected to grow rapidly, as leading Japanese retailers have already made public commitments to use CO₂ for refrigeration in their stores. Seeking to reduce costs in the long term and improve its carbon footprint, Lawson is seen as a pioneering end user in Japan for its investment in natural refrigerants. Since 2010, Lawson has been testing CO₂ technology for convenience stores. By February 2013, 75 convenience stores were up and running with the natural refrigerant CO₂. An additional 100 new stores are planned by February 2014. From 2009 to 2011, Japanese retailer Aeon opened 3 CO₂ stores, and in November 2011, Aeon made its first public commitment to use natural refrigerants. Aeon now has

plans to introduce CO₂ refrigeration systems in all new stores and to gradually convert Aeon's 3,500 existing stores to natural refrigerants. The 2012 fiscal year already saw the opening of 7 more CO₂ stores.

Tesco has installed 5 CO₂ cascade stores in China, 6 in South Korea and 2 in Thailand. A further CO₂ cascade system was installed in a store in Singapore. In Japan, 4 CO₂ cascade and secondary stores were counted in mid 2013. Japanese retailer Lawson will in 2013 conduct a pilot project to build the first CO₂ convenience stores in Indonesia. The project, if successful, will open the door to further R744 technology deployment in Lawson's network of convenience stores in South East Asia.

SOUTH AFRICA

In South Africa, 17 stores are already equipped with CO₂ TC systems, by retailers Woolworths and Makro. They show leadership with a combined 17 stores using TC CO₂ systems. Back in 2010, the Woolworths at the Palmyra Junction shopping centre in Claremont, Cape Town, was only the second store to install a CO₂ refrigeration system. Today Woolworths has at least 8 transcritical CO₂ installations. Makro's stores built after 2009 incorporate a series of 'green' technologies, which include energy efficient CO₂ refrigeration. One of the newest CO₂ installations in 2013 was the Amanzimtotu Makro store. This store will also feature heat reclaim from the refrigeration system, which will be used to produce hot water to control the temperature on the trading floor.

NEW ZEALAND & AUSTRALIA

The first cascade CO₂ supermarket system in New Zealand was commissioned in 2006 by the owners

of "The Warehouse" supermarket in Auckland. The system uses propylene and CO₂ and is the first New Zealand system to use CO₂ for low temperature cooling of display cabinets and cold rooms. New Zealand supermarket chain Countdown uses CO₂ refrigeration systems in several stores. In total, around 40 supermarkets were equipped with CO₂ cascade and secondary refrigeration in mid 2013.

New World in Devonport, part of the Foodstuffs supermarket chain, became the first store in New Zealand operating with CO₂ TC technology in 2012. Today, 2 CO₂ TC stores are operated in New Zealand.

In Australia, 160 CO₂ cascade and secondary stores were in operation in 2013. In 2008, Australian retailer Woolworths' stated that all new stores would be Green Stores, using energy efficient building guidelines. As part of this commitment, Woolworths' focuses on HFC-free commercial refrigeration and is investigating in different HFC-free concepts, including very small package CO₂ systems located at each frozen fixture, developed primarily for the smaller fleet of stores. Currently, there are three such installations with another 2 planned before the end of 2013. In addition, Woolworths was operating 100 hybrid systems using R134a for MT and CO₂ for LT by the end of July 2013.

TURKEY

In Turkey, Carrefour installed the country's first sub-critical CO₂ refrigeration system in a supermarket in Istanbul. The Kurtköy-Millennium Carrefour Express store was retrofitted with a CO₂ TC system in May 2012.

LEADING CO₂ TECHNOLOGY FOR REFRIGERATION AND HEAT PUMPS

- ENERGY SAVING AND ENVIRONMENTALLY FRIENDLY

Advansor is an internationally leading manufacturer of sustainable refrigeration, for supermarkets, industrial refrigeration, power plants, food processing industry, chemical industry and air conditioning of office spaces, with CO₂ as the only refrigerant.



compSUPER S



compSUPER XXS



compSUPER Sigma

- ❄️ 100% environmentally friendly
- ❄️ Non-toxic, inflammable
- ❄️ Single refrigerant applied
- ❄️ No global warming impact
- ❄️ No ozone depletion
- ❄️ No zone classification
- ❄️ Compact design
- ❄️ Low noise
- ❄️ Easy installation
- ❄️ Easy service
- ❄️ Low energy consumptions
- ❄️ Low cost of installation
- ❄️ Low cost of maintenance
- ❄️ Future proof solution

ADVANSORTM

by Hill PHOENIX

MAP OF CO₂ TRANSCRITICAL & CO₂ CASCADE/SECONDARY STORES WORLDWIDE IN 2013

DATA BY COUNTRY



These figures are based on a 2013 survey of leading system suppliers and commercial end-users. Feel free to contact us to add your data to the map. Send an email to research@shecco.com

MAP OF CO₂ TRANSCRITICAL & CO₂ CASCADE/SECONDARY STORES WORLDWIDE IN 2013

| COUNTRY | CO ₂ TC STORES | CO ₂ CASCADE/SECONDARY STORES |
|--------------|---------------------------|--|
| Argentina | | 1 |
| Australia | 1 | 160 |
| Brazil | 1 | 40 |
| Canada | 65+ | 12 |
| China | | 5 |
| Colombia | | 3 |
| Europe (50+) | 2.885 | 1.638 |
| Japan | 129 | 4 |
| New Zealand | 2 | 40 |
| Singapore | | 1 |
| South Africa | 17 | 3 |
| South Korea | | 6 |
| Thailand | | 2 |
| Turkey | 1 | 2 |
| USA | 2 | 102 |
| Venezuela | | 2 |
| TOTAL | 3.100+ | 2.020+ |

Data taken into account for drafting the market maps is based on shecco's continuous global research activities. While the below lists only indicate those companies that gave direct input, the total figures cover a significantly higher number of food retailers and suppliers.

SUPERMARKETS

AEON Co., Ltd.
 Ahold Europe
 Carrefour
 Coop Switzerland
 Coop Norway
 Delhaize Group
 FegroSelgros
 Lawson, Inc.
 Metro AG
 Migros AG
 Prodega/Growa Cash+Carry
 Tesco
 Sonae (2012)

Hauser GmbH
 Hafner-Muschler, Kälte- u.
 Klimatechnik
 Hillphoenix
 Knudsen Køling A/S
 SCM Frigo
 Space-Engineering Services
 SSP Kälteplaner AG
 Veld Koeltechnik BV

ASSOCIATIONS

ARA - Australian Refrigeration Association

SUPPLIERS

Advansor S/A
 Arneg s.p.a.
 BITZER Compressores Ltda.
 Carel
 Carnot Refrigeration
 Carrier Kältetechnik
 Deutschland GmbH
 Commercial Refrigeration Services Ltd.
 compact Kältetechnik
 Enex srl
 Epta s.p.a.
 Frigo-Consulting AG
 Green & Cool



Since 1918 we have always been making every effort to create reliable and high-performing products according to the best mechanical and craftsman practices, in the meticulous pursuit of our founder's motto: "the most important thing is that our products shall be always perfect". Today, after more than 95 years, we are a consolidated factory, but our mission remains the same: to create and launch onto the market technologically perfect, modern and reliable products with the support of a strong, unique and challenging personal relationship with our partners/customers.

 **ECOQUALITY**
SILENCE SAFETY SUSTAINABILITY
Soluzioni per il risparmio e l'efficienza energetica.

ECOQUALITY/ OFFICINE MARIO DORIN Spa, Florence (Italy)
www.dorin.com - dorin@dorin.com



DORIN

i n n o v a t i o n



INNOVATION FOR ENERGY EFFICIENCY AND SAVING SOLUTIONS

Specialising in refrigeration and air conditioning lubricants



...for our future

Shrieve. A global enterprise delivering world class technology yet flexible enough to build special relationships and meet your specific requirements. We have headquarters together with a new Technology Centre in the United States with expertise around the world ready to work with you.

Our **ZEROL® RFL-EP** lubricant range for R744 systems have attained world class compressor OEM approvals and deliver leading performance across Europe.

ZEROL® Series compressor lubricant advantages:

- Top tier performance in refrigeration and air conditioning systems
- Next generation technologies with environmental and performance advancements tailored for a wide range of natural refrigerants: ▶ CO₂ ▶ NH₃ ▶ HCs
- World class compressor OEM approvals
- Supported by an industry leading Application Engineering and Product Development team



Visit us at www.shrieve.com or call our European Office: **+44 (0)1732 520600**

Great Chemistry

THE EUROPEAN MARKET TODAY & TOMORROW

EUROPEAN NATURAL REFRIGERANT SUPPLIER MAP & COMMERCIAL AVAILABILITY 2013-2025



NATURAL REFRIGERANT SUPPLIER MAP

Already today there are over 400 European companies working with natural refrigerants. System manufacturers, component suppliers, contractors, consultancies, engineering and many other businesses offering natural refrigeration solutions are present not only in the North, but also in Southern European countries. Germany (67), UK (55), Denmark (51), Italy (42), Switzerland (34), the Netherlands (26) and Spain (16) comprise the highest numbers of natural refrigeration businesses.



NATURAL REFRIGERANT TECHNOLOGY - COMMERCIAL AVAILABILITY 2013-2025

In most refrigeration and air-conditioning sectors, natural refrigerants are already commercially available to some extent and/or will be available with sufficient production capacities in all EU countries in the short-term. To provide suppliers, end-users and policy-makers with an indication about the commercial availability of refrigeration and air-conditioning equipment using natural refrigerants, a table indicates their production capacity for a variety of sectors across the European Union, between today and 2025.

NATURAL REFRIGERANT SUPPLIER MAP & COMMERCIAL AVAILABILITY UNTIL 2025

EUROPEAN SUPPLIERS MAP

For the first time, shecco has started collecting data about the availability of European-based suppliers experienced in providing products and services for natural refrigerants - a prerequisite for any rapid and effective market uptake across the integrated European Union market and beyond.

Today, and as an indicative figure only, already more than 400 European system manufacturers, component suppliers, contractors, consultancies, engineering and many other businesses are active in the field of natural refrigerants. These companies are present not only in the North, where natural refrigerant technology has made inroads in various application areas, but they are also increasing in numbers in traditionally strong markets for HVAC&R technology, such as Italy.

The 1st European Natural Refrigerant Suppliers Map therefore provides evidence of three main trends:

(1) The total number of companies experienced in the supply of natural refrigerant-based technology solutions is constantly increasing in various parts of Europe. Southern or Central European countries, where regulatory frameworks driving the adoption of HFC-free technologies have not been as stringent as, for example, in Scandinavian or Western European countries, would also benefit from more ambitious support for companies investing in more sustainable refrigerant solutions. This can take various forms, ranging from taxation and charge limits for fluori-

nated gases, to bans in applications where HFC-free solutions have become mainstream, and/or government incentive schemes for producers and end-users of natural working fluids.

(2) The steady increase in suppliers with expertise on natural refrigerant solutions is also constantly increasing competition levels and is expected to further lead to growing R&D into innovative solutions while at the same time driving the cost down for HFC-free solutions. This is an important precondition for creating a level-playing field for technology associated with, in some cases, still higher initial costs as compared to HFC-based dominant market offers. Already today, various technologies and applications using natural refrigerants have reached similar or even lower capital and life cycle costs – a trend that is expected to still increase with rising direct (cost of substance) and indirect (various, such as taxes, use restrictions, additional obligations) costs of f-gases.

(3) As a result of greater activity in the natural refrigerant industry, technology is becoming increasingly available for different applications. While various applications have already switched to HFC-free solutions, such as domestic refrigeration and in large parts industrial refrigeration, other sectors will become increasingly interesting in the foreseeable future. Among them commercial refrigeration and various applications of heat pumps, to name just two.

COMMERCIAL AVAILABILITY 2013-2025

To provide policy-makers and other interested stakeholder groups with an answer about the commercial availability of refrigeration and air-conditioning equipment using natural refrigerants, shecco, with input from a large number of industry experts, put together a table indicating the level of commercial availability for a variety of sectors in Europe between today and 2025. The table shows that in most refrigeration and air-conditioning sectors, natural refrigerants are already commercially available to some extent and/or will be ready with sufficient production capacities in all EU countries in the short to medium-term.

While several national markets in Europe's refrigeration and A/C sector are already moving in the direction of limiting f-gas use even without regulatory measures, European companies are asking for political support to bring their innovative natural refrigerant-based solutions faster to market. Clear sector-specific f-Gas bans would give the growing European natural refrigerant industry further certainty and the impetus to become and remain technology leaders internationally. HFC bans are also considered a major driver for greater and faster adoption of natural refrigerants, especially by smaller end-users. There is still a significant potential for broader scale adoption of natural refrigerants, as far as smaller end-users are concerned, who unlike larger food retailers typically do not have sustainability strategies. This is the case for example for plug-in refrigeration equipment used at kiosks, and on premise accounts (bars, restaurants, hotels).

NATURAL REFRIGERANT SUPPLIER MAP EUROPE 2013

DATA BY COUNTRY

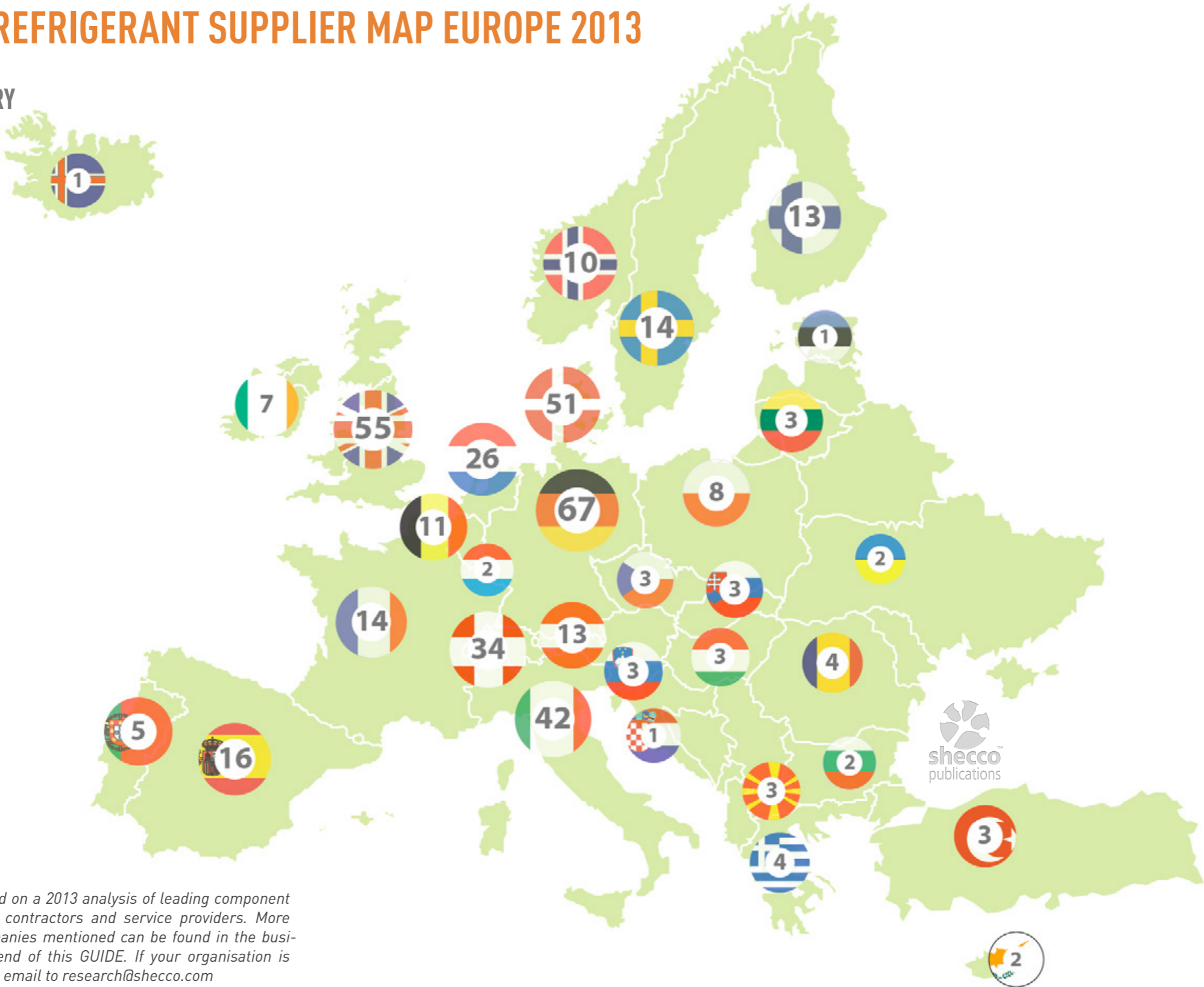

These figures are based on a 2013 analysis of leading component and system suppliers, contractors and service providers. More details about the companies mentioned can be found in the business directory at the end of this GUIDE. If your organisation is missing please send an email to research@shecco.com



Industrial Refrigeration & Heat Pump solutions provider

Natural five refrigerants 

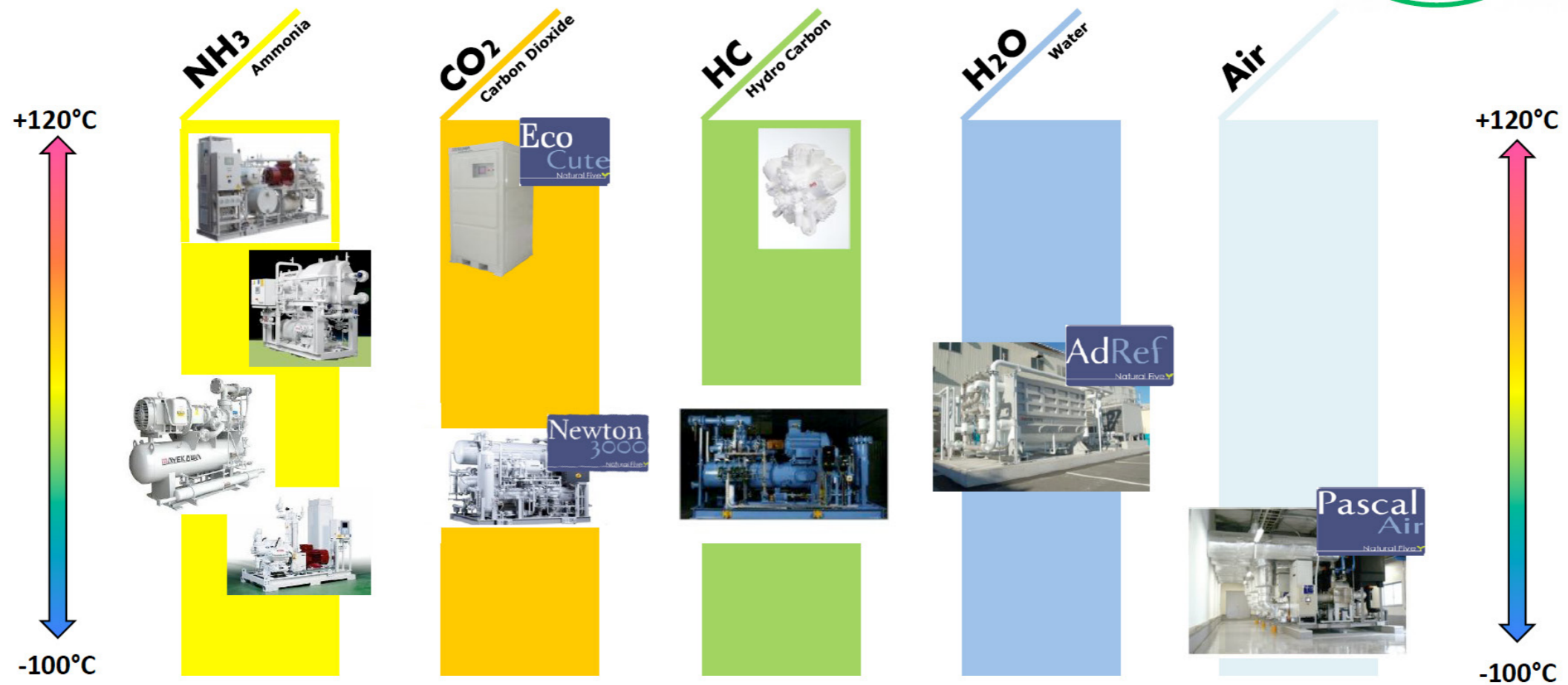

*If the displayed equipment does not match one of your applications ,
consult Mayekawa for an engineered solution*

MAYEKAWA
MYCOM

Manufacturing in Europe at our Zaventem plant in Belgium

www.mayekawa.eu

NATURAL REFRIGERANT COMMERCIAL AVAILABILITY 2013-2025

| REFRIGERATION | TODAY | 2015-2020 | 2020-2025 | 2025 |
|--|--------------------------------|---------------------------------------|-----------------------------|-----------------------------|
| Domestic Refrigeration | Commercially available | Commercially available | Commercially available | Commercially available |
| Stand-alone units | Semi commercially available | Commercially available | Commercially available | Commercially available |
| Condensing units | Semi commercially available | Semi commercially available (2018) | Commercially available | Commercially available |
| Centralised systems | Semi commercially available | Commercially available | Commercially available | Commercially available |
| Small industrial refrigeration | Semi commercially available | Commercially available | Commercially available | Commercially available |
| Large industrial refrigeration | Commercially available | Commercially available | Commercially available | Commercially available |
| Road transport refrigeration | Not yet commercially available | Not yet commercially available (2017) | Semi commercially available | Commercially available |
| Container refrigeration | Semi commercially available | Semi commercially available (2017) | Commercially available | Commercially available |
| AIR-CONDITIONING | TODAY | 2015-2020 | 2020-2025 | 2025 |
| Movable room A/C | Semi commercially available | Commercially available | Commercially available | Commercially available |
| Split A/C | Semi commercially available | Semi commercially available (2018) | Commercially available | Commercially available |
| Multisplit / VRF A/C | Semi commercially available | Semi commercially available | Semi commercially available | Semi commercially available |
| Rooftop A/C | Semi commercially available | Semi commercially available | Commercially available | Commercially available |
| Displacement chillers | Commercially available | Commercially available | Commercially available | Commercially available |
| Centrifugal chillers | Not yet commercially available | Not yet commercially available (2018) | Semi commercially available | Commercially available |
| Heat pump water heaters | Semi commercially available | Semi commercially available (2016) | Commercially available | Commercially available |
| Heat pumps for space and water heating | Semi commercially available | Semi commercially available (2018) | Commercially available | Commercially available |
| A/C in cargo ships | Semi commercially available | Semi commercially available | Commercially available | Commercially available |

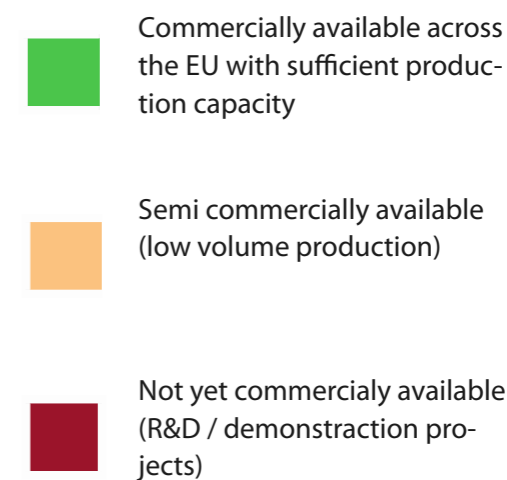

ATMO business case
sphere natural refrigerants

June 2014, San Francisco



THE BUSINESS CASE FOR NATURAL REFRIGERANTS IN NORTH AMERICA

The meeting place for industry experts to discuss natural refrigerant trends, the latest technologies and regulatory issues in North America is back for its **third edition!**

Taking place for the first time in **San Francisco in June 2014**, this event targets around 200 decision makers including leading retailers, suppliers, associations and more.

Presentation topics will focus on **regulation, standards and utilities**, as well as on **commercial and industrial refrigeration** applications with input from key government representatives, **end users** (retailers, consumer brands, cold storage) as well as technology **providers**.

New features for the 2014 edition include more networking opportunities, optional site visits (tbc) and several new technology case study sessions on heat pumps and HVAC.



June 2014

Coming soon: www.ATMO.org/America2014

Upcoming ATMOsphere Event



ATMOsphere Europe 2015 - Solutions for Europe
March 2015, Brussels, Belgium

More information about this event and other ATMOsphere events coming soon.

www.ATMO.org



Contact

Email: info@ATMO.org
Visit: www.ATMO.org

Phone North America: (+1) 202 657 6164
Phone Europe: (+32) 2 230 37 00

POLICY

EUROPEAN & NATIONAL PERSPECTIVE



EUROPEAN UNION POLICIES

Laws, standards and rules are among the decisive factors for building a prosperous business around natural refrigerants within a framework of investment security and joint leadership. This chapter provides an overview of selected policy initiatives in Europe that have an impact on the HVAC&R industry in general and the uptake of natural refrigerants in particular. The impact of the initiatives is assessed and visualised using four criteria.



NATIONAL POLICIES

Besides measures imposed at the supra-national level (e.g. EU), individual countries have set ambitious targets to either phase out HFCs and/or promote natural refrigerants directly at the national or regional level. This chapter discusses best practice policy initiatives at the national level in selected European countries, and provides an example of one national regulation restricting the use of natural refrigerants.

EU POLICIES: NATURAL REFRIGERANTS, VISION & ENFORCEABILITY

INTRODUCTION & METHODOLOGY

This section provides an overview of selected policy initiatives in Europe that have an impact on the HVAC&R industry in general and the uptake of natural refrigerants in particular. Best practice policy initiatives at the national level in two European countries are also discussed, and an example is given of one national regulation restricting the use of natural refrigerants.

The impact of the initiatives is assessed using four criteria. The individual legislation is rated based on the influence it has on the uptake of natural refrigerants. The indicators selected are training & know-how, technology & safety, awareness & psychology, and economy & costs – representing four of the most challenging areas with influence on a widespread use of natural refrigerants. The rating of each criterion ranges from 0 (no impact) to 4 (high impact):

TRAINING & KNOW-HOW: This criterion analyses how the legislation affects the development of necessary skills to handle natural refrigerants (directly or indirectly), including certification for the manufacturing, supply, commissioning, installation, maintenance / monitoring and decommissioning of HFC-free systems.

TECHNOLOGY & SAFETY: This criterion looks at how the policy initiative affects the availability, durability, reliability, safety, efficiency and cost-effectiveness of production processes, materials, refrigerants, servicing and disposal infrastructures, and components & systems.

AWARENESS & PSYCHOLOGY: This criterion investigates if and how information and awareness-raising campaigns, Business-to-Consumer and Government-to-Consumer elements are strengthened to address misconceptions about natural refrigerants within the industry and amongst the wider public.

ECONOMY & COSTS: Direct or indirect support for non-fluorinated gases is one of the most important measures to accelerate the deployment of natural refrigerant solutions. This criterion looks at the effectiveness of incentive-based measures (taxes, subsidies, marketable trading permits, funding/grants) or command-and-control measures (standards) in reducing price gaps.

EU POLICIES: MAC DIRECTIVE & F-GAS REGULATION REVIEW

IMPACT ANALYSIS



MAC DIRECTIVE

The MAC Directive has established a precedent in setting a maximum allowable Global Warming Potential (GWP) value (calculated over 100 years) of below 150 that refrigerants used in mobile air conditioning (MAC) may not surpass. It has driven interest in the development and optimisation of MAC systems and components suitable for use with low-GWP natural refrigerant CO₂. A recent commitment of a German carmaker to develop a CO₂ MAC system and start its introduction by 2016, has renewed interest in CO₂ for this application.



F-GAS REGULATION REVIEW

The existing EU Regulation on fluorinated gases relies primarily on containment and recovery measures to prevent hydrofluorocarbon (HFC) emissions from the HVAC&R sector. However, currently under review, the new legislation is expected to add more rigorous measures on fluorinated gases in the future, including a step-wise phase-down of HFCs, bans on f-gases in new equipment in certain sectors, and strengthened containment and recovery measures.

EU POLICIES: MAC DIRECTIVE & F-GAS REGULATION REVIEW

MOBILE AIR CONDITIONING (MAC) DIRECTIVE

Adopted in 2006, the MAC Directive (Directive 2006/40/EC relating to emissions from air-conditioning systems in motor vehicles) bans MAC systems working with fluorinated GHGs with a Global Warming Potential (GWP) higher than 150, for new types of vehicles since 2011, and for all new vehicles as of 2017. The ban therefore covers the most commonly used refrigerant, HFC134a (GWP = 1,430). With the automotive sector seeking a global solution for their MACs, EU manufacturers had announced that they would be using a next generation chemical refrigerant with low GWP to meet the requirements of the Directive.

However, after tests by a German car manufacturer revealed potential safety risks posed by the chosen low-GWP refrigerant in September 2012, a leading OEM decided to make a U-turn and announced its commitment to developing CO₂ technology as a “sustainable and safe solution”. The OEM claims to be working towards introducing CO₂ MAC in its new fleet by 2017, in time for complying with the second implementation phase of the Directive, and has already several supplier contracts signed for the purpose.

Less than a year after its renewed commitment to using CO₂ as a refrigerant in new MAC systems, the OEM has launched its first three prototypes reliant on the natural refrigerant. Another German car manufacturer is said to have prototypes under development and plans to have some series equipped with CO₂ already in 2016.

The European Commission and the German authorities continue investigating safety risks associated with the chemical refrigerant and the conformity of the manufacturer with the obligations of the MAC Directive. Given that the mechanism to implement the Directive is based on the type approval procedure at national level, some manufacturers have been able to avoid the obligations of the first implementation phase by producing vehicles under an extension of a previous type approval.

Even though the future of the MAC Directive is unclear at the moment, the recent developments have put CO₂ back on the ‘MAC scene’ and the renewed interest has already triggered a lot of activity in the market amongst system manufacturers and component suppliers. Many have recognised the opportunity to put CO₂ MAC solutions, developed after public commitments of German carmakers to CO₂ in 2007 and 2008, back on the shelves and continue developing the technology. Natural refrigerant CO₂ has also been seen as a good candidate to cover both heating and cooling needs for electric vehicles, which are to gain market share in the EU and worldwide.

F-GAS REGULATION REVIEW

To address the issue of emissions related to the use of HFCs, the EU F-Gas Regulation (Regulation No 842/2006 on certain fluorinated greenhouse gases) has been in place since June 2006. By means of provisions on prevention and reduction of leakages of f-gases such as hydrofluorocarbons (HFCs) especially in systems containing 3kg or more of refriger-

ant, the Regulation’s overall objective is to lower emissions of fluorinated gases.

Already the 2006 Regulation made the use of f-gases more burdensome, yet the greatest impetus for the development of natural refrigerant based solutions was probably the interpretation of the Regulation by the industry as a prognosis of even stricter f-gas rules in the future: In light of the stricter requirements anticipated in the future, several manufacturers of refrigeration and air-conditioning equipment have been since several years working on R&D and investing in natural refrigerants to insure against future strengthening of the Regulation and potential use and placing on the market restrictions.

Indeed, the interpretation was correct, a report assessing the effectiveness of the 2006 Regulation concluded that more action is required in addressing HFC emissions, if the EU is to meet its long-term emissions reduction targets (European Commission, 2011).

The F-Gas Regulation is currently undergoing a revision: The European Commission published a proposal for a new EU F-Gas Regulation in November 2012, kick-starting discussions and negotiations on the future legislation among the EU institutions. Key elements of the proposal included amongst other, an HFC phase-down mechanism involving a gradually declining cap on the total placement of bulk HFCs (in tonnes of CO₂ equivalent), placing on the market prohibitions on HFCs in new equipment in some sectors, certification and training provisions for handling not only fluorinated gases, but also replacement technologies.

In December 2013, and after several rounds of negotiations, the EU institutions reached an informal agreement on the future F-Gas Regulation. The agreement is expected to be officially endorsed by the EU institutions in the first half of 2014, the final Regulation to be published in the EU's Official Journal in summer 2014, and to enter into force in January 2015.

Commercial refrigeration is the sector for which the informal agreement entails the strongest signals, in terms of placing on the market prohibitions (bans) of HFCs in new equipment. The informal agreement foresees the following HFC bans:

- Ban on HFCs with GWP \geq 150 in domestic refrigeration as of 2015
- Ban on HFCs with GWP \geq 150 in hermetically sealed commercial refrigeration equipment as of 2022
- Ban on HFCs with GWP \geq 150 in centralised commercial refrigeration systems with a capacity of 40kW or more as of 2022, except in the primary refrigerant circuit of cascade systems where HFCs with a GWP $<$ 1,500 will still be allowed
- Ban on HFCs with GWP \geq 150 in movable room air-conditioning appliances as of 2020
- Ban on HFCs with GWP \geq 750 in small single split air-conditioning systems (containing less than 3kg of f-gases)

Besides HFC bans in the aforementioned sub-sectors, a HFC phase-down - a gradually declining "cap" on bulk HFCs placed on the EU market expressed in CO₂ equivalent - of 79% by 2030, as originally proposed by the European Commission, will be a key part of the new Regulation.

Moreover, HFCs with GWP \geq 2,500 will not be permitted neither in new stationary refrigeration equipment as of 2020, nor for the servicing of large

refrigeration systems (as of 2020 for virgin HFCs, as of 2030 for reclaimed or recycled HFCs), bringing essentially an end to the use of R404A in the refrigeration sector.

Overall, the rules on the use of HFCs are about to be tightened in the EU, creating more of a level playing field between conventional and natural refrigerant technologies.

New publication



HFC TAXES & FISCAL INCENTIVES FOR NATURAL REFRIGERANTS IN EUROPE

Which country had the highest tax on hydrofluorocarbons (HFCs) in Europe in 2013 and what can industry expect in 2014?

Where in Europe can businesses receive grants or tax relief for investing in natural refrigerant systems?

To answer these questions shecco has launched a new publication "GUIDE+: HFC taxes & fiscal incentives for natural refrigerants in Europe". The new GUIDE+ provides a comprehensive overview of existing and proposed fiscal measures in key European countries, aimed at reducing the use and emissions of HFCs in HVAC&R sectors while encouraging the switch to climate-friendly technologies.

Measures in 13 European countries are reviewed in this publication, varying from environmental taxes on HFCs to grants and enhanced tax relief schemes for investments in climate friendly technologies at the national as well as the regional level.

- HFC tax schemes
- HFC tax schemes - considered
- Investment grants
- Accelerated tax relief



PRICE
€500
(excl. VAT)

Available for purchase on
the NEW shecco publications website:
<http://publications.shecco.com>

CONTACT US

+32 2 230 3700
publications@shecco.com



EU POLICIES: HCFC PHASE-OUT, ECODESIGN & ECOLABEL

IMPACT ANALYSIS



HCFC PHASE-OUT IN THE EU

The recast of the EU Regulation on ozone depleting substances in 2009 accelerated the HCFC phase-out schedule by placing a complete ban on using HCFCs (both "virgin" or "recycled") by 2015, enhancing therefore the urgency to replace HCFC equipment/plants. Some entities seek to leapfrog HFCs, especially in equipment with a long lifetime and vast refrigerant inventories.



ECODESIGN FOR AIR CONDITIONERS & HEAT PUMPS

With Ecodesign aimed at improving overall environmental performance of products, the Ecodesign Regulation for room air conditioners establishes a 10% incentive in terms of lowered minimum energy efficiency requirements for products using refrigerants with $GWP \leq 150$. Recently adopted Ecodesign regulations for space and water heating heat pumps stipulate that such measures be assessed during the regulations' review in 2018 the latest.

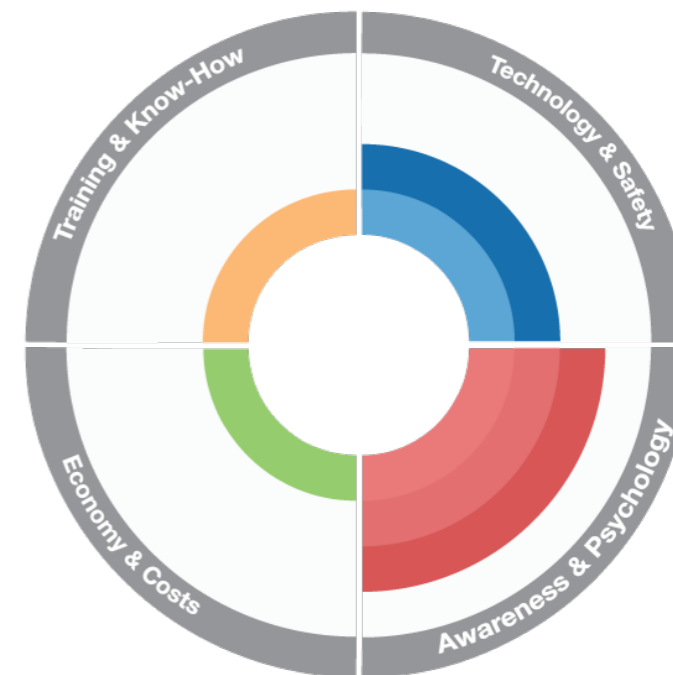

EU ECOLABEL

Products that are awarded the voluntary European Ecolabel allow users to identify products and services that are kinder to the environment. Minimum energy efficiency requirements for awarding the heat pump Ecolabel are easier to meet for products that use a refrigerant with $GWP < 150$. EU Ecolabel and Green Public Procurement (GPP) criteria are currently being developed for water-based (hydraulic) central heating products with refrigerant-related requirements being considered under the proposal.

EU POLICIES: HCFC PHASE-OUT, ECODESIGN & ECOLABEL

HCFC PHASE-OUT IN THE EU

Regulation No 1005/2009 on substances that deplete the ozone layer is the legal instrument in the European Union that sets out the HCFC phase-out schedule in its member countries. Accordingly, the use of HCFCs in new equipment has been banned in Europe since early 2000. Since January 2010, virgin HCFCs have been banned in the maintaining & servicing of existing systems, while at the same time a total ban on the supply of virgin HCFCs took effect. Reclaimed or recycled HCFCs can be used to service or maintain equipment until 2015. After this date, the European Union does not allow the use of ozone depleting substances any more, which means that plants/equipment with HCFCs can only continue running for as long as they do not need topping up, and after this point they would either need to stop operating or be replaced.

Many users with multiple systems have planned a replacement strategy to conserve their stock of HCFC-22 refrigerant, setting priorities for which system to replace or convert first by considering the age of the plant, likelihood of leakage and ease of conversion (RTOC, 2010).

Implementing retrofits and replacements of HCFC industrial refrigeration equipment, for example, offers replacement options ranging from hydrofluorocarbons (HFCs) to natural refrigerants like ammonia and carbon dioxide. With the complete HCFC phase out coming up in 2015, some companies are proposing natural refrigerant solutions as long-term replacements to their customers. Of course, HFCs are also often proposed as the re-

placement technologies in many applications. Nonetheless, the recast regulation, which brought forward the HCFC phase out in the EU, has been one of the reasons why several companies have been looking into natural refrigerants as future proof replacements, developing products, enhancing safety and reliability and reducing their costs. In combination with the fact that, in the meantime (2006), the F-Gas Regulation was introduced, the recast regulation has enhanced the urgency to replace HCFC equipment/ plants with forward-looking entities seeking to leapfrog HFCs, especially in applications for which equipment has a long lifetime and where HCFCs are still widely in use (e.g. industrial refrigeration plant stock).

The EU legislation has not only been effective in controlling ozone-depleting substances, but also acted as a driver for the development of innovative technologies (e.g. chillers with ammonia charge as low as 0,1kg per kW capacity).

ECODESIGN FOR AIR CONDITIONERS & HEAT PUMPS

Ecodesign rules consider the environmental impact of energy-using products throughout their entire life-cycle. Products not meeting certain requirements will not be allowed on the EU market. Under the life-cycle approach, direct emissions from the refrigerant are also taken into account. However, existing regulations and those under development currently focus mainly on efficiency.

An exception is the Ecodesign regulation for room air conditioners (Commission Regulation implementing Directive 2009/125/EC), which has set a

precedent in recognising the contribution of refrigerants in the environmental footprint of products by providing a bonus in energy efficiency requirements for products using refrigerants with a Global Warming Potential (GWP) below 150. However, the measure is an incentive not a requirement and has somewhat poor visibility, as it is not respected on the corresponding energy label.

Whilst similar measures have not been included in the recently adopted Ecodesign regulations for space and water heat pump heaters, the review clauses specify that the appropriateness of setting requirements related to direct emissions from refrigerants will be looked at in the process of regulations recast by 2018.

Similar opportunities for introducing low-GWP bonuses could arise for several other refrigerant containing product categories that are currently being discussed under the Ecodesign, including commercial & professional refrigeration and tertiary air conditioning. Overall, there is a large potential for advantageous requirements for natural refrigerants in Ecodesign regulations currently being revised or when regulations are reviewed (typically within 5 years after entry into force).

EU ECOLABEL

The EU Ecolabel is a voluntary scheme established in 1992 (and revised in 2009) to encourage businesses to market products and services that are kinder to the environment. Products and services awarded the Ecolabel carry the flower logo, allowing consumers – including public and private pur-

chasers - to identify them easily. Producers find that the label gives them a competitive advantage.

Today, the EU Ecolabel covers a wide range of products and services, with further groups being continuously added. The environmental criteria behind the EU Ecolabel are agreed at the European level based on life-cycle analysis. The label itself is only awarded after verification that the product meets these environmental and performance standards.

HVAC&R related product groups for which award criteria have been established include heat pumps, (both electric and gas heat-pumps with a maximum heating capacity of 100 kW but not heat pumps that can only provide domestic hot water for sanitary use). Current criteria for awarding the heat pump ecolabel are valid until 31 October 2014. With regards to the refrigerant used, the decision requires that its global warming potential (GWP) does not exceed a GWP value $> 2,000$ over a 100 year period. If the refrigerant has a GWP of less than 150, then the minimum requirements of the coefficient of performance (COP) and primary energy ratio (PER) in heating mode and the energy efficiency ratio (EER) in cooling mode shall be reduced by 15%.

Other HVAC&R product groups for which EU Ecolabel and Green Public Procurement (GPP) criteria (efficiency, greenhouse gas emissions, refrigerant etc.) are currently under development include water-based (hydronic) central heaters (up to 400 kW). There will be one label for all different types of generators, with oil generators having a disadvantage (high emissions) and heat pumps, on the other hand, having an advantage in meeting the award requirements. The draft Ecolabel includes a refrigerant criterion requiring the use of refrigerants with GWP below 2,000.

NATIONAL POLICIES: LEADERS, FOLLOWERS & LAGGARDS

Besides measures imposed on the supra-national level (e.g. EU), individual countries have set ambitious targets to either phase out HFCs and/or promote natural refrigerants directly at the national or regional level. At the other end of the spectrum, some national rules continue to pose a major hurdle for the NR industry due to inappropriate charge restrictions or system bans. The following provides just a glimpse of three countries – 1 leader, 1 follower and 1 laggard in the field of natural refrigerants – with different approaches to a natural refrigerants market uptake.

SWITZERLAND

Following the example of Denmark which has managed to significantly reduce the use of fluorinated gases as a result of its national policies introduced in 2001 and 2002, another European country introduced bans on synthetic refrigerants in new equipment in 2012. Switzerland amended its national f-gas legislation and has introduced bans on HFCs in certain applications as of December 2013. The amended Swiss Ordinance on Chemical Risk Reduction (ORRChem) introduces HFC bans in medium and large capacity stationary applications, including 1) air-conditioning (cooling capacity >600kW), 2) commercial refrigeration (cooling capacity >40kW for plus cooling and >30kW for minus cooling; >8kW for minus cooling if it is a combined plus & minus system), 3) industrial refrigeration systems (cooling capacity >400kW; 100kW for deep freezing) and 4) ice rinks.

These bans were agreed together with industry, which decided for itself the list of sub-sectors that bans apply to and the related capacities (kW). This

is an indication of strong confidence in the availability of HFC alternatives in a number of large capacity sub-sectors and of the leadership of the Swiss industry in HFC-free technology. Moreover, the amended Swiss regulation provides for the possibility of making case-by-case exemptions, which greatly adds to the degree of flexibility of these bans.

The result for NR: The HFC bans that have come into force at the end of 2013 have already given a strong signal to end users and system manufacturers, which has been visible especially in the sector of commercial refrigeration, where CO₂ has practically become a standard for Swiss retailers.

GERMANY

Germany's initiatives beyond the EU F-Gas Regulation include projects supported under the National Climate Initiative (NCI) and the International Climate Initiative (ICI), funding for R&D and pilot projects related to the use of halogen-free substances, the promotional programme for climate protection measures in the field of commercial refrigeration and the German Refrigeration Award, which has so far recognised several HVAC&R natural refrigerant products.

The National Climate Initiative, in particular, supports investment in more efficient and innovative technologies by the German industry. One example is the Climate Protection Incentive Programme for refrigeration plants, which seeks to reap the potential for savings in costs, energy and CO₂ emissions by deploying innovative refrigeration technologies available on the market. Since 2008, the

Federal Office of Economics and Export Control (BAFA) has deployed this programme, which has been substantially amended as of January 2014. The scheme provides investment grants for natural refrigerants in commercial and industrial refrigeration & AC in existing and new plants for: 1) compression refrigeration systems with 5 to 150 kW of electrical power; 2) compression air conditioners with 10 to 150kW of electrical power; and 3) sorption systems with 5 to 500 kW cooling capacity. In 2012, BAFA granted authorisation for 211 plants and disbursed grants in total value of €15 million. As a result, 45% average energy savings have been achieved by the subsidised plants.

The result for NR: The use of natural refrigerants is a requirement for new plants receiving funding, while for the refurbishment of existing plants, a higher investment grant level can be claimed for the use of HFC-free refrigerants. The funding programme has thus provided stimulus for the deployment of natural refrigerants, and especially natural refrigerant CO₂ in the German retail sector, as confirmed by several manufacturers. However, relevant players state that funding opportunities are somewhat modest as only end users have the option to apply for it, thus providing no strong incentive to suppliers. Also, at the international level, the International Climate Initiative (ICI) has been supporting projects in developing countries, emerging economies and transition countries since 2008. Funded projects include HVAC&R production plant conversions to natural refrigerants or facilitating the development and introduction of standards for natural refrigerants.

FRANCE

A French decree forbids the use of flammable refrigerants, including hydrocarbon refrigerants, in premises to which the public has access, such as supermarkets (Arrêté du 14 février 2000 — Etablissements recevant du Public, Article CH 35: Production, transport et utilisation du froid). The same decree allows for the use of ammonia in premises with public access only if the following conditions are met simultaneously: 1) it is used in an indirect system; 2) the ammonia refrigeration system is located in a separate machine room; and 3) the total amount of ammonia in a facility is limited to 150kg. This seems to have encouraged the continuation of HCFC use in the country at a larger scale than other countries in Europe. However, operators of facilities with public access will soon be facing the 2015 deadline, whereby they will not be able to top up their refrigeration systems with reclaimed or recycled HCFCs anymore and will soon after be expected to shift away from their use.

At the same time, on a recommendation of the Committee on Environmental taxation, the French government has indicated that it might be considering the introduction of a tax on fluorinated gases.

The result for NR: While regulatory restrictions render the use of traditional direct expansion ammonia systems in France very difficult, indirect ammonia systems with CO₂ secondary refrigerant could satisfy the regulatory conditions specified in French regulations: that ammonia is restricted in a plant room, that the system is an indirect one, and that the ammonia charge can be limited to 50-100 kg. However, with hydrocarbons completely out of the picture and limitations on the use of ammonia,

HFCs are expected to be widely phased in as HCFC replacements.



CASE STUDIES

Real-life examples of successfully working technologies are the strongest arguments for spreading innovative solutions, engaging legislators and convincing end-users. From the multitude of existing natural refrigerant-based systems, this section presents a selection of outstanding examples, covering commercial and industrial heating, air-conditioning and refrigeration solutions.

Examples cover suppliers based and/or active in Europe including: Advansor's transcritical CO₂ booster system - compSUPER Sigma –installed for retailer Coop; Alfa Laval's CO₂ refrigeration systems for retailer S-Market; Carrier's CO₂OLtec

Integral solution at a SPAR store; a seafood processing and cold storage plant using Danfoss components for its NH₃/CO₂ cascade system; DSI's plate freezers in a fish processing plant; a highly efficient ammonia heat pump concept developed by the Danish Technological Institute; a field test of a new CO₂ transcritical compressor by Emerson Climate Technologies in collaboration with Green & Cool; GEA Bock's CO₂ compressors in a Swiss supermarket and meat-processing plant, Mayekawa's NH₃ Heat Pump for a meat factory in Germany; and SINTEF Energy Research's involvement in the design of a Norwegian grocery store using a fully integrated ventilation, cooling and heating system with natural refrigerants.

INTEGRATED CO₂ BOOSTER FOR HIGH-EFFICIENCY COOLING, HEATING AND AIR CONDITIONING



ABOUT THE COMPANY

Advansor develops, produces and sells sustainable refrigeration and heat pump systems that utilise natural refrigerants. Advansor's products and expertise provide operating cost reductions for customers and help global companies meet restrictions related to greenhouse gas emissions. As a world leader with more than 950 operating systems using CO₂ as a refrigerant, Advansor continues to deliver systems globally from its factory in Denmark.

More information at:

info@advansor.dk and www.advansor.dk

CONTACT INFORMATION

Torben M. Hansen

Torben.Hansen@advansor.dk

INTRODUCTION

Swedish major supermarket chain, Coop, wanted to apply environmental friendly and cost efficient refrigeration to a newly build supermarket in the city Tocksfors, Sweden. Based on Coop's general climate strategy and goals of becoming climate neutral by 2020 through cutting emissions of greenhouse gasses, the decision heavily relied on using natural refrigerants to pursue a reduction of one fifth of Coop's emission sources which are based on refrigerants (<https://www.coop.se>).

The goal was to provide a system with minimal impact on the environment and consequently improve Coop's profitability on this store. The store requirements included a need for keeping products displayed and stored at medium temperature and low temperature, requiring cooling capacities of 154kW@-7°C and 56kW@-38°C, respectively. Furthermore, both heat production and air conditioning (AC) needed to be covered, requiring production of +60°C tap water and +7°C water for AC, respectively. This is while keeping power consumption and operating cost as low as possible through optimum system operating efficiency.

Advansor was chosen as supplier of a CO₂ solution, and the Coop supermarket received a newly developed system by Advansor - the compSUPER Sigma - which integrates every property acquired by the customer while accommodating both energy and construction savings compared to traditional solutions. The installation has renewed the range of alternative refrigeration solutions by offering a single plant design applicable to the different and simultaneous needs of a any supermarket, utilizing only one natural refrigerant - CO₂ (R744).

ABOUT THE SYSTEM

Advansor provided two identical transcritical CO₂ booster systems, enabling the opportunity for applying redundant systems. The two full packs, including an air cooled condenser/gas cooler for each plant, were each based on a single rack design fully fitted with compressors, oil management system, liquid receivers, safety equipment and electrical board including controller system. While utilizing our own baseline system concept proven by more than 950 operating systems, new developments has been implemented onto a strong and efficient baseline concept.

The traditional booster design consisting of a MT- and LT-suction group was modified partly by adding compressors in connection with the intermediate stage (parallel compressors). Each system hereby included a compressor configuration of 3 LT-compressors, 3 MT-

compressors and 2 parallel compressors of which the MT- and parallel compressors were equipped with frequency inverters for optimum control according to the load.

The addition of parallel compression to the intermediate stage favors an higher COP during operation. It enables the option for closing the receiver gas bypass and maintaining the receiver pressure by these compressors, rather than having to throttle it by a standard gas-by-pass valve, in which the intermediate pressure is lowered to a common suction pressure before compression by the MT compressors. However, keeping both operating/control options, allows the system to ensure lowest possible power consumption during summer operation with AC load, and winter operation with heat recovery.

Plate heat exchangers were integrated for heat recovery and air conditioning purposes. Heat recovery option becomes favorable with CO₂ compared to traditional HFC-refrigerants due to higher available discharge temperatures under the same normal operating conditions. Upon the integration of heat recovery, the store is able to utilize high discharge gas temperature for hot water production before the discharge gas enters the condenser/gas cooler. Optimum heat exchanger design and heat recovery control were applied by Advansor, providing a heat recovery capacity of 134kW by each refrigeration system and production of 60°C water to the store's heating system.

In addition, the plants were delivered with a "false load" evaporator, integrated into the externally supplied gas cooler. Through this, it is possible to utilize the same rejected heat from the gas cooler to create a artificial load on the system for hot water production when the evaporator loads on the medium- and low temperature shop cabinets are insufficient.

Lastly, a heat exchanger was added for production of 7°C (7/12°C) water for air conditioning, enabling an air conditioning capacity of 100kW in total. The AC-design is unique and ensures high evaporation temperature for this heat exchanger and is currently being patented by Advansor.

In total, Advansor's compSUPER Sigma system concept combines all thermal demands into one system, integrating properties applicable for any supermarket today:

- Cooling and frost: Based on the well-known CO₂ booster design
- Heat recovery and combined heat pump operation: The shop's heat demand can always be meet
- Air conditioning: Based on patent reported design
- Parallel compression: Enabling optimized performance and consequently low power consumption

"The compSUPER Sigma is a further development of our system design concept established by more than 750 operating systems worldwide. This provides a very strong baseline for further technology developments and improvements that

meet the latest customer needs presented by the properties of the compSUPER Sigma. By applying the technologically improvements according to the market demand, we will continue to show our commitment to both the customers and the environmental technology itself." - Torben M. Hansen, Advansor Sales Director

RESULTS

Installation: The AC integration is especially a key design development with respect for easy installation and control. This is mainly achieved since the AC pleate heat exchanger is designed for flooded operation. This excludes a need for controlling superheat or injection. Instead, the CO₂ temperature is controlled by the receiver pressure which in turn control the parallel compressors upon AC need. This enables uncomplicated control of the water or glycol and have allowed easy installation for the customer.

Energy efficiency: Simulated calculations of a comparison between a standard CO₂ transcritical booster system and the delivered system design with integrated parallel compression, shows favorable energy savings up to 6% of the total yearly energy consumption. This is mainly achieved by enabling operation with a lower compression pressure ratio by the parallel compressors versus throttling between the receiver and the system's common suction pressure determined by the medium temperature stage. Favorable for heat recovery, the integration of parallel compression enables improvements to the COPHEAT by up to 40% in a comparison between the load on the MT compressors versus the load on the parallel compressors.

Performance: The systems has been performing very well and utilize the properties applied, accommodating the demands from the customer. While experiencing reliable operation so far, the systems are monitored for maintaining continuous optimized performance.

"Our feedback on the delivered compSUPER Sigma system has been very positive according to the performance so far. We are very pleased to see that this delivery is being followed by an increasing number of inquiries for integrated properties provided by the compSUPER Sigma." - Torben M. Hansen, Advansor Sales Director

ADVANSORTM
by Hill PHOENIX

ALFA LAVAL'S CO₂ REFRIGERATION SYSTEM AT THE S-MARKET BUILDING IN HELSINKI, FINLAND



ABOUT THE COMPANY

Alfa Laval is a leading global provider of specialised products and engineered solutions. The company's equipment, systems and services are dedicated to helping customers to optimise the performance of their processes. Condensers, evaporators and gas coolers from Alfa Laval make transcritical CO₂ and cascading systems responsible, efficient, reliable and safe. Alfa Laval has the products and expertise from an air cooler to a complete transcritical CO₂ solution with heat recovery. Alfa Laval's worldwide organisation works closely with customers in almost 100 countries to help them stay ahead.

More information at:
www.alfalaval.com

CONTACT INFORMATION

Alireza Rasti
ali.rasti@alfalaval.com

INTRODUCTION

At the new S-Market building in Helsinki, Finland, cooling and terminal rooms are full of evaporators labelled and manufactured by Alfa Laval. Alfa Laval was able to help S-Market become one of the few supermarkets in Finland to use CO₂ refrigerant.

"In this very interesting project our customer, the S-Group, gave us a few prerequisites for the type of cooling equipment they wanted. The most crucial requirement was carbon dioxide, which had to be chosen as the refrigerant," says Taisto Tolonen, project manager at Norpe Finland, the company that installed the supermarket's cooling system. *"You know, the most commonly used refrigerant in Finnish supermarkets is still artificial. The challenge is that it does not meet the upcoming F-gas legislation, which will be enforced in a few years."*

Currently there are no more than 50 supermarkets in Finland where carbon dioxide is used as a refrigerant. According to Tolonen, Norpe and Alfa Laval have been co-operating since the 1970s. This latest project started with a visit to Alfa Laval Italy in December 2011, where the carbon dioxide evaporators are manufactured.

"Although carbon dioxide is nature's own gas, it does not act like traditional, more commonly used refrigerants," says Hannu Viikilä, Alfa Laval Nordic and project owner.

ABOUT THE SYSTEM

S-Market's cooling system includes an Optigo CC air heat exchanger in their freezer, and Optigo CD coolers in their fish, chicken, ready-food, fruit and vegetable cold storage rooms. Both models are part of Alfa Laval's Optigo range of energy-efficient and environmentally friendly air heat exchangers.

There are currently three models available in the range, which have been optimised for CO₂ and are easy to install, making them ideal for small to medium commercial applications, such as supermarkets, restaurants and chilled food storage.

Optigo CD

For cooling and freezing rooms where high activity demands increased airflow, the Optigo CD provides double airflow, but low air velocity and noise levels. As with the other products in the Alfa Laval Optigo product line, the CD model is easy to install and clean and follows HACCP guidelines for food safety.

S-Market's cooling system consists of one Optigo CD cooler in the fish cold room (0-2°C or 32-35.6°F), chicken cold room (0-2°C or 32-35.6°F), ready-food cold room (3-5°C or 37.4-41°F), fruit and vegetable cold room (6-8°C or 42.8-46.4°F), as well as three coolers in the terminal area (2-4°C or 35.6-39.2°F).

Optigo CC

Optigo CC is the perfect single flux choice for larger-volume applications. It has a clever design with a new highly efficient coil (for reduced refrigerant content) and the same footprint as the previous series. This makes it easy to install and connect, while high-energy efficiency gives low lifecycle costs. An Optigo CC has been installed in S-Market's freezing room (-20 to -18°C or -4 to -0.4°F).

RESULTS

"In order to guarantee the highest possible quality for our products, we tested certain units and then created design programs with which to secure exact capacities," says Hannu Viikilä. Carbon dioxide has good heat exchanging ability, but its draw back has always been its high pressures. However Viikilä points to the isolated bunker that Alfa Laval has built at its manufacturing site in Alonte, Italy, where long gas coolers can be pressure tested with 172 bar.



"I can proudly say that our clear strength is the ability to combine theory and praxis," adds Hannu Viikilä. *"We are able to show how carbon dioxide reacts at different pressures and our global development team was strongly committed to the correct CO₂ calculation methods."*

Norpe also knows that Alfa Laval has a long reference list concerning challenging refrigeration environments, including supermarkets. *"For us as an installer and contractor it was of great importance to have a reliable and experienced component supplier,"* states Lasse Silvan, project engineer from Norpe.

"We also appreciate the quick service in our native language, as well as high technical know-how on the part of Alfa Laval's contact persons."

According to Silvan, the project did not meet any significant challenges. Supplies came as agreed, and there were no surprises during the pressure and leak tests, which Norpe carried out after installation in November 2012.

SUMMARY

"Alfa Laval's high commitment to new, environmentally friendly cooling solutions is admirable. After many years of close co-operation I can say that they are honestly interested in customers' needs and are ready to fulfill needs to the smallest detail." - Lasse Silvan, Project Engineer, Norpe Finland.

"I appreciate Norpe's openness to the new and sustainable solutions we can offer. When operating with such a challenging refrigerant like carbon dioxide, it is rewarding that our partner also wants to see our R&D environment with all of its frills." - Hannu Viikilä, Segment Manager, Alfa Laval Nordic.



CO₂-POWERED SOLUTION TO COMBINE REFRIGERATION, HEATING & SPACE COOLING FOR REAL RESULTS



ABOUT THE COMPANY

Carrier is the world's leading provider of advanced technical solutions for heating, air conditioning and refrigeration engineering. Carrier offers sustainable solutions for energy-efficient products, building control engineering and energy services in the areas of residential buildings, commercial refrigeration, transport and food retailing. Carrier is part of UTC Climate, Controls & Security, a business division of United Technologies Corp.

More information at:

www.carrier.com
www.carrier-refrigeration.com

CONTACT INFORMATION

Christoph Brouwers
Christoph.Brouwers@carrier.utc.com

INTRODUCTION

Carrier Commercial Refrigeration has accrued sound CO₂ refrigeration technology experience over the last two decades, in close cooperation with the largest food retail customers. The company now counts more than 660 transcritical installations of its innovative CO₂OLtec[®] system, making Carrier a leader in deploying transcritical CO₂ refrigeration systems for European food retailers on a turnkey basis.

Ongoing studies of the installed CO₂OLtec systems demonstrate that food retailers achieve average energy efficiency gains of 10 % over traditional HFC refrigeration systems, in cold to moderate climates.

Committed to help its customers further reduce their carbon footprint and energy consumption, Carrier's engineering team continues to bring new solutions to market for broader deployment of natural refrigerants in the food retail industry. Carrier's CO₂OLtec Integral system provides a fully integrated approach for the store's refrigeration, space heating and cooling, using the natural refrigerant CO₂.

Already installed in more than 100 stores in Europe, the CO₂OLtec Integral system was the preferred choice of the SPAR group for its store in Schüpfen, Switzerland.

ABOUT THE SYSTEM

Carrier's CO₂OLtec Integral solution at the SPAR store in Schüpfen, Switzerland combines refrigeration, heating, cooling, ventilation and lighting.

Across the sales area of almost 400 sqm, all pieces of cooling and freezing equipment are powered by a transcritical CO₂ booster refrigeration system. Waste heat created during the refrigeration process is collected by the CO₂OLtec Integral outdoor unit and reused to deliver the necessary heating capacity for the sales, storage and staff areas for the whole store year round.

The central CO₂OLtec Integral outdoor unit secures cooling of the store when needed, by preparing cold water and distributing it via the hydraulic systems to various consumer points, such as the central air handling unit.



Innovative solutions,
naturally...

An additional system feature exhausts the cold air from the space in front of the open multidecks, thus helping to eliminate the "cold aisle effect", and redistributing the air at the required temperature level via the central air handling unit.

The efficiency of the fully integrated concept is determined primarily by the optimum interaction of the interfaces of various subsections and the intelligence of the higher-level building management system that ensures that the various systems are fully integrated and interact with one another with the best possible efficiency.

RESULTS

With Carrier's solution, the supermarket expects to achieve measurable gains by streamlining its operations, with a single point of contact for purchasing, installation and service for all system components of the commercial refrigeration, heating, cooling, ventilation and lighting.

With the CO₂OLtec Integral system, the supermarket can take advantage of demonstrated energy cost savings of up to 30 percent over the system's lifecycle, and a 50 percent reduction in the system's carbon footprint in comparison to one based on a conventional R404A refrigeration and gas heating system.

Combining water and space heating with refrigeration allows the SPAR store to completely eliminate the need for a conventional heating gas boiler system and the local usage of fossil fuels. Lastly, the solution offers the future-proof security that comes with using CO₂ as a refrigerant.

Carrier has the right refrigerant solution for every application, but not every refrigerant is suitable for every application. For further information about CO₂OLtec, visit www.carrier-refrigeration.com.



DANFOSS SECURES A MAJOR DESIGN WIN FOR A LANDMARK CO₂ REFRIGERATION PROJECT IN CHINA



ABOUT THE COMPANY

The Danfoss group is one of the largest Danish companies, operating in: Refrigeration & Air Conditioning, Heating & Water and Motion Controls. Its Refrigeration and Air conditioning division is specialized on automatic controls, compressors and electronic sensors.

More information at:

www.danfoss.com

CONTACT INFORMATION

Carsten Dahlgaard

CarstenDahlgaard@danfoss.dk

INTRODUCTION

Danfoss's award winning valve station for industrial refrigeration, called ICF Flexline™, recently achieved a major milestone in China. The whole Flexline™ family of valves were extensively applied in a landmark CO₂ refrigeration project at the scallop & sea cucumber processing centre of the Dalian Zhangzi Island Fishery Group.

The Zhangzi Island is located in the north end of the Yellow Sea, 56 nautical miles from the continent and free from pollution. The natural environment of the island is well suited for aquaculture, which combined with bottom-breeding technology, yields high quality seafood. Zhangzi Island's products are widely recognized as organic, green and pollution-free. Every year, Dalian Zhangzi Island distributes approximately 100 million seeds into the sea. At the bottom of the cultivation area there are so many marine creatures, that it is often referred to as a "seabed bank". Three main products, Yezo scallops, trepang, and abalone, all grow very well in this type of environment.

Overlooking the Zhangzi Island, a large silver building will certainly grab your attention. This building, that many say resembles a large ship, is the newly constructed seafood processing centre of Dalian Zhangzi Island group. It combines seafood processing and cold storage. After comprehensively considering safety, the environment, and efficiency, the Zhangzi Island group decided to use CO₂ as the refrigerant for this project. Danfoss was subsequently selected as the valve supplier due to our industry leading CO₂ technology, vast experience with CO₂ and our high-quality products.

ABOUT THE SYSTEM

For this project, one major objective was to protect the environment since Zhangzi Island is located in the southern China Changshan Islands in the clean and pollution-free area. For the sake of environment protection, the environmentally-friendly refrigerants ammonia (R717) and CO₂ (R744) were chosen to be used for this project.

Safety and energy savings were also major priorities for this project. With only 14.36 km², the Zhangzi Island is highly concentrated and populated. Safety of the

local residents is always a primary concern. In the newly developed seafood processing centre, the freezing plant utilizes a NH₃/CO₂ cascade system for refrigeration, which lowers the NH₃ charge amount by over 90% and limits the NH₃ refrigerant inside of the refrigeration control room, fully satisfying the safety requirements of Zhangzi Island group. The cold storage plant utilizes a CO₂ brine system and uses the abundant sea water as the cooling medium for the high level ammonia refrigeration. The setting up of the condenser heat recovery appliance prior to the cooling process, realized a good balance between safety and environment protection.

The reliability of the refrigeration system is an important element of the Zhangzi Island project, since the island is far from the mainland and transportation is limited. Seafood processing depends heavily on reliable refrigeration systems. This is the main reason why Danfoss CO₂ solutions and components were used for the Zhangzi Island project. With leading TDR technology, Danfoss AKS 4100U series radar liquid level sensor was adopted for liquid level controlling of the NH₃/CO₂ cascade system, working together with the ICM series motor control valve for precise control of the refrigeration liquid level control. The feeding line of the freezing room uses the Danfoss premier product ICF series valve station, which compressed the installation area by 2/3 and reduced the welding time by 80%. The newly launched SVL Flexline™ series of refrigeration line components were also widely used.

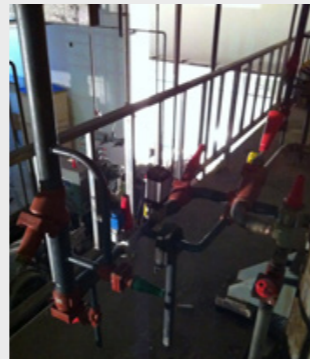

Danfoss Industrial Refrigeration Flexline™ platform:

Flexline™ - a modular solution

Line Component - SVL:

- Using just two basic valve housings - a straightway and an angleway - the platform offers 5 different functions
- The backbone of the platform is the common housing which is available as angle- or straightway. All five function modules: stop, regulating, stop/check, check and filter fit the same housing
- They all have the same high specification making selection, system design and mounting simple and trouble free

Valve station - ICF:

- Only two welding ensures the safety and fast installation with an improved efficiency
- Innovative modular design can have the function modules assembled in the single housing

Control valve - ICS:

- Direct welding form is used without flange, reducing the leakage risk by up to 80%
- The special V-port design in the ICS cone ensures optimum regulation characteristic to pilot operated main valves even at partial load
- The plug-in module adopts QPQ technology to realize excellent environmental adaptation

SUMMARY

For big scale industrial refrigeration region of China, the Zhangzi Island new processing plant is the first to combine both CO₂ cascade & brine systems. This is one reason why it is now considered a benchmark project in the green journey for China industrial refrigeration.

For the fishing and seafood processing industry, refrigeration is a key requirement for practically the entire process. Accurate and stable low temperature control is a crucial in pre-processing, pre-cooling, quick freezing, post-processing and refrigeration. With vast experience in this field, Danfoss provides many leading marine companies across the globe with both components and technical support. Danfoss is rapidly becoming the leading refrigeration supplier to the fishery industry due to our reliable, efficient, and environmental-friendly refrigeration solutions.



AUTOMATED AMMONIA PLATE FREEZER BY DSI FOR A FISH PROCESSING PLANT IN KLAIPEDA, LITHUANIA



ABOUT THE COMPANY

DSI is a leading company involved in designing and manufacturing manually-operated and automatic plate freezers. DSI manufactures many different types of manual horizontal and vertical plate freezers which are suitable for use in onshore and marine installations.

More information at:

www.dsi-as.com

CONTACT INFORMATION

Mads Sigsgaard

ms@dsi-as.com

INTRODUCTION

Espersen is a world leading fish processing company with production plants in Denmark, Poland, Lithuania and China. In Klaipeda, Lithuania, Espersen Lietuva UAB is operating one of the most modern fish processing plants in Europe, here they are preparing and freezing fish products for customers in Europe and United States. Products are white fish species that are prepared as frozen blocks, frozen fillets and breaded products. Espersen were looking at upgrading their freezer capacity with an automated plate freezing system to freeze white fish fillets in consumer packs.

The previous handling was mainly manual and demanding much manual labor to handle the product in and out of standard Horizontal Plate Freezers. There was also an expectation to reduce the drip loss from the product due to the faster handling of the product into the freezer.

ABOUT THE SYSTEM

The freezer installed by DSI is designed with the aim of getting cooling contact to the product as fast as possible.

The DSI horizontal single station opening freezer is only opening one station at a time for loading and unloading. The result is that as soon as the product is packed it is conveyed into the freezer and loaded onto the freezing station. The station is closed and there is double contact to the cold freezer plates.

The inline HS Inline Horizontal Plate Freezer type HKS 36/20 is designed to freeze 750 kg of consumer packed fish fillet products. Product is entering at +5°C and frozen to -18°C in less than 80 minutes.

The freezer operates on an ammonia system with pump circulation with evaporation temperature of -40°C

RESULTS

The continuous loading of the freezer results in a stable refrigeration load, comparing to a standard batch load freezing where the refrigeration load is varying from a very high load initially to a very low load when the product is frozen. This means that the overall energy efficiency is improved.

The product quality is improved due to the fast transfer of the product to the cold plates of the freezer. On top of this the drip loss of the product is reduced, also contributing to the overall economy of freezing in a continuous production flow.

The performance of the freezer is actually better than expected, so much that Espersen has taken some of the stations in the freezer out of operation, meaning that there is a possibility to increase the production if this is needed.

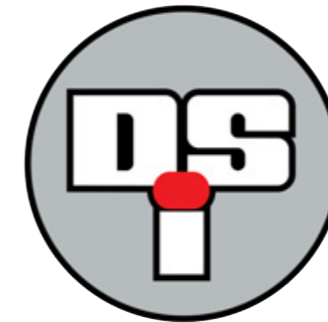

DANISH TECHNOLOGICAL INSTITUTE'S AMMONIA HEAT PUMP CONCEPT WITH SPLIT CONDENSER



ABOUT THE COMPANY

Danish Technological Institute in terms of Refrigeration and Heat Pump Technology specializes in research and development of refrigeration and heat pump technology and the use of natural refrigerants. Other key areas of expertise are e.g. solar energy, industrial drying and process optimization as well as preparing and carrying out training courses. The advanced state-of-the-art laboratories are used for research and development of new technology as well as for accredited testing of e.g. heat pumps.

More information at:

www.dti.dk

CONTACT INFORMATION

Claus Madsen

clma@teknologisk.dk

INTRODUCTION

Heat pumps play an increasingly important role in the search for more effective use of energy in our society. Highly efficient heat pumps can contribute to reduced energy consumption and improved economy of the systems which they are a part of.

The highly efficient ammonia heat pump concept developed with the support of the Danish ELFORSK program has provided valuable insight into the potential of splitting a condenser into two parts and the circumstances under which this is favorable. The split condenser concept makes it possible to obtain smaller temperature approaches, whereby the heat pump efficiency is improved at an equal heat exchanger area, when compared to the traditional solution with separate condenser and desuperheater.

The ammonia heat pump was built to test the following concepts:

- Optimizing the total heat exchanger area and cost by an optimal split of the condenser parts
- Optimizing the coefficient of performance (COP) by maximum utilization of the sub cooler and oil & cylinder head cooling
- Finding the optimum compromise between refrigerant pressure drop and heat transfer coefficients in the evaporator

ABOUT THE SYSTEM

The unit consists of a Mycom high pressure reciprocating compressor and an Alfa Laval flooded plate heat exchanger with a U-turn separator for the evaporator side. In order to test different configurations, the circulation of the ammonia liquid in the evaporator can by choice be either natural circulation or forced circulation by a Grundfos refrigerant pump. The unit is built with two Alfa Laval condensers of which the first condenser also functions as desuperheater.

This ammonia heat pump has been built by Svedan Industrial Refrigeration (Svedan Industri Køleanlæg). With a relatively large difference in water temperature in and out of the condenser, it is possible to reduce the required area of the condenser by splitting it into two parts.

The split condenser design can be used for heating a significant share of the total heating capacity to a temperature far above the condensing temperature.

Substantial energy savings can be reached in cases where the waterside temperature rise is high, and optimized design of the condensers may reduce the required total heat transfer surface. An alternative is to use the same area but to increase the COP by lowering the condensing temperature.

In order to achieve the full potential for reducing the condensation temperature, it is required to optimize water flows and temperature profiles for the condensers.

RESULTS

The project has shown the potential of optimizing the heat pump performance and efficiency by using sub cooling and a split condenser.

| | |
|------------------------------------|----------|
| Heating capacity | 220 kW |
| Heating coefficient of performance | 4,3 - |
| Evaporation temperature | +20 °C |
| Condensing temperature | +74 °C |
| Hot water in/ out | 40/80 °C |
| Cold water in/ out | 30/25 °C |
| Discharge temperature | 135 °C |

With this total efficiency, it was possible to deliver approximately 25% of the flow at 100 °C and 75% at approximately 74 °C.

Note that the capacity and the temperature of the hot stream cannot be varied independently without compromising overall efficiency.

Lessons learnt

The test installation is estimated to be able to perform even better and thus achieving COPs up to 4.7 at these operation conditions. However, due to an issue with a too high oil circulation ratio resulting in surplus oil content in the evaporator, there were restrictions to both efficiency and maximum capacity.

Spin off

The test set up of the U-turn separator is equipped with sight glasses, which has given the project partners valuable insights into the operation of this component. The set up with the possibility of both forced and natural circulation for the evaporator has been the inspiration of the training with the DTI ammonia training rig equipped with similar instrumentation.

Commercial availability

Today, the calculation of the heat exchangers has to be performed manually with the use of the relevant design software from the supplier. This is very time consuming and in order to facilitate widespread use of this technology, a new project group has been formed, and an application for funding by the EUDP program has been submitted to The Danish Energy Agency. The aim of this project group is to enable commercialization by modifying the calculation software for ease of use as well as to extend the use to other refrigerants. Another important area is the application window with regard to the optimal temperature profiles and the control strategy especially with regard to optimizing part load operation.

Link

More information about the project in English can be found at www.elforsk.dk/elforskProjects/343-059/343-059_Slutrapport_vers06.pdf



**DANISH
TECHNOLOGICAL
INSTITUTE**

ICA SUPERSTORE USING COPELAND STREAM CO₂ COMPRESSOR WITH CORESENSE DIAGNOSTICS



ABOUT THE COMPANY

Emerson Climate Technologies is the world's leading provider of heating, ventilation, air conditioning and refrigeration solutions for residential, industrial and commercial applications. The group combines best-in-class technology with proven engineering, design, distribution, educational and monitoring services to provide customized, integrated climate control solutions for customers worldwide.

More information at:
www.emerson.com

CONTACT INFORMATION

Sylvain Lamy
Sylvain.lamy@emerson.com

ABOUT THE COMPANY

Green & Cool is the market's leading supplier of refrigeration systems that use environment-friendly carbon dioxide (CO₂) as a refrigerant. Since 2007, high-quality carbon dioxide refrigeration is successfully distributed worldwide under the Green & Cool name.

More information at:
www.greenandcool.com

CONTACT INFORMATION

Micael Antonsson
Micael.Antonsson@greenandcool.com

INTRODUCTION

Emerson Climate Technologies has recently launched the Stream CO₂ series of transcritical compressors for medium temperature applications using CO₂ as a refrigerant. The 4MTL range covers applications ranging from 18kW to 200kW cooling capacity. Prior to market release, the compressors were installed and proven in a field test in partnership with the company Green & Cool.

The intent was to ensure the compressor reliability level as well as to demonstrate its performance in terms of efficiency, lubrication, sound, and vibration. The objective was also to prove the benefits associated with its on-board electronics that provide compressor advanced protection, diagnostics and monitoring through communications.

ABOUT THE SYSTEM

The system was commissioned in June 2012 in an ICA Kvantum Superstore in Varberg, Sweden and has been running successfully since then. The supermarket occupies a sales area of 8000 m² including a bakery and kitchen.

The refrigeration system is a dual temperature booster pack with heat recovery. It consists of 5 compressors for the chilled food cabinets and 2 compressors for the freezers. One compressor on each side is inverter driven as to provide optimum temperature and pressure control.

The use of high pressure design on the medium/transcritical side as well as on the low temperature/subcritical side ensure that in case of power outage, the safety valves of the system (rated at 60 bar) will not open until the temperature in the system climbs and reaches 23°C. This gives practically full system resilience in case of operation disruption.

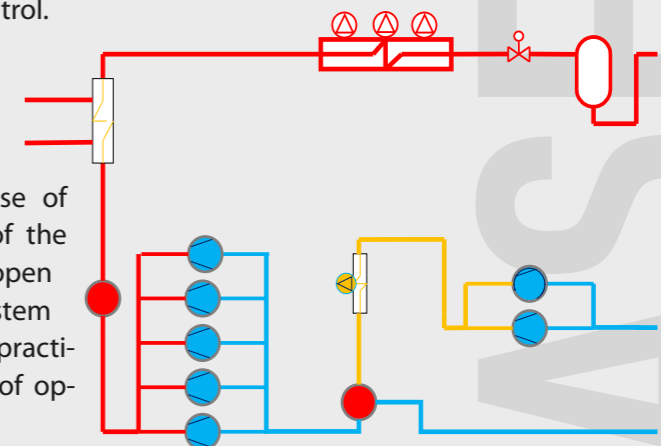

The supermarket was previously equipped with a booster system, made by a different manufacturer and using compressors from a different brand. The system was replaced by the Stream based Green & Cool booster pack, which allowed to have a decent case for performance comparison.

Details about the system are:

- Medium temperature pack
 - 4 Models 4MTL-30X (20m³/h)
 - 1 Model 4MTL-30X (20m³/h) Running with Inverter 30-70Hz
 - Load 180kW at Te/Pc -11°C/ 90Bar (35°C Gas Cooler)
 - Compressor Max. Pressures (Suction/Discharge): 90bar / 120bar
- Low temperature pack
 - 1 Model 4MSL-15X (20m³/h)
 - 1 Model 4MSL-15X (20m³/h) Running with Inverter 30-70Hz
 - Load 63kW at Te/Tc -36°C/-11°C
 - Compressor Max. Pressures (Suction/Discharge): 90bar / 90bar
- Overall System Standstill Pressure: 60bar
- Each compressor is fitted with an oil sensor that opens an injection solenoid valve whose openings are monitored



Green & Cool Stream Pack



CoreSense™ Diagnostics Module

RESULTS

In the observed operation period the compressors accumulated a total of 33.900 running hours. The inverter driven compressors reached 20.200 accumulated running hours giving entire satisfaction. One outstanding observation was the extremely low oil circulation rate of Stream thanks to its special design and the way the gas is routed through the crankcase. This gave the confidence that lubrication is optimum under all conditions. In addition, the low vibration level of Stream was observed on site, that turns into the absence of stress on the system piping but also into low sound level in the machine room.

Each Stream is fitted with a factory delivered CoreSense Diagnostics module. Thus, individual compressor data such as power consumption, current and voltage, discharge temperature and operational history is accessible from Green & Cool's monitoring system via Modbus. This gives the ability to the user to monitor at any time and down to the compressor level, system performance, operation and system reliability. The benefit is that

faulty situations if any can be identified before they occur and cause disruption of refrigeration.

| Results | Previous System | Stream Base System |
|-------------------------------|------------------------|---|
| Sound Pressure (Machine Room) | 100dB(A) | 80dB(A) |
| Oil Fills / Lubrication | 8 times / hour | 1 time / day |
| Electronics | Basic Motor Protection | Advanced Protection, Ability To Monitor Operations Down to Compressor Level |
| Compressors Power Monitoring | None | Via CoreSense |

SUMMARY

The new Stream CO₂ compressors have achieved real on-site performances and refrigeration levels to the total satisfaction of the supermarket owner. There was no disruption of the refrigeration in the 13 months period. CoreSense Diagnostics has proven to bring added value to the store and compressor pack and will be offered on all CO₂ models.

„Aggregates builders welcome an expanded ‘intelligence’ available on the components. CoreSense Diagnostics is a distinctive example of development that will bring user friendliness and reliability. With our easy to use control system, plant owners have the opportunity to follow their energy consumption and available cooling power.” - Michael Antonsson, Green & Cool



OPTIMAL SUPERMARKET REFRIGERATION & HEAT RECOVERY USING HIGH-EFFICIENCY CO₂ COMPRESSORS



ABOUT THE COMPANY

GEA Refrigeration Technologies is a leading global group in industrial refrigeration. GEA designs, engineers, installs and maintains innovative key components and technological solutions.

Among others, the group manufactures GEA Bock compressors for stationary and mobile applications as well as for transport refrigeration.

More information at:

<http://www.gearefrigeration.com>

CONTACT INFORMATION

Manuel Fröschle

Manuel.Froeschle@gea.com

INTRODUCTION

In the following, two different ranges of applications for GEA Bock CO₂ compressors are presented:

- **COOP supermarket in Birsfelden (Switzerland):** The supermarket offers fresh products and perfectly refrigerated foodstuffs to its customers. GEA Bock CO₂ compressors are responsible for the cooling of the complete supermarket. Thus, it is ensured that the right temperature will be maintained in cold storage rooms, cooling cabinets, freezer cabinets and freezer rooms.
- **Abattoir Zurich (Switzerland):** The abattoir, which is more than 100 years old, is one of the most important meat-processing plants in Switzerland. The owner of the site and building is the City of Zurich. The high temperature heat pumps with GEA Bock CO₂ compressors ensure that energy from waste heat can be recovered for heating and hot water. Using operating power which is generally electrical, heat pumps lift thermal energy from a low temperature level, which cannot be used, to a higher level, which can be used.

ABOUT THE SYSTEM

Both systems use GEA Bock CO₂ compressors. They are working with the natural and climate neutral refrigerant R744 (CO₂).

- **COOP supermarket in Birsfelden (Switzerland):** In the Swiss COOP supermarket, a CO₂ supermarket system which serves as a booster system was installed by the Kälte AG Basel in the year 2012. The rack builder was the Italian company Enex srl.
- In the high pressure stage, a frequency-controlled HGX34/150-4 S CO₂ T as well as three transcritical HGX34/150-4 ML CO₂ T compressors are used. A total of three HGX12P/40-4 CO₂ compressors – one of them is frequency-controlled – handle the subcritical low temperature cooling. The refrigerating capacity is in the design point of the system in the normal cooling at approximately 111 kW and in the low temperature at about 20 kW.

- The system works according to the heat recovery principle, so that the energy received from the refrigeration cabinets and rooms can be used efficiently – e.g. as heating or to supply hot water to the supermarket.
- **Abattoir Zurich (Switzerland):** The heat pumps in the abattoir were installed by Thermea Energiesysteme GmbH and consist of a total of 12 virtually maintenance-free GEA Bock CO₂ compressors. The heat output of the HGX34/150-4 SH CO₂ T models is a total of 800 kW.
- Heating water with a flow temperature of 90°C and a coefficient of performance (COP) of over 3.4 is generated. More than three times of the energy input used is available by this means as usable heat output. This high degree of efficiency is achieved by a high-efficient compressor and comprehensive hydraulic optimization of the supply system, so that low return temperatures from the systems for domestic hot water supply and building heating are possible throughout the year.



Heat pump in the abattoir of Zurich



Heat pumps with GEA Bock CO₂ compressors

RESULTS

Within refrigeration technology, carbon dioxide (CO₂) is known by the name R744 and has a long history. It is a colorless gas and has a slightly acidic smell and taste. Carbon dioxide has no ozone depletion potential (ODP = 0) and a negligible direct effect on global warming (GWP = 1) when used as a refrigerant in closed systems.

It is chemically inactive, heavier than air and not combustible. Carbon dioxide has a narcotic and asphyxiating effect on humans only at higher concentrations. Carbon dioxide is available naturally in large quantities.

GEA Bock compressors with R744 as refrigerant offer a lot of benefits in the field of supermarket refrigeration as well as heat recovery:

- **COOP supermarket in Birsfelden (Switzerland):** Regarding applications with CO₂ in low and medium temperature refrigeration, so-called Booster systems are used. High pressure of low temperature compressor is discharged directly to the suction side of the second compressor stage. Different plant constructions of these Booster applications are used for example in supermarket applications like the COOP supermarket in Birsfelden. Transcritical and subcritical GEA Bock CO₂ compressors are used.
- There are also special compressor versions for medium and low temperatures available. For higher pressures, compressors with stronger electrical motors and the possibility for wide frequency range can be used.
- **Abattoir Zurich (Switzerland):** Thanks to the concept of heat recovery with R744 as a refrigerant, not only energy costs, but also CO₂ emissions to the environment, are reduced significantly in the abattoir of Zurich: The annual output of carbon dioxide is reduced by more than 510 tonnes, while 260,000 m³ of natural gas are saved.
- The compressors are also available for higher evaporating temperatures like heat pump applications in special versions with strong electrical motor and optimized oil management.

CHILLERS & HEAT PUMPS BASED ON HC REFRIGERANTS INSTALLED AT AARHUS UNIVERSITY HOSPITAL



ABOUT THE COMPANY

Since its start in 1885, Johnson Controls has grown into a global leader in building efficiency, automotive experience, and power solutions.

JCI is one of the leading companies of refrigeration and chiller solutions based on natural refrigerants. It offers products and services that optimise energy use and improve comfort and security.

More information at:
www.johnsoncontrols.com

CONTACT INFORMATION

Alexander Cohr Pachai
alexander.c.pachai@jci.com

INTRODUCTION

Following the ban on the installation of new R22 systems and the ban on using virgin R22 from year 2000 in Denmark the government has introduced a maximum charge when it comes to HFC of 10 kg. Multiplexing systems using 10 kg or less are not allowed unless they can be proven to be more efficient than alternatives. Furthermore the government has introduced a taxation on HFC refrigerants based on the global warming potential (GWP) values for the individual refrigerants. The tax is collected at the importer's point of sale.

ABOUT THE SYSTEM

In light of this ban and tax Aarhus University Hospital Skejby had to make a decision regarding their future chiller systems for cooling different locations around the hospital and also regarding the condensers of refrigeration systems in different hospital sectors and research lab.

NH₃ (ammonia) was not considered as an option for the heat pumps as the technology was not developed at this point in time and will not be competitive in this size of application.

| | R600a | R600a | R744 | R744 |
|-------------|--------------|-----------|-----------|-----------|
| | 40 °C / 70°C | 40°C/80°C | 40°C/70°C | 40°C/80°C |
| COP heat | Te=5°C | Te=5°C | Te=5°C | Te=5°C |
| Assumptions | Tc=68°C | Tc=78°C | Pc=110bar | Pc=110bar |
| | Sc=25K | Sc=25K | Sc=25K | Sc=25K |

To choose the future systems a comparison was made between R600a and R744. Had warming of the water to higher temperatures been a requirement the R744 would have come out as the best candidate but for this application and site the R600a looked more promising for the heat pumps.

| | kW |
|-----------------------|-------|
| Cooling chillers | 2,250 |
| Cooling HP as chiller | 150 |
| Cooling from HP | 150 |
| Freecooler | 300 |
| Heating capacity | 450 |

For the chillers the preferred solution was R290. The 9 chillers each have a cooling capacity of 250 kW at 9° C/15° C using 27° C as ambient design temperature. The cooling media circulated to the hospital is 35% propylene glycol and this is to cover the needs for the existing build area that covers 160.000 m² . The future extension will cover another 190.000 m² .

The replaced R22 chillers were reaching the end of their service life and the experienced leak rates were making an exchange necessary because it was becoming more difficult to keep getting recycled R22 in a market where most of the recycled material was imported from other countries where the R22 era was coming to an end.

The required hot water supplies are 70° C in the summer period and 80° C in the winter period. It is important to note that there is always a cooling need also in the winter months, to some extent generated by locally installed refrigeration systems.

RESULTS

The system is running perfectly well after some surprises on the regulation side. There are some conditions that have to be thought through. One of the essential questions was: is a heat pump primarily a refrigeration unit or is it a heat pump?

The lesson learned is that it is essential to know if the heating load exists at the same time as the cooling load. At the end of the project the customer was very happy with the new system and is pretty impressed with what has been achieved within the project, which also has a value in it self.



MAYEKAWA'S NH₃ HEAT PUMP FOR A MEAT FACTORY IN STORKOW, GERMANY



ABOUT THE COMPANY

MAYEKAWA is a world-leading supplier of industrial cooling & freezing systems, refrigeration compressors, and heat pumps. It actively promotes the "Natural Five" refrigerants, among them ammonia, for air conditioning, freezing, and cold storage. Mayekawa/ MYCOM has more than 25,000 MYCOM compressors running in over 100 countries.

More information at:

www.mayekawa.eu

CONTACT INFORMATION

Eric Delforge

eric.delforge@mayekawa.eu

INTRODUCTION

The meat company located in Storkow, Germany, needs a heat pump to produce hot water up to 60°C for a hot water consumption of 160 m³/day for 18 to 20hrs/day during 5 days/week.

The hot water buffer tank has a capacity of 60 m³ and the energy-boiler vessel has a capacity of 20 m³. The heat capacity should be maximum 750 kW. The natural refrigerant NH₃ was selected as it has an ODP and GWP of 0. To obtain hot water at 60°C, a condensing temperature for NH₃ of 65°C is selected corresponding with a pressure of 28,5 barg. Between the NH₃ and the process water the secondary medium is selected by using glycol-water. As heat source the condenser circuit of the central refrigeration plant will be used. This means that the heat pump NH₃ evaporating temperature will be 25°C, corresponding with a pressure of 9.0 barg.

ABOUT THE SYSTEM

Two heat pumps compressor KVD1 and KVD2 are connected on the low pressure side to the open flash heat source tank, and to the condenser on the high pressure side.

Between the hot water buffer heat exchanger and the condenser the secondary glycol-water circuit with 3-way valve is located.

Two piston type compressors model N6HK are used for the heat pump units, equipped with frequency converter to allow speed control from 1450 to 970 rpm. Each compressor has mechanical cylinder banks, which can be unloaded in steps of 33%. The compressor performance varies between 393kW to 262 kW based on respectively 1450 to 970 rpm for each machine with an absorbed shaft power of resp. 69 to 44kW. The final design coefficient of heating performance corresponds with 5.7 to 5.9. The actual operating hours on 25/4/2013 amount to 9900 and 9562 hrs for KVD1 resp. KVD2.

The scheme shows the compressor with complete oil system on the left part. The oil system contains an oil pump (integrated in compressor), oil filter, external oil tank, a water-cooled oil cooler and a fine oil separator on the gas outlet of the com-

| MODEL | N6HK | |
|-----------------|------------|----------|
| QTY | 2 | |
| SITE LOCATION | | |
| COUNTRY | GERMANY | |
| TOWN | STORKOW | |
| REFRIGERANT | NH3 | |
| TE | 25 | |
| TC | 65 | |
| PS | barg 9 | |
| PD | barg 28.5 | |
| RPM | rpm | 970 1450 |
| IC | kW | 262 393 |
| 8KW | kW | 44 69 |
| COP-H | | 5.9 5.7 |
| OPERATING HOURS | 25/04/2013 | |
| KVD1 | hrs | 9900 |
| KVD2 | hrs | 9562 |

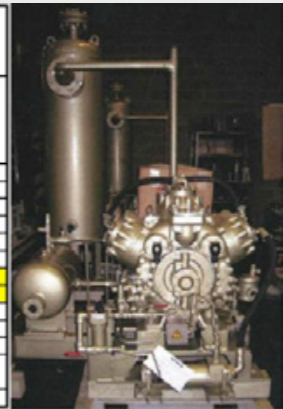

pressor. On the right hand side the condenser located with receiver and the expansion control devices to the heat source flash tank shown in the middle. On the flash tank the gas inlet from the refrigeration plant is visible and the oil recovery vessel.

The photo shows the compressors with main drive motor make SEVA 280M 90kW installed in the machine

room. The yellow painted line is the suction line with automatic closing valve mounted on the top to be closed at compressor standstill. On the discharge side of the compressor the insulated oil separator is visible. The installation was done in October 2010 and operation is approx. 10.600 hrs on year basis. The efficiency of the power drive is in the range of 97 to 98%. The main drive motor efficiency varies around 93.7 to 93.2 at resp. 100% and 50% load.

The operation status is shown on the visualised scheme from the control panel.

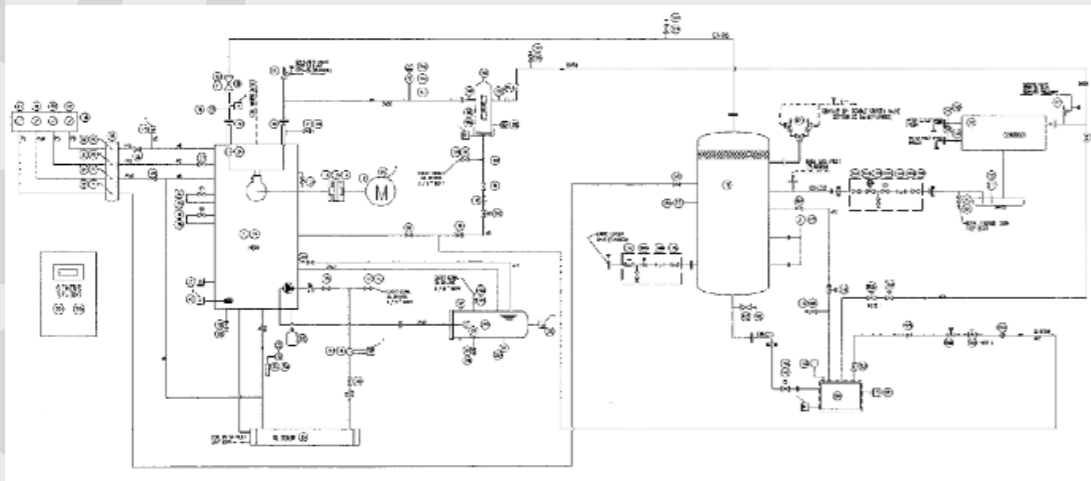

- On 24/4/2013 the total energy input is 479100 resp. 538881 kWh for resp. KVD1 and KVD2.
- The total number of operating hours is 9900, resp. 9562hrs for resp. KVD1, KVD2.
- The total heating energy output is 4.928.342 kWh, which corresponds with a net COP-H of 4.8
- The scheme shows the actual electrical power input of 153.6kW and actual heat energy output of 703.6kW corresponding with an actual COP-h of 4.6

RESULTS



For a total heating energy output of 4.928.342 kWh the comparison is made between conventional heating with gas and the heat pump. Based on a load ratio of 75% and an efficiency of 85% the boiler system energy input will be 7.730.732 kWh, what means a COP-H of 0.64. This gas boiler has an energy cost of 309.229 € based on a gas price of 0.04 €/kWh. For the heat pump the electrical energy input amounts to 1017981 kWh, what means a COP-H of 4.8. The energy cost for the heat pump amounts to 152.697 € based on an electricity price of 0.15 €/kWh, representing a saving of 156.532 € or 50% of the energy cost. For a heat pump

installation cost of 300,000€ and 10.600 hours of operation per year this represents a return of investment of 3.5 years.

This field case shows that the annual savings can be listed as follows:

- On operation 85.381 €
- On condenser water 2.244 Mw (2,5 m³ water + treatment) + lower condensing pressure in the refrigeration plant brings important savings on refrigeration power consumption.
- Natural waste heat and condenser (with condenser operation approx.. 10 kW is needed per hour for fans and water pumps).
- The return of investment: 3.5 years.
- The efficiency of the heat pump is higher than when applying other comparable technologies.
- The heat pump has a long lifetime (more than 25 years) and has low maintenance costs.

MAYEKAWA
MYCOM

SINTEF ENERGY RESEARCH



ABOUT THE COMPANY

SINTEF, the Foundation for Scientific and Industrial Research at the Norwegian Institute of Technology, is one of the largest independent research organisations in Europe. SINTEF Energy Research offers research and development services within the refrigeration and power processes industries. Natural refrigerants, in particular CO₂, have been a focus within refrigeration, mobile air conditioning (MAC) and heat pump systems.

The SINTEF research team was instrumental in the rediscovery of CO₂ as a natural refrigerant in the late 80's. The team is looking forward to being an active project partner in the new Horizon 2020 programme focusing on high efficiency heat pump systems with natural working fluids for various applications.

CONTACT INFORMATION

Armin Hafner

armin.hafner@sintef.no

INTRODUCTION

SINTEF Energy Research's team has been heavily involved in the design of the recently completed grocery store in Kroppanmarka in Trondheim, Norway.

ABOUT THE SYSTEM

A living laboratory

The store will be one of the most effective energy-saving grocery outlets in all of Europe. The key to its energy savings is:

- the use of daylight
- the technologies used in the ventilation system and refrigeration unit
- the handling of the heat exchange between systems
- the tuning of the overall control strategy & the monitoring of energy use in various sub-systems

The store's low-energy requirement results from two efficient energy consumption strategies:

(1) **Lighting control.** An automatic control system switches off fluorescent ceiling lights in sequences according to the amount of incoming daylight in the dedicated lighting zones of the store. The outer walls contain Aerogel, a translucent insulation material which distributes daylight effectively to the interior of the store. Using this material has also eliminated the need for expensive sun shading systems.

(2) **A fully integrated ventilation, cooling and heating system.** Surplus heat from cooling installations is stored temporarily in accumulation tanks and in the active concrete floor (floor heating). The ventilation system requires heat only from the accumulation tanks, as well as from rejected heat via energy wells into the ground. Heat is distributed into the store area through both the ventilation system and the heated floors, when required.

Four 170m deep energy wells were drilled outside the building and can be applied as a heat sink to cool and dehumidify interior air in the summer time. The refrigeration unit can also reject heat into the ground, which results in low refrigerant return temperatures, i.e. high system efficiencies. During the winter time, when inter-

nal cooling loads are short, the energy well can be applied as an additional heat source to support heat pump operation. Direct electrical heating is an inefficient form of space heating and will not be used.

The refrigerants, i.e. working fluids – the substances which transport heat out of the refrigerated counters and cabinets – contain no hydrofluorocarbon compounds, which are powerful greenhouse gases. Only natural working fluids such as CO₂ and hydrocarbons (propane and butane), are applied.

The building contains a single thermal installation control system which regulates all heat flow and monitors the energy consumption. Thus, there are no control conflicts between the different sub systems.



SINTEF

EUROPEAN INDUSTRY SURVEY

NATURAL REFRIGERANTS IN EUROPE TODAY AND BY 2020



CURRENT REFRIGERANT USE, SHARE OF PRODUCTS & GEOGRAPHIC MARKETS

This first section provides an overview of refrigerant use by application sector and response group. It highlights current leading European markets for NR, the present share of products & services from an organisation's total HVAC&R activities, and the expected change in such activities in the next 7 years.

PAGE 115



STAFF AND R&D, PURCHASING FACTORS & WILLINGNESS-TO-PAY

This section investigates the percentage of staff involved in NR-related activities, as well as the share of R&D activities dedicated to natural refrigerants currently and by 2020. Moreover, drivers for NR-related R&D and priority partners for such activities are identified. End-users' general purchasing criteria and their willingness to pay for NR technology are evaluated.

PAGE 119



OUTLOOK 2020: NATURAL REFRIGERANT APPLICATIONS IN EUROPE

The final section explores respondents' plans to provide new natural refrigerant products and services in the next 7 years. The expected total market share of NR solutions across Europe in 2020, by refrigerant and application, is shown.

PAGE 123

EUROPEAN INDUSTRY SURVEY ABOUT NATURAL REFRIGERANTS

INTRODUCTION

To quantify the market potential and detect technology trends for natural refrigerants in Europe, an online survey was conducted by shecco among the European HVAC&R industry. Between February and November 2013 a total of 365 responses were received that could be included in the analysis.

METHODOLOGY

After a global industry survey and a specific North American industry survey had already been conducted in 2011 and 2012, the new survey was the first one to specifically receive only input from industry stakeholders active in Europe. The survey consisted of a mixture of up to 25 close-ended and open-ended questions, depending on the question logic selected. The link to the survey was distributed to members of various industry associations and published on several European leading HVAC&R industry platforms.

MORE THAN ¾ OF RESPONDENTS USE NATURAL REFRIGERANTS

As the survey naturally attracted more respondents familiar with and/or interested in natural refrigerant (NR) technology solutions, this led to a clear overrepresentation of the “pro-Natural Refrigerant” industry. More than three-fourth (76,0%) of the organisations represented by the respondents hence already offer, use or deal with NR.

This bias was taken into consideration by introducing specific question logic throughout the survey that would show certain questions only to the “NR

group” but not the “Non-NR group”, or the other way around. Data analysis presented throughout the following sections always specifies if a question was answered by the whole response group, or only a sub-population.

MOST INTEREST FROM GERMANY AND THE UK

The large majority of the 365 respondents were located in Germany and the UK (15,9% each), followed by Italy (8,5%) and Spain (7,9%). Denmark as a leading country in adopting natural refrigerants is represented by 7,6% of the respondents. Responses from Belgium and France accounted for 6,6% each. The Netherlands (6,3%) and Sweden (5,2%) represented more than 5% of the total responses. In total, responses from 30 different European countries were collected.

Large organisations with more than 500 staff members represented the highest number of respondents (41,5%), followed by small organisations with less than 100 employees (40,5%). Medium-sized organizations were represented to a minor extent (18,0%).

SYSTEM MANUFACTURER AND ENGINEERING & CONTRACTOR SECTOR DOMINANT

More than one third of the responding organisations represented the system manufacturing sector (36,1%), followed by almost another one third representing the engineering & contracting business (31,7%), and component & refrigerant suppliers (29,5%). Training & Research, as well as Consul-

tancy & Marketing institutions were less represented with values of 15,3%, and 13,4%, respectively. Associations were significantly less represented with less than 1% of responses (0,8%). End-users accounted for 6,6% of the responses.

Respondents were asked to indicate which types of activities their organisation would be active in. Multiple choices were therefore possible and explain the sum of responses to be above 100%.

MOST RESPONDENTS ACTIVE IN (LIGHT-) COMMERCIAL REFRIGERATION

A large majority of 72% indicated to be active in light-commercial or commercial refrigeration, followed by industrial refrigeration (69%) and stationary air-conditioning (61%). Around a third of all respondents were active in mobile air conditioning (32%) and transport refrigeration (31%). Multiple responses were possible.

RESPONDENTS PROFILE

ORGANISATION LOCATION & SIZE

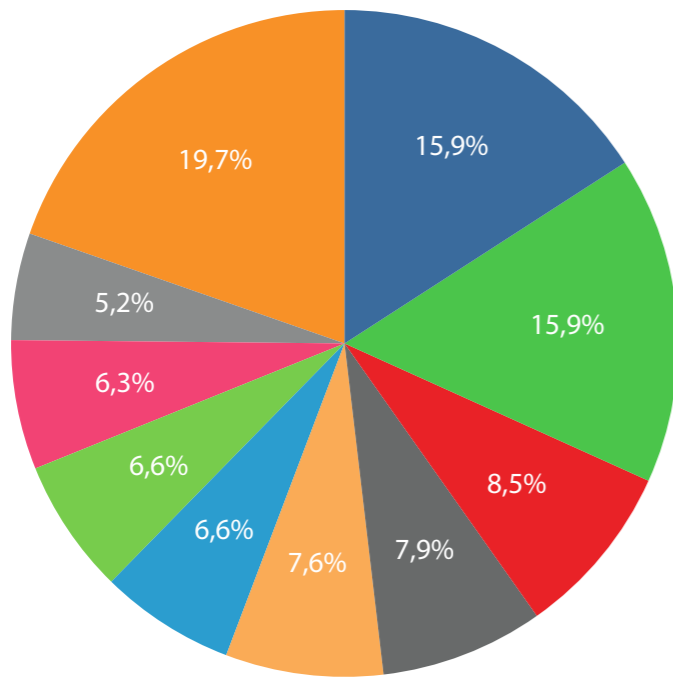

- Germany
- United Kingdom
- Italy
- Spain
- Denmark
- Belgium
- France
- Netherlands
- Sweden
- Other

Total responses: 365

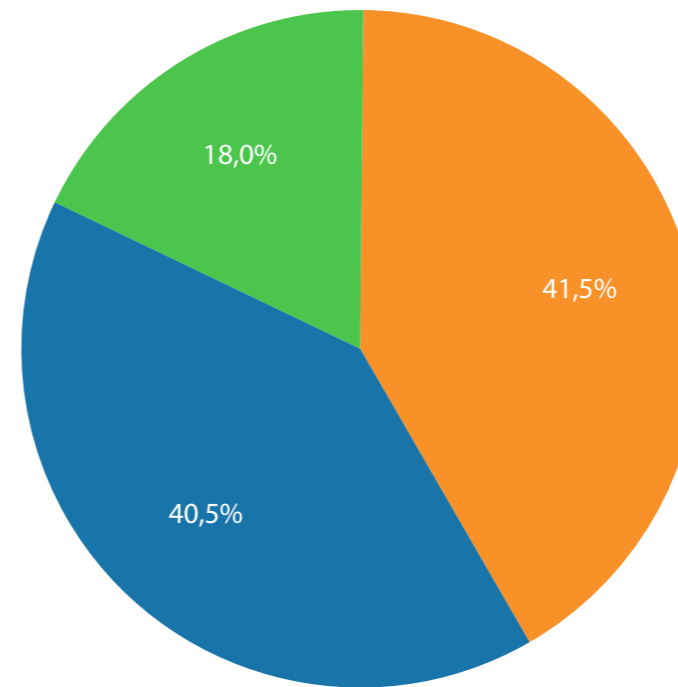

- Small (1-99)
- Medium-sized (100-499)
- Large (500+)

Total responses: 365

ORGANISATION LOCATION

A high number of the 365 respondents are based in Germany (16%) and the UK (16%), followed by Italy (9%), Spain (8%) and Denmark (8%). Respondents from Belgium and France are represented with close to 7% each. Besides the Netherlands (6%) and Sweden (5%), nearly 20% of the respondents are located in 21 "Other" European countries.

ORGANISATION SIZE

The highest number of respondents represent large organisations with more than 500 staff members (42%), followed by small organisations with less than 100 employees (40%). Medium-sized organizations are represented to a minor extent (18%).

RESPONDENTS PROFILE

ORGANISATION TYPE & ACTIVITY

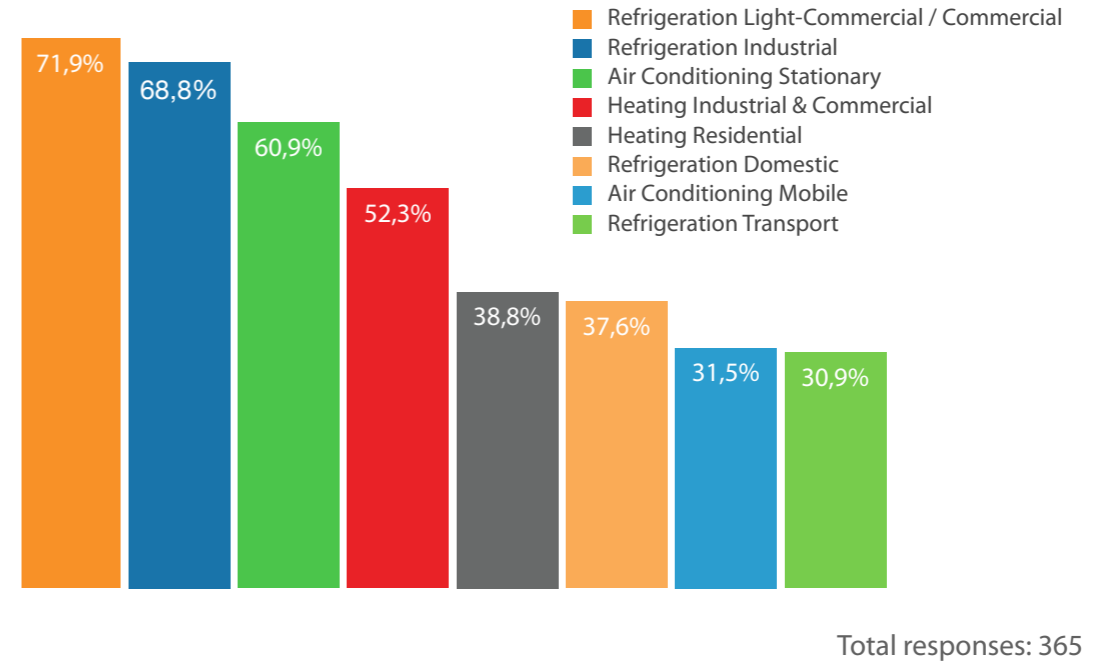
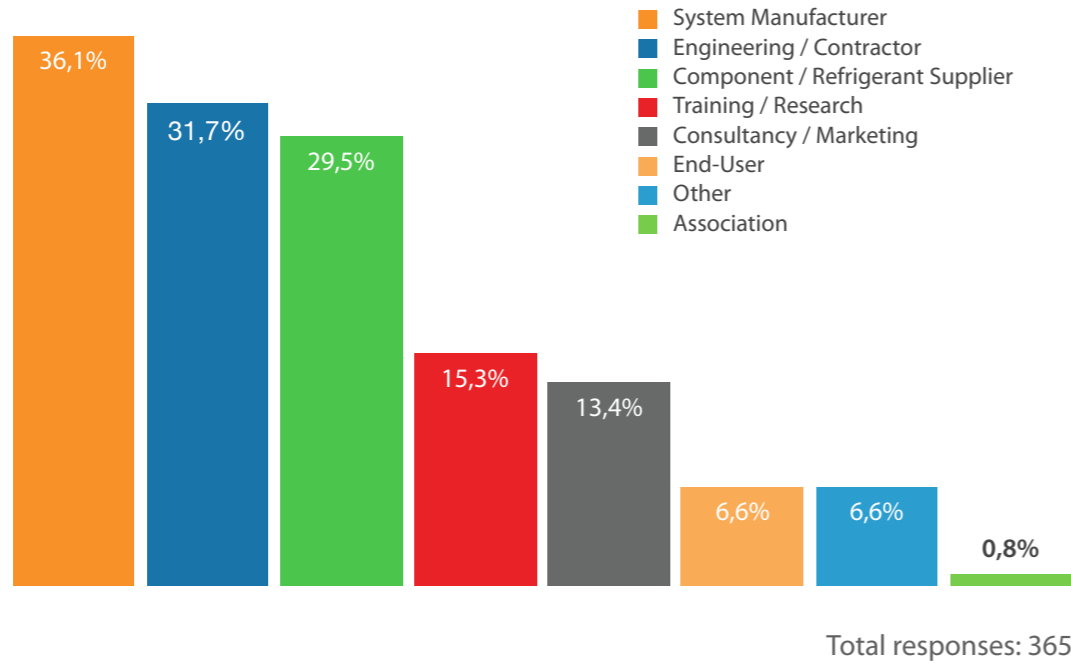

ORGANISATION TYPE

System manufacturers account for more than one third of HVAC&R respondents (36%), followed by the engineering & contracting sector (32%) and component & refrigerant suppliers (29%).

Training & research (15%) as well as consultancy & marketing (13%) organisations are significantly less represented. End-users and "Other" types of organisations both account for 7% each, associations for 1%. Multiple responses were possible.

ORGANISATION ACTIVITIES / INDUSTRY SECTORS

From a total of 327 respondents to this question, a large majority of 72% indicated that they are active in light-commercial / commercial refrigeration, followed by industrial refrigeration (69%) and stationary air-conditioning (61%). Around a third of all respondents are active in mobile air conditioning (32%) and transport refrigeration (31%). Multiple responses were possible.



Unlock the market for climate friendly technologies



shecco's market research department publishes an easy-to-access reference series for the global market for natural refrigerants known as "GUIDEs", which include the following:

- » Market outlook based on global industry surveys
- » Technology & market maps
- » End-user views and case studies

The GUIDE series includes editions on the European and North American market, as well as on developing countries in cooperation with UNIDO. It will soon be complemented with editions on China and Japan.



shecco's market research department offers:

- » Tailor-made market studies depending on your budget and needs
- » Multi-client market research for industry, trade, and NGOs
- » News monitoring & continuous market tracking
- » Policy audits & issue tracking
- » Funding audits & grant project management
- » Consultancy services, partner assessment, customer search



We provide quantitative and qualitative market research to ensure the most appropriate and cost effective methodologies are used for each project. Market research services include:

- » Research design and set-up
- » Online & telephone surveys, in-depth interviews
- » Data processing & analysis
- » SWOT analysis & trend forecasting



Whilst shecco's multidisciplinary team has a wealth of knowledge across the range of "green technologies", we have special access to a global network of industry and policy decision makers in the following areas:

- » Natural refrigerants
- » Heating, ventilation, air conditioning and refrigeration (HVAC&R)
- » Electric Vehicles (four wheelers, scooters / bikes etc.)

About shecco

shecco is a market development specialist helping companies worldwide to bring their climate friendly solutions faster to market. Within the HVAC&R sector we specialise in the natural refrigerants CO₂, hydrocarbons, ammonia, air & water.

For more information, contact:

Nina Masson, Head of Market Research
research@shecco.com
+32 473 468 194

NATURAL REFRIGERANTS USE & MARKETS

CURRENT USE AMONG RESPONDENTS & LEADING GEOGRAPHIC MARKETS

DOES YOUR ORGANISATION OFFER / USE / DEAL WITH NATURAL REFRIGERANTS (NR)?

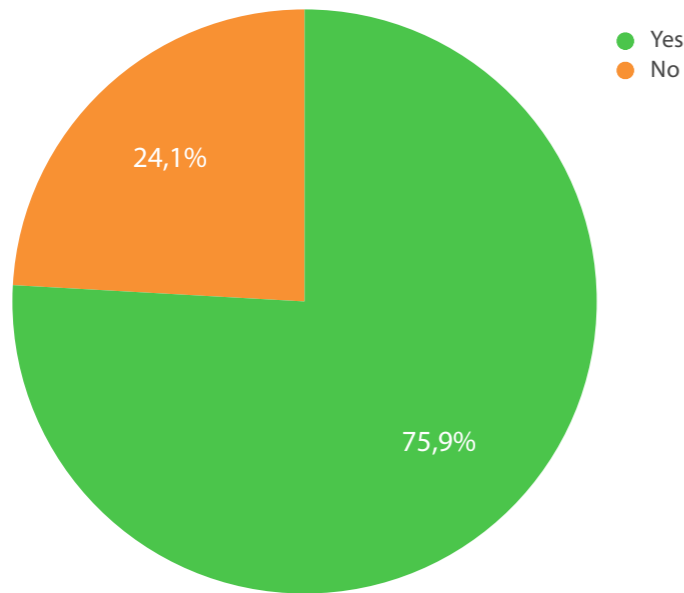

Total responses: 365

MORE THAN ¾ OF RESPONDENTS USE NATURAL REFRIGERANTS

More than three quarters (76%) of the 365 individuals that participated in the survey already use, offer or deal with natural refrigerants. 24% did not use ammonia, carbon dioxide, hydrocarbons, water, and/ or air in their activities.

IN WHICH MARKETS (COUNTRIES) DO YOU PROVIDE / USE MOST OF YOUR NATURAL REFRIGERANTS-RELATED PRODUCTS & SERVICES?

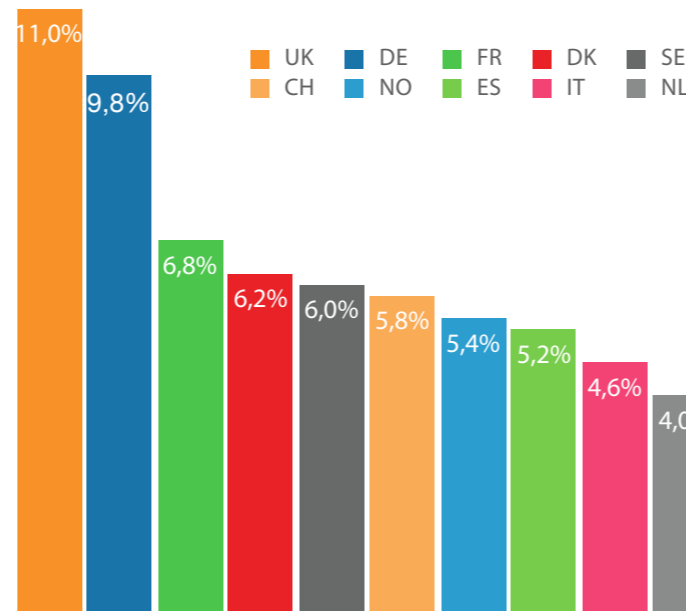

Total responses: 164

NR GROUP: UK & GERMANY LEADING MARKETS FOR NR-BASED SOLUTIONS

Those already dealing with natural refrigerants (“NR Group”) were asked to indicate maximum 4 countries in which they use and/or provide most of their natural refrigerants-related products & services worldwide. In total, a majority of organisations are active in the UK (11%) and Germany (10%). Other European countries completing the top 10 markets for natural refrigerants are France (7%), Denmark (6%), Sweden (6%), Switzerland (6%), Norway (5%), Spain (5%), Italy (5%) and the Netherlands (4%).

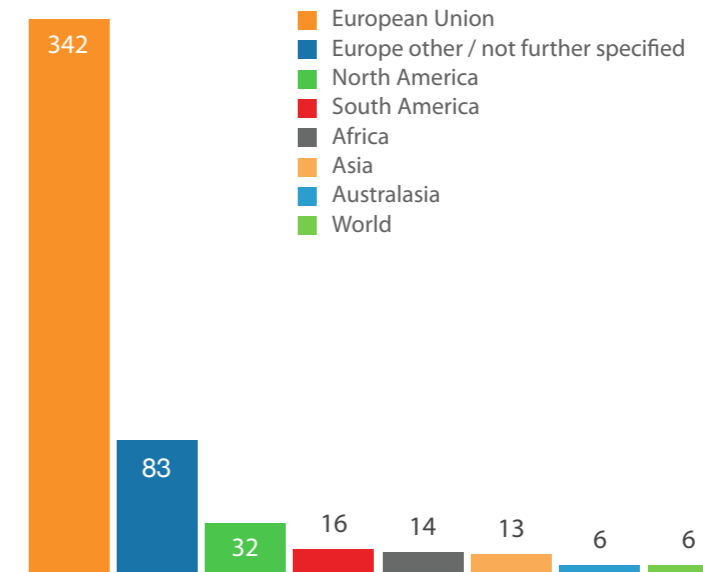

Total responses: 164

NR GROUP: STRONG EU BASE & GLOBAL POTENTIAL

While most respondents from the NR Group indicate that their 4 main markets to lie in the European Union (342 responses), they also offer their solutions in other European markets (83 responses) and outside Europe. It must be noted that a maximum of 4 countries was selected per respondent, suggesting that more European-based companies could already be active with NR solutions around the world. Results are, however, a strong indicator of the leading role the EU plays in the use of NR.

USE OF REFRIGERANTS PER APPLICATION

NATURAL REFRIGERANTS & NON NATURAL REFRIGERANTS GROUP

IN WHICH AREAS DOES YOUR ORGANISATION OPERATE? WHICH REFRIGERANTS DO YOU USE / OFFER / DEAL WITH IN EACH?

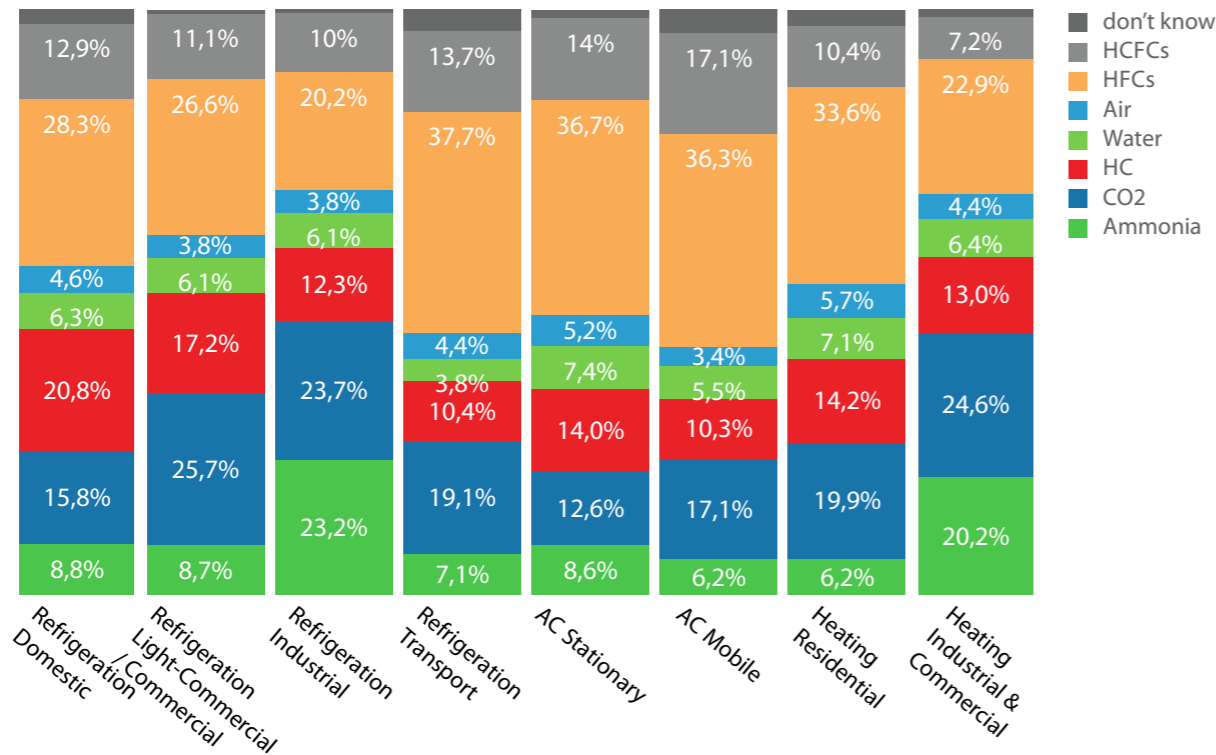

NR GROUP: NATURAL REFRIGERANTS TOOK OVER FOR F-GAS SOLUTIONS IN SEVERAL APPLICATIONS

Out of the 248 respondents already using or offering NR-based solutions (“NR Group”), the highest use of F-gas free refrigerants was indicated for CO₂ in commercial refrigeration (25%), followed by CO₂ in industrial & commercial heating (25%), as well as CO₂ (24%) and ammonia (23%) in industrial refrigeration. HCs, as expected, are the most widely spread NR solution in domestic refrigeration (21%). The use of water and air is currently significantly less pronounced across all applications, compared to other NR solutions. Overall, it is evident that for companies with NR-related products & services the share of HFCs is dominant, especially in transport refrigeration (38%), stationary A/C (37%) and mobile A/C (36%). HCFCs also still defend shares between 7-17% across applications.

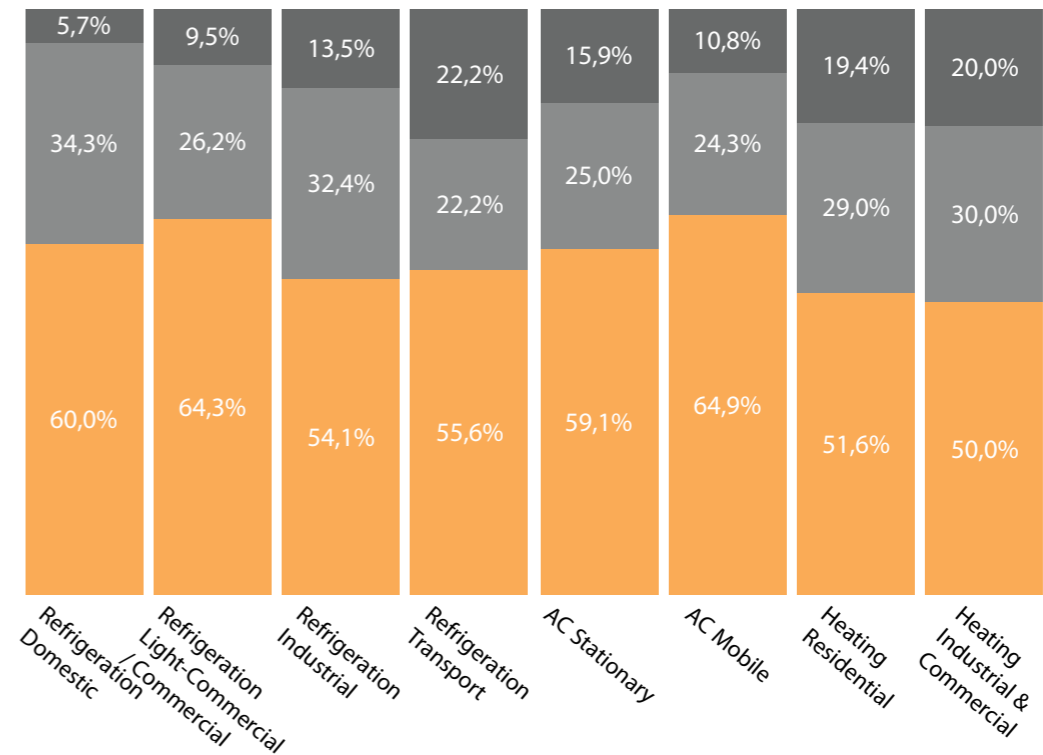

NON-NR GROUP: HCFCs STILL DEFEND MARKET SHARES

About one fourth of the survey participants stated that they do not work with natural refrigerants (79 respondents). Out of this “non natural refrigerant” (“Non-NR”) response group, the majority of organisations uses HFCs in different areas of refrigeration, air conditioning and heating. However, survey results also show that HCFCs still defend their market share, accounting for at least 22% of the working fluids respondents use, offer or deal with in the selected application areas. In domestic refrigeration, HCFCs still have a high share of 34% in organisations not working with natural refrigerants.

CURRENT AND FUTURE NATURAL REFRIGERANTS PRODUCTS & SERVICES

SHARE FROM TODAY'S HVAC/R ACTIVITIES & CHANGE BY 2020

FROM YOUR ORGANISATION'S TOTAL HVAC&R ACTIVITIES IN EUROPE, WHAT IS THE SHARE OF PRODUCTS & SERVICES OFFERED / USED WITH NATURAL REFRIGERANTS (NR)?

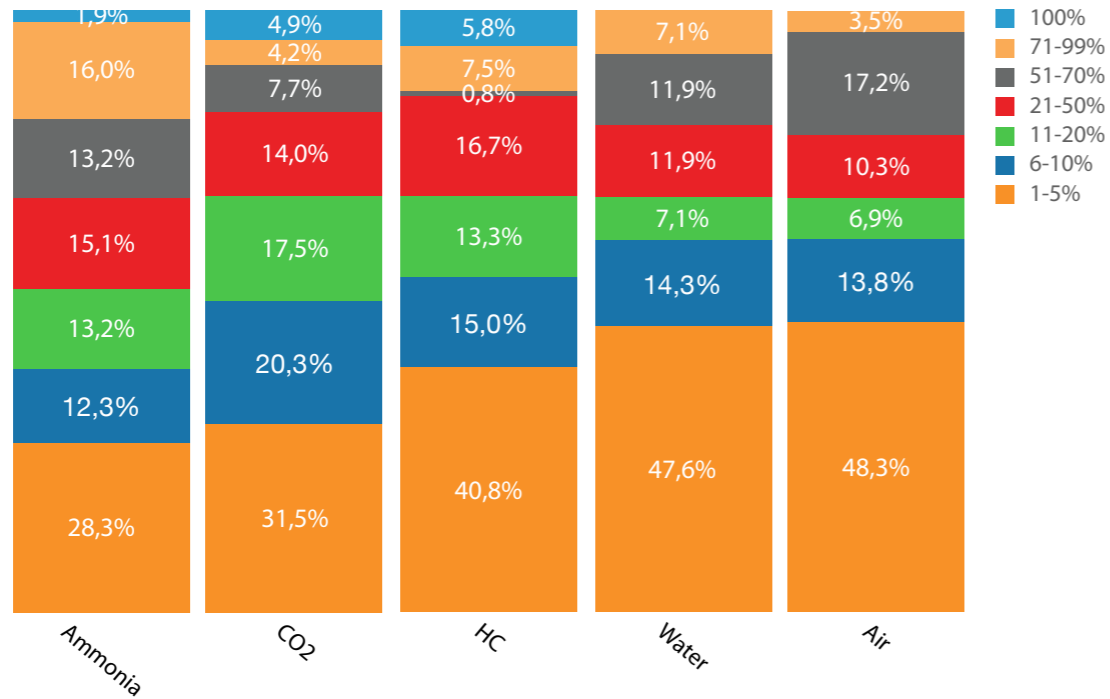

NR GROUP: AMMONIA HAS A DOMINANT SHARE AMONG NATURAL REFRIGERANT BUSINESSES

Those already using or offering NR solutions were asked about the percentage of products and services with natural refrigerants from their total HVAC&R activities in Europe. For ammonia, nearly a third (31%) indicate its share to be between 51-100% of their total activities. For CO₂ and hydrocarbons, 17% and 14%, respectively, state the same. Air and water are used to a much lesser extent.

IN YOUR OPINION, HOW WILL THIS SHARE OF PRODUCTS & SERVICES OFFERED / USED WITH NR BY YOUR ORGANISATION CHANGE IN THE NEXT 7 YEARS?

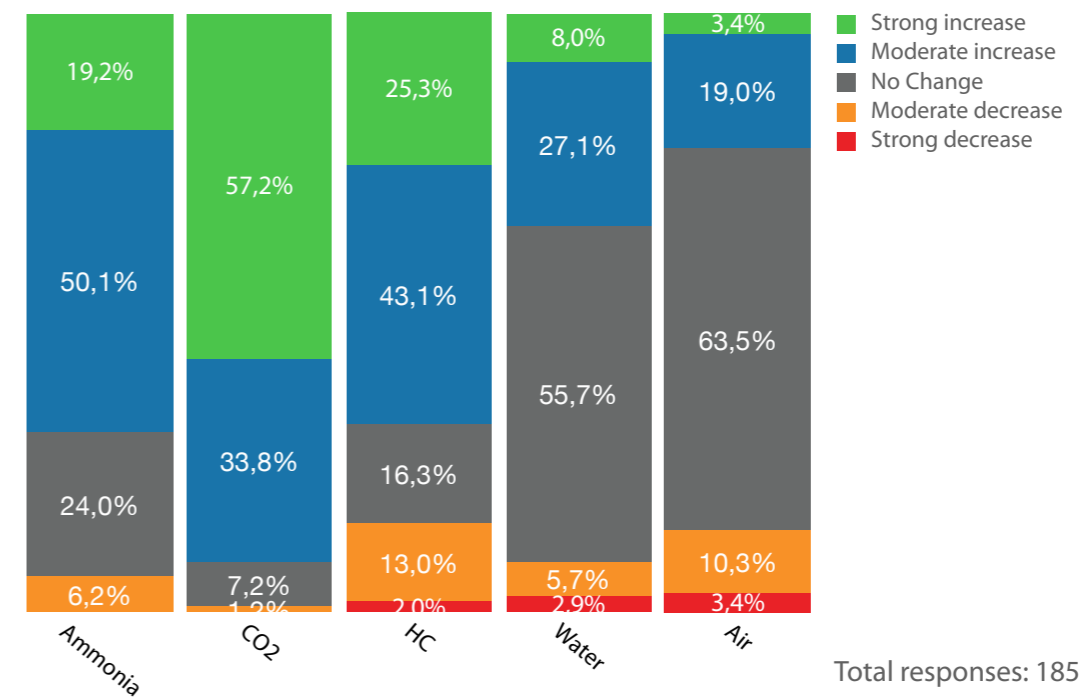

Total responses: 185

NR GROUP: BEST PROSPECTS FOR CO₂ UNTIL 2020

For the Natural Refrigerant group, the survey asked about the change in the availability of natural refrigerant products and services by 2020. The most positive outlook is indicated for CO₂, with 57% of NR respondents stating that its use will experience a "strong increase". For hydrocarbons (43%) and ammonia (50%), a "moderate increase" is the single most selected option.



“For NH₃, CO₂ and propane,

*the Güntner Product Calculator
allows for a quick and easy
thermodynamic design!”*



Dear readers,

The Güntner Product Calculator GPC is THE design software for planners and plant contractors. A thermodynamic calculation is performed and a selection of the suitable units is provided while considering your selected operating conditions – refrigerant or coolant, humidity, evaporating temperature – and selected accessories.

Your advantages:

- Thermodynamic calculation, also for extraordinary applications
- Quick logical design saves precious working time
- Update function via mouse click on the Internet
- Individual setting of several units possible
- Current prices and delivery times available
- Display of technical data sheet including price and delivery time

Free download
and contact person
on www.guentner.eu



Competent. Reliable. Personal.

NATURAL REFRIGERANTS STAFF

SHARE FROM TODAY'S ACTIVITIES & CHANGE BY 2020

WHAT IS THE SHARE OF STAFF INVOLVED IN NR ACTIVITIES IN YOUR ORGANISATION, ACROSS ALL DEPARTMENTS AND ACTIVITY FIELDS IN EUROPE?

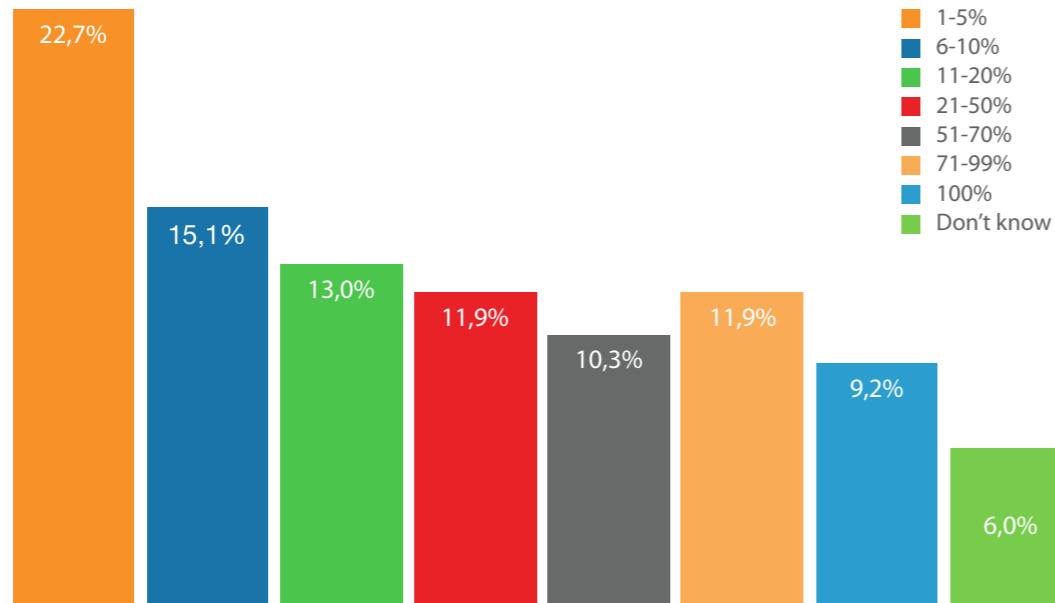

Total responses: 185

NR GROUP: IN NEARLY 1/3 OF ORGANISATIONS MORE THAN 50% OF STAFF IS INVOLVED IN NR ACTIVITIES

While 9% of respondents confirm that 100% of the staff employed in their organisation is involved in natural refrigerant activities, a total of 31% of respondents indicate that the share of staff members with NR-related activities is between 51-100% across all departments and activities in Europe. However, still nearly one quarter of respondents (23%) confirm that their organisation has only a 1-5% share of staff members involved in such activities.

IN YOUR OPINION, HOW WILL THIS SHARE OF STAFF INVOLVED IN NR ACTIVITIES IN YOUR ORGANISATION CHANGE IN THE NEXT 7 YEARS?

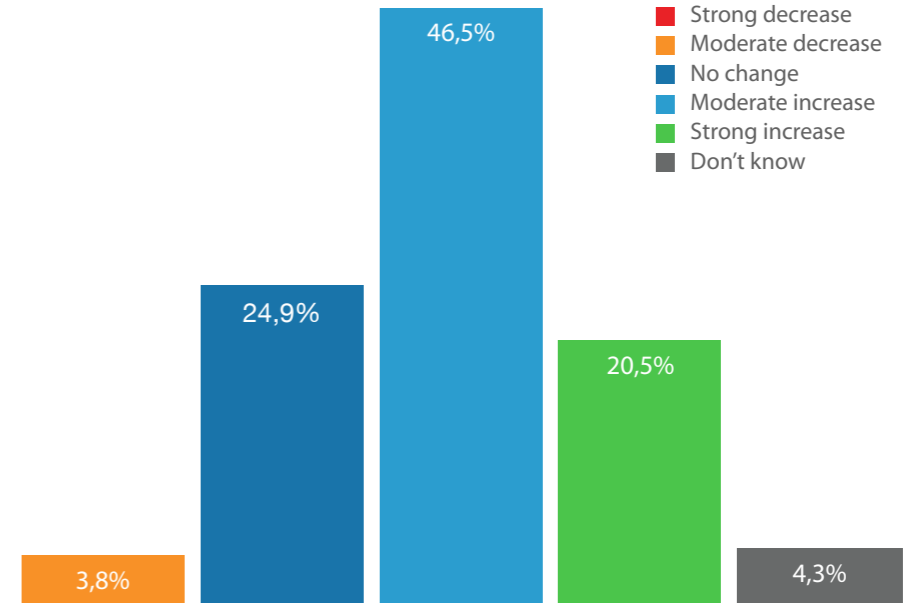

Total responses: 185

NR GROUP: 70% ARE CONFIDENT NR-RELATED STAFF ACTIVITIES WILL INCREASE BY 2020

When asked about changes in the number of staff that would be involved in NR activities, a fifth of respondents are sure a "strong increase" will occur over the next 7 years. Close to half of all participants from the NR group (47%) is confident a "moderate increase" will take place. No single respondent expects a "strong decrease" by 2020, but a quarter (25%) thinks the staff numbers involved in NR-related activities will remain the same as in 2013. 4% are not sure about the direction of this development.

NATURAL REFRIGERANTS R&D ACTIVITIES

SHARE FROM TODAY'S ACTIVITIES & CHANGE BY 2020

WHAT IS THE SHARE OF R&D ACTIVITIES DEDICATED TO NR, AS COMPARED TO ALL REFRIGERANT-RELATED R&D ACTIVITIES?

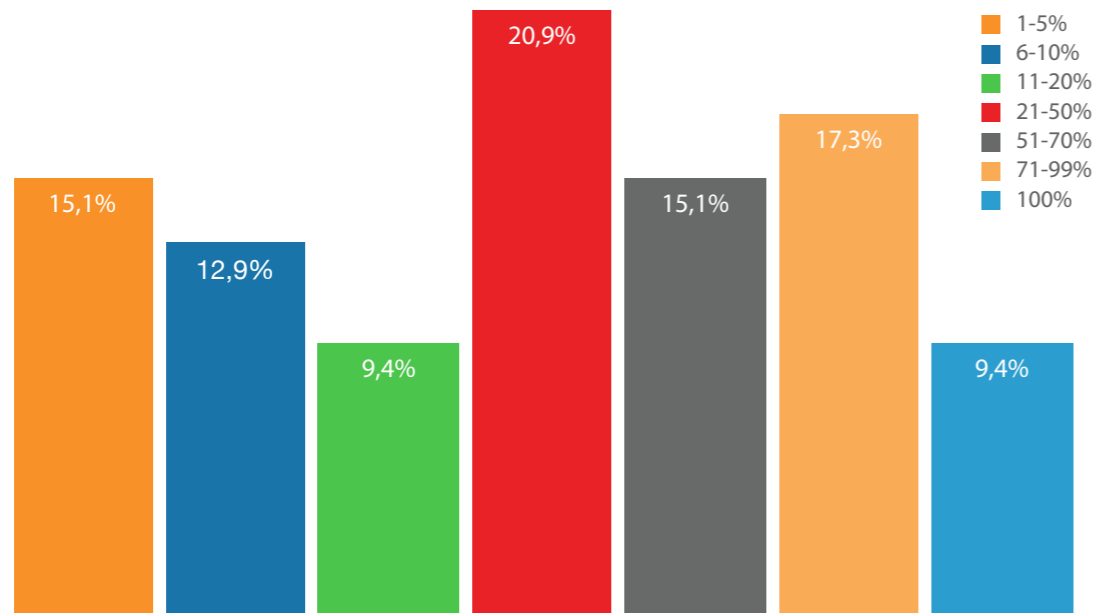

Total responses: 185

NR GROUP: MORE THAN 1/5 OF RESPONDENTS WITH R&D ACTIVITIES WITH DOMINANT FOCUS ON NR

A majority of respondents to this question (17%) have no R&D activities related to refrigerants. For those that do have such activities (see displayed chart), 28% have rather low R&D activities dedicated to NR (between 1-10% from total refrigerant-related activities), while a high 45% of respondents dedicate between 11-50% to HFC-free refrigerant R&D activities. Another 27% can be considered proactive innovators to drive the development of NR solutions, with a share of 71-100% of refrigerant R&D activities dedicated to natural working fluids.

IN YOUR OPINION, HOW WILL YOUR ORGANISATION'S R&D ACTIVITIES DEDICATED TO NR CHANGE IN THE NEXT 7 YEARS?

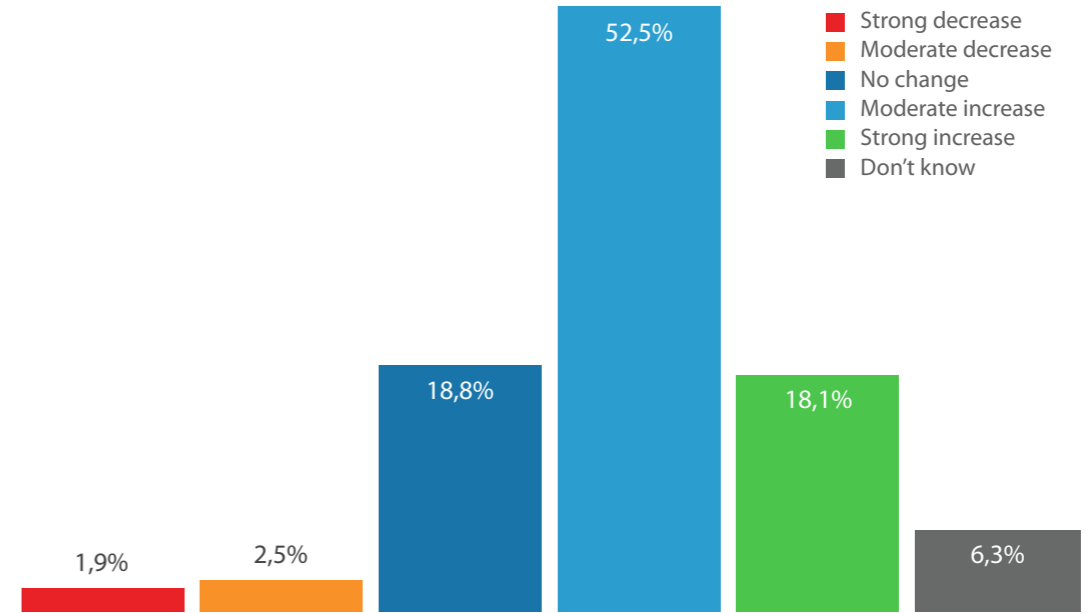

Total responses: 185

NR GROUP: HIGH MAJORITY EXPECT SIGNIFICANT INCREASE IN NATURAL REFRIGERANT R&D ACTIVITIES BY 2020

Out of those in the NR group with R&D activities related to refrigerants, a high 71% believe that natural refrigerant-focused initiatives would experience a "moderate" or even "strong increase". Only 4% are sure there will be a decrease in such activities by 2020. More than 6% are not sure yet which direction their R&D activities regarding refrigerants will take.

NATURAL REFRIGERANTS R&D ACTIVITIES

DRIVERS & MAIN PARTNERS

PLEASE RATE THE FOLLOWING FACTORS ACCORDING TO THEIR IMPORTANCE IN DRIVING R&D IN NR ACTIVITIES:

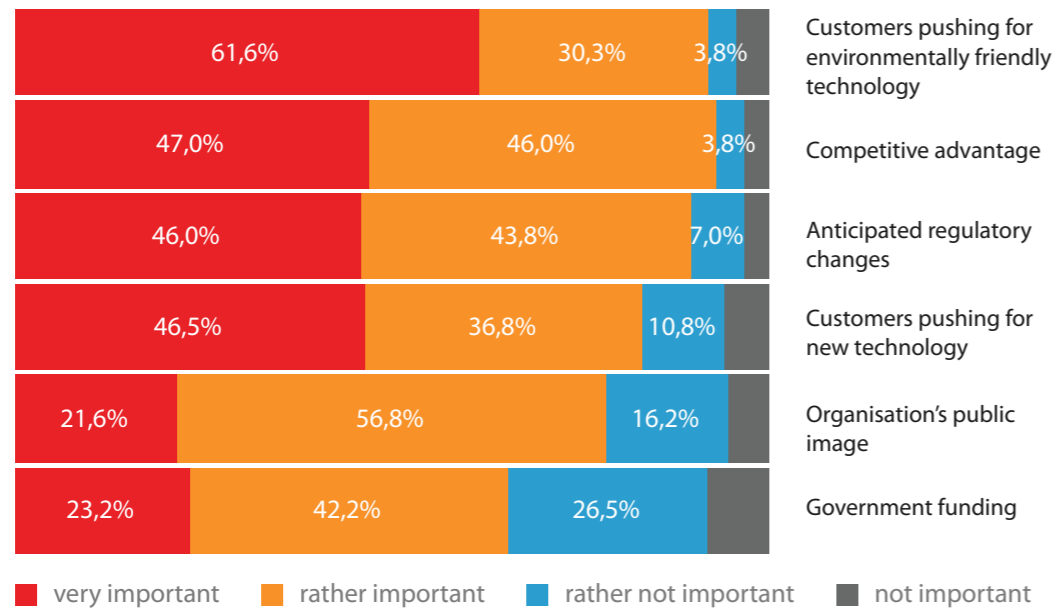

Total responses: 185

NR GROUP: CUSTOMERS, COMPETITIVE ADVANTAGE & REGULATIONS PRIMARY REASONS FOR DRIVING R&D ON NATURAL REFRIGERANTS

Out of a list of 6 factors, 62% of respondents already actively using or offering natural refrigerant solutions indicate that customers pushing for environmentally friendly technology (average value of 3.5, on a scale from 1= not important to 4= very important) would be "very important" for increasing efforts in NR-related research and development. This is followed by achieving a competitive advantage (3.4), and by anticipating regulatory changes (3.3), both translating into being "rather important".

IN THE FIELD OF NR DOES YOUR ORGANISATION ENGAGE IN JOINT R&D ACTIVITIES WITH ANY OF THE FOLLOWING PARTIES?

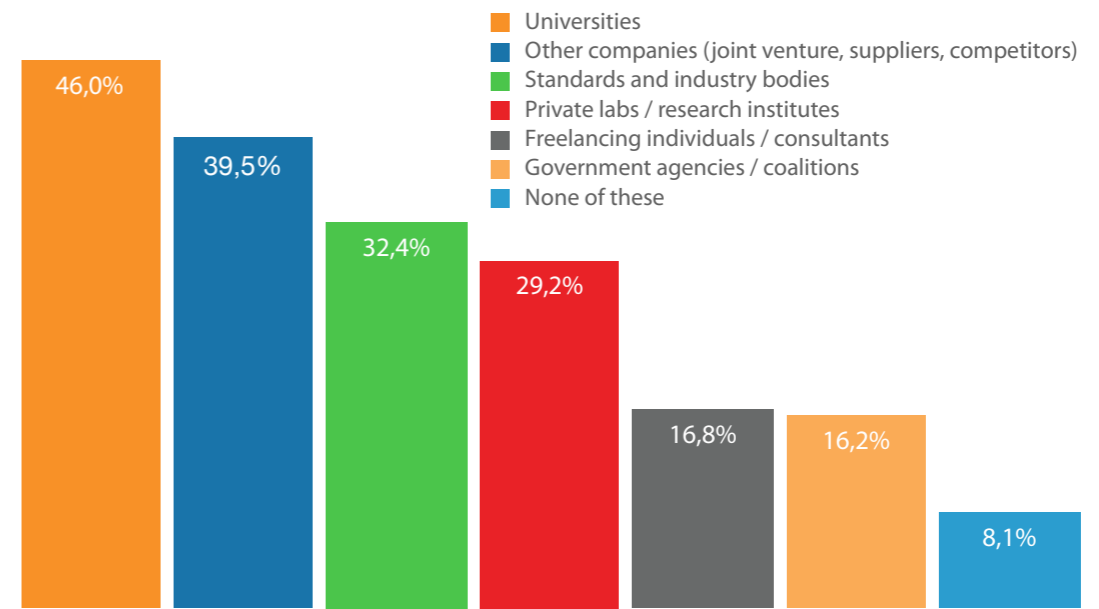

Total responses: 185

NR GROUP: UNIVERSITIES AND OTHER COMPANIES ARE PREFERRED PARTNERS IN NATURAL REFRIGERANT R&D

Close to half of those respondents with NR-related research and development activities (46%) currently work with universities to drive the development of such solutions forward, followed by cooperation with other companies (40%) in the same sector, including suppliers or competitors. Government bodies are only used by 16% of respondents. Multiple responses were possible.

PURCHASING CRITERIA FOR HVAC&R TECHNOLOGY & WILLINGNESS TO PAY FOR NR

AVERAGE VALUES & PRICE PREMIUM

HOW IMPORTANT ARE THE FOLLOWING PURCHASING CRITERIA FOR COMMERCIAL / INDUSTRIAL EUROPEAN END-USERS IN INVESTING IN HVAC&R TECHNOLOGY?

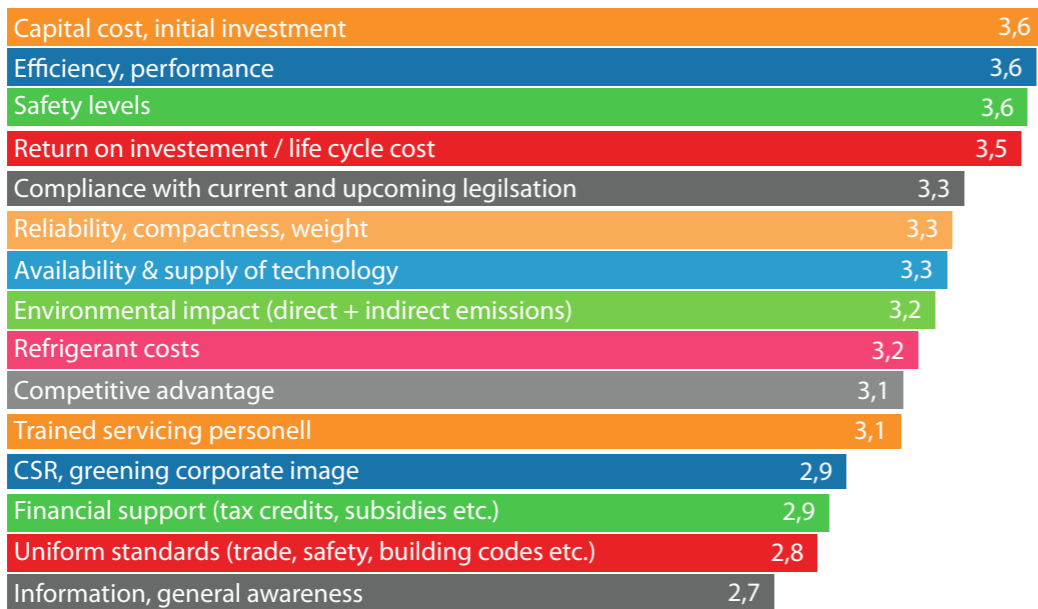

Total responses: 201

CAPITAL COST, EFFICIENCY, SAFETY & LIFE CYCLE COST ARE KEY DECISION FACTORS FOR ANY HVAC&R TECHNOLOGY

Faced with a list of purchasing criteria for HVAC&R technology for commercial and industrial end-users, respondent's selection allowed for 3 groups: 1) **High importance** in the decision for or against any technology such as the initial investment cost, a system's efficiency & performance, its safety, and the return on Investment. These values above 3.5 indicate a "very important" factor. 2) **Medium importance** in such decision factors such as compliance with legislation, reliability, availability, environmental impact, and trained servicing staff. All values above 3.0 indicate a "rather important" factor. 3) **Lower importance**, not in absolute but relative terms, have CSR considerations, financial support, uniform standards, and general information / awareness.

WHAT IS THE MAXIMUM PRICE PREMIUM ON THE INITIAL INVESTMENT, COMMERCIAL/INDUSTRIAL EUROPEAN ENDUSERS ARE WILLING TO PAY FOR A NATURAL REFRIGERANT APPLICATION?

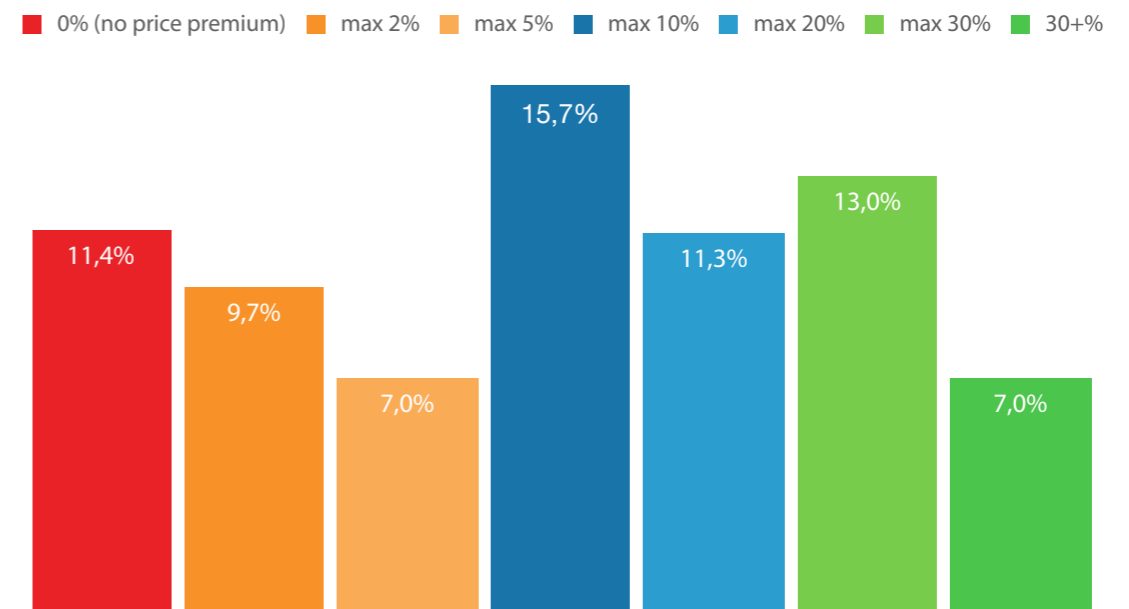

Total responses: 201

RESPONDENTS SPLIT OVER QUESTION ABOUT MAXIMUM WILLINGNESS TO PAY FOR NR-BASED TECHNOLOGY

Regarding the question about the maximum price premium commercial and industrial end-users are willing to pay (WTP) for an NR application, 3 distinct groups emerge: 1) **Low WTP below 5% price increase:** 11% of respondents believe no price premium is acceptable for NR solutions. Another 17% estimate end-users to pay maximum 5% more on such systems. 2) **Medium WTP 6-20% price increase:** Most respondents (16%) believe end-users are willing to accept a maximum 10% price increase, with another 11% saying it could go up to 20%. 3) **High WTP 21+% price increase:** A final group is more confident about end-users accepting a significantly higher price tag, with 20% saying that end-users are willing to pay more than 21% as compared to other solutions.

NATURAL REFRIGERANTS: NEW PRODUCTS & SERVICES

OUTLOOK BY 2020, PER REFRIGERANT

WILL YOU PROVIDE / USE ANY NEW NATURAL REFRIGERANT (NR) PRODUCTS & SERVICES WITHIN THE NEXT 7 YEARS?

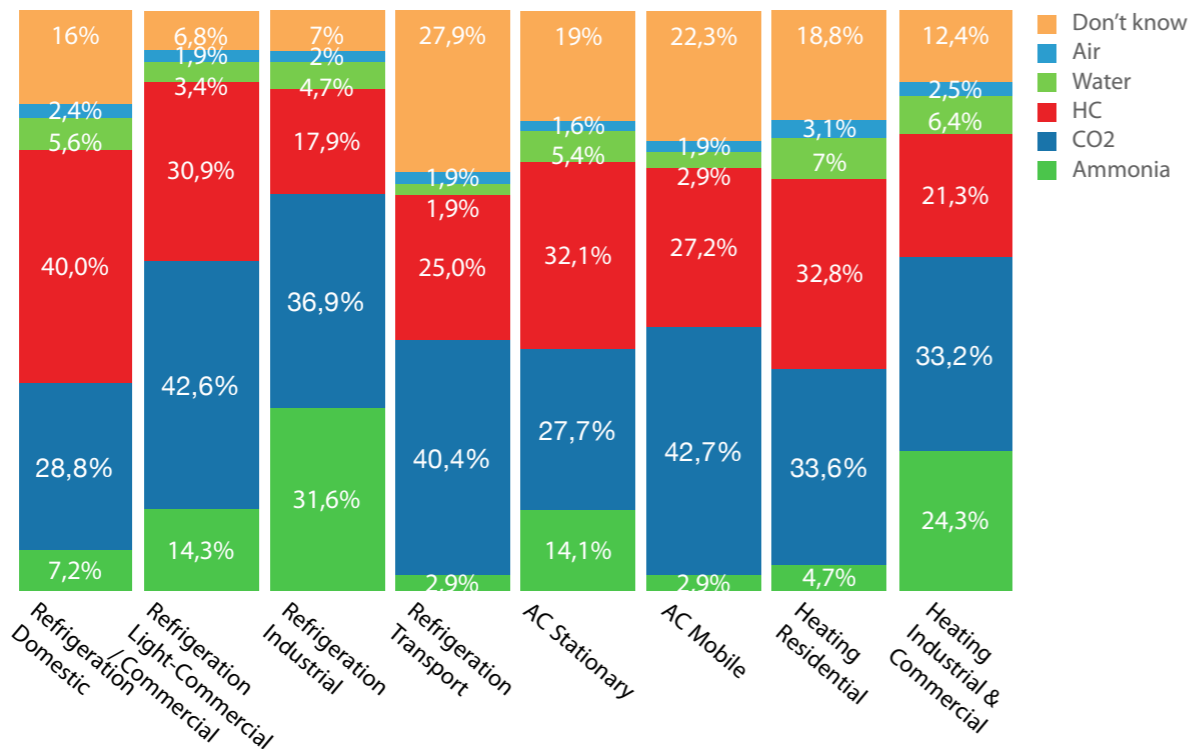

OUTLOOK 2020: NEW APPLICATIONS FOR NATURAL REFRIGERANTS ON THE HORIZON

Among all respondents to this question (220) - including companies using and not yet using natural refrigerants - a high 43% of companies active in mobile air conditioning expect CO₂ to be used in new products & services by 2020. Similarly positive is the outlook for CO₂ in Commercial Refrigeration (43%) and Transport Refrigeration (40%). Ammonia has the best prospects in Industrial Refrigeration (32%) and Industrial & Commercial Heating, while hydrocarbons will be used in new solutions for Domestic Refrigeration (40%), Residential Heating (33%) and Stationary A/C. Especially in Transport Refrigeration and Mobile Air Conditioning uncertainties seem to be high, with 28% and 22% not knowing what the future will bring.

NATURAL REFRIGERANTS: OUTLOOK 2020 BY APPLICATION

MARKET SHARE OF NATURAL REFRIGERANT TECHNOLOGY ACROSS EUROPE IN 2020

DOMESTIC REFRIGERATION

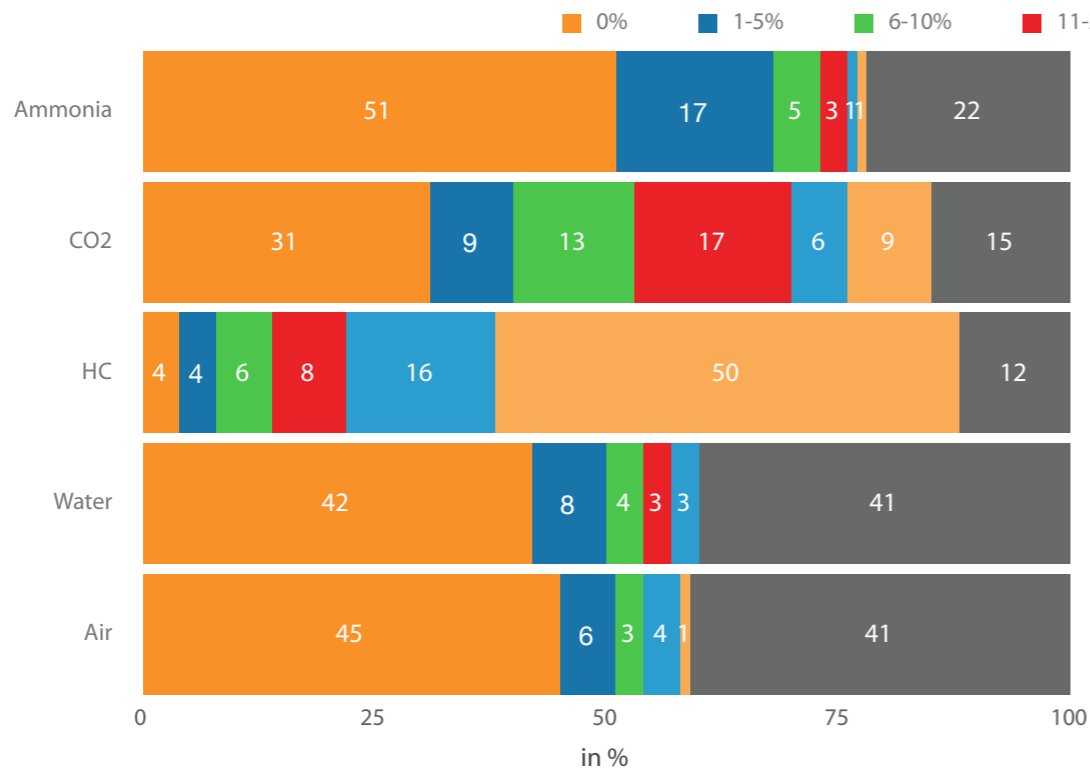

DOMESTIC REFRIGERATION: HYDROCARBON DOMINANCE TO CONTINUE

The leading role of HCs in European domestic refrigerators and freezers is to continue until 2020. Half of all respondents to this question (96 of 192 in total) estimate it to be "more than 50%". No other natural refrigerant-based solution achieves similar rates, although 15% of respondents state that CO₂ might take a 21+% share of the market.

LIGHT-COMMERCIAL & COMMERCIAL REFRIGERATION

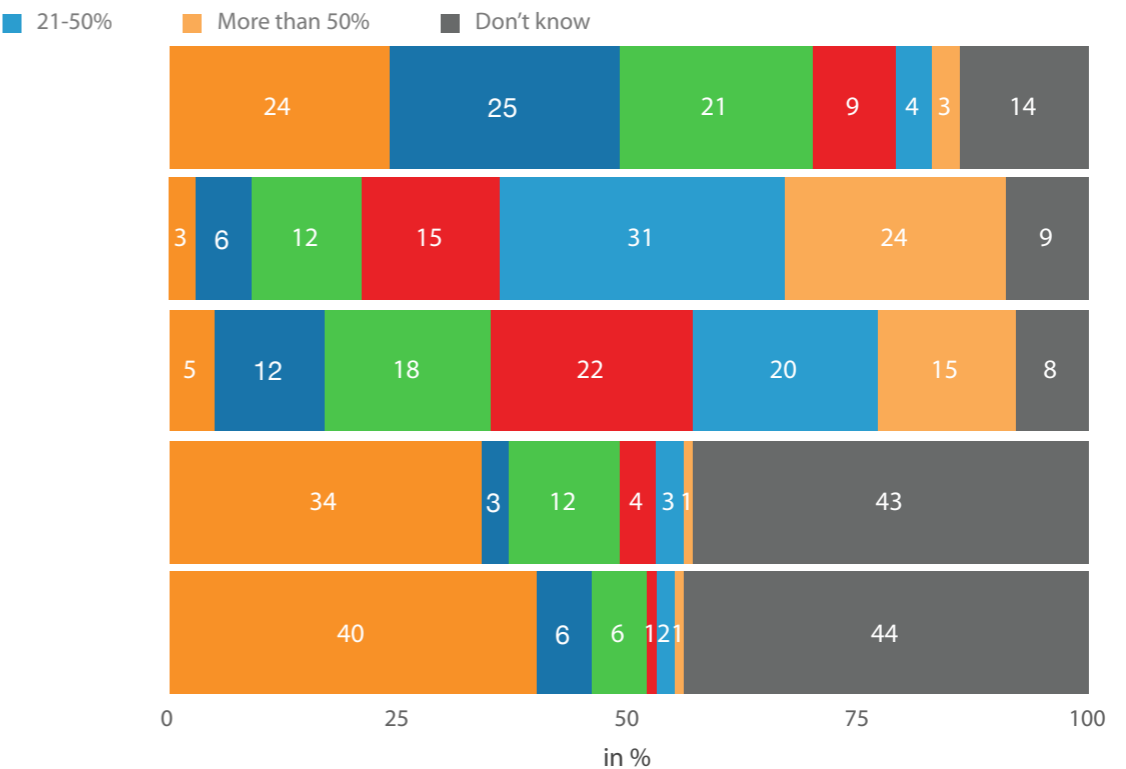

COMMERCIAL REFRIGERATION: CO₂ ON ITS WAY TO BE THE MAINSTREAM SOLUTION

The current positive market trend for CO₂ in Commercial Refrigeration will lead to an absolute market dominant position, nearly a quarter of all respondents (24%) estimate. Another 31% expect the market share of CO₂ to be at least at 21-50%. Together, this clear majority testifies to the development of CO₂ into a mainstream solution for the commercial refrigeration sector. On the other hand, more than 1/3 of respondents (35%) are confident that hydrocarbons will take a 21+% market share in 2020.

NATURAL REFRIGERANTS: OUTLOOK 2020 BY APPLICATION

MARKET SHARE OF NATURAL REFRIGERANT TECHNOLOGY ACROSS EUROPE IN 2020

INDUSTRIAL REFRIGERATION

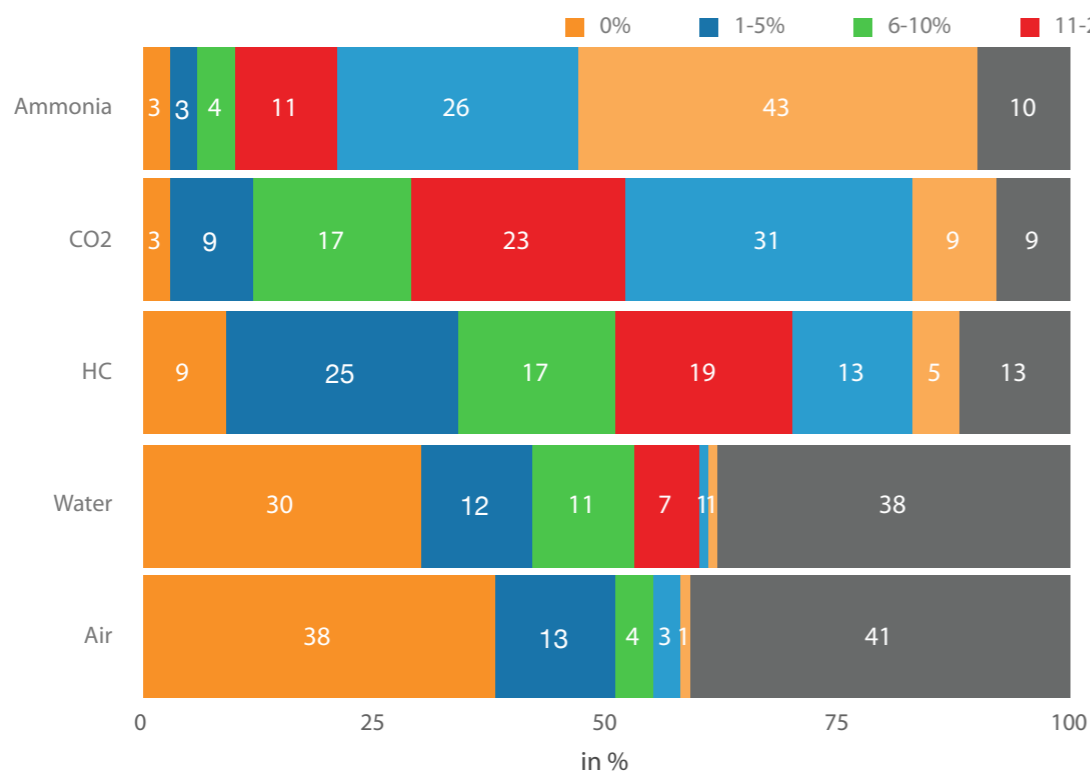

TRANSPORT REFRIGERATION

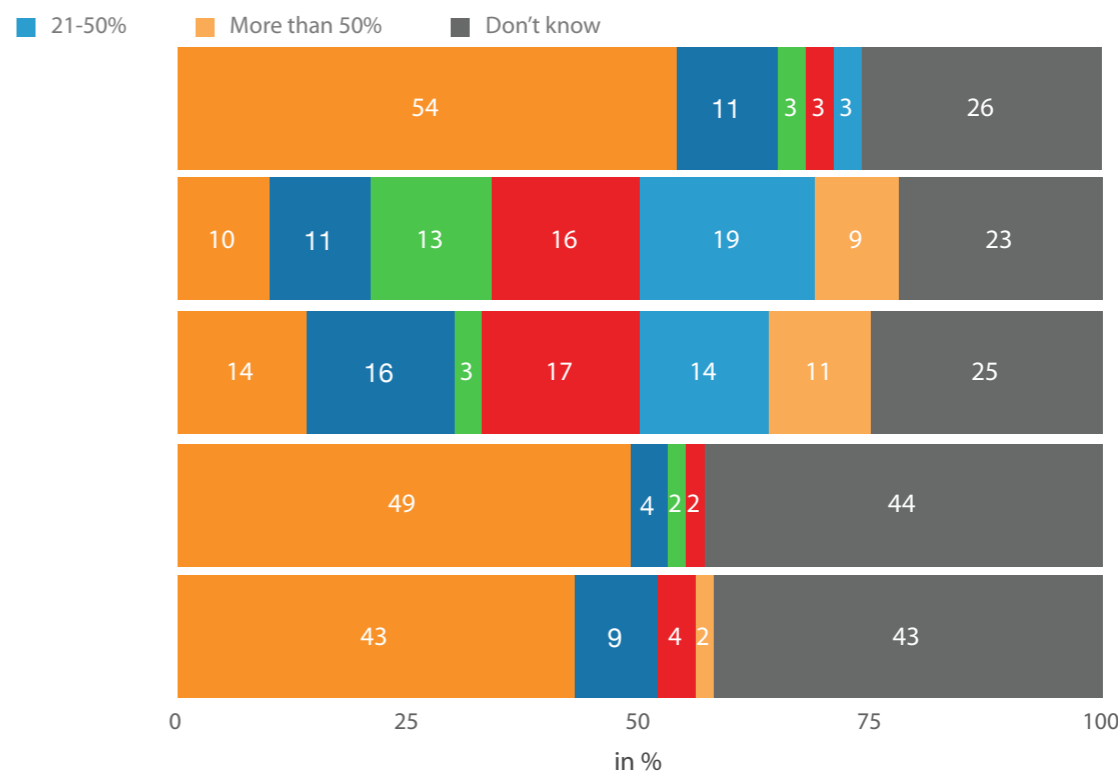

INDUSTRIAL REFRIGERATION: AMMONIA TO REMAIN REFERENCE FOR INDUSTRIAL REFRIGERATION; CO₂ TO CATCH UP

The dominant use of ammonia in industrial refrigeration is set to remain in existence by 2020, with 43% of respondents stating that the market share will be at 50+% in that year. Another quarter of respondents (26%) estimate it to be between 21 and 50% market share. 32% believe hydrocarbons could be at above 21% market share, while an absolute majority of 54% thinks that CO₂ will be a serious contender on the European industrial refrigeration market with a 21% or higher market share.

TRANSPORT REFRIGERATION: CO₂ AND HC USE PROMISES HIGH POTENTIAL BY 2020

While the current market share of both CO₂ and HC use in transport refrigeration is negligible, respondents experienced in this sector estimate their market to evolve dynamically over the next 7 years, to reach high to dominant market shares. Around 1/10 of respondents (11 and 9%, respectively) are sure the market share of HCs and CO₂ will be at above 50% from the total European market. Another 14% and 19%, respectively, would estimate their market share to be at 21-50% by then.

NATURAL REFRIGERANTS: OUTLOOK 2020 BY APPLICATION

MARKET SHARE OF NATURAL REFRIGERANT TECHNOLOGY ACROSS EUROPE IN 2020

STATIONARY AIR CONDITIONING

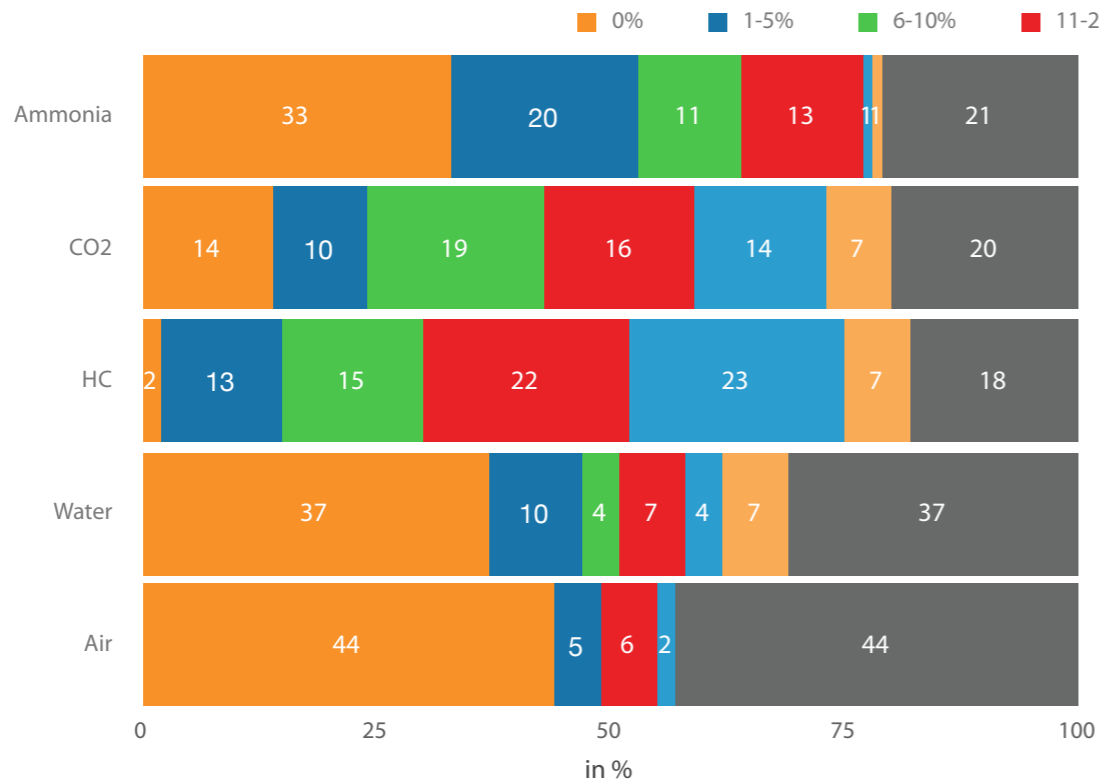

MOBILE AIR CONDITIONING

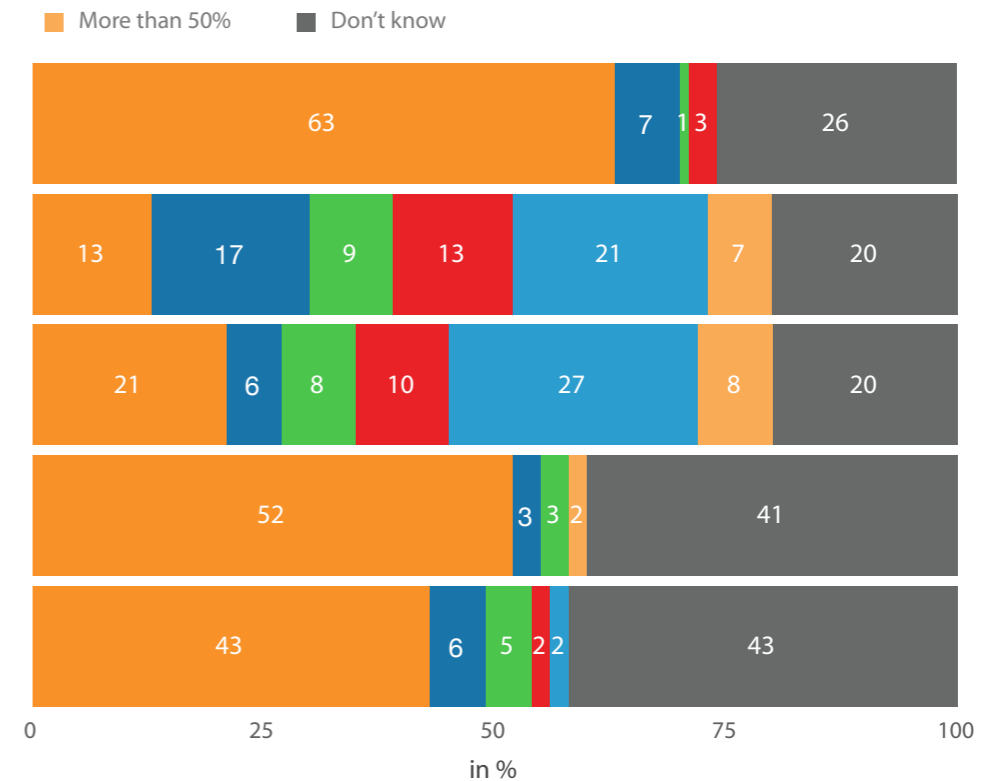

STATIONARY A/C: HYDROCARBONS SET TO INCREASE MARKET SHARE

Respondents are overall confident that out of the set of natural refrigerants, hydrocarbons would show the most promise in stationary air conditioning applications by 2020. The currently untapped potential for using HCs in residential A/C applications is expected to also have led to this positive estimation. 30% estimate it to be at a market share of above 21%. Another 21% of respondents believe CO₂ could take similar market shares. Water achieves its highest agreement rate across all investigated applications, with 7% saying the stationary A/C sector will be dominated by water refrigerant-based solutions (market share of 50+%). Overall, it needs to be noted that across all applications, respondents are largely not sure about the market prospects of both water and air.

MOBILE A/C: HYDROCARBONS AND CO₂ IN A RACE TO CAPTURE MORE MARKETS

Despite recent signals from selected European-based car manufacturers to launch CO₂-based Mobile Air Conditioning (MAC) in their vehicles before 2017, respondents testify to the positive prospects of using hydrocarbons in MAC, a trend that has been established outside Europe in a high number of vehicles equipped with HC-based systems. Overall, it can be noted that, starting from a factual non-existence of MAC solutions with natural refrigerants in Europe (with the exception of bus air conditioning), respondents expect the next 7 years to bring further impetus to this market, in a race between HC and CO₂ solutions.

NATURAL REFRIGERANTS: OUTLOOK 2020 BY APPLICATION

MARKET SHARE OF NATURAL REFRIGERANT TECHNOLOGY ACROSS EUROPE IN 2020

RESIDENTIAL HEATING

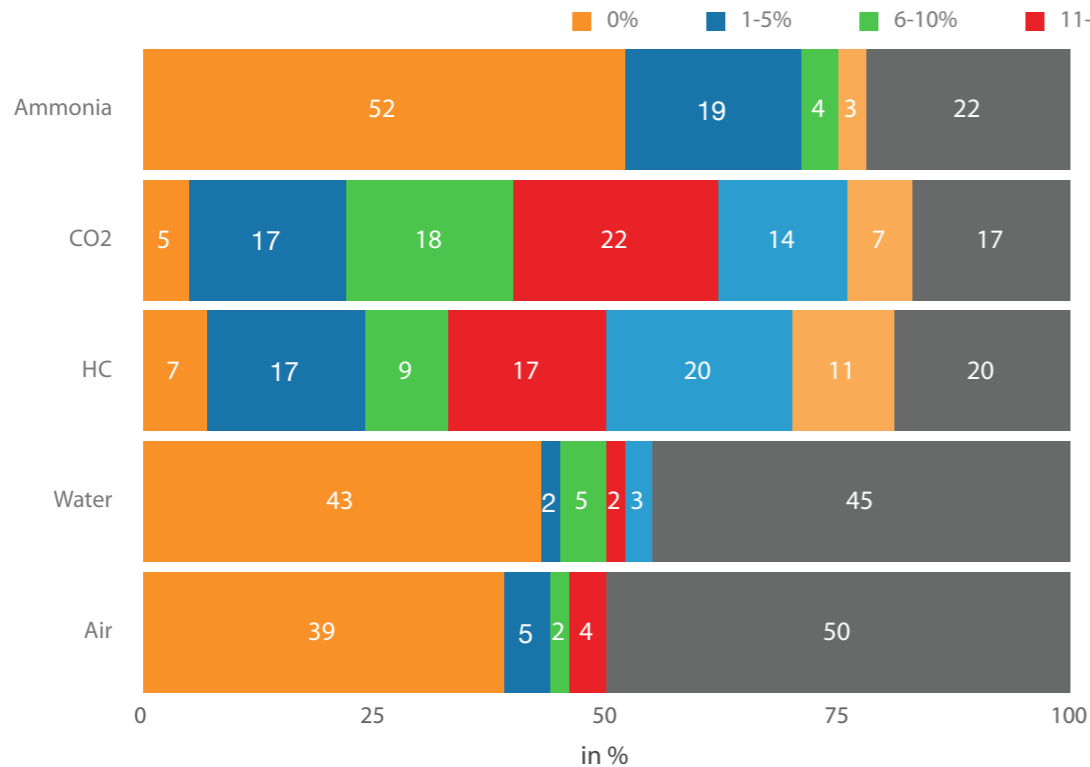

RESIDENTIAL HEATING: NEARLY 1/3 EXPECTS HC TO REACH 21+% MARKET SHARES

Again, the use of hydrocarbons and CO₂ seem to be the two most favoured solutions for an application not yet a mass market for natural refrigerants. Most respondents (22%) believe the market for CO₂ in residential heating could stand at 11-20%, while another 21% estimate it to be at 21+% market share in 2020. For hydrocarbons, 1/5 believe that the share of HCs in residential heating could increase to 21-50%, while another 11% state it could go up to 50+% market share by then.

COMMERCIAL & INDUSTRIAL HEATING

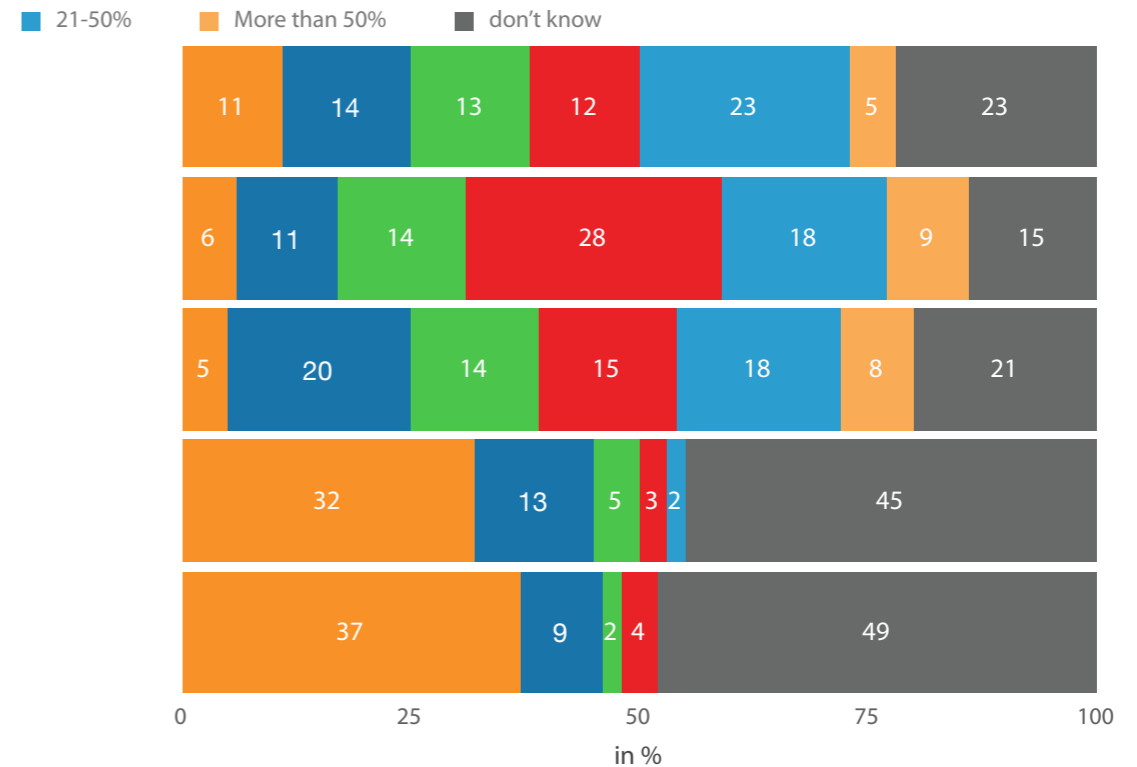

COMMERCIAL & INDUSTRIAL HEATING: NH₃, CO₂ AND HC ALL SERIOUS CONTENDERS IN EUROPE

For larger heating applications, the market is expected to be split among solutions using various natural refrigerants. The most positive prospects are predicted for CO₂, where an absolute majority of 55% states that at least a market share of 11% is possible. Included in this are 9% of respondents forecasting a market share of more than 50% in Europe. Hydrocarbons and ammonia reach agreement rates of 41% and 40%, respectively, for the same range of 11+% market share. 8% are of the opinion, HCs can take a 50+% market share by 2020.

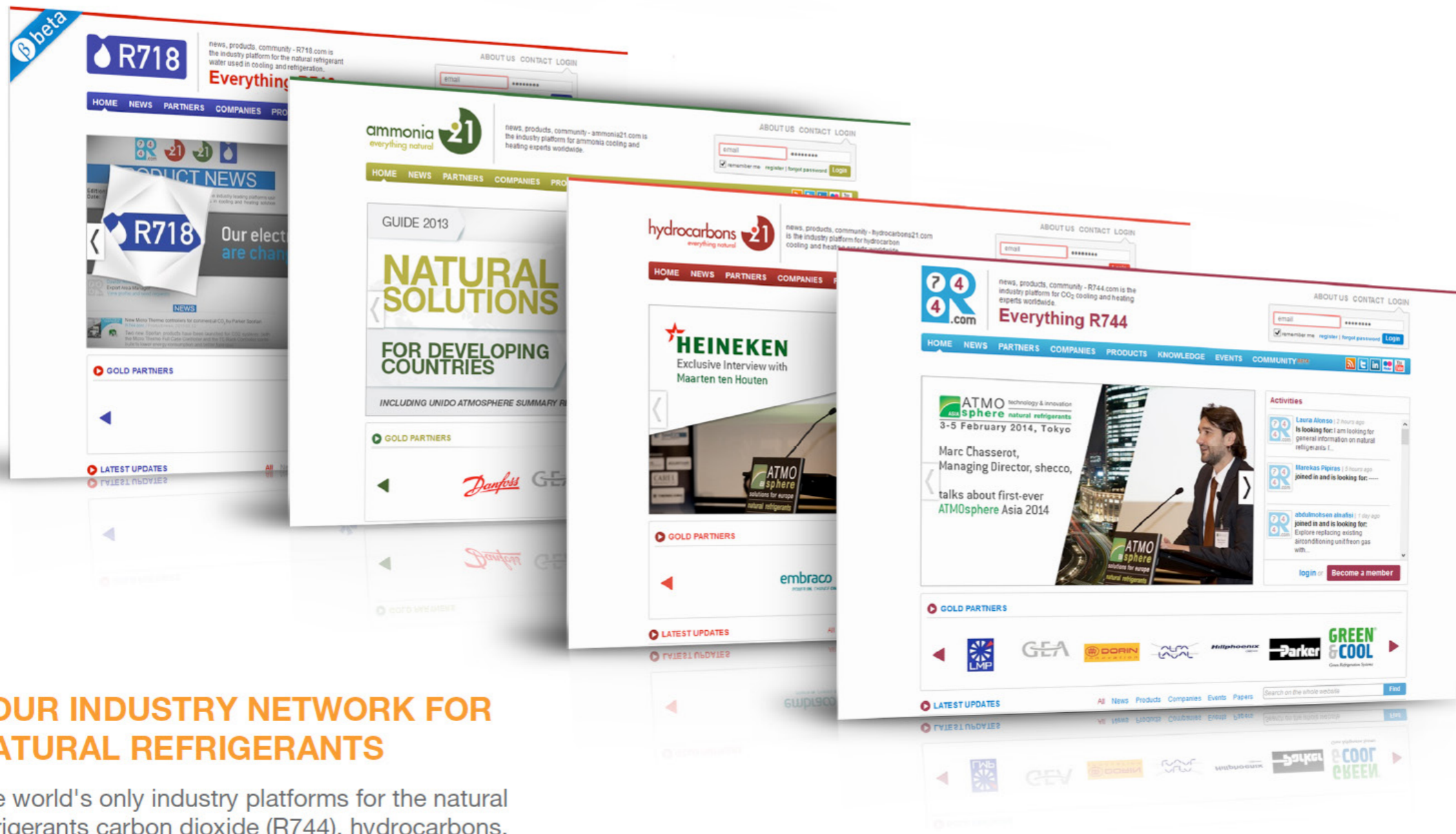

YOUR INDUSTRY NETWORK FOR NATURAL REFRIGERANTS

The world's only industry platforms for the natural refrigerants carbon dioxide (R744), hydrocarbons, ammonia and water (R718). Your only resource for products, news, knowledge, events, experts, and more.

- www.R744.com
- www.hydrocarbons21.com
- www.ammonia21.com
- www.R718.com



EUROPEAN NATURAL REFRIGERANT BUSINESS DIRECTORY

129

The European Natural Refrigerant Business Directory includes two parts: a directory listing the supporters for the GUIDE 2014 Natural Refrigerants: Continued Growth and Innovation in Europe, and a directory of other European-based companies involved in the natural refrigerants business.

Today, there are at least 400 European companies across Europe working with natural refrigerants, using CO₂, ammonia, hydrocarbons, air and water in their products and services.

Sorted by country, the directory indicates the type of activities, main HVAC&R industry sectors covered, as well as the natural refrigerants used in products and services. It lists and categorises system manufacturers, component suppliers, contractors & installers, as well as marketing and consulting firms in the sector in European countries.

If you want to be included in later editions of the GUIDES for Europe or other world regions, please contact research@shecco.com

SUPPORTERS DIRECTORY

ADVANSOR A/S



www.advansor.dk

System Manufacturer
Engineering / Contracting
Heating - Residential, Industrial & Commercial
Refrigeration - Industrial & Commercial
Air Conditioning - Industrial & Commercial

Bautavej 1A
8210 Aarhus V, Denmark
+45 721 701 74

ALFA LAVAL



www.alfalaval.com

System Manufacturer
Component Supplier
Engineering / Contracting
Air Conditioning - Commercial, Industrial,
Marine & OEM
Heating - Residential, Industrial, Commercial & OEM

Rudeboksvägen 1
22655 Lund, Sweden
+46 46 36 65 00

BITZER



www.bitzer.de

Component Supplier
Refrigeration - Commercial, Domestic, Transport, Industrial
Air Conditioning - Mobile, Industrial & Commercial
System Manufacturer

Eschenbrunnlestraße 15
71605 Sindelfingen, Germany
+49 703 193 20

CARRIER COMMERCIAL REFRIGERATION



www.carrier-refrigeration.com

System Manufacturer
Engineering / Contracting
Refrigeration - Industrial & Commercial
Refrigeration - Transport

Sürther Hauptstrasse 173
50999 Cologne
+49 223 660 101

DANFOSS



www.danfoss.com

Component Supplier
Engineering / Contracting
Refrigeration - Domestic, Transport, Industrial & Commercial
Air Conditioning - Industrial & Commercial
Heating - Residential, Industrial & Commercial

Jegstrupvej 3
8631 Hasselager, Denmark
+45 894 891 11

DORIN



www.dorin.com

Component Supplier
Heating - Residential
Refrigeration - Industrial & Commercial

Via Aretina 388
50061 Compiobbi, Italy
+39 055 623 211

DSI



www.dsi-as.com

System Manufacturer
Component Supplier
Refrigeration - Industrial

Parkvej 5
9352 Dybvad, Denmark
+45 988 642 99

DANISH TECHNOLOGICAL INSTITUTE



www.dti.dk

Consultancy / Research
Heating - Residential, Industrial & Commercial
Refrigeration - Domestic, Industrial & Commercial

Gregersensvej 1
2630 Taastrup, Denmark
+45 72 20 20 00

EMBRACO



www.embraco.com

Component Supplier
Refrigeration - Commercial

Zona Industriale D1,- Via Frateli Gambino 7
10023 Chieri (Torino), Italy
+39 011 940 5611

EMERSON CLIMATE TECHNOLOGIES

CO₂

www.emersonclimate.eu

System Manufacturer, Component Supplier, Engineering / Contracting
Refrigeration - Transport, Industrial & Commercial; AC - Mobile, Industrial & Commercial; Heating - Residential, Industrial & Commercial

NH₃

Pascalstr.65
52076 Aachen, Germany
+49 240 892 90

FRIGO-CONSULTING AG

CO₂

www.frigoconsulting.ch

Engineering / Contracting

Refrigeration - Industrial & Commercial
Air Conditioning - Commercial & Industrial

NH₃

Feldstrasse 30
3073 Guemlingen, Switzerland
+41 319 964 848

GEA

CO₂

www.gearefrigeration.com

System Manufacturer, Component Supplier, Engineering / Contracting

HC

Heating - Industrial & Commercial
Refrigeration - Industrial & Commercial
Air Conditioning - Industrial & Commercial

NH₃

Peter-Müller-Str. 12
40468 Düsseldorf, Germany
+49 211 913 60

GREEN & COOL

CO₂

www.greenandcool.com

System Manufacturer
Engineering / Contracting

Heating - Residential, Industrial & Commercial
Refrigeration - Industrial & Commercial
Air Conditioning - Industrial & Commercial

Handelsvägen 17
973 45 Luleå, Sweden
+46 920-24 54 50

GÜNTNER AG & CO.KG

CO₂

www.guentner.com

Component Supplier
Engineering / Contracting

Refrigeration - Industrial & Commercial
Air Conditioning - Commercial & Industrial

HC

NH₃

Hans-Güntner-Str. 2 - 6
82256 Fürstenfeldbruck, Germany
+49 8141 242 0

JOHNSON CONTROLS

CO₂

www.jci.com

System Manufacturer, Component Supplier, Engineering / Contracting

Heating - Industrial & Commercial
Refrigeration - Industrial & Commercial
Air Conditioning - Industrial & Commercial

HC

NH₃

H₂O

Christian D.X's Vej 201
8270 Højebjerg, Denmark
+45 873 670 00

LINDE

CO₂

www.linde-gas.com

Refrigerant Supplier
Refrigeration - Domestic, Transport, Industrial & Commercial
Air Conditioning - Mobile, Commercial & Industrial

HC

NH₃

Seitnerstrasse 70
82049 Pullach, Germany
+49 89 7446 2399

MAYEKAWA EUROPE

CO₂

www.mayekawa.eu

System Manufacturer
Component Supplier
Refrigeration - Industrial & Commercial
Air Conditioning - Industrial & Commercial

HC

NH₃

H₂O

AIR

Leuvensesteenweg 605
1930 Zaventem, Belgium
+32 275 790 75

PARKER HANNIFIN

CO₂

www.parker.com

Component Supplier
Refrigeration - Domestic, Transport, Industrial & Commercial
Air Conditioning - Industrial & Commercial

HC

NH₃

Wankelstr. 40
50996 Köln, Germany
+49 223 639 000

SANDEN MANUFACTURING EUROPE

CO₂

www.sanden-europe.fr

System Manufacturer
Heating - Residential, Industrial & Commercial
Air Conditioning - Mobile, Residential

NH₃

Le Quilliou - BP30
35190 Tinténiac, France
+33 299 45 58 58

SHRIEVE PRODUCTS INTERNATIONAL

CO₂

HC

NH₃

www.shrieve.com

Lubricant and fluid supplier
Refrigeration - Domestic, Transport, Industrial &
Commercial, Air Conditioning - Mobile, Industrial
& Commercial

Suite 39, 40 Churchill Square
ME194YU West Mailing (Kent), UK
+44 173 2520600

SINTEF

CO₂

HC

NH₃

H₂O

www.sintef.no

Consultancy / Research
Heating - Residential, Industrial & Commercial
Air Conditioning - Industrial & Commercial
Refrigeration - Domestic, Transport, Industrial &
Commercial

Strindveien 4
7465 Trondheim, Norway
+47 73 59 30 00

SSP KÄLTEPLANER AG

CO₂

www.kaelteplaner.ch

Engineering / Contracting

Refrigeration - Industrial & Commercial
Air Conditioning - Industrial & Commercial

NH₃

Bittertenstrasse 15
4702 Oensingen, Switzerland
+41 623 880 350

SWEP

CO₂

HC

NH₃

www.swep.net

Component Supplier
Heating - Residential
Heating - Industrial & Commercial
Refrigeration - Industrial & Commercial
Refrigeration - Transport
Air Conditioning - Industrial & Commercial

Hjalmar Brantings väg 5
26122 Landskrona
+46 418 400 400

DIRECTORY

AUSTRIA

AHT COOLING SYSTEMS

www.aht.at

System Manufacturer
Engineering / Contracting
Refrigeration - Commercial

HC

FRIGOPOL- KÄLTEANLAGEN GMBH

www.frigopol.com

System Manufacturer
Heating - Residential
Refrigeration - Industrial
Air Conditioning - Commercial & Industrial

CO₂

NH₃

GREEN SOLUTION: KÄLTE- KLIMA-ENERGIETECHNIK GMBH

www.green-solution.at

Contracting
Refrigeration - Industrial

CO₂

HC

NH₃

HAUSER

www.hauser.com

Component Supplier
System Manufacturer
Engineering / Contracting
Refrigeration - Commercial
Refrigeration - Industrial

CO₂

HEROLD KLIMA - UND KÄLTEANLAGEN GMBH

www.herold.at

Engineering / Contracting
Refrigeration - Commercial
Refrigeration - Industrial

CO₂

LIEBHERR-HAUSGERÄTE LIENZ GMBH

www.liebherr.com/en-GB/35268.wfw

Component Supplier
System Manufacturer
Refrigeration - Commercial
Refrigeration - Domestic

HC

LACHHOFER KÄLTETECHNIK GMBH

www.lachhofer.at

System Manufacturer
Engineering / Contracting
Refrigeration - Industrial

CO₂

HC

NH₃

M-TEC ENERGIE.INNOVATIV GMBH

www.m-tec.at

System Manufacturer
Engineering / Contracting
Heating - Residential
Heating - Industrial & Commercial
Refrigeration - Commercial

CO₂

NEURA

www.neura.at

System Manufacturer
Engineering / Contracting
Heating - Residential
Heating - Industrial & Commercial
Air Conditioning - Commercial & Industrial

HC

OBRIST

www.obrist.at

*Engineering / Contracting
Refrigeration - Transport
Air Conditioning - Commercial & Industrial
Air Conditioning - Mobile*



PINK

<http://pink.co.at>

*System Manufacturer
Engineering / Contracting
Refrigeration - Commercial
Refrigeration - Industrial
Air Conditioning - Commercial & Industrial*



PRIESTERATH.NET - KÄLTE- KLIMA-TECHNIK

<http://priesterath.net>

*Engineering / Contracting
Refrigeration - Commercial
Refrigeration - Industrial*



VENTREX

www.ventrex.com

*System Manufacturer
Engineering / Contracting
Refrigeration - Commercial
Refrigeration - Industrial
Air Conditioning - Commercial & Industrial*



BELGIUM

AB REFRIGERATION DIVISION

www.abcoolservice.be

*Engineering / Contracting
Refrigeration - Industrial*



BALTIMORE AIRCOIL INTERNA- TIONAL EU

www.baltimoreaircoil.eu

*System Manufacturer
Engineering / Contracting
Component Supplier
Refrigeration - Commercial
Refrigeration - Industrial
Air Conditioning - Commercial & Industrial*



DRU INTERNATIONAL

www.dru.be

*System Manufacturer
Refrigeration - Commercial*



ECO-FREEZE

www.eco-freeze.com

HC

*Component Supplier
Refrigerant Supplier
Refrigeration - Commercial
Refrigeration - Industrial*

EVAPCO EU

www.evapco.be

CO₂

HC

NH₃

*System Manufacturer
Component Supplier
Refrigeration - Industrial
Air Conditioning - Commercial & Industrial
Air Conditioning - Residential*

INDUSTRIËLE KOELTECHNIEK ROOSE

www.koeltechniekroose.be

NH₃

*Engineering / Contracting
Refrigeration - Commercial
Refrigeration - Industrial*

ITE N.V.

www.ite-tools.com

CO₂

HC

NH₃

*Component Supplier
Refrigeration - Domestic
Refrigeration - Commercial
Refrigeration - Industrial
Refrigeration - Transport
Air Conditioning - Residential
Air Conditioning - Mobile*

MASTER COOL EUROPE

www.mastercool.com

CO₂

HC

NH₃

*Component Supplier
Refrigeration - Commercial
Refrigeration - Industrial*

SABCobel

www.sabcobel.be

CO₂

*Refrigeration - Commercial
Refrigeration - Industrial*

SHECCO

www.shecco.com

CO₂

HC

NH₃

H₂O

AIR

Consultancy/Marketing

BULGARIA

BG CLIMA

www.bgclima.eu

*Component Supplier
Engineering / Contracting
Heating - Residential
Heating - Industrial & Commercial
Refrigeration - Commercial
Refrigeration - Industrial
Air Conditioning - Residential*



TECHNO-FRIGA

www.technofriga.com

*Component Supplier
Engineering / Contracting
Refrigeration - Commercial
Refrigeration - Industrial*



CROATIA

FRIGOMOTORS

www.frigomotors.com

*System Manufacturer
Component Supplier
Refrigerant Supplier
Engineering / Contracting
Refrigerant Supplier
Heating - Residential
Heating - Industrial & Commercial*



CYPRUS

AGMFOODTECH LTD

www.agmfoodtech.com

*Engineering / Contracting
Refrigeration - Industrial*



REFRIGERATION ENERGY TECHNOLOGIES LTD

<http://www.ret.com.cy>

*Engineering / Contracting
Refrigeration - Commercial
Refrigeration - Industrial*



CZECH REPUBLIC

BOHEMIACHLAD

www.bohemiachladpraha.cz

Component Supplier
Engineering / Contracting
Refrigeration - Industrial
Air Conditioning - Commercial & Industrial
Air Conditioning - Residential



OSTROV COMPLETE

www.ostrovcomplete.com

System Manufacturer
Refrigeration - Commercial
Refrigeration - Industrial



SINOP

www.sinop.cz

System Manufacturer
Component Supplier
Refrigeration - Commercial
Refrigeration - Industrial



DENMARK

2CR KØLETEKNIK

www.2cr.dk

Engineering / Contracting
Refrigeration - Transport
Refrigeration - Industrial



AGRAMKOW

www.agramkow.com

Component Supplier
Refrigeration - Commercial
Refrigeration - Domestic
Air Conditioning - Residential



ARCTIS

www.arctis.dk

Engineering / Contracting
Refrigeration - Commercial
Refrigeration - Industrial
Air Conditioning - Commercial & Industrial



B-COOL CONSULT

www.bcconsult.dk

Engineering / Contracting
Consultancy/Marketing
Refrigeration - Transport
Refrigeration - Industrial



BUNDGAARD KØLETEKNIK A/S

www.coolcare.dk

System Manufacturer
Component Supplier
Heating - Industrial & Commercial
Air Conditioning - Residential



BUUS KØLETEKNIK A/S

www.buus.dk

System Manufacturer
Refrigeration - Transport
Refrigeration - Industrial



CARAVELL

www.caravell.dk

System Manufacturer
Component Supplier
Refrigeration - Commercial

HC

CHRISTIAN BERG

www.christianberg.dk

Engineering / Contracting
Refrigeration - Commercial
Refrigeration - Industrial
Air Conditioning - Commercial & Industrial

CO₂

HC

NH₃

COOLING CONSULT

www.coolingconsult.dk

Engineering / Contracting
Consultancy/Marketing
Refrigeration - Industrial
Air Conditioning - Commercial & Industrial

CO₂

NH₃

CRONBORG

www.cronborg.dk

System Manufacturer
Engineering / Contracting
Heating - Residential
Heating - Industrial & Commercial
Air Conditioning - Commercial & Industrial
Air Conditioning - Residential

CO₂

HC

NH₃

DÆNCKER KØLEINVENTAR APS

www.daencker.dk

Engineering / Contracting
Consultancy/Marketing
Refrigeration - Commercial
Refrigeration - Industrial
Air Conditioning - Commercial & Industrial
Air Conditioning - Residential
Air Conditioning - Mobile

CO₂

NH₃

DANARCTICA

www.danarctica.com

System Manufacturer
Refrigeration - Transport
Refrigeration - Industrial

NH₃

DANFRIG AS

www.danfrig.dk

Engineering / Contracting
Heating - Residential
Refrigeration - Commercial
Air Conditioning - Residential

CO₂

DANKØL A/S

www.dankoel.dk

Engineering / Contracting
Consultancy/Marketing
Refrigerant Supplier
Refrigeration - Commercial
Refrigeration - Industrial

CO₂

HC

NH₃

DANKØLING A/S

<http://dankoeling.dk>

Engineering / Contracting
Consultancy/Marketing
Refrigeration - Industrial

CO₂

NH₃

EUREFA APS

www.eurefa.com

Engineering / Contracting
Consultancy/Marketing
Refrigeration - Industrial



ESBEN KØLESERVICE

www.esbenkoeleservice.dk

Contracting
Consultancy/Marketing
Refrigeration - Commercial



FRIGORTEK COOLING SYSTEMS

www.frigortek.dk

Engineering / Contracting
Refrigeration - Commercial
Refrigeration - Industrial



FRISKVAND

www.friskvand.dk

System Manufacturer
Refrigeration - Commercial



GERSTENBERG SCHRÖDER

www.gs-as.com

System Manufacturer
Refrigeration - Industrial



GK KØLE- OG KLIMATEKNIK APS

www.gk-k.dk

Engineering / Contracting
Refrigeration - Industrial



GRAM REFRIGERATION

www.gram-commercial.com

System Manufacturer
Refrigeration - Commercial



GRAMSTRUP KØLING A/S

www.gramstrup-as.dk

Engineering / Contracting
Refrigeration - Commercial
Refrigeration - Industrial



GRUNDFOS

www.grundfos.com

Component Supplier
Heating - Residential
Heating - Industrial & Commercial
Refrigeration - Commercial
Refrigeration - Industrial
Air Conditioning - Residential



HB PRODUCTS A/S

www.hbproducts.dk

Component Supplier
Refrigeration - Commercial
Refrigeration - Industrial



ICS ENERGY – INDUSTRIAL COOLING SYSTEMS

www.icsenergy.dk

Refrigeration - Commercial
Refrigeration - Industrial
Engineering / Design



IM GRUPPEN

www.uk.industri-montage.dk

System Manufacturer
Engineering / Contracting
Refrigeration - Commercial
Refrigeration - Transport
Refrigeration - Industrial



INNOTEK

www.innotek.dk

System Manufacturer
Component Supplier
Engineering / Contracting
Consultancy/Marketing
Refrigeration - Commercial
Refrigeration - Industrial



ISLEV VVS & KLIMA

www.islevvvs.dk

Engineering / Contracting
Heating - Residential



JF KØLETEKNIK

www.jf-koeleteknik.dk

Engineering / Contracting
Consultancy/Marketing
Refrigeration - Commercial
Refrigeration - Industrial
Refrigeration-Transport
Air Conditioning - Commercial & Industrial



JT3 KLIMA A/S

www.jt3.dk

Engineering / Contracting
Heating - Residential
Refrigeration - Commercial
Refrigeration - Industrial
Air Conditioning - Commercial & Industrial
Air Conditioning - Residential



KNUDSEN KØLING

www.knudsenkoling.dk

System Manufacturer
Engineering / Contracting
Consultancy/Marketing
Refrigeration - Commercial
Refrigeration - Industrial



KØLEMADSEN A/S

www.koelemadsen.dk

Engineering / Contracting
Consultancy/Marketing
Refrigeration - Commercial
Refrigeration - Industrial
Refrigeration-Transport
Air Conditioning - Commercial & Industrial



KUVATEK

www.kuvatek.dk

System Manufacturer
Refrigeration - Commercial

HC

METALFRIO SOLUTIONS A/S

www.metalfrio.dk

System Manufacturer
Component Supplier
Refrigeration - Commercial

CO₂

HC

MULTI KØL

www.multikoel.dk

Engineering / Contracting
Refrigeration - Commercial
Refrigeration - Industrial
Refrigeration-Transport

NH₃

NILAN

www.nilan.dk

System Manufacturer
Heating - Residential
Heating - Industrial & Commercial
Refrigeration - Commercial
Refrigeration - Industrial

CO₂

NORDKØL

www.nordkoel.dk

Engineering / Contracting
Refrigeration - Industrial
Refrigeration-Transport

NH₃

PG FLOWTEKNIK SCANDINAVIA APS

www.pgflowteknik.dk

Component Supplier
Refrigeration - Commercial
Refrigeration - Industrial

CO₂

HC

NH₃

SA-AL KØLETEKNIK APS

www.koleteknik.dk

Engineering / Contracting
Refrigeration - Commercial

CO₂

NH₃

SKIPPER'S KØLETEKNIK

www.skippers.dk

Engineering / Contracting
Refrigeration - Commercial
Refrigeration - Industrial

CO₂

SKJØDT KØLETEKNIK

www.xn--skjdt-xua.dk

Engineering / Contracting
Refrigeration - Commercial
Refrigeration - Industrial

NH₃

SØBORG KØL A/S

www.soborg-kol.dk

*Component Supplier
Engineering / Contracting
Refrigeration - Industrial*

NH₃

SUPER KØL

*Engineering / Contracting
Refrigeration - Commercial*

CO₂

HC

SVEDAN INDUSTRI KOELAN- LAEG A-S

www.svedan.com

*Engineering / Contracting
Refrigeration - Industrial
Air Conditioning - Commercial & Industrial*

CO₂

NH₃

VESTFROST

www.vestfrost.dk

*System Manufacturer
Refrigeration - Commercial
Refrigeration-Domestic*

HC

VOJENS KØLETEKNIK A/S

www.voko.dk

*Engineering / Contracting
Refrigeration - Commercial
Refrigeration - Industrial*

CO₂

ESTONIA

NORPE EESTI

www.norpe.ee

*System Manufacturer
Refrigeration - Commercial*

CO₂

HC

FINLAND

AX CONSULTING LTD

www.ax.fi

Engineering / Contracting
Consultancy/Marketing
Heating - Residential
Heating - Industrial & Commercial
Refrigeration - Commercial
Refrigeration - Industrial
Air Conditioning - Residential

CO₂

HC

NH₃

CUPORI

www.cupori.com

Component Supplier
Refrigeration - Commercial
Refrigeration - Industrial
Air Conditioning - Commercial & Industrial
Air Conditioning - Residential

HC

FINESS ENERGY LTD

www.finess.fi

Engineering / Contracting
Consultancy/Marketing
Heating - Industrial & Commercial
Refrigeration - Industrial

CO₂

NH₃

GRANLUND

www.granlund.fi

Engineering / Contracting
Refrigeration - Commercial
Refrigeration - Industrial

CO₂

NH₃

HUURRE GROUP OY

www.huurre.com

System Manufacturer
Engineering / Contracting
Refrigeration - Commercial
Refrigeration - Industrial

CO₂

JETITEK LTD

www.jetitek.fi

Engineering / Contracting
Refrigeration - Commercial
Refrigeration - Industrial

CO₂

LAKEUDEN KYLMÄKESKUS OY

www.lakeudenkylmakeskus.fi

Engineering / Contracting
Refrigeration - Commercial
Refrigeration - Industrial

CO₂

LUVATA

www.luvata.com

System Manufacturer
Component Supplier
Refrigeration - Commercial
Refrigeration - Industrial
Air Conditioning - Commercial & Industrial
Air Conditioning - Residential

CO₂

NH₃

NORPE

www.norpe.fi

System Manufacturer
Refrigeration - Commercial

CO₂

HC

OILON SCANCOOL

www.oilon.com/scancool/

Engineering / Contracting
Heating - Industrial & Commercial
Refrigeration - Commercial
Refrigeration - Industrial
Air Conditioning - Residential



PORKKA

www.porkka.fi

System Manufacturer
Engineering / Contracting
Refrigeration - Commercial
Refrigeration - Industrial
Refrigeration-Transport



RE-ENGINEERING LTD

www.re-suunnittelu.fi

Engineering / Contracting
Refrigeration - Industrial



VAHTERUS

www.vahterus.fi

System Manufacturer
Component Supplier
Heating - Industrial & Commercial
Refrigeration - Commercial
Refrigeration - Industrial



FRANCE

ALDES

www.aldes.fr

System Manufacturer
Engineering / Contracting
Consultancy/Marketing
Heating - Residential
Air Conditioning - Residential



AXIMA REFRIGERATION

www.aximaref.com

System Manufacturer
Component Supplier
Engineering / Contracting
Refrigeration - Commercial
Refrigeration - Industrial
Air Conditioning - Commercial & Industrial



BONNET NÉVÉ

www.bonnetneve.com

System Manufacturer
Engineering / Contracting
Refrigeration - Commercial



BOOSTHEAT

www.boostheat.com

System Manufacturer
Heating - Residential



CARLY

www.carly-sa.com

Component Supplier
Refrigeration - Commercial
Refrigeration - Industrial
Air Conditioning - Commercial & Industrial
Air Conditioning - Residential



CIAT

www.ciat.fr

System Manufacturer
Engineering / Contracting
Heating - Residential
Heating - Industrial & Commercial
Air Conditioning - Residential



CLAUGER

www.clauger.eu

System Manufacturer
Refrigeration - Industrial
Air Conditioning - Commercial & Industrial



LA GFF

www.lagff.com

Engineering / Contracting
Heating - Industrial & Commercial
Refrigeration - Commercial



LA ROBINET FRIGORIFIQUE FRANÇAIS

www.rff-france.com

Component Supplier
Refrigeration - Industrial



LITHEX

www.lithex.fr

Engineering / Contracting
Refrigeration - Commercial
Refrigeration - Industrial



PAUMIER

www.ets-paumier.fr

Manufacturer
Engineering / Contracting
Refrigeration - Industrial
Refrigeration-Transport
Air Conditioning - Commercial & Industrial



PROFROID

www.profroid.com

System Manufacturer
Refrigeration - Commercial
Refrigeration - Industrial



TECUMSEH EUROPE

www.tecumseh.com

HC

*Component Supplier
Refrigeration - Commercial
Refrigeration - Domestic*

GERMANY

3K KÄLTE- UND KLIMATECHNIK KRUSE GMBH

www.3k-kruse.de

NH₃

*Engineering / Contracting
Refrigeration - Industrial*

AGO AG ENERGIE + ANLAGEN

www.ago.ag

*Engineering / Contracting
Consultancy/Marketing
Heating - Industrial & Commercial
Refrigeration - Industrial*

NH₃

H₂O

ALLINOX GMBH – KUNZE FOOD TECHNOLOGY

CO₂

www.allinox.de

*System Manufacturer
Engineering / Contracting
Refrigeration - Commercial*

NH₃

ALPHA INNOTECH - AIT- DEUTSCHLAND GMBH

www.alpha-innotec.de

HC

*System Manufacturer
Heating - Residential
Heating - Industrial & Commercial*

ARCTOS INDUSTRIEKÄLTE AG

www.arctos-ag.com

*Engineering / Contracting
Refrigeration - Industrial*

CO₂

NH₃

ARMATURENWERK ALTEN- BURG

CO₂

www.awa-armaturenwerk.de

*Component Supplier
Refrigeration - Commercial
Refrigeration - Industrial*

CABERO

www.cabero.de

*System Manufacturer
Heating - Industrial & Commercial
Refrigeration - Industrial*



COMPACT KAELETETECHNIK

www.compact-kaeltetechnik.de

*System Manufacturer
Component Supplier
Refrigeration - Commercial
Refrigeration - Industrial*



CHRISTOF FISCHER GMBH

www.kaeltefischer.de

*Consultancy/Marketing
Refrigeration - Industrial*



DEKA CONTROLS

www.deka-controls.com

*Component Supplier
Refrigeration - Industrial*



DK-KÄLTEANLAGEN GMBH

www.dk-kaelteanlagen.de

*Component Supplier
Heating - Industrial & Commercial*



DRESDNER

www.dka-dresden.de

*Engineering / Contracting
Refrigeration - Commercial
Refrigeration - Industrial*



EKS LINDAU GMBH

www.eks-lindau.de

*Engineering / Contracting
Refrigeration - Industrial*



ESK SCHULTZE

www.esk-schultze.de

*Component Supplier
Heating - Industrial & Commercial
Refrigeration - Commercial
Refrigeration - Industrial
Air Conditioning - Commercial & Industrial
Air Conditioning - Mobile*



FREUDENBERG

www.fst.com

*Component Supplier
Air Conditioning - Mobile*



FRIGOTEAM

www.frigoteam.com

Engineering / Contracting
Refrigeration - Commercial
Refrigeration - Industrial
Air Conditioning - Residential



FUTRON

www.futron.de

System Manufacturer
Engineering / Contracting
Consultancy/Marketing
Heating - Industrial & Commercial
Refrigeration - Commercial
Air Conditioning - Commercial & Industrial



GFKK GESELLSCHAFT FÜR KÄLTETECHNIK - KLIMA- TECHNIK GMBH

www.gfkk.de

Engineering / Contracting
Refrigeration - Industrial
Air Conditioning - Residential



HAAS ANLAGENBAU GMBH

www.anlagenbau-haas.de

System Manufacturer
Component Supplier
Engineering / Contracting
Refrigeration - Industrial



HAFNER-MUSCHLER KÄLTE- UND KLIMATECHNIK GMBH & CO. KG

www.hafner-muschler.de

System Manufacturer
Component Supplier
Engineering / Contracting
Refrigeration - Commercial & Industrial



HAUTEC

www.hautec.eu

System Manufacturer
Heating - Residential
Heating - Industrial & Commercial



HEIFO RÜTERBORIES GMBH & CO. KG

www.heifo.de

Component Supplier
Engineering / Contracting
Refrigeration - Commercial
Refrigeration - Industrial
Refrigeration-Transport
Air Conditioning - Commercial & Industrial



HKT HUBER-KÄLTE-TECHNIK GMBH

www.hkt-goeldner.de

System Manufacturer
Refrigeration - Commercial
Refrigeration - Industrial
Refrigeration-Domestic



HUBER

www.huber-online.com

System Manufacturer
Engineering / Contracting
Refrigeration - Industrial



IXETIC

www.ixetic.com

*Component Supplier
Air Conditioning - Mobile*



KACO GMBH&CO. KG

www.kaco.de

*Component Supplier
Air Conditioning - Mobile*



KAELTE CONCEPT

www.kaelte-concept.de

*Engineering / Design
Refrigeration - Commercial*



KÄLTETECHNIK DRESEN + BREMEN GMBH

www.dresen-kaelte.de

*Engineering / Contracting
Refrigeration - Industrial*



KÄLTETECHNIK HARRER

www.kaeltetechnik-harrer.de

*Engineering / Contracting
Refrigeration - Industrial*



KB KÄLTEBERATUNG GMBH

www.kaelte-beratung.de

*Engineering / Contracting
Consultancy/Marketing
Refrigeration - Commercial
Refrigeration - Industrial*



KLIMAL

www.klimal.de

*Component Supplier
Refrigeration - Commercial
Refrigeration - Industrial
Air Conditioning - Residential*



KONVEKTA AG

www.konvekta.de

*System Manufacturer
Component Supplier
Refrigeration-Transport
Air Conditioning - Mobile*



KREUTZTRÄGER KÄLTE- TECHNIK GMBH & CO. KG

www.kreutztraeger-kaeltetechnik.de

*Engineering / Contracting
Refrigeration - Commercial
Refrigeration - Industrial*



LIPPELT

www.lippelt.de

*Engineering / Contracting
Refrigeration - Industrial*

NH₃

MAJA

www.maja.de

*System Manufacturer
Refrigeration - Industrial*

CO₂

MAKATEC

www.makatec.eu

*Component Supplier
Refrigeration - Industrial*

NH₃

MANGELS KÄLTE TECHNIK GMBH

www.mangels-kaeltetechnik.de

*Engineering / Contracting
Refrigeration - Commercial
Refrigeration - Industrial*

NH₃

MATTES ENGINEERING GMBH

www.mattes-int.com

*Engineering / Contracting
Refrigeration - Industrial*

NH₃

PAKT

www.pakt.de

*Engineering / Contracting
Refrigeration - Commercial
Refrigeration - Industrial*

NH₃

ROBERT SCHIESSL GMBH

www.schiessl-kaelte.de

*Component Supplier
Refrigerant Supplier
Refrigeration - Industrial*

CO₂

HC

REGELTECHNIK KORN- WESTHEIM GMBH

www.rtk.de

*Component Supplier
Refrigeration - Industrial
Refrigeration-Transport*

NH₃

SCHICK GRUPPE

www.schickgruppe.de

*Refrigerant Supplier
Refrigeration - Commercial
Refrigeration - Industrial*

CO₂

NH₃

SCHWIER GMBH

www.schwier-kaelte.de

*Component Supplier
Engineering / Contracting
Refrigeration - Commercial
Refrigeration - Industrial
Air Conditioning - Commercial & Industrial*



SPECK TRIPLEX

www.speck-triplex.de

*Component Supplier
Heating - Industrial & Commercial
Refrigeration - Industrial*



TEKO

www.teko-kaeltetechnik.com

*System Manufacturer
Component Supplier
Engineering / Contracting
Refrigeration - Commercial*



TEMTEC KÄLTE-KLIMA GMBH

www.temtec-kaelteklima.de

*Component Supplier
Refrigeration - Commercial
Refrigeration - Industrial
Air Conditioning - Commercial & Industrial*



TH. WITT KÄLTEMASCHINEN- FABRIK GMBH

www.th-witt.com

*Component Supplier
Refrigeration - Industrial*



THERMEA

www.thermea.de

*System Manufacturer
Component Supplier
Heating - Industrial & Commercial
Air Conditioning - Commercial & Industrial*



THERMOFIN GMBH

www.thermofin.de

*System Manufacturer
Component Supplier
Refrigeration - Commercial
Refrigeration - Industrial*



THERMOWAVE GESELLSCHAFT FÜR WÄRMETECHNIK

www.thermowave.de

*Component Supplier
Refrigeration - Industrial*



TLK-THERMO GMBH

www.tlk-thermo.com

*Engineering / Contracting
Heating - Residential, Industrial & Commercial
Refrigeration - Commercial, Industrial & Transport
Air Conditioning - Residential
Air Conditioning - Mobile*



VAILLANT

www.vaillant.de

HC

System Manufacturer
Engineering / Contracting
Heating - Residential
Refrigeration - Domestic
Air Conditioning - Residential

VAU THERMOTECH GMBH & CO

www.vau-thermotech.de

HC

Component Supplier
Refrigeration - Industrial

VULKAN LOKRING

www.vulkan-lokring.com

CO₂

Component Supplier
Refrigeration - Commercial
Refrigeration - Industrial
Refrigeration - Domestic
Air Conditioning - Commercial & Industrial
Air Conditioning - Residential

WALTER HAUPT GMBH

www.haupt-gmbh.de

CO₂

Engineering / Contracting
Refrigeration - Commercial
Refrigeration - Industrial

WALTER ROLLER GMBH & CO.

www.walterroller.com

CO₂

Component Supplier
Refrigeration - Industrial
Air Conditioning - Commercial & Industrial

WIELAND-WERKE AG

www.wieland.de

CO₂

HC

NH₃

Component Supplier
Heating - Residential
Heating - Industrial & Commercial
Refrigeration - Commercial
Refrigeration - Industrial
Refrigeration - Transport

WIKA

www.wika.de

CO₂

HC

NH₃

Component Supplier
Heating - Residential, Industrial & Commercial
Refrigeration - Commercial & Industrial
Refrigeration - Transport
Air Conditioning - Commercial & Industrial
Air Conditioning - Mobile

WILHELM SCHRIEFER GMBH

www.schriever-kaelte.de

HC

Engineering / Contracting
Heating - Industrial & Commercial
Refrigeration - Commercial
Air Conditioning - Commercial & Industrial

GREECE

AFOI MOUTEVELI LTD

www.afoimouteveli.gr

System Manufacturer
Engineering / Contracting
Refrigeration - Commercial
Refrigeration - Industrial

CO₂

HC

NH₃

FRIGOGLASS

www.frigoglass.com

System Manufacturer
Refrigeration - Commercial

CO₂

HC

HALCOR METAL WORKS S.A.

www.halcor.gr

Component Supplier
Heating - Residential
Heating - Industrial & Commercial
Air Conditioning - Commercial & Industrial

CO₂

I. KONTES SA

www.kontes.gr

System Manufacturer
Component Supplier
Engineering / Contracting
Refrigeration - Commercial
Refrigeration - Industrial
Refrigeration-Transport
Air Conditioning - Residential

CO₂

HC

NH₃

HUNGARY

LHG KFT.

www.lhg.hu

System Manufacturer
Engineering / Contracting
Refrigeration - Commercial
Refrigeration - Industrial

CO₂

NH₃

QPLAN KFT.

www.qplan.hu

System Manufacturer
Engineering / Contracting
Heating - Industrial & Commercial
Refrigeration - Commercial
Refrigeration - Industrial

CO₂

HC

NH₃

ROZMARING-SZALO LTD

www.rszalo.hu

Engineering / Contracting
Refrigeration - Commercial

CO₂

NH₃

ICELAND

KÆLIVER

www.kaeliver.is

*Engineering / Contracting
Refrigeration - Commercial
Refrigeration - Industrial*

NH₃

IRELAND

ECOCUTE INNOVATION AND DESIGN LTD

www.ecocute.ie

*Engineering / Contracting
Heating - Industrial & Commercial*

CO₂

H&K INTERNATIONAL

www.hki.com

*Engineering / Contracting
Refrigeration - Commercial*

HC

INGERSOLL RAND THERMO KING

www.company.ingersollrand.com

*Component Supplier
Engineering / Contracting
Heating - Residential, Industrial & Commercial
Refrigeration - Commercial & Industrial Air Conditioning - Residential*

CO₂

MJC ENGINEERING

www.mjceengineering.net

*Engineering / Contracting
Refrigeration - Industrial
Air Conditioning - Commercial & Industrial
Air Conditioning - Residential*

CO₂

HC

NH₃

H₂O

MRSREF

www.mrsref.com

*Engineering / Contracting
Refrigeration - Industrial*

CO₂

HC

NH₃

MURCO

www.murcogasdetection.com

*Component Supplier
Engineering / Contracting
Refrigeration - Commercial
Refrigeration - Industrial
Air Conditioning - Commercial & Industrial
Air Conditioning - Residential*

CO₂

HC

NH₃

RSL IRELAND

www.rslireland.com

*Component Supplier
Engineering / Designing
Refrigeration - Commercial
Refrigeration - Industrial*

CO₂

HC

NH₃

ITALY

ARNEG

www.arneg.it

*System Manufacturer
Component Supplier
Engineering / Designing
Refrigeration - Commercial*

CO₂

HC

BLUE BOX

www.bluebox.it

*System Manufacturer
Refrigeration - Commercial
Refrigeration - Industrial*

CO₂

HC

NH₃

BLUPURA

www.blupura.com

*System Manufacturer
Engineering / Designing
Refrigeration - Commercial
Refrigeration - Domestic*

HC

CAREL

www.carel.com

*Component Supplier
Engineering / Contracting
Refrigeration - Commercial*

CO₂

HC

NH₃

CASTEL

www.castel.it

*Component Supplier
Refrigeration - Commercial
Refrigeration - Industrial
Air Conditioning - Commercial & Industrial
Air Conditioning - Residential*

CO₂

COSTAN SPA

www.costan.com

*System Manufacturer
Engineering / Contracting
Refrigeration - Commercial*

CO₂

DELONGHI

www.delonghi.com

HC

System Manufacturer
Air Conditioning - Commercial & Industrial
Air Conditioning - Residential

ELIWELL CONTROLS SRL

www.eliwell.it

CO₂

HC

NH₃

Component Supplier
Engineering / Contracting
Refrigeration - Commercial
Refrigeration - Industrial

ENERBLUE

www.enerblue.it

CO₂

System Manufacturer
Heating - Residential
Air Conditioning - Residential

ENEX SRL

www.enex.it

CO₂

System Manufacturer
Engineering / Contracting
Heating - Industrial & Commercial
Refrigeration - Commercial
Refrigeration - Industrial
Air Conditioning - Commercial & Industrial

EUROKLIMAT

www.euroklimat.com

HC

System Manufacturer
Air Conditioning - Commercial & Industrial

EPTA

www.eptarefrigeration.com

CO₂

HC

NH₃

Component Supplier
Engineering / Contracting
Refrigeration - Commercial

FRASCOLD SPA

www.frascold.it

CO₂

HC

NH₃

Component Supplier
Engineering / Contracting
Refrigeration - Commercial
Refrigeration - Industrial
Refrigeration-Transport
Air Conditioning - Commercial & Industrial

FRICO TECNICA

www.fricotecnica.com

CO₂

System Manufacturer
Refrigeration - Industrial

G.I. INDUSTRIAL HOLDING

www.gind.it

CO₂

HC

System Manufacturer
Engineering / Contracting
Heating - Industrial & Commercial
Refrigeration-Domestic
Air Conditioning - Commercial & Industrial
Air Conditioning - Residential

GALILEO TP

www.galileotp.com

HC

*Component Supplier
Refrigeration - Commercial
Refrigeration - Industrial*

GEOCLIMA

www.geoclima.com

HC

*Component Supplier
Refrigeration - Commercial
Air Conditioning - Commercial & Industrial*

GTS

www.gtsspa.it

HC

*Refrigerant Supplier
Refrigeration - Commercial
Refrigeration - Domestic*

HPH IRC SRL

www.hph-irc.com

CO₂

*Component Supplier
Engineering / Contracting
Refrigeration - Industrial
Air Conditioning - Commercial & Industrial*

IARP

www.iarp.it

HC

*System Manufacturer
Refrigeration - Commercial*

IGLU COLD SYSTEMS SRL

www.iglu.it

CO₂

HC

*System Manufacturer
Engineering / Contracting
Refrigeration - Commercial
Refrigeration - Industrial*

INDESIT CO.

www.indesitcompany.com

HC

*System Manufacturer
Refrigeration-Domestic*

INDUSTRIAL FRIGO

www.industrialfrigo.com

HC

*System Manufacturer
Component Supplier
Refrigeration - Commercial
Refrigeration - Industrial*

INNOVARIA SRL

www.innovaria.com

CO₂

*Component Supplier
Air Conditioning - Commercial & Industrial
Air Conditioning - Residential
Air Conditioning - Mobile*

LU-VE

www.luve.it

System Manufacturer
Component Supplier
Refrigeration - Commercial
Refrigeration - Industrial
Air Conditioning - Commercial & Industrial



OCS DI MAGGIOLO GIAN-CARLO

www.ocsmaggiolo.it

Component Supplier
Refrigeration - Industrial



ONDA S.P.A.

www.onda-it.com

Component Supplier
Refrigeration - Commercial
Refrigeration - Industrial



REFRIGERA INDUSTRIALE SRL

www.refrigera.eu

Component Supplier
Refrigeration - Industrial



RINNAI ITALIA

www.rinnai.it

System Manufacturer
Heating - Residential
Heating - Industrial & Commercial



RIVACOLD

www.rivacold.com

System Manufacturer
Component Supplier
Engineering / Contracting
Refrigeration - Commercial
Refrigeration - Industrial



ROBUR

www.robur.it

System Manufacturer
Engineering / Contracting
Heating - Residential
Air Conditioning - Residential



SCM FRIGO

www.scmfrigo.com

System Manufacturer
Engineering / Contracting
Refrigeration - Commercial
Refrigeration - Industrial



SCOTSMAN FRIMONT SPA

www.frimont.it

System Manufacturer
Refrigeration - Commercial
Refrigeration - Industrial



SETTALA GAS SPA

www.settalagas.it



Refrigerant Supplier
Heating - Residential
Heating - Industrial & Commercial
Refrigeration - Commercial & Industrial
Refrigeration-Transport
Air Conditioning - Residential

STEFANI S.P.A.

www.stefani-online.com



System Manufacturer
Component Supplier
Air Conditioning - Commercial & Industrial
Air Conditioning - Residential

TEKLAB

www.teklab.eu



Component Supplier
Refrigeration - Commercial
Refrigeration - Industrial

THERMOCOLD

www.thermocold.it



System Manufacturer
Engineering / Contracting
Consultancy/Marketing
Heating - Residential
Heating - Industrial & Commercial
Air Conditioning - Residential

THERMOKEY

www.thermokey.it



Component Supplier
Air Conditioning - Commercial & Industrial

WIGAM

www.wigam.it



Component Supplier
Refrigeration - Commercial
Refrigeration - Industrial
Air Conditioning - Residential
Air Conditioning - Mobile

ZANOTTI

www.zanotti.com



System Manufacturer
Engineering / Contracting

LITHUANIA

JSC ROLVIKA

www.rolvika.lt

Engineering / Contracting
Heating - Industrial & Commercial
Refrigeration - Commercial
Refrigeration - Industrial
Air Conditioning - Commercial & Industrial
Air Conditioning - Residential



GREENGROUP

www.greengroup.lt

Engineering / Contracting
Heating - Industrial & Commercial
Refrigeration - Commercial
Refrigeration - Industrial
Air Conditioning - Commercial & Industrial



SNAIGÈ AB

www.snaige.lt

System Manufacturer
Refrigeration-Domestic



LUXEMBOURG

COOL-TEC SA

www.cool-tec.lu

Engineering / Contracting
Refrigeration - Commercial
Refrigeration - Industrial



DOMETIC

www.dometic.com

System Manufacturer



MACEDONIA

ENERGIJA

www.energija.com.mk

Engineering / Contracting
Heating - Residential
Refrigeration - Industrial
Air Conditioning - Residential



INFOSET LTD

www.infoset.com.mk

Component Supplier
Engineering / Contracting
Heating - Residential
Heating - Industrial & Commercial
Air Conditioning - Commercial & Industrial
Air Conditioning - Residential



OZON

www.ozon.com.mk

Component Supplier
Engineering / Contracting
Heating - Industrial & Commercial
Refrigeration - Commercial
Air Conditioning - Commercial & Industrial



THE NETHERLANDS

BDA COOLING SOLUTIONS

www.bda-cooling.nl

Engineering / Contracting
Refrigeration - Commercial
Refrigeration - Industrial



COLDSTOREDESIGN

www.coldstoredesign.com

Engineering / Contracting
Refrigeration - Industrial



COOL GREEN SOLUTIONS

www.coolgreensolutions.nl

Engineering / Contracting
Refrigeration - Commercial
Refrigeration - Industrial



COOLSULTANCY ROB JANS

www.coolsultancy.nl

Consultancy/Marketing
Refrigeration - Commercial
Refrigeration - Industrial



FLAMCO www.flamcogroup.com

Component Supplier
Heating - Industrial & Commercial
Refrigeration - Industrial
Air Conditioning - Commercial & Industrial



GOVERS KOELTECHNIEK B.V.

www.goverskoeltechniek.nl

Engineering / Contracting
Refrigeration - Commercial
Refrigeration - Industrial



IBK KOUDETECHNIEK

www.ibkgroep.nl

System Manufacturer
Refrigeration - Commercial
Refrigeration - Industrial



INDUTHERM

www.indutherm.nl

Component Supplier
Engineering / Contracting
Heating - Industrial & Commercial
Air Conditioning - Commercial & Industrial



KOMA

www.koma.com

System Manufacturer
Engineering / Contracting
Refrigeration - Commercial
Refrigeration - Industrial



KWA BUSINESS CONSULTANTS

www.kwa.nl

Consultancy/Marketing
Heating - Industrial & Commercial
Refrigeration - Industrial
Air Conditioning - Residential



MAREFSUP BV

www.marefsup.nl

System Manufacturer
Component Supplier
Refrigerant Supplier
Engineering / Contracting
Consultancy/Marketing
Refrigerant Supplier
Heating - Residential



NIJSSEN KOELING

www.nijssen.com

System Manufacturer
Component Supplier
Refrigerant Supplier
Engineering / Contracting
Consultancy/Marketing
Refrigerant Supplier
Heating - Residential



NLR

www.nlr.nl

Research



OMNIVENT

www.omnivent.nl

Engineering / Contracting
Refrigeration - Industrial



PCT INTERNATIONAL BV

www.pct.nl

Engineering / Contracting
Refrigeration - Industrial



POLYTECHNIEK BC

www.polytechniek.nl

Engineering / Contracting
Refrigeration - Industrial



P.W. VLASKAMP B.V. REFRIG- ERATION CONSULTANCY

www.vlaskamp.biz

Engineering / Contracting
Consultancy/Marketing
Refrigeration - Commercial
Refrigeration - Industrial
Air Conditioning - Commercial & Industrial



RETAIL TECHNICS

www.retailtechnics.com

Engineering / Contracting
Heating - Industrial & Commercial
Refrigeration - Commercial
Air Conditioning - Commercial & Industrial



ROBBERTSEN CONSULT

www.robbertsenconsult.nl

Consultancy/Marketing
Heating - Industrial & Commercial
Refrigeration - Industrial
Air Conditioning - Commercial & Industrial



UNIECHEMIE

www.uniechemie.nl

Component Supplier
Engineering / Contracting
Refrigeration - Commercial
Refrigeration - Industrial & Transport
Air Conditioning - Commercial & Industrial
Air Conditioning - Residential
Air Conditioning - Mobile



VAN ABELEN KOELTECHNIEK B.V.

www.vanabeelenkoeltechniek.nl

Engineering / Contracting
Refrigeration - Industrial
Air Conditioning - Commercial & Industrial



VAN KEMPEN KOUDETECHNIEK

www.vankempen-tiel.nl

Engineering / Contracting
Refrigeration - Industrial
Air Conditioning - Commercial & Industrial



VELD KOELTECHNIEK

www.veld.nl

Engineering / Contracting
Refrigeration - Commercial
Refrigeration - Industrial



VINK KOELTECHNIEK

www.vinkkoeltechniek.nl

Engineering / Contracting
Refrigeration - Commercial
Refrigeration - Industrial



VHK

www.vhk.nl

Consultancy/Marketing
Heating - Residential
Heating - Industrial & Commercial
Refrigeration - Commercial
Refrigeration - Industrial
Refrigeration - Transport
Air Conditioning - Residential & Mobile



WIJBENGA B.V.

www.wijbenga.nl

Component Supplier
Engineering / Contracting
Refrigeration - Industrial



NORWAY

BØRRESEN COOLTECH AS

www.borresen.no

Component Supplier
Engineering / Contracting
Heating - Industrial & Commercial
Refrigeration - Commercial
Refrigeration - Industrial
Air Conditioning - Commercial & Industrial

CO₂

ELMO TEKNIKK AS

www.elmo.no

Engineering / Contracting
Heating - Industrial & Commercial
Refrigeration - Commercial
Air Conditioning - Commercial & Industrial
Air Conditioning - Residential

HC

HØIAX

www.hoiax.no

System Manufacturer
Heating - Residential
Heating - Industrial & Commercial
Refrigeration - Commercial
Refrigeration - Industrial
Refrigeration-Transport

HC

HYDRO

www.hydro.com

Component Supplier
Air Conditioning - Mobile

CO₂

MODERNE KJØLING

www.renkulde.no

Component Supplier
Refrigeration - Commercial
Air Conditioning - Commercial & Industrial

CO₂

NH₃

NORSK KULDE

www.norskkulde.com

System Manufacturer
Heating - Residential
Heating - Industrial & Commercial
Refrigeration - Industrial
Refrigeration-Transport
Air Conditioning - Mobile

CO₂

NH₃

SWECO NORGE AS

www.sweco.no

Engineering / Contracting
Consultancy/Marketing
Heating - Industrial & Commercial
Refrigeration - Industrial
Air Conditioning - Commercial & Industrial

CO₂

NH₃

THERMO CONSULT AS

www.thermoconsult.no

Engineering / Contracting
Consultancy/Marketing
Heating - Residential
Heating - Industrial & Commercial
Refrigeration - Commercial
Refrigeration - Industrial

CO₂

NH₃

TRONDHEIM KULDE

www.trondheimkulde.no

Engineering / Contracting
Refrigeration - Commercial

CO₂

VALDRES VARMEPUMPE AS

www.valdresvp.no

*Engineering / Contracting
Heating - Residential
Heating - Industrial & Commercial*



POLAND

COLDEX

www.coldex.pl

*Component Supplier
Engineering / Contracting
Refrigeration - Industrial*



FIRMA LEMAN

www.firma-leman.pl

*Engineering / Contracting
Refrigeration-Transport*



KLIMA-THERM

www.klima-therm.pl

*Engineering / Contracting
Refrigeration - Commercial
Refrigeration - Industrial
Air Conditioning - Commercial & Industrial*



KRZYSZTOF MAKOWSKI CHŁOD- NICTWO

www.amoniak.com.pl

*Engineering / Contracting
Refrigeration - Industrial*



LODEKO

www.lodeko.eu

*Component Supplier
Engineering / Contracting
Refrigeration - Industrial*



PPH COOL

www.cool.pl

*System Manufacturer
Engineering / Contracting
Refrigeration - Commercial
Refrigeration - Industrial
Refrigeration-Domestic*



PRONIK POLSKA

www.prorink.pl

Component Supplier
Engineering / Contracting
Refrigeration - Industrial



ZRM URZĄDZEŃ CHŁODNIC- ZYCH I MLECZARSKICH S.C

www.coldfront.pl

Engineering / Contracting
Refrigeration - Industrial



PORTUGAL

CENTAURO

www.centauro.pt

Component Supplier
Engineering / Contracting
Refrigeration - Commercial
Air Conditioning - Commercial & Industrial



H.SEABRA FRIO INDUSTRIAL

www.hseabra.seabraglobal.com

Engineering / Contracting
Refrigeration - Industrial



TENSAI

www.tensai.pt

System Manufacturer
Component Supplier
Refrigeration - Commercial
Refrigeration - Domestic



A. SILVA MATOS METALOME- CANICA

www.asilvamatoss.pt

Component Supplier
Refrigeration - Commercial



NOVAFRIO

www.novafrio.pt

Refrigeration - Commercial
Refrigeration - Industrial



ROMANIA

AB TECHNIC PROFESIONAL SPRL

www.abtehnic.ro

*Engineering / Contracting
Consultancy/Marketing
Heating - Industrial & Commercial
Refrigeration - Commercial & Industrial
Air Conditioning - Commercial & Industrial*



ARCTIC

www.arctic.ro

*System Manufacturer
Refrigeration-Domestic*



SC FRIGOTEHNICS SERVICES

www.friginstall.ro

*Engineering / Contracting
Refrigeration - Commercial
Refrigeration - Industrial*



FRIGOCONSULT

www.frigoconsult.ro

*Engineering / Contracting
Refrigeration - Industrial*



SLOVAKIA

ABC FOOD MACHINERY

www.abcfood.sk

*Component Supplier
Engineering / Contracting
Refrigeration - Industrial*



INTECH SLOVAKIA

www.intechenergo.sk

Engineering / Contracting



PRIMACHLAD S.R.O.

www.primachlad.sk

*Engineering / Contracting
Refrigeration - Industrial*



SLOVENIA

VAKO

www.vako.si

Engineering / Contracting
Refrigeration - Commercial



KLIMAPETEK

www.klimapetek.si

Engineering / Contracting
Refrigeration - Commercial
Air Conditioning - Commercial & Industrial
Air Conditioning - Residential



KOTA D.O.O. PETROVČE

www.kota.si

Engineering / Contracting
Refrigeration - Industrial



SPAIN

AGEFRED SL

www.agefred.es

Engineering / Contracting
Heating - Industrial & Commercial
Refrigeration - Commercial
Refrigeration - Industrial



COFRICO SL

www.cofrico.com

System Manufacturer
Engineering / Contracting
Heating - Industrial & Commercial
Refrigeration - Commercial
Refrigeration - Industrial



CUBIGEL COMPRESSORS

www.cubigel.com

Component Supplier
Refrigerant Supplier
Refrigeration - Commercial
Refrigeration - Industrial



EFFICOLD

www.fficold.com

System Manufacturer
Refrigeration - Commercial
Refrigeration - Industrial



ELECTROAUTO SA.

www.electroauto.net

Component Supplier
Engineering / Contracting
Air Conditioning - Mobile



FRIMETAL

www.frimetal.es

Component Supplier
Refrigeration - Commercial
Refrigeration - Industrial



FROST-TROL

www.frost-trol.com

System Manufacturer
Engineering / Contracting
Refrigeration - Commercial

HC

INDUSTRIAS TÉCNICAS DE GALICIA, S.A. (INTEGASA)

www.integasa.com

Component Supplier
Refrigeration - Industrial
Air Conditioning - Commercial & Industrial

NH₃

KINARCA

www.kinarca.com

System Manufacturer
Engineering / Contracting
Refrigeration - Industrial
Refrigeration-Transport

NH₃

KOXKA

www.koxka.com

System Manufacturer
Refrigeration - Commercial

HC

RV COOLING TECH

www.rvcoolingtech.com

System Manufacturer
Engineering / Contracting
Refrigeration - Commercial
Refrigeration - Industrial

NH₃

REFRICOMP INGENIERÍA

www.refricomp.com

Component Supplier
Engineering / Contracting
Refrigeration - Industrial
Refrigeration-Transport

CO₂

NH₃

TEWIS SMART SYSTEMS

www.tewis.com

System Manufacturer
Engineering / Contracting
Consultancy/Marketing
Refrigeration - Commercial
Refrigeration - Industrial

CO₂

HC

NH₃

TIENSA

www.teinsa.net

System Manufacturer
Component Supplier
Engineering / Contracting
Heating - Residential, Industrial & Commercial
Refrigeration - Commercial & Industrial
Air Conditioning - Commercial & Industrial
Air Conditioning - Residential

CO₂

NH₃

TUCAL

www.tucal.es

Component Supplier
Engineering / Contracting
Refrigeration - Industrial
Refrigeration-Transport

CO₂

NH₃

VASEGRUP ESPAÑA

www.vg-es.com

*Component Supplier
Engineering / Contracting
Consultancy/Marketing
Heating - Industrial & Commercial
Refrigeration - Commercial
Refrigeration - Industrial*

NH₃

SWEDEN

CUPROBRAZE

www.cuprobraze.com

*Component Supplier
Heating - Industrial & Commercial
Refrigeration - Industrial
Air Conditioning - Commercial & Industrial*

CO₂

ENRAD AB

www.enrad.se

*System Manufacturer
Engineering / Contracting
Refrigeration - Commercial
Refrigeration - Industrial
Air Conditioning - Residential*

HC

FRIGINOR

www.friginor.se

*Engineering / Contracting
Heating - Residential
Heating - Industrial & Commercial
Refrigeration - Commercial
Refrigeration - Industrial
Air Conditioning - Residential*

CO₂

G&L BEIJER REF AB

www.beijerref.com

*Component Supplier
Engineering / Contracting
Heating - Industrial & Commercial
Refrigeration - Commercial
Refrigeration - Industrial
Air Conditioning - Commercial & Industrial*

CO₂

HC

NH₃

HAGLUND INDUSTRI

www.haglundindustri.se

*System Manufacturer
Refrigeration - Commercial*

HC

NIBE AB

www.nibe.se

*System Manufacturer
Engineering / Contracting
Heating - Residential
Heating - Industrial & Commercial*

HC

NR KYL

www.nrskyl.se

*Engineering / Contracting
Heating - Residential
Heating - Industrial & Commercial
Refrigeration - Commercial
Refrigeration - Industrial*



RAMBÖLL SVERIGE AB

www.ramboll.se

*Engineering / Contracting
Consultancy/Marketing
Refrigeration - Industrial*



SRS FRIGADON LTD

www.srs-frigadon.com

*Engineering / Contracting
Refrigeration - Industrial*



TEMPER TECHNOLOGY AB

www.temper.se

*Component Supplier
Refrigeration - Industrial*



TRANTER INTERNATIONAL AB

www.tranter.com

*Component Supplier
Refrigeration - Commercial
Refrigeration - Industrial*



SWITZERLAND

A. SCHLEISS AG

www.schleissag.ch

*Engineering / Contracting
Refrigeration - Commercial
Refrigeration - Industrial
Air Conditioning - Residential*



ACOENERGY GMBH

www.acoenergy.ch

*Engineering / Contracting
Consultancy/Marketing
Refrigeration - Commercial
Refrigeration - Industrial
Air Conditioning - Residential*



ALPIQ

www.alpiq-energyservices.ch

*Engineering / Contracting
Refrigeration - Commercial
Refrigeration - Industrial
Air Conditioning - Commercial & Industrial
Air Conditioning - Residential*



AMSTEIN + WALTHERT BERN AG



www.amstein-walthert.ch

Engineering / Contracting
Consultancy/Marketing
Heating - Industrial & Commercial
Refrigeration - Commercial & Industrial
Air Conditioning - Commercial & Industrial



BAUMGARTNER KÜHLANLAGEN AG



www.baumgartner-kaelte.ch

Engineering / Contracting
Refrigeration - Commercial
Refrigeration - Industrial
Air Conditioning - Commercial & Industrial



BUCHER AG



www.kaeltebucher.ch

Engineering / Contracting
Refrigeration - Commercial
Refrigeration - Industrial
Air Conditioning - Commercial & Industrial

BRASSER KAELE AG



www.brasserkaelte.ch

Engineering / Contracting
Refrigeration - Commercial
Refrigeration - Industrial
Air Conditioning - Commercial & Industrial

CELSIO KÄLTE + KLIMA AG



www.celsio.ch

Engineering / Contracting
Refrigeration - Commercial

CLIMANET

www.climanet.ch

Engineering / Contracting
Refrigeration - Commercial
Refrigeration - Industrial



CTA AG

www.cta.ch

System Manufacturer
Component Supplier
Engineering / Contracting
Heating - Industrial & Commercial
Refrigeration - Commercial
Refrigeration - Industrial
Air Conditioning - Commercial & Industrial



E. BIAGGINI SA



www.biaggini.com

Component Supplier
Engineering / Contracting
Refrigeration - Commercial
Refrigeration - Industrial

FRIGORIE SA



www.frigorie.ch

Engineering / Contracting
Refrigeration - Commercial



FRIOTHERM AG

www.friotherm.com

HC

System Manufacturer
Component Supplier
Engineering / Contracting
Heating - Residential
Heating - Industrial & Commercial & Industrial
Air Conditioning - Commercial & Industrial
Air Conditioning - Residential

FROSTEC KÄLTETECHNIK

www.frostec.ch

CO₂

NH₃

Engineering / Contracting
Refrigeration - Commercial
Refrigeration - Industrial

GEORG FISCHER PIPING SYSTEMS AG

www.georgfischer.com

NH₃

Component Supplier
Refrigeration - Industrial

HAVO GROUP

www.havo.ch

HC

Engineering / Contracting
Refrigeration - Commercial
Refrigeration - Industrial

JÄGGI/GÜNTNER AG

www.jaeggi-hybrid.ch

NH₃

System Manufacturer
Component Supplier
Refrigeration - Industrial
Air Conditioning - Commercial & Industrial

KÄLTE 3000 AG

www.kaelte3000.com

CO₂

NH₃

Engineering / Contracting
Refrigeration - Commercial
Refrigeration - Industrial

KÄLTE AG BASEL

www.kaelte-basel.ch

CO₂

NH₃

Engineering / Contracting
Refrigeration - Commercial
Refrigeration - Industrial

KB KÄLTEBERATUNG GMBH

www.kaelte-beratung.de

CO₂

Engineering / Contracting
Consultancy/Marketing
Refrigeration - Commercial
Refrigeration - Industrial

KÄLTE FM AG

www.kaelte-fm.com

CO₂

Engineering / Contracting
Refrigeration - Commercial

KÄLTE-STERN AG

www.kaelte-stern.ch

*Engineering / Contracting
Refrigeration - Commercial
Refrigeration - Industrial
Air Conditioning - Commercial & Industrial*



KÄLTERING AG

www.kaelteringag.ch

*Engineering / Contracting
Refrigeration - Commercial*



KIMESSA

www.kimessa.com

*Component Supplier
Engineering / Contracting
Heating - Residential
Heating - Industrial & Commercial
Refrigeration - Commercial
Refrigeration - Industrial*



KOLB KÄLTE AG

www.kolbkaelte.ch

*Engineering / Contracting
Refrigeration - Commercial
Refrigeration - Industrial*



LIECHTI AG

www.liechti-frauenfeld.ch

*Engineering / Contracting
Refrigeration - Commercial
Refrigeration - Industrial*



NEW FRIGOTECH SA

www.new-frigotech.ch

*Engineering / Contracting
Refrigeration - Commercial
Air Conditioning - Commercial & Industrial*



PAULUS SCHWEIZ AG

www.paulusag.ch

*Engineering / Contracting
Refrigeration - Commercial
Air Conditioning - Commercial & Industrial*



SCHECO

www.scheco.ch

*Engineering / Contracting
Heating - Industrial & Commercial
Refrigeration - Commercial
Refrigeration - Industrial
Air Conditioning - Commercial & Industrial*



STADELMANN UND LEVIN AG

www.stadelmann-levin.ch

*Engineering / Contracting
Refrigeration - Commercial
Air Conditioning - Commercial & Industrial*



TRUTTMANN AG KÜHLANAL- GEN

www.truttmannag.ch

Engineering / Contracting
Refrigeration - Commercial

CO₂

HC

WALTER WETTSTEIN AG

www.wwag.ch

Engineering / Contracting
Refrigeration - Industrial

CO₂

NH₃

TURKEY

FRITERM

www.friterm.com

System Manufacturer
Component Supplier
Engineering / Contracting
Refrigeration - Commercial
Refrigeration - Industrial

CO₂

NH₃

GOKCELER IC VE DIS TIC SOG SIS AS

www.gokcelersogutma.com

Engineering / Contracting
Refrigeration - Industrial

CO₂

HC

KARYER ISI TRANSFER SANAYI VE TICARET A.S.

www.karyergroup.com

Component Supplier
Refrigeration - Commercial
Refrigeration - Industrial
Air Conditioning - Commercial & Industrial

CO₂

HC

NH₃

UKRAINE

PRIMEHOLOD

www.primeholod.com.ua

Engineering / Contracting
Refrigeration - Commercial
Refrigeration - Industrial
Air Conditioning - Commercial & Industrial

NH₃

ДП "НИКОЛАЕВХОЛОД"

www.nikolaevholod.at.ua

Engineering / Contracting
Refrigeration - Industrial

NH₃

A-GASwww.agas.com

Refrigerant Supplier
 Refrigeration - Commercial
 Refrigeration - Industrial
 Refrigeration-Domestic
 Air Conditioning - Commercial & Industrial
 Air Conditioning - Residential

**ACE REFRIGERATION**www.acerefrigeration.co.uk

Engineering / Contracting
 Refrigeration - Commercial
 Refrigeration - Industrial

**ADANDE REFRIGERATION**www.adande.com

Engineering / Contracting
 Refrigeration - Commercial
 Refrigeration - Industrial

**ARCTIC CIRCLE LTD**www.acl-online.com

Component Supplier
 Engineering / Contracting
 Refrigeration - Commercial
 Refrigeration - Industrial
 Air Conditioning - Commercial & Industrial

**ARRIBA COOLTECH**www.arribacooltech.co.uk

Component Supplier
 Refrigeration - Commercial
 Refrigeration - Industrial

**BJA REFRIGERATION CONSULTING ENGINEERS**www.bjacool.co.uk

Engineering / Contracting
 Consultancy/Marketing
 Refrigeration - Commercial

**BLIGHLINE LTD**www.blighline.co.uk

Component Supplier
 Engineering / Contracting
 Refrigeration - Commercial

**BOC INDUSTRIAL GASES**www.boconline.co.uk

Engineering / Contracting
 Refrigeration - Industrial
 Refrigeration-Transport
 Air Conditioning - Commercial & Industrial

**BROOKTHERM REFRIGERATION LTD**www.brooktherm.co.uk

Engineering / Contracting
 Refrigeration - Industrial
 Refrigeration-Transport
 Air Conditioning - Commercial & Industrial



BURO HAPPOLD

www.burohappold.com

*Engineering / Contracting
Consultancy/Marketing
Heating - Industrial & Commercial
Air Conditioning - Commercial & Industrial*

HC

CARTER RETAIL EQUIPMENT

www.cre-ltd.co.uk

*Engineering / Contracting
Refrigeration - Commercial*

HC

NH₃

CARTER SYNERGY

www.cartersynergy.com

*Component Supplier
Engineering / Contracting
Refrigeration - Commercial*

CO₂

CCS REFRIGERATION LTD

www.ccsrefrigeration.com

*Engineering / Contracting
Refrigeration - Commercial*

CO₂

NH₃

CHEMVIRON CARBON

www.chemvironcarbon.com

Refrigerant Supplier

CO₂

CHILLCO NW LTD

www.chillconw.com

*Engineering / Contracting
Refrigeration - Industrial
Refrigeration-Transport*

NH₃

COOLCONCERNS LTD.

www.coolconcerns.co.uk

*Consultancy/Marketing
Refrigeration - Commercial
Air Conditioning - Commercial & Industrial*

HC

DCI REFRIGERATION

www.dcirefrigeration.co.uk

*Engineering / Contracting
Refrigeration - Commercial*

CO₂

DIMPLEX

www.dimplex.co.uk

*Component Supplier
Heating - Residential
Heating - Industrial & Commercial*

HC

ECOCOOLING

www.ecocooling.org

*Component Supplier
Engineering / Contracting
Refrigeration - Commercial
Refrigeration - Industrial
Air Conditioning - Commercial & Industrial*



ECO-FRIDGE UK LTD

www.eco-fridge.co.uk

*Engineering / Contracting
Refrigeration - Commercial*



ELSTAT

www.elstatgroup.com

*Component Supplier
Refrigeration - Commercial*



FT REFRIGERATION LTD

www.ftrefrigeration.co.uk

*Component Supplier
Engineering / Contracting
Refrigeration - Commercial
Refrigeration - Industrial
Air Conditioning - Commercial & Industrial*



FOSTER REFRIGERATION LTD

www.fosterrefrigerator.co.uk

Refrigeration - Commercial



FREEZERTECH

www.freezertech.co.uk

*Component Supplier
Engineering / Contracting
Refrigeration - Commercial
Refrigeration - Industrial*



FROST TECH

www.frosttech.co.uk

Refrigeration - Commercial



GEORGE BARKER&CO.

www.georgebarker.co.uk

*Engineering / Contracting
Refrigeration - Commercial*



GI ENERGY

www.gienergy.net

*Engineering / Contracting
Heating - Residential
Heating - Industrial & Commercial*



GR SCOTT LTD

www.grscott.co.uk

Engineering / Contracting
Refrigeration - Commercial
Refrigeration - Industrial



GREEN COOLING

www.greencooling.co.uk

Component Supplier
Heating - Industrial & Commercial
Refrigeration - Commercial
Refrigeration - Industrial



HAMILTON CLARK

www.hamilton-clark.co.uk

Engineering / Contracting
Refrigeration - Commercial
Refrigeration - Industrial



HENRY TECHNOLOGIES

www.henrytech.co.uk

Component Supplier
Refrigeration - Commercial
Refrigeration - Industrial



HRP LTD

www.hrponline.co.uk

Component Supplier
Engineering / Contracting
Refrigeration-Domestic
Refrigeration - Commercial
Refrigeration - Industrial
Refrigeration-Transport
Air Conditioning - Residential & Mobile



HUSKY GROUP

www.huskyproducts.com

Refrigeration - Commercial



I-A.C.SYSTEMS

www.i-acs.co.uk

Component Supplier
Engineering / Contracting
Heating - Industrial & Commercial
Refrigeration - Commercial
Refrigeration - Industrial
Air Conditioning - Residential



ICS HEATPUMPS

www.icsheatpumps.co.uk

Heating - Industrial & Commercial
Air Conditioning - Commercial & Industrial



IDS REFRIGERATION (CLIMATELIFE)

www.idsrefrigeration.co.uk

Refrigerant Supplier



MONTGOMERY TRANSPORT GROUP



www.montgomerytransportgroup.com

Refrigeration-Transport

NH3 REFRIGERATION

www.NH3.co.uk

Engineering / Contracting
Consultancy/Marketing
Refrigeration - Industrial



OCEANAIR (UK) LTD



www.oceanairuk.com

Engineering / Contracting
Air Conditioning - Commercial & Industrial

PANASONIC



www.panasonic.eu

Component Supplier
Refrigeration - Commercial

RCS ENERGY MANAGEMENT



www.rcsenergymanagement.co.uk

Component Supplier
Refrigeration - Commercial
Refrigeration - Industrial

RDA (ENVIRONMENTAL ENGINEERING LIMITED)



www.rda-eng.com

System Manufacturer
Refrigeration - Commercial
Refrigeration - Industrial

RESOURCE DATA MANAGEMENT



www.resourcedm.com

Component Supplier
Refrigeration - Commercial
Refrigeration - Industrial
Air Conditioning - Commercial & Industrial

SEWARD REFRIGERATION



www.sewardrefrigeration.com

Engineering / Contracting
Refrigeration - Industrial



SPACE ENGINEERING SERVICES



www.space-engineering.co.uk

Engineering / Contracting
Heating - Industrial & Commercial
Refrigeration - Commercial
Refrigeration - Industrial
Air Conditioning - Residential



STAR REFRIGERATION

www.star-ref.co.uk

*Engineering / Contracting
Consultancy/Marketing
Heating - Residential
Heating - Industrial & Commercial
Refrigeration - Commercial
Refrigeration - Industrial*



S I SEALY & ASSOCIATES LTD

www.sisealy.co.uk

*Engineering / Contracting
Refrigeration - Industrial
Air Conditioning - Commercial & Industrial*



TITAN ENGINEERING LTD.

www.titan-engineering.co.uk

*Component Supplier
Engineering / Contracting
Refrigeration - Commercial
Refrigeration - Industrial
Refrigeration-Transport*



THERMAL TRANSFER TECHNOLOGY LTD

www.three-t.co.uk

*Component Supplier
Refrigeration - Commercial
Refrigeration - Industrial*



TRUE MANUFACTURING

www.trumfg.com

Refrigeration - Commercial



VERCO LIMITED

www.ver.co.uk

Refrigeration - Commercial



WR REFRIGERATION

www.wrref.com

*Engineering / Contracting
Refrigeration - Commercial
Refrigeration - Industrial*



WILLIAMS REFRIGERATION

www.williams-refrigeration.com

Refrigeration - Commercial



REFERENCES

ABOUT NATURAL REFRIGERANTS

Heaney C, Swinard R., Pang A. and West S. (2007) Natural refrigerants case studies – information and case studies for Australian businesses, Australian Institute of Refrigeration, Air Conditioning and Heating (AIRAH). [ONLINE] Available at: <http://mail.airah.org.au/downloads/natural-refrigerants-case-studies.pdf> [Accessed 13 December 2013]

Kilicarlan A. and Muller N. (2005) A comparative study of water as a refrigerant with some current refrigerants. International Journal of Energy Research. [Online] 29, 947–959. Available from: http://www.egr.msu.edu/mueller/NMReferences/MuellerKilicarlan2005_IntJEnergyRes_ComparativeStudyR718.pdf [Accessed 13 December 2013]

Kalitzin N., Wobst E., and Apley R. (2004) Turbo Water Chiller with Water as Refrigerant, International Compressor Engineering Conference, 1625. School of Mechanical Engineering, Purdue University. [Online] Available from: <http://docs.lib.purdue.edu/cgi/viewcontent.cgi?article=2624&context=icec> [Accessed 13 December 2013]

The Grimsby Institute (n.d) Air Cycle Refrigeration, Food Refrigeration & Process Engineering Research Center. The Grimsby Institute of Further & Higher Education. [Online] Available from: http://www.grimsby.ac.uk/documents/frperc/research/aircycle_research.pdf [Accessed 13 December 2013]

Venkatarathnam G. and Srinivasa Murthy S. (2012) Refrigerants for Vapour Compression Refrigeration Systems. Resonance, Journal of the Indian Academy of Sciences. February, 139-162. [Online] Available from: <http://www.ias.ac.in/resonance/Volumes/17/02/0139-0162.pdf> [Accessed 31 January 2013]

NATURAL REFRIGERANT ECOSYSTEMS - EUROPE

CITY, BUILDINGS & TRANSPORT

ARCTOS (2013) NH₃ soil freezing units with screw compressors. [ONLINE] Available at: http://www.arctos-ag.com/englisch/pdf/Job%20Report%209_NH3%20soil%20freezing%20units_eng.pdf [Accessed 31 October 2013]

ARCTOS (2013) CO₂ / NH₃ soil-freezing containerised refrigeration unit. [ONLINE] Available at: http://www.arctos-ag.com/englisch/pdf/Job%20Report%202_CO2%20%20NH3%20soil%20freezing%20container_eng.pdf [Accessed 31 October 2013]

eurammon (2012) Environment-friendly heat supply with heat pumps using natural refrigerants. [ONLINE] Available at: <http://www.eurammon.com/node/314> [Accessed 30 October 2013]

Green Cooling (2012) First Hotel to use CO₂ refrigerant. [ONLINE] Available at: <http://www.greencooling.co.uk/case-study-1.php> [Accessed 8 November 2013]

Green Cooling (2012) A UK first - CO₂ for a hospital catering facility. [ONLINE] Available at: <http://www.greencooling.co.uk/case-study-2.php> [Accessed 8 November 2013]

hydrocarbons21.com (13 November 2013) Public Utilities in Lübbecke use R290 for economical and environmentally friendly cooling. [ONLINE] Available at: <http://www.hydrocarbons21.com/news/view/4697> [Accessed 14 November 2013]

hydrocarbons21.com (5 November 2013) UK's largest ever propane chiller installation at The Co-op's new headquarters. [ONLINE] Available at:

<http://www.hydrocarbons21.com/news/view/4682>
[Accessed 8 November 2013]

R718.com (15 November 2012) Adsorption chiller integrated into CO₂ transcritical system reduces energy consumption. [ONLINE] Available at:

<http://www.r718.com/news/view/3676>
[Accessed 31 October 2013]

R718.com (29 October 2013) MediaCityUK awarded for minimising environmental impact. [ONLINE] Available at:

<http://www.r718.com/news/view/4662>
[Accessed 30 October 2013]

R718.com (18 April 2013) Sustainable architecture: absorption chillers cool transformed Reichstag. [ONLINE] Available at:

<http://www.r718.com/news/view/4124>
[Accessed 30 October 2013]

R718.com (27 August 2013) 75% solar energy conversion using photovoltaic thermal system with adsorption cooling. [ONLINE] Available at:

<http://www.r718.com/news/view/4508>
[Accessed 31 October 2013]

R718.com (21 August 2013) Absorption refrigeration provides welcome cool to sunny Mediterranean. [ONLINE] Available at:

<http://www.r718.com/news/view/4495>
[Accessed 31 October 2013]

R718.com (12 August 2013) 18kW absorption chiller driven by solar energy and gas boiler. [ONLINE] Available at:

<http://www.r718.com/news/view/4473>
[Accessed 31 October 2013]

R718.com (30 October 2012) Copenhagen: the world's largest district cooling network with absorption chiller. [ONLINE] Available at:

<http://www.r718.com/news/view/3641>
[Accessed 31 October 2013]

R744.com (13 June 2013) Norwegian housing cooperative wins prize with Green & Cool CO₂ units. [ONLINE] Available at:

<http://www.r744.com/news/view/4311>
[Accessed 30 October 2013]

R744.com (7 May 2013) Large Furniture Store chooses Green & Cool refrigeration system. [ONLINE] Available at:

<http://www.r744.com/news/view/4201>
[Assessed 30 October 2013]

R744.com (5 December 2011) UPDATE: German federal subsidy for district heating with CO₂ heat pump. [ONLINE] Available at:

<http://www.r744.com/news/view/1372>
[Accessed 30 October 2013]

Stene, J. (2008) Design and application of ammonia heat pump systems for heating and cooling of non-residential buildings, SINTEF Energy Research, Department of Energy Processes. [ONLINE] Available at:

<http://www.unepie.org/ozonaction/information/mmcfiles/6298-e-SintefBuildings.pdf>
[Accessed 8 November 2013]

Sweco (2008), Information from Sweco Grøner AS, Norway
ABB (2013): "ABB motors power world's largest heat pump district heating plant"

<http://www.abb.com/cawp/seitp202/23d31cd6c92c87f6c1257bb7004d5c32.aspx>
[Accessed 30 October, 2013]

Vad Mathiesen, B., Boje Blarke, M., Hansen, K., Connolly, D. (2011) The role of large-scale heat pumps for short term integration of renewable energy, Department of Energy Technology, Aalborg University. [ONLINE] Available at:

http://energioresund.org/pic_m/16_verdi_182_LargeScaleHeatPumps.pdf
[Accessed 30 October 2013]

INDUSTRY

ammonia21.com (30 April 2013) First natural gas-free greenhouse in Netherlands. [ONLINE] Available at:

<http://www.ammonia21.com/news/view/4175>

[Accessed 13 November 2013]

ARCTOS (2013) CO₂/NH₃ soil-freezing containerised refrigeration unit. [ONLINE] Available at:
http://www.arctos-ag.com/englisch/pdf/Job%20Report%20_CO2%20%20NH3%20soil%20freezing%20container_eng.pdf
[Accessed 13 November 2013]

ARCTOS (2013) CO₂/propene cascade refrigeration system for low temperatures. [ONLINE] Available at:
http://www.arctos-ag.com/englisch/pdf/Job%20Report%203_CO2%20%20propene%20cascade%20refrigeration%20system_eng.pdf
[Accessed 13 November 2013]

Cofely Refrigeration (2009) Customised Industrial Refrigeration. [ONLINE] Available at:
http://www.cofely-refrigeration.de/export/sites/cofely.refrigeration/de/Download/Broschueren/COFELY_Refrigeration/englischbrosch/ENG_cofely_IKM-BROSCHUERE_2009-11-03_web.pdf
[Accessed 10 November 2013]

SPORTS

Danfoss (31 January 2013) Ice rink scores with 100% CO₂ system. [ONLINE] Available at:
<http://www.danfoss.com/SolutionsReady/NewsAndEvents/News/Ice-rink-scores-with-CO2-system/F100620A-6FF1-47A0-9242-81D34500AFD5.html>
[Accessed 3 October 2013]

eurammon (2012) "Lentpark" – ice skating and swimming stadium / Cologne, Germany. [ONLINE] Available at:
<http://www.eurammon.com/information-material/case-studies/lentpark-ice-skating-and-swimming-stadium-cologne-germany>
[Accessed 10 October 2013]

R744.com (2 October 2013) CO₂ in ice rink refrigeration. [ONLINE] Available at:
<http://www.r744.com/news/view/4596>
[Accessed 19 October 2013]

Tuyet Nguyen (2012) Carbon Dioxide in Ice Rink Refrigeration, KTH School of Industrial Engineering and Management. [ONLINE] Available at:
[http://www.r744.com/web/assets/link/4596_nguyen_tuyet_EGI-2013-013_msc%20\(2\).pdf](http://www.r744.com/web/assets/link/4596_nguyen_tuyet_EGI-2013-013_msc%20(2).pdf)
[Accessed 03 October 2013]

NATURAL REFRIGERANTS IN THE EUROPEAN FOOD CHAIN

APPLICATION AREAS

ACHRNews (11 December 2012) Refrigeration Uses Heat Pumps, Ammonia. [ONLINE] Available at:
<http://www.achrnews.com/articles/121349-commercial-uses-heat-pumps-ammonia>
[Accessed 03 October 2013]

ammonia21.com (31 January 2012) Star equips Welsh bakery with combined spiral freezer & refrigeration plant. [ONLINE] Available at:
<http://www.ammonia21.com/news/view/2075>
[Accessed 17 October 2013]

ammonia21.com (1 June 2012) Ammonia refrigeration is best practice in McDonald's supply chain. [ONLINE] Available at:
<http://www.ammonia21.com/news/view/3210>
[Accessed 17 October 2013]

ammonia21.com (31 May 2012) Polish dairies achieve 25% energy savings using GEA Grasso V NH₃ compressors and automated control systems. [ONLINE] Available at:
<http://www.ammonia21.com/news/view/3199>
[Accessed 1 November 2013]

ammonia21.com (20 February 2012) The perfect catch for the fishery cold chain: ammonia refrigeration. [ONLINE] Available at:
<http://www.ammonia21.com/news/view/2084>
[Accessed 5 November 2013]

ammonia21.com (15 November 2011) Exclusive interview with Paul Kidger on refrigeration needs of breweries. [ONLINE] Available at:

<http://www.ammonia21.com/news/view/2047>
[Accessed 5 November 2013]

ammonia21.com (19 July 2012) Ammonia keeps your beer ice cold while saving brewers energy costs. [ONLINE] Available at:

<http://www.ammonia21.com/news/view/3362>
[Accessed 5 November 2013]

ammonia21.com (3 April 2012) Bonduelle teams up with GEA in improving efficiency. [ONLINE] Available at:

<http://www.ammonia21.com/news/view/3077>
[Accessed 5 November 2013]

ammonia21.com (1 August 2013) NH₃ chillers feature at most environmentally friendly dairy in Europe. [ONLINE] Available at:

<http://www.ammonia21.com/news/view/4449>
[Accessed 10 October 2013]

Cofely Axima Refrigeration (2013) Customer Stories, Industrial Refrigeration, Food, Fruit and Vegetables. [ONLINE] Available at:

<http://refrigeration.cofelyaxima-gdfsuez.be/en/customer-stories/industrial-refrigeration/food/fruit-and-vegetables>
[Accessed 12 November 2013]

Cofely Axima Refrigeration (2013) Customer Stories, Industrial Refrigeration, Food, Breweries and soft drinks. [ONLINE] Available at:

<http://refrigeration.cofelyaxima-gdfsuez.be/en/customer-stories/industrial-refrigeration/food/breweries-and-soft-drinks>
[Accessed 12 November 2013]

Cofely Axima Refrigeration (2013) Customer Stories, Industrial Refrigeration, Food, Meat and Fish. [ONLINE] Available at:

<http://refrigeration.cofelyaxima-gdfsuez.be/en/customer-stories/industrial-refrigeration/food-meat-and-fish>
[Accessed 12 November 2013]

Cofely Axima Refrigeration (2013) Customer Stories, Industrial Refrigeration, Food, Dairy. [ONLINE] Available at:

<http://refrigeration.cofelyaxima-gdfsuez.be/en/customer-stories/industrial-refrigeration/food-dairy-products>
[Accessed 12 November 2013]

Cofely Axima Refrigeration (2013) Customer Stories, Industrial Refrigeration, Food, Bakeries, pasta, snacks and instant meals. [ONLINE] Available at:

<http://refrigeration.cofelyaxima-gdfsuez.be/en/customer-stories/industrial-refrigeration/food/bakeries-pasta-snacks-and-instant-meals>
[Accessed 12 November 2013]

Cofely Axima Refrigeration (2013) Customer Stories, Industrial Refrigeration, Distribution and wholesale. [ONLINE] Available at:

<http://refrigeration.cofelyaxima-gdfsuez.be/en/customer-stories/industrial-refrigeration/distribution-and-wholesale>
[Accessed 12 November 2013]

Emerson Climate Technologies (2012) Fish processing plant streamlines production with upgraded refrigeration system. [ONLINE] Available at:

http://www.emersonclimate.com/Documents/Vilter/Articles/Fish_Processing_plant.pdf
[Accessed 10 October 2013]

EPA (2010) Transitioning to low-GWP Alternatives in Transport Refrigeration. United States Environmental Protection Agency. [ONLINE] Available at:

http://www.epa.gov/ozone/downloads/EPA_HFC_Transport.pdf
[Accessed 19 October 2013]

eurammon(2013): Dual Temperature Cooling System, Hertfordshire (UK). [ONLINE] Available at:

<http://www.eurammon.com/information-material/case-studies/dual-temperature-cooling-system-hertfordshire-uk>
[Accessed 10 October 2013]

eurammon(2012): Project: Chilling the brewing water for Brauhaus Tegernsee. [ONLINE] Available at:

<http://www.eurammon.com/information-material/case-studies/project-chilling-brewing-water-brauhaus-tegernsee>
[Accessed 10 October 2013]

eurammon (2013) Cool Solution for Kuehne+Nagel Distribution Centre, Brinklow (UK). [ONLINE] Available at:

<http://www.eurammon.com/information-material/case-studies/cool-solution-kuehne-nagel-distribution-centre-brinklow-uk>
[Accessed 19 October 2013]

Green Cooling (2012): National Restaurant Chain - Standard or Bespoke Cold Rooms. [ONLINE] Available at:

<http://www.greencooling.co.uk/case-study-3.php>
[Accessed 8 November 2013]

hydrocarbons21.com (31 October 2013) Propane heating and cooling plants in series production. [ONLINE] Available at:

<http://www.hydrocarbons21.com/news/view/4672>
[Accessed 7 November 2013]

Lidl (2013) Klimafreundliche Logistikzentren. [ONLINE] Available at:

<http://www.lidl.de/de/Klimafreundliche-Logistikzentren>
[Accessed 10 October, 2013]

FreshPlaza (26 September 2012) Netherlands: Kloosterboer chooses Nijssen's innovative cooling system [ONLINE] Available at:

<http://www.freshplaza.com/article/101210/Netherlands-Kloosterboer-chooses-Nijssens-innovative-cooling-system>
[Accessed 10 October 2013]

R718.com (3 October 2012) 20 years of highly reliable, low maintenance and stable performance solar cooling system in France. [ONLINE] Available at:

<http://www.r718.com/news/view/3577>
[Accessed 3 October 2013]

R718.com (19 December 2012) Absorption chiller on board of the new AIDamar cruise liner. [ONLINE] Available at:

<http://www.r718.com/news/view/3764>

[Accessed 30 October 2013]

R744.com (30 May 2013) 1/3 of conventional service costs for Konvekta CO₂ MAC buses. [ONLINE] Available at:

<http://www.r744.com/news/view/4260>
[Accessed 10 October 2013]

R744.com (23 September 2013) CO₂ efficiency in bakeries, breweries, fishing vessels, heat pumps & more. [ONLINE] Available at:

<http://www.r744.com/news/view/4573>
[Accessed 10 October 2013]

SRS Frigadon (2013) SRS Projects. [ONLINE] Available at:

<http://www.srs-frigadon.com/projects.html>
[Accessed 03 October 2013]

The Alliance for CO₂ Solutions (2007) Documents Overview. [ONLINE] Available at:

http://www.alliance-co2-solutions.org/docs/overview_2.pdf
[Accessed 30 October 2013]

thermea (2012): thermeco2 Hochtemperaturwärmepumpenanlage für den Schlachtbetrieb Zürich. [ONLINE] Available at:

<http://www.thermea.de/praxis/praxisbeispiel-schlachtbetrieb-zuerich>
[Accessed 10 October 2013]

CO₂ TRANSCRITICAL STORES IN EUROPE

AXIMA REFRIGERATION (2013) Références en Grandes et moyennes surfaces - LECLERC : Ancenis. [ONLINE] Available at:

http://www.aximaref.com/photos/863_fiche_ref_LECLERC_Ancenis_06_13.pdf
[Accessed 14 November 2013]

de Rooij M. (2013) The Ahold steps to proven sustainability [Presentation] ATMosphere Europe 2013, Brussels, 16 October 2013. [ONLINE] Available at:

<http://www.atmo.org/media.presentation.php?id=313>
[Accessed 12 November 2013]

Deutsche Umwelthilfe (2013) Wie klimafreundlich kühlen Deutschlands Supermärkte? [ONLINE] Available at:

<http://www.r744.com/knowledge/papersView/1522>
[Accessed 3 December 2013]

EIA Chilling Facts V (2013) Retailers on the cusp of a global cooling revolution. Environmental Investigation Agency. [ONLINE] Available at:

http://www.eia-international.org/wp-content/uploads/EIA_Chilling_Facts_V_report_0813_FINAL_LOWRES.pdf
[Accessed 8 November 2013]

Migros (2012) Protecting the climate by using less energy. [ONLINE] Available at:

<http://m12.migros.ch/en/our-responsibility/environment/energy-and-climate>
[Accessed 12 November 2013]

R744.com (15 February 2013) Knut Lutnæs from Coop, Norway on transcritical CO₂ initiative and market projections. [ONLINE] Available at:

<http://www.r744.com/news/view/3882>
[Accessed 8 November 2013]

R744.com (23 November 2013) CO₂ systems save 30% heat energy in Kesco's stores in Finland. [ONLINE] Available at:

<http://www.r744.com/news/view/3698>
[Accessed 8 November 2013]

R744.com (11 June 2013) Worldwide, retailers commit to CO₂ – the view from CGF's "Moving away from HFCs... Naturally!" Summit. [ONLINE] Available at:

<http://www.r744.com/news/view/4302>
[Accessed 8 November 2013]

R744.com (9 July 2013) "CO₂ is on the way to becoming a standard" – exclusive interview with Robert Hurley, Tesco. [ONLINE] Available at:

<http://www.r744.com/news/view/4382>
[Accessed 8 November 2013]

R744.com (28 October 2013) ATMOsphere confirms preference for CO₂ refrigeration by many retailers and end-users. [ONLINE] Available at:

<http://www.r744.com/news/view/4655>

[Accessed 8 November 2013]

R744.com (29 November 2012) British retailer Booths expects all new stores to feature R744. [ONLINE] Available at:

<http://www.r744.com/news/view/3713>
[Accessed 8 November 2013]

R744.com (17 December 2010) 50 CO₂OLtec systems from Carrier for German retailer tegut. [ONLINE] Available at:

<http://www.r744.com/news/view/1308>
[Accessed 8 November 2013]

R744.com (10 April 2012) First CO₂ transcritical in a French supermarket. [ONLINE] Available at:

<http://www.r744.com/news/view/3097>
[Accessed 8 November 2013]

R744.com (21 May 2013) Ahold's global perspective on CO₂ systems: 100% CO₂ in 10 years? [ONLINE] Available at:

<http://www.r744.com/news/view/4231>
[Accessed 8 November 2013]

R744.com (18 June 2013) Sainsbury's tests first small CO₂ transcritical refrigeration system. [ONLINE] Available at:

<http://www.r744.com/news/view/4320>
[Accessed 8 November 2013]

R744.com: Aldi Süd (15 February 2013) 20% reduction in energy consumption with optimised CO₂ system. [ONLINE] Available at:

<http://www.r744.com/news/view/3881>
[Accessed 12 November 2013]

R744.com (19 December 2011) Spain: increasing investments in sustainable HVAC&R solutions. [ONLINE] Available at:

<http://www.r744.com/news/view/1556>
[Accessed 12 November 2013]

R744.com (5 October 2012) CAREL control system drives new transcritical supermarket in Italy. [ONLINE] Available at:

<http://www.r744.com/news/view/3588>
[Accessed 14 November 2013]

R744.com (28 November 2013) 100% green Norwegian supermarket to achieve 30% energy savings. [ONLINE] Available at: <http://www.r744.com/news/view/4748>
[Accessed 2 December 2013]

R744.com (29 November 2013) R744 achieves 20-30% energy savings in one of largest Scandinavian supermarkets. [ONLINE] Available at:
<http://www.r744.com/news/view/4751>
[Accessed 2 December 2013]

Sainsbury's (2013) Sainsbury's opens first 'Triple Zero' stores. [ONLINE] Available at:
<http://www.j-sainsbury.co.uk/media/latest-stories/2013/20131120-sainsburys-opens-first-triple-zero-stores/>
[Accessed 3 December 2013]

Skelton J. (2013) How Sainsbury's 20x20 sustainability plan has shaped its refrigeration strategy [Presentation] ATMOsphere Europe 2013, Brussels, 16 October 2013. [ONLINE] Available at:
<http://www.atmo.org/media.presentation.php?id=315>
[Accessed 12 November 2013]

Topley Lira J., Chasserot M., Menten F. (2013) ATMOsphere Europe 2013 - Summary Report of International Conference. [ONLINE] Brussels, shecco publications. [ONLINE] Available at:
http://publications.shecco.com/upload/file/org/1384183027438213_362072.pdf
[Accessed 12 November 2013]

Veld Koeltechniek BV (2013) C1000 Eddie Dijkman opent onder Jumbo vlag. [ONLINE] Available at:
http://www.veld.nl/retail/referenties/energiezuinig_koelsysteem_jumbo.aspx
[Accessed 13 November 2013]

Weinhofer G. (2012) CO₂ as refrigerant: from tests to standard [Presentation] ATMOsphere Europe 2012, Brussels, 7 November 2013. [ONLINE] Available at:
<http://www.atmo.org/media.presentation.php?id=187>

[Accessed 12 November 2013]

CO₂ CASCADE STORES IN EUROPE

Alway P. (2013) Current natural refrigerant technology and next steps towards HFC-free heat reclaim Refrigeration [Presentation] ATMOsphere Europe 2013, Brussels, 16 October 2013. [ONLINE] Available at:
<http://www.atmo.org/media.presentation.php?id=314>
[Accessed 12 November 2013]

AXIMA REFRIGERATION (2011) Références en Grandes et moyennes surfaces - LECLERC : Ploufragan (22). [Online] Available at:
http://www.aximaref.com/photos/761_Leclerc_Ploufragan_05_11_IMP.pdf
[Accessed 14 November 2013]

de Rooij M. (2013) The Ahold steps to proven sustainability Refrigeration [Presentation] ATMOsphere Europe 2013, Brussels, 16 October 2013. [ONLINE] Available at:
<http://www.atmo.org/media.presentation.php?id=313>
[Accessed 8 November 2013]

EIA Chilling Facts V (2013) Retailers on the cusp of a global cooling revolution. Environmental Investigation Agency. [ONLINE] Available at:
http://www.eia-international.org/wp-content/uploads/EIA_Chilling_Facts_V_report_0813_FINAL_LOWRES.pdf
[Accessed 8 November 2013]

R744.com (28 October 2013) ATMOsphere confirms preference for CO₂ refrigeration by many retailers and end-users. [ONLINE] Available at:
<http://www.r744.com/news/view/4655>
[Accessed 8 November 2013]

R744.com (21 May 2013) Ahold's global perspective on CO₂ systems: 100% CO₂ in 10 years? [ONLINE] Available at:
<http://www.r744.com/news/view/4231>
[Accessed 8 November 2013]

R744.com (13 July 2012) REWE International AG: CO₂ in deep freezing standard but not envisaged for medium temperature cooling yet. [ONLINE] Available at:

<http://www.r744.com/news/view/3350>
[Accessed 8 November 2013]

R744.com (30 October 2013) real,- opens green store using CO₂ for refrigeration. [ONLINE] Available at:

<http://www.r744.com/news/view/4670>
[Accessed 12 November 2013]

R744.com (30 November 2012) Carrefour opens new CO₂ store in France. [ONLINE] Available at:

<http://www.r744.com/news/view/3714>
[Accessed 12 November 2013]

R744.com (19 December 2011) Spain: increasing investments in sustainable HVAC&R solutions. [ONLINE] Available at:

<http://www.r744.com/news/view/1556>
[Accessed 12 November 2013]

R744.com (24 May 2013) DinoSol's first cascade CO₂ store brings R744 to Canary Islands. [ONLINE] Available at:

<http://www.r744.com/news/view/4248>
[Accessed 12 November 2013]

R744.com (06 August 2012) Carrefour Spain: 16% reduction in energy consumption with hybrid CO₂ refrigeration. [ONLINE] Available at:

<http://www.r744.com/news/view/3418>
[Accessed 12 November 2013]

R744.com (15 July 2013) Eroski supermarket achieves 65% energy savings with R134a/CO₂ system. [ONLINE] Available at:

<http://www.r744.com/news/view/4410>
[Accessed 12 November 2013]

Topley Lira J., Chasserot M., Menten F. (2013) ATMOsphere Europe 2013 - Summary Report of International Conference. [Online] Brussels, shecco publications. [Online] Available at:

http://publications.shecco.com/upload/file/org/1384183027438213_362072.pdf
[Accessed 12 November 2013]

R744.com (22 February 2012) QPlans CO₂/NH₃ cascade systems save 40% energy in Tesco and Auchan hypermarkets. [ONLINE] Available at:

<http://www.r744.com/news/view/1618>
[Accessed 13 November 2013]

Weinhofer G. (2012) CO₂ as refrigerant: from tests to standard [Presentation] ATMOsphere Europe 2012, Brussels, 07 November 2013. [ONLINE] Available at:

<http://www.atmo.org/media.presentation.php?id=187>
[Accessed 12 November 2013]

HC PLUG-IN AND INDIRECT NH₃ AND HC SUPERMARKETS IN EUROPE

Deutsche Umwelthilfe (2013) Wie klimafreundlich kühlen Deutschlands Supermärkte? [ONLINE] Available at:

<http://www.hydrocarbons21.com/knowledge/papersView/1522>
[Accessed 3 December 2013]

EIA Chilling Facts V (2013) Retailers on the cusp of a global cooling revolution. Environmental Investigation Agency. [ONLINE] Available at:

http://www.eia-international.org/wp-content/uploads/EIA_Chilling_Facts_V_report_0813_FINAL_LOWRES.pdf
[Accessed 8 November 2013]

hydrocarbons21.com (31 October 2013) Propane heating and cooling plants in series production. [ONLINE] Available at:

<http://www.hydrocarbons21.com/news/view/4672>
[Accessed 14 November 2013]

hydrocarbons21.com (20 September 2013) Hydrocarbons gain share in European commercial refrigeration- EIA's 'Chilling Facts V'. [ONLINE] Available from:

<http://www.hydrocarbons21.com/news/view/4570>
[Accessed 14 November 2013]

Resch R. (2013) Natural refrigerants for commercial freezers [Presentation] ATMOsphere Europe 2013, Brussels, 16 October 2013. [ONLINE] Available at:

<http://www.atmo.org/media.presentation.php?id=322>
[Accessed 19 November 2013]

LIGHT-COMMERCIAL REFRIGERATION

Azar A. (2013) Phase-out F-Gases in Commercial Refrigeration [Presentation] ATMOsphere Europe 2013, Brussels, 16 October 2013. [ONLINE] Available at:

<http://www.atmo.org/media.presentation.php?id=310>
[Accessed 21 November 2013]

Danish Ministry of the Environment (2012) Going Natural – The Danish road to natural refrigerants [ONLINE] Available at:

<https://www.thepmr.org/system/files/documents/Going%20Natural-Danish%20Experience%20with%20natural%20refrigerants.pdf>
[Accessed 22 November 2013]

hydrocarbons21.com (24 October 2013) ATMOsphere Europe 2013: Buoyant market for hydrocarbons in light commercial refrigeration. [ONLINE] Available at:

<http://www.hydrocarbons21.com/news/view/4648>
[Accessed 21 November 2013]

hydrocarbons21.com (17 August 2012) Light commercial refrigeration: latest from North America. [ONLINE] Available at:

<http://www.hydrocarbons21.com/news/view/3458>
[Accessed 22 November 2013]

hydrocarbons21.com: Nestlé: Over 11,000 hydrocarbon ice cream freezers in 7 countries. [ONLINE] Available at:

<http://www.hydrocarbons21.com/news/view/3179>
[Accessed 22 November 2013]

Jafa E. (2012) PepsiCo Journey HFC Alternatives Equipment Sustainability [Presentation] ATMOsphere America 2012, Washington DC, 13 June 2012. [ONLINE] Available at:

<http://www.atmo.org/media.presentation.php?id=151>

[Accessed 21 November 2013]

Nestlé (2013) Nestlé in Society: Creating Shared Value [ONLINE] Available at:

<http://ceowatermandate.org/files/endorsing/Nestle-CSV-Full-Report-2012-EN.pdf>
[Accessed 22 November 2013]

Refrigerants, Naturally! (2013) Statements – PepsiCo [ONLINE] Available at:

<http://www.refrigerantsnaturally.com/statements/pepsico.htm>
[Accessed 22 November 2013]

Topley Lira J., Chasserot M., Menten F. (2013) ATMOsphere Europe 2013 - Summary Report of International Conference. [Online] Brussels, shecco publications.

[Online] Available at:

http://publications.shecco.com/upload/file/org/1384183027438213_362072.pdf
[Accessed 12 November 2013]

CO₂ TRANSCRITICAL AND CASCADE / SECONDARY STORES WORLDWIDE

Cold Hard Facts 2 (2013) A study of the refrigeration and air conditioning industry in Australia. [ONLINE] Available at:

<http://www.hydrocarbons21.com/knowledge/papersView/1438>
[Accessed 16 November 2013]

EIA Chilling Facts V (2013) Retailers on the cusp of a global cooling revolution. Environmental Investigation Agency. [ONLINE] Available at:

http://www.eia-international.org/wp-content/uploads/EIA_Chilling_Facts_V_report_0813_FINAL_LOWRES.pdf
[Accessed 8 November 2013]

Hillphoenix (20 May 2013) Caputo's to Use Transcritical Refrigeration in Hybrid Location. [ONLINE] Available at:

<http://www.hillphoenix.com/wp-content/uploads/2011/06/Caputos-to-use-transcritical-refrigeration.pdf>
[Accessed 6 December 2013]

R744.com (11 June 2013) Worldwide, retailers commit to CO₂ – the view from CGF's "Moving away from HFCs... Naturally!" Summit. [ONLINE] Available at:

<http://www.r744.com/news/view/4302>
[Accessed 8 November 2013]

R744.com (09 July 2013) "CO₂ is on the way to becoming a standard" – exclusive interview with Robert Hurley, Tesco. [ONLINE] Available at:

<http://www.r744.com/news/view/4382>
[Accessed 8 November 2013]

R744.com (18 December 2012) Cascade CO₂ could be winning option in emerging economies - CCAC Forum, Part I. [ONLINE] Available at:

<http://www.r744.com/news/view/3755>
[Accessed 8 November 2013]

R744.com (13 August 2012) New World becomes New Zealand's first CO₂ transcritical store. [ONLINE] Available at:

<http://www.r744.com/news/view/3445>
[Accessed 13 November 2013]

R744.com (7 October 2013) First ATMOSphere network Tokyo event sees Lawson predict close to 40% energy savings with CO₂ TC in Indonesia. [ONLINE] Available at:

<http://www.r744.com/news/view/4599>
[Accessed 14 November 2013]

R744.com (18 June 2012) ATMOSphere America 2012: an exciting year ahead for CO₂ refrigeration. [ONLINE] Available at: <http://www.r744.com/news/view/3256>
[Accessed 14 November 2013]

R744.com (28 September 2012) New Zealand's 2nd transcritical CO₂ supermarket opens its doors. [ONLINE] Available at:

<http://www.r744.com/news/view/3566>
[Accessed 14 November 2013]

R744.com (19 June 2012) Carrefour installs first CO₂ transcritical system in Turkey. [ONLINE] Available at:

<http://www.r744.com/news/view/3261>
[Accessed 15 November 2013]

R744.com (2 September 2013) UPDATE: Delhaize opens first 100% CO₂ transcritical store in the US. [ONLINE] Available at:

<http://www.r744.com/news/view/4377>
[Accessed 15 November 2013]

R744.com (10 August 2012) SUPERVALU opens it's first all natural refrigerant store. [ONLINE] Available at:

<http://www.r744.com/news/view/3443>
[Accessed 15 November 2013]

R744.com (21 November 2013) Cost parity of CO₂ cascade refrigeration achieved in latest Brazilian R744 refrigeration installation. [ONLINE] Available at:

<http://www.r744.com/news/view/4723>
[Accessed 22 November 2013]

R744.com (27 November 2013) 17 transcritical CO₂ stores already installed in South Africa. [ONLINE] Available at:

<http://www.r744.com/news/view/4742>
[Accessed 3 December 2013]

R744.com (27 June 2013) CO₂ transcritical milestones - 3-year payback and now in the US - latest from ATMOSphere America. [ONLINE] Available at:

<http://www.r744.com/news/view/4345>
[Accessed 6 December 2013]

R744.com (25 November 2013) UPDATE: First ever net zero energy store by Walgreens relies on CO₂ heating and cooling. [ONLINE] Available at:

<http://www.r744.com/news/view/4068>
[Accessed 6 December 2013]

POLICY

EU POLICIES

Council Directive 2006/40/EC (2006) Directive 2006/40/ec of the European parliament and of the Council, of 17 May 2006 relating to emissions from air-conditioning systems in motor vehicles and amending Council Directive 70/156/EEC (Text with EEA relevance). Official Journal of the European Union. [ONLINE] Available at:

<http://eur-lex.europa.eu/LexUriServ/LexUriServ.do?uri=OJ:L:2006:161:0012:0018:EN:PDF>
[Accessed 17 December 2013]

European Commission (2011) Report from the Commission on the application, effects and adequacy of the Regulation on certain fluorinated greenhouse gases (Regulation (EC) No 842/2006).). [ONLINE] Available at:

http://ec.europa.eu/clima/policies/f-gas/docs/report_en.pdf
[Accessed 12 December 2013]

European Commission (2013) Commission Regulation (EU) No 813/2013 of 2 August 2013 implementing Directive 2009/125/EC of the European Parliament and of the Council with regard to ecodesign requirements for space heaters and combination heaters (Text with EEA relevance).). Official Journal of the European Union. [ONLINE] Available at:

<http://eur-lex.europa.eu/LexUriServ/LexUriServ.do?uri=OJ:L:2013:239:0136:0161:EN:PDF>
[Accessed 17 December 2013]

European Commission (2013) Commission Regulation (EU) No 814/2013 of 2 August 2013 implementing Directive 2009/125/EC of the European Parliament and of the Council with regard to ecodesign requirements for water heaters and hot water storage tanks (Text with EEA relevance). Official Journal of the European Union. [ONLINE] Available at:

<http://eur-lex.europa.eu/LexUriServ/LexUriServ.do?uri=OJ:L:2013:239:0162:0183:EN:PDF>
[Accessed 17 December 2013]

European Commission (2012) Proposal for a Regulation of the European Parliament and of the Council on fluorinated greenhouse gases. [ONLINE] Available at:

http://ec.europa.eu/clima/policies/f-gas/legislation/docs/com_2012_643_en.pdf
[Accessed 12 December 2013]

R744.com (27 August 2013) MAC update: French court rules in Daimler's favour; Toyota turns away from R1234yf. [ONLINE] Available at:

<http://www.r744.com/news/view/4510>
[Accessed 17 December 2013]

R744.com (22 October 2013) F-Gas discussions take centre stage at ATMosphere Europe 2013. [ONLINE] Available at:

<http://www.r744.com/news/view/4640>
[Accessed 17 December 2013]

NATIONAL POLICIES

BAFA (2013) Richtlinien zur Förderung von Maßnahmen an gewerblichen Kälteanlagen vom 01.01.2009. Bundesamt für Wirtschaft und Ausfuhrkontrolle (BAFA). [ONLINE] Available at:

<http://www.bafa.de/bafa/de/energie/kaelteanlagen/index.html>
[Accessed 17 December 2013]

German Federal Ministry for the Environment, Nature Conservation and Nuclear Safety (2009) Richtlinien zur Förderung von Maßnahmen an gewerblichen Kälteanlagen vom 1. Januar 2009. [ONLINE] Available at:

http://www.bafa.de/bafa/de/energie/kaelteanlagen/vorschriften/foerderrichtlinie_kaelte.pdf
[Accessed 17 December 2013]

hydrocarbons21.com (12 November 2012) Switzerland to introduce HFC bans in several AC and refrigeration applications. [ONLINE] Available at:

<http://www.hydrocarbons21.com/news/view/3659>
[Accessed 17 December 2013]

Maratou, A., Skačanová, K., Vanaga, G. (2013) GUIDE+: HFC taxes & fiscal incentives for natural refrigerants in Europe. shecco publications. [ONLINE] Available at:

<http://publications.shecco.com/publications/view/guidehfctaxesandfiscalincentivesfornrineurope>

The Swiss Federal Council (2013) Ordinance on the Reduction of Risks relating to the Use of Certain Particularly Dangerous Substances, Preparations and Articles (Chemical Risk Reduction Ordinance, ORRChem). [ONLINE] Available at:

<http://www.admin.ch/ch/e/rs/8/814.81.en.pdf>
[Accessed 17 December 2013]

ABOUT THE AUTHORS



MARC CHASSEROT
Publisher /
Managing Director

Marc holds degrees (incl. two Masters) in Economics, Politics, and Marketing. He has studied at the London School of Economics, INSEAD Singapore, Sciences Po Paris, and the College of Europe. He has specialized in natural refrigerants since 2003. He is an active member of ASHRAE. He founded the leading industry platforms R744.com, hydrocarbons21.com, and ammonia21.com. Since 2007 Marc is co-founder and Managing Director of shecco, an independent market development company specialised in bringing Natural Refrigerants 'faster to market'.



HUITING JIA
Market Research
Analyst

Huiting holds two Masters' degrees in Development Studies and International Relations from Groningen University, Netherlands and Uppsala University, Sweden. With a background in EU policy, politics, and the Chinese economy, Huiting currently works as part of shecco's Market Research team. Her expertise is in providing tailored analysis of key trends and developments, and assisting clients to optimise their strategy in target HVAC&R markets.



**ALEXANDRA
MARATOU**
Deputy Public Affairs
Manager

Environmental and energy issues are the drive and focus in what Alexandra does. After studying Environmental and Resource Economics at University College London, she was a research assistant at the Electricity Policy Research Group at the University of Cambridge, UK. Following that, she worked as an intern at Cabinet Dimas, Commissioner for the Environment at the European Commission before joining shecco. Today, she is Deputy Public Affairs Manager, analysing key policy trends and advising partners on strategic decisions.



NINA MASSON
Lead Author /
Head of Market
Research

Nina holds two Masters' degrees in Business Management and in Environmental Management. After serving in a communications role for Norsk Hydro, for the last 7 years she has been working in the field of environmental technologies, where she specialised on natural refrigerants. Today, she is active in business development for market intelligence and consultancy services, as well as special projects and publications. She drafted global studies for United Nations agencies, including UNEP and UNIDO. Nina is Associate Member of the Institute of Environmental Management and Assessment (IEMA).



SIMON BURKEL
Market Research
Analyst

Simon holds a degree in Business Administration and two Masters' degrees in Marketing and Commercial Management from Friedrich Alexander University in Nuremberg and the EM Strasbourg Business School. Prior to joining shecco, Simon worked in sales for a leading aluminium manufacturer. He currently works in shecco's Market Research department conducting and analysing quantitative and qualitative surveys to identify market figures and key trends in the HVAC&R industry for special projects and internationally distributed publications.



**KLÁRA
SKAČANOVÁ**
Policy Analyst

Klára holds a Masters' degree in International Relations from the University of Economics in Bratislava, Slovakia and has a background in European studies and international economic relations. Before joining shecco, she worked at the European Commission and a small business association. At her current position, Klára follows legislative developments having impact on the heating and cooling industry at national, European and international level, and informs decision-makers about the latest trends in the field of natural refrigerants.

shecco would also like to thank the following contributors: Ginta Vanaga, Janaina Topley Lira, Silvia Scaldaferrri, Janet Thompson, Pierre Wattré



Get in touch with us to learn how we can help you in gathering business intelligence, in getting your climate friendly technology faster to market, and in spreading your message among decision makers

EMAIL US AT

publications@shecco.com

TALK TO US ON THE PHONE

shecco europe
(+32) 2 230 3700

shecco japan
(+81) 3 3287 7330

OUR MAILING ADDRESSES

Europe
shecco
Rue Royale 15
1000, Brussels
Belgium

Japan
shecco Japan K.K.
Office 20 EGG JAPAN
Shin-Marunouchi Building 10F
Marunouchi 1-5-1, Chiyoda-ku
100-6590, Tokyo, Japan

powered by



Sustaining our atmosphere