

WINCOR
NIXDORF

BEETLE /mini POS System
Operating Manual

Linux™ is a registered trademark of Linus Torvalds
Pentium™ is a registered trademark of the Intel Corporation
MS-DOS™, Windows 95™, Windows 98™, Windows NT™, Windows 2000™,
Windows XP™ and Windows CE™ are registered trademarks of the Microsoft
Corporation
BEETLE™ is a registered trademark of Wincor Nixdorf GmbH & Co. KG

Copyright© Wincor Nixdorf GmbH & Co. KG, 2008

The reproduction, transmission or use of this document or its contents is not permitted without express authority. Offenders will be liable for damages. All rights, including rights created by patent grant or registration of a utility model or design, are reserved. Delivery subject to availability; technical modifications possible.

BEETLE /mini

POS System

Operating Manual

Edition Nov 2009

Contents

MANUFACTURERS CERTIFICATION AND NOTES	1
TESTED SAFETY	1
BSMI (EMC FOR TAIWAN).....	1
IMPORTANT NOTES.....	2
POWER CORD SELECTION	3
REPLACING THE LITHIUM BATTERY	4
INTRODUCTION	5
ABOUT THIS MANUAL	5
CARE OF THE BEETLE /MINI.....	6
RECYCLING THE BEETLE /MINI.....	6
WARRANTY	7
DEVICE OVERVIEW	8
FRONT VIEW.....	8
BASIC OPERATION.....	9
BEFORE SWITCHING ON THE SYSTEM	9
Unpacking and checking the System	9
Setting up the device.....	9
Cabling of the BEETLE /mini	10
Connecting to the Main Power Supply	10
SWITCHING ON THE SYSTEM.....	10
BEETLE /MINI – THE COMPONENTS	11
FUNCTIONS & INDICATORS ON THE BEETLE /MINI.....	11
❶ – ON/OFF Button.....	11
❷ – POWER-ON Indicator (LED)	11
❸ – HARD-DISK DRIVE Indicator (LED).....	11
❹ – USB Connector.....	12
REAR PANEL CONNECTORS ON THE BEETLE /MINI	13
DC 12V (Power Output Port)	14
Expansion Slots	15

Power Supply Unit.....	15
VGA Connector for Monitor or LCD-Display.....	16
Keyboard Connector (PS/2)	16
Mouse Connector (PS/2).....	16
Parallel Interface LPT1 for Modular Printer	16
Four COM ports for Standard PC Peripherals.....	16
LAN (RJ45) Socket for Network.....	17
USB (Universal Serial Bus) Port 1 and 2.....	17
Audio Port Sockets.....	17
HOW TO SLIDE OPEN THE TOP COVER OF THE CASE	18
SYSTEM CONFIGURATION.....	18
70H08-MINI ATX INTEL MOTHERBOARD	19
Motherboard Block Diagram	20
Motherboard Details.....	21
SYSTEM BIOS	22
SETUP ITEMS	23
APPENDIX	25
TECHNICAL DATA FOR THE BEETLE /MINI	25

Manufacturers Certification and notes



The device complies with the requirements of the EEC directive 2004/108/EC with regard to "Electromagnetic compatibility" and 2006/95/EC "Low Voltage Directive".

Therefore, you will find the CE mark on the device or packaging.

Tested Safety



In addition, the device has received the UL symbol and cUL symbol.

BSMI (EMC for Taiwan)



The device complies with the requirements of the BSMI (Bureau of Standards, Metrology and Inspection, Ministry of Economic Affairs) directive CNS14348 with regard to "Electromagnetic compatibility" with the limits for a Class B product.

Important notes

The BEETLE /mini POS system conforms to the current safety standards for data processing equipment.

- If this device is taken from a cold environment into the operating room, moisture condensation may form. The device must be absolutely dry before being put into service; an acclimatization period of at least two hours must therefore be observed.
- This device is equipped with a safety-tested power cable and may be connected only to a prescribed grounded-contact power socket.
- When setting up the device, ensure that the power socket on the device and the grounded-contact power socket are easily accessible.
- To disconnect the device from the supply voltage completely, switch off the device and disconnect the power plug.
- Ensure that no foreign objects (e.g. office clips) find their way into the device, as this may lead to electric shocks or short-circuits.
- Never plug in or unplug data communication lines during thunderstorms.
- Protect devices from vibrations, dust, moisture and heat.
- Always dispose of used parts, such as batteries, in an environmentally safe manner.
- The lithium battery must be disposed of in accordance with local regulations for special waste.
- In emergencies (e.g. damaged housing or damaged power cable, penetration by liquids or foreign bodies), the device must be switched off immediately, the power plug disconnected and the Customer Service of Wincor Nixdorf (WN) or your dealer must be notified.
- The device may only be repaired by authorized qualified personnel. Unauthorized opening of the device and inexpertly carried-out repairs may not only seriously jeopardize the safety of the user, but also cancel all warranty and liability agreements.

Power Cord Selection

If power cord is not provided with the display, user has to ensure that a certified power cord is used as required by the Safety Regulation of the country.

Replacing the Lithium Battery



Incorrect replacement of the Lithium Battery may lead to a risk of explosion

The end user must replace the lithium battery only by identical batteries or types recommended by Wincor Nixdorf.

Do not throw Lithium Batteries into the trash can. It must be disposed of in accordance with local regulations concerning special waste.

Make sure that you insert the Battery the right way round. The plus pole must be on the top!

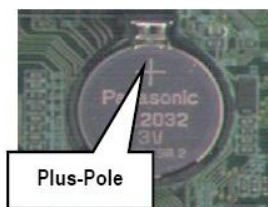

- Push the Latch **1** and remove the Lithium Battery from its Socket **2** .

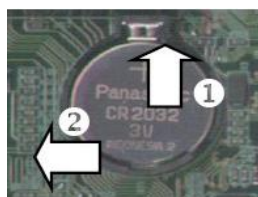

- Insert and press a new Lithium Battery of same type in the Socket **3** .

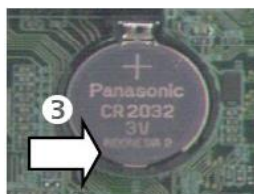

Introduction

About this manual

This manual describes the BEETLE /MINI POS system.

This documentation is intended to help you to work with the POS system and to serve as a reference work. The detailed table of contents helps you find the desired information quickly and easily.



Notes call attention to important information.



Cautions are included to help you avoid damaging hardware or losing data.



Warnings indicate conditions that, if not observed, can cause personal injury.

The type and scope of application programs depend on the customer's own selection; therefore, software will not be discussed further in this manual.

Separate manuals are included in the scope of the connectable peripherals. For this reason, a more detailed description of these devices will not be provided here. For more information see the relevant manuals.

Care of the BEETLE /mini



Clean your BEETLE /MINI at regular intervals with a suitable plastic-surface cleaner. Make sure that the power plug is disconnected, connector cables are unplugged and that no liquid finds its way into the device. The glass surface of your Touch Screen should be cleaned with a mild, commercially available glass cleaning product. All pH neutral materials (pH 6 to 8) are to be used for cleaning purposes.

Recycling the BEETLE /mini



Environmental protection does not begin when time comes to dispose of the BEETLE /mini; it begins with the manufacturer. This product was designed according to our internal norm “Environmental conscious product design and development”

The BEETLE /MINI POS System is manufactured without the use of CFCs and CCHS and is produced mainly from reusable components and materials.

The processed plastics can, for the most part, be recycled. Even the precious metals can be recovered, thus saving energy and costly raw materials.

Please do not stick labels onto plastic case parts. This would help us to re-use components and material.

You can protect our environment by switching on your equipment only when it is actually needed. If possible, even avoid the stand-by-mode as this wastes energy, too. Also switch your equipment off when you take a longer break or finish your work.

There are still some parts that are not reusable. Wincor Nixdorf guarantees the environmentally safe disposal of these parts in a Recycling Center, which is certified pursuant to ISO 9001.

So don't simply throw your BEETLE /mini POS system on the scrap heap when it has served its time, but take advantage of the environmentally smart, up-to-date recycling methods!

Please contact your competent branch office for information on how to return and re-use devices and disposable materials.

Wincor Nixdorf is always ready to answer any questions you may have about our environmental protection policies. We look forward to your message.

Warranty

Wincor Nixdorf guarantees a limited warranty engagement for 12 months beginning with the date of delivery. This warranty engagement covers all those damages which occur despite a normal use of the product.

Damages because of

- improper or insufficient maintenance,
- improper use of the product or unauthorized modifications of the product,
- inadequate location or surroundings

will not be covered by the warranty.

All parts of the product which are subject to wear and tear are not included in the warranty engagement.

Please order spare parts at the Wincor Nixdorf customer service.

Device Overview

BEETLE /mini is a compact POS system that features the Open Architecture design concept with high level of retail peripheral integration. It has the flexibility as a modular system as well as its ability to be connected to a variety of external peripherals, such as cash drawer, printer, customer display and even to a network.

Front view



Basic Operation

Before switching on the System

Unpacking and checking the System

Unpack the parts and check to see whether the delivery matches the information on the delivery note.

If damage has occurred during shipping or if the package contents do not match the delivery note, promptly inform your Wincor Nixdorf sales outlet.

NOTE

Transport the device only in its original packaging (to protect it against impact and shock).

Setting up the device

Set up the BEETLE /MINI POS system where it will not be exposed to extreme environmental conditions. Protect the device from vibrations, dust, moisture, heat and strong magnetic fields.

CAUTION

Make sure that the side ventilation slots on the BEETLE /MINI POS system are not obstructed in order to ensure that the device has sufficient ventilation.

Cabling of the BEETLE /mini

Follow the steps below in the order given when installing devices:

- The cable cover must be removed, if present.
- Plug one end of the power cable into the socket of the BEETLE /mini.
- Plug in and secure the data cable.
- Plug the other end of the power cable into the main power supply.



Always make sure that the system is switched off when you do cabling works.

Connecting to the Main Power Supply

All devices belonging to the BEETLE /MINI POS system that have a separate power cable must be connected to the same electric circuit.

- Make sure that all data cables on the system unit and peripherals are connected correctly.
- Plug the power cables belonging to the BEETLE /MINI and the peripherals into the grounded-contact power sockets.

Switching on the system

To switch on the BEETLE /MINI POS system,

- Push the ON button at the front of the box.

BEETLE /MINI – The Components

Functions & Indicators on the BEETLE /mini

The illustration below shows the possible components of the BEETLE /MINI POS system.

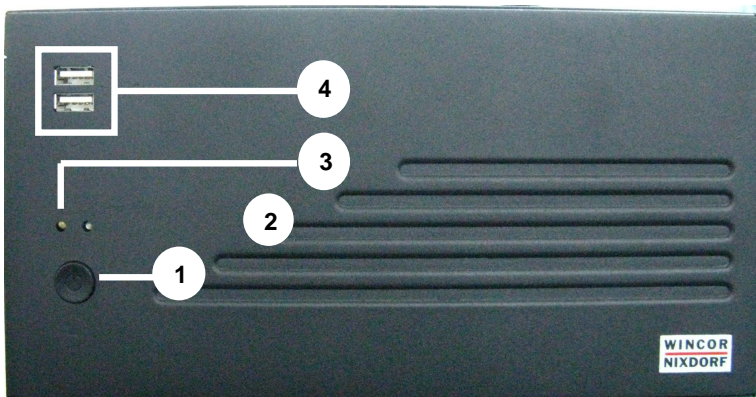

1 – ON/OFF Button

In an Micro ATX based system, the new soft touch power button replaces the main power switch that turns your system on and off. From an OFF state, you can switch the system ON by simply pressing the power button. From an ON state, pressing and holding the power button for four (4) seconds can turn OFF the system. The functions of the power button can also be altered in the Power Management section of the CMOS setup.

2 – POWER-ON Indicator (LED)

The indicator (LED) lights up **Green** when the system unit is switched on.

3 – HARD-DISK DRIVE Indicator (LED)

The indicator (LED) lights up **Amber** when the system unit is switched on.

④ – USB Connector

The 2 contact points are meant for connection of Universal Serial Bus (USB) devices.

Drives on the BEETLE /mini

The BEETLE /mini is equipped with a 3 ½” E-IDE Hard-Disk drive. The storage capacity is changed in line with market demand, but is currently at least 80 GB.

There is no floppy-Disk drive or CD-ROM Drive in the system.

Rear Panel Connectors on the BEETLE /mini

The illustration below shows the rear panel of the BEETLE /MINI with the position of the connecting sockets and connectors.

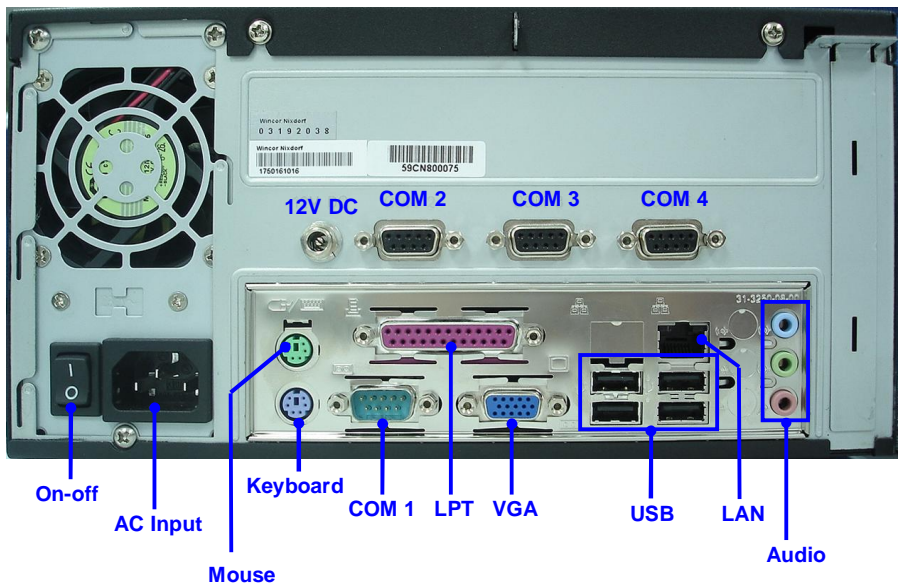

DC 12V (Power Output Port)

Appropriate LCD monitors can be connected via the low voltage jack 12V, max. 3A via non-LPS. A connecting cable with a DC plug is required for this.



WARNING

Connect only cables to the 12V connector which are marked with DP-1 or DP-2.

Do not connect the DC plug when the system is turned on, this can lead to an automatic reboot of the system.

Approved LCD Monitor List:

The following are the approved LCD monitors that are allowed to be connected to the BEETLE /mini's **12V Powered Output port**:

	Model	Manufacturer
1	BA72R, BA72R /n, BA72R /cTouch, BA72R /rTouch	Wincor Nixdorf
2	BA72R-2, BA72R-2 /n, BA72R-2 /cTouch, BA72R-2 /rTouch	Wincor Nixdorf
3	BA72R-3, BA72R-3 /n, BA72R-3 /cTouch, BA72R-3 /rTouch	Wincor Nixdorf
4	BA73R-1, BA73R-1 /n, BA73R-1 /cTouch, BA73R-1 /rTouch	Wincor Nixdorf
5	BA73R-2, BA73R-2 /n, BA73R-2 /cTouch, BA73R-2 /rTouch	Wincor Nixdorf
6	BA73R-3, BA73R-3 /n, BA73R-3 /cTouch, BA73R-3 /rTouch	Wincor Nixdorf
7	KTC 5005	KTC

Or alternately, the connecting LCD monitor includes its enclosure as fire hazard protection must be certified to relevant safety standards if it is not in the above approved list.



Connecting LCD monitor that is not in the above approved list to the **12V Powered Output port** may cause safety hazard and also endanger the user and nearby people. Please consult Wincor Nixdorf if in doubt.

Expansion Slots

There is one PCI Bus Master slot (rev. 2.2) on-board.

Power Supply Unit

The power supply unit automatically adjusts itself to the particular voltage. The power output of the power supply unit is maximum 220W.

VGA Connector for Monitor or LCD-Display



You can connect a Monitor or LCD-Display to the BEETLE /MINI via the **Blue** 15-Pin D-Sub Jack on the VGA Connector.

Keyboard Connector (PS/2)



The BEETLE /MINI has a **Purple** 6-pin Mini-DIN Jack for connecting a keyboard.



NOTE

Make sure that the connector is plugged firmly into the socket to prevent malfunctioning.

Mouse Connector (PS/2)

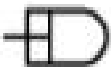

The BEETLE /MINI has a **Light-Green** 6-pin Mini-DIN Jack for connecting a Standard Mouse using a PS/2 plug.

Parallel Interface LPT1 for Modular Printer



The BEETLE /MINI standard **Burgundy** Parallel Interface LPT1 is intended for connecting a printer.

Four COM ports for Standard PC Peripherals



You can connect supplementary standard peripherals to the BEETLE /MINI Via COM1 (**Turquoise**)/ COM2 (black)/ COM3 (black)/ COM4 (black).



Make sure that all supplementary devices have been tested for RFI suppression pursuant to the legal requirements of your country.

LAN (RJ45) Socket for Network



The BEETLE /MINI POS system can be connected to a network (LAN) from the POS terminal rear panel.

USB (Universal Serial Bus) Port 1 and 2



Two USB ports are available at the rear panel of BEETLE /MINI POS system for connecting USB Devices.

Audio Port Sockets



The BEETLE /MINI has a **Lime** Line-out socket can be connected to Headphones or preferably Powered Speakers.



A Light-Blue Line-in socket allows Tape-Players or other Audio Sources to be records by your POS system or played through the **Lime** Line-out.



A **Pink** MIC socket allows microphones to be connected for inputting voice.

How to slide open the top cover of the case

Please see the picture as below:



System configuration

Please see the picture as below:

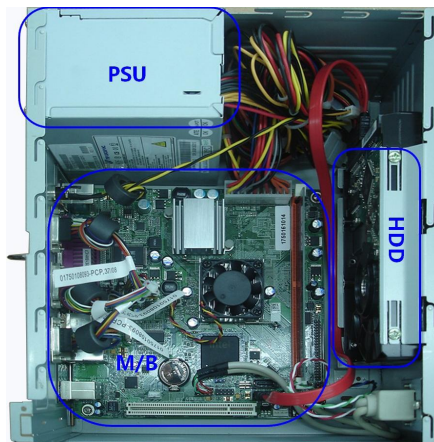

70H08-Mini ATX Intel Motherboard

BEETLE /MINI is using Intel motherboard with Intel 945GC+ ICH7 chipset and ATOM 230 CPU.

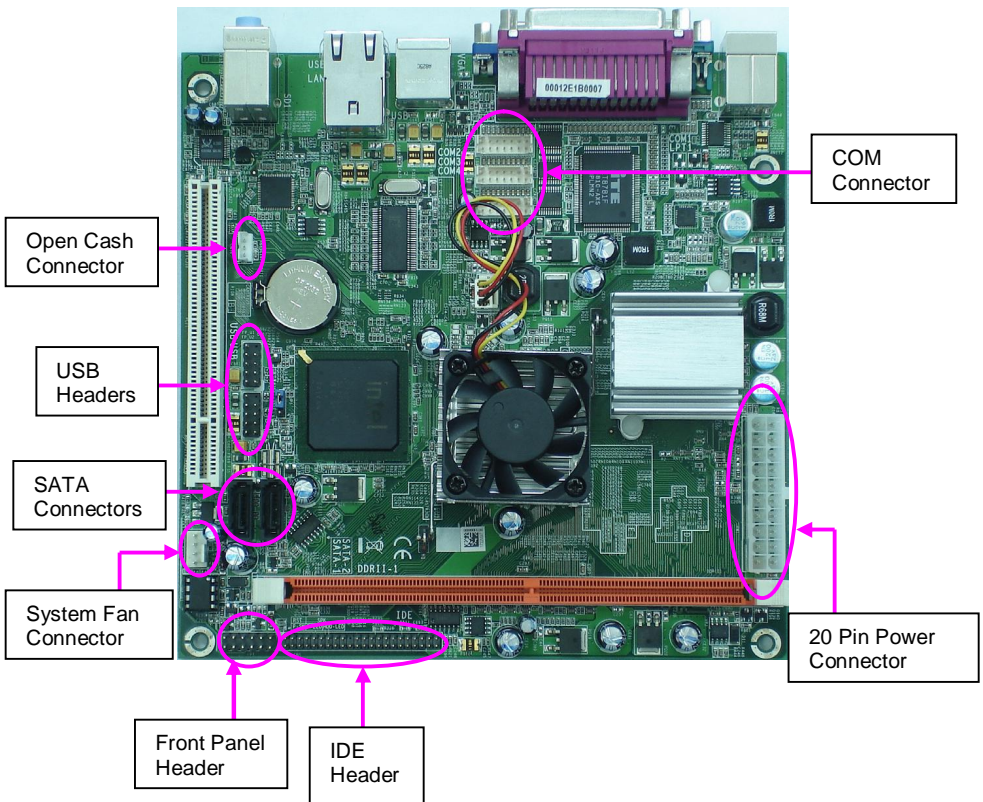

CAUTION

Static electricity can harm delicate components of the Main-Board. To prevent damage caused by static electricity, discharge the static electricity from your body before you touch any of the computers electronic components.

Motherboard Block Diagram

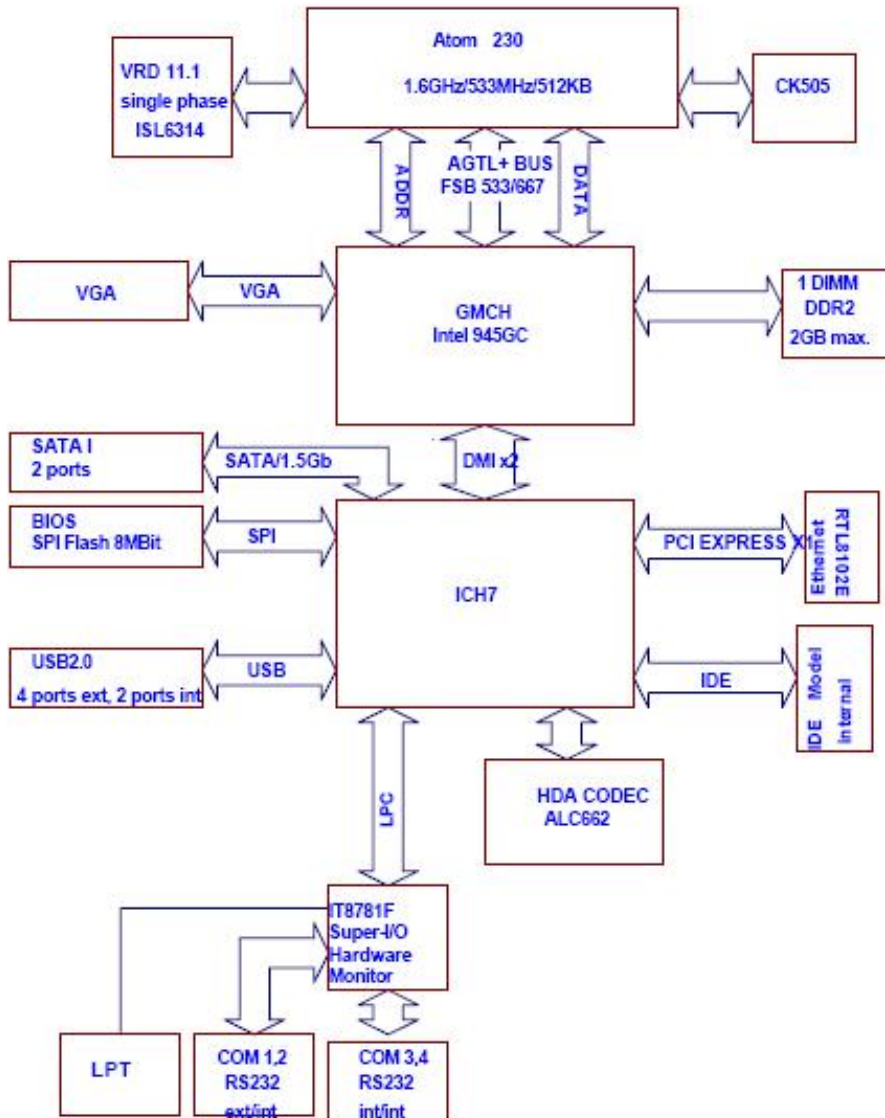

Motherboard Details

Processor	ATOM 230 1.6G /533 FSB
Chipset	Intel 945GC North Bridge. Intel ICH7 South Bridge
System Memory Support	1x un-buffered DIMM socket. DDR2 533/667 MHz. Up to 2GB Memory size.
Internal VGA	Integrated Intel GMA950 graphics card.
Expansion Slots	1 PCI
Onboard IDE	1x ATA IDE Connectors. 2x SATA
Onboard LAN	RTL8102E for Ethernet 10/100 base
Onboard Audio	ALC662 HD audio Codec
Onboard I/O Connectors	On board USB connectors for 2 additional USB 2.0 ports (option USB cable). 2 System Fan connectors. on board COM 2, 3 & 4 port
Back Panel Connectors	1 Parallel Port. 1 Serial port(COM 1). 1 RJ-45 LAN port. 4 USB ports. 1 VGA port. 3 audio jacks for line-out, line-in and mic-in. 1 PS2 mouse/keyboard port
BIOS	Award BIOS 8Mbit flash memory
System Monitoring & Management	CPU temperature monitoring System voltage monitoring
Dimension	6.69"x6.69"
Accessories	Driver CD

System BIOS

This section describes Award BIOS™ Setup program built into the ROM BIOS. The Setup program allows users to modify the basic system configuration. This special information is then stored in battery-backed RAM so that it retains the Setup information when the power is turned off.

The BIOS reads the system information contained in the CMOS and begins the process of checking out the system and configuring it. When it finishes, the BIOS will seek an operating system on one of the disks and then launch and turn control over to the operating system.

The Setup program can be activated by pressing the key when the following message appears briefly at the bottom of the screen during the POST (Power On Self-Test).

Press DEL to enter SETUP.

Below is the menu displayed on entering the Setup program.

CMOS Setup Utility - Copyright (C) 1984-1998

Standard CMOS Feature	Frequency/Voltage Control
Advanced BIOS Feature	Load Fail-Safe Defaults
Advanced Chipset Feature	Load Optimized Defaults
Integrated Peripherals	Set Supervisor Password
Power Management Setup	Set User Password
PnP/PCI Configurations	Save & Exit Setup
PC Health Status	Exit Without Saving
Esc : Quit	↑ ↓ ← → : Select Item
F10 : Save & Exit Setup	
Time, Date, Hard Disk Type....	

Setup Items

The main menu includes the following main setup categories.

Standard CMOS Features	Use this menu for basic system configuration.
Advanced BIOS Features	Use this menu to set the Advanced Features available on your system.
Advanced Chipset Features	Use this menu to change the values in the chipset registers and optimize your system's performance.
Integrated Peripherals	Use this menu to specify your settings for integrated peripherals.
Power Management Setup	Use this menu to specify your settings for power management.
PnP / PCI Configurations	This entry appears if your system supports PnP / PCI.
PC Health Status	Use this menu to enter the hardware monitoring screen.
Frequency/Voltage Control	Use this menu to specify your settings for frequency/voltage control.
Load Fail-Safe Defaults	Use this menu to load the BIOS default values for the minimal/stable performance for your system to operate.
Load Optimized Defaults	Use this menu to load the BIOS default values that are factory settings for optimal performance system operations. While Award has designed the custom BIOS to maximize performance, the factory has the right to change these defaults to meet their needs.
Supervisor / User Password	Use this menu to set User and Supervisor Passwords.

Save & Exit Setup	Save CMOS value changes to CMOS and exit setup.
------------------------------	---

Exit Without Save	Abandon all CMOS value changes and exit setup.
--------------------------	--

Appendix

Technical Data for the BEETLE /mini

Dimension (without cable cover)			
Width	254 mm		
Depth	216 mm		
Height	128 mm		
Weight	approx. 3.7 kg		
Climatic category			
Operating	IEC 721-3-3	Class 3K3	+5°C to +40°C
Transport	IEC 721-3-2	Class 2K2	-25°C to +60°C
Storage	IEC 721-3-1	Class 1K2	+5°C to +40°C
Input voltage	100 - 120 VAC	200 - 240 VAC	
Max. power consumption	3A	1.5A	
Frequency of system voltage	60Hz	50 Hz	

Published by
Wincor Nixdorf Pte Ltd
2, Kallang Sector
Singapore 349277

Part No.: **01750164247 C**