







# TABLE OF CONTENTS

	Gleaner Parts.....	3 - 8
	I.H. and N.H. Parts.....	9 - 16
	White Parts.....	17 - 20
	John Deere Parts .....	21 - 34
	Massey-Ferguson Parts .....	35 - 58
	Flighting .....	61
	Misc. Parts.....	59 - 64





## GLENER REPLACEMENT PARTS

Cornhead Parts.....	5
Elevator Chains.....	7
Feeder Drums.....	6
Feeder House Chains & Bottoms.....	6 & 7
Grain Table Parts.....	8
Grain Tank Loading Auger Tubes.....	8
Straw Chopper Repair Plates.....	7
Unloading Auger Ext. Kits.....	6
Unloading Auger Tubes & Augers.....	6
Walkers.....	7





**CENTER CORNHEAD SNOUTS**

70596555S	Gleaner Short Narrow Row – 29" Long
71502917S	Gleaner Long Narrow Row – 38" Long
70596556S	Gleaner Short & Long Wide Row – 38" Long
70595463S	Gleaner Snout Point
71366376S	Gleaner Hugger Head Narrow Row (Old #71347219)
71366379S	Gleaner Hugger Head Wide Row (Old #71352925)
71364963S	Gleaner Snout Point Hugger Head (Old #71351910)



**OUTSIDE CORNHEAD SNOUTS**

70573745S	Gleaner Snout Short L.H. – 33" Long
70573746S	Gleaner Snout Short R.H. – 33" Long
70598582S	Gleaner Snout Long R.H. – 38 1/2" Long
70598583S	Gleaner Snout Long L.H. – 38 1/2" Long
70595463S	Gleaner Snout Point
71364999S	Gleaner Snout Hugger Head L.H.
71365000S	Gleaner Snout Hugger Head R.H.
71364963S	Gleaner Snout Point Hugger Head (Old #71351910)

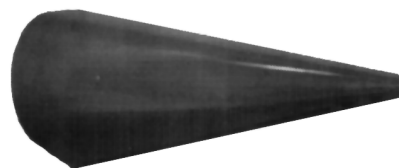

**CORNHEAD TROUGHS**

71504184S	Bottom Left Trough A430 Gleaner
71504183S	Bottom Right Trough A430 Gleaner
71504034S	Bottom Right Trough A630 Gleaner
70582211S	Bottom Left Trough A630 Gleaner
71358394S	Bottom Left Trough 630 Gleaner – Hugger – Prior S/N 25001
71506200S	Bottom Right Trough 630 Gleaner – Hugger – Prior S/N 25001
71360629S	Center Back Sheet – Early Hugger Heads

• Other Models of Hugger troughs can be made on request



**GRAIN BIN TROUGH BOTTOM**

71139875SR	Gleaner K2 & E3 Grain Bin Trough Repair Plate
71139874SR	Gleaner F Grain Bin Trough Repair Plate
71308640SR	Gleaner L Grain Bin Trough Repair Plate
71308641SR	Gleaner M Grain Bin Trough Repair Plate
71344399SR	Gleaner N Grain Bin Trough Repair Plate
71376663SR	Gleaner R40, R42, R50 & R52 Grain Bin Trough Repair Plate
71376663SRSS	Gleaner R40, R42, R50 & R52 Grain Bin Trough Repair Plate - Stainless
71376302SR	Gleaner R62, R65, R72 & R75 Grain Bin Trough Repair Plate
71376302SRSS	Gleaner R62, R65, R72 & R75 Grain Bin Trough Repair Plate – Stainless
BK1	Bolt & Pop Rivet Kit for R Series Grain Bin Trough Repair Plates

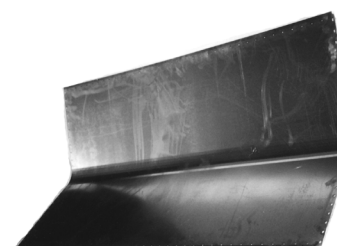

## UNLOADING TUBES

71168631S	Gleaner F, K and G Unloading Tubes (Manual Swing) – 139"- 146" Long Style
71300612S	Gleaner F2 and K2 Unloading Tubes (Hydraulic Swing) – 130 5/8"
71165732S	Gleaner L, M and N Unloading Tubes (Short) – 130 5/8" (New #71367445)
71383428SS	Gleaner L, M, N & R Unloading Tube (Long) 145 5/8" – Painted Silver (Old # 71352968 & 71368075)
71368075S	Gleaner L, M, N & R Unloading Tube (Long) – 145 5/8" Galvanized
71399669SS	Gleaner A65 & A75 Unloading Tube – 213.5" – Painted Silver
71390923S	Gleaner R62, R72, R65, R75 (Short) – 180 3/4" – 14" Diameter – Chassis Gray
71444325S	Gleaner S67 & S77 (Long) – 216 3/4" – 14" Diameter

## UNLOADING AUGERS

71340156S	Gleaner L, M, N Unloading Auger (164 1/8") No Rubber Drive Sleeve
71316963S	Gleaner F & K Hyd. Unloading Auger (144 3/4") No Rubber Drive Sleeve
71152878S	Gleaner F & K Manual Swing Auger (142")
71374184S	Gleaner R60, R70, R62 & R72 Unloading Auger (193 1/2") No Rubber Sleeve
71386299S	Gleaner R62, R72, R65, R75 – 193 1/2" – 13" Dia. – No Rubber Drive Sleeve
71457652S	Gleaner S67 & S77 – 229 1/4" – 13" Dia. – No Rubber Drive Sleeve (New #71486510)

## UNLOADING AUGER EXTENSION

SMC 15	Gleaner L, M, N & Early R Series – 30" Auger Ext. – 12" Diameter The outside tube is bolted on using existing hole at the inner mounting. Also lower elbow pivoted by chain attached to hydraulic cylinder.
SMC 25	Gleaner Late R Series - 30" Auger Ext. – 12" Diameter The outside tube is bolted on using flange mounted holes. Also lower elbow pivoted by hydraulic cylinder with tie rod ends.
SMC 26	Gleaner Late R & S Series - 36" Auger Ext. - 14" diameter The outside tube is bolted on using existing holes at the outer bolt mounting. (Painted Chassis Grey)



## UNLOADING ELBOW REPAIR PLATES

71339770SR	Repair Plate – Gleaner F2 & F3
71308152SR	Repair Plate – Gleaner L2, L3, M2 & M3
71363867SR	Repair Plate Housing – Gleaner R Series
71426590SR	Repair Plate – Gleaner R & S Series – 14" (Abrasion Resistance Steel)



## FEEDER BEATER DRUMS

71184783S	Gleaner K Feeder Beater Drum
71184784S	Gleaner F Feeder Beater Drum
71184789S	Gleaner L Feeder Beater Drum
71184787S	Gleaner M Feeder Beater Drum

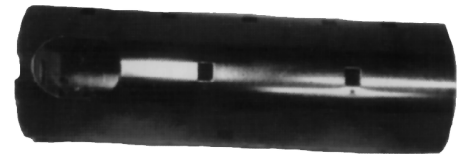

## FEEDER HOUSING BOTTOM

71330714S	Gleaner R40/R50 Bottom Wear Plate - Stainless
71364173S	Gleaner R42/R52 Bottom Wear Plate - Stainless
71317813S	Gleaner R60/R70 Bottom Wear Plate - Stainless
71362345S	Gleaner R62/72 Bottom Wear Plate – Stainless - R62 Prior S/N 63001 - R72 Prior S/N 73001
71375962S	Gleaner R62/R72 Bottom Wear Plate – Stainless – R62 S/N 63001 & up – R72 S/N 73001 & up

## GRAIN TANK LOADING AUGERS

71388929S	Gleaner R62 S/N 63001-HL62999 w/ Bin Ext. & R72 S/N 73001-HL72999 w/ Bin Ext. – 73.70" Long (Can use for 71388939)
71388932S	Gleaner R52 S/N 53001 & up, R72 Prior HL72999, A65 & A75 – 67.71" Long (Can use for 71388940)
71413017S	Gleaner A66, A76, & A86 (Abrasion Resistance Flighting) - Balanced
71469690S	Gleaner R66, R76, S67, S77, S68,S78,S88,S96,S97 & S98 (Abrasion Resistance Flighting) – Balanced

## STRAW WALKERS

1132348S	A.C. F, K, G & E Walker (ONLY 2 Available)
1315196S	A.C. F2 & K2 Walker
1171501S	A.C. L Walker (#1171501)
1155014S	A.C. M Walker (#1155014)
8020	A.C. F Grating (4' Section)
8021	A.C. M Rear Grating (4' Section)
8022	A.C. M Front Grating (1' Section)
8023	A.C. L Rear Grating (4' Section)
8024	A.C. L Front Grating (1' Section)

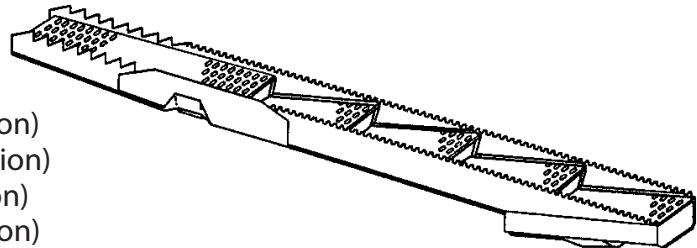

## STRAW CHOPPER REPAIR PLATES

71195441SR	Straw Chopper Housing Repair Plate K/K2
71195442SR	Straw Chopper Housing Repair Plate F2/F3
71195499SR	Straw Chopper Housing Repair Plate M2/M3
71195500SR	Straw Chopper Housing Repair Plate L2/L3
71409830SR	Straw Chopper Housing Repair Plate A66 & A65 – 25 Slots
71409835SR	Straw Chopper Housing Repair Plate A75, A76, A85 & A86 – 31 Slots

## ELEVATOR CHAINS

71393534S	Grain Elevator R76, R66, R65, R55, R72, R62, R52 (S/N 53001 & up) R42 (S/N 43001 & up)
71149844S	Grain Elevator R52 (S/N prior 53001) R42 (S/N prior 43001) R50, R40
71149843S	Returns Elevator R76, R66, R65, R55, R72, R62, R52, R42, R40

## CONVEYOR CHAIN CROSS BARS

71373687S	R42 (46001 & up) R52 (56001 & up) R55-26"
71373694S	R62 (63001 - 68000) R72 (73001 – 78000) – 36"
71375336S	R62 (68001 & up) R72 (78001 & up) R65 & R75 (3 strand) – 20 ½"
71408551S	R65, R75, R66 & R76 (4 strand) 15 ¼"

## FEEDER HOUSE CHAINS

### Front Feeder Chains

71149938S	R42, R52, R55 (557 Chain) – 16 slats
71149958S	R62, R72, R65, & R75 prior to 2007(557 Chain) 3 Strand Chain, 32 Slats *
71412327S	R66 & R76 (557 Chain) 4 Strand Chain, 48 Slats

### Rear Feeder Chains

71149940S	R40, R50, R42, R52, R55 (557 Chain) 14 Slats
71149960S	R62, R72, R65 & R75 prior to 2007 (557 Chain) 3 Strand Chain, 28 Slats *
71449024S	R66 & R76 (557 Chain) 4 Strand Chain, 42 Slats

\*Combines equipped with lateral tilt also needs 3 offset links per strand of chain

**GRAIN TABLE TROUGH REPAIR BOTTOMS**

- 71374275S Gleaner 800 Series – Center Pan – 18’ – 30’ – 78 ½” Long
- 71360476S Gleaner 500 Series – Center Pan – 18’ – 30’ – 78 5/8” Long
- 71327938S Gleaner “R” – Center Pan – 18’ – 24’ – 54 ½” Long
- 71343989S Gleaner CG Boot – L3 Effective S/N30501- M3 Effective S/N 27401 – R40/R50, R42 prior S/N43001, R52 Prior S/N55001
- 71368419S Gleaner F, L & M – Center Pan – 18’ – 24’ – 56 3/16” Long

<u>Complete Trough Sets Available on Request</u>	<u>Complete Trough Set Dealer Costs</u>
Series 2: K, F, L, M & N	13’ – 15’ \$ 330.00
300 F, L & M Series	16’ – 18’ \$ 351.00
300 R Series	20’ – 22’ \$ 374.00
500 Series	24’ – 25’ \$ 397.00
800/ 8000 Series	30’ \$ 425.00

**DRAPER HEAD END SHIELDS AND DIVIDER**

- 71368511SL LH Anti Wrap End Shields 9250 Draper Head
- 71368511SR RH Anti Wrap End Shields 9250 Draper Head
- 71426376S 9250 Divider – Reinforced at Bottom



**TABLE AUGER BEARING CENTER PLATE**

- 8050 Gleaner 500 & 800 Series,  
Repair plate can be installed through inspection cover hole



**GRAIN TABLE PARTS**

- 71324692S Finger Cover Plate for Table Auger
- 71332796S Table Auger Finger Shaft 800 Series 39 5/8” Long – 1 1/8” CR

**GRAIN TANK LOADING AUGER TUBES**

- 71338827S Tube Fits – R40, R50, R42 & R52 Prior to S/N 53001 – Tube Length 43 ¾”
- 71362970S Tube Fits – R52 S/N 53001 & up, R62 Prior to S/N HL62999, R55, A65, A75 w/ Standard Bin Fill – Tube Length 55 ½”
- 71367498S Tube Fits – R62 S/N 63001 & up, R72, R65, R75 w/ Extensions – Tube Length 61 ½”
- 71413012S Tube Fits – A66, A76 & A86 – 12” I.D.
- 71444317S Tube Fits – R66, R76, S67, S77, S68, S78, S88, S96, S97, & S98 (Replaces 71426602)

**CLEAN GRAIN ELEVATOR PARTS**

- 71188934S L, L2, M, M2 Elevator Divider
- 71302865S Lower Boot L, L2 & L3 (Prior S/N 13000-28000) High Capacity  
L2 & L3 (S/N 15501-30501) Standard  
M2 & M3 (S/N 15401-18400) High Capacity  
M2 & M3 (S/N 18401-27401) Standard
- 71343989S Lower Boot L2 & L3 (S/N 13001 & up)  
M3 (S/N 27401 & up), R40 & R50  
R42 (Prior S/N 43001), R52 (Prior S/N 53001)
- 71399816S Lower Boot R55 S/N HN52101 & up, R65 S/N 62101 & up, R75 HP72101 & up,  
R66 & R76
- 71400529S Door R55 S/N HN52101 & up, R65 S/N 62101 & up, R75 HP72101 & up, R66 & R76



**REAR HOOD PANEL**

- 71354354S Gleaner R40-R72 – Heavier – Made out of 16GA Galvanized

## I.H. / N.H. REPLACEMENT PARTS

Augers .....	12 - 14
Clean Grain Elevator Housing & Boot Parts .....	15
Conveyor Drums .....	12
Cornhead Parts .....	11 & 12
Grain Bin Trough Bottom .....	14
Grain Pan Parts .....	12
Grain Table Parts.....	16
Grain Tank Loading Tubes & Augers .....	13
Unloading Auger Ext. Kits .....	13
Unloading Auger Tubes & Augers .....	13 & 14
Vertical Unloading Housing.....	16
Walkers .....	12



**Ordering  
Code**

**Description**

**OUTSIDE SNOOTS**

176233S	I.H. Snout 800, 900 & 1000 Series L.H. (#176233C93)
176234S	I.H. Snout 800, 900 & 1000 Series R.H. (#176234C93)
176237S	I.H. Snout Point (176237C1) (Old # 199376C1)
199068S	I.H. Skid Shoe (199068C2)

**CENTER SNOOTS**

176228S	I.H. 800, 900 & 1000 Series Narrow Row (176228C94)
176221S	I.H. 800, 900 & 1000 Series Wide Row (176221C94)
176227S	I.H. Point 800, 900 & 1000 (176227C1)
199069S	I.H. Wide Skid Shoe
199070S	I.H. Narrow Skid Shoe

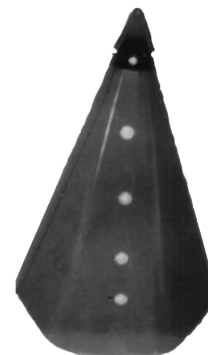

**CORNHEAD CENTER DIVIDERS**

1345370S	I.H. Divider - 28" & 30" - 800 L.H.
1345371S	I.H. Divider - 28" & 30" - 800 R.H.
176163S	I.H. Divider - 36", 38" & 40" - 800 L.H.
176164S	I.H. Divider - 36", 38" & 40" - 800 R.H.
1345363S	I.H. Divider Assy. - 30" - 900 & 1000
1345361S	I.H. Divider - 36", 38" & 40" - 900 & 1000 L.H.
1345362S	I.H. Divider - 36", 38" & 40" - 900 & 1000 R.H.

**OUTSIDE FENDERS**

176191S	I.H. Fender 800 L.H.
176192S	I.H. Fender 800 R.H.
199503S	I.H. Fender 900 & 1000 L.H.
199504S	I.H. Fender 900 & 1000 R.H.

**CORNHEAD TROUGHS**

179508S	Bottom Right Trough 863 I.H.	
179507S	Bottom Left Trough 863 I.H.	
179516S	Bottom Right Trough 883 I.H.	
179515S	Bottom Left Trough 883 I.H.	
176118S	Bottom Center Trough 863 & 883 I.H.	Trough Kits
319209S	Bottom Right Trough 963 & 1063 I.H.	
322349S	Back Right Sheet Assy 963 & 1063 I.H.	319209KIT
199783S	Back Right Angle 963 & 1063 I.H.	
319208S	Bottom Left Trough 963 & 1063 I.H.	
322341S	Back Left Sheet Assy 963 & 1063 I.H.	319208KIT
199782S	Back Left Angle 963 & 1063 I.H.	
319213S	Bottom Right Trough 983 & 1083 I.H.	
322351S	Back Right Sheet Assy 983 & 1083 I.H.	319213KIT
199787S	Back Right Angle 983 & 1083 I.H.	
319212S	Bottom Left Trough 983 & 1083 I.H.	
322343S	Back Left Sheet Assy 983 & 1083 I.H.	319212KIT
199786S	Back Left Angle 983 & 1083 I.H.	
199752S	Bottom Center Trough 963, 983, 1063, & 1083 I.H.	
86634166S	Bottom Center Trough 2200, 2400, 3200 & 3400 I.H. (Stainless) – (68" x 19 7/8")	
199749S	Center Back Sheet 900 & 1000 (Throat Area)	
176144S	Angle Support for Center Back Sheet 900 & 1000 (Throat Area)	



**Ordering Code**

**Description**

**CORNHEAD AUGERS**

176088S	Cornhead Auger 800 Series – 4 Row - Narrow
176100S	Cornhead Auger 800 Series – 6 Row – Narrow
199691S	Cornhead Auger 900/1000 Series – 4 Row - Narrow
199694S	Cornhead Auger 900/1000 Series – 6 Row – Narrow
338932S	Cornhead Auger 900 /1000 Series – 8 Row - Narrow
338927S	Cornhead Auger 900/ 1000 Series – 6 Row – Wide
86615202S	Cornhead Auger 2408/3208/3408 – 8 Row Narrow

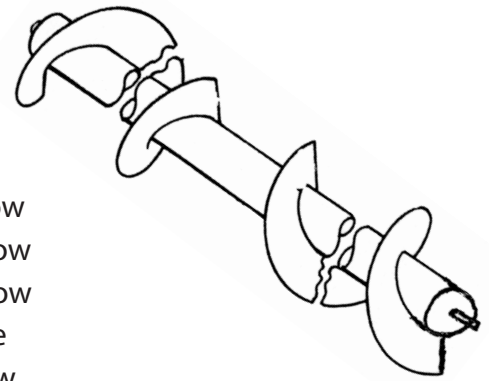

**CONVEYOR DRUMS**

175975S	I.H. 715, 815 SN 8001 - after 1420, 1440 SN Prior - 50406 1640 SN Prior - 52483, 1470
175976S	I.H. 914 & 915 SN 8001 - after, 1480 SN Prior - 54600, 1482
1957437S	I.H. 1440 SN 50407 - after, 1460 SN 52484 - after, 1640, 1660
1957438S	I.H. 1480 SN 54601 - after, 1680

**STRAW WALKERS**

**Reduced**

177204S	I.H. 815 & 915 Walker
8011	I.H. 815 & 915 Replacement Rear Grating (4' Section)
8012	I.H. 815 & 915 Replacement Front Grating 18"

**GRAIN PAN MATERIAL**

632695S	I.H. 615 & 303
632697S	I.H. 715 & 403
158046S	I.H. 815 Prior #4688 Complete Insert
175102S	I.H. 815 Above #4688 Back Section Only
158047S	I.H. 915 Prior #3179 Complete Insert
175107S	I.H. 915 Above #3179 Back Section Only
1040	N.H. 70, 75, 85, 86, 87 & 88
1042	N.H. 95, 96, 97 & 98

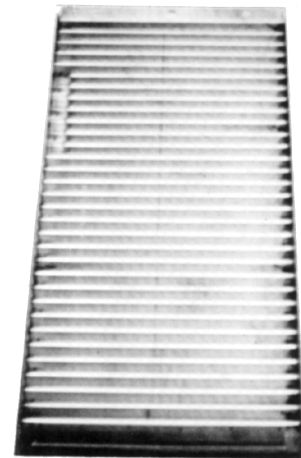

**FRONT SECTIONS**

175069S	I.H. 815 Above #4688
175078S	I.H. 915 Above #3179

**STRAW CHOPPER REPAIR PLATE FOR NEW HOLLAND**

273271SR      1400, 1500, 975, 980, 985, 990, 995, TR70, TR75 & TR85

The straw chopper housing repair plate is for repairing the area where the stationary knife holes are in the housing. The plate goes to within a couple inches from each end. It has an offset crimp on each end so it can be overlapped and gives extra support.



**Ordering Code**

**Description**

**UNLOADING TUBES**

195342S	I.H. 1420 - 1480 Outer Solid Unloading Tube - 87"
192838S	I.H. 1420 - 1480 Inner Unloading Tube Short - 49½"
192089S	I.H. 1420 - 1480 Inner Unloading Tube Long - 85½"
1317738S	I.H. 1620 - 2388 Inner Solid Unloading Tube - 90"
1317873S	I.H. 1620 - 2388 Inner Perforated Unloading Tube - 90"
1317734S	I.H. 1620 - 2388 Outer Unloading Tube 136" - 46½"
1317783S	I.H. 1620 - 2388 Outer Unloading Tube 172" - 82½"
1317899S	I.H. 1620 - 2388 Outer Unloading Tube 208" - 118½"
87557135S	I.H. 2577 & 2588 Inner Tube Solid for 18' and 21' - 126"
87557138S	I.H. 2577 & 2588 Inner Tube Perforated for 18' and 21' - 126"
87581650S	I.H. 2577 & 2588 Outer Tube 18' - 82 ½"
87581654S	I.H. 2577 & 2588 Outer Tube 21' - 118"
<b>NEW</b> 47624954S	I.H. 5088, 6088, 7088, 5130, 5140, 5150, 6130, 6140, 6150, 7130, 7140, 7150, 7230, 7240, 7250, 8230, 8240, 8250, 9230, 9240 & 9250 STD. RATE - 198 ¼" (red) replaces 87743673S
47405760S	I.H. 7240, 8230, 8240, 7230, 9230, & 9240 - 21' High Rate - 194 5/8"
47407783S	I.H. 7230, 7240, 7250, 8230, 8240, 8250, 9230, 9240, & 9250 Outer Unloading Tube - High Rate - Folding - 87 ½"
47439287S	I.H. 7130, 7230, 7240, 8230, 8240, 9230, & 9240 Inner Unloading Tube - High Rate - Folding - 172"
<b>NEW</b> 47551157S	I.H. 7240, 7250, 8240, 8250, 9240, & 9250 Inner Unloading Tube - High Rate - Folding - 172"
84071578S	N.H. CR 920, 940, 960, 970 & 980, CX840, 860 & 880, CX 8070 (A,3&4), CX 8080 (A,3&4), CX 8090 (A, 3&4) (black) - 198 ¼"
<b>NEW</b> 84536432S	I.H. Unloading Tube Extension - 21' High Rate - 67" Long - 7130, 7230, 7240, 7250, 8230, 8240, 8250, 9240, & 9250
87743673SR	Outer Unloading Tube half that will repair the IH 87743673 & NH84071578 Tubes. Will require cutting off outer end & sliding over, then welding on repair tube - 119 1/2" Long



**UNLOADING AUGERS**

1317935S	I.H. 1460 - 1680 One Piece Unloading Auger Round Drive - 172" system - 179"
198987S	I.H. 1640 - 2388 Inner Unloading Auger w/ spline bore - 172" and 208" systems
87556898S	I.H. 2388 S/N 300001 & up; 2577 & 2588 - Inner Auger - 126 ½" Long
87557246S	I.H. 1640 - 2388 Outer Unloading Auger - 172" system - 89 ¼" Long
87379141S	I.H. 1640 - 2388 Outer Unloading Auger - 208" system - 125 ¼" Long
220040S	I.H. 1640 - 2388 Unloading Auger Coupler Shaft - 6" Long (1" Hexagon)
84447941S	I.H. 5088, 6088, 7088, 5130, 6130, 7130, 8010AFX, 7120, 8120, 9120, 7230, 8230 & 9230 STD. RATE
<b>NEW</b> 47897750S	I.H. 7130, 7230, 7240, 7250, 8230, 8240, 8250, 9240, & 9250 High Rate

**UNLOADING AUGER EXTENSION**

SMC 18	I.H. 1400 & 1600 Series Unloading Auger Ext. 3 ft. (Round Drive)
SMC 24	I.H. 1600 & 2100 Series Unloading Auger Ext. 3 ft (Spline Drive)
SMC 28	The outside tube is inserted and bolted back at the elbow. The auger is installed at the drive end and supported by a hanger bearing. There is also a support rod extension with each kit. IH 5088, 6088, 7088, 5130, 6130, 7130, 8010AFX, 7120, 8120, 9120, 7230, 8230, & 9230 STD Rate, Unloading Auger Ext. 3ft. The outside tube is bolted on using existing holes at the outer bolt mounting. The auger is welded to original auger at outer end. 13 ½" tube



**GRAIN TANK VERTICAL AUGERS**

192835S	I.H. Auger, Vertical Fountain - Fits 1440, 1460, 1480, 1640 prior to SN97102 - 1660, Prior to SN 102896 & 1680 Prior to SN 115351
1347389S	I.H. Auger 1640 SN 97103 & up, 1660 SN 102897 & up, 1680 SN 115352 & up; 1644, 1666, 1680 - 1688, & 2144 - 2588
84447940S	I.H. Auger 5088, 5130, 5140, 6088, 6130, 6140, 7010, 7088, 7120, 7130, 7140, 8010, 8120, 9120 (7230, 8230 & 9230 Before 1-13)
<b>NEW</b> 51427981S	I.H. 7230, 7240, 7250, 8230, 8240, 8250, 9230, 9240, & 9250 High Rate

**Ordering Code**

**Description**

**BOTTOM UNLOADING AUGER**

390556S	I.H. Auger, Bottom Unloading 1440, 1460, 1480, 1640, 1660, 1680, 1644, 1666, 1668, 2144, 2166, 2188, 2344, 2366 & 2388
87280343S	I.H. Rear Bin Unloading Auger AXF8010, 7120, 7010, 7240, 8040, 8120, 8240, 9120, 9240, 9010, 7230, 8230 ,9230 Ext Wear R.H. – Standard Rate
87280345S	I.H. Rear Bin Unloading Auger AXF8010, 7120, 7010, 7240, 8040, 8120, 8240, 9120, 9240, 9010, 7230, 8230 ,9230 Ext Wear L.H. – Standard Rate

**BIN FILL AUGERS**

249275S	I.H. 1660, 1680, 1688, 2144, 2166, 2188, 2344, 2366, 2388, 2577 & 2588 inclined
320724S	I.H. 2144, 2166, 2188, 2344, 2366, 2388 inclined with sensor
87563930S	I.H. 5088, 6088, 7088, 5130, 6130, 7130
87733275S	I.H. 7010, 7120, 7230, 7240, 7250, 8010, 8120, 8230, 8240, 8250, 9120, 9230, 9240 & 9250

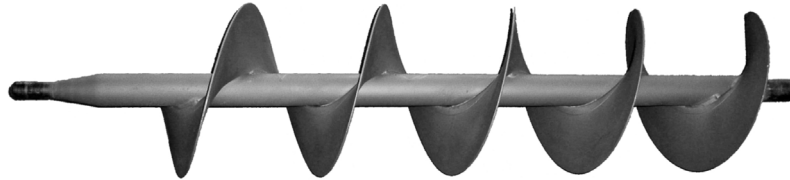

**BIN FILL AUGER TUBE LINER KITS**

84386327SR	Liner for AFX8010, 7010, 8010, 7120, 8120, 9120, 7230, 8230, & 9230
47696923SR	Liner for 7240, 7250, 8240, 8250, 9240, & 9250 – For tube with welded arms
<b>NEW</b> 47696909SR	Liner for 7240, 7250, 8240, 8250, 9240, & 9250 – For tube with bolted arms

**BIN FILL AUGER TUBES**

199006S	Lower Half Fits 2144 (S/N 172845) & up; 216 (S/N 0180000); 2188 (S/N 0191483); 2344, 2366, 2377 & 2388 (35" long w/ monitor)
1321557S	Lower Half; Fits 1660, 1666, 1680, 1688, 2144 to S/N 107844; 2166 to S/N 0179999; 2188 to S/N 0191482 (35" long)
1321560S	Top Half; Fits 1660, 1666, 1680, 1688, 2144, 2166, 2188, 2344, 2366, 2377 & 2388 (19¼" long)
47512737S	Tube Fits 5130, 6130, & 7130
84173032S	Tube Fits 5088, 6088, & 7088

**GRAIN BIN TROUGH BOTTOM**

7066	I.H. 1440, 1460, 1480, 1640, 1660, 1644, 1666, 1680, 1688, 2144, 2166, 2188, 2344, 2366, 2388, 2577 & 2588 – Front and Rear Stainless
7067	IH 5088, 6088, 7088, 5130, 6130 & 7130 – Front & Rear Stainless
7068	IH 7010, 8010, 9010, 7120, 8120, 9120, NH 9040, 9060, 9065, 9070, 9080, 9090, 920, 940, 960, 970, 980 – Front & Rear – Stainless – Standard Rate, Covers Entire Width of the Grain Tank!



**Ordering Code**

**Description**

**CLEAN GRAIN ELEVATOR HOUSING**

- 367708S Clean Grain Elevator Housing Fits 1640, 1660, 2144, 2166, 2344, 2366 without and with AFS
- 367308S Clean Grain Elevator Housing Fits 1680, 1688, 2188, 2377, 2388, 2577, 2588 without and AFS



**CLEAN GRAIN ELEVATOR HOUSING BOOT PARTS**

- 223237S Lower Boot Outer Side 1644, 1666, 1688, 2144, 2166, 2344, 2366, 2188, 2377, 2388, 2577, 2588 with AFS System
- 1318585S Lower Boot Outer Side 1640, 1644, 1660, 1680, 1688, 2144, 2166, 2344, 2366
- 176175S Lower Boot Outer Side 2188, 2377, 2388, 2577, 2588 without AFS System
- 1317673S Lower Boot Inner Side 1640, 1644, 1660, 1666, 2144, 2166, 2344, 2366
- 1318584S Lower Boot Inner Side 1680, 1688, 2188, 2377, 2388, 2577, 2588
- 1317270S Deflector 1640, 1644, 1660, 1666, 2144, 2166, 2344, 2366
- 1318590S Deflector 1680, 1688, 2188, 2377, 2388, 2577, 2588
- 1317273S Cover Front Boot 1640, 1644, 1660, 1666, 2144, 2166, 2344, 2366
- 1317439S Cover Front Boot 1680, 1688, 2188, 2377, 2388, 2577, 2588
- 1317271S Cover Rear Boot 1640, 1644, 1660, 1666, 2144, 2166, 2344, 2366
- 1317437S Cover Rear Boot 1680, 1688, 2188, 2377, 2388, 2577, 2588
- 1317276S Solid Door 1640, 1644, 1660, 1666, 2144, 2166, 2344, 2366
- 1317430S Solid Door 1680, 1688, 2188, 2377, 2388, 2577, 2588
- 1317442S Auger Cover for Lower Clean Grain Auger 1680, 1688, 2188, 2377, 2388, 2577, 2588\*
- 1317452S Auger Cover for Lower Clean Grain Auger 1640, 1644, 1660, 1666, 2144, 2166, 2344, 2366\*

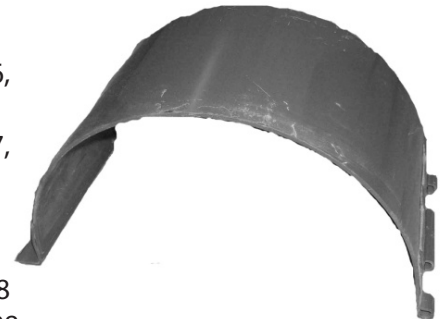
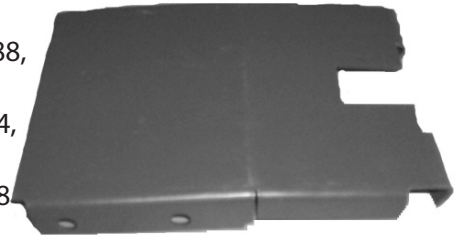

\* Auger cover is located between side of combine and elevator boot.

**LOWER CLEAN GRAIN AUGERS**

- 1317484S I.H. 1640, 1660, 1644, 1666, 2144, 2344, 2366
- 1317409S I.H. 1680 & 1688
- 87653248S I.H. 2188, 2388 to S/N 274396 – Old #143759AZ

## **VERTICAL UNLOADING HOUSING**

- 95650S I.H. Vertical Grain Tank Unloading Housing 1420 – 2588  
– Replaces B95650A, 248307A2, 87593313 and 192830C92
- 192475S I.H. Sump Grain Tank Unloading Housing 1420 – 2588 – 40% Heavier
- 189284S I.H. Door for the 192475S Housing
- 9050 I.H. Repair ring for vertical unloading housing on 5088 – 9230 – Standard Rate – 6 ½” wide to reinforce tube so does not collapse.



## **UNLOADING AUGER ELBOW**

- 87598258S IH Unloading Auger Elbow Housing 1420-2588 (Replaces 248308AZ and 87598258)

## **GRAIN TABLE REPAIR STUB**

- 8051 Stub Repair – Cut Off Bad End of Drive Shaft and Weld On - Small
- 8052 Stub Repair – Cut Off Bad End of Drive Shaft and Weld On – Large  
Used on 30’ & 35’ Tables



## **TABLE AUGER COVER**

- 87450151S Table Cover Door, 6 Bolt (Diamond Shaped Holes) 1010 & 1020 Center
- 87017844S Table Cover Door, 2 Bolt (6.3” Dia. Round Hole) 1010, 1020 Outer Used on Full Finger Auger, All 2010, 2020, 3020, NH73C & NH74C

## WHITE REPLACEMENT PARTS

Elevator Chains .....	19
Grain Pan Parts .....	19
Grain Table Parts .....	19
Straw Chopper Parts .....	19



## CHAINS FOR ELEVATOR TO CYLINDER

1835353S	White 7300
1667853S	White 7600/8600/8700
1667863S	White 8800/8900

## GRAIN PAN MATERIAL

1020	White 7300 - 32 ¼" Wide – 73 x 33 x 15
1021	White 7600, 8600 & 8700 – 43 ½" Wide
1022	White 7800, 8800 & 8900 – 50 ¼" Wide
1023	White 9700 & 9720 Rear Grain Pan
1024	White 9700 & 9720 Front Grain Pan

## GRAIN PANS

1586371S	White 7300 Grain Pan
1817801S	White 8800 & 8900 Grain Pan
1817811S	White 7600, 8600 & 8700 Grain Pan
2450141S	White 9700 & 9720 Rear Grain Pan
2552041S	White 9700 & 9720 Front Grain Pan

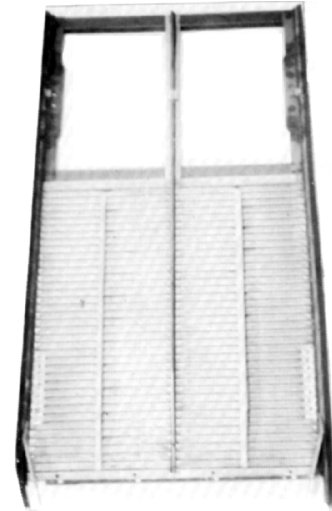

## GRAIN TABLE TROUGH REPAIR PLATES

10112	White 900 – 22'
10113	White 900 – 24'
10114	White 900 – 25'
10115	White 900 – 30'

## UNLOADING TUBES

2493021S	White 9700 & 9720 – 142.52" Long
1829373S	White 8700, 8900 & 8920 – 157.50" Long – Made to Order

## CORN HEAD TROUGHS

1577470S	White Bottom Center Trough All 700 Series
1597370S	White Bottom RH Trough 706N & 705W
1597380S	White Bottom LH Trough 706 & 705W
1687660S	White Bottom RH Trough 708
1687670S	White Bottom LH Trough 708





# JOHN DEERE REPLACEMENT PARTS

Augers .....	27 - 31
Clean Grain Auger Troughs.....	32
Clean Grain & Returns Auger Covers.....	32
Clean Grain & Returns Elevator Housing.....	26
Conveyor Drums .....	27
Cornhead Parts.....	23 & 24
Feeder House Floor Plates .....	33
Grain Table Parts.....	25
Grain Tank Loading Tubes & Augers .....	28
Unloading Auger Boot.....	32
Unloading Auger Ext. Kits.....	31
Unloading Auger Tubes & Augers .....	30
Walkers .....	25



**Ordering Code****Description****OUTSIDE FENDERS**

82434S	J.D. Fender High Tin R.H.
82435S	J.D. Fender High Tin L.H.
118342S	J.D. Fender Low Tin R.H.
118343S	J.D. Fender Low Tin L.H.

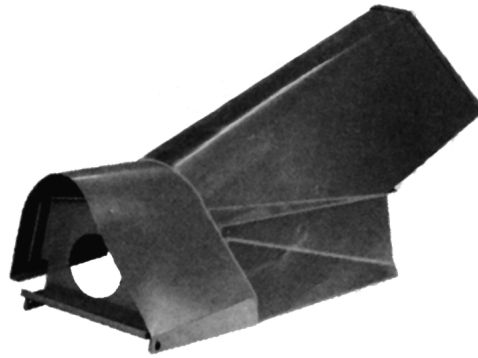
**CORN HEAD TROUGHES**

146025S	Bottom Trough 443JD to S/N 467620 Bottom Center Trough 643JD & 843JD
124153S	Bottom Trough 443JD S/N 467621 & up
82817S	Bottom Trough Right & Left 643JD to S/N 332700 Bottom Trough Left 643JD S/N 332701 & up – 28 1/4" Long
96522S	Bottom Trough Right 643JD S/N 332701 & up – 27 7/8" Long
102585S	Bottom Trough Left 843JD
102584S	Bottom Trough Right 843JD to S/N 332700 – 58 1/4" Long
96524S	Bottom Trough Right 843JD S/N 332701 & up – 57 7/8" Long
102296S	Bottom Center Trough 444JD to S/N 332700; 644JD to S/N 620636
146024S	Bottom Center Trough 444JD S/N 333701 & up; 644JD S/N 620637 & up; 844JD
146440S	Bottom Trough Right 1293 to S/N 695755
146441S	Bottom Trough Left 1293 to S/N 695755
151257S	Bottom Center Trough Narrow Row Early S/N - 90 Series
159357S	Bottom Center Trough Wide Row Early S/N - 90 Series
179193S	Bottom Center Trough Narrow Row Late S/N - 90 Series
179194S	Bottom Center Trough Wide Row Late S/N - 90 Series
151293S	Bottom Trough Left 693 to S/N 690980
151292S	Bottom Trough Right 693 to S/N 690980
179196S	Bottom Trough Left 693 S/N 690981 & Up
179195S	Bottom Trough Right 693 S/N 690981 & Up
146435S	Bottom Trough Left 694 to S/N 690618
146434S	Bottom Trough Right 694 to S/N 690618
179198S	Bottom Trough Left 694 S/N 690619 & Up
179197S	Bottom Trough Right 694 S/N 690619 & Up
151260S	Bottom Trough Left 893 to S/N 695521
151259S	Bottom Trough Right 893 to S/N 695521
153642S	Bottom Trough Right 1290 to S/N 690666
153643S	Bottom Trough Left 1290 to S/N 690666
179202S	Bottom Trough Left 893 S/N 695522 & Up
179201S	Bottom Trough Right 893 S/N 695522 & Up
179207S	Bottom Trough Left 1290 S/N 690667 & up
179208S	Bottom Trough Right 1290 S/N 690667 & up
179209S	Bottom Trough Right 1293 S/N 695756 & up
179210S	Bottom Trough Left 1293 S/N 695756 & up
231600SR	Bottom Center Trough (weld-in) 606, 608 & 612 to S/N 745100
123115S	Bottom Center Trough (bolt-in) 606, 608, 612, 616 & 618 S/N 745101 & up

**OUTSIDE CORN HEAD SNOOTS**

102484S	J.D. 20" High Tin R.H.
102485S	J.D. 20" High Tin L.H.
109667S	J.D. Snout High Tin L.H. Also fits 50 & 50 Series Row crop Bean Head (#AH109667)
109666S	J.D. Snout High Tin R.H. Also fits 50 & 50 Series Row crop Bean Head (#AH109666)
115402S	J.D. Snout Low Tin R.H. (#AH115402)
115403S	J.D. Snout Low Tin L.H. (#AH115403)
103631S	J.D. Snout Point (#N103631)
85104S	J.D. Skid Shoe (#H85104)
102372S	J.D. High Tin R.H. Pivot Bracket
102373S	J.D. High Tin L.H. Pivot Bracket

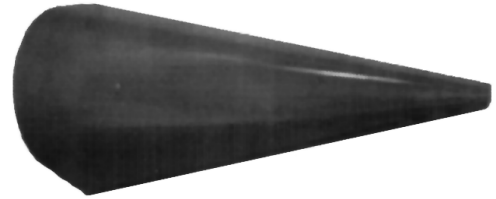

**CENTER SNOOTS**

84480S	J.D Point
101029S	J.D. 20" Row
129764S	J.D. Narrow Row (AH129764)
129766S	J.D. Wide Row (AH129766)
129768S	J.D. Narrow Row Bean
129769S	J.D. Wide Row Bean

**CORN HEAD CENTER DIVIDERS**

85632S	J.D. Divider – 20"
118338S	J.D. Divider - Narrow R.H.
118339S	J.D. Divider – Narrow L.H.
118340S	J.D. Divider – Wide R.H.
118341S	J.D. Divider – Wide L.H.
103206S	J.D. Divider Pivot Bracket R.H.
103207S	J.D. Divider Pivot Bracket L.H.
104376S	J.D. Divider Right Rear Corner Bracket
104377S	J.D. Divider Left Rear Corner Bracket

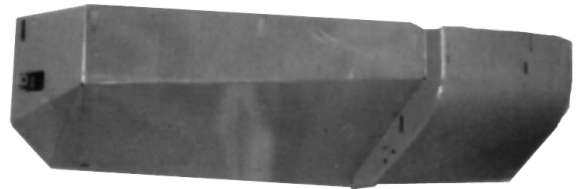

**Reduced  
Reduced**

**BEAN HEAD CENTER DIVIDERS**

98159S	RH – JD Divider – Bean Head – Narrow Row
98158S	LH – JD Divider – Bean Head – Narrow Row
96932S	RH – JD Divider – Bean Head – Filler Bracket Narrow Row
96931S	LH – JD Divider – Bean Head – Filler Bracket Narrow Row

## GRAIN TABLE PARTS

89390S	Divider Point 200 & 900 Series
136046S	Table Auger Cover 900 Series Oval - (Bolt On)
203897S	Table Auger Cover 900 Series Oval - (Clamp On)
87184S	Table Auger Cover 200 Series & Early 900 Series Round – (Bolt on)

## GRAIN TABLE TROUGH REPAIR KITS & PANELS

10100	J.D. 213 – Trough Kit
10101	J.D. 215 & J.D. 915 Prior S/N 638500 – Trough Kit
10102	J.D. 216 – Trough Kit
10103	J.D. 218 & J.D. 918 Prior S/N 638500 – Trough Kit
10104	J.D. 220 & J.D. 920 Prior S/N 638500 - Trough Kit
10105	J.D. 915 - Trough Kit - S/N 638500 & Up
10106	J.D. 918 - Trough Kit - S/N 638500 & Up
10107	J.D. 920 - Trough Kit - S/N 638500 & Up
10108	J.D. 922 - Trough Kit - S/N 638500 & Up
10109	J.D. 924 - Trough Kit - S/N 638500 & Up
10110	J.D. 925 - Trough Kit - S/N 638500 & Up
10111	J.D. 930 - Trough Kit - S/N 638500 & Up
10116	J.D. 625 – Trough Kit
10117	J.D. 630 – Trough Kit
10118	J.D. 635 – Trough Kit
218792S	J.D. 600 Series Center Repair Plate – 68 1/2" Wide – Weld In – Replaces original center panel.

## GRAIN BIN TROUGH BOTTOM

7095	J.D. 9400/9410, 9500/9510, CTS & CTS II Trough Kit-Front & Rear - Stainless
7096	J.D. 9600/9610 Trough Kit - Front & Rear - Stainless
7097	J.D. 6620 Trough Kit - Front & Rear - Stainless
7098	J.D. 7720 Trough Kit - Front & Rear - Stainless
7099	J.D. 8820 Trough Kit - Front & Rear - Stainless
8000	J.D. 9560STS, 9650STS, 9750STS; 9660STS, 9570STS & 9760STS w/ Standard Rate Cross Auger (7½" dia) Trough Kit
8001	J.D. 9450, 9550, 9560W, 9650CTS & 9660 CTS Trough Kit-Front & Rear-Stainless
8002	J.D. 9650W, 9660W Trough Kit - Front & Rear -Stainless
8003	J.D. 9660STS – 9870STS – Front & Rear – Stainless – High Rate
9000	J.D. 9400 - 9660W, CTS, CTSII Unloading Bottom Repair Plate
9001	J.D. 9560STS - 9760STS w/Standard Rate Cross Auger (7½" dia) Unloading Bottom Repair Plate
9002	J.D. 9660STS – 9870STS, S550, S650, S660, S670, S680, & S690 – Unloading Bottom Repair Plate – High Rate

## STRAW WALKERS

99693S	J.D. 4400/4420 Walker
93701S	J.D. 6600/7700 Walker
94469S	J.D. 6620/7720/8820 Walker
209840S	J.D. 9500/9660
210336S	J.D. 9400/9450
8030	J.D. 4400/4420 Grating (4' Section)
8031	J.D. 6600/8820 Grating (4' Section)

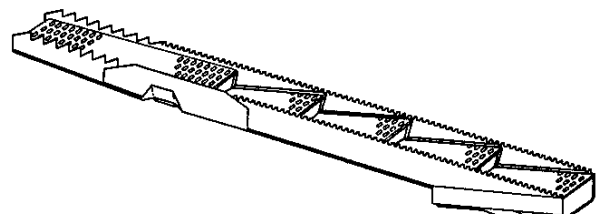

**CLEAN GRAIN ELEVATOR HOUSING**



112165S	Kit required when installing 112164S on the following models: 6600 & 7700; 6620 up to S/N 551900; 7720 up to S/N 556300; 8820 up to S/N 464350.
112164S	Clean Grain Elevator Housing Fits 6600, 6620, 7700, & 7720 – 8820 Up to S/N 464350
105850S	Clean Grain Elevator Housing Fits 8820 S/N 464351 & up
156594S	Lower Clean Grain Elevator Housing Fits 9400, 9410, 9500, & 9510
153743S	Upper Clean Grain Elevator Housing Fits 9400, 9410, 9500, & 9510
156596S	Lower Clean Grain Elevator Housing Fits 9600 & 9610
153741S	Upper Clean Grain Elevator Housing Fits 9600 & 9610
12250S	Clean Grain Elevator Housing Fits 9650 STS, 9750 STS, 9660STS, 9760STS, 9860STS, 9570STS & 9670
207172S	Clean Grain Elevator Housing Fits 9450, 9550, 9550SH, 9560, 9560SH, 9650, 9650CTS, 9660 & 9660CTS
12248S	Clean Grain Elevator Housing 9770STS & 9870STS
14371S	Clean Grain Elevator Housing Fits S550, S650, S660, & S670 – Standard Capacity
14370S	Clean Grain Elevator Housing Fits S670, S680, & S690 – High Capacity

**RETURN ELEVATOR HOUSING**

112080S	Kit, required when installing 112077S on 8820 up to S/N 610700
96371S	Return Elevator Housing Fits 6600 & 7700, 6620 up to S/N 610300 - 7720 up to S/N 610500
112077S	Return Elevator Housing Fits 6620 S/N 610301 & up 7720 S/N 610501 & up - 8820
169233S	Return Elevator Housing Fits 9400-9660
12678S	Return Elevator Door 6600 & 7700, 6620 up to S/N 610300 - 7720 up to S/N 610500, also Clean Grain Door 3300, 4400, & 4420
98029S	Return Elevator Door 6620 S/N 610301 & up 7720 S/N 610501 & up - 8820
130892S	Return Elevator Door 9400 – 9660
217786S	Return Elevator Door 9570STS, 9560STS, 9660STS, 9670STS, 9750STS, 9760STS, 9770STS, 9860STS, 9870STS, S550, S660 & S670 (Stainless)
234729S	Return Elevator Door – S680 & S690 (Stainless)

**CLEAN GRAIN ELEVATOR HOUSING BOOTS**

88989S	Upper Boot - Fits 6600 S/N 15650 & up 7700 S/N 163901 & up; 6620
97856S	Upper Boot - Fits 7720; 8820 up to S/N 464350
105498S	Upper Boot - Fits 8820 S/N 464351 & up
83511S	Lower Boot - Fits 6600 & 7700
93242S	Lower Boot - Fits 6620 & 7720; 8820 up to S/N 464350
105854S	Lower Boot - Fits 8820 S/N 464351 & up
149182S	Lower Boot - Fits 9400, 9410, 9500 & 9510
149181S	Lower Boot - Fits 9600 & 9610
69600S	Lower Boot - Fits 9450, 9550, 9650, 9560, 9660, 9650CTS, 9660CTS, 9650STS, 9750STS, 9560STS, 9660STS, 9760STS, 9860STS, 9550SH & 9560SH
72627S	Lower Boot – Fits 9770STS, 9870STS, S670 High Capacity & S670 Hill Master
66789S	Lower Boot – Fits 9570STS, 9670STS, S550, S660 & S670 Standard Capacity
77062S	Lower Boot Door 6600 - 8820 up to S/N 464350
105855S	Lower Boot Door 8820 S/N 464351 & up
129357S	Lower Boot Door 9400, 9410, 9500 & 9510
129358S	Lower Boot Door 9600 & 9610
138426S	Lower Boot Door 9450, 9550, 9650, 9560, 9660, 9650 CTS, 9660 CTS, 9650 STS, 9750 STS, 9560 STS, 9660 STS, 9760 STS, 9860 STS

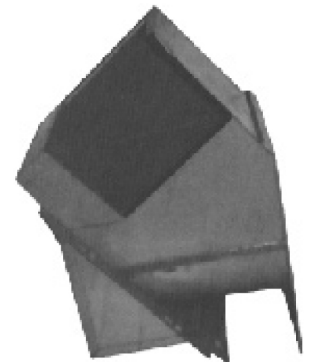

## CONVEYOR DRUMS



108852S	J.D. 4400 & 4420 drum
142393S	J.D. 9600, 9650 & 9610 - 63¼" Long
142394S	J.D. 9400, 9450, 9650STS, 9410, 9500, 9550, 9750STS, 9510 - 52¼" Long
143365S	J.D. 9600, 9650 & 9610 (w/ contour master) - 61" Long
216876S	J.D. 9670STS, 9770STS, 9870 S/N 730101 and up S650, S660, S670, S680, S690 to S/N 775000- 49 1/8" Long
220242S	J.D. 9660STS S/N 720301 & Up, J.D. 9760STS S/N 720401 & Up, J.D. 9860STS - S/N 720501 (9670STS, 9770STS, 9870STS Prior S/N 730100) - 51 5/8" Long
220243S	J.D. 9560STS S/N 720101 & Up & 9570STS - 40 15/16" Long
27254S	J.D. S650STS, S660STS, S670STS, S680STS & S690STS S/N775001 & up - 49 1/8" Long
220242SB KIT	J.D. Bearing Kit for 60 Series
220242SS KIT	J.D. Shaft and Arm Kit for 60 Series
220243SS KIT	J.D. Shaft and Arm Kit for 60 Series

CONVERSION ORDER CHART FOR NEW 4-BOLT BEARING STYLE DRUMS					
	220242S	220243S	220242SB KIT	220242SS KIT	220243SS KIT
9560STS Prior S/N 710559		REQUIRED	REQUIRED		REQUIRED
9560STS S/N 710560-720100		REQUIRED	REQUIRED		
9660STS Prior S/N 711301 & 9760STS Prior S/N 711197	REQUIRED		REQUIRED	REQUIRED	
9660STS S/N 711302-720300 & 9760STS S/N 711198-720400	REQUIRED		REQUIRED		
9860STS S/N Prior 710892	REQUIRED		REQUIRED	REQUIRED	
9860STS S/N 710893-720500	REQUIRED		REQUIRED		
~ Please check that your drum has not been converted to new style already ~					

## GRAIN TANK FRONT UNLOADING AUGERS

98211S	J.D. Auger - Fits 6620
98212S	J.D. Auger - Fits 7720 (AH98212)
107393S	J.D. Auger - Fits 8820 (AH107393)
201744S	J.D. Auger - Fits 9400, 9410, 9450, 9500, 9510, 9550, 9560, 9570, 9650, 9660, 9670, 9750 & 9760 CTS, CTS, CTSII, STS (STD. Rate)
202875S	J.D. Auger - Fits 9600, 9610 & 9650
202958S	J.D. Auger - Fits 9660 STS, 9760STS, 9670STS, 9770STS, 9860STS, 9870STS, 9880STS, S660, S670, S680, S690, S760, S770, S780, & S790 (High Rate) (New # AXE18081)

## GRAIN TANK REAR UNLOADING AUGERS

103727S	J.D. Auger - Fits 6620 up to SN 600000 w/ paddle
114715S	J.D. Auger - Fits 6620 SN 600001 & up
103728S	J.D. Auger - Fits 7720 up to SN 600000 w/ paddle
114716S	J.D. Auger - Fits 7720 SN 600001 & up
103729S	J.D. Auger - Fits 8820 up to SN 600000 w/ paddle
114717S	J.D. Auger - Fits 8820 SN 600001 & up
201743S	J.D. Auger - Fits 9400, 9410, 9450, 9500, 9510, 9550, 9560, 9650, 9660, 9670, 9750 & 9760 CTS, CTS, CTS II, STS (STD. Rate)
202881S	J.D. Auger - Fits 9600, 9610 & 9650
202959S	J.D. Auger - Fits 9660 STS, 9760STS, 9670STS, 9770STS, 9860STS, 9870STS, 9880STS, S660, S670, S680, S690, S760, S770, S780, & S790 (High Rate) (New # AXE18082)



**GRAIN TANK LOADING AUGERS**

127732S	J.D. Auger Fits 4400 Ser. #151501 & up; 4420 (#AH127732)
90624S	J.D. Auger Fits 6600 Ser. #163901 & up (#AH90624)
127728S	J.D. Auger Fits 6620; 7700 Ser. #163901 & up (#AH127728)
127729S	J.D. Auger Fits 7720 (#AH127729)
127730S	J.D. Auger Fits 8820 (#AH127730)
84824S	J.D. Auger Top Fits 4400 up to Ser. #151500 & 6600 up to Ser. #156500
84825S	J.D. Auger Top Fits 7700 up to Ser. #163900
84823S	J.D. Auger Center Fits 4400 up to Ser. #151500 & 6600 up to Ser. #163900
84822S	J.D. Auger Bottom Fits 6600 up to Ser. #156500 & 7700 up to Ser. #163900
84821S	J.D. Auger Bottom Fits 4400 up to Ser. #151500
136091S	J.D. Auger Fits 9400 up to Ser. #640100 & 9500 up to Ser. #640200
136635S	J.D. Auger Fits 9400 Ser. #640101 & up; 9500 Ser. #640201 & up, 9510
136092S	J.D. Auger Fits 9600 up to Ser. #640300
136636S	J.D. Auger Fits 9600 Ser. #640301 & up, 9610
146554S	J.D. Auger Fits 9410 & 9510 Top Folding
146214S	J.D. Auger Fits 9410 & 9510 Bottom Folding
146553S	J.D. Auger Fits 9610 Top Folding
146215S	J.D. Auger Fits 9610 Bottom Folding
205897S	J.D. Auger Fits 9450, 9650 W, 9550, 9560 W, 9650 STS, 9660 STS, 9860 STS, 9750 STS, 9760 STS & 9660W – Old Style w/ Bushing for Bearing
218485S	J.D. Auger Fits 9670STS – New Style – Can be used for 205897S w/ 19M7815 Bolt and 10384 Bearing
223220S	J.D. Auger Fits 9560 STS & 9570 STS (Old # AH205605)
230013S	J.D. Auger Fits 9770STS & 9870STS, S670 without power fold
69563S	J.D. Auger Fits S670, S680, S690, S780 & S790 – 400 Bushel- Manual & Power Fold
69564S	J.D. Auger Fits S660, S670, & S770 – 300 Bushel – Power Fold



**GRAIN TANK LOADING AUGER TUBES**

88983S	J.D. Tube Fits 4400 Ser. #151501 & up 6600 Ser. #163901 & up (#AH88983)
88982S	J.D. Tube Fits 6620; 7700 Ser. #163901 & up (#AH88982)
98300S	J.D. Tube Fits 7720 & 8820 (#AH98300)
83899S	J.D. Auger Extension Housing with Door-Fits 6600 up to Ser. #156500 & 7700 up to Ser. #163900 (#AH83899 and H77053)
76249S	J.D. Tube Fits 3300 (#AH76249)
78201S	J.D. Tube Fits 4400 up to Ser. #151500 (#AH78201)
75997S	J.D. Tube Fits 6600 up to Ser. #156500 (#AH75997)
77064S	J.D. Tube Fits 7700 up to Ser. #163900 (#AH77064)
131903S	J.D. Tube Fits 9400 up to Ser. #640100, 9500 up to Ser. #640200
131907S	J.D. Tube Fits 9600 up to Ser. #640300
135444S	J.D. Tube Fits 9400 Ser. #640101 & up, 9410, 9500 Ser. #640201 & up, 9510
135563S	J.D. Tube Fits 9600 Ser. #640301 & up, 9610
211160S	J.D. Tube Fits 9450, 9550, 9550SH, 9560, 9560SH, 9650, 9650CTS, 9660, 9660CTS – 45 3/16" Tube Stainless
217983S	J.D. Tube Fits 9770STS & 9870STS – 45 3/16" Tube - Stainless
219093S	J.D. Tube Fits 9650STS, 9660STS, 9670STS, 9750STS, 9760STS, 9860STS, S660 & S760 to S/N 805000 – Manual Fold – 45 3/16" Tube - Stainless
219096S	J.D. Tube Fits 9560STS, 9570STS, & S550 – 40 3/16" Tube - Stainless
12747S	J.D. Tube Fits S670 & S770 – Manual Fold – High Rate – 45 3/16" Tube - Stainless
56593S	J.D. Tube Fits S660, S670, S670, S760 to S/N 805000, & S770 to S/N 805000 – Power fold – 45 3/16" Tube - Stainless
56594S	J.D. Tube Fits S680, S690, S780, to S/N 805000, & S790 to S/N 805000 – Power fold – 53 1/16" Tube - Stainless
56595S	J.D. Tube Fits S680, S690, S780, & S790 – Manual Fold – (AXE 83882) 53 1/16" Tube - Stainless





## INNER UNLOADING AUGERS

76241S	J.D. Auger, Inner Unloading – Fits 4400
85409S	J.D. Auger, Inner Unloading – Fits 6600 (AH85409)
85410S	J.D. Auger, Inner Unloading – Fits 7700 (AH85410)

## GRAIN TANK VERTICAL AUGERS

123929S	J.D. Auger, Vertical Fountain - Fits all 6620, 7720 & 8820 (AH123929)
124852S	J.D. Auger, Vertical Fountain - Fits 9400, 9410, 9450 to S/N 695100, 9500, 9500SH, 9510, 9510SH; 9550 to S/N 695200; 9500SH to S/N 695700; 9600; 9610; 9650 to S/N 695300; 9650CTS to S/N 695400; CTS, CTS II
146840S	J.D. Auger, Vertical Fountain - Fits all 9650STS, 9750STS, 9560STS, 9660STS with standard rate auger
171550S	J.D. Auger, Vertical Fountain - Fits 9450 S/N 695101& up; 9550 S/N 695201 & up; 9550SH S/N 695701 & up; 9650 S/N 695301 & up; 9650CTS S/N 695401 & up; 9560, 9560SH, 9660, 9660CTS
202956S	J.D. Auger, Vertical Fountain - Fits 9660 STS, 9760 STS, 9860 STS, 9670 STS, 9770 STS & 9870 STS (High Rate)
AXE18070S	J.D. Auger, Vertical Fountain – Fits S660, S670, S680, S690, S760, S770, S780 & S790

## SHOE SUPPLY AUGERS

95945S	J.D. Auger - Fits 4400/4420
95946S	J.D. Auger - Fits 4400/4420
95943S	J.D. Auger R.H. - Fits 6600, 7700, 6620 & 7720 (AH95943)
95944S	J.D. Auger L.H. - Fits 6600, 7700, 6620 & 7720 (AH95944)
130424S	J.D. Auger R.H. - Fits 9400, 9500 & 9600 - steel
130425S	J.D. Auger L.H. - Fits 9400, 9500 & 9600 - steel
146786S	J.D. Auger L.H. - Fits 9650STS, 9560STS, 9760STS, 9750STS, 9660STS & 9860STS, 9570STS, 9670STS, 9770STS, 9870STS, S550, S650, S660, S670, S680, S690, S760, S770, S780, & S790
146787S	J.D. Auger R.H. - Fits 9650STS, 9560STS, 9760STS, 9750STS, 9660STS & 9860STS, 9570STS, 9670STS, 9770STS, 9870STS, S550, S650, S660, S670, S680, S690, S760, S770, S780, & S790

## LOWER CLEAN GRAIN AUGERS

76772S	J.D. Auger, Clean Grain - Fits 4400 & 4420
91468S	J.D. Auger, Clean Grain - Fits 6600
91469S	J.D. Auger, Clean Grain - Fits 7700
91283S	J.D. Auger, Clean Grain - Fits 6620
107442S	J.D. Auger, Clean Grain - Fits 7720
107400S	J.D. Auger, Clean Grain - Fits 8820 up to 464350 `79 & `80
105856S	J.D. Auger, Clean Grain - Fits 8820 - 464351 & up `81 - `89
141577S	J.D. Auger, Clean Grain - Fits 9400, 9410, 9500, 9510, CTS, CTS II
141576S	J.D. Auger, Clean Grain - Fits 9600 & 9610
162154S	J.D. Auger, Clean Grain - Fits 9450, 9550, 9560 W, 9650 STS, 9660 STS, 9750 STS, 9760 STS & 9860 STS
162153S	J.D. Auger, Clean Grain - Fits 9650 W, 9660 W
206109S	J.D. Auger, Clean Grain - Fits 9560 STS
219339S	J.D. Auger, Clean Grain – Fits 9770STS, 9870STS, S670, S680, S690, S760, S770, S780 & S790 (New #AXE S9539)
45389S	J.D. Auger, Clean Grain – Fits S690, & S790

**UNLOADING AUGER**

99394S	J.D. 6600/7700 Unloading Auger – 142 5/8"
112435S	J.D. 9400 - 9650 Short Auger (use on 2-piece unloading augers) - 74"
114138S	J.D. 4400/4420 Unloading Auger - 136"
143729S	J.D. 6620 - 9610 17' Unloading Auger - 200 7/8"
143731S	J.D. 6620 - 9750 14' Unloading Auger (use with 112435S for 20' auger) - 164 7/8"
143727S	J.D. 9400 - 9750 Unloading Auger (use with 112435S for 17' auger) 129"
169061S	J.D. 9650 STS above 690501, 9750 STS above 690601, 9760 STS, 9660 STS Inner Unloading - 82½"
173593S	J.D. 9650 STS, 9560W Outer Unloading (18½" system)
173595S	J.D. 9560 W, 9660 W, 9560 STS, 9660 STS, 9760 STS Outer Unloading (21½" system)
201797S	J.D. 9660 STS, 9760 STS, 9860STS, 9670STS, 9770STS, 9870STS, S660, S670, S680, S690, S760, S770, S780, S790 up to S/N 810000, Inner Unloading – High Rate 22.5 ft., 26 ft, 28.5 ft
72774S	J.D. S760, S770, S780, S790 S/N 810001 & up Inner Unloading High Rate 26 ft & 28.5 ft.
203021S	J.D. 9660 STS, 9760 STS, 9860 STS, 9670STS, 9770STS, S660, S670, S680 & S690 Outer Unloading Auger–High Rate 22.5ft
211828S	J.D. 9670STS, 9770STS, 9870STS, S670, S680 & S690– Outer Unloading Auger – High Rate Folding Auger – 22.5 ft. & 26 ft
226068S	J.D. 9670STS, 9770STS, 9870STS, S670, S680 & S690– Middle Unloading Auger – High Rate – Folding Auger – 22.5 ft
42895S	J.D. S660, S670, S680, S690, S760, S770, S780, S790 – Middle Unloading – High Rate – Folding Auger – 26 ft.
234554S	J.D. 9670STS, 9770STS, 9870STS, S670, S680 & S690 – Middle Unloading Auger – High Rate 26ft & 28.5 ft.
235525S	J.D. 9670STS, 9770STS, 9870STS, S670, S680 & S690 – Outer Unloading Auger – High Rate 26ft
41770S	J.D. S660, S670, S680, S760, S770, S780, & S790 – Outer Unloading Auger – High Rate 28.5 ft.

**UNLOADING TUBES**

87107S	J.D. 3300/4400 Solid Unloading Tube - 135½"
99414S	J.D. 6600/7700 Solid Unloading Tube - 142¾"
101599S	J.D. 4420 Solid Unloading Tube - 135½"
145047S	J.D. 9400 – 9750STS Unloading Tube Solid 14ft – 108 ½"
140334S	J.D. 6620, 7720, & 8820 Unloading Tube Solid 14 ft. (New #145049) - 144½"
	J.D. 9400 – 9750STS Unloading Tube Solid 17 ft. - 144½"
140335S	J.D. 6620, 7720 & 8820 Unloading Tube Screened 14 ft. - 144½"
	J.D. 9400 – 9750STS Unloading Tube Screened 17 ft. - 144½"
112865S	J.D. 6620, 7720 & 8820 Unloading Tube Solid 17 ft. (New #145050) - 180½"
	J.D. 9400 – 9750STS Unloading Tube Solid 20 ft. - 180½"
113392S	J.D. 6620, 7720 & 8820 Unloading Tube Screened 17 ft. - 180½"
	J.D. 9400, 9500 & 9600 Unloading Tube Screened 20 ft. - 180½"
210024S	J.D. 9560 W & 9560 STS - Unloading Tube Solid - 18.5 ft. - 144¼"
210023S	J.D. 9560 W - 9760 STS, S550 & S560 - Unloading Tube Solid - 21.5 ft. - 180¼"
210025S	J.D. 9560 W & 9560STS – Unloading Tube Screened – 18.5ft – 144 ¼"
210026S	J.D. 9560 W & 9560STS – Unloading Tube Screened – 21.5ft – 180"

## UNLOADING TUBES (cont.)

72375S	J.D. 9660STS, 9760STS, 9860STS, S660, S670, S680 & S690 Prior to 775000 Unloading Tube Outer - High Rate-22.5 ft. – 15'4" Long (Old #203020S)
68706S	JD S660, S670, S680, S690 S/N 775001 & up; S760, S770, S780, S790 – Unloading Tube Outer High Rate – 22.5 ft. – 161 5/8" Long
68701S	JD S660 S/N 765172 & up, S670 S/N 765253 & up, S680 S/N 766007 & up, S690 S/N 765250 & up, S760, S770, S780, & S790 Unloading Tube Middle Section High Rate – 26 ft & 28.5 ft. – 93 3/8" long
68700S	J.D. 9670STS, 9770STS, 9870STS, S660, S670, S680, S690, S760, S770, S780 & S790 Unloading Tube Outer Section - High Rate – 26 ft - 112 ¼" Long (old #AH26714, AH2344567 & AXE47450)
68702S	JD S660 S/N 5172 & up, S670 S/N 765253 & up, S680 S/N 766007 & up, S690 S/N 765250 & up, S760, S770, S780 & S790 Unloading Tube Outer Section High Rate – 28.5 ft. – 130 7/8" Long
72376S	J.D. 9670STS, 9770STS, 9870STS, S660, S670, S680 & S690 to S/N 77500 - Unloading Tube Middle Section – High-Rate Folding – 115 13/16" Long (Old #AH209128)
202240S	J.D. 9670STS, 9770STS, 9870STS, S660 Prior to 765171, S670 Prior to 765252, S680 Prior to 766006 & S690 Prior to 765249 Unloading Tube Outer Section – High-Rate Folding – 66" Long (NEW #AXE28972, AXE36427 & AXE47449)

## 6620-9760 UNLOADING AUGER EXTENSION

SMC 14	J.D. 6620 – 9750 - Unloading Auger Ext. 3 ft. (2 7/8" O.D. Inner Auger Tube)
SMC 16	J.D. 6620 – 9750 - Unloading Auger Ext. 3 ft. (3½" O.D. Inner Auger Tube)
SMC 33	J.D. 6620 – 9750 Unloading Auger Ext. 3 ft. (3 ½" O.D. Inner Auger Tube) converts to new style spout
SMC 34	J.D. 6620 - 9750 Unloading Auger Ext. approx. 24" - 30" (3½" O.D. Inner Auger Tube) converts to new style spout
SMC 35	J.D. 9560/9760 Unloading Auger with End Discharge 3 ft. Ext.
SMC 36	J.D. 9660STS, 9760STS, 9860STS, 9670 STS, 9770 STS, 9870 STS, S660, S670, S680, S690, S760, S770, S780, & S790 – High-Rate Ext. 3 ft.
SMC 37	J.D. 9660STS, 9760STS, 9860STS, S660, S670, S680 & S690 – High-Rate Ext. 3ft longer for 22 ½ ft. folding system. Will replace complete outer tube & auger. Also Replaces Inner Tube with Heavier New Tube. Original tube is 66" Long, this tube is 102" Long

## UNLOADING END BOOT CONVERSION KIT

SMC 210	Kit to Switch from Older Bottom Discharge to Newer End Discharge Unloading System. Use When Installing New Style Tube & Auger on Old Style System. Includes Spout, Grain Saver, Bearing & Housing Carrier and Hardware.
---------	---

## TAILINGS AUGERS

146322S	Lower Tailings 9400, 9410, 9450, 9500, 9500SH, 9510SH, 9550, 9550SH, 9560, 9560SH, 9650CTS, 9660CTS, CTS, CTS III
146313S	Lower Tailings 9600, 9610, 9610, 9650, 9660
147472S	Lower Tailings 9560STS, 9660STS, 9860STS, 9750STS, 9760STS, 9670STS, 9770STS, 9870STS, S650, S660 & S670
125895S	Upper Tailings 9400, 9410, 9450, 9500, 9500SH, 9510, 9510SH, 9550, 9550SH, 9560, 9560SH, 9650CTS, 9660CTS, CTS, CTS III
125894S	Upper Tailings 9600, 9610, 9650

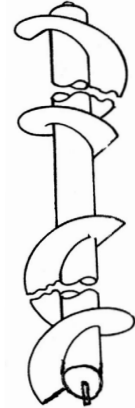

## CORNHEAD AUGERS

148503S	J.D. 693 – 6 Row Narrow – Above S/N 670451 - 22" Pitch
148505S	J.D. 893 – 8 Row Narrow – Above S/N 670051 - 22" Pitch

## RETURN AUGER COVERS

75975S	Auger Cover (2 used) Fits 3300, 4400, 4420, 6600, 6620 to S/N 610300; 7700; 7720 to S/N 610500
118676S	Auger Cover (2 used) Fits 6620 S/N 610300 & up; 7720 S/N 610501 & up; 8820 S/N 610701 & up
99488S	Auger Cover (2 used) Fits 8820 up to S/N 610700
136054S	Auger Cover (2 used) Fits 9400, 9410, 9450, 9500, 9510, 9550, 9600, 9610, 9650, 9660, 9650 CTS, 9660 CTS, CTS, CTS II



## CLEAN GRAIN AUGER COVER

77058S	Auger Cover (2 used) Fits 6600, 7700, 7720 & 8820
--------	---

## UNLOADING AUGER BOOT

211327S	Boot – New Style Spout Fits 9560 W & 9560 STS
---------	---

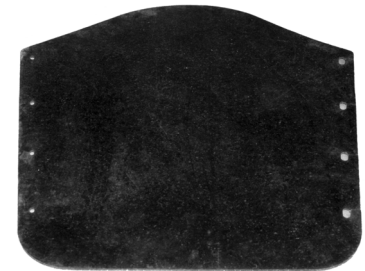

## CLEAN GRAIN AUGER TROUGHS

98485S	Trough Door 6620, 7720 & 8820 Center
98486S	Trough Door 6620 (2 Used)
98487S	Trough Door 7720 (2 Used); 8820 LH Side (1 Used)
98488S	Trough Door 8820 RH Side (1 Used)
139386S	Trough Door 9600, 9610, 9650 W & 9660 W
139388S	Trough Door 9400, 9500, 9410, 9510, 9450, 9550, 9650 CTS, 9650 STS, 9660 CTS, 9660 STS, 9670 STS, 9750 STS, 9760 STS, 9770 STS, 9860 STS, 9870 STS, CTS & CTS II
202970S	Trough Door 9560STS & 9570STS
15954S	Trough Door S650STS, S660STS, S670STS & S680STS

## GRAIN TANK CLEAN OUT DOOR

136572S	Door Fits 9400 – 9750STS (Front)
136573S	Door Fits 9400 – 9750STS (Rear)

## **FEEDER HOUSE FLOOR PLATES**

1159703S	Floor Plate – Fits CTS, CTS III, 9400, 9410, 9450, 9500, 9510, 9550, 9550SH, 9560SH, & 9650CTS
159704S	Floor Plate – Fits 9600, 9610, & 9650
24554S	Floor Plate – Fits 9660STS, 9760STS, 9770STS, 9870STS, S650, S660, S670, S680, S690 to S/N 775000
147800S	Floor Plate – Fits 9650STS & 9750STS
29353S	Floor Plate – Fits with Hydraulic Fore/Aft Tilt, S660, S670, S680, S690 S/N 775001 and up; S760, S770, S780, S790

## **FEEDER HOUSE FLOOR PLATE SEALS**

173903S	Plate Seal - Fits 9600, 9610, 9640WTS, 9660WTS, 9680WTS, 9650 & 9660
173904S	Plate Seal – Fits 9450, 9500, 9540WTS, 9560WTS, 9580WTS, 9550, 9560, 9650CTS, 9650STS, 9750STS, 9660STS, 9760STS, 9670STS, 9770STS, 9780CTS, & 9860STS
71732S	Plate Seal – Fits S650, S660, S670, S680, S690, S760, S770, S780 & S790



## MASSEY FERGUSON REPLACEMENT PARTS

Aluminum Reel Parts .....	41
Augers .....	43
Beater Covers .....	47
Clean Grain & Tailing Doors – Solid & Screened .....	50
Massey-Ferguson Unloading Tubes – High Rate.....	42
Concave Angles .....	45
Conveyor Chains & Parts .....	47 & 48
Conveyor Drums .....	46
Cornhead Adapters.....	54
Cornhead Parts .....	52 & 53
Cylinder Drive Parts.....	51
Elevator Chains & Paddles.....	49
Feeder Elevator Paddles, Angles & Bottoms.....	48
Final Drive Parts .....	54
Front Beaters .....	46
Four Wheel Drive Parts.....	57
Gears .....	55
Grain Pan Parts .....	38
Grain Tank Loading Auger Tube .....	44
Grain Table Parts.....	39 – 41
Ladder Kit .....	57
Rear Beater Bats .....	47
Repair Plates .....	50 & 51
Rotor Parts .....	44 & 45
Rubber Parts .....	48, 49, 53, & 57
Shafts .....	40, 53 - 56
Straw Chopper Parts.....	37
Throat Coupler Parts.....	56
Tractor Parts.....	57
Unloading Auger Ext. Kits.....	44
Unloading Auger Tubes.....	43
Variable Speed Hubs.....	56
Walkers .....	58





**Ordering Code**

**Description**

**STRAW CHOPPER HOUSING REPAIR**

- 1051900SR Straw Chopper Housing Repair Plate 540
- 1050055SR Straw Chopper Housing Repair Plate 550  
Prior Ser. #5947
- 1059583SR Straw Chopper Housing Repair Plate 550  
Ser. #5947 & up
- 1048577SR Straw Chopper Housing Repair plate 750 & 850  
Prior Ser. #26746
- 1059396SR Straw Chopper Housing Repair Plate 850  
Ser. #26746 & up
- 1048593SR Straw Chopper Housing Repair Plate 760 & 860  
Prior Ser. #19115
- 1059397SR Straw Chopper Housing Repair Plate 860 Ser. #19115 & up
- 1072465SR Straw Chopper Housing Repair Plate 8560
- 71389453SR Straw Chopper Housing Repair Plate - 8570 & 8780 (Redekop) – 25 Slots
- 116240SR Straw Chopper Housing Repair Plate - 8570 & 8780 (Redekop) - Solid
- 71409830SR Straw Chopper Housing Repair Plate – 9690 & 9695 (Redekop) – 25 Slots
- 71409835SR Straw Chopper Housing Repair Plate – 9790, 9795 & 9895 (Redekop) – 31 Slots



**STRAW CHOPPER REAR BOARD PARTS AND FINs**

- 103369S Rear Tail Board 8570 & early 8780
- 103370S Rear Side Panel RH 8570 & early 8780
- 103371S Rear Side Panel LH 8570 & early 8780
- 103378SW Special Widespread Fin RH for 8570 & early 8780
- 103379SW Special Widespread Fin LH for 8570 & early 8780
- 103380S Housing Bottom 8570 & early 8780
- 71379251SW Special Widespread Fin LH for 8780 Late
- 71379252SW Special Widespread Fin RH for 8780 Late

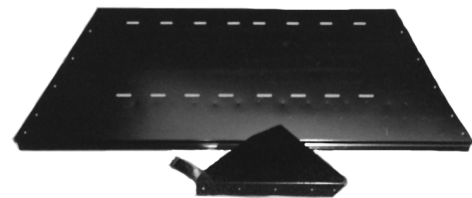

**STRAW CHOPPER KNIFE**

- REDUCED** 837029S Kit contains 3 knives, 3 hardened bushings & hardware - MF300 - 510  
Gleaner G all, Gleaner F & K prior SN36000
- REDUCED** 837030S Kit contains 3 knives, 3 hardened bushings & hardware - MF550 - 860 &  
8560, Gleaner F & K Late & L & M



**GRAIN PANS**

250530S	M.F. 410 & 540 Grain Pan
269859S	M.F. 510 & 550 Grain Pan
283004S	M.F. 760 & 860 Grain Pan
283006S	M.F. 750 & 850 Grain Pan
1817801S	M.F. 8560, 8570, 8780, 8780XP, 9520 & 9695 – NEW # 71418318
2450141S	M.F. 8590 – Rear Grain Pan
2552041S	M.F. 8590 – Front Grain Pan
2559881S	M.F. 8560/ 8570/ 8780/ 8780XP Front Grain Pan

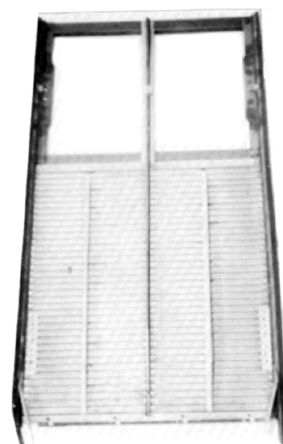

**GRAIN PAN FRONT SECTIONS**

244231S	M.F. 300 Bolt on Style
248069S	M.F. 410/540 Both Sides
253357S	M.F. 750 Early Both Sides
269860S	M.F. 510/550 Both Sides
271481S	M.F. 760 Early Left
272551S	M.F. 760 Early Right
283007S	M.F. 760/860 Late Left
283009S	M.F. 760/860 Late Right
283010S	M.F. 750/850 Late Right
283011S	M.F. 750/850 Late Left

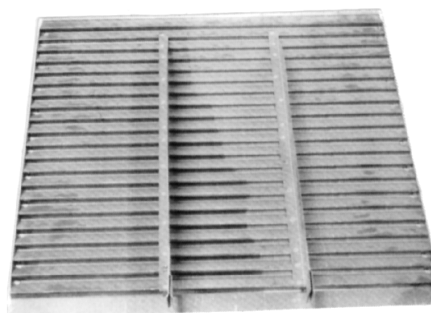

**GRAIN PAN MATERIAL**

1010	M.F. 300 38" Long
1011	M.F. 410/540 39 1/2" Long Set with (2) Fins
1012	M.F. 510/550 39 1/2" Long Set with (2) Fins
1013	M.F. 750/850 49" Long Set with (4) Fins
1014	M.F. 760/860 49" Long Set with (4) Fins
1022	M.F. 8570 & 8560 50 1/4" Wide
1023	M.F. 8590 Rear Grain Pan
1024	M.F. 8690 Front Grain Pan
1100	Rear Bearing Hanger Bracket 750 - 860

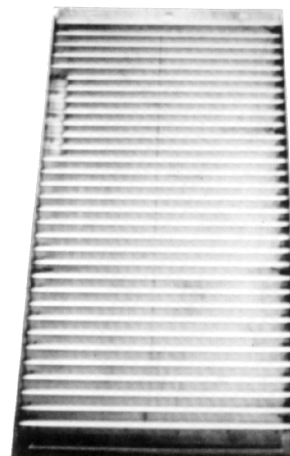

## GRAIN TABLE SKID PLATES & PARTS

71307321S	Right Skid Plate 1859 Series Old # 245624S
71307357S	Left Deflector Pan (Short Dividers), Old #1053164S
71189815S	Center Skid Plate 1859 Series, Old # 1053171S
71307322S	Left Skid Plate 1859 Series, Old #1053172S
71307316S	Stabilizer End, Old #1053206S
1057736S	Right Skid Plate 9000 Series
1057737S	Center Skid Plate 9000 Series
1057738S	Left Skid Plate 9000 Series



## DRAPER HEAD SKID PLATES

71476033S Fits 9250 and 9255 Draper Heads. Kit includes R.H. and L.H. plates. Skids are made of AR400 wear plate that last 3-4 times longer than original skid plates. Hardware included.

## GRAIN TABLE SHIELDS

7070	Apron Shield (48")
245539S	Feather Shield (27")
245540S	Feather Shield (39")
245541S	Feather Shield (50")
245543S	Feather Shield (54")
245544S	Feather Shield (63")
245553S	Wobble Drive Shield

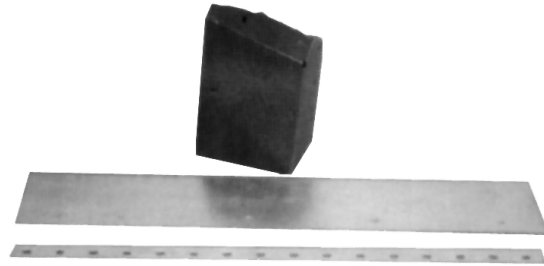

## GRAIN TABLE TROUGH REPAIR KITS

7090	1486 or 1859 Center Trough Repair 60" Wide
7091	2381 Center Trough Repair 72 1/2" Wide
7092	9000 Center Trough Repair - 72" Wide
7094	9750 Center Trough Repair - 60" Wide
7093	8200 Center Trough Repair - 60" Wide
10112	9200/9300/9750 - 22' Complete
10113	9200/9300/9750 - 24' Complete
10114	9200/9300/9750 - 25' Complete
10115	9200/9300/9750 - 30' Complete

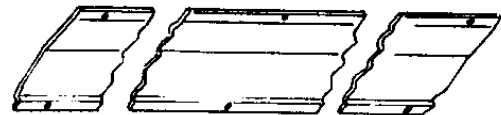

**GRAIN TABLE DIVIDERS**

147031S	R.H. Long Dividers M.F. Grain Head - 1859 & 9000 Series
148300S	L.H. Long Divider M.F. Grain Head - 9000 Series E000276 & up
9000GTK	Att. Kit for 9013 - 9020 Long Dividers
1859GTK	Att. Kit for H.C. III Long Dividers
1055470S	Left Deflector Pan Long Dividers
1055472S	Divider Point Long Dividers
1055481S	Right Deflector Pan Long Dividers
245561S	R.H. Short Divider M.F. Grain head
245562S	L.H. Short Divider M.F. Grain head (New #71306794)

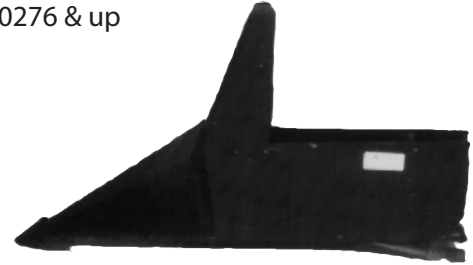

**DRAPER HEAD END SHIELDS AND DIVIDER**

71368511SL	L.H. Anti-Wrap End Shield 9250 Draper Head
71368511SR	R.H. Anti-Wrap End Shield 9250 Draper Head
71426376S	End Divider – 9250 – Reinforced at Bottom

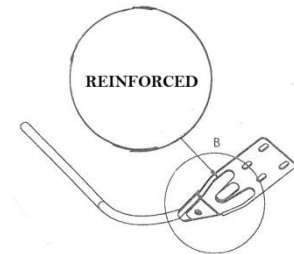

**TABLE AUGER BEARING CENTER PLATE**

8050	MF 9850 – Repair Plate can be installed through inspection cover hole
------	---



## ALUMINUM REEL PARTS

1038902S	Roller Assembly
1052667S	Rice Wire Finger
1052668S	Wire Finger
1052681S	Control Ring – 5 Bat
1052682S	Control Ring – 5 Bat
1052683S	Control Ring – 6 Bat
1052684S	Control Ring – 6 Bat
1052685S	Control Roller Assembly
1052689S	Arm Bearing Insert
1054031S	End Shield – 5 Bat
1054032S	End Shield – 6 Bat
2763064S	Plastic Finger
2763073S	Control Ring
2763089S	Roller Assembly

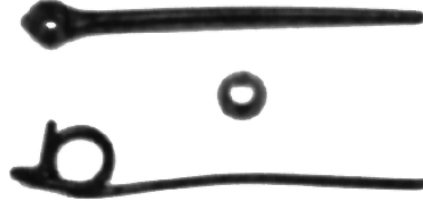

## GRAIN TABLE AUGER PARTS

148054S	Table Auger Cover 9000 Series
148055S	Table Auger Cover 9000 Series
228024S	Table Auger Finger Shaft 1486 Series
231320S	Table Auger Cover 1486 & 1859 Series
243261S	Table Auger Cover 1486 & 1859 Series
261820S	Table Auger Finger Shaft 1859 Series
71332796S	Table Auger Finger Shaft MF9850 1 1/8" CR 39 5/8" Long



## AUGER DRIVE HOUSING REPAIR PLATE FOR 300 & 540

7001	Repair Plate for M.F. 300 – all models
7002	Repair Plate for M.F. 540 – all models

This plate is made of 14 GA steel, cut and shaped to fit bearing that supports drive shaft. The plate can be field installed by drilling holes and securing with bolts or welding to original housing.

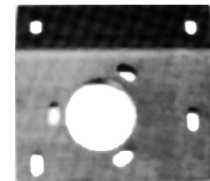

**MASSEY-FERGUSON UNLOADING TUBES – HIGH RATE**

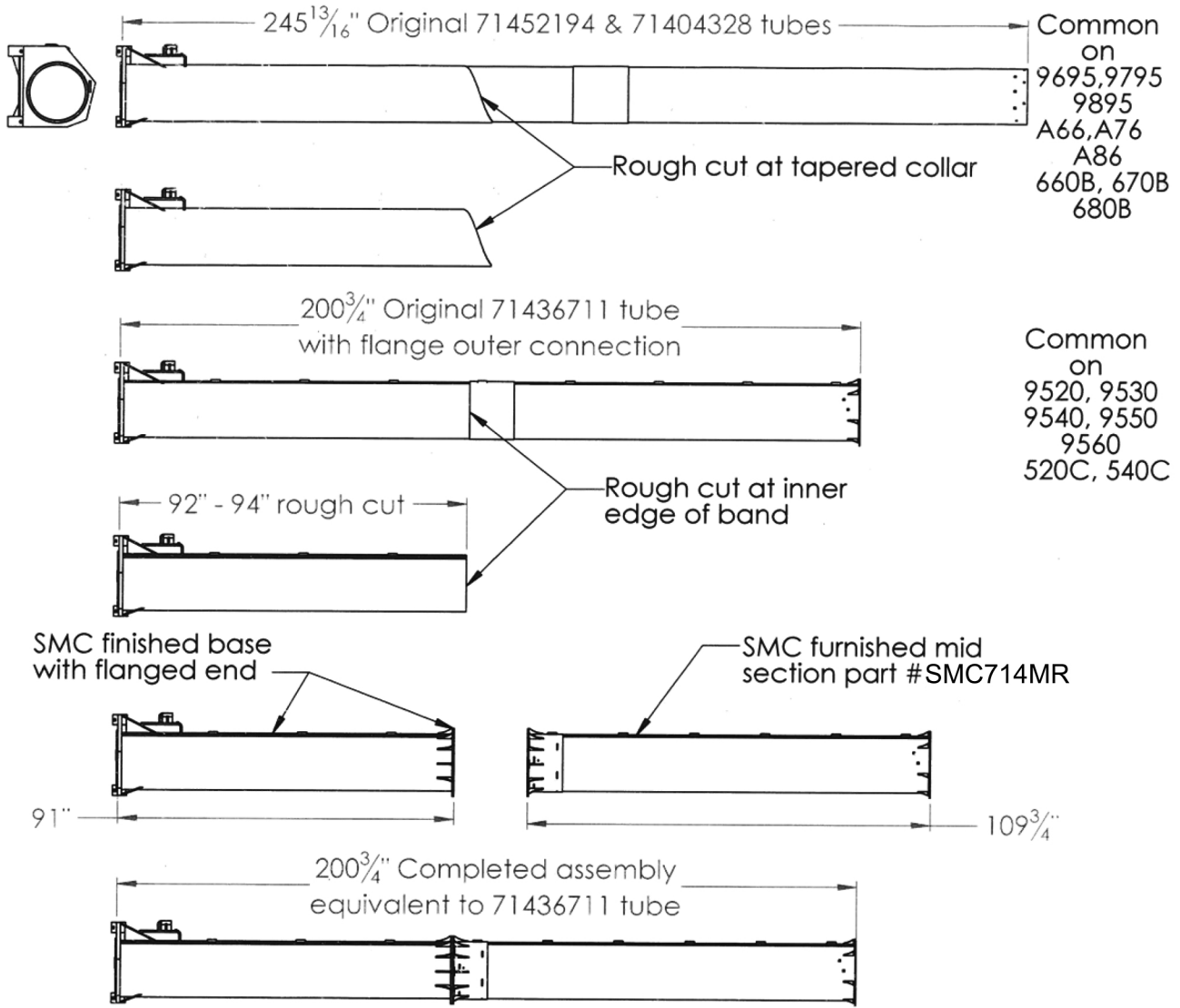

Repaired SMC assembly, equivalent to AGCO 71436711, can be finished with standard end of 71452194, or equivalent to any after market extension reusing original end bearing carrier & grain saver, or it will accommodate newer style end tubes AGCO part numbers 71436702 & 71436703 to retain or convert to newer style tubes. All outer tubes have an access hole to access inner bearing carrier if two piece auger system is used. Will call for cut Hinge Assy core to be shipped truck freight

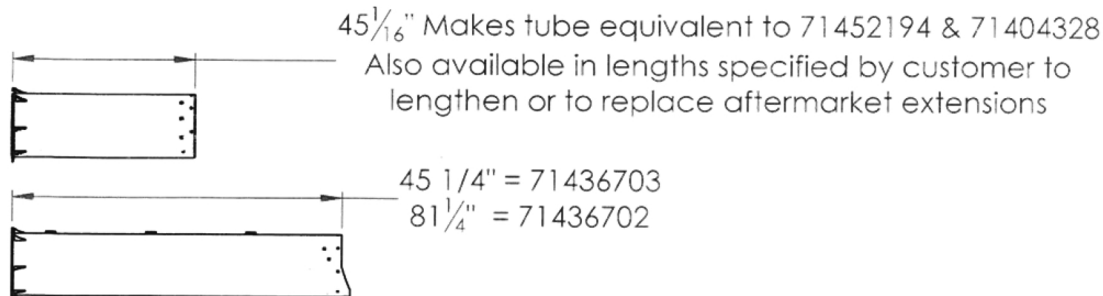



## Ordering Code

## Description

### AUGERS

104345S	Grain Tank Fill Auger 8570/8780 –can use for 102545M92 (1 1/8" Top Brg)
71390932RS	Grain Tank Fill Auger 8780XP Eff. S/N HK87101 (1 1/4" Top Brg)
2619921S	Grain Tank Fill Auger 8560
71388932S	Grain Tank Fill Auger 9690 & 9790 S/N HM36101 & up – 67.71" Long (can use for 71388940)
71413017S	Grain Tank Fill Auger 9520/9795 & 9895 Eff S/N HUC8101 – HSC8101 (Abrasion Resistance Flighting) BALANCED
71399854S	Unloading Auger 9690/9790 - 234.65" Long - RH Flighting
71390929S	Unloading Auger 8570/8780 - 199.65" Long
2496251S	Unloading Auger 8560/8570 - 163.65" Long
71396547SR	Unloading Auger 9695, 9795 & 9895 – Rebuilt – Need to exchange drive assembly & outer stub shaft.
2598061S	Vertical Unloading Auger 8560–9790 Early (New #71390926) - ¼" sectional flighting – No Hubs
71399858S	Vertical Unloading Auger 9690/9790 - RH Flighting - No Hubs – ¼" sec. (New #71446237)
250600S	Grain Auger 510/550
250818S	Vertical Unloading Auger 510/550
259819S	Vertical Unloading Auger 750/850
265121S	Vertical Unloading Auger 760/860
265112S	Horizontal Unloading Auger 750-860
265175S	Horizontal Unloading Auger 750-860 - 4 ft Extension
266475S	Cross Auger 510/550
253847S	Cross Auger 750/850
255368S	Cross Auger 760/860
71390523S	Cross Auger 8560-8780 – New Style – 2.00 ID (Optional Stub Shafts pg 55)
253146S	Leveling Auger 750 & 850 Prior #25658
285929S	Leveling Auger 850 Ser # 25658 & up
270711S	Leveling Auger 760 & 860 Prior #16558
285901S	Leveling Auger 860 Ser # 16558 & up
258839S	Clean Auger 750/850
273615S	Clean Auger 760/860
2619841S	Clean Auger 8560 - 8780
280384S	Returns Auger 750/850
280383S	Returns Auger 760/860
2618231S	Returns Auger 8560 - 8780 - Upper
2618251S	Returns Auger 8560 - 8780 – Lower
268809S	Horizontal Unloading Auger 550 Long
240422S	Horizontal Unloading Auger 510/550 - 3 ft Extension



### UNLOADING TUBES

240411S	M.F. 510/550 Unloading Tube - Short 81 3/8"
268813S	M.F. 550 Unloading Tube - Long 117 3/8"
240419S	M.F. 510/550 Unloading Tube - 3' Extension
105090S	M.F. 8570/8780 & 9690/9790 Early Unloading Tube 178.5" - (New #71396414)
2493021S	M.F. 8560/8780 Unloading Tube 142.5"
71399669S	M.F. 9690/9790 Unloading Tube 213.5"
71436702S	M.F. 9520, 9530, 9540, 9550 & 9560 – Long – 81 1/4"
71436703S	M.F. 9520, 9530, 9540, 9550 & 9560 – Short – 45 1/4"
71436711SR	*M.F. 9250, 9530, 9540, 9550 & 9560 – Rebuilt – Need to exchange Hinge Assy (2 piece) – 200 3/4"
71452194SR	*M.F. 9695, 9795 & 9895 – Rebuilt – Need to Exchange Hinge Assy (3 piece) – 245 13/16"
SMC714 MR	*MF 9695 – 9560 – Middle Tube on all SMC Rebuilt Tube Assy. – 109 3/4"
SMC714 OR	*MF 9695 – 9560 Special Outer Tube for Tubes w/aftermarket extensions – specify length – Extra Charge above standard tube.

**8560-9790 UNLOADING AUGER EXTENSION**

- SMC 13 8560/8570 Unloading Auger  
Ext. 3 ft. (163.65" Auger)
- SMC 19 8570 - 9790 Unloading Auger  
Ext. 3 ft. (199.65" Auger)
- SMC 27 9690 & 9790 Unloading Auger  
Ext. 3 ft. (2004 & Later) - RH Flighting



**850 & 860 UNLOADING AUGER EXTENSION**

- SMC 20 850 Unloading Auger Ext. 4 ft.
- SMC 21 860 Unloading Auger Ext. 4 ft.

**UNLOADING AUGER TUBE (VERTICAL)**

- 112977S Tube – MF 8560 – 9690 Early – Also fits 2598121W94
- 112977SR Tube Repair Kit/Tube only – No flange angle
- 71399654S Tube MF 9690 Eff. S/N HN87101  
MF 9790 Eff. S/N HM36101



**GRAIN TANK LOADING AUGER TUBES**

- 104490S Tube – Fits MF Late 8570/8780
- 102542S Tube – Fits MF Early 8570
- 2619951S Tube – Fits MF 8560
- 71362970S Tube – Fits MF 9690 Eff. S/N HM87101  
MF 9790 Eff. S/N HM36101 & 8680 – Tube Length 55 1/2"
- 71407580S Tube – Fits MF 9895 Eff S/N HSC8101 – Tube Length 59 1/2" – 9.57" I.D.
- 71413012S Tube – Fits MF 9795, 9895, 9695, 9560, 9550, 9540, 9530 & 9520 – 12" I.D.



**UNLOADING AUGER CYLINDER**

**REDUCED**

- 1748273S Chrome Shaft 510, 540 & 550
- 1748368S Cylinder 750, 760, 850 & 860
- 1748368SR Chrome Shaft for 1748368S Cylinder
- 1748368SS Seal Kit for 1748368S Cylinder



**REAR ROTOR DEFLECTORS**

- 71387826S RH Deflector 8570 (S/N P13101 & up) 8780 (S/N J55101 & up) & 8780 XP  
9690 & 9790 – Also fits 104785S \*
- 71387700S RH Deflector Extension 8570 (S/N P13101 & up) 8780 (S/N J55101 & up)  
& 8780 XP, 9690 & 9790 – Also fits 104790S \*

\* When replacing 104785S or 104790S must replace both deflectors with 71387826S and 71387700S



**Ordering  
Code**

**Description**

**SEPARATOR GRATE**

2618391S Separator Grate Assy. 8560/ 8570/ 8780

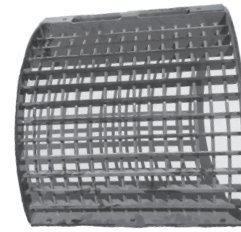

**ROTOR DRUM FRONT AUGER**

71410439S Rotor Drum Front Auger MF 8560 - 9790  
Hard coated Edge & Leaning Flighting  
Replaces 2469711S

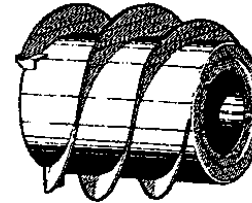

**ROTARY ROOF SHELL**

2619311S Front Shell 8560 - 8780 up to S/N #MJ87101  
71388301S Front Shell 8780 after S/N #MJ87101, 9690 & 9790  
2619011S Rear Shell 8560 - 8780 up to S/N # MJ87101  
71388432S Rear Shell 8780 after S/N #MJ87101  
71388439S Rear Shell 9690 & 9790

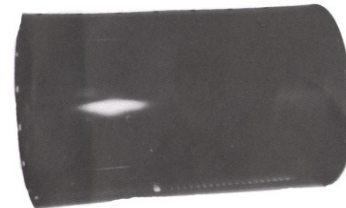

**CONCAVE**

104904S Concave 8570 & 8780 (1/4" Rod, Corn) High wire



**CONCAVE ANGLES**

240246S M.F. Concave Rear Angle 540  
240466S M.F. Concave Rear Angle 550  
248470S M.F. Concave Front Angle 540  
248795S M.F. Concave Front Angle 510 & 550  
253244S M.F. Concave Rear Angle 750 & 850  
253247S M.F. Concave Front Angle 750 & 850  
270616S M.F. Concave Rear Angle 760 & 860  
270618S M.F. Concave Front Angle 760 & 860  
278435S M.F. Concave Front Angle 860  
278438S M.F. Concave Front Angle 850



**COVER PLATE FOR CONCAVE EXTENSION**

- 6020 Cover Plate for M.F. 410 & 540 all models
- 6021 Cover Plate for M.F. 510 & 550 all models
- 6022 Cover Plate for M.F. 750 & 850 all models

The cover plate is needed in all models of combines to prevent straw of small grain or cobs and stalks of corn from going through extension onto lower grain shoe and sieves. This plate assists the rear beater is putting the straw, cobs, and stalks upon the walkers and out rear of combine. It also prevents over-loading of sieves.

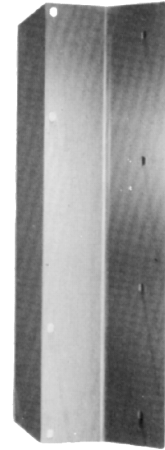

**CONVEYOR DRUMS**

- 2570091S M.F. 8560/8570 drum
- 260094S M.F. 410 & 540 Q.A. drum
- 260097S M.F. 510 & 550 Q.A. drum
- 268835S M.F. 550 S/N 5947 & up drum
- 278643S M.F. 760 & 860 drum
- 278646S M.F. 750 & 850 drum



**CONVEYOR DRUM BAND REPAIR KIT**

- 2570091SR M.F. 8560/8570 Band Repair Kit  
Includes 3 bands & 2 rings

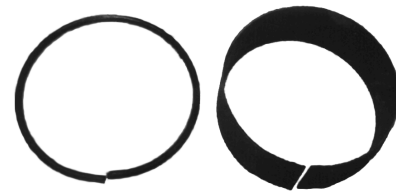

**FRONT BEATERS**

- 254365S M.F. Front Beater 750/850 Paddle Elevator
- 280830S M.F. Front Beater 750/850 Slat Elevator
- 271293S M.F. Front Beater 760/860 Paddle Elevator
- 274388S M.F. Front Beater 760/860 Slat Elevator



**Ordering  
Code**

**Description**

**FRONT BEATER REPAIR BRACKET**

112618SR MF 8780 Front Beater Drum Repair Bracket

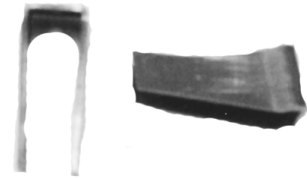

**FRONT BEATER DRUM PANEL**

2504490S MF 8560/8570 Front Beater Panel

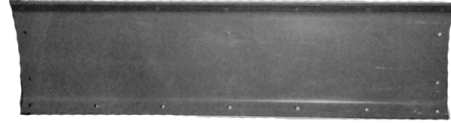

**REAR BEATER BATS**

218303S M.F. 410 & 540  
235176S M.F. 300  
240790S M.F. 510 & 550  
294101S M.F. 760 & 860  
294102S M.F. 750 & 850

**REDUCED**

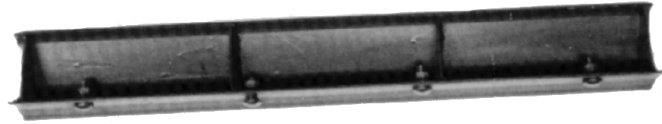

**BEATER COVERS**

254668S Beater Cover 750 & 850  
Prior to Ser. #25658  
273712S Beater Cover 760 & 860

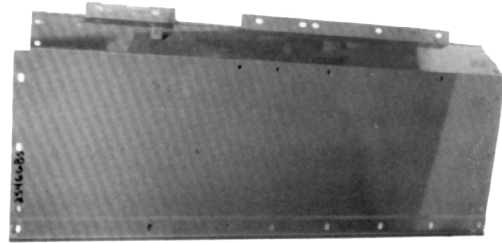

**CHAINS FOR ELEVATOR TO CYLINDER**

235915S M.F. 300 Prior S/N 13989  
260352S M.F. 300 S/N 13989 up or Q.A.  
260100S M.F. 410 & 540  
260103S M.F. 510 & 550  
278626S M.F. 750 & 850  
278611S M.F. 760 & 860  
2623913SA M.F. 8560 - 8780 (Prior to S/N W55101) 183 5/16" long, 28 slats  
71149964S M.F. 8780 (Above S/N W55101) 180 1/16" long, 28 slats  
71149972S M.F. 8780XP (Above S/N MJ87134) 194 3/4" long, 30 slats  
71449007S M.F. 9690 (Prior S/N HP87101) 180 1/16" long, 28 slats  
71461852S M.F. 9690 (Above S/N HP87101), MF 9790 (Eff. S/N HM36101),  
MF 9695, MF 9520 (Eff. S/N CHC16101-PHC16999) 185" long, 28 Slats  
71449003S M.F. 9790 (Prior S/N HP36101) 180 1/16" long, 28 slats  
71449017S M.F. 9790 (Eff. S/N HP36101- HR 36999) 185" long, 28 slats  
71449025S M.F. 9895 - 9790 (Above S/N HS) - 4 Chain Style 185" long, 42 slats  
71447108S M.F. 9540, 9545, 9560 & 9565 - 4 Chain Style, 195 1/2" long, 45 Slats

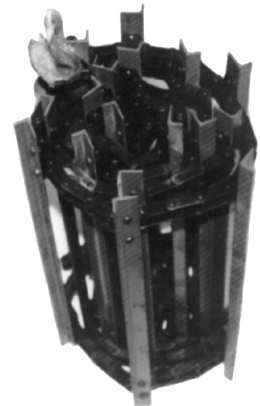

• Combines equipped with lateral tilt also need 3 offset links per strand of chain

**CHAINS CROSS BAR LESS ATTACHMENT LINK NEEDS HEAT TREATED BOLTS & LOCK NUTS**

4105	M.F. 300 Prior
4106	M.F.300 Q.A.
4107	M.F. 410 & 540
4108	M.F. 510 & 550
4109	M.F. 750 & 850
4110	M.F. 760 & 860
2570050S	M.F. 8560, 8570, & 8780XP
71387896S	M.F. 9790
71411426S	M.F. 9895
71461857S	MF 9690, 9695, 9790 & 9520 (Old #71395877)

**CYLINDER CHAIN PARTS**

4001	Grade 8 Bolts & Lock Nuts
4002	CA550 Conn. Link with Ears for Bars
4010	Feeder House Roller Chain Less Slats, Fits 300 Prior & 300 Q.A.
4011	Feeder House Roller Chain Less Slats, Fits 410, 510, 540 & 550
4012	Feeder House Roller Chain Less Slats, Fits 750, 760, 850 & 860
4013	Feeder House Roller Chain Less Slats, Fits 8560 & 8570

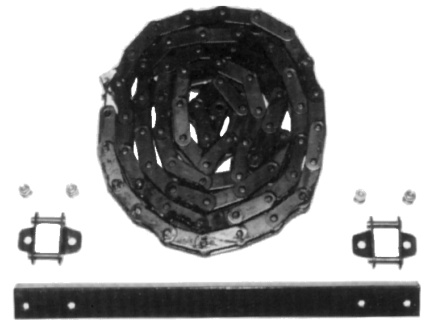

**FEEDER ELEVATOR PADDLES AND ANGLES**

259000S	Small Throat Angle 750/850
259001S	Large Throat Angle 750/850
273972S	Small Throat Angle 760/860
273973S	Large Throat Angle 760/860
293033S	Elevator Blade 760/860
293054S	Elevator Blade 750/850
293100S	Elevator Blade 760/860
293179S	Elevator Blade 750/850

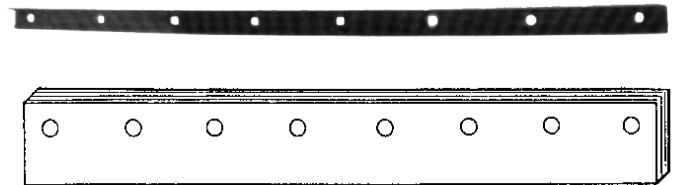

**FEEDER HOUSING BOTTOMS**

7005	M.F. 8560-8780 Early – Repair Plate Front Bottom of Feeder Housing Red Throat
116327S	M.F. 8780 Late-9695 – Repair Plate Front Bottom of Feeder Housing

**ELEVATOR CHAINS**

102817S	Grain Elevator 8570 & 8780 (All Rubber)- 37 Paddles – 3" x 9 1/2" Paddle
235587S	Grain Elevator 300 – 26 Paddles
248504S	Returns Elevator 410 - 550 (All Poly)- 11 Paddles
248551S	Grain Elevator 410, 510 & 550 (All Poly)- 28 Paddles
253167S	Grain Elevator 750 & 850 Prior S/N 25658 – 31 Paddles
253665S	Returns Elevator 750 – 860- 14 Paddles
268341S	Grain Elevator 550 Ser. #2121 & up (All Poly)- 33 Paddles
269469S	Grain Elevator 850 Ser. #25658 & up – 37 Paddles
270725S	Grain Elevator 760 – 34 Paddles
285889S	Grain Elevator 860 – 35 Paddles
2605873S	Grain Elevator 8560 (All Rubber) – 36 Paddles – 3" x 9 1/2" Paddle
2615233S	Returns Elevator 8560 - 8780 (All Rubber) – 29 Paddles
71393534S	Grain Elevator 9690 & 9790 – 37 Paddles – 4" x 8 1/2"
71406795S	Returns Elevator 9695, 9795 & 9895 – 29 Paddles
71409422S	Grain Elevator 9695, 9795 & 9895 – 37 Paddles – 4" x 8 1/2"
4120	Grain Elevator Extension 550 - 8 Paddles (All Poly) Late 410 & 510
4121	Grain Elevator Extension 700 - 800 - 5 Paddles

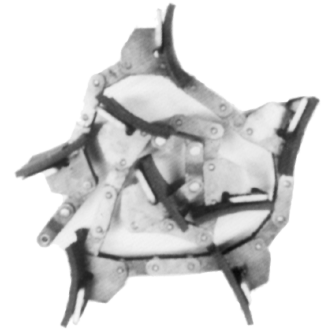

**ELEVATOR PADDLES**

248520SR	Return 410, 510, 540 & 550
248520SP	750, 760, 850 & 860. Repairs M.F. #242952M91, 248520M91 & 251134M91
250972SR	Clean Grain 410 Ser. #11754 & up
250972SP	510 Ser. #6018 & up & 550
273678SR	Clean Grain 750, 760, 850 & 860
273678SP	Clean Grain 750, 760, 850 & 860
236774SR	Clean Grain & Returns 300 (LM45V)
239838SR	Clean Grain & Returns 300 (CA550)
239838SP	Clean Grain & Returns 300 (CA550)
2412990SR	Clean Grain 8560 - 8780
2412990SP	Clean Grain 8560 - 8780
1511670SP	Returns 8560 – 8780
71433020SP	Clean Grain 9540

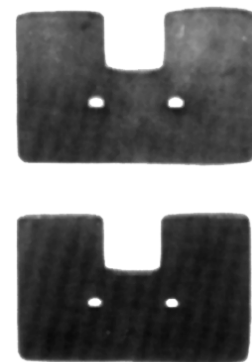

\*\* Ordering Codes ( R ) for Rubber Paddles and ( P ) for Poly Paddles

**CLEAN GRAIN AND TAILINGS DOORS - SOLID & SCREENED**

2554691S	Grain Elevator Door 8560 - 8780 Solid
71393526S	Grain Elevator Door 9790 Prior S/N HP36101 - Solid
71400431S	Grain Elevator Door 9790 Effective S/N HP36101 & 9795 - Solid
2554721S	Grain Elevator Door 8560 – 8780 – Perf.
71396467S	Grain Elevator Door Prior S/N HP36101 – Perf.
71410456S	Grain Elevator Door Effective S/N HP36101 – Perf.
2555211S	Tailings Elevator Door 8560 – 8780 & 9790 S/N HM36101 - Solid
71401224S	Tailings Elevator Door 9790 Effective S/N HP36101 & 9795 - Solid
2555231S	Tailings Elevator Door 8560 – 8780 & 9790 S/N HM36101 – Perf.
71410458S	Tailings Elevator Door 9790 Effective S/N HP36101 & 9795 – Perf.
2010	Grain Elevator Door 410, 510, 540 & 550
2011	Tailings Elevator Door 510, 550, 750, 760, 850 & 860
2012	Grain Elevator Door 750, 760, 850 & 860



**GRAIN ELEVATOR TOP HOUSING**

270720S	MF Housing – Fits 750 – 860
285883S	MF Housing – Fits 850 (S/N 25658 & up) Fits 860 (S/N 19115 & up) • Also replaces 293395M91

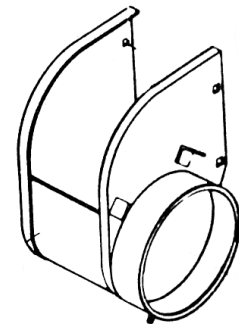

**REPLACEMENT CHANNEL FOR BEHIND  
CLEAN GRAIN AUGER SHAKER PULLEY**

7040	M.F. 410, 510 & 550 Channel Repair
------	------------------------------------

This channel repair is needed when the metal fatigues where the brackets bolt on. It can be installed and welded to repair the broken area.

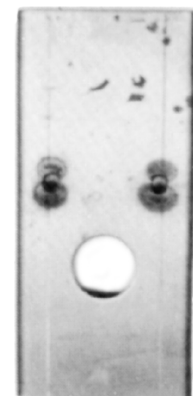



**CLEAN GRAIN & TAILINGS ELEVATOR REPAIR PLATE**

7019	M.F. 540 Clean Grain Repair Plate
7020	M.F. 510 & 550 Clean Grain Repair Plate
7021	M.F. 750, 760, 850 & 860 Clean Grain Repair Plate
7022	M.F. 750, 760, 850 & 860 Returns Grain Repair Plate
7023	M.F. 550 Complete Trough Grain No End
7024	M.F. 550 Complete Trough Return No End
253103S	M.F. 750 & 850 Complete Trough Return
253098S	M.F. 750 & 850 Complete Trough Grain
270420S	M.F. 760 & 860 Complete Trough Return
270416S	M.F. 760 & 860 Complete Trough Grain
7029	M.F. 750, 760, 850 & 860 Top Clean Grain Elevator Repair Plate
2619870S	MF 8560, 8570, 8780, 8780XP W53101 – HL87999 – Tube Clean Grain Elevator by lower boot
71393546S	MF 9690 prior HP87101 – Tube Clean Grain Elevator by lower boot

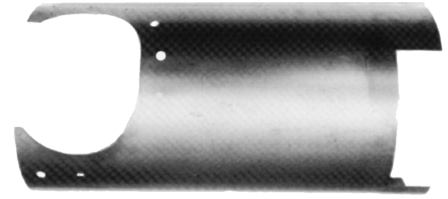

**REPAIR PLATE LOWER HORIZONTAL AUGER TUBE**

7010	M.F. 300 Repair Plate
7011	M.F. 410 Repair Plate
7012	M.F. 540 Repair Plate
7013	M.F. 510 & 550 Repair Plate
7014	M.F. 750 Prior Ser. #16539 Repair Plate
7015	M.F. 760 & 860 Repair Plate
7016	M.F. 750 Ser. #16539 & up and 850 Repair Plate
7017	M.F. 750 - 860 Repair Plate Right End of Bin Trough
7018	M.F. 510 - 550 Repair Plate Right End of Bin Trough



**CYLINDER DRIVE PARTS**

227351S	Variable Speed Pins 510 & 550
227361S	Hub for Inner Counter Shaft Pulley 510 & 550



**REINFORCEMENT RING FOR BASE OF UNLOADING AUGER**

7030	M.F. 750, 760, 85, & 860 Reinforcement Ring
7031	M.F. 750 Prior 16539 Reinforcement Ring

This ring is needed when the metal breaks in the bottom of the unloading auger. It should first be bolted in to align and then be welded in.

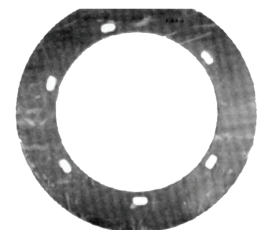

**CENTER CORNHEAD SNOUTS**

<b>REDUCED</b> 267620S	M.F. 1100 Series Narrow Row L.H. (267 620 M92)
<b>REDUCED</b> 267621S	M.F. 1100 Series Narrow Row R.H. (267 621 M92)
<b>REDUCED</b> 267724S	M.F. 1100 Series Wide Row L.H. (267 724 M92)
<b>REDUCED</b> 267725S	M.F. 1100 Series Wide Row R.H. (267 725 M92)
<b>REDUCED</b> 264574S	M.F. 64, 44, 34 & 24 Low Profile Wide Row L.H. (264 574 M92)
<b>REDUCED</b> 264580S	M.F. 64, 44, 34 & 24 Low Profile Wide Row R.H. (264 580 M92)
264626S	M.F. Narrow Row Point (264 626 M2)
<b>REDUCED</b> 264573S	M.F. Wide Row Point (264 573 M2)
<b>REDUCED</b> 106238S	M.F. 800 Series Row Point (Heavier)
<b>REDUCED</b> 71385367S	M.F. 800 Series Row Skid Shoe (Heavier) Can use for 106239W91 & 106240W91

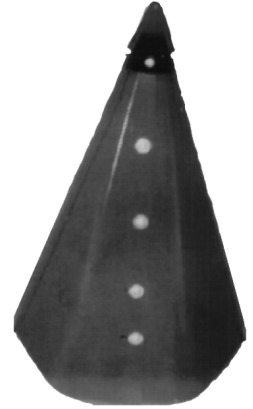

**OUTSIDE CORNHEAD SNOUTS**

267275S	M.F. Snout 1100 Series R.H.
267274S	M.F. Snout 1100 Series L.H.
147131S	M.F. Mounting Bracket 1100 Series R.H. ** **Note: Using this bracket with 267275S snout makes a 264 592 M91 snout for M.F. 63 Low Tin.
147130S	M.F. Mounting Bracket 1100 Series L.H.** **Note: Using this bracket with 267274S snout makes a 264 589 M91 snout for M.F. 63 Low Tin.



**CORNHEAD TROUGHS**

7058	Bottom Center Trough MF 800 Series M.F.
267433S	Bottom Left Trough 1143 M.F.
267434S	Bottom Right Trough 1143 M.F.
267627S	Bottom Left Rear Trough 1163 M.F.
267628S	Bottom Right Rear Trough 1163 M.F.
267682S	Bottom Right Trough 1183 M.F.
267683S	Bottom Left Trough 1183 M.F.
267684S	Bottom Left Trough 1163 M.F.
267685S	Bottom Right Trough 1163 M.F.
1577470S	Bottom Center Trough All 9000 Series
1597370S	Bottom RH Trough 9463 & 9454 M.F.
1597380S	Bottom LH Trough 9463 & 9454 M.F.
1687660S	Bottom RH Trough 9483 M.F.
1687670S	Bottom LH Trough 9483 M.F.

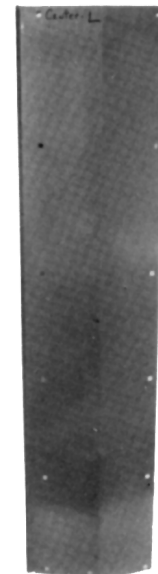



## CORNHEAD SNAPPING ROLL PARTS

	147654S	Snapping Roll Drive Shaft
<b>REDUCED</b>	263450S	Stripper Plate L.H. 63 - 44 Series
	263453S	Stripper Plate R.H. 1100, 63 - 44 Series
	264687S	Cornhead Flute
	267392S	Stripper Plate L.H. 1100 Series
<b>REDUCED</b>	267507S	Snapping Roll Driven Shaft
	1075208S	Cornhead Flange

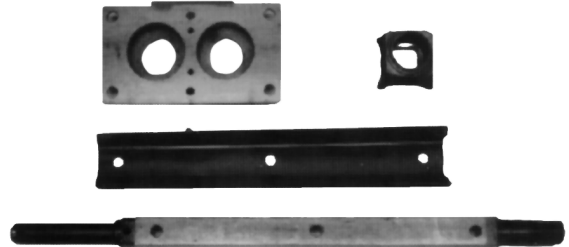

## OUTSIDE CORNHEAD FENDERS

	267932S	MF Fender 1100 LH
	267933S	MF Fender 1100 RH
	262425S	MF Fender Panel 1100 LH
	262426S	MF Fender Panel 1100 RH

## CORNHEAD DEFLECTORS

	262510S	Cornhead Deflector
	264595S	Cornhead Deflector
	264599S	Cornhead Deflector
	264690S	Cornhead Deflector
	264691S	Cornhead Deflector

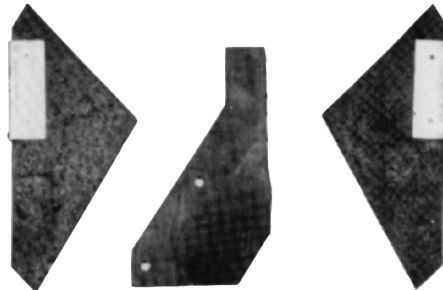

**ADAPTER FOR 800 SERIES TO BLACK THROAT COMBINE**

SMC 11      800 Series Cornhead Adapter to Black  
Throat Combine with No Lateral Tilt



**ADAPTER FOR 800 SERIES TO L.T.M. COMBINE**

SMC 12      800 Series Cornhead 93-97 with Narrow Frame  
to MF 8780 w/ Black Throat L.T.M. Ser # W  
and Newer, 8780XP, 9690 & 9790

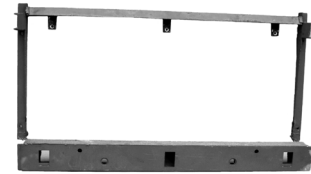

**STUB SHAFT REPAIR**

5010      All model Q.A. Cornhead – Stub Shaft & Sleeve  
5011      Coupler Sleeve for Cornhead or Grain Table Shafts – 1 1/2" ID



**FINAL DRIVE PINION SHAFT & RELATED PARTS**

**REDUCED**

259310SR      Splined Stub Shaft allows you to replace splines on either end of 259310M91 or 271465M91 Drive Shaft.

Saves your customer hundreds of \$\$\$.

**REDUCED**

274841S      Splined Shaft Assembly - 13" Long

**REDUCED**

274842S      Splined Shaft Assembly - 55 1/2" Long

**REDUCED**

280512S      Splined Shaft Assembly - 29 5/16" Long



**AUGER GEARS**

<b>REDUCED</b> 238979S	Bevel Gear 410, 510 & 550
250663S	Bevel Gear 300, 410, 510, 540 & 550
<b>REDUCED</b> 258834S	Bevel Gear 750

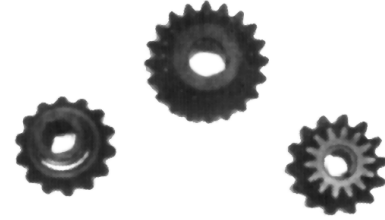

**GRAIN AUGER STUB SHAFTS**

248933S	510/550 Unloading Auger Stub Shaft
250822S	510/550 Unloading Auger Stub Shaft
266475SR	510/550 Grain Tank Cross Auger Stub Shaft
271625S	850/860 Unloading Auger Stub Shaft
2411200S	8560/8780 Grain Tank Cross Auger Stub Shaft – Brg End
2500360S	8560/8780 Grain Tank Cross Auger Stub Shaft – Keyed End

248933M1, 250822M1 & 271625M1 stub shafts are made longer so you can cut the old stub off and slide the new in for a true fit.



**COMBINE MAIN MACHINE PARTS**

253844S	Unloading Hex Drive Shaft 750 – 860
265466S	Unloading Drive Stud 750 – 860 – Grade 8
<b>REDUCED</b> 270748S	Beater Bearing Housing 760 & 860
273522S	Unloading Hex Drive Sleeve 750 - 860



**GRAIN BIN AUGER COVER**

SMC9	9695 – 9545 Bin Auger Cover to control flow on High Output Combines
------	---

## THROAT COUPLER DRIVE SHAFTS AND PARTS

249674S	Male Coupler
249675S	Coupler Pin
<b>REDUCED</b> 258159S	750/850 Throat Coupler Drive Shaft
<b>REDUCED</b> 268316S	410/540 Throat Coupler Drive Shaft
<b>REDUCED</b> 268317S	510/550 Throat Coupler Drive Shaft
<b>REDUCED</b> 273458S	760 Header Drive Coupler Sprocket



## SHAFTS FOR MAIN COMBINE AND ELEVATOR

<b>REDUCED</b> 255833S	Grain Elevator Top Shaft 850/860
<b>REDUCED</b> 256728S	Cleaning Fan Shaft 760/860



## VARIABLE SPEED HUBS

<b>REDUCED</b> 500 VS	Variable Speed Repair 9 hole 510 & 550 Consists of 252997M1 & 226865M1
-----------------------	---

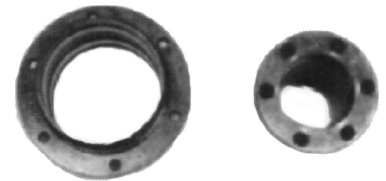

## TRACTOR DRIVE SHAFTS

**REDUCED** 516523S

Input Shaft (Multi Power Tran.)



## PTO DRIVE HUBS

**REDUCED** 736954S

Hub (flywheel mounted)  
6 bolt holes 1100 & 1130

**REDUCED** 740635S

Hub (flywheel mounted)  
12 bolt holes 1105, 1135 & 1150

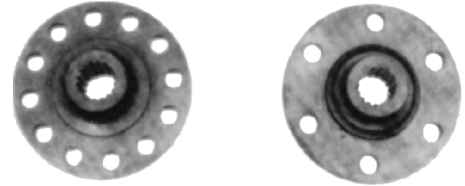

## FOUR WHEEL DRIVE PARTS

543585S

Hydraulic Reservoir 4000 Series

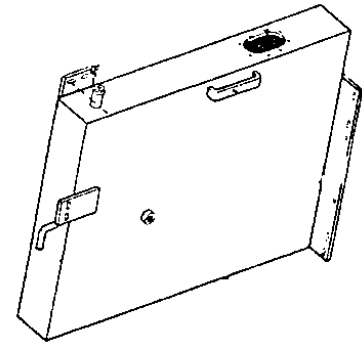

## COMBINE RUBBER PARTS

253325S

Grain Pan Seal

264286S

Fastener

265463S

Unloading Auger Boot

278573S

Unloading Auger Boot

403657S

Fastener

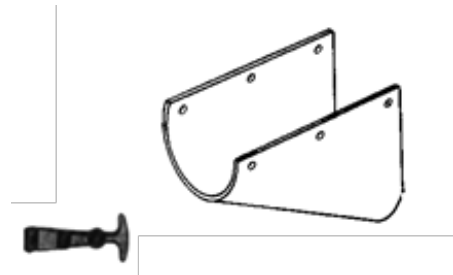

## STRAW WALKERS

258722S	M.F. 750 Walker
273745S	M.F. 760 Walke
283146S	M.F. 860 Walker
283147S	M.F. 850 Walker
235010S	M.F. 850/750 Front Grating (39 1/2")
271183S	M.F. 860/760 Front Grating (39 1/2")
8040	M.F. 860/760 Rear Grating (4` Section)
8041	M.F. 850/750 Rear Grating (4` Section)

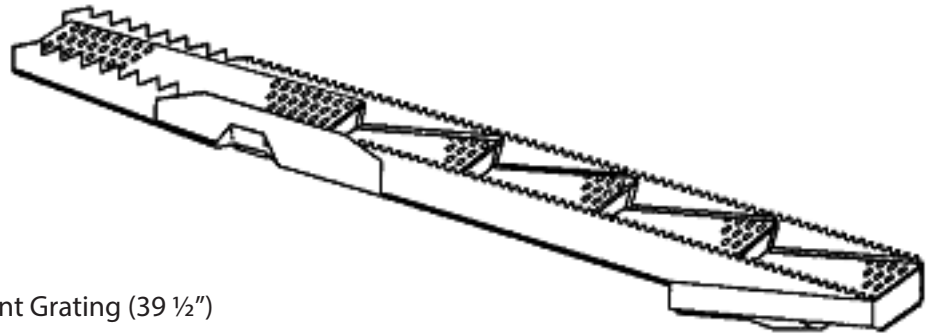

The Massey Ferguson walkers will have supports welded in the front end of the walkers, so they can be cut out and made into left or right-side walkers.

## STAW WALKER PAN BOLT HOLE REPAIR PLATES

7060	Front Bolt Hole Repair M.F. 750-860 Series - 1 3/4" Center Bolt Holes
7061	Rear Bolt Hole Repair M.F. 750 & 850 Series - 2" Center Bolt Holes Rear Bolt Hole Center 760 & 860
7062	Rear Bolt Hole Outside 760 & 860



## STRAW WALKER SHAFT CHANNEL REPAIR

7041	M.F. 410, 510 & 550 Channel Repair
------	------------------------------------

The channel repair is needed because the bolts and metal break out where the straw walker bearing flanges bolt on. This is also installed and welded.

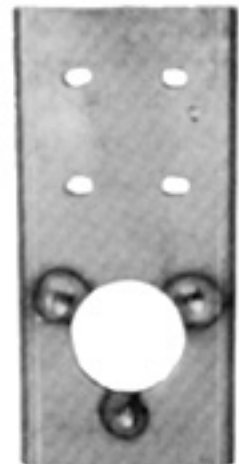

## MISC. SCHMIDT ACCESSORIES

Challenger Unloading Tube .....	64
Flighting .....	61
Grain Savers .....	64
Header Coupler Shaft Wrench.....	64
KSI Conveyors Mounting Kits for Kinze Planters .....	64
Running Gear Header Bracket Kits.....	64
Sunflower 6630 Rear Hitch.....	64
Table Auger Repair Tubes .....	62
Table Auger Dealers .....	63





# CONVEYOR AUGER FLIGHTING HELOCOID TYPE - 5 FOOT LENGTHS

## SPECIFICATION

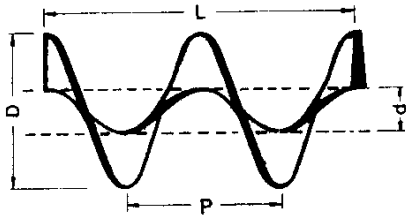

## HAND IDENTIFICATION

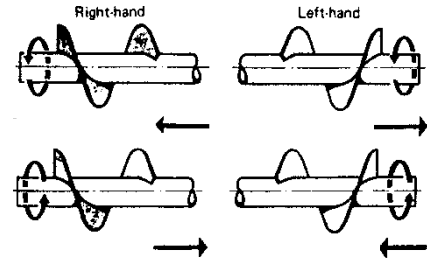

WHEN ORDERING PLEASE SPECIFY:

Outside Diameter (D)

Piece Length (L)

Inside Diameter (d)

Pitch Length (P)

Thickness, Right or Left Hand, Quantity

Conveyance direction

### Standard Pitch

### Short or Long Pitch

O.D.	1/8"	3/16"	1/4"	5/16"	3/8"	1/8"	3/16"	1/4"	5/16"	3/8"
3"	\$ 6.49	\$ 8.03	\$ 9.57			\$ 7.48	\$ 9.30			
3.5"	\$ 6.93	\$ 8.47	\$ 10.78			\$ 8.14	\$ 9.96			
4"	\$ 7.32	\$ 9.90	\$ 13.20			\$ 8.53	\$ 12.21	\$ 16.50		
4.5"	\$ 7.76	\$ 11.06	\$ 14.85			\$ 9.35	\$ 13.86	\$ 18.59		
5"	\$ 8.20	\$ 12.21	\$ 16.50	\$ 20.74		\$ 10.18	\$ 15.40	\$ 20.63		
5.5"	\$ 8.69	\$ 13.48	\$ 17.33	\$ 21.95		\$ 10.78	\$ 17.00	\$ 21.67		
6"	\$ 9.19	\$ 14.69	\$ 18.15	\$ 23.16	\$ 28.22	\$ 11.33	\$ 18.59	\$ 22.72	\$ 28.93	\$ 35.20
6.5"	\$ 10.12	\$ 15.62	\$ 20.08	\$ 25.19	\$ 30.20	\$ 12.60	\$ 19.58	\$ 25.08	\$ 31.41	\$ 37.73
7"	\$ 11.00	\$ 16.50	\$ 22.00	\$ 27.06	\$ 32.18	\$ 13.81	\$ 20.57	\$ 27.45	\$ 33.83	\$ 40.26
7.5"	\$ 11.83	\$ 17.66	\$ 23.54	\$ 29.04	\$ 34.93	\$ 14.80	\$ 22.00	\$ 29.26	\$ 36.74	\$ 43.56
8"	\$ 12.60	\$ 18.76	\$ 25.03	\$ 31.08	\$ 37.40	\$ 15.73	\$ 23.38	\$ 31.08	\$ 39.60	\$ 46.81
8.5"	\$ 13.37	\$ 19.91	\$ 26.68	\$ 33.17	\$ 39.77	\$ 17.27	\$ 24.86	\$ 33.17	\$ 41.75	\$ 49.72
9"	\$ 14.14	\$ 21.07	\$ 28.27	\$ 35.20	\$ 42.13	\$ 17.71	\$ 26.35	\$ 35.20	\$ 43.89	\$ 52.58
9.5"		\$ 22.22	\$ 29.70	\$ 37.13	\$ 44.50		\$ 27.83	\$ 37.13	\$ 46.31	\$ 55.55
10"		\$ 23.38	\$ 31.13	\$ 39.05	\$ 46.86		\$ 29.32	\$ 39.05	\$ 48.73	\$ 58.52
10.5"		\$ 24.59	\$ 32.78	\$ 41.09	\$ 49.28		\$ 30.86	\$ 41.09	\$ 51.32	\$ 61.60
11"		\$ 25.74	\$ 34.32	\$ 43.07	\$ 51.70		\$ 32.34	\$ 43.12	\$ 53.85	\$ 64.63
11.5"		\$ 28.11	\$ 35.92	\$ 44.94	\$ 53.96		\$ 33.77	\$ 44.99	\$ 56.16	\$ 67.38
12"		\$ 28.27	\$ 37.46	\$ 46.81	\$ 56.16		\$ 35.20	\$ 46.86	\$ 58.47	\$ 70.07
13"		\$ 30.58	\$ 40.65	\$ 50.88	\$ 61.05		\$ 38.12	\$ 50.82	\$ 63.47	\$ 76.18
14"		\$ 32.67	\$ 43.73	\$ 54.62	\$ 65.56		\$ 40.98	\$ 54.67	\$ 68.37	\$ 82.01
15"		\$ 34.98	\$ 46.64	\$ 58.36	\$ 69.96		\$ 43.84	\$ 58.36	\$ 77.22	\$ 87.62
16"		\$ 39.49	\$ 50.05	\$ 62.37	\$ 74.80		\$ 47.30	\$ 62.32	\$ 79.92	\$ 93.23
17"		\$ 39.71	\$ 53.02	\$ 66.22	\$ 79.53		\$ 50.33	\$ 66.28	\$ 82.56	\$ 96.03
18"		\$ 42.08	\$ 56.21	\$ 70.02	\$ 84.15		\$ 53.35	\$ 70.13	\$ 84.43	\$ 98.89
19"		\$ 44.50	\$ 59.24	\$ 72.93	\$ 86.08		\$ 54.84	\$ 72.05	\$ 85.53	\$ 101.09
20"					\$ 88.00					
22"					\$ 90.20					

THE ABOVE FLIGHTS ARE AVAILABLE IN A RANGE OF BORES (INSIDE DIAMETERS) TO SUIT MOST STANDARD PIPE, TUBE, AND SHAFT SIZES. THESE AUGERS ARE IN 5' LENGTHS AND CAN BE SHIPPED U.P.S.

\*\* 20% Discount on purchase of 50' of one size \*\*

## TABLE AUGER REPAIR TUBES FOR ALL MAKES OF COMBINES

WE HAVE TABLE CENTER REPAIR TUBES FOR ALL WIDTHS OF COMBINE TABLES. THE REPAIRED CENTER IS A HEAVIER GAUGE THAN THE ORIGINAL METAL. WE HAVE AUTHORIZED REBUILDING SHOPS TO COMPLETELY REBUILD AUGERS IN SOME AREAS OF THE U.S. IF NO SHOP IS NEAR YOU, WE CAN SHIP YOU A COMPLETE REBUILT AUGER ON AN EXCHANGE BASIS OR WILL SELL YOU THE REPAIR TUBE WHICH CAN BE INSTALLED AT YOUR SHOP WITH INSTRUCTIONS.

\*Older and Special Units Available at Request\*

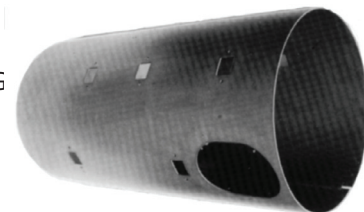

PART NO.	DESCRIPTION	WT.	IMPL. DEALERS	CUSTOMER
303	A.C.- E & K	44	\$269.80	\$350.35
304	A.C.- F	39	\$269.80	\$350.35
305	A.C.- G	46	\$269.80	\$350.35
306	A.C.- L, L2, M, & M2	61	\$316.45	\$411.00
308	A.C.- L3 & M3 & F3 Series 3 Head - 3/4" Finger (Use 314 Center)		\$316.45	\$411.00
307	A.C.- N	70	\$316.45	\$411.00
309	A.C.- N & R Series 3 Head - 3/4" Finger	52	\$316.45	\$411.00
411	Case/IH 3020 with oblong finger holes		\$316.45	\$411.00
703	Caterpillar w/ 18 Fingers	77	\$316.45	\$411.00
701	Claas (Ford & Early Massey Ferguson) w/ 17 Fingers	45	\$269.80	\$350.35
702	Claas (Late Massey Ferguson & Caterpillar) w/ 20 or 22 Fingers	80	\$316.45	\$411.00
316	Gleaner 8200 Axial w/ 21 Finger Holes	79	\$316.45	\$411.00
317	Gleaner 8200 Offset Throat		\$316.45	\$411.00
314	Gleaner C62 700C/800C & MF Rotary 9800 Series	72	\$316.45	\$411.00
315	Gleaner Late 7000/8000 R Series	78	\$316.45	\$411.00
406	Int. 1000 Series New Style & 1020 Early - 18 Fingers	72	\$269.80	\$350.35
408	Int. 1020 Late - 20 Fingers	77	\$316.45	\$411.00
606	Int. 2020 Early		\$316.45	\$411.00
409	Int. 2020 Late #CBJ020701 & Up w/ 21 Oblong Finger Holes	99	\$316.45	\$411.00
410	Int. 2020 Late Oblong Finger Holes #CBJ041118 & Up w/ Spiral Finger Pattern	99	\$316.45	\$411.00
401	Int. 810 & 820 - Early #25000 Prior	54	\$269.80	\$350.35
404	Int. 820 Late w/ New Oblong Finger Hole #25001 & Above	54	\$269.80	\$350.35
203	J.D. - 200 Series - 13' & 15'	75	\$316.45	\$411.00
204	J.D. - 200 Series & Early 900 Series 16' up 635100 Prior	87	\$316.45	\$411.00
205	J.D. - 4 row Forage Harvester -8 Fingers 22 1/4" Wide	31	\$269.80	\$350.35
206	J.D. - 900 Series Oval Hand Hole Cover - 16 Fingers (use 207 center)	96	\$316.45	\$411.00
208	J.D. - Hay Head Harvester -8 Fingers 23 3/4" Wide	88	\$269.80	\$350.35
209	J.D.- 600 Series	100	\$316.45	\$411.00
207	J.D. -900 Series Oval Hand Hole Cover- 23 Fingers 635101 & Up	107	\$316.45	\$411.00
202	J.D. Old Style - Big Finger - 5/8"	37	\$269.80	\$350.35
201	J.D. Old Style - Small Finger - 1/2"	37	\$269.80	\$350.35
209HD	J.D.-600 Series-Heavy Duty Reinforced		\$426.45	\$553.85
210	JD 645B Hay Pickup		\$316.45	\$411.00
103	M.F. 1859 - All	64	\$316.45	\$411.00
104	M.F. 2381	53	\$316.45	\$411.00
316	M.F. 8200 Centered Throat w/ 21 Finger Holes	79	\$316.45	\$411.00
105	M.F. 9000/9100 or 2166	67	\$316.45	\$411.00
503	M.F. 9200/9300 Rotary	90	\$316.45	\$411.00
506	MacDon Draper Head	93	\$316.45	\$411.00
106	MF Hay Head 260		\$316.45	\$411.00
314	MF Rotary 9800 Series & Gleaner 700C/800C		\$316.45	\$411.00
602	N.H. 970 & 972	68	\$316.45	\$411.00
605	N.H. 71C/ 73C		\$316.45	\$411.00
606	N.H. 72C/ 74C Early	98	\$316.45	\$411.00
409	N.H. 72C/ 74C Late #PN017801 & Up w/ 21 Oblong Finger Holes	99	\$316.45	\$411.00
601	N.H. 960 & 961	50	\$269.80	\$350.35
603	N.H. 971 & 973	75	\$316.45	\$411.00
604	N.H. Hay Head	32	\$269.80	\$350.35
411	NH 740CF with oblong finger holes		\$316.45	\$411.00
801	Shelbourne Stripper Head	42	\$316.45	\$411.00
804	Shelbourne Stripper Head Floating auger		\$316.45	\$411.00
802	Shelbourne Stripper Head w/ 24 Finger Holes - 4 Fingers Through Each Door (Use 803 Center)	85	\$316.45	\$411.00
803	Shelbourne Stripper Head w/ 24 Fingers w/ 2 Round Access Holes	85	\$316.45	\$411.00
503	White - 900 Series	90	\$316.45	\$411.00
501	White - All Oliver - Most w/ 17 Fingers	52	\$269.80	\$350.35
508	McDon Feed Drum		\$316.45	\$411.00

# Need a center replaced on your Table Auger??

6

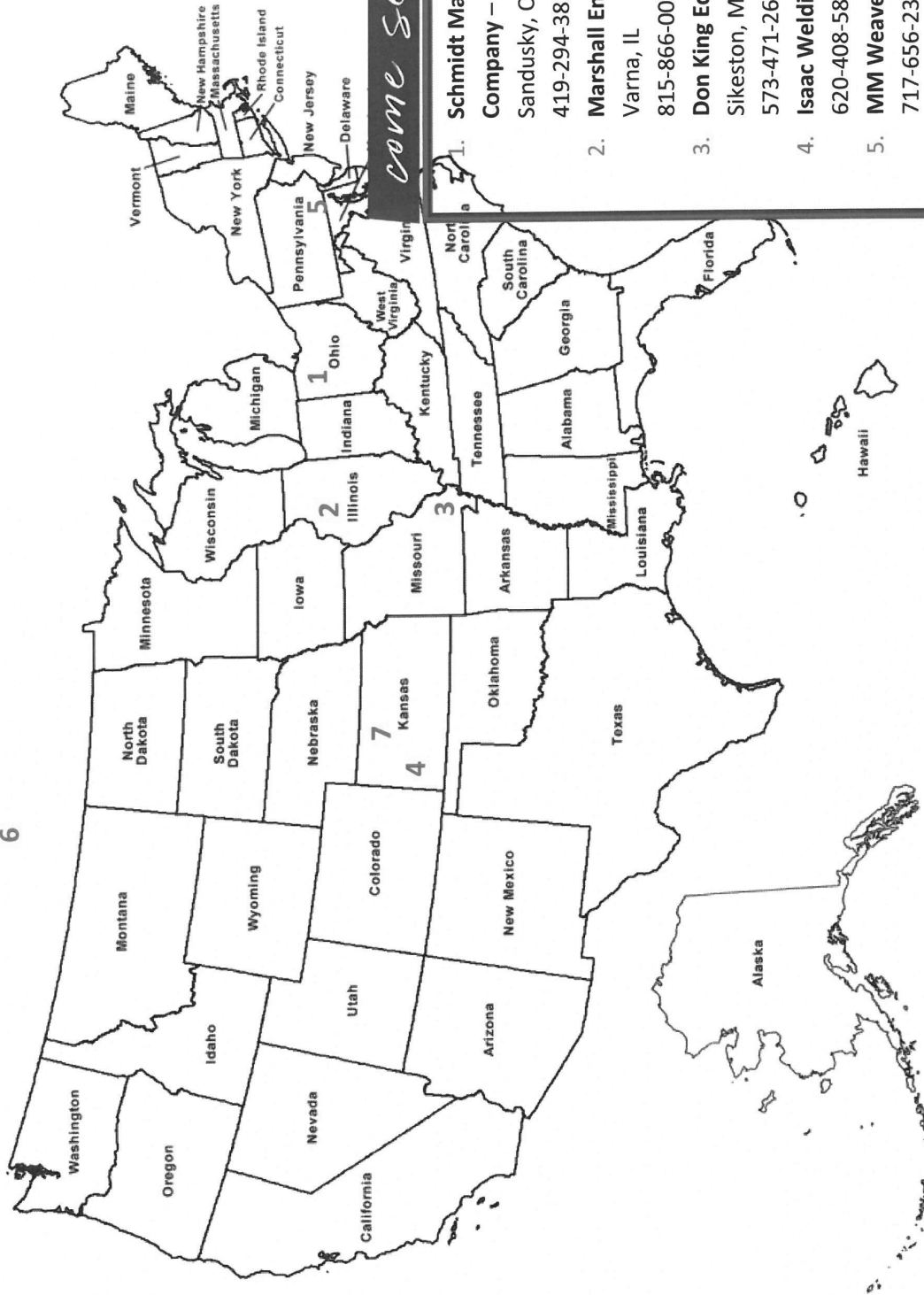

*come see us*

1. **Schmidt Machine Company – Upper Sandusky, OH**  
419-294-3814
2. **Marshall Enterprises – Varna, IL**  
815-866-0029
3. **Don King Equipment Co. – Sikeston, MO**  
573-471-2645
4. **Isaac Welding – Plains, KS**  
620-408-5884
5. **MM Weaver – Leola, PA**  
717-656-2321
6. **Combine World – Canada**  
800-667-4515
7. **MeadowLarc Welding**  
Montezuma, KS  
620-335-0418

## **RUNNING GEAR HEADER BRACKET KIT**

10001 Kit to install on running gear to carry grain tables. Adaptable by drilling holes or welding. Two sets of brackets supplied as per picture.

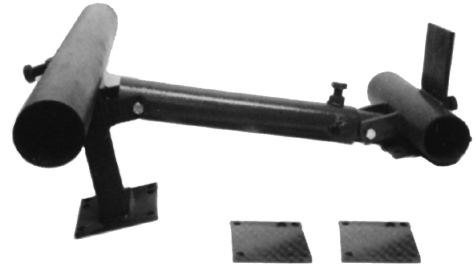

## **GRAIN SAVERS**

10GS Unloading Tube Grain Saver – 10" Tube  
12GS Unloading Tube Grain Saver – 12" Tube  
13GS Unloading Tube Grain Saver – 13" Tube



## **HEADER COUPLER SHAFT WRENCH**

71394674S MF 9690 & R42-R75 Wrench – Fits anything 98 and up (PTO style shaft)

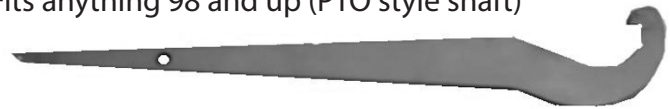

## **KSI CONVEYOR MOUNTING KITS FOR KINZE PLANTERS**

KSI 1 Kit to Mount KSI Conveyor on 3600 Kinze Planter  
KSI 2 Kit to Mount KSI Conveyor on 3660 Kinze Planter  
• Loader needs to be moved on 3660 Planter

## **SUNFLOWER REAR HITCH**

SMCH1 Hitch to bolt on back of Sunflower 6630 – Vertical Tillage Tools for 21ft., 24ft, 27ft, 29ft & 32ft – One Hydraulic Outlet Included  
SMCH1A Second Hydraulic Outlet  
SMCH1B Electrical Kit Available – 7 Pin Round Connector

## **CHALLENGER UNLOADING TUBE**

71399669SY 660 Eff. S/N HN87101 & 670 Eff. S/N 36101 – 213.5"  
105090SY 660 Prior S/N HN87101 & 670 Prior S/N 36101-178.5