

# Aspire 2930 Series Service Guide

Service guide files and updates are available on the ACER/CSD web; for more information, please refer to <http://csd.acer.com.tw>

PRINTED IN TAIWAN

---

# Revision History

Please refer to the table below for the updates made on Aspire 2930 Series service guide.

Date	Chapter	Updates

---

## Copyright

Copyright © 2008 by Acer Incorporated. All rights reserved. No part of this publication may be reproduced, transmitted, transcribed, stored in a retrieval system, or translated into any language or computer language, in any form or by any means, electronic, mechanical, magnetic, optical, chemical, manual or otherwise, without the prior written permission of Acer Incorporated.

## Disclaimer

The information in this guide is subject to change without notice.

Acer Incorporated makes no representations or warranties, either expressed or implied, with respect to the contents hereof and specifically disclaims any warranties of merchantability or fitness for any particular purpose. Any Acer Incorporated software described in this manual is sold or licensed "as is". Should the programs prove defective following their purchase, the buyer (and not Acer Incorporated, its distributor, or its dealer) assumes the entire cost of all necessary servicing, repair, and any incidental or consequential damages resulting from any defect in the software.

Acer is a registered trademark of Acer Corporation.

Intel is a registered trademark of Intel Corporation.

Pentium and Pentium II/III are trademarks of Intel Corporation.

Other brand and product names are trademarks and/or registered trademarks of their respective holders.

---

## Conventions

The following conventions are used in this manual:

<b>SCREEN MESSAGES</b>	Denotes actual messages that appear on screen.
<b>NOTE</b>	Gives bits and pieces of additional information related to the current topic.
<b>WARNING</b>	Alerts you to any damage that might result from doing or not doing specific actions.
<b>CAUTION</b>	Gives precautionary measures to avoid possible hardware or software problems.
<b>IMPORTANT</b>	Reminds you to do specific actions relevant to the accomplishment of procedures.



---

## Preface

Before using this information and the product it supports, please read the following general information.

1. This Service Guide provides you with all technical information relating to the BASIC CONFIGURATION decided for Acer's "global" product offering. To better fit local market requirements and enhance product competitiveness, your regional office MAY have decided to extend the functionality of a machine (e.g. add-on card, modem, or extra memory capability). These LOCALIZED FEATURES will NOT be covered in this generic service guide. In such cases, please contact your regional offices or the responsible personnel/channel to provide you with further technical details.
2. Please note WHEN ORDERING FRU PARTS, that you should check the most up-to-date information available on your regional web or channel. If, for whatever reason, a part number change is made, it will not be noted in the printed Service Guide. For ACER-AUTHORIZED SERVICE PROVIDERS, your Acer office may have a DIFFERENT part number code to those given in the FRU list of this printed Service Guide. You MUST use the list provided by your regional Acer office to order FRU parts for repair and service of customer machines.



<b>System Specifications</b>	<b>1</b>
Features	1
System Block Diagram	4
Your Acer Notebook tour	5
Front View	5
Closed Front View	6
Left View	7
Right View	7
Rear View	8
Bottom View	8
Indicators	9
Easy-Launch Buttons	9
Touch Pad Basics (with fingerprint reader)	10
Using the Keyboard	11
Lock Keys and embedded numeric keypad	11
Windows Keys	12
Hot Keys	13
Special Key (only for certain models)	13
Using the System Utilities	14
Acer GridVista (dual-display compatible)	14
Hardware Specifications and Configurations	16
 <b>System Utilities</b>	 <b>23</b>
BIOS Setup Utility	23
Navigating the BIOS Utility	23
Information	24
Main	25
Advanced	26
Security	28
Power	31
Boot	33
Exit	34
BIOS Flash Utilities	35
DOS Flash Utility	35
WinFlash Utility	37
Remove HDD/BIOS Utility	38
 <b>Machine Disassembly and Replacement</b>	 <b>41</b>
Disassembly Requirements	41
General Information	42
Pre-disassembly Instructions	42
Disassembly Process	42
External Module Disassembly Process	43
External Modules Disassembly Flowchart	43
Removing the Battery Pack	44
Removing the ExpressCard dummy card	45
Removing the SD dummy card	46
Removing the Lower Covers	47
Removing the WLAN Module	48
Removing the Hard Disk Drive Module	50
Removing the Optical Drive Module	52
Removing the DIMM Modules	54
Main Unit Disassembly Process	55
Main Unit Disassembly Flowchart	55

# Table of Contents

Removing the Switch Cover . . . . .	57
Removing the Keyboard . . . . .	59
Removing the Speaker Module . . . . .	60
Removing the Antenna . . . . .	62
Removing the LED Board . . . . .	64
Removing the Power Board . . . . .	65
Removing the LCD Module . . . . .	66
Removing the Upper Cover . . . . .	68
Removing the Finger Print Reader . . . . .	71
Removing the TouchPad Bracket . . . . .	72
Removing the Launch Board . . . . .	74
Removing the USB Board . . . . .	75
Removing the I/O Board . . . . .	76
Removing the Bluetooth Module . . . . .	77
Removing the Modem Module . . . . .	78
Removing the Mainboard . . . . .	80
Removing the RJ-11 Jack . . . . .	83
Removing the Fan/Thermal Module . . . . .	85
Removing the CPU . . . . .	86
LCD Module Disassembly Process . . . . .	87
LCD Module Disassembly Flowchart . . . . .	87
Removing the LCD Bezel . . . . .	88
Removing the Inverter Board . . . . .	90
Removing the Camera Module . . . . .	92
Removing the LCD Panel . . . . .	94
Removing the LCD Brackets and FPC Cable . . . . .	95
Removing the LCD Antenna . . . . .	96
Removing the LCD MIC . . . . .	97
LCD Module Reassembly Procedure . . . . .	98
Replacing the LCD Panel . . . . .	98
Replacing the LCD Bezel . . . . .	102
Main Module Reassembly Procedure . . . . .	104
Replacing the CPU . . . . .	104
Replacing the Thermal Module . . . . .	104
Replacing the RJ-11 Jack . . . . .	105
Replacing the Mainboard . . . . .	106
Replacing the Modem Module . . . . .	108
Replacing the Bluetooth Board . . . . .	108
Replacing the I/O Board . . . . .	109
Replacing the USB Board . . . . .	109
Replacing the Launch Board . . . . .	109
Replacing the TouchPad Bracket . . . . .	110
Replacing the Finger Print Reader . . . . .	111
Replacing the Upper Cover . . . . .	111
Replacing the LCD Module . . . . .	114
Replacing the Power Board . . . . .	117
Replacing the LED Board . . . . .	117
Replacing the Speaker Module . . . . .	117
Replacing the Keyboard . . . . .	118
Replacing the Switch Cover . . . . .	119
Replacing the WLAN Module . . . . .	119
Replacing the Hard Disk Drive Module . . . . .	120
Replacing the DIMM Modules . . . . .	121
Replacing the ODD Module . . . . .	122
Replacing the Lower Covers . . . . .	122

# Table of Contents

Replacing the Express and SD Card Trays	123
<b>Troubleshooting</b>	<b>125</b>
Common Problems	125
Power On Issue	126
No Display Issue	127
Random Loss of BIOS Settings	128
LCD Failure	129
Built-In Keyboard Failure	129
Touch Pad Failure	130
Internal Speaker Failure	130
Internal Microphone Failure	132
HDD Not Operating Correctly	133
ODD Failure	134
USB Failure (Rightside)	137
Modem Function Failure	137
Wireless Function Failure	138
EasyTouch Button Failure	138
MediaTouch Button Failure	139
Fingerprint Reader Failure	139
Thermal Unit Failure	140
HDTV Switch Failure	140
External Mouse Failure	141
Other Failures	141
Intermittent Problems	142
Undetermined Problems	142
POST Codes Tables	143
Port 80 POST Codes	143
POST Keys and Messages	145
<b>Jumper and Connector Locations</b>	<b>147</b>
Top View	147
Bottom View	148
Clearing Password Check and BIOS Recovery	149
Clearing Password Check	149
BIOS Recovery by Crisis Disk	150
<b>FRU (Field Replaceable Unit) List</b>	<b>151</b>
Aspire 2930 Exploded Diagrams	152
Upper/ Lower Cover	152
LCD Panel	153
Aspire 2930 FRU List	154
Screw List	162
<b>Model Definition and Configuration</b>	<b>164</b>
Aspire 2930 Series	164
<b>Test Compatible Components</b>	<b>229</b>
Microsoft® Windows® Vista Environment Test	230
<b>Online Support Information</b>	<b>235</b>
<b>Index</b>	<b>237</b>

# ***Table of Contents***

# System Specifications

---

## Features

Below is a brief summary of the computer's many feature:

### Operating System

- Genuine Windows® Vista™

### Platform

- Intel® Centrino® 2 processor technology, featuring:
  - Intel® Core™2 Duo processor
  - Mobile Intel® GM45 Express Chipset
  - Intel® Wireless WiFi Link 5100/5300\*
  - Intel® Wireless WiFi Link 5150/5350 (Subject to availability)

### System Memory

- Dual-Channel DDR2 SDRAM support
- Up to 2 GB of DDR2 667 MHz memory, upgradeable to 4 GB using two soDIMM modules\*

### Display and graphics

- 12.1" WXGA 1280 x 800
- Graphics • Mobile Intel® GM45 Express Chipset (Intel® Graphics Media Accelerator X4500HD)

### Storage subsystem

- 2.5" hard disk drive
- Optical drive options:
  - DVD-Super Multi double-layer drive
  - DVD/CD-RW combo drive
- 5-in-1 card reader

### Audio

- Dolby®-optimized surround sound system with two built-in stereo speakers
- High-definition audio support
- S/PDIF (Sony/Philips Digital Interface) support for digital speakers
- MS-Sound compatible
- Acer PureZone technology with two built-in stereo microphones

---

## Special keys and controls

- 88-/89-key keyboard
- Touchpad pointing device

## Power subsystem

- ACPI 3.0
- 48.8 W 4400 mAh 6-cell Li-ion battery pack
- 3-pin 65 W AC adapter
- Energy Star 4.0

## Dimensions and weight

- 304.8 (W) 230 (D) 35.7/42.1 (H) mm (12 x 9 x 1.4/1.6 inches)
- 2.1 kg (4.6 lbs.) with 6-cell battery pack

## Privacy control

- Acer Bio-Protection fingerprint solution\*
- BIOS user, supervisor, HDD passwords
- Kensington lock slot

## Communication

- Acer Video Conference, featuring:
  - Integrated Acer Crystal Eye webcam\*
  - Acer PureZone technology\*
  - Optional Acer Xpress VoIP phone\*
- WLAN: Intel® Wireless WiFi Link 5100/5300\*
- WiFi®/WiMAX™: Intel® Wireless WiFi Link 5150/5350

**NOTE:** Subject to availability.

- WPAN: Bluetooth® 2.0+EDR (Enhanced Data Rate)\*
- LAN: Gigabit Ethernet; Wake-on-LAN ready
- Modem: 56K ITU V.92

## I/O interface

- Acer EasyPort IV connector
- ExpressCard™/54 slot
- 5-in-1 card reader (SD/MMC/MS/MS PRO/xD)
- 3 USB 2.0 ports
- External display (VGA) port
- Headphones/speaker/line-out jack with S/PDIF support
- Microphone-in jack
- Line-in jack
- Ethernet (RJ-45) port
- Modem (RJ-11) port
- DC-in jack for AC adapter



---

## Environment

- Temperature:
  - Operating: 5 °C to 35 °C
  - Non-operating: -20 °C to 65 °C
- Humidity (non-condensing):
  - Operating: 20% to 80%
  - Non-operating: 20% to 80%

**NOTE:** Items marked with \* denote only selected models. The specifications listed above are for reference only. The exact configuration of your PC depends on the model purchased.





# Your Acer Notebook tour

After knowing your computer features, let us show you around your new computer.

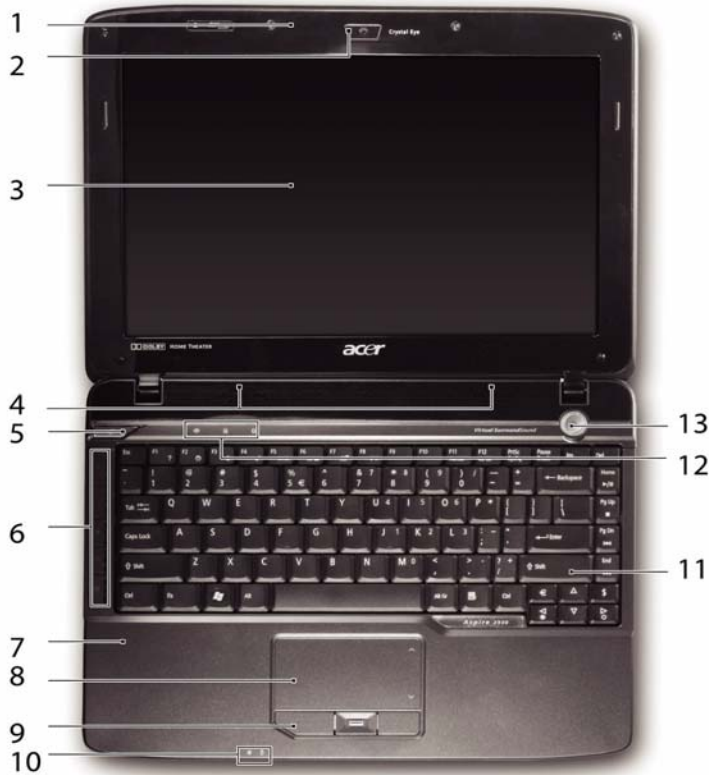
## Front View







No.	Icon	Item	Description
1		Acer PureZone	Two internal stereo microphones for sound recording.
2		Acer Crystal Eye	Web camera for video communication (only for certain models).
3		Display screen	Also called Liquid-Crystal Display (LCD), displays computer output.
4		Speakers	Left and right speakers deliver stereo audio output.
5		Empowering key	Launch Acer Empowering Technology
6		Easy-launch buttons	Buttons for launching frequently used programs.
7		Palmrest	Comfortable support area for your hands when you use the computer.
8		Touch Pad	Touch-sensitive pointing device which functions like a computer mouse.

No.	Icon	Item	Description
9		Click buttons (left, center* and right)	The left and right buttons function like the left and right mouse buttons. *The center button serves as Acer Bio-Protection fingerprint reader supporting Acer FingerNav 4-way control function (only for certain models).
10		Status indicators	Light-Emitting Diodes (LEDs) that light up to show the status of the computer's functions and components.
11		Keyboard	For entering data into your computer.
12		Status indicators	Light-Emitting Diodes (LEDs) that light up to show the status of the computer's functions and components.
13		Power button	Turns the computer on and off.





## Closed Front View



No.	Icon	Item	Description
1		Line-in jack	Accepts audio line-in devices (e.g. audio CD player, stereo walkman, mp3 player).
2		Microphone-in jack	Accepts input from external microphones.
3		Headphones/speaker/line-out jack with S/PDIF support	Connects to audio line-out devices (e.g. speakers, headphones).
4		Unlimited volume control wheel	Adjust the volume of the audio-out.
5		5-in-1 card reader	Accepts Secure Digital (SD), MultiMediaCard (MMC), Memory Stick (MS), Memory Stick Pro (MS PRO), xD-Picture Card. <b>Note:</b> Push to remove/install the card. Only one card can operate at any given time.





## Left View



No.	Icon	Item	Description
1		External display (VGA) port	Connects to a display device (e.g. external monitor, LCD projector).
2		Acer EasyPort IV connector	Connects to Acer EasyPort IV.
3		Ethernet (RJ-45) port	Connects to an Ethernet 10/100/1000-based network.
4		USB 2.0 ports	Connect to USB 2.0 devices (e.g. USB mouse, USB camera).
5		ExpressCard/54 slot	Accepts one ExpressCard/54 module. <b>Note:</b> Push to remove/install the card.

## Right View



No.	Icon	Item	Description
1		USB 2.0 ports	Connect to USB 2.0 devices (e.g. USB mouse, USB camera).
2		Optical drive	Internal optical drive; accepts CDs or DVDs.
3		Optical disk access indicator	Lights up when the optical drive is active.
4		Optical drive eject button	Ejects the optical disk from the drive.
5		Emergency eject hole	Ejects the optical drive tray when the computer is turned off. <b>Note:</b> Insert a paper clip into the emergency eject hole to eject the optical drive tray when the computer is off.
6		USB 2.0 ports	Connect to USB 2.0 devices (e.g. USB mouse, USB camera).
7		Modem (RJ-11) port	Connects to a phone line.
8		DC-in jack	Connects to an AC adapter





## Rear View

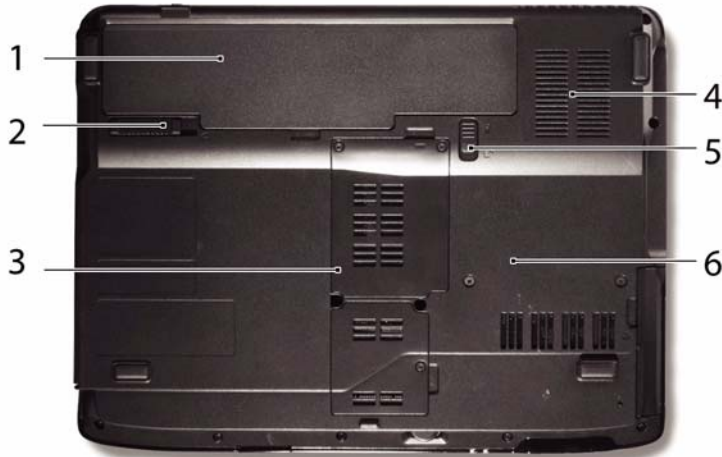

No.	Icon	Item	Description
1		Kensington lock slot	Connects to a Kensington-compatible computer security lock.
2		Ventilation slots	Enable the computer to stay cool, even after prolonged use.

## Bottom View









No.	Icon	Item	Description
1		Battery bay	Houses the computer's battery pack.
2		Battery release latch	Releases the battery for removal.
3		Memory compartment	Houses the computer's main memory.
4		Ventilation slots and cooling fan	Enable the computer to stay cool, even after prolonged use. <b>Note:</b> Do not cover or obstruct the opening of the fan.
5		Battery lock	Locks the battery in position.
6		Hard disk bay	Houses the computer's hard disk (secured with screws).

---

## Indicators

The computer has several easy-to-read status indicators. The front panel indicators are visible even when the computer cover is closed.





Icon	Function	Description
	HDD	Indicates when the hard disk drive is active.
	Num Lock	Lights up when Num Lock is activated.
	Caps Lock	Lights up when Caps Lock is activated.
	Power	Indicates the computer's power status.
	Battery	Indicates the computer's battery status.
	Bluetooth communication button/indicator	Enables/disables the Bluetooth function. Indicates the status of Bluetooth communication.
	Wireless communication button/indicator	Enables/disables the wireless function. Indicates the status of wireless LAN communication.

**NOTE:** 1. **Charging:** The light shows amber when the battery is charging. 2. **Fully charged:** The light shows green when in AC mode.

## Easy-Launch Buttons

Located beside the keyboard are application buttons. These buttons are called easy-launch buttons. They are: WLAN, Internet, email, Bluetooth and Acer Empowering Technology.

The mail and Web browser buttons are pre-set to email and Internet programs, but can be reset by users. To set the Web browser, mail and programmable buttons, run the Acer Launch Manager, you can access the Launch Manager by clicking on Start, All Programs, and then Launch Manager to start the application.

Icon	Function	Description
	Empowering Technology	Launch Acer Empowering Technology. (user-programmable)
	Web browser	Internet browser (user-Programmable)
	Mail	Email application (user-Programmable)
	Programmable key	User-programmable

# Touch Pad Basics (with fingerprint reader)

The following items show you how to use the Touch Pad with Acer Bio-Protection fingerprint reader:

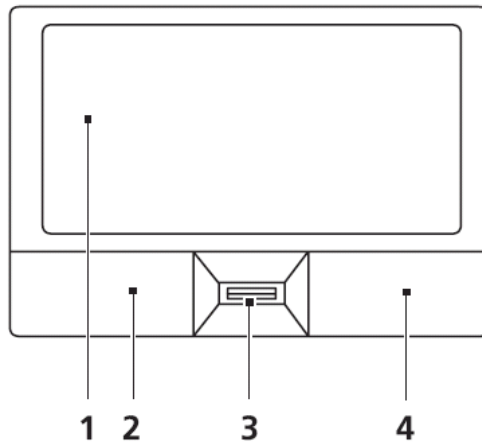

- Move your finger across the touchpad (1) to move the cursor.
- Press the left (2) and right (4) buttons located beneath the touchpad to perform selection and execution functions. These two buttons are similar to the left and right buttons on a mouse. Tapping on the touchpad is the same as clicking the left button.
- Use Acer Bio-Protection fingerprint reader (3) supporting Acer FingerNav 4-way control function (only for certain models) to scroll up or down and move left or right a page. This fingerprint reader or button mimics your cursor pressing on the right scroll bar of Windows applications.

Function	Left Button (2)	Right Button (4)	Main Touch Pad (1)	Center button (3)
Execute	Quickly click twice.		Tap twice (at the same speed as double-clicking a mouse button).	
Select	Click once.		Tap once.	
Drag	Click and hold, then use finger on the touchpad to drag the cursor.		Tap twice (at the same speed as double-clicking a mouse button); rest your finger on the touchpad on the second tap and drag the cursor.	
Access context menu		Click once.		
Scroll				Swipe up/down/left/right using Acer FingerNav 4-way control function (Manufacturing option).

**NOTE:** When using the Touch Pad, keep it - and your fingers - dry and clean. The Touch Pad is sensitive to finger movement; hence, the lighter the touch, the better the response. Tapping too hard will not increase the Touch Pad's responsiveness.



---

# Using the Keyboard

The keyboard has full-sized keys and an embedded numeric keypad, separate cursor, lock, Windows, function and special keys.

## Lock Keys and embedded numeric keypad

The keyboard has three lock keys which you can toggle on and off.



















Lock key	Description
Caps Lock	When Caps Lock is on, all alphabetic characters typed are in uppercase.
Num Lock <Fn> + <F11>	When Num Lock is on, the embedded keypad is in numeric mode. The keys function as a calculator (complete with the arithmetic operators +, -, *, and /). Use this mode when you need to do a lot of numeric data entry. A better solution would be to connect an external keypad. <b>Note:</b> <Fn> + <F11> only for certain models.
Scroll Lock <Fn> + <F12>	When Scroll Lock is on, the screen moves one line up or down when you press the up or down arrow keys respectively. Scroll Lock does not work with some applications.

The embedded numeric keypad functions like a desktop numeric keypad. It is indicated by small characters located on the upper right corner of the keycaps. To simplify the keyboard legend, cursor-control key symbols are not printed on the keys.

Desired access	Num Lock on	Num Lock off
Number keys on embedded keypad	Type numbers in a normal manner.	
Cursor-control keys on embedded keypad	Hold <Shift> while using cursor-control keys.	Hold <Fn> while using cursor-control keys.
Main keyboard keys	Hold <Fn> while typing letters on embedded keypad.	Type the letters in a normal manner.

# Windows Keys

The keyboard has two keys that perform Windows-specific functions.









Key	Description
 Windows key	<p>Pressed alone, this key has the same effect as clicking on the Windows Start button; it launches the Start menu. It can also be used with other keys to provide a variety of functions:</p> <ul style="list-style-type: none"> <li>&lt;  &gt;: Open or close the Start menu</li> <li>&lt;  &gt; + &lt;D&gt;: Display the desktop</li> <li>&lt;  &gt; + &lt;E&gt;: Open Windows Explore</li> <li>&lt;  &gt; + &lt;F&gt;: Search for a file or folder</li> <li>&lt;  &gt; + &lt;G&gt;: Cycle through Sidebar gadgets</li> <li>&lt;  &gt; + &lt;L&gt;: Lock your computer (if you are connected to a network domain), or switch users (if you're not connected to a network domain)</li> <li>&lt;  &gt; + &lt;M&gt;: Minimizes all windows</li> <li>&lt;  &gt; + &lt;R&gt;: Open the Run dialog box</li> <li>&lt;  &gt; + &lt;T&gt;: Cycle through programs on the taskbar</li> <li>&lt;  &gt; + &lt;U&gt;: Open Ease of Access Center</li> <li>&lt;  &gt; + &lt;X&gt;: Open Windows Mobility Center</li> <li>&lt;  &gt; + &lt;BREAK&gt;: Display the System Properties dialog box</li> <li>&lt;  &gt; + &lt;SHIFT+M&gt;: Restore minimized windows to the desktop</li> <li>&lt;  &gt; + &lt;TAB&gt;: Cycle through programs on the taskbar by using Windows Flip 3-D</li> <li>&lt;  &gt; + &lt;SPACEBAR&gt;: Bring all gadgets to the front and select Windows Sidebar</li> <li>&lt;CTRL&gt; + &lt;  &gt; + &lt;F&gt;: Search for computers (if you are on a network)</li> <li>&lt;CTRL&gt; + &lt;  &gt; + &lt;TAB&gt;: Use the arrow keys to cycle through programs on the taskbar by using Windows Flip 3-D</li> </ul> <p><b>Note:</b> Depending on your edition of Windows Vista or Windows XP, some shortcuts may not function as described.</p>
 Application key	<p>This key has the same effect as clicking the right mouse button; it opens the application's context menu.</p>

---

## Hot Keys

The computer employs hotkeys or key combinations to access most of the computer's controls like screen brightness, volume output and the BIOS utility.

To activate hot keys, press and hold the <Fn> key before pressing the other key in the hotkey combination.

Hotkey	Icon	Function	Description
<Fn> + <F1>	?	Hotkey help	Displays help on hotkeys.
<Fn> + <F2>		Acer eSettings Management	Launches Acer eSettings Management in Acer Empowering Technology.
<Fn> + <F3>		Acer ePower Management	Launches Acer ePower Management in Acer Empowering Technology.
<Fn> + <F4>	Z <sup>z</sup>	Sleep	Puts the computer in Sleep mode.
<Fn> + <F5>		Display toggle	Switches display output between the display screen, external monitor (if connected) and both.
<Fn> + <F6>		Screen blank	Turns the display screen backlight off to save power. Press any key to return.
<Fn> + <F7>		Touch Pad toggle	Turns the internal Touch Pad on and off.
<Fn> + <F8>		Speaker toggle	Turns the speakers on and off.
<Fn> + <F9>		Brightness up	Increases the screen brightness.
<Fn> + <F10>		Brightness down	Decreases the screen brightness.

## Special Key (only for certain models)

You can locate the Euro symbol and the US dollar sign at the upper-center and/or bottom-right of your keyboard.

### The Euro symbol

1. Open a text editor or word processor.
2. Press € at the bottom-right of the keyboard, or hold <Alt Gr> and then press the <5> key at the upper-center of the keyboard.

**NOTE:** Some fonts and software do not support the Euro symbol. Please refer to [www.microsoft.com/typography/faq/faq12.htm](http://www.microsoft.com/typography/faq/faq12.htm) for more information.

### The US dollar sign

1. Open a text editor or word processor.
2. Press \$ at the bottom-right of the keyboard, or hold <Shift> and then press the <4> key at the upper-center of the keyboard.

**NOTE:** This function varies by the operating system version.

# Using the System Utilities

Acer Bio-Protection (only for certain models) Acer Bio-Protection Fingerprint Solution is a multi-purpose fingerprint software package integrated with the Microsoft Windows operating system. Utilizing the uniqueness of one's fingerprint features, Acer Bio-Protection Fingerprint Solution has incorporated protection against unauthorized access to your computer with centralized password management with Password Bank, easy music player launching with Acer MusicLaunch, secure Internet favorites via Acer MyLaunch, and fast application/website launching and login with Acer FingerLaunch, while Acer ProfileLaunch can launch up to three applications/websites from a single finger swipe.

Acer Bio-Protection Fingerprint Solution also allows you to navigate through web browsers and documents using Acer FingerNav. With Acer Bio-Protection Fingerprint Solution, you can now enjoy an extra layer of protection for your personal computer, as well as the convenience of accessing your daily tasks with a simple swipe of your finger!

For more information refer to the Acer Bio-Protection help files.

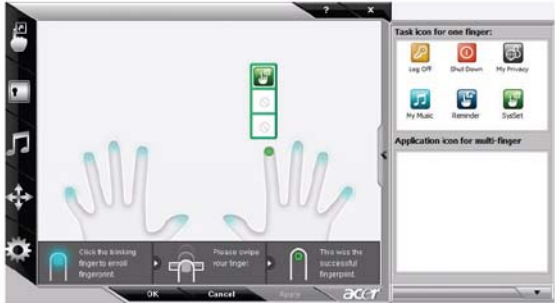

## Acer GridVista (dual-display compatible)

**NOTE:** This feature is only available on certain models.

To enable the dual monitor feature of the notebook, first ensure that the second monitor is connected, then select **Start, Control Panel, Display** and click on **Settings**. Select the secondary monitor (**2**) icon in the display box and then click the check box **Extend my windows desktop onto this monitor**. Finally, click **Apply** to confirm the new settings and click **OK** to complete the process.

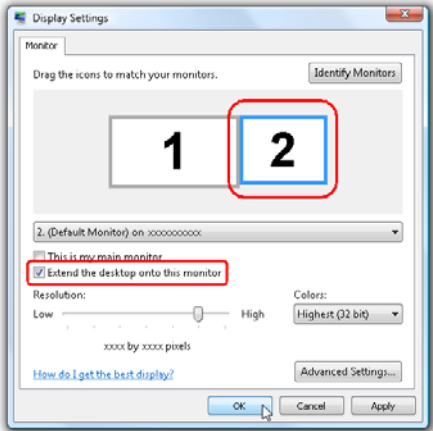

Acer GridVista is a handy utility that offers four pre-defined display settings so you can view multiple windows on the same screen. To access this function, please go to **Start → All Programs** and click on **Acer GridVista**. You may choose any one of the four display settings indicated below:



Double (vertical), Triple (primary at left), Triple (primary at right), or Quad Acer GridVista is dual-display compatible, allowing two displays to be partitioned independently.

Acer GridVista is dual-display compatible, allowing two displays to be partitioned independently.

AcerGridVista is simple to set up:

1. Run Acer GridVista and select your preferred screen configuration for each display from the task bar.
2. Drag and drop each window into the appropriate grid.
3. Enjoy the convenience of a well-organized desktop.

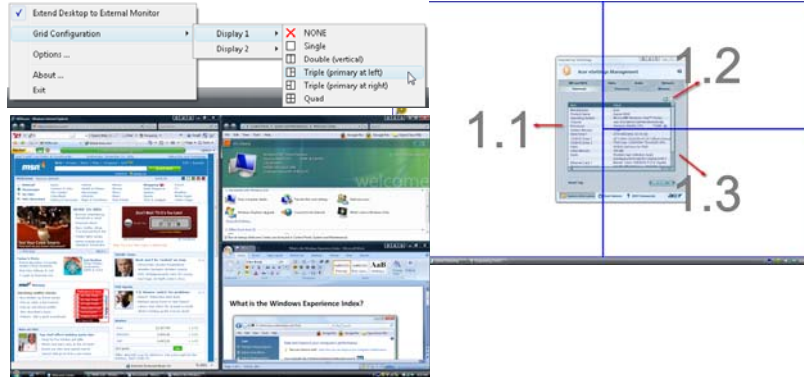

**NOTE:** Please ensure that the resolution setting of the second monitor is set to the manufacturer's recommended value.

# Hardware Specifications and Configurations

## Processor

Item	Specification
CPU type	Intel Montevina Centrino/PDC/Celeron
Chipset	Intel GL40+ICH9-M
Features	•
CPU core voltage	

## System Memory

Item	Specification
Memory controller	Built-in
Memory size	0MB (no on-board memory)
DIMM socket number	2 sockets
Supports memory size per socket	2 GB
Supports maximum memory size	4G for 64bit OS (with two 2GB SODIMM)
Supports DIMM type	DDR2 667/800 SDRAM memory interface design
Supports DIMM Speed	667/1066 MHz
Memory module combinations	You can install memory modules in any combinations as long as they match the above specifications.

## Memory Combinations

Slot 1	Slot 2	Total Memory
0MB	512MB	512MB
0MB	1024MB	1024MB
0MB	2048MB	2048MB
512MB	512MB	1024MB
512MB	1024MB	1536MB
512MB	2048MB	2560MB
1024MB	0MB	1024MB
1024MB	512MB	1536MB
1024MB	1024MB	2048MB
1024MB	2048MB	3072MB
2048MB	0MB	2048MB
2048MB	512MB	2560MB
2048MB	1024MB	3072MB
2048MB	2048MB	4096MB

### Hard Disk Drive Interface

Item	Specifications				
Vendor & Model Name	Hitachi 5K250-250 5K250-160	Segate ST9250827AS ST9160827AS ST9120817AS	Toshiba MK1646GSX MK1246GSX	WD WD2500BEVS WD1200BEVS	WD WD3200BEVT WD1600BEVT
Capacity (MB)	250, 160	250, 160, 120	160, 120	250, 120	320, 160
Bytes per sector	512	512	512	512	512
Data heads	4, 3	4, 3, 2	3, 2	4, 2	4, 2
Drive Format					
Disks	2, 2	2, 2, 1	2, 1	2, 1	2, 1
Spindle speed (RPM)	5400	5400	5400	5400	5400
Performance Specifications					
Buffer size	8 MB	8 MB	8 MB	8 MB	8 MB
Interface	SATA	SATA	SATA	SATA	SATA
Internal transfer rate (Mbits/sec, max)	643 ~ 665	778	370 ~ 730 typical	850 Mbits/s maximum	850 Mbits/s maximum
I/O data transfer rate (Mbytes/sec max)	150 / 300	300	300	150 maximum	300 maximum
DC Power Requirements					
Voltage	5V ±5%	5V ±5%	5V ±5%	5V ±5%	5V ±5%

### Super Multi Drive Module

Item	Specification	
Vendor & model name	HLDS/GSA-T50N, Philips DS-8A2S, Sony/AD-7560S, Toshiba Digi/TS-L633A	
Performance Specification	With CD Diskette	With DVD Diskette
Transfer rate (MB/sec)	Sustained: Max 3.5 Mbytes/sec	Sustained: Max 10 Mbytes/sec
Buffer Memory	2MB	
Interface	SATA	

Item	Specification
Applicable disc format	Applicable media types: Writing: Confirms to DVD+R Version 1.2 and DVD+RW Version 1.3 / DVD+R DL Version 1.0 / DVD-R Version 2.0 / DVD-RW Version 1.2 / DVD-R DL Version 3.0. Reading: DVD single/dual layer (PTP, OTP), DVD-R single/dual layer DVD+R single/double layer DVD-RW DVD+RW CD-DA CD-ROM CD-ROM/XA Photo-CD, Multi-session, Video CD CD-I FMV, CD Extra, CD Plus, CD-R, and CD-RW
Loading mechanism	Drawer (Solenoid Open) Tact SW (Open) Emergency Release (draw open hole)
Power Requirement	
Input Voltage	DC 5 V +/- 5%

#### Combo Drive Module

Item	Specification	
Vendor & model name	Sony BC-5500S	
Performance Specification	With CD Diskette	With DVD Diskette
Transfer rate (MB/sec)	Sustained: Max 2.4 Mbytes/sec	Sustained: Max 11 Mbytes/sec
Buffer Memory	4.5 MB	
Interface	SATA	
Applicable disc format	Applicable media types: BD-ROM (Single and Dual Layer) BD-R (Single and Dual Layer) BD-RE (Single and Dual Layer) DVD-ROM (Single and Dual Layer) DVD+R (Single and Double Layer) DVD-R (Single and Dual Layer) DVD+RW (Single Layer) and DVD-RW (Single Layer) discs DVD-RAM (Ver.2) CD-ROM CD-R CD-RW	
Loading mechanism	Drawer (Solenoid Open) Tact SW (Open) Emergency Release (draw open hole)	
Power Requirement		
Input Voltage	DC 5 V +/- 5%	



### Thermal Sensor Control

Item	Specification
Thermal Sensor Chip	
Package	
Features	
Interface	

### BIOS

Item	Specification
BIOS vendor	Insyde BIOS code
BIOS Version	v0.17-T01
BIOS ROM type	Serial Flash Memory
BIOS ROM size	1MB
BIOS package	8 pins SOIC
Supported protocols	<ul style="list-style-type: none"> <li>• Flash ROM 1MB- Support ISIPP</li> <li>• Support Acer UI</li> <li>• Support multi-boot</li> <li>• Suspend to RAM (S3)/Disk (S4)</li> <li>• Various hot-keys for system control</li> <li>• Support SMBIOS 2.3,PCI2.2</li> <li>• DMI utility for BIOS serial number configurable/asset tag- Support PXE</li> <li>• Support Y2K solution</li> <li>• Support WinFlash</li> <li>• Wake on LAN from S3</li> <li>• Wake on LAN from S4 in AC mode</li> <li>• System information</li> </ul>
BIOS password control	Set by setup manual

**LCD 12"** Click the red paper clip icon for more panel spec.



Item	Specification
Vendor/model name	
Screen Diagonal (mm)	
Active Area (mm)	
Display resolution (pixels)	
Pixel Pitch	
Pixel Arrangement	
Display Mode	
Typical White Luminance (cd/m <sup>2</sup> ) also called Brightness	
Luminance Uniformity	
Contrast Ratio	
Response Time (Optical Rise Time/Fall Time) msec	
Nominal Input Voltage VDD	
Typical Power Consumption (watt)	
Weight (without inverter)	

Item	Specification
Physical Size (mm)	
Electrical Interface	
Support Color	
Viewing Angle (degree) Horizontal: Right/Left Vertical: Upper/Lower	
Temperature Range (°C) Operating Storage (shipping)	

### KBC

Item	Specification
Chipset	Built in
Features	<ul style="list-style-type: none"> <li>LPC interface</li> </ul>

### Memory Card Reader

Item	Specification
Chipset	JMicro JMB385
Features	<ul style="list-style-type: none"> <li>5-in-1 Card Reader (MS, MS Pro, SD, MMC, xD)</li> <li>Push-push type, with dummy card</li> </ul>

### Audio Interface

Item	Specification
Audio Controller	Realtek ALC888S
Features	<ul style="list-style-type: none"> <li>HD Audio- Internal Mic. Array (digital)</li> <li>1.5Watt speaker x2-</li> <li>VC Audio Codec</li> <li>True 5.1 channel, Dolby Home Theater</li> </ul>

### LAN Interface

Item	Specification
LAN Chipset	Realtek RTL8111C-GR
Features	<ul style="list-style-type: none"> <li>PCI-E Giga LAN</li> </ul>

### Modem

Item	Specification
Chipset	Liteon-Agere
Features	<ul style="list-style-type: none"> <li>V.90/V.92, WWDA</li> <li>MDC1.5 card (HD)</li> <li>Apply CISPR22</li> <li>Wake-on-Ring (S3) support</li> </ul>

### Bluetooth Interface

Item	Specification
Chipset	Broadcom 2045/ 2070(NA)
Features	<ul style="list-style-type: none"> <li>Mini USB module</li> <li>Built-in 1 antenna- Bluetooth 2.0-</li> </ul>

---

**Keyboard**

Item	Specification
Type	Aspire 12"
Total number of keypads	88/89
Windows logo key	Support Windows keys and Application keys
Internal & external keyboard work simultaneously	Plug USB keyboard to the USB port directly: Yes

**Camera**

Item	Specification
Type	1.0M pixel, Fixed

**Finger Print Board**

Item	Specification
Chipset	Authentec AES1610
Features	USB interface

**Battery**

Item	Specification
Vendor	Sanyo/Sony/Panasonic/Simplo
Model name	AS2007A
Battery Type	Li-ion
Pack capacity	4400 mAh
Number of battery cell	6
Package configuration	3S2P



# System Utilities

---

## BIOS Setup Utility

The BIOS Setup Utility is a hardware configuration program built into your computer's BIOS (Basic Input/Output System).

Your computer is already properly configured and optimized, and you do not need to run this utility. However, if you encounter configuration problems, you may need to run Setup. Please also refer to Chapter 4 Troubleshooting when problem arises.

To activate the BIOS Utility, press **F2** during POST (when "Press <F2> to enter Setup" message is prompted on the bottom of screen).

Press **F2** to enter setup. The default parameter of F12 Boot Menu is set to "disabled". If you want to change boot device without entering BIOS Setup Utility, please set the parameter to "enabled".

Press <F12> during POST to enter multi-boot menu. In this menu, user can change boot device without entering BIOS SETUP Utility.

## Navigating the BIOS Utility

There are six menu options: Information, Main, Advanced, Security, Boot, and Exit.

Follow these instructions:

- To choose a menu, use the left and right arrow keys.
- To choose an item, use the up and down arrow keys.
- To change the value of a parameter, press **F5** or **F6**.
- A plus sign (+) indicates the item has sub-items. Press **Enter** to expand this item.
- Press **Esc** while you are in any of the menu options to go to the Exit menu.
- In any menu, you can load default settings by pressing **F9**. You can also press **F10** to save any changes made and exit the BIOS Setup Utility.

**NOTE:** You can change the value of a parameter if it is enclosed in square brackets. Navigation keys for a particular menu are shown on the bottom of the screen. Help for parameters are found in the Item Specific Help part of the screen. Read this carefully when making changes to parameter values. **Please note that system information is subject to different models.**

# Information

The Information screen displays a summary of your computer hardware information.

InsydeH20 Setup Utility		Rev. 3.5
Information	Main	Advanced Security Power Boot Exit
CPU Type:	Intel (R) Core (TM)2 Duo CPU	P9500 @ 2.53GHz
CPU Speed:	2.53GHz	
HDD Model Name:	WDC WD3200BEVT-22ZCTO	
HDD Serial Number:	WD-WXEY07340577	
ATAPI Model Name:	Optiarc BD ROM BC-5500S	
System BIOS Version:	V0.17-T01	
VGA BIOS Version:	Intel V1598	
Serial Number:		
Asset Tag Number:		
Product Name:		
Manufacturer Name:	Acer	
UUID:	FFFFFFFF-FFFF-FFFF-FFFF-002007011606	
F1 Help	↑↓ Select Item	F5/F6 Change Values F9 Setup Default
ESC Exit	←→ Select Menu	Enter Select▶SubMenu F10 Save and Exit

**NOTE:** The system information is subject to different models.

Parameter	Description
CPU Type	This field shows the CPU type and speed of the system.
CPU Speed	This field shows the speed of the CPU.
HDD Model Name	This field shows the model name of HDD installed on primary IDE master.
HDD Serial Number	This field displays the serial number of HDD installed on primary IDE master.
ATAPI Model Name	This field shows the model name of the Optical device installed in the system.
System BIOS Version	Displays system BIOS version.
VGA BIOS Version	This field displays the VGA firmware version of the system.
Serial Number	This field displays the serial number of this unit.
Asset Tag Number	This field displays the asset tag number of the system.
Product Name	This field shows product name of the system.
Manufacturer Name	This field displays the manufacturer of this system.
UUID Number	Universally Unique Identifier (UUID) is an identifier standard used in software construction, standardized by the Open Software Foundation (OSF) as part of the Distributed Computing Environment (DCE).

# Main

The Main screen allows the user to set the system time and date as well as enable and disable boot option and recovery.

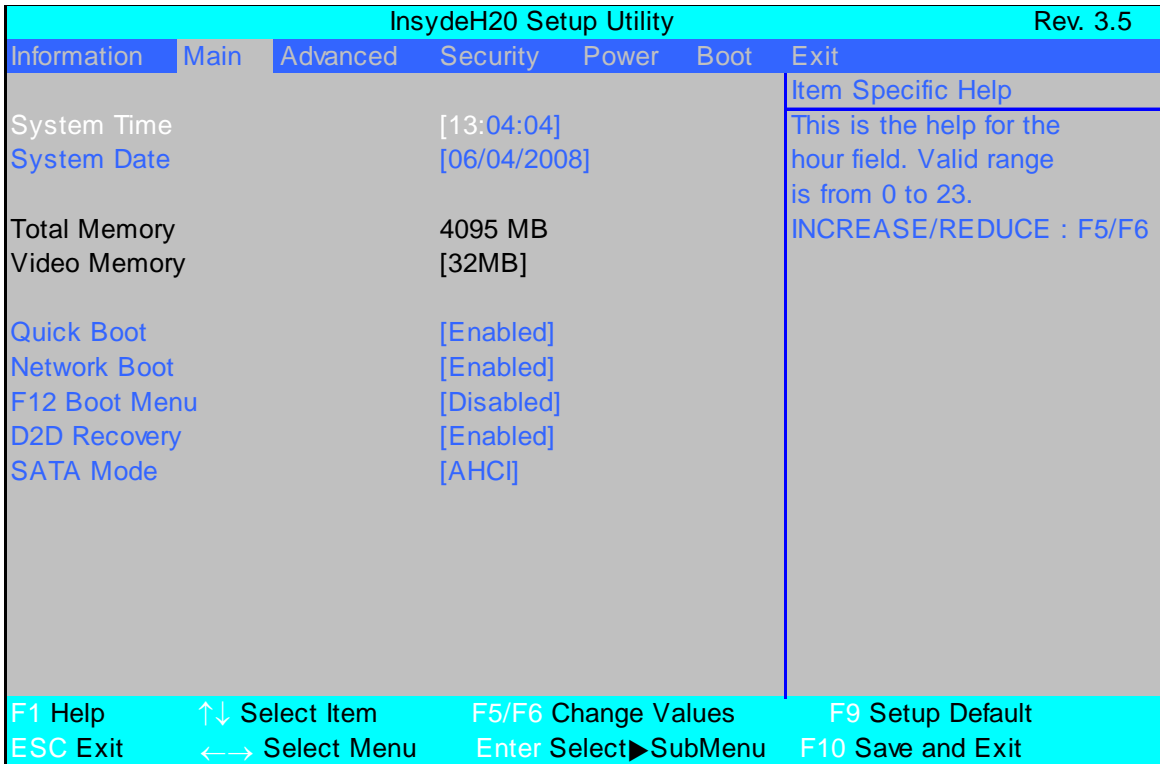

**NOTE:** The screen above is for your reference only. Actual values may differ.

The table below describes the parameters in this screen. Settings in **boldface** are the default and suggested parameter settings.

Parameter	Description	Format/Option
System Time	Sets the system time. The hours are displayed with 24-hour format.	Format: HH:MM:SS (hour:minute:second)
System Date	Sets the system date.	Format MM/DD/YYYY (month/day/year)
Total Memory	This field reports the memory size of the system. Memory size is fixed to 3017 MB.	N/A
Video Memory	Shows the video memory size. VGA Memory size=32 MB	N/A
Quick Boot	Allows startup to skip certain tests while booting, decreasing the time needed to boot the system.	Option: <b>Enabled</b> or Disabled
Network Boot	Enables, disables the system boot from LAN (remote server).	Option: <b>Enabled</b> or Disabled
F12 Boot Menu	Enables, disables Boot Menu during POST.	Option: <b>Disabled</b> or Enabled
D2D Recovery	Enables, disables D2D Recovery function. The function allows the user to create a hidden partition on hard disc drive to store operation system and restore the system to factory defaults.	Option: <b>Enabled</b> or Disabled
SATA Mode	Control the mode in which the SATA controller should operate.	Option: <b>AHCI Mode</b> or IDE Mode

**NOTE:** The sub-items under each device will not be shown if the device control is set to disable or auto. This is because the user is not allowed to control the settings in these cases.

# Advanced

The Advanced screen allows the user to configure the various advanced BIOS options.

**IMPORTANT:** Making incorrect settings to items on these pages may cause the system to malfunction. Unless you have experience adjusting these items, we recommend that you leave these settings at the default values. If making settings to items on these pages causes your system to malfunction or prevents the system from booting, open BIOS and choose Load Optimal Defaults in the Exit menu to boot up normally.

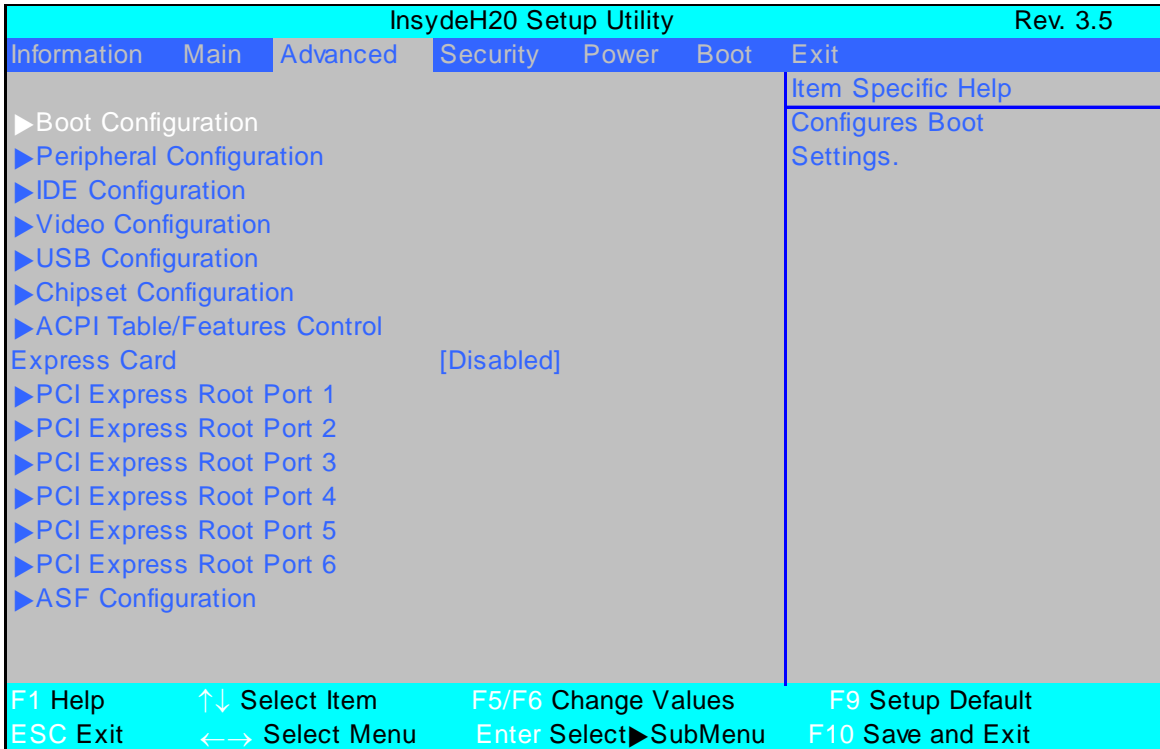

The table below describes the items, menus, and submenus in this screen. Settings in **boldface** are the default and suggested parameter settings.

Parameter	Description	Submenu Items
Boot Configuration	Enter the Boot Configuration menu.	<ul style="list-style-type: none"> <li>Numlock</li> <li>Zip Emulation Type</li> </ul>
Peripheral Configuration	Enter the Peripheral Configuration menu.	<ul style="list-style-type: none"> <li>Serial Port A</li> <li>Infrared Port</li> <li>Azalia</li> <li>LAN</li> </ul>
IDE Configuration	Enter the IDE Configuration menu.	<ul style="list-style-type: none"> <li>IDE Controller</li> <li>HDC Configure as</li> <li>ACHI Option ROM Support</li> <li>SATA Port 0, 1, 4, and 5 Hotplug</li> <li>Channel 1 to 4 Master and Slave</li> </ul>



Parameter	Description	Submenu Items
Video Configuration	Enter the Video Configuration menu.	<ul style="list-style-type: none"> <li>• IGD Device2, Function1</li> <li>• IGD Pre-allocate Memory</li> <li>• IGD DVMT Size</li> <li>• Clock Chip Intialize</li> <li>• Enabled CK SSC</li> <li>• IGD Boot Type</li> <li>• IGD LCD Panel Type</li> <li>• IGD TV</li> </ul>
USB Configuration	Enter the USB Configuration menu.	<ul style="list-style-type: none"> <li>• USB Driver Select</li> <li>• EHCI 1 and 2</li> <li>• UHCI 1 to 5</li> <li>• Per-Port Control</li> <li>• USB Port 1 to 11</li> </ul>
Chipset Configuration	Enter the Chipset Configuration menu.	<ul style="list-style-type: none"> <li>• Port 80h Cycles</li> <li>• DMI Link ASPM Control</li> <li>• Automatic ASPM</li> <li>• PCI Latency Timer</li> <li>• VT-d</li> <li>• iTPM</li> </ul>
ACPI Table/Features Control	Enter the ACPI Table/Features Control menu.	<ul style="list-style-type: none"> <li>• FACP C2 Latency Value</li> <li>• FACP C3 Latency Value</li> <li>• FACP RTC S4 Wakeup</li> <li>• APIC IO APIC Mode</li> <li>• HPET Support</li> <li>• Base Address Select</li> </ul>
Express Card	<b>Disable</b> or Enable the Express Card solution for windows Standby and Hibernation.	N/A
PCI Express Root Port 1 to 6	Enter the PCI Port 1 to 6 configuration menus.	<ul style="list-style-type: none"> <li>• VC1 Enable</li> <li>• ASPM</li> <li>• URR</li> <li>• FER</li> <li>• NFER</li> <li>• CER</li> <li>• CTO</li> <li>• SEFE</li> <li>• SENFE</li> <li>• SECE</li> <li>• PME Interrupt</li> <li>• PME SCI</li> <li>• Hot Plug SCI</li> </ul>
ASF Configuration	Enter the ASF Configuration menu.	<ul style="list-style-type: none"> <li>• Mini Watchdog Timeout</li> <li>• BIOS Boot Timeout</li> <li>• OS Boot Timeout</li> <li>• Power-on wait time</li> </ul>

# Security

The Security screen contains parameters that help safeguard and protect your computer from unauthorized use.

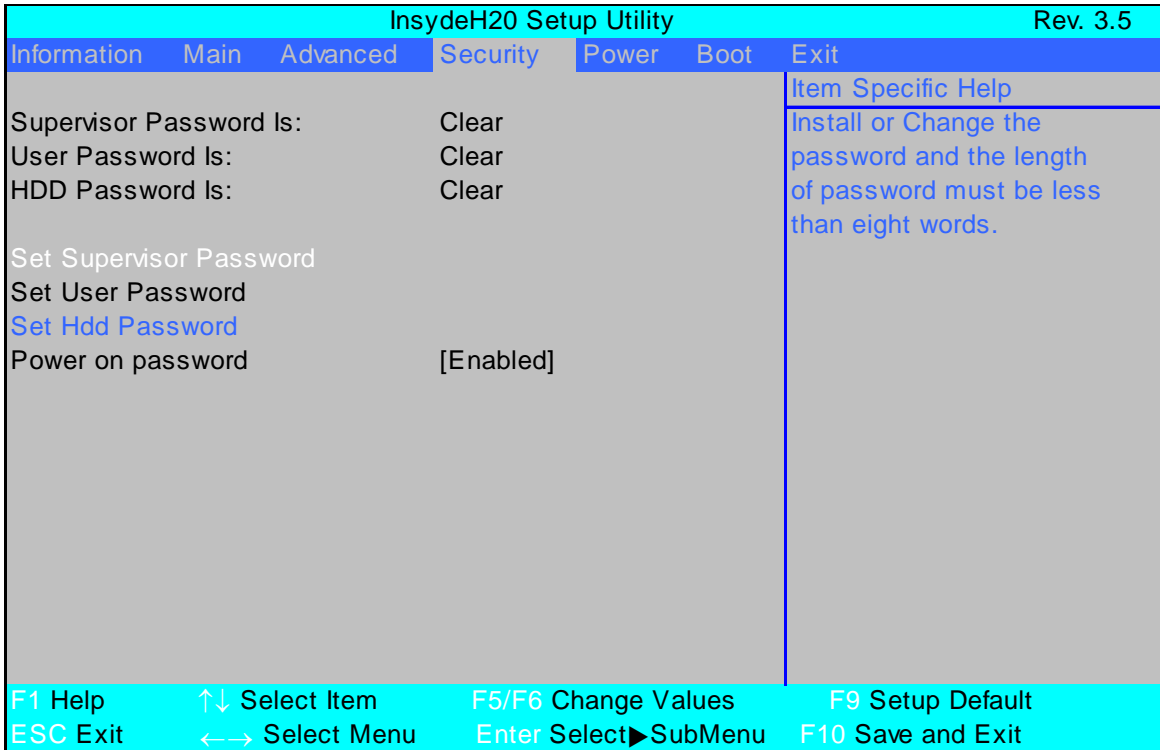

The table below describes the parameters in this screen. Settings in **boldface** are the default and suggested parameter settings.

Parameter	Description	Option
Supervisor Password Is	Shows the setting of the Supervisor password	<b>Clear</b> or Set
User Password Is	Shows the setting of the user password.	<b>Clear</b> or Set
HDD Password Is	Shows the setting of the hard disk password.	<b>Clear</b> or Set
Set Supervisor Password	Press Enter to set the supervisor password. When set, this password protects the BIOS Setup Utility from unauthorized access. The user can not either enter the Setup menu nor change the value of parameters.	
Set User Password	Press Enter to set the user password. When user password is set, this password protects the BIOS Setup Utility from unauthorized access. The user can enter Setup menu only and does not have right to change the value of parameters.	
Set HDD Password	Enter HDD Password.	
Password on Boot	Defines whether a password is required or not while the events defined in this group happened. The following sub-options are all requires the Supervisor password for changes and should be grayed out if the user password was used to enter setup.	<b>Disabled</b> or Enabled

**NOTE:** When you are prompted to enter a password, you have three tries before the system halts. Don't forget your password. If you forget your password, you may have to return your notebook computer to your dealer to reset it.

---

## Setting a Password

Follow these steps as you set the user or the supervisor password:

1. Use the ↑ and ↓ keys to highlight the Set Supervisor Password parameter and press the **Enter** key. The Set Supervisor Password box appears:

Set Supervisor Password		
Enter New Password	[	]
Confirm New Password	[	]

2. Type a password in the “Enter New Password” field. The password length can not exceeds 8 alphanumeric characters (A-Z, a-z, 0-9, not case sensitive). Retype the password in the “Confirm New Password” field.

**IMPORTANT:** Be very careful when typing your password because the characters do not appear on the screen.

3. Press **Enter**. After setting the password, the computer sets the User Password parameter to “Set”.
4. If desired, you can opt to enable the Password on boot parameter.
5. When you are done, press F10 to save the changes and exit the BIOS Setup Utility.

## Removing a Password

Follow these steps:

1. Use the ↑ and ↓ keys to highlight the Set Supervisor Password parameter and press the **Enter** key. The Set Password box appears:

Set Supervisor Password		
Enter current password	[	]
Enter New Password	[	]
Confirm New Password	[	]

2. Type the current password in the Enter Current Password field and press **Enter**.
3. Press **Enter** twice **without** typing anything in the Enter New Password and Confirm New Password fields. The computer then sets the Supervisor Password parameter to “Clear”.
4. When you have changed the settings, press u to save the changes and exit the BIOS Setup Utility.

---

## Changing a Password

1. Use the ↑ and ↓ keys to highlight the Set Supervisor Password parameter and press the **Enter** key. The Set Password box appears.

Set Supervisor Password		
Enter current password	[	]
Enter New Password	[	]
Confirm New Password	[	]

2. Type the current password in the Enter Current Password field and press **Enter**.
3. Type a password in the Enter New Password field. Retype the password in the Confirm New Password field.
4. Press **Enter**. After setting the password, the computer sets the User Password parameter to “Set”.
5. If desired, you can enable the Password on boot parameter.
6. When you are done, press F10 to save the changes and exit the BIOS Setup Utility.

If the verification is OK, the screen will display as following.

Setup Notice
Changes have been saved.
[ continue]

The password setting is complete after the user presses **Enter**.

If the current password entered does not match the actual current password, the screen will show you the Setup Warning.

Setup Warning
Invalid password
Re-enter Password
[ continue]

If the new password and confirm new password strings do not match, the screen will display the following message.

Setup Warning
Password do not match
Re-enter Password

# Power

The Power screen allows the user to configure various CPU and power management options and device wakeup behavior.

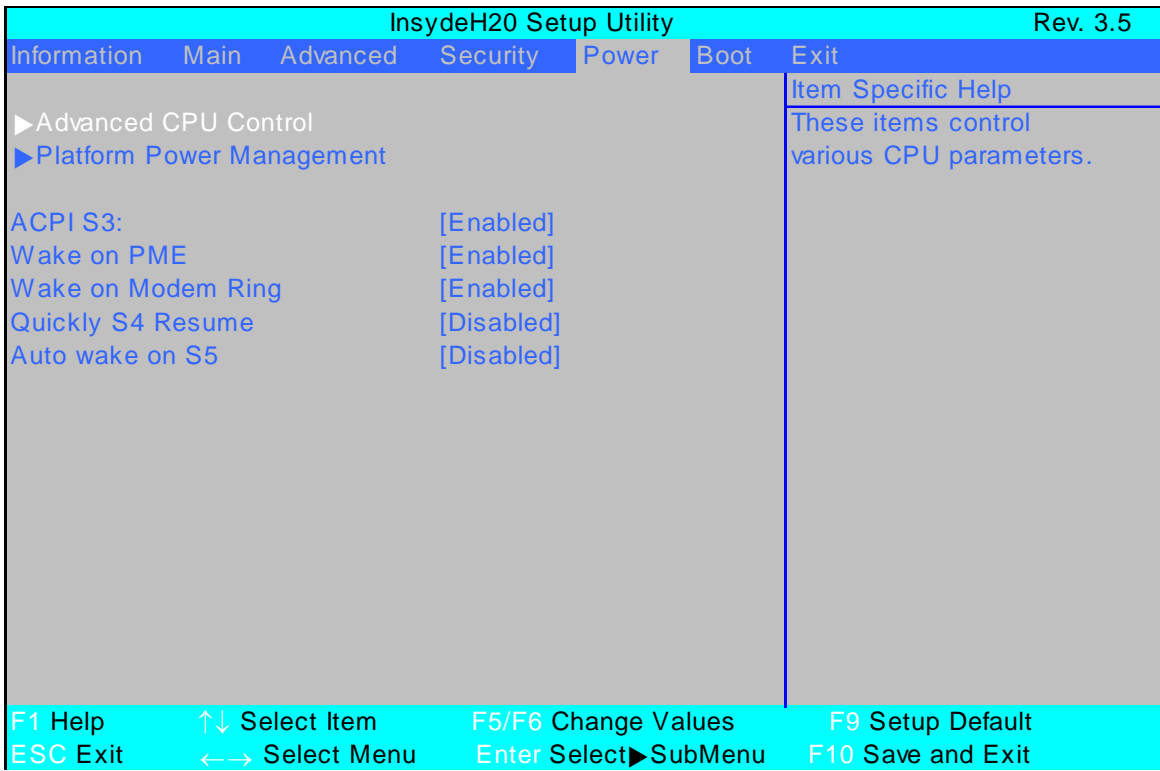

The table below describes the items, menus, and submenus in this screen. Settings in **boldface** are the default and suggested parameter settings.

Parameter	Description	Submenu Items
Advanced CPU Control	Enter the Advanced CPU Control menu.	<ul style="list-style-type: none"> <li>• P-States (IST)</li> <li>• Boot performance mode</li> <li>• Thermal Mode</li> <li>• CMP Support</li> <li>• Use XD capability</li> <li>• VT Support</li> <li>• SMRR Support</li> <li>• C-States</li> <li>• Enhanced C-States</li> <li>• C-State Pop Up Mode</li> <li>• C-State Pop Down Mode</li> <li>• C4 Exit Timing Mode</li> <li>• DeepC4</li> <li>• Hard C4E</li> <li>• Enable C6</li> <li>• EMTTM</li> <li>• Bi-directional PROCHOT#</li> <li>• Dynamic FSB Switching</li> <li>• Turbo Mode</li> <li>• ACPI 3.0 T-States</li> <li>• DTS</li> <li>• DTS Calibration</li> <li>• Thermal Trip Points Setting (Fan On Temp., Throttle On Temp.)</li> </ul>
Platform Power management	Enter the Platform Power Management menu.	<ul style="list-style-type: none"> <li>• PCI Clock Run</li> <li>• _CST - C4 Latency Value</li> <li>• C4 on C3 - Deeper Sleep</li> </ul>
ACPI S3	<b>Enable</b> or Disable ACPI S1/S3 Sleep State	N/A
Wake on PME	<b>Enable</b> or Disable wake up when the system power is off and a PCI Power Management Enable wake up event occurs.	N/A
Wake on Modem Ring	<b>Enable</b> or Disable wake up when the system power is off and a modem attached to the serial port is ringing.	N/A
Auto wake on S5	<b>Disable</b> or Enable auto wake up by date and time or at a fixed time everyday.	N/A
Quickly S4 Resume	Disable or Enable optional quick boot from S4 Resume.	N/A

# Boot

This menu allows the user to decide the order of boot devices to load the operating system. Bootable devices includes the USB diskette drives, the onboard hard disk drive and the DVD drive in the module bay.

InsydeH20 Setup Utility				Rev. 3.5		
Information	Main	Advanced	Security	Power	Boot	Exit
Boot priority order:						Item Specific Help
1. USB HDD :						Use <↑> or <↓> to select a device, then press <F5> to move it down the list, or <F6> to move it up the list. Press <Esc> to escape the menu
2. IDE1 : Optiarc BD ROM BC-5500S						
3. IDE0 : WDC WD3200BEVT-22ZCTO						
4. USB FDD :						
5. Network Boot : Realtek Boot Agent						
6. USB CDROM :						
F1 Help	↑↓ Select Item	F5/F6 Change Values		F9 Setup Default		
ESC Exit	←→ Select Menu	Enter Select▶ SubMenu		F10 Save and Exit		

# Exit

The Exit screen allows you to save or discard any changes you made and quit the BIOS Utility.

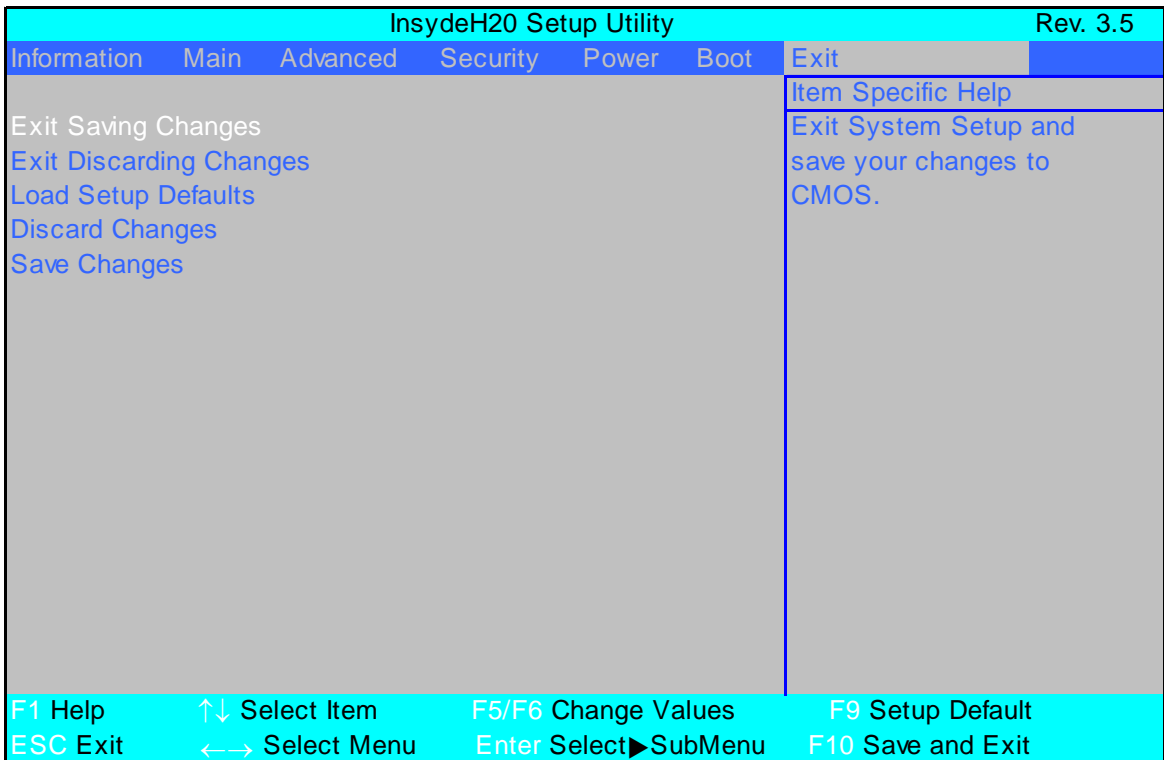

The table below describes the parameters in this screen.

Parameter	Description
Exit Saving Changes	Exit System Setup and save your changes to CMOS.
Exit Discarding Changes	Exit utility without saving setup data to CMOS.
Load Setup Default	Load default values for all SETUP item.
Discard Changes	Load previous values from CMOS for all SETUP items.
Save Changes	Save Setup Data to CMOS.



---

# BIOS Flash Utilities

The BIOS flash memory update is required for the following conditions:

- New versions of system programs
- New features or options
- Restore a BIOS when it becomes corrupted.

Use the Phlash utility to update the system BIOS flash ROM.

**NOTE:** Create a **Crisis Recovery Media** (such as USB HDD) before you use the Phlash utility.

**NOTE:** Do not install memory-related drivers (XMS, EMS, DPMI) when you use the Phlash.

**NOTE:** Please use the AC adaptor power supply when you run the Phlash utility. If the battery pack does not contain enough power to finish BIOS flash, the system will not boot as the BIOS is not loaded.

## DOS Flash Utility

Perform the following steps to use the DOS Flash Utility:

1. Press F2 during boot to enter the Setup Menu.
2. Select **Boot Menu** to modify the boot priority order, for example, if using USB HDD to Update BIOS, move USB HDD to position 1.

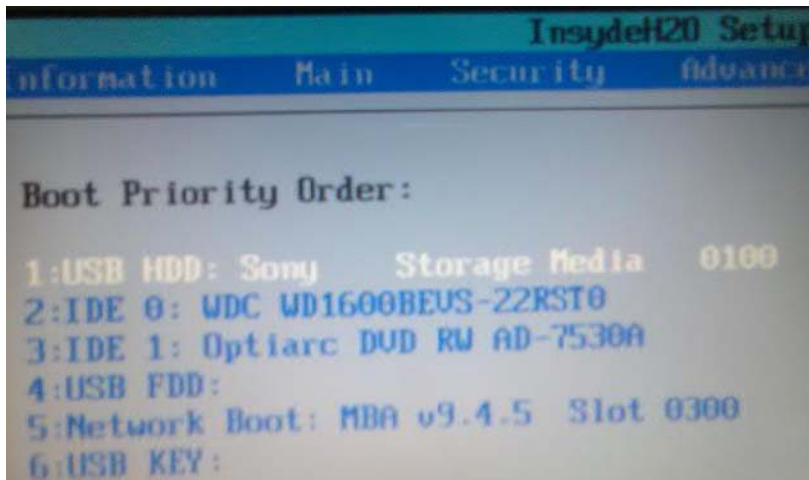

3. Execute the **IFLASH.BAT** batch file to update BIOS (Read xxxxx.fd to Memory).



4. In flash BIOS, the message **Please do not remove AC Power Source** displays.

**NOTE:** If the AC power is not connected, the following message displays.

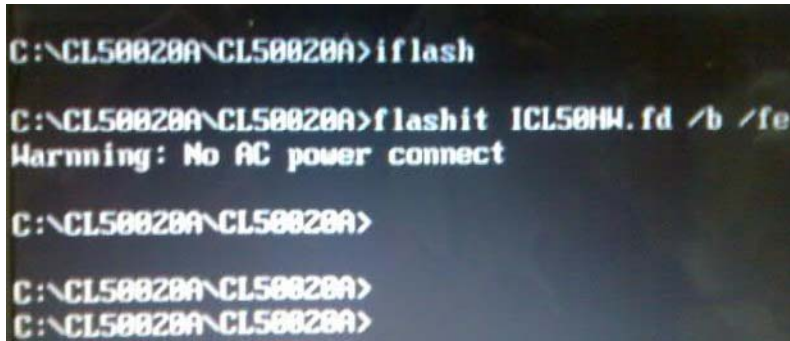

```
C:\CL50020A\CL50020A>iflash
C:\CL50020A\CL50020A>flashit ICL50HW.fd /b /fe
Warning: No AC power connect
C:\CL50020A\CL50020A>
C:\CL50020A\CL50020A>
C:\CL50020A\CL50020A>
```

Plug in the AC power to continue.

5. Flash is complete when the following message displays.

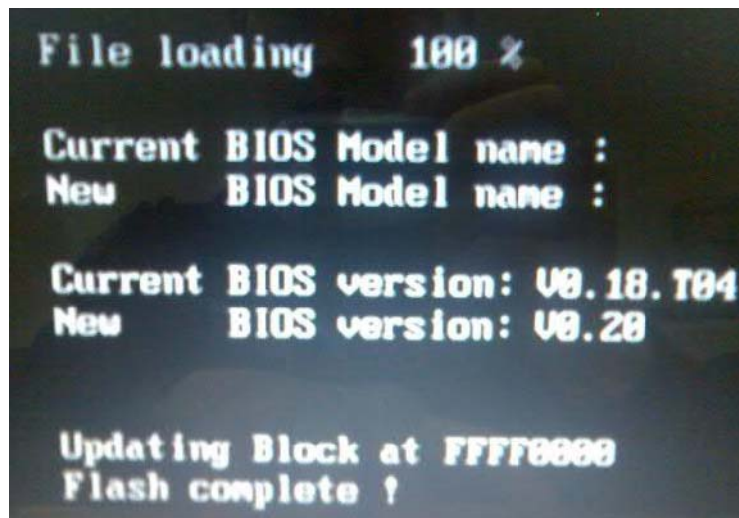

```
File loading 100 %
Current BIOS Model name :
New BIOS Model name :
Current BIOS version: V0.18.T04
New BIOS version: V0.20
Updating Block at FFFF0000
Flash complete !
```

6. Shutdown or reboot base on iflash.bat command.

---

## WinFlash Utility

Perform the following steps to use the InsydeFlash Utility:

1. Double click the InsydeFlash executable.

The InsydeFlash program begins updating the BIOS.

**IMPORTANT:** Do not turn off the computer during the update process.



2. When the upgrade finishes successfully, close all applications and reboot to complete the upgrade.

---

# Remove HDD/BIOS Utility

This section provide you with removing HDD/BIOS method:

## Remove HDD Password:

When the user keys in the wrong password three times, the system reports the following error code to user.

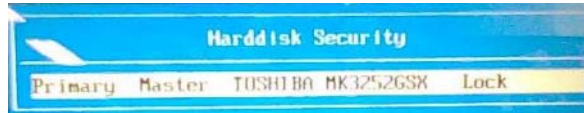

To unlock the HDD password, perform the following steps:

1. Press **Enter** to display the Select Item screen.

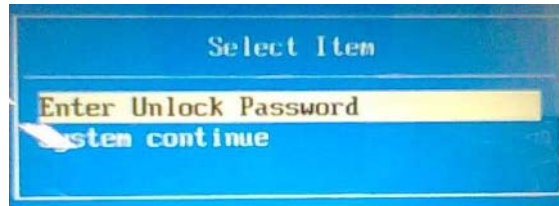

2. Select **Enter Unlock Password** and press **Enter**.

An Unlock Password displays.



3. Make a note of the key, **76943488** in the example.
4. Boot up the system and open a DOS prompt.
5. Enter the **UnlockHD.EXE** command and input the key to create an unlock code. Make a note of the result, for example **46548274**.
6. Reboot and enter the BIOS by pressing F2 when prompted.
7. Go to the Security menu and select Set Hdd Password (see "Security" on page 28).



8. Enter the unlock code generated by UnlockHD.EXE as the current password, **46548274** in the example, and complete the **New Password** and **Confirm** fields to create a new HDD password.
9. Save and exit the BIOS to complete the process.

## Removing BIOS Passwords:

If you key in the wrong Supervisor Password three times, System Disabled displays on the screen. See the image below.

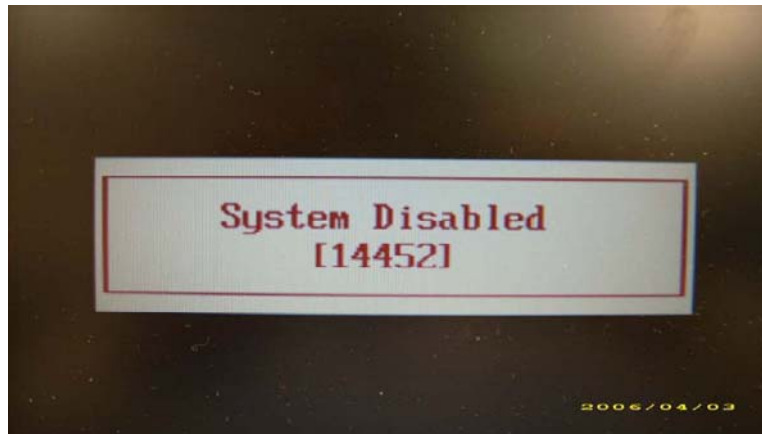

To reset the BIOS password, run BIOS\_PW.EXE as follows:

1. Key in **bios\_pw 14452 0**
2. Select one string from the list.

```
C:\WINDOWS\system32\cmd.exe
Microsoft Windows XP [Version 5.1.2600]
(C) Copyright 1985-2001 Microsoft Corp.

C:\Documents and Settings\M54>d:
D:\>bios_pw 14452 0
unlock6.exe v1.0 1 July 1997
qj119900
0?yqmjd
c.jl14tm
6mbzjaj
D:\>
```

3. Reboot the system and key in the selected string (qjig9vy, 07yqmjd etc.) for the BIOS user password.

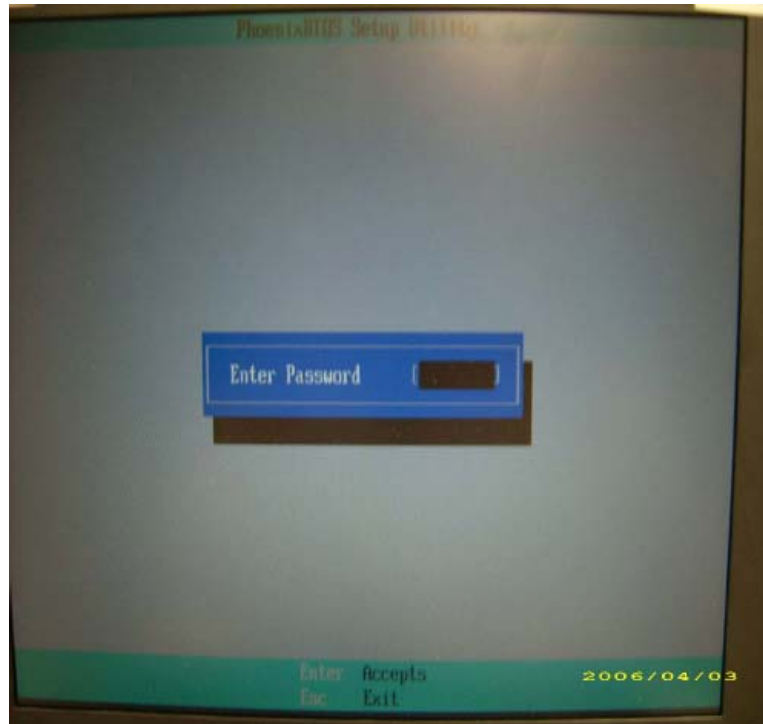

### Cleaning BIOS Passwords

To clear the password, perform the following steps:

1. From a DOS prompt, Execute **clnpwd.exe**

```
d:\Clnpwd>clnpwd
ACER Clean Password Utility V1.00
Press 1 or 2 to clean any password shown as below
  1.User Password
  2.Supervisor Password

Clean User Password Successfully!
```

2. Press 1 or 2 to clean the desired password shown on the screen.  
The onscreen message determines whether the function is successful or not.

# Machine Disassembly and Replacement

---

This chapter contains step-by-step procedures on how to disassemble the notebook computer for maintenance and troubleshooting.

## Disassembly Requirements

To disassemble the computer, you need the following tools:

- Wrist grounding strap and conductive mat for preventing electrostatic discharge
- Flat screwdriver
- Philips screwdriver
- Plastic flat screwdriver
- Plastic tweezers

**NOTE:** The screws for the different components vary in size. During the disassembly process, group the screws with the corresponding components to avoid mismatch when putting back the components.

---

# General Information

## Pre-disassembly Instructions

Before proceeding with the disassembly procedure, make sure that you do the following:

1. Turn off the power to the system and all peripherals.
2. Unplug the AC adapter and all power and signal cables from the system.



3. Place the system on a flat, stable surface.
4. Remove the battery pack.

## Disassembly Process

The disassembly process is divided into the following stages:

- External module disassembly
- Main unit disassembly
- LCD module disassembly

The flowcharts provided in the succeeding disassembly sections illustrate the entire disassembly sequence. Observe the order of the sequence to avoid damage to any of the hardware components. For example, if you want to remove the main board, you must first remove the keyboard, then disassemble the inside assembly frame in that order.

### Main Screw List

Screw	Quantity	Part Number
M2*3	19	86.ART02.001
M2*4	4	86.ART02.002
M2.5*4	12	86.ART02.003
M2.5*5	17	86.ART02.004
M2.5*8	8	86.ART02.005
M3*5	3	86.ART02.006
M3*3	4	86.ART02.007



# External Module Disassembly Process

## External Modules Disassembly Flowchart

The flowchart below gives you a graphic representation on the entire disassembly sequence and instructs you on the components that need to be removed during servicing. For example, if you want to remove the main board, you must first remove the keyboard, then disassemble the inside assembly frame in that order.

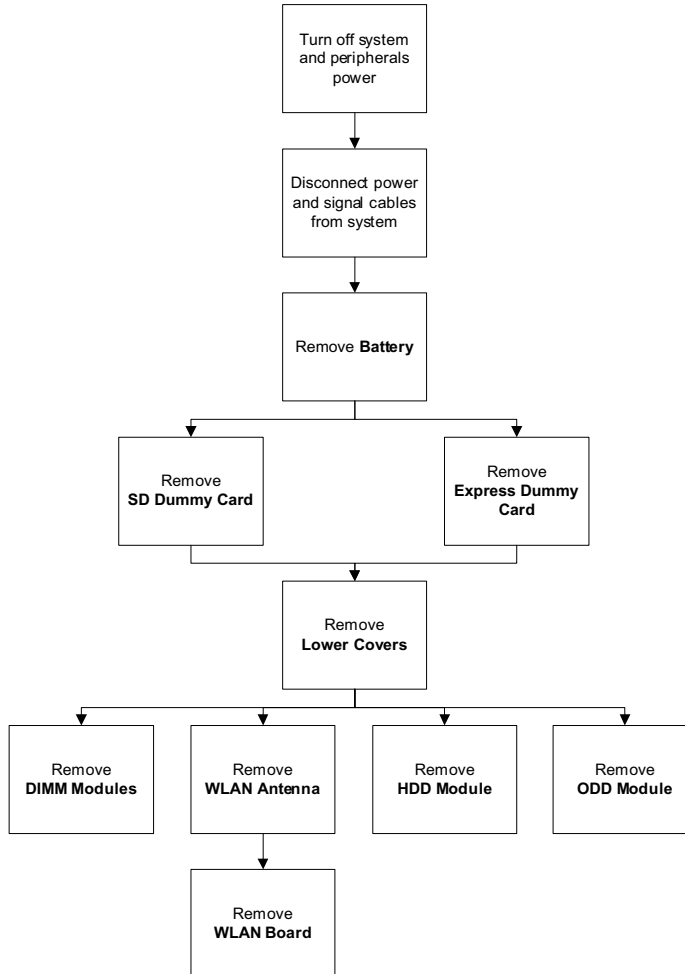

### Screw List

Step	Screw	Quantity	Part No.
WLAN Module	M2*3	2	86.ART02.001
HDD Module	M2.5*5	3	86.ART02.004
HDD Carrier	M3*3	4	86.ART02.007
ODD Module	M2.5*8	1	86.ART02.005
ODD Bracket	M2*3	2	86.ART02.001

---

## Removing the Battery Pack

1. Turn computer over.
2. Slide the battery lock/unlock latch to the unlock position.



3. Slide and hold the battery release latch to the release position (1), then slide out the battery pack from the main unit (2).

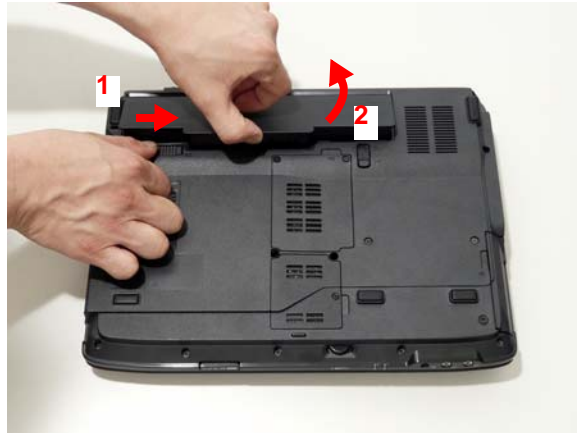

---

## Removing the ExpressCard dummy card

1. Push the ExpressCard dummy card all the way in to eject it.



2. Pull it out from the slot.



---

## Removing the SD dummy card

1. Push the SD dummy card all the way in to eject it.



2. Pull it out from the slot.



---

## Removing the Lower Covers

1. Remove the Battery Pack. See “Removing the Battery Pack” on page 44.
2. Loosen the 3 captive screws on the WLAN and Memory covers.

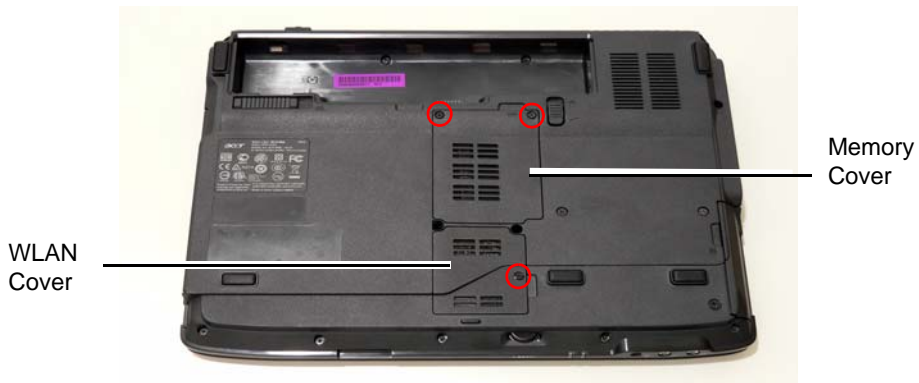

3. Carefully open the Memory Cover.

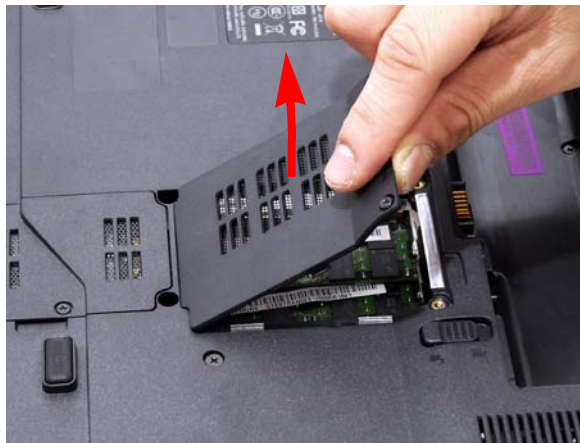

4. Remove the WLAN cover as shown.



# Removing the WLAN Module

1. Remove the Battery Pack. See “Removing the Battery Pack” on page 44.
2. Remove the Memory Cover. See “Removing the Lower Covers” on page 47.
3. Disconnect the 2 antenna cables from the WLAN board.



**NOTE:** When replacing, connect the black cable to the MAIN and the white to the AUX connector.

4. Move the antenna cables away and remove the two screws on the WLAN board to release the WLAN board.



Step	Size	Quantity	Screw Type
WLAN Module	M2*3	2	

---

5. Detach the WLAN board from the WLAN socket.



## Removing the Hard Disk Drive Module

1. See "Removing the Battery Pack" on page 44.
2. Remove the HDD2 cover. See "Removing the Lower Covers" on page 47.
3. Remove the three screws securing the HDD module.



Step	Size	Quantity	Screw Type
HDD Module	M3*5	3	

4. Pull the HDD out of the bay and clear out of the chassis.



**NOTE:** To prevent damage to device, avoid pressing down on it or placing heavy objects on top of it.



5. Remove the four screws securing the hard disk to the carrier.

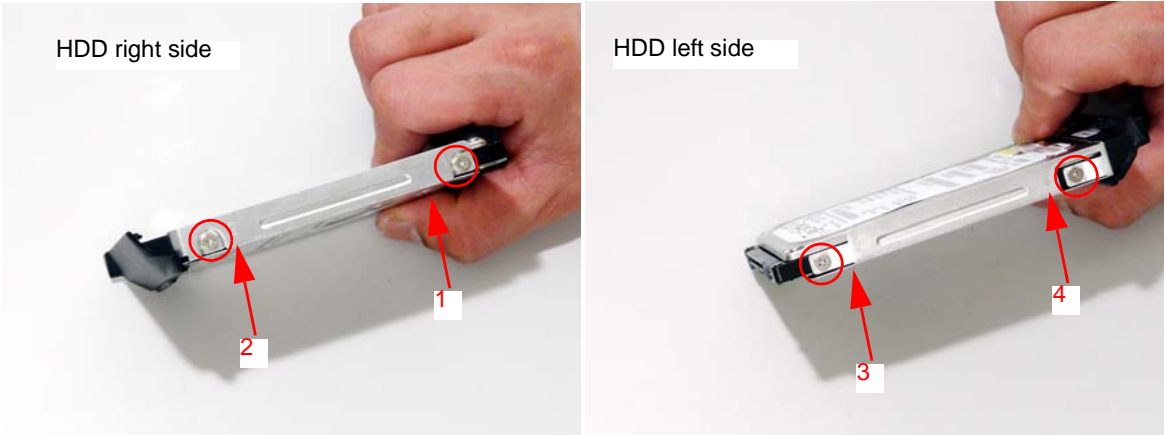

Step	Size	Quantity	Screw Type
HDD Carrier	M3*3	4	

**NOTE:** Replace the screws according to the numbering sequence as shown in the previous image.

6. Remove the HDD from the carrier.



# Removing the Optical Drive Module

1. See "Removing the Battery Pack" on page 44.
2. Loosen the screw to remove the ODD cap.
3. Remove the single securing screw.



Step	Size	Quantity	Screw Type
ODD Module	M2.5*8	1	

4. Using a screw driver, push the ODD module and grasp the front panel to remove from the computer.



5. Remove the two screws securing the ODD bracket and remove the ODD bracket from the optical disk drive module.



Step	Size	Quantity	Screw Type
ODD Bracket	M2*3	2	

**IMPORTANT:** Do not remove the ODD bezel by pulling on it entirely or damage will occur.

6. Grasp the edge of the bezel and firmly pry the top edge down and outward to remove.



---

## Removing the DIMM Modules

1. Remove the Memory Cover. See “Removing the Lower Covers” on page 47.

**IMPORTANT:** It is advisable to use a plastic pry during this procedure.

2. Use a pry to release the latches on both sides of the DIMM socket.

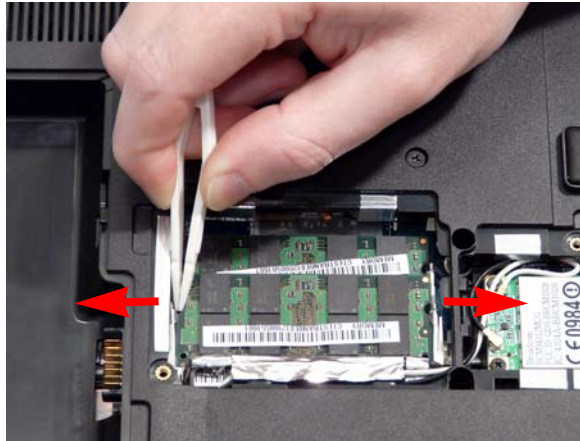

3. Remove the DIMM module.

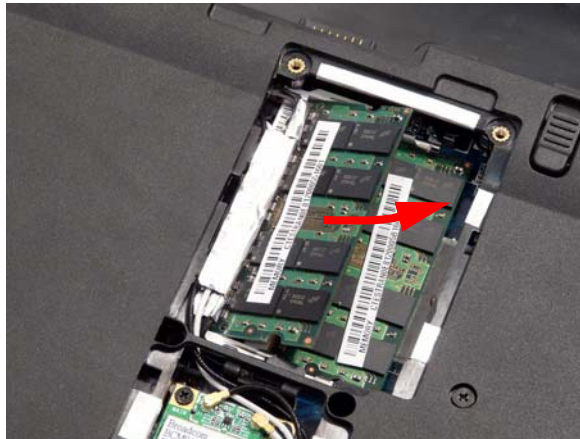

4. Repeat steps for the second DIMM module.

# Main Unit Disassembly Process

## Main Unit Disassembly Flowchart

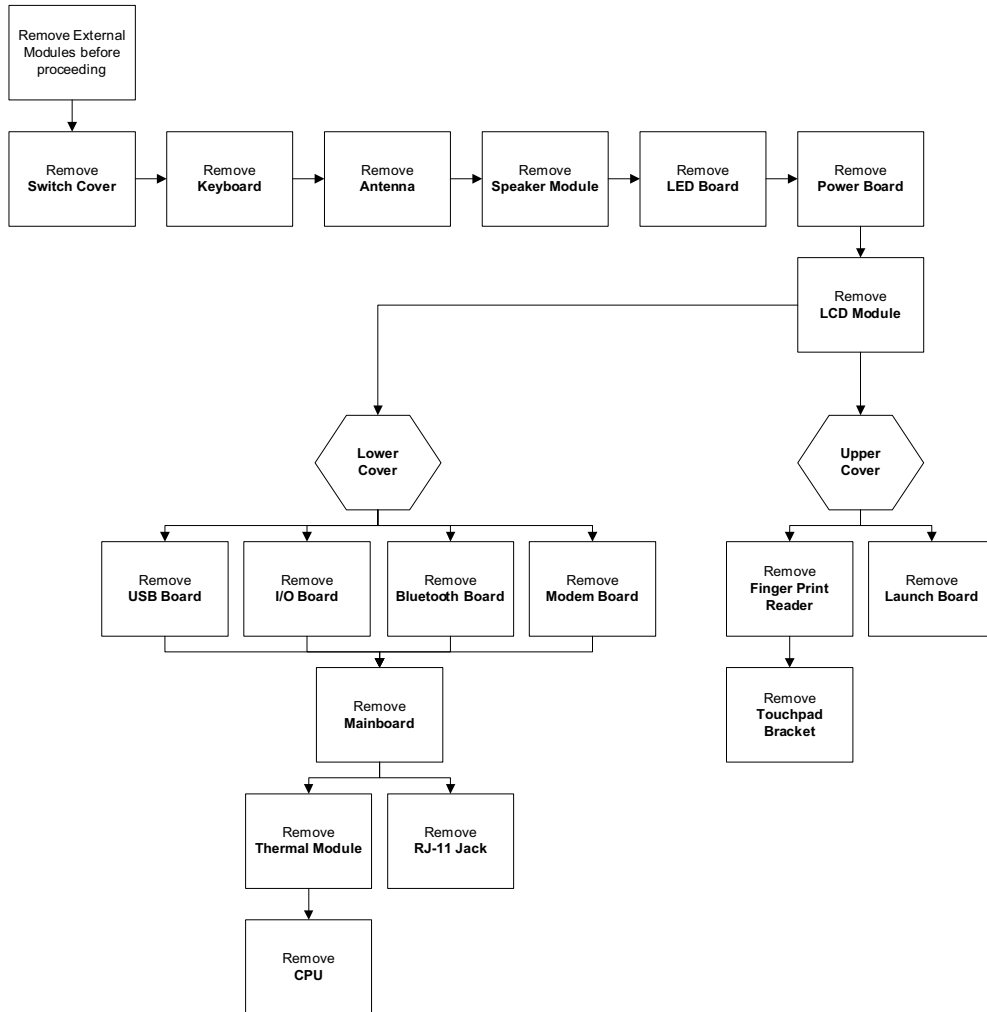

### Screw List

Step	Screw	Quantity	Part No.
Switch Cover	M2.5*5	2	86.ART02.004
Speaker Module	M2.5*4	4	86.ART02.003
LED Board	M2*3	1	86.ART02.001
Power Board	M2*3	1	86.ART02.001
LCD Module	M2.5*5	2	86.ART02.004
	M2.5*4	4	86.ART02.003
	M2*3	1	86.ART02.001
Upper Cover	M2.5*5	1	86.ART02.004
	M2.5*8	7	86.ART02.005
	M2.5*5	5	86.ART02.004
Finger Print Reader	M2*3	1	86.ART02.001
TouchPad Bracket	M2*3	1	86.ART02.001

---

Step	Screw	Quantity	Part No.
Launch Board	M2*3	3	86.ART02.001
USB Board	M2*3	1	86.ART02.001
I/O Board	M2*3	1	86.ART02.001
Modem Module	M2*3	2	86.ART02.001
Mainboard	M2*3	3	86.ART02.001

# Removing the Switch Cover

**CAUTION:** Using tools to remove the Switch Cover may cause damage to the outer casing. It is recommended that only fingers are used to remove the Switch Cover.

1. See "Removing the Battery Pack" on page 44.
2. Locate and remove the two securing screws as shown.

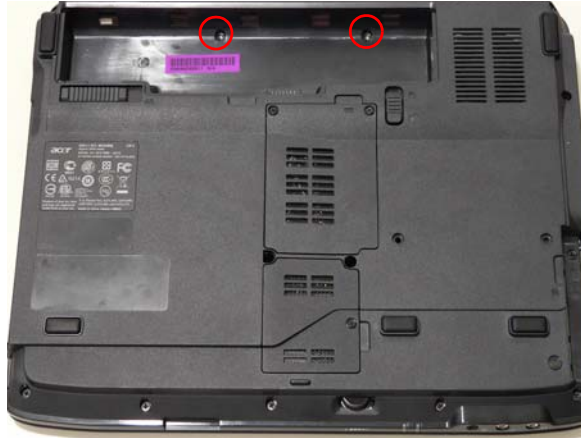

Step	Size	Quantity	Screw Type
Switch Cover	M2.5*5	2	

3. Turn the computer over and open the LCD module to expose the Switch Cover.
4. Pry the right corner up and partially lift up. Do not pull the Switch Cover completely off at this time.

**IMPORTANT:** Do not remove both sides of the Switch Cover together to prevent damage to the cover. Instead lift one end first and follow the instructions as directed.



- 
5. While holding the corner, firmly move the Switch Cover back (A) and forth (B) to release the locking catches (four in front and four in back) on the back and front of the Switch Cover.



6. Repeat the wiggling procedure until the Switch Cover is removed.  
7. After the Switch Cover is unlocked, lift it clear of the chassis.





---

## Removing the Keyboard

1. See “Removing the Switch Cover” on page 57.
2. Grasp the middle of the keyboard and firmly and lift up to remove.



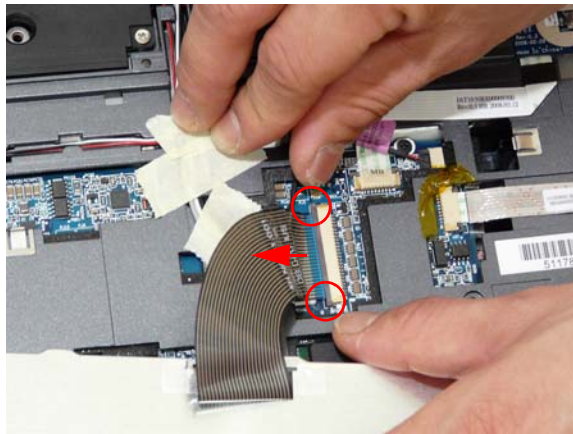

3. Turn the keyboard over and unlock the connector to release the FFC from the mainboard.

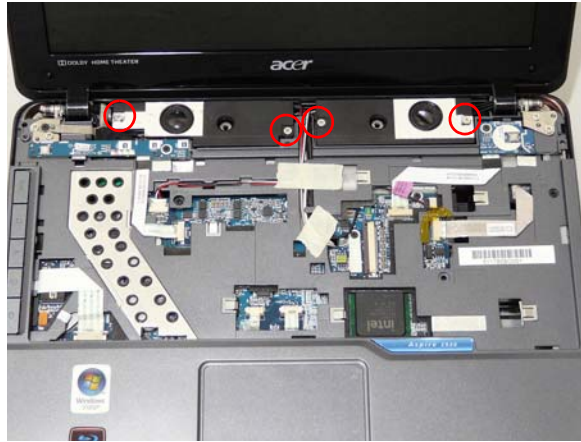

# Removing the Speaker Module

1. Remove the Keyboard. See "Removing the Keyboard" on page 59.
2. Remove the four securing screws.



Step	Size	Quantity	Screw Type
Speaker Module	M2.5*4	4	

3. Pull back the adhesive strips to expose the Speaker cabling.



4. Using the tweezers, disconnect the cabling as shown.

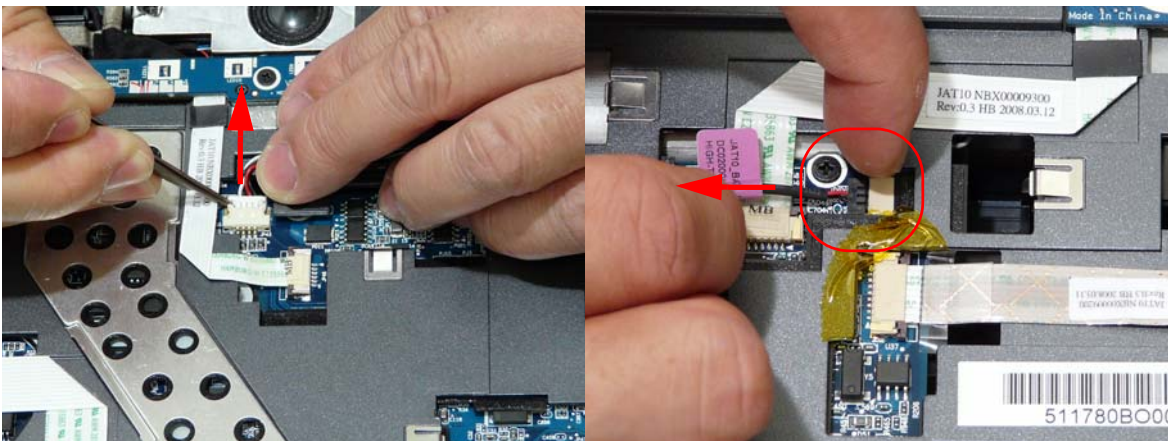

---

5. Remove both Speaker Modules.

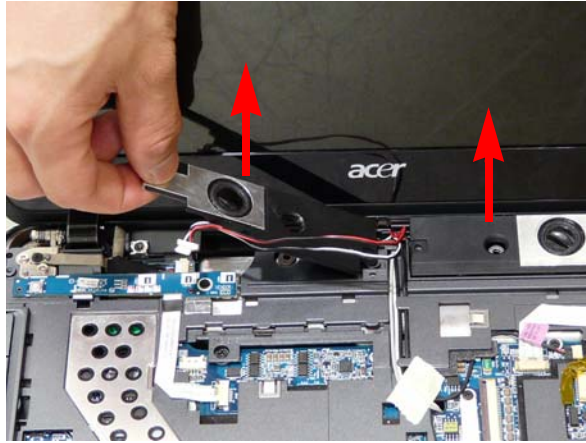

# Removing the Antenna

1. Remove the Memory Cover. See “Removing the Lower Covers” on page 47.
2. Remove the WLAN Module. See “Removing the WLAN Module” on page 48.
3. Remove the Keyboard. See “Removing the Keyboard” on page 59.
4. Peel back the cover to expose the Antenna cables.



5. Pull the cables completely through the housing.



6. Tilt the computer on its side and feed the cables through to remove from the housing.





---

7. Place the computer rightside up, and remove the cables from the housing.

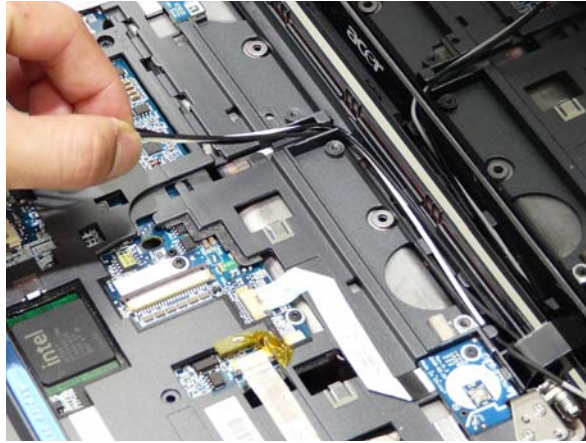

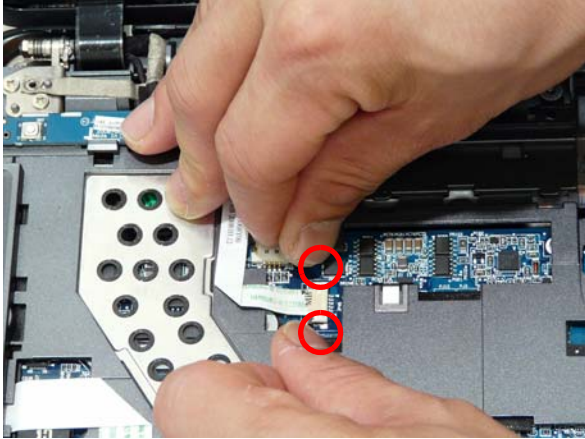

# Removing the LED Board

1. Remove the Keyboard. See "Removing the Keyboard" on page 59.
2. Unlock the FFC connector and remove the FFC.

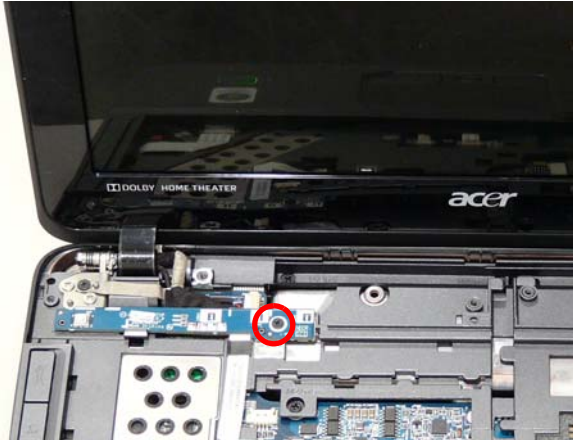

3. Remove the single securing screw.



Step	Size	Quantity	Screw Type
LED Board	M2*3	1	

4. Grasp the top side of the LED Board and pivot upwards to remove.



# Removing the Power Board

1. Remove the Keyboard. See "Removing the Keyboard" on page 59.
2. Unlock the FFC connector and remove the FFC.

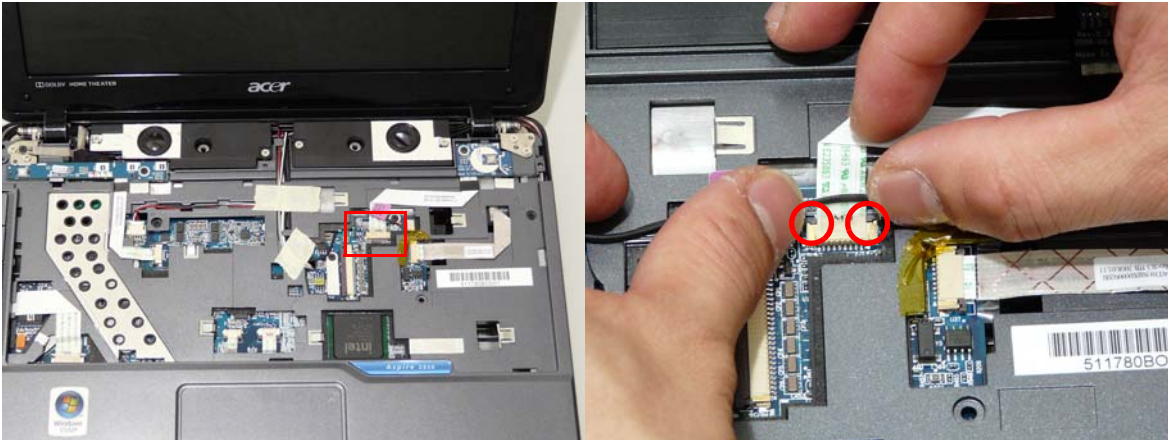

3. Remove the single securing screw.



Step	Size	Quantity	Screw Type
Power Board	M2*3	1	

4. Using your finger lift the bottom side of the Power Board to remove.

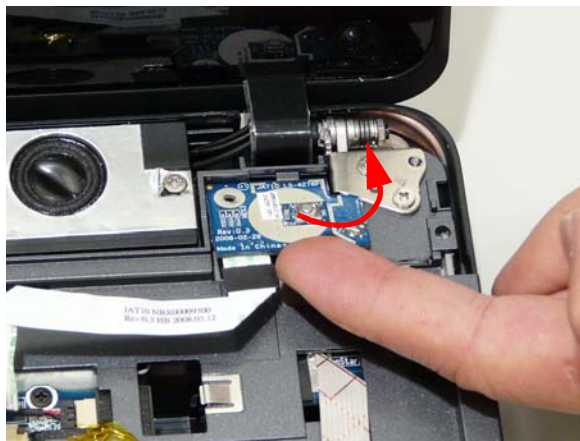

# Removing the LCD Module



1. Remove the Antenna cables. See "Removing the Antenna" on page 62.
2. Remove the LED Board. See "Removing the LED Board" on page 64.
3. Remove the Power Board. See "Removing the Power Board" on page 65.
4. Remove the two securing screws from the bottom of the chassis.

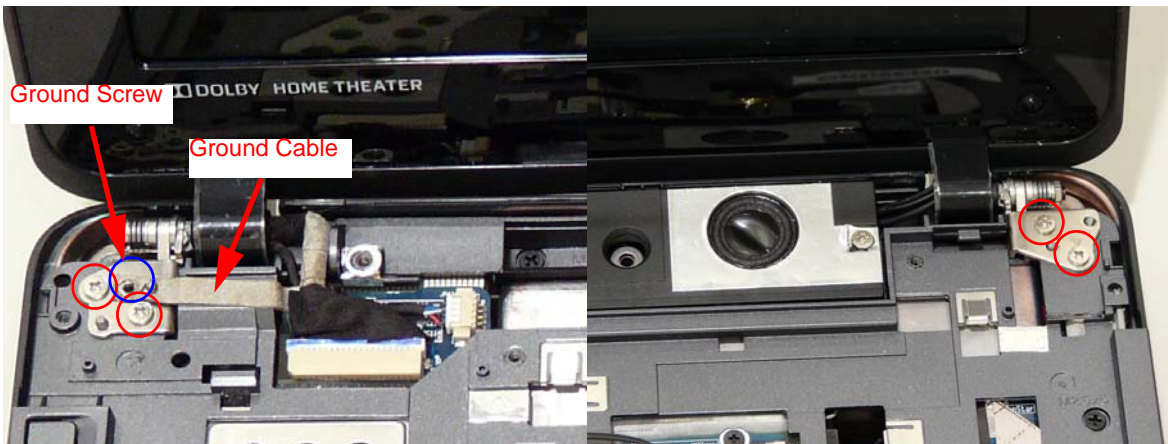

Step	Size	Quantity	Screw Type
LCD Module	M2.5*5	2	

5. Turn the computer over and remove the four securing screws (two on each side) from the LCD module.
6. Remove the Ground screw and Ground cable.



Step	Size	Quantity	Screw Type
LCD Module (red callout)	M2.5*4	4	
Ground Screw (blue callout)	M2*3	1	



7. Disconnect the Ground cable as shown.



8. Disconnect the two cables as shown.

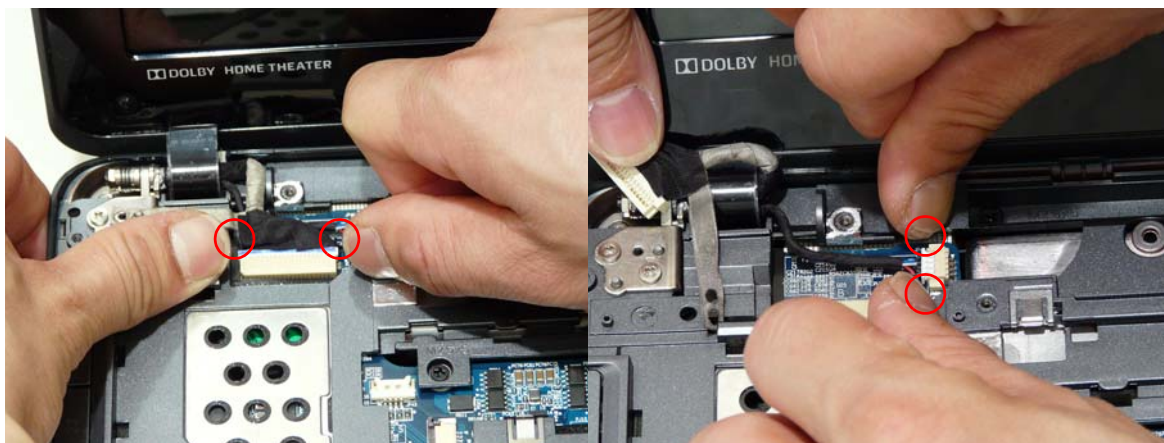

**NOTE:** The Power Board must be removed to expose the LCD cables.

9. Grip the LCD and carefully remove the module from the chassis.



**IMPORTANT:** Place the LCD module face up on a clean surface to prevent scratching or damage.

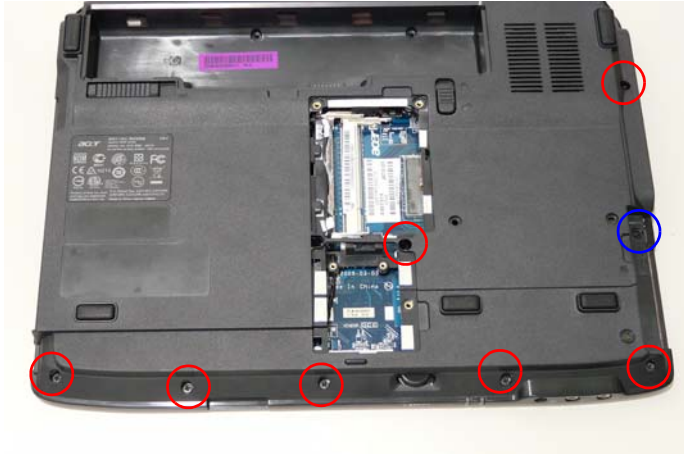

# Removing the Upper Cover

1. Remove the ExpressCard dummy card. See “Removing the ExpressCard dummy card” on page 45.
2. Remove the Switch Board. See “Removing the LED Board” on page 64.
3. Remove the LCD module. See “Removing the LCD Module” on page 66.
4. Turn the computer over. Remove the eight (8) screws on the bottom panel.



Step	Size	Quantity	Screw Type
Upper Cover (blue Call out)	M2.5*5	1	
Upper Cover (red Call out)	M2.5*8	7	

5. Turn the computer over. Remove the five screws on the top panel.

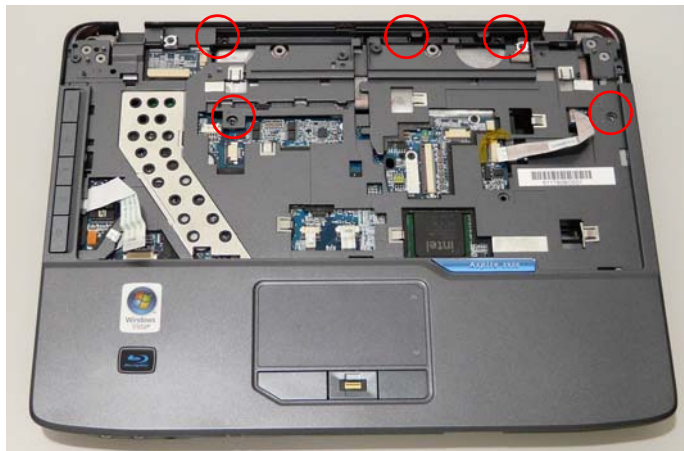

Step	Size	Quantity	Screw Type
Upper Cover	M2.5*5	5	

6. Disconnect the four cables from the mainboard as shown.

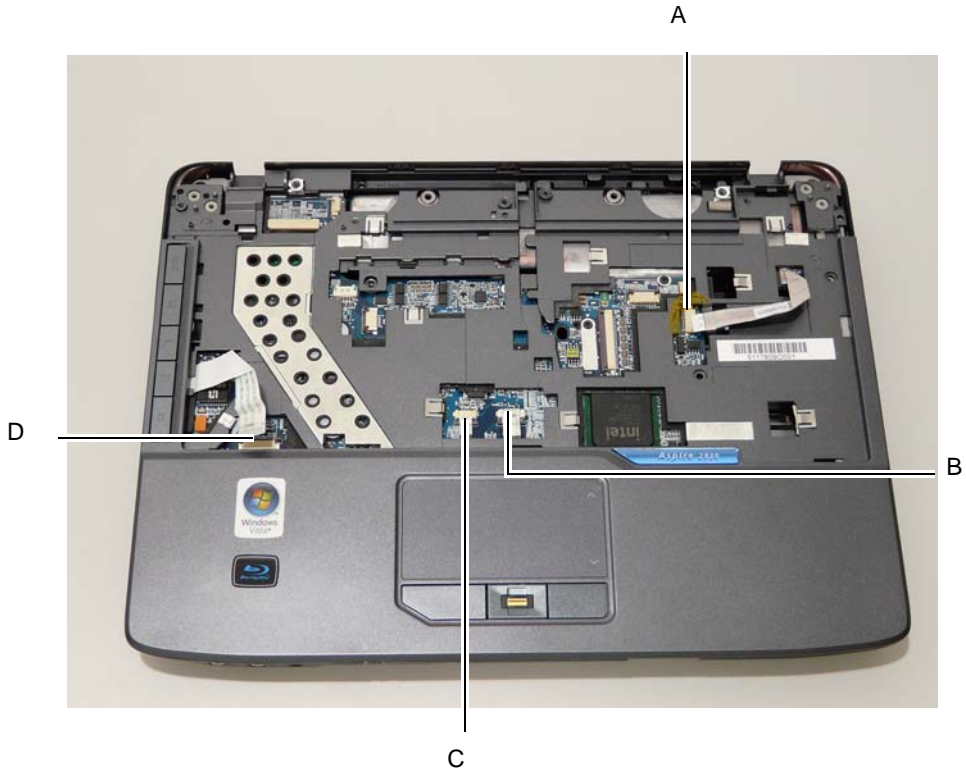

Release the securing latch and disconnect (A) as shown.

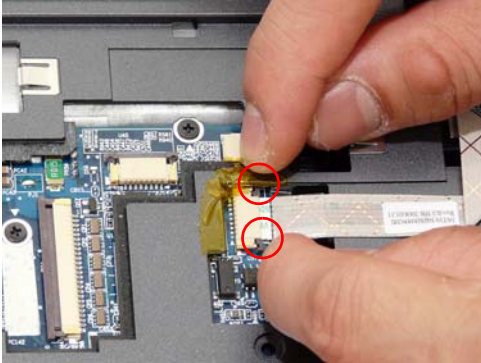

Release the securing latch and disconnect (B) as shown.

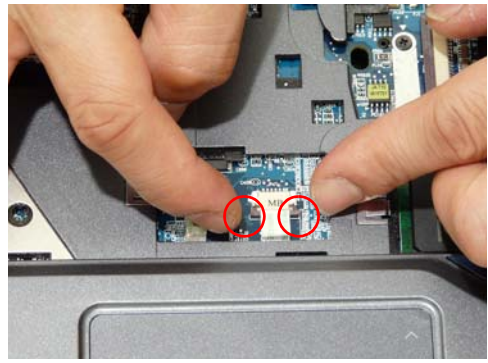

Release the securing latch and disconnect (C) as shown.

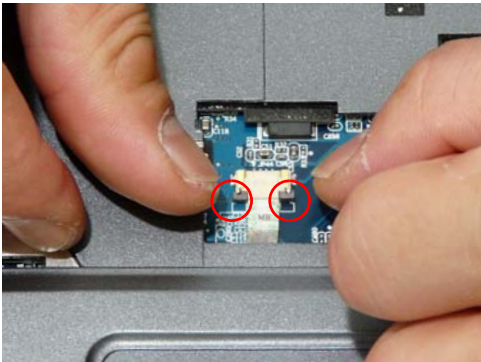

Release the securing latch and disconnect (D) as shown.

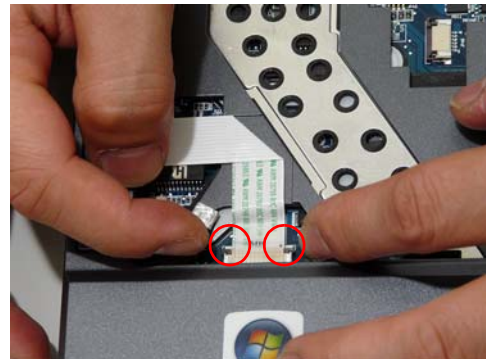

---

**IMPORTANT:** Do not lift the entire Upper Case up at the same time or damage may occur.

7. Grasp the top right corner of the Upper Case and pivot upwards.



8. Continue prying the right upwards until the right side is at a 45 degree angle.
9. Slide the Upper Case off the lower base.





# Removing the Finger Print Reader

1. See "Removing the Upper Cover" on page 68.
2. Remove the single securing screw from the Finger Print Reader bracket.

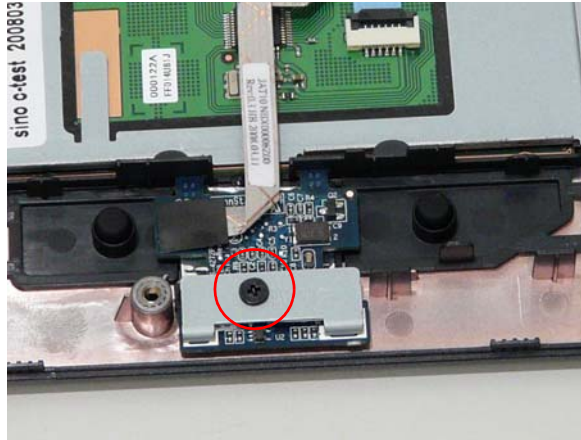

Step	Size	Quantity	Screw Type
Finger Print Reader	M2*3	1	

3. Remove the bracket as shown.

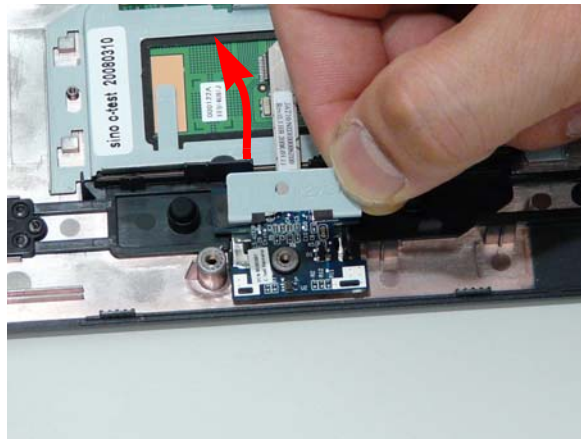

4. Using your fingers, gently lift the Finger Print Reader board from the Upper Cover.

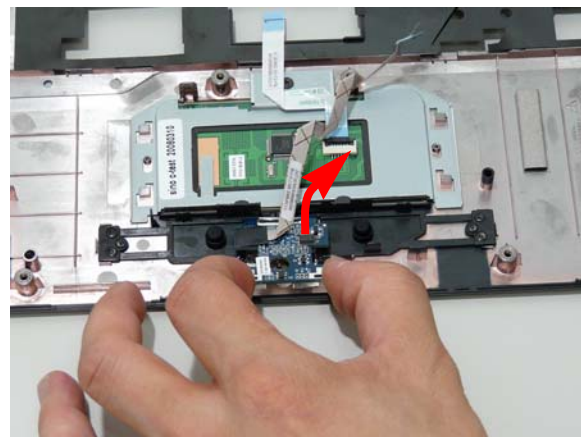

# Removing the TouchPad Bracket

1. Remove the Upper Cover. See "Removing the Finger Print Reader" on page 71.
2. Lift up the locking lever (1) and remove the Touch Pad FFC from the Touch Pad board (2).

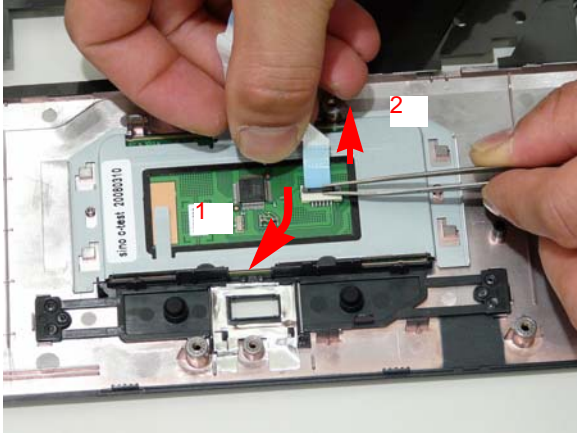

**NOTE:** To replace the Touch Pad, the entire Upper Cover must be replaced.

3. Remove the single securing screw.



Step	Size	Quantity	Screw Type
TouchPad Bracket	M2*3	1	

---

4. Grasp the left side of the bracket and angle upwards to remove.

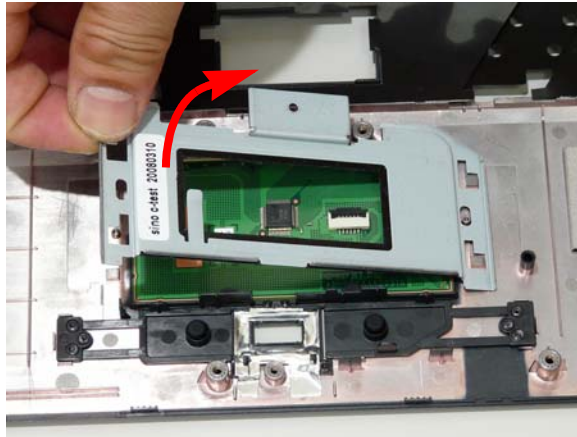

## Removing the Launch Board

1. See "Removing the Upper Cover" on page 68.
2. Remove the three securing screws.

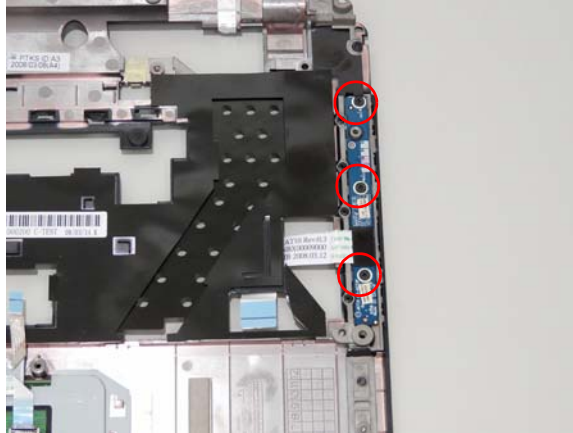

Step	Size	Quantity	Screw Type
Launch Board	M2*3	3	

3. Remove the Launch Board from the upper cover.

**IMPORTANT:** Take note of the FFC and ensure it does not catch on the upper cover.

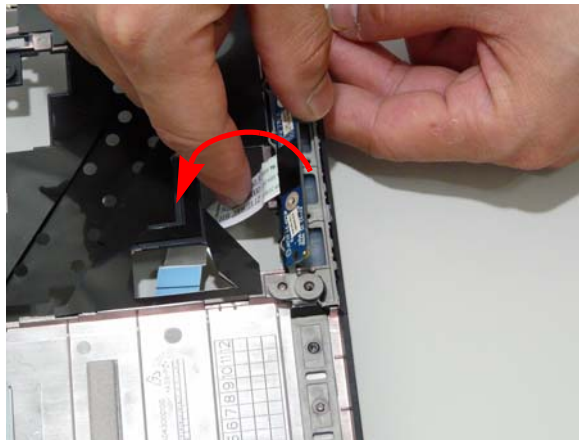



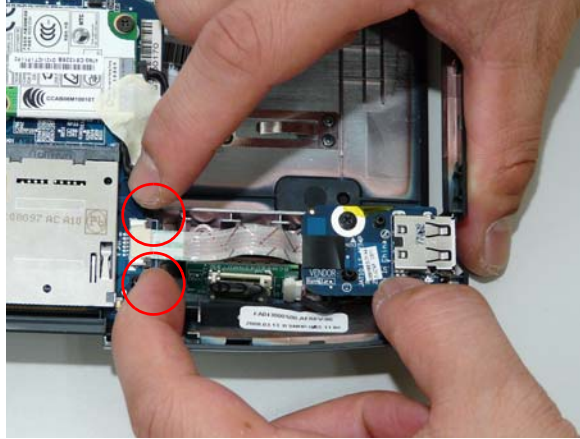

# Removing the USB Board

1. See "Removing the Upper Cover" on page 68.
2. Unlock the securing latch and release the FFC.

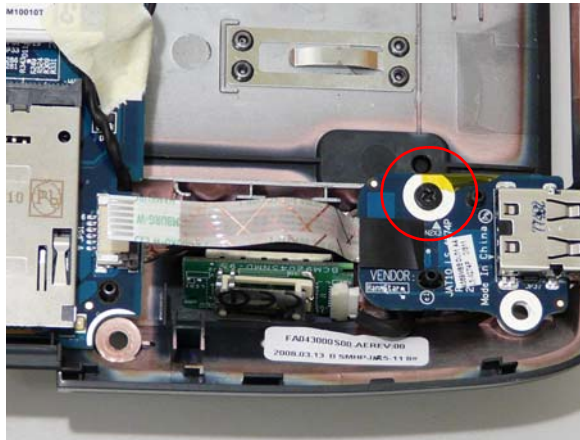

3. Remove the securing screw.



Step	Size	Quantity	Screw Type
USB Board	M2*3	1	

4. Grasp the module by the ends and lift to remove.

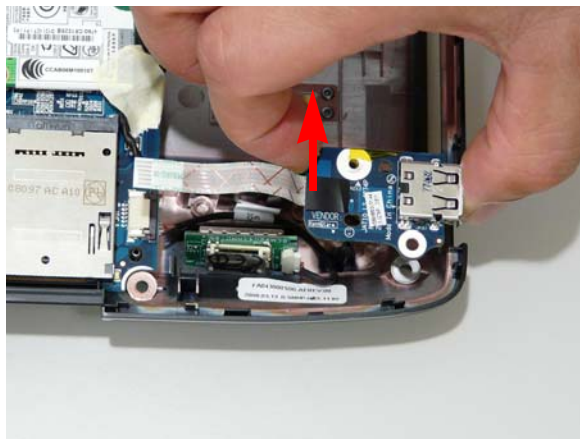

# Removing the I/O Board

- 1. See "Removing the Upper Cover" on page 68.
- 2. Remove the single securing screw.



Step	Size	Quantity	Screw Type
I/O Board	M2*3	1	

- 3. Grasp the module by the end, pivot and lift the board to remove.



---

## Removing the Bluetooth Module

1. Remove the USB Board. See “Removing the USB Board” on page 75.
2. Lift the Bluetooth module away from the base.



3. Disconnect the Bluetooth cable and remove the module.

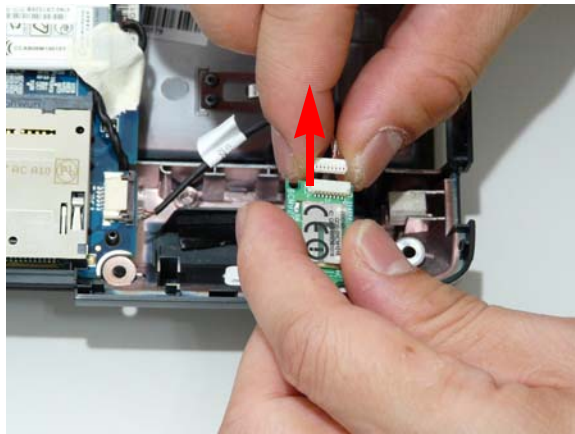

# Removing the Modem Module

1. See "Removing the Upper Cover" on page 68.
2. Peel back the adhesive strip to expose the cabling.

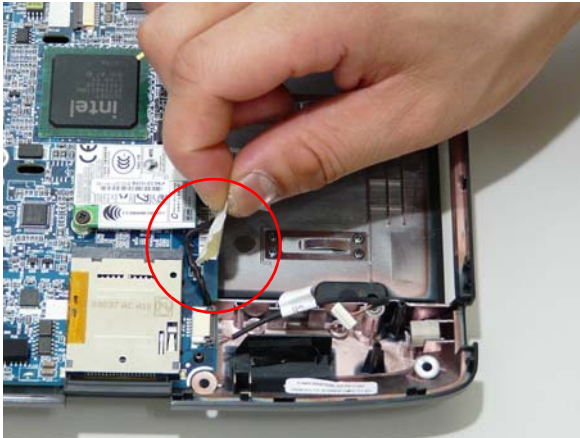

3. Remove the cable as shown.

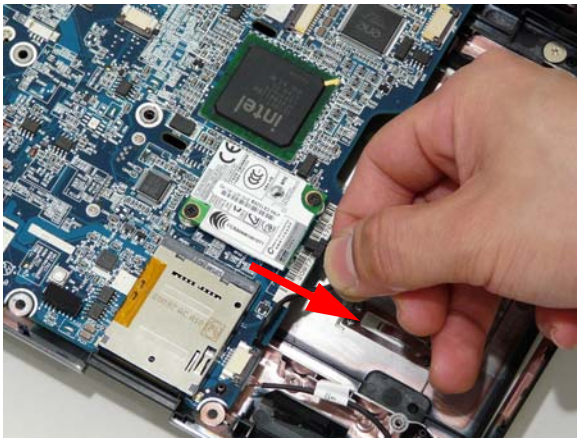

4. Remove the two securing screws from the modem module.

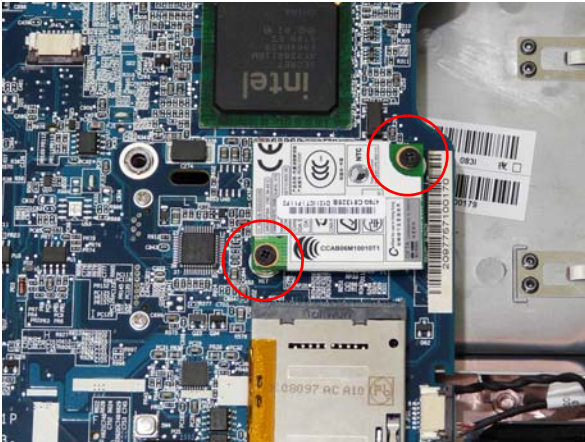

Step	Size	Quantity	Screw Type
Modem Module	M2*3	2	

5. Lift the module from the mainboard.

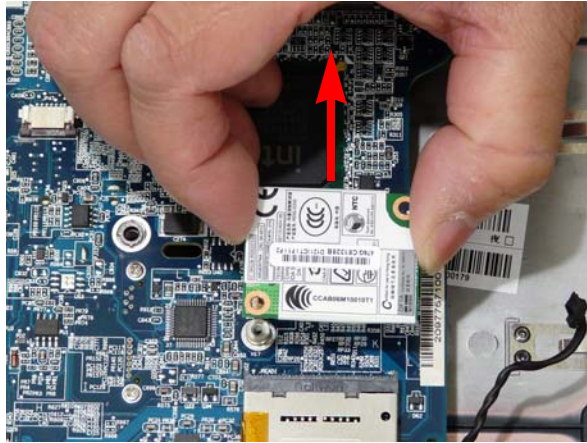



# Removing the Mainboard

- 1. See "Removing the Upper Cover" on page 68.
- 2. Remove the Bluetooth Module. See "Removing the Bluetooth Module" on page 77.
- 3. Remove the three securing screws.

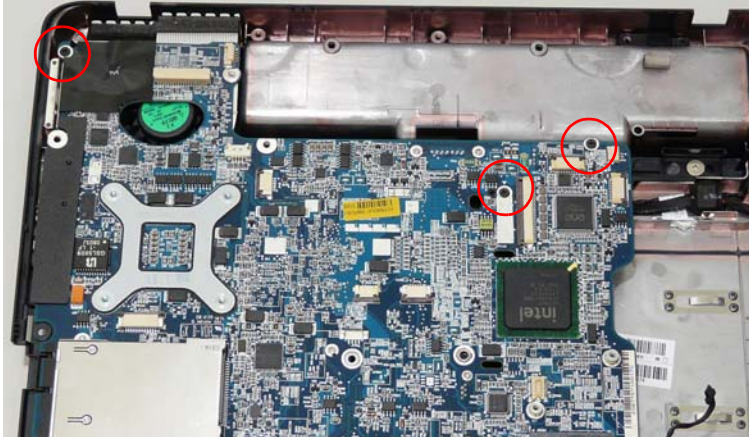

Step	Size	Quantity	Screw Type
Mainboard	M2*3	3	

- 4. Remove the DC-IN jack from its socket.

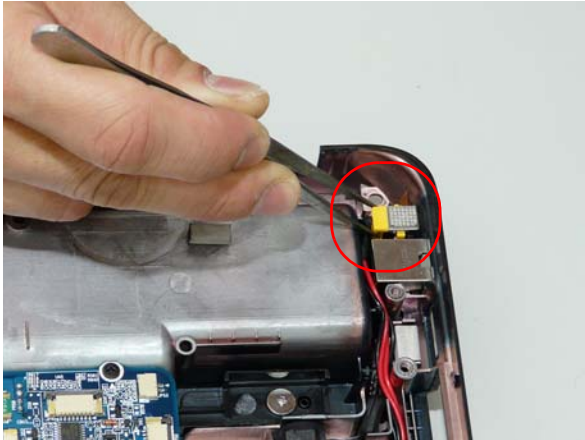

5. Lift the cable from the housing guide as shown.



6. Ensure the modem cable is disconnected from the bottom of the mainboard as well.

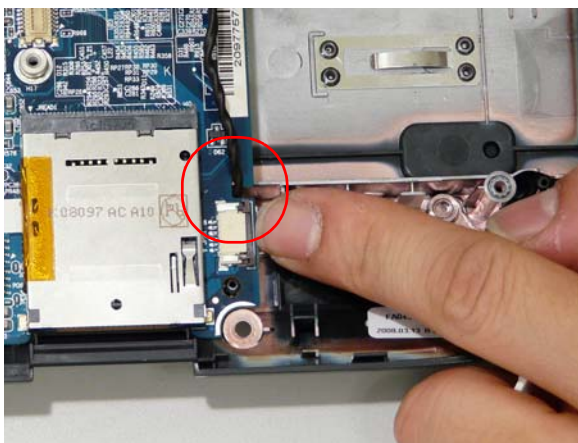

7. Pry the edge of the Lower Base outward then lift and pivot the Mainboard slightly upwards. Do not pull up completely.

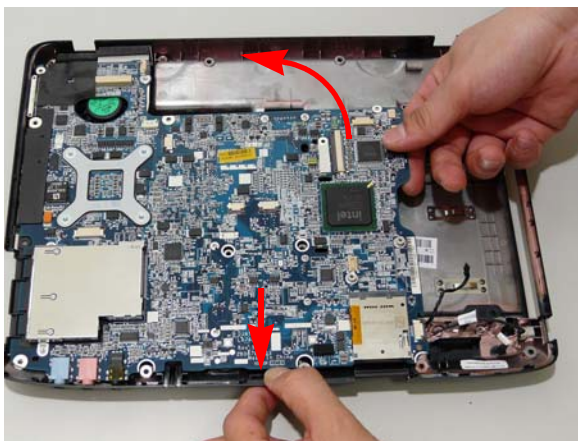

8. Continue to pry the base outward, while lifting the mainboard at the same time.

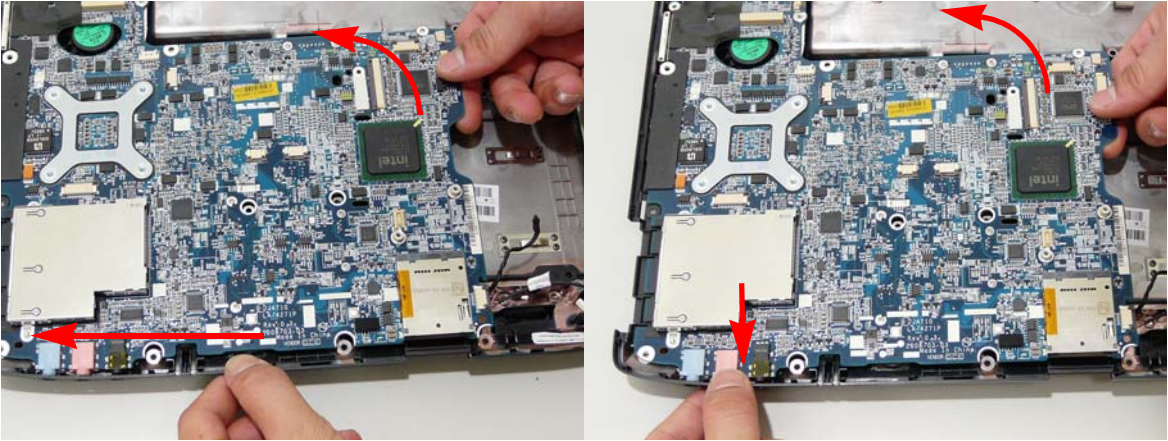

9. Once the bottom of the mainboard is clear of the lower case, continue lifting the mainboard. Take note of the DC-IN cable.

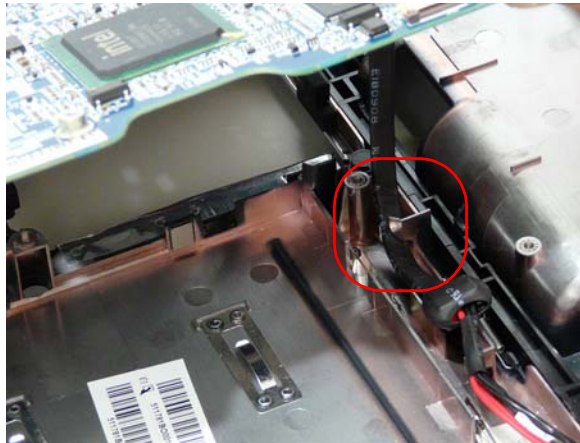

10. Remove the Mainboard from the lower base.





---

## Removing the RJ-11 Jack

1. Remove the Mainboard. See “Removing the Mainboard” on page 80.
2. Locate the RJ-11 cable end and remove the mylar cover.

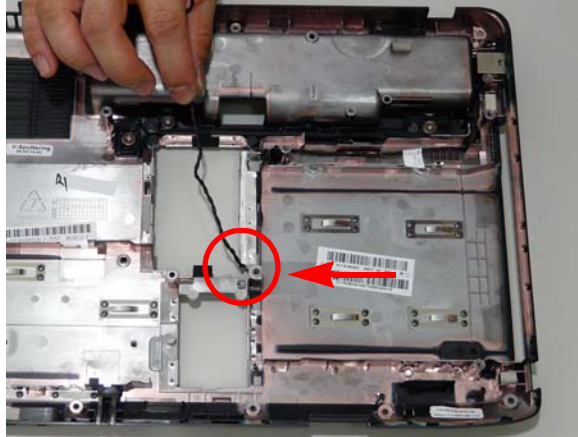

3. Remove the RJ-11 jack.

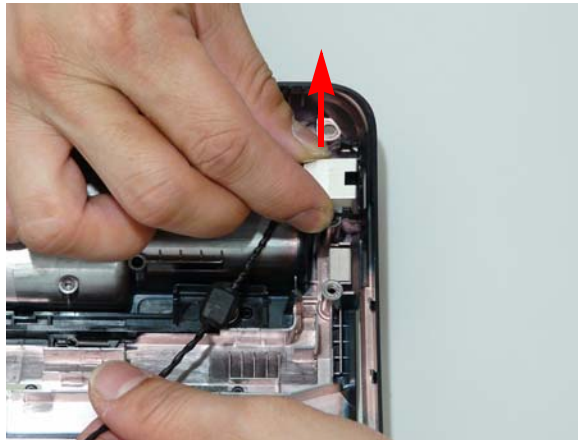

4. Turn the Lower Base over and pull back the mylar cover to release the cabling.



- 
5. Ensure all parts of the cabling are no longer secure to the base, and pull the cable completely through to remove.

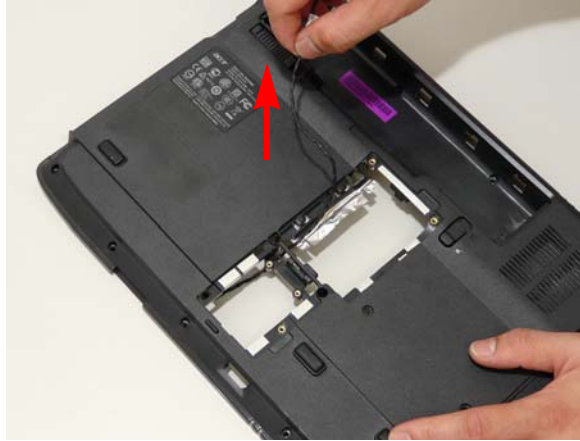

---

## Removing the Fan/Thermal Module

1. Remove the Mainboard. See “Removing the Mainboard” on page 80.
2. Disconnect the Fan cable from the mainboard.

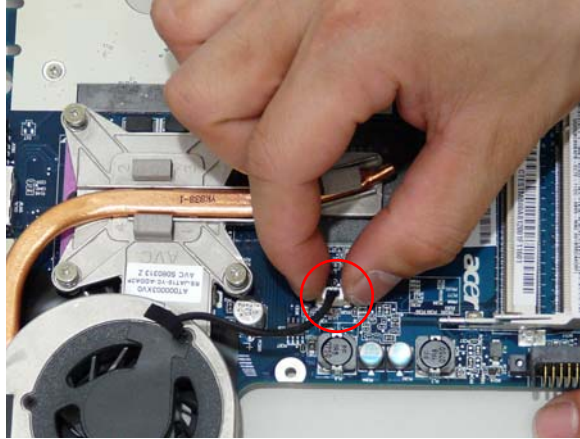

3. Loosen the four (4) captive screws in numerical order from 4 to 1.

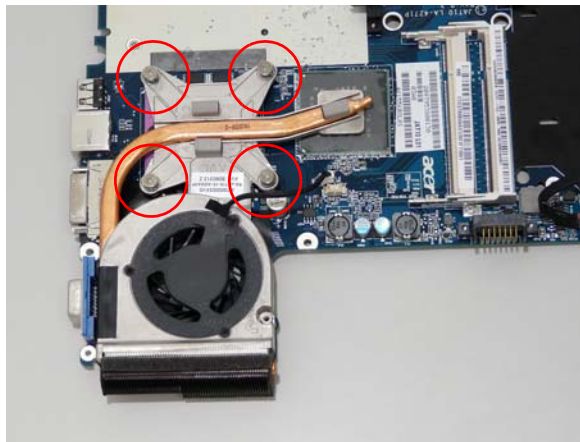

**IMPORTANT:**Lift the Fan/Thermal Module by the thermal assembly to avoid damage to the CPU

4. Grip the Thermal Module and pivot upwards to remove.

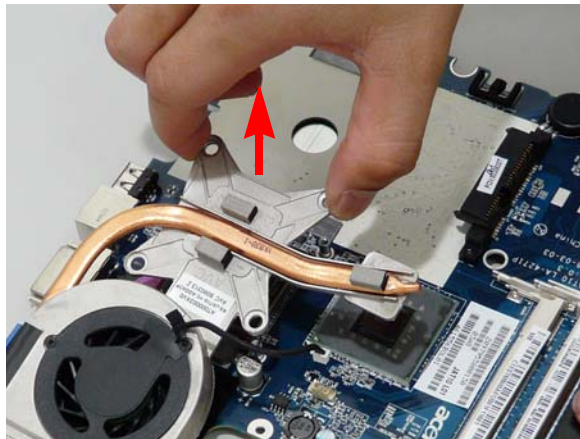

---

## Removing the CPU

1. Remove the Mainboard. See “Removing the Mainboard” on page 80.
2. Take note of the indicators on the socket cam screw. Using a flat screwdriver, turn the CPU socket screw counter-clockwise until it indicates unlocked.

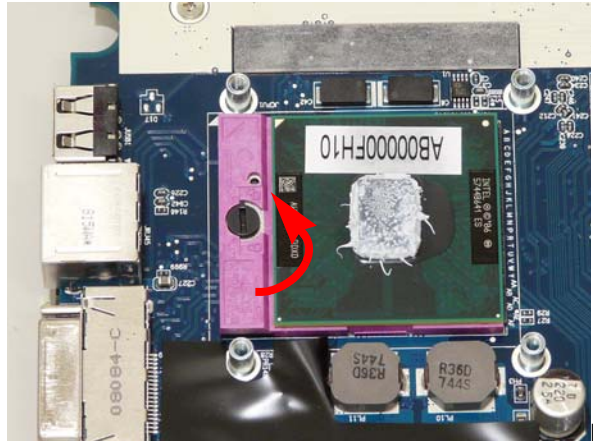

3. Lift the CPU clear of the Mainboard.

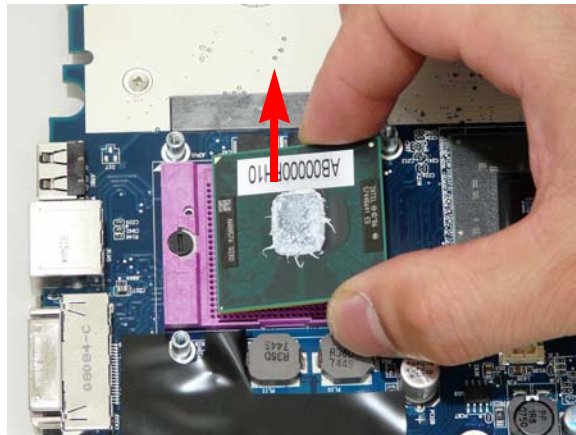

# LCD Module Disassembly Process

## LCD Module Disassembly Flowchart

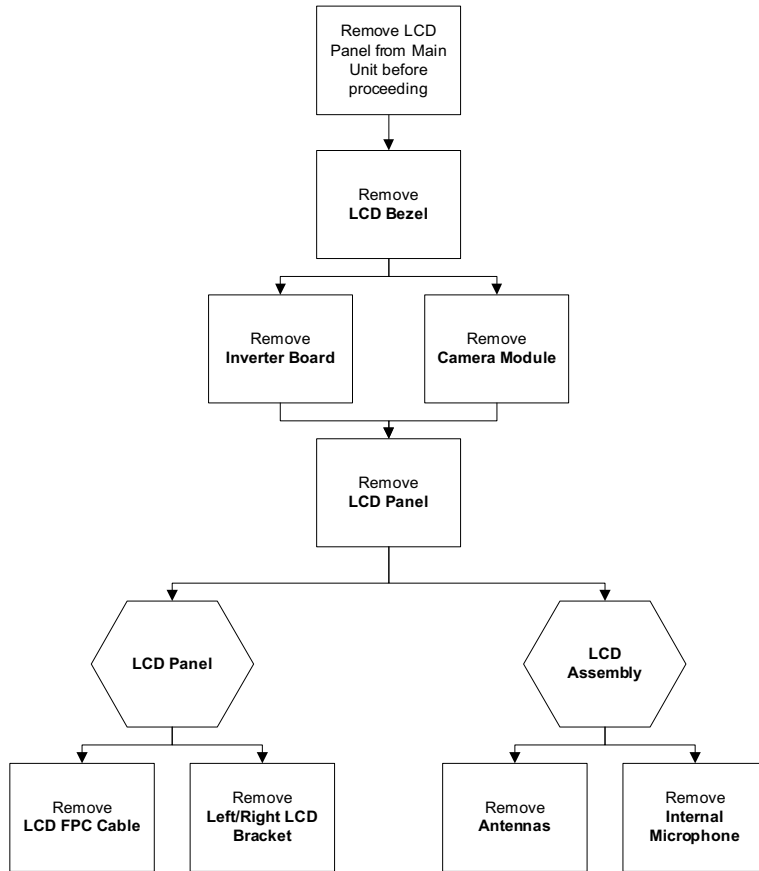

### Screw List

Step	Screw	Quantity	Part No.
LCD Bezel	M2.5*5	4	86.ART02.004
Inverter Board	M2.5*4	1	86.ART02.003
Camera Board	M2.5*4	1	86.ART02.003
LCD Panel	M2.5*4	2	86.ART02.003
LCD Brackets	M2*4	4	86.ART02.002

# Removing the LCD Bezel

1. Remove the LCD Module. See "Removing the LCD Module" on page 66.
2. Remove the four rubber covers and screws.



Step	Size	Quantity	Screw Type
LCD Bezel	M2.5*5	4	

3. Starting from the inside edges, pry the inside of the bezel upwards from the panel. Continue moving left until the bezel is removed. If necessary, use a plastic pry to release the corners of the bezel.





---

4. Lift up the bezel and disconnect the MIC module.



5. Remove the bezel from the LCD module.

# Removing the Inverter Board

1. Remove the LCD Bezel. See "Removing the LCD Bezel" on page 88.
2. Pull back the adhesive strip to expose the cabling.

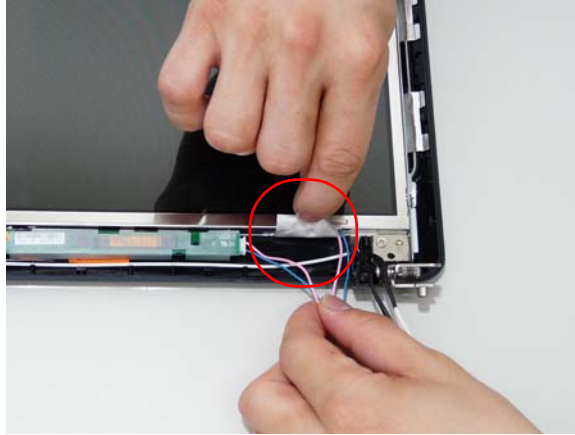

3. Remove the single securing screw.

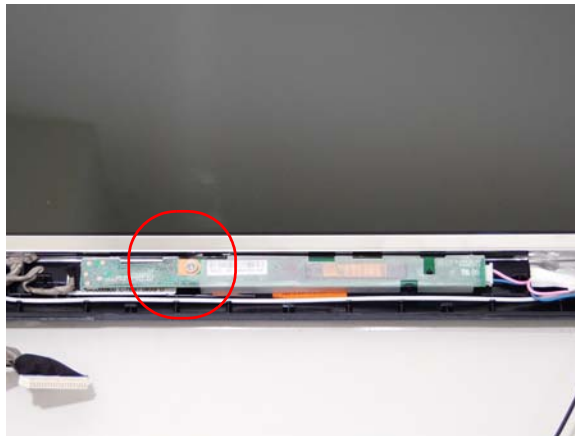

Step	Size	Quantity	Screw Type
Inverter Board	M2.5*4	1	

4. Lift the Inverter board clear of the LCD Module.

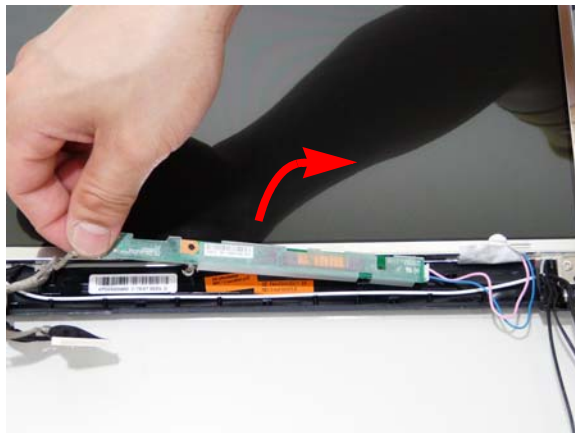



5. Disconnect the left and right Inverter board cables as shown.



## Removing the Camera Module

1. Remove the LCD Bezel. See "Removing the LCD Bezel" on page 88.
2. Remove the single securing screw.



Step	Size	Quantity	Screw Type
Camera Module	M2.5*4	1	

**IMPORTANT:** Be careful when using a sharp tool to remove the cable or camera module. The surface of the LCD panel can be easily scratched.

3. Remove the bracket from the back cover.

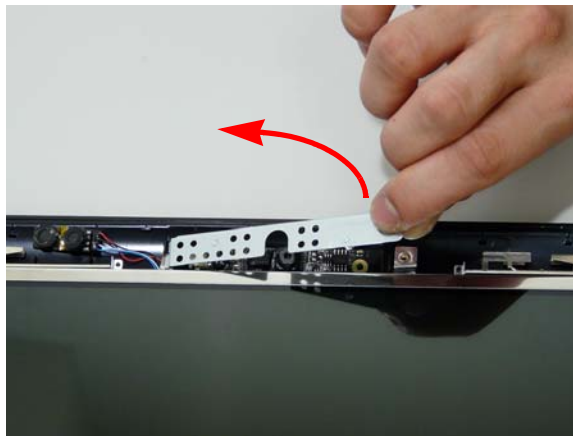

---

4. Lift the camera module as shown, but do not remove completely.

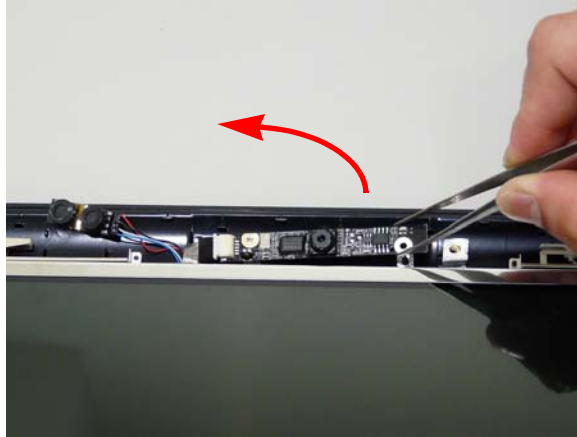

5. Hold the connector with one hand and pull the Camera Module to remove.

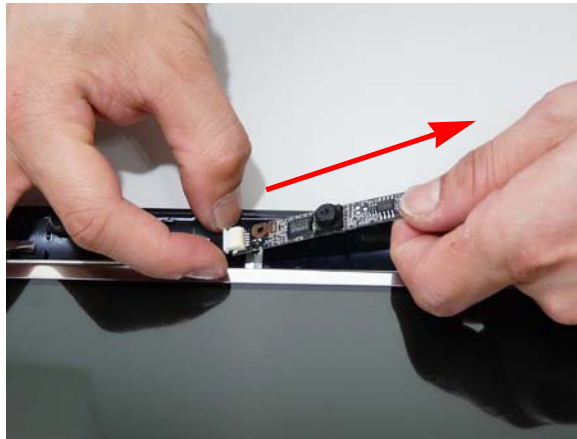

# Removing the LCD Panel

- 1. Remove the LCD Bezel. See "Removing the LCD Bezel" on page 88.
- 2. Remove the two securing screws from the LCD Module.

**IMPORTANT:**The correct screw sockets are indicated by a mark on the hinge.



Step	Size	Quantity	Screw Type
LCD Panel	M2.5*4	2	

- 3. Grasp the LCD Panel by the hinges and tilt upwards and away to remove the LCD Module.



# Removing the LCD Brackets and FPC Cable

1. Remove the LCD Panel. See "Removing the LCD Panel" on page 94.
2. Turn the LCD panel over to expose the rear. Remove the mylar strips securing the FPC cable.

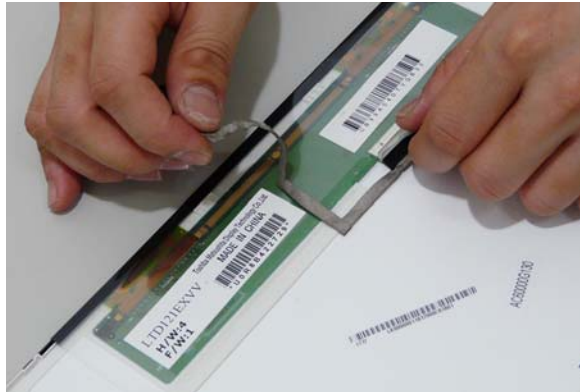

3. Grasp the pull-tab and disconnect the cable from the panel.

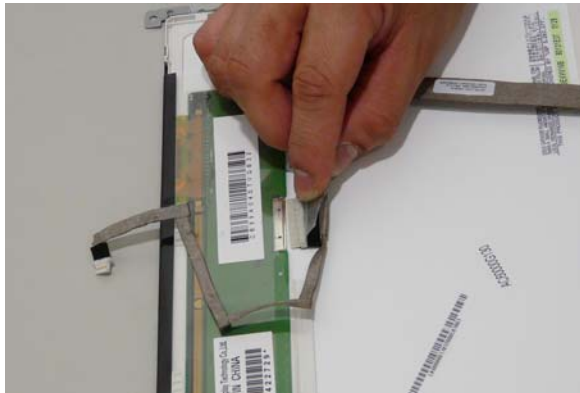

4. Remove the four securing screws (two on each side) from the LCD Panel brackets.

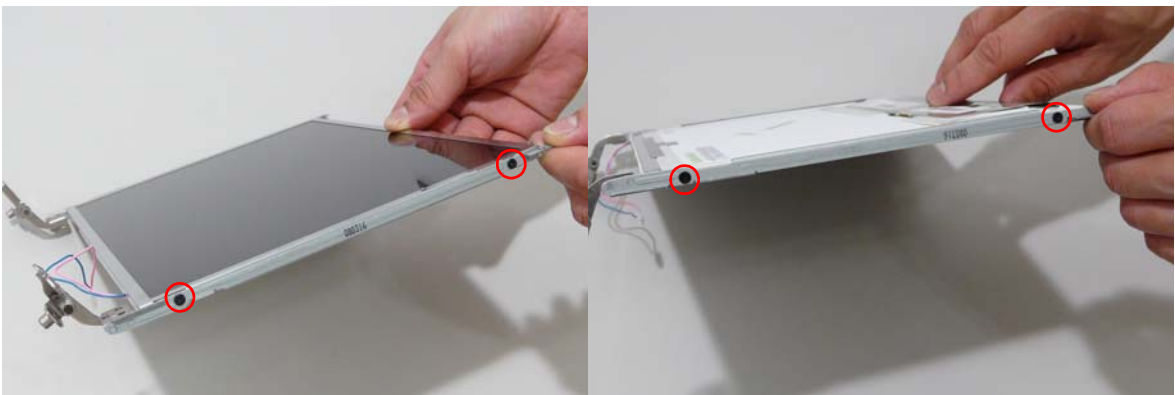

Step	Size	Quantity	Screw Type
LCD Brackets	M2*4	4	

- 
5. Remove the LCD brackets by pulling them away from the LCD Panel as shown.



## Removing the LCD Antenna

1. Pull back the adhesive strips to expose the Antenna cables.

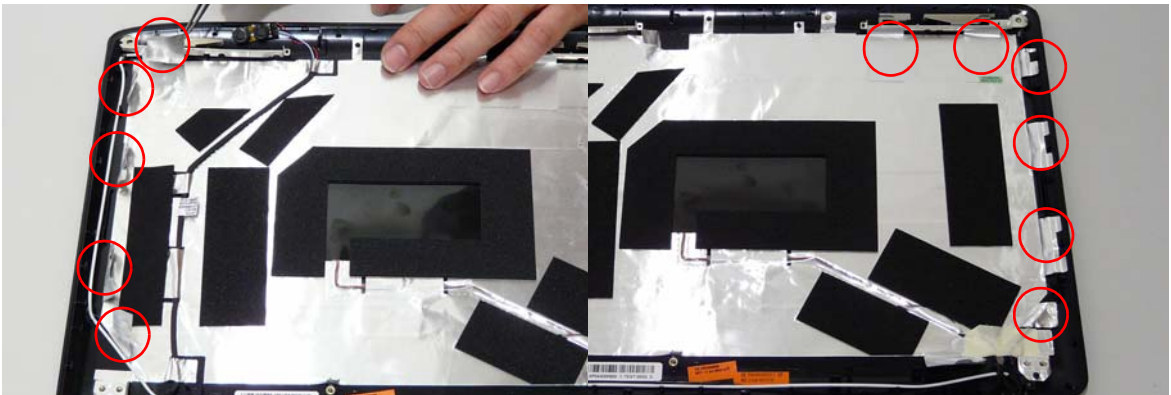

2. Pull up on the ends of the Antennas and remove the mylar strip from both Antennas.

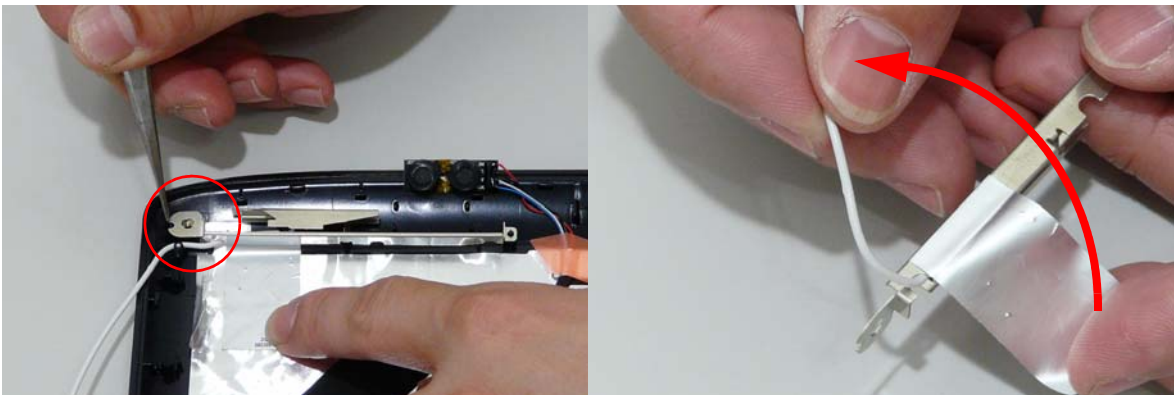



---

## Removing the LCD MIC

1. Remove the padding to expose the mylar cover.

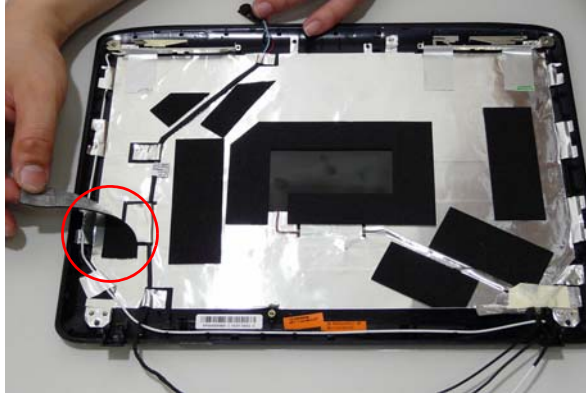

2. Pull back the tabs to expose the MIC cable.

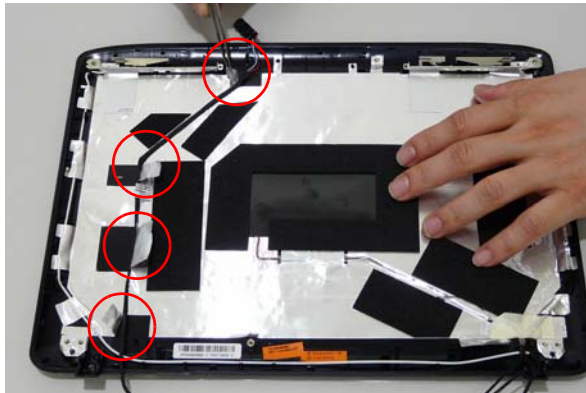

3. Grip the MIC cable and gently remove it from the back cover.

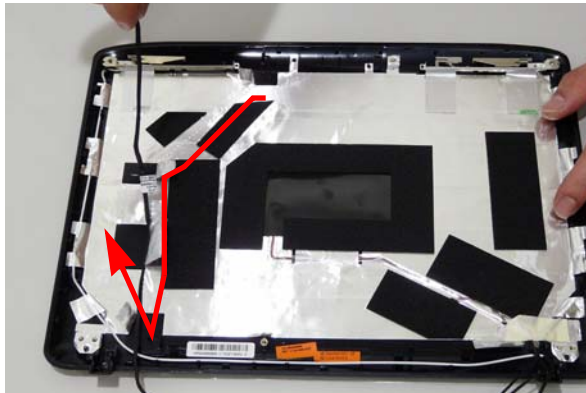

# LCD Module Reassembly Procedure

## Replacing the LCD Panel

1. Insert the MIC cable along the mylar tabs as shown.
2. Replace the tabs over the cable to secure in place.

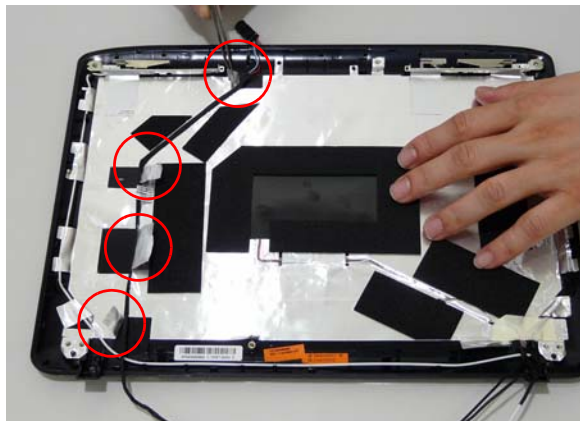
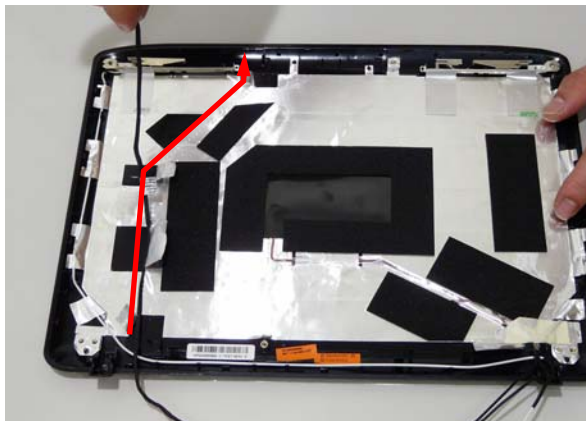

3. Replace the padding over the mylar cover.
4. Replace the mylar strip on both Antennas.

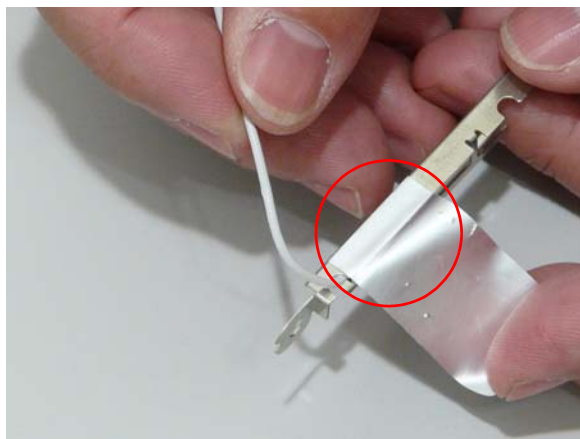
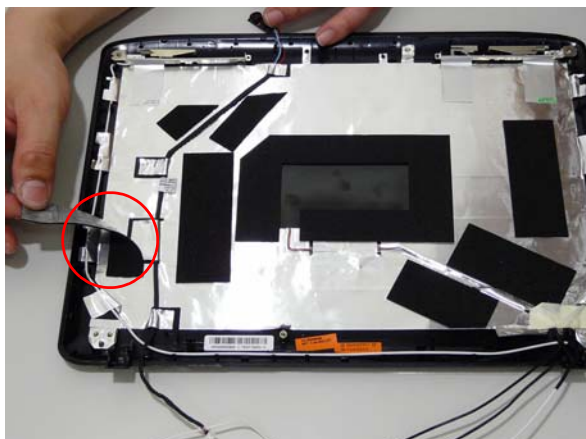

5. Replace both Antennas, take note of screw socket facing upwards.

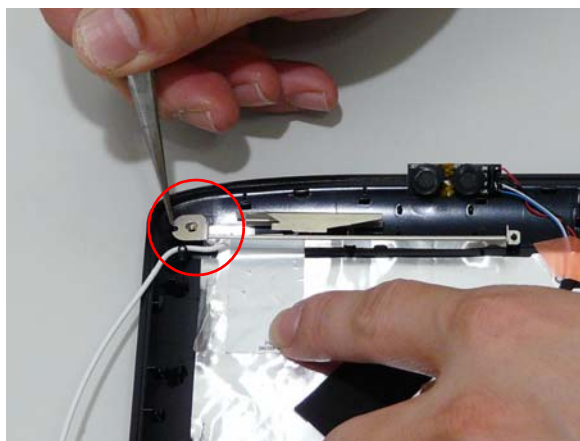



6. Replace the eleven (11) adhesive strips to secure the Antenna cables.

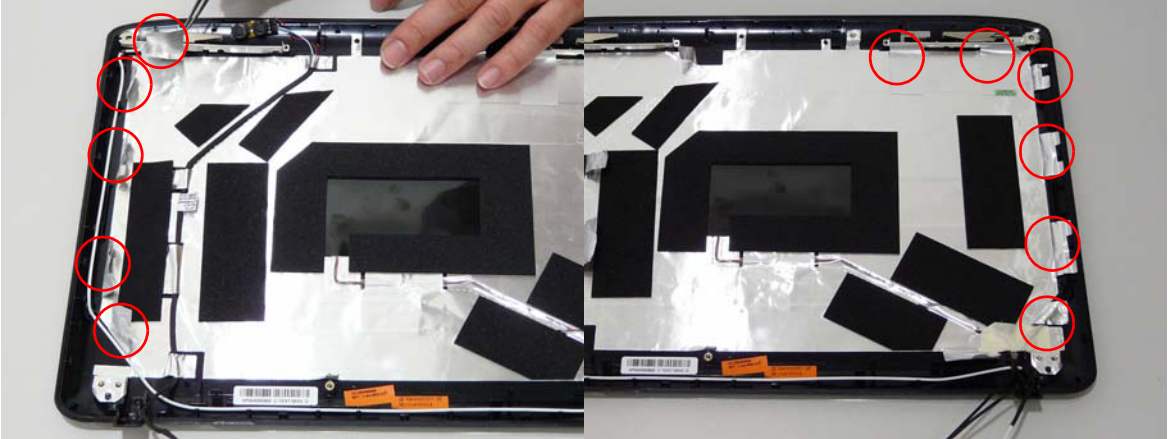

7. Secure the top of the brackets in place and pivot the brackets towards the LCD Panel as shown.

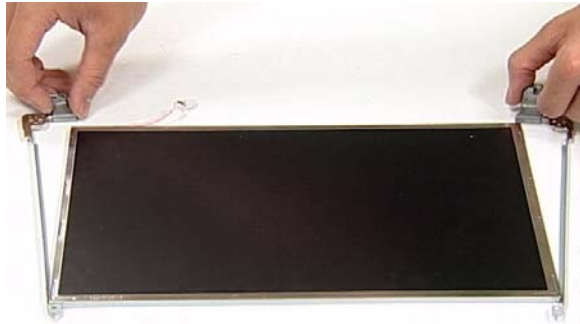

8. Replace the four securing screws (two on each side) from the LCD Panel brackets.

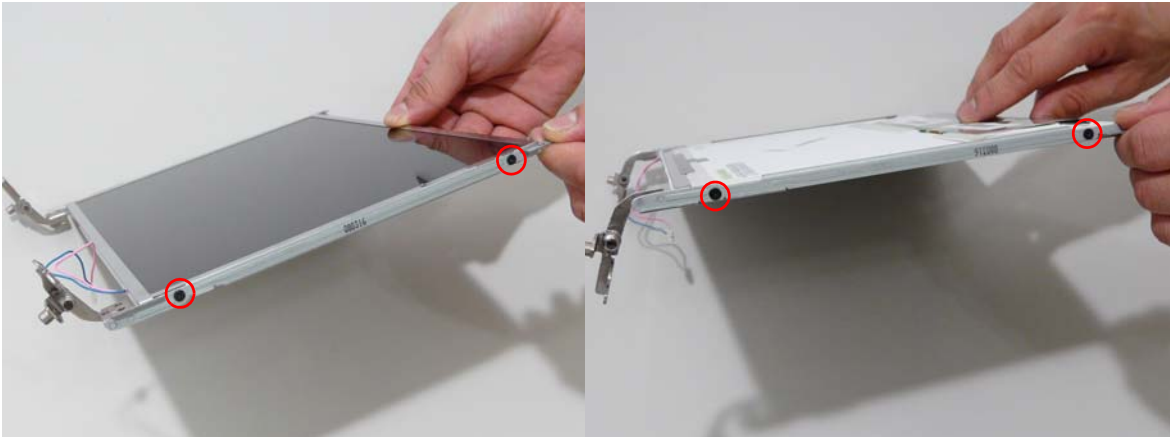

9. Connect the LCD cable to the panel.



10. Replace the cable and press down attach the adhesive strips.



11. Insert the top of LCD Panel first and tilt down in place.



**IMPORTANT:**Ensure all cabling is tucked correctly in the back cover.

12. Replace the two (2) securing screws on the LCD Module.

**IMPORTANT:**The correct screw sockets are indicated by the mark on the hinge.



13. Hold the connector with one hand and insert the Camera Module as shown.



14. Lower the camera module as shown

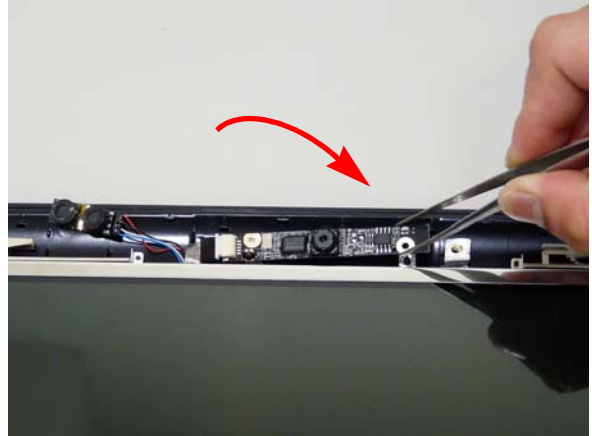

15. Replace the bracket over the Camera Board.

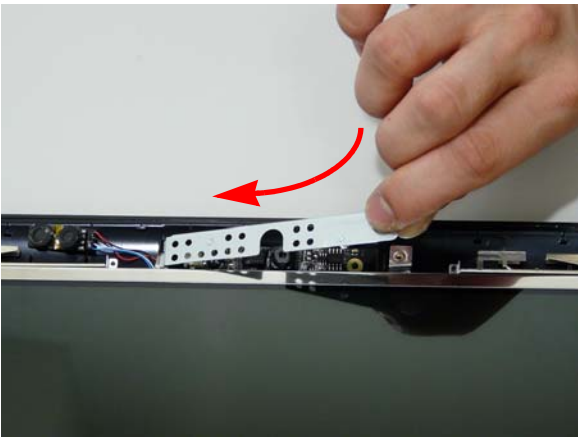

16. Replace the single securing screw.



17. Connect the left and right Inverter board cables as shown.



18. Insert the right side and lower Module in place.

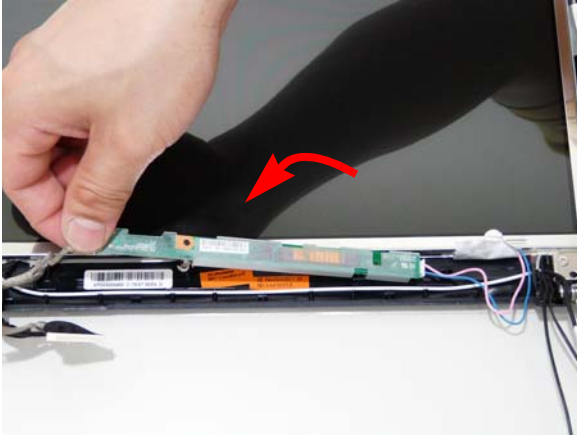

19. Replace the single securing screw.

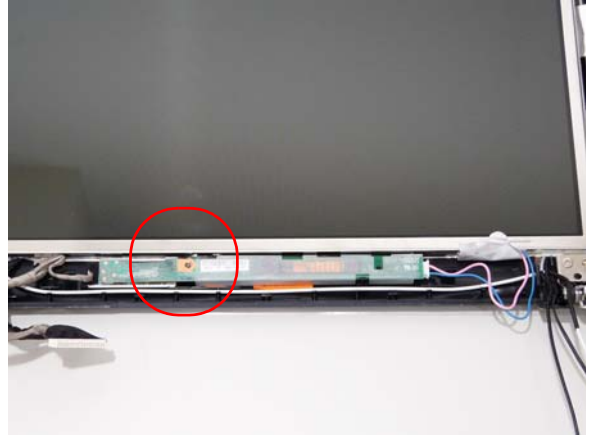

20. Replace the adhesive strip to secure the cabling in place.



**NOTE:** Ensure all cabling is tucked in under the adhesive strip to prevent damage.

## Replacing the LCD Bezel

1. Turn the bezel end up and insert the MIC into the underside of the Bezel as shown.





2. Insert the cabling inside the hinge wells to prevent damage or fraying.



3. Starting from the bottom and moving left to right, firmly press down to ensure the bezel is situated correctly (four locations on each side).



4. Replace the four screws and the rubber caps provided.



# Main Module Reassembly Procedure

## Replacing the CPU

1. Carefully turn the mainboard upside down (CPU socket side up), and insert the CPU into the CPU socket as shown.
2. Using a plastic screw driver, lock the CPU in the socket as shown.

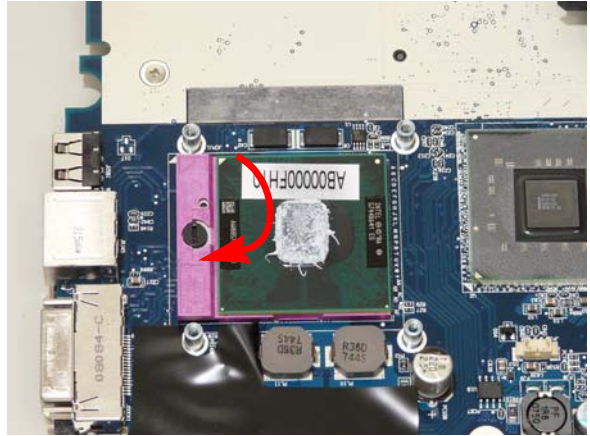
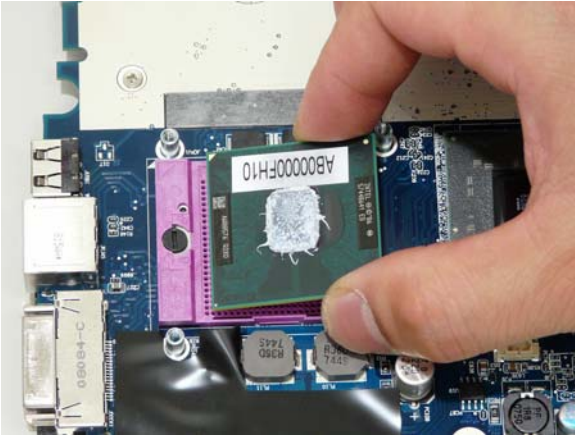

## Replacing the Thermal Module

1. Align the Fan Module on the screw brackets.
2. Tighten the four (4) captive screws in the order shown.

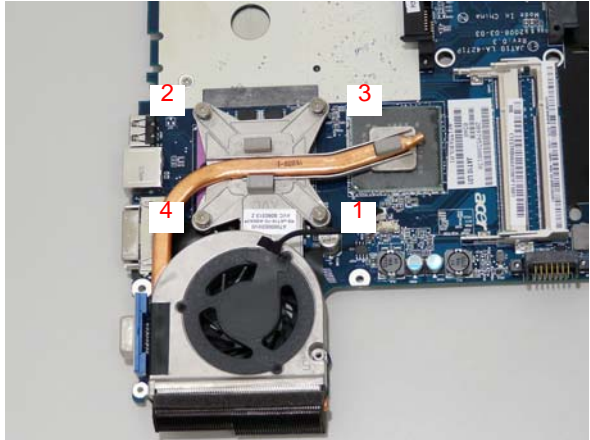
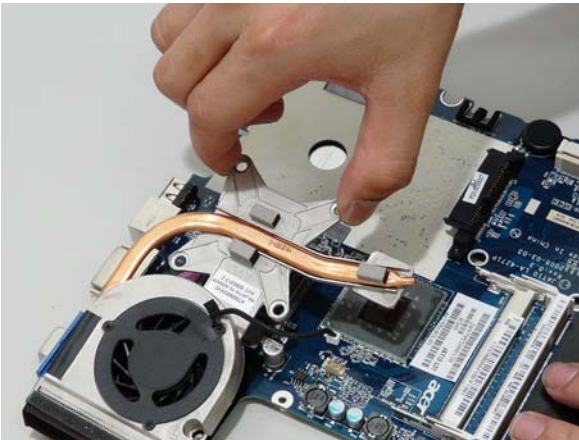

3. Connect the Fan cable to the Mainboard.

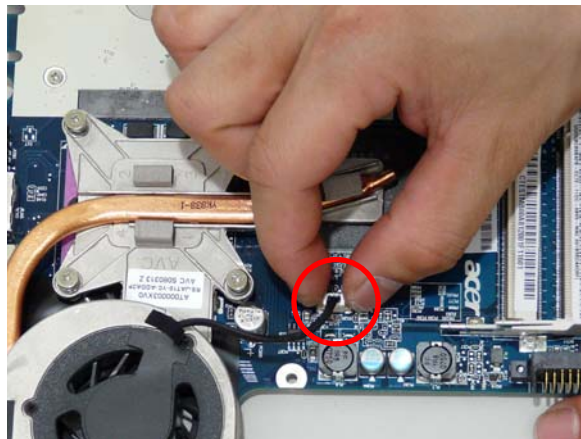

## Replacing the RJ-11 Jack

1. Insert the RJ-11 cable through the housing well and replace the cable cover to secure in place.
2. Turn the base over, and insert the cables along the well in the bottom cover as shown.

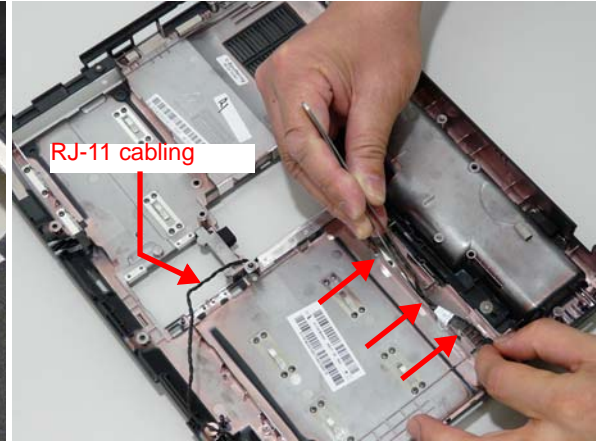
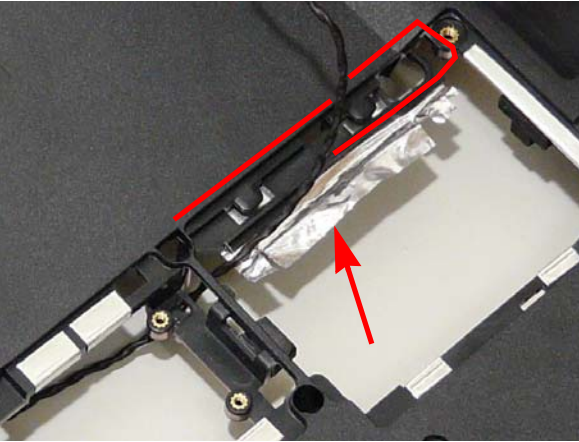

3. Replace the RJ-11 Jack and tuck in cabling in the housing well to prevent damage.

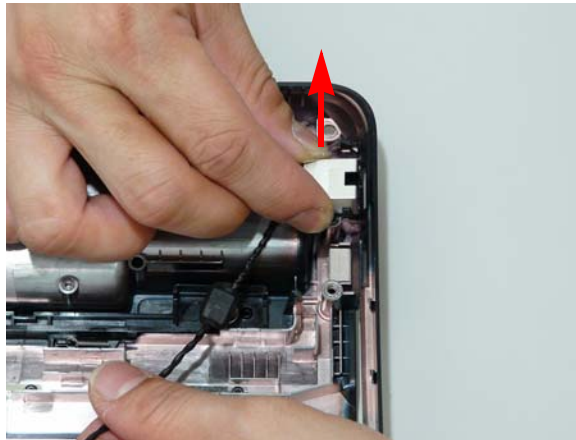



# Replacing the Mainboard

1. Ensure that the Mainboard is facing down (the Heatsink and CPU are not visible). Place the Mainboard in the chassis, making sure the I/O ports are positioned correctly through the lower cover, and the screw sockets are visible through the mainboard.

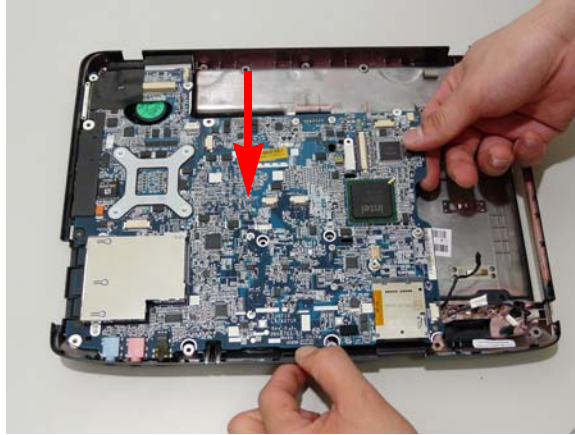

2. Before lowering the mainboard completely into place, take note of the DC-IN cable. Ensure it sits in the housing well as shown.

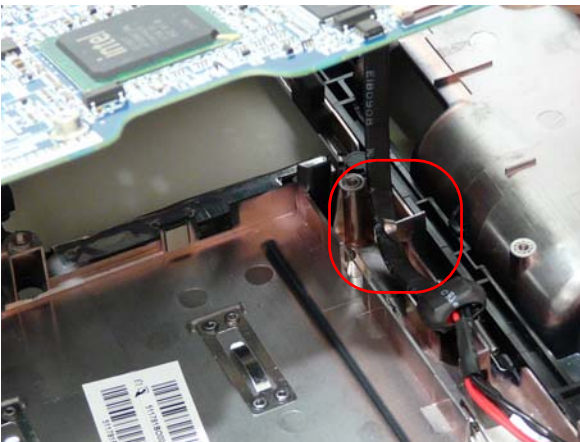

3. Pull the bottom of the chassis slightly outward to allow the I/O ports room for clearance. Lower the mainboard and release the lower cover.

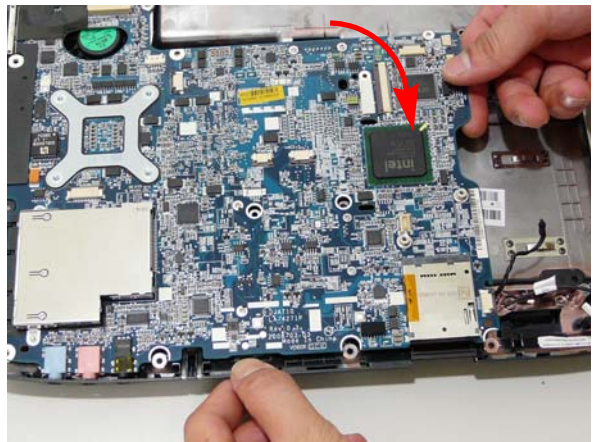

4. Connect the modem cable to the mainboard as shown.

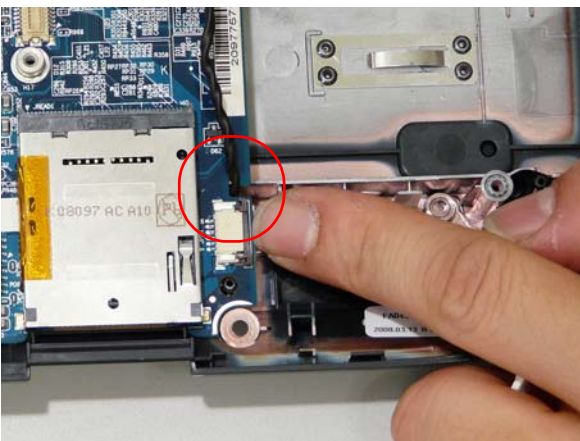

5. Replace the DC-In jack as shown.





---

6. Replace the three securing screws.

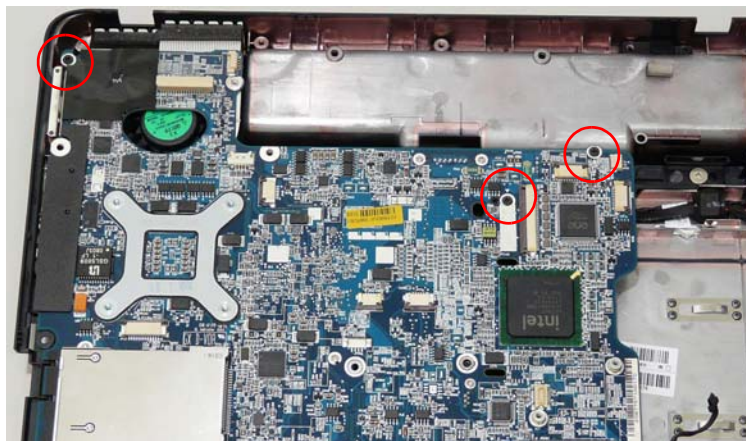

# Replacing the Modem Module

1. Align the connectors on the mainboard and the module and insert the module in place.
2. Replace the two securing screws on the modem module.

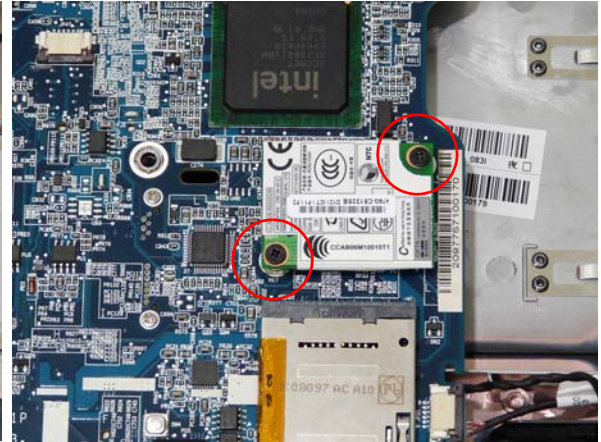
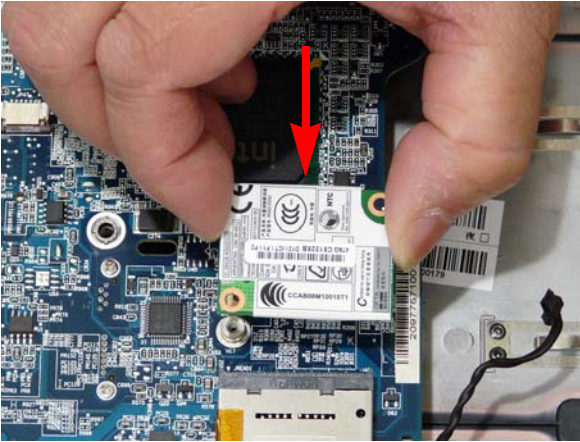

3. Connect the modem cable to the module.

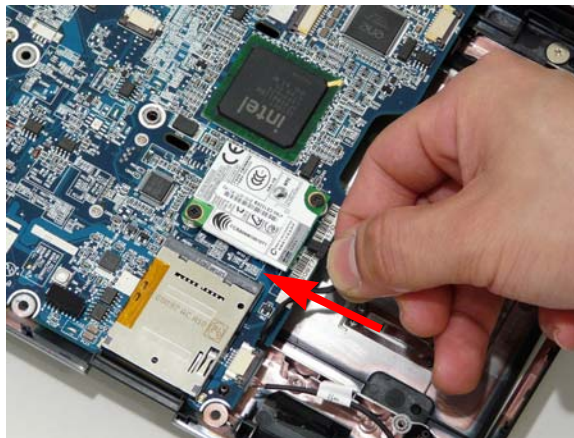

# Replacing the Bluetooth Board

1. Reconnect the cable to the module as shown.
2. Insert the module into the lower base as shown.

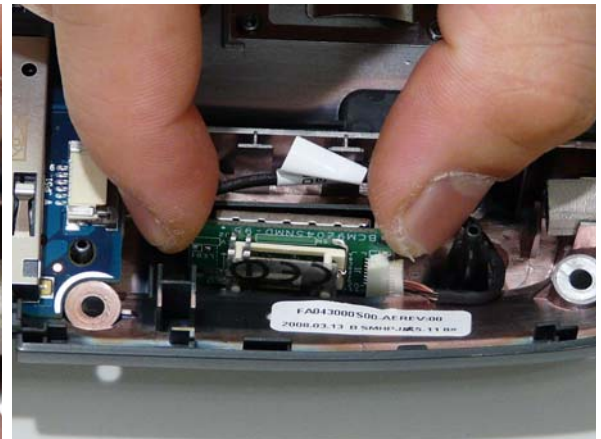
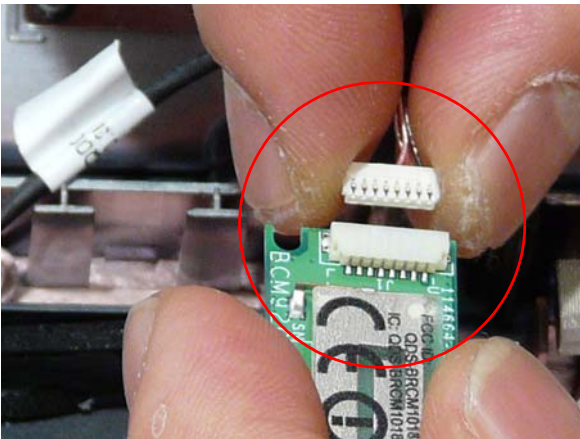

## Replacing the I/O Board

1. Insert the board at an angle, pivot and set it down in place.
2. Replace the single securing screw.



## Replacing the USB Board

1. Align the USB board with the screw socket and replace the single securing screw.
2. Replace the FFC in connector and lock the securing latches to hold the FFC in place.

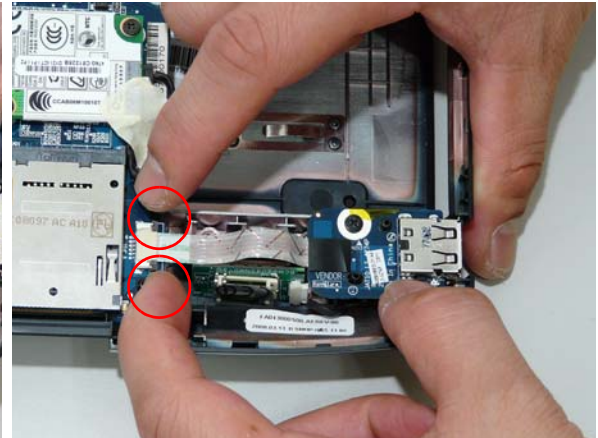
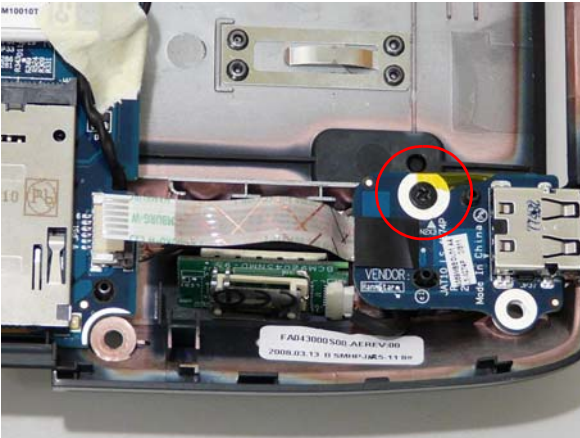

## Replacing the Launch Board

1. Replace the Launch Board in the bracket. Ensure that the FFC passes through the Upper Cover.
2. Replace the three securing screws.

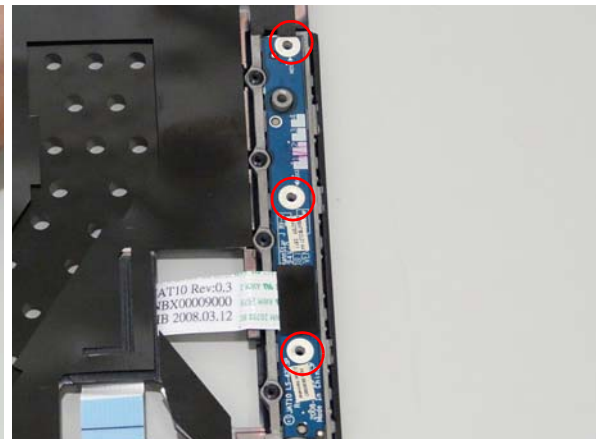
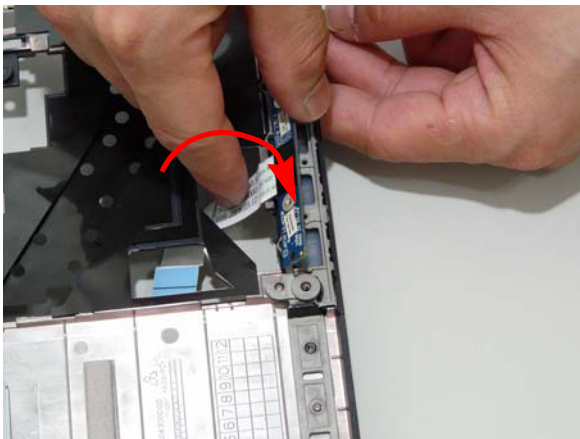



# Replacing the TouchPad Bracket

**IMPORTANT:**The TouchPad cannot be removed individually. To replace the TouchPad, replace the entire Upper Cover.

1. Insert the bracket at an angle as shown.

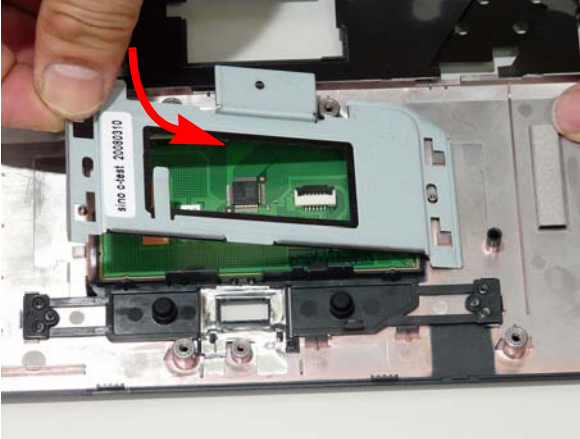

2. Replace the single securing screw.

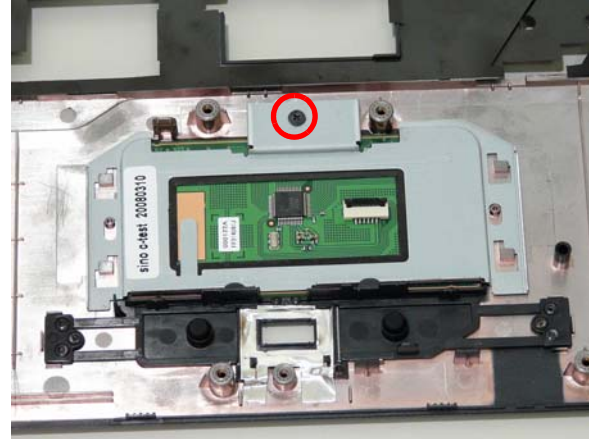

3. Insert the FFC flush with the connector and lock the securing latch.

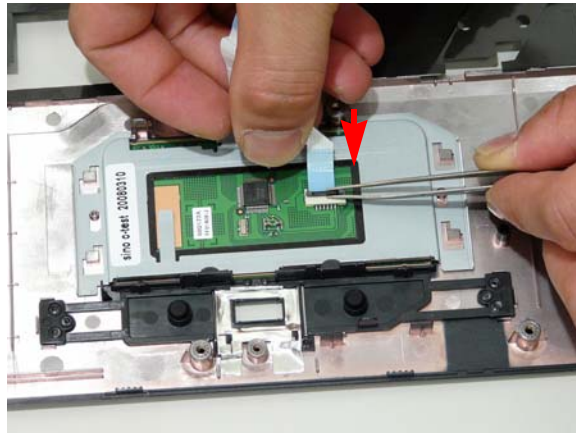

# Replacing the Finger Print Reader

1. Replace the Finger Print Reader board in the upper cover.

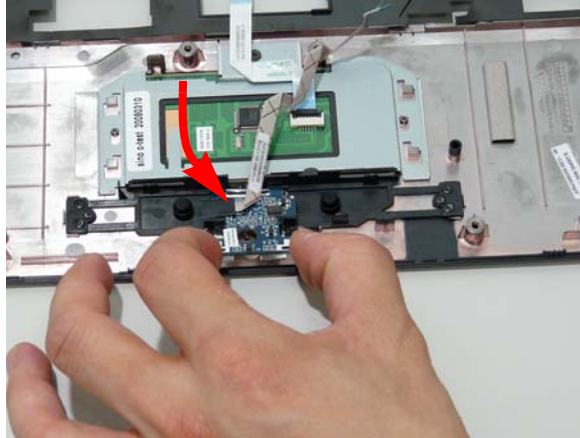

2. Align the bracket and replace over the board.

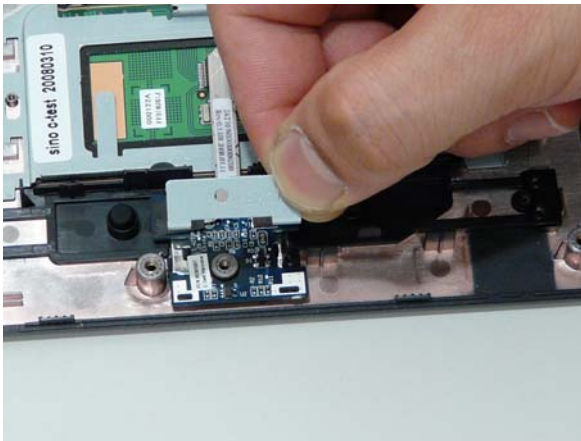

3. Replace the single securing screw.

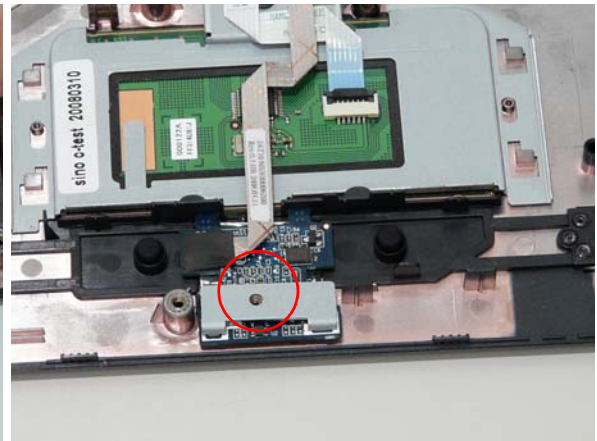

**NOTE:** Carefully insert the FFC cable ends fully into the connector. Take care to line up the cable square with the connector before securing the FFC connector latch.

# Replacing the Upper Cover

1. Tilt the Upper cover and insert the left side of the cover into place.
2. Lower the casing into place and ensure that the I/O board FFC passes through the casing.

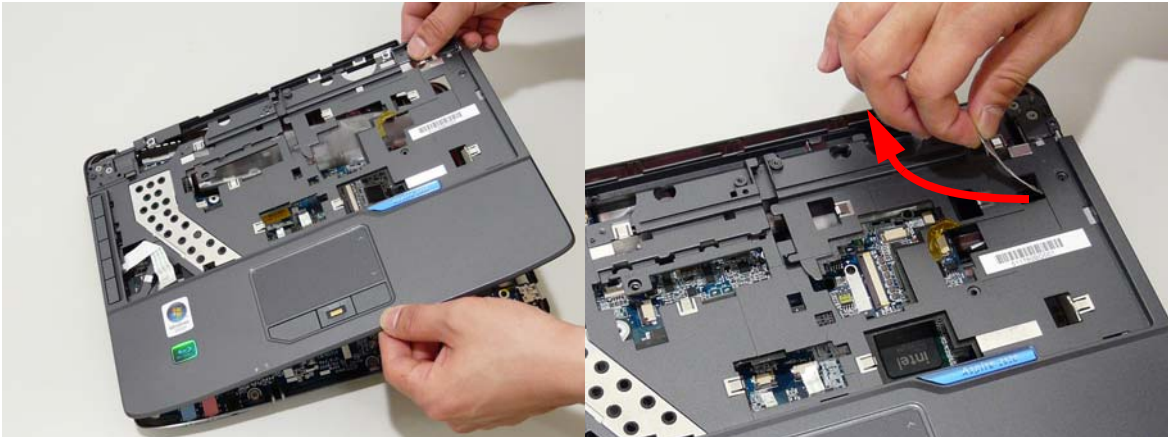

3. Press down around the edges of the casing to snap it into place.

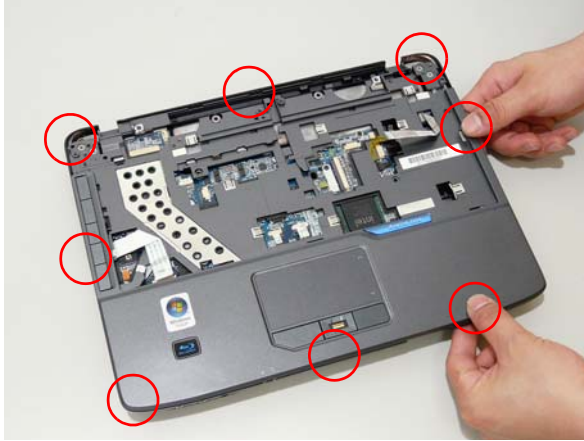

4. Connect the four cables to the mainboard as shown.

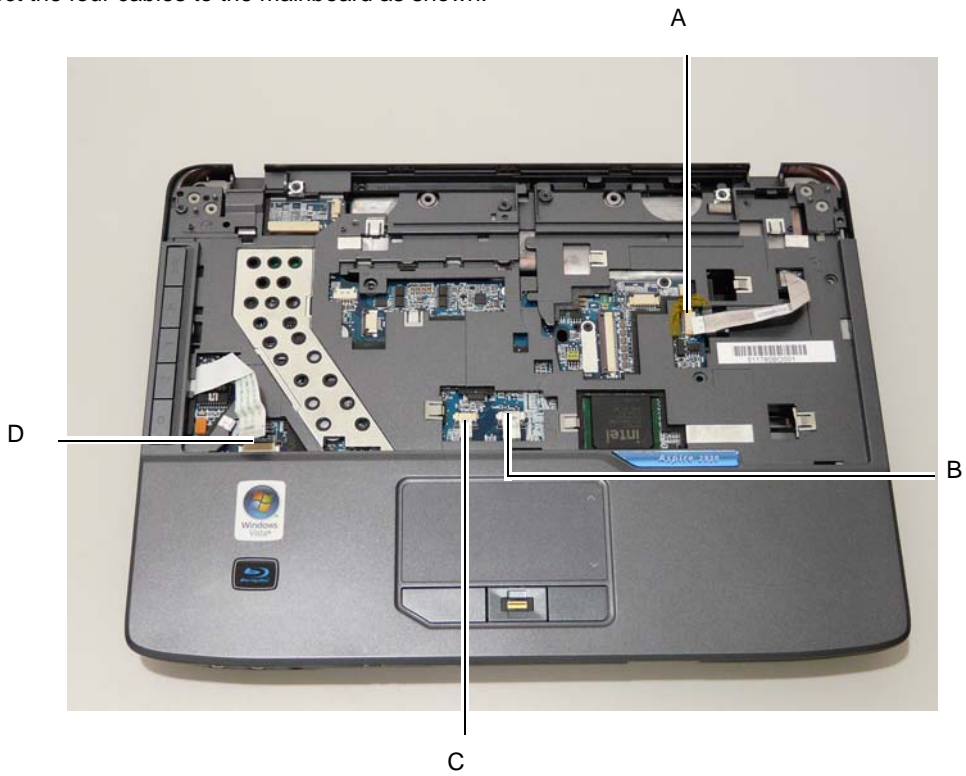



Insert the FFC flush with the connector and secure the latch as shown.



Insert the FFC flush with the connector and secure the latch as shown.

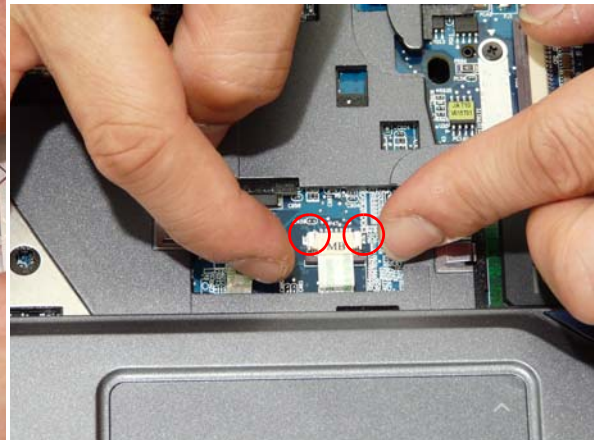

Insert the FFC flush with the connector and secure the latch as shown.



Insert the FFC flush with the connector and secure the latch as shown.

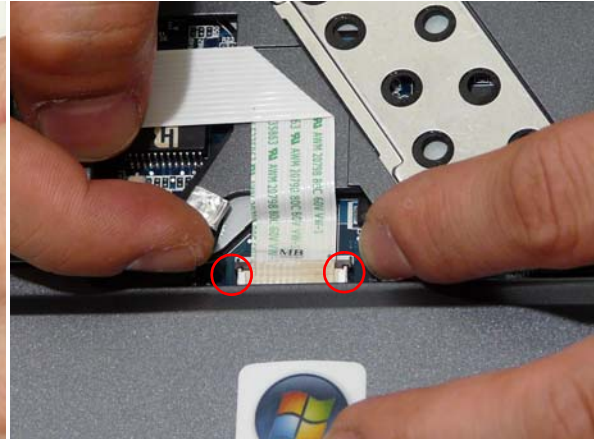

5. Replace the five securing screws on the top panel.



6. Turn over the computer and replace the eight securing screws on the bottom panel.

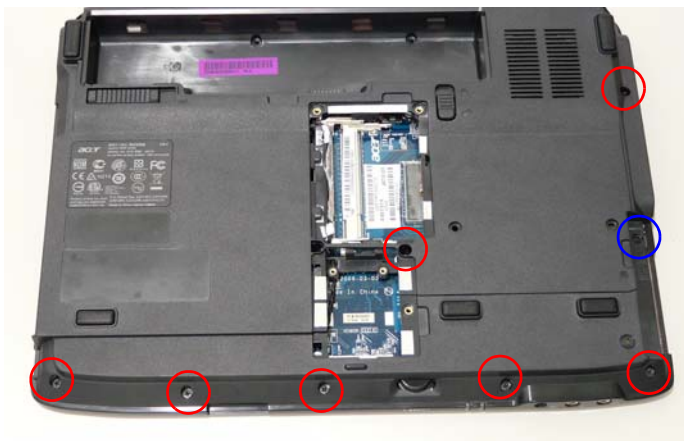

## Replacing the LCD Module

1. Align the LCD Module hinges with the alignment pins and gently set down.



2. Connect the two cables as shown.

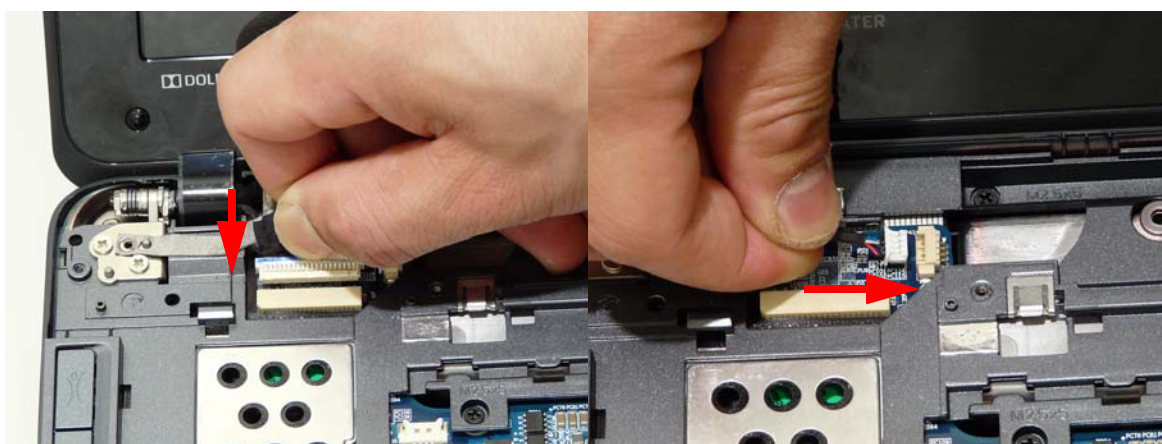



3. Replace the ground screw cable and screw and replace the four securing screws on the hinges.

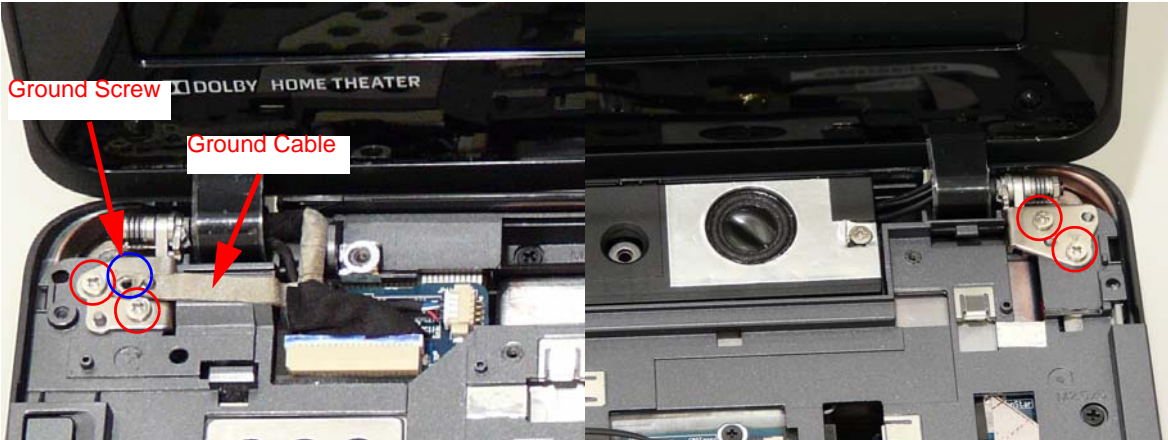

4. Secure the cables in place as shown.

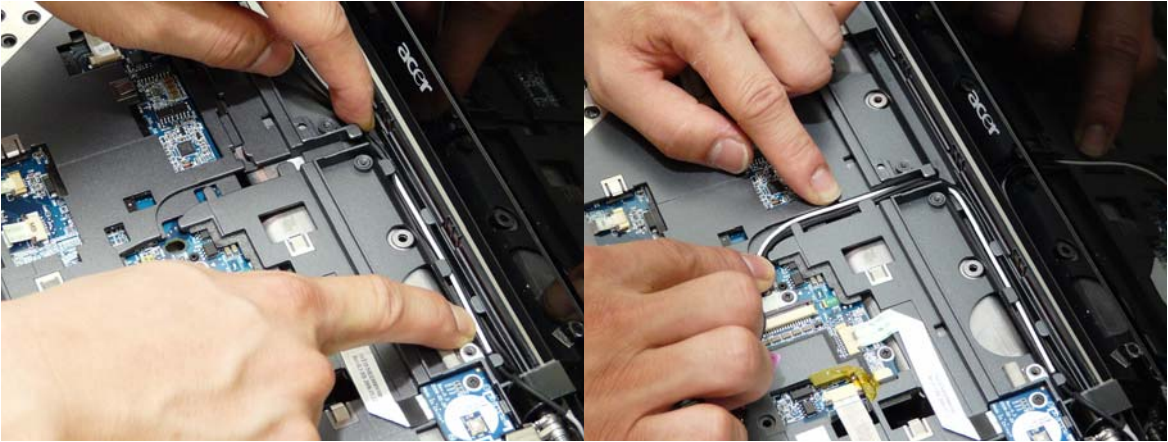

- 
5. Insert the Antenna Cables through the Upper Cover. Make sure they are accessible from the underside.



6. Turn the computer over and pull the antenna cables until they are taut.
7. Place the antenna cables in the cable channel and insert them through the casing into the WLAN bay.

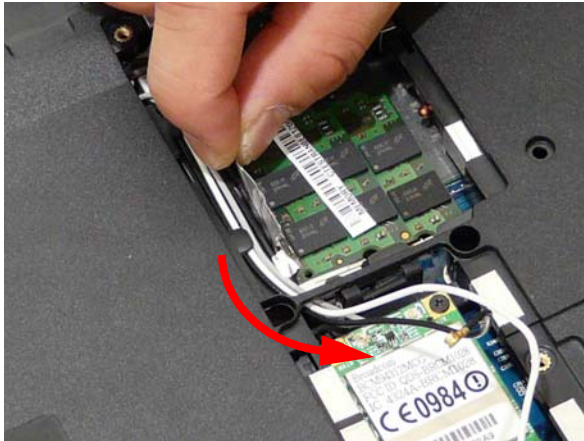

8. Replace the two securing screws on the bottom of the chassis.





## Replacing the Power Board

1. Place the Power Board in its location and replace the screw.
2. Replace the FFC and ensure the cable is flush with the connector. Secure by locking the latch.

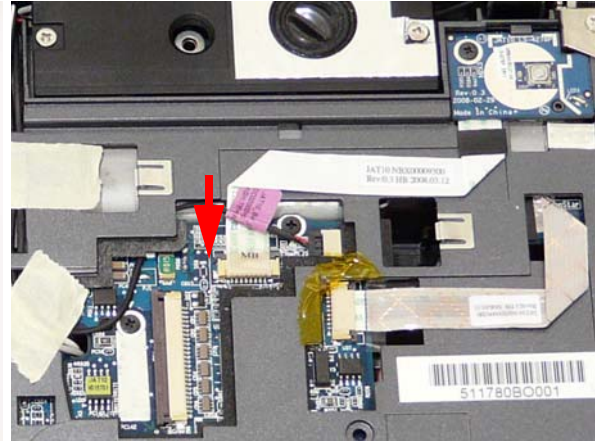
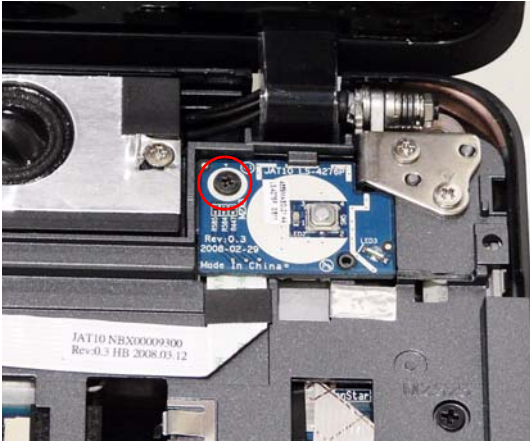

## Replacing the LED Board

1. Place the LED Board in its location and replace the screw.
2. Replace the FFC and ensure the cable is flush with the connector. Secure by locking the latch.

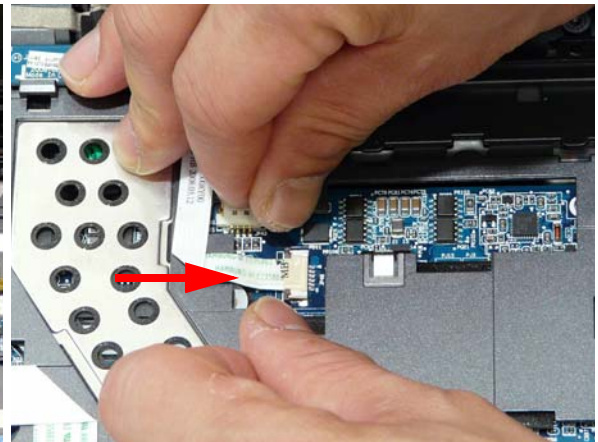
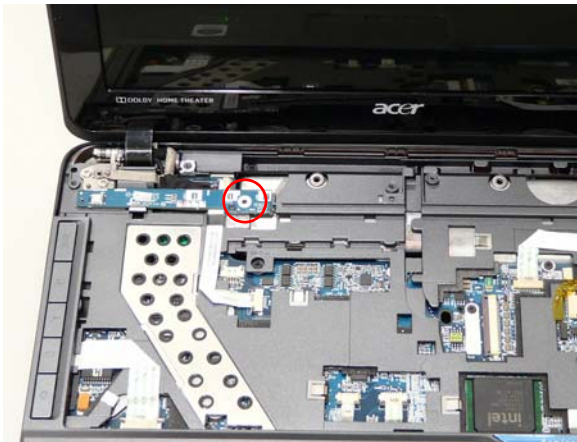

## Replacing the Speaker Module

1. Replace both speaker modules as shown.

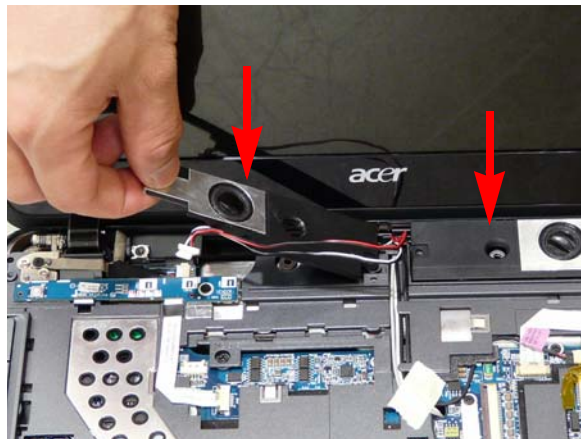

2. Insert the cables flush with the connectors.

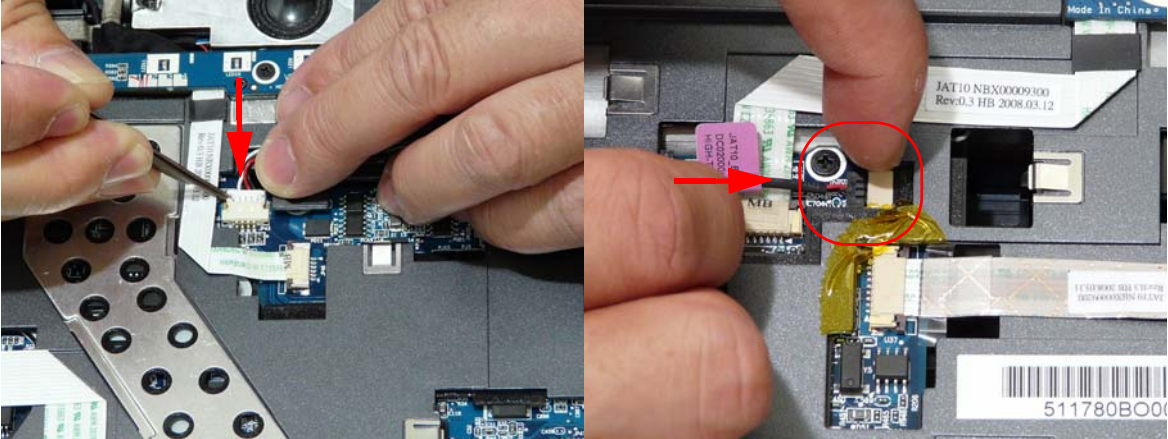

3. Replace the adhesive strip to secure the cabling.

4. Replace the four securing screws.

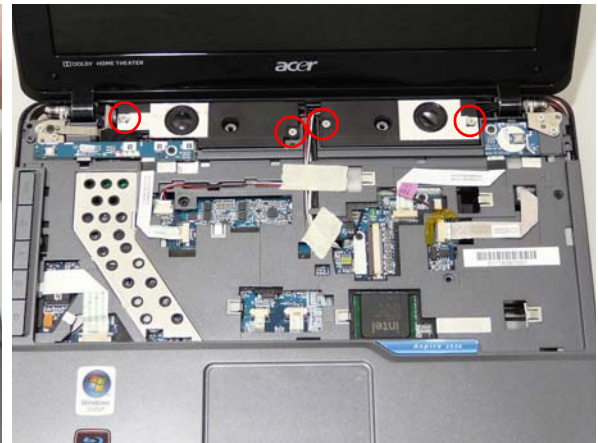

## Replacing the Keyboard

1. Replace keyboard cable to the mainboard, and secure the locking latch.

2. Turn the keyboard over and insert the bottom under the well guides on the upper cover.

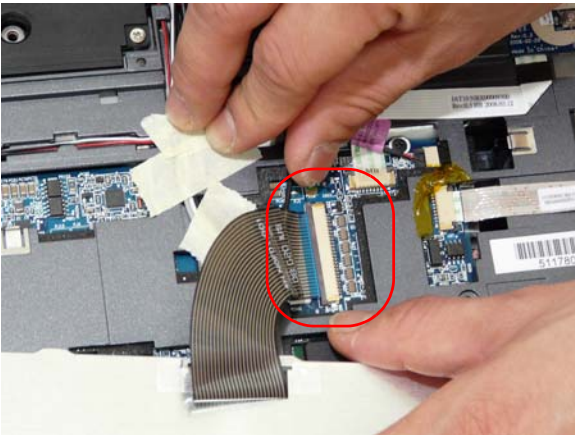



## Replacing the Switch Cover

1. Insert the bottom edge of the Switch Cover into the chassis.
2. Press down along the length of the cover to snap it into place.



## Replacing the WLAN Module

1. Insert the WLAN board into the WLAN socket.
2. Replace the two screws to secure the module.



3. Connect the three antenna cables to the module.



# Replacing the Hard Disk Drive Module

1. Slide the HDD in the carrier as shown.



2. Replace the four screws (two on each side) securing the hard disk to the carrier.

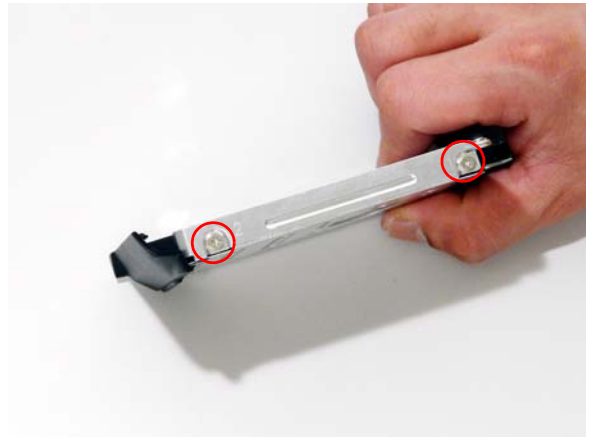

3. Replace the HDD in the bay as shown.



4. Replace the three securing screws.



---

## Replacing the DIMM Modules

1. Replace the DIMM modules bottom first and press down to lock in place.

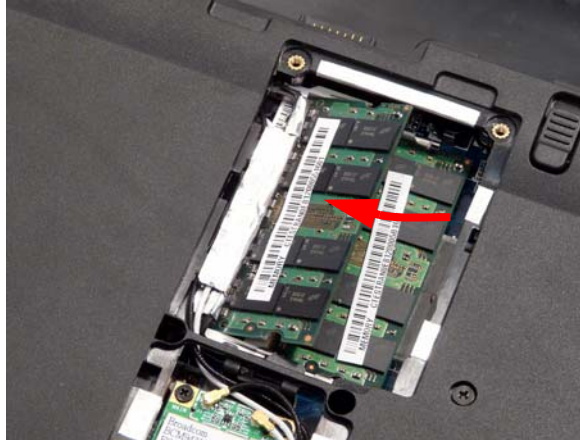

## Replacing the ODD Module

1. Insert the bezel into the module as shown.
2. Turn the ODD Module around and secure the bracket with the two screws, as provided.



3. Insert the ODD module into the bay as shown.
4. Replace the single securing screw.



## Replacing the Lower Covers

1. Replace the Memory Cover.
2. Tighten the two securing screws.

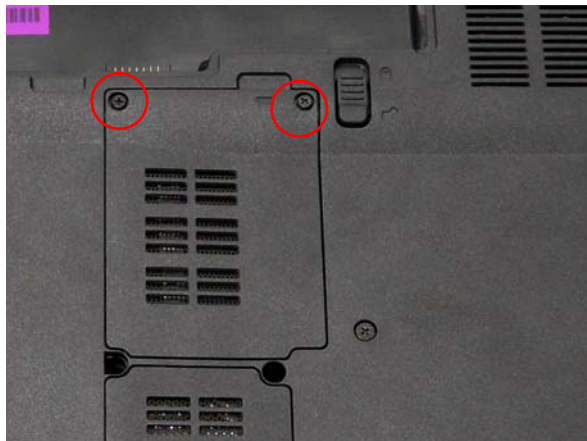



3. Replace the WLAN cover as shown.



4. Tighten the single securing screw.



## Replacing the Express and SD Card Trays

1. Insert the Express Card and push into the slot until flush with the chassis cover.



2. Insert the SD Card and push into the slot until flush with the chassis cover.





# Troubleshooting

---

## Common Problems

Use the following procedure as a guide for computer problems.

**NOTE:** The diagnostic tests are intended to test only Acer products. Non-Acer products, prototype cards, or modified options can give false errors and invalid system responses.

1. Obtain the failing symptoms in as much detail as possible.
2. Verify the symptoms by attempting to re-create the failure by running the diagnostic test or by repeating the same operation.
3. Use the following table with the verified symptom to determine which page to go to.

Symptoms (Verified)	Go To
Power On Issue	Page 126
No Display Issue	Page 127
LCD Failure	Page 129
Internal Keyboard Failure	Page 129
Touch Pad Failure	Page 130
Internal Speaker Failure	Page 130
Internal Microphone Failure	Page 132
ODD Failure	Page 134
Rightside USB Failure	Page 137
Modem Failure	Page 137
WLAN Failure	Page 138
Acer EasyLaunch Button Failure	Page 138
Acer MediaTouch Failure	Page 139
Fingerprint Reader Failure	Page 139
Thermal Unit Failure	Page 140
HDTV Switch Failure	Page 140
Other Functions Failure	Page 141
Intermittent Failures	Page 142
Undermined Failures	Page 142

4. If the Issue is still not resolved, see "Online Support Information" on page 235.

---

## Power On Issue

If the system doesn't power on, perform the following actions one at a time to correct the problem. Do not replace a non-defective FRUs:

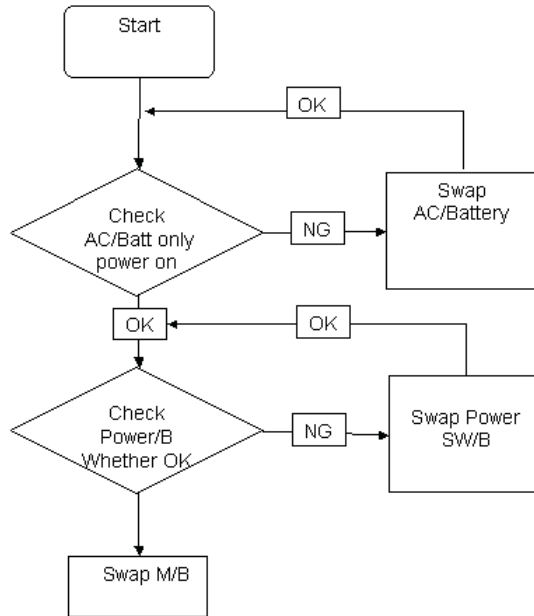

## Computer Shutdown Intermittently

If the system powers off at intervals, perform the following actions one at a time to correct the problem.

1. Check the power cable is properly connected to the computer and the electrical outlet.
2. Remove any extension cables between the computer and the outlet.
3. Remove any surge protectors between the computer and the electrical outlet. Plug the computer directly into a known good electrical outlet.
4. Disconnect the power and open the casing to check the Thermal Unit (see "Thermal Unit Failure" on page 140) and fan airways are free of obstructions.
5. Disable the power management settings in the BIOS to ensure they are not the cause of the problem (see "Power" on page 31).
6. Remove all external and non-essential hardware connected to the computer that are not necessary to boot the computer to the failure point.
7. Remove any recently installed software.
8. If the Issue is still not resolved, see "Online Support Information" on page 235.

# No Display Issue

If the **Display** doesn't work, perform the following actions one at a time to correct the problem. Do not replace a non-defective FRUs:

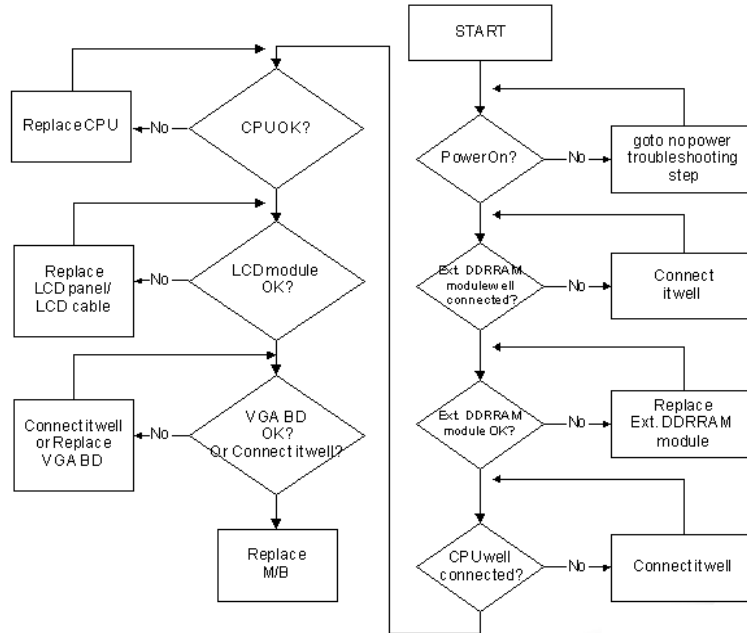

## No POST or Video

If the POST or video doesn't display, perform the following actions one at a time to correct the problem.

1. Make sure that the internal display is selected. On this notebook model, switching between the internal display and the external display is done by pressing **Fn+F5**. Reference Product pages for specific model procedures.
2. Make sure the computer has power by checking at least one of the following occurs:
  - Fans start up
  - Status LEDs light up

If there is no power, see "Power On Issue" on page 126.

3. Drain any stored power by removing the power cable and battery and holding down the power button for 10 seconds. Reconnect the power and reboot the computer.
4. Connect an external monitor to the computer and switch between the internal display and the external display is by pressing **Fn+F5** (on this model).

If the POST or video appears on the external display, see "LCD Failure" on page 129.

5. Disconnect power and all external devices including port replicators or docking stations. Remove any memory cards and CD/DVD discs. Restart the computer.

If the computer boots correctly, add the devices one by one until the failure point is discovered.

6. Reseat the memory modules.
7. Remove the drives (see "Disassembly Process" on page 42).
8. If the Issue is still not resolved, see "Online Support Information" on page 235.

---

## Abnormal Video Display

If video displays abnormally, perform the following actions one at a time to correct the problem.

1. Reboot the computer.
2. If permanent vertical/horizontal lines or dark spots display in the same location, the LCD is faulty and should be replaced. See “Disassembly Process” on page 42.
3. If extensive pixel damage is present (different colored spots in the same locations on the screen), the LCD is faulty and should be replaced. See “Disassembly Process” on page 42.
4. Adjust the brightness to its highest level. See the User Manual for instructions on adjusting settings.  
**NOTE:** Ensure that the computer is not running on battery alone as this may reduce display brightness.  
If the display is too dim at the highest brightness setting, the LCD is faulty and should be replaced. See “Disassembly Process” on page 42.
5. Check the display resolution is correctly configured:
  - a. Minimize or close all Windows.
  - b. If display size is only abnormal in an application, check the view settings and control/mouse wheel zoom feature in the application.
  - c. If desktop display resolution is not normal, right-click on the desktop and select **Personalize**→ **Display Settings**.
  - d. Click and drag the Resolution slider to the desired resolution.
  - e. Click **Apply** and check the display. Readjust if necessary.
6. Roll back the video driver to the previous version if updated.
7. Remove and reinstall the video driver.
8. Check the Device Manager to determine that:
  - The device is properly installed. There are no red Xs or yellow exclamation marks.
  - There are no device conflicts.
  - No hardware is listed under Other Devices.
9. If the Issue is still not resolved, see “Online Support Information” on page 235.
10. Run the Windows Memory Diagnostic from the operating system DVD and follow the onscreen prompts.
11. If the Issue is still not resolved, see “Online Support Information” on page 235.

## Random Loss of BIOS Settings

If the computer is experiencing intermittent loss of BIOS information, perform the following actions one at a time to correct the problem.

1. If the computer is more than one year old, replace the CMOS battery.
2. Run a complete virus scan using up-to-date software to ensure the computer is virus free.
3. If the computer is experiencing HDD or ODD BIOS information loss, disconnect and reconnect the power and data cables between devices.  
If the BIOS settings are still lost, replace the cables.
4. If HDD information is missing from the BIOS, the drive may be defective and should be replaced.
5. Replace the Motherboard.
6. If the Issue is still not resolved, see “Online Support Information” on page 235.

# LCD Failure

If the **LCD** fails, perform the following actions one at a time to correct the problem. Do not replace a non-defective FRUs:

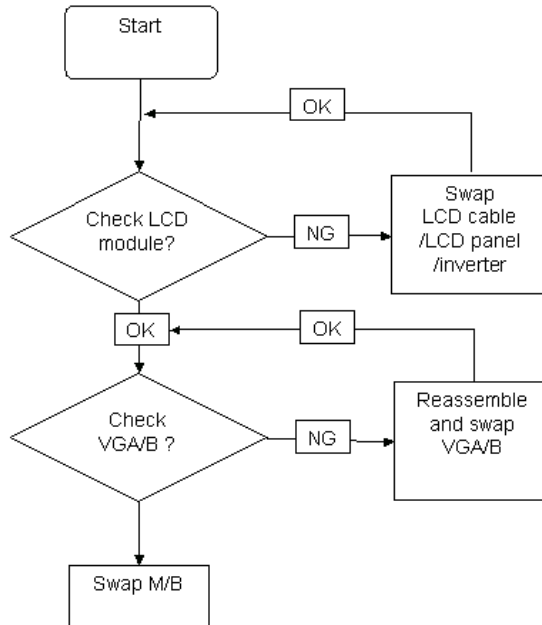

# Built-In Keyboard Failure

If the built-in **Keyboard** fails, perform the following actions one at a time to correct the problem. Do not replace a non-defective FRUs:

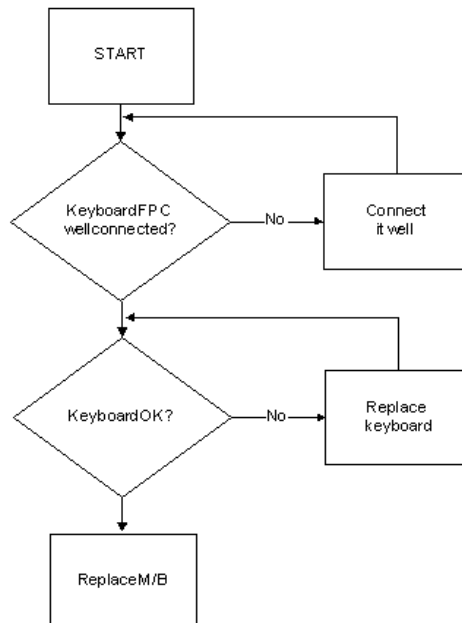

# Touch Pad Failure

If the **Touch Pad** doesn't work, perform the following actions one at a time to correct the problem. Do not replace a non-defective FRUs:

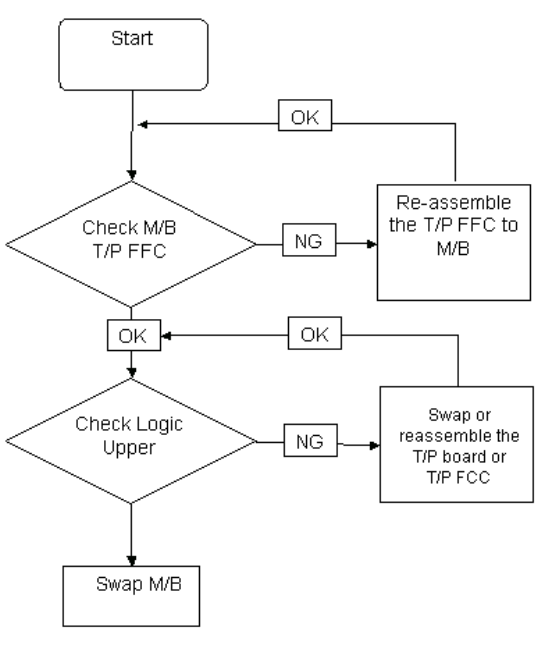

# Internal Speaker Failure

If the internal **Speakers** fail, perform the following actions one at a time to correct the problem. Do not replace a non-defective FRUs:

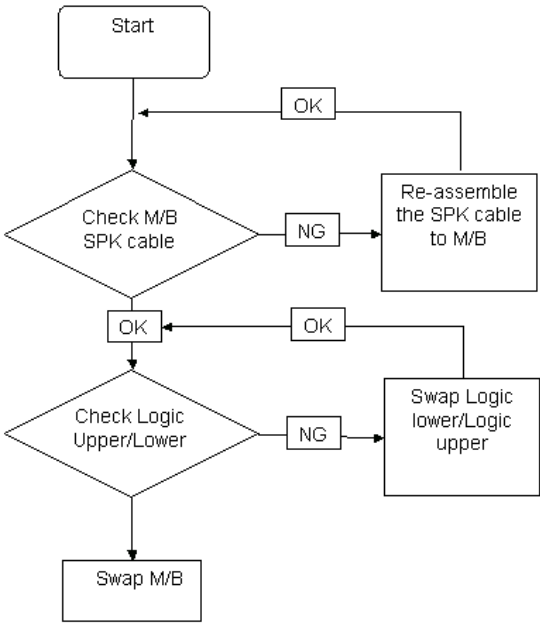



---

## Sound Problems

If sound problems are experienced, perform the following actions one at a time to correct the problem.

1. Reboot the computer.
2. Navigate to **Start** → **Control Panel** → **System and Maintenance** → **System** → **Device Manager**. Check the Device Manager to determine that:
  - The device is properly installed.
  - There are no red Xs or yellow exclamation marks.
  - There are no device conflicts.
  - No hardware is listed under Other Devices.
3. Roll back the audio driver to the previous version, if updated recently.
4. Remove and reinstall the audio driver.
5. Ensure that all volume controls are set mid range:
  - a. Click the volume icon on the taskbar and drag the slider to 50. Ensure that the volume is not muted.
  - b. Click Mixer to verify that other audio applications are set to 50 and not muted.
6. Navigate to **Start** → **Control Panel** → **Hardware and Sound** → **Sound**. Ensure that Speakers are selected as the default audio device (green check mark).

**NOTE:** If Speakers does not show, right-click on the **Playback** tab and select **Show Disabled Devices** (clear by default).
7. Select Speakers and click **Configure** to start **Speaker Setup**. Follow the onscreen prompts to configure the speakers.
8. Remove and recently installed hardware or software.
9. Restore system and file settings from a known good date using **System Restore**.

If the issue is not fixed, repeat the preceding steps and select an earlier time and date.
10. Reinstall the Operating System.
11. If the Issue is still not resolved, see “Online Support Information” on page 235.

---

# Internal Microphone Failure

If the internal **Microphone** fails, perform the following actions one at a time to correct the problem. Do not replace a non-defective FRUs:

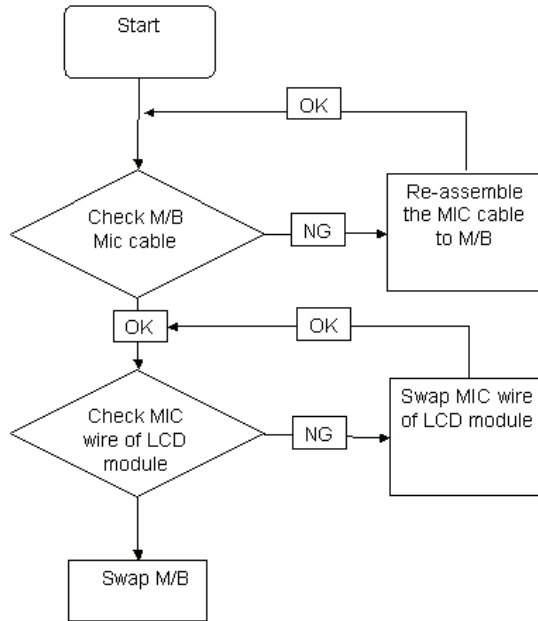

## Microphone Problems

If internal or external **Microphones** do not operate correctly, perform the following actions one at a time to correct the problem.

1. Check that the microphone is enabled. Navigate to **Start** → **Control Panel** → **Hardware and Sound** → **Sound** and select the **Recording** tab.
2. Right-click on the **Recording** tab and select **Show Disabled Devices** (clear by default).
3. The microphone appears on the **Recording** tab.
4. Right-click on the microphone and select **Enable**.
5. Select the microphone then click **Properties**. Select the **Levels** tab.
6. Increase the volume to the maximum setting and click **OK**.
7. Test the microphone hardware:
  - a. Select the microphone and click **Configure**.
  - b. Select **Set up microphone**.
  - c. Select the microphone type from the list and click **Next**.
  - d. Follow the onscreen prompts to complete the test.
8. If the Issue is still not resolved, see "Online Support Information" on page 235.

---

## HDD Not Operating Correctly

If the **HDD** does not operate correctly, perform the following actions one at a time to correct the problem.

1. Disconnect all external devices.
2. Run a complete virus scan using up-to-date software to ensure the computer is virus free.
3. Run the Windows Vista Startup Repair Utility:
  - a. insert the Windows Vista Operating System DVD in the ODD and restart the computer.
  - b. When prompted, press any key to start to the operating system DVD.
  - c. The **Install Windows** screen displays. Click **Next**.
  - d. Select **Repair your computer**.
  - e. The **System Recovery Options** screen displays. Click **Next**.
  - f. Select the appropriate operating system, and click **Next**.

**NOTE:** Click **Load Drivers** if controller drives are required.

- g. Select **Startup Repair**.
- h. Startup Repair attempts to locate and resolve issues with the computer.
- i. When complete, click **Finish**.

If an issue is discovered, follow the onscreen information to resolve the problem.

4. Run the Windows Memory Diagnostic Tool. For more information see Windows Help and Support.
5. Restart the computer and press F2 to enter the BIOS Utility. Check the BIOS settings are correct and that CD/DVD drive is set as the first boot device on the Boot menu.
6. Ensure all cables and jumpers on the HDD and ODD are set correctly.
7. Remove any recently added hardware and associated software.
8. Run the Windows Disk Defragmenter. For more information see Windows Help and Support.
9. Run Windows Check Disk by entering **chkdsk /r** from a command prompt. For more information see Windows Help and Support.
10. Restore system and file settings from a known good date using **System Restore**.

If the issue is not fixed, repeat the preceding steps and select an earlier time and date.
11. Replace the HDD. See "Disassembly Process" on page 42.

---

## ODD Failure

If the **ODD** fails, perform the following actions one at a time to correct the problem. Do not replace a non-defective FRUs:

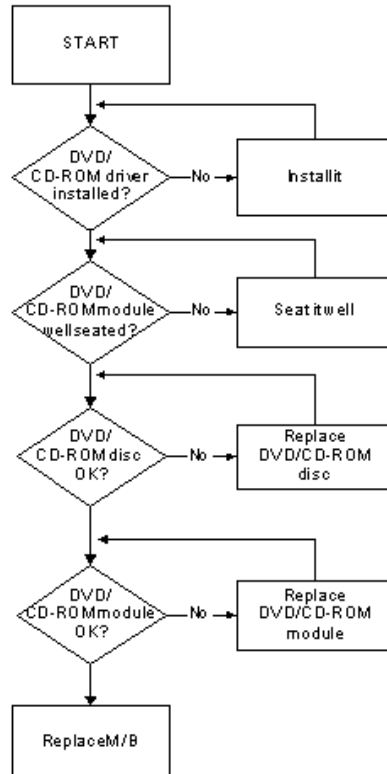

## ODD Not Operating Correctly

If the **ODD** exhibits any of the following symptoms it may be faulty:

- Audio CDs do not play when loaded
- DVDs do not play when loaded
- Blank discs do not burn correctly
- DVD or CD play breaks up or jumps
- Optical drive not found or not active:
  - Not shown in My Computer or the BIOS setup
  - LED does not flash when the computer starts up
  - The tray does not eject
- Access failure screen displays
- The ODD is noisy

Perform the following general solutions one at a time to correct the problem.

1. Reboot the computer and retry the operation.
2. Try an alternate disc.
3. Navigate to **Start** → **Computer**. Check that the ODD device is displayed in the **Devices with Removable Storage** panel.
4. Navigate to **Start** → **Control Panel** → **System and Maintenance** → **System** → **Device Manager**.

- 
- a. Double-click **IDE ATA/ATAPI controllers**. If a device displays a down arrow, right-click on the device and click **Enable**.
  - b. Double-click **DVD/CD-ROM drives**. If the device displays a down arrow, right-click on the device and click **Enable**.
  - c. Check that there are no yellow exclamation marks against the items in **IDE ATA/ATAPI controllers**. If a device has an exclamation mark, right-click on the device and uninstall and reinstall the driver.
  - d. Check that there are no yellow exclamation marks against the items in **DVD/CD-ROM drives**. If a device has an exclamation mark, right-click on the device and uninstall and reinstall the driver.
  - e. If the exclamation marker is not removed from the item in the lists, try removing any recently installed software and retrying the operation.

## Discs Do Not Play

If discs do not play when inserted in the drive, perform the following actions one at a time to correct the problem.

1. Check that the disc is correctly seated in the drive tray and that the label on the disc is visible.
2. Check that the media is clean and scratch free.
3. Try an alternate disc in the drive.
4. Ensure that **AutoPlay** is enabled:
  - a. Navigate to **Start** → **Control Panel** → **Hardware and Sound** → **AutoPlay**.
  - b. Select **Use AutoPlay for all media and devices**.
  - c. In the Audio CD and DVD Movie fields, select the desired player from the drop down menu.
5. Check that the Regional Code is correct for the selected media:

**IMPORTANT:**Region can only be changed a limited number of times. After Changes remaining reaches zero, the region cannot be changed even Windows is reinstalled or the drive is moved to another computer.

- a. Navigate to **Start** → **Control Panel** → **System and Maintenance** → **System** → **Device Manager**.
- b. Double-click **DVD/CD-ROM drives**.
- c. Right-click **DVD drive** and click **Properties**, then click the **DVD Region** tab.
- d. Select the region suitable for the media inserted in the drive.

## Discs Do Not Burn Properly

If discs can not be burned, perform the following actions one at a time to correct the problem.

1. Ensure that the default drive is record enabled:
  - a. Navigate to **Start** → **Computer** and right-click the writable ODD icon. Click **Properties**.
  - b. Select the **Recording** tab. In the **Desktop disc recording** panel, select the writable ODD from the drop down list.
  - c. Click **OK**.
2. Ensure that the software used for burning discs is the factory default. If using different software, refer to the software's user manual.

## Playback is Choppy

If playback is choppy or jumps, perform the following actions one at a time to correct the problem.

1. Check that system resources are not running low:
  - a. Try closing some applications.
  - b. Reboot and try the operation again.
2. Check that the ODD controller transfer mode is set to DMA:
  - a. Navigate to **Start** → **Control Panel** → **System and Maintenance** → **System** → **Device Manager**.

- 
- b. Double-click **IDE ATA/ATAPI controllers**, then right-click ATA Device 0.
  - c. Click **Properties** and select the **Advanced Settings** tab. Ensure that the **Enable DMA** box is checked and click **OK**.
  - d. Repeat for the other ATA Devices shown if applicable.

### Drive Not Detected

If Windows cannot detect the drive, perform the following actions one at a time to correct the problem.

1. Restart the computer and press F2 to enter the BIOS Utility.
2. Check that the drive is detected in the **ATAPI Model Name** field on the Information page.  
**NOTE:** Check that the entry is identical to one of the ODDs specified in “Hardware Specifications and Configurations” on page 16.
3. Turn off the power and remove the cover to inspect the connections to the ODD. See “Disassembly Process” on page 42.
  - a. Check for broken connectors on the drive, motherboard, and cables.
  - b. Check for bent or broken pins on the drive, motherboard, and cable connections.
  - c. Try an alternate cable, if available. If the drive works with the new cable, the original cable should be replaced.
4. Reseat the drive ensuring and all cables are connected correctly.
5. Replace the ODD. See “Disassembly Process” on page 42.

### Drive Read Failure

If discs cannot be read when inserted in the drive, perform the following actions one at a time to correct the problem.

1. Remove and clean the failed disc.
2. Retry reading the CD or DVD.
  - d. Test the drive using other discs.
  - e. Play a DVD movie
  - f. Listen to a music CD

If the ODD works properly with alternate discs, the original disc is probably defective and should be replaced.

3. Turn off the power and remove the cover to inspect the connections to the ODD. See “Disassembly Process” on page 42.
  - a. Check for broken connectors on the drive, motherboard, and cables.
  - b. Check for bent or broken pins on the drive, motherboard, and cable connections.
  - c. Try an alternate cable, if available. If the drive works with the new cable, the original cable should be replaced.
4. Replace the ODD. See “Disassembly Process” on page 42.



# USB Failure (Rightside)

If the rightside **USB** port fails, perform the following actions one at a time to correct the problem. Do not replace a non-defective FRUs:

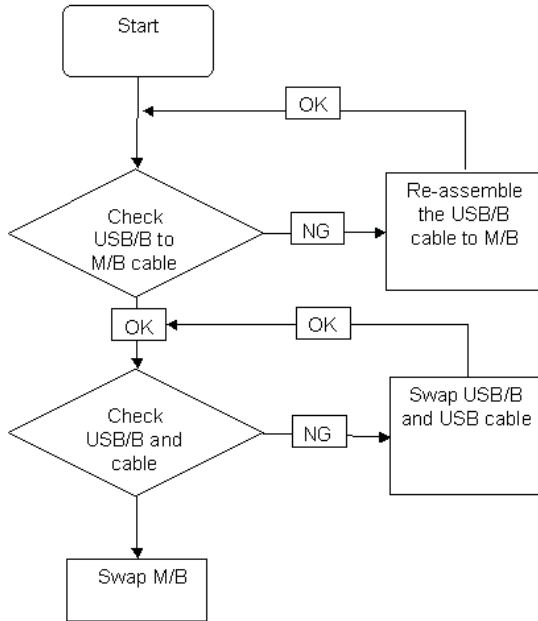

# Modem Function Failure

If the internal **Modem** fails, perform the following actions one at a time to correct the problem. Do not replace a non-defective FRUs:

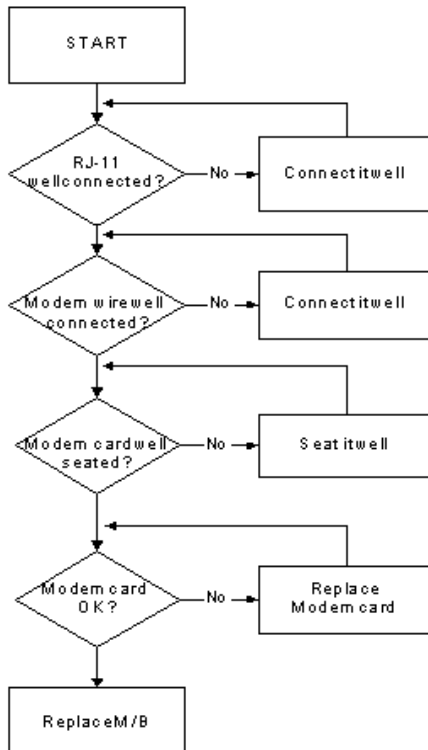

# Wireless Function Failure

If the **WLAN** fails, perform the following actions one at a time to correct the problem. Do not replace a non-defective FRUs:

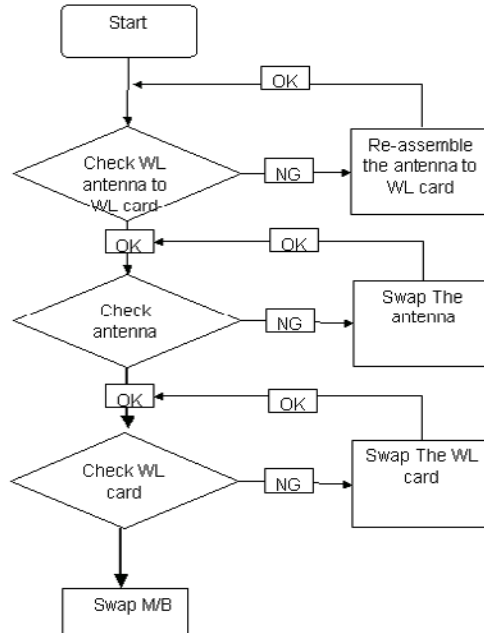

# EasyTouch Button Failure

If the **Acer EasyTouch** buttons fail, perform the following actions one at a time to correct the problem. Do not replace a non-defective FRUs:

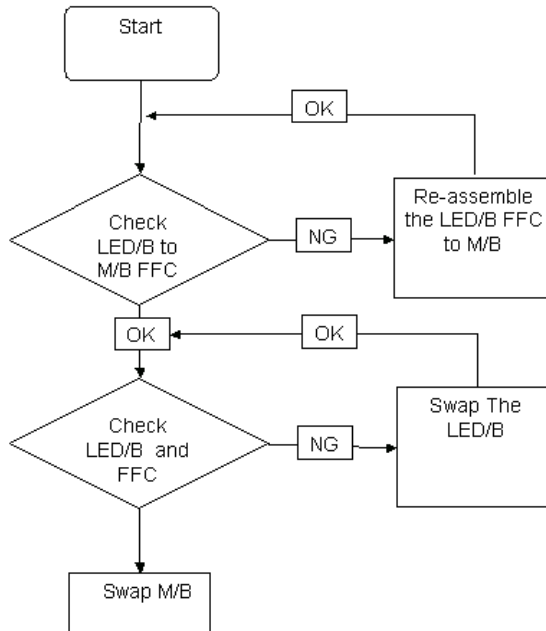

# MediaTouch Button Failure

If the **Acer MediaTouch** buttons fail, perform the following actions one at a time to correct the problem. Do not replace a non-defective FRUs:

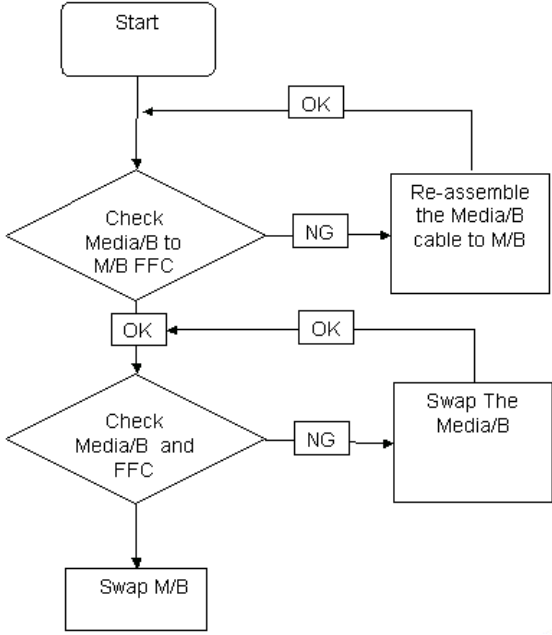

# Fingerprint Reader Failure

If the **Fingerprint Reader** fails, perform the following actions one at a time to correct the problem. Do not replace a non-defective FRUs:

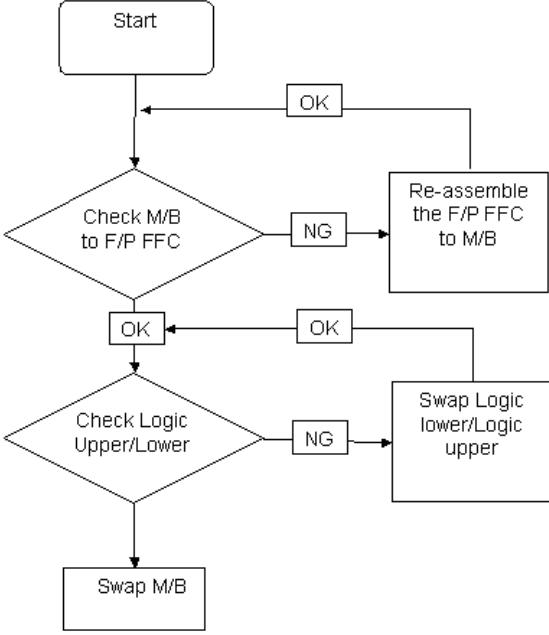

# Thermal Unit Failure

If the **Thermal Unit** fails, perform the following actions one at a time to correct the problem. Do not replace a non-defective FRUs:

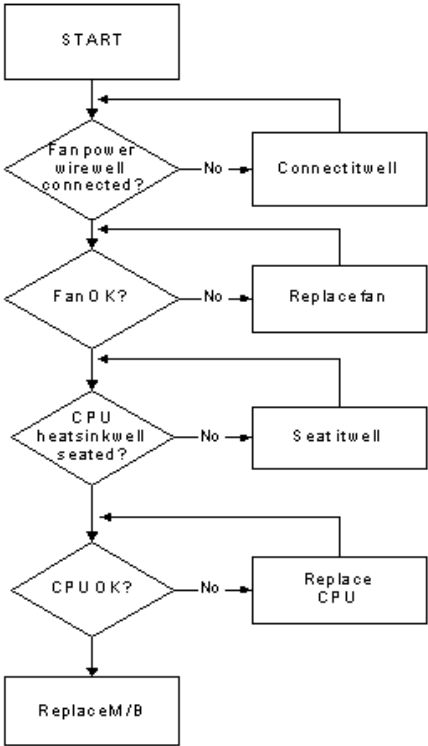

# HDTV Switch Failure

If the **HDTV Switch** fails, perform the following actions one at a time to correct the problem. Do not replace a non-defective FRUs:

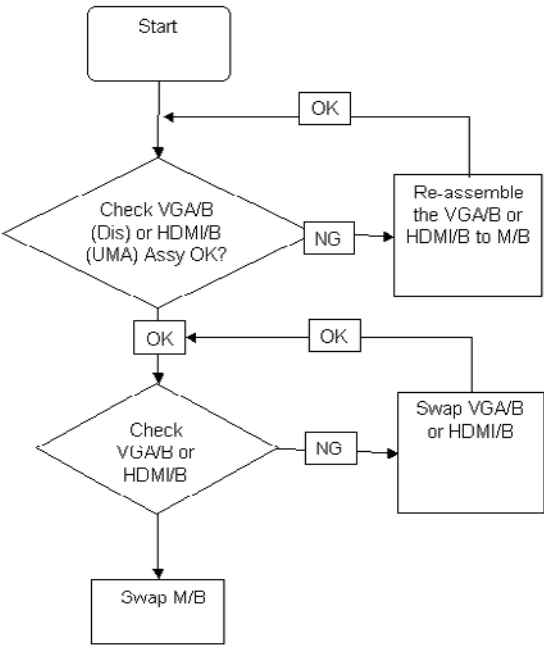

---

## External Mouse Failure

If an external **Mouse** fails, perform the following actions one at a time to correct the problem.

1. Try an alternative mouse.
2. If the mouse uses a wireless connection, insert new batteries and confirm there is a good connection. See the mouse user manual.
3. If the mouse uses a USB connection, try an alternate USB port.
4. Try an alternative program to verify mouse operation. Reinstall the program experiencing mouse failure.
5. Restart the computer.
6. Remove any recently added hardware and associated software.
7. Remove any recently added software and reboot.
8. Restore system and file settings from a known good date using **System Restore**.

If the issue is not fixed, repeat the preceding steps and select an earlier time and date.

9. Run the Event Viewer to check the events log for errors. For more information see Windows Help and Support.
10. Roll back the mouse driver to the previous version if updated recently.
11. Remove and reinstall the mouse driver.
12. Check the Device Manager to determine that:
  - The device is properly installed. There are no red Xs or yellow exclamation marks.
  - There are no device conflicts.
  - No hardware is listed under Other Devices.
13. If the Issue is still not resolved, see "Online Support Information" on page 235.

## Other Failures

If the CRT Switch, Dock, LAN Port, external MIC or Speakers, PCI Express Card, 5-in-1 Card Reader or Volume Wheel fail, perform the following general steps to correct the problem. Do not replace a non-defective FRUs:

1. Check Drive whether is OK.
2. Check Test Fixture is ok.
3. Swap M/B to Try.

---

# Intermittent Problems

Intermittent system hang problems can be caused by a variety of reasons that have nothing to do with a hardware defect, such as: cosmic radiation, electrostatic discharge, or software errors. FRU replacement should be considered only when a recurring problem exists.

When analyzing an intermittent problem, do the following:

1. Run the advanced diagnostic test for the system board in loop mode at least 10 times.
2. If no error is detected, do not replace any FRU.
3. If any error is detected, replace the FRU. Rerun the test to verify that there are no more errors.

# Undetermined Problems

The diagnostic problems does not identify which adapter or device failed, which installed devices are incorrect, whether a short circuit is suspected, or whether the system is inoperative.

Follow these procedures to isolate the failing FRU (do not isolate non-defective FRU).

**NOTE:** Verify that all attached devices are supported by the computer.

**NOTE:** Verify that the power supply being used at the time of the failure is operating correctly. (See “Power On Issue” on page 126.):

1. Power-off the computer.
2. Visually check them for damage. If any problems are found, replace the FRU.
3. Remove or disconnect all of the following devices:
  - Non-Acer devices
  - Printer, mouse, and other external devices
  - Battery pack
  - Hard disk drive
  - DIMM
  - CD-ROM/Diskette drive Module
  - PC Cards
4. Power-on the computer.
5. Determine if the problem has changed.
6. If the problem does not recur, reconnect the removed devices one at a time until you find the failing FRU.
7. If the problem remains, replace the following FRU one at a time. Do not replace a non-defective FRU:
  - System board
  - LCD assembly



---

# POST Codes Tables

These tables describe the POST codes, drivers, and keys for the POST.

## Port 80 POST Codes

The following table details the Port 80 POST codes and drivers used in the POST.

Driver Name	Port 80 Code	Driver Name	Port 80 Code
PeiEventLog	01	Cpulo	3E
OemServices	02	Cf9Reset	3F
Siolnit	03	PcRtc	40
MonoStatusCode	04	StatusCode	41
PentiumMCpuPeim	08	Variable	42
PlatformStage1	09	SmmVariable	CF
Variable	0A	EmuVariable	43
IchInit	0B	TcgDxe	A2
PlatformStage2	0D	PhysicalPresence	A3
IchSmbusArpDisabled	0E	TpmDriver	AE
ClockGen	12	TcgSmm	AE
OpPresence	13	PhysicalPresenceReadyToBoot	AE
TcgPei	14	DataHubRecordPolicy	AD
FindFv	15	Undi	86
DxeIpl	2F	SNP	90
LightMemoryInit	10	BC	91
S3ResumeSoftSmi	11	PxeDhcp4	92
Crc32SectionExtract	31	Ebc	93
OemServices	A4	IsaBus	4D
EventLog	A5	IsaSerial	4E
ScriptSave	32	Ps2Mouse	6D
AcpiS3Save	33	IdeBus	4F
SmartTimer	34	LightPciBus	50
JpegDecoder	35	UsbBot	6E
PcxDecoder	36	UsbCbi0	6F
PlatformBds	8A	UsbCbi1	70
MpCpu	37	UsbKb	71
LegacyMetronome	38	UsbMassStorage	72
FtwLite	39	UsbMouse	74
Runtime	3A	Ehci	8F
MonotonicCounter	3B	Uhci	73
WatchDogTimer	3C	UsbBus	75
SecurityStub	3D	SmmBase	C2

Driver Name	Port80 Code	Driver Name	Port80 Code
SmmDisp	C5	HiiDatabase	80
SmmReloc	C4	OemSetupBrowser	82
SmmRuntime	C7	Font(English)	7E
SmmThunk	C9	Font(French)	7F
OemServices	D8	Font(Chinese)	8D
ChipsetInit	44	UnicodeCollation	B1
SmmAccess	C0	ConPlatform	5A
PciHostBridge	46	ConSplitter	5D
PciExpress	47	GraphicsConsole	79
GmchMbi	CD	Terminal	7A
IchInit	48	VgaClass	5E
IdeController	49	SaveMemoryConfig	5B
SataController	4A	AcpiSupport	5C
IchSmbusLight	4B	AcpiPlatform	53
SmmControl	C1	DataHub	5F
Ich7MSmmDispatcher	C8	DataHubStdErr	7B
IsaAcpiDriver	4C	GenericMemoryTest	61
Fwh	52	Disklo	60
SmmFwh	CE	Fat	7C
PciHotPlug	54	Partition	7D
BootOptionPolicy	51	PciPlatform	6B
SetupUtility	76	AlertStandardForma	45
Platform	55	PciSerial	A8
PlatformIde	56	AsfInit	A7
Ppm	D9	IdeRController	A9
Platform	CC	Legacy8259	63
lhis	D0	LegacyRegion	64
SetupMouse	f9	LegacyInterrupt	65
Int15Microcode	D1	BiosKeyboard	66
SmmPnp	D2	BiosVideo	67
Smbios	57	MonitorKey	68
MemorySubClass	58	LegacyBios	69
MiscSubclassDriver	59	LegacyBiosPlatform	6A
SysPassword	AB	LegacyMouse	77
PswdConsole	AC	SmmUsbLegacy	78
HddPswdServiceBody	D7	AmbtXInvoke	AA
HddPswdService	A6	OemBadgingSupport	83

---

## POST Keys and Messages

The following keys are available during POST.

Key	Function
F2	Enter into Setup Menu
F12	Enter into Boot Manager

The following messages display during POST:

Before press function key
CPUID: XXXXXX Press F2 go to Setup Utility Press F12 go to Boot Manager Press [PXE HOT KEY] go to PXE Setup Menu

After press function key
If user pressed F2 CPUID: XXXXXX F2 is pressed. Go to Setup Utility.
If user pressed F12 CPUID: XXXXXX F12 is pressed. Go to Boot Manager.
If user didn't press any key CPUID: XXXXXX Prepare Boot to OS
If user pressed PXE HOT KEY CPUID: XXXXXX [PXE HOT KEY] is pressed. Go to PXE Setup Menu.



# Jumper and Connector Locations

---

## Top View

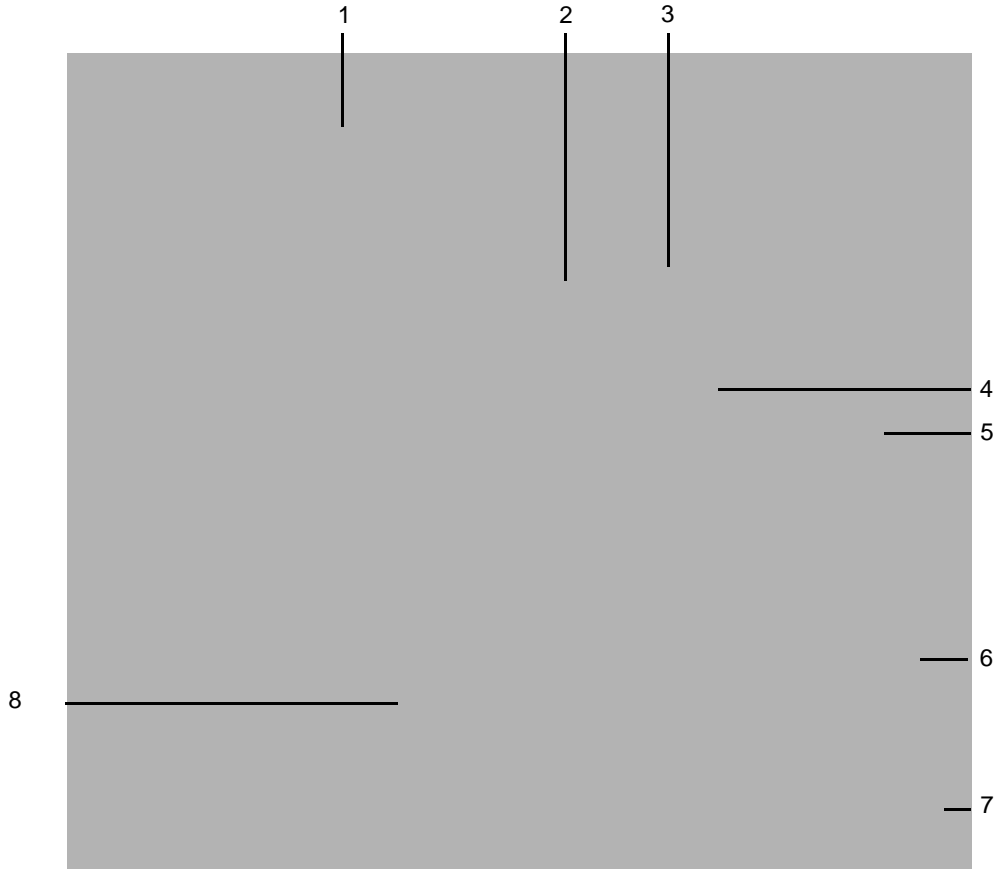

No.	Description	No.	Description
1	LCD Connector	5	MDC Connector
2	Powerboard Connector	6	ExpressCard Board Connector
3	Keyboard Connector	7	BLuetooth Connector
4	DDR3 Connector	8	PCMCIA Connector

# Bottom View

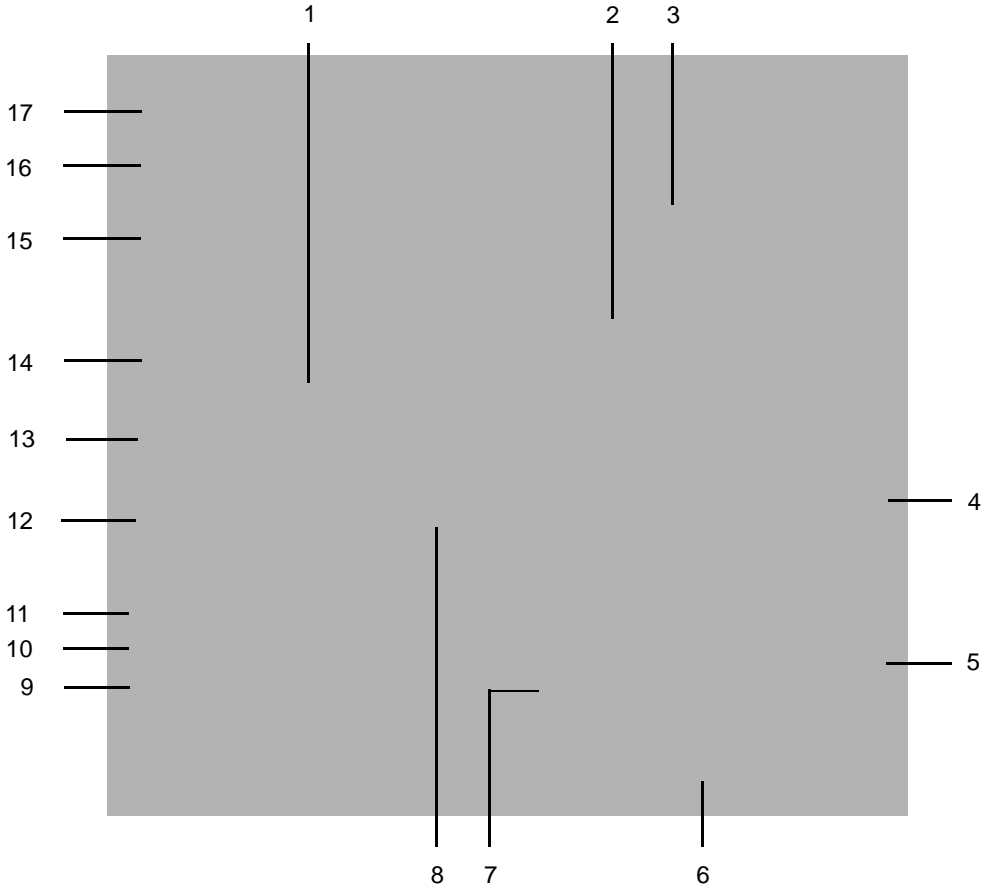

No.	Description	No.	Description
1	CPU Socket	10	Audio Connector
2	DDR2 Connector	11	SPDIF Connector
3	Battery Connector	12	USB Connector
4	ODD Connector	13	HDMI Connector
5	HDD Connector	14	CRT Connector
6	Card Reader Connector	15	Docking Connector
7	HDD Connector	16	RJ 45
8	MXM Connector	17	DC Jack
9	Audio Connector		

---

# Clearing Password Check and BIOS Recovery

This section provide you the standard operating procedures of clearing password and BIOS recovery for Aspire 2930. Aspire 2930 provide one Hardware Open Gap on main board for clearing password check, and one Hotkey for enabling BIOS Recovery.

## Clearing Password Check

### Hardware Open Gap Description

Item	Description
CLRP2	Clear CMOS Jumper

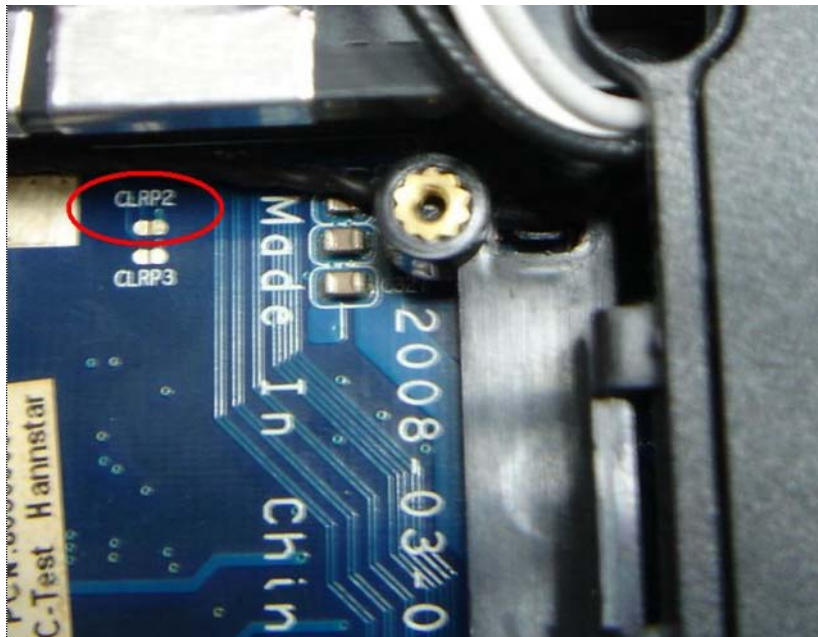

### Steps for Clearing BIOS Password Check

If users set BIOS Password (Supervisor Password and/or User Password) for a security reason, BIOS will ask the password during systems POST or when systems enter to BIOS Setup menu. However, once it is necessary to bypass the password check, users need to short the HW Gap to clear the password by the following steps:

- Power Off a system, and remove HDD, AC and Battery from the machine.
- Open the back cover of the machine, and find out the HW Gap on M/B as picture.
- Use an electric conductivity tool to short the two points of the HW Gap.
- Plug in AC, keep the short condition on the HW Gap, and press Power Button to power on the system till BIOS POST finish. Then remove the tool from the HW Gap.
- Restart system. Press F2 key to enter BIOS Setup menu.
- If there is no Password request, BIOS Password is cleared. Otherwise, please follow the steps and try again.

**NOTE:** The steps are only for clearing BIOS Password (Supervisor Password and User Password).



---

# BIOS Recovery by Crisis Disk

## BIOS Recovery Boot Block:

BIOS Recovery Boot Block is a special block of BIOS. It is used to boot up the system with minimum BIOS initialization. Users can enable this feature to restore the BIOS firmware to a successful one once the previous BIOS flashing process failed.

## BIOS Recovery Hotkey:

The system provides a function hotkey: **Fn+Esc**, for enable BIOS Recovery process when system is powered on during BIOS POST. To use this function, it is strongly recommended to have the AC adapter and Battery present. If this function is enabled, the system will force the BIOS to enter a special BIOS block, called Boot Block.

## Steps for BIOS Recovery from USB Storage:

Before doing this, prepare the Crisis USB key. The Crisis USB key could be made by executing the Crisis Disk program in another system with Windows XP OS.

Follow the steps below:

1. Save ROM file (file name: **JAT10x64.fd**) to the root directory of USB storage.
2. Plug USB storage into USB port.
3. Press **Fn + ESC** button then plug in AC.  
The Power button flashes once.
4. Press **Power** button to initiate system CRISIS mode.  
When CRISIS is complete, the system auto restarts with a workable BIOS.
5. Update the latest version BIOS for this machine by regular BIOS flashing process.

# FRU (Field Replaceable Unit) List

---

This chapter gives you the FRU (Field Replaceable Unit) listing in global configurations of Aspire 2930. Refer to this chapter whenever ordering for parts to repair or for RMA (Return Merchandise Authorization).

Please note that WHEN ORDERING FRU PARTS, you should check the most up-to-date information available on your regional web or channel. For whatever reasons a part number change is made, it will not be noted on the printed Service Guide. For ACER AUTHORIZED SERVICE PROVIDERS, your Acer office may have a DIFFERENT part number code from those given in the FRU list of this printed Service Guide. You MUST use the local FRU list provided by your regional Acer office to order FRU parts for repair and service of customer machines.

NOTE: To scrap or to return the defective parts, you should follow the local government ordinance or regulations on how to dispose it properly, or follow the rules set by your regional Acer office on how to return it.

# Aspire 2930 Exploded Diagrams

## Upper/ Lower Cover

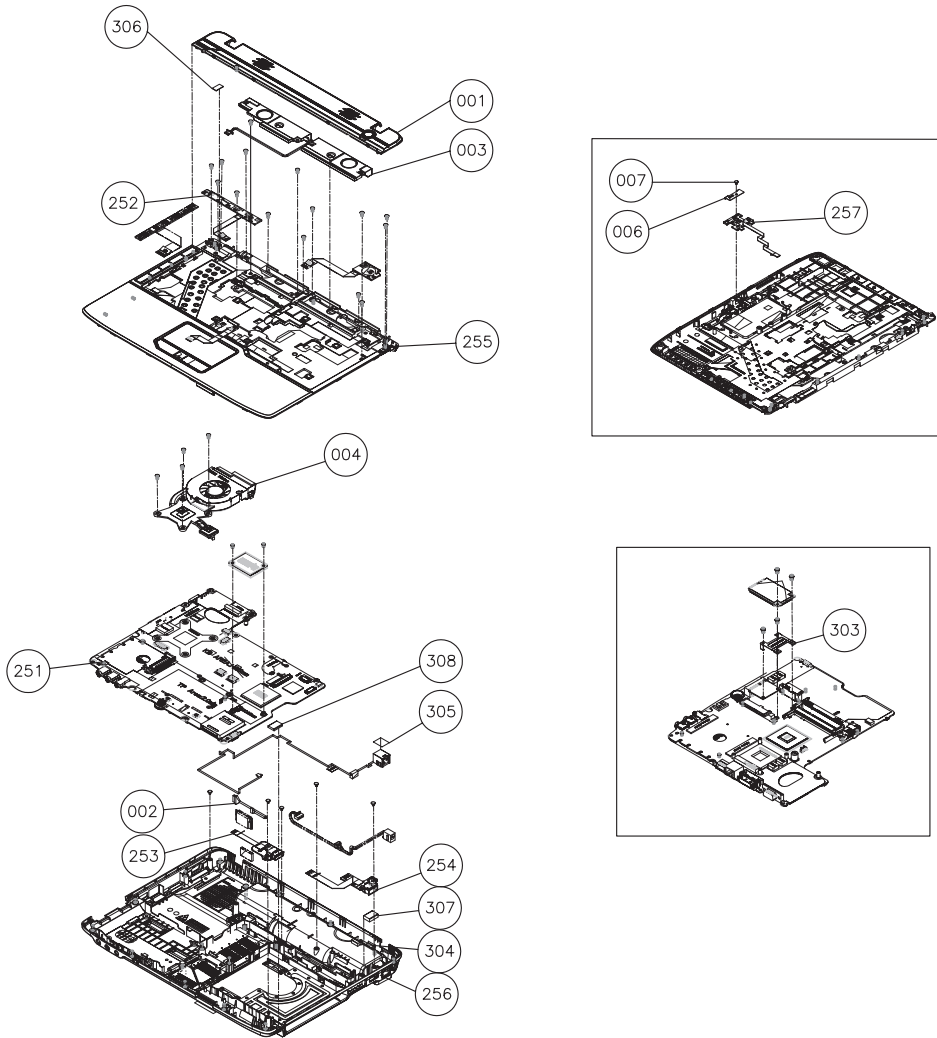

No.	Description	Part Number	No.	Description	Part Number
001	Strip Cover	42.ART02.001	255	Upper Case	60.APY02.001
002	RJ-11 Module	50.ART02.004	256	Lower Case	60.ART02.002
003	Speaker	23.ART02.001	257	F/P Board	55.APY02.001
004	Thermal Unit	60.ART02.006	303	MINI_EXP_CARD_BRK	33.ART02.001
006	ROBIN_THM_ADDA_3PH ASE_FAN	N/A	304	SPEAKER_GASKET	N/A
007	ROBIN_THM_SUNON_3P HASE_FAN	N/A	305	RJ11_GASKET	N/A
251	Mainboard w/dock Mainboard wo/dock	MB.ART02.001 MB.ART02.001	306	EMI_LOGIC_UP_FOIL_2	N/A
252	E Button Board	55.ART02.001	307	IO_USB_GASKET	N/A
253	USB Board	55.ART02.005	308	USB_GASKET	N/A
254	I/O Board	55.ART02.004			

# LCD Panel

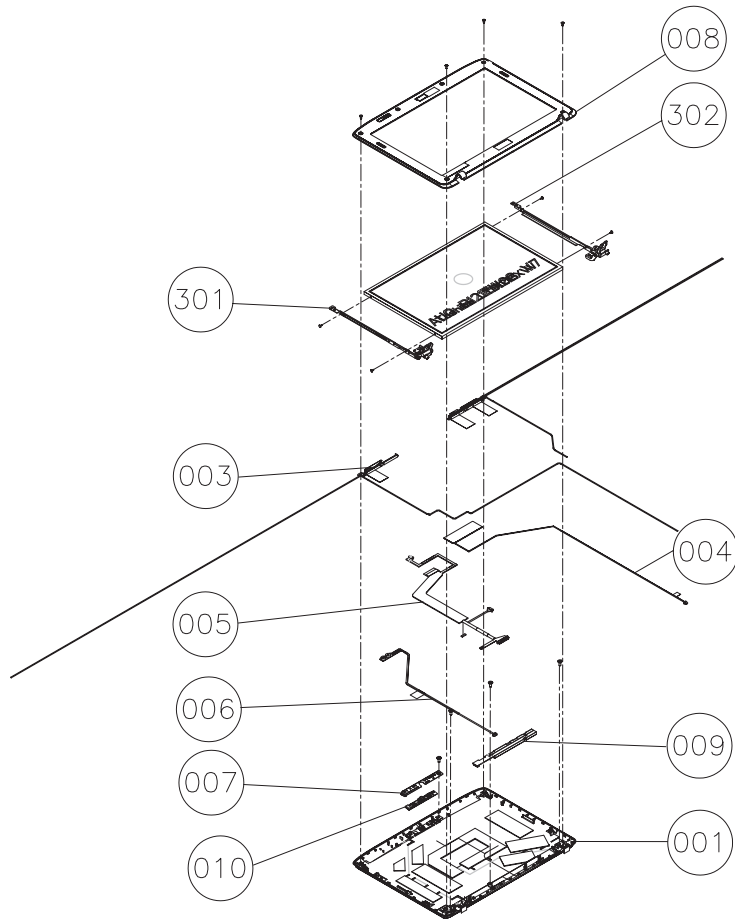







Number	Description	Part Number
001	LCD_COVER_SUB_ASSY	60.ART02.004
003	ANTENNA	50.ART02.001
004	H-CONN SET 043 LOGO BACK LIGHT	N/A
005	M/B-LCD Cable	50.ART02.006
006	MIC SET	23.ART02.002
007	LCD_CAMERA_BRK_ASSY	33.ART02.006
008	LCD_BEZEL_SUB_ASSY	60.ART02.005
009	INVERTER	19.ART02.001
010	CAMERA Module	57.ART02.001
301	HINGE_L	33.ART02.005
302	HINGE_R	33.ART02.004

## Aspire 2930 FRU List

Category	Description	Acer PN
<b>Adapter</b>		
	ADAPTER 65W 3PIN DELTA SADP-65KB	AP.06501.013
	ADAPTER 65W 3PIN SADP-65KB BFJA OBL DELTA	AP.06501.014
	ADAPTER 65W 3PIN LITEON PA-1650-02AC	AP.06503.016
	ADAPTER 65W 3PIN HIPRO AC-OK065B13	AP.0650A.010
<b>Battery</b>		
	BATTERY LI-ION 6CELLS 4.4KMAH SANYO 3S2P 4.4AH 7 043 0FA	BT.00603.041
	BATTERY LI-ION 6CELLS 4.4KMAH SONY 3S2P 4.4AH 7 043 0FA	BT.00604.024
	BATTERY LI-ION 6CELLS 4.4KMAH SIMPLO 3S2P 4.4AH 7 043 0FA	BT.00607.015
	BATTERY LI-ION 6CELLS 4.4KMAH PANASONIC 3S2P 4.4AH 7 043 0FA	BT.00605.020
<b>Board</b>		
	BLUETOOTH BOARD	54.ART02.001
	MODEM BOARD	54.ART02.002
	E BUTTON BOARD	55.ART02.001
	POWER BOARD	55.ART02.002
	FUNCTION BOARD	55.ART02.003
	FINGER PRINT BOARD	55.APY02.001

Category	Description	Acer PN
	IO BOARD	55.ART02.004
	USB BOARD	55.ART02.005
	WLAN CARD 802.11BG BCM4312 FOXCONN	NI.23600.029
	WLAN CARD 802.11BG T60H976.00 FOXCONN	TBD
	WLAN CARD INTEL 802.11ABGN 533AN_MMWG S/ MOW895362	KI.SPM01.001
	HALF WLAN CARD INTEL 802.11ABGN 533AN_HMWG S/MOW895401	KI.SPH01.001
	WLAN CARD INTEL 802.11ABGN 512AN_MMWG S/ MOW895361 NON-FCC/IC	KI.SPM01.006
	HALF WLAN CARD INTEL 802.11ABGN 512AN_HMWG S/MOW895373	KI.SPH01.003
	WLAN CARD INTEL 802.11ABGN WIMAX_MD 533ANXMMWG MOW895365	KI.EPM01.001
	WLAN CARD INTLE 802.11ABGN WIMAX_MD 512ANXMMWG MOW895364	KI.EPM01.003
<b>Cable</b>		
	ANTENNA-R (3*3)	50.ART02.001
	ANTENNA-R (1*2) ANTENNA-L	50.ART02.007
	ANTENNA-L	50.ART02.002
	BLUE TOOTH CABLE	50.ART02.003
	RJ11 CABLE	50.ART02.004

Category	Description	Acer PN
	T/P FFC	50.ART02.005
	POWER CORD US 3 PIN	27.TAVV5.001
	POWER CORD EU 3 PIN	27.TAVV5.002
	POWER CORD AUS 3 PIN	27.TAVV5.003
	POWER CORD UK 3 PIN	27.TAVV5.004
	POWER CORD CHINA 3 PIN	27.TAVV5.005
	POWER CORD SWISS 3 PIN	27.TAVV5.006
	POWER CORD ITALIAN 3 PIN	27.TAVV5.007
	POWER CORD DENMARK 3 PIN	27.TAVV5.008
	POWER CORD JP 3 PIN	27.TAVV5.009
	POWER CORD SOUTH AFRICA 3 PIN	27.TAVV5.010
	POWER CORD KOERA 3 PIN	27.TAVV5.011
	POWER CORD ISRAEL 3 PIN	27.TAVV5.012
	POWER CORD INDIA 3 PIN	27.TAVV5.013
	POWER CORD TWN 3 PIN	27.TAVV5.014
POWER CORD ARGENTINA 3 PIN	27.APV02.001	
<b>Case/Cover/Bracket/Assembly</b>		
	MIDDLE COVER	42.ART02.001
	UPPER CASE ASSY W/FP	60.APY02.001
	UPPER CASE ASSY W/O FP	60.ART02.001
	LOWER CASE ASSY W/ DOCKING	60.ART02.002
	LOWER CASE ASSY W/O DOCKING	60.ART02.003
	FINGER PRINT BOARD BRACKET	42.APY02.001
	T/P BRACKET	42.ART02.002





Category	Description	Acer PN
	MINI CARD DOOR	42.ART02.003
	RAM DOOR	42.ART02.004
	MINI PCI BRACKET-S	33.ART02.001
	EXPRESS DUMMY CARD	42.ART02.005
	SD DUMMY CARD	42.ART02.006
<b>CPU/Processor</b>		
	CPU INTEL P9500 2.53G AW80576SH0616M SLB4E C0	KC.95001.DPP
	CPU INTEL T9400 2.53G AW80576GH0616M SLB46 C0	KC.94001.DTP
	CPU INTEL P8600 2.4G AW80577SH0563M SLB3S M0	KC.86001.DPP
	CPU INTEL P8400 2.26G AW80577SH0513M SLB3R M0	KC.84001.DPP
	CPU INTEL P7350 2G AW80577SH0413M SLB53 M0	KC.73501.DPP
	CPU INTEL PENRYN C2DT9600 2.8G AW80576GH0726M SLB47 C0	KC.96001.DTP
	CPU INTEL PMDT3200 2G LF80537GF0411M SLAVG M0	KC.32001.DTP
	CPU INTEL PMDT3400 2.16G LF80537GF0481M SLB3P M0	KC.34001.DTP
	CPU INTEL T5800 2.0G LF80537GG041F SLB6E M0	KC.58001.DTP
	CPU INTEL T5900 2.2G LF80537GG049F SLB6D M0	KC.59001.DTP

Category	Description	Acer PN
<b>Combo Drive</b>		
	DVD/CDRW COMBO DRIVE MODULE	6M.ART02.003
	DVD/CDRW COMBO DRIVE TOSHIBA/TSST	TBD
	DVD/CDRW COMBO DRIVE SONY	TBD
	ODD BEZEL-COMBO	42.ART02.009
	ODD BRACKET	33.ART02.002
<b>Super Multi Drive</b>		
	DVD SUPER MULTI MODULE TRAY IN	6M.ART02.004
	DVD SUPER MULTI DRIVE HLDS GSA-T50N	KU.0080D.029
	DVD SUPER MULTI DRIVE HLDS GSA-T50N MALAYSIA	KU.0080D.034
	DVD SUPER MULTI DRIVE PIONEER DVR-TD08RS	KU.00805.044
	DVD SUPER MULTI DRIVE PANASONIC UJ-870A	KU.00807.059
	DVD SUPER MULTI DRIVE PLDS DS-8A2S	KU.0080F.001
	ODD BEZEL-SUPER MULTI	42.ART02.007
	ODD BRACKET	33.ART02.002
<b>Blueray Drive</b>		
	BLUE RAY MODULE	6M.ART02.005
	BR-DVD DRIVE SONY BC-5500S	KO.0020E.002
	ODD BEZEL-BR	42.ART02.008
	ODD BRACKET	33.ART02.002

Category	Description	Acer PN
<b>HDD</b>		
	HDD SATA 120G 5400RPM HGST HTS542512K9SA00	KH.12007.014
	HDD SATA 120G 5400RPM TOSHIBA MK1246GSX	KH.12004.007
	HDD SATA 120G 5400RPM SEAGATE ST9120817AS	KH.12001.032
	HDD SATA 120G 5400RPM WD WD1200BEVS-22UST0	KH.12008.019
	HDD SATA 160G 5400RPM HGST HTS542516K9SA00	KH.16007.016
	HDD SATA 160G 5400RPM TOSHIBA MK1646GSX	KH.16004.002
	HDD SATA 160G 5400RPM SEAGATE ST9160827AS	KH.16001.029
	HDD SATA 160G 5400RPM WD WD1600BEVT-22ZCT0	KH.16008.022
	HDD SATA 250G 5400RPM HGST HTS542525K9SA00	KH.25007.011
	HDD SATA 250G 5400RPM TOSHIBA MK2546GSX	KH.25004.001
	HDD SATA 250G 5400RPM SEAGATE ST9250827AS	KH.25001.011
	HDD SATA 250G 5400RPM WD WD2500BEVS-22UST0	KH.25008.018
	HDD SATA 320G 5400RPM WD WD3200BEVT-22ZCT0	KH.32008.013
	HDD BRACKET	33.ART02.003
<b>Keyboard</b>		
	KEYBOARD INTE(UI)	KB.INT00.406
	KEYBOARD ARABIC(ARE)	KB.INT00.438
	KEYBOARD BELGIAN(BE)	KB.INT00.437
	KEYBOARD Brazil Portuguese (BZ)	KB.INT00.436
	KEYBOARD CANADIAN(CF)	KB.INT00.435
	KEYBOARD Chinese (CH)	KB.INT00.434
	KEYBOARD CZECH(CZ)	KB.INT00.433
	KEYBOARD DANISH(DM)	KB.INT00.432
	KEYBOARD DUTCH(NL)	KB.INT00.431
	KEYBOARD FRENCH(FR)	KB.INT00.429
	KEYBOARD GERMAN(GR)	KB.INT00.428
	KEYBOARD GREEK(GK)	KB.INT00.427
	KEYBOARD HUNGARIAN(HG)	KB.INT00.426
	KEYBOARD ITALIAN(IT)	KB.INT00.423
	KEYBOARD KOREA(KO)	KB.INT00.421
	KEYBOARD NORWEGIAN(NW)	KB.INT00.419
	KEYBOARD PORTUGAL(PO)	KB.INT00.417
	KEYBOARD RUSSIAN(RU)	KB.INT00.416
	KEYBOARD Slovenia/CROATIAN(SA/CR)	KB.INT00.415
	KEYBOARD SLOVAK(SV)	KB.INT00.414
KEYBOARD SPANISH(SP)	KB.INT00.413	
KEYBOARD SWEDISH(SD/FN)	KB.INT00.412	

Category	Description	Acer PN
	KEYBOARD SWISS(SW)	KB.INT00.411
	KEYBOARD THAI(TI)	KB.INT00.410
	KEYBOARD TURKISH(TR)	KB.INT00.409
	KEYBOARD UK	KB.INT00.408
	KEYBOARD HEBREW(HB)	KB.INT00.407
	KEYBOARD JP	KB.INT00.422
	KEYBOARD Scandinavian (ND)	KB.INT00.440
	KEYBOARD Arabic_French (AR/FR)	KB.INT00.439
	KEYBOARD French_Canadian (CB)	KB.INT00.441
	KEYBOARD CZECH_SLOVAK(CZ/SK)	KB.I1200.001
<b>LCD</b>		
	ASSY LCD MODULE 12.1 IN. WXGA GLARE FOR CCD 0.3M	6M.ART02.001
	LCD PANEL G 12.1 WXGAG TOSHIBA LTD121EXVV-V01 new glass	LK.1210F.019
	LCD PANEL G 12.1 WXGAG TOSHIBA LTD121EXVV-V01 LF 200nit 30ms HW:3	LK.1210F.016
	LCD PANEL G 12.1 WXGAG AUO B121EW03	LK.12105.012
	INVERTER BOARD	19.ART02.001
	LCD CABLE	50.ART02.006
	LCD COVER	60.ART02.004
	LCD BEZEL	60.ART02.005
	LCD BRACKET-R	33.ART02.004
	LCD BRACKET-L	33.ART02.005
	CAMERA 0.3M	57.ART02.001
	CAMERA SUPPORT BRACKET	33.ART02.006
	SCREW PAD	47.ART02.001

Category	Description	Acer PN
	ASSY LCD MODULE 12.1 IN. WXGA GLARE FOR CCD 1.0M	6M.ART02.002
	LCD PANEL G 12.1 WXGAG TOSHIBA LTD121EXVV-V01 HW:4 new glass	LK.1210F.019
	LCD PANEL G 12.1 WXGAG TOSHIBA LTD121EXVV-V01 LF 200nit 30ms HW:3	LK.1210F.016
	LCD PANEL G 12.1 WXGAG AUO B121EW03	LK.12105.012
	INVERTER	19.ART02.001
	LCD CABLE	50.ART02.006
	LCD COVER	60.ART02.004
	LCD BEZEL	60.ART02.005
	LCD BRACKET-R	33.ART02.004
	LCD BRACKET-L	33.ART02.005
	CAMERA 1.0M	57.ART02.002
	CAMERA SUPPORT BRACKET	33.ART02.006
	SCREW PAD	47.ART02.001
<b>Mainboard</b>		
	Mainboard AS2930 UMA Intel GM45 ICH9 w/ Docking	MB.ART02.001
	Mainboard AS2930 UMA Intel GM45 ICH9 w/o Docking	MB.ART02.002
	Mainboard AS2930Z/AS2430 Intel GL40 ICH9 LF	MB.ARU02.001

Category	Description	Acer PN
<b>Memory</b>		
	RAM 512MB DDRII 667 HYNIX HYMP164S64CP6-Y5 LF	KN.5120G.024
	RAM 512MB DDRII 667 SAMSUNG M470T6464QZ3-CE6 LF	KN.5120B.026
	RAM 1GB DDRII 667 HYNIX HYMP112S64CP6-Y5 LF	KN.1GB0G.012
	RAM 1GB DDRII 667 SAMSUNG M470T2864QZ3-CE6 LF	KN.1GB0B.016
	RAM 1GB DDRII 667 NANYA NT1GT64U8HB0BN-3C (0.09U)	KN.1GB03.014
	RAM 1GB DDRII 667 MICRON MT8HTF12864HDY-667E1 LF	KN.1GB04.001
	RAM 2GB DDRII 667 HYNIX HYMP125S64CP8-Y5 LF	KN.2GB0G.004
	RAM 2GB DDRII 667 SAMSUNG M470T5663QZ3-CE6 LF	KN.2GB0B.003
	RAM 2GB DDRII 667 MICRON MT16HTF25664HY-667E1	KN.2GB04.001
<b>Heatsink</b>		
	CPU THERMAL MODULE	60.ART02.006
<b>Speaker</b>		
	SPEAKER R & L	23.ART02.001
	DIGITAL MIC SET	23.ART02.002
<b>Miscellaneous</b>		
	NAME PLATE-AS2930	47.ART02.002
	NAME PLATE-AS2430	TBD

## Screw List

Category	Description	Acer P/N
<b>Screw</b>		
	M2*3	86.ART02.001
	M2*4	86.ART02.002
	M2.5*4	86.ART02.003
	M2.5*5	86.ART02.004
	M2.5*8	86.ART02.005
	M3*5	86.ART02.006
	M3*3	86.ART02.007





# Model Definition and Configuration

## Aspire 2930 Series

Model	RO	Country	Acer Part No	Description	CPU
AS2930-842G25Mn	AAP	Thailand	LX.APY0X.014	AS2930-842G25Mn EM VHP32ATTH1 MC UMACOF 1*2G/ 250/BT/6L/5R/ CB_n2_FP_1.0D_HG_TH22	C2DP8400
AS2930-862G32Bn	AAP	Thailand	LX.APY0X.015	AS2930-862G32Bn EM VHP32ATTH1 MC UMACOF 1*2G/ 320/BT/6L/5R/ CB_n3_FP_1.0D_HG_TH22	C2DP8600
AS2930-842G25Mn	AAP	Thailand	LX.APY0X.013	AS2930-842G25Mn EM VHP32ATTH1 MC UMACOF 1*2G/ 250/BT/6L/5R/ CB_n3_FP_1.0D_HG_TH22	C2DP8400
AS2930-862G32Mn	AAP	Vietnam	LX.APY0X.019	AS2930-862G32Mn EM VHP32ATVN1 MC UMACOF 2*1G/ 320/BT/6L/5R/ CB_n3_FP_1.0D_HG_EN13	C2DP8600
AS2930-842G25Mn	AAP	Malaysia	LX.APY0X.016	AS2930-842G25Mn EM VHP32ATMY1 MC UMACOF 1*2G/ 250/BT/6L/5R/ CB_n2_FP_1.0D_HG_EN14	C2DP8400
AS2930-942G32Mn	TWN	GCTWN	LX.APY0X.017	AS2930-942G32Mn VHP32ATTW1 MC UMACOF 1*2G/320/BT/6L/5R/ CB_n2_FP_1.0D_HG_TC11	C2DT9400
AS2930-842G32Mn	AAP	Thailand	LX.APY0X.020	AS2930-842G32Mn EM VHP32ATTH1 MC UMACOF 1*2G/ 320/BT/6L/5R/ CB_n3_FP_1.0D_HG_TH22	C2DP8400
AS2930-732G16Mn	AAP	Philippines	LX.APY0X.092	AS2930-732G16Mn EM VHP32ATPH1 MC UMACOF 2*1G/ 160/BT/6L/5R/ CB_n2_FP_1.0D_HG_EN14	C2DP7350
AS2930-842G25Mn	AAP	Philippines	LX.APY0X.093	AS2930-842G25Mn EM VHP32ATPH1 MC UMACOF 2*1G/ 250/BT/6L/5R/ CB_n2_FP_1.0D_HG_EN14	C2DP8400
AS2930-862G25Mn	AAP	Philippines	LX.APY0X.094	AS2930-862G25Mn EM VHP32ATPH1 MC UMACOF 2*1G/ 250/BT/6L/5R/ CB_n2_FP_1.0D_HG_EN14	C2DP8600
AS2930-843G25Mn	EMEA	Germany	LX.APY0X.091	AS2930-843G25Mn VHP32ATDE1 MC UMACOF 2G+1G/250/BT/6L/5R/ CB_n2_FP_1.0D_HG_DE13	C2DP8400
AS2930-733G32Mn	EMEA	France	LX.APY0X.098	AS2930-733G32Mn VHP32ATFR1 MC UMACOF 2G+1G/320/6L/5R/ CB_n2_FP_1.0D_HG_FR23	C2DP7350
AS2930-733G25Mn	EMEA	France	LX.APY0X.097	AS2930-733G25Mn VHP32ATFR1 MC UMACOF 2G+1G/250/6L/5R/ CB_n2_FP_1.0D_HG_FR23	C2DP7350

Model	RO	Country	Acer Part No	Description	CPU
AS2930-732G25Mn	EMEA	Germany	LX.APY0X.095	AS2930-732G25Mn VHP32ATDE1 MC UMACOF 1*2G/250/BT/6L/5R/ CB_n2_FP_1.0D_HG_DE13	C2DP7350
AS2930-843G32Mn	EMEA	Germany	LX.APY0X.096	AS2930-843G32Mn VHP32ATDE1 MC UMACOF 2G+1G/320/BT/6L/5R/ CB_n2_FP_1.0D_HG_DE13	C2DP8400
AS2930-734G32Mn	EMEA	Spain	LX.APY0X.103	AS2930-734G32Mn VHP32ATES1 MC UMACOF 2*2G/320/BT/6L/5R/ CB_n2_FP_1.0D_HG_ES22	C2DP7350
AS2930-733G32Mn	EMEA	France	LX.APY0X.100	AS2930-733G32Mn VHP32ATFR1 MC UMACOF 2G+1G/320/BT/6L/5R/ CB_n2_FP_1.0D_HG_FR23	C2DP7350
AS2930-733G32Mn	EMEA	Norway	LX.APY0X.099	AS2930-733G32Mn VHP32ATNO1 MC UMACOF 2G+1G/320/BT/6L/5R/ CB_n2_FP_1.0D_HG_NO12	C2DP7350
AS2930-733G25Mn	EMEA	UK	LX.APY0X.101	AS2930-733G25Mn VHP32ATGB1 MC UMACOF 2G+1G/250/6L/5R/ CB_n2_FP_1.0D_HG_EN14	C2DP7350
AS2930-844G32Mn	EMEA	UK	LX.APY0X.102	AS2930-844G32Mn VHP32ATGB1 MC UMACOF 2*2G/320/6L/5R/ CB_n2_FP_1.0D_HG_EN14	C2DP8400
AS2930-732G25Mn	AAP	Thailand	LX.APY0X.104	AS2930-732G25Mn EM VHP32ATTH1 MC UMACOF 1*2G/ 250/BT/6L/5R/ CB_n2_FP_1.0D_PH_HG_TH22	C2DP7350
AS2930-731G16Mn	AAP	Indonesia	LX.APY0X.105	AS2930-731G16Mn EM VHP32ATID1 MC UMACOF 1*1G/160/BT/6L/5R/ CB_n2_FP_1.0D_HG_ID22	C2DP7350
AS2930-733G25Mn	EMEA	Luxembourg	LX.APY0X.067	AS2930-733G25Mn VHP32ATLU1 MC UMACOF 2G+1G/250/BT/6L/5R/ CB_n2_FP_1.0D_HG_IT42	C2DP7350
AS2930-733G25Mn	EMEA	Norway	LX.APY0X.068	AS2930-733G25Mn VHP32ATNO1 MC UMACOF 2G+1G/250/BT/6L/5R/ CB_n2_FP_1.0D_HG_NO12	C2DP7350
AS2930-733G25Mn	EMEA	Eastern Europe	LX.APY0X.069	AS2930-733G25Mn VHP32ATEU4 MC UMACOF 2G+1G/250/BT/6L/5R/ CB_n2_FP_1.0D_HG_FL12	C2DP7350
AS2930-733G25Mn	EMEA	Eastern Europe	LX.APY0X.070	AS2930-733G25Mn VHP32ATEU3 MC UMACOF 2G+1G/250/BT/6L/5R/ CB_n2_FP_1.0D_HG_RU21	C2DP7350
AS2930-733G25Mn	EMEA	Eastern Europe	LX.APY0X.071	AS2930-733G25Mn VHP32ATEU5 MC UMACOF 2G+1G/250/BT/6L/5R/ CB_n2_FP_1.0D_HG_PL11	C2DP7350
AS2930-733G25Mn	EMEA	Hungary	LX.APY0X.072	AS2930-733G25Mn VHP32ATHU1 MC UMACOF 2G+1G/250/BT/6L/5R/ CB_n2_FP_1.0D_HG_HU11	C2DP7350
AS2930-733G25Mn	EMEA	Eastern Europe	LX.APY0X.073	AS2930-733G25Mn VHP32ATEU3 MC UMACOF 2G+1G/250/BT/6L/5R/ CB_n2_FP_1.0D_HG_RU11	C2DP7350
AS2930-733G25Mn	EMEA	Slovenia/ Croatia	LX.APY0X.074	AS2930-733G25Mn VHP32ATSI1 MC UMACOF 2G+1G/250/BT/6L/5R/ CB_n2_FP_1.0D_HG_EN12	C2DP7350
AS2930-733G25Mn	EMEA	Portugal	LX.APY0X.075	AS2930-733G25Mn VHP32ATPT1 MC UMACOF 2G+1G/250/BT/6L/5R/ CB_n2_FP_1.0D_HG_PT12	C2DP7350

Model	RO	Country	Acer Part No	Description	CPU
AS2930-733G25Mn	EMEA	Spain	LX.APY0X.076	AS2930-733G25Mn VHP32ATES1 MC UMACOF 2G+1G/250/BT/6L/5R/ CB_n2_FP_1.0D_HG_ES22	C2DP7350
AS2930-733G25Mn	EMEA	Greece	LX.APY0X.077	AS2930-733G25Mn VHP32ATGR1 MC UMACOF 2G+1G/250/BT/6L/5R/ CB_n2_FP_1.0D_HG_EL32	C2DP7350
AS2930-733G25Mn	EMEA	Greece	LX.APY0X.078	AS2930-733G25Mn VHP32ATGR1 MC UMACOF 2G+1G/250/BT/6L/5R/ CB_n2_FP_1.0D_HG_EL22	C2DP7350
AS2930-733G25Mn	EMEA	Israel	LX.APY0X.079	AS2930-733G25Mn VHP32ATIL1 MC UMACOF 2G+1G/250/BT/6L/5R/ CB_n2_FP_1.0D_HG_HE11	C2DP7350
AS2930-733G25Mn	EMEA	Italy	LX.APY0X.080	AS2930-733G25Mn VHP32ATIT1 MC UMACOF 2G+1G/250/BT/6L/5R/ CB_n2_FP_1.0D_HG_IT12	C2DP7350
AS2930-733G25Mn	EMEA	Turkey	LX.APY0X.081	AS2930-733G25Mn EM VHP32ATTR1 MC UMACOF 2G+1G/250/BT/6L/5R/ CB_n2_FP_1.0D_HG_TR32	C2DP7350
AS2930-733G25Mn	EMEA	Middle East	LX.APY0X.082	AS2930-733G25Mn EM VHP32ATME9 MC UMACOF 2G+1G/250/BT/6L/5R/ CB_n2_FP_1.0D_HG_FR22	C2DP7350
AS2930-733G25Mn	EMEA	Middle East	LX.APY0X.083	AS2930-733G25Mn EM VHP32ATME2 MC UMACOF 2G+1G/250/BT/6L/5R/ CB_n2_FP_1.0D_HG_AR23	C2DP7350
AS2930-733G25Mn	EMEA	Middle East	LX.APY0X.084	AS2930-733G25Mn EM VHP32ATME6 MC UMACOF 2G+1G/250/BT/6L/5R/ CB_n2_FP_1.0D_HG_EN15	C2DP7350
AS2930-733G25Mn	EMEA	Middle East	LX.APY0X.085	AS2930-733G25Mn EM VHP32ATME3 MC UMACOF 2G+1G/250/BT/6L/5R/ CB_n2_FP_1.0D_HG_FR23	C2DP7350
AS2930-733G25Mn	EMEA	Middle East	LX.APY0X.086	AS2930-733G25Mn EM VHP32ATME2 MC UMACOF 2G+1G/250/BT/6L/5R/ CB_n2_FP_1.0D_HG_EN15	C2DP7350
AS2930-733G25Mn	EMEA	Middle East	LX.APY0X.087	AS2930-733G25Mn EM VHP32ATME2 MC UMACOF 2G+1G/250/BT/6L/5R/ CB_n2_FP_1.0D_HG_AR13	C2DP7350
AS2930-733G25Mn	EMEA	Middle East	LX.APY0X.088	AS2930-733G25Mn EM VHP32ATME4 MC UMACOF 2G+1G/250/BT/6L/5R/ CB_n2_FP_1.0D_HG_EN11	C2DP7350
AS2930-733G25Mn	EMEA	Switzerland	LX.APY0X.089	AS2930-733G25Mn VHP32ATCH1 MC UMACOF 2G+1G/250/BT/6L/5R/ CB_n2_FP_1.0D_HG_IT42	C2DP7350
AS2930-733G25Mn	EMEA	UK	LX.APY0X.090	AS2930-733G25Mn VHP32ATGB1 MC UMACOF 2G+1G/250/BT/6L/5R/ CB_n2_FP_1.0D_HG_EN14	C2DP7350
AS2930-732G16Mn	CHINA	Hong Kong	LX.APY0Y.036	AS2930-732G16Mn VHB32ATHK2 MC UMACOF 1*2G/160/BT/6L/5R/ CB_n2_FP_1.0D_HG_ZH31	C2DP7350

Model	RO	Country	Acer Part No	Description	CPU
AS2930-844G32Mn	PA	Canada	LX.APY0X.001	AS2930-844G32Mn VHP64ATCA2 MC UMACOF 2*2G/320/BT/6L/5R/ CB_n2_FP_1.0D_HG_FR31	C2DP8400
AS2930-844G32Mn	PA	USA	LX.APY0X.002	AS2930-844G32Mn VHP64ATCA2 MC UMACOF 2*2G/320/BT/6L/5R/ CB_n2_FP_1.0D_HG_EN11	C2DP8400
AS2930-844G32Mn	PA	ACLA-Spanish	LX.APY0X.003	AS2930-844G32Mn EM VHP64ATEA3 MC UMACOF 2*2G/320/BT/6L/5R/ CB_n2_FP_1.0D_HG_ES21	C2DP8400
AS2930-844G32Mn	PA	ACLA-Spanish	LX.APY0X.004	AS2930-844G32Mn EM VHP64ATEA1 MC UMACOF 2*2G/320/BT/6L/5R/ CB_n2_FP_1.0D_HG_ES21	C2DP8400
AS2930-844G32Mn	PA	ACLA-Portuguese	LX.APY0X.005	AS2930-844G32Mn EM VHP64ATXC1 MC UMACOF 2*2G/320/BT/6L/5R/ CB_n2_FP_1.0D_HG_XC21	C2DP8400
AS2930-843G25Mn	PA	USA	LX.APY0X.006	AS2930-843G25Mn VHP32ATUS1 MC UMACOF 2G+1G/250/BT/6L/5R/ CB_n2_FP_1.0D_HG_EN32	C2DP8400
AS2930-843G25Mn	PA	ACLA-Portuguese	LX.APY0X.007	AS2930-843G25Mn EM VHP32ATXC1 MC UMACOF 2G+1G/250/BT/6L/5R/ CB_n2_FP_1.0D_HG_XC22	C2DP8400
AS2930-843G25Mn	PA	Canada	LX.APY0X.008	AS2930-843G25Mn VHP32ATCA2 MC UMACOF 2G+1G/250/BT/6L/5R/ CB_n2_FP_1.0D_HG_FR31	C2DP8400
AS2930-843G25Mn	PA	ACLA-Spanish	LX.APY0X.009	AS2930-843G25Mn EM VHP32ATEA1 MC UMACOF 2G+1G/250/BT/6L/5R/ CB_n2_FP_1.0D_HG_ES22	C2DP8400
AS2930-843G25Mn	PA	ACLA-Spanish	LX.APY0X.010	AS2930-843G25Mn EM VHP32ATEA3 MC UMACOF 2G+1G/250/BT/6L/5R/ CB_n2_FP_1.0D_HG_ES22	C2DP8400
AS2930-842G25Mn	TWN	GCTWN	LX.APY0X.011	AS2930-842G25Mn VHP32ATTW1 MC UMACOF 1*2G/250/BT/6L/5R/ CB_n2_FP_1.0D_HG_TC11	C2DP8400
AS2930-862G32Mn	TWN	GCTWN	LX.APY0X.012	AS2930-862G32Mn VHP32ATTW1 MC UMACOF 1*2G/320/BT/6L/5R/ CB_n2_FP_1.0D_HG_TC11	C2DP8600
AS2930-842G16Mn	CHINA	China	LX.APY0Y.034	AS2930-842G16Mn VHB32ATCN1 MC UMACOF 1*2G/160/6L/5R/ CB_n2_FP_1.0D_HG_SC11	C2DP8400
AS2930-842G16Mn	CHINA	Hong Kong	LX.APY0Y.035	AS2930-842G16Mn VHB32ATHK2 MC UMACOF 1*2G/160/6L/5R/ CB_n2_FP_1.0D_HG_ZH31	C2DP8400
AS2930-944G32Mn	TWN	GCTWN	LX.APY0X.018	AS2930-944G32Mn VHP32ATTW1 MC UMACOF 2*2G/320/BT/6L/5R/ CB_n2_FP_1.0D_HG_TC11	C2DT9400
AS2930-844G32Mn	EMEA	South Africa	LX.APY0X.041	AS2930-844G32Mn EM VHP32ATZA2 MC UMACOF 2*2G/320/BT/6L/5R/ CB_n2_FP_1.0D_HG_EN16	C2DP8400

Model	RO	Country	Acer Part No	Description	CPU
AS2930-844G32Mn	EMEA	South Africa	LX.APY0X.042	AS2930-844G32Mn EM VHP32ATZA1 MC UMACOF 2*2G/320/BT/6L/5R/CB_n2_FP_1.0D_HG_FR23	C2DP8400
AS2930-844G32Mi	EMEA	Russia	LX.APY0X.021	AS2930-844G32Mi VHP32ATRU1 MC UMACOF 2*2G/320/BT/6L/5R/CB_abg_FP_1.0D_HG_RU11	C2DP8400
AS2930-844G32Mn	EMEA	Denmark	LX.APY0X.043	AS2930-844G32Mn VHP32ATDK1 MC UMACOF 2*2G/320/BT/6L/5R/CB_n2_FP_1.0D_HG_NO13	C2DP8400
AS2930-844G32Mn	EMEA	France	LX.APY0X.022	AS2930-844G32Mn VHP32ATFR1 MC UMACOF 2*2G/320/BT/6L/5R/CB_n2_FP_1.0D_HG_FR23	C2DP8400
AS2930-844G32Mn	EMEA	Germany	LX.APY0X.044	AS2930-844G32Mn VHP32ATDE1 MC UMACOF 2*2G/320/BT/6L/5R/CB_n2_FP_1.0D_HG_DE13	C2DP8400
AS2930-844G32Mn	EMEA	Belgium	LX.APY0X.045	AS2930-844G32Mn VHP32ATBE1 MC UMACOF 2*2G/320/BT/6L/5R/CB_n2_FP_1.0D_HG_NL13	C2DP8400
AS2930-844G32Mn	EMEA	Holland	LX.APY0X.023	AS2930-844G32Mn VHP32ATNL1 MC UMACOF 2*2G/320/BT/6L/5R/CB_n2_FP_1.0D_HG_NL12	C2DP8400
AS2930-844G32Mn	EMEA	Luxembourg	LX.APY0X.024	AS2930-844G32Mn VHP32ATLU1 MC UMACOF 2*2G/320/BT/6L/5R/CB_n2_FP_1.0D_HG_IT42	C2DP8400
AS2930-844G32Mn	EMEA	Norway	LX.APY0X.025	AS2930-844G32Mn VHP32ATNO1 MC UMACOF 2*2G/320/BT/6L/5R/CB_n2_FP_1.0D_HG_NO12	C2DP8400
AS2930-844G32Mn	EMEA	Sweden/ Finland	LX.APY0X.026	AS2930-844G32Mn VHP32ATSE1 MC UMACOF 2*2G/320/BT/6L/5R/CB_n2_FP_1.0D_HG_FI12	C2DP8400
AS2930-844G32Mn	EMEA	Czech	LX.APY0X.046	AS2930-844G32Mn VHP32ATCZ2 MC UMACOF 2*2G/320/BT/6L/5R/CB_n2_FP_1.0D_HG_SK11	C2DP8400
AS2930-844G32Mn	EMEA	Eastern Europe	LX.APY0X.027	AS2930-844G32Mn VHP32ATEU1 MC UMACOF 2*2G/320/BT/6L/5R/CB_n2_FP_1.0D_HG_CS21	C2DP8400
AS2930-844G32Mn	EMEA	Eastern Europe	LX.APY0X.028	AS2930-844G32Mn VHP32ATEU4 MC UMACOF 2*2G/320/BT/6L/5R/CB_n2_FP_1.0D_HG_FI12	C2DP8400
AS2930-844G32Mn	EMEA	Eastern Europe	LX.APY0X.029	AS2930-844G32Mn VHP32ATEU3 MC UMACOF 2*2G/320/BT/6L/5R/CB_n2_FP_1.0D_HG_RU21	C2DP8400
AS2930-844G32Mn	EMEA	Eastern Europe	LX.APY0X.030	AS2930-844G32Mn VHP32ATEU5 MC UMACOF 2*2G/320/BT/6L/5R/CB_n2_FP_1.0D_HG_PL11	C2DP8400
AS2930-844G32Mn	EMEA	Hungary	LX.APY0X.031	AS2930-844G32Mn VHP32ATHU1 MC UMACOF 2*2G/320/BT/6L/5R/CB_n2_FP_1.0D_HG_HU11	C2DP8400
AS2930-844G32Mn	EMEA	Eastern Europe	LX.APY0X.032	AS2930-844G32Mn VHP32ATEU3 MC UMACOF 2*2G/320/BT/6L/5R/CB_n2_FP_1.0D_HG_RU11	C2DP8400
AS2930-844G32Mn	EMEA	Slovenia/ Croatia	LX.APY0X.033	AS2930-844G32Mn VHP32ATSI1 MC UMACOF 2*2G/320/BT/6L/5R/CB_n2_FP_1.0D_HG_EN12	C2DP8400

Model	RO	Country	Acer Part No	Description	CPU
AS2930-844G32Mn	EMEA	Portugal	LX.APY0X.034	AS2930-844G32Mn VHP32ATPT1 MC UMACOF 2*2G/320/BT/6L/5R/ CB_n2_FP_1.0D_HG_PT12	C2DP8400
AS2930-844G32Mn	EMEA	Spain	LX.APY0X.035	AS2930-844G32Mn VHP32ATES1 MC UMACOF 2*2G/320/BT/6L/5R/ CB_n2_FP_1.0D_HG_ES22	C2DP8400
AS2930-844G32Mn	EMEA	Greece	LX.APY0X.036	AS2930-844G32Mn VHP32ATGR1 MC UMACOF 2*2G/320/BT/6L/5R/ CB_n2_FP_1.0D_HG_EL32	C2DP8400
AS2930-844G32Mn	EMEA	Greece	LX.APY0X.037	AS2930-844G32Mn VHP32ATGR1 MC UMACOF 2*2G/320/BT/6L/5R/ CB_n2_FP_1.0D_HG_EL22	C2DP8400
AS2930-844G32Mn	EMEA	Israel	LX.APY0X.038	AS2930-844G32Mn VHP32ATIL1 MC UMACOF 2*2G/320/BT/6L/5R/ CB_n2_FP_1.0D_HG_HE11	C2DP8400
AS2930-844G32Mn	EMEA	Italy	LX.APY0X.039	AS2930-844G32Mn VHP32ATIT1 MC UMACOF 2*2G/320/BT/6L/5R/ CB_n2_FP_1.0D_HG_IT12	C2DP8400
AS2930-844G32Mn	EMEA	Turkey	LX.APY0X.047	AS2930-844G32Mn EM VHP32ATTR1 MC UMACOF 2*2G/320/BT/6L/5R/ CB_n2_FP_1.0D_HG_TR32	C2DP8400
AS2930-844G32Mn	EMEA	Middle East	LX.APY0X.048	AS2930-844G32Mn EM VHP32ATME9 MC UMACOF 2*2G/320/BT/6L/5R/ CB_n2_FP_1.0D_HG_FR22	C2DP8400
AS2930-844G32Mn	EMEA	Middle East	LX.APY0X.049	AS2930-844G32Mn EM VHP32ATME2 MC UMACOF 2*2G/320/BT/6L/5R/ CB_n2_FP_1.0D_HG_AR23	C2DP8400
AS2930-844G32Mn	EMEA	Middle East	LX.APY0X.050	AS2930-844G32Mn EM VHP32ATME6 MC UMACOF 2*2G/320/BT/6L/5R/ CB_n2_FP_1.0D_HG_EN15	C2DP8400
AS2930-844G32Mn	EMEA	Middle East	LX.APY0X.051	AS2930-844G32Mn EM VHP32ATME3 MC UMACOF 2*2G/320/BT/6L/5R/ CB_n2_FP_1.0D_HG_FR23	C2DP8400
AS2930-844G32Mn	EMEA	Middle East	LX.APY0X.052	AS2930-844G32Mn EM VHP32ATME2 MC UMACOF 2*2G/320/BT/6L/5R/ CB_n2_FP_1.0D_HG_EN15	C2DP8400
AS2930-844G32Mn	EMEA	Middle East	LX.APY0X.053	AS2930-844G32Mn EM VHP32ATME2 MC UMACOF 2*2G/320/BT/6L/5R/ CB_n2_FP_1.0D_HG_AR13	C2DP8400
AS2930-844G32Mn	EMEA	Middle East	LX.APY0X.054	AS2930-844G32Mn EM VHP32ATME4 MC UMACOF 2*2G/320/BT/6L/5R/ CB_n2_FP_1.0D_HG_EN11	C2DP8400
AS2930-844G32Mn	EMEA	Switzerland	LX.APY0X.055	AS2930-844G32Mn VHP32ATCH1 MC UMACOF 2*2G/320/BT/6L/5R/ CB_n2_FP_1.0D_HG_IT42	C2DP8400
AS2930-844G32Mn	EMEA	UK	LX.APY0X.040	AS2930-844G32Mn VHP32ATGB1 MC UMACOF 2*2G/320/BT/6L/5R/ CB_n2_FP_1.0D_HG_EN14	C2DP8400

Model	RO	Country	Acer Part No	Description	CPU
AS2930-733G25Mn	EMEA	South Africa	LX.APY0X.056	AS2930-733G25Mn EM VHP32ATZA2 MC UMACOF 2G+1G/250/BT/6L/5R/CB_n2_FP_1.0D_HG_EN16	C2DP7350
AS2930-733G25Mn	EMEA	South Africa	LX.APY0X.057	AS2930-733G25Mn EM VHP32ATZA1 MC UMACOF 2G+1G/250/BT/6L/5R/CB_n2_FP_1.0D_HG_FR23	C2DP7350
AS2930-733G25Mn	EMEA	Denmark	LX.APY0X.058	AS2930-733G25Mn VHP32ATDK1 MC UMACOF 2G+1G/250/BT/6L/5R/CB_n2_FP_1.0D_HG_NO13	C2DP7350
AS2930-733G25Mn	EMEA	France	LX.APY0X.059	AS2930-733G25Mn VHP32ATFR1 MC UMACOF 2G+1G/250/BT/6L/5R/CB_n2_FP_1.0D_HG_FR23	C2DP7350
AS2930-733G25Mi	EMEA	Russia	LX.APY0X.060	AS2930-733G25Mi VHP32ATRU1 MC UMACOF 2G+1G/250/BT/6L/5R/CB_abg_FP_1.0D_HG_RU11	C2DP7350
AS2930-733G25Mn	EMEA	Sweden/ Finland	LX.APY0X.061	AS2930-733G25Mn VHP32ATSE1 MC UMACOF 2G+1G/250/BT/6L/5R/CB_n2_FP_1.0D_HG_FI12	C2DP7350
AS2930-733G25Mn	EMEA	Czech	LX.APY0X.062	AS2930-733G25Mn VHP32ATCZ2 MC UMACOF 2G+1G/250/BT/6L/5R/CB_n2_FP_1.0D_HG_SK11	C2DP7350
AS2930-733G25Mn	EMEA	Eastern Europe	LX.APY0X.063	AS2930-733G25Mn VHP32ATEU1 MC UMACOF 2G+1G/250/BT/6L/5R/CB_n2_FP_1.0D_HG_CS21	C2DP7350
AS2930-733G25Mn	EMEA	Germany	LX.APY0X.064	AS2930-733G25Mn VHP32ATDE1 MC UMACOF 2G+1G/250/BT/6L/5R/CB_n2_FP_1.0D_HG_DE13	C2DP7350
AS2930-733G25Mn	EMEA	Belgium	LX.APY0X.065	AS2930-733G25Mn VHP32ATBE1 MC UMACOF 2G+1G/250/BT/6L/5R/CB_n2_FP_1.0D_HG_NL13	C2DP7350
AS2930-733G25Mn	EMEA	Holland	LX.APY0X.066	AS2930-733G25Mn VHP32ATNL1 MC UMACOF 2G+1G/250/BT/6L/5R/CB_n2_FP_1.0D_HG_NL12	C2DP7350
AS2930-732G25Mi	EMEA	Russia	LX.APY0X.108	AS2930-732G25Mi VHP32ATRU1 MC UMACOF 2*1G/250/BT/6L/5R/CB_bg_FP_1.0D_HG_RU11	C2DP7350
AS2930-733G32Mn	EMEA	Greece	LX.APY0X.107	AS2930-733G32Mn VHP32ATGR1 MC UMACOF 2G+1G/320/BT/6L/5R/CB_n2_FP_1.0D_HG_EL32	C2DP7350
AS2930-733G32Mn	EMEA	Italy	LX.APY0X.106	AS2930-733G32Mn VHP32ATIT1 MC UMACOF 2G+1G/320/BT/6L/5R/CB_n2_FP_1.0D_HG_IT12	C2DP7350
AS2930-582G25Mn	CHINA	Hong Kong	LX.APY0Y.039	AS2930-582G25Mn VHB32ATHK2 MC UMACOF 1*2G/250/BT/6L/5R/CB_n2_FP_1.0D_HG_ZH31	C2DT5800
AS2930-583G25Mn	EMEA	Middle East	LX.APY0X.183	AS2930-583G25Mn EM VHP32ATME2 MC UMACOF 2G+1G/250/BT/6L/5R/CB_n_FP_1.0D_HG_AR23	C2DT5800
AS2930-593G25Mn	EMEA	Middle East	LX.APY0X.182	AS2930-593G25Mn EM VHP32ATME2 MC UMACOF 2G+1G/250/BT/6L/5R/CB_n_FP_1.0D_HG_AR23	C2DT5900



Model	RO	Country	Acer Part No	Description	CPU
AS2930-734G32Mn	EMEA	Middle East	LX.APY0X.188	AS2930-734G32Mn EM VHP32ATME6 MC UMACOF 2*2G/320/BT/6L/5R/ CB_n_FP_1.0D_HG_EN15	C2DP7350
AS2930-734G32Mn	EMEA	Russia	LX.APY0X.189	AS2930-734G32Mn VHP32ATRU1 MC UMACOF 2*2G/320/BT/6L/5R/ CB_n_FP_1.0D_HG_RU11	C2DP7350
AS2930-733G32Mn	AAP	Singapore	LX.APY0X.179	AS2930-733G32Mn VHP32ATSG1 MC UMACOF 2G+1G/320/BT/6L/5R/ CB_n3_FP_1.0D_HG_ZH31	C2DP7350
AS2930-584G32Mn	EMEA	Middle East	LX.APY0X.180	AS2930-584G32Mn EM VHP32ATME2 MC UMACOF 2*2G/320/BT/6L/5R/ CB_n_FP_1.0D_HG_AR23	C2DT5800
AS2930-583G32Mn	EMEA	Eastern Europe	LX.APY0X.181	AS2930-583G32Mn VHP32ATEU5 MC UMACOF 2G+1G/320/BT/6L/5R/ CB_n_FP_1.0D_HG_PL12	C2DT5800
AS2930-581G16Mn	AAP	Singapore	LX.APY0C.003	AS2930-581G16Mn LINPUSASG1 UMACOF 1*1G/160/BT/6L/5R/ CB_n_FP_1.0D_HG_EN11	C2DT5800
AS2930-592G25Mn	AAP	Philippines	LX.APY0X.177	AS2930-592G25Mn EM VHP32ATPH1 MC UMACOF 1*2G/250/BT/6L/5R/ CB_n2_FP_1.0D_PH_HG_EN14	C2DT5900
AS2930-731G16Mn	AAP	Philippines	LX.APY0X.176	AS2930-731G16Mn EM VHP32ATPH1 MC UMACOF 1*1G/160/BT/6L/5R/ CB_n2_FP_1.0D_PH_HG_EN14	C2DP7350
AS2930-843G25Mn	EMEA	Spain	LX.APY0X.192	AS2930-843G25Mn VHP32ATES1 MC UMACOF 2G+1G/250/6L/5R/ CB_n2_FP_1.0D_HG_ES22	C2DP8400
AS2930-583G16Mn	EMEA	Greece	LX.APY0X.187	AS2930-583G16Mn VHP32ATGR1 MC UMACOF 2G+1G/160/BT/6L/5R/ CB_n_FP_1.0D_HG_EL32	C2DT5800
AS2930-583G16Mn	EMEA	Italy	LX.APY0X.186	AS2930-583G16Mn VHP32ATIT1 MC UMACOF 2G+1G/160/BT/6L/5R/ CB_n_FP_1.0D_HG_IT12	C2DT5800
AS2930-734G25Mn	EMEA	Greece	LX.APY0X.185	AS2930-734G25Mn VHP32ATGR1 MC UMACOF 2*2G/250/BT/6L/5R/ CB_n_FP_1.0D_HG_EL32	C2DP7350
AS2930-734G25Mn	EMEA	Italy	LX.APY0X.184	AS2930-734G25Mn VHP32ATIT1 MC UMACOF 2*2G/250/BT/6L/5R/ CB_n_FP_1.0D_HG_IT12	C2DP7350
AS2930-582G32Mn	TWN	GCTWN	LX.APY0X.178	AS2930-582G32Mn VHP32ATTW1 MC UMACOF 1*2G/320/BT/6L/5R/ CB_n2_FP_1.0D_HG_TC11	C2DT5800
AS2930-581G25Mn	AAP	Indonesia	LX.APY0X.191	AS2930-581G25Mn EM VHP32ATID1 MC UMACOF 1*1G/250/BT/6L/5R/ CB_n2_FP_1.0D_HG_ID24	C2DT5800
AS2930-732G32Mn	AAP	Singapore	LX.APY0X.190	AS2930-732G32Mn VHP32ATSG1 MC UMACOF 1*2G/320/BT/6L/5R/ CB_n3_FP_1.0D_HG_ZH31	C2DP7350
AS2930-733G32Mn	EMEA	Germany	LX.APY0X.147	AS2930-733G32Mn VHP32ATDE1 MC UMACOF 2G+1G/320/BT/6L/5R/ CB_n2_FP_1.0D_HG_DE13	C2DP7350
AS2930-731G16Mn	AAP	Malaysia	LX.APY0C.002	AS2930-731G16Mn LINPUSAMY1 UMACOF 1*1G/160/BT/6L/5R/ CB_n2_FP_1.0D_HG_EN11	C2DP7350

Model	RO	Country	Acer Part No	Description	CPU
AS2930-732G16Mn	AAP	Malaysia	LX.APY0X.149	AS2930-732G16Mn EM VHP32ATMY1 MC UMACOF 1*2G/ 160/BT/6L/5R/ CB_n2_FP_1.0D_HG_EN14	C2DP7350
AS2930-731G25Mn	AAP	Malaysia	LX.APY0C.001	AS2930-731G25Mn LINPUSAMY1 UMACOF 1*1G/250/BT/6L/5R/ CB_n2_FP_1.0D_HG_EN11	C2DP7350
AS2930-732G25Mn	AAP	Malaysia	LX.APY0X.148	AS2930-732G25Mn EM VHP32ATMY1 MC UMACOF 1*2G/ 250/BT/6L/5R/ CB_n2_FP_1.0D_HG_EN14	C2DP7350
AS2930-843G32Mn	EMEA	South Africa	LX.APY0X.146	AS2930-843G32Mn EM VHP32ATZA2 MC UMACOF 2G+1G/ 320/BT/6L/5R/ CB_n2_FP_1.0D_HG_EN16	C2DP8400
AS2930-843G32Mn	EMEA	South Africa	LX.APY0X.145	AS2930-843G32Mn EM VHP32ATZA1 MC UMACOF 2G+1G/ 320/BT/6L/5R/ CB_n2_FP_1.0D_HG_FR23	C2DP8400
AS2930-843G32Mn	EMEA	Denmark	LX.APY0X.144	AS2930-843G32Mn VHP32ATDK1 MC UMACOF 2G+1G/320/BT/6L/5R/ CB_n2_FP_1.0D_HG_NO13	C2DP8400
AS2930-843G32Mn	EMEA	France	LX.APY0X.143	AS2930-843G32Mn VHP32ATFR1 MC UMACOF 2G+1G/320/BT/6L/5R/ CB_n2_FP_1.0D_HG_FR23	C2DP8400
AS2930-843G32Mn	EMEA	Belgium	LX.APY0X.142	AS2930-843G32Mn VHP32ATBE1 MC UMACOF 2G+1G/320/BT/6L/5R/ CB_n2_FP_1.0D_HG_NL13	C2DP8400
AS2930-843G32Mn	EMEA	Holland	LX.APY0X.141	AS2930-843G32Mn VHP32ATNL1 MC UMACOF 2G+1G/320/BT/6L/5R/ CB_n2_FP_1.0D_HG_NL12	C2DP8400
AS2930-843G32Mn	EMEA	Luxembourg	LX.APY0X.140	AS2930-843G32Mn VHP32ATLU1 MC UMACOF 2G+1G/320/BT/6L/5R/ CB_n2_FP_1.0D_HG_IT42	C2DP8400
AS2930-843G32Mn	EMEA	Norway	LX.APY0X.139	AS2930-843G32Mn VHP32ATNO1 MC UMACOF 2G+1G/320/BT/6L/5R/ CB_n2_FP_1.0D_HG_NO12	C2DP8400
AS2930-843G32Mi	EMEA	Russia	LX.APY0X.138	AS2930-843G32Mi VHP32ATRU1 MC UMACOF 2G+1G/320/BT/6L/5R/ CB_abg_FP_1.0D_HG_RU11	C2DP8400
AS2930-843G32Mn	EMEA	Sweden/ Finland	LX.APY0X.137	AS2930-843G32Mn VHP32ATSE1 MC UMACOF 2G+1G/320/BT/6L/5R/ CB_n2_FP_1.0D_HG_FI12	C2DP8400
AS2930-843G32Mn	EMEA	Czech	LX.APY0X.136	AS2930-843G32Mn VHP32ATCZ2 MC UMACOF 2G+1G/320/BT/6L/5R/ CB_n2_FP_1.0D_HG_SK11	C2DP8400
AS2930-843G32Mn	EMEA	Eastern Europe	LX.APY0X.135	AS2930-843G32Mn VHP32ATEU7 MC UMACOF 2G+1G/320/BT/6L/5R/ CB_n2_FP_1.0D_HG_ENG1	C2DP8400
AS2930-843G32Mn	EMEA	Eastern Europe	LX.APY0X.134	AS2930-843G32Mn VHP32ATEU6 MC UMACOF 2G+1G/320/BT/6L/5R/ CB_n2_FP_1.0D_HG_CS21	C2DP8400
AS2930-843G32Mn	EMEA	Eastern Europe	LX.APY0X.133	AS2930-843G32Mn VHP32ATEU3 MC UMACOF 2G+1G/320/BT/6L/5R/ CB_n2_FP_1.0D_HG_RU11	C2DP8400
AS2930-843G32Mn	EMEA	Eastern Europe	LX.APY0X.132	AS2930-843G32Mn VHP32ATEU1 MC UMACOF 2G+1G/320/BT/6L/5R/ CB_n2_FP_1.0D_HG_CS21	C2DP8400

Model	RO	Country	Acer Part No	Description	CPU
AS2930-843G32Mn	EMEA	Eastern Europe	LX.APY0X.131	AS2930-843G32Mn VHP32ATEU4 MC UMACOF 2G+1G/320/BT/6L/5R/CB_n2_FP_1.0D_HG_FI12	C2DP8400
AS2930-843G32Mn	EMEA	Eastern Europe	LX.APY0X.130	AS2930-843G32Mn VHP32ATEU3 MC UMACOF 2G+1G/320/BT/6L/5R/CB_n2_FP_1.0D_HG_RU21	C2DP8400
AS2930-843G32Mn	EMEA	Eastern Europe	LX.APY0X.129	AS2930-843G32Mn VHP32ATEU5 MC UMACOF 2G+1G/320/BT/6L/5R/CB_n2_FP_1.0D_HG_PL11	C2DP8400
AS2930-843G32Mn	EMEA	Hungary	LX.APY0X.128	AS2930-843G32Mn VHP32ATHU1 MC UMACOF 2G+1G/320/BT/6L/5R/CB_n2_FP_1.0D_HG_HU11	C2DP8400
AS2930-843G32Mn	EMEA	Slovenia/Croatia	LX.APY0X.127	AS2930-843G32Mn VHP32ATS1 MC UMACOF 2G+1G/320/BT/6L/5R/CB_n2_FP_1.0D_HG_EN12	C2DP8400
AS2930-843G32Mn	EMEA	Portugal	LX.APY0X.126	AS2930-843G32Mn VHP32ATPT1 MC UMACOF 2G+1G/320/BT/6L/5R/CB_n2_FP_1.0D_HG_PT12	C2DP8400
AS2930-843G32Mn	EMEA	Spain	LX.APY0X.125	AS2930-843G32Mn VHP32ATES1 MC UMACOF 2G+1G/320/BT/6L/5R/CB_n2_FP_1.0D_HG_ES22	C2DP8400
AS2930-843G32Mn	EMEA	Greece	LX.APY0X.124	AS2930-843G32Mn VHP32ATGR1 MC UMACOF 2G+1G/320/BT/6L/5R/CB_n2_FP_1.0D_HG_EL32	C2DP8400
AS2930-843G32Mn	EMEA	Greece	LX.APY0X.123	AS2930-843G32Mn VHP32ATGR1 MC UMACOF 2G+1G/320/BT/6L/5R/CB_n2_FP_1.0D_HG_EL22	C2DP8400
AS2930-843G32Mn	EMEA	Israel	LX.APY0X.122	AS2930-843G32Mn VHP32ATIL1 MC UMACOF 2G+1G/320/BT/6L/5R/CB_n2_FP_1.0D_HG_HE11	C2DP8400
AS2930-843G32Mn	EMEA	Italy	LX.APY0X.121	AS2930-843G32Mn VHP32ATIT1 MC UMACOF 2G+1G/320/BT/6L/5R/CB_n2_FP_1.0D_HG_IT12	C2DP8400
AS2930-843G32Mn	EMEA	Turkey	LX.APY0X.120	AS2930-843G32Mn EM VHP32ATTR1 MC UMACOF 2G+1G/320/BT/6L/5R/CB_n2_FP_1.0D_HG_TR32	C2DP8400
AS2930-843G32Mn	EMEA	Middle East	LX.APY0X.119	AS2930-843G32Mn EM VHP32ATME9 MC UMACOF 2G+1G/320/BT/6L/5R/CB_n2_FP_1.0D_HG_FR22	C2DP8400
AS2930-843G32Mn	EMEA	Middle East	LX.APY0X.118	AS2930-843G32Mn EM VHP32ATME2 MC UMACOF 2G+1G/320/BT/6L/5R/CB_n2_FP_1.0D_HG_AR13	C2DP8400
AS2930-732G16Mn	AAP	Philippines	LX.APY0X.109	AS2930-732G16Mn EM VHP32ATPH1 MC UMACOF 2*1G/160/BT/6L/5R/CB_n2_FP_1.0D_PH_HG_EN14	C2DP7350
AS2930-843G32Mn	EMEA	Middle East	LX.APY0X.117	AS2930-843G32Mn EM VHP32ATME2 MC UMACOF 2G+1G/320/BT/6L/5R/CB_n2_FP_1.0D_HG_EN15	C2DP8400
AS2930-843G32Mn	EMEA	Middle East	LX.APY0X.116	AS2930-843G32Mn EM VHP32ATME3 MC UMACOF 2G+1G/320/BT/6L/5R/CB_n2_FP_1.0D_HG_FR23	C2DP8400

Model	RO	Country	Acer Part No	Description	CPU
AS2930-843G32Mn	EMEA	Middle East	LX.APY0X.115	AS2930-843G32Mn EM VHP32ATME6 MC UMACOF 2G+1G/320/BT/6L/5R/CB_n2_FP_1.0D_HG_EN15	C2DP8400
AS2930-843G32Mn	EMEA	Middle East	LX.APY0X.114	AS2930-843G32Mn EM VHP32ATME2 MC UMACOF 2G+1G/320/BT/6L/5R/CB_n2_FP_1.0D_HG_AR23	C2DP8400
AS2930-843G32Mn	EMEA	Middle East	LX.APY0X.113	AS2930-843G32Mn EM VHP32ATME4 MC UMACOF 2G+1G/320/BT/6L/5R/CB_n2_FP_1.0D_HG_EN11	C2DP8400
AS2930-843G32Mn	EMEA	Switzerland	LX.APY0X.112	AS2930-843G32Mn VHP32ATCH1 MC UMACOF 2G+1G/320/BT/6L/5R/CB_n2_FP_1.0D_HG_IT42	C2DP8400
AS2930-843G32Mn	EMEA	UK	LX.APY0X.111	AS2930-843G32Mn VHP32ATGB1 MC UMACOF 2G+1G/320/BT/6L/5R/CB_n2_FP_1.0D_HG_EN14	C2DP8400
AS2930-731G16Mn	AAP	Singapore	LX.APY0X.162	AS2930-731G16Mn VHP32ATSG1 MC UMACOF 1*1G/160/BT/6L/5R/CB_n2_FP_1.0D_HG_ZH31	C2DP7350
AS2930-731G16Mn	AAP	Malaysia	LX.APY0X.161	AS2930-731G16Mn EM VHP32ATMY1 MC UMACOF 1*1G/160/BT/6L/5R/CB_n2_FP_1.0D_HG_EN14	C2DP7350
AS2930-842G25Mn	AAP	Singapore	LX.APY0X.160	AS2930-842G25Mn VHP32ATSG1 MC UMACOF 1*2G/250/BT/6L/5R/CB_n2_FP_1.0D_HG_ZH31	C2DP8400
AS2930-842G32Mn	AAP	Singapore	LX.APY0X.159	AS2930-842G32Mn VHP32ATSG1 MC UMACOF 1*2G/320/BT/6L/5R/CB_n3_FP_1.0D_HG_ZH31	C2DP8400
AS2930-843G32Mn	AAP	Singapore	LX.APY0X.158	AS2930-843G32Mn VHP32ATSG1 MC UMACOF 2G+1G/320/BT/6L/5R/CB_n3_FP_1.0D_HG_ZH31	C2DP8400
AS2930-844G32Mn	AAP	Singapore	LX.APY0X.157	AS2930-844G32Mn VHP32ATSG1 MC UMACOF 2*2G/320/BT/6L/5R/CB_n3_FP_1.0D_HG_ZH31	C2DP8400
AS2930-864G32Mn	AAP	Singapore	LX.APY0X.156	AS2930-864G32Mn VHP32ATSG1 MC UMACOF 2*2G/320/BT/6L/5R/CB_n3_FP_1.0D_HG_ZH31	C2DP8600
AS2930-863G32Mn	AAP	Singapore	LX.APY0X.155	AS2930-863G32Mn VHP32ATSG1 MC UMACOF 2G+1G/320/BT/6L/5R/CB_n3_FP_1.0D_HG_ZH31	C2DP8600
AS2930-862G32Mn	AAP	Singapore	LX.APY0X.154	AS2930-862G32Mn VHP32ATSG1 MC UMACOF 1*2G/320/BT/6L/5R/CB_n3_FP_1.0D_HG_ZH31	C2DP8600
AS2930-862G16Mn	AAP	Singapore	LX.APY0X.153	AS2930-862G16Mn VHP32ATSG1 MC UMACOF 1*2G/160/BT/6L/5R/CB_n3_FP_1.0D_HG_ZH31	C2DP8600
AS2930-582G16Mn	AAP	Singapore	LX.APY0X.150	AS2930-582G16Mn VHP32ATSG1 MC UMACOF 1*2G/160/BT/6L/5R/CB_n2_FP_1.0D_HG_ZH31	C2DT5800
AS2930-732G32Mn	EMEA	Germany	LX.APY0X.110	AS2930-732G32Mn VHP32ATDE1 MC UMACOF 1*2G/320/BT/6L/5R/CB_n2_FP_1.0D_HG_DE13	C2DP7350
AS2930-864G32Mn	TWN	GCTWN	LX.APY0X.163	AS2930-864G32Mn VHP32ATTW1 MC UMACOF 2*2G/320/BT/6L/5R/CB_n2_FP_1.0D_HG_TC11	C2DP8600

Model	RO	Country	Acer Part No	Description	CPU
AS2930-592G25Mn	AAP	Thailand	LX.APY0X.175	AS2930-592G25Mn EM VHP32ATTH1 MC UMACOF 1*2G/250/BT/6L/5R/CB_n2_FP_1.0D_HG_TH22	C2DT5900
AS2930-842G32Mn	TWN	GCTWN	LX.APY0X.166	AS2930-842G32Mn VHP32ATTW1 MC UMACOF 1*2G/320/BT/6L/5R/CB_n2_FP_1.0D_HG_TC11	C2DP8400
AS2930-584G32Mn	EMEA	Belgium	LX.APY0X.171	AS2930-584G32Mn VHP32ATBE1 MC UMACOF 2*2G/320/BT/6L/5R/CB_n2_FP_1.0D_HG_NL13	C2DT5800
AS2930-584G32Mn	EMEA	Holland	LX.APY0X.170	AS2930-584G32Mn VHP32ATNL1 MC UMACOF 2*2G/320/BT/6L/5R/CB_n2_FP_1.0D_HG_NL12	C2DT5800
AS2930-584G32Mn	EMEA	Luxembourg	LX.APY0X.169	AS2930-584G32Mn VHP32ATLU1 MC UMACOF 2*2G/320/BT/6L/5R/CB_n2_FP_1.0D_HG_IT42	C2DT5800
AS2930-592G25Mn	AAP	Thailand	LX.APY0X.173	AS2930-592G25Mn EM VHP32ATTH1 MC UMACOF 1*2G/250/BT/6L/5R/CB_n2_FP_1.0D_PH_HG_TH22	C2DT5900
AS2930-732G32Mn	AAP	Thailand	LX.APY0X.174	AS2930-732G32Mn EM VHP32ATTH1 MC UMACOF 1*2G/320/BT/6L/5R/CB_n2_FP_1.0D_HG_TH22	C2DP7350
AS2930-732G16Mn	WW	WW	S2.APY0X.002	AS2930-732G16Mn VHP32AWW1 MC UMACOF 2*1G/160/BT/6L/5R/CB_n2_FP_1.0D_HG_EN11	C2DP7350
AS2930-583G32Mn	EMEA	France	LX.APY0X.152	AS2930-583G32Mn VHP32ATFR1 MC UMACOF 2G+1G/320/BT/6L/5R/CB_n2_FP_1.0D_HG_FR23	C2DT5800
AS2930-582G32Mn	AAP	Singapore	LX.APY0X.165	AS2930-582G32Mn VHP32ATSG1 MC UMACOF 1*2G/320/BT/6L/5R/CB_n2_FP_1.0D_HG_ZH31	C2DT5800
AS2930-582G32Mn	AAP	Singapore	LX.APY0X.164	AS2930-582G32Mn VHP32ATSG1 MC UMACOF 1*2G/320/BT/6L/5R/CB_n3_FP_1.0D_HG_ZH31	C2DT5800
AS2930-734G32Mn	EMEA	UK	LX.APY0X.167	AS2930-734G32Mn VHP32ATGB1 MC UMACOF 2*2G/320/BT/6L/5R/CB_n2_FP_1.0D_HG_EN14	C2DP7350
AS2930-582G16Mn	CHINA	Hong Kong	LX.APY0Y.038	AS2930-582G16Mn VHB32ATHK2 MC UMACOF 1*2G/160/BT/6L/5R/CB_n2_FP_1.0D_HG_ZH31	C2DT5800
AS2930-581G25Mn	AAP	Indonesia	LX.APY0X.172	AS2930-581G25Mn EM VHP32ATID1 MC UMACOF 1*1G/250/BT/6L/5R/CB_n2_FP_1.0D_HG_ID22	C2DT5800
AS2930-734G32Mn	EMEA	France	LX.APY0X.151	AS2930-734G32Mn VHP32ATFR1 MC UMACOF 2*2G/320/BT/6L/5R/CB_n2_FP_1.0D_HG_FR23	C2DP7350
AS2930-584G32Mn	EMEA	Norway	LX.APY0X.168	AS2930-584G32Mn VHP32ATNO1 MC UMACOF 2*2G/320/BT/6L/5R/CB_n2_FP_1.0D_HG_NO12	C2DT5800
AS2930-860525Mn	AAP	Singapore	LX.ART0C.005	AS2930-860525Mn LINPUSASG1 UMACO 1*512/250/BT/6L/5R/CB_n3_1.0D_HG_EN11	C2DP8600
AS2930-940525Mn	AAP	Singapore	LX.ART0C.006	AS2930-940525Mn LINPUSASG1 UMACO 1*512/250/BT/6L/5R/CB_n3_1.0D_HG_EN11	C2DT9400

Model	RO	Country	Acer Part No	Description	CPU
AS2930-842G25Mn	AAP	Singapore	LX.ART0X.041	AS2930-842G25Mn VHP32ATSG1 MC UMACO 1*2G/250/BT/6L/5R/ CB_n3_1.0D_HG_EN12	C2DP8400
AS2930-862G25Mn	AAP	Singapore	LX.ART0X.042	AS2930-862G25Mn VHP32ATSG1 MC UMACO 1*2G/250/BT/6L/5R/ CB_n3_1.0D_HG_EN12	C2DP8600
AS2930-942G25Mn	AAP	Singapore	LX.ART0X.043	AS2930-942G25Mn VHP32ATSG1 MC UMACO 1*2G/250/BT/6L/5R/ CB_n3_1.0D_HG_EN12	C2DT9400
AS2930-842G32Mn	AAP	Singapore	LX.ART0X.044	AS2930-842G32Mn VHP32ATSG1 MC UMACO 1*2G/320/BT/6L/5R/ CB_n3_1.0D_HG_EN12	C2DP8400
AS2930-862G32Mn	AAP	Singapore	LX.ART0X.045	AS2930-862G32Mn VHP32ATSG1 MC UMACO 1*2G/320/BT/6L/5R/ CB_n3_1.0D_HG_EN12	C2DP8600
AS2930-942G32Mn	AAP	Singapore	LX.ART0X.046	AS2930-942G32Mn VHP32ATSG1 MC UMACO 1*2G/320/BT/6L/5R/ CB_n3_1.0D_HG_EN12	C2DT9400
AS2930-843G25Mn	AAP	Singapore	LX.ART0X.047	AS2930-843G25Mn VHP32ATSG1 MC UMACO 2G+1G/250/BT/6L/5R/ CB_n3_1.0D_HG_EN12	C2DP8400
AS2930-863G25Mn	AAP	Singapore	LX.ART0X.048	AS2930-863G25Mn VHP32ATSG1 MC UMACO 2G+1G/250/BT/6L/5R/ CB_n3_1.0D_HG_EN12	C2DP8600
AS2930-943G25Mn	AAP	Singapore	LX.ART0X.049	AS2930-943G25Mn VHP32ATSG1 MC UMACO 2G+1G/250/BT/6L/5R/ CB_n3_1.0D_HG_EN12	C2DT9400
AS2930-843G32Mn	AAP	Singapore	LX.ART0X.050	AS2930-843G32Mn VHP32ATSG1 MC UMACO 2G+1G/320/BT/6L/5R/ CB_n3_1.0D_HG_EN12	C2DP8400
AS2930-863G32Mn	AAP	Singapore	LX.ART0X.051	AS2930-863G32Mn VHP32ATSG1 MC UMACO 2G+1G/320/BT/6L/5R/ CB_n3_1.0D_HG_EN12	C2DP8600
AS2930-943G32Mn	AAP	Singapore	LX.ART0X.052	AS2930-943G32Mn VHP32ATSG1 MC UMACO 2G+1G/320/BT/6L/5R/ CB_n3_1.0D_HG_EN12	C2DT9400
AS2930-840516Mn	AAP	Singapore	LX.ART0C.001	AS2930-840516Mn LINPUSASG1 UMACO 1*512/160/BT/6L/5R/ CB_n3_1.0D_HG_EN11	C2DP8400
AS2930-860516Mn	AAP	Singapore	LX.ART0C.002	AS2930-860516Mn LINPUSASG1 UMACO 1*512/160/BT/6L/5R/ CB_n3_1.0D_HG_EN11	C2DP8600
AS2930-940516Mn	AAP	Singapore	LX.ART0C.003	AS2930-940516Mn LINPUSASG1 UMACO 1*512/160/BT/6L/5R/ CB_n3_1.0D_HG_EN11	C2DT9400
AS2930-840525Mn	AAP	Singapore	LX.ART0C.004	AS2930-840525Mn LINPUSASG1 UMACO 1*512/250/BT/6L/5R/ CB_n3_1.0D_HG_EN11	C2DP8400
AS2930-842G25Mn	AAP	Vietnam	LX.ART0X.053	AS2930-842G25Mn EM VHP32ATVN1 MC UMACO 2*1G/250/BT/6L/5R/ CB_n3_1.0D_HG_EN13	C2DP8400
AS2930-841G16Mn	AAP	Philippines	LX.ART0C.007	AS2930-841G16Mn LINPUSAPH1 UMACO 1*1G/160/BT/6L/5R/ CB_n2_1.0D_HG_EN11	C2DP8400

Model	RO	Country	Acer Part No	Description	CPU
AS2930-842G16Mn	AAP	Philippines	LX.ART0X.054	AS2930-842G16Mn EM VHP32ATPH1 MC UMACO 2*1G/160/BT/6L/5R/CB_n2_1.0D_HG_EN14	C2DP8400
AS2930-842G25Mn	AAP	Philippines	LX.ART0X.055	AS2930-842G25Mn EM VHP32ATPH1 MC UMACO 2*1G/250/BT/6L/5R/CB_n2_1.0D_HG_EN14	C2DP8400
AS2930-862G25Mn	AAP	Philippines	LX.ART0X.056	AS2930-862G25Mn EM VHP32ATPH1 MC UMACO 2*1G/250/BT/6L/5R/CB_n2_1.0D_HG_EN14	C2DP8600
AS2930-844G32Mn	EMEA	UK	LX.ART0X.057	AS2930-844G32Mn VHP32ATGB1 MC UMACO 2*2G/320/6L/5R/CB_n2_1.0D_HG_EN14	C2DP8400
AS2930-844G32Mn	EMEA	Middle East	LX.ART0X.059	AS2930-844G32Mn EM VHP32ATME4 MC UMACO 2*2G/320/BT/6L/5R/CB_n2_1.0D_HG_EN11	C2DP8400
AS2930-733G25Mn	EMEA	UK	LX.ART0X.058	AS2930-733G25Mn VHP32ATGB1 MC UMACO 2G+1G/250/6L/5R/CB_n2_1.0D_HG_EN14	C2DP7350
AS2930-732G25Mn	CHINA	China	LX.ART0Y.004	AS2930-732G25Mn VHB32ATCN1 MC UMACO 1*2G/250/6L/5R/CB_n2_1.0D_HG_SC11	C2DP7350
AS2930-844G32Mn	EMEA	South Africa	LX.ART0X.001	AS2930-844G32Mn EM VHP32ATZA2 MC UMACO 2*2G/320/BT/6L/5R/CB_n2_1.0D_HG_EN16	C2DP8400
AS2930-844G32Mn	EMEA	South Africa	LX.ART0X.002	AS2930-844G32Mn EM VHP32ATZA1 MC UMACO 2*2G/320/BT/6L/5R/CB_n2_1.0D_HG_FR23	C2DP8400
AS2930-844G32Mn	EMEA	France	LX.ART0X.004	AS2930-844G32Mn VHP32ATFR1 MC UMACO 2*2G/320/BT/6L/5R/CB_n2_1.0D_HG_FR23	C2DP8400
AS2930-844G32Mn	EMEA	Germany	LX.ART0X.005	AS2930-844G32Mn VHP32ATDE1 MC UMACO 2*2G/320/BT/6L/5R/CB_n2_1.0D_HG_DE13	C2DP8400
AS2930-844G32Mn	EMEA	Belgium	LX.ART0X.006	AS2930-844G32Mn VHP32ATBE1 MC UMACO 2*2G/320/BT/6L/5R/CB_n2_1.0D_HG_NL13	C2DP8400
AS2930-844G32Mi	EMEA	Russia	LX.ART0X.007	AS2930-844G32Mi VHP32ATRU1 MC UMACO 2*2G/320/BT/6L/5R/CB_abg_1.0D_HG_RU11	C2DP8400
AS2930-844G32Mn	EMEA	Sweden/ Finland	LX.ART0X.008	AS2930-844G32Mn VHP32ATSE1 MC UMACO 2*2G/320/BT/6L/5R/CB_n2_1.0D_HG_FI12	C2DP8400
AS2930-844G32Mn	EMEA	Czech	LX.ART0X.009	AS2930-844G32Mn VHP32ATCZ2 MC UMACO 2*2G/320/BT/6L/5R/CB_n2_1.0D_HG_SK11	C2DP8400
AS2930-844G32Mn	EMEA	Eastern Europe	LX.ART0X.010	AS2930-844G32Mn VHP32ATEU6 MC UMACO 2*2G/320/BT/6L/5R/CB_n2_1.0D_HG_CS21	C2DP8400
AS2930-844G32Mn	EMEA	Denmark	LX.ART0X.003	AS2930-844G32Mn VHP32ATDK1 MC UMACO 2*2G/320/BT/6L/5R/CB_n2_1.0D_HG_NO13	C2DP8400
AS2930-844G32Mn	EMEA	Eastern Europe	LX.ART0X.011	AS2930-844G32Mn VHP32ATEU4 MC UMACO 2*2G/320/BT/6L/5R/CB_n2_1.0D_HG_FI12	C2DP8400



Model	RO	Country	Acer Part No	Description	CPU
AS2930-844G32Mn	EMEA	Eastern Europe	LX.ART0X.012	AS2930-844G32Mn VHP32ATEU3 MC UMACO 2*2G/320/BT/6L/5R/ CB_n2_1.0D_HG_RU21	C2DP8400
AS2930-844G32Mn	EMEA	Holland	LX.ART0X.013	AS2930-844G32Mn VHP32ATNL1 MC UMACO 2*2G/320/BT/6L/5R/ CB_n2_1.0D_HG_NL12	C2DP8400
AS2930-844G32Mn	EMEA	Luxembourg	LX.ART0X.014	AS2930-844G32Mn VHP32ATLU1 MC UMACO 2*2G/320/BT/6L/5R/ CB_n2_1.0D_HG_IT42	C2DP8400
AS2930-844G32Mn	EMEA	Norway	LX.ART0X.015	AS2930-844G32Mn VHP32ATNO1 MC UMACO 2*2G/320/BT/6L/5R/ CB_n2_1.0D_HG_NO12	C2DP8400
AS2930-844G32Mn	EMEA	Eastern Europe	LX.ART0X.016	AS2930-844G32Mn VHP32ATEU5 MC UMACO 2*2G/320/BT/6L/5R/ CB_n2_1.0D_HG_PL11	C2DP8400
AS2930-844G32Mn	EMEA	Eastern Europe	LX.ART0X.018	AS2930-844G32Mn VHP32ATEU3 MC UMACO 2*2G/320/BT/6L/5R/ CB_n2_1.0D_HG_RU11	C2DP8400
AS2930-844G32Mn	EMEA	Slovenia/ Croatia	LX.ART0X.019	AS2930-844G32Mn VHP32ATS11 MC UMACO 2*2G/320/BT/6L/5R/ CB_n2_1.0D_HG_EN12	C2DP8400
AS2930-844G32Mn	EMEA	Portugal	LX.ART0X.020	AS2930-844G32Mn VHP32ATPT1 MC UMACO 2*2G/320/BT/6L/5R/ CB_n2_1.0D_HG_PT12	C2DP8400
AS2930-844G32Mn	EMEA	Spain	LX.ART0X.021	AS2930-844G32Mn VHP32ATES1 MC UMACO 2*2G/320/BT/6L/5R/ CB_n2_1.0D_HG_ES22	C2DP8400
AS2930-844G32Mn	EMEA	Greece	LX.ART0X.022	AS2930-844G32Mn VHP32ATGR1 MC UMACO 2*2G/320/BT/6L/5R/ CB_n2_1.0D_HG_EL32	C2DP8400
AS2930-844G32Mn	EMEA	Greece	LX.ART0X.023	AS2930-844G32Mn VHP32ATGR1 MC UMACO 2*2G/320/BT/6L/5R/ CB_n2_1.0D_HG_EL22	C2DP8400
AS2930-844G32Mn	EMEA	Israel	LX.ART0X.024	AS2930-844G32Mn VHP32ATIL1 MC UMACO 2*2G/320/BT/6L/5R/ CB_n2_1.0D_HG_HE11	C2DP8400
AS2930-844G32Mn	EMEA	Hungary	LX.ART0X.017	AS2930-844G32Mn VHP32ATHU1 MC UMACO 2*2G/320/BT/6L/5R/ CB_n2_1.0D_HG_HU11	C2DP8400
AS2930-844G32Mn	EMEA	Italy	LX.ART0X.025	AS2930-844G32Mn VHP32ATIT1 MC UMACO 2*2G/320/BT/6L/5R/ CB_n2_1.0D_HG_IT12	C2DP8400
AS2930-844G32Mn	EMEA	Turkey	LX.ART0X.026	AS2930-844G32Mn EM VHP32ATTR1 MC UMACO 2*2G/320/BT/6L/5R/ CB_n2_1.0D_HG_TR32	C2DP8400
AS2930-844G32Mn	EMEA	Middle East	LX.ART0X.027	AS2930-844G32Mn EM VHP32ATME9 MC UMACO 2*2G/320/BT/6L/5R/ CB_n2_1.0D_HG_FR22	C2DP8400
AS2930-844G32Mn	EMEA	Middle East	LX.ART0X.028	AS2930-844G32Mn EM VHP32ATME2 MC UMACO 2*2G/320/BT/6L/5R/ CB_n2_1.0D_HG_AR23	C2DP8400
AS2930-844G32Mn	EMEA	Middle East	LX.ART0X.029	AS2930-844G32Mn EM VHP32ATME6 MC UMACO 2*2G/320/BT/6L/5R/ CB_n2_1.0D_HG_EN15	C2DP8400

Model	RO	Country	Acer Part No	Description	CPU
AS2930-844G32Mn	EMEA	Middle East	LX.ART0X.030	AS2930-844G32Mn EM VHP32ATME3 MC UMACO 2*2G/320/BT/6L/5R/CB_n2_1.0D_HG_FR23	C2DP8400
AS2930-844G32Mn	EMEA	Middle East	LX.ART0X.032	AS2930-844G32Mn EM VHP32ATME2 MC UMACO 2*2G/320/BT/6L/5R/CB_n2_1.0D_HG_AR13	C2DP8400
AS2930-844G32Mn	EMEA	Switzerland	LX.ART0X.033	AS2930-844G32Mn VHP32ATCH1 MC UMACO 2*2G/320/BT/6L/5R/CB_n2_1.0D_HG_IT42	C2DP8400
AS2930-844G32Mn	EMEA	UK	LX.ART0X.034	AS2930-844G32Mn VHP32ATGB1 MC UMACO 2*2G/320/BT/6L/5R/CB_n2_1.0D_HG_EN14	C2DP8400
AS2930-842G16Mn	CHINA	China	LX.ART0Y.001	AS2930-842G16Mn VHB32ATCN1 MC UMACO 1*2G/160/6L/5R/CB_n2_1.0D_HG_SC11	C2DP8400
AS2930-842G25Mn	TWN	GCTWN	LX.ART0X.035	AS2930-842G25Mn VHP32ATTW1 MC UMACO 1*2G/250/BT/6L/5R/CB_n2_1.0D_HG_TC11	C2DP8400
AS2930-862G32Mn	TWN	GCTWN	LX.ART0X.036	AS2930-862G32Mn VHP32ATTW1 MC UMACO 1*2G/320/BT/6L/5R/CB_n2_1.0D_HG_TC11	C2DP8600
AS2930-842G16Mn	CHINA	Hong Kong	LX.ART0Y.002	AS2930-842G16Mn VHB32ATHK2 MC UMACO 1*2G/160/6L/5R/CB_n2_1.0D_HG_ZH31	C2DP8400
AS2930-844G32Mn	EMEA	Middle East	LX.ART0X.031	AS2930-844G32Mn EM VHP32ATME2 MC UMACO 2*2G/320/BT/6L/5R/CB_n2_1.0D_HG_EN15	C2DP8400
AS2930-844G32Mn	PA	USA	LX.ART0X.037	AS2930-844G32Mn VHP32ATUS1 MC UMACO 2*2G/320/6L/5R/CB_n2_1.0D_HG_EN32	C2DP8400
AS2930-844G32Mn	PA	Canada	LX.ART0X.038	AS2930-844G32Mn VHP32ATCA2 MC UMACO 2*2G/320/6L/5R/CB_n2_1.0D_HG_FR31	C2DP8400
AS2930-864G32Mn	PA	Canada	LX.ART0X.039	AS2930-864G32Mn VHP64ATCA2 MC UMACO 2*2G/320/BT/6L/5R/CB_n2_1.0D_HG_FR31	C2DP8600
AS2930-864G32Mn	PA	USA	LX.ART0X.040	AS2930-864G32Mn VHP64ATCA2 MC UMACO 2*2G/320/BT/6L/5R/CB_n2_1.0D_HG_EN11	C2DP8600
AS2930-732G16Mn	CHINA	China	LX.ART0Y.003	AS2930-732G16Mn VHB32ATCN1 MC UMACO 1*2G/160/6L/5R/CB_n2_1.0D_HG_SC11	C2DP7350
AS2930-731G16Mn	AAP	Vietnam	LX.ART0C.009	AS2930-731G16Mn LINPUSAVN1 UMACO 1*1G/160/BT/6L/5R/CB_n2_1.0D_HG_EN11	C2DP7350
AS2930-584G32Mn	PA	ACLA-Portuguese	LX.ART0X.197	AS2930-584G32Mn EM VHP64ATXC2 MC UMACO 2*2G/320/BT/6L/5R/CB_n_1.0D_HG_XC21	C2DT5800
AS2930-584G32Mn	PA	ACLA-Spanish	LX.ART0X.196	AS2930-584G32Mn EM VHP64ATEA3 MC UMACO 2*2G/320/BT/6L/5R/CB_n_1.0D_HG_ES21	C2DT5800
AS2930-584G32Mn	PA	ACLA-Spanish	LX.ART0X.195	AS2930-584G32Mn EM VHP64ATEA1 MC UMACO 2*2G/320/BT/6L/5R/CB_n_1.0D_HG_ES21	C2DT5800

Model	RO	Country	Acer Part No	Description	CPU
AS2930-592G32Mn	PA	ACLA-Portuguese	LX.ART0X.194	AS2930-592G32Mn EM VHP32ATXC2 MC UMACO 2*1G/320/6L/5R/CB_n_1.0D_HG_XC21	C2DT5900
AS2930-592G32Mn	PA	ACLA-Spanish	LX.ART0X.193	AS2930-592G32Mn EM VHP32ATEA1 MC UMACO 2*1G/320/6L/5R/CB_n_1.0D_HG_ES22	C2DT5900
AS2930-592G32Mn	PA	ACLA-Spanish	LX.ART0X.192	AS2930-592G32Mn EM VHP32ATEA3 MC UMACO 2*1G/320/6L/5R/CB_n_1.0D_HG_ES22	C2DT5900
AS2930-593G32Mn	PA	ACLA-Portuguese	LX.ART0X.191	AS2930-593G32Mn EM VHP32ATXC2 MC UMACO 2G+1G/320/BT/6L/5R/CB_n_1.0D_HG_XC21	C2DT5900
AS2930-593G32Mn	PA	ACLA-Spanish	LX.ART0X.190	AS2930-593G32Mn EM VHP32ATEA1 MC UMACO 2G+1G/320/BT/6L/5R/CB_n_1.0D_HG_ES22	C2DT5900
AS2930-593G32Mn	PA	ACLA-Spanish	LX.ART0X.189	AS2930-593G32Mn EM VHP32ATEA3 MC UMACO 2G+1G/320/BT/6L/5R/CB_n_1.0D_HG_ES22	C2DT5900
AS2930-582G16Mn	AAP	India	LX.ART0C.015	AS2930-582G16Mn LINPUSAIN1 UMACO 1*2G/160/BT/6L/5R/CB_n_1.0D_HG_EN11	C2DT5800
AS2930-583G32Mn	AAP	India	LX.ART0C.014	AS2930-583G32Mn LINPUSAIN1 UMACO 2G+1G/320/BT/6L/5R/CB_n_1.0D_HG_EN11	C2DT5800
AS2930-583G32Mn	AAP	India	LX.ART0C.013	AS2930-583G32Mn LINPUSAIN1 UMACO 2G+1G/320/BT/6L/5R/CB_n_1.0D_PH_HG_EN11	C2DT5800
AS2930-581G16Mn	AAP	India	LX.ART0C.012	AS2930-581G16Mn LINPUSAIN1 UMACO 1*1G/160/BT/6L/5R/CB_n_1.0D_HG_EN11	C2DT5800
AS2930-581G16Mn	AAP	Malaysia	LX.ART0C.011	AS2930-581G16Mn LINPUSAMY1 UMACO 1*1G/160/BT/6L/5R/CB_n_1.0D_HG_EN11	C2DT5800
AS2930-581G25Mn	AAP	Malaysia	LX.ART0C.010	AS2930-581G25Mn LINPUSAMY1 UMACO 1*1G/250/BT/6L/5R/CB_n_1.0D_HG_EN11	C2DT5800
AS2930-582G16Mn	AAP	Malaysia	LX.ART0X.188	AS2930-582G16Mn EM VHP32ATMY1 MC UMACO 1*2G/160/BT/6L/5R/CB_n_1.0D_HG_EN14	C2DT5800
AS2930-592G16Mn	AAP	Philippines	LX.ART0X.186	AS2930-592G16Mn EM VHP32ATPH1 MC UMACO 1*2G/160/BT/6L/5R/CB_n2_1.0D_PH_HG_EN14	C2DT5900
AS2930-592G25Mn	AAP	Philippines	LX.ART0X.185	AS2930-592G25Mn EM VHP32ATPH1 MC UMACO 1*2G/250/BT/6L/5R/CB_n2_1.0D_PH_HG_EN14	C2DT5900
AS2930-582G25Mn	AAP	Malaysia	LX.ART0X.187	AS2930-582G25Mn EM VHP32ATMY1 MC UMACO 1*2G/250/BT/6L/5R/CB_n_1.0D_HG_EN14	C2DT5800
AS2930-592G32Mn	AAP	Philippines	LX.ART0X.199	AS2930-592G32Mn EM VHP32ATPH1 MC UMACO 1*2G/320/BT/6L/5R/CB_n_1.0D_PH_HG_EN14	C2DT5900
AS2930-732G32Mn	AAP	Philippines	LX.ART0X.198	AS2930-732G32Mn EM VHP32ATPH1 MC UMACO 1*2G/320/BT/6L/5R/CB_n_1.0D_PH_HG_EN14	C2DP7350

Model	RO	Country	Acer Part No	Description	CPU
AS2930-732G16Mn	AAP	Philippines	LX.ART0X.061	AS2930-732G16Mn EM VHP32ATPH1 MC UMACO 2*1G/160/BT/6L/5R/CB_n2_1.0D_PH_HG_EN14	C2DP7350
AS2930-731G16Mn	AAP	Philippines	LX.ART0C.008	AS2930-731G16Mn LINPUSAPH1 UMACO 1*1G/160/BT/6L/5R/CB_n2_1.0D_PH_HG_EN11	C2DP7350
AS2930-733G25Mn	EMEA	Italy	LX.ART0X.060	AS2930-733G25Mn VHP32ATIT1 MC UMACO 2G+1G/250/BT/6L/5R/CB_n2_1.0D_HG_IT12	C2DP7350
AS2930-733G25Mn	EMEA	Italy	LX.ART0U.001	AS2930-733G25Mn VUT32ATIT1 MC UMACO 2G+1G/250/BT/6L/5R/CB_n2_1.0D_HG_IT12	C2DP7350
AS2930-734G32Mn	EMEA	Eastern Europe	LX.ART0X.062	AS2930-734G32Mn VHP32ATEU5 MC UMACO 2*2G/320/BT/6L/5R/CB_n2_1.0D_HG_PL11	C2DP7350
AS2930-731G16Mn	AAP	Singapore	LX.ART0X.063	AS2930-731G16Mn VHP32ATSG1 MC UMACO 1*1G/160/BT/6L/5R/CB_n2_1.0D_HG_ZH31	C2DP7350
AS2930-582G25Mn	EMEA	UK	LX.ART0X.176	AS2930-582G25Mn VHP32ATGB1 MC UMACO 1*2G/250/BT/6L/5R/CB_n2_1.0D_HG_EN14	C2DT5800
AS2930-582G25Mn	PA	ACLA-Portuguese	LX.ART0X.179	AS2930-582G25Mn EM VHP32ATXC2 MC UMACO 2*1G/250/BT/6L/5R/CB_n2_1.0D_HG_XC21	C2DT5800
AS2930-582G25Mn	PA	ACLA-Spanish	LX.ART0X.178	AS2930-582G25Mn EM VHP32ATEA3 MC UMACO 2*1G/250/BT/6L/5R/CB_n2_1.0D_HG_ES22	C2DT5800
AS2930-582G25Mn	PA	ACLA-Spanish	LX.ART0X.177	AS2930-582G25Mn EM VHP32ATEA1 MC UMACO 2*1G/250/BT/6L/5R/CB_n2_1.0D_HG_ES22	C2DT5800
AS2930-593G25Mn	EMEA	Middle East	LX.ART0X.182	AS2930-593G25Mn EM VHP32ATME2 MC UMACO 2G+1G/250/BT/6L/5R/CB_n2_1.0D_HG_AR23	C2DT5900
AS2930-582G25Mn	CHINA	China	LX.ART0Y.009	AS2930-582G25Mn VHB32ATCN1 MC UMACO 2*1G/250/BT/6L/5R/CB_n2_1.0D_HG_SC11	C2DT5800
AS2930-583G25Mn	PA	Canada	LX.ART0X.184	AS2930-583G25Mn VHP32ATCA2 MC UMACO 2G+1G/250/6L/5R/CB_n2_1.0D_HG_FR31	C2DT5800
AS2930-583G25Mn	PA	USA	LX.ART0X.183	AS2930-583G25Mn VHP32ATUS1 MC UMACO 2G+1G/250/6L/5R/CB_n2_1.0D_HG_EN32	C2DT5800
AS2930-581G12Mn	EMEA	Middle East	LX.ART0Y.011	AS2930-581G12Mn EM VHB32ATME2 MC UMACO 1*1G/120/6L/5R/CB_n2_1.0D_HG_AR23	C2DT5800
AS2930-583G25Mn	EMEA	Middle East	LX.ART0X.155	AS2930-583G25Mn EM VHP32ATME6 MC UMACO 2G+1G/250/6L/5R/CB_n2_1.0D_HG_EN15	C2DT5800
AS2930-583G25Mn	EMEA	Middle East	LX.ART0X.151	AS2930-583G25Mn EM VHP32ATME2 MC UMACO 2G+1G/250/6L/5R/CB_n2_1.0D_HG_AR23	C2DT5800

Model	RO	Country	Acer Part No	Description	CPU
AS2930-583G25Mn	EMEA	Middle East	LX.ART0X.152	AS2930-583G25Mn EM VHP32ATME4 MC UMACO 2G+1G/250/6L/5R/CB_n2_1.0D_HG_EN11	C2DT5800
AS2930-583G25Mn	EMEA	Switzerland	LX.ART0X.153	AS2930-583G25Mn VHP32ATCH1 MC UMACO 2G+1G/250/6L/5R/CB_n2_1.0D_HG_IT42	C2DT5800
AS2930-583G25Mn	EMEA	UK	LX.ART0X.154	AS2930-583G25Mn VHP32ATGB1 MC UMACO 2G+1G/250/6L/5R/CB_n2_1.0D_HG_EN14	C2DT5800
AS2930-583G25Mn	EMEA	South Africa	LX.ART0X.137	AS2930-583G25Mn EM VHP32ATZA2 MC UMACO 2G+1G/250/BT/6L/5R/CB_n2_1.0D_HG_EN16	C2DT5800
AS2930-583G25Mn	EMEA	South Africa	LX.ART0X.136	AS2930-583G25Mn EM VHP32ATZA1 MC UMACO 2G+1G/250/BT/6L/5R/CB_n2_1.0D_HG_FR23	C2DT5800
AS2930-583G25Mn	EMEA	Denmark	LX.ART0X.135	AS2930-583G25Mn VHP32ATDK1 MC UMACO 2G+1G/250/BT/6L/5R/CB_n2_1.0D_HG_NO13	C2DT5800
AS2930-583G25Mn	EMEA	France	LX.ART0X.131	AS2930-583G25Mn VHP32ATFR1 MC UMACO 2G+1G/250/BT/6L/5R/CB_n2_1.0D_HG_FR23	C2DT5800
AS2930-583G25Mn	EMEA	Germany	LX.ART0X.132	AS2930-583G25Mn VHP32ATDE1 MC UMACO 2G+1G/250/BT/6L/5R/CB_n2_1.0D_HG_DE13	C2DT5800
AS2930-583G25Mn	EMEA	Belgium	LX.ART0X.133	AS2930-583G25Mn VHP32ATBE1 MC UMACO 2G+1G/250/BT/6L/5R/CB_n2_1.0D_HG_NL13	C2DT5800
AS2930-583G25Mn	EMEA	Holland	LX.ART0X.134	AS2930-583G25Mn VHP32ATNL1 MC UMACO 2G+1G/250/BT/6L/5R/CB_n2_1.0D_HG_NL12	C2DT5800
AS2930-583G25Mn	EMEA	Luxembourg	LX.ART0X.128	AS2930-583G25Mn VHP32ATLU1 MC UMACO 2G+1G/250/BT/6L/5R/CB_n2_1.0D_HG_IT42	C2DT5800
AS2930-583G25Mn	EMEA	Norway	LX.ART0X.129	AS2930-583G25Mn VHP32ATNO1 MC UMACO 2G+1G/250/BT/6L/5R/CB_n2_1.0D_HG_NO12	C2DT5800
AS2930-583G25Mi	EMEA	Russia	LX.ART0X.130	AS2930-583G25Mi VHP32ATRU1 MC UMACO 2G+1G/250/BT/6L/5R/CB_abg_1.0D_HG_RU11	C2DT5800
AS2930-591G16Mn	AAP	Philippines	LX.ART0Y.010	AS2930-591G16Mn EM VHB32ATPH1 MC UMACO 1*1G/160/BT/6L/5R/CB_n2_1.0D_PH_HG_EN14	C2DT5900
AS2930-583G25Mn	EMEA	Sweden/ Finland	LX.ART0X.127	AS2930-583G25Mn VHP32ATSE1 MC UMACO 2G+1G/250/BT/6L/5R/CB_n2_1.0D_HG_FI12	C2DT5800
AS2930-583G25Mn	EMEA	Czech	LX.ART0X.126	AS2930-583G25Mn VHP32ATCZ2 MC UMACO 2G+1G/250/BT/6L/5R/CB_n2_1.0D_HG_SK11	C2DT5800
AS2930-583G25Mn	EMEA	Eastern Europe	LX.ART0X.125	AS2930-583G25Mn VHP32ATEU7 MC UMACO 2G+1G/250/BT/6L/5R/CB_n2_1.0D_HG_ENG1	C2DT5800
AS2930-583G25Mn	EMEA	Eastern Europe	LX.ART0X.121	AS2930-583G25Mn VHP32ATEU6 MC UMACO 2G+1G/250/BT/6L/5R/CB_n2_1.0D_HG_CS21	C2DT5800

Model	RO	Country	Acer Part No	Description	CPU
AS2930-583G25Mn	EMEA	Eastern Europe	LX.ART0X.122	AS2930-583G25Mn VHP32ATEU3 MC UMACO 2G+1G/250/BT/6L/5R/CB_n2_1.0D_HG_RU11	C2DT5800
AS2930-583G25Mn	EMEA	Eastern Europe	LX.ART0X.123	AS2930-583G25Mn VHP32ATEU1 MC UMACO 2G+1G/250/BT/6L/5R/CB_n2_1.0D_HG_CS21	C2DT5800
AS2930-583G25Mn	EMEA	Eastern Europe	LX.ART0X.124	AS2930-583G25Mn VHP32ATEU4 MC UMACO 2G+1G/250/BT/6L/5R/CB_n2_1.0D_HG_FI12	C2DT5800
AS2930-583G25Mn	EMEA	Eastern Europe	LX.ART0X.118	AS2930-583G25Mn VHP32ATEU3 MC UMACO 2G+1G/250/BT/6L/5R/CB_n2_1.0D_HG_RU21	C2DT5800
AS2930-583G25Mn	EMEA	Eastern Europe	LX.ART0X.119	AS2930-583G25Mn VHP32ATEU5 MC UMACO 2G+1G/250/BT/6L/5R/CB_n2_1.0D_HG_PL11	C2DT5800
AS2930-583G25Mn	EMEA	Hungary	LX.ART0X.120	AS2930-583G25Mn VHP32ATHU1 MC UMACO 2G+1G/250/BT/6L/5R/CB_n2_1.0D_HG_HU11	C2DT5800
AS2930-583G25Mn	EMEA	Slovenia/Croatia	LX.ART0X.117	AS2930-583G25Mn VHP32ATSI1 MC UMACO 2G+1G/250/BT/6L/5R/CB_n2_1.0D_HG_EN12	C2DT5800
AS2930-583G25Mn	EMEA	Portugal	LX.ART0X.116	AS2930-583G25Mn VHP32ATPT1 MC UMACO 2G+1G/250/BT/6L/5R/CB_n2_1.0D_HG_PT12	C2DT5800
AS2930-583G25Mn	EMEA	Spain	LX.ART0X.115	AS2930-583G25Mn VHP32ATES1 MC UMACO 2G+1G/250/BT/6L/5R/CB_n2_1.0D_HG_ES22	C2DT5800
AS2930-583G25Mn	EMEA	Greece	LX.ART0X.111	AS2930-583G25Mn VHP32ATGR1 MC UMACO 2G+1G/250/BT/6L/5R/CB_n2_1.0D_HG_EL32	C2DT5800
AS2930-583G25Mn	EMEA	Greece	LX.ART0X.112	AS2930-583G25Mn VHP32ATGR1 MC UMACO 2G+1G/250/BT/6L/5R/CB_n2_1.0D_HG_EL22	C2DT5800
AS2930-583G25Mn	EMEA	Israel	LX.ART0X.113	AS2930-583G25Mn VHP32ATIL1 MC UMACO 2G+1G/250/BT/6L/5R/CB_n2_1.0D_HG_HE11	C2DT5800
AS2930-583G25Mn	EMEA	Italy	LX.ART0X.114	AS2930-583G25Mn VHP32ATIT1 MC UMACO 2G+1G/250/BT/6L/5R/CB_n2_1.0D_HG_IT12	C2DT5800
AS2930-583G25Mn	EMEA	Turkey	LX.ART0X.108	AS2930-583G25Mn EM VHP32ATTR1 MC UMACO 2G+1G/250/BT/6L/5R/CB_n2_1.0D_HG_TR32	C2DT5800
AS2930-583G25Mn	EMEA	Middle East	LX.ART0X.109	AS2930-583G25Mn EM VHP32ATME9 MC UMACO 2G+1G/250/BT/6L/5R/CB_n2_1.0D_HG_FR22	C2DT5800
AS2930-583G25Mn	EMEA	Middle East	LX.ART0X.110	AS2930-583G25Mn EM VHP32ATME2 MC UMACO 2G+1G/250/BT/6L/5R/CB_n2_1.0D_HG_AR13	C2DT5800
AS2930-583G25Mn	EMEA	Middle East	LX.ART0X.107	AS2930-583G25Mn EM VHP32ATME2 MC UMACO 2G+1G/250/BT/6L/5R/CB_n2_1.0D_HG_EN15	C2DT5800

Model	RO	Country	Acer Part No	Description	CPU
AS2930-583G25Mn	EMEA	Middle East	LX.ART0X.106	AS2930-583G25Mn EM VHP32ATME3 MC UMACO 2G+1G/250/BT/6L/5R/CB_n2_1.0D_HG_FR23	C2DT5800
AS2930-583G25Mn	EMEA	Middle East	LX.ART0X.105	AS2930-583G25Mn EM VHP32ATME6 MC UMACO 2G+1G/250/BT/6L/5R/CB_n2_1.0D_HG_EN15	C2DT5800
AS2930-583G25Mn	EMEA	Middle East	LX.ART0X.104	AS2930-583G25Mn EM VHP32ATME2 MC UMACO 2G+1G/250/BT/6L/5R/CB_n2_1.0D_HG_AR23	C2DT5800
AS2930-583G25Mn	EMEA	Middle East	LX.ART0X.103	AS2930-583G25Mn EM VHP32ATME4 MC UMACO 2G+1G/250/BT/6L/5R/CB_n2_1.0D_HG_EN11	C2DT5800
AS2930-583G25Mn	EMEA	Switzerland	LX.ART0X.102	AS2930-583G25Mn VHP32ATCH1 MC UMACO 2G+1G/250/BT/6L/5R/CB_n2_1.0D_HG_IT42	C2DT5800
AS2930-583G25Mn	EMEA	UK	LX.ART0X.101	AS2930-583G25Mn VHP32ATGB1 MC UMACO 2G+1G/250/BT/6L/5R/CB_n2_1.0D_HG_EN14	C2DT5800
AS2930-733G25Mn	EMEA	South Africa	LX.ART0X.097	AS2930-733G25Mn EM VHP32ATZA2 MC UMACO 2G+1G/250/BT/6L/5R/CB_n2_1.0D_HG_EN16	C2DP7350
AS2930-733G25Mn	EMEA	South Africa	LX.ART0X.098	AS2930-733G25Mn EM VHP32ATZA1 MC UMACO 2G+1G/250/BT/6L/5R/CB_n2_1.0D_HG_FR23	C2DP7350
AS2930-733G25Mn	EMEA	Denmark	LX.ART0X.099	AS2930-733G25Mn VHP32ATDK1 MC UMACO 2G+1G/250/BT/6L/5R/CB_n2_1.0D_HG_NO13	C2DP7350
AS2930-733G25Mn	EMEA	France	LX.ART0X.096	AS2930-733G25Mn VHP32ATFR1 MC UMACO 2G+1G/250/BT/6L/5R/CB_n2_1.0D_HG_FR23	C2DP7350
AS2930-733G25Mn	EMEA	Germany	LX.ART0X.095	AS2930-733G25Mn VHP32ATDE1 MC UMACO 2G+1G/250/BT/6L/5R/CB_n2_1.0D_HG_DE13	C2DP7350
AS2930-733G25Mn	EMEA	Belgium	LX.ART0X.094	AS2930-733G25Mn VHP32ATBE1 MC UMACO 2G+1G/250/BT/6L/5R/CB_n2_1.0D_HG_NL13	C2DP7350
AS2930-733G25Mn	EMEA	Holland	LX.ART0X.090	AS2930-733G25Mn VHP32ATNL1 MC UMACO 2G+1G/250/BT/6L/5R/CB_n2_1.0D_HG_NL12	C2DP7350
AS2930-733G25Mn	EMEA	Luxembourg	LX.ART0X.091	AS2930-733G25Mn VHP32ATLU1 MC UMACO 2G+1G/250/BT/6L/5R/CB_n2_1.0D_HG_IT42	C2DP7350
AS2930-733G25Mn	EMEA	Norway	LX.ART0X.092	AS2930-733G25Mn VHP32ATNO1 MC UMACO 2G+1G/250/BT/6L/5R/CB_n2_1.0D_HG_NO12	C2DP7350
AS2930-733G25Mi	EMEA	Russia	LX.ART0X.093	AS2930-733G25Mi VHP32ATRU1 MC UMACO 2G+1G/250/BT/6L/5R/CB_abg_1.0D_HG_RU11	C2DP7350
AS2930-733G25Mn	EMEA	Sweden/ Finland	LX.ART0X.087	AS2930-733G25Mn VHP32ATSE1 MC UMACO 2G+1G/250/BT/6L/5R/CB_n2_1.0D_HG_FI12	C2DP7350



Model	RO	Country	Acer Part No	Description	CPU
AS2930-733G25Mn	EMEA	Czech	LX.ART0X.088	AS2930-733G25Mn VHP32ATCZ2 MC UMACO 2G+1G/250/BT/6L/5R/ CB_n2_1.0D_HG_SK11	C2DP7350
AS2930-733G25Mn	EMEA	Eastern Europe	LX.ART0X.089	AS2930-733G25Mn VHP32ATEU7 MC UMACO 2G+1G/250/BT/6L/5R/ CB_n2_1.0D_HG_ENG1	C2DP7350
AS2930-733G25Mn	EMEA	Eastern Europe	LX.ART0X.086	AS2930-733G25Mn VHP32ATEU6 MC UMACO 2G+1G/250/BT/6L/5R/ CB_n2_1.0D_HG_CS21	C2DP7350
AS2930-733G25Mn	EMEA	Eastern Europe	LX.ART0X.085	AS2930-733G25Mn VHP32ATEU3 MC UMACO 2G+1G/250/BT/6L/5R/ CB_n2_1.0D_HG_RU11	C2DP7350
AS2930-733G25Mn	EMEA	Eastern Europe	LX.ART0X.084	AS2930-733G25Mn VHP32ATEU1 MC UMACO 2G+1G/250/BT/6L/5R/ CB_n2_1.0D_HG_CS21	C2DP7350
AS2930-733G25Mn	EMEA	Eastern Europe	LX.ART0X.080	AS2930-733G25Mn VHP32ATEU4 MC UMACO 2G+1G/250/BT/6L/5R/ CB_n2_1.0D_HG_FI12	C2DP7350
AS2930-733G25Mn	EMEA	Eastern Europe	LX.ART0X.081	AS2930-733G25Mn VHP32ATEU3 MC UMACO 2G+1G/250/BT/6L/5R/ CB_n2_1.0D_HG_RU21	C2DP7350
AS2930-733G25Mn	EMEA	Eastern Europe	LX.ART0X.082	AS2930-733G25Mn VHP32ATEU5 MC UMACO 2G+1G/250/BT/6L/5R/ CB_n2_1.0D_HG_PL11	C2DP7350
AS2930-733G25Mn	EMEA	Hungary	LX.ART0X.083	AS2930-733G25Mn VHP32ATHU1 MC UMACO 2G+1G/250/BT/6L/5R/ CB_n2_1.0D_HG_HU11	C2DP7350
AS2930-733G25Mn	EMEA	Slovenia/ Croatia	LX.ART0X.077	AS2930-733G25Mn VHP32ATS11 MC UMACO 2G+1G/250/BT/6L/5R/ CB_n2_1.0D_HG_EN12	C2DP7350
AS2930-733G25Mn	EMEA	Portugal	LX.ART0X.078	AS2930-733G25Mn VHP32ATPT1 MC UMACO 2G+1G/250/BT/6L/5R/ CB_n2_1.0D_HG_PT12	C2DP7350
AS2930-733G25Mn	EMEA	Spain	LX.ART0X.079	AS2930-733G25Mn VHP32ATES1 MC UMACO 2G+1G/250/BT/6L/5R/ CB_n2_1.0D_HG_ES22	C2DP7350
AS2930-733G25Mn	EMEA	Greece	LX.ART0X.076	AS2930-733G25Mn VHP32ATGR1 MC UMACO 2G+1G/250/BT/6L/5R/ CB_n2_1.0D_HG_EL32	C2DP7350
AS2930-733G25Mn	EMEA	Greece	LX.ART0X.075	AS2930-733G25Mn VHP32ATGR1 MC UMACO 2G+1G/250/BT/6L/5R/ CB_n2_1.0D_HG_EL22	C2DP7350
AS2930-733G25Mn	EMEA	Israel	LX.ART0X.074	AS2930-733G25Mn VHP32ATIL1 MC UMACO 2G+1G/250/BT/6L/5R/ CB_n2_1.0D_HG_HE11	C2DP7350
AS2930-733G25Mn	EMEA	Turkey	LX.ART0X.070	AS2930-733G25Mn EM VHP32ATTR1 MC UMACO 2G+1G/ 250/BT/6L/5R/ CB_n2_1.0D_HG_TR32	C2DP7350
AS2930-733G25Mn	EMEA	Middle East	LX.ART0X.071	AS2930-733G25Mn EM VHP32ATME9 MC UMACO 2G+1G/ 250/BT/6L/5R/ CB_n2_1.0D_HG_FR22	C2DP7350
AS2930-733G25Mn	EMEA	Middle East	LX.ART0X.072	AS2930-733G25Mn EM VHP32ATME2 MC UMACO 2G+1G/ 250/BT/6L/5R/ CB_n2_1.0D_HG_AR13	C2DP7350

Model	RO	Country	Acer Part No	Description	CPU
AS2930-733G25Mn	EMEA	Middle East	LX.ART0X.073	AS2930-733G25Mn EM VHP32ATME2 MC UMACO 2G+1G/250/BT/6L/5R/CB_n2_1.0D_HG_EN15	C2DP7350
AS2930-733G25Mn	EMEA	Middle East	LX.ART0X.067	AS2930-733G25Mn EM VHP32ATME3 MC UMACO 2G+1G/250/BT/6L/5R/CB_n2_1.0D_HG_FR23	C2DP7350
AS2930-733G25Mn	EMEA	Middle East	LX.ART0X.068	AS2930-733G25Mn EM VHP32ATME6 MC UMACO 2G+1G/250/BT/6L/5R/CB_n2_1.0D_HG_EN15	C2DP7350
AS2930-733G25Mn	EMEA	Middle East	LX.ART0X.069	AS2930-733G25Mn EM VHP32ATME2 MC UMACO 2G+1G/250/BT/6L/5R/CB_n2_1.0D_HG_AR23	C2DP7350
AS2930-733G25Mn	EMEA	Middle East	LX.ART0X.066	AS2930-733G25Mn EM VHP32ATME4 MC UMACO 2G+1G/250/BT/6L/5R/CB_n2_1.0D_HG_EN11	C2DP7350
AS2930-733G25Mn	EMEA	Switzerland	LX.ART0X.065	AS2930-733G25Mn VHP32ATCH1 MC UMACO 2G+1G/250/BT/6L/5R/CB_n2_1.0D_HG_IT42	C2DP7350
AS2930-733G25Mn	EMEA	UK	LX.ART0X.064	AS2930-733G25Mn VHP32ATGB1 MC UMACO 2G+1G/250/BT/6L/5R/CB_n2_1.0D_HG_EN14	C2DP7350
AS2930-583G25Mn	EMEA	South Africa	LX.ART0X.171	AS2930-583G25Mn EM VHP32ATZA2 MC UMACO 2G+1G/250/6L/5R/CB_n2_1.0D_HG_EN16	C2DT5800
AS2930-583G25Mn	EMEA	South Africa	LX.ART0X.172	AS2930-583G25Mn EM VHP32ATZA1 MC UMACO 2G+1G/250/6L/5R/CB_n2_1.0D_HG_FR23	C2DT5800
AS2930-583G25Mn	EMEA	Denmark	LX.ART0X.173	AS2930-583G25Mn VHP32ATDK1 MC UMACO 2G+1G/250/6L/5R/CB_n2_1.0D_HG_NO13	C2DT5800
AS2930-583G25Mn	EMEA	France	LX.ART0X.174	AS2930-583G25Mn VHP32ATFR1 MC UMACO 2G+1G/250/6L/5R/CB_n2_1.0D_HG_FR23	C2DT5800
AS2930-583G25Mn	EMEA	Germany	LX.ART0X.168	AS2930-583G25Mn VHP32ATDE1 MC UMACO 2G+1G/250/6L/5R/CB_n2_1.0D_HG_DE13	C2DT5800
AS2930-583G25Mn	EMEA	Belgium	LX.ART0X.169	AS2930-583G25Mn VHP32ATBE1 MC UMACO 2G+1G/250/6L/5R/CB_n2_1.0D_HG_NL13	C2DT5800
AS2930-583G25Mn	EMEA	Holland	LX.ART0X.170	AS2930-583G25Mn VHP32ATNL1 MC UMACO 2G+1G/250/6L/5R/CB_n2_1.0D_HG_NL12	C2DT5800
AS2930-583G25Mn	EMEA	Luxembourg	LX.ART0X.167	AS2930-583G25Mn VHP32ATLU1 MC UMACO 2G+1G/250/6L/5R/CB_n2_1.0D_HG_IT42	C2DT5800
AS2930-583G25Mn	EMEA	Norway	LX.ART0X.166	AS2930-583G25Mn VHP32ATNO1 MC UMACO 2G+1G/250/6L/5R/CB_n2_1.0D_HG_NO12	C2DT5800
AS2930-583G25Mi	EMEA	Russia	LX.ART0X.162	AS2930-583G25Mi VHP32ATRU1 MC UMACO 2G+1G/250/6L/5R/CB_abg_1.0D_HG_RU11	C2DT5800

Model	RO	Country	Acer Part No	Description	CPU
AS2930-583G25Mn	EMEA	Sweden/ Finland	LX.ART0X.163	AS2930-583G25Mn VHP32ATSE1 MC UMACO 2G+1G/250/6L/5R/ CB_n2_1.0D_HG_FI12	C2DT5800
AS2930-583G25Mn	EMEA	Czech	LX.ART0X.164	AS2930-583G25Mn VHP32ATCZ2 MC UMACO 2G+1G/250/6L/5R/ CB_n2_1.0D_HG_SK11	C2DT5800
AS2930-583G25Mn	EMEA	Eastern Europe	LX.ART0X.165	AS2930-583G25Mn VHP32ATEU7 MC UMACO 2G+1G/250/6L/5R/ CB_n2_1.0D_HG_ENG1	C2DT5800
AS2930-583G25Mn	EMEA	Eastern Europe	LX.ART0X.159	AS2930-583G25Mn VHP32ATEU6 MC UMACO 2G+1G/250/6L/5R/ CB_n2_1.0D_HG_CS21	C2DT5800
AS2930-583G25Mn	EMEA	Eastern Europe	LX.ART0X.160	AS2930-583G25Mn VHP32ATEU3 MC UMACO 2G+1G/250/6L/5R/ CB_n2_1.0D_HG_RU11	C2DT5800
AS2930-583G25Mn	EMEA	Eastern Europe	LX.ART0X.161	AS2930-583G25Mn VHP32ATEU1 MC UMACO 2G+1G/250/6L/5R/ CB_n2_1.0D_HG_CS21	C2DT5800
AS2930-583G25Mn	EMEA	Eastern Europe	LX.ART0X.158	AS2930-583G25Mn VHP32ATEU4 MC UMACO 2G+1G/250/6L/5R/ CB_n2_1.0D_HG_FI12	C2DT5800
AS2930-583G25Mn	EMEA	Eastern Europe	LX.ART0X.157	AS2930-583G25Mn VHP32ATEU3 MC UMACO 2G+1G/250/6L/5R/ CB_n2_1.0D_HG_RU21	C2DT5800
AS2930-583G25Mn	EMEA	Eastern Europe	LX.ART0X.156	AS2930-583G25Mn VHP32ATEU5 MC UMACO 2G+1G/250/6L/5R/ CB_n2_1.0D_HG_PL11	C2DT5800
AS2930-583G25Mn	EMEA	Hungary	LX.ART0X.148	AS2930-583G25Mn VHP32ATHU1 MC UMACO 2G+1G/250/6L/5R/ CB_n2_1.0D_HG_HU11	C2DT5800
AS2930-583G25Mn	EMEA	Slovenia/ Croatia	LX.ART0X.149	AS2930-583G25Mn VHP32ATS11 MC UMACO 2G+1G/250/6L/5R/ CB_n2_1.0D_HG_EN12	C2DT5800
AS2930-583G25Mn	EMEA	Portugal	LX.ART0X.150	AS2930-583G25Mn VHP32ATPT1 MC UMACO 2G+1G/250/6L/5R/ CB_n2_1.0D_HG_PT12	C2DT5800
AS2930-583G25Mn	EMEA	Spain	LX.ART0X.144	AS2930-583G25Mn VHP32ATES1 MC UMACO 2G+1G/250/6L/5R/ CB_n2_1.0D_HG_ES22	C2DT5800
AS2930-583G25Mn	EMEA	Greece	LX.ART0X.147	AS2930-583G25Mn VHP32ATGR1 MC UMACO 2G+1G/250/6L/5R/ CB_n2_1.0D_HG_EL32	C2DT5800
AS2930-583G25Mn	EMEA	Greece	LX.ART0X.146	AS2930-583G25Mn VHP32ATGR1 MC UMACO 2G+1G/250/6L/5R/ CB_n2_1.0D_HG_EL22	C2DT5800
AS2930-583G25Mn	EMEA	Israel	LX.ART0X.145	AS2930-583G25Mn VHP32ATIL1 MC UMACO 2G+1G/250/6L/5R/ CB_n2_1.0D_HG_HE11	C2DT5800
AS2930-583G25Mn	EMEA	Italy	LX.ART0X.141	AS2930-583G25Mn VHP32ATIT1 MC UMACO 2G+1G/250/6L/5R/ CB_n2_1.0D_HG_IT12	C2DT5800
AS2930-583G25Mn	EMEA	Turkey	LX.ART0X.142	AS2930-583G25Mn EM VHP32ATTR1 MC UMACO 2G+1G/ 250/6L/5R/CB_n2_1.0D_HG_TR32	C2DT5800
AS2930-583G25Mn	EMEA	Middle East	LX.ART0X.143	AS2930-583G25Mn EM VHP32ATME9 MC UMACO 2G+1G/ 250/6L/5R/CB_n2_1.0D_HG_FR22	C2DT5800

Model	RO	Country	Acer Part No	Description	CPU
AS2930-583G25Mn	EMEA	Middle East	LX.ART0X.140	AS2930-583G25Mn EM VHP32ATME2 MC UMACO 2G+1G/250/6L/5R/CB_n2_1.0D_HG_AR13	C2DT5800
AS2930-583G25Mn	EMEA	Middle East	LX.ART0X.139	AS2930-583G25Mn EM VHP32ATME2 MC UMACO 2G+1G/250/6L/5R/CB_n2_1.0D_HG_EN15	C2DT5800
AS2930-583G25Mn	EMEA	Middle East	LX.ART0X.138	AS2930-583G25Mn EM VHP32ATME3 MC UMACO 2G+1G/250/6L/5R/CB_n2_1.0D_HG_FR23	C2DT5800
AS2930-733G32Mn	AAP	Singapore	LX.ART0X.175	AS2930-733G32Mn VHP32ATSG1 MC UMACO 2G+1G/320/BT/6L/5R/CB_n2_1.0D_HG_ZH31	C2DP7350
AS2930-582G16Mn	CHINA	China	LX.ART0Y.008	AS2930-582G16Mn VHB32ATCN1 MC UMACO 2*1G/160/BT/6L/5R/CB_n2_1.0D_HG_SC11	C2DT5800
AS2930-593G25Mn	EMEA	UK	LX.ART0X.180	AS2930-593G25Mn VHP32ATGB1 MC UMACO 2G+1G/250/BT/6L/5R/CB_n2_1.0D_HG_EN14	C2DT5900
AS2930-584G25Mn	EMEA	Switzerland	LX.ART0X.181	AS2930-584G25Mn VHP32ATCH1 MC UMACO 2*2G/250/BT/6L/5R/CB_n2_1.0D_HG_IT42	C2DT5800
AS2930-732G32Mn	CHINA	China	LX.ART0Y.012	AS2930-732G32Mn VHB32ATCN1 MC UMACO 1*2G/320/BT/6L/5R/CB_n2_1.0D_HG_SC11	C2DP7350
AS2930-582G32Mn	CHINA	China	LX.ART0Y.013	AS2930-582G32Mn VHB32ATCN1 MC UMACO 2*1G/320/BT/6L/5R/CB_n2_1.0D_HG_SC11	C2DT5800
AS2930Z-322G16Mi	EMEA	Sweden/ Finland	LX.ARU0X.156	AS2930Z-322G16Mi VHP32ATSE1 MC UMACO 1*2G/160/BT/6L/5R/CB_bg_1.0D_HG_FI12	PMDT3200
AS2930Z-321G16Mn	AAP	Philippines	LX.ARU0C.007	AS2930Z-321G16Mn LIMPUSAPH1 UMACO 1*1G/160/BT/6L/5R/CB_bgn_1.0D_PH_HG_EN11	PMDT3200
AS2930Z-342G16Mn	AAP	Philippines	LX.ARU0C.006	AS2930Z-342G16Mn LIMPUSAPH1 UMACO 1*2G/160/BT/6L/5R/CB_bgn_1.0D_PH_HG_EN11	PMDT3400
AS2930Z-343G32Mi	EMEA	Russia	LX.ARU0X.153	AS2930Z-343G32Mi VHP32ATRU1 MC UMACO 2G+1G/320/BT/6L/5R/CB_bg_1.0D_HG_RU11	PMDT3400
AS2930Z-323G25Mi	EMEA	Russia	LX.ARU0C.011	AS2930Z-323G25Mi LIMPUSARU1 UMACO 2G+1G/250/BT/6L/5R/CB_bg_1.0D_HG_EN71	PMDT3200
AS2930Z-321G16Mn	AAP	Indonesia	LX.ARU0Y.013	AS2930Z-321G16Mn EM VHB32ATID1 MC UMACO 1*1G/160/BT/6L/5R/CB_bgn_1.0D_HG_ID24	PMDT3200
AS2930Z-322G16Mn	EMEA	Middle East	LX.ARU0C.010	AS2930Z-322G16Mn LIMPUSAME6 UMACO 1*2G/160/BT/6L/5R/CB_bgn_1.0D_HG_EN13	PMDT3200
AS2930Z-322G32Mn	EMEA	Czech	LX.ARU0X.149	AS2930Z-322G32Mn VHP32ATCZ2 MC UMACO 1*2G/320/BT/6L/5R/CB_bgn_1.0D_HG_SK12	PMDT3200
AS2930Z-321G16Mn	AAP	Singapore	LX.ARU0Y.010	AS2930Z-321G16Mn VHB32ATSG1 MC UMACO 1*1G/160/6L/5R/CB_bgn_1.0D_HG_ZH31	PMDT3200
AS2930Z-322G16Mn	CHINA	China	LX.ARU0C.009	AS2930Z-322G16Mn LIMPUSACN1 UMACO 2*1G/160/6L/5R/CB_bgn_1.0D_PH_HG_EN91	PMDT3200

Model	RO	Country	Acer Part No	Description	CPU
AS2930Z-321G16Mn	AAP	Indonesia	LX.ARU0C.012	AS2930Z-321G16Mn LIMPUSAID1 UMACO 1*1G/160/BT/6L/5R/ CB_bgn_1.0D_HG_ID22	PMDT3200
AS2930Z-321G16Mn	AAP	Philippines	LX.ARU0Y.009	AS2930Z-321G16Mn EM VHB32ATPH1 MC UMACO 1*1G/ 160/BT/6L/5R/ CB_bgn_1.0D_PH_HG_EN14	PMDT3200
AS2930Z-341G16Mn	AAP	Philippines	LX.ARU0Y.008	AS2930Z-341G16Mn EM VHB32ATPH1 MC UMACO 1*1G/ 160/BT/6L/5R/ CB_bgn_1.0D_PH_HG_EN14	PMDT3400
AS2930Z-322G16Mn	EMEA	Middle East	LX.ARU0X.150	AS2930Z-322G16Mn EM VHP32ATME2 MC UMACO 1*2G/ 160/BT/6L/5R/ CB_bgn_1.0D_HG_AR23	PMDT3200
AS2930Z-321G16Mn	EMEA	Middle East	LX.ARU0X.157	AS2930Z-321G16Mn EM VHP32ATME2 MC UMACO 1*1G/ 160/BT/6L/5R/ CB_bgn_1.0D_HG_AR23	PMDT3200
AS2930Z-342G25Mn	AAP	Philippines	LX.ARU0Y.012	AS2930Z-342G25Mn EM VHB32ATPH1 MC UMACO 1*2G/ 250/BT/6L/5R/ CB_bgn_1.0D_PH_HG_EN14	PMDT3400
AS2930Z-321G16Mn	CHINA	China	LX.ARU0C.013	AS2930Z-321G16Mn LIMPUSACN1 UMACO 1*1G/160/6L/5R/ CB_bgn_1.0D_PH_HG_EN91	PMDT3200
AS2930Z-323G32Mn	EMEA	Hungary	LX.ARU0X.155	AS2930Z-323G32Mn VHP32ATHU1 MC UMACO 2G+1G/320/BT/6L/5R/ CB_bgn_1.0D_HG_HU12	PMDT3200
AS2930Z-323G32Mn	EMEA	Eastern Europe	LX.ARU0X.154	AS2930Z-323G32Mn VHP32ATEU5 MC UMACO 2G+1G/320/BT/6L/5R/ CB_bgn_1.0D_HG_PL12	PMDT3200
AS2930Z-321G16Mn	AAP	Vietnam	LX.ARU0C.008	AS2930Z-321G16Mn LIMPUSAVN1 UMACO 1*1G/160/BT/6L/5R/ CB_bgn_1.0D_HG_EN11	PMDT3200
AS2930Z-322G16Mn	EMEA	Middle East	LX.ARU0Y.011	AS2930Z-322G16Mn EM VHB32ATME2 MC UMACO 1*2G/ 160/BT/6L/5R/ CB_bgn_1.0D_HG_AR23	PMDT3200
AS2930Z-322G16Mn	EMEA	Greece	LX.ARU0X.152	AS2930Z-322G16Mn VHP32ATGR1 MC UMACO 1*2G/160/BT/6L/5R/ CB_bgn_1.0D_HG_EL32	PMDT3200
AS2930Z-322G16Mn	EMEA	Italy	LX.ARU0X.151	AS2930Z-322G16Mn VHP32ATIT1 MC UMACO 1*2G/160/BT/6L/5R/ CB_bgn_1.0D_HG_IT12	PMDT3200
AS2930Z-323G25Mn	EMEA	South Africa	LX.ARU0X.118	AS2930Z-323G25Mn EM VHP32ATZA2 MC UMACO 2G+1G/ 250/6L/5R/CB_bgn_1.0D_HG_EN16	PMDT3200
AS2930Z-323G25Mn	EMEA	South Africa	LX.ARU0X.117	AS2930Z-323G25Mn EM VHP32ATZA1 MC UMACO 2G+1G/ 250/6L/5R/CB_bgn_1.0D_HG_FR23	PMDT3200
AS2930Z-323G25Mn	EMEA	Denmark	LX.ARU0X.116	AS2930Z-323G25Mn VHP32ATDK1 MC UMACO 2G+1G/250/6L/5R/ CB_bgn_1.0D_HG_NO13	PMDT3200
AS2930Z-323G25Mn	EMEA	France	LX.ARU0X.115	AS2930Z-323G25Mn VHP32ATFR1 MC UMACO 2G+1G/250/6L/5R/ CB_bgn_1.0D_HG_FR23	PMDT3200

Model	RO	Country	Acer Part No	Description	CPU
AS2930Z-323G25Mn	EMEA	Germany	LX.ARU0X.114	AS2930Z-323G25Mn VHP32ATDE1 MC UMACO 2G+1G/250/6L/5R/ CB_bgn_1.0D_HG_DE13	PMDT3200
AS2930Z-323G25Mn	EMEA	Belgium	LX.ARU0X.113	AS2930Z-323G25Mn VHP32ATBE1 MC UMACO 2G+1G/250/6L/5R/ CB_bgn_1.0D_HG_NL13	PMDT3200
AS2930Z-323G25Mn	EMEA	Holland	LX.ARU0X.112	AS2930Z-323G25Mn VHP32ATNL1 MC UMACO 2G+1G/250/6L/5R/ CB_bgn_1.0D_HG_NL12	PMDT3200
AS2930Z-323G25Mn	EMEA	Luxembourg	LX.ARU0X.111	AS2930Z-323G25Mn VHP32ATLU1 MC UMACO 2G+1G/250/6L/5R/ CB_bgn_1.0D_HG_IT42	PMDT3200
AS2930Z-323G25Mn	EMEA	Norway	LX.ARU0X.110	AS2930Z-323G25Mn VHP32ATNO1 MC UMACO 2G+1G/250/6L/5R/ CB_bgn_1.0D_HG_NO12	PMDT3200
AS2930Z-323G25Mi	EMEA	Russia	LX.ARU0X.109	AS2930Z-323G25Mi VHP32ATRU1 MC UMACO 2G+1G/250/6L/5R/ CB_bg_1.0D_HG_RU11	PMDT3200
AS2930Z-323G25Mn	EMEA	Sweden/ Finland	LX.ARU0X.108	AS2930Z-323G25Mn VHP32ATSE1 MC UMACO 2G+1G/250/6L/5R/ CB_bgn_1.0D_HG_FI12	PMDT3200
AS2930Z-323G25Mn	EMEA	Czech	LX.ARU0X.107	AS2930Z-323G25Mn VHP32ATCZ2 MC UMACO 2G+1G/250/6L/5R/ CB_bgn_1.0D_HG_SK11	PMDT3200
AS2930Z-323G25Mn	EMEA	Eastern Europe	LX.ARU0X.106	AS2930Z-323G25Mn VHP32ATEU7 MC UMACO 2G+1G/250/6L/5R/ CB_bgn_1.0D_HG_ENG1	PMDT3200
AS2930Z-323G25Mn	EMEA	Eastern Europe	LX.ARU0X.105	AS2930Z-323G25Mn VHP32ATEU6 MC UMACO 2G+1G/250/6L/5R/ CB_bgn_1.0D_HG_CS21	PMDT3200
AS2930Z-323G25Mn	EMEA	Eastern Europe	LX.ARU0X.104	AS2930Z-323G25Mn VHP32ATEU3 MC UMACO 2G+1G/250/6L/5R/ CB_bgn_1.0D_HG_RU11	PMDT3200
AS2930Z-323G25Mn	EMEA	Eastern Europe	LX.ARU0X.103	AS2930Z-323G25Mn VHP32ATEU1 MC UMACO 2G+1G/250/6L/5R/ CB_bgn_1.0D_HG_CS21	PMDT3200
AS2930Z-323G25Mn	EMEA	Eastern Europe	LX.ARU0X.102	AS2930Z-323G25Mn VHP32ATEU4 MC UMACO 2G+1G/250/6L/5R/ CB_bgn_1.0D_HG_FI12	PMDT3200
AS2930Z-323G25Mn	EMEA	Eastern Europe	LX.ARU0X.101	AS2930Z-323G25Mn VHP32ATEU3 MC UMACO 2G+1G/250/6L/5R/ CB_bgn_1.0D_HG_RU21	PMDT3200
AS2930Z-323G25Mn	EMEA	Eastern Europe	LX.ARU0X.099	AS2930Z-323G25Mn VHP32ATEU5 MC UMACO 2G+1G/250/6L/5R/ CB_bgn_1.0D_HG_PL11	PMDT3200
AS2930Z-323G25Mn	EMEA	Hungary	LX.ARU0X.098	AS2930Z-323G25Mn VHP32ATHU1 MC UMACO 2G+1G/250/6L/5R/ CB_bgn_1.0D_HG_HU11	PMDT3200
AS2930Z-323G25Mn	EMEA	Slovenia/ Croatia	LX.ARU0X.097	AS2930Z-323G25Mn VHP32ATS1 MC UMACO 2G+1G/250/6L/5R/ CB_bgn_1.0D_HG_EN12	PMDT3200
AS2930Z-323G25Mn	EMEA	Portugal	LX.ARU0X.096	AS2930Z-323G25Mn VHP32ATPT1 MC UMACO 2G+1G/250/6L/5R/ CB_bgn_1.0D_HG_PT12	PMDT3200
AS2930Z-323G25Mn	EMEA	Spain	LX.ARU0X.095	AS2930Z-323G25Mn VHP32ATES1 MC UMACO 2G+1G/250/6L/5R/ CB_bgn_1.0D_HG_ES22	PMDT3200

Model	RO	Country	Acer Part No	Description	CPU
AS2930Z-323G25Mn	EMEA	Greece	LX.ARU0X.094	AS2930Z-323G25Mn VHP32ATGR1 MC UMACO 2G+1G/250/6L/5R/ CB_bgn_1.0D_HG_EL32	PMDT3200
AS2930Z-323G25Mn	EMEA	Greece	LX.ARU0X.093	AS2930Z-323G25Mn VHP32ATGR1 MC UMACO 2G+1G/250/6L/5R/ CB_bgn_1.0D_HG_EL22	PMDT3200
AS2930Z-323G25Mn	EMEA	Israel	LX.ARU0X.092	AS2930Z-323G25Mn VHP32ATIL1 MC UMACO 2G+1G/250/6L/5R/ CB_bgn_1.0D_HG_HE11	PMDT3200
AS2930Z-323G25Mn	EMEA	Italy	LX.ARU0X.091	AS2930Z-323G25Mn VHP32ATIT1 MC UMACO 2G+1G/250/6L/5R/ CB_bgn_1.0D_HG_IT12	PMDT3200
AS2930Z-323G25Mn	EMEA	Turkey	LX.ARU0X.090	AS2930Z-323G25Mn EM VHP32ATTR1 MC UMACO 2G+1G/250/6L/5R/CB_bgn_1.0D_HG_TR32	PMDT3200
AS2930Z-323G25Mn	EMEA	Middle East	LX.ARU0X.089	AS2930Z-323G25Mn EM VHP32ATME9 MC UMACO 2G+1G/250/6L/5R/CB_bgn_1.0D_HG_FR22	PMDT3200
AS2930Z-323G25Mn	EMEA	Middle East	LX.ARU0X.088	AS2930Z-323G25Mn EM VHP32ATME2 MC UMACO 2G+1G/250/6L/5R/CB_bgn_1.0D_HG_AR13	PMDT3200
AS2930Z-323G25Mn	EMEA	Middle East	LX.ARU0X.087	AS2930Z-323G25Mn EM VHP32ATME2 MC UMACO 2G+1G/250/6L/5R/CB_bgn_1.0D_HG_EN15	PMDT3200
AS2930Z-323G25Mn	EMEA	Middle East	LX.ARU0X.086	AS2930Z-323G25Mn EM VHP32ATME3 MC UMACO 2G+1G/250/6L/5R/CB_bgn_1.0D_HG_FR23	PMDT3200
AS2930Z-323G25Mn	EMEA	Middle East	LX.ARU0X.085	AS2930Z-323G25Mn EM VHP32ATME6 MC UMACO 2G+1G/250/6L/5R/CB_bgn_1.0D_HG_EN15	PMDT3200
AS2930Z-323G25Mn	EMEA	Middle East	LX.ARU0X.084	AS2930Z-323G25Mn EM VHP32ATME2 MC UMACO 2G+1G/250/6L/5R/CB_bgn_1.0D_HG_AR23	PMDT3200
AS2930Z-323G25Mn	EMEA	Middle East	LX.ARU0X.083	AS2930Z-323G25Mn EM VHP32ATME4 MC UMACO 2G+1G/250/6L/5R/CB_bgn_1.0D_HG_EN11	PMDT3200
AS2930Z-323G25Mn	EMEA	Switzerland	LX.ARU0X.082	AS2930Z-323G25Mn VHP32ATCH1 MC UMACO 2G+1G/250/6L/5R/ CB_bgn_1.0D_HG_IT42	PMDT3200
AS2930Z-323G25Mn	EMEA	UK	LX.ARU0X.081	AS2930Z-323G25Mn VHP32ATGB1 MC UMACO 2G+1G/250/6L/5R/ CB_bgn_1.0D_HG_EN14	PMDT3200
AS2930Z-321G16Mn	AAP	Singapore	LX.ARU0X.079	AS2930Z-321G16Mn VHP32ATSG1 MC UMACO 1*1G/160/BT/6L/5R/ CB_bgn_1.0D_HG_EN12	PMDT3200
AS2930Z-321G16Mn	AAP	Singapore	LX.ARU0Y.003	AS2930Z-321G16Mn VHB32ATSG1 MC UMACO 1*1G/160/BT/6L/5R/ CB_bgn_1.0D_HG_ZH31	PMDT3200
AS2930Z-321G16Mn	AAP	Singapore	LX.ARU0Y.002	AS2930Z-321G16Mn EM VHB32ATSG1 MC UMACO 1*1G/160/BT/6L/5R/ CB_bgn_1.0D_HG_EN14	PMDT3200
AS2930Z-321G16Mn	AAP	Singapore	LX.ARU0X.076	AS2930Z-321G16Mn VHP32ATSG1 MC UMACO 1*1G/160/BT/6L/5R/ CB_bgn_1.0D_HG_ZH31	PMDT3200



Model	RO	Country	Acer Part No	Description	CPU
AS2930Z-322G16Mn	AAP	Singapore	LX.ARU0X.080	AS2930Z-322G16Mn VHP32ATSG1 MC UMACO 1*2G/160/BT/6L/5R/ CB_bgn_1.0D_HG_ZH31	PMDT3200
AS2930Z-321G16Mn	AAP	Thailand	LX.ARU0X.001	AS2930Z-321G16Mn EM VHP32ATTH1 MC UMACO 1*1G/160/BT/6L/5R/ CB_bgn_1.0D_HG_TH22	PMDT3200
AS2930Z-321G16Mn	AAP	Thailand	LX.ARU0C.001	AS2930Z-321G16Mn LINPUSATH1 UMACO 1*1G/160/BT/6L/5R/ CB_bgn_N_HG_EN11	PMDT3200
AS2930Z-321G16Mn	AAP	Singapore	LX.ARU0C.003	AS2930Z-321G16Mn LINPUSASG1 UMACO 1*1G/160/BT/6L/5R/ CB_bgn_1.0D_HG_EN11	PMDT3200
AS2930Z-320512Mn	AAP	Singapore	LX.ARU0C.002	AS2930Z-320512Mn LINPUSASG1 UMACO 1*512/120/BT/6L/5R/ CB_bgn_1.0D_HG_EN11	PMDT3200
AS2930Z-322G16Mn	AAP	Singapore	LX.ARU0Y.001	AS2930Z-322G16Mn VHB32ATSG1 MC UMACO 1*2G/160/BT/6L/5R/ CB_bgn_1.0D_HG_ZH31	PMDT3200
AS2930Z-322G25Mn	EMEA	Italy	LX.ARU0X.049	AS2930Z-322G25Mn VHP32ATIT1 MC UMACO 1*2G/250/BT/6L/5R/ CB_bgn_1.0D_HG_IT12	PMDT3200
AS2930Z-322G25Mn	EMEA	Turkey	LX.ARU0X.050	AS2930Z-322G25Mn EM VHP32ATTR1 MC UMACO 1*2G/250/BT/6L/5R/ CB_bgn_1.0D_HG_TR32	PMDT3200
AS2930Z-322G25Mn	EMEA	Middle East	LX.ARU0X.048	AS2930Z-322G25Mn EM VHP32ATME9 MC UMACO 1*2G/250/BT/6L/5R/ CB_bgn_1.0D_HG_FR22	PMDT3200
AS2930Z-322G25Mn	EMEA	Middle East	LX.ARU0X.047	AS2930Z-322G25Mn EM VHP32ATME2 MC UMACO 1*2G/250/BT/6L/5R/ CB_bgn_1.0D_HG_AR13	PMDT3200
AS2930Z-322G25Mn	EMEA	Middle East	LX.ARU0X.046	AS2930Z-322G25Mn EM VHP32ATME2 MC UMACO 1*2G/250/BT/6L/5R/ CB_bgn_1.0D_HG_EN15	PMDT3200
AS2930Z-322G25Mn	EMEA	Middle East	LX.ARU0X.042	AS2930Z-322G25Mn EM VHP32ATME3 MC UMACO 1*2G/250/BT/6L/5R/ CB_bgn_1.0D_HG_FR23	PMDT3200
AS2930Z-322G25Mn	EMEA	Middle East	LX.ARU0X.043	AS2930Z-322G25Mn EM VHP32ATME6 MC UMACO 1*2G/250/BT/6L/5R/ CB_bgn_1.0D_HG_EN15	PMDT3200
AS2930Z-322G25Mn	EMEA	Middle East	LX.ARU0X.044	AS2930Z-322G25Mn EM VHP32ATME2 MC UMACO 1*2G/250/BT/6L/5R/ CB_bgn_1.0D_HG_AR23	PMDT3200
AS2930Z-322G25Mn	EMEA	Middle East	LX.ARU0X.045	AS2930Z-322G25Mn EM VHP32ATME4 MC UMACO 1*2G/250/BT/6L/5R/ CB_bgn_1.0D_HG_EN11	PMDT3200
AS2930Z-322G25Mn	EMEA	Switzerland	LX.ARU0X.041	AS2930Z-322G25Mn VHP32ATCH1 MC UMACO 1*2G/250/BT/6L/5R/ CB_bgn_1.0D_HG_IT42	PMDT3200

Model	RO	Country	Acer Part No	Description	CPU
AS2930Z-322G25Mn	EMEA	UK	LX.ARU0X.040	AS2930Z-322G25Mn VHP32ATGB1 MC UMACO 1*2G/250/BT/6L/5R/ CB_bgn_1.0D_HG_EN14	PMDT3200
AS2930Z-323G25Mn	EMEA	South Africa	LX.ARU0X.038	AS2930Z-323G25Mn EM VHP32ATZA2 MC UMACO 2G+1G/250/BT/6L/5R/ CB_bgn_1.0D_HG_EN16	PMDT3200
AS2930Z-323G25Mn	EMEA	South Africa	LX.ARU0X.037	AS2930Z-323G25Mn EM VHP32ATZA1 MC UMACO 2G+1G/250/BT/6L/5R/ CB_bgn_1.0D_HG_FR23	PMDT3200
AS2930Z-323G25Mn	EMEA	Denmark	LX.ARU0X.036	AS2930Z-323G25Mn VHP32ATDK1 MC UMACO 2G+1G/250/BT/6L/5R/ CB_bgn_1.0D_HG_NO13	PMDT3200
AS2930Z-323G25Mn	EMEA	France	LX.ARU0X.032	AS2930Z-323G25Mn VHP32ATFR1 MC UMACO 2G+1G/250/BT/6L/5R/ CB_bgn_1.0D_HG_FR23	PMDT3200
AS2930Z-323G25Mn	EMEA	Germany	LX.ARU0X.033	AS2930Z-323G25Mn VHP32ATDE1 MC UMACO 2G+1G/250/BT/6L/5R/ CB_bgn_1.0D_HG_DE13	PMDT3200
AS2930Z-323G25Mn	EMEA	Belgium	LX.ARU0X.034	AS2930Z-323G25Mn VHP32ATBE1 MC UMACO 2G+1G/250/BT/6L/5R/ CB_bgn_1.0D_HG_NL13	PMDT3200
AS2930Z-323G25Mn	EMEA	Holland	LX.ARU0X.035	AS2930Z-323G25Mn VHP32ATNL1 MC UMACO 2G+1G/250/BT/6L/5R/ CB_bgn_1.0D_HG_NL12	PMDT3200
AS2930Z-323G25Mn	EMEA	Luxembourg	LX.ARU0X.029	AS2930Z-323G25Mn VHP32ATLU1 MC UMACO 2G+1G/250/BT/6L/5R/ CB_bgn_1.0D_HG_IT42	PMDT3200
AS2930Z-323G25Mn	EMEA	Norway	LX.ARU0X.030	AS2930Z-323G25Mn VHP32ATNO1 MC UMACO 2G+1G/250/BT/6L/5R/ CB_bgn_1.0D_HG_NO12	PMDT3200
AS2930Z-323G25Mi	EMEA	Russia	LX.ARU0X.031	AS2930Z-323G25Mi VHP32ATRU1 MC UMACO 2G+1G/250/BT/6L/5R/ CB_bgn_1.0D_HG_RU11	PMDT3200
AS2930Z-323G25Mn	EMEA	Sweden/ Finland	LX.ARU0X.028	AS2930Z-323G25Mn VHP32ATSE1 MC UMACO 2G+1G/250/BT/6L/5R/ CB_bgn_1.0D_HG_FI12	PMDT3200
AS2930Z-323G25Mn	EMEA	Czech	LX.ARU0X.027	AS2930Z-323G25Mn VHP32ATCZ2 MC UMACO 2G+1G/250/BT/6L/5R/ CB_bgn_1.0D_HG_SK11	PMDT3200
AS2930Z-323G25Mn	EMEA	Eastern Europe	LX.ARU0X.026	AS2930Z-323G25Mn VHP32ATEU7 MC UMACO 2G+1G/250/BT/6L/5R/ CB_bgn_1.0D_HG_ENG1	PMDT3200
AS2930Z-323G25Mn	EMEA	Eastern Europe	LX.ARU0X.025	AS2930Z-323G25Mn VHP32ATEU6 MC UMACO 2G+1G/250/BT/6L/5R/ CB_bgn_1.0D_HG_CS21	PMDT3200
AS2930Z-323G25Mn	EMEA	Eastern Europe	LX.ARU0X.024	AS2930Z-323G25Mn VHP32ATEU3 MC UMACO 2G+1G/250/BT/6L/5R/ CB_bgn_1.0D_HG_RU11	PMDT3200
AS2930Z-323G25Mn	EMEA	Eastern Europe	LX.ARU0X.022	AS2930Z-323G25Mn VHP32ATEU1 MC UMACO 2G+1G/250/BT/6L/5R/ CB_bgn_1.0D_HG_CS21	PMDT3200
AS2930Z-323G25Mn	EMEA	Eastern Europe	LX.ARU0X.023	AS2930Z-323G25Mn VHP32ATEU4 MC UMACO 2G+1G/250/BT/6L/5R/ CB_bgn_1.0D_HG_FI12	PMDT3200

Model	RO	Country	Acer Part No	Description	CPU
AS2930Z-323G25Mn	EMEA	Eastern Europe	LX.ARU0X.019	AS2930Z-323G25Mn VHP32ATEU3 MC UMACO 2G+1G/250/BT/6L/5R/CB_bgn_1.0D_HG_RU21	PMDT3200
AS2930Z-323G25Mn	EMEA	Eastern Europe	LX.ARU0X.020	AS2930Z-323G25Mn VHP32ATEU5 MC UMACO 2G+1G/250/BT/6L/5R/CB_bgn_1.0D_HG_PL11	PMDT3200
AS2930Z-323G25Mn	EMEA	Hungary	LX.ARU0X.021	AS2930Z-323G25Mn VHP32ATHU1 MC UMACO 2G+1G/250/BT/6L/5R/CB_bgn_1.0D_HG_HU11	PMDT3200
AS2930Z-323G25Mn	EMEA	Slovenia/Croatia	LX.ARU0X.018	AS2930Z-323G25Mn VHP32ATS1 MC UMACO 2G+1G/250/BT/6L/5R/CB_bgn_1.0D_HG_EN12	PMDT3200
AS2930Z-323G25Mn	EMEA	Portugal	LX.ARU0X.017	AS2930Z-323G25Mn VHP32ATPT1 MC UMACO 2G+1G/250/BT/6L/5R/CB_bgn_1.0D_HG_PT12	PMDT3200
AS2930Z-323G25Mn	EMEA	Spain	LX.ARU0X.016	AS2930Z-323G25Mn VHP32ATES1 MC UMACO 2G+1G/250/BT/6L/5R/CB_bgn_1.0D_HG_ES22	PMDT3200
AS2930Z-323G25Mn	EMEA	Greece	LX.ARU0X.015	AS2930Z-323G25Mn VHP32ATGR1 MC UMACO 2G+1G/250/BT/6L/5R/CB_bgn_1.0D_HG_EL32	PMDT3200
AS2930Z-323G25Mn	EMEA	Greece	LX.ARU0X.014	AS2930Z-323G25Mn VHP32ATGR1 MC UMACO 2G+1G/250/BT/6L/5R/CB_bgn_1.0D_HG_EL22	PMDT3200
AS2930Z-323G25Mn	EMEA	Israel	LX.ARU0X.013	AS2930Z-323G25Mn VHP32ATIL1 MC UMACO 2G+1G/250/BT/6L/5R/CB_bgn_1.0D_HG_HE11	PMDT3200
AS2930Z-323G25Mn	EMEA	Italy	LX.ARU0X.012	AS2930Z-323G25Mn VHP32ATIT1 MC UMACO 2G+1G/250/BT/6L/5R/CB_bgn_1.0D_HG_IT12	PMDT3200
AS2930Z-323G25Mn	EMEA	Turkey	LX.ARU0X.008	AS2930Z-323G25Mn EM VHP32ATTR1 MC UMACO 2G+1G/250/BT/6L/5R/CB_bgn_1.0D_HG_TR32	PMDT3200
AS2930Z-323G25Mn	EMEA	Middle East	LX.ARU0X.009	AS2930Z-323G25Mn EM VHP32ATME9 MC UMACO 2G+1G/250/BT/6L/5R/CB_bgn_1.0D_HG_FR22	PMDT3200
AS2930Z-323G25Mn	EMEA	Middle East	LX.ARU0X.010	AS2930Z-323G25Mn EM VHP32ATME2 MC UMACO 2G+1G/250/BT/6L/5R/CB_bgn_1.0D_HG_AR13	PMDT3200
AS2930Z-322G25Mn	EMEA	South Africa	LX.ARU0X.075	AS2930Z-322G25Mn EM VHP32ATZA2 MC UMACO 1*2G/250/BT/6L/5R/CB_bgn_1.0D_HG_EN16	PMDT3200
AS2930Z-322G25Mn	EMEA	South Africa	LX.ARU0X.074	AS2930Z-322G25Mn EM VHP32ATZA1 MC UMACO 1*2G/250/BT/6L/5R/CB_bgn_1.0D_HG_FR23	PMDT3200
AS2930Z-323G25Mn	EMEA	Middle East	LX.ARU0X.011	AS2930Z-323G25Mn EM VHP32ATME2 MC UMACO 2G+1G/250/BT/6L/5R/CB_bgn_1.0D_HG_EN15	PMDT3200
AS2930Z-323G25Mn	EMEA	Middle East	LX.ARU0X.005	AS2930Z-323G25Mn EM VHP32ATME3 MC UMACO 2G+1G/250/BT/6L/5R/CB_bgn_1.0D_HG_FR23	PMDT3200

Model	RO	Country	Acer Part No	Description	CPU
AS2930Z-323G25Mn	EMEA	Middle East	LX.ARU0X.006	AS2930Z-323G25Mn EM VHP32ATME6 MC UMACO 2G+1G/250/BT/6L/5R/ CB_bgn_1.0D_HG_EN15	PMDT3200
AS2930Z-323G25Mn	EMEA	Middle East	LX.ARU0X.007	AS2930Z-323G25Mn EM VHP32ATME2 MC UMACO 2G+1G/250/BT/6L/5R/ CB_bgn_1.0D_HG_AR23	PMDT3200
AS2930Z-323G25Mn	EMEA	Middle East	LX.ARU0X.004	AS2930Z-323G25Mn EM VHP32ATME4 MC UMACO 2G+1G/250/BT/6L/5R/ CB_bgn_1.0D_HG_EN11	PMDT3200
AS2930Z-323G25Mn	EMEA	Switzerland	LX.ARU0X.003	AS2930Z-323G25Mn VHP32ATCH1 MC UMACO 2G+1G/250/BT/6L/5R/ CB_bgn_1.0D_HG_IT42	PMDT3200
AS2930Z-323G25Mn	EMEA	UK	LX.ARU0X.002	AS2930Z-323G25Mn VHP32ATGB1 MC UMACO 2G+1G/250/BT/6L/5R/ CB_bgn_1.0D_HG_EN14	PMDT3200
AS2930Z-322G25Mn	EMEA	Denmark	LX.ARU0X.073	AS2930Z-322G25Mn VHP32ATDK1 MC UMACO 1*2G/250/BT/6L/5R/ CB_bgn_1.0D_HG_NO13	PMDT3200
AS2930Z-322G25Mn	EMEA	France	LX.ARU0X.072	AS2930Z-322G25Mn VHP32ATFR1 MC UMACO 1*2G/250/BT/6L/5R/ CB_bgn_1.0D_HG_FR23	PMDT3200
AS2930Z-322G25Mn	EMEA	Germany	LX.ARU0X.071	AS2930Z-322G25Mn VHP32ATDE1 MC UMACO 1*2G/250/BT/6L/5R/ CB_bgn_1.0D_HG_DE13	PMDT3200
AS2930Z-322G25Mn	EMEA	Belgium	LX.ARU0X.070	AS2930Z-322G25Mn VHP32ATBE1 MC UMACO 1*2G/250/BT/6L/5R/ CB_bgn_1.0D_HG_NL13	PMDT3200
AS2930Z-322G25Mn	EMEA	Holland	LX.ARU0X.069	AS2930Z-322G25Mn VHP32ATNL1 MC UMACO 1*2G/250/BT/6L/5R/ CB_bgn_1.0D_HG_NL12	PMDT3200
AS2930Z-322G25Mn	EMEA	Luxembourg	LX.ARU0X.068	AS2930Z-322G25Mn VHP32ATLU1 MC UMACO 1*2G/250/BT/6L/5R/ CB_bgn_1.0D_HG_IT42	PMDT3200
AS2930Z-322G25Mn	EMEA	Norway	LX.ARU0X.067	AS2930Z-322G25Mn VHP32ATNO1 MC UMACO 1*2G/250/BT/6L/5R/ CB_bgn_1.0D_HG_NO12	PMDT3200
AS2930Z-322G25Mi	EMEA	Russia	LX.ARU0X.066	AS2930Z-322G25Mi VHP32ATRU1 MC UMACO 1*2G/250/BT/6L/5R/ CB_bgn_1.0D_HG_RU11	PMDT3200
AS2930Z-322G25Mn	EMEA	Sweden/ Finland	LX.ARU0X.065	AS2930Z-322G25Mn VHP32ATSE1 MC UMACO 1*2G/250/BT/6L/5R/ CB_bgn_1.0D_HG_FI12	PMDT3200
AS2930Z-322G25Mn	EMEA	Czech	LX.ARU0X.064	AS2930Z-322G25Mn VHP32ATCZ2 MC UMACO 1*2G/250/BT/6L/5R/ CB_bgn_1.0D_HG_SK11	PMDT3200
AS2930Z-322G25Mn	EMEA	Eastern Europe	LX.ARU0X.063	AS2930Z-322G25Mn VHP32ATEU7 MC UMACO 1*2G/250/BT/6L/5R/ CB_bgn_1.0D_HG_ENG1	PMDT3200
AS2930Z-322G25Mn	EMEA	Eastern Europe	LX.ARU0X.062	AS2930Z-322G25Mn VHP32ATEU6 MC UMACO 1*2G/250/BT/6L/5R/ CB_bgn_1.0D_HG_CS21	PMDT3200
AS2930Z-322G25Mn	EMEA	Eastern Europe	LX.ARU0X.061	AS2930Z-322G25Mn VHP32ATEU3 MC UMACO 1*2G/250/BT/6L/5R/ CB_bgn_1.0D_HG_RU11	PMDT3200

Model	RO	Country	Acer Part No	Description	CPU
AS2930Z-322G25Mn	EMEA	Eastern Europe	LX.ARU0X.060	AS2930Z-322G25Mn VHP32ATEU1 MC UMACO 1*2G/250/BT/6L/5R/ CB_bgn_1.0D_HG_CS21	PMDT3200
AS2930Z-322G25Mn	EMEA	Eastern Europe	LX.ARU0X.059	AS2930Z-322G25Mn VHP32ATEU4 MC UMACO 1*2G/250/BT/6L/5R/ CB_bgn_1.0D_HG_FI12	PMDT3200
AS2930Z-322G25Mn	EMEA	Eastern Europe	LX.ARU0X.058	AS2930Z-322G25Mn VHP32ATEU3 MC UMACO 1*2G/250/BT/6L/5R/ CB_bgn_1.0D_HG_RU21	PMDT3200
AS2930Z-322G25Mn	EMEA	Eastern Europe	LX.ARU0X.057	AS2930Z-322G25Mn VHP32ATEU5 MC UMACO 1*2G/250/BT/6L/5R/ CB_bgn_1.0D_HG_PL11	PMDT3200
AS2930Z-322G25Mn	EMEA	Hungary	LX.ARU0X.056	AS2930Z-322G25Mn VHP32ATHU1 MC UMACO 1*2G/250/BT/6L/5R/ CB_bgn_1.0D_HG_HU11	PMDT3200
AS2930Z-322G25Mn	EMEA	Slovenia/ Croatia	LX.ARU0X.055	AS2930Z-322G25Mn VHP32ATS11 MC UMACO 1*2G/250/BT/6L/5R/ CB_bgn_1.0D_HG_EN12	PMDT3200
AS2930Z-322G25Mn	EMEA	Portugal	LX.ARU0X.054	AS2930Z-322G25Mn VHP32ATPT1 MC UMACO 1*2G/250/BT/6L/5R/ CB_bgn_1.0D_HG_PT12	PMDT3200
AS2930Z-322G25Mn	EMEA	Spain	LX.ARU0X.053	AS2930Z-322G25Mn VHP32ATES1 MC UMACO 1*2G/250/BT/6L/5R/ CB_bgn_1.0D_HG_ES22	PMDT3200
AS2930Z-322G25Mn	EMEA	Greece	LX.ARU0X.052	AS2930Z-322G25Mn VHP32ATGR1 MC UMACO 1*2G/250/BT/6L/5R/ CB_bgn_1.0D_HG_EL32	PMDT3200
AS2930Z-322G25Mn	EMEA	Greece	LX.ARU0X.051	AS2930Z-322G25Mn VHP32ATGR1 MC UMACO 1*2G/250/BT/6L/5R/ CB_bgn_1.0D_HG_EL22	PMDT3200
AS2930Z-322G25Mn	EMEA	Israel	LX.ARU0X.039	AS2930Z-322G25Mn VHP32ATIL1 MC UMACO 1*2G/250/BT/6L/5R/ CB_bgn_1.0D_HG_HE11	PMDT3200
AS2930Z-322G16Mn	EMEA	South Africa	LX.ARU0X.144	AS2930Z-322G16Mn EM VHP32ATZA2 MC UMACO 1*2G/160/ BT/6L/5R/CB_bgn_1.0D_HG_EN16	PMDT3200
AS2930Z-323G32Mn	EMEA	Czech	LX.ARU0X.148	AS2930Z-323G32Mn VHP32ATCZ2 MC UMACO 2G+1G/320/BT/6L/5R/ CB_bgn_1.0D_HG_SK11	PMDT3200
AS2930Z-322G16Mn	EMEA	Middle East	LX.ARU0C.005	AS2930Z-322G16Mn LINPUSAME2 UMACO 1*2G/160/BT/6L/5R/ CB_bgn_1.0D_HG_EN13	PMDT3200
AS2930Z-342G25Mn	EMEA	Middle East	LX.ARU0X.142	AS2930Z-342G25Mn EM VHP32ATME2 MC UMACO 1*2G/ 250/BT/6L/5R/ CB_bgn_1.0D_HG_AR23	PMDT3400
AS2930Z-343G32Mn	EMEA	Middle East	LX.ARU0X.120	AS2930Z-343G32Mn EM VHP32ATME2 MC UMACO 2G+1G/ 320/BT/6L/5R/ CB_bgn_1.0D_HG_AR23	PMDT3400
AS2930Z-321G16Mn	CHINA	China	LX.ARU0Y.007	AS2930Z-321G16Mn VHB32ATCN1 MC UMACO 1*1G/160/6L/5R/ CB_bgn_1.0D_PH_HG_SC11	PMDT3200
AS2930Z-323G25Mn	PA	USA	LX.ARU0X.143	AS2930Z-323G25Mn VHP32ATUS1 MC UMACO 2G+1G/250/BT/6L/5R/ CB_bgn_1.0D_HG_EN32	PMDT3200

Model	RO	Country	Acer Part No	Description	CPU
AS2930Z-321G25Mn	AAP	Thailand	LX.ARU0X.147	AS2930Z-321G25Mn EM VHP32ATTH1 MC UMACO 1*1G/250/BT/6L/5R/ CB_bgn_1.0D_HG_TH22	PMDT3200
AS2930Z-341G25Mn	AAP	Thailand	LX.ARU0X.146	AS2930Z-341G25Mn EM VHP32ATTH1 MC UMACO 1*1G/250/BT/6L/5R/ CB_bgn_1.0D_HG_TH22	PMDT3400
AS2930Z-341G16Mn	AAP	Thailand	LX.ARU0X.119	AS2930Z-341G16Mn EM VHP32ATTH1 MC UMACO 1*1G/160/BT/6L/5R/ CB_bgn_1.0D_PH_HG_TH22	PMDT3400
AS2930Z-342G16Mn	AAP	Philippines	LX.ARU0Y.006	AS2930Z-342G16Mn EM VHB32ATPH1 MC UMACO 1*2G/160/BT/6L/5R/ CB_bgn_1.0D_HG_EN14	PMDT3400
AS2930Z-322G16Mn	CHINA	China	LX.ARU0Y.004	AS2930Z-322G16Mn VHB32ATCN1 MC UMACO 2*1G/160/6L/5R/ CB_bgn_1.0D_PH_HG_SC11	PMDT3200
AS2930Z-322G25Mi	PA	ACLA-Portuguese	LX.ARU0X.126	AS2930Z-322G25Mi EM VHP32ATXC2 MC UMACO 2*1G/250/6L/5R/CB_bg_1.0D_HG_XC21	PMDT3200
AS2930Z-322G25Mi	PA	ACLA-Spanish	LX.ARU0X.125	AS2930Z-322G25Mi EM VHP32ATEA3 MC UMACO 2*1G/250/6L/5R/CB_bg_1.0D_HG_ES22	PMDT3200
AS2930Z-322G25Mi	PA	ACLA-Spanish	LX.ARU0X.124	AS2930Z-322G25Mi EM VHP32ATEA1 MC UMACO 2*1G/250/6L/5R/CB_bg_1.0D_HG_ES22	PMDT3200
AS2930Z-322G25Mi	PA	ACLA-Portuguese	LX.ARU0X.123	AS2930Z-322G25Mi EM VHP32ATXC2 MC UMACO 2*1G/250/BT/6L/5R/ CB_bg_1.0D_HG_XC21	PMDT3200
AS2930Z-322G25Mi	PA	ACLA-Spanish	LX.ARU0X.122	AS2930Z-322G25Mi EM VHP32ATEA3 MC UMACO 2*1G/250/BT/6L/5R/ CB_bg_1.0D_HG_ES22	PMDT3200
AS2930Z-322G25Mi	PA	ACLA-Spanish	LX.ARU0X.121	AS2930Z-322G25Mi EM VHP32ATEA1 MC UMACO 2*1G/250/BT/6L/5R/ CB_bg_1.0D_HG_ES22	PMDT3200
AS2930Z-321G16Mn	CHINA	Hong Kong	LX.ARU0Y.005	AS2930Z-321G16Mn VHB32ATHK2 MC UMACO 1*1G/160/6L/5R/ CB_bgn_1.0D_PH_HG_ZH31	PMDT3200
AS2930Z-323G25Mn	PA	Canada	LX.ARU0X.137	AS2930Z-323G25Mn VHP32ATCA2 MC UMACO 2G+1G/250/6L/5R/ CB_bgn_1.0D_HG_FR32	PMDT3200
AS2930Z-323G25Mn	PA	Canada	LX.ARU0X.138	AS2930Z-323G25Mn VHP32ATCA2 MC UMACO 2G+1G/250/6L/5R/ CB_bgn_1.0D_HG_FR31	PMDT3200
AS2930Z-323G25Mn	PA	Canada	LX.ARU0X.139	AS2930Z-323G25Mn VHP32ATCA2 MC UMACO 2G+1G/250/6L/5R/ CB_bgn_1.0D_HG_FR34	PMDT3200
AS2930Z-323G25Mn	PA	USA	LX.ARU0X.140	AS2930Z-323G25Mn VHP32ATUS1 MC UMACO 2G+1G/250/6L/5R/ CB_bgn_1.0D_HG_EN35	PMDT3200
AS2930Z-323G25Mn	PA	USA	LX.ARU0X.136	AS2930Z-323G25Mn VHP32ATUS1 MC UMACO 2G+1G/250/6L/5R/ CB_bgn_1.0D_HG_EN32	PMDT3200

Model	RO	Country	Acer Part No	Description	CPU
AS2930Z-323G25Mn	PA	USA	LX.ARU0X.134	AS2930Z-323G25Mn VHP32ATUS1 MC UMACO 2G+1G/250/6L/5R/ CB_bgn_1.0D_HG_EN34	PMDT3200
AS2930Z-323G25Mn	PA	ACLA-Portuguese	LX.ARU0X.133	AS2930Z-323G25Mn VHP32ATXC2 MC UMACO 2G+1G/250/6L/5R/ CB_bgn_1.0D_HG_XC22	PMDT3200
AS2930Z-323G25Mn	PA	ACLA-Portuguese	LX.ARU0X.135	AS2930Z-323G25Mn EM VHP32ATXC2 MC UMACO 2G+1G/250/6L/5R/CB_bgn_1.0D_HG_XC21	PMDT3200
AS2930Z-323G25Mn	PA	ACLA-Portuguese	LX.ARU0X.132	AS2930Z-323G25Mn EM VHP32ATXC1 MC UMACO 2G+1G/250/6L/5R/CB_bgn_1.0D_HG_XC22	PMDT3200
AS2930Z-323G25Mn	PA	ACLA-Portuguese	LX.ARU0X.131	AS2930Z-323G25Mn VHP32ATXC1 MC UMACO 2G+1G/250/6L/5R/ CB_bgn_1.0D_HG_XC21	PMDT3200
AS2930Z-323G25Mn	PA	ACLA-Spanish	LX.ARU0X.130	AS2930Z-323G25Mn VHP32ATEA3 MC UMACO 2G+1G/250/6L/5R/ CB_bgn_1.0D_HG_ES21	PMDT3200
AS2930Z-323G25Mn	PA	ACLA-Spanish	LX.ARU0X.129	AS2930Z-323G25Mn EM VHP32ATEA3 MC UMACO 2G+1G/250/6L/5R/CB_bgn_1.0D_HG_ES22	PMDT3200
AS2930Z-323G25Mn	PA	ACLA-Spanish	LX.ARU0X.128	AS2930Z-323G25Mn EM VHP32ATEA1 MC UMACO 2G+1G/250/6L/5R/CB_bgn_1.0D_HG_ES22	PMDT3200
AS2930Z-323G25Mn	PA	ACLA-Spanish	LX.ARU0X.127	AS2930Z-323G25Mn VHP32ATEA1 MC UMACO 2G+1G/250/6L/5R/ CB_bgn_1.0D_HG_ES21	PMDT3200
AS2930Z-323G32Mn	EMEA	Norway	LX.ARU0X.141	AS2930Z-323G32Mn VHP32ATNO1 MC UMACO 2G+1G/320/BT/6L/5R/ CB_bgn_1.0D_HG_NO12	PMDT3200
AS2930Z-343G32Mn	EMEA	Middle East	LX.ARU0X.145	AS2930Z-343G32Mn EM VHP32ATME6 MC UMACO 2G+1G/320/BT/6L/5R/ CB_bgn_1.0D_HG_EN15	PMDT3400
AS2930Z-321G16Mn	AAP	Indonesia	LX.ARU0C.004	AS2930Z-321G16Mn LIMPUSAID1 UMACO 1*1G/160/BT/6L/5R/ CB_bgn_1.0D_HG_ID21	PMDT3200
AS2930Z-321G25Mn	CHINA	China	LX.ARU0C.014	AS2930Z-321G25Mn LIMPUSACN1 UMACO 1*1G/250/6L/5R/ CB_bgn_1.0D_PH_HG_EN91	PMDT3200
AS2930Z-321G16Mn	CHINA	China	LX.ARU0Y.015	AS2930Z-321G16Mn VHB32ATCN1 MC UMACO 1*1G/160/6L/5R/ CB_bgn_1.0D_HG_SC11	PMDT3200
AS2930Z-321G16Mn	CHINA	Hong Kong	LX.ARU0Y.014	AS2930Z-321G16Mn VHB32ATHK2 MC UMACO 1*1G/160/6L/5R/ CB_bgn_1.0D_HG_ZH31	PMDT3200
AS2430-571G12Mn	CHINA	China	LX.AVQ0C.001	AS2430-571G12Mn LIMPUSACN1 UMACO 1*1G/120/6L/5R/ CB_bgn_1.0D_HG_EN91	CM575
AS2430-571G16Cn	CHINA	China	LX.AVQ0C.002	AS2430-571G16Cn LIMPUSACN1 UMACO 1*1G/160/BT/6L/5R/ CB_bgn_1.0D_HG_EN91	CM575
AS2430-571G16C	CHINA	China	LX.AVQ0C.004	AS2430-571G16CLIMPUSACN1 UMACO 1*1G/160/6L/5R/ CB_1.0D_HG_EN91	CM575



Model	RO	Country	Acer Part No	Description	CPU
AS2430-571G16Cn	CHINA	China	LX.AVQ0C.003	AS2430-571G16Cn LINPUSACN1 UMACO 1*1G/160/6L/5R/ CB_bgn_1.0D_HG_EN91	CM575

Model	LCD	Memory 1	Memory 2	HDD 1(GB)	ODD
AS2930-842G25Mn	N12.1WXGAG	SO2GBII6	N	N250GB5.4KS	NSM8XS
AS2930-862G32Bn	N12.1WXGAG	SO2GBII6	N	N320GB5.4KS	NBDCB2XS
AS2930-842G25Mn	N12.1WXGAG	SO2GBII6	N	N250GB5.4KS	NSM8XS
AS2930-862G32Mn	N12.1WXGAG	SO1GBII6	SO1GBII6	N320GB5.4KS	NSM8XS
AS2930-842G25Mn	N12.1WXGAG	SO2GBII6	N	N250GB5.4KS	NSM8XS
AS2930-942G32Mn	N12.1WXGAG	SO2GBII6	N	N320GB5.4KS	NSM8XS
AS2930-842G32Mn	N12.1WXGAG	SO2GBII6	N	N320GB5.4KS	NSM8XS
AS2930-732G16Mn	N12.1WXGAG	SO1GBII6	SO1GBII6	N160GB5.4KS	NSM8XS
AS2930-842G25Mn	N12.1WXGAG	SO1GBII6	SO1GBII6	N250GB5.4KS	NSM8XS
AS2930-862G25Mn	N12.1WXGAG	SO1GBII6	SO1GBII6	N250GB5.4KS	NSM8XS
AS2930-843G25Mn	N12.1WXGAG	SO2GBII6	SO1GBII6	N250GB5.4KS	NSM8XS
AS2930-733G32Mn	N12.1WXGAG	SO2GBII6	SO1GBII6	N320GB5.4KS	NSM8XS
AS2930-733G25Mn	N12.1WXGAG	SO2GBII6	SO1GBII6	N250GB5.4KS	NSM8XS
AS2930-732G25Mn	N12.1WXGAG	SO2GBII6	N	N250GB5.4KS	NSM8XS
AS2930-843G32Mn	N12.1WXGAG	SO2GBII6	SO1GBII6	N320GB5.4KS	NSM8XS
AS2930-734G32Mn	N12.1WXGAG	SO2GBII6	SO2GBII6	N320GB5.4KS	NSM8XS
AS2930-733G32Mn	N12.1WXGAG	SO2GBII6	SO1GBII6	N320GB5.4KS	NSM8XS
AS2930-733G32Mn	N12.1WXGAG	SO2GBII6	SO1GBII6	N320GB5.4KS	NSM8XS
AS2930-733G25Mn	N12.1WXGAG	SO2GBII6	SO1GBII6	N250GB5.4KS	NSM8XS
AS2930-844G32Mn	N12.1WXGAG	SO2GBII6	SO2GBII6	N320GB5.4KS	NSM8XS
AS2930-732G25Mn	N12.1WXGAG	SO2GBII6	N	N250GB5.4KS	NSM8XS
AS2930-731G16Mn	N12.1WXGAG	SO1GBII6	N	N160GB5.4KS	NSM8XS
AS2930-733G25Mn	N12.1WXGAG	SO2GBII6	SO1GBII6	N250GB5.4KS	NSM8XS
AS2930-733G25Mn	N12.1WXGAG	SO2GBII6	SO1GBII6	N250GB5.4KS	NSM8XS
AS2930-733G25Mn	N12.1WXGAG	SO2GBII6	SO1GBII6	N250GB5.4KS	NSM8XS
AS2930-733G25Mn	N12.1WXGAG	SO2GBII6	SO1GBII6	N250GB5.4KS	NSM8XS
AS2930-733G25Mn	N12.1WXGAG	SO2GBII6	SO1GBII6	N250GB5.4KS	NSM8XS
AS2930-733G25Mn	N12.1WXGAG	SO2GBII6	SO1GBII6	N250GB5.4KS	NSM8XS
AS2930-733G25Mn	N12.1WXGAG	SO2GBII6	SO1GBII6	N250GB5.4KS	NSM8XS
AS2930-733G25Mn	N12.1WXGAG	SO2GBII6	SO1GBII6	N250GB5.4KS	NSM8XS
AS2930-733G25Mn	N12.1WXGAG	SO2GBII6	SO1GBII6	N250GB5.4KS	NSM8XS
AS2930-733G25Mn	N12.1WXGAG	SO2GBII6	SO1GBII6	N250GB5.4KS	NSM8XS
AS2930-733G25Mn	N12.1WXGAG	SO2GBII6	SO1GBII6	N250GB5.4KS	NSM8XS
AS2930-733G25Mn	N12.1WXGAG	SO2GBII6	SO1GBII6	N250GB5.4KS	NSM8XS
AS2930-733G25Mn	N12.1WXGAG	SO2GBII6	SO1GBII6	N250GB5.4KS	NSM8XS
AS2930-733G25Mn	N12.1WXGAG	SO2GBII6	SO1GBII6	N250GB5.4KS	NSM8XS
AS2930-733G25Mn	N12.1WXGAG	SO2GBII6	SO1GBII6	N250GB5.4KS	NSM8XS
AS2930-733G25Mn	N12.1WXGAG	SO2GBII6	SO1GBII6	N250GB5.4KS	NSM8XS
AS2930-733G25Mn	N12.1WXGAG	SO2GBII6	SO1GBII6	N250GB5.4KS	NSM8XS
AS2930-733G25Mn	N12.1WXGAG	SO2GBII6	SO1GBII6	N250GB5.4KS	NSM8XS
AS2930-733G25Mn	N12.1WXGAG	SO2GBII6	SO1GBII6	N250GB5.4KS	NSM8XS
AS2930-733G25Mn	N12.1WXGAG	SO2GBII6	SO1GBII6	N250GB5.4KS	NSM8XS
AS2930-733G25Mn	N12.1WXGAG	SO2GBII6	SO1GBII6	N250GB5.4KS	NSM8XS
AS2930-733G25Mn	N12.1WXGAG	SO2GBII6	SO1GBII6	N250GB5.4KS	NSM8XS







Model	LCD	Memory 1	Memory 2	HDD 1(GB)	ODD
AS2930-843G32Mn	N12.1WXGAG	SO2GBII6	SO1GBII6	N320GB5.4KS	NSM8XS
AS2930-843G32Mn	N12.1WXGAG	SO2GBII6	SO1GBII6	N320GB5.4KS	NSM8XS
AS2930-843G32Mn	N12.1WXGAG	SO2GBII6	SO1GBII6	N320GB5.4KS	NSM8XS
AS2930-843G32Mn	N12.1WXGAG	SO2GBII6	SO1GBII6	N320GB5.4KS	NSM8XS
AS2930-731G16Mn	N12.1WXGAG	SO1GBII6	N	N160GB5.4KS	NSM8XS
AS2930-731G16Mn	N12.1WXGAG	SO1GBII6	N	N160GB5.4KS	NSM8XS
AS2930-842G25Mn	N12.1WXGAG	SO2GBII6	N	N250GB5.4KS	NSM8XS
AS2930-842G32Mn	N12.1WXGAG	SO2GBII6	N	N320GB5.4KS	NSM8XS
AS2930-843G32Mn	N12.1WXGAG	SO2GBII6	SO1GBII6	N320GB5.4KS	NSM8XS
AS2930-844G32Mn	N12.1WXGAG	SO2GBII6	SO2GBII6	N320GB5.4KS	NSM8XS
AS2930-864G32Mn	N12.1WXGAG	SO2GBII6	SO2GBII6	N320GB5.4KS	NSM8XS
AS2930-863G32Mn	N12.1WXGAG	SO2GBII6	SO1GBII6	N320GB5.4KS	NSM8XS
AS2930-862G32Mn	N12.1WXGAG	SO2GBII6	N	N320GB5.4KS	NSM8XS
AS2930-862G16Mn	N12.1WXGAG	SO2GBII6	N	N160GB5.4KS	NSM8XS
AS2930-582G16Mn	N12.1WXGAG	SO2GBII6	N	N160GB5.4KS	NSM8XS
AS2930-732G32Mn	N12.1WXGAG	SO2GBII6	N	N320GB5.4KS	NSM8XS
AS2930-864G32Mn	N12.1WXGAG	SO2GBII6	SO2GBII6	N320GB5.4KS	NSM8XS
AS2930-592G25Mn	N12.1WXGAG	SO2GBII6	N	N250GB5.4KS	NSM8XS
AS2930-842G32Mn	N12.1WXGAG	SO2GBII6	N	N320GB5.4KS	NSM8XS
AS2930-584G32Mn	N12.1WXGAG	SO2GBII6	SO2GBII6	N320GB5.4KS	NSM8XS
AS2930-584G32Mn	N12.1WXGAG	SO2GBII6	SO2GBII6	N320GB5.4KS	NSM8XS
AS2930-584G32Mn	N12.1WXGAG	SO2GBII6	SO2GBII6	N320GB5.4KS	NSM8XS
AS2930-592G25Mn	N12.1WXGAG	SO2GBII6	N	N250GB5.4KS	NSM8XS
AS2930-732G32Mn	N12.1WXGAG	SO2GBII6	N	N320GB5.4KS	NSM8XS
AS2930-732G16Mn	N12.1WXGAG	SO1GBII6	SO1GBII6	N160GB5.4KS	NSM8XS
AS2930-583G32Mn	N12.1WXGAG	SO2GBII6	SO1GBII6	N320GB5.4KS	NSM8XS
AS2930-582G32Mn	N12.1WXGAG	SO2GBII6	N	N320GB5.4KS	NSM8XS
AS2930-582G32Mn	N12.1WXGAG	SO2GBII6	N	N320GB5.4KS	NSM8XS
AS2930-734G32Mn	N12.1WXGAG	SO2GBII6	SO2GBII6	N320GB5.4KS	NSM8XS
AS2930-582G16Mn	N12.1WXGAG	SO2GBII6	N	N160GB5.4KS	NSM8XS
AS2930-581G25Mn	N12.1WXGAG	SO1GBII6	N	N250GB5.4KS	NSM8XS
AS2930-734G32Mn	N12.1WXGAG	SO2GBII6	SO2GBII6	N320GB5.4KS	NSM8XS
AS2930-584G32Mn	N12.1WXGAG	SO2GBII6	SO2GBII6	N320GB5.4KS	NSM8XS
AS2930-860525Mn	N12.1WXGAG	SO512MBII6	N	N250GB5.4KS	NSM8XS
AS2930-940525Mn	N12.1WXGAG	SO512MBII6	N	N250GB5.4KS	NSM8XS
AS2930-842G25Mn	N12.1WXGAG	SO2GBII6	N	N250GB5.4KS	NSM8XS
AS2930-862G25Mn	N12.1WXGAG	SO2GBII6	N	N250GB5.4KS	NSM8XS
AS2930-942G25Mn	N12.1WXGAG	SO2GBII6	N	N250GB5.4KS	NSM8XS
AS2930-842G32Mn	N12.1WXGAG	SO2GBII6	N	N320GB5.4KS	NSM8XS
AS2930-862G32Mn	N12.1WXGAG	SO2GBII6	N	N320GB5.4KS	NSM8XS
AS2930-942G32Mn	N12.1WXGAG	SO2GBII6	N	N320GB5.4KS	NSM8XS
AS2930-843G25Mn	N12.1WXGAG	SO2GBII6	SO1GBII6	N250GB5.4KS	NSM8XS
AS2930-863G25Mn	N12.1WXGAG	SO2GBII6	SO1GBII6	N250GB5.4KS	NSM8XS





Model	LCD	Memory 1	Memory 2	HDD 1(GB)	ODD
AS2930-844G32Mn	N12.1WXGAG	SO2GBII6	SO2GBII6	N320GB5.4KS	NSM8XS
AS2930-844G32Mn	N12.1WXGAG	SO2GBII6	SO2GBII6	N320GB5.4KS	NSM8XS
AS2930-844G32Mn	N12.1WXGAG	SO2GBII6	SO2GBII6	N320GB5.4KS	NSM8XS
AS2930-844G32Mn	N12.1WXGAG	SO2GBII6	SO2GBII6	N320GB5.4KS	NSM8XS
AS2930-844G32Mn	N12.1WXGAG	SO2GBII6	SO2GBII6	N320GB5.4KS	NSM8XS
AS2930-844G32Mn	N12.1WXGAG	SO2GBII6	SO2GBII6	N320GB5.4KS	NSM8XS
AS2930-842G16Mn	N12.1WXGAG	SO2GBII6	N	N160GB5.4KS	NSM8XS
AS2930-842G25Mn	N12.1WXGAG	SO2GBII6	N	N250GB5.4KS	NSM8XS
AS2930-862G32Mn	N12.1WXGAG	SO2GBII6	N	N320GB5.4KS	NSM8XS
AS2930-842G16Mn	N12.1WXGAG	SO2GBII6	N	N160GB5.4KS	NSM8XS
AS2930-844G32Mn	N12.1WXGAG	SO2GBII6	SO2GBII6	N320GB5.4KS	NSM8XS
AS2930-844G32Mn	N12.1WXGAG	SO2GBII6	SO2GBII6	N320GB5.4KS	NSM8XS
AS2930-844G32Mn	N12.1WXGAG	SO2GBII6	SO2GBII6	N320GB5.4KS	NSM8XS
AS2930-864G32Mn	N12.1WXGAG	SO2GBII6	SO2GBII6	N320GB5.4KS	NSM8XS
AS2930-864G32Mn	N12.1WXGAG	SO2GBII6	SO2GBII6	N320GB5.4KS	NSM8XS
AS2930-732G16Mn	N12.1WXGAG	SO2GBII6	N	N160GB5.4KS	NSM8XS
AS2930-731G16Mn	N12.1WXGAG	SO1GBII6	N	N160GB5.4KS	NSM8XS
AS2930-584G32Mn	N12.1WXGAG	SO2GBII6	SO2GBII6	N320GB5.4KS	NSM8XS
AS2930-584G32Mn	N12.1WXGAG	SO2GBII6	SO2GBII6	N320GB5.4KS	NSM8XS
AS2930-584G32Mn	N12.1WXGAG	SO2GBII6	SO2GBII6	N320GB5.4KS	NSM8XS
AS2930-592G32Mn	N12.1WXGAG	SO1GBII6	SO1GBII6	N320GB5.4KS	NSM8XS
AS2930-592G32Mn	N12.1WXGAG	SO1GBII6	SO1GBII6	N320GB5.4KS	NSM8XS
AS2930-592G32Mn	N12.1WXGAG	SO1GBII6	SO1GBII6	N320GB5.4KS	NSM8XS
AS2930-593G32Mn	N12.1WXGAG	SO2GBII6	SO1GBII6	N320GB5.4KS	NSM8XS
AS2930-593G32Mn	N12.1WXGAG	SO2GBII6	SO1GBII6	N320GB5.4KS	NSM8XS
AS2930-593G32Mn	N12.1WXGAG	SO2GBII6	SO1GBII6	N320GB5.4KS	NSM8XS
AS2930-582G16Mn	N12.1WXGAG	SO2GBII6	N	N160GB5.4KS	NSM8XS
AS2930-583G32Mn	N12.1WXGAG	SO2GBII6	SO1GBII6	N320GB5.4KS	NSM8XS
AS2930-583G32Mn	N12.1WXGAG	SO2GBII6	SO1GBII6	N320GB5.4KS	NSM8XS
AS2930-581G16Mn	N12.1WXGAG	SO1GBII6	N	N160GB5.4KS	NSM8XS
AS2930-581G16Mn	N12.1WXGAG	SO1GBII6	N	N160GB5.4KS	NSM8XS
AS2930-581G25Mn	N12.1WXGAG	SO1GBII6	N	N250GB5.4KS	NSM8XS
AS2930-582G16Mn	N12.1WXGAG	SO2GBII6	N	N160GB5.4KS	NSM8XS
AS2930-592G16Mn	N12.1WXGAG	SO2GBII6	N	N160GB5.4KS	NSM8XS
AS2930-592G25Mn	N12.1WXGAG	SO2GBII6	N	N250GB5.4KS	NSM8XS
AS2930-582G25Mn	N12.1WXGAG	SO2GBII6	N	N250GB5.4KS	NSM8XS
AS2930-592G32Mn	N12.1WXGAG	SO2GBII6	N	N320GB5.4KS	NSM8XS
AS2930-732G32Mn	N12.1WXGAG	SO2GBII6	N	N320GB5.4KS	NSM8XS
AS2930-732G16Mn	N12.1WXGAG	SO1GBII6	SO1GBII6	N160GB5.4KS	NSM8XS
AS2930-731G16Mn	N12.1WXGAG	SO1GBII6	N	N160GB5.4KS	NSM8XS
AS2930-733G25Mn	N12.1WXGAG	SO2GBII6	SO1GBII6	N250GB5.4KS	NSM8XS
AS2930-733G25Mn	N12.1WXGAG	SO2GBII6	SO1GBII6	N250GB5.4KS	NSM8XS























Model	Card Reader	Wireless LAN	Bluetooth	Finger Print
AS2930-733G25Mn	5 in 1-Build in	SP1x2MMW	BT 2.0	AES1610
AS2930-733G25Mn	5 in 1-Build in	SP1x2MMW	BT 2.0	AES1610
AS2930-733G25Mn	5 in 1-Build in	SP1x2MMW	BT 2.0	AES1610
AS2930-733G25Mn	5 in 1-Build in	SP1x2MMW	BT 2.0	AES1610
AS2930-733G25Mn	5 in 1-Build in	SP1x2MMW	BT 2.0	AES1610
AS2930-733G25Mn	5 in 1-Build in	SP1x2MMW	BT 2.0	AES1610
AS2930-733G25Mn	5 in 1-Build in	SP1x2MMW	BT 2.0	AES1610
AS2930-733G25Mn	5 in 1-Build in	SP1x2MMW	BT 2.0	AES1610
AS2930-733G25Mn	5 in 1-Build in	SP1x2MMW	BT 2.0	AES1610
AS2930-733G25Mn	5 in 1-Build in	SP1x2MMW	BT 2.0	AES1610
AS2930-733G25Mn	5 in 1-Build in	SP1x2MMW	BT 2.0	AES1610
AS2930-733G25Mn	5 in 1-Build in	SP1x2MMW	BT 2.0	AES1610
AS2930-733G25Mn	5 in 1-Build in	SP1x2MMW	BT 2.0	AES1610
AS2930-733G25Mn	5 in 1-Build in	SP1x2MMW	BT 2.0	AES1610
AS2930-733G25Mn	5 in 1-Build in	SP1x2MMW	BT 2.0	AES1610
AS2930-732G16Mn	5 in 1-Build in	SP1x2MMW	BT 2.0	AES1610
AS2930-844G32Mn	5 in 1-Build in	SP1x2MMW	BT 2.0	AES1610
AS2930-844G32Mn	5 in 1-Build in	SP1x2MMW	BT 2.0	AES1610
AS2930-844G32Mn	5 in 1-Build in	SP1x2MMW	BT 2.0	AES1610
AS2930-844G32Mn	5 in 1-Build in	SP1x2MMW	BT 2.0	AES1610
AS2930-844G32Mn	5 in 1-Build in	SP1x2MMW	BT 2.0	AES1610
AS2930-843G25Mn	5 in 1-Build in	SP1x2MMW	BT 2.0	AES1610
AS2930-843G25Mn	5 in 1-Build in	SP1x2MMW	BT 2.0	AES1610
AS2930-843G25Mn	5 in 1-Build in	SP1x2MMW	BT 2.0	AES1610
AS2930-843G25Mn	5 in 1-Build in	SP1x2MMW	BT 2.0	AES1610
AS2930-843G25Mn	5 in 1-Build in	SP1x2MMW	BT 2.0	AES1610
AS2930-842G25Mn	5 in 1-Build in	SP1x2MMW	BT 2.0	AES1610
AS2930-862G32Mn	5 in 1-Build in	SP1x2MMW	BT 2.0	AES1610
AS2930-842G16Mn	5 in 1-Build in	SP1x2MMW	N	AES1610
AS2930-842G16Mn	5 in 1-Build in	SP1x2MMW	N	AES1610
AS2930-944G32Mn	5 in 1-Build in	SP1x2MMW	BT 2.0	AES1610
AS2930-844G32Mn	5 in 1-Build in	SP1x2MMW	BT 2.0	AES1610
AS2930-844G32Mn	5 in 1-Build in	SP1x2MMW	BT 2.0	AES1610
AS2930-844G32Mi	5 in 1-Build in	SP1x2MABG	BT 2.0	AES1610
AS2930-844G32Mn	5 in 1-Build in	SP1x2MMW	BT 2.0	AES1610
AS2930-844G32Mn	5 in 1-Build in	SP1x2MMW	BT 2.0	AES1610
AS2930-844G32Mn	5 in 1-Build in	SP1x2MMW	BT 2.0	AES1610
AS2930-844G32Mn	5 in 1-Build in	SP1x2MMW	BT 2.0	AES1610
AS2930-844G32Mn	5 in 1-Build in	SP1x2MMW	BT 2.0	AES1610
AS2930-844G32Mn	5 in 1-Build in	SP1x2MMW	BT 2.0	AES1610
AS2930-844G32Mn	5 in 1-Build in	SP1x2MMW	BT 2.0	AES1610





Model	Card Reader	Wireless LAN	Bluetooth	Finger Print
AS2930-843G32Mn	5 in 1-Build in	SP1x2MMW	BT 2.0	AES1610
AS2930-843G32Mn	5 in 1-Build in	SP1x2MMW	BT 2.0	AES1610
AS2930-843G32Mn	5 in 1-Build in	SP1x2MMW	BT 2.0	AES1610
AS2930-843G32Mn	5 in 1-Build in	SP1x2MMW	BT 2.0	AES1610
AS2930-843G32Mn	5 in 1-Build in	SP1x2MMW	BT 2.0	AES1610
AS2930-843G32Mn	5 in 1-Build in	SP1x2MMW	BT 2.0	AES1610
AS2930-732G16Mn	5 in 1-Build in	SP1x2MMW	BT 2.0	AES1610
AS2930-843G32Mn	5 in 1-Build in	SP1x2MMW	BT 2.0	AES1610
AS2930-843G32Mn	5 in 1-Build in	SP1x2MMW	BT 2.0	AES1610
AS2930-843G32Mn	5 in 1-Build in	SP1x2MMW	BT 2.0	AES1610
AS2930-843G32Mn	5 in 1-Build in	SP1x2MMW	BT 2.0	AES1610
AS2930-843G32Mn	5 in 1-Build in	SP1x2MMW	BT 2.0	AES1610
AS2930-843G32Mn	5 in 1-Build in	SP1x2MMW	BT 2.0	AES1610
AS2930-843G32Mn	5 in 1-Build in	SP1x2MMW	BT 2.0	AES1610
AS2930-731G16Mn	5 in 1-Build in	SP1x2MMW	BT 2.0	AES1610
AS2930-731G16Mn	5 in 1-Build in	SP1x2MMW	BT 2.0	AES1610
AS2930-842G25Mn	5 in 1-Build in	SP1x2MMW	BT 2.0	AES1610
AS2930-842G32Mn	5 in 1-Build in	SP3x3MMW	BT 2.0	AES1610
AS2930-843G32Mn	5 in 1-Build in	SP3x3MMW	BT 2.0	AES1610
AS2930-844G32Mn	5 in 1-Build in	SP3x3MMW	BT 2.0	AES1610
AS2930-864G32Mn	5 in 1-Build in	SP3x3MMW	BT 2.0	AES1610
AS2930-863G32Mn	5 in 1-Build in	SP3x3MMW	BT 2.0	AES1610
AS2930-862G32Mn	5 in 1-Build in	SP3x3MMW	BT 2.0	AES1610
AS2930-862G16Mn	5 in 1-Build in	SP3x3MMW	BT 2.0	AES1610
AS2930-582G16Mn	5 in 1-Build in	SP1x2MMW	BT 2.0	AES1610
AS2930-732G32Mn	5 in 1-Build in	SP1x2MMW	BT 2.0	AES1610
AS2930-864G32Mn	5 in 1-Build in	SP1x2MMW	BT 2.0	AES1610
AS2930-592G25Mn	5 in 1-Build in	SP1x2MMW	BT 2.0	AES1610
AS2930-842G32Mn	5 in 1-Build in	SP1x2MMW	BT 2.0	AES1610
AS2930-584G32Mn	5 in 1-Build in	SP1x2MMW	BT 2.0	AES1610
AS2930-584G32Mn	5 in 1-Build in	SP1x2MMW	BT 2.0	AES1610
AS2930-584G32Mn	5 in 1-Build in	SP1x2MMW	BT 2.0	AES1610
AS2930-584G32Mn	5 in 1-Build in	SP1x2MMW	BT 2.0	AES1610
AS2930-592G25Mn	5 in 1-Build in	SP1x2MMW	BT 2.0	AES1610
AS2930-732G32Mn	5 in 1-Build in	SP1x2MMW	BT 2.0	AES1610
AS2930-732G16Mn	5 in 1-Build in	SP1x2MMW	BT 2.0	AES1610
AS2930-583G32Mn	5 in 1-Build in	SP1x2MMW	BT 2.0	AES1610
AS2930-582G32Mn	5 in 1-Build in	SP1x2MMW	BT 2.0	AES1610
AS2930-582G32Mn	5 in 1-Build in	SP3x3MMW	BT 2.0	AES1610
AS2930-734G32Mn	5 in 1-Build in	SP1x2MMW	BT 2.0	AES1610
AS2930-582G16Mn	5 in 1-Build in	SP1x2MMW	BT 2.0	AES1610
AS2930-581G25Mn	5 in 1-Build in	SP1x2MMW	BT 2.0	AES1610
AS2930-734G32Mn	5 in 1-Build in	SP1x2MMW	BT 2.0	AES1610





Model	Card Reader	Wireless LAN	Bluetooth	Finger Print
AS2930-844G32Mn	5 in 1-Build in	SP1x2MMW	BT 2.0	N
AS2930-844G32Mn	5 in 1-Build in	SP1x2MMW	BT 2.0	N
AS2930-844G32Mn	5 in 1-Build in	SP1x2MMW	BT 2.0	N
AS2930-844G32Mn	5 in 1-Build in	SP1x2MMW	BT 2.0	N
AS2930-844G32Mn	5 in 1-Build in	SP1x2MMW	BT 2.0	N
AS2930-844G32Mn	5 in 1-Build in	SP1x2MMW	BT 2.0	N
AS2930-844G32Mn	5 in 1-Build in	SP1x2MMW	BT 2.0	N
AS2930-844G32Mn	5 in 1-Build in	SP1x2MMW	BT 2.0	N
AS2930-844G32Mn	5 in 1-Build in	SP1x2MMW	BT 2.0	N
AS2930-844G32Mn	5 in 1-Build in	SP1x2MMW	BT 2.0	N
AS2930-844G32Mn	5 in 1-Build in	SP1x2MMW	BT 2.0	N
AS2930-844G32Mn	5 in 1-Build in	SP1x2MMW	BT 2.0	N
AS2930-844G32Mn	5 in 1-Build in	SP1x2MMW	BT 2.0	N
AS2930-844G32Mn	5 in 1-Build in	SP1x2MMW	BT 2.0	N
AS2930-844G32Mn	5 in 1-Build in	SP1x2MMW	BT 2.0	N
AS2930-844G32Mn	5 in 1-Build in	SP1x2MMW	BT 2.0	N
AS2930-842G16Mn	5 in 1-Build in	SP1x2MMW	N	N
AS2930-842G25Mn	5 in 1-Build in	SP1x2MMW	BT 2.0	N
AS2930-862G32Mn	5 in 1-Build in	SP1x2MMW	BT 2.0	N
AS2930-842G16Mn	5 in 1-Build in	SP1x2MMW	N	N
AS2930-844G32Mn	5 in 1-Build in	SP1x2MMW	BT 2.0	N
AS2930-844G32Mn	5 in 1-Build in	SP1x2MMW	N	N
AS2930-844G32Mn	5 in 1-Build in	SP1x2MMW	N	N
AS2930-864G32Mn	5 in 1-Build in	SP1x2MMW	BT 2.0	N
AS2930-864G32Mn	5 in 1-Build in	SP1x2MMW	BT 2.0	N
AS2930-732G16Mn	5 in 1-Build in	SP1x2MMW	N	N
AS2930-731G16Mn	5 in 1-Build in	SP1x2MMW	BT 2.0	N
AS2930-584G32Mn	5 in 1-Build in	SP1x2MMW	BT 2.0	N
AS2930-584G32Mn	5 in 1-Build in	SP1x2MMW	BT 2.0	N
AS2930-584G32Mn	5 in 1-Build in	SP1x2MMW	BT 2.0	N
AS2930-592G32Mn	5 in 1-Build in	SP1x2MMW	N	N
AS2930-592G32Mn	5 in 1-Build in	SP1x2MMW	N	N
AS2930-592G32Mn	5 in 1-Build in	SP1x2MMW	N	N
AS2930-593G32Mn	5 in 1-Build in	SP1x2MMW	BT 2.0	N
AS2930-593G32Mn	5 in 1-Build in	SP1x2MMW	BT 2.0	N
AS2930-593G32Mn	5 in 1-Build in	SP1x2MMW	BT 2.0	N
AS2930-582G16Mn	5 in 1-Build in	SP1x2MMW	BT 2.0	N
AS2930-583G32Mn	5 in 1-Build in	SP1x2MMW	BT 2.0	N
AS2930-583G32Mn	5 in 1-Build in	SP1x2MMW	BT 2.0	N
AS2930-581G16Mn	5 in 1-Build in	SP1x2MMW	BT 2.0	N
AS2930-581G16Mn	5 in 1-Build in	SP1x2MMW	BT 2.0	N



Model	Card Reader	Wireless LAN	Bluetooth	Finger Print
AS2930-581G25Mn	5 in 1-Build in	SP1x2MMW	BT 2.0	N
AS2930-582G16Mn	5 in 1-Build in	SP1x2MMW	BT 2.0	N
AS2930-592G16Mn	5 in 1-Build in	SP1x2MMW	BT 2.0	N
AS2930-592G25Mn	5 in 1-Build in	SP1x2MMW	BT 2.0	N
AS2930-582G25Mn	5 in 1-Build in	SP1x2MMW	BT 2.0	N
AS2930-592G32Mn	5 in 1-Build in	SP1x2MMW	BT 2.0	N
AS2930-732G32Mn	5 in 1-Build in	SP1x2MMW	BT 2.0	N
AS2930-732G16Mn	5 in 1-Build in	SP1x2MMW	BT 2.0	N
AS2930-731G16Mn	5 in 1-Build in	SP1x2MMW	BT 2.0	N
AS2930-733G25Mn	5 in 1-Build in	SP1x2MMW	BT 2.0	N
AS2930-733G25Mn	5 in 1-Build in	SP1x2MMW	BT 2.0	N
AS2930-734G32Mn	5 in 1-Build in	SP1x2MMW	BT 2.0	N
AS2930-731G16Mn	5 in 1-Build in	SP1x2MMW	BT 2.0	N
AS2930-582G25Mn	5 in 1-Build in	SP1x2MMW	BT 2.0	N
AS2930-582G25Mn	5 in 1-Build in	SP1x2MMW	BT 2.0	N
AS2930-582G25Mn	5 in 1-Build in	SP1x2MMW	BT 2.0	N
AS2930-582G25Mn	5 in 1-Build in	SP1x2MMW	BT 2.0	N
AS2930-593G25Mn	5 in 1-Build in	SP1x2MMW	BT 2.0	N
AS2930-582G25Mn	5 in 1-Build in	SP1x2MMW	BT 2.0	N
AS2930-583G25Mn	5 in 1-Build in	SP1x2MMW	N	N
AS2930-583G25Mn	5 in 1-Build in	SP1x2MMW	N	N
AS2930-581G12Mn	5 in 1-Build in	SP1x2MMW	N	N
AS2930-583G25Mn	5 in 1-Build in	SP1x2MMW	N	N
AS2930-583G25Mn	5 in 1-Build in	SP1x2MMW	N	N
AS2930-583G25Mn	5 in 1-Build in	SP1x2MMW	N	N
AS2930-583G25Mn	5 in 1-Build in	SP1x2MMW	N	N
AS2930-583G25Mn	5 in 1-Build in	SP1x2MMW	N	N
AS2930-583G25Mn	5 in 1-Build in	SP1x2MMW	N	N
AS2930-583G25Mn	5 in 1-Build in	SP1x2MMW	N	N
AS2930-583G25Mn	5 in 1-Build in	SP1x2MMW	N	N
AS2930-583G25Mn	5 in 1-Build in	SP1x2MMW	N	N
AS2930-583G25Mn	5 in 1-Build in	SP1x2MMW	N	N
AS2930-583G25Mn	5 in 1-Build in	SP1x2MMW	N	N
AS2930-583G25Mn	5 in 1-Build in	SP1x2MMW	N	N
AS2930-583G25Mn	5 in 1-Build in	SP1x2MMW	N	N
AS2930-583G25Mn	5 in 1-Build in	SP1x2MMW	N	N
AS2930-583G25Mn	5 in 1-Build in	SP1x2MMW	N	N
AS2930-583G25Mn	5 in 1-Build in	SP1x2MMW	N	N
AS2930-583G25Mn	5 in 1-Build in	SP1x2MMW	N	N
AS2930-583G25Mi	5 in 1-Build in	SP1x2MMW	BT 2.0	N
AS2930-591G16Mn	5 in 1-Build in	SP1x2MMW	BT 2.0	N
AS2930-583G25Mn	5 in 1-Build in	SP1x2MMW	BT 2.0	N
AS2930-583G25Mn	5 in 1-Build in	SP1x2MMW	BT 2.0	N
AS2930-583G25Mn	5 in 1-Build in	SP1x2MMW	BT 2.0	N
AS2930-583G25Mn	5 in 1-Build in	SP1x2MMW	BT 2.0	N
AS2930-583G25Mn	5 in 1-Build in	SP1x2MMW	BT 2.0	N
AS2930-583G25Mn	5 in 1-Build in	SP1x2MMW	BT 2.0	N
AS2930-583G25Mn	5 in 1-Build in	SP1x2MMW	BT 2.0	N
AS2930-583G25Mn	5 in 1-Build in	SP1x2MMW	BT 2.0	N





Model	Card Reader	Wireless LAN	Bluetooth	Finger Print
AS2930-583G25Mn	5 in 1-Build in	SP1x2MMW	N	N
AS2930-583G25Mn	5 in 1-Build in	SP1x2MMW	N	N
AS2930-583G25Mn	5 in 1-Build in	SP1x2MMW	N	N
AS2930-583G25Mn	5 in 1-Build in	SP1x2MMW	N	N
AS2930-733G32Mn	5 in 1-Build in	SP1x2MMW	BT 2.0	N
AS2930-582G16Mn	5 in 1-Build in	SP1x2MMW	BT 2.0	N
AS2930-593G25Mn	5 in 1-Build in	SP1x2MMW	BT 2.0	N
AS2930-584G25Mn	5 in 1-Build in	SP1x2MMW	BT 2.0	N
AS2930-732G32Mn	5 in 1-Build in	SP1x2MMW	BT 2.0	N
AS2930-582G32Mn	5 in 1-Build in	SP1x2MMW	BT 2.0	N
AS2930Z-322G16Mi	5 in 1-Build in	3rd WiFi 1x2 BGN	BT 2.0	N
AS2930Z-321G16Mn	5 in 1-Build in	3rd WiFi 1x2 BGN	BT 2.0	N
AS2930Z-342G16Mn	5 in 1-Build in	3rd WiFi 1x2 BGN	BT 2.0	N
AS2930Z-343G32Mi	5 in 1-Build in	3rd WiFi 1x2 BGN	BT 2.0	N
AS2930Z-323G25Mi	5 in 1-Build in	3rd WiFi 1x2 BGN	BT 2.0	N
AS2930Z-321G16Mn	5 in 1-Build in	3rd WiFi 1x2 BGN	BT 2.0	N
AS2930Z-322G16Mn	5 in 1-Build in	3rd WiFi 1x2 BGN	BT 2.0	N
AS2930Z-322G32Mn	5 in 1-Build in	3rd WiFi 1x2 BGN	BT 2.0	N
AS2930Z-321G16Mn	5 in 1-Build in	3rd WiFi 1x2 BGN	N	N
AS2930Z-322G16Mn	5 in 1-Build in	3rd WiFi 1x2 BGN	N	N
AS2930Z-321G16Mn	5 in 1-Build in	3rd WiFi 1x2 BGN	BT 2.0	N
AS2930Z-321G16Mn	5 in 1-Build in	3rd WiFi 1x2 BGN	BT 2.0	N
AS2930Z-341G16Mn	5 in 1-Build in	3rd WiFi 1x2 BGN	BT 2.0	N
AS2930Z-322G16Mn	5 in 1-Build in	3rd WiFi 1x2 BGN	BT 2.0	N
AS2930Z-321G16Mn	5 in 1-Build in	3rd WiFi 1x2 BGN	BT 2.0	N
AS2930Z-342G25Mn	5 in 1-Build in	3rd WiFi 1x2 BGN	BT 2.0	N
AS2930Z-321G16Mn	5 in 1-Build in	3rd WiFi 1x2 BGN	N	N
AS2930Z-323G32Mn	5 in 1-Build in	3rd WiFi 1x2 BGN	BT 2.0	N
AS2930Z-323G32Mn	5 in 1-Build in	3rd WiFi 1x2 BGN	BT 2.0	N
AS2930Z-321G16Mn	5 in 1-Build in	3rd WiFi 1x2 BGN	BT 2.0	N
AS2930Z-322G16Mn	5 in 1-Build in	3rd WiFi 1x2 BGN	BT 2.0	N
AS2930Z-322G16Mn	5 in 1-Build in	3rd WiFi 1x2 BGN	BT 2.0	N
AS2930Z-322G16Mn	5 in 1-Build in	3rd WiFi 1x2 BGN	BT 2.0	N
AS2930Z-322G16Mn	5 in 1-Build in	3rd WiFi 1x2 BGN	BT 2.0	N
AS2930Z-323G25Mn	5 in 1-Build in	3rd WiFi 1x2 BGN	N	N
AS2930Z-323G25Mn	5 in 1-Build in	3rd WiFi 1x2 BGN	N	N
AS2930Z-323G25Mn	5 in 1-Build in	3rd WiFi 1x2 BGN	N	N
AS2930Z-323G25Mn	5 in 1-Build in	3rd WiFi 1x2 BGN	N	N
AS2930Z-323G25Mn	5 in 1-Build in	3rd WiFi 1x2 BGN	N	N
AS2930Z-323G25Mn	5 in 1-Build in	3rd WiFi 1x2 BGN	N	N
AS2930Z-323G25Mn	5 in 1-Build in	3rd WiFi 1x2 BGN	N	N
AS2930Z-323G25Mn	5 in 1-Build in	3rd WiFi 1x2 BGN	N	N
AS2930Z-323G25Mn	5 in 1-Build in	3rd WiFi 1x2 BGN	N	N
AS2930Z-323G25Mn	5 in 1-Build in	3rd WiFi 1x2 BGN	N	N
AS2930Z-323G25Mi	5 in 1-Build in	3rd WiFi 1x2 BGN	N	N









Model	Card Reader	Wireless LAN	Bluetooth	Finger Print
AS2930Z-321G16Mn	5 in 1-Build in	3rd WiFi 1x2 BGN	N	N
AS2930Z-323G25Mn	5 in 1-Build in	3rd WiFi 1x2 BGN	N	N
AS2930Z-323G25Mn	5 in 1-Build in	3rd WiFi 1x2 BGN	N	N
AS2930Z-323G25Mn	5 in 1-Build in	3rd WiFi 1x2 BGN	N	N
AS2930Z-323G25Mn	5 in 1-Build in	3rd WiFi 1x2 BGN	N	N
AS2930Z-323G25Mn	5 in 1-Build in	3rd WiFi 1x2 BGN	N	N
AS2930Z-323G25Mn	5 in 1-Build in	3rd WiFi 1x2 BGN	N	N
AS2930Z-323G25Mn	5 in 1-Build in	3rd WiFi 1x2 BGN	N	N
AS2930Z-323G25Mn	5 in 1-Build in	3rd WiFi 1x2 BGN	N	N
AS2930Z-323G25Mn	5 in 1-Build in	3rd WiFi 1x2 BGN	N	N
AS2930Z-323G25Mn	5 in 1-Build in	3rd WiFi 1x2 BGN	N	N
AS2930Z-323G25Mn	5 in 1-Build in	3rd WiFi 1x2 BGN	N	N
AS2930Z-323G25Mn	5 in 1-Build in	3rd WiFi 1x2 BGN	N	N
AS2930Z-323G25Mn	5 in 1-Build in	3rd WiFi 1x2 BGN	N	N
AS2930Z-323G32Mn	5 in 1-Build in	3rd WiFi 1x2 BGN	BT 2.0	N
AS2930Z-343G32Mn	5 in 1-Build in	3rd WiFi 1x2 BGN	BT 2.0	N
AS2930Z-321G16Mn	5 in 1-Build in	3rd WiFi 1x2 BGN	BT 2.0	N
AS2930Z-321G25Mn	5 in 1-Build in	3rd WiFi 1x2 BGN	N	N
AS2930Z-321G16Mn	5 in 1-Build in	3rd WiFi 1x2 BGN	N	N
AS2930Z-321G16Mn	5 in 1-Build in	3rd WiFi 1x2 BGN	N	N
AS2430-571G12Mn	5 in 1-Build in	3rd WiFi 1x2 BGN	N	N
AS2430-571G16Cn	5 in 1-Build in	3rd WiFi 1x2 BGN	BT 2.0	N
AS2430-571G16C	5 in 1-Build in	N	N	N
AS2430-571G16Cn	5 in 1-Build in	3rd WiFi 1x2 BGN	N	N



# Test Compatible Components

---

This computer's compatibility is tested and verified by Acer's internal testing department. All of its system functions are tested under Windows® XP Home, Windows® XP Pro environment.

Refer to the following lists for components, adapter cards, and peripherals which have passed these tests. Regarding configuration, combination and test procedures, please refer to the Aspire 2930 series Compatibility Test Report released by the Acer Mobile System Testing Department.

# Microsoft® Windows® Vista Environment Test

Vendor	Type	Description
<b>Headphones</b>		
9999995 ONE TIME VENDER	Headphone	NB Aspire Headphone
<b>Adapter</b>		
F0000183 DELTA CN	65W	Adapter DELTA 65W 1.7x5.5x11 SADP-65KB DFA LF level 4
10001023 LITE-ON	65W	Adapter LITE-ON 65W 1.7x5.5x11 PA-1650-02AC LF level 4
60002015 HIPRO	65W	Adapter HIPRO 65W 19V 1.7x5.5x11 Yellow HP-OK065B13 LED LF level 4
F0000183 DELTA CN	65W-DE	Adapter DELTA 65W 1.7x5.5x11 SADP-65KB BFJA LV4 LF for OBL only
<b>Audio Codec</b>		
9999995 ONE TIME VENDER	ALC888S	ALC888S
<b>Battery</b>		
60001921 SANYO	6CELL2.2	Battery SANYO AS-2007A Li-Ion 3S2P SANYO 6 cell 4400mAh Main COMMON Normal Type
10001063 SONY	6CELL2.2	Battery SONY AS-2007A Li-Ion 3S2P SONY 6 cell 4400mAh Main COMMON Normal Type
60001535 PANASONIC	6CELL2.2	Battery PANASONIC AS-2007A Li-Ion 3S2P PANASONIC 6 cell 4400mAh Main COMMON PSS
60002162 SIMPLO	6CELL2.2	Battery SIMPLO AS-2007A Li-Ion 3S2P PANASONIC 6 cell 4400mAh Main COMMON PSS
<b>Bluetooth</b>		
9999995 ONE TIME VENDER	BT 2.0	Foxconn Bluetooth FOX_BRM_2.0 F/W 300
<b>Camera</b>		
9999995 ONE TIME VENDER	1.0M DV	Suyin Camera 1.0M DV Tulip
<b>Card Reader</b>		
9999995 ONE TIME VENDER	5 in 1-Build in	5 in 1-Build in MS, MS Pro, SD, SC, XD
<b>CPU</b>		
10001067 INTEL	C2DP7350	CPU Intel Core2Dual P7350 PGA 2.0G 3M 1066 25W
10001067 INTEL	C2DP8400	CPU Intel Core2Dual P8400 PGA 2.26G 3M 1066 25W
10001067 INTEL	C2DP8600	CPU Intel Core2Dual P8600 PGA 2.4G 1066 25W 3M
10001067 INTEL	C2DP9500	CPU Intel Core2Dual P9500 PGA 2.53G 6M 1066 25W

Vendor	Type	Description
10001067 INTEL	C2DT9400	CPU Intel Core2Dual T9400 PGA 2.53G 6M 1066 35W
10001067 INTEL	C2DT9600	CPU Intel Core2Dual T9600 PGA 2.8G 6M 1066 35W
<b>Finger Print Reader</b>		
9999995 ONE TIME VENDER	AES1610	Authentec AES1610
<b>HDD</b>		
60002036 SEAGATE	N120GB5.4KS	HDD SEAGATE 2.5" 5400rpm 120GB ST9120817AS Corsair SATA LF F/W:3.AAA
60001922 TOSHIBA DIGI	N120GB5.4KS	HDD TOSHIBA 2.5" 5400rpm 120GB MK1246GSX Leo BS SATA I LF F/W:LB213J
60001994 WD	N120GB5.4KS	HDD WD 2.5" 5400rpm 120GB WD1200BEVS-22UST0 ML125 SATA LF F/W:01.01A01
60002036 SEAGATE	N160GB5.4KS	HDD SEAGATE 2.5" 5400rpm 160GB ST9160827AS Corsair SATA LF F/W:3.AAA
60001922 TOSHIBA DIGI	N160GB5.4KS	HDD TOSHIBA 2.5" 5400rpm 160GB MK1646GSX Leo BS SATA I LF F/W:LB113J
60002005 HGST SG	N160GB5.4KS	HDD HGST 2.5" 5400rpm 160GB HTS542516K9SA00 Bronco-B SATA II LF F/W:C31P
60001994 WD	N160GB5.4KS	HDD WD 2.5" 5400rpm 160GB WD1600BEVT-22ZCT0 ML160 SATA LF F/W:11.01A11
60002036 SEAGATE	N250GB5.4KS	HDD SEAGATE 2.5" 5400rpm 250GB ST9250827AS Corsair SATA LF F/W:3.AAA
60002005 HGST SG	N250GB5.4KS	HDD HGST 2.5" 5400rpm 250GB HTS542525K9SA00 Bronco-B SATA II LF F/W:C31P
60001994 WD	N250GB5.4KS	HDD WD 2.5" 5400rpm 250GB WD2500BEVS-22UST0 ML125 SATA LF F/W:01.01A01
60001994 WD	N320GB5.4KS	HDD WD 2.5" 5400rpm 320GB WD3200BEVT-22ZCT0 ML160 SATA LF F/W:11.01A11
<b>Keyboard</b>		
820123 DARFON	12_13KB-FV4 Black	Keyboard 12_13KB-FV4 Black Mont Blanc Standard (Aspire Black)
<b>LAN</b>		
9999995 ONE TIME VENDER	RTL8111C	Realtek Lan RTL8111C
<b>LCD</b>		
60003316 AUO	N12.1WXGAG	LCD AUO 12.1" WXGA Glare B121EW03 V7 LF 220nit 16ms
60001953 TOSHIBA ELEC	N12.1WXGAG	LCD TOSHIBA 12.1" WXGA Glare LTD121EXVV-V01 LF 200nit 30ms
60001953 TOSHIBA ELEC	N12.1WXGAG	LCD TOSHIBA 12.1" WXGA Glare LTD121EXVV-V01 G new glass LF 200nit 30ms

Vendor	Type	Description
<b>Memory</b>		
60001993 NANYA	SO1GBII6	SO-DIMM DDRII 667 1GB NT1GT64U8HB0BN-3C (0.09U)
60002215 SAMSUNG	SO1GBII6	Memory SAMSUNG SO-DIMM DDRII 667 1GB M470T2864QZ3-CE6 LF
60002045 HYNIX	SO1GBII6	Memory HYNIX SO-DIMM DDRII 667 1GB HYMP112S64CP6-Y5 LF
16081942 MICRON	SO2GBII6	Memory MICRON SO-DIMM DDRII 667 2GB MT16HTF25664HY-667E1 LF
60002215 SAMSUNG	SO2GBII6	Memory SAMSUNG SO-DIMM DDRII 667 2GB M470T5663QZ3-CE6 LF
60002045 HYNIX	SO2GBII6	Memory HYNIX SO-DIMM DDRII 667 2GB HYMP125S64CP8-Y5 LF
60002215 SAMSUNG	SO512MBII6	Memory SAMSUNG SO-DIMM DDRII 667 512MB M470T6464QZ3-CE6 LF
60002045 HYNIX	SO512MBII6	Memory HYNIX SO-DIMM DDRII 667 512MB HYMP164S64CP6-Y5 LF 64*16 0.065um
<b>Modem</b>		
10001023 LITE-ON	Lite+Con MC4Z 1.5_3.3V Aus	Lite-On Conexant -Unizion 1.5_3.3v AUS RD02-D330
<b>Northbridge</b>		
10001067 INTEL	GM45	NB Chipset Intel CS GM45NB
<b>ODD</b>		
10001063 SONY	NBDCB2XS	ODD SONY BD COMBO 12.7mm Tray DL 2X BC-5500S LF W/O bezel SATA
23418669 HLDS	NSM8XS	ODD HLDS Super-Multi DRIVE 12.7mm Tray DL 8X GSA-T50N LF W/O bezel SATA
23418669 HLDS	NSM8XS	ODD HLDS Super-Multi DRIVE 12.7mm Tray DL 8X GSA-T50N LF W/O bezel SATA Malaysia
10001070 PHILIPS	NSM8XS	ODD PLDS Super-Multi DRIVE 12.7mm Tray DL 8X DS-8A2S LF W/O bezel SATA
<b>Southbridge</b>		
10001067 INTEL	ICH9M	SB Chipset Intel CS ICH9M
<b>Software</b>		
10000981 MISC	McAfee	Antivirus application McAfee
<b>WLAN</b>		
9999995 ONE TIME VENDER	3rd WiFi 1x2 BGN	Foxconn Wireless LAN Wireless LAN Ralink RT2700E 1x2 BGN
23707801 FOXCONN TW	3rd WiFi BG	Foxconn FOX_ATH_XB63 Foxconn Atheros XB63 minicard b/g
10001067 INTEL	SP1x2HMW	Lan Intel WLAN 512AN_HMWG Shirley Peak 5100 MM#895373

<b>Vendor</b>	<b>Type</b>	<b>Description</b>
10001067 INTEL	SP1x2MABG	Lan Intel WLAN 512AG_MMWG Shirley Peak 5100 MM#897004
10001067 INTEL	SP1x2MMW	Lan Intel WLAN 512AN_MMWG Shirley Peak 5100 MM#895361
10001067 INTEL	SP3x3HMW	Lan Intel WLAN 533AN_HMWG Shirley Peak MM#895401
10001067 INTEL	SP3x3MMW	Lan Intel WLAN 533AN_MMWG Shirley Peak MM#895362
10001067 INTEL	SP3x3MMW	Lan Intel WLAN 533AN_MMWG Shirley Peak 5300 non-FCC/IC





# Online Support Information

---

This section describes online technical support services available to help you repair your Acer Systems.

If you are a distributor, dealer, ASP or TPM, please refer your technical queries to your local Acer branch office. Acer Branch Offices and Regional Business Units may access our website. However some information sources will require a user i.d. and password. These can be obtained directly from Acer CSD Taiwan.

Acer's Website offers you convenient and valuable support resources whenever you need them.

In the Technical Information section you can download information on all of Acer's Notebook, Desktop and Server models including:

- Service guides for all models
- User's manuals
- Training materials
- Bios updates
- Software utilities
- Spare parts lists
- TABs (Technical Announcement Bulletin)

For these purposes, we have included an Acrobat File to facilitate the problem-free downloading of our technical material.

Also contained on this website are:

- Detailed information on Acer's International Traveler's Warranty (ITW)
- Returned material authorization procedures
- An overview of all the support services we offer, accompanied by a list of telephone, fax and email contacts for all your technical queries.

We are always looking for ways to optimize and improve our services, so if you have any suggestions or comments, please do not hesitate to communicate these to us.



**A**

AFLASH Utility 35

**B**

Battery Pack 44

BIOS

- package 19
- password control 19
- ROM size 19
- ROM type 19
- vendor 19
- Version 19

BIOS Supports protocol 19

BIOS Utility 23–35

- Advanced 26
- Boot 33
- Exit 34
- Navigating 23
- Onboard Device Configuration 29
- Power 31
- Save and Exit 34
- Security 28
- System Security 34

Bluetooth module 77

Board Layout

- Top View 147

brightness

- hotkeys 13

**C**

Camera Module 92

caps lock

- on indicator 9

Common Problems 126

computer

- on indicator 9

CPU 86

**D**

DIMM Module 54

Display 4

display

- hotkeys 13

**E**

EasyTouch Failure 138

Euro 13

External Module Disassembly

- Flowchart 43

**F**

Fan/Thermal Module 85

Features 1

Fingerprint Reader Failure 139

Flash Utility 35

FPC Cable 95

FRU (Field Replaceable Unit) List 151

**H**

Hard Disk Drive Module 50

HDTV Switch Failure 140

Hibernation mode

- hotkey 13

Hot Keys 11

**I**

I/O Board 76

Indicators 9

Intermittent Problems 142

Internal Microphone Failure 132

Internal Speaker Failure 130

inverter board 90

**J**

Jumper and Connector Locations 147

- Top View 147

**K**

Keyboard 59

Keyboard Failure 129

**L**

Launch Board 74

---

- LCD Bezel 88
- LCD Brackets 95
- LCD Failure 129
- LCD Module Disassembly
  - Flowchart 87
- LCD Panel 94
- LED board 64
- Lower Cover 47

## M

- Main Unit Disassembly
  - Flowchart 55
- Mainboard 80
- media access
  - on indicator 9
- MediaTouch Button Failure 139
- Memory Check 126
- Model Definition 164
- Modem Failure 137
- Modem Module 78

## N

- No Display Issue 127
- Notebook Manager
  - hotkey 13
- num lock
  - on indicator 9

## O

- ODD Failure 134
- Online Support Information 235
- optical drive module 52

## P

- Panel 5
  - Bottom 8
  - left 5
- PC Card 9
- Port 80 POST Codes 143
- POST Codes
  - Port 80 143
- Power board 65

- Power On Failure 126

## R

- RJ-11 Jack 83

## S

- speakers
  - hotkey 13
- System
  - Block Diagram 4

## T

- Test Compatible Components 229
- Thermal Unit Failure 140
- Top 147
- Touch Pad
  - hotkey 13
- Touch Pad Failure 130
- TouchPad Bracket 72
- Troubleshooting
  - Built-in KB Failure 129
  - EasyTouch Buttons 138
  - Fingerprint Reader 139
  - HDTV Switch 140
  - Internal Microphone 132
  - Internal Speakers 130
  - LCD Failure 129
  - MediTouch Buttons 139
  - Modem 137
  - No Display 127
  - ODD 134
  - Other Failures 141
  - Power On 126
  - Thermal Unit 140
  - Touch Pad 130
  - USB 137
  - WLAN 138

## U

- Undetermined Problems 142
- USB Board 75
- USB Failure (Rightside) 137
- utility
  - BIOS 23–35

## W

- Windows 2000 Environment Test 230

---

Wireless Function Failure 138

WLAN Board 48

