

Aspire 3000/3500/5000 Series

Service Guide

Service guide files and updates are available on the ACER/CSD web; for more information, please refer to <http://csd.acer.com.tw>

PRINTED IN TAIWAN

Revision History

Please refer to the table below for the updates made on Aspire 3000/3500/5000 service guide.

Date	Chapter	Updates

Copyright

Copyright © 2005 by Acer Incorporated. All rights reserved. No part of this publication may be reproduced, transmitted, transcribed, stored in a retrieval system, or translated into any language or computer language, in any form or by any means, electronic, mechanical, magnetic, optical, chemical, manual or otherwise, without the prior written permission of Acer Incorporated.

Disclaimer

The information in this guide is subject to change without notice.

Acer Incorporated makes no representations or warranties, either expressed or implied, with respect to the contents hereof and specifically disclaims any warranties of merchantability or fitness for any particular purpose. Any Acer Incorporated software described in this manual is sold or licensed "as is". Should the programs prove defective following their purchase, the buyer (and not Acer Incorporated, its distributor, or its dealer) assumes the entire cost of all necessary servicing, repair, and any incidental or consequential damages resulting from any defect in the software.

Acer is a registered trademark of Acer Corporation.

Intel is a registered trademark of Intel Corporation.

Pentium and Pentium II/III are trademarks of Intel Corporation.

Other brand and product names are trademarks and/or registered trademarks of their respective holders.

Conventions

The following conventions are used in this manual:

SCREEN MESSAGES	Denotes actual messages that appear on screen.
NOTE	Gives bits and pieces of additional information related to the current topic.
WARNING	Alerts you to any damage that might result from doing or not doing specific actions.
CAUTION	Gives precautionary measures to avoid possible hardware or software problems.
IMPORTANT	Reminds you to do specific actions relevant to the accomplishment of procedures.

Preface

Before using this information and the product it supports, please read the following general information.

1. This Service Guide provides you with all technical information relating to the BASIC CONFIGURATION decided for Acer's "global" product offering. To better fit local market requirements and enhance product competitiveness, your regional office MAY have decided to extend the functionality of a machine (e.g. add-on card, modem, or extra memory capability). These LOCALIZED FEATURES will NOT be covered in this generic service guide. In such cases, please contact your regional offices or the responsible personnel/channel to provide you with further technical details.
2. Please note WHEN ORDERING FRU PARTS, that you should check the most up-to-date information available on your regional web or channel. If, for whatever reason, a part number change is made, it will not be noted in the printed Service Guide. For ACER-AUTHORIZED SERVICE PROVIDERS, your Acer office may have a DIFFERENT part number code to those given in the FRU list of this printed Service Guide. You MUST use the list provided by your regional Acer office to order FRU parts for repair and service of customer machines.

Chapter 1	System Introduction	1
	Features	1
	System Block Diagram (For Aspire 3000/5000)	3
	System Block Diagram (For Aspire 3500)	4
	Board Layout (For Aspire 3000/5000)	5
	Top View	5
	Bottom View	6
	Panel	8
	Front view	8
	Closed front view	9
	Left view	9
	Right view	10
	Rear view	10
	Bottom view	11
	Indicators	12
	Launch Keys	13
	Using the keyboard	14
	Lock keys and embedded numeric keypad	14
	Windows keys	15
	Hot Keys	15
	Special keys	16
	Touchpad	18
	Touchpad basics	18
	Hardware Specifications and Configurations	20
	BIOS Setup Utility	32
Chapter 2	System Utilities	32
	Navigating the BIOS Utility	33
	Information	34
	Main	35
	Security	37
	Boot	41
	Exit	42
	BIOS Flash Utility	43
Chapter 3	Machine Disassembly and Replacement	46
	General Information	47
	Before You Begin	47
	Disassembly Procedure Flowchart	48
	Removing the Battery	50
	Removing the Hard Disc Drive Module	50
	Disassembling the Hard Disc Drive Module	50
	Removing the Optical Disc Drive Module	51
	Disassembling the Optical Disc Drive Module	51
	Removing the Memory	51
	Removing the LCD Module	53
	Removing the Middle Cover	53
	Removing the Keyboard	53
	Removing the Fan, the CPU Thermal Module and the CPU	53
	Removing the Wireless LAN Card	54
	Removing the LCD Module	55
	Disassembling the LCD Module	56
	Removing the LCD Bezel	56
	Disassembling the Main Unit	58

Table of Contents

Removing the Upper Case Assembly	58
Removing the Power Board	58
Removing the Touchpad Bracket, the Touchpad Board and the Touchpad ...	59
Removing the Speaker Set	60
Removing the SW DJ Board Assembly	60
Removing the Audio Board	61
Removing the VGA Thermal Module	61
Removing the Modem Board	62
Removing the Main Board	62
Removing the Control Board	63
Chapter 4 Troubleshooting	66
System Check Procedures	67
External Diskette Drive Check	67
External CD-ROM Drive Check	67
Keyboard or Auxiliary Input Device Check	67
Memory check	68
Power System Check	68
Touchpad Check	70
Power-On Self-Test (POST) Error Message	71
Index of Error Messages	72
Phoenix BIOS Beep Codes	75
Index of Symptom-to-FRU Error Message	79
Intermittent Problems	82
Undetermined Problems	83
Chapter 5 Jumper and Connector Locations	84
Top View	84
Bottom View	86
Chapter 6 FRU (Field Replaceable Unit) List	88
Aspire 3000/5000 Exploded Diagram	89
Aspire 3000/3500/5000 Series	101
Appendix A Model Definition and Configuration	101
Appendix B Test Compatible Components	104
Microsoft Windows XP Environment Test	105
Appendix C Online Support Information	110

Table of Contents

System Introduction

Features

This computer was designed with the user in mind. Here are just a few of its many features:

Microprocessor

- Mobile AMD Turion 64 processor ML-28/ML-30 or higher for Aspire 5000
- Mobile AMD Sempron processor 2600+ to 3000+ or higher for Aspire 3000
- Intel® Celeron® M 350/360/370 processor at 1.3/1.4/1.5 GHz, 400 MHz FSB for Aspire 3500 series
- Intel® Pentium® M 715 processor at 1.5 GHz, 400 MHz FSB for Aspire 3500 series

Memory

- 256 MB or 512 MB of DDR 333 SDRAM standard, upgradeable to 1 GB with dual so DIMM modules
- 512 KB flash ROM BIOS for models employing Intel® Celeron® M processor (Aspire 3500 series); 2 MB flash ROM BIOS for models employing Intel® Pentium® processor (Aspire 3500 series)

Data storage

- 40/60/80 GB ATA/100 hard disk
- DVD-Dual or Combo drive

Display and graphics

- Color Thin-Film Transistor (TFT) LCD displaying at
 - 15" XGA (1024 X 768)
 - 15.4" WXGA (1280 X 800)
 - 15.4" WXGA Acer CrystalBrite (1280 X 800)
- SiSM661MX integrated 3D graphics with up to 64 MB of VRAM, supporting Microsoft® DirectX® 7.0
- Dual independent display support
- MPEG-2/DVD hardware-assisted capability

Communication

- Modem: 56K ITU V.92 modem with PTT approval; Wake-on-Ring ready
- LAN: 10/100 Mbps Fast Ethernet; Wake-on-LAN ready
- Wireless LAN (optional): integrated miniPCI 802.11b/g Wi-Fi CERTIFIED™ solution
- Wireless PAN (optional): integrated Bluetooth®

Audio

- Audio system with two built-in speakers
- Sound Blaster Pro™ and MS-Sound compatible
- Built-in microphone

Input devices

- 88-/89-key Acer FineTouch™ keyboard
- Touchpad with 4-way integrated scroll button
- Four easy-launch buttons
- Two front-panel buttons: wireless LED-button and Bluetooth® LED-button

I/O interface

- Three USB 2.0 ports
- Ethernet (RJ-45) port
- Modem (RJ-11) port
- External display (VGA) port
- Microphone/line-in jack
- Headphones/speaker/line-out port
- Type II PC Card slot
- DC-in jack for AC adaptor

System Block Diagram (For Aspire 3000/5000)

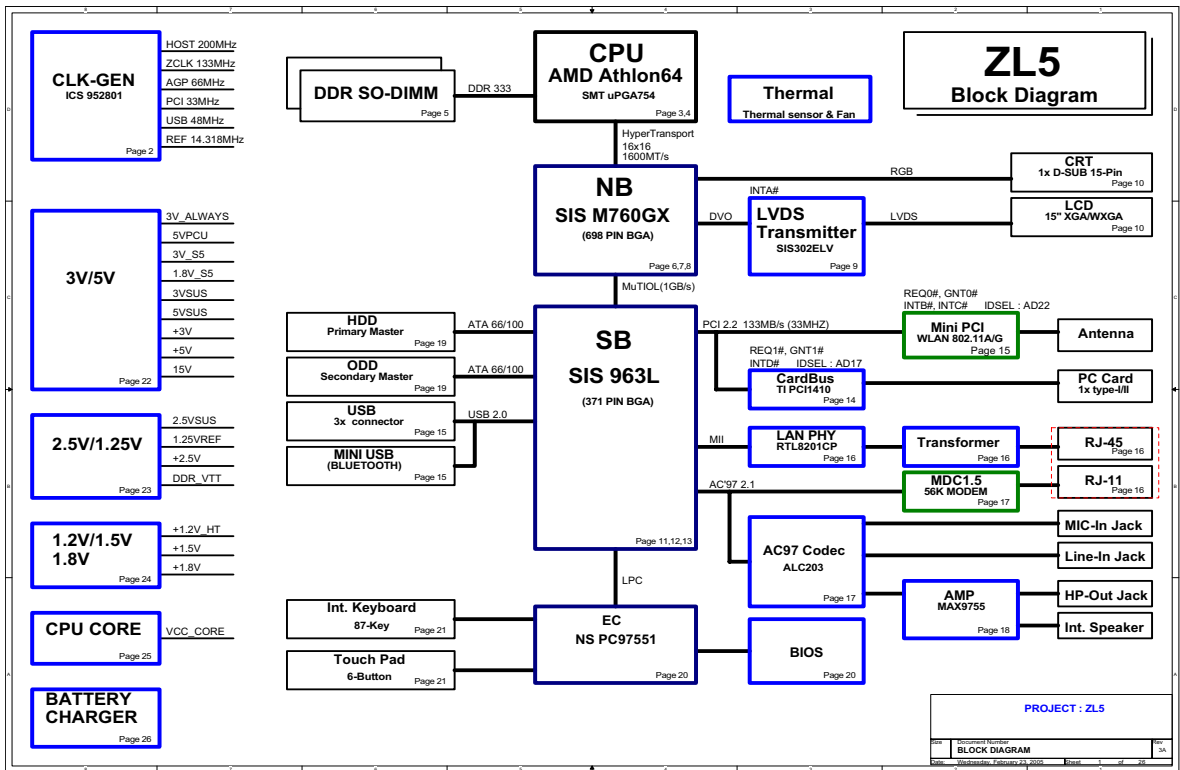

System Block Diagram (For Aspire 3500)

Aspire 3500 is Intel® platform. It has different system block diagram from Aspire 3000/5000. Aspire 3500 system block diagram will be released later.

Board Layout (For Aspire 3000/5000)

Top View

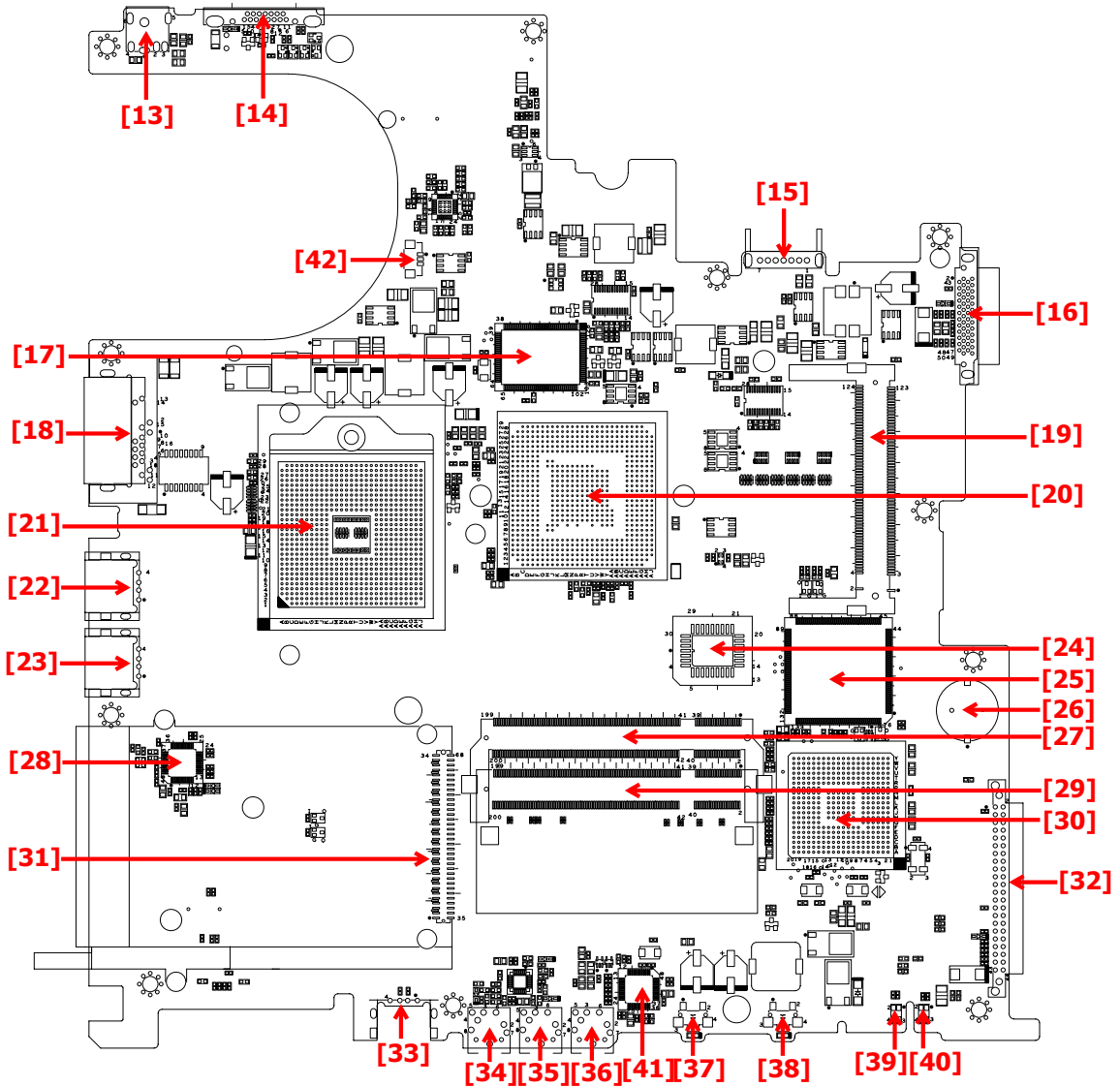

13	Power Jack	14	CRT Connector
15	Battery Connector	16	ODD Connector
17	302ELV LVDS Encoder	18	RJ45 & RJ11 Connector
19	MINI PCI	20	Northbridge M760GX
21	CPU Socket	22	USB Connector
23	USB Connector	24	BIOS ROM
25	EC PC97551	26	RTC Battery
27	DDR SO-DIMM Socket1	28	LAN PHY RTL8201CP

29	DDR SO-DIMM Socket2	30	Southbridge 963L
31	PCMCIA Connector	32	HDD Connector
33	USB Connector	34	LineOut Jack
35	Microphone Jack	36	LineIn Jack
37	WLAN Button	38	Bluetooth button
39	Battery LED	40	Power LED
41	Audio Codec ALC203	42	FAN Connector

Bottom View

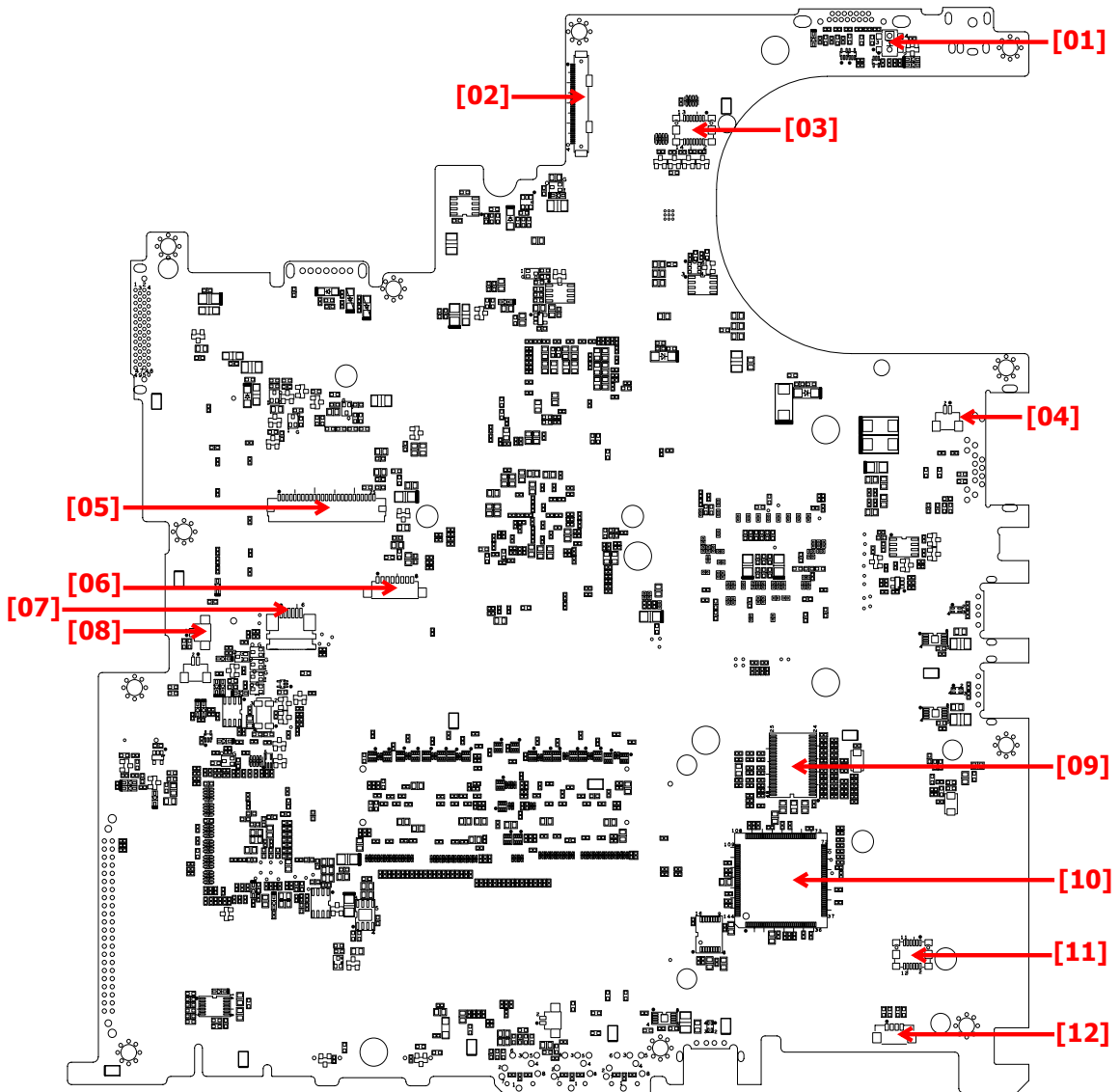

1 Lid Switch

2 Panel Connector

3	LED Board Connector	4	Modem Connector
5	Keyboard Connector	6	Bluetooth Module Connector
7	Touchpad Board Connector	8	Internal Microphone Connector
9	Clock Generator	10	PCMCIA Connector
11	MDC Connector	12	Internal Speaker Connector

Panel

This is a brief introduction to the I/O ports, the features and the indicators.









Front view



#	Item	Description
1	Display screen	Also called LCD (Liquid Crystal Display), displays computer output.
2	Microphone	Internal microphone for sound recording.
3	Keyboard	For entering data into you computer.
4	Palmrest	Comfortable support area for your hands when you use the computer.
5	Click buttons (Left and right)	The left and right buttons function like the left and right mouse buttons.
6	Touchpad	Touch-sensitive pointing device which functions like a computer mouse.
7	Status indicators	LEDs (Light Emitting Diodes) that turn on and off to show the status of the computer and its functions and components.
8	Launch keys	Buttons for launching frequently used programs.
9	Power button	Turns the computer on and off.

Closed front view



#	Icon	Item/ Port	Description
1		Speakers	Left and right speakers deliver stereo audio output.
2		Power indicator	Lights up when the computer is on.
3		Battery indicator	Lights up when the battery is being charged.
4		Bluetooth communication button/ indicator (for selected models)	Press to enable/disable the Bluetooth function. Indicates the status of Bluetooth communication (optional).
5		Wireless communication button/ indicator	Press to enable/disable the wireless function. Indicates the status of wireless LAN communication (optional).
6		Line-in jack	Accepts audio line-in devices (e.g., audio CD player, stereo walkman).
7		Mic-in jack	Accepts inputs from external microphones.
8		Speaker/Line-Out/Headphone jack	Connects to audio line-out devices (e.g., speakers, headphones).
9		USB 2.0 port	Connects to Universal Serial Bus (USB) 2.0 devices (e.g., USB mouse, UsB camera).





Left view

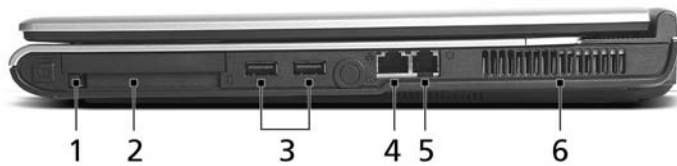

#	Icon	Item/ Port	Description
1		Optical drive	Internal optical drive; accepts CDs or DVDs depending on the optical drive type.
2		LED indicator	Lights up when the optical drive is active.
3		Emergency eject hole	Ejects the optical drive tray when the computer is turned off.
4		Optical drive eject button	Ejects the optical drive tray from the drive.



Right view



#	Icon	Item/ Port	Description
1		PC Card slot eject button	Ejects the PC Card from the slot
2		PC card slot	Accepts one Type II CardBus PC Card.
3		USB 2.0 port	Connects to Universal Serial Bus (USB) 2.0 devices (e.g., USB mouse, USB camera).
4		Network jack	Connects to an Ethernet 10/100 based network.
5		Modem jack	Connects to a phone line.
6		Ventilation slots	Enable the computer to stay cool, even after prolonged use.

Rear view



#	Icon	Port	Description
1		Power jack	Connects to an AC adaptor.
2		External display port	Connects to a display device (e.g., external monitor, LCD projector).
3		Security keylock	Connects to a Kensington-compatible computer security lock.

Bottom view

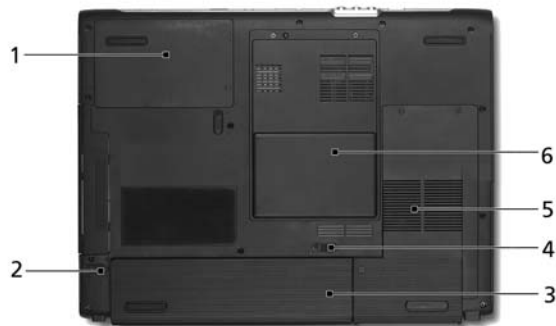

#	Item	Description
1	Hard disc bay	Houses the computer's hard disc (secured by a screw).
2	Battery release latch	Unlatches the battery to remove the battery pack.
3	Battery bay	Houses the computer's battery pack.
4	Battery lock	Locks the battery in place.
5	Cooling fan	Helps keep the computer cool. Note: Do not cover or obstruct the opening of the fan.
6	Memory compartment	House the computer's main memory.

Indicators

The computer has three easy-to-read status icons on the upper-right above the keyboard, and four on the front panel.



#	Icon	Function	Description
1		Caps Lock	Lights when Caps Lock is activated.
2		Num Lock (Fn-F11)	Lights when Numeric Lock is activated.
3		Media activity	Indicates when the hard disk or optical drive is active.
		Bluetooth	Indicates the status of Bluetooth communication.
		Wireless LAN	Indicates the status of Bluetooth communication.
4		Power	Lights when the computer is on.
5		Battery	Lights when the battery is being charged.

NOTE: 1. Charging: the light shows amber when the battery is charging.

NOTE: 2. Fully charged: light shows green when in AC mode.

Launch Keys

Located at the upper-right, above the keyboard are four buttons. These buttons are called launch keys. They are mail, Web browser, Acer Empowering key “*e*”, and one user-programmable button.

Press “*e*” to run the Acer eManager. The mail and Web buttons are pre-set of email and internet programs, but can be reset by users. To set the Web browser, mail and programmable keys, run the Acer Launch Manager.



Launch key	Default application
P	User-programmable
<i>e</i>	Acer eManager (user-programmable)
Web browser	Internet browser (user-programmable)
Mail	Email application (user-programmable)







Using the keyboard

The keyboard has full-sized keys and an embedded keypad, separate cursor keys, two Windows keys and twelve function keys.

Lock keys and embedded numeric keypad

The keyboard has three lock keys which you can toggle on and off.



Lock key	Description
Caps Lock 	When  is on, all alphabetic characters typed are in uppercase.
Num Lock (Fn-F11) 	When  is on, the embedded keypad is in numeric mode. The keys function as a calculator (complete with the arithmetic operators), -, *, and /). Use this mode when you need to do a lot of numeric data entry. A better solution would be to connect an external keypad.
Scroll Lock (Fn-F12) 	When  is on, the screen moves one line up or down when you press the up or down arrow keys respectively.  does not work with some applications.

The embedded numeric keypad functions like a desktop numeric keypad. It is indicated by small characters located on the upper right corner of the keycaps. To simplify the keyboard legend, cursor-control key symbols are not printed on the keys.











Desired access	Num lock on	Num lock off
Number keys on embedded keypad	Type numbers in a normal manner.	
Cursor-control keys on embedded keypad	Hold <Shift> while using cursor-control keys.	Hold <Fn> while using cursor-control keys.

Desired access	Num lock on	Num lock off
Main keyboard keys	Hold <Fn> while typing letters on embedded keypad.	Type the letters in a normal manner.

Windows keys

The keyboard has two keys that perform Windows-specific functions.

























Keys	Description
Windows logo key 	Start button. Combinations with this key perform shortcut functions. Below are a few examples:  + <Tab> (Activates the next Taskbar button)  + <E> (Opens the My Computer window)  + <F1> (Opens Help and Support)  + <F> (Opens the Find: All Files dialog box)  + <R> (Opens the Run dialog box)  + <M> (Minimizes all windows) <shift>+  + < M> (Undoes the minimize all windows)
Application key 	This key has the same effect as clicking the right mouse button; it opens the application's context menu.

Hot Keys

The computer employs hot keys or key combinations to access most of the computer's controls like screen contrast and brightness, volume output and the BIOS Utility.

To activate hot keys, press and hold the <Fn> key before pressing the other key in the hot key combination.



Hot Key	Icon	Function	Description
Fn- 		Hotkey help	Displays a list of the hotkeys and their functions.
Fn- 		Acer eSetting	Launches Acer eSetting in Acer eManager.
Fn- 		Acer Power Management	Launches Power Management options.
Fn- 		Sleep	Puts the computer in Sleep mode.
Fn- 		Display toggle	Switches display output between the display screen, external monitor (if connected) and both the display screen and external monitor.
Fn- 		Screen blank	Turns the display screen backlight off to save power. Press any key to return.
Fn- 		Touchpad Toggle	Turns the internal touchpad on and off.
Fn- 		Speaker on/off	Turns the speakers on and off; mutes the sound.
Fn- 		Volume up	Increases the sound volume.
Fn- 		Volume down	Decreases the sound volume.
Fn- 		Brightness up	Increases the screen brightness.
Fn- 		Brightness down	Decreases the screen brightness.

Special keys

You can locate the Euro symbol at the upper-center (for European keyboard) and/or bottom-right (Chinese keyboard) of your keyboard. To type:



The Euro symbol

1. Open a text editor or word processor.
2. Either directly press the <Euro> key at the bottom-right of the keyboard (for Chinese keyboard), or hold <Alt Gr> and then press the <5> key at the upper-center of the keyboard.symbol at the upper-center of the keyboard (for European keyboard, you can use both method).

NOTE: Some fonts and software do not support the Euro symbol. Please refer to www.microsoft.com/typography/faq/faq12.htm for more information.

The US dollar sign

1. Open a text editor or word processor.
2. Either directly press the <Euro> key at the bottom-right of the keyboard (for Chinese keyboard), or hold <Shift> and then press the <4> key at the upper-center of the keyboard.symbol at the upper-center of the keyboard (for European keyboard, you can use both method).

NOTE: This function varies according to the language settings.

Touchpad

The built-in touchpad is a pointing device that senses movement on its surface. This means the cursor responds as you move your finger on the surface of the touchpad. The central location on the palmrest provides optimum comfort and support.



Touchpad basics

The following items teach you how to use the touchpad:



- * Move your finger across the touchpad (2) to move the cursor.
- * Press the left (1) and right (4) buttons located on the edge of the touchpad to do selection and execution functions. These two buttons are similar to the left and right buttons on a mouse. Tapping on the touchpad is the same as clicking the left button.
- * Use the 4-way scroll (3) button to scroll up or down and move left or right a page. This button mimics your cursor pressing on the right scroll bar of Windows applications.

Function	Left button (1)	Right button (4)	Touchpad (2)	Center button (3)
Execute	Click twice quickly.		Tap twice (at the same speed as double-clicking a mouse button).	
Select	Click once.		Tap once.	
Drag	Click and hold, then use finger to drag the cursor on the touchpad.		Tap twice (at the same speed as double-clicking a mouse button); hold finger to the touchpad on the second tap and drag the cursor.	
Access context menu		Click once.		
Scroll				Click and hold to move up/down/left/right.

NOTE: Keep your fingers dry and clean when using the touchpad. Also keep the touchpad dry and clean. The touchpad is sensitive to finger movement, hence, the lighter the touch, the better the response. Taping harder will not increase the touchpad's responsiveness.

Hardware Specifications and Configurations

System Board Major Chip

Item	Controller
System core logic	SiS M760GX+SiS 963L for Aspire 3000/5000 SiS M661MX+SiS 963L for Aspire 3500
Audio controller	RealTek ALC203 AC 97 Codec
Video controller	built-in SiS M760GX for Aspire 300/5000 built-in SiS M661MX for Aspire 3500
Keyboard controller	KB910
CardBus Controller	ENE CB712
IEEE Controller	VIA VT6301S

Processor

Item	Specification
CPU type	Mobile AMD Turion 64 processor ML-28/ML-30 or higher for Aspire 5000 Mobile AMD Sempron processor 2600+ to 3000+ or higher for Aspire 3000 Intel® Celeron® M 350/360/370 processor at 1.3/1.4/1.5 GHz, 400 MHz FSB for Aspire 3500 series Intel® Pentium® M 715 processor at 1.5 GHz, 400 MHz FSB for Aspire 3500 series
CPU package	SMT μ PGA 754 pin
CPU core voltage	Low speed: 0.8V High speed: 1.5V
CPU I/O voltage	1.2V

BIOS

Item	Specification
BIOS vendor	Pheonix BIOS
BIOS Version	Aspire 3000 V1.00; Aspire 5000 V1.00; AS3500 V1.00
BIOS ROM type	Flash ROM
BIOS ROM size	
BIOS package	32 Pin PLCC
Supported protocols	ACPI 2.0 (if available, at least 1.0b), SMBIOS 2.3, PCI 2.2, Boot Block, PXE 2.0, Mobile PC2001, Hard Disk Password, INT 13h Extensions, PCI Bus Power Management interface Specification, EI Torito-Bootable CD-ROM Format Specification V1.0, Simple Boot Flag 1.0
BIOS password control	Set by switch, see SW1 settings

Second Level Cache

Item	Specification
Cache controller	Built-in CPU

Second Level Cache

Item	Specification
Cache size	1024KB/512KB (exclusive) total effective cache: 1152KB/640KB for Mobile AMD Turion 64 processor (Aspire 5000) 256KB/128KB (exclusive) total effective cache: 384KB/256KB for Mobile AMD Sempron processor (Aspire 3000) 512KB for Intel [®] Celeron [®] M processor (Aspire 3500) 2MB for Intel [®] Pentium [®] M processor (Aspire 3500)
1st level cache control	Always Enabled
2nd level cache control	Always Enabled
Cache scheme control	Fixed-in write back

System Memory

Item	Specification
Memory controller	built-in CPU Mobile AMD Turion 64 processor ML-28/ML-30 or higher for Aspire 5000 Mobile AMD Sempron processor 2600+ to 3000+ or higher for Aspire 3000 Intel [®] Celeron [®] M 350/360/370 processor at 1.3/1.4/1.5 GHz, 400 MHz FSB for Aspire 3500 series Intel [®] Pentium [®] M 715 processor at 1.5 GHz, 400 MHz FSB for Aspire 3500 series
Onboard memory size	0MB
DIMM socket number	2 Sockets
Supports memory size per socket	256MB
Supports maximum memory size	1024MB
Supports DIMM type	DDR-DRAM
Supports DIMM Speed	333 MHz
Supports DIMM voltage	2.5 V/1.25V
Supports DIMM package	200-pin so-DIMM
Memory module combinations	You can install memory modules in any combinations as long as they match the above specifications .

Memory Combinations

Slot 1	Slot 2	Total Memory
0MB	256MB	256MB
0MB	512MB	512MB
0MB	1024MB	1024MB
256MB	0MB	256MB
256MB	256MB	512MB
256MB	512MB	768MB
256MB	1024MB	1280MB
512MB	0MB	512MB
512MB	256MB	768MB
512MB	512MB	1024MB
512MB	1024MB	1536MB
1024MB	0MB	1024MB

Memory Combinations

Slot 1	Slot 2	Total Memory
1024MB	256MB	1280MB
1024MB	512MB	1536MB
1024MB	1024MB	2048MB

Above table lists some system memory configurations. You may combine DIMMs with various capacities to form other combinations.

LAN Interface

Item	Specification
Chipset	
Supports LAN protocol	10/100
LAN connector type	RJ45
LAN connector location	Right side

Modem Interface

Item	Specification
Chipset	CS1037 Internal Agere Scorpio chipset (Scorpio+CSP1037B)
Fax modem data baud rate (bps)	14.4K
Data modem data baud rate (bps)	56K
Supports modem protocol	V.92MDC
Modem connector type	RJ11
Modem connector location	Right side

Wireless Module 802.11b/g (optional device)

Item	Specification
Chipset	Intel
Data throughput	11M~54M bps
Protocol	802.11 b+g
Interface	Mini-PCI type II

Floppy Disk Drive Interface

Item	Specification		
Vendor & model name	There is no FDD module for this product		
Floppy Disk Specifications			
Media recognition	2DD (720KB)	2HD (1.2 MB, 3 mode)	2HD (1.44MB)
Sectors/track	9	15	18
Tracks	80	80	80
Data transfer rate (Kbit/s)	1 MB	1.6 MB	2 MB
Rotational speed (RPM)	300	360	300
Read/write heads	2		
Encoding method	MFM		
Power Requirement			
Input Voltage (V)	+5V		

Hard Disk Drive Interface

Item			
Vendor & Model Name	HGST MORAGA IC25N060ATMR04-0 08K0634 Seagate N2 ST960821A TOSHIBA PLUTO MK6025GAS	HGST MORAGA IC25N080ATMR04-0 08K635 Seagate N2 ST9808210A TOSHIBA PLUTO MK6025GAS	TOSHIBA PLUTO MK1031GAS SEAGATE N2 ST9100822A
Capacity (MB)	60000	80000	100000
Bytes per sector	512	512	512
Logical heads	16	16	16
Logical sectors	63	63	63
Drive Format			
Logical cylinders	16383	16383	16383
Physical read/write heads	3/3/4	4/3/2	4
Disks	2/2/4	2/2/4	2
Spindle speed (RPM)	4200RPM	4200RPM	4200RPM
Performance Specifications			
Buffer size	8MBytes (8192kbytes)	8MBytes (8192kbytes)	8MBytes
Interface	ATA-6	ATA/ATAPI-6	ATA/ATAPI-6
Data transfer, rate (host~buffer, Mbytes/s)	100 MB/Sec	100 MB/Sec	100 MB/Sec
DC Power Requirements			
Voltage tolerance	5 +/- 5%	5 +/- 5%	5 +/- 5%

Combo Drive Interface

Item	Specification	Remark
Vendor & model name	DVD/CDRW TOSHIBA TS-L462A	
General Specification		
Interface	Enhanced IDE (ATAPI)	
Disc Diameter	8cm/12cm	
Loading Type	Drawer Type	
Drive Mounting	Horizontal/Vertical	
Read/Write	Read Speed: Max. 24X(3,600 KB/sec) for CD-ROM Max. 24X(3,600 KB/sec) for CD-RW Write Speed: Max. 24X(3,600 KB/sec) for CD-R Max. 10X(1,500 KB/sec) for CD-RW Max. 24X(3,600 KB/sec) for US-RW	CAV 24X CAV 24X P-CAV 24X/20X/16X ; CLV 10X/8X/4X CLV 10X/4X P-CAV 24X/16X
Mounting Orientation	Horizontal/Vertical	All angles
Buffer Under Run	2MB	
Power consumption	DC +5v/1.2A	
Interface	Enhanced IDE(ATAPI) compatible	

Combo Drive Interface

Item	Specification	Remark
Media compatibility	CD: 120mm CD-ROM (Read Only) 80mm CD 800/700/650/550MB CD-Recordable (Read & Write) 700/650MB CD-Rewritable (Read & Write) 700/650MB High Speed CD-Rewritable (Read & Write) DVD: 5/9/10/18 DVD-Single/Dual (PTP, OTP) 3.9/4.7G DVD-R (Read Only) 4.7GDVD+R (Read Only) DVD±RW (Read only) 80mm DVD	
Format compatibility	CD CD-DA (Red Book) - Standard Audio CD & CD-TEXT CD-ROM (Yellow Book Mode1 & 2) - Standard Data CD-ROM XA (Mode2 Form1 & 2) - Photo CD, Multi-Session CD-I /FMV (Green Book, Mode2 Form1 & 2, Ready, Bridge) CD-Extra/ CD-Plus (Blue Book) - Audio & Text/Video Video-CD (White Book) - MPEG1 Video DVD DVD-ROM (Book 1.02), DVD-Video (Book 1.1) DVD-R (Book 1.0, 3.9G) DVD-R (Book 2.0, 4.7G) - General & Authoring DVD+R (Version 1.0) DVD±RW Play DVD-AUDIO except the case that required CPPM (Content protection for prerecorded Media) Write Method	
Loading mechanism	Load: Manual Release: (a) Electrical Release (Release Button) (b) Release by ATAPI command (c) Emergency Release	
Power Requirement		
Input Voltage	DC +5V+/- 5% (operation) DC +5V+/- 8% (start up)	

DVD-RW Interface

Item	Specification
Vendor & model name	TOSHIBA TS-L532A
Performance Specification	

DVD-RW Interface

Item	Specification
Transfer rate (KB/sec)	
(1) Read DVD-ROM	MAX 8X CAV (MAX 10800kB/s)
DVD-R	MAX 4X CAV (MAX 5400kB/s)
CD-ROM	MAX 24X CAV (MAX 3600kB/s)
(2) Write CD-R	4X, 8X (CLV), MAX. 24X(ZCLV)
CD-RW	4X (CLV)
HS-RW	4X, 8X, 10X (CLV)
US-RW	8X, 10X(CLV), MAX. 16X (ZCLV)
(3) ATAPI Interface	
PIO mode	16.6MB/s: PIO mode4
DMA mode	16.6MB/s: Multi word mode2
Ultra DMA mode	33.3MB/s: Ultra DMA mode2
Buffer Memory	2MB
Interface	Enhanced IDE(ATAPI) compatible
Applicable disc format	Read: copy-protected DVD discs, CD-ROM, CD audio, DVD-ROM and DVD-RAM, DVD-R/-RW, DVD+R/+RW and CD-R/-RW, DVD-ROM, DVD-R/+R, DVD-R/+R, DVD-RW/+RW, 4.38GB DVD-RAM, CD-DA discs, CD-ROM discs, CD-R discs, CD-RW discs Write: CD-R, CD-RW, high-speed CD-RW, Ultra-speed CD-RW, DVD-R, DVD-RW, DVD+R, DVD+RW
Loading mechanism	Load: Manual Release: (a) Electrical Release (Release Button) (b) Release by ATAPI command (c) Emergency Release
Power Requirement	
Input Voltage	5 V +/- 5 % (Operating)

Audio Interface

Item	Specification
Audio Controller	Realtek ALC203
Audio onboard or optional	Built-in
Mono or Stereo	Stereo
Resolution	18 bit stereo full duplex
Compatibility	AC97 2.2 S/PDIF extension compliant codec
Sampling rate	1Hz resolution VSR (Variable Sampling Rate)
Internal microphone	Yes
Internal speaker / Quantity	Yes
Supports PnP DMA channel	DMA channel 0 DMA channel 1
Supports PnP IRQ	IRQ10, IRQ11

Video Interface

Item	Specification
Vendor & Model Name	built-in SiS M760GX for Aspire 300/5000 built-in SiS M661MX for Aspire 3500

Video Interface

Item	Specification
Video memory size	up to 128MB for Aspire 3000/5000 up to 64MB for Aspire 3500
Chip voltage	Core / 2.5V, 1.5V,
Supports ZV (Zoomed Video) port	NO
Graph interface	4X AGP (Accelerated Graphic Port) Bus
Maximum resolution LCD	1600X1200 (UXGA)
Maximum resolution CRT	2048X1536@60HZ

Video Resolutions Mode

Monitor Resolution	Hz
2D Display Mode	
640x480	120
800x600	120
1024x768	120
1152X864	120
1280X1024	120
1600x1200	85
1920x1080*16:9	75
1920x1200	75
1920x1440	75
2048x1536	60

Resolution, colors and maximum refresh rate (Hz) in 256, 65K or 16.7M colors.

NOTE: 16:9 aspect ratio monitors are supported on 1920x1080 and 848x480 on Windows(R)XP, Windows(R) 2000 and Windows(R)ME. The complete list of resolutions depends on the driver version and operating system. NOTE: resolutions are limited by the performance of the attached monitor.

USB Port

Item	Specification
USB Compliancy Level	2.0
OHCI	USB 2.0
Number of USB port	3
Location	Two on the right side; one on the front side
Serial port function control	Enable/Disable by BIOS Setup

PCMCIA Port

Item	Specification
PCMCIA controller	
Supports card type	Type II (No Type III)
Number of slots	One type II
Access location	Right side
Supports ZV (Zoomed Video) port	NO
Supports 32 bit CardBus	Yes (IRQ17)

Keyboard

Item	Specification
Keyboard controller	EC NS PC97551 keyboard controller
Keyboard vendor	Darfon
Total number of keypads	88-/89-key
Windows keys	Yes
Internal & external keyboard work simultaneously	Yes

Battery

Item	Specification
Vendor & model name	SANYO PANASONIC SANYO LI-ION 4UR18650F-2-QC141 SIMPPL0
Battery Type	Lithium-ION
Pack capacity	4400mAH
Nominal voltage	14.8V
Number of battery cell	8
Package configuration	4S2P for Sanyo and Panasonic 4S1P for Sanyo QC141 and SIMPPL0
Package voltage	41.8V / 9.6V

LCD

Item	Specification	
Vendor & model name	SAMSUNG LTN154X3-L01-G GLARE	LG LP154W01-A3 GLARE
Screen Diagonal (mm)	15.4inch	15.4inch
Active Area (mm)	331.2(H)x207.0(V)	331.2(H)x207.0(V)
Display resolution (pixels)	WXGA (1080x800)	WXGA (1080x800)
Pixel Pitch	0.25875(H)x0.25875(H)mm	0.25875(H)x0.25875(H)mm
Pixel Arrangement	RGB vertical stripe	RGB vertical stripe
Display Mode	Normally white	Normally white
Surface Treatment	Haze 0 (Glare), Hardness 3H	Hard coating (2H) glare+ Anti reflective treatment of the front polarizer
Typical White Luminance (cd/m ²) also called Brightness	200	185
Luminance Uniformity	not show	not show
Contrast Ratio	300	300
Response Time (Optical Rise Time/Fall Time)msec	25(rise+falling)	30(rise+falling)
Nominal Input Voltage VDD	not show	not show
Typical Power Consumption (watt)	3.7 (for backlight unit)	Total 5.26 @LCM circuit 1.12, backlight input 4.14
Weight	not show	590
Physical Size(mm)	344(W)x222(H)x6.5(D)	344(W)x222(H)x6.5(D)
Support Color	Native 262K colours	262K colours

LCD

Item	Specification	
Viewing Angle (degree) Horizontal: Right/Left Vertical: Upper/Lower	45/45 15/35	60/60 40/50
Temperature Range(° C) Operating Storage (shipping)	0 to 50 -20 to -60	0 to 50 -20 to -60

AC Adapter

Item	Specification
Vendor & model name	DELTA SADP-65KB BFD LITE-ON PA-1650-02 Q2 19V HIPRO HP-OK066B13QT
Input Requirements	
Maximum input current (A, @90Vac, full load)	1.5 A @ 110Vac 1.0 A @ 240Vac
Nominal frequency (Hz)	50-60
Frequency variation range (Hz)	47-63
Input voltage range (Vrms)	90-270
Inrush current	The maximum inrush current will be less than 50A and 100A when the adapter is connected to 115Vac and 230Vac respectively.
Efficiency	It should provide an efficiency of 80% minimum, when measured at maximum load under 115Vac.
Output Ratings (CV mode)	
DC output voltage	19V
Noise + Ripple	300mVp-pmax (20 MHz bandwidth)
Load	0(min) 3.16A(max)
Output Ratings (CC mode)	
DC output voltage	19V +/-1.0V for CV mode
Constant current mode	3.6 +/- 0.3A
Dynamic Output Characteristics	
Turn-on delay time	3 sec (@ 115Vac)
Hold up time	5ms (@115Vac, Full load)
Over Voltage Protection (OVP)	24V
Short circuit protection	3.9A max can be protected and output can be shorted without damage
Electrostatic discharge (ESD)	15KV (at air discharge) 8KV (at contact discharge)
Dielectric Withstand Voltage	
Primary to secondary	3000Vac
Leakage current	0.25 mA max. (@ 254Vac, 60Hz)

AC Adapter

Item	Specification
Regulatory Requirements	<p>Safety Requirements:</p> <ol style="list-style-type: none"> 1.The subject product rated 100-120V 60Hz must be listed under UL 1950 and certified with SCA Standard C22.2 No.950. 2.The subject product rated 200-240V 50Hz must comply with low voltage directive 73/23EEC. <p>EMI Requirements:</p> <ol style="list-style-type: none"> 1.The subject product rated 100-120V 60Hz must meet the EMI requirements of FCC part 15, Subpart B for Class B Digital Device and get FCC Certification before marketing into USA and Canada. 2.The subject product rated 200-240V 50Hz must meet the EMC Directive 89/336/EEC. 3.The subject product rated 100-120V must meet the VCCI-2 EMI requirements.

Power Management

Power Saving Mode	Phenomenon
<p>Standby Mode Enter Standby Mode when</p> <ol style="list-style-type: none"> 1.Standby/Hibernation hot-key is pressed and system is not ready to enter Hibernation mode. 2.System standby/ Hibernation timer expires and system is not ready to enter Hibernation mode. 	<input type="checkbox"/> The buzzer beeps <input type="checkbox"/> The Sleep indicator lights up
<p>Hibernation Mode Enter Hibernation Mode (suspend to HDD) when</p> <ol style="list-style-type: none"> 1.Hibernation hot-key is pressed and system is ready to enter Hibernation mode 2.System Hibernation timer expires and system is ready to enter Hibernation mode. 	<input type="checkbox"/> All power shuts off
<p>Display Standby Mode Keyboard, built-in touchpad, and an external PS/2 pointing device are idle for a specified period.</p>	<input type="checkbox"/> The display shuts off
<p>Hard Disk Standby Mode Hard disk is idle within a specified period of time.</p>	<input type="checkbox"/> Hard disk drive is in standby mode. (spindle turned-off)

Environmental Requirements

Item	Specification
Temperature	
Operating	+0~+35 °C
Non-operating	-20~+65 °C
Package storage	-20~+65 °C
Humidity	
Operating	10% to 90% RH, non-condensing
Non-operating	10% to 90% RH, non-condensing (Unpacked)
Non-operating	10% to 90% RH, non-condensing (Storage package)
Vibration	

Environmental Requirements

Item	Specification
Operating (unpacked)	Operation vibration: 1.0G ,X,Y,Zaxis, 30 minutes/axis
Non-operating (unpacked)	5~27.1Hz: 0.6G 27.1~50Hz: 0.04mm (peak to peak) 50~500Hz: 2.0G
Non-operating (packed)	5~62.6Hz: 0.51mm (peak to peak) 62.6~500Hz: 4.0G

Mechanical Specification

Item	Specification
Dimensions	364(W) x 279(D) x 33.9/38.98 (H)mm 14.3 X 11 x 1.3/1.5 inches
Weight	6.08 lbs (2.76kg) for 15" XGA LCD model 6.17 lbs (2.8kg) for 15.4" WXGA LCD model
I/O Ports	Three USB 2.0 ports Ethernet (RJ-45) port Modem (RJ-11) port External display (VGA) port Microphone/line-in jack Headphones/speaker/line-out jack Type II PC Card slot DC-in jack for AC adaptor
Drive Bays	One
Material	Plastic
Indicators	LED indicator for keyboard hot key: Caps Lock, Scroll Lock, Number lock LED indicator for function indicator: System power-on, HDD/ODD, Wireless on/off, Arcade LED mode, DC-in, Battery/Charging indicator
Switch	Power

System Utilities

BIOS Setup Utility

The BIOS Setup Utility is a hardware configuration program built into your computer's BIOS (Basic Input/Output System).

Your computer is already properly configured and optimized, and you do not need to run this utility. However, if you encounter configuration problems, you may need to run Setup. Please also refer to Chapter 4 Troubleshooting when problem arises.

To activate the BIOS Utility, press **F2** during POST (when "Press <F2> to enter Setup" message is prompted on the bottom of screen).

Press **F2** to enter setup. The default parameter of F12 Boot Menu is set to "disabled". If you want to change boot device without entering BIOS Setup Utility, please set the parameter to "enabled".

Press <F12> during POST to enter multi-boot menu. In this menu, user can change boot device without entering BIOS SETUP Utility.

PhoenixBIOS Setup Utility					
Info.	Main	Advanced	Security	Boot	Exit
CPU Type : Mobile AMD Sempron (TM) Processor 2600+ CPU Speed : HDD Model Name : HDD Serial Number : ATAPI Model Name : ATAPI Serial Number None System BIOS Ver V1.0 VGA BIOS Ver KBC Ver Serial Number xxxxxxxxxxxxxxxxxxxxxxxx 22 Byte Asset Tag Number N/A 32 Byte Produce Name Aspire 3000 16 Byte Manufacturer Name: Acer 16 Byte UUID: xxxxxxxxxxxxxxxxxxxxxxxx 32 Byte					
F1 Help	↑↓ Select Item	F5/F6 Change Values	F9 Setup Defaults		
Esc Exit	←→ Select Menu	Enter Select	▶ Sub-Menu	F10 Save and Exit	

Navigating the BIOS Utility

There are six menu options: Info., Main, System Devices, Security, Boot, and Exit.

Follow these instructions:

- ❑ To choose a menu, use the cursor left/right keys (← →).
- ❑ To choose a parameter, use the cursor up/down keys (↑ ↓).
- ❑ To change the value of a parameter, press F8 or F6.
- ❑ A plus sign (+) indicates the item has sub-items. Press ENTER to expand this item.
- ❑ Press ESC while you are in any of the menu options to go to the Exit menu.
- ❑ In any menu, you can load default settings by pressing F8. You can also press F6 to save any changes made and exit the BIOS Setup Utility.

NOTE: You can change the value of a parameter if it is enclosed in square brackets. Navigation keys for a particular menu are shown on the bottom of the screen. Help for parameters are found in the Item Specific Help part of the screen. Read this carefully when making changes to parameter values. Please note that system information vary in models.

Information

PhoenixBIOS Setup Utility

Info.
Main
Advanced
Security
Boot
Exit

```

CPU Type :           Mobile AMD Sempron (TM) Processor 2600+
CPU Speed :
HDD Model Name :
HDD Serial Number :
ATAPI Model Name :
ATAPI Serial Number None
System BIOS Ver     V1.0
VGA BIOS Ver
KBC Ver
Serial Number       xxxxxxxxxxxxxxxxxxxxxxxx           22 Byte
Asset Tag Number    N/A                       32 Byte
Produce Name        Aspire 3000                   16 Byte
Manufacturer Name:  Acer                       16 Byte
UUID:               xxxxxxxxxxxxxxxxxxxxxxxx           32 Byte
                
```

F1 Help ↑↓ Select Item F5/F6 Change Values F9 Setup Defaults
Esc Exit ←→ Select Menu Enter Select ▶ Sub-Menu F10 Save and Exit

NOTE: The system information is subject to different models.

Parameter	Description
HDD Model Name	This field shows the model name of HDD installed on primary IDE master.
HDD Serial Number	This field displays the serial number of HDD installed on primary IDE master.
ATAPI Model Name	This field displays the model name of devices installed on secondary IDE master. The hard disk drive or optical drive model name is automatically detected by the system.
ATAPI Serial Number	This field shows the serial number of devices installed on secondary IDE master.
Serial Number	This field displays the serial number of this unit.
UUID Number	This will be visible only when an internal LAN device is presenting. UUID=32bytes

Main

The Main screen displays a summary of your computer hardware information, and also includes basic setup parameters. It allows the user to specify standard IBM PC AT system parameters.

PhoenixBIOS Setup Utility					
Info.	Main	Advanced	Security	Boot	Exit
					Item Specific Help
System Time:	[15:56:48]				<Tab>, <Shift-Tab>, or <Enter> selects field.
System Date:	[03/18/2005]				
System Memory:	640 KB	Shows system base memory size			
Extended Memory:	446MB	Shows extended memory size			
Video Memory	[64 MB]	VGA memory size			
Quiet Boot:	[Enabled]				
Power on display:	[Auto]				
Network boot	[Enabled]				
F12 Boot Menu	[Disabled]				
D2D Recovery	[Disabled]				
USB BIOS Legacy	[Enabled]				
F1 Help	↑↓ Select Item	F5/F6 Change Values	F9 Setup Defaults		
Esc Exit	←→ Select Menu	Enter Select	▶ Sub-Menu	F10 Save and Exit	

NOTE: The screen above is for reference only. Actual values may differ.

The table below describes the parameters in this screen. Settings in **boldface** are the default and suggested parameter settings.

Parameter	Description	Format/Option
System Time	Sets the system time. The hours are displayed with 24-hour format.	Format: HH:MM:SS (hour:minute:second) System Time
System Date	Sets the system date.	Format MM/DD/YYYY (month/day/year) System Date
System Memory	This field reports the memory size of the system. Memory size is fixed to 640MB	
Extended Memory	This field reports the memory size of the extended memory in the system. Extended Memory size=Total memory size-1MB	
VGA Memory	Shows the VGA memory size. VGA Memory size=64/128MB	
Fast Boot	Determines if Customer Logo will be displayed or not; shows Summary Screen is disabled or enabled. Enabled: Customer Logo is displayed, and Summary Screen is disabled. Disabled: Customer Logo is not displayed, and Summary Screen is enabled.	Option: Enabled or Disabled
Power on display	Auto: During power process, the system will detect if any display device is connected on external video port. If any external display device is connected, the power on display will be in CRT (or projector) only mode. Otherwise it will be in LCD only mode. Both: Simultaneously enable both the integrated LCD screen and the system's external video port (for an external CRT or projector).	Option: Auto or Both
Network Boot	Enables, disables the system boot from LAN (remote server).	Option: Enabled or Disabled
F12 Boot Menu	Enables, disables Boot Menu during POST.	Option: Disabled or Enabled
D2D Recovery	Enables, disables D2D Recovery function. The function allows the user to create a hidden partition on hard disc drive to store operation system and restore the system to factory defaults.	Option: Enabled or Disabled
USB BIOS Legacy Support	Enables or disables legacy USB devices under DOS mode.	Option: Enabled or Disabled

NOTE: The sub-items under each device will not be shown if the device control is set to disable or auto. This is because the user is not allowed to control the settings in these cases.

Security

The Security screen contains parameters that help safeguard and protect your computer from unauthorized use.

PhoenixBIOS Setup Utility															
Info.	Main	Advanced	Security	Boot	Exit										
					Item Specific Help										
Supervisor Password Is:		Clear		<p>When shown as [Locked], the hard drive password currently can not be changed or disabled.</p> <p>To change or disable it, turn off the system and enter Setup immediately after turning it back on.</p> <p>Press [Enter] to input, change, or disable hard drive passwords.</p>											
User Password Is:		Clear													
Primary HardDisk Security:		Clear													
HDD Master ID:		43883445													
Set Supervisor Password		[Enter]													
Set User Passord		[Enter]													
Set HDD Password		[Enter]													
Password on Boot		[Disabled]													
<table border="0"> <tr> <td>F1 Help</td> <td>↑↓ Select Item</td> <td>F5/F6 Change Values</td> <td>F9 Setup Defaults</td> </tr> <tr> <td>Esc Exit</td> <td>←→ Select Menu</td> <td>Enter Select ▶ Sub-Menu</td> <td>F10 Save and Exit</td> </tr> </table>						F1 Help	↑↓ Select Item	F5/F6 Change Values	F9 Setup Defaults	Esc Exit	←→ Select Menu	Enter Select ▶ Sub-Menu	F10 Save and Exit		
F1 Help	↑↓ Select Item	F5/F6 Change Values	F9 Setup Defaults												
Esc Exit	←→ Select Menu	Enter Select ▶ Sub-Menu	F10 Save and Exit												

The table below describes the parameters in this screen. Settings in **boldface** are the default and suggested parameter settings.

Parameter	Description	Option
User Password is	Shows the setting of the user password.	Clear or Set
Supervisor Password is	Shows the setting of the Supervisor password	Clear or Set
Set User Password	Press Enter to set the user password. When user password is set, this password protects the BIOS Setup Utility from unauthorized access. The user can enter Setup menu only and does not have right to change the value of parameters.	
Set Supervisor Password	Press Enter to set the supervisor password. When set, this password protects the BIOS Setup Utility from unauthorized access. The user can not either enter the Setup menu nor change the value of parameters.	
Primary Harddisk Security	This feature is available to user when Supervisor password is set. Password can be written on HDD only when Supervisor password or user password is set and password on HDD is set to enabled. Supervisor Password is written to HDD only when Supervisor password is being set. User password is written to HDD when both passwords are set. When both Supervisor and user password are present, both passwords can unlock the HDD.	Disabled or Enabled
Password on Boot	Defines whether a password is required or not while the events defined in this group happened. The following sub-options are all requires the Supervisor password for changes and should be grayed out if the user password was used to enter setup.	Disabled or Enabled

NOTE: When you are prompted to enter a password, you have three tries before the system halts. Don't forget your password. If you forget your password, you may have to return your notebook computer to your dealer to reset it.

Setting a Password

Follow these steps as you set the user or the supervisor password:

1. Use the **↑** and **↓** keys to highlight the Set Supervisor Password parameter and press the **ENTER** key. The Set Supervisor Password box appears:

Set Supervisor Password

Enter New Password []

Confirm New Password []

2. Type a password in the "Enter New Password" field. The password length can not exceeds 8 alphanumeric characters (A-Z, a-z, 0-9, not case sensitive). Retype the password in the "Confirm New Password" field.

IMPORTANT: Be very careful when typing your password because the characters do not appear on the screen.

3. Press **ENTER**.
After setting the password, the computer sets the User Password parameter to “Set”.
4. If desired, you can opt to enable the Password on boot parameter.
5. When you are done, press **F10** to save the changes and exit the BIOS Setup Utility.

Removing a Password

Follow these steps:

1. Use the **↑** and **↓** keys to highlight the Set Supervisor Password parameter and press the **ENTER** key. The Set Password box appears:

Set Supervisor Password		
Enter current password	[]
Enter New Password	[]
Confirm New Password	[]

2. Type the current password in the Enter Current Password field and press **ENTER**.
3. Press **ENTER** twice **without** typing anything in the Enter New Password and Confirm New Password fields. The computer then sets the Supervisor Password parameter to “Clear”.
4. When you have changed the settings, press **F10** to save the changes and exit the BIOS Setup Utility.

Changing a Password

1. Use the **↑** and **↓** keys to highlight the Set Supervisor Password parameter and press the **ENTER** key. The Set Password box appears:

Set Supervisor Password		
Enter current password	[]
Enter New Password	[]
Confirm New Password	[]

2. Type the current password in the Enter Current Password field and press **ENTER**.
3. Type a password in the Enter New Password field. Retype the password in the Confirm New Password field.
4. Press **ENTER**. After setting the password, the computer sets the User Password parameter to “Set”.
5. If desired, you can enable the Password on boot parameter.
6. When you are done, press **F10** to save the changes and exit the BIOS Setup Utility.

If the verification is OK, the screen will display as following.

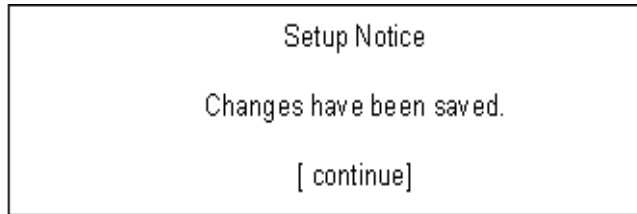

The password setting is complete after the user presses .

If the current password entered does not match the actual current password, the screen will show you the Setup Warning.

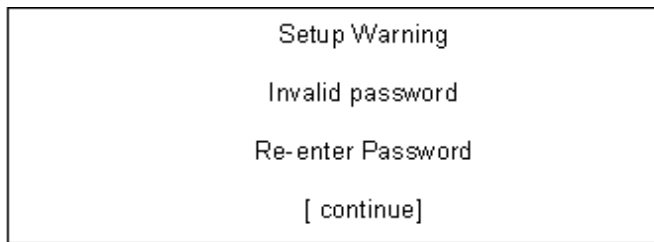

If the new password and confirm new password strings do not match, the screen will display the following message.

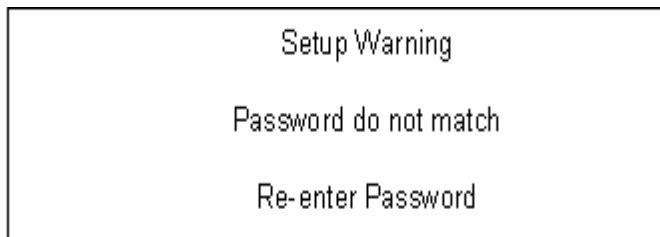

Boot

This menu allows the user to decide the order of boot devices to load the operating system. Bootable devices includes the distette drive in module bay, the onboard hard disk drive and the CD-ROM in module bay.

PhoenixBIOS Setup Utility					
Info.	Main	Advanced	Security	Boot	Exit
CD-ROM/DVD Drive Floppy Devices +Hard Drive Network Boot				Item Specific Help	
				+ and - indicate device categories. Use <Enter> to expand/collapses. Boot order is top-down using only the top device in each category. Use <F6> and <F5> to move highlighted item up and down.	
F1 Help	↑↓ Select Item	F5/F6 Change Values	F9 Setup Defaults		
Esc Exit	←→ Select Menu	Enter Select ▶ Sub-Menu	F10 Save and Exit		

Exit

The Exit screen contains parameters that help safeguard and protect your computer from unauthorized use.

PhoenixBIOS Setup Utility							
Info.	Main	Advanced	Security	Boot	Exit		
<table border="1"> <tr> <td rowspan="2"> Exit Saving Changes Exit Discarding Changes Load Setup Defaults Discard Changes Save Changes </td> <td>Item Specific Help</td> </tr> <tr> <td>Exit System Setup and save your changes to CMOS.</td> </tr> </table>					Exit Saving Changes Exit Discarding Changes Load Setup Defaults Discard Changes Save Changes	Item Specific Help	Exit System Setup and save your changes to CMOS.
Exit Saving Changes Exit Discarding Changes Load Setup Defaults Discard Changes Save Changes	Item Specific Help						
	Exit System Setup and save your changes to CMOS.						
F1 Help	↑↓ Select Item	F5/F6 Change Values	F9 Setup Defaults				
Esc Exit	←→ Select Menu	Enter Select	▶ Sub-Menu	F10 Save and Exit			

The table below describes the parameters in this screen.

Parameter	Description
Exit Saving Changes	Exit System Setup and save your changes to CMOS.
Exit Discarding Changes	Exit utility without saving setup data to CMOS.
Load Setup Default	Load default values for all SETUP item.
Discard Changes	Load previous values from CMOS for all SETUP items.
Save Changes	Save Setup Data to CMOS.

BIOS Flash Utility

The BIOS flash memory update is required for the following conditions:

- New versions of system programs
- New features or options
- Restore a BIOS when it becomes corrupted.

Use the Phlash utility to update the system BIOS flash ROM.

NOTE: If you do not have a crisis recovery diskette at hand, then you should create a **Crisis Recovery Diskette** before you use the Phlash utility.

NOTE: Do not install memory-related drivers (XMS, EMS, DPMS) when you use the Phlash.

NOTE: Please use the AC adaptor power supply when you run the Phlash utility. If the battery pack does not contain enough power to finish BIOS flash, you may not boot the system because the BIOS is not completely loaded.

Follow the steps below to run the Phlash.

1. Prepare a bootable diskette.
2. Copy the Phlash utilities to the bootable diskette.
3. Then boot the system from the bootable diskette. The Phlash utility has auto-execution function.

Machine Disassembly and Replacement

This chapter contains step-by-step procedures on how to disassemble the notebook computer for maintenance and troubleshooting.

To disassemble the computer, you need the following tools:

- Wrist grounding strap and conductive mat for preventing electrostatic discharge
- Flat-bladed screw driver
- Phillips screw driver
- Tweezers
- Plastic Flat-bladed screw driver
- Hexed Screw Driver

NOTE: The screws for the different components vary in size. During the disassembly process, group the screws with the corresponding components to avoid mismatch when putting back the components.

General Information

Before You Begin

Before proceeding with the disassembly procedure, make sure that you do the following:

1. Turn off the power to the system and all peripherals.
2. Unplug the AC adapter and all power and signal cables from the system

NOTE: Aspire 9100 series product uses mylar or tape to fasten the FFC/FPC/connectors/cable, you may need to tear the tape or mylar before you disconnect different FFC/FPC/connectors.

Disassembly Procedure Flowchart

The flowchart on the succeeding page gives you a graphic representation on the entire disassembly sequence and instructs you on the components that need to be removed during servicing. For example, if you want to remove the main board, you must first remove the keyboard, then disassemble the inside assembly frame in that order.

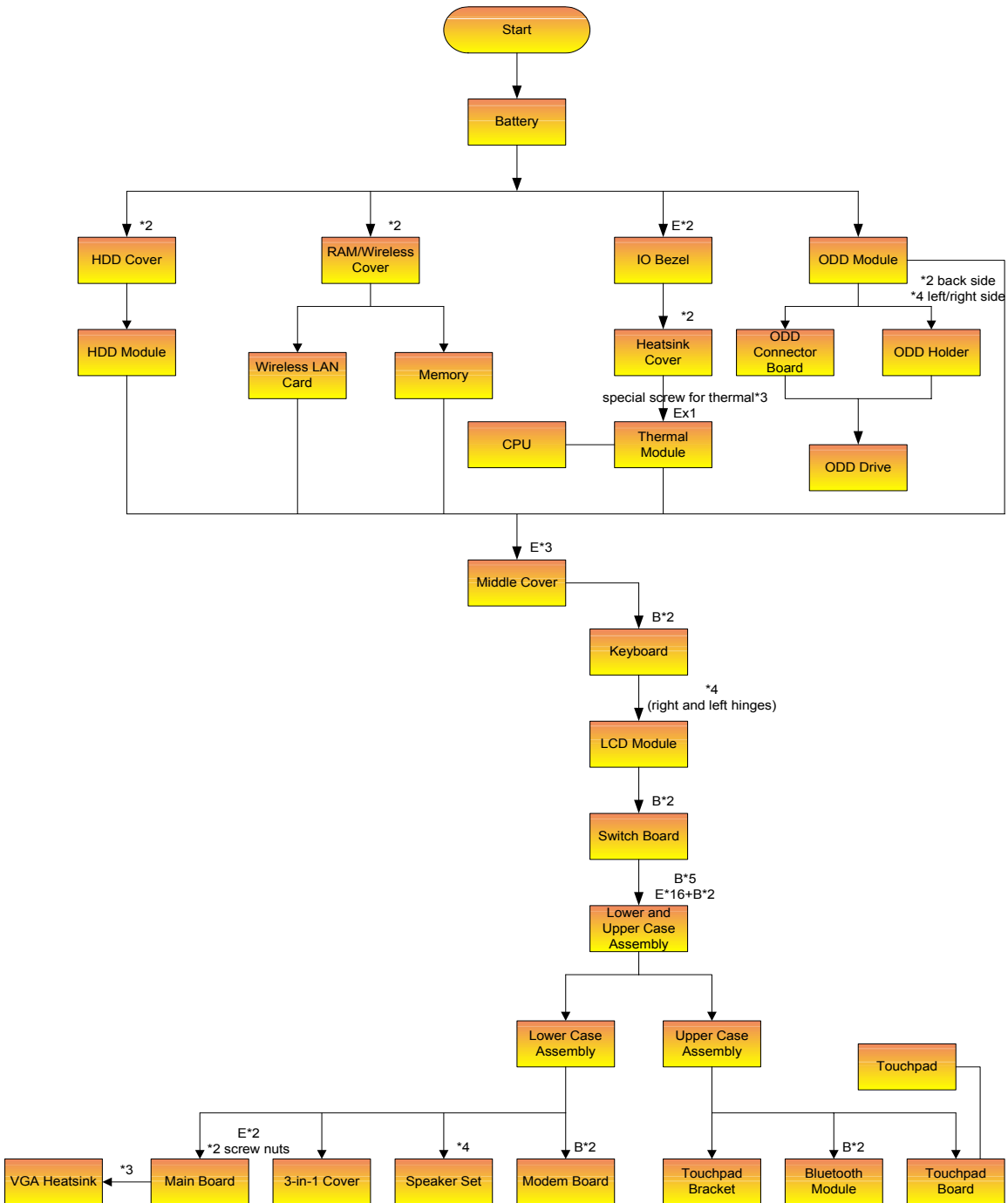

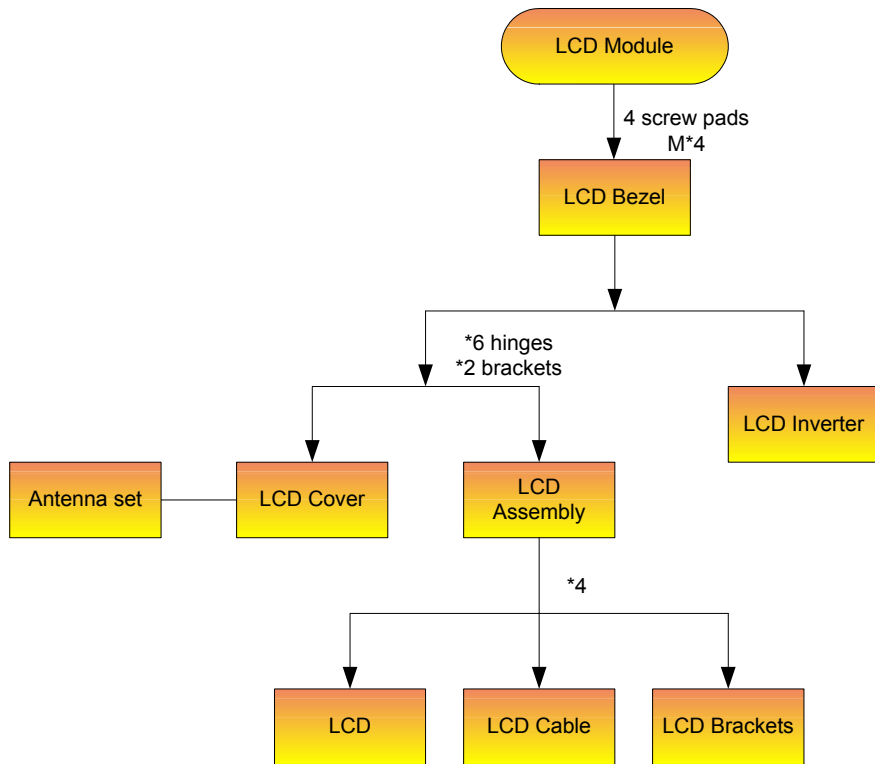

Screw List

Item	Description
A	SCREW F040 9 5.0X5.0 9.5X(IO) R00
B	SCREW M2.0X0.4P+3FP ZK(NL)
C	SCREW M2.5 K 5/2 X0.85 4 ZK(NL)
D	SCREW M2.5X0.45+10K NIL
E	SCREW M2.5X0.45+8K ZBL
F	SCREW M2.5X0.45P+3F NI
G	SCREW M3.0X0.8P+3K NL

Removing the Battery Pack

1. Unlock the battery lock.
2. Slide the battery latch as shown.
3. Then remove the battery pack.



Removing the HDD Module/the Memory and the Wireless LAN Card/ the Thermal Module and the CPU/ODD Module and LCD Module

Removing the HDD Module

1. Remove the two screws holding the HDD cover.
2. Remove the HDD cover.



3. Remove the screw fastening the HDD module to the notebook.
4. Then detach the HDD module from the notebook.



Removing the Memory and the Wireless LAN Card

1. Remove the two screws that secure the RAM/Wireless cover.
2. Remove the RAM/Wireless cover.



3. Pop up the memory then remove it.
4. Disconnect the auxiliary and the main wireless antennae.
5. Pop the wireless LAN card then remove it.



Removing the Thermal Module and CPU

1. Remove the three screws holding the thermal door
2. Detach the thermal door.
3. Disconnect the fan cable from the main board.



4. Remove the three screws fastening the thermal module.
5. Disconnect the fan cable.



NOTE: When you remove the screws fastening the thermal module, please follow the number order 3, 2, 1 on the thermal module. When you need to assemble the thermal module, fasten the screws as the order 1, 2, 3 on the thermal module.

6. Use a flat-bladed screwdriver to release the CPU lock.
7. Remove the CPU from the socket carefully.

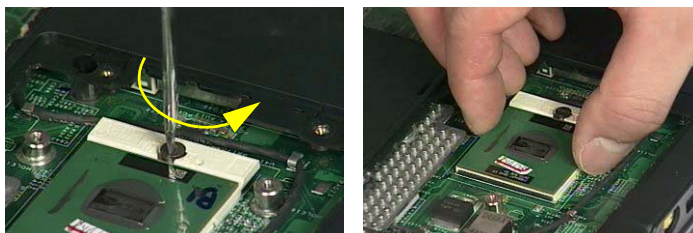

Removing the ODD Module

1. Remove the three screws holding the middle cover.
2. Detach the middle cover carefully.
3. Then remove the two screws fastening the keyboard.



4. Turn over the keyboard as shown.
5. Disconnect the keyboard cable from the main board then remove the keyboard.

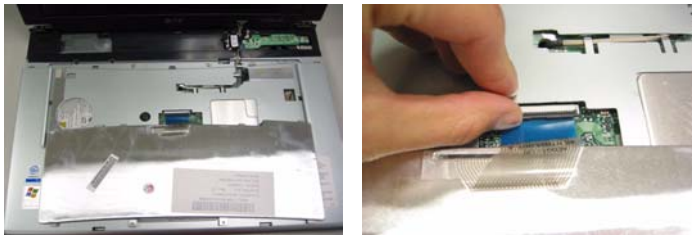

6. Remove the screw that fastens the ODD module.
7. Turn over the notebook computer then detach the ODD module carefully.

NOTE: When you reattach the ODD, please make sure you attach the ODD module completely to the main unit. Otherwise, you can not fasten the screw and the screw may damage the main board.

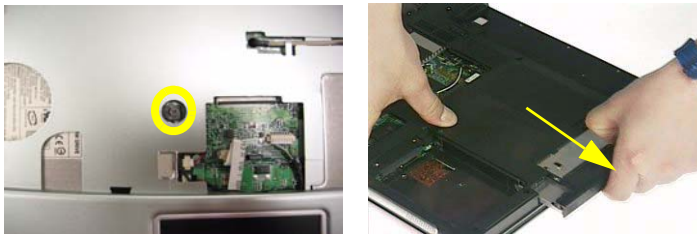

Removing the LCD Module

1. Remove the three screws holding the keyboard cover.
2. Open the LCD module as the picture shown then detach the keyboard cover from the main unit.

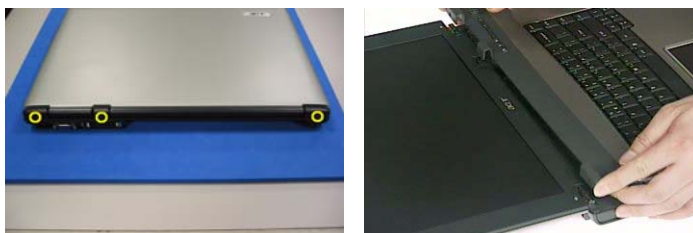

3. Remove the two screws that secure the keyboard as shown.
4. Turn over the keyboard as shown and disconnect the keyboard cable then remove the keyboard.
5. Pull out the antenna set with a tweezers then take out the antenna set from the main unit.

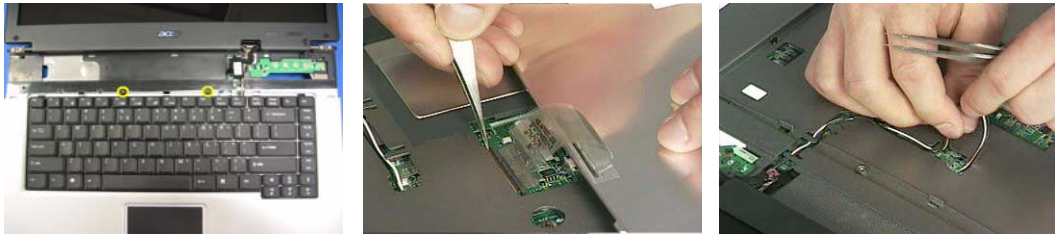

6. Disconnect the LCD coaxial cable.
7. Remove the four screws holding the right and the left hinge. Two on each side.
8. Then detach the LCD module from the main unit.



Disassembling the Main Unit

Separate the Main Unit Into the Upper and the Lower Case Assembly

1. Remove the two screws holding the switch board.
2. Remove the switch board.
3. Disconnect the touchpad FFC from the main board.



4. Disconnect the bluetooth cable.
5. Remove the five screws that secure the upper case.
6. Remove the 17 screws on the bottom as shown.

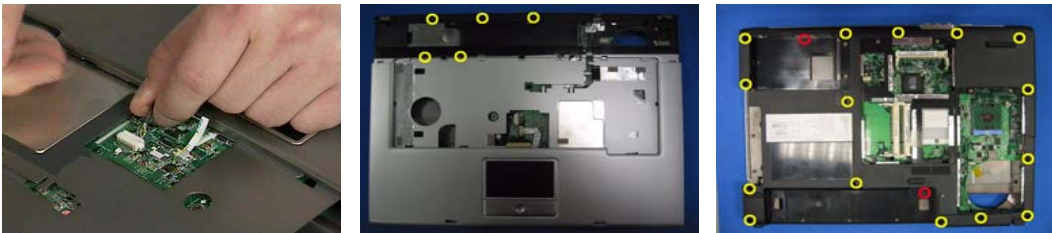

7. Detach the upper case assembly and place it next to the lower case assembly.
8. Disconnect the microphone cable then remove the upper case assembly.

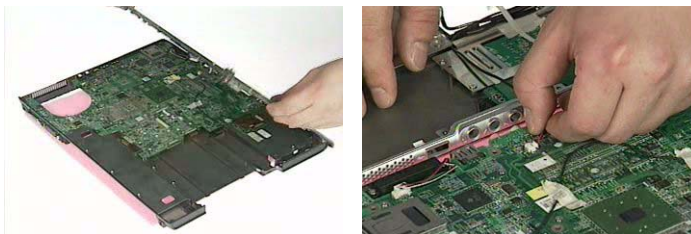

Disassembling the Upper Case Assembly

1. Disconnect the touchpad board to touchpad FFC.
2. Disconnect the touchpad board to main board FFC.
3. Then detach the touchpad board to main board FFC from the touchpad board.

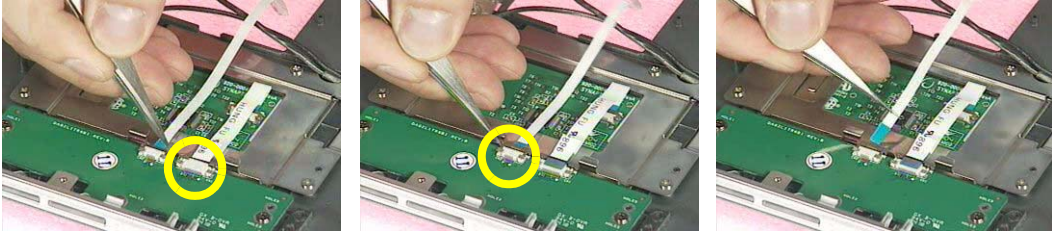

4. Remove the three screws that secure the touchpad board.
5. Remove the touchpad board from the upper case.
6. Disconnect the touchpad board to touchpad FFC.



7. Remove the touchpad board to touchpad FFC from the upper case assembly.
8. Remove the four screws holding the touchpad bracket.
9. Detach the touchpad bracket from the upper case assembly.

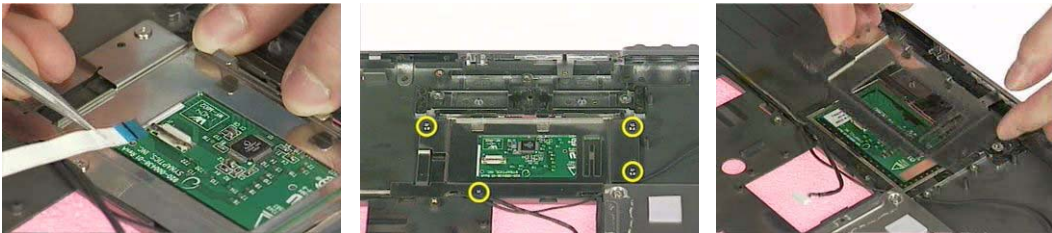

10. Remove the touchpad from the upper case.
11. Remove the two screws that secure the bluetooth module.
12. Disconnect the bluetooth module then remove it.



Disassembling the Lower Case Assembly

1. Disconnect the MDC cable from the modem board.

2. Detach the MDC cable from the main board.
3. Remove the two screws holding the modem board then disconnect the modem board from the main board.



4. Disconnect the speaker cable from the main board.
5. Remove the screw that secure the main board.

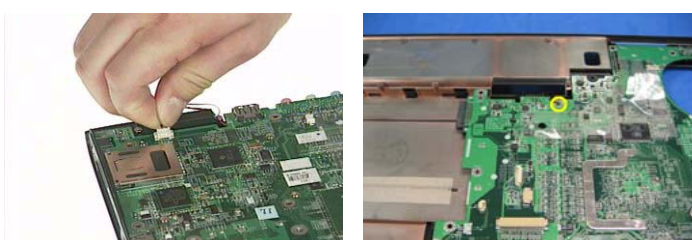

6. Remove the two screw nuts as shown.
7. The you can detach the main board from the upper case.
8. Remove the two screws that fasten the N/B heatsink.



9. Remove the N/B heatsink from the main board as shown.
10. Remove the card reader dummy card from the lower case. (For SKU with three-in-one card reader, please remove three in one cover).
11. Remove the two screws that secure the speaker set on one side.



12. Then remove another two screws holding the speaker set on the other side.
13. Then take out the speaker set from the lower case.



IMPORTANT:When assembling/disassembling the main board, whenever there is a mylar on the main board (see the highlighted with red below; the mylar is semi-transparent, film-like stuff), it should be transferred “if necessary” to the replacement main board. Because the main board mylar should be stuck to the main board to prevent the antenna cable and the main board components short circuit. The short could cause the main board or the antenna cable burned.

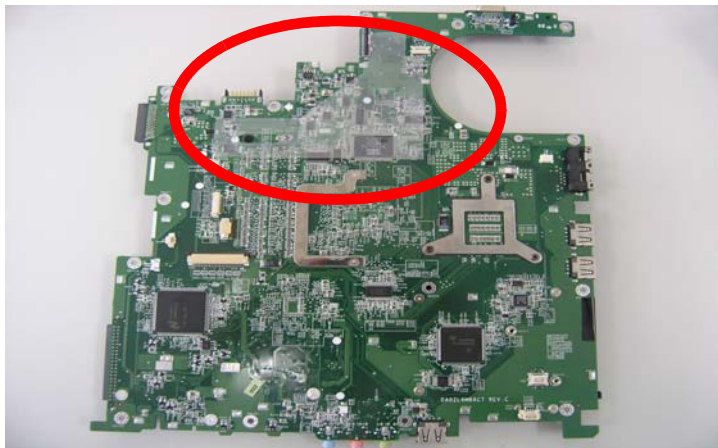

Disassembling the LCD Module

1. Remove the four screw caps as shown.
2. Remove the four screws holding the LCD bezel.
3. Then detach the LCD bezel from the LCD module.



4. Disconnect the inverter board then remove it.
5. Remove the three screws holding the right hinge.
6. Then remove the three screws that secure the left hinge.

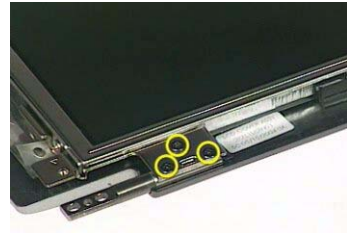
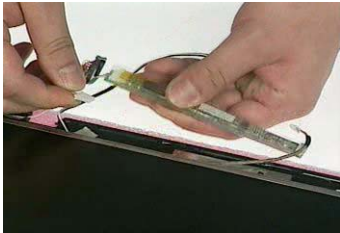

7. Remove one screw that secure the LCD bracket.
8. Remove another screw holding the LCD bracket on the other side.
9. Then detach the LCD panel from the LCD cover carefully.



10. Remove the two screws holding the right bracket.
11. Then remove the right bracket.
12. Remove another two screws that tighten the left bracket.



- 13.** Remove the left bracket as the picture shows.
- 14.** Tear off the tape fastening the LCD cable.
- 15.** Tear off the the LCD cable fastening the LCD cable, then remove it..

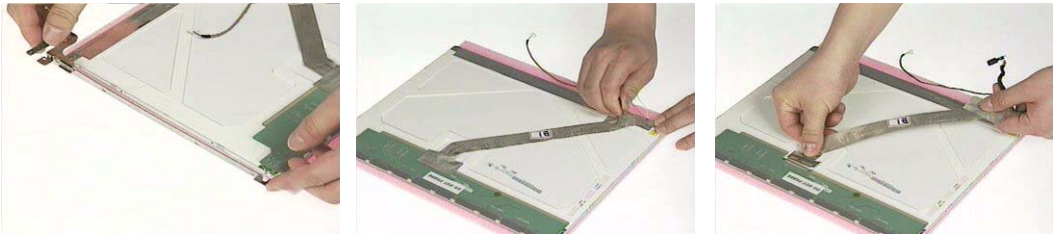

Disassembling the External Modules

Disassembling the HDD Module

1. Remove the two screws holding the HDD bracket on one side.
2. Remove another two screws holding the HDD bracket on the other side.
3. Then take the hard disc drive out from the HDD bracket.



Disassembling the Optical Drive Module

1. Remove the four screws as the picture shows.
2. Remove the two screws that secure the optical disc drive and the ODD holder.

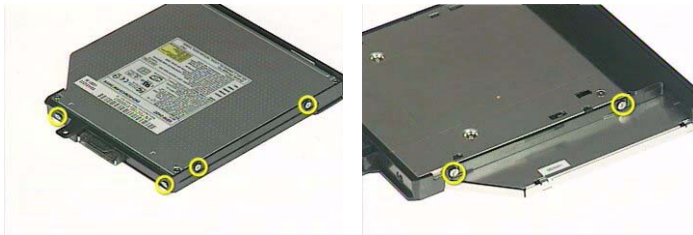

3. Push the ODD holder as shown.
4. Detach the ODD holder.
5. Disconnect the ODD connector board then remove it.

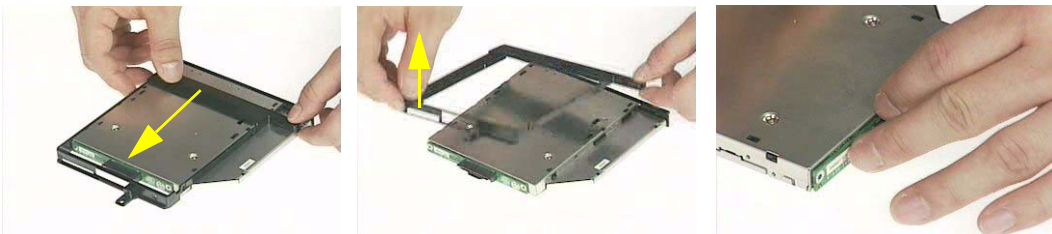

Troubleshooting

Use the following procedure as a guide for computer problems.

NOTE: The diagnostic tests are intended to test only Acer products. Non-Acer products, prototype cards, or modified options can give false errors and invalid system responses.

1. Obtain the failing symptoms in as much detail as possible.
2. Verify the symptoms by attempting to re-create the failure by running the diagnostic test or by repeating the same operation.
3. Use the following table with the verified symptom to determine which page to go to.

Symptoms (Verified)	Go To
Power failure. (The power indicator does not go on or stay on.)	"Power System Check" on page 68.
POST does not complete. No beep or error codes are indicated.	"Power-On Self-Test (POST) Error Message" on page 71 "Undetermined Problems" on page 83
POST detects an error and displayed messages on screen.	"Error Message List" on page 72
Other symptoms (i.e. LCD display problems or others).	"Power-On Self-Test (POST) Error Message" on page 71
Symptoms cannot be re-created (intermittent problems).	Use the customer-reported symptoms and go to "Power-On Self-Test (POST) Error Message" on page 71 "Intermittent Problems" on page 82 "Undetermined Problems" on page 83

System Check Procedures

External Diskette Drive Check

Do the following to isolate the problem to a controller, driver, or diskette. A write-enabled, diagnostic diskette is required.

NOTE: Make sure that the diskette does not have more than one label attached to it. Multiple labels can cause damage to the drive or cause the drive to fail.

Do the following to select the test device.

1. Boot from the diagnostics diskette and start the diagnostics program.
2. See if FDD Test is passed as the program runs to FDD Test.
3. Follow the instructions in the message window.

If an error occurs with the internal diskette drive, reconnect the diskette connector on the system board.

If the error still remains:

1. Reconnect the external diskette drive/DVD-ROM module.
2. Replace the external diskette drive/CD-ROM module.
3. Replace the main board.

External CD-ROM Drive Check

Do the following to isolate the problem to a controller, drive, or CD-ROM. Make sure that the CD-ROM does not have any label attached to it. The label can cause damage to the drive or can cause the drive to fail.

Do the following to select the test device:

1. Boot from the diagnostics diskette and start the diagnostics program.
2. See if CD-ROM Test is passed when the program runs to CD-ROM Test.
3. Follow the instructions in the message window.

If an error occurs, reconnect the connector on the System board. If the error still remains:

1. Reconnect the external diskette drive/CD-ROM module.
2. Replace the external diskette drive/CD-ROM module.
3. Replace the main board.

Keyboard or Auxiliary Input Device Check

Remove the external keyboard if the internal keyboard is to be tested.

If the internal keyboard does not work or an unexpected character appears, make sure that the flexible cable extending from the keyboard is correctly seated in the connector on the system board.

If the keyboard cable connection is correct, run the Keyboard Test.

If the tests detect a keyboard problem, do the following one at a time to correct the problem. Do not replace a non-defective FRU:

1. Reconnect the keyboard cables.
2. Replace the keyboard.
3. Replace the main board.

The following auxiliary input devices are supported by this computer:

- Numeric keypad
- External keyboard

If any of these devices do not work, reconnect the cable connector and repeat the failing operation.

Memory check

Memory errors might stop system operations, show error messages on the screen, or hang the system.

1. Boot from the diagnostics diskette and start the doagmpstotics program (please refer to main board).
2. Go to the diagnostic memory in the test items.
3. Press F2 in the test items.
4. Follow the instructions in the message window.

NOTE: Make sure that the DIMM is fully installed into the connector. A loose connection can cause an error.

Power System Check

To verify the symptom of the problem, power on the computer using each of the following power sources:

1. Remove the battery pack.
2. Connect the power adapter and check that power is supplied.
3. Disconnect the power adapter and install the charged battery pack; then check that power is supplied by the battery pack.

If you suspect a power problem, see the appropriate power supply check in the following list:

- “Check the Power Adapter” on page 69
- “Check the Battery Pack” on page 70

Check the Power Adapter

Unplug the power adapter cable from the computer and measure the output voltage at the plug of the power adapter cable. See the following figure

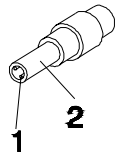

Pin 1: +19 to +20.5V
Pin 2: 0V, Ground

1. If the voltage is not correct, replace the power adapter.
2. If the voltage is within the range, do the following:
 - Replace the System board.
 - If the problem is not corrected, see “Undetermined Problems” on page 83.
 - If the voltage is not correct, go to the next step.

NOTE: An audible noise from the power adapter does not always indicate a defect.

3. If the power-on indicator does not light up, check the power cord of the power adapter for correct continuity and installation.
4. If the operational charge does not work, see “Check the Battery Pack” on page 70.

Check the Battery Pack

To check the battery pack, do the following:

From Software:

1. Check out the Power Management in control Panel
2. In Power Meter, confirm that if the parameters shown in the screen for Current Power Source and Total Battery Power Remaining are correct.
3. Repeat the steps 1 and 2, for both battery and adapter.
4. This helps you identify first the problem is on recharging or discharging.

From Hardware:

1. Power off the computer.
2. Remove the battery pack and measure the voltage between battery terminals 1(+) and 6(ground). See the following figure

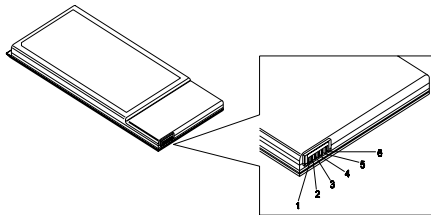

3. If the voltage is still less than 7.5 Vdc after recharging, replace the battery.

To check the battery charge operation, use a discharged battery pack or a battery pack that has less than 50% of the total power remaining when installed in the computer.

If the battery status indicator does not light up, remove the battery pack and let it return to room temperature. Re-install the battery pack.

If the charge indicator still does not light up, replace the battery pack. If the charge indicator still does not light up, replace the DC/DC charger board.

Touchpad Check

If the touchpad doesn't work, do the following actions one at a time to correct the problem. Do not replace a non-defective FRU:

1. Reconnect the touchpad cables.
2. Replace the touchpad.
3. Replace the system board.

After you use the touchpad, the pointer drifts on the screen for a short time. This self-acting pointer movement can occur when a slight, steady pressure is applied to the touchpad pointer. This symptom is not a hardware problem. No service actions are necessary if the pointer movement stops in a short period of time.

Power-On Self-Test (POST) Error Message

The POST error message index lists the error message and their possible causes. The most likely cause is listed first.

NOTE: Perform the FRU replacement or actions in the sequence shown in FRU/Action column, if the FRU replacement does not solve the problem, put the original part back in the computer. Do not replace a non-defective FRU.

This index can also help you determine the next possible FRU to be replaced when servicing a computer.

If the symptom is not listed, see “Undetermined Problems” on page 83.

The following lists the error messages that the BIOS displays on the screen and the error symptoms classified by function.

NOTE: Most of the error messages occur during POST. Some of them display information about a hardware device, e.g., the amount of memory installed. Others may indicate a problem with a device, such as the way it has been configured.

NOTE: If the system fails after you make changes in the BIOS Setup Utility menus, reset the computer, enter Setup and install Setup defaults or correct the error.

Index of Error Messages

Error Code List

Error Codes	Error Messages
006	Equipment Configuration Error Causes: 1. CPU BIOS Update Code Mismatch 2. IDE Primary Channel Master Drive Error (The causes will be shown before "Equipment Configuration Error")
010	Memory Error at xxxx:xxxx:xxxxh (R:xxxxh, W:xxxxh)
070	Real Time Clock Error
071	CMOS Battery Bad
072	CMOS Checksum Error
110	System disabled. Incorrect password is specified.
<No error code>	Battery critical LOW In this situation BIOS will issue 4 short beeps then shut down system, no message will show.
<No error code>	Thermal critical High In this situation BIOS will shut down system, not show message.

Error Message List

Error Messages	FRU/Action in Sequence
Failure Fixed Disk	Reconnect hard disk drive connector. "Load Default Settings" in BIOS Setup Utility. Hard disk drive System board
Stuck Key	see "Keyboard or Auxiliary Input Device Check" on page 67.
Keyboard error	see "Keyboard or Auxiliary Input Device Check" on page 67.
Keyboard Controller Failed	see "Keyboard or Auxiliary Input Device Check" on page 67.
Keyboard locked - Unlock key switch	Unlock external keyboard
Monitor type does not match CMOS - Run Setup	Run "Load Default Settings" in BIOS Setup Utility.
Shadow RAM Failed at offset: nnnn	BIOS ROM System board
System RAM Failed at offset: nnnn	DIMM System board
Extended RAM Failed at offset: nnnn	DIMM System board
System battery is dead - Replace and run Setup	Replace RTC battery and Run BIOS Setup Utility to reconfigure system time, then reboot system.
System CMOS checksum bad - Default configuration used	RTC battery Run BIOS Setup Utility to reconfigure system time, then reboot system.
System timer error	RTC battery Run BIOS Setup Utility to reconfigure system time, then reboot system. System board

Error Message List

Error Messages	FRU/Action in Sequence
Real time clock error	RTC battery Run BIOS Setup Utility to reconfigure system time, then reboot system. System board
Previous boot incomplete - Default configuration used	Run "Load Default Settings" in BIOS Setup Utility. RTC battery System board
Memory size found by POST differed from CMOS	Run "Load Default Settings" in BIOS Setup Utility. DIMM System board
Diskette drive A error	Check the drive is defined with the proper diskette type in BIOS Setup Utility See "External Diskette Drive Check" on page 67.
Incorrect Drive A type - run SETUP	Check the drive is defined with the proper diskette type in BIOS Setup Utility
System cache error - Cache disabled	System board
CPU ID:	System board
DMA Test Failed	DIMM System board
Software NMI Failed	DIMM System board
Fail-Safe Timer NMI Failed	DIMM System board
Device Address Conflict	Run "Load Default Settings" in BIOS Setup Utility. RTC battery System board
Allocation Error for device	Run "Load Default Settings" in BIOS Setup Utility. RTC battery System board
Failing Bits: nnnn	DIMM BIOS ROM System board
Fixed Disk n	None
Invalid System Configuration Data	BIOS ROM System board
I/O device IRQ conflict	Run "Load Default Settings" in BIOS Setup Utility. RTC battery System board
Operating system not found	Enter Setup and see if fixed disk and drive A: are properly identified. Diskette drive Hard disk drive System board

Error Message List

No beep Error Messages	FRU/Action in Sequence
No beep, power-on indicator turns off and LCD is blank.	Power source (battery pack and power adapter). See "Power System Check" on page 68. Ensure every connector is connected tightly and correctly. Reconnect the DIMM. LED board. System board.
No beep, power-on indicator turns on and LCD is blank.	Power source (battery pack and power adapter). See "Power System Check" on page 68. Reconnect the LCD connector Hard disk drive LCD inverter ID LCD cable LCD Inverter LCD System board
No beep, power-on indicator turns on and LCD is blank. But you can see POST on an external CRT.	Reconnect the LCD connectors. LCD inverter ID LCD cable LCD inverter LCD System board
No beep, power-on indicator turns on and a blinking cursor shown on LCD during POST.	Ensure every connector is connected tightly and correctly. System board
No beep during POST but system runs correctly.	Speaker System board

Phoenix BIOS Beep Codes

Code	Beeps	POST Routine Description
02h		Verify Real Mode
03h		Disable Non-Maskable Interrupt (NMI)
04h		Get CPU type
06h		Initialize system hardware
08h		Initialize chipset with initial POST values
09h		Set IN POST flag
0Ah		Initialize CPU registers
0Bh		Enable CPU cache
0Ch		Initialize caches to initial POST values
0Eh		Initialize I/O component
0Fh		Initialize the local bus IDE
10h		Initialize Power Management
11h		Load alternate registers with initial POST values
12h		Restore CPU control word during warm boot
13h		Initialize PCI Bus Mastering devices
14h		Initialize keyboard controller
16h	1-2-2-3	BIOS ROM checksum
17h		Initialize cache before memory autosize
18h		8254 timer initialization
1Ah		8237 DMA controller initialization
1Ch		Reset Programmable Interrupt Controller
20h	1-3-1-1	Test DRAM refresh
22h	1-3-1-3	Test 8742 Keyboard Controller
24h		Set ES segment register to 4 GB
26h		Enable A20 line
28h		Autosize DRAM
29h		Initialize POST Memory Manager
2Ah		Clear 215 KB base RAM
2Ch	1-3-4-1	RAM failure on address line xxxx
2Eh	1-3-4-3	RAM failure on data bits xxxx of low byte of memory bus
2Fh		Enable cache before system BIOS shadow
30h	1-4-1-1	RAM failure on data bits xxxx of high byte of memory bus
32h		Test CPU bus-clock frequency
33h		Initialize Phoenix Dispatch Manager
36h		Warm start shut down
38h		Shadow system BIOS ROM
3Ah		Autosize cache
3Ch		Advanced configuration of chipset registers
3Dh		Load alternate registers with CMOS values
42h		Initialize interrupt vectors
45h		POST device initialization

Code	Beeps	POST Routine Description
46h	2-1-2-3	Check ROM copyright notice
48h		Check video configuration against CMOS
49h		Initialize PCI bus and devices
4Ah		Initialize all video adapters in system
4Bh		QuietBoot start (optional)
4Ch		Shadow video BIOS ROM
4Eh		Display BIOS copyright notice
50h		Display CPU type and speed
51h		Initialize EISA board
52h		Test keyboard
54h		Set key click if enabled
58h	2-2-3-1	Test for unexpected interrupts
59h		Initialize POST display service
5Ah		Display prompt "Press F2 to enter SETUP"
5Bh		Disable CPU cache
5Ch		Test RAM between 512 and 640 KB
60h		Test extended memory
62h		Test extended memory address lines
64h		Jump to User Patch1
66h		Configure advanced cache registers
67h		Initialize Multi Processor APIC
68h		Enable external and CPU caches
69h		Setup System Management Mode (SMM) area
6Ah		Display external L2 cache size
6Bh		Load custom defaults (optional)
6Ch		Display shadow-area message
6Eh		Display possible high address for UMB recovery
70h		Display error messages
72h		Check for configuration errors
76h		Check for keyboard errors
7Ch		Set up hardware interrupt vectors
7Eh		Initialize coprocessor if present
80h		Disable onboard Super I/O ports and IRQs
81h		Late POST device initialization
82h		Detect and install external RS232 ports
83h		Configure non-MCD IDE controllers
84h		Detect and install external parallel ports
85h		Initialize PC-compatible PnP ISA devices
86h		Re-initialize onboard I/O ports
87h		Configure Motherboard Configurable Devices (optional)
88h		Initialize BIOS Area
89h		Enable Non-Maskable Interrupts (NMI)
8Ah		Initialize Extended BIOS Data Area
8Bh		Test and initialize PS/2 mouse

Code	Beeps	POST Routine Description
8Ch		Initialize floppy controller
8Fh		Determine number of ATA drives (optional)
90h		Initialize hard-disk controllers
91h		Initialize local-bus hard-disk controllers
92h		Jump to UserPatch2
93h		Build MPTABLE for multi-processor boards
95h		Install CD ROM for boot
96h		Clear huge ES segment register
97h		Fixup Multi Processor table
98h	1-2	Search for option ROMs. One long, two short beeps on checksum failure.
99h		Check for SMART drive (optional)
9Ah		Shadow option ROMs
9Ch		Set up Power Management
9Dh		Initialize security engine (optional)
9Eh		Enable hardware interrupts
9Fh		Determine number of ATA and SCSI drives
A0h		Set time of day
A2h		Check key lock
A4h		Initialize Typematic rate
A8h		Erase F2 prompt
AAh		Scan for F2 key stroke
ACh		Enter SETUP
AEh		Clear Boot flag
B0h		Check for errors
B2h		POST done- prepare to boot operating system
B4h	1	One short beep before boot
B5h		Terminate QuietBoot (optional)
B6h		Check password (optional)
B9h		Prepare Boot
BAh		Initialize DMI parameters
BBh		Initialize PnP Option ROMs
BCh		Clear parity checkers
BDh		Display MultiBoot menu
BEh		Clear screen (optional)
BFh		Check virus and backup reminders
C0h		Try to boot with INT 19
C1h		Initialize POST Error Manager (PEM)
C2h		Initialize error logging
C3h		Initialize error display function
C4h		Initialize system error handler
C5h		PnPnd dual CMOS (optional)
C6h		Initialize notebook docking (optional)
C7h		Initialize notebook docking late
C8h		Force check (optional)
C9h		Extended checksum (optional)

Code	Beeps	POST Routine Description
D2h		Unknown interrupt

Code	Beeps	POST Routine Description
E0h		Initialize the chipset
E1h		Initialize the bridge
E2h		Initialize the CPU
E3h		Initialize the system timer
E4h		Initialize system I/O
E5h		Check force recovery boot
E6h		Checksum BIOS ROM
E7h		Go to BIOS
E8h		Set Huge Segment
E9h		Initialize Multi Processor
EAh		Initialize OEM special code
EBh		Initialize PIC and DMA
ECh		Initialize Memory type
EDh		Initialize Memory size
EEh		Shadow Boot Block
EFh		System memory test
F0h		Initialize interrupt vectors
F1h		Initialize Run Time Clock
F2h		Initialize video
F3h		Initialize System Management Mode
F4h	1	Output one beep before boot
F5h		Boot to Mini DOS
F6h		Clear Huge Segment
F7h		Boot to Full DOS

Index of Symptom-to-FRU Error Message

LCD-Related Symptoms

Symptom / Error	Action in Sequence
LCD backlight doesn't work LCD is too dark LCD brightness cannot be adjusted LCD contrast cannot be adjusted	Enter BIOS Utility to execute "Load Setup Default Settings", then reboot system. Reconnect the LCD connectors. Keyboard (if contrast and brightness function key doesn't work). LCD inverter ID LCD cable LCD inverter LCD System board
Unreadable LCD screen Missing pels in characters Abnormal screen Wrong color displayed	Reconnect the LCD connector LCD inverter ID LCD cable LCD inverter LCD System board
LCD has extra horizontal or vertical lines displayed.	LCD inverter ID LCD inverter LCD cable LCD System board

Indicator-Related Symptoms

Symptom / Error	Action in Sequence
Indicator incorrectly remains off or on, but system runs correctly	Reconnect the inverter board Inverter board System board

Power-Related Symptoms

Symptom / Error	Action in Sequence
Power shuts down during operation	Power source (battery pack and power adapter). See "Power System Check" on page 68. Battery pack Power adapter Hard drive & battery connection board System board
The system doesn't power-on.	Power source (battery pack and power adapter). See "Power System Check" on page 68. Battery pack Power adapter Hard drive & battery connection board System board
The system doesn't power-off.	Power source (battery pack and power adapter). See "Power System Check" on page 68. Hold and press the power switch for more than 4 seconds. System board

Power-Related Symptoms

Symptom / Error	Action in Sequence
Battery can't be charged	See "Check the Battery Pack" on page 70. Battery pack System board

PCMCIA-Related Symptoms

Symptom / Error	Action in Sequence
System cannot detect the PC Card (PCMCIA)	PCMCIA slot assembly System board
PCMCIA slot pin is damaged.	PCMCIA slot assembly

Memory-Related Symptoms

Symptom / Error	Action in Sequence
Memory count (size) appears different from actual size.	Enter BIOS Setup Utility to execute "Load Default Settings, then reboot system. DIMM System board

Speaker-Related Symptoms

Symptom / Error	Action in Sequence
In Windows, multimedia programs, no sound comes from the computer.	Audio driver Speaker System board
Internal speakers make noise or emit no sound.	Speaker System board

Power Management-Related Symptoms

Symptom / Error	Action in Sequence
The system will not enter hibernation	Keyboard (if control is from the keyboard) Hard disk drive System board
The system doesn't enter hibernation mode and four short beeps every minute.	See "Hibernation Mode" on page 34. Press Fn+  and see if the computer enters hibernation mode. Touchpad Keyboard Hard disk connection board Hard disk drive System board
The system doesn't enter standby mode after closing the LCD	See "Hibernation Mode" on page 34. LCD cover switch System board
The system doesn't resume from hibernation mode.	See "Hibernation Mode" on page 34. Hard disk connection board Hard disk drive System board
The system doesn't resume from standby mode after opening the LCD.	See "Hibernation Mode" on page 34. LCD cover switch System board

Power Management-Related Symptoms

Symptom / Error	Action in Sequence
Battery fuel gauge in Windows doesn't go higher than 90%.	Remove battery pack and let it cool for 2 hours. Refresh battery (continue use battery until power off, then charge battery). Battery pack System board
System hangs intermittently.	Reconnect hard disk/CD-ROM drives. Hard disk connection board System board

Peripheral-Related Symptoms

Symptom / Error	Action in Sequence
System configuration does not match the installed devices.	Enter BIOS Setup Utility to execute "Load Default Settings", then reboot system. Reconnect hard disk/CD-ROM/diskette drives.
External display does not work correctly.	Press Fn+F5, LCD/CRT/Both display switching System board
USB does not work correctly	System board
Print problems.	Ensure the "Parallel Port" in the "Onboard Devices Configuration" of BIOS Setup Utility is set to Enabled. Onboard Devices Configuration Run printer self-test. Printer driver Printer cable Printer System Board
Serial or parallel port device problems.	Ensure the "Serial Port" in the Devices Configuration" of BIOS Setup Utility is set to Enabled. Device driver Device cable Device System board

Keyboard/Touchpad-Related Symptoms

Symptom / Error	Action in Sequence
Keyboard (one or more keys) does not work.	Reconnect the keyboard cable. Keyboard System board
Touchpad does not work.	Reconnect touchpad cable. Touchpad board System board

Modem-Related Symptoms

Symptom / Error	Action in Sequence
Internal modem does not work correctly.	Modem phone port modem combo board System board

NOTE: If you cannot find a symptom or an error in this list and the problem remains, see "Undetermined Problems" on page 83.

Intermittent Problems

Intermittent system hang problems can be caused by a variety of reasons that have nothing to do with a hardware defect, such as: cosmic radiation, electrostatic discharge, or software errors. FRU replacement should be considered only when a recurring problem exists.

When analyzing an intermittent problem, do the following:

1. Run the advanced diagnostic test for the system board in loop mode at least 10 times.
2. If no error is detected, do not replace any FRU.
3. If any error is detected, replace the FRU. Rerun the test to verify that there are no more errors.

Undetermined Problems

The diagnostic problems does not identify which adapter or device failed, which installed devices are incorrect, whether a short circuit is suspected, or whether the system is inoperative.

Follow these procedures to isolate the failing FRU (do not isolate non-defective FRU).

NOTE: Verify that all attached devices are supported by the computer.

NOTE: Verify that the power supply being used at the time of the failure is operating correctly. (See "Power System Check" on page 68):

1. Power-off the computer.
2. Visually check them for damage. If any problems are found, replace the FRU.
3. Remove or disconnect all of the following devices:
 - Non-Acer devices
 - Printer, mouse, and other external devices
 - Battery pack
 - Hard disk drive
 - DIMM
 - CD-ROM/Diskette drive Module
 - PC Cards
4. Power-on the computer.
5. Determine if the problem has changed.
6. If the problem does not recur, reconnect the removed devices one at a time until you find the failing FRU.
7. If the problem remains, replace the following FRU one at a time. Do not replace a non-defective FRU:
 - System board
 - LCD assembly

Jumper and Connector Locations

Top View

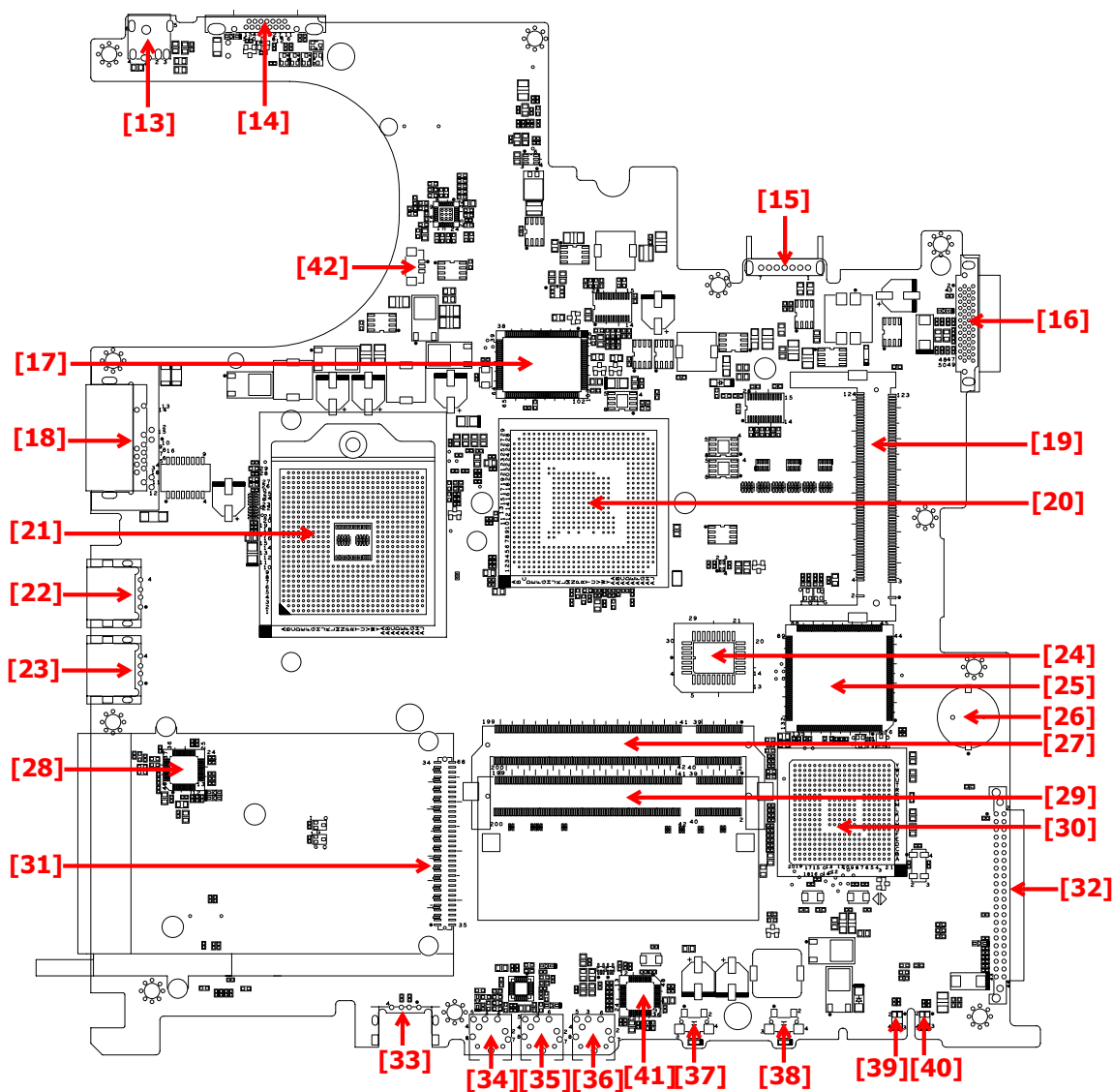

13 (PJ1)	Power Jack	14 (CN12)	CRT Connector
15 (CN14)	Battery Connector	16 (CN15)	ODD Connector
17 (U18)	302ELV LVDS Encoder	18 (CN16)	RJ45 & RJ11 Connector
19 (CN17)	MINI PCI	20 (U20)	Northbridge M760GX
21 (U21)	CPU Socket	22 (CN18)	USB Connector

23 (CN19)	USB Connector	24 (U22)	BIOS ROM
25 (U23)	EC PC97551	26 (BT1)	RTC Battery
27 (CN20)	DDR SO-DIMM Socket1	28 (U25)	LAN PHY RTL8201CP
29 (CN21)	DDR SO-DIMM Socket2	30 (U26)	Southbridge 963L
31 (CN22)	PCMCIA Connector	32 (CN23)	HDD Connector
33 (CN24)	USB Connector	34 (CN26)	LineOut Jack
35 (CN25)	Microphone Jack	36 (CN27)	LineIn Jack
37 (SW2)	WLAN Button	38 (SW3)	Bluetooth button
39 (LED2)	Battery LED	40 (LED1)	Power LED
41 (U30)	Audio Codec ALC203	42 (CN13)	FAN Connector

Bottom View

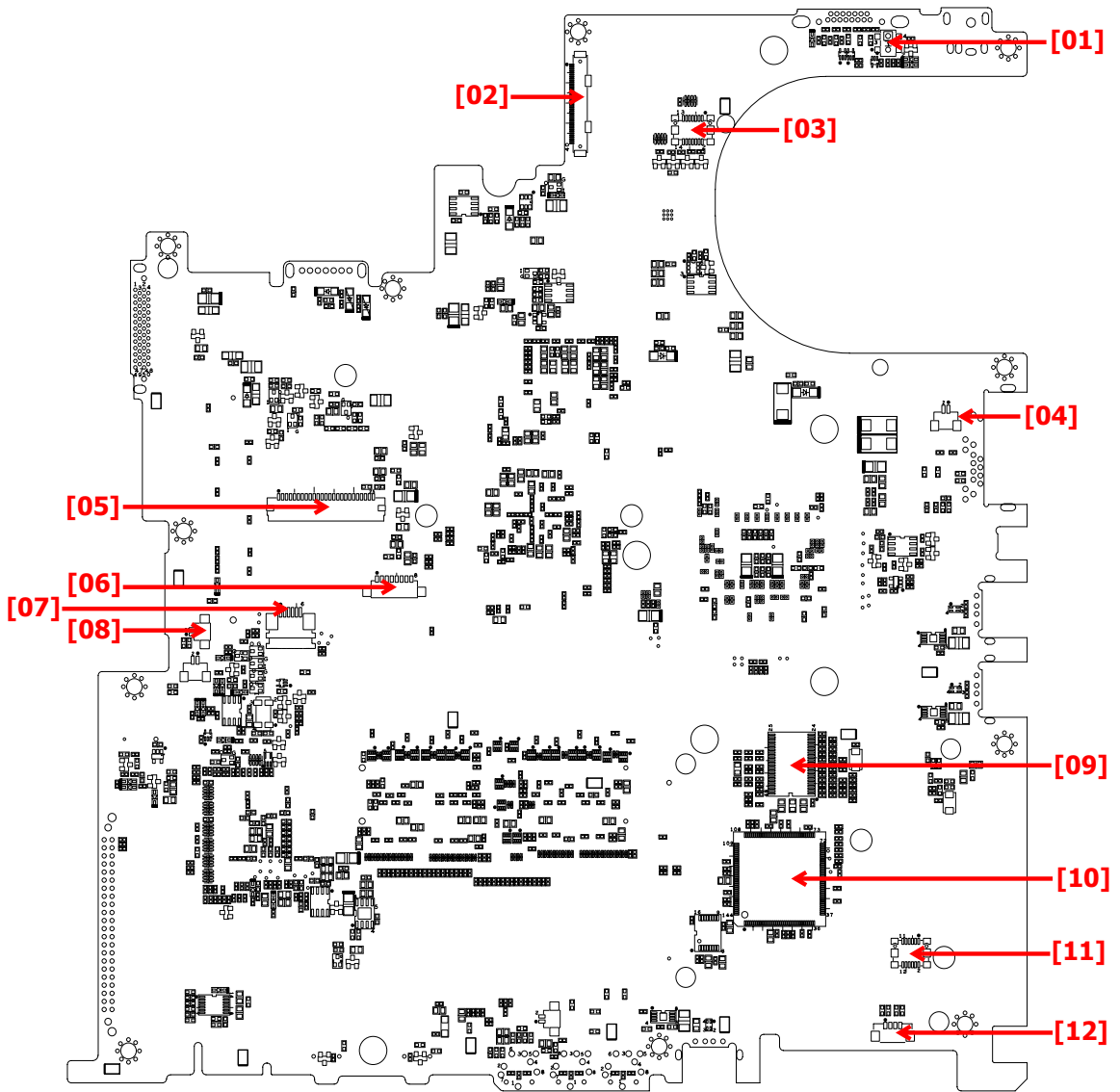

- | | | | |
|----------|--------------------------|-----------|-------------------------------|
| 1 (SW1) | Lid Switch | 2 (CN1) | Panel Connector |
| 3 (CN2) | LED Board Connector | 4 (CN3) | Modem Connector |
| 5 (CN4) | Keyboard Connector | 6 (CN5) | Bluetooth Module Connector |
| 7 (CN6) | Touchpad Board Connector | 8 (CN7) | Internal Microphone Connector |
| 9 (U12) | Clock Generator | 10 (U13) | PCMCIA Connector |
| 11 (CN9) | MDC Connector | 12 (CN11) | Internal Speaker Connector |

FRU (Field Replaceable Unit) List

This chapter gives you the FRU (Field Replaceable Unit) listing in global configurations of Aspire 3000/3500/5000. Refer to this chapter whenever ordering for parts to repair or for RMA (Return Merchandise Authorization).

Please note that WHEN ORDERING FRU PARTS, you should check the most up-to-date information available on your regional web or channel. For whatever reasons a part number change is made, it will not be noted on the printed Service Guide. For ACER AUTHORIZED SERVICE PROVIDERS, your Acer office may have a DIFFERENT part number code from those given in the FRU list of this printed Service Guide. You MUST use the local FRU list provided by your regional Acer office to order FRU parts for repair and service of customer machines.

NOTE: To scrap or to return the defective parts, you should follow the local government ordinance or regulations on how to dispose it properly, or follow the rules set by your regional Acer office on how to return it.



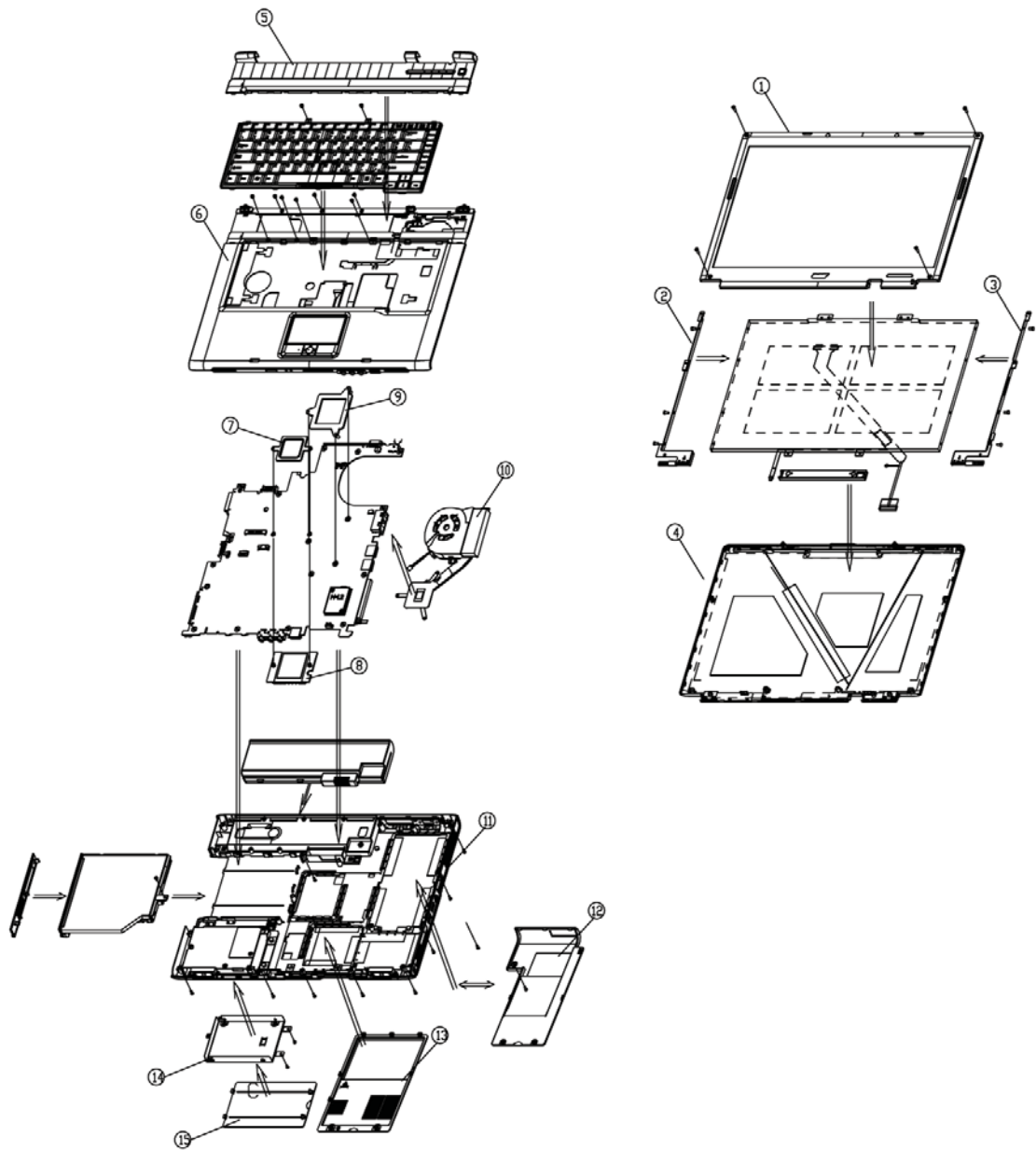



Aspire 3000/5000 Exploded Diagram



Aspire 3000/5000 FRU List

Adapter			
	NS	ADAPTER 65W 3 PIN DELTA SADP-65KB BF 19V	AP.06501.005
	NS	ADAPTER 65W 3 PIN LITE-ON PA-1650-02 Q2 19V	AP.06503.006
	NS	ADAPTER 65W 3 PIN HIPRO HP-OK066B13QT	AP.06506.001
Battery			

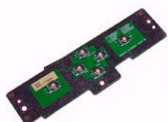
Aspire 3000/5000 FRU List

	NS	BATTERY SANYO LI-ION 4S2P 4.4A 4UR18650F-2-QC140	BT.T5003.001
		BATTERY PANASONIC LI-ION 4S2P 4.4A CGR-B/8B5AE	BT.T5005.001
		BATTERY SANYO LI-ION 4S1P 2.2A 4UR18650F-2-QC141	BT.T5003.002
		BATTERY SIMPPLO PACK LI-ION 4S1P 2.0A	BT.00407.001
Board			
	NS	MODEM BOARD 56K(MDC) T60M893.03 S.P.	54.T72V7.001
	NS	BLUETOOTH MODULE W/ANTENNA	54.T48V7.001
	NS	WIRELESS LAN BOARD FOXCONN ABT_BRM4318BG	54.A51V7.002
	NS	LAUNCH BOARD	55.T50V7.001
	NS	TOUCH PAD BOARD	55.T50V7.002
Cable			
	NS	FFC CABLE - TP/B TO MB	50.T50V7.001
	NS	MODEM CABLE	50.A510V7.001

Aspire 3000/5000 FRU List

	NS	POWER CORD US (3 PIN)	27.A03V7.001
		POWER CORD PRC (3 PIN)	27.A03V7.003
		POWER CORD KOERA (Pin)	27.T23V7.006
		POWER CORD EU (3 PIN)	27.A03V7.002
		POWER CORD UK (3 PIN)	27.A03V7.004
		POWER CORD ITALIAN (3 PIN)	27.A03V7.005
		POWER CORD- SWISS	27.A03V7.007
		POWER CORD AU (3 PIN)	27.A03V7.008
		POWER CORD DANISH (3 PIN)	27.A03V7.006
		POWER CORD AF (3 PIN)	27.T48V7.001
Case/Cover/Bracket Assembly			
	5	MIDDLE COVER W/BUTTON	42.A27V7.001
	6	UPPER CASE W/TP,CABLE, TP BRACKET, MIC, BLUETOOTH CABLE	60.A51V7.001
	11	LOWER CASE W/SPEAKER	60.A51V7.002
	NS	I/O BEZEL	42.T51V7.001
	13	DIMM/WIRELESS COVER	42.A51V7.001
	12	HEATSINK COVER W/O DOCKING	42.A51V7.002

Aspire 3000/5000 FRU List

	15	HDD COVER	42.T63V7.004
	NS	3 IN 1 DUMMY COVER	42.T51V7.003
	14	HDD BRACKET	33.T50V7.001
Communication Module			
	NS	WIRELESS LAN ANTENNA	50.T50V7.003
CPU/Processor			
	NS	AMD MOBILE SEMPRON 2800+ 25WD	KC.S2802.25D
		AMD MOBILE SEMPRON 3000+ 25WD	KC.S3002.25D
		AMD MOBILE TURION 64 ML28	KC.TML02.280
		AMD MOBILE TURION 64 ML30	KC.TML02.300
		AMD MOBILE TURION 64 ML32	KC.TML02.320
		AMD MOBILE TURION 64 ML34	KC.TML02.340
		AMD MOBILE TURION 64 ML37	KC.TML02.370
Optical Disk Drive Module			
	NS	DVD/CDRW COMBO MODULE 24X QSI SBW-242C	6M.T51V7.001



Aspire 3000/5000 FRU List

	NS	DVD/CDRW COMBO DRIVE 24X QSI SBW-242C	KO.02407.014
	NS	OPTICAL DEVICE HOLDER-FIX	42.T51V7.003
	NS	DVD/CDRW BEZEL FOR G BASE	42.T51V7.004
		DVD/CDRW COMBO MODULE KME UIDA-760	6M.T51V7.002
		DVD/CDRW COMBO DRIVE 24X KME UIDA-760	KO.02406.008
		OPTICAL DEVICE HOLDER-FIX	42.T51V7.003
		DVD/CDRW BEZEL FOR KME	42.T50V7.009
		DVD DUAL MODULE PIONEER DVR-K15RA G BASE	6M.T51V7.002
		DVD DUAL DRIVE PIONEER DVR-K15RA D. LAYER G BASE	KU.00805.006
		OPTICAL DEVICE HOLDER-FIX	42.T51V7.003
		DVD DUAL BEZEL G BASE	42.T50V7.012
		DVD DUAL MODULE PANASONIC UJ-840BAA2 G BASE	6M.A51V7.003
		DVD DUAL DRIVE PANASONIC UJ-840BAA2 D. LAYER G BASE	KU.00807.010
		OPTICAL DEVICE HOLDER-FIX	42.T51V7.003
		DVD DUAL BEZEL G BASE	42.T50V7.012
HDD/Hard Disk Drive			
	NS	HGST 40G 2.5" 4200 MORAGA+ HTS424040M9AT00 13G1132 FW:A71A	KH.04007.012
		HGST 60G 4200rpm MORAGA IC25N060ATMR04-0 08K0634 F/W:AD4A	KH.06007.006



Aspire 3000/5000 FRU List

		SEAGATE N2 (50) 60GB 4200RPM, ST960821A	KH.06001.002
		HGST MORAGA 80GB 4200RPM, IC25N080ATMR04-0 08K635	KH.08007.007
		SEAGATE N2 (50) 80GB 4200RPM, ST9808210A	KH.08001.012
Keyboard			
	NS	AS1680/AS1410 KEYBOARD DARFON US International	KB.A2707.001
		AS1680/AS1410 KEYBOARD DARFON Chinese	KB.A2707.002
		AS1680/AS1410 KEYBOARD DARFON Spanish	KB.A2707.003
		AS1680/AS1410 KEYBOARD DARFON Thai	KB.A2707.004
		AS1680/AS1410 KEYBOARD DARFON Brazilian Portuguese	KB.A2707.005
		AS1680/AS1410 KEYBOARD DARFON Korea	KB.A2707.006
		AS1680/AS1410 KEYBOARD DARFON UK	KB.A2707.007
		AS1680/AS1410 KEYBOARD DARFON German	KB.A2707.008
		AS1680/AS1410 KEYBOARD DARFON Italian	KB.A2707.009
		AS1680/AS1410 KEYBOARD DARFON French	KB.A2707.010
		AS1680/AS1410 KEYBOARD DARFON Swiss/G	KB.A2707.011
		AS1680/AS1410 KEYBOARD DARFON Portuguese	KB.A2707.012
		AS1680/AS1410 KEYBOARD DARFON Arabic	KB.A2707.013
		AS1680/AS1410 KEYBOARD DARFON Belgium	KB.A2707.014
		AS1680/AS1410 KEYBOARD DARFON Sweden	KB.A2707.015
		AS1680/AS1410 KEYBOARD DARFON Czech	KB.A2707.016
		AS1680/AS1410 KEYBOARD DARFON Hungarian	KB.A2707.017
		AS1680/AS1410 KEYBOARD DARFON Norway	KB.A2707.018
		AS1680/AS1410 KEYBOARD DARFON Danish	KB.A2707.019
		AS1680/AS1410 KEYBOARD DARFON Turkish	KB.A2707.020
		AS1680/AS1410 KEYBOARD DARFON Canadian French	KB.A2707.021

Aspire 3000/5000 FRU List

		AS1680/AS1410 KEYBOARD DARFON Japanese	KB.A2707.022
		AS1680/AS1410 KEYBOARD DARFON Greek	KB.A2707.023
		AS1680/AS1410 KEYBOARD DARFON Hebrew	KB.A2707.024
		AS1680/AS1410 KEYBOARD DARFON Russian	KB.A2707.025
LCD Module			
	NS	6M.A51V7.011	6M.A51V7.011
	NS	LCD 15 IN. TFT XGA CMO N150X3-L07 REV.C	LK.1500D.008
	NS	LCD INVERTER BOARD	19.T50V7.001
	NS	LCD CABLE - 15 IN. XGA	50.T50V7.004
	NS	LCD BRACKET W/HINGE 15 IN. - L	33.T50V7.002
	NS	LCD BRACKET W/HINGE 15 IN. - R	33.T50V7.003

Aspire 3000/5000 FRU List

	NS	LCD PANEL W/LOGO ANTENNA 14/ 15 IN.	60.A27V7.002
	NS	LCD BEZEL W/RUBBER PAD 15 IN.	60.T50V7.004
		LCD MODULE 15 IN. XGA SAMSUNG LTN150XB-L03-C00	6M.A51V7.012
		LCD 15 IN. XGA SAMSUNG LTN150XB-L03-C00 (MADE IN CHINA)	LK.15006.007
		LCD INVERTER BOARD	19.T50V7.001
		LCD CABLE - 15 IN. XGA	50.T50V7.004
		LCD BRACKET W/HINGE 15 IN. - L	33.T50V7.002
		LCD BRACKET W/HINGE 15 IN. - R	33.T50V7.003
		LCD PANEL W/LOGO ANTENNA 14/ 15 IN.	60.A27V7.002
		LCD BEZEL W/RUBBER PAD 15 IN.	60.T50V7.004
		LCD MODULE 15 IN. TFT XGA LG LP150X08-A3	6M.A43V7.004
		LCD 15 IN. TFT XGA LG LP150X08- A3	LK.15008.007
		LCD 15 IN. TFT XGA LG LP150X08- A3 (MADE IN CHINA)	LK.15008.016
		LCD INVERTER BOARD	19.T50V7.001
		LCD CABLE - 15 IN. XGA	50.T50V7.004
		LCD BRACKET W/HINGE 15 IN. - L	33.T50V7.002
		LCD BRACKET W/HINGE 15 IN. - R	33.T50V7.003
		LCD PANEL W/LOGO ANTENNA 14/ 15 IN.	60.A27V7.002
		LCD BEZEL W/RUBBER PAD 15 IN.	60.T50V7.004
	NS	LCD MODULE 15.4 IN. WXGA CMO N15411-L09	6M.A51V7.013
	NS	LCD 15.4 IN. WXGA CMO N15411- L09	LK.1540D.002
	NS	LCD INVERTER BOARD	19.T50V7.001
	NS	LCD CABLE - 15.4 IN. XGA	50.T50V7.006

Aspire 3000/5000 FRU List

	2	LCD BRACKET W/HINGE 15.4 IN. - L	33.T50V7.004
	3	LCD BRACKET W/HINGE 15.4 IN. - R	33.T50V7.005
	4	LCD PANEL W/LOGO ANTENNA 14/ 15 IN.	60.A27V7.003
	1	LCD BEZEL W/RUBBER PAD 15.4 IN.	60.T50V7.006
		LCD MODULE 15.4 IN. WXGA QDI QD15TL02-02 (GLARE)	6M.A43V7.005
		LCD 15.4 IN. WXGA QDI QD15TL02- 02 (GLARE)	LK.15409.003
		LCD INVERTER BOARD	19.T50V7.001
		LCD CABLE - 15.4 IN. WXGA	50.T50V7.006
		LCD BRACKET W/HINGE 15.4 IN. - L	33.T50V7.004
		LCD BRACKET W/HINGE 15.4 IN. - R	33.T50V7.005
		LCD PANEL W/LOGO ANTENNA 14/ 15.4 IN.	60.A27V7.003
		LCD BEZEL W/RUBBER PAD 15.4 IN.	60.T50V7.006
		LCD MODULE 15.4 IN. WXGA QDI QD15TL02-01	6M.A27V7.006
		LCD 15.4 IN. WXGA QDI QD15TL02- 01	LK.15409.001
		LCD INVERTER BOARD	19.T50V7.001
		LCD CABLE - 15.4 IN. WXGA	50.T50V7.006
		LCD BRACKET W/HINGE 15.4 IN. - L	33.T50V7.004
		LCD BRACKET W/HINGE 15.4 IN. - R	33.T50V7.005
		LCD PANEL W/LOGO ANTENNA 15.4 IN.	60.A27V7.003
		LCD BEZEL W/RUBBER PAD 15.4 IN.	60.T50V7.006
		LCD MODULE 15 IN. XGA CMO N150X3-L07 REV.C W/O ANTENNA	6M.A51V7.021
		LCD 15 IN. TFT XGA CMO N150X3- L07 REV.C	LK.1500D.008
		LCD INVERTER BOARD	19.T50V7.001
		LCD CABLE - 15 IN. XGA	50.T50V7.004
		LCD BRACKET W/HINGE 15 IN. - L	33.T50V7.002
		LCD BRACKET W/HINGE 15 IN. - R	33.T50V7.003
		LCD PANEL W/LOGO W/O ANTENNA 14/15 IN.	60.A51V7.003
		LCD BEZEL W/RUBBER PAD 15 IN.	60.T50V7.004
		LCD MODULE 15 IN. XGA SAMSUNG LTN150XB-L03-C00 W/O ANTENNA	6M.A51V7.022
		LCD 15 IN. XGA SAMSUNG LTN150XB-L03-C00 (MADE IN CHINA)	LK.15006.007
		LCD INVERTER BOARD	19.T50V7.001

Aspire 3000/5000 FRU List

		LCD CABLE - 15 IN. XGA	50.T50V7.004
		LCD BRACKET W/HINGE 15 IN. - L	33.T50V7.002
		LCD BRACKET W/HINGE 15 IN. - R	33.T50V7.003
		LCD PANEL W/LOGO W/O ANTENNA 14/15 IN.	60.A51V7.003
		LCD BEZEL W/RUBBER PAD 15 IN.	60.T50V7.004
		LCD MODULE 15 IN. TFT XGA LG LP150X08-A3 W/O ANTENNA	6M.A51V7.023
		LCD 15 IN. TFT XGA LG LP150X08-A3	LK.15008.007
		LCD 15 IN. TFT XGA LG LP150X08-A3 (MADE IN CHINA)	LK.15008.016
		LCD INVERTER BOARD	19.T50V7.001
		LCD CABLE - 15 IN. XGA	50.T50V7.004
		LCD BRACKET W/HINGE 15 IN. - L	33.T50V7.002
		LCD BRACKET W/HINGE 15 IN. - R	33.T50V7.003
		LCD PANEL W/LOGO W/O ANTENNA 14/15 IN.	60.A51V7.003
		LCD BEZEL W/RUBBER PAD 15 IN.	60.T50V7.004
		LCD MODULE 15.4 IN. WXGA CMO N15411-L09 W/O ANTENNA	6M.A51V7.024
		LCD 15.4 IN. WXGA CMO N15411-L09	LK.1540D.002
		LCD INVERTER BOARD	19.T50V7.001
		LCD CABLE - 15.4 IN. WXGA	50.T50V7.006
		LCD BRACKET W/HINGE 15.4 IN. - L	33.T50V7.004
		LCD BRACKET W/HINGE 15.4 IN. - R	33.T50V7.005
		LCD PANEL W/LOGO W/O ANTENNA 15.4 IN.	60.A51V7.004
		LCD BEZEL W/RUBBER PAD 15.4 IN.	60.T50V7.006
		LCD MODULE 15.4 IN. WXGA GLARE QDI QD15TL02-02 W/O ANTENNA	6M.A51V7.025
		LCD 15.4 IN. WXGA GLARE QDI QD15TL02-02	LK.15409.003
		LCD INVERTER BOARD	19.T50V7.001
		LCD CABLE - 15.4 IN. WXGA	50.T50V7.006
		LCD BRACKET W/HINGE 15.4 IN. - L	33.T50V7.004
		LCD BRACKET W/HINGE 15.4 IN. - R	33.T50V7.005
		LCD PANEL W/LOGO W/O ANTENNA 15.4 IN.	60.A51V7.004
		LCD BEZEL W/RUBBER PAD 15.4 IN.	60.T50V7.006
Main Board			

Aspire 3000/5000 FRU List

	NS	MAINBOARD SIS M760 W/PCMCIA SLOT W/O CPU MEMORY	LB.A5106.001
Memory			
	NS	MEMORY DDR333 256MB INFINEON HYS64D32020HDL-6-C (.11u)	KN.25602.012
		MEMORY DDR333 256MB NANYA NT256D64SH8COGM-6K	KN.25603.019
		MEMORY DDR333 256MB SAMSUNG M470L3224FT0-CB3	KN.2560B.008
		MEMORY DDR333 256MB HYNIX HYMD232M646D6-J	KN.2560G.001
		MEMORY DDR333 512MB INFINEON HYS64D64020HBDL-6-C (.11u)	KN.51202.025
		MEMORY DDR333 512MB SAMSUNG M470L6524BT0-CB3	KN.5120B.006
		MEMORY DDR333 256MB HYNIX HYMD564M646B6-J	KN.5120G.006
Speaker			
	N/S	SPEAKER SET	23.T50V7.001
Heatsink			
	10	THERMAL MODULE	60.A51V7.005
	8	N/B HEATSINK W/PAD	23.A51V7.001
Miscellaneous			
	NS	NAME PLATE-AS3000	40.A55V7.001
	NS	NAME PLATE-AS5000	40.A51V7.001
	NS	RUBBER FOOT	47.T50V7.002
	NS	LCD SCREW RUBBER PAD	47.T50V7.003
	NS	LCD BEZEL RUBBER PAD	47.T50V7.004

Aspire 3000/5000 FRU List

Screw			
	NS	SCREW M2.0X3.0-I-NI-NYLOK	86.A03V7.012
	NS	SCREW I2.5*3M-BNIH(M2.5L3)	86.T25V7.012
	NS	SCREW M2.5*4L-BZN-NYLOK	86.A03V7.006
	NS	SCREW M2.0X5-I-NI-NYLOK	86.T23V7.006
	NS	SCREW MM25060IL69	86.A08V7.004
	NS	SCREW M2.0*5-I(NI)(NYLOK)	86.T23V7.010
	NS	SCREW M2.0X2.5-I-NI-NYLOK	86.A03V7.007
	NS	SCREW I2*3M-NIHY (M2L3)	86.T25V7.008
	NS	SCREW M1.7*3.0-I (BK)	86.T50V7.001
	NS	SCREW I3*3.5M-NIH(M3L3.5)	86.A03V7.011

Model Definition and Configuration

Aspire 3000/3500/5000 Series

Model Number	CPU	LCD	Memory	HDD (GB)	ODD	Card Reader	Wireless LAN
AS5001LM	ATML28	N15XGA	SO256M B*2	N60GB 4.2K	NDU8X	N	N
AS5001LCi	ATML28	N15XGA	SO256M B	N60GB 4.2K	NCB24X	N	ABT_BRM43 18BG
AS5001WLMi	ATML28	N15.4WXG AG	SO256M B*2	N60GB 4.2K	NDU8X	N	ABT_BRM43 18BG
AS5002LM	ATML30	N15XGA	SO256M B*2	N60GB 4.2K	NDU8X	N	N
AS5002LMi	ATML30	N15XGA	SO256M B*2	N60GB 4.2K	NDU8X	N	ABT_BRM43 18BG
AS3002LC	AMD Sempron processor 2800+	N15XGA	SO256M B	N40GB 4.2K	NCB24X	N	N
AS3002NLC	AMD Sempron processor 2800+	N15XGA	SO256M B	N40GB /60GB 4.2K	NCB24X	N	N
AS3002LCi	AMD Sempron processor 2800+	N15XGA	SO256M B	N40GB /60GB 4.2K	NCB24X	N	ABT_BRM43 18BG
AS3002NLCi	AMD Sempron processor 2800+	N15XGA	SO256M B	N40GB 4.2K	NCB24X	N	ABT_BRM43 18BG
AS3002LM	AMD Sempron processor 2800+	N15XGA	SO256M B*2	N60GB 4.2K	NDU8X	N	N
AS3002LMi	AMD Sempron processor 2800+	N15XGA	SO256M B*2	N60GB 4.2K	NDU8X	N	ABT_BRM43 18BG
AS3002NWLCi	AMD Sempron processor 2800+	N15.4WXG AG	SO256M B	N60GB 4.2K	NCB24X	N	ABT_BRM43 18BG
AS3003WLMi	AMD Sempron processor 3000+	N15.4WXG AG	SO256M B	N60GB 4.2K	NDU8X	N	ABT_BRM43 18BG

Model Number	CPU	LCD	Memory	HDD (GB)	ODD	Card Reader	Wireless LAN
AS3003W LCi	AMD Sempron processor 3000+	N15.4WXG AG	SO256M B	N60GB 4.2K	NDU8X	N	ABT_BRM43 18BG

Test Compatible Components

This computer's compatibility is tested and verified by Acer's internal testing department. All of its system functions are tested under Windows® XP Home environment.

Refer to the following lists for components, adapter cards, and peripherals which have passed these tests. Regarding configuration, combination and test procedures, please refer to the Aspire 3000/5000 series Compatibility Test Report released by the Acer Mobile System Testing Department.

Microsoft Windows XP Environment Test

Item	Specifications
Processor	Aspire 3000: MOBILE SEMPRON 2800+ 25W D MOBILE SEMPRON 3000+ 25W D Aspire 5000 MOBILE TURION 64 ML28 MOBILE TURION 64 ML30 MOBILE TURION 64 ML32 MOBILE TURION 64 ML34 MOBILE TURION 64 ML37
Memory	SO-DIMM DDR333 1GB EBD11UD8ADD A SO-DIMM DDR333 256MB HYS64D320 20HDL-6-C 32X64 (.11U) SO-DIMM DDR333 256MB NT256D64SH8C0GM-6K (.11U) SO-DIMM DDR333 256MB M470L3224 FT0-CB3 (.13U) SO-DIMM DDR333 256MB HYMD232M6 46D6-J AA SO-DIMM DDR333 512MB HYS64D64020HBDL-6-C 64MX64 (0.11U/ GREEN SO-DIMM DDR333 512MB M470L6524 BT0-CB300 (512MB) SO-DIMM 512MB HYMD564M646B6-J
LCD	15.4" WXGA NB LC AU B154EW01V.5 15.4" WXGA NB LCD SAMSUNGLTN154X3-L01-0 non-glare 15.4" WXGA NB LCD LPL LP154W01-TL12 (lead-free) 15.4" WXGA NB LCD QDI QD15TL02V.01 NON-GLARE TYPE 15.4" WXGA NB LCD QDI QD15TL02-03 NON-GLARE TYPE LEAD-FREE 15.4" WXGA CMO LCD N154I1-L09 15.4" WXGA NB LCD AUO B154W01V.7 (Glare type) 15.4" WXGA NB LCD LPL LP154W1-A5K2 GLARE TYPE 15.4" WXGA NB LCD QDI QD15TL02-02 GLARE TYPE 15.4" WXGA NB LCD QDI QD15TL02-04 GLARE TYPE LEAD-FREE 15.4" WXGA NB LCD N154I1-L07GLARE TYPE
LCD	15" XGA NB LCD AUO B150XG01V2.XXXXX (Driver IC:MEC/TOS 15" XGA NB LCD SAMSUNG LTN150XB-L03-C00 MADE IN CHINA 15" XGA NB LCD LG LP150X08-A3MADE IN CHINA 15" XGA NB LCD QDI QD150XL06-01(160NITS) 15" XGA NB LCD N150X3-L07 V.C2
Hard Disk Drive	40G SEAGATE 2.5 4200RPM N1 ST94019A 2M F/W 3.05 40G TOSHIBA 2.5" 4200RPM PLUTO MK4025GAS (ROHS) F/W KA100A 40G HGST 2.5" 4.2RPM MORAGA+HTS424040M9AT00 13G1132 F/W:A71A 60G SEAGATE 2.5" 4.2RPM N2ST960821A F/W 3.01 60G TOSHIBA 2.5" 4200RPM PLUTO MK6025GAS (ROHS) F/W KA200 80G TOSHIBA 2.5" 4200RPM PLUTO MK8025GAS (ROHS) F/W KA023 80G HGST MORAGA 4200RPM IC25N0 80ATMR04-0 08K635 FW:AD4A

Item	Specifications
ODD	24X COMBO KME UJDA-760 FOR K ESTREL 8X DVD DUAL LITEON SOSW-852SSINGLE LAYER FOR KESTREL #PRS7 8X DVD DUAL , LITEON SOSW-833,DOUBLE LAYER,GBASE FOR CRANE 8X DVD DUAL,PANASONIC UJ-840BAA2,DOUBLE LAYER,GBASE FR CRANE 8X SUPERMULTI,PANASONIC UJ-840BAA,DOUBLE LAYER,GBASE(CRANE)
AC Adapter (3 pin)	Delta NB Asapter 65W, SADP-65KB BF Lite-on NB Adapter 65W, PA-1650-02 LSE NB Adapter 65W, P0335A1965
Power Cord	King Cord
Battery Li-Ion, 8 cells	LI-ION KESTREL 4S2P 4.4Ah W/OINDICATOR (W/Z SANYO CELLS) LI-ION KESTREL 4S2P PANASONIC PACK CELL 4.4AH W/O INDICATOR
Network Adapters	
LAN Ethernet/10baseT/100base	3Com Etherlink III 3C589D IBM EtherJet CardBus Adapter 10/100 Intel Ether Express Pro/100 Mobile Adapter MBLA3200 Xircom CardBus Ethernet 10/100 32 Bit CBE-10/100BTX
Multifunction Card (Combo)	3Com Megahertz 10/100 LAN + 56K Modem PC Card Xircom RealPort CardBus Ethenet 10/100 + Modem 56
LAN Token Ring	IBM Token Ring 16/4 Adapter II
Wireless LAN Card	IBM Wireless LAN Cardbus Adapter Intel Pro-Wireless LAN PC Card Proxim Skyline 802.11a Cardbus PC Card Cisco Aironet 350 series Wireless Lan Card NeWeb Wireless Lan Card 802.11b
Modem Adapters	
Modem (up to 56K)	3Com Megahertz 56K Modem PC Card Xircom Credit Card Modem 56 IBM 56K Double Jack Modem
ISDN	US Robotics Megahertz 128K ISDN Card 405R17T7117M IBM OBI International ISDN PC Card
I/O Peripheral	
I/O - Display	Acer 211c 21" Viewsonic PF790 19" Acer FP751 17" TFT LCD IBM Color TFT LCD 14" Compaq Color Monitor NET Color Monitor 20" Mozo 17" TFT LCD (DVI)
I/O - Projector	NEC MultiSync MT-1040
I/O - Legacy (Parallel) Printer/Scanner	Canon BJC-600J Epson Stylus Color 740 Parallel Interface HP DeskJet 890C HP DeskJet 880C Parallel Interface HP LaserJet 6MP HP LaserJet 2200

Item	Specifications
I/O - IR Printer	HP LaserJet 6MP use IR HP LaserJet 2200 use IR
I/O - USB Keyboard/Mouse	Chicony USB Keyboard KU-8933 Microsoft Natural Keyboard Pro Acer Aspire USB mouse Logicool US Mouse Logitech Cordless Mouseman Wheel USB Interface Logitech USB Wheel Mouse M-BB48 Microsoft IntelliMouse Optical USB Interface
I/O - Legacy (PS2/Serial) Keyboard/Mouse	IBM 101 key keyboard IBM 109 key keyboard Acer PS2 keyboard Acer KB-101A IBM Numeric Keypad III IBM Numeric Keypad Acer Mouse IBM PS2 Mini Mouse IBM PS2 Mouse Logitech Cordless MouseMan Wheel PS2 interface Logitech Serial Mouse M-M35 Microsoft IntelliMouse PS2 interface Microsoft IntelliMouse Optical PS2 interface Logitech First Mouse Three Button Serial Mouse
I/O - USB (Printer/Scanner)	Epson Stylus Color 740 USB interface HP DeskJet 880C USB interface Canon CanonScan D1250 (USB 2.0, JP OS only) HP ScanJet 3300C Color Scanner
I/O - USB (Speaker/Joystick)	JS USB Digital Speaker Panasonic USB Speaker EAB-MPC57USB AIWA Multimedia Digital Speaker Microsoft SideWinder Precision Pro Joystick Logitech WingMan RumblePad
I/O - USB Camera	Intel Easy PC Camera Logitech QuickCam Express Internet Logitech QuickCam Home PC Video Camera Orange Micro USB 2.0 Web Cam
I/O - USB Storage Drive	Logitech CDRW +DVDROM combo USB interface Iomega USB Zip 250MB
I/O-USB Flash Drive	IBM 32MB USB Memory key Apacer USB Handy Drive 32MB Apacer USB Handy Drive 256MB
I/O - USB Hub	Belkin 4 Port USB Hub Eizo I Station USB Hub Elecom USB Hub 4 Port Sanwa USB Hub 4 Port 4 Port Hub USB 2.0
I/O - Access Point (802.11b)	Hitachi DC-CN3300 Lucent RG-1000 Lucent WavePoint-II Cisco Aironet 350 Orinoco AP-500

Item	Specifications
I/O Access Point (802.11a/b)	Intel Dual Pro/Wireless 5000
I/O Access Point (802.11a)	Intel Pro/Wireless 5000
PCMCIA	
PCMCIA - ATA	IBM Microdrive 340MB IBM Microdrive 1G Iomega Click! 40MB Sony Memory Stick 64MB Sandisk Flash Card 20MB Apacer SD Flash Card 128MB Apacer SD Flash Card 256MB Transcend SD Card 32MB Transcend SD Card 256MB Hagiwara sys-com SD Card 256MBT
PCMCIA - USB 2.0	Apricorn EZ-USB2.0 Cardbus PC Card DTK USB 2.0 2Port CardBus Host Controller Adaptec USB2CONNECT
PCMCIA - 1394	Buffalo 1394 Interface Cardbus IFC-ILCB/DV I-O Data 1394 Interface Cardbus CB1394/DVC Pixela 1394 Cardbus PC Card PIX-PCMC/FW1
PCMCIA-SCSI	Adaptec 1408 or B SCSI CB NewMedia Bus Toaster SCSI II
PCMCIA - Bluetooth	IBM Community Bluetooth PC Card Toshiba Bluetooth PC Card

Online Support Information

This section describes online technical support services available to help you repair your Acer Systems.

If you are a distributor, dealer, ASP or TPM, please refer your technical queries to your local Acer branch office. Acer Branch Offices and Regional Business Units may access our website. However some information sources will require a user i.d. and password. These can be obtained directly from Acer CSD Taiwan.

Acer's Website offers you convenient and valuable support resources whenever you need them.

In the Technical Information section you can download information on all of Acer's Notebook, Desktop and Server models including:

- Service guides for all models
- User's manuals
- Training materials
- Bios updates
- Software utilities
- Spare parts lists
- TABs (Technical Announcement Bulletin)

For these purposes, we have included an Acrobat File to facilitate the problem-free downloading of our technical material.

Also contained on this website are:

- Detailed information on Acer's International Traveler's Warranty (ITW)
- Returned material authorization procedures
- An overview of all the support services we offer, accompanied by a list of telephone, fax and email contacts for all your technical queries.

We are always looking for ways to optimize and improve our services, so if you have any suggestions or comments, please do not hesitate to communicate these to us.

A

- AC Adapter 28
- AFLASH Utility 43
- Audio 20

B

- Battery 27
- BIOS 20
 - package 20
 - ROM size 20
 - ROM type 20
 - vendor 20
 - Version 20
- BIOS Supports protocol 20
- BIOS Utility 32
 - Navigating 33
 - Onboard Device Configuration 38
 - Startup Configuration 37
 - System Security 42
- Board Layout
 - Bottom View 6, 86
 - Top View 5, 84
- brightness
 - hotkeys 16

C

- Cache
 - controller 20
 - size 21
- caps lock
 - on indicator 12
- CardBus 26
- Chipsets 20
- contrast
 - hotkeys 16
- Controllers 20
- Core logic 20
- CPU
 - core voltage 20
 - I/O voltage 20
 - package 20
 - type 20

D

- DIMM
 - Combinations 21
- Disassembly

- Battery Pack 49
- Procedure Flowchart 48

- Display 2
 - display
 - hotkeys 16
- Display Standby Mode 29
- DVD-ROM Interface 23, 24

E

- Environmental Requirements 29
- Error Symptom-to-Spare Part Index 71
- External CD-ROM Drive Check 67

F

- Features 1
- Flash Utility 43
- Floppy Disk Drive Interface 22
- FRU (Field Replaceable Unit) List 88

H

- Hard disk 23
- Hard Disk Standby Mode 29
- Hardware Specifications and Configurations 20
- HDD 23
- Hibernation Mode 29
- Hibernation mode
 - hotkey 16
- Hot Keys 15

I

- Indicators 12
- Intermittent Problems 82

J

- Jumper and Connector Locations 84
 - Top View 84

K

- Keyboard 20, 27
- Keyboard or Auxiliary Input Device Check 67

L

- L2 cache 20

M

Mechanical Specification 30
media access
 on indicator 12
Memory Check 68
Model Definition 101
Modem 22

N

Notebook Manager
 hotkey 16
num lock
 on indicator 12

O

Online Support Information 110

P

Panel
 Bottom 11
 right 10
PC Card 12, 26
PCMCIA 26
Power Management 29
Power System Check 68
 Battery Pack 70
 Power Adapter 69

R

Removing the Battery Pack 50

S

Second Level Cache 20
speakers
 hotkey 16
Standby Mode 29
System Check Procedures 67
System Diagnostic Diskette 43
System Memory 21
System Utilities 32
System Utility Diskette 43

T

Temperature 29
Test Compatible Components 104
Touchpad 20
touchpad
 hotkey 16
Touchpad Check 70

Troubleshooting 66

U

Undetermined Problems 83
USB 26
utility
 BIOS 32

V

Video 25
 Resolutions 26
Video controller 20

