

Aspire 4730Z/4730ZG/4330 Series Service Guide

Service guide files and updates are available on the ACER/CSD web; for more information, please refer to <http://csd.acer.com.tw>

PRINTED IN TAIWAN

Revision History

Please refer to the table below for the updates made on Aspire 4720Z/4730ZG/4330 Series service guide.

Date	Chapter	Updates

Copyright

Copyright © 2008 by Acer Incorporated. All rights reserved. No part of this publication may be reproduced, transmitted, transcribed, stored in a retrieval system, or translated into any language or computer language, in any form or by any means, electronic, mechanical, magnetic, optical, chemical, manual or otherwise, without the prior written permission of Acer Incorporated.

Disclaimer

The information in this guide is subject to change without notice.

Acer Incorporated makes no representations or warranties, either expressed or implied, with respect to the contents hereof and specifically disclaims any warranties of merchantability or fitness for any particular purpose. Any Acer Incorporated software described in this manual is sold or licensed *as is*. Should the programs prove defective following their purchase, the buyer (and not Acer Incorporated, its distributor, or its dealer) assumes the entire cost of all necessary servicing, repair, and any incidental or consequential damages resulting from any defect in the software.

Acer is a registered trademark of Acer Corporation.

Intel is a registered trademark of Intel Corporation.

Pentium and Pentium II/III are trademarks of Intel Corporation.

Other brand and product names are trademarks and/or registered trademarks of their respective holders.

Conventions

The following conventions are used in this manual:

SCREEN MESSAGES	Denotes actual messages that appear on screen.
NOTE	Gives bits and pieces of additional information related to the current topic.
WARNING	Alerts you to any damage that might result from doing or not doing specific actions.
CAUTION	Gives precautionary measures to avoid possible hardware or software problems.
IMPORTANT	Reminds you to do specific actions relevant to the accomplishment of procedures.

Preface

Before using this information and the product it supports, please read the following general information.

1. This Service Guide provides you with all technical information relating to the BASIC CONFIGURATION decided for Acer's *global* product offering. To better fit local market requirements and enhance product competitiveness, your regional office MAY have decided to extend the functionality of a machine (e.g. add-on card, modem, or extra memory capability). These LOCALIZED FEATURES will NOT be covered in this generic service guide. In such cases, please contact your regional offices or the responsible personnel/channel to provide you with further technical details.
2. Please note WHEN ORDERING FRU PARTS, that you should check the most up-to-date information available on your regional web or channel. If, for whatever reason, a part number change is made, it will not be noted in the printed Service Guide. For ACER-AUTHORIZED SERVICE PROVIDERS, your Acer office may have a DIFFERENT part number code to those given in the FRU list of this printed Service Guide. You MUST use the list provided by your regional Acer office to order FRU parts for repair and service of customer machines.

System Specifications	1
Features	1
System Block Diagram	4
Your Acer Notebook tour	5
Front View	5
Closed Front View	6
Left View	7
Right View	8
Rear View	8
Bottom View	9
Indicators	10
Easy-Launch Buttons	10
Touchpad Basics (with fingerprint reader)	11
Using the Keyboard	12
Lock Keys and embedded numeric keypad	12
Windows Keys	13
Hot Keys	14
Special Key	15
Using the System Utilities	16
Acer GridVista (dual-display compatible)	16
Hardware Specifications and Configurations	18
 System Utilities	 27
BIOS Setup Utility	27
Navigating the BIOS Utility	27
Information	28
Main	29
Security	30
Boot	33
Exit	34
BIOS Flash Utility	35
Remove HDD/BIOS Utility	37
Removing BIOS Passwords:	39
 Machine Disassembly and Replacement	 41
Disassembly Requirements	41
General Information	42
Pre-disassembly Instructions	42
Disassembly Process	42
External Module Disassembly Process	43
External Modules Disassembly Flowchart	43
Removing the Battery Pack	44
Removing the SD dummy card	45
Removing the ExpressCard dummy card	46
Removing the Lower Covers	47
Removing the DIMM Modules	49
Removing the WLAN Module	50
Removing the Hard Disk Drive Module	52
Removing the Optical Drive Module	55
Main Unit Disassembly Process	58
Main Unit Disassembly Flowchart	58
Removing the Switch Cover	59
Removing the Keyboard	61
Removing the Antenna	63

Table of Contents

Removing the LCD Module	66
Removing the Upper Cover	68
Removing the Touch Pad Bracket	72
Removing the Finger Print Reader	74
Removing the Launch Board	75
Removing the Speaker Module	76
Removing the Switch Board	78
Removing the Touch Pad Board	79
Removing the I/O Board	80
Removing the Bluetooth module	82
Removing the Modem Module	84
Removing the Main Board	86
Removing the Thermal Module	89
Removing the CPU	90
Removing the CPU Fan	91
Removing the HDMI Module	93
LCD Module Disassembly Process	94
LCD Module Disassembly Flowchart	94
Removing the LCD Bezel	95
Removing the Inverter Board	97
Removing the Camera Module	99
Removing the LCD Panel	101
Removing the LCD Brackets and FPC Cable	102
Removing the Antennas	104
Removing the MIC Module	105
LCD Module Reassembly Procedure	106
Replacing the LCD Panel	106
Replacing the LCD Bezel	109
Main Module Reassembly Procedure	110
Replacing the CPU	110
Replacing the Thermal Module	110
Replacing the CPU Fan Module	111
Replacing the HDMI Module	111
Replacing the Mainboard	112
Replacing the I/O Board	114
Replacing the Bluetooth Board	114
Replacing the Modem Module	115
Replacing the Finger Print Reader	116
Replacing the Touch Pad Bracket	117
Replacing the Launch Board	118
Replacing the Switch Board	118
Replacing the Antenna Cables	119
Replacing the Speaker Module	120
Replacing the Keyboard	120
Replacing the Switch Cover	122
Replacing the WLAN Module	122
Replacing the Hard Disk Drive Module	123
Replacing the DIMM Modules	124
Replacing the ODD Module	125
Replacing the Lower Covers	126
Replacing the Express and SD Card Trays	127

Troubleshooting

129

Common Problems	129
Power On Issue	130

Table of Contents

No Display Issue	131
Random Loss of BIOS Settings	132
LCD Failure	133
Built-In Keyboard Failure	133
Touchpad Failure	134
Internal Speaker Failure	134
Internal Microphone Failure	136
HDD Not Operating Correctly	137
ODD Failure	138
Modem Function Failure	141
Wireless Function Failure	141
EasyTouch Button Failure	142
Thermal Unit Failure	142
External Mouse Failure	143
Other Failures	143
Intermittent Problems	144
Undetermined Problems	144
POST Codes Tables	145
Sec	145
Memory:	145
BDS & Specific action:	146
Each PEIM entry point used in 80_PORT	147
Each Driver entry point used in 80_PORT	147
Each SmmDriver entry point used in 80_PORT	150
Jumper and Connector Locations	151
Top View	151
Bottom View	152
Clearing Password Check and BIOS Recovery	153
Clearing Password Check	153
BIOS Recovery by Crisis Disk	154
FRU (Field Replaceable Unit) List	155
Aspire 4730Z/4730ZG/4330 Exploded Diagrams	156
Main Module	156
LCD Module	157
Aspire 4730Z/4730ZG/4330 FRU List	158
Screw List	165
Model Definition and Configuration	166
Aspire 4730Z/4730ZG/4330 Series	166
Test Compatible Components	177
Microsoft® Windows® Vista Environment Test	178
Online Support Information	185
Index	187

Table of Contents

System Specifications

Features

Below is a brief summary of the computer's many features:

NOTE: Items marked with * denote only selected models.

Operating System

- Genuine Windows Vista™

Platform

- Intel® Pentium® Dual-Core mobile processor*
- Intel® Celeron® Dual-Core processor*
- Intel® Celeron® processor*
- Mobile Intel® PM45 Express Chipset*
- Mobile Intel® GL40 Express Chipset*
- Acer InviLink™ Nplify™ 802.11b/g/Draft-N*
- Acer InviLink™ 802.11b/g*

System Memory

- Dual-Channel DDR2 SDRAM support
- Up to 2 GB of DDR2 667 MHz memory, upgradeable to 4 GB using two soDIMM modules*

Display and graphics

- 14.1" WXGA 1280 x 800
- Mobile Intel® GL40 Express Chipset*
- ATI Mobility Radeon™ HD 3470*

Storage subsystem

- 2.5" hard disk drive
- Optical drive options:
 - DVD-Super Multi double-layer drive*
 - DVD/CD-RW combo drive*
- 5-in-1 card reader

Audio

- Two built-in stereo speakers
- High-definition audio support
- MS-Sound compatible
- Built-in microphone

Communication

- Acer Video Conference, featuring:
 - Integrated Acer Crystal Eye webcam
 - Optional Acer Xpress VoIP phone
- WLAN:
 - Acer InviLink™ Nplify™ 802.11b/g/Draft-N*
 - Acer InviLink™ 802.11b/g*
- WPAN: Bluetooth® 2.0+EDR
- LAN: Gigabit Ethernet, Wake-on-LAN ready
- Modem: 56K ITU V.92

Privacy control

- BIOS user, supervisor, HDD passwords
- Kensington lock slot

Dimensions and Weight

- 340.4 (W) x 247 (D) x 22.9/42.3 (H) mm (13.4 x 9.7 x 0.9/1.6 inches)
- 2.4 kg (5.29 lbs)

Power subsystem

- ACPI 3.0
- 48.8 W 4400 mAh
- 3-pin 65 W AC adapter*
- 3-pin 90 W AC adapter*
- Energy Star 4.0

Special keys and controls

- 88-/89-/93-key keyboard
- Touchpad pointing device
- Empowering Key
- Easy-launch buttons: WLAN, volume up and down and Bluetooth®

I/O interface

- ExpressCard™/54 slot
- 5-in-1 card reader (SD™, MMC, MS, MS PRO, xD)
- Two USB 2.0 ports
- External display (VGA) port
- Headphone/speaker/line-out jack
- Microphone-in jack
- Line-in jack
- Ethernet (RJ-45) port

-
- Modem (RJ-11) port
 - DC-in jack for AC adapter

Environment

- Temperature:
 - Operating: 5 °C to 35 °C
 - Non-operating: -20 °C to 65 °C
- Humidity (non-condensing):
 - Operating: 20% to 80%
 - Non-operating: 20% to 80%

NOTE: Items marked with * denote only selected models. The specifications listed above are for reference only. The exact configuration of your PC depends on the model purchased.

System Block Diagram

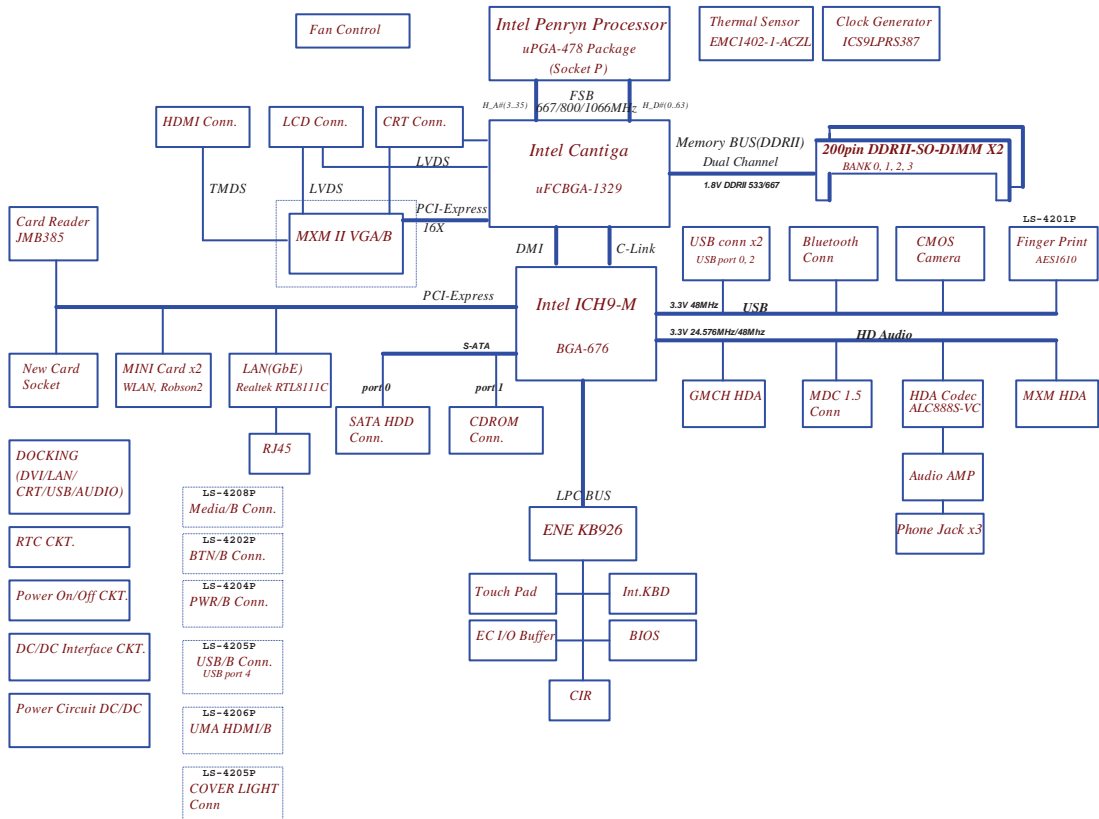

Your Acer Notebook tour

After knowing your computer features, let us show you around your new computer.

Front View



No.	Icon	Item	Description
1		Acer Crystal Eye	Web camera for video communication.
2		Microphone	Internal microphone for sound recording.
3		Display screen	Also called Liquid-Crystal Display (LCD), displays computer output.
4		Status indicators	Light-Emitting Diodes (LEDs) that light up to show the status of the computer's functions and components.
5		Empowering key	Launch Acer Empowering Technology.
6		Wireless communication button	Enables/disables the wireless function.
7		Volume Up/ Volume Down	Increase system volume/decrease system volume.
8		Bluetooth communication button	Enables/disables the 3G/Bluetooth function.

No.	Icon	Item	Description
9		Touchpad	Touch-sensitive pointing device which functions like a computer mouse.
10		Click buttons (left and right)	The left and right buttons function like the left and right mouse buttons.
11		Palmrest	Comfortable support area for your hands when you use the computer.
12		Keyboard	For entering data into your computer.
13		Speakers	Left and right speakers deliver stereo audio output.
14		Power button	Turns the computer on and off.







Closed Front View

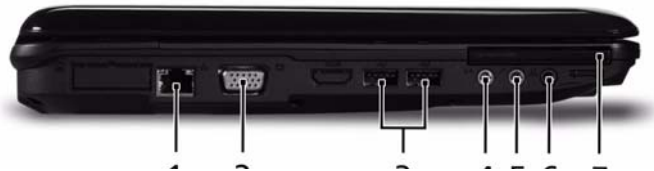

No.	Icon	Item	Description
1		5-in-1 card reader	Accepts Secure Digital (SD), MultiMediaCard (MMC), Memory Stick (MS), Memory Stick PRO (MS PRO), xD-Picture Card (xD). Note: Push to remove/install the card. Only one card can operate at any given time.
2		Latch	Locks and releases the lid.



Left View



No.	Icon	Item	Description
1		Ethernet (RJ-45) port	Connects to an Ethernet 10/100/1000-based network.
2		External display (VGA) port	Connects to a display device (e.g. external monitor, LCD projector).
3		2 USB 2.0 ports	Connect to USB 2.0 devices (e.g. USB mouse, USB camera).
4		Line-in jack	Accepts audio line-in devices (e.g., audio CD player, stereo walkman, mp3 player).
5		Microphone jack	Accepts inputs from external microphones.
6		Headphones/speaker/line-out jack	Connects to audio line-out devices (e.g., speakers, headphones).
7	ExpressCard / 54	ExpressCard/54 slot	Accepts one ExpressCard/54 module.

Right View



No.	Icon	Item	Description
1		Kensington lock slot	Connects to a Kensington-compatible computer security lock.
2		Optical drive	Internal optical drive; accepts CDs or DVDs.
3		Optical disk access indicator	Lights up when the optical drive is active.
4		Optical drive eject button	Ejects the optical disk from the drive.
5		Emergency eject hole	Ejects the optical drive tray when the computer is turned off. Note: Insert a paper clip into the emergency eject hole to eject the optical drive tray when the computer is off.
6		Modem (RJ-11) port	Connects to a phone line.
7		DC-in jack	Connects to an AC adapter





Rear View

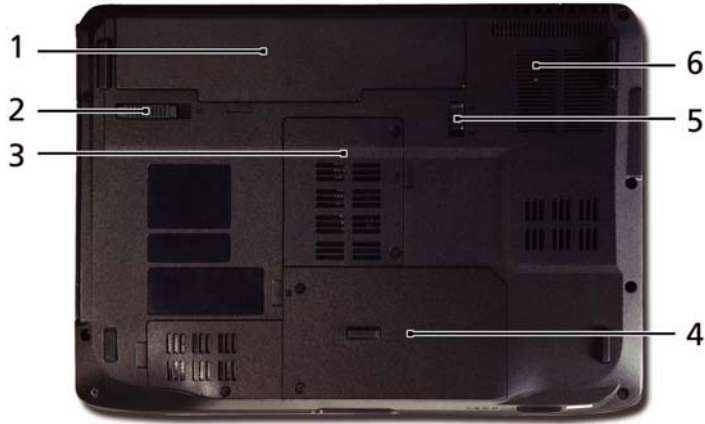

No.	Icon	Item	Description
1		Ventilation slots	Enable the computer to stay cool, even after prolonged use.

Bottom View









No.	Icon	Item	Description
1		Battery bay	Houses the computer's battery pack.
2		Battery release latch	Releases the battery for removal.
3		Memory compartment	Houses the computer's main memory.
4		Hard disk bay	Houses the computer's hard disk (secured with screws).
5		Battery lock	Locks the battery in position.
6		Ventilation slots and cooling fan	Enable the computer to stay cool, even after prolonged use.

Indicators

The computer has several easy-to-read status indicators:

The front panel indicators are visible even when the computer cover is closed.





Icon	Function	Description
	Bluetooth	Indicates the status of Bluetooth communication.
	WLAN	Indicates the status of wireless LAN communication.
	Power	Indicates the computer's power status.
	Battery	Indicates the computer's battery status.
	HDD	Indicates when the hard disk drive is active.
	Num Lock	Lights up when Num Lock is activated.
	Caps Lock	Lights up when Caps Lock is activated.

NOTE: 1. **Charging:** The battery light shows amber when the battery is charging. 2. **Fully charged:** The light shows green when in AC mode.

Easy-Launch Buttons

Located beside the keyboard are application buttons. These buttons are called easy-launch buttons. They are: WLAN, Internet, email, Bluetooth, Arcade and Acer Empowering Technology.

The mail and Web browser buttons are pre-set to email and Internet programs, but can be reset by users. To set the Web browser, mail and programmable buttons, run the Acer Launch Manager.

Icon	Function	Description
	Empowering Technology	Launch Acer Empowering Technology. (user-programmable)
	Web browser	Internet browser (user-Programmable)
	Mail	Email application (user-Programmable)
	Bluetooth communication switch	Enables/disables the Bluetooth function.
	Wireless communication switch	Enables/disables the wireless function.

Touchpad Basics (with fingerprint reader)

The following items show you how to use the touchpad with Acer Bio-Protection fingerprint reader:

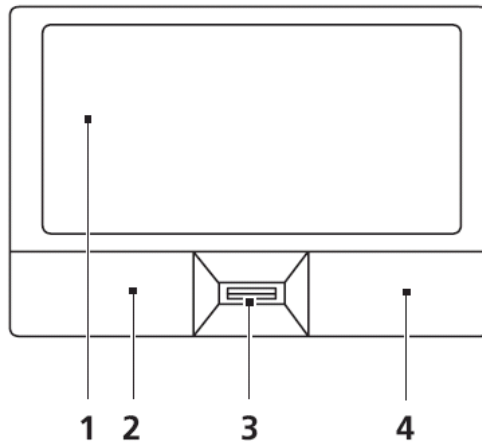

- Move your finger across the touchpad (2) to move the cursor.
- Press the left (1) and right (4) buttons located beneath the touchpad to perform selection and execution functions. These two buttons are similar to the left and right buttons on a mouse. Tapping on the touchpad is the same as clicking the left button.
- Use Acer Bio-Protection fingerprint reader (3) supporting Acer FingerNav 4-way control function (only for certain models) or the 4-way scroll (3) button (only for certain models) to scroll up or down and move left or right a page. This fingerprint reader or button mimics your cursor pressing on the right scroll bar of Windows applications.

Function	Left Button (1)	Right Button (3)	Main touchpad (2)
Execute	Quickly click twice.		Tap twice (at the same speed as double-clicking a mouse button).
Select	Click once.		Tap once.
Drag	Click and hold, then use finger on the touchpad to drag the cursor.		Tap twice (at the same speed as double-clicking a mouse button); rest your finger on the touchpad on the second tap and drag the cursor.
Access context menu		Click once.	

NOTE: When using the touchpad, keep it - and your fingers - dry and clean. The touchpad is sensitive to finger movement; hence, the lighter the touch, the better the response. Tapping too hard will not increase the touchpad's responsiveness.

Using the Keyboard

The keyboard has full-sized keys and an embedded numeric keypad, separate cursor, lock, Windows, function and special keys.

Lock Keys and embedded numeric keypad

The keyboard has three lock keys which you can toggle on and off.





















Lock key	Description
Caps Lock	When Caps Lock is on, all alphabetic characters typed are in uppercase.
Num Lock <Fn> + <F11>	When Num Lock is on, the embedded keypad is in numeric mode. The keys function as a calculator (complete with the arithmetic operators +, -, *, and /). Use this mode when you need to do a lot of numeric data entry. A better solution would be to connect an external keypad.
Scroll Lock <Fn> + <F12>	When Scroll Lock is on, the screen moves one line up or down when you press the up or down arrow keys respectively. Scroll Lock does not work with some applications.

The embedded numeric keypad functions like a desktop numeric keypad. It is indicated by small characters located on the upper right corner of the keycaps. To simplify the keyboard legend, cursor-control key symbols are not printed on the keys.

Desired access	Num Lock on	Num Lock off
Number keys on embedded keypad	Type numbers in a normal manner.	
Cursor-control keys on embedded keypad	Hold <Shift> while using cursor-control keys.	Hold <Fn> while using cursor-control keys.
Main keyboard keys	Hold <Fn> while typing letters on embedded keypad.	Type the letters in a normal manner.

Windows Keys

The keyboard has two keys that perform Windows-specific functions.

Key	Description
 Windows key	<p>Pressed alone, this key has the same effect as clicking on the Windows Start button; it launches the Start menu. It can also be used with other keys to provide a variety of functions:</p> <ul style="list-style-type: none"> <  >: Open or close the Start menu <  > + <D>: Display the desktop <  > + <E>: Open Windows Explore <  > + <F>: Search for a file or folder <  > + <G>: Cycle through Sidebar gadgets <  > + <L>: Lock your computer (if you are connected to a network domain), or switch users (if you're not connected to a network domain) <  > + <M>: Minimizes all windows <  > + <R>: Open the Run dialog box <  > + <T>: Cycle through programs on the taskbar <  > + <U>: Open Ease of Access Center <  > + <X>: Open Windows Mobility Center <  > + <BREAK>: Display the System Properties dialog box <  > + <SHIFT+M>: Restore minimized windows to the desktop <  > + <TAB>: Cycle through programs on the taskbar by using Windows Flip 3-D <  > + <SPACEBAR>: Bring all gadgets to the front and select Windows Sidebar <CTRL> + <  > + <F>: Search for computers (if you are on a network) <CTRL> + <  > + <TAB>: Use the arrow keys to cycle through programs on the taskbar by using Windows Flip 3-D <p>Note: Depending on your edition of Windows Vista, some shortcuts may not function as described.</p>
 Application key	<p>This key has the same effect as clicking the right mouse button; it opens the application's context menu.</p>

Hot Keys

The computer employs hotkeys or key combinations to access most of the computer's controls like screen brightness, volume output and the BIOS utility.

To activate hot keys, press and hold the <Fn> key before pressing the other key in the hotkey combination.



Hotkey	Icon	Function	Description
<Fn> + <F1>	?	Hotkey help	Displays help on hotkeys.
<Fn> + <F2>		Acer eSettings Management	Launches Acer eSettings Management in Acer Empowering Technology.
<Fn> + <F3>		Acer ePower Management	Launches Acer ePower Management in Acer Empowering Technology.
<Fn> + <F4>	Z ^z	Sleep	Puts the computer in Sleep mode.
<Fn> + <F5>		Display toggle	Switches display output between the display screen, external monitor (if connected) and both.
<Fn> + <F6>		Screen blank	Turns the display screen backlight off to save power. Press any key to return.
<Fn> + <F7>		Touchpad toggle	Turns the internal touchpad on and off.
<Fn> + <F8>		Speaker toggle	Turns the speakers on and off.
<Fn> + <D>		Brightness up	Increases the screen brightness.
<Fn> + <D>		Brightness down	Decreases the screen brightness.
<Fn> + <F1>	?	Hotkey help	Displays help on hotkeys.
<Fn> + <F2>		Acer eSettings Management	Launches Acer eSettings Management in Acer Empowering Technology.

Special Key

You can locate the Euro symbol and the US dollar sign at the upper-center and/or bottom-right of your keyboard.



The Euro symbol

1. Open a text editor or word processor.
2. Hold <Alt Gr> and then press the <5> key at the upper-center of the keyboard.

NOTE: Note: Some fonts and software do not support the Euro symbol. Please refer to www.microsoft.com/typography/faq/faq12.htm for more information.

The US dollar sign

1. Open a text editor or word processor.
2. Hold <Shift> and then press the <4> key at the upper-center of the keyboard.

NOTE: This function varies by the operating system version.

Using the System Utilities

Acer Bio-Protection (only for certain models) Acer Bio-Protection Fingerprint Solution is a multi-purpose fingerprint software package integrated with the Microsoft Windows operating system. Utilizing the uniqueness of one's fingerprint features, Acer Bio-Protection Fingerprint Solution has incorporated protection against unauthorized access to your computer with centralized password management with Password Bank, easy music player launching with Acer MusicLaunch, secure Internet favorites via Acer MyLaunch, and fast application/website launching and login with Acer FingerLaunch, while Acer ProfileLaunch can launch up to three applications/websites from a single finger swipe.

Acer Bio-Protection Fingerprint Solution also allows you to navigate through web browsers and documents using Acer FingerNav. With Acer Bio-Protection Fingerprint Solution, you can now enjoy an extra layer of protection for your personal computer, as well as the convenience of accessing your daily tasks with a simple swipe of your finger!

For more information refer to the Acer Bio-Protection help files.



Acer GridVista (dual-display compatible)

NOTE: This feature is only available on certain models.

To enable the dual monitor feature of the notebook, first ensure that the second monitor is connected, then select **Start, Control Panel, Display** and click on **Settings**. Select the secondary monitor (**2**) icon in the display box and then click the check box **Extend my windows desktop onto this monitor**. Finally, click **Apply** to confirm the new settings and click **OK** to complete the process.

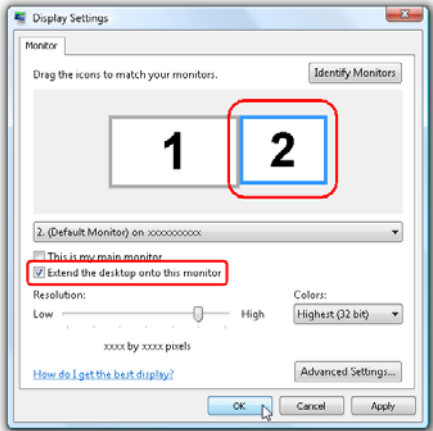

Acer GridVista is a handy utility that offers four pre-defined display settings so you can view multiple windows on the same screen. To access this function, please go to **Start → All Programs** and click on **Acer GridVista**. You may choose any one of the four display settings indicated below:



Double (vertical), Triple (primary at left), Triple (primary at right), or Quad Acer GridVista is dual-display compatible, allowing two displays to be partitioned independently.

Acer GridVista is dual-display compatible, allowing two displays to be partitioned independently.

AcerGridVista is simple to set up:

1. Run Acer GridVista and select your preferred screen configuration for each display from the task bar.
2. Drag and drop each window into the appropriate grid.
3. Enjoy the convenience of a well-organized desktop.

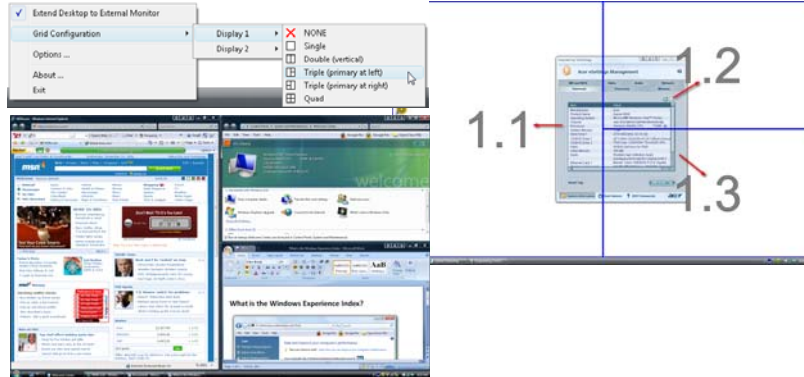

NOTE: Please ensure that the resolution setting of the second monitor is set to the manufacturer's recommended value.

Hardware Specifications and Configurations

Processor

Item	Specification
CPU type	<ul style="list-style-type: none"> Intel® Core™2 Duo processor based Intel® Celeron processor and Intel® Pentium processor, 667-MHz FSB support on Cantiga GL40 platform Intel® Core™2 Duo processors and Intel® Core™2 Extreme processors, 667-MHz, 800-MHz and 1066-MHz FSB support on Cantiga PM40 platform
Core logic	<ul style="list-style-type: none"> Intel Cantiga GL40 (667MHz FSB supported)/ Intel Cantiga PM40 (667/800/1066MHz FSB supported) ICH9-M ENE KB926 for Keyboard Controller, Battery management Unit. JMICRON JMB385 for Card Reader, 5 in 1 controller. Integrated VGA solution for CANTIGA GL40/ External VGA card for CANTIGA PM REALTEK ALC268 for High Definition Audio Codec. REALTEK RTL8111C-GR for Giga LAN
CPU package	Micro uPGA-478 package CPU

CPU Fan True Value Table DIS SKU

CPU Temperature		Fan Speed (RPM)	SPL Spec (dBA)
Core 0	Core 1		
50	50	3000	31
60	60	3400	34
70	70	3800	37
77	77	4200	40
85	85	4200	40

- Throttling 50%: On= 85°C; OFF=78°C
- OS shut down at 90°C; H/W shut down at 96°C

CPU Fan True Value Table UMA SKU

CPU Temperature		Fan Speed (RPM)	SPL Spec (dBA)
Core 0	Core 1		
50	50	3000	31
60	60	3400	34
70	70	3700	37
77	77	4000	40
85	85	4000	40

- Throttling 50%: On= 85°C; OFF=78°C
- OS shut down at 90°C; H/W shut down at 96°C

BIOS

Item	Specification
BIOS vendor	InsydeH20
BIOS Version	v1.03-T2
BIOS ROM type	Flash
BIOS ROM size	1 MB
Supported protocols	<ul style="list-style-type: none">• Support Acer UI• Support multi-boot• Suspend to RAM (S3)/Disk (S4)• Various hot-keys for system control• Support SMBUS 2.0, PCI2.3• ACPI 2.0 compliance with Intel Speed Step Support C1, C2, C3 and S3, S4 for mobile CPU• DMI utility for BIOS serial number configurable/asset tag• Support PXE• Support Y2K solution• Support Win Flash Wake on LAN from S3• Wake on LAN form S4 in AC mode• System information

Cache

Item	Specification
Cache controller	Built in
Cache size	L2 Cache dependent on CPU

System Memory

Item	Specification
Memory controller	Built in
Memory size	0 MB on board
DIMM socket number	2
Supports memory size per socket	2 GB
Supports maximum memory size	4 GB
Supports DIMM type	GL40 supporting DDR II 667 SDRAM memory interface / PM40 supporting DDR II 667/800 SDRAM memory interface
Supports DIMM Speed	667/800 MHz

Memory Combinations

Slot 1	Slot 2	Total Memory
0MB	512MB	512MB
0MB	1024MB	1024MB
0MB	2048MB	2048MB
512MB	512MB	1024MB
512MB	1024MB	1536MB
512MB	2048MB	2560MB
1024MB	0MB	1024MB
1024MB	512MB	1536MB
1024MB	1024MB	2048MB
1024MB	2048MB	3072MB
2048MB	0MB	2048MB
2048MB	512MB	2560MB
2048MB	1024MB	3072MB
2048MB	2048MB	4096MB

NOTE: Above table lists some system memory configurations. You may combine DIMMs with various capacities to form other combinations. On above table, the configuration of slot 1 and slot 2 could be reversed.

Graphics Controller

Item	Specification
Chipset	<ul style="list-style-type: none"> Cantiga GL: Intel Integrated Graphic Cantiga PM: MXM Graphic Adopter
Features	<ul style="list-style-type: none"> Estimated 400-MHz core render clock @ 1.05-V core voltage

LAN Interface

Item	Specification
LAN Chipset	Realtek RTL8111C-GR
Supports LAN protocol	10/100/1000 Mbps
LAN connector type	RJ45
LAN connector location	Left side
Features	PCI-E Giga LAN Support Wake-On-Lan (AC mode S5) No ASF 2.0/iAMT 4.0

Bluetooth Interface

Item	Specification
Chipset	Broadcom 2045 & Broadcom 2070
Protocol	Bluetooth 2.0
Interface	Mini USB module and built-in antenna
Connector type	Mini USB

Wireless Module 802.11b/g

Item	Specification
Chipset	Intel Shirley Peak and Echo Peak (for Centrino platform) Atheros WLAN XB63 and Broadcom WLAN BCM4312 (for Non-Centrino)
Data throughput	11~54 Mbps, up to 270 Mbps for Draft-N
Protocol	802.11b+g, Draft-N
Interface	PCI bus (mini PCI socket for wireless module)

Hard Disk Drive Interface

Item	Specifications			
Vendor & Model Name	Hitachi 5K250-250 5K250-160 5K250-120	Hitachi 5K350-250 5K350-160 5K350-120	Seagate ST9250827AS ST9160827AS ST9120817AS	Seagate ST9320320AS ST9160310AS
Capacity (MB)	250, 160, 120	320, 160, 120	250, 160, 120	320, 160
Bytes per sector	512	512	512	512
Data heads	4, 3, 2	4, 2, 2	4, 3, 2	4, 2
Drive Format				
Disks	2, 2, 1	2, 1, 1	2, 2, 1	2 or 1, 1
Spindle speed (RPM)	5400	5400	5400	5400
Performance Specifications				
Buffer size	8 MB	8 MB	8 MB	8 MB
Interface	SATA	SATA	SATA	SATA
Internal transfer rate (Mbits/sec, max)	643 ~ 665	674 ~ 729	778	352
I/O data transfer rate (Mbytes/sec max)	150 / 300	300	300	150
DC Power Requirements				
Voltage	5V ±5%	5V ±5%	5V ±5%	5V ±5%

Item	Specifications			
Vendor & Model Name	Toshiba MK2546GSX MK1646GSX MK1246GSX	Toshiba MK1252GSX	WD WD2500BEVS WD1200BEVS	WD WD3200BEVT WD1600BEVT
Capacity (MB)	250, 160, 120	120	250, 120	320, 160
Bytes per sector	512	512	512	512
Data heads	4, 3, 2	2	4, 2	4, 2
Drive Format				
Disks	2, 2, 1	1	2, 1	2, 1
Spindle speed (RPM)	5400	5400	5400	5400
Performance Specifications				
Buffer size	8 MB	8 MB	8 MB	8 MB
Interface	SATA	SATA	SATA	SATA

Item	Specifications			
Internal transfer rate (Mbits/sec, max)	370 ~ 730 typical	400 ~ 794 typical	850 Mbits/s maximum	850 Mbits/s maximum
I/O data transfer rate (Mbytes/sec max)	300	300	150 maximum	300 maximum
DC Power Requirements				
Voltage	5V ±5%	5V ±5%	5V ±5%	5V ±5%

Combo Drive Module

Item	Specification
Manufacturer and Model	Sony DL 24X CRX890S Toshiba DL 24X TS-L463A
Type	Drawer type
Interface	SATA
Data Transfer Mode	PIO Mode4
Buffer Memory Size	2 MB
Maximum Write Speed	<ul style="list-style-type: none"> CD 3,600 KB/sec
Maximum Read Speed	<ul style="list-style-type: none"> CD 3,600 KB/sec DVD 10,800 KB/sec
Formats Supported	<p>CD</p> <ul style="list-style-type: none"> CD-DA (Red Book) - Standard Audio CD & CD-TEXT CD-ROM (Yellow Book Mode1 & 2) - Standard Data CD-ROM XA (Mode2 Form1 & 2) - Photo CD, Multi-Session CD-I (Green Book, Mode2 Form1 & 2, Ready, Bridge) CD-Extra/ CD-Plus (Blue Book) - Audio & Text/Video Video-CD (White Book) - MPEG1 Video CD-R (Orange Book Part 1) CD-RW & HSRW (Orange Book Part 2 Volume1 & Volume2) Super Audio CD (SACD) Hybrid type US & US+ RW <p>DVD</p> <ul style="list-style-type: none"> DVD-ROM (Book 1.02), DVD-Dual DVD-Video (Book 1.1) DVD-R (Book 1.0, 3.9G) DVD-R (Book 2.0, 4.7G) - General & Authoring DVD+R (Version 1.0) DVD-RW, DVD+RW DVD+R DL DVD-R DL Support CPRM (read) Support VCPS (read)
Power Supply	DC +5V / 1.3A
Voltage Allowance	DC +5V (5% (Operating), DC +5V(8% (Start Up))

Super-Multi Combo Module

Item	Specification	
Manufacturer and Model	Sony DL 8X AD-7560S Toshiba DL 8X TS-L633A	Pioneer DVR-TD08RS
Type	Drawer type	Drawer loading
Interface	SATA	Serial ATA Revision 2.6
Data Transfer Modes	<ul style="list-style-type: none"> PIO Mode4 DMA Multiword Mode2 ULTRA DMA Mode2 	Gen1i 1.5Gbits / sec
Buffer Memory Size	2 MB	2 MB
Maximum Write Speed	<ul style="list-style-type: none"> CD-R Max. 24X (3,600 KB/sec) DVD+RW Max 8X (10,800 KB/sec) 	<ul style="list-style-type: none"> 8X Zone CLV at DVD-R / +R, DVD+RW 6X Zone CLV at DVD-R DL / +R DL, DVD-RW 5X Zone CLV at DVD-RAM 24X Zone CLV at CD-R / RW
Maximum Read Speed	<ul style="list-style-type: none"> CD 3,600 KB/sec DVD 10,800 KB/sec 	<ul style="list-style-type: none"> 8X CAV at DVD-ROM SL, DVD-R / +R, -RW / +RW, DVD-ROM DL, DVD-R DL / +R DL 5X Zone CLV at DVD-RAM 24X CAV at CD-ROM, CD-R / RW
Format Compatibility	<p>CD</p> <ul style="list-style-type: none"> CD-DA (Red Book) - Standard Audio CD & CD-TEXT CD-ROM (Yellow Book Mode1 & 2) - Standard Data CD-ROM XA (Mode2 Form1 & 2) - Photo CD, Multi-Session CD-I (Green Book, Mode2 Form1 & 2, Ready, Bridge) CD-Extra/ CD-Plus (Blue Book) - Audio & Text/Video Video-CD (White Book) - MPEG1 Video CD-R (Orange Book Part 1) †U) CD-RW & HSRW (Orange Book Part IV Volume1 & Volume2) Super Audio CD (SACD) Hybrid type US & US+ RW <p>DVD</p> <ul style="list-style-type: none"> DVD-ROM (Book 1.02), DVD-Dual DVD-Video (Book 1.1) DVD-R (Book 1.0, 3.9G) DVD-R (Book 2.0, 4.7G) - General & Authoring DVD+R (Version 1.0) DVD+RW DVD-RW (Non CPRM & CPRM) DVD±R Dual DVD-RAM 	<ul style="list-style-type: none"> KODAK Photo CD Single and Multi-session CD Extra (CD PLUS) Video CD CD text data (Read / Write) CD-R discs (Read / Write) CD-RW discs (Read / Write) DVD-ROM DVD-R Ver.2.0 & 2.1 for General (Read / Write) DVD-R DL Ver.3.0 (Read/Write) DVD-RW Ver.1.0 & 1.1 & 1.2 (Read / Write) DVD+R Ver.1.3 (Read/Write) DVD+R DL Ver1.0 & 1.1 (Read / Write) DVD+RW Ver.1.3 (Read/Write) DVD+RW high speed Ver.1.0 (Read/Write) DVD-RAM Ver.2.0 & 2.1 & 2.2
Power Supply	DC +5V / 1.3A	5V
Voltage Allowance	DC +5V (5% (Operating), DC +5V(8% (Start Up))	±5% (operating) -8% (startup)

Item	Specification	
Vendor & model name	HLDS/GSA-T50N, Philips DS-8A2S, Sony/AD-7560S, Toshiba Digi/TS-L633A	
Performance Specification	With CD Diskette	With DVD Diskette
Transfer rate (MB/sec)	Sustained: Max 3.5 Mbytes/sec	Sustained: Max 10 Mbytes/sec
Buffer Memory	2MB	
Interface	SATA	
Applicable disc format	Applicable media types: Writing: Confirms to DVD+R Version 1.2 and DVD+RW Version 1.3 / DVD+R DL Version 1.0 / DVD-R Version 2.0 / DVD-RW Version 1.2 / DVD-R DL Version 3.0. Reading: DVD single/dual layer (PTP, OTP), DVD-R single/dual layer DVD+R single/double layer DVD-RW DVD+RW CD-DA CD-ROM CD-ROM/XA Photo-CD, Multi-session, Video CD CD-I FMV, CD Extra, CD Plus, CD-R, and CD-RW	
Loading mechanism	Drawer (Solenoid Open) Tact SW (Open) Emergency Release (draw open hole)	
Power Requirement		
Input Voltage	DC 5 V +/- 5%	

Card Reader

Item	Specification
Chipset	JMICRON JMB385
Features	Combo (SD/MMC/MS/MS Duo/MS-HG (1/4/8-bit) & xD access) supports D3 Enhancement (D3E) mode

Audio Interface

Item	Specification
Audio Controller	REALTEK ALC268
Audio onboard or optional	Onboard
Mono or Stereo	Stereo
Resolution	2 Channel
Internal microphone	1 x Analog MIC
Internal speaker / Quantity	2 x stereo speaker

USB Interface

Item	Specification
Chipset	ICH9M
USB Compliancy Level	2.0
Number of USB port	2
Location	Left Side

Keyboard

Item	Specification
Keyboard controller	KB926
Total number of keypads	88/89/93
Windows logo key	Yes
Internal & external keyboard work simultaneously	Yes

Battery

Item	Specification
Vendor & model name	Sanyo AS07A Sony AS07A Simplo AS07A Panasonic AS07A
Battery Type	Li-ion
Pack capacity	4400 mAh
Number of battery cell	6
Package configuration	3 cells in series, 2 series in parallel

LCD 14.1"

Item	Specification
Vendor/model name	LG.Philips/LP141WX3, AUO/B141EW04 V4, Chimei/N14113 - L02, Samsung/LTN141W3-L01
Screen Diagonal (mm)	14.1 inches
Active Area (mm)	303.74 x 189.84 mm
Display resolution (pixels)	1280 x 800 WXGA
Pixel Pitch	0.2373 x 0.2373 mm
Pixel Arrangement	R.G.B. Vertical Stripe
Display Mode	Transmissive mode, normally white
Typical White Luminance (cd/m ²) also called Brightness	200 cd/m ² (Typ.5 point)
Luminance Uniformity	1.3 max.
Contrast Ratio	300 minimum
Response Time (Optical Rise Time/Fall Time) msec	16
Nominal Input Voltage VDD	+3.3V
Typical Power Consumption (watt)	1.4W max.
Weight (without inverter)	400g max.
Physical Size (mm)	319.5 (±0.5) x 205.5 (± 0.5) x 5.5 max.
Electrical Interface	3.3V LVDS interface with 1 pixel/clock

Item	Specification
Support Color	greater than 262144
Viewing Angle (degree) Horizontal: Right/Left Vertical: Upper/Lower	Minimum: 40/40, Typical: 45/45 Minimum: 10/30, Typical: 20/35
Temperature Range (°C) Operating Storage (shipping)	0 to +50 -20 to +60

LCD Camera

Item	Specification		
Vendor	Bison BN30V4O7-010	Sirtek CN0314-SN30-OV03-1	Suyin CN1014-S36B-OV01
Focusing range	Fixed	40 cm to infinity	40 cm to infinity
Dimension (L x W x H mm)	W9 * L65 * H5.3 mm	65 * 9.0 * 5.30 mm +/-0.20 mm	65 * 9.0 * 5.26 mm
Sensor	Up to SXGA (1280x1024) size CMOS sensor	OV7725 CMOS Sensor 350K Pixel	1.0 Megabit CMOS Sensor
Pixel Resolution	640(H) * 480(V) VGA	640 * 480	1280X800
Pixel Size	6.0µm * 6.0µm	6.0 µm * 6.0 µm	3.0µm * 3.0µm

LCD Inverter

Item	Specification
Vendor & model name	YEC YNV-C01H
Brightness conditions	N/A
Input voltage (V)	9~20(V)
Input current (mA)	Typical 0.33(mA)
Output voltage (V, rms)	Typical 650 Vrms
Output current (mA, rms)	MAX. 6.8mA
Output voltage frequency (k Hz)	45~65 (KHz)

AC Adapter

Item	Specification
Input rating	100~240Vac/ 50-60Hz
Maximum input AC current	1.5A
Inrush current	No damage
Efficiency	Meet EPA level-4 requirement

System Power Management

Item	Specification
Features	<ul style="list-style-type: none"> • Mech. Off (G3) • Soft Off (G2/S5) • Working (G0/S0) • Suspend to RAM (S3) • Save to Disk (S4)

System Utilities

BIOS Setup Utility

The BIOS Setup Utility is a hardware configuration program built into your computer's BIOS (Basic Input/Output System).

Your computer is already properly configured and optimized, and you do not need to run this utility. However, if you encounter configuration problems, you may need to run Setup. Please also refer to Chapter 4 Troubleshooting when problem arises.

To activate the BIOS Utility, press **F2** during POST (when "Press <F2> to enter Setup" message is prompted on the bottom of screen).

Press **F2** to enter setup. The default parameter of F12 Boot Menu is set to "disabled". If you want to change boot device without entering BIOS Setup Utility, please set the parameter to "enabled".

Press <F12> during POST to enter multi-boot menu. In this menu, user can change boot device without entering BIOS SETUP Utility.

Navigating the BIOS Utility

There are six menu options: Information, Main, Advanced, Security, Boot, and Exit.

Follow these instructions:

- To choose a menu, use the left and right arrow keys.
- To choose an item, use the up and down arrow keys.
- To change the value of a parameter, press **F5** or **F6**.
- A plus sign (+) indicates the item has sub-items. Press **Enter** to expand this item.
- Press **Esc** while you are in any of the menu options to go to the Exit menu.
- In any menu, you can load default settings by pressing **F9**. You can also press **F10** to save any changes made and exit the BIOS Setup Utility.

NOTE: You can change the value of a parameter if it is enclosed in square brackets. Navigation keys for a particular menu are shown on the bottom of the screen. Help for parameters are found in the Item Specific Help part of the screen. Read this carefully when making changes to parameter values. **Please note that system information is subject to different models.**

Information

The Information screen displays a summary of your computer hardware information.

InsydeH20 Setup Utility		Rev. 3.5
Information	Main	Security Boot Exit
CPU Type:	Intel (R) Core (TM)2 Duo CPU	P8400 @ 2.26GHz
CPU Speed:	2.26GHz	
HDD Model Name:	WDC WD1600BEVT-22ZCT0	
HDD Serial Number:	WD-WXHY07373693	
ATAPI Model Name:	TSSTcorp CDDVDW TS-L633A	
System BIOS Version:	v1.03-T2	
VGA BIOS Version:	Intel V1625	
Serial Number:	LXJAW500068221C97C1601	
Asset Tag Number:		
Product Name:	Aspire 4730Z	
Manufacturer Name:	Acer	
UUID:	309E6330-6B60-16FA-ADF9-001EEC448964	
F1 Help	↑↓ Select Item	F5/F6 Change Values F9 Setup Default
ESC Exit	←→ Select Menu	Enter Select▶SubMenu F10 Save and Exit

NOTE: The system information is subject to different models.

Parameter	Description
CPU Type	This field shows the CPU type and speed of the system.
CPU Speed	This field shows the speed of the CPU.
HDD Model Name	This field shows the model name of HDD installed on primary IDE master.
HDD Serial Number	This field displays the serial number of HDD installed on primary IDE master.
ATAPI Model Name	This field shows the model name of the Optical device installed in the system.
System BIOS Version	Displays system BIOS version.
VGA BIOS Version	This field displays the VGA firmware version of the system.
Serial Number	This field displays the serial number of this unit.
Asset Tag Number	This field displays the asset tag number of the system.
Product Name	This field shows product name of the system.
Manufacturer Name	This field displays the manufacturer of this system.
UUID Number	Universally Unique Identifier (UUID) is an identifier standard used in software construction, standardized by the Open Software Foundation (OSF) as part of the Distributed Computing Environment (DCE).

Main

The Main screen allows the user to set the system time and date as well as enable and disable boot option and recovery.

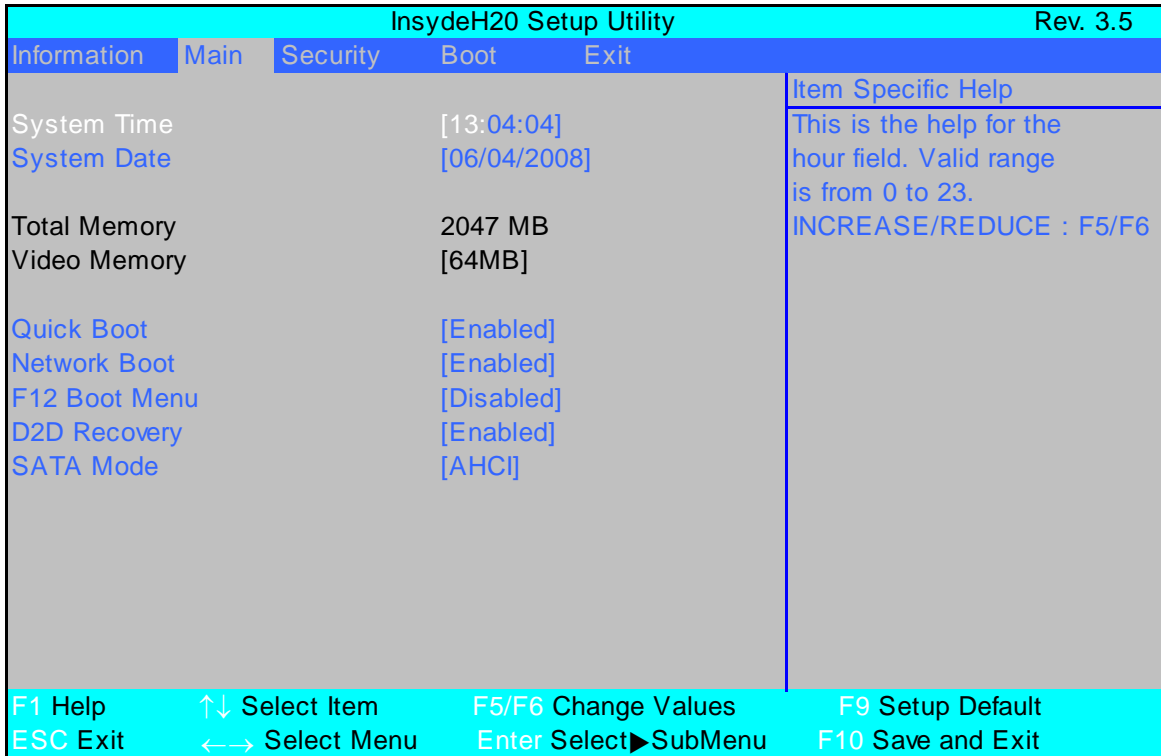

NOTE: The screen above is for your reference only. Actual values may differ.

The table below describes the parameters in this screen. Settings in **boldface** are the default and suggested parameter settings.

Parameter	Description	Format/Option
System Time	Sets the system time. The hours are displayed with 24-hour format.	Format: HH:MM:SS (hour:minute:second)
System Date	Sets the system date.	Format MM/DD/YYYY (month/day/year)
Total Memory	This field reports the memory size of the system. Memory size is fixed to 2047 MB.	N/A
Video Memory	Shows the video memory size. VGA Memory size=64 MB	N/A
Quick Boot	Allows startup to skip certain tests while booting, decreasing the time needed to boot the system.	Option: Enabled or Disabled
Network Boot	Enables, disables the system boot from LAN (remote server).	Option: Enabled or Disabled
F12 Boot Menu	Enables, disables Boot Menu during POST.	Option: Disabled or Enabled
D2D Recovery	Enables, disables D2D Recovery function. The function allows the user to create a hidden partition on hard disc drive to store operation system and restore the system to factory defaults.	Option: Enabled or Disabled
SATA Mode	Control the mode in which the SATA controller should operate.	Option: AHCI or IDE Mode

NOTE: The sub-items under each device will not be shown if the device control is set to disable or auto. This is because the user is not allowed to control the settings in these cases.

Security

The Security screen contains parameters that help safeguard and protect your computer from unauthorized use.

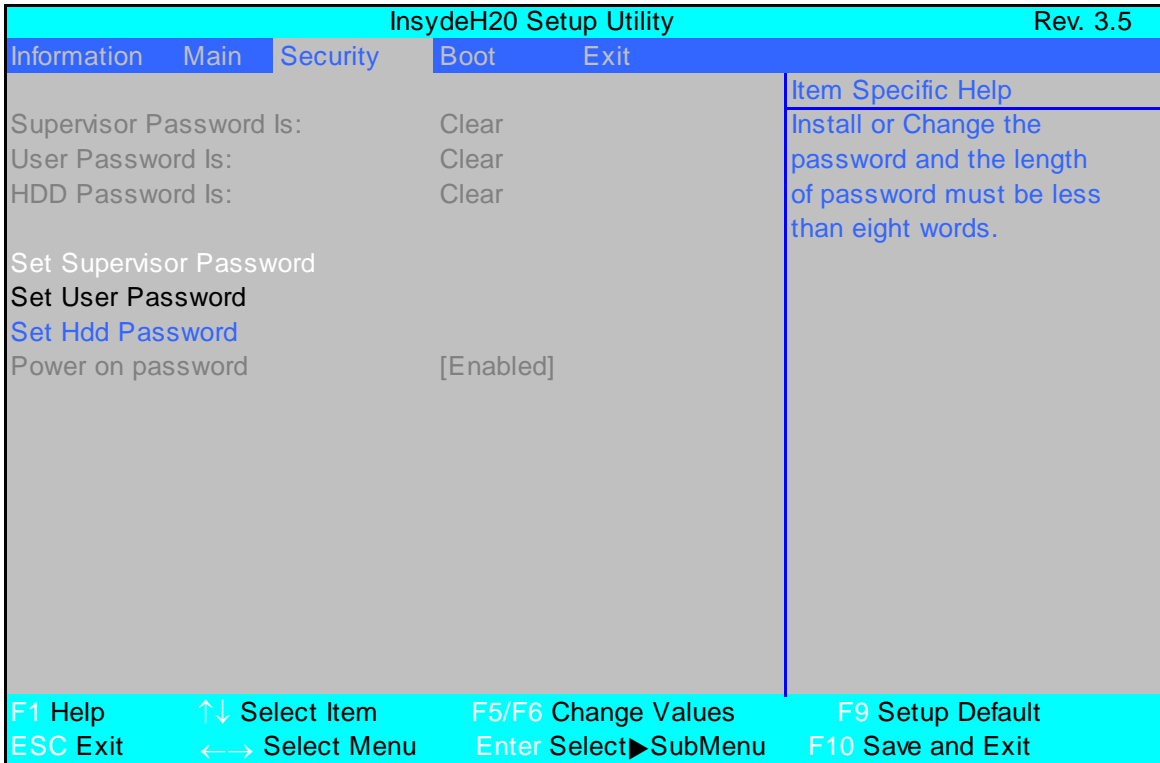

The table below describes the parameters in this screen. Settings in **boldface** are the default and suggested parameter settings.

Parameter	Description	Option
Supervisor Password Is	Shows the setting of the Supervisor password	Clear or Set
User Password Is	Shows the setting of the user password.	Clear or Set
HDD Password Is	Shows the setting of the hard disk password.	Clear or Set
Set Supervisor Password	Press Enter to set the supervisor password. When set, this password protects the BIOS Setup Utility from unauthorized access. The user can not either enter the Setup menu nor change the value of parameters.	
Set User Password	Press Enter to set the user password. When user password is set, this password protects the BIOS Setup Utility from unauthorized access. The user can enter Setup menu only and does not have right to change the value of parameters.	
Set HDD Password	Enter HDD Password.	
Power on password	Defines whether a password is required or not while the events defined in this group happened. The following sub-options are all requires the Supervisor password for changes and should be grayed out if the user password was used to enter setup.	Enabled or Disabled

NOTE: When you are prompted to enter a password, you have three tries before the system halts. Don't forget your password. If you forget your password, you may have to return your notebook computer to your dealer to reset it.

Setting a Password

Follow these steps as you set the user or the supervisor password:

1. Use the ↑ and ↓ keys to highlight the Set Supervisor Password parameter and press the **Enter** key. The Set Supervisor Password box appears:

Set Supervisor Password		
Enter New Password	[]
Confirm New Password	[]

2. Type a password in the “Enter New Password” field. The password length can not exceeds 8 alphanumeric characters (A-Z, a-z, 0-9, not case sensitive). Retype the password in the “Confirm New Password” field.

IMPORTANT: Be very careful when typing your password because the characters do not appear on the screen.

3. Press **Enter**. After setting the password, the computer sets the User Password parameter to “Set”.
4. If desired, you can opt to enable the Password on boot parameter.
5. When you are done, press F10 to save the changes and exit the BIOS Setup Utility.

Removing a Password

Follow these steps:

1. Use the ↑ and ↓ keys to highlight the Set Supervisor Password parameter and press the **Enter** key. The Set Password box appears:

Set Supervisor Password		
Enter current password	[]
Enter New Password	[]
Confirm New Password	[]

2. Type the current password in the Enter Current Password field and press **Enter**.
3. Press **Enter** twice **without** typing anything in the Enter New Password and Confirm New Password fields. The computer then sets the Supervisor Password parameter to “Clear”.
4. When you have changed the settings, press u to save the changes and exit the BIOS Setup Utility.

Changing a Password

1. Use the ↑ and ↓ keys to highlight the Set Supervisor Password parameter and press the **Enter** key. The Set Password box appears.

Set Supervisor Password		
Enter current password	[]
Enter New Password	[]
Confirm New Password	[]

2. Type the current password in the Enter Current Password field and press **Enter**.
3. Type a password in the Enter New Password field. Retype the password in the Confirm New Password field.
4. Press **Enter**. After setting the password, the computer sets the User Password parameter to “Set”.
5. If desired, you can enable the Password on boot parameter.
6. When you are done, press F10 to save the changes and exit the BIOS Setup Utility.

If the verification is OK, the screen will display as following.

Setup Notice
Changes have been saved.
[continue]

The password setting is complete after the user presses **Enter**.

If the current password entered does not match the actual current password, the screen will show you the Setup Warning.

Setup Warning
Invalid password
Re-enter Password
[continue]

If the new password and confirm new password strings do not match, the screen will display the following message.

Setup Warning
Password do not match
Re-enter Password

Boot

This menu allows the user to decide the order of boot devices to load the operating system. Bootable devices includes the USB diskette drives, the onboard hard disk drive and the DVD drive in the module bay.

InsydeH20 Setup Utility				Rev. 3.5
Information	Main	Security	Boot	Exit
Boot priority order:				Item Specific Help
1. IDE0 : WDC WD1600BEVT-22ZCT0				Use <↑> or <↓> to select a device, then press <F5> to move it down the list, or <F6> to move it up the list. Press <Esc> to escape the menu
2. IDE1 : TSSTcorp CDDVDW TS-L633A				
3. USB FDD :				
4. Network Boot : Realtek Boot Agent				
5. USB HDD :				
6. USB CDROM :				
F1 Help	↑↓ Select Item	F5/F6 Change Values	F9 Setup Default	
ESC Exit	←→ Select Menu	Enter Select	▶ SubMenu	F10 Save and Exit

Exit

The Exit screen allows you to save or discard any changes you made and quit the BIOS Utility.

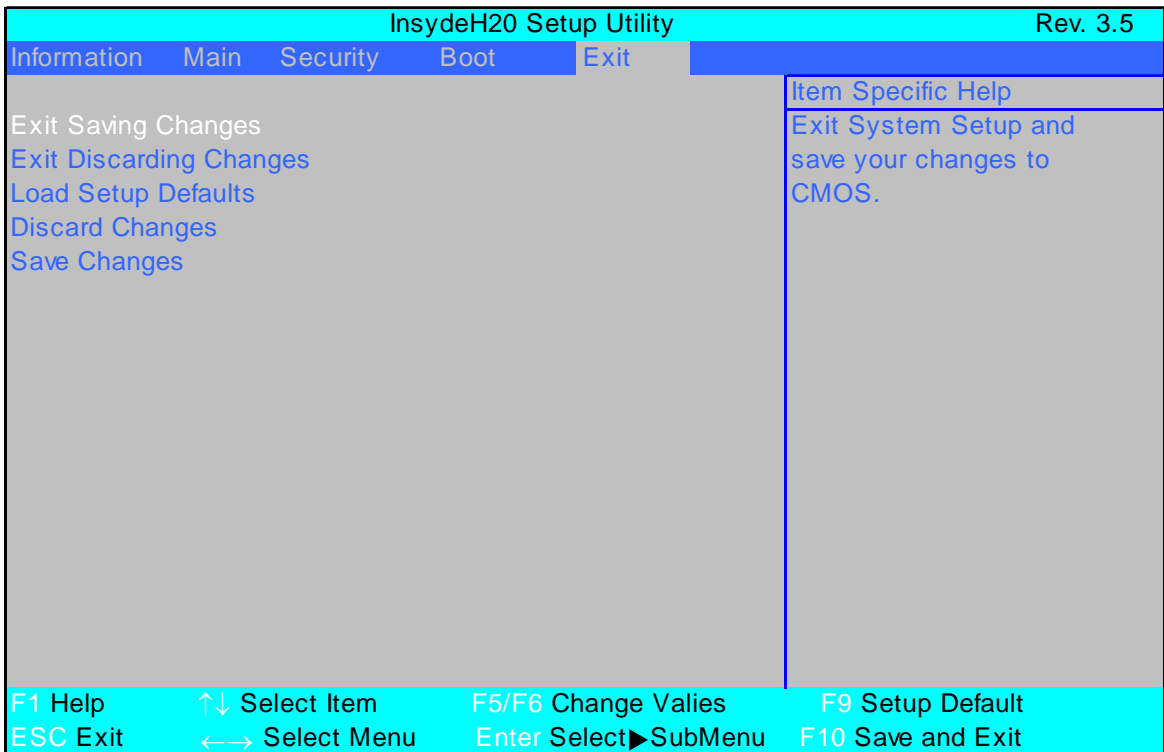

The table below describes the parameters in this screen.

Parameter	Description
Exit Saving Changes	Exit System Setup and save your changes to CMOS.
Exit Discarding Changes	Exit utility without saving setup data to CMOS.
Load Setup Default	Load default values for all SETUP item.
Discard Changes	Load previous values from CMOS for all SETUP items.
Save Changes	Save Setup Data to CMOS.

BIOS Flash Utility

The BIOS flash memory update is required for the following conditions:

- New versions of system programs
- New features or options
- Restore a BIOS when it becomes corrupted.

Use the Phlash utility to update the system BIOS flash ROM.

NOTE: Create a **Crisis Recovery Media** (such as USB HDD) before you use the Phlash utility.

NOTE: Do not install memory-related drivers (XMS, EMS, DPMI) when you use the Phlash.

NOTE: Please use the AC adaptor power supply when you run the Phlash utility. If the battery pack does not contain enough power to finish BIOS flash, the system will not boot as the BIOS is not loaded.

Perform the following steps to use the Flash Utility:

1. Press F2 during boot to enter the Setup Menu.
2. Select **Boot Menu** to modify the boot priority order, for example, if using USB HDD to Update BIOS, move USB HDD to position 1.

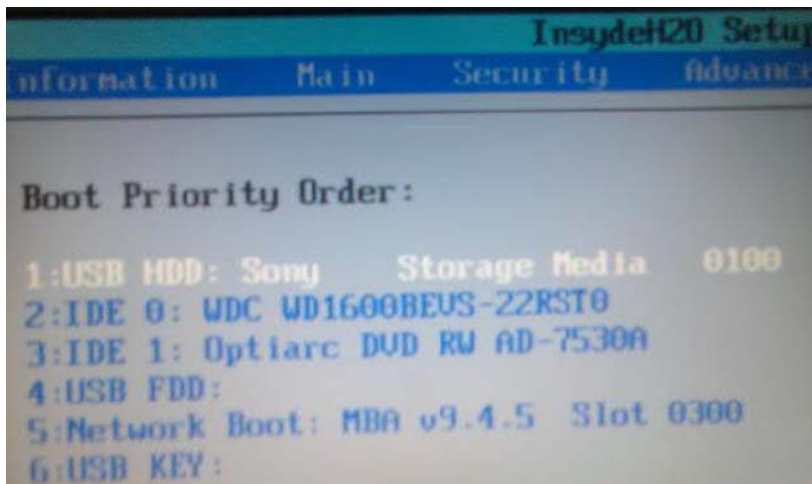

3. Execute the **IFLASH.BAT** batch file to update BIOS (Read xxxxx.fd to Memory).



4. In flash BIOS, the message **Please do not remove AC Power Source** displays.

NOTE: If the AC power is not connected, the following message displays.

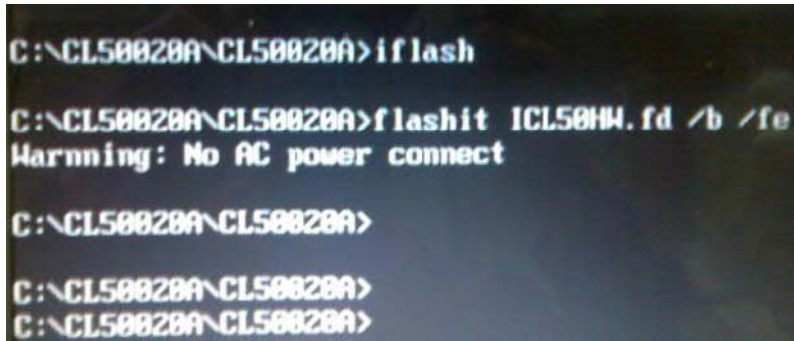

```
C:\CL50020A\CL50020A>iflash
C:\CL50020A\CL50020A>flashit ICL50HW.fd /b /fe
Warning: No AC power connect
C:\CL50020A\CL50020A>
C:\CL50020A\CL50020A>
C:\CL50020A\CL50020A>
```

Plug in the AC power to continue.

5. Flash is complete when the following message displays.



```
File loading 100 %
Current BIOS Model name :
New BIOS Model name :
Current BIOS version: V0.18.T04
New BIOS version: V0.20
Updating Block at FFFF0000
Flash complete !
```

6. Shutdown or reboot base on iflash.bat command.

Remove HDD/BIOS Utility

This section provide you with removing HDD/BIOS method:

Remove HDD Password:

- If you key in wrong HDD password three times, Hdd password error code displays. See the image below.



To reset the HDD password, run HDD_PW.EXE as follows:

1. Key in **hdd_pw 15494 0**
2. Press 2.
3. Select one upper-case string from the list.

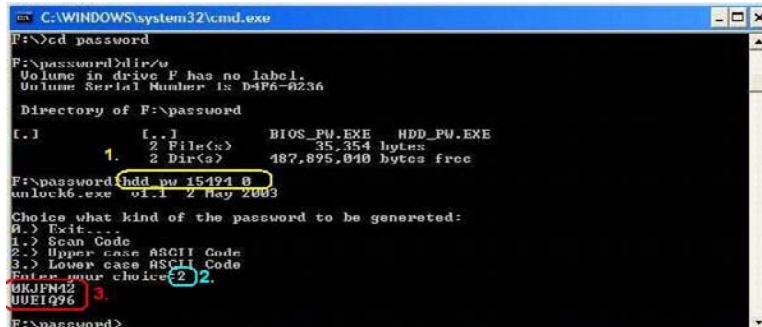

4. Reboot system and key in the selected string (0KJFN42 or UVEIQ96) on the HDD User Password screen.



Remove BIOS Password:

If you key in the wrong Supervisor Password three times, System Disabled displays on the screen. See the image below.

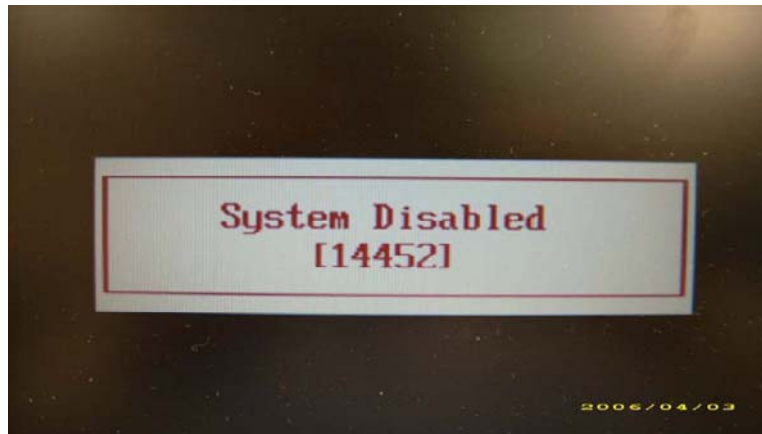

To reset the BIOS password, run BIOS_PW.EXE as follows:

1. Key in **bios_pw 14452 0**
2. Select one string from the list.

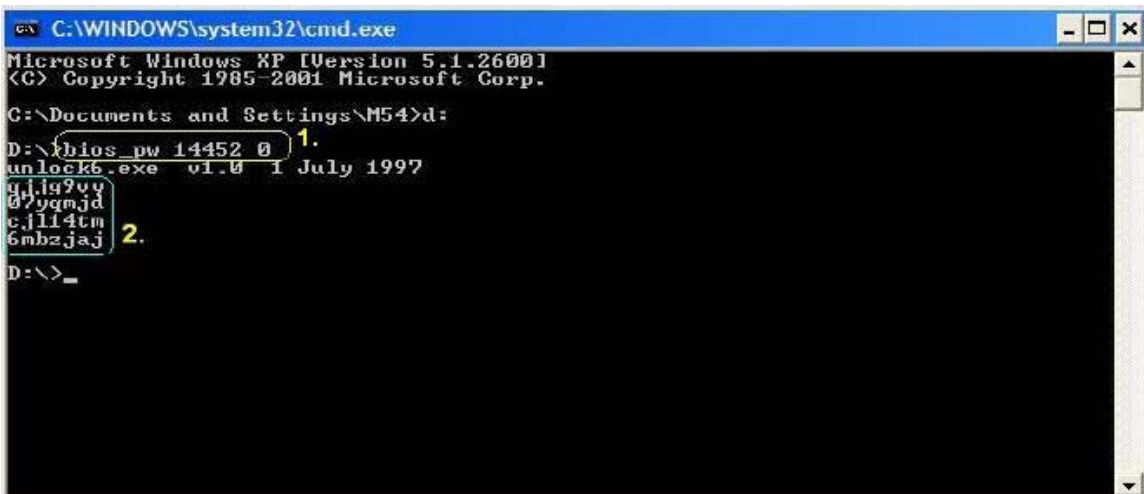

```
C:\WINDOWS\system32\cmd.exe
Microsoft Windows XP [Version 5.1.2600]
(C) Copyright 1985-2001 Microsoft Corp.
C:\Documents and Settings\M54>d:
D:\>bios_pw 14452 0
unlock6.exe v1.0 1 July 1997
qj119700
0?yqmjd
c.jl14tm
6mbzjaj
D:\>
```

3. Reboot the system and key in the selected string (qjig9vy, 07yqmd etc.) for the BIOS user password.

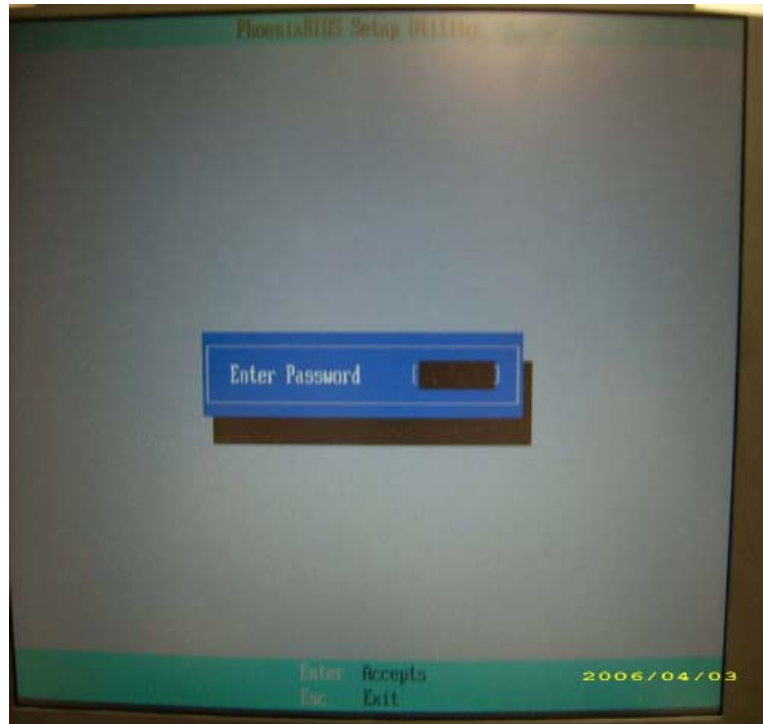

Removing BIOS Passwords:

To clear the password, perform the following steps:

1. From a DOS prompt, Execute **clnpwd.exe**

```
d:\Clnpwd>clnpwd
ACER Clean Password Utility V1.00
Press 1 or 2 to clean any password shown as below
    1.User Password
    2.Supervisor Password

Clean User Password Successfully!
```

2. Press 1 or 2 to clean the desired password shown on the screen.

The onscreen message determines whether the function is successful or not.

Machine Disassembly and Replacement

This chapter contains step-by-step procedures on how to disassemble the notebook computer for maintenance and troubleshooting.

Disassembly Requirements

To disassemble the computer, you need the following tools:

- Wrist grounding strap and conductive mat for preventing electrostatic discharge
- Flat screwdriver
- Philips screwdriver
- Plastic flat screwdriver
- Plastic tweezers

NOTE: The screws for the different components vary in size. During the disassembly process, group the screws with the corresponding components to avoid mismatch when putting back the components.

IMPORTANT: Various images depict the use of a regular metal screwdriver, however, a plastic screwdriver is advised when disassembling parts near or around the motherboard and to prevent scratching of the computer surface.

General Information

Pre-disassembly Instructions

Before proceeding with the disassembly procedure, make sure that you do the following:

1. Turn off the power to the system and all peripherals.
2. Unplug the AC adapter and all power and signal cables from the system.



3. Place the system on a flat, stable surface.
4. Remove the battery pack.

Disassembly Process

The disassembly process is divided into the following stages:

- External module disassembly
- Main unit disassembly
- LCD module disassembly

The flowcharts provided in the succeeding disassembly sections illustrate the entire disassembly sequence. Observe the order of the sequence to avoid damage to any of the hardware components. For example, if you want to remove the main board, you must first remove the keyboard, then disassemble the inside assembly frame in that order.

Main Screw List

Screw	Quantity	Part Number
M2.5*8 (NL)	15	86.AR102.001
M2.5*5 (NL)	22	86.AR102.002
M2*3 (NL)	36	86.AR102.004
M2*6 (NL)	4	86.AR102.007
M2*4-NI (NL)	5	86.AR102.006
M3*3 (NL)	4	86.AR102.009
M2.5*6.5	4	86.AR102.012

External Module Disassembly Process

External Modules Disassembly Flowchart

The flowchart below gives you a graphic representation on the entire disassembly sequence and instructs you on the components that need to be removed during servicing. For example, if you want to remove the main board, you must first remove the keyboard, then disassemble the inside assembly frame in that order.

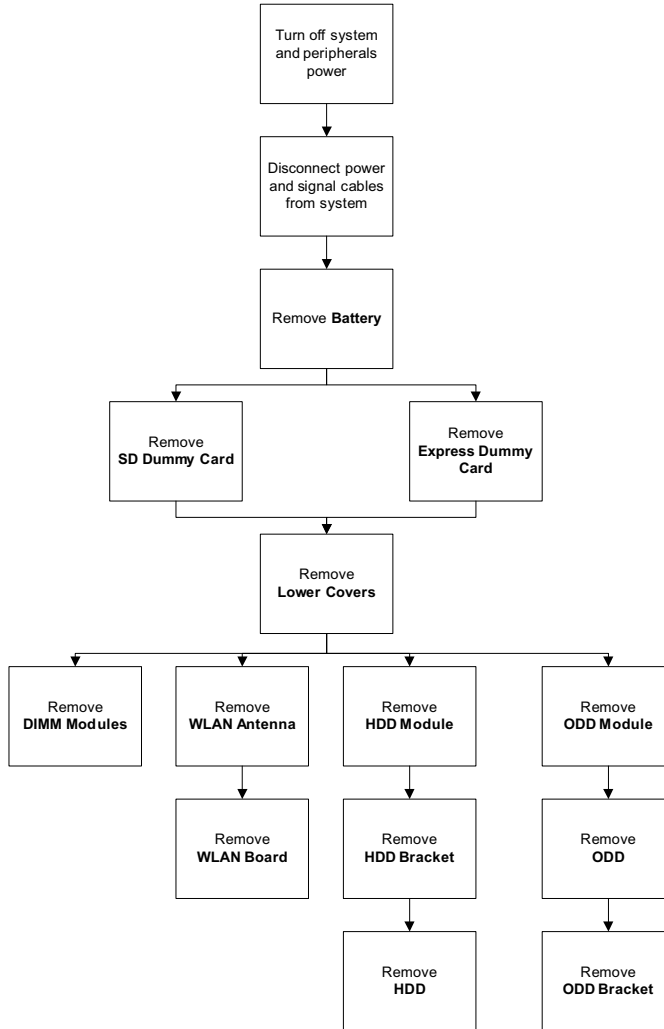

Screw List

Step	Screw	Quantity	Color	Part No.
Memory Cover	M2.5*8 (NL)	2	Black	86.AR102.001
WLAN Cover	M2.5*8 (NL)	1	Black	86.AR102.001
WLAN Module	M2*3 (NL)	2	Black	86.AR102.004
HDD Carrier	M3*3 (NL)	4	Silver	86.AR102.009
ODD Module	M2.5*5(NL)	1	Black	86.AR102.002
ODD Bracket	M2*3 (NL)	3	Black	86.AR102.004

Removing the Battery Pack

1. Turn computer over.
2. Slide the battery lock/unlock latch to the unlock position.



3. Slide and hold the battery release latch to the release position (1), then slide out the battery pack from the main unit (2).



Removing the SD dummy card

1. Push the SD dummy card all the way in to eject it.



2. Pull it out from the slot.



Removing the ExpressCard dummy card

1. Push the ExpressCard dummy card all the way in to eject it.





2. Pull it out from the slot.

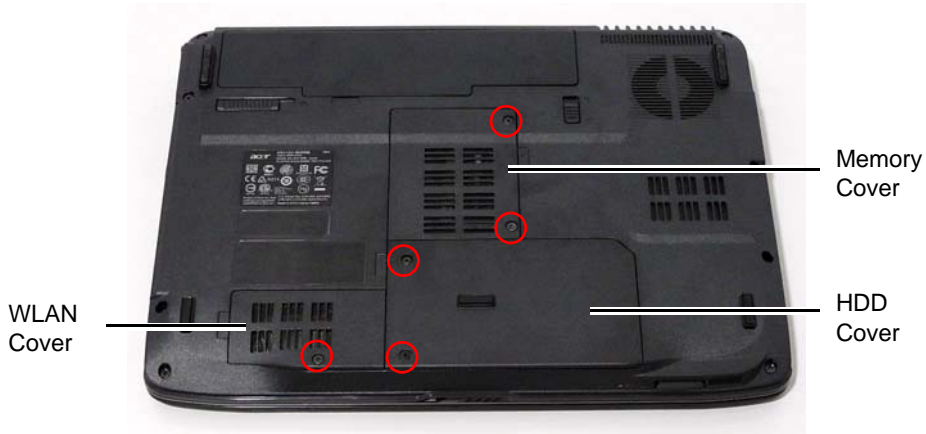

Removing the Lower Covers

1. See "Removing the Battery Pack" on page 44.
2. See "Removing the SD dummy card" on page 45.
3. See "Removing the ExpressCard dummy card" on page 46.
4. Remove the three screws from the memory and WLAN bays and loosen the two captive screws on the HDD cover.



Step	Size	Quantity	Screw Type
Memory Cover	M2.5*8 (NL)	2	
WLAN Cover	M2.5*8 (NL)	1	

5. Carefully open the memory cover.



6. Remove the HDD cover as shown.

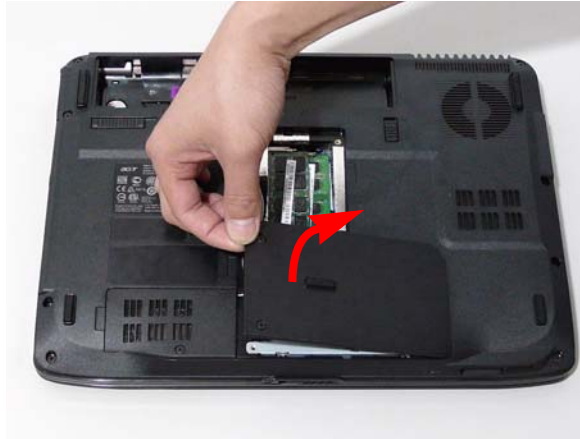

7. Remove the WLAN cover as shown.

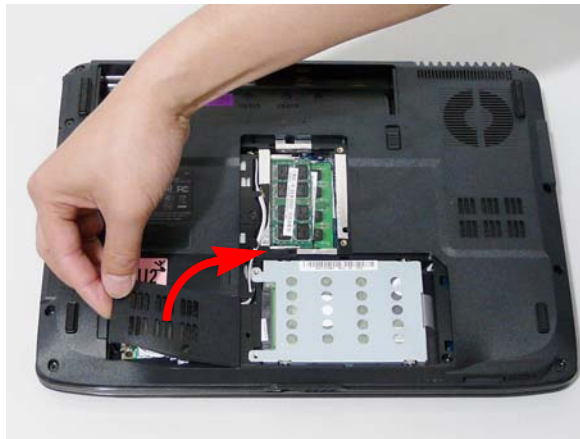

Removing the DIMM Modules

1. See “Removing the Battery Pack” on page 44.
2. Remove the Memory Module cover See “Removing the Lower Covers” on page 47.
3. Push out the release latches on both sides of the DIMM socket to release the DIMM module.

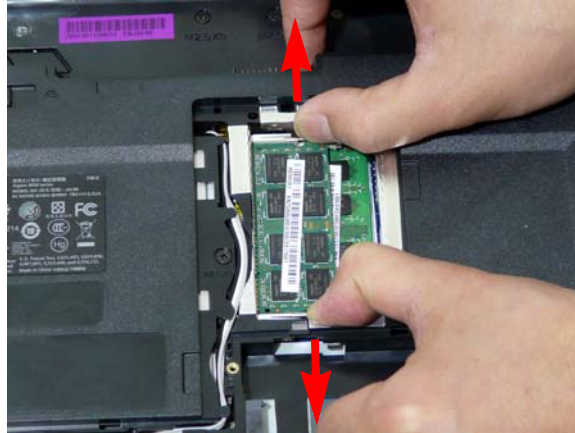

4. Remove the DIMM module.

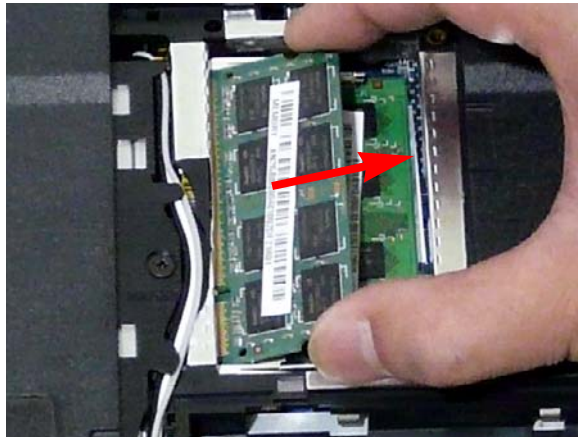

5. Repeat steps for the second DIMM module if present.

Removing the WLAN Module

1. See "Removing the Battery Pack" on page 44.
2. Remove the WLAN cover. See "Removing the Lower Covers" on page 47.
3. Disconnect the antenna cables from the WLAN board.



4. Move the antenna away and remove the two screws on the WLAN board to release the WLAN board.



Step	Size	Quantity	Screw Type
WLAN Module	M2*3 (NL)	2	

5. Detach the WLAN board from the WLAN socket.



NOTE: When attaching the antenna back to the WLAN board, make sure the cables are sitting in the housing to prevent damage.

Removing the Hard Disk Drive Module

1. See “Removing the Battery Pack” on page 44.
2. Remove the HDD cover, See “Removing the Lower Covers” on page 47.
3. Use the pull-tab to pull and lift the hard disk drive module out of the bay.



NOTE: To prevent damage to device, avoid pressing down on it or placing heavy objects on top of it.

4. Remove the four screws securing the hard disk to the carrier.

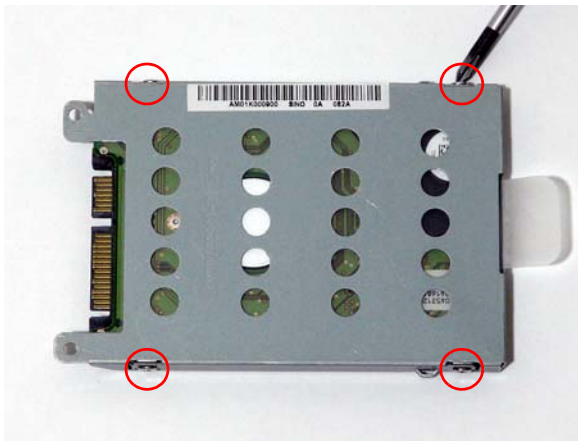

Step	Size	Quantity	Screw Type
HDD Carrier	M3*3 (NL)	4	

5. Remove the HDD from the carrier.

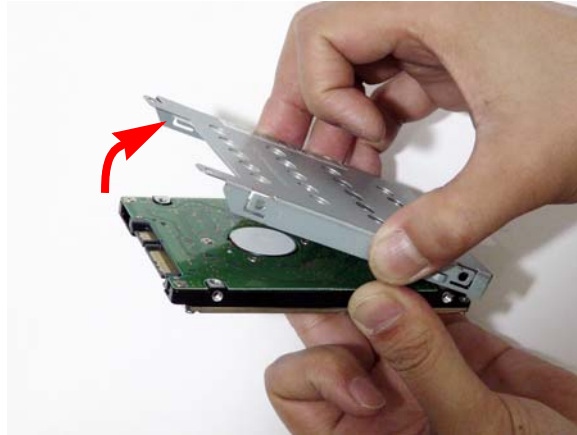

Removing the Optical Drive Module

1. See "Removing the Battery Pack" on page 44.
2. Remove the Memory cover. See "Removing the Lower Covers" on page 47.
3. Remove the screw securing the ODD module.



Step	Size	Quantity	Screw Type
ODD Module	M2.5*5(NL)	1	

4. Carefully insert a screw driver to release the locking latch.



NOTE: A plastic screw driver is recommended to prevent scratching the surface of the computer.

5. Pull the optical drive module out from the chassis.

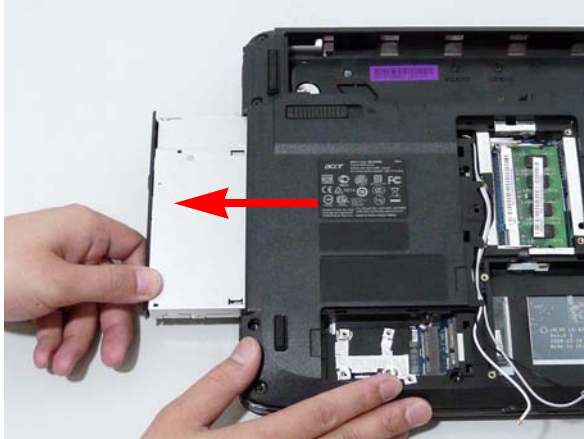

6. Remove the three screws securing the ODD bracket and remove the ODD bracket from the optical disk drive module.



Step	Size	Quantity	Screw Type
ODD Bracket	M2*3 (NL)	3	

7. Insert a pin in the eject hole of the ODD to eject the ODD tray.

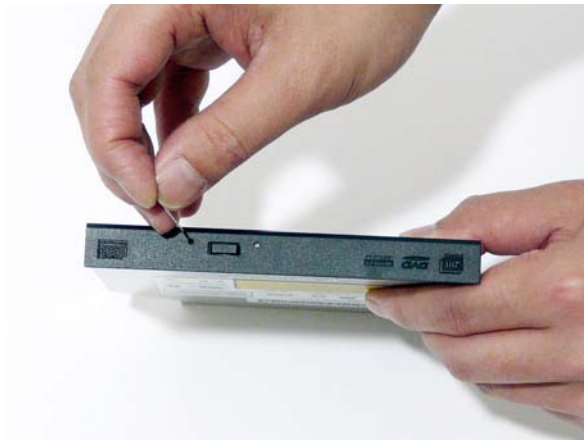

8. Press down on the locking catch to release the ODD cover and remove.

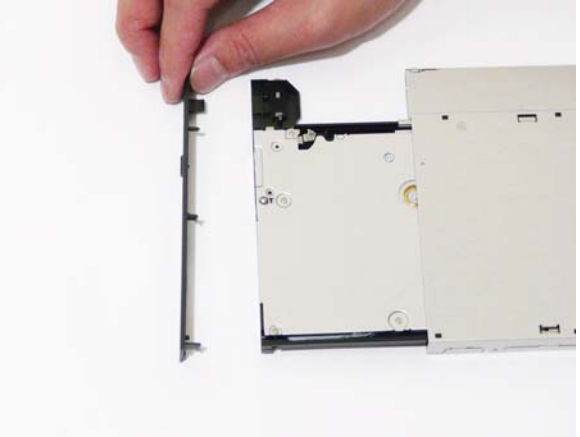

Main Unit Disassembly Process

Main Unit Disassembly Flowchart

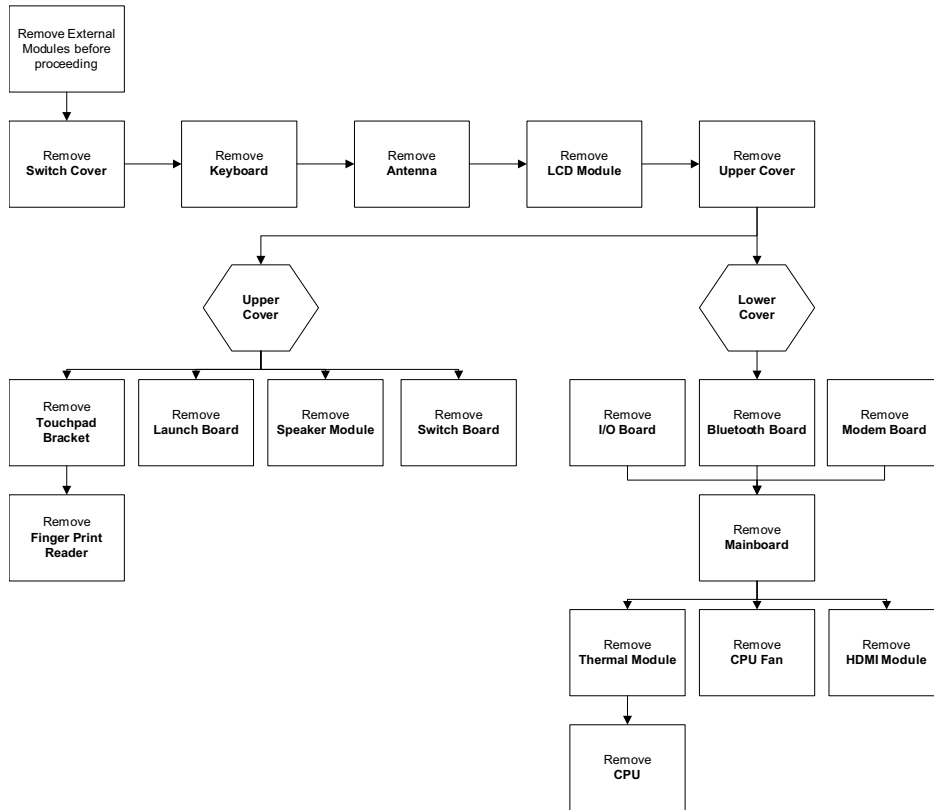

Screw List

Step	Screw	Quantity	Color	Part No.
Switch Cover	M2*3 (NL)	2	Black	86.AR102.004
LCD Module	M2.5*8(NL)	4	Black	86.AR102.001
	M2.5*5 (NL)	2	Black	86.AR102.002
Upper Cover	M2.5*8 (NL)	8	Black	86.AR102.001
	M2.5*5 (NL)	7	Black	86.AR102.002
Touch Pad Bracket	M2*3 (NL)	2	Black	86.AR102.004
Launch Board	M2*3 (NL)	2	Black	86.AR102.004
Speaker	M2*3 (NL)	4	Black	86.AR102.004
I/O Board	M2.5*5 (NL)	1	Black	86.AR102.002
Bluetooth Board	M2*3 (NL)	1	Black	86.AR102.004
Modem Module	M2*3 (NL)	2	Black	86.AR102.004
Mainboard	M2.5*5 (NL)	1	Black	86.AR102.002
Thermal Module	M2.5*6.5	4	Black	86.AR102.012
CPU Fan	M2*4-NI (NL)	3	Black	86.AR102.006
HDMI Module	M2*4-NI (NL)	2	Black	86.AR102.006

Removing the Switch Cover

CAUTION: Using tools to remove the Switch Cover may cause damage to the outer casing. It is recommended that you only use your fingers to remove the Switch Cover.

1. See "Removing the Battery Pack" on page 44.
2. Locate and remove the two securing screws as shown.



Step	Size	Quantity	Screw Type
Switch Cover	M2*3(NL)	2	

3. Turn the computer over and open the LCD module to expose the Switch Cover.
4. Lift the Switch Cover as shown, and move from right to left side.



5. Turn the Switch Cover over to expose the FFC cable and detach it using the tweezers.



6. Lift the Switch Cover clear of the chassis.

Removing the Keyboard

1. See “Removing the Battery Pack” on page 44.
2. Using a plastic pry, push in the two securing latches and slide the pry under the keyboard.



3. Once both latches are released, lift the keyboard away from the chassis as shown.



4. Turn the keyboard over on the Touch Pad area to expose the FFC cable.



5. Using a pry, pull both sides of the retainer to disconnect the FFC cable from the mainboard.

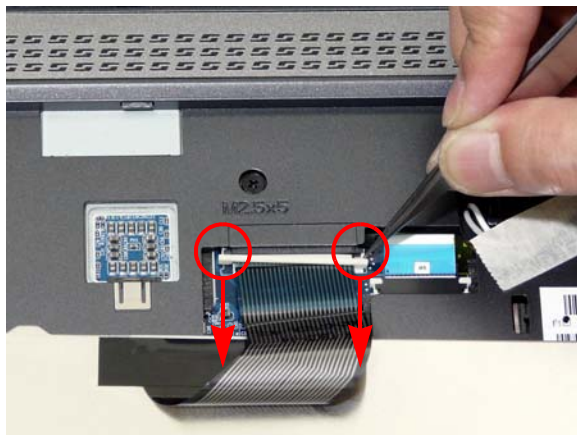

Removing the Antenna

1. Remove the Antenna Cables from the securing pins as shown.

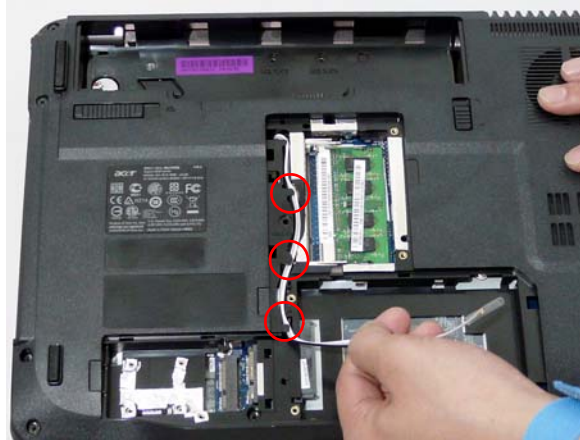

2. Turn the computer over. Remove the adhesive strips holding the antenna cables.



3. Feed the antenna cables from the underside of the computer.

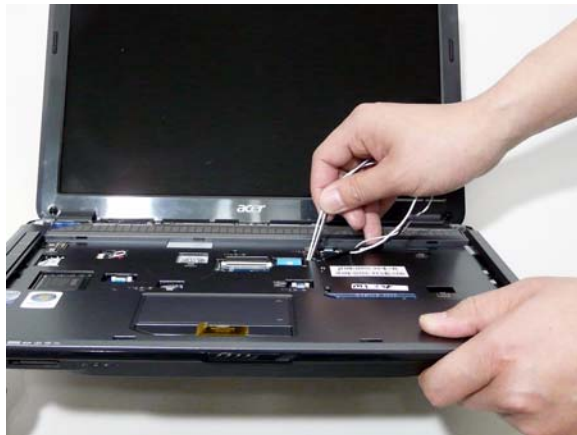

4. Remove the Antenna Cables from the securing pins as shown.

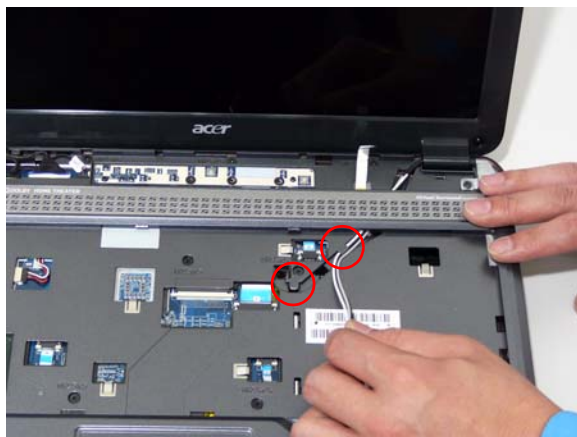

5. Pull the cables through the speaker panel as shown.

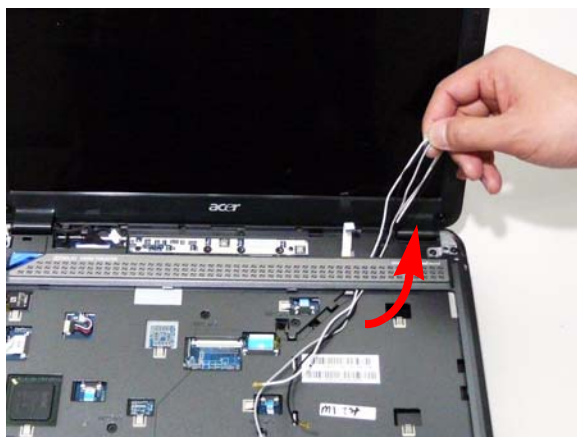

6. Fully remove the antenna cables and move them out of the way to prevent damage.

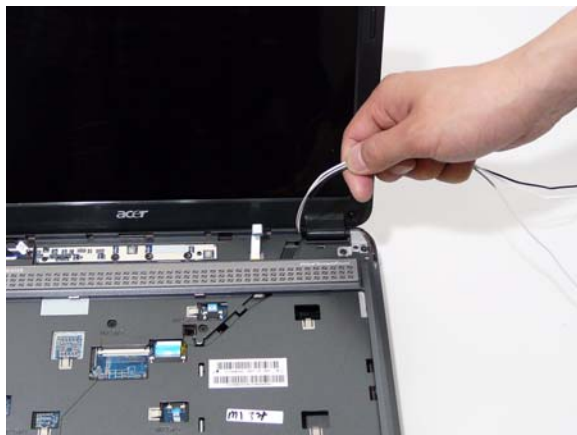

Removing the LCD Module

1. See "Removing the Battery Pack" on page 44.
2. See "Removing the Lower Covers" on page 47.
3. See "Removing the WLAN Module" on page 50.
4. See "Removing the Keyboard" on page 61.
5. See "Removing the Antenna" on page 63.
6. Remove the two securing screws from the bottom of the chassis.





Step	Size	Quantity	Screw Type
LCD Module	M2.5*8(NL)	2	

7. Turn the computer over. Disconnect the three LCD interface cables from the chassis.



8. Remove the four securing screws (two each side) from the LCD module.



Step	Size	Quantity	Screw Type
LCD Module	M2.5*8 (NL)	2	
LCD Module	M2.5*5 (NL)	2	

9. Carefully remove the LCD module from the chassis.

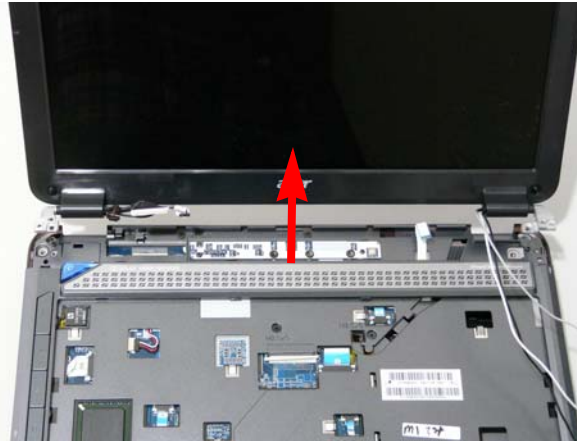

Removing the Upper Cover

1. See "Removing the Battery Pack" on page 44.
2. See "Removing the SD dummy card" on page 45.
3. See "Removing the ExpressCard dummy card" on page 46.
4. See "Removing the Lower Covers" on page 47.
5. See "Removing the DIMM Modules" on page 49.
6. See "Removing the WLAN Module" on page 50.
7. See "Removing the Hard Disk Drive Module" on page 52.
8. See "Removing the Optical Drive Module" on page 55.
9. See "Removing the Switch Cover" on page 59.
10. See "Removing the Keyboard" on page 61.
11. See "Removing the LCD Module" on page 66.
12. Turn the computer over. Remove the eight screws on the bottom panel.

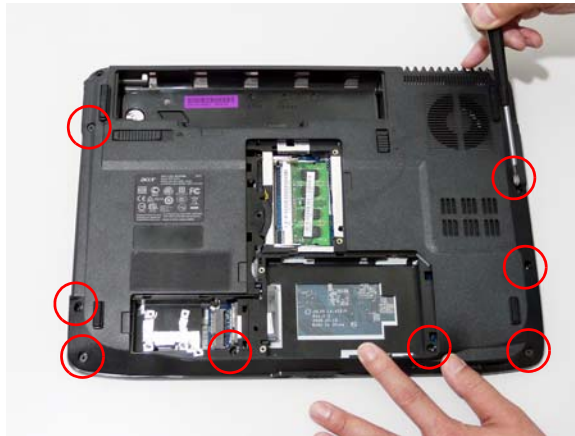

Step	Size	Quantity	Screw Type
Upper Cover	M2.5*8 (NL)	8	

13. Turn the computer over. Remove the seven screws on the top panel.

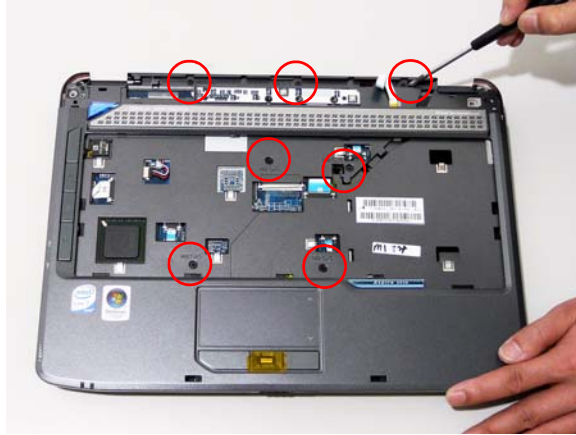

Step	Size	Quantity	Screw Type
Upper Cover	M2.5*5 (NL)	7	

14. Disconnect the five cables from the mainboard as shown.

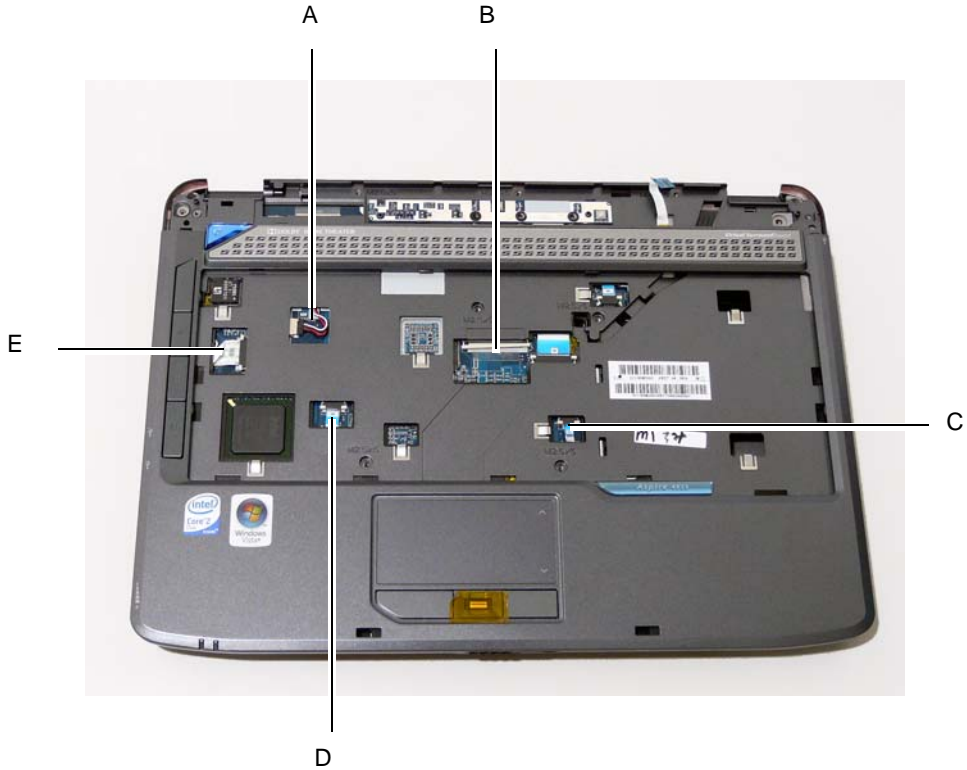

Disconnect A as shown.

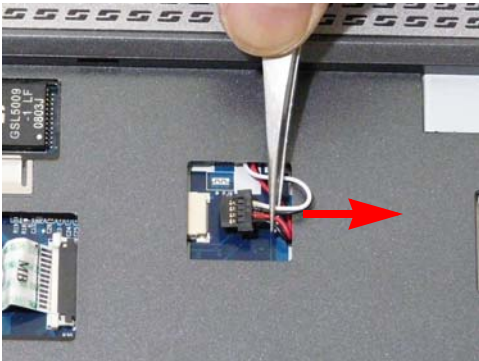

Release the securing latches and disconnect B as shown.

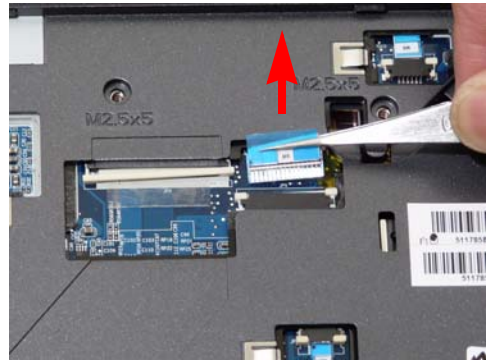

Release the securing latches and disconnect C as shown.

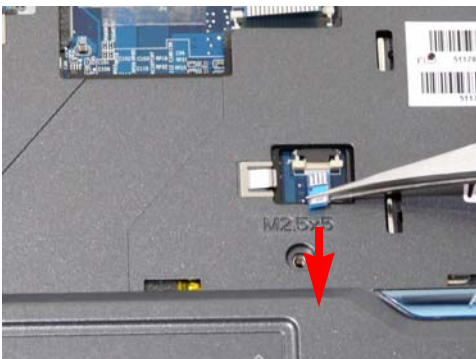

Release the securing latches and disconnect D as shown.

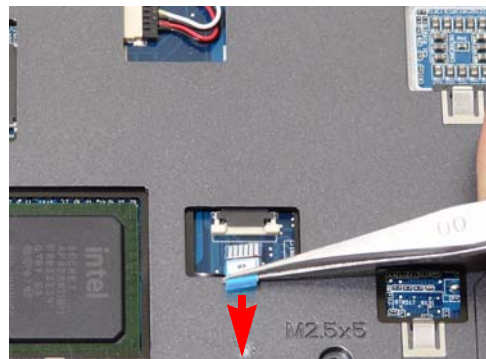

Release the securing latches and disconnect E as shown.



15. Remove the upper cover by lifting upward from the chassis, rear edge first.



16. Turn the upper cover over. The upper cover appears as follows.

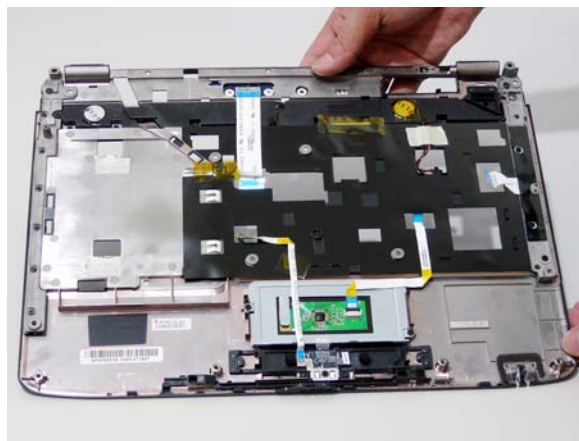

NOTE: Avoid pulling on the cables directly to prevent damage to the connectors.

NOTE: Use the pull-tabs on the FFC cables whenever available to prevent damage to the FFC cables.

Removing the Touch Pad Bracket

1. See "Removing the Upper Cover" on page 68.
2. Disconnect the Touch Pad cable from the Touch Pad board.

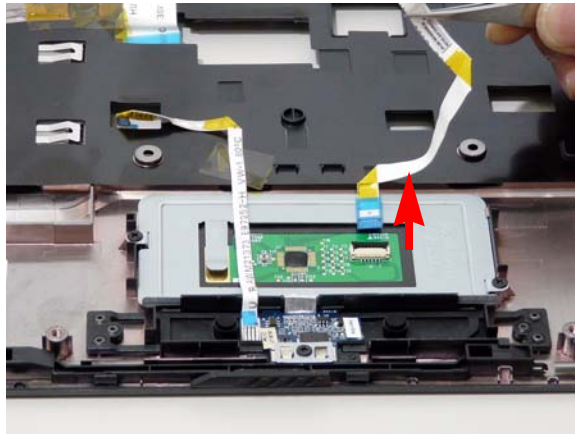
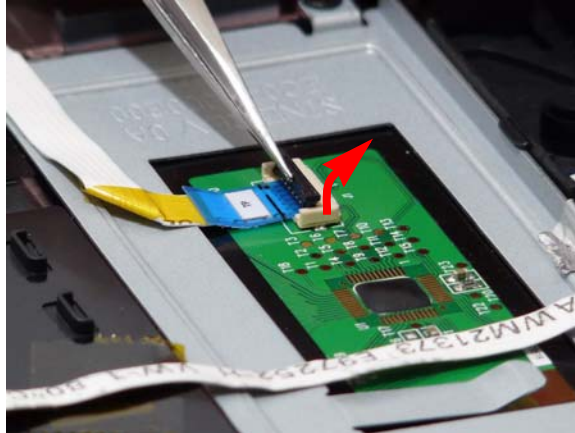

3. Move the Finger Print Reader FFC cable out of the way to prevent damage.

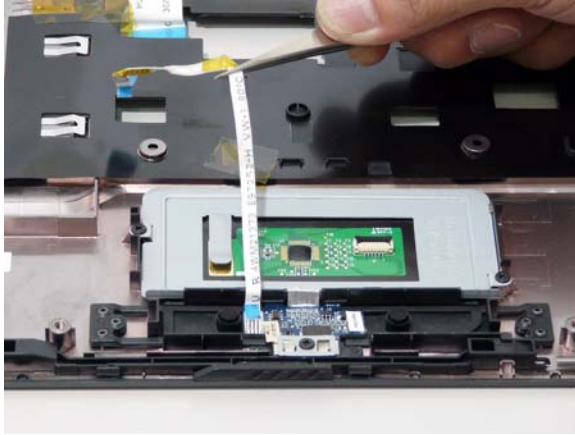

4. Remove the two securing screws from the Touch Pad bracket.

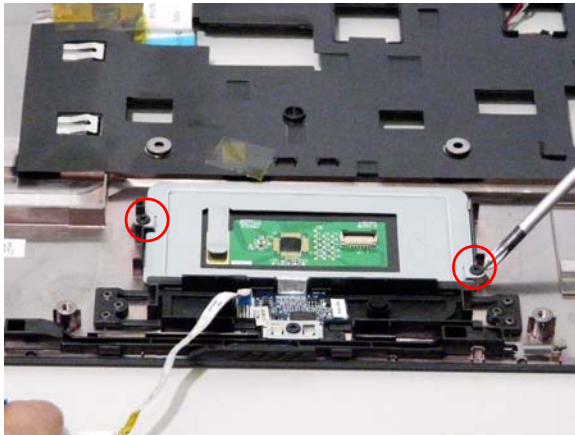

Step	Size	Quantity	Screw Type
Touch Pad Bracket	M2*3 (NL)	2	

5. Remove the Touch Pad bracket.

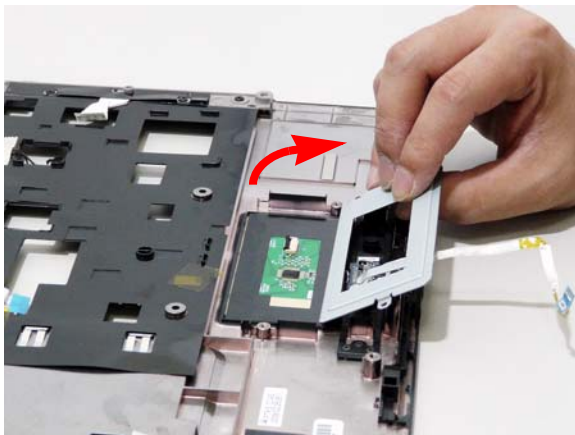

IMPORTANT:The Touch Pad cannot be removed individually. To replace the Touch Pad, replace the entire Upper Cover.

Removing the Finger Print Reader

1. See "Removing the Upper Cover" on page 68.
2. Remove the securing screw from the Finger Print Reader board.

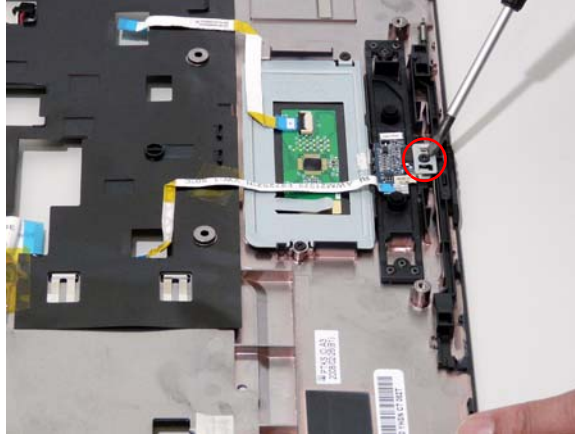

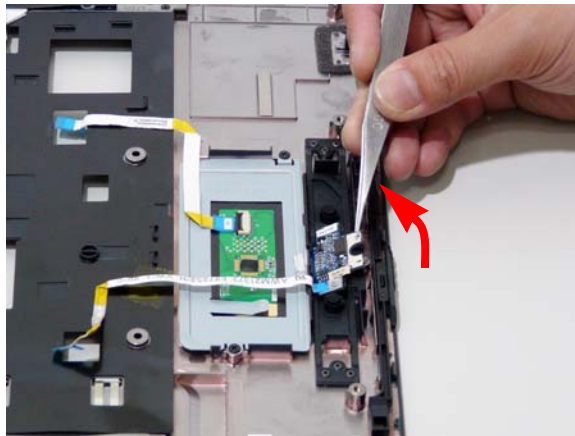

3. Remove the Finger Print Reader board from the Upper Cover.

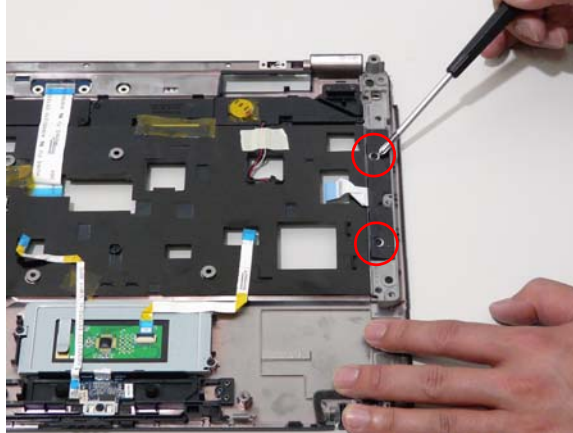

Removing the Launch Board

1. See "Removing the Upper Cover" on page 68.
2. Remove the two screws from the Launch Board.



Step	Size	Quantity	Screw Type
Launch Board	M2*3 (NL)	2	

3. Remove the Launch Board from the Upper Cover.

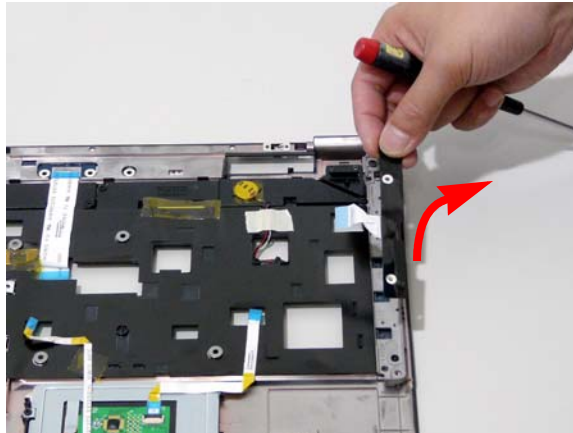

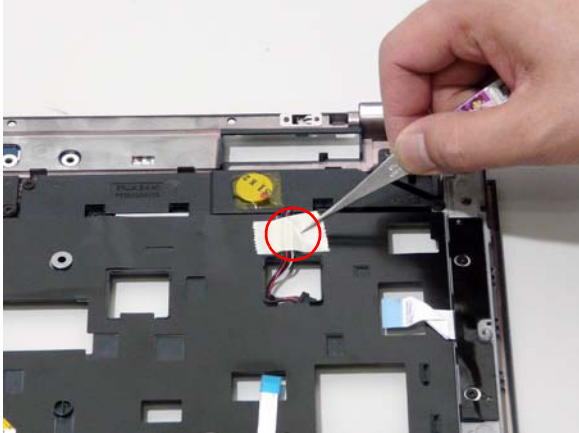

Removing the Speaker Module

1. See "Removing the Upper Cover" on page 68.
2. Remove the adhesive tape from the speaker cable.

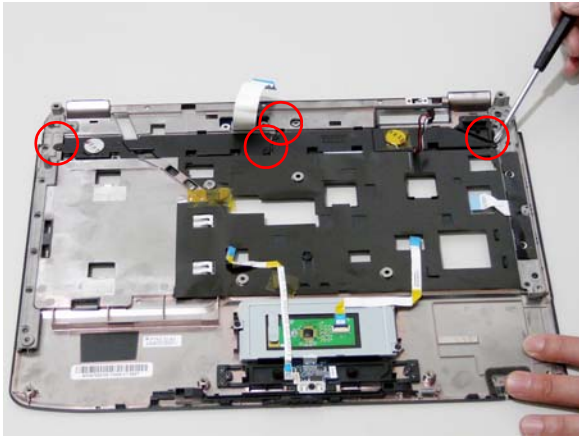

3. Remove the four screws holding the Speaker Module in place.



Step	Size	Quantity	Screw Type
Speaker	M2*3 (NL)	4	

4. Remove the Speaker Module from the upper cover.

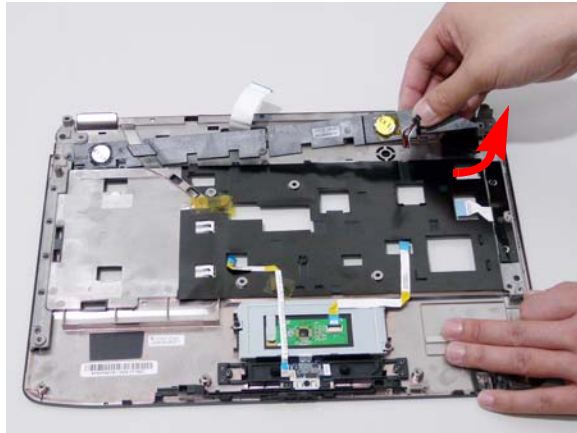

Removing the Switch Board

1. See "Removing the Upper Cover" on page 68.
2. Ensure the Switch Board cable is free from any obstructions.

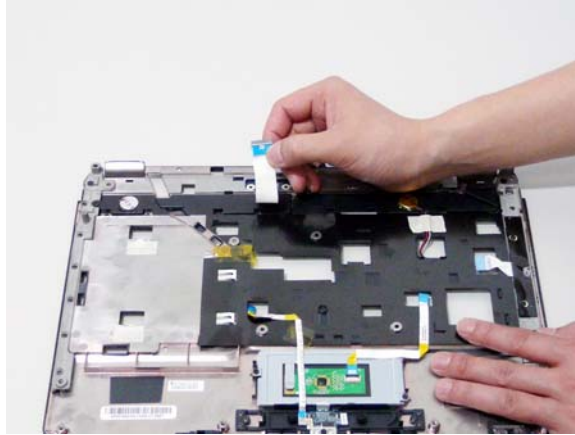

3. Turn the Upper Cover. Remove the Switch Board as shown.



Removing the Touch Pad Board

IMPORTANT:The Touch Pad board is integrated into the design of the Upper Cover. To replace the Touch Pad board, remove all components from the Upper Cover and install an entirely new Upper Cover.

IMPORTANT:The MOSFET pad is attached to the Upper Cover and is reusable. If the replacement Upper Cover does not have a MOSFET pad (see highlighted area below), remove the MOSFET pad from the replaced Upper Cover and stick it to the new Upper Cover.

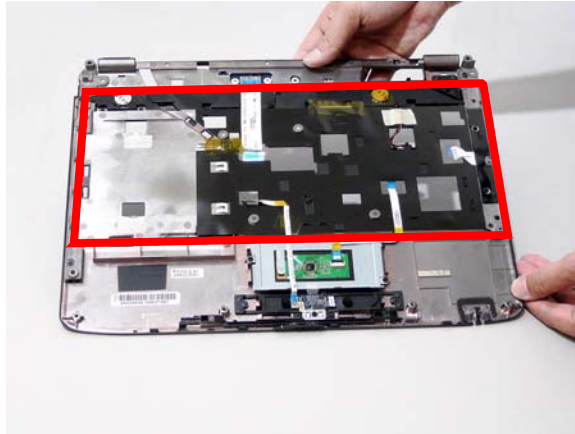

1. See “Removing the Battery Pack” on page 44.
2. See “Removing the SD dummy card” on page 45.
3. See “Removing the ExpressCard dummy card” on page 46.
4. See “Removing the Lower Covers” on page 47.
5. See “Removing the DIMM Modules” on page 49.
6. See “Removing the WLAN Module” on page 50.
7. See “Removing the Hard Disk Drive Module” on page 52.
8. See “Removing the Optical Drive Module” on page 55.
9. See “Removing the Keyboard” on page 61.
10. See “Removing the LCD Module” on page 66.
11. See “Removing the Upper Cover” on page 68.
12. See “Removing the Touch Pad Bracket” on page 72.
13. See “Removing the Finger Print Reader” on page 74.
14. See “Removing the Launch Board” on page 75.
15. See “Removing the Speaker Module” on page 76.
16. See “Removing the Switch Board” on page 78.

Removing the I/O Board

- 1. See "Removing the Upper Cover" on page 68.
- 2. Remove the securing screw from the I/O Board.

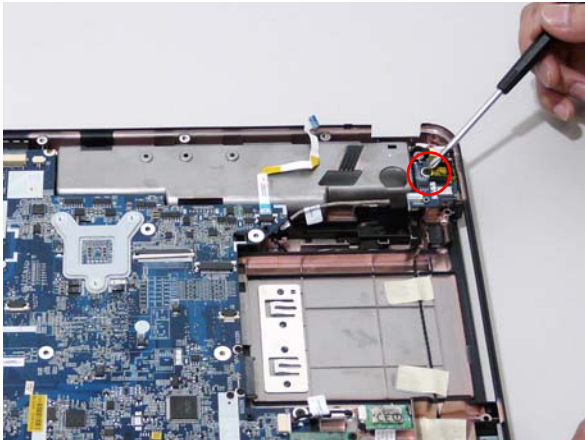

Step	Size	Quantity	Screw Type
I/O Board	M2.5*5 (NL)	1	

- 3. Lift the I/O Board clear of the Lower cover.

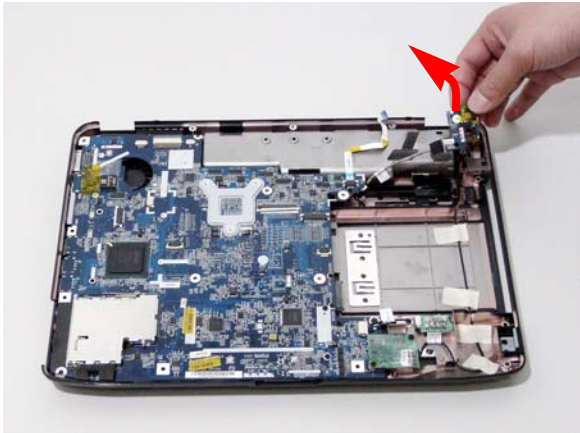

4. Disconnect the I/O Board cable and remove the board.



Removing the Bluetooth module

- 1. See "Removing the Upper Cover" on page 68.
- 2. Remove the securing screw from the Bluetooth module.



Step	Size	Quantity	Screw Type
Bluetooth Board	M2*3 (NL)	1	

- 3. Lift the Bluetooth module away from the mainboard and disconnect the mainboard cable.

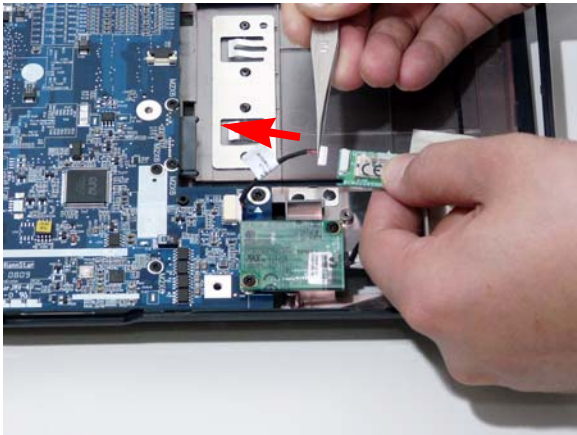

4. Disconnect the cable from the mainboard.

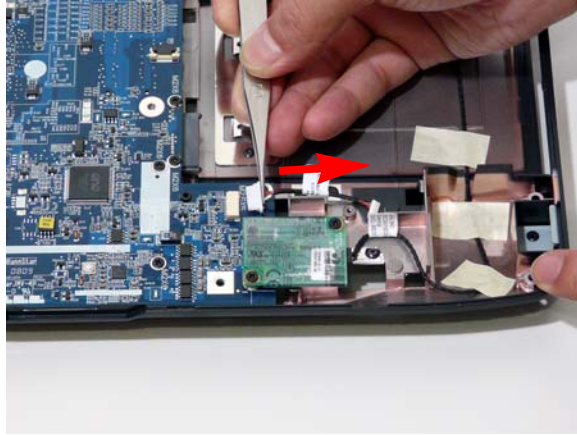

Removing the Modem Module

1. See "Removing the Upper Cover" on page 68.
2. Remove the adhesive strip securing the Modem cable to the Lower Cover.

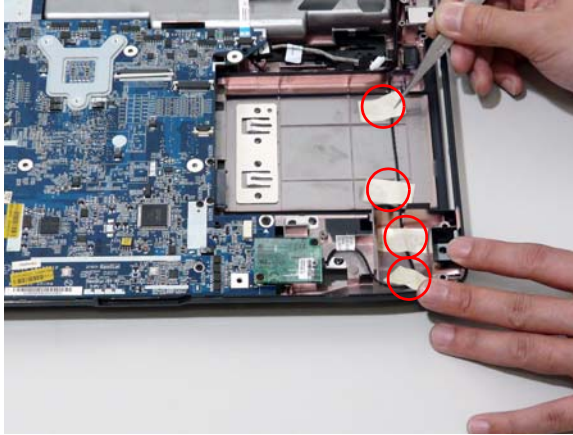

3. Remove the RJ-11 port from the leftside of the Lower Cover.

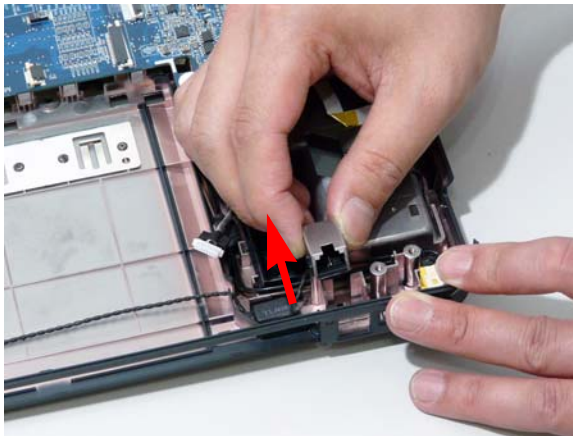

4. Disconnect the Modem cable from the Modem module.



5. Remove the two screws securing the Modem module.

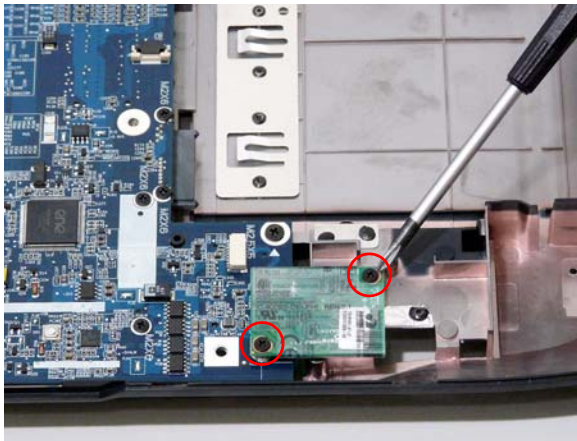

Step	Size	Quantity	Screw Type
Modem Module	M2*3 (NL)	2	

6. Remove the Modem module from the Lower Cover.



Removing the Main Board

1. See "Removing the Upper Cover" on page 68.
2. Disconnect the power jack from the power port on the Lower Cover.

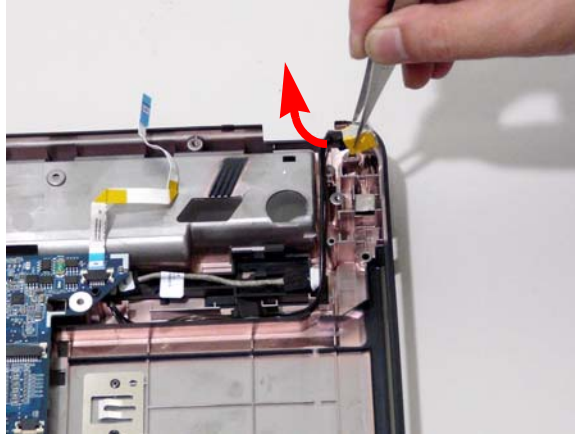

3. Lift the cabling clear of the securing pins and ensure it is free of obstruction.

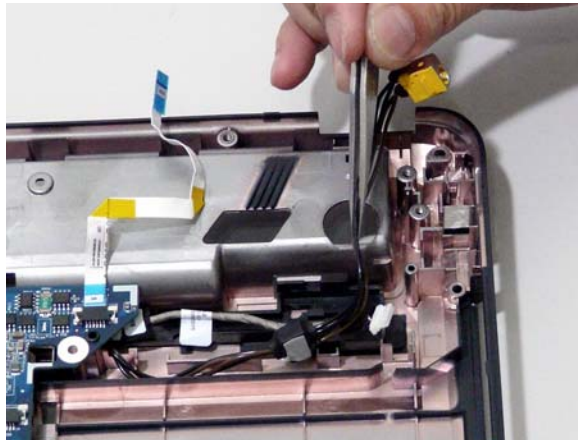

4. Remove the securing screw from the Mainboard.

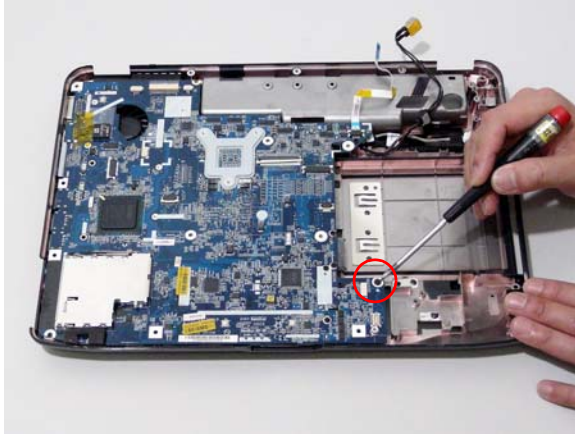

Step	Size	Quantity	Screw Type
Mainboard	M2.5*5 (NL)	1	

5. Remove the main board, rightside first, as shown.

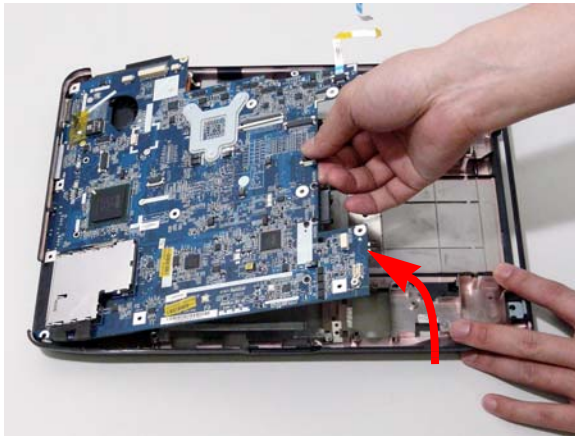

6. Release the securing latches and remove the Switch Cover FFC.

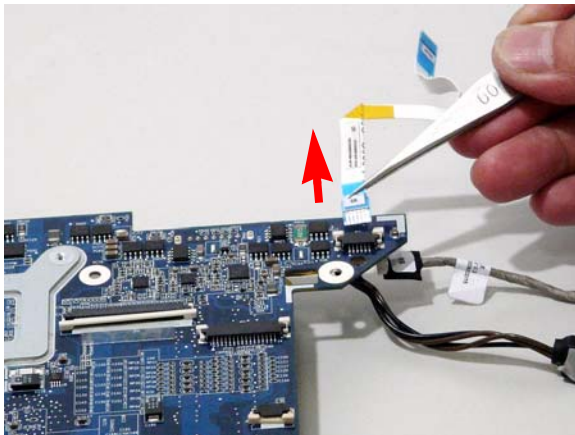

7. Turn the Mainboard over. Disconnect the I/O Cable from the Mainboard.

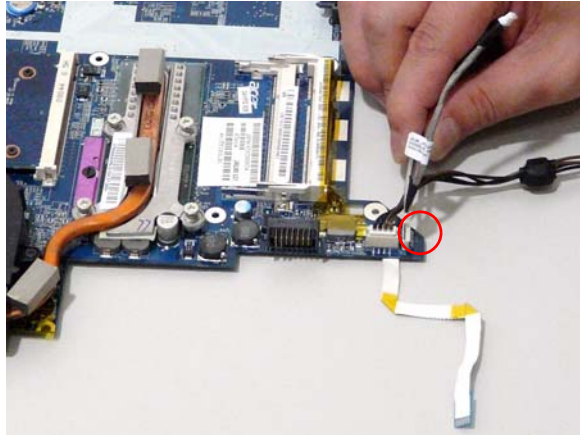

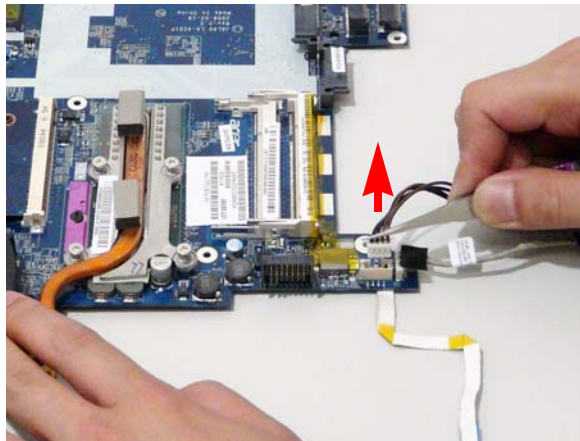

8. Disconnect the DC IN Cable from the Mainboard.

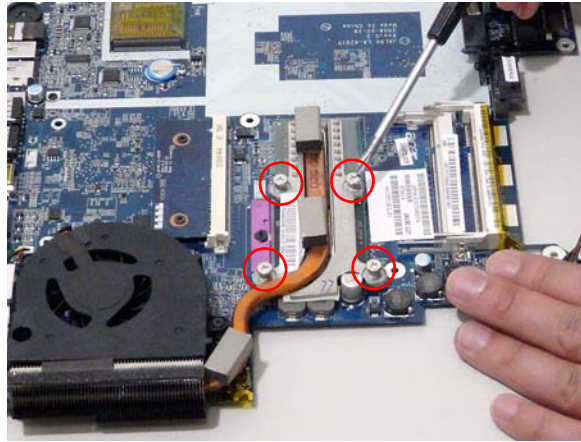

Removing the Thermal Module

1. See "Removing the Main Board" on page 86.
2. Remove the four securing screws from the Thermal Module.



Step	Size	Quantity	Screw Type
Thermal Module	M2.5*6.5	4	

3. Lift the Thermal Module clear of the Mainboard.

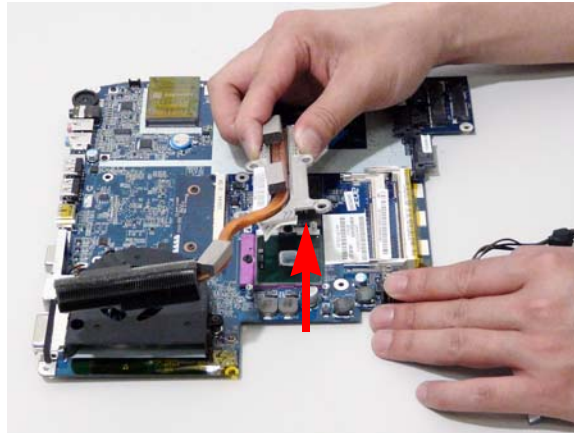

Removing the CPU

1. See “Removing the Main Board” on page 86.
2. See “Removing the Thermal Module” on page 89.
3. Using a flat screwdriver, turn the CPU socket latch counter-clockwise 180° to release the CPU.

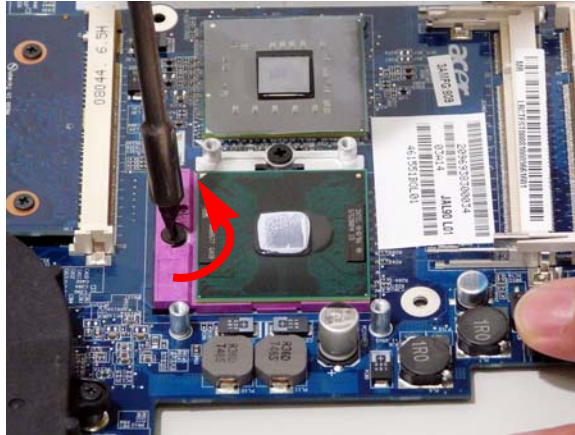

4. Lift the CPU clear of the Mainboard.



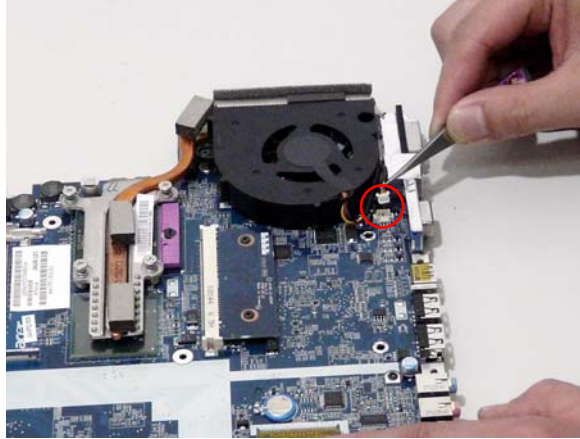

Removing the CPU Fan

1. See "Removing the Main Board" on page 86.
2. Disconnect the Fan cable from the Mainboard.

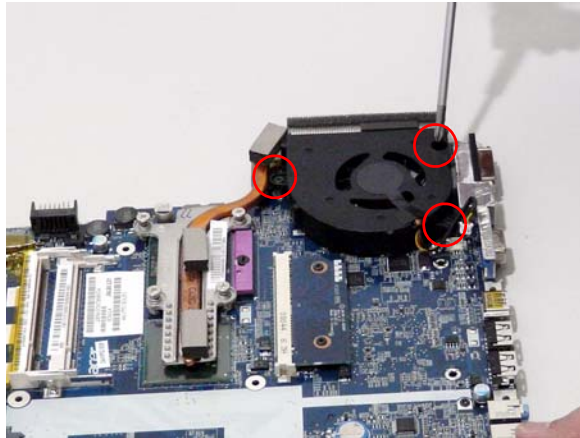

3. Remove the three securing screws from the Fan module.



Step	Size	Quantity	Screw Type
CPU Fan	M2*4-NI (NL)	3	

4. Lift the Fan module clear of the Mainboard.

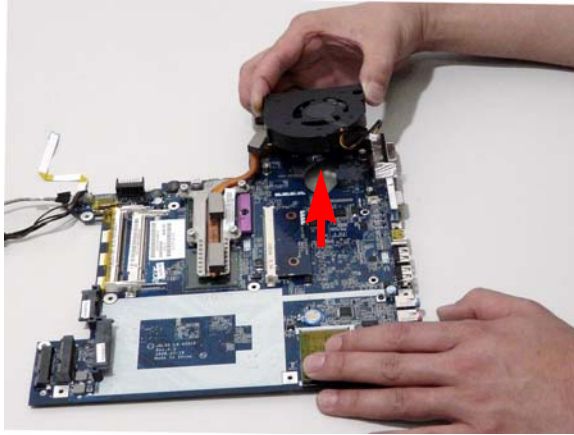

Removing the HDMI Module

1. See "Removing the Main Board" on page 86.
2. Remove the two securing screws from the HDMI Module.

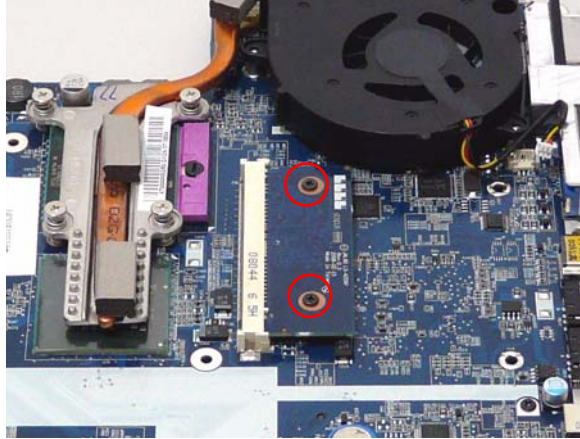

Step	Size	Quantity	Screw Type
HDMI Module	M2*4-NI (NL)	2	

3. Remove the HDMI Module as shown.

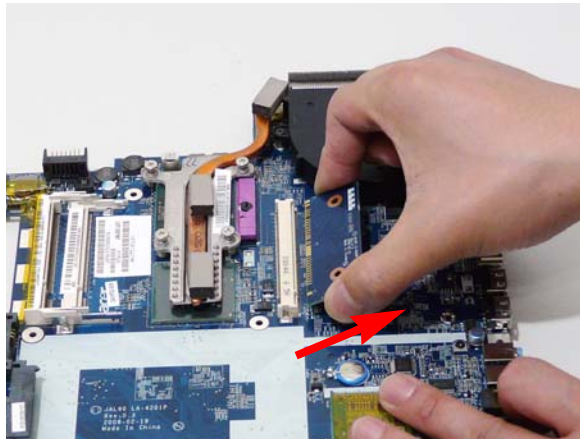

LCD Module Disassembly Process

LCD Module Disassembly Flowchart

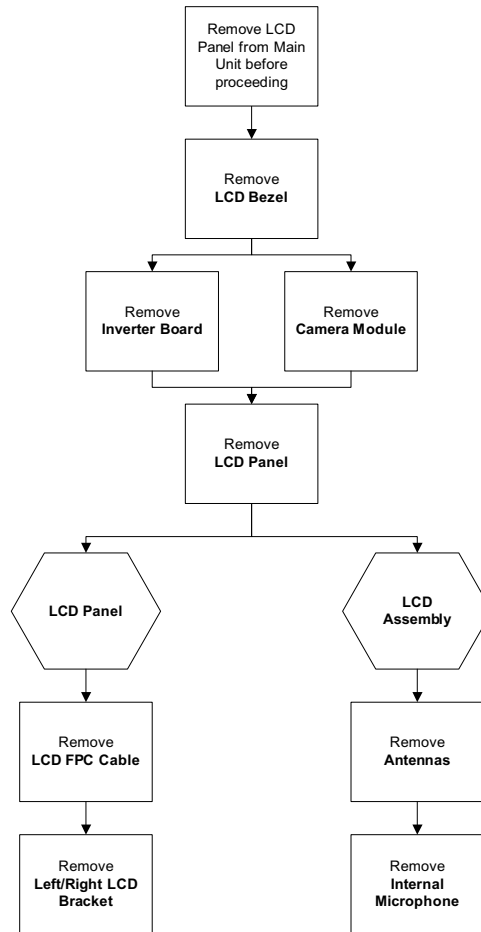

Screw List

Step	Screw	Quantity	Color	Part No.
LCD Bezel	M2.5*5 (NL)	4	Black	86.AR102.002
Inverter Board	M2.5*5 (NL)	1	Black	86.AR102.002
Camera Module	M2*3 (NL)	2	Black	86.AR102.004
LCD Panel	M2.5*5 (NL)	2	Black	86.AR102.002
LCD Brackets	M2*3 (NL)	8	Black	86.AR102.004

Removing the LCD Bezel

1. See "Removing the LCD Module" on page 66.
2. Remove the two upper and two lower bezel screw caps.



3. Remove the four securing screws from the LCD module.



Step	Size	Quantity	Screw Type
LCD Bezel	M2.5*5 (NL)	4	

-
- Starting from the inside edges of the bezel, pry the bezel upwards and away from the panel. Move along the sides until all sides of the bezel are removed.

NOTE: If necessary, use a plastic pry to lift up the outside edges of the bezel.



Removing the Inverter Board

1. See "Removing the LCD Bezel" on page 95.
2. Disconnect the left and right Inverter board cables as shown.

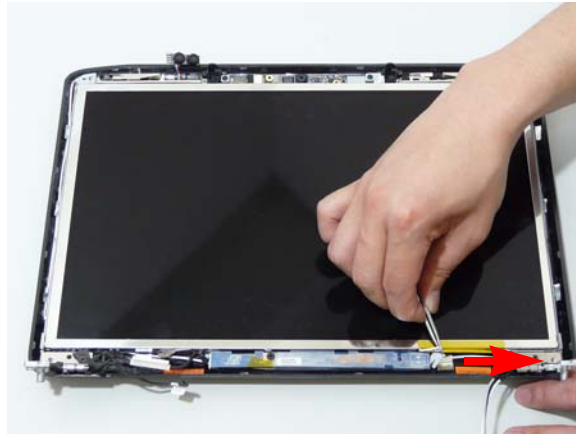

3. Remove the securing screw from the Inverter board.



Step	Size	Quantity	Screw Type
Inverter Board	M2.5*5 (NL)	1	

4. Lift the Inverter board clear of the LCD Module.



Removing the Camera Module

- 1. See "Removing the LCD Bezel" on page 95.
- 2. Disconnect the Camera Module cable as shown.



- 3. Remove the two securing screws from the Camera Module.



Step	Size	Quantity	Screw Type
Camera Module	M2*3 (NL)	2	

4. Lift the Camera Module clear of the LCD Module.



Removing the LCD Panel

1. See "Removing the LCD Bezel" on page 95.
2. Remove the two securing screws from the LCD Module.

IMPORTANT:The leftside screw holds the ground connector in place. Ensure that the ground is replaced during reassembly.



Step	Size	Quantity	Screw Type
LCD Panel	M2.5*5 (NL)	2	

3. Lift the LCD Panel clear of the LCD Module.



Removing the LCD Brackets and FPC Cable

1. See "Removing the LCD Panel" on page 101.
2. Turn the LCD panel over to expose the rear. Disconnect the cable from the LCD Panel using the tab provided.

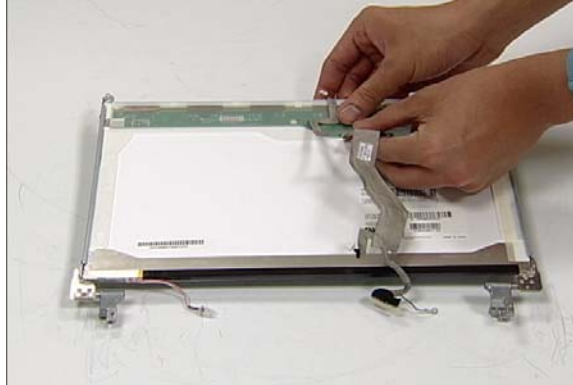

3. Grip the FPC cable and lift upward to detach the adhesive pads.

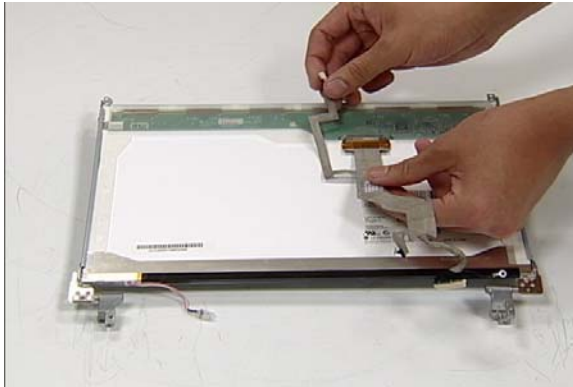

4. Remove the eight securing screws (four on each side) from the LCD Panel brackets.

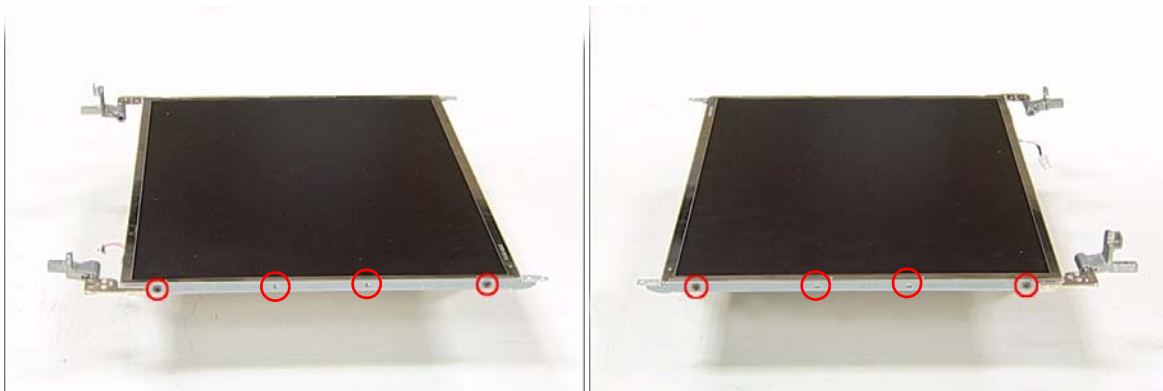

Step	Size	Quantity	Screw Type
LCD Brackets	M2*3 NL	8	

5. Remove the LCD brackets by pulling away from the LCD Panel as shown.

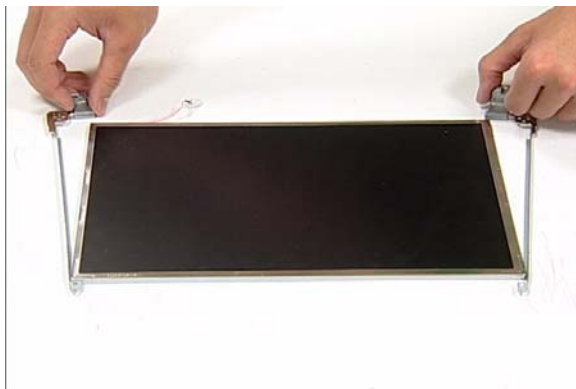

Removing the Antennas

1. See "Removing the LCD Panel" on page 101.
2. Remove the strips holding the antenna cables in place. Ensure the cables are free from obstructions.

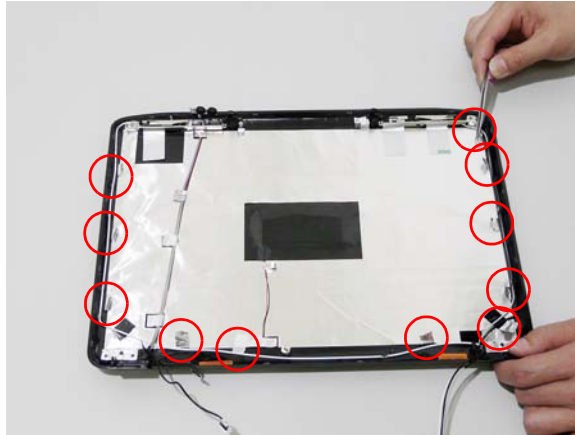

3. Remove the tab securing the left and right antennas to the LCD module.

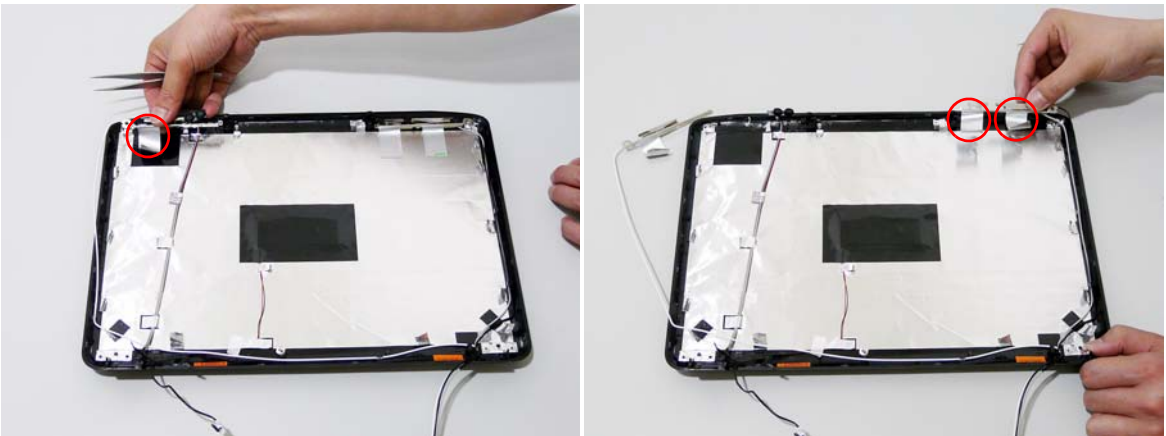

4. Remove the antenna cables and assembly from the LCD module.

Removing the MIC Module

1. See "Removing the Antennas" on page 104.
2. Remove the strips holding the MIC Module cable in place. Ensure the cable is free from obstructions.

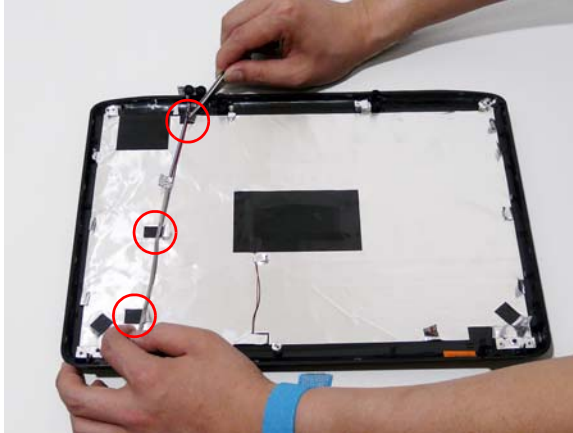

3. Remove the MIC cable and Module from the LCD module.

LCD Module Reassembly Procedure

Replacing the LCD Panel

1. Align the LCD brackets with the eight screw holes (four on each side) on the LCD Panel as shown.

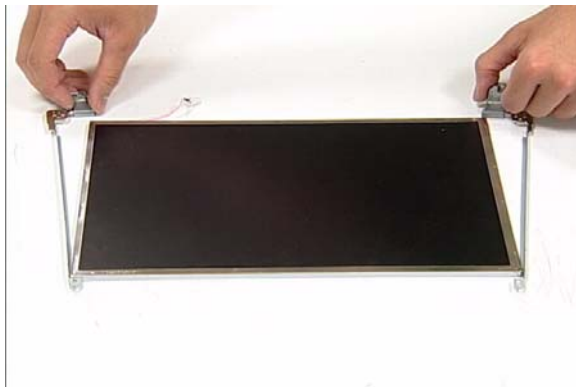

2. Secure the LCD brackets to the LCD panel.

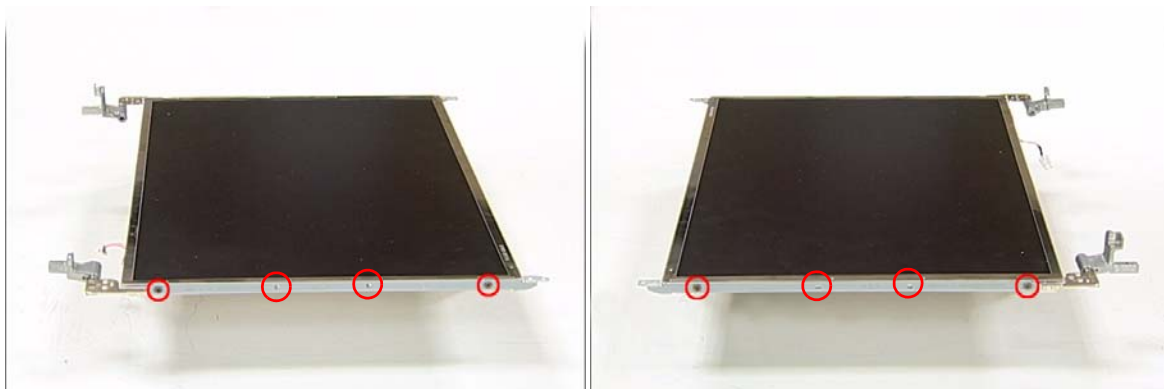

3. Turn the panel over. Insert the LCD Panel cable into the LCD Panel as shown.

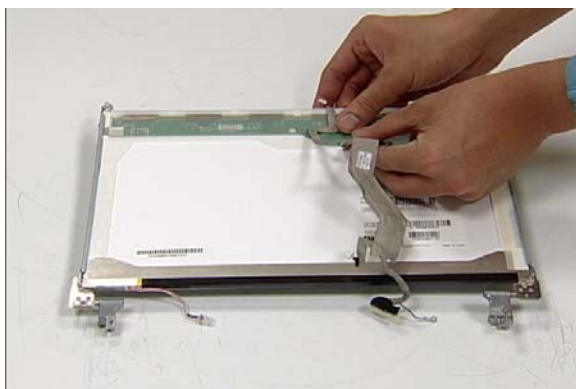

4. Align the LCD Panel cable as shown and press down to engage the adhesive pads.

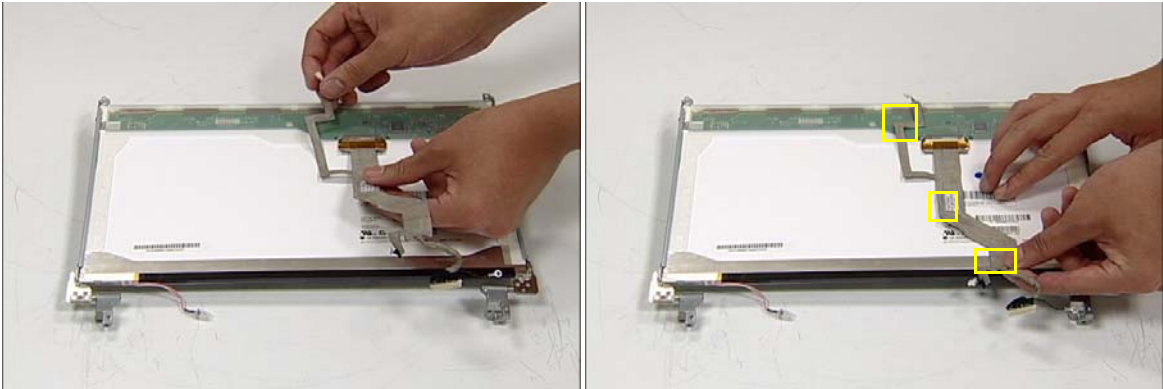

5. Replace the MIC cable under the mylar tab strips, and replace the MIC as shown. Secure the cable by pressing down on the strips.

6. Replace the antenna cable as shown. Ensure that the cable is inserted under each tab strip.

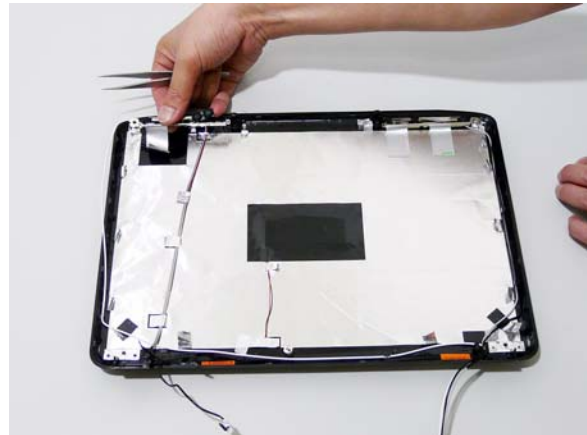
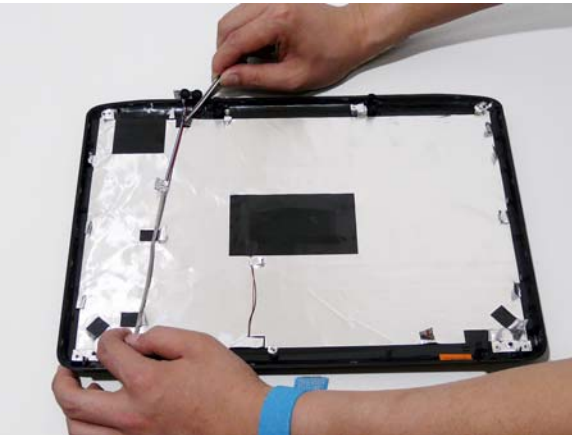

7. Secure the cable by pressing down on the securing strip.

8. Place the LCD Panel in the back cover.

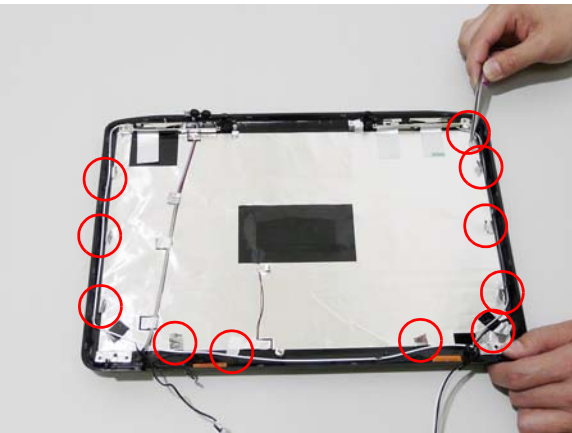

9. Secure the LCD module with the two securing screws.

IMPORTANT: Ensure that the ground connector is secured in place with the leftside panel screw.

10. Insert the Camera Module (adhesive side down), and secure by pressing down to insure cohesion.



11. Replace the two securing screws.

12. Connect the Camera Module cable.



13. Replace the Inverter board and secure with the single screw.



14. Connect the left and right Inverter cables.

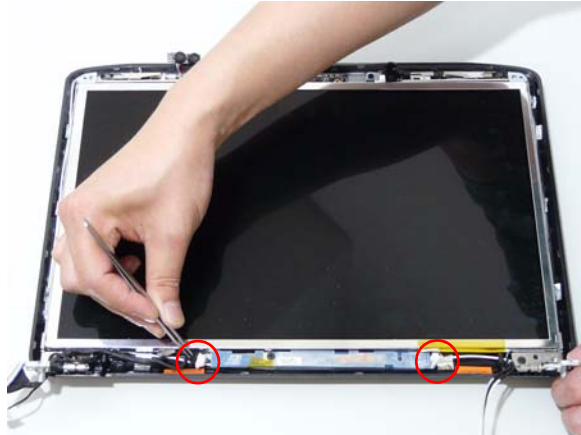

Replacing the LCD Bezel

1. Locate the bezel correctly and press down the edges until there are no gaps between the bezel and the LCD Module,



2. Replace the four screws and the rubber screw caps provided.



Main Module Reassembly Procedure

Replacing the CPU

1. Carefully turn the mainboard upside down (CPU side up), and insert the CPU into the CPU bracket as shown.
2. Using a plastic screw driver, lock the CPU in the socket as shown.



Replacing the Thermal Module

1. Align and place the Thermal Module in the mounting as shown.

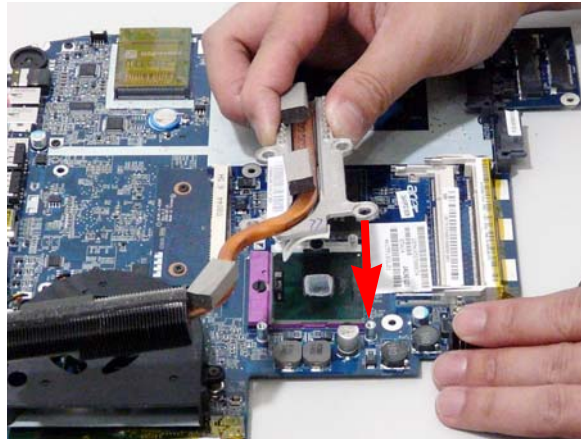

2. Replace the four securing screws to secure the Thermal Module.

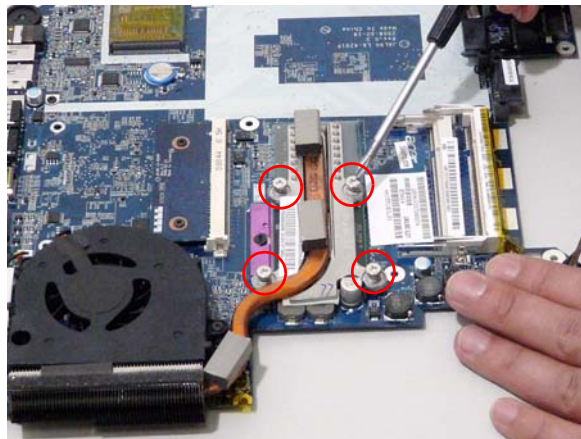

Replacing the CPU Fan Module

1. Align the Fan Module on the screw brackets.
2. Replace the 3 screws and secure.

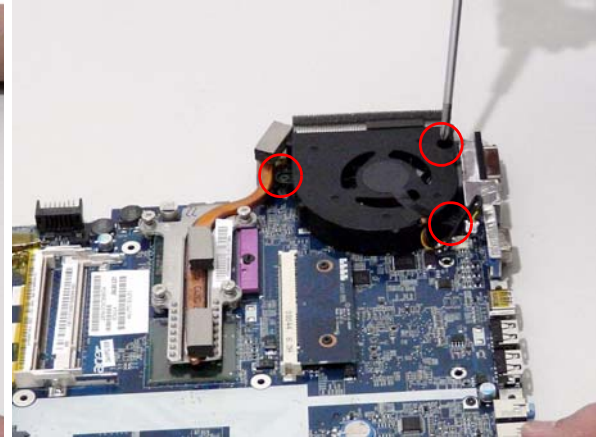

3. Connect the Fan cable to the Mainboard.

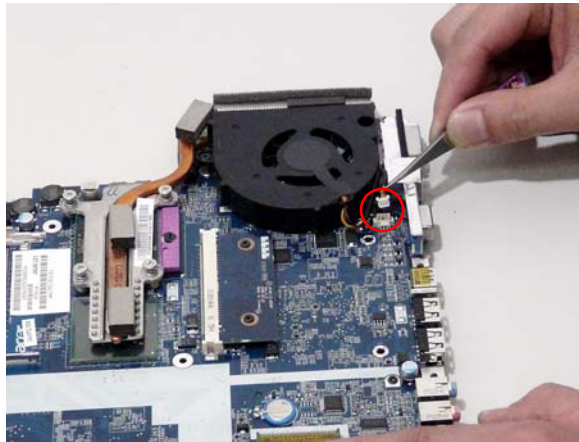

Replacing the HDMI Module

1. Insert the HDMI Module as shown, and press down to locate in place.
2. Replace the 2 screws to secure.

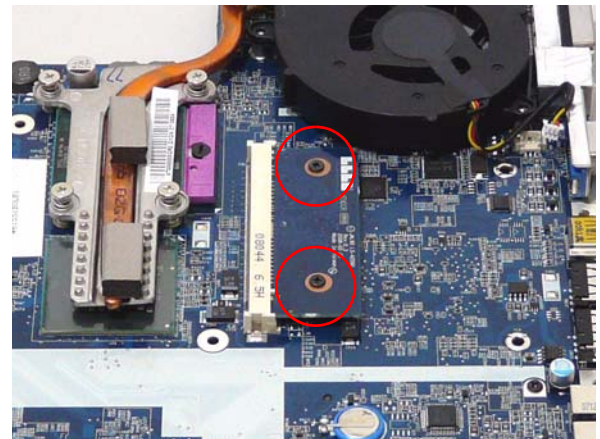
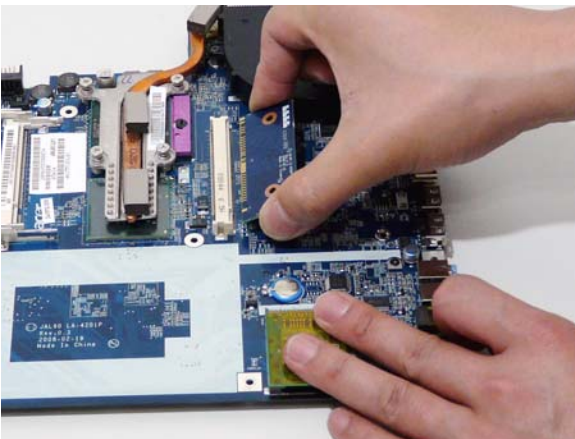

Replacing the Mainboard

1. Turn the Mainboard over. Connect the DC IN Cable to the Mainboard.
2. Connect the I/O Cable to the Mainboard.

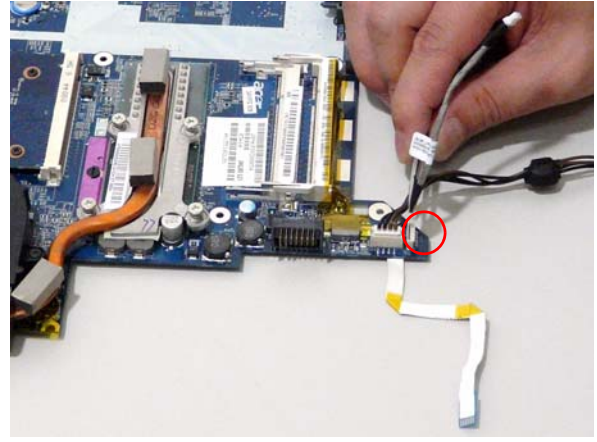
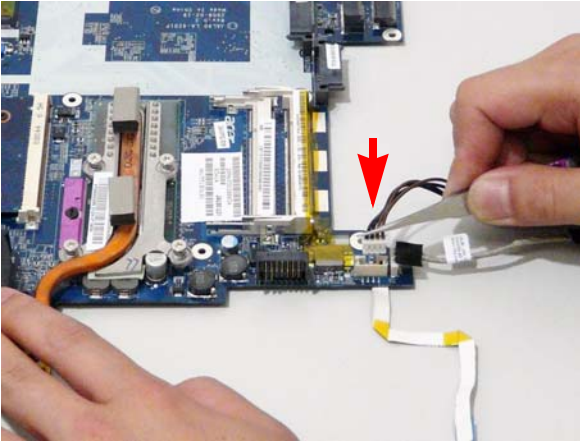

3. Replace the Switch Cover FFC and lock the securing latches in place.

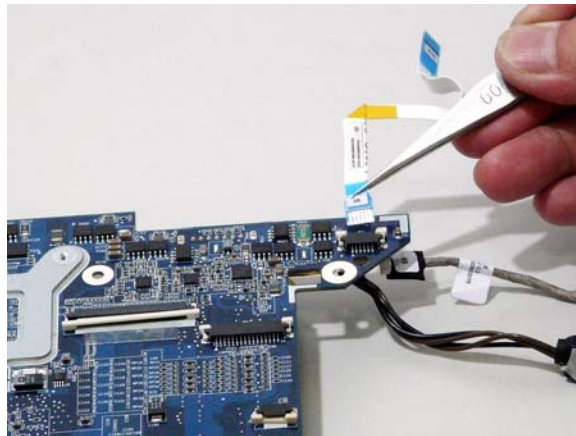

4. Ensure that the Mainboard is face up (the Heatsink and CPU are not visible). Place the Mainboard in the chassis, rear edge first, and press down to install. Replace the two securing screws as shown.

NOTE: Make sure the I/O ports are positioned correctly through the lower cover, and the screw sockets are visible through the mainboard.

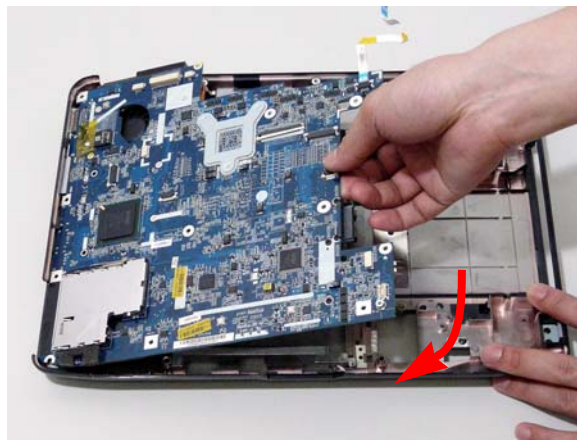

5. Replace the securing screw.

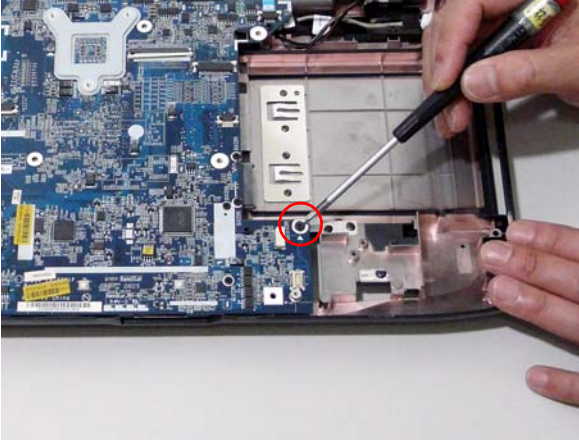

6. Replace the cabling through the securing pins.

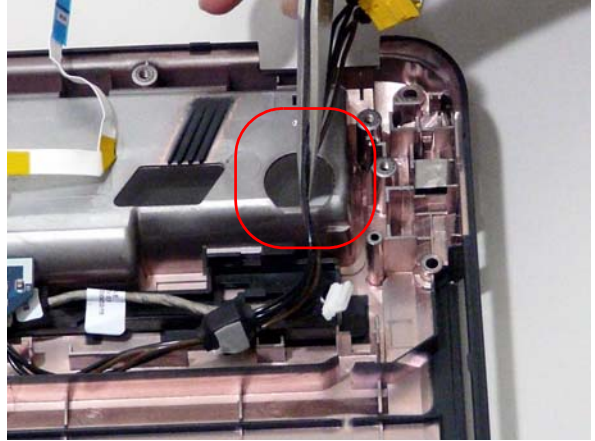

7. Connect the power jack to the power port on the Lower Cover.

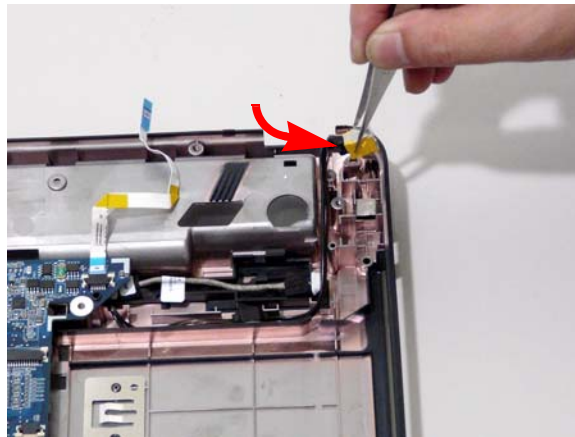

Replacing the I/O Board

1. Connect the FFC to the I/O Board

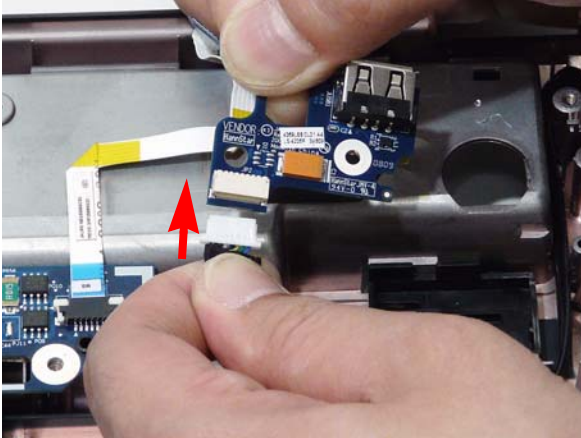

2. Locate the I/O over the lower cover and replace.

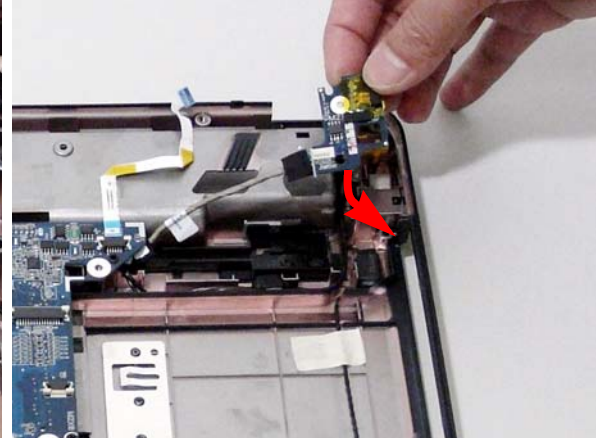

3. Replace the single securing screw.

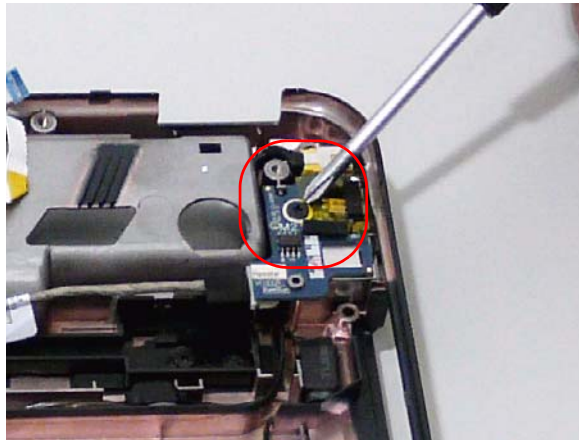

Replacing the Bluetooth Board

1. Connect one end of the Bluetooth cable to the mainboard as shown.

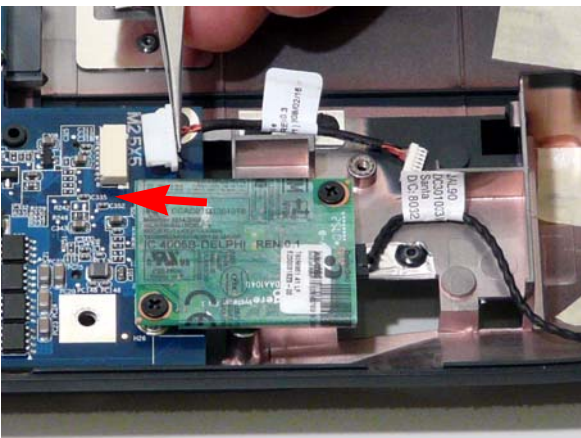

2. Connect the other end of the Bluetooth cable to the Bluetooth Module as shown.

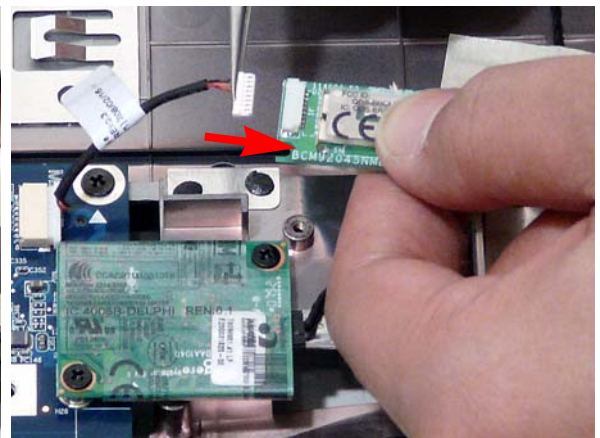

3. Locate the Bluetooth Module and replace the single securing screw.

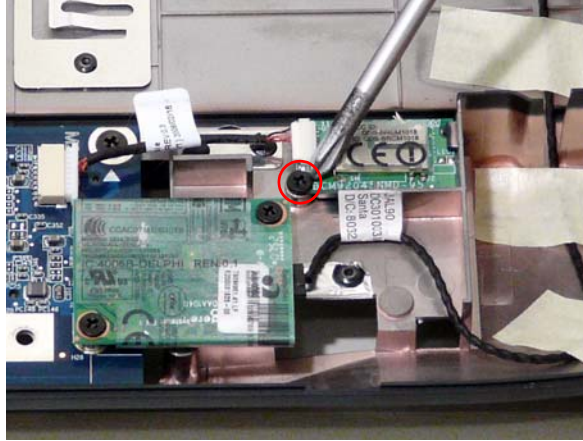

Replacing the Modem Module

1. Replace the Modem Module and secure the two screws as shown.

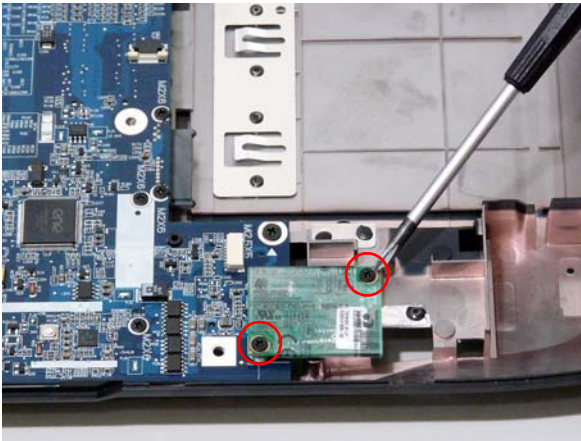

2. Connect the Modem cable to the Modem Module as shown.

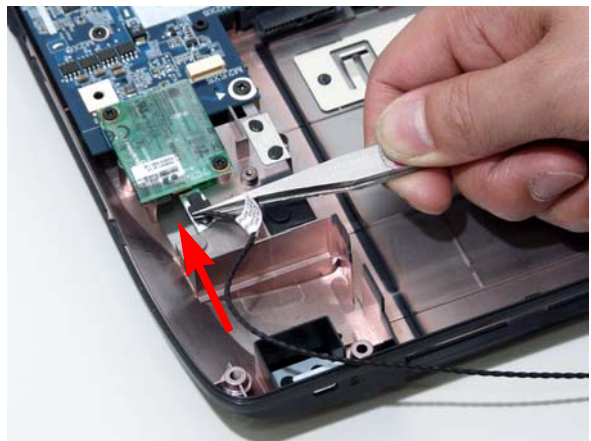

3. Connect the RJ-11 port to the left side of the Lower Cover.



4. Replace the adhesive strips to secure the Modem cable to the Lower Cover.

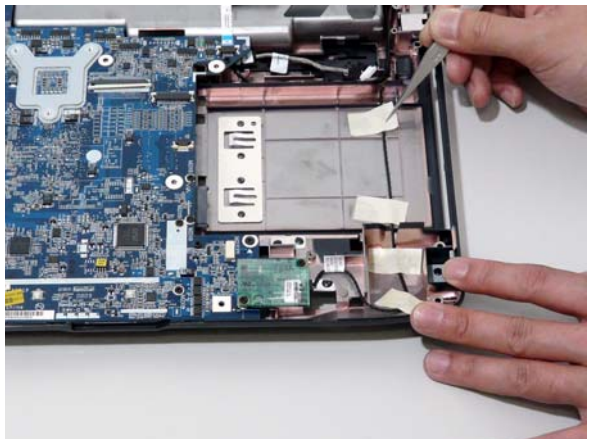

Replacing the Finger Print Reader

1. Replace the Finger Print Reader board in the upper cover.

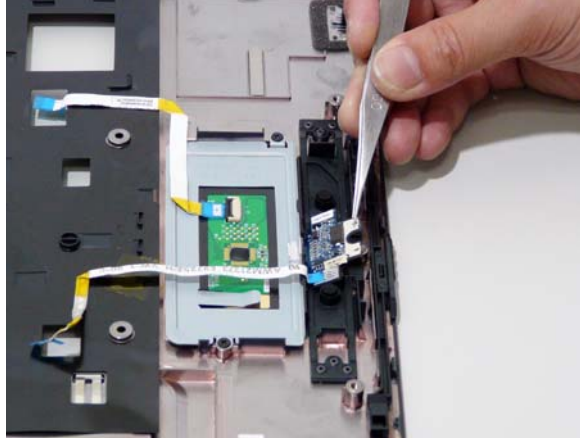

2. Replace the securing screw.

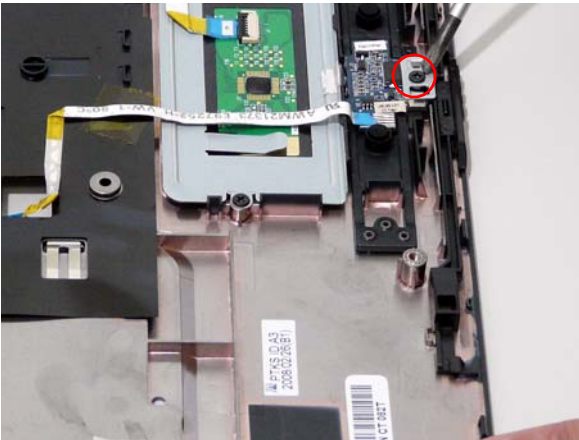

3. Secure the FFC to the upper cover by using the adhesive tape.

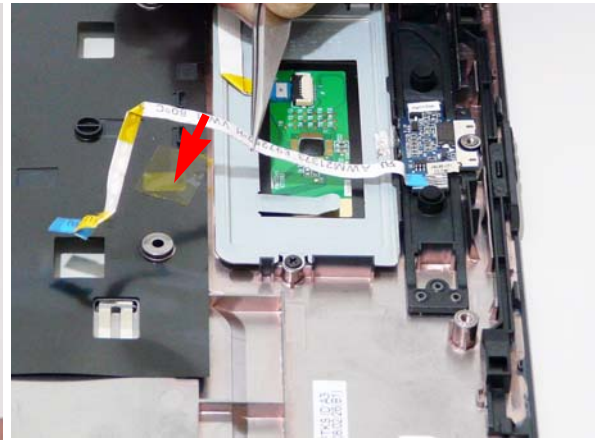

Replacing the Touch Pad Bracket

IMPORTANT: The Touch Pad cannot be removed individually. To replace the Touch Pad, replace the entire Upper Cover.

1. Replace the Touch Pad bracket.

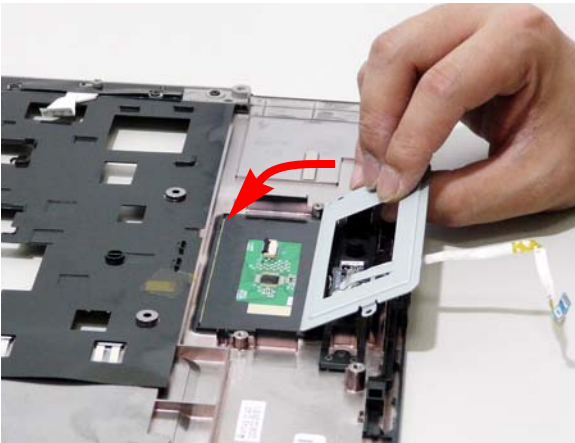

2. Replace the two securing screws from the Touch Pad bracket.

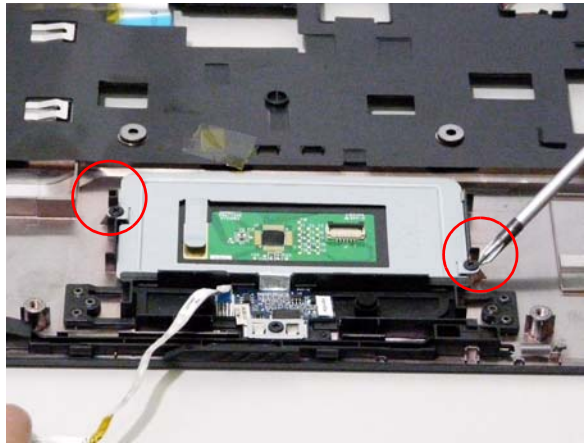

3. Replace the Finger Print reader FFC and secure with the adhesive strips.

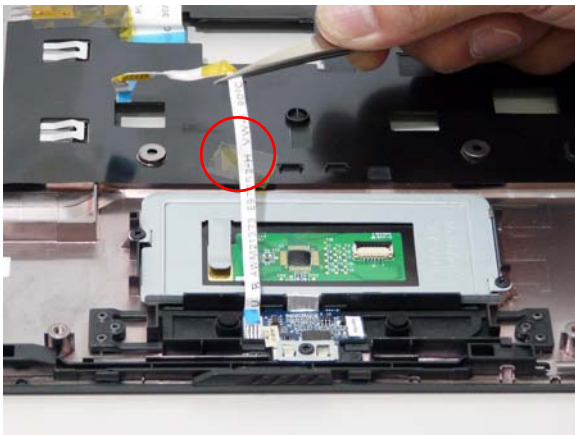

4. Replace the Touch Pad FFC and secure with the adhesive strips.

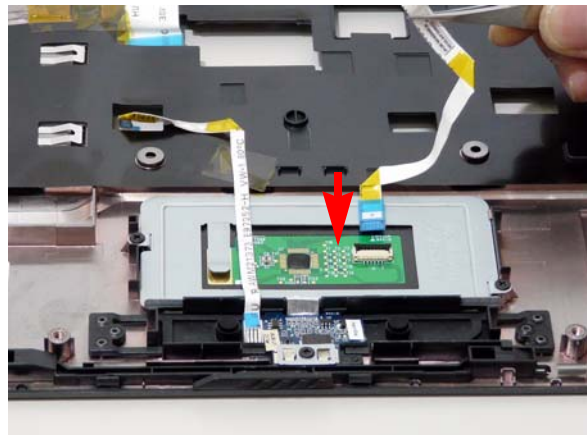

5. Connect the Touch Pad cable to the Touch Pad board.

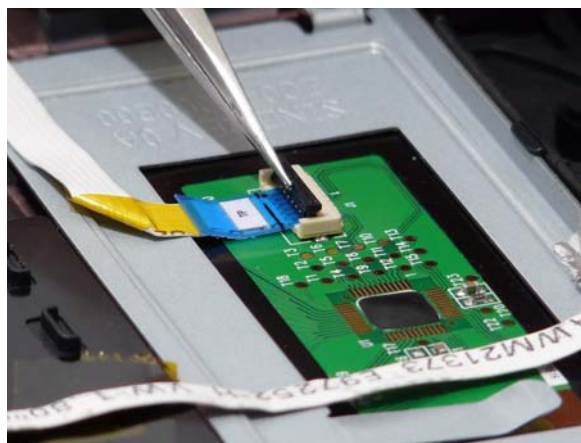

Replacing the Launch Board

1. Replace the Launch Board on the upper cover.
2. Replace the two securing screws.

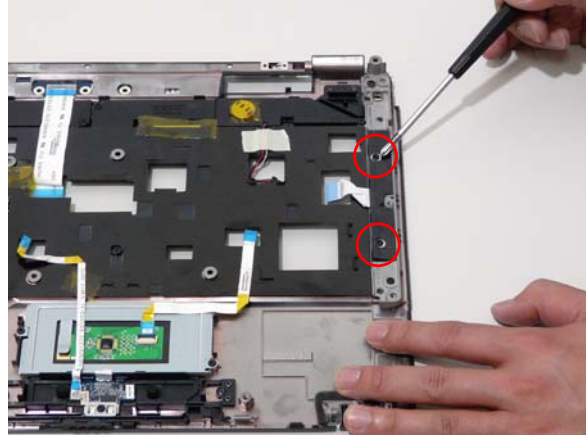
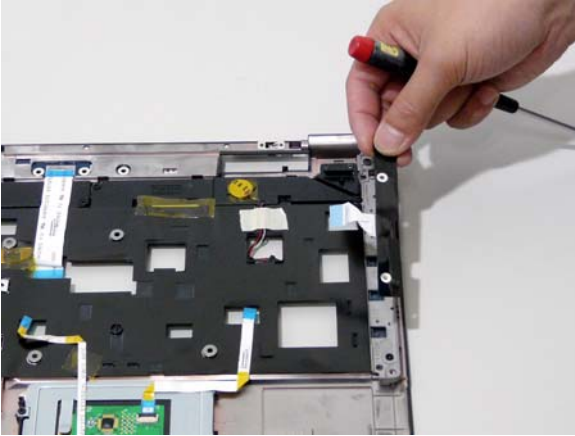

Replacing the Switch Board

1. Turn the Upper Cover over and insert the FFC through the cover as shown.
2. Flip the Upper Cover over and replace the Switch Board as shown.

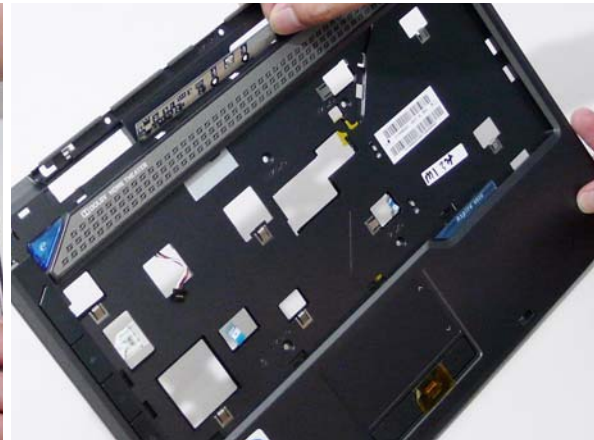
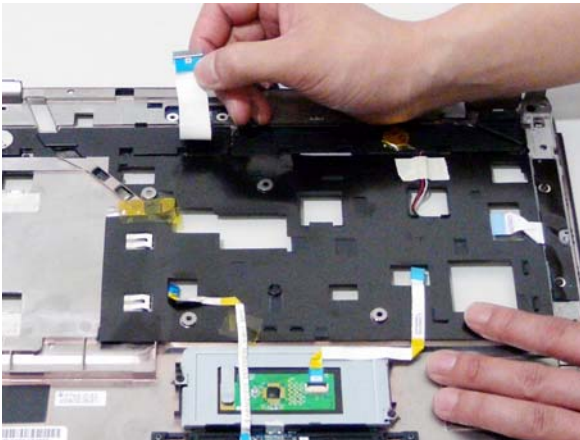

Replacing the Antenna Cables

Ensure that the three Antenna cables pass through the Mainboard and are accessible from the underside of lower cover.

1. Insert the Antenna Cables through the Upper Cover. Make sure they are accessible from the underside.
2. Secure the cables in place as shown.

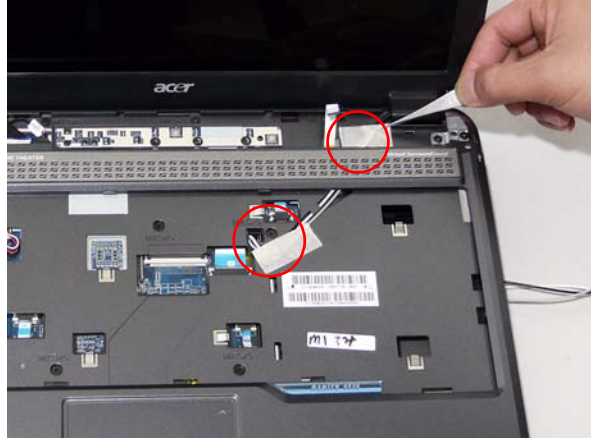

3. Pull the cables through.



4. Place the cabling in the wiring conduit as shown.

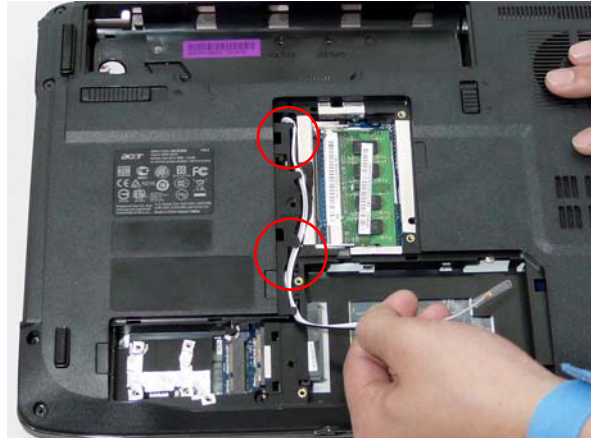

Replacing the Speaker Module

1. Align and replace the Speaker Module in the upper cover.
2. Replace the four securing screws.

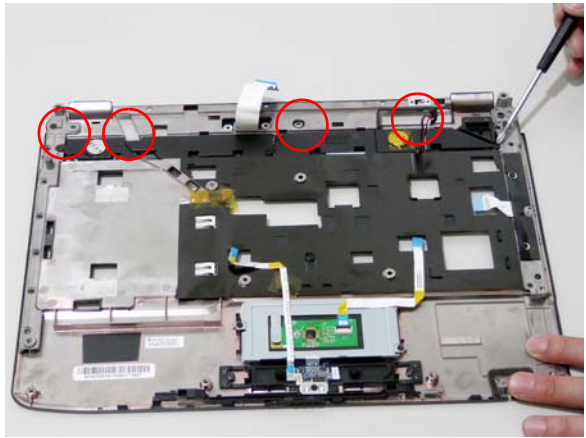
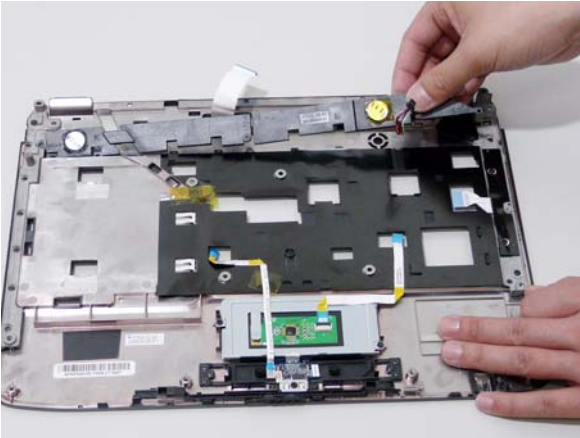

3. Attach the adhesive strip on the speaker cabling to secure in place.

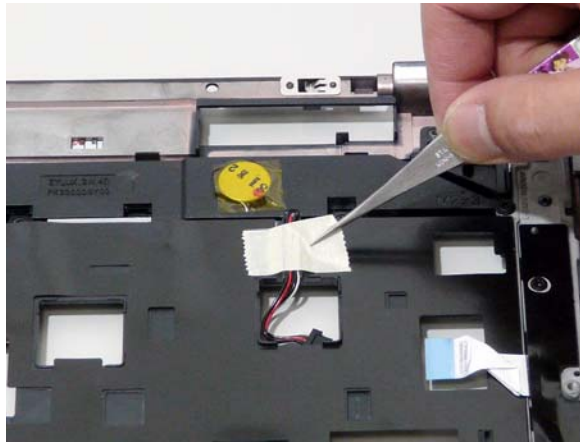

Replacing the Keyboard

1. Replace keyboard cable to the mainboard, and secure the locking latch.
2. Turn the keyboard over and place the front edge first in the mounting.

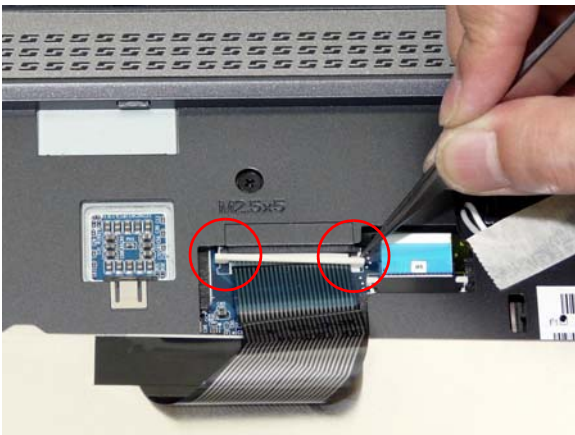

3. Press down on the areas marked below to secure in place.



Replacing the Switch Cover

1. Connect the Switch Cover FFC as shown.
2. Replace the Switch cover, and press down to secure in place.



3. Turn the computer over and replace the two securing screws.



Replacing the WLAN Module

1. Insert the WLAN board into the WLAN socket.
2. Replace the two screws to secure the module.



3. Connect the two antenna cables to the module.



Replacing the Hard Disk Drive Module

1. Place the HDD in the HDD carrier.

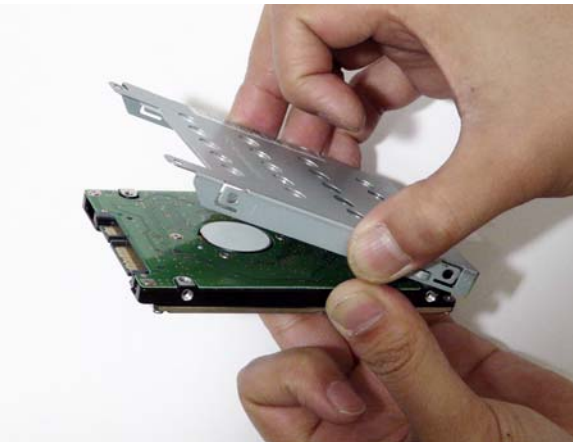

2. Replace the four screws to secure the carrier.

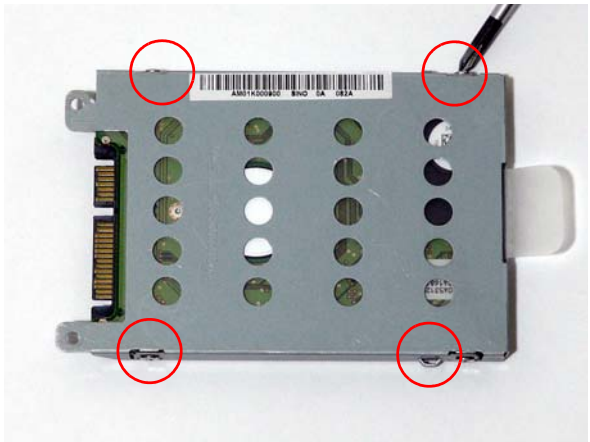

3. Insert the HDD, interface side first, until HDD firmly slides in place.



4. Push the HDD down to secure in place.

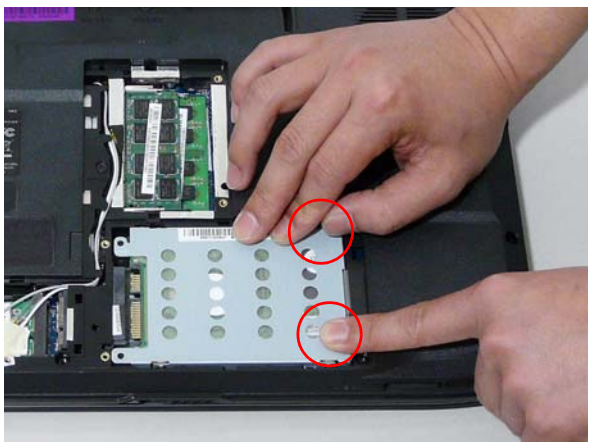

Replacing the DIMM Modules

NOTE: To replace DIMM Module 2, first remove DIMM Module 1. In this procedure, only DIMM Module 1 is shown.

1. Insert the DIMM Module in place.

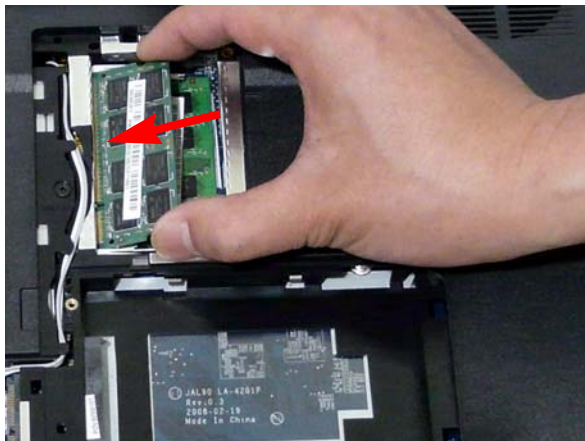

2. Press down to lock the DIMM module.

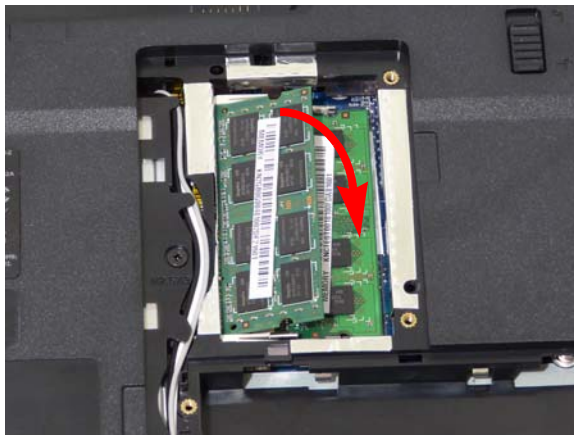

Replacing the ODD Module

1. With the ODD tray in the eject position, replace the ODD cover on the new ODD Module.
2. Press the cover into the tray, bottom edge first, to secure.

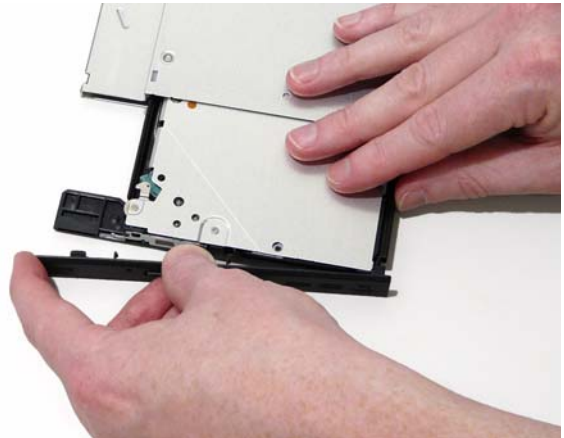
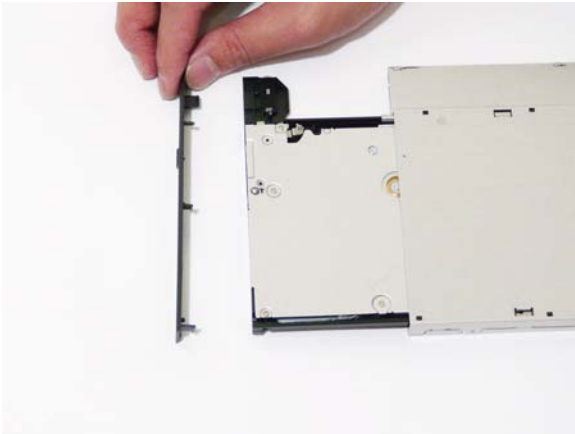

3. Turn ODD Module around and secure bracket with three screws.
4. Slide the module in the chassis and press until the module is flush with the chassis.

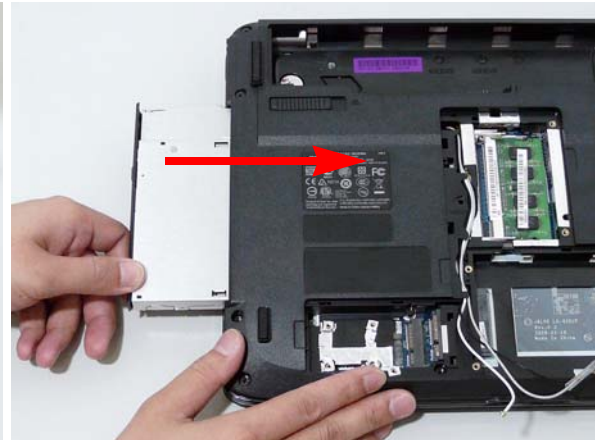
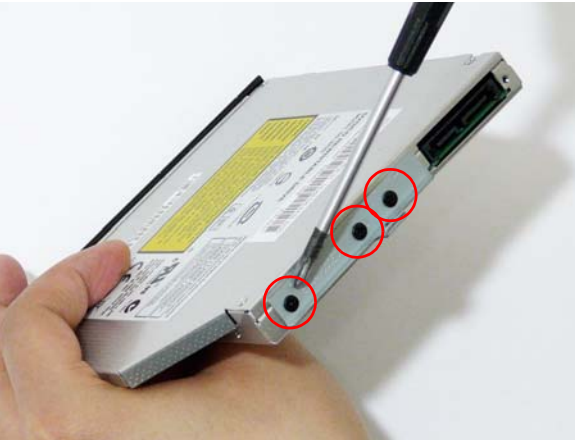

5. Replace the single screw to secure the Module.

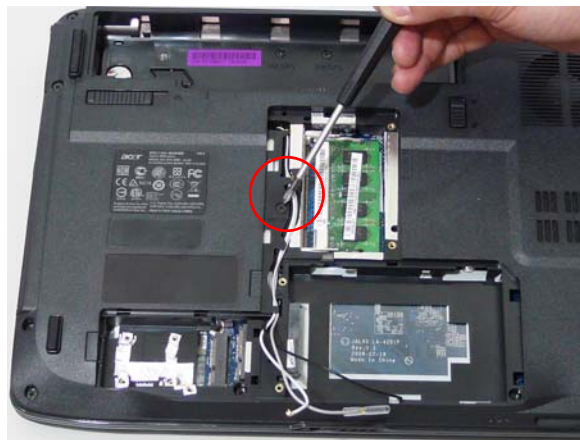

Replacing the Lower Covers

1. Replace the Memory Cover.



2. Replace the two screws to secure in place.

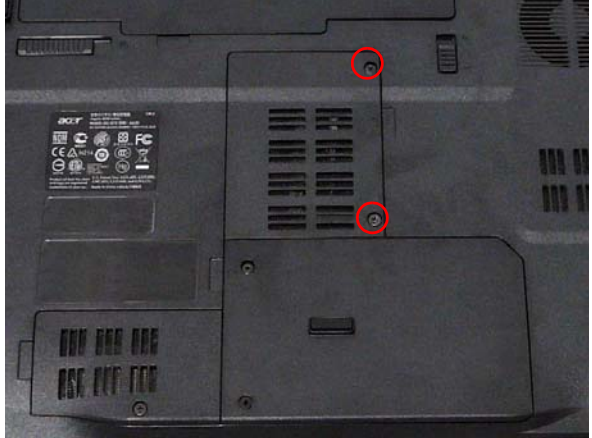

3. Replace the WLAN Cover.



4. Replace the screw to secure in place.



5. Replace HDD Cover.



6. Tighten the two screws to secure in place.



Replacing the Express and SD Card Trays

1. Insert the Express Card and push into the slot until flush with the chassis cover.
2. Insert the SD Card and push into the slot until flush with the chassis cover.



Troubleshooting

Common Problems

Use the following procedure as a guide for computer problems.

NOTE: The diagnostic tests are intended to test only Acer products. Non-Acer products, prototype cards, or modified options can give false errors and invalid system responses.

1. Obtain the failing symptoms in as much detail as possible.
2. Verify the symptoms by attempting to re-create the failure by running the diagnostic test or by repeating the same operation.
3. Use the following table with the verified symptom to determine which page to go to.

Symptoms (Verified)	Go To
Power On Issue	Page 130
No Display Issue	Page 131
LCD Failure	Page 133
Internal Keyboard Failure	Page 133
Touchpad Failure	Page 134
Internal Speaker Failure	Page 134
Internal Microphone Failure	Page 136
ODD Failure	Page 138
Modem Failure	Page 141
Wireless Failure	Page 141
Acer EasyLaunch Button Failure	Page 142
Thermal Unit Failure	Page 142
Other Functions Failure	Page 143
Intermittent Failures	Page 144
Undetermined Failures	Page 144

4. If the Issue is still not resolved, see "Online Support Information" on page 185.

Power On Issue

If the system doesn't power on, perform the following actions one at a time to correct the problem. Do not replace a non-defective FRUs:

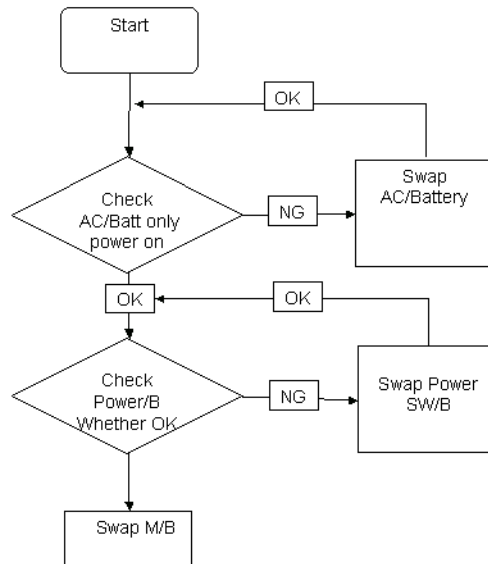

Computer Shutdown Intermittently

If the system powers off at intervals, perform the following actions one at a time to correct the problem.

1. Check the power cable is properly connected to the computer and the electrical outlet.
2. Remove any extension cables between the computer and the outlet.
3. Remove any surge protectors between the computer and the electrical outlet. Plug the computer directly into a known good electrical outlet.
4. Disconnect the power and open the casing to check the Thermal Unit (see "Thermal Unit Failure" on page 142) and fan airways are free of obstructions.
5. Disable the power management settings in the BIOS to ensure they are not the cause of the problem (see "Boot" on page 33).
6. Remove all external and non-essential hardware connected to the computer that are not necessary to boot the computer to the failure point.
7. Remove any recently installed software.
8. If the Issue is still not resolved, see "Online Support Information" on page 185.

No Display Issue

If the **Display** doesn't work, perform the following actions one at a time to correct the problem. Do not replace a non-defective FRUs:

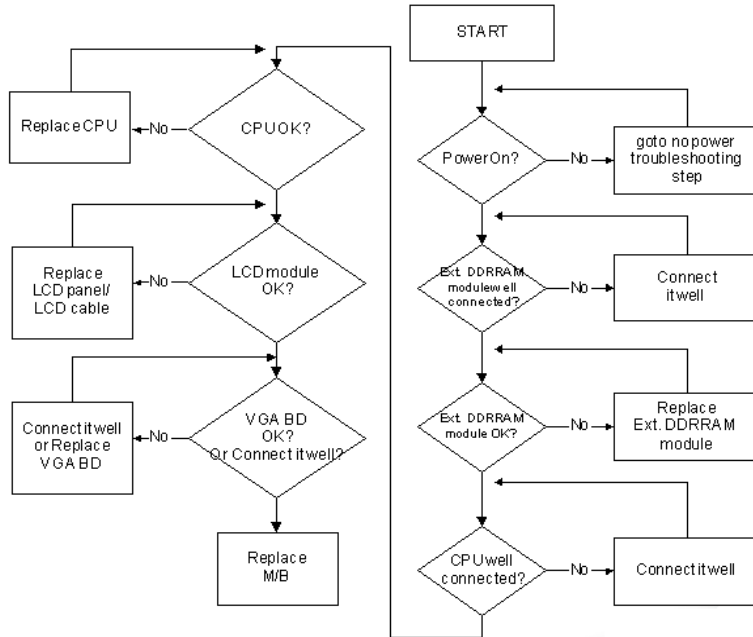

No POST or Video

If the POST or video doesn't display, perform the following actions one at a time to correct the problem.

1. Make sure that the internal display is selected. On this notebook model, switching between the internal display and the external display is done by pressing **Fn+F5**. Reference Product pages for specific model procedures.
2. Make sure the computer has power by checking at least one of the following occurs:
 - Fans start up
 - Status LEDs light up

If there is no power, see “Power On Issue” on page 130.

3. Drain any stored power by removing the power cable and battery and holding down the power button for 10 seconds. Reconnect the power and reboot the computer.
4. Connect an external monitor to the computer and switch between the internal display and the external display is by pressing **Fn+F5** (on this model).

If the POST or video appears on the external display, see “LCD Failure” on page 133.

5. Disconnect power and all external devices including port replicators or docking stations. Remove any memory cards and CD/DVD discs. Restart the computer.

If the computer boots correctly, add the devices one by one until the failure point is discovered.

6. Reseat the memory modules.
7. Remove the drives (see “Disassembly Process” on page 42).
8. If the Issue is still not resolved, see “Online Support Information” on page 185.

Abnormal Video Display

If video displays abnormally, perform the following actions one at a time to correct the problem.

1. Reboot the computer.
2. If permanent vertical/horizontal lines or dark spots display in the same location, the LCD is faulty and should be replaced. See “Disassembly Process” on page 42.
3. If extensive pixel damage is present (different colored spots in the same locations on the screen), the LCD is faulty and should be replaced. See “Disassembly Process” on page 42.
4. Adjust the brightness to its highest level. See the User Manual for instructions on adjusting settings.
NOTE: Ensure that the computer is not running on battery alone as this may reduce display brightness.
If the display is too dim at the highest brightness setting, the LCD is faulty and should be replaced. See “Disassembly Process” on page 42.
5. Check the display resolution is correctly configured:
 - a. Minimize or close all Windows.
 - b. If display size is only abnormal in an application, check the view settings and control/mouse wheel zoom feature in the application.
 - c. If desktop display resolution is not normal, right-click on the desktop and select **Personalize**→ **Display Settings**.
 - d. Click and drag the Resolution slider to the desired resolution.
 - e. Click **Apply** and check the display. Readjust if necessary.
6. Roll back the video driver to the previous version if updated.
7. Remove and reinstall the video driver.
8. Check the Device Manager to determine that:
 - The device is properly installed. There are no red Xs or yellow exclamation marks.
 - There are no device conflicts.
 - No hardware is listed under Other Devices.
9. If the Issue is still not resolved, see “Online Support Information” on page 185.
10. Run the Windows Memory Diagnostic from the operating system DVD and follow the onscreen prompts.
11. If the Issue is still not resolved, see “Online Support Information” on page 185.

Random Loss of BIOS Settings

If the computer is experiencing intermittent loss of BIOS information, perform the following actions one at a time to correct the problem.

1. If the computer is more than one year old, replace the CMOS battery.
2. Run a complete virus scan using up-to-date software to ensure the computer is virus free.
3. If the computer is experiencing HDD or ODD BIOS information loss, disconnect and reconnect the power and data cables between devices.
If the BIOS settings are still lost, replace the cables.
4. If HDD information is missing from the BIOS, the drive may be defective and should be replaced.
5. Replace the Motherboard.
6. If the Issue is still not resolved, see “Online Support Information” on page 185.

LCD Failure

If the **LCD** fails, perform the following actions one at a time to correct the problem. Do not replace a non-defective FRUs:

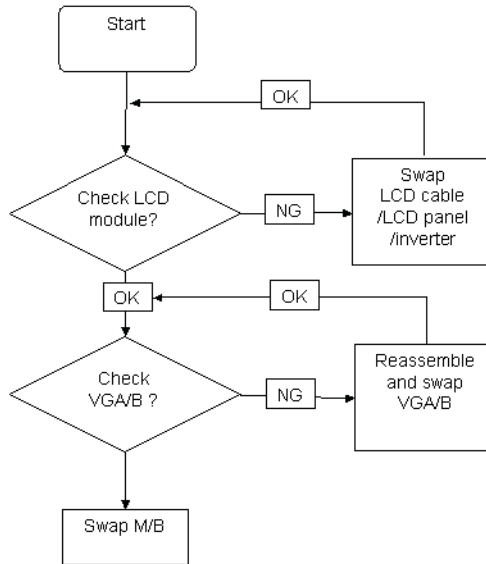

Built-In Keyboard Failure

If the built-in **Keyboard** fails, perform the following actions one at a time to correct the problem. Do not replace a non-defective FRUs:

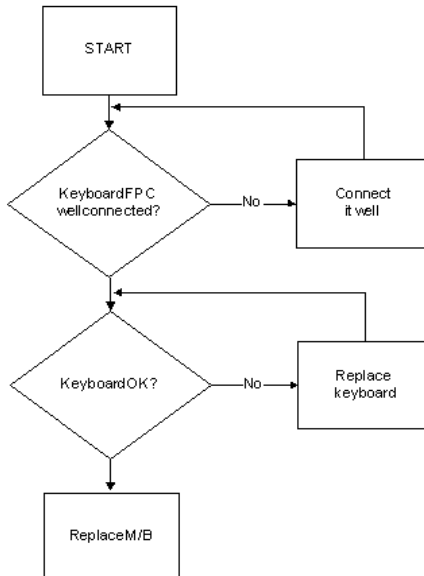

Touchpad Failure

If the **Touchpad** doesn't work, perform the following actions one at a time to correct the problem. Do not replace a non-defective FRUs:

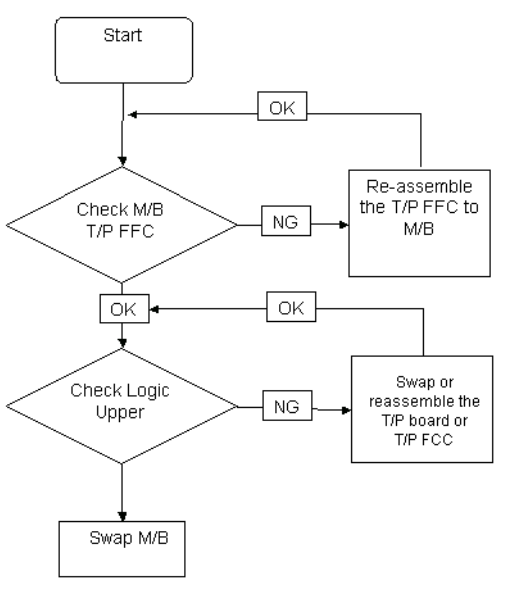

Internal Speaker Failure

If the internal **Speakers** fail, perform the following actions one at a time to correct the problem. Do not replace a non-defective FRUs:

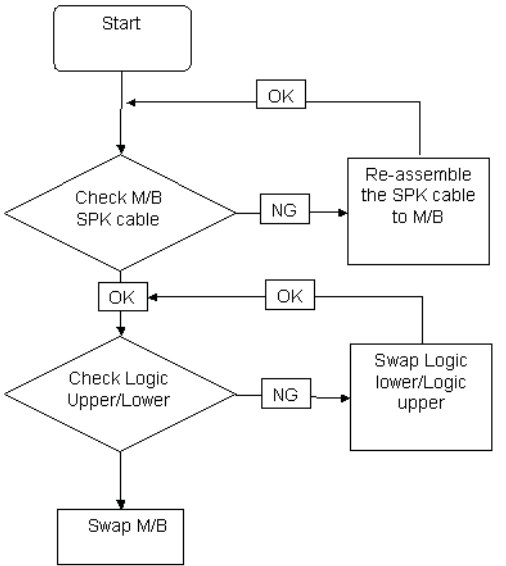

Sound Problems

If sound problems are experienced, perform the following actions one at a time to correct the problem.

1. Reboot the computer.
2. Navigate to **Start** → **Control Panel** → **System and Maintenance** → **System** → **Device Manager**. Check the Device Manager to determine that:
 - The device is properly installed.
 - There are no red Xs or yellow exclamation marks.
 - There are no device conflicts.
 - No hardware is listed under Other Devices.
3. Roll back the audio driver to the previous version, if updated recently.
4. Remove and reinstall the audio driver.
5. Ensure that all volume controls are set mid range:
 - a. Click the volume icon on the taskbar and drag the slider to 50. Ensure that the volume is not muted.
 - b. Click Mixer to verify that other audio applications are set to 50 and not muted.
6. Navigate to **Start** → **Control Panel** → **Hardware and Sound** → **Sound**. Ensure that Speakers are selected as the default audio device (green check mark).

NOTE: If Speakers does not show, right-click on the **Playback** tab and select **Show Disabled Devices** (clear by default).
7. Select Speakers and click **Configure** to start **Speaker Setup**. Follow the onscreen prompts to configure the speakers.
8. Remove and recently installed hardware or software.
9. Restore system and file settings from a known good date using **System Restore**.

If the issue is not fixed, repeat the preceding steps and select an earlier time and date.
10. Reinstall the Operating System.
11. If the Issue is still not resolved, see “Online Support Information” on page 185.

Internal Microphone Failure

If the internal **Microphone** fails, perform the following actions one at a time to correct the problem. Do not replace a non-defective FRUs:

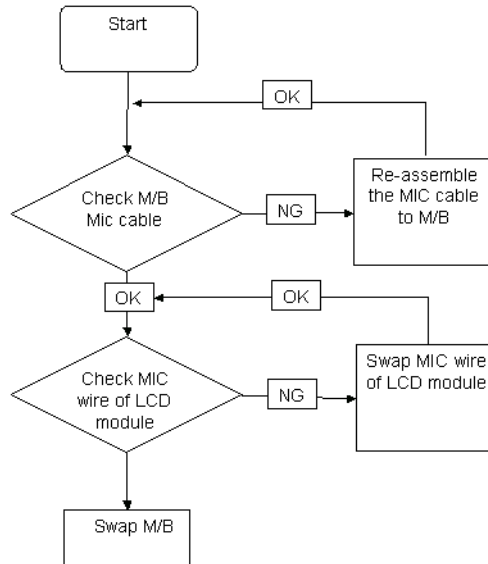

Microphone Problems

If internal or external **Microphones** do not operate correctly, perform the following actions one at a time to correct the problem.

1. Check that the microphone is enabled. Navigate to **Start** → **Control Panel** → **Hardware and Sound** → **Sound** and select the **Recording** tab.
2. Right-click on the **Recording** tab and select **Show Disabled Devices** (clear by default).
3. The microphone appears on the **Recording** tab.
4. Right-click on the microphone and select **Enable**.
5. Select the microphone then click **Properties**. Select the **Levels** tab.
6. Increase the volume to the maximum setting and click **OK**.
7. Test the microphone hardware:
 - a. Select the microphone and click **Configure**.
 - b. Select **Set up microphone**.
 - c. Select the microphone type from the list and click **Next**.
 - d. Follow the onscreen prompts to complete the test.
8. If the Issue is still not resolved, see "Online Support Information" on page 185.

HDD Not Operating Correctly

If the **HDD** does not operate correctly, perform the following actions one at a time to correct the problem.

1. Disconnect all external devices.
2. Run a complete virus scan using up-to-date software to ensure the computer is virus free.
3. Run the Windows Vista Startup Repair Utility:
 - a. insert the Windows Vista Operating System DVD in the ODD and restart the computer.
 - b. When prompted, press any key to start to the operating system DVD.
 - c. The **Install Windows** screen displays. Click **Next**.
 - d. Select **Repair your computer**.
 - e. The **System Recovery Options** screen displays. Click **Next**.
 - f. Select the appropriate operating system, and click **Next**.

NOTE: Click **Load Drivers** if controller drives are required.

- g. Select **Startup Repair**.
- h. Startup Repair attempts to locate and resolve issues with the computer.
- i. When complete, click **Finish**.

If an issue is discovered, follow the onscreen information to resolve the problem.

4. Run the Windows Memory Diagnostic Tool. For more information see Windows Help and Support.
5. Restart the computer and press F2 to enter the BIOS Utility. Check the BIOS settings are correct and that CD/DVD drive is set as the first boot device on the Boot menu.
6. Ensure all cables and jumpers on the HDD and ODD are set correctly.
7. Remove any recently added hardware and associated software.
8. Run the Windows Disk Defragmenter. For more information see Windows Help and Support.
9. Run Windows Check Disk by entering **chkdsk /r** from a command prompt. For more information see Windows Help and Support.
10. Restore system and file settings from a known good date using **System Restore**.

If the issue is not fixed, repeat the preceding steps and select an earlier time and date.
11. Replace the HDD. See "Disassembly Process" on page 42.

ODD Failure

If the **ODD** fails, perform the following actions one at a time to correct the problem. Do not replace a non-defective FRUs:

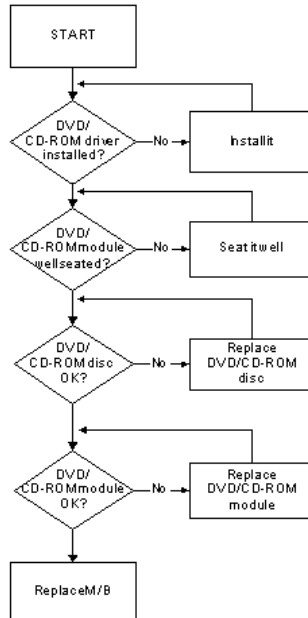

ODD Not Operating Correctly

If the **ODD** exhibits any of the following symptoms it may be faulty:

- Audio CDs do not play when loaded
- DVDs do not play when loaded
- Blank discs do not burn correctly
- DVD or CD play breaks up or jumps
- Optical drive not found or not active:
 - Not shown in My Computer or the BIOS setup
 - LED does not flash when the computer starts up
 - The tray does not eject
- Access failure screen displays
- The ODD is noisy

Perform the following general solutions one at a time to correct the problem.

1. Reboot the computer and retry the operation.
2. Try an alternate disc.
3. Navigate to **Start** → **Computer**. Check that the ODD device is displayed in the **Devices with Removable Storage** panel.
4. Navigate to **Start** → **Control Panel** → **System and Maintenance** → **System** → **Device Manager**.
 - a. Double-click **IDE ATA/ATAPI controllers**. If a device displays a down arrow, right-click on the device and click **Enable**.
 - b. Double-click **DVD/CD-ROM drives**. If the device displays a down arrow, right-click on the device and click **Enable**.

-
- c. Check that there are no yellow exclamation marks against the items in **IDE ATA/ATAPI controllers**. If a device has an exclamation mark, right-click on the device and uninstall and reinstall the driver.
 - d. Check that there are no yellow exclamation marks against the items in **DVD/CD-ROM drives**. If a device has an exclamation mark, right-click on the device and uninstall and reinstall the driver.
 - e. If the exclamation marker is not removed from the item in the lists, try removing any recently installed software and retrying the operation.

Discs Do Not Play

If discs do not play when inserted in the drive, perform the following actions one at a time to correct the problem.

1. Check that the disc is correctly seated in the drive tray and that the label on the disc is visible.
2. Check that the media is clean and scratch free.
3. Try an alternate disc in the drive.
4. Ensure that **AutoPlay** is enabled:
 - a. Navigate to **Start** → **Control Panel** → **Hardware and Sound** → **AutoPlay**.
 - b. Select **Use AutoPlay for all media and devices**.
 - c. In the Audio CD and DVD Movie fields, select the desired player from the drop down menu.
5. Check that the Regional Code is correct for the selected media:

IMPORTANT:Region can only be changed a limited number of times. After Changes remaining reaches zero, the region cannot be changed even Windows is reinstalled or the drive is moved to another computer.

- a. Navigate to **Start** → **Control Panel** → **System and Maintenance** → **System** → **Device Manager**.
- b. Double-click **DVD/CD-ROM drives**.
- c. Right-click **DVD drive** and click **Properties**, then click the **DVD Region** tab.
- d. Select the region suitable for the media inserted in the drive.

Discs Do Not Burn Properly

If discs can not be burned, perform the following actions one at a time to correct the problem.

1. Ensure that the default drive is record enabled:
 - a. Navigate to **Start** → **Computer** and right-click the writable ODD icon. Click **Properties**.
 - b. Select the **Recording** tab. In the **Desktop disc recording** panel, select the writable ODD from the drop down list.
 - c. Click **OK**.
2. Ensure that the software used for burning discs is the factory default. If using different software, refer to the software's user manual.

Playback is Choppy

If playback is choppy or jumps, perform the following actions one at a time to correct the problem.

1. Check that system resources are not running low:
 - a. Try closing some applications.
 - b. Reboot and try the operation again.
2. Check that the ODD controller transfer mode is set to DMA:
 - a. Navigate to **Start** → **Control Panel** → **System and Maintenance** → **System** → **Device Manager**.
 - b. Double-click **IDE ATA/ATAPI controllers**, then right-click ATA Device 0.
 - c. Click **Properties** and select the **Advanced Settings** tab. Ensure that the **Enable DMA** box is checked and click **OK**.

-
- d. Repeat for the other ATA Devices shown if applicable.

Drive Not Detected

If Windows cannot detect the drive, perform the following actions one at a time to correct the problem.

1. Restart the computer and press F2 to enter the BIOS Utility.
2. Check that the drive is detected in the **ATAPI Model Name** field on the Information page.
NOTE: Check that the entry is identical to one of the ODDs specified in “Hardware Specifications and Configurations” on page 18.
3. Turn off the power and remove the cover to inspect the connections to the ODD. See “Disassembly Process” on page 42.
 - a. Check for broken connectors on the drive, motherboard, and cables.
 - b. Check for bent or broken pins on the drive, motherboard, and cable connections.
 - c. Try an alternate cable, if available. If the drive works with the new cable, the original cable should be replaced.
4. Reseat the drive ensuring and all cables are connected correctly.
5. Replace the ODD. See “Disassembly Process” on page 42.

Drive Read Failure

If discs cannot be read when inserted in the drive, perform the following actions one at a time to correct the problem.

1. Remove and clean the failed disc.
2. Retry reading the CD or DVD.
 - d. Test the drive using other discs.
 - e. Play a DVD movie
 - f. Listen to a music CD

If the ODD works properly with alternate discs, the original disc is probably defective and should be replaced.

3. Turn off the power and remove the cover to inspect the connections to the ODD. See “Disassembly Process” on page 42.
 - a. Check for broken connectors on the drive, motherboard, and cables.
 - b. Check for bent or broken pins on the drive, motherboard, and cable connections.
 - c. Try an alternate cable, if available. If the drive works with the new cable, the original cable should be replaced.
4. Replace the ODD. See “Disassembly Process” on page 42.

Modem Function Failure

If the internal **Modem** fails, perform the following actions one at a time to correct the problem. Do not replace a non-defective FRUs:

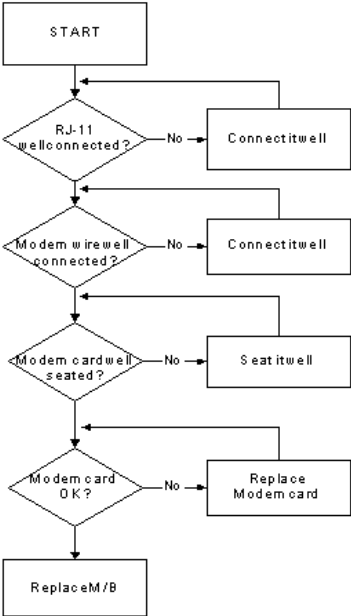

Wireless Function Failure

If the **WLAN** fails, perform the following actions one at a time to correct the problem. Do not replace a non-defective FRUs:

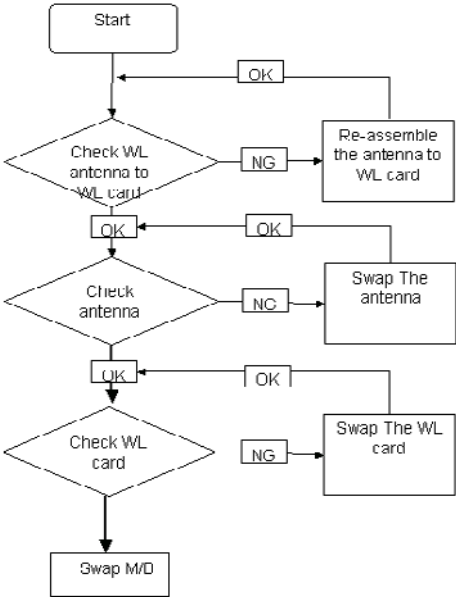

EasyTouch Button Failure

If the **Acer EasyTouch** buttons fail, perform the following actions one at a time to correct the problem. Do not replace a non-defective FRUs:

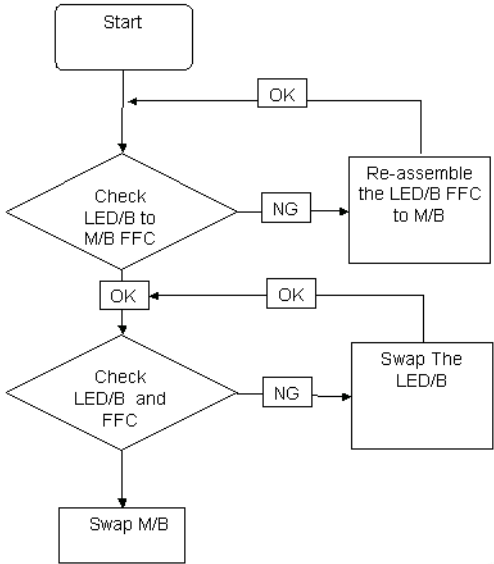

Thermal Unit Failure

If the **Thermal Unit** fails, perform the following actions one at a time to correct the problem. Do not replace a non-defective FRUs:

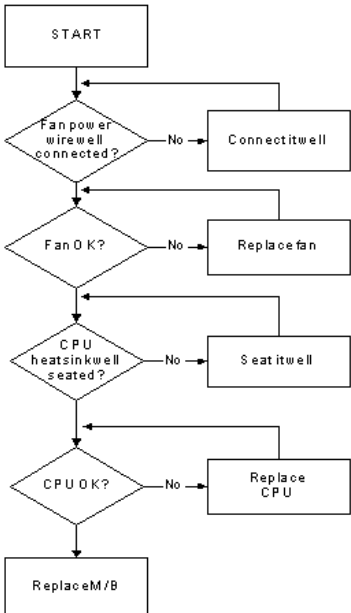

External Mouse Failure

If an external **Mouse** fails, perform the following actions one at a time to correct the problem.

1. Try an alternative mouse.
2. If the mouse uses a wireless connection, insert new batteries and confirm there is a good connection. See the mouse user manual.
3. If the mouse uses a USB connection, try an alternate USB port.
4. Try an alternative program to verify mouse operation. Reinstall the program experiencing mouse failure.
5. Restart the computer.
6. Remove any recently added hardware and associated software.
7. Remove any recently added software and reboot.
8. Restore system and file settings from a known good date using **System Restore**.

If the issue is not fixed, repeat the preceding steps and select an earlier time and date.

9. Run the Event Viewer to check the events log for errors. For more information see Windows Help and Support.
10. Roll back the mouse driver to the previous version if updated recently.
11. Remove and reinstall the mouse driver.
12. Check the Device Manager to determine that:
 - The device is properly installed. There are no red Xs or yellow exclamation marks.
 - There are no device conflicts.
 - No hardware is listed under Other Devices.
13. If the Issue is still not resolved, see "Online Support Information" on page 185.

Other Failures

If the CRT Switch, Dock, LAN Port, external MIC or Speakers, PCI Express Card, 5-in-1 Card Reader or Volume Wheel fail, perform the following general steps to correct the problem. Do not replace a non-defective FRUs:

1. Check Drive whether is OK.
2. Check Test Fixture is ok.
3. Swap M/B to Try.

Intermittent Problems

Intermittent system hang problems can be caused by a variety of reasons that have nothing to do with a hardware defect, such as: cosmic radiation, electrostatic discharge, or software errors. FRU replacement should be considered only when a recurring problem exists.

When analyzing an intermittent problem, do the following:

1. Run the advanced diagnostic test for the system board in loop mode at least 10 times.
2. If no error is detected, do not replace any FRU.
3. If any error is detected, replace the FRU. Rerun the test to verify that there are no more errors.

Undetermined Problems

The diagnostic problems does not identify which adapter or device failed, which installed devices are incorrect, whether a short circuit is suspected, or whether the system is inoperative.

Follow these procedures to isolate the failing FRU (do not isolate non-defective FRU).

NOTE: Verify that all attached devices are supported by the computer.

NOTE: Verify that the power supply being used at the time of the failure is operating correctly. (See “Power On Issue” on page 130.):

1. Power-off the computer.
2. Visually check them for damage. If any problems are found, replace the FRU.
3. Remove or disconnect all of the following devices:
 - Non-Acer devices
 - Printer, mouse, and other external devices
 - Battery pack
 - Hard disk drive
 - DIMM
 - CD-ROM/Diskette drive Module
 - PC Cards
4. Power-on the computer.
5. Determine if the problem has changed.
6. If the problem does not recur, reconnect the removed devices one at a time until you find the failing FRU.
7. If the problem remains, replace the following FRU one at a time. Do not replace a non-defective FRU:
 - System board
 - LCD assembly

POST Codes Tables

These tables describe the POST codes, drivers, and keys for the POST.

Sec

NO_EVICTION_MODE_DEBUG EQU 1 (CommonPlatform\sec\la32\SecCore.inc)

Code	Description
0xC2	MTRR setup
0xC3	Enable cache
0xC4	Establish cache tags
0xC5	Enter NEM, Place the BSP in No Fill mode, set CR0.CD = 1, CR0.NW = 0.
0xCF	Cache Init Finished

Memory:

DEBUG_BIOS equ 1 (Chipset\Alviso\MemoryInitAsm\IA32\IMEMORY.INC)

Code	Description
0xA0	First memory check point
0x01	Enable MCHBAR
0x02	Check for DRAM initialization interrupt and reset fail
0x03	Verify all DIMMs are DDR or DDR2 and unbuffered
0x04	Detect an improper warm reset and handle
0x05	Detect if ECC SO-DIMMs are present in the system
0x06	Verify all DIMMs are single or double sided and not asymmetric
0x07	Verify all DIMMs are x8 or x16 width
0x08	Find a common CAS latency between the DIMMS and the MCH
0x09	Determine the memory frequency and CAS latency to program
0x10	Determine the smallest common TRAS for all DIMMs
0x11	Determine the smallest common TRP for all DIMMs
0x12	Determine the smallest common TRCD for all DIMMs
0x13	Determine the smallest refresh period for all DIMMs
0x14	Verify burst length of 8 is supported by all DIMMs
0x15	Determine the smallest tWR supported by all DIMMs
0x16	Determine DIMM size parameters
0x17	Program the correct system memory frequency
0x18	Determine and set the mode of operation for the memory channels
0x19	Program clock crossing registers
0x20	Disable Fast Dispatch
0x21	Program the DRAM Row Attributes and DRAM Row Boundary registers
0x22	Program the DRAM Bank Architecture register
0x23	Program the DRAM Timing & and DRAM Control registers
0x24	Program ODT
0x25	Perform steps required before memory init
0x26	Program the receive enable reference timing control register Program the DLL Timing Control Registers, RCOMP settings

Code	Description
0x27	Enable DRAM Channel I/O Buffers
0x28	Enable all clocks on populated rows
0x29	Perform JEDEC memory initialization for all memory rows
0x30	Perform steps required after memory init
0x31	Program DRAM throttling and throttling event registers
0x32	Setup DRAM control register for normal operation and enable
0x33	Enable RCOMP
0x34	Clear DRAM initialization bit in the SB
0x35	Initialization Sequence Completed, program graphic clocks
0x43	Program Thermal Throttling

BDS & Specific action:

Code	Description
0x00	Report the legacy boot is happening
0x12	Wake up the Aps
0x13	Initialize SMM Private Data and relocate BSP SMBASE
0x21	PC init begin at the stage1
0x27	Report every memory range do the hard ware ECC init
0x28	Report status code of every memory range
0x50	Get the root bridge handle
0x51	Notify pci bus driver starts to program the resource
0x58	Reset the host controller
0x5A	IdeBus begin initialization
0x79	Report that the remote terminal is being disabled
0x7A	Report that the remote terminal is being enabled
0x90	Keyboard reset
0x91	USB Keyboard disable
0x92	Keyboard detection
0x93	Report that the usb keyboard is being enabled
0x94	Clear the keyboard buffer
0x95	Init Keyboard
0x98	Mouse reset
0x99	Mouse disable
0x9A	Detect PS2 mouse
0x9B	Report that the mouse is being enabled
0xB8	Peripheral removable media reset (ex: IsaFloppy, USB device)
0xB9	Peripheral removable media disable
0xBB	Peripheral removable media enable
0xE4	Report Status Code here for DXE_ENTRY_POINT once it is available
0xF8	Report that ExitBootServices() has been called
0xF9	Runtime driver set virtual address map

Each PEIM entry point used in 80_PORT

Code	Description
0x00	
0x01	PEI_EVENT_LOG
0xA1	PEI_OEM_SERVICE
0xA2	PEI_SIO_INIT
0xA3	PEI_MONO_STATUS_CODE
0xA4	PEI_CPU_IO_PCI_CFG
0x06	PEI_CPU_IO
0x07	PEI_PCI_CFG
0xA5	PEI_CPU_PEIM
0xA6	PEI_PLATFORM_STAGE1
0xA7	PEI_VARIABLE
0xA8	PEI_SB_INIT
0x0C	PEI_CAPSULE
0xAA	PEI_PLATFORM_STAGE2
0xAC	PEI_SB_SMBUS_ARP_DISABLED
0x0F	PEI_HOST_TO_SYSTEM
0x40	PEI_MEMORY_INIT
0x41	PEI_S3_RESUME
0xAD	PEI_CLOCK_GEN
0xAB	PEI_OP_PRESENCE
0xAE	PEI_FIND_FV
0x16	PEI_H2O_DEBUG_IO
0x17	PEI_H2O_DEBUG_COMM
0x16~0x1F	PEI_RESERVED
0x20~0x2E	PEI_OEM_DEFINED
0xAF	PEI_DXE_IPL

Each Driver entry point used in 80_PORT

Code	Description
0x30	RESERVED
0xB6	DXE_CRC32_SECTION_EXTRACT
0xB8	SCRIPT_SAVE
0xB9	ACPI_S3_SAVE
0xBA	SMART_TIMER
0xBB	JPEG_DECODER
0xBC	PCX_DECODER
0xBE	HT_CPU / MP_CPU
0xBF	LEGACY_METRONOME
0xC0	FTWLITE
0xC1	RUN_RIME
0xC2	MONOTONIC_COUNTER
0xC3	WATCH_DOG_TIMER

Code	Description
0xC4	SECURITY_STUB
0xC5	DXE_CPU_IO
0xC6	CF9_RESET
0xC7	PC_RTC
0xC8	STATUS_CODE
0xC9	VARIABLE EMU_VARIABLE
0xD9	DXE_CHIPSET_INIT
0x45	DXE_ALERT_FORMAT
0xD6	PCI_HOST_BRIDGE
0xD7	PCI_EXPRESS
0xD5	DXE_SB_INIT
0xDA	IDE_CONTROLLER
0xDB	SATA_CONTROLLER
0xDD	SB_SM_BUS
0xE7	ISA_ACPI_DRIVER
0xE8	ISA_BUS
0xE9	ISA_SERIAL
0xED	BUS_PCI_UNDI
0xEC	PCI_BUS
0xF6	BOOT_PRIORITY
0xF7	FVB_SERVICE
0xF8	ACPI_PLATFORM
0xFB	PCI_HOT_PLUG
0xFC	DXE_PLATFORM
0xFD	PLATFORM_IDE
0x97	SMBIOS
0x98	MEMORY_SUB_CLASS
0x99	MISC_SUB_CLASS
0x82	CON_PLATFORM
0x83	SAVE_MEMORY_CONFIG
0x84	ACPI_SUPPORT
0x85	CON_SPLITTER_UGA_VGA / CON_SPLITTER
0x88	VGA_CLASS
0x89	DATA_HUB
0x60	DISK_IO
0x8B	MEMORY_TEST
0x62	CRISIS_RECOVERY
0x8D	LEGACY_8259
0x8E	LEGACY_REGION
0x8F	LEGACY_INTERRUPT
0x70	BIOS_KEYBOARD
0x71	BIOS_VEDIO

Code	Description
0x72	MONITER_KEY
0x73	LEGACY_BIOS
0x75	LEGACY_BIOS_PLATFORM
0x76	PCI_PLATFORM
0x6C	ISA_FLOOPY
0x6D	PS2_MOUSE
0x6E	USB_BOT
0x6F	USB_CBIO
0x74	USB_MOUSE
0xFA	SETUP_UTILITY
0x90	FW_BLOCK_SERVICE
0x78	SMM_USB_LEGACY
0x86	GRAPHICS_CONSOLE
0x87	TERMINAL
0x8A	DATA_HUB_STD_ERR
0x7C	FAT
0x7D	PARTITION
0x7E	ENGLISH
0x7F	FRENCH
0x9E	HII_DATABASE
0x9F	OEM_SETUP_BROWSER
0x8C	OEM_BADGING_SUPPORT
0xF9	SETUP_MOUSE
0x72	MONITOR_KEY
0xBD	PLATFORM_BDS
0x8D	RESERVED
0x8E	RESERVED
0x8F	RESERVED
0xA0	DXE_H2O_DEBUG_IO
0xB3	DXE_TPM_TCG
0xB4	DXE_TPM_PHYSICAL_PRESENCE
0xB7	DXE_OEM_SERVICE
0x9B	DXE_SECURITY_HDD_PASSWORD_SERVICE
0xA9	DXE_LAN_IDER_CONTROLLER
0x9C	DXE_SECURITY_SYSTEM_PASSWORD_SERVICE
0x9D	DXE_SECURITY_PASSWORD_CONSOLE
0xCB	DXE_DATA_HUB_RECORD_POLICY
0xB5	DXE_TPM_DRIVER
0x11	CHINESE
0xB0	JAPANESE
0xB1	DXE_UNICODE_COLLATION

Each SmmDriver entry point used in 80_PORT

Code	Description
0xD4	SMM_ACCESS
0xDE	SMM_CONTROL
0xCC	SMM_BASE
0xD2	SMM_RUNTIME
0xDF	SB_SMM_DISPATCH
0xD0	SMM_THUNK
0xCA	SMM_ACPI_SW_CHILD
0xFE	SMM_PLATFORM
0xD8	SMM_GMCH_MBI
0x90	SMM_FW_BLOCK_SERVICE
0x91	SMM_VARIABLE
0x92	SMM_IHISI
0x93	SMM_INT15_MICROCODE
0x94	SMM_PNP
0x95	SMM_INIT_PPM
0xD3	SMM_OEM_SERVICE

Jumper and Connector Locations

Top View

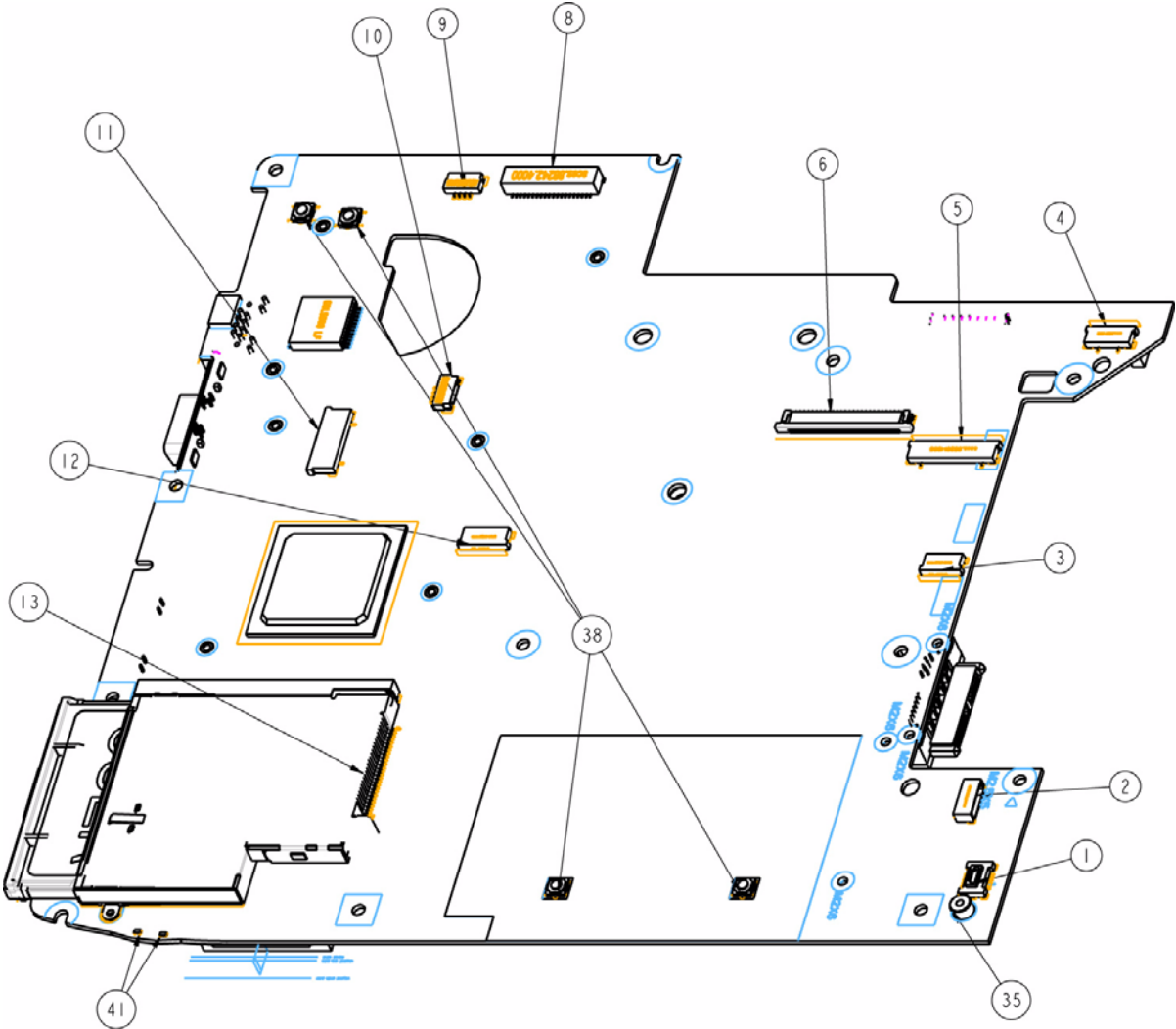

Location	Description	Location	Description
1	MDC Conn	10	Speaker Conn
2	BT Conn	11	Function PCB to MB Conn
3	Finger to MB Conn	12	TP to MB Conn
4	Media PCB to MB Conn	13	Express Card Conn
5	Power PCB to MB Conn	35	MDC Standoff (M2xH3)
6	KB Conn	38	Switch
8	LVDS Cnn	41	LED
9	MIC Conn		

Bottom View

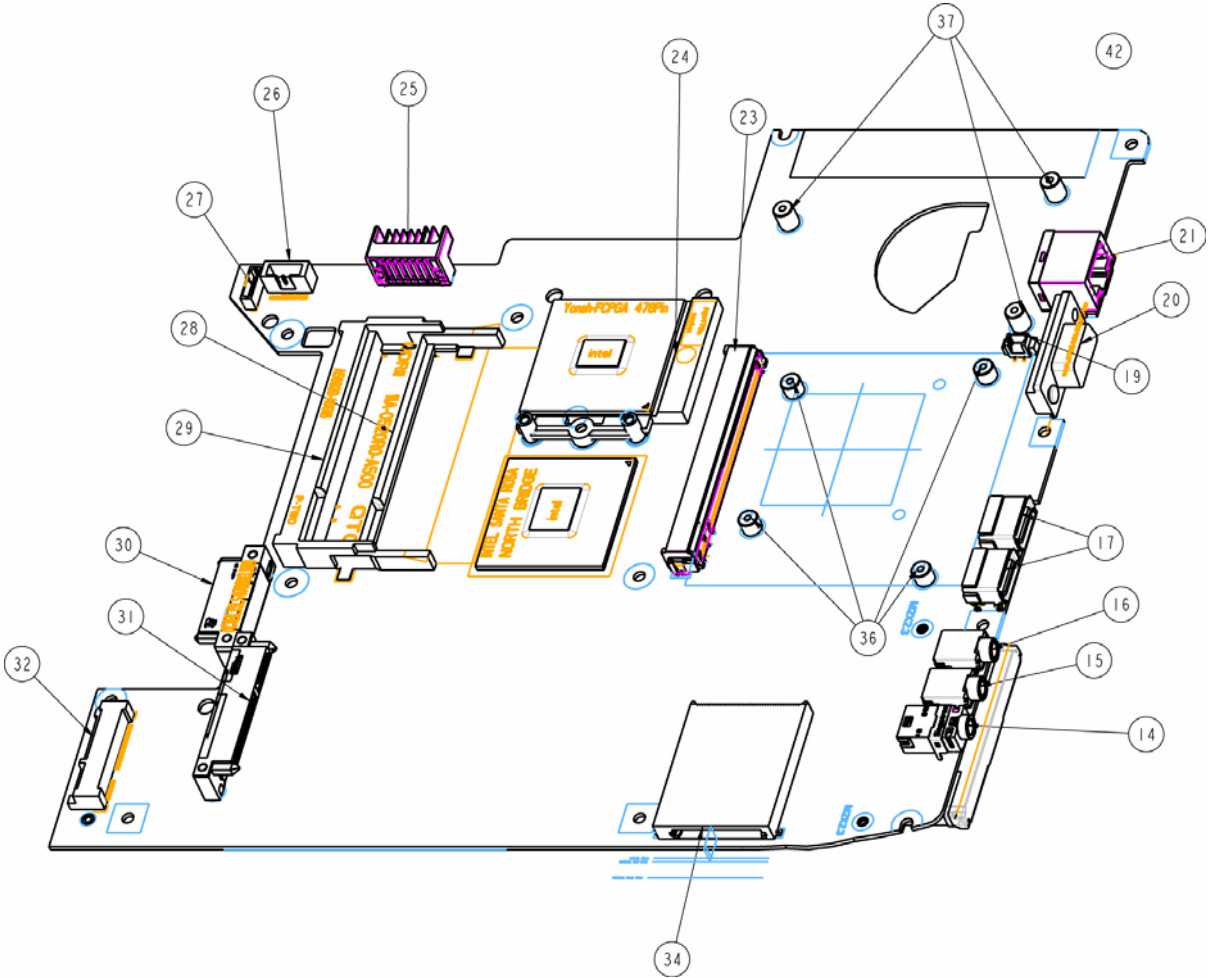

Location	Description	Location	Description
14	SPDIF Conn	27	USB PCB to MB
15	Audio Conn (pink)	28	DDR2 5.2 mm (Rev.)
16	Audio Conn (blue)	29	DDR2 9.2 mm (Rev.)
17	USB (single Rev)	30	ODD SATA Conn
19	Fan Conn	31	HDD SATA Conn
20	CRT Conn (blue)	32	Mini PCI Express (5.2)
21	RJ45	34	Card Reader
23	MXM Conn	36	MXM Standoff (M2xH4)
24	CPU Socket	37	Fan Standoff (M2xH6)—UMA only
25	Battery Conn	42	ICL50 MB Fan Standoff—DIS only
26	DCIN Cable Conn		

Clearing Password Check and BIOS Recovery

This section provide you the standard operating procedures of clearing password and BIOS recovery for Aspire 4730Z/4730ZG/4330. Aspire 4730Z/4730ZG/4330 provide one Hardware Open Gap on main board for clearing password check, and one Hotkey for enabling BIOS Recovery.

Clearing Password Check

Hardware Open Gap Description

Item	Description	Location
R347 (RTC_RST)	Clear CMOS Jumper	Memory bay



Steps for Clearing BIOS Password Check

If users set BIOS Password (Supervisor Password and/or User Password) for a security reason, BIOS will ask the password during systems POST or when systems enter to BIOS Setup menu. However, once it is necessary to bypass the password check, users need to short the HW Gap to clear the password by the following steps:

- Power Off a system, and remove HDD, AC and Battery from the machine.
- Open the back cover of the machine, and find out the HW Gap on M/B as picture.
- Use an electric conductivity tool to short the two points of the HW Gap.
- Plug in AC, keep the short condition on the HW Gap, and press Power Button to power on the system till BIOS POST finish. Then remove the tool from the HW Gap.
- Restart system. Press F2 key to enter BIOS Setup menu.
- If there is no Password request, BIOS Password is cleared. Otherwise, please follow the steps and try again.

NOTE: The steps are only for clearing BIOS Password (Supervisor Password and User Password).

BIOS Recovery by Crisis Disk

BIOS Recovery Boot Block:

BIOS Recovery Boot Block is a special block of BIOS. It is used to boot up the system with minimum BIOS initialization. Users can enable this feature to restore the BIOS firmware to a successful one once the previous BIOS flashing process failed.

BIOS Recovery Hotkey:

The system provides a function hotkey: **Fn+Esc**, for enable BIOS Recovery process when system is powered on during BIOS POST. To use this function, it is strongly recommended to have the AC adapter and Battery present. If this function is enabled, the system will force the BIOS to enter a special BIOS block, called Boot Block.

Steps for BIOS Recovery by Crisis Disk:

Before doing this, one Crisis Disk should be prepared ready in hand. The Crisis Disk could be made by executing the Crisis Disk program in another system with Windows XP OS.

Follow the steps below:

1. Power Off failed system.
2. Attach a USB floppy drive to the failed system.
3. Insert the Crisis Disk in to the USB floppy drive attached to the BIOS flash failed system.
4. In the power-off state, press and hold **Fn+Esc** then press the Power button.

The system powers on and the Crisis BIOS Recovery process begins.

BIOS Boot Block begins restoring the BIOS code from the Crisis floppy disk to BIOS ROM on the failed systems.

When the Crisis flash process is finished, the system restarts with a workable BIOS.

5. Update to the latest version BIOS for the system using the regular BIOS flashing process.

FRU (Field Replaceable Unit) List

This chapter gives you the FRU (Field Replaceable Unit) listing in global configurations of Aspire 4730Z/4730ZG/4330. Refer to this chapter whenever ordering for parts to repair or for RMA (Return Merchandise Authorization).

Please note that WHEN ORDERING FRU PARTS, you should check the most up-to-date information available on your regional web or channel. For whatever reasons a part number change is made, it will not be noted on the printed Service Guide. For ACER AUTHORIZED SERVICE PROVIDERS, your Acer office may have a DIFFERENT part number code from those given in the FRU list of this printed Service Guide. You MUST use the local FRU list provided by your regional Acer office to order FRU parts for repair and service of customer machines.

NOTE: To scrap or to return the defective parts, you should follow the local government ordinance or regulations on how to dispose it properly, or follow the rules set by your regional Acer office on how to return it.

Aspire 4730Z/4730ZG/4330 Exploded Diagrams

Main Module

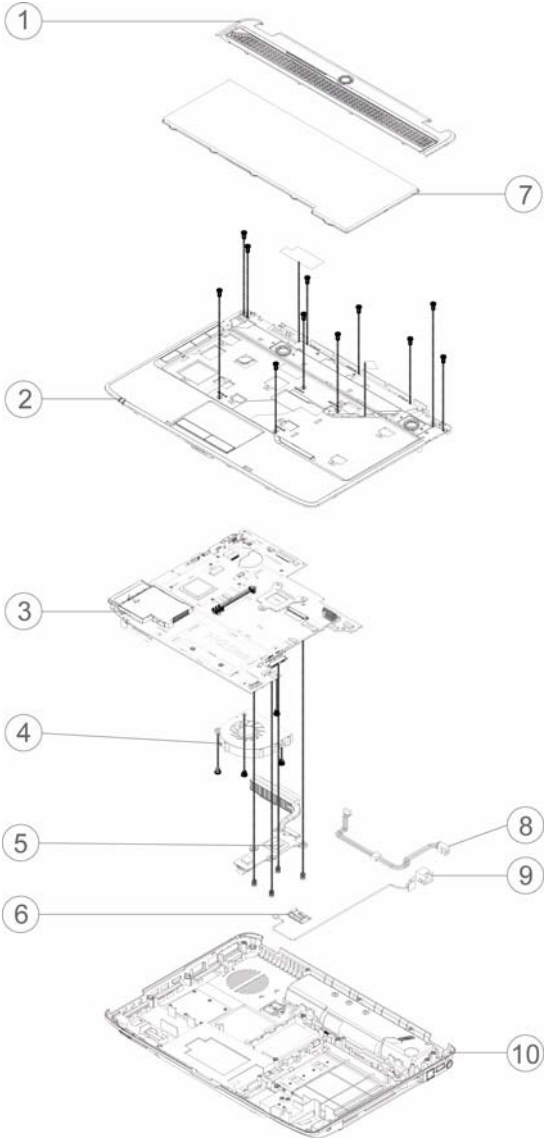

Item	Description	Part No.	Item	Description	Part No.
1	Middle Cover	60.AT902.001	6	Bluetooth Module	TBD
2	Upper Cover	60.AT902.002	7	Keyboard	KB.INT00.442
3	Mainboard	MB.ATV02.001	8	Power Cable	TBD
4	CPU Fan	23.AT902.001	9	RJ-11 Cable	60.AT902.003
5	Thermal Module	60.AT902.007	10	Lower Cover	

LCD Module

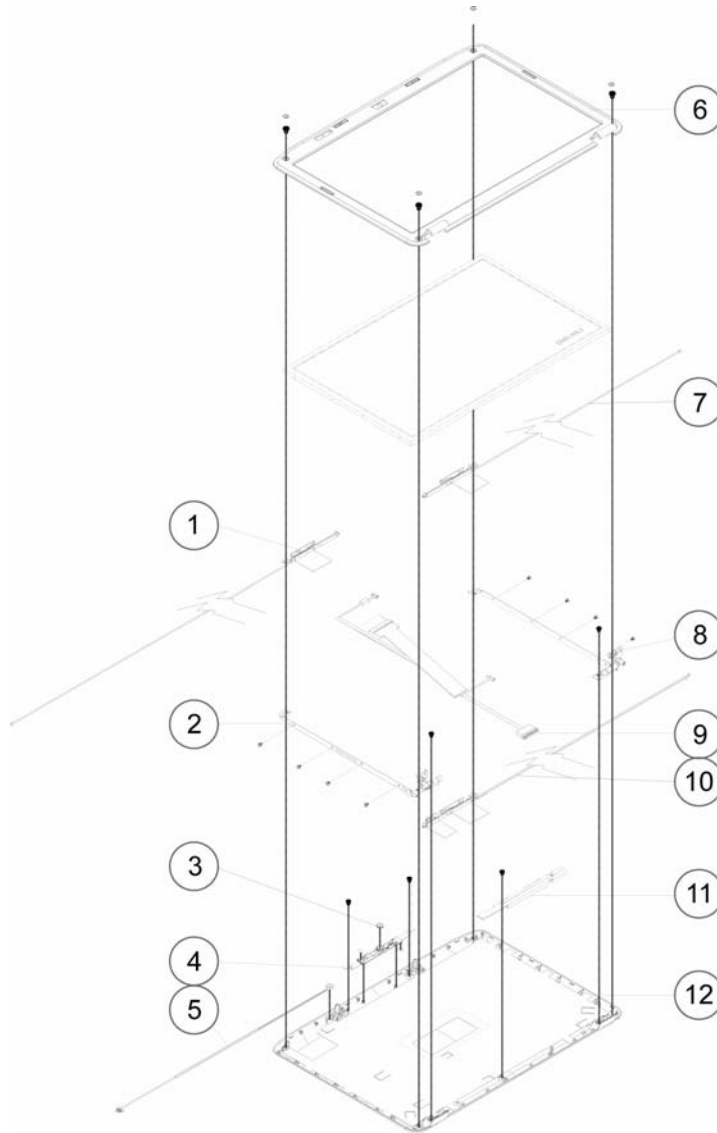







Item	Description	Part No.	Item	Description	Part No.
1	Antenna_L	50.AT902.004	7	Antenna_R	50.AT902.003
2	Bracket_L	33.AT902.005	8	Bracket_R	33.AT902.004
3	Camera	57.AT902.001	9	LCD Cable	50.AT902.002
4	Camera Bracket		10	Antenna	TBD
5	MIC Cable	23.AT902.002	11	Inverter	55.AT902.003
6	Bezel	60.AT902.006	12	LCD Casing	60.AT902.005



Aspire 4730Z/4730ZG/4330 FRU List

NOTE: The outside housing and color may vary from the mass produced model.

Category	Description	Acer Part No.
Adapter		
	ADAPTER 65W 3PIN DELTA SADP65KB BFJA OBL SADP-65KB DFA	AP.06501.014
	ADAPTER 65W 3PIN DELTA SADP-65KB DFA	
	ADAPTER 65W 3PIN LITEON PA-1650-02AC	AP.06503.016
	ADAPTER 65W 3PIN HIPRO AC-OK065B13	AP.0650A.010
	ADAPTER 90W 3PIN DELTA ADP-90SB BBEA	
	ADAPTER 90W 3PIN DELTA ADP90SB BBEN OBL	
	ADAPTER 90W 3PIN LITEON PA-1900-24AR	
	ADAPTER 90W 3PIN HIPRO AC-OL093B13P LF	
Battery		
	BATTERY LI-ION 6CELLS 4.4AH SANYO	BT.00603.041
	BATTERY LI-ION 6CELLS 4.4AH SONY	BT.00604.024
	BATTERY LI-ION 6CELLS 4.4AH PA 3S2P SIMPLO	
	BATTERY LI-ION 6CELLS 4.4AH SM 3S2P SIMPLO	
	BATTERY LI-ION 6CELLS 4.4AH LG 3S2P SIMPLO	
	BATTERY LI-ION 6CELLS 4.4AH PANASONIC	BT.00605.020
	BATTERY LI-ION 6CELLS 4.8AH SM 3S2P SIMPLO	
Board		
	FUNCTION BOARD	55.AT902.001
	POWER BOARD	55.AT902.002
	MODEM BOARD	
	MINI CARD BROADCOM T77H030.00 54MBPS BRCM4312	NI.23600.029
	MINI CARD Atheros T60H976.00 (FW-06) 54M XB63	NI.23600.007
	MINI CARD 150M XB91 Atheros	
	MINI CARD T77H028.00 RALINK	
	VGA BOARD M82ME-XT	

Category	Description	Acer Part No.
Cable		
	T/P FFC	50.AT902.001
	POWER CORD US 3 PIN	27.TAVV5.001
	POWER CORD EU 3 PIN	27.TAVV5.002
	POWER CORD AUS 3 PIN	27.TAVV5.003
	POWER CORD UK 3 PIN	27.TAVV5.004
	POWER CORD CHINA 3 PIN	27.TAVV5.005
	POWER CORD SWISS 3 PIN	27.TAVV5.006
	POWER CORD ITALIAN 3 PIN	27.TAVV5.007
	POWER CORD DENMARK 3 PIN	27.TAVV5.008
	POWER CORD JP 3 PIN	27.TAVV5.009
	POWER CORD SOUTH AFRICA 3 PIN	27.TAVV5.010
	POWER CORD KOERA 3 PIN	27.TAVV5.011
	POWER CORD ISRAEL 3 PIN	27.TAVV5.012
	POWER CORD INDIA 3 PIN	27.TAVV5.013
	POWER CORD TWN 3 PIN	27.TAVV5.014
POWER CORD ARGENTINA 3 PIN	27.APV02.001	
Case/Cover/Bracket Assembly		
	MIDDLE COVER	60.AT902.001
	UPPER CASE ASSY	60.AT902.002
	LOWER CASE ASSY W/ RJ11	60.AT902.003
	LOWER CASE ASSY W/O RJ11	60.AT902.004
	T/P BRACKET	33.AT902.001
	RAM DOOR	42.AT902.001

Category	Description	Acer Part No.
	MINI DOOR	42.AT902.002
	HDD DOOR	42.AT902.003
CPU/Processor		
	CPU INTEL P575 2G LF80537NF0411M SLB6M M0	TBD
	CPU INTEL P585 2.16G LF80537NF0481M SLB6L M0	
	CPU INTEL T1600 1.66G LF80537NF0281MN SLB6J M0	
	CPU INTEL T1700 1.83G LF80537NF0341MN SLB6H M0	
	CPU INTEL T3200 2G LF80537GF0411M SLAVG M0	
	CPU INTEL T3400 2.16G LF80537GF0481M SLB3P M0	
	CPU INTEL T5800 2G LF80537GG041F SLB6E M0	
	CPU INTEL T5900 2.2G LF80537GG049F SLB6D M0	
Multi Drive		
	DVD SUPER MULTI DRIVE MODULE	6M.AT902.001
	DVD SUPER MULTI DRIVE HLDS GSA-T50N	KU.0080D.029
	DVD SUPER MULTI DRIVE HLDS GSA-T50N (ML)	KU.0080D.034
	DVD SUPER MULTI DRIVE PIONEER DVR-TD08RS	KU.00805.044
	DVD SUPER MULTI DRIVE PLDS DS-8A2S	KU.0080F.001
	DVD SUPER MULTI DRIVE SONY AD-7560S	KU.0080E.009
	DVD SUPER MULTI DRIVE TOSHIBA TS-L633A	KU.00801.021
	ODD BEZEL-SUPER MULTI	42.AT902.004
	ODD BRACKET	33.AT902.002
Combo Drive		
	DVD/CDRW COMBO DRIVE MODULE	6M.AT902.002
	DVD/CDRW COMBO DRIVE TSST TS-L463A	KO.02401.006
	DVD/CDRW COMBO DRIVE SONY CRX890S	KO.0240E.009
	ODD BEZEL-COMBO	42.AT902.005
	ODD BRACKET	33.AT902.002

Category	Description	Acer Part No.
HDD		
	HDD SATA 120G 5400RPM HGST HTS542512K9SA00	KH.12007.014
	HDD SATA 120G 5400RPM TOSHIBA MK1246GSX 0FA	KH.12004.007
	HDD SATA 120G 5400RPM SEAGATE ST9120817AS	KH.12001.032
	HDD SATA 120G 5400RPM WD WD1200BEVS-22UST0	KH.12008.019
	HDD SATA 160G 5400RPM HGST HTS542516K9SA00	KH.16007.016
	HDD SATA 160G 5400RPM HGST HTS543216L9A300 0FA	
	HDD SATA 160G 5400RPM TOSHIBA MK1646GSX	KH.16004.002
	HDD SATA 160G 5400RPM TOSHIBA MK1652GSX 0FA	
	HDD SATA 160G 5400RPM SEAGATE ST9160827AS	KH.16001.029
	HDD SATA 160G 5400RPM WD WD1600BEVT-22ZCT0	KH.16008.022
	HDD SATA 250G 5400RPM HGST HTS542525K9SA00	KH.25007.011
	HDD SATA 250G 5400RPM HGST HTS543225L9A300 0FA	
	HDD SATA 250G 5400RPM TOSHIBA MK2546GSX	KH.25004.001
	HDD SATA 250G 5400RPM SEAGATE ST9250827AS	KH.25001.011
	HDD SATA 250G 5400RPM WD WD2500BEVS-22UST0	KH.25008.018
	HDD SATA 320G 5400RPM HGST HTS543232L9A300	KH.32007.004
	HDD SATA 320G 5400RPM SEAGATE ST9320320AS	KH.32001.008
HDD SATA 320G 5400RPM WD WD3200BEVT-22ZCT0	KH.32008.013	
HDD SATA 320G 5400RPM TOSHIBA MK3252GSX 0FA		
	HDD CARRIER	33.AT902.003

Category	Description	Acer Part No.
Keyboard		
	KEYBOARD INTE(UI) BLACK AS	KB.INT00.442
	KEYBOARD ARABIC/ENGLISH BLACK AS	KB.INT00.474
	KEYBOARD BELGIUM BLACK AS	KB.INT00.473
	KEYBOARD BRAZILIAN BLACK AS	KB.INT00.472
	KEYBOARD CANADIAN/FRENCH BLACK AS	KB.INT00.471
	KEYBOARD CHINESE BLACK AS	KB.INT00.470
	KEYBOARD CZECH BLACK AS	KB.INT00.469
	KEYBOARD DENMARK BLACK AS	KB.INT00.468
	KEYBOARD NETHERLANDS BLACK AS	KB.INT00.467
	KEYBOARD FRENCH BLACK AS	KB.INT00.465
	KEYBOARD GERMAN BLACK AS	KB.INT00.464
	KEYBOARD GREEK BLACK AS	KB.INT00.463
	KEYBOARD HUNGARY BLACK AS	KB.INT00.462
	KEYBOARD ITALY BLACK AS	KB.INT00.459
	KEYBOARD KOREAN BLACK AS	KB.INT00.457
	KEYBOARD NORWEGIAN BLACK AS	KB.INT00.455
	KEYBOARD PORTUGUESE BLACK AS	KB.INT00.453
	KEYBOARD RUSSIAN BLACK AS	KB.INT00.452
	KEYBOARD SLOVENIAN BLACK AS	KB.INT00.451
	KEYBOARD SLOVAKIAN BLACK AS CZECH/SLOVAK	KB.I1400.002
	KEYBOARD SPANISH BLACK AS	KB.INT00.449
	KEYBOARD SWEDISH BLACK AS	KB.INT00.448
	KEYBOARD SWITZERLAND BLACK AS	KB.INT00.447
	KEYBOARD THAILAND BLACK AS	KB.INT00.446
	KEYBOARD TURKISH BLACK AS	KB.INT00.445
	KEYBOARD UK BLACK AS	KB.INT00.444
	KEYBOARD HEBREW BLACK AS	KB.INT00.443
	KEYBOARD JP BLACK AS	KB.INT00.458
KEYBOARD SCANDINAVIAN BLACK AS	TBD	
KEYBOARD ARABIC/FRENCH BLACK AS	KB.INT00.475	
KEYBOARD CANADIAN/ENGLISH BLACK AS	KB.INT00.477	
LCD		
	ASSY LCD MODULE 14.1 IN. WXGA GLARE FOR CCD 0.3M W/ANTENNA	6M.AT902.003
	LCD PANEL G 14.1" WXGA AUO B141EW04 V4	LK.14105.018
	LCD PANEL G 14.1" WXGA SAMSUNG LTN141W3-L01-J	LK.14106.014
	LCD PANEL G 14.1" WXGA CMO N141I3-L02	LK.1410D.016
	LCD PANEL G 14.1" WXGA LPL LP141WX3-TLN1	LK.14108.014
	INVERTER BOARD	55.AT902.003

Category	Description	Acer Part No.
	LCD CABLE	50.AT902.002
	LCD COVER-IMR	60.AT902.005
	LCD BEZEL	60.AT902.006
	LCD BRACKET-R	33.AT902.004
	LCD BRACKET-L	33.AT902.005
	ANTENNA-R	50.AT902.003
	ANTENNA-L	50.AT902.004
	CAMERA MODULE 0.3M	57.AT902.001
	SCREW PAD	47.AT902.001
Mainboard		
	MAINBOARD AS4330 INTEL GL40 ICH9 LF WITH ALL CONNECTERS	MB.ATV02.001

Category	Description	Acer Part No.
Memory		
	RAM 512MB DDRII 667 NANYA NT512T64UH8B0FN-3C	KN.51203.032
	RAM 512MB DDRII 667 SAMSUNG M470T6464QZ3-CE6	KN.5120B.026
	RAM 512MB DDRII 667 HYNIX HYMP164S64CP6-Y5	KN.5120G.024
	RAM 1GB DDRII 667 NANYA NT1GT64U8HB0BN-3C	KN.1GB03.014
	RAM 1GB DDRII 667 SAMSUNG M470T2864QZ3-CE6	KN.1GB0B.016
	RAM 1GB DDRII 667 HYNIX HYMP112S64CP6-Y5	KN.1GB0G.012
	RAM 2GB DDRII 667 HYNIX HYMP125S64CP8-Y5	KN.2GB0G.004
	RAM 2GB DDRII 667 SAMSUNG M470T5663QZ3-CE6	KN.2GB0B.003
Fan		
	FAN-UMA	23.AT902.001
Heatsink		
	CPU THERMAL MODULE-UMA	60.AT902.007
	CPU THERMAL MODULE-DIS	TBD
Speaker		
	MIC SET	23.AT902.002
	SPEAKER R&L	23.AT902.003
Miscellaneous		
	NAME PLATE-AS4730Z	47.AT902.002
	NAME PLATE-AS4330	47.ATV02.001
	RUBBER FOOT-L	47.AT902.003
	RUBBER FOOT-S	47.AT902.004
	RUBBER FOOT-HDD DOOR	47.AT902.005

Screw List

Category	Description	Acer Part No.
SCREW	M2.5X8(NL)	86.AT902.001
SCREW	M2.5X5(NL)	86.AT902.002
SCREW	M2X3(NL)	86.AT902.003
SCREW	M2.5X4(NL)	86.AT902.004
SCREW	M2X4-NI(NL)	86.AT902.005
SCREW	M3X3(NL)	86.AT902.006
SCREW	M2.5X6.5(NL)	86.AT902.007

Model Definition and Configuration

TravelMate 4730Z/4730ZG/4330 Series

Model	RO	Country	Acer P/N	Description	CPU	BT
AS4730Z-321G16Mi	AAP	Australia/ New Zealand	LX.AT90C.014	AS4730Z-321G16Mi LINPUSAAU1 UMACЕ 1*1G/ 160/6L/5R/ CB_bg_0.3D_HG_EN11	PMDT3200	N
AS4730Z-321G16Mn	CHINA	China	LX.AT90C.020	AS4730Z-321G16Mn LINPUSACN1 UMACЕ 1*1G/ 160/6L/5R/ CB_bgn_0.3D_HG_EN91	PMDT3200	N
AS4730Z-322G25Mn	EMEA	Middle East	LX.AT90X.019	AS4730Z-322G25Mn EM VHP32ATME2 MC UMACЕ 1*2G/250/BT/6L/5R/ CB_bgn_0.3D_HG_AR23	PMDT3200	BT 2.0
AS4730Z-321G16i	AAP	Thailand	LX.AT90C.003	AS4730Z-321G16i LINPUSATH1 UMACЕ 1*1G/160/BT/6L/5R/ CB_bg_0.3D_HG_EN11	PMDT3200	BT 2.0
AS4730Z-321G16n	AAP	Thailand	LX.AT90C.002	AS4730Z-321G16n LINPUSATH1 UMACЕ 1*1G/160/ BT/6L/5R/ CB_bgn_0.3D_HG_EN11	PMDT3200	BT 2.0
AS4730Z-341G16n	AAP	Thailand	LX.AT90C.001	AS4730Z-341G16n LINPUSATH1 UMACЕ 1*1G/160/ BT/6L/5R/ CB_bgn_0.3D_HG_EN11	PMDT3400	BT 2.0
AS4730Z-322G12Mi	PA	Canada	LX.AT90X.017	AS4730Z-322G12Mi VHP32ATCA2 MC UMACЕ 1*2G/ 120/6L/5R/ CB_bg_0.3D_HG_FR35	PMDT3200	N
AS4730Z-322G12Mi	PA	Canada	LX.AT90X.016	AS4730Z-322G12Mi VHP32ATCA2 MC UMACЕ 1*2G/ 120/6L/5R/ CB_bg_0.3D_HG_FR33	PMDT3200	N
AS4730Z-322G12Mi	PA	Canada	LX.AT90X.015	AS4730Z-322G12Mi VHP32ATCA2 MC UMACЕ 1*2G/ 120/6L/5R/ CB_bg_0.3D_HG_FR32	PMDT3200	N
AS4730Z-322G12Mi	PA	Canada	LX.AT90X.014	AS4730Z-322G12Mi VHP32ATCA2 MC UMACЕ 1*2G/ 120/6L/5R/ CB_bg_0.3D_HG_FR31	PMDT3200	N
AS4730Z-322G12Mi	PA	Canada	LX.AT90X.013	AS4730Z-322G12Mi VHP32ATCA2 MC UMACЕ 1*2G/ 120/6L/5R/ CB_bg_0.3D_HG_FR34	PMDT3200	N
AS4730Z-322G12Mi	PA	USA	LX.AT90X.012	AS4730Z-322G12Mi VHP32ATUS1 MC UMACЕ 1*2G/ 120/6L/5R/ CB_bg_0.3D_HG_EN33	PMDT3200	N

Model	RO	Country	Acer P/N	Description	CPU	BT
AS4730Z-322G12Mi	PA	USA	LX.AT90X.011	AS4730Z-322G12Mi VHP32ATUS1 MC UMACЕ 1*2G/ 120/6L/5R/ CB_bg_0.3D_HG_EN35	PMDT3200	N
AS4730Z-322G12Mi	PA	USA	LX.AT90X.010	AS4730Z-322G12Mi VHP32ATUS1 MC UMACЕ 1*2G/ 120/6L/5R/ CB_bg_0.3D_HG_EN32	PMDT3200	N
AS4730Z-322G12Mi	PA	USA	LX.AT90X.009	AS4730Z-322G12Mi VHP32ATUS1 MC UMACЕ 1*2G/ 120/6L/5R/ CB_bg_0.3D_HG_EN34	PMDT3200	N
AS4730Z-322G12Mi	PA	ACLA-Portuguese	LX.AT90X.008	AS4730Z-322G12Mi VHP32ATXC2 MC UMACЕ 1*2G/ 120/6L/5R/ CB_bg_0.3D_HG_XC22	PMDT3200	N
AS4730Z-322G12Mi	PA	ACLA-Portuguese	LX.AT90X.007	AS4730Z-322G12Mi EM VHP32ATXC2 MC UMACЕ 1*2G/ 120/6L/5R/ CB_bg_0.3D_HG_XC21	PMDT3200	N
AS4730Z-322G12Mi	PA	ACLA-Portuguese	LX.AT90X.006	AS4730Z-322G12Mi EM VHP32ATXC1 MC UMACЕ 1*2G/ 120/6L/5R/ CB_bg_0.3D_HG_XC22	PMDT3200	N
AS4730Z-322G12Mi	PA	ACLA-Portuguese	LX.AT90X.005	AS4730Z-322G12Mi VHP32ATXC1 MC UMACЕ 1*2G/ 120/6L/5R/ CB_bg_0.3D_HG_XC21	PMDT3200	N
AS4730Z-322G12Mi	PA	ACLA-Spanish	LX.AT90X.004	AS4730Z-322G12Mi VHP32ATEA3 MC UMACЕ 1*2G/ 120/6L/5R/ CB_bg_0.3D_HG_ES21	PMDT3200	N
AS4730Z-322G12Mi	PA	ACLA-Spanish	LX.AT90X.003	AS4730Z-322G12Mi EM VHP32ATEA3 MC UMACЕ 1*2G/ 120/6L/5R/ CB_bg_0.3D_HG_ES22	PMDT3200	N
AS4730Z-322G12Mi	PA	ACLA-Spanish	LX.AT90X.002	AS4730Z-322G12Mi EM VHP32ATEA1 MC UMACЕ 1*2G/ 120/6L/5R/ CB_bg_0.3D_HG_ES22	PMDT3200	N
AS4730Z-322G12Mi	PA	ACLA-Spanish	LX.AT90X.001	AS4730Z-322G12Mi VHP32ATEA1 MC UMACЕ 1*2G/ 120/6L/5R/ CB_bg_0.3D_HG_ES21	PMDT3200	N
AS4730Z-321G16Mi	AAP	Singapore	LX.AT90C.017	AS4730Z-321G16Mi LINPUSASG1 UMACЕ 1*1G/ 160/6L/5R/ CB_bg_0.3D_HG_EN11	PMDT3200	N
AS4730Z-321G16Mi	AAP	India	LX.AT90C.016	AS4730Z-321G16Mi LINPUSAIN1 UMACЕ 1*1G/160/ 6L/5R/CB_bg_0.3D_HG_EN11	PMDT3200	N
AS4730Z-321G16Mi	AAP	Indonesia	LX.AT90C.015	AS4730Z-321G16Mi LINPUSAID1 UMACЕ 1*1G/160/ 6L/5R/CB_bg_0.3D_HG_EN12	PMDT3200	N
AS4730Z-321G16Mi	AAP	Indonesia	LX.AT90C.013	AS4730Z-321G16Mi LINPUSAID1 UMACЕ 1*1G/160/ 6L/5R/CB_bg_0.3D_HG_ID21	PMDT3200	N

Model	RO	Country	Acer P/N	Description	CPU	BT
AS4730Z-321G16Mi	AAP	Japan	LX.AT90C.012	AS4730Z-321G16Mi LINPUSAJP1 UMACE 1*1G/160/ 6L/5R/CB_bg_0.3D_HG_ENB1	PMDT3200	N
AS4730Z-321G16Mi	AAP	Philippines	LX.AT90C.011	AS4730Z-321G16Mi LINPUSAPH1 UMACE 1*1G/ 160/6L/5R/ CB_bg_0.3D_HG_EN11	PMDT3200	N
AS4730Z-321G16Mi	AAP	Malaysia	LX.AT90C.010	AS4730Z-321G16Mi LINPUSAMY1 UMACE 1*1G/ 160/6L/5R/ CB_bg_0.3D_HG_EN11	PMDT3200	N
AS4730Z-321G16Mi	AAP	Thailand	LX.AT90C.009	AS4730Z-321G16Mi LINPUSATH1 UMACE 1*1G/160/ 6L/5R/CB_bg_0.3D_HG_EN11	PMDT3200	N
AS4730Z-321G16Mi	AAP	Vietnam	LX.AT90C.008	AS4730Z-321G16Mi LINPUSAVN1 UMACE 1*1G/160/ 6L/5R/CB_bg_0.3D_HG_EN11	PMDT3200	N
AS4730Z-320512Mi	AAP	Malaysia	LX.AT90C.007	AS4730Z-320512Mi LINPUSAMY1 UMACE 1*512/ 120/6L/5R/ CB_bg_0.3D_HG_EN11	PMDT3200	N
AS4730Z-321G12Mi	AAP	Malaysia	LX.AT90Y.006	AS4730Z-321G12Mi EM VHB32ATMY1 MC UMACE 1*1G/120/6L/5R/ CB_bg_0.3D_HG_EN14	PMDT3200	N
AS4730Z-343G32Mn	EMEA	Middle East	LX.AT90X.018	AS4730Z-343G32Mn EM VHP32ATME2 MC UMACE 2G+1G/320/BT/6L/5R/ CB_bgn_0.3D_HG_AR23	PMDT3400	BT 2.0
AS4730Z-342G16Mi	AAP	India	LX.AT90C.019	AS4730Z-342G16Mi LINPUSAIN1 UMACE 2*1G/160/ BT/6L/5R/ CB_bg_0.3D_HG_EN11	PMDT3400	BT 2.0
AS4730Z-322G16Mi	AAP	India	LX.AT90C.018	AS4730Z-322G16Mi LINPUSAIN1 UMACE 2*1G/160/ BT/6L/5R/ CB_bg_0.3D_HG_EN11	PMDT3200	BT 2.0
AS4730Z-321G12Mn	AAP	Philippines	LX.AT90C.006	AS4730Z-321G12Mn LINPUSAPH1 UMACE 1*1G/ 120/6L/5R/ CB_bgn_0.3D_HG_EN11	PMDT3200	N
AS4730Z-341G16Mn	AAP	Philippines	LX.AT90Y.005	AS4730Z-341G16Mn EM VHB32ATPH1 MC UMACE 1*1G/ 160/BT/6L/5R/ CB_bgn_0.3D_HG_EN14	PMDT3400	BT 2.0
AS4730Z-321G16Mn	AAP	Philippines	LX.AT90C.005	AS4730Z-321G16Mn LINPUSAPH1 UMACE 1*1G/ 160/BT/6L/5R/ CB_bgn_0.3D_HG_EN11	PMDT3200	BT 2.0
AS4730Z-321G12Mn	AAP	Philippines	LX.AT90Y.004	AS4730Z-321G12Mn EM VHB32ATPH1 MC UMACE 1*1G/ 120/BT/6L/5R/ CB_bgn_0.3D_HG_EN14	PMDT3200	BT 2.0
AS4730Z-341G16Mn	AAP	Philippines	LX.AT90C.004	AS4730Z-341G16Mn LINPUSAPH1 UMACE 1*1G/ 160/BT/6L/5R/ CB_bgn_0.3D_HG_EN11	PMDT3400	BT 2.0

Model	RO	Country	Acer P/N	Description	CPU	BT
AS4730Z-322G16i	TWN	GCTWN	LX.AT90Y.003	AS4730Z-322G16i VHB32ATTW1 MC UMACE 1*2G/160/BT/6L/5R/ CB_bg_0.3D_HG_TC11	PMDT3200	BT 2.0
AS4730Z-322G16i	CHINA	China	LX.AT90Y.002	AS4730Z-322G16i VHB32ATCN1 MC UMACE 1*2G/160/BT/6L/5R/ CB_bg_0.3D_HG_SC11	PMDT3200	BT 2.0
AS4730Z-322G16i	CHINA	Hong Kong	LX.AT90Y.001	AS4730Z-322G16i VHB32ATHK2 MC UMACE 1*2G/ 160/BT/6L/5R/ CB_bg_0.3D_HG_ZH31	PMDT3200	BT 2.0
AS4330-161G12Mi	PA	Canada	LX.ATV0Y.020	AS4330-161G12Mi VHB32ATCA2 MC UMACE 1*1G/ 120/6L/5R/ CB_bg_0.3D_HG_FR32	CMT1600	N
AS4330-161G12Mi	PA	Canada	LX.ATV0Y.019	AS4330-161G12Mi VHB32ATCA1 MC UMACE 1*1G/ 120/6L/5R/ CB_bg_0.3D_HG_FR11	CMT1600	N
AS4330-161G12Mi	PA	Canada	LX.ATV0Y.018	AS4330-161G12Mi VHB32ATCA2 MC UMACE 1*1G/ 120/6L/5R/ CB_bg_0.3D_HG_FR31	CMT1600	N
AS4330-161G12Mi	PA	USA	LX.ATV0Y.017	AS4330-161G12Mi VHB32ATUS1 MC UMACE 1*1G/ 120/6L/5R/ CB_bg_0.3D_HG_EN34	CMT1600	N
AS4330-161G12Mi	PA	USA	LX.ATV0Y.013	AS4330-161G12Mi VHB32ATUS1 MC UMACE 1*1G/ 120/6L/5R/ CB_bg_0.3D_HG_EN33	CMT1600	N
AS4330-161G12Mi	PA	USA	LX.ATV0Y.014	AS4330-161G12Mi VHB32ATUS1 MC UMACE 1*1G/ 120/6L/5R/ CB_bg_0.3D_HG_EN32	CMT1600	N
AS4330-161G12Mi	PA	ACLA-Portuguese	LX.ATV0Y.015	AS4330-161G12Mi EM VHB32ATXC2 MC UMACE 1*1G/ 120/6L/5R/ CB_bg_0.3D_HG_XC21	CMT1600	N
AS4330-161G12Mi	PA	ACLA-Portuguese	LX.ATV0Y.016	AS4330-161G12Mi VHB32ATXC2 MC UMACE 1*1G/ 120/6L/5R/ CB_bg_0.3D_HG_XC22	CMT1600	N
AS4330-161G12Mi	PA	ACLA-Portuguese	LX.ATV0Y.010	AS4330-161G12Mi EM VHB32ATXC1 MC UMACE 1*1G/ 120/6L/5R/ CB_bg_0.3D_HG_XC22	CMT1600	N
AS4330-161G12Mi	PA	ACLA-Portuguese	LX.ATV0Y.011	AS4330-161G12Mi VHB32ATXC1 MC UMACE 1*1G/ 120/6L/5R/ CB_bg_0.3D_HG_XC21	CMT1600	N
AS4330-161G12Mi	PA	ACLA-Spanish	LX.ATV0Y.012	AS4330-161G12Mi VHB32ATEA3 MC UMACE 1*1G/ 120/6L/5R/ CB_bg_0.3D_HG_ES21	CMT1600	N

Model	RO	Country	Acer P/N	Description	CPU	BT
AS4330-161G12Mi	PA	ACLA-Spanish	LX.ATV0Y.009	AS4330-161G12Mi EM VHB32ATEA3 MC UMAC 1*1G/120/6L/5R/CB_bg_0.3D_HG_ES22	CMT1600	N
AS4330-161G12Mi	PA	ACLA-Spanish	LX.ATV0Y.008	AS4330-161G12Mi EM VHB32ATEA1 MC UMAC 1*1G/120/6L/5R/CB_bg_0.3D_HG_ES22	CMT1600	N
AS4330-161G12Mi	PA	ACLA-Spanish	LX.ATV0Y.007	AS4330-161G12Mi VHB32ATEA1 MC UMAC 1*1G/120/6L/5R/CB_bg_0.3D_HG_ES21	CMT1600	N
AS4330-161G12Mn	AAP	Australia/ New Zealand	LX.ATV0C.007	AS4330-161G12Mn LINPUSAAU1 UMAC 1*1G/120/6L/5R/CB_bgn_0.3D_HG_EN11	CMT1600	N
AS4330-161G12Mn	AAP	Singapore	LX.ATV0C.008	AS4330-161G12Mn LINPUSASG1 UMAC 1*1G/120/6L/5R/CB_bgn_0.3D_HG_EN11	CMT1600	N
AS4330-161G12Mn	AAP	India	LX.ATV0C.006	AS4330-161G12Mn LINPUSAIN1 UMAC 1*1G/120/6L/5R/CB_bgn_0.3D_HG_EN11	CMT1600	N
AS4330-161G12Mn	AAP	Indonesia	LX.ATV0C.009	AS4330-161G12Mn LINPUSAI1 UMAC 1*1G/120/6L/5R/CB_bgn_0.3D_HG_EN12	CMT1600	N
AS4330-161G12Mn	AAP	Indonesia	LX.ATV0C.005	AS4330-161G12Mn LINPUSAI1 UMAC 1*1G/120/6L/5R/CB_bgn_0.3D_HG_ID21	CMT1600	N
AS4330-161G12Mn	AAP	Philippines	LX.ATV0C.004	AS4330-161G12Mn LINPUSAPH1 UMAC 1*1G/120/6L/5R/CB_bgn_0.3D_HG_EN11	CMT1600	N
AS4330-161G12Mn	AAP	Malaysia	LX.ATV0C.003	AS4330-161G12Mn LINPUSAMY1 UMAC 1*1G/120/6L/5R/CB_bgn_0.3D_HG_EN11	CMT1600	N
AS4330-161G12Mn	AAP	Thailand	LX.ATV0C.002	AS4330-161G12Mn LINPUSATH1 UMAC 1*1G/120/6L/5R/CB_bgn_0.3D_HG_EN11	CMT1600	N
AS4330-161G12Mn	AAP	Vietnam	LX.ATV0C.001	AS4330-161G12Mn LINPUSAVN1 UMAC 1*1G/120/6L/5R/CB_bgn_0.3D_HG_EN11	CMT1600	N
AS4330-571G12M	CHINA	China	LX.ATV0C.014	AS4330-571G12MLINPUSACN1 UMAC 1*1G/120/6L/5R/CB_0.3D_HG_EN91	CM575	N
AS4330-161G12M	CHINA	China	LX.ATV0C.013	AS4330-161G12MLINPUSACN1 UMAC 1*1G/120/6L/5R/CB_0.3D_HG_EN91	CMT1600	N
AS4330-161G12C	CHINA	China	LX.ATV0C.012	AS4330-161G12CLINPUSACN1 UMAC 1*1G/120/6L/5R/CB_0.3D_HG_EN91	CMT1600	N
AS4330-161G16Mi	AAP	Thailand	LX.ATV0C.015	AS4330-161G16Mi LINPUSATH1 UMAC 1*1G/160/6L/5R/CB_bg_0.3D_HG_EN11	CMT1600	N

Model	RO	Country	Acer P/N	Description	CPU	BT
AS4330-161G16Mi	AAP	Thailand	LX.ATV0C.011	AS4330-161G16Mi LINPUSATH1 UMACE 1*1G/160/ BT/6L/5R/ CB_bg_0.3D_HG_EN11	CMT1600	BT 2.0
AS4330-171G16Mi	AAP	Thailand	LX.ATV0C.010	AS4330-171G16Mi LINPUSATH1 UMACE 1*1G/160/ BT/6L/5R/ CB_bg_0.3D_HG_EN11	CMT1700	BT 2.0
AS4330-571G12Mi	TWN	GCTWN	LX.ATV0Y.006	AS4330-571G12Mi VHB32ATTW1 MC UMACE 1*1G/120/6L/5R/ CB_bg_0.3D_HG_TC11	CM575	N
AS4330-161G12Mi	TWN	GCTWN	LX.ATV0Y.005	AS4330-161G12Mi VHB32ATTW1 MC UMACE 1*1G/120/6L/5R/ CB_bg_0.3D_HG_TC11	CMT1600	N
AS4330-161G12Mi	CHINA	China	LX.ATV0Y.004	AS4330-161G12Mi VHB32ATCN1 MC UMACE 1*1G/120/6L/5R/ CB_bg_0.3D_HG_SC11	CMT1600	N
AS4330-161G12Mi	CHINA	Hong Kong	LX.ATV0Y.003	AS4330-161G12Mi VHB32ATHK2 MC UMACE 1*1G/ 120/6L/5R/ CB_bg_0.3D_HG_ZH31	CMT1600	N
AS4330-571G12Mi	CHINA	China	LX.ATV0Y.002	AS4330-571G12Mi VHB32ATCN1 MC UMACE 1*1G/120/6L/5R/ CB_bg_0.3D_HG_SC11	CM575	N
AS4330-571G12Mi	CHINA	Hong Kong	LX.ATV0Y.001	AS4330-571G12Mi VHB32ATHK2 MC UMACE 1*1G/ 120/6L/5R/ CB_bg_0.3D_HG_ZH31	CM575	N
AS4730ZG - 322G25Mn	TWN	GCTWN	LX.AW20Y.003	AS4730ZG-322G25Mn VHB32ATTW1 MC 82MEXTHM256CE 1*2G/250/ BT/6L/5R/ CB_bgn_0.3D_HG_TC11	PMDT3200	BT 2.0
AS4730ZG - 322G25Mn	CHINA	China	LX.AW20Y.002	AS4730ZG-322G25Mn VHB32ATCN1 MC 82MEXTHM256CE 1*2G/250/6L/ 5R/CB_bgn_0.3D_HG_SC11	PMDT3200	N
AS4730ZG - 322G25Mn	CHINA	Hong Kong	LX.AW20Y.001	AS4730ZG-322G25Mn VHB32ATHK2 MC 82MEXTHM256CE 1*2G/250/6L/ 5R/CB_bgn_0.3D_HG_ZH31	PMDT3200	N

Model	LCD	Mem1	Mem2	HDD 1 (GB)	ODD	WLAN1	WLAN 2
AS4730Z-321G16Mi	N14.1WXGAG	SO1GBII6	N	N160GB5.4KS	NSM8XS	3rd WiFi BG	3rd WiFi BG
AS4730Z-321G16Mn	N14.1WXGAG	SO1GBII6	N	N160GB5.4KS	NSM8XS	3rd WiFi 1x2 BGN	3rd WiFi 1x2 BGN
AS4730Z-322G25Mn	N14.1WXGAG	SO2GBII6	N	N250GB5.4KS	NSM8XS	3rd WiFi 1x2 BGN	3rd WiFi 1x2 BGN
AS4730Z-321G16i	N14.1WXGAG	SO1GBII6	N	N160GB5.4KS	N	3rd WiFi BG	3rd WiFi BG
AS4730Z-321G16n	N14.1WXGAG	SO1GBII6	N	N160GB5.4KS	N	3rd WiFi 1x2 BGN	3rd WiFi 1x2 BGN

Model	LCD	Mem1	Mem2	HDD 1 (GB)	ODD	WLAN1	WLAN 2
AS4730Z-320512Mi	N14.1WXGAG	SO512MBII6	N	N120GB5.4KS	NSM8XS	3rd WiFi BG	3rd WiFi BG
AS4730Z-321G12Mi	N14.1WXGAG	SO1GBII6	N	N120GB5.4KS	NSM8XS	3rd WiFi BG	3rd WiFi BG
AS4730Z-343G32Mn	N14.1WXGAG	SO2GBII6	SO1GBII6	N320GB5.4KS	NSM8XS	3rd WiFi 1x2 BGN	3rd WiFi 1x2 BGN
AS4730Z-342G16Mi	N14.1WXGAG	SO1GBII6	SO1GBII6	N160GB5.4KS	NSM8XS	3rd WiFi BG	3rd WiFi BG
AS4730Z-322G16Mi	N14.1WXGAG	SO1GBII6	SO1GBII6	N160GB5.4KS	NSM8XS	3rd WiFi BG	3rd WiFi BG
AS4730Z-321G12Mn	N14.1WXGAG	SO1GBII6	N	N120GB5.4KS	NSM8XS	3rd WiFi 1x2 BGN	3rd WiFi 1x2 BGN
AS4730Z-341G16Mn	N14.1WXGAG	SO1GBII6	N	N160GB5.4KS	NSM8XS	3rd WiFi 1x2 BGN	3rd WiFi 1x2 BGN
AS4730Z-321G16Mn	N14.1WXGAG	SO1GBII6	N	N160GB5.4KS	NSM8XS	3rd WiFi 1x2 BGN	3rd WiFi 1x2 BGN
AS4730Z-321G12Mn	N14.1WXGAG	SO1GBII6	N	N120GB5.4KS	NSM8XS	3rd WiFi 1x2 BGN	3rd WiFi 1x2 BGN
AS4730Z-341G16Mn	N14.1WXGAG	SO1GBII6	N	N160GB5.4KS	NSM8XS	3rd WiFi 1x2 BGN	3rd WiFi 1x2 BGN
AS4730Z-322G16i	N14.1WXGAG	SO2GBII6	N	N160GB5.4KS	N	3rd WiFi BG	3rd WiFi BG
AS4730Z-322G16i	N14.1WXGAG	SO2GBII6	N	N160GB5.4KS	N	3rd WiFi BG	3rd WiFi BG
AS4730Z-322G16i	N14.1WXGAG	SO2GBII6	N	N160GB5.4KS	N	3rd WiFi BG	3rd WiFi BG
AS4330-161G12Mi	N14.1WXGAG	SO1GBII6	N	N120GB5.4KS	NSM8XS	3rd WiFi BG	3rd WiFi BG
AS4330-161G12Mi	N14.1WXGAG	SO1GBII6	N	N120GB5.4KS	NSM8XS	3rd WiFi BG	3rd WiFi BG
AS4330-161G12Mi	N14.1WXGAG	SO1GBII6	N	N120GB5.4KS	NSM8XS	3rd WiFi BG	3rd WiFi BG
AS4330-161G12Mi	N14.1WXGAG	SO1GBII6	N	N120GB5.4KS	NSM8XS	3rd WiFi BG	3rd WiFi BG
AS4330-161G12Mi	N14.1WXGAG	SO1GBII6	N	N120GB5.4KS	NSM8XS	3rd WiFi BG	3rd WiFi BG
AS4330-161G12Mi	N14.1WXGAG	SO1GBII6	N	N120GB5.4KS	NSM8XS	3rd WiFi BG	3rd WiFi BG
AS4330-161G12Mi	N14.1WXGAG	SO1GBII6	N	N120GB5.4KS	NSM8XS	3rd WiFi BG	3rd WiFi BG
AS4330-161G12Mi	N14.1WXGAG	SO1GBII6	N	N120GB5.4KS	NSM8XS	3rd WiFi BG	3rd WiFi BG
AS4330-161G12Mi	N14.1WXGAG	SO1GBII6	N	N120GB5.4KS	NSM8XS	3rd WiFi BG	3rd WiFi BG
AS4330-161G12Mi	N14.1WXGAG	SO1GBII6	N	N120GB5.4KS	NSM8XS	3rd WiFi BG	3rd WiFi BG
AS4330-161G12Mi	N14.1WXGAG	SO1GBII6	N	N120GB5.4KS	NSM8XS	3rd WiFi BG	3rd WiFi BG
AS4330-161G12Mi	N14.1WXGAG	SO1GBII6	N	N120GB5.4KS	NSM8XS	3rd WiFi BG	3rd WiFi BG
AS4330-161G12Mi	N14.1WXGAG	SO1GBII6	N	N120GB5.4KS	NSM8XS	3rd WiFi BG	3rd WiFi BG
AS4330-161G12Mi	N14.1WXGAG	SO1GBII6	N	N120GB5.4KS	NSM8XS	3rd WiFi BG	3rd WiFi BG
AS4330-161G12Mi	N14.1WXGAG	SO1GBII6	N	N120GB5.4KS	NSM8XS	3rd WiFi BG	3rd WiFi BG
AS4330-161G12Mi	N14.1WXGAG	SO1GBII6	N	N120GB5.4KS	NSM8XS	3rd WiFi BG	3rd WiFi BG
AS4330-161G12Mi	N14.1WXGAG	SO1GBII6	N	N120GB5.4KS	NSM8XS	3rd WiFi BG	3rd WiFi BG
AS4330-161G12Mi	N14.1WXGAG	SO1GBII6	N	N120GB5.4KS	NSM8XS	3rd WiFi BG	3rd WiFi BG
AS4330-161G12Mi	N14.1WXGAG	SO1GBII6	N	N120GB5.4KS	NSM8XS	3rd WiFi BG	3rd WiFi BG

Model	LCD	Mem1	Mem2	HDD 1 (GB)	ODD	WLAN1	WLAN 2
AS4330-161G12Mn	N14.1WXGAG	SO1GBII6	N	N120GB5.4KS	NSM8XS	3rd WiFi 1x2 BGN	3rd WiFi 1x2 BGN
AS4330-161G12Mn	N14.1WXGAG	SO1GBII6	N	N120GB5.4KS	NSM8XS	3rd WiFi 1x2 BGN	3rd WiFi 1x2 BGN
AS4330-161G12Mn	N14.1WXGAG	SO1GBII6	N	N120GB5.4KS	NSM8XS	3rd WiFi 1x2 BGN	3rd WiFi 1x2 BGN
AS4330-161G12Mn	N14.1WXGAG	SO1GBII6	N	N120GB5.4KS	NSM8XS	3rd WiFi 1x2 BGN	3rd WiFi 1x2 BGN
AS4330-161G12Mn	N14.1WXGAG	SO1GBII6	N	N120GB5.4KS	NSM8XS	3rd WiFi 1x2 BGN	3rd WiFi 1x2 BGN
AS4330-161G12Mn	N14.1WXGAG	SO1GBII6	N	N120GB5.4KS	NSM8XS	3rd WiFi 1x2 BGN	3rd WiFi 1x2 BGN
AS4330-161G12Mn	N14.1WXGAG	SO1GBII6	N	N120GB5.4KS	NSM8XS	3rd WiFi 1x2 BGN	3rd WiFi 1x2 BGN
AS4330-161G12Mn	N14.1WXGAG	SO1GBII6	N	N120GB5.4KS	NSM8XS	3rd WiFi 1x2 BGN	3rd WiFi 1x2 BGN
AS4330-161G12Mn	N14.1WXGAG	SO1GBII6	N	N120GB5.4KS	NSM8XS	3rd WiFi 1x2 BGN	3rd WiFi 1x2 BGN
AS4330-571G12M	N14.1WXGAG	SO1GBII6	N	N120GB5.4KS	NSM8XS	N	N
AS4330-161G12M	N14.1WXGAG	SO1GBII6	N	N120GB5.4KS	NSM8XS	N	N
AS4330-161G12C	N14.1WXGAG	SO1GBII6	N	N120GB5.4KS	NCB24XS	N	N
AS4330-161G16Mi	N14.1WXGAG	SO1GBII6	N	N160GB5.4KS	NSM8XS	3rd WiFi BG	3rd WiFi BG
AS4330-161G16Mi	N14.1WXGAG	SO1GBII6	N	N160GB5.4KS	NSM8XS	3rd WiFi BG	3rd WiFi BG
AS4330-171G16Mi	N14.1WXGAG	SO1GBII6	N	N160GB5.4KS	NSM8XS	3rd WiFi BG	3rd WiFi BG
AS4330-571G12Mi	N14.1WXGAG	SO1GBII6	N	N120GB5.4KS	NSM8XS	3rd WiFi BG	3rd WiFi BG
AS4330-161G12Mi	N14.1WXGAG	SO1GBII6	N	N120GB5.4KS	NSM8XS	3rd WiFi BG	3rd WiFi BG
AS4330-161G12Mi	N14.1WXGAG	SO1GBII6	N	N120GB5.4KS	NSM8XS	3rd WiFi BG	3rd WiFi BG
AS4330-161G12Mi	N14.1WXGAG	SO1GBII6	N	N120GB5.4KS	NSM8XS	3rd WiFi BG	3rd WiFi BG
AS4330-571G12Mi	N14.1WXGAG	SO1GBII6	N	N120GB5.4KS	NSM8XS	3rd WiFi BG	3rd WiFi BG
AS4330-571G12Mi	N14.1WXGAG	SO1GBII6	N	N120GB5.4KS	NSM8XS	3rd WiFi BG	3rd WiFi BG
AS4730ZG - 322G25Mn	N14.1WXGAG	SO2GBII6	N	N250GB5.4KS	NSM8XS	3rd WiFi 1x2 BGN	3rd WiFi 1x2 BGN
AS4730ZG - 322G25Mn	N14.1WXGAG	SO2GBII6	N	N250GB5.4KS	NSM8XS	3rd WiFi 1x2 BGN	3rd WiFi 1x2 BGN
AS4730ZG - 322G25Mn	N14.1WXGAG	SO2GBII6	N	N250GB5.4KS	NSM8XS	3rd WiFi 1x2 BGN	3rd WiFi 1x2 BGN

Test Compatible Components

This computer's compatibility is tested and verified by Acer's internal testing department. All of its system functions are tested under Windows® XP Home, Windows® XP Pro environment.

Refer to the following lists for components, adapter cards, and peripherals which have passed these tests. Regarding configuration, combination and test procedures, please refer to the TravelMate 4730Z/4330 series Compatibility Test Report released by the Acer Mobile System Testing Department.

Microsoft® Windows® Vista Environment Test

Vendor	Type	Description
Adapter Test		
F0000183 DELTA CN	65W	Adapter DELTA 65W 1.7x5.5x11 SADP-65KB DFA LF level 4
10001023 LITE-ON	65W	Adapter LITE-ON 65W 1.7x5.5x11 PA-1650-02AC LF level 4
60002015 HIPRO	65W	Adapter HIPRO 65W 19V 1.7x5.5x11 Yellow HP-OK065B13 LED LF level 4
F0000183 DELTA CN	90W	Adapter DELTA 90W 1.7x5.5x11 ADP-90SB BBEA LF level 4
10001023 LITE-ON	90W	Adapter LITE-ON 90W 19V 1.7x5.5x11 Blue PA-1900-24AR LED LF level 4
60002015 HIPRO	90W	Adapter HIPRO 90W 19V 1.7x5.5x11 Blue HP-OL093B13P LED LF level 4
F0000183 DELTA CN	65W-DE	Adapter DELTA 65W 1.7x5.5x11 SADP-65KB BFJA LV4 LF for OBL only
F0000183 DELTA CN	90W	Adapter DELTA 90W 1.7x5.5x11 ADP-90SB BBEA LF level 4
F0000183 DELTA CN	90W	Adapter DELTA 90W 1.7x5.5x11 ADP-90SB BBEA LF level 4
60002015 HIPRO	90W	Adapter HIPRO 90W 19V 1.7x5.5x11 Blue HP-OL093B13P LED LF level 4
10001023 LITE-ON	90W	Adapter LITE-ON 90W 19V 1.7x5.5x11 Blue PA-1900-24AR LED LF level 4
60002015 HIPRO	90W	Adapter HIPRO 90W 19V 1.7x5.5x11 Blue HP-OL093B13P LED LF level 4
10001023 LITE-ON	90W	Adapter LITE-ON 90W 19V 1.7x5.5x11 Blue PA-1900-24AR LED LF level 4
F0000183 DELTA CN	90W	Adapter DELTA 90W 1.7x5.5x11 ADP-90SB BBEA LF level 4
60002015 HIPRO	90W	Adapter HIPRO 90W 19V 1.7x5.5x11 Blue HP-OL093B13P LED LF level 4
10001023 LITE-ON	90W	Adapter LITE-ON 90W 19V 1.7x5.5x11 Blue PA-1900-24AR LED LF level 4
Audio Codec Test		
9999995 ONE TIME VENDER	ALC268	ALC268
Battery Test		
60001921 SANYO	6CELL2.2	Battery SANYO AS-2007A Li-Ion 3S2P SANYO 6 cell 4400mAh Main COMMON Normal Type
10001063 SONY	6CELL2.2	Battery SONY AS-2007A Li-Ion 3S2P SONY 6 cell 4400mAh Main COMMON Normal Type
60001535 PANASONIC	6CELL2.2	Battery PANASONIC AS-2007A Li-Ion 3S2P PANASONIC 6 cell 4400mAh Main COMMON PSS
60002162 SIMPLO	6CELL2.2	Battery SIMPLO AS-2007A Li-Ion 3S2P PANASONIC 6 cell 4400mAh Main COMMON PSS
60002162 SIMPLO	6CELL2.2	Battery SIMPLO AS-2007A Li-Ion 3S2P SAMSUNG 6 cell 4400mAh Main COMMON SDI 2.2mAh F type

Vendor	Type	Description
60002162 SIMPLO	6CELL2.4	Battery SIMPLO AS-2007A Li-Ion 3S2P SAMSUNG 6 cell 2400mAh 2nd COMMON
Bluetooth Test		
9999995 ONE TIME VENDER	BT 2.0	Foxconn Bluetooth FOX_BRM_2.0 F/W 300
Camera Test		
9999995 ONE TIME VENDER	0.3M DV	Chicony 0.3M DV Calla_2
9999995 ONE TIME VENDER	0.3M DV	Suyin 0.3M DV Camellia_2
9999995 ONE TIME VENDER	0.3M DV	Chicony 0.3M DV Calla_2
9999995 ONE TIME VENDER	0.3M DV	Chicony 0.3M DV Calla_2
9999995 ONE TIME VENDER	0.3M DV	Bison 0.3M DV Lotus_2
Card Reader Test		
9999995 ONE TIME VENDER	5 in 1-Build in	5 in 1-Build in MS, MS Pro, SD, SC, XD
Card Bus1 Test		
9999995 ONE TIME VENDER	JMB385	JMicron JMB385 Card Reader: SD/MMC/MS/MS Duo/MS-HG (1/4/8-bit) & xD (PCI Express)
9999995 ONE TIME VENDER	JMB385	JMicron JMB385 Card Reader: SD/MMC/MS/MS Duo/MS-HG (1/4/8-bit) & xD (PCI Express)
9999995 ONE TIME VENDER	JMB385	JMicron JMB385 Card Reader: SD/MMC/MS/MS Duo/MS-HG (1/4/8-bit) & xD (PCI Express)
CPU Test		
10001067 INTEL	MVPQS	CPU Intel Core2Dual QS Montevina Penryn QS sample
10001067 INTEL	C2DP9500	CPU Intel Core2Dual P9500 PGA 2.53G 6M 1066 25W
10001067 INTEL	C2DT9400	CPU Intel Core2Dual T9400 PGA 2.53G 6M 1066 35W
10001067 INTEL	C2DP8400	CPU Intel Core2Dual P8400 PGA 2.26G 3M 1066 25W
10001067 INTEL	C2DP8600	CPU Intel Core2Dual P8600 PGA 2.4G 1066 25W 3M
10001067 INTEL	C2DT9600	CPU Intel Core2Dual T9600 PGA 2.8G 6M 1066 35W
10001067 INTEL	CM585	CPU Intel Celeron 585 PGA 2.16G 1M 667 MV

Vendor	Type	Description
10001067 INTEL	CM575	CPU Intel Celeron 575 PGA 2.0G 1M 667 MV
10001067 INTEL	C2DP7350	CPU Intel Core2Dual P7350 PGA 2.0G 3M 1066 25W
10001067 INTEL	C2DT5800	CPU Intel Core2Dual T5800 PGA 2.0G 2M 800 MV, TJ, noVT
10001067 INTEL	PMDT3400	CPU Intel Pentium Dual-Core T3400 PGA 2.16G 1M 667 MV
10001067 INTEL	PMDT3200	CPU Intel Pentium Dual-Core T3200 2.0G 1M 667 MV
10001067 INTEL	C2DP7450	CPU Intel Core2Dual P7450 PGA 2.13G 3M 1066 TJ, noVT
10001067 INTEL	C2DT5900	CPU Intel Core2Dual T5900 PGA 2.2G 2M 800 MV, TJ, noVT
10001067 INTEL	CMT1700	CPU Intel CeleronM T1700 PGA 1.83G 1M 667 Dual Core, MV
10001067 INTEL	CMT1600	CPU Intel CeleronM T1600 1.66G 1M 667 Dual Core, MV
HDD Test		
60001922 TOSHIBA DIGI	N120GB5.4KS	HDD TOSHIBA 2.5" 5400rpm 120GB MK1246GSX Leo BS SATA I LF F/W:LB213J
60002005 HGST SG	N120GB5.4KS	HDD HGST 2.5" 5400rpm 120GB HTS542512K9SA00 Bronco-B SATA II LF F/W:C31P
60001994 WD	N120GB5.4KS	HDD WD 2.5" 5400rpm 120GB WD1200BEVS-22UST0 ML125 SATA LF F/W:01.01A01
60002036 SEAGATE	N160GB5.4KS	HDD SEAGATE 2.5" 5400rpm 160GB ST9160827AS Corsair SATA LF F/W:3.AAA
60001922 TOSHIBA DIGI	N160GB5.4KS	HDD TOSHIBA 2.5" 5400rpm 160GB MK1646GSX Leo BS SATA I LF F/W:LB113J
60002005 HGST SG	N160GB5.4KS	HDD HGST 2.5" 5400rpm 160GB HTS542516K9SA00 Bronco-B SATA II LF F/W:C31P
60001994 WD	N160GB5.4KS	HDD WD 2.5" 5400rpm 160GB WD1600BEVT-22ZCT0 ML160 SATA LF F/W:11.01A11
60002036 SEAGATE	N250GB5.4KS	HDD SEAGATE 2.5" 5400rpm 250GB ST9250827AS Corsair SATA LF F/W:3.AAA
60001922 TOSHIBA DIGI	N250GB5.4KS	HDD TOSHIBA 2.5" 5400rpm 250GB MK2546GSX Leo BS SATA I LF F/W:LB013J
60002005 HGST SG	N250GB5.4KS	HDD HGST 2.5" 5400rpm 250GB HTS542525K9SA00 Bronco-B SATA II LF F/W:C31P
60001994 WD	N250GB5.4KS	HDD WD 2.5" 5400rpm 250GB WD2500BEVS-22UST0 ML125 SATA LF F/W:01.01A01
60001994 WD	N320GB5.4KS	HDD WD 2.5" 5400rpm 320GB WD3200BEVT-22ZCT0 ML160 SATA LF F/W:11.01A11
60002036 SEAGATE	N120GB5.4KS	HDD SEAGATE 2.5" 5400rpm 120GB ST9120817AS Corsair SATA LF F/W:3.AAA
60002005 HGST SG	N320GB5.4KS	HDD HGST 2.5" 5400rpm 320GB HTS543232L9A300 Falcon-B SATA LF F/W:C40C

Vendor	Type	Description
60002036 SEAGATE	N320GB5.4KS	HDD SEAGATE 2.5" 5400rpm 320GB ST9320320AS Crockett SATA LF F/W:0303
60002005 HGST SG	N160GB5.4KS	HDD HGST 2.5" 5400rpm 160GB HTS543216L9A300 Falcon-B SATA LF F/W:C40C
60002036 SEAGATE	N160GB5.4KS	HDD SEAGATE 2.5" 5400rpm 160GB ST9160310AS Crockett SATA LF F/W:0303
60001922 TOSHIBA DIGI	N120GB5.4KS	HDD TOSHIBA 2.5" 5400rpm 120GB MK1252GSX Virgo BS SATA LF F/W:LV010J
60002005 HGST SG	N120GB5.4KS	HDD HGST 2.5" 5400rpm 120GB HTS543212L9A300 Falcon-B SATA LF F/W:C40C
Keyboard Test		
820123 DARFON	14_15KB-FV2	Keyboard 14_15KB-FV2 Tahoe/Chapala Standard (New ID)
820123 DARFON	14_15KB-FV2	Keyboard 14_15KB-FV2 Tahoe/Chapala Standard (New ID)
820123 DARFON	14_15KB-FV3 Black	Keyboard 14_15KB-FV3 Black McKinley/Eiger Standard (Aspire Black)
820123 DARFON	14_15KB-FV2	Keyboard 14_15KB-FV2 Tahoe/Chapala Standard (New ID)
LAN Test		
9999995 ONE TIME VENDER	RTL8111C	Realtek Lan RTL8111C
LCD Test		
60003089 LG	N14.1WXGAG	LCD LPL 14.1" WXGA Glare LP141WX3-TLN1 LF 200nit 16ms
60003316 AUO	N14.1WXGAG	LCD AUO 14.1" WXGA Glare B141EW04-V4 LF 200nit 16ms
60002215 SAMSUNG	N14.1WXGAG	LCD SAMSUNG 14.1" WXGA Glare LTN141W3-L01-J L6 LF 200nit 16ms
10001038 CMO	N14.1WXGAG	LCD CMO 14.1" WXGA Glare N14113-L02 LF 200nit 10ms
Memory Test		
60001993 NANYA	SO1GBII6	SO-DIMM DDRII 667 1GB NT1GT64U8HB0BN-3C (0.09U)
60002045 HYNIX	SO1GBII6	Memory HYNIX SO-DIMM DDRII 667 1GB HYMP112S64CP6-Y5 LF
60001993 NANYA	SO512MBII6	Memory NANYA SO-DIMM DDRII 667 512MB NT512T64UH8B0FN-3C LF 32*16 0.09um
60002045 HYNIX	SO512MBII6	Memory HYNIX SO-DIMM DDRII 667 512MB HYMP164S64CP6-Y5 LF 64*16 0.065um
60002215 SAMSUNG	SO1GBII6	Memory SAMSUNG SO-DIMM DDRII 667 1GB M470T2864DZ3-CE6 LF
60002045 HYNIX	SO2GBII6	Memory HYNIX SO-DIMM DDRII 667 2GB HYMP125S64CP8-Y5 LF
60002215 SAMSUNG	SO512MBII6	Memory SAMSUNG SO-DIMM DDRII 667 512MB M470T6554EZ3-CE6 LF 32*16 0.08um
60002215 SAMSUNG	SO2GBII6	Memory SAMSUNG SO-DIMM DDRII 667 2GB M470T5663QZ3-CE6 LF

Vendor	Type	Description
60002215 SAMSUNG	SO1GBII6	Memory SAMSUNG SO-DIMM DDRII 667 1GB M470T2864QZ3-CE6 LF
60002215 SAMSUNG	SO1GBII6	Memory SAMSUNG SO-DIMM DDRII 667 1GB M470T2864DZ3-CE6 LF
60002215 SAMSUNG	SO1GBII6	Memory SAMSUNG SO-DIMM DDRII 667 1GB M470T2864DZ3-CE6 LF
60002215 SAMSUNG	SO512MBII6	Memory SAMSUNG SO-DIMM DDRII 667 512MB M470T6554EZ3-CE6 LF 32*16 0.08um
60002215 SAMSUNG	SO512MBII6	Memory SAMSUNG SO-DIMM DDRII 667 512MB M470T6554EZ3-CE6 LF 32*16 0.08um
60002215 SAMSUNG	SO512MBII6	Memory SAMSUNG SO-DIMM DDRII 667 512MB M470T6464QZ3-CE6 LF
60001993 NANYA	SO2GBII6	Memory NANYA SO-DIMM DDRII 667 2GB NT2GT64U8HD0BN-3C LF 128*8 0.07um
60001993 NANYA	SO1GBII6	Memory NANYA SO-DIMM DDRII 667 1GB NT1GT64UH8D0FN-3C LF 64*16 0.07um
Modem Test		
23707801 FOXCONN TW	Fox+Con MC4Z 1.5_3.3V	Foxconn Conexant -Unizion 1.5_3.3v T60M955.02
23707801 FOXCONN TW	Fox+LSI AM5 V2H 1.5_3.3V	Foxconn Delphi-AM5 V2H 1.5_3.3v T60M951
23707801 FOXCONN TW	Fox+LSI AM5 V2 3.3V Aus	Foxconn Delphi-AM5 V2 3.3v Aus T60M951.3x
Northbridge Chipset Test		
10001067 INTEL	Cantiga-NB	Intel Cantiga-NB for Montevina
10001067 INTEL	Cantiga-NB	Intel Cantiga-NB for Montevina
10001067 INTEL	Cantiga-NB	Intel Cantiga-NB for Montevina
10001067 INTEL	GL40	NB Chipset Intel CS GL40NB
10001067 INTEL	PM45	NB Chipset Intel CS PM45NB
ODD Test		
60001922 TOSHIBA DIGI	NCB24XS	ODD TOSHIBA COMBO 12.7mm Tray DL 24X TS-L463A LF W/ O bezel SATA
10001063 SONY	NCB24XS	ODD SONY COMBO 12.7mm Tray DL 24X CRX880S LF W/O bezel SATA
60001922 TOSHIBA DIGI	NSM8XS	ODD TOSHIBA Super-Multi DRIVE 12.7mm Tray DL 8X TS- L633A LF W/O bezel SATA
60001939 PIONEER	NSM8XS	ODD PIONEER Super-Multi DRIVE 12.7mm Tray DL 8X DVR- TD08RS LF W/O bezel SATA
60001535 PANASONIC	NSM8XS	ODD PANASONIC Super-Multi DRIVE 12.7mm Tray DL 8X UJ- 870A LF W/O bezel SATA

Vendor	Type	Description
23418669 HLDS	NSM8XS	ODD HLDS Super-Multi DRIVE 12.7mm Tray DL 8X GSA-T50N LF W/O bezel SATA
10001063 SONY	NSM8XS	ODD SONY Super-Multi DRIVE 12.7mm Tray DL 8X AD-7560S LF W/O bezel SATA
10001070 PHILIPS	NSM8XS	ODD PLDS Super-Multi DRIVE 12.7mm Tray DL 8X DS-8A2S LF W/O bezel SATA
10001063 SONY	NCB24XS	ODD SONY COMBO 12.7mm Tray DL 24X CRX880S LF W/O bezel SATA
10001063 SONY	NCB24XS	ODD SONY COMBO 12.7mm Tray DL 24X CRX880S LF W/O bezel SATA
10001063 SONY	NCB24XS	ODD SONY COMBO 12.7mm Tray DL 24X CRX890S LF W/O bezel SATA
23418669 HLDS	NSM8XS	ODD HLDS Super-Multi DRIVE 12.7mm Tray DL 8X GSA-T50N LF W/O bezel SATA Malaysia
60001535 PANASONIC	NSM8XS	ODD PANASONIC Super-Multi DRIVE 12.7mm Tray DL 8X UJ-870A LF W/O bezel SATA
60001535 PANASONIC	NSM8XS	ODD PANASONIC Super-Multi DRIVE 12.7mm Tray DL 8X UJ-870A LF W/O bezel SATA
610105 HLDS	NSM8XS	ODD HLDS Super-Multi DRIVE 12.7mm Tray DL 8X GT10N LF W/O bezel SATA
60001939 PIONEER	NSM8XS	ODD PIONEER Super-Multi DRIVE 12.7mm Tray DL 8X DVR-TD08RS LF W/O bezel FW 1.06 SATA
Southbridge Chipset Test		
10001067 INTEL	Cantiga-SB	Intel Cantiga-SB for Montevina
10001067 INTEL	ICH9M	SB Chipset Intel CS ICH9M
10001067 INTEL	Cantiga-SB	Intel Cantiga-SB for Montevina
10001067 INTEL	Cantiga-SB	Intel Cantiga-SB for Montevina
Software Test		
10000981 MISC	NIS	Antivirus application NIS
10000981 MISC	McAfee	Antivirus application McAfee
VGA Chip Test		
10001024 MSI	82MEXTHM256M	MSI VGA Card AMD M82ME-XT DDRII 256M 400MHz 32*16 MXM II w/ HDCP w/ O2 PowerIC
22554573 AMD	82MEXTHM	AMD 82MEXTHM w/ HDCP w/o Macrovision
VRAM Test		
9999995 ONE TIME VENDER	N	N no VRAM
9999995 ONE TIME VENDER	256M-GD2	256M-GD2

Vendor	Type	Description
WLAN Test		
9999995 ONE TIME VENDER	3rd WiFi BG	Foxconn Wireless LAN Broadcom 4312 minicard b/g
23707801 FOXCONN TW	3rd WiFi BG	Foxconn FOX_ATH_XB63 Foxconn Atheros XB63 minicard b/g
9999995 ONE TIME VENDER	3rd WiFi 1x2 BGN	Foxconn Wireless LAN Atheros AR5B91 1x2 BGN
9999995 ONE TIME VENDER	3rd WiFi 1x2 BGN	Foxconn Wireless LAN Wireless LAN Ralink RT2700E 1x2 BGN

Online Support Information

This section describes online technical support services available to help you repair your Acer Systems.

If you are a distributor, dealer, ASP or TPM, please refer your technical queries to your local Acer branch office. Acer Branch Offices and Regional Business Units may access our website. However some information sources will require a user i.d. and password. These can be obtained directly from Acer CSD Taiwan.

Acer's Website offers you convenient and valuable support resources whenever you need them.

In the Technical Information section you can download information on all of Acer's Notebook, Desktop and Server models including:

- Service guides for all models
- User's manuals
- Training materials
- Bios updates
- Software utilities
- Spare parts lists
- TABs (Technical Announcement Bulletin)

For these purposes, we have included an Acrobat File to facilitate the problem-free downloading of our technical material.

Also contained on this website are:

- Detailed information on Acer's International Traveler's Warranty (ITW)
- Returned material authorization procedures
- An overview of all the support services we offer, accompanied by a list of telephone, fax and email contacts for all your technical queries.

We are always looking for ways to optimize and improve our services, so if you have any suggestions or comments, please do not hesitate to communicate these to us.

A

AFLASH Utility 35
Antennas 104

B

Battery Pack 44
BIOS
 ROM size 19
 ROM type 19
 vendor 19
 Version 19
BIOS Passwords
 Removing 39
BIOS Supports protocol 19
BIOS Utility 27–35
 Boot 33
 Exit 34
 Navigating 27
 Onboard Device Configuration 31
 Save and Exit 34
 Security 30
 System Security 34
Bluetooth module 82
Board Layout
 Top View 151
brightness
 hotkeys 14

C

Cache
 controller 19
 size 19
Camera Module 99
caps lock
 on indicator 10
Common Problems 130
computer
 on indicator 10
CPU 90

D

DIMM Module 49

Display 4
display
 hotkeys 14

E

EasyTouch Failure 142
Euro 15
External Module Disassembly
 Flowchart 43

F

Features 1
Fingerprint Reader Failure 142
Flash Utility 35
FPC Cable 102
FRU (Field Replaceable Unit) List 155

H

Hard Disk Drive Module 52
Hibernation mode
 hotkey 14
Hot Keys 12

I

I/O Board 80
Indicators 10
Intermittent Problems 144
Internal Microphone Failure 136
Internal Speaker Failure 134
inverter board 97

J

Jumper and Connector Locations 151
 Top View 151

K

Keyboard 61
Keyboard Failure 133

L

- Launch Board 75
- LCD Bezel 95
- LCD Brackets 102
- LCD Failure 133
- LCD Module Disassembly
 - Flowchart 94
- LCD Panel 101
- lower cover 47

M

- Main Unit Disassembly
 - Flowchart 58
- Mainboard 86
- media access
 - on indicator 10
- MediaTouch Button Failure 142
- Memory Check 130
- Model Definition 166
- Modem Board 84
- Modem Failure 141

N

- No Display Issue 131
- Notebook Manager
 - hotkey 14
- num lock
 - on indicator 10

O

- ODD Failure 138
- Online Support Information 185
- optical drive module 55

P

- Panel 5
 - Bottom 9
 - left 5
- PC Card 10
- Power On Failure 130

S

- Speaker Module 76
- speakers

- hotkey 14
- System
 - Block Diagram 4

T

- Test Compatible Components 177
- Thermal Unit Failure 142
- Top 151
- Touch Pad Board Plate 79
- Touch Pad Bracket 72
- touchpad
 - hotkey 14
- Touchpad Failure 134
- Troubleshooting
 - Built-in KB Failure 133
 - EasyTouch Buttons 142
 - Fingerprint Reader 142
 - Internal Microphone 136
 - Internal Speakers 134
 - LCD Failure 133
 - MediTouch Buttons 142
 - Modem 141
 - No Display 131
 - ODD 138
 - Other Failures 143
 - Power On 130
 - Thermal Unit 142
 - Touchpad 134
 - WLAN 141

U

- Undetermined Problems 144
- utility
 - BIOS 27–35

W

- Windows 2000 Environment Test 178
- Wireless Function Failure 141
- WLAN Board 50