

Aspire 5741/5741G Series Service Guide

Service guide files and updates are available on the ACER/CSD web; for more information, please refer to <http://csd.acer.com.tw>

PRINTED IN TAIWAN

Revision History

Please refer to the table below for the updates made on Aspire 5741/5741G service guides.

Date	Chapter	Updates

Copyright

Copyright © 2010 by Acer Incorporated. All rights reserved. No part of this publication may be reproduced, transmitted, transcribed, stored in a retrieval system, or translated into any language or computer language, in any form or by any means, electronic, mechanical, magnetic, optical, chemical, manual or otherwise, without the prior written permission of Acer Incorporated.

Disclaimer

The information in this guide is subject to change without notice.

Acer Incorporated makes no representations or warranties, either expressed or implied, with respect to the contents hereof and specifically disclaims any warranties of merchantability or fitness for any particular purpose. Any Acer Incorporated software described in this manual is sold or licensed "as is". Should the programs prove defective following their purchase, the buyer (and not Acer Incorporated, its distributor, or its dealer) assumes the entire cost of all necessary servicing, repair, and any incidental or consequential damages resulting from any defect in the software.

Acer is a registered trademark of Acer Corporation.

Intel is a registered trademark of Intel Corporation.

Other brand and product names are trademarks and/or registered trademarks of their respective holders.

Conventions

The following conventions are used in this manual:

SCREEN MESSAGES	Denotes actual messages that appear on screen.
NOTE	Gives bits and pieces of additional information related to the current topic.
WARNING	Alerts you to any damage that might result from doing or not doing specific actions.
CAUTION	Gives precautionary measures to avoid possible hardware or software problems.
IMPORTANT	Reminds you to do specific actions relevant to the accomplishment of procedures.



NOTE: This symbol where placed in the Service Guide designates a component that should be recycled according to the local regulations.

Preface

Before using this information and the product it supports, please read the following general information.

1. This Service Guide provides you with all technical information relating to the BASIC CONFIGURATION decided for Acer's "global" product offering. To better fit local market requirements and enhance product competitiveness, your regional office MAY have decided to extend the functionality of a machine (e.g. add-on card, modem, or extra memory capability). These LOCALIZED FEATURES will NOT be covered in this generic service guide. In such cases, please contact your regional offices or the responsible personnel/channel to provide you with further technical details.
2. Please note WHEN ORDERING FRU PARTS, that you should check the most up-to-date information available on your regional web or channel. If, for whatever reason, a part number change is made, it will not be noted in the printed Service Guide. For ACER-AUTHORIZED SERVICE PROVIDERS, your Acer office may have a DIFFERENT part number code to those given in the FRU list of this printed Service Guide. You MUST use the list provided by your regional Acer office to order FRU parts for repair and service of customer machines.

System Specifications	1
Features	1
System Block Diagram	5
Your Acer Notebook tour	6
Front View	6
Closed Front View	7
Left View	7
Right View	8
Bottom View	9
Indicators	9
TouchPad Basics	10
Using the Keyboard	11
Lock Keys and embedded numeric keypad	11
Windows Keys	12
Hot Keys	13
Hardware Specifications and Configurations	14
 System Utilities	 21
BIOS Setup Utility	21
Navigating the BIOS Utility	21
Aspire 5741/5741G BIOS	22
Information	22
Main	23
Security	24
Boot	27
Exit	28
BIOS Flash Utilities	29
DOS Flash Utility	30
WinFlash Utility	32
Remove HDD/BIOS Password Utilities	33
 Machine Disassembly and Replacement	 39
Disassembly Requirements	39
Pre-disassembly Instructions	40
Disassembly Process	41
External Module Disassembly Process	42
External Modules Disassembly Flowchart	42
Removing the Battery Pack	43
Removing the SD Dummy Card	44
Removing the Optical Drive Module	45
Removing the Logic Lower Door	47
Removing the 3G Cover	48
Removing the DIMM Module	49
Removing the WLAN Module	50
Removing the Hard Disk Drive Module	52
Main Unit Disassembly Process	54
Main Unit Disassembly Flowchart	54
Removing the Keyboard	55
Removing the Upper Cover	57
Removing the Left Speaker Module	61
Removing the Right Speaker Module	63
Removing the Power Board	65
Removing the TouchPad Bracket	66
Removing the Card Reader Board	68

Table of Contents

Removing the USB Board	69
Removing the Bluetooth Board	70
Removing the Mainboard	71
Removing the Thermal Module	75
Removing the CPU	77
LCD Module Disassembly Process	78
LCD Module Disassembly Flowchart	78
Removing the LCD Assembly	79
Removing the LCD Bezel	82
Removing the Camera Module	83
Removing the LCD Panel	84
Removing the LCD Brackets and FPC Cable	86
Removing the Microphone Cable	89
Removing the Antennas	91
LCD Module Reassembly Procedure	93
Replacing the Antennas	93
Replacing the Microphone Cable	95
Replacing the LCD Brackets and FPC Cable	96
Replacing the LCD Panel	98
Replacing the Camera Module	99
Replacing the LCD Bezel	100
Replacing the LCD Assembly	101
Main Module Reassembly Procedure	104
Replacing the CPU	104
Replacing the Thermal Module	105
Replacing the Mainboard	106
Replacing the Bluetooth Board	109
Replacing the USB Board	110
Replacing the Card Reader Board	111
Replacing the TouchPad Bracket	112
Replacing the Power Board	114
Replacing the Right Speaker Module	115
Replacing the Left Speaker Module	116
Replacing the Upper Cover	117
Replacing the Keyboard	120
Replacing the Hard Disk Drive Module	121
Replacing the WLAN Module	122
Replacing the DIMM Modules	123
Replacing the 3G Cover	124
Replacing the Logic Lower Door	125
Replacing the ODD Module	126
Replacing the SD Dummy Card	127
Replacing the Battery	128

Troubleshooting

129

Common Problems	129
Power On Issue	130
No Display Issue	131
Random Loss of BIOS Settings	132
LCD Failure	133
Built-In Keyboard Failure	133
TouchPad Failure	134
Internal Speaker Failure	134
HDD Not Operating Correctly	136
ODD Failure	137

Table of Contents

Wireless Function Failure	140
Thermal Unit Failure	140
External Mouse Failure	141
Other Failures	141
Intermittent Problems	142
Undetermined Problems	142
Post Codes	143
Jumper and Connector Locations	149
Top View	149
Bottom View	150
USB/B Board	151
Power Board	151
3G/B Board	152
CR/B Board	152
Clearing Password Check and BIOS Recovery	153
Clearing Password Check	153
Clear CMOS Jumper	153
BIOS Recovery by Crisis Disk	154
FRU (Field Replaceable Unit) List	155
Aspire 5741/5741G Exploded Diagrams	156
Main Assembly	156
Upper Assembly	157
LCD Assembly	158
Aspire 5741/5741G FRU List	160
Screw List	168
Model Definition and Configuration	170
Aspire 5741	171
Aspire 5741G	191
Test Compatible Components	229
Microsoft® Windows® 7 Environment Test	230
Online Support Information	243
Index	245

Table of Contents

System Specifications

Features

Below is a brief summary of the computer's many features:

NOTE: Items denoted with an (*) are only available for selected models.

Operating System

- Genuine Windows® 7 Home Premium 64-bit*
- Genuine Windows® 7 Home Basic 64-bit*

Platform

- Intel® Core i3-330M/i3-350M processor (3 MB L3 cache, 2.13/2.26 GHz, 35 W), supporting Intel® 64 architecture, Intel® Smart Cache
- Mobile Intel® HM55 Express Chipset

System Memory

- Dual-channel DDR3 SDRAM support:
 - Up to 4 GB of DDR3 1066 MHz memory, upgradeable to 8 GB using two soDIMM modules

Display

- 15.6" HD 1366 x 768 pixel resolution, high-brightness (220-nit) Acer CineCrystal™ TFT LCD
- 16:9 aspect ratio
- 8 ms high-def response time
- 60% color gamut

Graphics

- Intel® HD Graphics with 128 MB of dedicated system memory, supporting Microsoft® DirectX® 10 (Aspire 5741)
- NVIDIA® GeForce® GT 320M with 1024 MB of dedicated DDR3 VRAM, supporting NVIDIA® CUDA™, PhysX™, PureVideo® HD technology, OpenEXR High Dynamic-Range (HDR) technology, Shader Model 4.0, Microsoft® DirectX® 10.1(Aspire 5741G)
- ATI Mobility Radeon™ HD 5470 with 512 MB of dedicated DDR3 VRAM, supporting Unified Video Decoder (UVD), OpenEXR High Dynamic-Range (HDR) technology, Shader Model 5.0, Microsoft® DirectX® 11, OpenGL® 3.1, OpenCL™ 1.1(Aspire 5741G)
- Dual independent display support
- 16.7 million colors
- External resolution / refresh rates:
 - VGA port up to 2048 x 1536: 85 Hz
 - HDMI™ port up to 1920 x 1080: 60 Hz

-
- MPEG-2/DVD decoding
 - WMV9 (VC-1) and H.264 (AVC) decoding
 - Microsoft® DirectX® Video Acceleration (DXVA) application interface (API) (Aspire 5741G)
 - HDMI™ (High-Definition Multimedia Interface) with HDCP (High-bandwidth Digital Content Protection) support

Storage subsystem

- 2.5" hard disk drive
- DVD-Super Multi double-layer drive
- Multi-in-1 card reader

Audio

- Two built-in stereo speakers
- High-definition audio support
- MS-Sound compatible
- Built-in microphone

Storage

- 160/250/320/500/640 GB or larger hard disk drive
- Multi-in-1 card reader, supporting Secure Digital™ (SD) Card, MultiMediaCard (MMC), Memory Stick™ (MS), Memory Stick PRO™ (MS PRO), xD-Picture Card™ (xD)

Optical Media Drive

- 4X Blu-ray Disc™/DVD-Super Multi double-layer drive*:-
 - Read: 24X CD-ROM, 24X CD-R, 24X CD-RW, 8X DVD-ROM, 8X DVD-R, 8X DVD+R, 8X DVD-ROM DL, 6X DVD-R DL, 6X DVD+R DL, 8X DVD-RW, 8X DVD+RW, 5X DVD-RAM, 4X BD-ROM, 4X BD-R, 2X BD-RE, 4X BD-ROM DL, 4X BD-R DL, 2X BD-RE DL
 - Write: 24X CD-R, 16X CD-RW, 8X DVD-R, 8X DVD+R, 6X DVD-RW, 6X DVD+RW, 5X DVD-RAM, 4X DVD+R DL, 4X DVD-R DL
- 8X DVD-Super Multi double-layer drive*:-
 - Read: 24X CD-ROM, 24X CD-R, 24X CD-RW, 8X DVD-ROM, 8X DVD-R, 8X DVD+R, 6X DVD-ROM DL, 6X DVD-R DL, 6X DVD+R DL, 6X DVD-RW, 6X DVD+RW, 5X DVD-RAM
 - Write: 24X CD-R, 16X CD-RW, 8X DVD-R, 8X DVD+R, 4X DVD-R DL, 4X DVD+R DL, 6X DVD-RW, 8X DVD+RW, 5X DVD-RAM

Communication

- Acer Video Conference, featuring:
 - Acer Crystal Eye high-def webcam with 1280 x 1024 resolution
- WLAN:-
 - Acer InViLink™ Nplify™ 802.11b/g/n Wi-Fi CERTIFIED™
 - Acer InViLink™ 802.11b/g Wi-Fi CERTIFIED™
 - Supporting Acer SignalUp™ wireless technology
- WPAN: Bluetooth® 2.1+EDR
- LAN: Gigabit Ethernet, Wake-on-LAN ready

Privacy control

- BIOS user, supervisor, HDD passwords
- Kensington lock slot

Dimensions and weight

- 381 (W) x 253 (D) x 25/34 (H) mm (15 x 9.9 x 0.98/1.3 inches) 2.6 kg (5.74 lbs.) 10 with 6-cell battery pack

Power subsystem

- ACPI 3.0 CPU power management standard: supports Standby and Hibernation power-saving modes
- 3-pin 65 W AC adapter (Aspire 5741):
 - 108 (W) x 46 (D) x 29.5 (H) mm (4.25 x 1.81 x 1.16 inches)
 - 225 g (0.49 lbs.) 10 with 180 cm DC cable
- 3-pin 90 W AC adapter (Aspire 5741G):
 - 133 (W) x 59 (D) x 31 (H) mm (5.23 x 2.32 x 1.22 inches)
 - 390 g (0.86 lbs.) 10 with 180 cm DC cable
- Acer QuicCharge™ technology (Aspire 5741G):
 - 80% charge in 1 hour
 - 2-hour rapid charge system-off
- 48.8 W 4400 mAh 6-cell Li-ion standard battery pack
- Estimated battery life: up to 4.0 hours (Aspire 5741)
- Estimated battery life: up to 3.0 hours (Aspire 5741G)
- ENERGY STAR®

Special keys and controls

- 103-/104-/107-key keyboard, with inverted "T" cursor layout, 1.8 mm (minimum) key travel
- Multi-gesture touchpad, supporting two-finger scroll, pinch, rotate, flip
- 11 function keys, four cursor keys, two Windows® keys, hotkey controls, independent standard numeric keypad, international language support
- Media keys (printed on keyboard): play/pause, stop, previous, next

I/O interface

- Multi-in-1 card reader (SD™, MMC, MS, MS PRO, xD)
- Three USB 2.0 ports
- HDMI™ port with HDCP support
- External display (VGA) port
- Headphone/speaker/line-out jack
- Microphone-in jack
- Ethernet (RJ-45) port
- DC-in jack for AC adapter

Software

- Acer Crystal Eye
- Acer eRecovery Management
- Acer Backup Manager
- Adobe® Flash® Player
- Adobe® Reader®
- Cyberlink® Power DVD™
- eSobi™
- Google Toolbar™
- McAfee® Internet Security Suite 2009 Trial
- Microsoft® Works with Office Home and Student 2007 Trial
- MyWinLocker®
- Norton™ Online Backup
- NTI Media Maker™
- Oberon GameZone
- WildTangent®

Optional Items

- 1 GB / 2 GB / 4 GB DDR3 1066 MHz soDIMM module
- 6-cell Li-ion battery pack
- 3-pin 65 W AC adapter (Aspire 5741)
- 3-pin 90 W AC adapter (Aspire 5741G)
- External USB floppy disk drive

Warranty

- One-year International Travelers Warranty (ITW)

Environment

- Temperature:
 - Operating: 5 °C to 35 °C
 - Non-operating: -20 °C to 65 °C
- Humidity (non-condensing):
 - Operating: 20% to 80%
 - Non-operating: 20% to 80%

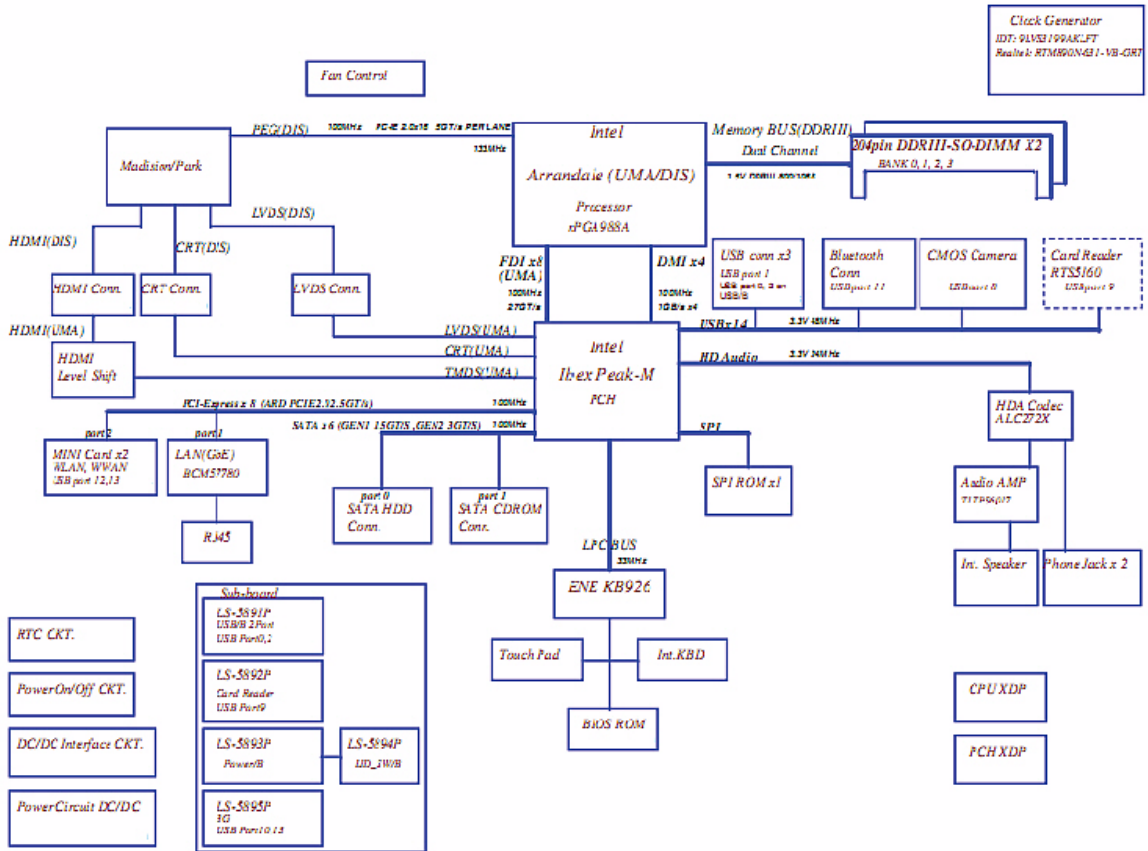

System Block Diagram



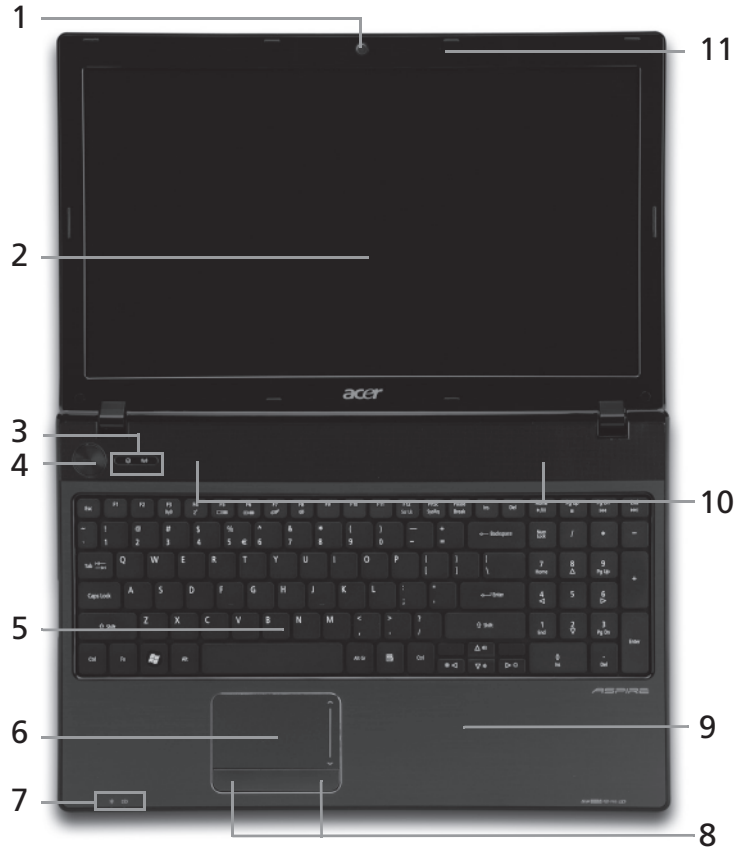

Your Acer Notebook tour

Front View



No.	Icon	Item	Description
1		Acer Crystal Eye webcam	Web camera for video communication (for selected models).
2		Display screen	Also called Liquid-Crystal Display (LCD), displays computer output.
3		HDD	Indicates when the hard disk drive is active.
		Communication indicator	Indicates the computer's wireless connectivity device status.
4		Power button	Turns the computer on and off.
5		Keyboard	For entering data into your computer.
6		TouchPad	Touch-sensitive pointing device which functions like a computer mouse.

No.	Icon	Item	Description
7		Power ¹	Indicates the computer's power status.
		Battery ¹	Indicates the computer's battery status. 1. Charging: The light shows amber when the battery is charging. 2. Fully charged: The light shows blue when in AC mode.
8		Click buttons (left and right)	The left and right buttons function like the left and right mouse buttons.
9		Palmrest	Comfortable support area for your hands when you use the computer.
10		Speakers	Left and right speakers deliver stereo audio output.
11		Microphone	Internal microphone for recording sound.

NOTE: ¹ The front panel indicators are visible even when the computer cover is closed.



Closed Front View





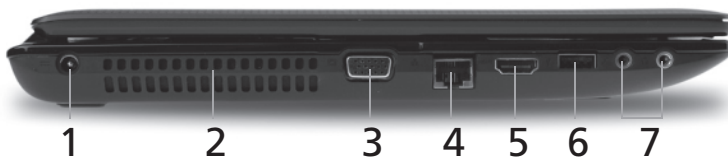

No.	Icon	Item	Description
1		Multi-in-1 card reader	Accepts Secure Digital (SD), MultiMediaCard (MMC), Memory Stick (MS), Memory Stick PRO (MS PRO), xDPicture Card (xD). NOTE: Push to remove/install the card. Only one card can operate at any given time.

Left View





No.	Icon	Item	Description
1		DC-in jack	Connects to an AC adapter
2		Ventilation slots	Enable the computer to stay cool, even after prolonged use.
3		External display (VGA) port	Connects to a display device (e.g. external monitor, LCD projector).

No.	Icon	Item	Description
4		Ethernet (RJ-45) port	Connects to an Ethernet 10/100/1000-based network.
5		HDMI	Connect to HDMI devices
6		USB 2.0 ports	Connect to USB 2.0 devices (e.g. USB mouse, USB camera).
7		Microphone-in jack	Accepts input from external microphones.
		Headphones/speaker/line-out jack	Connects to audio line-out devices (e.g. speakers, headphones).

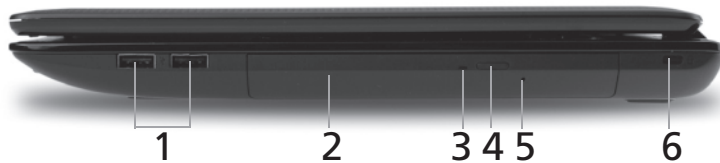

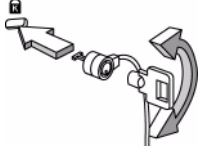

Right View

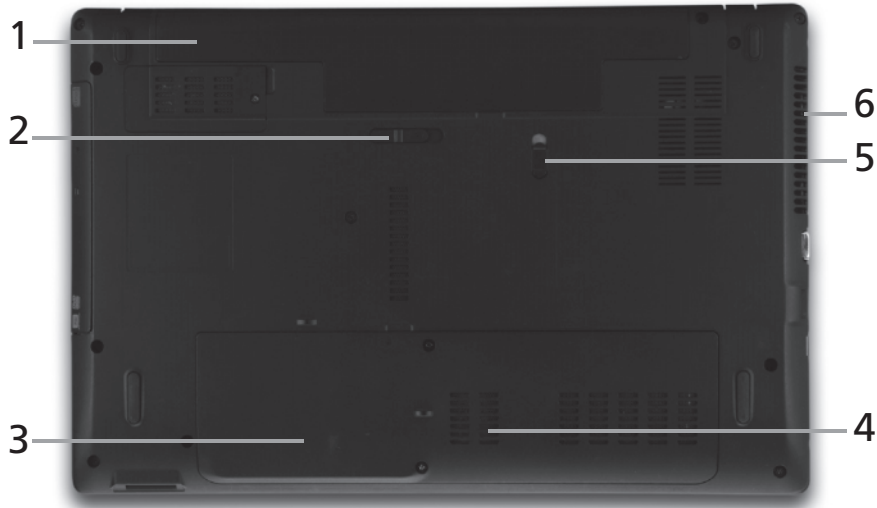

No.	Icon	Item	Description
1		USB 2.0 ports	Connect to USB 2.0 devices (e.g. USB mouse, USB camera).
2		Optical drive	Internal optical drive; accepts CDs or DVDs.
3		Optical disk access indicator	Lights up when the optical drive is active.
4		Optical drive eject button	Ejects the optical disk from the drive.
5		Emergency eject hole	Ejects the optical drive tray when the computer is turned off. Note: Insert a paper clip into the emergency eject hole to eject the optical drive tray when the computer is off.
6		Kensington lock slot 	Connects to a Kensington-compatible computer security lock. Note: Wrap the computer security lock cable around an immovable object such as a table or handle of a locked drawer. Insert the lock into the notch and turn the key to secure the lock. Some keyless models are also available.





Bottom View



No.	Icon	Item	Description
1		Battery bay	Houses the computer's battery pack.
2		Battery release latch	Releases the battery for removal.
3		Hard disk bay	Houses the computer's hard disk (secured with screws).
4		Memory compartment	Houses the computer's main memory.
5		Battery lock	Locks the battery in position.
6		Ventilation slots and cooling fan	Enable the computer to stay cool, even after prolonged use. Note: Do not cover or obstruct the fan opening.

Indicators

The computer has several easy-to-read status indicators.

Icon	Function	Description
	Power	Indicates the computer's power status.
	Battery	Indicates the computer's battery status. NOTE: 1. Charging: The light shows amber when the battery is charging. 2. Fully charged: The light shows green when in AC mode.
	HDD	Indicates when the hard disk drive is active.
	Communication indicator	Indicates the computer's wireless connectivity device status.

TouchPad Basics

The following items show you how to use the TouchPad:

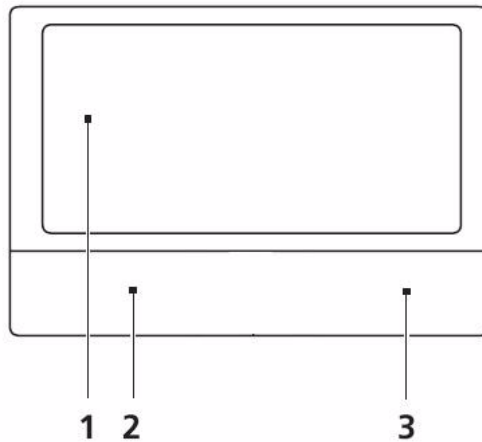

- Move your finger across the TouchPad (1) to move the cursor.
- Press the left (2) and right (3) buttons located beneath the TouchPad to perform selection and execution functions. These two buttons are similar to the left and right buttons on a mouse. Tapping on the TouchPad is the same as clicking the left button.

Function	Left Button (2)	Right Button (3)	Main TouchPad (1)
Execute	Quickly click twice.		Tap twice (at the same speed as double-clicking a mouse button).
Select	Click once.		Tap once.
Drag	Click and hold, then use finger on the TouchPad to drag the cursor.		Tap twice (at the same speed as double-clicking a mouse button); rest your finger on the TouchPad on the second tap and drag the cursor.
Access context menu		Click once.	

NOTE: When using the TouchPad, keep it - and your fingers - dry and clean. The TouchPad is sensitive to finger movement; hence, the lighter the touch, the better the response. Tapping too hard will not increase the TouchPad's responsiveness.

Using the Keyboard

The keyboard has full-sized keys and an embedded numeric keypad, separate cursor, lock, Windows, function and special keys.

Lock Keys and embedded numeric keypad



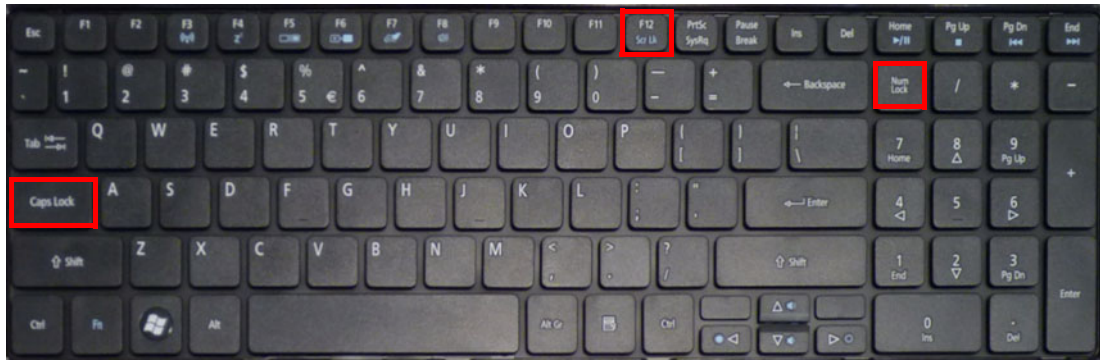















The keyboard has two lock keys which you can toggle on and off.



Lock key	Description
Caps Lock	When Caps Lock is on, all alphabetic characters typed are in uppercase.
Scroll Lock	When Scroll Lock is on, the contents of a text window scroll without moving the cursor.
Num Lock	When Num Lock is on, the embedded keypad is in numeric mode.

Windows Keys

The keyboard has two keys that perform Windows-specific functions.

Key	Description
 Windows key	<p>Pressed alone, this key has the same effect as clicking on the Windows Start button; it launches the Start menu. It can also be used with other keys to provide a variety of functions:</p> <ul style="list-style-type: none"> <  >: Open or close the Start menu <  > + <D>: Display the desktop <  > + <E>: Open Windows Explore <  > + <F>: Search for a file or folder <  > + <G>: Cycle through Sidebar gadgets <  > + <L>: Lock your computer (if you are connected to a network domain), or switch users (if you're not connected to a network domain) <  > + <M>: Minimizes all windows <  > + <R>: Open the Run dialog box <  > + <T>: Cycle through programs on the taskbar <  > + <U>: Open Ease of Access Center <  > + <X>: Open Windows Mobility Center <  > + <BREAK>: Display the System Properties dialog box <  > + <SHIFT+M>: Restore minimized windows to the desktop <  > + <TAB>: Cycle through programs on the taskbar by using Windows Flip 3-D <  > + <SPACEBAR>: Bring all gadgets to the front and select Windows Sidebar <CTRL> + <  > + <F>: Search for computers (if you are on a network) <CTRL> + <  > + <TAB>: Use the arrow keys to cycle through programs on the taskbar by using Windows Flip 3-D <p>Note: Depending on your edition of Windows 7, some shortcuts may not function as described.</p>
 Application key	<p>This key has the same effect as clicking the right mouse button; it opens the application's context menu.</p>

Hot Keys

The computer employs hotkeys or key combinations to access most of the computer's controls like screen brightness, volume output and the BIOS utility.

To activate hot keys, press and hold the <Fn> key before pressing the other key in the hotkey combination.



Hotkey	Icon	Function	Description
<Fn> + <F3>		Communication key	Enables / disables the computer's communication devices. (Communication devices may vary by configuration.)
<Fn> + <F4>		Sleep	Puts the computer in Sleep mode.
<Fn> + <F5>		Display toggle	Switches display output between the display screen, external monitor (if connected) and both.
<Fn> + <F6>		Display Off	Turns the display screen backlight off to save power. Press any key to return.
<Fn> + <F7>		Touchpad toggle	Turns the internal touchpad on and off.
<Fn> + <F8>		Speaker toggle	Turns the speakers on and off.
<Fn> + <▷>		Brightness up	Increases the screen brightness.
<Fn> + <◁>		Brightness down	Decreases the screen brightness.
<Fn> + <△>		Volume up	Increases the sound volume.
<Fn> + <▽>		Volume down	Decreases the sound volume.
<Fn> + <Home>		Play/Pause	Play or pause a selected media file.
<Fn> + <Pg Up>		Stop	Stop playing the selected media file.
<Fn> + <Pg Dn>		Previous	Return to the previous media file.
<Fn> + <End>		Next	Jump to the next media file.

Hardware Specifications and Configurations

Item	Specification
CPU	Intel Mobile Calpella
Graphics	Integrated VGA for Arrandale
CPU Package	rPGA988A
Power	4M (Arrandale) L3 shared among all cores
On-die Cache	32KB L1 & 256K L2 for each core

Processor Specifications

Item	CPU Speed	Cores	Bus Speed	Cache Size	Package	Core Voltage	Acer P/N
Ci3330M	2.13	2	330 M	3 MB	PGA988	35W	KC.33001.DMP
Ci3350M	2.26	2	350 M	3 MB	PGA988	35W	KC.35001.DMP
Ci5430M	2.26	2	430 M	3 MB	PGA988	35W	KC.43001.DMP
Ci5520M	2.24	2	520 M	3 MB	PGA988P	35W	KC.52001.DMP
Ci5540M	2.53	2	540 M	3 MB	PGA988	35W	KC.54001.DMP
Ci7620M	2.66	2	620 M	4 MB	PGA988P	35W	KC.62001.DMP

CPU Fan True Value Table (Tj = 90)

CPU Temp (°C) Core 0	CPU Temp (°C) Core 1	Fan Speed (rpm)	SPL Spec (dBA)
45	57	2300	28
52	64	3000	31
59	70	3100	34
65	78	3500	37
72	85	3900	40

- Throttling 50%: On=85°C, Off=72°C
- OS Shutdown: 104°C
- H/W Shutdown: 92°C

CPU Fan True Value Table (Tj = 105)

CPU Temp (°C) Core 0	CPU Temp (°C) Core 1	Fan Speed (rpm)	SPL Spec (dBA)
45	60	2300	28
55	70	3000	31
65	80	3100	34
75	90	3500	37
85	100	3900	40

- Throttling 50%: On=100°C, Off=85°C
- OS Shutdown: 104°C
- H/W Shutdown: 92°C

Fan Acoustic Specifications

Operation Mode	Application	SPL dBA	Loudness (Sone)	Tone (dB)
Fan off	Windows Idle (HDD random seek)	N/A	<ul style="list-style-type: none"> 20~3.99kHz less than or equal to: 0.5 4K~20kHz less than or equal to: 0.035 	7
Fan 1	Windows Idle	28	N/A	7
Fan 2	Windows Idle, HDD spinning	31	N/A	7
Fan 3	Play Movie (read from HDD), Play TV (TV tuner sku)	34	N/A	7
Fan 4	3DMark06,Prime95, Prime95+Play TV(TV tuner sku), acer screen saver, HDD spinning	37	N/A	7
Fan 5	TAT100% or Thermanow100%,3DMark06, at ambient 35C, HDD spinning	40	N/A	7

NOTE: Tone:20~399Hz refer to slope of Ecma-074, 400~20K Hz < 7 Prominence ratio, No pattern occurred on Prominence vs. time diagram

BIOS

Item	Specification
BIOS vendor	Insyde BIOS
BIOS ROM type	Flash
Features	<ul style="list-style-type: none"> Flash ROM 4MB Support ISIPP Support Acer UI Support multi-boot Suspend to RAM (S3)/Disk (S4) Various hot-keys for system control Support SMBIOS 2.3, PCI2.2. Refer to Acer BIOS specification. DMI utility for BIOS serial number configurable/asset tag Support PXE Support Y2K solution Support WinFlash Wake on LAN from S3 Wake on LAN form S4 in AC mode System information

System Memory

Item	Specification
Memory size	8GB maximum
DIMM socket number	2
Supports memory size per socket	4GB
Supports DIMM type	204-pin +1.5V DDRIII
Supports DIMM Speed	800/1066 MHz

Item	Specification
Supports DIMM voltage	1.5V

Memory Combinations

Slot 1	Slot 2	Total Memory
0MB	1024MB	1024MB
0MB	2048MB	2048MB
0MB	4096MB	4096MB
1024MB	0MB	1024MB
1024MB	1024MB	2048MB
1024MB	2048MB	3072MB
2048MB	0MB	2048MB
2048MB	1024MB	3072MB
2048MB	2048MB	4096MB
2048MB	4096MB	6144MB
4096MB	4096MB	8192MB

NOTE: Above table lists some system memory configurations. You may combine DIMMs with various capacities to form other combinations. In the above table, the configuration of slot 1 and slot 2 could be reversed.

Onboard LAN

Item	Specification
Manufacturer	Broadcom 57780KMLG for GIGA LAN <ul style="list-style-type: none"> • Integrated 10/100/1000BASE-T transceiver • Automatic MDI crossover function • PCIe V1.1 compliant • 10/100/1000BASE-T full -duplex/half -duplex MAC • Receive side scaling(RSS) for multicore processors • Complies with IEEE 802.3, 802.3u, 802.3ab, and 802.1p • Wake on LAN (WOL) support meeting the ACPI requirements • Statistics for SNMP MIB II, Ethernet-like MIB, and Ethernet MIB (IEEE 802.3z, Clause 30) • Self-boot feature, utilizing smaller EEPROM size with ability to use on-chip memory • Supports iSCSI boot • PCI Express CLKREQ support • Integrated switching regulator for improved power consumption • IPv4 and IPv6 large send offload and checksum offload(LSO/TCO)

Hard Disk Drive Interface

Item	Specification			
Vendor & Model Name	Seagate	HGST	Toshiba	Western Digital
Capacity (MB)	160, 250, 320, 500	160, 250, 320, 500	160, 250, 320, 500	160, 250, 320, 500, 640
Bytes per sector	512			
Data heads	2-4			
Drive Format				
Disks	1-2			
Spindle speed (RPM)	5400			
Performance Specifications				
Buffer size	8 MB			
Interface	SATA			
DC Power Requirements				
Voltage tolerance	5V ±5%	5V ±5%	5V ±5%	5V ±5%

Super-Multi Drive Module

Item	Specification			
Vendor & model name	HLDS GT20N		Sony AD7580S	
Performance Specification	With CD Diskette	With DVD Diskette	With CD Diskette	With DVD Diskette
Transfer rate (MB/sec)	Sustained: 3,600 KB/s (24x) max.	Sustained: 11.08 Mbytes/s (8x) max.	Sustained: 1,571 (typical)	Sustained: 10,993 (typical)
Buffer Memory	2 MB			
Interface	SATA			

Item	Specification	
Applicable disc formats	DVD-ROM: 4.7GB (Single Layer) 8.5GB (Dual Layer) DVD-R: 3.95GB (Ver. 1.0: read only) 4.7GB (Ver. 2.0 for Authoring: read only) 4.7GB (Ver. 2.1 for General: read & write) (DL) 8.5GB (Ver. 3.0) DVD-RW: 4.7GB (Ver. 1.2/ Rev 1.0, 2.0, 3.0) DVD-RAM: 1.46GB/side, 4.7GB/side (Ver. 2.2) DVD+R: 4.7GB (Ver. 1.3) (DL) 8.5GB (Ver. 1.1) DVD+RW: 4.7GB (Vol.1 Ver.1.3) CD-ROM Mode-1 data disc CD-ROM Mode-2 data disc CD-ROM XA, CD-I, Photo-CD Multi-Session, Video CD CD-Audio Disc Mixed mode CD-ROM disc (data and audio) CD-Extra CD-Text CD-R (Conforming to "Orange Book Part 2": read & write) CD-RW (Conforming to "Orange Book Part 3": read & write)	DVD Read: DVD-ROM (DVD-5, DVD-9, DVD-10, DVD-18), DVD-Video, DVD-Audio, SACD (Hybrid), UDF DVD, DVD-R, DVD-R DL, DVD-R 3.95 GB, DVD-R Authoring, DVD-R Multi-Border, DVD-RW, DVD+R, DVD+R DL, DVD+R Multi-Session, DVD+RW, DVD-RAM V1.0, DVDRAM V2.0 & 2.1 & 2.2. CD Read: CD-DA, CD-ROM Mode-1, CD-ROM/XA Mode-2 Form-1 and Mode-2 Form-2, CD-i, CD-i Bridge, Video-CD (MPEG-1), Karaoke CD, Photo-CD, Enhanced CD, CD Plus, CD Extra, itrax CD, CD-Text, UDF CD, CD-R, and CD-RW DVD Write: DVD Data & Video CD Read: CD-DA, CD-ROM Mode-1, CD-ROM/XA Mode-2 Form-1 and Mode-2 Form-2, CD-i, Video-CD, CD-Text
Loading mechanism	Drawer (Solenoid Open) Tact SW (Open) Emergency Release (draw open hole)	
Power Requirement		
Input Voltage	DC 5 V +/- 5%	

Audio Interface

Item	Specification
Chipset	Realtek ALC272-X
Features	<ul style="list-style-type: none"> High Definition Audio Codec Single Analogue MIC 2.0 Watt speaker/5cc chamber/speaker size 18 phi, x2 Headphone-out w/o SPDIF-out

Power and Keyboard Controller

Item	Specification
Controller	ENE KB926
Total number of keypads	99-/100-/103-key keyboard
Windows logo key	Yes
Hotkeys	See "Hot Keys" on page 13.

Battery

Item	Specification
	6 Cell
Vendor & model name	SANYO/SONY/PANASONIC/SAMSUNG/SIMPLO AS2009A
Battery Type	Li-ion
Pack capacity	4400 mAh
Normal Voltage	2.2 Ah
Package configuration	3S2P

LCD 15.6"

Item	Specification
Vendor/model name	AUO/CPT/CMO/Samsung/LCD/INL
Screen Diagonal (mm)	15.6 inches
Display resolution (pixels)	1366 x 768 WXGA Clare
Pixel Pitch	0.204 x 0.204
Display Mode	Normal
Typical White Luminance (cd/m ²) (also called Brightness)	220
Contrast Ratio	500 typical
Response Time (Optical Rise Time/Fall Time) msec	8
Luminance Uniformity	1.25 max
Electrical Interface	LVDS
Support Color	262K
Viewing Angle (up/down/right/ left)	15/35/45/45
Temperature Range (°C) Operating Storage (shipping)	0 to +50 -20 to +60

Card Reader

Item	Specification
Part Name	RealTek RT5160
Package	5-in-1 card reader
General Features	<ul style="list-style-type: none">• PCI-E interface• Push-push type• Dummy card

System Utilities

BIOS Setup Utility

The BIOS Setup Utility is a hardware configuration program built into your computer's BIOS (Basic Input/Output System).

Your computer is already properly configured and optimized, and you do not need to run this utility. However, if you encounter configuration problems, you may need to run Setup. Please also refer to Chapter 4 Troubleshooting when problem arises.

To activate the BIOS Utility, press **F2** during POST (when "Press <F2> to enter Setup" message is prompted on the bottom of screen).

The default parameter of F12 Boot Menu is set to "disabled". If you want to change boot device without entering BIOS Setup Utility, please set the parameter to "enabled".

Press <F12> during POST to enter multi-boot menu. In this menu, user can change boot device without entering BIOS SETUP Utility.

Navigating the BIOS Utility

There are six menu options: Information, Main, Security, Boot, and Exit.

Follow these instructions:

- To choose a menu, use the left and right arrow keys.
- To choose an item, use the up and down arrow keys.
- To change the value of a parameter, press **F5** or **F6**.
- Press **Esc** while you are in any of the menu options to go to the Exit menu.
- In any menu, you can load default settings by pressing **F9**. You can also press **F10** to save any changes made and exit the BIOS Setup Utility.

NOTE: You can change the value of a parameter if it is enclosed in square brackets. Navigation keys for a particular menu are shown on the bottom of the screen. Help for parameters are found in the Item Specific Help part of the screen. Read this carefully when making changes to parameter values. **Please note that system information is subject to different models.**

Aspire 5741/5741G BIOS

Information

The Information screen displays a summary of the computer hardware information.

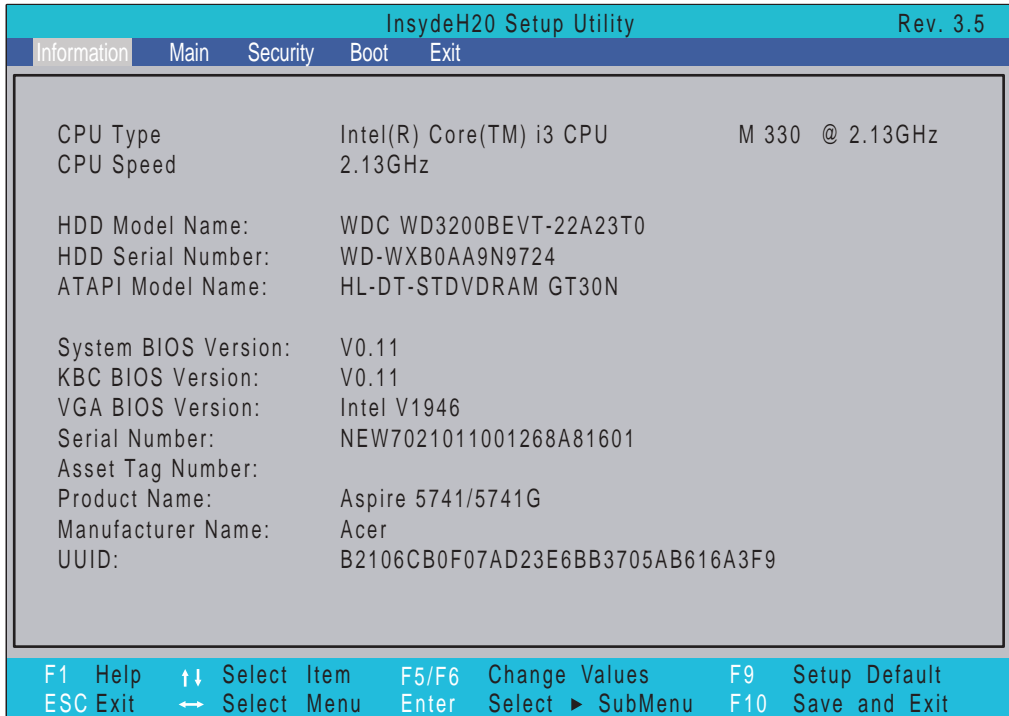

NOTE: The screen above is for your reference only. Actual values may differ according to model.

The table below describes the parameters in this screen.

Parameter	Description
CPU Type	This field shows the CPU type and speed of the system.
CPU Speed	This field shows the speed of the CPU.
HDD Model Name	This field shows the model name of HDD installed on primary IDE master.
HDD Serial Number	This field displays the serial number of HDD installed on primary IDE master.
ATAPI Model Name	This field shows the model name of the Optical device installed in the system.
System BIOS Version	Displays system BIOS version.
KBC BIOS Version	This field displays the KBC firmware version of the system.
VGA BIOS Version	This field displays the VGA firmware version of the system.
Serial Number	This field displays the serial number of this unit.
Asset Tag Number	This field displays the asset tag number of the system.
Product Name	This field shows product name of the system.
Manufacturer Name	This field displays the manufacturer of this system.
UUID	Universally Unique Identifier (UUID) is an identifier standard used in software construction, standardized by the Open Software Foundation (OSF) as part of the Distributed Computing Environment (DCE).

Main

The Main screen allows the user to set the system time and date as well as enable and disable boot options and recovery.

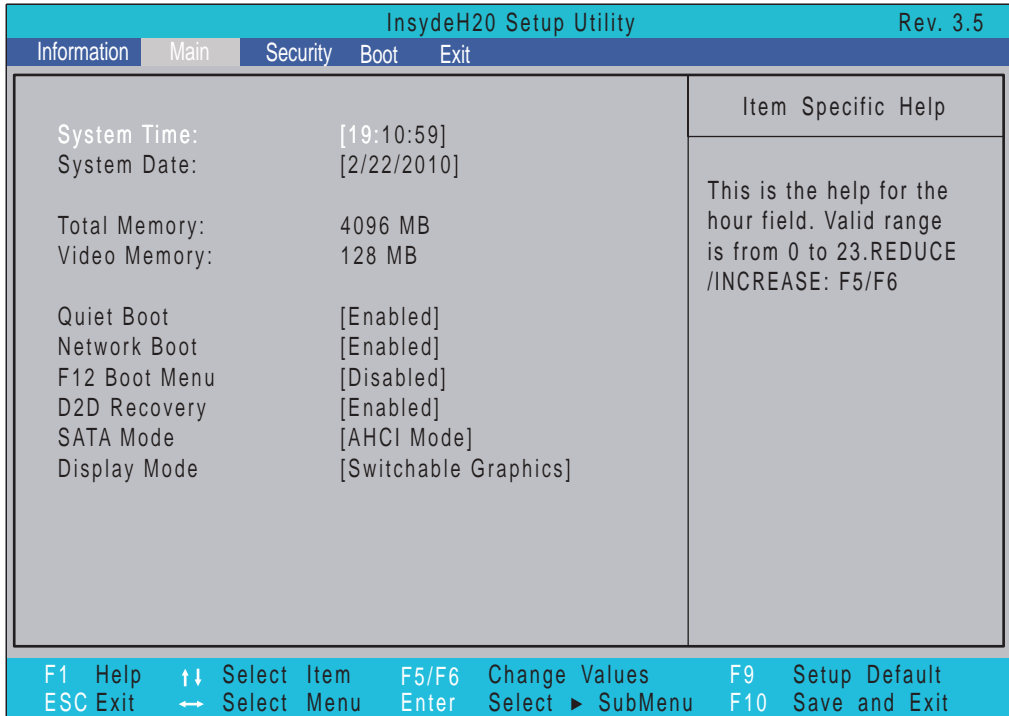

NOTE: The screen above is for your reference only. Actual values may differ.

The table below describes the parameters in this screen.

Parameter	Description	Format/Option
System Time	Sets the system time. The hours are displayed with 24-hour format.	Format: HH:MM:SS (hour:minute:second)
System Date	Sets the system date.	Format MM/DD/YYYY (month/day/year)
Total Memory	Displays the total memory available.	N/A
Video Memory	Displays the available memory for Video.	N/A
Quiet Boot	Quiet Boot replaces the customary technical messages during POST with a more visually pleasing and comfortable display (OEM Logo screen).	Option: Enabled or Disabled
Network Boot	Enables, disables the system boot from LAN (remote server).	Option: Enabled or Disabled
F12 Boot Menu	Enables, disables Boot Menu during POST.	Option: Enabled or Enabled
D2D Recovery	Enables, disables D2D Recovery function. The function allows the user to create a hidden partition on hard disc drive to store operation system and restore the system to factory defaults.	Option: Enabled or Disabled
SATA Mode	Control the mode in which the SATA controller should operate.	Option: AHCI Mode or IDE Mode
Display Mode	Control the graphics display mode. Note: Switchable Graphis is displayed as an option if supported by the system.	Options: Integrated Graphics, Discrete Graphics or Switchable Graphics

Security

The Security screen contains parameters that help safeguard and protect your computer from unauthorized use.

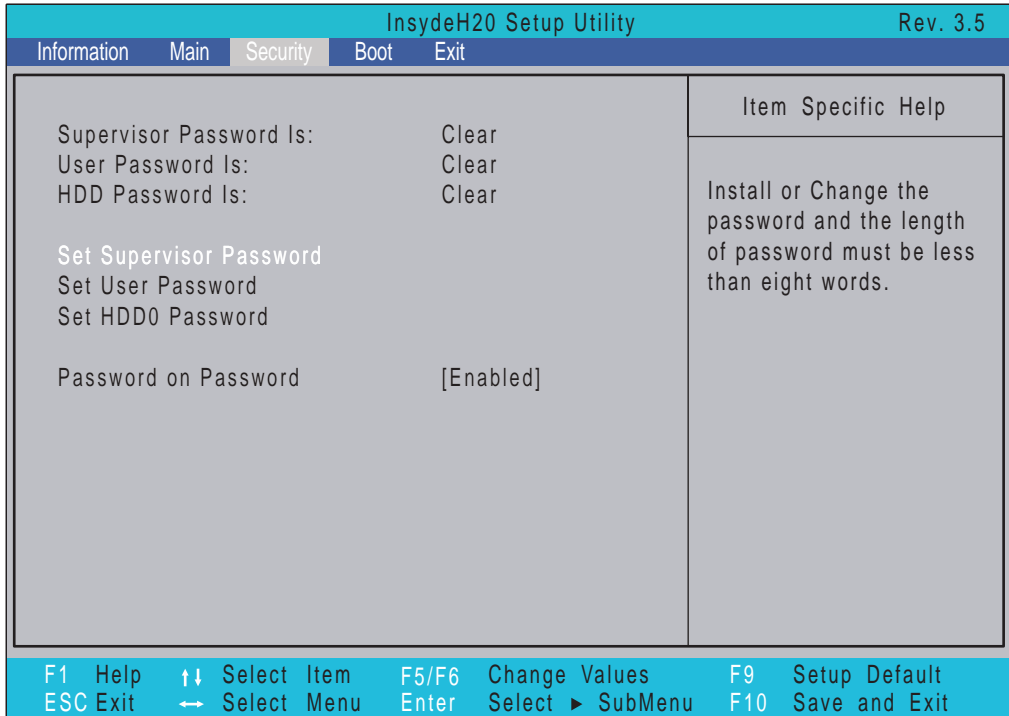

The table below describes the parameters in this screen. Settings in **boldface** are the default and suggested parameter settings.

Parameter	Description	Option
Supervisor Password Is	Shows the setting of the Supervisor password	Clear or Set
User Password Is	Shows the setting of the user password.	Clear or Set
HDD0 Password Is	Shows the setting of the hard disk password.	Clear or Set
Set Supervisor Password	Press Enter to set the supervisor password. When set, this password protects the BIOS Setup Utility from unauthorized access. The user can not either enter the Setup menu nor change the value of parameters.	N/A
Set User Password	Press Enter to set the user password. When user password is set, this password protects the BIOS Setup Utility from unauthorized access. The user can enter Setup menu only and does not have right to change the value of parameters.	N/A
Set HDD Password	Enter HDD Password.	N/A
Password on Password	Defines whether a password is required or not while the events defined in this group happened. The following sub-options are all requires the Supervisor password for changes and should be grayed out if the user password was used to enter setup.	Disabled or Enabled

NOTE: When you are prompted to enter a password, you have three tries before the system halts. Don't forget your password. If you forget your password, you may have to return your notebook computer to your dealer to reset it.

Setting a Password

Follow these steps as you set the user or the supervisor password:

1. Use the ↑ and ↓ keys to highlight the Set Supervisor Password parameter and press the **Enter** key. The Set Supervisor Password box appears:

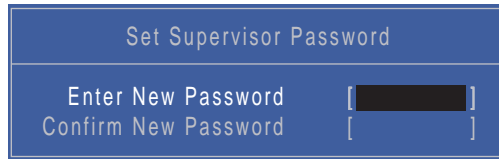

The screenshot shows a blue-bordered box titled "Set Supervisor Password". Inside the box, there are two rows of text. The first row is "Enter New Password" followed by a blacked-out input field. The second row is "Confirm New Password" followed by another blacked-out input field.

2. Type a password in the "Enter New Password" field. The password length can not exceed 8 alphanumeric characters (A-Z, a-z, 0-9, not case sensitive). Retype the password in the "Confirm New Password" field.

IMPORTANT: Be very careful when typing your password because the characters do not appear on the screen.

3. Press **Enter**. After setting the password, the computer sets the User Password parameter to "Set".
4. If desired, you can opt to enable the Password on boot parameter.
5. When you are done, press F10 to save the changes and exit the BIOS Setup Utility.

Removing a Password

Follow these steps:

1. Use the ↑ and ↓ keys to highlight the Set Supervisor Password parameter and press the **Enter** key. The Set Password box appears:



The screenshot shows a blue-bordered box titled "Set Supervisor Password". Inside the box, there are three rows of text. The first row is "Enter Current Password" followed by a blacked-out input field. The second row is "Enter New Password" followed by an empty input field. The third row is "Confirm New Password" followed by another empty input field.

2. Type the current password in the Enter Current Password field and press **Enter**.
3. Press **Enter** twice **without** typing anything in the Enter New Password and Confirm New Password fields. The computer then sets the Supervisor Password parameter to "Clear".
4. When you have changed the settings, press u to save the changes and exit the BIOS Setup Utility.

Changing a Password

1. Use the ↑ and ↓ keys to highlight the Set Supervisor Password parameter and press the **Enter** key. The Set Password box appears.



The screenshot shows a blue-themed BIOS screen titled "Set Supervisor Password". It contains three input fields: "Enter Current Password" with a blacked-out field, "Enter New Password" with an empty field, and "Confirm New Password" with an empty field. Each field is followed by a closing square bracket "]".

2. Type the current password in the Enter Current Password field and press **Enter**.
3. Type a password in the Enter New Password field. Retype the password in the Confirm New Password field.
4. Press **Enter**. After setting the password, the computer sets the User Password parameter to "Set".
5. If desired, you can enable the Password on boot parameter.
6. When you are done, press F10 to save the changes and exit the BIOS Setup Utility.

If the verification is OK, the screen will display as following.

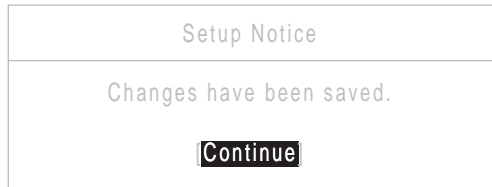

The screenshot shows a white-themed BIOS screen titled "Setup Notice". The text "Changes have been saved." is displayed in the center. Below the text is a black button with the word "Continue" in white.

The password setting is complete after the user presses **Enter**.

If the current password entered does not match the actual current password, the screen will show you the Setup Warning.



The screenshot shows a white-themed BIOS screen titled "Setup Warning" in red text. Below the title, the text "Invalid Password." is displayed in red. At the bottom, there is a black button with the word "Continue" in white.

If the new password and confirm new password strings do not match, the screen will display the following message.



The screenshot shows a white-themed BIOS screen titled "Setup Warning" in red text. Below the title, the text "Passwords do not match. Re-enter password." is displayed in red. At the bottom, there is a black button with the word "Continue" in white.

Boot

This menu allows the user to decide the order of boot devices to load the operating system. Bootable devices includes the USB diskette drives, the onboard hard disk drive and the DVD drive in the module bay.

Select Boot Devices to select specific devices to support boot.

InsydeH20 Setup Utility				Rev. 3.5	
Information	Main	Security	Boot	Exit	
Boot priority order:			Item Specific Help		
1. IDE0 : TOSHIBA MK3265GSX			Use <↑> or <↓> to select a device, then press <F5> to move it down the list, or <F6> to move it up the list. Press <Esc> to escape the menu		
2. IDE1 : TSSTcorp CDDVDW TS-L633C					
3. USB FDD :					
4. Network Boot : LEGACY PCI DEVICE					
5. USB HDD :					
6. USB CDROM :					
F1 Help	↑↓ Select Item	F5/F6 Change Values	F9 Setup Default		
ESC Exit	←→ Select Menu	Enter Select ► SubMenu	F10 Save and Exit		

Exit

The Exit screen allows you to save or discard any changes you made and quit the BIOS Utility.

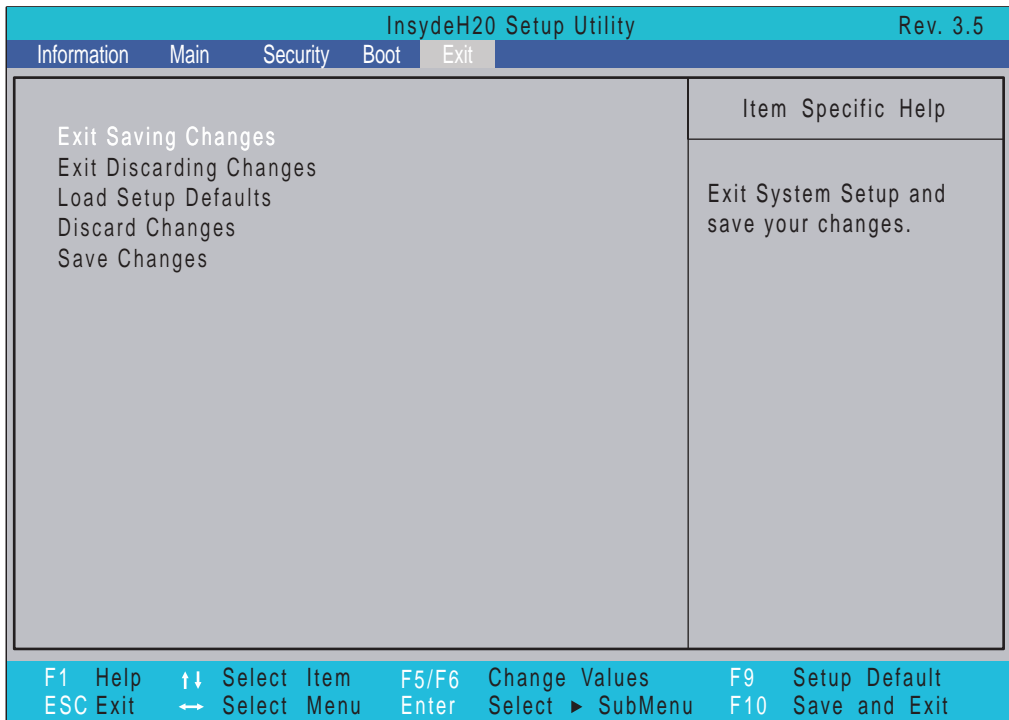

The table below describes the parameters in this screen.

Parameter	Description
Exit Saving Changes	Exit System Setup and save your changes.
Exit Discarding Changes	Exit utility without saving setup data.
Load Setup Default	Load default values for all SETUP item.
Discard Changes	Load previous values for all SETUP items.
Save Changes	Save Setup Data.

BIOS Flash Utilities

The BIOS flash memory update is required for the following conditions:

- New versions of system programs
- New features or options
- Restore a BIOS when it becomes corrupted.

Use the Flash utility to update the system BIOS Flash ROM.

NOTE: If you do not have a crisis recovery diskette at hand, then you should create a **Crisis Recovery Diskette** before you use the Flash utility.

NOTE: Do not install memory-related drivers (XMS, EMS, DPMI) when you use the Flash.

NOTE: Please use the AC adaptor power supply when you run the Flash utility. If the battery pack does not contain enough power to finish BIOS Flash, you may not boot the system because the BIOS is not completely loaded.

Follow the steps below to run the Flash.

1. Prepare a bootable diskette.
2. Copy the Flash utilities to the bootable diskette.
3. Then boot the system from the bootable diskette. The Flash utility has auto-execution function.

DOS Flash Utility

Perform the following steps to use the DOS Flash Utility:

1. Press F2 during boot to enter the Setup Menu.
2. Select **Boot Menu** to modify the boot priority order, for example, if using USB HDD to Update BIOS, move USB HDD to position 1.

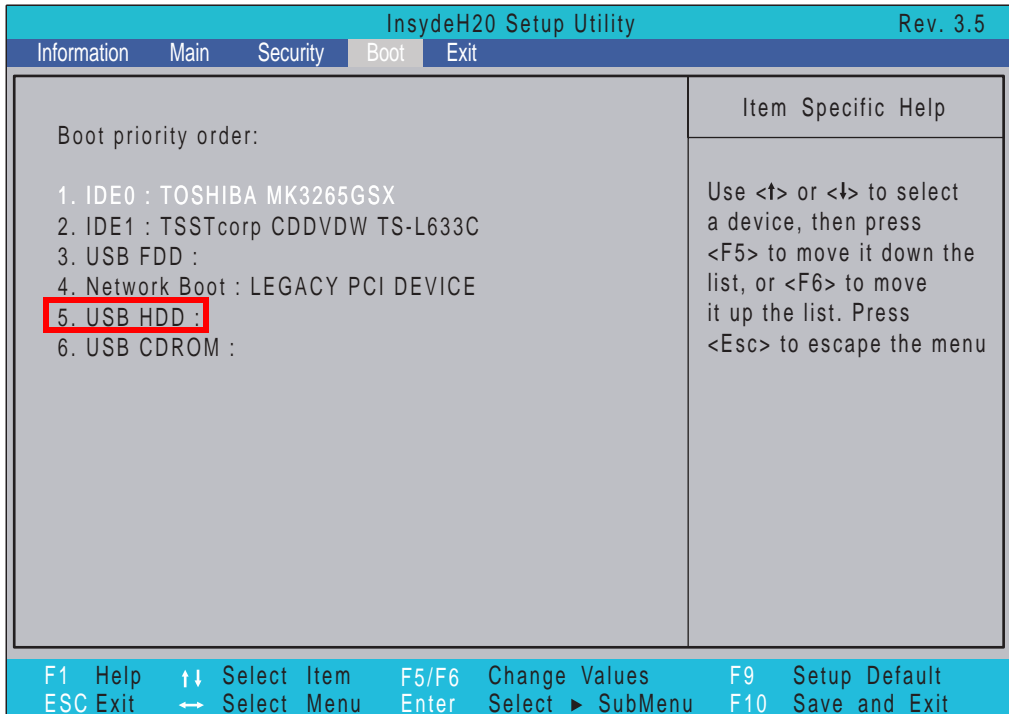

3. Execute the **BIOS.BAT** batch file to update BIOS.

The flash process begins as shown.

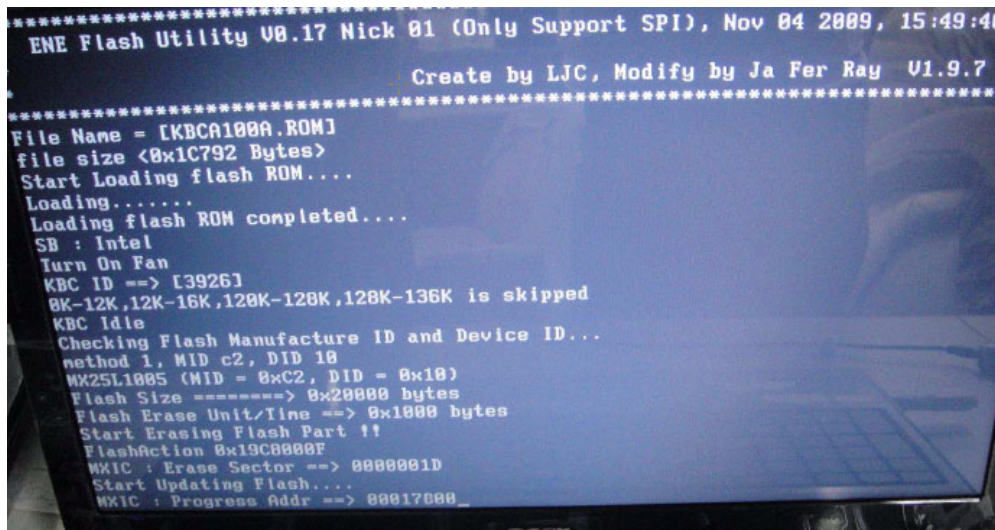

4. In flash BIOS, the message **Please do not remove AC Power Source** displays.

NOTE: If the AC power is not connected, the following message displays.



Plug in the AC power to continue.

5. Flash is complete when the message Flash programming complete displays.

WinFlash Utility

Perform the following steps to use the WinFlash Utility:

1. Double-click the WinFlash executable.
2. Click **OK** to begin the update. A progress screen displays.



Remove HDD/BIOS Password Utilities

This section provides you with details about removing HDD/BIOS password:

Remove HDD Password:

If you key in the wrong HDD password three times, an error is generated.



To reset the HDD password, perform the following steps:

1. After the error is displayed, select the **Enter Unlock Password** option on the screen.



2. An Encode key is generated for unlocking utilities. Note down this key.

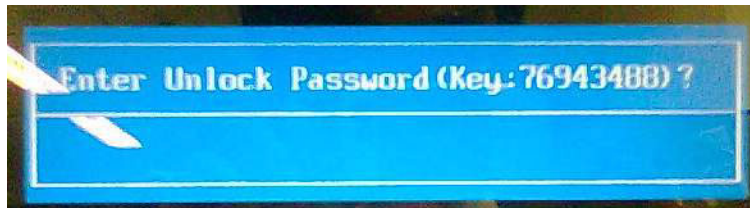

3. Execute the **UnlockHD.EXE** file to create the unlock code in DOS Mode using the format **UnlockHD [Encode code]** with the code noted in the previous step, as follows:

```
UnlockHD 76943488
```

4. The command generates a password which can be used for unlocking the HDD.

```
Password : 46548274
```

5. Key in the password from the previous step to unlock the HDD as shown.

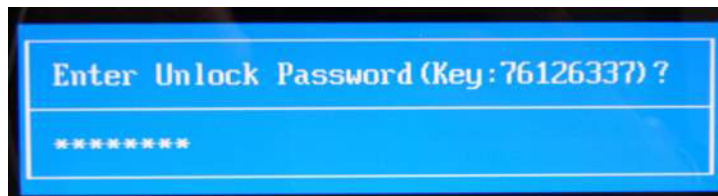

Removing BIOS Passwords:

To clear the User or Supervisor passwords, open the DIMM door and use a metal instrument to short the **RTC_RST** point.

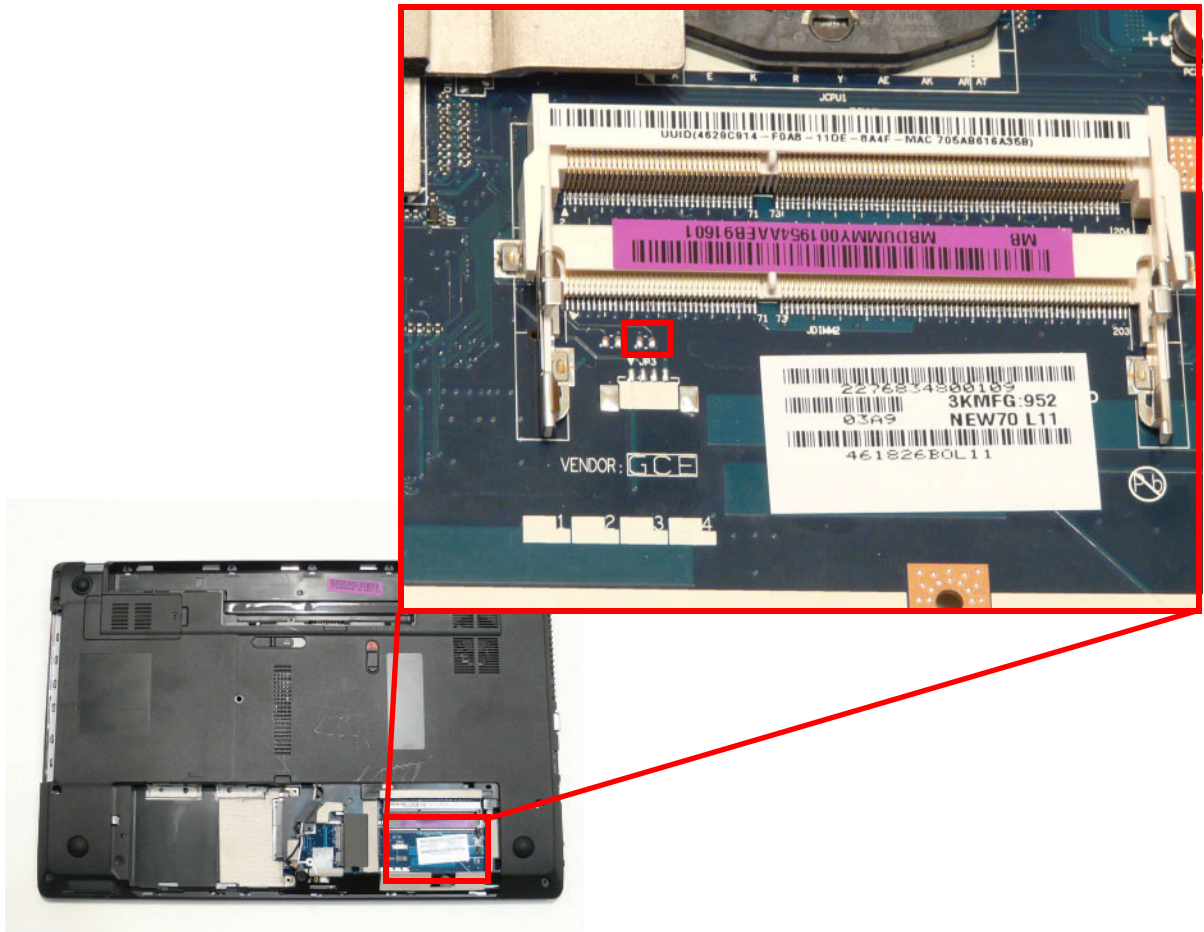

Cleaning BIOS Passwords

To clean the User or Supervisor passwords, perform the following steps:

1. From a DOS prompt, execute **clnPwd.exe**
2. Press 1 or 2 to clean the desired password shown on the screen.

```
d:\ClNpwd>clnPwd
ACER Clean Password Utility V1.00
Press 1 or 2 to clean any password shown as below
  1.User Password
  2.Supervisor Password

Clean User Password Successfully!
```

The onscreen message determines whether the function is successful or not.

Using Boot Sequence Selector

The Boot Sequence Selector allows the boot order to be changed without accessing the BIOS. To use Boot Sequence Selector, perform the following steps:

1. Enter into DOS.
2. Execute **BS.exe** to display the usage screen.

```
d:\BOOTSEQ>bs
*** Boot Sequence Selector Version 0.03 ***
Create by Rockwell Chuang 10/01/2005.
Usage:
      BS [ 1 | 2 | 3 | 4 ]
BS 1 : [ Floppy ] => [ HardDisk ] => [ CD-ROM ] => [ LAN   ]
BS 2 : [ HardDisk ] => [ CD-ROM ] => [ LAN   ] => [ Floppy ]
BS 3 : [ CD-ROM ] => [ HardDisk ] => [ LAN   ] => [ Floppy ]
BS 4 : [ LAN   ] => [ Floppy ] => [ HardDisk ] => [ CD-ROM ]
d:\BOOTSEQ>
```

3. Select the desired boot sequence by entering the corresponding sequence. For example, enter **BS2** to change the boot sequence to HDD | CD ROM | LAN | Floppy.

Using DMI Tools

The DMI (Desktop Management Interface) Tool copies BIOS information to EEPROM to be used in the DMI pool for hardware management.

When the BIOS displays **Verifying DMI pool data** it is checking that the table correlates with the hardware before sending to the operating system (Windows, etc.).

To update the DMI Pool, perform the following steps:

1. Boot into DOS.
2. Execute **dmitools**. The following messages report to screen to confirm completion:
 - `dmitools /r ==>` Read dmi string from bios
 - `dmitools /wm xxxx ==>` Write manufacturer name to eeprom (max. 16 characters)
 - `dmitools /wp xxxx ==>` Write product name to eeprom (max. 16 characters)
 - `dmitools /ws xxxx ==>` Write serial number to eeprom (max. 22 characters)
 - `dmitools /wu xxxx ==>` Write uuid to eeprom
 - `dmitools /wa xxxx ==>` Write asset tag to eeprom (max. 32 characters)

The following examples show the commands and the corresponding output information.

Read DMI Information from Memory

Input:

```
dmitools /r
```

Output:

```
Manufacturer (Type1, Offset04h): Acer
Product Name (Type1, Offset05h): TravelMate xxxxx
Serial Number (Type1, Offset07h): 01234567890123456789
UUID String (Type1, Offset08h): xxxxxxxx-xxxx-xxxx-xxxx-xxxxxxxxxxxxx
Asset Tag (Type3, Offset04h): Acet Asstag
```

Write Product Name to EEPROM

Input:

```
dmitools /wp Acer
```

Write Serial Number to EEPROM

Input:

```
dmitools /ws 01234567890123456789
```

4). Write UUID to EEPROM (Create UUID from Intel WFM20.pdf)

Input:

```
dmitools /wu
```

5). Write Asset Tag to EEPROM

Input:

```
dmitools /wa Acet Asstag
```

NOTE: When using any of the Write options, restart the system to make the new DMI data effective.

Using the LAN MAC EEPROM Utility

You can use the MAC.BAT utility to write the MAC.CFG file to the EEPROM under DOS mode.

1. Use a text editor (for example: Notepad) to open the MAC.CFG file. You can see the MAC.CFG contents as below:



```
MAC.CFG - 記事本
檔案(F) 編輯(E) 格式(O) 檢視(V) 說明(H)
Title= MAC Address byte
WriteData='001122334455'
StartAddr=7A
WriteLeng=6
KeepByte=0
```

WriteData = '001122334455'	MAC value
StartAddr=7A	MAC address
WriteLeng=6	MAC value length
KeepByte=0	don't care

2. In DOS mode, run the **MAC.BAT** file to write MAC values to eeprom.

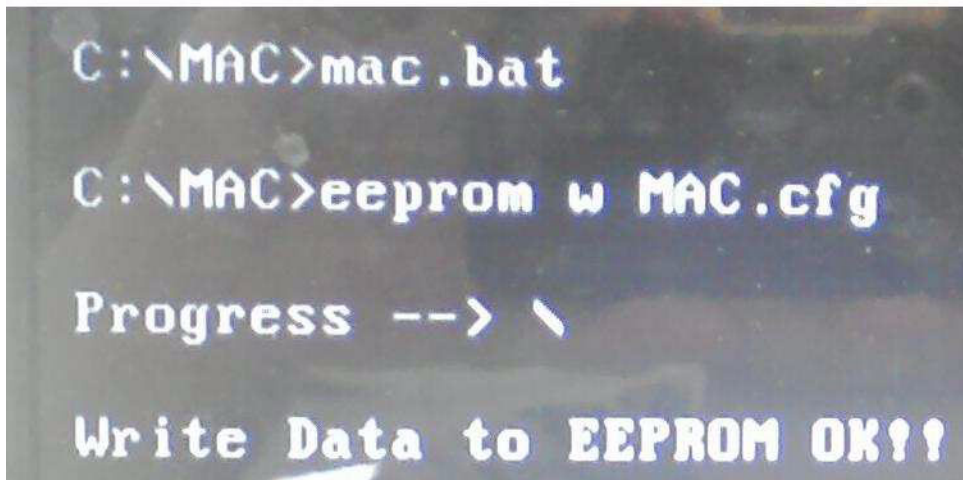

```
C:\MAC>mac.bat
C:\MAC>eeprom w MAC.cfg
Progress --> \
Write Data to EEPROM OK!!
```

Machine Disassembly and Replacement

IMPORTANT: The outside housing and color may vary from the mass produced model.

This chapter contains step-by-step procedures on how to disassemble the notebook computer for maintenance and troubleshooting.

Disassembly Requirements

To disassemble the computer, you need the following tools:

- Wrist grounding strap and conductive mat for preventing electrostatic discharge
- Flat screwdriver
- Philips screwdriver
- Plastic flat screwdriver
- Plastic tweezers

NOTE: The screws for the different components vary in size. During the disassembly process, group the screws with the corresponding components to avoid mismatch when putting back the components.

Pre-disassembly Instructions

Before proceeding with the disassembly procedure, make sure that you do the following:

1. Turn off the power to the system and all peripherals.
2. Unplug the AC adapter and all power and signal cables from the system.



3. Place the system on a flat, stable surface.
4. Remove the battery pack.

Disassembly Process

IMPORTANT: The LCD Module cannot be disassembled outside of factory conditions. If any part of the LCD Module is faulty, such as the camera, antenna or LCD panel, the whole module must be replaced.

The disassembly process is divided into the following stages:

- External module disassembly
- Main unit disassembly
- LCD module disassembly

The flowcharts provided in the succeeding disassembly sections illustrate the entire disassembly sequence. Observe the order of the sequence to avoid damage to any of the hardware components. For example, if you want to remove the mainboard, you must first remove the keyboard, then disassemble the inside assembly frame in that order.

Main Screw List

Screw	Quantity	Part Number
M2.5*8	19	86.PSV02.002
M2*3	26	86.PSV02.004
M2.5*5	8	86.PSV02.001
M1.98*3	4	86.PSV02.004
M2.5*6	4	86.PSV02.003

External Module Disassembly Process

IMPORTANT: The outside housing and color may vary from the mass produced model.

External Modules Disassembly Flowchart

The flowchart below gives you a graphic representation of the external module disassembly sequence and instructs you on the components that need to be removed during servicing. For example, if you want to remove the keyboard, you must first remove the switch board.

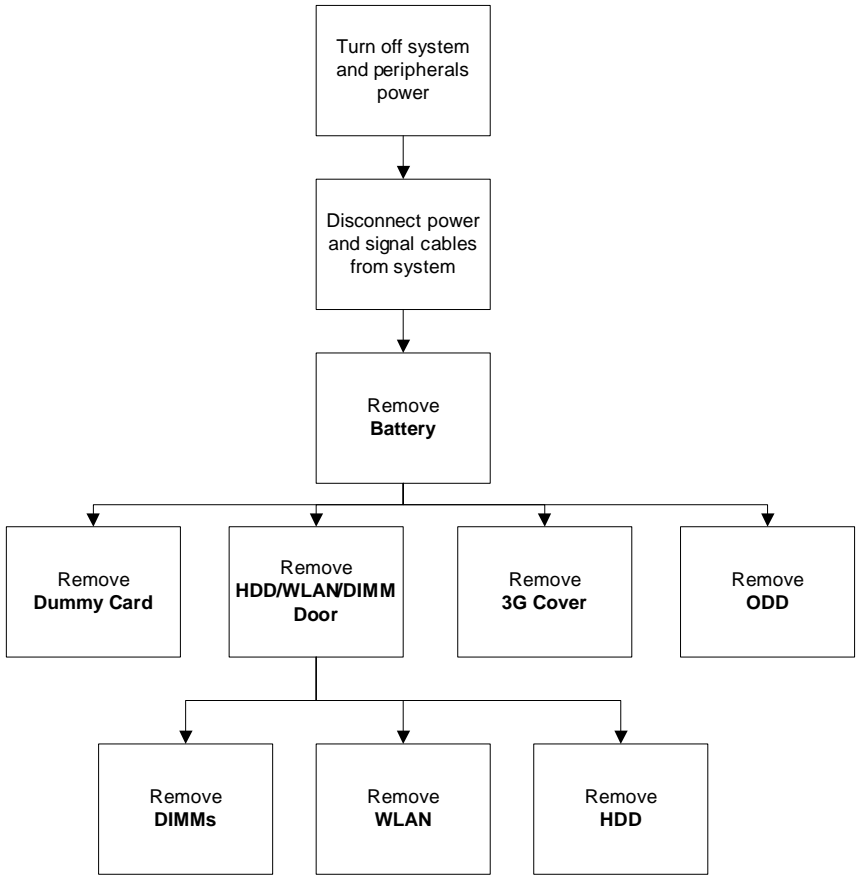

Screw List

Step	Screw	Quantity	Part No.
ODD Module	M 2.5*8	1	86.PSV02.002
ODD Bracket	M2*3	2	86.PSV02.004
3G Cover	M2.5*8	1	86.PSV02.002
Logic Lower Door	M2.5*8	2	86.PSV02.002
WLAN Module	M2*3	1	86.PSV02.004
HDD Carrier	M2*3	4	86.PSV02.004

Removing the Battery Pack

1. Turn computer over. Slide the battery lock in the direction shown.

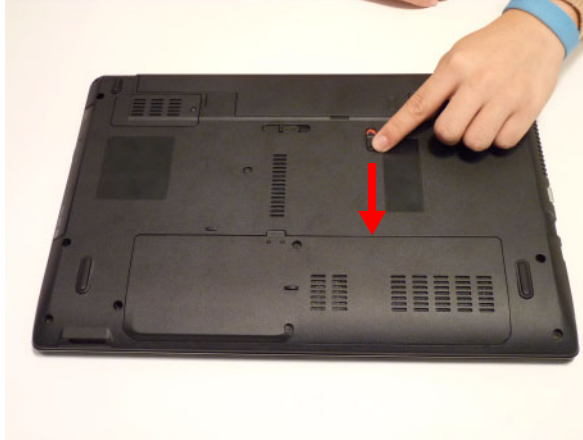

2. Slide and hold the battery release latch to the release position (1), then lift out the battery pack from the main unit (2).

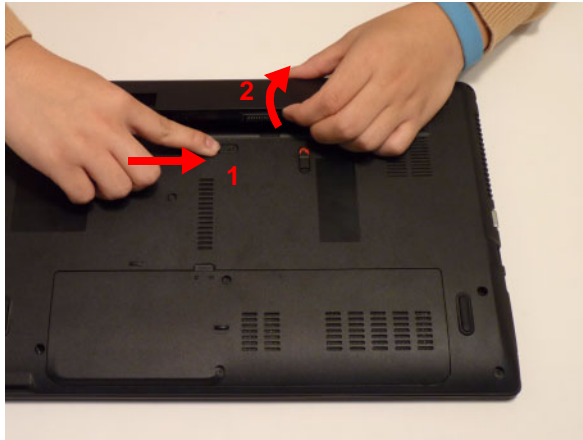

NOTE: Please follow local regulations for disposal.

Removing the SD Dummy Card

1. Push the SD dummy card all the way in to eject it.



2. Pull it out from the slot.



Removing the Optical Drive Module

1. See "Removing the Battery Pack" on page 43.
2. Remove the screw securing the ODD module.



Step	Size	Quantity	Screw Type
ODD Module	M2.5*8	1	

3. Pull the optical drive module out from the chassis.

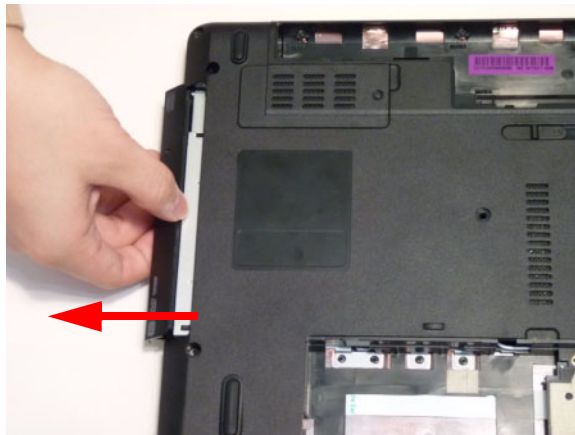

4. Remove the two (2) screws securing the ODD bracket and remove the ODD bracket from the optical disk drive module.



Step	Size	Quantity	Screw Type
ODD Bracket	M2*3	2	

5. Remove the ODD bezel by prying the top edge away and clear of the module.



Removing the Logic Lower Door

1. Remove two (2) screws from the logic lower door.

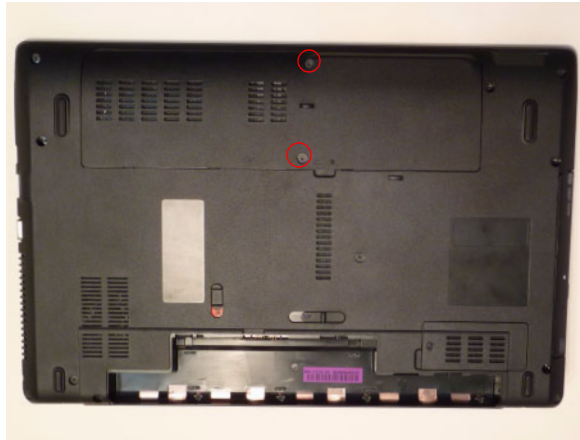

Step	Size	Quantity	Screw Type
Logic lower door	M2.5*8	2	

2. Lift the door beginning from the inner edge as shown.

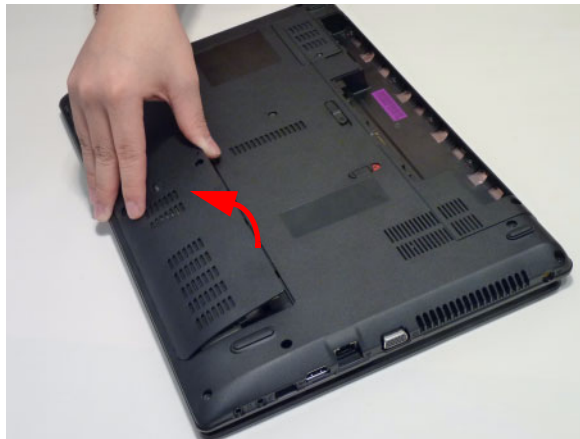

3. Lift the door clear of the device, exposing the HDD, DIMM, and WLAN modules.



Removing the 3G Cover

1. Remove one (1) screw from the 3G Cover.



Step	Size	Quantity	Screw Type
3G Cover	M2.5*8	1	

2. Lift the 3G Cover from the right edge first, then remove completely.

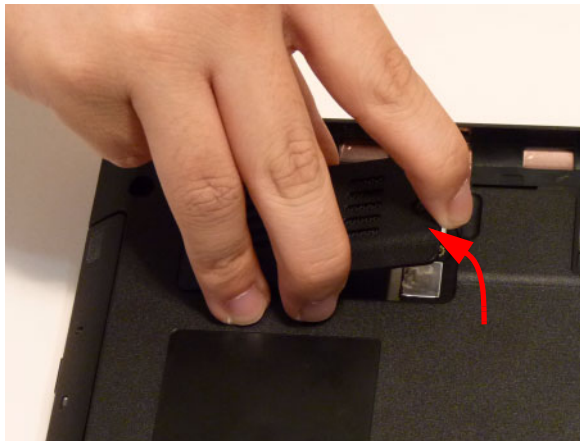

Removing the DIMM Module

1. See “Removing the Logic Lower Door” on page 47.
2. Push out the release latches on both sides of the DIMM socket to release the DIMM module.

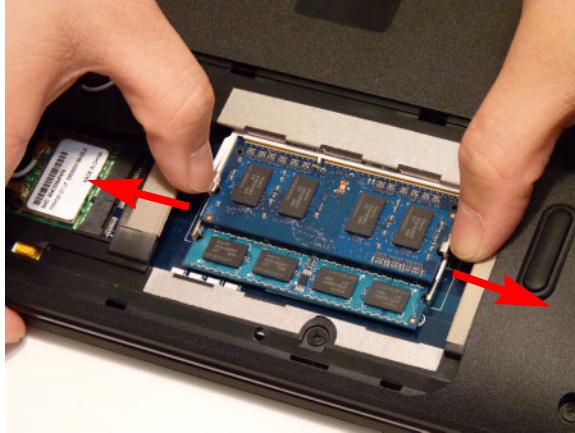

3. Remove the DIMM module.

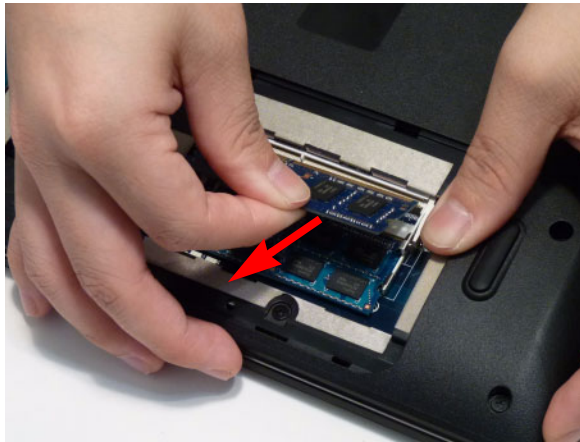

4. Repeat steps 2 and 3 for the second DIMM module if present.

Removing the WLAN Module

1. See "Removing the Logic Lower Door" on page 47.
2. Disconnect the antenna cables from the WLAN Board.



NOTE: Cable placement is **Black** to the **MAIN** terminal and **White** to the **AUX** terminal.

3. Move the antenna away and remove the two (1) screws to release the WLAN Board.

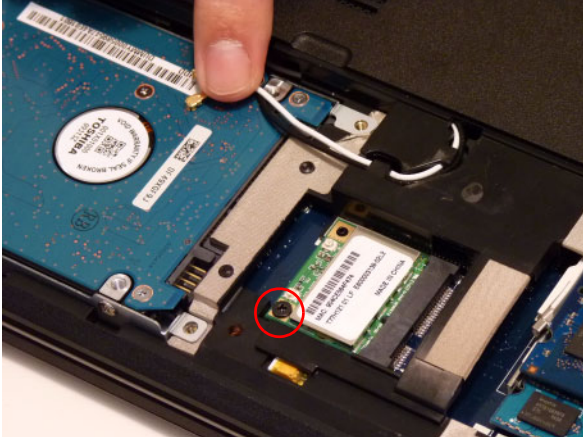

Step	Size	Quantity	Screw Type
WLAN Module	M2*3	1	

Removing the Hard Disk Drive Module

1. See “Removing the Logic Lower Door” on page 47.
2. Using the pull-tab, slide the HDD Module in the direction of the arrow to disconnect the interface.



3. Lift the HDD Module clear of the HDD bay.

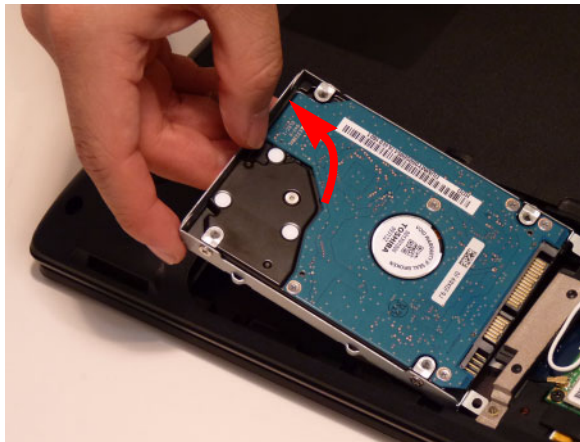

NOTE: To prevent damage to device, avoid pressing down on it or placing heavy objects on top of it.

4. Remove the four (4) screws (two each side) securing the hard disk to the carrier.



Step	Size	Quantity	Screw Type
HDD Carrier	M3*3	4	

5. Remove the HDD from the carrier.

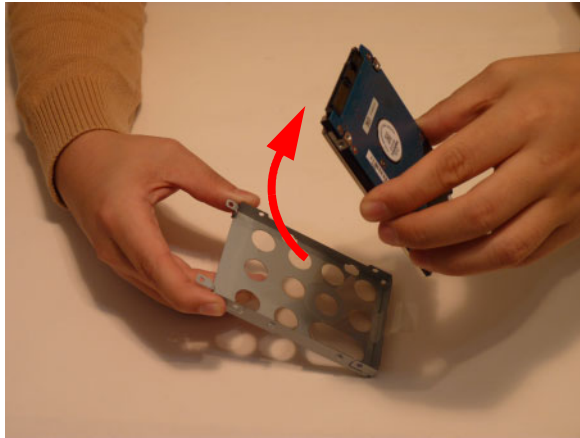

Main Unit Disassembly Process

Main Unit Disassembly Flowchart

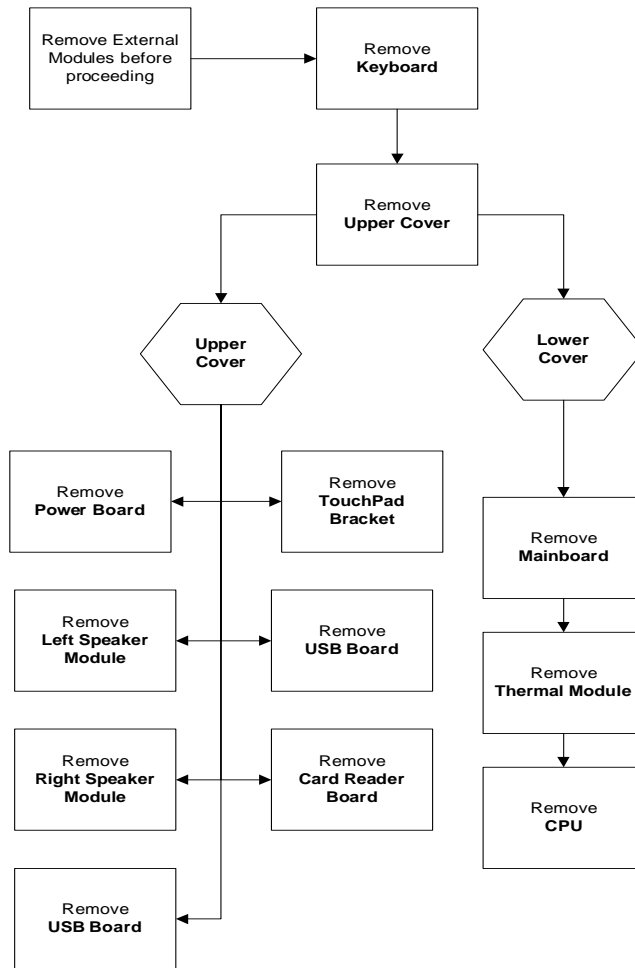

Screw List

Step	Screw	Quantity	Part No.
Upper Cover	M2.5*5	7	86.PSV02.001
Lower Cover	M2.5*8	11	86.PSV02.002
Battery Bay	M2*3	4	86.PSV02.004
Left Speaker Module	M2*3	2	86.PSV02.004
Right Speaker Module	M2*3	2	86.PSV02.004
Power Board	M2*3	2	86.PSV02.004
Card Reader	M2*3	1	86.PSV02.004
USB Board	M2*3	1	86.PSV02.004
TouchPad Bracket	M2*3	1	86.PSV02.004
Mainboard	M2.5*5	1	86.PSV02.001
Thermal Module	M1.98*3	4	86.PSV02.006

Removing the Keyboard

1. Unlock the six (6) keyboard locks.



2. Pry up the centre of the Keyboard and rotate it upward away from the Upper Cover.



3. Turn the keyboard over on to the TouchPad area to expose the FFC connector.

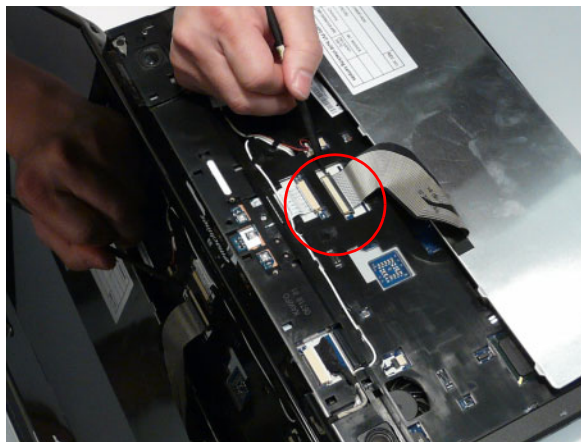

4. Open the locking latch and disconnect the FFC from the mainboard.

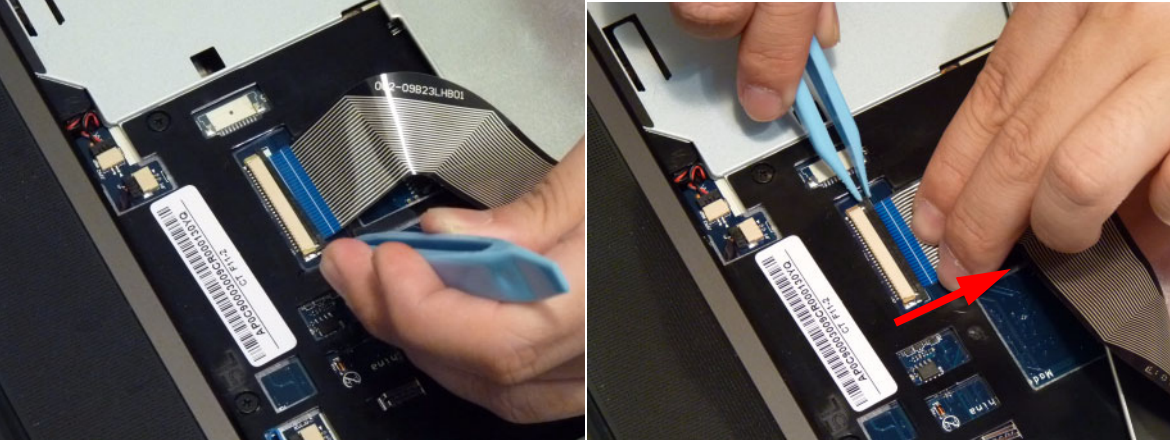



5. Lift the keyboard clear of the Upper Cover.

Removing the Upper Cover

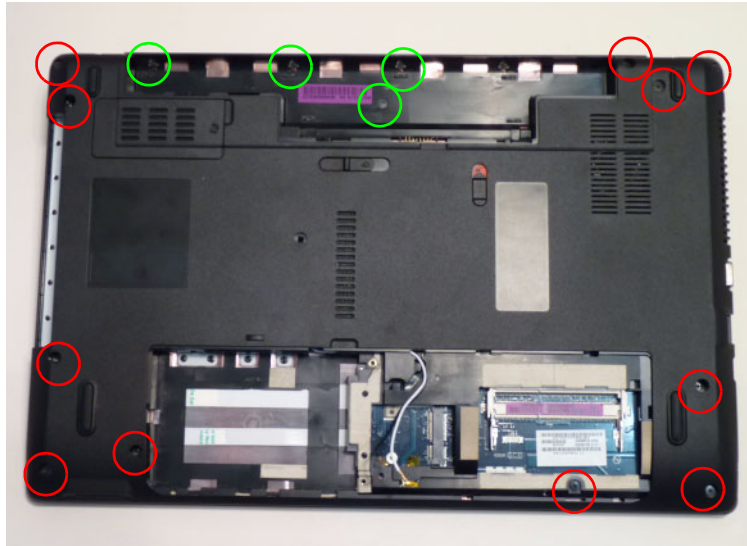
1. See "External Module Disassembly Process" on page 42.
2. Turn the computer over. Remove the eleven (11) screws on the lower cover and four (4) screws from the battery bay.



Step	Size	Quantity	Screw Type
Upper Cover (red callout)	M2.5*8	11	
Battery Bay (green callout)	M2*3	4	

3. Turn the computer over and disconnect the following four (4) cables from the Mainboard.

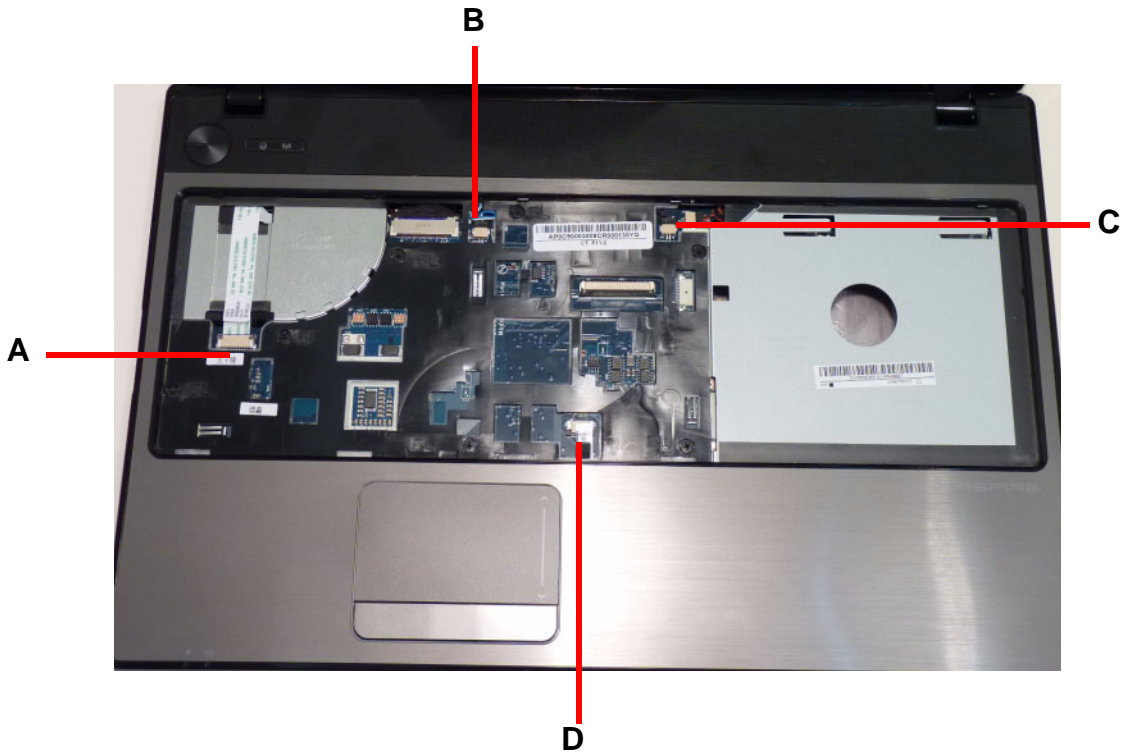

4. Release the locking latch on **A**.

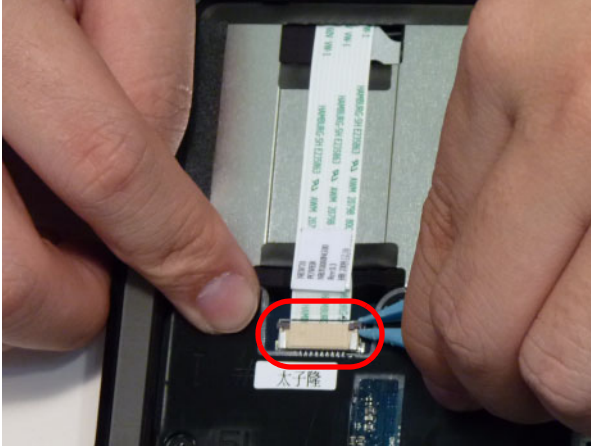

5. Disconnect **A** as shown.

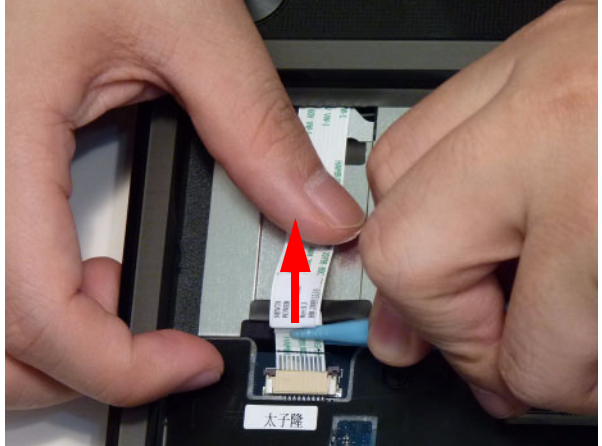

6. Release the locking latch on **B** and remove the cable as shown.

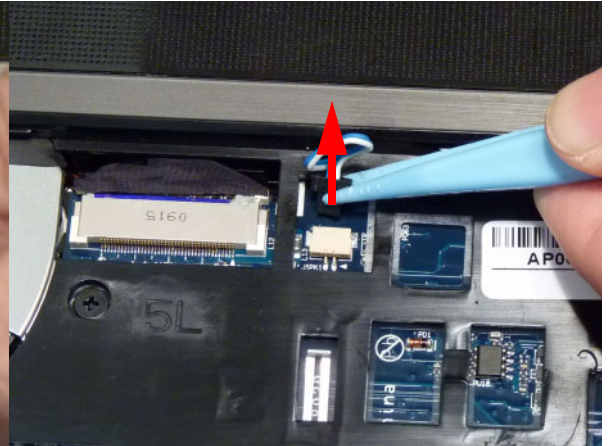
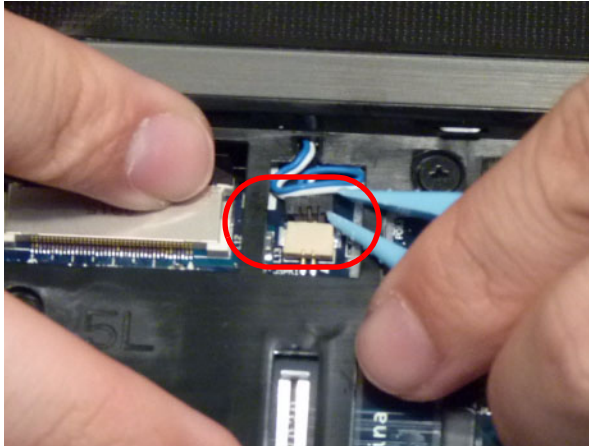

7. Release the locking latch on **C** and remove the cable as shown.

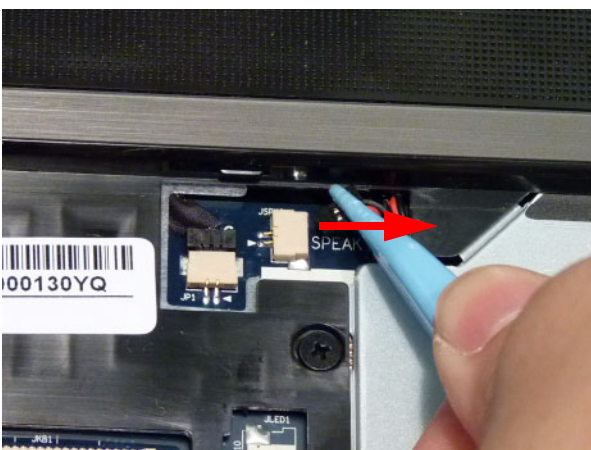

8. Release the locking latch on **D** and remove the cable as shown.

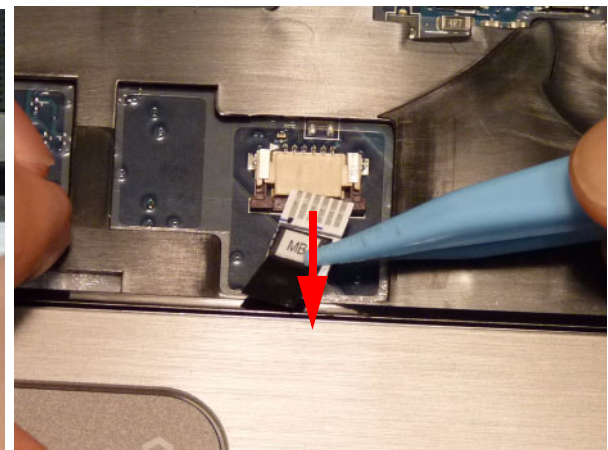

NOTE: Avoid pulling on cables directly to prevent damage to the connectors.

NOTE: Use the pull-tabs on FCCs whenever available to prevent damage.

9. Remove the seven (7) screws on the Upper Cover as shown.

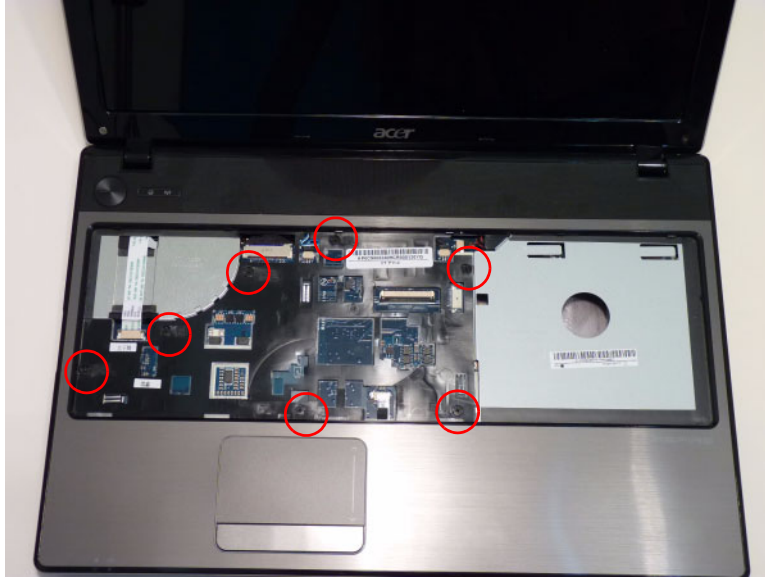

Step	Size	Quantity	Screw Type
Upper Cover	M2.5*5	7	

10. Starting at the top right side of the cover, pry apart the Upper and Lower Covers as shown. Work along the front edge of the casing to the left as shown, then lift the Upper Cover clear of the Lower Cover.

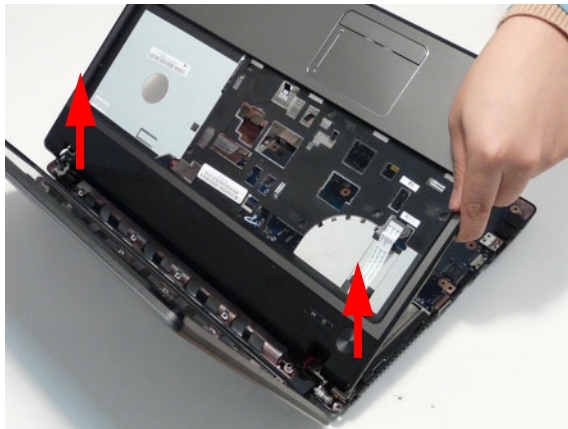
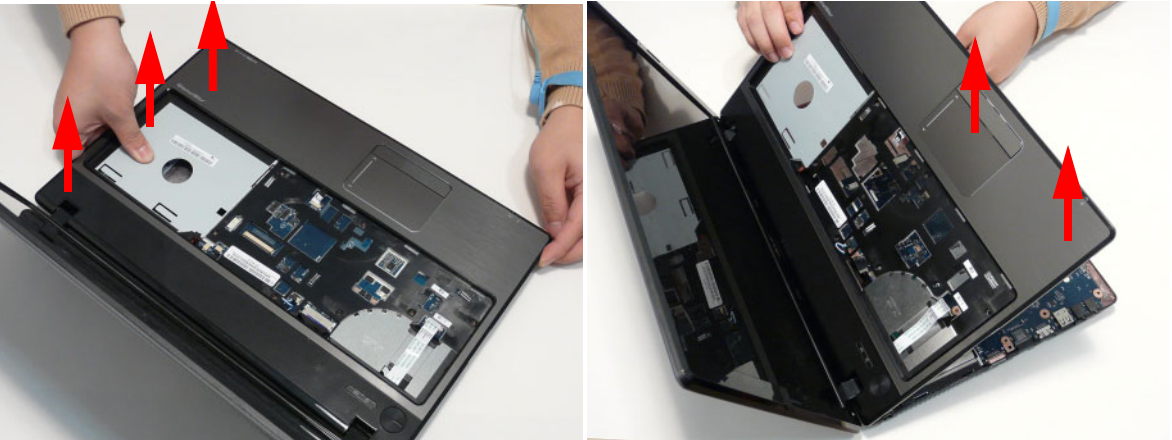

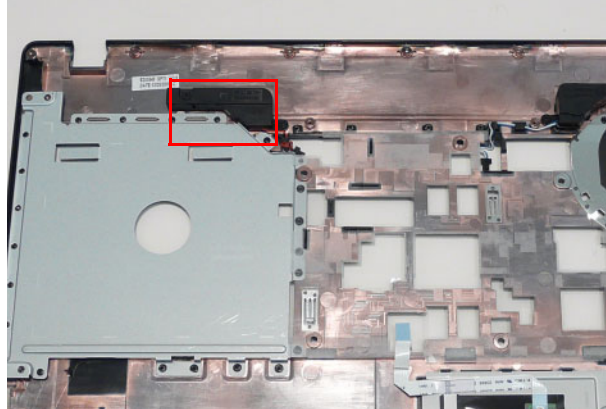

Removing the Left Speaker Module

1. See "Removing the Upper Cover" on page 57.
2. Locate the Left Speaker Module on the Upper Cover as shown.

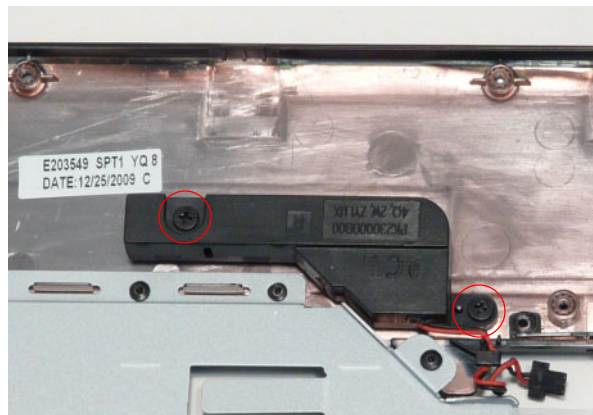

3. Remove two (2) screws from the left speaker module.



Step	Size	Quantity	Screw Type
Left Speaker Module	M2*3	2	

4. Remove the Speaker cable from the cable channel. Ensure that the cable is free from all cable clips.

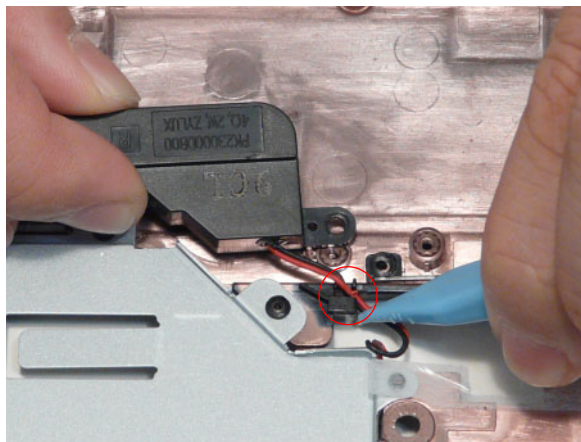

5. Lift the Speaker clear of the Upper Cover.

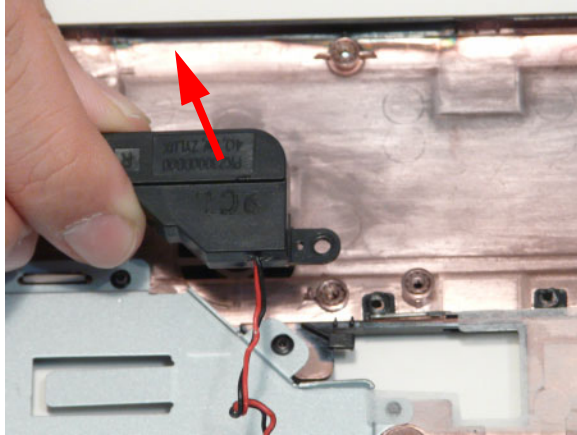

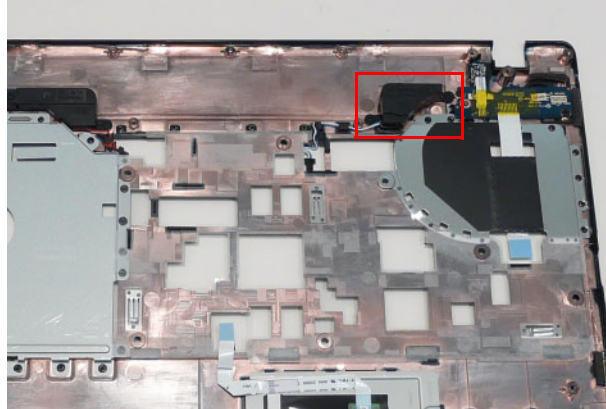

Removing the Right Speaker Module

1. See "Removing the Upper Cover" on page 57.
2. Locate the Right Speaker Module on the Upper Cover as shown.

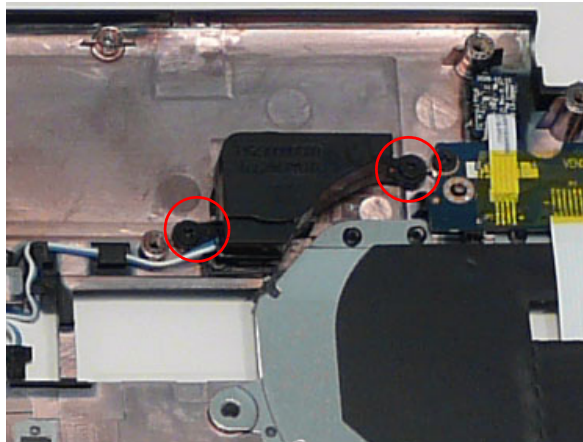

3. Remove the two (2) securing screws from the Right Speaker Module.



Step	Size	Quantity	Screw Type
Right Speaker Module	M2*3	2	

4. Remove the Right Speaker Module cable from the cable channel. Ensure that the cable is free from all cable clips.

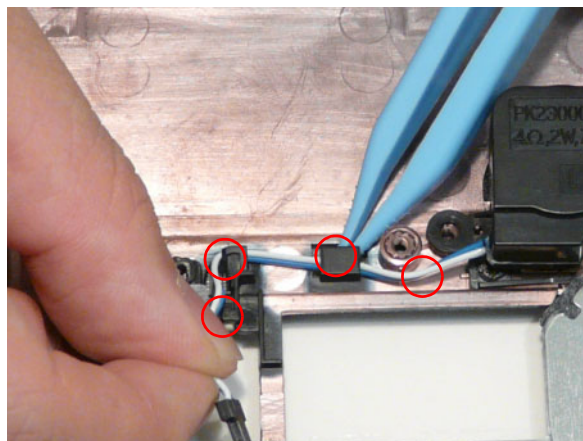

5. Lift the Right Speaker Module clear of the device.

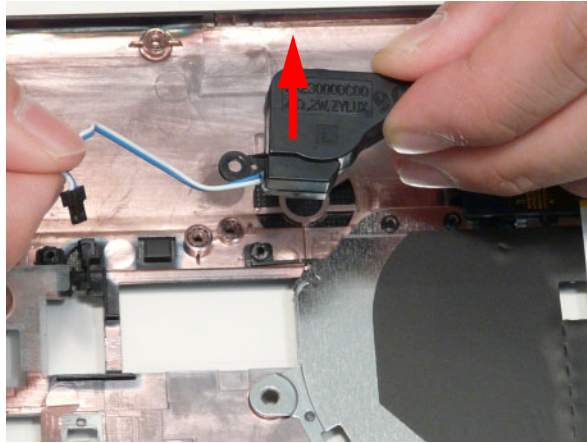



Removing the Power Board

1. See "Removing the Upper Cover" on page 57.
2. Turn the upper cover over and remove the power board cable. Pass the cable through the upper cover as shown.

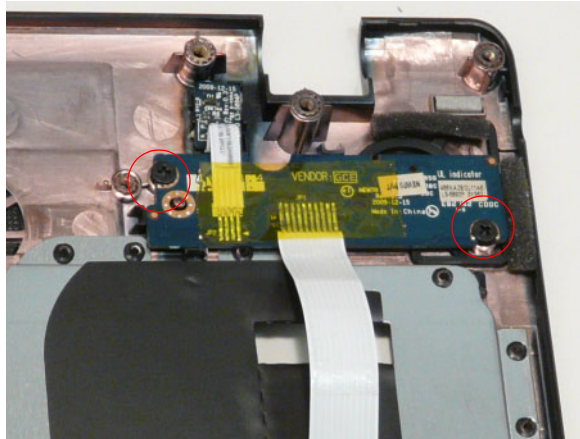

3. Remove two (2) screws from the power board.



Step	Size	Quantity	Screw Type
Power board	M2*3	2	

4. Remove the power board assembly and lift the power board clear of the device.

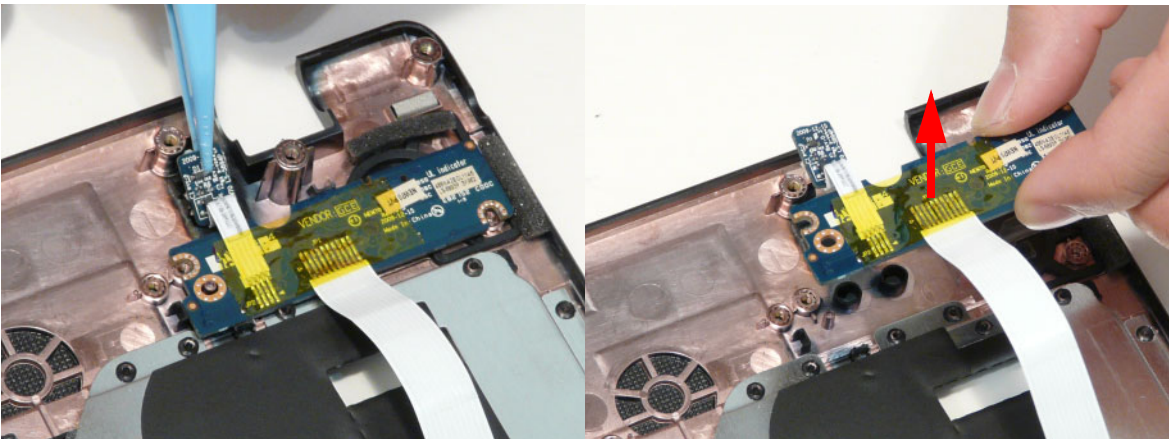

Removing the TouchPad Bracket

IMPORTANT: The TouchPad Board cannot be removed individually. To replace the TouchPad Board, replace the entire Upper Cover.

1. See “Removing the Upper Cover” on page 57.
2. Lift the FFC to detach the adhesive securing the cable to the Upper Cover.

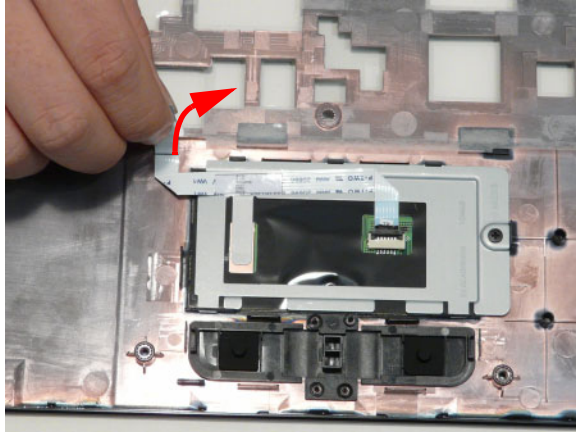

3. Release the FFC locking latch and disconnect the TouchPad FFC from the cover.

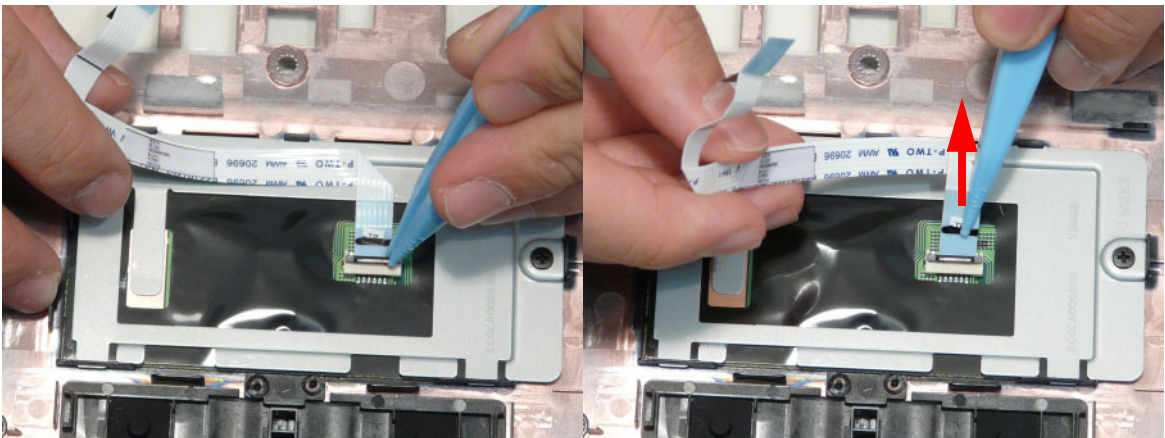

4. Remove the one (1) screw from TouchPad bracket.

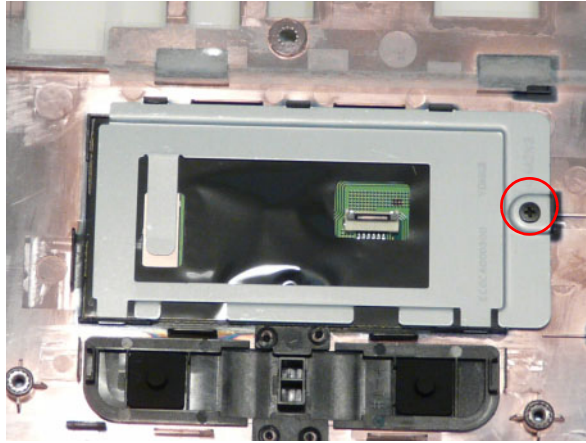

Step	Size	Quantity	Screw Type
TouchPad Bracket	M2*3	1	

5. Pry the Touchpad bracket off the adhesive and remove it as shown.

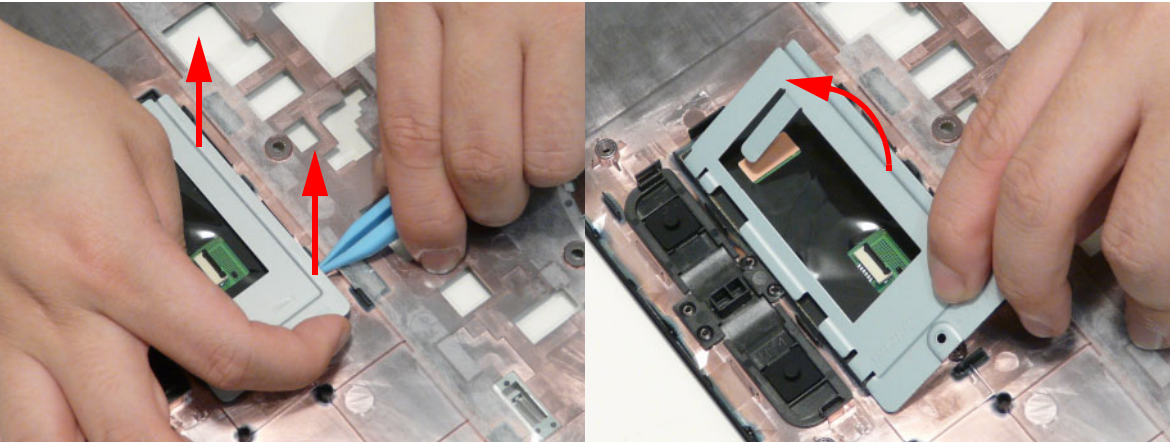

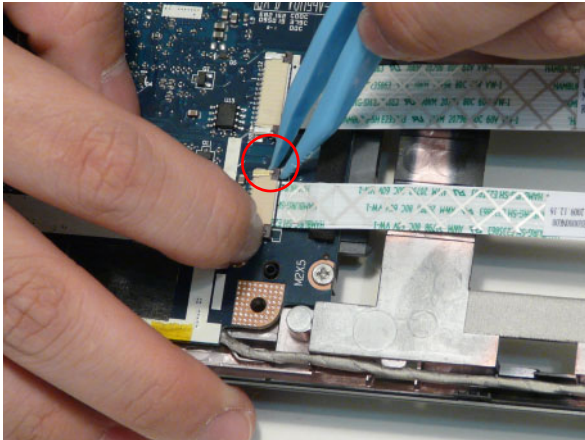

Removing the Card Reader Board

1. See "Removing the Upper Cover" on page 57.
2. Unlock the mainboard to card reader cable connector.

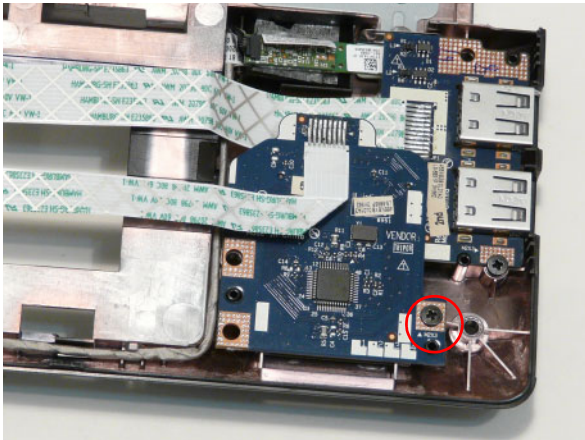

3. Remove one (1) screw from the card reader board.



Step	Size	Quantity	Screw Type
Card Reader	M2*3	1	

4. Lift the card reader board clear of the device.

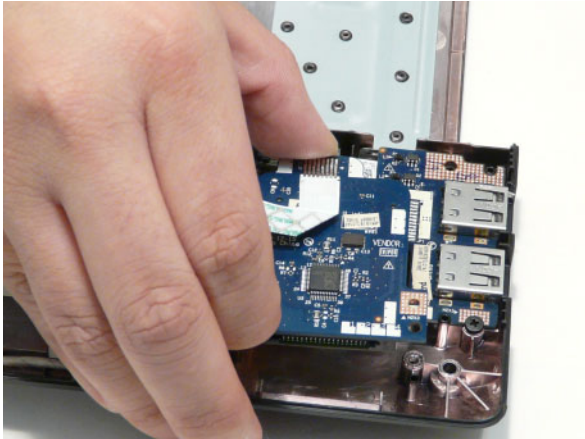

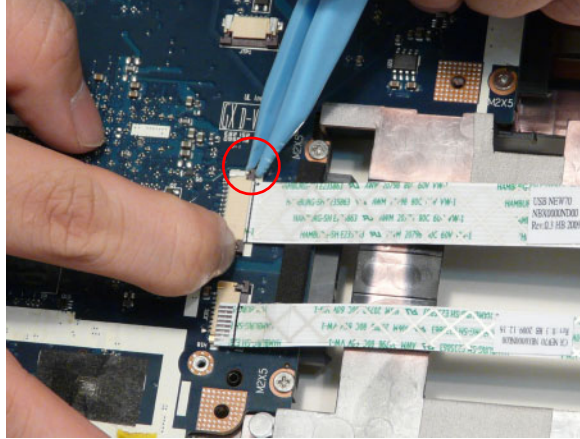

Removing the USB Board

- 1. See "Removing the Upper Cover" on page 57.
- 2. Unlock the mainboard to USB cable connector.

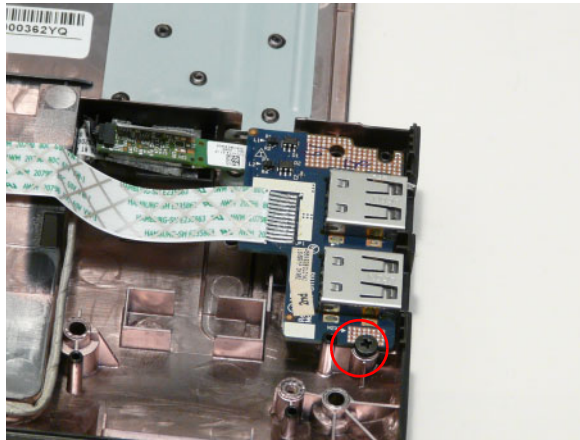

- 3. Remove one (1) screw from the USB board.



Step	Size	Quantity	Screw Type
USB	M2*3	1	

- 4. Lift the USB board clear of the device.

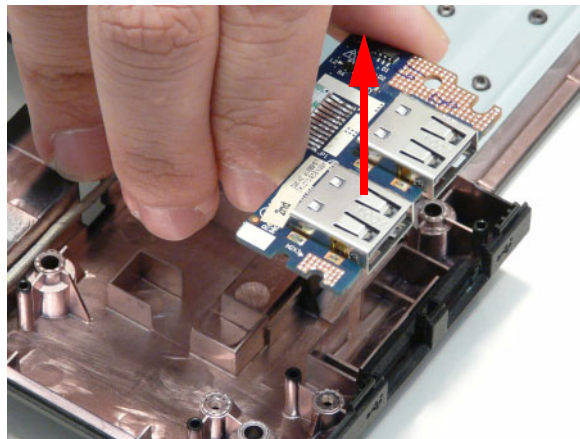

Removing the Bluetooth Board

1. See "Removing the Upper Cover" on page 57.
2. Pry the Bluetooth board from the adhesive.

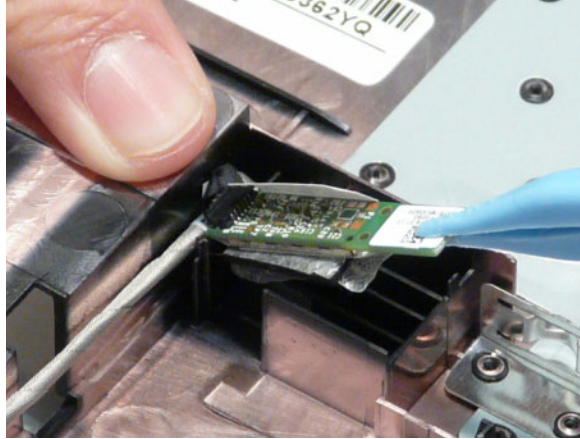

3. Disconnect the mainboard to Bluetooth cable.

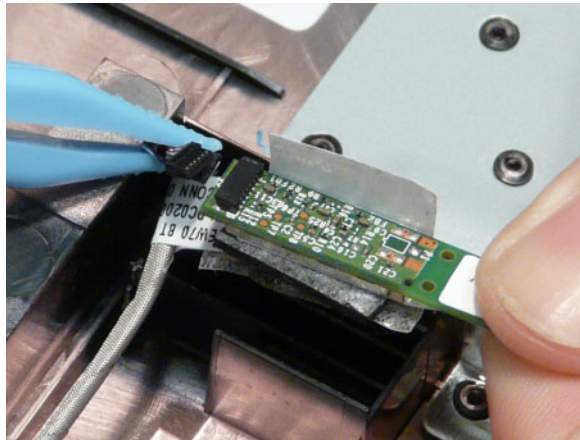

4. Lift the Bluetooth board away from the cable channel as shown.

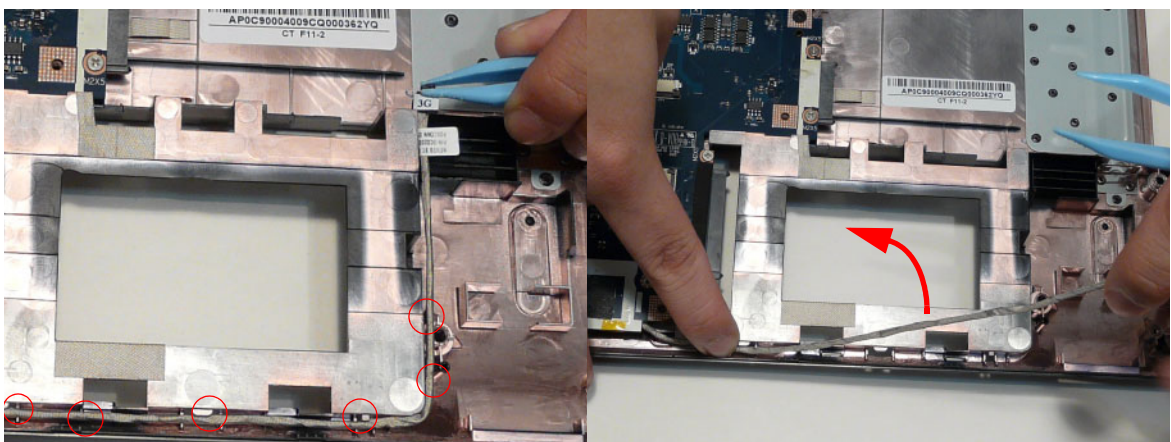

Removing the Mainboard

1. See "Removing the Upper Cover" on page 57.
2. Unlock the microphone cable connector and disconnect the cable.

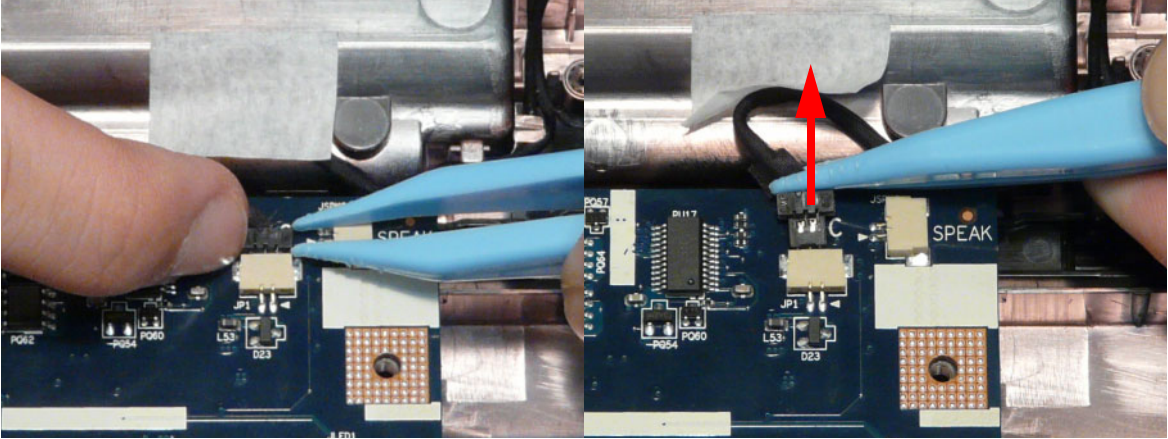

3. Disconnect the LVDS cable.

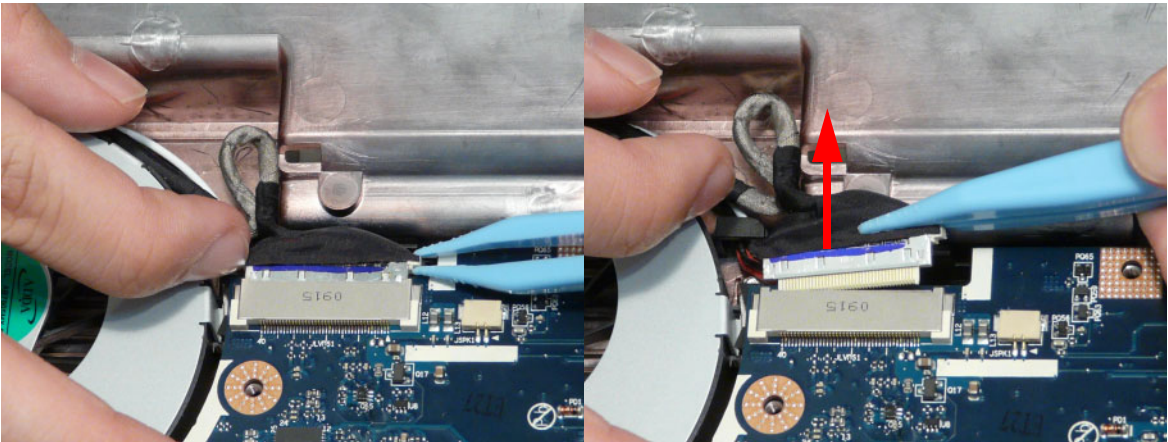

4. Remove the one (1) securing screw from the Mainboard.

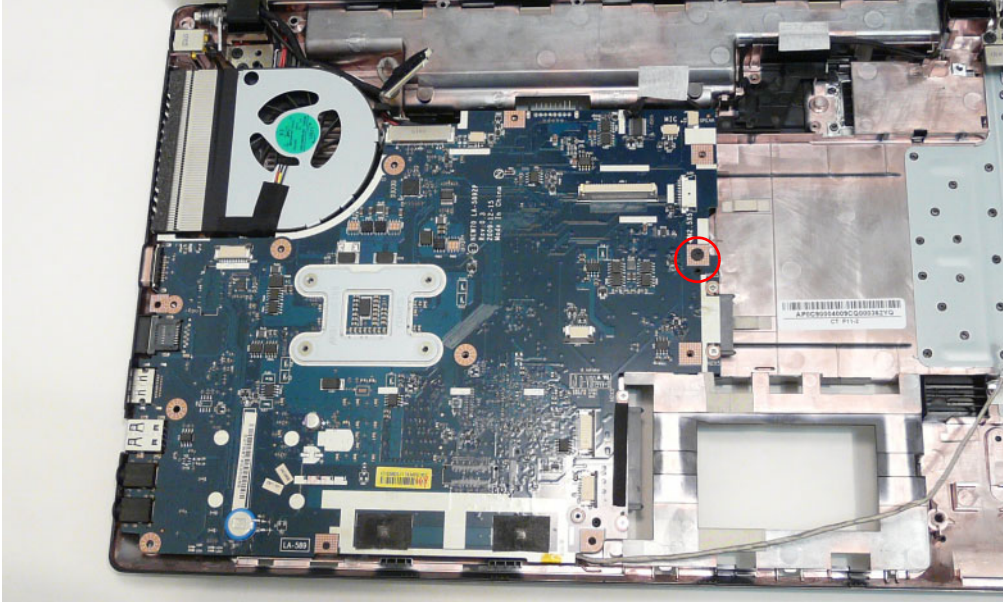

Step	Size	Quantity	Screw Type
Mainboard	M2.5*5	1	

5. Lift the right edge of the mainboard first to free it from the lower case, without removing the mainboard completely from the chassis.

CAUTION: Do not remove the mainboard completely. The mainboard is still connected to the chassis.

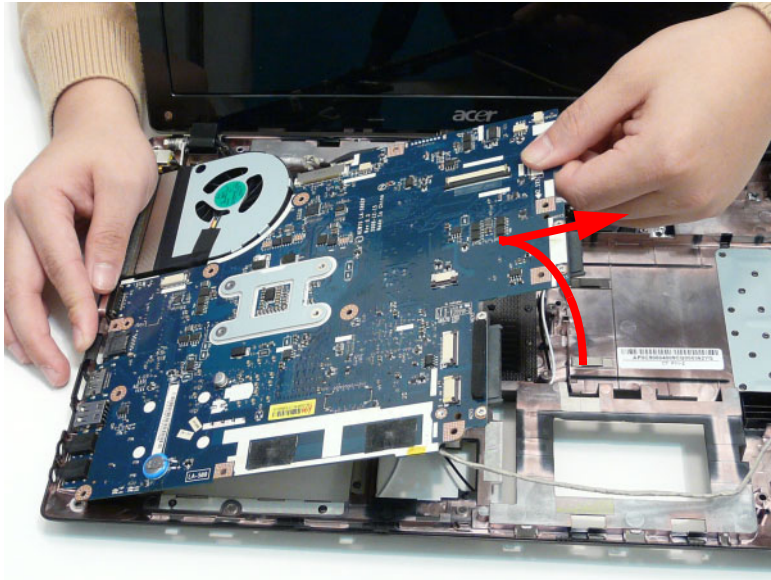

6. Carefully turn the mainboard over and place it on a clean, dust-free surface.

CAUTION: Do not use excessive force when turning the mainboard over as it is still connected to the chassis by the power cable.

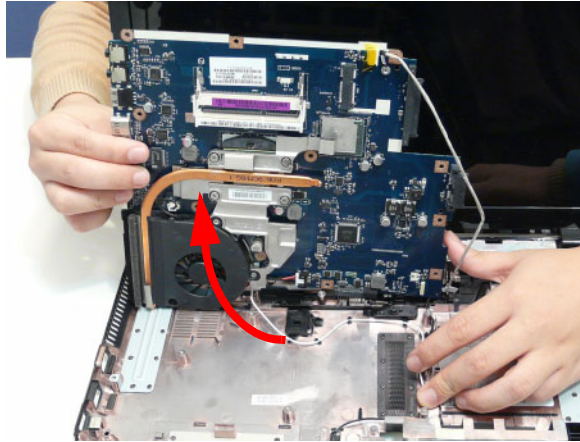

7. Disconnect the power cable.

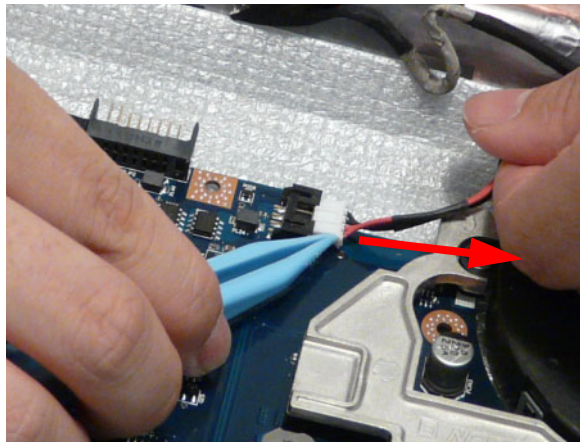

8. Remove the mainboard from the chassis and turn it over.

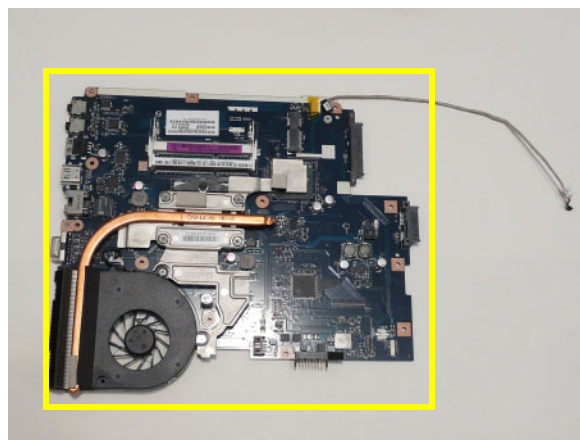

NOTE: Circuit boards >10 cm² have been highlighted with a yellow rectangle as shown in the previous image. Please detach the Circuit board and follow local regulations for disposal.

9. Remove the adhesive tape from the bluetooth cable.

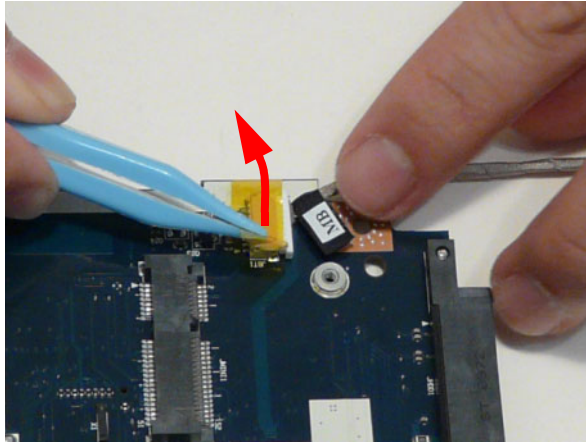

10. Unlock the connector and disconnect the bluetooth to mainboard cable.

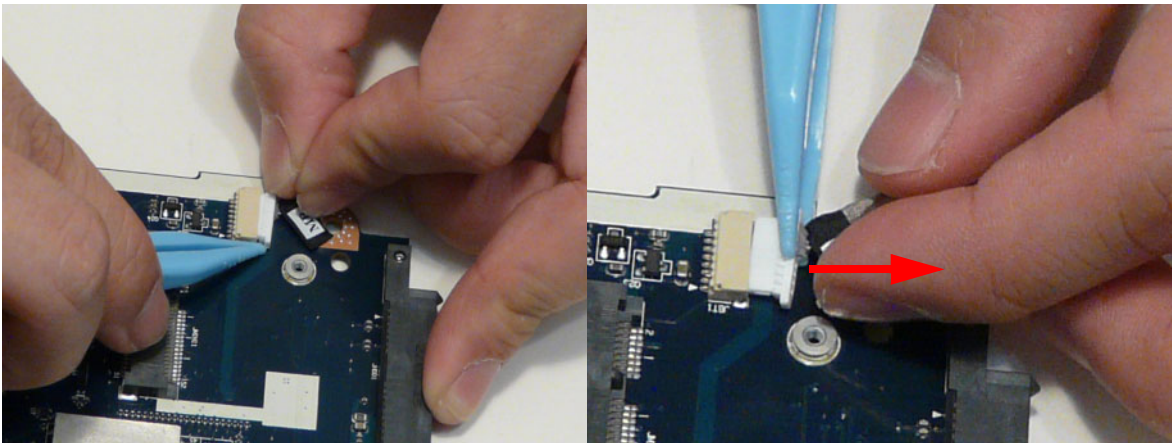

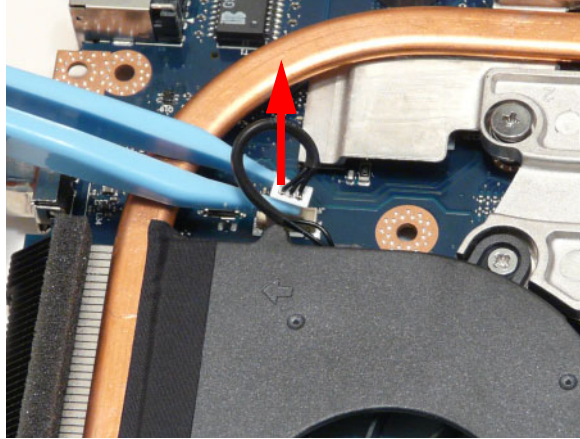

Removing the Thermal Module

1. See "Removing the Upper Cover" on page 57.
2. Disconnect the fan cable.

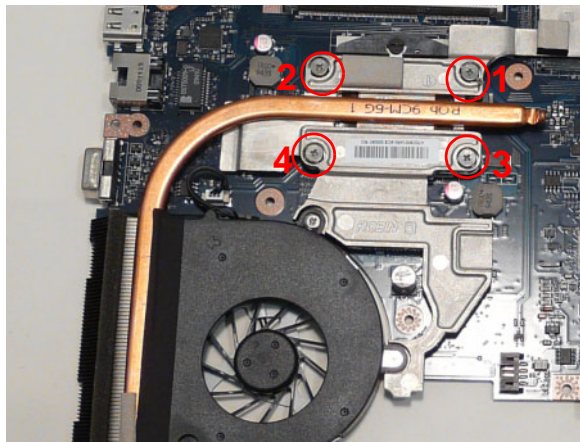

3. Remove the four (4) securing screws (in reverse numerical order from screw 4 to 1) from the Thermal Module.



Step	Size	Quantity	Screw Type
Thermal Module	M1.98*3	4	

4. Carefully lift the Thermal Module clear of the Mainboard.

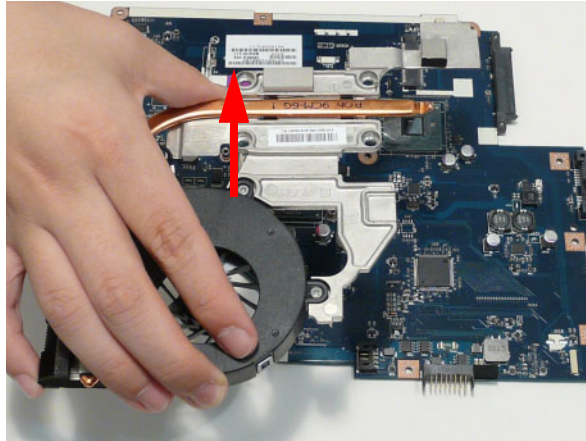

Removing the CPU

IMPORTANT: The pins on the underside of the CPU are very delicate. If they are damaged, the CPU may malfunction. Place the CPU on a clean, dry surface when it is not installed.

1. See “Removing the Thermal Module” on page 75.
2. Using a flat-bladed screw driver, rotate the CPU locking screw 180° counter-clockwise as shown.

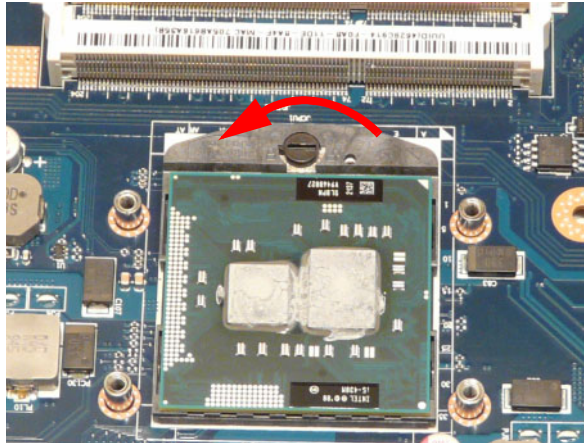

3. Lift the CPU clear of the socket as shown.

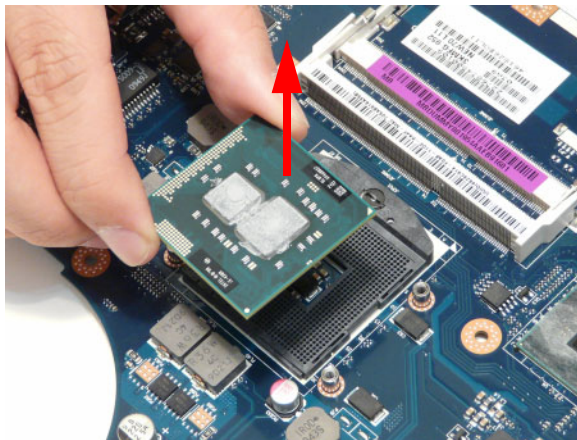

LCD Module Disassembly Process

LCD Module Disassembly Flowchart

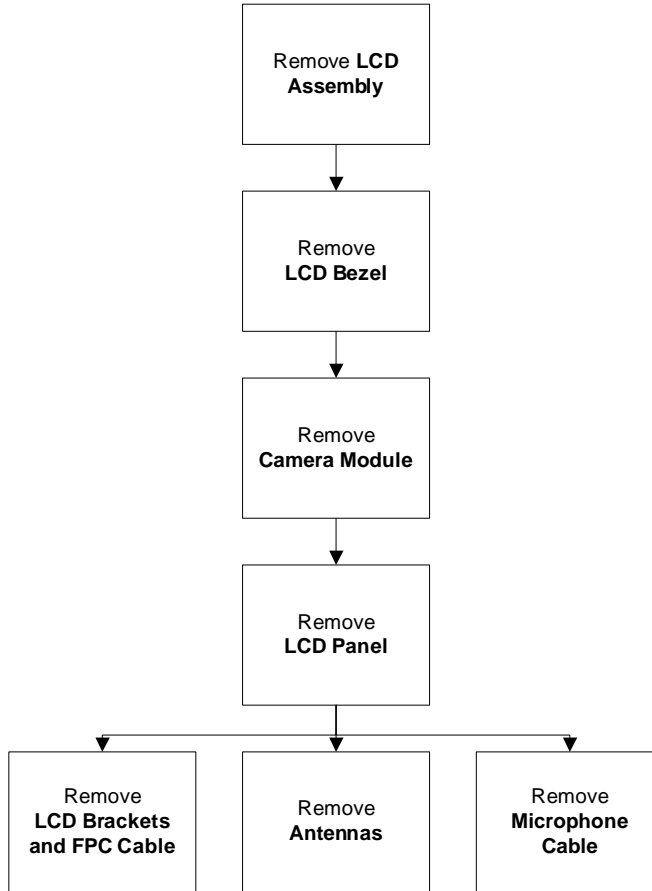

Screw List

Step	Screw	Quantity	Part No.
LCD Assy	M2.5*8	4	86.PSV02.002
LCD Bezel	M2.5*6	2	86.PSV02.003
LCD Panel	M2.5*6	2	86.PSV02.003
LCD Brackets	M2*3	6	86.PSV02.004

Removing the LCD Assembly

1. See "Removing the Upper Cover" on page 57.
2. Turn the device over and pass the black and white antenna cables through the lower cover.

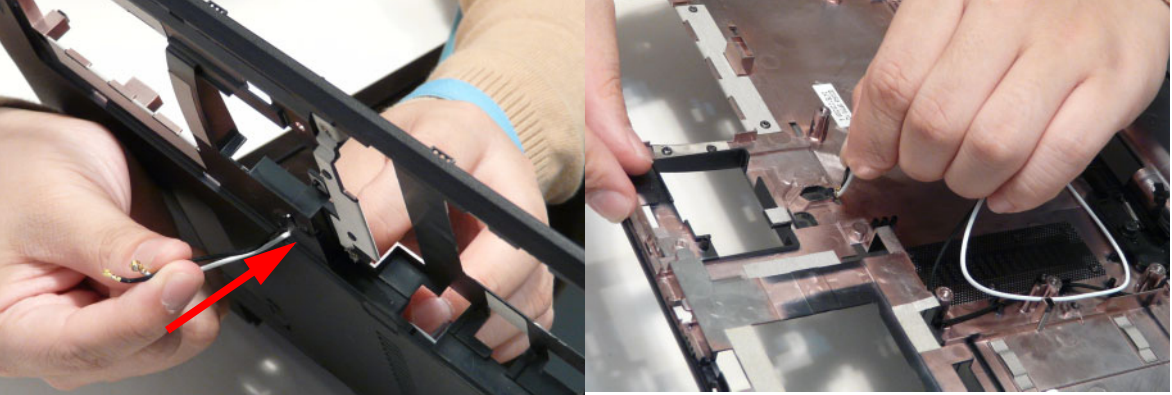

3. Free the black and white antenna cables from the cable channel as shown.

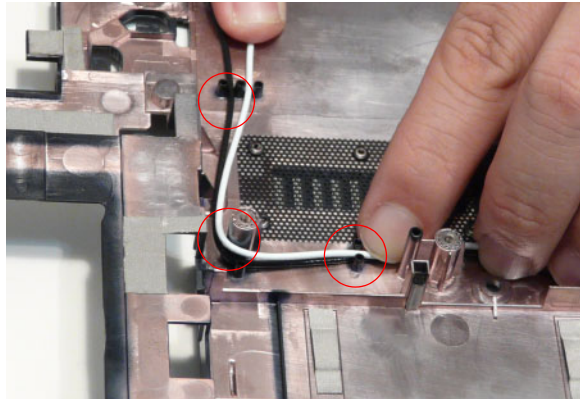

4. Continue removing the white antenna cable from the cable channel.

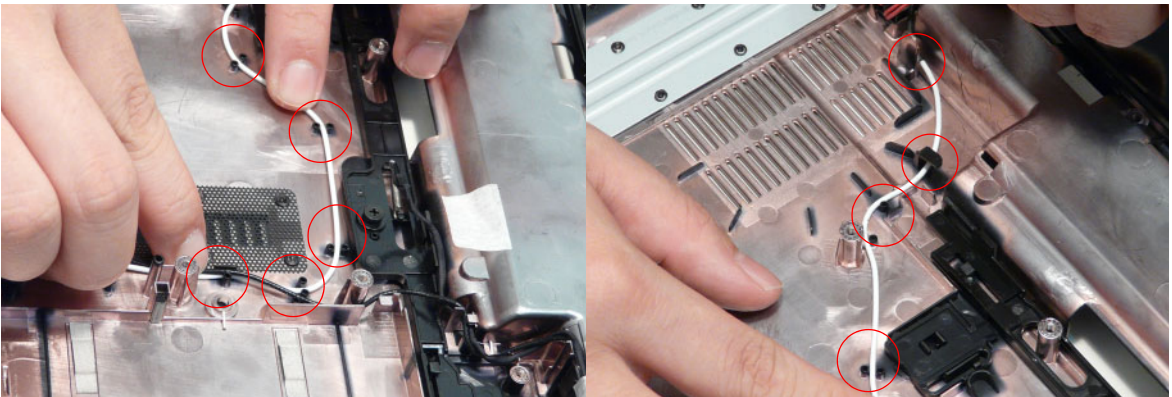

5. Remove the LVDS cable from the cable channel.

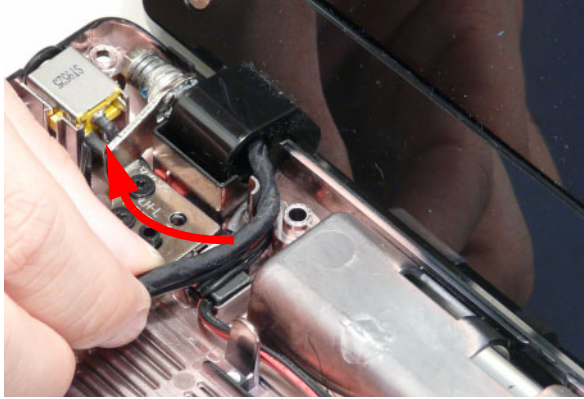

6. Remove the adhesive tape from the black antenna cable.

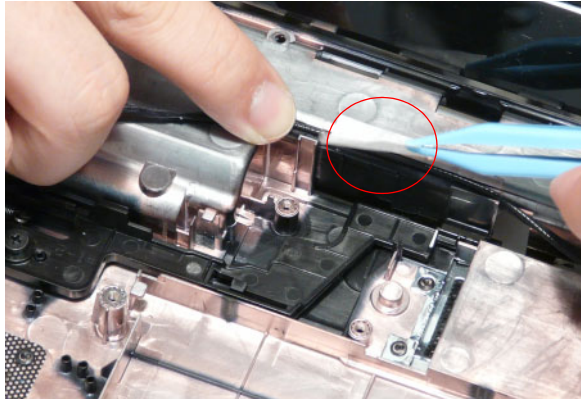

7. Free the cable from the cable channel as shown.

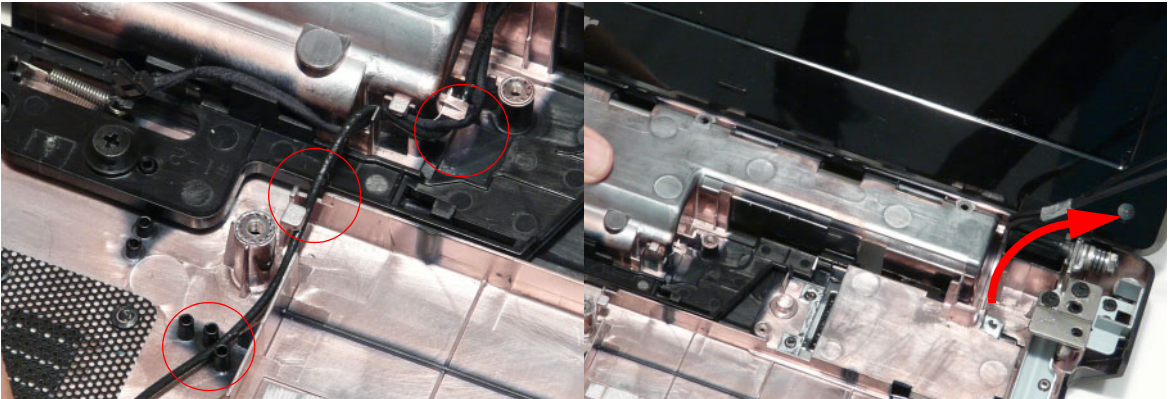

8. Remove four (4) screws from the LCD assembly.

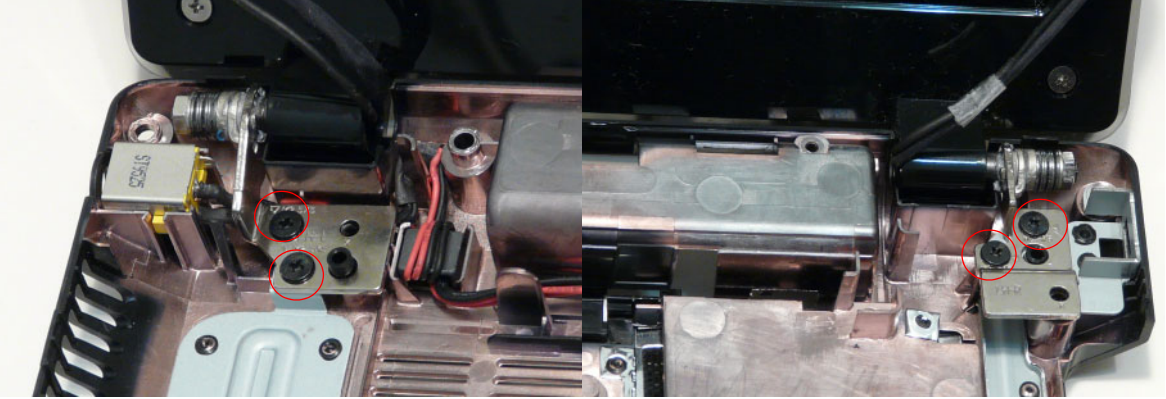

Step	Size	Quantity	Screw Type
LCD assembly	M2.5*8	4	

9. Remove the LCD assembly from the lower cover.

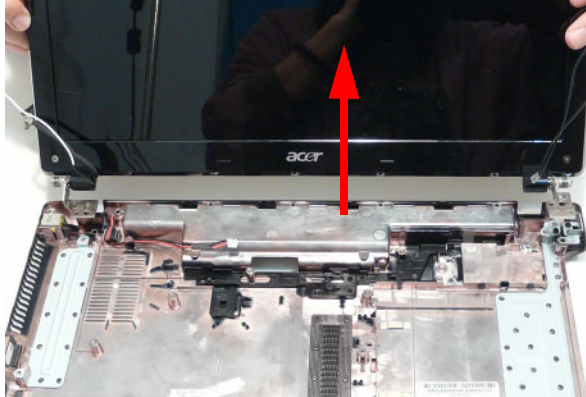

Removing the LCD Bezel

1. See "Removing the LCD Assembly" on page 79.
2. Remove the two bezel screw caps and screws.



Step	Size	Quantity	Screw Type
LCD Bezel	M2.5*6	2	

3. Starting from the bottom edge of the bezel, pry the bezel upwards and away from the panel. Work along the right side toward the top of the bezel, prying the covers apart. Continue along the top edge and down the left side to remove the bezel.



NOTE: If necessary, use a pry to lift up the outside edges of the bezel.

Removing the Camera Module

1. See "Removing the LCD Assembly" on page 79.
2. Locate the Camera Module at the top of the LCD Module and disconnect the camera cable.

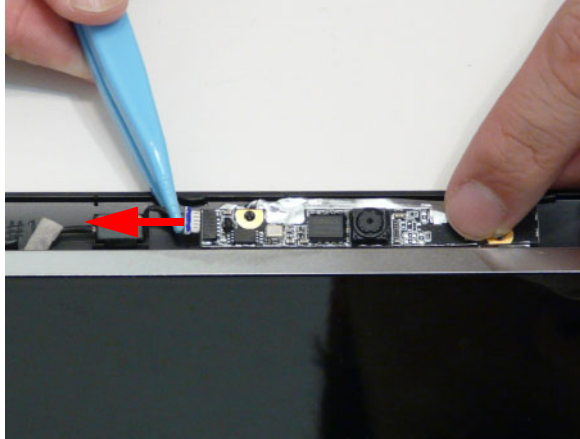

3. Remove the Camera from the module.

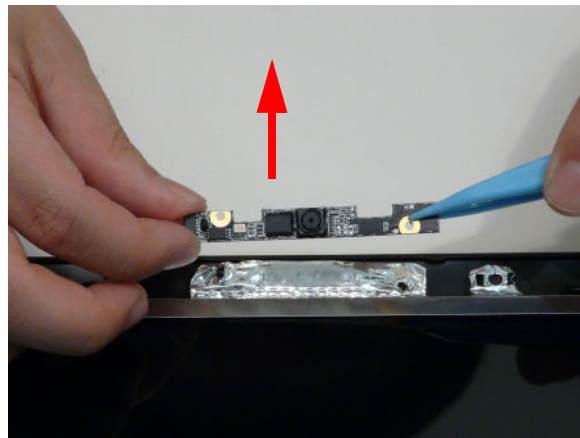

Removing the LCD Panel

- 1. See "Removing the Camera Module" on page 83.
- 2. Remove the two (2) securing screws from the LCD Panel.



Step	Size	Quantity	Screw Type
LCD Panel	M2.5*6	2	

- 3. Remove the adhesive strip holding the cables in place.

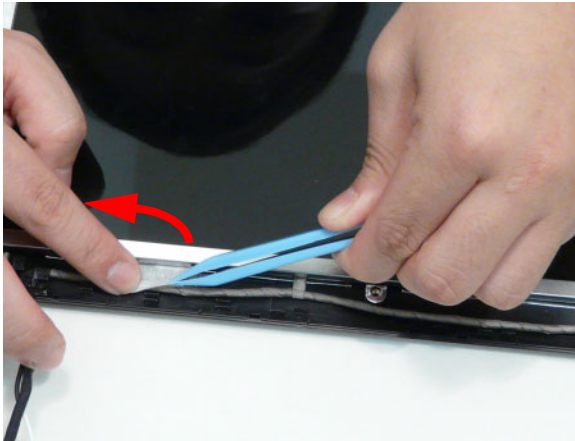

- 4. Remove the cable from the LCD Module as shown.

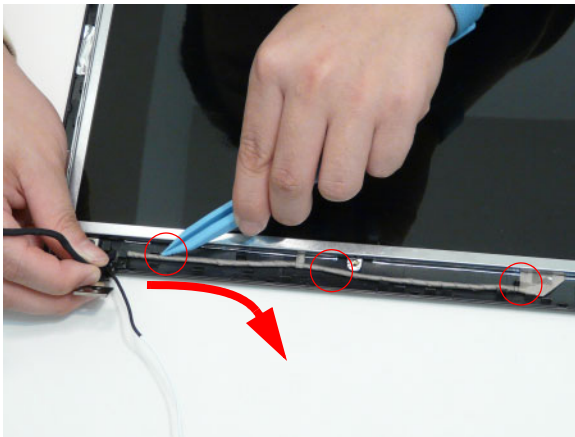



5. Lift the LCD Panel clear of the module.

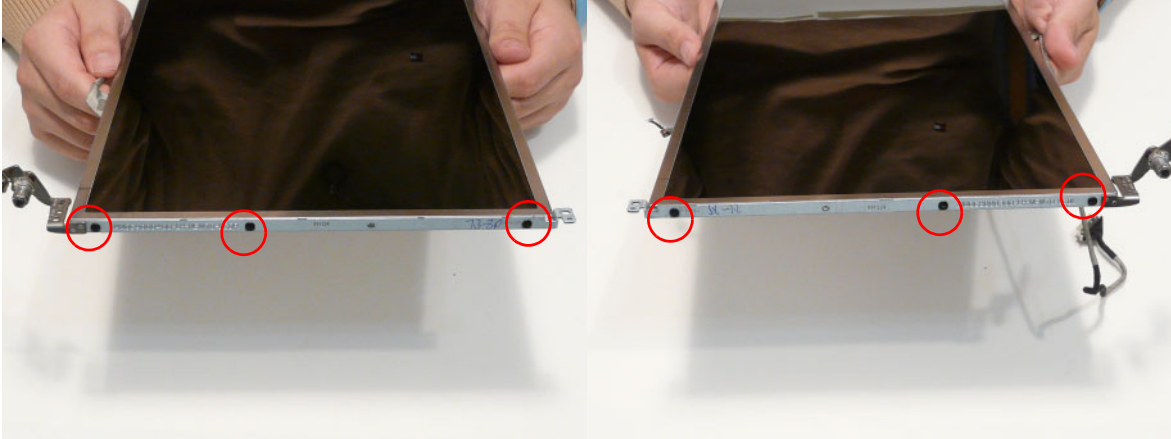

Removing the LCD Brackets and FPC Cable

- 1. See "Removing the LCD Panel" on page 84.
- 2. Remove the six (6) securing screws (three on each side) from the LCD Panel brackets.



Step	Size	Quantity	Screw Type
LCD Brackets	M2*3	6	

- 3. Remove the LCD brackets by pulling away from the LCD Panel.



4. Turn the LCD panel over to expose the rear. Pull the cable up as shown.

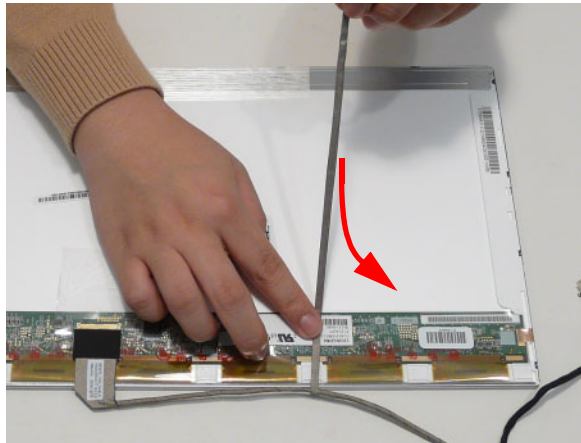

5. Remove the adhesive tape from the cable.

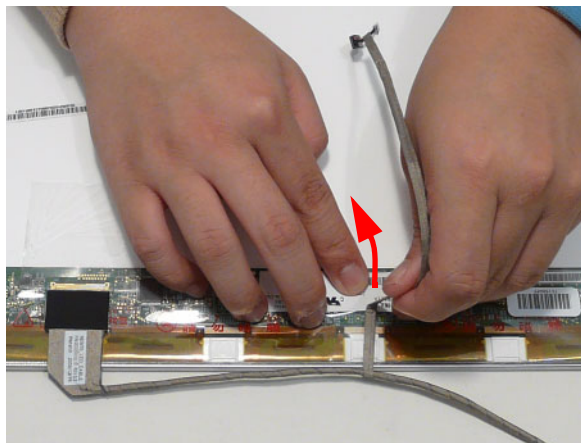

6. Peel back the mylar securing the LVDS cable.

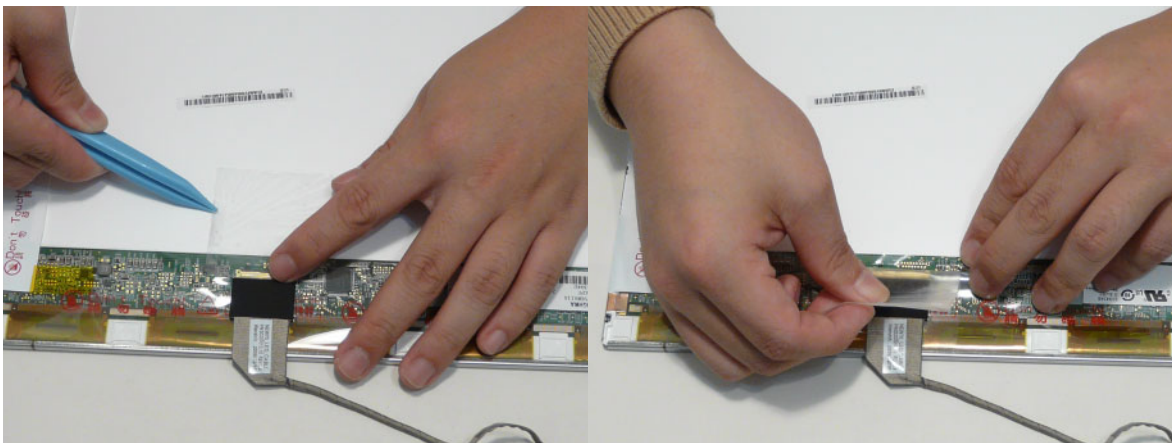

7. Disconnect the LVDS cable from the panel.

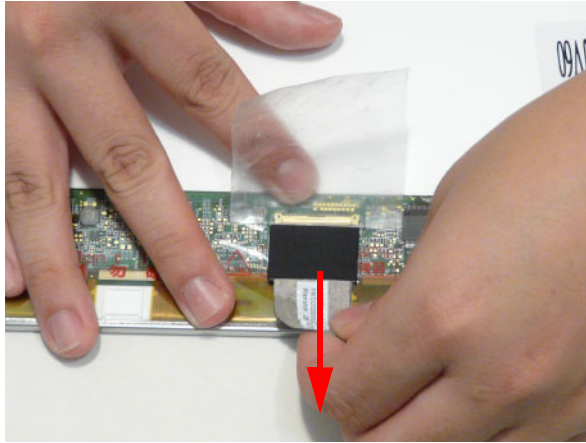

Removing the Microphone Cable

1. See "Removing the LCD Panel" on page 84.
2. Remove the cable bundle from the hinge channel.

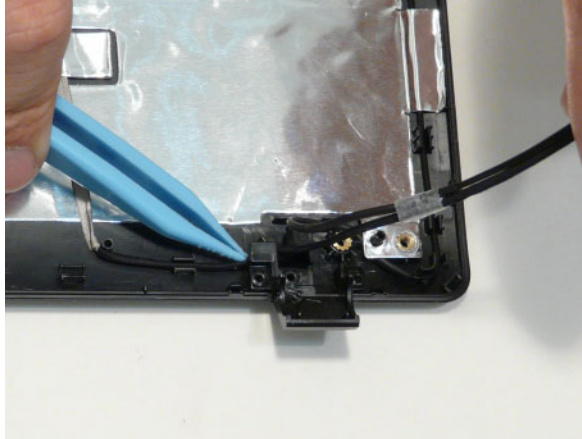

3. Peel back the foil tabs and remove the microphone cable from the cable channel.

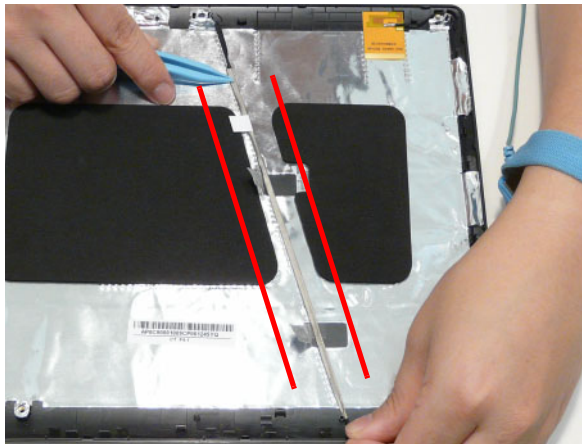

4. Continue removing the cable from the cable channel.



5. Lift the microphone set clear of the panel.

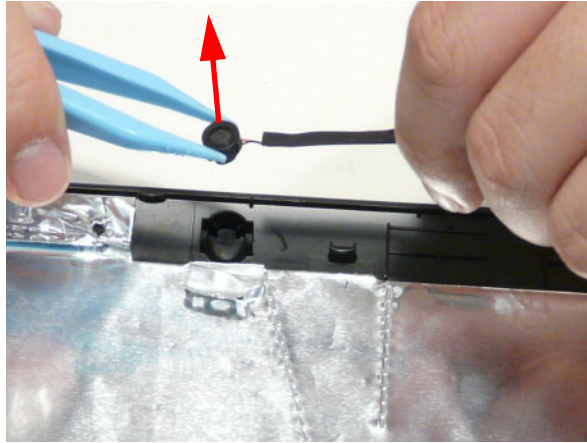

Removing the Antennas

1. See “Removing the LCD Panel” on page 84.
2. Remove the black antenna from the cable channel.

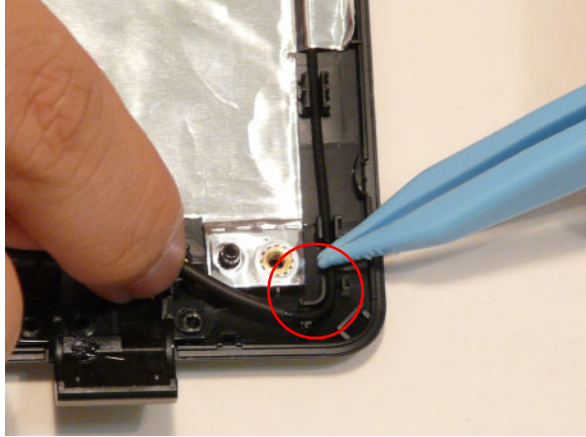

3. Peel back the foil tabs and remove the cable from the cable channel.

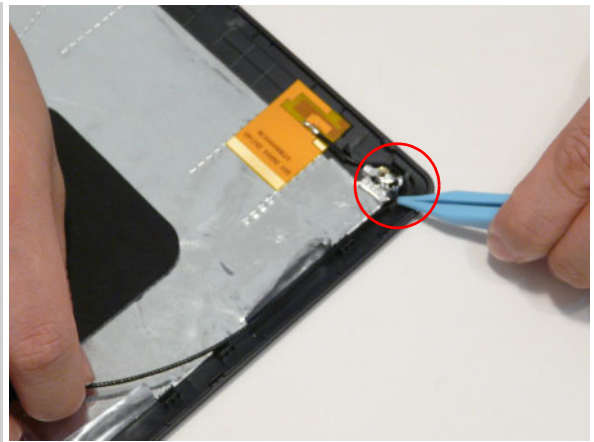
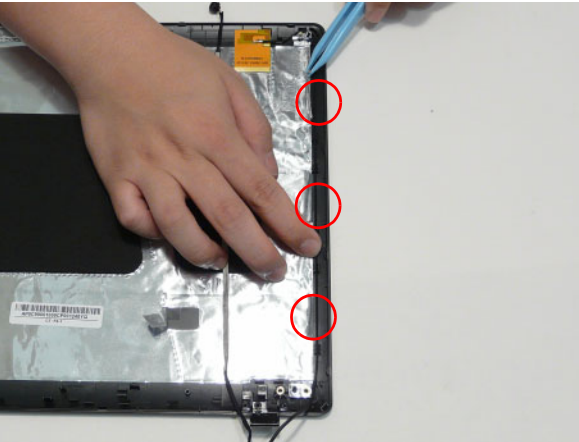

4. Pry the antenna assembly clear of the device.

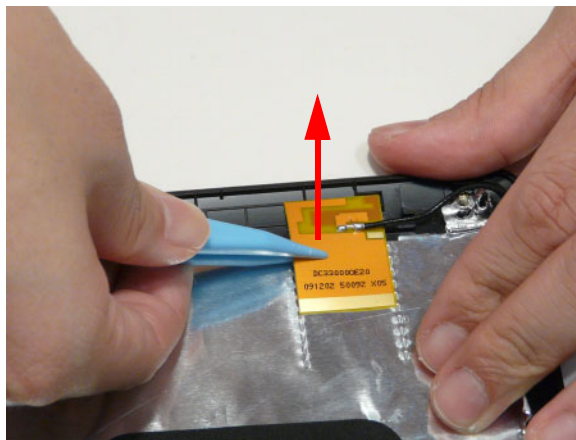

5. Remove the white antenna from the hinge channel.



6. Peel back the foil tabs and remove the cable from the cable channel.

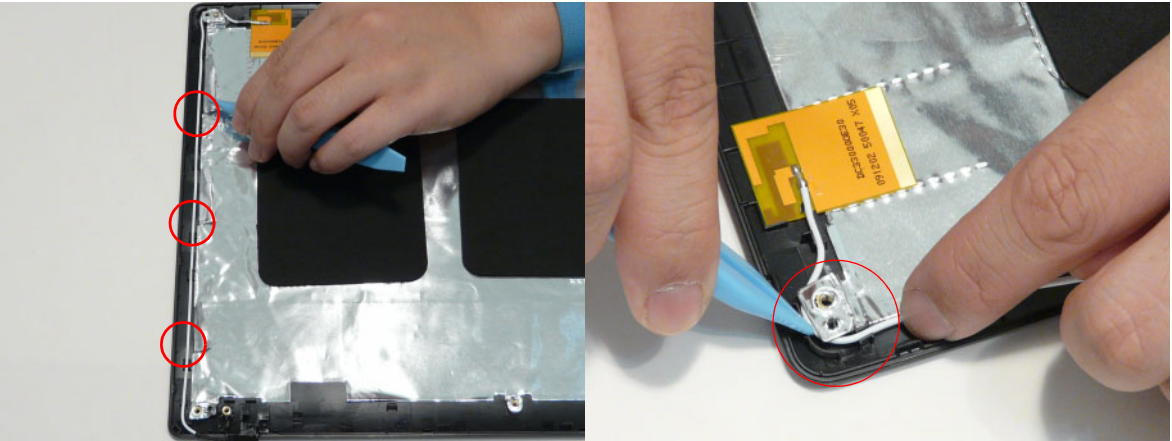

7. Pry the antenna assembly clear of the device.

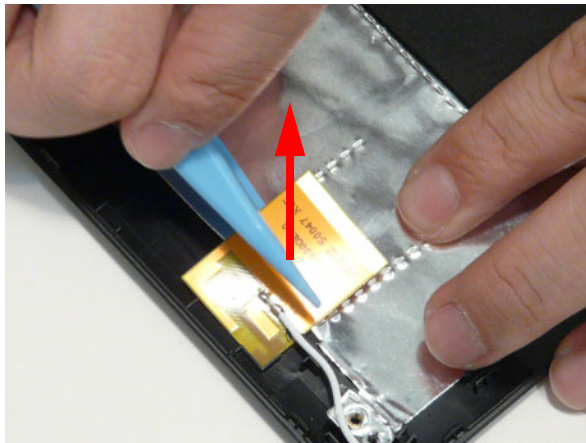

LCD Module Reassembly Procedure

Replacing the Antennas

1. Adhere the white antenna assembly to the LCD cover.

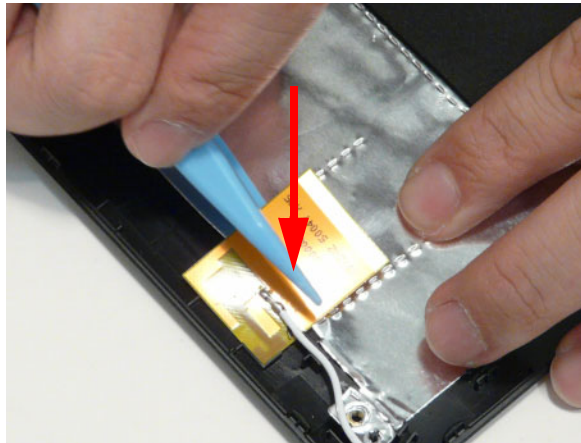

2. Run the cable along the cable channel and fold over the foil tabs to secure the cable in place.

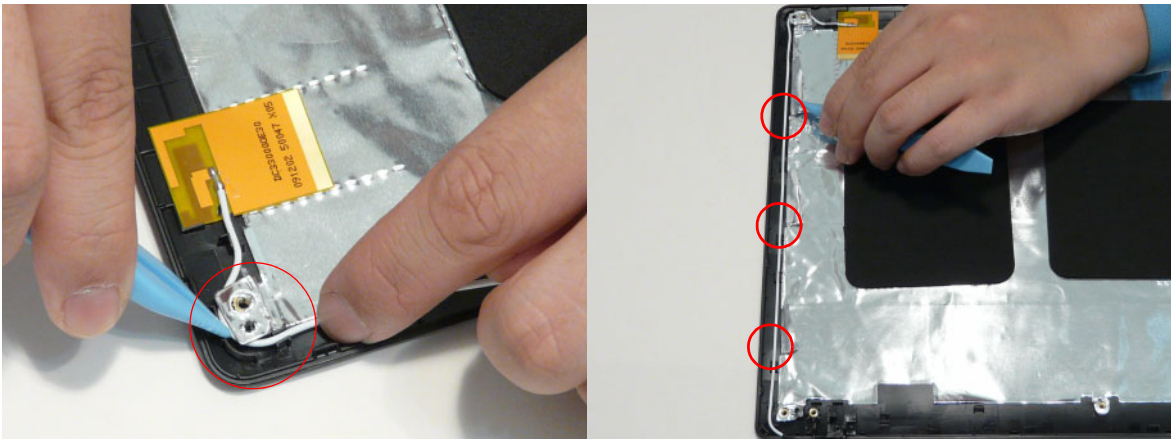

3. Run the white antenna along the hinge channel.



4. Adhere the black antenna assembly on the LCD cover.

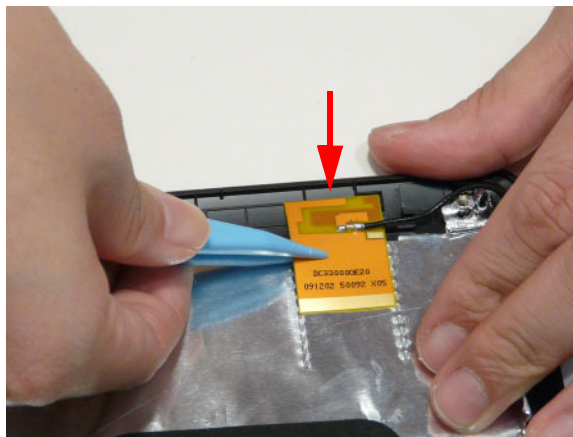

5. Run the cable along the cable channel and fold over the foil tabs to secure the cable in place.

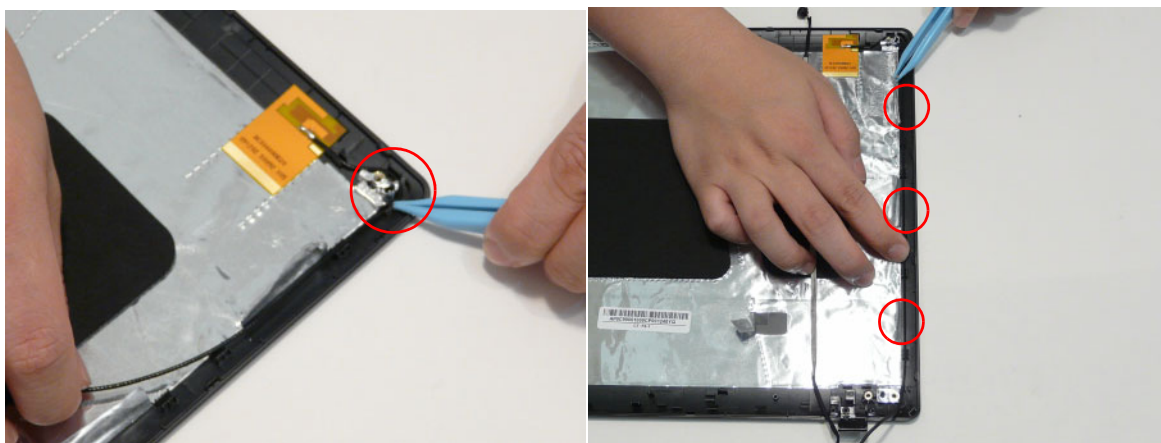

6. Run the black antenna cable along the cable channel.

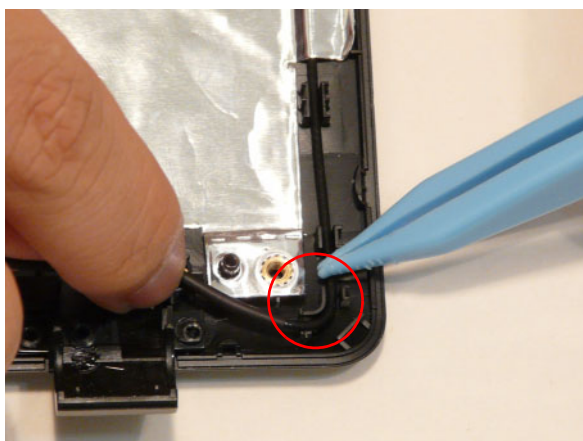

Replacing the Microphone Cable

1. Place the microphone set in the panel.

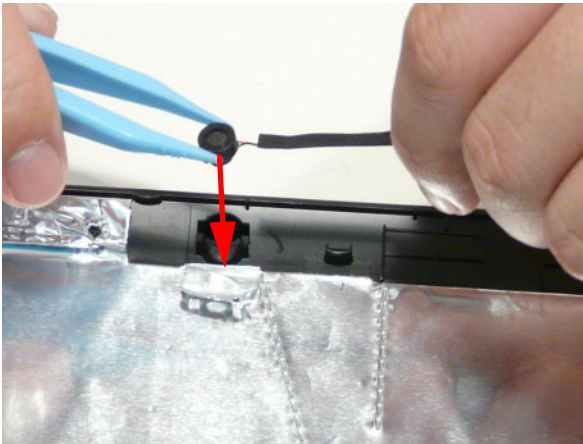

2. Run the cable along the cable channel.



3. Fold over the foil tabs and continue running the microphone cable along the cable channel indicated between the red callouts.

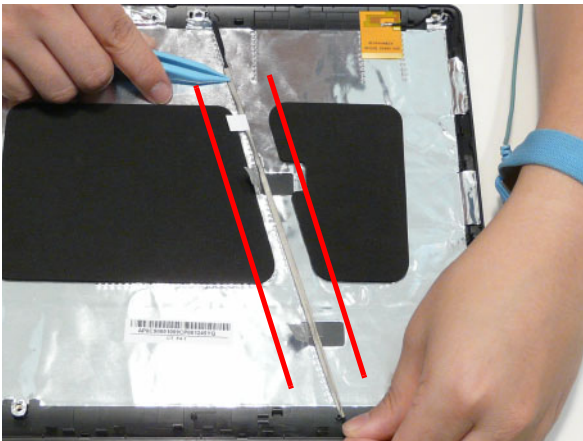

4. Run the cable bundle along the hinge channel.

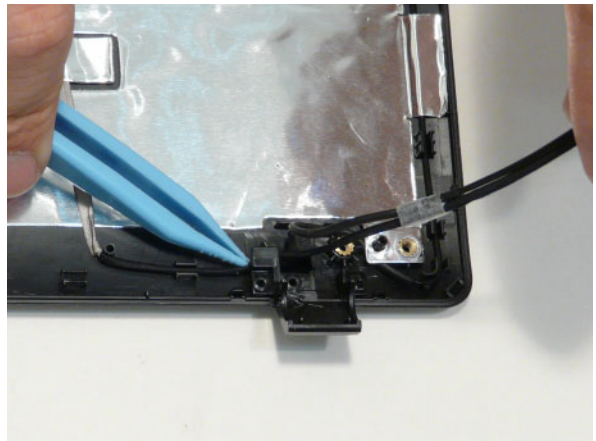

IMPORTANT: Ensure that the LCD cable runs between the callouts to avoid trapping when the panel is replaced in the LCD Module.

Replacing the LCD Brackets and FPC Cable

1. Connect the LVDS cable to the LCD panel.

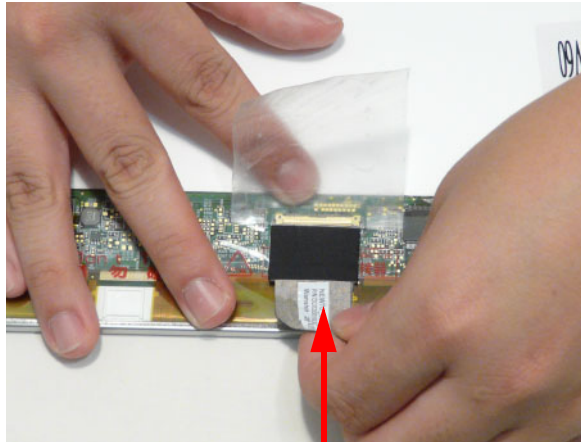

2. Adhere the LVDS mylar to the LCD panel.

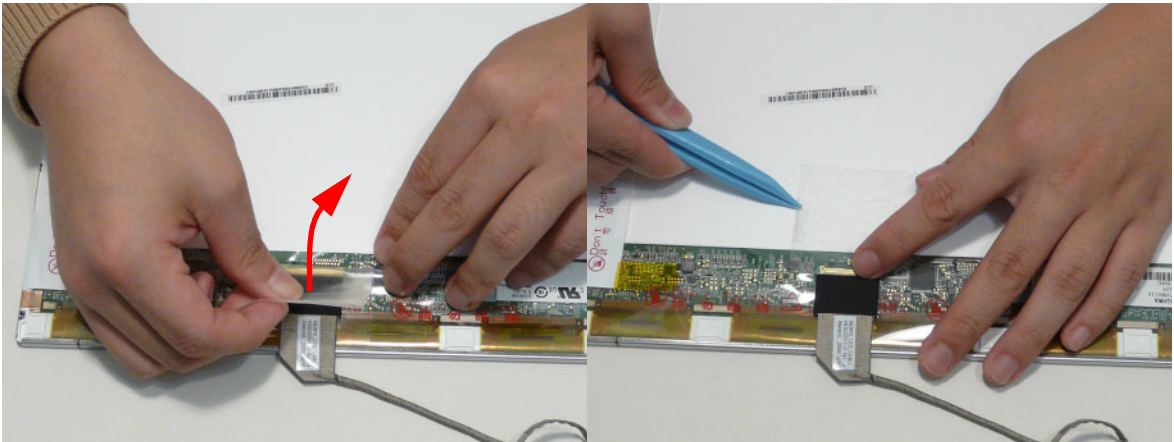

3. Adhere the LVDS cable to the panel by running it between the callouts as shown.

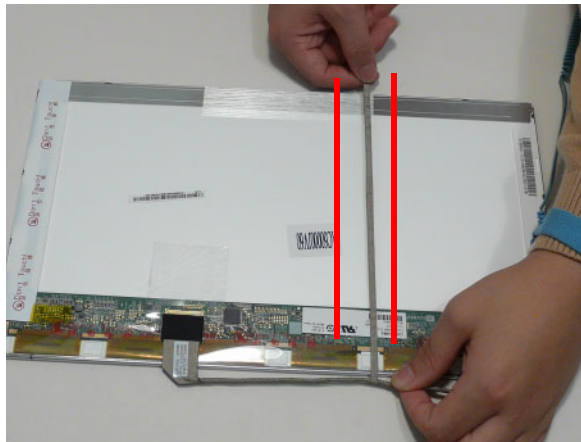

4. Attach the LCD brackets to the LCD Panel.



5. Replace six (6) securing screws (three on each side) of the LCD Panel brackets.

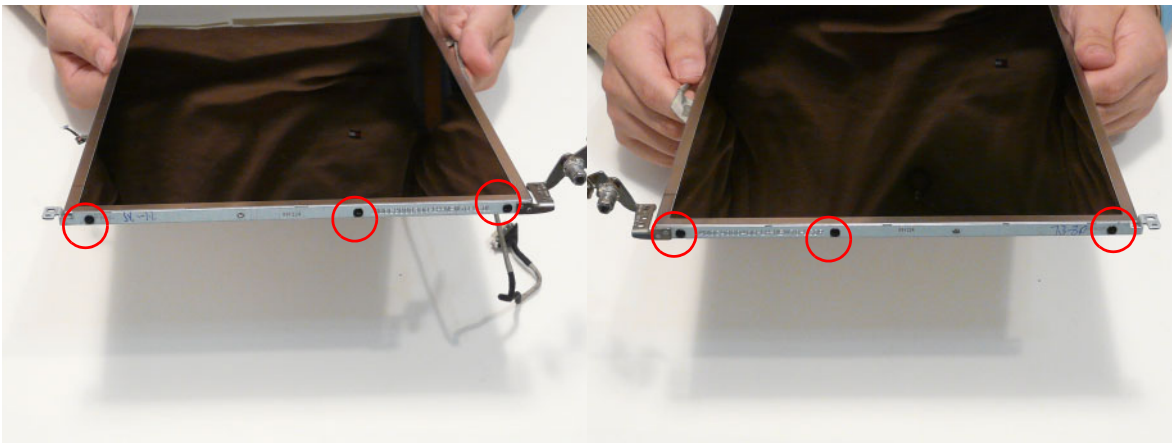

Replacing the LCD Panel

1. Place the LCD Panel in the module.
2. Run the cable along the channel in the LCD Module as shown.



3. Apply the adhesive strip to hold the cable in place.
4. Secure the panel using two (2) securing screws.

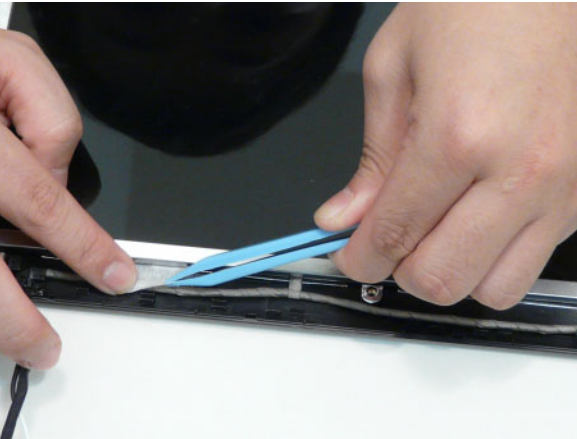

Replacing the Camera Module

1. Place the Camera in the module.

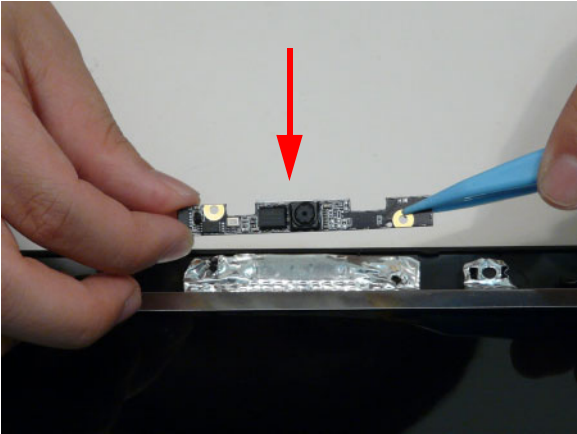

2. Connect the camera cable.

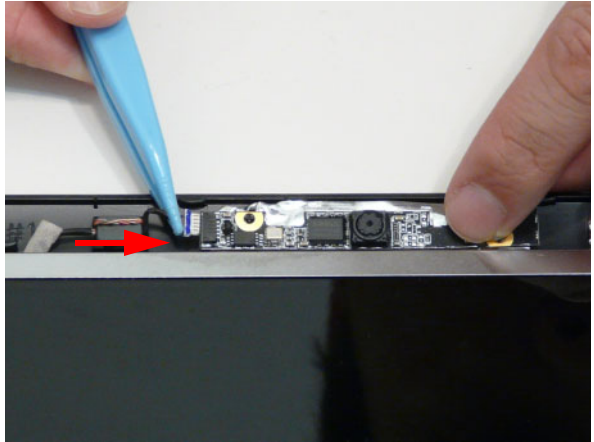

Replacing the LCD Bezel

1. Replace the bezel and press down until there are no gaps between the bezel and the LCD Module.

IMPORTANT: Ensure that the LCD cables pass through the hinge wells and are not trapped by the bezel.



2. Replace the two (2) screws and screw caps.



Replacing the LCD Assembly

1. Place the LCD assembly on the lower cover.

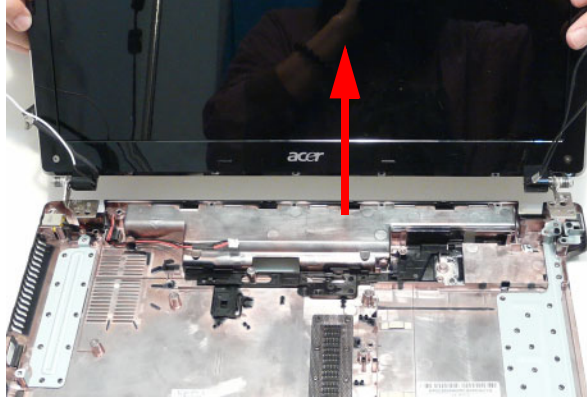

2. Secure the LCD assembly using four (4) screws.

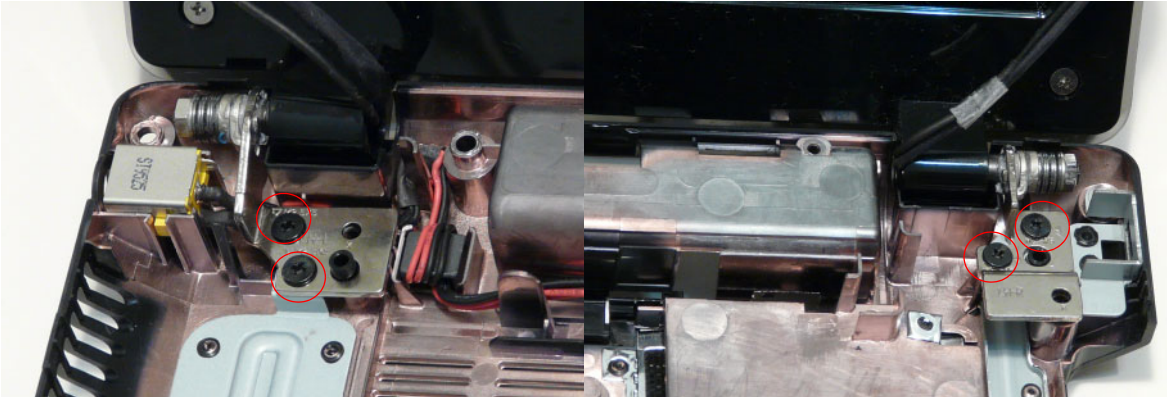

-
3. Run the black antenna cable along the cable channel.

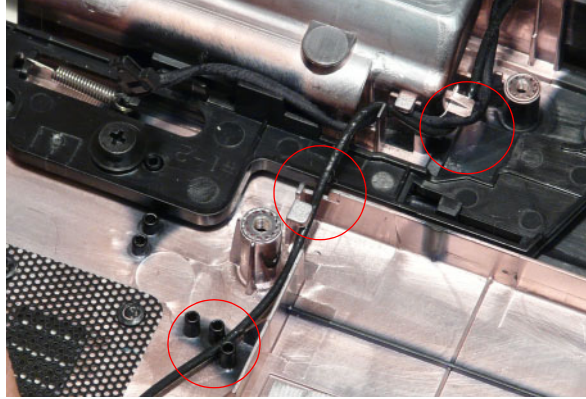

4. Replace the adhesive tape to secure the cable to the chassis.

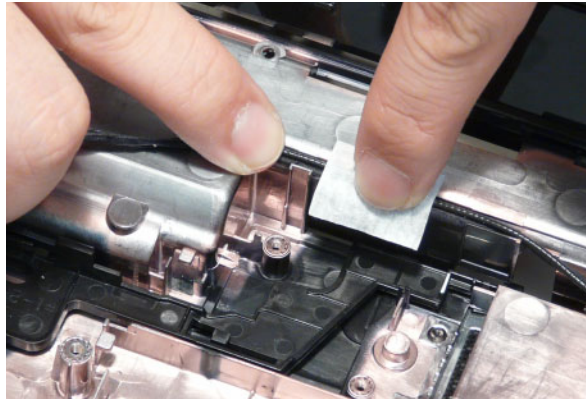

5. Near the left hinge, run the LVDS cable along the cable channel.

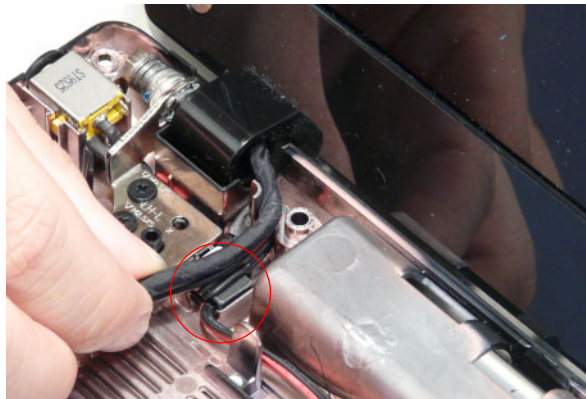

6. Run the white antenna cable along the cable channel as shown.

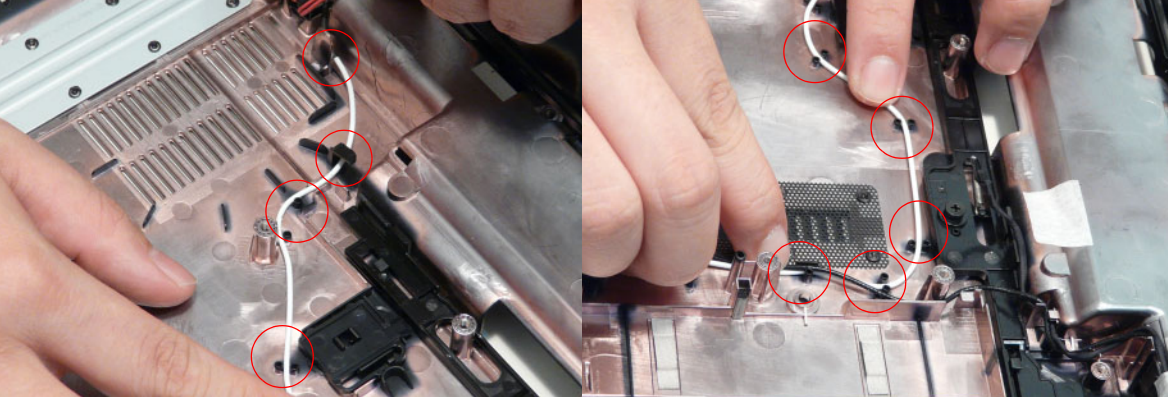

7. Continue running the black and white antenna cables along the cable channel.

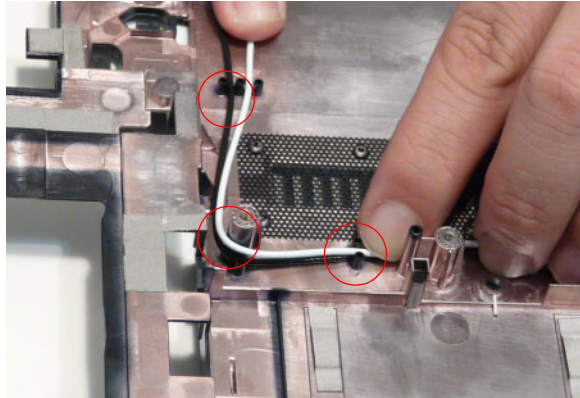

8. Pass the black and white antenna cables through the lower cover.



Main Module Reassembly Procedure

Replacing the CPU

IMPORTANT: The CPU has a Pin1 locator that must be positioned corresponding to the marker on the CPU socket.

1. Place the CPU into the CPU socket as shown, taking note of the Pin1 locator.

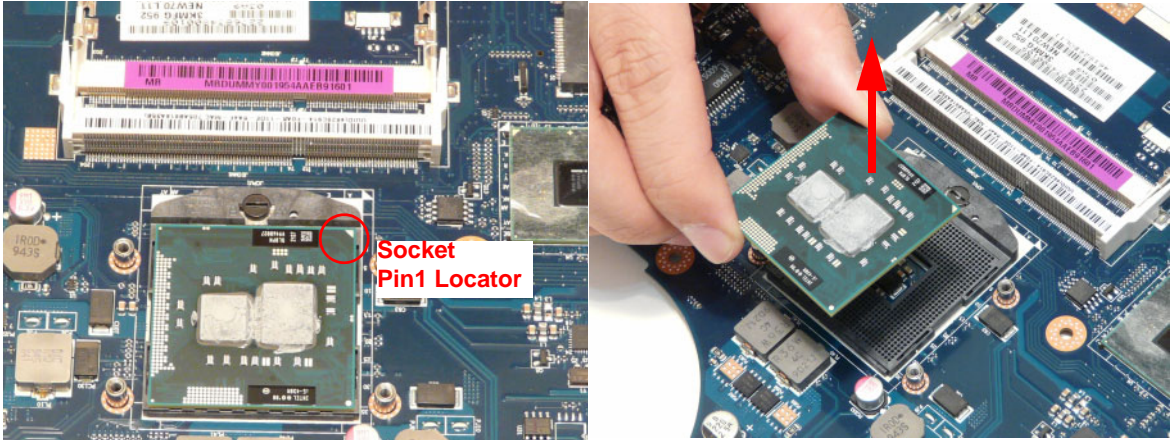

2. Using a flat-bladed screw driver, rotate the CPU locking screw 180° clockwise to secure the CPU in place.

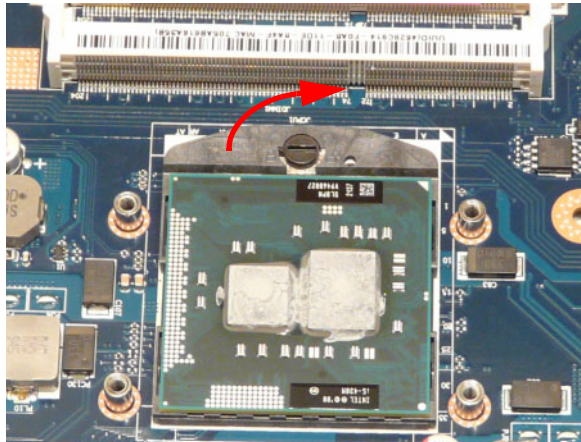

Replacing the Thermal Module

IMPORTANT: Apply a suitable thermal grease and ensure all heat pads are in place before replacing the Thermal Module.

The following thermal grease types are approved for use:

- Silmore GP50
- Hone (1)ywell
- Jet Motor 7762

The following thermal pads are approved for use:

- Eapus XR-PE
1. Remove all traces of thermal grease from the CPU using a lint-free cloth or cotton swab and Isopropyl Alcohol, Acetone (1), or other approved cleaning agent.
 2. Apply a small amount of thermal grease to the centre of the CPU—there is no need to spread the grease manually, the force used during the installation of the Thermal Module is sufficient.
 3. Align the screw holes on the Thermal Module and Mainboard then replace the module. Keep the module as level as possible to spread the thermal grease evenly.
 4. Replace the four (4) securing screws (in numerical order from screw 1 to screw 4) to secure the Thermal Module in place.

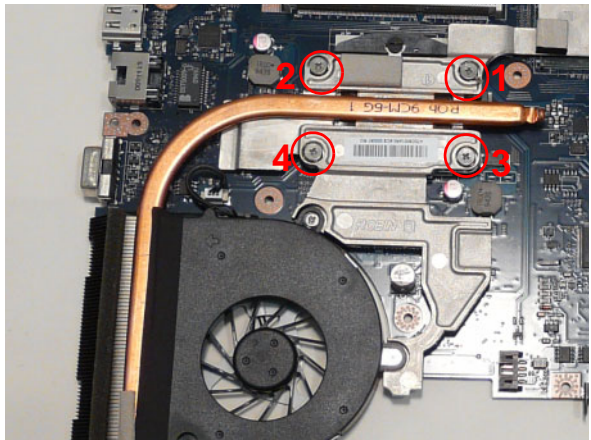
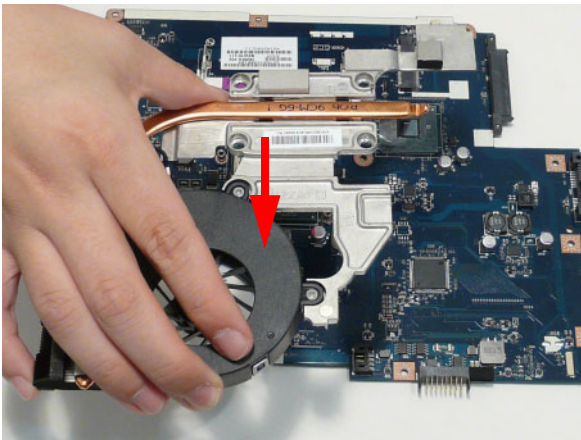

5. Connect the fan cable.

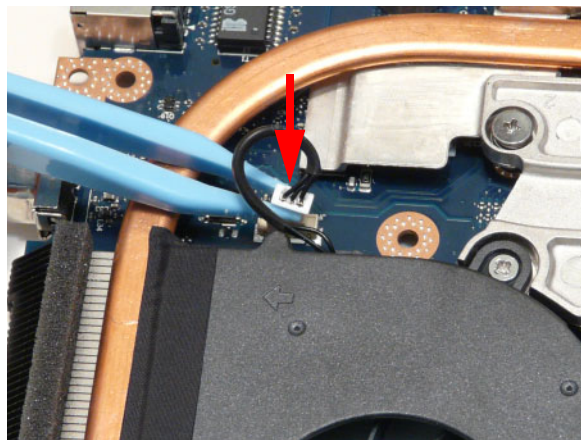

Replacing the Mainboard

1. Connect the Bluetooth to mainboard cable.

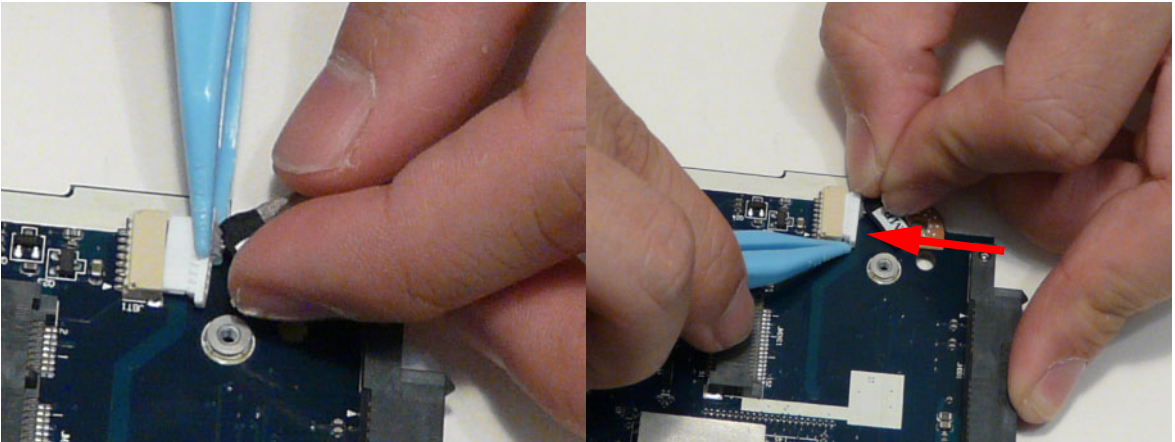

2. Apply the adhesive tape to the Bluetooth cable.

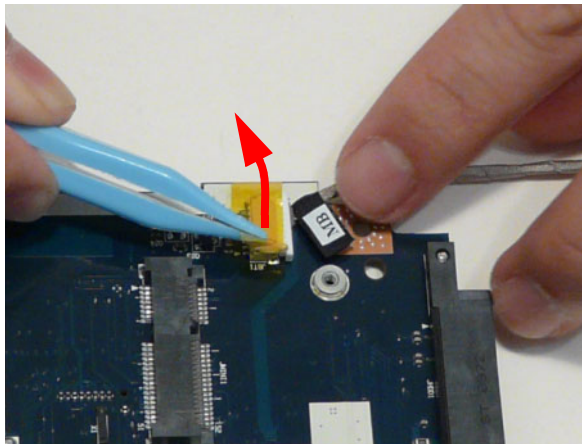

3. Place the mainboard on a clean, dust-free surface. Connect the power cable.

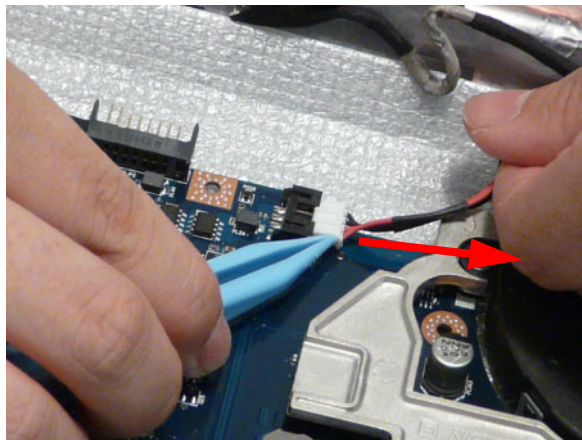

NOTE: Ensure the I/O ports are positioned correctly through the casing.

4. Place the mainboard in the chassis, left edge first to line up the I/O ports.

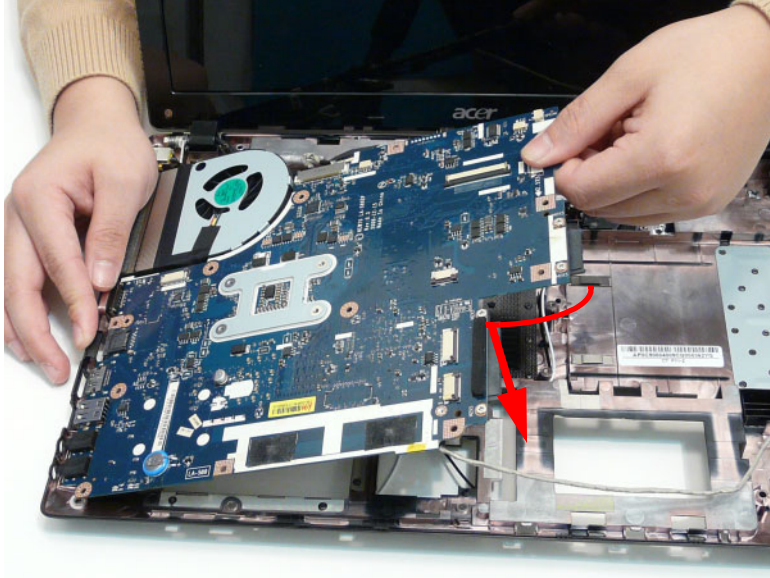

5. Secure the one (1) securing screw on the Mainboard.

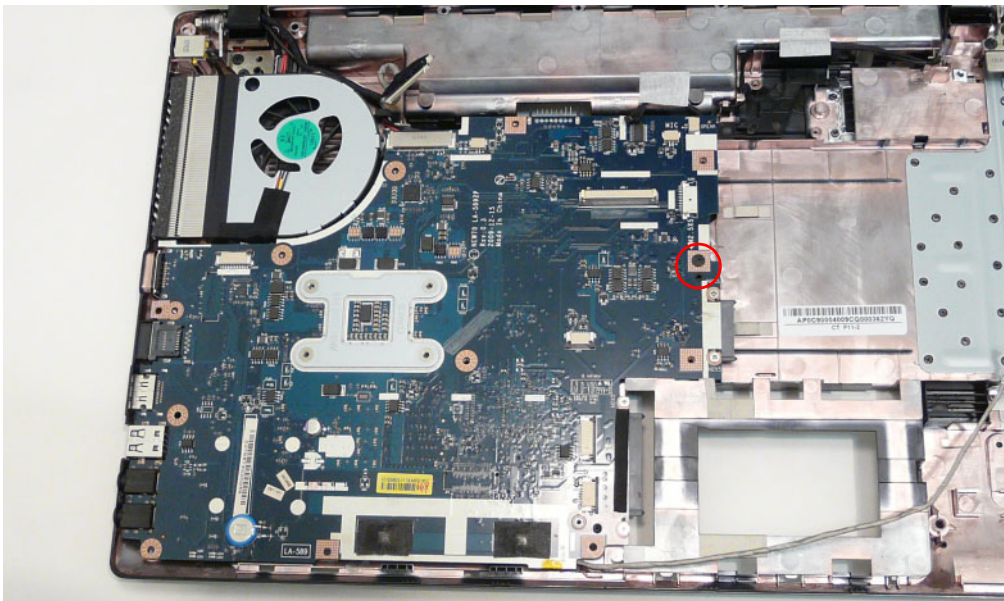

6. Connect the LVDS cable and lock the connector.

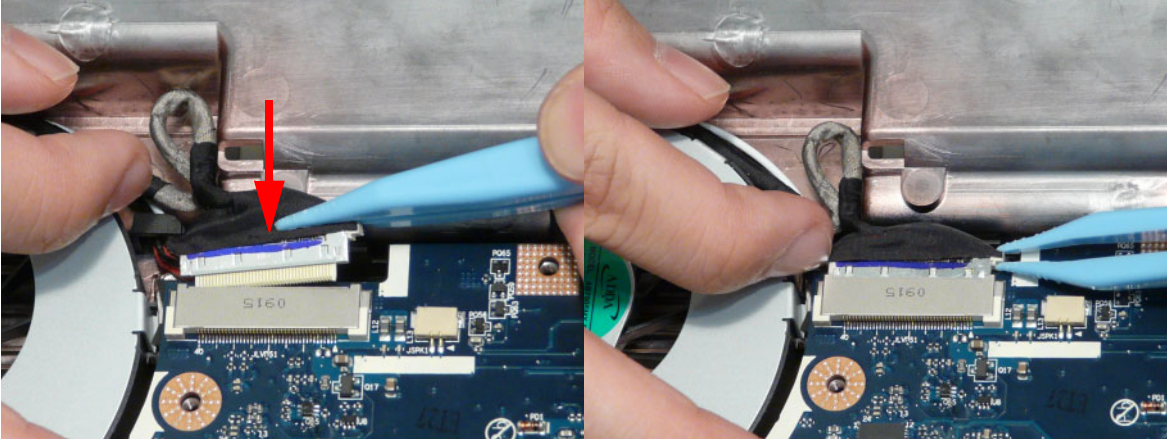

7. Connect the microphone cable.

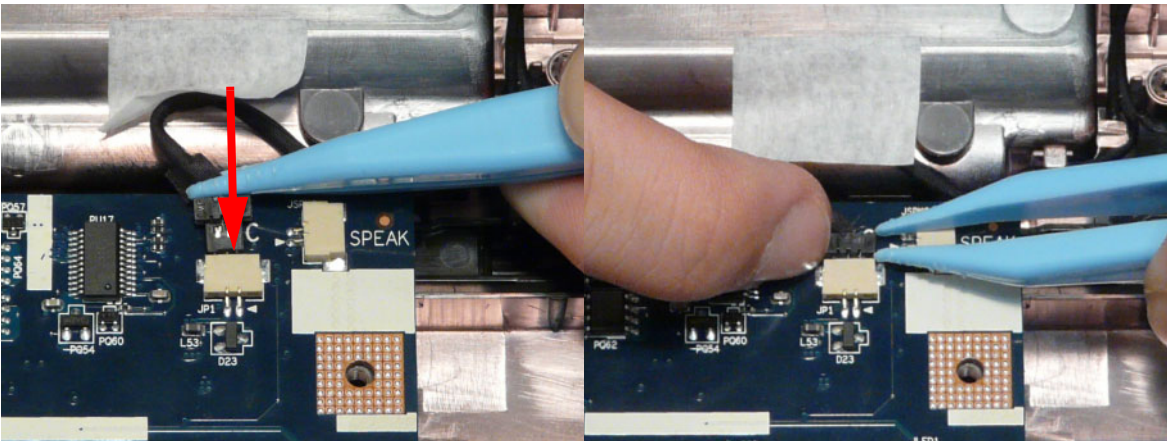

Replacing the Bluetooth Board

1. Run the Bluetooth cable along the channel as shown.

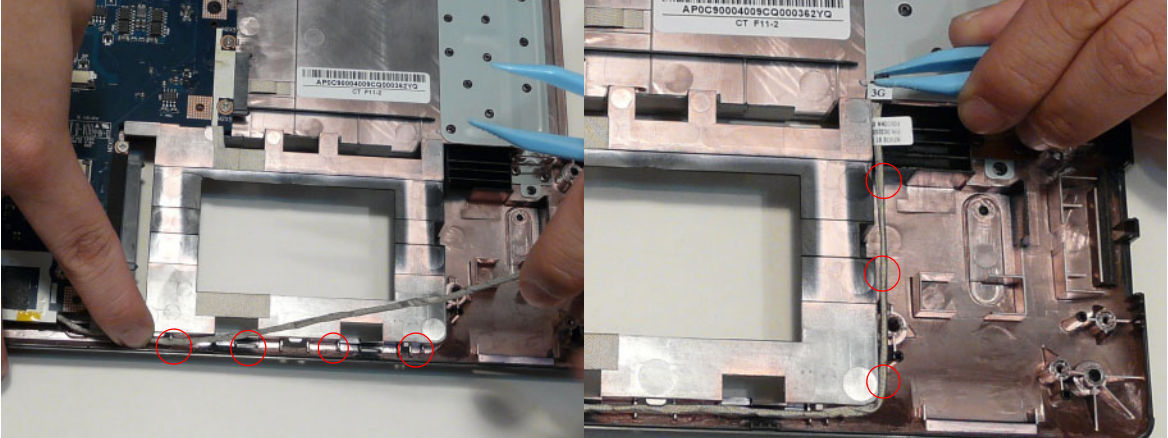

2. Connect the mainboard to Bluetooth cable.

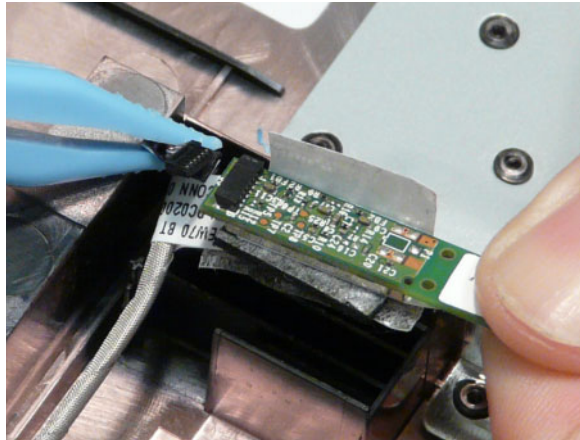

3. Adhere the Bluetooth board to the adhesive.

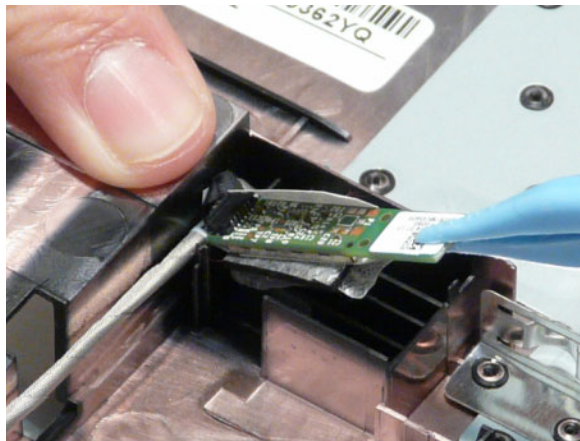

Replacing the USB Board

1. Place the USB board in the device.

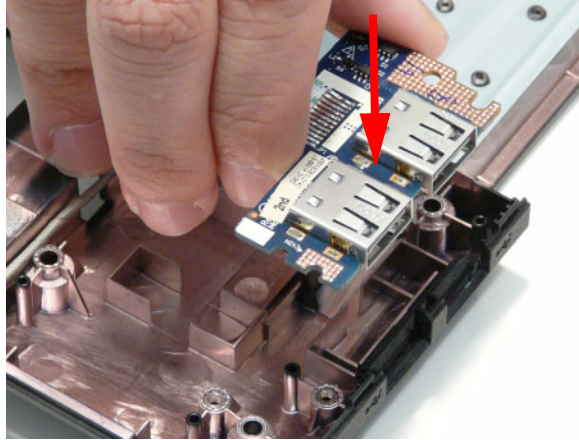

2. Secure the one (1) screw on the USB board.

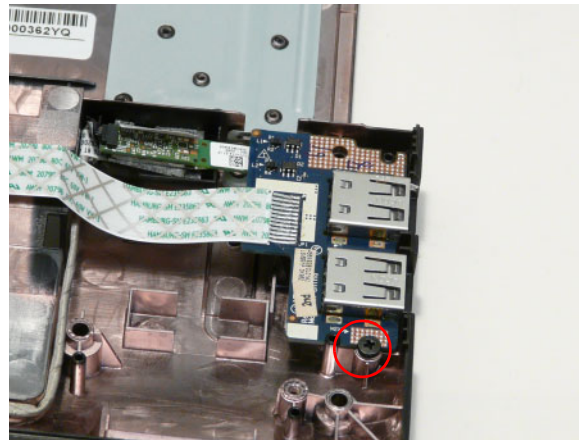

3. Connect the USB cable to the mainboard and lock the connector.

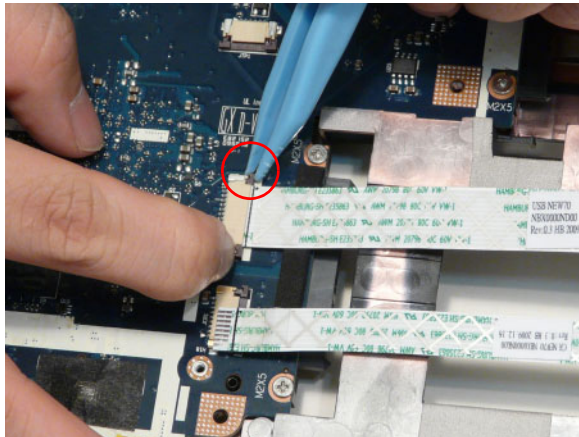

Replacing the Card Reader Board

1. Place the card reader board in the device.

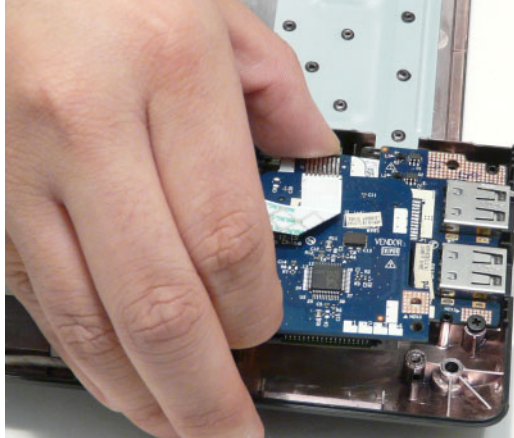

2. Secure one (1) screw on the card reader board.

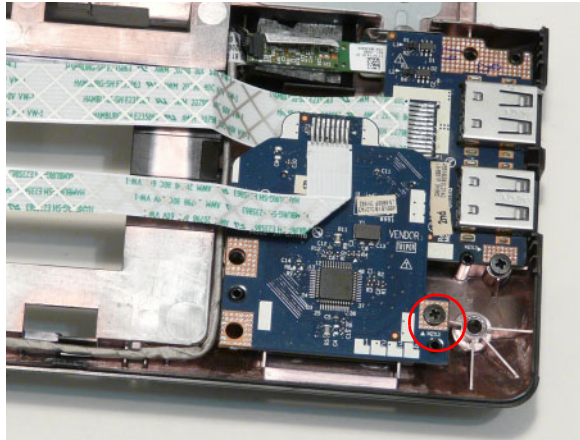

3. Connect the card reader cable and lock the connector.

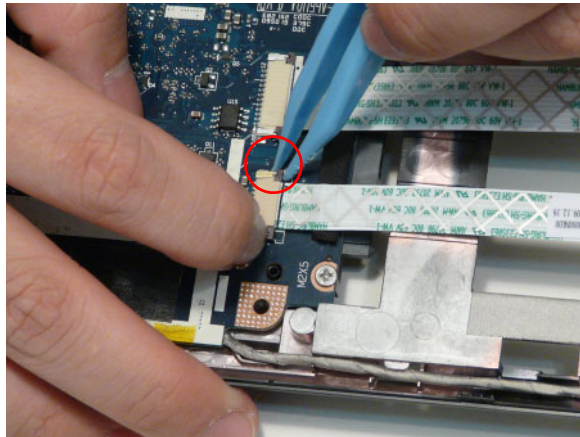

Replacing the TouchPad Bracket

1. Replace the TouchPad bracket top edge first to engage the securing clips and press down firmly.

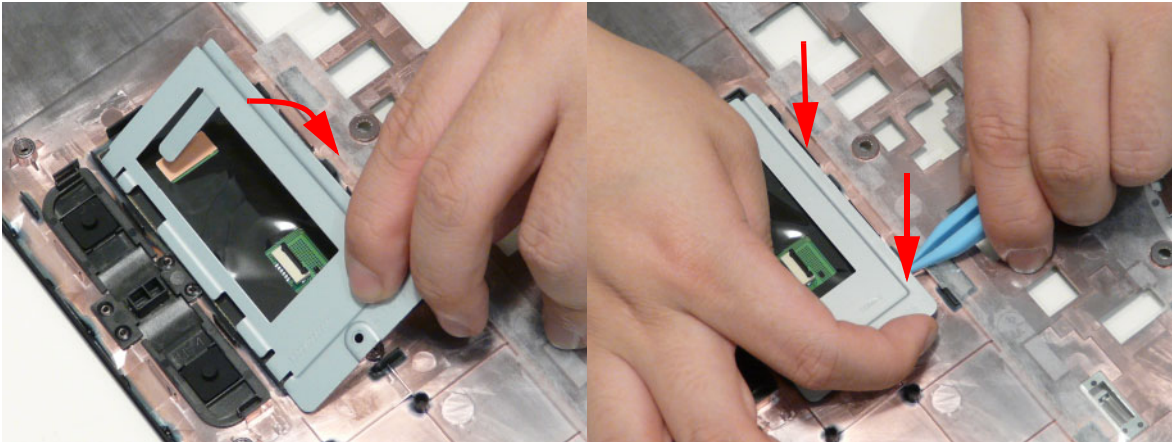

2. Replace the one (1) screws to secure the TouchPad Bracket to the Upper Cover.

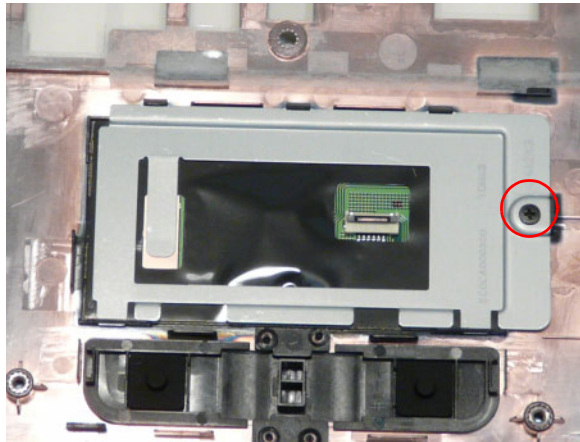

3. Replace the TouchPad FFC and close the locking latch on the connector.

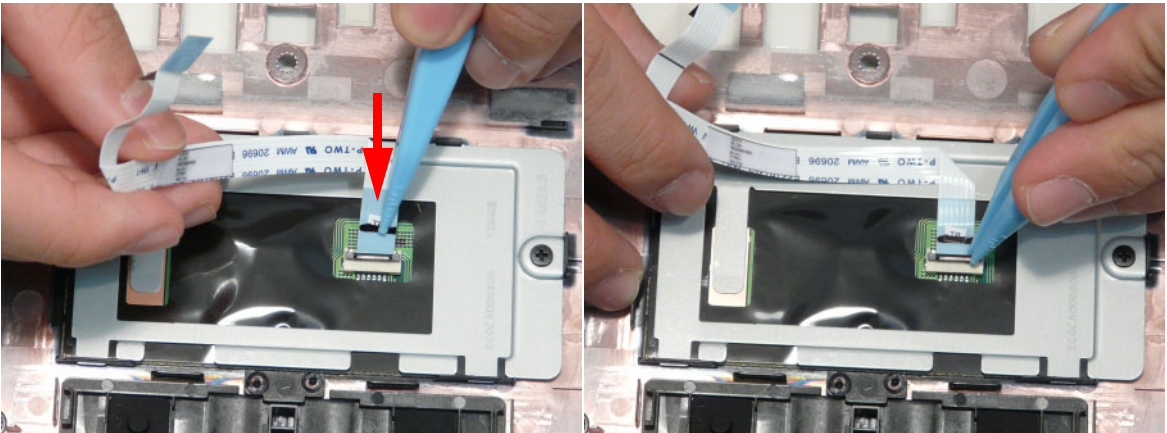

4. Replace the FFC and press down as indicated to secure it to the Upper Cover.

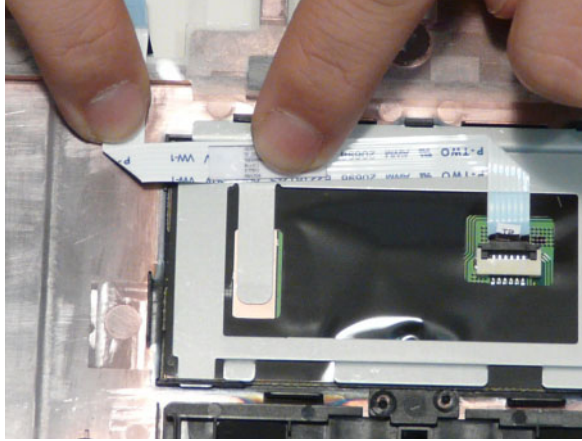

Replacing the Power Board

1. Place the power board in the chassis. Adhere the power board assembly as shown.

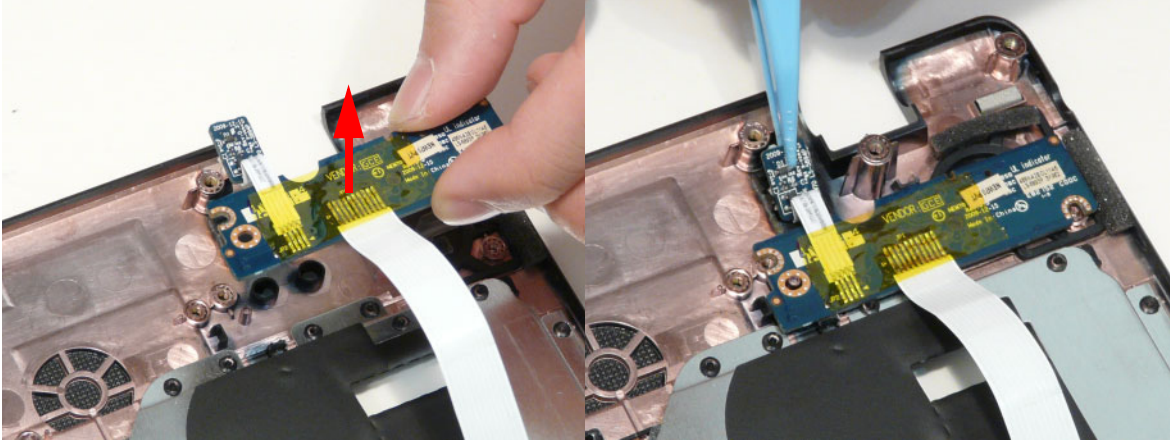

2. Secure two (2) screws on the power board.

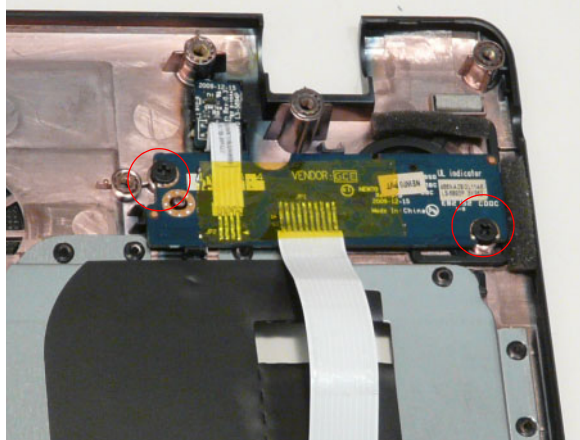

3. Pass the power board cable through the upper cover. Adhere the power board cable as shown.

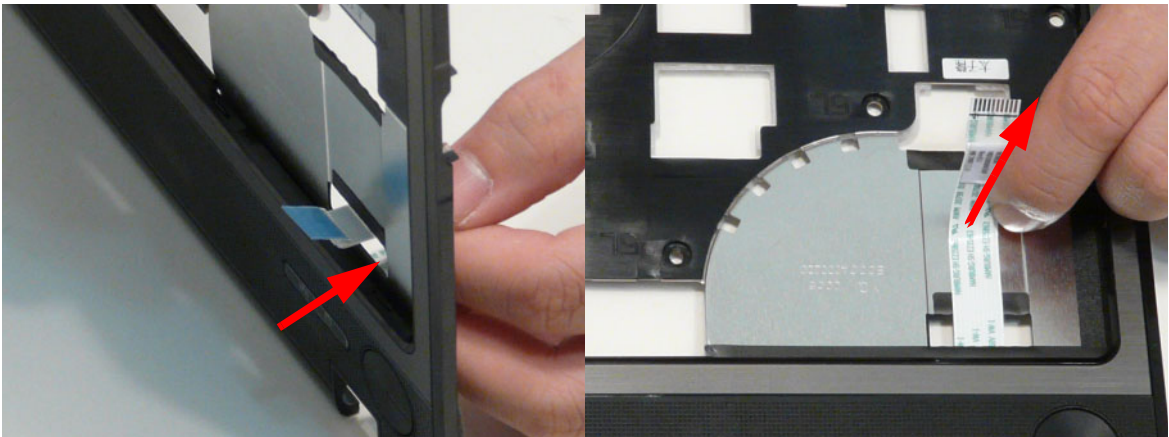

Replacing the Right Speaker Module

1. Place the right speaker module in the chassis as shown.

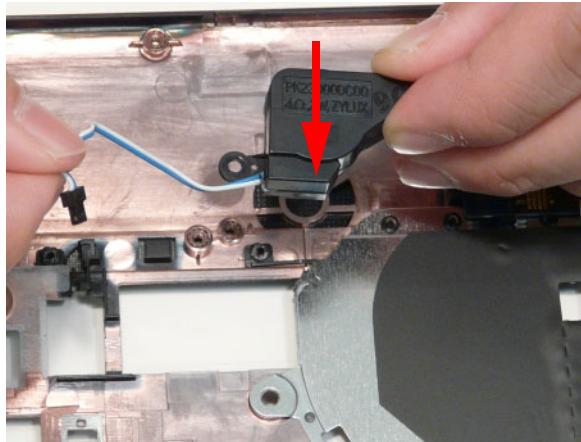

2. Run the speaker cable along the channel.

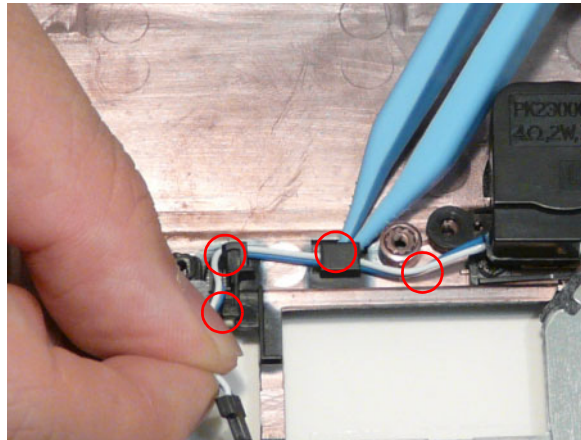

3. Secure the two (2) securing screws on the Right Speaker Module.

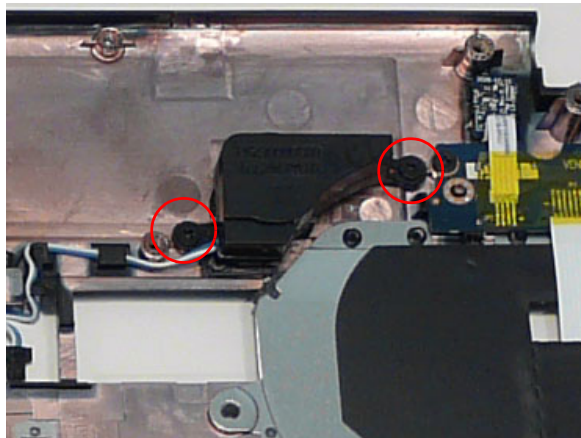

Replacing the Left Speaker Module

1. Place the module right side first on the Upper Cover as shown.
2. Run the Speaker cable along the cable channel.

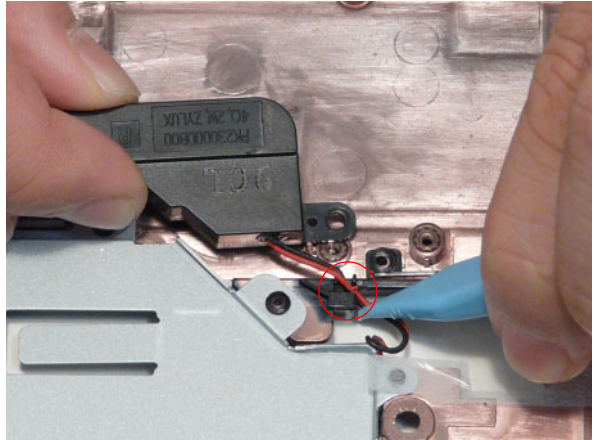
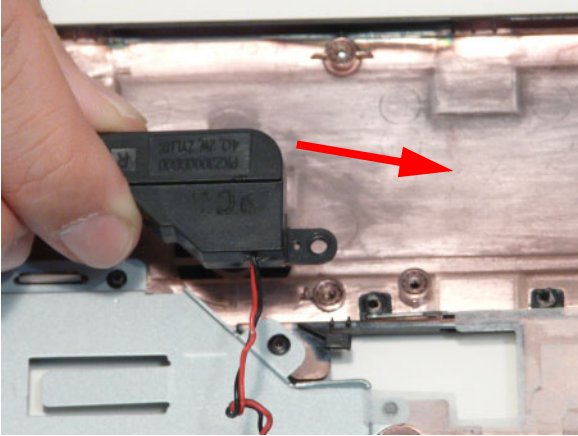

3. Secure two (2) screws from the left speaker module.

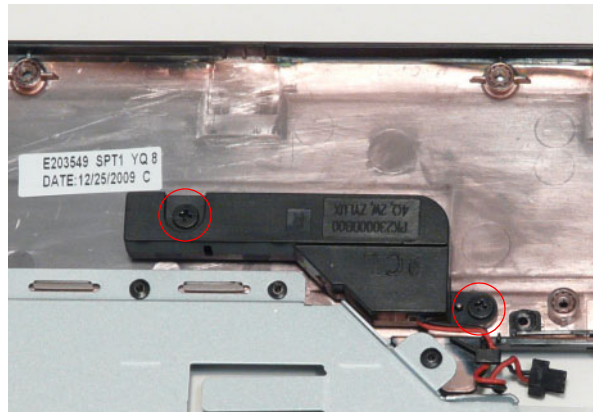

Replacing the Upper Cover

1. Place the Upper Cover on the Lower Cover as shown.

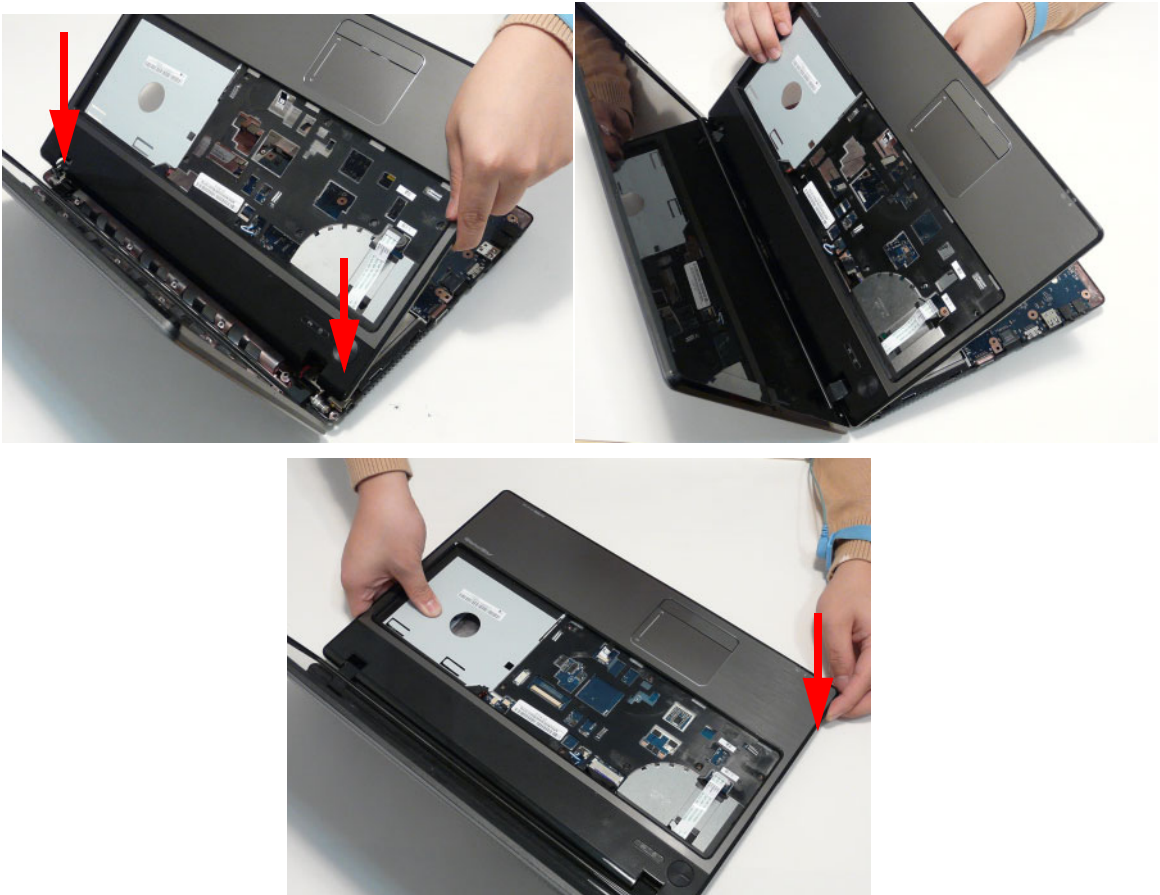

2. Secure the seven (7) screws on the Upper Cover as shown.

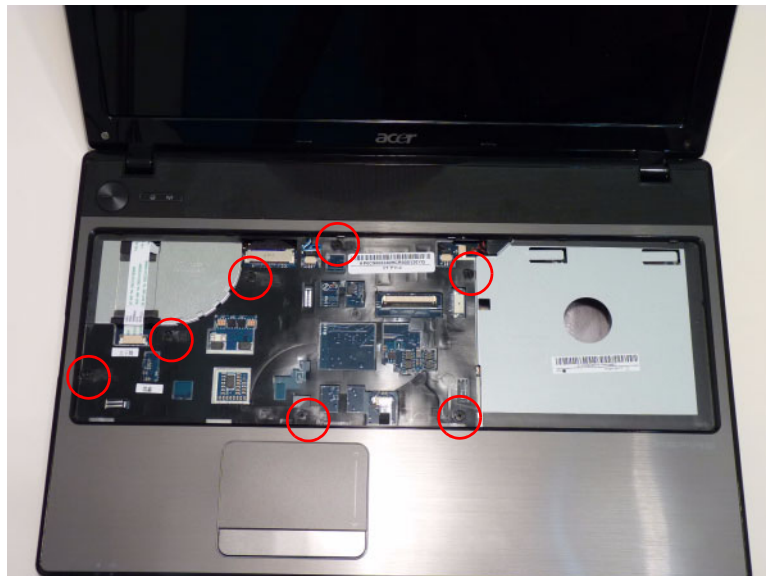

3. Connect the following cables to the Mainboard.

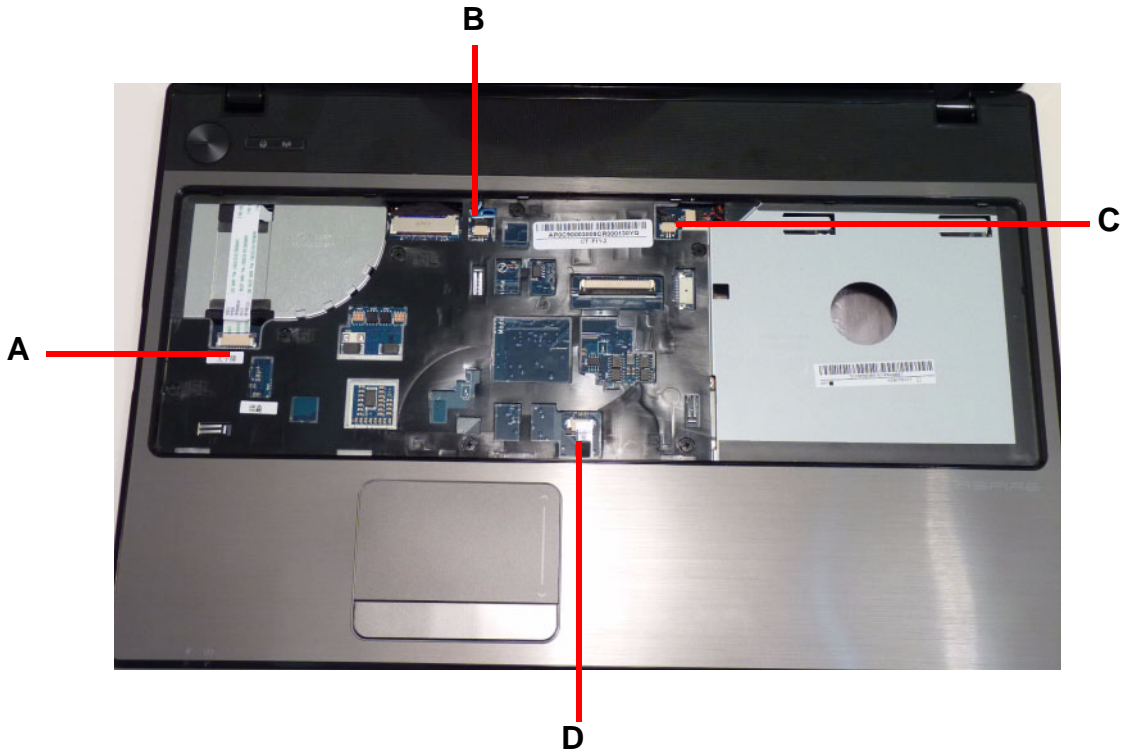

4. Connect D as shown.

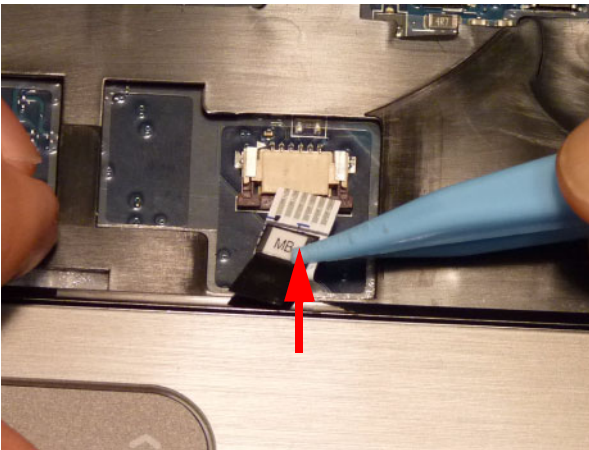

5. Connect C as shown.

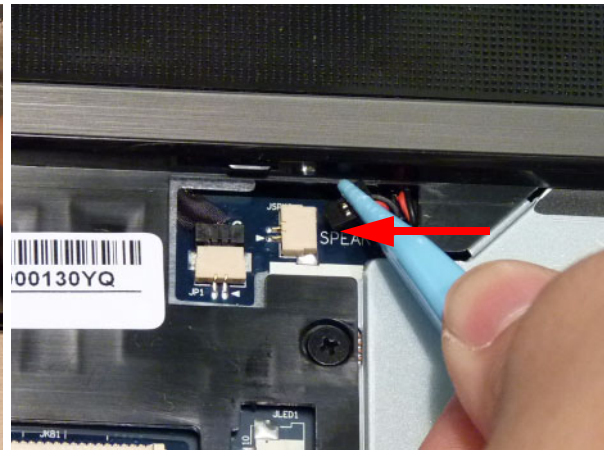

6. Connect B as shown.

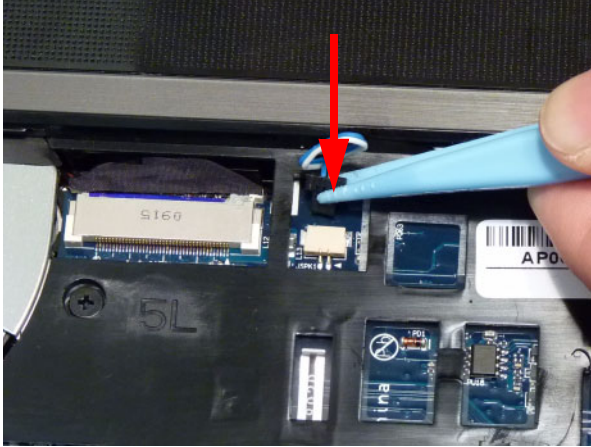

7. Connect A as shown.

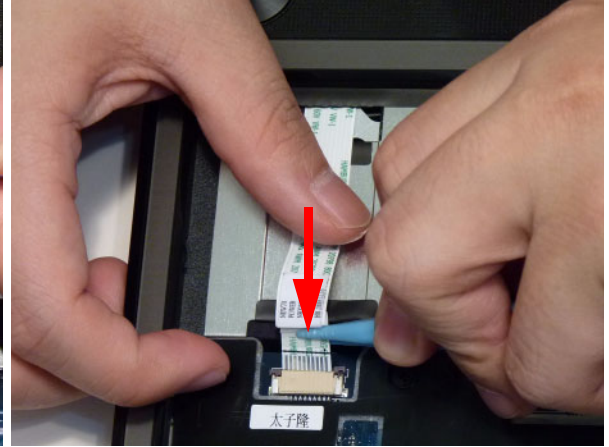

8. Turn the computer over. Remove the eleven (11) screws on the lower cover and four (4) screws from the battery bay.

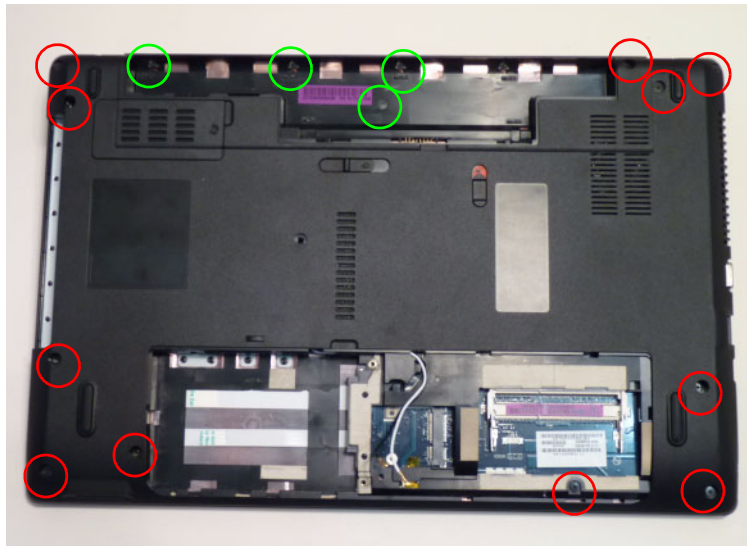

Replacing the Keyboard

1. Connect the Keyboard FFC to the Mainboard and close the locking latch to secure the cable in place.

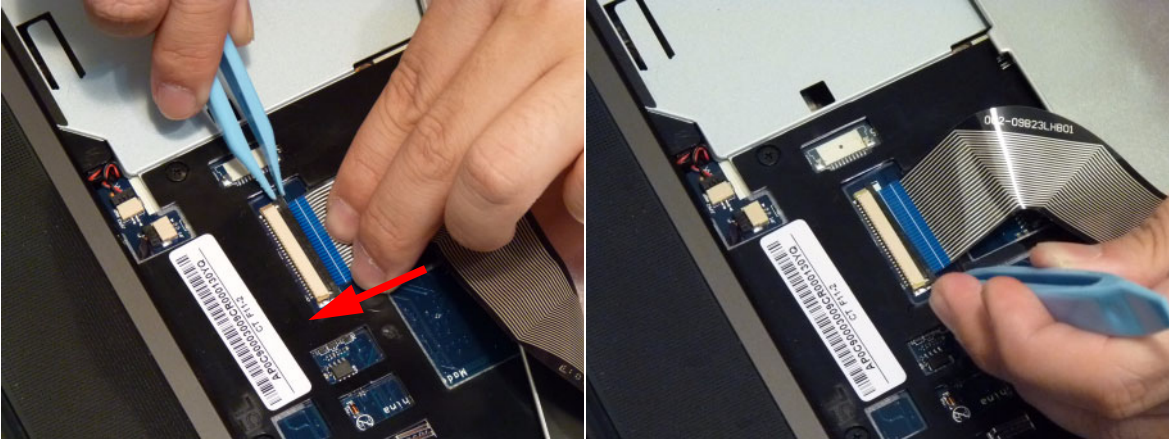

2. Replace the Keyboard by first lining up the bottom edge. Press down firmly to lock.



Replacing the Hard Disk Drive Module

1. Place the HDD in the HDD carrier.

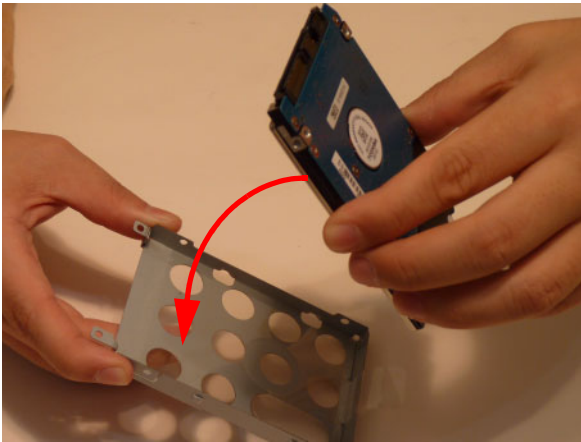

2. Replace the four (4) screws (two each side) to secure the carrier.

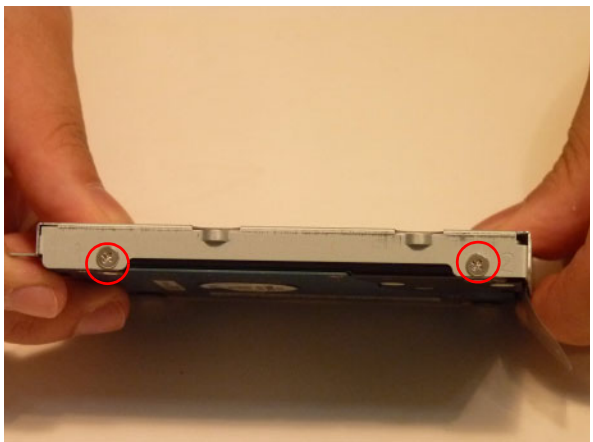

3. Insert the HDD, as indicated and lower it into place.



4. Slide the HDD in the direction of the arrow to connect the interface.



Replacing the WLAN Module

1. Insert the WLAN Module into the WLAN socket.
2. Replace the two (2) screws to secure the module.

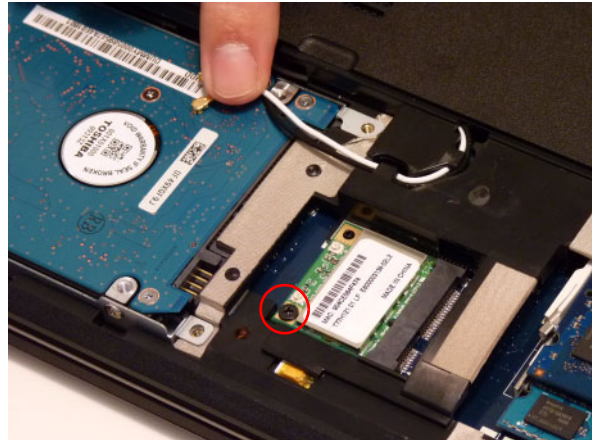
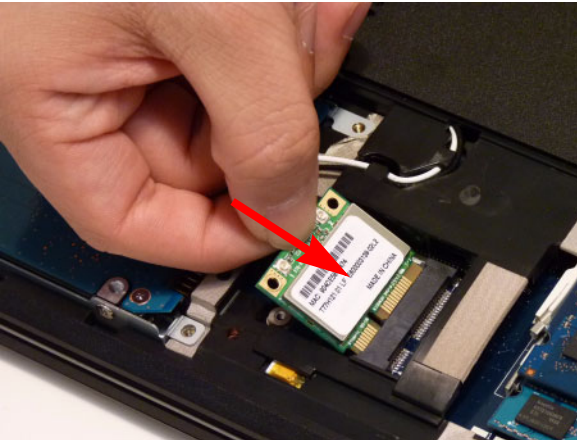

3. Connect the two (2) Antenna cables to the module.

NOTE: The black cable connects to the upper terminal (MAIN) and the white cable to the lower terminal (MAIN).

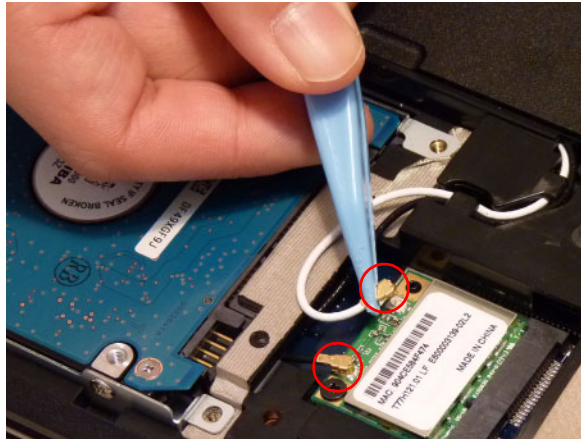

Replacing the DIMM Modules

1. Insert the DIMM Module in place.

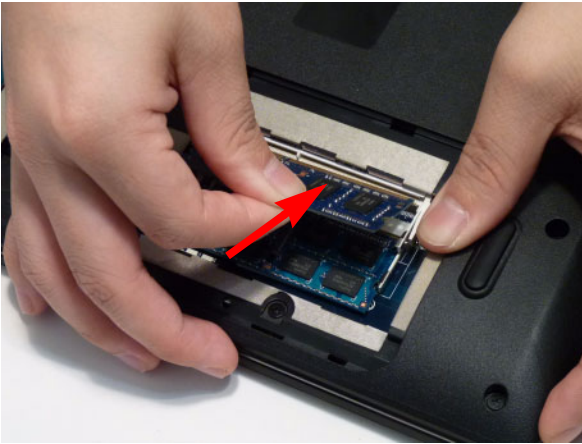

2. Press down to lock the DIMM module in place.

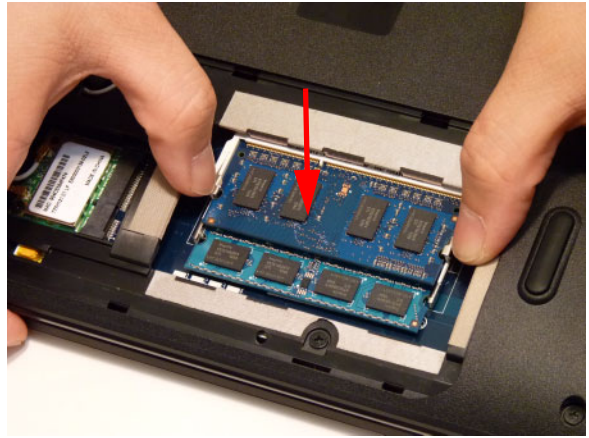

3. Repeat steps for the second DIMM module if present.

Replacing the 3G Cover

1. Line up the left edge of the 3G cover with the device, before replacing completely.



2. Replace one (1) screw on the 3G Cover.



Replacing the Logic Lower Door

1. Replace the lower cover by first lining up the top edge as shown.



2. Secure two (2) screws on the lower cover.

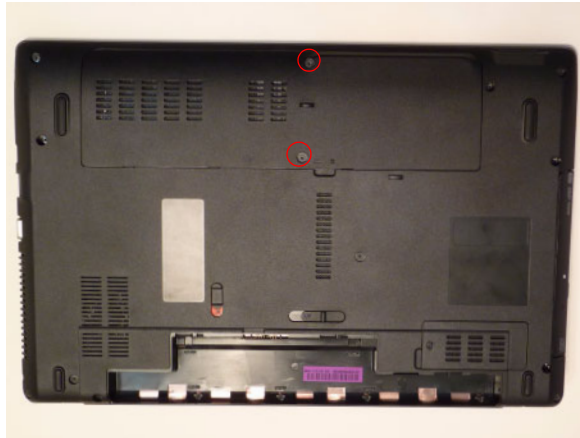

Replacing the ODD Module

1. Press the bezel into the tray, bottom edge first, to secure it to the ODD Module.
2. Place the bracket on the ODD module.



3. Secure the ODD bracket with the two (2) screws.

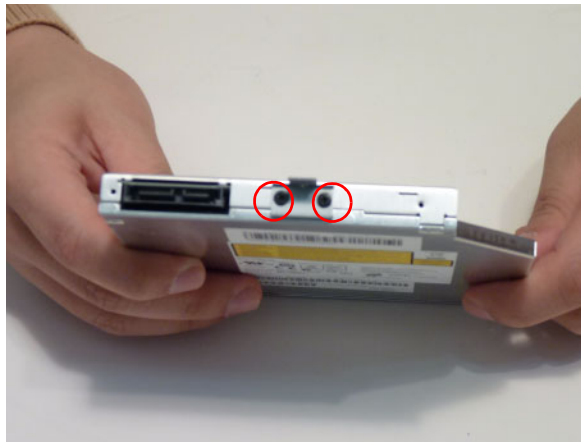

4. Push the ODD Module into the ODD bay until it is flush with the casing.
5. Replace the one (1) screw to secure the Module.

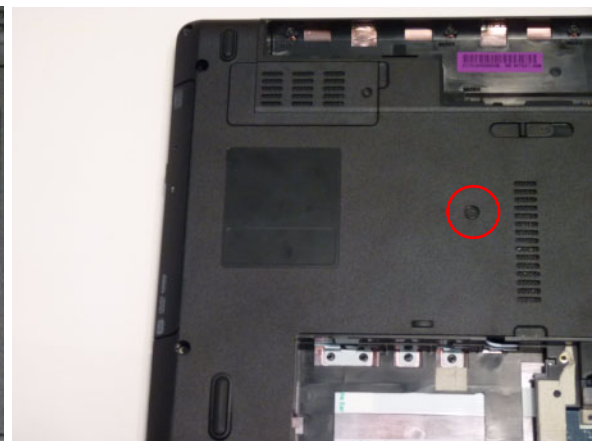
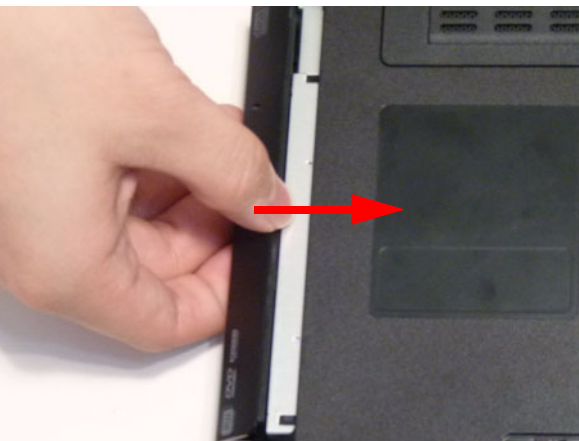

Replacing the SD Dummy Card

1. Insert the SD Dummy Card into the slot as shown.
2. Push until the card clicks into place and is flush with the casing.



Replacing the Battery

1. Slide and hold the battery release latch to the release position (1), insert the battery pack and press down (2).

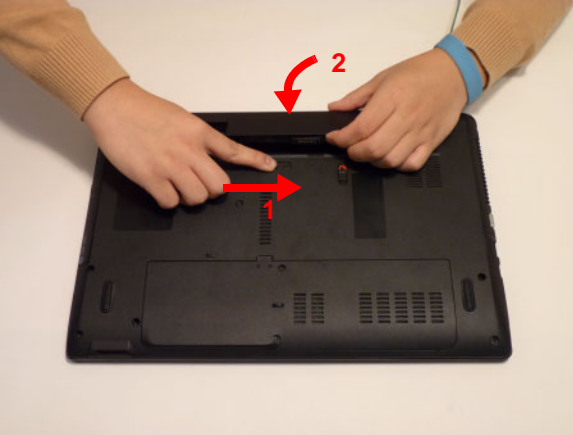

2. Slide the battery lock in the direction shown to secure the battery in place.

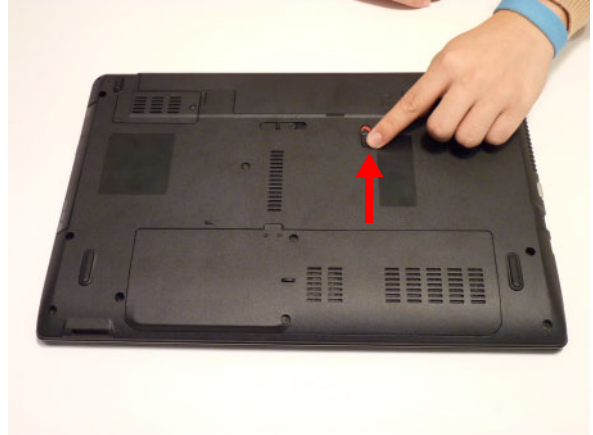

Troubleshooting

Common Problems

Use the following procedure as a guide for computer problems.

NOTE: The diagnostic tests are intended to test only Acer products. Non-Acer products, prototype cards, or modified options can give false errors and invalid system responses.

1. Obtain the failing symptoms in as much detail as possible.
2. Verify the symptoms by attempting to re-create the failure by running the diagnostic test or by repeating the same operation.
3. Use the following table with the verified symptom to determine which page to go to.

Symptoms (Verified)	Go To
Power On Issue	Page 130
No Display Issue	Page 131
LCD Failure	Page 133
Internal Keyboard Failure	Page 133
TouchPad Failure	Page 134
Internal Speaker Failure	Page 134
ODD Failure	Page 137
WLAN Failure	Page 140
Thermal Unit Failure	Page 140
Other Functions Failure	Page 141
Intermittent Failures	Page 142
Undermined Failures	Page 142

4. If the Issue is still not resolved, see "Online Support Information" on page 243.

Power On Issue

If the system doesn't power on, perform the following actions one at a time to correct the problem. Do not replace a non-defective FRUs:

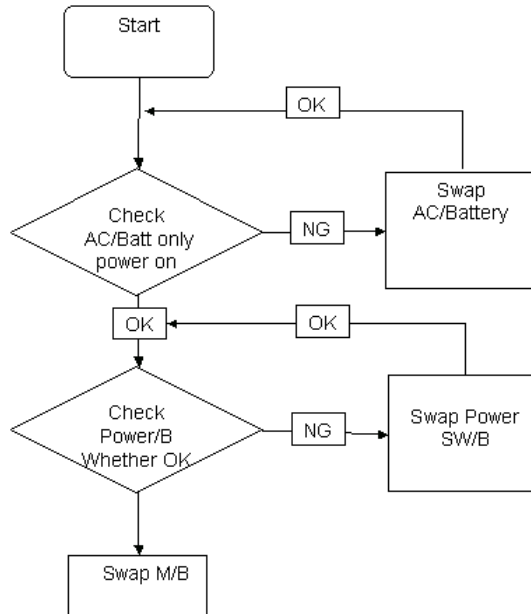

Computer Shutdown Intermittently

If the system powers off at intervals, perform the following actions one at a time to correct the problem.

1. Check the power cable is properly connected to the computer and the electrical outlet.
2. Remove any extension cables between the computer and the outlet.
3. Remove any surge protectors between the computer and the electrical outlet. Plug the computer directly into a known good electrical outlet.
4. Disconnect the power and open the casing to check the Thermal Unit (see "Thermal Unit Failure" on page 140) and fan airways are free of obstructions.
5. Remove all external and non-essential hardware connected to the computer that are not necessary to boot the computer to the failure point.
6. Remove any recently installed software.
7. If the Issue is still not resolved, see "Online Support Information" on page 243.

No Display Issue

If the **Display** doesn't work, perform the following actions one at a time to correct the problem. Do not replace a non-defective FRUs:

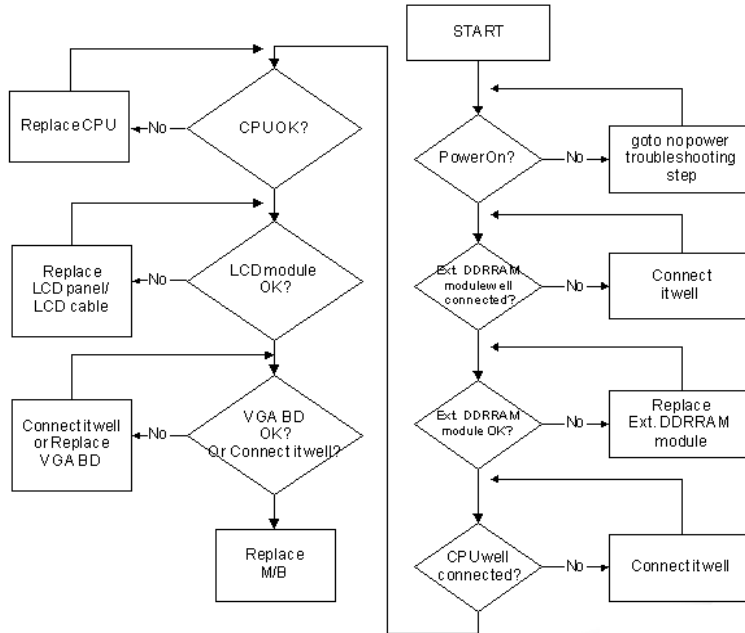

No POST or Video

If the POST or video doesn't display, perform the following actions one at a time to correct the problem.

1. Make sure that the internal display is selected. On this notebook model, switching between the internal display and the external display is done by pressing **Fn+F5**. Reference Product pages for specific model procedures.
2. Make sure the computer has power by checking at least one of the following occurs:
 - Fans start up
 - Status LEDs light up

If there is no power, see "Power On Issue" on page 130.

3. Drain any stored power by removing the power cable and battery and holding down the power button for 10 seconds. Reconnect the power and reboot the computer.
4. Connect an external monitor to the computer and switch between the internal display and the external display is by pressing **Fn+F5** (on this model).

If the POST or video appears on the external display, see "LCD Failure" on page 133.

5. Disconnect power and all external devices including port replicators or docking stations. Remove any memory cards and CD/DVD discs. Restart the computer.

If the computer boots correctly, add the devices one by one until the failure point is discovered.

6. Reseat the memory modules.
7. Remove the drives (see "Disassembly Process" on page 41).
8. If the Issue is still not resolved, see "Online Support Information" on page 243.

Abnormal Video Display

If video displays abnormally, perform the following actions one at a time to correct the problem.

1. Reboot the computer.
2. If permanent vertical/horizontal lines or dark spots display in the same location, the LCD is faulty and should be replaced. See “Disassembly Process” on page 41.
3. If extensive pixel damage is present (different colored spots in the same locations on the screen), the LCD is faulty and should be replaced. See “Disassembly Process” on page 41.
4. Adjust the brightness to its highest level. See the User Manual for instructions on adjusting settings.
NOTE: Ensure that the computer is not running on battery alone as this may reduce display brightness.
If the display is too dim at the highest brightness setting, the LCD is faulty and should be replaced. See “Disassembly Process” on page 41.
5. Check the display resolution is correctly configured:
 - a. Minimize or close all Windows.
 - b. If display size is only abnormal in an application, check the view settings and control/mouse wheel zoom feature in the application.
 - c. If desktop display resolution is not normal, right-click on the desktop and select **Personalize**→ **Display Settings**.
 - d. Click and drag the Resolution slider to the desired resolution.
 - e. Click **Apply** and check the display. Readjust if necessary.
6. Roll back the video driver to the previous version if updated.
7. Remove and reinstall the video driver.
8. Check the Device Manager to determine that:
 - The device is properly installed. There are no red Xs or yellow exclamation marks.
 - There are no device conflicts.
 - No hardware is listed under Other Devices.
9. If the Issue is still not resolved, see “Online Support Information” on page 243.
10. Run the Windows Memory Diagnostic from the operating system DVD and follow the onscreen prompts.
11. If the Issue is still not resolved, see “Online Support Information” on page 243.

Random Loss of BIOS Settings

If the computer is experiencing intermittent loss of BIOS information, perform the following actions one at a time to correct the problem.

1. If the computer is more than one year old, replace the CMOS battery.
2. Run a complete virus scan using up-to-date software to ensure the computer is virus free.
3. If the computer is experiencing HDD or ODD BIOS information loss, disconnect and reconnect the power and data cables between devices.
If the BIOS settings are still lost, replace the cables.
4. If HDD information is missing from the BIOS, the drive may be defective and should be replaced.
5. Replace the Motherboard.
6. If the Issue is still not resolved, see “Online Support Information” on page 243.

LCD Failure

If the **LCD** fails, perform the following actions one at a time to correct the problem. Do not replace a non-defective FRUs:

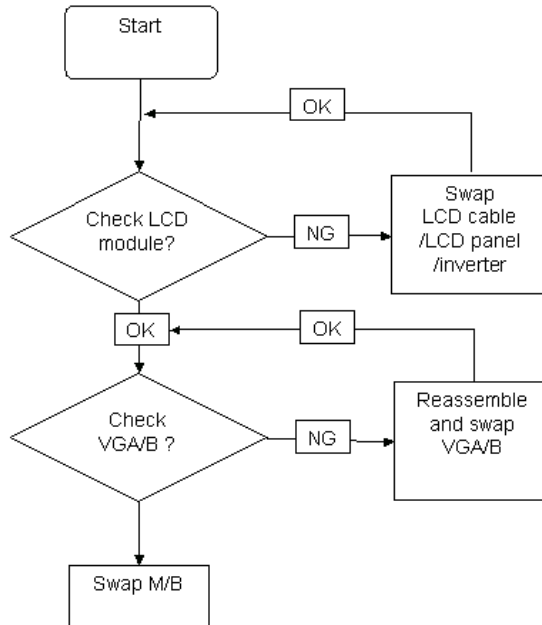

Built-In Keyboard Failure

If the built-in **Keyboard** fails, perform the following actions one at a time to correct the problem. Do not replace a non-defective FRUs:

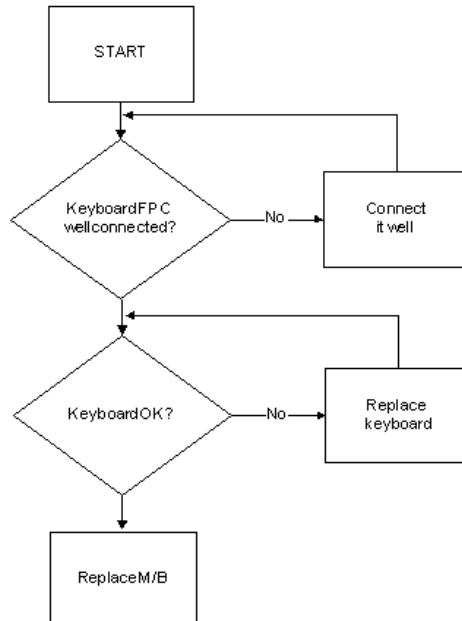

TouchPad Failure

If the **TouchPad** doesn't work, perform the following actions one at a time to correct the problem. Do not replace a non-defective FRUs:

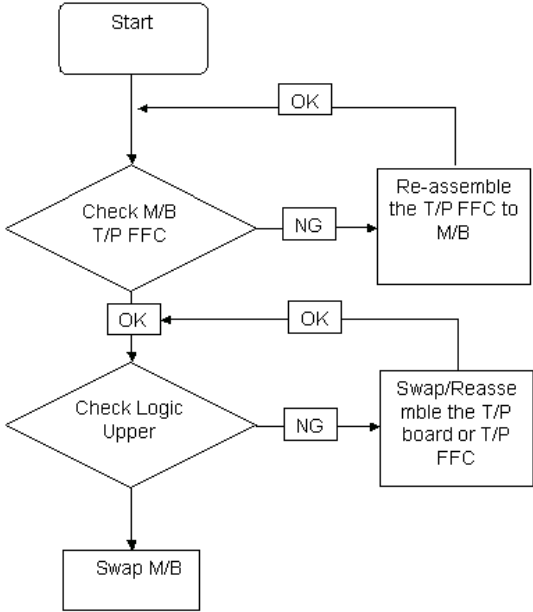

Internal Speaker Failure

If the internal **Speakers** fail, perform the following actions one at a time to correct the problem. Do not replace a non-defective FRUs:

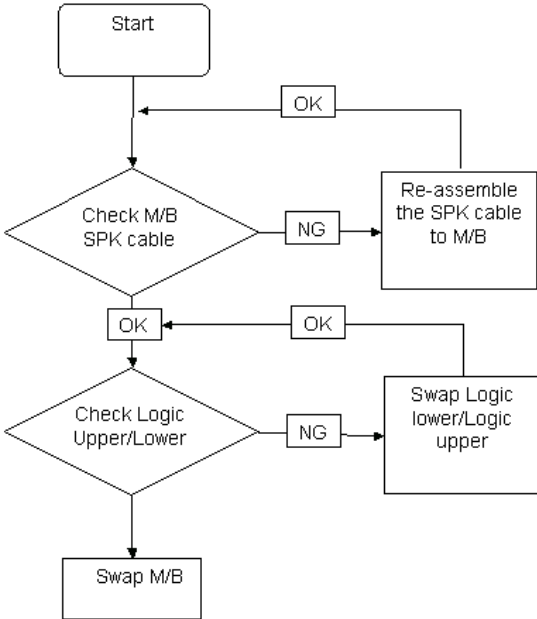

Sound Problems

If sound problems are experienced, perform the following actions one at a time to correct the problem.

1. Reboot the computer.
2. Navigate to **Start**→ **Control Panel**→ **System and Maintenance**→ **System**→ **Device Manager**. Check the Device Manager to determine that:
 - The device is properly installed.
 - There are no red Xs or yellow exclamation marks.
 - There are no device conflicts.
 - No hardware is listed under Other Devices.
3. Roll back the audio driver to the previous version, if updated recently.
4. Remove and reinstall the audio driver.
5. Ensure that all volume controls are set mid range:
 - a. Click the volume icon on the taskbar and drag the slider to 50. Ensure that the volume is not muted.
 - b. Click Mixer to verify that other audio applications are set to 50 and not muted.
6. Navigate to **Start**→ **Control Panel**→ **Hardware and Sound**→ **Sound**. Ensure that Speakers are selected as the default audio device (green check mark).

NOTE: If Speakers does not show, right-click on the **Playback** tab and select **Show Disabled Devices** (clear by default).
7. Select Speakers and click **Configure** to start **Speaker Setup**. Follow the onscreen prompts to configure the speakers.
8. Remove and recently installed hardware or software.
9. Restore system and file settings from a known good date using **System Restore**.

If the issue is not fixed, repeat the preceding steps and select an earlier time and date.
10. Reinstall the Operating System.
11. If the Issue is still not resolved, see “Online Support Information” on page 243.

Microphone Problems

If internal or external **Microphones** do not operate correctly, perform the following actions one at a time to correct the problem.

1. Check that the microphone is enabled. Navigate to **Start**→ **Control Panel**→ **Hardware and Sound**→ **Sound** and select the **Recording** tab.
2. Right-click on the **Recording** tab and select **Show Disabled Devices** (clear by default).
3. The microphone appears on the **Recording** tab.
4. Right-click on the microphone and select **Enable**.
5. Select the microphone then click **Properties**. Select the **Levels** tab.
6. Increase the volume to the maximum setting and click **OK**.
7. Test the microphone hardware:
 - a. Select the microphone and click **Configure**.
 - b. Select **Set up microphone**.
 - c. Select the microphone type from the list and click **Next**.
 - d. Follow the onscreen prompts to complete the test.
8. If the Issue is still not resolved, see “Online Support Information” on page 243.

HDD Not Operating Correctly

If the **HDD** does not operate correctly, perform the following actions one at a time to correct the problem.

1. Disconnect all external devices.
2. Run a complete virus scan using up-to-date software to ensure the computer is virus free.
3. Run the Windows Vista Startup Repair Utility:
 - a. insert the Windows Vista Operating System DVD in the ODD and restart the computer.
 - b. When prompted, press any key to start to the operating system DVD.
 - c. The **Install Windows** screen displays. Click **Next**.
 - d. Select **Repair your computer**.
 - e. The **System Recovery Options** screen displays. Click **Next**.
 - f. Select the appropriate operating system, and click **Next**.

NOTE: Click **Load Drivers** if controller drives are required.

- g. Select **Startup Repair**.
- h. Startup Repair attempts to locate and resolve issues with the computer.
- i. When complete, click **Finish**.

If an issue is discovered, follow the onscreen information to resolve the problem.

4. Run the Windows Memory Diagnostic Tool. For more information see Windows Help and Support.
5. Restart the computer and press F2 to enter the BIOS Utility. Check the BIOS settings are correct and that CD/DVD drive is set as the first boot device on the Boot menu.
6. Ensure all cables and jumpers on the HDD and ODD are set correctly.
7. Remove any recently added hardware and associated software.
8. Run the Windows Disk Defragmenter. For more information see Windows Help and Support.
9. Run Windows Check Disk by entering **chkdsk /r** from a command prompt. For more information see Windows Help and Support.
10. Restore system and file settings from a known good date using **System Restore**.

If the issue is not fixed, repeat the preceding steps and select an earlier time and date.
11. Replace the HDD. See "Disassembly Process" on page 41.

ODD Failure

If the **ODD** fails, perform the following actions one at a time to correct the problem. Do not replace a non-defective FRUs:

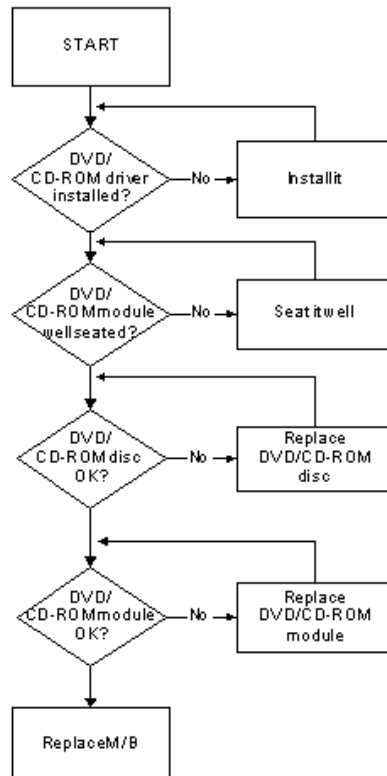

ODD Not Operating Correctly

If the **ODD** exhibits any of the following symptoms it may be faulty:

- Audio CDs do not play when loaded
- DVDs do not play when loaded
- Blank discs do not burn correctly
- DVD or CD play breaks up or jumps
- Optical drive not found or not active:
 - Not shown in My Computer or the BIOS setup
 - LED does not flash when the computer starts up
 - The tray does not eject
- Access failure screen displays
- The ODD is noisy

Perform the following general solutions one at a time to correct the problem.

1. Reboot the computer and retry the operation.
2. Try an alternate disc.
3. Navigate to **Start** → **Computer**. Check that the ODD device is displayed in the **Devices with Removable Storage** panel.
4. Navigate to **Start** → **Control Panel** → **System and Maintenance** → **System** → **Device Manager**.

-
- a. Double-click **IDE ATA/ATAPI controllers**. If a device displays a down arrow, right-click on the device and click **Enable**.
 - b. Double-click **DVD/CD-ROM drives**. If the device displays a down arrow, right-click on the device and click **Enable**.
 - c. Check that there are no yellow exclamation marks against the items in **IDE ATA/ATAPI controllers**. If a device has an exclamation mark, right-click on the device and uninstall and reinstall the driver.
 - d. Check that there are no yellow exclamation marks against the items in **DVD/CD-ROM drives**. If a device has an exclamation mark, right-click on the device and uninstall and reinstall the driver.
 - e. If the exclamation marker is not removed from the item in the lists, try removing any recently installed software and retrying the operation.

Discs Do Not Play

If discs do not play when inserted in the drive, perform the following actions one at a time to correct the problem.

1. Check that the disc is correctly seated in the drive tray and that the label on the disc is visible.
2. Check that the media is clean and scratch free.
3. Try an alternate disc in the drive.
4. Ensure that **AutoPlay** is enabled:
 - a. Navigate to **Start** → **Control Panel** → **Hardware and Sound** → **AutoPlay**.
 - b. Select **Use AutoPlay for all media and devices**.
 - c. In the Audio CD and DVD Movie fields, select the desired player from the drop down menu.
5. Check that the Regional Code is correct for the selected media:

IMPORTANT:Region can only be changed a limited number of times. After Changes remaining reaches zero, the region cannot be changed even Windows is reinstalled or the drive is moved to another computer.

- a. Navigate to **Start** → **Control Panel** → **System and Maintenance** → **System** → **Device Manager**.
- b. Double-click **DVD/CD-ROM drives**.
- c. Right-click **DVD drive** and click **Properties**, then click the **DVD Region** tab.
- d. Select the region suitable for the media inserted in the drive.

Discs Do Not Burn Properly

If discs can not be burned, perform the following actions one at a time to correct the problem.

1. Ensure that the default drive is record enabled:
 - a. Navigate to **Start** → **Computer** and right-click the writable ODD icon. Click **Properties**.
 - b. Select the **Recording** tab. In the **Desktop disc recording** panel, select the writable ODD from the drop down list.
 - c. Click **OK**.
2. Ensure that the software used for burning discs is the factory default. If using different software, refer to the software's user manual.

Playback is Choppy

If playback is choppy or jumps, perform the following actions one at a time to correct the problem.

1. Check that system resources are not running low:
 - a. Try closing some applications.
 - b. Reboot and try the operation again.
2. Check that the ODD controller transfer mode is set to DMA:
 - a. Navigate to **Start** → **Control Panel** → **System and Maintenance** → **System** → **Device Manager**.

-
- b. Double-click **IDE ATA/ATAPI controllers**, then right-click ATA Device 0.
 - c. Click **Properties** and select the **Advanced Settings** tab. Ensure that the **Enable DMA** box is checked and click **OK**.
 - d. Repeat for the other ATA Devices shown if applicable.

Drive Not Detected

If Windows cannot detect the drive, perform the following actions one at a time to correct the problem.

1. Restart the computer and press F2 to enter the BIOS Utility.
2. Check that the drive is detected in the **ATAPI Model Name** field on the Information page.
NOTE: Check that the entry is identical to one of the ODDs specified in “Hardware Specifications and Configurations” on page 14.
3. Turn off the power and remove the cover to inspect the connections to the ODD. See “Disassembly Process” on page 41.
 - a. Check for broken connectors on the drive, motherboard, and cables.
 - b. Check for bent or broken pins on the drive, motherboard, and cable connections.
 - c. Try an alternate cable, if available. If the drive works with the new cable, the original cable should be replaced.
4. Reseat the drive ensuring and all cables are connected correctly.
5. Replace the ODD. See “Disassembly Process” on page 41.

Drive Read Failure

If discs cannot be read when inserted in the drive, perform the following actions one at a time to correct the problem.

1. Remove and clean the failed disc.
2. Retry reading the CD or DVD.
 - d. Test the drive using other discs.
 - e. Play a DVD movie
 - f. Listen to a music CD

If the ODD works properly with alternate discs, the original disc is probably defective and should be replaced.

3. Turn off the power and remove the cover to inspect the connections to the ODD. See “Disassembly Process” on page 41.
 - a. Check for broken connectors on the drive, motherboard, and cables.
 - b. Check for bent or broken pins on the drive, motherboard, and cable connections.
 - c. Try an alternate cable, if available. If the drive works with the new cable, the original cable should be replaced.
4. Replace the ODD. See “Disassembly Process” on page 41.

Wireless Function Failure

If the **WLAN** fails, perform the following actions one at a time to correct the problem. Do not replace a non-defective FRUs:

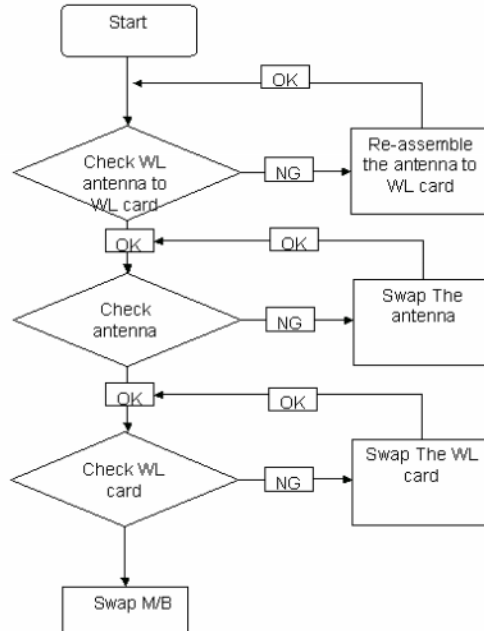

Thermal Unit Failure

If the **Thermal Unit** fails, perform the following actions one at a time to correct the problem. Do not replace a non-defective FRUs:

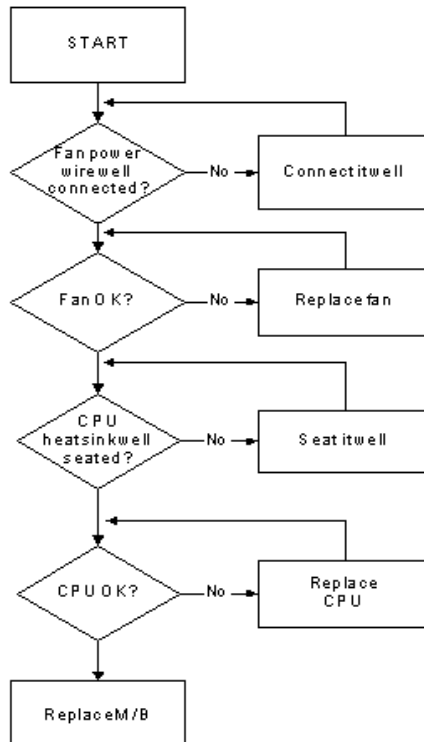

External Mouse Failure

If an external **Mouse** fails, perform the following actions one at a time to correct the problem.

1. Try an alternative mouse.
2. If the mouse uses a wireless connection, insert new batteries and confirm there is a good connection. See the mouse user manual.
3. If the mouse uses a USB connection, try an alternate USB port.
4. Try an alternative program to verify mouse operation. Reinstall the program experiencing mouse failure.
5. Restart the computer.
6. Remove any recently added hardware and associated software.
7. Remove any recently added software and reboot.
8. Restore system and file settings from a known good date using **System Restore**.
If the issue is not fixed, repeat the preceding steps and select an earlier time and date.
9. Run the Event Viewer to check the events log for errors. For more information see Windows Help and Support.
10. Roll back the mouse driver to the previous version if updated recently.
11. Remove and reinstall the mouse driver.
12. Check the Device Manager to determine that:
 - The device is properly installed. There are no red Xs or yellow exclamation marks.
 - There are no device conflicts.
 - No hardware is listed under Other Devices.
13. If the Issue is still not resolved, see "Online Support Information" on page 243.

Other Failures

If the CRT Switch, Dock, LAN Port, external MIC or Speakers, PCI Express Card, 5-in-1 Card Reader or Volume Wheel fail, perform the following general steps to correct the problem. Do not replace a non-defective FRUs:

1. Check Drive whether is OK.
2. Check Test Fixture is ok.
3. Swap M/B to Try.

Intermittent Problems

Intermittent system hang problems can be caused by a variety of reasons that have nothing to do with a hardware defect, such as: cosmic radiation, electrostatic discharge, or software errors. FRU replacement should be considered only when a recurring problem exists.

When analyzing an intermittent problem, do the following:

1. Run the advanced diagnostic test for the system board in loop mode at least 10 times.
2. If no error is detected, do not replace any FRU.
3. If any error is detected, replace the FRU. Rerun the test to verify that there are no more errors.

Undetermined Problems

The diagnostic problems does not identify which adapter or device failed, which installed devices are incorrect, whether a short circuit is suspected, or whether the system is inoperative.

Follow these procedures to isolate the failing FRU (do not isolate non-defective FRU).

NOTE: Verify that all attached devices are supported by the computer.

NOTE: Verify that the power supply being used at the time of the failure is operating correctly. (See “Power On Issue” on page 130.):

1. Power-off the computer.
2. Visually check them for damage. If any problems are found, replace the FRU.
3. Remove or disconnect all of the following devices:
 - Non-Acer devices
 - Printer, mouse, and other external devices
 - Battery pack
 - Hard disk drive
 - DIMM
 - CD-ROM/Diskette drive Module
 - PC Cards
4. Power-on the computer.
5. Determine if the problem has changed.
6. If the problem does not recur, reconnect the removed devices one at a time until you find the failing FRU.
7. If the problem remains, replace the following FRU one at a time. Do not replace a non-defective FRU:
 - System board
 - LCD assembly

Post Codes

These tables describe the POST codes and descriptions during the POST.

Post Code Range

Phase	POST Code Range
SEC	0x01 - 0x0F
PEI	0x70 - 0x9F
DXE	0x40 - 0x6F
BDS	0x10 - 0x3F
SMM	0xA0 - 0xBF
S3	0xC0 - 0xCF
ASL	0x51 – 0x55
	0xE1 – 0xE4
PostBDS	0xF9 – 0xFE
InsydeH2ODDT™ Reserve	0xD0 – 0xD7
OEM Reserve	0xE8 – 0xEB
Reserved	0xD8 – 0xE0
	0xE5 – 0xE7
	0xEC – 0xF8

SEC Phase POST Code Table

Functionality Name (Include PostCode.h)	Phase	Post Code	Description
SEC_SYSTEM_POWER_ON	SEC	1	CPU power on and switch to Protected mode
SEC_BEFORE_MICROCODE_PATCH	SEC	2	Patching CPU microcode
SEC_AFTER_MICROCODE_PATCH	SEC	3	Setup Cache as RAM
SEC_ACCESS_CSR	SEC	4	PCIE MMIO Base Address initial
SEC_GENERIC_MSRINIT	SEC	5	CPU Generic MSR initialization
SEC_CPU_SPEEDCFG	SEC	6	Setup CPU speed
SEC_SETUP_CAR_OK	SEC	7	Cache as RAM test
SEC_FORCE_MAX_RATIO	SEC	8	Tune CPU frequency ratio to maximum level
SEC_GO_TO_SECSTARTUP	SEC	9	Setup BIOS ROM cache
SEC_GO_TO_PEICORE	SEC	0A	Enter Boot Firmware Volume

NOTE: The color bar items indicate 3rd party related functions that are platform dependent.

PEI Phase POST Code Table:

Functionality Name (Include PostCode.h)	Phase	Post Code	Description
PEI_SIO_INIT	PEI	70	Super I/O Initialization
PEI_CPU_REG_INIT	PEI	71	CPU Early Initialization
PEI_CPU_AP_INIT	PEI	72	Multi-processor Early Initial
PEI_CPU_HT_RESET	PEI	73	HyperTransport Initialization
PEI_PCIE_MMIO_INIT	PEI	74	PCIE MMIO BAR Initialization
PEI_NB_REG_INIT	PEI	75	North Bridge Early Initialization
PEI_SB_REG_INIT	PEI	76	South Bridge Early Initialization
PEI_PCIE_TRAINING	PEI	77	PCIE Training
PEI_TPM_INIT	PEI	78	TPM Initialization
PEI_SMBUS_INIT	PEI	79	SMBUS Early Initialization
PEI_PROGRAM_CLOCK_GEN	PEI	7A	Clock Generator Initialization
PEI_IGD_EARLY_INITIAL	PEI	7B	Internal Graphic device early Initialization
PEI_HECI_INIT	PEI	7C	HECI Initialization
PEI_WATCHDOG_INIT	PEI	7D	Watchdog timer Initialization
PEI_MEMORY_INIT	PEI	7E	Memory Initial for Normal boot.
PEI_MEMORY_INIT_FOR_CRISIS	PEI	7F	Memory Initial for Crisis Recovery
PEI_MEMORY_INSTALL	PEI	80	Simple Memory test
PEI_TXTPEI	PEI	81	TXT function early Initialization
PEI_SWITCH_STACK	PEI	82	Start to use Memory
PEI_MEMORY_CALLBACK	PEI	83	Set cache for physical memory
PEI_ENTER_RECOVERY_MODE	PEI	84	Recovery device Initialization
PEI_RECOVERY_MEDIA_FOUND	PEI	85	Found Recovery image
PEI_RECOVERY_MEDIA_NOT_FOUND	PEI	86	Recovery image not found
PEI_RECOVERY_LOAD_FILE_DONE	PEI	87	Load Recovery Image completed
PEI_RECOVERY_START_FLASH	PEI	88	Start Flash BIOS with Recovery image
PEI_ENTER_DXEIPL	PEI	89	Loading BIOS image to RAM
PEI_FINDING_DXE_CORE	PEI	8A	Loading DXE core
PEI_GO_TO_DXE_CORE	PEI	8B	Enter DXE core

NOTE: The color bar items indicate 3rd party related functions that are platform dependent.

DXE Phase POST Code Table:

Functionality Name (Include PostCode.h)	Phase	PostCode	Description
DXE_TCGDXE	DXE	40	TPM initial in DXE
DXE_SB_SPI_INIT	DXE	41	South bridge SPI initialization
DXE_CF9_RESET	DXE	42	Setup Reset service
DXE_SB_SERIAL_GPIO_INIT	DXE	43	South bridge Serial GPIO initialization
DXE_SMMACCESS	DXE	44	Setup SMM ACCE SS service
DXE_NB_INIT	DXE	45	North bridge Middle initialization
DXE_SIO_INIT	DXE	46	Super I/O DXE initialization
DXE_LEGACY_REGION	DXE	47	Setup Legacy Region service
DXE_SB_INIT	DXE	48	South Bridge Middle initialization
DXE_IDENTIFY_FLASH_DEVICE	DXE	49	Identify Flash device
DXE_FTW_INIT	DXE	4A	Fault Tolerant Write verification
DXE_VARIABLE_INIT	DXE	4B	Variable Service initialization
DXE_VARIABLE_INIT_FAIL	DXE	4C	Fail to initial Variable Service
DXE_MTC_INIT	DXE	4D	MTC Initial
DXE_CPU_INIT	DXE	4E	CPU Middle Initialization
DXE_MP_CPU_INIT	DXE	4F	Multi-processor MiddleInitialization
DXE_SMBUS_INIT	DXE	50	SMBUS Driver Initialization
DXE_SMART_TIMER_INIT	DXE	51	8259 Initialization
DXE_PCRTC_INIT	DXE	52	RTC Initialization
DXE_SATA_INIT	DXE	53	SATA Controller earlyInitialization
DXE_SMM_CONTROLLER_INIT	DXE	54	Setup SMM Control service
DXE_LEGACY_INTERRUPT	DXE	55	Setup Legacy Interrupt service
DXE_RELOCATE_SMBASE	DXE	56	Relocate SMM BASE
DXE_FIRST_SMI	DXE	57	SMI test
DXE_VTD_INIT	DXE	58	VTD Initial
DXE_BEFORE_CSM16_INIT	DXE	59	Legacy BIOS Initialization
DXE_AFTER_CSM16_INIT	DXE	5A	Legacy interrupt function Initialization
DXE_LOAD_ACPI_TABLE	DXE	5B	ACPI Table Initialization
DXE_SB_DISPATCH	DXE	5C	Setup SB SMM Dispatcher service
DXE_SB_IOTRAP_INIT	DXE	5D	Setup SB IOTRAP Service
DXE_SUBCLASS_DRIVER	DXE	5E	Build AMT Table
DXE_PPM_INIT	DXE	5F	PPM Initialization
DXE_HECIDRV_INIT	DXE	60	HECIDRV Initialization

NOTE: The color bar items indicate 3rd party related functions that are platform dependent.

BDS Phase POST Code Table:

Functionality Name (Include PostCode.h)	Phase	Post Code	Description
BDS_ENTER_BDS	BDS	10	Enter BDS entry
BDS_INSTALL_HOTKEY	BDS	11	Install Hotkey service
BDS_ASF_INIT	BDS	12	ASF Initialization
BDS_PCI_ENUMERATION_START	BDS	13	PCI enumeration
BDS_BEFORE_PCIE_INSTALL	BDS	14	PCI resource assign complete
BDS_PCI_ENUMERATION_END	BDS	15	PCI enumeration complete
BDS_CONNECT_CONSOLE_IN	BDS	16	Keyboard Controller, Keyboard and Mouse initialization
BDS_CONNECT_CONSOLE_OUT	BDS	17	Video device initialization
BDS_CONNECT_STD_ERR	BDS	18	Error report device initialization
BDS_CONNECT_USB_HC	BDS	19	USB host controller initialization
BDS_CONNECT_USB_BUS	BDS	1A	USB BUS driver initialization
BDS_CONNECT_USB_DEVICE	BDS	1B	USB device driver initialization
BDS_NO_CONSOLE_ACTION	BDS	1C	Console device initial fail
BDS_DISPLAY_LOGO_SYSTEM_INFO	BDS	1D	Display logo or system information
BDS_START_IDE_CONTROLLER	BDS	1E	IDE controller initialization
BDS_START_SATA_CONTROLLER	BDS	1F	SATA controller initialization
BDS_START_ISA_ACPI_CONTROLLER	BDS	20	SIO controller initialization
BDS_START_ISA_BUS	BDS	21	ISA BUS driver initialization
BDS_START_ISA_FDD	BDS	22	Floppy device initialization
BDS_START_ISA_SEIRAL	BDS	23	Serial device initialization
BDS_START_IDE_BUS	BDS	24	IDE device initialization
BDS_START_AHCI_BUS	BDS	25	AHCI device initialization
BDS_CONNECT_LEGACY_ROM	BDS	26	Dispatch option ROMs
BDS_ENUMERATE_ALL_BOOT_OPTION	BDS	27	Get boot device information
BDS_END_OF_BOOT_SELECTION	BDS	28	End of boot selection
BDS_ENTER_SETUP	BDS	29	Enter Setup Menu
BDS_ENTER_BOOT_MANAGER	BDS	2A	Enter Boot manager
BDS_BOOT_DEVICE_SELECT	BDS	2B	Try to boot system to OS
BDS_EFI64_SHADOW_ALL_LEGACY_ROM	BDS	2C	Shadow Misc Option ROM
BDS_ACPI_S3SAVE	BDS	2D	Save S3 resume required data in RAM
BDS_READY_TO_BOOT_EVENT	BDS	2E	Last Chipset initial before boot to OS
BDS_GO_LEGACY_BOOT	BDS	2F	Start to boot Legacy OS
BDS_GO_UEFI_BOOT	BDS	30	Start to boot UEFI OS
BDS_LEGACY16_PREPARE_TO_BOOT	BDS	31	Prepare to Boot to Legacy OS
BDS_EXIT_BOOT_SERVICES	BDS	32	Send END of POST Message to ME via HECI
BDS_LEGACY_BOOT_EVENT	BDS	33	Last Chipset initial before boot to Legacy OS.
BDS_ENTER_LEGACY_16_BOOT	BDS	34	Ready to Boot Legacy OS.

Functionality Name (Include\ PostCode.h)	Phase	Post Code	Description
BDS_RECOVERY_START_FLASH	BDS	35	Fast Recovery Start Flash.

NOTE: The color bar items indicate 3rd party related functions that are platform dependent.

PostBDS POST Code Table

Functionality Name (Include\ PostCode.h)	Phase	Post Code	Description
POST_BDS_NO_BOOT_DEVICE	POST_BDS	F9	No Boot Device
POST_BDS_START_IMAGE	POST_BDS	FB	UEFI Boot Start Image
POST_BDS_ENTER_INT19	POST_BDS	FD	Legacy 16 boot entry
POST_BDS_JUMP_BOOT_SECTOR	POST_BDS	FE	Try to Boot with INT 19

S3 Functions POST Code Table

Functionality Name (Include\ PostCode.h)	Phase	Post Code	Description
POST_BDS_NO_BOOT_DEVICE	POST_BDS	F9	No Boot Device
POST_BDS_START_IMAGE	POST_BDS	FB	UEFI Boot Start Image
POST_BDS_ENTER_INT19	POST_BDS	FD	Legacy 16 boot entry
POST_BDS_JUMP_BOOT_SECTOR	POST_BDS	FE	Try to Boot with INT 19

ACPI Functions POST Code Table

Functionality Name (Include\ PostCode.h)	Phase	Post Code	Description
ASL_ENTER_S1	ASL	51	Prepare to enter S1
ASL_ENTER_S3	ASL	53	Prepare to enter S3
ASL_ENTER_S4	ASL	54	Prepare to enter S4
ASL_ENTER_S5	ASL	55	Prepare to enter S5
ASL_WAKEUP_S1	ASL	E1	System wakeup from S1
ASL_WAKEUP_S3	ASL	E3	System wakeup from S3
ASL_WAKEUP_S4	ASL	E4	System wakeup from S4

SMM Functions POST Code Table

Functionality Name (Include\ PostCode.h)	Phase	Post Code	Description
SMM_IDENTIFY_FLASH_DEVICE	SMM	0xA0	Identify Flash device in SMM
SMM_SMM_PLATFORM_INIT	SMM	0xA2	SMM service initial
SMM_ACPI_ENABLE_START	SMM	0xA6	OS call ACPI enable function
SMM_ACPI_ENABLE_END	SMM	0xA7	ACPI enable function complete
SMM_S1_SLEEP_CALLBACK	SMM	0xA1	Enter S1
SMM_S3_SLEEP_CALLBACK	SMM	0xA3	Enter S3
SMM_S4_SLEEP_CALLBACK	SMM	0xA4	Enter S4
SMM_S5_SLEEP_CALLBACK	SMM	0xA5	Enter S5

Functionality Name (Include\ PostCode.h)	Phase	Post Code	Description
SMM_ACPI_DISABLE_START	SMM	0xA8	OS call ACPI disable function
SMM_ACPI_DISABLE_END	SMM	0xA9	ACPI disable function complete

InsydeH2ODDT Debugger POST Code Table

Functionality Name (Include\ PostCode.h)	PostCode	Description
Used by Insyde debugger	0x0D	Waiting for device connect
Used by Insyde debugger	0xD0	Waiting for device connect
Used by Insyde debugger	0xD1	InsydeH2ODDT Ready
Used by Insyde debugger	0xD2	EHCI not found
Used by Insyde debugger	0xD3	Debug port connect low speed device
Used by Insyde debugger	0xD4	DDT Cable become low speed device
Used by Insyde debugger	0xD5	DDT Cable Transmission Error (Get descriptor fail)
Used by Insyde debugger	0xD6	DDT Cable Transmission Error (Set Debug mode fail)
Used by Insyde debugger	0xD7	DDT Cable Transmission Error (Set address fail)

Jumper and Connector Locations

Top View

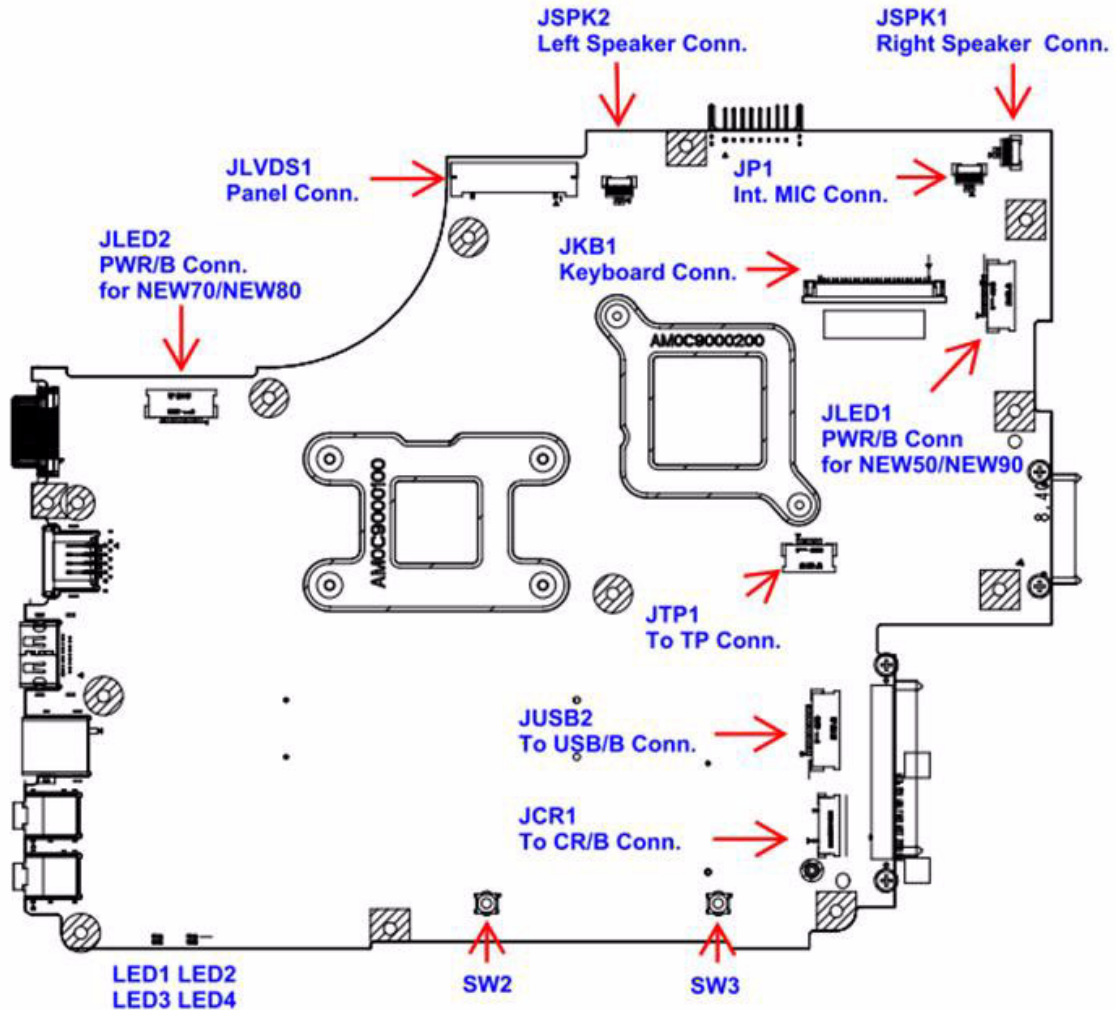

Item	Description	Item	Description
JLVDS1	Connect to LED / CCFL Connector	JLED1	Connect to Powerboard (FFC)
JSPK2	Connect to Left Speaker	JLED2	Connect to Powerboard (FFC)
JSPK1	Connect to Right Speaker	JP1	Connect to internal MIC
JKB1	Connect to Keyboard	SW2/SW3	Left button / Right button
JTP1	Connect to Touch pad (FFC)	LED1/LED3	Power State Indicator
JUSB2	Connect to Power USB Board (FFC)	LED2/LED4	Battery Charging Indicator
JCR1	Connect Card Reader Board (FFC)		

Bottom View

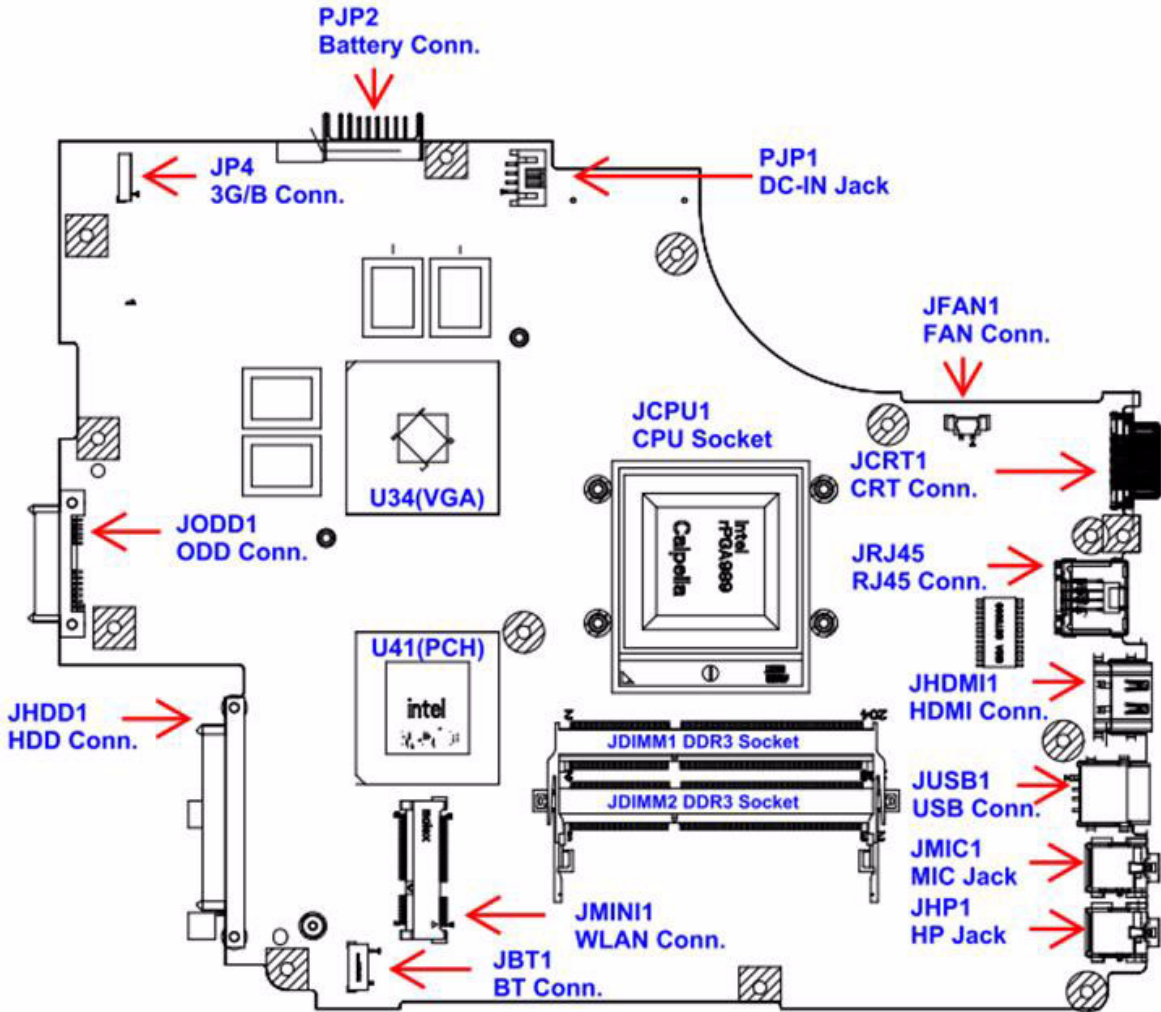

Item	Description	Item	Description
PJP2	Connect to Battery	JHP1	Connect to external headphone
PJP1	DC-IN jack	JBT1	Connect to BT
JDIMM1/ JDIMM2	DDR3 memory socket	JHDD1	Connect to SATAHDD
JCRT1	Connect to external CRT	JODD1	Connect to SATAODD
JRJ45	RJ45 LAN	JP4	Connect to 3G board
JHDMI1	HDMI connector	JFAN1	Connect to FAN
JMINI1	Connect to WLAN	JCPU1	CPU socket
JUSB1	USB connector	U41	PCH
JMIC1	Connect to external microphone		

USB/B Board

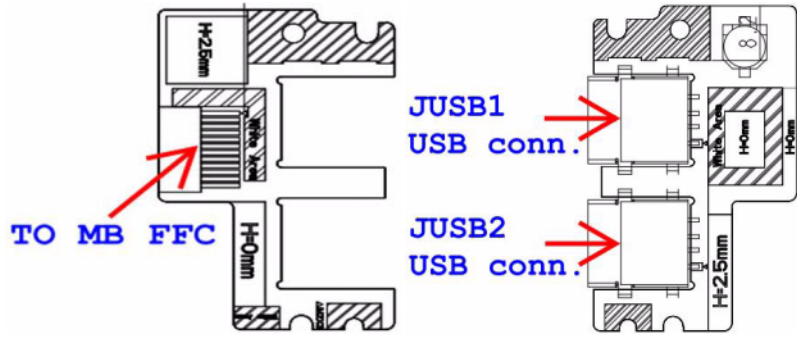

ITEM	DESCRIPTION
JUSB1/JUSB2	USB Connector

Power Board

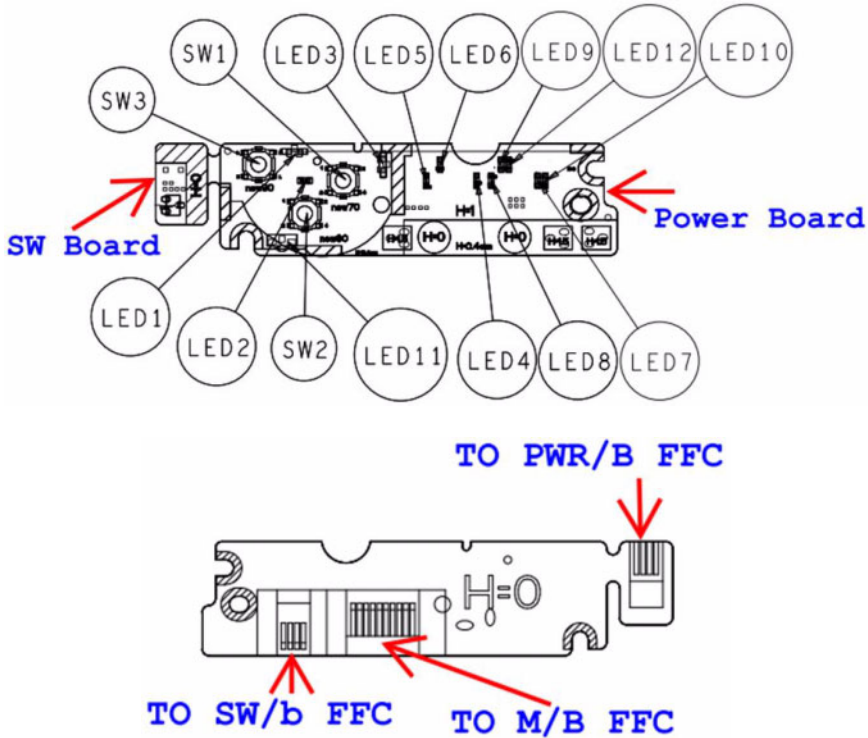

ITEM	DESCRIPTION	ITEM	DESCRIPTION
LED1	For NEW70 ON/OFF LED	LED9	For NEW50 WWAN LED
LED2	For NEW80 ON/OFF LED	LED10	For NEW70 WLAN LED
LED3	For NEW90 ON/OFF LED	LED11	For NEW50 POWER LED
LED4	For NEW70 MEDIA LED	LED12	For NEW50/NEW90 WLAN LED
LED5	For NEW80 MEDIA LED	SW1	For NEW70 Power BTN
LED6	For NEW50/NEW90 MEDIA LED	SW2	For NEW80 Power BTN
LED7	For NEW70 WWAN LED	SW3	For NEW90 Power BTN
LED8	For NEW80 WLAN LED		

3G/B Board

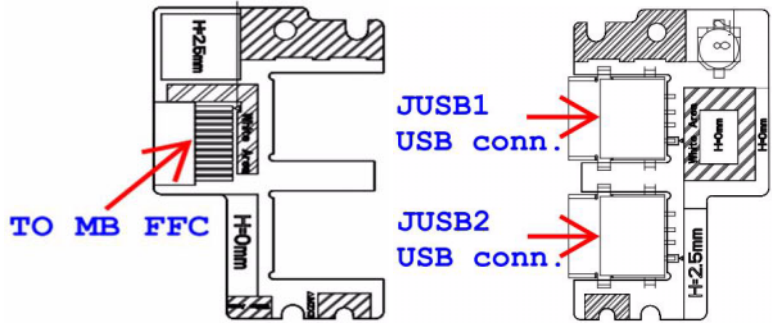

ITEM	DESCRIPTION
JMINI2	Connect to WWAN
JSIM1	SIM card connector
JP1	Connector to MB (FFC)

CR/B Board

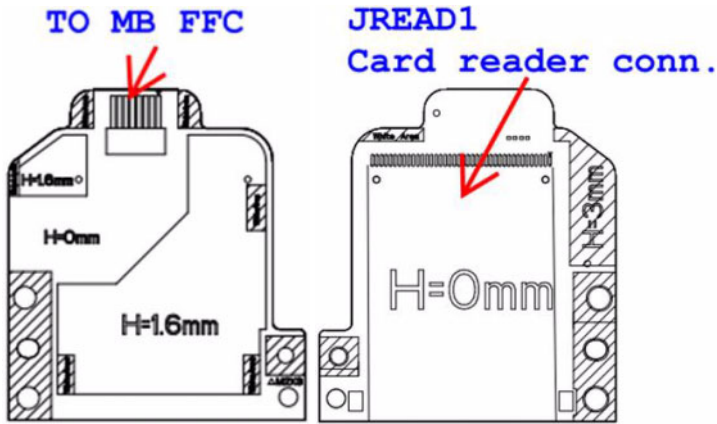

ITEM	DESCRIPTION
JREAD1	Card reader connector

Clearing Password Check and BIOS Recovery

This section provides you with the standard operating procedures of clearing password and BIOS recovery for the Aspire 5741/5741G. The machine provides one Hardware Open Gap on main board for clearing password check, and one Hotkey for enabling BIOS Recovery.

Clearing Password Check

Steps for Clearing BIOS Password Check

If users set BIOS Password (Supervisor Password and/or User Password) for a security reason, BIOS will ask the password during systems POST or when systems enter to BIOS Setup menu. However, once it is necessary to bypass the password check, users need to short the HW Gap to clear the password by the following steps:

1. Power Off the system, and remove HDD, AC and Battery from the machine.
2. Disconnect the RTC Battery cable and locate the RTC_RST jumper.
3. Use an electric conductivity tool to short the two points of the HW Gap.
4. Plug in AC, keeping the HW Gap shorted. Press Power Button until BIOS POST is finished, then remove the tool from the HW Gap.
5. Restart the system. Press **F2** key to enter BIOS Setup menu.
6. If there is no Password request, BIOS Password is cleared. Otherwise, please follow the steps and try again.

NOTE: These steps are only for clearing BIOS Password (Supervisor Password and User Password).

Clear CMOS Jumper

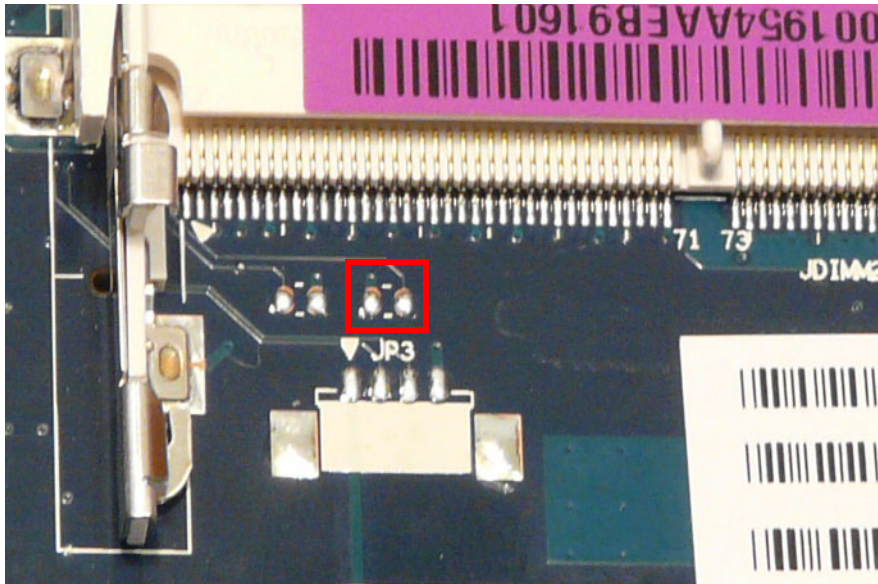

Item	Description
RTC_RST	Clear CMOS Jumper

BIOS Recovery by Crisis Disk

BIOS Recovery Boot Block:

BIOS Recovery Boot Block is a special block of BIOS. It is used to boot up the system with minimum BIOS initialization. Users can enable this feature to restore the BIOS firmware to a successful one once the previous BIOS flashing process failed.

BIOS Recovery Hotkey:

The system provides a function hotkey: **Fn+Esc**, for enable BIOS Recovery process when system is powered on during BIOS POST. To use this function, it is strongly recommended to have the AC adapter and Battery present. If this function is enabled, the system will force the BIOS to enter a special BIOS block, called Boot Block.

Steps for BIOS Recovery from USB Storage:

Before doing this, prepare the Crisis USB key. The Crisis USB key could be made by executing the Crisis Disk program in another system with Windows XP OS.

Follow the steps below:

1. Format the USB storage disk using the Fast Format option.
2. Save ROM file (file name: **NEW70x64.fd**) to the root directory of USB storage. Make sure that there is no other BIOS file saved in the same directory.
3. Plug USB storage into USB port.
4. Press **Fn + ESC** button then plug in AC power.
The Power button flashes once.
5. Press **Power** button to initiate system CRISIS mode.
When CRISIS is complete, the system auto restarts with a workable BIOS.
6. Update the latest version BIOS for this machine by regular BIOS flashing process.

FRU (Field Replaceable Unit) List

This chapter gives you the FRU (Field Replaceable Unit) listing in global configurations of Aspire 5741/5741G. Refer to this chapter whenever ordering for parts to repair or for RMA (Return Merchandise Authorization).

Please note that WHEN ORDERING FRU PARTS, you should check the most up-to-date information available on your regional web or channel. For whatever reasons a part number change is made, it will not be noted on the printed Service Guide. For ACER AUTHORIZED SERVICE PROVIDERS, your Acer office may have a DIFFERENT part number code from those given in the FRU list of this printed Service Guide. You MUST use the local FRU list provided by your regional Acer office to order FRU parts for repair and service of customer machines.

NOTE: To scrap or to return the defective parts, you should follow the local government ordinance or regulations on how to dispose it properly, or follow the rules set by your regional Acer office on how to return it.

Aspire 5741/5741G Exploded Diagrams

Main Assembly

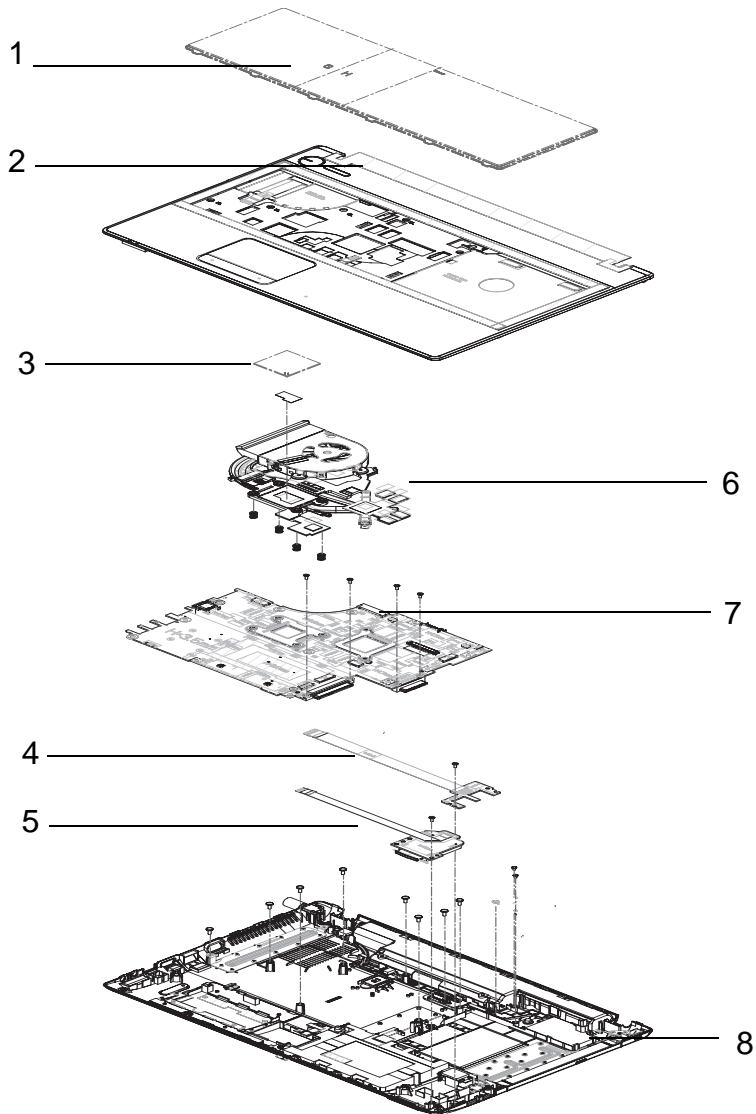

No.	Description	Acer P/N
1	Keyboard	KB.I170A.056
2	Upper Cover	60.PSV02.001
3	CPU	KC.52001.DMP
4	USB Board	55.PSV02.003
5	Card Reader Board	55.PSV02.002
6	Thermal Module	60.PSV02.005
7	Mainboard	MB.PSV02.001
8	Lower Cover	60.PSV02.002

Upper Assembly

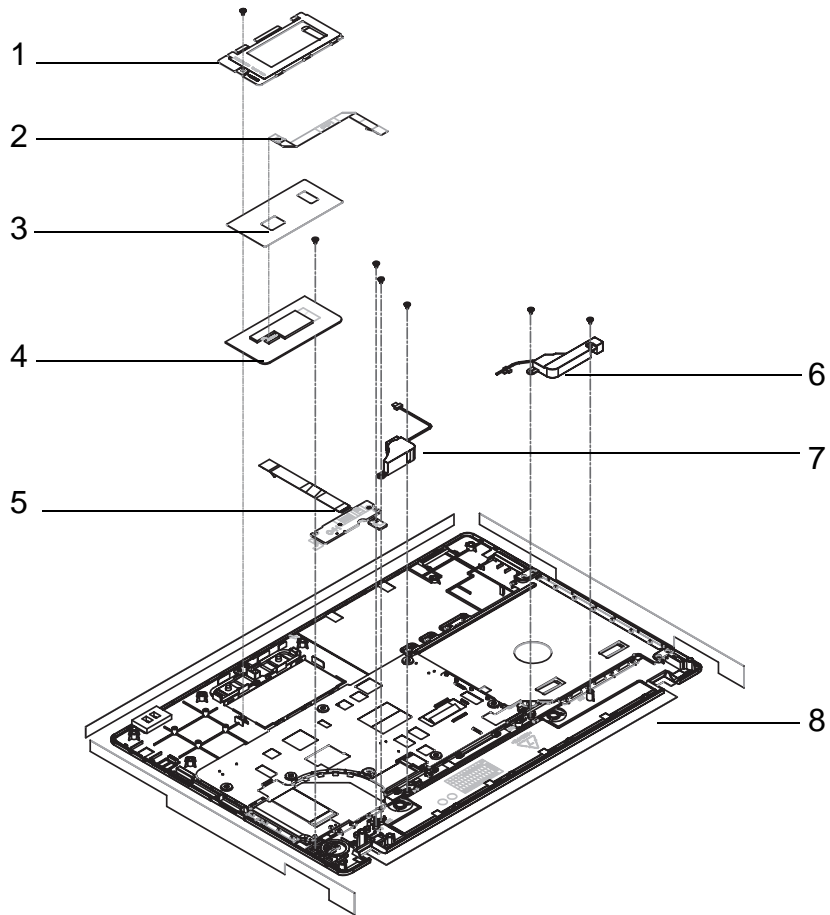

No.	Description	Acer P/N
1	Touchpad Bracket	33.PSV02.001
2	Touchpad Cable	50.PSV02.004
3	Touchpad board	TBD
4	Touchpad Assy	TBD
5	Powerboard Cable	TBD
	Speaker Right	23.PSV02.002
	Speaker Left	23.PSV02.003
	Upper Cover	60.PSV02.001

LCD Assembly

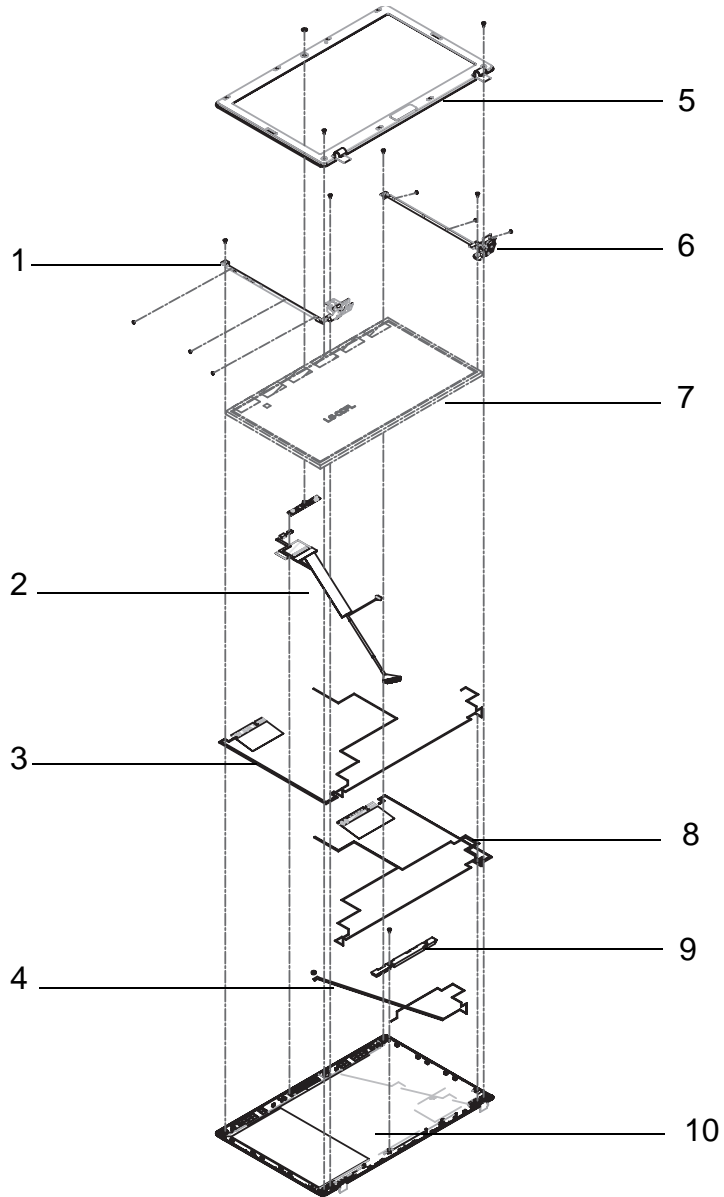





No.	Description	Acer P/N
1	LCD Bracket (L)	33.PSV02.004
2	LVDS Cable	50.PSW02.002
3	ANTENNA WLAN-MAIN	50.PSV02.005
4	Microphone Cable	23.PSV02.001
5	LCD Bezel	60.PSW02.001
6	LCD Bracket (R)	33.PSV02.004
7	LCD Panel	LK.15605.010
8	ANTENNA WLAN-AUX	50.PSV02.006
9	Web Camera Module	57.PSV02.001

No.	Description	Acer P/N
10	LCD Cover	60.PSV02.003

Aspire 5741/5741G FRU List



CATEGORY	Acer Description	AcerPN
BOARD		
	FOXCONN BLUETOOTH BRM 2046 BT2.1 (T60H928.33) F/W:861	BH.21100.004
		TBD
	POWER BOARD FOR 3G	55.PSV02.001
	POWER BOARD FOR W/O 3G	55.PSV02.006
	CARD READER BOARD	55.PSV02.002
	USB BOARD	55.PSV02.003
	3G BOARD	55.PSV02.004
	FOXCONN WIRELESS LAN ATHEROS HB93 2X2 BGN (HM)	NI.23600.062
	QMI WIRELESS LAN ATHEROS HB93 2X2 BGN (HM) EM306	NI.23600.064
		TBD
	FOXCONN WIRELESS LAN ATHEROS HB95 1X1 BG (HM)	NI.23600.047
	FOXCONN WIRELESS LAN BROADCOMM 43225 2X2 BGN (HM) T77H103.00	NI.23600.066
	3G CARD HUAWEI EM770W	LC.21300.008
CABLE		
	BLUE TOOTH CABLE-8PIN	50.PSV02.001
	BLUE TOOTH CABLE-6PIN	50.PSV02.002
	3G CABLE	50.PSV02.003
	TP FFC	50.PSV02.004
	DC-IN CABLE-65W	50.PSV02.011
	DC-IN CABLE-90W	50.PTD02.001

CATEGORY	Acer Description	AcerPN
	POWER CORD US 3 PIN	27.TAVV5.001
	POWER CORD EU 3 PIN	27.TAVV5.002
	POWER CORD AUS 3 PIN	27.TAVV5.003
	POWER CORD UK 3 PIN	27.TAVV5.004
	POWER CORD CHINA 3 PIN	27.TAVV5.005
	POWER CORD SWISS 3 PIN	27.TAVV5.006
	POWER CORD ITALIAN 3 PIN	27.TAVV5.007
	POWER CORD DENMARK 3 PIN	27.TAVV5.008
	POWER CORD JP 3 PIN	27.TAVV5.009
	POWER CORD SOUTH AFRICA 3 PIN	27.TAVV5.010
	POWER CORD KOREA 3 PIN	27.TAVV5.011
	POWER CORD ISRAEL 3 PIN	27.TAVV5.012
	POWER CORD INDIA 3 PIN	27.TAVV5.013
	POWER CORD TWN 3 PIN	27.TAVV5.014
	POWER CORD ARGENTINA 3 PIN	27.APV02.001
CASE/COVER/BRACKET ASSEMBLY		
	UPPER CASE ASSY, INCL. TP/TP MYLAR	60.PSV02.001
	LOWER CASE	60.PSV02.002
	LOGIC LOWER DOOR	42.PSV02.001
	3G DOOR	42.PSV02.002
	TP BRACKET	33.PSV02.001
	HDD CARRIER	33.PSV02.002

CATEGORY	Acer Description	AcerPN
CASE/COVER/BRACKET ASSEMBLY		
	ODD BD COMBO MODULE	6M.PSV02.001
	ODD SUPER-MULTI DRIVE MODULE	6M.PSV02.002
	ODD BRACKET	33.PSV02.003
	ODD BEZEL-SM	42.PSV02.003
	ODD BEZEL-BD(HIGH SPEED)	42.PSV02.004
KEYBOARD		
	Keyboard ACER AC7T JV50 Internal 17 Standard 103KS Black US International Texture	KB.I170A.056
	Keyboard ACER AC7T JV50 Internal 17 Standard 103KS Black Greek Texture	KB.I170A.041
	Keyboard ACER AC7T JV50 Internal 17 Standard 103KS Black Arabic Texture	KB.I170A.032
	Keyboard ACER AC7T JV50 Internal 17 Standard 103KS Black Chinese Texture	KB.I170A.036
	Keyboard ACER AC7T JV50 Internal 17 Standard 103KS Black Russian Texture	KB.I170A.048
	Keyboard ACER AC7T JV50 Internal 17 Standard 103KS Black US International w/ Hebrew Texture	KB.I170A.057
	Keyboard ACER AC7T JV50 Internal 17 Standard 103KS Black Thailand Texture	KB.I170A.053
	Keyboard ACER AC7T JV50 Internal 17 Standard 104KS Black UK Texture	KB.I170A.055
	Keyboard ACER AC7T JV50 Internal 17 Standard 104KS Black German Texture	KB.I170A.040
	Keyboard ACER AC7T JV50 Internal 17 Standard 104KS Black Swiss/G Texture	KB.I170A.052
	Keyboard ACER AC7T JV50 Internal 17 Standard 104KS Black Belgium Texture	KB.I170A.033
	Keyboard ACER AC7T JV50 Internal 17 Standard 104KS Black Danish Texture	KB.I170A.037
	Keyboard ACER AC7T JV50 Internal 17 Standard 104KS Black Italian Texture	KB.I170A.043
	Keyboard ACER AC7T JV50 Internal 17 Standard 104KS Black French Texture	KB.I170A.039
	Keyboard ACER AC7T JV50 Internal 17 Standard 104KS Black Hungarian Texture	KB.I170A.042
Keyboard ACER AC7T JV50 Internal 17 Standard 104KS Black Norwegian Texture	KB.I170A.046	
Keyboard ACER AC7T JV50 Internal 17 Standard 104KS Black Portuguese Texture	KB.I170A.047	

CATEGORY	Acer Description	AcerPN
	Keyboard ACER AC7T JV50 Internal 17 Standard 104KS Black Spanish Texture	KB.I170A.050
	Keyboard ACER AC7T JV50 Internal 17 Standard 104KS Black US w/ Canadian French Texture	KB.I170A.058
	Keyboard ACER AC7T JV50 Internal 17 Standard 104KS Black Turkish Texture	KB.I170A.054
	Keyboard ACER AC7T JV50 Internal 17 Standard 104KS Black Sweden Texture	KB.I170A.051
	Keyboard ACER AC7T JV50 Internal 17 Standard 104KS Black FR/Arabic Texture	KB.I170A.038
	Keyboard ACER AC7T JV50 Internal 17 Standard 104KS Black Nordic Texture	KB.I170A.045
	Keyboard ACER AC7T JV50 Internal 17 Standard 104KS Black SLO/CRO Texture	KB.I170A.049
	Keyboard ACER AC7T JV50 Internal 17 Standard 104KS Black CZ/SK Texture	KB.I170A.035
	Keyboard ACER AC7T JV50 Internal 17 Standard 104KS Black Brazilian Portuguese Texture	KB.I170A.034
	Keyboard ACER AC7T JV50 Internal 17 Standard 107KS Black Japanese Texture	KB.I170A.044
LCD		
	ASSY LED MODULE 15.6"W WXGA GLARE w/ ANTENNA*2, W/O CCD	6M.PSW02.001
	ASSY LED MODULE 15.6"W WXGA GLARE w/ ANTENNA*2, 3G, W/O CCD	6M.PSW02.002
	ASSY LED MODULE 15.6"W WXGA GLARE w/ ANTENNA*2, CCD 1.3M	6M.PSV02.003
	ASSY LED MODULE 15.6"W WXGA GLARE w/ ANTENNA*2, CCD 1.3M, 3G	6M.PSV02.004
	LCD COVER IMR - BLACK	60.PSV02.003
	ANTENNA WLAN-MAIN	50.PSV02.005
	ANTENNA WLAN-AUX	50.PSV02.006
	ANTENNA 3G-MAIN	50.PSV02.007
	ANTENNA 3G-AUX	50.PSV02.008
	LED CABLE FOR W/O CMOS	50.PSW02.002
	LED CABLE FOR W/CMOS	50.PSV02.010
	LED BRACKET R&L	33.PSV02.005

CATEGORY	Acer Description	AcerPN
	CAMERA 1.3M	57.PSV02.001
	LCD BEZEL FOR W/CMOS	60.PSV02.004
	LCD BEZEL FOR W/O CMOS	60.PSW02.001
	LCD CABLE FOR W/CMOS	50.PSV02.009
	LCD CABLE FOR W/O CMOS	50.PSW02.001
	LCD BRACKET R&L	33.PSV02.004
	LED BRACKET R&L	33.PSV02.005
	INVERTER BOARD	55.PSV02.005
MAINBOARD		
	Mainboard AS5741 Intel HM55 V1.0 LF UMA	MB.PSV02.001
	Mainboard AS5741G Intel HM55 512M-GD3 V1.0 LF PARK_XT	MB.PSZ02.001
	Mainboard AS5741G Intel HM55 V1.0 LF N11PGV2H_1GB	MB.PTD02.001
		TBD
		same as A2
HEATSINK		
	THERMAL MOUDLE-UMA	60.PSV02.005
	THERMAL MOUDLE-PARK	60.PSZ02.001
	THERMAL MOUDLE-MADISON	60.PSX02.001
SPEAKER		
	MIC SET	23.PSV02.001
	SPEAKER R	23.PSV02.002
	SPEAKER L	23.PSV02.003
MISCELLANEOUS		
	LCD SCREW PAD	47.PSV02.001

CATEGORY	Acer Description	AcerPN
CPU/PROCESSOR		
	CPU INTEL CORE I5 520M 2.4G 3M	KC.52001.DMP
	CPU INTEL CORE I5 430M PGA 2.26G ARD, UP TO SC 2.53G, 3M L3	KC.43001.DMP
	CPU INTEL CORE I3 330M PGA 2.13G 35W ARRANDALE, TJ90, VT, 3M L3	KC.33001.DMP
LCD PANEL		
	LED LCD AUO 15.6"W WXGA GLARE B156XW02 V2 LF 200NIT 8MS 500:1 (POWER SAVING)	LK.15605.010
	LED LCD LPL 15.6"W WXGA GLARE LP156WH2-TLE1 LF 220NIT 8MS 400:1	LK.15608.002
	LED LCD CMO 15.6"W WXGA GLARE N156B6-L0B LF 220NIT 8MS 650:1	LK.1560D.010
	LED LCD INNOLUX 15.6"W WXGA GLARE BT156GW01 V2 LF 220NIT 8MS 600:1	LK.1560N.001
HDD/HARD DISK DRIVE		
	HDD HGST 2.5" 5400RPM 160GB HTS545016B9A300 PANTHER B SATA LF F/W:C60F DISK IMBALANCE CRITERIA = 0.014G-CM	KH.16007.026
	HDD HGST 2.5" 5400RPM 250GB HTS545025B9A300 PANTHER B SATA LF F/W:C60F DISK IMBALANCE CRITERIA = 0.014G-CM	KH.25007.016
	HDD HGST 2.5" 5400RPM 320GB HTS545032B9A300 PANTHER B SATA LF F/W:C60F DISK IMBALANCE CRITERIA = 0.014G-CM	KH.32007.008
	HDD SEAGATE 2.5" 5400RPM 500GB ST9500325AS WYATT SATA LF F/W:0001SDM1	KH.50001.011
	HDD HGST 2.5" 5400RPM 500GB HTS545050B9A300 PANTHER B SATA LF F/W:C60F DISK IMBALANCE CRITERIA = 0.014G-CM	KH.50007.010
	HDD SEAGATE 2.5" 5400RPM 160GB ST9160314AS WYATT SATA LF F/W:0001SDM1	KH.16001.042
	HDD SEAGATE 2.5" 5400RPM 320GB ST9320325AS WYATT SATA LF F/W:0001SDM1	KH.32001.017
	HDD WD 2.5" 5400RPM 640GB WD6400BEVT-22A0RT0, ML320 SATA 8MB LF F/W:01.01A01	KH.64008.004
	HDD WD 2.5" 5400RPM 160GB WD1600BEVT-22A23T0 , WD, ML320S SATA 8MB LF F/W:01.01A01	KH.16008.027
	HDD WD 2.5" 5400RPM 250GB WD2500BEVT-22A23T0, WD, ML320S SATA 8MB LF F/W:01.01A01.	KH.25008.025
	HDD WD 2.5" 5400RPM 320GB WD3200BEVT-22A23T0,ML320S,WD SATA 8MB LF F/W:01.01A01	KH.32008.019
	HDD TOSHIBA 2.5" 5400RPM 160GB MK1665GSX, CAPRICORN BS, 320G/P SATA 8MB LF F/W:GJ002J	KH.16004.008
	HDD TOSHIBA 2.5" 5400RPM 320GB CAPRICORN BS ,MK3265GSX SATA 8MB LF F/W:GJ002J	KH.32004.004
HDD TOSHIBA 2.5" 5400RPM 500GB MK5065GSX,CAPRICORN BS, 320G/P SATA 8MB LF F/W:GJ002J	KH.50004.002	

CATEGORY	Acer Description	AcerPN
	HDD TOSHIBA 2.5" 5400RPM 250GB MK2565GSX, CAPRICORN BS, 320G/P SATA 8MB LF F/W:GJ002J	KH.25004.005
DVD RW DRIVE		
	ODD TOSHIBA SUPER-MULTI DRIVE 12.7MM TRAY DL 8X TS-L633C LF W/O BEZEL SATA (HF + WINDOWS 7)	KU.00801.035
	ODD HLDS SUPER-MULTI DRIVE 12.7MM TRAY DL 8X GT30N LF W/O BEZEL SATA (HF + WINDOWS 7)	KU.0080D.048
	ODD PANASONIC SUPER-MULTI DRIVE 12.7MM TRAY DL 8X UJ890A LF W/O BEZEL SATA (HF + WINDOWS 7)	KU.00807.070
	ODD SONY SUPER-MULTI DRIVE 12.7MM TRAY DL 8X AD-7585H LF W/O BEZEL SATA (HF + WINDOWS 7)	KU.0080E.027
	ODD PLDS SUPER-MULTI DRIVE 12.7MM TRAY DL 8X DS-8A4SH LF W/O BEZEL SATA (HF + WINDOWS 7)	KU.0080F.006
BD COMBO DRIVE		
	ODD PLDS BD COMBO 12.7MM TRAY DL 4X DS-4E1S LF W/O BEZEL SATA (WINDOWS 7)	KO.0040F.003
	ODD HLDS BD COMBO 12.7MM TRAY DL 4X CT21N LF W/O BEZEL 1.00 SATA (HF + WINDOWS 7)	KO.0040D.004
	ODD SONY BD COMBO 12.7MM TRAY DL 4X BC-5500H LF W/O BEZEL SATA (HF + WINDOWS 7)	KO.0040E.003
BATTERY		
	BATTERY SANYO AS10D LI-ION 3S2P SANYO 6 CELL 4400MAH MAIN COMMON ID:AS10D31	BT.00603.111
	BATTERY SAMSUNG AS10D LI-ION 3S2P SAMSUNG 6 CELL 4400MAH MAIN COMMON ID:AS10D61	BT.00606.008
	BATTERY SIMPLO AS10D LI-ION 3S2P PANASONIC 6 CELL 4400MAH MAIN COMMON ID:AS10D71	BT.00607.125
	BATTERY SIMPLO AS10D LI-ION 3S2P SAMSUNG 6 CELL 4400MAH MAIN COMMON ID:AS10D	BT.00607.127
MEMORY		
	MEMORY MICRON SO-DIMM DDRIII 1066 2GB MT16JSF25664HZ-1G1F1 LF 128*8 0.065UM	KN.2GB04.015
	MEMORY SAMSUNG SO-DIMM DDRIII 1066 2GB M471B5673EH1-CF8 LF 128*8 0.055UM	KN.2GB0B.012
	MEMORY SAMSUNG SO-DIMM DDRIII 1066 1GB M471B2873EH1-CF8 LF 64*16 0.055UM	KN.1GB0B.028
	MEMORY ELPIDA SO-DIMM DDRIII 1066 2GB EBJ21UE8BDS0-AE-F LF 128*8 0.065UM	KN.2GB09.006
	MEMORY ELPIDA SO-DIMM DDRIII 1066 1GB EBJ10UE8BDS0-AE-F LF 128*8 0.065UM	KN.1GB09.012

CATEGORY	Acer Description	AcerPN
ADAPTER		
	ADAPTER LITE-ON 90W 19V 1.7X5.5X11 BLUE PA-1900-34AR, LV5 LED LF	AP.09003.021
	ADAPTER DELTA 90W 19V 1.7X5.5X11 BLUE ADP-90CD DB A, LV5 LED LF	AP.09001.027
	ADAPTER DELTA 65W 19V 1.7X5.5X11 YELLOW ADP-65JH DB A, LV5 LED LF	AP.06501.026
	ADAPTER LITE-ON 65W 19V 1.7X5.5X11 YELLOW PA-1650-22AC LV5 LED LF	AP.06503.024
	ADAPTER HIPRO 65W 19V 1.7X5.5X11 YELLOW HP-A0652R3B 1LF, LV5 LED LF	AP.0650A.012
	ADAPTER HIPRO 90W 19V 1.7X5.5X11 BLUE HP-A0904A3 B1LF, LV5 LED LF	AP.0900A.005

Screw List

CATEGORY	DESCRIPTION	AcerPN
SCREW		
	SCREW 2.5D 5L K 5.5D ZK NL CR3	86.PSV02.001
	SCREW 2.45D 8.0L K 5.5D 0.8T ZK NL	86.PSV02.002
	SCREW 2.5D 6L K 5.5D NI NL	86.PSV02.003
	SCREW 1.98D 3.0L K 4.6D 0.8T ZK NL	86.PSV02.004
	SCREW 3.0D 3.0L K 4.9D NI	86.PSV02.005
	SCREW ASSY CPU THERMA	86.PSV02.006
	SCREW 2.0D 3L K 3.5D ZK NL	86.PSV02.007

Model Definition and Configuration

Aspire 5741

Model	Acer Part No	RO	Country	Description
AS5741-352G32Mn	LX.PSV0C.010	AAP	Vietnam	AS5741-352G32Mn LINPUSAVN1 UMACsk_3 1*2G/320/BT/6L2.2/5R/ CB_bgn_1.3C_GEs_EN11
AS5741-333G32Mn	LX.PSV0C.009	AAP	India	AS5741-333G32Mn LINPUSAIN1 UMACsk_3 2G+1G/320/BT/6L2.2/5R/ CB_bgn_1.3C_GEs_EN11
AS5741-353G50Mn	LX.PSV0C.008	AAP	Vietnam	AS5741-353G50Mn LINPUSAVN1 UMACsk_3 2G+1G/500_L/BT/6L2.2/5R/ CB_bgn_1.3C_GEs_EN11
AS5741-332G25Mn	LX.PSV0C.007	AAP	India	AS5741-332G25Mn LINPUSAIN1 UMACsk_3 1*2G/250/BT/6L2.2/5R/ CB_bgn_1.3C_GEs_EN11
AS5741-334G64Mn	LX.PSV02.091	EMEA	Spain	AS5741-334G64Mn W7HP64ATES1 MC UMACsk_3 2*2G/640/6L2.2/5R/ CB_bgn_1.3C_GEs_ES51
AS5741-333G32Mn	LX.PSV0C.006	EMEA	Eastern Europe	AS5741-333G32Mn LINPUSAEU5 UMACsk_3 2G+1G/320/BT/6L2.2/5R/ CB_bgn_1.3C_GEs_ENF1
AS5741-334G32Mn	LX.PSV02.090	EMEA	Germany	AS5741-334G32Mn W7HP64ATDE1 MC UMACsk_3 2*2G/320/6L2.2/5R/ CB_bgn_1.3C_GEs_DE11
AS5741-432G32Mn	LX.PSV02.089	AAP	Australia/New Zealand	AS5741-432G32Mn W7HP64ATAU1 MC UMACsk_3 1*2G/320/6L2.2/5R/ CB_bgn_1.3C_GEs_ES61
AS5741-334G32Mn	LX.PSV02.088	AAP	Australia/New Zealand	AS5741-334G32Mn W7HP64ATAU1 MC UMACsk_3 2*2G/320/6L2.2/5R/ CB_bgn_1.3C_GEs_ES61
AS5741-434G32Mn	LX.PSV02.087	AAP	Australia/New Zealand	AS5741-434G32Mn W7HP64ATAU1 MC UMACsk_3 2*2G/320/6L2.2/5R/ CB_bgn_1.3C_GEs_ES61
AS5741-332G32Mn	LX.PSV02.086	AAP	Australia/New Zealand	AS5741-332G32Mn W7HP64ATAU1 MC UMACsk_3 1*2G/320/6L2.2/5R/ CB_bgn_1.3C_GEs_ES61
AS5741-332G25Mn	LX.PSV0C.004	EMEA	Middle East	AS5741-332G25Mn LINPUSAME2 UMACsk_3 1*2G/250/BT/6L2.2/5R/ CB_bgn_1.3C_GEs_EN13
AS5741-333G32Mn	LX.PSV0C.005	EMEA	Middle East	AS5741-333G32Mn LINPUSAME2 UMACsk_3 2G+1G/320/BT/6L2.2/5R/ CB_bgn_1.3C_GEs_EN13
AS5741-332G32Mn	LX.PSV02.085	AAP	Korea	AS5741-332G32Mn W7HP64KATKR1 MC UMACsk_3 1*2G/320/6L2.2/5R/ CB_bgn_1.3C_GEs_KO11
AS5741-334G25Mn	LX.PSV02.084	EMEA	Poland	AS5741-334G25Mn W7HP64ATPL1 MC UMACsk_3 2*2G/250/6L2.2/5R/ CB_bgn_1.3C_GEs_PL11
AS5741-334G32Mn	LX.PSV02.083	EMEA	Italy	AS5741-334G32Mn W7HP64ATIT1 MC UMACsk_3 2*2G/320/6L2.2/5R/ CB_bgn_1.3C_GEs_IT11
AS5741-433G25Mn	LX.PSV02.082	EMEA	Holland	AS5741-433G25Mn W7HP64ATNL1 MC UMACsk_3 2G+1G/250/6L2.2/5R/ CB_bgn_1.3C_GEs_NL11

Model	Acer Part No	RO	Country	Description
AS5741-433G25Mn	LX.PSV02.081	EMEA	Luxembourg	AS5741-433G25Mn W7HP64ATLU3 MC UMACsk_3 2G+1G/250/6L2.2/5R/ CB_bgn_1.3C_GEs_IT41
AS5741-433G25Mn	LX.PSV02.080	EMEA	Belgium	AS5741-433G25Mn W7HP64ATBE1 MC UMACsk_3 2G+1G/250/6L2.2/5R/ CB_bgn_1.3C_GEs_NL11
AS5741-334G32Mn	LX.PSV02.079	EMEA	Denmark	AS5741-334G32Mn W7HP64ATDK2 MC UMACsk_3 2*2G/320/6L2.2/5R/ CB_bgn_1.3C_GEs_ENS1
AS5741-332G64Mn	LX.PSV02.078	TWN	GCTWN	AS5741-332G64Mn W7HP64ATTW1 MC UMACsk_3 1*2G/640/BT/6L2.2/5R/ CB_bgn_1.3C_GEs_TC11
AS5741-334G32Mn	LX.PSV02.077	EMEA	Switzerland	AS5741-334G32Mn W7HP64ATCH1 MC UMACsk_3 2*2G/320/6L2.2/5R/ CB_bgn_1.3C_GEs_IT41
AS5741-333G25Mn	LX.PSV02.076	EMEA	Holland	AS5741-333G25Mn W7HP64ATNL1 MC UMACsk_3 2G+1G/250/6L2.2/5R/ CB_bgn_1.3C_GEs_NL11
AS5741-333G25Mn	LX.PSV02.075	EMEA	Luxembourg	AS5741-333G25Mn W7HP64ATLU3 MC UMACsk_3 2G+1G/250/6L2.2/5R/ CB_bgn_1.3C_GEs_IT41
AS5741-334G32Mn	LX.PSV02.073	EMEA	Luxembourg	AS5741-334G32Mn W7HP64ATLU3 MC UMACsk_3 2*2G/320/6L2.2/5R/ CB_bgn_1.3C_GEs_IT41
AS5741-334G32Mn	LX.PSV02.074	EMEA	Holland	AS5741-334G32Mn W7HP64ATNL1 MC UMACsk_3 2*2G/320/6L2.2/5R/ CB_bgn_1.3C_GEs_NL11
AS5741-333G25Mn	LX.PSV02.072	EMEA	Belgium	AS5741-333G25Mn W7HP64ATBE1 MC UMACsk_3 2G+1G/250/6L2.2/5R/ CB_bgn_1.3C_GEs_NL11
AS5741-334G50Mn	LX.PSV02.071	EMEA	Holland	AS5741-334G50Mn W7HP64ATNL1 MC UMACsk_3 2*2G/500_L/6L2.2/5R/ CB_bgn_1.3C_GEs_NL11
AS5741-334G50Mn	LX.PSV02.070	EMEA	Luxembourg	AS5741-334G50Mn W7HP64ATLU3 MC UMACsk_3 2*2G/500_L/6L2.2/5R/ CB_bgn_1.3C_GEs_IT41
AS5741-334G50Mn	LX.PSV02.069	EMEA	Belgium	AS5741-334G50Mn W7HP64ATBE1 MC UMACsk_3 2*2G/500_L/6L2.2/5R/ CB_bgn_1.3C_GEs_NL11
AS5741-334G64Mn	LX.PSV02.068	EMEA	Holland	AS5741-334G64Mn W7HP64ATNL1 MC UMACsk_3 2*2G/640/6L2.2/5R/ CB_bgn_1.3C_GEs_NL11
AS5741-334G64Mn	LX.PSV02.067	EMEA	Luxembourg	AS5741-334G64Mn W7HP64ATLU3 MC UMACsk_3 2*2G/640/6L2.2/5R/ CB_bgn_1.3C_GEs_IT41
AS5741-334G64Mn	LX.PSV02.066	EMEA	Belgium	AS5741-334G64Mn W7HP64ATBE1 MC UMACsk_3 2*2G/640/6L2.2/5R/ CB_bgn_1.3C_GEs_NL11
AS5741-334G32Mn	LX.PSV02.065	EMEA	Belgium	AS5741-334G32Mn W7HP64ATBE1 MC UMACsk_3 2*2G/320/6L2.2/5R/ CB_bgn_1.3C_GEs_NL11

Model	Acer Part No	RO	Country	Description
AS5741-332G32Mn	LX.PSV01.001	CHINA	China	AS5741-332G32Mn W7HB64SCATCN1 MC UMACsk_3 1*2G/320/6L2.2/5R/ CB_bgn_1.3C_GEs_SC13
AS5741-354G50Mn	LX.PSV02.064	AAP	Singapore	AS5741-354G50Mn W7HP64ATSG1 MC UMACsk_3 2*2G/500_L/BT/6L2.2/5R/ CB_bgn_1.3C_GEs_ZH31
AS5741-354G32Mn	LX.PSV02.063	AAP	Singapore	AS5741-354G32Mn W7HP64ATSG1 MC UMACsk_3 2*2G/320/BT/6L2.2/5R/ CB_bgn_1.3C_GEs_ZH31
AS5741-334G32Mn	LX.PSV02.062	AAP	Singapore	AS5741-334G32Mn W7HP64ATSG1 MC UMACsk_3 2*2G/320/BT/6L2.2/5R/ CB_bgn_1.3C_GEs_ZH31
AS5741-333G32Mn	LX.PSV02.061	AAP	Singapore	AS5741-333G32Mn W7HP64ATSG1 MC UMACsk_3 2G+1G/320/BT/6L2.2/5R/ CB_bgn_1.3C_GEs_ZH31
AS5741-333G32Mn	LX.PSV0C.003	AAP	Singapore	AS5741-333G32Mn LINPUSASG1 UMACsk_3 2G+1G/320/BT/6L2.2/5R/ CB_bgn_1.3C_GEs_EN11
AS5741-332G32Mn	LX.PSV0C.002	AAP	Singapore	AS5741-332G32Mn LINPUSASG1 UMACsk_3 1*2G/320/BT/6L2.2/5R/ CB_bgn_1.3C_GEs_EN11
AS5741-332G32Mn	LX.PSV0C.001	CHINA	China	AS5741-332G32Mn LINPUSACN1 UMACsk_3 1*2G/320/6L2.2/5R/ CB_bgn_1.3C_GEs_EN91
AS5741-333G32Mn	LX.PSV02.060	EMEA	Ukraine	AS5741-333G32Mn W7HP64RUATUK1 MC UMACsk_3 2G+1G/320/6L2.2/5R/ CB_bgn_1.3C_GEs_RU61
AS5741-333G32Mi	LX.PSV02.059	EMEA	Russia	AS5741-333G32Mi W7HP64RUATRU1 MC UMACsk_3 2G+1G/320/6L2.2/5R/ CB_bg_1.3C_GEs_RU11
AS5741-333G32Mn	LX.PSV02.058	EMEA	Middle East	AS5741-333G32Mn EM W7HP64EMATME4 MC UMACsk_3 2G+1G/320/6L2.2/5R/ CB_bgn_1.3C_GEs_RU61
AS5741-333G32Mn	LX.PSV02.057	EMEA	Middle East	AS5741-333G32Mn EM W7HP64EMATME2 MC UMACsk_3 2G+1G/320/6L2.2/5R/ CB_bgn_1.3C_GEs_ES61
AS5741-333G32Mn	LX.PSV02.056	EMEA	South Africa	AS5741-333G32Mn EM W7HP64EMATZA2 MC UMACsk_3 2G+1G/320/6L2.2/5R/ CB_bgn_1.3C_GEs_ES61
AS5741-333G32Mn	LX.PSV02.055	EMEA	Turkey	AS5741-333G32Mn EM W7HP64EMATTR1 MC UMACsk_3 2G+1G/320/6L2.2/5R/ CB_bgn_1.3C_GEs_TR31
AS5741-333G32Mn	LX.PSV02.054	EMEA	Middle East	AS5741-333G32Mn EM W7HP64EMATMEB MC UMACsk_3 2G+1G/320/6L2.2/5R/ CB_bgn_1.3C_GEs_ARA1

Model	Acer Part No	RO	Country	Description
AS5741-333G32Mn	LX.PSV02.053	EMEA	Middle East	AS5741-333G32Mn EM W7HP64EMATME2 MC UMACsk_3 2G+1G/320/6L2.2/5R/ CB_bgn_1.3C_GEs_AR21
AS5741-333G32Mn	LX.PSV02.052	EMEA	Middle East	AS5741-333G32Mn EM W7HP64EMATME9 MC UMACsk_3 2G+1G/320/6L2.2/5R/ CB_bgn_1.3C_GEs_ES81
AS5741-333G32Mn	LX.PSV02.051	EMEA	Germany	AS5741-333G32Mn W7HP64ATDE1 MC UMACsk_3 2G+1G/320/6L2.2/5R/ CB_bgn_1.3C_GEs_DE11
AS5741-333G32Mn	LX.PSV02.050	EMEA	Poland	AS5741-333G32Mn W7HP64ATPL1 MC UMACsk_3 2G+1G/320/6L2.2/5R/ CB_bgn_1.3C_GEs_PL11
AS5741-333G32Mn	LX.PSV02.048	EMEA	Luxembourg	AS5741-333G32Mn W7HP64ATLU3 MC UMACsk_3 2G+1G/320/6L2.2/5R/ CB_bgn_1.3C_GEs_IT41
AS5741-333G32Mn	LX.PSV02.049	EMEA	Baltic	AS5741-333G32Mn W7HP64ATBC5 MC UMACsk_3 2G+1G/320/6L2.2/5R/ CB_bgn_1.3C_GEs_LT11
AS5741-333G32Mn	LX.PSV02.047	EMEA	Holland	AS5741-333G32Mn W7HP64ATNL1 MC UMACsk_3 2G+1G/320/6L2.2/5R/ CB_bgn_1.3C_GEs_NL11
AS5741-333G32Mn	LX.PSV02.046	EMEA	Belgium	AS5741-333G32Mn W7HP64ATBE1 MC UMACsk_3 2G+1G/320/6L2.2/5R/ CB_bgn_1.3C_GEs_NL11
AS5741-333G32Mn	LX.PSV02.045	EMEA	Switzerland	AS5741-333G32Mn W7HP64ATCH1 MC UMACsk_3 2G+1G/320/6L2.2/5R/ CB_bgn_1.3C_GEs_IT41
AS5741-333G32Mn	LX.PSV02.044	EMEA	Algeria	AS5741-333G32Mn EM W7HP64EMATDZ1 MC UMACsk_3 2G+1G/320/6L2.2/5R/ CB_bgn_1.3C_GEs_ES81
AS5741-333G32Mn	LX.PSV02.043	EMEA	South Africa	AS5741-333G32Mn EM W7HP64EMATZA1 MC UMACsk_3 2G+1G/320/6L2.2/5R/ CB_bgn_1.3C_GEs_ES81
AS5741-333G32Mn	LX.PSV02.042	EMEA	Middle East	AS5741-333G32Mn EM W7HP64EMATME4 MC UMACsk_3 2G+1G/320/6L2.2/5R/ CB_bgn_1.3C_GEs_ES61
AS5741-333G32Mn	LX.PSV02.041	EMEA	Middle East	AS5741-333G32Mn EM W7HP64EMATME2 MC UMACsk_3 2G+1G/320/6L2.2/5R/ CB_bgn_1.3C_GEs_AR11
AS5741-333G32Mn	LX.PSV02.040	EMEA	Middle East	AS5741-333G32Mn EM W7HP64EMATME3 MC UMACsk_3 2G+1G/320/6L2.2/5R/ CB_bgn_1.3C_GEs_ES81
AS5741-333G32Mn	LX.PSV02.039	EMEA	Middle East	AS5741-333G32Mn EM W7HP64EMATME6 MC UMACsk_3 2G+1G/320/6L2.2/5R/ CB_bgn_1.3C_GEs_ES61

Model	Acer Part No	RO	Country	Description
AS5741-333G32Mn	LX.PSV02.038	EMEA	South Africa	AS5741-333G32Mn EM W7HP64EMATZA4 MC UMACsk_3 2G+1G/320/6L2.2/5R/ CB_bgn_1.3C_GEs_ES61
AS5741-333G32Mn	LX.PSV02.037	EMEA	Eastern Europe	AS5741-333G32Mn W7HP64ATEU5 MC UMACsk_3 2G+1G/320/6L2.2/5R/ CB_bgn_1.3C_GEs_RO11
AS5741-333G32Mn	LX.PSV02.036	EMEA	Latvia	AS5741-333G32Mn W7HP64ATLV1 MC UMACsk_3 2G+1G/320/6L2.2/5R/ CB_bgn_1.3C_GEs_RU22
AS5741-333G32Mn	LX.PSV02.035	EMEA	Latvia	AS5741-333G32Mn W7HP64ATLV1 MC UMACsk_3 2G+1G/320/6L2.2/5R/ CB_bgn_1.3C_GEs_LT11
AS5741-333G32Mn	LX.PSV02.034	EMEA	Eastern Europe	AS5741-333G32Mn W7HP64ATEU5 MC UMACsk_3 2G+1G/320/6L2.2/5R/ CB_bgn_1.3C_GEs_PL71
AS5741-333G32Mn	LX.PSV02.033	EMEA	UK	AS5741-333G32Mn W7HP64ATGB1 MC UMACsk_3 2G+1G/320/6L2.2/5R/ CB_bgn_1.3C_GEs_EN11
AS5741-333G32Mn	LX.PSV02.032	EMEA	Hungary	AS5741-333G32Mn W7HP64ATHU1 MC UMACsk_3 2G+1G/320/6L2.2/5R/ CB_bgn_1.3C_GEs_HU11
AS5741-333G32Mn	LX.PSV02.031	EMEA	Israel	AS5741-333G32Mn W7HP64ATIL1 MC UMACsk_3 2G+1G/320/6L2.2/5R/ CB_bgn_1.3C_GEs_HE11
AS5741-333G32Mn	LX.PSV02.030	EMEA	Czech	AS5741-333G32Mn W7HP64ATCZ2 MC UMACsk_3 2G+1G/320/6L2.2/5R/ CB_bgn_1.3C_GEs_SK11
AS5741-333G32Mn	LX.PSV02.029	EMEA	Baltic	AS5741-333G32Mn W7HP64ATBC4 MC UMACsk_3 2G+1G/320/6L2.2/5R/ CB_bgn_1.3C_GEs_LT11
AS5741-333G32Mn	LX.PSV02.028	EMEA	Portugal	AS5741-333G32Mn W7HP64ATPT1 MC UMACsk_3 2G+1G/320/6L2.2/5R/ CB_bgn_1.3C_GEs_PT11
AS5741-333G32Mn	LX.PSV02.027	EMEA	Cyprus	AS5741-333G32Mn W7HP64ATCY1 MC UMACsk_3 2G+1G/320/6L2.2/5R/ CB_bgn_1.3C_GEs_ES61
AS5741-333G32Mn	LX.PSV02.026	EMEA	Baltic	AS5741-333G32Mn W7HP64ATBC3 MC UMACsk_3 2G+1G/320/6L2.2/5R/ CB_bgn_1.3C_GEs_SV21
AS5741-333G32Mn	LX.PSV02.025	EMEA	Serbia/ Macedonia	AS5741-333G32Mn W7HP64ATCS1 MC UMACsk_3 2G+1G/320/6L2.2/5R/ CB_bgn_1.3C_GEs_SL11
AS5741-333G32Mn	LX.PSV02.024	EMEA	Eastern Europe	AS5741-333G32Mn W7HP64ATEU4 MC UMACsk_3 2G+1G/320/6L2.2/5R/ CB_bgn_1.3C_GEs_SV21
AS5741-333G32Mn	LX.PSV02.023	EMEA	Italy	AS5741-333G32Mn W7HP64ATIT1 MC UMACsk_3 2G+1G/320/6L2.2/5R/ CB_bgn_1.3C_GEs_IT11
AS5741-333G32Mn	LX.PSV02.022	EMEA	Denmark	AS5741-333G32Mn W7HP64ATDK2 MC UMACsk_3 2G+1G/320/6L2.2/5R/ CB_bgn_1.3C_GEs_ENS1

Model	Acer Part No	RO	Country	Description
AS5741-333G32Mn	LX.PSV02.021	EMEA	Spain	AS5741-333G32Mn W7HP64ATES1 MC UMACsk_3 2G+1G/320/6L2.2/5R/ CB_bgn_1.3C_GEs_ES51
AS5741-333G32Mn	LX.PSV02.020	EMEA	Eastern Europe	AS5741-333G32Mn W7HP64ATEU7 MC UMACsk_3 2G+1G/320/6L2.2/5R/ CB_bgn_1.3C_GEs_ENQ1
AS5741-333G32Mn	LX.PSV02.019	EMEA	Greece	AS5741-333G32Mn W7HP64ATGR1 MC UMACsk_3 2G+1G/320/6L2.2/5R/ CB_bgn_1.3C_GEs_EL31
AS5741-333G32Mn	LX.PSV02.018	EMEA	Austria	AS5741-333G32Mn W7HP64ATAT1 MC UMACsk_3 2G+1G/320/6L2.2/5R/ CB_bgn_1.3C_GEs_DE61
AS5741-333G32Mn	LX.PSV02.017	EMEA	France	AS5741-333G32Mn W7HP64ATFR1 MC UMACsk_3 2G+1G/320/6L2.2/5R/ CB_bgn_1.3C_GEs_FR21
AS5741-333G32Mn	LX.PSV02.016	EMEA	Eastern Europe	AS5741-333G32Mn W7HP64ATEU7 MC UMACsk_3 2G+1G/320/6L2.2/5R/ CB_bgn_1.3C_GEs_SL11
AS5741-334G32Mn	LX.PSV02.015	PA	ACLA-Spanish	AS5741-334G32Mn EM W7HP64EMATEA1 MC UMACsk_3 2*2G/320/6L2.2/5R/CB_bgn_1.3C_GEs_ES51
AS5741-334G32Mn	LX.PSV02.014	PA	USA	AS5741-334G32Mn W7HP64ATUS1 MC UMACsk_3 2*2G/320/6L2.2/5R/ CB_bgn_1.3C_GEs_FRB5
AS5741-334G32Mn	LX.PSV02.013	PA	USA	AS5741-334G32Mn W7HP64ATUS1 MC UMACsk_3 2*2G/320/6L2.2/5R/ CB_bgn_1.3C_GEs_FRB1
AS5741-334G32Mn	LX.PSV02.012	PA	Canada	AS5741-334G32Mn W7HP64ATCA2 MC UMACsk_3 2*2G/320/6L2.2/5R/ CB_bgn_1.3C_GEs_FR81
AS5741-334G50Mn	LX.PSV02.011	PA	ACLA-Spanish	AS5741-334G50Mn EM W7HP64EMATEA1 MC UMACsk_3 2*2G/500_L/6L2.2/5R/ CB_bgn_1.3C_GEs_ES51
AS5741-334G50Mn	LX.PSV02.010	PA	USA	AS5741-334G50Mn W7HP64ATUS1 MC UMACsk_3 2*2G/500_L/6L2.2/5R/ CB_bgn_1.3C_GEs_FRB5
AS5741-333G32Mn	LX.PSV02.009	PA	ACLA-Spanish	AS5741-333G32Mn EM W7HP64EMATEA1 MC UMACsk_3 2G+1G/320/6L2.2/5R/ CB_bgn_1.3C_GEs_ES51
AS5741-333G32Mn	LX.PSV02.008	PA	USA	AS5741-333G32Mn W7HP64ATUS1 MC UMACsk_3 2G+1G/320/6L2.2/5R/ CB_bgn_1.3C_GEs_FRB5
AS5741-333G32Mn	LX.PSV02.007	PA	USA	AS5741-333G32Mn W7HP64ATUS1 MC UMACsk_3 2G+1G/320/6L2.2/5R/ CB_bgn_1.3C_GEs_FRB1
AS5741-334G50Mn	LX.PSV02.006	PA	USA	AS5741-334G50Mn W7HP64ATUS1 MC UMACsk_3 2*2G/500_L/6L2.2/5R/ CB_bgn_1.3C_GEs_FRB1
AS5741-334G50Mn	LX.PSV02.005	PA	Canada	AS5741-334G50Mn W7HP64ATCA2 MC UMACsk_3 2*2G/500_L/6L2.2/5R/ CB_bgn_1.3C_GEs_FR81

Model	Acer Part No	RO	Country	Description
AS5741-333G32Mn	LX.PSV02.004	PA	Canada	AS5741-333G32Mn W7HP64ATCA2 MC UMACsk_3 2G+1G/320/6L2.2/5R/ CB_bgn_1.3C_GEs_FR81
AS5741-332G25Mn	LX.PSV02.003	EMEA	UK	AS5741-332G25Mn W7HP64ATGB1 MC UMACsk_3 1*2G/250/6L2.2/5R/ CB_bgn_1.3C_GEs_EN11
AS5741-334G32Mn	LX.PSV02.002	EMEA	UK	AS5741-334G32Mn W7HP64ATGB1 MC UMACsk_3 2*2G/320/6L2.2/5R/ CB_bgn_1.3C_GEs_EN11
AS5741-333G25Mn	LX.PSV02.001	EMEA	UK	AS5741-333G25Mn W7HP64ATGB1 MC UMACsk_3 2G+1G/250/6L2.2/5R/ CB_bgn_1.3C_GEs_EN11
AS5741-352G32Mn	S2.PSV0C.001	WW	WW	AS5741-352G32Mn LIMPUSAWW1 UMACss 2*1G/320/6L2.2/5R/ CB_bgn_1.3C_GEs_EN11

Model	Acer Part No	CPU	LCD	VGA Chip	VRAM 1	Memory 1	Memory 2
AS5741-352G32Mn	LX.PSV0C.010	Ci3350M	NLED15.6 WXGAG	UMA	N	SO2GBIII10	N
AS5741-333G32Mn	LX.PSV0C.009	Ci3330M	NLED15.6 WXGAG	UMA	N	SO2GBIII10	SO1GBIII10
AS5741-353G50Mn	LX.PSV0C.008	Ci3350M	NLED15.6 WXGAG	UMA	N	SO2GBIII10	SO1GBIII10
AS5741-332G25Mn	LX.PSV0C.007	Ci3330M	NLED15.6 WXGAG	UMA	N	SO2GBIII10	N
AS5741-334G64Mn	LX.PSV02.091	Ci3330M	NLED15.6 WXGAG	UMA	N	SO2GBIII10	SO2GBIII10
AS5741-333G32Mn	LX.PSV0C.006	Ci3330M	NLED15.6 WXGAG	UMA	N	SO2GBIII10	SO1GBIII10
AS5741-334G32Mn	LX.PSV02.090	Ci3330M	NLED15.6 WXGAG	UMA	N	SO2GBIII10	SO2GBIII10
AS5741-432G32Mn	LX.PSV02.089	Ci5430M	NLED15.6 WXGAG	UMA	N	SO2GBIII10	N
AS5741-334G32Mn	LX.PSV02.088	Ci3330M	NLED15.6 WXGAG	UMA	N	SO2GBIII10	SO2GBIII10
AS5741-434G32Mn	LX.PSV02.087	Ci5430M	NLED15.6 WXGAG	UMA	N	SO2GBIII10	SO2GBIII10
AS5741-332G32Mn	LX.PSV02.086	Ci3330M	NLED15.6 WXGAG	UMA	N	SO2GBIII10	N
AS5741-332G25Mn	LX.PSV0C.004	Ci3330M	NLED15.6 WXGAG	UMA	N	SO2GBIII10	N
AS5741-333G32Mn	LX.PSV0C.005	Ci3330M	NLED15.6 WXGAG	UMA	N	SO2GBIII10	SO1GBIII10
AS5741-332G32Mn	LX.PSV02.085	Ci3330M	NLED15.6 WXGAG	UMA	N	SO2GBIII10	N
AS5741-334G25Mn	LX.PSV02.084	Ci3330M	NLED15.6 WXGAG	UMA	N	SO2GBIII10	SO2GBIII10
AS5741-334G32Mn	LX.PSV02.083	Ci3330M	NLED15.6 WXGAG	UMA	N	SO2GBIII10	SO2GBIII10

Model	Acer Part No	CPU	LCD	VGA Chip	VRAM 1	Memory 1	Memory 2
AS5741-433G25Mn	LX.PSV02.082	Ci5430M	NLED15.6 WXGAG	UMA	N	SO2GBIII10	SO1GBIII10
AS5741-433G25Mn	LX.PSV02.081	Ci5430M	NLED15.6 WXGAG	UMA	N	SO2GBIII10	SO1GBIII10
AS5741-433G25Mn	LX.PSV02.080	Ci5430M	NLED15.6 WXGAG	UMA	N	SO2GBIII10	SO1GBIII10
AS5741-334G32Mn	LX.PSV02.079	Ci3330M	NLED15.6 WXGAG	UMA	N	SO2GBIII10	SO2GBIII10
AS5741-332G64Mn	LX.PSV02.078	Ci3330M	NLED15.6 WXGAG	UMA	N	SO2GBIII10	N
AS5741-334G32Mn	LX.PSV02.077	Ci3330M	NLED15.6 WXGAG	UMA	N	SO2GBIII10	SO2GBIII10
AS5741-333G25Mn	LX.PSV02.076	Ci3330M	NLED15.6 WXGAG	UMA	N	SO2GBIII10	SO1GBIII10
AS5741-333G25Mn	LX.PSV02.075	Ci3330M	NLED15.6 WXGAG	UMA	N	SO2GBIII10	SO1GBIII10
AS5741-334G32Mn	LX.PSV02.073	Ci3330M	NLED15.6 WXGAG	UMA	N	SO2GBIII10	SO2GBIII10
AS5741-334G32Mn	LX.PSV02.074	Ci3330M	NLED15.6 WXGAG	UMA	N	SO2GBIII10	SO2GBIII10
AS5741-333G25Mn	LX.PSV02.072	Ci3330M	NLED15.6 WXGAG	UMA	N	SO2GBIII10	SO1GBIII10
AS5741-334G50Mn	LX.PSV02.071	Ci3330M	NLED15.6 WXGAG	UMA	N	SO2GBIII10	SO2GBIII10
AS5741-334G50Mn	LX.PSV02.070	Ci3330M	NLED15.6 WXGAG	UMA	N	SO2GBIII10	SO2GBIII10
AS5741-334G50Mn	LX.PSV02.069	Ci3330M	NLED15.6 WXGAG	UMA	N	SO2GBIII10	SO2GBIII10
AS5741-334G64Mn	LX.PSV02.068	Ci3330M	NLED15.6 WXGAG	UMA	N	SO2GBIII10	SO2GBIII10
AS5741-334G64Mn	LX.PSV02.067	Ci3330M	NLED15.6 WXGAG	UMA	N	SO2GBIII10	SO2GBIII10
AS5741-334G64Mn	LX.PSV02.066	Ci3330M	NLED15.6 WXGAG	UMA	N	SO2GBIII10	SO2GBIII10
AS5741-334G32Mn	LX.PSV02.065	Ci3330M	NLED15.6 WXGAG	UMA	N	SO2GBIII10	SO2GBIII10
AS5741-332G32Mn	LX.PSV01.001	Ci3330M	NLED15.6 WXGAG	UMA	N	SO2GBIII10	N
AS5741-354G50Mn	LX.PSV02.064	Ci3350M	NLED15.6 WXGAG	UMA	N	SO2GBIII10	SO2GBIII10
AS5741-354G32Mn	LX.PSV02.063	Ci3350M	NLED15.6 WXGAG	UMA	N	SO2GBIII10	SO2GBIII10
AS5741-334G32Mn	LX.PSV02.062	Ci3330M	NLED15.6 WXGAG	UMA	N	SO2GBIII10	SO2GBIII10
AS5741-333G32Mn	LX.PSV02.061	Ci3330M	NLED15.6 WXGAG	UMA	N	SO2GBIII10	SO1GBIII10
AS5741-333G32Mn	LX.PSV0C.003	Ci3330M	NLED15.6 WXGAG	UMA	N	SO2GBIII10	SO1GBIII10

Model	Acer Part No	CPU	LCD	VGA Chip	VRAM 1	Memory 1	Memory 2
AS5741-332G32Mn	LX.PSV0C.002	Ci3330M	NLED15.6 WXGAG	UMA	N	SO2GBIII10	N
AS5741-332G32Mn	LX.PSV0C.001	Ci3330M	NLED15.6 WXGAG	UMA	N	SO2GBIII10	N
AS5741-333G32Mn	LX.PSV02.060	Ci3330M	NLED15.6 WXGAG	UMA	N	SO2GBIII10	SO1GBIII10
AS5741-333G32Mi	LX.PSV02.059	Ci3330M	NLED15.6 WXGAG	UMA	N	SO2GBIII10	SO1GBIII10
AS5741-333G32Mn	LX.PSV02.058	Ci3330M	NLED15.6 WXGAG	UMA	N	SO2GBIII10	SO1GBIII10
AS5741-333G32Mn	LX.PSV02.057	Ci3330M	NLED15.6 WXGAG	UMA	N	SO2GBIII10	SO1GBIII10
AS5741-333G32Mn	LX.PSV02.056	Ci3330M	NLED15.6 WXGAG	UMA	N	SO2GBIII10	SO1GBIII10
AS5741-333G32Mn	LX.PSV02.055	Ci3330M	NLED15.6 WXGAG	UMA	N	SO2GBIII10	SO1GBIII10
AS5741-333G32Mn	LX.PSV02.054	Ci3330M	NLED15.6 WXGAG	UMA	N	SO2GBIII10	SO1GBIII10
AS5741-333G32Mn	LX.PSV02.053	Ci3330M	NLED15.6 WXGAG	UMA	N	SO2GBIII10	SO1GBIII10
AS5741-333G32Mn	LX.PSV02.052	Ci3330M	NLED15.6 WXGAG	UMA	N	SO2GBIII10	SO1GBIII10
AS5741-333G32Mn	LX.PSV02.051	Ci3330M	NLED15.6 WXGAG	UMA	N	SO2GBIII10	SO1GBIII10
AS5741-333G32Mn	LX.PSV02.050	Ci3330M	NLED15.6 WXGAG	UMA	N	SO2GBIII10	SO1GBIII10
AS5741-333G32Mn	LX.PSV02.048	Ci3330M	NLED15.6 WXGAG	UMA	N	SO2GBIII10	SO1GBIII10
AS5741-333G32Mn	LX.PSV02.049	Ci3330M	NLED15.6 WXGAG	UMA	N	SO2GBIII10	SO1GBIII10
AS5741-333G32Mn	LX.PSV02.047	Ci3330M	NLED15.6 WXGAG	UMA	N	SO2GBIII10	SO1GBIII10
AS5741-333G32Mn	LX.PSV02.046	Ci3330M	NLED15.6 WXGAG	UMA	N	SO2GBIII10	SO1GBIII10
AS5741-333G32Mn	LX.PSV02.045	Ci3330M	NLED15.6 WXGAG	UMA	N	SO2GBIII10	SO1GBIII10
AS5741-333G32Mn	LX.PSV02.044	Ci3330M	NLED15.6 WXGAG	UMA	N	SO2GBIII10	SO1GBIII10
AS5741-333G32Mn	LX.PSV02.043	Ci3330M	NLED15.6 WXGAG	UMA	N	SO2GBIII10	SO1GBIII10
AS5741-333G32Mn	LX.PSV02.042	Ci3330M	NLED15.6 WXGAG	UMA	N	SO2GBIII10	SO1GBIII10
AS5741-333G32Mn	LX.PSV02.041	Ci3330M	NLED15.6 WXGAG	UMA	N	SO2GBIII10	SO1GBIII10
AS5741-333G32Mn	LX.PSV02.040	Ci3330M	NLED15.6 WXGAG	UMA	N	SO2GBIII10	SO1GBIII10
AS5741-333G32Mn	LX.PSV02.039	Ci3330M	NLED15.6 WXGAG	UMA	N	SO2GBIII10	SO1GBIII10

Model	Acer Part No	CPU	LCD	VGA Chip	VRAM 1	Memory 1	Memory 2
AS5741-333G32Mn	LX.PSV02.03 8	Ci3330M	NLED15.6 WXGAG	UMA	N	SO2GBIII10	SO1GBIII10
AS5741-333G32Mn	LX.PSV02.03 7	Ci3330M	NLED15.6 WXGAG	UMA	N	SO2GBIII10	SO1GBIII10
AS5741-333G32Mn	LX.PSV02.03 6	Ci3330M	NLED15.6 WXGAG	UMA	N	SO2GBIII10	SO1GBIII10
AS5741-333G32Mn	LX.PSV02.03 5	Ci3330M	NLED15.6 WXGAG	UMA	N	SO2GBIII10	SO1GBIII10
AS5741-333G32Mn	LX.PSV02.03 4	Ci3330M	NLED15.6 WXGAG	UMA	N	SO2GBIII10	SO1GBIII10
AS5741-333G32Mn	LX.PSV02.03 3	Ci3330M	NLED15.6 WXGAG	UMA	N	SO2GBIII10	SO1GBIII10
AS5741-333G32Mn	LX.PSV02.03 2	Ci3330M	NLED15.6 WXGAG	UMA	N	SO2GBIII10	SO1GBIII10
AS5741-333G32Mn	LX.PSV02.03 1	Ci3330M	NLED15.6 WXGAG	UMA	N	SO2GBIII10	SO1GBIII10
AS5741-333G32Mn	LX.PSV02.03 0	Ci3330M	NLED15.6 WXGAG	UMA	N	SO2GBIII10	SO1GBIII10
AS5741-333G32Mn	LX.PSV02.02 9	Ci3330M	NLED15.6 WXGAG	UMA	N	SO2GBIII10	SO1GBIII10
AS5741-333G32Mn	LX.PSV02.02 8	Ci3330M	NLED15.6 WXGAG	UMA	N	SO2GBIII10	SO1GBIII10
AS5741-333G32Mn	LX.PSV02.02 7	Ci3330M	NLED15.6 WXGAG	UMA	N	SO2GBIII10	SO1GBIII10
AS5741-333G32Mn	LX.PSV02.02 6	Ci3330M	NLED15.6 WXGAG	UMA	N	SO2GBIII10	SO1GBIII10
AS5741-333G32Mn	LX.PSV02.02 5	Ci3330M	NLED15.6 WXGAG	UMA	N	SO2GBIII10	SO1GBIII10
AS5741-333G32Mn	LX.PSV02.02 4	Ci3330M	NLED15.6 WXGAG	UMA	N	SO2GBIII10	SO1GBIII10
AS5741-333G32Mn	LX.PSV02.02 3	Ci3330M	NLED15.6 WXGAG	UMA	N	SO2GBIII10	SO1GBIII10
AS5741-333G32Mn	LX.PSV02.02 2	Ci3330M	NLED15.6 WXGAG	UMA	N	SO2GBIII10	SO1GBIII10
AS5741-333G32Mn	LX.PSV02.02 1	Ci3330M	NLED15.6 WXGAG	UMA	N	SO2GBIII10	SO1GBIII10
AS5741-333G32Mn	LX.PSV02.02 0	Ci3330M	NLED15.6 WXGAG	UMA	N	SO2GBIII10	SO1GBIII10
AS5741-333G32Mn	LX.PSV02.01 9	Ci3330M	NLED15.6 WXGAG	UMA	N	SO2GBIII10	SO1GBIII10
AS5741-333G32Mn	LX.PSV02.01 8	Ci3330M	NLED15.6 WXGAG	UMA	N	SO2GBIII10	SO1GBIII10
AS5741-333G32Mn	LX.PSV02.01 7	Ci3330M	NLED15.6 WXGAG	UMA	N	SO2GBIII10	SO1GBIII10
AS5741-333G32Mn	LX.PSV02.01 6	Ci3330M	NLED15.6 WXGAG	UMA	N	SO2GBIII10	SO1GBIII10
AS5741-334G32Mn	LX.PSV02.01 5	Ci3330M	NLED15.6 WXGAG	UMA	N	SO2GBIII10	SO2GBIII10

Model	Acer Part No	CPU	LCD	VGA Chip	VRAM 1	Memory 1	Memory 2
AS5741-334G32Mn	LX.PSV02.014	Ci3330M	NLED15.6 WXGAG	UMA	N	SO2GBIII10	SO2GBIII10
AS5741-334G32Mn	LX.PSV02.013	Ci3330M	NLED15.6 WXGAG	UMA	N	SO2GBIII10	SO2GBIII10
AS5741-334G32Mn	LX.PSV02.012	Ci3330M	NLED15.6 WXGAG	UMA	N	SO2GBIII10	SO2GBIII10
AS5741-334G50Mn	LX.PSV02.011	Ci3330M	NLED15.6 WXGAG	UMA	N	SO2GBIII10	SO2GBIII10
AS5741-334G50Mn	LX.PSV02.010	Ci3330M	NLED15.6 WXGAG	UMA	N	SO2GBIII10	SO2GBIII10
AS5741-333G32Mn	LX.PSV02.009	Ci3330M	NLED15.6 WXGAG	UMA	N	SO2GBIII10	SO1GBIII10
AS5741-333G32Mn	LX.PSV02.008	Ci3330M	NLED15.6 WXGAG	UMA	N	SO2GBIII10	SO1GBIII10
AS5741-333G32Mn	LX.PSV02.007	Ci3330M	NLED15.6 WXGAG	UMA	N	SO2GBIII10	SO1GBIII10
AS5741-334G50Mn	LX.PSV02.006	Ci3330M	NLED15.6 WXGAG	UMA	N	SO2GBIII10	SO2GBIII10
AS5741-334G50Mn	LX.PSV02.005	Ci3330M	NLED15.6 WXGAG	UMA	N	SO2GBIII10	SO2GBIII10
AS5741-333G32Mn	LX.PSV02.004	Ci3330M	NLED15.6 WXGAG	UMA	N	SO2GBIII10	SO1GBIII10
AS5741-332G25Mn	LX.PSV02.003	Ci3330M	NLED15.6 WXGAG	UMA	N	SO2GBIII10	N
AS5741-334G32Mn	LX.PSV02.002	Ci3330M	NLED15.6 WXGAG	UMA	N	SO2GBIII10	SO2GBIII10
AS5741-333G25Mn	LX.PSV02.001	Ci3330M	NLED15.6 WXGAG	UMA	N	SO2GBIII10	SO1GBIII10
AS5741-352G32Mn	S2.PSV0C.001	Ci3350M	NLED15.6 WXGAG	UMA	N	SO1GBIII10	SO1GBIII10

Model	Acer Part No	Memory 3	Memory 4	HDD 1(GB)	HDD 2(GB)	ODD	Media Processor
AS5741-352G32Mn	LX.PSV0C.010	N	N	N320GB5.4KS	N	NSM8XS	N
AS5741-333G32Mn	LX.PSV0C.009	N	N	N320GB5.4KS	N	NSM8XS	N
AS5741-353G50Mn	LX.PSV0C.008	N	N	N500GB5.4KS	N	NSM8XS	N
AS5741-332G25Mn	LX.PSV0C.007	N	N	N250GB5.4KS	N	NSM8XS	N
AS5741-334G64Mn	LX.PSV02.091	N	N	N640GB5.4KS	N	NSM8XS	N
AS5741-333G32Mn	LX.PSV0C.006	N	N	N320GB5.4KS	N	NSM8XS	N
AS5741-334G32Mn	LX.PSV02.090	N	N	N320GB5.4KS	N	NSM8XS	N

Model	Acer Part No	Memory 3	Memory 4	HDD 1(GB)	HDD 2(GB)	ODD	Media Processor
AS5741-432G32Mn	LX.PSV02.089	N	N	N320GB5.4KS	N	NSM8XS	N
AS5741-334G32Mn	LX.PSV02.088	N	N	N320GB5.4KS	N	NSM8XS	N
AS5741-434G32Mn	LX.PSV02.087	N	N	N320GB5.4KS	N	NSM8XS	N
AS5741-332G32Mn	LX.PSV02.086	N	N	N320GB5.4KS	N	NSM8XS	N
AS5741-332G25Mn	LX.PSV0C.004	N	N	N250GB5.4KS	N	NSM8XS	N
AS5741-333G32Mn	LX.PSV0C.005	N	N	N320GB5.4KS	N	NSM8XS	N
AS5741-332G32Mn	LX.PSV02.085	N	N	N320GB5.4KS	N	NSM8XS	N
AS5741-334G25Mn	LX.PSV02.084	N	N	N250GB5.4KS	N	NSM8XS	N
AS5741-334G32Mn	LX.PSV02.083	N	N	N320GB5.4KS	N	NSM8XS	N
AS5741-433G25Mn	LX.PSV02.082	N	N	N250GB5.4KS	N	NSM8XS	N
AS5741-433G25Mn	LX.PSV02.081	N	N	N250GB5.4KS	N	NSM8XS	N
AS5741-433G25Mn	LX.PSV02.080	N	N	N250GB5.4KS	N	NSM8XS	N
AS5741-334G32Mn	LX.PSV02.079	N	N	N320GB5.4KS	N	NSM8XS	N
AS5741-332G64Mn	LX.PSV02.078	N	N	N640GB5.4KS	N	NSM8XS	N
AS5741-334G32Mn	LX.PSV02.077	N	N	N320GB5.4KS	N	NSM8XS	N
AS5741-333G25Mn	LX.PSV02.076	N	N	N250GB5.4KS	N	NSM8XS	N
AS5741-333G25Mn	LX.PSV02.075	N	N	N250GB5.4KS	N	NSM8XS	N
AS5741-334G32Mn	LX.PSV02.073	N	N	N320GB5.4KS	N	NSM8XS	N
AS5741-334G32Mn	LX.PSV02.074	N	N	N320GB5.4KS	N	NSM8XS	N
AS5741-333G25Mn	LX.PSV02.072	N	N	N250GB5.4KS	N	NSM8XS	N
AS5741-334G50Mn	LX.PSV02.071	N	N	N500GB5.4KS	N	NSM8XS	N
AS5741-334G50Mn	LX.PSV02.070	N	N	N500GB5.4KS	N	NSM8XS	N
AS5741-334G50Mn	LX.PSV02.069	N	N	N500GB5.4KS	N	NSM8XS	N
AS5741-334G64Mn	LX.PSV02.068	N	N	N640GB5.4KS	N	NSM8XS	N

Model	Acer Part No	Memory 3	Memory 4	HDD 1(GB)	HDD 2(GB)	ODD	Media Processor
AS5741-334G64Mn	LX.PSV02.067	N	N	N640GB5.4KS	N	NSM8XS	N
AS5741-334G64Mn	LX.PSV02.066	N	N	N640GB5.4KS	N	NSM8XS	N
AS5741-334G32Mn	LX.PSV02.065	N	N	N320GB5.4KS	N	NSM8XS	N
AS5741-332G32Mn	LX.PSV01.001	N	N	N320GB5.4KS	N	NSM8XS	N
AS5741-354G50Mn	LX.PSV02.064	N	N	N500GB5.4KS	N	NSM8XS	N
AS5741-354G32Mn	LX.PSV02.063	N	N	N320GB5.4KS	N	NSM8XS	N
AS5741-334G32Mn	LX.PSV02.062	N	N	N320GB5.4KS	N	NSM8XS	N
AS5741-333G32Mn	LX.PSV02.061	N	N	N320GB5.4KS	N	NSM8XS	N
AS5741-333G32Mn	LX.PSV0C.003	N	N	N320GB5.4KS	N	NSM8XS	N
AS5741-332G32Mn	LX.PSV0C.002	N	N	N320GB5.4KS	N	NSM8XS	N
AS5741-332G32Mn	LX.PSV0C.001	N	N	N320GB5.4KS	N	NSM8XS	N
AS5741-333G32Mn	LX.PSV02.060	N	N	N320GB5.4KS	N	NSM8XS	N
AS5741-333G32Mi	LX.PSV02.059	N	N	N320GB5.4KS	N	NSM8XS	N
AS5741-333G32Mn	LX.PSV02.058	N	N	N320GB5.4KS	N	NSM8XS	N
AS5741-333G32Mn	LX.PSV02.057	N	N	N320GB5.4KS	N	NSM8XS	N
AS5741-333G32Mn	LX.PSV02.056	N	N	N320GB5.4KS	N	NSM8XS	N
AS5741-333G32Mn	LX.PSV02.055	N	N	N320GB5.4KS	N	NSM8XS	N
AS5741-333G32Mn	LX.PSV02.054	N	N	N320GB5.4KS	N	NSM8XS	N
AS5741-333G32Mn	LX.PSV02.053	N	N	N320GB5.4KS	N	NSM8XS	N
AS5741-333G32Mn	LX.PSV02.052	N	N	N320GB5.4KS	N	NSM8XS	N
AS5741-333G32Mn	LX.PSV02.051	N	N	N320GB5.4KS	N	NSM8XS	N
AS5741-333G32Mn	LX.PSV02.050	N	N	N320GB5.4KS	N	NSM8XS	N
AS5741-333G32Mn	LX.PSV02.048	N	N	N320GB5.4KS	N	NSM8XS	N
AS5741-333G32Mn	LX.PSV02.049	N	N	N320GB5.4KS	N	NSM8XS	N

Model	Acer Part No	Memory 3	Memory 4	HDD 1(GB)	HDD 2(GB)	ODD	Media Processor
AS5741-333G32Mn	LX.PSV02.047	N	N	N320GB5.4KS	N	NSM8XS	N
AS5741-333G32Mn	LX.PSV02.046	N	N	N320GB5.4KS	N	NSM8XS	N
AS5741-333G32Mn	LX.PSV02.045	N	N	N320GB5.4KS	N	NSM8XS	N
AS5741-333G32Mn	LX.PSV02.044	N	N	N320GB5.4KS	N	NSM8XS	N
AS5741-333G32Mn	LX.PSV02.043	N	N	N320GB5.4KS	N	NSM8XS	N
AS5741-333G32Mn	LX.PSV02.042	N	N	N320GB5.4KS	N	NSM8XS	N
AS5741-333G32Mn	LX.PSV02.041	N	N	N320GB5.4KS	N	NSM8XS	N
AS5741-333G32Mn	LX.PSV02.040	N	N	N320GB5.4KS	N	NSM8XS	N
AS5741-333G32Mn	LX.PSV02.039	N	N	N320GB5.4KS	N	NSM8XS	N
AS5741-333G32Mn	LX.PSV02.038	N	N	N320GB5.4KS	N	NSM8XS	N
AS5741-333G32Mn	LX.PSV02.037	N	N	N320GB5.4KS	N	NSM8XS	N
AS5741-333G32Mn	LX.PSV02.036	N	N	N320GB5.4KS	N	NSM8XS	N
AS5741-333G32Mn	LX.PSV02.035	N	N	N320GB5.4KS	N	NSM8XS	N
AS5741-333G32Mn	LX.PSV02.034	N	N	N320GB5.4KS	N	NSM8XS	N
AS5741-333G32Mn	LX.PSV02.033	N	N	N320GB5.4KS	N	NSM8XS	N
AS5741-333G32Mn	LX.PSV02.032	N	N	N320GB5.4KS	N	NSM8XS	N
AS5741-333G32Mn	LX.PSV02.031	N	N	N320GB5.4KS	N	NSM8XS	N
AS5741-333G32Mn	LX.PSV02.030	N	N	N320GB5.4KS	N	NSM8XS	N
AS5741-333G32Mn	LX.PSV02.029	N	N	N320GB5.4KS	N	NSM8XS	N
AS5741-333G32Mn	LX.PSV02.028	N	N	N320GB5.4KS	N	NSM8XS	N
AS5741-333G32Mn	LX.PSV02.027	N	N	N320GB5.4KS	N	NSM8XS	N
AS5741-333G32Mn	LX.PSV02.026	N	N	N320GB5.4KS	N	NSM8XS	N
AS5741-333G32Mn	LX.PSV02.025	N	N	N320GB5.4KS	N	NSM8XS	N
AS5741-333G32Mn	LX.PSV02.024	N	N	N320GB5.4KS	N	NSM8XS	N

Model	Acer Part No	Memory 3	Memory 4	HDD 1(GB)	HDD 2(GB)	ODD	Media Processor
AS5741-333G32Mn	LX.PSV02.023	N	N	N320GB5.4KS	N	NSM8XS	N
AS5741-333G32Mn	LX.PSV02.022	N	N	N320GB5.4KS	N	NSM8XS	N
AS5741-333G32Mn	LX.PSV02.021	N	N	N320GB5.4KS	N	NSM8XS	N
AS5741-333G32Mn	LX.PSV02.020	N	N	N320GB5.4KS	N	NSM8XS	N
AS5741-333G32Mn	LX.PSV02.019	N	N	N320GB5.4KS	N	NSM8XS	N
AS5741-333G32Mn	LX.PSV02.018	N	N	N320GB5.4KS	N	NSM8XS	N
AS5741-333G32Mn	LX.PSV02.017	N	N	N320GB5.4KS	N	NSM8XS	N
AS5741-333G32Mn	LX.PSV02.016	N	N	N320GB5.4KS	N	NSM8XS	N
AS5741-334G32Mn	LX.PSV02.015	N	N	N320GB5.4KS	N	NSM8XS	N
AS5741-334G32Mn	LX.PSV02.014	N	N	N320GB5.4KS	N	NSM8XS	N
AS5741-334G32Mn	LX.PSV02.013	N	N	N320GB5.4KS	N	NSM8XS	N
AS5741-334G32Mn	LX.PSV02.012	N	N	N320GB5.4KS	N	NSM8XS	N
AS5741-334G50Mn	LX.PSV02.011	N	N	N500GB5.4KS	N	NSM8XS	N
AS5741-334G50Mn	LX.PSV02.010	N	N	N500GB5.4KS	N	NSM8XS	N
AS5741-333G32Mn	LX.PSV02.009	N	N	N320GB5.4KS	N	NSM8XS	N
AS5741-333G32Mn	LX.PSV02.008	N	N	N320GB5.4KS	N	NSM8XS	N
AS5741-333G32Mn	LX.PSV02.007	N	N	N320GB5.4KS	N	NSM8XS	N
AS5741-334G50Mn	LX.PSV02.006	N	N	N500GB5.4KS	N	NSM8XS	N
AS5741-334G50Mn	LX.PSV02.005	N	N	N500GB5.4KS	N	NSM8XS	N
AS5741-333G32Mn	LX.PSV02.004	N	N	N320GB5.4KS	N	NSM8XS	N
AS5741-332G25Mn	LX.PSV02.003	N	N	N250GB5.4KS	N	NSM8XS	N
AS5741-334G32Mn	LX.PSV02.002	N	N	N320GB5.4KS	N	NSM8XS	N
AS5741-333G25Mn	LX.PSV02.001	N	N	N250GB5.4KS	N	NSM8XS	N
AS5741-352G32Mn	S2.PSV0C.001	N	N	N320GB5.4KS	N	NSM8XS	N

Model	Acer Part No	Extra SW1	Card Reader	Wireless LAN1	Bluetooth	VOIP Phone	Finger Print
AS5741-352G32Mn	LX.PSV0C.010	N	5 in 1- Build in	3rd WiFi 2x2 BGN	BT 2.1	N	N
AS5741-333G32Mn	LX.PSV0C.009	N	5 in 1- Build in	3rd WiFi 2x2 BGN	BT 2.1	N	N
AS5741-353G50Mn	LX.PSV0C.008	N	5 in 1- Build in	3rd WiFi 2x2 BGN	BT 2.1	N	N
AS5741-332G25Mn	LX.PSV0C.007	N	5 in 1- Build in	3rd WiFi 2x2 BGN	BT 2.1	N	N
AS5741-334G64Mn	LX.PSV02.091	McAfee	5 in 1- Build in	3rd WiFi 2x2 BGN	N	N	N
AS5741-333G32Mn	LX.PSV0C.006	N	5 in 1- Build in	3rd WiFi 2x2 BGN	BT 2.1	N	N
AS5741-334G32Mn	LX.PSV02.090	McAfee	5 in 1- Build in	3rd WiFi 2x2 BGN	N	N	N
AS5741-432G32Mn	LX.PSV02.089	McAfee	5 in 1- Build in	3rd WiFi 2x2 BGN	N	N	N
AS5741-334G32Mn	LX.PSV02.088	McAfee	5 in 1- Build in	3rd WiFi 2x2 BGN	N	N	N
AS5741-434G32Mn	LX.PSV02.087	McAfee	5 in 1- Build in	3rd WiFi 2x2 BGN	N	N	N
AS5741-332G32Mn	LX.PSV02.086	McAfee	5 in 1- Build in	3rd WiFi 2x2 BGN	N	N	N
AS5741-332G25Mn	LX.PSV0C.004	N	5 in 1- Build in	3rd WiFi 2x2 BGN	BT 2.1	N	N
AS5741-333G32Mn	LX.PSV0C.005	N	5 in 1- Build in	3rd WiFi 2x2 BGN	BT 2.1	N	N
AS5741-332G32Mn	LX.PSV02.085	McAfee	5 in 1- Build in	3rd WiFi 2x2 BGN	N	N	N
AS5741-334G25Mn	LX.PSV02.084	McAfee	5 in 1- Build in	3rd WiFi 2x2 BGN	N	N	N
AS5741-334G32Mn	LX.PSV02.083	McAfee	5 in 1- Build in	3rd WiFi 2x2 BGN	N	N	N
AS5741-433G25Mn	LX.PSV02.082	McAfee	5 in 1- Build in	3rd WiFi 2x2 BGN	N	N	N
AS5741-433G25Mn	LX.PSV02.081	McAfee	5 in 1- Build in	3rd WiFi 2x2 BGN	N	N	N
AS5741-433G25Mn	LX.PSV02.080	McAfee	5 in 1- Build in	3rd WiFi 2x2 BGN	N	N	N
AS5741-334G32Mn	LX.PSV02.079	McAfee	5 in 1- Build in	3rd WiFi 2x2 BGN	N	N	N
AS5741-332G64Mn	LX.PSV02.078	McAfee	5 in 1- Build in	3rd WiFi 2x2 BGN	BT 2.1	N	N
AS5741-334G32Mn	LX.PSV02.077	McAfee	5 in 1- Build in	3rd WiFi 2x2 BGN	N	N	N
AS5741-333G25Mn	LX.PSV02.076	McAfee	5 in 1- Build in	3rd WiFi 2x2 BGN	N	N	N
AS5741-333G25Mn	LX.PSV02.075	McAfee	5 in 1- Build in	3rd WiFi 2x2 BGN	N	N	N

Model	Acer Part No	Extra SW1	Card Reader	Wireless LAN1	Bluetooth	VOIP Phone	Finger Print
AS5741-334G32Mn	LX.PSV02.073	McAfee	5 in 1-Build in	3rd WiFi 2x2 BGN	N	N	N
AS5741-334G32Mn	LX.PSV02.074	McAfee	5 in 1-Build in	3rd WiFi 2x2 BGN	N	N	N
AS5741-333G25Mn	LX.PSV02.072	McAfee	5 in 1-Build in	3rd WiFi 2x2 BGN	N	N	N
AS5741-334G50Mn	LX.PSV02.071	McAfee	5 in 1-Build in	3rd WiFi 2x2 BGN	N	N	N
AS5741-334G50Mn	LX.PSV02.070	McAfee	5 in 1-Build in	3rd WiFi 2x2 BGN	N	N	N
AS5741-334G50Mn	LX.PSV02.069	McAfee	5 in 1-Build in	3rd WiFi 2x2 BGN	N	N	N
AS5741-334G64Mn	LX.PSV02.068	McAfee	5 in 1-Build in	3rd WiFi 2x2 BGN	N	N	N
AS5741-334G64Mn	LX.PSV02.067	McAfee	5 in 1-Build in	3rd WiFi 2x2 BGN	N	N	N
AS5741-334G64Mn	LX.PSV02.066	McAfee	5 in 1-Build in	3rd WiFi 2x2 BGN	N	N	N
AS5741-334G32Mn	LX.PSV02.065	McAfee	5 in 1-Build in	3rd WiFi 2x2 BGN	N	N	N
AS5741-332G32Mn	LX.PSV01.001	McAfee	5 in 1-Build in	3rd WiFi 2x2 BGN	N	N	N
AS5741-354G50Mn	LX.PSV02.064	McAfee	5 in 1-Build in	3rd WiFi 2x2 BGN	BT 2.1	N	N
AS5741-354G32Mn	LX.PSV02.063	McAfee	5 in 1-Build in	3rd WiFi 2x2 BGN	BT 2.1	N	N
AS5741-334G32Mn	LX.PSV02.062	McAfee	5 in 1-Build in	3rd WiFi 2x2 BGN	BT 2.1	N	N
AS5741-333G32Mn	LX.PSV02.061	McAfee	5 in 1-Build in	3rd WiFi 2x2 BGN	BT 2.1	N	N
AS5741-333G32Mn	LX.PSV0C.003	N	5 in 1-Build in	3rd WiFi 2x2 BGN	BT 2.1	N	N
AS5741-332G32Mn	LX.PSV0C.002	N	5 in 1-Build in	3rd WiFi 2x2 BGN	BT 2.1	N	N
AS5741-332G32Mn	LX.PSV0C.001	N	5 in 1-Build in	3rd WiFi 2x2 BGN	N	N	N
AS5741-333G32Mn	LX.PSV02.060	McAfee	5 in 1-Build in	3rd WiFi 2x2 BGN	N	N	N
AS5741-333G32Mi	LX.PSV02.059	McAfee	5 in 1-Build in	3rd WiFi BG	N	N	N
AS5741-333G32Mn	LX.PSV02.058	McAfee	5 in 1-Build in	3rd WiFi 2x2 BGN	N	N	N
AS5741-333G32Mn	LX.PSV02.057	McAfee	5 in 1-Build in	3rd WiFi 2x2 BGN	N	N	N
AS5741-333G32Mn	LX.PSV02.056	McAfee	5 in 1-Build in	3rd WiFi 2x2 BGN	N	N	N
AS5741-333G32Mn	LX.PSV02.055	McAfee	5 in 1-Build in	3rd WiFi 2x2 BGN	N	N	N

Model	Acer Part No	Extra SW1	Card Reader	Wireless LAN1	Bluetooth	VOIP Phone	Finger Print
AS5741-333G32Mn	LX.PSV02.054	McAfee	5 in 1-Build in	3rd WiFi 2x2 BGN	N	N	N
AS5741-333G32Mn	LX.PSV02.053	McAfee	5 in 1-Build in	3rd WiFi 2x2 BGN	N	N	N
AS5741-333G32Mn	LX.PSV02.052	McAfee	5 in 1-Build in	3rd WiFi 2x2 BGN	N	N	N
AS5741-333G32Mn	LX.PSV02.051	McAfee	5 in 1-Build in	3rd WiFi 2x2 BGN	N	N	N
AS5741-333G32Mn	LX.PSV02.050	McAfee	5 in 1-Build in	3rd WiFi 2x2 BGN	N	N	N
AS5741-333G32Mn	LX.PSV02.048	McAfee	5 in 1-Build in	3rd WiFi 2x2 BGN	N	N	N
AS5741-333G32Mn	LX.PSV02.049	McAfee	5 in 1-Build in	3rd WiFi 2x2 BGN	N	N	N
AS5741-333G32Mn	LX.PSV02.047	McAfee	5 in 1-Build in	3rd WiFi 2x2 BGN	N	N	N
AS5741-333G32Mn	LX.PSV02.046	McAfee	5 in 1-Build in	3rd WiFi 2x2 BGN	N	N	N
AS5741-333G32Mn	LX.PSV02.045	McAfee	5 in 1-Build in	3rd WiFi 2x2 BGN	N	N	N
AS5741-333G32Mn	LX.PSV02.044	McAfee	5 in 1-Build in	3rd WiFi 2x2 BGN	N	N	N
AS5741-333G32Mn	LX.PSV02.043	McAfee	5 in 1-Build in	3rd WiFi 2x2 BGN	N	N	N
AS5741-333G32Mn	LX.PSV02.042	McAfee	5 in 1-Build in	3rd WiFi 2x2 BGN	N	N	N
AS5741-333G32Mn	LX.PSV02.041	McAfee	5 in 1-Build in	3rd WiFi 2x2 BGN	N	N	N
AS5741-333G32Mn	LX.PSV02.040	McAfee	5 in 1-Build in	3rd WiFi 2x2 BGN	N	N	N
AS5741-333G32Mn	LX.PSV02.039	McAfee	5 in 1-Build in	3rd WiFi 2x2 BGN	N	N	N
AS5741-333G32Mn	LX.PSV02.038	McAfee	5 in 1-Build in	3rd WiFi 2x2 BGN	N	N	N
AS5741-333G32Mn	LX.PSV02.037	McAfee	5 in 1-Build in	3rd WiFi 2x2 BGN	N	N	N
AS5741-333G32Mn	LX.PSV02.036	McAfee	5 in 1-Build in	3rd WiFi 2x2 BGN	N	N	N
AS5741-333G32Mn	LX.PSV02.035	McAfee	5 in 1-Build in	3rd WiFi 2x2 BGN	N	N	N
AS5741-333G32Mn	LX.PSV02.034	McAfee	5 in 1-Build in	3rd WiFi 2x2 BGN	N	N	N
AS5741-333G32Mn	LX.PSV02.033	McAfee	5 in 1-Build in	3rd WiFi 2x2 BGN	N	N	N
AS5741-333G32Mn	LX.PSV02.032	McAfee	5 in 1-Build in	3rd WiFi 2x2 BGN	N	N	N
AS5741-333G32Mn	LX.PSV02.031	McAfee	5 in 1-Build in	3rd WiFi 2x2 BGN	N	N	N

Model	Acer Part No	Extra SW1	Card Reader	Wireless LAN1	Bluetooth	VOIP Phone	Finger Print
AS5741-333G32Mn	LX.PSV02.030	McAfee	5 in 1-Build in	3rd WiFi 2x2 BGN	N	N	N
AS5741-333G32Mn	LX.PSV02.029	McAfee	5 in 1-Build in	3rd WiFi 2x2 BGN	N	N	N
AS5741-333G32Mn	LX.PSV02.028	McAfee	5 in 1-Build in	3rd WiFi 2x2 BGN	N	N	N
AS5741-333G32Mn	LX.PSV02.027	McAfee	5 in 1-Build in	3rd WiFi 2x2 BGN	N	N	N
AS5741-333G32Mn	LX.PSV02.026	McAfee	5 in 1-Build in	3rd WiFi 2x2 BGN	N	N	N
AS5741-333G32Mn	LX.PSV02.025	McAfee	5 in 1-Build in	3rd WiFi 2x2 BGN	N	N	N
AS5741-333G32Mn	LX.PSV02.024	McAfee	5 in 1-Build in	3rd WiFi 2x2 BGN	N	N	N
AS5741-333G32Mn	LX.PSV02.023	McAfee	5 in 1-Build in	3rd WiFi 2x2 BGN	N	N	N
AS5741-333G32Mn	LX.PSV02.022	McAfee	5 in 1-Build in	3rd WiFi 2x2 BGN	N	N	N
AS5741-333G32Mn	LX.PSV02.021	McAfee	5 in 1-Build in	3rd WiFi 2x2 BGN	N	N	N
AS5741-333G32Mn	LX.PSV02.020	McAfee	5 in 1-Build in	3rd WiFi 2x2 BGN	N	N	N
AS5741-333G32Mn	LX.PSV02.019	McAfee	5 in 1-Build in	3rd WiFi 2x2 BGN	N	N	N
AS5741-333G32Mn	LX.PSV02.018	McAfee	5 in 1-Build in	3rd WiFi 2x2 BGN	N	N	N
AS5741-333G32Mn	LX.PSV02.017	McAfee	5 in 1-Build in	3rd WiFi 2x2 BGN	N	N	N
AS5741-333G32Mn	LX.PSV02.016	McAfee	5 in 1-Build in	3rd WiFi 2x2 BGN	N	N	N
AS5741-334G32Mn	LX.PSV02.015	McAfee	5 in 1-Build in	3rd WiFi 2x2 BGN	N	N	N
AS5741-334G32Mn	LX.PSV02.014	McAfee	5 in 1-Build in	3rd WiFi 2x2 BGN	N	N	N
AS5741-334G32Mn	LX.PSV02.013	McAfee	5 in 1-Build in	3rd WiFi 2x2 BGN	N	N	N
AS5741-334G32Mn	LX.PSV02.012	McAfee	5 in 1-Build in	3rd WiFi 2x2 BGN	N	N	N
AS5741-334G50Mn	LX.PSV02.011	McAfee	5 in 1-Build in	3rd WiFi 2x2 BGN	N	N	N
AS5741-334G50Mn	LX.PSV02.010	McAfee	5 in 1-Build in	3rd WiFi 2x2 BGN	N	N	N
AS5741-333G32Mn	LX.PSV02.009	McAfee	5 in 1-Build in	3rd WiFi 2x2 BGN	N	N	N
AS5741-333G32Mn	LX.PSV02.008	McAfee	5 in 1-Build in	3rd WiFi 2x2 BGN	N	N	N
AS5741-333G32Mn	LX.PSV02.007	McAfee	5 in 1-Build in	3rd WiFi 2x2 BGN	N	N	N

Model	Acer Part No	Extra SW1	Card Reader	Wireless LAN1	Bluetooth	VOIP Phone	Finger Print
AS5741-334G50Mn	LX.PSV02.006	McAfee	5 in 1-Build in	3rd WiFi 2x2 BGN	N	N	N
AS5741-334G50Mn	LX.PSV02.005	McAfee	5 in 1-Build in	3rd WiFi 2x2 BGN	N	N	N
AS5741-333G32Mn	LX.PSV02.004	McAfee	5 in 1-Build in	3rd WiFi 2x2 BGN	N	N	N
AS5741-332G25Mn	LX.PSV02.003	McAfee	5 in 1-Build in	3rd WiFi 2x2 BGN	N	N	N
AS5741-334G32Mn	LX.PSV02.002	McAfee	5 in 1-Build in	3rd WiFi 2x2 BGN	N	N	N
AS5741-333G25Mn	LX.PSV02.001	McAfee	5 in 1-Build in	3rd WiFi 2x2 BGN	N	N	N
AS5741-352G32Mn	S2.PSV0C.001	N	5 in 1-Build in	3rd WiFi 2x2 BGN	N	N	N

Aspire 5741G

Model	Acer Part No	RO	Country	Description
AS5741G-334G50Mn	LX.PTD0C.006	EMEA	Eastern Europe	AS5741G-334G50Mn LINPUSAEU5 N11PGV2H1GBCsk_3V3 2*2G/ 500_L/BT/6L2.2/5R/ CB_bgn_1.3C_GEs_ENF1
AS5741G-434G50Mn	LX.PTD0C.005	EMEA	Eastern Europe	AS5741G-434G50Mn LINPUSAEU5 N11PGV2H1GBCsk_3V3 2*2G/ 500_L/BT/6L2.2/5R/ CB_bgn_1.3C_GEs_ENF1
AS5741G-434G32Mn	LX.PTD0C.004	EMEA	Eastern Europe	AS5741G-434G32Mn LINPUSAEU5 N11PGV2H1GBCsk_3V3 2*2G/320/ BT/6L2.2/5R/ CB_bgn_1.3C_GEs_ENF1
AS5741G-334G64Mn	LX.PTD02.084	EMEA	France	AS5741G-334G64Mn W7HP64ATFR1 MC N11PGV2H1GBCsk_3V3 2*2G/640/ 6L2.2/5R/CB_bgn_1.3C_GEs_FR21
AS5741G-434G50Mn	LX.PTD02.083	EMEA	Spain	AS5741G-434G50Mn W7HP64ATES1 MC N11PGV2H1GBCsk_3V3 2*2G/ 500_L/6L2.2/5R/ CB_bgn_1.3C_GEs_ES51
AS5741G-334G32Mn	LX.PTD0C.003	EMEA	Eastern Europe	AS5741G-334G32Mn LINPUSAEU5 N11PGV2H1GBCsk_3V3 2*2G/320/ BT/6L2.2/5R/ CB_bgn_1.3C_GEs_ENF1
AS5741G-334G32Mn	LX.PTD02.082	EMEA	Germany	AS5741G-334G32Mn W7HP64ATDE1 MC N11PGV2H1GBCsk_3V3 2*2G/320/ 6L2.2/5R/CB_bgn_1.3C_GEs_DE11
AS5741G-334G50Bn	LX.PTD02.081	EMEA	Germany	AS5741G-334G50Bn W7HP64ATDE1 MC N11PGV2H1GBCsk_3V3 2*2G/ 500_L/6L2.2/5R/ CB_bgn_1.3C_GEs_DE11
AS5741G-434G64Bn	LX.PTD02.080	EMEA	Germany	AS5741G-434G64Bn W7HP64ATDE1 MC N11PGV2H1GBCsk_3V3 2*2G/640/ BT/6L2.2/5R/ CB_bgn_1.3C_GEs_DE11
AS5741G-333G32Mn	LX.PTD02.079	EMEA	Turkey	AS5741G-333G32Mn EM W7HP64EMATTR1 MC N11PGV2H1GBCsk_3V3 2G+1G/ 320/BT/6L2.2/5R/ CB_bgn_1.3C_GEs_TR31
AS5741G-334G50Mn	LX.PTD0C.002	EMEA	Middle East	AS5741G-334G50Mn LINPUSAME2 N11PGV2H1GBCsk_3V3 2*2G/ 500_L/BT/6L2.2/5R/ CB_bgn_1.3C_GEs_EN13

Model	Acer Part No	RO	Country	Description
AS5741G-436G64Bn	LX.PTD02.078	EMEA	Greece	AS5741G-436G64Bn W7HP64ATGR1 MC N11PGV2H1GBCsk_3V3 4G+2G/ 640/6L2.2/5R/ CB_bgn_1.3C_GEs_EL31
AS5741G-434G50Bn	LX.PTD02.077	EMEA	Greece	AS5741G-434G50Bn W7HP64ATGR1 MC N11PGV2H1GBCsk_3V3 2*2G/ 500_L/6L2.2/5R/ CB_bgn_1.3C_GEs_EL31
AS5741G-333G32Mn	LX.PTD02.076	AAP	Korea	AS5741G-333G32Mn W7HP64KATKR1 MC N11PGV2H1GBCsk_3V3 2G+1G/ 320/6L2.2/5R/ CB_bgn_1.3C_GEs_KO11
AS5741G-434G50Mn	LX.PTD02.075	EMEA	Italy	AS5741G-434G50Mn W7HP64ATIT1 MC N11PGV2H1GBCsk_3V3 2*2G/ 500_L/6L2.2/5R/ CB_bgn_1.3C_GEs_IT11
AS5741G-334G32Mn	LX.PTD02.074	EMEA	Italy	AS5741G-334G32Mn W7HP64ATIT1 MC N11PGV2H1GBCsk_3V3 2*2G/ 320/6L2.2/5R/ CB_bgn_1.3C_GEs_IT11
AS5741G-434G50Mn	LX.PTD02.073	EMEA	Germany	AS5741G-434G50Mn W7HP64ATDE1 MC N11PGV2H1GBCsk_3V3 2*2G/ 500_L/6L2.2/5R/ CB_bgn_1.3C_GEs_DE11
AS5741G-334G64Mn	LX.PTD02.072	EMEA	Poland	AS5741G-334G64Mn W7HP64ATPL1 MC N11PGV2H1GBCsk_3V3 2*2G/640/ 6L2.2/5R/CB_bgn_1.3C_GEs_PL11
AS5741G-332G25Mn	LX.PTD02.071	EMEA	Poland	AS5741G-332G25Mn W7HP64ATPL1 MC N11PGV2H1GBCsk_3V3 1*2G/250/ 6L2.2/5R/CB_bgn_1.3C_GEs_PL11
AS5741G-334G50Mn	LX.PTD02.070	EMEA	Poland	AS5741G-334G50Mn W7HP64ATPL1 MC N11PGV2H1GBCsk_3V3 2*2G/ 500_L/6L2.2/5R/ CB_bgn_1.3C_GEs_PL11
AS5741G-432G32Mn	LX.PTD01.003	CHINA	China	AS5741G-432G32Mn W7HB64SCATCN1 MC N11PGV2H1GBCsk_3V3 1*2G/320/ 6L2.2/5R/CB_bgn_1.3C_GEs_SC13
AS5741G-332G32Mn	LX.PTD01.004	CHINA	China	AS5741G-332G32Mn W7HB64SCATCN1 MC N11PGV2H1GBCsk_3V3 1*2G/320/ 6L2.2/5R/CB_bgn_1.3C_GEs_SC13
AS5741G-436G64Bn	LX.PTD02.069	EMEA	Holland	AS5741G-436G64Bn W7HP64ATNL1 MC N11PGV2H1GBCsk_3V3 4G+2G/ 640/BT/6L2.2/5R/ CB_bgn_1.3C_GEs_NL11

Model	Acer Part No	RO	Country	Description
AS5741G-436G64Bn	LX.PTD02.068	EMEA	Luxembourg	AS5741G-436G64Bn W7HP64ATLU3 MC N11PGV2H1GBCsk_3V3 4G+2G/640/BT/6L2.2/5R/CB_bgn_1.3C_GEs_IT41
AS5741G-436G64Bn	LX.PTD02.067	EMEA	Belgium	AS5741G-436G64Bn W7HP64ATBE1 MC N11PGV2H1GBCsk_3V3 4G+2G/640/BT/6L2.2/5R/CB_bgn_1.3C_GEs_NL11
AS5741G-436G64Mn	LX.PTD02.066	EMEA	Holland	AS5741G-436G64Mn W7HP64ATNL1 MC N11PGV2H1GBCsk_3V3 4G+2G/640/6L2.2/5R/CB_bgn_1.3C_GEs_NL11
AS5741G-436G64Mn	LX.PTD02.065	EMEA	Luxembourg	AS5741G-436G64Mn W7HP64ATLU3 MC N11PGV2H1GBCsk_3V3 4G+2G/640/6L2.2/5R/CB_bgn_1.3C_GEs_IT41
AS5741G-436G64Mn	LX.PTD02.064	EMEA	Belgium	AS5741G-436G64Mn W7HP64ATBE1 MC N11PGV2H1GBCsk_3V3 4G+2G/640/6L2.2/5R/CB_bgn_1.3C_GEs_NL11
AS5741G-434G32Mn	LX.PTD02.063	EMEA	Holland	AS5741G-434G32Mn W7HP64ATNL1 MC N11PGV2H1GBCsk_3V3 2*2G/320/6L2.2/5R/CB_bgn_1.3C_GEs_NL11
AS5741G-434G32Mn	LX.PTD02.062	EMEA	Luxembourg	AS5741G-434G32Mn W7HP64ATLU3 MC N11PGV2H1GBCsk_3V3 2*2G/320/6L2.2/5R/CB_bgn_1.3C_GEs_IT41
AS5741G-434G32Mn	LX.PTD02.061	EMEA	Belgium	AS5741G-434G32Mn W7HP64ATBE1 MC N11PGV2H1GBCsk_3V3 2*2G/320/6L2.2/5R/CB_bgn_1.3C_GEs_NL11
AS5741G-332G64Mn	LX.PTD02.060	TWN	GCTWN	AS5741G-332G64Mn W7HP64ATTW1 MC N11PGV2H1GBCsk_3V3 1*2G/640/BT/6L2.2/5R/CB_bgn_1.3C_GEs_TC11
AS5741G-334G50Mn	LX.PTD02.059	EMEA	Turkey	AS5741G-334G50Mn EM W7HP64EMATTR1 MC N11PGV2H1GBCsk_3V3 2*2G/500_L/BT/6L2.2/5R/CB_bgn_1.3C_GEs_TR31
AS5741G-333G32Mn	LX.PTD01.002	EMEA	Turkey	AS5741G-333G32Mn EM W7HB64EMATTR1 MC N11PGV2H1GBCsk_3V3 2G+1G/320/6L2.2/5R/CB_bgn_1.3C_GEs_TR31
AS5741G-334G64Mn	LX.PTD02.058	EMEA	Holland	AS5741G-334G64Mn W7HP64ATNL1 MC N11PGV2H1GBCsk_3V3 2*2G/640/6L2.2/5R/CB_bgn_1.3C_GEs_NL11

Model	Acer Part No	RO	Country	Description
AS5741G-334G64Mn	LX.PTD02.057	EMEA	Luxembourg	AS5741G-334G64Mn W7HP64ATLU3 MC N11PGV2H1GBCsk_3V3 2*2G/640/ 6L2.2/5R/CB_bgn_1.3C_GEs_IT41
AS5741G-334G64Mn	LX.PTD02.056	EMEA	Belgium	AS5741G-334G64Mn W7HP64ATBE1 MC N11PGV2H1GBCsk_3V3 2*2G/640/ 6L2.2/5R/CB_bgn_1.3C_GEs_NL11
AS5741G-332G50Mn	LX.PTD01.001	CHINA	China	AS5741G-332G50Mn W7HB64SCATCN1 MC N11PGV2H1GBCsk_3V3 1*2G/ 500_L/6L2.2/5R/ CB_bgn_1.3C_GEs_SC13
AS5741G-334G64Mn	LX.PTD02.055	EMEA	Eastern Europe	AS5741G-334G64Mn W7HP64ATEU5 MC N11PGV2H1GBCsk_3V3 2*2G/640/ BT/6L2.2/5R/ CB_bgn_1.3C_GEs_RO11
AS5741G-334G64Mn	LX.PTD02.054	EMEA	Eastern Europe	AS5741G-334G64Mn W7HP64ATEU7 MC N11PGV2H1GBCsk_3V3 2*2G/640/ BT/6L2.2/5R/ CB_bgn_1.3C_GEs_SL11
AS5741G-334G50Mn	LX.PTD02.052	EMEA	Eastern Europe	AS5741G-334G50Mn W7HP64ATEU5 MC N11PGV2H1GBCsk_3V3 2*2G/ 500_L/BT/6L2.2/5R/ CB_bgn_1.3C_GEs_RO11
AS5741G-334G50Mn	LX.PTD02.053	EMEA	Eastern Europe	AS5741G-334G50Mn W7HP64ATEU7 MC N11PGV2H1GBCsk_3V3 2*2G/ 500_L/BT/6L2.2/5R/ CB_bgn_1.3C_GEs_SL11
AS5741G-334G50Mn	LX.PTD0C.001	EMEA	Eastern Europe	AS5741G-334G50Mn LINPUSAEU5 N11PGV2H1GBCsk_3V3 1*4G/ 500_L/BT/6L2.2/5R/ CB_bgn_1.3C_GEs_ENF1
AS5741G-354G50Mn	LX.PTD02.051	AAP	Singapore	AS5741G-354G50Mn W7HP64ATSG1 MC N11PGV2H1GBCsk_3V3 2*2G/ 500_L/BT/6L2.2/5R/ CB_bgn_1.3C_GEs_ZH31
AS5741G-352G50Mn	LX.PTD02.050	AAP	Singapore	AS5741G-352G50Mn W7HP64ATSG1 MC N11PGV2H1GBCsk_3V3 1*2G/ 500_L/BT/6L2.2/5R/ CB_bgn_1.3C_GEs_ZH31
AS5741G-332G50Mn	LX.PTD02.049	AAP	Singapore	AS5741G-332G50Mn W7HP64ATSG1 MC N11PGV2H1GBCsk_3V3 1*2G/ 500_L/BT/6L2.2/5R/ CB_bgn_1.3C_GEs_ZH31

Model	Acer Part No	RO	Country	Description
AS5741G-334G50Mn	LX.PTD02.048	AAP	Singapore	AS5741G-334G50Mn W7HP64ATSG1 MC N11PGV2H1GBCsk_3V3 2*2G/ 500_L/BT/6L2.2/5R/ CB_bgn_1.3C_GEs_ZH31
AS5741G-334G32Mn	LX.PTD02.047	AAP	Singapore	AS5741G-334G32Mn W7HP64ATSG1 MC N11PGV2H1GBCsk_3V3 2*2G/320/ BT/6L2.2/5R/ CB_bgn_1.3C_GEs_ZH31
AS5741G-333G32Mn	LX.PTD02.046	EMEA	Ukraine	AS5741G-333G32Mn W7HP64RUATUK1 MC N11PGV2H1GBCsk_3V3 2G+1G/ 320/6L2.2/5R/ CB_bgn_1.3C_GEs_RU61
AS5741G-333G32Mi	LX.PTD02.045	EMEA	Russia	AS5741G-333G32Mi W7HP64RUATRU1 MC N11PGV2H1GBCsk_3V3 2G+1G/ 320/6L2.2/5R/ CB_bg_1.3C_GEs_RU11
AS5741G-333G32Mn	LX.PTD02.044	EMEA	Middle East	AS5741G-333G32Mn EM W7HP64EMATME4 MC N11PGV2H1GBCsk_3V3 2G+1G/ 320/6L2.2/5R/ CB_bgn_1.3C_GEs_RU61
AS5741G-333G32Mn	LX.PTD02.043	EMEA	Middle East	AS5741G-333G32Mn EM W7HP64EMATME2 MC N11PGV2H1GBCsk_3V3 2G+1G/ 320/6L2.2/5R/ CB_bgn_1.3C_GEs_ES61
AS5741G-333G32Mn	LX.PTD02.042	EMEA	South Africa	AS5741G-333G32Mn EM W7HP64EMATZA2 MC N11PGV2H1GBCsk_3V3 2G+1G/ 320/6L2.2/5R/ CB_bgn_1.3C_GEs_ES61
AS5741G-333G32Mn	LX.PTD02.041	EMEA	Turkey	AS5741G-333G32Mn EM W7HP64EMATTR1 MC N11PGV2H1GBCsk_3V3 2G+1G/ 320/6L2.2/5R/ CB_bgn_1.3C_GEs_TR31
AS5741G-333G32Mn	LX.PTD02.040	EMEA	Middle East	AS5741G-333G32Mn EM W7HP64EMATMEB MC N11PGV2H1GBCsk_3V3 2G+1G/ 320/6L2.2/5R/ CB_bgn_1.3C_GEs_ARA1
AS5741G-333G32Mn	LX.PTD02.039	EMEA	Middle East	AS5741G-333G32Mn EM W7HP64EMATME2 MC N11PGV2H1GBCsk_3V3 2G+1G/ 320/6L2.2/5R/ CB_bgn_1.3C_GEs_AR21
AS5741G-333G32Mn	LX.PTD02.038	EMEA	Middle East	AS5741G-333G32Mn EM W7HP64EMATME9 MC N11PGV2H1GBCsk_3V3 2G+1G/ 320/6L2.2/5R/ CB_bgn_1.3C_GEs_ES81

Model	Acer Part No	RO	Country	Description
AS5741G-333G32Mn	LX.PTD02.037	EMEA	Algeria	AS5741G-333G32Mn EM W7HP64EMATDZ1 MC N11PGV2H1GBCsk_3V3 2G+1G/ 320/6L2.2/5R/ CB_bgn_1.3C_GEs_ES81
AS5741G-333G32Mn	LX.PTD02.036	EMEA	South Africa	AS5741G-333G32Mn EM W7HP64EMATZA1 MC N11PGV2H1GBCsk_3V3 2G+1G/ 320/6L2.2/5R/ CB_bgn_1.3C_GEs_ES81
AS5741G-333G32Mn	LX.PTD02.035	EMEA	Middle East	AS5741G-333G32Mn EM W7HP64EMATME4 MC N11PGV2H1GBCsk_3V3 2G+1G/ 320/6L2.2/5R/ CB_bgn_1.3C_GEs_ES61
AS5741G-333G32Mn	LX.PTD02.034	EMEA	Middle East	AS5741G-333G32Mn EM W7HP64EMATME2 MC N11PGV2H1GBCsk_3V3 2G+1G/ 320/6L2.2/5R/ CB_bgn_1.3C_GEs_AR11
AS5741G-333G32Mn	LX.PTD02.033	EMEA	Middle East	AS5741G-333G32Mn EM W7HP64EMATME3 MC N11PGV2H1GBCsk_3V3 2G+1G/ 320/6L2.2/5R/ CB_bgn_1.3C_GEs_ES81
AS5741G-333G32Mn	LX.PTD02.032	EMEA	Middle East	AS5741G-333G32Mn EM W7HP64EMATME6 MC N11PGV2H1GBCsk_3V3 2G+1G/ 320/6L2.2/5R/ CB_bgn_1.3C_GEs_ES61
AS5741G-333G32Mn	LX.PTD02.031	EMEA	South Africa	AS5741G-333G32Mn EM W7HP64EMATZA4 MC N11PGV2H1GBCsk_3V3 2G+1G/ 320/6L2.2/5R/ CB_bgn_1.3C_GEs_ES61
AS5741G-333G32Mn	LX.PTD02.030	EMEA	Germany	AS5741G-333G32Mn W7HP64ATDE1 MC N11PGV2H1GBCsk_3V3 2G+1G/ 320/6L2.2/5R/ CB_bgn_1.3C_GEs_DE11
AS5741G-333G32Mn	LX.PTD02.029	EMEA	Poland	AS5741G-333G32Mn W7HP64ATPL1 MC N11PGV2H1GBCsk_3V3 2G+1G/ 320/6L2.2/5R/ CB_bgn_1.3C_GEs_PL11
AS5741G-333G32Mn	LX.PTD02.028	EMEA	Baltic	AS5741G-333G32Mn W7HP64ATBC5 MC N11PGV2H1GBCsk_3V3 2G+1G/ 320/6L2.2/5R/ CB_bgn_1.3C_GEs_LT11
AS5741G-333G32Mn	LX.PTD02.027	EMEA	Luxembourg	AS5741G-333G32Mn W7HP64ATLU3 MC N11PGV2H1GBCsk_3V3 2G+1G/ 320/6L2.2/5R/ CB_bgn_1.3C_GEs_IT41

Model	Acer Part No	RO	Country	Description
AS5741G-333G32Mn	LX.PTD02.026	EMEA	Holland	AS5741G-333G32Mn W7HP64ATNL1 MC N11PGV2H1GBCsk_3V3 2G+1G/ 320/6L2.2/5R/ CB_bgn_1.3C_GEs_NL11
AS5741G-333G32Mn	LX.PTD02.025	EMEA	Belgium	AS5741G-333G32Mn W7HP64ATBE1 MC N11PGV2H1GBCsk_3V3 2G+1G/ 320/6L2.2/5R/ CB_bgn_1.3C_GEs_NL11
AS5741G-333G32Mn	LX.PTD02.024	EMEA	Eastern Europe	AS5741G-333G32Mn W7HP64ATEU5 MC N11PGV2H1GBCsk_3V3 2G+1G/ 320/6L2.2/5R/ CB_bgn_1.3C_GEs_RO11
AS5741G-333G32Mn	LX.PTD02.023	EMEA	Eastern Europe	AS5741G-333G32Mn W7HP64ATEU5 MC N11PGV2H1GBCsk_3V3 2G+1G/ 320/6L2.2/5R/ CB_bgn_1.3C_GEs_PL71
AS5741G-333G32Mn	LX.PTD02.022	EMEA	UK	AS5741G-333G32Mn W7HP64ATGB1 MC N11PGV2H1GBCsk_3V3 2G+1G/ 320/6L2.2/5R/ CB_bgn_1.3C_GEs_EN11
AS5741G-333G32Mn	LX.PTD02.021	EMEA	Hungary	AS5741G-333G32Mn W7HP64ATHU1 MC N11PGV2H1GBCsk_3V3 2G+1G/ 320/6L2.2/5R/ CB_bgn_1.3C_GEs_HU11
AS5741G-333G32Mn	LX.PTD02.020	EMEA	Israel	AS5741G-333G32Mn W7HP64ATIL1 MC N11PGV2H1GBCsk_3V3 2G+1G/ 320/6L2.2/5R/ CB_bgn_1.3C_GEs_HE11
AS5741G-333G32Mn	LX.PTD02.019	EMEA	Czech	AS5741G-333G32Mn W7HP64ATCZ2 MC N11PGV2H1GBCsk_3V3 2G+1G/ 320/6L2.2/5R/ CB_bgn_1.3C_GEs_SK11
AS5741G-333G32Mn	LX.PTD02.018	EMEA	Baltic	AS5741G-333G32Mn W7HP64ATBC4 MC N11PGV2H1GBCsk_3V3 2G+1G/ 320/6L2.2/5R/ CB_bgn_1.3C_GEs_LT11
AS5741G-333G32Mn	LX.PTD02.017	EMEA	Portugal	AS5741G-333G32Mn W7HP64ATPT1 MC N11PGV2H1GBCsk_3V3 2G+1G/ 320/6L2.2/5R/ CB_bgn_1.3C_GEs_PT11
AS5741G-333G32Mn	LX.PTD02.016	EMEA	Cyprus	AS5741G-333G32Mn W7HP64ATCY1 MC N11PGV2H1GBCsk_3V3 2G+1G/ 320/6L2.2/5R/ CB_bgn_1.3C_GEs_ES61

Model	Acer Part No	RO	Country	Description
AS5741G-333G32Mn	LX.PTD02.015	EMEA	Baltic	AS5741G-333G32Mn W7HP64ATBC3 MC N11PGV2H1GBCsk_3V3 2G+1G/ 320/6L2.2/5R/ CB_bgn_1.3C_GEs_SV21
AS5741G-333G32Mn	LX.PTD02.014	EMEA	Serbia/ Macedonia	AS5741G-333G32Mn W7HP64ATCS1 MC N11PGV2H1GBCsk_3V3 2G+1G/ 320/6L2.2/5R/ CB_bgn_1.3C_GEs_SL11
AS5741G-333G32Mn	LX.PTD02.013	EMEA	Eastern Europe	AS5741G-333G32Mn W7HP64ATEU4 MC N11PGV2H1GBCsk_3V3 2G+1G/ 320/6L2.2/5R/ CB_bgn_1.3C_GEs_SV21
AS5741G-333G32Mn	LX.PTD02.011	EMEA	Latvia	AS5741G-333G32Mn W7HP64ATLV1 MC N11PGV2H1GBCsk_3V3 2G+1G/ 320/6L2.2/5R/ CB_bgn_1.3C_GEs_RU22
AS5741G-333G32Mn	LX.PTD02.012	EMEA	Switzerland	AS5741G-333G32Mn W7HP64ATCH1 MC N11PGV2H1GBCsk_3V3 2G+1G/ 320/6L2.2/5R/ CB_bgn_1.3C_GEs_IT41
AS5741G-333G32Mn	LX.PTD02.010	EMEA	Latvia	AS5741G-333G32Mn W7HP64ATLV1 MC N11PGV2H1GBCsk_3V3 2G+1G/ 320/6L2.2/5R/ CB_bgn_1.3C_GEs_LT11
AS5741G-333G32Mn	LX.PTD02.009	EMEA	Italy	AS5741G-333G32Mn W7HP64ATIT1 MC N11PGV2H1GBCsk_3V3 2G+1G/ 320/6L2.2/5R/ CB_bgn_1.3C_GEs_IT11
AS5741G-333G32Mn	LX.PTD02.008	EMEA	Spain	AS5741G-333G32Mn W7HP64ATES1 MC N11PGV2H1GBCsk_3V3 2G+1G/ 320/6L2.2/5R/ CB_bgn_1.3C_GEs_ES51
AS5741G-333G32Mn	LX.PTD02.007	EMEA	Denmark	AS5741G-333G32Mn W7HP64ATDK2 MC N11PGV2H1GBCsk_3V3 2G+1G/ 320/6L2.2/5R/ CB_bgn_1.3C_GEs_ENS1
AS5741G-333G32Mn	LX.PTD02.006	EMEA	Eastern Europe	AS5741G-333G32Mn W7HP64ATEU7 MC N11PGV2H1GBCsk_3V3 2G+1G/ 320/6L2.2/5R/ CB_bgn_1.3C_GEs_ENQ1
AS5741G-333G32Mn	LX.PTD02.005	EMEA	Greece	AS5741G-333G32Mn W7HP64ATGR1 MC N11PGV2H1GBCsk_3V3 2G+1G/ 320/6L2.2/5R/ CB_bgn_1.3C_GEs_EL31

Model	Acer Part No	RO	Country	Description
AS5741G-333G32Mn	LX.PTD02.004	EMEA	Austria	AS5741G-333G32Mn W7HP64ATAT1 MC N11PGV2H1GBCsk_3V3 2G+1G/320/6L2.2/5R/CB_bgn_1.3C_GEs_DE61
AS5741G-333G32Mn	LX.PTD02.003	EMEA	France	AS5741G-333G32Mn W7HP64ATFR1 MC N11PGV2H1GBCsk_3V3 2G+1G/320/6L2.2/5R/CB_bgn_1.3C_GEs_FR21
AS5741G-333G32Mn	LX.PTD02.002	EMEA	Eastern Europe	AS5741G-333G32Mn W7HP64ATEU7 MC N11PGV2H1GBCsk_3V3 2G+1G/320/6L2.2/5R/CB_bgn_1.3C_GEs_SL11
AS5741G-334G64Mn	LX.PTD02.001	EMEA	UK	AS5741G-334G64Mn W7HP64ATGB1 MC N11PGV2H1GBCsk_3V3 2*2G/640/6L2.2/5R/CB_bgn_1.3C_GEs_EN11
AS5741G-332G50Mn	S2.PTD02.001	WW	WW	AS5741G-332G50Mn W7HP64AWW1 MC N11PGV2H1GBCss_3V3 2*1G/500_L/BT/6L2.2/5R/CB_bgn_1.3C_GEs_ES62
AS5741G-332G50Mn	S2.PTD02.001	WW	WW	AS5741G-332G50Mn W7HP64AWW1 MC N11PGV2H1GBCss_3V3 2*1G/500_L/BT/6L2.2/5R/CB_bgn_1.3C_GEs_ES62
AS5741G-334G50Mn	LX.PSZ02.064	EMEA	France	AS5741G-334G50Mn W7HP64ATFR1 MC PARK_XT512Csk_3V3 2*2G/500_L/6L2.2/5R/CB_bgn_1.3C_GEs_FR21
AS5741G-353G50Mn	LX.PSZ0C.009	AAP	Vietnam	AS5741G-353G50Mn LINPUSAVN1 PARK_XT512Csk_3V3 2G+1G/500_L/BT/6L2.2/5R/CB_bgn_1.3C_GEs_EN11
AS5741G-352G32Mn	LX.PSZ0C.008	AAP	Vietnam	AS5741G-352G32Mn LINPUSAVN1 PARK_XT512Csk_3V3 1*2G/320/BT/6L2.2/5R/CB_bgn_1.3C_GEs_EN11
AS5741G-436G50Mn	LX.PSZ02.063	EMEA	Spain	AS5741G-436G50Mn W7HP64ATES1 MC PARK_XT512Csk_3V3 4G+2G/500_L/6L2.2/5R/CB_bgn_1.3C_GEs_ES51
AS5741G-434G50Mn	LX.PSZ02.062	EMEA	Spain	AS5741G-434G50Mn W7HP64ATES1 MC PARK_XT512Csk_3V3 2*2G/500_L/6L2.2/5R/CB_bgn_1.3C_GEs_ES51
AS5741G-333G32Mn	LX.PSZ0C.007	EMEA	Eastern Europe	AS5741G-333G32Mn LINPUSAEU5 PARK_XT512Csk_3V3 2G+1G/320/BT/6L2.2/5R/CB_bgn_1.3C_GEs_ENF1

Model	Acer Part No	RO	Country	Description
AS5741G-334G50Mn	LX.PSZ02.061	EMEA	Germany	AS5741G-334G50Mn W7HP64ATDE1 MC PARK_XT512Csk_3V3 2*2G/500_L/ 6L2.2/5R/CB_bgn_1.3C_GEs_DE11
AS5741G-434G64Mn	LX.PSZ0C.006	EMEA	Middle East	AS5741G-434G64Mn LINPUSAME2 PARK_XT512Csk_3V3 2*2G/640/BT/ 6L2.2/5R/CB_bgn_1.3C_GEs_EN13
AS5741G-334G50Mn	LX.PSZ0C.005	EMEA	Middle East	AS5741G-334G50Mn LINPUSAME2 PARK_XT512Csk_3V3 2*2G/500_L/ BT/6L2.2/5R/ CB_bgn_1.3C_GEs_EN13
AS5741G-333G32Mn	LX.PSZ0C.004	EMEA	Middle East	AS5741G-333G32Mn LINPUSAME2 PARK_XT512Csk_3V3 2G+1G/320/ BT/6L2.2/5R/ CB_bgn_1.3C_GEs_EN13
AS5741G-434G32Mn	LX.PSZ02.060	EMEA	Italy	AS5741G-434G32Mn W7HP64ATIT1 MC PARK_XT512Csk_3V3 2*2G/320/ 6L2.2/5R/CB_bgn_1.3C_GEs_IT11
AS5741G-333G32Mn	LX.PSZ02.059	AAP	Korea	AS5741G-333G32Mn W7HP64KATKR1 MC PARK_XT512Csk_3V3 2G+1G/320/ 6L2.2/5R/CB_bgn_1.3C_GEs_KO11
AS5741G-334G32Bn	LX.PSZ02.058	EMEA	Germany	AS5741G-334G32Bn W7HP64ATDE1 MC PARK_XT512Csk_3V3 2*2G/320/ 6L2.2/5R/CB_bgn_1.3C_GEs_DE11
AS5741G-334G32Mn	LX.PSZ02.057	EMEA	South Africa	AS5741G-334G32Mn EM W7HP64EMATZA2 MC PARK_XT512Csk_3V3 2*2G/320/BT/ 6L2.2/5R/CB_bgn_1.3C_GEs_ES61
AS5741G-334G50Mn	LX.PSZ02.056	EMEA	South Africa	AS5741G-334G50Mn EM W7HP64EMATZA2 MC PARK_XT512Csk_3V3 2*2G/500_L/ BT/6L2.2/5R/ CB_bgn_1.3C_GEs_ES61
AS5741G-333G32Mn	LX.PSZ02.055	EMEA	Poland	AS5741G-333G32Mn W7HP64ATPL1 MC PARK_XT512Csk_3V3 1G+2G/320/ 6L2.2/5R/CB_bgn_1.3C_GEs_PL11
AS5741G-333G32Mn	LX.PSZ0C.003	EMEA	Middle East	AS5741G-333G32Mn LINPUSAME2 PARK_XT512Csk_3V3 2G+1G/320/ 6L2.2/5R/CB_bgn_1.3C_GEs_EN13
AS5741G-432G32Mn	LX.PSZ01.003	CHINA	China	AS5741G-432G32Mn W7HB64SCATCN1 MC PARK_XT512Csk_3V3 1*2G/320/ 6L2.2/5R/CB_bgn_1.3C_GEs_SC13
AS5741G-332G50Mn	LX.PSZ02.054	TWN	GCTWN	AS5741G-332G50Mn W7HP64ATTW1 MC PARK_XT512Csk_3V3 1*2G/500_L/ BT/6L2.2/5R/ CB_bgn_1.3C_GEs_TC11

Model	Acer Part No	RO	Country	Description
AS5741G-334G50Mn	LX.PSZ02.053	EMEA	Denmark	AS5741G-334G50Mn W7HP64ATDK2 MC PARK_XT512Csk_3V3 2*2G/500_L/ 6L2.2/5R/CB_bgn_1.3C_GEs_ENS1
AS5741G-332G64Mn	LX.PSZ02.052	TWN	GCTWN	AS5741G-332G64Mn W7HP64ATTW1 MC PARK_XT512Csk_3V3 1*2G/640/BT/ 6L2.2/5R/CB_bgn_1.3C_GEs_TC11
AS5741G-333G32Mn	LX.PSZ01.002	EMEA	Turkey	AS5741G-333G32Mn EM W7HB64EMATTR1 MC PARK_XT512Csk_3V3 2G+1G/320/ 6L2.2/5R/CB_bgn_1.3C_GEs_TR31
AS5741G-334G64Mn	LX.PSZ02.051	EMEA	Holland	AS5741G-334G64Mn W7HP64ATNL1 MC PARK_XT512Csk_3V3 2*2G/640/ 6L2.2/5R/CB_bgn_1.3C_GEs_NL11
AS5741G-334G64Mn	LX.PSZ02.050	EMEA	Luxembourg	AS5741G-334G64Mn W7HP64ATLU3 MC PARK_XT512Csk_3V3 2*2G/640/ 6L2.2/5R/CB_bgn_1.3C_GEs_IT41
AS5741G-334G64Mn	LX.PSZ02.049	EMEA	Belgium	AS5741G-334G64Mn W7HP64ATBE1 MC PARK_XT512Csk_3V3 2*2G/640/ 6L2.2/5R/CB_bgn_1.3C_GEs_NL11
AS5741G-332G32Mn	LX.PSZ01.001	CHINA	China	AS5741G-332G32Mn W7HB64SCATCN1 MC PARK_XT512Csk_3V3 1*2G/320/ 6L2.2/5R/CB_bgn_1.3C_GEs_SC13
AS5741G-334G32Mn	LX.PSZ0C.002	EMEA	Eastern Europe	AS5741G-334G32Mn LINPUSAEU7 PARK_XT512Csk_3V3 2*2G/320/BT/ 6L2.2/5R/CB_bgn_1.3C_GEs_ENQ1
AS5741G-334G32Mn	LX.PSZ0C.001	EMEA	Eastern Europe	AS5741G-334G32Mn LINPUSAEU5 PARK_XT512Csk_3V3 2*2G/320/BT/ 6L2.2/5R/CB_bgn_1.3C_GEs_ENF1
AS5741G-334G32Mn	LX.PSZ02.048	EMEA	Ukraine	AS5741G-334G32Mn W7HP64RUATUK1 MC PARK_XT512Csk_3V3 2*2G/320/ 6L2.2/5R/CB_bgn_1.3C_GEs_RU61
AS5741G-334G32Mi	LX.PSZ02.047	EMEA	Russia	AS5741G-334G32Mi W7HP64RUATRU1 MC PARK_XT512Csk_3V3 2*2G/320/ 6L2.2/5R/CB_bg_1.3C_GEs_RU11
AS5741G-334G32Mn	LX.PSZ02.046	EMEA	Middle East	AS5741G-334G32Mn EM W7HP64EMATME4 MC PARK_XT512Csk_3V3 2*2G/320/ 6L2.2/5R/CB_bgn_1.3C_GEs_RU61
AS5741G-334G32Mn	LX.PSZ02.045	EMEA	Middle East	AS5741G-334G32Mn EM W7HP64EMATME2 MC PARK_XT512Csk_3V3 2*2G/320/ 6L2.2/5R/CB_bgn_1.3C_GEs_ES61
AS5741G-334G32Mn	LX.PSZ02.044	EMEA	South Africa	AS5741G-334G32Mn EM W7HP64EMATZA2 MC PARK_XT512Csk_3V3 2*2G/320/ 6L2.2/5R/CB_bgn_1.3C_GEs_ES61

Model	Acer Part No	RO	Country	Description
AS5741G-334G32Mn	LX.PSZ02.043	EMEA	Turkey	AS5741G-334G32Mn EM W7HP64EMATTR1 MC PARK_XT512Csk_3V3 2*2G/320/ 6L2.2/5R/CB_bgn_1.3C_GEs_TR31
AS5741G-334G32Mn	LX.PSZ02.042	EMEA	Middle East	AS5741G-334G32Mn EM W7HP64EMATMEB MC PARK_XT512Csk_3V3 2*2G/320/ 6L2.2/5R/CB_bgn_1.3C_GEs_ARA1
AS5741G-334G32Mn	LX.PSZ02.041	EMEA	Middle East	AS5741G-334G32Mn EM W7HP64EMATME2 MC PARK_XT512Csk_3V3 2*2G/320/ 6L2.2/5R/CB_bgn_1.3C_GEs_AR21
AS5741G-334G32Mn	LX.PSZ02.040	EMEA	Middle East	AS5741G-334G32Mn EM W7HP64EMATME9 MC PARK_XT512Csk_3V3 2*2G/320/ 6L2.2/5R/CB_bgn_1.3C_GEs_ES81
AS5741G-334G32Mn	LX.PSZ02.039	EMEA	Algeria	AS5741G-334G32Mn EM W7HP64EMATDZ1 MC PARK_XT512Csk_3V3 2*2G/320/ 6L2.2/5R/CB_bgn_1.3C_GEs_ES81
AS5741G-334G32Mn	LX.PSZ02.038	EMEA	South Africa	AS5741G-334G32Mn EM W7HP64EMATZA1 MC PARK_XT512Csk_3V3 2*2G/320/ 6L2.2/5R/CB_bgn_1.3C_GEs_ES81
AS5741G-334G32Mn	LX.PSZ02.037	EMEA	Middle East	AS5741G-334G32Mn EM W7HP64EMATME4 MC PARK_XT512Csk_3V3 2*2G/320/ 6L2.2/5R/CB_bgn_1.3C_GEs_ES61
AS5741G-334G32Mn	LX.PSZ02.036	EMEA	Middle East	AS5741G-334G32Mn EM W7HP64EMATME2 MC PARK_XT512Csk_3V3 2*2G/320/ 6L2.2/5R/CB_bgn_1.3C_GEs_AR11
AS5741G-334G32Mn	LX.PSZ02.035	EMEA	Middle East	AS5741G-334G32Mn EM W7HP64EMATME3 MC PARK_XT512Csk_3V3 2*2G/320/ 6L2.2/5R/CB_bgn_1.3C_GEs_ES81
AS5741G-334G32Mn	LX.PSZ02.034	EMEA	Middle East	AS5741G-334G32Mn EM W7HP64EMATME6 MC PARK_XT512Csk_3V3 2*2G/320/ 6L2.2/5R/CB_bgn_1.3C_GEs_ES61
AS5741G-334G32Mn	LX.PSZ02.033	EMEA	South Africa	AS5741G-334G32Mn EM W7HP64EMATZA4 MC PARK_XT512Csk_3V3 2*2G/320/ 6L2.2/5R/CB_bgn_1.3C_GEs_ES61
AS5741G-334G32Mn	LX.PSZ02.032	EMEA	Germany	AS5741G-334G32Mn W7HP64ATDE1 MC PARK_XT512Csk_3V3 2*2G/320/ 6L2.2/5R/CB_bgn_1.3C_GEs_DE11
AS5741G-334G32Mn	LX.PSZ02.031	EMEA	Poland	AS5741G-334G32Mn W7HP64ATPL1 MC PARK_XT512Csk_3V3 2*2G/320/ 6L2.2/5R/CB_bgn_1.3C_GEs_PL11

Model	Acer Part No	RO	Country	Description
AS5741G-334G32Mn	LX.PSZ02.030	EMEA	Baltic	AS5741G-334G32Mn W7HP64ATBC5 MC PARK_XT512Csk_3V3 2*2G/320/ 6L2.2/5R/CB_bgn_1.3C_GEs_LT11
AS5741G-334G32Mn	LX.PSZ02.029	EMEA	Luxembourg	AS5741G-334G32Mn W7HP64ATLU3 MC PARK_XT512Csk_3V3 2*2G/320/ 6L2.2/5R/CB_bgn_1.3C_GEs_IT41
AS5741G-334G32Mn	LX.PSZ02.028	EMEA	Holland	AS5741G-334G32Mn W7HP64ATNL1 MC PARK_XT512Csk_3V3 2*2G/320/ 6L2.2/5R/CB_bgn_1.3C_GEs_NL11
AS5741G-334G32Mn	LX.PSZ02.027	EMEA	Belgium	AS5741G-334G32Mn W7HP64ATBE1 MC PARK_XT512Csk_3V3 2*2G/320/ 6L2.2/5R/CB_bgn_1.3C_GEs_NL11
AS5741G-334G32Mn	LX.PSZ02.026	EMEA	Switzerland	AS5741G-334G32Mn W7HP64ATCH1 MC PARK_XT512Csk_3V3 2*2G/320/ 6L2.2/5R/CB_bgn_1.3C_GEs_IT41
AS5741G-334G32Mn	LX.PSZ02.025	EMEA	Latvia	AS5741G-334G32Mn W7HP64ATLV1 MC PARK_XT512Csk_3V3 2*2G/320/ 6L2.2/5R/CB_bgn_1.3C_GEs_RU22
AS5741G-334G32Mn	LX.PSZ02.024	EMEA	Latvia	AS5741G-334G32Mn W7HP64ATLV1 MC PARK_XT512Csk_3V3 2*2G/320/ 6L2.2/5R/CB_bgn_1.3C_GEs_LT11
AS5741G-334G32Mn	LX.PSZ02.023	EMEA	Eastern Europe	AS5741G-334G32Mn W7HP64ATEU5 MC PARK_XT512Csk_3V3 2*2G/320/ 6L2.2/5R/CB_bgn_1.3C_GEs_RO11
AS5741G-334G32Mn	LX.PSZ02.022	EMEA	Eastern Europe	AS5741G-334G32Mn W7HP64ATEU5 MC PARK_XT512Csk_3V3 2*2G/320/ 6L2.2/5R/CB_bgn_1.3C_GEs_PL71
AS5741G-334G32Mn	LX.PSZ02.021	EMEA	UK	AS5741G-334G32Mn W7HP64ATGB1 MC PARK_XT512Csk_3V3 2*2G/320/ 6L2.2/5R/CB_bgn_1.3C_GEs_EN11
AS5741G-334G32Mn	LX.PSZ02.020	EMEA	Hungary	AS5741G-334G32Mn W7HP64ATHU1 MC PARK_XT512Csk_3V3 2*2G/320/ 6L2.2/5R/CB_bgn_1.3C_GEs_HU11
AS5741G-334G32Mn	LX.PSZ02.019	EMEA	Israel	AS5741G-334G32Mn W7HP64ATIL1 MC PARK_XT512Csk_3V3 2*2G/320/ 6L2.2/5R/CB_bgn_1.3C_GEs_HE11
AS5741G-334G32Mn	LX.PSZ02.018	EMEA	Czech	AS5741G-334G32Mn W7HP64ATCZ2 MC PARK_XT512Csk_3V3 2*2G/320/ 6L2.2/5R/CB_bgn_1.3C_GEs_SK11
AS5741G-334G32Mn	LX.PSZ02.017	EMEA	Baltic	AS5741G-334G32Mn W7HP64ATBC4 MC PARK_XT512Csk_3V3 2*2G/320/ 6L2.2/5R/CB_bgn_1.3C_GEs_LT11

Model	Acer Part No	RO	Country	Description
AS5741G-334G32Mn	LX.PSZ02.016	EMEA	Portugal	AS5741G-334G32Mn W7HP64ATPT1 MC PARK_XT512Csk_3V3 2*2G/320/ 6L2.2/5R/CB_bgn_1.3C_GEs_PT11
AS5741G-334G32Mn	LX.PSZ02.015	EMEA	Cyprus	AS5741G-334G32Mn W7HP64ATCY1 MC PARK_XT512Csk_3V3 2*2G/320/ 6L2.2/5R/CB_bgn_1.3C_GEs_ES61
AS5741G-334G32Mn	LX.PSZ02.014	EMEA	Baltic	AS5741G-334G32Mn W7HP64ATBC3 MC PARK_XT512Csk_3V3 2*2G/320/ 6L2.2/5R/CB_bgn_1.3C_GEs_SV21
AS5741G-334G32Mn	LX.PSZ02.013	EMEA	Serbia/ Macedonia	AS5741G-334G32Mn W7HP64ATCS1 MC PARK_XT512Csk_3V3 2*2G/320/ 6L2.2/5R/CB_bgn_1.3C_GEs_SL11
AS5741G-334G32Mn	LX.PSZ02.012	EMEA	Eastern Europe	AS5741G-334G32Mn W7HP64ATEU4 MC PARK_XT512Csk_3V3 2*2G/320/ 6L2.2/5R/CB_bgn_1.3C_GEs_SV21
AS5741G-334G32Mn	LX.PSZ02.011	EMEA	Italy	AS5741G-334G32Mn W7HP64ATIT1 MC PARK_XT512Csk_3V3 2*2G/320/ 6L2.2/5R/CB_bgn_1.3C_GEs_IT11
AS5741G-334G32Mn	LX.PSZ02.010	EMEA	Spain	AS5741G-334G32Mn W7HP64ATES1 MC PARK_XT512Csk_3V3 2*2G/320/ 6L2.2/5R/CB_bgn_1.3C_GEs_ES51
AS5741G-334G32Mn	LX.PSZ02.009	EMEA	Denmark	AS5741G-334G32Mn W7HP64ATDK2 MC PARK_XT512Csk_3V3 2*2G/320/ 6L2.2/5R/CB_bgn_1.3C_GEs_ENS1
AS5741G-334G32Mn	LX.PSZ02.008	EMEA	Eastern Europe	AS5741G-334G32Mn W7HP64ATEU7 MC PARK_XT512Csk_3V3 2*2G/320/ 6L2.2/5R/CB_bgn_1.3C_GEs_ENQ1
AS5741G-334G32Mn	LX.PSZ02.007	EMEA	Greece	AS5741G-334G32Mn W7HP64ATGR1 MC PARK_XT512Csk_3V3 2*2G/320/ 6L2.2/5R/CB_bgn_1.3C_GEs_EL31
AS5741G-334G32Mn	LX.PSZ02.006	EMEA	Austria	AS5741G-334G32Mn W7HP64ATAT1 MC PARK_XT512Csk_3V3 2*2G/320/ 6L2.2/5R/CB_bgn_1.3C_GEs_DE61
AS5741G-334G32Mn	LX.PSZ02.005	EMEA	France	AS5741G-334G32Mn W7HP64ATFR1 MC PARK_XT512Csk_3V3 2*2G/320/ 6L2.2/5R/CB_bgn_1.3C_GEs_FR21
AS5741G-334G32Mn	LX.PSZ02.004	EMEA	Eastern Europe	AS5741G-334G32Mn W7HP64ATEU7 MC PARK_XT512Csk_3V3 2*2G/320/ 6L2.2/5R/CB_bgn_1.3C_GEs_SL11
AS5741G-332G32Mn	LX.PSZ02.003	CHINA	Hong Kong	AS5741G-332G32Mn W7HP64ATHK2 MC PARK_XT512Csk_3V3 1*2G/320/BT/ 6L2.2/5R/CB_bgn_1.3C_GEs_ZH34

Model	Acer Part No	RO	Country	Description
AS5741G-334G32Mn	S2.PSZ0C.003	WW	WW	AS5741G-334G32Mn LINPUSAWW1 PARK_XT512Css_3V3 2*2G/320/BT/ 6L2.2/5R/CB_bgn_1.3C_GEs_EN11
AS5741G-333G32Bn	LX.PSZ02.002	EMEA	UK	AS5741G-333G32Bn W7HP64ATGB1 MC PARK_XT512Csk_3V3 2G+1G/320/ 6L2.2/5R/CB_bgn_1.3C_GEs_EN11
AS5741G-334G50Mn	LX.PSZ02.001	EMEA	UK	AS5741G-334G50Mn W7HP64ATGB1 MC PARK_XT512Csk_3V3 2*2G/500_L/ 6L2.2/5R/CB_bgn_1.3C_GEs_EN11
AS5741G-434G32Mn	S2.PSZ0C.002	WW	WW	AS5741G-434G32Mn LINPUSAWW1 PARK_XT512Css_V3 2*2G/320/BT/ 6L2.2/5R/CB_bgn_1.3C_GEs_EN11
AS5741G-334G32Mn	S2.PSZ0C.001	WW	WW	AS5741G-334G32Mn LINPUSAWW1 PARK_XT512Css_V3 2*2G/320/ 6L2.2/5R/CB_bgn_1.3C_GEs_EN11

Model	Acer Part No	CPU	LCD	VGA Chip	VRAM 1	Memory 1	Memory 2
AS5741G-334G50Mn	LX.PTD0C.006	Ci3330M	NLED15.6 WXGAG	N11PG V2H	1G-DDR3 (64*16*8)	SO2GBI II10	SO2GBIII 10
AS5741G-434G50Mn	LX.PTD0C.005	Ci5430M	NLED15.6 WXGAG	N11PG V2H	1G-DDR3 (64*16*8)	SO2GBI II10	SO2GBIII 10
AS5741G-434G32Mn	LX.PTD0C.004	Ci5430M	NLED15.6 WXGAG	N11PG V2H	1G-DDR3 (64*16*8)	SO2GBI II10	SO2GBIII 10
AS5741G-334G64Mn	LX.PTD02.084	Ci3330M	NLED15.6 WXGAG	N11PG V2H	1G-DDR3 (64*16*8)	SO2GBI II10	SO2GBIII 10
AS5741G-434G50Mn	LX.PTD02.083	Ci5430M	NLED15.6 WXGAG	N11PG V2H	1G-DDR3 (64*16*8)	SO2GBI II10	SO2GBIII 10
AS5741G-334G32Mn	LX.PTD0C.003	Ci3330M	NLED15.6 WXGAG	N11PG V2H	1G-DDR3 (64*16*8)	SO2GBI II10	SO2GBIII 10
AS5741G-334G32Mn	LX.PTD02.082	Ci3330M	NLED15.6 WXGAG	N11PG V2H	1G-DDR3 (64*16*8)	SO2GBI II10	SO2GBIII 10
AS5741G-334G50Bn	LX.PTD02.081	Ci3330M	NLED15.6 WXGAG	N11PG V2H	1G-DDR3 (64*16*8)	SO2GBI II10	SO2GBIII 10
AS5741G-434G64Bn	LX.PTD02.080	Ci5430M	NLED15.6 WXGAG	N11PG V2H	1G-DDR3 (64*16*8)	SO2GBI II10	SO2GBIII 10
AS5741G-333G32Mn	LX.PTD02.079	Ci3330M	NLED15.6 WXGAG	N11PG V2H	1G-DDR3 (64*16*8)	SO2GBI II10	SO1GBIII 10
AS5741G-334G50Mn	LX.PTD0C.002	Ci3330M	NLED15.6 WXGAG	N11PG V2H	1G-DDR3 (64*16*8)	SO2GBI II10	SO2GBIII 10
AS5741G-436G64Bn	LX.PTD02.078	Ci5430M	NLED15.6 WXGAG	N11PG V2H	1G-DDR3 (64*16*8)	SO4GBI II10	SO2GBIII 10
AS5741G-434G50Bn	LX.PTD02.077	Ci5430M	NLED15.6 WXGAG	N11PG V2H	1G-DDR3 (64*16*8)	SO2GBI II10	SO2GBIII 10
AS5741G-333G32Mn	LX.PTD02.076	Ci3330M	NLED15.6 WXGAG	N11PG V2H	1G-DDR3 (64*16*8)	SO2GBI II10	SO1GBIII 10
AS5741G-434G50Mn	LX.PTD02.075	Ci5430M	NLED15.6 WXGAG	N11PG V2H	1G-DDR3 (64*16*8)	SO2GBI II10	SO2GBIII 10

Model	Acer Part No	CPU	LCD	VGA Chip	VRAM 1	Memory 1	Memory 2
AS5741G-334G32Mn	LX.PTD02.074	Ci3330M	NLED15.6 WXGAG	N11PG V2H	1G-DDR3 (64*16*8)	SO2GBI II10	SO2GBIII 10
AS5741G-434G50Mn	LX.PTD02.073	Ci5430M	NLED15.6 WXGAG	N11PG V2H	1G-DDR3 (64*16*8)	SO2GBI II10	SO2GBIII 10
AS5741G-334G64Mn	LX.PTD02.072	Ci3330M	NLED15.6 WXGAG	N11PG V2H	1G-DDR3 (64*16*8)	SO2GBI II10	SO2GBIII 10
AS5741G-332G25Mn	LX.PTD02.071	Ci3330M	NLED15.6 WXGAG	N11PG V2H	1G-DDR3 (64*16*8)	SO2GBI II10	N
AS5741G-334G50Mn	LX.PTD02.070	Ci3330M	NLED15.6 WXGAG	N11PG V2H	1G-DDR3 (64*16*8)	SO2GBI II10	SO2GBIII 10
AS5741G-432G32Mn	LX.PTD01.003	Ci5430M	NLED15.6 WXGAG	N11PG V2H	1G-DDR3 (64*16*8)	SO2GBI II10	N
AS5741G-332G32Mn	LX.PTD01.004	Ci3330M	NLED15.6 WXGAG	N11PG V2H	1G-DDR3 (64*16*8)	SO2GBI II10	N
AS5741G-436G64Bn	LX.PTD02.069	Ci5430M	NLED15.6 WXGAG	N11PG V2H	1G-DDR3 (64*16*8)	SO4GBI II10	SO2GBIII 10
AS5741G-436G64Bn	LX.PTD02.068	Ci5430M	NLED15.6 WXGAG	N11PG V2H	1G-DDR3 (64*16*8)	SO4GBI II10	SO2GBIII 10
AS5741G-436G64Bn	LX.PTD02.067	Ci5430M	NLED15.6 WXGAG	N11PG V2H	1G-DDR3 (64*16*8)	SO4GBI II10	SO2GBIII 10
AS5741G-436G64Mn	LX.PTD02.066	Ci5430M	NLED15.6 WXGAG	N11PG V2H	1G-DDR3 (64*16*8)	SO4GBI II10	SO2GBIII 10
AS5741G-436G64Mn	LX.PTD02.065	Ci5430M	NLED15.6 WXGAG	N11PG V2H	1G-DDR3 (64*16*8)	SO4GBI II10	SO2GBIII 10
AS5741G-436G64Mn	LX.PTD02.064	Ci5430M	NLED15.6 WXGAG	N11PG V2H	1G-DDR3 (64*16*8)	SO4GBI II10	SO2GBIII 10
AS5741G-434G32Mn	LX.PTD02.063	Ci5430M	NLED15.6 WXGAG	N11PG V2H	1G-DDR3 (64*16*8)	SO2GBI II10	SO2GBIII 10
AS5741G-434G32Mn	LX.PTD02.062	Ci5430M	NLED15.6 WXGAG	N11PG V2H	1G-DDR3 (64*16*8)	SO2GBI II10	SO2GBIII 10
AS5741G-434G32Mn	LX.PTD02.061	Ci5430M	NLED15.6 WXGAG	N11PG V2H	1G-DDR3 (64*16*8)	SO2GBI II10	SO2GBIII 10
AS5741G-332G64Mn	LX.PTD02.060	Ci3330M	NLED15.6 WXGAG	N11PG V2H	1G-DDR3 (64*16*8)	SO2GBI II10	N
AS5741G-334G50Mn	LX.PTD02.059	Ci3330M	NLED15.6 WXGAG	N11PG V2H	1G-DDR3 (64*16*8)	SO2GBI II10	SO2GBIII 10
AS5741G-333G32Mn	LX.PTD01.002	Ci3330M	NLED15.6 WXGAG	N11PG V2H	1G-DDR3 (64*16*8)	SO2GBI II10	SO1GBIII 10
AS5741G-334G64Mn	LX.PTD02.058	Ci3330M	NLED15.6 WXGAG	N11PG V2H	1G-DDR3 (64*16*8)	SO2GBI II10	SO2GBIII 10
AS5741G-334G64Mn	LX.PTD02.057	Ci3330M	NLED15.6 WXGAG	N11PG V2H	1G-DDR3 (64*16*8)	SO2GBI II10	SO2GBIII 10
AS5741G-334G64Mn	LX.PTD02.056	Ci3330M	NLED15.6 WXGAG	N11PG V2H	1G-DDR3 (64*16*8)	SO2GBI II10	SO2GBIII 10
AS5741G-332G50Mn	LX.PTD01.001	Ci3330M	NLED15.6 WXGAG	N11PG V2H	1G-DDR3 (64*16*8)	SO2GBI II10	N
AS5741G-334G64Mn	LX.PTD02.055	Ci3330M	NLED15.6 WXGAG	N11PG V2H	1G-DDR3 (64*16*8)	SO2GBI II10	SO2GBIII 10

Model	Acer Part No	CPU	LCD	VGA Chip	VRAM 1	Memory 1	Memory 2
AS5741G-334G64Mn	LX.PTD02.054	Ci3330M	NLED15.6 WXGAG	N11PG V2H	1G-DDR3 (64*16*8)	SO2GBI II10	SO2GBIII 10
AS5741G-334G50Mn	LX.PTD02.052	Ci3330M	NLED15.6 WXGAG	N11PG V2H	1G-DDR3 (64*16*8)	SO2GBI II10	SO2GBIII 10
AS5741G-334G50Mn	LX.PTD02.053	Ci3330M	NLED15.6 WXGAG	N11PG V2H	1G-DDR3 (64*16*8)	SO2GBI II10	SO2GBIII 10
AS5741G-334G50Mn	LX.PTD0C.001	Ci3330M	NLED15.6 WXGAG	N11PG V2H	1G-DDR3 (64*16*8)	SO4GBI II10	N
AS5741G-354G50Mn	LX.PTD02.051	Ci3350M	NLED15.6 WXGAG	N11PG V2H	1G-DDR3 (64*16*8)	SO2GBI II10	SO2GBIII 10
AS5741G-352G50Mn	LX.PTD02.050	Ci3350M	NLED15.6 WXGAG	N11PG V2H	1G-DDR3 (64*16*8)	SO2GBI II10	N
AS5741G-332G50Mn	LX.PTD02.049	Ci3330M	NLED15.6 WXGAG	N11PG V2H	1G-DDR3 (64*16*8)	SO2GBI II10	N
AS5741G-334G50Mn	LX.PTD02.048	Ci3330M	NLED15.6 WXGAG	N11PG V2H	1G-DDR3 (64*16*8)	SO2GBI II10	SO2GBIII 10
AS5741G-334G32Mn	LX.PTD02.047	Ci3330M	NLED15.6 WXGAG	N11PG V2H	1G-DDR3 (64*16*8)	SO2GBI II10	SO2GBIII 10
AS5741G-333G32Mn	LX.PTD02.046	Ci3330M	NLED15.6 WXGAG	N11PG V2H	1G-DDR3 (64*16*8)	SO2GBI II10	SO1GBIII 10
AS5741G-333G32Mi	LX.PTD02.045	Ci3330M	NLED15.6 WXGAG	N11PG V2H	1G-DDR3 (64*16*8)	SO2GBI II10	SO1GBIII 10
AS5741G-333G32Mn	LX.PTD02.044	Ci3330M	NLED15.6 WXGAG	N11PG V2H	1G-DDR3 (64*16*8)	SO2GBI II10	SO1GBIII 10
AS5741G-333G32Mn	LX.PTD02.043	Ci3330M	NLED15.6 WXGAG	N11PG V2H	1G-DDR3 (64*16*8)	SO2GBI II10	SO1GBIII 10
AS5741G-333G32Mn	LX.PTD02.042	Ci3330M	NLED15.6 WXGAG	N11PG V2H	1G-DDR3 (64*16*8)	SO2GBI II10	SO1GBIII 10
AS5741G-333G32Mn	LX.PTD02.041	Ci3330M	NLED15.6 WXGAG	N11PG V2H	1G-DDR3 (64*16*8)	SO2GBI II10	SO1GBIII 10
AS5741G-333G32Mn	LX.PTD02.040	Ci3330M	NLED15.6 WXGAG	N11PG V2H	1G-DDR3 (64*16*8)	SO2GBI II10	SO1GBIII 10
AS5741G-333G32Mn	LX.PTD02.039	Ci3330M	NLED15.6 WXGAG	N11PG V2H	1G-DDR3 (64*16*8)	SO2GBI II10	SO1GBIII 10
AS5741G-333G32Mn	LX.PTD02.038	Ci3330M	NLED15.6 WXGAG	N11PG V2H	1G-DDR3 (64*16*8)	SO2GBI II10	SO1GBIII 10
AS5741G-333G32Mn	LX.PTD02.037	Ci3330M	NLED15.6 WXGAG	N11PG V2H	1G-DDR3 (64*16*8)	SO2GBI II10	SO1GBIII 10
AS5741G-333G32Mn	LX.PTD02.036	Ci3330M	NLED15.6 WXGAG	N11PG V2H	1G-DDR3 (64*16*8)	SO2GBI II10	SO1GBIII 10
AS5741G-333G32Mn	LX.PTD02.035	Ci3330M	NLED15.6 WXGAG	N11PG V2H	1G-DDR3 (64*16*8)	SO2GBI II10	SO1GBIII 10
AS5741G-333G32Mn	LX.PTD02.034	Ci3330M	NLED15.6 WXGAG	N11PG V2H	1G-DDR3 (64*16*8)	SO2GBI II10	SO1GBIII 10
AS5741G-333G32Mn	LX.PTD02.033	Ci3330M	NLED15.6 WXGAG	N11PG V2H	1G-DDR3 (64*16*8)	SO2GBI II10	SO1GBIII 10
AS5741G-333G32Mn	LX.PTD02.032	Ci3330M	NLED15.6 WXGAG	N11PG V2H	1G-DDR3 (64*16*8)	SO2GBI II10	SO1GBIII 10

Model	Acer Part No	CPU	LCD	VGA Chip	VRAM 1	Memory 1	Memory 2
AS5741G-333G32Mn	LX.PTD02.031	Ci3330M	NLED15.6 WXGAG	N11PG V2H	1G-DDR3 (64*16*8)	SO2GBI II10	SO1GBIII 10
AS5741G-333G32Mn	LX.PTD02.030	Ci3330M	NLED15.6 WXGAG	N11PG V2H	1G-DDR3 (64*16*8)	SO2GBI II10	SO1GBIII 10
AS5741G-333G32Mn	LX.PTD02.029	Ci3330M	NLED15.6 WXGAG	N11PG V2H	1G-DDR3 (64*16*8)	SO2GBI II10	SO1GBIII 10
AS5741G-333G32Mn	LX.PTD02.028	Ci3330M	NLED15.6 WXGAG	N11PG V2H	1G-DDR3 (64*16*8)	SO2GBI II10	SO1GBIII 10
AS5741G-333G32Mn	LX.PTD02.027	Ci3330M	NLED15.6 WXGAG	N11PG V2H	1G-DDR3 (64*16*8)	SO2GBI II10	SO1GBIII 10
AS5741G-333G32Mn	LX.PTD02.026	Ci3330M	NLED15.6 WXGAG	N11PG V2H	1G-DDR3 (64*16*8)	SO2GBI II10	SO1GBIII 10
AS5741G-333G32Mn	LX.PTD02.025	Ci3330M	NLED15.6 WXGAG	N11PG V2H	1G-DDR3 (64*16*8)	SO2GBI II10	SO1GBIII 10
AS5741G-333G32Mn	LX.PTD02.024	Ci3330M	NLED15.6 WXGAG	N11PG V2H	1G-DDR3 (64*16*8)	SO2GBI II10	SO1GBIII 10
AS5741G-333G32Mn	LX.PTD02.023	Ci3330M	NLED15.6 WXGAG	N11PG V2H	1G-DDR3 (64*16*8)	SO2GBI II10	SO1GBIII 10
AS5741G-333G32Mn	LX.PTD02.022	Ci3330M	NLED15.6 WXGAG	N11PG V2H	1G-DDR3 (64*16*8)	SO2GBI II10	SO1GBIII 10
AS5741G-333G32Mn	LX.PTD02.021	Ci3330M	NLED15.6 WXGAG	N11PG V2H	1G-DDR3 (64*16*8)	SO2GBI II10	SO1GBIII 10
AS5741G-333G32Mn	LX.PTD02.020	Ci3330M	NLED15.6 WXGAG	N11PG V2H	1G-DDR3 (64*16*8)	SO2GBI II10	SO1GBIII 10
AS5741G-333G32Mn	LX.PTD02.019	Ci3330M	NLED15.6 WXGAG	N11PG V2H	1G-DDR3 (64*16*8)	SO2GBI II10	SO1GBIII 10
AS5741G-333G32Mn	LX.PTD02.018	Ci3330M	NLED15.6 WXGAG	N11PG V2H	1G-DDR3 (64*16*8)	SO2GBI II10	SO1GBIII 10
AS5741G-333G32Mn	LX.PTD02.017	Ci3330M	NLED15.6 WXGAG	N11PG V2H	1G-DDR3 (64*16*8)	SO2GBI II10	SO1GBIII 10
AS5741G-333G32Mn	LX.PTD02.016	Ci3330M	NLED15.6 WXGAG	N11PG V2H	1G-DDR3 (64*16*8)	SO2GBI II10	SO1GBIII 10
AS5741G-333G32Mn	LX.PTD02.015	Ci3330M	NLED15.6 WXGAG	N11PG V2H	1G-DDR3 (64*16*8)	SO2GBI II10	SO1GBIII 10
AS5741G-333G32Mn	LX.PTD02.014	Ci3330M	NLED15.6 WXGAG	N11PG V2H	1G-DDR3 (64*16*8)	SO2GBI II10	SO1GBIII 10
AS5741G-333G32Mn	LX.PTD02.013	Ci3330M	NLED15.6 WXGAG	N11PG V2H	1G-DDR3 (64*16*8)	SO2GBI II10	SO1GBIII 10
AS5741G-333G32Mn	LX.PTD02.011	Ci3330M	NLED15.6 WXGAG	N11PG V2H	1G-DDR3 (64*16*8)	SO2GBI II10	SO1GBIII 10
AS5741G-333G32Mn	LX.PTD02.012	Ci3330M	NLED15.6 WXGAG	N11PG V2H	1G-DDR3 (64*16*8)	SO2GBI II10	SO1GBIII 10
AS5741G-333G32Mn	LX.PTD02.010	Ci3330M	NLED15.6 WXGAG	N11PG V2H	1G-DDR3 (64*16*8)	SO2GBI II10	SO1GBIII 10
AS5741G-333G32Mn	LX.PTD02.009	Ci3330M	NLED15.6 WXGAG	N11PG V2H	1G-DDR3 (64*16*8)	SO2GBI II10	SO1GBIII 10
AS5741G-333G32Mn	LX.PTD02.008	Ci3330M	NLED15.6 WXGAG	N11PG V2H	1G-DDR3 (64*16*8)	SO2GBI II10	SO1GBIII 10

Model	Acer Part No	CPU	LCD	VGA Chip	VRAM 1	Memory 1	Memory 2
AS5741G-333G32Mn	LX.PTD02.007	Ci3330M	NLED15.6 WXGAG	N11PG V2H	1G-DDR3 (64*16*8)	SO2GBI I110	SO1GBIII 10
AS5741G-333G32Mn	LX.PTD02.006	Ci3330M	NLED15.6 WXGAG	N11PG V2H	1G-DDR3 (64*16*8)	SO2GBI I110	SO1GBIII 10
AS5741G-333G32Mn	LX.PTD02.005	Ci3330M	NLED15.6 WXGAG	N11PG V2H	1G-DDR3 (64*16*8)	SO2GBI I110	SO1GBIII 10
AS5741G-333G32Mn	LX.PTD02.004	Ci3330M	NLED15.6 WXGAG	N11PG V2H	1G-DDR3 (64*16*8)	SO2GBI I110	SO1GBIII 10
AS5741G-333G32Mn	LX.PTD02.003	Ci3330M	NLED15.6 WXGAG	N11PG V2H	1G-DDR3 (64*16*8)	SO2GBI I110	SO1GBIII 10
AS5741G-333G32Mn	LX.PTD02.002	Ci3330M	NLED15.6 WXGAG	N11PG V2H	1G-DDR3 (64*16*8)	SO2GBI I110	SO1GBIII 10
AS5741G-334G64Mn	LX.PTD02.001	Ci3330M	NLED15.6 WXGAG	N11PG V2H	1G-DDR3 (64*16*8)	SO2GBI I110	SO2GBIII 10
AS5741G-332G50Mn	S2.PTD02.001	Ci3330M	NLED15.6 WXGAG	N11PG V2H	1G-DDR3 (64*16*8)	SO1GBI I110	SO1GBIII 10
AS5741G-332G50Mn	S2.PTD02.001	Ci3330M	NLED15.6 WXGAG	N11PG V2H	1G-DDR3 (64*16*8)	SO1GBI I110	SO1GBIII 10
AS5741G-334G50Mn	LX.PSZ02.064	Ci3330M	NLED15.6 WXGAG	PARK_XT	512M-DDR3 (32*16*8)	SO2GBI I110	SO2GBIII 10
AS5741G-353G50Mn	LX.PSZ0C.009	Ci3350M	NLED15.6 WXGAG	PARK_XT	512M-DDR3 (32*16*8)	SO2GBI I110	SO1GBIII 10
AS5741G-352G32Mn	LX.PSZ0C.008	Ci3350M	NLED15.6 WXGAG	PARK_XT	512M-DDR3 (32*16*8)	SO2GBI I110	N
AS5741G-436G50Mn	LX.PSZ02.063	Ci5430M	NLED15.6 WXGAG	PARK_XT	512M-DDR3 (32*16*8)	SO4GBI I110	SO2GBIII 10
AS5741G-434G50Mn	LX.PSZ02.062	Ci5430M	NLED15.6 WXGAG	PARK_XT	512M-DDR3 (32*16*8)	SO2GBI I110	SO2GBIII 10
AS5741G-333G32Mn	LX.PSZ0C.007	Ci3330M	NLED15.6 WXGAG	PARK_XT	512M-DDR3 (32*16*8)	SO2GBI I110	SO1GBIII 10
AS5741G-334G50Mn	LX.PSZ02.061	Ci3330M	NLED15.6 WXGAG	PARK_XT	512M-DDR3 (32*16*8)	SO2GBI I110	SO2GBIII 10
AS5741G-434G64Mn	LX.PSZ0C.006	Ci5430M	NLED15.6 WXGAG	PARK_XT	512M-DDR3 (32*16*8)	SO2GBI I110	SO2GBIII 10
AS5741G-334G50Mn	LX.PSZ0C.005	Ci3330M	NLED15.6 WXGAG	PARK_XT	512M-DDR3 (32*16*8)	SO2GBI I110	SO2GBIII 10
AS5741G-333G32Mn	LX.PSZ0C.004	Ci3330M	NLED15.6 WXGAG	PARK_XT	512M-DDR3 (32*16*8)	SO2GBI I110	SO1GBIII 10
AS5741G-434G32Mn	LX.PSZ02.060	Ci5430M	NLED15.6 WXGAG	PARK_XT	512M-DDR3 (32*16*8)	SO2GBI I110	SO2GBIII 10

Model	Acer Part No	CPU	LCD	VGA Chip	VRAM 1	Memory 1	Memory 2
AS5741G-333G32Mn	LX.PSZ02.059	Ci3330M	NLED15.6 WXGAG	PARK_XT	512M-DDR3 (32*16*8)	SO2GBI II10	SO1GBIII 10
AS5741G-334G32Bn	LX.PSZ02.058	Ci3330M	NLED15.6 WXGAG	PARK_XT	512M-DDR3 (32*16*8)	SO2GBI II10	SO2GBIII 10
AS5741G-334G32Mn	LX.PSZ02.057	Ci3330M	NLED15.6 WXGAG	PARK_XT	512M-DDR3 (32*16*8)	SO2GBI II10	SO2GBIII 10
AS5741G-334G50Mn	LX.PSZ02.056	Ci3330M	NLED15.6 WXGAG	PARK_XT	512M-DDR3 (32*16*8)	SO2GBI II10	SO2GBIII 10
AS5741G-333G32Mn	LX.PSZ02.055	Ci3330M	NLED15.6 WXGAG	PARK_XT	512M-DDR3 (32*16*8)	SO1GBI II10	SO2GBIII 10
AS5741G-333G32Mn	LX.PSZ0C.003	Ci3330M	NLED15.6 WXGAG	PARK_XT	512M-DDR3 (32*16*8)	SO2GBI II10	SO1GBIII 10
AS5741G-432G32Mn	LX.PSZ01.003	Ci5430M	NLED15.6 WXGAG	PARK_XT	512M-DDR3 (32*16*8)	SO2GBI II10	N
AS5741G-332G50Mn	LX.PSZ02.054	Ci3330M	NLED15.6 WXGAG	PARK_XT	512M-DDR3 (32*16*8)	SO2GBI II10	N
AS5741G-334G50Mn	LX.PSZ02.053	Ci3330M	NLED15.6 WXGAG	PARK_XT	512M-DDR3 (32*16*8)	SO2GBI II10	SO2GBIII 10
AS5741G-332G64Mn	LX.PSZ02.052	Ci3330M	NLED15.6 WXGAG	PARK_XT	512M-DDR3 (32*16*8)	SO2GBI II10	N
AS5741G-333G32Mn	LX.PSZ01.002	Ci3330M	NLED15.6 WXGAG	PARK_XT	512M-DDR3 (32*16*8)	SO2GBI II10	SO1GBIII 10
AS5741G-334G64Mn	LX.PSZ02.051	Ci3330M	NLED15.6 WXGAG	PARK_XT	512M-DDR3 (32*16*8)	SO2GBI II10	SO2GBIII 10
AS5741G-334G64Mn	LX.PSZ02.050	Ci3330M	NLED15.6 WXGAG	PARK_XT	512M-DDR3 (32*16*8)	SO2GBI II10	SO2GBIII 10
AS5741G-334G64Mn	LX.PSZ02.049	Ci3330M	NLED15.6 WXGAG	PARK_XT	512M-DDR3 (32*16*8)	SO2GBI II10	SO2GBIII 10
AS5741G-332G32Mn	LX.PSZ01.001	Ci3330M	NLED15.6 WXGAG	PARK_XT	512M-DDR3 (32*16*8)	SO2GBI II10	N
AS5741G-334G32Mn	LX.PSZ0C.002	Ci3330M	NLED15.6 WXGAG	PARK_XT	512M-DDR3 (32*16*8)	SO2GBI II10	SO2GBIII 10
AS5741G-334G32Mn	LX.PSZ0C.001	Ci3330M	NLED15.6 WXGAG	PARK_XT	512M-DDR3 (32*16*8)	SO2GBI II10	SO2GBIII 10

Model	Acer Part No	CPU	LCD	VGA Chip	VRAM 1	Memory 1	Memory 2
AS5741G-334G32Mn	LX.PSZ02.048	Ci3330M	NLED15.6 WXGAG	PARK_XT	512M-DDR3 (32*16*8)	SO2GBI II10	SO2GBIII 10
AS5741G-334G32Mi	LX.PSZ02.047	Ci3330M	NLED15.6 WXGAG	PARK_XT	512M-DDR3 (32*16*8)	SO2GBI II10	SO2GBIII 10
AS5741G-334G32Mn	LX.PSZ02.046	Ci3330M	NLED15.6 WXGAG	PARK_XT	512M-DDR3 (32*16*8)	SO2GBI II10	SO2GBIII 10
AS5741G-334G32Mn	LX.PSZ02.045	Ci3330M	NLED15.6 WXGAG	PARK_XT	512M-DDR3 (32*16*8)	SO2GBI II10	SO2GBIII 10
AS5741G-334G32Mn	LX.PSZ02.044	Ci3330M	NLED15.6 WXGAG	PARK_XT	512M-DDR3 (32*16*8)	SO2GBI II10	SO2GBIII 10
AS5741G-334G32Mn	LX.PSZ02.043	Ci3330M	NLED15.6 WXGAG	PARK_XT	512M-DDR3 (32*16*8)	SO2GBI II10	SO2GBIII 10
AS5741G-334G32Mn	LX.PSZ02.042	Ci3330M	NLED15.6 WXGAG	PARK_XT	512M-DDR3 (32*16*8)	SO2GBI II10	SO2GBIII 10
AS5741G-334G32Mn	LX.PSZ02.041	Ci3330M	NLED15.6 WXGAG	PARK_XT	512M-DDR3 (32*16*8)	SO2GBI II10	SO2GBIII 10
AS5741G-334G32Mn	LX.PSZ02.040	Ci3330M	NLED15.6 WXGAG	PARK_XT	512M-DDR3 (32*16*8)	SO2GBI II10	SO2GBIII 10
AS5741G-334G32Mn	LX.PSZ02.039	Ci3330M	NLED15.6 WXGAG	PARK_XT	512M-DDR3 (32*16*8)	SO2GBI II10	SO2GBIII 10
AS5741G-334G32Mn	LX.PSZ02.038	Ci3330M	NLED15.6 WXGAG	PARK_XT	512M-DDR3 (32*16*8)	SO2GBI II10	SO2GBIII 10
AS5741G-334G32Mn	LX.PSZ02.037	Ci3330M	NLED15.6 WXGAG	PARK_XT	512M-DDR3 (32*16*8)	SO2GBI II10	SO2GBIII 10
AS5741G-334G32Mn	LX.PSZ02.036	Ci3330M	NLED15.6 WXGAG	PARK_XT	512M-DDR3 (32*16*8)	SO2GBI II10	SO2GBIII 10
AS5741G-334G32Mn	LX.PSZ02.035	Ci3330M	NLED15.6 WXGAG	PARK_XT	512M-DDR3 (32*16*8)	SO2GBI II10	SO2GBIII 10
AS5741G-334G32Mn	LX.PSZ02.034	Ci3330M	NLED15.6 WXGAG	PARK_XT	512M-DDR3 (32*16*8)	SO2GBI II10	SO2GBIII 10
AS5741G-334G32Mn	LX.PSZ02.033	Ci3330M	NLED15.6 WXGAG	PARK_XT	512M-DDR3 (32*16*8)	SO2GBI II10	SO2GBIII 10
AS5741G-334G32Mn	LX.PSZ02.032	Ci3330M	NLED15.6 WXGAG	PARK_XT	512M-DDR3 (32*16*8)	SO2GBI II10	SO2GBIII 10

Model	Acer Part No	CPU	LCD	VGA Chip	VRAM 1	Memory 1	Memory 2
AS5741G-334G32Mn	LX.PSZ02.031	Ci3330M	NLED15.6 WXGAG	PARK_XT	512M-DDR3 (32*16*8)	SO2GBI I110	SO2GBIII 10
AS5741G-334G32Mn	LX.PSZ02.030	Ci3330M	NLED15.6 WXGAG	PARK_XT	512M-DDR3 (32*16*8)	SO2GBI I110	SO2GBIII 10
AS5741G-334G32Mn	LX.PSZ02.029	Ci3330M	NLED15.6 WXGAG	PARK_XT	512M-DDR3 (32*16*8)	SO2GBI I110	SO2GBIII 10
AS5741G-334G32Mn	LX.PSZ02.028	Ci3330M	NLED15.6 WXGAG	PARK_XT	512M-DDR3 (32*16*8)	SO2GBI I110	SO2GBIII 10
AS5741G-334G32Mn	LX.PSZ02.027	Ci3330M	NLED15.6 WXGAG	PARK_XT	512M-DDR3 (32*16*8)	SO2GBI I110	SO2GBIII 10
AS5741G-334G32Mn	LX.PSZ02.026	Ci3330M	NLED15.6 WXGAG	PARK_XT	512M-DDR3 (32*16*8)	SO2GBI I110	SO2GBIII 10
AS5741G-334G32Mn	LX.PSZ02.025	Ci3330M	NLED15.6 WXGAG	PARK_XT	512M-DDR3 (32*16*8)	SO2GBI I110	SO2GBIII 10
AS5741G-334G32Mn	LX.PSZ02.024	Ci3330M	NLED15.6 WXGAG	PARK_XT	512M-DDR3 (32*16*8)	SO2GBI I110	SO2GBIII 10
AS5741G-334G32Mn	LX.PSZ02.023	Ci3330M	NLED15.6 WXGAG	PARK_XT	512M-DDR3 (32*16*8)	SO2GBI I110	SO2GBIII 10
AS5741G-334G32Mn	LX.PSZ02.022	Ci3330M	NLED15.6 WXGAG	PARK_XT	512M-DDR3 (32*16*8)	SO2GBI I110	SO2GBIII 10
AS5741G-334G32Mn	LX.PSZ02.021	Ci3330M	NLED15.6 WXGAG	PARK_XT	512M-DDR3 (32*16*8)	SO2GBI I110	SO2GBIII 10
AS5741G-334G32Mn	LX.PSZ02.020	Ci3330M	NLED15.6 WXGAG	PARK_XT	512M-DDR3 (32*16*8)	SO2GBI I110	SO2GBIII 10
AS5741G-334G32Mn	LX.PSZ02.019	Ci3330M	NLED15.6 WXGAG	PARK_XT	512M-DDR3 (32*16*8)	SO2GBI I110	SO2GBIII 10
AS5741G-334G32Mn	LX.PSZ02.018	Ci3330M	NLED15.6 WXGAG	PARK_XT	512M-DDR3 (32*16*8)	SO2GBI I110	SO2GBIII 10
AS5741G-334G32Mn	LX.PSZ02.017	Ci3330M	NLED15.6 WXGAG	PARK_XT	512M-DDR3 (32*16*8)	SO2GBI I110	SO2GBIII 10
AS5741G-334G32Mn	LX.PSZ02.016	Ci3330M	NLED15.6 WXGAG	PARK_XT	512M-DDR3 (32*16*8)	SO2GBI I110	SO2GBIII 10
AS5741G-334G32Mn	LX.PSZ02.015	Ci3330M	NLED15.6 WXGAG	PARK_XT	512M-DDR3 (32*16*8)	SO2GBI I110	SO2GBIII 10

Model	Acer Part No	CPU	LCD	VGA Chip	VRAM 1	Memory 1	Memory 2
AS5741G-334G32Mn	LX.PSZ02.014	Ci3330M	NLED15.6 WXGAG	PARK_XT	512M-DDR3 (32*16*8)	SO2GBI II10	SO2GBIII 10
AS5741G-334G32Mn	LX.PSZ02.013	Ci3330M	NLED15.6 WXGAG	PARK_XT	512M-DDR3 (32*16*8)	SO2GBI II10	SO2GBIII 10
AS5741G-334G32Mn	LX.PSZ02.012	Ci3330M	NLED15.6 WXGAG	PARK_XT	512M-DDR3 (32*16*8)	SO2GBI II10	SO2GBIII 10
AS5741G-334G32Mn	LX.PSZ02.011	Ci3330M	NLED15.6 WXGAG	PARK_XT	512M-DDR3 (32*16*8)	SO2GBI II10	SO2GBIII 10
AS5741G-334G32Mn	LX.PSZ02.010	Ci3330M	NLED15.6 WXGAG	PARK_XT	512M-DDR3 (32*16*8)	SO2GBI II10	SO2GBIII 10
AS5741G-334G32Mn	LX.PSZ02.009	Ci3330M	NLED15.6 WXGAG	PARK_XT	512M-DDR3 (32*16*8)	SO2GBI II10	SO2GBIII 10
AS5741G-334G32Mn	LX.PSZ02.008	Ci3330M	NLED15.6 WXGAG	PARK_XT	512M-DDR3 (32*16*8)	SO2GBI II10	SO2GBIII 10
AS5741G-334G32Mn	LX.PSZ02.007	Ci3330M	NLED15.6 WXGAG	PARK_XT	512M-DDR3 (32*16*8)	SO2GBI II10	SO2GBIII 10
AS5741G-334G32Mn	LX.PSZ02.006	Ci3330M	NLED15.6 WXGAG	PARK_XT	512M-DDR3 (32*16*8)	SO2GBI II10	SO2GBIII 10
AS5741G-334G32Mn	LX.PSZ02.005	Ci3330M	NLED15.6 WXGAG	PARK_XT	512M-DDR3 (32*16*8)	SO2GBI II10	SO2GBIII 10
AS5741G-334G32Mn	LX.PSZ02.004	Ci3330M	NLED15.6 WXGAG	PARK_XT	512M-DDR3 (32*16*8)	SO2GBI II10	SO2GBIII 10
AS5741G-332G32Mn	LX.PSZ02.003	Ci3330M	NLED15.6 WXGAG	PARK_XT	512M-DDR3 (32*16*8)	SO2GBI II10	N
AS5741G-334G32Mn	S2.PSZ0C.003	Ci3330M	NLED15.6 WXGAG	PARK_XT	512M-DDR3 (32*16*8)	SO2GBI II10	SO2GBIII 10
AS5741G-333G32Bn	LX.PSZ02.002	Ci3330M	NLED15.6 WXGAG	PARK_XT	512M-DDR3 (32*16*8)	SO2GBI II10	SO1GBIII 10
AS5741G-334G50Mn	LX.PSZ02.001	Ci3330M	NLED15.6 WXGAG	PARK_XT	512M-DDR3 (32*16*8)	SO2GBI II10	SO2GBIII 10
AS5741G-434G32Mn	S2.PSZ0C.002	Ci5430M	NLED15.6 WXGAG	PARK_XT	512M-DDR3 (32*16*8)	SO2GBI II10	SO2GBIII 10
AS5741G-334G32Mn	S2.PSZ0C.001	Ci3330M	NLED15.6 WXGAG	PARK_XT	512M-DDR3 (32*16*8)	SO2GBI II10	SO2GBIII 10

Model	Acer Part No	Memory 3	Memory 4	HDD 1(GB)	HDD 2(GB)	ODD
AS5741G-334G50Mn	LX.PTD0C.006	N	N	N500GB5.4KS	N	NSM8XS
AS5741G-434G50Mn	LX.PTD0C.005	N	N	N500GB5.4KS	N	NSM8XS
AS5741G-434G32Mn	LX.PTD0C.004	N	N	N320GB5.4KS	N	NSM8XS
AS5741G-334G64Mn	LX.PTD02.084	N	N	N640GB5.4KS	N	NSM8XS
AS5741G-434G50Mn	LX.PTD02.083	N	N	N500GB5.4KS	N	NSM8XS
AS5741G-334G32Mn	LX.PTD0C.003	N	N	N320GB5.4KS	N	NSM8XS
AS5741G-334G32Mn	LX.PTD02.082	N	N	N320GB5.4KS	N	NSM8XS
AS5741G-334G50Bn	LX.PTD02.081	N	N	N500GB5.4KS	N	NBDCB4XS
AS5741G-434G64Bn	LX.PTD02.080	N	N	N640GB5.4KS	N	NBDCB4XS
AS5741G-333G32Mn	LX.PTD02.079	N	N	N320GB5.4KS	N	NSM8XS
AS5741G-334G50Mn	LX.PTD0C.002	N	N	N500GB5.4KS	N	NSM8XS
AS5741G-436G64Bn	LX.PTD02.078	N	N	N640GB5.4KS	N	NBDCB4XS
AS5741G-434G50Bn	LX.PTD02.077	N	N	N500GB5.4KS	N	NBDCB4XS
AS5741G-333G32Mn	LX.PTD02.076	N	N	N320GB5.4KS	N	NSM8XS
AS5741G-434G50Mn	LX.PTD02.075	N	N	N500GB5.4KS	N	NSM8XS
AS5741G-334G32Mn	LX.PTD02.074	N	N	N320GB5.4KS	N	NSM8XS
AS5741G-434G50Mn	LX.PTD02.073	N	N	N500GB5.4KS	N	NSM8XS
AS5741G-334G64Mn	LX.PTD02.072	N	N	N640GB5.4KS	N	NSM8XS
AS5741G-332G25Mn	LX.PTD02.071	N	N	N250GB5.4KS	N	NSM8XS
AS5741G-334G50Mn	LX.PTD02.070	N	N	N500GB5.4KS	N	NSM8XS
AS5741G-432G32Mn	LX.PTD01.003	N	N	N320GB5.4KS	N	NSM8XS
AS5741G-332G32Mn	LX.PTD01.004	N	N	N320GB5.4KS	N	NSM8XS
AS5741G-436G64Bn	LX.PTD02.069	N	N	N640GB5.4KS	N	NBDCB4XS
AS5741G-436G64Bn	LX.PTD02.068	N	N	N640GB5.4KS	N	NBDCB4XS

Model	Acer Part No	Memory 3	Memory 4	HDD 1(GB)	HDD 2(GB)	ODD
AS5741G-436G64Bn	LX.PTD02.067	N	N	N640GB5.4KS	N	NBDCB4XS
AS5741G-436G64Mn	LX.PTD02.066	N	N	N640GB5.4KS	N	NSM8XS
AS5741G-436G64Mn	LX.PTD02.065	N	N	N640GB5.4KS	N	NSM8XS
AS5741G-436G64Mn	LX.PTD02.064	N	N	N640GB5.4KS	N	NSM8XS
AS5741G-434G32Mn	LX.PTD02.063	N	N	N320GB5.4KS	N	NSM8XS
AS5741G-434G32Mn	LX.PTD02.062	N	N	N320GB5.4KS	N	NSM8XS
AS5741G-434G32Mn	LX.PTD02.061	N	N	N320GB5.4KS	N	NSM8XS
AS5741G-332G64Mn	LX.PTD02.060	N	N	N640GB5.4KS	N	NSM8XS
AS5741G-334G50Mn	LX.PTD02.059	N	N	N500GB5.4KS	N	NSM8XS
AS5741G-333G32Mn	LX.PTD01.002	N	N	N320GB5.4KS	N	NSM8XS
AS5741G-334G64Mn	LX.PTD02.058	N	N	N640GB5.4KS	N	NSM8XS
AS5741G-334G64Mn	LX.PTD02.057	N	N	N640GB5.4KS	N	NSM8XS
AS5741G-334G64Mn	LX.PTD02.056	N	N	N640GB5.4KS	N	NSM8XS
AS5741G-332G50Mn	LX.PTD01.001	N	N	N500GB5.4KS	N	NSM8XS
AS5741G-334G64Mn	LX.PTD02.055	N	N	N640GB5.4KS	N	NSM8XS
AS5741G-334G64Mn	LX.PTD02.054	N	N	N640GB5.4KS	N	NSM8XS
AS5741G-334G50Mn	LX.PTD02.052	N	N	N500GB5.4KS	N	NSM8XS
AS5741G-334G50Mn	LX.PTD02.053	N	N	N500GB5.4KS	N	NSM8XS
AS5741G-334G50Mn	LX.PTD0C.001	N	N	N500GB5.4KS	N	NSM8XS
AS5741G-354G50Mn	LX.PTD02.051	N	N	N500GB5.4KS	N	NSM8XS
AS5741G-352G50Mn	LX.PTD02.050	N	N	N500GB5.4KS	N	NSM8XS
AS5741G-332G50Mn	LX.PTD02.049	N	N	N500GB5.4KS	N	NSM8XS
AS5741G-334G50Mn	LX.PTD02.048	N	N	N500GB5.4KS	N	NSM8XS
AS5741G-334G32Mn	LX.PTD02.047	N	N	N320GB5.4KS	N	NSM8XS

Model	Acer Part No	Memory 3	Memory 4	HDD 1(GB)	HDD 2(GB)	ODD
AS5741G-333G32Mn	LX.PTD02.046	N	N	N320GB5.4KS	N	NSM8XS
AS5741G-333G32Mi	LX.PTD02.045	N	N	N320GB5.4KS	N	NSM8XS
AS5741G-333G32Mn	LX.PTD02.044	N	N	N320GB5.4KS	N	NSM8XS
AS5741G-333G32Mn	LX.PTD02.043	N	N	N320GB5.4KS	N	NSM8XS
AS5741G-333G32Mn	LX.PTD02.042	N	N	N320GB5.4KS	N	NSM8XS
AS5741G-333G32Mn	LX.PTD02.041	N	N	N320GB5.4KS	N	NSM8XS
AS5741G-333G32Mn	LX.PTD02.040	N	N	N320GB5.4KS	N	NSM8XS
AS5741G-333G32Mn	LX.PTD02.039	N	N	N320GB5.4KS	N	NSM8XS
AS5741G-333G32Mn	LX.PTD02.038	N	N	N320GB5.4KS	N	NSM8XS
AS5741G-333G32Mn	LX.PTD02.037	N	N	N320GB5.4KS	N	NSM8XS
AS5741G-333G32Mn	LX.PTD02.036	N	N	N320GB5.4KS	N	NSM8XS
AS5741G-333G32Mn	LX.PTD02.035	N	N	N320GB5.4KS	N	NSM8XS
AS5741G-333G32Mn	LX.PTD02.034	N	N	N320GB5.4KS	N	NSM8XS
AS5741G-333G32Mn	LX.PTD02.033	N	N	N320GB5.4KS	N	NSM8XS
AS5741G-333G32Mn	LX.PTD02.032	N	N	N320GB5.4KS	N	NSM8XS
AS5741G-333G32Mn	LX.PTD02.031	N	N	N320GB5.4KS	N	NSM8XS
AS5741G-333G32Mn	LX.PTD02.030	N	N	N320GB5.4KS	N	NSM8XS
AS5741G-333G32Mn	LX.PTD02.029	N	N	N320GB5.4KS	N	NSM8XS
AS5741G-333G32Mn	LX.PTD02.028	N	N	N320GB5.4KS	N	NSM8XS
AS5741G-333G32Mn	LX.PTD02.027	N	N	N320GB5.4KS	N	NSM8XS
AS5741G-333G32Mn	LX.PTD02.026	N	N	N320GB5.4KS	N	NSM8XS
AS5741G-333G32Mn	LX.PTD02.025	N	N	N320GB5.4KS	N	NSM8XS
AS5741G-333G32Mn	LX.PTD02.024	N	N	N320GB5.4KS	N	NSM8XS
AS5741G-333G32Mn	LX.PTD02.023	N	N	N320GB5.4KS	N	NSM8XS

Model	Acer Part No	Memory 3	Memory 4	HDD 1(GB)	HDD 2(GB)	ODD
AS5741G-333G32Mn	LX.PTD02.022	N	N	N320GB5.4KS	N	NSM8XS
AS5741G-333G32Mn	LX.PTD02.021	N	N	N320GB5.4KS	N	NSM8XS
AS5741G-333G32Mn	LX.PTD02.020	N	N	N320GB5.4KS	N	NSM8XS
AS5741G-333G32Mn	LX.PTD02.019	N	N	N320GB5.4KS	N	NSM8XS
AS5741G-333G32Mn	LX.PTD02.018	N	N	N320GB5.4KS	N	NSM8XS
AS5741G-333G32Mn	LX.PTD02.017	N	N	N320GB5.4KS	N	NSM8XS
AS5741G-333G32Mn	LX.PTD02.016	N	N	N320GB5.4KS	N	NSM8XS
AS5741G-333G32Mn	LX.PTD02.015	N	N	N320GB5.4KS	N	NSM8XS
AS5741G-333G32Mn	LX.PTD02.014	N	N	N320GB5.4KS	N	NSM8XS
AS5741G-333G32Mn	LX.PTD02.013	N	N	N320GB5.4KS	N	NSM8XS
AS5741G-333G32Mn	LX.PTD02.011	N	N	N320GB5.4KS	N	NSM8XS
AS5741G-333G32Mn	LX.PTD02.012	N	N	N320GB5.4KS	N	NSM8XS
AS5741G-333G32Mn	LX.PTD02.010	N	N	N320GB5.4KS	N	NSM8XS
AS5741G-333G32Mn	LX.PTD02.009	N	N	N320GB5.4KS	N	NSM8XS
AS5741G-333G32Mn	LX.PTD02.008	N	N	N320GB5.4KS	N	NSM8XS
AS5741G-333G32Mn	LX.PTD02.007	N	N	N320GB5.4KS	N	NSM8XS
AS5741G-333G32Mn	LX.PTD02.006	N	N	N320GB5.4KS	N	NSM8XS
AS5741G-333G32Mn	LX.PTD02.005	N	N	N320GB5.4KS	N	NSM8XS
AS5741G-333G32Mn	LX.PTD02.004	N	N	N320GB5.4KS	N	NSM8XS
AS5741G-333G32Mn	LX.PTD02.003	N	N	N320GB5.4KS	N	NSM8XS
AS5741G-333G32Mn	LX.PTD02.002	N	N	N320GB5.4KS	N	NSM8XS
AS5741G-334G64Mn	LX.PTD02.001	N	N	N640GB5.4KS	N	NSM8XS
AS5741G-332G50Mn	S2.PTD02.001	N	N	N500GB5.4KS	N	NSM8XS
AS5741G-332G50Mn	S2.PTD02.001	N	N	N500GB5.4KS	N	NSM8XS

Model	Acer Part No	Memory 3	Memory 4	HDD 1(GB)	HDD 2(GB)	ODD
AS5741G-334G50Mn	LX.PSZ02.064	N	N	N500GB5.4KS	N	NSM8XS
AS5741G-353G50Mn	LX.PSZ0C.009	N	N	N500GB5.4KS	N	NSM8XS
AS5741G-352G32Mn	LX.PSZ0C.008	N	N	N320GB5.4KS	N	NSM8XS
AS5741G-436G50Mn	LX.PSZ02.063	N	N	N500GB5.4KS	N	NSM8XS
AS5741G-434G50Mn	LX.PSZ02.062	N	N	N500GB5.4KS	N	NSM8XS
AS5741G-333G32Mn	LX.PSZ0C.007	N	N	N320GB5.4KS	N	NSM8XS
AS5741G-334G50Mn	LX.PSZ02.061	N	N	N500GB5.4KS	N	NSM8XS
AS5741G-434G64Mn	LX.PSZ0C.006	N	N	N640GB5.4KS	N	NSM8XS
AS5741G-334G50Mn	LX.PSZ0C.005	N	N	N500GB5.4KS	N	NSM8XS
AS5741G-333G32Mn	LX.PSZ0C.004	N	N	N320GB5.4KS	N	NSM8XS
AS5741G-434G32Mn	LX.PSZ02.060	N	N	N320GB5.4KS	N	NSM8XS
AS5741G-333G32Mn	LX.PSZ02.059	N	N	N320GB5.4KS	N	NSM8XS
AS5741G-334G32Bn	LX.PSZ02.058	N	N	N320GB5.4KS	N	NBDCB4XS
AS5741G-334G32Mn	LX.PSZ02.057	N	N	N320GB5.4KS	N	NSM8XS
AS5741G-334G50Mn	LX.PSZ02.056	N	N	N500GB5.4KS	N	NSM8XS
AS5741G-333G32Mn	LX.PSZ02.055	N	N	N320GB5.4KS	N	NSM8XS
AS5741G-333G32Mn	LX.PSZ0C.003	N	N	N320GB5.4KS	N	NSM8XS
AS5741G-432G32Mn	LX.PSZ01.003	N	N	N320GB5.4KS	N	NSM8XS
AS5741G-332G50Mn	LX.PSZ02.054	N	N	N500GB5.4KS	N	NSM8XS
AS5741G-334G50Mn	LX.PSZ02.053	N	N	N500GB5.4KS	N	NSM8XS
AS5741G-332G64Mn	LX.PSZ02.052	N	N	N640GB5.4KS	N	NSM8XS
AS5741G-333G32Mn	LX.PSZ01.002	N	N	N320GB5.4KS	N	NSM8XS
AS5741G-334G64Mn	LX.PSZ02.051	N	N	N640GB5.4KS	N	NSM8XS
AS5741G-334G64Mn	LX.PSZ02.050	N	N	N640GB5.4KS	N	NSM8XS

Model	Acer Part No	Memory 3	Memory 4	HDD 1(GB)	HDD 2(GB)	ODD
AS5741G-334G64Mn	LX.PSZ02.049	N	N	N640GB5.4KS	N	NSM8XS
AS5741G-332G32Mn	LX.PSZ01.001	N	N	N320GB5.4KS	N	NSM8XS
AS5741G-334G32Mn	LX.PSZ0C.002	N	N	N320GB5.4KS	N	NSM8XS
AS5741G-334G32Mn	LX.PSZ0C.001	N	N	N320GB5.4KS	N	NSM8XS
AS5741G-334G32Mn	LX.PSZ02.048	N	N	N320GB5.4KS	N	NSM8XS
AS5741G-334G32Mi	LX.PSZ02.047	N	N	N320GB5.4KS	N	NSM8XS
AS5741G-334G32Mn	LX.PSZ02.046	N	N	N320GB5.4KS	N	NSM8XS
AS5741G-334G32Mn	LX.PSZ02.045	N	N	N320GB5.4KS	N	NSM8XS
AS5741G-334G32Mn	LX.PSZ02.044	N	N	N320GB5.4KS	N	NSM8XS
AS5741G-334G32Mn	LX.PSZ02.043	N	N	N320GB5.4KS	N	NSM8XS
AS5741G-334G32Mn	LX.PSZ02.042	N	N	N320GB5.4KS	N	NSM8XS
AS5741G-334G32Mn	LX.PSZ02.041	N	N	N320GB5.4KS	N	NSM8XS
AS5741G-334G32Mn	LX.PSZ02.040	N	N	N320GB5.4KS	N	NSM8XS
AS5741G-334G32Mn	LX.PSZ02.039	N	N	N320GB5.4KS	N	NSM8XS
AS5741G-334G32Mn	LX.PSZ02.038	N	N	N320GB5.4KS	N	NSM8XS
AS5741G-334G32Mn	LX.PSZ02.037	N	N	N320GB5.4KS	N	NSM8XS
AS5741G-334G32Mn	LX.PSZ02.036	N	N	N320GB5.4KS	N	NSM8XS
AS5741G-334G32Mn	LX.PSZ02.035	N	N	N320GB5.4KS	N	NSM8XS
AS5741G-334G32Mn	LX.PSZ02.034	N	N	N320GB5.4KS	N	NSM8XS
AS5741G-334G32Mn	LX.PSZ02.033	N	N	N320GB5.4KS	N	NSM8XS
AS5741G-334G32Mn	LX.PSZ02.032	N	N	N320GB5.4KS	N	NSM8XS
AS5741G-334G32Mn	LX.PSZ02.031	N	N	N320GB5.4KS	N	NSM8XS
AS5741G-334G32Mn	LX.PSZ02.030	N	N	N320GB5.4KS	N	NSM8XS
AS5741G-334G32Mn	LX.PSZ02.029	N	N	N320GB5.4KS	N	NSM8XS

Model	Acer Part No	Memory 3	Memory 4	HDD 1(GB)	HDD 2(GB)	ODD
AS5741G-334G32Mn	LX.PSZ02.028	N	N	N320GB5.4KS	N	NSM8XS
AS5741G-334G32Mn	LX.PSZ02.027	N	N	N320GB5.4KS	N	NSM8XS
AS5741G-334G32Mn	LX.PSZ02.026	N	N	N320GB5.4KS	N	NSM8XS
AS5741G-334G32Mn	LX.PSZ02.025	N	N	N320GB5.4KS	N	NSM8XS
AS5741G-334G32Mn	LX.PSZ02.024	N	N	N320GB5.4KS	N	NSM8XS
AS5741G-334G32Mn	LX.PSZ02.023	N	N	N320GB5.4KS	N	NSM8XS
AS5741G-334G32Mn	LX.PSZ02.022	N	N	N320GB5.4KS	N	NSM8XS
AS5741G-334G32Mn	LX.PSZ02.021	N	N	N320GB5.4KS	N	NSM8XS
AS5741G-334G32Mn	LX.PSZ02.020	N	N	N320GB5.4KS	N	NSM8XS
AS5741G-334G32Mn	LX.PSZ02.019	N	N	N320GB5.4KS	N	NSM8XS
AS5741G-334G32Mn	LX.PSZ02.018	N	N	N320GB5.4KS	N	NSM8XS
AS5741G-334G32Mn	LX.PSZ02.017	N	N	N320GB5.4KS	N	NSM8XS
AS5741G-334G32Mn	LX.PSZ02.016	N	N	N320GB5.4KS	N	NSM8XS
AS5741G-334G32Mn	LX.PSZ02.015	N	N	N320GB5.4KS	N	NSM8XS
AS5741G-334G32Mn	LX.PSZ02.014	N	N	N320GB5.4KS	N	NSM8XS
AS5741G-334G32Mn	LX.PSZ02.013	N	N	N320GB5.4KS	N	NSM8XS
AS5741G-334G32Mn	LX.PSZ02.012	N	N	N320GB5.4KS	N	NSM8XS
AS5741G-334G32Mn	LX.PSZ02.011	N	N	N320GB5.4KS	N	NSM8XS
AS5741G-334G32Mn	LX.PSZ02.010	N	N	N320GB5.4KS	N	NSM8XS
AS5741G-334G32Mn	LX.PSZ02.009	N	N	N320GB5.4KS	N	NSM8XS
AS5741G-334G32Mn	LX.PSZ02.008	N	N	N320GB5.4KS	N	NSM8XS
AS5741G-334G32Mn	LX.PSZ02.007	N	N	N320GB5.4KS	N	NSM8XS
AS5741G-334G32Mn	LX.PSZ02.006	N	N	N320GB5.4KS	N	NSM8XS
AS5741G-334G32Mn	LX.PSZ02.005	N	N	N320GB5.4KS	N	NSM8XS

Model	Acer Part No	Memory 3	Memory 4	HDD 1(GB)	HDD 2(GB)	ODD
AS5741G-334G32Mn	LX.PSZ02.004	N	N	N320GB5.4KS	N	NSM8XS
AS5741G-332G32Mn	LX.PSZ02.003	N	N	N320GB5.4KS	N	NSM8XS
AS5741G-334G32Mn	S2.PSZ0C.003	N	N	N320GB5.4KS	N	NSM8XS
AS5741G-333G32Bn	LX.PSZ02.002	N	N	N320GB5.4KS	N	NBDCB4XS
AS5741G-334G50Mn	LX.PSZ02.001	N	N	N500GB5.4KS	N	NSM8XS
AS5741G-434G32Mn	S2.PSZ0C.002	N	N	N320GB5.4KS	N	NSM8XS
AS5741G-334G32Mn	S2.PSZ0C.001	N	N	N320GB5.4KS	N	NSM8XS

Model	Acer Part No	Media Processor	Extra SW1	Card Reader	Wireless LAN1	Bluetooth	VOIP Phone
AS5741G-334G50Mn	LX.PTD0C.006	N	N	5 in 1-Build in	3rd WiFi 2x2 BGN	BT 2.1	N
AS5741G-434G50Mn	LX.PTD0C.005	N	N	5 in 1-Build in	3rd WiFi 2x2 BGN	BT 2.1	N
AS5741G-434G32Mn	LX.PTD0C.004	N	N	5 in 1-Build in	3rd WiFi 2x2 BGN	BT 2.1	N
AS5741G-334G64Mn	LX.PTD02.084	N	McAfee	5 in 1-Build in	3rd WiFi 2x2 BGN	N	N
AS5741G-434G50Mn	LX.PTD02.083	N	McAfee	5 in 1-Build in	3rd WiFi 2x2 BGN	N	N
AS5741G-334G32Mn	LX.PTD0C.003	N	N	5 in 1-Build in	3rd WiFi 2x2 BGN	BT 2.1	N
AS5741G-334G32Mn	LX.PTD02.082	N	McAfee	5 in 1-Build in	3rd WiFi 2x2 BGN	N	N
AS5741G-334G50Bn	LX.PTD02.081	N	McAfee	5 in 1-Build in	3rd WiFi 2x2 BGN	N	N
AS5741G-434G64Bn	LX.PTD02.080	N	McAfee	5 in 1-Build in	3rd WiFi 2x2 BGN	BT 2.1	N
AS5741G-333G32Mn	LX.PTD02.079	N	McAfee	5 in 1-Build in	3rd WiFi 2x2 BGN	BT 2.1	N
AS5741G-334G50Mn	LX.PTD0C.002	N	N	5 in 1-Build in	3rd WiFi 2x2 BGN	BT 2.1	N
AS5741G-436G64Bn	LX.PTD02.078	N	McAfee	5 in 1-Build in	3rd WiFi 2x2 BGN	N	N
AS5741G-434G50Bn	LX.PTD02.077	N	McAfee	5 in 1-Build in	3rd WiFi 2x2 BGN	N	N
AS5741G-333G32Mn	LX.PTD02.076	N	McAfee	5 in 1-Build in	3rd WiFi 2x2 BGN	N	N
AS5741G-434G50Mn	LX.PTD02.075	N	McAfee	5 in 1-Build in	3rd WiFi 2x2 BGN	N	N

Model	Acer Part No	Media Processor	Extra SW1	Card Reader	Wireless LAN1	Bluetooth	VOIP Phone
AS5741G-334G32Mn	LX.PTD02.074	N	McAfee	5 in 1-Build in	3rd WiFi 2x2 BGN	N	N
AS5741G-434G50Mn	LX.PTD02.073	N	McAfee	5 in 1-Build in	3rd WiFi 2x2 BGN	N	N
AS5741G-334G64Mn	LX.PTD02.072	N	McAfee	5 in 1-Build in	3rd WiFi 2x2 BGN	N	N
AS5741G-332G25Mn	LX.PTD02.071	N	McAfee	5 in 1-Build in	3rd WiFi 2x2 BGN	N	N
AS5741G-334G50Mn	LX.PTD02.070	N	McAfee	5 in 1-Build in	3rd WiFi 2x2 BGN	N	N
AS5741G-432G32Mn	LX.PTD01.003	N	McAfee	5 in 1-Build in	3rd WiFi 2x2 BGN	N	N
AS5741G-332G32Mn	LX.PTD01.004	N	McAfee	5 in 1-Build in	3rd WiFi 2x2 BGN	N	N
AS5741G-436G64Bn	LX.PTD02.069	N	McAfee	5 in 1-Build in	3rd WiFi 2x2 BGN	BT 2.1	N
AS5741G-436G64Bn	LX.PTD02.068	N	McAfee	5 in 1-Build in	3rd WiFi 2x2 BGN	BT 2.1	N
AS5741G-436G64Bn	LX.PTD02.067	N	McAfee	5 in 1-Build in	3rd WiFi 2x2 BGN	BT 2.1	N
AS5741G-436G64Mn	LX.PTD02.066	N	McAfee	5 in 1-Build in	3rd WiFi 2x2 BGN	N	N
AS5741G-436G64Mn	LX.PTD02.065	N	McAfee	5 in 1-Build in	3rd WiFi 2x2 BGN	N	N
AS5741G-436G64Mn	LX.PTD02.064	N	McAfee	5 in 1-Build in	3rd WiFi 2x2 BGN	N	N
AS5741G-434G32Mn	LX.PTD02.063	N	McAfee	5 in 1-Build in	3rd WiFi 2x2 BGN	N	N
AS5741G-434G32Mn	LX.PTD02.062	N	McAfee	5 in 1-Build in	3rd WiFi 2x2 BGN	N	N
AS5741G-434G32Mn	LX.PTD02.061	N	McAfee	5 in 1-Build in	3rd WiFi 2x2 BGN	N	N
AS5741G-332G64Mn	LX.PTD02.060	N	McAfee	5 in 1-Build in	3rd WiFi 2x2 BGN	BT 2.1	N
AS5741G-334G50Mn	LX.PTD02.059	N	McAfee	5 in 1-Build in	3rd WiFi 2x2 BGN	BT 2.1	N
AS5741G-333G32Mn	LX.PTD01.002	N	McAfee	5 in 1-Build in	3rd WiFi 2x2 BGN	N	N
AS5741G-334G64Mn	LX.PTD02.058	N	McAfee	5 in 1-Build in	3rd WiFi 2x2 BGN	N	N
AS5741G-334G64Mn	LX.PTD02.057	N	McAfee	5 in 1-Build in	3rd WiFi 2x2 BGN	N	N
AS5741G-334G64Mn	LX.PTD02.056	N	McAfee	5 in 1-Build in	3rd WiFi 2x2 BGN	N	N
AS5741G-332G50Mn	LX.PTD01.001	N	McAfee	5 in 1-Build in	3rd WiFi 2x2 BGN	N	N
AS5741G-334G64Mn	LX.PTD02.055	N	McAfee	5 in 1-Build in	3rd WiFi 2x2 BGN	BT 2.1	N

Model	Acer Part No	Media Processor	Extra SW1	Card Reader	Wireless LAN1	Bluetooth	VOIP Phone
AS5741G-334G64Mn	LX.PTD02.054	N	McAfee	5 in 1-Build in	3rd WiFi 2x2 BGN	BT 2.1	N
AS5741G-334G50Mn	LX.PTD02.052	N	McAfee	5 in 1-Build in	3rd WiFi 2x2 BGN	BT 2.1	N
AS5741G-334G50Mn	LX.PTD02.053	N	McAfee	5 in 1-Build in	3rd WiFi 2x2 BGN	BT 2.1	N
AS5741G-334G50Mn	LX.PTD0C.001	N	N	5 in 1-Build in	3rd WiFi 2x2 BGN	BT 2.1	N
AS5741G-354G50Mn	LX.PTD02.051	N	McAfee	5 in 1-Build in	3rd WiFi 2x2 BGN	BT 2.1	N
AS5741G-352G50Mn	LX.PTD02.050	N	McAfee	5 in 1-Build in	3rd WiFi 2x2 BGN	BT 2.1	N
AS5741G-332G50Mn	LX.PTD02.049	N	McAfee	5 in 1-Build in	3rd WiFi 2x2 BGN	BT 2.1	N
AS5741G-334G50Mn	LX.PTD02.048	N	McAfee	5 in 1-Build in	3rd WiFi 2x2 BGN	BT 2.1	N
AS5741G-334G32Mn	LX.PTD02.047	N	McAfee	5 in 1-Build in	3rd WiFi 2x2 BGN	BT 2.1	N
AS5741G-333G32Mn	LX.PTD02.046	N	McAfee	5 in 1-Build in	3rd WiFi 2x2 BGN	N	N
AS5741G-333G32Mi	LX.PTD02.045	N	McAfee	5 in 1-Build in	3rd WiFi BG	N	N
AS5741G-333G32Mn	LX.PTD02.044	N	McAfee	5 in 1-Build in	3rd WiFi 2x2 BGN	N	N
AS5741G-333G32Mn	LX.PTD02.043	N	McAfee	5 in 1-Build in	3rd WiFi 2x2 BGN	N	N
AS5741G-333G32Mn	LX.PTD02.042	N	McAfee	5 in 1-Build in	3rd WiFi 2x2 BGN	N	N
AS5741G-333G32Mn	LX.PTD02.041	N	McAfee	5 in 1-Build in	3rd WiFi 2x2 BGN	N	N
AS5741G-333G32Mn	LX.PTD02.040	N	McAfee	5 in 1-Build in	3rd WiFi 2x2 BGN	N	N
AS5741G-333G32Mn	LX.PTD02.039	N	McAfee	5 in 1-Build in	3rd WiFi 2x2 BGN	N	N
AS5741G-333G32Mn	LX.PTD02.038	N	McAfee	5 in 1-Build in	3rd WiFi 2x2 BGN	N	N
AS5741G-333G32Mn	LX.PTD02.037	N	McAfee	5 in 1-Build in	3rd WiFi 2x2 BGN	N	N
AS5741G-333G32Mn	LX.PTD02.036	N	McAfee	5 in 1-Build in	3rd WiFi 2x2 BGN	N	N
AS5741G-333G32Mn	LX.PTD02.035	N	McAfee	5 in 1-Build in	3rd WiFi 2x2 BGN	N	N
AS5741G-333G32Mn	LX.PTD02.034	N	McAfee	5 in 1-Build in	3rd WiFi 2x2 BGN	N	N
AS5741G-333G32Mn	LX.PTD02.033	N	McAfee	5 in 1-Build in	3rd WiFi 2x2 BGN	N	N
AS5741G-333G32Mn	LX.PTD02.032	N	McAfee	5 in 1-Build in	3rd WiFi 2x2 BGN	N	N

Model	Acer Part No	Media Processor	Extra SW1	Card Reader	Wireless LAN1	Bluetooth	VOIP Phone
AS5741G-333G32Mn	LX.PTD02.031	N	McAfee	5 in 1-Build in	3rd WiFi 2x2 BGN	N	N
AS5741G-333G32Mn	LX.PTD02.030	N	McAfee	5 in 1-Build in	3rd WiFi 2x2 BGN	N	N
AS5741G-333G32Mn	LX.PTD02.029	N	McAfee	5 in 1-Build in	3rd WiFi 2x2 BGN	N	N
AS5741G-333G32Mn	LX.PTD02.028	N	McAfee	5 in 1-Build in	3rd WiFi 2x2 BGN	N	N
AS5741G-333G32Mn	LX.PTD02.027	N	McAfee	5 in 1-Build in	3rd WiFi 2x2 BGN	N	N
AS5741G-333G32Mn	LX.PTD02.026	N	McAfee	5 in 1-Build in	3rd WiFi 2x2 BGN	N	N
AS5741G-333G32Mn	LX.PTD02.025	N	McAfee	5 in 1-Build in	3rd WiFi 2x2 BGN	N	N
AS5741G-333G32Mn	LX.PTD02.024	N	McAfee	5 in 1-Build in	3rd WiFi 2x2 BGN	N	N
AS5741G-333G32Mn	LX.PTD02.023	N	McAfee	5 in 1-Build in	3rd WiFi 2x2 BGN	N	N
AS5741G-333G32Mn	LX.PTD02.022	N	McAfee	5 in 1-Build in	3rd WiFi 2x2 BGN	N	N
AS5741G-333G32Mn	LX.PTD02.021	N	McAfee	5 in 1-Build in	3rd WiFi 2x2 BGN	N	N
AS5741G-333G32Mn	LX.PTD02.020	N	McAfee	5 in 1-Build in	3rd WiFi 2x2 BGN	N	N
AS5741G-333G32Mn	LX.PTD02.019	N	McAfee	5 in 1-Build in	3rd WiFi 2x2 BGN	N	N
AS5741G-333G32Mn	LX.PTD02.018	N	McAfee	5 in 1-Build in	3rd WiFi 2x2 BGN	N	N
AS5741G-333G32Mn	LX.PTD02.017	N	McAfee	5 in 1-Build in	3rd WiFi 2x2 BGN	N	N
AS5741G-333G32Mn	LX.PTD02.016	N	McAfee	5 in 1-Build in	3rd WiFi 2x2 BGN	N	N
AS5741G-333G32Mn	LX.PTD02.015	N	McAfee	5 in 1-Build in	3rd WiFi 2x2 BGN	N	N
AS5741G-333G32Mn	LX.PTD02.014	N	McAfee	5 in 1-Build in	3rd WiFi 2x2 BGN	N	N
AS5741G-333G32Mn	LX.PTD02.013	N	McAfee	5 in 1-Build in	3rd WiFi 2x2 BGN	N	N
AS5741G-333G32Mn	LX.PTD02.011	N	McAfee	5 in 1-Build in	3rd WiFi 2x2 BGN	N	N
AS5741G-333G32Mn	LX.PTD02.012	N	McAfee	5 in 1-Build in	3rd WiFi 2x2 BGN	N	N
AS5741G-333G32Mn	LX.PTD02.010	N	McAfee	5 in 1-Build in	3rd WiFi 2x2 BGN	N	N
AS5741G-333G32Mn	LX.PTD02.009	N	McAfee	5 in 1-Build in	3rd WiFi 2x2 BGN	N	N
AS5741G-333G32Mn	LX.PTD02.008	N	McAfee	5 in 1-Build in	3rd WiFi 2x2 BGN	N	N

Model	Acer Part No	Media Processor	Extra SW1	Card Reader	Wireless LAN1	Bluetooth	VOIP Phone
AS5741G-333G32Mn	LX.PTD02.007	N	McAfee	5 in 1-Build in	3rd WiFi 2x2 BGN	N	N
AS5741G-333G32Mn	LX.PTD02.006	N	McAfee	5 in 1-Build in	3rd WiFi 2x2 BGN	N	N
AS5741G-333G32Mn	LX.PTD02.005	N	McAfee	5 in 1-Build in	3rd WiFi 2x2 BGN	N	N
AS5741G-333G32Mn	LX.PTD02.004	N	McAfee	5 in 1-Build in	3rd WiFi 2x2 BGN	N	N
AS5741G-333G32Mn	LX.PTD02.003	N	McAfee	5 in 1-Build in	3rd WiFi 2x2 BGN	N	N
AS5741G-333G32Mn	LX.PTD02.002	N	McAfee	5 in 1-Build in	3rd WiFi 2x2 BGN	N	N
AS5741G-334G64Mn	LX.PTD02.001	N	McAfee	5 in 1-Build in	3rd WiFi 2x2 BGN	N	N
AS5741G-332G50Mn	S2.PTD02.001	N	McAfee	5 in 1-Build in	3rd WiFi 2x2 BGN	BT 2.1	N
AS5741G-332G50Mn	S2.PTD02.001	N	McAfee	5 in 1-Build in	3rd WiFi 2x2 BGN	BT 2.1	N
AS5741G-334G50Mn	LX.PSZ02.064	N	McAfee	5 in 1-Build in	3rd WiFi 2x2 BGN	N	N
AS5741G-353G50Mn	LX.PSZ0C.009	N	N	5 in 1-Build in	3rd WiFi 2x2 BGN	BT 2.1	N
AS5741G-352G32Mn	LX.PSZ0C.008	N	N	5 in 1-Build in	3rd WiFi 2x2 BGN	BT 2.1	N
AS5741G-436G50Mn	LX.PSZ02.063	N	McAfee	5 in 1-Build in	3rd WiFi 2x2 BGN	N	N
AS5741G-434G50Mn	LX.PSZ02.062	N	McAfee	5 in 1-Build in	3rd WiFi 2x2 BGN	N	N
AS5741G-333G32Mn	LX.PSZ0C.007	N	N	5 in 1-Build in	3rd WiFi 2x2 BGN	BT 2.1	N
AS5741G-334G50Mn	LX.PSZ02.061	N	McAfee	5 in 1-Build in	3rd WiFi 2x2 BGN	N	N
AS5741G-434G64Mn	LX.PSZ0C.006	N	N	5 in 1-Build in	3rd WiFi 2x2 BGN	BT 2.1	N
AS5741G-334G50Mn	LX.PSZ0C.005	N	N	5 in 1-Build in	3rd WiFi 2x2 BGN	BT 2.1	N
AS5741G-333G32Mn	LX.PSZ0C.004	N	N	5 in 1-Build in	3rd WiFi 2x2 BGN	BT 2.1	N
AS5741G-434G32Mn	LX.PSZ02.060	N	McAfee	5 in 1-Build in	3rd WiFi 2x2 BGN	N	N
AS5741G-333G32Mn	LX.PSZ02.059	N	McAfee	5 in 1-Build in	3rd WiFi 2x2 BGN	N	N
AS5741G-334G32Bn	LX.PSZ02.058	N	McAfee	5 in 1-Build in	3rd WiFi 2x2 BGN	N	N
AS5741G-334G32Mn	LX.PSZ02.057	N	McAfee	5 in 1-Build in	3rd WiFi 2x2 BGN	BT 2.1	N
AS5741G-334G50Mn	LX.PSZ02.056	N	McAfee	5 in 1-Build in	3rd WiFi 2x2 BGN	BT 2.1	N

Model	Acer Part No	Media Processor	Extra SW1	Card Reader	Wireless LAN1	Bluetooth	VOIP Phone
AS5741G-333G32Mn	LX.PSZ02.055	N	McAfee	5 in 1-Build in	3rd WiFi 2x2 BGN	N	N
AS5741G-333G32Mn	LX.PSZ0C.003	N	N	5 in 1-Build in	3rd WiFi 2x2 BGN	N	N
AS5741G-432G32Mn	LX.PSZ01.003	N	McAfee	5 in 1-Build in	3rd WiFi 2x2 BGN	N	N
AS5741G-332G50Mn	LX.PSZ02.054	N	McAfee	5 in 1-Build in	3rd WiFi 2x2 BGN	BT 2.1	N
AS5741G-334G50Mn	LX.PSZ02.053	N	McAfee	5 in 1-Build in	3rd WiFi 2x2 BGN	N	N
AS5741G-332G64Mn	LX.PSZ02.052	N	McAfee	5 in 1-Build in	3rd WiFi 2x2 BGN	BT 2.1	N
AS5741G-333G32Mn	LX.PSZ01.002	N	McAfee	5 in 1-Build in	3rd WiFi 2x2 BGN	N	N
AS5741G-334G64Mn	LX.PSZ02.051	N	McAfee	5 in 1-Build in	3rd WiFi 2x2 BGN	N	N
AS5741G-334G64Mn	LX.PSZ02.050	N	McAfee	5 in 1-Build in	3rd WiFi 2x2 BGN	N	N
AS5741G-334G64Mn	LX.PSZ02.049	N	McAfee	5 in 1-Build in	3rd WiFi 2x2 BGN	N	N
AS5741G-332G32Mn	LX.PSZ01.001	N	McAfee	5 in 1-Build in	3rd WiFi 2x2 BGN	N	N
AS5741G-334G32Mn	LX.PSZ0C.002	N	N	5 in 1-Build in	3rd WiFi 2x2 BGN	BT 2.1	N
AS5741G-334G32Mn	LX.PSZ0C.001	N	N	5 in 1-Build in	3rd WiFi 2x2 BGN	BT 2.1	N
AS5741G-334G32Mn	LX.PSZ02.048	N	McAfee	5 in 1-Build in	3rd WiFi 2x2 BGN	N	N
AS5741G-334G32Mi	LX.PSZ02.047	N	McAfee	5 in 1-Build in	3rd WiFi BG	N	N
AS5741G-334G32Mn	LX.PSZ02.046	N	McAfee	5 in 1-Build in	3rd WiFi 2x2 BGN	N	N
AS5741G-334G32Mn	LX.PSZ02.045	N	McAfee	5 in 1-Build in	3rd WiFi 2x2 BGN	N	N
AS5741G-334G32Mn	LX.PSZ02.044	N	McAfee	5 in 1-Build in	3rd WiFi 2x2 BGN	N	N
AS5741G-334G32Mn	LX.PSZ02.043	N	McAfee	5 in 1-Build in	3rd WiFi 2x2 BGN	N	N
AS5741G-334G32Mn	LX.PSZ02.042	N	McAfee	5 in 1-Build in	3rd WiFi 2x2 BGN	N	N
AS5741G-334G32Mn	LX.PSZ02.041	N	McAfee	5 in 1-Build in	3rd WiFi 2x2 BGN	N	N
AS5741G-334G32Mn	LX.PSZ02.040	N	McAfee	5 in 1-Build in	3rd WiFi 2x2 BGN	N	N
AS5741G-334G32Mn	LX.PSZ02.039	N	McAfee	5 in 1-Build in	3rd WiFi 2x2 BGN	N	N
AS5741G-334G32Mn	LX.PSZ02.038	N	McAfee	5 in 1-Build in	3rd WiFi 2x2 BGN	N	N

Model	Acer Part No	Media Processor	Extra SW1	Card Reader	Wireless LAN1	Bluetooth	VOIP Phone
AS5741G-334G32Mn	LX.PSZ02.037	N	McAfee	5 in 1-Build in	3rd WiFi 2x2 BGN	N	N
AS5741G-334G32Mn	LX.PSZ02.036	N	McAfee	5 in 1-Build in	3rd WiFi 2x2 BGN	N	N
AS5741G-334G32Mn	LX.PSZ02.035	N	McAfee	5 in 1-Build in	3rd WiFi 2x2 BGN	N	N
AS5741G-334G32Mn	LX.PSZ02.034	N	McAfee	5 in 1-Build in	3rd WiFi 2x2 BGN	N	N
AS5741G-334G32Mn	LX.PSZ02.033	N	McAfee	5 in 1-Build in	3rd WiFi 2x2 BGN	N	N
AS5741G-334G32Mn	LX.PSZ02.032	N	McAfee	5 in 1-Build in	3rd WiFi 2x2 BGN	N	N
AS5741G-334G32Mn	LX.PSZ02.031	N	McAfee	5 in 1-Build in	3rd WiFi 2x2 BGN	N	N
AS5741G-334G32Mn	LX.PSZ02.030	N	McAfee	5 in 1-Build in	3rd WiFi 2x2 BGN	N	N
AS5741G-334G32Mn	LX.PSZ02.029	N	McAfee	5 in 1-Build in	3rd WiFi 2x2 BGN	N	N
AS5741G-334G32Mn	LX.PSZ02.028	N	McAfee	5 in 1-Build in	3rd WiFi 2x2 BGN	N	N
AS5741G-334G32Mn	LX.PSZ02.027	N	McAfee	5 in 1-Build in	3rd WiFi 2x2 BGN	N	N
AS5741G-334G32Mn	LX.PSZ02.026	N	McAfee	5 in 1-Build in	3rd WiFi 2x2 BGN	N	N
AS5741G-334G32Mn	LX.PSZ02.025	N	McAfee	5 in 1-Build in	3rd WiFi 2x2 BGN	N	N
AS5741G-334G32Mn	LX.PSZ02.024	N	McAfee	5 in 1-Build in	3rd WiFi 2x2 BGN	N	N
AS5741G-334G32Mn	LX.PSZ02.023	N	McAfee	5 in 1-Build in	3rd WiFi 2x2 BGN	N	N
AS5741G-334G32Mn	LX.PSZ02.022	N	McAfee	5 in 1-Build in	3rd WiFi 2x2 BGN	N	N
AS5741G-334G32Mn	LX.PSZ02.021	N	McAfee	5 in 1-Build in	3rd WiFi 2x2 BGN	N	N
AS5741G-334G32Mn	LX.PSZ02.020	N	McAfee	5 in 1-Build in	3rd WiFi 2x2 BGN	N	N
AS5741G-334G32Mn	LX.PSZ02.019	N	McAfee	5 in 1-Build in	3rd WiFi 2x2 BGN	N	N
AS5741G-334G32Mn	LX.PSZ02.018	N	McAfee	5 in 1-Build in	3rd WiFi 2x2 BGN	N	N
AS5741G-334G32Mn	LX.PSZ02.017	N	McAfee	5 in 1-Build in	3rd WiFi 2x2 BGN	N	N
AS5741G-334G32Mn	LX.PSZ02.016	N	McAfee	5 in 1-Build in	3rd WiFi 2x2 BGN	N	N
AS5741G-334G32Mn	LX.PSZ02.015	N	McAfee	5 in 1-Build in	3rd WiFi 2x2 BGN	N	N
AS5741G-334G32Mn	LX.PSZ02.014	N	McAfee	5 in 1-Build in	3rd WiFi 2x2 BGN	N	N

Model	Acer Part No	Media Processor	Extra SW1	Card Reader	Wireless LAN1	Bluetooth	VOIP Phone
AS5741G-334G32Mn	LX.PSZ02.013	N	McAfee	5 in 1-Build in	3rd WiFi 2x2 BGN	N	N
AS5741G-334G32Mn	LX.PSZ02.012	N	McAfee	5 in 1-Build in	3rd WiFi 2x2 BGN	N	N
AS5741G-334G32Mn	LX.PSZ02.011	N	McAfee	5 in 1-Build in	3rd WiFi 2x2 BGN	N	N
AS5741G-334G32Mn	LX.PSZ02.010	N	McAfee	5 in 1-Build in	3rd WiFi 2x2 BGN	N	N
AS5741G-334G32Mn	LX.PSZ02.009	N	McAfee	5 in 1-Build in	3rd WiFi 2x2 BGN	N	N
AS5741G-334G32Mn	LX.PSZ02.008	N	McAfee	5 in 1-Build in	3rd WiFi 2x2 BGN	N	N
AS5741G-334G32Mn	LX.PSZ02.007	N	McAfee	5 in 1-Build in	3rd WiFi 2x2 BGN	N	N
AS5741G-334G32Mn	LX.PSZ02.006	N	McAfee	5 in 1-Build in	3rd WiFi 2x2 BGN	N	N
AS5741G-334G32Mn	LX.PSZ02.005	N	McAfee	5 in 1-Build in	3rd WiFi 2x2 BGN	N	N
AS5741G-334G32Mn	LX.PSZ02.004	N	McAfee	5 in 1-Build in	3rd WiFi 2x2 BGN	N	N
AS5741G-332G32Mn	LX.PSZ02.003	N	McAfee	5 in 1-Build in	3rd WiFi 2x2 BGN	BT 2.1	N
AS5741G-334G32Mn	S2.PSZ0C.003	N	N	5 in 1-Build in	3rd WiFi 2x2 BGN	BT 2.1	N
AS5741G-333G32Bn	LX.PSZ02.002	N	McAfee	5 in 1-Build in	3rd WiFi 2x2 BGN	N	N
AS5741G-334G50Mn	LX.PSZ02.001	N	McAfee	5 in 1-Build in	3rd WiFi 2x2 BGN	N	N
AS5741G-434G32Mn	S2.PSZ0C.002	N	N	5 in 1-Build in	3rd WiFi 2x2 BGN	BT 2.1	N
AS5741G-334G32Mn	S2.PSZ0C.001	N	N	5 in 1-Build in	3rd WiFi 2x2 BGN	N	N

Test Compatible Components

This computer's compatibility is tested and verified by Acer's internal testing department. All of its system functions are tested under Windows® 7 environment.

Refer to the following lists for components, adapter cards, and peripherals which have passed these tests. Regarding configuration, combination and test procedures, please refer to the Aspire 5741/5741G Compatibility Test Report released by the Acer Mobile System Testing Department.

Microsoft® Windows® 7 Environment Test

Vendor	Type	Description	PN
CPU			
Intel	Arrandale 2.13G (Ci3330M)	IC CP80617004122AG SLBMD C2 2.13G PGA988	
Intel	Arrandale 2.26G (Ci3350M)	IC CP80617004161AC SLBPK C2 2.26G PGA988	
Intel	Arrandale 2.26G (Ci5430M)	IC CP80617004161AD SLBPN C2 2.26G PGA988	
Intel	Arrandale 2.4G (Ci5520M)	IC CP80617004119AE SLBNB C2 2.4G PGA988P	
Intel	Arrandale 2.53G (Ci5540M)	IC CP80617004116AD SLBPG C2 2.53G PGA988	
Intel	Arrandale 2.66G (Ci7620M)	IC CP80617003981AH SLBPD C2 2.66G PGA 988P	
Intel	Q3GG C2 2.13G	CPU Intel Core i3 330M PGA 2.13G 35W Arrandale, TJ90, VT, 3M L3	
Intel	Q3LN C2 2.26G	CPU Intel Core i3 350M PGA 2.26G 35W Arrandale, TJ90, VT, 3M L3	
Intel	Q3LR C2 2.26G	CPU Intel Core i5 430M PGA 2.26G ARD, uP to SC 2.53G, 3M L3	
RAM SODIMM DDR3-1G 1066			
SAMSUNG	1G DDR3-1066	DDR3 MODU SAM M471B2873EH1-CF8 1GB/1066	
ELDIPA	1G DDR3-1066	DDR3 MODU SAM EBJ11UE6BDS0-AE-F 1GB/1066	
HYNIX	1G DDR3-1066	DDR3 MODU HYN HMT112S6BFR6C-G7N0 1G/1066	
RAM SODIMM DDR3-2G 1066			
MICRON	2G DDR3-1066	MT16JSF25664HZ-1G1F1	
SAMSUNG	2G DDR3-1066	DDR3 MODU SAM M471B5673EH1-CF8 2G/1066	
ELDIPA	2G DDR3-1066	DDR3 MODU ELP EBJ21UE8BDS0-AE-F 2G/1066	
HYNIX	2G DDR3-1066	DDR3 MODU HYN HMT125S6BFR8C-G7N0 2G/1066	
RAM SODIMM DDR3-4G 1066			
SAMSUNG	4G DDR3-1066	M471B5273BH1-CF8	
ELPIDA	4G DDR3-1066	Memory NONE SO-DIMM DDRIII 1066 4GB dummy P/N LF	
RAM SODIMM DDR3-1G 1333			
SAMSUNG	1G DDR3-1333	M471B2873FHS-CH9	
RAM SODIMM DDR3-2G 1333			
SAMSUNG	2G DDR3-1333	M471B5673FH0-CH9 LF	
RAM SODIMM DDR3-4G 1333			
SAMSUNG	4G DDR3-1333	M471B5273CH0-CH9	

Vendor	Type	Description	PN
ELPIDA	4G DDR3-1333	DDDR3 4G EBJ41UF8BAS0-DJ-F	
LCD N15.6WXGAG			
AUO (70/80/90)	N15.6WXGAG	LCD MODU B156XW01 V2 15.6" HD G 0FA	
CPT(70/80/90)	N15.6WXGAG	LCD MODU CLAA156WA01A 15.6" HD G 0FA	
CMO (80)	N15.6WXGAG	LCD MODU N156B3-L02 15.6" HD G 0FA	
Samsung(N EW80)	N15.6WXGAG	LCD MODU LTN156AT01-A01 15.6" HD G 0FA	
LGD(80)	N15.6WXGAG	LCD MODU LP156WH1-TLA3 15.6" HD G 0FA	
LCD NLED15.6WXGAG			
AUO (70/80/90)	NLED15.6WXGAG	LCD_LED_M B156XW02 V2 156 HD G HW:4A 0FA	
CPT(70/80/90)	NLED15.6WXGAG	LCD_LED_M CLAA156WA11A 15.6" HD G 0FA	
CMO (70/90)	NLED15.6WXGAG	LCD_LED_M N156B6-L0B 15.6" HD G 0FA	
Samsung(N EW70/80/90)	NLED15.6WXGAG	LCD_LED_M LTN156AT02-A04 15.6" HD G	
Samsung(N EW70/90)	NLED15.6WXGAG	LCD_LED_M LTN156AT02-A02 15.6" HD G ABO!	
SAMSUNG	NLED15.6WXGAG	SAMSUNG 15.6"W WXGA Glare LTN156AT02-A04 LF 220nit 8ms	
LGD(70/80/90)	NLED15.6WXGAG	LCD_LED_M LP156WH2-TLE1 15.6" HD G 0FA	
INL(70/90)	NLED15.6WXGAG	LCD_LED_M BT156GW01 V2 15.6" HD G 0FA	
CMO	NLED15.6WXGAG	LCD_LED_M N156B6-L0D 15.6" HD ABO !	
AUO	NLED15.6WXGAG	LCD_LED_M B156XW03 V1 15.6" HD G ABO !	
AUO	NLED15.6WXGAG		
SAMSUNG	NLED15.6WXGAG	LCD_LED_M LTN156AT07-A01 15.6" HD G ABO!	
LPL	NLED15.6WXGAG	LCD_LED_M LP156WH3-TLA2 15.6" HD G ABO !	
LPL	NLED15.6WXGAG		
HDD			
SEAGATE	160G 5.4K rPm	HDD 160G 2.75"W .37"H ST9160314AS 0FA	
TOSHIBA	160G 5.4K rPm	HDD 160G .37"H MK1665GSX 0FA	
HGST	160G 5.4K rPm	HDD 160G .37"H HTS545016B9A300 L/V 0FA	
WD	160G 5.4K rPm	HDD 160G .37"H WD1600BEVT-22A23T0 0FA	
SEAGATE	250G 5.4K rPm	HDD 250G .37"H ST9250315AS 0FA	
TOSHIBA	250G 5.4K rPm	HDD 250G .37"H MK2565GSX 0FA	

Vendor	Type	Description	PN
HGST	250G 5.4K rPm	HDD 250G .37"H HTS545025B9A300 L/V 0FA	
WD	250G 5.4K rPm	HDD 250G .37"H WD2500BEVT-22A23T0 0FA	
SEAGATE	320G 5.4K rPm	HDD 320G 2.75"W .37"H ST9320325AS 0FA	
TOSHIBA	320G 5.4K rPm	HDD 320G .37"H MK3265GSX 0FA	
HGST	320G 5.4K rPm	HDD 320G .37"H HTS545032B9A300 L/V 0FA	
WD	320G 5.4K rPm	HDD 320G .37"H WD3200BEVT-22A23T0 0FA	
SEAGATE	500G 5.4K rPm	HDD 500G .37" ST9500325AS 0FA	
TOSHIBA	500G 5.4K rPm	HDD 500G .37"H MK5065GSX 0FA	
HGST	500G 5.4K rPm	HDD 500G .37"H HTS545050B9A300 L/V 0FA	
WD	500G 5.4K rPm	HDD 500G .37"H WD5000BEVT-22A0RT0 0FA	
WD	640G 5.4K rPm	HDD 640G .37"H WD6400BEVT-22A0RT0 0FA	
ODD			
HLDS	NBDCB4XS (CD-RW Ultra SPeed)	BRDVD_DRV 50G .5H CT21N KO.0040D.004 0FA	
PLDS (Refresh)	NBDCB4XS (CD-RW Ultra SPeed)	BRDVD_DRV 50G DS-4E1S KO.0040F.003 0FA	
SONY	NBDCB4XS (CD-RW High SPeed)	BRDVD_DRV BC-5500H-AR KO.0040E.003 0FA	
TSST	NSM8XS	TS-L633C	
Panasonic	NSM8XS	DVDRW DRV UJ890ADAA-A KU.00807.070 0FA	
HLDS	NSM8XS	DVDRW DRV 8X .5"H GT30N KU.0080D.048 0FA	
SONY-QSI	NSM8XS	AD-7585H	
PLDS	NSM8XS	DVDRW DRV 8X DS-8A4SH KU.0080F.006 0FA	
HLDS	NSM8XS	DVDRW DRV 8X .5"H GT30N KU.0080D.048 0FA	
SONY	NSM8XS	ODD SONY Super-Multi DRIVE 12.7mm Tray DL 8X AD-7580S LF W/O bezel FW FX20 SATA (Windows 7)	
HLDS	NSM8XS	DVDRW DRV 8X .5"H GT31N KU.0080D.054 0FA	
VGA ChiP			
AMD	Madsion Pro	S IC 216-0772000 MADISON PRO FCBGA 0FA	
AMD	Park XTM2	S IC 216-0774007 A11 PARK PRO M2 0FA	
	INTEL		
VRAM			

Vendor	Type	Description	PN
SAMSUNG	1GB	VRAM SAMSUNG GraPhic DDRIII 800 1Gb K4W1G1646E-HC12 LF	
HYNIX	1GB	VRAM HYNIX GraPhic DDRIII 800 1Gb H5TQ1G63BFR-12C LF	
AMD	1GB	VRAM ATI GraPhic DDRIII 800 1Gb 23EY2387MA12-SZ LF+HF	
SAMSUNG	512MB		
HYNIX	512MB		
AMD	512MB		
NB ChiPset			
INTEL	PCH	S IC BD82HM57 QMNS B3 FCBGA 1071 PCH	
INTEL	PCH	S IC BD82HM55 QMNT B3 FCBGA 1071 PCH	
INTEL	PCH	S IC BD82HM55 SLGZS B3 FCBGA 1071 PCH	
AdaPter			
DELTA	65W (UMA)	AC ADAP DELTA ADP-65JH DBA 65W 3P	
LITE-ON	65W (UMA)	AC ADAP LITE-ON PA-1650-22AC 65W 3P	
HIPRO	65W (UMA) LV5 OBL	AC ADAP HIPRO HP-A0652R3B 1LF 65W 3P	
DELTA	90W (Discrete) LV5 OBL	AC ADAP DELTA ADP-90CD DBA 90W 3P	
LITE-ON	90W (Discrete)	AC ADAP LITEON PA-1900-34AR 90W 3P	
HIPRO	90W (Discrete) LV5 OBL	AC ADAP HIPRO HP-A0904A3 B1LF 90W 3P	
Power Cord			
Linetek	3Pin	PWR CORD LP30BX1.8MXLS15 US 3P L	
I-Sheng	3Pin	PWR CORD SP305AX1.8MXIS034 SPT-2 BLK	
WS	3Pin	PWR CORD WS-001F-2X1.8MXWS-083 3P US W	
Battery			
SANYO	6CELL2.2	BATT SA SA 3S2P 4.4AH 7 0C9 0FA	
SONY	6CELL2.2	BATT SY SY 3S2P 4.4AH 7 0C9 0FA	
PANASONI C	6CELL2.2	BATT PA PA 3S2P 4.4AH 7 0C9 0FA	
SAMSUNG	6CELL2.2	BATT SM SM 3S2P 4.4AH 7 0C9 0FA	
SIMPLO (PANASON IC)	6CELL2.2	BATT SP PA 3S2P 4.4AH 7 0C9 0FA	
SIMPLO (LGC)	6CELL2.2	BATT SP LG 3S2P 4.4AH 7 0C9 0FA	
SIMPLO (SAMSUNG)	6CELL2.2	BATT SP SM 3S2P 4.4AH 7 0C9 0FA	
K/B			
DARFON		KB 9J.N1H82 DARFON INT'E 09F	

Vendor	Type	Description	PN
Chicony		KB MP-09B2 CHICONY INT'E 09F	
Sunrex		KB V104702 SUNREX INT'E 09F	
DARFON (NEW90)		KB 9Z.N1H82 DARFON INT'E 0C8 GP8T	
Chicony (NEW90)		KB MP-09B2 CHICONY INT'E 0C8 GP8T	
Sunrex (NEW90)		KB V104702 SUNREX INT'E 0C8 GP8T	
Touch Pad			
SYNAPTIC S	MULTI	TRACK PAD SYNAPTICS TM-01146-005 MULTI	
ALPS	MULTI	TRACK PAD ALPS KGDF0026A MULTI- FINGER	
ELANTEC H	MULTI	TOUCH PAD ELANTECH S8442D-5100	
Hinge			
SZS	LCD_BRK_L_156_A SSY	NEW70_LCD_BRK_L_156_ASSY	
GANGYI	LCD_BRK_L_156_A SSY	NEW70_LCD_BRK_L_156_ASSY	
WANHE	LCD_BRK_L_156_A SSY	NEW70_LCD_BRK_L_156_ASSY	
SZS	LCD_BRK_R_156_ ASSY	NEW70_LCD_BRK_R_156_ASSY	
GANGYI	LCD_BRK_R_156_ ASSY	NEW70_LCD_BRK_R_156_ASSY	
WANHE	LCD_BRK_R_156_ ASSY	NEW70_LCD_BRK_R_156_ASSY	
SZS	LED_BRK_L_156_A SSY	NEW70_LED_BRK_L_156_ASSY	
GANGYI	LED_BRK_L_156_A SSY	NEW70_LED_BRK_L_156_ASSY	
WANHE	LED_BRK_L_156_A SSY	NEW70_LED_BRK_L_156_ASSY	
SZS	LED_BRK_R_156_A SSY	NEW70_LED_BRK_R_156_ASSY	
GANGYI	LED_BRK_R_156_A SSY	NEW70_LED_BRK_R_156_ASSY	
WANHE	LED_BRK_R_156_A SSY	NEW70_LED_BRK_R_156_ASSY	
SZS	LCD_BRK_L_156_A SSY	NEW80_LCD_BRK_L_156_ASSY	
LH	LCD_BRK_L_156_A SSY	NEW80_LCD_BRK_L_156_ASSY	
CHAOLI	LCD_BRK_L_156_A SSY	NEW80_LCD_BRK_L_156_ASSY	
S.H.	LCD_BRK_L_156_A SSY	NEW80_LCD_BRK_L_156_ASSY	

Vendor	Type	Description	PN
SZS	LCD_BRK_R_156_ASSY	NEW80_LCD_BRK_R_156_ASSY	
LH	LCD_BRK_R_156_ASSY	NEW80_LCD_BRK_R_156_ASSY	
CHAOLI	LCD_BRK_R_156_ASSY	NEW80_LCD_BRK_R_156_ASSY	
S.H.	LCD_BRK_R_156_ASSY	NEW80_LCD_BRK_R_156_ASSY	
SZS	LED_BRK_L_156_ASSY	NEW80_LED_BRK_L_156_ASSY	
LH	LED_BRK_L_156_ASSY	NEW80_LED_BRK_L_156_ASSY	
CHAOLI	LED_BRK_L_156_ASSY	NEW80_LED_BRK_L_156_ASSY	
S.H.	LED_BRK_L_156_ASSY	NEW80_LED_BRK_L_156_ASSY	
SZS	LED_BRK_R_156_ASSY	NEW80_LED_BRK_R_156_ASSY	
LH	LED_BRK_R_156_ASSY	NEW80_LED_BRK_R_156_ASSY	
CHAOLI	LED_BRK_R_156_ASSY	NEW80_LED_BRK_R_156_ASSY	
S.H.	LED_BRK_R_156_ASSY	NEW80_LED_BRK_R_156_ASSY	
SZS	LCD_BRK_L_156_ASSY	NEW90_LCD_BRK_L_156_ASSY	
SH	LCD_BRK_L_156_ASSY	NEW90_LCD_BRK_L_156_ASSY	
LH	LCD_BRK_L_156_ASSY	NEW90_LCD_BRK_L_156_ASSY	
SZS	LCD_BRK_R_156_ASSY	NEW90_LCD_BRK_R_156_ASSY	
SH	LCD_BRK_R_156_ASSY	NEW90_LCD_BRK_R_156_ASSY	
LH	LCD_BRK_R_156_ASSY	NEW90_LCD_BRK_R_156_ASSY	
SZS	LED_BRK_L_156_ASSY	NEW90_LED_BRK_L_156_ASSY	
SH	LED_BRK_L_156_ASSY	NEW90_LED_BRK_L_156_ASSY	
LH	LED_BRK_L_156_ASSY	NEW90_LED_BRK_L_156_ASSY	
SZS	LED_BRK_R_156_ASSY	NEW90_LED_BRK_R_156_ASSY	
SH	LED_BRK_R_156_ASSY	NEW90_LED_BRK_R_156_ASSY	
LH	LED_BRK_R_156_ASSY	NEW90_LED_BRK_R_156_ASSY	
3G card			
HUAWEI		W/LAN_3G 07A EM770W 7.2MBPS 0FA	

Vendor	Type	Description	PN
Ericsson		W/W F3307 KRD 131 16/02 7.2M GSM900 0FA	
WLAN Card			
Foxconn (Atheros)	Mini-card WLAN (3rd WiFi 1x2 BGN)	W/L CARD 086 T77H047.31 150MBPS HB93	
Liteon	Mini-card WLAN (3rd WiFi 1x2 BGN)_New75/85	W/L CARD 07P B853GN900G 54MBPS HB93	
Foxconn	Mini-card WLAN (3rd WiFi 1x2 BGN)	W/L _ T77H103.00 300MBPS BCM943225HM	
Foxconn (NEW70)	Mini-card WLAN (3rd WiFi BG) (NEW70)	W/L CARD 085 T77H121.01 54MBPS HB95	
FOXCONN TW	Mini-card WLAN (3rd WiFi 2x2 BGN)	W/L CARD 086 T77H047.31 150MBPS HB93	
LITE-ON	Mini-card WLAN (3rd WiFi 2x2 BGN)	W/L WN6602AH-AA B853GU210G 300M HB93V046	
LITE-ON	Mini-card WLAN (3rd WiFi 2x2 BGN)	W/L WN6603LH-AA B853GZ600D RTL8192SE	
FOXCONN TW	Mini-card WLAN (3rd WiFi BG)	Foxconn Wirelss LAN Atheros HB95 1x1 BG (HM)	
	INTEL Conder Peak	W/L 112BNHMMW _ 300M CONDOR PEAK1X2 0FA	
	PLM00010 QMI HB93	W/L CARD 086 EM306-AR 300MBPS HB93	
Intel		622ANXHMMW _ intel 6250	
Foxconn		Foxconn T77H121.10 HB95	
Foxconn		Foxconn T77H167.07 HB97	
Antenna			
WNC	Antenna WIFI/ WIMAX L	ANTENNA 0C6 81.EJT15.GEE WIFI AUX/L	
WNC	Antenna WIFI/ WIMAX R	ANTENNA 0C6 81.EJT15.GED WIFI M R	
WNC	Antenna 3G main+WIFI aux	ANTENNA 0C6 81.EJT15.GEB 3G M/WIFI A	
WNC	Antenna 3G aux+WIFI main+GPS	ANTENNA 0C6 81.EJT15.GEC 3G A/WIFI M/G	
WNC	Antenna WIFI/ WIMAX L	ANTENNA 0C7 81.EJT15.GEJ WIFI A/L	
WNC	Antenna WIFI/ WIMAX R	ANTENNA 0C7 81.EJT15.GEH WIFI M/R	
WNC	Antenna 3G main+WIFI aux	ANTENNA 0C7 81.EJT15.GEF 3G M/WIFI A	
WNC	Antenna 3G aux+WIFI main+GPS	ANTENNA 0C7 81.EJT15.GEG 3G A/WIFI M/G	
WNC	Antenna WIFI/ WIMAX L	ANTENNA 0C8 81.EJT15.GEN WIFI A/L	

Vendor	Type	Description	PN
WNC	Antenna WIFI/ WIMAX R	ANTENNA 0C8 81.EJT15.GEM WIFI M/R	
WNC	X	ANTENNA 0C8 81.EJT15.GEK 3G M/WIFI A	
WNC	Antenna 3G aux+WIFI main+GPS	ANTENNA 0C8 81.EJT15.GEL 3G A/WIFI M/G	
Blue Tooth			
Foxconn	BT	B_T_ MODU 0C9 FOXCONN T77H114.01 BCM2070	
Foxconn	BT	Foxconn Bluetooth BRM 2046 BT2.1 (T60H928.33) FW:861	
Foxconn	BT	B_T_ MODU 085 FOXCONN T77H056.00 AR3011	
Camera			
Chicony	1.3M	CH9665SN (CNF9157)	
Suyin	1.3M	SY9665SN	
Liteon	1.3M	LT9665AL (09P2SF119)	
DC-IN Jack			
		65W	
		65W	
		65W	
		90W	
		90W	
		90W	
Wire Set			
??	MIC	MIC SET 0CB 6D H2.2 -42DB 1MIC	
Kingstate	MIC	MIC SET 0CB 6D H2.2 -42DB 1MIC	
Fujikon	MIC	MIC SET 0CB 6D H2.2 -42DB 1MIC	
MEC	CCFL	H-CONN SET 0C9 CCFL LCD-M/B W/ CAMERA	
High-Tek	CCFL		
MEC	CCFL With 3G	H-CONN SET 0C9 CCFL LCD-M/B W/ CAMERA	
High-Tek			
MEC	CCFL w/o CMOS	H-CONN SET 0C9 CCFL LCD-M/B W/O CAMERA	
High-Tek			
MEC	CCFL w/o CMOS With 3G	H-CONN SET 0C9 CCFL LCD-M/B W/O CAMERA	
High-Tek			
MEC	LED	H-CONN SET 0C9 LED LCD-M/B W/ CAMERA	
"MEC,HIGH-TEK,Foxconn			

Vendor	Type	Description	PN
"LED 2nd source(IPE X compatible)	H-CONN SET 0C9 LED LCD-M/B W/ CAMERA 2nd source(IPEX compatible)		
MEC	LED w/o CMOS	H-CONN SET 0C9 LED LCD-M/B W/O CAMERA	
"MEC			
""LED w/o CMOS			
"H-CONN SET 0C9 LED LCD-M/B W/O CAMERA			
MEC	LED With 3G	H-CONN SET 0C9 LED LCD-MB W/CAM W/3G H_C	
"MEC			
""LED With 3G			
"H-CONN SET 0C9 LED LCD-MB W/CAM W/3G H_C			
MEC	LED w/o CMOS With 3G	H-CONN SET 0C9 LED LCD-MB WOCAM W/3G H_C	
"MEC			
""LED w/o CMOS With 3G			
"H-CONN SET 0C9 LED LCD-MB WOCAM W/3G H_C			
"MEC			

Vendor	Type	Description	PN
"3G	H-CONN SET 0C9 M/B-3G/B		
"MEC			
"BT 8Pin	H-CONN SET 0C9 M/B-BT 8P		
"MEC			
"BT 86Pin	H-CONN SET 0C9 M/B-BT 6P		
FFC			
Humburg	CardRead/B	FFC 8P H P1 PAD=0.7 187MM CARD READER/B-M/B	
Cvilux	CardRead/B	FFC 8P H P1 PAD=0.7 187MM CARD READER/B-M/B	
Humburg	TP-M/B	FFC 6P G P1 PAD=0.65 116MM TP-M/B	
Cvilux	TP-M/B	FFC 6P G P1 PAD=0.65 116MM TP-M/B	
Humburg	USB-M/B	FFC 12P H P1 PAD=0.7 192MM USB-M/B	
Cvilux	USB-M/B	FFC 12P H P1 PAD=0.7 192MM USB-M/B	
Humburg	POWER/B-M/B	FFC 10P H P1 PAD=0.6 89MM POWER/B- M/B	
Cvilux	POWER/B-M/B	FFC 10P H P1 PAD=0.6 89MM POWER/B- M/B	
Humburg	POWER/B-M/B	FFC 10P H P1 PAD=0.6 89MM POWER/B- M/B	
Cvilux	POWER/B-M/B	FFC 10P H P1 PAD=0.6 89MM POWER/B- M/B	
Humburg	POWER/B-M/B	FFC 10P H P1 PAD=0.6 174MM POWER/ B-M/B	
Cvilux	POWER/B-M/B	FFC 10P H P1 PAD=0.6 174MM POWER/ B-M/B	
Humburg	LID/B-M/B	FFC 4P H P1 PAD=0.7 32MM SW/B-M/B	
Cvilux	LID/B-M/B	FFC 4P H P1 PAD=0.7 32MM SW/B-M/B	
Humburg	LID/B-M/B	FFC 4P H P1 PAD=0.65 34.85MM SW/B-M/ B	
Cvilux	LID/B-M/B	FFC 4P H P1 PAD=0.65 34.85MM SW/B-M/ B	
Humburg	LID/B-M/B	FFC 4P H P1 PAD=0.6 64.27MM SW/B-M/B	
Cvilux	LID/B-M/B	FFC 4P H P1 PAD=0.6 64.27MM SW/B-M/B	
Inverter			
Darfon		INVERTER 06G 15-17 VK.21071.804 DARF MPS	
YEC		INVERTER 06G 15-17 YNV-C01AC YEC MPS	

Vendor	Type	Description	PN
YEC		INVERTER 06G 15-17 YNV-C01AC YEC MPS	
Sumida			
SPEAKER			
Zylux	SPK-R	SPK PACK 0CB 2W 4OHM MAIN SPEAKER R	
Galax	SPK-R	SPK PACK 0CB 2W 4OHM MAIN SPEAKER R	
NJL	SPK-R	SPK PACK 0CB 2W 4OHM MAIN SPEAKER R	
Zylux	SPK-L	SPK PACK 0CB 2W 4OHM MAIN SPEAKER L	
Galax	SPK-L	SPK PACK 0CB 2W 4OHM MAIN SPEAKER L	
NJL	SPK-L	SPK PACK 0CB 2W 4OHM MAIN SPEAKER L	
MIC			
Fujikon		MIC SET 0CB 6D H2.2 -42DB 1MIC	
Kingstate		MIC SET 0CB 6D H2.2 -42DB 1MIC	
Xing-Meng		MIC SET 0CB 6D H2.2 -42DB 1MIC	
Thermal Module (UMA)			
Delta	CCI	NEW70_UMA_THM_MAIN_ASSY_Delta_C CI	
ADDA	CCI	NEW70_UMA_THM_MAIN_ASSY_ADDA_ CCI	
Delta	Robin	NEW70_UMA_THM_MAIN_ASSY_Delta_R OBIN	
ADDA	Robin	NEW70_UMA_THM_MAIN_ASSY_ADDA_ ROBIN	
Delta	AVC	NEW70_UMA_THM_MAIN_ASSY_Delta_A VC	
ADDA	AVC	NEW70_UMA_THM_MAIN_ASSY_ADDA_ AVC	
Sunon	Sunon	NEW70_UMA_THM_MAIN_ASSY_SUNON_ _SUNON	
Delta	CCI	NEW70_PARK_THM_MAIN_ASSY_Delta_ CCI	
ADDA	CCI	NEW70_PARK_THM_MAIN_ASSY_ADDA_ _CCI	
Delta	Robin	NEW70_PARK_THM_MAIN_ASSY_Delta_ ROBIN	
ADDA	Robin	NEW70_PARK_THM_MAIN_ASSY_ADDA_ _ROBIN	
Delta	AVC	NEW70_PARK_THM_MAIN_ASSY_Delta_ AVC	
ADDA	AVC	NEW70_PARK_THM_MAIN_ASSY_ADDA_ _AVC	

Vendor	Type	Description	PN
Sunon	Sunon	NEW70_PARK_THM_MAIN_ASSY_SUNON_SUNON	
Delta	CCI	NEW70_MADISON_THM_MAIN_ASSY_Delta_CCI	
ADDA	CCI	NEW70_MADISON_THM_MAIN_ASSY_ADDA_CCI	
Delta	Robin	NEW70_MADISON_THM_MAIN_ASSY_Delta_ROBIN	
ADDA	Robin	NEW70_MADISON_THM_MAIN_ASSY_ADDA_ROBIN	
Delta	AVC	NEW70_MADISON_THM_MAIN_ASSY_Delta_AVC	
ADDA	AVC	NEW70_MADISON_THM_MAIN_ASSY_ADDA_AVC	
Sunon	Sunon	NEW70_MADISON_THM_MAIN_ASSY_SUNON_SUNON	
Core Logic			
SILEGO	CLK GEN	S IC SLG8SP626VTR QFN 72P CLK GEN	
BROADCOM	GbE LAN	S IC BCM57780A1KMLG QFN 48P E-LAN CTRL	
ENE	EC	S IC KB926QFD3 LQFP 128P KB CONTROL	
ENE	Card Reader Controller	S IC UB6250NF A1-110 QFN 32P CARD READER	
MXIC	BIOS	S IC FL 16M MX25L1605DM2I-12G SOP 8P ROM	
ADI	Thermal Sensor	S IC ADM1032ARMZ MSOP 8P TEMP SENSOR	
REALTEK	HD Audio codec	S IC ALC272X-GR LQFP 48P CODEC	
TI	Audio Amplifier	S IC TPA6017A2PWPR TSSOP 20P AMP	
ANPEC	FAN controller	S IC APL5607KI-TRG SOP 8P	

Online Support Information

This section describes online technical support services available to help you repair your Acer Systems.

If you are a distributor, dealer, ASP or TPM, please refer your technical queries to your local Acer branch office. Acer Branch Offices and Regional Business Units may access our website. However some information sources will require a user i.d. and password. These can be obtained directly from Acer CSD Taiwan.

Acer's Website offers you convenient and valuable support resources whenever you need them.

In the Technical Information section you can download information on all of Acer's Notebook, Desktop and Server models including:

- Service guides for all models
- User's manuals
- Bios updates
- Software utilities
- Spare parts lists
- TABs (Technical Announcement Bulletin)

For these purposes, we have included an Acrobat File to facilitate the problem-free downloading of our technical material.

Also contained on this website are:

- Detailed information on Acer's International Traveler's Warranty (ITW)
- Returned material authorization procedures
- An overview of all the support services we offer, accompanied by a list of telephone, fax and email contacts for all your technical queries.

We are always looking for ways to optimize and improve our services, so if you have any suggestions or comments, please do not hesitate to communicate these to us.

A

AFLASH Utility 29

Antennas

Removing 89, 91

Replacing 93

B

Battery

Replacing 128

Battery Pack

Removing 43

BIOS

ROM type 15

vendor 15

BIOS Utility 21–29

Advanced 24

Boot 27

Exit 28

Navigating 21

Onboard Device Configuration 25

Power 27

Save and Exit 28

Security 24

System Security 28

Board Layout

Top View 149

brightness

hotkeys 13

C

Camera Module

Removing 83

Replacing 96, 98, 99, 101

Common Problems 130

computer

on indicator 9

CPU

Removing 77

Replacing 104

D

DIMM Modules

Replacing 123

Display 5

display

hotkeys 13

E

EasyTouch Failure 140

External Module Disassembly

Flowchart 42

F

Features 1

Flash Utility 29

FPC Cable

Removing 86

FRU (Field Replaceable Unit) List 155

H

Hard Disk Drive

Removing 52

Replacing 121

HDTV Switch Failure 141

Hibernation mode

hotkey 13

Hot Keys 11

I

Indicators 9

Intermittent Problems 142

Internal Microphone Failure 135

Internal Speaker Failure 134

J

Jumper and Connector Locations 149

K

Keyboard

Removing 55

Replacing 120

Keyboard Failure 133

L

LCD Bezel

Replacing 100

LCD Brackets

- Removing 86
- Replacing 95

LCD Cable

- Replacing 95

LCD Failure 133

LCD Module Disassembly

- Flowchart 78

LCD Module Reassembly Procedure 93

LCD Panel

- Removing 84
- Replacing 95

Left Speaker Module

- Removing 61
- Replacing 116

M

Main Unit Disassembly

- Flowchart 54

Mainboard

- Removing 68, 69, 70, 71
- Replacing 106

media access

- on indicator 9

Memory

- Replacing 123

Memory Check 130

Model Definition 170

N

No Display Issue 131

O

ODD Failure 137

Online Support Information 243

Optical Disk Drive

- Replacing 125, 126

Optical Drive Module

- Removing 45

P

Panel 6

- Bottom 9

PC Card 9

Power On Failure 130

R

Replacing 114, 116

Right Speaker Module

- Removing 63
- Replacing 114

S

SD Dummy Card

- Removing 44
- Replacing 127

Speakers 114, 116

- Removing 61, 63

System

- Block Diagram 5

T

Test Compatible Components 229

Thermal Module

- Removing 75
- Replacing 105

Thermal Unit Failure 140

TouchPad

- Removing 66

TouchPad Bracket

- Removing 66
- Replacing 112, 115

TouchPad Failure 134

Troubleshooting

- Built-in KB Failure 133
- EasyTouch Buttons 140
- HDTV Switch 141
- Internal Microphone 135
- Internal Speakers 134
- LCD Failure 133
- No Display 131
- ODD 137
- Other Failures 141
- Power On 130
- Thermal Unit 140
- TouchPad 134
- WLAN 140

U

Undetermined Problems 142

Upper Cover

Removing 57
Replacing 117

utility

BIOS 21–29

W

Windows 2000 Environment Test 230

Wireless Function Failure 140

WLAN Module

Removing 50

Replacing 122

