

# Aspire 7230/7530/7530G Series Service Guide

Service guide files and updates are available on the ACER/CSD web; for more information, please refer to <http://csd.acer.com.tw>

PRINTED IN TAIWAN

---

# Revision History

Please refer to the table below for the updates made on Aspire 7230/7530/7530G Series service guide.

Date	Chapter	Updates

---

## Copyright

Copyright © 2008 by Acer Incorporated. All rights reserved. No part of this publication may be reproduced, transmitted, transcribed, stored in a retrieval system, or translated into any language or computer language, in any form or by any means, electronic, mechanical, magnetic, optical, chemical, manual or otherwise, without the prior written permission of Acer Incorporated.

## Disclaimer

The information in this guide is subject to change without notice.

Acer Incorporated makes no representations or warranties, either expressed or implied, with respect to the contents hereof and specifically disclaims any warranties of merchantability or fitness for any particular purpose. Any Acer Incorporated software described in this manual is sold or licensed "as is". Should the programs prove defective following their purchase, the buyer (and not Acer Incorporated, its distributor, or its dealer) assumes the entire cost of all necessary servicing, repair, and any incidental or consequential damages resulting from any defect in the software.

Acer is a registered trademark of Acer Corporation.

Intel is a registered trademark of Intel Corporation.

Pentium and Pentium II/III are trademarks of Intel Corporation.

Other brand and product names are trademarks and/or registered trademarks of their respective holders.

---

## Conventions

The following conventions are used in this manual:

<b>SCREEN MESSAGES</b>	Denotes actual messages that appear on screen.
<b>NOTE</b>	Gives bits and pieces of additional information related to the current topic.
<b>WARNING</b>	Alerts you to any damage that might result from doing or not doing specific actions.
<b>CAUTION</b>	Gives precautionary measures to avoid possible hardware or software problems.
<b>IMPORTANT</b>	Reminds you to do specific actions relevant to the accomplishment of procedures.

---

## Preface

Before using this information and the product it supports, please read the following general information.

1. This Service Guide provides you with all technical information relating to the BASIC CONFIGURATION decided for Acer's "global" product offering. To better fit local market requirements and enhance product competitiveness, your regional office MAY have decided to extend the functionality of a machine (e.g. add-on card, modem, or extra memory capability). These LOCALIZED FEATURES will NOT be covered in this generic service guide. In such cases, please contact your regional offices or the responsible personnel/channel to provide you with further technical details.
2. Please note WHEN ORDERING FRU PARTS, that you should check the most up-to-date information available on your regional web or channel. If, for whatever reason, a part number change is made, it will not be noted in the printed Service Guide. For ACER-AUTHORIZED SERVICE PROVIDERS, your Acer office may have a DIFFERENT part number code to those given in the FRU list of this printed Service Guide. You MUST use the list provided by your regional Acer office to order FRU parts for repair and service of customer machines.



<b>System Specifications</b>	<b>1</b>
Features	1
System Block Diagram	4
Your Acer Notebook tour	5
Front View	5
Closed Front View	6
Left View	7
Right View	8
Rear View	8
Bottom View	9
Indicators	10
Easy-Launch Buttons	10
Touch Pad Basics (with fingerprint reader)	11
Using the Keyboard	12
Lock Keys and embedded numeric keypad	12
Windows Keys	13
Hot Keys	14
Special Key	15
Using the System Utilities	16
Acer GridVista (dual-display compatible)	16
Hardware Specifications and Configurations	18
 <b>System Utilities</b>	 <b>29</b>
BIOS Setup Utility	29
Navigating the BIOS Utility	29
Information	30
Main	31
Advanced	32
Security	34
Boot	37
Power	38
Exit	40
BIOS Flash Utility	41
Remove HDD/BIOS Utility	42
 <b>Machine Disassembly and Replacement</b>	 <b>45</b>
Disassembly Requirements	45
General Information	46
Pre-disassembly Instructions	46
Disassembly Process	46
External Module Disassembly Process	47
External Modules Disassembly Flowchart	47
Removing the Battery Pack	48
Removing the SD dummy card	48
Removing the ExpressCard dummy card	49
Removing the Lower Covers	50
Removing the DIMM Modules	51
Removing the MXM Module	52
Removing the TV Tuner module	53
Removing the WLAN Module	54
Removing the Hard Disk Drive Module	56
Removing the Optical Drive Module	58
Main Unit Disassembly Process	60
Main Unit Disassembly Flowchart	60

# Table of Contents

Removing the Switch Cover . . . . .	62
Removing the Switch Board . . . . .	63
Removing the Keyboard . . . . .	64
Removing the Modem Module . . . . .	65
Removing the Antenna, MIC and Speaker Cables . . . . .	66
Removing the LCD Module . . . . .	68
Removing the Upper Cover . . . . .	70
Removing the Finger Print Reader . . . . .	74
Removing the Touch Pad . . . . .	76
Removing the Launch Board . . . . .	77
Removing the Speaker Module . . . . .	78
Removing the eKey Board . . . . .	79
Removing the Bluetooth board . . . . .	80
Removing the Subwoofer Module . . . . .	81
Removing the ExpressCard Module . . . . .	83
Removing the Mainboard . . . . .	85
Removing the CPU Fan Module . . . . .	86
Removing the CPU . . . . .	88
LCD Module Disassembly Process . . . . .	89
LCD Module Disassembly Flowchart . . . . .	89
Removing the LCD Bezel . . . . .	90
Removing the Inverter Board . . . . .	92
Removing the Camera Module . . . . .	93
Removing the LCD Panel . . . . .	94
Removing the LCD Brackets and FPC Cable . . . . .	96
LCD Module Reassembly Procedure . . . . .	98
Replacing the LCD Panel . . . . .	98
Replacing the LCD Bezel . . . . .	101
Main Module Reassembly Procedure . . . . .	102
Replacing the CPU . . . . .	102
Replacing the CPU Fan Module . . . . .	102
Replacing the Mainboard . . . . .	104
Replacing the Bluetooth Board . . . . .	104
Replacing the ExpressCard Module . . . . .	105
Replacing the Subwoofer Module . . . . .	106
Replacing the Finger Print Reader . . . . .	107
Replacing the eKey Board . . . . .	109
Replacing the Touch Pad . . . . .	110
Replacing the Launch Board . . . . .	110
Replacing the Finger Print Reader . . . . .	111
Replacing the Upper Cover . . . . .	112
Replacing the LCD Module . . . . .	116
Replacing the Antenna, MIC and Speaker Cables . . . . .	117
Replacing the Modem Module . . . . .	119
Replacing the Keyboard . . . . .	120
Replacing the Switch Board . . . . .	121
Replacing the Switch Cover . . . . .	122
Replacing the ODD Module . . . . .	123
Replacing the Hard Disk Drive Module . . . . .	123
Replacing the WLAN Board . . . . .	125
Replacing the TV Tuner Module . . . . .	125
Replacing the MXM Module . . . . .	126
Replacing the DIMM Modules . . . . .	126
Replacing the Lower Covers . . . . .	127
Replacing the ExpressCard Dummy Tray . . . . .	127



# Table of Contents

Replacing the SD Dummy Tray .....	128
Replacing the Battery .....	128
<b>Troubleshooting</b>	<b>129</b>
Common Problems .....	129
Power On Issue .....	130
No Display Issue .....	131
Random Loss of BIOS Settings .....	132
LCD Failure .....	133
Built-In Keyboard Failure .....	133
Touch Pad Failure .....	134
Internal Speaker Failure .....	134
Internal Microphone Failure .....	136
HDD Not Operating Correctly .....	137
ODD Failure .....	138
USB Failure (Rightside) .....	141
Modem Function Failure .....	141
Wireless Function Failure .....	142
EasyTouch Button Failure .....	142
MediaTouch Button Failure .....	143
Fingerprint Reader Failure .....	143
Thermal Unit Failure .....	144
HDTV Switch Failure .....	144
External Mouse Failure .....	145
Other Failures .....	145
Intermittent Problems .....	146
Undetermined Problems .....	146
POST Codes Tables .....	147
Chipset POST Codes .....	147
Core POST Codes .....	149
<b>Jumper and Connector Locations</b>	<b>157</b>
Top View .....	157
Bottom View .....	158
Clearing Password Check and BIOS Recovery .....	159
Clearing Password Check .....	159
BIOS Recovery by Crisis Disk .....	160
<b>FRU (Field Replaceable Unit) List</b>	<b>161</b>
Aspire 7230/7530/7530G Exploded Diagram .....	162
Aspire 7230/7530/7530G FRU List .....	163
Screw List .....	171
<b>Model Definition and Configuration</b>	<b>172</b>
Aspire 7230/7530/7530G Series .....	172
<b>Test Compatible Components</b>	<b>189</b>
Microsoft® Windows® Vista Environment Test .....	190
<b>Online Support Information</b>	<b>195</b>
<b>Index</b>	<b>197</b>

# ***Table of Contents***

# System Specifications

---

## Features

Below is a brief summary of the computer's many feature:

### Operating System

- Genuine Windows® Vista™

### Platform

- AMD Better By Design program, featuring:
  - AMD Turion™ X2 Ultra dual-core processor\*
  - AMD Turion™ X2 dual-core processor\*
  - AMD Athlon™ X2 dual-core processor\*
  - Mobile AMD Sempron™ processor\*
  - NVIDIA® nForce® MCP77MH
  - Acer InviLink™ 802.11b/g

### System Memory

- Dual-Channel DDR2 SDRAM support
- Up to 2 GB of DDR2 667 MHz memory, upgradeable to 4 GB using two soDIMM modules\*

### TV Tuner

- Digital TV-tuner supporting DVB-T\*

### Display and graphics

- 17" WXGA+ 1440 x 900
- NVIDIA® GeForce® 9100M G\*
- NVIDIA® GeForce® 9400M\*
- NVIDIA® GeForce® 9600M GT\*

### Storage subsystem

- 2.5" hard disk drive
- Optical drive options:
  - Blu-ray Disc™ /DVD-Super Multi double-layer drive\*
  - DVD-Super Multi double-layer drive\*
- 5-in-1 card reader

---

## Audio

- Dolby®-certified surround sound system with two built-in stereo speakers and one subwoofer\* supporting low-frequency effects
- True5.1-channel surround sound output
- S/PDIF (Sony/Philips Digital Interface) support for digital speakers
- Built-in microphone

## Dimensions and Weight

- 402 (W) x 297 (D) x 41/43.9 (H) mm (15.83 x 11.69 x 1.61/1.73 inches)
- 3.90 kg (8.59 lbs.) with 2 HDDs and 8-cell battery pack\*
- 3.80 kg (8.37 lbs.) with one HDD and 6-cell battery pack\*

## Privacy control

- Acer Bio-Protection fingerprint solution\*
- BIOS user, supervisor, HDD passwords
- Kensington lock slot

## Communication

- Acer Video Conference, featuring:
  - Integrated Acer Crystal Eye webcam\*
  - Optional Acer Xpress VoIP phone\*
- WLAN: Acer InViLink™ 802.11b/g\*
- WPAN: Bluetooth® 2.0+Enhanced Data Rate (EDR)\*
- LAN: Gigabit Ethernet; Wake-on-LAN ready
- Modem: 56K ITU V.92

## Power subsystem

- ACPI 3.0
- 71 W 4800 mAh\*
- 48.8 W 4400 mAh\*
- 3-pin 90 W AC adapter\*
- 3-pin 65 W AC adapter\*
- Energy Star 4.0

## Special keys and controls

- 105/106-key keyboard
- Touchpad pointing device

## I/O interface

- Acer EasyPort IV connector\*
- ExpressCard™/54 slot
- 5-in-1 card reader (SD/MMC/MS/MS PRO/xD)

- 
- 4 USB 2.0 ports
  - HDMI™ port with HDCP support\*
  - Consumer infrared (CIR) port
  - External display (VGA) port
  - RF-in jack\*
  - Headphones/speaker/line-out jack with S/PDIF support\*
  - Microphone-in jack
  - Line-in jack
  - Ethernet (RJ-45) port
  - Modem (RJ-11) port
  - DC-in jack for AC adapter

## Environment

- Temperature:
  - Operating: 5 °C to 35 °C
  - Non-operating: -20 °C to 65 °C
- Humidity (non-condensing):
  - Operating: 20% to 80%
  - Non-operating: 20% to 80%

**NOTE:** Items marked with \* denote only selected models. The specifications listed above are for reference only. The exact configuration of your PC depends on the model purchased.

# System Block Diagram

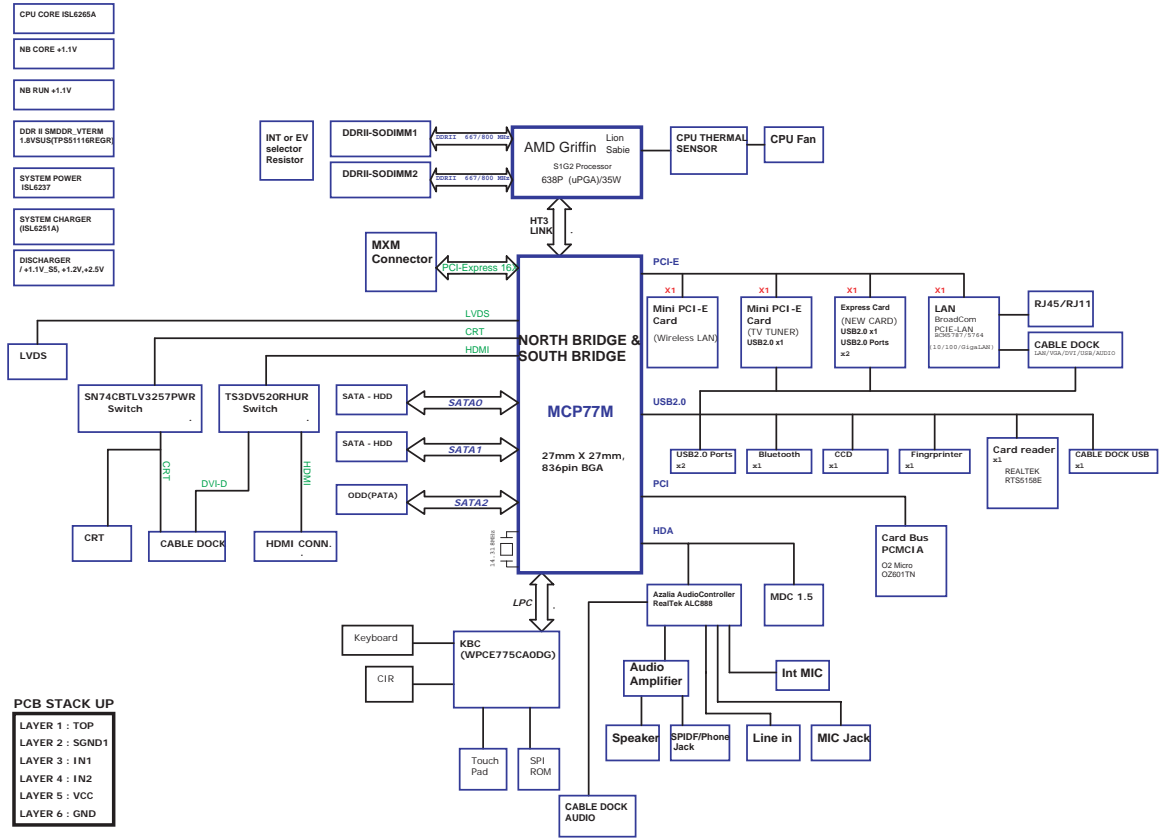



# Your Acer Notebook tour

After knowing your computer features, let us show you around your new computer.

## Front View





No.	Icon	Item	Description
1		Acer Crystal Eye	Web camera for video communication (only for certain models).
2		Microphone	Internal microphone for sound recording.
3		Display screen	Also called Liquid-Crystal Display (LCD), displays computer output.
4		Power button	Turns the computer on and off.
5		Easy-launch buttons	Buttons for launching frequently used program.
6		Palmrest	Comfortable support area for your hands when you use the computer.
7		Status indicators	Light-Emitting Diodes (LEDs) that light up to show the status of the computer's functions and components.

No.	Icon	Item	Description
8		Click buttons (left, center* and right)	The left and right buttons function like the left and right mouse buttons. *The center button serves as Acer Bio-Protection fingerprint reader supporting Acer FingerNav 4-way control function (only for certain models).
9		Touch Pad	Touch-sensitive pointing device which functions like a computer mouse.
10		Keyboard	For entering data into your computer.
11		Speakers	Left and right speakers deliver stereo audio output.
12		Empowering key	Launch Acer Empowering Technology

## Closed Front View











No.	Icon	Item	Description
1		CIR receiver	Receives signals from a remote control.
2		Unlimited volume control wheel	Adjust the volume of the audio-out.
3		5-in-1 card reader	Accepts Secure Digital (SD), MultiMediaCard (MMC), Memory Stick (MS), Memory Stick PRO (MS PRO), xD-Picture Card (xD).
4		Latch	Locks and releases the lid







## Left View



No.	Icon	Item	Description
1		DC-in jack	Connects to an AC adapter
2		Ethernet (RJ-45) port	Connects to an Ethernet 10/100/1000-based network.
3		Acer EasyPort IV connector	Connects to Acer EasyPort IV (only for certain models).
4		External display (VGA) port	Connects to a display device (e.g. external monitor, LCD projector).
5	HDMI	HDMI	Connects to a television or display device with HDMI input (only for certain models).
6		USB 2.0 port	Connect to USB 2.0 devices (e.g. USB mouse, USB camera).
7		Headphones/speaker/line-out jack with S/PDIF support	Connects to audio line-out devices (e.g. speakers, headphones).
		Microphone jack	Accepts input from external microphones.
		Line-in jack	Accepts audio line-in devices (e.g. audio CD player, stereo walkman, mp3 player).

## Right View



No.	Icon	Item	Description
1	ExpressCard / 54	ExpressCard/54 slot	Accepts one ExpressCard/54 module.
2		USB 2.0 port	Connect to USB 2.0 devices (e.g. USB mouse, USB camera).
3		Optical drive	Internal optical drive; accepts CDs or DVDs.
4		Optical disk access indicator	Lights up when the optical drive is active.
5		Optical drive eject button	Ejects the optical disk from the drive.
6		Emergency eject hole	Ejects the optical drive tray when the computer is turned off. <b>Note:</b> Insert a paper clip into the emergency eject hole to eject the optical drive tray when the computer is off.
7		RF-in port	Accepts input signals from digital TVtuner devices (only for certain models).
8		Modem (RJ-11) port	Connects to a phone line.
9		Kensington lock slot	Connects to a Kensington-compatible computer security lock.







## Rear View

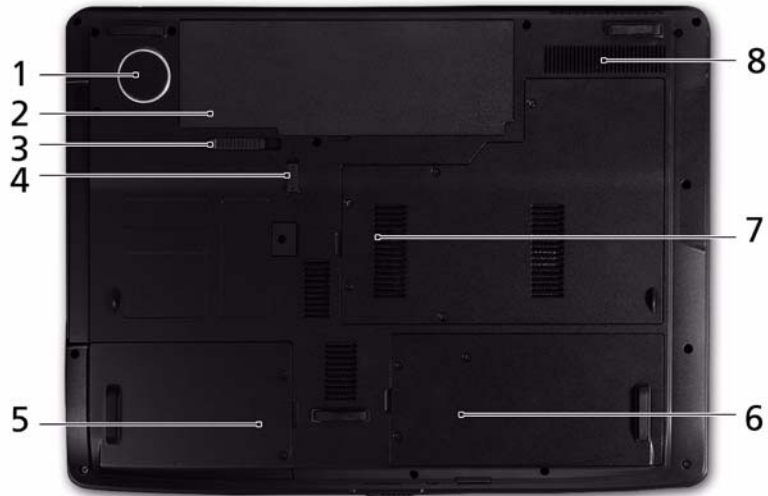

No.	Icon	Item	Description
1		Ventilation slots	Enable the computer to stay cool, even after prolonged use.





## Bottom View



No.	Icon	Item	Description
1		Subwoofer	Emits low frequency sound output (only for certain models).
2		Battery bay	Houses the computer's battery pack.
3		Battery release latch	Releases the battery for removal.
4		Battery lock	Locks the battery in position.
5		Hard disk bay-Main	Houses the computer's hard disk (secured with screws).
6		Hard disk bay-Secondary	Houses the computer's hard disk (secured with screws). Only for certain models.
7		Memory compartment	Houses the computer's main memory.
8		Ventilation slots and cooling fan	Enable the computer to stay cool, even after prolonged use. <b>Note:</b> Do not cover or obstruct the opening of the fan.

# Indicators

The computer has several easy-to-read status indicators. The front panel indicators are visible even when the computer cover is closed.







Icon	Function	Description
	Power	Indicates the computer's power status.
	Battery	Indicates the computer's battery status.
	HDD	Indicates when the hard disk drive is active.
	Num Lock	Lights up when Num Lock is activated.
	Caps Lock	Lights up when Caps Lock is activated.

**NOTE:** 1. **Charging:** The light shows amber when the battery is charging. 2. **Fully charged:** The light shows green when in AC mode.

# Easy-Launch Buttons

Located beside the keyboard are application buttons. These buttons are called easy-launch buttons. They are: WLAN, Internet, email, Bluetooth, Arcade and Acer Empowering Technology.

The mail and Web browser buttons are pre-set to email and Internet programs, but can be reset by users. To set the Web browser, mail and programmable buttons, run the Acer Launch Manager.

Icon	Function	Description
	Empowering Technology	Launch Acer Empowering Technology. (user-programmable)
	Acer Arcade	Launch Acer Arcade utility
	Wireless communication button/indicator	Enables/disables the wireless function. Indicates the status of wireless LAN communication.
	Web browser	Internet browser (user-Programmable)
	Mail	Email application (user-Programmable)
	Bluetooth communication button/indicator	Enables/disables the Bluetooth function. Indicates the status of Bluetooth communication.

# Touch Pad Basics (with fingerprint reader)

The following items show you how to use the Touch Pad with Acer Bio-Protection fingerprint reader:

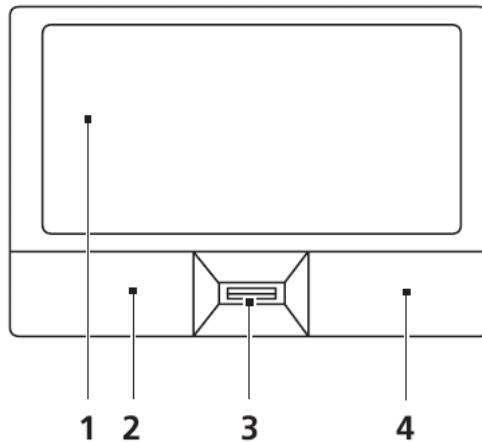

- Move your finger across the Touch Pad (1) to move the cursor.
- Press the left (2) and right (4) buttons located beneath the Touch Pad to perform selection and execution functions. These two buttons are similar to the left and right buttons on a mouse. Tapping on the Touch Pad is the same as clicking the left button.
- Use Acer Bio-Protection fingerprint reader (3) supporting Acer FingerNav 4-way control function (only for certain models) or the 4-way scroll (3) button (only for certain models) to scroll up or down and move left or right a page. This fingerprint reader or button mimics your cursor pressing on the right scroll bar of Windows applications.

Function	Left Button (2)	Right Button (4)	Main Touch Pad (1)
Execute	Quickly click twice.		Tap twice (at the same speed as double-clicking a mouse button).
Select	Click once.		Tap once.
Drag	Click and hold, then use finger on the Touch Pad to drag the cursor.		Tap twice (at the same speed as double-clicking a mouse button); rest your finger on the Touch Pad on the second tap and drag the cursor.
Access context menu		Click once.	

**NOTE:** When using the Touch Pad, keep it - and your fingers - dry and clean. The Touch Pad is sensitive to finger movement; hence, the lighter the touch, the better the response. Tapping too hard will not increase the Touch Pad's responsiveness.

---

# Using the Keyboard

The keyboard has full-sized keys and an embedded numeric keypad, separate cursor, lock, Windows, function and special keys.

## Lock Keys and embedded numeric keypad

The keyboard has three lock keys which you can toggle on and off.



















Lock key	Description
Caps Lock	When Caps Lock is on, all alphabetic characters typed are in uppercase.
Num Lock <Fn> + <F11>	When Num Lock is on, the embedded keypad is in numeric mode. The keys function as a calculator (complete with the arithmetic operators +, -, *, and /). Use this mode when you need to do a lot of numeric data entry. A better solution would be to connect an external keypad.
Scroll Lock <Fn> + <F12>	When Scroll Lock is on, the screen moves one line up or down when you press the up or down arrow keys respectively. Scroll Lock does not work with some applications.

The embedded numeric keypad functions like a desktop numeric keypad. It is indicated by small characters located on the upper right corner of the keycaps. To simplify the keyboard legend, cursor-control key symbols are not printed on the keys.

Desired access	Num Lock on	Num Lock off
Number keys on embedded keypad	Type numbers in a normal manner.	
Cursor-control keys on embedded keypad	Hold <Shift> while using cursor-control keys.	Hold <Fn> while using cursor-control keys.
Main keyboard keys	Hold <Fn> while typing letters on embedded keypad.	Type the letters in a normal manner.

# Windows Keys

The keyboard has two keys that perform Windows-specific functions.

Key	Description
 Windows key	<p>Pressed alone, this key has the same effect as clicking on the Windows Start button; it launches the Start menu. It can also be used with other keys to provide a variety of functions:</p> <ul style="list-style-type: none"> <li>&lt;  &gt;: Open or close the Start menu</li> <li>&lt;  &gt; + &lt;D&gt;: Display the desktop</li> <li>&lt;  &gt; + &lt;E&gt;: Open Windows Explore</li> <li>&lt;  &gt; + &lt;F&gt;: Search for a file or folder</li> <li>&lt;  &gt; + &lt;G&gt;: Cycle through Sidebar gadgets</li> <li>&lt;  &gt; + &lt;L&gt;: Lock your computer (if you are connected to a network domain), or switch users (if you're not connected to a network domain)</li> <li>&lt;  &gt; + &lt;M&gt;: Minimizes all windows</li> <li>&lt;  &gt; + &lt;R&gt;: Open the Run dialog box</li> <li>&lt;  &gt; + &lt;T&gt;: Cycle through programs on the taskbar</li> <li>&lt;  &gt; + &lt;U&gt;: Open Ease of Access Center</li> <li>&lt;  &gt; + &lt;X&gt;: Open Windows Mobility Center</li> <li>&lt;  &gt; + &lt;BREAK&gt;: Display the System Properties dialog box</li> <li>&lt;  &gt; + &lt;SHIFT+M&gt;: Restore minimized windows to the desktop</li> <li>&lt;  &gt; + &lt;TAB&gt;: Cycle through programs on the taskbar by using Windows Flip 3-D</li> <li>&lt;  &gt; + &lt;SPACEBAR&gt;: Bring all gadgets to the front and select Windows Sidebar</li> <li>&lt;CTRL&gt; + &lt;  &gt; + &lt;F&gt;: Search for computers (if you are on a network)</li> <li>&lt;CTRL&gt; + &lt;  &gt; + &lt;TAB&gt;: Use the arrow keys to cycle through programs on the taskbar by using Windows Flip 3-D</li> </ul> <p><b>Note:</b> Depending on your edition of Windows Vista, some shortcuts may not function as described.</p>
 Application key	<p>This key has the same effect as clicking the right mouse button; it opens the application's context menu.</p>

# Hot Keys

The computer employs hotkeys or key combinations to access most of the computer's controls like screen brightness, volume output and the BIOS utility.

To activate hot keys, press and hold the **<Fn>** key before pressing the other key in the hotkey combination.

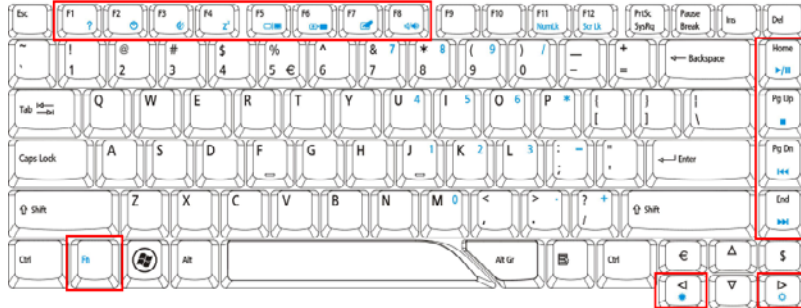

Hotkey	Icon	Function	Description
<Fn> + <F1>	?	Hotkey help	Displays help on hotkeys.
<Fn> + <F2>		Acer eSettings Management	Launches Acer eSettings Management in Acer Empowering Technology.
<Fn> + <F3>		Acer ePower Management	Launches Acer ePower Management in Acer Empowering Technology.
<Fn> + <F4>	Z <sup>z</sup>	Sleep	Puts the computer in Sleep mode.
<Fn> + <F5>		Display toggle	Switches display output between the display screen, external monitor (if connected) and both.
<Fn> + <F6>		Screen blank	Turns the display screen backlight off to save power. Press any key to return.
<Fn> + <F7>		Touch Pad toggle	Turns the internal Touch Pad on and off.
<Fn> + <F8>		Speaker toggle	Turns the speakers on and off.
<Fn> + <▷>		Brightness up	Increases the screen brightness.
<Fn> + <◁>		Brightness down	Decreases the screen brightness.
<Fn> + <Home>		Play/Pause	Play/Pause the current media.
<Fn> + <Pg Up>		Stop	Stop the current media.
<Fn> + <Pg Dn>		Skip Backward	Skip to the next track of the current media.
<Fn> + <End>		Skip Forward	Skip to the previous track of the current media.



---

## Special Key

You can locate the Euro symbol and the US dollar sign at the upper-center and/or bottom-right of your keyboard.



### The Euro symbol

1. Open a text editor or word processor.
2. Hold <Alt Gr> and then press the <5> key at the upper-center of the keyboard.

**NOTE: Note:** Some fonts and software do not support the Euro symbol. Please refer to [www.microsoft.com/typography/faq/faq12.htm](http://www.microsoft.com/typography/faq/faq12.htm) for more information.

### The US dollar sign

1. Open a text editor or word processor.
2. Hold <Shift> and then press the <4> key at the upper-center of the keyboard.

**NOTE:** This function varies by the operating system version.

# Using the System Utilities

Acer Bio-Protection (only for certain models) Acer Bio-Protection Fingerprint Solution is a multi-purpose fingerprint software package integrated with the Microsoft Windows operating system. Utilizing the uniqueness of one's fingerprint features, Acer Bio-Protection Fingerprint Solution has incorporated protection against unauthorized access to your computer with centralized password management with Password Bank, easy music player launching with Acer MusicLaunch, secure Internet favorites via Acer MyLaunch, and fast application/website launching and login with Acer FingerLaunch, while Acer ProfileLaunch can launch up to three applications/websites from a single finger swipe.

Acer Bio-Protection Fingerprint Solution also allows you to navigate through web browsers and documents using Acer FingerNav. With Acer Bio-Protection Fingerprint Solution, you can now enjoy an extra layer of protection for your personal computer, as well as the convenience of accessing your daily tasks with a simple swipe of your finger!

For more information refer to the Acer Bio-Protection help files.

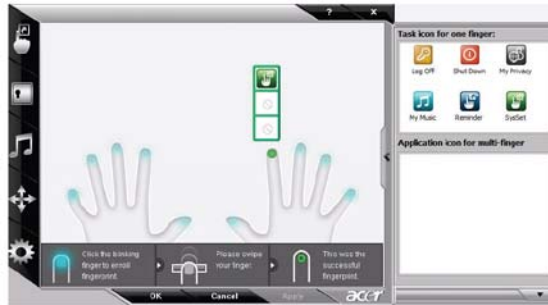

## Acer GridVista (dual-display compatible)

**NOTE:** This feature is only available on certain models.

To enable the dual monitor feature of the notebook, first ensure that the second monitor is connected, then select **Start, Control Panel, Display** and click on **Settings**. Select the secondary monitor (**2**) icon in the display box and then click the check box **Extend my windows desktop onto this monitor**. Finally, click **Apply** to confirm the new settings and click **OK** to complete the process.

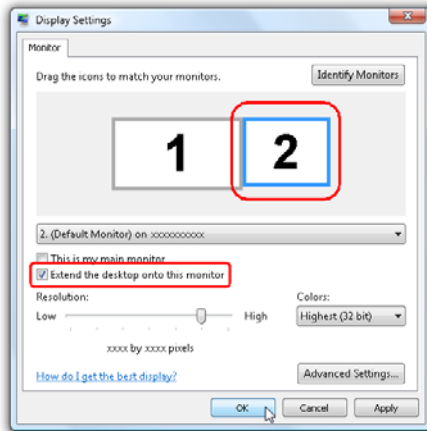

Acer GridVista is a handy utility that offers four pre-defined display settings so you can view multiple windows on the same screen. To access this function, please go to **Start → All Programs** and click on **Acer GridVista**. You may choose any one of the four display settings indicated below:



Double (vertical), Triple (primary at left), Triple (primary at right), or Quad Acer Gridvista is dual-display compatible, allowing two displays to be partitioned independently.

Acer Gridvista is dual-display compatible, allowing two displays to be partitioned independently.

AcerGridVista is simple to set up:

1. Run Acer GridVista and select your preferred screen configuration for each display from the task bar.
2. Drag and drop each window into the appropriate grid.
3. Enjoy the convenience of a well-organized desktop.

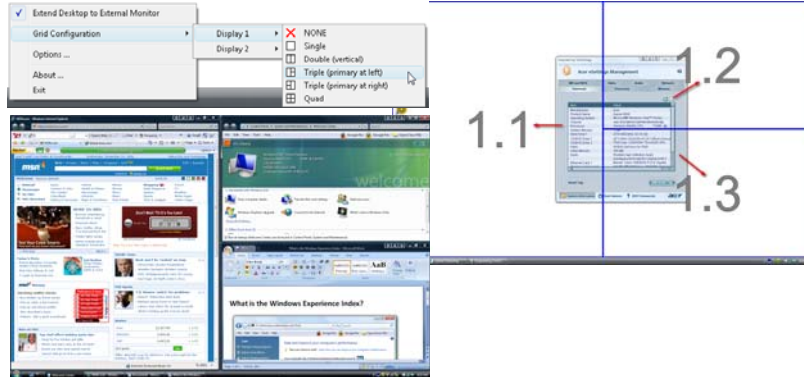

**NOTE:** Please ensure that the resolution setting of the second monitor is set to the manufacturer's recommended value.

# Hardware Specifications and Configurations

## Processor

Item	Specification
CPU type	AMD CPU S1g2 Processor (Griffin Series - Turion / Sempron); HT3 (1.2~2.6 GT/s) (Bandwidth: 9.6GB/S to 20.8GB/s) 1.8GHz ~ 2.3GHz CPU
CPU package	638-Pin Lidless Micro PGA package (35mm * 35mm)
Features	The AMD Socket S1g2 processor is a superb, high-performance product for mobile systems. With HyperTransport™ 3 technology bus and on-chip memory controller
CPU core voltage	<ul style="list-style-type: none"> <li>VCC_CORE0(based on CPU)</li> <li>VCC_CORE1(based on CPU)</li> <li>CPU_VDDNB (based on CPU)</li> <li>VLDT 1.2V_HT</li> <li>VDD I/O 1.8VSUS</li> <li>CPU Memory Interface SMDDR_VTEM</li> </ul>

## CPU Fan True Value Table

Level	Fan On Temp.	Fan Off Temp.	RPM	Throttling dB (A)
0	52	48	3100	31
1	60	55	3500	34
2	70	65	4100	37
3	90	80	4500	40

- Throttling 50%: On =97C; Off=88C
- OS Shut down: 105C
- H/W Shut down: 110C
- Fan default 3.5V

## Core Logic

Item	Specification
Type	NVidia MCP77MH MCP77MH (North Bridge + South Bridge)
Package	MCP77M is a 27 × 27 package with 836 balls and a 0.8 mm ball pitch.
Features	<p>The NVIDIA nForce® MCP77 family of graphics, media and communications processors (GMCP) are the notebook industry's first single-chip solutions providing DirectX 10 shader model 4.0 graphics features, a dedicated video processor, HDMI, LVDS, dual mode display Port support and a rich feature set including a second generation PCI Express interface, industry first HyperTransport 3 with link power management, native Gigabit Ethernet MAC, Serial ATA and ATA-133 support, high definition audio, USB2.0, PCI, real-time power management processor, and other standard peripheral functions.</p> <p>Paired with an AMD Griffin Series -Turion64, Turion64X2, or Mobile Sempron CPU, all the key features needed for next generation entertainment, computing, and communications come together in MCP77. MCP77 also support innovative new hybrid-SLI functionality that increases performance and typical battery life for notebooks that also include an NVIDIA GPU.</p> <p>The MCP77M master feature set includes the following features:</p> <ul style="list-style-type: none"> <li>• Single chip for small form factor notebook designs</li> <li>• Microsoft Windows Vista premium support for all 2008 requirements visual user interface support.</li> <li>• Integrated GeForce DirectX 10 model 4.0 graphics processor1. Unified Shader model 4.0 for geometry, vertex and pixel processor2. NVIDIA® Intellisample™ AA technology</li> <li>• Next generation NVIDIA® PureVideo™ HD video processor for full HD content decode and Playback with long battery life or with lower cost single core CPUs.</li> <li>• PowerMizer SX (System eXtensions) reduces system power usage.</li> <li>• Integrated Display Cache 2.0 allows CPU to spend extended periods in Alt-vid Deeper Sleepstate without the cost or wasted power of a local frame buffer.</li> <li>• Integrated 300 MHz DAC for external desktop displays</li> <li>• Integrated TMDS interface with HDCP (High-Definition Content Protection) key support and optional protected audio stream mixing for HDMI support</li> <li>• HDCP support without the need for external key ROMs</li> <li>• Integrated dual channel LVDS interface for up to 1920 × 1200 LCD displays</li> <li>• Integrated high definition TV encoder with YPrPb component video support to HyperTransport 3.0x16 up and down links to the AMD Socket S1 g2 CPU with full HT3 link</li> <li>• Support for PCI Express Base Specification, Gen 2</li> <li>• Hybrid SLI support for simultaneous support of integrated and discrete GPUs for longer battery life in premium performance notebooks.</li> <li>• PCI Express x16 link interface for external graphics processors</li> <li>• Up to six PCI Express x1 link interfaces, with dedicated controller for other peripherals</li> <li>• AHCI SATA controller with support for four drives at 1.5 Gbps or 3.0 Gbps speeds</li> <li>• Fast ATA-133 IDE controller</li> </ul>

Item	Specification
Features (continued)	<ul style="list-style-type: none"> <li>• Fast ATA-133 IDE controller</li> <li>• NVIDIA® MediaShield™ RAID with support for RAID 0, RAID 1</li> <li>• IEEE 802.3 NVIDIA MAC for 1000BASE-T/100BASE-T/10BASE-T Gigabit/Fast Ethernet/Ethernet. RGMII for Gigabit/Fast Ethernet/Ethernet, aria. MII for Fast Ethernet/Ethernet</li> <li>• ASF 2.0 support for remote management</li> <li>• SPI Interface to Serial flash EEPROM</li> <li>• Able to load SBIOS and boot from SPI EEPROM without the use of extra LPC-based EEPROM</li> <li>• TPM 1.2 support</li> <li>• Dual USB 2.0 EHCI and USB 1.1 OHCI (supports up to twelve ports)</li> <li>• PCI 2.3 interface</li> <li>• Supports up to five PCI devices with dedicated REQ/GNT pairs</li> <li>• Dual SMBus 2.0 interfaces</li> <li>• UAA (Universal Audio Architecture) High Definition Audio (HDA) interface <ul style="list-style-type: none"> <li>• Supports up to two external UAA High Definition Audio codecs for 7.1 channel audio</li> <li>• Supports 32-bit/192 kHz audio functionality</li> </ul> </li> <li>• LPC bus 1.0 compatible interface</li> <li>• Integrated programmable clock synthesizer with spread spectrum support</li> <li>• Support for Microsoft Vista ReadyDrive feature using commodity hard-drives and flash devices</li> <li>• Support for direct input from accelerometer for more responsive hard disk park control</li> <li>• ASF 2.0 support for remote manageability</li> <li>• Separately programmable spread spectrum support for key interfaces including LVDS, SATA, HT</li> <li>• AMD CPU power sequencing protection logic</li> </ul>
CPU core voltage	<ul style="list-style-type: none"> <li>• +NB_CORE for MCP77M CORE Power(+1.0V)</li> <li>• +1.1V_NB for MCP77M Hyper Transport Power</li> <li>• +1.1V for Hyper Transport, PCI-E, Sleep mode Core power, SATA Interface, TV DAC supply</li> <li>• +1.8V for LVDS digital supply</li> <li>• +3.3V for PLL, CRTDAC, RGB DAC supply, USB Interface, CPU Interface</li> <li>• LAN MAC, Display</li> </ul>

#### Crystal and Oscillator

Item	Specification
Features	<ul style="list-style-type: none"> <li>• 32.768Khz crystal for RTC inside MCP77 and WINBOND WPC8769LDG</li> <li>• 25MHZ crystal for MCP77 controller</li> <li>• 25MHZ crystal for BroadCom Lan controller BCM5764</li> </ul>

### System Memory

Item	Specification
Memory controller	Built-in
Memory size	0MB (no on-board memory)
DIMM socket number	2 sockets
Supports memory size per socket	2 GB
Supports maximum memory size	4G for 64bit OS (with two 2GB SODIMM)
Supports DIMM type	DDR II SDRAM memory interface design
Supports DIMM Speed	533/677 Mhz
Memory module combinations	You can install memory modules in any combinations as long as they match the above specifications.

### Memory Combinations

Slot 1	Slot 2	Total Memory
0MB	512MB	512MB
0MB	1024MB	1024MB
0MB	2048MB	2048MB
512MB	512MB	1024MB
512MB	1024MB	1536MB
512MB	2048MB	2560MB
1024MB	0MB	1024MB
1024MB	512MB	1536MB
1024MB	1024MB	2048MB
1024MB	2048MB	3072MB
2048MB	0MB	2048MB
2048MB	512MB	2560MB
2048MB	1024MB	3072MB
2048MB	2048MB	4096MB

## Hard Disk Drive

Item	Specifications		
Vendor	Western Digital		
Model Name	WD1200BEVS	WD1600BEVS	WD2500BEVS
Capacity (MB)	120,034	160,041	250,059
Bytes per sector	512	512	512
Data heads	3	3	4
Drive Format			
Disk No.	1	2	2
Spindle speed (RPM)	5400	5400	5400
Performance Specifications			
Buffer size	8 MB		
Interface	SATA 1.5 Gb/s	SATA 1.5 Gb/s	SATA 1.5 Gb/s
Data Transfer Rate (max.)	1.5 Gb/s maximum 850 Mbits/s maximum		
DC Power Requirements			
Supply voltage	+5.0V ±5%		
Power supply ripple	Maximum Frequency: 100 mV (double amplitude) 0-30 MHz		

## Blue-Ray Combo Drive Module

Item	Specification	
Vendor & model name	Sony BC-5500S	
Performance Specification	With CD Diskette	With DVD Diskette
Transfer rate (MB/sec)	Sustained: Max 2.4 Mbytes/sec	Sustained: Max 11 Mbytes/sec
Buffer Memory	4.5 MB	
Interface	SATA	
Applicable disc format	Applicable media types: BD-ROM (Single and Dual Layer) BD-R (Single and Dual Layer) BD-RE (Single and Dual Layer) DVD-ROM (Single and Dual Layer) DVD+R (Single and Double Layer) DVD-R (Single and Dual Layer) DVD+RW (Single Layer) and DVD-RW (Single Layer) discs DVD-RAM (Ver.2) CD-ROM CD-R CD-RW	
Loading mechanism	Drawer (Solenoid Open) Tact SW (Open) Emergency Release (draw open hole)	
Power Requirement		
Input Voltage	DC 5 V +/- 5%	



## Super-Multi Drive Module

Item	Specification	
Vendor & model name	HLDS/GSA-T50N, Philips DS-8A2S, Toshiba Digi/TS-L633A	
Performance Specification	With CD Diskette	With DVD Diskette
Transfer rate (MB/sec)	Sustained: Max 3.5 Mbytes/sec	Sustained: Max 10 Mbytes/sec
Buffer Memory	2MB	
Interface	SATA	
Applicable disc format	Applicable media types: Writing: Confirms to DVD+R Version 1.2 and DVD+RW Version 1.3 / DVD+R DL Version 1.0 / DVD-R Version 2.0 / DVD-RW Version 1.2 / DVD-R DL Version 3.0. Reading: DVD single/dual layer (PTP, OTP), DVD-R single/dual layer DVD+R single/double layer DVD-RW DVD+RW CD-DA CD-ROM CD-ROM/XA Photo-CD, Multi-session, Video CD CD-I FMV, CD Extra, CD Plus, CD-R, and CD-RW	
Loading mechanism	Drawer (Solenoid Open) Tact SW (Open) Emergency Release (draw open hole)	
Power Requirement		
Input Voltage	DC 5 V +/- 5%	

## Thermal Sensor Control

Item	Specification
Thermal Sensor Chip	GMT-786 / W83L771
Package	8-pin SSOP
Features	Thermal sensor control Interface
Interface	I <sup>2</sup> C bus, address: 98h

## BIOS

Item	Specification
BIOS vendor	Phoenix BIOS code
BIOS Version	v0.3325 (for MP units)
BIOS ROM type	WND 1MB CMOS Boot Block Flash Memory
BIOS ROM size	1MB
BIOS package	8 pins SOP
Block size	64kbytes per block
Supply Current	<ul style="list-style-type: none"> <li>Active current = 5 mA (Typical)</li> <li>Standby current= 1 <math>\mu</math>A (Typical)</li> </ul>

**LCD 17.0"**

Item	Specification
Vendor/model name	Samsung LTN170BT07-G01
Active Area (mm) / Screen Diagonal (mm)	367.20(H) x 229.50(V) 17.0" diagonal
Display resolution (pixels)	1440 x 900 (Wide XGA+)
Pixel Pitch	0.255(H) x 0.255(V) (TYP.)
Pixel Arrangement	RGB vertical stripe
Display Mode	Normally white
Typical White Luminance (cd/m <sup>2</sup> ) also called Brightness	Minimum 190, Typical 220
Contrast Ratio	Minimum 300, Typical 500
Response Time (Optical Rise Time/Fall Time) msec	Typical 8, Maximum 16
Nominal Input Voltage VDD	Minimum 3.0, Typical 3.3, Maximum 3.6
Typical Power Consumption (watt)	4.68
Weight (g)	Typical 715, Maximum 735
Physical Size (mm)	382 (H) x 244.5 (V) x 6.7 (D)
Electrical Interface	LVDS
Support Color	262,144
Viewing Angle (degree) Horizontal: Right/Left Vertical: Upper/Lower	40, 45 / 40, 45 15, 20 / 20, 25
Temperature Range (°C) Operating Storage (shipping)	0 / 50 -20 / 60

**KBC**

Item	Specification
Chipset	WND WPCE775CA0DG
Features	<ul style="list-style-type: none"> <li>• Share BIOS memory</li> <li>• Support for SPI flash memories</li> <li>• Flash page programming support</li> <li>• Host-controlled CIR Port</li> <li>• High-accuracy, high-speed ADC</li> <li>• Up to 84 GPIO ports (including KB scanning) with a variety of wake-up events</li> <li>• 16 bit RISC core, with up to 4 Mbytes of external address space, running at up to 25MHz</li> <li>• 128 pin LQFP package</li> <li>• PC01 REV 1.0 and ACPI3.0 compliant.</li> <li>• Supports Microsoft® Advanced Power Management (APM) Specifications Rev 1.2</li> </ul>

## VGA Subsystem

Item	Specification
Chipset	NVidia Graphic
Package	nVIDIA MCP77
Features	<ul style="list-style-type: none"> <li>• Dual Head Display Controller</li> <li>• Full NVIDIA® nView™ multi-display technology capability, with two independent display controllers supporting a combination of any two of the following CRT, TV, LVDS and HDMI/DVI/DP interfaces</li> <li>• Each controller can drive same or different display contents to different resolutions and refresh rates</li> <li>• Video mirroring support</li> <li>• Display Cache support CRT Display DAC</li> <li>• 300 MHz RAMDAC for analog displays with resolutions up to and including 1920 x1440 at 60 Hz depending on dual head and video configurations.</li> <li>• Single channel TMDS interface for 25MHz to 165MHz pixel data rate</li> <li>• Support version 1.1 of the Display Port interface standard for flat panel display, Projectors, PCs and CE devices.</li> <li>• High-quality video scaling and filtering.</li> <li>• Up to WUXGA resolution support on HDMI, and up to 2560 X 1600 resolution supporting Display Port mode.</li> <li>• SPWG compliant</li> <li>• Support for LCD panel EDID</li> <li>• Power based on MCP67M:               <ul style="list-style-type: none"> <li>• +NB_CORE for MCP77M CORE Power(+1.0V)</li> <li>• +1.1V_NB for MCP77 Hyper Transport Power</li> <li>• +1.1V for Hyper Transport, PCI-E, Sleep mode Core power, SATA Interface, TV DAC supply</li> <li>• +1.8V for LVDS digital supply</li> <li>• +3.3V for PLL, CRTDAC, RGB DAC supply, USB Interface, CPU Interface, LAN MAC, Display</li> </ul> </li> </ul>
Discrete Graphic (MXM)	<ul style="list-style-type: none"> <li>• MSI MS-V115A3-9MGS256 (256MB)/ Yuan YSTP621GP 1(256MB)</li> <li>• NVIDIA NB9M-GS (G3-64 package)</li> <li>• Featuring:               <ul style="list-style-type: none"> <li>• 16 Lane PCI Express support</li> <li>• LVDS Interface support</li> <li>• VGA support</li> <li>• Video out support</li> <li>• Upgradeable graphics</li> <li>• Power: 19V, 5V, 3.3V, 2.5V, 1.8V</li> </ul> </li> </ul>
Power	19V, 5V, 3.3V, 2.5V, 1.8V

## Memory Card Reader

Item	Specification
Type	Realtek RTS5158E (One-LUN USB 2.0 Card Controller)
Package	48-pin LQFP (size= 9x9mm)
Features	<ul style="list-style-type: none"> <li>• The RTS5158E is an ultimate throughput USB 2.0 compliant card reader controller that integrates USB 2.0 Transceiver, MCU, SIE, regulators and memory card access units into a single chip.</li> <li>• The RTS5158E can support Memory Stick, Memory Stick Pro, Memory Stick PRO-HG Duo, Secure Digital, Multi-Media Card and xD-Picture Card, but only 1-LUN configuration, i.e. only one of these memory cards can be inserted into RTS5158E system at the same time.</li> <li>• Compliant with Universal Serial Bus Specification Revision 2.0.</li> <li>• Compliant with USB Mass Storage Class Bulk only Transport Specification Rev. 1.0.</li> <li>• Support High-speed (480Mbps) and Full-speed (12Mbps) Data Transfer.</li> <li>• USB bus power operation.</li> <li>• Support Control, Bulk IN / OUT data pipes.</li> <li>• Support the following memory card interfaces:               <ul style="list-style-type: none"> <li>• Secure Digital™ (SD),</li> <li>• MultiMediaCard™ (MMC),</li> <li>• Mini-SD, Micro-SD (T-flash),</li> <li>• RS-MMC, Mobile-MMC and MMC-micro-Memory Stick™ (MS),</li> <li>• Memory Stick PRO™ (MS-PRO),</li> <li>• MS Duo, MS-PRO Duo and Micro-MS (M2)-MSPRO-HG Duo 8-bit mode</li> <li>• xD-Picture Card™ (xD) including Type M and Type H.</li> </ul> </li> <li>• Support hardware ECC (Error Correction Code) function.</li> <li>• Support hardware CRC (Cyclic Redundancy Check) function.</li> <li>• Programmable clock rate for flash memory card interfaces.</li> <li>• Support MS-PRO v1.02.</li> <li>• Support MS v1.43.</li> <li>• Support MS PRO-HG Duo v1.01.</li> <li>• Support SD version 2.0. Support MMC version 4.2.</li> <li>• Support xD v1.2.</li> <li>• Integrated Fast 8051 microprocessor.</li> <li>• External serial EEPROM interface.</li> <li>• 12MHz crystal oscillator with integrated PLL.</li> <li>• Support 48Mhz directly input from clock generator.</li> <li>• On chip 3.3V to 1.8V regulator.</li> <li>• On chip MOSFET with 250mA capability for direct power control of all types memory cards.</li> <li>• Support Spread Spectrum Clock for SD/MMC and MS/MSPRO/HG to reduce EMI effect.</li> <li>• Support USB remote wake-up ability with memory card inserted and removal operation.</li> <li>• Provide Selective Suspend driver to reduce power consumption.</li> <li>• 48-pin LQFP package</li> </ul>
Power	<ul style="list-style-type: none"> <li>• +3.3V</li> <li>• +3V_CARD</li> </ul>

**IR**

Item	Specification
Type	EVERLIGHT ELECTRONICS IRM-V038/TR1-P
Features	<ul style="list-style-type: none"> <li>• High immunity against ambient light.</li> <li>• Long reception distance.</li> <li>• Suitable burst length =&gt;10 pulses/burst.</li> <li>• Low voltage and low power consumption.</li> </ul>

**Audio Interface**

Item	Specification
Audio Controller	Realtek ALC888 Azadia Codec and Amplifier GMT G1441&G1412
Features	<ul style="list-style-type: none"> <li>• HD Audio</li> <li>• 97dB SNR DACs &amp; 90dB SNR ADCs</li> <li>• Ten DAC channels support 16/20/24-bit PCM format for 7.1 sound playback, plus 2channels of independent stereo sound output (multiple streaming) through the front panel output</li> <li>• Two stereo ADCs support 16/20/24-bit PCM format, one for stereo microphone, one for legacy mixer recording</li> <li>• All DACs supports 44.1k/48k/96k/192kHz sample rate</li> <li>• All ADCs support 44.1k/48k/96k sample rate</li> <li>• Two independent 16/20/24-bit S/PDIF-OUT converters support 44.1k/48k/96k/192kHzsample rate, one for nominal digital audio, the other one for digital audio output to HDMI transmitter</li> <li>• Enable VoIP function</li> <li>• Subwoofer support</li> </ul>

**LAN Interface**

Item	Specification
LAN Chipset	BroadCom Lan controller BCM5764
Features	<ul style="list-style-type: none"> <li>• PCI-E interface LAN controller</li> <li>• PCIE V1.1 compliant.</li> <li>• Support wake on LAN meeting the ACPI requirements.</li> <li>• 68-pin QFN package.</li> </ul>

**Bluetooth Interface**

Item	Specification
Chipset	FOXCON T60H928.11 Bluetooth miniUSB module
Features	<ul style="list-style-type: none"> <li>• Internal Mini USB solution with antenna</li> <li>• Bluetooth 2.0+EDR</li> <li>• Bluetooth control for BT optical mouse</li> </ul>

**Keyboard**

Item	Specification
Type	Aspire series: New Acer Non-Ergo Keyboard
Total number of keypads	104-key
Windows logo key	Yes
Internal & external keyboard work simultaneously	Plug USB keyboard to the USB port directly: Yes

## MDC Card

Item	Specification
Chipset	Intel® Wireless WiFi Link 5100/5300
Features	<ul style="list-style-type: none"> <li>The modem supports ITU-T V.92, V.90, V.34 (33600 bits/s), V.32bis and fallbacks.</li> <li>It also supports V.42 LAPM, MNP 2-4 error correction.</li> <li>V.44, V.42bis and MNP 5 data compression.</li> <li>Send and receive rates up to 14400bps, support ITU-T V.17, V.29, V.27ter, and V.21Ch2 fax.</li> <li>TIA/EIA 602 Standard for AT command set, and Fax TIA/EIA 578 Class 1 command set.</li> <li>DTMF and call progress monitor</li> </ul>

## Camera

Item	Specification
Vendor and model name	Suyin CN0314-SN30-OV03-1
Interface	USB 2.0
Optical aperture	F2.0
Focusing range	40 cm to infinity
Dimensions (L x W x H mm)	65 x 9.0 x 5.30 (±0.20)
Sensor type	OV7725 CMOS Sensor 350K Pixel
Pixel resolution	640 x 480
Pixel size	6.0µm x 6.0µm
Image size (mm)	3.98 (H) x 2.95 (V)

## Finger Print Board

Item	Specification
Features	<p>TruePrint® and TrueMatch® Technology.            TrueNav® Cursor and Menu Navigation Technology            High Definition 128 x 8 Pixel Array            Multiple battery-friendly operating modes @ 3.3V            Built-in low power Finger Detection w/ remote wakeup capability            USB 2.0 Full Speed Interface</p>

## Battery

Item	Specification	
Vendor & model name	Sanyo, Simplo, Sony, Panasonic	Sanyo, Simplo, Panasonic
Battery Type	Li-ion	Li-ion
Pack capacity	4400 mAh	4800 mAh
Number of battery cell	6	8
Package configuration	3S2P	4S2P

# System Utilities

---

## BIOS Setup Utility

The BIOS Setup Utility is a hardware configuration program built into your computer's BIOS (Basic Input/Output System).

Your computer is already properly configured and optimized, and you do not need to run this utility. However, if you encounter configuration problems, you may need to run Setup. Please also refer to Chapter 4 Troubleshooting when problem arises.

To activate the BIOS Utility, press **F2** during POST (when "Press <F2> to enter Setup" message is prompted on the bottom of screen).

Press **F2** to enter setup. The default parameter of F12 Boot Menu is set to "disabled". If you want to change boot device without entering BIOS Setup Utility, please set the parameter to "enabled".

Press <F12> during POST to enter multi-boot menu. In this menu, user can change boot device without entering BIOS SETUP Utility.

## Navigating the BIOS Utility

There are six menu options: Information, Main, Advanced, Security, Boot, and Exit.

Follow these instructions:

- To choose a menu, use the left and right arrow keys.
- To choose an item, use the up and down arrow keys.
- To change the value of a parameter, press **F5** or **F6**.
- A plus sign (+) indicates the item has sub-items. Press **Enter** to expand this item.
- Press **Esc** while you are in any of the menu options to go to the Exit menu.
- In any menu, you can load default settings by pressing **F9**. You can also press **F10** to save any changes made and exit the BIOS Setup Utility.

**NOTE:** You can change the value of a parameter if it is enclosed in square brackets. Navigation keys for a particular menu are shown on the bottom of the screen. Help for parameters are found in the Item Specific Help part of the screen. Read this carefully when making changes to parameter values. **Please note that system information is subject to different models.**

# Information

The Information screen displays a summary of your computer hardware information.

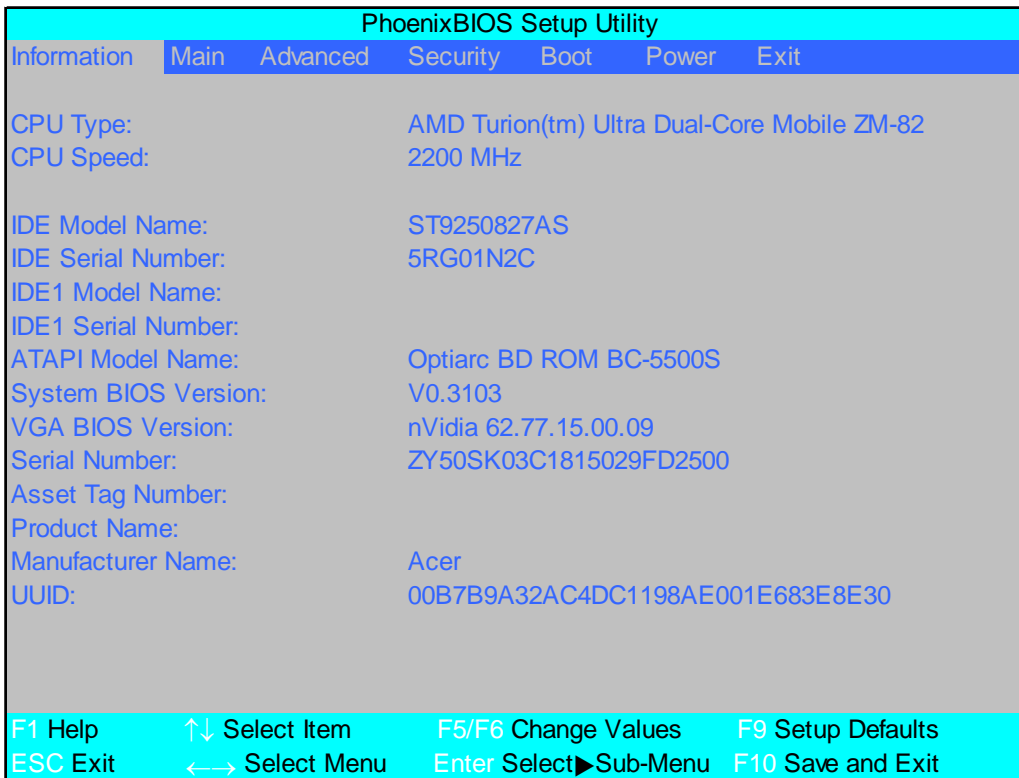

**NOTE:** The system information is subject to different models.

Parameter	Description
CPU Type	This field shows the CPU type and speed of the system.
CPU Speed	This field shows the speed of the CPU.
IDE Model Name	This field shows the model name of HDD installed on primary IDE master.
IDE Serial Number	This field displays the serial number of HDD installed on primary IDE master.
IDE1 Model Name	This field shows the model name of HDD installed on secondary IDE master.
IDE1 Serial Number	This field displays the serial number of HDD installed on secondary IDE master.
ATAPI Model Name	This field shows the model name of the Optical device installed in the system.
System BIOS Version	Displays system BIOS version.
VGA BIOS Version	This field displays the VGA firmware version of the system.
Serial Number	This field displays the serial number of this unit.
Asset Tag Number	This field displays the asset tag number of the system.
Product Name	This field shows product name of the system.
Manufacturer Name	This field displays the manufacturer of this system.
UUID Number	Universally Unique Identifier (UUID) is an identifier standard used in software construction, standardized by the Open Software Foundation (OSF) as part of the Distributed Computing Environment (DCE).



# Main

The Main screen allows the user to set the system time and date as well as enable and disable boot option and recovery.

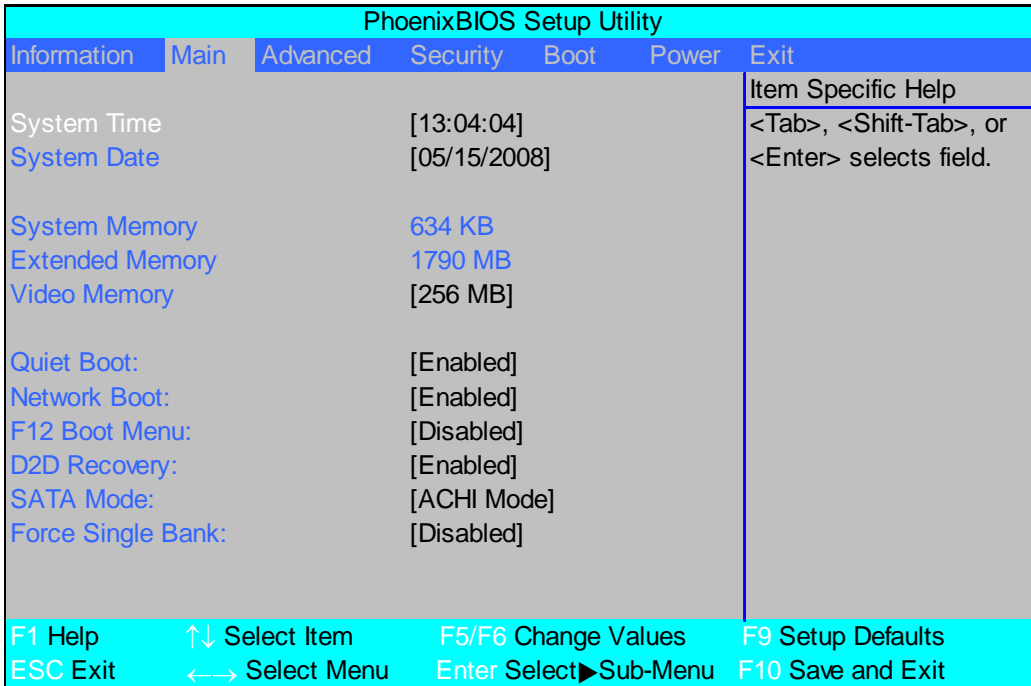

**NOTE:** The screen above is for your reference only. Actual values may differ.

The table below describes the parameters in this screen. Settings in **boldface** are the default and suggested parameter settings.

Parameter	Description	Format/Option
System Time	Sets the system time. The hours are displayed with 24-hour format.	Format: HH:MM:SS (hour:minute:second)
System Date	Sets the system date.	Format MM/DD/YYYY (month/day/year)
System Memory	This field reports the memory size of the system. Memory size is fixed to 3071 MB.	N/A
Extended Memory	This field reports the Extended Memory size. Memory size is fixed to 4094 MB.	N/A
Video Memory	Shows the video memory size. VGA Memory size=32 MB	N/A
Quiet Boot	Displays the logo screen while booting.	Option: <b>Enabled</b> or Disabled
Network Boot	Enables, disables the system boot from LAN (remote server).	Option: <b>Enabled</b> or Disabled
F12 Boot Menu	Enables, disables Boot Menu during POST.	Option: <b>Disabled</b> or Enabled
D2D Recovery	Enables, disables D2D Recovery function. The function allows the user to create a hidden partition on hard disc drive to store operation system and restore the system to factory defaults.	Option: <b>Enabled</b> or Disabled
SATA Mode	Control the mode in which the SATA controller should operate.	Option: <b>AHCI Mode</b> or IDE Mode
Force Single Bank	When enabled, limits memory DIMM to a single bank regardless of DIMM content.	Option: <b>Disabled</b> or Enabled

# Advanced

The Advanced screen allows the user to configure the various advanced BIOS options.

**IMPORTANT:** Making incorrect settings to items on these pages may cause the system to malfunction. Unless you have experience adjusting these items, we recommend that you leave these settings at the default values. If making settings to items on these pages causes your system to malfunction or prevents the system from booting, open BIOS and choose Load Optimal Defaults in the Exit menu to boot up normally.

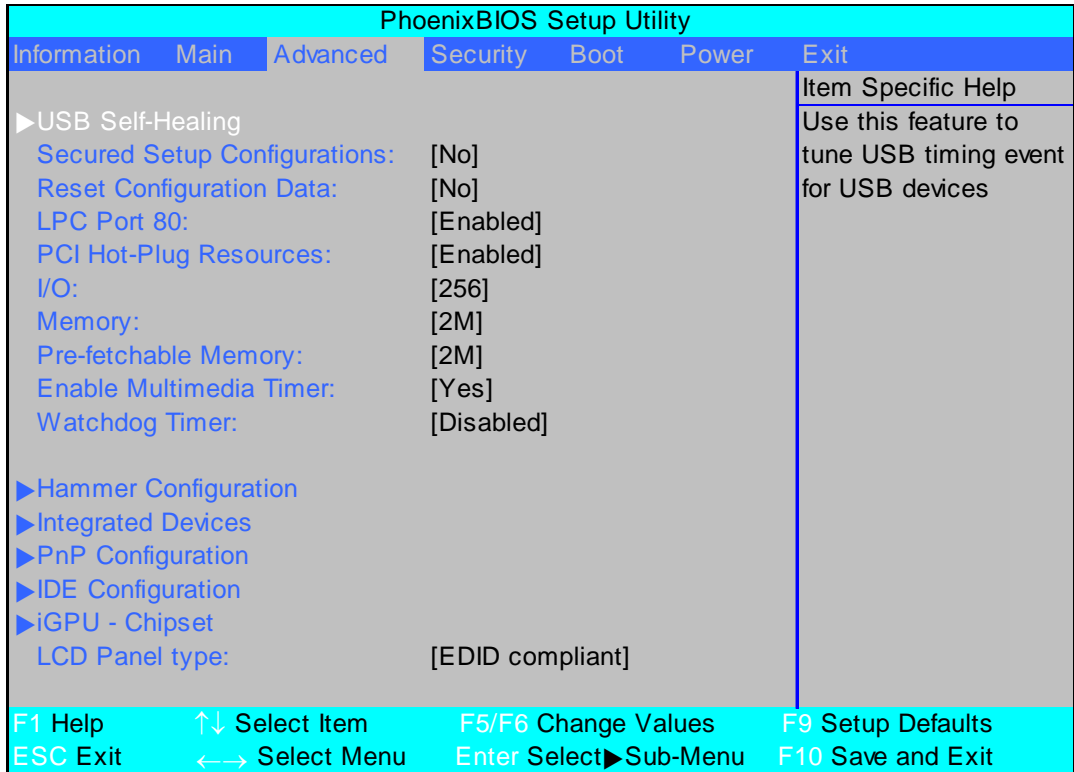

The table below describes the items, menus, and submenus in this screen. Settings in **boldface** are the default and suggested parameter settings.

Parameter	Description	Submenu Items
USB Self-Healing	Enter the USB Self-Healing menu.	<ul style="list-style-type: none"> <li>• Self-Healing</li> <li>▶ OCHI Self-Healing</li> <li>▶ EHCI Self-Healing</li> </ul>
Secured Setup Configuration	Prevents Plug and Play devices from changing system settings.	N/A
Reset Configuration Data	Clear the Extended System Configuration Data (ESCD) area using this option.	N/A
LPC Port 80	<b>Enable</b> or Disable LPC Port 80.	N/A
PCI Hot-Plug Resources	<b>Enable</b> or Disable Hot-Plug support.	N/A
I/O	Set the amount of I/O (in bytes) available to the Hot-Plug slots.	N/A
Memory	Set the amount of Memory (in bytes) available to Hot-Plug slots.	N/A
Pre-fetchable Memory	Set the amount of Pre-fetchable Memory (in bytes) available to the Hot-Plug slots.	N/A

Parameter	Description	Submenu Items
Enable Multimedia Timer	Enable [ <b>Yes</b> ] or Disable [ <b>No</b> ] Multimedia Timer support.	N/A
Watchdog Timer	<b>Disable</b> or Enable the OS Watchdog Timer using ACPI WDAT.	N/A
Hammer Configuration	Enter the Hammer Configuration menu.	<ul style="list-style-type: none"> <li>• HT-LDT Frequency</li> <li>• HT-LDT Width</li> <li>• DDR2 Memory Frequency</li> <li>• LS Table loading</li> <li>• ISO Flow Control</li> <li>• Hi Priority Channel</li> <li>• Display Refresh</li> <li>• Sync Flood Detection</li> </ul>
Integrated Devices	Enter the Integrated Devices menu.	<ul style="list-style-type: none"> <li>• USB Control</li> <li>• USB2 Control</li> <li>• USB BIOS Legacy Support</li> <li>• MAC LAN</li> <li>• Azalia Codec</li> <li>• Integrated Codec</li> <li>• SATA Mode</li> <li>• SATA AHCI Mode</li> <li>• SATA Hotplug</li> <li>• Power on options</li> <li>• Interrupt Mode</li> <li>• PCI Express MSI</li> <li>• S5 WOL</li> <li>• Software Based PMU FW Loading</li> <li>• SMU</li> <li>• Dynamic Crush Voltage</li> <li>• PMU iGPU Stutter Mode</li> <li>• PMU System Stutter Mode</li> <li>• PMU LMM Mode</li> <li>• Dynamic FPCI Clock</li> </ul>
PnP Configuration	Enter the PnP Configuration menu.	<ul style="list-style-type: none"> <li>▶ PCI Device, Slot #1</li> <li>▶ PCI/PNP ISA UMB Region Exclusion</li> <li>▶ PCI/PNP ISA IRQ Resource Exclusion</li> </ul>
IDE Configuration	Enter the IDE Configuration menu.	<ul style="list-style-type: none"> <li>• Large Disk Access Mode</li> <li>• Local Bus IDE adapter</li> <li>▶ Primary Master</li> <li>▶ Primary Slave</li> </ul>
iGPU - Chipset	Enter the iGPU - Chipset menu.	<ul style="list-style-type: none"> <li>• Integrated Graphic</li> <li>• Video Memory</li> <li>• Hybrid Graphics</li> <li>• mGPU nPW</li> <li>• MXM LVDS/TV</li> <li>• MXM CRT/DVI</li> </ul>
LCD Panel type	Select the correct LCD panel type for testing purposes.	N/A

# Security

The Security screen contains parameters that help safeguard and protect your computer from unauthorized use.

PhoenixBIOS Setup Utility						
Information	Main	Advanced	Security	Boot	Power	Exit
						Item Specific Help
Supervisor Password Is			Clear	Supervisor Password controls access to the setup utility.		
User Password Is			Clear			
SATA Port 0 Disk Status			Clear			
Set Supervisor Password			[Enter]			
Set User Password			[Enter]			
Set SATA Port 0 HDD Password			[Enter]			
Password on boot			[Disabled]			
F1 Help      ↑↓ Select Item      F5/F6 Change Values      F9 Setup Defaults ESC Exit      ←→ Select Menu      Enter Select▶ Sub-Menu      F10 Save and Exit						

The table below describes the parameters in this screen. Settings in **boldface** are the default and suggested parameter settings.

Parameter	Description	Option
Supervisor Password Is	Shows the setting of the Supervisor password	<b>Clear</b> or Set
User Password Is	Shows the setting of the user password.	<b>Clear</b> or Set
SATA Port 0 Disk Status	Shows the setting of the hard disk password.	<b>Clear</b> or Set
Set Supervisor Password	Press Enter to set the supervisor password. When set, this password protects the BIOS Setup Utility from unauthorized access. The user can not either enter the Setup menu nor change the value of parameters.	N/A
Set User Password	Press Enter to set the user password. When user password is set, this password protects the BIOS Setup Utility from unauthorized access. The user can enter Setup menu only and does not have right to change the value of parameters.	N/A
Set SATA Port 0 HDD Password	Enter HDD Password.	N/A
Password on boot	Defines whether a password is required or not while the events defined in this group happened. The following sub-options are all requires the Supervisor password for changes and should be grayed out if the user password was used to enter setup.	<b>Disabled</b> or Enabled

**NOTE:** When you are prompted to enter a password, you have three tries before the system halts. Don't forget your password. If you forget your password, you may have to return your notebook computer to your dealer to reset it.

---

## Setting a Password

Follow these steps as you set the user or the supervisor password:

1. Use the ↑ and ↓ keys to highlight the Set Supervisor Password parameter and press the **Enter** key. The Set Supervisor Password box appears:

Set Supervisor Password		
Enter New Password	[	]
Confirm New Password	[	]

2. Type a password in the “Enter New Password” field. The password length can not exceeds 8 alphanumeric characters (A-Z, a-z, 0-9, not case sensitive). Retype the password in the “Confirm New Password” field.

**IMPORTANT:** Be very careful when typing your password because the characters do not appear on the screen.

3. Press **Enter**. After setting the password, the computer sets the User Password parameter to “Set”.
4. If desired, you can opt to enable the Password on boot parameter.
5. When you are done, press F10 to save the changes and exit the BIOS Setup Utility.

## Removing a Password

Follow these steps:

1. Use the w and y keys to highlight the Set Supervisor Password parameter and press the **Enter** key. The Set Password box appears:

Set Supervisor Password		
Enter current password	[	]
Enter New Password	[	]
Confirm New Password	[	]

2. Type the current password in the Enter Current Password field and press **Enter**.
3. Press e twice **without** typing anything in the Enter New Password and Confirm New Password fields. The computer then sets the Supervisor Password parameter to “Clear”.
4. When you have changed the settings, press u to save the changes and exit the BIOS Setup Utility.

---

## Changing a Password

1. Use the ↑ and ↓ keys to highlight the Set Supervisor Password parameter and press the **Enter** key. The Set Password box appears.

Set Supervisor Password		
Enter current password	[	]
Enter New Password	[	]
Confirm New Password	[	]

2. Type the current password in the Enter Current Password field and press **Enter**.
3. Type a password in the Enter New Password field. Retype the password in the Confirm New Password field.
4. Press **Enter**. After setting the password, the computer sets the User Password parameter to “Set”.
5. If desired, you can enable the Password on boot parameter.
6. When you are done, press F10 to save the changes and exit the BIOS Setup Utility.

If the verification is OK, the screen will display as following.

Setup Notice
Changes have been saved.
[ continue]

The password setting is complete after the user presses **Enter**.

If the current password entered does not match the actual current password, the screen will show you the Setup Warning.

Setup Warning
Invalid password
Re-enter Password
[ continue]

If the new password and confirm new password strings do not match, the screen will display the following message.

Setup Warning
Password do not match
Re-enter Password



# Power

The Power screen allows the user to configure various CPU and power management options and device wakeup behavior.

PhoenixBIOS Setup Utility						
Information	Main	Advanced	Security	Boot	Power	Exit
C1E Configuration [Auto] CPU Throttle: [Disabled] CPU Spread Spectrum: [Enabled] iGPU Spread Spectrum: [3.00% Triangular Centre] PCIE Spread Spectrum: [Disabled] SATA Spread Spectrum: [Linear Down] PState Configuration [Enabled] USB CSC Resume [Disabled] DIPM [Disabled] HIPM [Disabled] SATA FPCI Clock: [133Mhz] SATA Low Power [SALP OFF] PCI Clocks: [Enabled] AltVid [Disabled] ASPM (L0s/L1s) [Disabled] PCIE Lane Swizzle: [Disabled]						Item Specific Help Enable or Disable C1E Dual-Core related CPU power State.  Auto enables C1E if dual core is detected and disables C1E if single core is detected.
<b>F1 Help</b> <b>↑↓ Select Item</b> <b>F5/F6 Change Values</b> <b>F9 Setup Defaults</b> <b>ESC Exit</b> <b>←→ Select Menu</b> <b>Enter Select▶ Sub-Menu</b> <b>F10 Save and Exit</b>						

The table below describes the items, menus, and submenus in this screen. Settings in **boldface** are the default and suggested parameter settings.

Parameter	Description	Option
C1E Configuration	Enable or Disable C1E Dual-Core related CPU power State.	<b>Auto</b> , Griffin Mode or Disabled
CPU Throttle	Enable or disable CPU Throttle.	<b>Disabled</b> or Enabled
CPU Spread Spectrum	Enable or disable CPU Spread Spectrum.	<b>Disabled</b> or Enabled
iGPU Spread Spectrum	Set the iGPU Spread Spectrum percentage.	1.00%, 2.00%, <b>3.00%</b> , 4.00%, 5.00% or Disabled
PCIE Spread Spectrum	Enable or disable PCIE Spread Spectrum.	<b>Disabled</b> or Enabled
SATA Spread Spectrum	Enable or disable SATA Spread Spectrum.	<b>Linear Down</b> or Disabled
PState Configuration	Enable or disable ACPI PState Support	<b>Enabled</b> or Disabled
USB CSC Resume	Enable or disable wake up from S3 by USB plug or unplug.	<b>Disabled</b> or Enabled
Cannot_Find_String	Enable or disable the Cannot_Find_String message during boot.	<b>Disabled</b> or Enabled
HIPM	Enable or disable Aggressive Link Power Management (HIPM).	<b>Disabled</b> or Enabled
SATA FPCI Clock	Set the SATA low power control level.	<b>133 MHz</b> or 200 MHz
SATA Low Power	Set SATA low power control type.	<b>SALP Off</b> , Partial on, Slumber on or SALP On



---

<b>Parameter</b>	<b>Description</b>	<b>Option</b>
PCI Clocks	Enable all PCI clocks or lock down all PCI clocks to Port 80.	<b>Enabled</b> or Auto
AltVid	Enable or disable AltVid functionality.	<b>Disabled</b> or Enabled
ASPM (L0s/L1s)	Enable or disable Active State Power Management (ASPM) states for L0s and L1.	<b>Disabled</b> or Enabled
PCIE Lane Swizzle	Enable or disable PCIE Lane Swizzle for PCIE x 16 slot.	<b>Disabled</b> or Enabled

# Exit

The Exit screen allows you to save or discard any changes you made and quit the BIOS Utility.

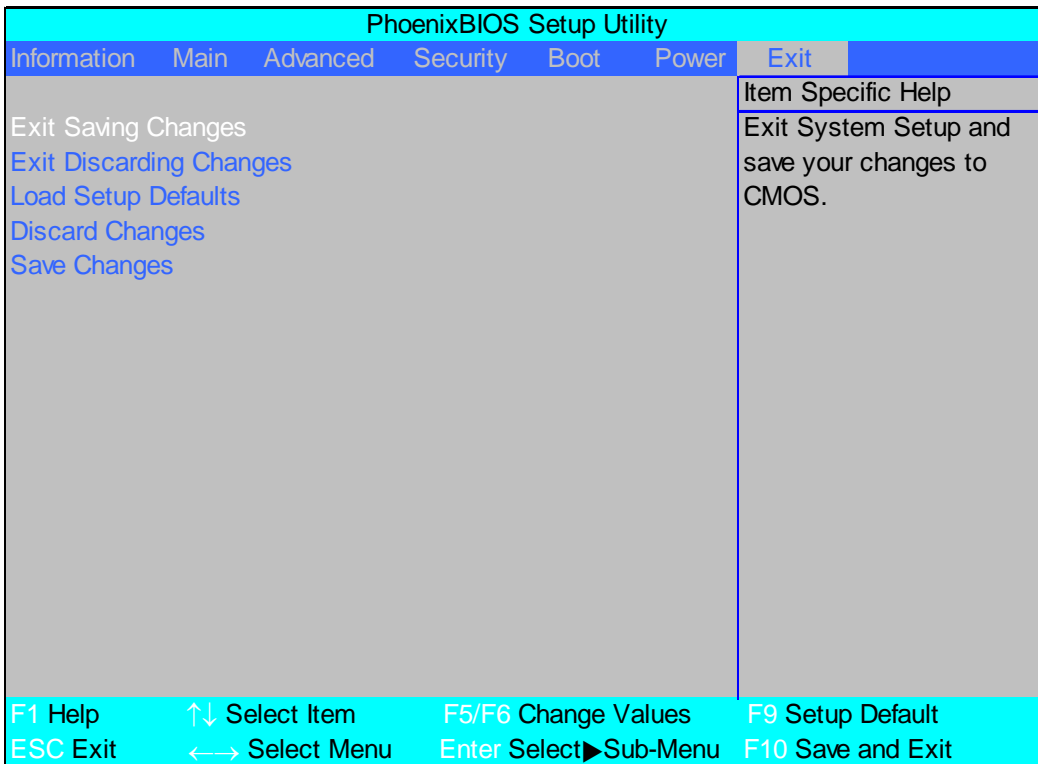

The table below describes the parameters in this screen.

Parameter	Description
Exit Saving Changes	Exit System Setup and save your changes to CMOS.
Exit Discarding Changes	Exit utility without saving setup data to CMOS.
Load Setup Default	Load default values for all SETUP item.
Discard Changes	Load previous values from CMOS for all SETUP items.
Save Changes	Save Setup Data to CMOS.

---

# BIOS Flash Utility

The BIOS flash memory update is required for the following conditions:

- New versions of system programs
- New features or options
- Restore a BIOS when it becomes corrupted.

Use the Phlash utility to update the system BIOS flash ROM.

**NOTE:** If you do not have a crisis recovery diskette at hand, then you should create a **Crisis Recovery Diskette** before you use the Phlash utility.

**NOTE:** Do not install memory-related drivers (XMS, EMS, DPMI) when you use the Phlash.

**NOTE:** Please use the AC adaptor power supply when you run the Phlash utility. If the battery pack does not contain enough power to finish BIOS flash, you may not boot the system because the BIOS is not completely loaded.

Follow the steps below to run the Phlash.

1. Prepare a bootable diskette.
2. Copy the flash utilities to the bootable diskette.
3. Then boot the system from the bootable diskette. The flash utility has auto-execution function.

# Remove HDD/BIOS Utility

This section provide you with removing HDD/BIOS method:

## Remove HDD Password:

If you key in the wrong HDD password three times, HDD password error code displays. See the image below.



To reset the HDD password, run HDD\_PW.EXE as follows:

1. Key in **hdd\_pw 15494 0**
2. Press 2.
3. Select one upper-case string from the list.



4. Reboot system and key in the selected string (0KJFN42 or UVEIQ96) on the HDD User Password screen.



---

### Remove BIOS Password:

If you key in the wrong Supervisor Password three times, System Disabled displays on the screen. See the image below.

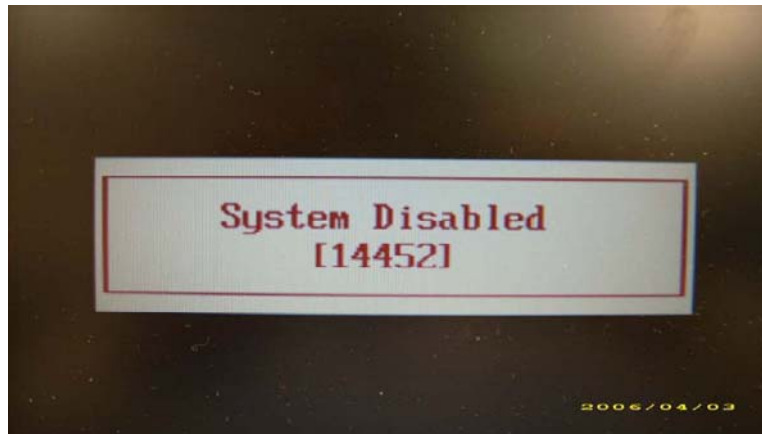

To reset the BIOS password, run BIOS\_PW.EXE as follows:

1. Key in **bios\_pw 14452 0**
2. Select one string from the list.



- 
3. Reboot the system and key in the selected string (qjig9vy, 07yqmjd etc.) for the BIOS user password.



# Machine Disassembly and Replacement

---

This chapter contains step-by-step procedures on how to disassemble the notebook computer for maintenance and troubleshooting.

## Disassembly Requirements

To disassemble the computer, you need the following tools:

- Wrist grounding strap and conductive mat for preventing electrostatic discharge
- Flat screwdriver
- Philips screwdriver
- Plastic flat screwdriver
- Plastic tweezers

**NOTE:** The screws for the different components vary in size. During the disassembly process, group the screws with the corresponding components to avoid mismatch when putting back the components.

---

# General Information

## Pre-disassembly Instructions

Before proceeding with the disassembly procedure, make sure that you do the following:

1. Turn off the power to the system and all peripherals.
2. Unplug the AC adapter and all power and signal cables from the system.



3. Place the system on a flat, stable surface.
4. Remove the battery pack.

## Disassembly Process

The disassembly process is divided into the following stages:

- External module disassembly
- Main unit disassembly
- LCD module disassembly

The flowcharts provided in the succeeding disassembly sections illustrate the entire disassembly sequence. Observe the order of the sequence to avoid damage to any of the hardware components. For example, if you want to remove the main board, you must first remove the keyboard, then disassemble the inside assembly frame in that order.

### Main Screw List

Screw	Quantity	Part No.
M2.5*6.5	40	86.ARE07.001
M2*3	37	86.ARE07.002
M2.5*3	13	86.T25V7.012
M3*0.5+3.5	4	86.A03V7.011
M2*2.5	2	86.A03V7.007



# External Module Disassembly Process

## External Modules Disassembly Flowchart

The flowchart below gives you a graphic representation on the entire disassembly sequence and instructs you on the components that need to be removed during servicing. For example, if you want to remove the main board, you must first remove the keyboard, then disassemble the inside assembly frame in that order.

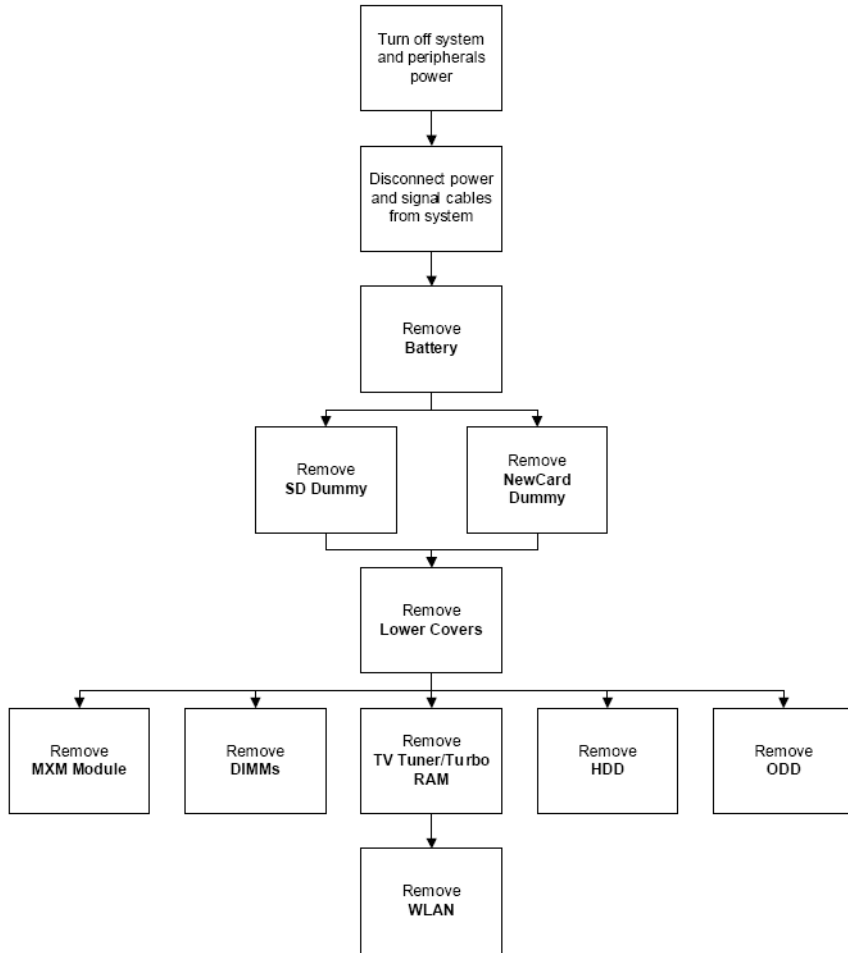

### Screw List

Step	Screw	Quantity	Part No.
MXM Module	M2.5*9	4	N/A
TV Tuner Module	M2*3	2	86.ARE07.002
WLAN Module	M2*3	2	86.ARE07.002
HDD Module	M2*3	2	86.ARE07.002
HDD Carrier	M3*0.5+3.5	4	86.A03V7.011
ODD Bracket	M2*2.5	2	86.A03V7.007

---

## Removing the Battery Pack

1. Turn computer over.
2. Slide the battery lock/unlock latch to the unlock position.



3. Slide and hold the battery release latch to the release position (1), then slide out the battery pack from the main unit (2).

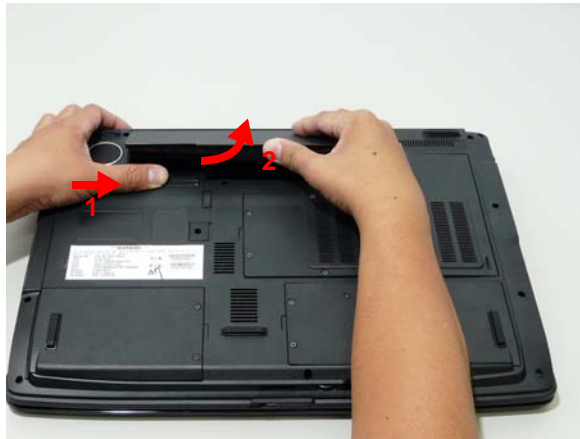

## Removing the SD dummy card

1. Push the SD dummy card all the way in to eject it.



---

2. Pull it out from the slot.



## Removing the ExpressCard dummy card

1. Push the ExpressCard dummy card all the way in to eject it.



2. Pull it out from the slot.



---

## Removing the Lower Covers

1. See "Removing the Battery Pack" on page 48.
2. Loosen the ten captive screws from the Memory, HDD1, and HDD2 Covers.

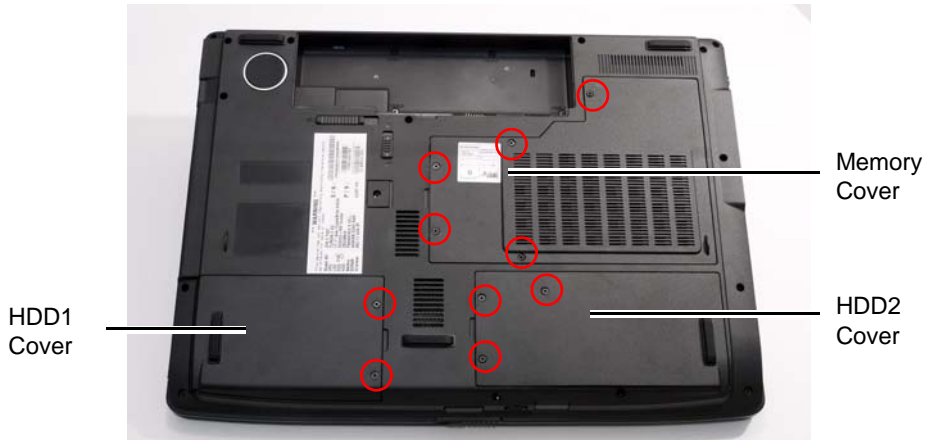

3. Carefully open the memory cover.

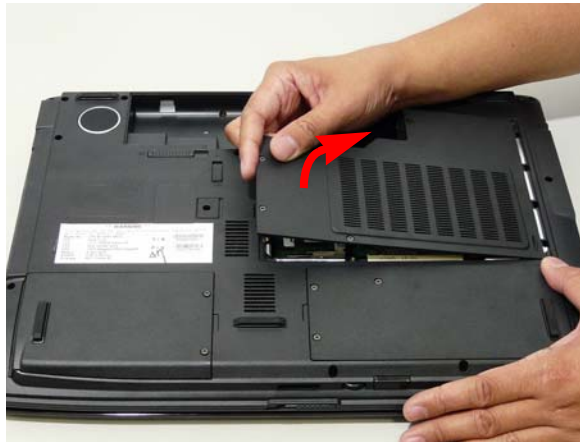

4. Remove the HDD1 cover as shown.



5. Remove the HDD2 cover as shown.



## Removing the DIMM Modules

1. Remove the battery. See “Removing the Battery Pack” on page 48.
2. Remove the Memory Module cover. See “Removing the Lower Covers” on page 50.
3. Push out the release latches on both sides of the DIMM socket to release the DIMM module.

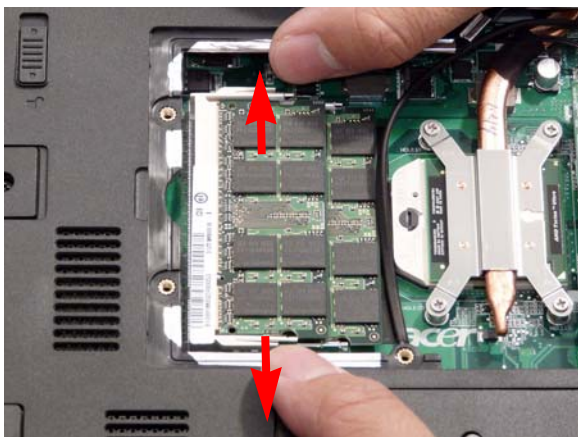

4. Remove the DIMM module.

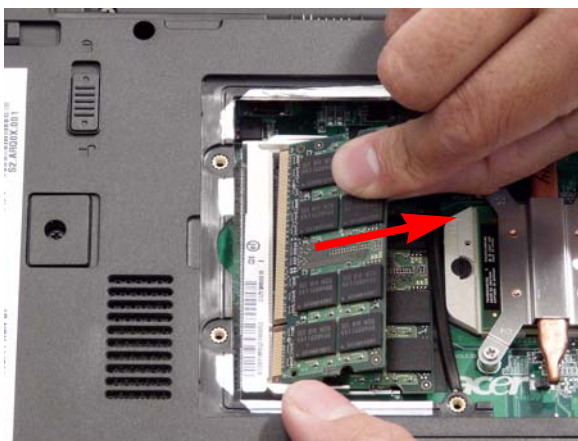

5. Repeat steps for the second DIMM module.

## Removing the MXM Module

1. Remove the battery. See “Removing the Battery Pack” on page 48.
2. Remove the four securing screws.

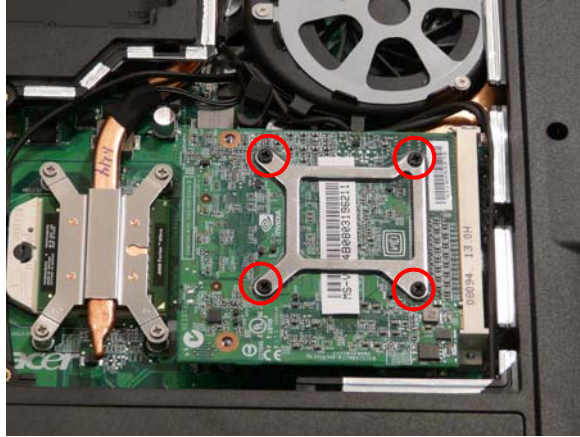

Step	Size	Quantity	Screw Type
MXM Module	M2.5*9 (NL)	4	

3. Grasp the module and remove.

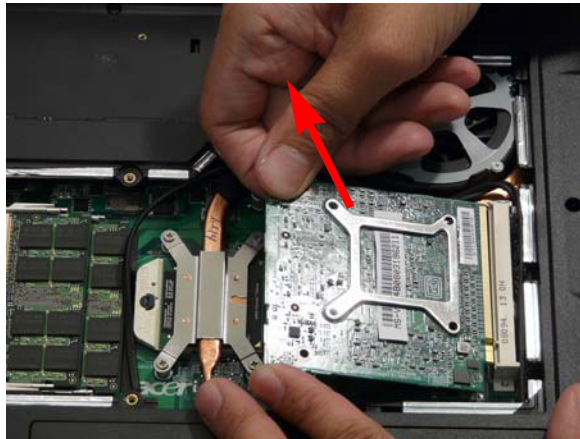





## Removing the TV Tuner module

1. See "Removing the Battery Pack" on page 48.
2. Remove the HDD2 cover. See "Removing the Lower Covers" on page 50.
3. Disconnect the TV Tuner cable from the module.

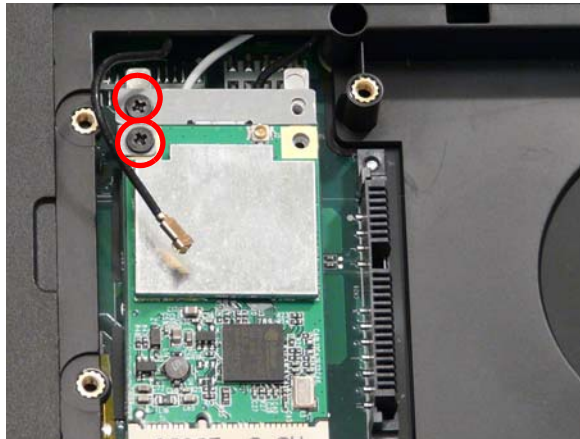

4. Remove the two securing screws.



Step	Size	Quantity	Screw Type
Tv Tuner Module	M2*3 (NL)	2	

5. Remove the TV Tuner module.

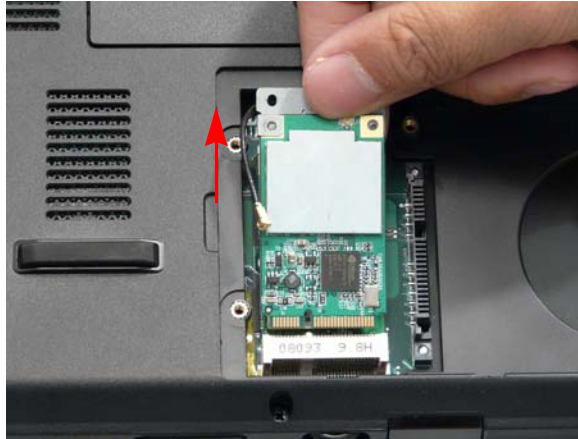

**NOTE:** Some models come equipped with either a TV Tuner module or a Turbo RAM module.

6. Remove the bracket from the module.



## Removing the WLAN Module

1. Remove the battery. See “Removing the Battery Pack” on page 48.
2. Remove the Tv Tuner module. See “Removing the TV Tuner module” on page 53.
3. Disconnect the antenna cables from the WLAN board.



**NOTE:** The following is the correct cable-color to connector designation: TR1 to Gray and TR2 to Black.



4. Move the cables to avoid damaging them, and remove the two securing screws to release the WLAN board.



Step	Size	Quantity	Screw Type
WLAN Module	M2*3	2	

5. Detach the WLAN board from the WLAN socket.



# Removing the Hard Disk Drive Module

1. Remove the Battery Pack. See “Removing the Battery Pack” on page 48.
2. Remove the HDD1 cover. See “Removing the Lower Covers” on page 50.
3. Remove the two securing screws.



Step	Size	Quantity	Screw Type
HDD	M2*3	2	

4. Use the pull-tab to lift up the HDD module to remove.



**NOTE:** To prevent damage to device, avoid pressing down on it or placing heavy objects on top of it.

5. Remove the four screws (two on each side) securing the HDD to the carrier.

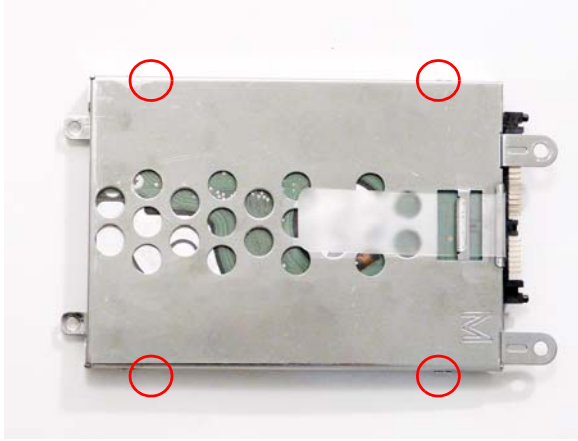

Step	Size	Quantity	Screw Type
HDD Carrier	M3*0.5+3.5	4	

6. Turn the HDD module upside down, and lift the HDD carrier up.

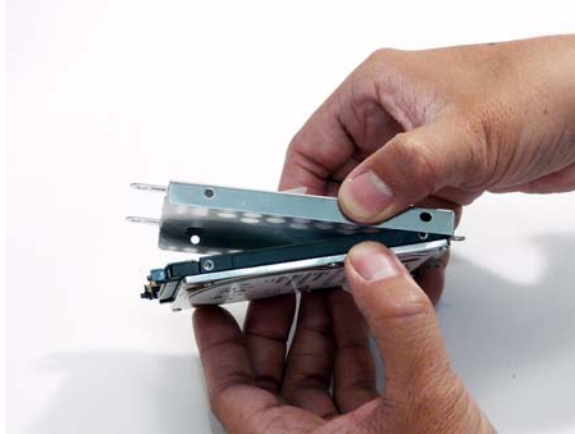

7. Remove the connector from the HDD.



---

## Removing the Optical Drive Module

1. Remove the Battery Pack. See “Removing the Battery Pack” on page 48.
2. Loosen the captive screw securing the ODD module and remove the ODD cap.



3. Carefully use a screwdriver to push the locking catch and remove the ODD module.



4. Grasp the module and pull out from the main unit.



5. Remove the two screws securing the ODD bracket and remove the ODD bracket from the optical disk drive module.

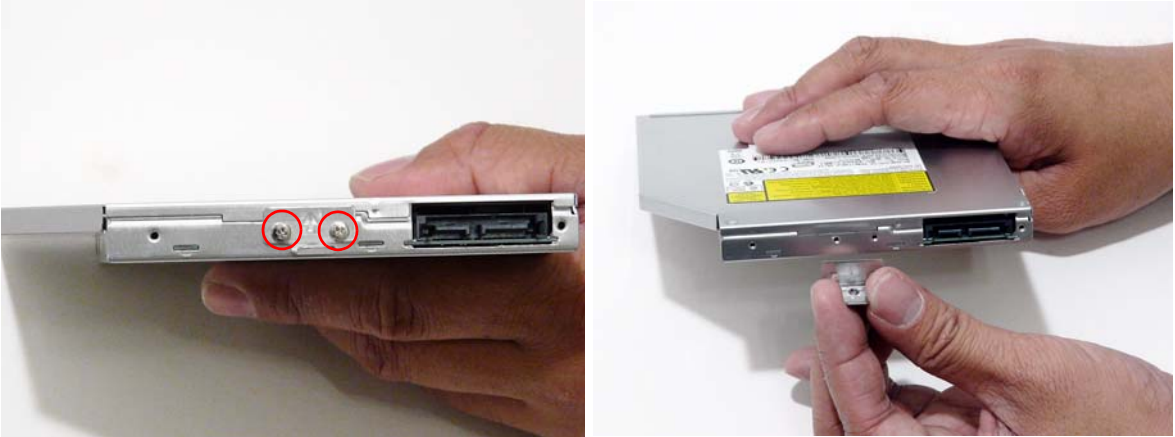

Step	Size	Quantity	Screw Type
ODD Bracket	M2*2.5	2	

6. Insert a pin in the eject hole of the ODD to eject the ODD tray.



7. Press down on the locking catch to release the ODD cover and remove.

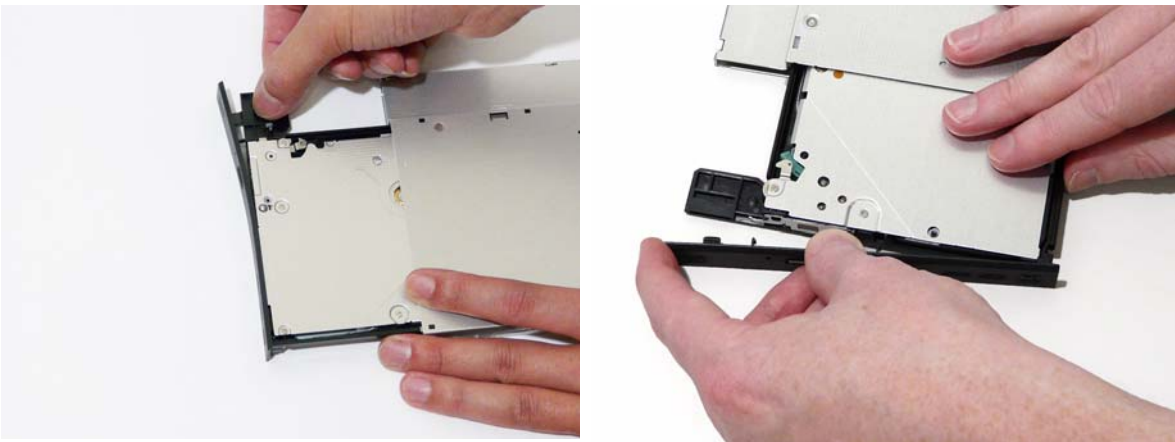

# Main Unit Disassembly Process

## Main Unit Disassembly Flowchart

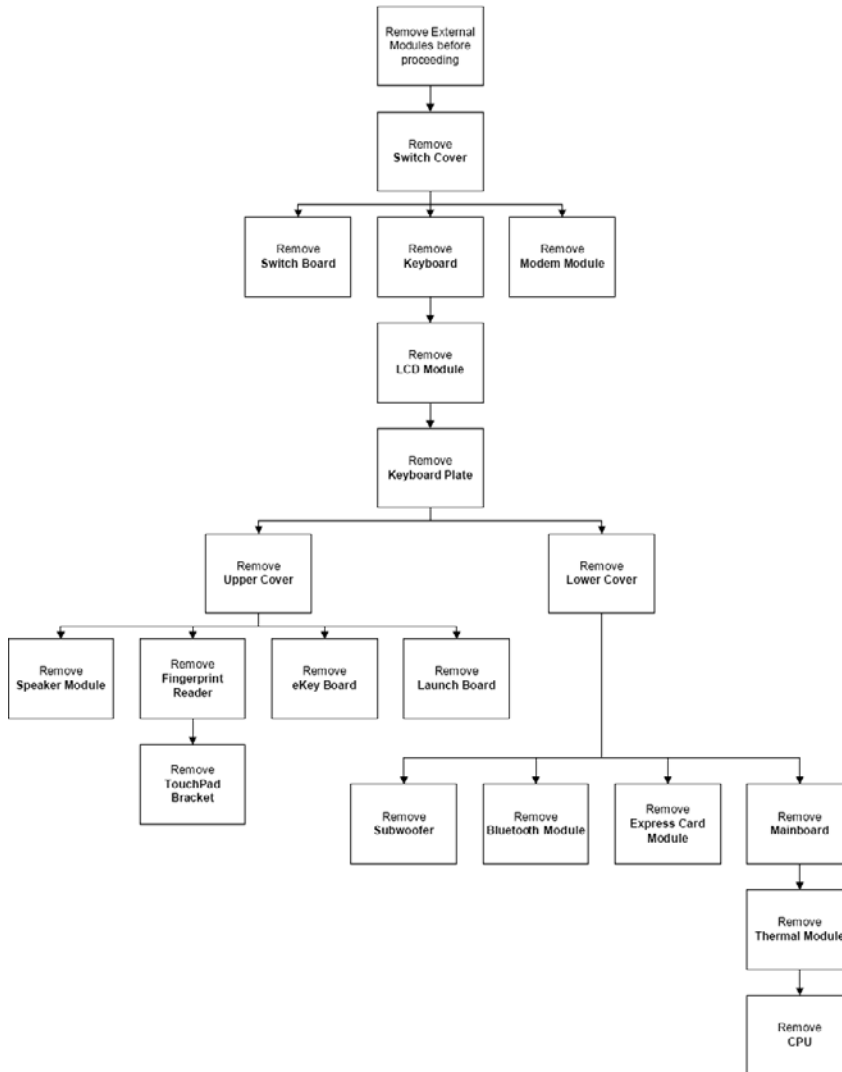

### Screw List

Step	Screw	Quantity	Part No.
Switch Cover	M2.5*3	4	86.T25V7.012
	M2.5*6.5	5	86.ARE07.001
Switch Board	M2*3	2	86.ARE07.002
Modem Module	M2*3	2	86.ARE07.002
LCD Module	M2.5*6.5	2	86.ARE07.001
	M2.5*6.5	4	86.ARE07.001
	M2.5*3	1	86.T25V7.012
Upper Cover	M2.5*6.5	11	86.ARE07.001
	M2*3	1	86.ARE07.002
	M2.5*3	4	86.T25V7.012
Touch Pad Bracket	M2*3	4	86.ARE07.002

---

Step	Screw	Quantity	Part No.
Launch Board	M2*3	4	86.ARE07.002
Speaker	M2.5*6.5	4	86.ARE07.001
eKey Board	M2*3	2	86.ARE07.002
Bluetooth Board	M2*3	1	86.ARE07.002
Subwoofer	M2.5*3	4	86.T25V7.012
ExpressCard Module	M2*3	2	86.ARE07.002
Mainboard	M2.5*6.5	1	86.ARE07.001
CPU Fan	M2.5*6.5	1	86.ARE07.001





# Removing the Switch Cover

**CAUTION:** Using tools to remove the Switch Cover may cause damage to the outer casing. It is recommended that only fingers are used to remove the Switch Cover.

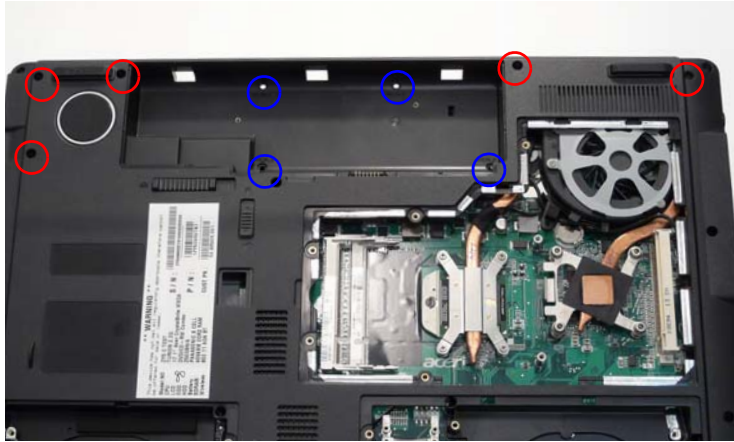
1. Remove the Battery Pack. See “Removing the Battery Pack” on page 48.
2. Locate and remove the nine securing screws as shown.



Step	Size	Quantity	Screw Type
Switch Cover	M2.5*3 Blue Callout	4	
Switch Cover	M2.5*6.5 Red Callout	5	

3. Turn the computer over and open the LCD module fully to expose the Switch Cover.
4. Lift the Switch Cover up and away.

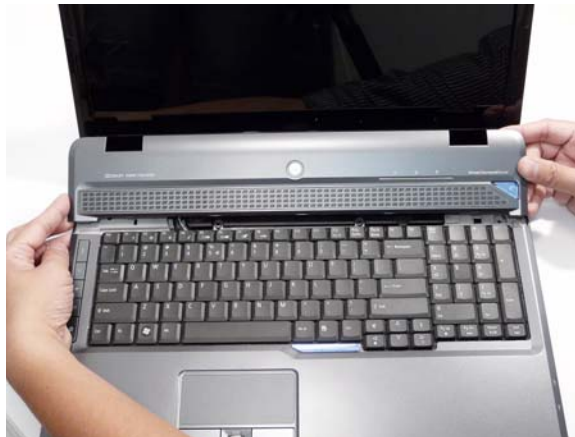



# Removing the Switch Board

1. Remove the Switch Cover. See “Removing the Switch Cover” on page 62.
2. Lift the locking lever and remove the FFC cable on the left as shown.



3. Disconnect both cables on the right as shown.

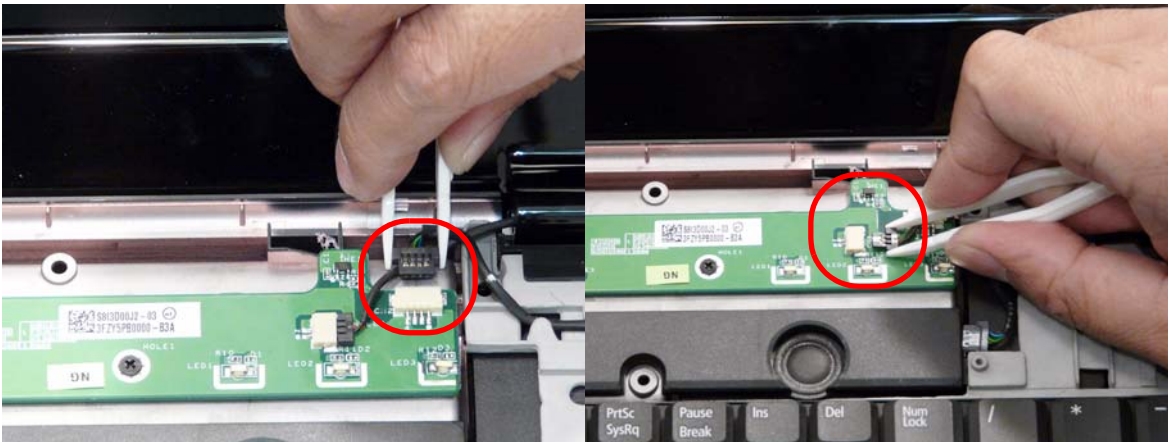

4. Remove the two securing screws from the Switch Board and lift the board clear.



Step	Size	Quantity	Screw Type
Switch Board	M2*3 (NL)	2	

---

## Removing the Keyboard

1. Remove the Switch Cover. See “Removing the Switch Cover” on page 62.
2. Grasp the keyboard and turn it over to expose the FFC cable.



3. Lift up the locking lever and remove the FFC cable.

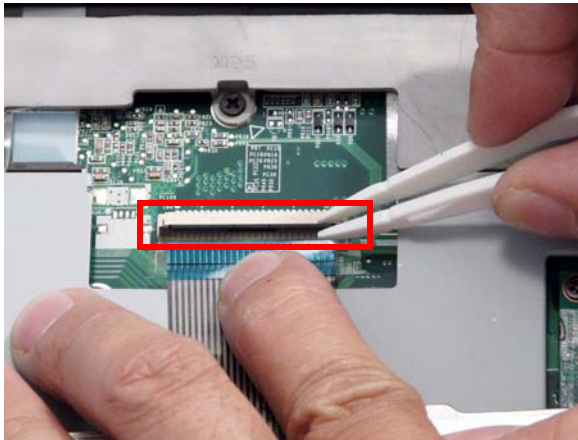

4. Remove the keyboard and place it on a clean surface.

## Removing the Modem Module

1. Remove the Keyboard. See "Removing the Keyboard" on page 64.
2. Remove the two securing screws.

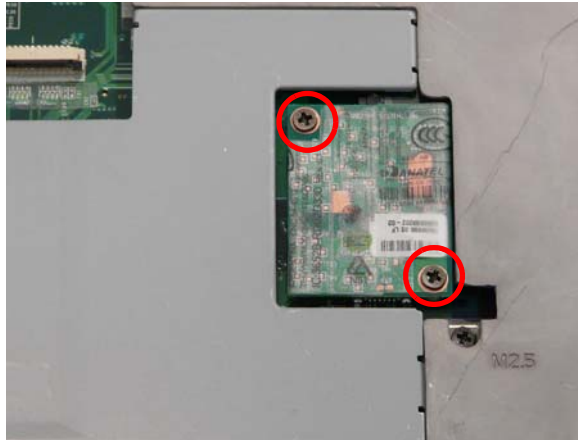

Step	Size	Quantity	Screw Type
Modem Module	M2*3 (NL)	2	

3. Using a plastic pry, partially lift up the module to expose the connector.

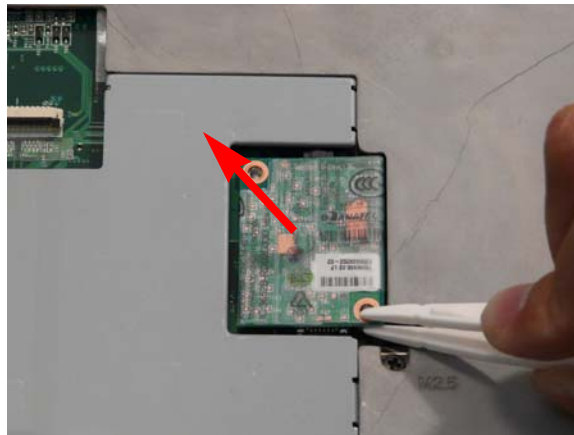

4. While holding the cable in place, pull the module away and remove.

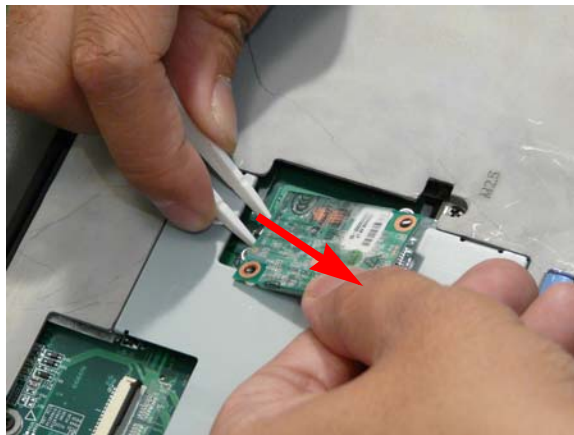

# Removing the Antenna, MIC and Speaker Cables

**IMPORTANT:** Ensure the Antenna Cables are free of any obstructions before attempting to fully remove them from the lower base.

1. Remove the WLAN Module. See “Removing the WLAN Module” on page 54.
2. Remove the memory cover. See “Removing the Lower Covers” on page 50.
3. Remove the Keyboard. See “Removing the Keyboard” on page 64.
4. Gently pull the Antenna Cables through the HDD housing.

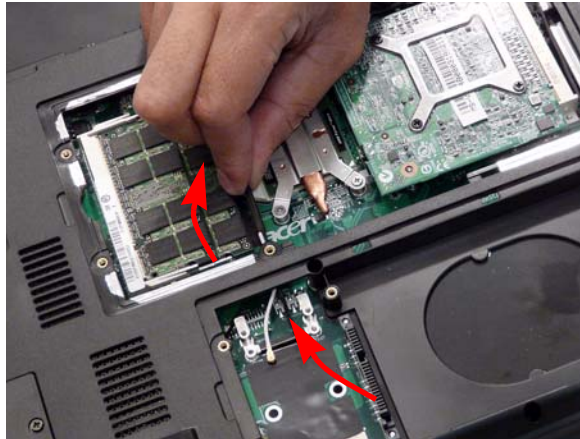

5. Disconnect the MIC and speaker cables.

**IMPORTANT:** Use tweezers to remove the cable connectors. Do not pull on the cable itself to prevent stripping.



**NOTE:** If you are only removing the LCD module, disconnect the MIC cable; otherwise, disconnect all three cables at this time to disassemble the upper and lower bases.



6. Gently pull the MIC cable through the HDD housing.



7. Turn the computer on its side, and feed the cables through to the upperside.



8. Pull the cables completely through.

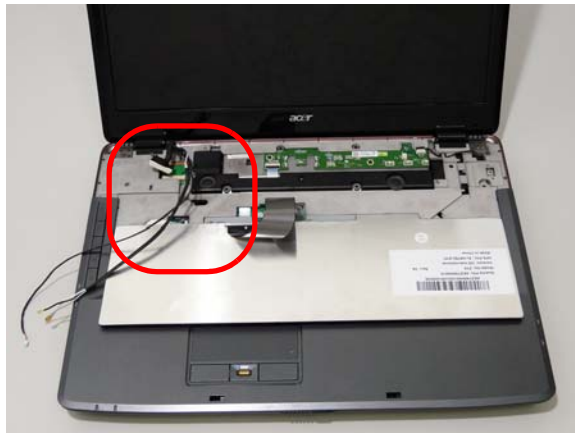

# Removing the LCD Module

1. Remove the Memory Cover. See "Removing the Lower Covers" on page 50.
2. Remove the WLAN Module. See "Removing the WLAN Module" on page 54.
3. Disconnect the Antenna, MIC and Speaker cables. See "Removing the Antenna, MIC and Speaker Cables" on page 66.
4. Remove the two securing screws from the bottom of the chassis.



Step	Size	Quantity	Screw Type
LCD Module	M2.5*6.5	2	

5. Turn the computer over. Use the tweezers to disconnect the LCD interface cable from the chassis.

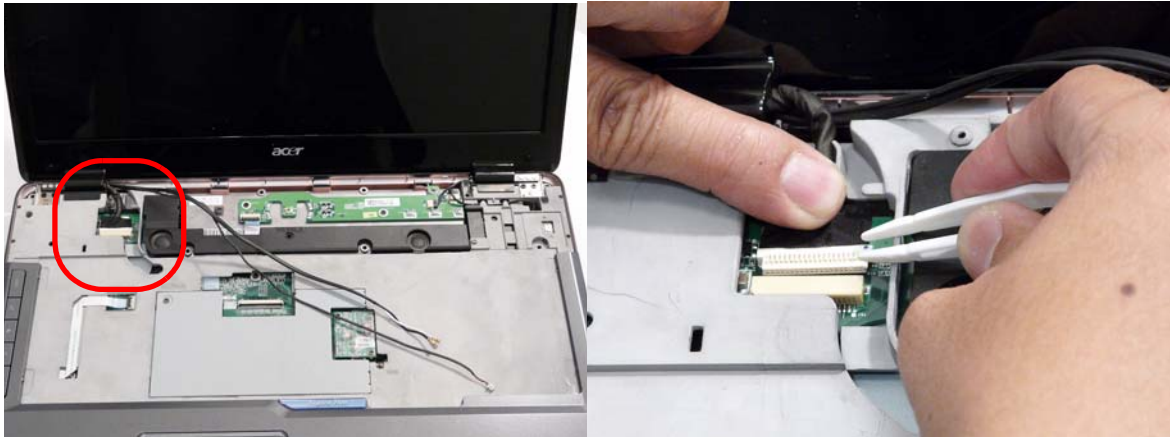

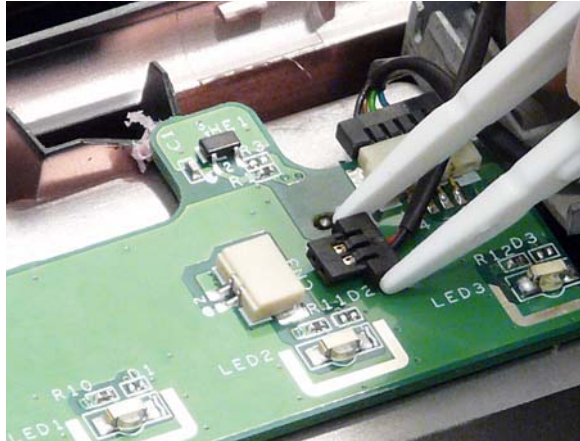

6. Disconnect the LCD back light cable as shown.

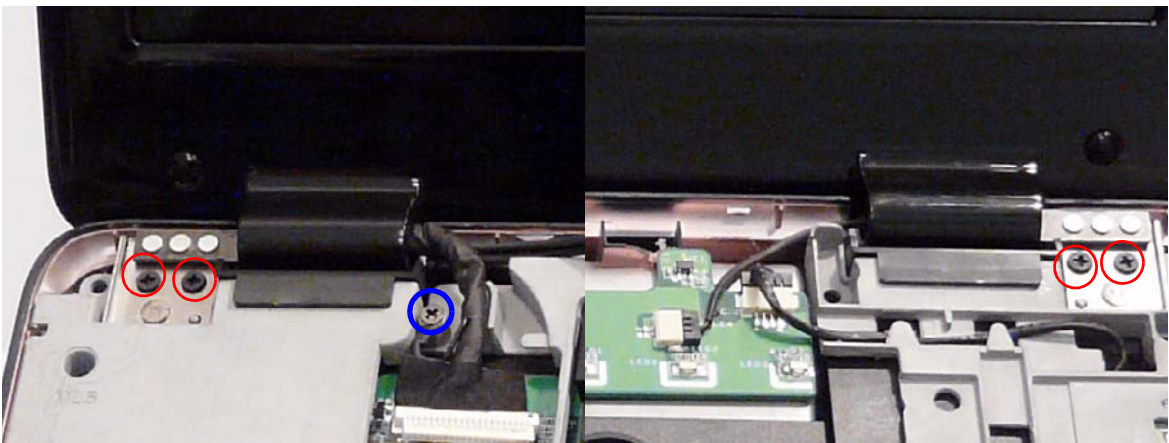

7. Remove the single ground screw and four securing screws (two each side) connecting the LCD module.



Step	Size	Quantity	Screw Type
LCD Module	M2.5*6.5 (NL) Red Callout	4	
Ground	M2.5*3 (NL) Blue Callout	1	

8. Carefully remove the LCD module from the chassis.

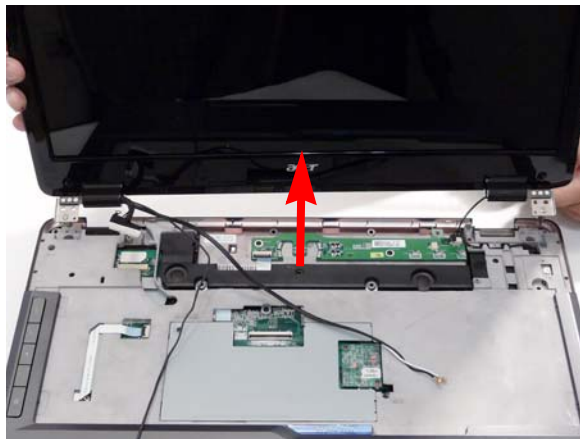

# Removing the Upper Cover

1. See "Removing the LCD Module" on page 68.
2. Place the computer upside down and remove the remaining eleven screws on the bottom panel.

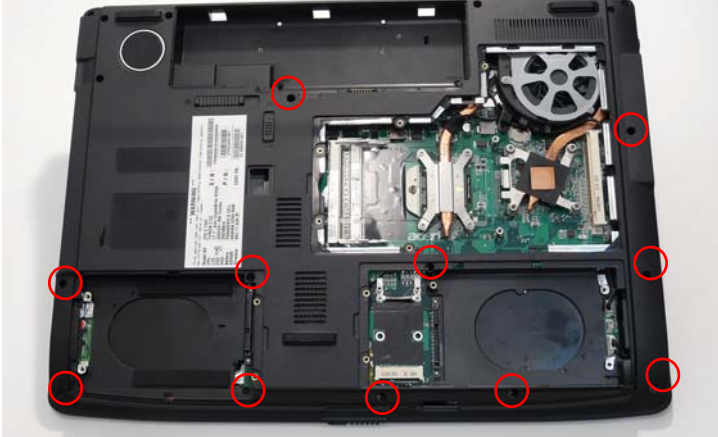

Step	Size	Quantity	Screw Type
Upper Cover	M2.5*6.5	11	

3. Turn the computer over and remove the securing screw from the keyboard plate.

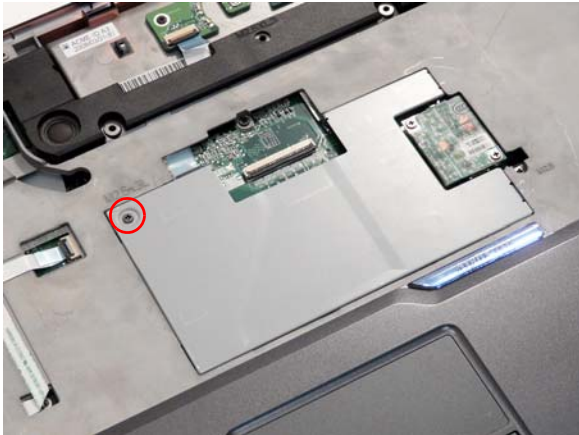

Step	Size	Quantity	Screw Type
DDR Plate	M2*3	1	



4. Remove the keyboard plate. If necessary, use a plastic pry to lift the plate.

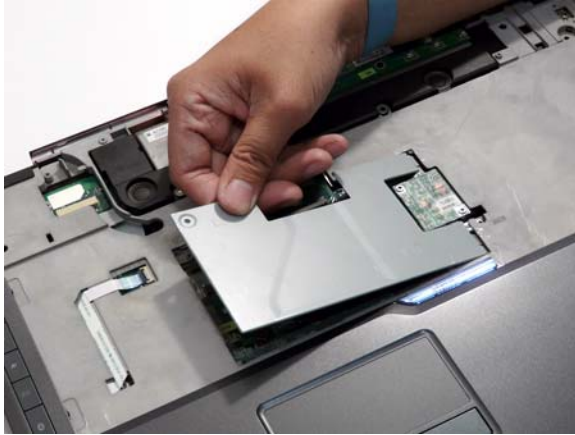

5. Disconnect the five cables from the mainboard as shown.

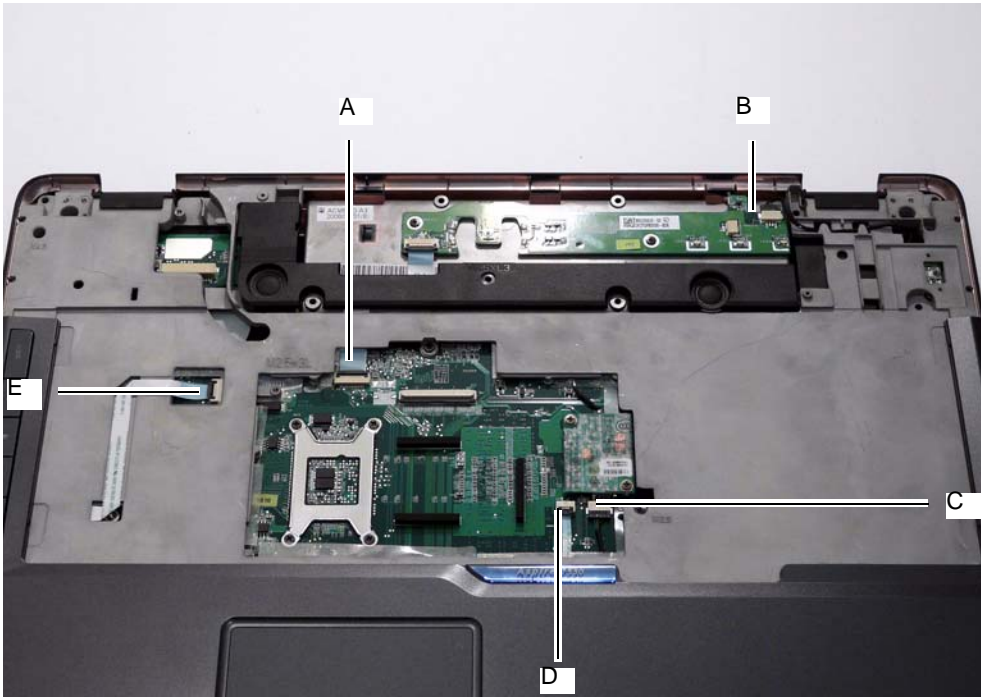

**IMPORTANT:**When removing cables, always hold the cable by the pull-tab or by the connector. Do not pull the cable itself to prevent stripping.

Disconnect A as shown.

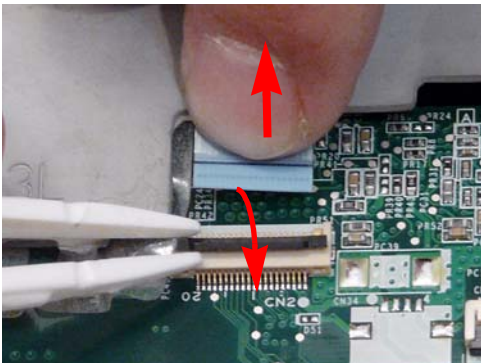

Release the securing latches and disconnect B as shown.

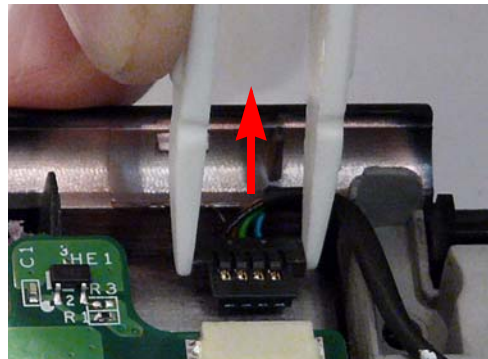

Release the securing latches and disconnect C as shown.

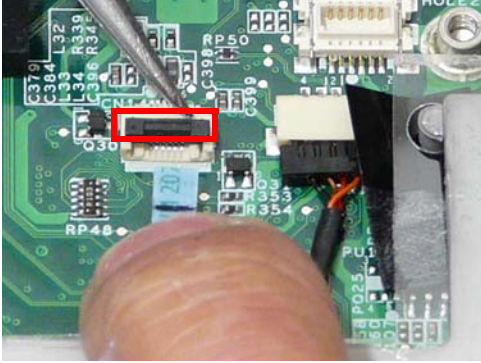

Release the securing latches and disconnect D as shown.

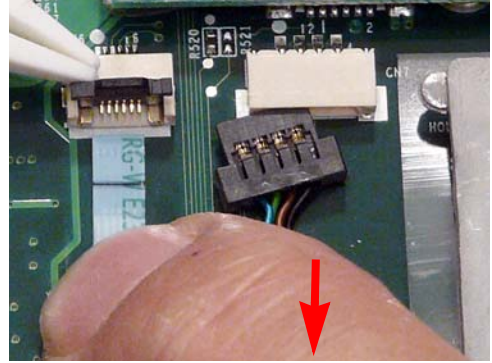

Release the securing latches and disconnect E as shown.

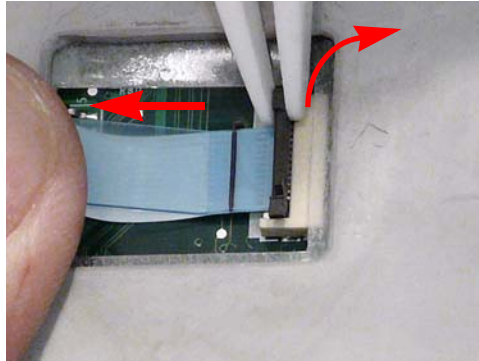

6. Remove the four securing screws from the upper cover.



Step	Size	Quantity	Screw Type
Upper Cover	M2.5*3	4	

- 
7. Grasp the Upper Cover by the hinge socket and pry it open. Do not lift the cover completely off.  
**NOTE:** Do not try to pry open more than one edge at a time.

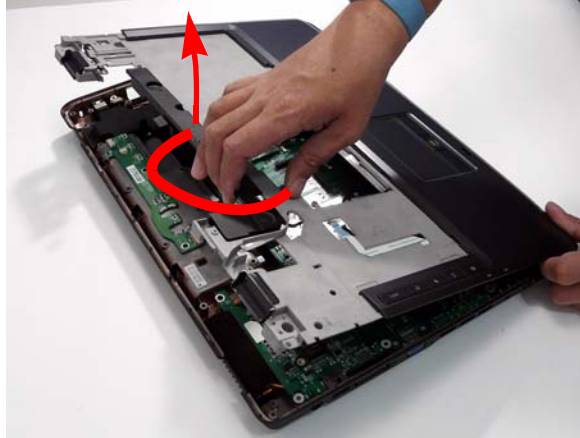

8. While holding the cover open, pull through any remaining cables.

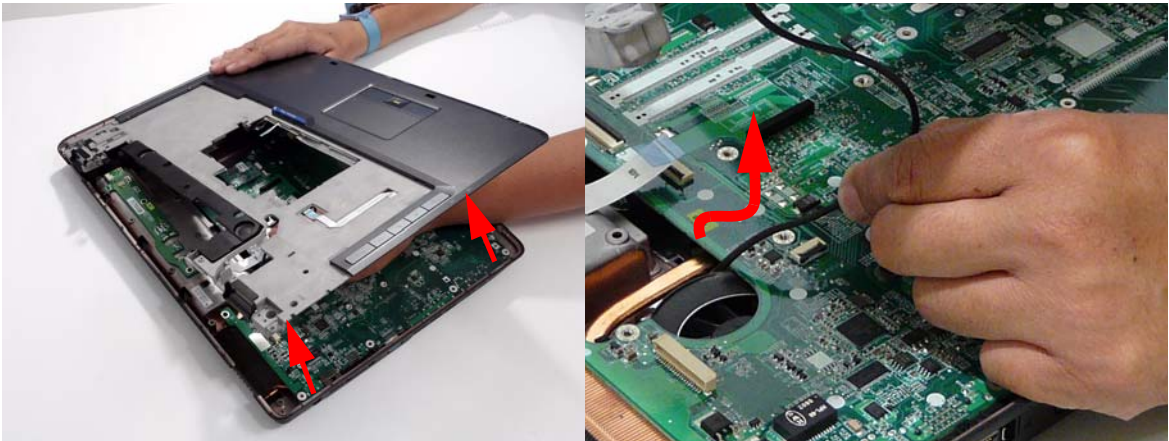

9. Grasp the cover by the opposite edge and lift up to remove the Upper Cover.

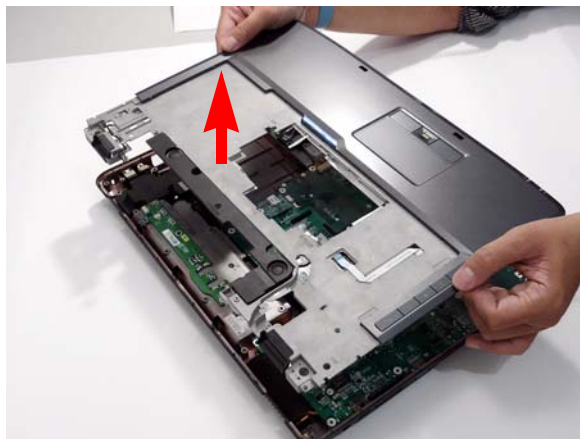



# Removing the Finger Print Reader

1. Remove the Upper Cover. See "Removing the Upper Cover" on page 70.
2. Disconnect the cable as shown.

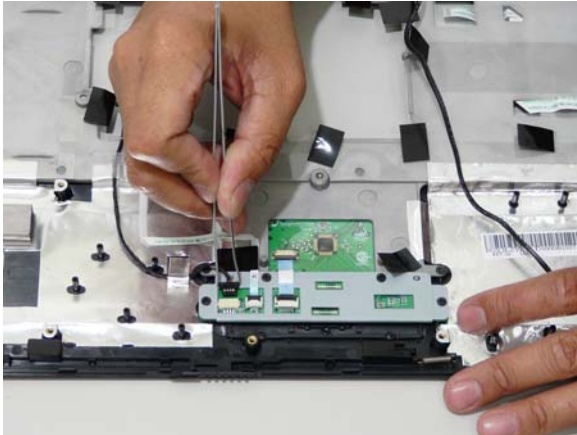

3. Disconnect the two FFC cables as shown.

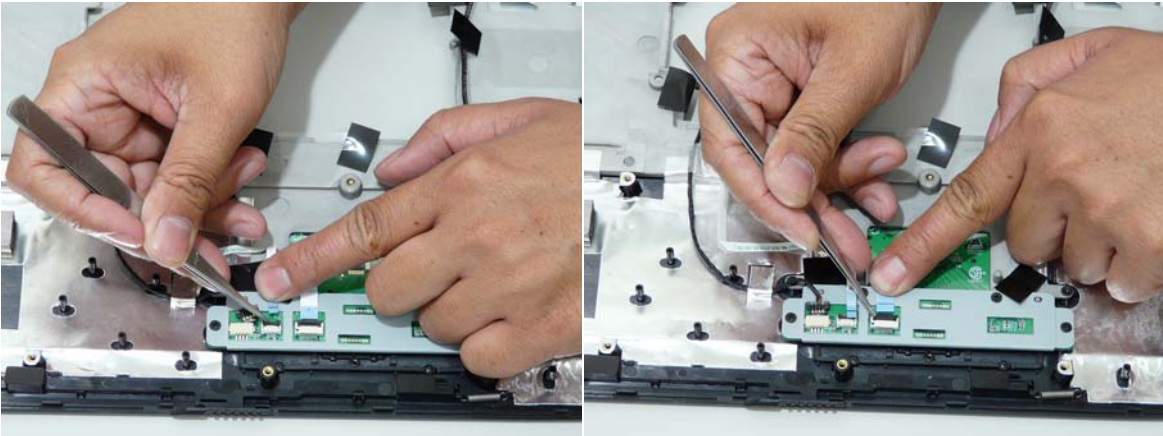

4. Remove the four securing screw from the Finger Print Reader board.

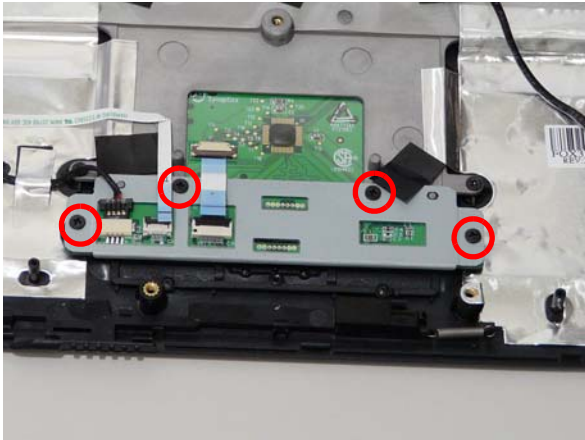

Step	Size	Quantity	Screw Type
Finger Print Reader	M2*3	4	

5. Remove the bracket from the board.

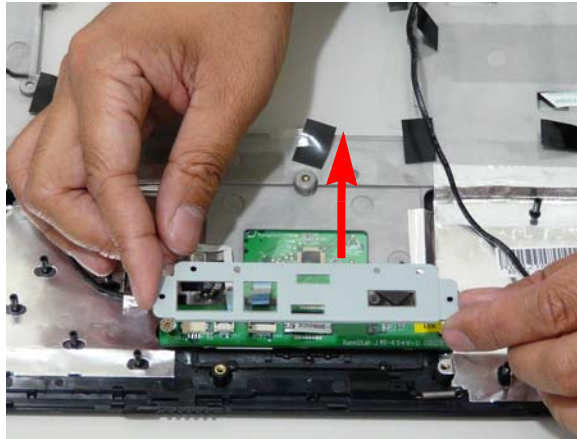

6. Remove the Finger Print Reader board from the Upper Cover.

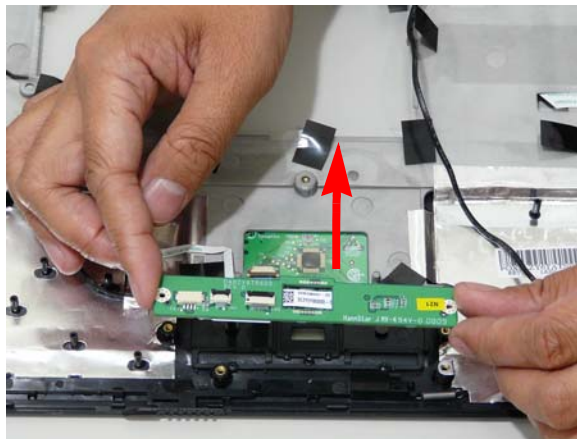

---

## Removing the Touch Pad

1. Remove the Upper Cover. See “Removing the Upper Cover” on page 70.
2. Disconnect the Touch Pad cable from the Touch Pad board.



**IMPORTANT:**The Touch Pad cannot be removed individually. To replace the Touch Pad, replace the entire Upper Cover.

# Removing the Launch Board

- 1. Remove the Upper Cover. See "Removing the Upper Cover" on page 70.
- 2. Lift up the locking latch and remove the FFC cable as shown.

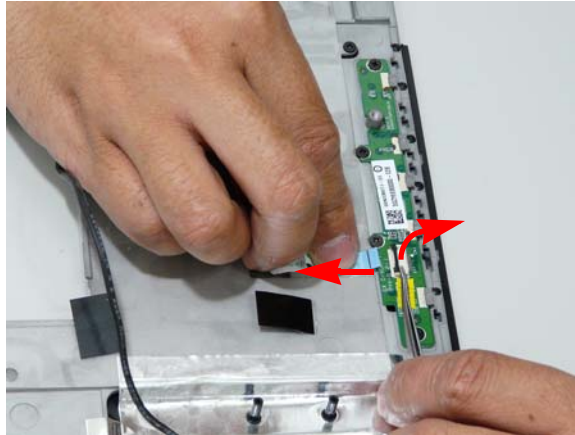

- 3. Remove the four screws from the Launch Board.

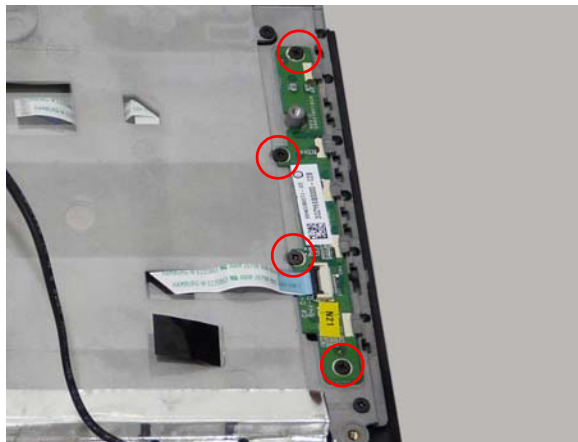

Step	Size	Quantity	Screw Type
Launch Board	M2*3	4	

- 4. Remove the Launch Board from the Upper Cover.

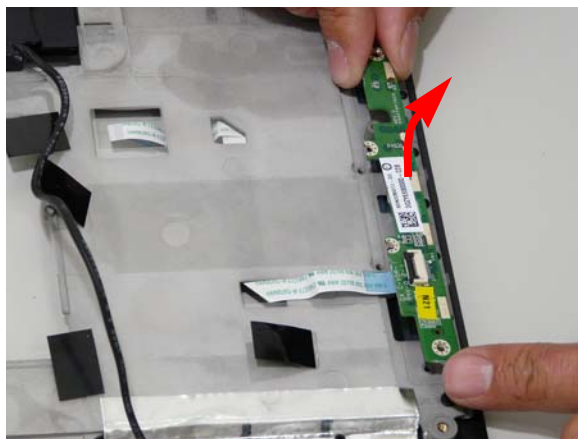

## Removing the Speaker Module

1. Remove the Upper Cover. See "Removing the Upper Cover" on page 70.
2. Remove four securing screws connecting the Speaker Module.

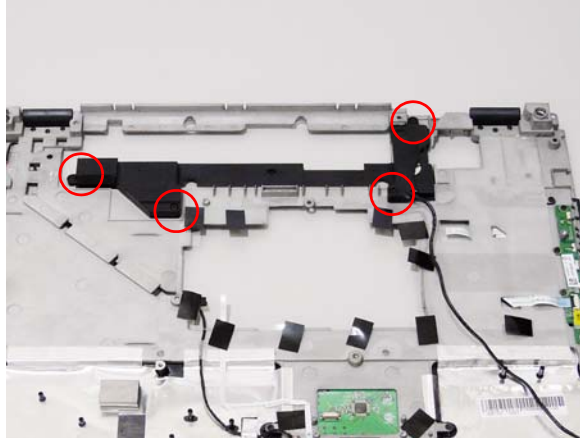

Step	Size	Quantity	Screw Type
Speaker Module	M2*6	4	

3. Remove the Speaker Module from the upper cover.

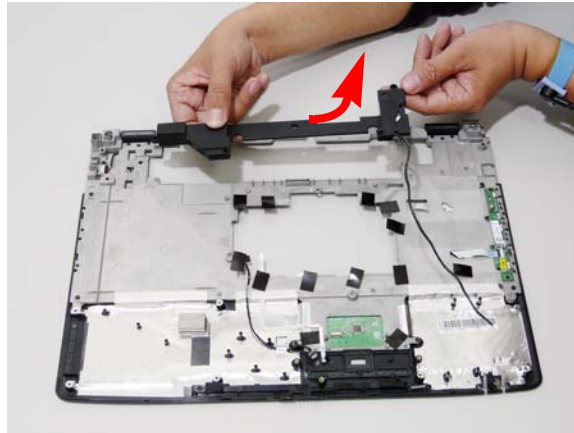



## Removing the eKey Board

1. Remove the Upper Cover. See "Removing the Upper Cover" on page 70.
2. Turn the Upper Cover upside down and remove the two securing screws connecting the eKey board.
3. Disconnect the eKey Board cable.

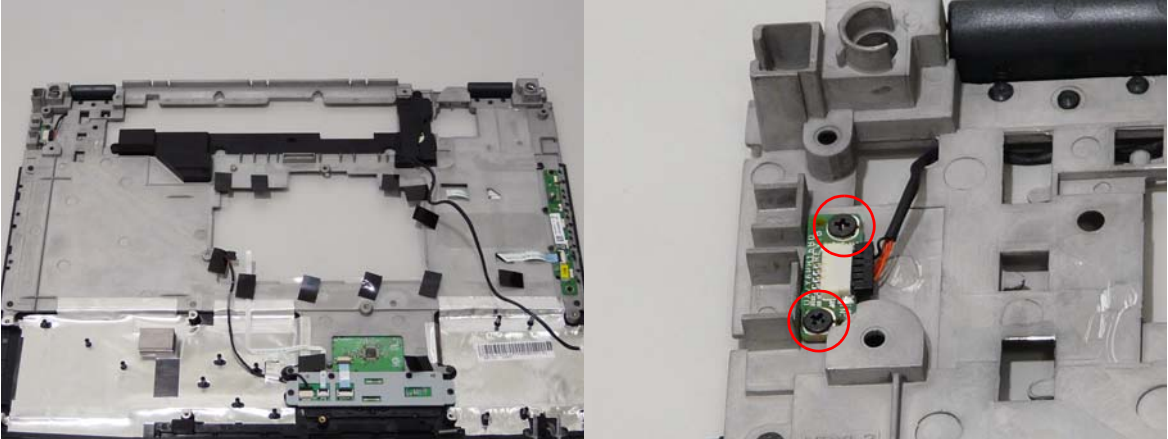

Step	Size	Quantity	Screw Type
eKey Board	M2*3	2	

4. Remove the board as shown.

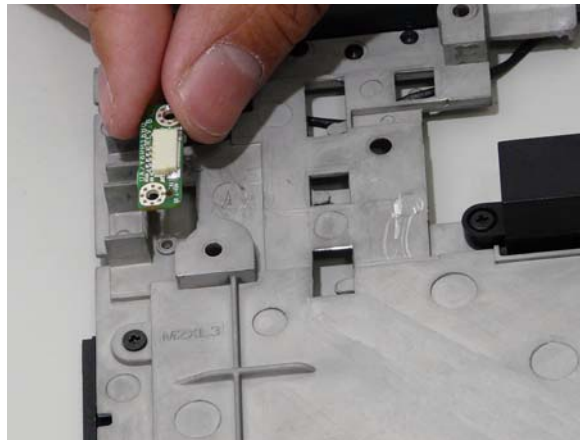

# Removing the Bluetooth board

1. Remove the Upper Cover. See "Removing the Upper Cover" on page 70.
2. Remove the securing screw from the Bluetooth board.

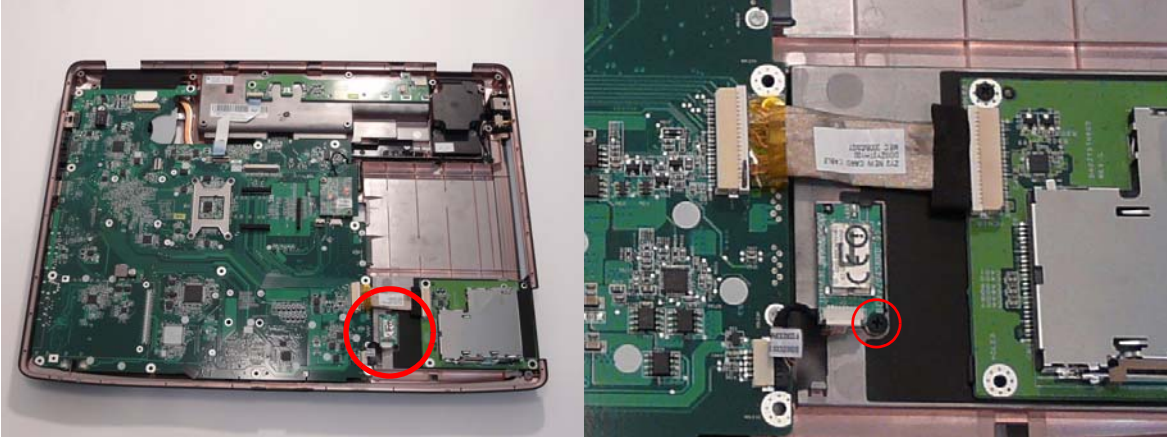

Step	Size	Quantity	Screw Type
Bluetooth Board	M2*3	1	

3. Disconnect the mainboard to bluetooth cable as shown.

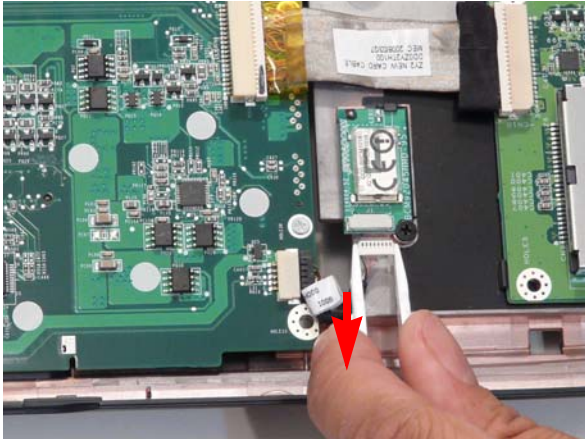

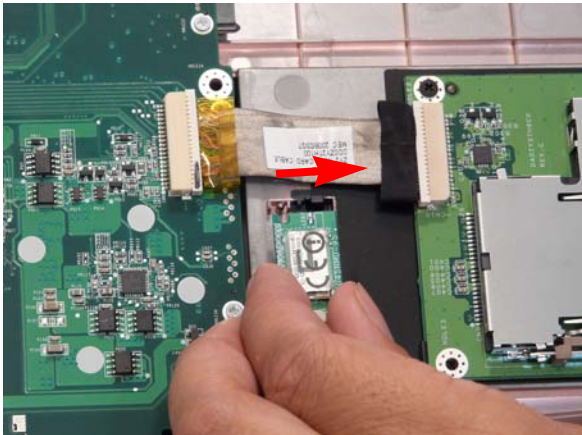

4. Disconnect the cable from the mainboard.

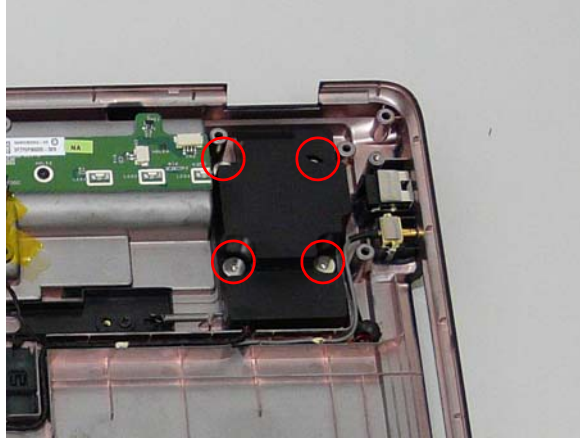

## Removing the Subwoofer Module

1. See "Removing the Upper Cover" on page 70.
2. Remove the four securing screws from the Subwoofer Module.



Step	Size	Quantity	Screw Type
Subwoofer Module	M2.5*4	4	

3. Grasp the cable by the end and guide it out of its housing as shown in the following images.

**IMPORTANT:** The housing guides are hooked to hold the cable in place. Do not pull the cable to remove it or damage can occur.

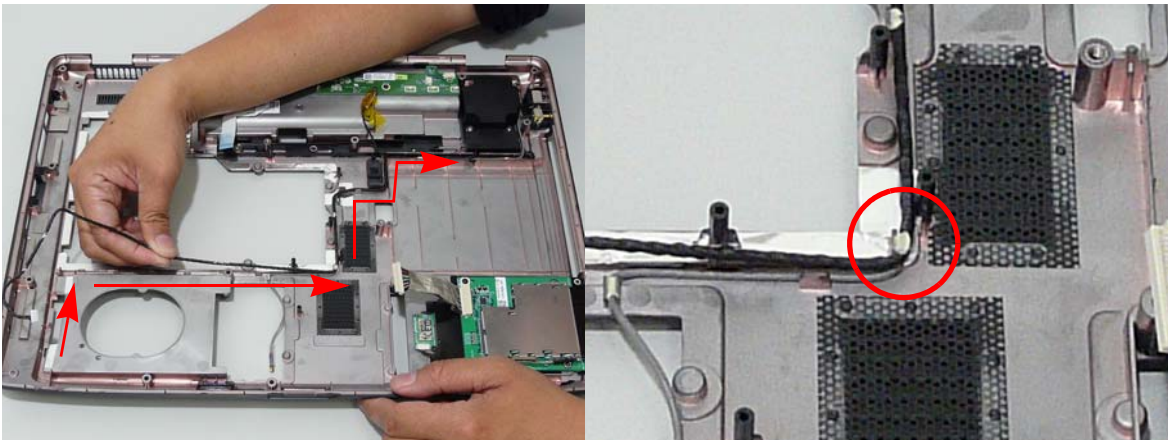

---

4. Grasp the Subwoofer Module and lift it up to remove.

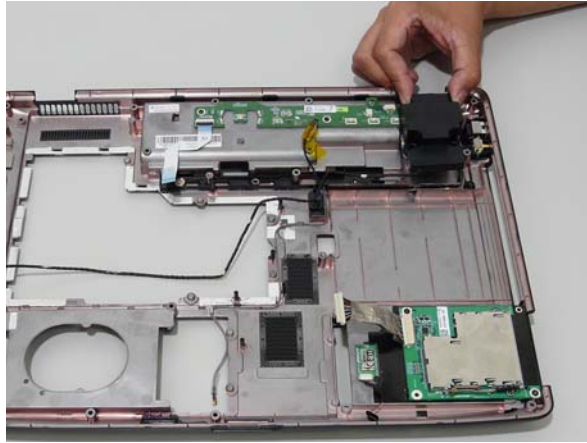

# Removing the ExpressCard Module

1. See "Removing the Upper Cover" on page 70.
2. Disconnect the cable connecting the ExpressCard module.

**IMPORTANT:** Do not grasp the cable itself to prevent fraying.

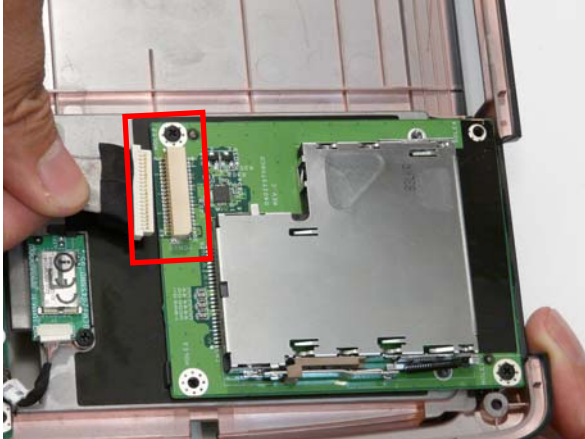

3. Remove the two securing screws.

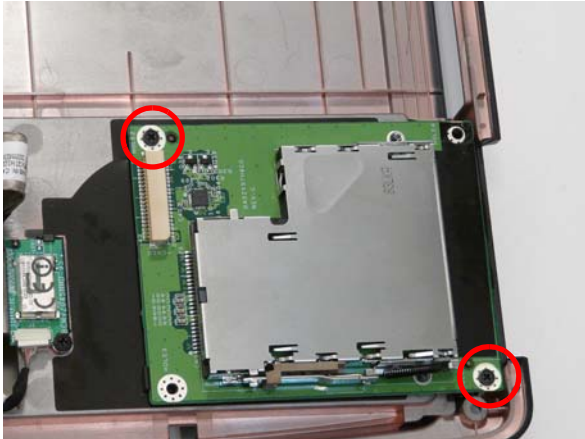

Step	Size	Quantity	Screw Type
ExpressCard Module	M2*3	2	



---

4. Lift the ExpressCard module away from the upper cover.

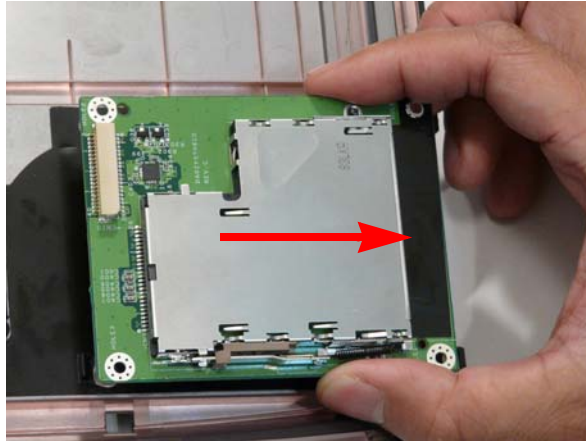

# Removing the Mainboard

1. Remove the Upper Cover. See "Removing the Upper Cover" on page 70.
2. Disconnect the two cables connected to the motherboard.

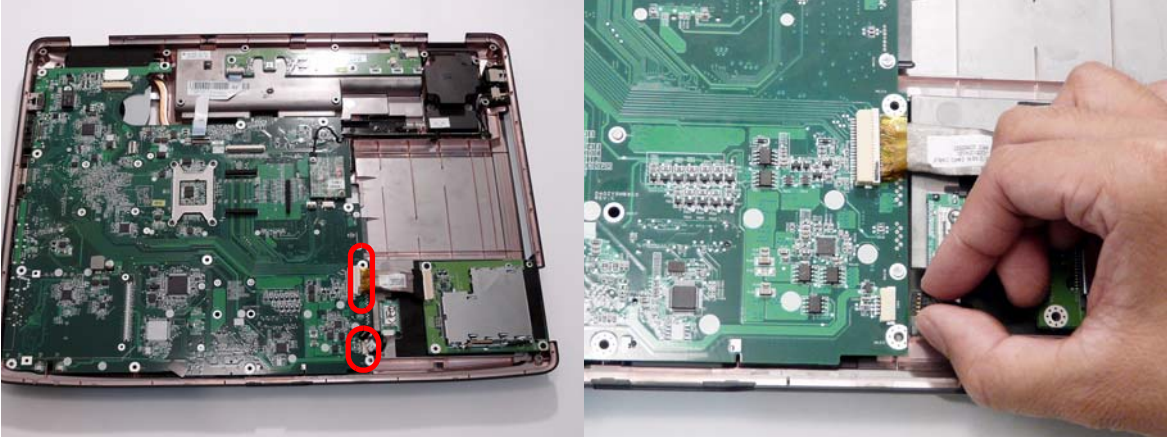

3. Remove the securing screw from the Mainboard.



Step	Size	Quantity	Screw Type
Mainboard	M2.5*6.5	1	

4. Pull the edge of the lower base outward and lift the motherboard up to remove.

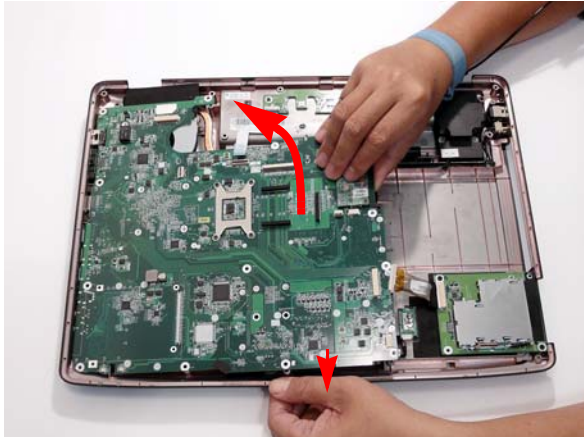

---

## Removing the CPU Fan Module

1. See “Removing the Battery Pack” on page 48.
2. Remove the Mainboard. See “Removing the Mainboard” on page 85.
3. Turn the Mainboard right side up, and place it on a clean surface.
4. Using tweezers, grip the cable connector and disconnect the Fan cable from the Mainboard.

**IMPORTANT:** Do not grip the cable itself to prevent stripping.

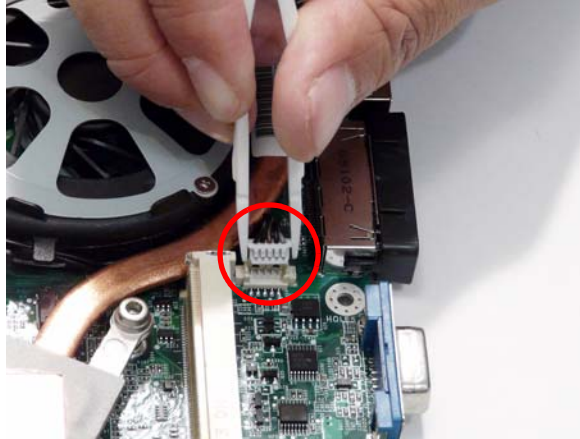

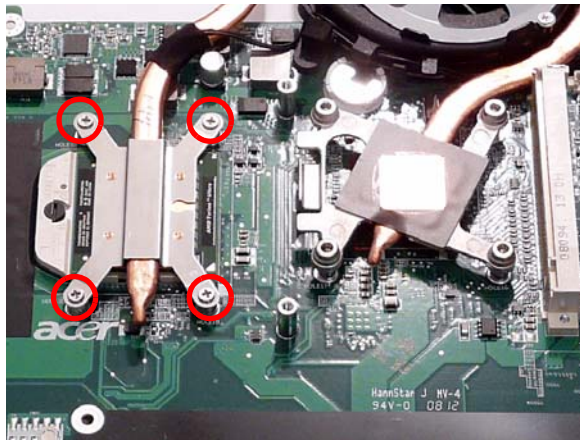

5. Loosen the four captive screws from the heatsink.



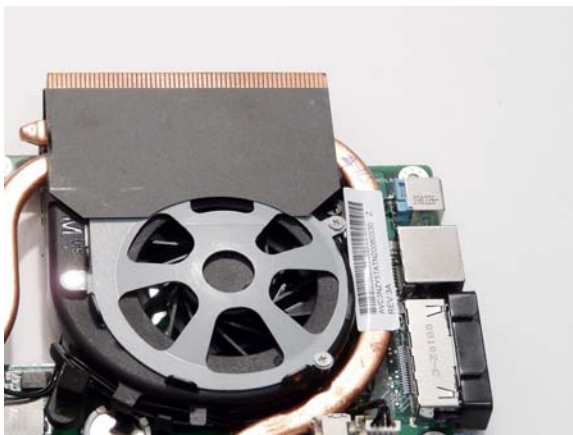

6. Lift the cover to expose the single securing screw. Remove the screw.



Step	Size	Quantity	Screw Type
CPU Fan Module	M2.5*6.5	1	

7. Lift the Fan module clear of the Mainboard.

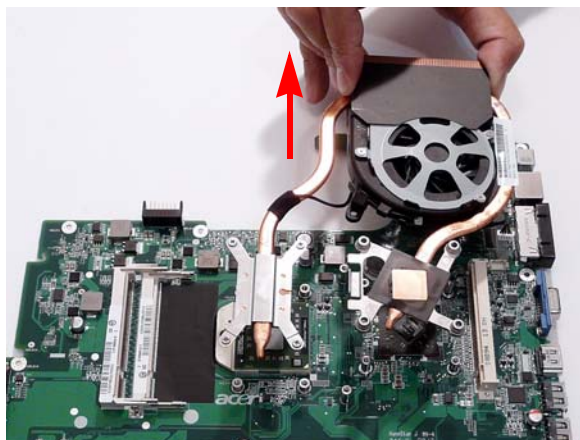

---

## Removing the CPU

1. Remove the CPU Fan Module. See “Removing the CPU Fan Module” on page 86.
2. Using a flat screwdriver, turn the CPU socket latch clockwise 180° to release the CPU.

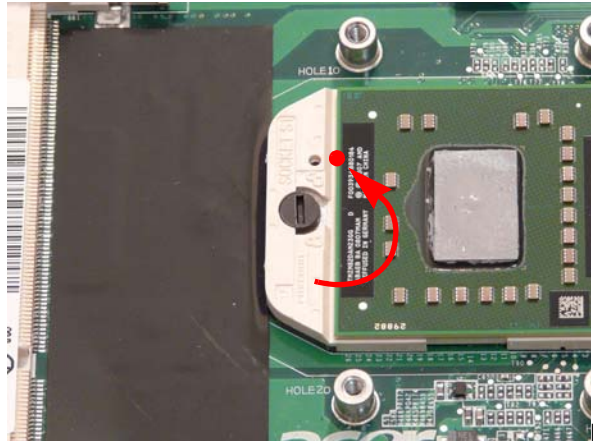

3. Lift the CPU clear of the Mainboard.

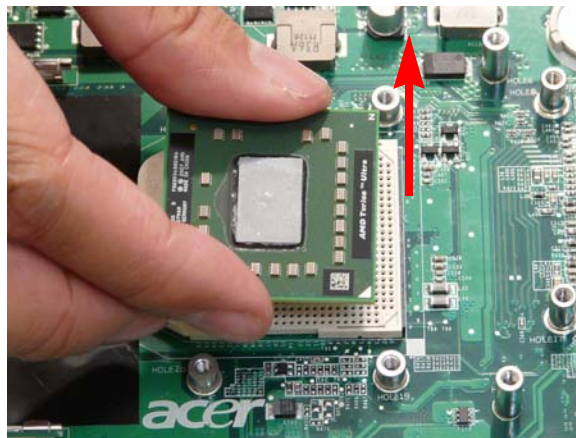

# LCD Module Disassembly Process

## LCD Module Disassembly Flowchart

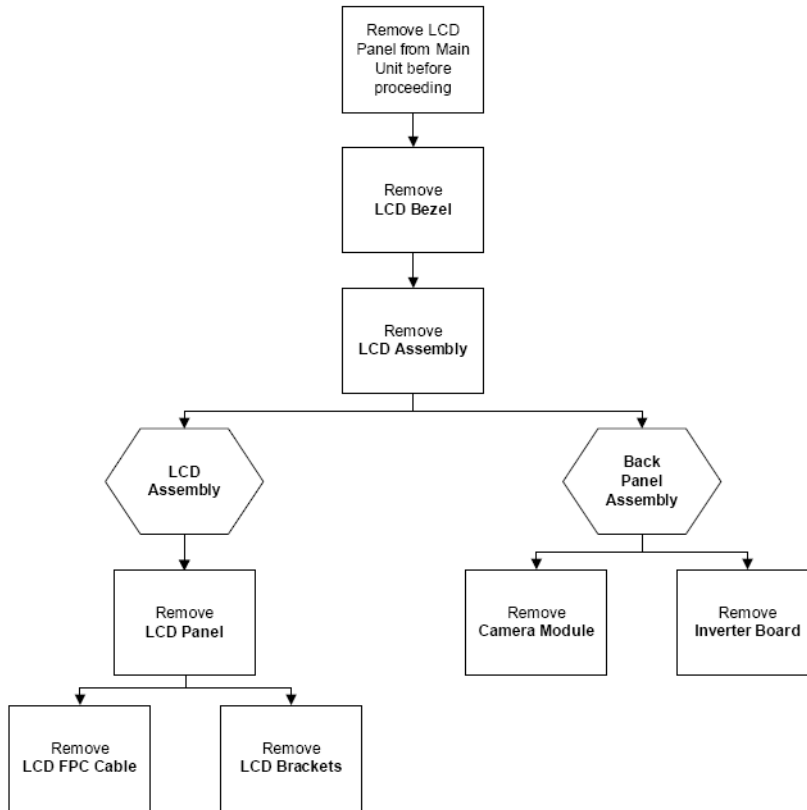

### Screw List

Step	Screw	Quantity	Part No.
LCD Bezel	M2.5*6.5	6	86.ARE07.001
Camera Module	M2*3	1	86.ARE07.002
LCD Panel	M2.5*6.5	6	86.ARE07.001
LCD Brackets	M2*3	8	86.ARE07.002

# Removing the LCD Bezel

- 1. Remove the LCD Module. See "Removing the LCD Module" on page 68.
- 2. Remove the six rubber covers and screws.



Step	Size	Quantity	Screw Type
LCD Bezel	M2.5*6.5	6	

- 3. Starting from the inside edges, pry the inside of the bezel upwards from the panel. Continue moving left until the bezel is removed. If necessary, use a plastic pry to release the corners of the bezel.



- 
4. Lift up the bezel and remove it from the LCD Module.



---

## Removing the Inverter Board

1. Remove the LCD Bezel. See "Removing the LCD Bezel" on page 90.
2. Disconnect the left and right Inverter board cables as shown.



3. Lift up the Inverter Board and remove.



## Removing the Camera Module

1. Remove the LCD Bezel. See "Removing the LCD Bezel" on page 90.
2. Remove the two securing screws from the Camera Module.



Step	Size	Quantity	Screw Type
Camera Module	M2*3	1	

3. Disconnect the Camera Module cable as shown.

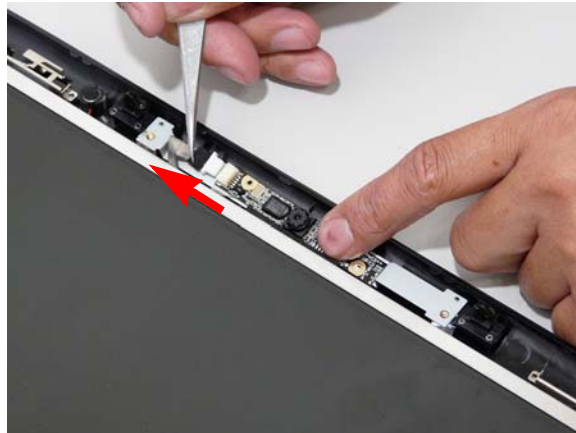



# Removing the LCD Panel

- 1. Remove the LCD Bezel. See "Removing the LCD Bezel" on page 90.
- 2. Remove the six securing screws from the LCD Module.

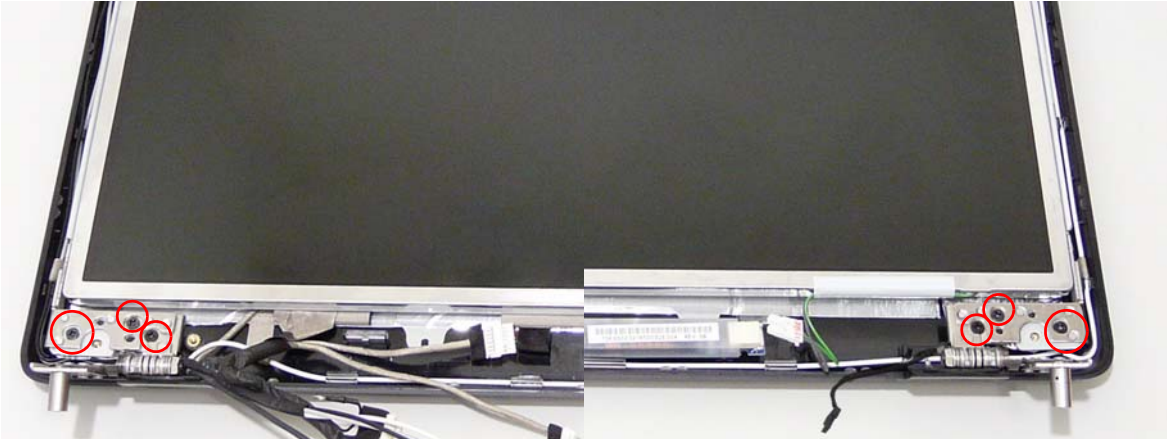

Step	Size	Quantity	Screw Type
LCD Panel	M2.5*6.5	6	

- 3. Disconnect the left and right sides of the Inverter cable.



- 4. Disconnect the Camera Module cable as shown.

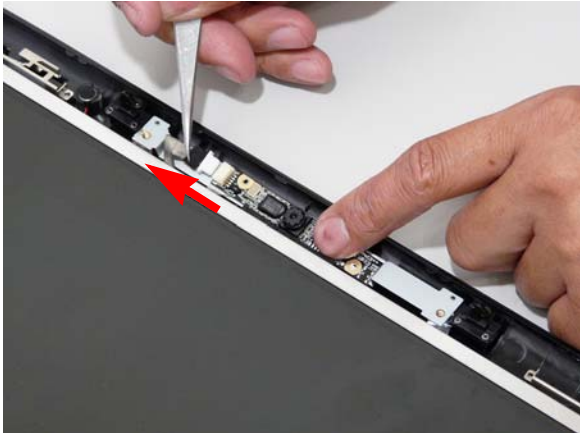



---

5. Grasp the panel by both ends and lift to remove.



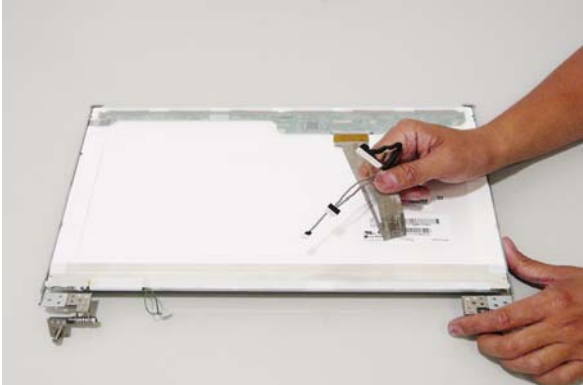

# Removing the LCD Brackets and FPC Cable

1. Remove the LCD Panel. See "Removing the LCD Panel" on page 94.
2. Turn the LCD panel over to expose the rear. Grip the FPC cable and lift upward to detach the adhesive pads.

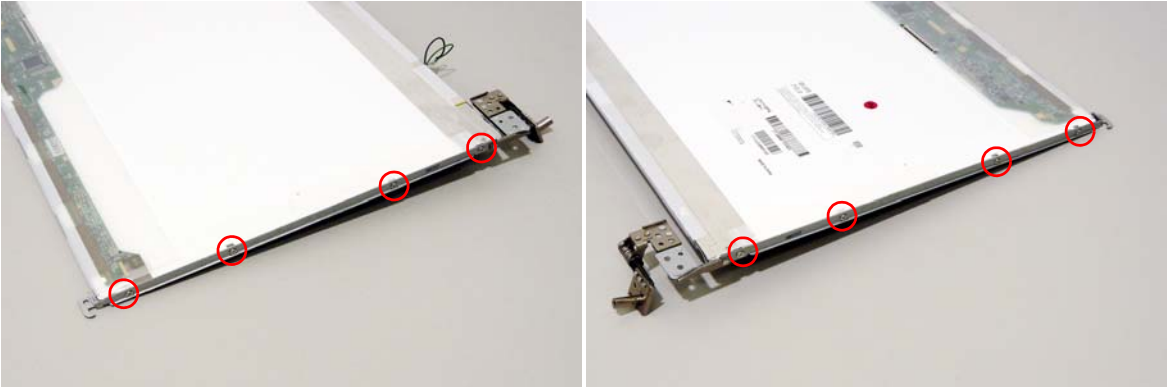

3. Remove the eight securing screws (four on each side) from the LCD Panel brackets.



Step	Size	Quantity	Screw Type
LCD Brackets	M2*3	8	

---

4. Remove the LCD brackets by pulling away from the LCD Panel as shown.



---

# LCD Module Reassembly Procedure

## Replacing the LCD Panel

1. Align the LCD brackets with the eight screw holes (four on each side) on the LCD Panel as shown.



2. Secure the LCD brackets to the LCD panel.

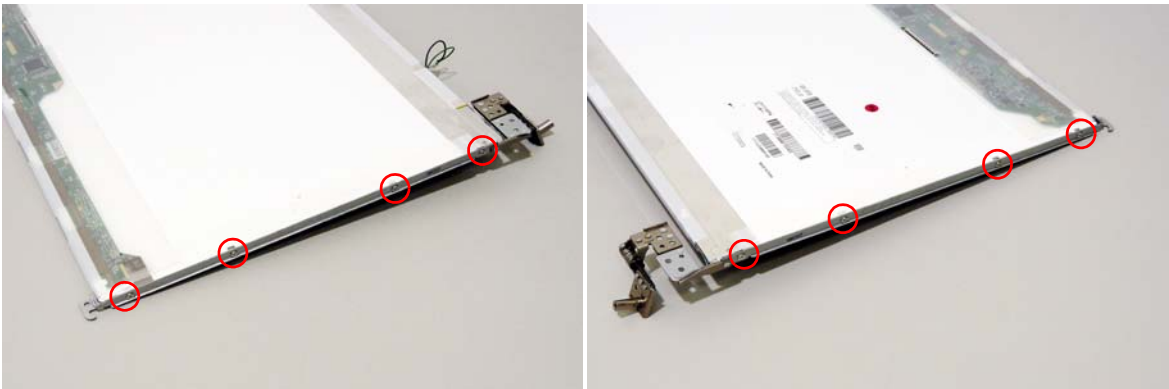

3. Turn the panel over. Insert the LCD Panel cable into the LCD Panel as shown.

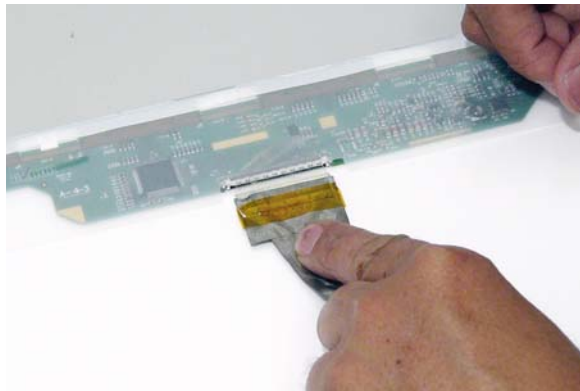

4. Align the LCD Panel cable as shown and press down to secure in place.

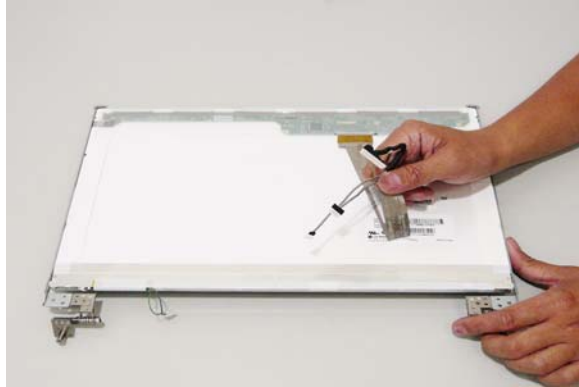

5. Take care to insert the top of the panel first and then angle it in place. 6. Place the LCD Panel in the back cover.



7. Secure the LCD module with the six securing screws.

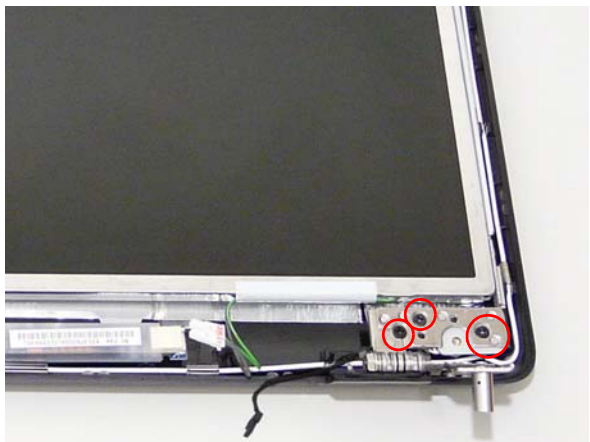

8. Connect the left and right Inverter cables.



9. Connect the camera cable.

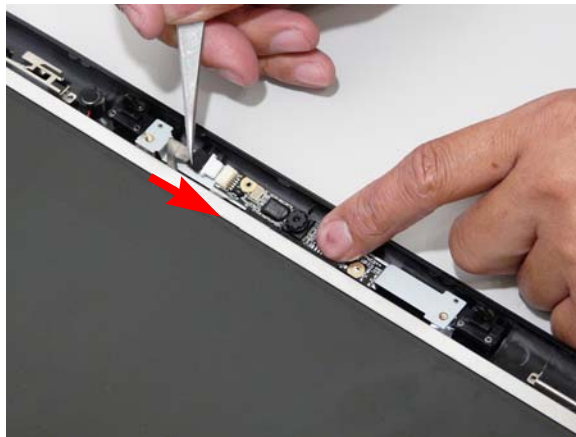

---

## Replacing the LCD Bezel

1. Starting from the bottom, locate the bezel correctly and press down the edges until there are no gaps between the bezel and the LCD Module,



2. Replace the six screws and the rubber screw caps provided.





# Main Module Reassembly Procedure

## Replacing the CPU

1. Carefully turn the mainboard upside down (CPU side up), and insert the CPU into the CPU bracket as shown.
2. Using a plastic screw driver, lock the CPU in the socket as shown.

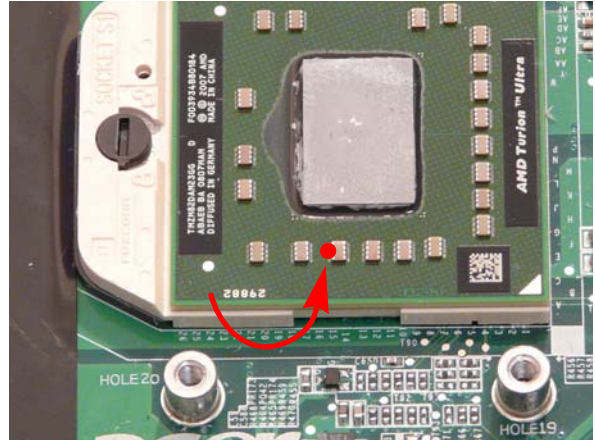
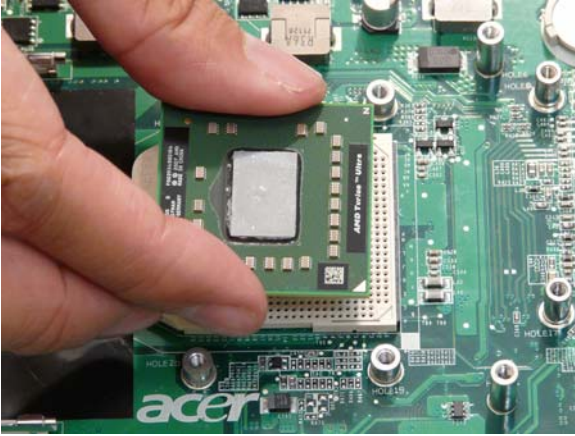

## Replacing the CPU Fan Module

1. Replace the Fan module on the Mainboard.
2. Lift the cover to replace the single screw located in the back of the fan module.

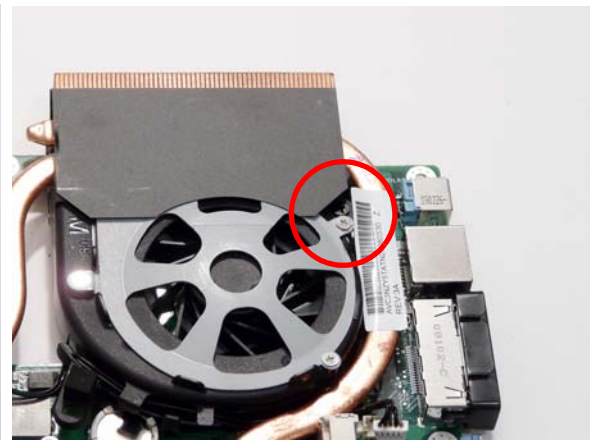
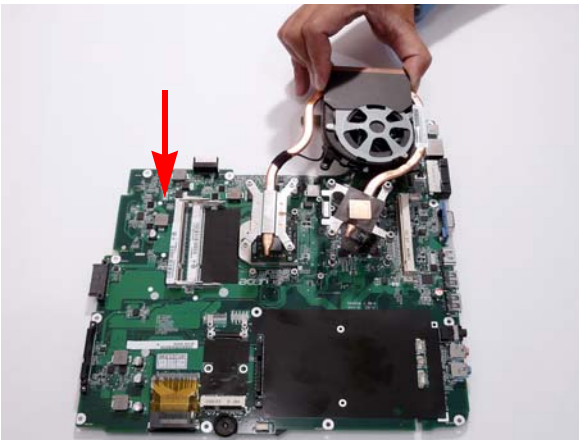



3. Tighten the four (4) captive screws on the heatsink. 4. Connect the Fan cable to the Mainboard.

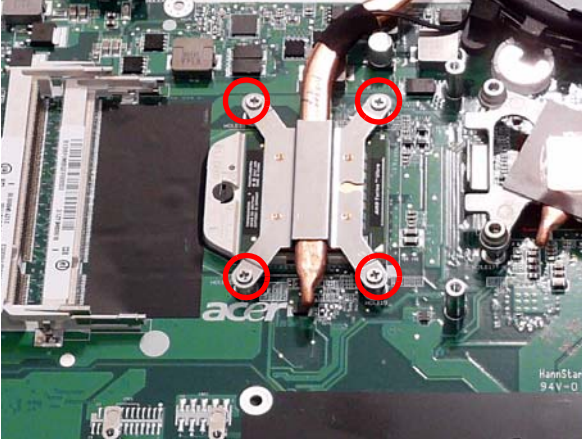

## Replacing the Mainboard

1. Pull the edge of the lower base outward and insert the motherboard in the lower base.
2. Replace the securing screw on the Mainboard.

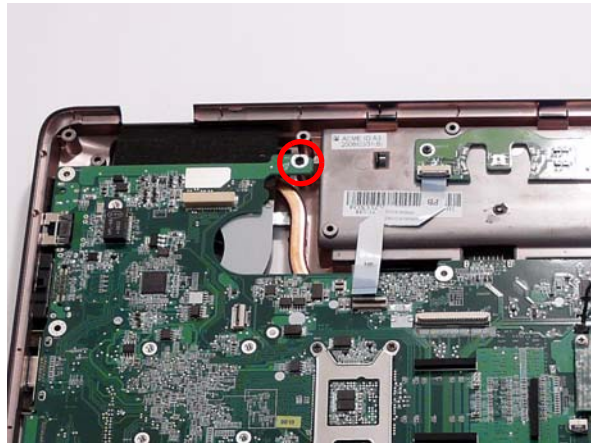
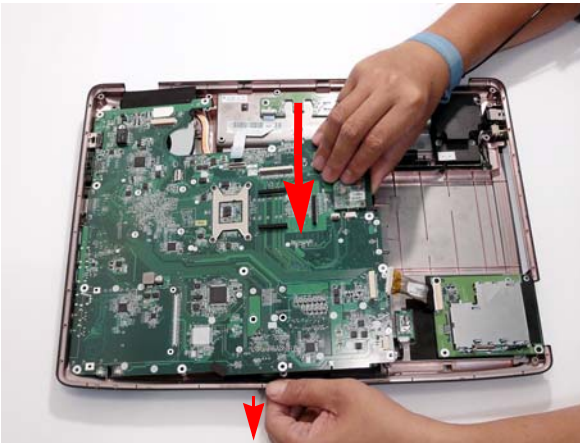

3. Connect the two cables on the mainboard side.

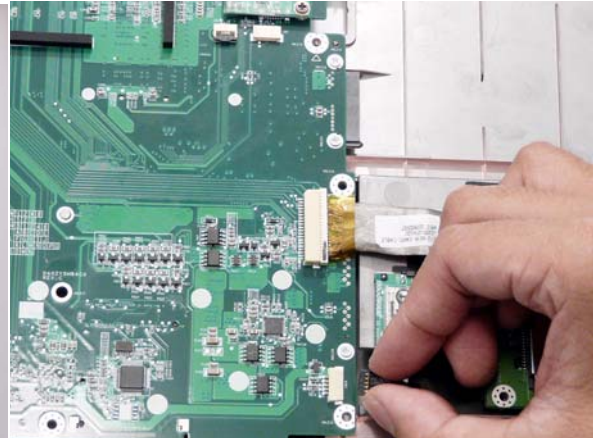
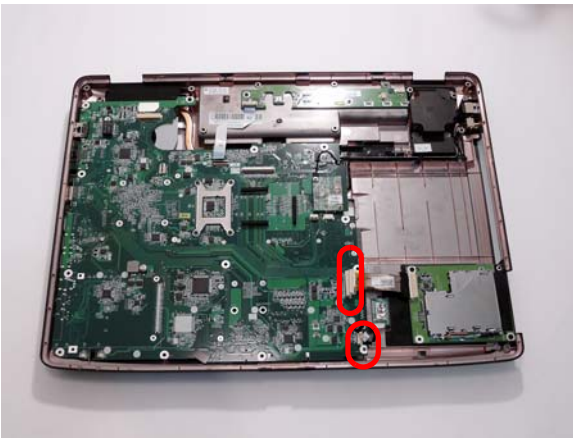

## Replacing the Bluetooth Board

1. Insert the module into the alignment pin and press down to secure.
2. Connect the Bluetooth cable and replace the securing screw as shown.

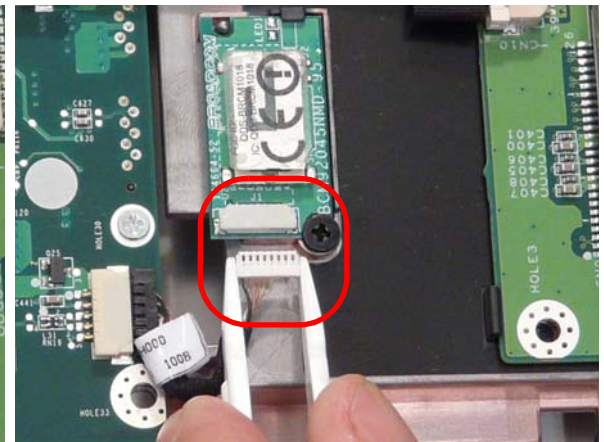
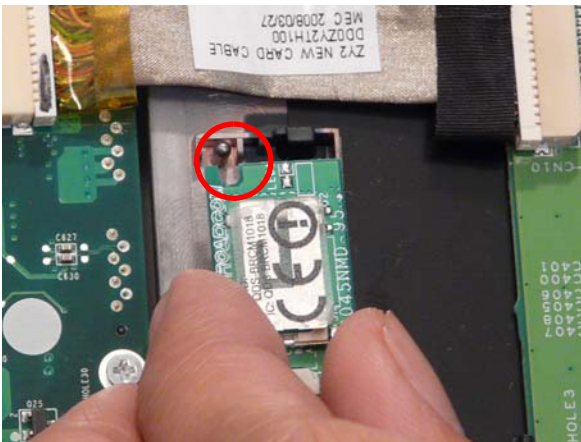

---

# Replacing the ExpressCard Module

1. Replace the ExpressCard module on the upper cover.

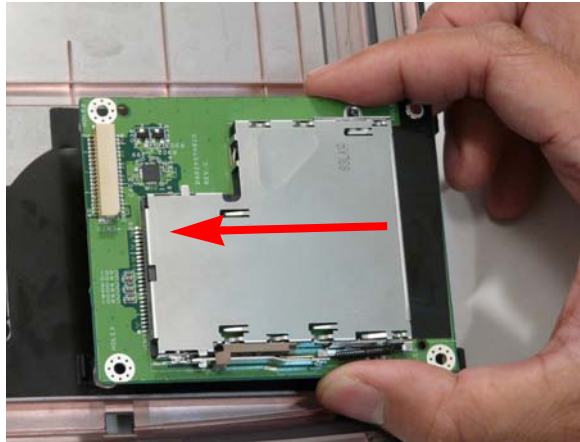

2. Replace the two securing screws.

**IMPORTANT:**The correct location of the ExpressCard Module screws is illustrated in the following image. Do not insert the screws in the remaining screw sockets. They are locations for upper cover screws.



3. Connect the cable connecting the ExpressCard module.

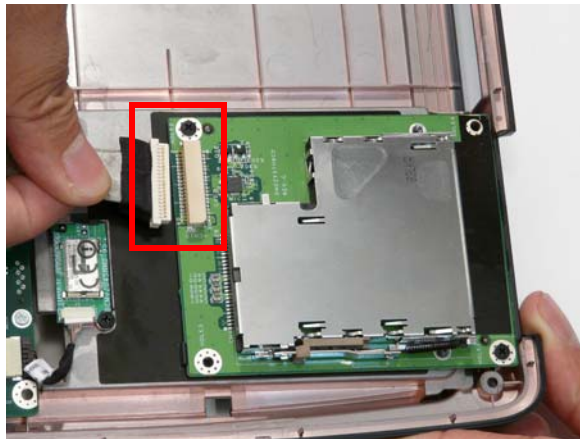



---

# Replacing the Subwoofer Module

1. Grasp the Subwoofer Module and insert in the lower base.

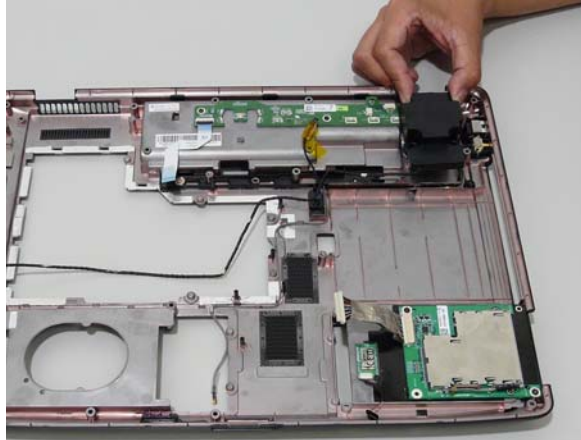

2. Insert the cables under the housing guide as shown.

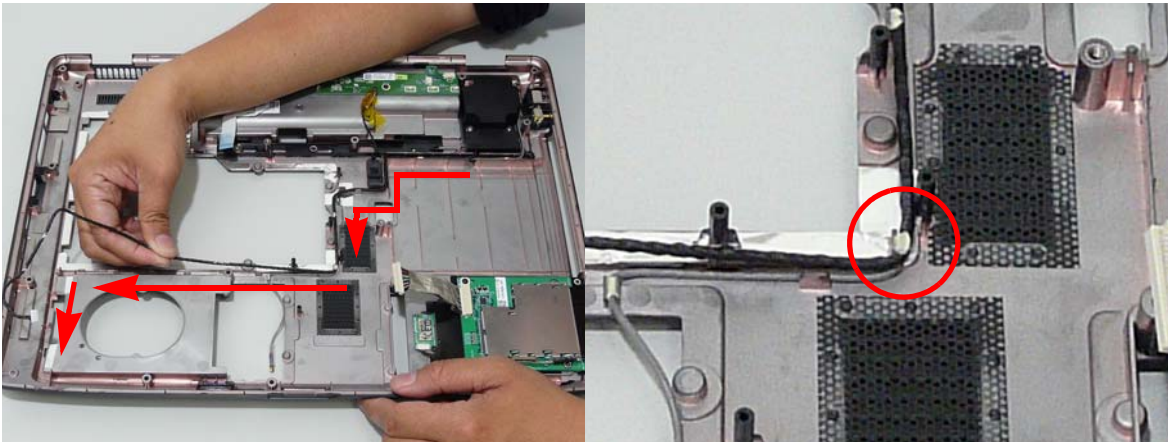

3. Replace the four securing screws on the Subwoofer Module.

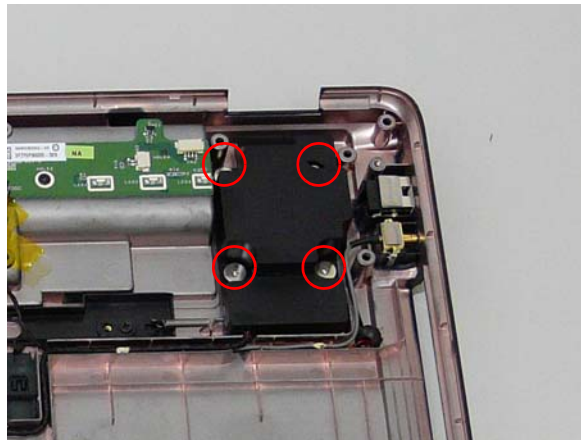

---

# Replacing the Finger Print Reader

1. Remove the Finger Print Reader board from the Upper Cover.

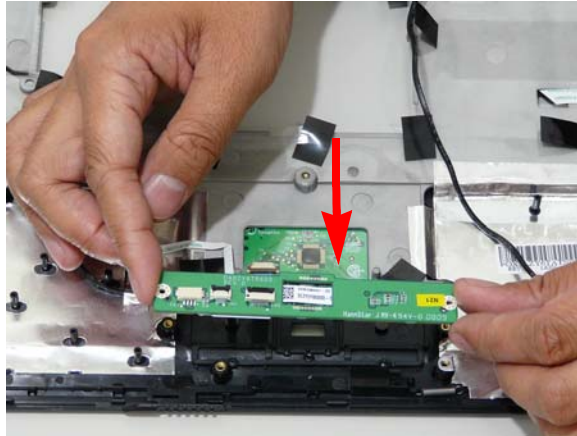

2. Remove the bracket from the board.

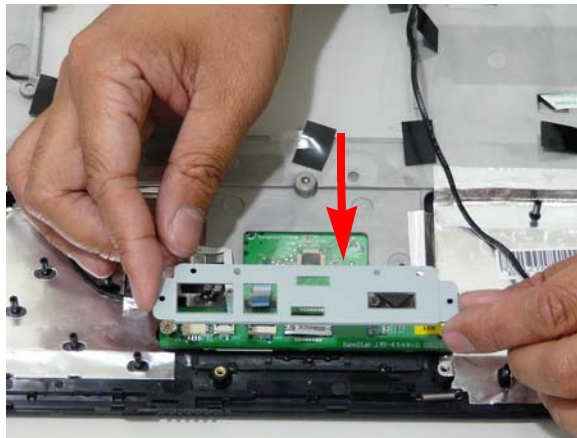

3. Replace the four securing screw on the Finger Print Reader board.

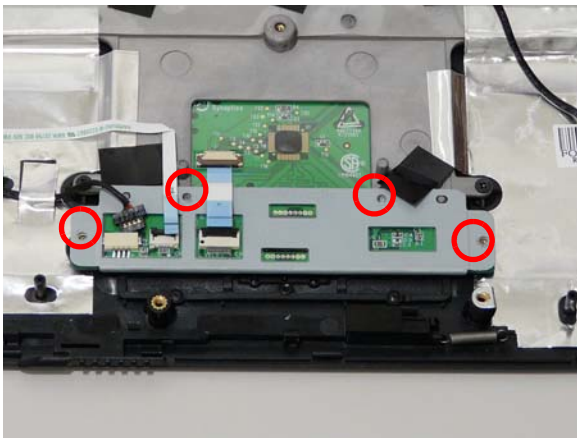

**NOTE:** Move back the cabling to allow for easier access to the screw sockets.

4. Connect the two FFC cables as shown.

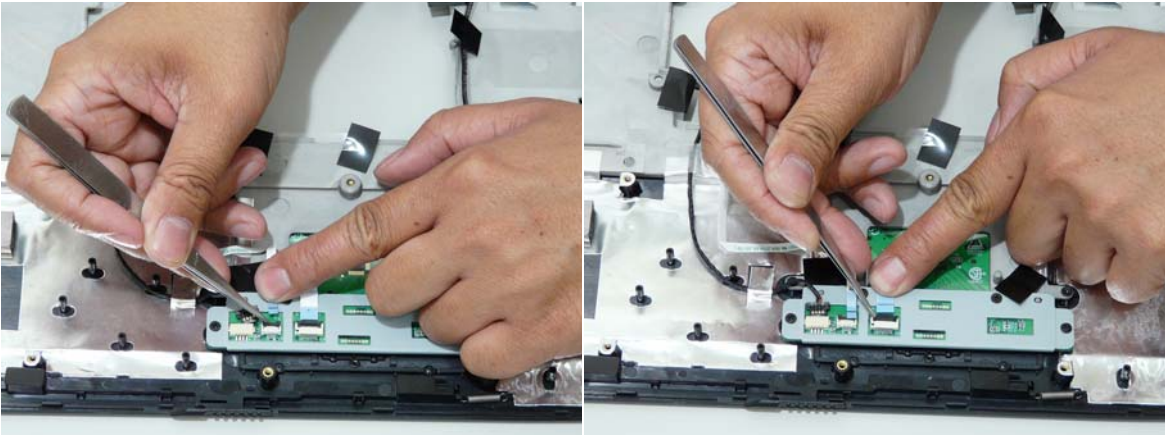

5. Connect the cable as shown.

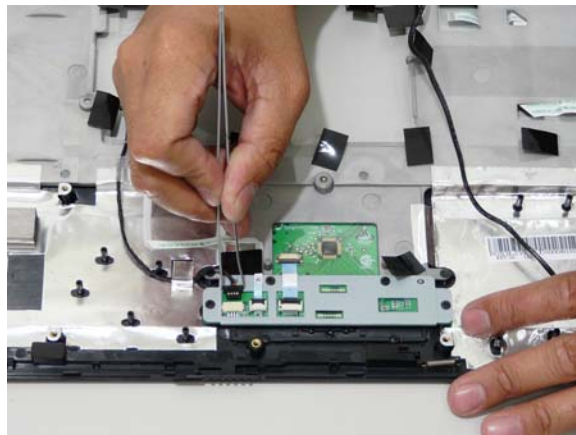

---

## Replacing the eKey Board

**IMPORTANT:** Take note of the eKey button when installing. It must face down and the cable connector up in order to install the module correctly.

1. Locate and replace the board as shown.

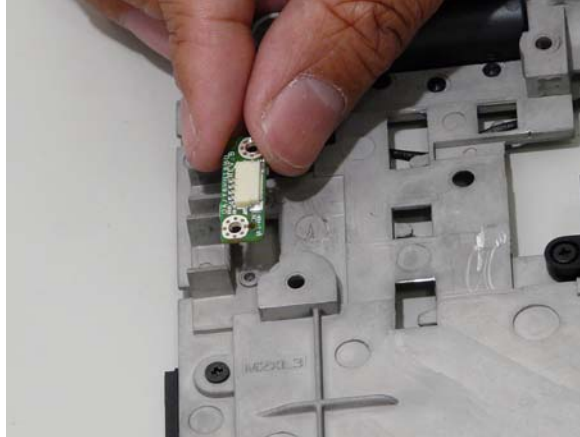

2. Connect the eKey Board cable and replace the two securing screws.

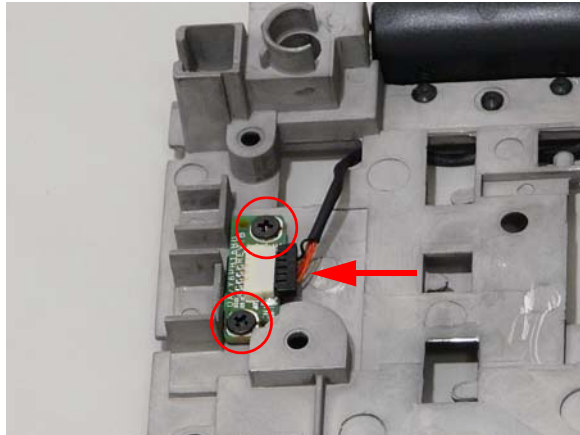



---

## Replacing the Touch Pad

**IMPORTANT:**The Touch Pad cannot be removed individually. To replace the Touch Pad, replace the entire Upper Cover.

1. Connect the Touch Pad cable as shown



## Replacing the Launch Board

1. Replace the Launch Board on the upper cover.
2. Replace the four securing screws.

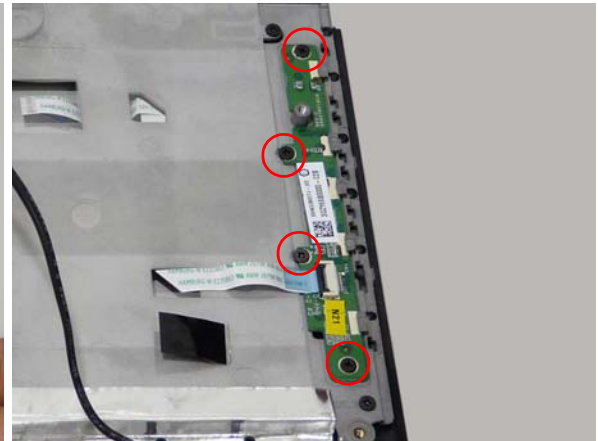
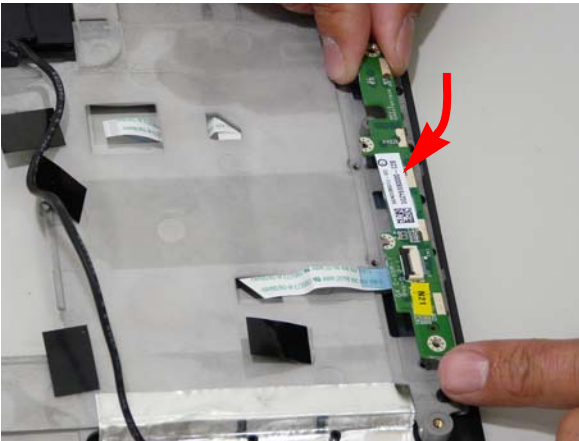

3. Insert the FFC flush with the connector and press down on the locking latch to secure.

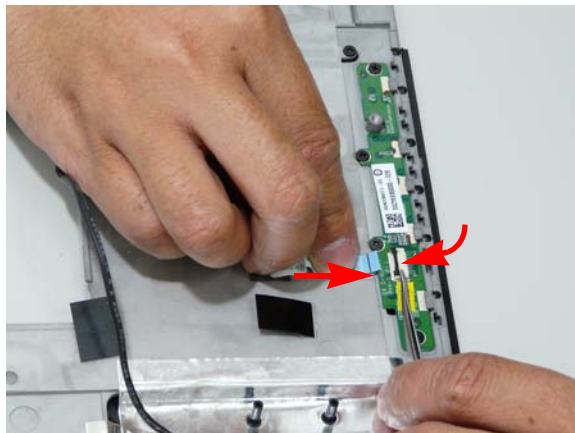



---

# Replacing the Finger Print Reader

1. Replace the Finger Print Reader board on the Upper Cover.

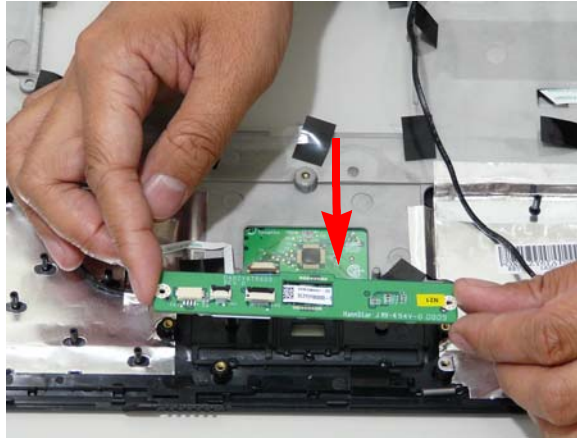

2. Replace the bracket on the board.

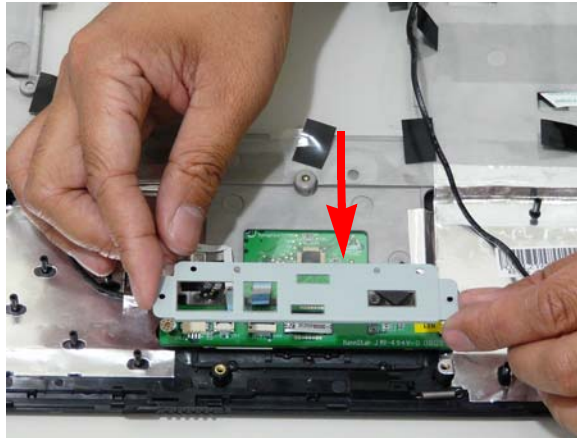

3. Replace the four securing screw on the Finger Print Reader board.

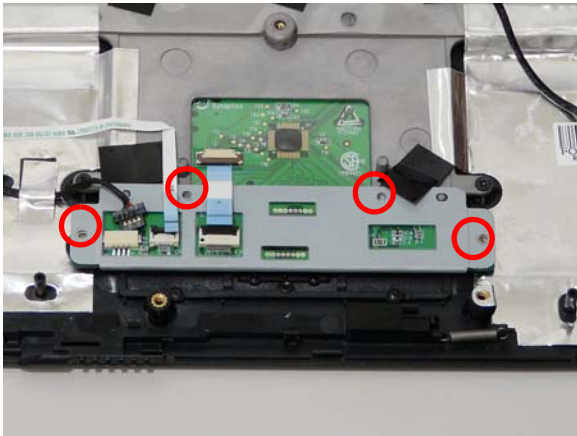

**NOTE:** Move back the cabling to allow for easier access to the screw sockets.

4. Connect the two FFC cables as shown.

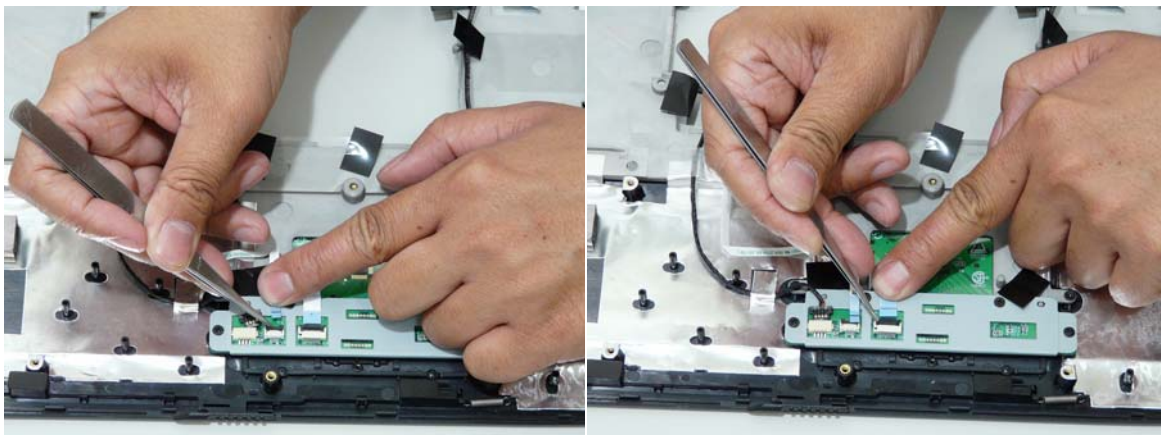

5. Connect the cable as shown.

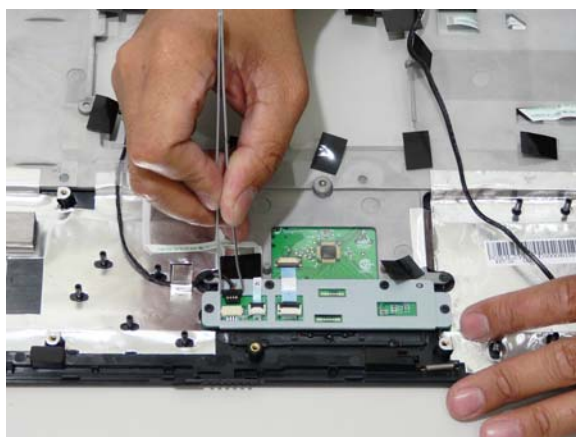

## Replacing the Upper Cover

1. Locate the upper cover over the lower base taking note of the screw sockets.



- 
2. Angle the right end of the Upper Cover in place, and insert any remaining cables through the lower base as shown.



3. Set the Upper Cover down on the lower base.

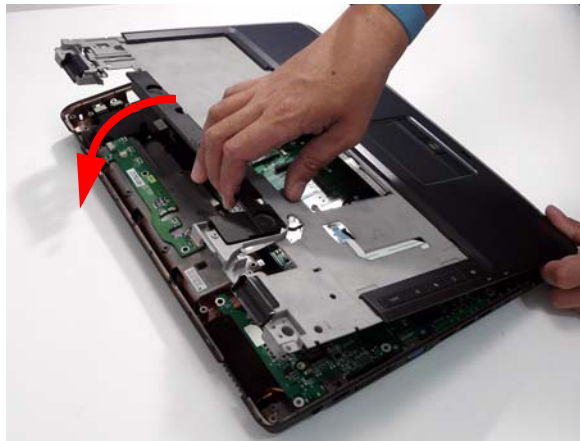

4. Replace the four securing screws on the Upper Cover.





5. Connect the five cables to the mainboard as shown.

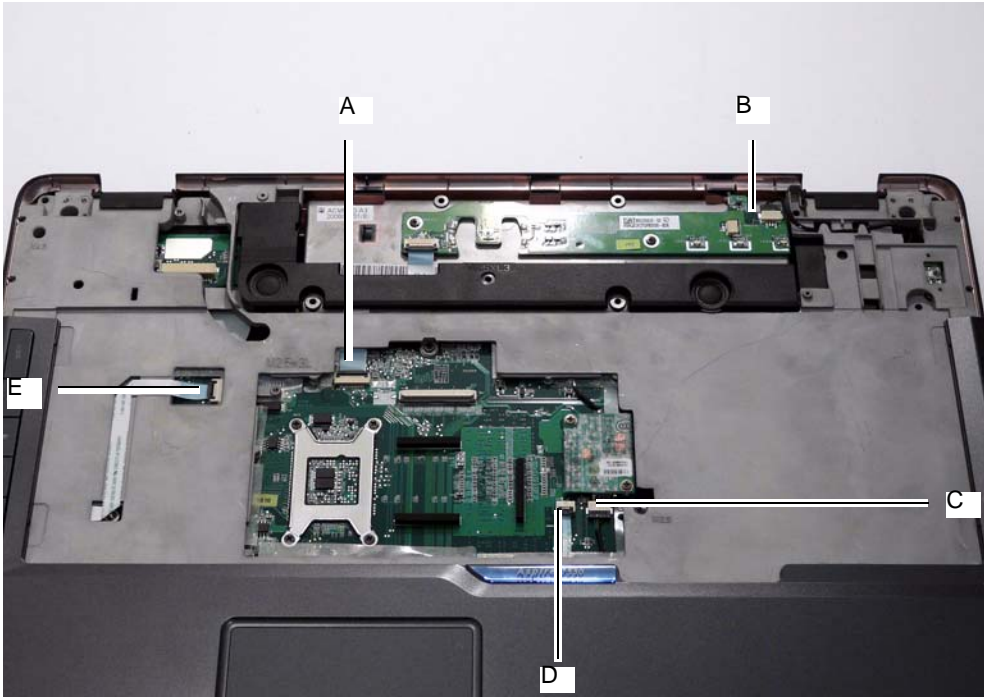

**IMPORTANT:**When replacing cables, always hold the cable by the pull-tab or by the connector. Do not hold the pull by the cable itself to prevent stripping.

Connect A as shown.

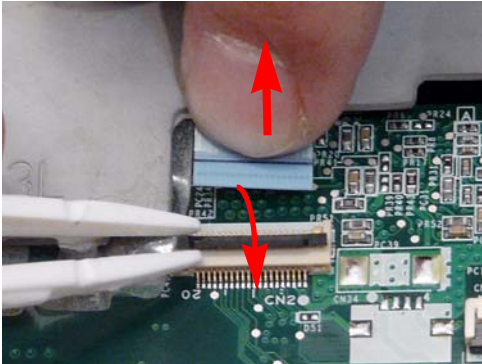

Connect B as shown.

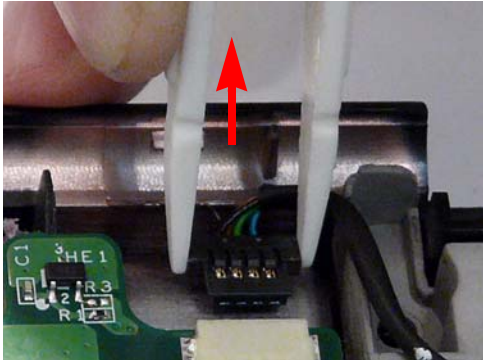

Connect C as shown.

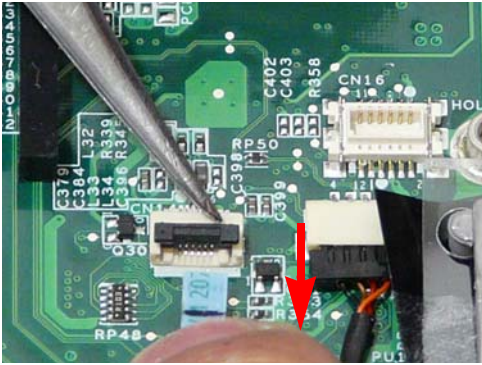

Connect D as shown.

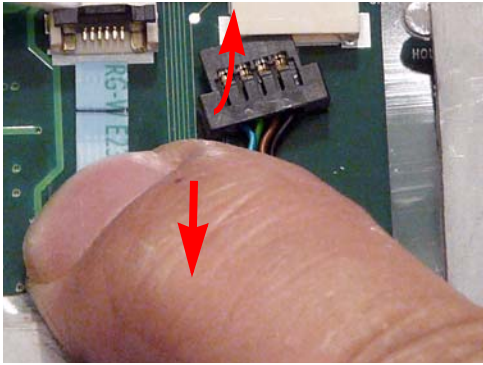

Connect E as shown.

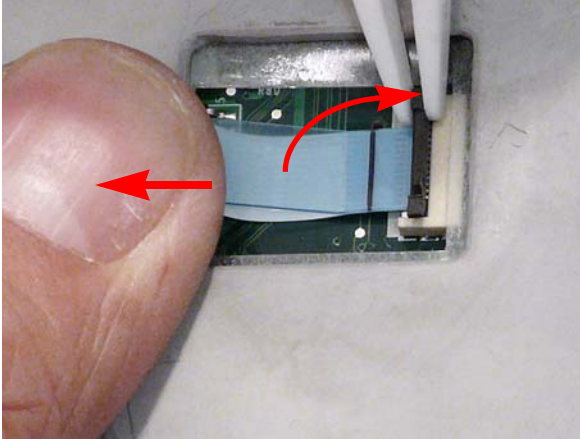

6. Angle the keyboard plate and insert as shown.



7. Replace the securing screw on the keyboard plate.

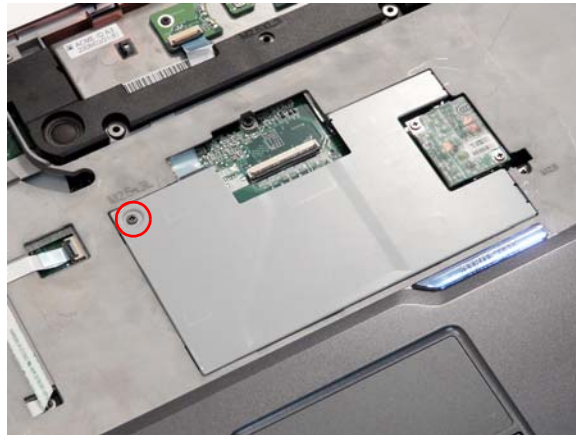

8. Turn the computer upside down and replace the eleven securing screws on the bottom panel to attach the bottom and lower covers.

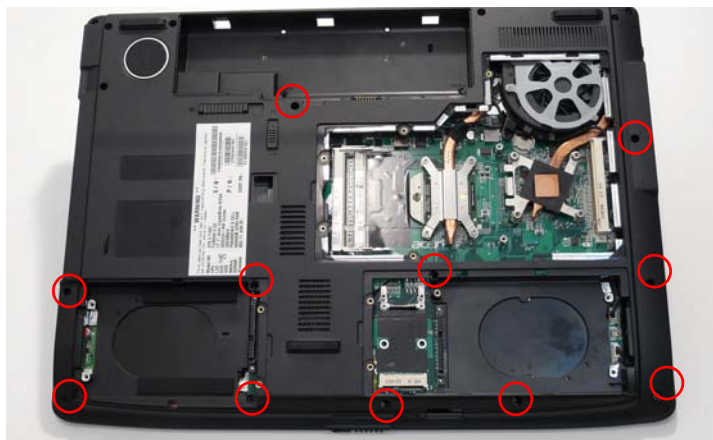

# Replacing the LCD Module

1. Replace the LCD Module on the Lower Case as shown.

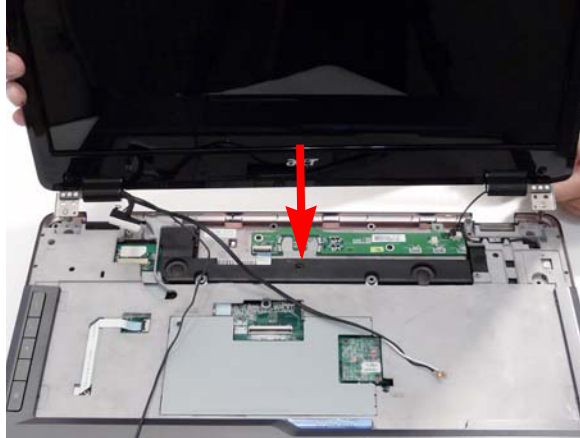

2. Replace the single ground screw and four securing screws (two each side) connecting the LCD module.

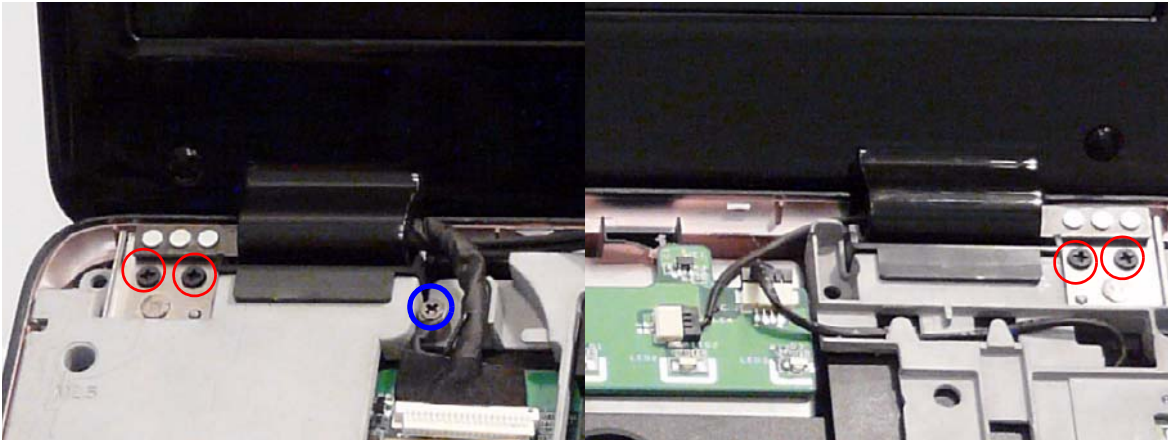

3. Replace the LCD Interface and back light cables as shown.

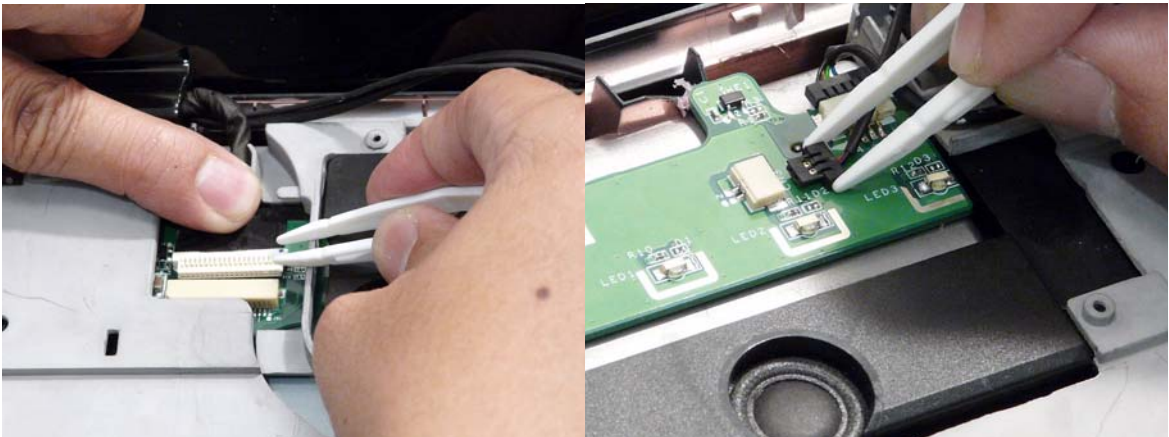



4. Turn the computer over and replace the two securing screws.



## Replacing the Antenna, MIC and Speaker Cables

**IMPORTANT:** Ensure that all cables pass through the Mainboard and are accessible from the underside of lower cover.

1. Insert the cabling through the housing as shown.
2. Ensure that the cabling is tucked in and secured.

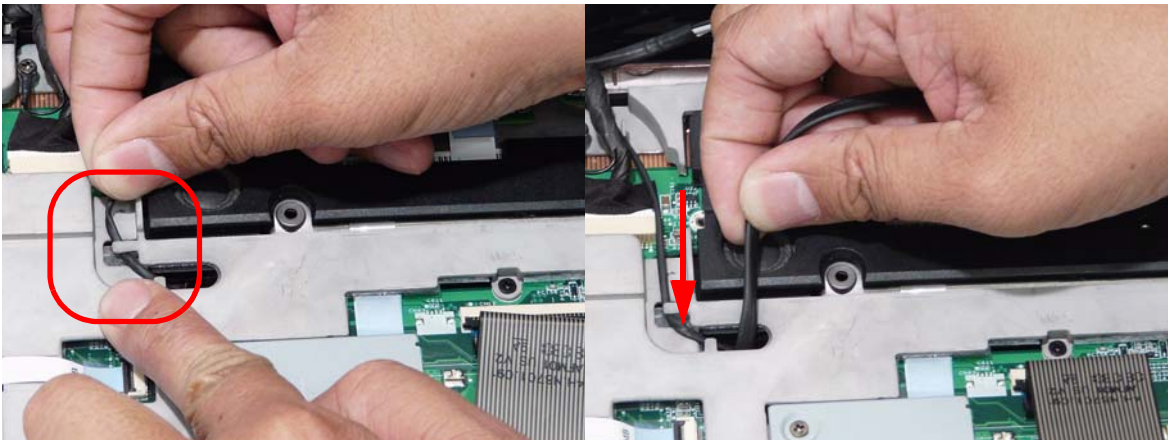

3. Turn the computer on its side, feed cables through to the underside.



4. Place the computer upside down, and insert the MIC and Speaker cables through the HDD housing.



5. Take note of the cabling arrangement. Ensure that the cabling is secured as shown to prevent damage.

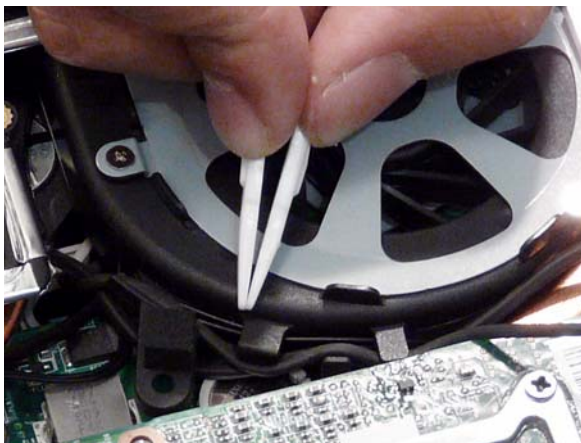

6. Connect the MIC and speaker cables.





7. Gently pull the Antenna Cables through the HDD housing.

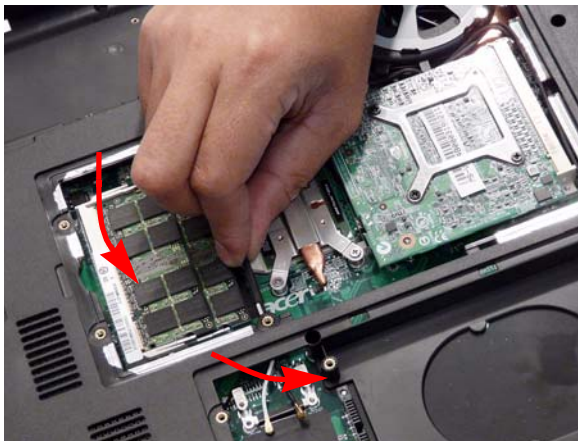

## Replacing the Modem Module

1. Angle the Modem Module as shown and attach to the connector.

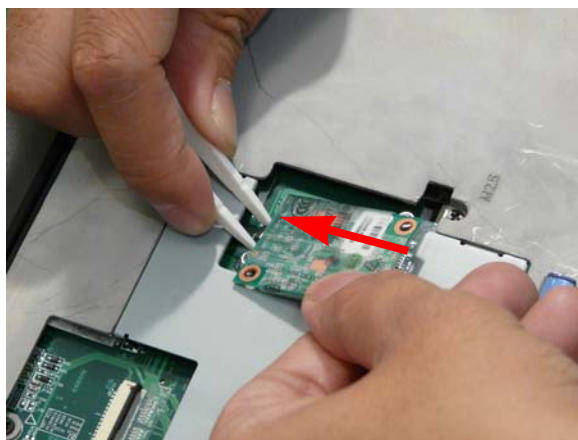

2. Insert the module and replace the two securing screws.

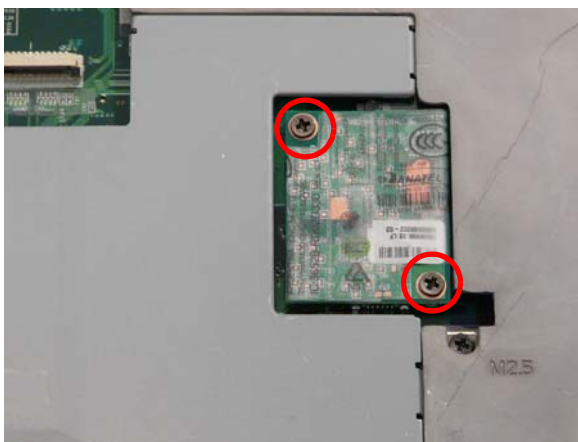

---

# Replacing the Keyboard

1. Replace the keyboard cable to the mainboard, and secure the locking latch.
2. Turn the keyboard over and place the front edge first in the mounting.

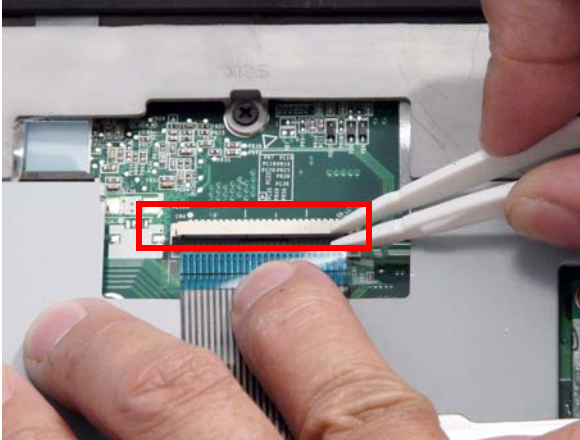

3. Press down on the areas marked below to secure in place.



# Replacing the Switch Board

1. Reseat the Switch Board and replace the two securing screws.



2. Connect both cables on the right as shown.

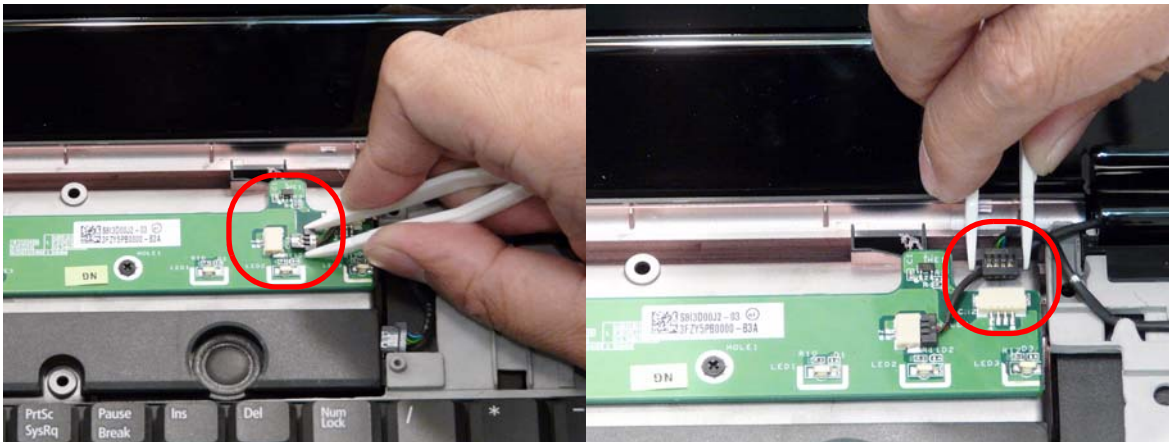

3. Replace the FFC cable on the left as shown and close the locking latch.



---

## Replacing the Switch Cover

1. Replace the Switch cover, and press down to secure in place.



2. Turn the computer over and replace the nine securing screws.





## Replacing the ODD Module

1. Eject the ODD tray and press the cover into the tray, bottom edge first, to secure.
2. Turn ODD Module around and secure bracket with two screws.

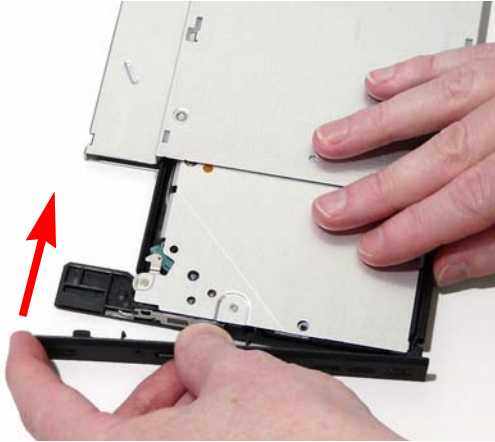

3. Slide Module in chassis and press until Module is flush with chassis.
4. Replace the ODD Cap and secure the single captive screw.

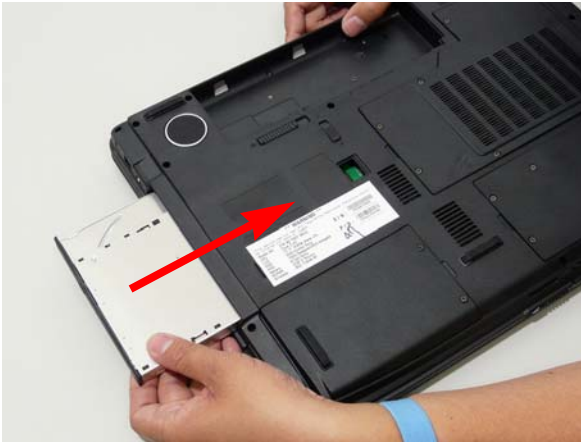

## Replacing the Hard Disk Drive Module

1. Replace the connector on the HDD.
2. Place the HDD in the HDD carrier.

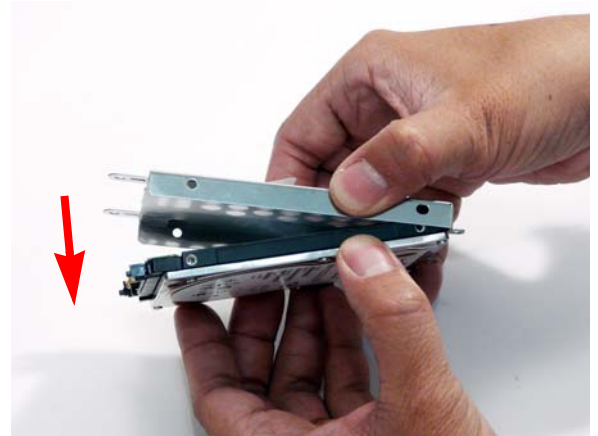
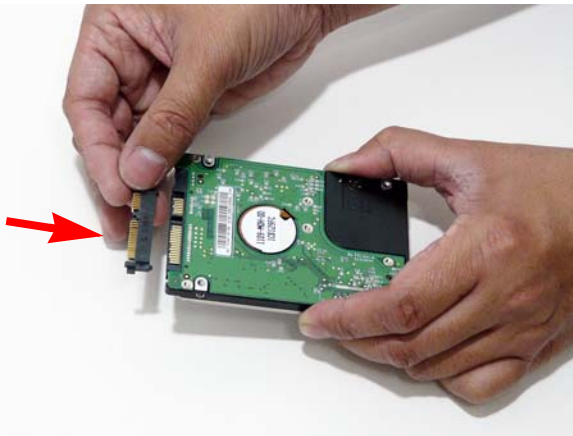

3. Replace the four screws (two each side) to secure the carrier.

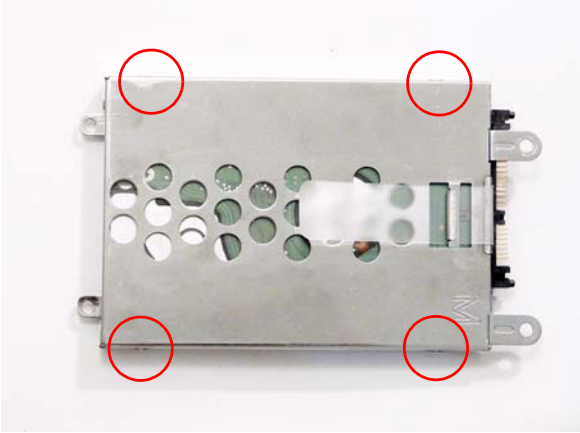

4. Insert the HDD, left side first, and push down to locate the interface correctly.



5. Replace the two securing screws.



## Replacing the WLAN Board

1. Insert the WLAN board in to the socket.
2. Push the board down and replace the two securing screws.



3. Replace the two antenna cables.

**NOTE:** The following is the correct cable-color to connector designation: TR1 to Gray and TR2 to Black.



## Replacing the TV Tuner Module

1. Attach the bracket to the module.
2. Insert the TV Tuner board in to the socket.





3. Replace the two securing screws.

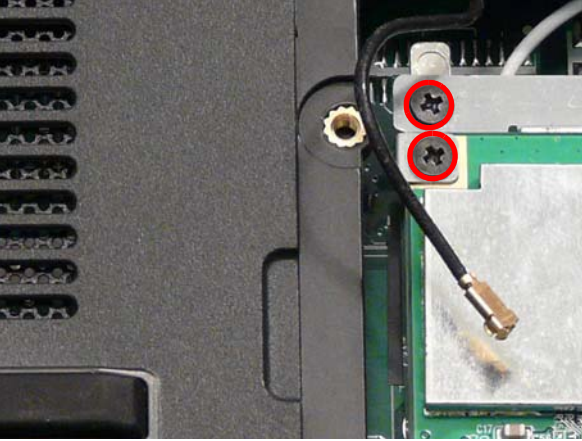

4. Replace the antenna cable.

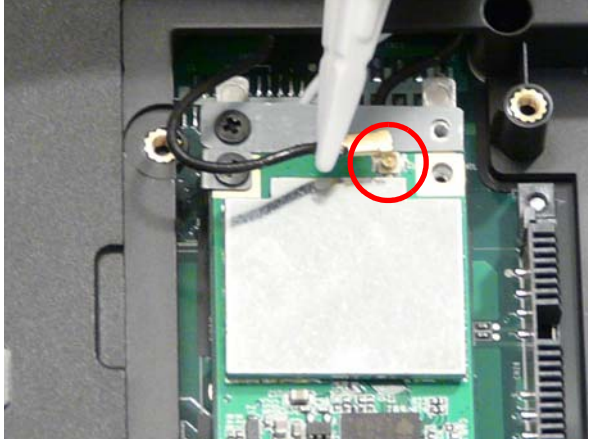

## Replacing the MXM Module

1. Insert the MXM board in to the socket.

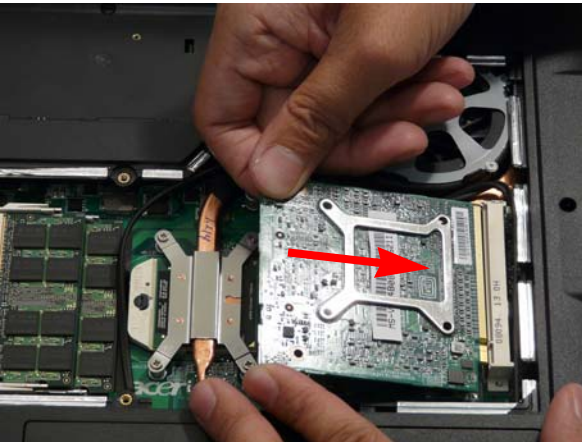

2. Replace the four securing screws.

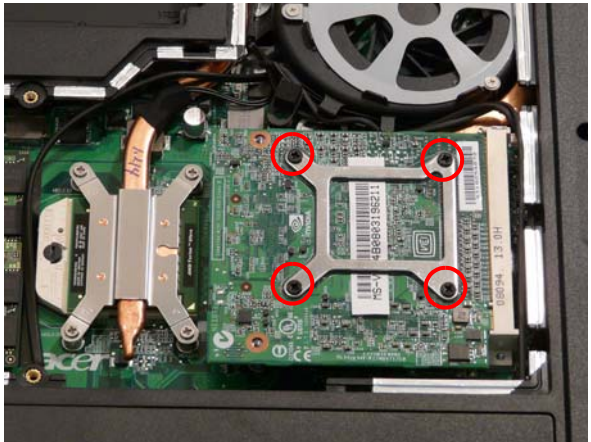

## Replacing the DIMM Modules

1. Insert DIMM in to the socket.

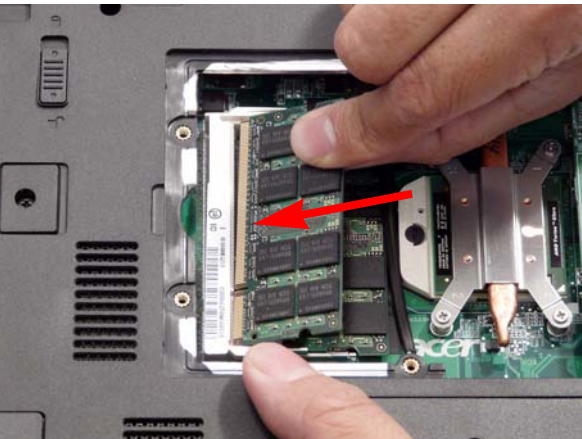

2. Press down to locate DIMM correctly.

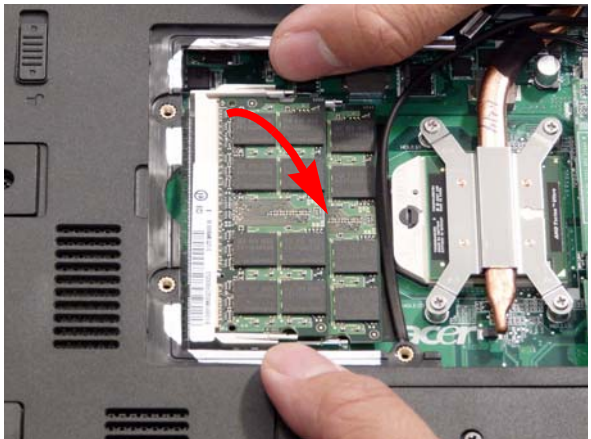

3. Repeat steps 1 and 2 for the second DIMM module.

## Replacing the Lower Covers

1. Replace the HDD2 cover.



2. Replace the HDD1 cover.



3. Replace the Memory cover.



4. Secure the ten captive screws in the covers.

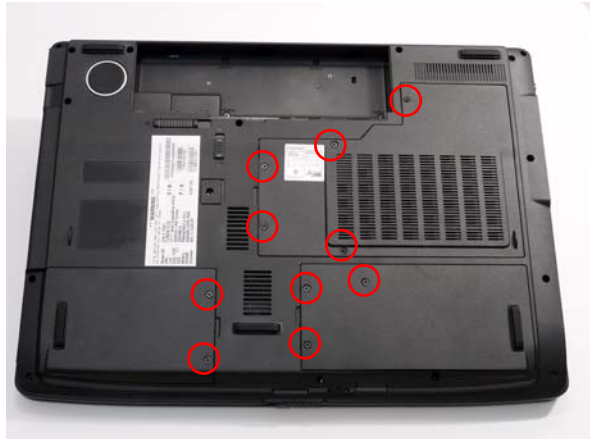

## Replacing the ExpressCard Dummy Tray

1. Insert the ExpressCard dummy as shown.



2. Push into the slot until flush with the chassis cover.



---

## Replacing the SD Dummy Tray

1. Insert the SD dummy as shown.



2. Push into the slot until flush with the chassis cover.



## Replacing the Battery

1. Slide and hold the battery release latch (1), insert battery in to the main unit (2).



2. Slide the battery lock/unlock latch to the lock position.



# Troubleshooting

---

## Common Problems

Use the following procedure as a guide for computer problems.

**NOTE:** The diagnostic tests are intended to test only Acer products. Non-Acer products, prototype cards, or modified options can give false errors and invalid system responses.

1. Obtain the failing symptoms in as much detail as possible.
2. Verify the symptoms by attempting to re-create the failure by running the diagnostic test or by repeating the same operation.
3. Use the following table with the verified symptom to determine which page to go to.

Symptoms (Verified)	Go To
Power On Issue	Page 130
No Display Issue	Page 131
LCD Failure	Page 133
Internal Keyboard Failure	Page 133
Touch Pad Failure	Page 134
Internal Speaker Failure	Page 134
Internal Microphone Failure	Page 136
ODD Failure	Page 138
Rightside USB Failure	Page 141
Modem Failure	Page 141
WLAN Failure	Page 142
Acer EasyLaunch Button Failure	Page 142
Acer MediaTouch Failure	Page 143
Fingerprint Reader Failure	Page 143
Thermal Unit Failure	Page 144
HDTV Switch Failure	Page 144
Other Functions Failure	Page 145
Intermittent Failures	Page 146
Undermined Failures	Page 146

4. If the Issue is still not resolved, see "Online Support Information" on page 195.



---

## Power On Issue

If the system doesn't power on, perform the following actions one at a time to correct the problem. Do not replace a non-defective FRUs:

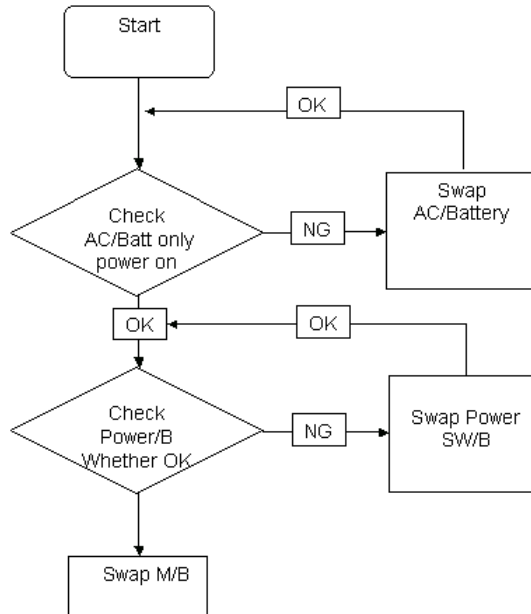

## Computer Shutdown Intermittently

If the system powers off at intervals, perform the following actions one at a time to correct the problem.

1. Check the power cable is properly connected to the computer and the electrical outlet.
2. Remove any extension cables between the computer and the outlet.
3. Remove any surge protectors between the computer and the electrical outlet. Plug the computer directly into a known good electrical outlet.
4. Disconnect the power and open the casing to check the Thermal Unit (see "Thermal Unit Failure" on page 144) and fan airways are free of obstructions.
5. Disable the power management settings in the BIOS to ensure they are not the cause of the problem (see "Boot" on page 37).
6. Remove all external and non-essential hardware connected to the computer that are not necessary to boot the computer to the failure point.
7. Remove any recently installed software.
8. If the Issue is still not resolved, see "Online Support Information" on page 195.

# No Display Issue

If the **Display** doesn't work, perform the following actions one at a time to correct the problem. Do not replace a non-defective FRUs:

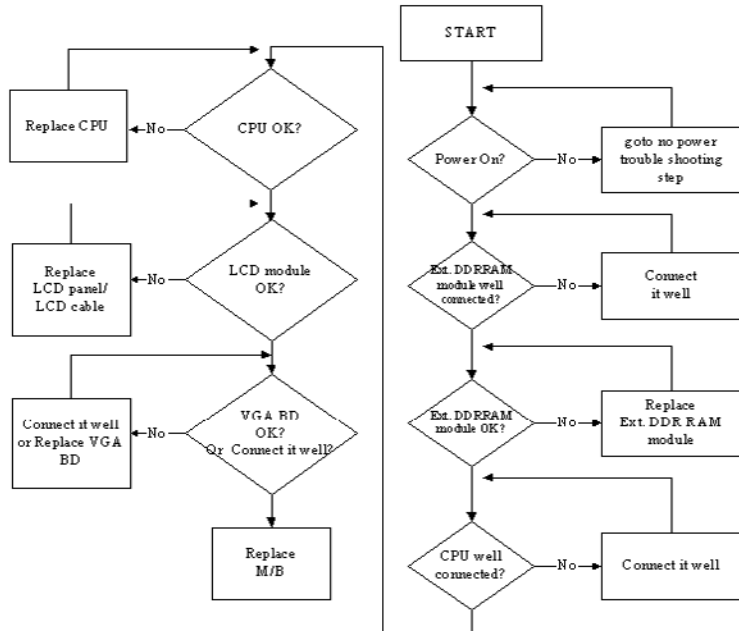

## No POST or Video

If the POST or video doesn't display, perform the following actions one at a time to correct the problem.

1. Make sure that the internal display is selected. On this notebook model, switching between the internal display and the external display is done by pressing **Fn+F5**. Reference Product pages for specific model procedures.
2. Make sure the computer has power by checking at least one of the following occurs:
  - Fans start up
  - Status LEDs light up

If there is no power, see "Power On Issue" on page 130.

3. Drain any stored power by removing the power cable and battery and holding down the power button for 10 seconds. Reconnect the power and reboot the computer.
4. Connect an external monitor to the computer and switch between the internal display and the external display is by pressing **Fn+F5** (on this model).

If the POST or video appears on the external display, see "LCD Failure" on page 133.

5. Disconnect power and all external devices including port replicators or docking stations. Remove any memory cards and CD/DVD discs. Restart the computer.

If the computer boots correctly, add the devices one by one until the failure point is discovered.

6. Reseat the memory modules.
7. Remove the drives (see "Disassembly Process" on page 46).
8. If the Issue is still not resolved, see "Online Support Information" on page 195.

---

## Abnormal Video Display

If video displays abnormally, perform the following actions one at a time to correct the problem.

1. Reboot the computer.
2. If permanent vertical/horizontal lines or dark spots display in the same location, the LCD is faulty and should be replaced. See “Disassembly Process” on page 46.
3. If extensive pixel damage is present (different colored spots in the same locations on the screen), the LCD is faulty and should be replaced. See “Disassembly Process” on page 46.
4. Adjust the brightness to its highest level. See the User Manual for instructions on adjusting settings.  
**NOTE:** Ensure that the computer is not running on battery alone as this may reduce display brightness.  
If the display is too dim at the highest brightness setting, the LCD is faulty and should be replaced. See “Disassembly Process” on page 46.
5. Check the display resolution is correctly configured:
  - a. Minimize or close all Windows.
  - b. If display size is only abnormal in an application, check the view settings and control/mouse wheel zoom feature in the application.
  - c. If desktop display resolution is not normal, right-click on the desktop and select **Personalize**→ **Display Settings**.
  - d. Click and drag the Resolution slider to the desired resolution.
  - e. Click **Apply** and check the display. Readjust if necessary.
6. Roll back the video driver to the previous version if updated.
7. Remove and reinstall the video driver.
8. Check the Device Manager to determine that:
  - The device is properly installed. There are no red Xs or yellow exclamation marks.
  - There are no device conflicts.
  - No hardware is listed under Other Devices.
9. If the Issue is still not resolved, see “Online Support Information” on page 195.
10. Run the Windows Memory Diagnostic from the operating system DVD and follow the onscreen prompts.
11. If the Issue is still not resolved, see “Online Support Information” on page 195.

## Random Loss of BIOS Settings

If the computer is experiencing intermittent loss of BIOS information, perform the following actions one at a time to correct the problem.

1. If the computer is more than one year old, replace the CMOS battery.
2. Run a complete virus scan using up-to-date software to ensure the computer is virus free.
3. If the computer is experiencing HDD or ODD BIOS information loss, disconnect and reconnect the power and data cables between devices.  
If the BIOS settings are still lost, replace the cables.
4. If HDD information is missing from the BIOS, the drive may be defective and should be replaced.
5. Replace the Motherboard.
6. If the Issue is still not resolved, see “Online Support Information” on page 195.



# LCD Failure

If the **LCD** fails, perform the following actions one at a time to correct the problem. Do not replace a non-defective FRUs:

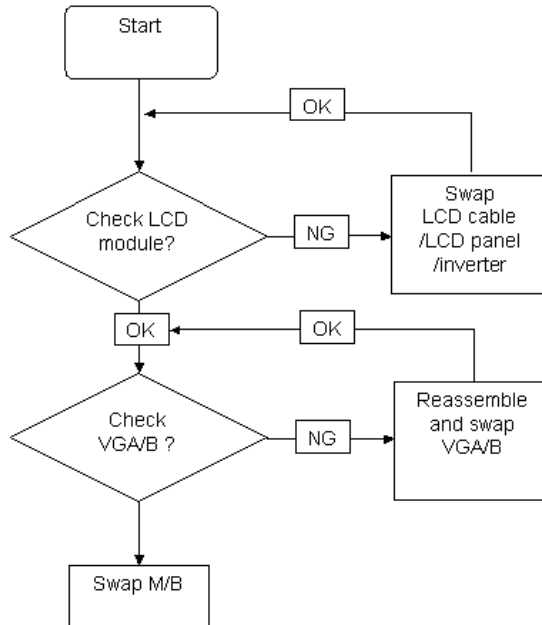

# Built-In Keyboard Failure

If the built-in **Keyboard** fails, perform the following actions one at a time to correct the problem. Do not replace a non-defective FRUs:

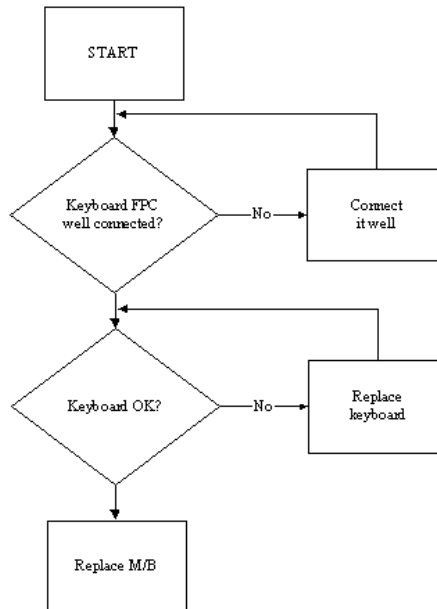

# Touch Pad Failure

If the **Touch Pad** doesn't work, perform the following actions one at a time to correct the problem. Do not replace a non-defective FRUs:

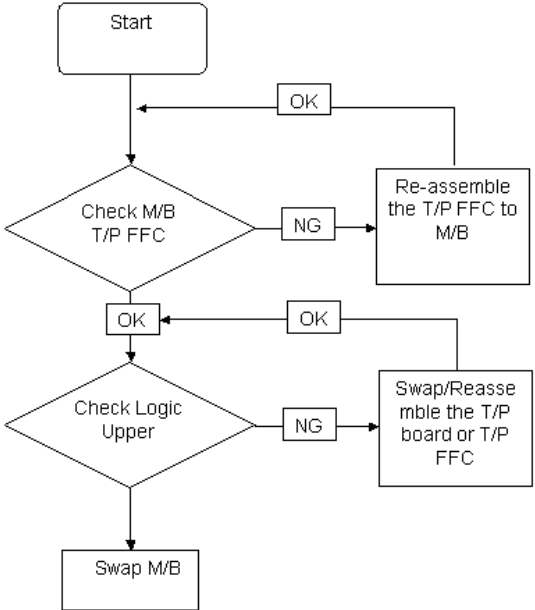

# Internal Speaker Failure

If the internal **Speakers** fail, perform the following actions one at a time to correct the problem. Do not replace a non-defective FRUs:

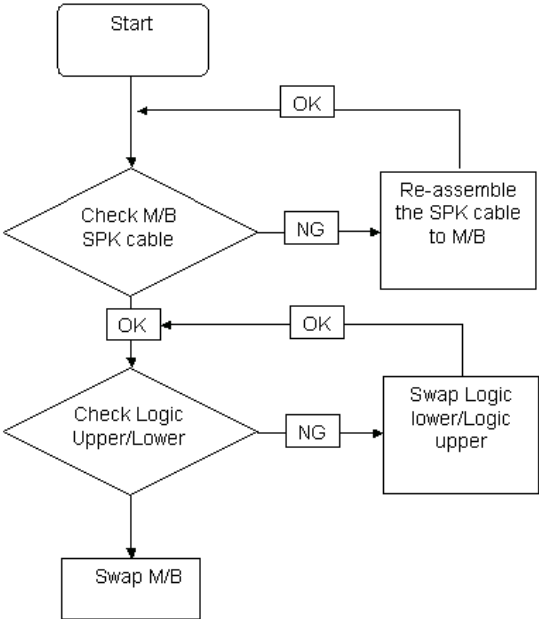

---

## Sound Problems

If sound problems are experienced, perform the following actions one at a time to correct the problem.

1. Reboot the computer.
2. Navigate to **Start** → **Control Panel** → **System and Maintenance** → **System** → **Device Manager**. Check the Device Manager to determine that:
  - The device is properly installed.
  - There are no red Xs or yellow exclamation marks.
  - There are no device conflicts.
  - No hardware is listed under Other Devices.
3. Roll back the audio driver to the previous version, if updated recently.
4. Remove and reinstall the audio driver.
5. Ensure that all volume controls are set mid range:
  - a. Click the volume icon on the taskbar and drag the slider to 50. Ensure that the volume is not muted.
  - b. Click Mixer to verify that other audio applications are set to 50 and not muted.
6. Navigate to **Start** → **Control Panel** → **Hardware and Sound** → **Sound**. Ensure that Speakers are selected as the default audio device (green check mark).

**NOTE:** If Speakers does not show, right-click on the **Playback** tab and select **Show Disabled Devices** (clear by default).
7. Select Speakers and click **Configure** to start **Speaker Setup**. Follow the onscreen prompts to configure the speakers.
8. Remove and recently installed hardware or software.
9. Restore system and file settings from a known good date using **System Restore**.

If the issue is not fixed, repeat the preceding steps and select an earlier time and date.
10. Reinstall the Operating System.
11. If the Issue is still not resolved, see “Online Support Information” on page 195.

# Internal Microphone Failure

If the internal **Microphone** fails, perform the following actions one at a time to correct the problem. Do not replace a non-defective FRUs:

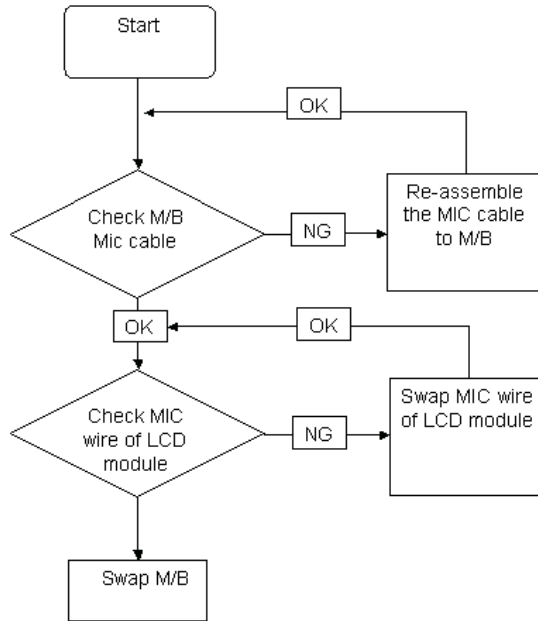

## Microphone Problems

If internal or external **Microphones** do not operate correctly, perform the following actions one at a time to correct the problem.

1. Check that the microphone is enabled. Navigate to **Start** → **Control Panel** → **Hardware and Sound** → **Sound** and select the **Recording** tab.
2. Right-click on the **Recording** tab and select **Show Disabled Devices** (clear by default).
3. The microphone appears on the **Recording** tab.
4. Right-click on the microphone and select **Enable**.
5. Select the microphone then click **Properties**. Select the **Levels** tab.
6. Increase the volume to the maximum setting and click **OK**.
7. Test the microphone hardware:
  - a. Select the microphone and click **Configure**.
  - b. Select **Set up microphone**.
  - c. Select the microphone type from the list and click **Next**.
  - d. Follow the onscreen prompts to complete the test.
8. If the Issue is still not resolved, see “Online Support Information” on page 195.

---

## HDD Not Operating Correctly

If the **HDD** does not operate correctly, perform the following actions one at a time to correct the problem.

1. Disconnect all external devices.
2. Run a complete virus scan using up-to-date software to ensure the computer is virus free.
3. Run the Windows Vista Startup Repair Utility:
  - a. insert the Windows Vista Operating System DVD in the ODD and restart the computer.
  - b. When prompted, press any key to start to the operating system DVD.
  - c. The **Install Windows** screen displays. Click **Next**.
  - d. Select **Repair your computer**.
  - e. The **System Recovery Options** screen displays. Click **Next**.
  - f. Select the appropriate operating system, and click **Next**.

**NOTE:** Click **Load Drivers** if controller drives are required.

- g. Select **Startup Repair**.
- h. Startup Repair attempts to locate and resolve issues with the computer.
- i. When complete, click **Finish**.

If an issue is discovered, follow the onscreen information to resolve the problem.

4. Run the Windows Memory Diagnostic Tool. For more information see Windows Help and Support.
5. Restart the computer and press F2 to enter the BIOS Utility. Check the BIOS settings are correct and that CD/DVD drive is set as the first boot device on the Boot menu.
6. Ensure all cables and jumpers on the HDD and ODD are set correctly.
7. Remove any recently added hardware and associated software.
8. Run the Windows Disk Defragmenter. For more information see Windows Help and Support.
9. Run Windows Check Disk by entering **chkdsk /r** from a command prompt. For more information see Windows Help and Support.
10. Restore system and file settings from a known good date using **System Restore**.

If the issue is not fixed, repeat the preceding steps and select an earlier time and date.
11. Replace the HDD. See "Disassembly Process" on page 46.

---

## ODD Failure

If the **ODD** fails, perform the following actions one at a time to correct the problem. Do not replace a non-defective FRUs:

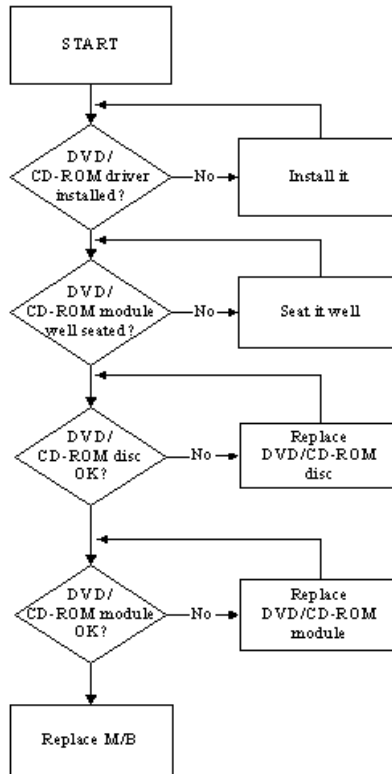

## ODD Not Operating Correctly

If the **ODD** exhibits any of the following symptoms it may be faulty:

- Audio CDs do not play when loaded
- DVDs do not play when loaded
- Blank discs do not burn correctly
- DVD or CD play breaks up or jumps
- Optical drive not found or not active:
  - Not shown in My Computer or the BIOS setup
  - LED does not flash when the computer starts up
  - The tray does not eject
- Access failure screen displays
- The ODD is noisy

Perform the following general solutions one at a time to correct the problem.

1. Reboot the computer and retry the operation.
2. Try an alternate disc.
3. Navigate to **Start** → **Computer**. Check that the ODD device is displayed in the **Devices with Removable Storage** panel.
4. Navigate to **Start** → **Control Panel** → **System and Maintenance** → **System** → **Device Manager**.



- 
- a. Double-click **IDE ATA/ATAPI controllers**. If a device displays a down arrow, right-click on the device and click **Enable**.
  - b. Double-click **DVD/CD-ROM drives**. If the device displays a down arrow, right-click on the device and click **Enable**.
  - c. Check that there are no yellow exclamation marks against the items in **IDE ATA/ATAPI controllers**. If a device has an exclamation mark, right-click on the device and uninstall and reinstall the driver.
  - d. Check that there are no yellow exclamation marks against the items in **DVD/CD-ROM drives**. If a device has an exclamation mark, right-click on the device and uninstall and reinstall the driver.
  - e. If the exclamation marker is not removed from the item in the lists, try removing any recently installed software and retrying the operation.

## Discs Do Not Play

If discs do not play when inserted in the drive, perform the following actions one at a time to correct the problem.

1. Check that the disc is correctly seated in the drive tray and that the label on the disc is visible.
2. Check that the media is clean and scratch free.
3. Try an alternate disc in the drive.
4. Ensure that **AutoPlay** is enabled:
  - a. Navigate to **Start** → **Control Panel** → **Hardware and Sound** → **AutoPlay**.
  - b. Select **Use AutoPlay for all media and devices**.
  - c. In the Audio CD and DVD Movie fields, select the desired player from the drop down menu.
5. Check that the Regional Code is correct for the selected media:

**IMPORTANT:**Region can only be changed a limited number of times. After Changes remaining reaches zero, the region cannot be changed even Windows is reinstalled or the drive is moved to another computer.

- a. Navigate to **Start** → **Control Panel** → **System and Maintenance** → **System** → **Device Manager**.
- b. Double-click **DVD/CD-ROM drives**.
- c. Right-click **DVD drive** and click **Properties**, then click the **DVD Region** tab.
- d. Select the region suitable for the media inserted in the drive.

## Discs Do Not Burn Properly

If discs can not be burned, perform the following actions one at a time to correct the problem.

1. Ensure that the default drive is record enabled:
  - a. Navigate to **Start** → **Computer** and right-click the writable ODD icon. Click **Properties**.
  - b. Select the **Recording** tab. In the **Desktop disc recording** panel, select the writable ODD from the drop down list.
  - c. Click **OK**.
2. Ensure that the software used for burning discs is the factory default. If using different software, refer to the software's user manual.

## Playback is Choppy

If playback is choppy or jumps, perform the following actions one at a time to correct the problem.

1. Check that system resources are not running low:
  - a. Try closing some applications.
  - b. Reboot and try the operation again.
2. Check that the ODD controller transfer mode is set to DMA:
  - a. Navigate to **Start** → **Control Panel** → **System and Maintenance** → **System** → **Device Manager**.

- 
- b. Double-click **IDE ATA/ATAPI controllers**, then right-click ATA Device 0.
  - c. Click **Properties** and select the **Advanced Settings** tab. Ensure that the **Enable DMA** box is checked and click **OK**.
  - d. Repeat for the other ATA Devices shown if applicable.

### Drive Not Detected

If Windows cannot detect the drive, perform the following actions one at a time to correct the problem.

1. Restart the computer and press F2 to enter the BIOS Utility.
2. Check that the drive is detected in the **ATAPI Model Name** field on the Information page.  
**NOTE:** Check that the entry is identical to one of the ODDs specified in “Hardware Specifications and Configurations” on page 18.
3. Turn off the power and remove the cover to inspect the connections to the ODD. See “Disassembly Process” on page 46.
  - a. Check for broken connectors on the drive, motherboard, and cables.
  - b. Check for bent or broken pins on the drive, motherboard, and cable connections.
  - c. Try an alternate cable, if available. If the drive works with the new cable, the original cable should be replaced.
4. Reseat the drive ensuring and all cables are connected correctly.
5. Replace the ODD. See “Disassembly Process” on page 46.

### Drive Read Failure

If discs cannot be read when inserted in the drive, perform the following actions one at a time to correct the problem.

1. Remove and clean the failed disc.
2. Retry reading the CD or DVD.
  - d. Test the drive using other discs.
  - e. Play a DVD movie
  - f. Listen to a music CD

If the ODD works properly with alternate discs, the original disc is probably defective and should be replaced.

3. Turn off the power and remove the cover to inspect the connections to the ODD. See “Disassembly Process” on page 46.
  - a. Check for broken connectors on the drive, motherboard, and cables.
  - b. Check for bent or broken pins on the drive, motherboard, and cable connections.
  - c. Try an alternate cable, if available. If the drive works with the new cable, the original cable should be replaced.
4. Replace the ODD. See “Disassembly Process” on page 46.

# USB Failure (Rightside)

If the rightside **USB** port fails, perform the following actions one at a time to correct the problem. Do not replace a non-defective FRUs:

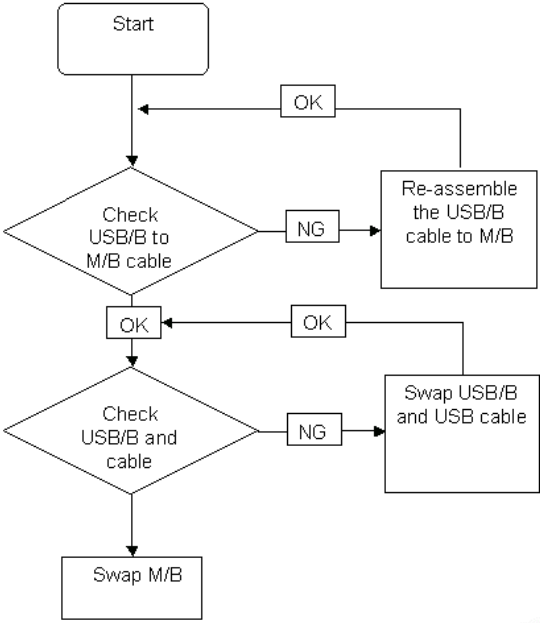

# Modem Function Failure

If the internal **Modem** fails, perform the following actions one at a time to correct the problem. Do not replace a non-defective FRUs:

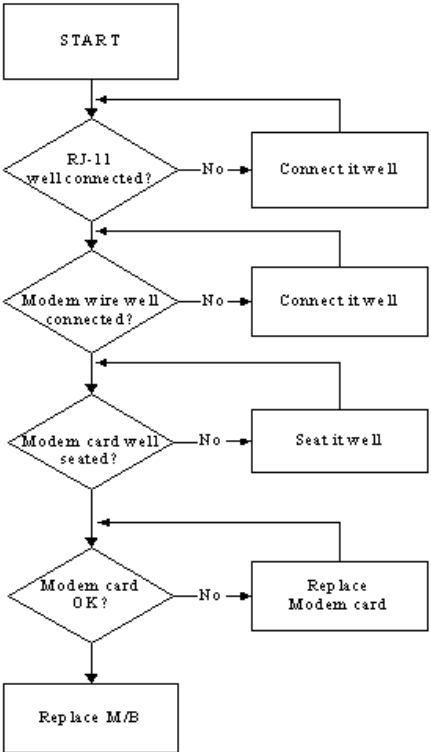

# Wireless Function Failure

If the **WLAN** fails, perform the following actions one at a time to correct the problem. Do not replace a non-defective FRUs:

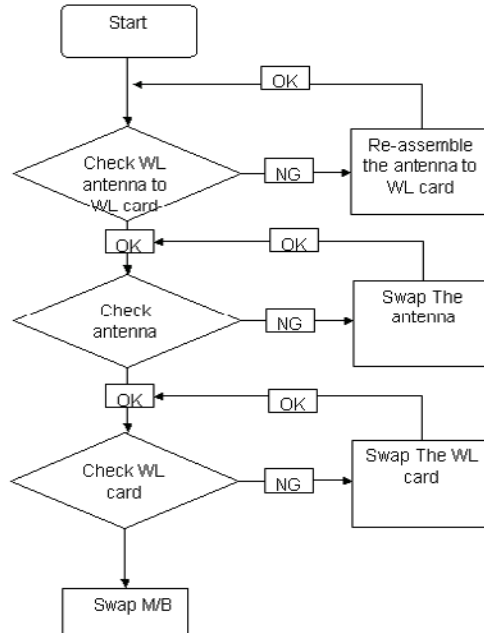

# EasyTouch Button Failure

If the **Acer EasyTouch** buttons fail, perform the following actions one at a time to correct the problem. Do not replace a non-defective FRUs:

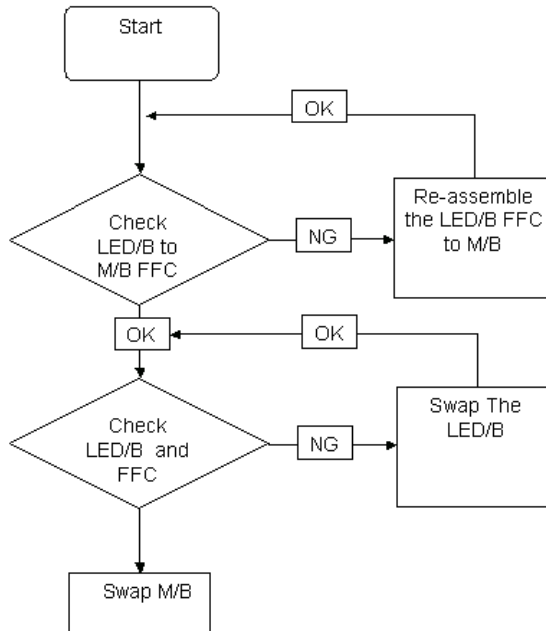

# MediaTouch Button Failure

If the **Acer MediaTouch** buttons fail, perform the following actions one at a time to correct the problem. Do not replace a non-defective FRUs:

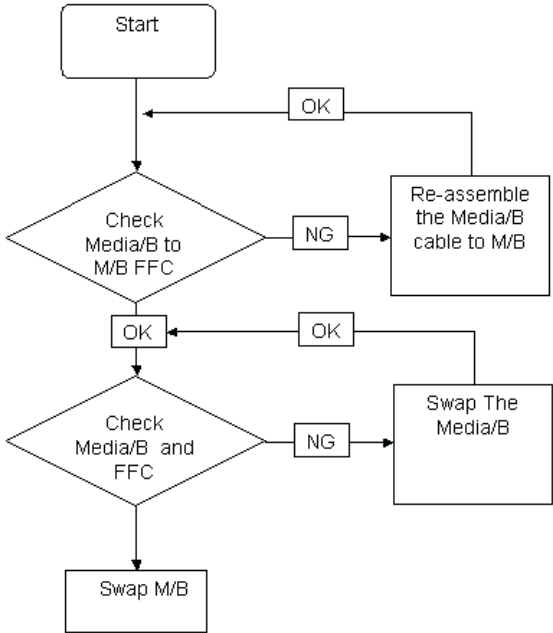

# Fingerprint Reader Failure

If the **Fingerprint Reader** fails, perform the following actions one at a time to correct the problem. Do not replace a non-defective FRUs:

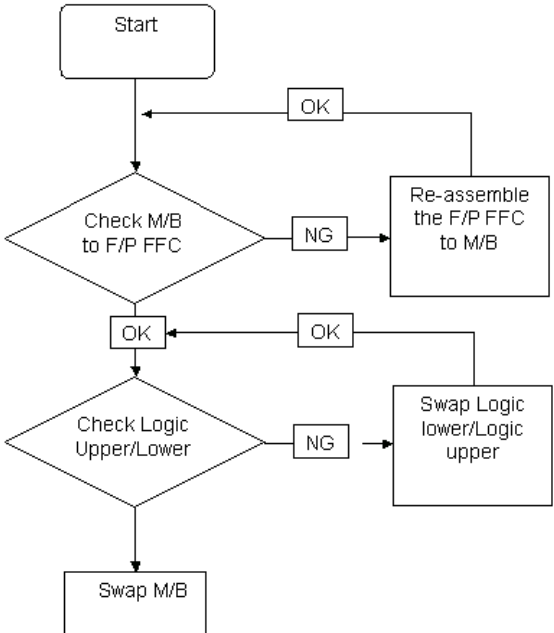

# Thermal Unit Failure

If the **Thermal Unit** fails, perform the following actions one at a time to correct the problem. Do not replace a non-defective FRUs:

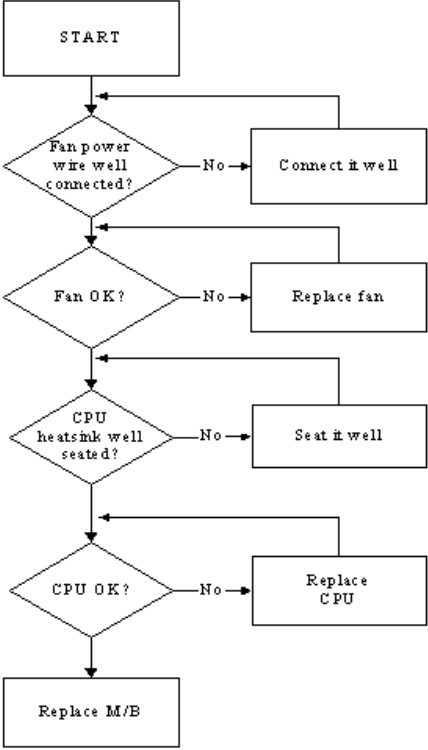

# HDTV Switch Failure

If the **HDTV Switch** fails, perform the following actions one at a time to correct the problem. Do not replace a non-defective FRUs:

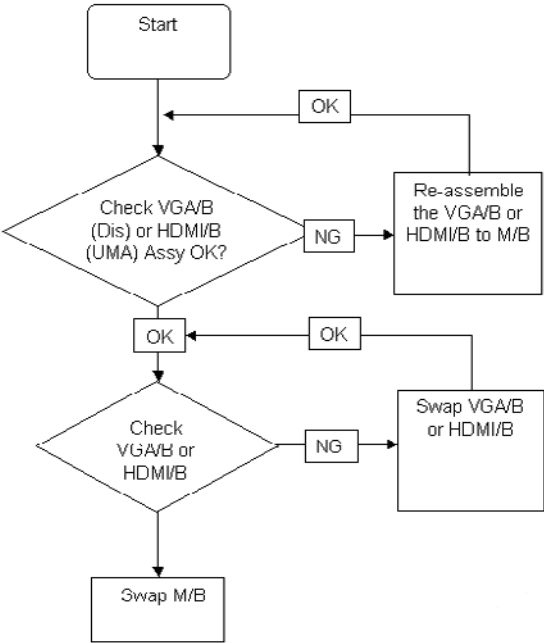

---

## External Mouse Failure

If an external **Mouse** fails, perform the following actions one at a time to correct the problem.

1. Try an alternative mouse.
2. If the mouse uses a wireless connection, insert new batteries and confirm there is a good connection. See the mouse user manual.
3. If the mouse uses a USB connection, try an alternate USB port.
4. Try an alternative program to verify mouse operation. Reinstall the program experiencing mouse failure.
5. Restart the computer.
6. Remove any recently added hardware and associated software.
7. Remove any recently added software and reboot.
8. Restore system and file settings from a known good date using **System Restore**.

If the issue is not fixed, repeat the preceding steps and select an earlier time and date.

9. Run the Event Viewer to check the events log for errors. For more information see Windows Help and Support.
10. Roll back the mouse driver to the previous version if updated recently.
11. Remove and reinstall the mouse driver.
12. Check the Device Manager to determine that:
  - The device is properly installed. There are no red Xs or yellow exclamation marks.
  - There are no device conflicts.
  - No hardware is listed under Other Devices.
13. If the Issue is still not resolved, see "Online Support Information" on page 195.

## Other Failures

If the CRT Switch, Dock, LAN Port, external MIC or Speakers, PCI Express Card, 5-in-1 Card Reader or Volume Wheel fail, perform the following general steps to correct the problem. Do not replace a non-defective FRUs:

1. Check Drive whether is OK.
2. Check Test Fixture is ok.
3. Swap M/B to Try.



---

# Intermittent Problems

Intermittent system hang problems can be caused by a variety of reasons that have nothing to do with a hardware defect, such as: cosmic radiation, electrostatic discharge, or software errors. FRU replacement should be considered only when a recurring problem exists.

When analyzing an intermittent problem, do the following:

1. Run the advanced diagnostic test for the system board in loop mode at least 10 times.
2. If no error is detected, do not replace any FRU.
3. If any error is detected, replace the FRU. Rerun the test to verify that there are no more errors.

# Undetermined Problems

The diagnostic problems does not identify which adapter or device failed, which installed devices are incorrect, whether a short circuit is suspected, or whether the system is inoperative.

Follow these procedures to isolate the failing FRU (do not isolate non-defective FRU).

**NOTE:** Verify that all attached devices are supported by the computer.

**NOTE:** Verify that the power supply being used at the time of the failure is operating correctly. (See “Power On Issue” on page 130.):

1. Power-off the computer.
2. Visually check them for damage. If any problems are found, replace the FRU.
3. Remove or disconnect all of the following devices:
  - Non-Acer devices
  - Printer, mouse, and other external devices
  - Battery pack
  - Hard disk drive
  - DIMM
  - CD-ROM/Diskette drive Module
  - PC Cards
4. Power-on the computer.
5. Determine if the problem has changed.
6. If the problem does not recur, reconnect the removed devices one at a time until you find the failing FRU.
7. If the problem remains, replace the following FRU one at a time. Do not replace a non-defective FRU:
  - System board
  - LCD assembly

# POST Codes Tables

These tables describe the chipset and core POST codes, functions, phases, and components for the POST.

## Chipset POST Codes

The following table details the chipset POST codes and functions used in the POST.

POST Code	Function	Phase	Component
0xA0	MRC Entry	PEI	chipset/MRC
0x01	Enable MCHBAR	PEI	chipset/MRC
0x02	Check ME existence	PEI	chipset/MRC
0x03	Check for DRAM initialization interrupt and reset fail	PEI	chipset/MRC
0x04	Determine the system Memory type based on first populated socket	PEI	chipset/MRC
0x05	Verify all DIMMs are DDR2 and SO-DIMMS, which are unbuffered	PEI	chipset/MRC
0x06	Verify all DIMMs are Non-ECC	PEI	chipset/MRC
0x07	Verify all DIMMs are single or double sided and not mixed	PEI	chipset/MRC
0x08	Verify all DIMMs are x8 or x16 width	PEI	chipset/MRC
0x09	Calculate number of Row and Column bits	PEI	chipset/MRC
0x10	Calculate number of banks for each DIMM	PEI	chipset/MRC
0x11	Determine raw card type	PEI	chipset/MRC
0x12	Find a common CAS latency between the DIMMS and the MCH	PEI	chipset/MRC
0x13	Determine the memory frequency and CAS latency to program	PEI	chipset/MRC
0x14	Determine the smallest common timing value for all DIMMS	PEI	chipset/MRC
0x17	Power management resume	PEI	chipset/MRC
0x18	Program DRAM type (DDR2/DDR3) and Power up sequence	PEI	chipset/MRC
0x19	Program the correct system memory frequency	PEI	chipset/MRC
0x20	Program the correct Graphics memory frequency	PEI	chipset/MRC
0x21	Early DRC initialization	PEI	chipset/MRC
0x22	Program the DRAM Row Attributes and DRAM Row Boundary registers PRE JEDEC.	PEI	chipset/MRC
0x23	Program the RCOMP SRAM registers	PEI	chipset/MRC
0x24	Program DRAM type (DDR2/DDR3) and Power up sequence	PEI	chipset/MRC
0x25	Program the DRAM Timing	PEI	chipset/MRC
0x26	Program the DRAM Bank Architecture register	PEI	chipset/MRC
0x27	Enable all clocks on populated rows	PEI	chipset/MRC
0x28	Program MCH ODT	PEI	chipset/MRC
0x29	Program tRD	PEI	chipset/MRC
0x30	Miscellaneous Pre JEDEC steps	PEI	chipset/MRC
0x31	Program clock crossing registers	PEI	chipset/MRC

POST Code	Function	Phase	Component
0x32	Program the Egress port timings	PEI	chipset/MRC
0x33	Program the Memory IO registers	PEI	chipset/MRC
0x34	Perform steps required before JEDEC	PEI	chipset/MRC
0x35	Perform JEDEC memory initialization for all memory rows	PEI	chipset/MRC
0x36	Setup DRAM control register for normal operation and enable	PEI	chipset/MRC
0x37	Do ZQ calibration for DDR3	PEI	chipset/MRC
0x38	Perform final Dra/Drb programming, Set the mode of operation for the memory channels	PEI	chipset/MRC
0x39	Set Enhanced addressing mode for each channel	PEI	chipset/MRC
0x40	Perform steps required after JEDEC init	PEI	chipset/MRC
0x41	Program the receive enable reference timing control register	PEI	chipset/MRC
0x42	Post receive enable initialization	PEI	chipset/MRC
0x43	Enable sense amps. Reset read/write DQS pointers	PEI	chipset/MRC
0x44	Perform ME steps	PEI	chipset/MRC
0x45	Clear DRAM initialization bit in the ICH.	PEI	chipset/MRC
0x46	Program Thermal Management	PEI	chipset/MRC
0x47	Program TS on DIMM	PEI	chipset/MRC
0x48	Program TS on Board	PEI	chipset/MRC
0xAF	Exit MRC	PEI	chipset/MRC
0xE0	#define MEM_ERR_BAD_DIMM (S11)	PEI	chipset/MRC
0xE1	#define MEM_ERR_ECC_DIMM (S06)	PEI	chipset/MRC
0xE2	#define MEM_ERR_SIDES (S07)	PEI	chipset/MRC
0xE3	#define MEM_ERR_WIDTH (S08, S10)	PEI	chipset/MRC
0xE4	#define MEM_ERR_TRFC (FindTrasTrpTrcd)	PEI	chipset/MRC
0xE5	#define MEM_ERR_CAS_LATENCY (S12, S13)	PEI	chipset/MRC
0xE6	#define MEM_ERR_REFRESH (ProgDrt)	PEI	chipset/MRC
0xE7	#define MEM_ERR_BL8 (S14)	PEI	chipset/MRC
0xE9	#define MEM_ERR_FREQUENCY (findTCLTacTCIk, S13, S12, ProgramGraphicsFrequency, ProgMchOdt, GetPlatformData)	PEI	chipset/MRC
0xEA	#define MEM_ERR_SIZE (S14)	PEI	chipset/MRC
0xEC	#define MEM_ERR_TRAS (FindTrasTrpTrcd)	PEI	chipset/MRC
0xED	#define MEM_ERR_TRP (FindTrasTrpTrcd)	PEI	chipset/MRC
0xEE	#define MEM_ERR_TRCD (FindTrasTrpTrcd)	PEI	chipset/MRC
0xEF	#define MEM_ERR_TWR (FindTrasTrpTrcd)	PEI	chipset/MRC
0xF0	#define MEM_ERR_RCVEN_FINDLOW (CalibrateRcvenForGroup)	PEI	chipset/MRC
0xF1	#define MEM_ERR_RCVEN_FINDEDGE (CalibrateRcvenForGroup)	PEI	chipset/MRC
0xF2	#define MEM_ERR_RCVEN_FINDPREAMBLE (CalibrateRcvenForGroup)	PEI	chipset/MRC
0xF6	#define MEM_ERR_RCVEN_PREAMBLEEDGE (CalibrateRcvenForGroup)	PEI	chipset/MRC

POST Code	Function	Phase	Component
0xF3	#define MEM_ERR_RCVEN_FINDCENTER (CalibrateRcvenForGroup)	PEI	chipset/MRC
0xFZ	#define MEM_ERR_TYPE (S11, S04)	PEI	chipset/MRC
0xF5	#define MEM_ERR_RAWCARD (S11)	PEI	chipset/MRC
0xFA	#define MEM_ERR_SFF (ProgWrioDll)	PEI	chipset/MRC
0xFB	#define MEM_ERR_THERMAL (ProgramThrottling)	PEI	chipset/MRC
0xA0xx	Launch BIOS ACMSclean	PEI	chipset/TXT
0xA4xx	Launch BIOS ACMScheck	PEI	chipset/TXT
0xE5	Wait for ME ready	DXE	HECI/iAMT
0xE6	ME Ready	DXE	HECI/iAMT

## Core POST Codes

The following table details the core POST codes and functions used in the POST.

POST Code	Function	Phase	Component
0x00	Early Microcode update for CAR	CEI / SEC	Core
0x01	Enable CAR	CEI / SEC	Core
0x02	CAR Done, initial stack	CEI / SEC	Core
0xEE	unknown CPU ID to load uCode	CEI / SEC	CPU
0xEF	unknown DT CPU to load uCode	CEI / SEC	CPU
0xnn	File count found in a volume	PEI	Core
0x11	Debug Test driver for debug test PPI 1 (If install debugTest driver)	PEI	Core
0x22	Debug Test driver for debug test PPI 2 (If install debugTest driver)	PEI	Core
0x33	Debug Test driver for debug test PPI 3 (If install debugTest driver)	PEI	Core
0x44	Entry point of loadfile	PEI	Core
0x88	Entry point of apMuLoader	PEI	Core
0x80	A PEIM found	PEI	Core
0x82	PEIM not dispatched yet	PEI	Core
0x84	PEIM satisfies depex	PEI	Core
0x86	Image loaded but fail on security	PEI	Core
0x88	Executing a PEIM	PEI	Core
0x8A	Processing notify event for newly installed PPI	PEI	Core
0x8C	Handing off to next phase (DXE)	PEI	Core
0x8F	Fail to hand off to next phase, system halt	PEI	Core
0x90	All PEIM dispatched! Going to DxeIpl	PEI	Core
0xCC	AP Micro-code update	PEI	Core
0x20	S3 resume entry	S3 resume	Core
0x21	Start running Boot-time bootscripts	S3 resume	Core
0x22	Start running Run-time bootscripts	S3 resume	Core
0x23	End of S3 resume, jump back to Waking vector	S3 resume	Core
0x80	Initialize the chipset	Crisis Recovery	Core
0x81	Initialize the bridge	Crisis Recovery	Core

POST Code	Function	Phase	Component
0x82	Initialize the CPU	Crisis Recovery	Core
0x89	Set Huge Segment	Crisis Recovery	Core
0x83	Initialize system timer	Crisis Recovery	Core
0x84	Initialize system I/O	Crisis Recovery	Core
0x88	Initialize Multi Processor	Crisis Recovery	Core
0x8A	Initialize OEM special code	Crisis Recovery	Core
0x8B	Initialize PIC and DMA	Crisis Recovery	Core
0x8C	Initialize Memory type	Crisis Recovery	Core
0x8D	Initialize Memory size	Crisis Recovery	Core
0x8F	Initialize SMM	Crisis Recovery	Core
0x90	System memory test	Crisis Recovery	Core
0x91	Initialize interrupt vectors	Crisis Recovery	Core
0x92	Initialize Run Time Clock	Crisis Recovery	Core
0x99	Initialize security	Crisis Recovery	Core
0x93	Initialize video	Crisis Recovery	Core
0x94	Output one beep	Crisis Recovery	Core
0x98	USB Initialization	Crisis Recovery	Core
0x95	Initialize the installed boot devices	Crisis Recovery	Core
0x96	Clear Huge segment	Crisis Recovery	Core
0x97	Boot Crisis Disk	Crisis Recovery	Core
0x20	DXE starts	DXE	Core
0x30	BIOSPSM	DXE	Core
0x02	BIOSBlockIO	DXE	Core
0x00	BIOSPSM Exception Handler - Divide error	BIOSPSM	Core
0x38	Cannot locate LegacyRegion DXE	BIOSPSM	Core
0xB1	ACPISupport driver Installed	DXE	Core
0xE0	BDS Entry	DXE	Core
0x07	IA32 variable driver entry	DXE	Core
0x0D	conspliter driver entry	DXE	Core
0x10	partition driver entry	DXE	Core
0x49	pciRootBridge driver entry	DXE	Core
0xC6	pciBusDriver entry	DXE	Core
0xE0	Go to legacy BIOS or BDS Entry Point	DXE	Core
0x90	Start Image	DXE	Core
0x90	Start Image Successfully	DXE	Core
0x90	Start Image Failed	DXE	Core
0x33	Debug Test driver for debug test PPI 1	DXE	Core
0x22	Debug Test driver for debug test PPI 2	DXE	Core
0x11	Debug Test driver for debug test PPI 3	DXE	Core
0x02	Invalid event # for measuring Separator Event	DXE	TCG
0x02	Invalid event # for measuring Separator Event	DXE	TCG
0x02	PCR Index over limit (PCR > 23)	DXE	TCG
0x02	TCG copy memory failed	DXE	TCG

POST Code	Function	Phase	Component
0x09	TCG log event failed	DXE	TCG
0x09	Setup event log failed	DXE	TCG
0x12	TIS set active locality failed	DXE	TCG
0x12	TIS relinquish active locality failed	DXE	TCG
0x12	TIS wait command ready failed (prepare to send)	DXE	TCG
0x12	TIS abort 'send 'command due to timeout	DXE	TCG
0x12	TIS abort 'sendAndGo 'command due to timeout	DXE	TCG
0x04	TIS wait bit set failed before send last byte	DXE	TCG
0x12	TIS abort command due to timeout before send last byte	DXE	TCG
0x04	TIS wait bit clear failed when sending last byte	DXE	TCG
0x22	TCG Physical Presence execution	DXE	TCG
0xB1	TCG DXE common pass through	DXE	TCG
0xE3	First Legacy BIOS Task table for legacy reset	LBT	Core
0x20	Verify that DRAM refresh is operating by polling the refresh bit in PORTB.	LBT	Core
0xDA	Dummy PCIE Init entry, now handled by driver	LBT	Core
0x29	PMM (POST Memory Manager) init	LBT	Core
0xE5	WHEA init	LBT	Core
0x33	PDM (Post Dispatcher Manager) init	LBT	Core
0x01	IPMI init	LBT	Core
0xD8	ASF Init	LBT	Core
0x09	Set in-POST flag in CMOS that indicates we are in POST. If this bit is not cleared by postClearBootFlagJ (AEh), the TrustedCore on next boot determines that the current configuration caused POST to fail and uses default values for configuration.	LBT	Core
0x2B	Enhanced CMOS init	LBT	Core
0xE0	EFI Variable Init	LBT	Core
0xC1	PEM (Post Error Manager) init	LBT	Core
0x3B	Debug Service Init (ROM Polit)	LBT	Core
0xDC	POST Update Error	LBT	Core
0x3A	Autosize external cache and program cache size for enabling later in POST.	LBT	Core
0x0B	Enable CPU cache. Set bits in cmos related to cache.	LBT	Core
0x0F	Enable the local bus IDE as primary or secondary depending on other drives detected.	LBT	Core
0x10	Initialize Power Management.	LBT	Core
0x14	Verify that the 8742 keyboard controller is responding. Send a self-test command to the 8742 and wait for results. Also read the switch inputs from the 8742 and write the keyboard controller command byte.	LBT	Core

POST Code	Function	Phase	Component
0x1A	Initialize DMA command register with these settings: 1. Memory to memory disabled 2. Channel 0 hold address disabled 3. Controller enabled 4. Normal timing 5. Fixed priority 6. Late write selection 7. DREQ sense active 8. DACK sense active low.	LBT	Core
0x22	Reset the keyboard.	LBT	Core
0x40	Test A20 line	LBT	Core
0x67	Quick initialization of all Application Processors in a multi-processor system	LBT	Core
0x32	Compute CPU speed.	LBT	Core
0x69	Initialize the handler for SMM.	LBT	Core
0x6B	If CMOS is bad, load Custom Defaults from flash into CMOS. If successful, reboot.	LBT	Core
0x3C	If CMOS is valid, load chipset registers with values from CMOS, otherwise load defaults and display Setup prompt. If Auto Configuration is enabled, always load the chipset registers with the Setup defaults (Rel 6.0).	LBT	Core
0x3D	Load alternate registers with CMOS values	LBT	Core
0x42	Initialize interrupt vectors 0 thru 77h	LBT	Core
0x46	Verify the ROM copyright notice	LBT	Core
0x45	Initialize all motherboard devices.	LBT	Core
0x49	1. Size the PCI bus topology and set bridge bus numbers. 2. Set the system max bus number. 3. Write a 0 to the command register of every PCI device. 4. Write a 0 to all 6 base registers in every PCI device. 5. Write a -1 to the status register of every PC	LBT	Core
0xC6	Initialize note dock	LBT	Core
0xC5	PnPnd dual CMOS (optional)	LBT	Core
0x48	Verify that the equipment specified in the CMOS matches the hardware currently installed. If the monitor type is set to 00 then a video ROM must exist. If the monitor type is 1 or 2 set the video switch to CGA. If monitor type 3, set the video switch to m	LBT	Core
0xD1	Initialize BIOS stack	LBT	Core
0xD3	Setup E820h and WAD memory map	LBT	Core
0x24	Set segment-register addressability to 4 GB	LBT	Core
0xCC	Redirect Int 10h to enable target board to use a remote serial video (PICO BIOS).	LBT	Core
0x8A	Initialize Extended BIOS Data Area and initialize the mouse.	LBT	Core
0x9D	Initialize Security Engine.	LBT	Core
0x55	USB Initialization	LBT	Core
0x52	Verify keyboard reset.	LBT	Core
0x54	Initialize keystroke clicker if enabled in Setup.	LBT	Core
0x76	Check status bits for keyboard-related failures. Display error messages on the screen.	LBT	Core
0x4A	Initialize all video adapters in system	LBT	Core



POST Code	Function	Phase	Component
0x4C	Shadow video BIOS ROM if specified by Setup, and CMOS is valid and the previous boot was OK.	LBT	Core
0x59	Register POST Display Services, fonts, and languages with the POST Dispatch Manager.	LBT	Core
0x57	Initialize 1394 Firewire	LBT	Core
0xD6	Initialize PC card	LBT	Core
0x58	Test for unexpected interrupts. First do an STI for hot interrupts. Secondly, test the NMI for an unexpected interrupt. Thirdly, enable the parity checkers and read from memory, checking for an unexpected interrupt.	LBT	Core
0x3F	ROMPolit memory init	LBT	Core
0xC4	Install the IRQ vectors (Sever Hotkey)	LBT	Core
0x7C	Initialize the hardware interrupt vectors from 08 to 0F and from 70h to 77H. Also set the interrupt vectors from 60h to 66H to zero.	LBT	Core
0x41	ROM Pilot Init	LBT	Core
0x4B	Initialize QuietBoot if it is installed. Enable both keyboard and timer interrupts (IRQ0 and IRQ1). If your POST tasks require interrupts off, preserve them with a PUSHF and CLI at the beginning and a POPF at the end.	LBT	Core
0xDE	Initialize and UNDI ROM (fro remote flash)	LBT	Core
0xC6	Initial and install console for UCR	LBT	Core
0x4E	Display copyright notice.	LBT	Core
0xD4	Get CPU branding string	LBT	Core
0x50	Display CPU type and speed	LBT	Core
0xC9	pretask before EISA init	LBT	Core
0x51	EISA Init	LBT	Core
0x5A	Display prompt "Press F2 to enter SETUP"	LBT	Core
0x5B	Disable CPU cache.	LBT	Core
0x5C	Test RAM between 512K and 640K.	LBT	Core
0x60	Determine and test the amount of extended memory available. Determine if memory exists by writing to a few strategic locations and see if the data can be read back. If so, perform an address-line test and a RAM test on the memory.	LBT	Core
0x62	The amount of memory available. This test is dependent on the processor, since the test will vary depending on the width of memory (16 or 32 bits). This test will also use A20 as the skew address to prevent corruption of the system memory.	LBT	Core
0x64	Jump to UserPatch1.	LBT	Core
0x66	Set cache registers to their CMOS values if CMOS is valid, unless auto configuration is enabled, in which case load cache registers from the Setup default table.	LBT	Core
0x68	Enable external cache and CPU cache if present. Configure non-cacheable regions if necessary.	LBT	Core

POST Code	Function	Phase	Component
0x6A	Display external cache size on the screen if it is non-zero.	LBT	Core
0x6C	Display shadow message	LBT	Core
0xCA	post EISA init	LBT	Core
0x70	Check flags in CMOS and in the TrustedCore data area for errors detected during POST. Display error messages on the screen.	LBT	Core
0x72	Check status bits to see if configuration problems were detected. If so, display error messages on the screen.	LBT	Core
0x4F	Initialize MultiBoot. Allocate memory for old and new MultiBoot history tables.	LBT	Core
0xCD	Reclaim console vector after HW vectors initialized.	LBT	Core
0x7D	Initialize Intelligent System Monitoring.	LBT	Core
0x7E	The Coprocessor initialization test. Use the floating point instructions to determine if a coprocessor exists instead of the ET bit in CR0.	LBT	Core
0xC1	Check Boot Type (Server BIOS)	LBT	Core
0x80	Disable onboard COM and LPT ports before testing for presence of external I/O devices.	LBT	Core
0xCA	Redirect Int 15h to enable target board to use remote keyboard (PICO BIOS).	LBT	Core
0x88	Initialize interrupt controller.	LBT	Core
0x81	Run late device initialization routines.	LBT	Core
0x87	Initialize motherboard configurable devices.	LBT	Core
0x85	Display any ESCD read errors and configure all PnP ISA devices.	LBT	Core
0x82	Test and identify RS232 ports.	LBT	Core
0x84	Test and identify parallel ports.	LBT	Core
0x86	Initialize onboard I/O and BDA according to CMOS and presence of external devices.	LBT	Core
0x83	Configure Fisk Disk Controller.	LBT	Core
0xCE	Initialize digitizer device and display installed message if successful.	LBT	Core
0x89	Enable non-maskable interrupts.	LBT	Core
0x8C	Initialize both of the floppy disks and display an error message if failure was detected. Check both drives to establish the appropriate diskette types in the TrustedCore data area	LBT	Core
0xCB	Redirect Int 13h to Memory Technologies Devices such as ROM, RAM, PCMCIA, and serial disk (PICO BIOS).	LBT	Core
0xCD	Remap I/O and memory address space for PCMCIA (PICO BIOS).	LBT	Core
0x90	Initialize hard-disk controller. If the CMOS ram is valid and intact, and fixed disks are defined, call the fixed disk init routine to initialize the fixed disk system and take over the appropriate interrupt vectors.	LBT	Core

POST Code	Function	Phase	Component
0x8B	Setup interrupt vector and present bit in Equipment byte.	LBT	Core
0x95	1. Check CMOS for CD-ROM drive present 2. Activate the drive by checking for media present 3. Check sector 11h (17) for Boot Record Volume Descriptor 4. Check the boot catalog for validity 5. Pick a boot entry 6. Create a Specification Packet	LBT	Core
0x92	Jump to UserPatch2.	LBT	Core
0xB6	If password on boot is enabled, a call is made to Setup to check password. If the user does not enter a valid password, Setup does not return.	LBT	Core
0x98	Search for option ROMs. Rom scan the area from C800h for a length of BCP_ROM_Scan_Size (or to E000h by default) on every 2K boundary, looking for add on cards that need initialization.	LBT	Core
0x93	Build the MPTABLE for multi-processor boards	LBT	Core
0xD9	IPMI late init	LBT	Core
0x9C	Set up Power Management. Initiate power - management state machine.	LBT	Core
0xC7	Late note dock init	LBT	Core
0x9E	Enable hardware interrupts	LBT	Core
0xA0	Setup time tick for current date/time	LBT	Core
0xA2	Setup Numlock indicator. Display a message if key switch is locked.	LBT	Core
0xA4	Initialize typematic rate	LBT	Core
0xDB	StrongROM Test	LBT	Core
0xE2	OEM security key test	LBT	Core
0xC2	Write PEM errors.	LBT	Core
0xBA	Initialize the SMBIOS header and sub-structures.	LBT	Core
0xC3	Display PEM errors.	LBT	Core
0xA8	Overwrite the "Press F2 for Setup" prompt with spaces, erasing it from the screen.	LBT	Core
0xAA	Scan the key buffer to see if the F2 key was struck after keyboard interrupts were enabled. If an F2 keystroke is found, set a flag.	LBT	Core
0xE1	Start Periodic Timer (TC Subscribe)	LBT	Core
0xAC	Check if "Enter SETUP" is pressed.	LBT	Core
0x8F	Count the number of ATA drives in the system and update the number in bdaFdiskcount.	LBT	Core
0x91	Configure the local bus IDE timing register based on the drives attached to it.	LBT	Core
0x9F	Check the total number of Fast Disks (ATA and SCSI) and update the bdaFdiskCount.	LBT	Core
0xD7	Check if FirstWare HPA exists	LBT	Core
0xAE	Clear ConfigFailedBit and InPostBit in CMOS.	LBT	Core
0xB0	Check for errors and decide if needs to run Setup.	LBT	Core
0xB2	Change status bits in CMOS and/or the TrustedCore data area to reflect the fact that POST is complete.	LBT	Core

POST Code	Function	Phase	Component
0xB5	Fade out OEM Logo or post string	LBT	Core
0xC5	End hotkey detection (Server BIOS)	LBT	Core
0xBE	If BCP option is enabled, clear the screen before booting.	LBT	Core
0xB6	If password on boot is enabled, a call is made to Setup to check password. If the user does not enter a valid password, Setup does not return.	LBT	Core
0xBC	Clear parity-error latch	LBT	Core
0xB7	Initialize ACPI BIOS.	LBT	Core
0x9B	Enable CPU management (Geyserville I)	LBT	Core
0xBD	Display Boot First menu if MultiBoot is installed and hotkey pressed.	LBT	Core
0xBF	Check virus and backup reminders.	LBT	Core
0x97	Create pointer to MP table in Extended BDA.	LBT	Core
0x99	Check support status for Self-Monitoring Analysis Reporting Technology (disk-failure warning).	LBT	Core
0xB1	Unload ROM Pilot	LBT	Core
0xDD	Perform remote flash if requested	LBT	Core
0xC7	If UCR redirection is installed, remove display manager and unhook INT10	LBT	Core
0XDF	Shutdown the PXE UNDI code	LBT	Core
0xB3	Store enhanced CMOS values in non-volatile area	LBT	Core
0xE4	Last Legacy BIOS Task before hand off to UEFI/DXE	LBT	Core
0xB9	Clear all screen graphics before booting.	bootLegacy	Core
0xC0	INT19 entry for legacy boot	bootLegacy	Core
0xEF	Invalid AP #	SDXE	Core
0xEF	Non-Yohna and non-Morem class CPU found for SDXE (getTSCFreq)	SDXE	Core
0xEE	AP cannot synch BSP in SDXE (syncWithBSP)	SDXE	Core
0xEE	BSP cannot synch w/ AP in SDXE (syncWithAP)	SDXE	Core

# Jumper and Connector Locations

## Top View

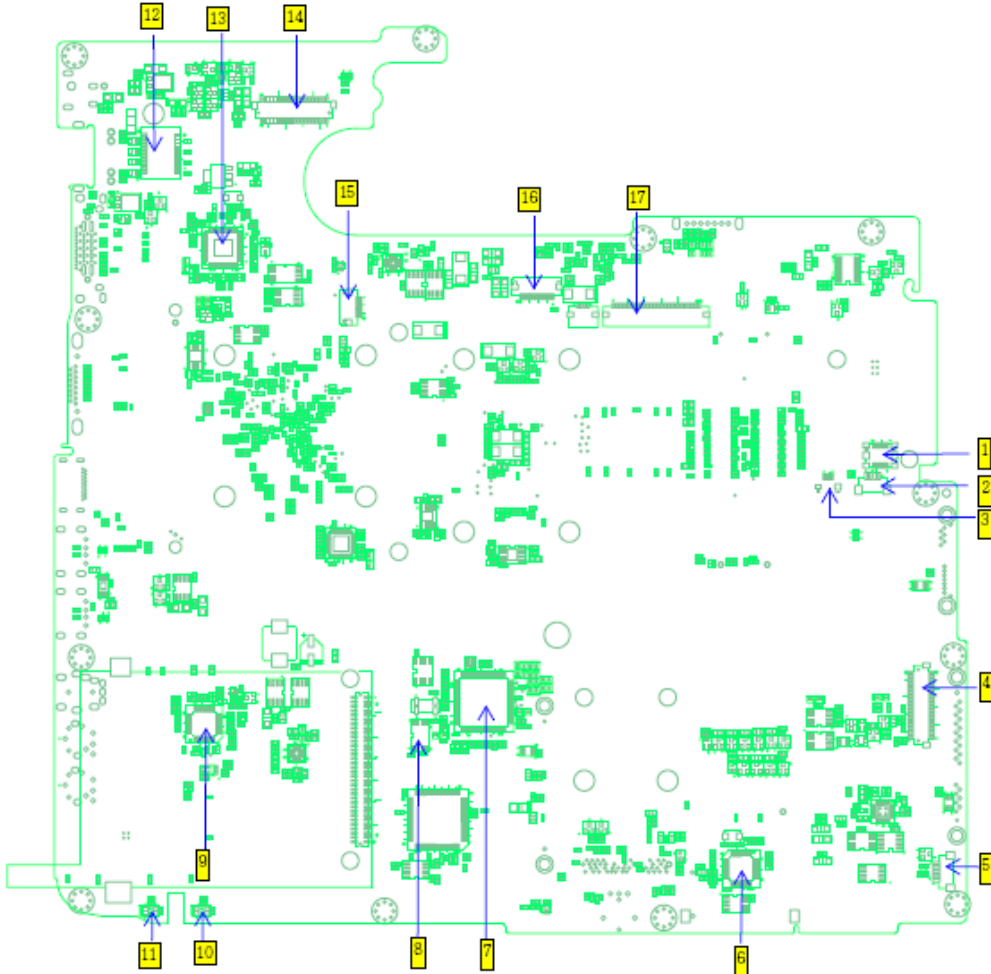

No.	Jumper	Description	No.	Jumper	Description
1	CN5	MODEM CONN.	10	LED2	BATTERY LED
2	CN7	FINGER CONN.	11	LED1	SYSTEM LED
3	CN6	TOUCH PAD CONN.	12	U1	TRANSFORMER
4	CN8	NEW CARD CONN.	13	U2	LAN CHIP
5	CN10	BLUE TOOTH CONN.	14	CH1	LCD CONN.
6	U17	CARD READER CHIP	15	CN3	SWITCH BOARD CONN.
7	U12	EC WINBOND	16	CN2	POWER BOARD CONN.
8	U14	BIOS	17	CN4	KEYBOARD CONN.
9	U13	AUDIO CHIP			

# Bottom View

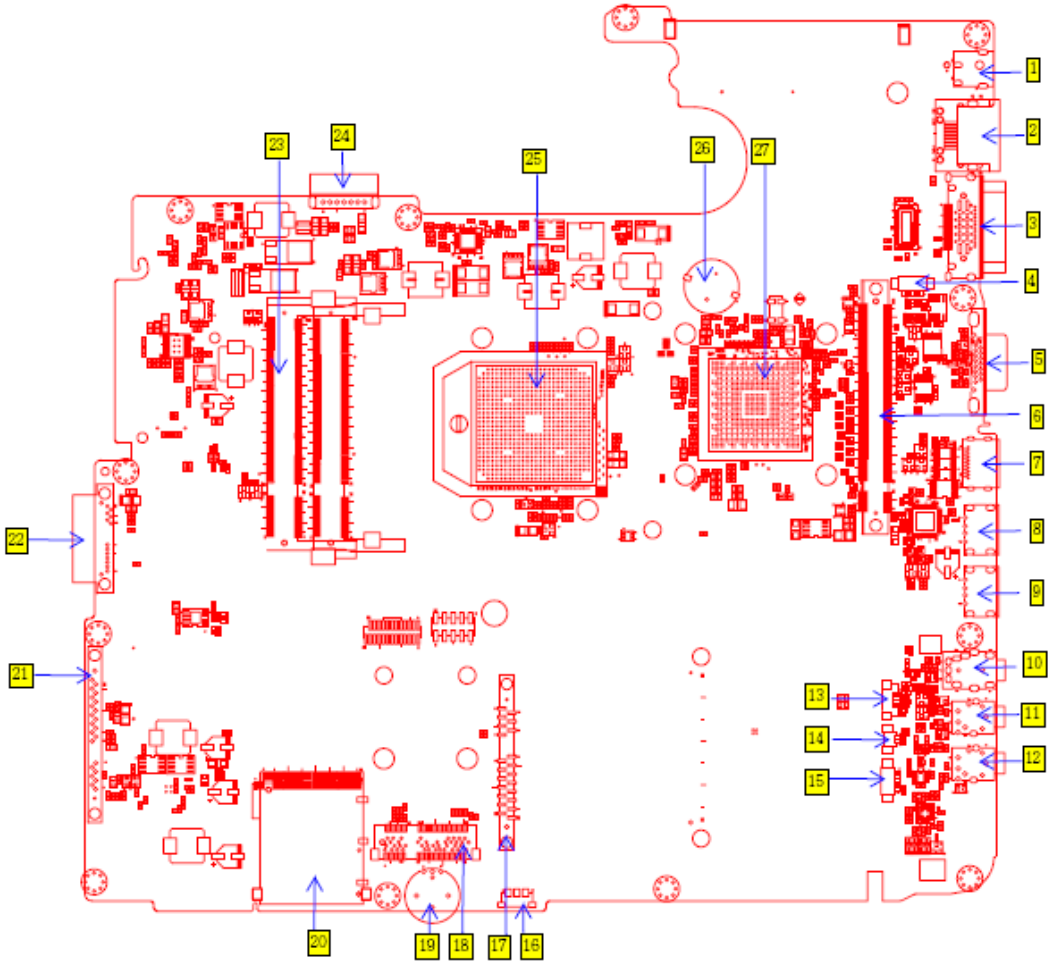

No.	Jumper	Description	No.	Jumper	Description
1	PJ1	DC JACK	15	CN30	SUBWOOFER CONN.
2	CN11	RJ5 CONN.	16	U34	CIR
3	CN12	DOCKING CONN.	17	CN28	2nd HDD CONN.
4	CN14	FAN CONN.	18	CN33	MINI CARD
5	CN15	CRT CONN.	19	VR1	VOLUME WHEEL
6	CN16	MXM CONN.	20	CN31	CARD READER
7	CN17	HDMI CONN.	21	CN26	1st HDD CONN.
8	CN18	USB CONN.	22	CN19	ODD CONN.
9	CN20	USB CONN.	23	J1	SODIMM CONN.
10	CN29	S/PDIF JACK	24	PCN1	BATTERY CONN.
11	CN25	MIC CONN.	25	T90	CPU SOCKET
12	CN23	LINE-IN CONN.	26	CN13	RTC SOKET
13	CN27	SPEAKER CONN.	27	U24	NVIDIA MCP7
14	CN24	MIC CONN.			

# Clearing Password Check and BIOS Recovery

This section provide you the standard operating procedures of clearing password and BIOS recovery for Aspire 7230/7530/7530G. Aspire 7230/7530/7530G provide one Hardware Open Gap on main board for clearing password check, and one Hotkey for enabling BIOS Recovery.

## Clearing Password Check

### Hardware Open Gap Description

Item	Description
G1	Clear CMOS Jumper



### Steps for Clearing BIOS Password Check

If users set BIOS Password (Supervisor Password and/or User Password) for a security reason, BIOS will ask the password during systems POST or when systems enter to BIOS Setup menu. However, once it is necessary to bypass the password check, users need to short the G1 jumper to clear the password.

To reset the Supervisor and User BIOS passwords, perform the following steps:

- Power Off the system and remove the AC power and battery pack from the machine.
- Open the back cover of the machine (DDR & Thermal)
- Remove the CMOS battery form battery socket on M/B.
- Use an electric conductivity tool to short the Short G1 jumper near CMOS battery.
- Replace the CMOS battery, battery pack, and AC power and start the system.
- Hit **F2** to enter BIOS and check the passwords are clear.

**NOTE:** The steps are only for clearing BIOS Password (Supervisor Password and User Password).



---

# BIOS Recovery by Crisis Disk

## BIOS Recovery Boot Block:

BIOS Recovery Boot Block is a special block of BIOS. It is used to boot up the system with minimum BIOS initialization. Users can enable this feature to restore the BIOS firmware to a successful one once the previous BIOS flashing process failed.

## BIOS Recovery Hotkey:

The system provides a function hotkey: **Fn+Esc**, for enable BIOS Recovery process when system is powered on during BIOS POST. To use this function, it is strongly recommended to have the AC adapter and Battery present. If this function is enabled, the system will force the BIOS to enter a special BIOS block, called Boot Block.

## Steps for BIOS Recovery from USB Storage:

Before doing this, prepare the Crisis USB key. The Crisis USB key could be made by executing the Crisis Disk program in another system with Windows XP OS.

Follow the steps below:

1. Save ROM file (file name: **JAL90x64.fd**) to the root directory of USB storage.
2. Plug USB storage into USB port.
3. Press **Fn + ESC** button then plug in AC.  
The Power button flashes once.
4. Press **Power** button to initiate system CRISIS mode.  
When CRISIS is complete, the system auto restarts with a workable BIOS.
5. Update the latest version BIOS for this machine by regular BIOS flashing process.

## FRU (Field Replaceable Unit) List

---

This chapter gives you the FRU (Field Replaceable Unit) listing in global configurations of Aspire 7230/7530/7530G. Refer to this chapter whenever ordering for parts to repair or for RMA (Return Merchandise Authorization).

Please note that WHEN ORDERING FRU PARTS, you should check the most up-to-date information available on your regional web or channel. For whatever reasons a part number change is made, it will not be noted on the printed Service Guide. For ACER AUTHORIZED SERVICE PROVIDERS, your Acer office may have a DIFFERENT part number code from those given in the FRU list of this printed Service Guide. You MUST use the local FRU list provided by your regional Acer office to order FRU parts for repair and service of customer machines.

NOTE: To scrap or to return the defective parts, you should follow the local government ordinance or regulations on how to dispose it properly, or follow the rules set by your regional Acer office on how to return it.

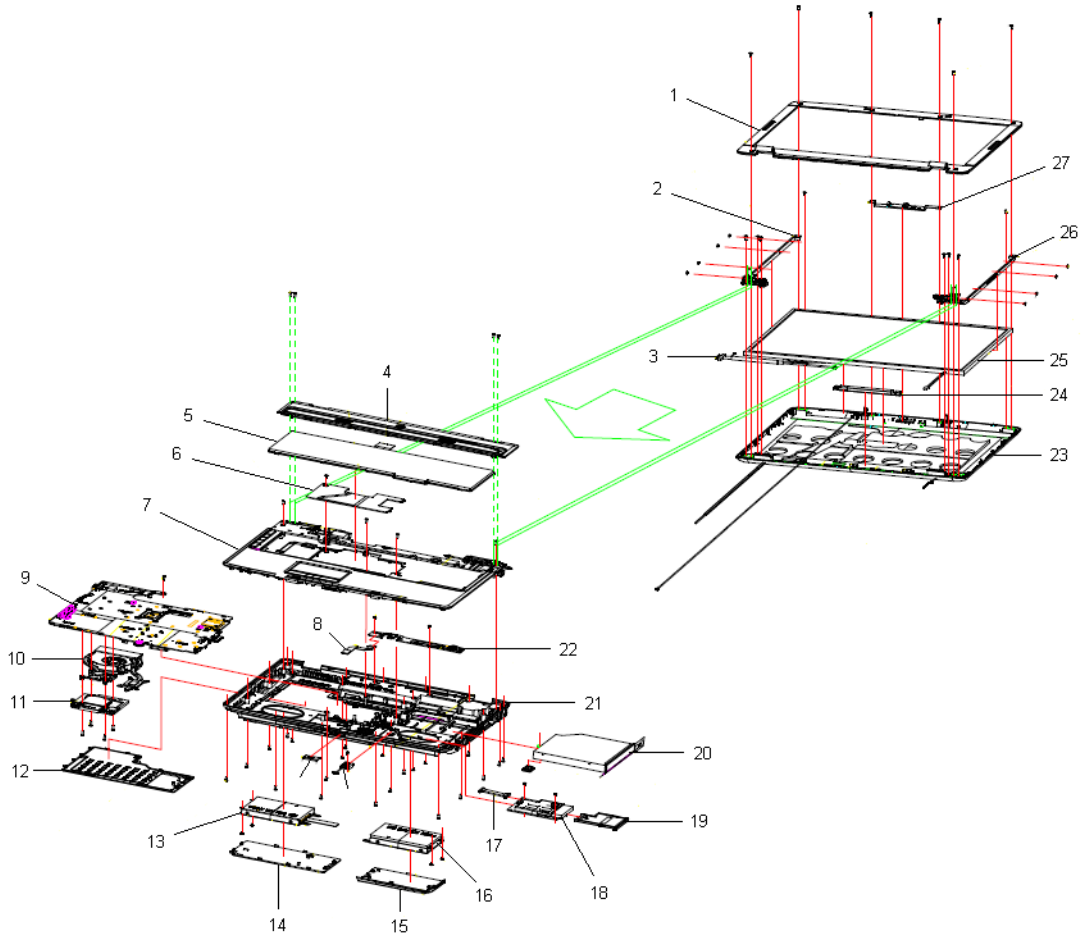

# Aspire 7230/7530/7530G Exploded Diagram



Item	Description	Part Number	Item	Description	Part Number
1	LCD Bezel	60.AR907.005	15	1st HDD Door	42.AR907.003
2	LCD Bracket L	33.AR907.007	16	1st HDD	KH.12004.007
3	LCD Cable	50.AR907.002	17	Card Reader Cable	50.TPK07.002
4	Middle Cover	42.AR907.001	18	Card Reader	55.ARL07.001
5	Keyboard	KB.INT00.478	19	Dummy Express Card	N/A
6	DDR Cover	33.AR907.001	20	ODD	6M.AR907.002
7	Upper Case	60.AS307.001	21	Lower Case	60.AR907.002
8	Power Board Cable	50.AR907.001	22	Power Board	55.ARL07.002
9	Mainboard	MB.ARL06.001	23	LCD Case	60.ARL07.001
10	Thermal Module	60.ARL07.003	24	Inverter Module	19.TPK07.001
11	VGA Module	VG.9MG06.001	25	LCD Panel	6M.ARL07.001
12	Memory Door	42.ARL07.001	26	LCD Bracket R	33.AR907.006
13	2nd HDD Module	KH.12004.007	27	Camera Module	57.ARE07.001
14	2nd HDD Door	42.AR907.004			

# Aspire 7230/7530/7530G FRU List



Category	Description	Acer Part No.
<b>Adapter</b>		
	ADAPTER 65W 3PIN DELTA SADP-65KB DFA	AP.06501.013
	ADAPTER 65W LITEON PA-1650-02AC LF	AP.06503.016
	ADAPTER 65W 3PIN HIPRO AC-OK065B13	AP.0650A.010
	ADAPTER DELTA 90W ADP-90SB BBEA LF	AP.09001.013
	ADAPTER LITE-ON 90W 19V BLUE PA-1900-24AR LED LF	AP.09003.011
<b>Battery</b>		
	Battery SONY AS-2007B Li-Ion 3S2P SONY 6 cell 4400mAh Main COMMON Normal Type	BT.00604.025
	Battery PANASONIC AS-2007B Li-Ion 3S2P PANASONIC 6 cell 4400mAh Main COMMON PSS	BT.00605.021
	Battery SANYO AS-2007B Li-Ion 3S2P SANYO 6 cell 4400mAh Main COMMON Normal Type	BT.00603.042
	Battery SIMPLO AS-2007B Li-Ion 3S2P PANASONIC 6 cell 4400mAh Main COMMON PSS	BT.00607.016
	Battery PANASONIC AS-2007B Li-Ion 4S2P PANASONIC 8 cell 4800mAh Main COMMON	BT.00805.011
	Battery SANYO AS-2007B Li-Ion 4S2P SANYO 8 cell 4800mAh Main COMMON	BT.00803.024
	Battery SIMPLO AS-2007B Li-Ion 4S2P PANASONIC 8 cell 4800mAh Main COMMON PSS	BT.00807.015
<b>Board</b>		
	MODEM BOARD T60M955.02	54.AGW07.001
	BLUETOOTH MODULE (T60H928.11)	BT.21100.005
	WIRELESS LAN CARD FOXCONN T60h976.00 MINI	54.AZL07.001
	NEW CARD BOARD	55.ARL07.001
	POWER BOARD	55.ARL07.002

Category	Description	Acer Part No.
	SWITCH BOARD	55.ARL07.003
	TOUCHPAD BOARD	55.ARL07.004
	TOUCHPAD BOARD W/FP	55.ARL07.005
	EMPOWER BOARD	55.ARL07.006
	MSI VGA Card nVidia NB9M-GS DDRII 256M 400MHz 32*16 MXM I w/ HDCP w/ Intersil PowerIC	VG.9MG06.001
	MSI VGA Card nVidia NB9P-GS DDRIII 512M 800MHz 32*32 MXM II w/ HDCP w/ Intersil PowerIC	VG.9PG06.002
<b>Cable</b>		
	PWR CORD V943B30001218008 DANISH 3P	27.A03V7.006
	PWR CORD(ISR)1.8M 3PBLK FZ0I0008-038	27.TATV7.005
	PWR CORD V50CB3T3012180QD TW-110V,3P	27.A99V7.002
	POWER CORD(SWI)1.8M 3PBLACK FZ010008-011	27.A99V7.004
	POWER CORD(IT) 1.8M 3PBLACK FZ010008-008	27.A99V7.005
	POWER CORD(S.A) 1.8M 3BLACK FZ010008-006	27.T48V7.001
	POWER CORD US 3PIN ROHS	27.TAXV7.001
	POWER CORD(EU) 1.8M 3PBLACK FM010008-010	27.TATV7.001
	POWER CORD(UK) 1.8M 3PBLACK FP010008-013	27.TATV7.003
	BLUETOOTH CABLE	50.TPK07.001
	NEW CARD CABLE	50.TPK07.002
	FFC CABLE - POWER/B TO MB	50.AR907.001

Category	Description	Acer Part No.
<b>Case/Cover/Bracket Assembly</b>		
	MIDDLE COVER	42.AR907.001
	UPPER CASE W/SPEAKER, FFC, CABLE, TP FOR NON-FP	60.AS307.001
	UPPER CASE W/SPEAKER, FFC, CABLE, TP FOR FP	60.AR907.001
	LOWER CASE ASSY W/SUB-WOOF,RJ11 W/O TV	60.AR907.002
	LOWER CASE ASSY W/SUB-WOOF,RJ11,TV OUT CABLE	60.AS307.002
	RAM COVER	42.ARL07.001
	HDD COVER - 1	42.AR907.003
	HDD COVER - 2ND	42.AR907.004
	DDR BRACKET	33.AR907.001
	TP BRACKET	33.AR907.002
	ODD CAP	42.AR907.007

Category	Description	Acer Part No.
<b>CPU/Processor</b>		
	CPU AMD TurionX2 ZM80 PGA 2.1G 2M 638 35W Griffin B1	KC.TZM02.800
	CPU AMD TurionX2 ZM82 PGA 2.2G 2M 638 35W Griffin B1	KC.TZM02.820
	CPU AMD SempronM SI40 PGA 2.0G 512K 638 25W Griffin B1	KC.SSI02.400
	CPU AMD TurionX2 ZM84 PGA 2.3G 2M 638 35W Griffin B1	KC.TZM02.840
	CPU AMD Athlon64X2 QL60 PGA 1.9G 1M 638 35W Griffin B1	KC.AQL02.600
	CPU AMD TurionX2 RM70 PGA 2.0G 1M 638 35W Griffin B1	KC.TRM02.700
<b>Super Multi Drive</b>		
	DVD/RW SUPER MULTI MODULE	6M.AR907.002
	TOSHIBA Super-Multi DRIVE Tray DL 8X TS-L633A LF W/O bezel SATA	KU.00801.021
	ODD HLDS Super-Multi DRIVE 12.7mm Tray DL 8X GSA-T50N LF W/O bezel SATA FW:RP05	KU.0080D.029
	ODD PLDS Super-Multi DRIVE 12.7mm Tray DL 8X DS-8A2S LF W/O bezel SATA	KU.0080F.001
	OPTICAL BRACKET	33.AR907.003
	ODD BEZEL - SUPER MULTI	42.AGW07.004
<b>Combo Drive</b>		
	BLUE RAY COMBO MODULE	6M.AR907.003
	BLUE RAY COMBO TRAY 2X SONY BC-5500S-AR	KO.0020E.002
	OPTICAL BRACKET	33.AR907.003
	BD COMBO BEZEL	42.AR907.006



Category	Description	Acer Part No.
<b>HDD</b>		
	HDD TOSHIBA 5400rpm 120GB MK1246GSX Leo BS SATA I LF F/W:LB213J	KH.12004.007
	HDD WD 5400rpm 120GB WD1200BEVS-22UST0 ML125 SATA LF F/W:01.01A01	KH.12008.019
	HDD(160G) ST9160827AS 9DG133-188 STN B/S SEAGATE F/W:3.AAA	KH.16001.029
	HDD TOSHIBA 5400rpm 160GB MK1646GSX Leo BS SATA I LF F/W:LB113J	KH.16004.002
	HDD HGST 2.5" 5400rpm 160GB HTS542516K9SA00 Bronco-B SATA II LF F/W:C31P	KH.16007.016
	HDD WD 2.5" 5400rpm 160GB WD1600BEVT-22ZCTO ML160 SATA LF F/W:11.01A11	KH.16008.022
	HDD SEAGATE 2.5" 5400rpm 250GB ST9250827AS Corsair SATA LF F/W:3.AAA	KH.25001.011
	HDD TOSHIBA 2.5" 5400rpm 250GB MK2546GSX Leo BS SATA I LF F/W:LB013J	KH.25004.001
	HDD WD 2.5 IN. 5400rpm 250GB WD2500BEVS-22UST0 ML125 SATA LF F/W:01.01A01	KH.25008.018
	HDD 250GB 5400RPM SATA II HGST HTS542525K9SA00 LF F/W:C31P	KH.25007.011
	HDD HGST 5400rpm 120GB HTS542512K9SA00 Bronco- B SATA II LF F/W:C31P	KH.12007.014
	HDD MASTER BRACKET	33.AR907.005
	HDD BRACKET ASSY	33.AR907.004
	HDD CONNECTOR	20.AR907.001

Category	Description	Acer Part No.
<b>Keyboard</b>		
	Keyboard 17KB-FV3 Black Mammoth 105KS Black US International Hebrew	KB.INT00.478
	Keyboard 17KB-FV3 Black Mammoth 105KS Black US International	KB.INT00.478
	Keyboard 17KB-FV3 Black Mammoth 106KS Black UK	KB.INT00.480
	Keyboard 17KB-FV3 Black Mammoth 106KS Black Turkish	KB.INT00.481
	Keyboard 17KB-FV3 Black Mammoth 105KS Black Thailand	KB.INT00.482
	Keyboard 17KB-FV3 Black Mammoth 106KS Black Swiss/G	KB.INT00.483
	Keyboard 17KB-FV3 Black Mammoth 106KS Black Swedish	KB.INT00.484
	Keyboard 17KB-FV3 Black Mammoth 106KS Black Spanish	KB.INT00.485
	Keyboard 17KB-FV3 Black Mammoth 106KS Black Slovak	KB.INT00.486
	Keyboard 17KB-FV3 Black Mammoth 106KS Black SLO/CRO	KB.INT00.487
	Keyboard 17KB-FV3 Black Mammoth 105KS Black Russian	KB.INT00.488
	Keyboard 17KB-FV3 Black Mammoth 106KS Black Portuguese	KB.INT00.489
	Keyboard 17KB-FV3 Black Mammoth 106KS Black Polish	KB.INT00.490
	Keyboard 17KB-FV3 Black Mammoth 106KS Black Norwegian	KB.INT00.491
	Keyboard 17KB-FV3 Black Mammoth 105KS Black Korean	KB.INT00.493
	Keyboard 17KB-FV3 Black Mammoth 106KS Black Italian	KB.INT00.494
	Keyboard 17KB-FV3 Black Mammoth 106KS Black Hungarian	KB.INT00.497
	Keyboard 17KB-FV3 Black Mammoth 105KS Black Greek	KB.INT00.498
	Keyboard 17KB-FV3 Black Mammoth 106KS Black German	KB.INT00.499
	Keyboard 17KB-FV3 Black Mammoth 106KS Black French	KB.INT00.500
	Keyboard 17KB-FV3 Black Mammoth 106KS Black Danish	KB.INT00.503
	Keyboard 17KB-FV3 Black Mammoth 106KS Black Czech	KB.INT00.504
	Keyboard 17KB-FV3 Black Mammoth 105KS Black Traditional Chinese	KB.INT00.505
	Keyboard 17KB-FV3 Black Mammoth 106KS Black Canadian French	KB.INT00.506
Keyboard 17KB-FV3 Black Mammoth 106KS Black Brazilian Portuguese	KB.INT00.507	
Keyboard 17KB-FV3 Black Mammoth 106KS Black Belgium	KB.INT00.508	
Keyboard 17KB-FV3 Black Mammoth 105KS Black Arabic/English	KB.INT00.509	
Keyboard 17KB-FV3 Black Mammoth 106KS Black Nordic	KB.INT00.511	

Category	Description	Acer Part No.
<b>LCD</b>		
	LCD MODULE 17.1 IN WXGAG IMR HOLO 3D CCD W/ ANTENNA	6M.ARL07.001
	LCD AUO 17.1" WXGA+ Glare B170PW06 V2 LF 220nit 8ms	LK.17105.009
	LCD SAMSUNG 17.1" WXGA+ Glare LTN170BT07-G01 LF 220nit 8ms 500:1	LK.17106.004
	INVERTER BOARD	19.TPK07.001
	LCD CABLE FOR CCD	50.AR907.002
	LCD COVER IMR HOLO 3D W/CCD CABLE MIC ANTENNA	60.ARL07.001
	LCD BEZEL PAINTING FOR CCD	60.AR907.005
	LCD BRACKET W/HINGE - R	33.AR907.006
	LCD BRACKET W/HINGE - L	33.AR907.007
	CCD MODULE 0.3M	57.ARE07.001
	LCD MODULE 17.1 IN WXGAG IMR HOLO 3D CCD W/O ANTENNA	6M.ARL07.002
	LCD AUO 17.1" WXGA+ Glare B170PW06 V2 LF 220nit 8ms	LK.17105.009
	LCD SAMSUNG 17.1" WXGA+ Glare LTN170BT07-G01 LF 220nit 8ms 500:1	LK.17106.004
	INVERTER BOARD	19.TPK07.001
	LCD CABLE FOR CCD	50.AR907.002
	LCD COVER IMR HOLO 3D W/CCD CABLE MIC W/O ANTENNA	60.ARL07.002

Category	Description	Acer Part No.
	LCD BEZEL PAINTING FOR CCD	60.AR907.005
	LCD BRACKET W/HINGE - R	33.AR907.006
	LCD BRACKET W/HINGE - L	33.AR907.007
	CCD MODULE 0.3M	57.ARE07.001
<b>MainBoard</b>		
	MAINBOARD UMA MCH77MH/GIGALAN W/CARD READER W/O CPU RAM	MB.ARL06.001
	MAINBOARD DIS MCP77MH/GIGALAN W/CARD READER W/O CPU RAM	MB.ARH06.001
<b>Memory</b>		
	SO-DIMM DDRII 667 NANYA 1GB NT1GT64U8HB0BN-3C (0.09U)	KN.1GB03.014
	Memory HYNIX SO-DIMM DDRII 667 1GB HYMP112S64CP6-Y5 LF	KN.1GB0G.012
	SO-DIMM DDRII667 512MB NT512T64UH8B0FN-37C (0.09U)\NANYA	KN.51203.032
	Memory MICRON SO-DIMM DDRII 667 2GB MT16HTF25664HY-667E1 LF	KN.2GB04.001
	Memory SAMSUNG SO-DIMM DDRII 667 2GB M470T5663QZ3-CE6 LF	KN.2GB0B.003
	SODIMM 1GB DDRII667 INFINEON HYS64T128021EDL-3S LF	KN.1GB02.036
	Memory HYNIX SO-DIMM DDRII 667 512MB HYMP164S64CP6-Y5 LF	KN.5120G.024
	MEMORY HYNIX SO-DIMM DDRII 667 2GB HYMP125S64CP8-Y5 LF	KN.2GB0G.004
	Memory SAMSUNG SO-DIMM DDRII 667 1GB M470T2864QZ3-CE6 LF	KN.1GB0B.016
<b>Heatsink</b>		
	THERMAL MODULE - UMA	60.ARL07.003
	THERMAL MODULE - MXM	60.ARL07.004
<b>Miscellaneous</b>		
	NAME PLATE AS7230	47.ARL07.001

Category	Description	Acer Part No.
	NAME PLATE AS7530	47.ARL07.002
	LCD GLOSS RUBBER PAD	47.AR907.002
	RUBBER FOOT	47.AR907.003
	RUBBER FOOT LOW	47.AR907.004
<b>Speaker</b>		
	SPEAKER	23.AR907.001

## Screw List

Category	Description	Part No.
SCREW	M2.5*6.5	86.ARE07.001
SCREW	M2*3	86.ARE07.002
SCWER	M2.5*3	86.T25V7.012
SCREW	M3*0.5+3.5	86.A03V7.011
SCERW	M2*2.5	86.A03V7.007

# Model Definition and Configuration

## Aspire 7230/7530/7530G Series

Model	RO	Country	Acer Part No	Description	CPU	BT
AS7530G-822G16Mi	WW	WW	S2.ARHOX.001	AS7530G-822G16Mi VHP32AWW1 MC 9MGSHM256CO 2*1G/160/BT/6L/ 5R/CB_bg_0.3D_HG_EN11	ATUzM82	BT 2.0
AS7530G-704G32Mi	EMEA	Germany	LX.ARHOX.037	AS7530G-704G32Mi VHP32ATDE1 MC 9MGSHM256CO 2*2G/320/6L/5R/ CB_bg_0.3D_HG_DE13	ATRM70	N
AS7530G-704G32Mi	EMEA	Switzerland	LX.ARHOX.038	AS7530G-704G32Mi VHP32ATCH1 MC 9MGSHM256CO 2*2G/320/6L/5R/ CB_bg_0.3D_HG_IT42	ATRM70	N
AS7530G-704G32Bi	EMEA	Germany	LX.ARHOX.042	AS7530G-704G32Bi VHP32ATDE1 MC 9MGSHM256CO 2*2G/320/6L/ 5R/CB_bg_0.3D_HG_DE13	ATRM70	N
AS7530G-704G32Mi	EMEA	Belgium	LX.ARHOX.040	AS7530G-704G32Mi VHP32ATBE1 MC 9MGSHM256CO 2*2G/320/6L/5R/ CB_bg_0.3D_HG_NL13	ATRM70	N
AS7530G-604G50Mi	EMEA	Denmark	LX.ARHOX.043	AS7530G-604G50Mi VHP32ATDK1 MC 9MGSHM256CO 2*2G/250+250/ 6L/5R/CB_bg_0.3D_HG_NO13	AAQL60	N
AS7530G-704G32Mi	EMEA	Luxembourg	LX.ARHOX.039	AS7530G-704G32Mi VHP32ATLU1 MC 9MGSHM256CO 2*2G/320/6L/ 5R/CB_bg_0.3D_HG_IT42	ATRM70	N
AS7530G-704G32Mi	EMEA	Sweden/ Finland	LX.ARHOX.044	AS7530G-704G32Mi VHP32ATSE1 MC 9MGSHM256CO 2*2G/320/6L/5R/ CB_bg_0.3D_HG_FI12	ATRM70	N
AS7530G-704G32Mi	EMEA	Holland	LX.ARHOX.041	AS7530G-704G32Mi VHP32ATNL1 MC 9MGSHM256CO 2*2G/320/6L/ 5R/CB_bg_0.3D_HG_NL12	ATRM70	N
AS7530G-804G32Mi	EMEA	Sweden/ Finland	LX.ARHOX.046	AS7530G-804G32Mi VHP32ATSE1 MC 9MGSHM256CO 2*2G/320/6L/5R/ CB_bg_0.3D_HG_FI12	ATUzM80	N
AS7530G-703G32Mi	EMEA	Middle East	LX.ARHOX.055	AS7530G-703G32Mi EM VHP32ATME4 MC 9MGSHM256CO 2G+1G/320/6L/ 5R/CB_bg_0.3D_HG_EN11	ATRM70	N
AS7530G-603G32Mi	EMEA	Spain	LX.ARHOX.047	AS7530G-603G32Mi VHP32ATES1 MC 9MGSHM256CO 2G+1G/320/6L/ 5R/CB_bg_0.3D_HG_ES22	AAQL60	N
AS7530G-703G32Mi	EMEA	Middle East	LX.ARHOX.060	AS7530G-703G32Mi EM VHP32ATME3 MC 9MGSHM256CO 2G+1G/320/6L/ 5R/CB_bg_0.3D_HG_FR23	ATRM70	N

Model	RO	Country	Acer Part No	Description	CPU	BT
AS7530G-703G32Mi	EMEA	Middle East	LX.ARHOX.061	AS7530G-703G32Mi EM VHP32ATME2 MC 9MGSHM256CO 2G+1G/320/6L/5R/CB_bg_0.3D_HG_EN15	ATRM70	N
AS7530G-703G32Mi	EMEA	Middle East	LX.ARHOX.058	AS7530G-703G32Mi EM VHP32ATME2 MC 9MGSHM256CO 2G+1G/320/6L/5R/CB_bg_0.3D_HG_AR23	ATRM70	N
AS7530G-703G32Mi	EMEA	UK	LX.ARHOX.048	AS7530G-703G32Mi VHP32ATGB1 MC 9MGSHM256CO 2G+1G/320/6L/5R/CB_bg_0.3D_HG_EN14	ATRM70	N
AS7530G-703G32Mi	EMEA	Switzerland	LX.ARHOX.050	AS7530G-703G32Mi VHP32ATCH1 MC 9MGSHM256CO 2G+1G/320/6L/5R/CB_bg_0.3D_HG_IT42	ATRM70	N
AS7530G-703G32Mi	EMEA	Middle East	LX.ARHOX.059	AS7530G-703G32Mi EM VHP32ATME6 MC 9MGSHM256CO 2G+1G/320/6L/5R/CB_bg_0.3D_HG_EN15	ATRM70	N
AS7530G-703G32Mi	EMEA	Turkey	LX.ARHOX.069	AS7530G-703G32Mi EM VHP32ATTR1 MC 9MGSHM256CO 2G+1G/320/6L/5R/CB_bg_0.3D_HG_TR32	ATRM70	N
AS7530G-703G32Mi	EMEA	Middle East	LX.ARHOX.064	AS7530G-703G32Mi EM VHP32ATME2 MC 9MGSHM256CO 2G+1G/320/6L/5R/CB_bg_0.3D_HG_AR13	ATRM70	N
AS7530G-703G32Mi	EMEA	Spain	LX.ARHOX.078	AS7530G-703G32Mi VHP32ATES1 MC 9MGSHM256CO 2G+1G/320/6L/5R/CB_bg_0.3D_HG_ES22	ATRM70	N
AS7530G-703G32Mi	EMEA	Italy	LX.ARHOX.070	AS7530G-703G32Mi VHP32ATIT1 MC 9MGSHM256CO 2G+1G/320/6L/5R/CB_bg_0.3D_HG_IT12	ATRM70	N
AS7530G-703G32Mi	EMEA	Israel	LX.ARHOX.072	AS7530G-703G32Mi VHP32ATIL1 MC 9MGSHM256CO 2G+1G/320/6L/5R/CB_bg_0.3D_HG_HE11	ATRM70	N
AS7530G-703G32Mi	EMEA	Greece	LX.ARHOX.074	AS7530G-703G32Mi VHP32ATGR1 MC 9MGSHM256CO 2G+1G/320/6L/5R/CB_bg_0.3D_HG_EL22	ATRM70	N
AS7530G-703G32Mi	EMEA	Greece	LX.ARHOX.075	AS7530G-703G32Mi VHP32ATGR1 MC 9MGSHM256CO 2G+1G/320/6L/5R/CB_bg_0.3D_HG_EL32	ATRM70	N
AS7530G-703G32Mi	EMEA	Middle East	LX.ARHOX.066	AS7530G-703G32Mi EM VHP32ATME9 MC 9MGSHM256CO 2G+1G/320/6L/5R/CB_bg_0.3D_HG_FR22	ATRM70	N
AS7530G-703G32Mi	EMEA	Portugal	LX.ARHOX.081	AS7530G-703G32Mi VHP32ATPT1 MC 9MGSHM256CO 2G+1G/320/6L/5R/CB_bg_0.3D_HG_PT12	ATRM70	N
AS7530G-703G32Mi	EMEA	Eastern Europe	LX.ARHOX.088	AS7530G-703G32Mi VHP32ATEU1 MC 9MGSHM256CO 2G+1G/320/6L/5R/CB_bg_0.3D_HG_CS21	ATRM70	N



Model	RO	Country	Acer Part No	Description	CPU	BT
AS7530G-703G32Mi	EMEA	Eastern Europe	LX.ARHOX.090	AS7530G-703G32Mi VHP32ATEU4 MC 9MGSHM256CO 2G+1G/320/6L/ 5R/CB_bg_0.3D_HG_FI12	ATRM70	N
AS7530G-703G32Mi	EMEA	Eastern Europe	LX.ARHOX.087	AS7530G-703G32Mi VHP32ATEU3 MC 9MGSHM256CO 2G+1G/320/6L/ 5R/CB_bg_0.3D_HG_RU21	ATRM70	N
AS7530G-703G32Mi	EMEA	Eastern Europe	LX.ARHOX.086	AS7530G-703G32Mi VHP32ATEU5 MC 9MGSHM256CO 2G+1G/320/6L/ 5R/CB_bg_0.3D_HG_PL11	ATRM70	N
AS7530G-703G32Mi	EMEA	Hungary	LX.ARHOX.084	AS7530G-703G32Mi VHP32ATHU1 MC 9MGSHM256CO 2G+1G/320/6L/ 5R/CB_bg_0.3D_HG_HU11	ATRM70	N
AS7530G-703G32Mi	EMEA	Eastern Europe	LX.ARHOX.093	AS7530G-703G32Mi VHP32ATEU3 MC 9MGSHM256CO 2G+1G/320/6L/ 5R/CB_bg_0.3D_HG_RU11	ATRM70	N
AS7530G-703G32Mi	EMEA	Russia	LX.ARHOX.098	AS7530G-703G32Mi VHP32ATRU1 MC 9MGSHM256CO 2G+1G/320/6L/ 5R/CB_bg_0.3D_HG_RU11	ATRM70	N
AS7530G-703G32Mi	EMEA	Eastern Europe	LX.ARHOX.092	AS7530G-703G32Mi VHP32ATEU6 MC 9MGSHM256CO 2G+1G/320/6L/ 5R/CB_bg_0.3D_HG_CS21	ATRM70	N
AS7530G-703G32Mi	EMEA	Czech	LX.ARHOX.100	AS7530G-703G32Mi VHP32ATCZ2 MC 9MGSHM256CO 2G+1G/320/6L/ 5R/CB_bg_0.3D_HG_SK11	ATRM70	N
AS7530G-703G32Mi	EMEA	Sweden/ Finland	LX.ARHOX.099	AS7530G-703G32Mi VHP32ATSE1 MC 9MGSHM256CO 2G+1G/320/6L/ 5R/CB_bg_0.3D_HG_FI12	ATRM70	N
AS7530G-703G32Mi	EMEA	Slovenia/ Croatia	LX.ARHOX.083	AS7530G-703G32Mi VHP32ATS1 MC 9MGSHM256CO 2G+1G/320/ 6L/5R/CB_bg_0.3D_HG_EN12	ATRM70	N
AS7530G-703G32Mi	EMEA	Luxembourg	LX.ARHOX.120	AS7530G-703G32Mi VHP32ATLU1 MC 9MGSHM256CO 2G+1G/320/ 6L/5R/CB_bg_0.3D_HG_IT42	ATRM70	N
AS7530G-703G32Mi	EMEA	Holland	LX.ARHOX.119	AS7530G-703G32Mi VHP32ATNL1 MC 9MGSHM256CO 2G+1G/320/ 6L/5R/CB_bg_0.3D_HG_NL12	ATRM70	N
AS7530G-703G32Mi	EMEA	Belgium	LX.ARHOX.118	AS7530G-703G32Mi VHP32ATBE1 MC 9MGSHM256CO 2G+1G/320/6L/ 5R/CB_bg_0.3D_HG_NL13	ATRM70	N
AS7530G-703G32Mi	EMEA	Germany	LX.ARHOX.105	AS7530G-703G32Mi VHP32ATDE1 MC 9MGSHM256CO 2G+1G/320/6L/ 5R/CB_bg_0.3D_HG_DE13	ATRM70	N
AS7530G-703G32Mi	EMEA	France	LX.ARHOX.109	AS7530G-703G32Mi VHP32ATFR1 MC 9MGSHM256CO 2G+1G/320/6L/ 5R/CB_bg_0.3D_HG_FR23	ATRM70	N

Model	RO	Country	Acer Part No	Description	CPU	BT
AS7530G-703G32Mi	EMEA	South Africa	LX.ARHOX.112	AS7530G-703G32Mi EM VHP32ATZA2 MC 9MGSHM256CO 2G+1G/320/6L/5R/CB_bg_0.3D_HG_EN16	ATRM70	N
AS7530G-703G32Mi	EMEA	South Africa	LX.ARHOX.113	AS7530G-703G32Mi EM VHP32ATZA1 MC 9MGSHM256CO 2G+1G/320/6L/5R/CB_bg_0.3D_HG_FR23	ATRM70	N
AS7530G-703G32Mi	EMEA	Denmark	LX.ARHOX.110	AS7530G-703G32Mi VHP32ATDK1 MC 9MGSHM256CO 2G+1G/320/6L/5R/CB_bg_0.3D_HG_NO13	ATRM70	N
AS7530G-703G32Mi	EMEA	Norway	LX.ARHOX.103	AS7530G-703G32Mi VHP32ATNO1 MC 9MGSHM256CO 2G+1G/320/6L/5R/CB_bg_0.3D_HG_NO12	ATRM70	N
AS7530G-702G25Mi	EMEA	Russia	LX.ARHOX.121	AS7530G-702G25Mi VHP32ATRU1 MC 9MGSHM256CO 1*2G/250/6L/5R/CB_bg_0.3D_HG_RU11	ATRM70	N
AS7530G-703G32Mi	EMEA	South Africa	LX.ARHOX.111	AS7530G-703G32Mi EM VHP32AZA2 MC 9MGSHM256CO 2G+1G/320/6L/5R/CB_bg_0.3D_HG_EN16	ATRM70	N
AS7530G-703G32Mi	EMEA	Sweden/ Finland	LX.ARHOX.096	AS7530G-703G32Mi VHP32ASE1 MC 9MGSHM256CO 2G+1G/320/6L/5R/CB_bg_0.3D_HG_FI12	ATRM70	N
AS7530G-703G32Mi	EMEA	Czech	LX.ARHOX.095	AS7530G-703G32Mi VHP32ACZ2 MC 9MGSHM256CO 2G+1G/320/6L/5R/CB_bg_0.3D_HG_SK11	ATRM70	N
AS7530G-703G32Mi	EMEA	Eastern Europe	LX.ARHOX.094	AS7530G-703G32Mi VHP32AEU6 MC 9MGSHM256CO 2G+1G/320/6L/5R/CB_bg_0.3D_HG_CS21	ATRM70	N
AS7530G-703G32Mi	EMEA	Eastern Europe	LX.ARHOX.101	AS7530G-703G32Mi VHP32AEU1 MC 9MGSHM256CO 2G+1G/320/6L/5R/CB_bg_0.3D_HG_CS21	ATRM70	N
AS7530G-703G32Mi	EMEA	Eastern Europe	LX.ARHOX.102	AS7530G-703G32Mi VHP32AEU4 MC 9MGSHM256CO 2G+1G/320/6L/5R/CB_bg_0.3D_HG_FI12	ATRM70	N
AS7530G-703G32Mi	EMEA	Eastern Europe	LX.ARHOX.089	AS7530G-703G32Mi VHP32AEU3 MC 9MGSHM256CO 2G+1G/320/6L/5R/CB_bg_0.3D_HG_RU21	ATRM70	N
AS7530G-703G32Mi	EMEA	Eastern Europe	LX.ARHOX.091	AS7530G-703G32Mi VHP32AEU5 MC 9MGSHM256CO 2G+1G/320/6L/5R/CB_bg_0.3D_HG_PL11	ATRM70	N
AS7530G-703G32Mi	EMEA	Hungary	LX.ARHOX.085	AS7530G-703G32Mi VHP32AHU1 MC 9MGSHM256CO 2G+1G/320/6L/5R/CB_bg_0.3D_HG_HU11	ATRM70	N
AS7530G-703G32Mi	EMEA	Slovenia/ Croatia	LX.ARHOX.080	AS7530G-703G32Mi VHP32AS11 MC 9MGSHM256CO 2G+1G/320/6L/5R/CB_bg_0.3D_HG_EN12	ATRM70	N
AS7530G-703G32Mi	EMEA	Portugal	LX.ARHOX.082	AS7530G-703G32Mi VHP32APT1 MC 9MGSHM256CO 2G+1G/320/6L/5R/CB_bg_0.3D_HG_PT12	ATRM70	N
AS7530G-703G32Mi	EMEA	Denmark	LX.ARHOX.115	AS7530G-703G32Mi VHP32ADK1 MC 9MGSHM256CO 2G+1G/320/6L/5R/CB_bg_0.3D_HG_NO13	ATRM70	N

Model	RO	Country	Acer Part No	Description	CPU	BT
AS7530G-703G32Mi	EMEA	France	LX.ARHOX.116	AS7530G-703G32Mi VHP32AFR1 MC 9MGSHM256CO 2G+1G/320/6L/5R/CB_bg_0.3D_HG_FR23	ATRM70	N
AS7530G-703G32Mi	EMEA	Germany	LX.ARHOX.117	AS7530G-703G32Mi VHP32ADE1 MC 9MGSHM256CO 2G+1G/320/6L/5R/CB_bg_0.3D_HG_DE13	ATRM70	N
AS7530G-703G32Mi	EMEA	Belgium	LX.ARHOX.108	AS7530G-703G32Mi VHP32ABE1 MC 9MGSHM256CO 2G+1G/320/6L/5R/CB_bg_0.3D_HG_NL13	ATRM70	N
AS7530G-703G32Mi	EMEA	Holland	LX.ARHOX.107	AS7530G-703G32Mi VHP32ANL1 MC 9MGSHM256CO 2G+1G/320/6L/5R/CB_bg_0.3D_HG_NL12	ATRM70	N
AS7530G-703G32Mi	EMEA	Luxembourg	LX.ARHOX.106	AS7530G-703G32Mi VHP32ALU1 MC 9MGSHM256CO 2G+1G/320/6L/5R/CB_bg_0.3D_HG_IT42	ATRM70	N
AS7530G-703G32Mi	EMEA	Norway	LX.ARHOX.104	AS7530G-703G32Mi VHP32ANO1 MC 9MGSHM256CO 2G+1G/320/6L/5R/CB_bg_0.3D_HG_NO12	ATRM70	N
AS7530G-703G32Mi	EMEA	Russia	LX.ARHOX.097	AS7530G-703G32Mi VHP32ARU1 MC 9MGSHM256CO 2G+1G/320/6L/5R/CB_bg_0.3D_HG_RU11	ATRM70	N
AS7530G-703G32Mi	EMEA	South Africa	LX.ARHOX.114	AS7530G-703G32Mi EM VHP32AZA1 MC 9MGSHM256CO 2G+1G/320/6L/5R/CB_bg_0.3D_HG_FR23	ATRM70	N
AS7530G-703G32Mi	EMEA	Middle East	LX.ARHOX.062	AS7530G-703G32Mi EM VHP32AME2 MC 9MGSHM256CO 2G+1G/320/6L/5R/CB_bg_0.3D_HG_EN15	ATRM70	N
AS7530G-703G32Mi	EMEA	Middle East	LX.ARHOX.063	AS7530G-703G32Mi EM VHP32AME2 MC 9MGSHM256CO 2G+1G/320/6L/5R/CB_bg_0.3D_HG_AR13	ATRM70	N
AS7530G-703G32Mi	EMEA	Turkey	LX.ARHOX.067	AS7530G-703G32Mi EM VHP32ATR1 MC 9MGSHM256CO 2G+1G/320/6L/5R/CB_bg_0.3D_HG_TR31	ATRM70	N
AS7530G-703G32Mi	EMEA	Turkey	LX.ARHOX.068	AS7530G-703G32Mi EM VHP32ATR1 MC 9MGSHM256CO 2G+1G/320/6L/5R/CB_bg_0.3D_HG_TR22	ATRM70	N
AS7530G-703G32Mi	EMEA	Middle East	LX.ARHOX.065	AS7530G-703G32Mi EM VHP32AME4 MC 9MGSHM256CO 2G+1G/320/6L/5R/CB_bg_0.3D_HG_EN11	ATRM70	N
AS7530G-703G32Mi	EMEA	Middle East	LX.ARHOX.056	AS7530G-703G32Mi EM VHP32AME4 MC 9MGSHM256CO 2G+1G/320/6L/5R/CB_bg_0.3D_HG_EN12	ATRM70	N
AS7530G-703G32Mi	EMEA	Spain	LX.ARHOX.079	AS7530G-703G32Mi VHP32AES1 MC 9MGSHM256CO 2G+1G/320/6L/5R/CB_bg_0.3D_HG_ES22	ATRM70	N
AS7530G-703G32Mi	EMEA	Greece	LX.ARHOX.077	AS7530G-703G32Mi VHP32AGR1 MC 9MGSHM256CO 2G+1G/320/6L/5R/CB_bg_0.3D_HG_EL32	ATRM70	N
AS7530G-703G32Mi	EMEA	Greece	LX.ARHOX.076	AS7530G-703G32Mi VHP32AGR1 MC 9MGSHM256CO 2G+1G/320/6L/5R/CB_bg_0.3D_HG_EL22	ATRM70	N

Model	RO	Country	Acer Part No	Description	CPU	BT
AS7530G-703G32Mi	EMEA	Israel	LX.ARHOX.073	AS7530G-703G32Mi VHP32AIL1 MC 9MGSHM256CO 2G+1G/320/6L/5R/CB_bg_0.3D_HG_HE11	ATRM70	N
AS7530G-703G32Mi	EMEA	Italy	LX.ARHOX.071	AS7530G-703G32Mi VHP32AIT1 MC 9MGSHM256CO 2G+1G/320/6L/5R/CB_bg_0.3D_HG_IT12	ATRM70	N
AS7530G-703G32Mi	EMEA	Switzerland	LX.ARHOX.051	AS7530G-703G32Mi VHP32ACH1 MC 9MGSHM256CO 2G+1G/320/6L/5R/CB_bg_0.3D_HG_IT42	ATRM70	N
AS7530G-703G32Mi	EMEA	UK	LX.ARHOX.049	AS7530G-703G32Mi VHP32AGB1 MC 9MGSHM256CO 2G+1G/320/6L/5R/CB_bg_0.3D_HG_EN14	ATRM70	N
AS7530G-703G32Mi	EMEA	Middle East	LX.ARHOX.054	AS7530G-703G32Mi EM VHP32AME9 MC 9MGSHM256CO 2G+1G/320/6L/5R/CB_bg_0.3D_HG_FR21	ATRM70	N
AS7530G-703G32Mi	EMEA	Middle East	LX.ARHOX.052	AS7530G-703G32Mi EM VHP32AME2 MC 9MGSHM256CO 2G+1G/320/6L/5R/CB_bg_0.3D_HG_AR23	ATRM70	N
AS7530G-703G32Mi	EMEA	Middle East	LX.ARHOX.053	AS7530G-703G32Mi EM VHP32AME6 MC 9MGSHM256CO 2G+1G/320/6L/5R/CB_bg_0.3D_HG_EN15	ATRM70	N
AS7530G-703G32Mi	EMEA	Middle East	LX.ARHOX.057	AS7530G-703G32Mi EM VHP32AME3 MC 9MGSHM256CO 2G+1G/320/6L/5R/CB_bg_0.3D_HG_FR23	ATRM70	N
AS7530G-703G25Mi	EMEA	Czech	LX.ARHOX.122	AS7530G-703G25Mi VHP32ATCZ2 MC 9MGSHM256CO 2G+1G/250/BT/6L/5R/CB_bg_0.3D_HG_SK11	ATRM70	BT 2.0
AS7530G-604G16Bi	EMEA	Sweden/ Finland	LX.ARHOX.045	AS7530G-604G16Bi VHP32ATSE1 MC 9MGSHM256CO 2*2G/160/6L/5R/CB_bg_0.3D_HG_FI12	AAQL60	N
AS7530G-703G25Bi	EMEA	Eastern Europe	LX.ARHOX.013	AS7530G-703G25Bi VHP32ATEU4 MC 9MGSHM256CO 2G+1G/250/6L/5R/CB_bg_0.3D_HG_FI12	ATRM70	N
AS7530G-703G25Bi	EMEA	Eastern Europe	LX.ARHOX.014	AS7530G-703G25Bi VHP32ATEU3 MC 9MGSHM256CO 2G+1G/250/6L/5R/CB_bg_0.3D_HG_RU21	ATRM70	N
AS7530G-703G25Bi	EMEA	Eastern Europe	LX.ARHOX.015	AS7530G-703G25Bi VHP32ATEU5 MC 9MGSHM256CO 2G+1G/250/6L/5R/CB_bg_0.3D_HG_PL11	ATRM70	N
AS7530G-703G32Bi	EMEA	Eastern Europe	LX.ARHOX.036	AS7530G-703G32Bi VHP32ATEU5 MC 9MGSHM256CO 2G+1G/320/BT/8L/5R/CB_bg_0.3D_HG_PL11	ATRM70	BT 2.0
AS7530G-703G25Bi	EMEA	Hungary	LX.ARHOX.016	AS7530G-703G25Bi VHP32ATHU1 MC 9MGSHM256CO 2G+1G/250/6L/5R/CB_bg_0.3D_HG_HU11	ATRM70	N
AS7530G-703G25Bi	EMEA	Slovenia/ Croatia	LX.ARHOX.019	AS7530G-703G25Bi VHP32ATS11 MC 9MGSHM256CO 2G+1G/250/6L/5R/CB_bg_0.3D_HG_EN12	ATRM70	N
AS7530G-703G25Bi	EMEA	Portugal	LX.ARHOX.020	AS7530G-703G25Bi VHP32ATPT1 MC 9MGSHM256CO 2G+1G/250/6L/5R/CB_bg_0.3D_HG_PT12	ATRM70	N

Model	RO	Country	Acer Part No	Description	CPU	BT
AS7530G-703G25Bi	EMEA	Spain	LX.ARHOX.021	AS7530G-703G25Bi VHP32ATES1 MC 9MGSHM256CO 2G+1G/250/6L/5R/CB_bg_0.3D_HG_ES22	ATRM70	N
AS7530G-703G25Bi	EMEA	Greece	LX.ARHOX.022	AS7530G-703G25Bi VHP32ATGR1 MC 9MGSHM256CO 2G+1G/250/6L/5R/CB_bg_0.3D_HG_EL32	ATRM70	N
AS7530G-703G25Bi	EMEA	Greece	LX.ARHOX.023	AS7530G-703G25Bi VHP32ATGR1 MC 9MGSHM256CO 2G+1G/250/6L/5R/CB_bg_0.3D_HG_EL22	ATRM70	N
AS7530G-703G25Bi	EMEA	Israel	LX.ARHOX.024	AS7530G-703G25Bi VHP32ATIL1 MC 9MGSHM256CO 2G+1G/250/6L/5R/CB_bg_0.3D_HG_HE11	ATRM70	N
AS7530G-703G25Bi	EMEA	Italy	LX.ARHOX.025	AS7530G-703G25Bi VHP32ATIT1 MC 9MGSHM256CO 2G+1G/250/6L/5R/CB_bg_0.3D_HG_IT12	ATRM70	N
AS7530G-703G25Bi	EMEA	Switzerland	LX.ARHOX.033	AS7530G-703G25Bi VHP32ATCH1 MC 9MGSHM256CO 2G+1G/250/6L/5R/CB_bg_0.3D_HG_IT42	ATRM70	N
AS7530G-703G25Bi	EMEA	UK	LX.ARHOX.034	AS7530G-703G25Bi VHP32ATGB1 MC 9MGSHM256CO 2G+1G/250/6L/5R/CB_bg_0.3D_HG_EN14	ATRM70	N
AS7530G-703G25Bi	EMEA	France	LX.ARHOX.004	AS7530G-703G25Bi VHP32ATFR1 MC 9MGSHM256CO 2G+1G/250/6L/5R/CB_bg_0.3D_HG_FR23	ATRM70	N
AS7530G-703G25Bi	EMEA	Germany	LX.ARHOX.005	AS7530G-703G25Bi VHP32ATDE1 MC 9MGSHM256CO 2G+1G/250/6L/5R/CB_bg_0.3D_HG_DE13	ATRM70	N
AS7530G-703G25Bi	EMEA	Belgium	LX.ARHOX.006	AS7530G-703G25Bi VHP32ATBE1 MC 9MGSHM256CO 2G+1G/250/6L/5R/CB_bg_0.3D_HG_NL13	ATRM70	N
AS7530G-703G25Bi	EMEA	Holland	LX.ARHOX.007	AS7530G-703G25Bi VHP32ATNL1 MC 9MGSHM256CO 2G+1G/250/6L/5R/CB_bg_0.3D_HG_NL12	ATRM70	N
AS7530G-703G25Bi	EMEA	Luxembourg	LX.ARHOX.008	AS7530G-703G25Bi VHP32ATLU1 MC 9MGSHM256CO 2G+1G/250/6L/5R/CB_bg_0.3D_HG_IT42	ATRM70	N
AS7530G-703G25Bi	EMEA	Norway	LX.ARHOX.017	AS7530G-703G25Bi VHP32ATNO1 MC 9MGSHM256CO 2G+1G/250/6L/5R/CB_bg_0.3D_HG_NO12	ATRM70	N
AS7530G-703G32Bi	EMEA	Norway	LX.ARHOX.035	AS7530G-703G32Bi VHP32ATNO1 MC 9MGSHM256CO 2G+1G/320/BT/8L/5R/CB_bg_0.3D_HG_NO12	ATRM70	BT 2.0
AS7530G-703G25Bi	EMEA	Russia	LX.ARHOX.009	AS7530G-703G25Bi VHP32ATRU1 MC 9MGSHM256CO 2G+1G/250/6L/5R/CB_bg_0.3D_HG_RU11	ATRM70	N
AS7530G-703G25Bi	EMEA	Sweden/ Finland	LX.ARHOX.010	AS7530G-703G25Bi VHP32ATSE1 MC 9MGSHM256CO 2G+1G/250/6L/5R/CB_bg_0.3D_HG_FL12	ATRM70	N
AS7530G-703G25Bi	EMEA	Eastern Europe	LX.ARHOX.018	AS7530G-703G25Bi VHP32ATEU3 MC 9MGSHM256CO 2G+1G/250/6L/5R/CB_bg_0.3D_HG_RU11	ATRM70	N
AS7530G-703G25Bi	EMEA	Denmark	LX.ARHOX.003	AS7530G-703G25Bi VHP32ATDK1 MC 9MGSHM256CO 2G+1G/250/6L/5R/CB_bg_0.3D_HG_NO13	ATRM70	N

Model	RO	Country	Acer Part No	Description	CPU	BT
AS7530G-703G25Bi	EMEA	Middle East	LX.ARHOX.027	AS7530G-703G25Bi EM VHP32ATME9 MC 9MGSHM256CO 2G+1G/250/6L/5R/CB_bg_0.3D_HG_FR22	ATRM70	N
AS7530G-703G25Bi	EMEA	Middle East	LX.ARHOX.028	AS7530G-703G25Bi EM VHP32ATME2 MC 9MGSHM256CO 2G+1G/250/6L/5R/CB_bg_0.3D_HG_AR23	ATRM70	N
AS7530G-703G25Bi	EMEA	Middle East	LX.ARHOX.029	AS7530G-703G25Bi EM VHP32ATME6 MC 9MGSHM256CO 2G+1G/250/6L/5R/CB_bg_0.3D_HG_EN15	ATRM70	N
AS7530G-703G25Bi	EMEA	Middle East	LX.ARHOX.030	AS7530G-703G25Bi EM VHP32ATME3 MC 9MGSHM256CO 2G+1G/250/6L/5R/CB_bg_0.3D_HG_FR23	ATRM70	N
AS7530G-703G25Bi	EMEA	Middle East	LX.ARHOX.031	AS7530G-703G25Bi EM VHP32ATME2 MC 9MGSHM256CO 2G+1G/250/6L/5R/CB_bg_0.3D_HG_EN15	ATRM70	N
AS7530G-703G25Bi	EMEA	Middle East	LX.ARHOX.032	AS7530G-703G25Bi EM VHP32ATME2 MC 9MGSHM256CO 2G+1G/250/6L/5R/CB_bg_0.3D_HG_AR13	ATRM70	N
AS7530G-703G25Bi	EMEA	South Africa	LX.ARHOX.001	AS7530G-703G25Bi EM VHP32ATZA2 MC 9MGSHM256CO 2G+1G/250/6L/5R/CB_bg_0.3D_HG_EN16	ATRM70	N
AS7530G-703G25Bi	EMEA	South Africa	LX.ARHOX.002	AS7530G-703G25Bi EM VHP32ATZA1 MC 9MGSHM256CO 2G+1G/250/6L/5R/CB_bg_0.3D_HG_FR23	ATRM70	N
AS7530G-703G25Bi	EMEA	Turkey	LX.ARHOX.026	AS7530G-703G25Bi EM VHP32ATTR1 MC 9MGSHM256CO 2G+1G/250/6L/5R/CB_bg_0.3D_HG_TR32	ATRM70	N
AS7530G-703G25Bi	EMEA	Eastern Europe	LX.ARHOX.012	AS7530G-703G25Bi VHP32ATEU6 MC 9MGSHM256CO 2G+1G/250/6L/5R/CB_bg_0.3D_HG_CS21	ATRM70	N
AS7530G-703G25Bi	EMEA	Czech	LX.ARHOX.011	AS7530G-703G25Bi VHP32ATCZ2 MC 9MGSHM256CO 2G+1G/250/6L/5R/CB_bg_0.3D_HG_SK11	ATRM70	N
AS7530G-704G25Bi	EMEA	Norway	LX.ARHOX.123	AS7530G-704G25Bi VHP32ATNO1 MC 9MGSHM256CO 2*2G/250/6L/5R/CB_bg_0.3D_HG_NO12	ATRM70	N
AS7530G-704G25Bi	EMEA	Middle East	LX.ARHOX.127	AS7530G-704G25Bi EM VHP32ATME2 MC 9MGSHM256CO 2*2G/250/6L/5R/CB_bg_0.3D_HG_AR23	ATRM70	N
AS7530G-704G25Bi	EMEA	Middle East	LX.ARHOX.132	AS7530G-704G25Bi EM VHP32ATME9 MC 9MGSHM256CO 2*2G/250/6L/5R/CB_bg_0.3D_HG_FR22	ATRM70	N
AS7530G-704G25Bi	EMEA	Middle East	LX.ARHOX.130	AS7530G-704G25Bi EM VHP32ATME2 MC 9MGSHM256CO 2*2G/250/6L/5R/CB_bg_0.3D_HG_EN15	ATRM70	N

Model	RO	Country	Acer Part No	Description	CPU	BT
AS7530G-704G25Bi	EMEA	Spain	LX.ARHOX.138	AS7530G-704G25Bi VHP32ATES1 MC 9MGSHM256CO 2*2G/250/6L/5R/CB_bg_0.3D_HG_ES22	ATRM70	N
AS7530G-704G25Bi	EMEA	Portugal	LX.ARHOX.139	AS7530G-704G25Bi VHP32ATPT1 MC 9MGSHM256CO 2*2G/250/6L/5R/CB_bg_0.3D_HG_PT12	ATRM70	N
AS7530G-704G25Bi	EMEA	Slovenia/ Croatia	LX.ARHOX.140	AS7530G-704G25Bi VHP32ATS1I MC 9MGSHM256CO 2*2G/250/6L/5R/CB_bg_0.3D_HG_EN12	ATRM70	N
AS7530G-704G25Bi	EMEA	Greece	LX.ARHOX.137	AS7530G-704G25Bi VHP32ATGR1 MC 9MGSHM256CO 2*2G/250/6L/5R/CB_bg_0.3D_HG_EL32	ATRM70	N
AS7530G-704G25Bi	EMEA	Greece	LX.ARHOX.136	AS7530G-704G25Bi VHP32ATGR1 MC 9MGSHM256CO 2*2G/250/6L/5R/CB_bg_0.3D_HG_EL22	ATRM70	N
AS7530G-704G25Bi	EMEA	Israel	LX.ARHOX.135	AS7530G-704G25Bi VHP32ATIL1 MC 9MGSHM256CO 2*2G/250/6L/5R/CB_bg_0.3D_HG_HE11	ATRM70	N
AS7530G-704G25Bi	EMEA	Middle East	LX.ARHOX.126	AS7530G-704G25Bi EM VHP32ATME4 MC 9MGSHM256CO 2*2G/250/6L/5R/CB_bg_0.3D_HG_EN11	ATRM70	N
AS7530G-704G25Bi	EMEA	Italy	LX.ARHOX.134	AS7530G-704G25Bi VHP32ATIT1 MC 9MGSHM256CO 2*2G/250/6L/5R/CB_bg_0.3D_HG_IT12	ATRM70	N
AS7530G-704G25Bi	EMEA	Switzerland	LX.ARHOX.125	AS7530G-704G25Bi VHP32ATCH1 MC 9MGSHM256CO 2*2G/250/6L/5R/CB_bg_0.3D_HG_IT42	ATRM70	N
AS7530G-704G25Bi	EMEA	UK	LX.ARHOX.124	AS7530G-704G25Bi VHP32ATGB1 MC 9MGSHM256CO 2*2G/250/6L/5R/CB_bg_0.3D_HG_EN14	ATRM70	N
AS7530G-704G25Bi	EMEA	Turkey	LX.ARHOX.133	AS7530G-704G25Bi EM VHP32ATTR1 MC 9MGSHM256CO 2*2G/250/6L/5R/CB_bg_0.3D_HG_TR32	ATRM70	N
AS7530G-704G25Bi	EMEA	Middle East	LX.ARHOX.131	AS7530G-704G25Bi EM VHP32ATME2 MC 9MGSHM256CO 2*2G/250/6L/5R/CB_bg_0.3D_HG_AR13	ATRM70	N
AS7530G-704G25Bi	EMEA	Eastern Europe	LX.ARHOX.143	AS7530G-704G25Bi VHP32ATEU3 MC 9MGSHM256CO 2*2G/250/6L/5R/CB_bg_0.3D_HG_RU21	ATRM70	N
AS7530G-704G25Bi	EMEA	Eastern Europe	LX.ARHOX.142	AS7530G-704G25Bi VHP32ATEU5 MC 9MGSHM256CO 2*2G/250/6L/5R/CB_bg_0.3D_HG_PL11	ATRM70	N
AS7530G-704G25Bi	EMEA	Hungary	LX.ARHOX.141	AS7530G-704G25Bi VHP32ATHU1 MC 9MGSHM256CO 2*2G/250/6L/5R/CB_bg_0.3D_HG_HU11	ATRM70	N
AS7530G-704G25Bi	EMEA	Middle East	LX.ARHOX.129	AS7530G-704G25Bi EM VHP32ATME3 MC 9MGSHM256CO 2*2G/250/6L/5R/CB_bg_0.3D_HG_FR23	ATRM70	N
AS7530G-704G25Bi	EMEA	Middle East	LX.ARHOX.128	AS7530G-704G25Bi EM VHP32ATME6 MC 9MGSHM256CO 2*2G/250/6L/5R/CB_bg_0.3D_HG_EN15	ATRM70	N



Model	RO	Country	Acer Part No	Description	CPU	BT
AS7530G-704G25Bi	EMEA	Eastern Europe	LX.ARHOX.146	AS7530G-704G25Bi VHP32ATEU3 MC 9MGSHM256CO 2*2G/250/6L/5R/CB_bg_0.3D_HG_RU11	ATRM70	N
AS7530G-704G25Bi	EMEA	Sweden/Finland	LX.ARHOX.150	AS7530G-704G25Bi VHP32ATSE1 MC 9MGSHM256CO 2*2G/250/6L/5R/CB_bg_0.3D_HG_FI12	ATRM70	N
AS7530G-704G25Bi	EMEA	Russia	LX.ARHOX.151	AS7530G-704G25Bi VHP32ATRU1 MC 9MGSHM256CO 2*2G/250/6L/5R/CB_bg_0.3D_HG_RU11	ATRM70	N
AS7530G-704G25Bi	EMEA	Luxembourg	LX.ARHOX.152	AS7530G-704G25Bi VHP32ATLU1 MC 9MGSHM256CO 2*2G/250/6L/5R/CB_bg_0.3D_HG_IT42	ATRM70	N
AS7530G-704G25Bi	EMEA	Holland	LX.ARHOX.153	AS7530G-704G25Bi VHP32ATNL1 MC 9MGSHM256CO 2*2G/250/6L/5R/CB_bg_0.3D_HG_NL12	ATRM70	N
AS7530G-704G25Bi	EMEA	Belgium	LX.ARHOX.154	AS7530G-704G25Bi VHP32ATBE1 MC 9MGSHM256CO 2*2G/250/6L/5R/CB_bg_0.3D_HG_NL13	ATRM70	N
AS7530G-704G25Bi	EMEA	Eastern Europe	LX.ARHOX.148	AS7530G-704G25Bi VHP32ATEU7 MC 9MGSHM256CO 2*2G/250/6L/5R/CB_bg_0.3D_HG_ENG1	ATRM70	N
AS7530G-704G25Bi	EMEA	Eastern Europe	LX.ARHOX.145	AS7530G-704G25Bi VHP32ATEU1 MC 9MGSHM256CO 2*2G/250/6L/5R/CB_bg_0.3D_HG_CS21	ATRM70	N
AS7530G-704G25Bi	EMEA	Eastern Europe	LX.ARHOX.144	AS7530G-704G25Bi VHP32ATEU4 MC 9MGSHM256CO 2*2G/250/6L/5R/CB_bg_0.3D_HG_FI12	ATRM70	N
AS7530G-704G25Bi	EMEA	Czech	LX.ARHOX.149	AS7530G-704G25Bi VHP32ATCZ2 MC 9MGSHM256CO 2*2G/250/6L/5R/CB_bg_0.3D_HG_SK11	ATRM70	N
AS7530G-704G25Bi	EMEA	Eastern Europe	LX.ARHOX.147	AS7530G-704G25Bi VHP32ATEU6 MC 9MGSHM256CO 2*2G/250/6L/5R/CB_bg_0.3D_HG_CS21	ATRM70	N
AS7530G-704G25Bi	EMEA	South Africa	LX.ARHOX.158	AS7530G-704G25Bi EM VHP32ATZA1 MC 9MGSHM256CO 2*2G/250/6L/5R/CB_bg_0.3D_HG_FR23	ATRM70	N
AS7530G-704G25Bi	EMEA	France	LX.ARHOX.156	AS7530G-704G25Bi VHP32ATFR1 MC 9MGSHM256CO 2*2G/250/6L/5R/CB_bg_0.3D_HG_FR23	ATRM70	N
AS7530G-704G25Bi	EMEA	South Africa	LX.ARHOX.159	AS7530G-704G25Bi EM VHP32ATZA2 MC 9MGSHM256CO 2*2G/250/6L/5R/CB_bg_0.3D_HG_EN16	ATRM70	N
AS7530G-704G25Bi	EMEA	Germany	LX.ARHOX.155	AS7530G-704G25Bi VHP32ATDE1 MC 9MGSHM256CO 2*2G/250/6L/5R/CB_bg_0.3D_HG_DE13	ATRM70	N
AS7530G-704G25Bi	EMEA	Denmark	LX.ARHOX.157	AS7530G-704G25Bi VHP32ATDK1 MC 9MGSHM256CO 2*2G/250/6L/5R/CB_bg_0.3D_HG_NO13	ATRM70	N
AS7530G-703G25Mi	EMEA	Italy	LX.ARHOX.160	AS7530G-703G25Mi VHP32ATIT1 MC 9MGSHM256CO 2G+1G/250/6L/5R/CB_bg_0.3D_HG_IT12	ATRM70	N

Model	LCD	Memory1	Memory2	HDD1	HDD2	ODD	WLAN
AS7530G-822G16Mi	N17WXGA+G	SO1GBI16	SO1GBI16	N160GB 5.4KS	N	NSM8XS	3rd WiFi BG















Model	LCD	Memory1	Memory2	HDD1	HDD2	ODD	WLAN
AS7530G-704G25Bi	N17WXGA+G	SO2GBII6	SO2GBII6	N250GB 5.4KS	N	NBDCB2XS	3rd WiFi BG
AS7530G-704G25Bi	N17WXGA+G	SO2GBII6	SO2GBII6	N250GB 5.4KS	N	NBDCB2XS	3rd WiFi BG
AS7530G-704G25Bi	N17WXGA+G	SO2GBII6	SO2GBII6	N250GB 5.4KS	N	NBDCB2XS	3rd WiFi BG
AS7530G-703G25Mi	N17WXGA+G	SO2GBII6	SO1GBII6	N250GB 5.4KS	N	NSM8XS	3rd WiFi BG

# Test Compatible Components

---

This computer's compatibility is tested and verified by Acer's internal testing department. All of its system functions are tested under Windows® XP Home, Windows® XP Pro environment.

Refer to the following lists for components, adapter cards, and peripherals which have passed these tests. Regarding configuration, combination and test procedures, please refer to the Aspire 7230/7530/7530G series Compatibility Test Report released by the Acer Mobile System Testing Department.

# Microsoft® Windows® Vista Environment Test

Vendor	Type	Description
<b>Adapter Test</b>		
F0000183 DELTA CN	90W	Adapter DELTA 90W 1.7x5.5x11 ADP-90SB BBEA LF level 4
F0000183 DELTA CN	90W-DE	Adapter DELTA 90W 1.7x5.5x11 ADP-90SB BBEN (for OBL Spec.) LV4 LF
10001023 LITE-ON	90W	Adapter LITE-ON 90W 19V 1.7x5.5x11 Blue PA-1900-24AR LED LF level 4
60002015 HIPRO	90W	Adapter HIPRO 90W 19V 1.7x5.5x11 Blue HP-OL093B13P LED LF level 4
<b>Audio Codec Test</b>		
9999995 ONE TIME VENDER	ALC888S	ALC888S
<b>Battery Test</b>		
60001921 SANYO	6CELL2.2	Battery SANYO AS-2007B Li-Ion 3S2P SANYO 6 cell 4400mAh Main COMMON Normal Type
10001063 SONY	6CELL2.2	Battery SONY AS-2007B Li-Ion 3S2P SONY 6 cell 4400mAh Main COMMON Normal Type
60001535 PANASONIC	6CELL2.2	Battery PANASONIC AS-2007B Li-Ion 3S2P PANASONIC 6 cell 4400mAh Main COMMON PSS
60002162 SIMPLO	6CELL2.2	Battery SIMPLO AS-2007B Li-Ion 3S2P PANASONIC 6 cell 4400mAh Main COMMON PSS
60001921 SANYO	8CELL2.4	Battery SANYO AS-2007B Li-Ion 4S2P SANYO 8 cell 4800mAh Main COMMON
60001535 PANASONIC	8CELL2.4	Battery PANASONIC AS-2007B Li-Ion 4S2P PANASONIC 8 cell 4800mAh Main COMMON
60002162 SIMPLO	8CELL2.4	Battery SIMPLO AS-2007B Li-Ion 4S2P PANASONIC 8 cell 4800mAh Main COMMON PSS
<b>Bluetooth Test</b>		
9999995 ONE TIME VENDER	BT 2.0	Foxconn Bluetooth FOX_BRM_2.0 F/W 300
<b>Camera Test</b>		
9999995 ONE TIME VENDER	0.3M DV	Suyin 0.3M DV Camellia_2
9999995 ONE TIME VENDER	0.3M DV	Bison 0.3M DV Lotus_2
<b>Card Reader Test</b>		
9999995 ONE TIME VENDER	5 in 1-Build in	5 in 1-Build in MS, MS Pro, SD, SC, XD
<b>Card Bus1 Test</b>		
9999995 ONE TIME VENDER	RTS5158E-GR	Realtek RTS5158E-GR Card Reader: SD/MMC/MS/MS Duo/xD (USB 2.0)

Vendor	Type	Description
<b>CPU Test</b>		
22554573 AMD	AAQL60	CPU AMD Athlon64X2 QL60 PGA 1.9G 1M 638 35W Griffin B1
22554573 AMD	ATRM70	CPU AMD TurionX2 RM70 PGA 2.0G 1M 638 35W Griffin B1
22554573 AMD	ATUZM80	CPU AMD TurionX2 ZM80 PGA 2.1G 2M 638 35W Griffin B1
22554573 AMD	ATUZM82	CPU AMD TurionX2 ZM82 PGA 2.2G 2M 638 35W Griffin B1
22554573 AMD	ATUZM84	CPU AMD TurionX2 ZM84 PGA 2.3G 2M 638 35W Griffin B1
22554573 AMD	ATUZM86	CPU AMD TurionX2 ZM86 PGA 2.4G 2M 638 35W Griffin B1
<b>HDD Test</b>		
60002036 SEAGATE	N120GB5.4KS	HDD SEAGATE 2.5" 5400rpm 120GB ST9120817AS Corsair SATA LF F/W:3.AAA
60001922 TOSHIBA DIGI	N120GB5.4KS	HDD TOSHIBA 2.5" 5400rpm 120GB MK1246GSX Leo BS SATA I LF F/W:LB213J
60002005 HGST SG	N120GB5.4KS	HDD HGST 2.5" 5400rpm 120GB HTS542512K9SA00 Bronco-B SATA II LF F/W:C31P
60001994 WD	N120GB5.4KS	HDD WD 2.5" 5400rpm 120GB WD1200BEVS-22UST0 ML125 SATA LF F/W:01.01A01
60002036 SEAGATE	N160GB5.4KS	HDD SEAGATE 2.5" 5400rpm 160GB ST9160827AS Corsair SATA LF F/W:3.AAA
60002036 SEAGATE	N160GB5.4KS	HDD SEAGATE 2.5" 5400rpm 160GB ST9160310AS Crockett SATA LF F/W:0303
60001922 TOSHIBA DIGI	N160GB5.4KS	HDD TOSHIBA 2.5" 5400rpm 160GB MK1646GSX Leo BS SATA I LF F/W:LB113J
60002005 HGST SG	N160GB5.4KS	HDD HGST 2.5" 5400rpm 160GB HTS542516K9SA00 Bronco-B SATA II LF F/W:C31P
60002005 HGST SG	N160GB5.4KS	HDD HGST 2.5" 5400rpm 160GB HTS543216L9A300 Falcon-B SATA LF F/W:C40C
60001994 WD	N160GB5.4KS	HDD WD 2.5" 5400rpm 160GB WD1600BEVT-22ZCTO ML160 SATA LF F/W:11.01A11
60002036 SEAGATE	N250GB5.4KS	HDD SEAGATE 2.5" 5400rpm 250GB ST9250827AS Corsair SATA LF F/W:3.AAA
60001922 TOSHIBA DIGI	N250GB5.4KS	HDD TOSHIBA 2.5" 5400rpm 250GB MK2546GSX Leo BS SATA I LF F/W:LB013J
60002005 HGST SG	N250GB5.4KS	HDD HGST 2.5" 5400rpm 250GB HTS542525K9SA00 Bronco-B SATA II LF F/W:C31P
60002005 HGST SG	N250GB5.4KS	HDD HGST 2.5" 5400rpm 250GB HTS543225L9A300 Falcon-B SATA LF F/W:C40C
60001994 WD	N250GB5.4KS	HDD WD 2.5" 5400rpm 250GB WD2500BEVS-22UST0 ML125 SATA LF F/W:01.01A01
60002005 HGST SG	N320GB5.4KS	HDD HGST 2.5" 5400rpm 320GB HTS543232L9A300 Falcon-B SATA LF F/W:C40C

Vendor	Type	Description
60001994 WD	N320GB5.4KS	HDD WD 2.5" 5400rpm 320GB WD3200BEVT-22ZCT0 ML160 SATA LF F/W:11.01A11
60002005 HGST SG	N500GB5.4KSH	HDD HGST 2.5" 5400rpm 500GB HTS545050KTA300 Bronco K SATA LF F/W:C60G
<b>HDD2 Test</b>		
60002036 SEAGATE	N120GB5.4KS	HDD SEAGATE 2.5" 5400rpm 120GB ST9120817AS Corsair SATA LF F/W:3.AAA
60001922 TOSHIBA DIGI	N120GB5.4KS	HDD TOSHIBA 2.5" 5400rpm 120GB MK1246GSX Leo BS SATA I LF F/W:LB213J
60002005 HGST SG	N120GB5.4KS	HDD HGST 2.5" 5400rpm 120GB HTS542512K9SA00 Bronco-B SATA II LF F/W:C31P
60001994 WD	N120GB5.4KS	HDD WD 2.5" 5400rpm 120GB WD1200BEVS-22UST0 ML125 SATA LF F/W:01.01A01
60002036 SEAGATE	N160GB5.4KS	HDD SEAGATE 2.5" 5400rpm 160GB ST9160827AS Corsair SATA LF F/W:3.AAA
60001922 TOSHIBA DIGI	N160GB5.4KS	HDD TOSHIBA 2.5" 5400rpm 160GB MK1646GSX Leo BS SATA I LF F/W:LB113J
60002005 HGST SG	N160GB5.4KS	HDD HGST 2.5" 5400rpm 160GB HTS542516K9SA00 Bronco-B SATA II LF F/W:C31P
60001994 WD	N160GB5.4KS	HDD WD 2.5" 5400rpm 160GB WD1600BEVT-22ZCT0 ML160 SATA LF F/W:11.01A11
60002036 SEAGATE	N250GB5.4KS	HDD SEAGATE 2.5" 5400rpm 250GB ST9250827AS Corsair SATA LF F/W:3.AAA
60001922 TOSHIBA DIGI	N250GB5.4KS	HDD TOSHIBA 2.5" 5400rpm 250GB MK2546GSX Leo BS SATA I LF F/W:LB013J
60002005 HGST SG	N250GB5.4KS	HDD HGST 2.5" 5400rpm 250GB HTS542525K9SA00 Bronco-B SATA II LF F/W:C31P
60001994 WD	N250GB5.4KS	HDD WD 2.5" 5400rpm 250GB WD2500BEVS-22UST0 ML125 SATA LF F/W:01.01A01
60002005 HGST SG	N320GB5.4KS	HDD HGST 2.5" 5400rpm 320GB HTS543232L9A300 Falcon-B SATA LF F/W:C40C
60001994 WD	N320GB5.4KS	HDD WD 2.5" 5400rpm 320GB WD3200BEVT-22ZCT0 ML160 SATA LF F/W:11.01A11
<b>Keyboard Test</b>		
820123 DARFON	17KB-FV3 Black	Keyboard 17KB-FV3 Black Mammoth Standard (Aspire Black)
<b>LAN Test</b>		
610112 BROADCOM	BCM5764	Broadcom BCM5764
<b>LCD Test</b>		
60003316 AUO	N17WXGA+G	LCD AUO 17.1" WXGA+ Glare B170PW06 V2 LF 220nit 8ms
60002215 SAMSUNG	N17WXGA+G	LCD SAMSUNG 17.1" WXGA+ Glare LTN170BT07-G01 LF 220nit 8ms 500:1
60003089 LG	N17WXGA+G	LCD LPL 17.1" WXGA+ Glare LP171WP4-TLR1 LF 220nit 8ms

Vendor	Type	Description
<b>Memory Test</b>		
60001993 NANYA	SO1GBII6	SO-DIMM DDRII 667 1GB NT1GT64U8HB0BN-3C (0.09U)
60001993 NANYA	SO1GBII6	Memory NANYA SO-DIMM DDRII 667 1GB NT1GT64UH8D0FN-3C LF 64*16 0.07um
60002215 SAMSUNG	SO1GBII6	Memory SAMSUNG SO-DIMM DDRII 667 1GB M470T2864QZ3-CE6 LF
60002045 HYNIX	SO1GBII6	Memory HYNIX SO-DIMM DDRII 667 1GB HYMP112S64CP6- Y5 LF
60001993 NANYA	SO2GBII6	Memory NANYA SO-DIMM DDRII 667 2GB NT2GT64U8HD0BN-3C LF 128*8 0.07um
60002215 SAMSUNG	SO2GBII6	Memory SAMSUNG SO-DIMM DDRII 667 2GB M470T5663QZ3-CE6 LF
60002045 HYNIX	SO2GBII6	Memory HYNIX SO-DIMM DDRII 667 2GB HYMP125S64CP8- Y5 LF
60001993 NANYA	SO512MBII6	Memory NANYA SO-DIMM DDRII 667 512MB NT512T64UH8B0FN-3C LF 32*16 0.09um
60002215 SAMSUNG	SO512MBII6	Memory SAMSUNG SO-DIMM DDRII 667 512MB M470T6464QZ3-CE6 LF
60002045 HYNIX	SO512MBII6	Memory HYNIX SO-DIMM DDRII 667 512MB HYMP164S64CP6-Y5 LF 64*16 0.065um
<b>Modem Test</b>		
23707801 FOXCONN TW	Fox+Con MC4Z 1.5_3.3V	Foxconn Conexant -Unizion 1.5_3.3v T60M955.02
23707801 FOXCONN TW	Fox+Con MC4Z 1.5_3.3V Aus	Foxconn Conexant -Unizion 1.5_3.3v AUS T60M955.0x
<b>Northbridge Chipset Test</b>		
60001915 NVIDIA	NVMCP77MH	NVIDIA MCP77MH w/ HDCP EEPROM
<b>ODD Test</b>		
10001063 SONY	NBDCB2XS	ODD SONY BD COMBO 12.7mm Tray DL 2X BC-5500S LF W/ O bezel SATA
60001922 TOSHIBA DIGI	NSM8XS	ODD TOSHIBA Super-Multi DRIVE 12.7mm Tray DL 8X TS- L633A LF W/O bezel SATA
60001939 PIONEER	NSM8XS	ODD PIONEER Super-Multi DRIVE 12.7mm Tray DL 8X DVR- TD08RS LF W/O bezel SATA
23418669 HLDS	NSM8XS	ODD HLDS Super-Multi DRIVE 12.7mm Tray DL 8X GSA-T50N LF W/O bezel SATA
23418669 HLDS	NSM8XS	ODD HLDS Super-Multi DRIVE 12.7mm Tray DL 8X GSA-T50N LF W/O bezel SATA Malaysia
10001070 PHILIPS	NSM8XS	ODD PLDS Super-Multi DRIVE 12.7mm Tray DL 8X DS-8A2S LF W/O bezel SATA
<b>Software Test</b>		
10000981 MISC	McAfee	Antivirus application McAfee

Vendor	Type	Description
<b>VGA Test</b>		
60001915 NVIDIA	9MGSHM	NVIDIA 9MGSHM w/ HDCP
<b>VoIP Test</b>		
10000286 WISTRON	BT VoIP Xpress	Wistron Acer Xpress Card Phone Kit Rev 2.0
<b>VRAM Test</b>		
9999995 ONE TIME VENDER	256M-GD2	256M-GD2
<b>Wireless Antenna Test</b>		
9999995 ONE TIME VENDER	PIFA	PIFA
<b>WLAN Test</b>		
23707801 FOXCONN TW	3rd WiFi BG	Foxconn FOX_ATH_XB63 Foxconn Atheros XB63 minicard b/g
9999995 ONE TIME VENDER	3rd WiFi BG	QMI ATH_XB63 Atheros XB63 minicard b/g
9999995 ONE TIME VENDER	3rd WiFi BG	Foxconn Wireless LAN Broadcom 4312 minicard b/g



# Online Support Information

---

This section describes online technical support services available to help you repair your Acer Systems.

If you are a distributor, dealer, ASP or TPM, please refer your technical queries to your local Acer branch office. Acer Branch Offices and Regional Business Units may access our website. However some information sources will require a user i.d. and password. These can be obtained directly from Acer CSD Taiwan.

Acer's Website offers you convenient and valuable support resources whenever you need them.

In the Technical Information section you can download information on all of Acer's Notebook, Desktop and Server models including:

- Service guides for all models
- User's manuals
- Training materials
- Bios updates
- Software utilities
- Spare parts lists
- TABs (Technical Announcement Bulletin)

For these purposes, we have included an Acrobat File to facilitate the problem-free downloading of our technical material.

Also contained on this website are:

- Detailed information on Acer's International Traveler's Warranty (ITW)
- Returned material authorization procedures
- An overview of all the support services we offer, accompanied by a list of telephone, fax and email contacts for all your technical queries.

We are always looking for ways to optimize and improve our services, so if you have any suggestions or comments, please do not hesitate to communicate these to us.



**A**

AFLASH Utility 41

**B**

Battery Pack 48

BIOS

- package 23
- ROM size 23
- ROM type 23
- vendor 23
- Version 23

BIOS Utility 29–41

- Advanced 32
- Boot 37
- Exit 40
- Navigating 29
- Onboard Device Configuration 35
- Power 37, 38
- Save and Exit 40
- Security 34
- System Security 40

Bluetooth board 80

Board Layout

- Top View 157

brightness

- hotkeys 14

**C**

Camera Module 93

caps lock

- on indicator 10

Chipset POST Codes 147

Common Problems 130

computer

- on indicator 10

Core POST Codes 149

CPU 88

**D**

DIMM Module 51, 52

Display 4

display

- hotkeys 14

**E**

EasyTouch Failure 142

Euro 15

ExpressCard Module 83

External Module Disassembly

- Flowchart 47

**F**

Features 1

Fingerprint Reader Failure 143

Flash Utility 41

FPC Cable 96

FRU (Field Replaceable Unit) List 161

**H**

Hard Disk Drive1 Module 56

HDTV Switch Failure 144

Hibernation mode

- hotkey 14

Hot Keys 12

**I**

Indicators 10

Intermittent Problems 146

Internal Microphone Failure 136

Internal Speaker Failure 134

inverter board 92

**J**

Jumper and Connector Locations 157

- Top View 157

**K**

Keyboard 64

Keyboard Failure 133

**L**

Launch Board 77

LCD Bezel 90

---

- LCD Brackets 96
- LCD Failure 133
- LCD Module Disassembly
  - Flowchart 89
- LCD Panel 94
- lower covers 50

## M

- Main Unit Disassembly
  - Flowchart 60
- Mainboard 85
- media access
  - on indicator 10
- MediaTouch Button Failure 143
- Memory Check 130
- Model Definition 172
- Modem Board 65
- Modem Failure 141

## N

- No Display Issue 131
- Notebook Manager
  - hotkey 14
- num lock
  - on indicator 10

## O

- ODD Failure 138
- Online Support Information 195
- optical drive module 58

## P

- Panel 5
  - Bottom 9
  - left 5
- PC Card 10
- POST Codes
  - Chipset 147
  - Core 149
- Power On Failure 130

## S

- Speaker Module 78

- speakers
  - hotkey 14
- System
  - Block Diagram 4

## T

- Test Compatible Components 189
- Thermal Unit Failure 144
- Top 157
- Touch Pad
  - hotkey 14
- Touch Pad Bracket 76
- Touch Pad Failure 134
- Troubleshooting
  - Built-in KB Failure 133
  - EasyTouch Buttons 142
  - Fingerprint Reader 143
  - HDTV Switch 144
  - Internal Microphone 136
  - Internal Speakers 134
  - LCD Failure 133
  - MediTouch Buttons 143
  - Modem 141
  - No Display 131
  - ODD 138
  - Other Failures 145
  - Power On 130
  - Thermal Unit 144
  - Touch Pad 134
  - USB 141
  - WLAN 142
- TV Tuner Module 53

## U

- Undetermined Problems 146
- USB Failure (Rightside) 141
- utility
  - BIOS 29–41

## W

- Windows 2000 Environment Test 190
- Wireless Function Failure 142
- WLAN Board 54