

# **Aspire 9800 Series Service Guide**

Service guide files and updates are available on the ACER/CSD web; for more information, please refer to <http://csd.acer.com.tw>

PRINTED IN TAIWAN

---

## Revision History

Please refer to the table below for the updates made on Aspire 9800 service guide.

Date	Chapter	Updates

---

## Copyright

Copyright © 2006 by Acer Incorporated. All rights reserved. No part of this publication may be reproduced, transmitted, transcribed, stored in a retrieval system, or translated into any language or computer language, in any form or by any means, electronic, mechanical, magnetic, optical, chemical, manual or otherwise, without the prior written permission of Acer Incorporated.

## Disclaimer

The information in this guide is subject to change without notice.

Acer Incorporated makes no representations or warranties, either expressed or implied, with respect to the contents hereof and specifically disclaims any warranties of merchantability or fitness for any particular purpose. Any Acer Incorporated software described in this manual is sold or licensed "as is". Should the programs prove defective following their purchase, the buyer (and not Acer Incorporated, its distributor, or its dealer) assumes the entire cost of all necessary servicing, repair, and any incidental or consequential damages resulting from any defect in the software.

Acer is a registered trademark of Acer Corporation.

Intel is a registered trademark of Intel Corporation.

Pentium and Pentium II/III are trademarks of Intel Corporation.

Other brand and product names are trademarks and/or registered trademarks of their respective holders.

---

## Conventions

The following conventions are used in this manual:

<b>SCREEN MESSAGES</b>	Denotes actual messages that appear on screen.
<b>NOTE</b>	Gives bits and pieces of additional information related to the current topic.
<b>WARNING</b>	Alerts you to any damage that might result from doing or not doing specific actions.
<b>CAUTION</b>	Gives precautionary measures to avoid possible hardware or software problems.
<b>IMPORTANT</b>	Reminds you to do specific actions relevant to the accomplishment of procedures.

---

## Preface

Before using this information and the product it supports, please read the following general information.

1. This Service Guide provides you with all technical information relating to the BASIC CONFIGURATION decided for Acer's "global" product offering. To better fit local market requirements and enhance product competitiveness, your regional office MAY have decided to extend the functionality of a machine (e.g. add-on card, modem, or extra memory capability). These LOCALIZED FEATURES will NOT be covered in this generic service guide. In such cases, please contact your regional offices or the responsible personnel/channel to provide you with further technical details.
2. Please note WHEN ORDERING FRU PARTS, that you should check the most up-to-date information available on your regional web or channel. If, for whatever reason, a part number change is made, it will not be noted in the printed Service Guide. For ACER-AUTHORIZED SERVICE PROVIDERS, your Acer office may have a DIFFERENT part number code to those given in the FRU list of this printed Service Guide. You MUST use the list provided by your regional Acer office to order FRU parts for repair and service of customer machines.



# System Specifications

---

## Features

Below is a brief summary of the computer's many features:

### Operating system

- Genuine Windows<sup>®</sup> Vista<sup>™</sup> Capable
- Genuine Windows<sup>®</sup> XP Home Edition (Service Pack 2)
- Genuine Windows<sup>®</sup> XP Media Center Edition 2005 (Rollup 2)

**NOTE:** Windows<sup>®</sup> Vista<sup>™</sup> Capable PCs come with Windows<sup>®</sup> XP installed, and can be upgraded to Windows<sup>®</sup> Vista<sup>™</sup>. For more information on Windows<sup>®</sup> Vista<sup>™</sup> and how to upgrade, go to: [Microsoft.com/windowsvista](http://Microsoft.com/windowsvista).

### Platform and memory

- Intel<sup>®</sup> Centrino<sup>®</sup> Duo mobile technology, featuring:
  - ▶ Intel<sup>®</sup> Core<sup>™</sup> Duo processor T2300/T2400/T2500/T2600 (2 MB L2 cache, 1.66/1.83/2/2.16 GHz, 667 MHz FSB) or higher
  - ▶ Intel<sup>®</sup> 945PM Express chipset
- Integrated Intel<sup>®</sup> PRO/Wireless 3945ABG network connection (dual-band tri-mode 802.11a/b/g) Wi-Fi CERTIFIED<sup>™</sup> solution, supporting Acer SignalUp<sup>™</sup> wireless technology
- Core logic: Intel<sup>®</sup> 945PM+ICH7M (north bridge+ south bridge)
- Up to 2GB of DDR2 677 MHz memory, upgradeable to 4GB using two soDIMM modules (dual-channel support)

### Display and graphics

- 20.1" WSXGA+ high-brightness Acer CrystalBrite<sup>™</sup> TFT LCD, 1680 x 1050 pixel resolution, 6 lamps
- 19" WXGA+ high-brightness Acer CrystalBrite<sup>™</sup> TFT LCD, 1440 x 900 pixel resolution, 4 lamps
- 16 ms typical on/off and 8 ms average gray-to-gray response time
- Simultaneous multi-window viewing via Acer Vista<sup>™</sup> supported
- NVIDIA<sup>®</sup> GeForce<sup>®</sup> Go 7600 with up to 512MB TurboCache<sup>™</sup> (256 MB of dedicated GDDR2 VRAM and up to 256 MB of shared system memory) or,
- NVIDIA<sup>®</sup> GeForce<sup>®</sup> Go 7300 with up to 256MB TurboCache<sup>™</sup> (128 MB of dedicated GDDR2 VRAM and up to 128 MB of shared system memory)
- Supporting NVIDIA<sup>®</sup> PureVideo<sup>™</sup> technology (WMV HD, High-Definition MPEG-2 Hardware Acceleration, integrated HDTV encoder) dual-link DVI, Microsoft<sup>®</sup> DirectX<sup>®</sup> 9.0, Shader Model 3.0, OpenEXR High Dynamic Range (HDR) technology, NVIDIA<sup>®</sup> PowerMizer<sup>™</sup> 6.0 and PCI Express<sup>®</sup>
- Dual independent display
- 16.7 million colors (20.1" LCD model)
- 16.2 million colors (19" LCD model)
- MPEG-2/DVD hardware-assisted capability
- S-video/TV-out (NTSC/PAL) support

- 
- DVI-D (true digital video interface) with HDCP (High-bandwidth Digital Content Protection) support
  - Acer Arcade™ featuring Acer CinemaVision™ and Acer ClearVision technologies

### TV-tuner

- Acer TV-tuner options:
  - ▶ Analog TV-tuner supporting hardware MPEG-2 stream encoding
  - ▶ Digital and analog hybrid TV-tuner supporting hardware MPEG-2 stream encoding
  - ▶ Digital and analog hybrid TV-tuner supporting software MPEG-2 stream encoding
- Analog TV-tuner supporting international analog TV standards (NTSC/PAL/SECAM)
- Digital TV-tuner supporting DVB-T (Digital Video Broadcasting Terrestrial) standard (6 MHz to 8MHz)
- TV-tuner I/O:
  - ▶ RF jack for digital/analog TV antenna cable input
  - ▶ AV-in port for composite/S-video/line-in audio/video input
- TV-tuner cables:
  - ▶ PAL cable for digital/analog TV input, PAL/SECAM to NTSC port converter
  - ▶ Mini DIN cable: RCA jack and S-video port for audio/video input
- Acer DVB-T antenna (UHF/VHF reception) supporting Acer SignalUp™ wireless technology

### Audio

- Audio system with two built-in Acer 3DSonic (1.5W) stereo speakers and one Acer BasSonic Subwoofer
- Dolby® Digital Live and DTS Neo: PC support
- Intel® High Definition audio support
- S/PDIF (Sony/Philips Digital Interface) support for digital speakers (1.5W)
- Sound Blaster Pro™ and MS Sound compatible
- Two built-in stereo microphone

### Storage subsystem

- One or two 80/100/120 GB Serial ATA hard disk drive, supporting software RAID 0/1
- Optical drive options: DVD-Super Multi double-layer drive (slot-load)
- 5-in-1 card reader, supporting Secure Digital (SD), MultiMediaCard (MMC), Memory Stick® (MS), Memory Stick PRO™ (MS PRO), xD-Picture Card™ (xD)

### Input devices

- 88/89-key Acer FineTouch™ keyboard with 5-degree curve
- Touchpad with 4-way scroll button
- Four easy-launch buttons
- Two front-access switches: WLAN LED and Bluetooth® LED-switches (for selected models)

### Communication

- Acer Video Conference, featuring Voice and Video over Internet Protocol (VVoIP) support via Acer OrbiCam™ and optional Acer Bluetooth® VoIP phone
- Acer OrbiCam™ 1.3 megapixel CMOS camera, featuring:
  - ▶ 30 degree ergonomic rotation
  - ▶ Acer VisageOn™ technology



---

◆ Acer PrimaLite™ technology

- Modem: 56K ITU V.92 modem with PTT approval; wake-on ring ready
- LAN: gigabit Ethernet; wake-on-LAN ready
- WPAN: Bluetooth® 2.0+EDR (Enhanced Data Rate)
- WLAN: Intel® PRO/Wireless 3945ABG network connection (dual-band tri-mode 802.11a/b/g) Wi-Fi® CERTIFIED™ solution, supporting Acer SignalUp™ wireless technology

## I/O Ports

- ExpressCard™/54 slot
- PC Card slot (one Type II)
- 5-in-1 card reader (SD/MMC/MS/MS PRO/xD)
- Four USB 2.0 ports
- DVI-D port with HDCP support
- IEEE 1394 port
- Consumer infrared (CIR) port
- Fast infrared (FIR) port
- External display (VGA) port
- S-video/TV-out (NTSC/PAL) port
- AV-in port
- TV-tuner antenna-in port
- Headphones/speaker/line-out port with S/PDIF support
- Microphone-in jack
- Line-in jack
- Parallel port
- Serial port
- Ethernet (RJ-45) port
- Modem (RJ-11) port
- DC-in jack for AC adaptor

**NOTE:** HDCP is acronym for High-bandwidth Digital Content Protection. An encryption system for enforcing digital rights management (DRM) over DVI and HDMI interfaces

## Environment

- Temperature:
  - ◆ operating: 5° C to 35° C
  - ◆ Non-operating: -20° C to 65° C
- Humidity (non-condensing):
  - ◆ operating: 20%~80%
  - ◆ Non-operating: 20%~80%

# System Block Diagram

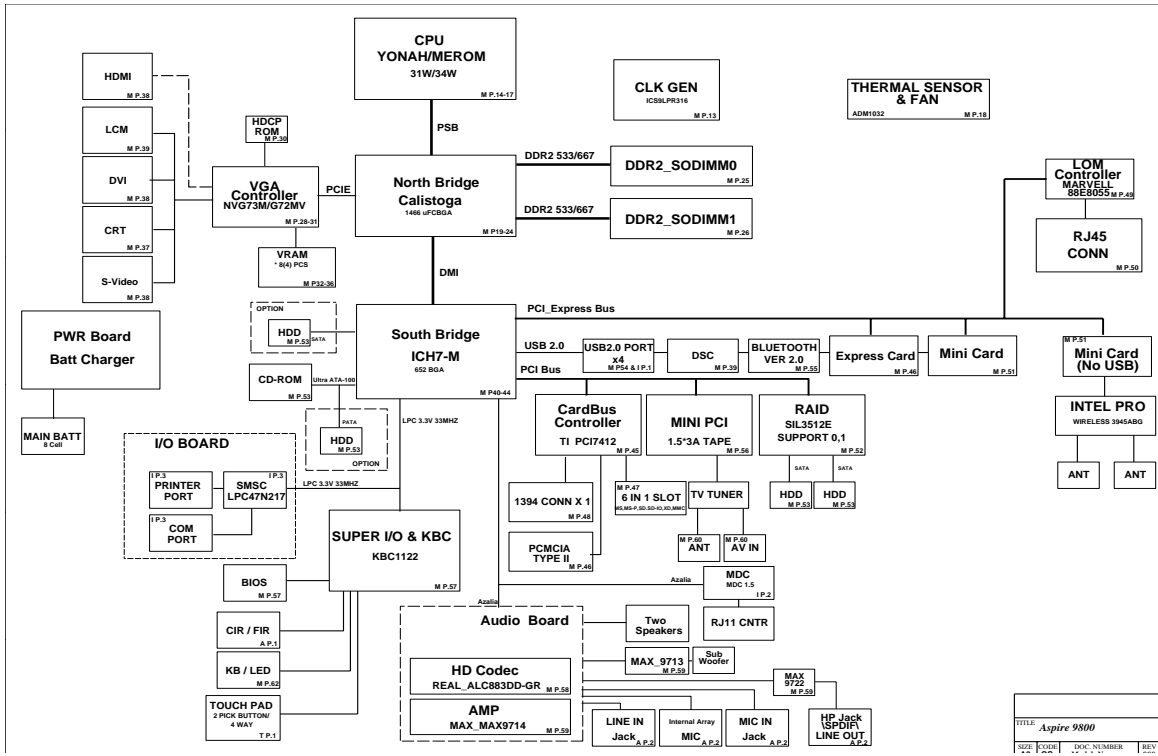

# Board Layout

## Top View

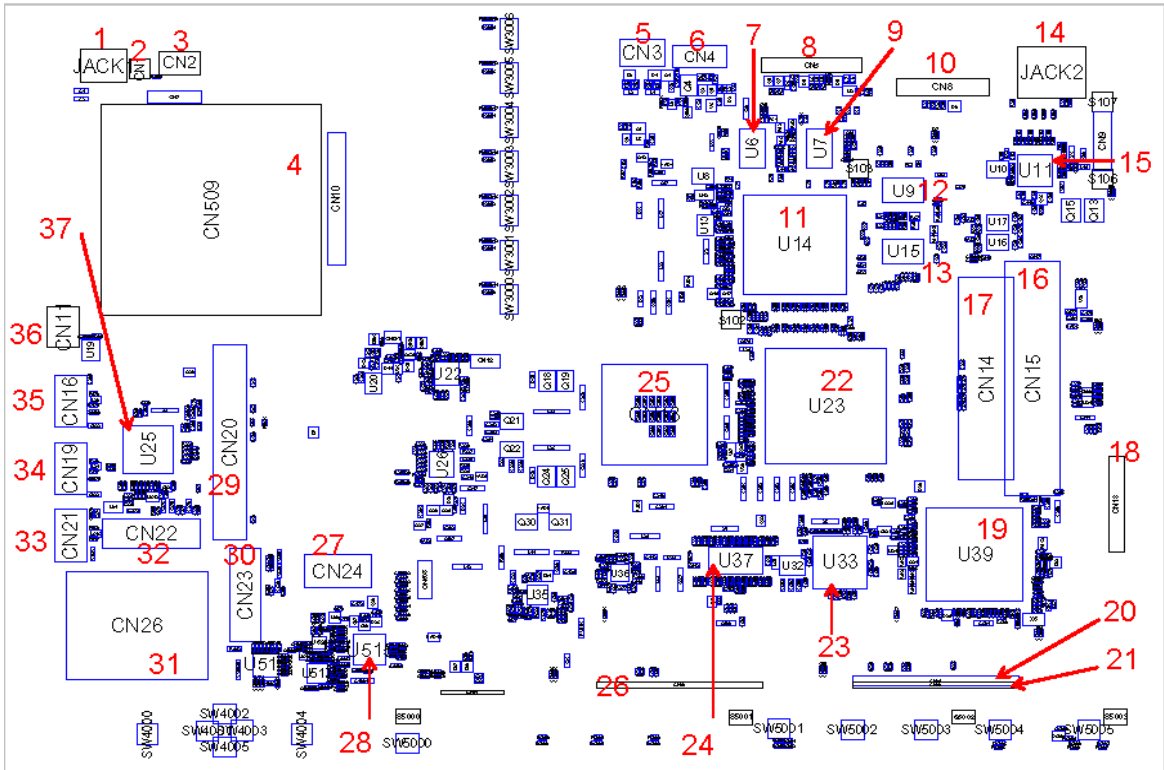

1	JACK1	AV-in Jack	20	CN29	PATA HDD Connector
2	CN1	TV Antenna Connector	21	CN30	SATA HDD Connector
3	CN2	S-Video Connector	22	U23	North Bridge
4	CN509	Card Bus Socket	23	U33	RAID Controller
5	CN3	S-Video Connector	24	U37	Timing Controller
6	CN4	HDMI Connector	25	CN13	CPU Socket
7	U6	Video Memory	26	CN28	SATA HDD Connector
8	CN5	I/O Board to Main Board Connector	27	CN24	BIOS Flash Memory
9	U7	Video Memory	28	U515	Audio Codec
10	CN8	DVI-D Port	29	CN20	Mini PCI Socket
11	U14	Graphic Controller	30	CN23	Mini Card Connector
12	U9	DDR2 SDRAM IC	31	CN26	Media Board Connector
13	U15	DDR2 SDRAM IC	32	CN22	Wireless LAN Card Connector
14	JACK2	Microphone Jack	33	CN21	USB Connector
15	U11	Ethernet Controller	34	CN19	USB Connector
16	CN15	DIMM Socket	35	CN16	USB Connector
17	CN14	DIMM Socket	36	CN11	IEEE port
18	CN18	Optical Disk Drive Connector	37	U25	PCI cardbus/Media Board/1394 IC
19	U39	South Bridge			

# Bottom View

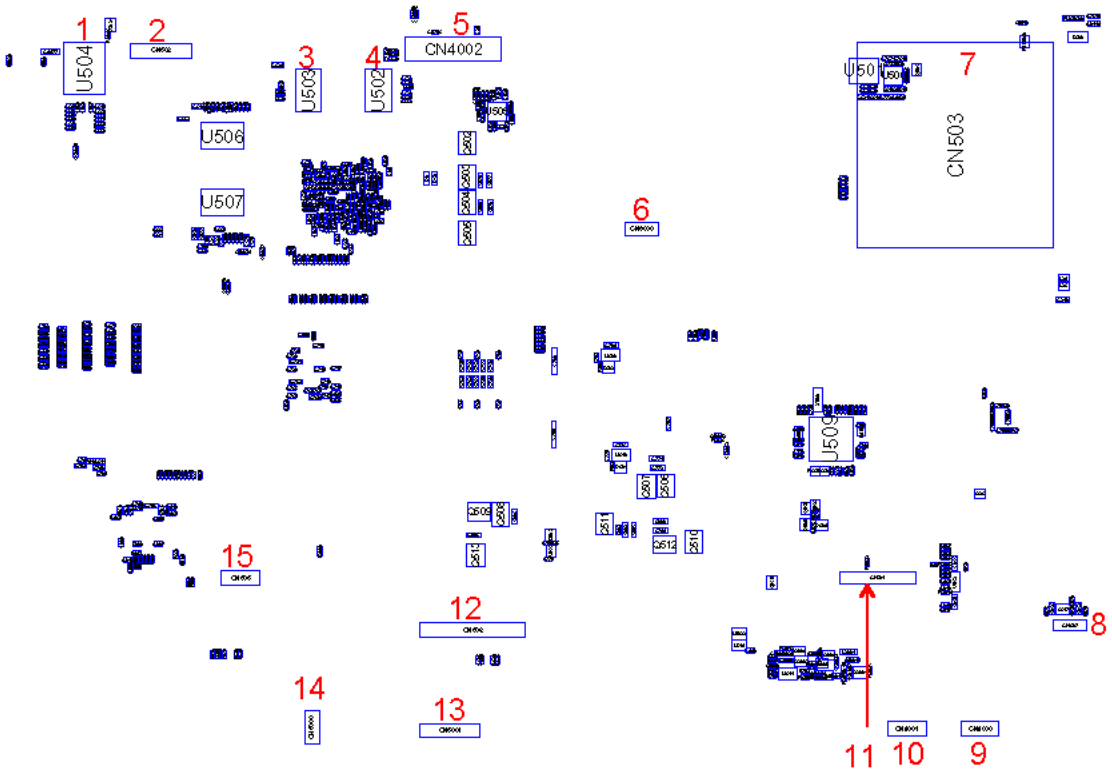

1	U504	LAN Transformer GSN 5009	9	CN4000	Touchpad Connector (Touchpad to main board)
2	CN502	Launch Board Connector	10	CN4001	6-pin Touchpad Board Connector
3	U503	Video Memory	11	CN504	Audio Board Connector
4	U502	Video Memory	12	CN506	DDR2 SDRAM IC
5	CN4002	LCD Connector	13	CN5001	Hotkey Board Connector
6	CN3000	Hotkey Board Connector	14	CN5000	Main Board to Media Board Connector
7	CN503	Express Card Slot	15	CN505	Touchpad Board Connector
8	CN507	DDR2 SDRAM IC			

# Your Acer Notebook tour

After knowing your computer features, let us show you around your new Aspire computer.

## Front View











#	Icon	Item	Description
1		Built-in camera	1.3 megapixel web camera for video communication.
2		Display screen	Also called Liquid-Crystal Display (LCD), displays computer output.
3		Media/volume buttons	For use with Acer Arcade and other media playing programs.
4/8		Microphone	Internal microphone for sound recording.
5		Touchpad	Touch-sensitive pointing device which functions like a computer mouse.
6		Click buttons (left, center and right)	The left and right buttons function like the left and right mouse buttons; the center button serves as a 4-way scroll button.
7		Palmrest	Comfortable support area for your hands when you use the computer.
9		Keyboard	For entering data into your computer.

10/11		Easy-launch buttons	Buttons for launching frequently used programs.
12		Power button	Turns the computer on and off.



## Closed Front View



#	Icon	Item	Description
1		Speaker	Left and right speakers deliver stereo audio output.
2		Infrared port/CIR receiver	Interfaces with infrared devices (e.g., infrared printer and IR-aware computer)/ Receives signals from a remote control.
3		Line-in jack	Accepts audio line-in devices (e.g., audio CD player, stereo walkman).
4		Microphone-in jack	Accepts input from external microphones.
5		Headphones/speaker/line-out jack with S/PDIF support	Connects to audio line-out devices (e.g., speakers, headphones).
6		Power indicator	Indicates the computer's power status.
7		Battery indicator	Indicates the computer's battery status.
8		Bluetooth® communication button/indicator	Enables/disables the Bluetooth® function. Indicates the status of Bluetooth communication.
9		Wireless communication button/indicator	Enables/disables the wireless function. Indicates the status of wireless LAN communication.

## Left View







#	Icon	Item	Description
1		USB 2.0 ports	Connects to USB 2.0 devices (e.g., USB mouse, USB camera).
2		Modem (RJ-11) port	Connects to a phone line.
3		Optical drive	Internal optical drive; accepts CDs or DVDs (slot-load or tray-load depending on model).
4		Optical disk access indicator	Lights up when the optical drive is active.
5		Optical drive eject button	Ejects the optical disk from the drive.
6		Emergency eject hole	Ejects the optical drive tray when the computer is turned off.
7		Latch	Locks and releases the lid.

## Right View





#	Icon	Item	Description
1		Latch	Locks and releases the lid.
2		5-in-1 card reader	Accepts Secure Digital (SD), MultiMediaCard (MMC), Memory Stick (MS), Memory Stick PRO (MS PRO), xD-Picture Card (xD).





3		3 USB 2.0 ports	Connect to USB 2.0 devices (e.g., USB mouse, USB camera).
4		4-pin IEEE 1394 port	Connects to IEEE 1394 devices.
5		PC Card slot eject button	Ejects the PC Card from the slot.
6		PC Card slot	Accepts one Type II PC Card.
7		Express Card/54 slot	Accepts and ExpressCard/34 module Note: ExpressCards are third generation of PC cards, hot-swappable and smaller than previous PC Cards. Designed for both desktop and mobile use, ExpressCards use either USB 2.0 or a single lane PCI Express technology that provides 500 Mbytes/sec total throughput. Formerly code named "NEWCARD," ExpressCards are 5 mm thick like Type II PC Cards, but do not use the same 86x54 mm footprint. ExpressCards come in 75x54 mm and 75x34 mm sizes. Express Card/54 slot means this notebook accepts 75x54mm ExpressCards.

## Rear view



#	Icon	Item	Description
1		DC-in jack	Connects to an AC adapter.
2		TV-in port	Accepts input signals from analog/digital TV-tuner devices (for selected models).
3		AV-in port	Accepts input signals from audio/video (AV) devices (manufacturing option).
4		Kensington lock slot	Connects to a Kensington-compatible computer security lock.



#	Icon	Item	Description
5		Ventilation slots	Enable the computer to stay cool, even after prolonged use.
6		S-video/TV-out (NTSC/PAL) port	Connects to a television or display device with S-video input.
7		External display (VGA) port	Connects to a display device (e.g., external monitor, LCD projector).
8	DVI-D	DVI-D port	Supports digital video connections.
9		Ethernet (RJ-45)	Connects to an Ethernet 10/100/1000-based network (for selected models).
10		Parallel port	Connects to a printer.
11		Serial port	Connects to a serial device.

## Base view



#	Item	Description
1	Ventilation slots and cooling fan	Enable the computer to stay cool, even after prolonged use. Note: Do not cover or obstruct the opening of the fan.





2	Memory compartment	Houses the computer's main memory.
3	Battery lock	Locks the battery in position.
4	Battery release latch	Releases the battery for removal.
5	Battery bay	Houses the computer's battery pack.
6	Hard disk bay	Houses the computer's hard disk (secured with screws)
7	Sub woofer	Emits low frequency sound output.



## Indicators

The computer has several easy-to-read status indicators.



The front panel indicators are visible even when the computer cover is closed up.

Icon	Function	Description
Zz	Standby	Indicates the computer's standby status.
	HDD	Indicates when the hard disc or optical drive is active.
	Cap lock	Lights when Cap Lock is activated
	Num lock	Lights when Num Lock is activated.
	Power	Lights up when the computer is on.

Icon	Function	Description
	Battery	Lights up when the battery is being charged.
	Bluetooth	Indicates the status of Bluetooth communication.
	Wireless LAN	Indicates the status of wireless LAN communication.

**NOTE:** 1. **Charging:** The light shows amber when the battery is charging. 2. **Fully charged:** The light shows green when in AC mode.

## Easy-Launch Buttons

Located above the keyboard are four buttons. These buttons are called easy-launch buttons. They are: mail Web browser, Empowering Key “*e*” and one user-programmable button.

Press “*e*” to run the Acer Empowering Technology. The mail and Web browser buttons are pre-set to email and Internet programs, but can be reset by users. To set the Web browser, mail and programmable buttons, run the Acer Launch Manager.



Launch key	Default application
<i>e</i>	Acer Empowering Technology (user-programmable)
P	User-programmable
Web browser	Internet browser (user-programmable)
Mail	Email application (user-programmable)

## Touchpad Basics

The following teaches you how to use the touchpad:

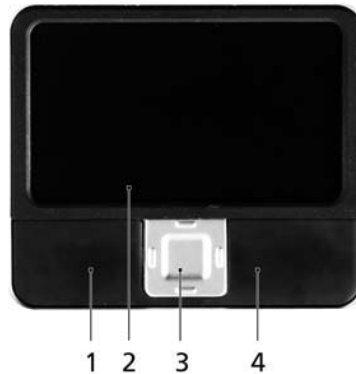

- Move your finger across the touchpad (2) to move the cursor.
- Press the left (1) and right (4) buttons located beneath the touchpad to perform selection and execution functions. These two buttons are similar to the left and right buttons on a mouse. Tapping on the touchpad is the same as clicking the left button.
- Use the 4-way scroll (3) button to scroll up or down and move left or right a page. This button mimics your cursor pressing on the right scroll bar of Windows applications.

Function	Left Button (1)	Right Button (4)	Main touchpad (2)	Center button (3)
Execute	Click twice quickly		Tap twice (at the same speed as double-clicking the mouse button)	
Select	Click once		Tap once	
Drag	Click and hold, then use finger on the touchpad to drag the cursor.		Tap twice (at the same speed as double-clicking a mouse button); rest your finger on the touchpad on the second tap and drag the cursor.	
Access context menu		Click once		
Scroll				Click and hold to move up/down/left/right.

**NOTE:** When using the touchpad, keep it - and your fingers - dry and clean. The touchpad is sensitive to finger movements; hence, the lighter the touch, the better the response. Tapping too hard will not increase the touchpad's responsiveness.

## Using the Keyboard

The keyboard has full-sized keys and an embedded keypad, separate cursor keys, two Windows keys and twelve function keys.

### Lock Keys and embedded numeric keypad

The keyboard has three lock keys which you can toggle on and off.

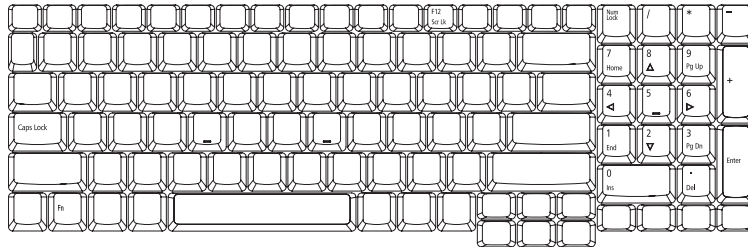









Lock Key	Description
Caps Lock	When Caps Lock is on, all alphabetic characters typed are in uppercase.
Num lock <Fn>+<F11>	When Num Lock is on, the embedded keypad is in numeric mode. The keys function as a calculator (complete with the arithmetic operators +, -, *, and /). Use this mode when you need to do a lot of numeric data entry. A better solution would be to connect an external keypad.
Scroll lock <Fn>+<F12>	When Scroll Lock is on, the screen moves one line up or down when you press the up or down arrow keys respectively. Scroll Lock does not work with some applications.

The embedded numeric keypad functions like a desktop numeric keypad. It is indicated by small characters located on the upper right corner of the keycaps. To simplify the keyboard legend, cursor-control key symbols are not printed on the keys.

Desired Access	Num Lock On	Num Lock Off
Number keys on embedded keypad	Type numbers in a normal manner.	
Cursor-control keys on embedded keypad	Hold <Shift> while using cursor-control keys.	Hold <Fn> while using cursor-control keys.
Main keyboard keys	Hold <Fn> while typing letters on embedded keypad.	Type the letters in a normal manner.

## Windows Keys

The keyboard has two keys that perform Windows-specific functions.



Key	Icon	Description
Windows key 		<p>Pressed alone, this key has the same effect as clicking on the Windows Start button; it launches the Start menu. It can also be used with other keys to provide a variety of function:</p> <ul style="list-style-type: none"> <li> + &lt;Tab&gt; Activates next taskbar button.</li> <li> + &lt;E&gt; Opens the My Computer window</li> <li> + &lt;F1&gt; Opens Help and Support.</li> <li> + &lt;F&gt; Opens the Find: All Files dialog box.</li> <li> + &lt;R&gt; Opens the Run dialog box.</li> <li> + M Minimizes all windows.</li> </ul> <p>&lt;Shift&gt;+  + &lt;M&gt; Undoes the minimize all windows action.</p>
 Application key		This key has the same effect as clicking the right mouse button; it opens the application's context menu.





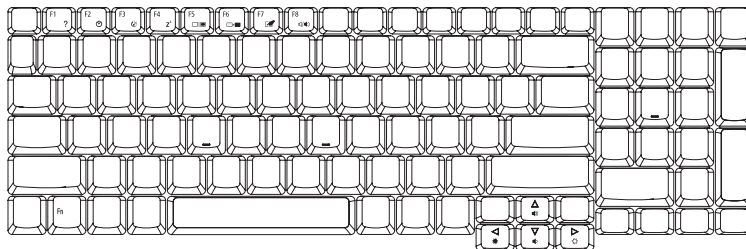



## Hot Keys

The computer employs hotkeys or key combinations to access most of the computer's controls like screen brightness, volume output and the BIOS utility.

To activate hot keys, press and hold the <Fn> key before pressing the other key in the hotkey combination.



Hot Key	Icon	Function	Description
<Fn>+<F1>	?	Hot key help	Displays help on hot keys.
<Fn>+<F2>		Acer eSetting	Launches the Acer eSettings in Acer eManager.
<Fn>+<F3>		Acer ePowerManagement	Launches the Acer ePowerManagement in Acer Empowering Technology. <b>See "Acer Empowering Technology" on page 19.</b>

Hot Key	Icon	Function	Description
<Fn>+<F4>		Sleep	Puts the computer in Sleep mode.
<Fn>+<F5>		Display toggle	Switches display output between the display screen, external monitor (if connected) and both.
<Fn>+<F6>		Screen blank	Turns the display screen backlight off to save power. Press any key to return.
<Fn>+<F7>		Touchpad toggle	Turns the internal touchpad on and off.
<Fn>+<F8>		Speaker toggle	Turns the speakers on and off.
<Fn>+<F9>		Volume up	Increases the speaker volume.
<Fn>+<F10>		Volume down	Decreases the speaker volume.
<Fn>+<F11>		Brightness up	Increases the screen brightness.
<Fn>+<F12>		Brightness down	Decreases the screen brightness

## Special Key

You can locate the Euro symbol and US dollar sign at the upper-center and/or bottom-right of your keyboard. To type:

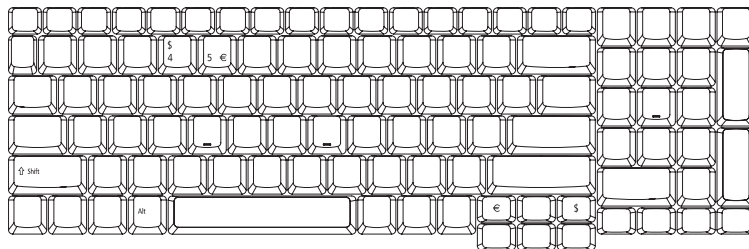

## The Euro symbol

1. Open a text editor or word processor.

- 
2. Either directly press the < € > symbol at the bottom-right of the keyboard, or hold <Alt Gr> and then press the <5> symbol at the upper-center of the keyboard.

**NOTE:** Some fonts and software do not support the Euro symbol. Please refer to [www.microsoft.com/typography/faq/faq12.htm](http://www.microsoft.com/typography/faq/faq12.htm) for more information.

### The US dollar sign

1. Open a text editor or word processor.
2. Either directly press the < \$ > key at the bottom-right of the keyboard, or hold <Shift> and then press the <4> key at the upper-center of the keyboard.

**NOTE:** This function varies by the operating system version.



---

## Acer Empowering Technology

Acer's innovative Empowering Technology makes it easy for you to access frequently used functions and manage your new Acer notebook. It features the following handy utilities:

- ❑ **Acer eNet Management** hooks up to location-based networks intelligently.
- ❑ **Acer ePower Management** extends battery power via versatile usage profiles.
- ❑ **Acer ePresentation Management** connects to a projector and adjusts display settings conveniently.
- ❑ **Acer eDataSecurity Management** protects data with passwords and advanced encryption algorithms.
- ❑ **Acer eLock Management** limits access to external storage media.
- ❑ **Acer eRecovery Management** backs up and recovers data flexibly, reliably and completely.
- ❑ **Acer eSettings Management** accesses system information and adjusts settings easily.
- ❑ **Acer ePerformance Management** improves system performance by optimizing disk space, memory and registry settings.



For more information, press the < *e* > key to launch the Empowering Technology menu, then click on the appropriate utility and select the Help or Tutorial function.

### Empowering Technology password

Before using Acer eLock Management and Acer eRecovery Management, you must initialize the Empowering Technology password. Right-click on the Empowering Technology toolbar and select "Password Setup" to do so. If you do not initialize the Empowering Technology password, you will be prompted to do so when running Acer eLock Management or Acer eRecovery Management for the first time.

### Acer eNet Management

Acer eNet Management helps you to quickly and easily connect to both wired and wireless networks in a variety of locations. To access this utility, either click on the "**Acer eNet Management**" icon on your netebook, or start the program from the Start menu. You also have the option to set Acer eNet Management to start automatically when you boot up your PC.

Acer eNet Management automatically detects the best settings for a new location, while offering you the freedom to manually adjust the settings to match your needs.

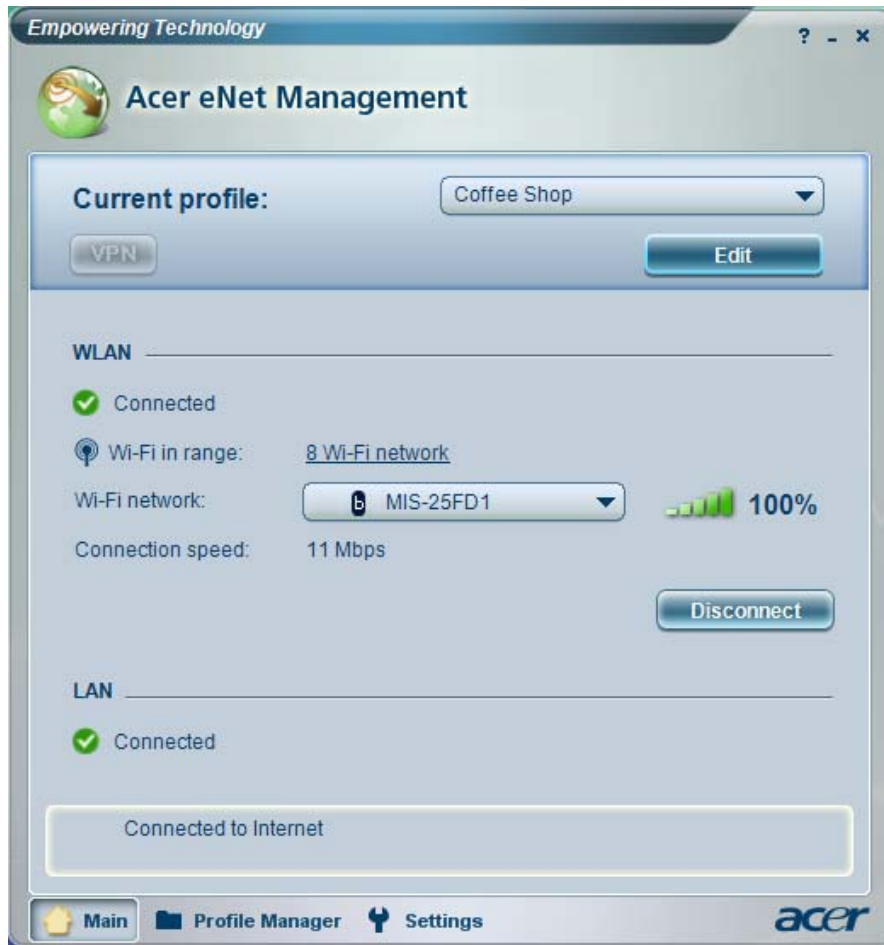

Acer eNet Management can save network settings for a location to a profile, and automatically switch to the appropriate profile when you move from one location to another. Settings stored include network connection settings (IP and DNS settings, wireless AP details, etc.), as well as default printer settings. Security and safety concerns mean that Acer eNet Management does not store username and password information.

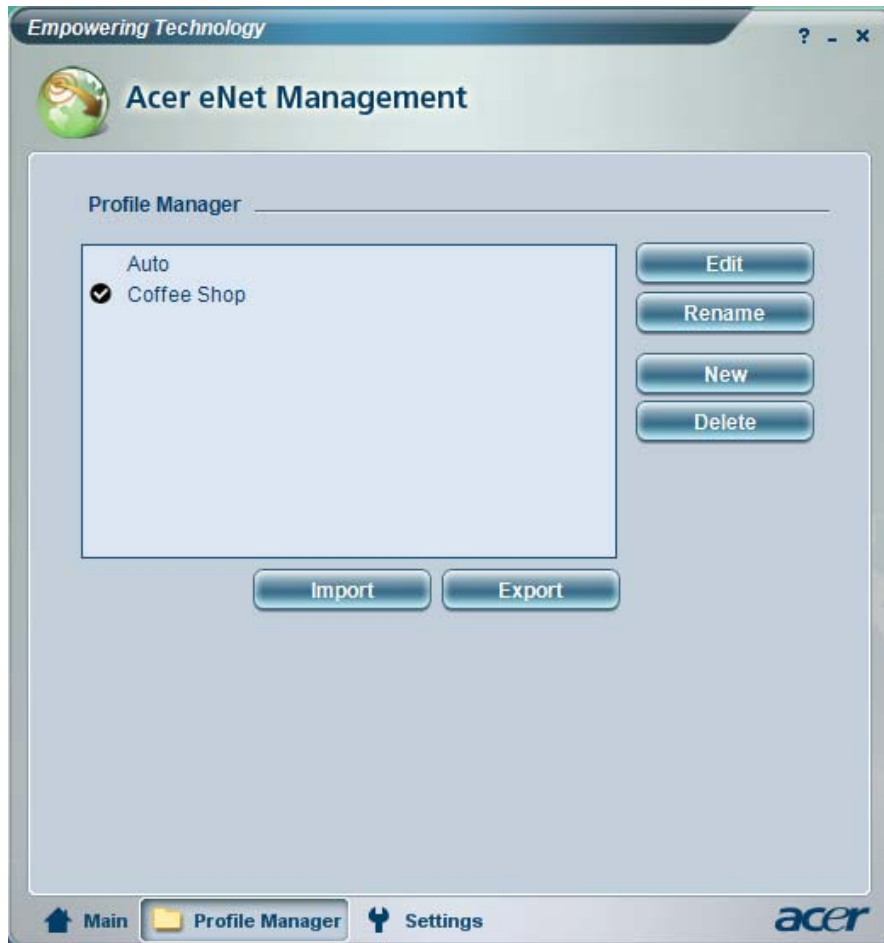

## Acer ePower Management

Acer ePower Management features a straightforward user interface. To launch it, select Acer ePower Management from the Empowering Technology interface.

### AC Mode (Adapter mode)

The default setting is “Maximum Performance.” You can adjust CPU speed, LCD brightness and other settings, or click on buttons to turn the following functions on/off: Wireless LAN, Bluetooth, CardBus, FireWire (1394), Wired LAN and Optical Device if supported.

### DC Mode (Battery mode)

There are four pre-defined profiles - Entertainment, Presentation, Word Processing, and Battery Life. You can also define up to three of your own.

### To create new power profile

1. Change power settings as desired.
2. Click “Save as...” to save to a new power profile.
3. Name the newly created profile.
4. Select whether this profile is for Adapter or Battery mode, then click OK.
5. The new profile will appear in the profile list.

## Battery status

For real-time battery life estimates based on current usage, refer to the panel on the lower left-hand side of the window.



For additional options, click **“Settings”** to:

- Set alarms.
- Re-load factory defaults.
- Select what actions will be taken when the cover is closed or the power button is pressed.
- View information about Acer ePower Management.



## Acer ePresentation Management

Acer ePresentation Management lets you project your computer's display to an external device or project using the hot key: Fn + F5. If auto-detection hardware is implemented in the system, your system display will be automatically switched out when an external display is connected to the system.



## Acer eDataSecurity Management

Acer eDataSecurity Management is handy file encryption utility that protects your files from being accessed by unauthorized persons. It is conveniently integrated with Windows explorer as a shell extension for quick and easy data encryption/decryption and also supports on-the-fly file encryption for MSN Messenger and Microsoft Outlook.

The Acer eDataSecurity Management setup wizard will prompt you for a supervisor password and default encryption. This encryption will be used to encrypt files by default, or you can choose to enter your own file-specific password when encrypting a file.

**NOTE:** The password used to encrypt a file is the unique key that the system needs to decrypt it. If you lose the password, the supervisor password is the only other key capable of decrypting the file. If you lose both passwords, there will be no way to decrypt your encrypted file! **Be sure to safeguard all related passwords!**

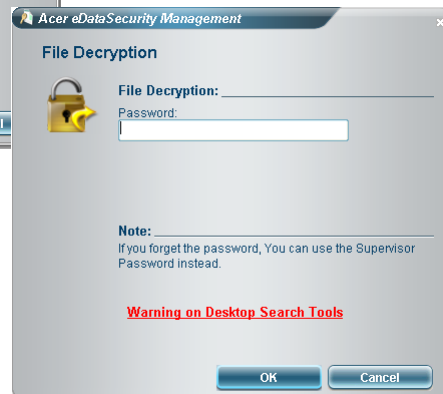
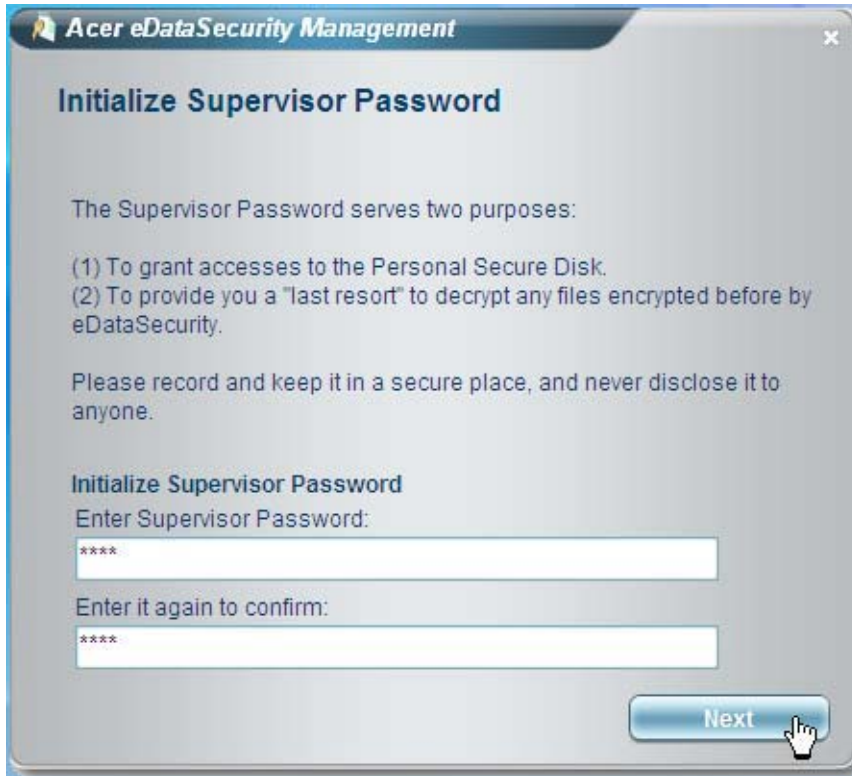

## Acer eLock Management

Acer eLock Management is a security utility that allows you to lock your removable data, optical and floppy drives to ensure that data can't be stolen while your notebook is unattended.

- Removable data devices - includes USB disk drives, USB pen drives, USB flash drives, USB MP3 drives, USB memory card readers, IEEE 1394 disk drives and any other removable disk drives that can be mounted as a file system when plugged into the system.
- Optical drive devices - includes any kind of CD-ROM or DVD-ROM drives.
- Floppy disk drives - 3.5-inch disks only.
- Interfaces - includes serial ports, parallel port, infrared (IR), and Bluetooth.

To activate Acer eLock Management, a password must be set first. Once set, you can apply locks to any of the devices. Lock(s) will immediately be set without any reboot necessary, and will remain locked after rebooting, until unlocked.

**NOTE:** If you lose your password, there is no method to reset it except by reformatting your notebook or taking your notebook to an Acer Customer Service Center. Be sure to remember or write down your password.

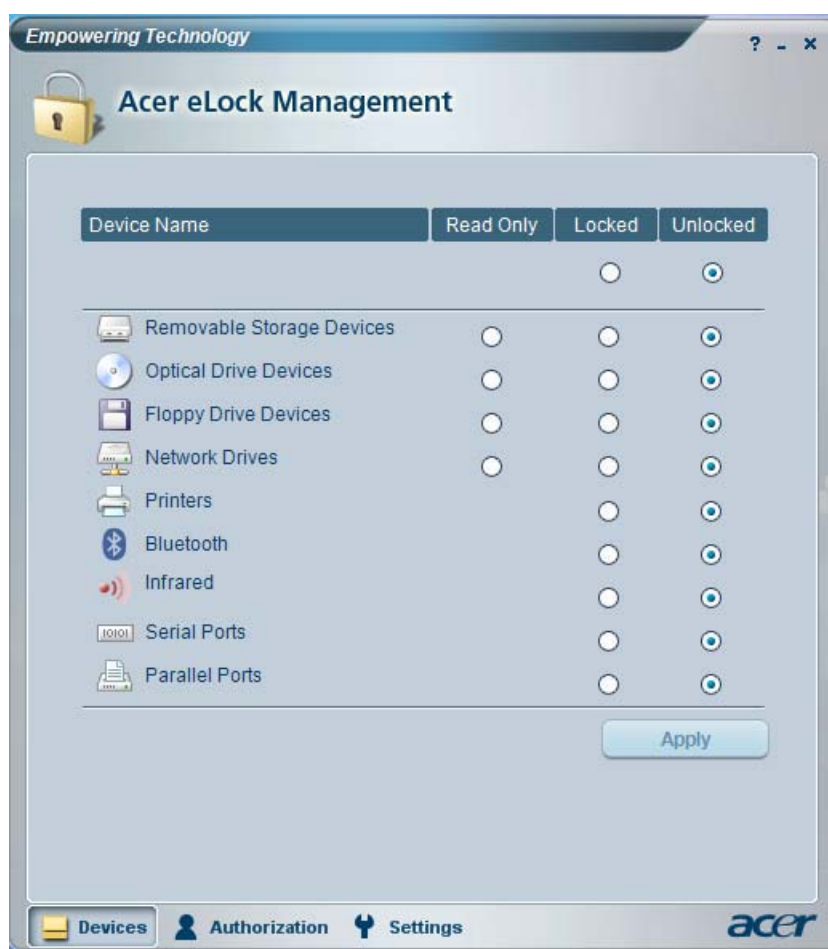

## Acer eRecovery Management

Acer eRecovery Management is a powerful utility that does away with the need for recovery disks provided by the manufacturer. The Acer eRecovery Management utility occupies space in a hidden partition on your system's HDD. User-created backups are stored on D:\ drive. Acer eRecovery Management provides you with:

- Password protection.
- Recovery of applications and drivers.



- Image/data backup:
  - Back up to HDD (set recovery point).
  - Back up to CD/DVD.
- Image/data recovery tools:
  - Recover from a hidden partition (factory defaults).
  - Recover from the HDD (most recent user-defined recovery point).
  - Recover from CD/DVD.

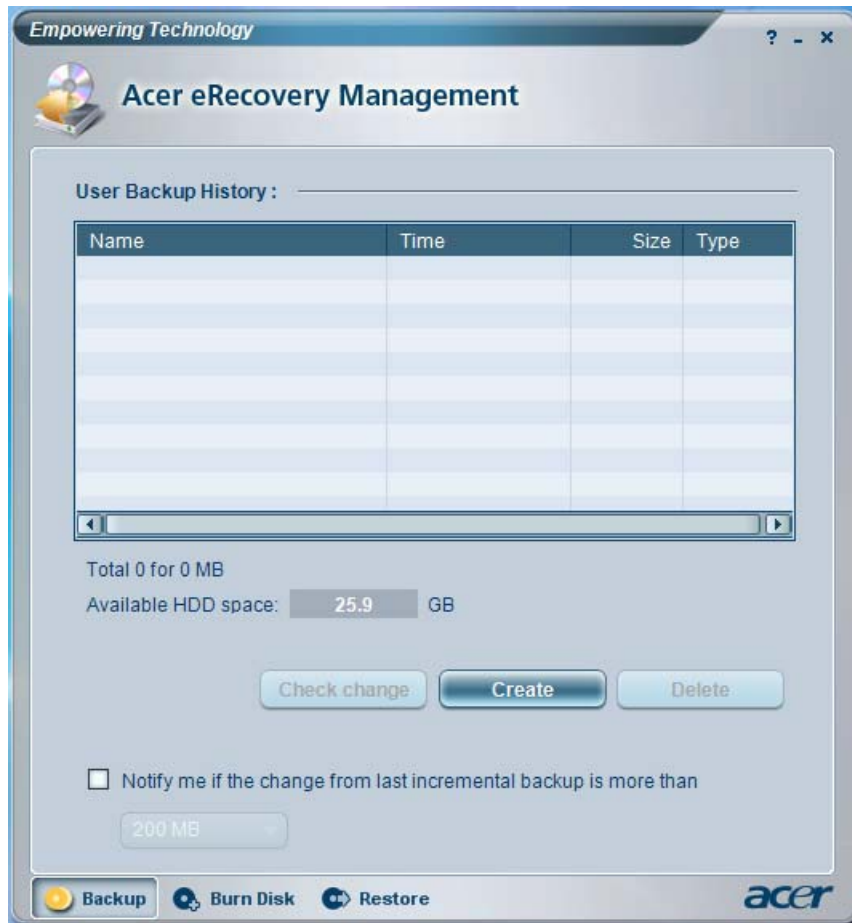

For more information, please refer to “Acer eRecovery Management”

**NOTE:** If your computer did not come with a Recovery CD or System CD, please use Acer eRecovery Management’s “System backup to optical disk” feature to burn a backup image to CD or DVD. To ensure the best results when recovering your system using a CD or Acer eRecovery Management, detach all peripherals (except the external Acer ODD, if your computer has one), including your Acer ezDock.

## Acer eSettings Management

Acer eSettings Management allows you to inspect hardware specifications and to monitor the system health status. Furthermore, Acer eSettings Management enables you to optimize your Windows operating system, so your computer runs faster, smoother and better.

Acer eSettings Management also:

- Provides a simple graphical user interface for navigating.
- Displays general system status and advanced monitoring for power users.



## Acer ePerformance Management

Acer ePerformance Management is a system optimization tool that boosts the performance of your Acer notebook. It provides an express optimization method to release unused memory and disk space quickly. The user can also enable advanced options for full control over the following option:

- Memory optimization - releases unused memory and check usage.
- Disk optimization - removes unneeded items and files.
- Speed optimization - improves the usability and performance of your Windows XP system.



## Acer OrbiCam

The Acer OrbiCam is a 1.3 megapixel CMOS camera appropriately mounted on the top of the LCD panel. The camera's 225-degree ergonomic rotation allows you to capture high-resolution photos or videos up front or at the back of the LCD panel. The Acer OrbiCam fully supports the Acer Video Conference technology so that you can transmit the best video quality over an instant Messenger service.

### Getting to know your Acer OrbiCam

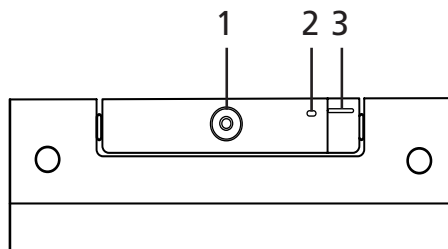

No.	Item
1	Lens
2	Power indicator

No.	Item
3	Rubber grip (selected models only)

### Rotating the Acer OrbiCam

The Acer OrbiCam rotates 225 degrees counterclockwise to achieve the desired angle. Refer to the illustrations below:

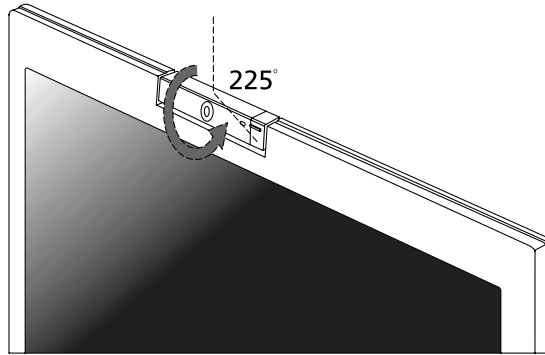

For your convenience, the camera snaps 45 degrees to match the position of your face in front or at the back of the LCD panel.

**NOTE:** Do not rotate the camera clockwise to prevent damage to the device.

### Launching the Acer OrbiCam

To launch the Acer OrbiCam, double click on the Acer OrbiCam icon on the screen.

OR

Click Start > All programs > Acer > Acer OrbiCam. The Acer OrbiCam capture windows window appears.

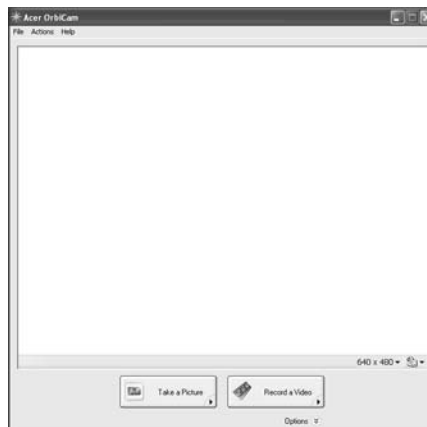

### Changing the Acer OrbiCam settings

Resolution

To change the capture resolution, click the displayed resolution at the bottom right corner of the capture window, then select the desired resolution.

Options

Click Options to display the Window, Preview, and Folder tabs. Use the options to change the capture window size, preview settings, and the folder for captured photos or videos.



## Camera Settings

- ❑ Basic settings: Click the Camera Settings icon on the bottom right corner of the capture display, then select Camera Settings from the pop-up menu. You can adjust the Video, Audio, and Zoom/Face tracking options from this window.



- ❑ Capture settings: From the Camera Settings window, click the Driver Settings button. The Properties window will appear.



- ❑ Device Settings allows you to change the camera brightness, contrast, hue, saturation, sharpness, etc.
- ❑ Advanced Settings allows you to achieve gain control, implement image mirror, select image enhancements and anti-flicker settings, and turn on/off the camera indicator.
- ❑ Zoom/Face Track Settings allows you to adjust the zoom level and turn the face tracking feature on or off.

### Capturing photos or videos

To capture a photo or a video clip, rotate the Acer OrbiCam to get the desired angle, then click the Take a Picture or Record a Video button. The Windows Picture and Fax Viewer or the Windows Media Player automatically launches to display or play a preview of the photo/video clip.

**NOTE:** By default, all photos and videos are saved in the My Pictures and My Videos folder.

### Using the Acer OrbiCam as webcam

The Acer OrbiCam is automatically selected as the capture device of any instant messenger (IM) application. To use the Acer OrbiCam as a webcam, open the IM service, then select the video/webcam feature. You can now broadcast from your location to an IM partner anywhere in the world.

### Enabling the Acer VisageON

The Acer VisageON technology comes with two features: Face tracking and Video effects (selected models only). The Face Tracking feature tracks your head movement and automatically centers your face in the capture window. The video effects feature allows you to select and apply an effect to your video transmissions.

**NOTE:** The face tracking feature is not capable of centering your face beyond the capture window frame. Minimal head movements are tracked more efficiently.

To enable the Acer VisageON:

1. Right click on this icon, then select VisageON from the pop-up menu.

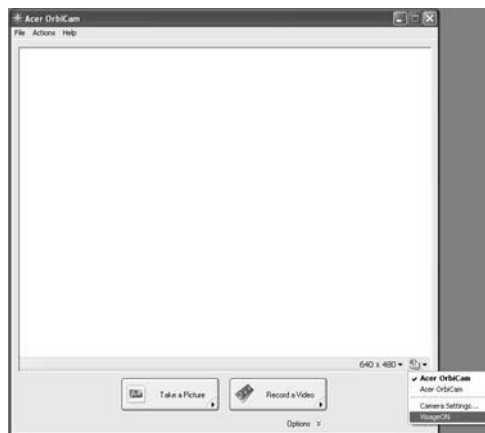

The VisageON window appears as below:



2. Select and apply a video effect in the left section of the VisageON window. Change the face tracking settings and options in the right section.

Using the face tracking feature

To use the face tracking feature:

1. Click the left icon down arrow button, then select Single User or Multiple Users from the pop-up menu. For multiple users, the face tracking feature automatically centers all the users' face in the capture window, otherwise the utility centers the face of the user closest to the camera.



2. Click the right icon to zoom in/out or reset the current view.



3. Click VisageON to display a menu that allows to change the configuration of the camera, face tracking and video effects settings.

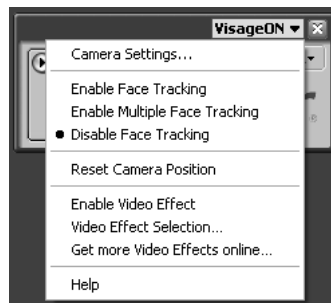

Using video effects (selected models only)

The Video Settings section allows you to select an avatar or accessory video effect from the list. To select an effect:

1. Click the encircled icon to display the available video effects. The Video Effect Selection window appears as below:



2. Click on a video effect to use. The selected effect appears in the video effects section of the VisageON window.

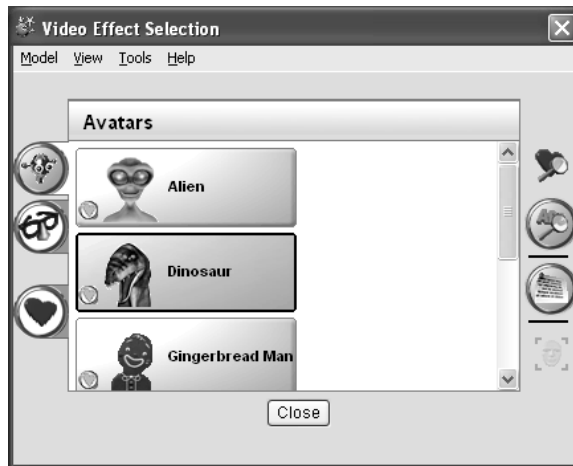

**NOTE:** When using avatars, you may have to calibrate the face points to achieve better tracking. Follow screen instructions in the VisageON to continue.

**NOTE:** You may use video effects when using the camera for IM chat/video sessions or call conferences.



# Using the System Utilities

**NOTE:** The system utilities work under Microsoft Windows XP only.

## Acer GridVista (dual-display compatible)

**NOTE:** This feature is only available on certain models.

To enable the dual monitor feature of the notebook, first ensure that the second monitor is connected, then select **Start, Control Panel, Display** and click on **Settings**. Select the secondary monitor (**2**) icon in the display box and then click the check box **Extend my windows desktop onto this monitor**. Finally, click **Apply** to confirm the new settings and click **OK** to complete the process.

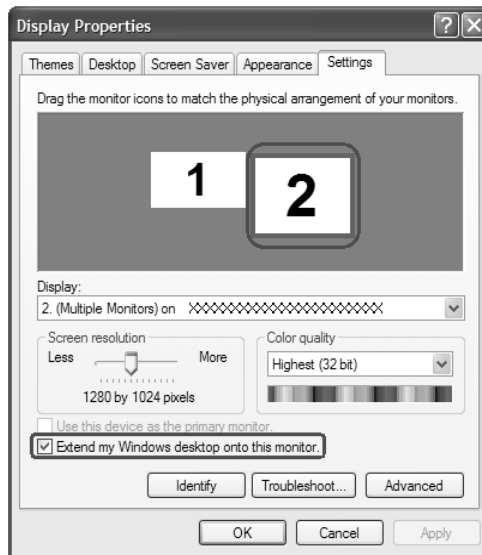

Acer GridVista is a handy utility that offers four pre-defined display settings so you can view multiple windows on the same screen. To access this function, please go to **Start>All Programs** and click on **Acer GridVista**. You may choose any one of the four display settings indicated below:



Double (verticle), Triple (primary at left), Triple (primary at right), or Quad Acer Gridvista is dual-display compatible, allowing two displays to be partitioned independently.

Acer Gridvista is dual-display compatible, allowing two displays to be partitioned independently.

AcerGridVista is imple to set up:

1. Run Acer GridVista and select your preferred screen configuration for each display from the task bar.
2. Drag and drop each window into the appropriate grid.
3. Enjoy the convenience of a well-organized desktop.

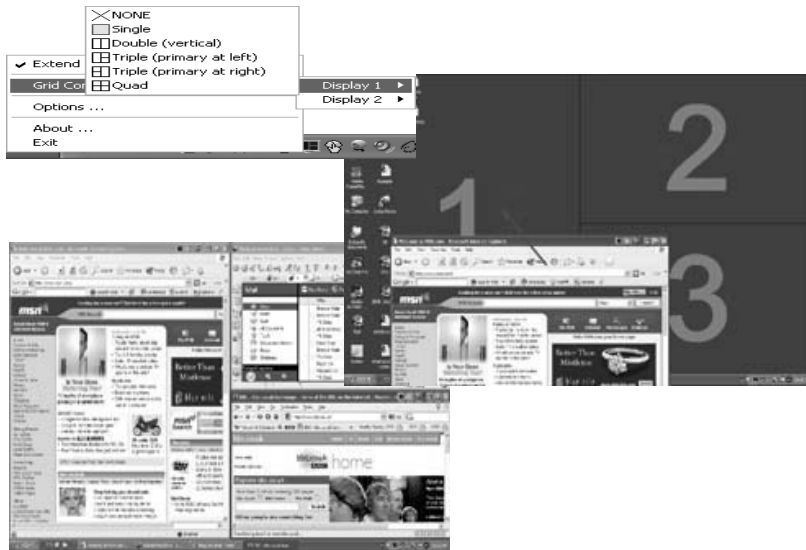

**NOTE:** Please ensure that the resolution setting of the second monitor is set to the manufacturer's recommended value.

## Launch Manager

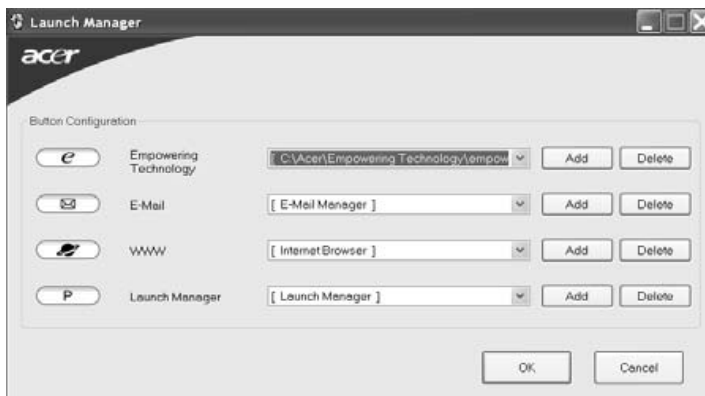

Launch Manager allows you to set the four easy-launch buttons located above the keyboard. You can access the Launch Manager by clicking on Start > All Programs > Launch Manager to start the application.

# Hardware Specifications and Configurations

## Processor

Item	Specification
CPU type	Intel® Core™ Duo processor T2300/T2400/T2500/T2600 (2 MB L2 cache, 1.66/1.83/2/2.16 GHz, 667 MHz FSB) or higher
Core logic	Intel® 945PM Express chipset+ICH7
CPU package	Intel socketable 478pin Micro-BGA
CPU core voltage	0.944~1.3V

## CPU Fan True Value Table

TEST Condition: 35W@Ambient 35 degree C			
CPU Temperature		Fan Speed	Acoustic Level
Core 0	Core 1	(rpm)	(dBA)
86	86	3700	39
88	88	3450	36.5
91	91	3150	34.5
95	95	2800	31

## BIOS

Item	Specification
BIOS vendor	PhneoiX
BIOS Version	
BIOS ROM type	Flash ROM
BIOS ROM size	512KB
BIOS package	32-pin PLCC
Supported protocols	ACPI 1.0b/2.0/3.0, PCI 2.2, System/HDD Password Security Control, INT 13h Extensions, PnP BIOS 1.0a, SMBIOS 2.4, Simple Boot Flag 1.0, Boot Block, PCI Bus Power Management Interface Specification, USB1.1/2.0, IEEE 1394 1.0, USB/1394 CD-ROM Boot Up support, PC Card 95 (PCMCIA 3.0 Compliant Device), IrDA 1.0, Intel AC97 CNR Specification, WfM 2.0, PXE (Preboot Execution Environment), BIS 1.0 (Boot Integrity Service Application Program Interface), PC99a and Mobile PC2001 Compliant, Intel Enganced SpeedStep Technology
BIOS password control	Set by setup manual

**NOTE:** If you need to check PXE version, press F2 to enter BIOS then enable boot from LAN function. After that, power off the system and remove the HDD. Last, reboot the laptop. Then you will see PXE version displaying on the screen.

## Second Level Cache

Item	Specification
Cache controller	Built-in CPU
Cache size	2MB
1st level cache control	Always enabled
2st level cache control	Always enabled
Cache scheme control	Fixed in write-back

## System Memory

Item	Specification
Memory controller	Built-in Intel® 945PM
Memory size	0MB (no on-board memory)
DIMM socket number	2 sockets
Supports memory size per socket	2GB
Supports maximum memory size	4GB (by two 1024MB SO-DIMM module)
Supports DIMM type	DDR 2 Synchronous DRAM
Supports DIMM Speed	667 MHz
Supports DIMM voltage	1.8V and 0.9V
Supports DIMM package	200-pin soDIMM
Memory module combinations	You can install memory modules in any combinations as long as they match the above specifications.

## Memory Combinations

Slot 1	Slot 2	Total Memory
0MB	128MB	128MB
0MB	256MB	256MB
0MB	512MB	512MB
0MB	1024MB	1024MB
0MB	2048MB	2048MB
128MB	128MB	256MB
128MB	256MB	384MB
128MB	512MB	640MB
128MB	1024MB	1152MB
128MB	2048MB	2176MB
256MB	128MB	384MB
256MB	256MB	512MB
256MB	512MB	768MB
256MB	1024MB	1280MB
256MB	2048MB	2304MB
512MB	128MB	640MB
512MB	256MB	768MB
512MB	512MB	1024MB
512MB	1024MB	1536MB
512MB	2048MB	2560MB
1024MB	0MB	1024MB
1024MB	128MB	1152MB
1024MB	256MB	1280MB
1024MB	512MB	1536MB
1024MB	1024MB	2048MB
1024MB	2048MB	3072MB

**NOTE:** Above table lists some system memory configurations. You may combine DIMMs with various capacities to form other combinations. On above table, the configuration of slot 1 and slot 2 could be

reversed.

### LAN Interface

Item	Specification
Chipset	MARVELL 88E8055
Supports LAN protocol	10/100/1000 Ethernet Giga LAN
LAN connector type	RJ45
LAN connector location	Rear side
Features	Integrated 10/100/1000 BASE-T transceiver Wake on LAN support compliant with ACPI 2.0 PCI v2.2

### Modem Interface

Item	Specification
Data modem data baud rate (bps)	56K
Supports modem protocol	V.92
Modem connector type	RJ11
Modem connector location	Left side

### Bluetooth Interface

Item	Specification
Chipset	Built-in ICH7-M
Data throughput	723 bps (full speed data rate)
Protocol	Bluetooth 1.1 (Upgradeable to Bluetooth 1.2 when SIG specification is ratified).
Interface	USB 1.1
Connector type	USB

### Wireless Module 802.11b/g (optional device)

Item	Specification
Chipset	Built-in ICH7M
Data throughput	11~54 Mbps
Protocol	802.11b+g
Interface	PCI

### Hard Disk Drive Interface

Item			
Vendor & Model Name	Seagate 40G ST9402112A Toshiba MK4025GAS Hitachi HTS421240H9AT00 WD WD400UE-22HCT0 Samsung M40MP0402H	Seagate ST96812A Seagate ST960821A Toshiba MK6025GAS HGST HTS541260H9AT00 WD WD600UE-22HCT0	TOSHIBA MK8025GAS HITACHI HTS421280H9AT00 SEAGATE ST9808210A SEAGATE ST98823A TOSHIBA MK8026GAX HGST HTS541280H9AT00 WD WD800UE-22HCT0
Capacity (MB)	40000	60000	80000
Bytes per sector	512	512	512

## Hard Disk Drive Interface

Item			
Data heads	2	3 (for Hitachi and Seagate) 4 (for Toshiba)	4 (for Hitachi) 3 (for Seagate)
Drive Format			
Disks	1	2	2
Spindle speed (RPM)	4200 RPM	4200 RPM	4200 RPM
Performance Specifications			
Buffer size	2048KB	8192KB	8192KB
Interface	ATA/ATAPI-6; ATA-6	ATA/ATAPI-6; ATA-6	ATA/ATA-6; ATA-6
Max. media transfer rate (disk-buffer, Mbytes/s)	372	350	350
Data transfer rate (host-buffer, Mbytes/s)	100 MB/Sec. Ultra DMA mode-5	100 MB/Sec. Ultra DMA mode-5	100 MB/Sec. Ultra DMA mode-5
DC Power Requirements			
Voltage tolerance	5V(DC) +/- 5%	5V(DC) +/- 5%	5V(DC) +/- 5%

## DVD-Dual Interface

Item	Specification	
Vendor & model name	LITEON SOSW-833S PIONEER DVR-K16RA	
Performance Specification	With CD Diskette	With DVD Diskette
Transfer rate (KB/sec)	Sustained: Max 3.6Mbytes/sec	Sustained: Max 10.8Mbytes/sec
Buffer Memory	2MB	
Interface	Enhanced IDE(ATAPI) compatible	
Applicable disc format	Support disc formats 1. Reads data in each CD-ROM, CD-ROM XA, CD-1, Video CD, CD-Extra and CD-Text 2. Reads data in Photo CD (single and Multi-session) 3. Reads standard CD-DA 4. Reads and writes CD-R discs 5. Reads and writes CD-RW discs 6. Reads and writes in each dVD+R/RW (Ver. 1.1) 7. Reads data in each DVD-ROM and DVD-R (Ver. 2.0 for Authoring) 8. Reads and writes in each DVD-R (Ver. 2.0 for general), DVD-RW and DVD+R/RW (Ver1.1)	
Loading mechanism	Load: Manual Release: (a) Electrical Release (Release Button) (b) Release by ATAPI command (c) Emergency Release	
Power Requirement		
Input Voltage	5 V +/- 5 % (Operating)	

## Audio Interface

Item	Specification
Audio Controller	Realtek ALC833 (Audio amplifier Maxim MAX9714)
Audio onboard or optional	Built-in
Mono or Stereo	Stereo
Resolution	18 bit stereo full duplex
Compatibility	HD audio Interface; S/PDIF output for PCM or AC-3 content
Sampling rate	1Hz resolution VSR (Variable Sampling Rate)
Internal microphone	Yes
Internal speaker / Quantity	Yes/2(1.5W speakers)
Supports PnP DMA channel	DMA channel 0 DMA channel 1
Supports PnP IRQ	IRQ10, IRQ11

## Video Interface

Item	Specification
Chipset	nVIDIA® GeForce® Go 7600 nVIDIA® GeForce® Go 7300
Package	35.5 mm x 40 mm 1257 pin mBGA
Interface	internal PCIE
Supports ZV (Zoomed Video) port	Yes

## Video Memory

Item	Specification
Chipset	nVIDIA® GeForce® Go 7600 nVIDIA® GeForce® Go 7300
Memory size	Dedicated Video memory size: 128MB (nVIDIA® GeForce® Go 7300) 256MB (for nVIDIA® GeForce® Go 7600)
Interface	GDDR2

## USB Port

Item	Specification
Chipset	Built-in ICH7-M
USB Compliancy Level	2.0
OHCI	USB 1.1 and USB 2.0 Host controller
Number of USB port	4
Location	One on the left side; three on the rear side
Serial port function control	Enable/Disable by BIOS Setup

## PCMCIA Port

Item	Specification
PCMCIA controller	TI PCI 7412
Supports card type	Type-II

## PCMCIA Port

Item	Specification
Number of slots	One type-II
Access location	Left panel
Supports ZV (Zoomed Video) port	No ZV support
Supports 32 bit CardBus	Yes

## Express Card Interface

Item	Specification
PCMCIA controller	Built-in ICH7M
Supports card type	75mmx54mm(W)x5mm
Number of slots	One
Access location	Right panel
Interface	PCI Express

## System Board Major Chips

Item	Controller
Core logic	Intel® 945GM/PM+ICH7M
VGA	nVIDIA® GeForce® Go 7600 nVIDIA® GeForce® Go 7300
LAN	MARVELL 88E8055
USB 2.0	Built in ICH7-M
Super I/O controller	KBC1122
MODEM	Built-in ICH7-M
Bluetooth	Built-in ICH7-M
Wireless 802.11 b+g	Built-in ICH7-M
PCMCIA	TI PCI 7412
Audio	Realtek ALC883

## Keyboard

Item	Specification
Keyboard controller	KBC1122
Total number of keypads	88-/89-key
Windows logo key	Yes
Internal & external keyboard work simultaneously	Plug USB keyboard to the USB port directly: Yes

## Battery

Item	Specification
Vendor & model name	BATTERY PACK SANYO LI-ION 8 CELL2.4, 4800MAH BATTERY PACK SONY LI-ION 8CELL2.4, 4800MAH
Battery Type	Li-ion
Pack capacity	4800 mAh
Number of battery cell	8



## Battery

Item	Specification
Package configuration	4 cells in series, 2 series in parallel
Normal voltage	14.8V
Charge voltage	16.8+-0.2v

## LCD 19.1" inch

Item	Specification			
Vendor & model name	SAMSUNG LTN190-M2- 000 NON- GLARE	CMO M190A1- L01 NON- GLARE	SAMSUNG LTM190-M2- L01-G GLARE TYPE	CMO M190A1- L03 GLARE TYPE
Screen Diagonal (mm)	19.1 inches	19.1 inches	19.1 inches	19.1 inches
Active Area (mm)	304.1x228.1	304.1x228.1	304.1x228.1	
Display resolution (pixels)	1440x900 WXGA+	1440x900 WXGA+	1440x900 WXGA+	1440x900 WXGA+
Pixel Pitch	0.297x0.297	0.099x0.297	0.297x0.297	
Pixel Arrangement	R.G.B. Vertical Stripe	R.G.B. Vertical Stripe	R.G.B. Vertical Stripe	R.G.B. Vertical Stripe
Display Mode	Normally White	Normally White	Normally White	Normally White
Typical White Luminance (cd/m <sup>2</sup> ) also called Brightness	300	300	300	300
Luminance Uniformity	N/A	N/A	70	70
Contrast Ratio	300	300	250	250
Response Time (Optical Rise Time/Fall Time)msec	8	8	8	8
Nominal Input Voltage VDD	+3.3V Typ.	+3.3V	3.3V	3.3V
Typical Power Consumption (watt)	5.6/5.7	3.96	N/A	N/A
Weight	550	570	600	600
Physical Size(mm)	317.3x242.0x6. 0	317.3x242.0x5. 9	317.3x242.0x6. 5	317.3x242.0x6. 5
Electrical Interface	1 channel LVDS	1 channel LVDS	1 channel LVDS	1 channel LVDS
Support Color	262K colors (RGB 6-bit data driver)	262,144	262,144	262,144
Viewing Angle (degree) Horizontal: Right/Left Vertical: Upper/Lower	40/40 10/30	45/45 15/35	40/40 20/40	40/40 20/40
Temperature Range(° C) Operating Storage (shipping)	0 to +50 -20 to +60	0 to +50 -25 to +60	0 to +50 -20 to +60	0 to +50 -20 to +60

## LCD 20" inch

Item	Specification			
Vendor & model name	QDI QD20AL0101 NON-GLARE	AUO M201EW01 V.0 NON-GLARE	QDI QD20AL0102 GLARE TYPE	AUO M201EW01 V.2 GLARE
Screen Diagonal (mm)	20 inches	20 inches	20 inches	20 inches
Active Area (mm)	304.1x228.1	304.1x228.1	304.1x228.1	

## LCD 20" inch

Item	Specification			
Display resolution (pixels)	1680x1050 WSXGA+	1680x1050 WSXGA	1680x1050 WSXGA+	1680x1050 WSXGA
Pixel Pitch	0.297x0.297	0.099x0.297	0.297x0.297	
Pixel Arrangement	R.G.B. Vertical Stripe	R.G.B. Vertical Stripe	R.G.B. Vertical Stripe	R.G.B. Vertical Stripe
Display Mode	Normally White	Normally White	Normally White	Normally White
Typical White Luminance (cd/m <sup>2</sup> ) also called Brightness	300	300	300	300
Luminance Uniformity	N/A	N/A	70	N/A
Contrast Ratio	300	300	250	250
Response Time (Optical Rise Time/Fall Time)msec	8	8	8	8
Nominal Input Voltage VDD	+3.3V Typ.	+3.3V	3.3V	3.3V
Typical Power Consumption (watt)	5.6/5.7	3.96	N/A	N/A
Weight	550	570	600	600
Physical Size(mm)	317.3x242.0x6. 0	317.3x242.0x5. 9	317.3x242.0x6. 5	317.3x242.0x6. 5
Electrical Interface	1 channel LVDS	1 channel LVDS	1 channel LVDS	1 channel LVDS
Support Color	262K colors (RGB 6-bit data driver)	262,144	262,144	262,144
Viewing Angle (degree) Horizontal: Right/Left Verial: Upper/Lower	40/40 10/30	45/45 15/35	40/40 20/40	40/40 20/40
Temperature Range(° C) Operating Storage (shipping)	0 to +50 -20 to +60	0 to +50 -25 to +60	0 to +50 -20 to +60	0 to +50 -20 to +60

## LCD Inverter

Item	Specification
Vendor & model name	Darfon/V189-301GP
Brightness conditions	N/A
Input voltage (V)	9~21
Input current (mA)	2.56 (max)
Output voltage (V, rms)	780V (2000V for kick off)
Output current (mA, rms)	6.5 (max)
Output voltage frequency (k Hz)	65K Hz (max)

## AC Adaptor

Item	Specification
Input rating	90V AC to 264V AC, 47Hz to 63Hz
Maximum input AC current	1.7A
Inrush current	220A@115VAC 220A@230VAC
Efficiency	82% min. @115VAC input full load

---

## System Power Management

ACPI mode	Power Management
Mech. Off (G3)	All devices in the system are turned off completely.
Soft Off (G2/S5)	OS initiated shutdown. All devices in the system are turned off completely.
Working (G0/S0)	Individual devices such as the CPU and hard disc may be power managed in this state.
Suspend to RAM (S3)	CPU set power down VGA Suspend PCMCIA Suspend Audio Power Down Hard Disk Power Down CD-ROM Power Down Super I/O Low Power mode
Save to Disk (S4)	Also called Hibernation Mode. System saves all system states and data onto the disc prior to power off the whole system.



## System Utilities

### BIOS Setup Utility

The BIOS Setup Utility is a hardware configuration program built into your computer's BIOS (Basic Input/Output System).

Your computer is already properly configured and optimized, and you do not need to run this utility. However, if you encounter configuration problems, you may need to run Setup. Please also refer to Chapter 4 Troubleshooting when problem arises.

To activate the BIOS Utility, press **F2** during POST (when "Press <F2> to enter Setup" message is prompted on the bottom of screen).

Press **F2** to enter setup. The default parameter of F12 Boot Menu is set to "disabled". If you want to change boot device without entering BIOS Setup Utility, please set the parameter to "enabled".

Press <F12> during POST to enter multi-boot menu. In this menu, user can change boot device without entering BIOS SETUP Utility.

PhoenixBIOS Setup Utility					
Information	Main	Advanced	Security	Boot	Exit
CPU Type :	Genuine Intel (R) CPU	T2600@2.166GHz			
CPU Speed :	2130 MHz				
IDE0 Model Name :	Intel RAID0				
IDE1 Model Name :	TSSTcorpCD/DVDW TS-L632D-MP2YH1XBGALJEE				
System BIOS Version:	V0.10				
VGA BIOS Version:	nVIDIA G73 E463	5.73.22.15FA			
KBC BIOS Version:	V0.21				
Serial Number	xxxxxxxxxxxxxxxxxxxxxxx			22 Byte	
Asset Tag Number	N/A			32 Byte	
Produce Name	Aspire 9800			16 Byte	
Manufacturer Name:	Acer Inc.			16 Byte	
UUID:	xxxxxxxxxxxxxxxxxxxxxxxxxxxxxxxxxxxx			32 Byte	
F1 Help	↑↓ Select Item	F5/F6 Change Values	F9 Setup Defaults		
Esc Exit	←→ Select Menu	Enter Select	▶ Sub-Menu	F10 Save and Exit	

---

## Navigating the BIOS Utility

There are six menu options: Info., Main, System Devices, Security, Boot, and Exit.

Follow these instructions:

- ❑ To choose a menu, use the cursor left/right keys (← →).
- ❑ To choose a parameter, use the cursor up/down keys (↑ ↓).
- ❑ To change the value of a parameter, press F8 or F6.
- ❑ A plus sign (+) indicates the item has sub-items. Press ENTER to expand this item.
- ❑ Press ESC while you are in any of the menu options to go to the Exit menu.
- ❑ In any menu, you can load default settings by pressing F8. You can also press F6 to save any changes made and exit the BIOS Setup Utility.

**NOTE:** You can change the value of a parameter if it is enclosed in square brackets. Navigation keys for a particular menu are shown on the bottom of the screen. Help for parameters are found in the Item Specific Help part of the screen. Read this carefully when making changes to parameter values. **Please note that system information is subject to different models.**

# Information

PhoenixBIOS Setup Utility

Information
Main
Advanced
Security
Boot
Exit

```

CPU Type :           Genuine Intel (R) CPU    T2600@2.166GHz
CPU Speed :         2130 MHz

IDE0 Model Name :   Intel RAID0
IDE1 Model Name :   TSSTcorpCD/DVDW TS-L632D-MP2YH1XBGALJEE

System BIOS Version: V0.10
VGA BIOS Version:   nVIDIA G73 E463 5.73.22.15FA
KBC BIOS Version:   V0.21

Serial Number       xxxxxxxxxxxxxxxxxxxxxxxx           22 Byte
Asset Tag Number    N/A                               32 Byte
Produce Name        Aspire 9800                               16 Byte
Manufacturer Name:   Acer Inc.                16 Byte
UUID:               xxxxxxxxxxxxxxxxxxxxxxxx           32 Byte
    
```

F1 Help
↑↓ Select Item
F5/F6 Change Values
F9 Setup Defaults
Esc Exit
←→ Select Menu
Enter Select ▶ Sub-Menu
F10 Save and Exit

**NOTE:** The system information is subject to different models.

Parameter	Description
CPU Type	This field shows the CPU type and speed of the system.
IDE1 Model Name	This field shows the model name of HDD installed on primary IDE master.
IDE1 Serial Number	This field displays the serial number of HDD installed on primary IDE master.
IDE2I Model Name	This field displays the mofel name of devices installed on secondary IDE master. The hard disk drive or optical drive model name is automatically detected by the system.
IDE2 Serial Number	This field shows the serial number of devices installed on secondary IDE master.
System BIOS ver	Displays system BIOS version.
VGA BIOS Ver	This field displays the VGA firmware version of the system.
KBC Ver	This field shows the keyboard
Serial Number	This field displays the serial number of this unit.
Asset Tag Number	This field displays the asset tag number of the system.
Product Name	This field shows product name of the system.
Manufacturer Name	This field displays the manufacturer of this system.

---

Parameter	Description
UUID Number	This will be visible only when an internal LAN device is presenting. UUID=32bytes



# Main

The Main screen displays a summary of your computer hardware information, and also includes basic setup parameters. It allows the user to specify standard IBM PC AT system parameters.

PhoenixBIOS Setup Utility													
Information	Main	Advanced	Security	Boot	Exit								
					Item Specific Help								
System Time:	[19:03:49]				<Tab>, <Shift-Tab>, or <Enter> selects field.								
System Date:	[04/25/2006]												
System Memory:	633 KB	Shows system base memory size											
Extended Memory:	1022 MB	Shows extended memory size											
Quiet Boot:	[Enabled]												
Power on display:	[Auto ]												
Network boot	[Enabled]												
F12 Boot Menu	[Disabled]												
D2D Recovery	[Enabled]												
<table border="0"> <tr> <td>F1 Help</td> <td>↑↓ Select Item</td> <td>F5/F6 Change Values</td> <td>F9 Setup Defaults</td> </tr> <tr> <td>Esc Exit</td> <td>←→ Select Menu</td> <td>Enter Select</td> <td>▶ Sub-Menu</td> </tr> </table>						F1 Help	↑↓ Select Item	F5/F6 Change Values	F9 Setup Defaults	Esc Exit	←→ Select Menu	Enter Select	▶ Sub-Menu
F1 Help	↑↓ Select Item	F5/F6 Change Values	F9 Setup Defaults										
Esc Exit	←→ Select Menu	Enter Select	▶ Sub-Menu										

**NOTE:** The screen above is for your reference only. Actual values may differ.

The table below describes the parameters in this screen. Settings in **boldface** are the default and suggested parameter settings.

Parameter	Description	Format/Option
System Time	Sets the system time. The hours are displayed with 24-hour format.	Format: HH:MM:SS (hour:minute:second) System Time
System Date	Sets the system date.	Format MM/DD/YYYY (month/day/year) System Date
System Memory	This field reports the memory size of the system. Memory size is fixed to 640MB	
Extended Memory	This field reports the memory size of the extended memory in the system. Extended Memory size=Total memory size-1MB	
VGA Memory	Shows the VGA memory size. VGA Memory size=64/128MB	
Quiet Boot	Determines if Customer Logo will be displayed or not; shows Summary Screen is disabled or enabled.  Enabled: Customer Logo is displayed, and Summary Screen is disabled. Disabled: Customer Logo is not displayed, and Summary Screen is enabled.	Option: <b>Enabled</b> or Disabled
Power on display	Auto: During power process, the system will detect if any display device is connected on external video port. If any external display device is connected, the power on display will be in CRT (or projector) only mode. Otherwise it will be in LCD only mode.  Both: Simultaneously enable both the integrated LCD screen and the system's external video port (for an external CRT or projector).	Option: <b>Auto</b> or Both
Network Boot	Enables, disables the system boot from LAN (remote server).	Option: <b>Enabled</b> or Disabled
F12 Boot Menu	Enables, disables Boot Menu during POST.	Option: <b>Disabled</b> or Enabled
D2D Recovery	Enables, disables D2D Recovery function. The function allows the user to create a hidden partition on hard disc drive to store operation system and restore the system to factory defaults.	Option: <b>Enabled</b> or Disabled

**NOTE:** The sub-items under each device will not be shown if the device control is set to disable or auto. This is because the user is not allowed to control the settings in these cases.

# Advanced

The Advanced screen displays advanced settings in BIOS.

PhoenixBIOS Setup Utility		
Information	Main	Advanced
Serial port :	[Auto]	Item Specific Help
Parallel port :	[Enabled]	[Disabled] Infrared port is not active.
Mode :	[ECP]	[Enabled] Infrared port is active and is user configured.
IrDA Device :	[Enabled]	[Auto] BIOS or OS chooses configuration
Mode :	[IRDA4PPM (FIR)]	(OS Controlled) Displayed when controlled by OS

F1 Help	↑ ↓ Select Item	F5/F6 Change Values	F9 Setup Defaults
Esc Exit	← → Select Menu	Enter Select ▶ Sub-Menu	F10 Save and Exit

The table below describes the parameters in this screen. Settings in **boldface** are the default and suggested parameter settings.

Parameter	Description	Option
Serial port	Displays the settings of the serial port	<b>Enabled</b> or Disabled
Parallel port	Shows the settings of the parallel port	<b>Enabled</b> or Disabled
IrDA Device	Shows the setting of the infrared port	<b>Enabled</b> or Disabled

# Security

The Security screen contains parameters that help safeguard and protect your computer from unauthorized use.

PhoenixBIOS Setup Utility			
Information	Main	Advanced	Security
			Boot      Exit
			Item Specific Help
Supervisor Password Is :		Clear	Supervisor Password controls accesses of the whole setup utility. It can be used to boot up when Password on boot is enabled.
User Password Is :		Clear	
Set Supervisor Password		[Enter]	
Set User Password		[Enter]	
Password on Boot		[Disabled]	
F1 Help	↑ ↓ Select Item	F5/F6 Change Values	F9 Setup Defaults
Esc Exit	← → Select Menu	Enter Select ▶ Sub-Menu	F10 Save and Exit

The table below describes the parameters in this screen. Settings in **boldface** are the default and suggested parameter settings.

Parameter	Description	Option
User Password is	Shows the setting of the user password.	<b>Clear</b> or Set
Supervisor Password is	Shows the setting of the Supervisor password	<b>Clear</b> or Set
Set User Password	Press Enter to set the user password. When user password is set, this password protects the BIOS Setup Utility from unauthorized access. The user can enter Setup menu only and does not have right to change the value of parameters.	
Set Supervisor Password	Press Enter to set the supervisor password. When set, this password protects the BIOS Setup Utility from unauthorized access. The user can not either enter the Setup menu nor change the value of parameters.	
Primary HardDisk Security	Enables or disables primary hard disk security function.	
Password on Boot	Defines whether a password is required or not while the events defined in this group happened. The following sub-options are all requires the Supervisor password for changes and should be grayed out if the user password was used to enter setup.	<b>Disabled</b> or Enabled

**NOTE:** When you are prompted to enter a password, you have three tries before the system halts. Don't forget your password. If you forget your password, you may have to return your notebook computer to your dealer to reset it.

## Setting a Password

Follow these steps as you set the user or the supervisor password:

1. Use the **↑** and **↓** keys to highlight the Set Supervisor Password parameter and press the **ENTER** key. The Set Supervisor Password box appears:

Set Supervisor Password

Enter New Password    [                    ]

Confirm New Password    [                    ]

2. Type a password in the "Enter New Password" field. The password length can not exceeds 8 alphanumeric characters (A-Z, a-z, 0-9, not case sensitive). Retype the password in the "Confirm New Password" field.

**IMPORTANT:** Be very careful when typing your password because the characters do not appear on the screen.

3. Press **ENTER**.
4. After setting the password, the computer sets the User Password parameter to "Set".
4. If desired, you can opt to enable the Password on boot parameter.
5. When you are done, press **F10** to save the changes and exit the BIOS Setup Utility.

## Removing a Password

Follow these steps:

1. Use the **↑** and **↓** keys to highlight the Set Supervisor Password parameter and press the **ENTER** key. The Set Password box appears:

Set Supervisor Password		
Enter current password	[	]
Enter New Password	[	]
Confirm New Password	[	]

2. Type the current password in the Enter Current Password field and press **ENTER**.
3. Press **ENTER** twice **without** typing anything in the Enter New Password and Confirm New Password fields. The computer then sets the Supervisor Password parameter to “Clear”.
4. When you have changed the settings, press **F10** to save the changes and exit the BIOS Setup Utility.

## Changing a Password

1. Use the **↑** and **↓** keys to highlight the Set Supervisor Password parameter and press the **ENTER** key. The Set Password box appears:

Set Supervisor Password		
Enter current password	[	]
Enter New Password	[	]
Confirm New Password	[	]

2. Type the current password in the Enter Current Password field and press **ENTER**.
3. Type a password in the Enter New Password field. Retype the password in the Confirm New Password field.
4. Press **ENTER**. After setting the password, the computer sets the User Password parameter to “Set”.
5. If desired, you can enable the Password on boot parameter.
6. When you are done, press **F10** to save the changes and exit the BIOS Setup Utility.

If the verification is OK, the screen will display as following.

Setup Notice
Changes have been saved.
[ continue]

The password setting is complete after the user presses **F10**.

If the current password entered does not match the actual current password, the screen will show you the Setup Warning.

---

Setup Warning  
Invalid password  
Re-enter Password  
[ continue]

If the new password and confirm new password strings do not match, the screen will display the following message.

Setup Warning  
Password do not match  
Re-enter Password

## Boot

This menu allows the user to decide the order of boot devices to load the operating system. Bootable devices includes the distette drive in module bay, the onboard hard disk drive and the CD-ROM in module bay.

PhoenixBIOS Setup Utility				
Information	Main	Security	Boot	Exit
Boot priority order: 1: PCI SCSI : Intel RAID0 2: HDD 3: CD/DVD TSSTcorpCD/DVDW TS-L632D- 4: LAN B02 D00 Yukon PXE 5: USB HDD 6: USB CD/DVD 7: FDD 8: USB Dongle			Item Specific Help  Use<↑> or <↓> to select a device, then press <F6> to move it up the list, or <F5> to move it down the list. Press <Esc> to escape the menu.	
F1 Help	↑↓ Select Item	F5/F6 Change Values	F9 Setup Defaults	
Esc Exit	←→ Select Menu	Enter Select	▶ Sub-Menu	F10 Save and Exit



# Exit

The Exit screen contains parameters that help safeguard and protect your computer from unauthorized use.

PhoenixBIOS Setup Utility

Information Main Advanced Security Boot Exit

Exit Saving Changes  
 Exit Discarding Changes  
 Load Setup Defaults  
 Discard Changes  
 Save Changes

Item Specific Help  
 Exit System Setup and save your changes to CMOS.

F1 Help    ↑↓ Select Item    F5/F6 Change Values    F9 Setup Defaults  
 Esc Exit    ←→ Select Menu    Enter Select Sub-Menu    F10 Save and Exit

The table below describes the parameters in this screen.

Parameter	Description
Exit Saving Changes	Exit System Setup and save your changes to CMOS.
Exit Discarding Changes	Exit utility without saving setup data to CMOS.
Load Setup Default	Load default values for all SETUP item.
Discard Changes	Load previous values from CMOS for all SETUP items.
Save Changes	Save Setup Data to CMOS.

---

# BIOS Flash Utility

The BIOS flash memory update is required for the following conditions:

- New versions of system programs
- New features or options
- Restore a BIOS when it becomes corrupted.

Use the Phlash utility to update the system BIOS flash ROM.

**NOTE:** If you do not have a crisis recovery diskette at hand, then you should create a **Crisis Recovery Diskette** before you use the Phlash utility.

**NOTE:** Do not install memory-related drivers (XMS, EMS, DPMS) when you use the Phlash.

**NOTE:** Please use the AC adaptor power supply when you run the Phlash utility. If the battery pack does not contain enough power to finish BIOS flash, you may not boot the system because the BIOS is not completely loaded.

Follow the steps below to run the Phlash.

1. Prepare a bootable diskette.
2. Copy the flash utilities to the bootable diskette.
3. Then boot the system from the bootable diskette. The flash utility has auto-execution function.

# Machine Disassembly and Replacement

---

This chapter contains step-by-step procedures on how to disassemble the notebook computer for maintenance and troubleshooting.

To disassemble the computer, you need the following tools:

- Wrist grounding strap and conductive mat for preventing electrostatic discharge
- Small Philips screw driver
- Philips screwdriver
- Plastic flat head screw driver
- Tweezers

**NOTE:** The screws for the different components vary in size. During the disassembly process, group the screws with the corresponding components to avoid mismatch when putting back the components. When you remove the stripe cover, please be careful not to scrape the cover.

---

## General Information

### Before You Begin

Before proceeding with the disassembly procedure, make sure that you do the following:

1. Turn off the power to the system and all peripherals.
2. Unplug the AC adapter and all power and signal cables from the system.
3. Remove the battery pack.

# Disassembly Procedure Flowchart

The flowchart on the succeeding page gives you a graphic representation on the entire disassembly sequence and instructs you on the components that need to be removed during servicing. For example, if you want to remove the system board, you must first remove the keyboard, then disassemble the inside assembly frame in that order.

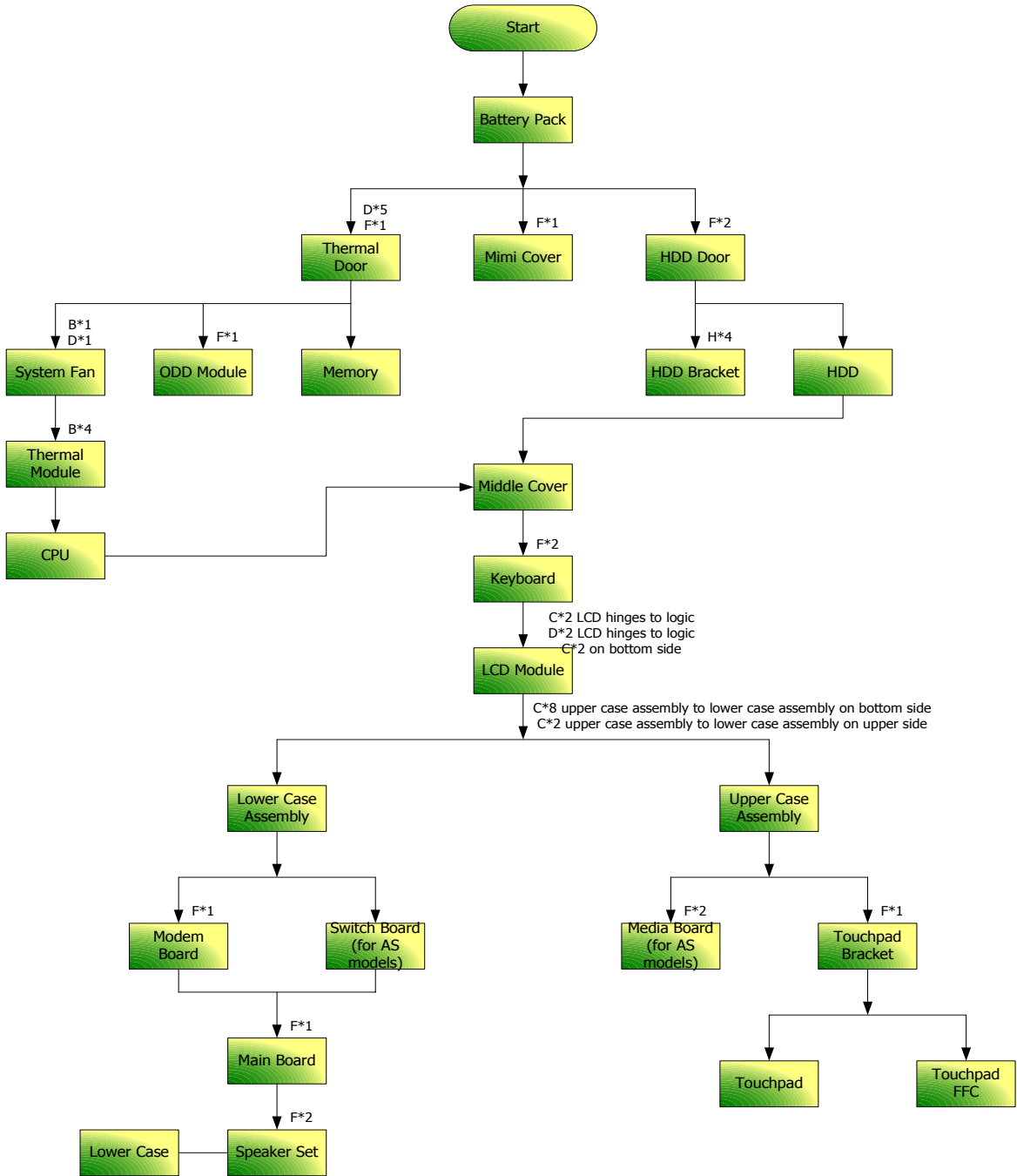

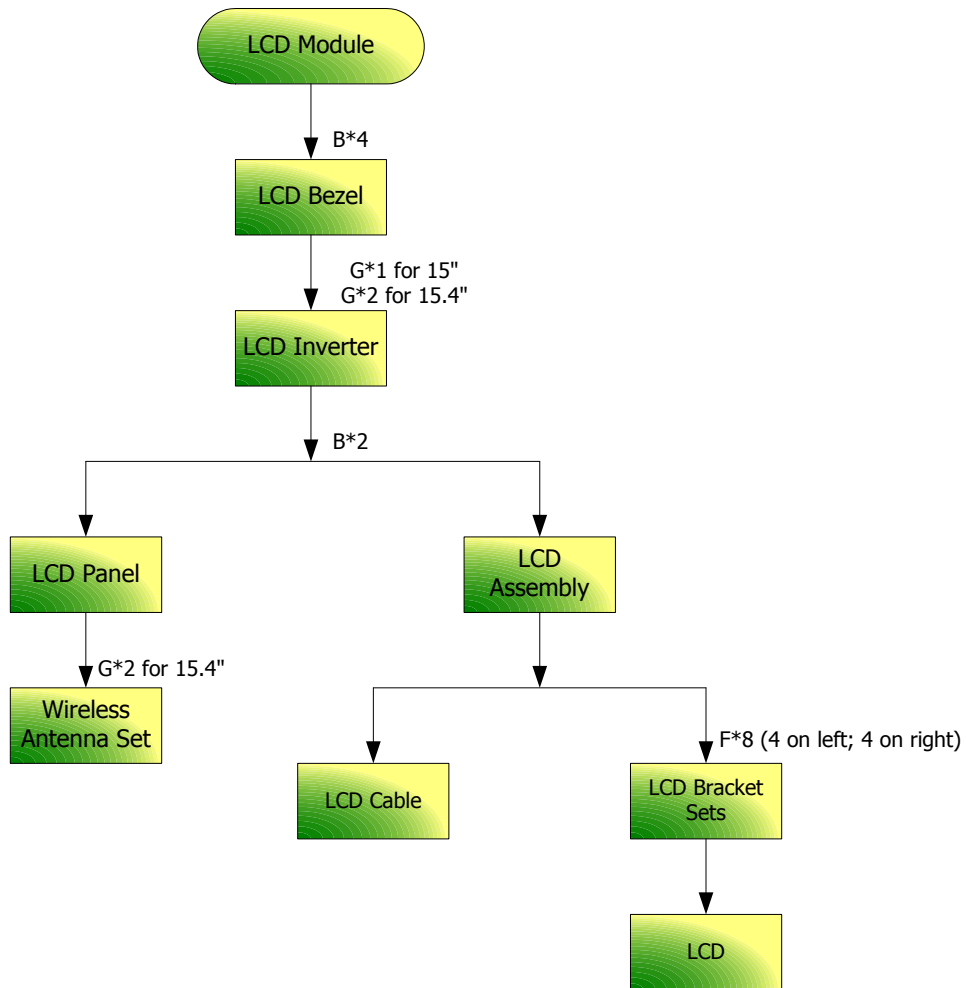

**Screw List**

Item	Description	Part Number
A	SCREW M2.5*3(NL)	86.TAVV5.001
B	SCREW M2.5*6(NL)	86.TAVV5.002
C	SCREW M2.5*10(NL)	86.TAVV5.003
D	SCREW M2.5*15(NL)	86.TAVV5.004
E	SCREW M2*2.2	86.TAVV5.005
F	SCREW M2*3(NL)	86.TAVV5.006
G	SCREW M2*4	86.TAVV5.007
H	SCREW M3*4(NL)	86.TAVV5.008
I	SCREW D-SUB 4#X40* 1/5-NI (NL)	86.TAVV5.009

---

## Removing the Battery Pack

1. Release the battery.
2. Slide the battery latch then remove the battery.



---

# Removing the HDD Modules/Memory/Wireless LAN Card/TV Tuner Card/System Fan/Thermal Modules/CPU and the LCD Module

## Removing the HDD Module

1. Remove the three screws fastening the HDD door.
2. Detach the HDD door from the notebook.
3. Then disconnect the two HDD modules as shown (Some notebooks may have only one HDD module).



## Removing the Memory

4. Remove the four screws holding the thermal cover.
5. Detach the thermal cover from the main unit.
6. Pop out the memory from the DIMM socket then remove it (If the notebook has two memory, then repeat this step).



## Removing the Wireless LAN Card/TV Tunder Card and System Fan

7. Remove the two screws fastening the wireless LAN card.
8. Disconnect the main and auxiliary antennae from the wireless LAN card.
9. Then take out the wireless LAN card from the main unit.



10. Take out the wireless antennae set from the groove as shown.
11. Pop out the TV tuner card.



12. Then disconnect the TV tuner card antenna.

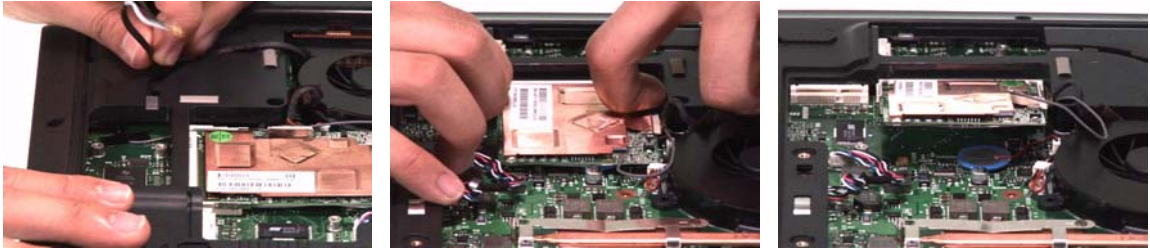

13. Disconnect the TV-in cable then remove the TV tuner card.

14. Remove two screws holding the support holder as shown.

15. Remove four screws fastening the support holder on the rear side as shown.



16. Detach the support holder from the main unit.

17. Remove the three screws holding the system fan.

18. Disconnect the fan cable from the main board.



19. Disconnect the fan cable from the main board.

20. Take out the system fan from the main unit as shown.



---

## Removing the Thermal Modules and the CPU

21. Remove the two screws holding the finger heatsink.
22. Detach the finger heatsink from the main board.

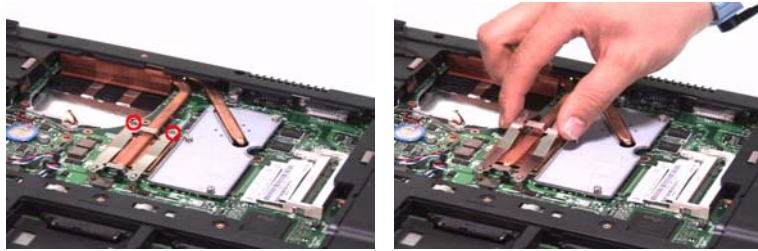

23. Then take out the CPU heatsink from the main board.
24. Remove the three screws fastening the VGA heatsink.
25. Detach the VGA heatsink from the main board.



26. Use a flat screwdriver to release the CPU lock (Turn counter clock-wise).
27. Remove the CPU from the CPU socket carefully.



## Removing the LCD Module

28. Disconnect the speaker cable from the main board.
29. Remove the two screws holding the middle cover.

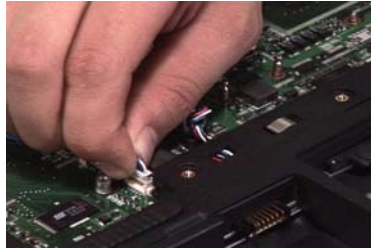

- 30. Open the notebook as shown.
- 31. Detach the middle cover from the rear side as shown.



- 32. Then detach the middle cover from the front side and remove it.
- 33. Take out the LCD cable from the groove.
- 34. Disconnect the LCD cable from the main board.

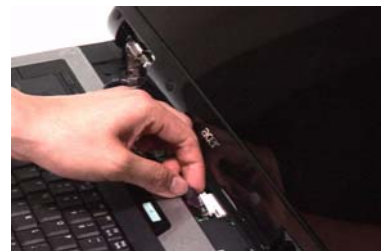

- 35. Pull out the Then take out the CPU heatsink from the main board.
- 36. Remove the three screws fastening the VGA heatsink.
- 37. Detach the LCD module from the main unit.





# Disassembling the Main Unit

## Separate the Main Unit Into the Upper and the Lower Case Assembly

1. Release the four keyboard lock as shown (Use a flat screwdriver and push the keyboard lock upwards).
2. Turn over the keyboard as the image shows.



3. Disconnect the keyboard cable from the main board.
4. Then remove the keyboard from the main unit.
5. Remove the screw fastening the optical disk drive module on the bottom.



6. Use a tool to push the optical disk drive module outwards and remove the ODD module.
7. Remove the express dummy card.
8. Then remove the PC dummy card.
- 9.



10. Remove the 16 screws fastening the upper case and the lower case assembly as shown.
11. Remove the four screws fastening the upper case assembly and the lower case assembly on the front side.
12. Disconnect the touchpad board FFC from the main board.

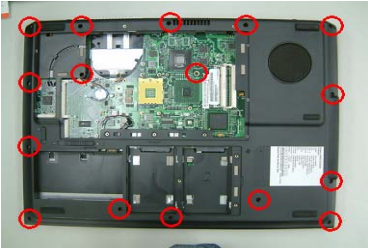

13. Disconnect the audio board FFC from the main board.
14. Disconnect the launch board FFC from the main board.
15. Carefully detach the upper case assembly from the lower case assembly.



## Disassembling the Lower Case Assembly

16. Disconnect the bluetooth cable from the main board and detach the bluetooth module from the lower case.
17. Remove the two screws fastening the modem board and disconnect the modem board from the main board.
18. Disconnect the modem cable and remove the modem board.



19. Remove the three screws fastening the main board to the lower case.
20. Detach the main board from the lower case assembly.

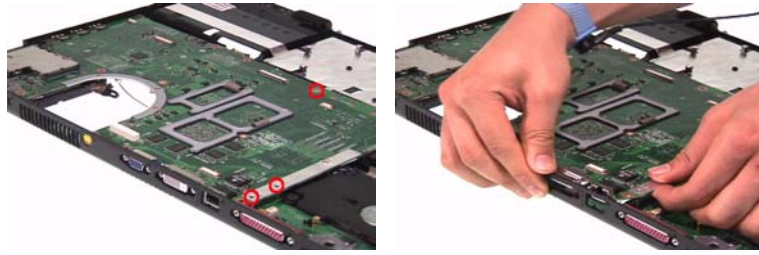

21. Remove the three screws holding the IO board to the lower case.
22. Detach the IO board from the lower case.
23. Then detach the modem cable (with RJ11 connector) from the lower case.



24. Tear off the mylar holding the speaker set cable carefully.
25. Remove the eight screws fastening the speaker and sub-woofer set.
26. Then remove the speaker and sub-woofer set from the lower case.



## Disassembling the Upper Case Assembly

1. Disconnect the touchpad board to main board FFC and remove it.
2. Remove the seven screws and disconnect the touchpad to touchpad board FFC.

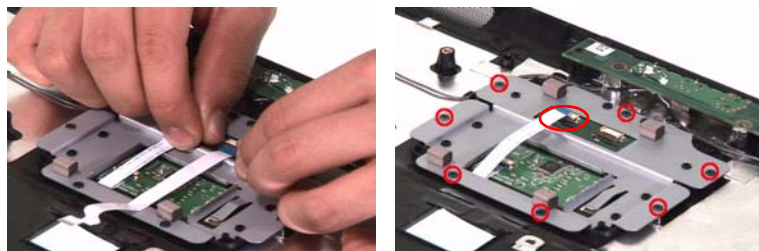

3. Detach the touchpad bracket from the upper case.



4. Remove the touchpad board from the upper case.
5. Disconnect the touchpad to touchpad board FFC then remove the FFC and the touchpad.

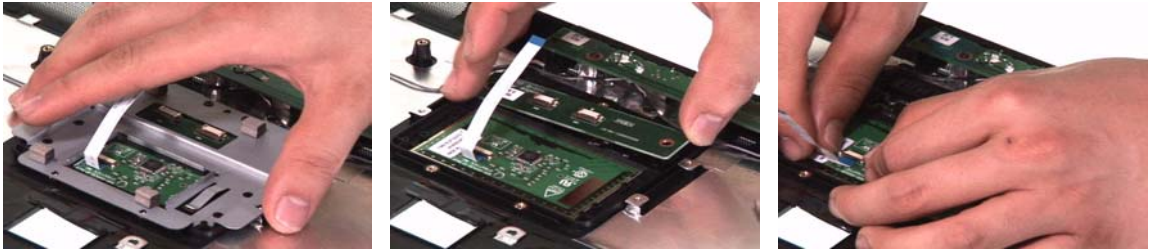

6. Disconnect the launch board FFC from the launch board and the media board and remove the FFC.
7. Remove the three screws fastening the media board to the upper case.
8. Remove the media board from the upper case.



9. Remove the two screws holding the audio board to the upper case.
10. Tear off the audio cable from the lower case.
11. Turn over the audio board as shown.

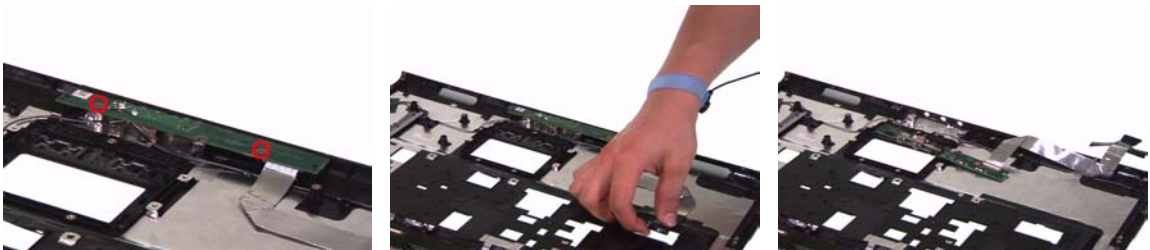

12. Disconnect the audio board cable from the audio board and remove the cable.
13. Disconnect the microphone cable and remove the audio board.
14. Carefully take out the microphone cable and the microphones from the lower case.

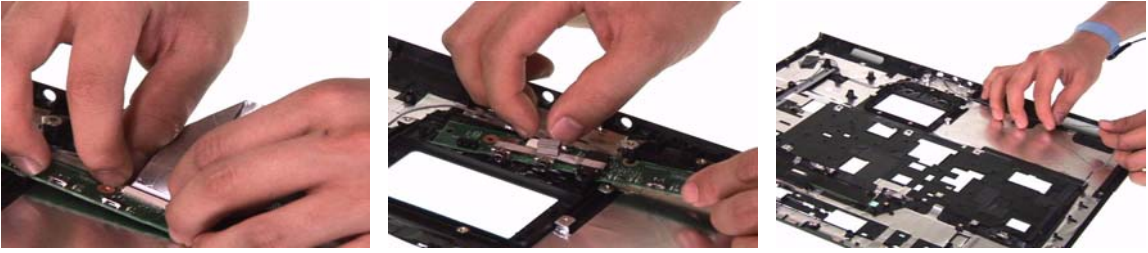

15. Detach and disconnect the launch board cable and remove it.
16. Detach the launch board insulator as shown.

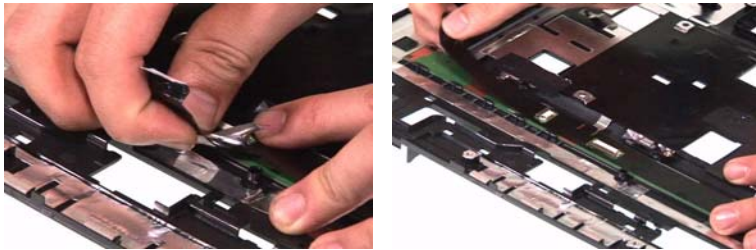

17. Remove the four screws fastening the launch board.
18. Take out the launch board from the upper case.
19. Then take out the touchpad frame from the upper case.

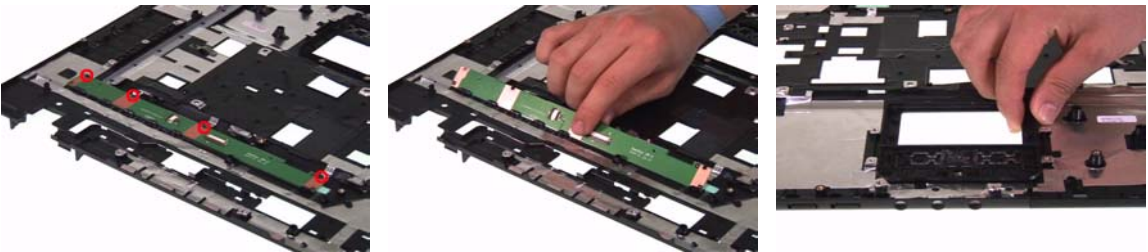



---

## Disassembling the LCD Module

1. Remove the eight screw rubber as shown.
2. Then remove the eight screws fastening the LCD bezel.
3. Detach the LCD from the LCD module carefully.



4. Remove the four screws holding the LCD.
5. Disconnect the CCD cable from the CCD board.



6. Take out the LCD from the LCD panel.
7. Remove the two screws fastening the right LCD bracket.
8. Detach the right LCD bracket.



9. Remove the two screws fastening the left LCD bracket.
10. Then remove the left LCD bracket.
11. Disconnect the LCD cable from the LCD and from the inverter.

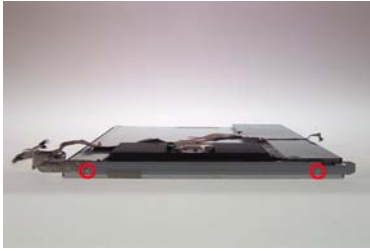

12. Disconnect the inverter cable and detach the inverter.
13. Detach the CCD board from the LCD panel.
14. Remove the two screws fastening the wireless antenna set and take out the antenna set from the LCD panel.

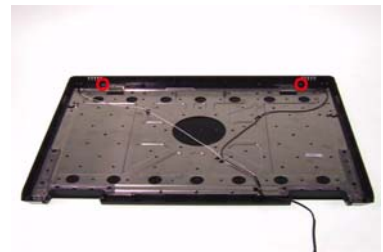
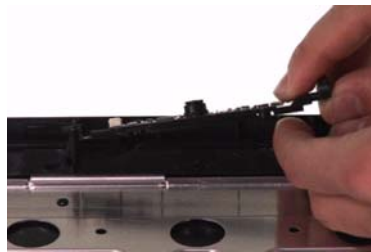

---

## Disassembling the External Modules

### Disassembling the HDD Module

1. Remove the four screws holding the HDD (hard disk drive) foil; two on each side.
2. Carefully take out the hard disk drive from the HDD foil.



### Disassembling the ODD Module

1. Remove the two screws holding the optical bracket.
2. Then remove the optical bracket from the optical disk drive.





# Troubleshooting

Use the following procedure as a guide for computer problems.

**NOTE:** The diagnostic tests are intended to test only Acer products. Non-Acer products, prototype cards, or modified options can give false errors and invalid system responses.

1. Obtain the failing symptoms in as much detail as possible.
2. Verify the symptoms by attempting to re-create the failure by running the diagnostic test or by repeating the same operation.
3. Use the following table with the verified symptom to determine which page to go to.

Symptoms (Verified)	Go To
Power failure. (The power indicator does not go on or stay on.)	"Power System Check" on page 81.
POST does not complete. No beep or error codes are indicated.	"Power-On Self-Test (POST) Error Message" on page 84 "Undetermined Problems" on page 96
POST detects an error and displayed messages on screen.	"Error Message List" on page 85
Other symptoms (i.e. LCD display problems or others).	"Power-On Self-Test (POST) Error Message" on page 84
Symptoms cannot be re-created (intermittent problems).	Use the customer-reported symptoms and go to "Power-On Self-Test (POST) Error Message" on page 84 "Intermittent Problems" on page 95 "Undetermined Problems" on page 96

---

# System Check Procedures

## External Diskette Drive Check

Do the following to isolate the problem to a controller, driver, or diskette. A write-enabled, diagnostic diskette is required.

**NOTE:** Make sure that the diskette does not have more than one label attached to it. Multiple labels can cause damage to the drive or cause the drive to fail.

Do the following to select the test device.

1. Boot from the diagnostics diskette and start the diagnostics program.
2. See if FDD Test is passed as the program runs to FDD Test.
3. Follow the instructions in the message window.

If an error occurs with the internal diskette drive, reconnect the diskette connector on the system board.

If the error still remains:

1. Reconnect the external diskette drive/DVD-ROM module.
2. Replace the external diskette drive/CD-ROM module.
3. Replace the main board.

## External CD-ROM Drive Check

Do the following to isolate the problem to a controller, drive, or CD-ROM. Make sure that the CD-ROM does not have any label attached to it. The label can cause damage to the drive or can cause the drive to fail.

Do the following to select the test device:

1. Boot from the diagnostics diskette and start the diagnostics program.
2. See if CD-ROM Test is passed when the program runs to CD-ROM Test.
3. Follow the instructions in the message window.

If an error occurs, reconnect the connector on the System board. If the error still remains:

1. Reconnect the external diskette drive/CD-ROM module.
2. Replace the external diskette drive/CD-ROM module.
3. Replace the main board.

## Keyboard or Auxiliary Input Device Check

Remove the external keyboard if the internal keyboard is to be tested.

If the internal keyboard does not work or an unexpected character appears, make sure that the flexible cable extending from the keyboard is correctly seated in the connector on the system board.

If the keyboard cable connection is correct, run the Keyboard Test.

If the tests detect a keyboard problem, do the following one at a time to correct the problem. Do not replace a non-defective FRU:

1. Reconnect the keyboard cables.
2. Replace the keyboard.
3. Replace the main board.

The following auxiliary input devices are supported by this computer:

- Numeric keypad
- External keyboard

---

If any of these devices do not work, reconnect the cable connector and repeat the failing operation.

## Memory check

Memory errors might stop system operations, show error messages on the screen, or hang the system.

1. Boot from the diagnostics diskette and start the doagmpstotics program (please refer to main board).
2. Go to the diagnostic memory in the test items.
3. Press F2 in the test items.
4. Follow the instructions in the message window.

**NOTE:** Make sure that the DIMM is fully installed into the connector. A loose connection can cause an error.

## Power System Check

To verify the symptom of the problem, power on the computer using each of the following power sources:

1. Remove the battery pack.
2. Connect the power adapter and check that power is supplied.
3. Disconnect the power adapter and install the charged battery pack; then check that power is supplied by the battery pack.

If you suspect a power problem, see the appropriate power supply check in the following list:

- “Check the Power Adapter” on page 82
- “Check the Battery Pack” on page 83

---

## Check the Power Adapter

Unplug the power adapter cable from the computer and measure the output voltage at the plug of the power adapter cable. See the following figure

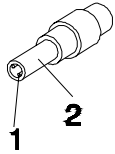

Pin 1: +19 to +20.5V  
Pin 2: 0V, Ground

1. If the voltage is not correct, replace the power adapter.
2. If the voltage is within the range, do the following:
  - Replace the System board.
  - If the problem is not corrected, see “Undetermined Problems” on page 96.
  - If the voltage is not correct, go to the next step.

**NOTE:** An audible noise from the power adapter does not always indicate a defect.

3. If the power-on indicator does not light up, check the power cord of the power adapter for correct continuity and installation.
4. If the operational charge does not work, see “Check the Battery Pack” on page 83.



---

## Check the Battery Pack

To check the battery pack, do the following:

From Software:

1. Check out the Power Management in control Panel
2. In Power Meter, confirm that if the parameters shown in the screen for Current Power Source and Total Battery Power Remaining are correct.
3. Repeat the steps 1 and 2, for both battery and adapter.
4. This helps you identify first the problem is on recharging or discharging.

From Hardware:

1. Power off the computer.
2. Remove the battery pack and measure the voltage between battery terminals 1(+) and 6(ground). See the following figure

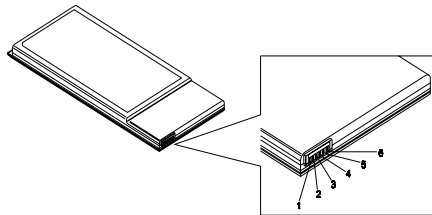

3. If the voltage is still less than 7.5 Vdc after recharging, replace the battery.

To check the battery charge operation, use a discharged battery pack or a battery pack that has less than 50% of the total power remaining when installed in the computer.

If the battery status indicator does not light up, remove the battery pack and let it return to room temperature. Re-install the battery pack.

If the charge indicator still does not light up, replace the battery pack. If the charge indicator still does not light up, replace the DC/DC charger board.

## Touchpad Check

If the touchpad doesn't work, do the following actions one at a time to correct the problem. Do not replace a non-defective FRU:

1. Reconnect the touchpad cables.
2. Replace the touchpad.
3. Replace the system board.

After you use the touchpad, the pointer drifts on the screen for a short time. This self-acting pointer movement can occur when a slight, steady pressure is applied to the touchpad pointer. This symptom is not a hardware problem. No service actions are necessary if the pointer movement stops in a short period of time.

---

# Power-On Self-Test (POST) Error Message

The POST error message index lists the error message and their possible causes. The most likely cause is listed first.

**NOTE:** Perform the FRU replacement or actions in the sequence shown in FRU/Action column, if the FRU replacement does not solve the problem, put the original part back in the computer. Do not replace a non-defective FRU.

This index can also help you determine the next possible FRU to be replaced when servicing a computer.

If the symptom is not listed, see “Undetermined Problems” on page 96.

The following lists the error messages that the BIOS displays on the screen and the error symptoms classified by function.

**NOTE:** Most of the error messages occur during POST. Some of them display information about a hardware device, e.g., the amount of memory installed. Others may indicate a problem with a device, such as the way it has been configured.

**NOTE:** If the system fails after you make changes in the BIOS Setup Utility menus, reset the computer, enter Setup and install Setup defaults or correct the error.

# Index of Error Messages

## Error Code List

Error Codes	Error Messages
006	Equipment Configuration Error Causes: 1. CPU BIOS Update Code Mismatch 2. IDE Primary Channel Master Drive Error (The causes will be shown before "Equipment Configuration Error")
010	Memory Error at xxxx:xxxx:xxxxh (R:xxxxh, W:xxxxh)
070	Real Time Clock Error
071	CMOS Battery Bad
072	CMOS Checksum Error
110	System disabled. Incorrect password is specified.
<No error code>	Battery critical LOW In this situation BIOS will issue 4 short beeps then shut down system, no message will show.
<No error code>	Thermal critical High In this situation BIOS will shut down system, not show message.

## Error Message List

Error Messages	FRU/Action in Sequence
Failure Fixed Disk	Reconnect hard disk drive connector. "Load Default Settings" in BIOS Setup Utility. Hard disk drive System board
Stuck Key	see "Keyboard or Auxiliary Input Device Check" on page 80.
Keyboard error	see "Keyboard or Auxiliary Input Device Check" on page 80.
Keyboard Controller Failed	see "Keyboard or Auxiliary Input Device Check" on page 80.
Keyboard locked - Unlock key switch	Unlock external keyboard
Monitor type does not match CMOS - Run Setup	Run "Load Default Settings" in BIOS Setup Utility.
Shadow RAM Failed at offset: nnnn	BIOS ROM System board
System RAM Failed at offset: nnnn	DIMM System board
Extended RAM Failed at offset: nnnn	DIMM System board
System battery is dead - Replace and run Setup	Replace RTC battery and Run BIOS Setup Utility to reconfigure system time, then reboot system.
System CMOS checksum bad - Default configuration used	RTC battery Run BIOS Setup Utility to reconfigure system time, then reboot system.
System timer error	RTC battery Run BIOS Setup Utility to reconfigure system time, then reboot system. System board

## Error Message List

Error Messages	FRU/Action in Sequence
Real time clock error	RTC battery Run BIOS Setup Utility to reconfigure system time, then reboot system. System board
Previous boot incomplete - Default configuration used	Run "Load Default Settings" in BIOS Setup Utility. RTC battery System board
Memory size found by POST differed from CMOS	Run "Load Default Settings" in BIOS Setup Utility. DIMM System board
Diskette drive A error	Check the drive is defined with the proper diskette type in BIOS Setup Utility See "External Diskette Drive Check" on page 80.
Incorrect Drive A type - run SETUP	Check the drive is defined with the proper diskette type in BIOS Setup Utility
System cache error - Cache disabled	System board
CPU ID:	System board
DMA Test Failed	DIMM System board
Software NMI Failed	DIMM System board
Fail-Safe Timer NMI Failed	DIMM System board
Device Address Conflict	Run "Load Default Settings" in BIOS Setup Utility. RTC battery System board
Allocation Error for device	Run "Load Default Settings" in BIOS Setup Utility. RTC battery System board
Failing Bits: nnnn	DIMM BIOS ROM System board
Fixed Disk n	None
Invalid System Configuration Data	BIOS ROM System board
I/O device IRQ conflict	Run "Load Default Settings" in BIOS Setup Utility. RTC battery System board
Operating system not found	Enter Setup and see if fixed disk and drive A: are properly identified. Diskette drive Hard disk drive System board

## Error Message List

No beep Error Messages	FRU/Action in Sequence
No beep, power-on indicator turns off and LCD is blank.	Power source (battery pack and power adapter). See "Power System Check" on page 81.. Ensure every connector is connected tightly and correctly. Reconnect the DIMM. LED board. System board.
No beep, power-on indicator turns on and LCD is blank.	Power source (battery pack and power adapter). See "Power System Check" on page 81.. Reconnect the LCD connector Hard disk drive LCD inverter ID LCD cable LCD Inverter LCD System board
No beep, power-on indicator turns on and LCD is blank. But you can see POST on an external CRT.	Reconnect the LCD connectors. LCD inverter ID LCD cable LCD inverter LCD System board
No beep, power-on indicator turns on and a blinking cursor shown on LCD during POST.	Ensure every connector is connected tightly and correctly. System board
No beep during POST but system runs correctly.	Speaker System board

# Phoenix BIOS Beep Codes

Code	Beeps	POST Routine Description
02h		Verify Real Mode
03h		Disable Non-Maskable Interrupt (NMI)
04h		Get CPU type
06h		Initialize system hardware
08h		Initialize chipset with initial POST values
09h		Set IN POST flag
0Ah		Initialize CPU registers
0Bh		Enable CPU cache
0Ch		Initialize caches to initial POST values
0Eh		Initialize I/O component
0Fh		Initialize the local bus IDE
10h		Initialize Power Management
11h		Load alternate registers with initial POST values
12h		Restore CPU control word during warm boot
13h		Initialize PCI Bus Mastering devices
14h		Initialize keyboard controller
16h	1-2-2-3	BIOS ROM checksum
17h		Initialize cache before memory autosize
18h		8254 timer initialization
1Ah		8237 DMA controller initialization
1Ch		Reset Programmable Interrupt Controller
20h	1-3-1-1	Test DRAM refresh
22h	1-3-1-3	Test 8742 Keyboard Controller
24h		Set ES segment register to 4 GB
26h		Enable A20 line
28h		Autosize DRAM
29h		Initialize POST Memory Manager
2Ah		Clear 215 KB base RAM
2Ch	1-3-4-1	RAM failure on address line xxxx
2Eh	1-3-4-3	RAM failure on data bits xxxx of low byte of memory bus
2Fh		Enable cache before system BIOS shadow
30h	1-4-1-1	RAM failure on data bits xxxx of high byte of memory bus
32h		Test CPU bus-clock frequency
33h		Initialize Phoenix Dispatch Manager
36h		Warm start shut down
38h		Shadow system BIOS ROM
3Ah		Autosize cache
3Ch		Advanced configuration of chipset registers
3Dh		Load alternate registers with CMOS values
42h		Initialize interrupt vectors
45h		POST device initialization

Code	Beeps	POST Routine Description
46h	2-1-2-3	Check ROM copyright notice
48h		Check video configuration against CMOS
49h		Initialize PCI bus and devices
4Ah		Initialize all video adapters in system
4Bh		QuietBoot start (optional)
4Ch		Shadow video BIOS ROM
4Eh		Display BIOS copyright notice
50h		Display CPU type and speed
51h		Initialize EISA board
52h		Test keyboard
54h		Set key click if enabled
58h	2-2-3-1	Test for unexpected interrupts
59h		Initialize POST display service
5Ah		Display prompt "Press F2 to enter SETUP"
5Bh		Disable CPU cache
5Ch		Test RAM between 512 and 640 KB
60h		Test extended memory
62h		Test extended memory address lines
64h		Jump to User Patch1
66h		Configure advanced cache registers
67h		Initialize Multi Processor APIC
68h		Enable external and CPU caches
69h		Setup System Management Mode (SMM) area
6Ah		Display external L2 cache size
6Bh		Load custom defaults (optional)
6Ch		Display shadow-area message
6Eh		Display possible high address for UMB recovery
70h		Display error messages
72h		Check for configuration errors
76h		Check for keyboard errors
7Ch		Set up hardware interrupt vectors
7Eh		Initialize coprocessor if present
80h		Disable onboard Super I/O ports and IRQs
81h		Late POST device initialization
82h		Detect and install external RS232 ports
83h		Configure non-MCD IDE controllers
84h		Detect and install external parallel ports
85h		Initialize PC-compatible PnP ISA devices
86h		Re-initialize onboard I/O ports
87h		Configure Motherboard Configurable Devices (optional)
88h		Initialize BIOS Area
89h		Enable Non-Maskable Interrupts (NMI)
8Ah		Initialize Extended BIOS Data Area
8Bh		Test and initialize PS/2 mouse

Code	Beeps	POST Routine Description
8Ch		Initialize floppy controller
8Fh		Determine number of ATA drives (optional)
90h		Initialize hard-disk controllers
91h		Initialize local-bus hard-disk controllers
92h		Jump to UserPatch2
93h		Build MPTABLE for multi-processor boards
95h		Install CD ROM for boot
96h		Clear huge ES segment register
97h		Fixup Multi Processor table
98h	1-2	Search for option ROMs. One long, two short beeps on checksum failure.
99h		Check for SMART drive (optional)
9Ah		Shadow option ROMs
9Ch		Set up Power Management
9Dh		Initialize security engine (optional)
9Eh		Enable hardware interrupts
9Fh		Determine number of ATA and SCSI drives
A0h		Set time of day
A2h		Check key lock
A4h		Initialize Typematic rate
A8h		Erase F2 prompt
AAh		Scan for F2 key stroke
ACh		Enter SETUP
AEh		Clear Boot flag
B0h		Check for errors
B2h		POST done- prepare to boot operating system
B4h	1	One short beep before boot
B5h		Terminate QuietBoot (optional)
B6h		Check password (optional)
B9h		Prepare Boot
BAh		Initialize DMI parameters
BBh		Initialize PnP Option ROMs
BCh		Clear parity checkers
BDh		Display MultiBoot menu
BEh		Clear screen (optional)
BFh		Check virus and backup reminders
C0h		Try to boot with INT 19
C1h		Initialize POST Error Manager (PEM)
C2h		Initialize error logging
C3h		Initialize error display function
C4h		Initialize system error handler
C5h		PnPnd dual CMOS (optional)
C6h		Initialize notebook docking (optional)
C7h		Initialize notebook docking late
C8h		Force check (optional)
C9h		Extended checksum (optional)



Code	Beeps	POST Routine Description
D2h		Unknown interrupt

Code	Beeps	POST Routine Description
E0h		Initialize the chipset
E1h		Initialize the bridge
E2h		Initialize the CPU
E3h		Initialize the system timer
E4h		Initialize system I/O
E5h		Check force recovery boot
E6h		Checksum BIOS ROM
E7h		Go to BIOS
E8h		Set Huge Segment
E9h		Initialize Multi Processor
EAh		Initialize OEM special code
EBh		Initialize PIC and DMA
ECh		Initialize Memory type
EDh		Initialize Memory size
EEh		Shadow Boot Block
EFh		System memory test
F0h		Initialize interrupt vectors
F1h		Initialize Run Time Clock
F2h		Initialize video
F3h		Initialize System Management Mode
F4h	1	Output one beep before boot
F5h		Boot to Mini DOS
F6h		Clear Huge Segment
F7h		Boot to Full DOS

# Index of Symptom-to-FRU Error Message

## LCD-Related Symptoms

Symptom / Error	Action in Sequence
LCD backlight doesn't work LCD is too dark LCD brightness cannot be adjusted LCD contrast cannot be adjusted	Enter BIOS Utility to execute "Load Setup Default Settings", then reboot system. Reconnect the LCD connectors. Keyboard (if contrast and brightness function key doesn't work). LCD inverter ID LCD cable LCD inverter LCD System board
Unreadable LCD screen Missing pels in characters Abnormal screen Wrong color displayed	Reconnect the LCD connector LCD inverter ID LCD cable LCD inverter LCD System board
LCD has extra horizontal or vertical lines displayed.	LCD inverter ID LCD inverter LCD cable LCD System board

## Indicator-Related Symptoms

Symptom / Error	Action in Sequence
Indicator incorrectly remains off or on, but system runs correctly	Reconnect the inverter board Inverter board System board

## Power-Related Symptoms

Symptom / Error	Action in Sequence
Power shuts down during operation	Power source (battery pack and power adapter). See "Power System Check" on page 81. Battery pack Power adapter Hard drive & battery connection board System board
The system doesn't power-on.	Power source (battery pack and power adapter). See "Power System Check" on page 81. Battery pack Power adapter Hard drive & battery connection board System board
The system doesn't power-off.	Power source (battery pack and power adapter). See "Power System Check" on page 81. Hold and press the power switch for more than 4 seconds. System board

### Power-Related Symptoms

Symptom / Error	Action in Sequence
Battery can't be charged	See "Check the Battery Pack" on page 83. Battery pack System board

### PCMCIA-Related Symptoms

Symptom / Error	Action in Sequence
System cannot detect the PC Card (PCMCIA)	PCMCIA slot assembly System board
PCMCIA slot pin is damaged.	PCMCIA slot assembly

### Memory-Related Symptoms

Symptom / Error	Action in Sequence
Memory count (size) appears different from actual size.	Enter BIOS Setup Utility to execute "Load Default Settings, then reboot system. DIMM System board

### Speaker-Related Symptoms

Symptom / Error	Action in Sequence
In Windows, multimedia programs, no sound comes from the computer.	Audio driver Speaker System board
Internal speakers make noise or emit no sound.	Speaker System board

### Power Management-Related Symptoms

Symptom / Error	Action in Sequence
The system will not enter hibernation	See "Save to Disk (S4)" on page 45. Keyboard (if control is from the keyboard) Hard disk drive System board
The system doesn't enter hibernation mode and four short beeps every minute.	Press Fn+  and see if the computer enters hibernation mode. Touchpad Keyboard Hard disk connection board Hard disk drive System board
The system doesn't enter standby mode after closing the LCD	See "Save to Disk (S4)" on page 45. LCD cover switch System board
The system doesn't resume from hibernation mode.	See "Save to Disk (S4)" on page 45. Hard disk connection board Hard disk drive System board
The system doesn't resume from standby mode after opening the LCD.	See "Save to Disk (S4)" on page 45. LCD cover switch System board

## Power Management-Related Symptoms

Symptom / Error	Action in Sequence
Battery fuel gauge in Windows doesn't go higher than 90%.	Remove battery pack and let it cool for 2 hours. Refresh battery (continue use battery until power off, then charge battery). Battery pack System board
System hangs intermittently.	Reconnect hard disk/CD-ROM drives. Hard disk connection board System board

## Peripheral-Related Symptoms

Symptom / Error	Action in Sequence
System configuration does not match the installed devices.	Enter BIOS Setup Utility to execute "Load Default Settings", then reboot system. Reconnect hard disk/CD-ROM/diskette drives.
External display does not work correctly.	Press Fn+F5, LCD/CRT/Both display switching System board
USB does not work correctly	System board
Print problems.	Ensure the "Parallel Port" in the "Onboard Devices Configuration" of BIOS Setup Utility is set to Enabled. Onboard Devices Configuration Run printer self-test. Printer driver Printer cable Printer System Board
Serial or parallel port device problems.	Ensure the "Serial Port" in the Devices Configuration" of BIOS Setup Utility is set to Enabled. Device driver Device cable Device System board

## Keyboard/Touchpad-Related Symptoms

Symptom / Error	Action in Sequence
Keyboard (one or more keys) does not work.	Reconnect the keyboard cable. Keyboard System board
Touchpad does not work.	Reconnect touchpad cable. Touchpad board System board

## Modem-Related Symptoms

Symptom / Error	Action in Sequence
Internal modem does not work correctly.	Modem phone port modem combo board System board

**NOTE:** If you cannot find a symptom or an error in this list and the problem remains, see "Undetermined Problems" on page 96.

---

# Intermittent Problems

Intermittent system hang problems can be caused by a variety of reasons that have nothing to do with a hardware defect, such as: cosmic radiation, electrostatic discharge, or software errors. FRU replacement should be considered only when a recurring problem exists.

When analyzing an intermittent problem, do the following:

1. Run the advanced diagnostic test for the system board in loop mode at least 10 times.
2. If no error is detected, do not replace any FRU.
3. If any error is detected, replace the FRU. Rerun the test to verify that there are no more errors.

---

# Undetermined Problems

The diagnostic problems does not identify which adapter or device failed, which installed devices are incorrect, whether a short circuit is suspected, or whether the system is inoperative.

Follow these procedures to isolate the failing FRU (do not isolate non-defective FRU).

**NOTE:** Verify that all attached devices are supported by the computer.

**NOTE:** Verify that the power supply being used at the time of the failure is operating correctly. (See "Power System Check" on page 81.):

1. Power-off the computer.
2. Visually check them for damage. If any problems are found, replace the FRU.
3. Remove or disconnect all of the following devices:
  - Non-Acer devices
  - Printer, mouse, and other external devices
  - Battery pack
  - Hard disk drive
  - DIMM
  - CD-ROM/Diskette drive Module
  - PC Cards
4. Power-on the computer.
5. Determine if the problem has changed.
6. If the problem does not recur, reconnect the removed devices one at a time until you find the failing FRU.
7. If the problem remains, replace the following FRU one at a time. Do not replace a non-defective FRU:
  - System board
  - LCD assembly



17	CN14	DIMM Socket	36	CN11	IEEE port
18	CN18	Optical Disk Drive Connector	37	U25	PCI cardbus/Media Board/1394 IC
19	U39	South Bridge			

## Bottom View

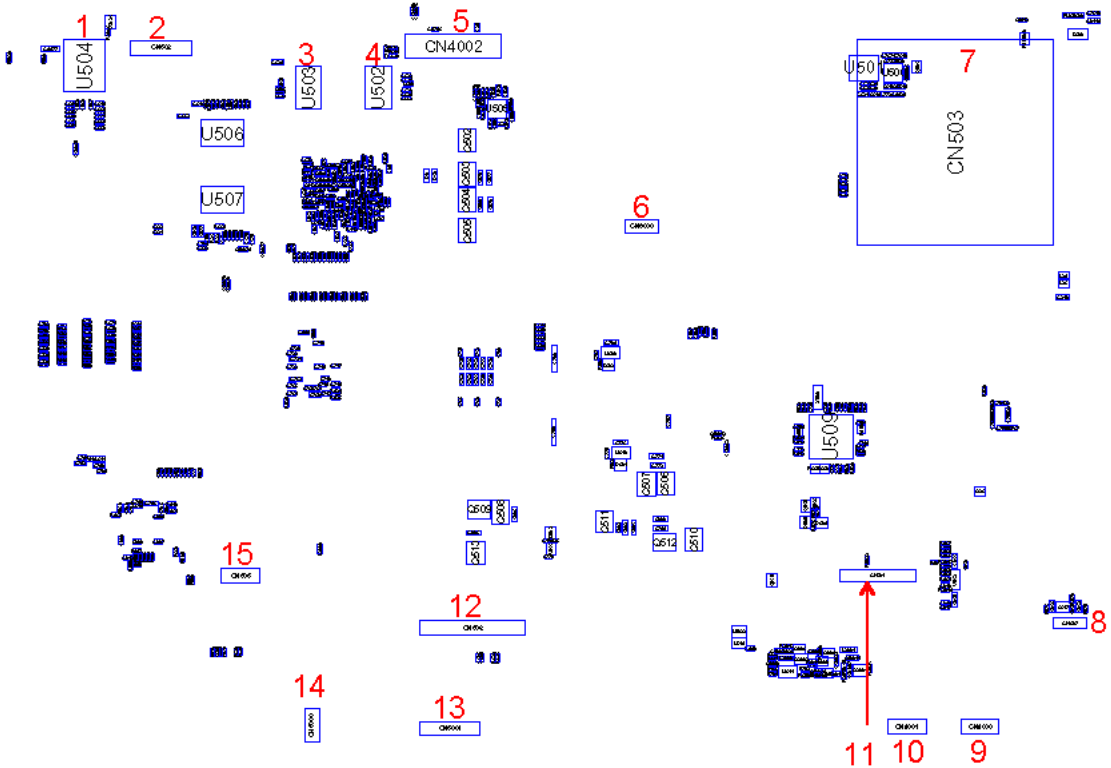

1	U504		9	CN4000	
2	CN502	Launch Board Connector	10	CN4001	
3	U503		11	CN504	Audio Board Connector
4	U502		12	CN506	DDR2 SDRAM IC
5	CN4002		13	CN5001	
6	CN3000		14	CN5000	
7	CN503	Express Card Slot	15	CN505	Touchpad Board Connector
8	CN507	DDR2 SDRAM IC			



## FRU (Field Replaceable Unit) List

---









This chapter gives you the FRU (Field Replaceable Unit) listing in global configurations of Aspire 9800. Refer to this chapter whenever ordering for parts to repair or for RMA (Return Merchandise Authorization).







Please note that WHEN ORDERING FRU PARTS, you should check the most up-to-date information available on your regional web or channel. For whatever reasons a part number change is made, it will not be noted on the printed Service Guide. For ACER AUTHORIZED SERVICE PROVIDERS, your Acer office may have a DIFFERENT part number code from those given in the FRU list of this printed Service Guide. You MUST use the local FRU list provided by your regional Acer office to order FRU parts for repair and service of customer machines.

**NOTE:** To scrap or to return the defective parts, you should follow the local government ordinance or regulations on how to dispose it properly, or follow the rules set by your regional Acer office on how to return it.







# Aspire 9800 Exploded Diagram

Category	No.	Part Name and Description	Acer Part No.
ADAPTER			
		ADAPTER 135W 19V 3PIN W/LED DELTA ADP-135DB BBJF LF	AP.13501.004
		ADAPTER 135W 19V 3PIN LITE-ON PA-131-08 RI LF	AP.13503.006
		ADAPTER 135W 3PIN LSE SLS0317A19A52LF LF	AP.13506.002
BATTERY			
		BATTERY PACK SANYO LI-ION 8 CELL2.4, 4800MAH	BT.00803.019
		BATTERY PACK SONY LI-ION 8CELL2.4, 4800MAH	BT.00804.016
BOARD			
		MODEM BOARD FOXCONN T60M845.02	54.AAMVN.001
		WIRELESS LAN BOARD 802.11BG FOXCONN ABT_ATH5413BG	54.AAMVN.002
		WIRELESS LAN BOARD 802.11BG PCI EXPRESS FOXCONN ABT_BRM4318BG	54.AAMVN.003
		MINI WIRELESS BOARD 802.11 A/B/G MOW1 INTEL MM872612	KI.GLN01.001
		MINI WIRELESS BOARD 802.11 A/B/G MOW2 INTEL MM872659	KI.GLN01.002
		MINI WIRELESS BOARD 802.11 A/B/G ROW INTEL MM874511	KI.GLN01.003
		MINI WIRELESS BOARD 802.11 A/B/G JP INTEL MM874740	KI.GLN01.004
		MINI WIRELESS LAN BOARD 802.11BG INTEL WM3945AGBG	KI.GLN01.005
		BLUETOOTH BOARD FOXCONN T60H928.01	54.AAMVN.004

Category	No.	Part Name and Description	Acer Part No.
		I/O BOARD	55.AAMVN.001
 		LAUNCH BOARD (Above image is top view; below image is bottom view)	55.AAMVN.002
 		MEDIA BOARD (Above image is top view; below image is bottom view)	55.AAMVN.003
		AUDIO BOARD	55.AAMVN.004
		TOUCHPAD BOTTON BOARD	55.AAMVN.005
		TOUCHPAD SYNAPTICS TM61P-372	56.AAMVN.001
CABLE			
		POWER CORD 3PIN USA	27.AAMVN.001
		POWER CORD 3PIN EUR	27.AAMVN.002
		POWER CORD AUSTRALIA W/LABEL	27.AAMVN.003
		POWER CORD 3PIN UK	27.AAMVN.004
		POWER CORD 3PIN CHINA	27.AAMVN.005
		POWER CORD 3PIN SWISS	27.AAMVN.006

Category	No.	Part Name and Description	Acer Part No.
		POWER CORD SOUTH AFRICA (AIL)	27.AAMVN.007
		POWER CORD 3PIN SOUTH AFRICA	27.AAMVN.008
		POERR CORD 3PIN ITALIAN	27.AAMVN.009
		POWER CORD 3PIN DENMARK	27.AAMVN.010
		POWER CORD ISRAEL	27.AAMVN.011
		BLUETOOTH CABLE	50.AAMVN.002
		HOT KEYBOARD CABLE	50.AAMVN.003
		MIDEA BOARD CABLE	50.AAMVN.004
		AUDIO BOARD CABLE	50.AAMVN.005
		BUTTON BOARD CABLE 6 PINS	50.AAMVN.006
		BUTTON BOARD CABLE 12 PINS	50.AAMVN.007

Category	No.	Part Name and Description	Acer Part No.
		MODEM CABLE WITH RJ11 CONNECTOR	50.AAMVN.010
CASE/COVER/BRACKET ASSEMBLY			
		LOWER CASE	60.AAMVN.001
		UPPER CASE	60.AAMVN.002
		MIDDLE COVER	60.AAMVN.003
		ASSY THERMAL COVER	60.AAMVN.004
		SUPPORT COVER	60.AAMVN.005



Category	No.	Part Name and Description	Acer Part No.
		HDD COVER	42.AAMVN,001
		TOUCHPAD FRAME	42.AAMVN,002
		MINI DUMMY CARD	42.AAMVN.003
		PCMCIA DUMMY CARD	42.AAMVN.004
		TOUCHPAD BRACKET (Note: The ACTUAL spare part: touchpad bracket does NOT contain touchpad bracket gesket. However the touchpad bracket image here has the touchpad bracket gesket. If you need to replace the touchpad bracket, please take off the gesket from old touchpad bracket and then stick them to new touchpad bracket..	33.AAMVN.001
CPU/PROCESSOR			
		CPU INTEL YONAH CORE DUO FSB-667 1.66G 2M SL8VR	KC.23001.DTP
		CPU INTEL YONAH CORE DUO FSB-667 1.66G 2M SL9DM (NO VT)	KC.23E01.DTP
		CPU INTEL YONAH CORE DUO FSB-667 1.83G 2M SL8VQ	KC.24001.DTP





Category	No.	Part Name and Description	Acer Part No.
		CPU INTEL YONAH CORE DUO FSB-667 2.0G 2M SL8VP	KC.25001.DTP
		CPU INTEL YONAH CORE DUO FSB-667 2.16G 2M SL8VN	KC.26001.DTP
		CPU INTEL YONAH CORE SOLO FSB-667 1.66G 2M SL8VY	KC.13001.STP
COMBO MODULE			
		COMBO MODULE 24X GBASE W/ BEZEL	6M.AAMVN.001
		OPTICAL BRACKET	33.AAMVN.002
		COMBO BEZEL G-BASE	42.AAMVN.011
		DVD COMBO,PHILIPS SCB5265 ,GB,LF	KO.02403.007
		DVD/CDRW COMBO 24X DRIVE PANASONIC UJDA-770	KO.02406.013
DVD-RW DRIVE			
		DVD-RW MODULE 24X DUAL GBASE W/BEZEL	6M.AAMVN.002
		OPTICAL BRACKET	33.AAMVN.002
		DVD DUAL BEZEL G-BASE	42.AAMVN.012

Category	No.	Part Name and Description	Acer Part No.
		DVD-RW DRIVE 8X DUAL PHILIPS SDVD841 W/O BEZEL	KU.00809.004
		DVD-RW DRIVE 8X DUAL TOSHIBA TS-L532U W/O BEZEL	KU.00801.005
		DVD-RW MODULE 24X SUPER MULTI GBASE W/BEZEL	6M.AAMVN.003
		OPTICAL BRACKET	33.AAMVN.002
		SUPER MULTI BEZEL GBASE	42.AAMVN.013
		DVD-RW DRIVE 8X SUPER MULTI TOSHIBA TS-L632D W/O BEZEL	KU.00801.014
		DVD-RW DRIVE 8X S-MUTI PANASONIC UJ-850 W/O BEZEL	KU.00807.025
		DVD-RW MODULE SUPER MULTI SLOT-IN PIONEER GBASE W/BEZEL	6M.AAMVN.004
		OPTICAL BRACKET	33.AAMVN.002
		SUPER MULIA SLOT-IN BEZEL PIONEER	42.AAMVN.014
		DVD-RW DRIVE 8X SUPER MULTI SLOT IN PIONEER DVR-K06RS W/O BEZEL	KU.00805.027
		DVD-RW MODULE SUPER MULTI SLO-IN KME GBASE W/BEZEL	6M.AAMVN.005
		OPTICAL BRACKET	33.AAMVN.002
		SUPER MULTI SLOT-IN BEZEL KME	42.AAMVN.015
		DVD-RW DRIVE 8X SUPER MULTI SLOT IN PANASONIC UJ-855 W/O BEZEL	KU.00807.029
		DVD-RW MODULE HD DVD ROM GBASE W/BEZEL	6M.AAMVN.006
		OPTICAL BRACKET	33.AAMVN.002
		HD DVD BEZEL	42.AAMVN.016
		HD 1X DVD ROM TOSHIBA TS-L802A LF W/O BEZEL	KV.01H01.001
FAN			
	FAN	FAN	23.AAMVN.003



Category	No.	Part Name and Description	Acer Part No.
HDD/HARD DISK DRIVER			
		HDD 100G 5400RPM SEAGATE ST9100824A	KH.10001.007
		HDD 100G 5400RPM TOSHIBA MK1032GAX	KH.10004.002
		HDD100G 5400RPM HGST MORAGA+ HTS541010G9AT00 ROHS F/W:A60A	KH.10007.004
		HDD 100G 5400RPM SAMSUNG HM100JC	KH.1000B.002
		HDD 120G 5400RPM SEAGATE ST9120821A LF MERCURY 2 FW:3.06	KH.12001.024
		HDD 120GB TOSHIBA 2.5 IN. 5400RPM MK1234GAX LF TAURUS FW:AC001A	KH.12004.002
		HDD 120G 5400RPM SAMSUNG HM120JC M60 LF FW: YL100-08	KH.1200B.001
		HDD 160G 5400RPM SEAGATE ST9160821A VENUS LF FW:3.ALA	KH.16001.020
		HDD INSULATOR	42.AAMVN.005
		HDD 80G SEAGATE 5.4K SATA ST98823AS MERCURY 2 FW:3.06 LF	KH.08001.023
		HDD 80G HGST 5.4K SATA 1.5G NCQ MORAGA+HTS541080G9SA00,C60D	KH.08007.015
		HDD 80G 5400RPM SATA TOSHIBA ARES-B_S MK8032GSX F/W AS111G	KH.08004.005
		HDD 80G SAMSUNG 5400RPM SATA HM080II M60S LF FW:YC200-08	KH.0800B.005
		HDD 100G HGST SATA 1.5G NCQMORAGA+HTS541010G9SA00 FW:S60D	KH.10007.005
		HDD 100G SEAGATE 5.4K SATA ST9100824AS MERCURY 2 FW:3.06 LF	KH.10001.008
		HDD 100G TOSHIBA SATA 5.4K ARES-B_S MK1032GSX F/W AS021G	KH.10004.003
		HDD 100G 5400RPM SATA SAMSUNG HM100JI M60S LF FW:YH100-10	KH.1000B.003
		HDD 120G SEAGATE 5.4K SATA ST9120821AS LF MERCURY 2 FW:3.06	KH.12001.025
		HDD 120G TOSHIBA 5.4K SATA1.5G W/NCQ MK1234GSX LF TAURUS FW:AH001A	KH.12004.003

Category	No.	Part Name and Description	Acer Part No.
		HDD 120G 5400RPM SATA SAMSUNG HM120JI M60S LF FW: YF100-10	KH.1200B.002
		HDD INSULATOR	42.AAMVN.005
HEATSINK			
		CPU HEATSINK	34.AAMVN.001
		FINGER HEATSINK	34.AAMVN.002
KEYBOARD			
		AS9800 KEYBOARD DARFON US INTERNATIONAL	KB.AAK07.001
		AS9800 KEYBOARD DARFON CHINESE	KB.AAK07.002
		AS9800 KEYBOARD DARFON SPANISH	KB.AAK07.003
		AS9800 KEYBOARD DARFON THAI	KB.AAK07.004
		AS9800 KEYBOARD DARFON BRAZILIAN PROTUGESE	KB.AAK07.005
		AS9800 KEYBOARD DARFON KOREA	KB.AAK07.006
		AS9800 KEYBOARD DARFON UK	KB.AAK07.007
		AS9800 KEYBOARD DARFON GERMAN	KB.AAK07.008
		AS9800 KEYBOARD DARFON ITALIAN	KB.AAK07.009
		AS9800 KEYBOARD DARFON FRENCH	KB.AAK07.010
		AS9800 KEYBOARD DARFON SWISS/ G	KB.AAK07.011
		AS9800 KEYBOARD DARFON PORTUGUESE	KB.AAK07.012
		AS9800 KEYBOARD DARFON ARABIC	KB.AAK07.013
		AS9800 KEYBOARD DARFON BELGIUM	KB.AAK07.014
		AS9800 KEYBOARD DARFON SWEDEN	KB.AAK07.015
		AS9800 KEYBOARD DARFON CZECH	KB.AAK07.016

Category	No.	Part Name and Description	Acer Part No.
		AS9800 KEYBOARD DARFON HUNGAIAN	KB.AAK07.017
		AS9800 KEYBOARD DARFON NORWAY	KB.AAK07.018
		AS9800 KEYBOARD DARFON DANISH	KB.AAK07.019
		AS9800 KEYBOARD DARFON TURKISH	KB.AAK07.020
		AS9800 KEYBOARD DARFON CANADIAN FRENCH	KB.AAK07.021
		AS9800 KEYBOARD DARFON GREEK	KB.AAK07.023
		AS9800 KEYBOARD DARFON HEBREW	KB.AAK07.024
		AS9800 KEYBOARD DARFON RUSSIAN	KB.AAK07.025
		AS9800 KEYBOARD DARFON SLOVENIA (SLO)	KB.AAK07.026
		AS9800 KEYBOARD DARFON CROATIA (CR )	KB.AAK07.027
LCD			
		LCD MODULE 19.1" WXGA+ SAMSUNG NON-GLARE	6M.AAMVN.011
		INVERTER BOARD 19IN. TDK XAD369NR 4 LAMPS	19.AAMVN.001
		LCD CABLE 19.1IN. SAMSUNG W/CCD CABLE	50.AAMVN.011
		WIRELESS ANTENNA FOR 19.1IN.	25.AAMVN.001
		CCD CAMERA 1.3M LOGITECH	56.AAMVN.002

Category	No.	Part Name and Description	Acer Part No.
		LCD BEZEL 19" W/LOGO	60.AAMVN.006
		LCD COVER W/LOGO	60.AAMVN.007
		LCD BARCKET L W/HINGE 19.1IN. SAMSUNG	33.AAMVN.003
		LCD BARCKET R W/HINGE 19.1IN. SAMSUNG	33.AAMVN.004
		LCD 19IN. WXGA+ SAMSUNG LTN190- M2-000 8MS 300NITS NON-GLARE	LK.19106.002
		LCD MODULE 19.1" WXGA+ CMO NON-GLARE	6M.AAMVN.012
		INVERTER BOARD 19IN. TDK XAD369NR 4 LAMPS	19.AAMVN.001
		LCD CABLE 19.1IN. CMO W/CCD CABLE	50.AAMVN.012
		WIRELESS ANTENNA FOR 19.1IN.	25.AAMVN.001
		CCD CAMERA 1.3M LOGITECH	56.AAMVN.002
		LCD BEZEL 19" W/LOGO	60.AAMVN.006
		LCD COVER W/LOGO	60.AAMVN.007
		LCD BARCKET L W/HINGE 19.1IN. CMO	33.AAMVN.005
		LCD BARCKET R W/HINGE 19.1IN. CMO	33.AAMVN.006
		LCD 19WXGA+ CMO M190A1-L01 8MS 300NITS NON-GLARE	LK.1910D.003



Category	No.	Part Name and Description	Acer Part No.
		LCD MODULE 19.1" WXGA+ SAMSUNG GLARE	6M.AAMVN.013
		INVERTER BOARD 19IN. TDK XAD369NR 4 LAMPS	19.AAMVN.001
		LCD CABLE 19.1IN. SAMSUNG W/CCD CABLE	50.AAMVN.011
		WIRELESS ANTENNA FOR 19.1IN.	25.AAMVN.001
		CCD CAMERA 1.3M LOGITECH	56.AAMVN.002
		LCD BEZEL 19" W/LOGO	60.AAMVN.006
		LCD COVER W/LOGO	60.AAMVN.007
		LCD BARCKET L W/HINGE 19.1IN. SAMSUNG	33.AAMVN.003
		LCD BARCKET R W/HINGE 19.1IN. SAMSUNG	33.AAMVN.004
		LCD 19IN. WXGA+ SAMSUNG LTM190-M2-L01-G 8MS 300NITS GLARE TYPE	LK.19006.007
		LCD MODULE 19.1" WXGA+ CMO GLARE	6M.AAMVN.014
		INVERTER BOARD 19IN. TDK XAD369NR 4 LAMPS	19.AAMVN.001
		LCD CABLE 19.1IN. CMO W/CCD CABLE	50.AAMVN.012
		WIRELESS ANTENNA FOR 19.1IN.	25.AAMVN.001
		CCD CAMERA 1.3M LOGITECH	56.AAMVN.002
		LCD BEZEL 19" W/LOGO	60.AAMVN.006
		LCD COVER W/LOGO	60.AAMVN.007
		LCD BARCKET L W/HINGE 19.1IN. CMO	33.AAMVN.005
		LCD BARCKET R W/HINGE 19.1IN. CMO	33.AAMVN.006
		LCD 19IN. WXGA+ CMO M190A1-L03 8MS 300NITS GLARE TYPE	LK.1900D.004
		LCD MODULE 20.1" WXGA+ QDI NON-GLARE	6M.AAMVN.021
		INVERTER BOARD 20IN. TDK XAD313NR 6 LAMPS	19.AAMVN.002
		LCD CABLE 20.1IN. QDI W/CCD CABLE	50.AAMVN.021
		WIRELESS ANTENNA FOR 20.1IN.	25.AAMVN.002
		CCD CAMERA 1.3M LOGITECH	56.AAMVN.002
		LCD BEZEL 20" W/LOGO	60.AAMVN.008
		LCD COVER W/LOGO	60.AAMVN.007
		LCD BARCKET L W/HINGE 20.1IN.	33.AAMVN.007
		LCD BARCKET R W/HINGE 20.1IN.	33.AAMVN.008
		LCD 20.1IN. WSXGA+ QDI QD20AL0101 8MS 300NITS NON-GLARE	LK.20109.001

Category	No.	Part Name and Description	Acer Part No.
		LCD MODULE 20.1" WXGA+ AUO NON-GLARE	6M.AAMVN.022
		INVERTER BOARD 20IN. TDK XAD313NR 6 LAMPS	19.AAMVN.002
		LCD CABLE 20.1IN. AUO W/CCD CABLE	50.AAMVN.022
		WIRELESS ANTENNA FOR 20.1IN.	25.AAMVN.002
		CCD CAMERA 1.3M LOGITECH	56.AAMVN.002
		LCD BEZEL 20" W/LOGO	60.AAMVN.008
		LCD COVER W/LOGO	60.AAMVN.007
		LCD BARCKET L W/HINGE 20.1IN.	33.AAMVN.007
		LCD BARCKET R W/HINGE 20.1IN.	33.AAMVN.008
		LCD 20.1IN. WSXGA+ AUO M201EW01 V.0 8MS 300NITS NON-GLARE	LK.20105.002
		LCD MODULE 20.1" WXGA+ QDI GLARE	6M.AAMVN.023
		INVERTER BOARD 20IN. TDK XAD313NR 6 LAMPS	19.AAMVN.002
		LCD CABLE 20.1IN. QDI W/CCD CABLE	50.AAMVN.021
		WIRELESS ANTENNA FOR 20.1IN.	25.AAMVN.002
		CCD CAMERA 1.3M LOGITECH	56.AAMVN.002
		LCD BEZEL 20" W/LOGO	60.AAMVN.008
		LCD COVER W/LOGO	60.AAMVN.007
		LCD BARCKET L W/HINGE 20.1IN.	33.AAMVN.007
		LCD BARCKET R W/HINGE 20.1IN.	33.AAMVN.008
		LCD 20.1IN. WSXGA+ QDI QD20AL0102 8MS 300NITS GLARE TYPE	LK.20109.005
		LCD MODULE 20.1" WXGA+ AUO GLARE	6M.AAMVN.024
		INVERTER BOARD 20IN. TDK XAD313NR 6 LAMPS	19.AAMVN.002
		LCD CABLE 20.1IN. AUO W/CCD CABLE	50.AAMVN.022
		WIRELESS ANTENNA FOR 20.1IN.	25.AAMVN.002
		CCD CAMERA 1.3M LOGITECH	56.AAMVN.002
		LCD BEZEL 20" W/LOGO	60.AAMVN.008
		LCD COVER W/LOGO	60.AAMVN.007
		LCD BARCKET L W/HINGE 20.1IN.	33.AAMVN.007
		LCD BARCKET R W/HINGE 20.1IN.	33.AAMVN.008
		LCD 20.1IN. WSXGA+ AUO M201EW01 V.2 8MS 300NITS GLARE	LK.20105.003
MAINBOARD			

Category	No.	Part Name and Description	Acer Part No.
		MAINBOARD G72M/128MB SATA W/O CPU W/VGA HEATSINK & PCMCIA SLOT & RTC BATTERY	MB.AAK0B.001
		MAINBOARD G72M/128MB SATA W/O CPU W/VGA HEATSINK & PCMCIA SLOT & RTC BATTERY	MB.AAK0B.001
		MAINBOARD G72M/256MB SATA W/O CPU W/VGA HEATSINK & PCMCIA SLOT & RTC BATTERY	MB.AAK0B.002
		MAINBOARD G73M/128MB SATA W/O CPU W/VGA HEATSINK & PCMCIA SLOT & RTC BATTERY	MB.AAK0B.003
		MAINBOARD G73M/256MB SATA W/O CPU W/VGA HEATSINK & PCMCIA SLOT & RTC BATTERY	MB.AAK0B.004
		MAINBOARD G73M/256MB SATA W/O CPU W/VGA HEATSINK & PCMCIA SLOT & RTC BATTERY	MB.AAK0B.004
		MAINBOARD G73M/256MB SATA W/O CPU W/VGA HEATSINK & PCMCIA SLOT & RTC BATTERY	MB.AAK0B.004
		MAINBOARD G73M/512MB SATA W/O CPU W/VGA HEATSINK & PCMCIA SLOT & RTC BATTERY	MB.AAK0B.005
		MAINBOARD G72MV/128MB SATA W/O CPU W/VGA HEATSINK & PCMCIA SLOT & RTC BATTERY W/O RF-IN & AV-IN CONNECTOR	MB.AAK0B.006
		MAINBOARD G73M/256MB SATA W/O CPU W/VGA HEATSINK & PCMCIA SLOT & RTC BATTERY W/O RF-IN & AV-IN CONNECTOR	MB.AAK0B.007
<b>MEMORY(DDR2 533)</b>			
		SO-DIMM DDRII533 256MB SAMSUNG M470T3354CZ3-CD5 LF	KN.2560B.017
		SO-DIMM DDRII533 256M MICRON MT4HTF3264HY-53EB4	KN.25604.030
		SO-DIMM DDRII533 256M HYNIX HYMP532S64BP6-C4	KN.2560G.012
		SO-DIMM DDRII533 256MB NANYA NT256T64UH4A1FN-37B LF	KN.25603.029
		SO-DIMM DDRII533 512MB SAMSUNG M470T6554CZ3-CD500 LF	KN.5120B.015
		SO-DIMM DDRII533512M HYNIX HYMP564S64BP6-C4	KN.5120G.013

Category	No.	Part Name and Description	Acer Part No.
		SO-DIMM DDRII533 512MB NANYA NT512T64UH8A1FN-37B LF	KN.51203.023
		SO-DIMM DDRII533 512M ELPIDA GU33512AGEPN612C	KN.51209.005
		SO-DIMM DDRII533 1GB MANYA NT1GT64UH8A0BN-37B LF	KN.1GB03.006
		SO-DIMM DDRII533 1GB INFINEON HYS64T128021HDL-3.7-B	KN.1GB02.030
		SO-DIMM DDRII533 1GB SAMSUNG M470T2953CZ3-CD5 LF	KN.1GB0B.004
MEMORY(DDR2 667)			
		SO-DIMM DDRII667 256MB SAMSUNG M470T3354CZ3-CE6 LF	KN.2560B.018
		SO-DIMM DDRII667 256MB NANYA NT256T64UH4A1FN-3C LF	KN.25603.027
		SO-DIMM DDRII667 256MB INFINEON HYS64T32000HDL-3S-B (.09U/G)	KN.25602.032
		SO-DIMM DDRII667 256MB HYNIX HYMP532S64BP6-Y5 LF (.09UM)	KN.2560G.013
		SO-DIMM DDRII667 512MB SAMSUNG M470T6554CZ3-CE6 LF	KN.5120B.018
		SO-DIMM DDRII667 512MB NANYA NT512T64UH8A1FN-3C LF	KN.51203.025
		SO-DIMM DDRII667 512MB INFINEON HYS64T64020HDL-3S-B (.09U/G)	KN.51202.035
		SO-DIMM DDRII667 512MB HYNIX HYMP564S64BP6-Y5 LF (.09UM)	KN.5120G.014
		SO-DIMM DDRII667 512MB ELPIDA GU33512AJEPN612C LF	KN.51209.006
		SO-DIMM DDRII667 1GB SAMSUNG M470T2953CZ3-CE6	KN.1GB0B.005
		SO-DIMM DDRII667 1GB INFINEON HYS64T128021HDL-3S-B (.09U/G)	KN.1GB02.029
		SO-DIMM DDRII667 1GB NANYA NT1GT64U8HA0BN-3C LF	KN.1GB03.009
		SO-DIMM DDRII667 1GB ELPIDA GU331G0AJEPN6E2C LF	KN.1GB09.005
MISCELLANEOUS			
		LCD RUBBER CUSHION	47.AAMVN.001
		SPEAKER BUMPER	47.AAMVN.002

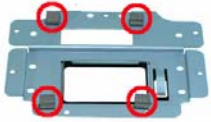

Category	No.	Part Name and Description	Acer Part No.
		TOUCHPAD BRACKET GASKET (Highlighted with red circles)	47.AAMVN.003
		EXTERNAL ANTENNA SET	25.AAMVN.004
ACCESSORY			
		ACER BLUETOOTH VOIP CARD PHONE KIT V2.2 W/CD & MANUAL	LC.BTH01.008
		REMOTE CONTROLLER RC-802 48KEY	RT.8020A.001
		MCERC-200 REMOTE CONTROLLER	LC.MCE05.001
		MCEIR-210 RECEIVER	LC.MCE05.002
		MCEBS-220 IR BLASTER	LC.MCE05.003
ACCESSORY(BOARD)			
		TV TUNER M103 S/W MPEG (HYBRID)	55.AAMVN.006
		TV TUNER M104 HW MPEG (ANALOG)	55.AAMVN.007
		TV TUNER M115 ADT (HYBRID)	55.AAMVN.008
ACCESSORY(CABLE)			
		CABLE AV-IN	50.AAMVN.008
		CABLE PAL/SECAM	50.AAMVN.009
MISCELLANEOUS			
		NTSC ADAPTER	25.AAMVN.003
MICROPHONE			
		MICROPHONE	23.AAMVN.001
SPEAKER			
		SPEAKER SET	23.AAMVN.002
SCERW			
		SCREW	86.AAMVN.001
		SCREW	86.AAMVN.002
		SCREW	86.AAMVN.003
		SCREW	86.AAMVN.004
		SCREW	86.AAMVN.005
		SCREW	86.AAMVN.006

---

Category	No.	Part Name and Description	Acer Part No.
		SCREW	86.AAMVN.007
		SCREW	86.AAMVN.008
		SCREW	86.AAMVN.009
		SCREW	86.AAMVN.010
		SCREW	86.AAMVN.011
		SCREW	86.AAMVN.012