

**Acer**

**Aspire ASX1200/ ASX3200  
Service Guide**

Service guide files and updates are available on the ACER/CSD web; for more information, please refer to <http://csd.acer.com.tw>

PRINTED IN TAIWAN

---

# Revision History

Please refer to the table below for the updates made on ASX1200/ ASX3200 service guide.

Date	Chapter	Updates

---

## Copyright

Copyright © 2008 by Acer Incorporated. All rights reserved. No part of this publication may be reproduced, transmitted, transcribed, stored in a retrieval system, or translated into any language or computer language, in any form or by any means, electronic, mechanical, magnetic, optical, chemical, manual or otherwise, without the prior written permission of Acer Incorporated.

---

## Disclaimer

The information in this guide is subject to change without notice.

Acer Incorporated makes no representations or warranties, either expressed or implied, with respect to the contents hereof and specifically disclaims any warranties of merchantability or fitness for any particular purpose. Any Acer Incorporated software described in this manual is sold or licensed "as is". Should the programs prove defective following their purchase, the buyer (and not Acer Incorporated, its distributor, or its dealer) assumes the entire cost of all necessary servicing, repair, and any incidental or consequential damages resulting from any defect in the software.

Acer is a registered trademark of Acer Corporation.

AMD, the AMD Arrow logo, AMD Athlon, AMD Phenom, AMD Sempron, and combinations thereof, are trademarks of Advanced Micro Devices Inc.

Other brand and product names are trademarks and/or registered trademarks of their respective holders.

---

## Conventions

The following conventions are used in this manual:

<b>SCREEN MESSAGES</b>	Denotes actual messages that appear on screen.
<b>NOTE</b>	Gives additional information related to the current topic.
<b>WARNING</b>	Alerts you to any physical risk or system damage that might result from doing or not doing specific actions.
<b>CAUTION</b>	Gives precautionary measures to avoid possible hardware or software problems.
<b>IMPORTANT</b>	Reminds you to do specific actions relevant to the accomplishment of procedures.

---

## Service Guide Coverage

This Service Guide provides you with all technical information relating to the BASIC CONFIGURATION decided for Acer's "global" product offering. To better fit local market requirements and enhance product competitiveness, your regional office MAY have decided to extend the functionality of a machine (e.g. add-on card, modem, or extra memory capability). These LOCALIZED FEATURES will NOT be covered in this generic service guide. In such cases, please contact your regional offices or the responsible personnel/channel to provide you with further technical details.

## FRU Information

Please note WHEN ORDERING FRU PARTS, that you should check the most up-to-date information available on your regional web or channel. If, for whatever reason, a part number change is made, it will not be noted in the printed Service Guide. For ACER-AUTHORIZED SERVICE PROVIDERS, your Acer office may have a DIFFERENT part number code to those given in the FRU list of this printed Service Guide. You MUST use the list provided by your regional Acer office to order FRU parts for repair and service of customer machines.

# Table of Contents

<b>System Tour</b>	<b>1</b>
Features	1
Aspire ASX1200/3200 Tour	3
Front Panel	3
Rear Panel	4
Internal Components	5
System LED Indicators	6
<b>System Utilities</b>	<b>7</b>
Phoenix BIOS Setup Utility	7
Entering BIOS setup	8
Navigating Through the Setup Utility	8
Setup Utility Menus	9
<b>System Disassembly</b>	<b>31</b>
Disassembly Requirements	31
Pre-disassembly Procedure	32
Main Unit Disassembly	33
External Modules Disassembly Flowchart	33
Removing the Side Panel	34
Removing the Front Bezel	35
Removing the Heat Sink Fan Assembly	36
Removing the Processor	38
Removing the Optical Drive	40
Removing the Hard Disk Drive	42
Removing the Power Supply	46
Removing the Memory Modules	49
Removing the PCI Card	51
Removing the Front I/O and Card Reader Boards	53
Removing the Mainboard	57
<b>System Troubleshooting</b>	<b>59</b>
Hardware Diagnostic Procedure	59
System Check Procedures	60
Power System Check	60
System External Inspection	60
System Internal Inspection	60
POST Error and Beep Codes	61
Online Support Information	67
<b>System Block Diagram and Board Layout</b>	<b>69</b>
System Block Diagram	69
Board Layout	70
Mainboard	70
System Jumpers	71
<b>FRU (Field Replaceable Unit) List</b>	<b>73</b>
Aspire ASX1200/ ASX3200 Exploded Diagram	74
Aspire ASX1200/ ASX3200 FRU List (81.3V001.010G)	75
<b>Technical Specifications</b>	<b>83</b>





# System Tour

---

## Features

Below is a brief summary of the computer's many feature:

**NOTE:** The features listed in this section is for your reference only. The exact configuration of the server depends on the model purchased.

### Processor

- AMD Athlon LE-1600/1620/1640 processor
- AMD Athlon X2 Dual-Core BE-2300/2350/2400 or 4200+/4400+/4800+/5000+/5200+/5600+ processor
- AMD Phenom X3 Triple-Core 8400/8450/8600/8650 processor
- AMD Phenom X4 Quad-Core 9100e/9150e/9500/9550/9600/9650 processor
- AMD Sempron LE-1250/1300 or 2100 processor

### Chipset

- NVIDIA nForce MCP78

### Memory subsystem

- Supports up to two DDR2-667 registered ECC modules

### Media storage

- DVD-ROM SATA drive
- Super-Multi SATA DVD drive
- 160 GB SATA hard disk drive

### Serial ATA controller

- Embedded SATA2 controller
- Two SATA ports

### Networking

- One Gigabit Ethernet LAN port (RJ-45)

### PCI I/O

- One PCI Express x16 bus slot
- One PCI Express x1 bus slot

### I/O ports

- Front
  - ✦ Three USB 2.0 ports
  - ✦ Memory Stick
  - ✦ Memory Stick PRO
  - ✦ Secure Digital (SD) Card

- 
- ✦ miniSD Card
  - ✦ Headphone/speaker-out/line-out jack
  - ✦ Microphone-in jack
  - ✦ CF/I/II (CompactFlash Type i/II) slot
  - ✦ IEEE 1394 port (4-pin)
  - Rear
    - ✦ PS/2 keyboard port
    - ✦ PS/2 mouse port
    - ✦ Line-out jack
    - ✦ Microphone/speaker-out/line-in jack
    - ✦ Rear speaker/surround out jack
    - ✦ Center speaker/subwoofer jack
    - ✦ Line-in jack
    - ✦ S/PDIF port
    - ✦ Four USB 2.0 ports
    - ✦ eSATA port
    - ✦ CRT/LCD monitor port
    - ✦ HDMI port
    - ✦ Gigabit LAN ports
    - ✦ VGA/monitor port
    - ✦ Two USB 2.0 ports
    - ✦ Two Ethernet LAN ports (RJ-45)

## Operating system and software

- Operating system options:
  - ✦ Genuine Windows Vista® Ultimate (32/64-bit)
  - ✦ Genuine Windows Vista Home Premium (32/64-bit)
- Applications
  - ✦ Acer Empowering Technology (Acer eRecovery Management)
  - ✦ Acer Arcade Live
  - ✦ McAfee Internet Security Suite 2008 Trial version
  - ✦ Adobe Reader
  - ✦ eSobi
  - ✦ NTI MediaMaker

## Power supply







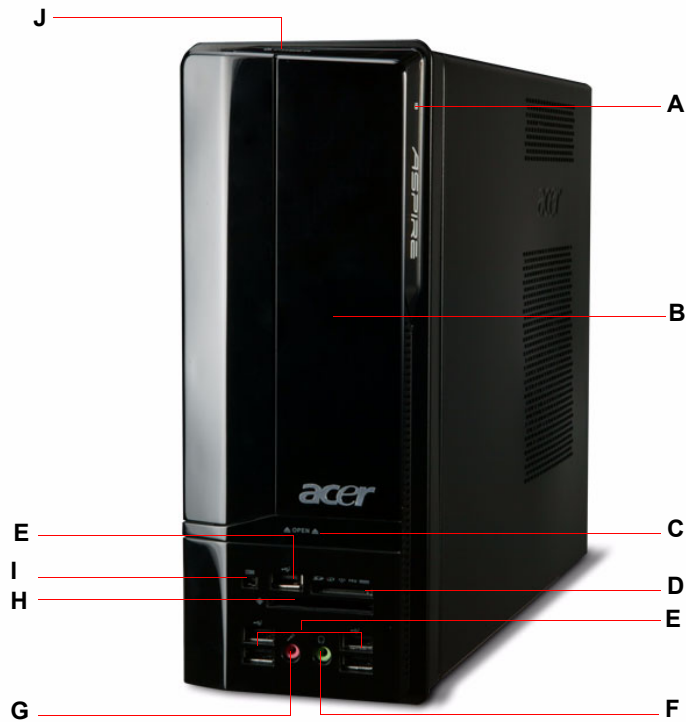

- 220-watts (115/230 Vac) power supply

# Aspire ASX1200/3200 Tour

This section is a virtual tour of the ASX1200/3200 system's interior and exterior components.









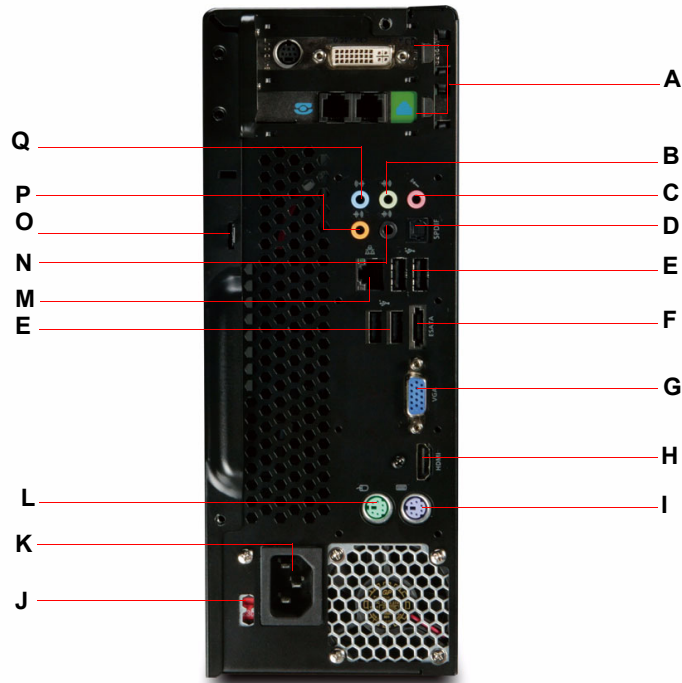

## Front Panel



Item	Icon	Component
A		HDD activity indicator
B		Drive bay door
C		Drive bay door eject button Press to open drive bay door and access the optical drive.
D		Media card reader
E		USB 2.0 ports
F		Headphone/Speaker-out/line-out jack
G		Microphone-in jack
H		CF I/II (CompactFlash Type I/II) slot
I		IEEE 1394 port (4-pin)
J		Power/sleep button

# Rear Panel



Item	Icon	Component
A		Expansion slot (Photo shows graphics card and network/modem card)
B		Line-out jack
C		Microphone/speaker-out/line-in jack
D	<b>SPDIF</b>	S/PDIF port
E		USB 2.0 ports
F	<b>ESATA</b>	eSATA port
G		CRT/LCD monitor port
H	<b>HDMI</b>	HDMI port
I		PS2 keyboard port
J		Power connector
K		Voltage selector switch
L		PS2 mouse port
M		Gigabit LAN port (10/100/1000 Mbps)
N		Rear speaker/surround out jack
O		Keyhole
P		Center speaker/subwoofer jack
Q		Line-in jack

---

# Internal Components

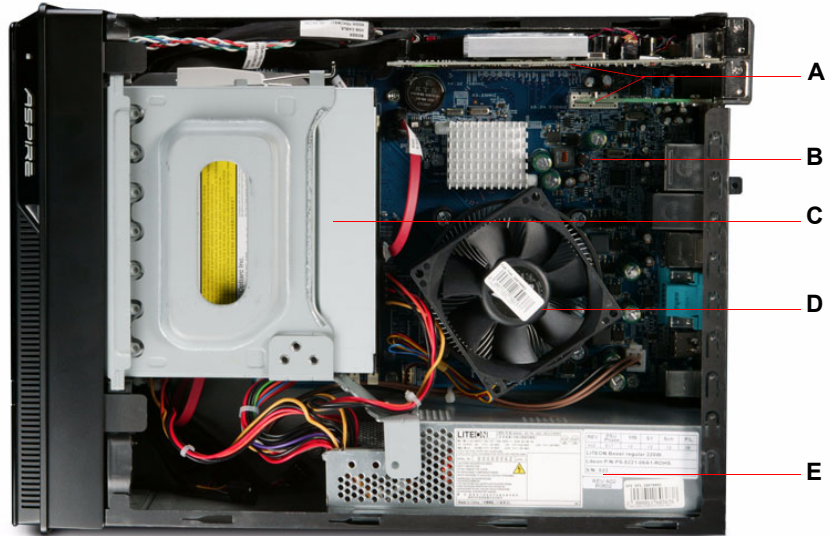



Item	Component
A	Expansion card
B	Mainboard
C	Optical drive
D	Heat sink fan assembly
E	Power supply

---

## System LED Indicators

This section describes the different system LED indicators.

LED indicator	Color	LED status	Description
Power 	Green	On	The system has AC power and is powered on.
	Green	Blinking	The system is in standby mode.
	—	Off	System is not powered on.
HDD activity 	Green	On	HDD is installed and functioning correctly.
	Green	Blinking	Ongoing HDD activity.
	Green/ Amber	Flashing	HDD is rebuilding data.
	Amber	On	HDD failure
LAN port network speed LED (left)	Amber	On	GbE link network access
	Green	On	100 Mbps link network access
	—	Off	10 Mbps link network access
LAN port network connection LED (right)	Green	On	Active network link
		Blinking	Ongoing network data activity
		Off	Off-line network

# System Utilities

---

## Phoenix BIOS Setup Utility

BIOS setup is a hardware configuration program built into the system's Basic Input/Output System (BIOS). Since most systems are already properly configured and optimized, there is no need to run this utility. You will need to run this utility under the following conditions.

- When changing the system configuration settings
- When redefining the communication ports to prevent any conflicts
- When modifying the power management configuration
- When changing the password or making other changes to the security setup
- When a configuration error is detected by the system and you are prompted ("Run Setup" message) to make changes to the BIOS setup

**NOTE:** If you repeatedly receive Run Setup messages, the battery may be bad. In this case, the system cannot retain configuration values in CMOS. Ask a qualified technician for assistance.

BIOS setup loads the configuration values in a battery-backed nonvolatile memory called CMOS RAM. This memory area is not part of the system RAM which allows configuration data to be retained when power is turned off.

Before you run the *Phoenix*BIOS Setup Utility, make sure that you have saved all open files. The system reboots immediately after you close the Setup.

**NOTE:** *Phoenix*BIOS Setup Utility will be simply referred to as "Setup" or "Setup utility" in this guide.

The screenshots used in this guide display default system values. These values may not be the same those found in your system.

---

## Entering BIOS setup

1. Turn on the server and the monitor.

If the server is already turned on, close all open applications, then restart the server.

2. During POST, press **Delete**.

If you fail to press **Delete** before POST is completed, you will need to restart the server.

The Setup Main menu will be displayed showing the Setup's menu bar. Use the left and right arrow keys to move between selections on the menu bar.

## Navigating Through the Setup Utility

Use the following keys to move around the Setup utility.

- Left** and **Right** arrow keys – Move between selections on the menu bar.
- Up** and **Down** arrow keys – Move the cursor to the field you want.
- PgUp** and **PgDn** keys – Move the cursor to the previous and next page of a multiple page menu.
- Home** – Move the cursor to the first page of a multiple page menu.
- End** – Move the cursor to the last page of a multiple page menu.
- +** and **-** keys – Select a value for the currently selected field (only if it is user-configurable). Press these keys repeatedly to display each possible entry, or the **Enter** key to choose from a pop-up menu.

**NOTE:** Grayed-out fields are not user-configurable.

- Enter** key – Display a submenu screen.

**NOTE:** Availability of submenu screen is indicated by a (>).

- Esc** – If you press this key:
  - On one of the primary menu screens, the Exit menu displays.
  - On a submenu screen, the previous screen displays.
  - When you are making selections from a pop-up menu, closes the pop-up without making a selection.
- F1** – Display the BIOS setup General Help panel.
- F5** – Press to load previous default system values.
- F6** – Press to load fail-safe default system values.
- F7** – Press to load optimized default system values.
- F10** – Save changes made the Setup and close the utility.



---

## Setup Utility Menus

The tabs on the Setup menu bar correspond to the six primary BIOS Setup menus, namely:

- Product Information
- Standard CMOS Features
- Advanced BIOS Features
- Advanced Chipset Features
- Integrated Peripherals
- Power Management Setup
- PnP/PCI Configurations
- PC Health Status
- Load Default Settings
- Set Supervisor Password
- Set User Password
- Save & Exit Setup
- Exit Without Saving

In the descriptive table following each of the menu screenshots, settings in **boldface** are the default and suggested settings.

---

## Product Information

The Product Information menu displays basic information about the system. These entries are for your reference only and are not user-configurable.

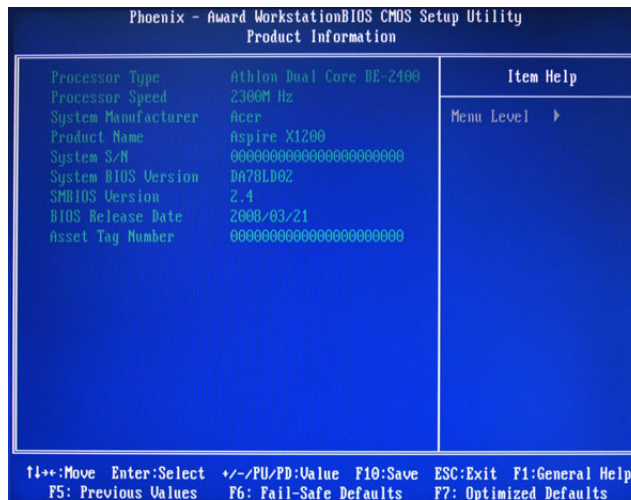

## Standard CMOS Features

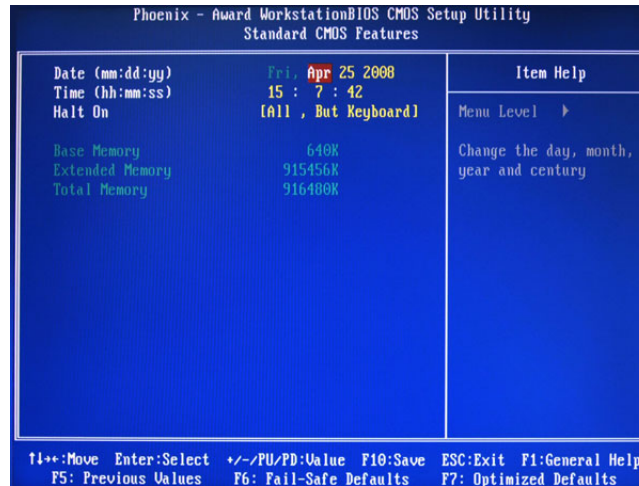

Parameter	Description	Option
Date	Set the date following the weekday-month-day-year format.	
Time	Set the system time following the hour-minute-second format.	
Halt On	Determines whether the system will stop for an error during the POST.	<b>All, But Keyboard</b> No Errors All Errors All, But Diskette All, But Disk/Key
Base Memory	Also called conventional memory. Typically, 640 KB will be reserved for the MS-DOS OS.	
Extended Memory	Total size of extended memory detected during POST	
Total Memory	Total size of system memory detected during POST	

# Advanced BIOS Features

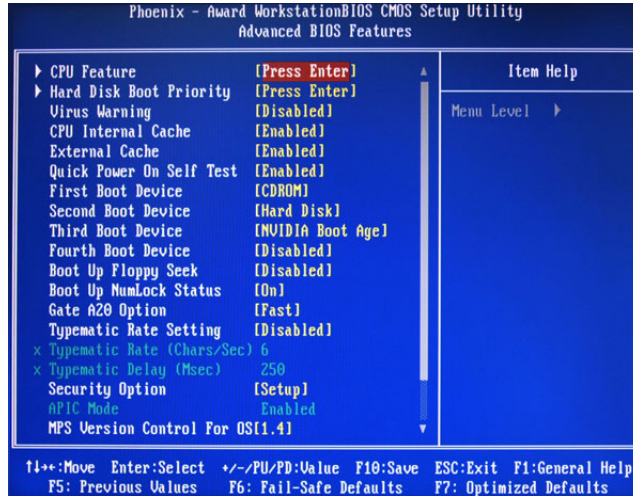

Parameter	Description	Option
CPU Feature	Press <b>Enter</b> to configure the CPU Virtualization and AMD K8 Cool and Quiet Control features.	
Hard Disk Boot Priority	Press <b>Enter</b> to select hard disk boot device priority.	
Virus Warning	Specifies the virus warning feature for IDE hard disk boot sector protection. If enabled, BIOS will show a warning message on the screen or an alarm beep when someone attempts to write data into this area.	<b>Disabled</b> Enabled
CPU Internal Cache	Enables or disables CPU internal cache.	<b>Enabled</b> Disabled
External Cache	Enables or disables internal cache.	<b>Enabled</b> Disabled
Quick Power On Self Test	Allows the system to skip certain test while booting. This will decrease the time needed to boot the system.	<b>Enabled</b> Disabled
First/Second/Third/Fourth Boot Device	Specifies the boot order from the available devices.	CDROM, Hard Disk, NVIDIA Boot Age, Floppy, ZIP, USB-FDD, USB-ZIP, USB-CDROM, USB-HDD, Legacy LAN, Disabled
Boot Up Floppy Seek	Enables or disables floppy drive testing to determine whether they have 40 to 80 tracks.	<b>Disabled</b> Enabled
Boot Up NumLock Status	Selects power on state for Num Lock.	<b>On</b> Off
Gate A20 Option	When set to fast, the motherboard chipset controls the operation of Gate A20. But when set to normal, a pin in the keyboard controller controls Gate A20.	<b>Fast</b> Normal
Typematic Rate Setting	When enabled, you can manually adjust the settings using the two typematic controls (Typematic Rate and Typematic Rate Delay). If disabled, the BIOS will use the default setting.	<b>Disabled</b> Enabled
Typematic Rate (Chars/Sec)	Rate at which the keyboard will repeat the keystroke if you press it continuously.	6, 8, 10, 12, 15, 20, 24, 30
Typematic Delay (MSec)	Delay, in Msec, before the keyboard automatically repeats the keystroke that you have pressed continuously.	250, 500, 750, 1000

Parameter	Description	Option
Security Option	When set to system, BIOS will ask for the password each time the system boots up. If set to setup, the password is only required for access into the BIOS setup menus.	<b>Setup</b> System
MPS Version Control For OS	Specifies the version of the Multiprocessor Specification (MPS) that the mainboard will use.	<b>1.4</b> 1.1
OS Select For DRAM > 64 MB	Select OS/2 if the system is running OS/2 operating system and the system memory is more than 64 MB in size.	<b>Non-OS/2</b> OS/2
Full Screen Logo Show	Enables or disables the display of the full screen boot logo.	<b>Enabled</b> Disabled
Small Logo (EPA) Show	Enables or disables the display of the EPA logo.	<b>Disabled</b> Enabled

## CPU Feature

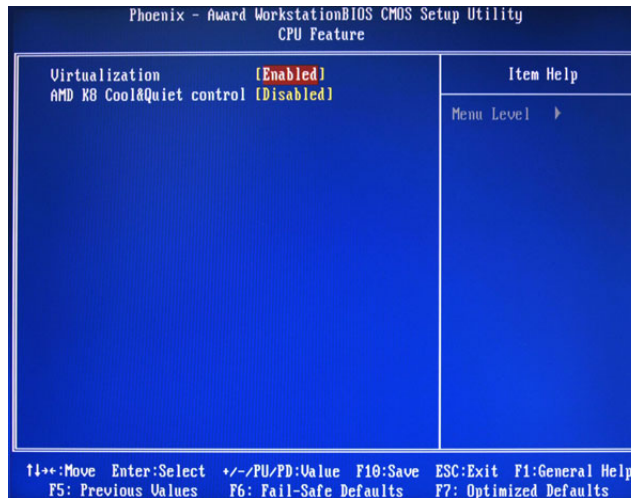

Parameter	Description	Option
Virtualization	Select whether to enable or disable the AMD Virtualization Technology (VT) function. VT allows a single platform to run multiple operating systems in independent partitions.	<b>Enabled</b> Disabled
AMD K8 Cool&Quiet control	When set to auto, the AMD Cool'n'Quiet driver dynamically adjust the CPU clock and VIA to reduce heat output from your computer and its power consumption.	<b>Disabled</b> Auto

## Hard Disk Boot Priority

The Hard Disk Boot Priority submenu allows you to specify the sequence of loading the OS from the installed hard drives. Use the up or down arrow key to select a hard drive, then press the <+> key or the <-> key to move it up or down on the list. |

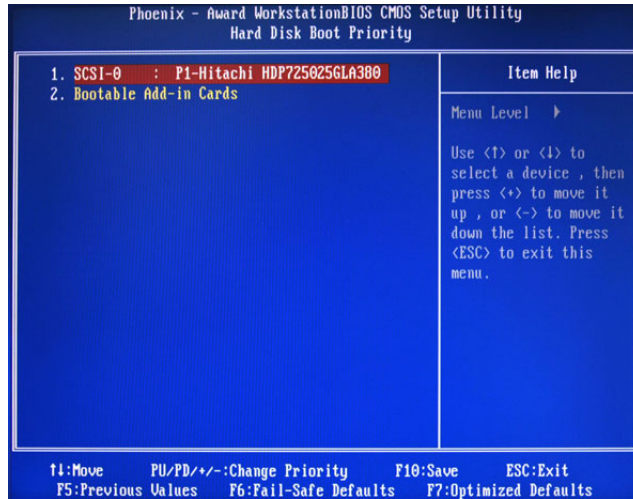

## Advanced Chipset Features

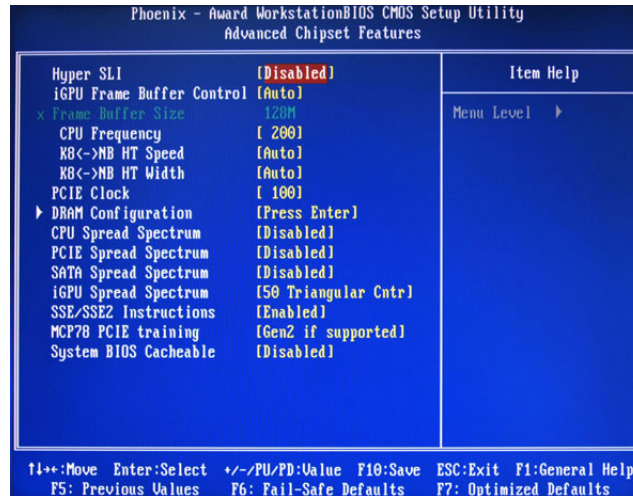

Parameter	Description	Option
Hyper SLI	Enable or disable the Scalable Link Interface (SLI) technology.	<b>Disabled</b> Enabled
iGPU Frame Buffer Control	When set to auto, BIOS will automatically setup the frame buffer size. When set to manual, you can set the frame buffer size. Frame buffer size is the total amount of system memory allocated solely for the onboard graphics controller.	<b>Auto</b> Manual
Frame Buffer Size	This parameter can be configured if the iGPU Frame Buffer Control is set to Manual.	<b>64</b> , 16, 32, 128, 256 MB
CPU Frequency	Sets processor minimum and maximum frequency.	<b>200</b> Minimum 100 Maximum 500
KB->NB HT Speed	Controls the physical speed of the processor to the Northbridge HT link.	<b>Auto</b> 200, 400, 600, 800 MHz, 1 GHz
KB->NB HT Width	Controls the processor to the Northbridge link bandwidth.	<b>Auto</b> Up 8/16 Down 8/16
PCIE Clock	Sets the PCI Express clock frequency.	<b>100</b> Minimum 100 Maximum 200
DRAM Configuration	Press <b>Enter</b> to configure memory timing and operation settings.	
CPU Spread Spectrum	Allows you to reduce the EMI of the front side bus by modulating the signals it generates so that the spikes are reduced to flatter curves.	<b>Disabled</b> -0.5%, 1.0%
PCIE Spread Spectrum	Allows you to reduce the EMI of the PCI Express bus by modulating the signals it generates so that the spikes are reduced to flatter curves. When set to down spread, the chipset modulates the PCI Express bus' baseline signal downwards by a small amount. When set to disabled, the chipset disables any modulation of the PCI Express bus' baseline signal.	<b>Disabled</b> Down Spread
SATA Spread Spectrum	Allows you to reduce the EMI of the SATA bus by modulating the signals it generates so that the spikes are reduced to flatter curves. When set to down spread, the chipset modulates the SATA bus' baseline signal downwards by a small amount. When set to disabled, the chipset disables any modulation of the SATA bus' baseline signal.	<b>Disabled</b> Down Spread

Parameter	Description	Option
iGPU Spread Spectrum	Allows you to set the integrated GPU spread spectrum.	<b>50 Triangular Cntr</b> 100/200/300 Triangular Cntr
SSE/SSE2 Instructions	Enables or disables the processor's SSE and SSE2 instruction sets.	<b>Enabled</b> Disabled
MCP78 PCIE Training	Cards supporting Gen2 mode will be trained in Gen2 mode.	Gen2 if supported Only Gen1
System BIOS cacheable	Enables or disables the caching of the mainboard BIOS ROM from F0000h to FFFFFh by the processor's Level 2 cache.	<b>Disabled</b> Enabled



## DRAM Configuration

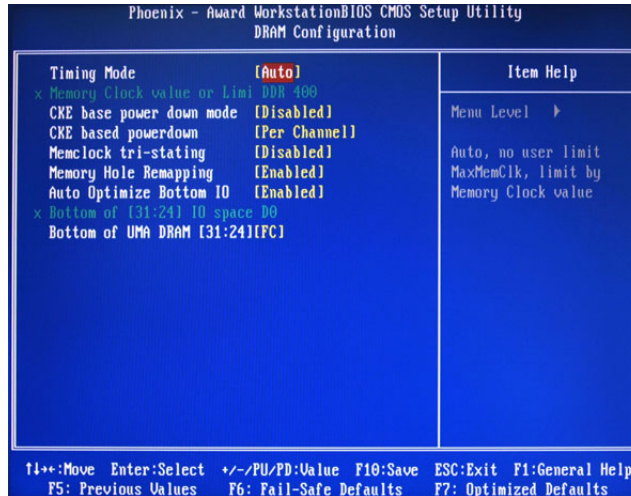

Parameter	Description	Option
Timing Mode	When set to auto mode, the system reads the electronic data sheet of the memory modules and adjusts the timings accordingly. When set to MaxMemClk, you can manually specify the memory clock frequency independent of the system bus frequency.	<b>Auto</b> MaxMemClk
Memory Clock value or Limit	Displays the current memory clock frequency.	
CKE base power down mode	All synchronous memory devices can go into sleep mode as soon as the clock enable (CKE) signal is disasserted. In that case, the internal clocks are disabled and the memory chip goes into auto-refresh mode which is the lowest power state at which the memory retains data. If then power is turned off, the device will lose all data, however, as long as standby power is maintained, no data loss will occur.	<b>Disabled</b> Enabled
CKE based power down	Sets the CKE power saving through disasserting clock enable using system level or per channel basis.	<b>Per Channel</b> Per CS
Memclock tri-stating	Enables or disables the memory clock tri-stating during C3 an Alt VD feature.	<b>Disabled</b> Memclock tri-stating during C3 and Alt VD
Memory Hole Remapping	Enables or disables memory remapping around the memory hole.	<b>Enabled</b> Disabled
Auto Optimize Bottom IO	Allows you to auto optimize maximal memory size when kernel assigns PCI Resources.	<b>Enabled</b> Disabled
Bottom of UMA DRAM [31:24] [FC]	Allows you to enter a HEX number ranging from 0000 to 00F0.	<b>Minimim 0000</b> Maximum 00FC

# Integrated Peripherals

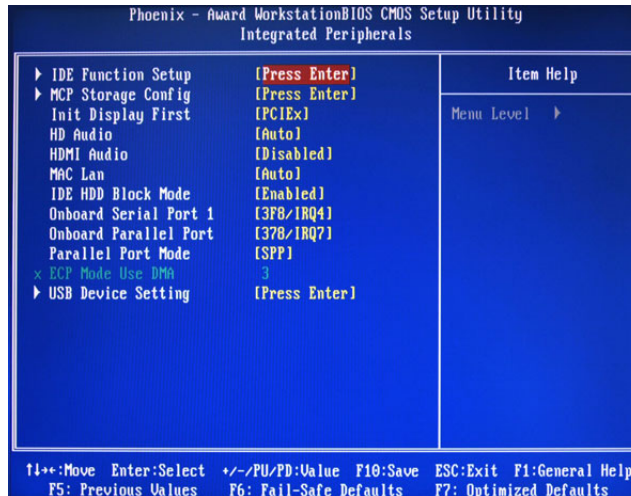

Parameter	Description	Option
IDE Function Setup	Press <b>Enter</b> to access the IDE Function Setup submenu.	
MCP Storage Config	Press <b>Enter</b> to access the MCP Storage Config submenu.	
Init Display First	Select whether to boot the system using the AGP graphic card or a PCI card installed on the PCI Express slot or PCI slot.	PCIEx PCI Slot Onboard
HD Audio	Enables or disables the onboard audio controller.	Auto Disabled
HDMI Audio	Allows you to control the audio function of the onboard HDMI.	<b>Disabled</b> Auto
MAC LAN	Enables or disables the built-in network interface card.	<b>Auto</b> Disabled
IDE HDD Block Mode	When enabled, the BIOS will automatically detect if your hard disk supports block transfers and set the proper block transfer settings for it. Depending on the IDE controller, up to 64 KB of data can be transferred per interrupt when block transfers are enabled. When disabled, only 512 bytes of data can be transferred per interrupt.	<b>Enabled</b> Disabled
Onboard Serial Port 1	Select the I/O address and IRQ for the first serial port.	<b>3F8/IRQ4</b> 2F8/IRQ3 3E8/IRQ4 2E8/IRQ3 Auto Disabled
Onboard Parallel Port	Select the I/O address and IRQ for the onboard parallel port.	<b>378/IRQ7</b> 278/IRQ5 3BC/IRQ7 Disabled
Parallel Port Mode	Select an operating mode for the onboard parallel port.	<b>SPP</b> EPP ECP ECP+EPP
ECP Mode Use DMA	Select DMA channel for the LPT port in ECP mode. This parameter can be configured if the parallel port mode is set to ECP or ECP +EPP mode.	<b>3</b> 1
USB Device Setting	Press <b>Enter</b> to access the USB Device Setting submenu.	

## IDE Function Setup

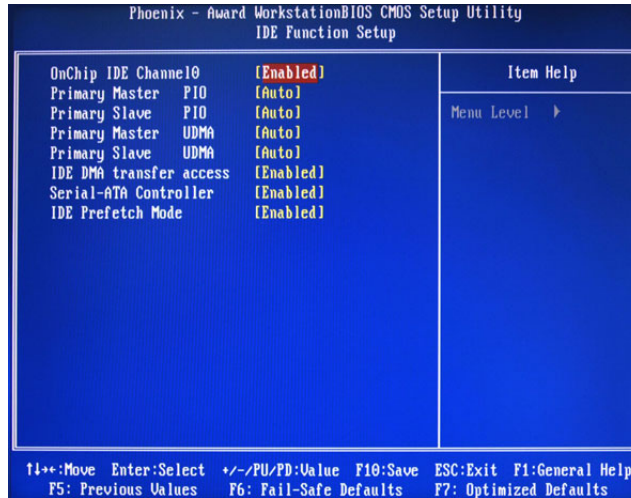

Parameter	Description	Option
OnChip IDE Channel 0	Enables or disables the first IDE channel.	<b>Enabled</b> Disabled
Primary Master PIO	When set to Auto, BIOS setup automatically detects if the installed hard disk supports the function. If supported, it allows for faster data recovery and read/write timing that reduces hard disk activity time. This results in better hard disk performance. Mode 0 to 4 provide progressive increase of performance.	<b>Auto</b> Mode 0 Mode 1 Mode 2 Mode 3 Mode 4
Primary Slave PIO		<b>Auto</b> Mode 0 Mode 1 Mode 2 Mode 3 Mode 4
Primary Master UDMA	Enables or disables the primary and master UDMA mode	<b>Auto</b> Disabled
Primary Slave UDMA		<b>Auto</b> Disabled
IDE DMA Transfer	Enables or disables DMA (Direct Memory Access) transfers for all IDE drives.	<b>Enabled</b> Disabled
Serial-ATA Controller	Enables or disables the serial ATA controller.	<b>Enabled</b> Disabled
IDE Prefetch Mode	Enables or disables the IDE controller to prefetch data from the IDE drive.	<b>Enabled</b> Disabled

## MCP Storage Config

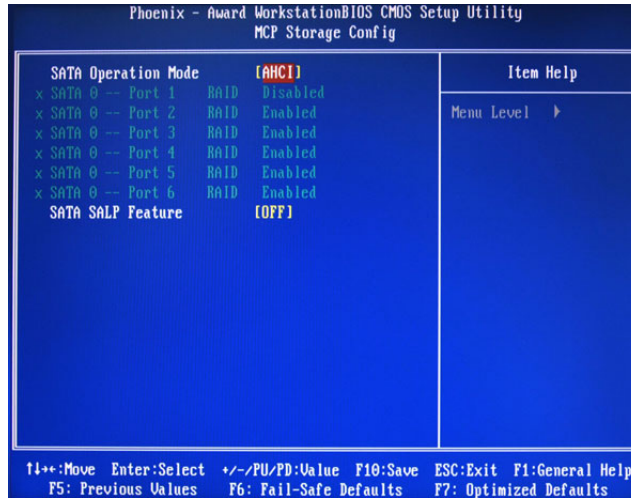

Parameter	Description	Option
SATA Operation Mode	Select a SATA operation mode.	<b>AHCI</b> IDE RAID Linux AHCI
SATA 0 -- Port 1 ~ 6	Enables or disables the SATA RAID on ports 1 to 6. This parameter can be configured if the SATA Operation Mode is set to RAID	<b>Disabled</b> Enabled
SATA SALP Feature	Select a Supports Aggressive Link Power Management (SALP) feature.	<b>Off</b> Partial Slumber

## USB Device Setting

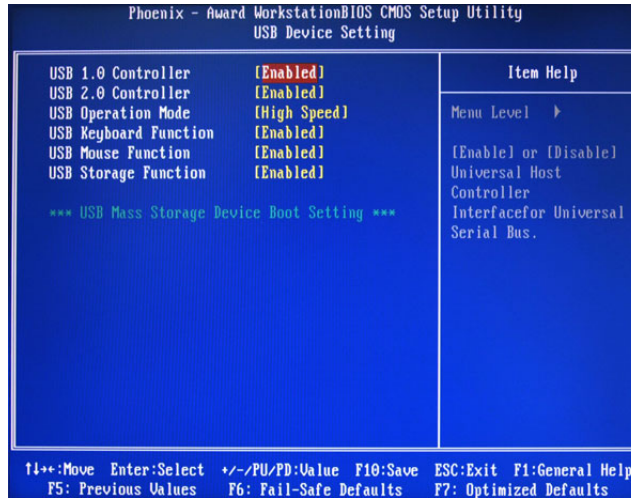

Parameter	Description	Option
USB 1.0 Controller	Enables or disables the onboard USB controller.	<b>Enabled</b> Disabled
USB 2.0 Controller		<b>Enabled</b> Disabled
USB Operation Mode	Select a USB device operation speed.	<b>High Speed</b> Full Low Speed
USB Keyboard Function	Enables or disables legacy support of the USB keyboard.	<b>Enabled</b> Disabled
USB Mouse Function	Enables or disables legacy support of the USB mouse.	<b>Enabled</b> Disabled
USB Storage Function	Enables or disables legacy support of the USB storage device.	<b>Enabled</b> Disabled

# Power Management Setup

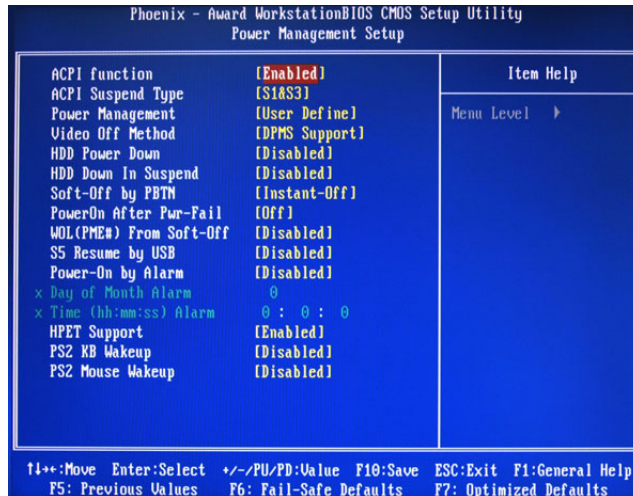

Parameter	Description	Option
ACPI function	Enables or disables the Advanced Configuration and Power Management (ACPI) function.	<b>Enabled</b> Disabled
ACPI Suspend Type	Select an ACPI state.	<b>S1 &amp; S3</b> S1 (POS) S3 (STR)
Power Management	Select a power saving method for the following modes: <ul style="list-style-type: none"> <li>HDD power down</li> <li>Suspend mode</li> </ul>	<b>User Define</b> Min. Saving Max Saving
Video Off Method	Determines the manner when the monitor goes blank.	<b>DPMS Support</b> Blank Screen V/H Sync + Blank
HDD Power Down	Set a time when the hard disk drives will power down after a period inactivity.	<b>Disabled</b> 1 to 14 Min
HDD Down in Suspend	Enables or disables the HDD power down function in suspend mode.	<b>Disabled</b> Enabled
Soft-Off by PBTN	Determines the behavior of system power button.	<b>Instant-Off</b> Delay 4 Sec
PowerOn After Pwr-Fail	Set the system to automatically start itself up after a power failure.	<b>Off</b> On Former-Sts
WOL (PME#)/From Soft-Off	Enables or disables to wake up the system from a power saving mode through an event on a LAN device or using soft-off.	<b>Disabled</b> Enabled
S5 Resume by USB	If enabled, press any key or click the mouse will wake system from S1/S3 state.	<b>Disabled</b> Enabled
Power-On by Alarm	Enables or disables to boot the system on scheduled date/time.	<b>Disabled</b> Enabled
Day of Month Alarm	This parameter can be configured if the Power-On by Alarm is set to enable.	
Time (hh:mm:ss) Alarm		
HPET Support	Enables or disables the High Precision Event Timer (HPET) function.	<b>Enabled</b> Disabled
PS2 KB Wakeup	Enables or disables to wake up the system from a power saving mode using a PS2 keyboard.	<b>Disabled</b> Enabled
PS2 Mouse Wakeup	Enables or disables to wake up the system from a power saving mode using a PS2 mouse.	<b>Disabled</b> Enabled

## PnP/PCI Configurations

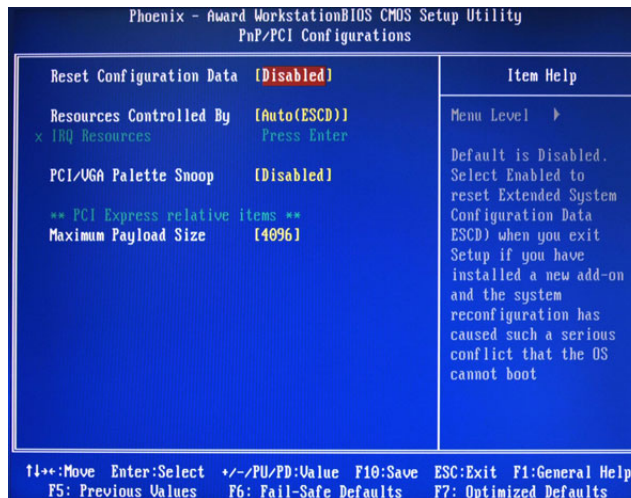

Parameter	Description	Option
Reset Configuration Data	If enabled, the system is forced to update Extended System Configuration Data (ESCD) and then is automatically set to the disabled mode. If disabled, the system ESCD will update only when the new configuration varies from the last one.	<b>Disabled</b> Enabled
Resources Controlled By	When set to auto ESCD, the system BIOS will detect the system resources and automatically assign the relative IRQ and DMA channel for each peripheral. When set to manual, you have to assign the IRQ and DMA for add-on cards.	<b>Auto ESCD</b> Manual
IRQ Resources	This parameter can be configured if the Resources Controlled By is set to Manual. It allows you to assign each system interrupt a type, depending on the type of device using the interrupt.	<b>IRQ-5</b> IRQ-7, IRQ-9, IRQ-10, IRQ-11, IRQ-14
PCI/VGA Palette Snoop	Enables or disables the system graphic card to allow VGA palette snooping.	<b>Disabled</b> Enabled
Maximum Payload Size	Set the maximum payload size for Transaction packets (TLP).	<b>4096</b> 128, 256, 512, 1024 2048

## PC Health Status

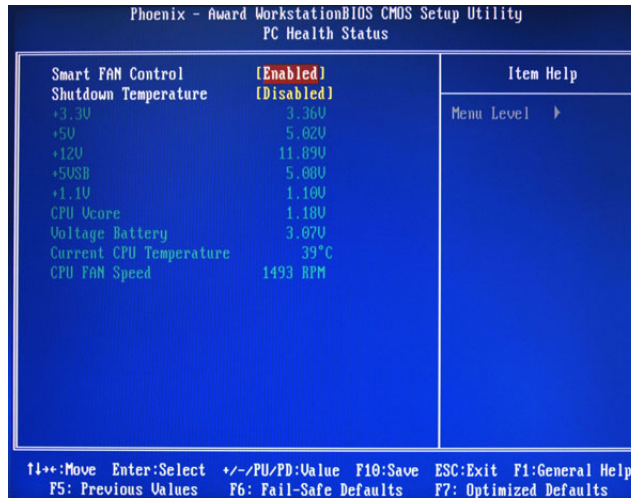

Parameter	Description	Option
Smart FAN Control	Enables or disables the smart system fan control function.	<b>Enabled</b> Disabled
Shutdown Temperature	Set the CPU shutdown temperature.	<b>Disabled</b> 60° C/140° F 65° C/149° F 70° C/158° F



---

## Load Default Settings

The Load Default Settings menu allows you to load the default settings for all BIOS setup parameters. Setup defaults are quite demanding in terms of resources consumption. If you are using low-speed memory chips or other kinds of low-performance components and you choose to load these settings, the system might not function properly.

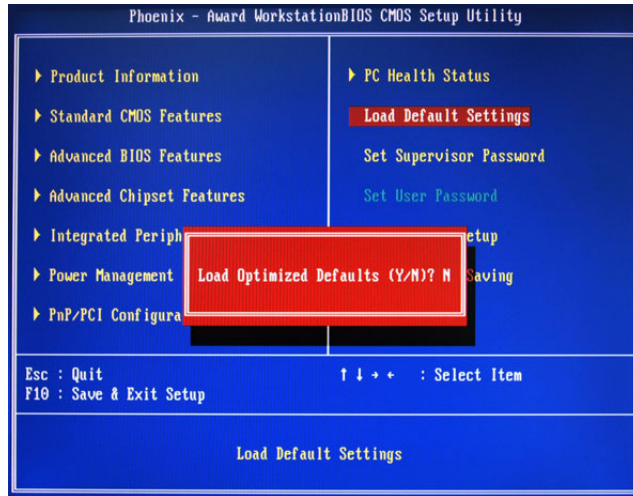

---

## Set Supervisor Password

The Set Supervisor Password menu allows you to set a supervisor password. The supervisor password allows you to access and change all settings in the Setup Utility.

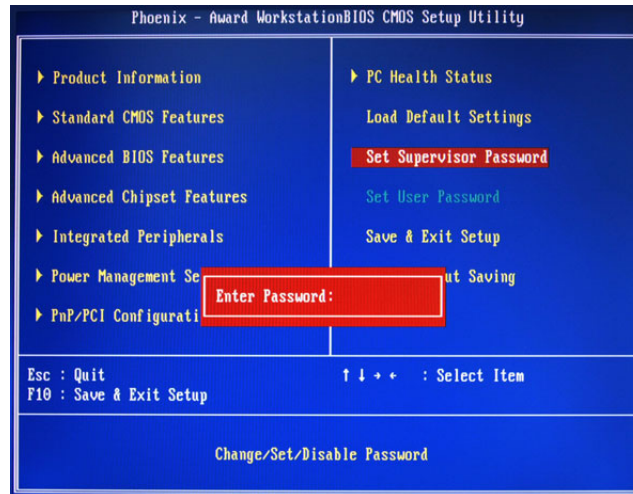

### Setting a supervisor password

1. Use the up/down arrow keys to select Set Supervisor Password menu then press **Enter**.  
A password box will appear.
2. Type a password then press **Enter**.  
The password may consist up to six alphanumeric characters (A-Z, a-z, 0-9)
3. Retype the password to verify the first entry then press **Enter** again.
4. Press **F10**.
5. Select **Yes** to save the new password and close the Setup Utility.

### Changing the supervisor password

1. Use the up/down arrow keys to select Set Supervisor Password menu then press **Enter**.
2. Type the original password then press **Enter**.
3. Type a new password then press **Enter**.
4. Retype the password to verify the first entry then press **Enter** again.
5. Press **F10**.
6. Select **Yes** to save the new password and close the Setup Utility.

### Removing a supervisor password

1. Use the up/down arrow keys to select Set Supervisor Password menu then press **Enter**.
2. Enter the current password then press **Enter**.
3. Press **Enter** twice without entering anything in the password fields.

---

## Set User Password

The Set User Password menu allows you to set a user password. Entering this password will restrict a user's access to the Setup menus. A supervisor password must be set first before you can enable or disable this field. A user can only access and modify the system time, system date, and set user password.

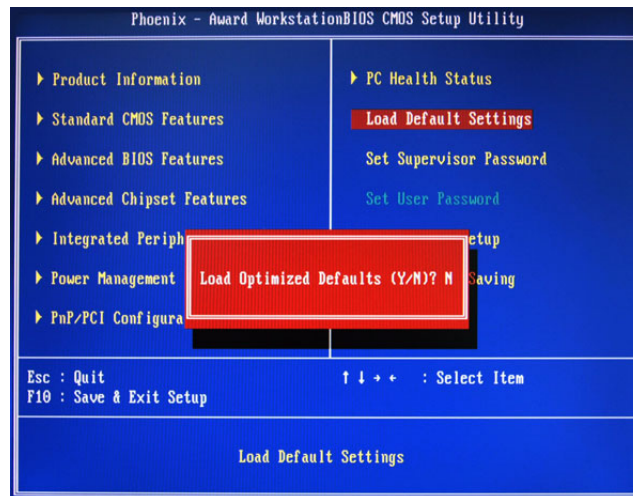

### Setting a user password

1. Use the up/down arrow keys to select Set User Password menu then press **Enter**.  
A password box will appear.
2. Type a password then press **Enter**.  
The password may consist up to six alphanumeric characters (A-Z, a-z, 0-9)
3. Retype the password to verify the first entry then press **Enter** again.
4. Press **F10**.
5. Select **Yes** to save the new password and close the Setup Utility.

### Changing the user password

1. Use the up/down arrow keys to select Set User Password menu then press **Enter**.
2. Type the original password then press **Enter**.
3. Type a new password then press **Enter**.
4. Retype the password to verify the first entry then press **Enter** again.
5. Press **F10**.
6. Select **Yes** to save the new password and close the Setup Utility.

### Removing a user password

1. Use the up/down arrow keys to select Set User Password menu then press **Enter**.
2. Enter the current password then press **Enter**.
3. Press **Enter** twice without entering anything in the password fields.

# Save & Exit Setup

The Save & Exit Setup menu allows you to save changes made and close the Setup Utility.

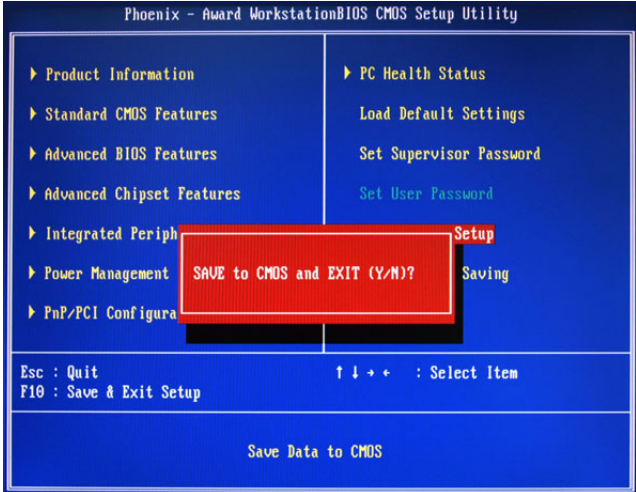

---

## Exit Without Saving

The Exit Without Saving menu allows you to discard changes made and close the Setup Utility.

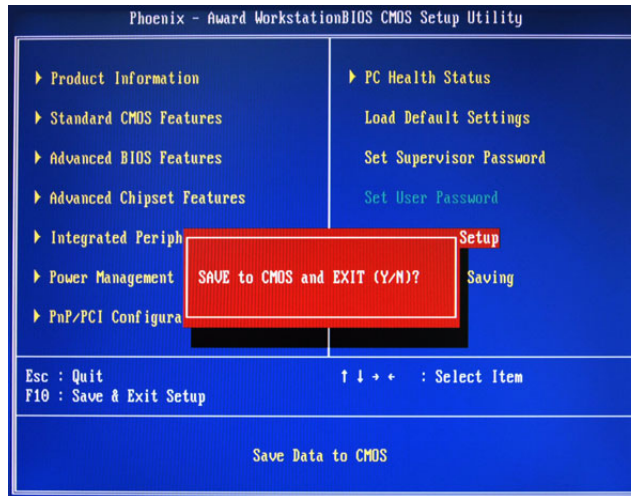



# System Disassembly

---

This chapter contains step-by-step procedures on how to disassemble the desktop computer for maintenance and troubleshooting.

## Disassembly Requirements

To disassemble the computer, you need the following tools:

- Wrist grounding strap and conductive mat for preventing electrostatic discharge
- Flat-blade screwdriver
- Philips screwdriver
- Hex screwdriver
- Plastic flat-blade screwdriver
- Plastic tweezers

**NOTE:** The screws for the different components vary in size. During the disassembly process, group the screws with the corresponding components to avoid mismatch when putting back the components.

---

# Pre-disassembly Procedure

Before proceeding with the disassembly procedure, perform the steps listed below:

1. Turn off the system and all the peripherals connected to it.
2. Unplug the power cord from the power outlets.
3. Unplug the power cord from the system.
4. Unplug all peripheral cables from the system.
5. Place the system unit on a flat, stable surface.



# Main Unit Disassembly

## External Modules Disassembly Flowchart

The flowchart below gives you a graphic representation on the entire disassembly sequence and instructs you on the components that need to be removed during servicing.

### MAIN UNIT DISASSEMBLY

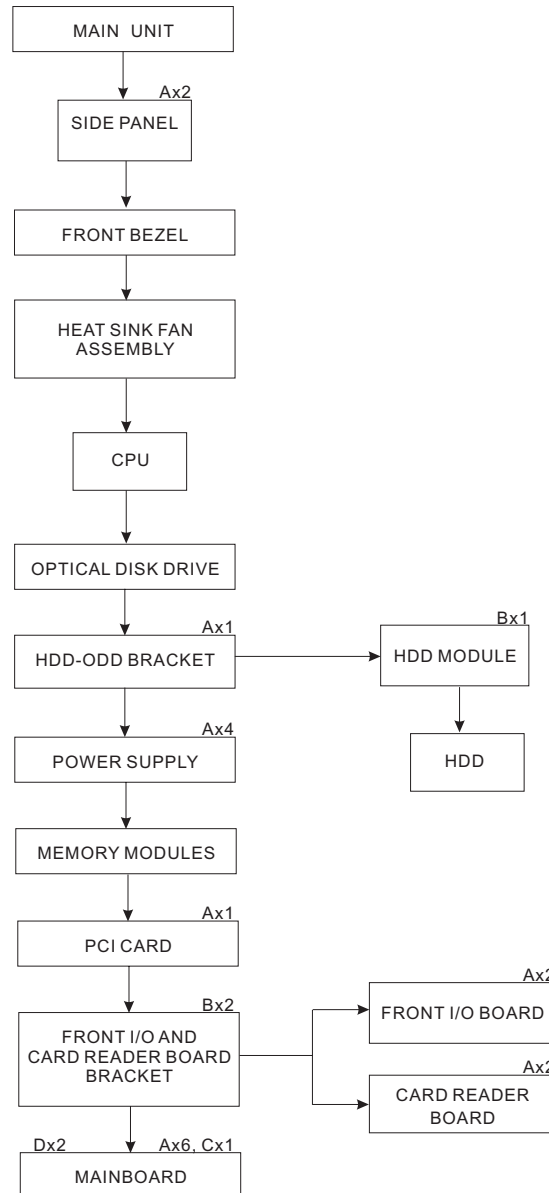

### Screw List

	Screw	Part No.
A	#6-32 L5 BZN	86.00J07.B60
B	#6-32*3/16 NI	86.5A5B6.012
C	M3xL5 BZN	86.1A324.5R0
D	Hex screw	N/A

# Removing the Side Panel

- 1. Perform the pre-disassembly procedure described on page 32.
- 2. Remove the screw (A) located on the rear edge of the side panel.



Screw (Quantity)	Color	Torque	Part No.
#6-32 L5 BZN (2)	Black	5.5 to 6.5 kgf-cm	86.00J07.B60

- 3. Slide the side panel toward the back of the chassis until the tabs on the cover disengage with the slots on the chassis.
- 4. Lift the side panel away from the server and put it aside for reinstallation later.



---

## Removing the Front Bezel

1. Remove the side panel. Refer to the previous section for instructions.
2. Release the front bezel retention tab from the chassis interior.
3. Pull the bezel away from the chassis.

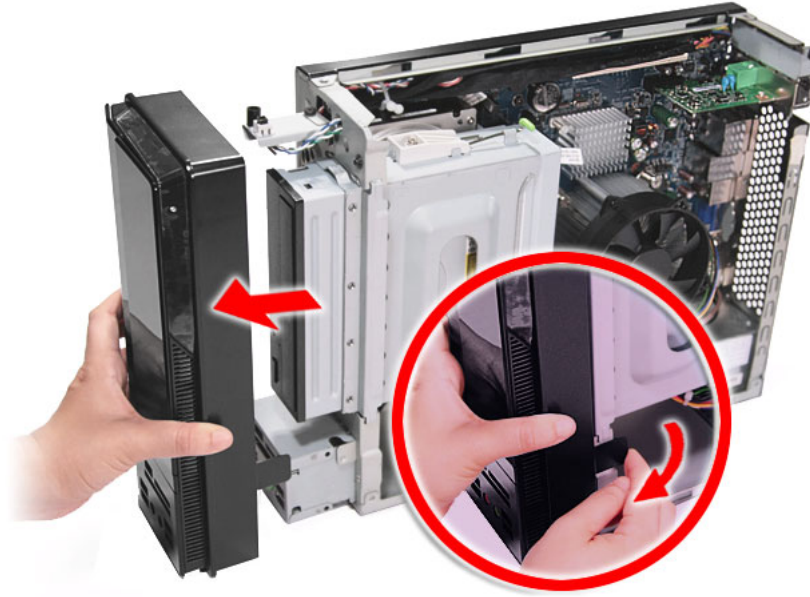

---

## Removing the Heat Sink Fan Assembly

**WARNING:** The heat sink becomes very hot when the system is on. NEVER touch the heat sink with any metal or with your hands.

1. See “Removing the Side Panel” on page 34.
2. See “Removing the Front Bezel” on page 35.
3. Use a long-nosed screwdriver to loosen the four screws on the heat sink, in the order as shown below.

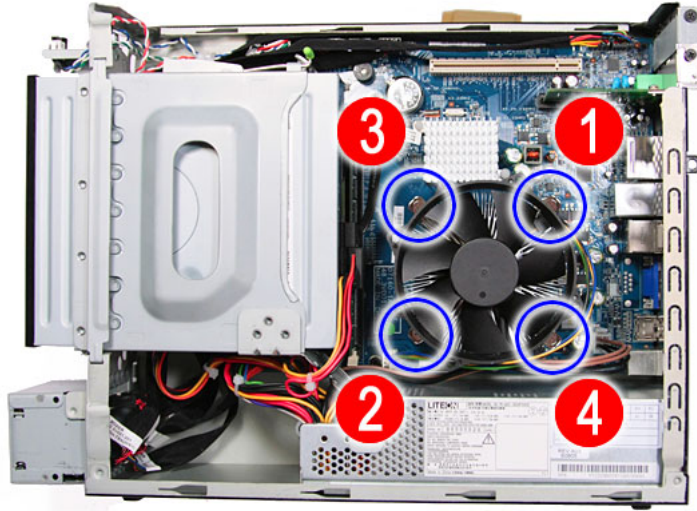

4. Lift the heat sink fan assembly away from the mainboard.

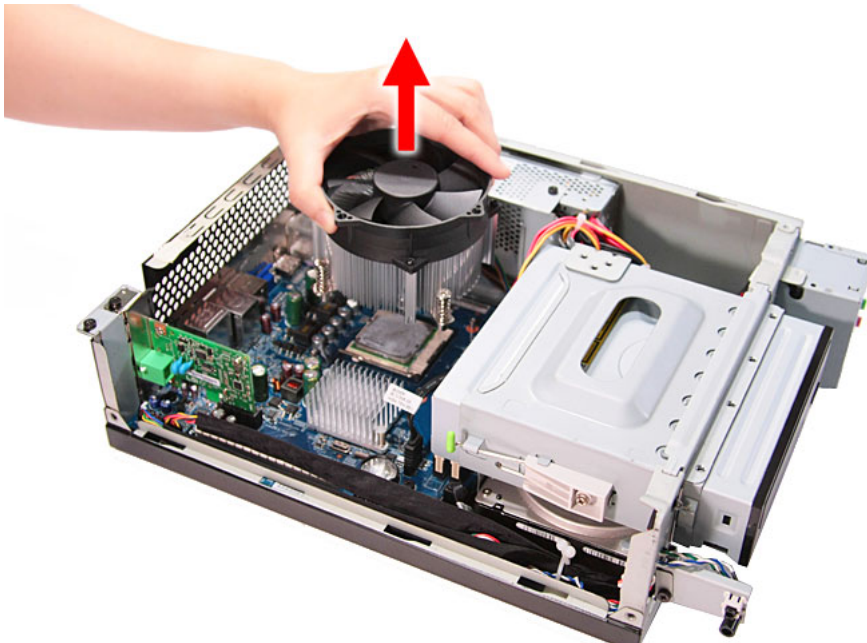

5. Disconnect the fan cable from the mainboard.

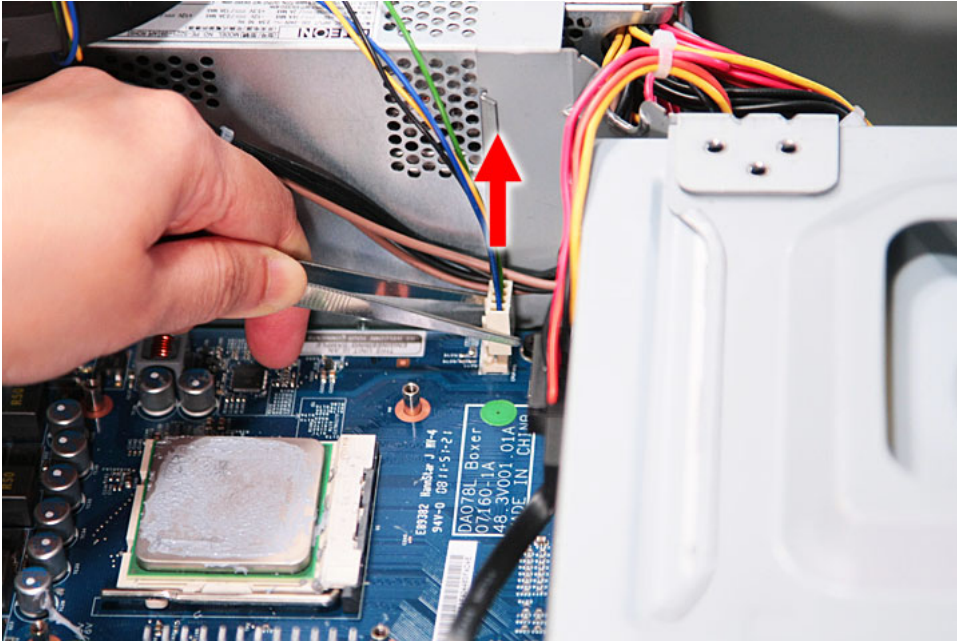

6. Lay down the heat sink fan assembly in an upright position—with the thermal patch facing upward. Do not let the thermal patch touch the work surface.
7. Use an alcohol pad to wipe off the thermal grease from both the heat sink and the processor socket retention plate.

---

## Removing the Processor

**IMPORTANT:** Before removing a processor from the mainboard, make sure to create a backup file of all important data.

**WARNING:** The processor becomes very hot when the system is on. Allow it to cool off first before handling.

1. See “Removing the Side Panel” on page 34.
2. See “Removing the Front Bezel” on page 35.
3. See “Removing the Heat Sink Fan Assembly” on page 36.
4. Release the load lever.

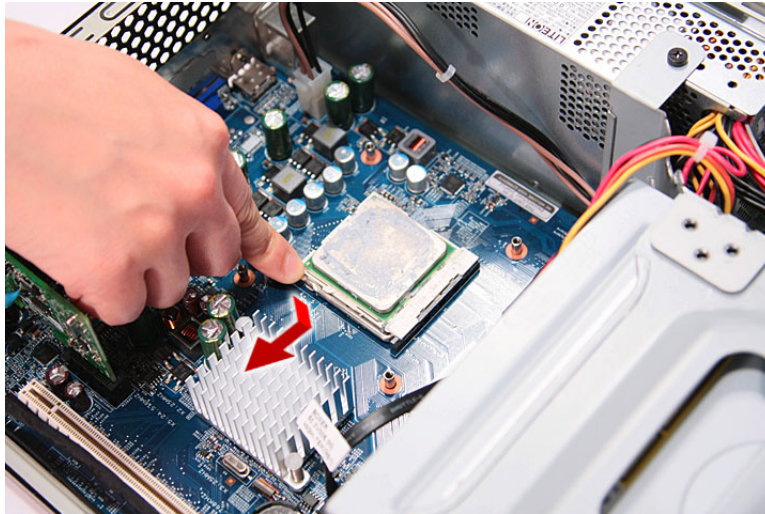

5. Pull the load lever to the fully open, upright position.

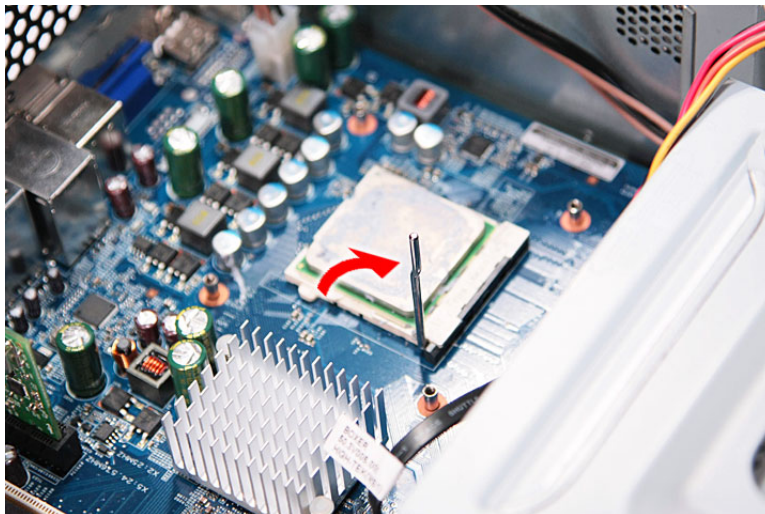

6. Pull out the processor from the socket.

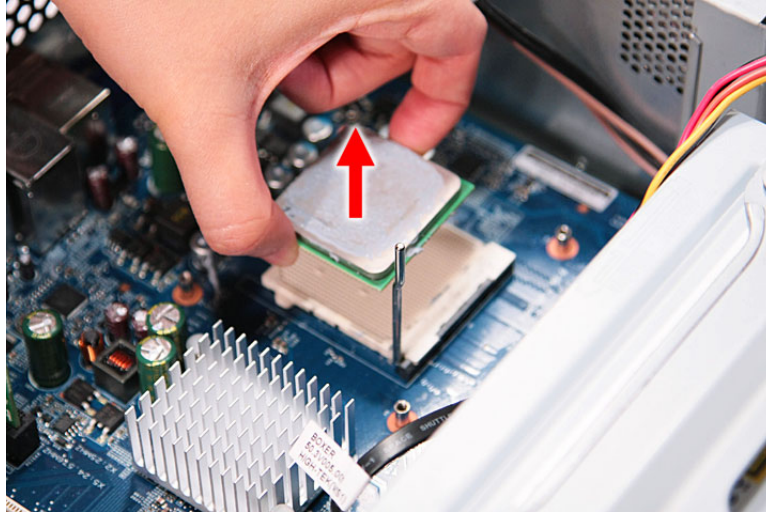

**IMPORTANT:** If you are going to install a new processor, note the arrow on the corner to make sure the processor is properly oriented over the socket.



---

## Removing the Optical Drive

1. See “Removing the Side Panel” on page 34.
2. See “Removing the Front Bezel” on page 35.
3. See “Removing the Heat Sink Fan Assembly” on page 36.
4. See “Removing the Processor” on page 38.
5. Disconnect the data and power cables from the rear of the optical drive and the mainboard.

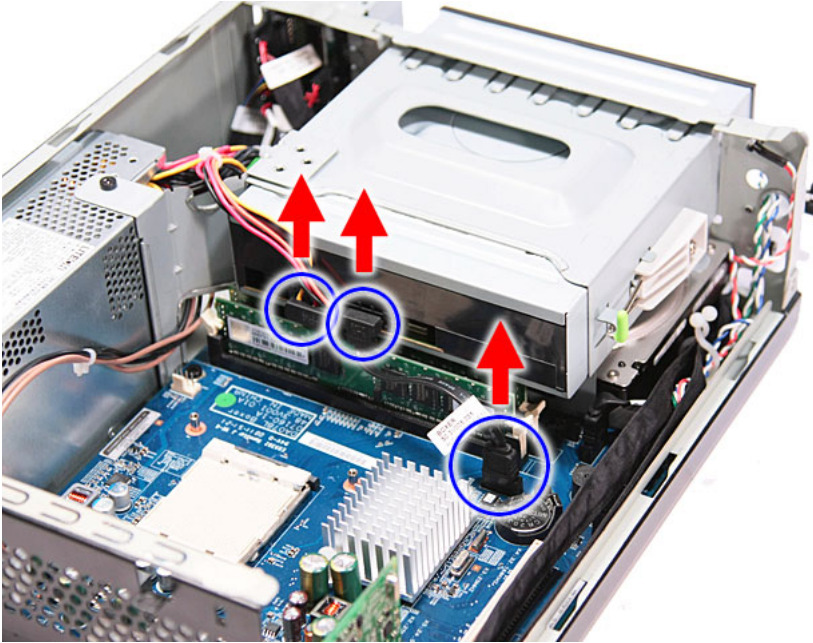

6. Release the drive bay retention release lever.

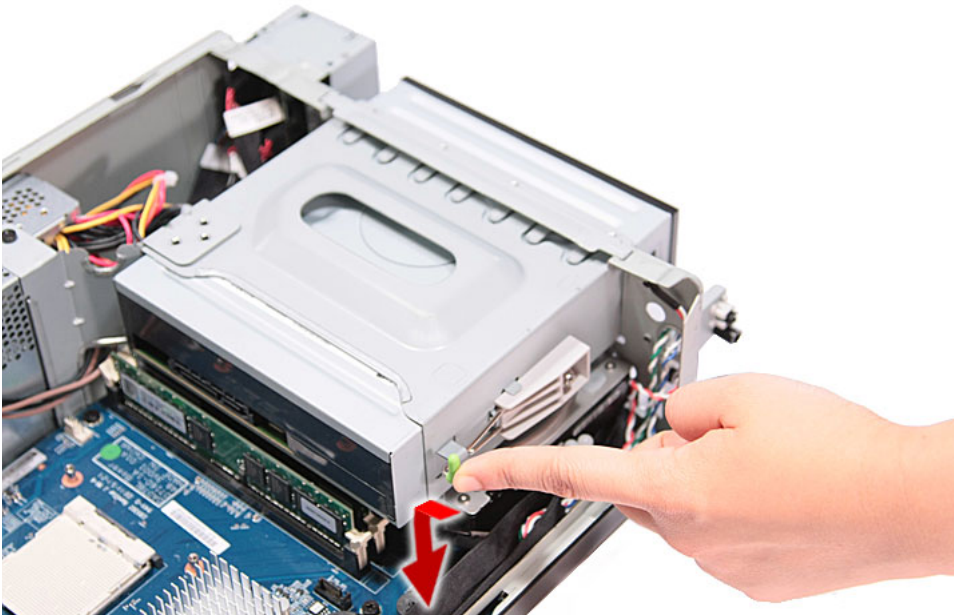



- 
7. Pull the lever to the fully open position, as shown below.



8. Pull the drive out of the drive bay.

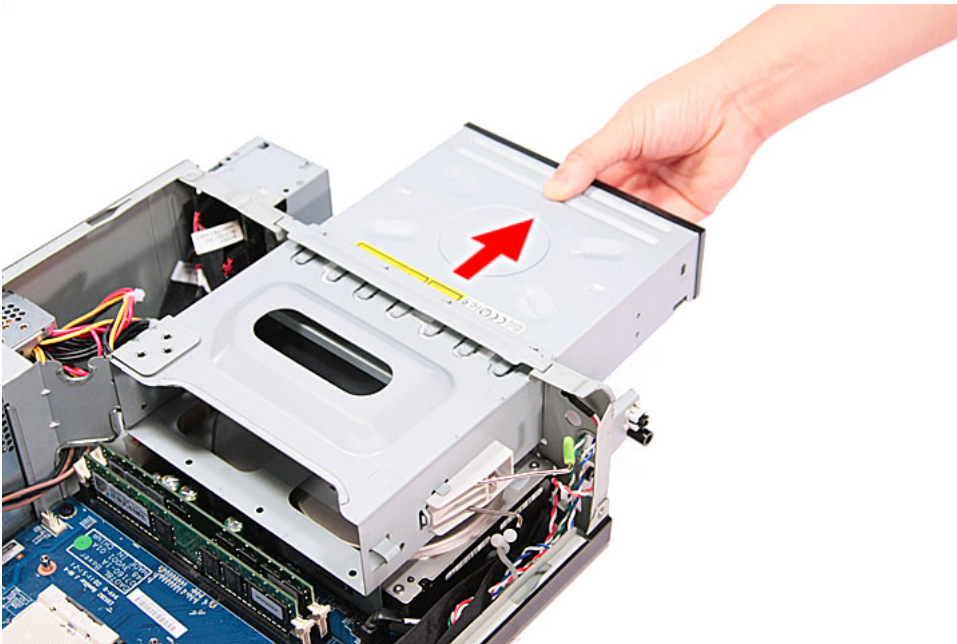

# Removing the Hard Disk Drive

1. See “Removing the Side Panel” on page 34.
2. See “Removing the Front Bezel” on page 35.
3. See “Removing the Heat Sink Fan Assembly” on page 36.
4. See “Removing the Processor” on page 38.
5. See “Removing the Optical Drive” on page 40.
6. Remove the HDD-ODD bracket.
  - a. Remove the screw (A) that secures the HDD bracket to the chassis.



Screw (Quantity)	Color	Torque	Part No.
#6-32 L5 BZN (1)	Black	5.5 to 6.5 kgf-cm	86.00J07.B60

- 
- b. Lift the bracket out of the chassis.

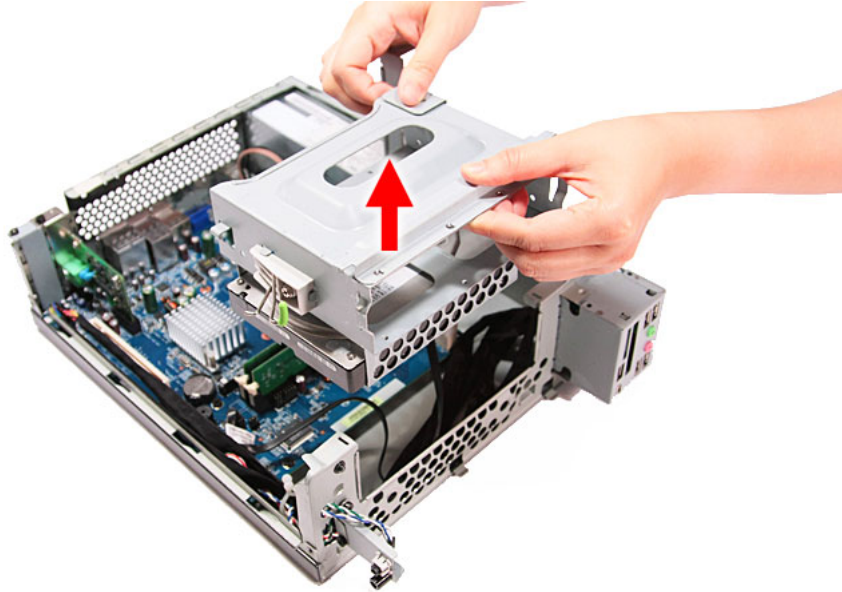

7. Disconnect the data cable from the mainboard.

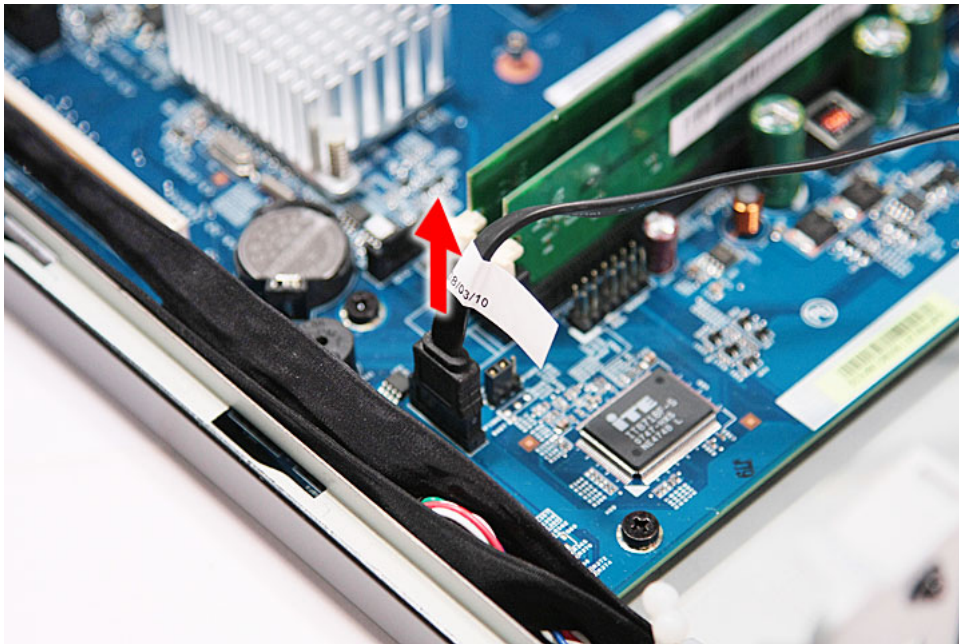

- 
8. Disconnect the data cable from the rear of the hard drive.

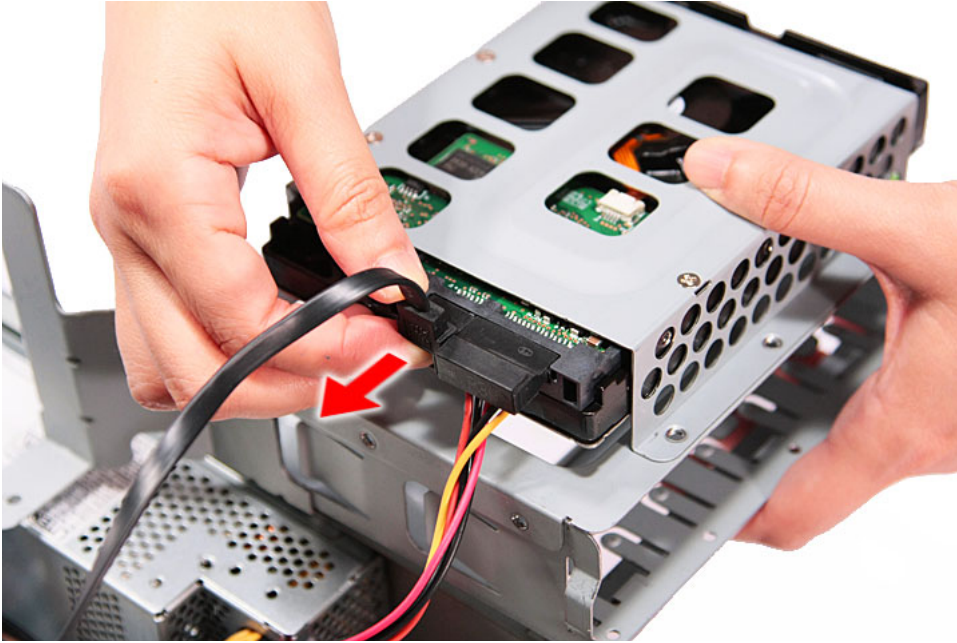

9. Disconnect the power cable from the rear of the hard drive.

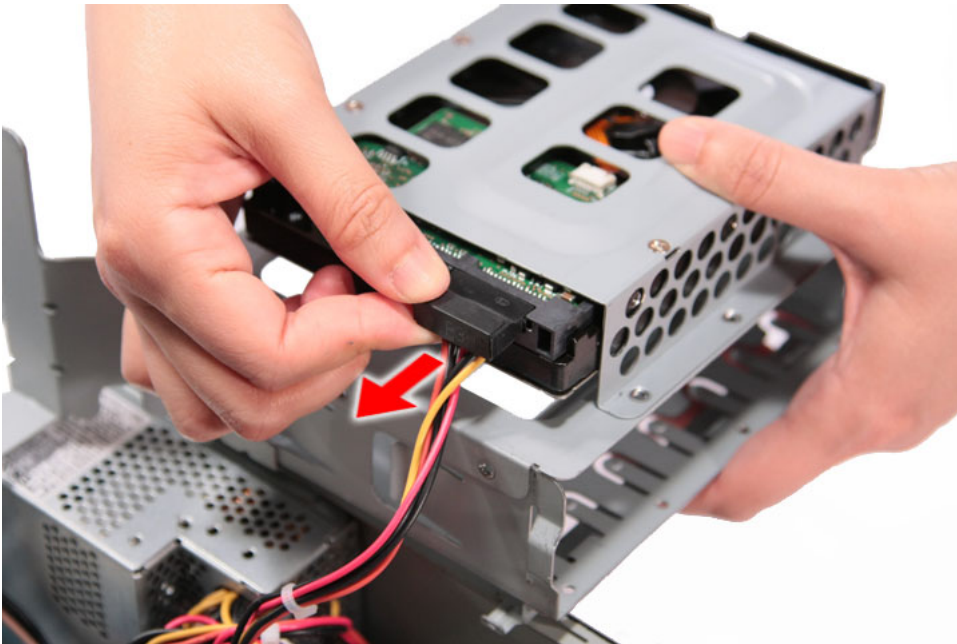

10. Place the bracket on a clean, static-free work surface.

11. Remove the HDD module.

- a. Remove the four screws (B) that secures the HDD module to the HDD bracket.



Screw (Quantity)	Color	Torque	Part No.
#6-32*3/16 NI (4)	Silver	5.5 to 6.5 kgf-cm	86.5A5B6.012

- b. Slide the HDD out of the bracket.



---

## Removing the Power Supply

1. See “Removing the Side Panel” on page 34.
2. See “Removing the Front Bezel” on page 35.
3. See “Removing the Heat Sink Fan Assembly” on page 36.
4. See “Removing the Processor” on page 38.
5. See “Removing the Optical Drive” on page 40.
6. See “Removing the Hard Disk Drive” on page 42.
7. Disconnect the 8-pin power supply cable from the mainboard.

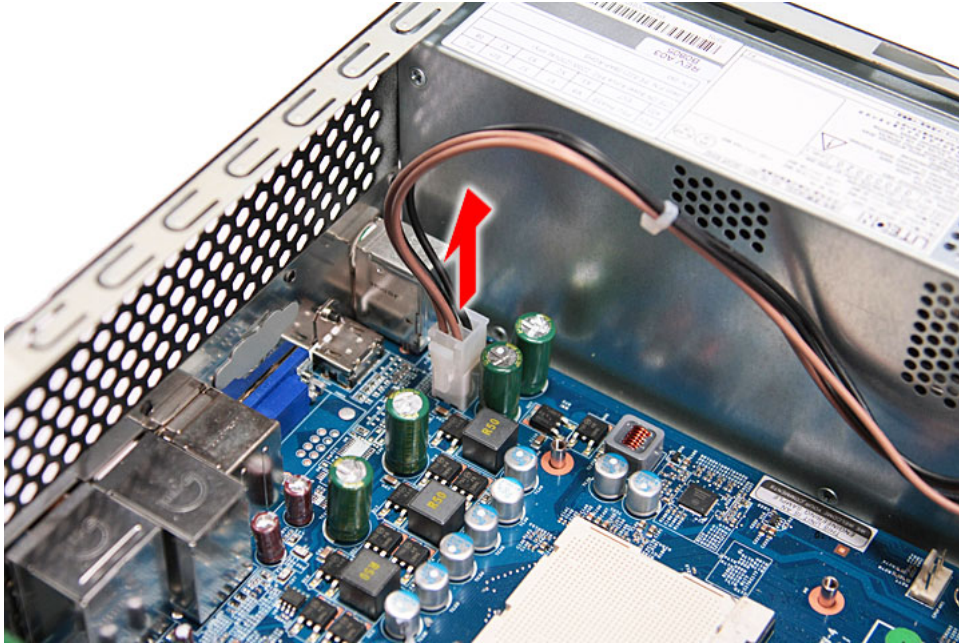

8. Disconnect the 24-pin power supply cable from the mainboard.

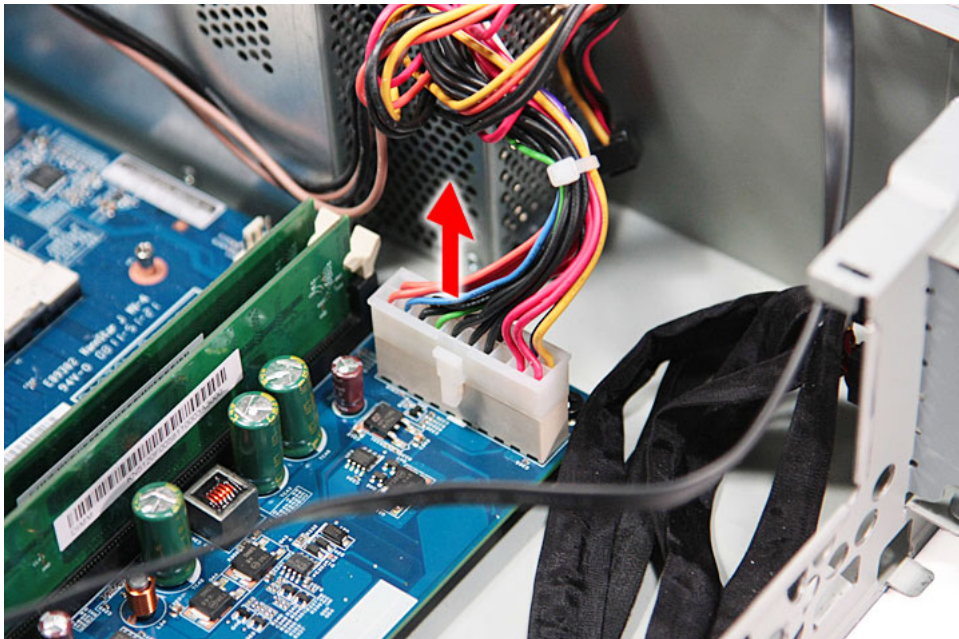

9. Remove the screw (A) that secures the power supply to the chassis.



Screw (Quantity)	Color	Torque	Part No.
#6-32 L5 BZN (1)	Black	5.5 to 6.5 kgf-cm	86.00J07.B60

10. Remove the three screws (A) that secure the power supply to the rear panel.



Screw (Quantity)	Color	Torque	Part No.
#6-32 L5 BZN (3)	Black	5.5 to 6.5 kgf-cm	86.00J07.B60

---

11. Lift the power supply module out of the chassis.





---

## Removing the Memory Modules

**IMPORTANT:** Before removing any DIMM from the memory board, make sure to create a backup file of all important data.

1. See “Removing the Side Panel” on page 34.
2. See “Removing the Front Bezel” on page 35.
3. See “Removing the Heat Sink Fan Assembly” on page 36.
4. See “Removing the Processor” on page 38.
5. See “Removing the Optical Drive” on page 40.
6. See “Removing the Hard Disk Drive” on page 42.
7. Press the holding clips on both sides of the DIMM slot outward to release the DIMM.

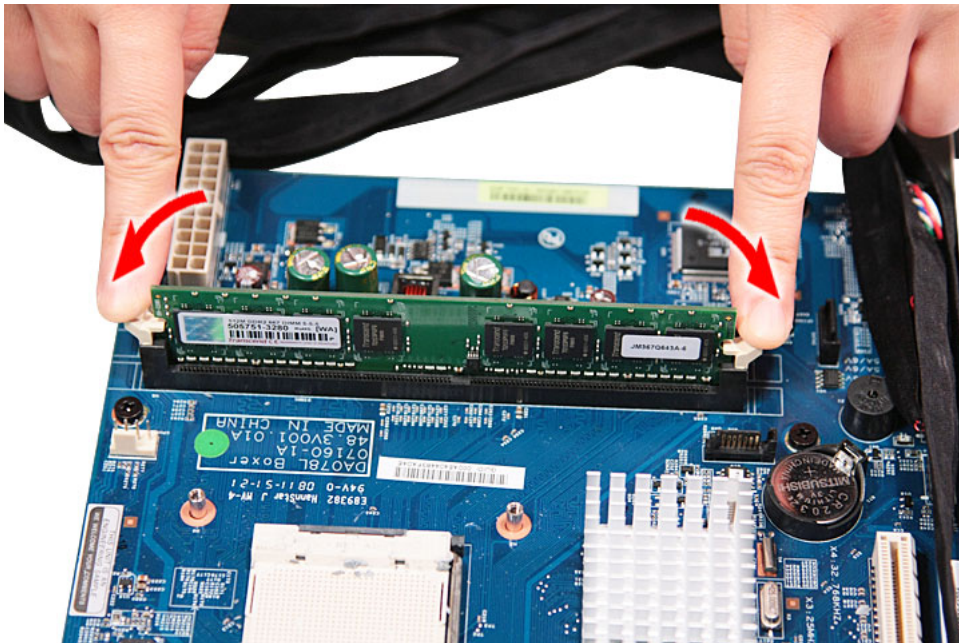

8. Gently pull the DIMM upward to pull it away from the chassis.

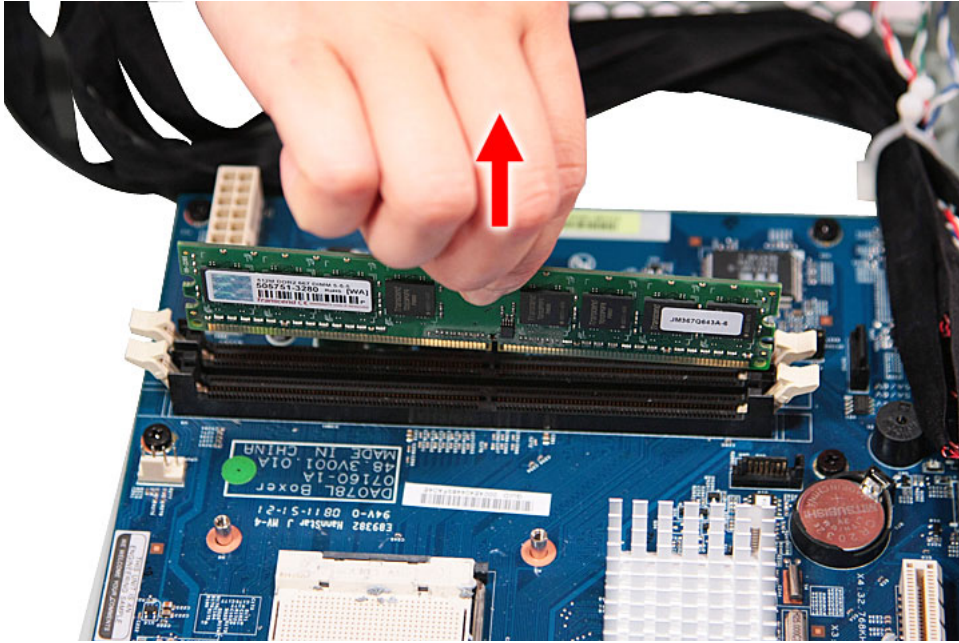

## Removing the PCI Card

1. See “Removing the Side Panel” on page 34.
2. See “Removing the Front Bezel” on page 35.
3. See “Removing the Heat Sink Fan Assembly” on page 36.
4. See “Removing the Processor” on page 38.
5. See “Removing the Optical Drive” on page 40.
6. See “Removing the Hard Disk Drive” on page 42.
7. Remove the screw (A) that secures the card to the chassis.

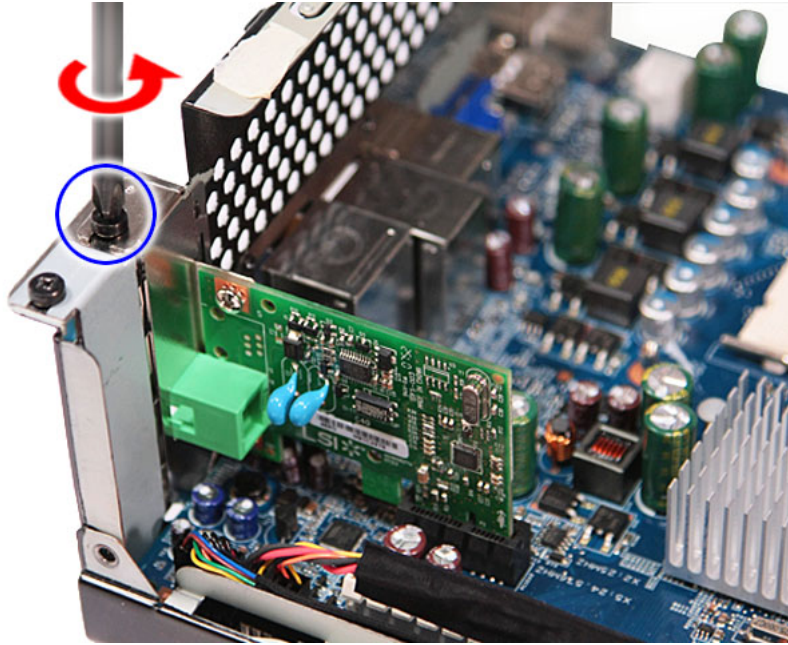

Screw (Quantity)	Color	Torque	Part No.
#6-32 L5 BZN (1)	Black	5.5 to 6.5 kgf-cm	86.00J07.B60

- 
8. Gently pull the card to remove it from the mainboard.

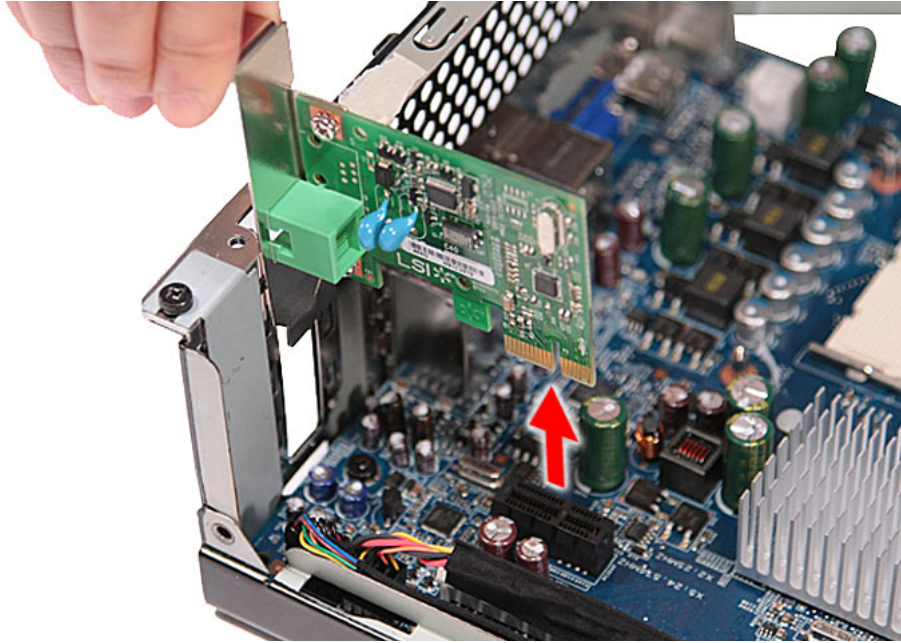

---

## Removing the Front I/O and Card Reader Boards

1. See “Removing the Side Panel” on page 34.
2. See “Removing the Front Bezel” on page 35.
3. See “Removing the Heat Sink Fan Assembly” on page 36.
4. See “Removing the Processor” on page 38.
5. See “Removing the Optical Drive” on page 40.
6. See “Removing the Hard Disk Drive” on page 42.
7. See “Removing the Memory Modules” on page 49.
8. Disconnect one end of the three USB (1, 2, and 4), audio (2), and 1394 (5) cables from the rear of the I/O and card reader boards.

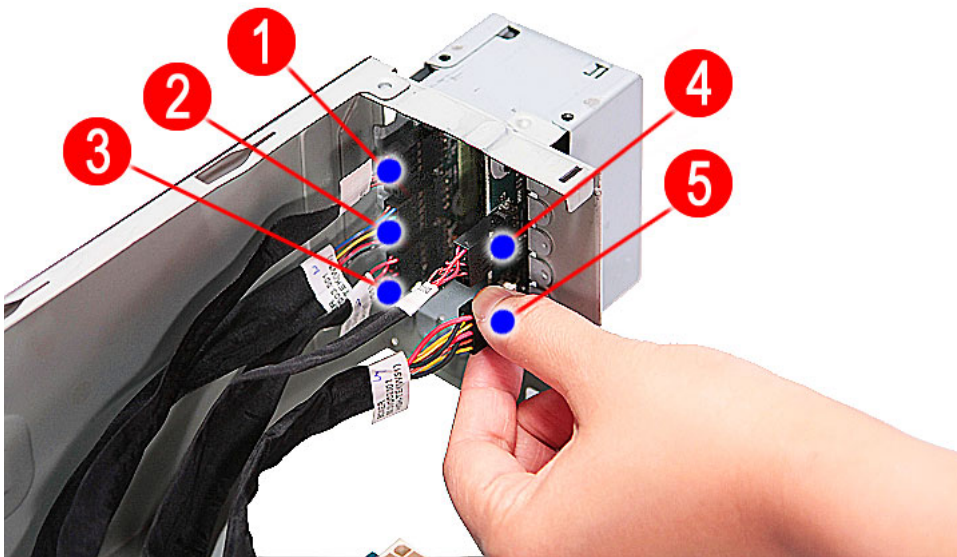

9. Disconnect the other end of the cables from the mainboard.

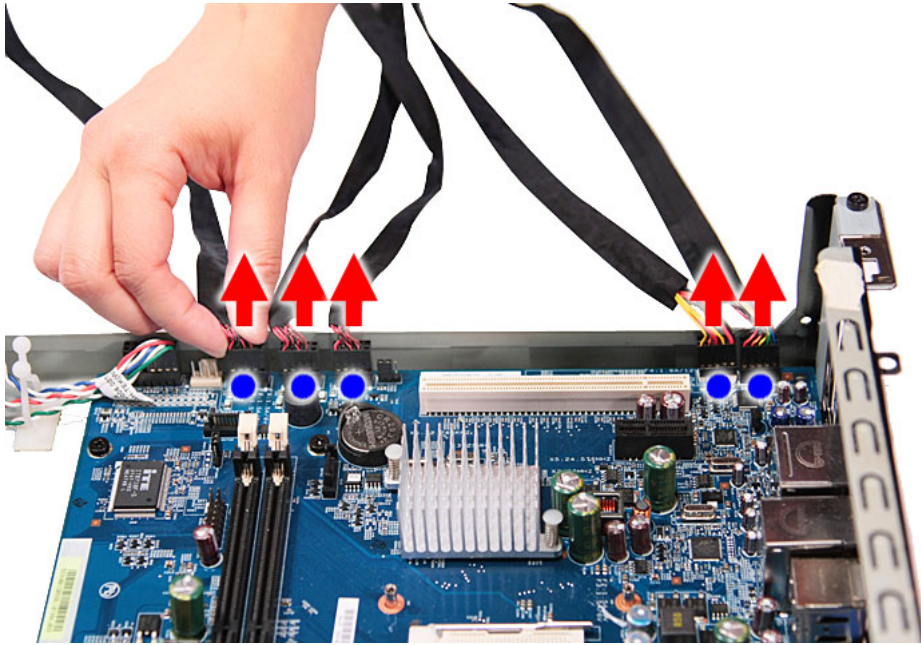

10. Remove the front I/O and card reader board bracket.

a. Remove the two screws (B) that secures the bracket to the chassis.

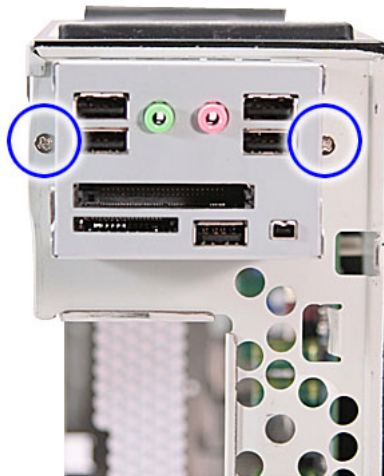

Screw (Quantity)	Color	Torque	Part No.
#6-32*3/16 NI (2)	Silver	5.5 to 6.5 kgf-cm	86.5A5B6.012

- b. Push the bracket inward, then remove the bracket from the chassis.

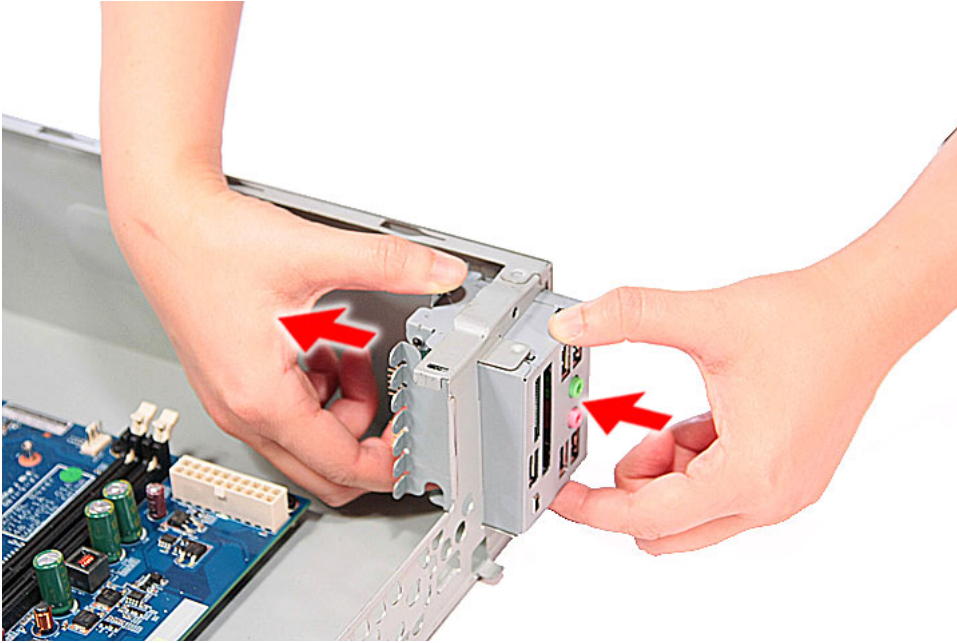

11. Remove the card reader board.

- a. Remove the two screws (A) that secure the card reader board to the bracket.

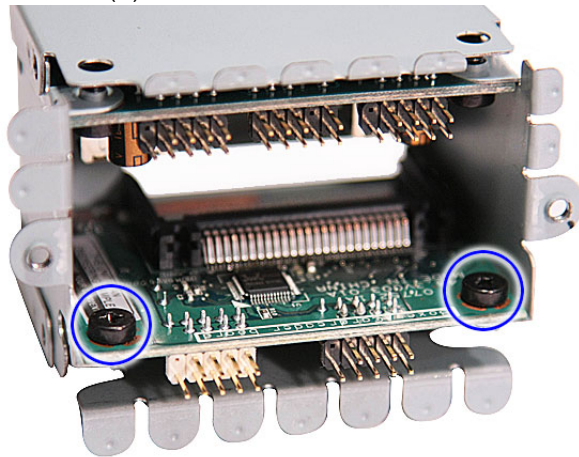

Screw (Quantity)	Color	Torque	Part No.
#6-32 L5 BZN (2)	Black	5.5 to 6.5 kgf-cm	86.00J07.B60

- b. Pull the card reader board out of the bracket.



12. Remove the front I/O board.

- a. Remove the two screws (A) that secure the I/O board to the bracket.

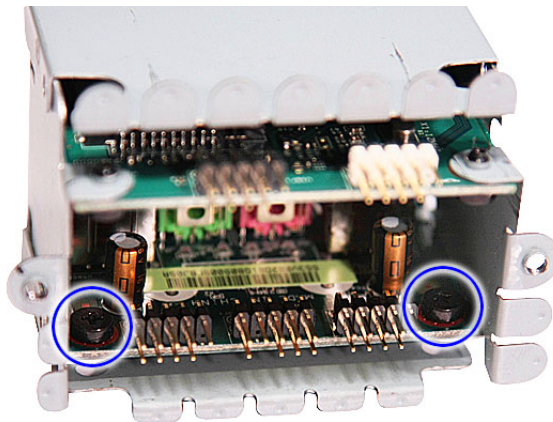

Screw (Quantity)	Color	Torque	Part No.
#6-32 L5 BZN (2)	Black	5.5 to 6.5 kgf-cm	86.00J07.B60

- b. Pull the I/O board out of the bracket.

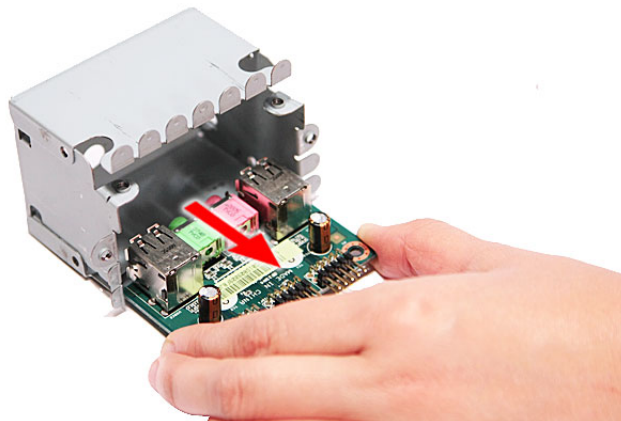



# Removing the Mainboard

1. See “Removing the Side Panel” on page 34.
2. See “Removing the Front Bezel” on page 35.
3. See “Removing the Heat Sink Fan Assembly” on page 36.
4. See “Removing the Processor” on page 38.
5. See “Removing the Optical Drive” on page 40.
6. See “Removing the Hard Disk Drive” on page 42.
7. See “Removing the Memory Modules” on page 49.
8. See “Removing the PCI Card” on page 51.
9. See “Removing the Front I/O and Card Reader Boards” on page 53.
10. Disconnect the LED cable from the mainboard.

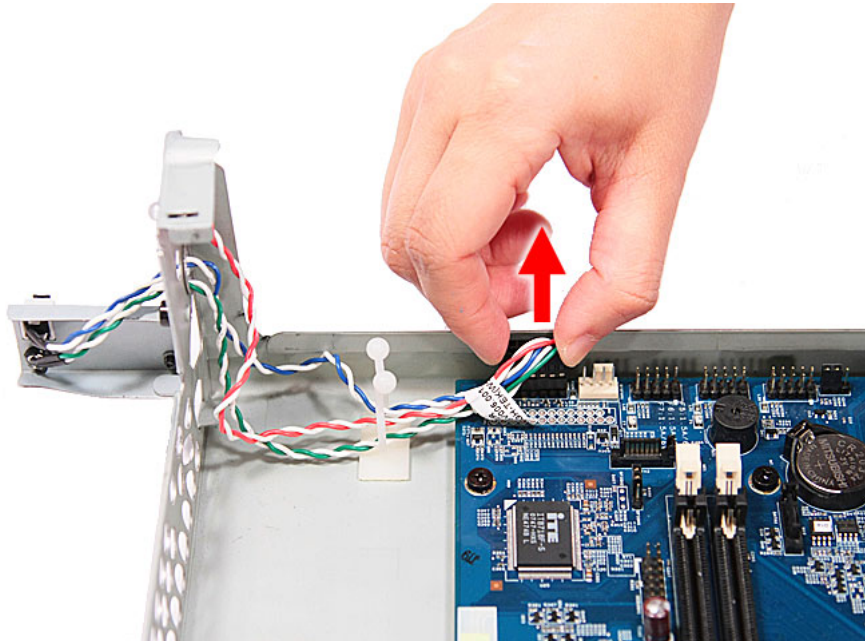

11. Remove the three screws (C, D) from the rear panel.



Screw (Quantity)	Color	Torque	Part No.
M3xL5 BZN (1)	Black	5.5 to 6.5 kgf-cm	86.1A324.5R0
Hex screw (2)	Silver	N/A	N/A

12. Remove the six screws (A) that secures the mainboard to the chassis, in the order shown.

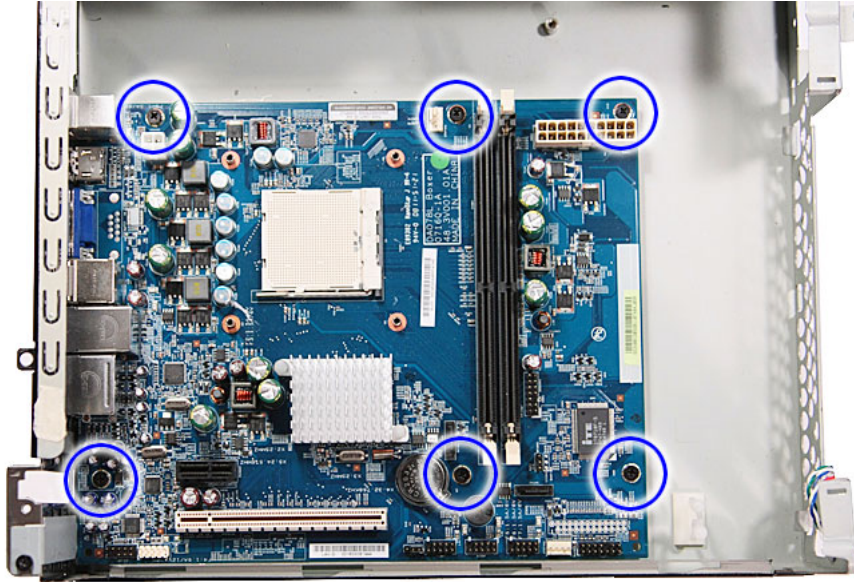

Screw (Quantity)	Color	Torque	Part No.
#6-32 L5 BZN (6)	Black	5.5 to 6.5 kgf-cm	86.00J07.B60

13. Lift the board from the chassis.

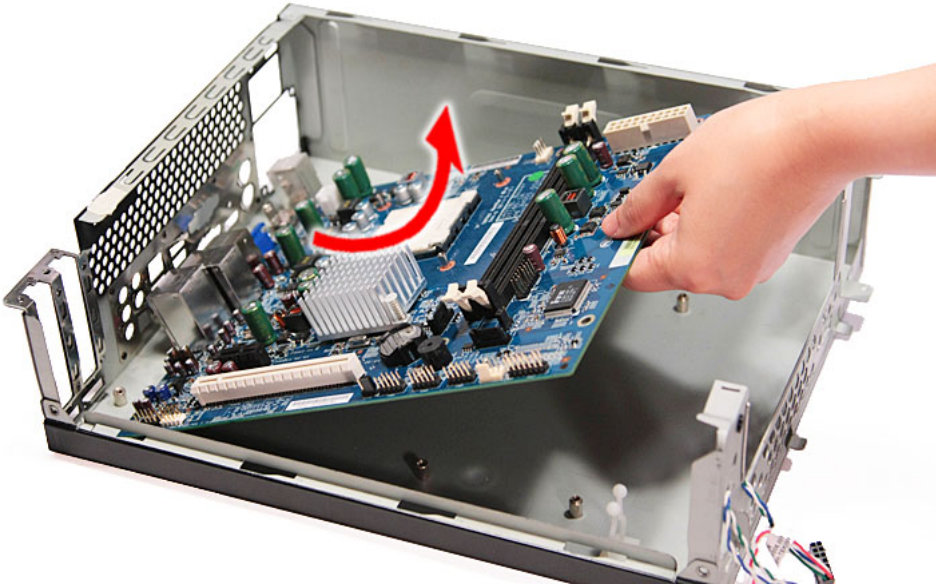

# System Troubleshooting

---

This chapter provides instructions on how to troubleshoot system hardware problems.

## Hardware Diagnostic Procedure

**IMPORTANT:** The diagnostic tests described in this chapter are only intended to test Acer products. Non-Acer products, prototype cards, or modified options can give false errors and invalid system responses.

1. Obtain the failing symptoms in as much detail as possible.
2. Verify the symptoms by attempting to recreate the failure by running the diagnostic tests or repeating the same operation.
3. Refer to the table below to determine which corrective action to perform.

Problem	Symptom	Section to Refer to
Power failure	The power indicator does not light up or stay lit.	"Power System Check" on page 60
POST failure	POST does not complete. No beep or error codes issued.	"POST Error and Beep Codes" on page 61.
	POST detects an error and displayed messages on screen.	

---

# System Check Procedures

## Power System Check

If the system will power on, skip this section. Refer to System External Inspection.

If the system will not power on, do the following:

- Check if the power cable is properly connected to the system and AC source.
- Check if the voltage selector switch is set to the correct voltage setting.

## System External Inspection

1. Inspect the LED indicators on the front panel, which can indicate the malfunction. For the LED locations and description of their behaviour, see “System LED Indicators” on page 6.
2. Make sure that air flow is not blocked.
3. Make sure nothing in the system is making contact that could short out power.
4. If the problem is not evident, continue with System Internal Inspection.

## System Internal Inspection

1. Turn off the system and all the peripherals connected to it.
2. Unplug the power cord from the power outlets.
3. Unplug the power cord from the system.
4. Unplug all peripheral cables from the system.
5. Place the system unit on a flat, stable surface.
6. Remove the system covers. For instructions on removing system covers, refer to “System Disassembly” on page 25.
7. Verify that components are properly seated.
8. Verify that all cable connectors inside the system are firmly and correctly attached to their appropriate connectors.
9. Verify that all components are Acer-qualified and supported.
10. Replace the system covers.
11. Power on the system.
12. If the problem with the system is not evident, you can try viewing the POST messages and BIOS event logs during the system startup.

# POST Error and Beep Codes

**NOTE:** Perform the FRU replacement or actions in the sequence shown in FRU/Action column, if the FRU replacement does not solve the problem, put the original part back in the computer. Do not replace a non-defective FRU.

The error messages in the following table indicate the BIOS signals on the screen and the error symptoms classified by functions. If the symptom is not included on the list, please refer to “Undetermined Problems”.

**NOTE:** Most of the error messages occur during POST. Some of them display information about a hardware device, e.g., the amount of memory installed. Others may indicate a problem with a device, such as the way it has been configured.

**NOTE:** If the system fails after you make changes in the BIOS Setup Utility menus, reset the computer, enter Setup and install Setup defaults or correct the error.

POST Code (Hex)	POST Routine Description
CFh	Test CMOS R/W functionality
C0h	Early chipset initialization <input type="checkbox"/> Disable shadow RAM <input type="checkbox"/> Disable L2 cache (socket 7 or below) <input type="checkbox"/> Program basic chipset registers
C1h	Detect memory <input type="checkbox"/> Auto-detection of DRAM size, type, and ECC <input type="checkbox"/> Auto-detection of L2 cache (socket 7 or below)
C3h	Expand compressed BIOS code to DRAM
C5h	Call chipset hook to copy BIOS back to E000 and F000 shadow RAM
01h	Expand the X group codes locating in physical address 1000:0
02h	Reserved
03h	Initial Superio_Earl_Init switch
04h	Reserved
05h	1 Blank out screen 2 Clear CMOS error flag
06h	Reserved
07h	1 Clear 8042 interface 2 Initialize 8042 self-test
08h	1 Test special keyboard controller for Winbond 977 series Super I/O chips 2 Enabled keyboard interface
09h	Reserved
0Ah	1 Disable PS/2 mouse interface (optional) 2 Auto detect ports for keyboard and mouse followed by a port and interface swap (optional) 3 Reset keyboard for Winbond 977 series Super I/O chops
0Bh	Reserved
0Ch	Reserved
0Dh	Reserved
0Eh	Test F000h segment shadow to see whether it is rewritable or not. If test fails, keep beeping the speaker.
0Fh	Reserved
10h	Auto detect flash type to load appropriate flash rewritable codes into the run time area in F000 for ESCD & DMI support.
11h	Reserved

POST Code (Hex)	POST Routine Description
12h	Use walking 1's algorithm to check out interface in CMOS circuitry. Also set real-time clock power status, and then check for override.
13h	Reserved
14h	Program chipset default values into chipset. Chipset default values are MODBINable by OEM customers.
15h	Reserved
16h	Initial onboard clock generator if Early_Init_Onboard_Generator is defined. See also POST 26h.
17h	Reserved
18h	Detect CPU information including brand, SMI type (Cyrix or Intel) and CPU level (586 or 686).
19h	Reserved
1Ah	Reserved
1Bh	Initial interrupts vector table. If no special specified, all H/W interrupts are directed to SPURIOUS_INT_HDLR & S/W interrupts to SPURIOUS_soft_HDLR.
1Ch	Reserved
1Dh	Initial EARLY_PM_INIT switch.
1Eh	Reserved
1Fh	Load keyboard matrix (notebook platform)
20h	Reserved
21h	HPM initialization (notebook platform)
22h	Reserved
23h	<ol style="list-style-type: none"> <li>1 Check validity of RTC value: e.g. a value of 5Ah is an invalid value for RTC minute.</li> <li>2 Load CMOS settings into BIOS stack. If CMOS checksum fails, use default value instead.</li> </ol>
24h	Prepare BIOS resource map for PCI & PnP use. If ESCD is valid, take into consideration of the ESCD's legacy information.
25h	<p>Early PCI Initialization:</p> <ul style="list-style-type: none"> <li><input type="checkbox"/> Enumerate PCI bus number</li> <li><input type="checkbox"/> Assign memory &amp; I/O resource</li> <li><input type="checkbox"/> Search for a valid VGA device &amp; VGA BIOS, and put it into C000:0</li> </ul>
26h	<ol style="list-style-type: none"> <li>1 If Early_Init_Onboard_Generator is not defined Onboard clock generator initialization. Disable respective clock resource to empty PCI &amp; DIMM slots.</li> <li>2 Init onboard PWM</li> <li>3 Init onboard H/W monitor devices</li> </ol>
27h	Initialize INT 09 buffer
28h	Reserved
29h	<ol style="list-style-type: none"> <li>1 Program CPU internal MTRR (P6 &amp; PII) for 0-640K memory address.</li> <li>2 Initialize the APIC for Pentium class CPU.</li> <li>3 Program early chipset according to CMOS setup. Example: onboard IDE controller. Measure CPU speed.</li> </ol>
2Ah	Reserved
2Bh	Invoke Video BIOS
2Ch	Reserved

POST Code (Hex)	POST Routine Description
2Dh	<ol style="list-style-type: none"> <li>1 Initialize double-byte language font (Optional)</li> <li>2 Put information on screen display, including Award title, CPU type, CPU speed, full screen logo.</li> </ol>
2Eh	Reserved
2Fh	Reserved
30h	Reserved
31h	Reserved
32h	Reserved
33h	Reset keyboard if Early_Reset_KB is defined e.g. Winbond 977 series Super I/O chips. See also POST 63h.
34h	Reserved
35h	Test DMA Channel 0
36h	Reserved
37h	Test DMA Channel 1
38h	Reserved
39h	Test DMA page registers
3Ah	Reserved
3Bh	Reserved
3Ch	Test 8254
3Dh	Reserved
3Eh	Test 8259 interrupt mask bits for channel 1
3Fh	Reserved
40h	Test 8259 interrupt mask bits for channel 2
41h	Reserved
42h	Reserved
43h	Test 8259 functionality
44h	Reserved
45h	Reserved
46h	Reserved
47h	Initialize EISA slot
48h	Reserved
49h	<ol style="list-style-type: none"> <li>1 Calculate total memory by testing the last double word of each 64K page.</li> <li>2 Program write allocation for AMD K5 CPU.</li> </ol>
4Ah	Reserved
4Bh	Reserved
4Ch	Reserved
4Dh	Reserved
4Eh	<ol style="list-style-type: none"> <li>1 Program MTRR of M1 CPU</li> <li>2 Initialize L2 cache for P6 class CPU &amp; program CPU with proper cacheable range</li> <li>3 Initialize the APIC for P6 class CPU</li> <li>4 On MP platform, adjust the cacheable range to smaller one in case the cacheable ranges between each CPU are not identical</li> </ol>
4Fh	Reserved
50h	Initialize the USB Keyboard & Mouse

POST Code (Hex)	POST Routine Description
51h	Reserved
52h	Test all memory (clear all extended memory to 0)
53h	Clear password according to H/W jumper (Optional)
54h	Reserved
55h	Display number of processors (multi-processor platform)
56h	Reserved
57h	<ol style="list-style-type: none"> <li>1 Display PnP logo</li> <li>2 Early ISA PnP initialization <ul style="list-style-type: none"> <li><input type="checkbox"/> Assign CSN to every ISA PnP device</li> </ul> </li> </ol>
58h	Reserved
59h	Initialize the combined Trend Anti-Virus code
5Ah	Reserved
5Bh	(Optional Feature) Show message for entering AWDFLASH.EXE from FDD
5Ch	Reserved
5Dh	<ol style="list-style-type: none"> <li>1 Initialize Init_Onboard_Super_IO</li> <li>2 Initialize Init_Onboard_AUDIO</li> </ol>
5Eh	Reserved
5Fh	Reserved
60h	Okay to enter Setup utility; i.e. not until this POST stage can users enter the CMOS setup utility.
6 h	Reserved
6 h	Reserved
6 h	Reset keyboard if Early_Reset_KB is not defined
6 h	Reserved
6 h	Initialize PS/2 Mouse
6h	Reserved
67h	Prepare memory size information for function call: INT 15h ax=E820h
68h	Reserved
69h	Turn on L2 cache
6Ah	Reserved
6Bh	Program chipset registers according to items described in Setup & Auto-configuration table.
6Ch	Reserved
6Dh	<ol style="list-style-type: none"> <li>1 Assign resources to all ISA PnP devices.</li> <li>2 Auto assign ports to onboard COM ports if the corresponding item in Setup is set to "AUTO".</li> </ol>
6Eh	Reserved
6Fh	<ol style="list-style-type: none"> <li>1 Initialize floppy controller</li> <li>2 Set up floppy related fields in 40:hardware</li> </ol>
70h	Reserved
71h	Reserved
72h	Reserved
73h	Reserved
74h	Reserved
75h	Detect & install all IDE devices: HDD, LS120, ZIP, CDROM.....



POST Code (Hex)	POST Routine Description
76h	(Optional Feature) Enter AWDFLASH.EXE if: -AWDFLASH.EXE is found in floppy drive. -ALT+F2 is pressed.
77h	Detect serial ports & parallel ports
78h	Reserved
79h	Reserved
7Ah	Detect & install co-processor
7Bh	Reserved
7Ch	Init HDD write protect
7Dh	Reserved
7Eh	Reserved
7Fh	Switch back to text mode if full screen logo is supported. <input type="checkbox"/> If errors occur, report errors & wait for keys <input type="checkbox"/> If no errors occur or F1 key is pressed to continue: <input type="checkbox"/> Clear EPA or customization logo
80h	Reserved
81h	Reserved
E8POST.ASM starts	
82h	1 Call chipset power management hook 2 Recover the text font used by EPA logo (not for full screen logo) 3 If password is set, ask for password
83h	Save all data in stack back to CMOS
84h	Initialize ISA PnP boot devices
85h	1 USB final Initialization 2 Switch screen back to text mode
86h	Reserved
87h	NET PC: Build SYSID Structure
88h	Reserved
89h	1 Assign IRQs to PCI devices 2 Set up ACPI table at top of the memory
8Ah	Reserved
8Bh	1 Invoke all ISA adapter ROMs 2 Invoke all PCI ROMs (except VGA)
8Ch	Reserved
8Dh	1 Enable/Disable Parity Check according to CMOS setup 2 APM Initialization
8Eh	Reserved
8Fh	Clear noise of IRQs
90h	Reserved
91h	Reserved
92h	Reserved
93h	Read HDD boot sector information for Trend Anti-Virus code

POST Code (Hex)	POST Routine Description
94h	<ol style="list-style-type: none"> <li>1 Enable L2 cache</li> <li>2 Program Daylight Saving</li> <li>3 Program boot up speed</li> <li>4 Chipset final initialization</li> <li>5 Power management final initialization</li> <li>6 Clear screen &amp; display summary table</li> <li>7 Program K6 write allocation</li> <li>8 Program P6 class write combining</li> </ol>
95h	Update keyboard LED & typematic rate
96h	<ol style="list-style-type: none"> <li>1 Build MP table</li> <li>2 Build &amp; update ESCD</li> <li>3 Set CMOS century to 20h or 19h</li> <li>4 Load CMOS time into DOS timer tick</li> <li>5 Build MSIRQ routing table</li> </ol>
FFh	Boot attempt (INT 19h)

---

# Online Support Information

This section describes online technical support services available to help you repair the desktop computer.

If you are a distributor, dealer, ASP or TPM, please refer your technical queries to your local Acer branch office. Acer Branch Offices and Regional Business Units may access our website at <http://global.acer.com/support/index>. However some information sources will require a user ID and password. These can be obtained directly from Acer CSD Taiwan.

Acer's Website offers you convenient and valuable support resources whenever you need them.

In the Support & Downloads tab you can download information materials for all of Acer notebook, desktop and server models including:

- Service guides for all models
- User's manuals
- Training materials
- BIOS updates
- Software utilities
- Spare parts lists
- Technical Announcement Bulletins (TABs)

For these purposes, we have included an Acrobat File to facilitate a hassle-free downloading of our technical materials.

The following are also available in the Support & Downloads tab:

- Detailed information on Acer's International Traveler's Warranty (ITW)
- Returned material authorization procedures
- An overview of all the support services we offer, accompanied by a list of telephone, fax, and email contacts for all your technical queries.

We are always looking for ways to optimize and improve our services, so if you have any suggestions or comments, please do not hesitate to communicate these to us.



# System Block Diagram and Board Layout

## System Block Diagram

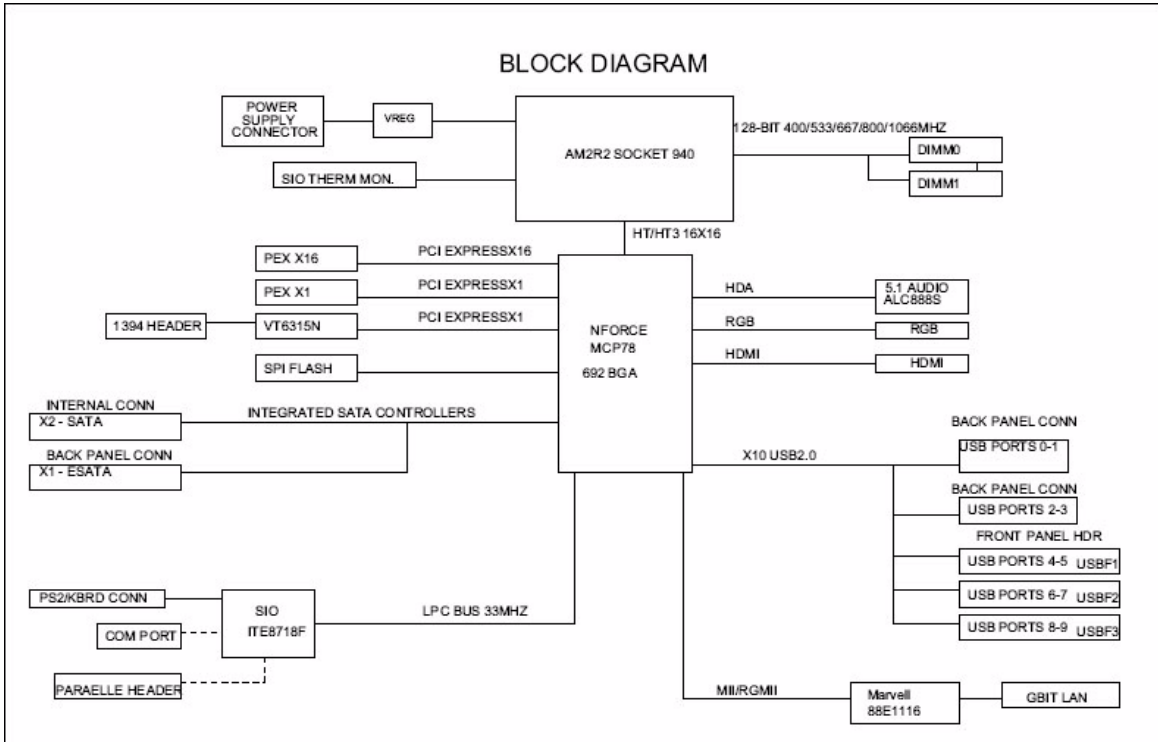

# Board Layout

## Mainboard

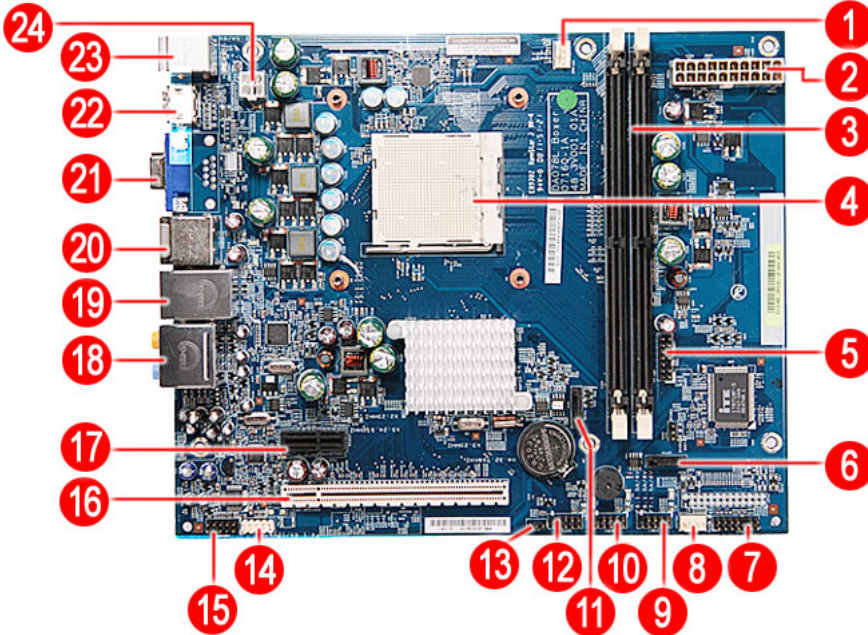

No	Code	Description	No	Code	Description
1	CPUFAN1	Processor fan cable connector	13	JBIOS1	Clear CMOS jumper
2	PWR2	24-pin ATX power connector	14	FIREH1	IEEE 1394 connector
3	DIMM1 and 2	System memory slots	15	AUDIOF1	Front audio connector
4	UI	Processor socket	16	PCIEX16	PCI Express x16 slot
5	DEBUGH1	Debug connector	17	PCIEX1	PCI Express x1 slot
6	SATA2	SATA 2 data cable connector	18		Top: Line-out and line-in jack and rear speaker and center speaker jack Bottom: Microphone port and S/PDIF port
7	LEDH1	LED cable connector	19		Top: Gigabit LAN port Bottom: USB ports
8	SYSFAN1	System fan cable connector	20		Top: USB ports Bottom: eSATA port
9	USBF3	Front USB connectors	21		VGA port
10	USBF2		22		HDMI port
11	SATA1	SATA 1 data cable connector	23		Top: PS2 Mouse Port Bottom: PS2 Keyboard Port
12	USBF1	Front USB connector	24	PWR1	8-pin ATX power connector

---

# System Jumpers

Name	Location	Default	Settings
Clear CMOS/NVRAM	JBIOS1	1-2 2-3	Normal (default) Clear CMOS
SKU selection	GPIOH1	1-2 2-3	SSID = 0153 AX1200 SSID = 0157 AX3200





## FRU (Field Replaceable Unit) List

---

This chapter offers the FRU (Field Replaceable Unit) list in global configuration of the Aspire ASX1200/ ASX3200 desktop computer. Refer to this chapter whenever ordering the parts to repair or for RMA (Return Merchandise Authorization).

### NOTES:

- ❑ When ordering FRU parts, check the most up-to-date information available on your regional web or channel. For whatever reasons a part number is changed, it will NOT be noted on the printed Service Guide. For Acer authorized service providers, your Acer office may have a different part number code from those given in the FRU list of this printed Service Guide. You MUST use the local FRU list provided by your regional Acer office to order FRU parts for service.
- ❑ To scrap or to return the defective parts, follow the local government ordinance or regulations on how to dispose it properly, or follow the rules set by your regional Acer office on how to return it.
- ❑ This document will be updated as more information about the FRU list becomes available.

# Aspire ASX1200/ ASX3200 Exploded Diagram

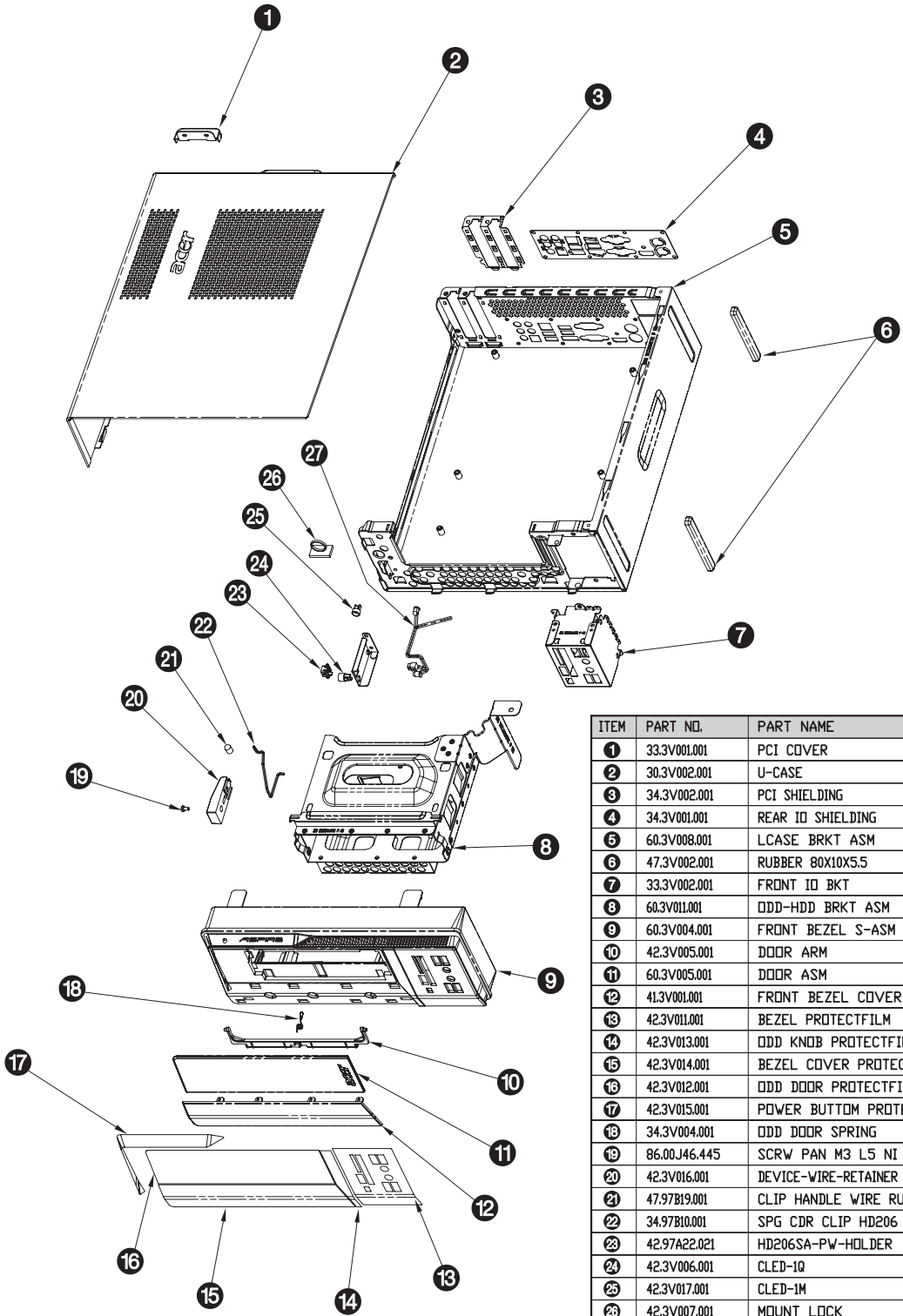

ITEM	PART NO.	PART NAME	QTY
1	33.3V001.001	PCI COVER	1
2	30.3V002.001	U-CASE	1
3	34.3V002.001	PCI SHIELDING	1
4	34.3V001.001	REAR ID SHIELDING	1
5	60.3V008.001	LCASE BRKT ASM	1
6	47.3V002.001	RUBBER 80X10X5.5	2
7	33.3V002.001	FRONT ID BKT	1
8	60.3V011.001	ODD-HDD BRKT ASM	1
9	60.3V004.001	FRONT BEZEL S-ASM	1
10	42.3V005.001	DOOR ARM	1
11	60.3V005.001	DOOR ASM	1
12	41.3V001.001	FRONT BEZEL COVER	1
13	42.3V011.001	BEZEL PROTECTFILM	1
14	42.3V013.001	ODD KNOB PROTECTFILM	1
15	42.3V014.001	BEZEL COVER PROTECTFILM	1
16	42.3V012.001	ODD DOOR PROTECTFILM	1
17	42.3V015.001	POWER BUTTOM PROTECTFILM	1
18	34.3V004.001	ODD DOOR SPRING	1
19	86.00J46.445	SCRW PAN M3 L5 NI	1
20	42.3V016.001	DEVICE-WIRE-RETAINER	1
21	47.97B19.001	CLIP HANDLE WIRE RUBBER	1
22	34.97B10.001	SPG CDR CLIP HD206	1
23	42.97A22.021	HD206SA-PW-HOLDER	1
24	42.3V006.001	CLED-1Q	1
25	42.3V017.001	CLED-1M	1
26	42.3V007.001	MOUNT LOCK	1
27	50.3J901.001	C.A. PWR SW L200 HD218	1

# Aspire ASX1200/ ASX3200 FRU List (81.3V001.010G)

Component	QTY	Part Name	Description	Acer Part Number
<b>Board</b>				
Front I/O board	1	FRONT I/O BOARD	DA078L/BOXER FRONT I/O BD MRP	55.SAR01.001
Card reader board	1	CARD READER BOARD	DA078L/BOXER CARD READER MRP	55.SAR01.002
Modem card	1	MODEM CARD LITE-ON D-1156E#A10A LOW-PROFILE PCI-E 56K V.92	MODEM 56K ATX LSI UNIVERSAL (P)	FX.10100.003
TV tuner card	1	TV TUNNER CARD YUAN PE585QA PCI-E HYBRID S/W MPEG (ATSC+NTSC) W/LP BRKT	TV TUNER CARD PE585QA PCI-E HY	TU.10500.010
	1	TV TUNNER CARD HAUPPAUGE HVR-1200 PCIE HYBRID DVB-T S/ W ENCODER W/LP BRKT	HAUPPAGUE WIN-TV HVR-1200 PCIE	TU.10500.011
VGA card	1	VGA CARD PC PARTNER GEFORCE 8400 256MB DDRII VGA+TVO+DVI PAL W/LP BRK LF	VGA CARD GEFORCE 8400 256MB	VG.PC84L.013
	1	VGA CARD PC PARTNER GEFORCE 8400 256MB DDRII VGA+TVO+DVI NTSC W/LP BRK LF	VGA CARD GEFORCE 8400 256MB	VG.PC84L.014
<b>Cable</b>				
Card reader (1394)	1	CARD READER CABLE	C.A. 1394 BOXER VSO	50.SAR01.001
USB board cable	1	USB BOARD CABLE	C.A. USB BOXER VSO	50.SAR01.002
Audio board cable	1	AUDIO BOARD CABLE	C.A. AUDIO BOXER VSO	50.SAR01.003
SATA ODD cable	1	SATA ODD CABLE (SHORT)	C.A. SATA ODD BOXER VSO	50.SAR01.004
SATA HDD - MB	1	SATA HDD CABLE (LONG)	C.A. SATA HDD BOXER VSO	50.SAR01.005
Power board and LED board cable	2	POWER BOARD&LED BOARD CABLE	C.A. LED-SWITCH BOXER VSO	50.SAR01.006
<b>Case/Cover/Bracket Assembly</b>				
Front bezel	1	FRONT BEZEL WITH NAME PLATE	ASSY FRONT-BEZEL-ASM BOXER95	60.SAR01.001
Upper case	1	UPPER CASE	ASSY DOOR BOXER95	60.SAR01.002
Chassis with power and LED cable	1	CHASSIS WITH POWER & LED CABLE	ASSY MAIN-CHASSIS BOXER95	60.SAR01.003
I/O dummy cover bracket	1	IO DUMMY COVER BRACKET	BRKT F-IO BOXER95	33.SAR01.001
I/O holder	1	IO HOLDER	SHIELDING REAR IO BOXER95	33.SAR01.002
HDD and ODD cover bracket	1	HDD&ODD COVER BRACKET	ASSY BRKT-ODD-HDD	33.SAR01.003
<b>CPU</b>				
Athlon 64 X2, 65W	1	CPU AMD 2.5G ADO4850IAA5DO ATHLON	IC CPU ATHLON 4850E 2.5G G2	KC.AE002.485
	1	CPU AMD 2.2G ADO4200IAA5DO ATHLON64*2	IC CPU ATHLON64*2 4200+ 2.2G	KC.A4202.X2Z
	1	CPU AMD 2.3G ADO4400IAA5DO ATHLON64*2	IC CPU ATHLON64*2 4400+ 2.3G	KC.A4402.X2Z

Component	QTY	Part Name	Description	Acer Part Number
Athlon 64 X2, 65W	1	CPU AMD 2.4G ADO4600IAA5DO ATHLON64*2	IC CPU ATHLON64*2 4600+ 2.4G	KC.A4602.X2Z
	1	CPU AMD 2.5G G2 ADO4800IAA5DO ATHLON64*2	IC CPU ATHLON64*2 4800+ G2	KC.A4802.X2Z
	1	CPU AMD 2.6G ADO5000IAA5DO ATHLON64*2	IC CPU ATHLON64*2 5000+ 2.6G	KC.A5002.X2Z
	1	CPU AMD 2.7G G2 ADO5200IAA5DO ATHLON64*2	IC CPU ATHLON64*2 5200+ G2	KC.A5202.X2Z
	1	CPU AMD 2.8G ADO5600IAA5DO ATHLON64*2	IC CPU ATHLON64*2 5600+ 2.8G	KC.A5602.X2Z
Athlon X2, 45W	1	CPU AMD 2.9G ADH2300IAA5DO ATHLON64*2	IC CPU ATHLON64*2 BE-2300 1.9G	KC.ABZ02.230
	1	CPU AMD 2.1G ADH2350IAA5DO ATHLON64*2	IC CPU ATHLON64*2 BE-2350 2.1G	KC.ABZ02.235
	1	CPU AMD 2.3G ADH2400IAA5DO ATHLON64*2	IC CPU ATHLON64*2 BE-2400 2.3G	KC.ABZ02.240
Athlon, 45W	1	CPU AMD 2.7G G2 ADH1640IAA4DP ATHLON LE-1640	IC CPU ATHLON LE-1640 2.7G G2	KC.ALE02.164
	1	CPU AMD 2.8G G2 ADH1660IAA4DP ATHLON LE-1660	IC CPU ATHLON LE-1660 2.8G G2	KC.ALE02.166
	1	CPU AMD 2.2G ADA4000IAA4DH ATHLON LE-1600	IC CPU ATHLON LE-1600 2.2G	KC.ALF02.160
	1	CPU AMD 2.4G ADH1620IAA5DH ATHLON LE-1620	IC CPU ATHLON LE-1620 2.4G	KC.ALF02.162
Phenom, Quad Core, 65W	1	CPU AMD 1.8G HD91000BJ4BGD PHENOM 9100E	IC CPU PHENOM 9100E 1.8G	KC.PHE02.910
	1	CPU AMD 1.8G HD91500BJ4BGD PHENOM 9150E	IC CPU PHENOM 9150E 1.8G	KC.PHE02.915
Phenom, Triple Core, 89W	1	CPU AMD 2.1G HD8400WCJ3BGD PHENOM 8400	IC CPU PHENOM 8400 2.1G	KC.PHN02.840
	1	CPU AMD 2.1G HD8450WCJ3BGD PHENOM 8450	IC CPU PHENOM 8450 2.1G	KC.PHN02.845
	1	CPU AMD 2.3G HD8600WCJ3BGD PHENOM 8600	IC CPU PHENOM 8600 2.3G	KC.PHN02.860
	1	CPU AMD 2.3G HD8650WCJ3BGD PHENOM 8650	IC CPU PHENOM 8650 2.3G	KC.PHN02.865
	1	CPU AMD 2.5G HD8700WCJ3BGD PHENOM 8700	IC CPU PHENOM 8700 2.5G	KC.PHN02.870
	1	CPU AMD 2.4G HD8750WCJ3BGD PHENOM 8750	IC CPU PHENOM 8750 2.4G	KC.PHN02.875
Phenom, Quad Core, 95W	1	CPU AMD 2.2G HD9500WCJ4BGD PHENOM 9500	IC CPU PHENOM 9500 2.2G	KC.PHN02.950
	1	CPU AMD 2.2G HD9550WCJ4BGD PHENOM 9550	IC CPU PHENOM 9550 2.2G	KC.PHN02.955
	1	CPU AMD 2.4G HD9600WCJ4BGD PHENOM 9600	IC CPU PHENOM 9600 2.4G	KC.PHN02.960
	1	CPU AMD 2.3G HD9650WCJ4BGD PHENOM 9650	IC CPU PHENOM 9650 2.3G	KC.PHN02.965
	1	CPU AMD 2.4G HD9750WCJ4BGD PHENOM 9750	IC CPU PHENOM 9750 2.4G	KC.PHU02.975

Component	QTY	Part Name	Description	Acer Part Number
Sempron, 45W	1	CPU AMD 2.2G SDH1250IAA4DP SEMPRON LE-1250	IC CPU SEMPRON LE-1250 2.2G	KC.SLE02.125
	1	CPU AMD 2.5G G2 SDH1300IAA4DP SEMPRON LE-1300	IC CPU SEMPRON LE-1300 2.5G G2	KC.SLE02.130
<b>Optical drive</b>				
DVD-RW drive	1	DVD-RW DRIVE BD 4X HLDS GGW-H20N LF BLACK BEZEL SATA	BD-R HLDS GGW-H20N BOXER	KU.0040D.012
	1	DVD-RW DRIVE SUPER MULTI 16X PHILIPS DH-16A3S LF BLACK BEZEL SATA	SUPER MULTI SATA DH-16A3S BOXE	KU.01609.005
	1	DVD-RW DRIVE SUPER MULTI 16X HLDS GH15N LF BLACK BEZEL SATA	SUPER MULTI SATA GH-15N BOXER	KU.0160D.034
	1	DVD-RW DRIVE SUPER MULTI 16X SONY AD-7170S LF SATA	S-MUL SATA SONY/AD-7170S OSCAR	KU.0160E.001
	1	DVD-RW DRIVE BD 4X HLDS GGC-H20N LF BALCK BEZEL SATA	BD 4X HLDS GGC-H20N BOXER	KV.0040D.001
	1	DVD-ROM DRIVE 16X PHIPLIS DH-16D2S LF W/O BEZEL SATA	DVDROM SATA PLDS/DH-16D2S OSCA	KV.01609.003
	1	DVD-ROM DRIVE 16X HLDS GDR-H20N LF BALCK BEZEL SATA	DVDROM SATA HLDS/GDR-H20N PERS	KV.0160D.014
<b>Hard disk drive</b>				
160 GB	1	HDD 160GB 3.5" 7200RPM SATA II HGST HDS721616PLA380 LF F/ W:BEA	HGST 160GB SATA 8MB 7200 NCQ	KH.16007.017
	1	HDD 160GB 3.5" 7200RPM SATA II SEAGATE ST3160815AS LF F/ W:3.AAE	HDD 160GB SGT ST3160815AS	KH.16001.030
250 GB	1	HDD 250GB SEAGATE ST3250310AS	HDD 250GB SEAGATE ST3250310AS	KH.25001.010
	1	HDD 250GB 3.5" 7200RPM SATA II HGST HDP725025GLA380 LF F/ W:52A	HDD 250GB HGST HDP725025GLA380	KH.25007.012
320 GB	1	HDD 320GB 3.5" 7200RPM SATA II SEAGATE ST3320820AS LF F/ W:3.AAD	HDD SEAGATE 320GB ST3320820AS	KH.32001.007
	1	HDD 320GB SATA HGST HDP725032GLA380	HDD 320GB HGST HDP725032GLA380	KH.32007.003
	1	HDD 320GB 3.5" 7200RPM SATA WD WD3200AAJS-22VWA0 LF F/ W:12.01B02	HDD 320GB WD WD3200AAJS-22VWA0	KH.32008.012
500 GB	1	HDD 500GB 3.5" 7200RPM SATA II SEAGATE ST3500830AS LF F/ W:3.AAD	HDD 500GB SGT SATA ST3500830AS	KH.50001.004
	1	HDD 500GB 3.5" 7200RPM SATA II HGST HDP725050GLA380 LF F/ W:52A	HDD 500GB HGST HDP725050GLA380	KH.50007.003
	1	HDD 500G 3.5" 7200RPM SATA II WD WD5000AAJS-22YFAO LF F/ W:12.01C02	HDD 500GB WD WD5000AAJS-22YFAO	KH.50008.005
	1	HDD 500GB 3.5" 7200RPM SATA II WD WD5000AAJS-22A8B0 LF F/ W:01.03A01	HDD 500GB WD5000AAJS-22A8B0	KH.50008.009

Component	QTY	Part Name	Description	Acer Part Number
640 GB	1	HDD 640GB 3.5" 7200RPM SATA II WD WD6400AAKS-22A7B0 LF F/ W:01.03B01	HDD 640GB WD WD6400AAKS-22A7B0	KH.64008.001
750 GB	1	HDD 750GB 3.5" 7200RPM SATA II SEAGATE ST3750840AS LF F/ W:3.AAD	SEAGATE 750G SATA 8MB 7200 NCQ	KH.75001.003
	1	HDD 750GB 3.5" 7200RPM SATA II HGST HDS721075KLA330 LF F/ W:70M	HGST 750GB SATA 8MB 7200 NCQ	KH.75007.001
	1	HDD 750GB 3.5" 7200RPM SATA II WD WD7500AAKS-22RBA0 LF F/ W:30.04G30	HDD WD 750GB SATA 8MB 7200 NCQ	KH.75008.001
1 TB	1	HDD 1000GB 3.5" 7200RPM SATA II HGST HDS721010KLA330 LF F/ W:70M	HDD HGST 1TB SATA 8MB 7200 NCQ	KH.01K07.001
<b>Heat sink</b>				
	1	CPU COOLER WITH FAN LGA775 TMD06 (TMD06 W/O FAN DUCT)	ASSY COOLER LGA775 ATX	HI.10800.012
<b>Keyboard</b>				
	1	KEYBOARD PS2 104KEY CHICONY KB-07593US2552V US2552V US BLAC	KB PS2 KB-07593US2552V US BLAC	KB.PS203.096
	1	KEYBOARD PS2 104KEY CHICONY KB-07593RD2552V TRADITIONAL CHINESE BLACK	KB PS2 KB-0759 T-CN BLACK 104K	KB.PS203.097
	1	KEYBOARD PS2 104KEY CHICONY KB-07593RE2552V SIMPLE CHINESE BLACK	KB PS2 KB-0759 S-CN BLACK 104K	KB.PS203.098
	1	KEYBOARD PS2 104KEY CHICONY KB-07593U42552V US-I BLACK	KB PS2 KB-0759 US-I BLACK 104K	KB.PS203.099
	1	KEYBOARD PS2 104KEY CHICONY KB-07593A02552V ARABIC/ENGLISH	KB PS2 KB-0759 ARABIC/ENGLISH	KB.PS203.100
	1	KEYBOARD PS2 104KEY CHICONY KB-07593T02552V THAI BLACK	KB PS2 KB-0759 THAI BLACK 104K	KB.PS203.101
	1	KEYBOARD PS2 105KEY CHICONY KB-07596E02552V SPANISH BLACK	KB PS2 KB-0759 SPANISH BLACK 1	KB.PS203.102
	1	KEYBOARD PS2 105KEY CHICONY KB-07596P02552V PORTUGUESE BLACK	KB PS2 KB-0759 PORTUGUESE BLAC	KB.PS203.103
	1	KEYBOARD PS2 105KEY CHICONY KB-07596CA2552V CANADA/FRENCH	KB PS2 KB-0759 CA-FRENCH BLACK	KB.PS203.104
	1	KEYBOARD PS2 107KEY CHICONY KB-07598PA2552V BRAZILIAN PORTU	KB PS2 KB-0759 BRAZILIAN PORTU	KB.PS203.105
	1	KEYBOARD PS2 109KEY CHICONY KB-07590J02552V JAPANESE BLACK	KB PS2 KB-0759 JAPANESE BLACK	KB.PS203.106
	1	KEYBOARD PS2 105KEY CHICONY KB-07596D12552V GERMAN BLACK	KB PS2 KB-0759 GERMAN BLACK 10	KB.PS203.107

Component	QTY	Part Name	Description	Acer Part Number
Keyboard	1	KEYBOARD PS2 105KEY CHICONY KB-07596I02552V ITALIAN BLACK	KB PS2 KB-0759 ITALIAN BLACK 1	KB.PS203.108
	1	KEYBOARD PS2 105KEY CHICONY KB-07596F12552V FRENCH BLACK	KB PS2 KB-0759 FRENCH BLACK105	KB.PS203.109
	1	KEYBOARD PS2 105KEY CHICONY KB-07596S02552V SWEDISH BLACK	KB PS2 KB-0759 SWEDISH BLACK 1	KB.PS203.110
	1	KEYBOARD PS2 105KEY CHICONY KB-07596GB2552V UK BLACK	KB PS2 KB-0759 UK BLACK 105KS	KB.PS203.111
	1	KEYBOARD PS2 105KEY CHICONY KB-07596NL2552V DUTCH BLACK	KB PS2 KB-0759 DUTCH BLACK 105	KB.PS203.112
	1	KEYBOARD PS2 105KEY CHICONY KB-07596CH2552V SWISS/G BLACK	KB PS2 KB-0759 SWISS/G BLACK 1	KB.PS203.113
	1	KEYBOARD PS2 105KEY CHICONY KB-07596B02552V BELGIUM BLACK	KB PS2 KB-0759 BELGIUM BLACK 1	KB.PS203.114
	1	KEYBOARD PS2 105KEY CHICONY KB-07596IC2552V ICELANDIC BLACK	KB PS2 KB-0759 ICELANDIC BLACK	KB.PS203.115
	1	KEYBOARD PS2 105KEY CHICONY KB-07596N02552V NORWEGIAN BLACK	KB PS2 KB-0759 NORWEGIAN BLACK	KB.PS203.116
	1	KEYBOARD PS2 104KEY CHICONY KB-07593HB2552V HEBREW BLACK	KB PS2 KB-0759 HEBREW BLACK104	KB.PS203.117
	1	KEYBOARD PS2 105KEY CHICONY KB-07596PL2552V POLISH BLACK	KB PS2 KB-0759 POLISH BLACK105	KB.PS203.118
	1	KEYBOARD PS2 105KEY CHICONY KB-07596YU2552V SLOVENIAN BLACK	KB PS2 KB-0759 SLOVENIAN BLACK	KB.PS203.119
	1	KEYBOARD PS2 105KEY CHICONY KB-07596CL2552V SLOVAK BLACK	KB PS2 KB-0759 SLOVAK BLACK105	KB.PS203.120
	1	KEYBOARD PS2 104KEY CHICONY KB-07593S32552V RUSSIAN BLACK	KB PS2 KB-0759 RUSSIAN BLACK 1	KB.PS203.121
	1	KEYBOARD PS2 105KEY CHICONY KB-07596HU2552V HUNGARIAN BLACK	KB PS2 KB-0759 HUNGARIAN BLACK	KB.PS203.122
	1	KEYBOARD PS2 104KEY CHICONY KB-07593GR2552V GREEK BLACK	KB PS2 KB-0759 GREEK BLACK 104	KB.PS203.123
	1	KEYBOARD PS2 105KEY CHICONY KB-07596DK2552V DANISH BLACK	KB PS2 KB-0759 DANISH BLACK105	KB.PS203.124
	1	KEYBOARD PS2 104KEY CHICONY KB-07593C02552V CZECH BLACK	KB PS2 KB-0759 CZECH BLACK 104	KB.PS203.125

Component	QTY	Part Name	Description	Acer Part Number
Keyboard	1	KEYBOARD PS2 105KEY CHICONY KB-07596R02552V ROMANIAN BLACK	KB PS2 KB-0759 ROMANIAN BLACK	KB.PS203.126
	1	KEYBOARD PS2 105KEY CHICONY KB-07596TF2552V TURKISH BLACK	KB PS2 KB-0759 TURKISH BLACK 1	KB.PS203.127
	1	KEYBOARD PS2 105KEY CHICONY KB-07596LA2552V SPANISH LATIN	KB PS2 KB-0759 SPANISH LATIN	KB.PS203.128
	1	KEYBOARD PS2 105KEY CHICONY KB-07596TQ2552V TURKISH-Q BLACK	KB PS2 KB-0759 TURKISH-Q BLACK	KB.PS203.129
	1	KEYBOARD PS2 105KEY CHICONY KB-07596AF2552V ARABIC/FRENCH	KB PS2 KB-0759 ARABIC/FRENCH B	KB.PS203.130
	1	KEYBOARD USB 104KEY CHICONY KU-07603US2552V STANDARD WITH EKEY BLACK	KEYBOARD CHICONY KU-0760 USB S	KB.USB03.062
	1	KEYBOARD USB 104KEY CHICONY KU-07603RD2552V T-CN BLACK	KB USB KU-0760 T-CN BLACK 104K	KB.USB03.063
	1	KEYBOARD USB 104KEY CHICONY KU-07603RE2552V S-CN BLACK	KB USB KU-0760 S-CN BLACK 104K	KB.USB03.064
	1	KEYBOARD USB 104KEY CHICONY KU-07603U42552V US INTERNATIONAL BLACK	KB USB KU-0760 US-I BLACK 104K	KB.USB03.065
	1	KEYBOARD USB 104KEY CREATIX KU-07603A02552V ARABIC/ ENGLISH	KB USB KU-0760 ARABIC/ ENGLISH	KB.USB03.066
	1	KEYBOARD USB 104KEY CHICONY KU-07603T02552V THAI BLACK	KB USB KU-0760 THAI BLACK 104K	KB.USB03.067
	1	KEYBOARD USB 105KEY CHICONY KU-07606E02552V SPANISH BLACK	KB USB KU-0760 SPANISH BLACK 1	KB.USB03.068
	1	KEYBOARD USB 105KEY CHICONY KU-07606P02552V PORTUGUESE BLAC	KB USB KU-0760 PORTUGUESE BLAC	KB.USB03.069
	1	KEYBOARD USB 105KEY CHICONY KU-07606CA2552V CANADIAN FRENCH BLACK	KB USB KU-0760 CA-FRENCH BLACK	KB.USB03.070
	1	KEYBOARD USB 107KEY CHICONY KU-07608PA2552V BRAZILIAN PORTU	KB USB KU-0760 BRAZILIAN PORTU	KB.USB03.071
	1	KEYBOARD USB 109KEY CHICONY KU-07600J02552V JAPANESE BLACK	KB USB KU-0760 JAPANESE BLACK	KB.USB03.072
	1	KEYBOARD USB 105KEY CHICONY KU-07606D12552V GERMAN BLACK	KB USB KU-0760 GERMAN BLACK 10	KB.USB03.073
	1	KEYBOARD USB 105KEY CHICONY KU-07606I02552V ITALIAN BLACK	KB USB KU-0760 ITALIAN BLACK 1	KB.USB03.074



Component	QTY	Part Name	Description	Acer Part Number
Keyboard	1	KEYBOARD USB 105KEY CHICONY KU-07606F12552V FRENCH BLACK	KB USB KU-0760 FRENCH BLACK 10	KB.USB03.075
	1	KEYBOARD USB 105KEY CHIOCNY KU-07606S02552V SWEDISH BLACK	KB USB KU-0760 SWEDISH BLACK 1	KB.USB03.076
	1	KEYBOARD USB 105KEY CHICONY KU-07606GB2552V UK BLACK	KB USB KU-0760 UK BLACK 105KS	KB.USB03.077
	1	KEYBOARD USB 105KEY CHICONY KU-07606NL2552V DUTCH BLACK	KB USB KU-0760 DUTCH BLACK 105	KB.USB03.078
	1	KEYBOARD USB 105KEY CHICONY KU-07606CH2552V SWISS/G BLACK	KB USB KU-0760 SWISS/G BLACK 1	KB.USB03.079
	1	KEYBOARD USB 105KEY CHICONY KU-07606B02552V BELGIUM BLACK	KB USB KU-0760 BELGIUM BLACK 1	KB.USB03.080
	1	KEYBOARD USB 105KEY CHICONY KU-07606IC2552V ICELANDIC	KB USB KU-0760 ICELANDIC BLACK	KB.USB03.081
	1	KEYBOARD USB 105KEY CHICONY KU-07606N02552V NORWEGIAN BLACK	KB USB KU-0760 NORWEGIAN BLACK	KB.USB03.082
	1	KEYBOARD USB 104KEY CHIOCNY KU-07603HB2552V HEBREW BLACK	KB USB KU-0760 HEBREW BLACK 10	KB.USB03.083
	1	KEYBOARD USB 105KEY CHICONY KU-07606PL2552V POLISH BLACK	KB USB KU-0760 POLISH BLACK 10	KB.USB03.084
	1	KEYBOARD USB 105KEY CHICONY KU-07606YU2552V SLOVENIAN BLACK	KB USB KU-0760 SLOVENIAN BLACK	KB.USB03.085
	1	KEYBOARD USB 105KEY CHICONY KU-07606CL2552V SLOVAK BLACK	KB USB KU-0760 SLOVAK BLACK 10	KB.USB03.086
	1	KEYBOARD USB 104KEY CHICONY KU-07603S32552V RUSSIAN BLACK	KB USB KU-0760 RUSSIAN BLACK 1	KB.USB03.087
	1	KEYBOARD USB 105KEY CHIOCNY KU-07606HU2552V HUNGARIANBLACK	KB USB KU-0760 HUNGARIANBLACK	KB.USB03.088
	1	KEYBOARD USB 104KEY CHICONY KU-07603GR2552V GREEK BLACK	KB USB KU-0760 GREEK BLACK 104	KB.USB03.089
	1	KEYBOARD USB 105KEY CHICONY KU-07606DK2552V DANISH BLACK	KB USB KU-0760 DANISH BLACK 10	KB.USB03.090
	1	KEYBOARD USB 104KEY CHICONY KU-07603C02552V CZECH BLACK	KB USB KU-0760 CZECH BLACK 104	KB.USB03.091
	1	KEYBOARD USB 105KEY CHICONY KU-07606R02552V ROMANIAN BLACK	KB USB KU-0760 ROMANIAN BLACK	KB.USB03.092

Component	QTY	Part Name	Description	Acer Part Number
Keyboard	1	KEYBOARD USB 105KEY CHICONY KU-07606TF2552V TURKISH BLACK	KB USB KU-0760 TURKISH BLACK 1	KB.USB03.093
	1	KEYBOARD USB 105KEY CHICONY KU-07606LA2552V SPANISH TUALATIN INTEL	KB USB KU-0760 SPANISH LATIN B	KB.USB03.094
	1	KEYBOARD USB 105KEY CHICONY KU-07606TQ2552V TURKISH-Q BLACK	KB USB KU-0760 TURKISH-Q BLACK	KB.USB03.095
<b>Mainboard</b>				
	1	MAINBOARD BOXER nVidia MCP78 W/1394 LF	MB WMCP78PV W/O SPDIF	MB.SAR01.001
<b>Memory</b>				
	1	SDIMM 1GB DDRII 667 UNIFOSA GU341G0AJEPR6C2C4CE	DIMM 1G GU341G0AJEPR6C2C4CE	KN.1GB0H.008
	1	SDIMM 512MB DDRII 667 PROMOS V916764K24QCFW-F5	DIMM 512M V916764K24QCFW-F5	KN.5120M.005
	1	SDIMM 1GB DDRII 667 HYNIX HYMP112U64CP8-Y5	DIMM 1G HYMP112U64CP8-Y5 LF	KN.1GB0G.013
	1	SDIMM 2GB DDRII 667 MICRON MT16HTF25664AY-667E1	DDR2 2GB MT16HTF25664AY-667E1	KN.2GB04.003
	1	SDIMM 512MB DDRII 667 TRANSCEND JM367Q643A-6	UNB. DIMM 512M JM367Q643A-6	KN.5120F.005
<b>Mouse</b>				
	1	LOGITECH 0810_USB OPTICAL MOUSE USB M-UAY-ACR2	MOUSE USB OPT 910-000850 LOGI	MS.11200.014
	1	LOGITECH 0810_PS2 OPTICAL MOUSE PS2 M-SBR-ACR2	MOUSE PS2 OPT 910-000849 LOGI	MS.11200.013
	1	LOGITECH USB OPTICAL MOUSE,MUV-ACR1, LEAD-FREE, W/STK LABEL	MOUSE USB OPT MUV_ACR1 931196-	MS.MUV01.005
<b>Power supply</b>				
	1	POWER SUPPLY 220W NON-PFC 115V/230V LITEON PS-5221-06A1-ROHS	SPS 220W NPFC 115V/230V LITEON	PY.2200B.001
	1	POWER SUPPLY 220W 115VAC/230V NON-PFC DPS-220UB A	SPS 220W 115VAC/230V NPFC DPS-	PY.22009.002
	1	POWER SUPPLY 220W PFC 230V DPS-220UB-1 A	SPS 220W PFC 230V DPS-220UB-	PY.22009.003
	1	POWER SUPPLY 220W PFC 230V LITEON PE-5221-08AP-ROHS	SPS 220W PFC 230V LITEON PE-52	PY.2200B.002
<b>Speaker</b>				
	1	USB SPEAKER DXP 1007011-0G	SPEAKER USB BLACK 1007011-0G	SP.10600.010
<b>Screw</b>				
	16	SCRW I NO6-32 L5 BZN	SCRW I NO6-32 L5 BZN	86.00J07.B60
		SCRW PAN #6-32 L6 NI BOXER WZS	SCRW PAN #6-32 L6 NI BOXER WZS	86.00J44.C60
	1	SCRW PAN M3 L5 BZN	SCRW PAN M3 L5 BZN	86.1A324.5R0
	6	SCREW FLAT #6-32*3/16 NI	SCREW FLAT #6-32*3/16 NI	86.5A5B6.012

# Technical Specifications

This section provides technical specifications for the system.

## Processor

### AMD Athlon Processor

Item	Specification			
Type	AMD Athlon			
Model number	LE-1600	LE-1620	LE-1640	1660
Frequency (MHz)	2200	2400	2600	2800
L2 cache size (KB)	1024	1024	1024	—
HyperTransport (MHz)	2000	2000	2000	—
Socket type	AM2	AM2	AM2	AM2
Stepping	F3	F3	G2	—
Manufacturing tech (CMOS)	90 nm SOI	90 nm SOI	90 nm SOI	—
Wattage (W)	45	45	45	—
System bus (MHz)	2000	2000	—	—

### AMD Athlon X2 Dual-Core Processor

Item	Specification		
Type	AMD Athlon X2 Dual-Core		
Model number	BE-2300	BE-2350	BE-2400
Frequency (MHz)	1900	2100	2300
L2 cache size (KB)	512	512	512
HyperTransport (MHz)	1000	1000	1000
Socket type	AM2	AM2	AM2
Stepping	G1	G1	G2
Manufacturing tech (CMOS)	65 nm SOI	65 nm SOI	65 nm SOI
Wattage (W)	45	45	45
System bus (MHz)	2000	2000	2000

### AMD Athlon X2 Dual-Core Processor

Item	Specification							
Type	AMD Athlon X2 Dual-Core							
Model number	4850e	4200+	4400+	4600+	4800+	5000+	5200+	5600+
Frequency (MHz)	2100	2200	2300	2400	2500	2600	2700	2800
L2 cache size (KB)	512	512	512	512	512	512	512	1024
HyperTransport (MHz)	—	2000	2000	1000	2000	2000	2000	2000
Socket type	AM2	AM2	AM2	AM2	AM2	AM2	AM2	AM2
Stepping	G2	—	—	G2	G2	—	G2	F3
Manufacturing tech (CMOS)	65 nm SOI	65 nm SOI	65 nm SOI	65 nm SOI	65 nm SOI	65 nm SOI	65 nm SOI	90 nm SOI
Wattage (W)	45	65	65	65	65	65	65	89
System bus (MHz)	2000	2000	2000	2000	2000	2000	2000	2000

### AMD Phenom X3 Triple-Core Processor

Item	Specification					
Type	AMD Phenom X3 Triple-Core					
Model number	8400	8450	8600	8650	8700	8750
Frequency (MHz)	2100	2100	2300	2300	—	2400
L2 cache size (KB)	512	512	512	512	—	512
HyperTransport (MHz)	1800	1800	1800	1800	—	1800
Socket type	AM2+	AM2+	AM2+	AM2	AM2	AM2
Stepping	B2	B3	B2	G2	—	B3
Manufacturing tech (CMOS)	65 nm	65 nm	65 nm	65 nm SOI	—	65 nm
Wattage (W)	95	95	95	95	—	95
System bus (MHz)	3600	3600	3600	3600	—	3600

### AMD Phenom X4 Quad-Core Processor

Item	Specification						
Type	AMD Phenom X4 Quad-Core						
Model number	9100e	9150e	9500	9550	9600	9650	9750
Frequency (MHz)	1800	—	2200	2200	2300	2300	2400
L2 cache size (KB)	512	—	512	512	512	512	512
HyperTransport (MHz)	1600	—	1800	1800	1800	1800	1800
Socket type	AM2+	AM2+	AM2+	AM2+	AM2+	AM2+	AM2+
Stepping	B2	—	B2	B3	B3	B3	B3
Manufacturing tech (CMOS)	65 nm	—	65 nm	65 nm SOI	65 nm SOI	65 nm	65 nm
Wattage (W)	65	—	95	95	95	95	95
System bus (MHz)	3200	—	3600	3600	3600	3600	3600

## AMD Sempron Processor

Item	Specification	
Type	AMD Sempron	
Model number	LE-1250	LE-1300
Frequency (MHz)	2200	2300
L2 cache size (KB)	512	512
HyperTransport (MHz)	800	800
Socket type	AM2	AM2
Stepping	G2	G2
Manufacturing tech (CMOS)	65 nm SOI	65 nm SOI
Wattage (W)	45	45
System bus (MHz)	1600	—

## System Board Major Chips

Item	Specification
System core logic	NVIDIA NForce MCP78 692 BGA
Storage controller	NVIDIA NForce MCP78 692 BGA
Video controller	NVIDIA NForce MCP78 692 BGA
PCI controller	NVIDIA NForce MCP78 692 BGA
LAN controller	NVIDIA NForce MCP78 692 BGA + Marvell 88E1116

## System Memory

Item	Specification				
Memory type	DDR2-667/800 registered DIMM				
Organization	ECC				
Pin count	240				
DIMM sockets	2				
DIMM size	512 MB, 1 GB, or 2 GB				
Minimum memory	512 MB				
Maximum memory	2 GB				
Vendor	Unifosa	Promos	Hynix	Micron	Transcend
Model name	GU341G0AJE PR6C2C4CE	V916764K24Q CFW-F5	HYMP112U64 CP8-Y5	MT16HTF256 64AY-667E1	JM367Q643A -6
Type	DDR2	DDR2	DDR2	DDR2	DDR2
DIMM size		512 MB	2 GB	2 GB	512 MB
DIMM speed (MHz)	667	667	667	667	667
	—	PC2-5300	PC-5400	—	—
ECC or non-ECC	—	Non-ECC	Non-ECC	Non-ECC	ECC
Pin	240				

---

## System BIOS

Item	Specification
BIOS vendor	Pheonix
BIOS version	DA78LD02
SMBIOS version	2.4

## PCI Interface

Item	Specification
PCI Express controller	NVIDIA NForce MCP78 692 BGA
Number of slots	<ul style="list-style-type: none"><li>• One PCI Express x16 bus slots</li><li>• One PCI Express x 1 slot</li></ul>

## Network Interface

Item	Specification
LAN controller	NVIDIA NForce MCP78 692 BGA + Marvell 88E1116
Supports LAN protocol	10/100/1000 Mbps
LAN connector type	RJ45

## SATA Interface

Item	Specification
SAS controller	Embedded SATA controller
Connectors	<ul style="list-style-type: none"><li>• Two SATA ports</li><li>• One eSATA port</li></ul>

## Keyboard and Input Devices

Item	Specification
Controller	NVIDIA NForce MCP78 692 BGA + SIO ITE8718F

## Optical Drive

### BD-R

Item	Specification	
Vendor	HLDS	
Model name	GGW-H20N	GGC-H20N
Drive type	BD-R	BD-R

**BD-R**

Item	Specification	
Write Speed	BD-R(SL) 2x, 4x CLV BD-R(DL)/BD-RE(SL/DL) 2x CLV DVD-R 2x, 4x CLV, 8x ZCLV DVD-R(DL) 2x, 4x CLV DVD-RW 2x, 4x CLV, 6x ZCLV DVD+R 2.4x, 4x CLV, 8x ZCLV DVD+R( DL) 2.4x , 4x CLV DVD+RW 2.4x, 4x, 6x CLV, 8x ZCLV CD-R 10x CLV, 16x CLV CD-RW 4x, 10x, 16x CLV	DVD-RAM 5x PCAV DVD+R( DL) 4x CLV DVD+RW 8x ZCLV DVD+R 16x PCAV DVD-R( DL) 4x CLV DVD-RW 6x CLV DVD-R 16x PCAV CD-RW 24x ZCLV CD-R 40x PCAV
Read Speed	BD-ROM(SL) 4x max. CAV BD-ROM(DL) 3.2x max. CAV BD-R(SL) 4x max. CAV BD-R(DL)/BD-RE(SL/DL) 3.2x max. CAV HD DVD-ROM(SL) 3x max. CAV HD DVD-ROM(DL) 2.4x max. CAV DVD-R/RW/ROM(SL/DL) 10x / 8x / 12x / 8x max. CAV DVD-R DL 6x max. CAV DVD-Video(CSS Compliant Disc) 6x max. (Single/Dual layer) CAV DVD+R/+RW 10x / 8x max. CAV DVD+R DL 6x max. CAV CD-R/RW/ROM 32x / 24x / 32x max. CAV CD-DA (DAE) 24x max. CAV	HD DVD 3x BD 6x DVD 16x CD 40x
Data Transfer Rate	BD-ROM 143.86 Mbits/s (4x) max HD DVD-ROM 109.65 Mbits/s (3x) max DVD-ROM 16.62 Mbytes/s (12x) max CD-ROM 4,800 Kbytes/s (32x) max	—
Access Time	BD-ROM 370 ms typ HD DVD-ROM 340 ms typ DVD-ROM 270 ms typ CD-ROM 250 ms typ	—
Buffer Size	4 MB	4 MB
Interface Type	Serial ATA	Serial ATA

**Super Multi**

Item	Specification		
Vendor	HLDS	Philips	Sony
Model name	GH-15N	DH-16A3S	AD-7170S
Drive type	Super Multi	Super Multi	Super Multi
Write Speed	—	—	DVD-R: 18x max. DVD +R: 18x max. DVD-RW: 6x max. DVD +RW: 8x max. DVD-R DL: 8x max. DVD +R9: 8x max. DVD-RAM: 12x max. CD-R: 48x max. CD-RW: 32x max.

## Super Multi

Item	Specification		
Read Speed	—	—	DVD: 16x max. CD: 48x max.
Data Transfer Rate	—	—	—
Access Time	—	—	DVD: 160 ms CD: 140 ms
Buffer Size	4 MB	4 MB	—
Interface Type	Serial ATA	Serial ATA	Serial ATA

## DVD-ROM

Item	Specification	
Vendor	HLDS	PLDS
Model name	GDR-H20N	DH-16D2S
Drive type	DVD-ROM	DVD-ROM
Write Speed	—	—
Read Speed	CD-ROM Max 52x DVD-ROM Max 16x	CD-RAM 5x CD Max 48x DVD Max 16x
Data Transfer Rate	CD Max 7.8 Mbytes DVD Max 22.1 Mbytes	—
Access Time	(Random) CD 90 ms (Random) DVD 100 ms (Full) CD 140 ms (Full) DVD 160 ms	CD 12 ms DVD 140 ms DVD-RAM 150 ms
Buffer Size	198KB with buffer under run prevention technology	198 KB
Interface Type	Serial ATA	Serial ATA