

Ferrari 1200 Series Service Guide

Service guide files and updates are available on the ACER/CSD web; for more information, please refer to <http://csd.acer.com.tw>

PRINTED IN TAIWAN

Revision History

Please refer to the table below for the updates made on Ferrari 1200 Series service guide.

Date	Chapter	Updates

Copyright

Copyright © 2008 by Acer Incorporated. All rights reserved. No part of this publication may be reproduced, transmitted, transcribed, stored in a retrieval system, or translated into any language or computer language, in any form or by any means, electronic, mechanical, magnetic, optical, chemical, manual or otherwise, without the prior written permission of Acer Incorporated.

Disclaimer

The information in this guide is subject to change without notice.

Acer Incorporated makes no representations or warranties, either expressed or implied, with respect to the contents hereof and specifically disclaims any warranties of merchantability or fitness for any particular purpose. Any Acer Incorporated software described in this manual is sold or licensed "as is". Should the programs prove defective following their purchase, the buyer (and not Acer Incorporated, its distributor, or its dealer) assumes the entire cost of all necessary servicing, repair, and any incidental or consequential damages resulting from any defect in the software.

Acer is a registered trademark of Acer Corporation.

Intel is a registered trademark of Intel Corporation.

Pentium and Pentium II/III are trademarks of Intel Corporation.

Other brand and product names are trademarks and/or registered trademarks of their respective holders.

Conventions

The following conventions are used in this manual:

SCREEN MESSAGES	Denotes actual messages that appear on screen.
NOTE	Gives bits and pieces of additional information related to the current topic.
WARNING	Alerts you to any damage that might result from doing or not doing specific actions.
CAUTION	Gives precautionary measures to avoid possible hardware or software problems.
IMPORTANT	Reminds you to do specific actions relevant to the accomplishment of procedures.

Preface

Before using this information and the product it supports, please read the following general information.

1. This Service Guide provides you with all technical information relating to the BASIC CONFIGURATION decided for Acer's "global" product offering. To better fit local market requirements and enhance product competitiveness, your regional office MAY have decided to extend the functionality of a machine (e.g. add-on card, modem, or extra memory capability). These LOCALIZED FEATURES will NOT be covered in this generic service guide. In such cases, please contact your regional offices or the responsible personnel/channel to provide you with further technical details.
2. Please note WHEN ORDERING FRU PARTS, that you should check the most up-to-date information available on your regional web or channel. If, for whatever reason, a part number change is made, it will not be noted in the printed Service Guide. For ACER-AUTHORIZED SERVICE PROVIDERS, your Acer office may have a DIFFERENT part number code to those given in the FRU list of this printed Service Guide. You MUST use the list provided by your regional Acer office to order FRU parts for repair and service of customer machines.

Table of Contents

Chapter one	System Specifications	1
Features	1	
System Block Diagram	3	
Your Acer Notebook tour	4	
Right View	7	
Indicators	13	
Easy-Launch Buttons	13	
Touchpad Basics	14	
Using the Keyboard	16	
Lock Keys and embedded numeric keypad	16	
Windows Keys	17	
Hot Keys	18	
Special Key	19	
Acer Empowering Technology	20	
Empowering Technology password	20	
Acer eNet Management	20	
Acer ePower Management	22	
Acer eAudio Management	24	
Acer ePresentation Management	24	
Acer eDataSecurity Management (for selected models)	25	
Acer eLock Management	27	
Acer eRecovery Management	27	
Acer eSettings Management	28	
Windows Mobility Center	29	
Using the System Utilities	31	
Acer GridVista (dual-display compatible)	31	
Launch Manager	32	
Norton Internet Security	32	
Hardware Specifications and Configurations	34	
Chapter two	System Utilities	43
BIOS Setup Utility	43	
Navigating the BIOS Utility	44	
Information	45	
Main	46	
Advanced	48	
Security	49	
Boot	53	
Exit	54	
BIOS Flash Utility	55	
Remove HDD/BIOS Utility	56	
Disassembly Requirements	61	
Chapter three	Machine Disassembly and Replacement	61
General Information	62	
Pre-disassembly Instructions	62	
Disassembly Process	62	
External Module Disassembly Process	63	
External Modules Disassembly Flowchart	63	
Removing the Battery Pack	64	
Removing the SD dummy card	64	
Removing the ExpressCard dummy card	65	

Table of Contents

Removing the Lower Cover	65
Removing the DIMM	66
Removing the WLAN Board Modules	67
Removing the Hard Disk Drive Module	68
Main Unit Disassembly Process	70
Main Unit Disassembly Flowchart	70
Removing the Keyboard	71
Removing the Middle Cover	72
Removing the LCD Module	74
Separating the Upper Case from the Lower Case	78
Removing the Button Board	80
Removing the Fingerprint Board Module	84
Removing the Touch Pad Board Module	86
Removing the Optical Drive Module	87
Removing the Main Board	89
Removing the CPU and VGA Heatsink Module	92
Removing the CPU	93
Removing the Modem Board	94
Removing the Speaker Modules	95
Removing the Card Reader Board	97
LCD Module Disassembly Process	99
LCD Module Disassembly Flowchart	99
Removing the LCD Bezel	100
Removing the LCD module with the Brackets	102
Removing the FPC Cable	103
Removing the LCD Brackets	105
Removing the Antennas	106
Removing the Web Camera	108
Chapter four Troubleshooting	109
System Check Procedures	110
External Diskette Drive Check	110
External CD-ROM Drive Check	110
Keyboard or Auxiliary Input Device Check	110
Memory check	111
Power System Check	111
Touchpad Check	113
Power-On Self-Test (POST) Error Message	114
Index of Error Messages	115
Phoenix BIOS Beep Codes	119
Index of Symptom-to-FRU Error Message	124
Intermittent Problems	128
Undetermined Problems	129
Chapter five Jumper and Connector Locations	131
Top and Bottom View	131
Clearing Password Check and BIOS Recovery	132
Clearing Password Check	132
BIOS Recovery by Crisis Disk	134
Chapter six FRU (Field Replaceable Unit) List	135
Ferrari 1200 Exploded Diagram	136
Ferrari 1200 Series	148

Table of Contents

Appendix A	Model Definition and Configuration	148
Appendix B	Test Compatible Components	149
	Microsoft® Windows® Vista Environment Test	150
Appendix C	Online Support Information	153
Index		155

System Specifications

Features

Below is a brief summary of the computer's many feature:

Platform

AMD Better By Design program, featuring:

- AMD Turion™ X2 Ultra dual-core mobile processor
- AMD Turion™ X2 dual-core mobile processor
- AMD Athlon™ X2 dual-core mobile processor
- AMD M780G Chipset
- Acer InviLink™ Nplify™ 802.11b/g/Draft-N, or
- Acer InviLink™ 802.11b/g
- Core logic: AMD RS780M+SB700

System Memory

- Dual-Channel SDRAM support
- Up to 2 GB of DDR2 667 MHz memory, upgradeable to 4 GB using two soDIMM modules

Display and graphics

- 12.1" WXGA (200-nit) Acer CrystalBrite™ TFT LCD with white LED backlight, 1280 x 800 pixel resolution, supporting simultaneous multi-window viewing via Acer GridVista™
- ATI Radeon™ X1250 integrated 3D graphics with up to 960 MB of HyperMemory™ (64 MB of dedicated GDDR2 VRAM, up to 896 MB of shared system memory), supporting Microsoft® DirectX® 9
- Dual independent display support
- 16.7 million colors
- MPEG-2/DVD acceleration
- WMV9 (VC-1) and H.264 (AVC) acceleration
- S-video/TV-out (NTSC/PAL) support

Storage subsystem

- 120/160/250 GB or larger hard disk drive with enhanced Acer DASP (Disk Anti-Shock Protection)
- DVD-Super Multi double-layer (slim type slot-in 9.5 mm) drive
- 5-in-1 card reader, supporting Secure Digital™ (SD), MultiMediaCard (MMC), Memory Stick® (MS), Memory Stick PRO™ (MS PRO), xD-Picture Card™ (xD)

Input devices

- 84-/85-key keyboard with inverted "T" cursor layout, 2.5 mm (minimum) key travel
- Touchpad pointing device
- Bluetooth® optical mouse
- Acer Bio-Protection fingerprint reader, featuring Acer FingerNav 4-way control function
- 12 function keys, four cursor keys, two Windows® keys, hotkey controls, embedded numeric keypad,

-
- international language support
 - Empowering Key
 - Easy-launch buttons featuring capacitive technology: email, Internet, programmable, Ferrari World
 - Front-access switches: WLAN, Bluetooth®

Audio

- Dolby®-certified surround sound system with two built-in stereo speakers
- High-definition audio support
- S/PDIF (Sony/Philips Digital Interface) support for digital speakers
- MS-Sound compatible
- Acer PureZone technology with two built-in stereo microphones featuring beam forming, echo cancellation, and noise suppression technologies

Communication

- Acer Video Conference, featuring Acer Crystal Eye webcam
 - Optional Acer Xpress VoIP phone
- WLAN:
 - Acer InviLink™ Nplify™ 802.11/b/g/Draft-N
 - Acer InviLink™ 802.11b/g
- WPAN: Bluetooth® 2.0+EDR (Enhanced Data Rate)
- LAN: Gigabit Ethernet, Wake-on-LAN ready
- Modem: 56K ITU V.92 with PTT approval, Wake-on-Ring ready

I/O Ports

- Acer EasyPort IV connector
- ExpressCard™/54 slot
- Acer Bio-Protection fingerprint reader
- 5-in-1 card reader (SD™, MMC, MS, MS PRO, xD)
- Three USB 2.0 ports
- IEEE 1394 port
- Fast infrared (FIR) port
- External display (VGA) port
- Headphone/speaker/line-out jack with S/PDIF support
- Microphone-in jack
- Line-in jack
- Ethernet (RJ-45) port
- Modem (RJ-11) port
- DC-in jack for AC adapter

Environment

- Temperature:
 - Operating: 5 °C to 35 °C
 - Non-operating: -20 °C to 65 °C
- Humidity (non-condensing):
 - Operating: 20% to 80%
 - Non-operating: 20% to 80%

System Block Diagram

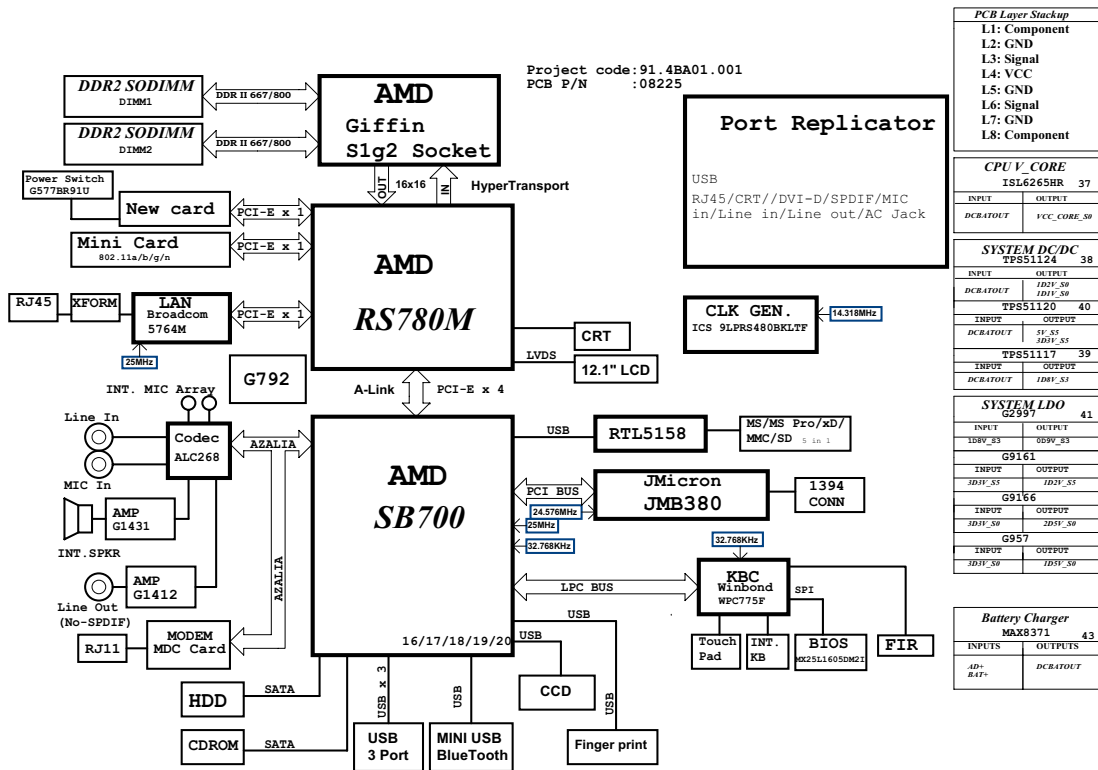

Your Acer Notebook tour

After knowing your computer features, let us show you around your new Ferrari computer.

Front View



	Icon	Item	Description
1		Acer Crystal Eye webcam	Web camera for video communication.
2		Display screen	Also called Liquid-Crystal Display (LCD), displays computer output.
3		Empowering key	Launch Acer Empowering Technology
4		Power button	Turns the computer on and off.
5		Keyboard	For entering data into your computer.
6		Palmrest	Comfortable support area for your hands when you use the computer.
7		Touchpad	Touch-sensitive pointing device which functions like a computer mouse.

	Icon	Item	Description
8		Speakers	Left and right speakers deliver stereo audio output.
9/13		Status indicators	Light-Emitting Diodes (LEDs) that light up to show the status of the computer's functions and components.
10		Click buttons (left and right)	The left and right buttons function like the left and right mouse buttons.
11		Acer Bio-Protection fingerprint reader	Acer Bio-Protection fingerprint reader supporting Acer FingerNav 4-way control function.
12		Easy-launch button	Buttons for launching frequently used program.
14		Microphone	Internal microphone for sound recording.

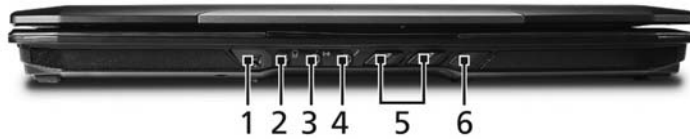

Closed Front View



	Icon	Item	Description
1		4-pin IEEE 1394 port	Connects to IEEE 1394 devices.
2		Headphones/speaker/line-out jack with S/PDIF support	Connects to audio line-out devices (e.g., speakers, headphones).
3		Line-in jack	Accepts audio line-in devices (e.g., audio CD player, stereo walkman).
4		Microphone-in jack	Accepts input from external microphones.
5		Easy-launch buttons	Buttons for launching frequently used programs.
6		Infrared port	Interfaces with infrared devices (e.g., infrared printer and IR-aware computer).

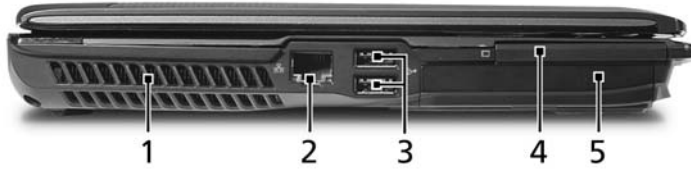

Left View



#	Icon	Item	Description
1		Ventilation slots	Enable the computer to stay cool, even after prolonged use.
2		Ethernet (RJ-45) port	Connects to an Ethernet 10/100-based network.
3		2 USB 2.0 ports	Connect to USB 2.0 devices (e.g., USB mouse, USB camera).
4	ExpressCard / 54	ExpressCard/54 slot	Accepts one ExpressCard/54 module.
5		Hard disk bay	Houses the computer's hard disk (secured with screws)

Right View





#	Icon	Item	Description
1		Slot-load optical drive eject button	Ejects the optical disk from the drive.
2		Optical disk access indicator	Lights up when the optical drive is active.
3		Slot-load optical drive	Internal optical drive; accepts CDs or DVDs.
4		5-in-1 card reader	Accepts Memory Stick (MS), Memory Stick PRO (MS PRO), MultiMediaCard (MMC), Secure Digital (SD) and xD-Picture Card (xD) (manufacturing option). Note: Only one card can operate at any given time.
5		USB 2.0 port	Connect to USB 2.0 devices (e.g., USB mouse, USB camera).
6		DC-in jack	Connects to an AC adapter.

	Icon	Item	Description
7		Modem (RJ-11) port	Connects to a phone line.

Rear View



#	Icon	Item	Description
1		Kensington lock slot	Connects to a Kensington-compatible computer security lock.
2		Acer EasyPort I connector	Connects to Acer EasyPort IV.
3		External display (VGA) port	Connects to a display device (e.g., external monitor, LCD projector).

Base View



#	Icon	Item	Description
1		Battery bay	Houses the computer's battery pack.
2		Battery lock	Locks the battery in position
3		Battery release latch	Releases the battery for removal.
4		Memory compartment	Houses the computer's main memory.
5		Acer Disk Anti-Shock Protection (DASP)	Protects the hard disk drive from shocks and bumps.
6		Ventilation slots and cooling fan	Enable the computer to stay cool, even after prolonged use. Note: Do not cover or obstruct the opening of the fan

Bluetooth optical mouse



#	Icon	Item	Description
1		Left click button	Press the left button to perform selection and execution functions.
2		Scroll wheel	To scroll up or down a page.
3		Right click button	Press the right button to perform selection and execution functions.
4		Status indicator	Indicates the Bluetooth connection/pairing status and the mouse's battery status.
5		Battery release latch	Release the battery for removal.
6		Bluetooth connection/pairing button	Enable/disables the Bluetooth function.
7		Power button	Turns the mouse on and off.

Bluetooth VoIP phone (optional)

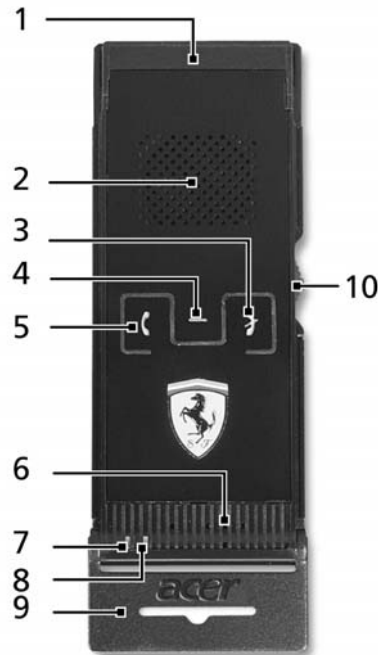







#	Icon	Item	Description
1		ExpressCard interface connector	Connects the computer's ExpressCard interface.
2		Speaker	Speaker delivers audio output.
3		Cancel button	Hang up the call. Hold for at 2 seconds to power on/off.
4		Function button	Hold for least 3 seconds to enable BT pairing. Switch between headset or hands-free after the call is accepted.
5		OK button	Answer an incoming call.
6		Microphone	Internal microphone for sound recording.
7		LED-Amber	Flashing - Power low Blinking - Switched on but not connected to an Acer Laptop.
8		LED-Blue	Flashing - Busy pairing Blinking - Connected to an Acer laptop
9		Flip	Flip out the internal microphone.
10		Volume up/down button	Increases/decreases the sound volume or scroll up/down a page.

Indicators

The computer has several easy-to-read status indicators:



The front panel indicators are visible even when the computer cover is closed.

Icon	Function	Description
	Power	Indicates the computer's power status.
	Battery	Indicates the computer's battery status.
	Bluetooth	Indicates the status of Bluetooth communication.
	Wireless LAN	Indicates the status of wireless LAN communication.
	Caps Lock	Lights up when Caps Lock is activated.
	Num Lock	Lights up when Num Lock is activated.
	HDD	Indicates when the hard disk drive is active.

NOTE: 1. **Charging:** The light shows amber when the battery is charging. 2. **Fully charged:** The light shows green when in AC mode.

Easy-Launch Buttons

There are several conveniently located easy-launch buttons. They are: mail, Web browser, Empowering Key <  >, one user-programmable button and Ferrari World.

Press < *e* > to run the Acer Empowering Technology. The mail and Web browser buttons are pre-set to email and Internet programs, but can be reset by users. To set the Web browser, mail and programmable buttons, run the Acer Launch Manager. Press Ferrari World to browse the Ferrari World website.



Icon	Description
<i>e</i>	Empowering Technology Launch Acer Empowering Technology. (user-programmable)
✉	Email application (user-Programmable)
🌐	Internet browser (user-Programmable)
P	User-programmable
Ferrari	Launches the Ferrari World website (user-programmable)

Touchpad Basics

The following teaches you how to use the touchpad:



- Move your finger across the touchpad (2) to move the cursor.
- Press the left (1) and right buttons located beneath the touchpad to perform selection and execution functions. These two buttons are similar to the left and right buttons on a mouse. Tapping on the touchpad is the same as clicking the left button.

Function	Left Button (1)	Right Button	Main touchpad (2)
Execute	Quickly click twice.		Tap twice (at the same speed as double-clicking a mouse button).

Function	Left Button (1)	Right Button	Main touchpad (2)
Select	Click once.		Tap once.
Drag	Click and hold, then use finger on the touchpad to drag the cursor.		Tap twice (at the same speed as double-clicking a mouse button); rest your finger on the touchpad on the second tap and drag the cursor.
Access context menu		Click once.	

NOTE: When using the touchpad, keep it - and your fingers - dry and clean. The touchpad is sensitive to finger movement; hence, the lighter the touch, the better the response. Tapping too hard will not increase the touchpad's responsiveness.

Using the Keyboard

The keyboard has full-sized keys and an embedded numeric keypad, separate cursor, lock, Windows, function and special keys.

Lock Keys and embedded numeric keypad

The keyboard has three lock keys which you can toggle on and off.





















Lock key	Description
Caps Lock	When Caps Lock is on, all alphabetic characters typed are in uppercase.
Num Lock <Fn> + <F11>	When Num Lock is on, the embedded keypad is in numeric mode. The keys function as a calculator (complete with the arithmetic operators +, -, *, and /). Use this mode when you need to do a lot of numeric data entry. A better solution would be to connect an external keypad.
Scroll Lock <Fn> + <F12>	When Scroll Lock is on, the screen moves one line up or down when you press the up or down arrow keys respectively. Scroll Lock does not work with some applications.

The embedded numeric keypad functions like a desktop numeric keypad. It is indicated by small characters located on the upper right corner of the keycaps. To simplify the keyboard legend, cursor-control key symbols are not printed on the keys.

Desired access	Num Lock on	Num Lock off
Number keys on embedded keypad	Type numbers in a normal manner.	
Cursor-control keys on embedded keypad	Hold <Shift> while using cursor-control keys.	Hold <Fn> while using cursor-control keys.
Main keyboard keys	Hold <Fn> while typing letters on embedded keypad.	Type the letters in a normal manner.

Windows Keys

The keyboard has two keys that perform Windows-specific functions.

Key	Description
 Windows key	<p>Pressed alone, this key has the same effect as clicking on the Windows Start button; it launches the Start menu.</p> <p>It can also be used with other keys to provide a variety of functions:</p> <ul style="list-style-type: none"> <  > : Open or close the Start menu <  > + <D>: Display the desktop <  > + <E>: Open Windows Explore <  > + <F>: Search for a file or folder <  > + <G>: Cycle through Sidebar gadgets <  > + <L>: Lock your computer (if you are connected to a network domain), or switch users (if you're not connected to a network domain) <  > + <M>: Minimizes all windows <  > + <R>: Open the Run dialog box <  > + <T>: Cycle through programs on the taskbar <  > + <U>: Open Ease of Access Center <  > + <X>: Open Windows Mobility Center <  > + <BREAK>: Display the System Properties dialog box <  > + <SHIFT+M>: Restore minimized windows to the desktop <  > + <TAB>: Cycle through programs on the taskbar by using Windows Flip 3-D <  > + <SPACEBAR>: Bring all gadgets to the front and select Windows Sidebar <CTRL> + <  > + <F>: Search for computers (if you are on a network) <CTRL> + <  > + <TAB>: Use the arrow keys to cycle through programs on the taskbar by using Windows Flip 3-D <p>Note: Depending on your edition of Windows Vista, some shortcuts may not function as described.</p>
 Application key	<p>This key has the same effect as clicking the right mouse button; it opens the application's context menu.</p>

Hot Keys

The computer employs hotkeys or key combinations to access most of the computer's controls like screen brightness, volume output and the BIOS utility.

To activate hot keys, press and hold the <Fn> key before pressing the other key in the hotkey combination.

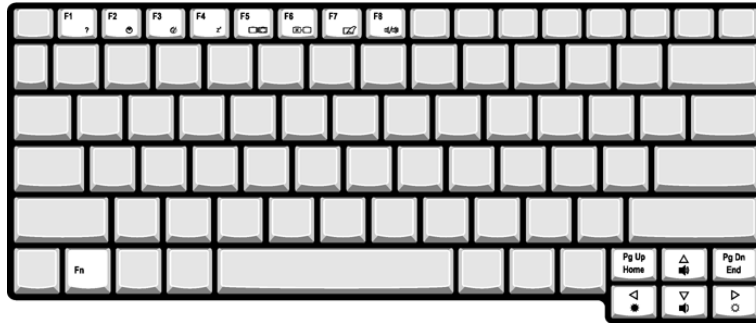

Hotkey	Icon	Function	Description
<Fn> + <F1>	?	Hotkey help	Displays help on hotkeys.
<Fn> + <F2>		Acer eSettings Management	Launches Acer eSettings Management in Acer Empowering Technology.
<Fn> + <F3>		Acer ePower Management	Launches Acer ePower Management in Acer Empowering Technology.
<Fn> + <F4>	Zz	Sleep	Puts the computer in Sleep mode.
<Fn> + <F5>		Display toggle	Switches display output between the display screen, external monitor (if connected) and both.
<Fn> + <F6>		Screen blank	Turns the display screen backlight off to save power. Press any key to return.
<Fn> + <F7>		Touchpad toggle	Turns the internal touchpad on and off.
<Fn> + <F8>		Speaker toggle	Turns the speakers on and off.
<Fn> + <△>		Volume up	Increases the sound volume.
<Fn> + <▽>		Volume down	Decreases the sound volume.
<Fn> + <▷>		Brightness up	Increases the screen brightness.
<Fn> + <◁>		Brightness down	Decreases the screen brightness.

Special Key

You can locate the Euro symbol and the US dollar sign at the upper-center and/or bottom-right of your keyboard.



The Euro symbol

1. Open a text editor or word processor.
2. Hold <Alt Gr> and then press the <5> key at the upper-center of the keyboard.

NOTE: Note: Some fonts and software do not support the Euro symbol. Please refer to www.microsoft.com/typography/faq/faq12.htm for more information.

The US dollar sign

1. Open a text editor or word processor.
2. Hold <Shift> and then press the <4> key at the upper-center of the keyboard.

NOTE: This function varies by the operating system version.

Acer Empowering Technology

The Empowering Technology toolbar makes it easy for you to access frequently used functions and manage your new Acer system. Displayed by default in the upper half of your screen, it provides access to the following utilities:

- **Acer eNet Management** hooks up to location-based networks intelligently.
- **Acer ePower Management** optimizes battery usage via customizable power plans.
- **Acer ePresentation Management** connects to a projector and adjusts display settings.
- **Acer eDataSecurity Management** protects data with passwords and encryption.
- **Acer eLock Management** limits access to external storage media.
- **Acer eRecovery Management** backs up and recovers data flexibly, reliably and completely.
- **Acer eSettings Management** accesses system information and adjusts settings easily.

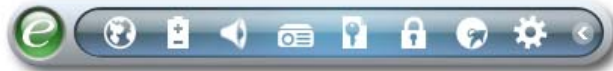

For more information, right click on the Empowering Technology toolbar, then select the **"Help"** or **"Tutorial"** function.

Empowering Technology password

Before using Acer eLock Management and Acer eRecovery Management, you must initialize the Empowering Technology password. Right-click on the Empowering Technology toolbar and select **"Password Setup"** to do so. If you have not initialized the Empowering Technology password and run Acer eLock Management or Acer eRecovery Management, you will be asked to create it.

NOTE: If you lose the Empowering Technology password, there is no way to reset it except by reformatting your system. Make sure to remember or write down your password!

Acer eNet Management

Acer eNet Management helps you quickly connect to both wired and wireless networks in a variety of locations. To access this utility, select **"Acer eNet Management"** from the Empowering Technology toolbar or run the program from the Acer Empowering Technology program group in Start menu. You can also set Acer eNet Management to start automatically when you boot up your PC.

Acer eNet Management automatically detects the best settings for a new location, while offering you the option to manually adjust the settings to match your needs.

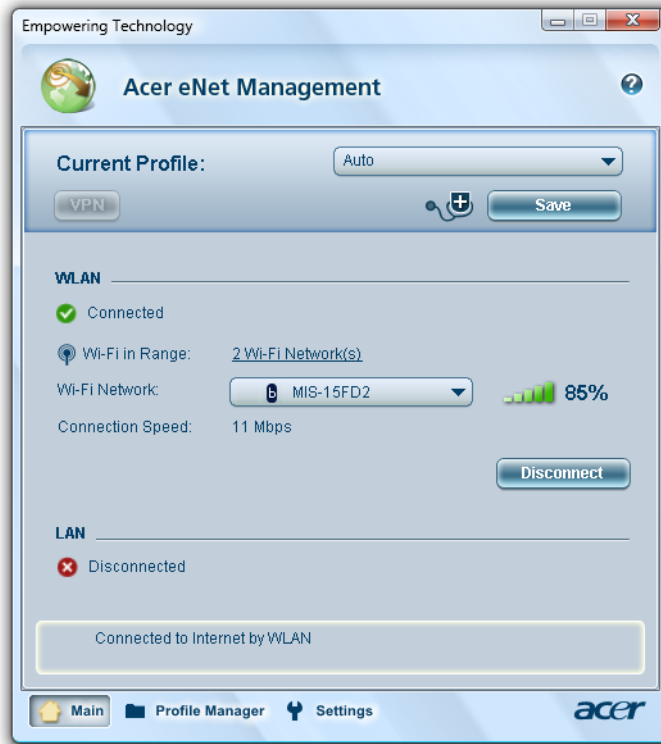

Acer eNet Management can save network settings for a location to a profile, and automatically switch to the appropriate profile when you move from one location to another. Settings stored include network connection settings (IP and DNS settings, wireless AP details, etc.), as well as default printer settings. Security and safety concerns mean that Acer eNet Management does not store username and password information.

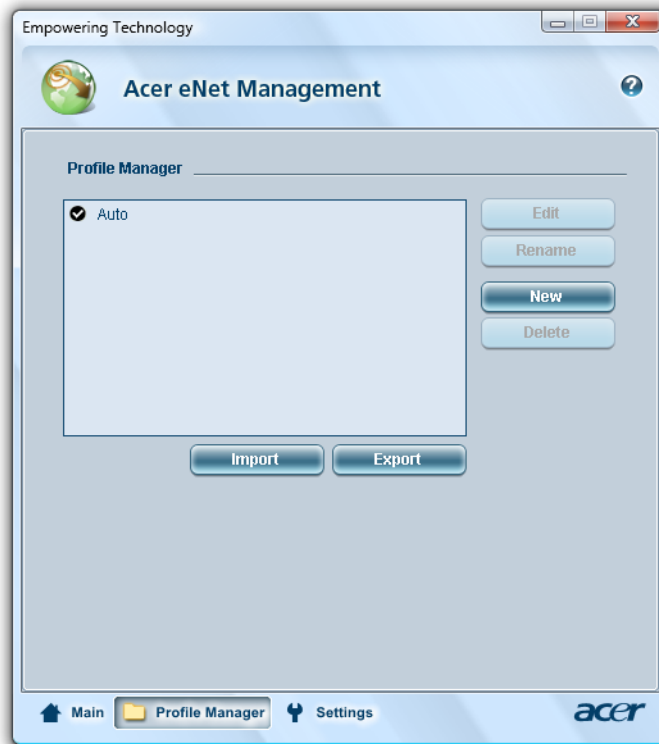

Acer ePower Management

Acer ePower Management features a straightforward user interface for configuring your power management options. To access this utility, select **"Acer ePower Management"** from the Empowering Technology toolbar, run the program from the Acer Empowering Technology program group in Start menu, or right-click the Windows power icon in the system tray and select **"Acer ePower Management"**.

Using power plans

Acer ePower Management comes with three predefined power plans: Balanced, High performance and Power saver. You can also create customized power plans. You can create, switch between, edit, delete and restore power plans, as described below.

View and adjust settings for On Battery and Plugged In modes by clicking the appropriate tabs. You can open Windows power options by clicking **"More Power Options"**.

NOTE: You cannot delete the predefined power plans.

To create a new power plan:

Creating customized power plans allows you to save and quickly switch to a personalized set of power options.

1. Click the Create Power Plan icon. 
2. Enter a name for your new power plan.
3. Choose a predefined power plan to base your customized plan on.
4. If necessary, change the display and sleep settings you want your computer to use.
5. Click **"OK"** to save your new power plan.

To switch between power plans:

1. Select the power plan you wish to switch to from the drop-down list.
2. Click **"Apply"**.

To edit a power plan:

Editing a power plan allows you to adjust system settings like LCD brightness and CPU speed. You can also turn on/off system components to extend battery life.

1. Switch to the power plan you wish to edit
2. Adjust settings as required.
3. Click **"Apply"** to save your new settings.

To delete a power plan:

You cannot delete the power plan you are currently using. If you want to delete the active power plan, switch to another one first.

1. Select the power plan you wish to delete from the drop-down list.
2. Click the Delete Power Plan icon. 

Battery status

For real-time battery life estimates based on current usage, refer to the panel in the upper half of the window. Click the  to view estimated battery life in sleep and hibernate modes.



Acer eAudio Management

Acer eAudio Management allows you to easily control the enhanced sound effects of Dolby® Home Theater™ on your system. Select "**Movie**" or "**Game**" mode to experience the awesome realism of 5.1-channel surround sound from just 2 speakers, via Dolby Virtual Speaker technology. "**Music**" mode lets you enjoy your favorite tunes, in vivid detail.



Acer ePresentation Management

Acer ePresentation Management lets you project your computer's display to an external display device or projector using the hotkey: **<Fn> + <F5>**. If auto-detection hardware is implemented in the system and the external display supports it, your system display will be automatically switched out when an external display is connected to the system. For projectors and external devices that are not auto-detected, launch Acer ePresentation Management to choose an appropriate display setting.



NOTE: If the restored resolution is not correct after disconnecting a projector, or you need to use an external resolution that is not supported by Acer ePresentation Management, adjust your display settings using Display Properties or the utility provided by the graphics vendor.

Acer eDataSecurity Management (for selected models)

Acer eDataSecurity Management is an encryption utility that protects your files from being accessed by unauthorized persons. It is conveniently integrated with Windows Explorer as a shell extension for quick data encryption/decryption and also supports on-the-fly file encryption for Lotus Notes and Microsoft Outlook.

The Acer eDataSecurity Management setup wizard will prompt you for a supervisor password and default encryption password. This password will be used to encrypt files by default, or you can choose to enter your own password when encrypting a file.



NOTE: The password used to encrypt a file is the unique key that the system needs to decrypt it. If you lose the password, the supervisor password is the only other key capable of decrypting the file. If you lose both passwords, there will be no way to decrypt your encrypted file! **Be sure to safeguard all related passwords!**

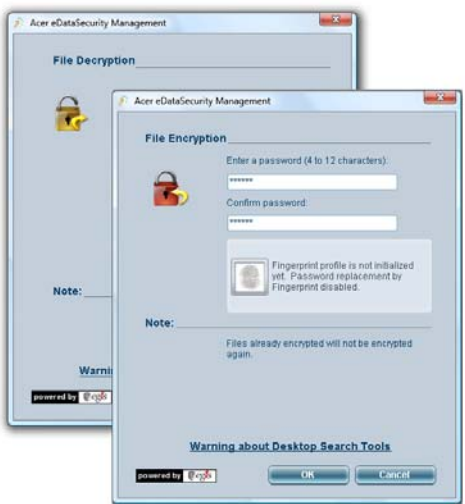

Acer eLock Management

Acer eLock Management is simple yet effective utility that allows you to lock removable storage, optical and floppy drive devices to ensure that data can't be stolen while your system is unattended.

- Removable Storage Devices — includes USB disk drives, USB pen drives, USB flash drives, USB MP3 drives, USB memory card readers, IEEE 1394 disk drives, and any other removable storage devices that can be mounted as a file system when plugged into the system.
- Optical Drive Devices — includes any kind of CD-ROM, DVD-ROM, HD-DVD or Blu-ray drive devices.
- Floppy Drive Devices — 3.5-inch floppy drives only.

To use Acer eLock Management, the Empowering Technology password must be set first. Once set, you can apply locks to any of the devices types. Lock(s) will immediately be set without any reboot necessary, and will remain after rebooting, until removed.

NOTE: If you lose the Empowering Technology password, there is no method to reset it except by reformatting your system. Make sure to remember or write down your password.



Acer eRecovery Management

Acer eRecovery Management is a versatile backup utility. It allows you to create full or incremental backups, burn the factory default image to optical disc, and restore from previously created backups or reinstall applications and drivers. By default, user-created backups are stored to the D:\ drive.

Acer eRecovery Management provides you with:

- Password protection (Empowering Technology password)
- Full and incremental backups to hard disk or optical disc
- Creation of backups:
 - Factory default image

- User backup image
- Current system configuration
- Application backup
- Restore and recovery:
 - Factory default image
 - User backup image
 - From previously-created CD/DVD
 - Reinstall applications/drivers

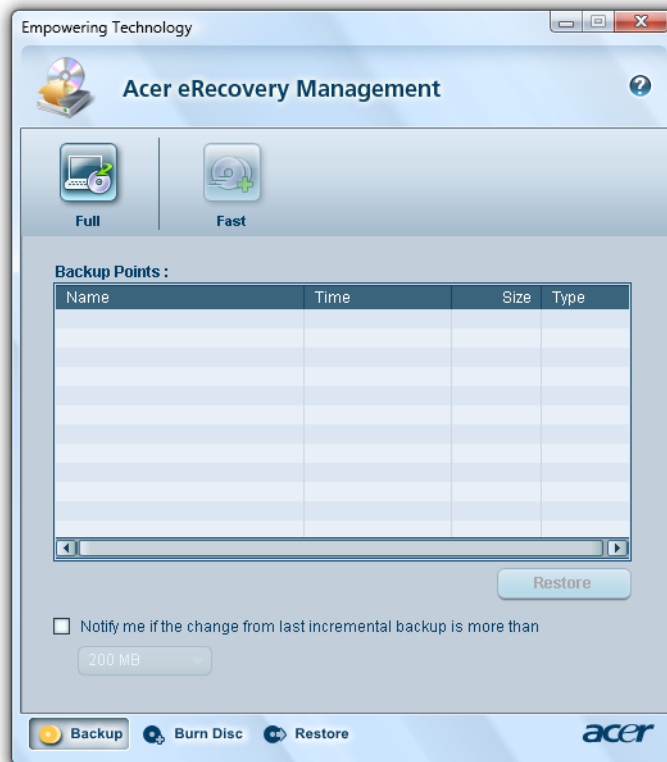

NOTE: If your computer did not come with a Recovery CD or System CD, please use Acer eRecovery Management's "System backup to optical disc" feature to burn a backup image to CD or DVD. To ensure the best results when recovering your system using a CD or Acer eRecovery Management, detach all peripherals (except the external Acer ODD, if your computer has one), including your Acer ezDock.

Acer eSettings Management

Acer eSettings Management allows you to inspect hardware specifications, set BIOS passwords and modify boot options.

Acer eSettings Management also:

- Provides a simple graphical user interface for navigation.
- Prints and saves hardware specifications.

- Lets you set an asset tag for your system.



Windows Mobility Center

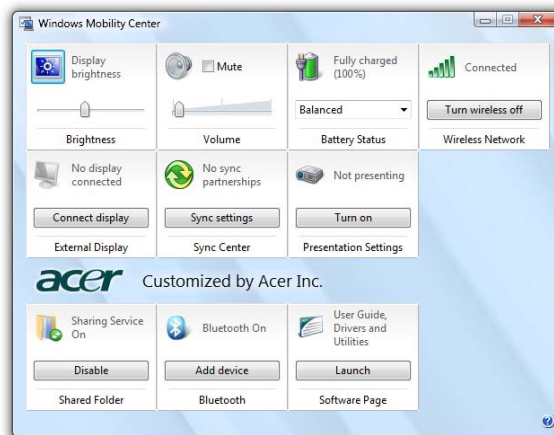

The Windows Mobility Center collects key mobile-related system settings in one easy-to-find place, so you can quickly configure your Acer system to fit the situation as you change locations, networks or activities. Settings include display brightness, power plan, volume, wireless networking on/off, external display settings, display orientation and synchronization status.

Windows Mobility Center also includes Acer-specific settings like Bluetooth Add Device (if applicable), sharing folders overview/sharing service on or off, and a shortcut to the Acer user guide, drivers and utilities.

To launch Windows Mobility Center:

- Use the shortcut key <Windows> + <X>
- Start Windows Mobility Center from the Control panel

-
- Start Windows Mobility Center from the Accessories program group in the Start menu.

Using the System Utilities

Acer GridVista (dual-display compatible)

NOTE: This feature is only available on certain models.

To enable the dual monitor feature of the notebook, first ensure that the second monitor is connected, then select **Start, Control Panel, Display** and click on **Settings**. Select the secondary monitor (**2**) icon in the display box and then click the check box **Extend my windows desktop onto this monitor**. Finally, click **Apply** to confirm the new settings and click **OK** to complete the process.

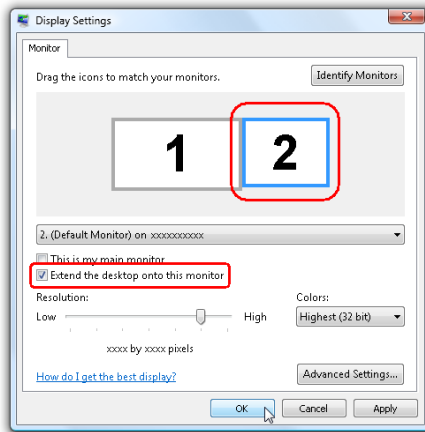

Acer GridVista is a handy utility that offers four pre-defined display settings so you can view multiple windows on the same screen. To access this function, please go to **Start>All Programs** and click on **Acer GridVista**. You may choose any one of the four display settings indicated below:

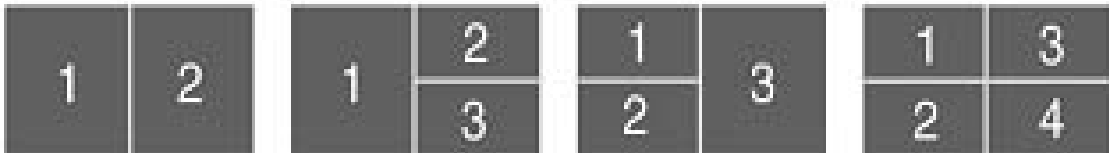

Double (verticle), Triple (primary at left), Triple (primary at right), or Quad Acer Gridvista is dual-display compatible, allowing two displays to be partitioned indepently.

Acer Gridvista is dual-display compatible, allowing two displays to be partitioned independently.

AcerGridVista is imple to set up:

1. Run Acer GridVista and select your preferred screen configuration for each display from the task bar.
2. Drag and drop each window into the appropriate grid.
3. Enjoy the convenience of a well-organized desktop.

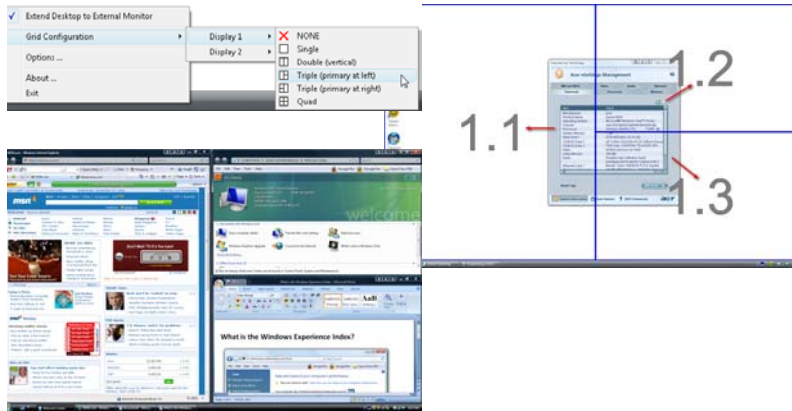

NOTE: Please ensure that the resolution setting of the second monitor is set to the manufacturer's recommended value.

Launch Manager

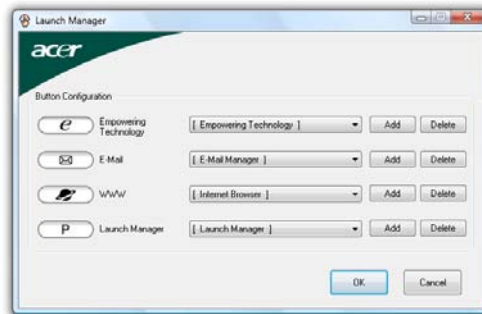

Launch Manager allows you to set the four easy-launch buttons located above the keyboard. You can access the Launch Manager by clicking on Start > All Programs > Launch Manager to start the application.

Norton Internet Security

Norton Internet Security is an anti-virus utility that can protect against viruses, keeping your data safe and secure.

How do I check for viruses?

1. Double-click the **Norton Internet Security** icon on the Windows desktop.
2. Select **Tasks & Scans**.

3. Select **Run Scan** to scan your system.



4. When the scan is complete, review the results of the scan.

NOTE: For optimal security, run a Full System Scan when scanning your computer for the first time.

You can schedule customized virus scans that run unattended on specific dates and times or at periodic intervals. If you are using the computer when the scheduled scan begins, it runs in the background so that you do not have to stop working.

For more information refer to the Norton Internet Security help files.

Hardware Specifications and Configurations

Processor

Item	Specification
CPU type	AMD Turion™ X2 Dual-Core Mobile processor RM-70/RM-72/RM-74/RM-75 (1000KB L2 cache, 2.0/2.1/2.2/2.2 GHz), supporting AMD HyperTransport™ 3.0 technology AMD Turion™ X2 Ultra Dual-Core Mobile Processor ZM-80/ZM-82/ZM-84/ZM-85/ZM-86/ZM-87 (2000KB L2 cache, 2.1/2.2/2.3/2.3/2.4/2.4 GHz), supporting AMD HyperTransport™ 3.0 technology
Core logic	AMD RS780M+SB700
CPU package	Socket S1
Power Consumption	31 to 35W

Processor Specification

Processor#	CPU Speed	Cores	System Bus Speed	Mfg Tech	Cache Size	Package	Acer PN
RM-70	2.0 GHz	2	3600MHz	65nm SOI	1000KB	Socket S1	KC.TRM0 2.70K
RM-72	2.1 GHz	2	3600MHz	65nm SOI	1000KB	Socket S1	KC.TRM0 2.720
RM-74	2.2 GHz	2	3600MHz	65nm SOI	1000KB	Socket S1	KC.TRM0 2.740
RM-75	2.2 GHz	2	3600MHz	65nm SOI	1000KB	Socket S1	KC.TRM0 2.750
ZM-80	2.1 GHz	2	3600MHz	65nm SOI	2000KB	Socket S1	KC.TZM0 2.800
ZM-82	2.2 GHz	2	3600MHz	65nm SOI	2000KB	Socket S1	KC.TZM0 2.820
ZM-84	2.3 GHz	2	3600MHz	65nm SOI	2000KB	Socket S1	KC.TZM0 2.840
ZM-85	2.3 GHz	2	3600MHz	65nm SOI	2000KB	Socket S1	KC.TZM0 2.850
ZM-86	2.4 GHz	2	3600MHz	65nm SOI	2000KB	Socket S1	KC.TZM0 2.860
ZM-87	2.4 GHz	2	3600MHz	65nm SOI	2000KB	Socket S1	KC.TZM0 2.870

CPU Fan True Value Table

DTS(degree C)	Fan Speed (rpm)	Acoustic Level (dBA)
45-50	0-3000	29
55-66	0-3300	33
68-74	3300-3800	38
78-83	3800-4100	40
86-91	4100-4800	40

Throttling 50%: On= 99 ° C; OFF=93 ° C

OS shut down at 105° C; H/W shot down at 110° .C

BIOS

Item	Specification
BIOS vendor	Phoenix
BIOS Version	1.02 (MP version)
BIOS ROM type	SST/AMD 1MB CMOS Boot Block Flash Memory
BIOS ROM size	1M byte FLASH ROM SST
BIOS package	10-lead TSOP (10mmx20mm)
Supported protocols	ACPI 1.0b/2.0/3.0 compliance, PCI 2.2, System/HDD Password Security Control, INT 13H Extensions, PnP BIOS 1.0a SMBIOS 2.4, BIOS Boot Specification, Simple Boot Flag 1.0, Boot Block, PCI Bus Power Management Interface Specification, USB Specification 1.1/2.0, IEEE 1394 1.0, USB/1394 CD-ROM Boot Up support, PC Card Standard 1995 (PCMCIA 3.0 Compliant Device), IrDA 1.0, Intel AC97 CNR Specification, WfM 2.0, PXE 2.1, Boot Integrity Service Application Program Interface (BIS) 1.0, PC99a and Mobile PC2001 Compliant
BIOS password control	Set by setup manual

Item	Specification
Cache controller	Built-in CPU
Cache size	64 + 64 KB/core (See CPU type)

System Memory

Item	Specification
Memory controller	Built-in
Memory size	0MB (no on-board memory)
DIMM socket number	2 sockets
Supports memory size per socket	2048MB
Supports maximum memory size	4G for 64bit OS(with two 2GB SODIMM)
Supports DIMM type	DDR 2 Synchronous DRAM
Supports DIMM Speed	667/800 MHz
Supports DIMM voltage	1.8V and 0.9V
Supports DIMM package	200-pin soDIMM
Memory module combinations	You can install memory modules in any combinations as long as they match the above specifications.

Memory Combinations

Slot 1	Slot 2	Total Memory
0MB	256MB	256MB
0MB	512MB	512MB
0MB	1024MB	1024MB
0MB	2048MB	2048MB
256MB	256MB	512MB
256MB	512MB	768MB
256MB	1024MB	1280MB
256MB	2048MB	2304MB
512MB	256MB	768MB
512MB	512MB	1024MB
512MB	1024MB	1536MB
512MB	2048MB	2560MB
1024MB	0MB	1024MB
1024MB	256MB	1280MB
1024MB	512MB	1536MB
1024MB	1024MB	2048MB
1024MB	2048MB	3072MB
2048MB	0MB	2048MB
2048MB	256MB	2304MB
2048MB	512MB	2560MB
2048MB	1024MB	3072MB
2048MB	2048MB	4096MB

NOTE: Above table lists some system memory configurations. You may combine DIMMs with various capacities to form other combinations. On above table, the configuration of slot 1 and slot 2 could be reversed.

Item	Specification
LAN Chipset	Broadcom 5787M
Supports LAN protocol	10/100/1000 Mbps
LAN connector type	RJ45
LAN connector location	Left side
Features	Integrated 10/100 BASE-T transceiver Wake on LAN support compliant with ACPI 2.0 PCI v2.2

Bluetooth Interface

Item	Specification
Chipset	Foxconn TT60H928.11
Data throughput	723 bps (full speed data rate)
Protocol	Bluetooth 1.1 (Upgradeable to Bluetooth 1.2 when SIG specification is ratified).
Interface	USB 1.1

Bluetooth Interface

Item	Specification
Connector type	USB

Wireless Module 802.11b/g

Item	Specification
Chipset	Acer InviLink™ Nplify™ 802.11a/b/g/Draft-N Wi-Fi CERTIFIED® network connection, supporting Acer SignalUp™ wireless technology, or Acer InviLink™ 802.11b/g Wi-Fi CERTIFIED® network connection, supporting Acer SignalUp™ wireless technology
Data throughput	11~54 Mbps, up to 270 Mbps for Draft-N
Protocol	802.11b+g, Draft-N
Interface	PCI bus (mini PCI socket for wireless module)

Hard Disk Drive Interface

Item				
Vendor & Model Name	SEAGATE ST9120822AS TOSHIBA MK1237GSX HGST HTS541612J9SA00 WD WD1200BEVS	SEAGATE ST9160821AS TOSHIBA MK1637GSX HGST HTS541616J9SA00 WD WD1600BEVS- 22RST0 ML80	WD WD2500BEVS- 22UST0 ML125	WD WD3200BEVT- 22ZCT0 ML160 WD WD5000BEVT- 22ZAT0 ML250
Capacity (MB)	120000	160000	250000	320000/500000
Bytes per sector	512	512	512	512
Data heads	3	3/4	4	
Drive Format				
Disks	2	2	2	
Spindle speed (RPM)	5400 RPM	5400 RPM	5400 RPM	
Performance Specifications				
Buffer size	8MB	8MB	8MB	
Interface	SATA	SATA	SATA	
Max. media transfer rate (disk-buffer, Mbytes/s)	540	540	540	
Data transfer rate (host~buffer, Mbytes/s)	150 MB/Sec. Ultra DMA mode-5	150 MB/Sec. Ultra DMA mode-5	150 MB/Sec. Ultra DMA mode-5	
DC Power Requirements				

Hard Disk Drive Interface

Item				
Voltage tolerance	5V(DC) +/- 5%	5V(DC) +/- 5%	5V(DC) +/- 5%	

Super-Multi Drive module

Item	Specification
Vendor & model name	PANASONIC Super-Multi DRIVE 9.5mm Slot DL 8X UJ-875
Performance Specification	With CD Diskette With DVD Diskette
Transfer rate (KB/sec)	Sustained: Max 3.6Mbytes/sec Sustained: Max 10.08Mbytes/sec
Buffer Memory	2MB
Interface	PATA
Applicable disc format	Applicable disc format CD: CD-DA, CD-ROM, CD-ROM XA, PhotoCD (multi-session), Video CD, Cd-Extra (CD+), CD-text DVD: DVD-VIDEO, DVD-ROM, DVD-R (3.9GB, 4.7GB) DVD-R DL, DVD-RW, DVD-RAM, DVD+R, DVD+R DL, DVD+RW CD-DA (Red Book) - Standard Audio CD & CD-TEXT CD-ROM (Yellow Book Mode1 & 2) - Standard Data CD-ROM XA (Mode2 Form1 & 2) - Photo CD, Multi-Session CD-I (Green Book, Mode2 Form1 & 2, Ready, Bridge) CD-Extra/ CD-Plus (Blue Book) - Audio & Text/Video Video-CD (White Book) - MPEG1 Video CD-R (Orange Book Part) CD-RW & HSRW (Orange Book Part Volume1 & Volume 2 Super Audio CD (SACD) Hybrid type US & US+ RW DVD: DVD-ROM (Book 1.02), DVD-Dual DVD-Video (Book 1.1) DVD-R (Book 1.0, 3.9G) DVD-R (Book 2.0, 4.7G) - General & Authoring DVD+R (Version 1.0) DVD+RW DVD-RW (Non CPRM & CPRM) DVD ^{DR} R Dual
Loading mechanism	Load: Manual Release: (a) Electrical Release (Release Button) (b) Release by ATAPI command (c) Emergency Release
Power Requirement	
Input Voltage	5 V +/- 5 % (Operating)

Audio Interface

Item	Specification
Audio Controller	Realtek ALC883 Azalia and Amplifier Maxim MAX9710 & MAX4411
Audio onboard or optional	Built-in
Mono or Stereo	Stereo
Resolution	18 bit stereo full duplex
Compatibility	HD audio Interface; S/PDIF output for PCM or AC-3 content
Sampling rate	1Hz resolution VSR (Variable Sampling Rate)
Internal microphone	Yes
Internal speaker / Quantity	Yes/2 (1.5W speakers)

Video Memory

Item	Specification
Chipset	UMA
Memory size	8 MB

Item	Specification
Chipset	ICH8M
USB Compliancy Level	2.0
OHCI	USB 1.1 and USB 2.0 Host controller
Number of USB port	4
Location	Two on the left side/one on the right side
Serial port function control	Enable/Disable by BIOS Setup

System Board Major Chips

Item	Controller
Core logic	Mobile Intel® GM965/GL960 + ICH8M Express Chipset
VGA	UMA
LAN	Realtek 8100SBL/CL
USB 2.0	Intel ICH8M
Super I/O controller	N/A
MODEM	ALC 883
Bluetooth	Built-in ATI SB460
Wireless 802.11 b+g	Built-in ATI SB460
PCMCIA/ 5 in 1 Card Reader	ENE CB714/1410
Audio Codec	Realtek ALC883

Keyboard

Item	Specification
Keyboard controller	NS PC97541V
Total number of keypads	84-/85-key
Windows logo key	Yes
Internal & external keyboard work simultaneously	Plug USB keyboard to the USB port directly: Yes

Battery

Item	Specification
Vendor & model name	Panasonic 3S2P
Battery Type	Li-ion
Pack capacity	6Cell 2.9 MAH
Number of battery cell	6
Package configuration	3 cells in series, 2 series in parallel
Normal voltage	11.1V
Charge voltage	19.0 v

LCD 12.1" inch

Item	Specification
Vendor & model name	AUO B121EW09 V0 (Glare)
Screen Diagonal (mm)	12.1 inches
Active Area (mm)	261.12 x 163.2
Display resolution (pixels)	1280 x 800 WXGA
Pixel Pitch	0.204 x 0.204
Pixel Arrangement	R.G.B. Vertical Stripe
Display Mode	Normally White
Typical White Luminance (NIT) also called Brightness	220
Luminance Uniformity	1.25 max
Contrast Ratio	400 typical
Response Time (Optical Rise Time/Fall Time)msec	16 typ/25 max
Nominal Input Voltage VDD	+3.3V
Typical Power Consumption (watt)	4.5W max
Weight (without inverter)	270 max.
Physical Size(mm)	275.82 x 178 x 5.5 max.
Electrical Interface	1 channel LVDS
Support Color	262,144
Viewing Angle (degree) Horizontal: Right/Left Vertical: Upper/Lower	45/45 15/35

LCD 12.1" inch

Item	Specification
Temperature Range(° C) Operating Storage (shipping)	0 to +50 -20 to +60

AC Adaptor

Item	Specification
Input rating	90V AC to 264V AC, 47Hz to 63Hz
Maximum input AC current	1.7A
Inrush current	220A@115VAC 220A@230VAC
Efficiency	82% min. @115VAC input full load

System Power Management

ACPI mode	Power Management
Mech. Off (G3)	All devices in the system are turned off completely.
Soft Off (G2/S5)	OS initiated shutdown. All devices in the system are turned off completely.
Working (G0/S0)	Individual devices such as the CPU and hard disc may be power managed in this state.
Suspend to RAM (S3)	CPU set power down VGA Suspend PCMCIA Suspend Audio Power Down Hard Disk Power Down CD-ROM Power Down Super I/O Low Power mode
Save to Disk (S4)	Also called Hibernation Mode. System saves all system states and data onto the disc prior to power off the whole system.

System Utilities

BIOS Setup Utility

The BIOS Setup Utility is a hardware configuration program built into your computer's BIOS (Basic Input/Output System).

Your computer is already properly configured and optimized, and you do not need to run this utility. However, if you encounter configuration problems, you may need to run Setup. Please also refer to Chapter 4 Troubleshooting when problem arises.

To activate the BIOS Utility, press **F2** during POST (when "Press <F2> to enter Setup" message is prompted on the bottom of screen).

Press **F2** to enter setup. The default parameter of F12 Boot Menu is set to "disabled". If you want to change boot device without entering BIOS Setup Utility, please set the parameter to "enabled".

Press <F12> during POST to enter multi-boot menu. In this menu, user can change boot device without entering BIOS SETUP Utility.

```

Phoenix TrustedCore(tm) Setup Utility
-----
Information  Main  Advanced  Security  Boot  Exit

CPU Type:          AMD Turion(tm) 64 X2 Mobile
CPU Speed:         1.90 GHz
IDE0 Model Name:   XXXXXXXXXXXX-(XX)
IDE0 Serial Number: XXXXXXXX
ATAPI Model Name:  XXXXXXXXXXXX-XXX XX-XXXX-(XX)
System BIOS Version: VX.XX
VGA BIOS Version:  XX-XXX XXXXXX.XXX.XXX.XXX.XXXXXX
KBC Version:       XX.XX
Serial Number:     XXXXXXXXXXXXXXXXXXXXXXXXXX
Asset Tag Number:  None
Product Name:     Ferrari 1200
Manufacturer Name: Acer
UUID:             XXXxXxXX-xXxX-XXxx-xXXx-xXXxXXxXxxXX

F1  Help  ↑↓  Select Item  -/+  Change Values  F9  Setup Defaults
Esc Exit  ←  Select Menu  Enter  Select  ► Sub-Menu  F10 Save and Exit

```

NOTE: System information is subject to different configuration.

Navigating the BIOS Utility

There are six menu options: Information, Main, Advanced, Security, Boot, and Exit.

Follow these instructions:

- To choose a menu, use the left and right arrow keys.
- To choose an item, use the up and down arrow keys.
- To change the value of a parameter, press **F5** or **F6**.
- A plus sign (+) indicates the item has sub-items. Press **Enter** to expand this item.
- Press **Esc** while you are in any of the menu options to go to the Exit menu.
- In any menu, you can load default settings by pressing **F9**. You can also press **F10** to save any changes made and exit the BIOS Setup Utility.

NOTE: You can change the value of a parameter if it is enclosed in square brackets. Navigation keys for a particular menu are shown on the bottom of the screen. Help for parameters are found in the Item Specific Help part of the screen. Read this carefully when making changes to parameter values. **Please note that system information is subject to different models.**

Information

The Information screen displays a summary of your computer hardware information.

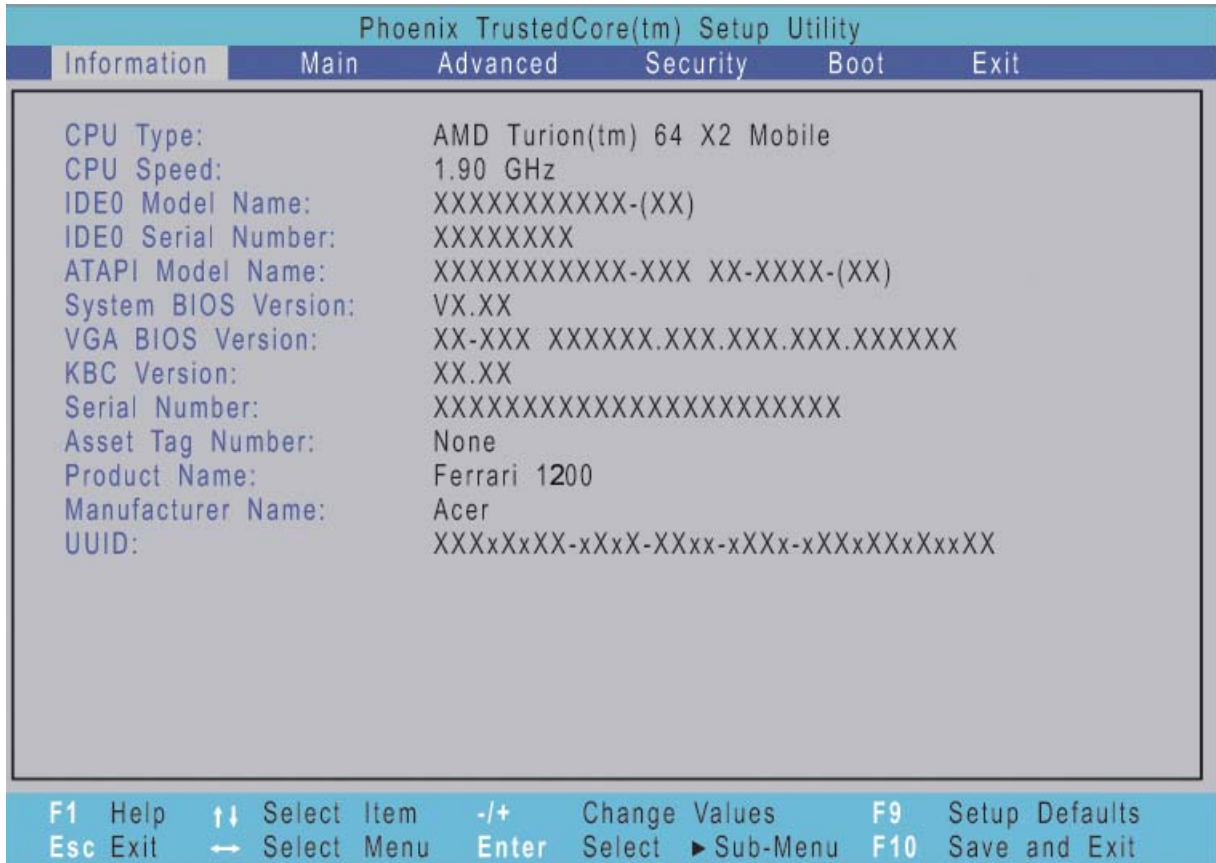

NOTE: The system information is subject to different models.

Parameter	Description
CPU Type	This field shows the CPU type and speed of the system.
CPU Speed	This field shows the speed of the CPU.
IDE0 Model Name	This field shows the model name of HDD installed on primary IDE master.
IDE0 Serial Number	This field displays the serial number of HDD installed on primary IDE master.
ATAPI Model Name	This field shows the model name of the Optical device installed in the system.
System BIOS Version	Displays system BIOS version.
VGA BIOS Version	This field displays the VGA firmware version of the system.
KBC Ver	This field shows the keyboard
Serial Number	This field displays the serial number of this unit.
Asset Tag Number	This field displays the asset tag number of the system.
Product Name	This field shows product name of the system.
Manufacturer Name	This field displays the manufacturer of this system.
UUID Number	Universally Unique Identifier (UUID) is an identifier standard used in software construction, standardized by the Open Software Foundation (OSF) as part of the Distributed Computing Environment (DCE).

Main

The Main screen allows the user to set the system time and date as well as enable and disable boot option and recovery.

Phoenix TrustedCore(tm) Setup Utility						
Information	Main	Advanced	Security	Boot	Exit	
System Time: [10:10:10]				Item Specific Help		
System Date: [11/18/2007]				<Tab>, <Shift-Tab>, or <Enter> selects field.		
System Memory: 640 KB						
Extended Memory: 766 MB						
Video Memory: [256] MB						
Quiet Boot: [Enabled]						
Network Boot: [Enabled]						
F12 Boot Menu: [Disabled]						
D2D Recovery: [Enabled]						
F1 Help ↑↓ Select Item -/+ Change Values F9 Setup Defaults						
Esc Exit ←→ Select Menu Enter Select ► Sub-Menu F10 Save and Exit						

NOTE: The screen above is for your reference only. Actual values may differ.

The table below describes the parameters in this screen. Settings in **boldface** are the default and suggested parameter settings.

Parameter	Description	Format/Option
System Time	Sets the system time. The hours are displayed with 24-hour format.	Format: HH:MM:SS (hour:minute:second) System Time
System Date	Sets the system date.	Format MM/DD/YYYY (month/day/year) System Date
System Memory	This field reports the memory size of the system. Memory size is fixed to 640MB	
Extended Memory	This field reports the memory size of the extended memory in the system. Extended Memory size=Total memory size-1MB	
VGA Memory	Shows the VGA memory size. VGA Memory size=128/256 MB	
Quiet Boot	Determines if Customer Logo will be displayed or not; shows Summary Screen is disabled or enabled. Enabled: Customer Logo is displayed, and Summary Screen is disabled. Disabled: Customer Logo is not displayed, and Summary Screen is enabled.	Option: Enabled or Disabled
Network Boot	Enables, disables the system boot from LAN (remote server).	Option: Enabled or Disabled
F12 Boot Menu	Enables, disables Boot Menu during POST.	Option: Disabled or Enabled
D2D Recovery	Enables, disables D2D Recovery function. The function allows the user to create a hidden partition on hard disc drive to store operation system and restore the system to factory defaults.	Option: Enabled or Disabled

NOTE: The sub-items under each device will not be shown if the device control is set to disable or auto. This is because the user is not allowed to control the settings in these cases.

Advanced

The Advanced screen allows the user to set the serial, infrared and parallel ports.

Phoenix TrustedCore(tm) Setup Utility

Information
Main
Advanced
Security
Boot
Exit

Serial Port: [Enabled] Infrared Port: [Enabled] Parallel Port: [Enabled] Mode: [ECP]	Item Specific Help <hr/> Configure serial port using options: [Disabled] No configuration [Enabled] User configuration
---	---

F1 Help	↑↓ Select Item	-/+ Change Values	F9 Setup Defaults
Esc Exit	←→ Select Menu	Enter Select	F10 Save and Exit

The table below describes the parameters in this screen. Settings in **boldface** are the default and suggested parameter settings.

Parameter	Description	Format/Option
Serial Port	Enable or Disable the serial port	Option: Enabled or Disabled
Infrared Port	Enable or Disable the infrared port	Option: Enabled or Disabled
Parallel Port	Enable or Disable the parallel port	Option: Enabled or Disabled
Mode	Set the mode for the parallel port using option. Options: Bi-directional EPP ECP	

Security

The Security screen contains parameters that help safeguard and protect your computer from unauthorized use.

Phoenix TrustedCore(tm) Setup Utility					
Information	Main	Advanced	Security	Boot	Exit
Supervisor Password is: Clear User Password is: Clear HDD Password is: Clear Set Supervisor Password [Enter] Set User Password [Enter] Set HDD Password [Enter] Password on Boot: [Disabled]				Item Specific Help Supervisor Password controls access of the whole setup utility. It can be used to boot up when Password on boot is enabled.	
F1 Help ↑↓ Select Item -/+ Change Values F9 Setup Defaults Esc Exit ←→ Select Menu Enter Select ▶ Sub-Menu F10 Save and Exit					

NOTE: Please refer to “Remove HDD/BIOS Password” section if you need to know how to remove HDD/BIOS Password.

The table below describes the parameters in this screen. Settings in **boldface** are the default and suggested parameter settings.

Parameter	Description	Option
Supervisor Password Is	Shows the setting of the Supervisor password	Clear or Set
User Password Is	Shows the setting of the user password.	Clear or Set
HDD Password Is	Shows the setting of the hard disk password.	Clear or Set
Set Supervisor Password	Press Enter to set the supervisor password. When set, this password protects the BIOS Setup Utility from unauthorized access. The user can not either enter the Setup menu nor change the value of parameters.	
Set User Password	Press Enter to set the user password. When user password is set, this password protects the BIOS Setup Utility from unauthorized access. The user can enter Setup menu only and does not have right to change the value of parameters.	
Set HDD Password	Enter HDD Password.	
Password on Boot	Defines whether a password is required or not while the events defined in this group happened. The following sub-options are all requires the Supervisor password for changes and should be grayed out if the user password was used to enter setup.	Disabled or Enabled

NOTE: When you are prompted to enter a password, you have three tries before the system halts. Don't forget your password. If you forget your password, you may have to return your notebook computer to your dealer to reset it.

Setting a Password

Follow these steps as you set the user or the supervisor password:

1. Use the **w** and **y** keys to highlight the Set Supervisor Password parameter and press the **e** key. The Set Supervisor Password box appears:

Set Supervisor Password

Enter New Password []

Confirm New Password []

2. Type a password in the "Enter New Password" field. The password length can not exceeds 8 alphanumeric characters (A-Z, a-z, 0-9, not case sensitive). Retype the password in the "Confirm New Password" field.

IMPORTANT: Be very careful when typing your password because the characters do not appear on the screen.

3. Press **e**.
After setting the password, the computer sets the User Password parameter to "Set".
4. If desired, you can opt to enable the Password on boot parameter.
5. When you are done, press **u** to save the changes and exit the BIOS Setup Utility.

Removing a Password

Follow these steps:

1. Use the `w` and `y` keys to highlight the Set Supervisor Password parameter and press the `e` key. The Set Password box appears:

Set Supervisor Password		
Enter current password	[]
Enter New Password	[]
Confirm New Password	[]

2. Type the current password in the Enter Current Password field and press `e`.
3. Press `e` twice **without** typing anything in the Enter New Password and Confirm New Password fields. The computer then sets the Supervisor Password parameter to "Clear".
4. When you have changed the settings, press `u` to save the changes and exit the BIOS Setup Utility.

Changing a Password

1. Use the `w` and `y` keys to highlight the Set Supervisor Password parameter and press the `e` key. The Set Password box appears:

Set Supervisor Password		
Enter current password	[]
Enter New Password	[]
Confirm New Password	[]

2. Type the current password in the Enter Current Password field and press `e`.
3. Type a password in the Enter New Password field. Retype the password in the Confirm New Password field.
4. Press `e`. After setting the password, the computer sets the User Password parameter to "Set".
5. If desired, you can enable the Password on boot parameter.
6. When you are done, press `u` to save the changes and exit the BIOS Setup Utility.

If the verification is OK, the screen will display as following.

Setup Notice
Changes have been saved.
[continue]

The password setting is complete after the user presses `u`.

If the current password entered does not match the actual current password, the screen will show you the Setup Warning.

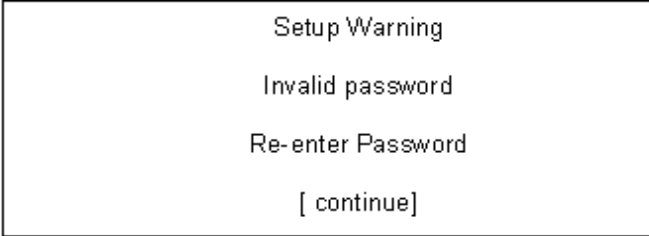

Setup Warning
Invalid password
Re-enter Password
[continue]

A rectangular dialog box with a black border containing four lines of centered text.

If the new password and confirm new password strings do not match, the screen will display the following message.

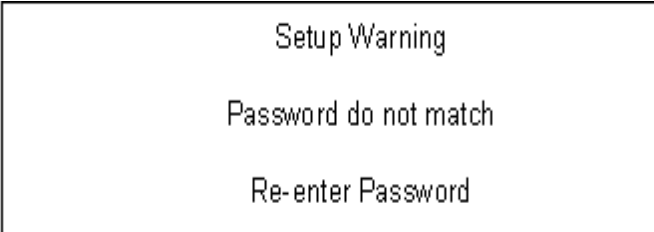

Setup Warning
Password do not match
Re-enter Password

A rectangular dialog box with a black border containing three lines of centered text.

Boot

This menu allows the user to decide the order of boot devices to load the operating system. Bootable devices includes the distette drive in module bay, the onboard hard disk drive and the CD-ROM in module bay.

Phoenix TrustedCore(tm) Setup Utility					
Information	Main	Advanced	Security	Boot	Exit
Boot priority order: 1: IDE0: XXXXXXXXXXXX-(XX) 2: CD/DVD: XXXXXXXXXXXX-XXX XX-XXXX-XX 3: PCI LAN: MBA vXX.X.X Slot XXXX 4: USB HDD: 5: USB FDD: 6: USB Key: 7: USB CD/DVD ROM:				Item Specific Help Use <↑> or <↓> to select a device, then press <F6> to move it up the list, or <F5> to move it down the list. Press <Esc> to escape the menu.	
F1 Help	↑↓ Select Item	-/+ Change Values	F9 Setup Defaults		
Esc Exit	←→ Select Menu	Enter Select	▶ Sub-Menu	F10 Save and Exit	

Exit

The Exit screen contains parameters that help safeguard and protect your computer from unauthorized use.

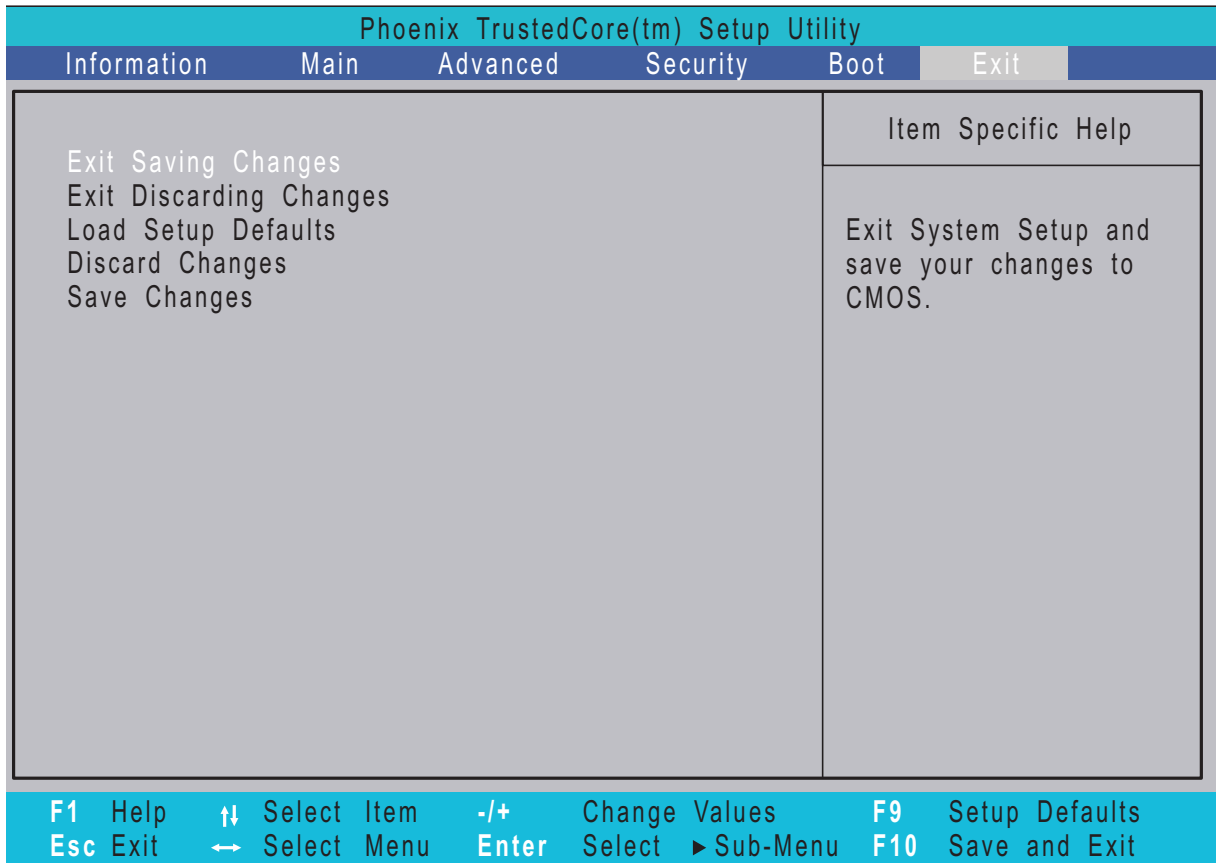

The table below describes the parameters in this screen.

Parameter	Description
Exit Saving Changes	Exit System Setup and save your changes to CMOS.
Exit Discarding Changes	Exit utility without saving setup data to CMOS.
Load Setup Default	Load default values for all SETUP item.
Discard Changes	Load previous values from CMOS for all SETUP items.
Save Changes	Save Setup Data to CMOS.

BIOS Flash Utility

The BIOS flash memory update is required for the following conditions:

- New versions of system programs
- New features or options
- Restore a BIOS when it becomes corrupted.

Use the Phlash utility to update the system BIOS flash ROM.

NOTE: If you do not have a crisis recovery diskette at hand, then you should create a **Crisis Recovery Diskette** before you use the Phlash utility.

NOTE: Do not install memory-related drivers (XMS, EMS, DPMS) when you use the Phlash.

NOTE: Please use the AC adaptor power supply when you run the Phlash utility. If the battery pack does not contain enough power to finish BIOS flash, you may not boot the system because the BIOS is not completely loaded.

Follow the steps below to run the Phlash.

1. Prepare a bootable diskette.
2. Copy the flash utilities to the bootable diskette.
3. Then boot the system from the bootable diskette. The flash utility has auto-execution function.

Remove HDD/BIOS Utility

This section provide you with removing HDD/BIOS method:

Remove HDD Password:

- If you key in wrong HDD password for three time, “HDD password error code” would display on the screen. See the image below.

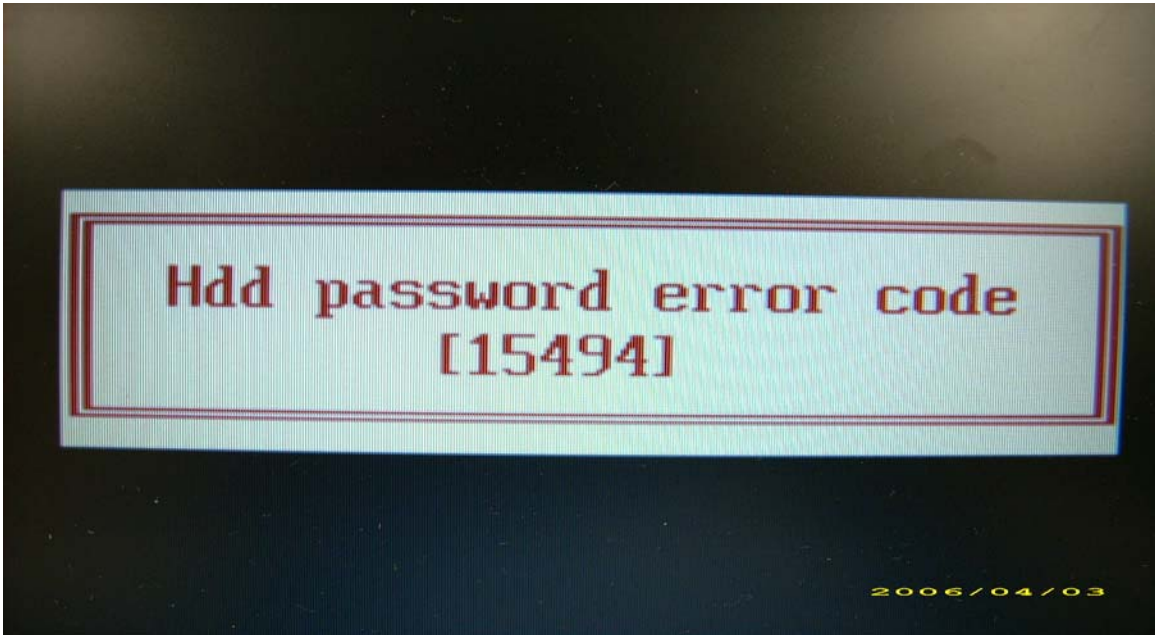

- If you need to solve HDD password locked problem, you can run HDD_PW.EXE
 1. Key in “hdd_pw 15494 0”
 2. Select “2”
 3. Choose one upper-case string

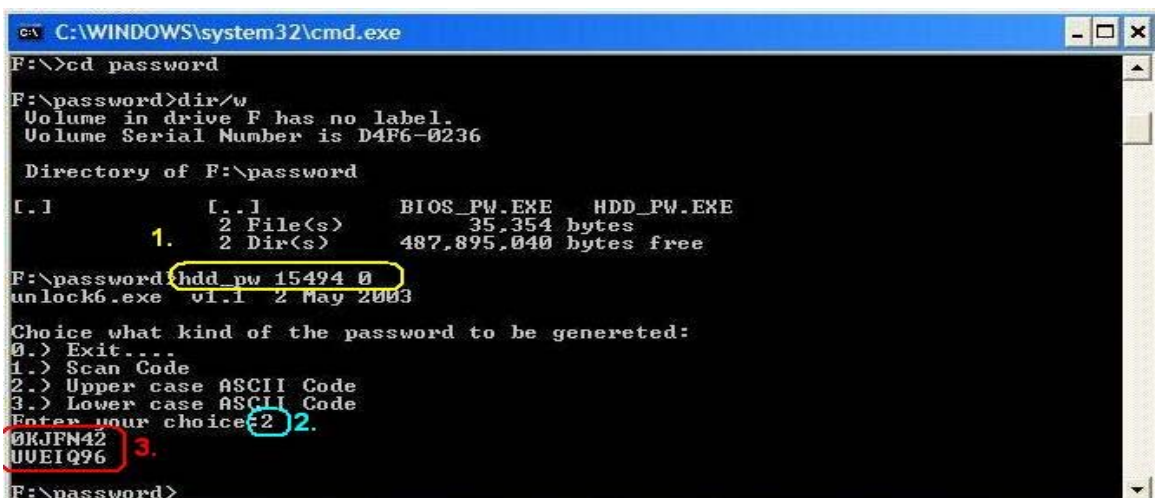

- Reboot system and key in “0KJFN42” or “UVEIQ96” to HDD user password.

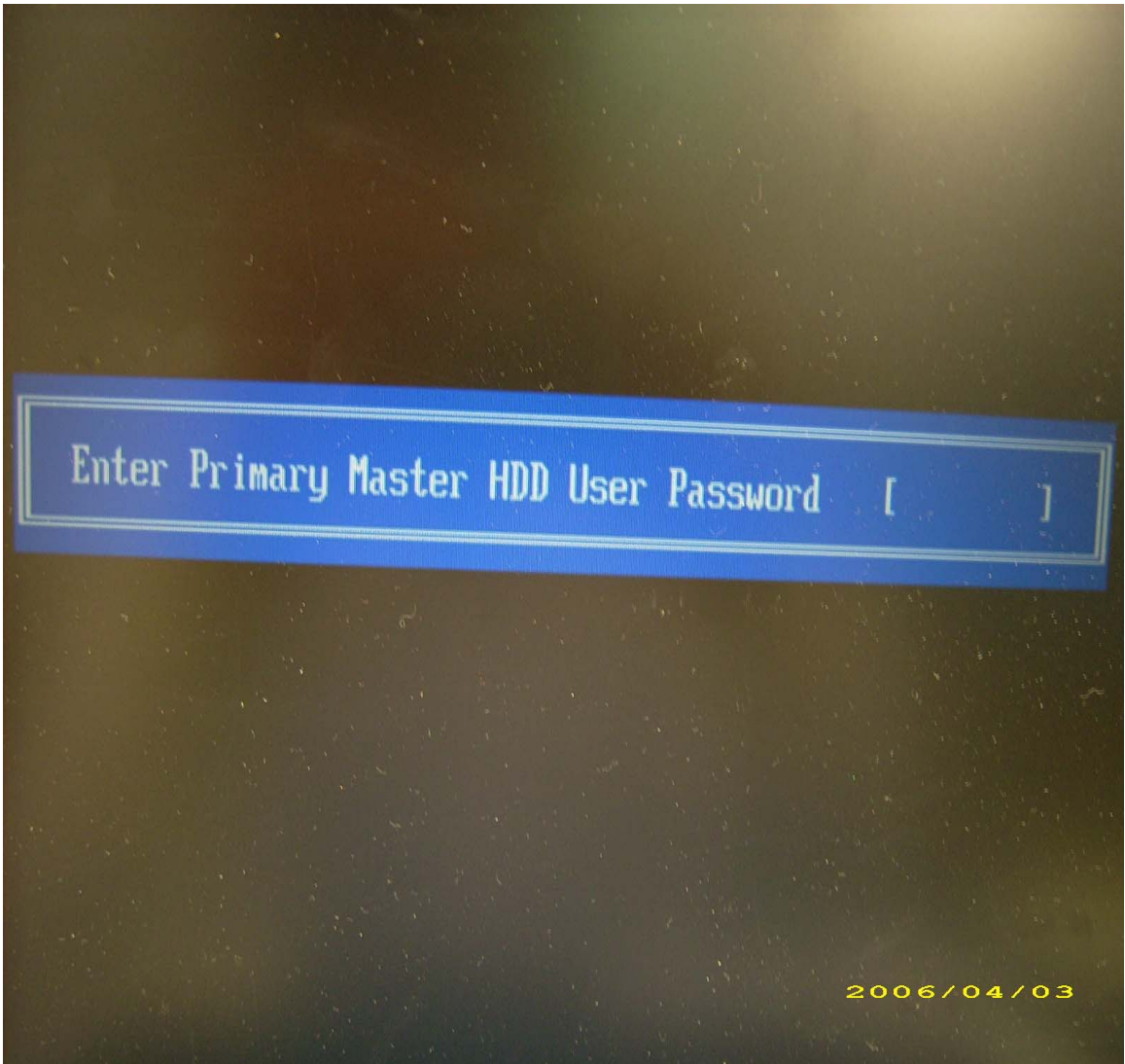

Remove BIOS Password:

- If you key in wrong Supervisor Password for three time, "System Disabled" would display on the screen. See the image below.

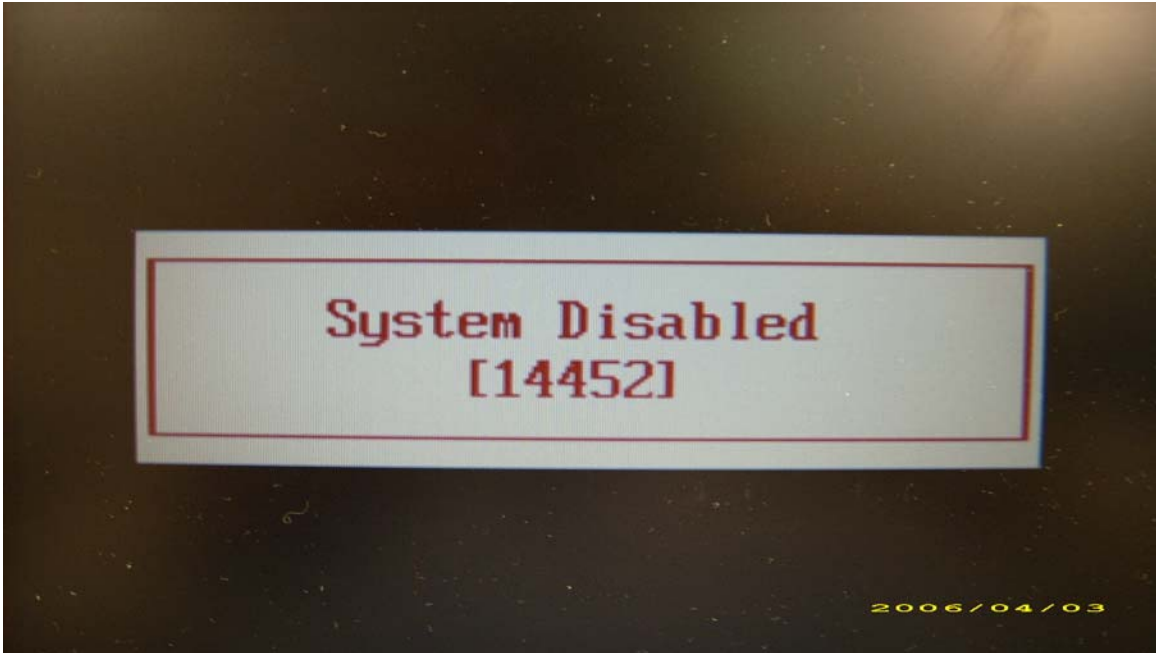

- If you need to solve BIOS password locked problem, you can run BIOS_PW.EXE
 1. Key in "bios_pw 14452 0"
 2. Choose one upper-case string

```
C:\WINDOWS\system32\cmd.exe
Microsoft Windows XP [Version 5.1.2600]
(C) Copyright 1985-2001 Microsoft Corp.
C:\Documents and Settings\M54>d:
D:\>bios_pw 14452 0
unlock6.exe v1.0 1 July 1997
qjjg9vy
07yqmjd
cjl14tm
6mbzjaj
D:\>_
```

- Reboot the system and key in "qjjg9vy" or "07yqmjd" to BIOS user password.



Machine Disassembly and Replacement

This chapter contains step-by-step procedures on how to disassemble the notebook computer for maintenance and troubleshooting.

Disassembly Requirements

To disassemble the computer, you need the following tools:

- Wrist grounding strap and conductive mat for preventing electrostatic discharge
- Flat screwdriver
- Philips screwdriver
- Hex screwdriver
- Plastic flat screwdriver
- Plastic tweezers

NOTE: The screws for the different components vary in size. During the disassembly process, group the screws with the corresponding components to avoid mismatch when putting back the components.

General Information

Pre-disassembly Instructions

Before proceeding with the disassembly procedure, make sure that you do the following:

1. Turn off the power to the system and all peripherals.
2. Unplug the AC adapter and all power and signal cables from the system.



3. Place the system on a flat, stable surface.
4. Remove the battery pack.

Disassembly Process

The disassembly process is divided into the following stages:

- External module disassembly
- Main unit disassembly
- LCD module disassembly

The flowcharts provided in the succeeding disassembly sections illustrate the entire disassembly sequence. Observe the order of the sequence to avoid damage to any of the hardware components. For example, if you want to remove the main board, you must first remove the keyboard, then disassemble the inside assembly frame in that order.

Main Screw List

Item	Screw	Color	Part No.
A	M2.5 x L6	Black	86.00E33.736
B	M2 x L3	Black	86.00F80.723
C	M3 x L4	Silver	86.9A554.4R0
D	M2.5 x L4	Black	86.00F00.734
E	M2 x L4	Silver	86.9A552.4R0
F	M2 x L4	Black	86.00F24.724
G	M2 x L2.5	Silver	86.00F22.722
H	M2 x L4	Black	86.00G58.725
I	M2 x L4	Silver	86.00G92.524
J	M2 x L3	Silver	86.00C07.220

External Module Disassembly Process

External Modules Disassembly Flowchart

The flowchart below gives you a graphic representation on the entire disassembly sequence and instructs you on the components that need to be removed during servicing. For example, if you want to remove the main board, you must first remove the keyboard, then disassemble the inside assembly frame in that order.

EXTERNAL MODULE DISASSEMBLY

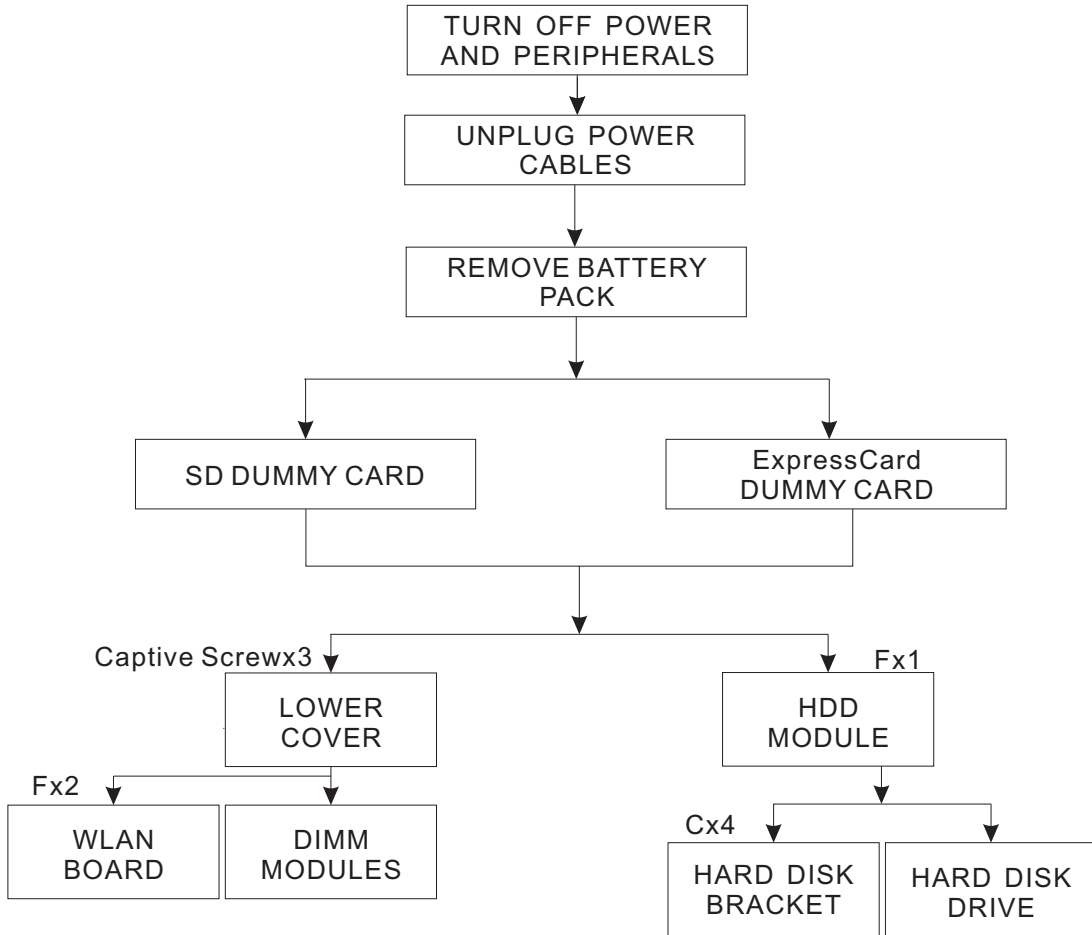

Screw List

Item	Screw	Color	Part No.
C	M3 x L4	Silver	86.9A554.4R0
F	M2 x L4	Black	86.00F24.724

Removing the Battery Pack

1. Turn base unit over.
2. Slide the battery lock/unlock latch to the unlock position.



3. Slide and hold the battery release latch to the release position (1), then slide out the battery pack from the main unit (2).



Removing the SD dummy card

1. Push the SD dummy card all the way in to eject it.



2. Pull it out from the slot.



Removing the ExpressCard dummy card

1. Push the ExpressCard dummy card all the way in to eject it.



2. Pull it out from the slot.



Removing the Lower Cover

1. See “Removing the Battery Pack” on page 64.

2. Remove the three captive screws on the lower cover.



3. Use a plastic screw driver to carefully pry open the lower cover.



4. Remove the lower cover from the lower case.



Removing the DIMM

1. See “Removing the Battery Pack” on page 64.
2. See “Removing the Lower Cover” on page 65..

3. Push out the latches on both sides of the DIMM socket to release the DIMM.



4. Remove the DIMM module.



Removing the WLAN Board Modules

1. See “Removing the Battery Pack” on page 64.
2. See “Removing the Lower Cover” on page 65.
3. Disconnect the antenna cables from the WLAN board.



4. Move the antenna away from the WLAN board and remove the two screws (F) on the WLAN board to release the WLAN board.



Step	Size (Quantity)	Color	Torque
1~2	M2 x L4 (2)	Black	1.6 kgf-cm

5. Detach the WLAN board from the WLAN socket.



NOTE: When attaching the antenna back to the WLAN board, make sure the cable are arranged properly.

Removing the Hard Disk Drive Module

1. See “Removing the Battery Pack” on page 64.
2. See “Removing the Lower Cover” on page 65.
3. Remove the one screw (F) securing the hard disk drive module.



Step	Size (Quantity)	Color	Torque
1	M2 x L4 (1)	Black	1.6 kgf-cm

- Slide out the hard disk drive module from the bay.



NOTE: To prevent damage to device, avoid pressing down on it or placing heavy objects on top of it.

- Remove the four screws (C) securing the hard disk to the bracket.

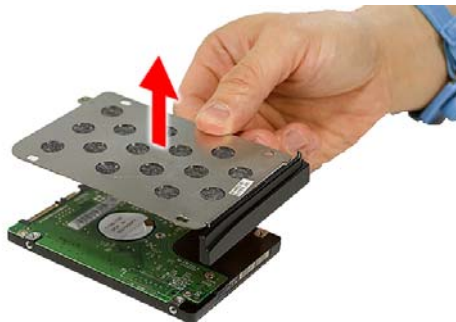
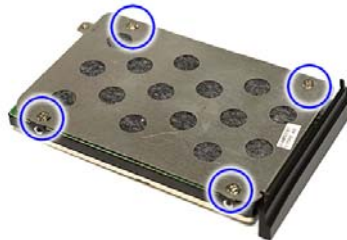

Step	Size (Quantity)	Color	Torque
1~4	M3 x L4 (4)	Silver	3.0 kgf-cm

Main Unit Disassembly Process

Main Unit Disassembly Flowchart

MAIN UNIT DISASSEMBLY

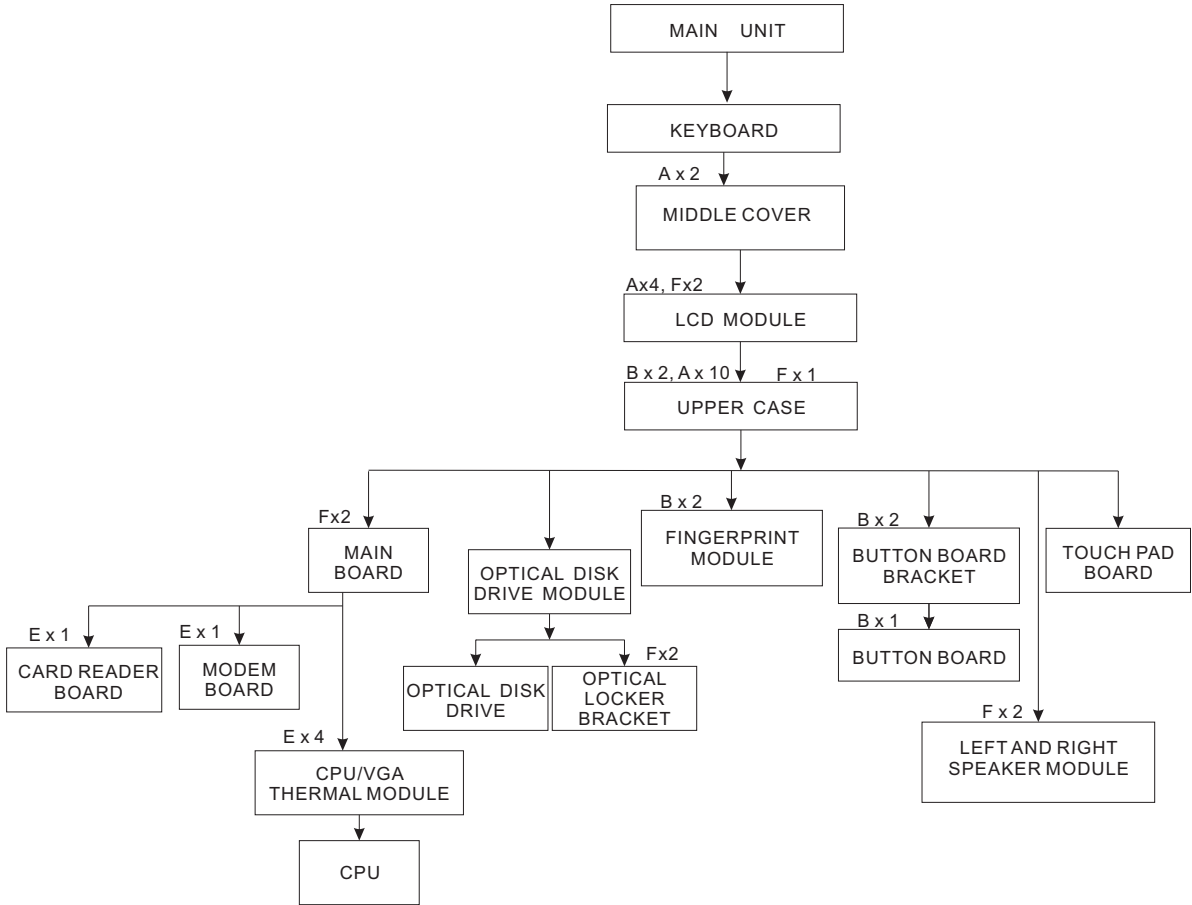

Screw List

Item	Screw	Color	Part No.
A	M2.5 x L6	Black	86.00E33.736
B	M2 x L3	Black	86.00F80.723
D	M2.5 x L4	Black	86.00F00.734
E	M2 x L4	Silver	86.9A552.4R0
F	M2 x L4	Black	86.00F24.724
G	M2 x L2.5	Silver	86.00F22.722

Removing the Keyboard

1. See “Removing the Battery Pack” on page 64.
2. Push down on the lock and release the latches securing the keyboard to the upper case.



3. Carefully pry loose the keyboard and turn it over on the touchpad area.



4. Remove the adhesive strip over the connector.



5. Disconnect the keyboard cable from the main board to remove the keyboard.

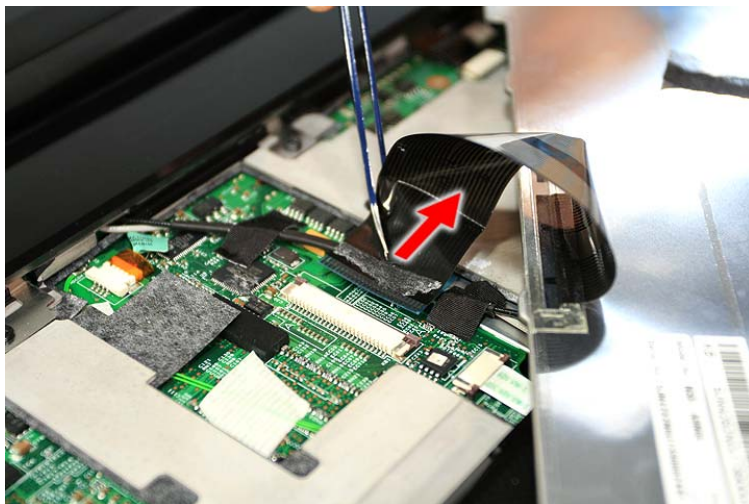
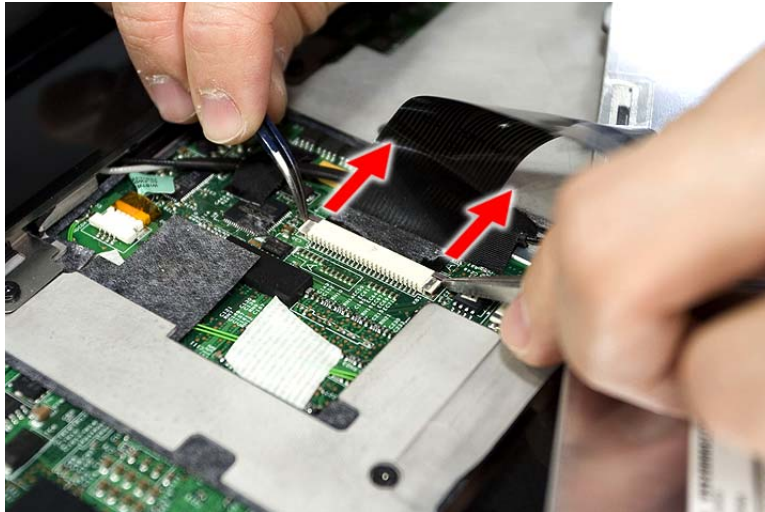

Removing the Middle Cover

1. See “Removing the Battery Pack” on page 64.

2. See “Removing the Keyboard” on page 71.
3. Disconnect the switch connector from the mainboard.

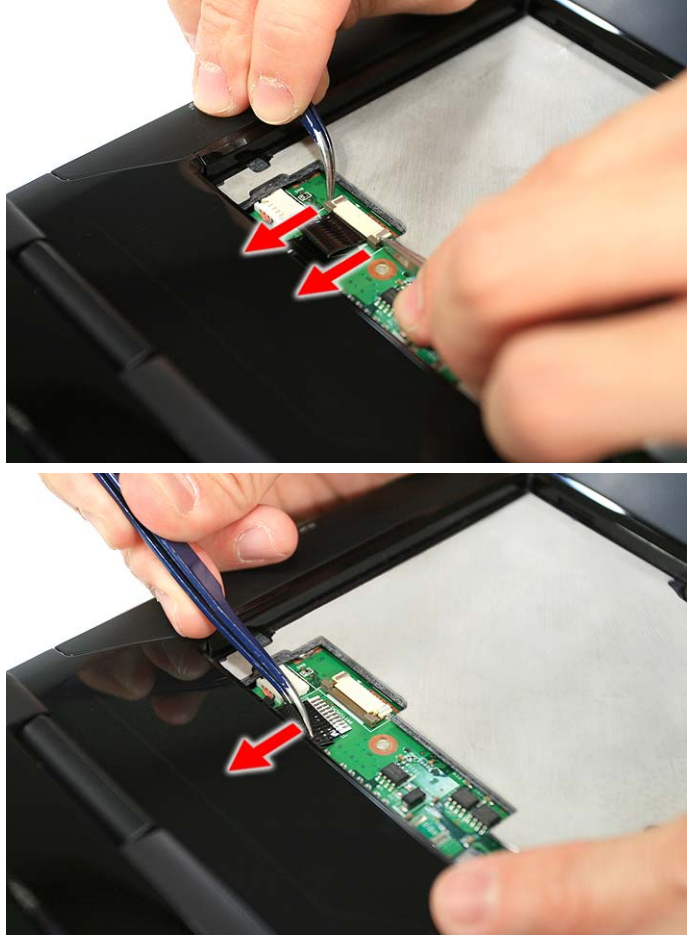

4. Remove the two screws (A) securing the middle cover.



Step	Size (Quantity)	Color	Torque
1~2	M2.5 x L6 (2)	Black	3.0 kgf-cm

-
5. Carefully pry loose the middle cover and remove it from the system.



Removing the LCD Module

1. See “Removing the Battery Pack” on page 64.
2. See “Removing the Lower Cover” on page 65.
3. See “Removing the WLAN Board Modules” on page 67.
4. See “Removing the Keyboard” on page 71.

- Remove the two screws (F) from the left hinge cover and carefully pry loose and remove the left hinge cover.

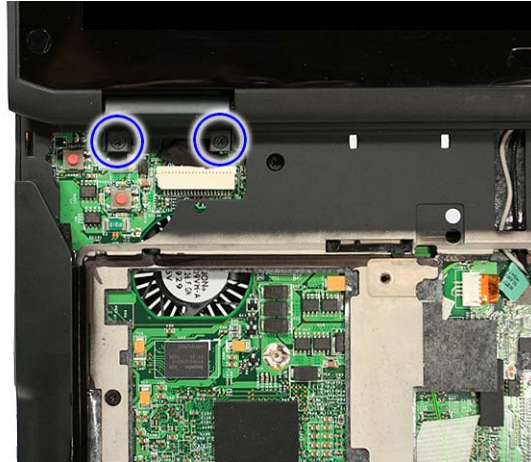

Step	Size (Quantity)	Color	Torque
1~2	M2 x L4 (2)	Black	1.6 kgf-cm

- Carefully pry loose the latch on the right hinge cover; close the LCD panel and then pull up the right hinge cover to remove.





7. Carefully pull out the wireless antenna cables from the hole and remove any adhesive tapes securing the cables.

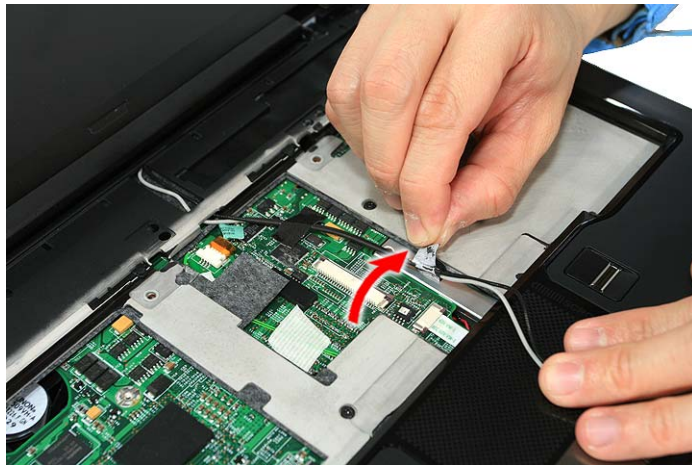

8. Remove the large adhesive tape by the battery bay area and carefully pull the wireless antenna cables through the routing hole.

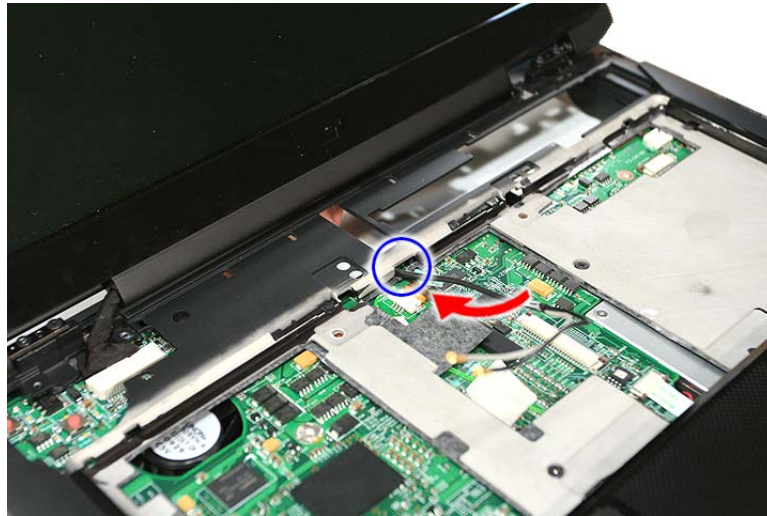

9. Disconnect the LCD cable connector from the main board.

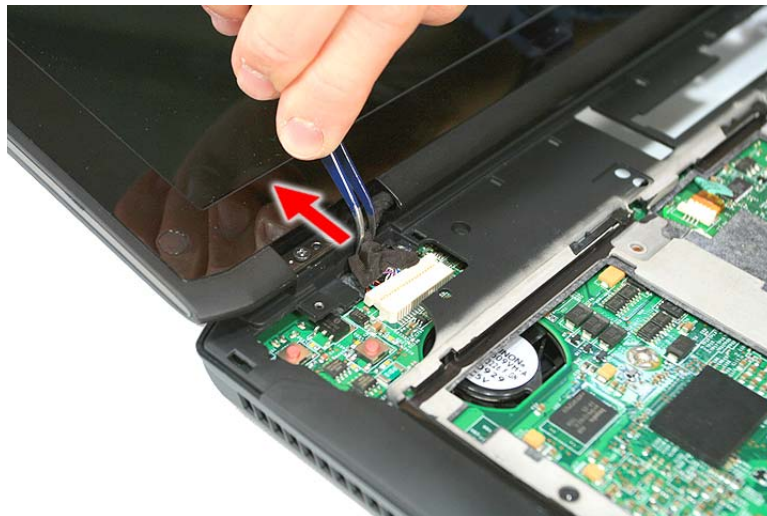

10. Remove the four screws (A) from the left and right hinge of the LCD module.

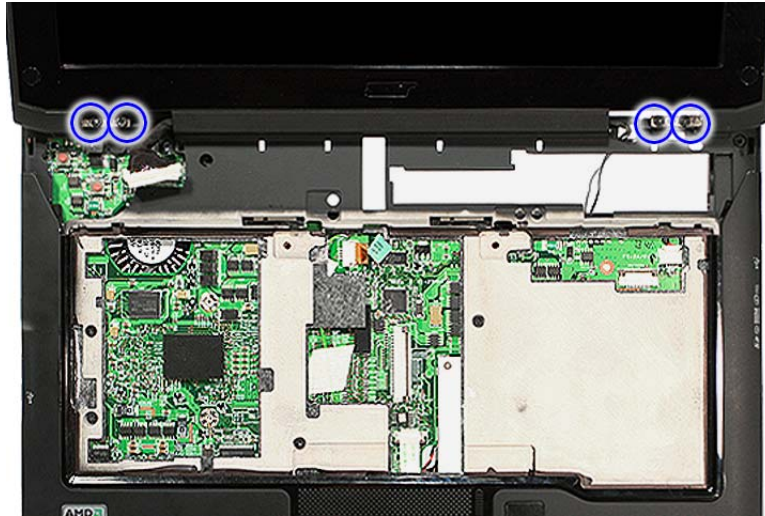

Step	Size (Quantity)	Color	Torque
1~4	M2.5 x L6 (4)	Black	4.0 kgf-cm

11. Carefully remove the LCD module from the base unit.



NOTE: When connecting the cable back to the unit, please note that the cable should be routed well.

Separating the Upper Case from the Lower Case

1. See “Removing the Battery Pack” on page 64.
2. See “Removing the SD dummy card” on page 64.
3. See “Removing the ExpressCard dummy card” on page 65.
4. See “Removing the Lower Cover” on page 65.
5. See “Removing the DIMM” on page 66.
6. See “Removing the WLAN Board Modules” on page 67.
7. See “Removing the Hard Disk Drive Module” on page 68.
8. See “Removing the Keyboard” on page 71.
9. See “Removing the Middle Cover” on page 72.
10. See “Removing the LCD Module” on page 74.

11. Disconnect the touchpad cable from the TPAD1 on the main board.

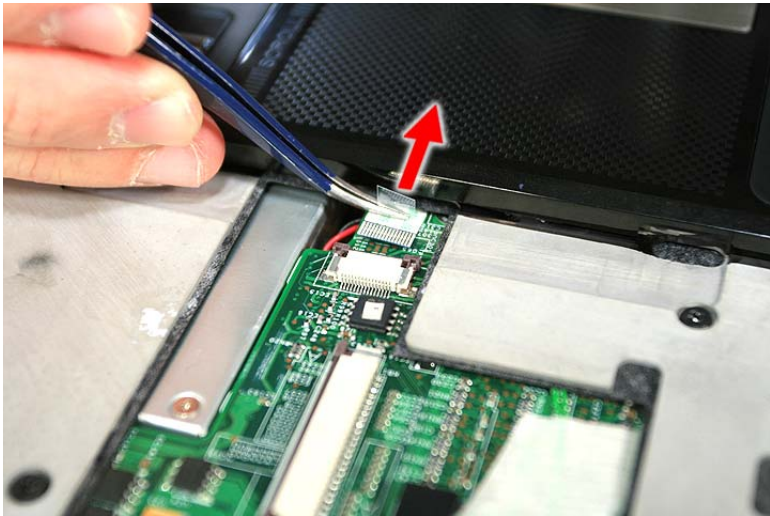

12. Remove the thirteen screws (2 x B, 10 x A, 1 x F) on the bottom and top panel.

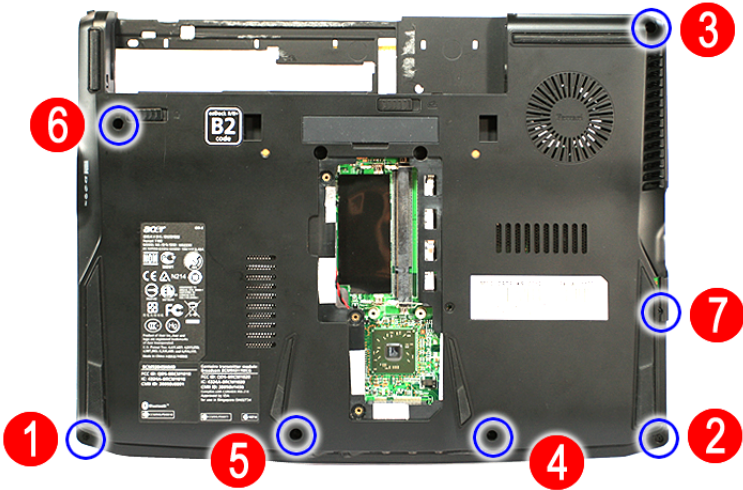

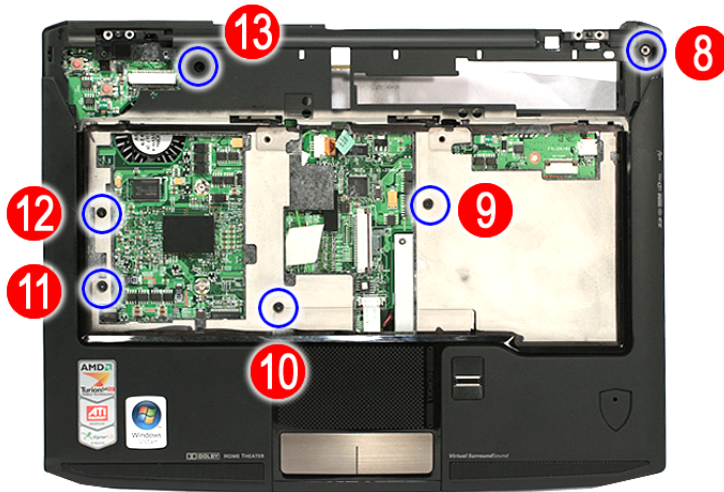

Step	Size (Quantity)	Color	Torque
1~2	M2 x L3 (2)	Black	1.6 kgf-cm
3~6	M2.5 L6 (4)	Black	3.0 kgf-cm
7	M2 x L4 (1)	Black	1.6 kgf-cm
8~13	M2.5 L6 (6)	Black	3.0 kgf-cm

13. Gently remove the upper case from the lower case.



Removing the Button Board

1. See “Removing the Battery Pack” on page 64.
2. See “Removing the SD dummy card” on page 64.
3. See “Removing the ExpressCard dummy card” on page 65.
4. See “Removing the Lower Cover” on page 65.
5. See “Removing the DIMM” on page 66.
6. See “Removing the WLAN Board Modules” on page 67.
7. See “Removing the Hard Disk Drive Module” on page 68.
8. See “Removing the Keyboard” on page 71.

9. See “Removing the Middle Cover” on page 72.
10. See “Removing the LCD Module” on page 74.
11. See “Separating the Upper Case from the Lower Case” on page 78.
12. Release the latch and disconnect the two cables from the button board.

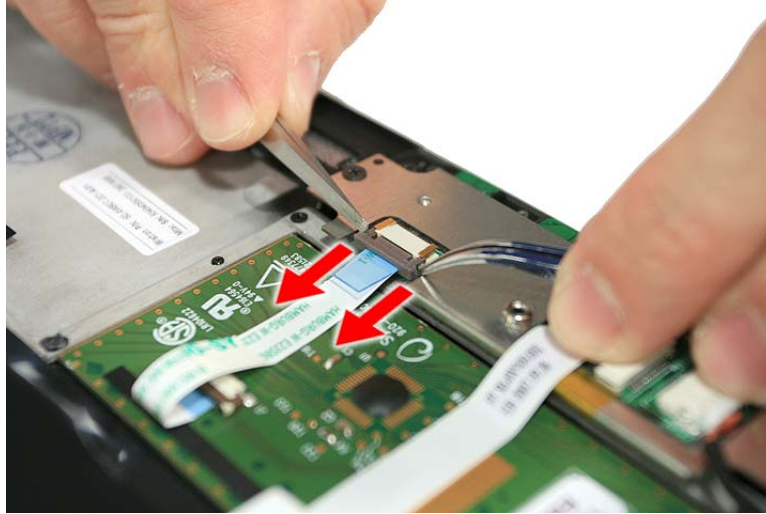

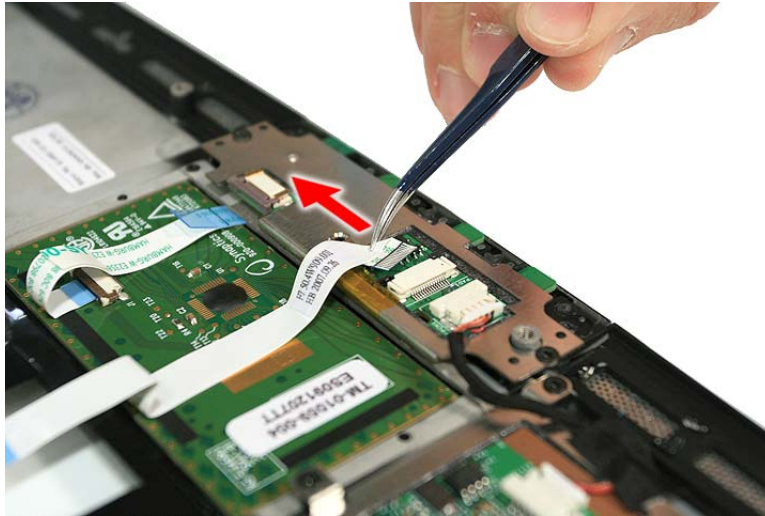

13. Disconnect the fingerprint cable from the button board.



14. Remove the two screws (B) securing the button board bracket and remove the button board bracket together with the button board.

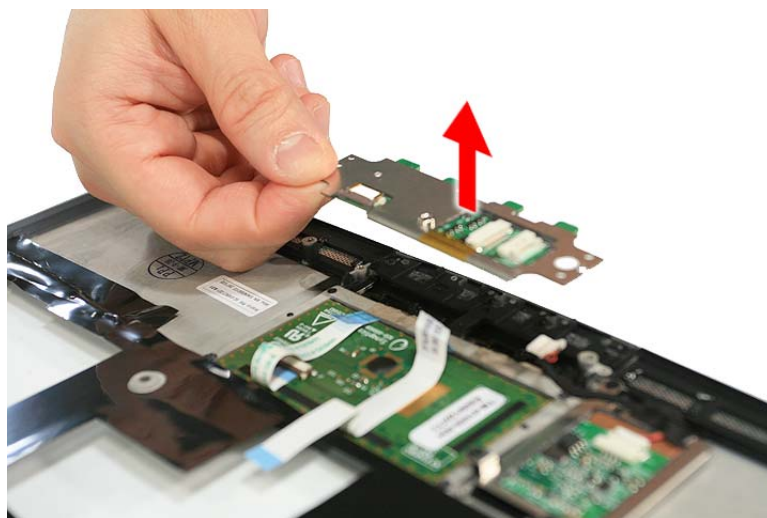
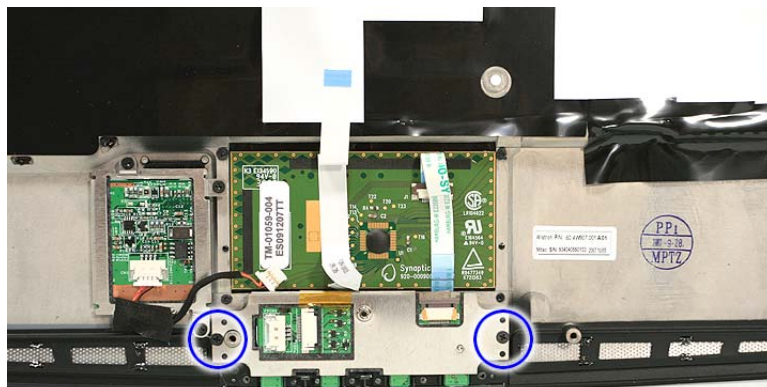

Step	Size (Quantity)	Color	Torque
1~2	M2 x L3 (2)	Black	1.6 kgf-cm

15. Remove the one screw (B) and remove the button board from the bracket.



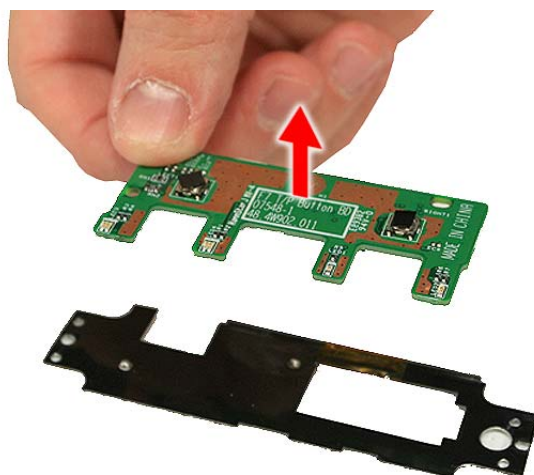

Step	Size (Quantity)	Color	Torque
1	M2 x L3 (1)	Black	1.6 kgf-cm

Removing the Fingerprint Board Module

1. See “Removing the Battery Pack” on page 64.
2. See “Removing the SD dummy card” on page 64.
3. See “Removing the ExpressCard dummy card” on page 65.
4. See “Removing the Lower Cover” on page 65.
5. See “Removing the DIMM” on page 66.
6. See “Removing the WLAN Board Modules” on page 67.
7. See “Removing the Hard Disk Drive Module” on page 68.
8. See “Removing the Keyboard” on page 71.
9. See “Removing the Middle Cover” on page 72.
10. See “Removing the LCD Module” on page 74.
11. See “Separating the Upper Case from the Lower Case” on page 78.
12. See “Removing the Button Board” on page 80.

13. Remove the adhesive tape.



14. Remove the three screws (B) securing the fingerprint module to the upper case.

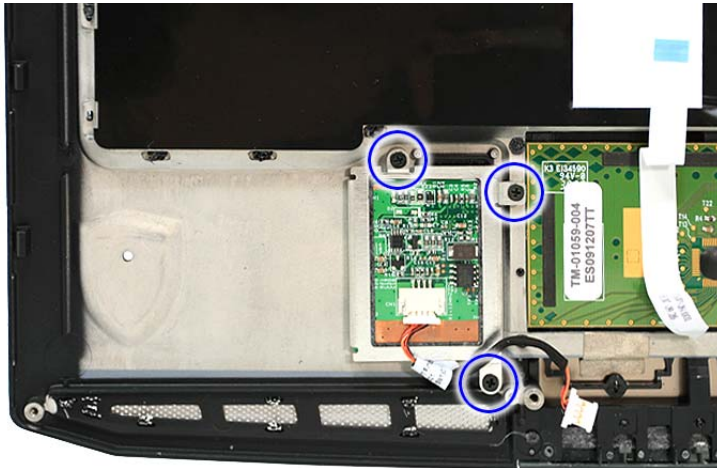

Step	Size (Quantity)	Color	Torque
1~3	M2 x L3 (3)	Black	1.6 kgf-cm

15. Remove the fingerprint board module from the upper case.



Removing the Touch Pad Board Module

1. See “Removing the Battery Pack” on page 64.
2. See “Removing the SD dummy card” on page 64.
3. See “Removing the ExpressCard dummy card” on page 65.
4. See “Removing the Lower Cover” on page 65.
5. See “Removing the DIMM” on page 66.
6. See “Removing the WLAN Board Modules” on page 67.
7. See “Removing the Hard Disk Drive Module” on page 68.
8. See “Removing the Keyboard” on page 71.
9. See “Removing the Middle Cover” on page 72.
10. See “Removing the LCD Module” on page 74.
11. See “Separating the Upper Case from the Lower Case” on page 78.
12. See “Removing the Button Board” on page 80.
13. See “Removing the Fingerprint Board Module” on page 84.
14. Carefully pry loose and remove the touch pad board.

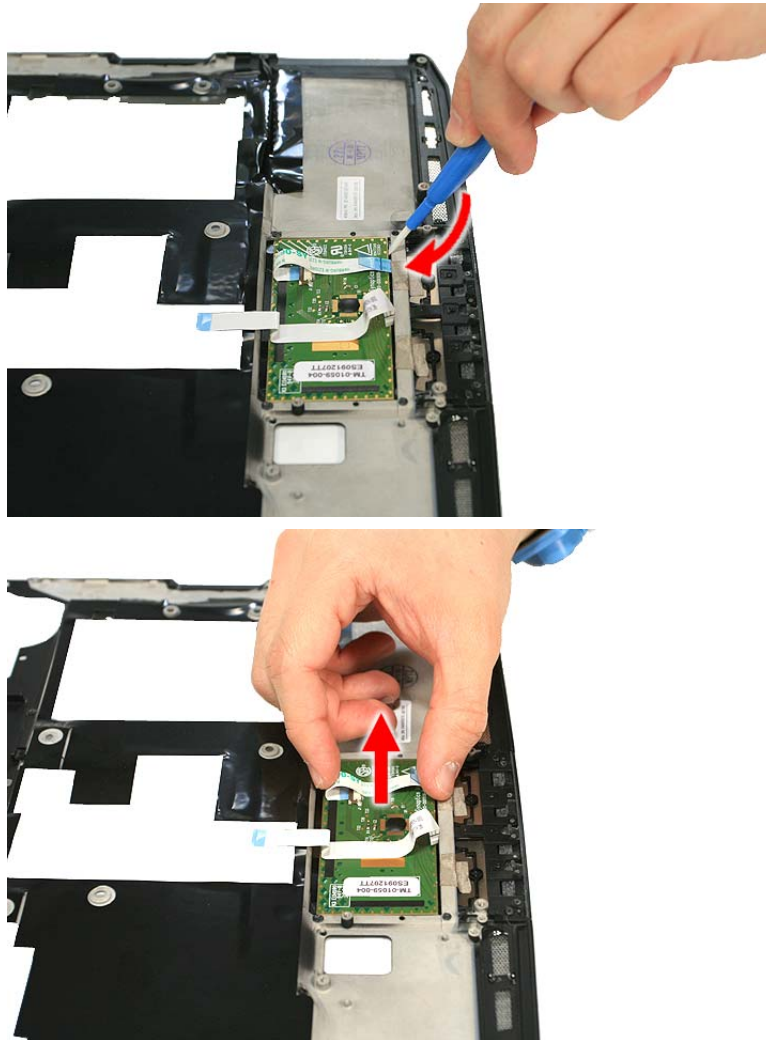

WARNING: The touchpad board is glued to the upper case, only remove the touchpad board if it is defective.

Removing the Optical Drive Module

1. See “Removing the Battery Pack” on page 64.
2. See “Removing the SD dummy card” on page 64.
3. See “Removing the ExpressCard dummy card” on page 65.
4. See “Removing the Lower Cover” on page 65.
5. See “Removing the DIMM” on page 66.
6. See “Removing the WLAN Board Modules” on page 67.
7. See “Removing the Hard Disk Drive Module” on page 68.
8. See “Removing the Keyboard” on page 71.
9. See “Removing the Middle Cover” on page 72.
10. See “Removing the LCD Module” on page 74.
11. See “Separating the Upper Case from the Lower Case” on page 78.
12. Remove the two screws (F) securing the optical drive module.

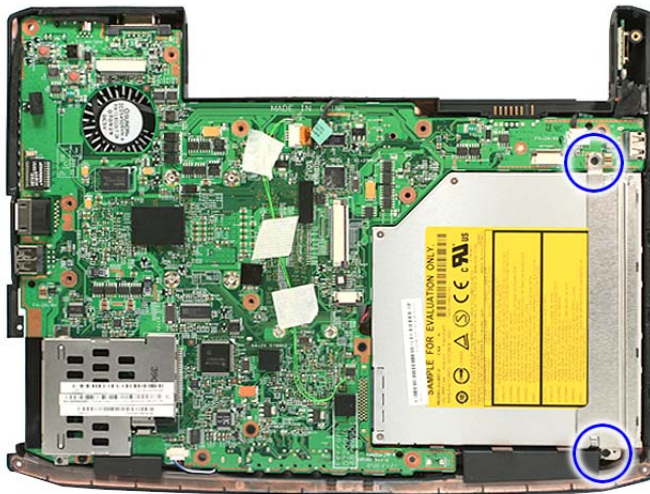

Step	Size (Quantity)	Color	Torque
1~2	M2 x L4 (2)	Black	1.6 kgf-cm

13. Carefully slide out and lift the optical drive module to remove it.





14. Remove the one screw (G) securing the locker bracket and remove the locker bracket from the optical disk drive module.

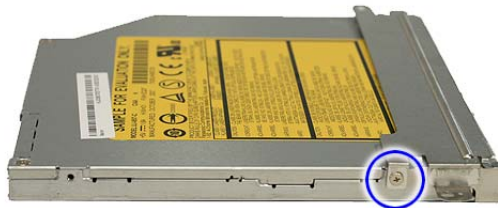

Step	Size (Quantity)	Color	Torque
1	M2 x L2.5 (1)	Black	1.6 kgf-cm

Removing the Main Board

1. See “Removing the Battery Pack” on page 64.
2. See “Removing the SD dummy card” on page 64.
3. See “Removing the ExpressCard dummy card” on page 65.
4. See “Removing the Lower Cover” on page 65.
5. See “Removing the DIMM” on page 66.
6. See “Removing the WLAN Board Modules” on page 67.
7. See “Removing the Hard Disk Drive Module” on page 68.
8. See “Removing the Keyboard” on page 71.
9. See “Removing the Middle Cover” on page 72.
10. See “Removing the LCD Module” on page 74.
11. See “Separating the Upper Case from the Lower Case” on page 78.
12. Disconnect the RTC battery cable from RTC1 on the main board.



13. Disconnect the speaker cable from the SPKR1 on the main board.

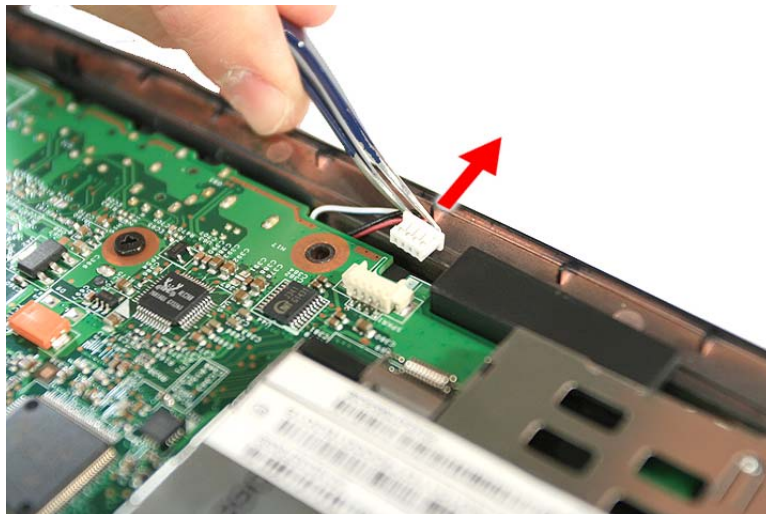

14. Disconnect the bluetooth cable from the BLUE1 on the main board.



15. Disconnect the modem cable from the MDCDK1 on the main board.



16. Disconnect the cable from the modem board.

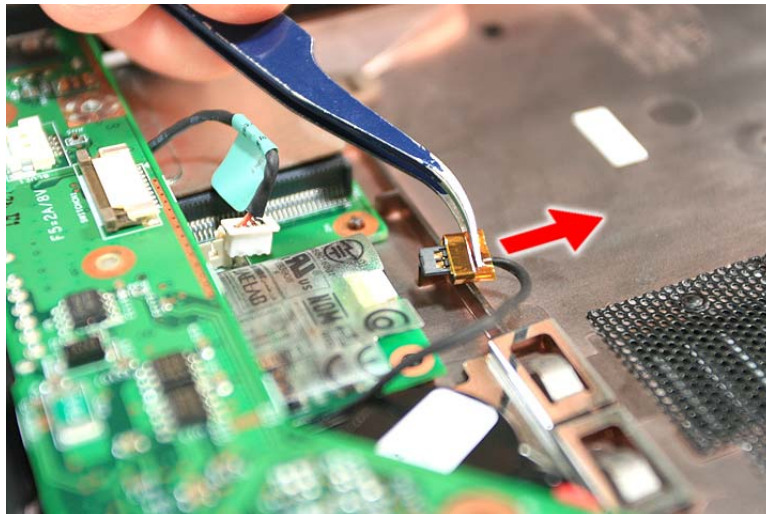

17. Disconnect the cable from the card reader board.

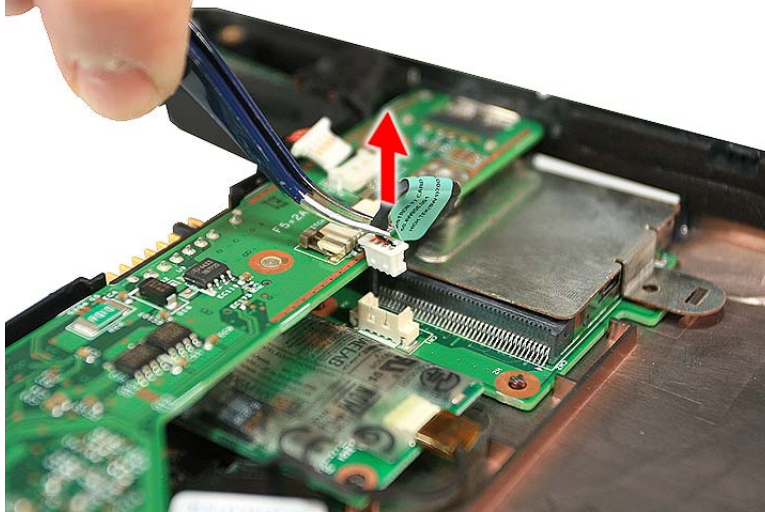

18. Remove the three screws (D) securing the main board in place.

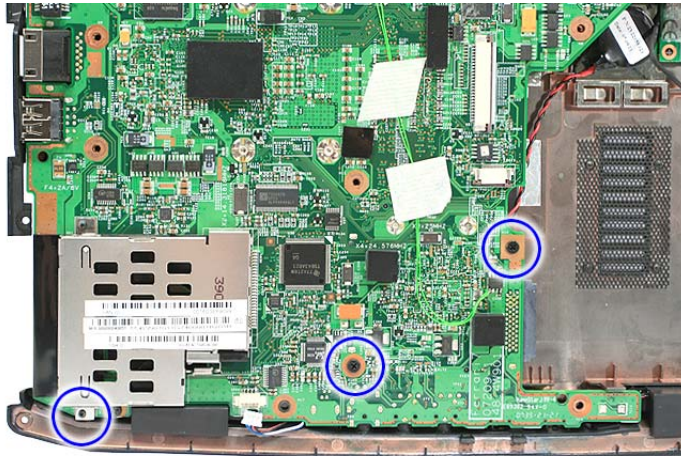

Step	Size (Quantity)	Color	Torque
1~3	M2.5 x L4 (3)	Black	3.0 kgf-cm

19. Carefully remove the main board.



Removing the CPU and VGA Heatsink Module

1. See “Removing the Battery Pack” on page 64.
2. See “Removing the SD dummy card” on page 64.
3. See “Removing the ExpressCard dummy card” on page 65.
4. See “Removing the Lower Cover” on page 65.
5. See “Removing the DIMM” on page 66.
6. See “Removing the WLAN Board Modules” on page 67.
7. See “Removing the Hard Disk Drive Module” on page 68.
8. See “Removing the Keyboard” on page 71.
9. See “Removing the Middle Cover” on page 72.
10. See “Removing the LCD Module” on page 74.
11. See “Separating the Upper Case from the Lower Case” on page 78.
12. See “Removing the Main Board” on page 89.
13. Disconnect the heatsink fan connector from the main board.

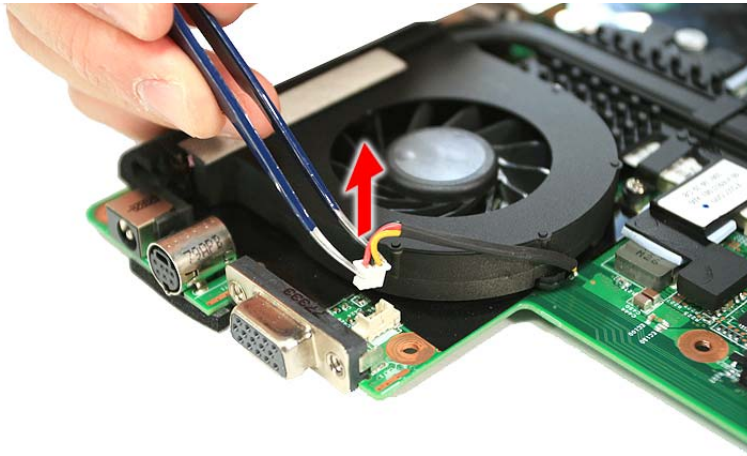

14. Remove the four screws (E) securing the CPU and VGA heatsink module in place.

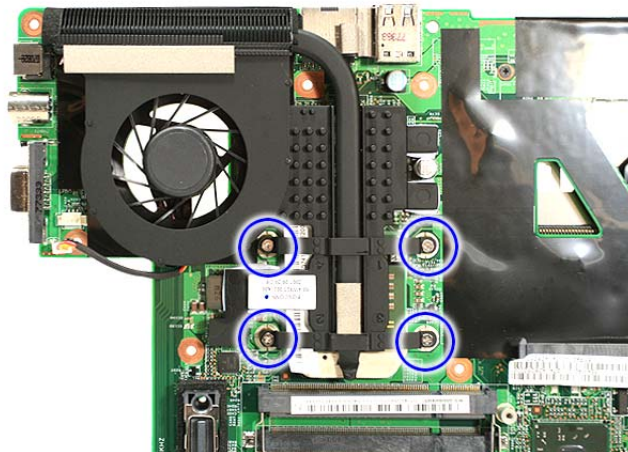

Step	Size (Quantity)	Color	Torque
1~4	M2 x L4 (4)	Silver	1.6 kgf-cm

15. Carefully lift up the heatsink module.



Removing the CPU

1. See “Removing the Battery Pack” on page 64.
2. See “Removing the SD dummy card” on page 64.
3. See “Removing the ExpressCard dummy card” on page 65.
4. See “Removing the Lower Cover” on page 65.
5. See “Removing the DIMM” on page 66.
6. See “Removing the WLAN Board Modules” on page 67.
7. See “Removing the Hard Disk Drive Module” on page 68.
8. See “Removing the Keyboard” on page 71.
9. See “Removing the Middle Cover” on page 72.
10. See “Removing the LCD Module” on page 74.
11. See “Separating the Upper Case from the Lower Case” on page 78.
12. See “Removing the Main Board” on page 89.
13. See “Removing the CPU and VGA Heatsink Module” on page 92.
14. Using a flat screwdriver, turn the CPU socket latch counter-clockwise to release the CPU.

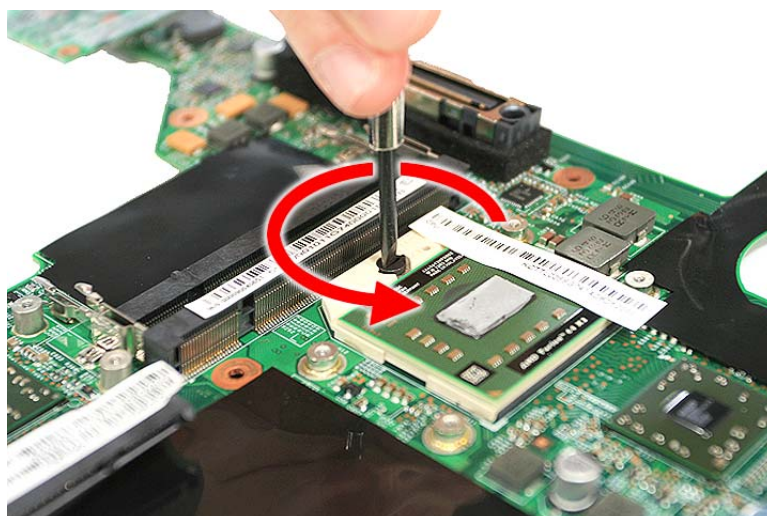

15. Lift up carefully to remove the CPU.

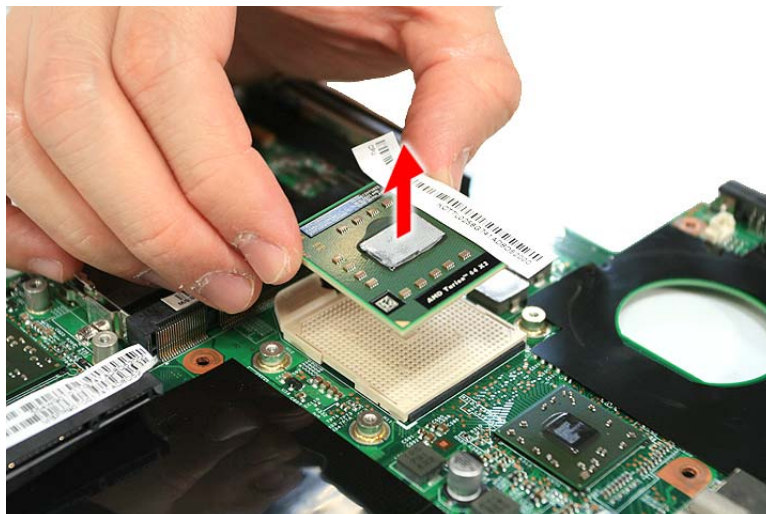

NOTE: When installing the CPU, make sure to install the CPU with PIN 1 at the corner as shown.

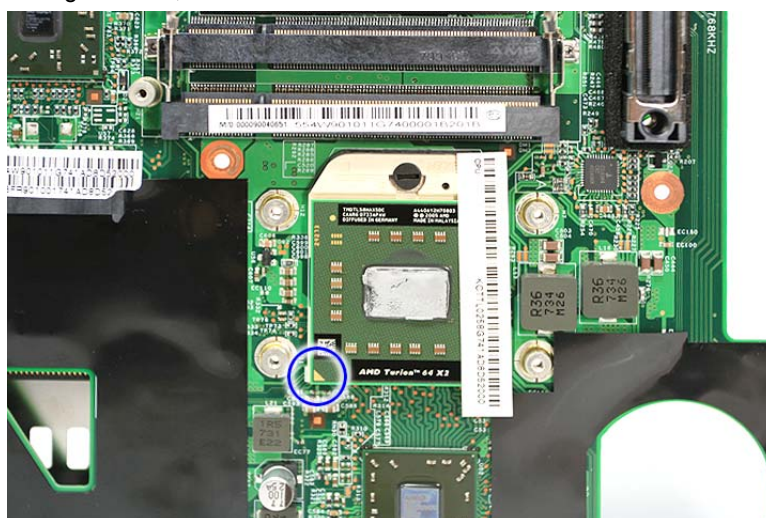

Removing the Modem Board

1. See “Removing the Battery Pack” on page 64.
2. See “Removing the SD dummy card” on page 64.
3. See “Removing the ExpressCard dummy card” on page 65.
4. See “Removing the Lower Cover” on page 65.
5. See “Removing the DIMM” on page 66.
6. See “Removing the WLAN Board Modules” on page 67.
7. See “Removing the Hard Disk Drive Module” on page 68.
8. See “Removing the Keyboard” on page 71.
9. See “Removing the Middle Cover” on page 72.
10. See “Removing the LCD Module” on page 74.
11. See “Separating the Upper Case from the Lower Case” on page 78.
12. See “Removing the Main Board” on page 89.

13. Remove the one screw (E) securing the modem card.

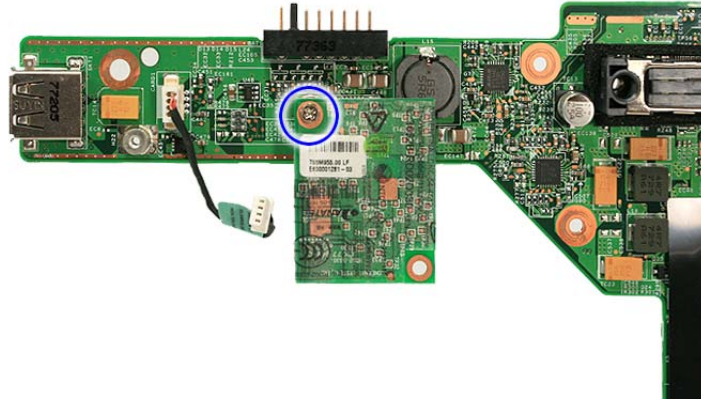

Step	Size (Quantity)	Color	Torque
1	M2 x L4 (1)	Silver	1.6 kgf-cm

14. Remove the modem board from the main board.

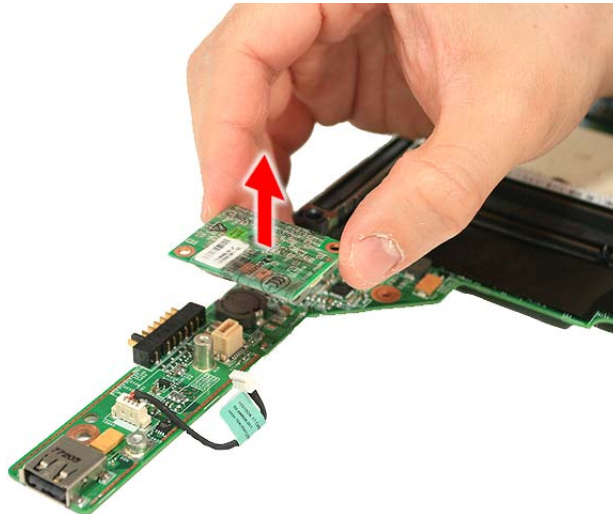

Removing the Speaker Modules

1. See “Removing the Battery Pack” on page 64.
2. See “Removing the SD dummy card” on page 64.
3. See “Removing the ExpressCard dummy card” on page 65.
4. See “Removing the Lower Cover” on page 65.
5. See “Removing the DIMM” on page 66.
6. See “Removing the WLAN Board Modules” on page 67.
7. See “Removing the Hard Disk Drive Module” on page 68.
8. See “Removing the Keyboard” on page 71.
9. See “Removing the Middle Cover” on page 72.
10. See “Removing the LCD Module” on page 74.
11. See “Separating the Upper Case from the Lower Case” on page 78.

- 12. See “Removing the Main Board” on page 89.
- 13. Remove any adhesive tape securing the speaker cables.

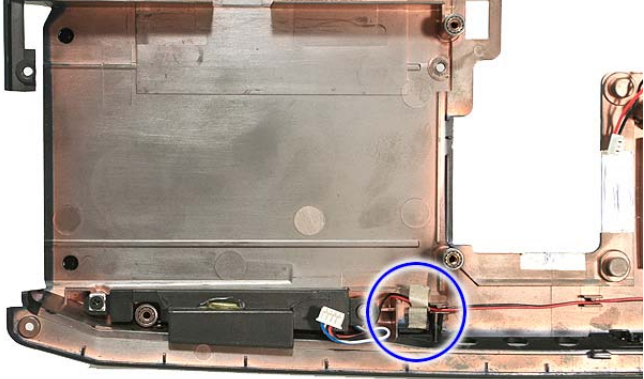

- 14. Remove the two screws (F) holding the left and right speakers.

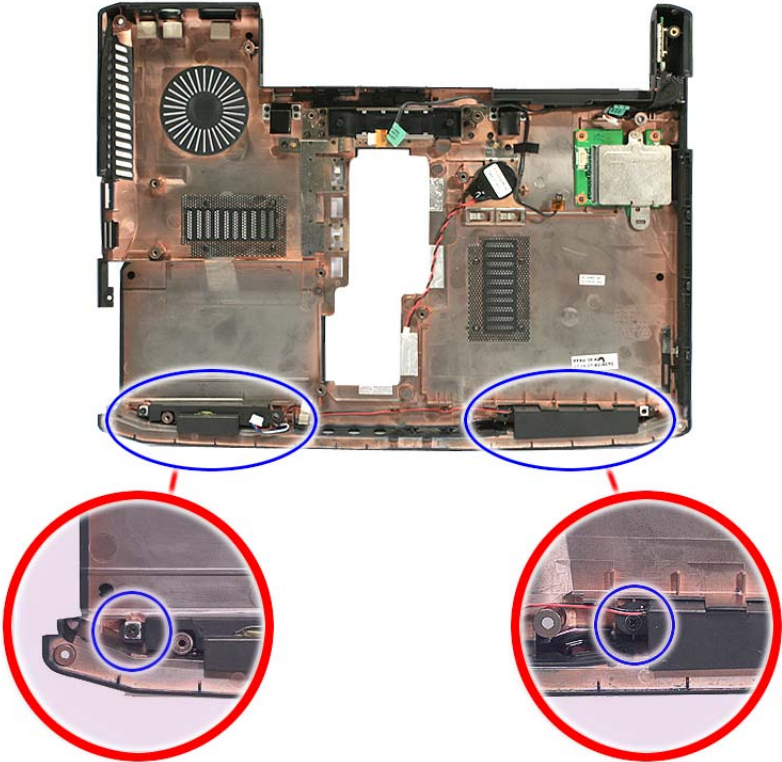

Step	Size (Quantity)	Color	Torque
1~2	M2 x L4 (2)	Silver	1.6 kgf-cm

-
15. Remove the left and right speakers from the upper case.

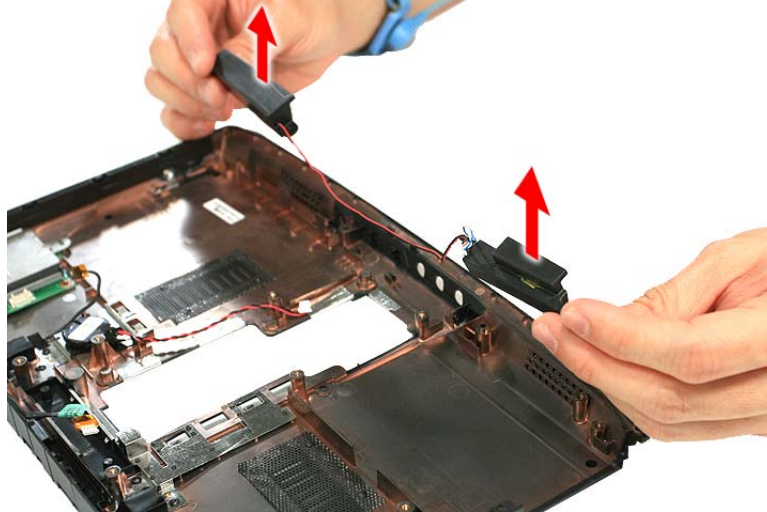

Removing the Card Reader Board

1. See “Removing the Battery Pack” on page 64.
2. See “Removing the SD dummy card” on page 64.
3. See “Removing the ExpressCard dummy card” on page 65.
4. See “Removing the Lower Cover” on page 65.
5. See “Removing the DIMM” on page 66.
6. See “Removing the WLAN Board Modules” on page 67.
7. See “Removing the Hard Disk Drive Module” on page 68.
8. See “Removing the Keyboard” on page 71.
9. See “Removing the Middle Cover” on page 72.
10. See “Removing the LCD Module” on page 74.
11. See “Separating the Upper Case from the Lower Case” on page 78.
12. See “Removing the Main Board” on page 89.

13. Remove the one screw (E) securing the bracket to the card reader board.

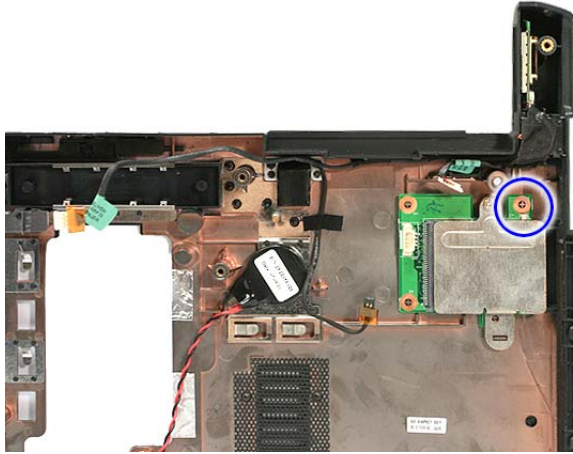

Step	Size (Quantity)	Color	Torque
1	M2 x L4 (1)	Silver	1.6 kgf-cm

14. Remove the bracket from the card reader board.

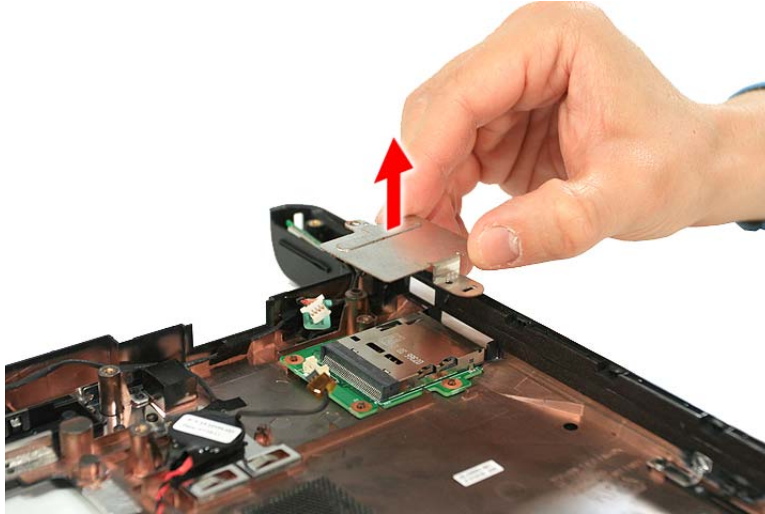

15. Remove the card reader board from the lower case.

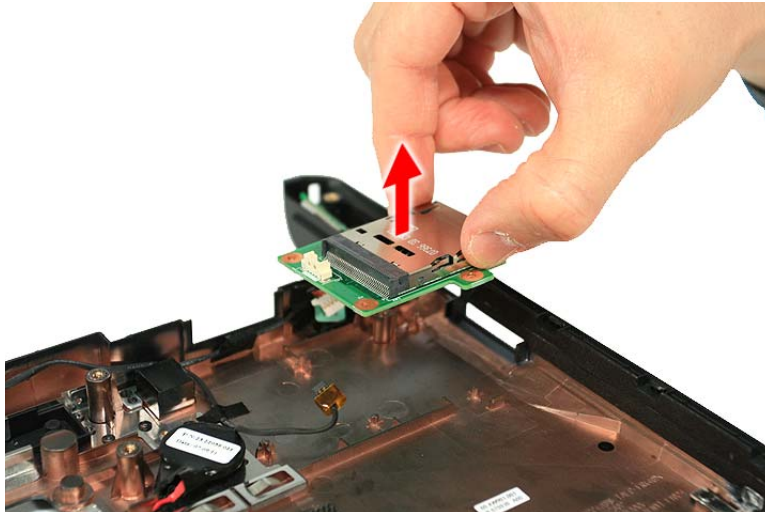

LCD Module Disassembly Process

LCD Module Disassembly Flowchart

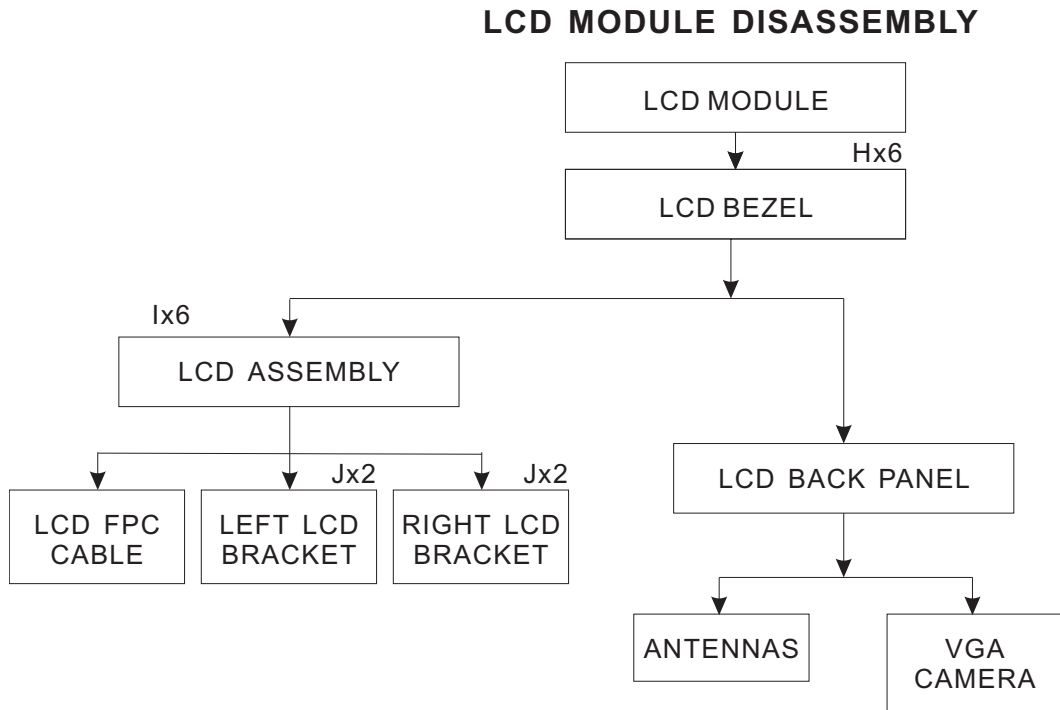

Screw List

Item	Screw	Color	Part No.
H	M2 x L4	Black	86.00G58.725
I	M2 x L4	Silver	86.00G92.524
J	M2 x L3	Silver	86.00C07.220

Removing the LCD Bezel

1. See “Removing the Battery Pack” on page 64.
2. See “Removing the Lower Cover” on page 65.
3. See “Removing the WLAN Board Modules” on page 67.
4. See “Removing the Keyboard” on page 71.
5. See “Removing the Middle Cover” on page 72.
6. See “Removing the LCD Module” on page 74.
7. Remove the four screw covers and the two rubber cover.



8. Remove the six screws (H) on the LCD module as shown.



Step	Size (Quantity)	Color	Torque
1~6	M2 x L4 (6)	Black	1.6 kgf-cm

9. Carefully pry open the LCD bezel and place the bezel on top of the LCD panel.

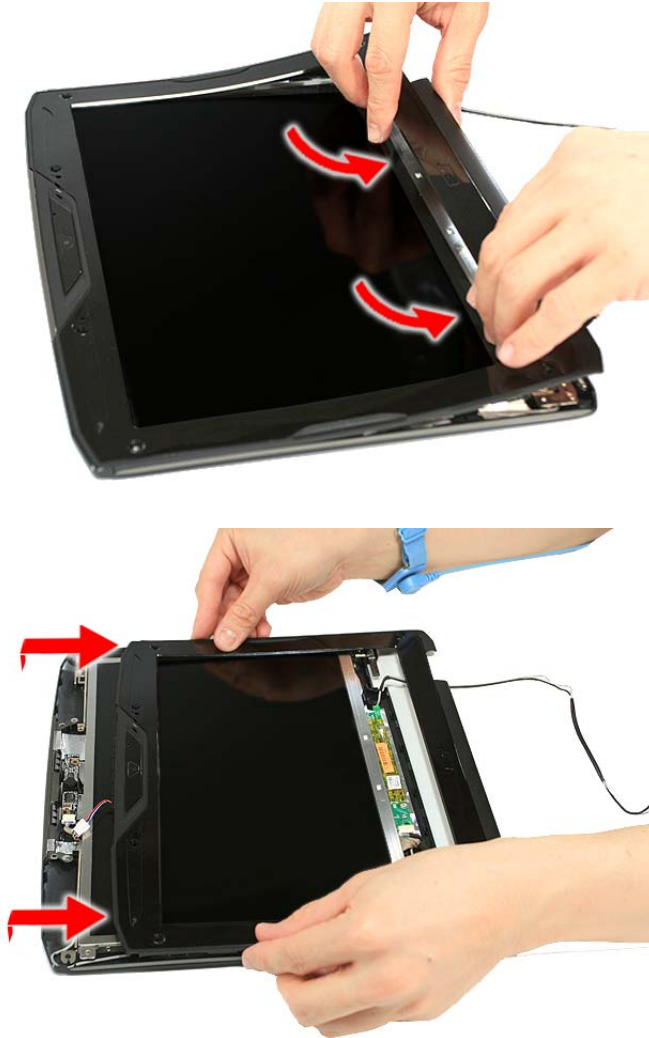

10. Disconnect the microphone cable and remove the bezel from the LCD panel.

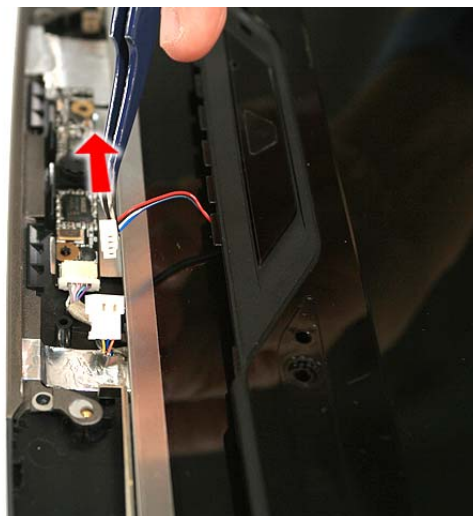

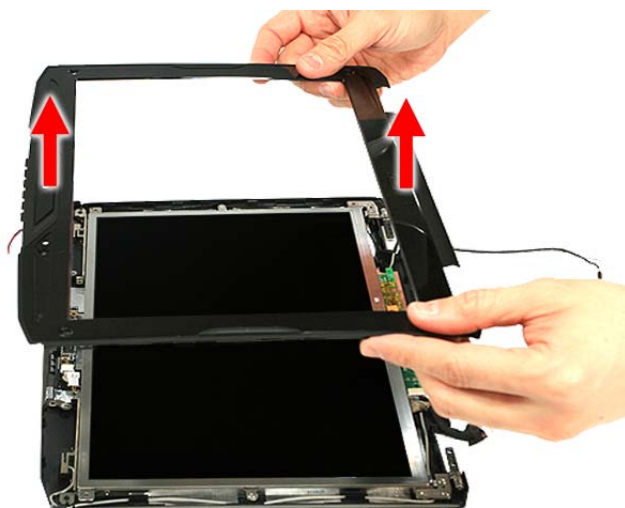

Removing the LCD module with the Brackets

1. See “Removing the Battery Pack” on page 64.
2. See “Removing the Lower Cover” on page 65.
3. See “Removing the WLAN Board Modules” on page 67.
4. See “Removing the Keyboard” on page 71.
5. See “Removing the Middle Cover” on page 72.
6. See “Removing the LCD Module” on page 74.
7. See “Removing the LCD Bezel” on page 100.
8. Disconnect the cable from the web camera.



9. Remove the six screws (I) securing the LCD module.



Step	Size (Quantity)	Color	Torque
1~6	M2 x L4 (6)	Silver	1.6 kgf-cm

10. Remove the LCD with the brackets from the back cover.

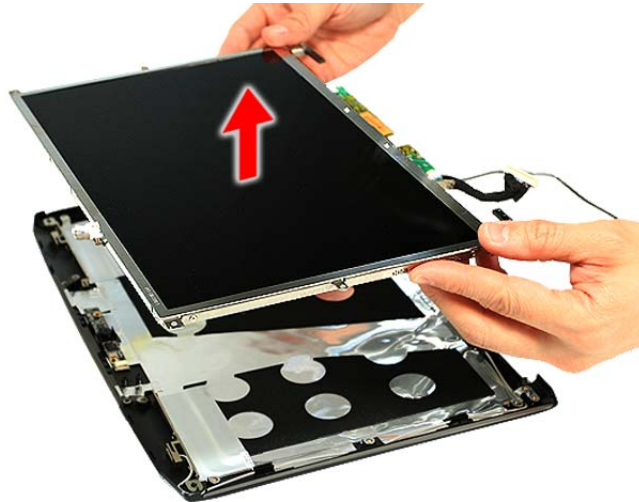

Removing the FPC Cable

1. See "Removing the Battery Pack" on page 64.
2. See "Removing the Lower Cover" on page 65.
3. See "Removing the WLAN Board Modules" on page 67.
4. See "Removing the Keyboard" on page 71.
5. See "Removing the Middle Cover" on page 72.
6. See "Removing the LCD Module" on page 74.
7. See "Removing the LCD Bezel" on page 100.
8. See "Removing the LCD module with the Brackets" on page 102.

9. Disconnect the inverter board cable from its connector.

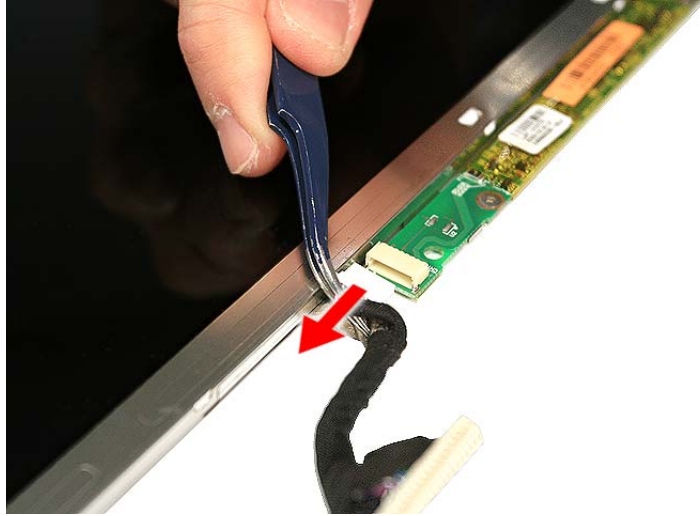

10. Detach the acetic tapes holding the FPC cable from the LCD panel and detach the acetic tape securing the FPC connector.

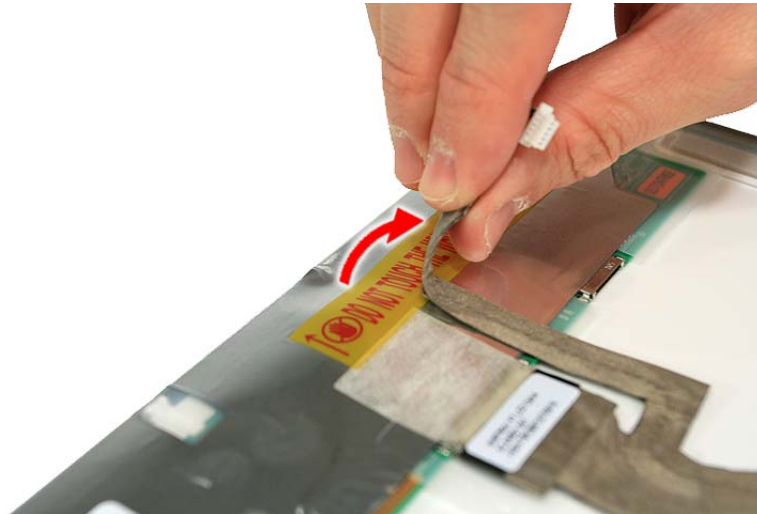
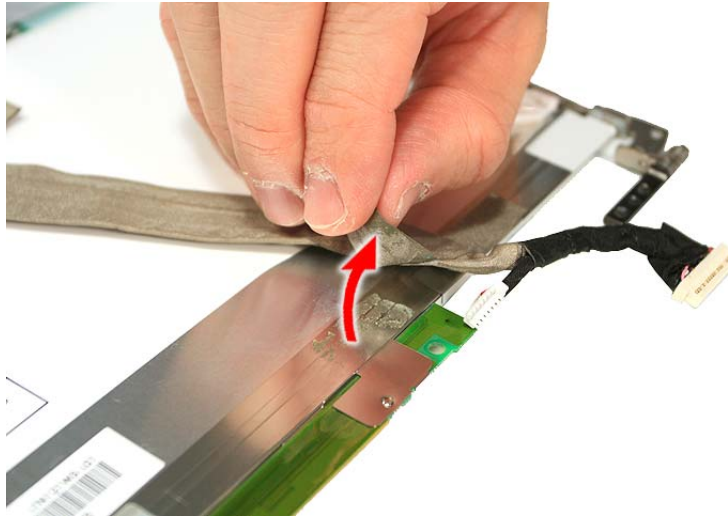



11. Disconnect the FPC cable from the LCD panel.

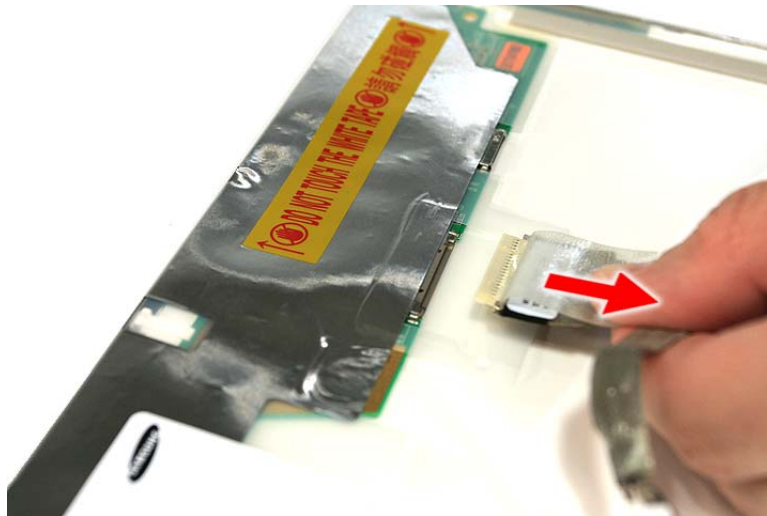

Removing the LCD Brackets

1. See “Removing the Battery Pack” on page 64.
2. See “Removing the Lower Cover” on page 65.
3. See “Removing the WLAN Board Modules” on page 67.
4. See “Removing the Keyboard” on page 71.
5. See “Removing the Middle Cover” on page 72.
6. See “Removing the LCD Module” on page 74.
7. See “Removing the LCD Bezel” on page 100.
8. See “Removing the LCD module with the Brackets” on page 102.
9. See “Removing the FPC Cable” on page 103.

10. Remove the four screws (J) securing the left and right LCD brackets to remove the brackets.



Step	Size (Quantity)	Color	Torque
1~4	M2 x L3 (4)	Silver	1.6 kgf-cm

Removing the Antennas

1. See “Removing the Battery Pack” on page 64.
2. See “Removing the Lower Cover” on page 65.
3. See “Removing the WLAN Board Modules” on page 67.
4. See “Removing the Keyboard” on page 71.
5. See “Removing the Middle Cover” on page 72.
6. See “Removing the LCD Module” on page 74.
7. See “Removing the LCD Bezel” on page 100.
8. See “Removing the LCD module with the Brackets” on page 102.
9. Release the antenna cables from the aluminium tapes.

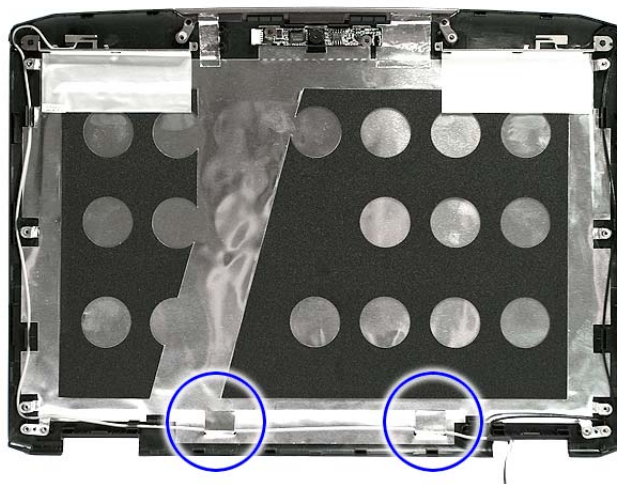

10. Remove the tapes holding the antenna cables in place and release the cables from the latches.

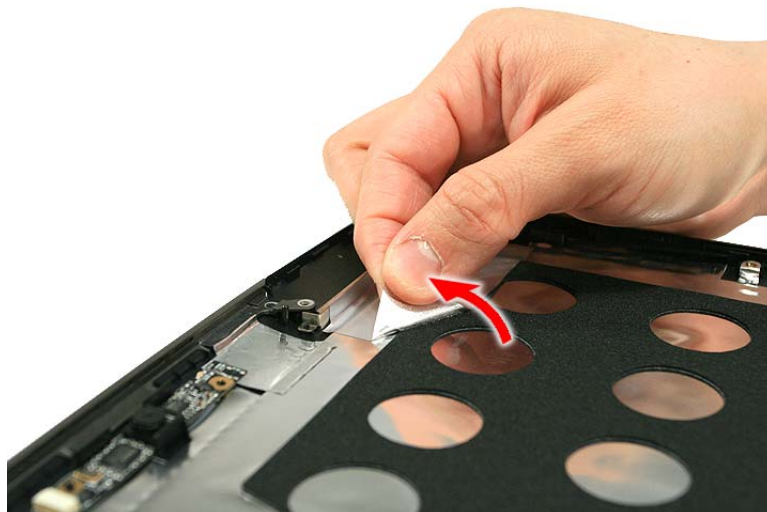

11. Remove the antenna cables from the back cover.





Removing the Web Camera

1. See “Removing the Battery Pack” on page 64.
2. See “Removing the Lower Cover” on page 65.
3. See “Removing the WLAN Board Modules” on page 67.
4. See “Removing the Keyboard” on page 71.
5. See “Removing the Middle Cover” on page 72.
6. See “Removing the LCD Module” on page 74.
7. See “Removing the LCD Bezel” on page 100.
8. See “Removing the LCD module with the Brackets” on page 102.
9. Remove the Web camera from the back cover.

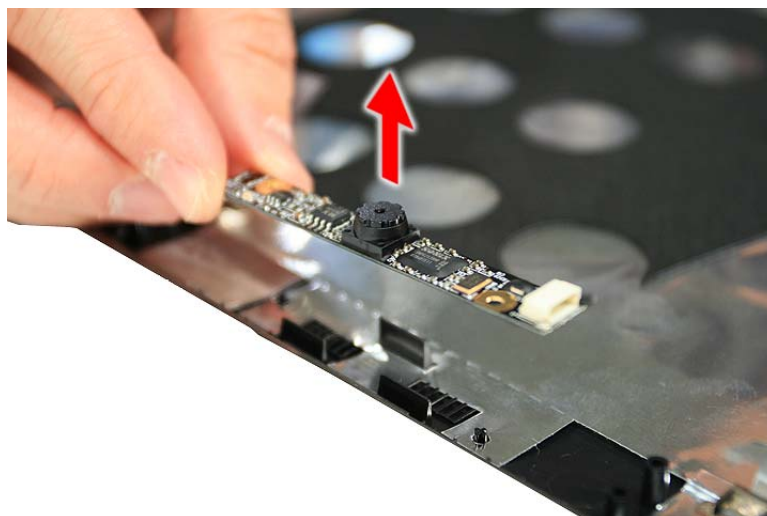

Troubleshooting

Use the following procedure as a guide for computer problems.

NOTE: The diagnostic tests are intended to test only Acer products. Non-Acer products, prototype cards, or modified options can give false errors and invalid system responses.

1. Obtain the failing symptoms in as much detail as possible.
2. Verify the symptoms by attempting to re-create the failure by running the diagnostic test or by repeating the same operation.
3. Use the following table with the verified symptom to determine which page to go to.

Symptoms (Verified)	Go To
Power failure. (The power indicator does not go on or stay on.)	"Power System Check" on page 111.
POST does not complete. No beep or error codes are indicated.	"Power-On Self-Test (POST) Error Message" on page 114 "Undetermined Problems" on page 129
POST detects an error and displayed messages on screen.	"Error Message List" on page 115
Other symptoms (i.e. LCD display problems or others).	"Power-On Self-Test (POST) Error Message" on page 114
Symptoms cannot be re-created (intermittent problems).	Use the customer-reported symptoms and go to "Power-On Self-Test (POST) Error Message" on page 114 "Intermittent Problems" on page 128 "Undetermined Problems" on page 129

System Check Procedures

External Diskette Drive Check

Do the following to isolate the problem to a controller, driver, or diskette. A write-enabled, diagnostic diskette is required.

NOTE: Make sure that the diskette does not have more than one label attached to it. Multiple labels can cause damage to the drive or cause the drive to fail.

Do the following to select the test device.

1. Boot from the diagnostics diskette and start the diagnostics program.
2. See if FDD Test is passed as the program runs to FDD Test.
3. Follow the instructions in the message window.

If an error occurs with the internal diskette drive, reconnect the diskette connector on the system board.

If the error still remains:

1. Reconnect the external diskette drive/DVD-ROM module.
2. Replace the external diskette drive/CD-ROM module.
3. Replace the main board.

External CD-ROM Drive Check

Do the following to isolate the problem to a controller, drive, or CD-ROM. Make sure that the CD-ROM does not have any label attached to it. The label can cause damage to the drive or can cause the drive to fail.

Do the following to select the test device:

1. Boot from the diagnostics diskette and start the diagnostics program.
2. See if CD-ROM Test is passed when the program runs to CD-ROM Test.
3. Follow the instructions in the message window.

If an error occurs, reconnect the connector on the System board. If the error still remains:

1. Reconnect the external diskette drive/CD-ROM module.
2. Replace the external diskette drive/CD-ROM module.
3. Replace the main board.

Keyboard or Auxiliary Input Device Check

Remove the external keyboard if the internal keyboard is to be tested.

If the internal keyboard does not work or an unexpected character appears, make sure that the flexible cable extending from the keyboard is correctly seated in the connector on the system board.

If the keyboard cable connection is correct, run the Keyboard Test.

If the tests detect a keyboard problem, do the following one at a time to correct the problem. Do not replace a non-defective FRU:

1. Reconnect the keyboard cables.
2. Replace the keyboard.
3. Replace the main board.

The following auxiliary input devices are supported by this computer:

- Numeric keypad

-
- External keyboard

If any of these devices do not work, reconnect the cable connector and repeat the failing operation.

Memory check

Memory errors might stop system operations, show error messages on the screen, or hang the system.

1. Boot from the diagnostics diskette and start the doagmpstotics program (please refer to main board).
2. Go to the diagnostic memory in the test items.
3. Press F2 in the test items.
4. Follow the instructions in the message window.

NOTE: Make sure that the DIMM is fully installed into the connector. A loose connection can cause an error.

Power System Check

To verify the symptom of the problem, power on the computer using each of the following power sources:

1. Remove the battery pack.
2. Connect the power adapter and check that power is supplied.
3. Disconnect the power adapter and install the charged battery pack; then check that power is supplied by the battery pack.

If you suspect a power problem, see the appropriate power supply check in the following list:

- “Check the Power Adapter” on page 112
- “Check the Battery Pack” on page 113

Check the Power Adapter

Unplug the power adapter cable from the computer and measure the output voltage at the plug of the power adapter cable. See the following figure

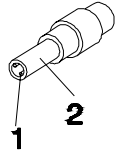

Pin 1: +19 to +20.5V

Pin 2: 0V, Ground

1. If the voltage is not correct, replace the power adapter.
2. If the voltage is within the range, do the following:
 - Replace the System board.
 - If the problem is not corrected, see “Undetermined Problems” on page 129.
 - If the voltage is not correct, go to the next step.

NOTE: An audible noise from the power adapter does not always indicate a defect.

3. If the power-on indicator does not light up, check the power cord of the power adapter for correct continuity and installation.
4. If the operational charge does not work, see “Check the Battery Pack” on page 113.

Check the Battery Pack

To check the battery pack, do the following:

From Software:

1. Check out the Power Management in control Panel
2. In Power Meter, confirm that if the parameters shown in the screen for Current Power Source and Total Battery Power Remaining are correct.
3. Repeat the steps 1 and 2, for both battery and adapter.
4. This helps you identify first the problem is on recharging or discharging.

From Hardware:

1. Power off the computer.
2. Remove the battery pack and measure the voltage between battery terminals 1(+) and 6(ground).
3. If the voltage is still less than 7.5 Vdc after recharging, replace the battery.

To check the battery charge operation, use a discharged battery pack or a battery pack that has less than 50% of the total power remaining when installed in the computer.

If the battery status indicator does not light up, remove the battery pack and let it return to room temperature. Re-install the battery pack.

If the charge indicator still does not light up, replace the battery pack. If the charge indicator still does not light up, replace the DC/DC charger board.

Touchpad Check

If the touchpad doesn't work, do the following actions one at a time to correct the problem. Do not replace a non-defective FRU:

1. Reconnect the touchpad cables.
2. Replace the touchpad.
3. Replace the system board.

After you use the touchpad, the pointer drifts on the screen for a short time. This self-acting pointer movement can occur when a slight, steady pressure is applied to the touchpad pointer. This symptom is not a hardware problem. No service actions are necessary if the pointer movement stops in a short period of time.

Power-On Self-Test (POST) Error Message

The POST error message index lists the error message and their possible causes. The most likely cause is listed first.

NOTE: Perform the FRU replacement or actions in the sequence shown in FRU/Action column, if the FRU replacement does not solve the problem, put the original part back in the computer. Do not replace a non-defective FRU.

This index can also help you determine the next possible FRU to be replaced when servicing a computer.

If the symptom is not listed, see “Undetermined Problems” on page 129.

The following lists the error messages that the BIOS displays on the screen and the error symptoms classified by function.

NOTE: Most of the error messages occur during POST. Some of them display information about a hardware device, e.g., the amount of memory installed. Others may indicate a problem with a device, such as the way it has been configured.

NOTE: If the system fails after you make changes in the BIOS Setup Utility menus, reset the computer, enter Setup and install Setup defaults or correct the error.

Index of Error Messages

Error Code List

Error Codes	Error Messages
006	Equipment Configuration Error Causes: 1. CPU BIOS Update Code Mismatch 2. IDE Primary Channel Master Drive Error (The causes will be shown before "Equipment Configuration Error")
010	Memory Error at xxxx:xxxx:xxxxh (R:xxxxh, W:xxxxh)
070	Real Time Clock Error
071	CMOS Battery Bad
072	CMOS Checksum Error
110	System disabled. Incorrect password is specified.
<No error code>	Battery critical LOW In this situation BIOS will issue 4 short beeps then shut down system, no message will show.
<No error code>	Thermal critical High In this situation BIOS will shut down system, not show message.

Error Message List

Error Messages	FRU/Action in Sequence
Failure Fixed Disk	Reconnect hard disk drive connector. "Load Default Settings" in BIOS Setup Utility. Hard disk drive System board
Stuck Key	see "Keyboard or Auxiliary Input Device Check" on page 110.
Keyboard error	see "Keyboard or Auxiliary Input Device Check" on page 110.
Keyboard Controller Failed	see "Keyboard or Auxiliary Input Device Check" on page 110.
Keyboard locked - Unlock key switch	Unlock external keyboard
Monitor type does not match CMOS - Run Setup	Run "Load Default Settings" in BIOS Setup Utility.
Shadow RAM Failed at offset: nnnn	BIOS ROM System board
System RAM Failed at offset: nnnn	DIMM System board
Extended RAM Failed at offset: nnnn	DIMM System board
System battery is dead - Replace and run Setup	Replace RTC battery and Run BIOS Setup Utility to reconfigure system time, then reboot system.
System CMOS checksum bad - Default configuration used	RTC battery Run BIOS Setup Utility to reconfigure system time, then reboot system.

Error Message List

Error Messages	FRU/Action in Sequence
System timer error	RTC battery Run BIOS Setup Utility to reconfigure system time, then reboot system. System board
Real time clock error	RTC battery Run BIOS Setup Utility to reconfigure system time, then reboot system. System board
Previous boot incomplete - Default configuration used	Run "Load Default Settings" in BIOS Setup Utility. RTC battery System board
Memory size found by POST differed from CMOS	Run "Load Default Settings" in BIOS Setup Utility. DIMM System board
Diskette drive A error	Check the drive is defined with the proper diskette type in BIOS Setup Utility See "External Diskette Drive Check" on page 110.
Incorrect Drive A type - run SETUP	Check the drive is defined with the proper diskette type in BIOS Setup Utility
System cache error - Cache disabled	System board
CPU ID:	System board
DMA Test Failed	DIMM System board
Software NMI Failed	DIMM System board
Fail-Safe Timer NMI Failed	DIMM System board
Device Address Conflict	Run "Load Default Settings" in BIOS Setup Utility. RTC battery System board
Allocation Error for device	Run "Load Default Settings" in BIOS Setup Utility. RTC battery System board
Failing Bits: nnnn	DIMM BIOS ROM System board
Fixed Disk n	None
Invalid System Configuration Data	BIOS ROM System board
I/O device IRQ conflict	Run "Load Default Settings" in BIOS Setup Utility. RTC battery System board
Operating system not found	Enter Setup and see if fixed disk and drive A: are properly identified. Diskette drive Hard disk drive System board

Error Message List

No beep Error Messages	FRU/Action in Sequence
No beep, power-on indicator turns off and LCD is blank.	Power source (battery pack and power adapter). See "Power System Check" on page 111.. Ensure every connector is connected tightly and correctly. Reconnect the DIMM. LED board. System board.
No beep, power-on indicator turns on and LCD is blank.	Power source (battery pack and power adapter). See "Power System Check" on page 111.. Reconnect the LCD connector Hard disk drive LCD inverter ID LCD cable LCD Inverter LCD System board
No beep, power-on indicator turns on and LCD is blank. But you can see POST on an external CRT.	Reconnect the LCD connectors. LCD inverter ID LCD cable LCD inverter LCD System board
No beep, power-on indicator turns on and a blinking cursor shown on LCD during POST.	Ensure every connector is connected tightly and correctly. System board
No beep during POST but system runs correctly.	Speaker System board

Phoenix BIOS Beep Codes

Code	Beeps	POST Routine Description
02h		Verify Real Mode
03h		Disable Non-Maskable Interrupt (NMI)
04h		Get CPU type
06h		Initialize system hardware
08h		Initialize chipset with initial POST values
09h		Set IN POST flag
0Ah		Initialize CPU registers
0Bh		Enable CPU cache
0Ch		Initialize caches to initial POST values
0Eh		Initialize I/O component
0Fh		Initialize the local bus IDE
10h		Initialize Power Management
11h		Load alternate registers with initial POST values
12h		Restore CPU control word during warm boot
13h		Initialize PCI Bus Mastering devices
14h		Initialize keyboard controller
16h	1-2-2-3	BIOS ROM checksum
17h		Initialize cache before memory autosize
18h		8254 timer initialization
1Ah		8237 DMA controller initialization
1Ch		Reset Programmable Interrupt Controller
20h	1-3-1-1	Test DRAM refresh
22h	1-3-1-3	Test 8742 Keyboard Controller
24h		Set ES segment register to 4 GB
26h		Enable A20 line
28h		Autosize DRAM
29h		Initialize POST Memory Manager
2Ah		Clear 215 KB base RAM
2Ch	1-3-4-1	RAM failure on address line xxxx
2Eh	1-3-4-3	RAM failure on data bits xxxx of low byte of memory bus
2Fh		Enable cache before system BIOS shadow
30h	1-4-1-1	RAM failure on data bits xxxx of high byte of memory bus
32h		Test CPU bus-clock frequency
33h		Initialize Phoenix Dispatch Manager
36h		Warm start shut down
38h		Shadow system BIOS ROM
3Ah		Autosize cache

Code	Beeps	POST Routine Description
3Ch		Advanced configuration of chipset registers
3Dh		Load alternate registers with CMOS values
42h		Initialize interrupt vectors
45h		POST device initialization
46h	2-1-2-3	Check ROM copyright notice
48h		Check video configuration against CMOS
49h		Initialize PCI bus and devices
4Ah		Initialize all video adapters in system
4Bh		QuietBoot start (optional)
4Ch		Shadow video BIOS ROM
4Eh		Display BIOS copyright notice
50h		Display CPU type and speed
51h		Initialize EISA board
52h		Test keyboard
54h		Set key click if enabled
58h	2-2-3-1	Test for unexpected interrupts
59h		Initialize POST display service
5Ah		Display prompt "Press F2 to enter SETUP"
5Bh		Disable CPU cache
5Ch		Test RAM between 512 and 640 KB
60h		Test extended memory
62h		Test extended memory address lines
64h		Jump to User Patch1
66h		Configure advanced cache registers
67h		Initialize Multi Processor APIC
68h		Enable external and CPU caches
69h		Setup System Management Mode (SMM) area
6Ah		Display external L2 cache size
6Bh		Load custom defaults (optional)
6Ch		Display shadow-area message
6Eh		Display possible high address for UMB recovery
70h		Display error messages
72h		Check for configuration errors
76h		Check for keyboard errors
7Ch		Set up hardware interrupt vectors
7Eh		Initialize coprocessor if present
80h		Disable onboard Super I/O ports and IRQs
81h		Late POST device initialization

Code	Beeps	POST Routine Description
82h		Detect and install external RS232 ports
83h		Configure non-MCD IDE controllers
84h		Detect and install external parallel ports
85h		Initialize PC-compatible PnP ISA devices
86h		Re-initialize onboard I/O ports
87h		Configure Motherboard Configurable Devices (optional)
88h		Initialize BIOS Area
89h		Enable Non-Maskable Interrupts (NMIs)
8Ah		Initialize Extended BIOS Data Area
8Bh		Test and initialize PS/2 mouse
8Ch		Initialize floppy controller
8Fh		Determine number of ATA drives (optional)
90h		Initialize hard-disk controllers
91h		Initialize local-bus hard-disk controllers
92h		Jump to UserPatch2
93h		Build MPTABLE for multi-processor boards
95h		Install CD ROM for boot
96h		Clear huge ES segment register
97h		Fixup Multi Processor table
98h	1-2	Search for option ROMs. One long, two short beeps on checksum failure.
99h		Check for SMART drive (optional)
9Ah		Shadow option ROMs
9Ch		Set up Power Management
9Dh		Initialize security engine (optional)
9Eh		Enable hardware interrupts
9Fh		Determine number of ATA and SCSI drives
A0h		Set time of day
A2h		Check key lock
A4h		Initialize Typematic rate
A8h		Erase F2 prompt
AAh		Scan for F2 key stroke
ACh		Enter SETUP
A Eh		Clear Boot flag
B0h		Check for errors
B2h		POST done- prepare to boot operating system
B4h	1	One short beep before boot
B5h		Terminate QuietBoot (optional)
B6h		Check password (optional)

Code	Beeps	POST Routine Description
B9h		Prepare Boot
BAh		Initialize DMI parameters
BBh		Initialize PnP Option ROMs
BCh		Clear parity checkers
BDh		Display MultiBoot menu
BEh		Clear screen (optional)
BFh		Check virus and backup reminders
C0h		Try to boot with INT 19
C1h		Initialize POST Error Manager (PEM)
C2h		Initialize error logging
C3h		Initialize error display function
C4h		Initialize system error handler
C5h		PnPnd dual CMOS (optional)
C6h		Initialize notebook docking (optional)
C7h		Initialize notebook docking late
C8h		Force check (optional)
C9h		Extended checksum (optional)
D2h		Unknown interrupt

Code	Beeps	POST Routine Description
E0h		Initialize the chipset
E1h		Initialize the bridge
E2h		Initialize the CPU
E3h		Initialize the system timer
E4h		Initialize system I/O
E5h		Check force recovery boot
E6h		Checksum BIOS ROM
E7h		Go to BIOS
E8h		Set Huge Segment
E9h		Initialize Multi Processor
EAh		Initialize OEM special code
EBh		Initialize PIC and DMA
ECh		Initialize Memory type
EDh		Initialize Memory size
EEh		Shadow Boot Block
EFh		System memory test
F0h		Initialize interrupt vectors
F1h		Initialize Run Time Clock
F2h		Initialize video
F3h		Initialize System Management Mode
F4h	1	Output one beep before boot

Code	Beeps	
F5h		Boot to Mini DOS
F6h		Clear Huge Segment
F7h		Boot to Full DOS

Index of Symptom-to-FRU Error Message

LCD-Related Symptoms

Symptom / Error	Action in Sequence
LCD backlight doesn't work LCD is too dark LCD brightness cannot be adjusted LCD contrast cannot be adjusted	Enter BIOS Utility to execute "Load Setup Default Settings", then reboot system. Reconnect the LCD connectors. Keyboard (if contrast and brightness function key doesn't work). LCD inverter ID LCD cable LCD inverter LCD System board
Unreadable LCD screen Missing pels in characters Abnormal screen Wrong color displayed	Reconnect the LCD connector LCD inverter ID LCD cable LCD inverter LCD System board
LCD has extra horizontal or vertical lines displayed.	LCD inverter ID LCD inverter LCD cable LCD System board

Indicator-Related Symptoms

Symptom / Error	Action in Sequence
Indicator incorrectly remains off or on, but system runs correctly	Reconnect the inverter board Inverter board System board

Power-Related Symptoms

Symptom / Error	Action in Sequence
Power shuts down during operation	Power source (battery pack and power adapter). See "Power System Check" on page 111. Battery pack Power adapter Hard drive & battery connection board System board
The system doesn't power-on.	Power source (battery pack and power adapter). See "Power System Check" on page 111. Battery pack Power adapter Hard drive & battery connection board System board

Power-Related Symptoms

Symptom / Error	Action in Sequence
The system doesn't power-off.	Power source (battery pack and power adapter). See "Power System Check" on page 111. Hold and press the power switch for more than 4 seconds. System board
Battery can't be charged	See "Check the Battery Pack" on page 113. Battery pack System board

PCMCIA-Related Symptoms

Symptom / Error	Action in Sequence
System cannot detect the PC Card (PCMCIA)	PCMCIA slot assembly System board
PCMCIA slot pin is damaged.	PCMCIA slot assembly

Memory-Related Symptoms

Symptom / Error	Action in Sequence
Memory count (size) appears different from actual size.	Enter BIOS Setup Utility to execute "Load Default Settings, then reboot system. DIMM System board

Speaker-Related Symptoms

Symptom / Error	Action in Sequence
In Windows, multimedia programs, no sound comes from the computer.	Audio driver Speaker System board
Internal speakers make noise or emit no sound.	Speaker System board

Power Management-Related Symptoms

Symptom / Error	Action in Sequence
The system will not enter hibernation	See "Save to Disk (S4)" on page 41. Keyboard (if control is from the keyboard) Hard disk drive System board
The system doesn't enter hibernation mode and four short beeps every minute.	Press Fn+0 and see if the computer enters hibernation mode. Touchpad Keyboard Hard disk connection board Hard disk drive System board
The system doesn't enter standby mode after closing the LCD	See "Save to Disk (S4)" on page 41. LCD cover switch System board

Power Management-Related Symptoms

Symptom / Error	Action in Sequence
The system doesn't resume from hibernation mode.	See "Save to Disk (S4)" on page 41. Hard disk connection board Hard disk drive System board
The system doesn't resume from standby mode after opening the LCD.	See "Save to Disk (S4)" on page 41. LCD cover switch System board
Battery fuel gauge in Windows doesn't go higher than 90%.	Remove battery pack and let it cool for 2 hours. Refresh battery (continue use battery until power off, then charge battery). Battery pack System board
System hangs intermittently.	Reconnect hard disk/CD-ROM drives. Hard disk connection board System board

Peripheral-Related Symptoms

Symptom / Error	Action in Sequence
System configuration does not match the installed devices.	Enter BIOS Setup Utility to execute "Load Default Settings", then reboot system. Reconnect hard disk/CD-ROM/diskette drives.
External display does not work correctly.	Press Fn+F5, LCD/CRT/Both display switching System board
USB does not work correctly	System board
Print problems.	Ensure the "Parallel Port" in the "Onboard Devices Configuration" of BIOS Setup Utility is set to Enabled. Onboard Devices Configuration Run printer self-test. Printer driver Printer cable Printer System Board
Serial or parallel port device problems.	Ensure the "Serial Port" in the Devices Configuration" of BIOS Setup Utility is set to Enabled. Device driver Device cable Device System board

Keyboard/Touchpad-Related Symptoms

Symptom / Error	Action in Sequence
Keyboard (one or more keys) does not work.	Reconnect the keyboard cable. Keyboard System board

Keyboard/Touchpad-Related Symptoms

Symptom / Error	Action in Sequence
Touchpad does not work.	Reconnect touchpad cable. Touchpad board System board

Modem-Related Symptoms

Symptom / Error	Action in Sequence
Internal modem does not work correctly.	Modem phone port modem combo board System board

NOTE: If you cannot find a symptom or an error in this list and the problem remains, see “Undetermined Problems” on page 129.

Intermittent Problems

Intermittent system hang problems can be caused by a variety of reasons that have nothing to do with a hardware defect, such as: cosmic radiation, electrostatic discharge, or software errors. FRU replacement should be considered only when a recurring problem exists.

When analyzing an intermittent problem, do the following:

1. Run the advanced diagnostic test for the system board in loop mode at least 10 times.
2. If no error is detected, do not replace any FRU.
3. If any error is detected, replace the FRU. Rerun the test to verify that there are no more errors.

Undetermined Problems

The diagnostic problems does not identify which adapter or device failed, which installed devices are incorrect, whether a short circuit is suspected, or whether the system is inoperative.

Follow these procedures to isolate the failing FRU (do not isolate non-defective FRU).

NOTE: Verify that all attached devices are supported by the computer.

NOTE: Verify that the power supply being used at the time of the failure is operating correctly. (See "Power System Check" on page 111.):

1. Power-off the computer.
2. Visually check them for damage. If any problems are found, replace the FRU.
3. Remove or disconnect all of the following devices:
 - Non-Acer devices
 - Printer, mouse, and other external devices
 - Battery pack
 - Hard disk drive
 - DIMM
 - CD-ROM/Diskette drive Module
 - PC Cards
4. Power-on the computer.
5. Determine if the problem has changed.
6. If the problem does not recur, reconnect the removed devices one at a time until you find the failing FRU.
7. If the problem remains, replace the following FRU one at a time. Do not replace a non-defective FRU:
 - System board
 - LCD assembly

Jumper and Connector Locations

Top and Bottom View

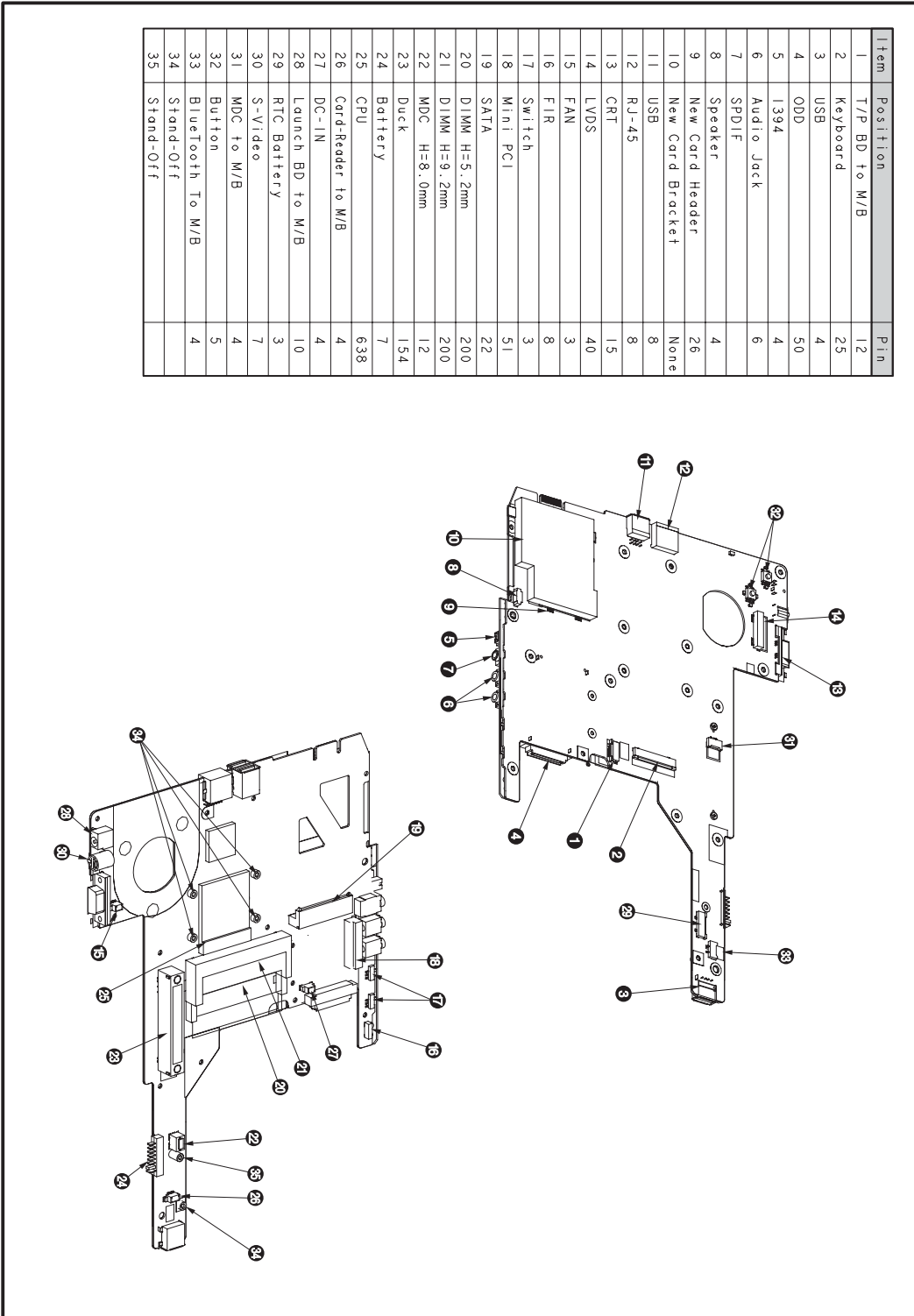

Clearing Password Check and BIOS Recovery

This section provide you the standard operating procedures of clearing password and BIOS recovery for Ferrari 1100. Ferrari 1100 provide one Hardware Open Gap on main board for clearing password check, and one Hotkey for enabling BIOS Recovery.

Clearing Password Check

Hardware Open Gap Description

Hardware	Default Setting	Operation Description
Gap	Open (Normal)	Short (Clearing Password Check)

HW Gap position on M/B space:

Gap name in Ferrari 1100 is G65

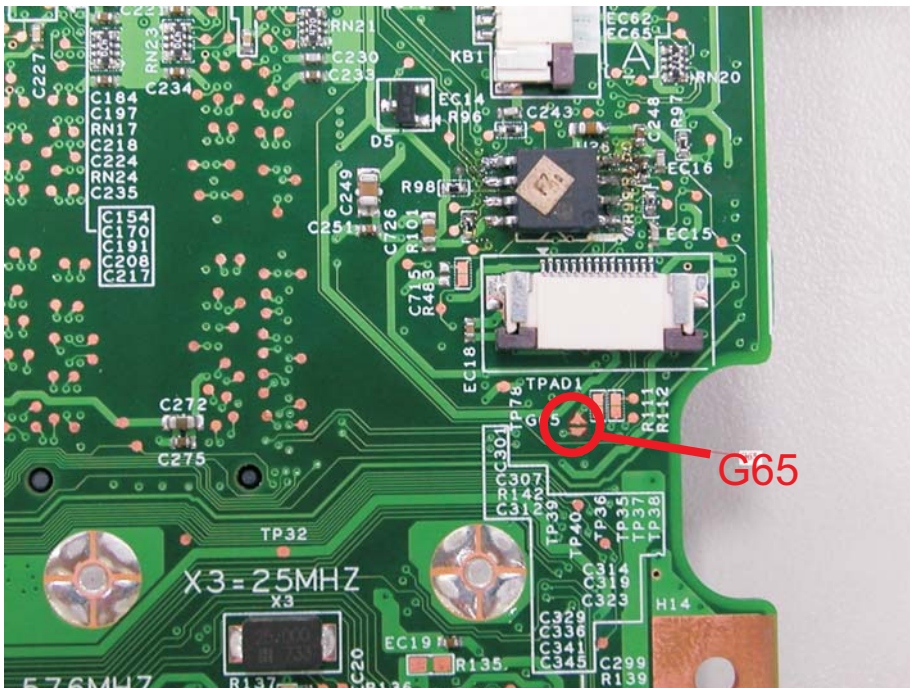

Steps for Clearing BIOS Password Check

If users set BIOS Password (Supervisor Password and/or User Password) for a security reason, BIOS will ask the password during systems POST or when systems enter to BIOS Setup menu. However, once it is necessary to bypass the password check, users need to short the HW Gap to clear the password by the following steps:

- Power Off a system, and remove HDD, AC and Battery from the machine.
- Open the back cover of the machine, and find out the HW Gap on M/B as picture.
- Use an electric conductivity tool to short the two points of the HW Gap.
- Plug in AC, keep the short condition on the HW Gap, and press Power Button to power on the system till BIOS POST finish. Then remove the tool from the HW Gap.
- Restart system. Press F2 key to enter BIOS Setup menu.

-
- If there is no Password request, BIOS Password is cleared. Otherwise, please follow the steps and try again.

NOTE: The steps are only for clearing BIOS Password (Supervisor Password and User Password).

BIOS Recovery by Crisis Disk

BIOS Recovery Boot Block:

BIOS Recovery Boot Block is a special block of BIOS. It is used to boot up the system with minimum BIOS initialization. Users can enable this feature to restore the BIOS firmware to a successful one once the previous BIOS flashing process failed.

BIOS Recovery Hotkey:

The system provides a function hotkey: **Fn+Esc**, for enable BIOS Recovery process when system is powered on during BIOS POST. To use this function, it is strongly recommended to have the AC adapter and Battery present. If this function is enabled, the system will force the BIOS to enter a special BIOS block, called Boot Block.

Steps for BIOS Recovery by Crisis Disk:

Before doing this, one Crisis Disk should be prepared ready in hand. The Crisis Disk could be made by executing the Crisis Disk program in another system with Windows XP OS.

Follow the steps below:

1. Power Off system.
2. Insert the Crisis Disk to a USB floppy drive which is attached to the BIOS flash failed machine.
3. In the power-off state, press **Fn+Esc** and hold them and then press Power Button. The system should be powered on with Crisis BIOS Recovery process.
4. BIOS Boot Block starts to restore the BIOS code from the Crisis floppy disk to BIOS ROM on the failed machine.
5. If the Crisis flashing process is finished, the system will restart.

If the Crisis Recovery process is finished, the system should be powered on with successful and workable BIOS. Then a person can update the latest version BIOS for this machine by regular BIOS flashing process.

FRU (Field Replaceable Unit) List

This chapter gives you the FRU (Field Replaceable Unit) listing in global configurations of Ferrari 1200. Refer to this chapter whenever ordering for parts to repair or for RMA (Return Merchandise Authorization).



Please note that WHEN ORDERING FRU PARTS, you should check the most up-to-date information available on your regional web or channel. For whatever reasons a part number change is made, it will not be noted on the printed Service Guide. For ACER AUTHORIZED SERVICE PROVIDERS, your Acer office may have a DIFFERENT part number code from those given in the FRU list of this printed Service Guide. You MUST use the local FRU list provided by your regional Acer office to order FRU parts for repair and service of customer machines.

NOTE: To scrap or to return the defective parts, you should follow the local government ordinance or regulations on how to dispose it properly, or follow the rules set by your regional Acer office on how to return it.

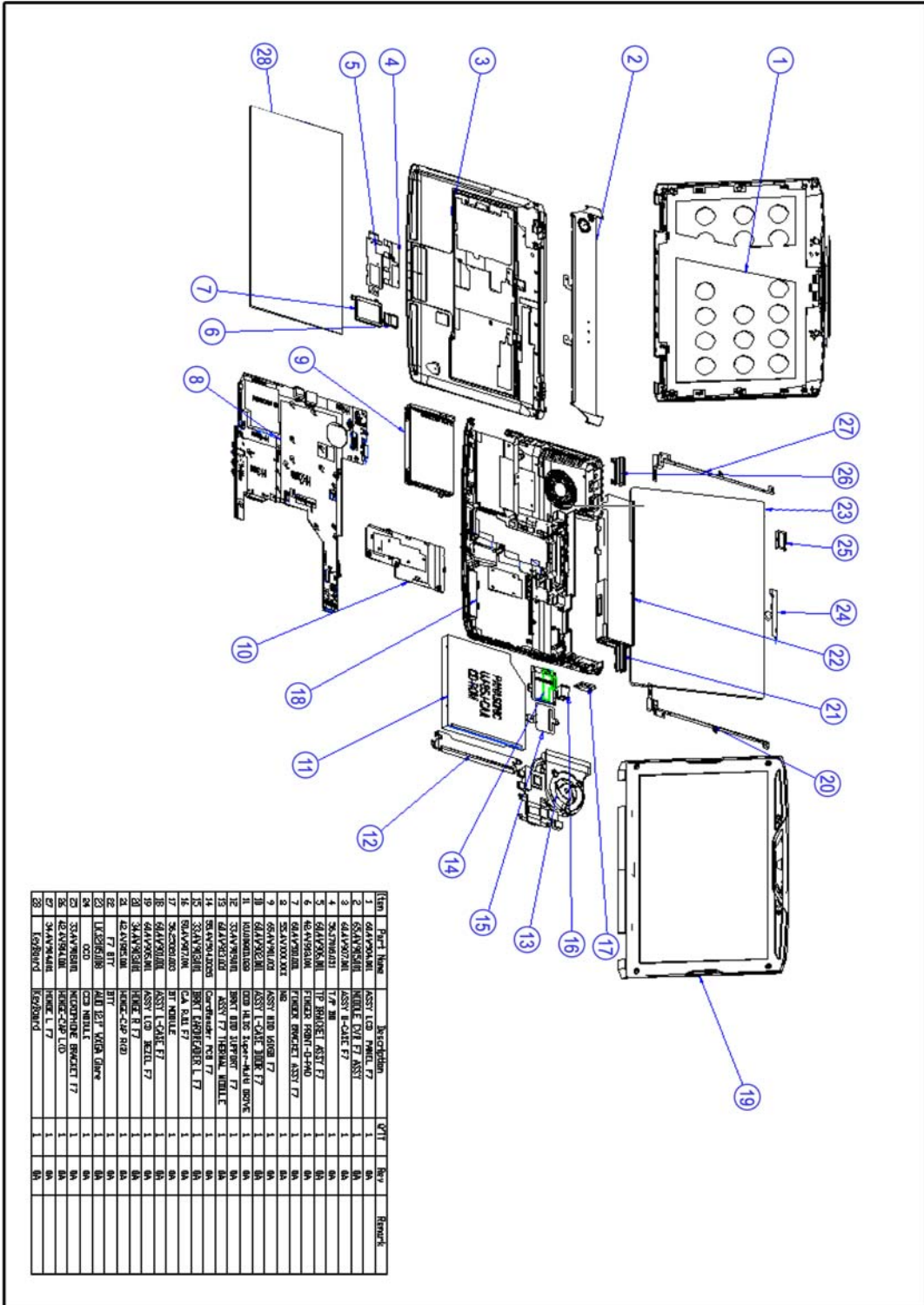
Ferrari 1200 Exploded Diagram

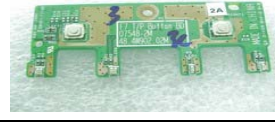
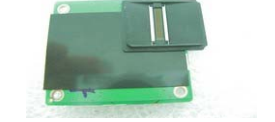

Ferrari 1200 FRU List

Category	No.	Part Name and description	ACER PART NO.
Adapter			
		ADAPTER DELTA 65W 19V 1.7X5.5X11 YELLOW SADP-65KB DFJ LED LF	AP.06501.022
		ADAPTER LITE-ON 65W 1.7X5.5X11 PA- 1650-02AC LF LEVEL 4	AP.06503.016
		ADAPTER LITE-ON 65W 19V 1.7X5.5X11 YELLOW PA-1650-02AC LV4 (FOR FLICKER ISSUE) LED LF	AP.06503.023
		ADAPTER HIPRO 65W 19V 1.7X5.5X11 YELLOW HP-OK065B13 LV4 (FOR FLICKER ISSUE) LED LF	AP.0650A.011
		ADAPTER 65W 3PIN DELTA SADP-65KB BFJA LF LEVEL-4 FOR OBL ONLY	AP.06501.014
Battery			
		BATTERY PACK LI-ION 3S2P PANASONIC 6CELL 2.9MAH FERRARI	BT.00605.027
Board			
		CARD READER BOARD	55.FR901.003
		MEDIA BUTTON BOARD CAPACITIVE JWAF21434XI	55.FR901.004
		TOUCHPAD BUTTON BOARD	55.FRA01.001
		FINGER PRINT BOARD	55.FRA01.002

Category	No.	Part Name and description	ACER PART NO.
		TOUCHPAD SYNAPTICS TM-01059-004	56.FR901.001
		BLUETOOTH BOARD FOXCONN BCM2045 V2 T60H928.11	BT.21100.005
		VOIP PHONE FOR FERRARI7	LC.VIP00.016
		MINI WLAN/B FOXCONN 802.11BGN ATHEROS XB63 BG T60H976.00 FW:V06 MINICARD	NI.23600.007
		WIRELESS LAN BOARD 802.11BG XB63 ATHEROS MINICARD QMI EM105	NI.23600.028
		WIRELESS LAN BOARD 802.11BGN FOXCONN BCM4312 T77H030.00 MINICARD	NI.23600.029
		WIRELESS LAN BOARD 802.11BGN FOXCONN T77H053.00 Atheros AR5B91 1X2	NI.23600.030
		WIRELESS LAN BOARD 802.11BGN QMI EM303-AR Atheros AR5B91 1X2 MINICARD	NI.23600.033
		MODEM BOARD LITEON CONEXANT - UNIZION 1.5_3.3V AUS B85247600G	FX.22500.021
Cable			
		POWER CORD 10A 125V US	27.T30V1.001
		POWER CORD 10A 125V 3PIN US BK	27.01518.641
		POWER CORD 2.5A 125V USA	27.01518.781
		POWER CORD 3A 250V 3PIN UK	27.01518.541
		POWER CORD 5A 250V 3PIN UK BK	27.03118.001
		POWER CORD 250V 3PIN EUR BK	27.T30V1.004
		POWER CABLE 16A 250V 3PIN EUR BK	27.01518.731
		POWER CORD 10A 250V 3PIN CHINA	27.01518.591
		POWER CORD 10A 250V 3PIN CHINA BK	27.01518.701
		POWER CORD 2.5A 250V SOUTH AFRICA BK (INDIA)	27.01518.631
		POWER CORD 10A 250V SOUTH AFRICA BK (INDIA)	27.01518.721

Category	No.	Part Name and description	ACER PART NO.
		POWER CORD 10A 3PIN BK DENMARK	27.01518.561
		POWER CORD 10A 250V 3PIN DENMARK BK	27.01518.671
		POWER CORD 10A 250V 3PIN BK SOUTH AFRICA	27.01518.571
		POWER CORD 16A 250V SOUTH AFRICA BK	27.01518.681
		POWER CORD 10A 250V SWISS	27.01518.581
		POWER CORD 10A 250V 3PIN SWISS BK	27.01518.691
		POWER CORD 10A 250V 3PIN ITALY	27.01518.611
		POWER CORD 10A 250V 3PIN ITALY BK	27.01518.711
		POWER CORD 2.5A 250V AUSTRALIA	27.01518.621
		POWER CORD ACA / ACNZ	27.03218.021
		POWER CORD 7A 125V 2PIN JAPEN	27.01518.551
		POWER CODE 7A 125V 2PIN JAPAN	27.03518.161
		POWER CORD 250V 10A 3PIN ISRAEL	27.01518.761
		POWER CORD 10A 250V ARGENTINE	27.01518.0U1
		TOUCHPAD BOARD CABLE	50.FR901.001
		FINGERPRINT BOARD CABLE	50.FR901.002
		CARDREADER CABLE	50.FR901.003
		TOUCHPAD CABLE	50.FR901.004
		BLUETOOTH CABLE	50.FRA01.002
CASE/COVER/BACKET ASSEMBLY			
		TOUCHPAD BRACKET	33.FR901.001

Category	No.	Part Name and description	ACER PART NO.
		FINGERPRINT BOARD BRACKET	33.FR901.002
		CARDREADER BRACKET	33.FR901.003
		HINGE COVER LEFT	42.FR901.003
		HINGE COVER RIGHT	42.FR901.004
		FINGERPRINT PAD COVER	42.FR901.005
		DUMMY NEW CARD FOR FERRARI7	42.FR901.006
		UNITLOAD COVER	42.FRA01.001
		SD DUMMY CARD	42.TKJ01.001

Category	No.	Part Name and description	ACER PART NO.
		LOWER CASE W/MODEM&DC-IN CABLE&SPEAKER	60.FRA01.001
		UPPER CASE W/FINGER PRINT HOLE	60.FRA01.002
		MIDDLE COVER	42.FR901.001
Speaker			
		SPEAKER	23.FRA01.001
CPU/Processor			
		CPU AMD TURIONX2 RM70 PGA 2.0G 1M 638 35W GRIFFIN B1	KC.TRM02.70K
		CPU AMD TURIONX2 ZM80 PGA 2.1G 2M 638 35W GRIFFIN B1	KC.TZM02.800
		CPU AMD TURIONX2 ZM82 PGA 2.2G 2M 638 35W GRIFFIN B1	KC.TZM02.820
		CPU AMD TURIONX2 ZM84 PGA 2.3G 2M 638 35W GRIFFIN B1	KC.TZM02.840
		CPU AMD TURIONX2 ZM86 PGA 2.4G 2M 638 35W GRIFFIN B1	KC.TZM02.860
DVD-RW Drive Module			

Category	No.	Part Name and description	ACER PART NO.
		ASSEMBLY SUPLER MULTI SLOT-IN MODULE 8X	6M.FRA01.001
		OPTICAL BRACKET SUPPORT	33.FR901.005
		OPTICAL BRACKET	33.FRA01.001
		DVD SUPER MULTI DRIVE 8X 9.5MM SLOT-IN PANASONIC UJ867 LF W/O BEZEL SATA	KU.00807.063
HDD Module			
		HDD HOLDER	42.FRA01.002
		HDD 160GB 5400RPM SATA WD SEAGATE ST9160827AS F/W:2.ALA	KH.16001.029
		HDD 160GB 5400RPM SATA HGST HTS543216L9A300 F/W:C30C	KH.16007.019
		HDD 160GB 5400RPM SATA WD WD1600BEVT-22ZCT0 FW:11.01A11	KH.16008.022
		HDD 250GB 5400RPM SATA SEAGATE ST9250827AS F/W:2.ALA	KH.25001.011
		HDD 250GB 5400RPM SATA HGST HTS543225L9A300 LF F/W:C40C	KH.25007.013
		HDD 250GB 5400RPM SATA WD WD2500BEVT-22ZCT0 FW:11.01A11	KH.25008.021
		HDD 320GB 5400RPM SATA HGST HTS543232L9A300 F/W:C30C	KH.32007.004

Category	No.	Part Name and description	ACER PART NO.
		HDD 320GB 5400RPM SATA WD WD3200BEVT-22ZCT0 ML125 F/ W:01.01A01	KH.32008.013
Heatsink			
		CPU HEATSINK WITH FAN	60.FRA01.003
		UPPER CASE THERMAL PIPE	60.FRA01.004
Keyboard			
		KEYBOARD 12KB-FV1 84KS BLACK US	KB.INT00.171
		KEYBOARD 12KB-FV1 84KS BLACK HEBREW	KB.INT00.172
		KEYBOARD 12KB-FV1 85KS BLACK UK	KB.INT00.173
		KEYBOARD 12KB-FV1 85KS BLACK TURKISH	KB.INT00.174
		KEYBOARD 12KB-FV1 84KS BLACK THAILAND	KB.INT00.175
		KEYBOARD 12KB-FV1 85KS BLACK SWISS	KB.INT00.176
		KEYBOARD 12KB-FV1 85KS BLACK SWEDISH	KB.INT00.177
		KEYBOARD 12KB-FV1 85KS BLACK SPANISH	KB.INT00.178
		KEYBOARD 12KB-FV1 85KS BLACK SLOVAK	KB.INT00.180
		KEYBOARD 12KB-FV1 85KS BLACK SLO/ CRO	KB.INT00.181
		KEYBOARD 12KB-FV1 84KS BLACK RUSSIAN	KB.INT00.182
		KEYBOARD 12KB-FV1 85KS BLACK PORTUGUESE	KB.INT00.183
		KEYBOARD 12KB-FV1 85KS BLACK POLISH	KB.INT00.184
		KEYBOARD 12KB-FV1 85KS BLACK NORWEGIAN	KB.INT00.185
		KEYBOARD 12KB-FV1 84KS BLACK KOREAN	KB.INT00.187

Category	No.	Part Name and description	ACER PART NO.
		KEYBOARD 12KB-FV1 88KS BLACK JAPANESE	KB.INT00.188
		KEYBOARD 12KB-FV1 85KS BLACK ITALIAN	KB.INT00.189
		KEYBOARD 12KB-FV1 84KS BLACK ISRAEL	KB.INT00.190
		KEYBOARD 12KB-FV1 85KS BLACK HUNGARIAN	KB.INT00.192
		KEYBOARD 12KB-FV1 84KS BLACK GREEK	KB.INT00.193
		KEYBOARD 12KB-FV1 85KS BLACK GERMAN	KB.INT00.194
		KEYBOARD 12KB-FV1 85KS BLACK FRENCH	KB.INT00.195
		KEYBOARD 12KB-FV1 85KS BLACK DANISH	KB.INT00.198
		KEYBOARD 12KB-FV1 85KS BLACK CZECH	KB.INT00.199
		KEYBOARD 12KB-FV1 84KS BLACK TAIWAN	KB.INT00.201
		KEYBOARD 12KB-FV1 85KS BLACK CANADIAN FRENCH	KB.INT00.202
		KEYBOARD 12KB-FV1 85KS BLACK BRAZILIAN PORTUGUESE	KB.INT00.203
		KEYBOARD 12KB-FV1 85KS BLACK BELGIUM	KB.INT00.204
		KEYBOARD 12KB-FV1 84KS BLACK ARABIC	KB.INT00.205
		KEYBOARD 12KB-FV1 85KS BLACK ARABIC/FRENCH	KB.INT00.252
		KEYBOARD 12KB-FV1 85KS BLACK NORDIC	KB.INT00.253
		KEYBOARD 12KB-FV1 85KS BLACK ENGLISH FRENCH CANADIAN	KB.INT00.254
LCD Module			
		LED LCD MODULE 12.1" WXGAG GLARE W/ANTENNA & 0.3M CAMERA & MICROPHONE	6M.FRA01.002
		LCD BRACKET LEFT W/HINGE	33.FR901.007
		LCD BRACKET RIGHT W/HINGE	33.FR901.008

Category	No.	Part Name and description	ACER PART NO.
		LCD/CAMERA CABLE 12.1"	50.FRA01.001
		CAMERA 0.3M SUYIN CN0314-SN30-OV03-1	57.TQ901.001
		CAMERA 0.3M CHICONY CNF701721004971L	57.TQ901.002
		LCD COVER 12.1" W/LOGO&ANTENNA	60.FR901.005
		LCD BEZEL 12.1" W/CAMERA HOLE & MIC	60.FRA01.005
		LED LCD AUO 12.1" WXGA GLARE B121EW09 V0 LF 220NIT 16MS	LK.12105.014
Mainboard			
	MAINBOARD	MAINBOARD FERRARI_7_GT ATI RS780 LF W/RTC BATTERY & MODEM BOARD	MB.FRA01.001
Memory			
		SODIMM 1GB DDRII667 NANYA NT1GT64U8HB0BN-3C LF (0.09U)	KN.1GB03.014
		SODIMM 1GB DDRII667 SAMSUNG M470T2864QZ3-CE6 LF	KN.1GB0B.016
		SODIMM 1GB DDRII667 HYNIX HYMP112S64CP6-Y5 LF	KN.1GB0G.012

Category	No.	Part Name and description	ACER PART NO.
		SODIMM 2GB DDRII667 MICRON MT16HTF25664HY-667E1	KN.2GB04.001
		SODIMM 2GB DDRII667 SAMSUNG M470T5663QZ3-CE6 LF	KN.2GB0B.003
		SODIMM 2GB DDRII667 HYNIX HYMP125S64CP8-Y5 LF	KN.2GB0G.004
MISCELLANEOUS			
		RUBBER FOOT FRONT RIGHT FOR FERRARI7	47.FR901.001
		RUBBER FOOT FRONT LEFT FOR FERRARI7	47.FR901.002
		RUBBER FOOT BACK RIGHT FOR FERRARI7	47.FR901.003
		LCD SCREW RUBBER RIGHT	47.FR901.008
		LCD SCREW RUBBER LEFT	47.FR901.009
		RUBBER FOOT FRONT SMALL RIGHT FOR FERRARI7	47.FR901.005
		RUBBER FOOT FRONT SMALL LEFT FOR FERRARI7	47.FR901.006
		LCD SCREW RUBBER	47.FRA01.001
Pointing Device			
		ACER FERRARI 7 MOUSE MS_F7 BLUETOOTH	MS.20700.006
Screw			
		SCREW	86.00C07.220
		SCREW	86.00E33.736
		SCREW	86.00E92.724
		SCREW	86.00F22.722
		SCREW	86.00F24.724
		SCREW	86.9A524.4R0
		SCREW	86.9A552.4R0
		SCREW	86.FR901.001
		SCRE M2-0.4X5ZN/BL+NY	86.FR901.002
		SCREW M2*4 NI NYLOK	86.FR901.003

Model Definition and Configuration

Ferrari 1200 Series

Test Compatible Components

This computer's compatibility is tested and verified by Acer's internal testing department. All of its system functions are tested under Windows® XP Home, Windows® XP Pro environment.

Refer to the following lists for components, adapter cards, and peripherals which have passed these tests. Regarding configuration, combination and test procedures, please refer to the Ferrari 1200 series Compatibility Test Report released by the Acer Mobile System Testing Department.

Microsoft® Windows® Vista Environment Test

Item	Specification
CRT Port Test	
CRT Monitor	Acer 211c 21", ViewSonic G220F, ViewSonic PF790 19"
LCD Monitor	Acer FP751 17" TFT LCD, Acer AL1521, Acer AL1721, ViewSonic VD201b, Westinghouse W37G, HP LP2065, HP S9500
Projector	Dell 3300MP
USB Port Test	
USB Keyboard/Mouse	Microsoft Natural Keyboard Pro Dell USB Keyboard Logicool USB Mouse (OWCM-USB) Logitech USB Wheel Mouse Logitech First Wheel Mouse Dell Dell by Logitech Dell Internet Navigator Keyboard Dell Smart Card Keyboard HP USB Optical Austin Mouse Belkin Miniglow Optical USB Mouse HP USB Optical Mouse (RB129AA)
USB Speaker/Joystick	Aiwa Multimedia Digital Speaker (SC-UC78) Panasonic USB Speaker EAB-MPC57USB
USB Storage Drive	Iomega USB Zip 250MB Transcend 80G HDD Plextor DVD+R/RW LG DVD+R/RW Sony DVD+R/RW
USB Camera	Intel Easy PC Camera (A20953-001) Orange Micro USB 2.0 Web Cam
USB HUB and Others	A TEN UH-204 IOGEAR 4-Port Hub Corega CG-WLUSBST11
USB Printer/Scanner	HP 450WBT Deskjet Printer
USB Flash Drive	Sony Memory Key 128MB Sony Micro Vault Pro USD-5G IBM 128MB Memory Key IBM 512MB Memory Key Apacer Handy Drive Apacer The USB Flash Drive 256MB
USB ODD	Logitech CDRW+DVDROM combo LG DVD+R/RW Sony DVD+R/RW
1394 Camera	Sony DV-TRV10
Access Point 802.11a	Intel Pro/Wireless 5000 NetGear HE 102
Access Point 802.11g	D-Link Building Networks People WiFi Certified a/b/g Wireless 108AG
Access Point 802.11n	Belkin N1MIMO Wireless Router High Performance wireless 802.11n
Bluetooth Device	Sony Ericsson Wireless Headset Sony Ericsson T610 X Bridge Bluetooth Access Point BT300

Item	Specification
PCMCIA Test	
LAN/Modem Card	TDK CardBus Ethernet 10/100 32-Bit CBE-10/100BTX
Storage Card	Hitachi Microdrive 4G
1394 Card	Buffalo 1394 Interface Cardbus (IFC-ILCB/DV)
USB2.0 Card	IBM EtherJet CardBus Adapter 10/100
Wireless Lan Card (Not recommended for wireless ready model)	Cisco Wireless LAN Card 802.11a NETGEAR Wireless LAN card 802.11a
ISDN Card	Toshiba Type B for Bluetooth 128K ISDN Card
GPRS Card	Vodafone QL1ACC-21581 3G/GPRS card Sony Ericsson GC83 GPRS card Sony Ericsson GC89 GPRS card
ExpressCard Test	
Express Card	Abcom 5-in-1 Adapter ExpressCard Reader Abcom GigaLan ExpressCard Sunix ECF2400 2 Ports 1394A ExpressCard
Memory Card Test (SD/MS/MMC/SM/CF/Microdrive/XD)	
SD Card	Apacer 128/256MB SanDisk 256MB Apacer 2GB (150x Hi-Speed) KINGMAX 1GB (66x Hi-Speed) SanDisk 1GB RiDATA 4GB SD PRO Memory Card
MS Card	Sony 512 MS PRO Lexar 512MB MS PRO Lexar 1GB MS PRO Sony 2GB MS PRO
MMC Card	SanDisk 32MB Transcend 64/128MB Transcend 256MB SanDisk RS-MMC 128MB PQI RS-MMC 256MB Transcend 512MB A-DATA Turbo 200X 2GB MMC Card
XD Card	Apacer 256/512MB SanDisk 2GB Olympus 512MB
CF Card	Apacer 256/512 SanDisk 2GB

Online Support Information

This section describes online technical support services available to help you repair your Acer Systems.

If you are a distributor, dealer, ASP or TPM, please refer your technical queries to your local Acer branch office. Acer Branch Offices and Regional Business Units may access our website. However some information sources will require a user i.d. and password. These can be obtained directly from Acer CSD Taiwan.

Acer's Website offers you convenient and valuable support resources whenever you need them.

In the Technical Information section you can download information on all of Acer's Notebook, Desktop and Server models including:

- Service guides for all models
- User's manuals
- Bios updates
- Software utilities
- Spare parts lists
- TABs (Technical Announcement Bulletin)

For these purposes, we have included an Acrobat File to facilitate the problem-free downloading of our technical material.

Also contained on this website are:

- Detailed information on Acer's International Traveler's Warranty (ITW)
- Returned material authorization procedures
- An overview of all the support services we offer, accompanied by a list of telephone, fax and email contacts for all your technical queries.

We are always looking for ways to optimize and improve our services, so if you have any suggestions or comments, please do not hesitate to communicate these to us.

A

AFLASH Utility 51
Antennas 102
Audio 36

B

Battery Pack 60
BIOS 32

- package 32
- password control 32
- ROM size 32
- ROM type 32
- vendor 32
- Version 32

BIOS Supports protocol 32
BIOS Utility 39–51

- Navigating 40
- Onboard Device Configuration 46
- Security 43, 45
- System Security 50

Board Layout

- Top View 125

brightness

- hotkeys 16

Button Board 76

C

Cache

- controller 32
- size 32

caps lock

- on indicator 11

Card Reader board 93
computer

- on indicator 7, 11

CPU 89
CPU Fan True Value Table 32

D

DIMM Module 62
Display 4
display

hotkeys 16

E

Error Symptom-to-Spare Part Index 110
Euro 17
External CD-ROM Drive Check 106
External Module Disassembly
Flowchart 59

F

Features 1
Fingerprint Board 80
Flash Utility 51
fpc cable 99
FRU (Field Replaceable Unit) List 129

H

Hard disk 34
Hard Disk Drive Module 64
HDD 34
Hibernation mode

- hotkey 16

Hot Keys 14

I

Indicators 11
Intermittent Problems 123

J

Jumper and Connector Locations 125
Top View 125

K

Keyboard 37, 67
Keyboard or Auxiliary Input Device Check 106

L

Launch Board 76
LCD Bezel 96

LCD Brackets 101
LCD Module Disassembly
 Flowchart 95
LCD with the Brackets 98
lower cover 61

M

Main Unit Disassembly
 Flowchart 66
Mainboard 85
media access
 on indicator 11
Memory Check 107
Model Definition 138
Modem Board 90

N

Notebook Manager
 hotkey 16
num lock
 on indicator 11

O

Online Support Information 165
optical drive module 83

P

Panel 5
 Bottom 10
 left 5
PC Card 11
Power System Check 107
 Battery Pack 109
 Power Adapter 108
Processor 32

S

Screw List 58
Speaker Module 91
speakers
 hotkey 16
System
 Block Diagram 4

System Check Procedures 106
System Memory 32
System Utilities 39

T

Test Compatible Components 161
Top 125
Touch Pad Board 82
touchpad
 hotkey 16
Touchpad Check 109
Troubleshooting 105

U

Undetermined Problems 124
utility
 BIOS 39–51

V

view
 left 8
 rear 9
 right 8

W

Windows 2000 Environment Test 162
WLAN Board 63