

Ferrari one Series

Service Guide

Service guide files and updates are available on the ACER/CSD web; for more information, please refer to <http://csd.acer.com.tw>

PRINTED IN TAIWAN

Revision History

Please refer to the table below for the updates made on this service guide.

Date	Chapter	Updates

Copyright

Copyright © 2009 by Acer Incorporated. All rights reserved. No part of this publication may be reproduced, transmitted, transcribed, stored in a retrieval system, or translated into any language or computer language, in any form or by any means, electronic, mechanical, magnetic, optical, chemical, manual or otherwise, without the prior written permission of Acer Incorporated.

Disclaimer

The information in this guide is subject to change without notice.

Acer Incorporated makes no representations or warranties, either expressed or implied, with respect to the contents hereof and specifically disclaims any warranties of merchantability or fitness for any particular purpose. Any Acer Incorporated software described in this manual is sold or licensed "as is". Should the programs prove defective following their purchase, the buyer (and not Acer Incorporated, its distributor, or its dealer) assumes the entire cost of all necessary servicing, repair, and any incidental or consequential damages resulting from any defect in the software.

Acer is a registered trademark of Acer Corporation.

Intel is a registered trademark of Intel Corporation.

Pentium and Pentium II/III are trademarks of Intel Corporation.

Other brand and product names are trademarks and/or registered trademarks of their respective holders.

Conventions

The following conventions are used in this manual:

SCREEN MESSAGES	Denotes actual messages that appear on screen.
NOTE	Gives bits and pieces of additional information related to the current topic.
WARNING	Alerts you to any damage that might result from doing or not doing specific actions.
CAUTION	Gives precautionary measures to avoid possible hardware or software problems.
IMPORTANT	Reminds you to do specific actions relevant to the accomplishment of procedures.

Preface

Before using this information and the product it supports, please read the following general information.

1. This Service Guide provides you with all technical information relating to the BASIC CONFIGURATION decided for Acer's "global" product offering. To better fit local market requirements and enhance product competitiveness, your regional office MAY have decided to extend the functionality of a machine (e.g. add-on card, modem, or extra memory capability). These LOCALIZED FEATURES will NOT be covered in this generic service guide. In such cases, please contact your regional offices or the responsible personnel/channel to provide you with further technical details.
2. Please note WHEN ORDERING FRU PARTS, that you should check the most up-to-date information available on your regional web or channel. If, for whatever reason, a part number change is made, it will not be noted in the printed Service Guide. For ACER-AUTHORIZED SERVICE PROVIDERS, your Acer office may have a DIFFERENT part number code to those given in the FRU list of this printed Service Guide. You MUST use the list provided by your regional Acer office to order FRU parts for repair and service of customer machines.

System Specifications	1
Features	1
System Block Diagram	3
Your Notebook Tour	4
Front View	4
Closed Front View	5
Left View	6
Right View	6
Base View	7
Rear View	8
Indicators	8
Touchpad Basics	9
Using the Keyboard	10
Lock Keys and embedded numeric keypad	10
Windows Keys	11
Hot Keys	12
Special Keys	13
Hardware Specifications and Configurations	14
System Utilities	23
BIOS Setup Utility	23
Navigating the BIOS Utility	23
Information	24
Main	25
Security	26
Boot	29
Exit	30
BIOS Flash Utility	31
DOS Flash Utility	32
WinFlash Utility	33
Remove HDD/BIOS Password Utilities	34
Removing BIOS Passwords:	35
Miscellaneous Utilities	36
Machine Disassembly and Replacement	39
Disassembly Requirements	39
Related Information	39
Replacement Requirements	39
General Information	39
Pre-disassembly Instructions	39
Disassembly Process	40
External Module Disassembly Process	40
External Modules Disassembly Flowchart	41
Removing the Battery Pack	42
Removing the Dummy Card	43
Removing the SIM Card	43
Removing the Hard Disk Drive Module	44
Removing the 3G Module	46
Removing the DIMM Module	49
Removing the WLAN Module	51
Main Unit Disassembly Process	54
Main Unit Disassembly Flowchart	54
Removing the Keyboard	56
Removing the Upper Cover	58

Table of Contents

Removing the Button Board	62
Removing the Bluetooth Module	65
Removing the I/O Board	66
Removing the LCD Module	69
Removing the Mainboard	71
Removing the Thermal Module	73
Removing the CPU	75
Removing the RTC Battery	75
Removing the Speaker Modules	77
LCD Module Disassembly Process	79
LCD Module Disassembly Flowchart	79
Removing the LCD Bezel	81
Removing the Camera Board	83
Removing the LCD Panel	84
Removing the LCD Brackets	86
Removing the FPC Cable	87
Removing the Antennas	89
LCD Reassembly Procedure	91
Replacing the Antennas	91
Replacing the FPC Cable	93
Replacing the LCD Brackets	95
Replacing the LCD Panel	95
Replacing the Camera Board	97
Replacing the LCD Bezel	97
Main Unit Reassembly Process	100
Replacing the Speaker Module	100
Replacing the RTC battery	101
Replacing the CPU	101
Replacing the Thermal Module	102
Replacing the Mainboard	104
Replacing the LCD Module	105
Replacing the I/O Board	106
Replacing the Bluetooth Module	109
Replacing the Button Board	110
Replacing the Upper Cover	113
Replacing the Keyboard	117
Replacing the WLAN Module	117
Replacing the DIMM Module	118
Replacing the 3G Module	119
Replacing the HDD Module	121
Replacing the Lower Covers	122
Replacing the SIM Card	124
Replacing the Battery	124
Replacing the Dummy Card	125

Troubleshooting

127

Common Problems	127
Power On Issue	128
No Display Issue	129
Random Loss of BIOS Settings	130
LCD Failure	131
Built-In Keyboard Failure	132
Touchpad Failure	133
Internal Speaker Failure	134
Internal Microphone Failure	135

Table of Contents

HDD Not Operating Correctly	136
USB Failure (Right up/down side)	137
Other Failures	137
Intermittent Problems	138
Undetermined Problems	138
POST Code Reference Tables	139
Jumper and Connector Locations	143
Mainboard Top View	143
BIOS Recovery	145
BIOS Recovery by Crisis Disk	145
FRU (Field Replaceable Unit) List	147
California Exploded Diagrams	148
Main Assembly	148
LCD Assembly	149
California FRU ListV	151
Model Definition and Configuration	159
Test Compatible Components	167
Online Support Information	169
Index	171

Table of Contents

System Specifications

Features

Below is a brief summary of the computer's many features:

Operating System

- Genuine Windows 7

Platform

- AMD Athlon™ 64 X2 dual-core processor
- AMD M780G Chipset

System Memory

- Dual-Channel SDRAM support
- Up to 2 GB of DDR2 667 MHz memory, upgradeable to 4 GB using two soDIMM modules
- Up to 2 GB of DDR2 800 MHz memory, upgradeable to 4 GB using two soDIMM modules

Display and graphics

- 16:9 aspect ratio
- 11.6" high-brightness Acer CrystalBrite™ LCD
- ATI Radeon™ HD 3200 Graphics

Storage subsystem

- 2.5" hard disk drive
- Multi-in-1 card reader

Audio subsystem

- High-definition audio support
- S/PDIF (Sony/Philips Digital Interface) support for digital speakers
- MS-Sound compatible
- Built-in microphone

Communication

- Integrated Acer Crystal Eye webcam
- WWAN: UMTS/HSPA at 850/900/1900/2100 MHz and quad-band GSM/GPRS/EDGE (850/900/1800/1900 MHz)*
- WLAN:
 - Acer InViLink™ Nplify™ 802.11b/g/Draft-N*

-
- Acer InViLink™ 802.11b/g*
 - WPAN: Bluetooth® 2.1+Enhanced Data Rate (EDR)
 - LAN: Gigabit Ethernet; Wake-on-LAN ready

Privacy control

- BIOS user, supervisor, HDD passwords
- Kensington lock slot

Dimensions and Weight)

- 285 (W) x 204 (D) x 24/30 (H) mm (11.22 x 8.03 x 0.9/1.2 inches)
- 1.5 kg (3.31 lbs.) with 6-cell Li-ion battery pack

Power subsystem

- ACPI 3.0
- 6-cell Li-ion battery pack
- 3-pin 65 W AC adapter
- ENERGY STAR®

Special keys and controls

- 84-/85-/88-key keyboard
- Touchpad pointing device

I/O interface

- Acer DynaVivid Graphics Dock™ connector
- Multi-in-1 card reader (SD/MMC/MS/MS PRO/xD)
- USB 2.0 port
- External display (VGA) port
- Headphones/speaker/line-out jack with S/PDIF support
- Microphone-in jack
- Ethernet (RJ-45) port
- DC-in jack for AC adapter

Environment

- Temperature:
 - Operating: 5 °C to 35 °C
 - Non-operating: -20 °C to 65 °C
- Humidity (non-condensing):
 - Operating: 20% to 80%
 - Non-operating: 20% to 80%

NOTE: The specifications listed above are for reference only. The exact configuration of the PC depends on the model purchased.

System Block Diagram

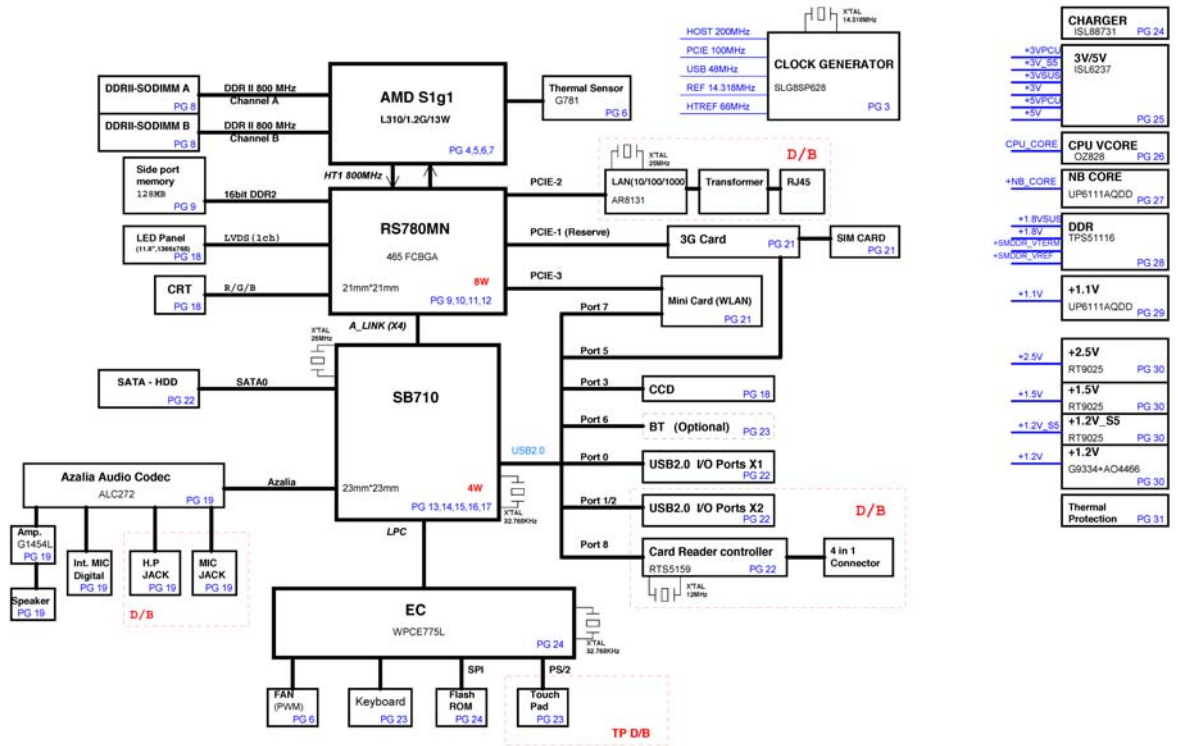









Your Notebook Tour

This section provides an overview of the features and functions of the notebook.

Front View





No.	Icon	Item	Description
1		Acer Crystal Eye webcam	Web camera for video communication.
2		Microphone	Internal microphone for sound recording.
3		Display screen	Also called Liquid-Crystal Display (LCD), displays computer output (Configuration may vary by models).
4		HDD	Indicates when the hard disk drive is active.
		Num Lock	Lights up when Num Lock is activated.
		Caps Lock	Lights up when Caps Lock is activated.
5		Keyboard	For entering data into your computer.

No.	Icon	Item	Description
6		Touchpad	Touch-sensitive pointing device which functions like a computer mouse.
7		Click buttons (left and right)	The left and right buttons function like the left and right mouse buttons.
8		Communication indicator	Indicates the status of WLAN / 3G communication. (only for certain models)
		Power	Indicates the computer's power status.
		Battery	Indicates the computer's battery status. 1. Charging: The light shows amber when the battery is charging. 2. Fully charged: The light shows blue when in AC mode.
		Bluetooth communication indicator	Indicates the status of Bluetooth communication. (only for certain models)
9		Palmrest	Comfortable support area for your hands when you use the computer.
10		Power button / indicator	Turns the computer on and off. / Indicates the computer's power status.

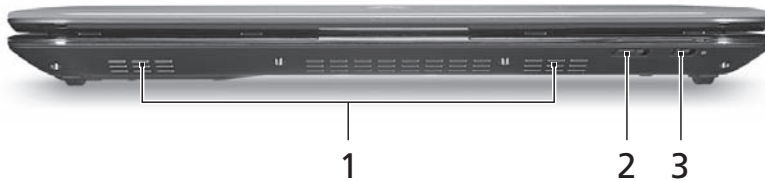

Closed Front View



No.	Icon	Item	Description
1		Speakers	
2		Communication indicator	Indicates the status of WLAN / 3G communication. (only for certain models)
3		Bluetooth communication indicator	Indicates the status of Bluetooth communication. (only for certain models)

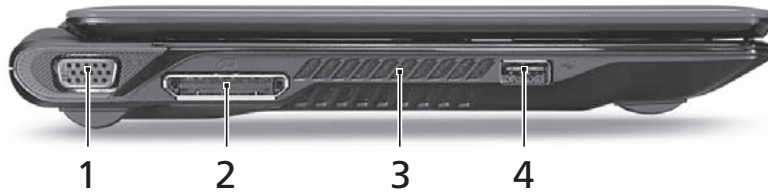



Left View



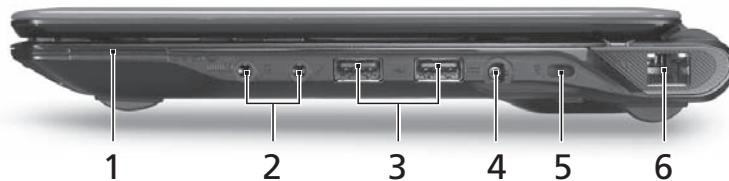

No.	Icon	Item	Description
1		External display (VGA) port	Connects to a display device (e.g., external monitor, LCD projector).
2		Acer DynaVivid Graphics Dock connector	Connects to an Acer DynaVivid Graphics Dock device.
3		Ventilation slots	Enable the computer to stay cool, even after prolonged use.
4		USB 2.0 port	Connect to USB 2.0 devices (e.g., USB mouse, USB camera).

Right View



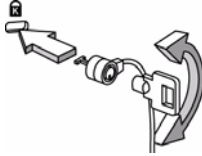

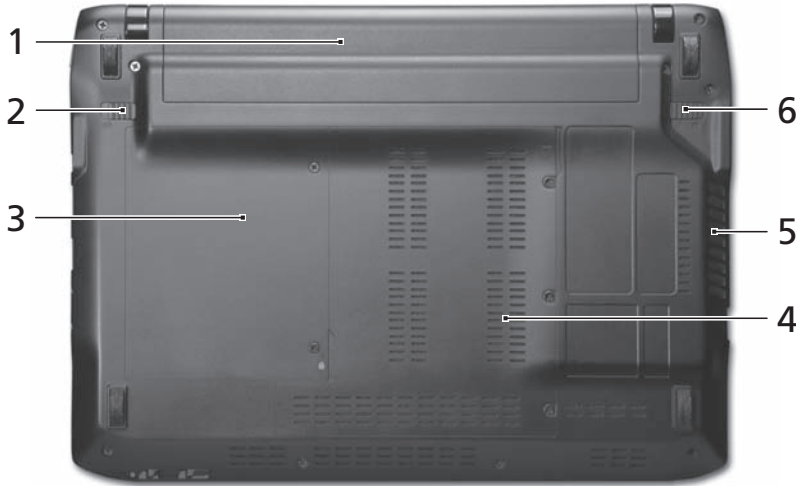

No.	Icon	Item	Description
1		Multi-in-1 card reader	Accepts Secure Digital (SD), MultiMediaCard (MMC), Memory Stick (MS), Memory Stick PRO (MS PRO), xD-Picture Card (xD). Note: Push to remove/install the card. Only one card can operate at any given time.
2		Headphones/speaker/line-out jack with S/PDIF support	Connects to audio line-out devices (e.g., speakers, headphones).
3		USB 2.0 port	Connect to USB 2.0 devices (e.g., USB mouse, USB camera).
4		DC-in jack	Connects to an AC adapter.

5		Kensington lock 	Connects to a Kensington-compatible computer security lock. Note: Wrap the computer security lock cable around an immovable object such as a table or handle of a locked drawer. Insert the lock into the notch and turn the key to secure the lock. Some keyless models are also available.
6		Ethernet (RJ-45) port	Connects to an Ethernet 10/100/1000- based network.

Base View



No.	Icon	Item	Description
1		Battery bay	Houses the computer's battery pack.
2		Battery lock	Locks the battery in position.
3		Hard disk bay	Houses the computer's hard disk (secured with screws).
4		Memory compartment	Houses the computer's main memory.
5		Ventilation slots and cooling fan	Enable the computer to stay cool, even after prolonged use. Note: Do not cover or obstruct the opening of the fan.
6		Battery release latch	Releases the battery for removal.



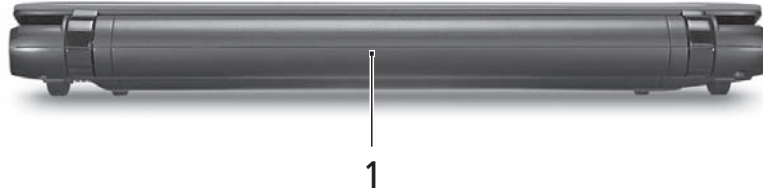



Rear View



No.	Icon	Item	Description
1		Battery	Houses the computer's battery pack.

Indicators

The computer has several easy-to-read status indicators. The battery indicator is visible even when the computer cover is closed.

Icon	Function	Description
	Bluetooth	Indicates the status of Bluetooth communication.
	Wireless LAN	Indicates the status of Wireless LAN communication.
	3G communication	Indicates the status of 3G communication.
	HDD	Indicates when the hard disk drive is active.
	Num Lock	Lights up when Num Lock is activated.
	Caps Lock	Lights up when Caps Lock is activated.
	Battery	Indicates the computer's battery status.

NOTE: 1. **Charging:** The battery light shows amber when the battery is charging. 2. **Fully charged:** The light shows green when in AC mode.

Touchpad Basics

The following items show you how to use the Touchpad:

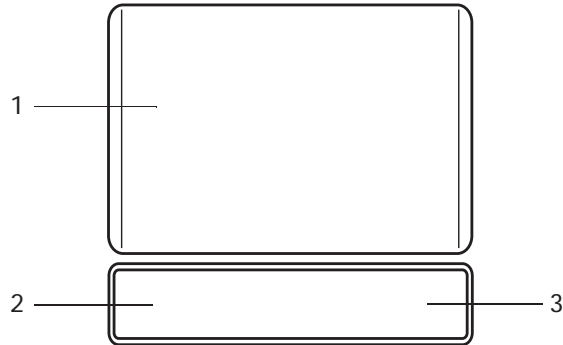

- Move your finger across the Touchpad (1) to move the cursor.
- Press the left (2) and right (3) buttons located beneath the Touchpad to perform selection and execution functions. These two buttons are similar to the left and right buttons on a mouse. Tapping on the Touchpad is the same as clicking the left button.

p

Function	Left Button (2)	Right Button (3)	Main Touchpad (1)
Execute	Quickly click twice.		Tap twice (at the same speed as double-clicking a mouse button).
Select	Click once.		Tap once.
Drag	Click and hold, then use finger on the Touchpad to drag the cursor.		Tap twice (at the same speed as double-clicking a mouse button); rest your finger on the Touchpad on the second tap and drag the cursor.
Access context menu		Click once.	

NOTE: When using the Touchpad, keep it - and your fingers - dry and clean. The Touchpad is sensitive to finger movement; hence, the lighter the touch, the better the response. Tapping too hard will not increase the Touchpad's responsiveness.

Using the Keyboard

Your computer has a close-to-full-sized keyboard and an embedded numeric keypad, separate cursor, lock, function and special keys.

Lock Keys and embedded numeric keypad

The keyboard has three lock keys which you can toggle on and off.













Lock key	Description
Caps Lock	When Caps Lock is on, all alphabetic characters typed are in uppercase.
Num Lock <Fn> + <F11>	When Num Lock is on, the embedded keypad is in numeric mode. The keys function as a calculator (complete with the arithmetic operators +, -, *, and /). Use this mode when you need to do a lot of numeric data entry. A better solution would be to connect an external keypad.
Scroll Lock <Fn> + <F12>	When Scroll Lock is on, the screen moves one line up or down when you press the up or down arrow keys respectively. Scroll Lock does not work with some applications.

The embedded numeric keypad functions like a desktop numeric keypad. It is indicated by small characters located on the upper right corner of the keycaps. To simplify the keyboard legend, cursor-control key symbols are not printed on the keys.

Desired access	Num Lock on	Num Lock off
Number keys on embedded keypad	Type numbers in a normal manner.	
Cursor-control keys on embedded keypad	Hold <Shift> while using cursor-control keys.	Hold <Fn> while using cursor-control keys.
Main keyboard keys	Hold <Fn> while typing letters on embedded keypad.	Type the letters in a normal manner.

Windows Keys













The keyboard has two keys that perform Windows-specific functions.

Key	Description
 Windows key	<p>Pressed alone, this key has the same effect as clicking on the Windows Start button; it launches the Start menu. It can also be used with other keys to provide a variety of functions:</p> <ul style="list-style-type: none"><  >: Open or close the Start menu<  > + <D>: Display the desktop<  > + <E>: Open Windows Explore<  > + <F>: Search for a file or folder<  > + <L>: Lock your computer (if you are connected to a network domain), or switch users (if you're not connected to a network domain)<  > + <M>: Minimizes all windows<  > + <R>: Open the Run dialog box<  > + <U>: Open Ease of Access Center<  > + <BREAK>: Display the System Properties dialog box<  > + <TAB>: Cycle through programs on the taskbar<CTRL> + <  > + <F>: Search for computers (if you are on a network) <p>Note: Depending on your edition of Windows XP, some shortcuts may not function as described.</p>
 Application key	This key has the same effect as clicking the right mouse button; it opens the application's context menu.

Hot Keys

The computer employs hotkeys or key combinations to access most of the computer's controls like screen brightness and volume output.

To activate hotkeys, press and hold the <Fn> key before pressing the other key in the hotkey combination.

Hotkey	Icon	Function	Description
<Fn> + <F1>		Power management	Launch Windows power management.
<Fn> + <F2>		System Properties	Display the System Properties dialog box.
<Fn> + <F3>		Bluetooth communication switch	Enables/disables the Bluetooth function.
<Fn> + <F4>		Sleep	Puts the computer in Sleep mode.
<Fn> + <F5>		Display toggle	Switches display output between the display screen, external monitor (if connected) and both.
<Fn> + <F6>		Screen blank	Turns the display screen backlight off to save power. Press any key to return.
<Fn> + <F7>		Touchpad toggle	Turns the internal touchpad on and off.
<Fn> + <F8>		Speaker toggle	Turns the speakers on and off.
<Fn> + <F10>		Ferrari	Opens the Ferrari website.
<Fn> + <▷>		Brightness up	Increases the screen brightness.
<Fn> + <◁>		Brightness down	Decreases the screen brightness.
<Fn> + <△>		Volume up	Increases the sound volume.
<Fn> + <▽>		Volume down	Decreases the sound volume.

Special Keys

You can locate the Euro symbol and the US dollar sign at the upper-center and/or bottom-right of your keyboard.

The Euro symbol

1. Open a text editor or word processor.
2. Hold <Alt Gr> and then press the <5> key at the upper-center of the keyboard.

NOTE: Some fonts and software do not support the Euro symbol. See www.microsoft.com/typography/faq/faq12.htm for more information.

The US dollar sign

1. Open a text editor or word processor.
2. Hold <Shift> and then press the <4> key at the upper-center of the keyboard.

NOTE: This function varies according to the language settings.

Hardware Specifications and Configurations

Processor

Item	Specification
CPU type	AMD L310/Dual core/1.2G
CPU package	638-pin lidless micro-PGA
Power	<ul style="list-style-type: none"> VCC-CORE: voltage for the future processor will depend on VID0-5 for battery mode and setting via software for adapter mode for the future processor
Features	<ul style="list-style-type: none"> AMD Athlon™ 64 X2 Processor L310 Speed: 1.2GHz On-die Cache: 1MB total dedicated L2 HT-Link: 16-bit link supporting; speeds up to 800MHz TDP: 13 W

Processor Specifications

Item	CPU Speed	Cores	Mfg Tech	Cache Size	Package	Core Voltage	Acer P/N
S1g1	TBC	2	TBC	TBC	TBC	TBC	TBC

CPU Fan True Value Table

CPU Temperature (Celsius)	Fan Speed (RPM)	SPL Spec (dBA)
80	5500	36
70	5000	34
60	4500	31
50	4000	28

Throttling 50%: On= 85°C; OFF=95°C

OS shut down at 95°C; H/W shut down at 87°C

North Bridge Specifications

Item	Specification
Chipset	RS780MN
Package	528-Pin FCBGA Package (21 x 21 mm)
Power	+1.1V, +1.2V, +1.8V, +3V, +NB_CORE

Item	Specification
Features	<ul style="list-style-type: none"> • Supports the mobile and desktop Athlon 64/Athlon 64FX/ Athlon X2/AMD Sempron/AMD Turion 64 processors, including both AM2 and S1 socket CPUs. • Supports 16-bit up/down HyperTransport(HT) 3.0 interface up to 4.4GT/s. • Supports 200, 400, 600, 800 and 1000MHz HT1 frequencies. • Supports LDTSTP interface, CPU throttling and stutter mode. • Supports ATI HyperMemory™* technology. • Compliant with the PCI Express(PCI-E) Gen2 Specification. <ul style="list-style-type: none"> • A dual-port, x16 graphics interface. • Supports six PCI Express general purpose Lane, for up to six devices on specific ports. • One x4 A-Link Express II interface (PCI Express Gen2 compliant) for connection to an AMD Southbridge. • Multiple Display Features(LCD+CRT). • Integrated LVDS dual-link 24-bit LVDS interface. • Supports a TMDS interface, enabling DVI or HDMI (pass HDMI CTS v1.3b), which is multiplexed on the PCI-E external graphics interface. • Supports ACPI 2.0 for S0, S3, S4 and S5 states. • Support for AMD PowerNow!™. • Supports PowerExpress™ and PowerPlay™(enhanced with PowerShift™ feature) • Dynamic self-refresh for the side-port memory. • Integrated spread spectrum PLLs on the memory and LVDS interface.

South Bridge Specifications

Item	Specification
Chipset	SB710
Package	528-FCBGA Package (21 x 21 mm)
Power	+1.2V, +1.8V, +3V, +1.2V_S5, +3V_S5

Item	Specification
Features	<ul style="list-style-type: none"> • Supports AMD Athlon 64/Athlon 64FX/Opteron/AMD Sempron/Mobile Sempron/Athlon XP-M and Turion processors, Dual-core CPUs are supported. • A-Link Express II interface to AMD Northbridges; high data transfer bandwidth(up to 2.5Gb/s / Lane) • PCI Host Bus controller <ul style="list-style-type: none"> • Supports PCI bus at 33MHz • PCI Rev. 2.3 specification support • Supports up to 6 bus master devices • 5 OHCI and 2 EHCI Host controllers to supports 12 USB 2.0 ports and 2 dedicated USB 1.1 ports • AMD RAID Support - supports integrated RAID 0, RAID 1 and RAID 10 • SATA Controller <ul style="list-style-type: none"> • Supports six SATA ports with transfer rates up to 3Gb/s • Complies with SATA 2.5 specification. • Supports both SATA 1.5 and SATA 3.0 compliance devices • Two operating mode supported: 1. Legacy Mode using I/O space. 2. AHCI mode using the Memory space. • Supports e-SATA • Single PATA channel support • High Definition Audio <ul style="list-style-type: none"> • Support up to 4 codec's • Up to 192kHz Sample Rate and 32-bit Audio • Unified Audio Architecture(UAA) compatible • 4 Independent output streams(DMA) • 4 Independent input streams(DMA) • ACPI specification 3.0 compliant power management schemes • RTC / Timers integrated

System Memory

Item	Specification
Memory Controller	Integrated with L310
Memory size	0MB (No on-board Memory)
DIMM socket number	2 sockets
Supports memory size per socket	2GB
Supports maximum memory size	4GB for 64bit OS (with two 2GB SO-DIMM)
Supports DIMM type	DDR2 Synchronous DRAM
Supports DIMM Speed	800/ 667 MHz
Support DIMM voltage	1.8V
Support DIMM package	200-pin DDR2-800/ 667 SO-DIMM
Memory module combinations	You can install memory modules in any combination as long as they match the above specifications.

Video Specifications

Item	Specification
Chipset	ATI Radeon™ HD 3200 Graphics

Item	Specification
Package	TBC
Features	<ul style="list-style-type: none"> • Microsoft® DirectX®10 • PCI Express® 2.0 • Vari-Bright™ Technology • 12 USB 2.0 ports and two USB 1.0 • DisplayPort, HDMI, and DVI • On-Chip HDCP • Display Cache

Hard Disk Drive Interface

Item	Specification			
Vendor & Model Name	Hitachi HTS545050B9A 300	Hitachi HTS545032B9A 300	Hitachi HTS545025B9A 300	Hitachi HTS545016B9A 300
Capacity (GB)	500	320	250	160
Bytes per sector	512			
Data heads	4	3	2	2
Drive Format				
Disks	2	2	1	1
Spindle speed (RPM)	5400			
Performance Specifications				
Buffer size	8MB			
Interface	SATA			
Internal transfer rate (Gbits/sec., max)	3GB/s maximum			
I/O data transfer rate (Mbytes/sec. max)	875 Mbits/s maximum			845 Mbits/s maximum
DC Power Requirements				
Voltage tolerance	5.0V ± 5%			

Item	Specifications			
Vendor & Model Name	Seagate ST9160310AS	Seagate ST9250315AS	Seagate ST9320320AS	Seagate ST9500325AS
Capacity (GB)	160	250	320	500
Bytes per sector	512	512	512	512
Data heads	2	2	4	4
Drive Format				
Disks	1	1	2	2
Spindle speed (RPM)	5400	5400	5400	5400
Performance Specifications				
Buffer size	8 MB	8 MB	8MB	8 MB
Interface	SATA	SATA	SATA	SATA

Item	Specifications			
Internal transfer rate (Mbits/sec, max)	830	1175	830	1175
I/O data transfer rate (Mbytes/sec max)	875 Mbits/s maximum			845 Mbits/s maximum
DC Power Requirements				
Voltage	+5.0V ± 5%.			

Item	Specifications			
Vendor & Model Name	Toshiba MK1655GSX	Toshiba MK2555GSX	Toshiba MK3255GSX	Toshiba MK5055GSX
Capacity (GB)	160	250	320	500
Bytes per sector	512	512	512	512
Data heads	2	2	4	4
Drive Format				
Disks	1	1	2	2
Spindle speed (RPM)	5400			
Performance Specifications				
Buffer size	8MB			
Interface	SATA			
Internal transfer rate (Mbits/sec, max)	363 ~ 952 typical			
I/O data transfer rate (Mbytes/sec max)	300			
DC Power Requirements				
Voltage	5V ±5%			

BIOS

Item	Specification
BIOS vendor	Phoenix
BIOS Version	v3102
BIOS ROM Type	W25X80AVSSIG
BIOS ROM Size	8Mb
BIOS Package	8 PIN SOIC
Supported Protocol	SPI
BIOS Password control	Set manually

LCD

Item	Specifications			
Vendor/model name	LED LCD AUO 11.6" WXGA Glare B116XW02 V0 1A (3G) LF 200nit 8ms 500:1	LED LCD CMO 11.6" WXGA Glare N116B6-L02 C2 LF 200nit 10ms 500:1	LED LCD SAMSUNG 11.6" WXGA Glare LTN116AT01-A01 LF 200nit 8ms	LED LCD LPL 11.6" WXGA Glare LP116WH1-TLA1 LF 200nit 8ms 500:1
Screen Diagonal (mm)	11.6"			

Item	Specifications																						
Active Area (mm)	256.125 (H) x 144.0 (V)																						
Display resolution (pixels)	1366 x 768																						
Pixel Pitch (mm)	0.1875 (H) x 0.1875 (V)																						
Typical White Luminance (cd/m ²) also called Brightness	200 nit																						
Contrast Ratio	500:1 typ																						
Response Time (Optical Rise Time/Fall Time) msec	8 mS typ																						
Typical Power Consumption (watt)	3.86W																						
Weight (with inverter)	235g max.																						
Physical Size (mm)	Length: 278.5 max Width: 168 max Thickness: 3.6																						
Normal Input Voltage	+3.3V																						
Electrical Interface	1 channel LVDS																						
Viewing Angle (degree) Horizontal (Right) / (Left) Vertical (Upper) / (Lower)	<table border="1"> <thead> <tr> <th rowspan="4">Viewing Angle</th> <th>θ_R</th> <th>Horizontal (Right)</th> <th>40</th> <th>45</th> <th>-</th> <th rowspan="4">degree</th> </tr> </thead> <tbody> <tr> <td>θ_L</td> <td>CR = 10 (Left)</td> <td>40</td> <td>45</td> <td>-</td> </tr> <tr> <td>ϕ_H</td> <td>Vertical (Upper)</td> <td>10</td> <td>15</td> <td>-</td> </tr> <tr> <td>ϕ_L</td> <td>CR = 10 (Lower)</td> <td>30</td> <td>35</td> <td>-</td> </tr> </tbody> </table>	Viewing Angle	θ_R	Horizontal (Right)	40	45	-	degree	θ_L	CR = 10 (Left)	40	45	-	ϕ_H	Vertical (Upper)	10	15	-	ϕ_L	CR = 10 (Lower)	30	35	-
Viewing Angle	θ_R		Horizontal (Right)	40	45	-	degree																
	θ_L		CR = 10 (Left)	40	45	-																	
	ϕ_H		Vertical (Upper)	10	15	-																	
	ϕ_L	CR = 10 (Lower)	30	35	-																		
Temperature Range	Storage: -20 to 60°C Operating: 0 to 50°C																						

Bluetooth

Item	Specification
Bluetooth Controller	Foxconn Bluetooth BCM 2046 BT2.1 (T60H928.33) F/W: 856
Features	<ul style="list-style-type: none"> Fully Qualified Bluetooth v2.1 with Class 2 specification RF output power. Enhanced Data Rate(EDR) compliant. Full Piconet and Scatternet operation. Integrated PIFA Antenna with better RF performance. USB 2.0 compliant interface. F/W upgradable via Flash downloads. Very low power consumption. Support Coexistence with Intel WCS(Wireless Coexistence System) & AFH(Adaptive Frequency Hopping)
Power	<ul style="list-style-type: none"> 3.3V

Audio Codec and Amplifier

Item	Specification
Audio Controller	Realtek ALC272 Azalizia CODEC Amplifier GMT G1454L
Internal Speakers	Two Med-High Speakers (1W/4Ω)
Internal Microphone	Digital MICRO PHONE ZK2(HFM-M101-006-L19-G) Digital MICRO PHONE ZK2(A-OA2408FM-018)

Item	Specification
Features	<ul style="list-style-type: none"> Headphone-out with S/PDIF, and Microphone-In. Meets performance and function requirements for Microsoft WLP 3.10, and stricter performance requirements for future WLP Two stereo DAC supports 16/20/24-bit PCM for two independent playback(multiple streaming). Two stereo ADC supports 16/20/24-bit PCM format for two independent recording. All DACs/ADCs supports independent 44.1k/48k/96k/192kHz sample rate Two independent S/PDIF outputs support 16/20/24-bit format and 44.1k/48k/88.2k/96k/192kHz rate.

LAN Interface

Item	Specification
LAN Chipset	Atheros AR8131L
Package	48pin QFN (6 x 6 mm)
Power	3.3V
Features	<p>The AR8131L is the third generation Giga-bit Ethernet (GbE) controller solution from Atheros. It is an ultra-high performance, ultra-low cost and ultra-low power fully integrated 10/100/1000 Mbps NIC/LOM Ethernet controller perfectly suited for both PC and embedded applications.</p> <ul style="list-style-type: none"> Embedded switching and LDO voltage regulators IEEE 802.3x compliant flow control support Integrated PHY for 10/100/1000 Mbps IEEE 802.3ab Auto-Negotiation support IEEE 802.3ab PHY compliance and compatibility Cable Diagnostic Test(CDT) for open, short cable, cable length detection, and incorrect or mismatched impedance. Supported PM states: L0, L1, L0s Compliance with PCI Express power management and ACPI Wake on LAN support Supports Energy Star 4.0 PCIE Features <ul style="list-style-type: none"> PCI Express base 1.1 compliant Supports PME and error messaging Supports clock enable / disable using CLK REQUEST pin

Keyboard

Item	Specification
Type	Darfon K/B(UI) ZH6 (AEZH6R00,3A)API
Total number of keypads	TBC
Windows logo key	Yes
Internal & external keyboard work simultaneously	Plug USB keyboard to the USB port directly: Yes

Media Card Reader

Item	Specification
Chipset	RTS5159-GR
Features	<ul style="list-style-type: none"> Compliant with USB Mass Storage Class Bulk only Transport Specification Rev. 1.0 Support the following memory card interfaces: <ul style="list-style-type: none"> SD/MMC/Mini-SD/Micro-SD(T-flash)/RS-MMC/Mobile- MMC/MMC-micro Memory Stick / Memory Stick PRO / MS Duo / MS-PRO Duo and Micro-MS(M2) MSPRO-HG Duo 8-bit mode xD – Picture Card (xD) including Type M and Type H Support hardware ECC(Error Correction Code) function Support hardware CRC(Cyclic Redundancy Check) function Programmable clock rate for flash memory card interfaces Provide Selective Suspend driver to reduce power consumption
Compliance	<ul style="list-style-type: none"> Support MS-PRO v1.02 Support MS v1.43 Support MS PRO-HG Duo v1.01 Support SD version 2.0 Support MMC version 4.2 Support xD v1.2
Power	3.3V
Package	48-pin LQFP

Camera

Item	Specifications		
Vendor and model	Chicony CNF9016	Suyin Model No.CN0316-S30C-OV06-1	Chicony CNF9011
Type	640 x 480 VGA (0.3M) size 1/6" CMOS	640 x 480 VGA (0.3M) size 1/6" CMOS	640 x 480 VGA (0.3M) size 1/6" CMOS
Interface	USB 2.0 high speed interface	USB 2.0 high speed interface	USB 2.0 high speed interface
Optical aperture		F2.4	F2.4 ± 5%
Focusing range	17.4cm ~ Infinity, focus on 40cm	40 cm to Infinity	17.4cm ~ Infinity, focus on 40cm
Dimensions (L x W x H mm)	64.8±0.3 x 7.9±0.1 x 3.64+0.15/- 0.25mm	65X 7.9 x 3.8+/-0.2mm	64.8±0.3 x 7.9±0.1 x 3.64+0.15/-0.25 mm
Sensor type	CMOS	CMOS image sensor	CMOS
Pixel resolution	640 x 480	640X480	640 x 480
Pixel size	TBD	3.6um X3.6um	TBD
Image size	TBD	2.36mm(H) X1.76mm(V)	TBD

Wireless LAN

Item	Specification	Specification	Specification	Specification
Model	<ul style="list-style-type: none"> Foxconn Wireless LAN Atheros HB95 1x1 BG (HM) Foxconn Wireless LAN Atheros HB93 			
Protocol	802.11a/b/g			
Interface	PCI-Express			

3G Module

Item	Specification
3G Model	Foxconn Gobi2000
Technical Standard	<ul style="list-style-type: none"> CDMA2000 1X CDMA2000 1xEV-DO(Release0 and Rev. A) WCDMA(UMTS) High-Speed Downlink Packet Access (HSDPA) High-Speed Uplink Packet Access (HSUPA) Receive Diversity in CDMA2000 1X, CDMA2000 1xEV-DO and WCDMA (UMTS) GSM Release 4 GPRS/EGPRS Multi-slot Class12, Release 4 Standalone GPS
Interface	USB 2.0
Antenna	USB 2.0

Battery

Item	Specification
	6 Cell
Vendor & model name	SANYO UM-2009E Li-ion 3S2P PANASONIC UM-2009E Li-ion 3S2P SIMPLO UM-2009E Li-Ion 3S2P
Battery Type	Li-ion
Pack capacity	SANYO 6 cell 4400mAh SANYO 6 cell 5600mAh PANASONIC 6 cell 4400mAh PANASONIC 6 cell 5800mAh Simplo 6 cell 4400mAh Simplo 6 cell 5600mAh
Number of battery cell	6
Package configuration	3 cells in series, 2 series in parallel
Normal voltage	11.1V
Charge voltage	12.6V

System Utilities

BIOS Setup Utility

The BIOS Setup Utility is a hardware configuration program built into your computer's BIOS (Basic Input/Output System).

Your computer is already properly configured and optimized, and you do not need to run this utility. However, if you encounter configuration problems, you may need to run Setup. Please also refer to Chapter 4 Troubleshooting when problem arises.

To activate the BIOS Utility, press **F2** during POST (when **Press <F2> to enter Setup** message is prompted on the bottom of screen).

Press **F2** to enter setup. The default parameter of F12 Boot Menu is set to "disabled". If you want to change boot device without entering BIOS Setup Utility, please set the parameter to "enabled".

Press **<F12>** during POST to enter multi-boot menu. In this menu, user can change boot device without entering BIOS SETUP Utility.

Navigating the BIOS Utility

There are six menu options: Information, Main, Advanced, Security, Power, Boot, and Exit.

Follow these instructions:

- To choose a menu, use the left and right arrow keys.
- To choose an item, use the up and down arrow keys.
- To change the value of a parameter, press **F5** or **F6**.
- A plus sign (+) indicates the item has sub-items. Press **Enter** to expand this item.
- Press **Esc** while you are in any of the menu options to go to the Exit menu.
- In any menu, you can load default settings by pressing **F9**. You can also press **F10** to save any changes made and exit the BIOS Setup Utility.

NOTE: You can change the value of a parameter if it is enclosed in square brackets. Navigation keys for a particular menu are shown on the bottom of the screen. Help for parameters are found in the Item Specific Help part of the screen. Read this carefully when making changes to parameter values. **Please note that system information is subject to different models.**

Information

The Information screen displays a summary of your computer hardware information.

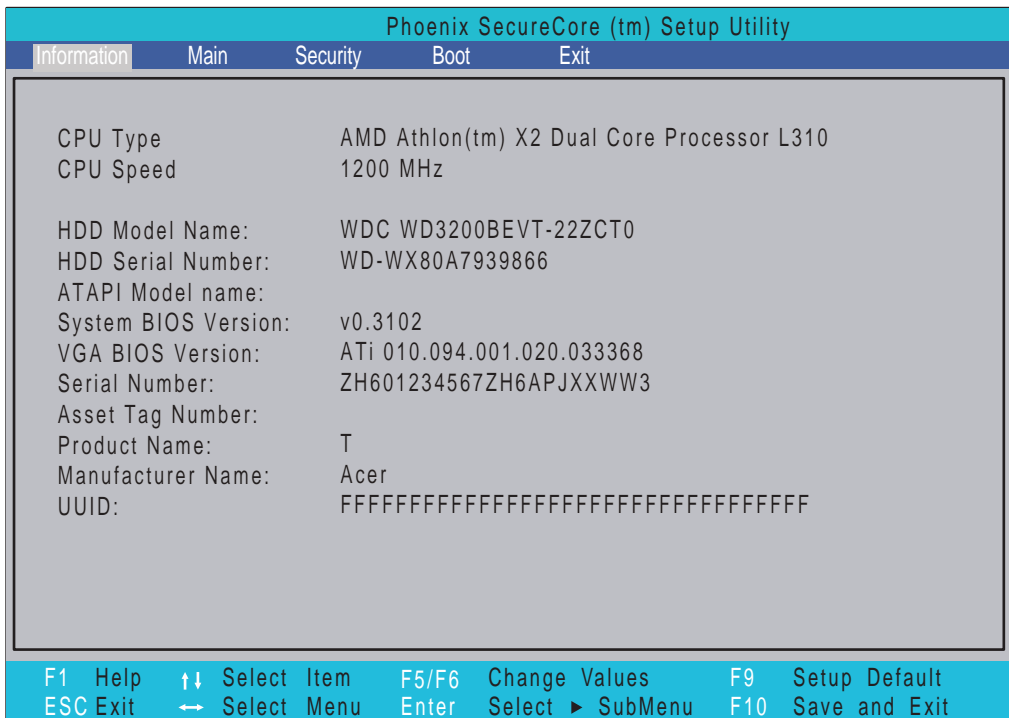

NOTE: The system information is subject to different models.

Parameter	Description
CPU Type	This field shows the CPU type and speed of the system.
CPU Speed	This field shows the speed of the CPU.
HDD Model Name	This field shows the model name of HDD installed on primary IDE master.
HDD Serial Number	This field displays the serial number of HDD installed on primary IDE master.
ATAPI Model Name	This field displays the model name of the installed ODD drive.
System BIOS Version	Displays system BIOS version.
VGA BIOS Version	This field displays the VGA firmware version of the system.
Serial Number	This field displays the serial number of this unit.
Asset Tag Number	This field displays the asset tag number of the system.
Product Name	This field shows product name of the system.
Manufacturer Name	This field displays the manufacturer of this system.
UUID Number	Universally Unique Identifier (UUID) is an identifier standard used in software construction, standardized by the Open Software Foundation (OSF) as part of the Distributed Computing Environment (DCE).

Main

The Main screen allows the user to set the system time and date as well as enable and disable boot option and recovery.

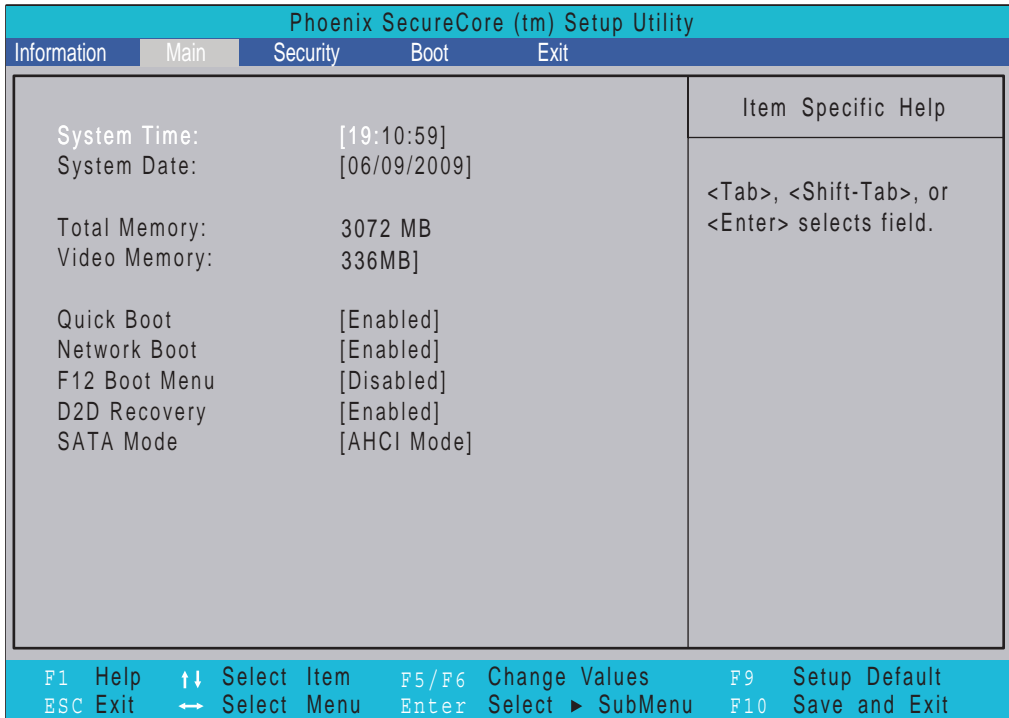

NOTE: The screen above is for your reference only. Actual values may differ.

The table below describes the parameters in this screen. Settings in **boldface** are the default and suggested parameter settings.

Parameter	Description	Format/Option
System Time	Sets the system time. The hours are displayed with 24-hour format.	Format: HH:MM:SS (hour:minute:second)
System Date	Sets the system date.	Format MM/DD/YYYY (month/day/year)
Total Memory	This field reports the memory size of the system. Memory size is fixed to 3017 MB.	N/A
Video Memory	Shows the video memory size. VGA Memory size=32 MB	N/A
Quick Boot	Allows startup to skip certain tests while booting, decreasing the time needed to boot the system.	Option: Enabled or Disabled
Network Boot	Enables, disables the system boot from LAN (remote server).	Option: Enabled or Disabled
F12 Boot Menu	Enables, disables Boot Menu during POST.	Option: Enabled or Enabled
D2D Recovery	Enables, disables D2D Recovery function. The function allows the user to create a hidden partition on hard disc drive to store operation system and restore the system to factory defaults.	Option: Enabled or Disabled
SATA Mode	Control the mode in which the SATA controller should operate.	Option: AHCI or IDE

Security

The Security screen contains parameters that help safeguard and protect your computer from unauthorized use.

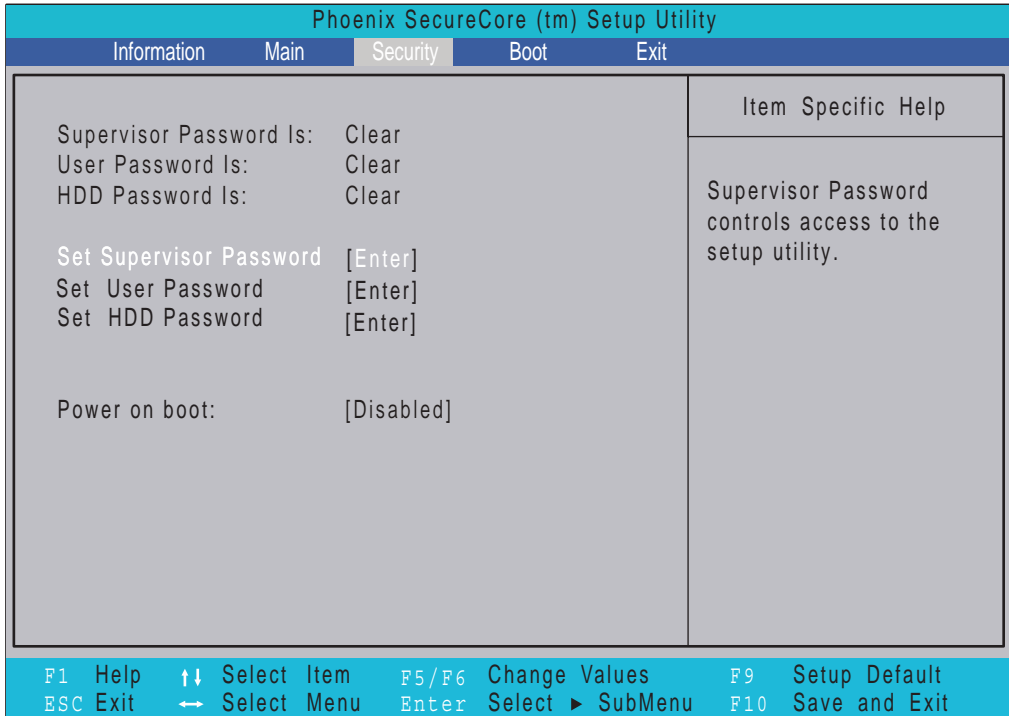

The table below describes the parameters in this screen. Settings in **boldface** are the default and suggested parameter settings.

Parameter	Description	Option
Supervisor Password Is	Shows the setting of the Supervisor password	Clear or Set
User Password Is	Shows the setting of the user password.	Clear or Set
Set Supervisor Password	Press Enter to set the supervisor password. When set, this password protects the BIOS Setup Utility from unauthorized access. The user can not either enter the Setup menu nor change the value of parameters.	
Set User Password	Press Enter to set the user password. When user password is set, this password protects the BIOS Setup Utility from unauthorized access. The user can enter Setup menu only and does not have right to change the value of parameters.	
Set Hdd Password	Enter HDD password.	
Power on password	Defines whether a password is required or not while the events defined in this group happened. The following sub-options are all requires the Supervisor password for changes and should be grayed out if the user password was used to enter setup.	Enabled or Disabled

NOTE: When you are prompted to enter a password, you have three tries before the system halts. Don't forget your password. If you forget your password, you may have to return your notebook computer to your dealer to reset it.

Setting a Password

Follow these steps as you set the user or the supervisor password:

1. Use the ↑ and ↓ keys to highlight the Set Supervisor Password parameter and press the **Enter** key. The Set Supervisor Password box appears:

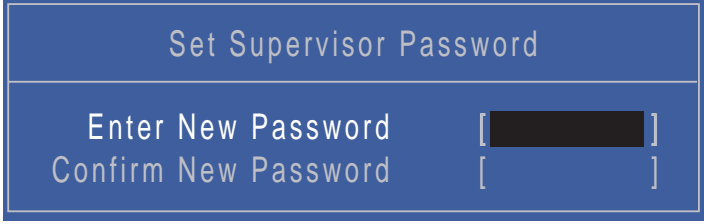

The screenshot shows a blue BIOS screen titled "Set Supervisor Password". Below the title, there are two input fields: "Enter New Password" and "Confirm New Password". The "Enter New Password" field contains a blacked-out password, and the "Confirm New Password" field is empty.

2. Type a password in the "Enter New Password" field. The password length can not exceed 8 alphanumeric characters (A-Z, a-z, 0-9, not case sensitive). Retype the password in the "Confirm New Password" field.

IMPORTANT: Be very careful when typing your password because the characters do not appear on the screen.

3. Press **Enter**. After setting the password, the computer sets the User Password parameter to "Set".
4. If desired, you can opt to enable the Password on boot parameter.
5. When you are done, press F10 to save the changes and exit the BIOS Setup Utility.

Removing a Password

Follow these steps:

1. Use the ↑ and ↓ keys to highlight the Set Supervisor Password parameter and press the **Enter** key. The Set Password box appears:



The screenshot shows a blue BIOS screen titled "Set Supervisor Password". Below the title, there are three input fields: "Enter Current Password", "Enter New Password", and "Confirm New Password". The "Enter Current Password" field contains a blacked-out password, while the other two fields are empty.

2. Type the current password in the Enter Current Password field and press **Enter**.
3. Press **Enter** twice **without** typing anything in the Enter New Password and Confirm New Password fields. The computer then sets the Supervisor Password parameter to "Clear".
4. When you have changed the settings, press u to save the changes and exit the BIOS Setup Utility.

Changing a Password

1. Use the ↑ and ↓ keys to highlight the Set Supervisor Password parameter and press the **Enter** key. The Set Password box appears.



The screenshot shows a blue BIOS screen titled "Set Supervisor Password". It contains three input fields: "Enter Current Password", "Enter New Password", and "Confirm New Password". The first field is filled with black characters, while the other two are empty.

2. Type the current password in the Enter Current Password field and press **Enter**.
3. Type a password in the Enter New Password field. Retype the password in the Confirm New Password field.
4. Press **Enter**. After setting the password, the computer sets the User Password parameter to "Set".
5. If desired, you can enable the Password on boot parameter.
6. When you are done, press **F10** to save the changes and exit the BIOS Setup Utility.

If the verification is OK, the screen will display as following.

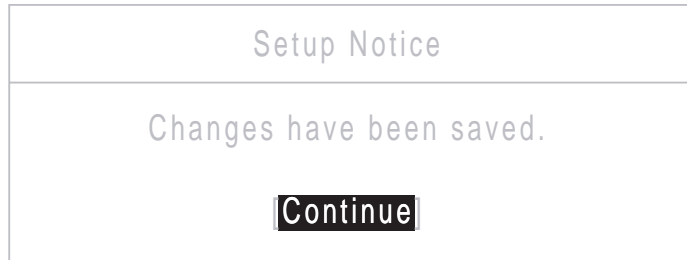

The screenshot shows a white BIOS screen titled "Setup Notice". The text "Changes have been saved." is displayed in the center. At the bottom, there is a black button labeled "Continue".

The password setting is complete after the user presses **Enter**.

If the current password entered does not match the actual current password, the screen will show you the Setup Warning.



The screenshot shows a white BIOS screen titled "Setup Warning" in red text. Below the title, the text "Invalid Password." is displayed in red. At the bottom, there is a black button labeled "Continue".

If the new password and confirm new password strings do not match, the screen displays the following message.



The screenshot shows a white BIOS screen titled "Setup Warning" in red text. Below the title, the text "Passwords do not match. Re-enter password." is displayed in red. At the bottom, there is a black button labeled "Continue".

Boot

This menu allows the user to decide the order of boot devices to load the operating system. Bootable devices includes various USB diskette drives and the onboard hard disk drive.

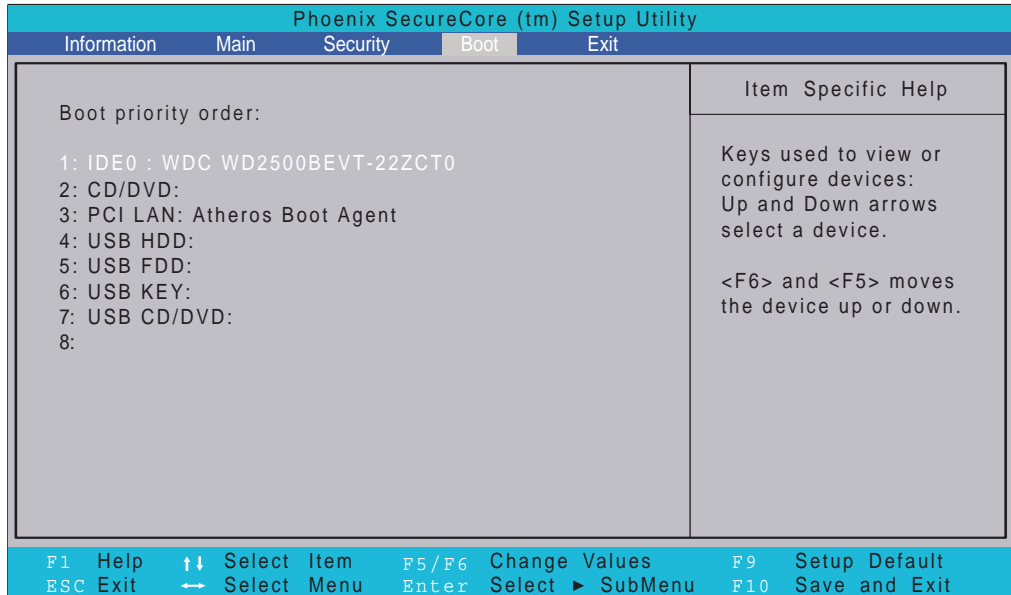

Exit

The Exit screen allows you to save or discard any changes you made and quit the BIOS Utility.

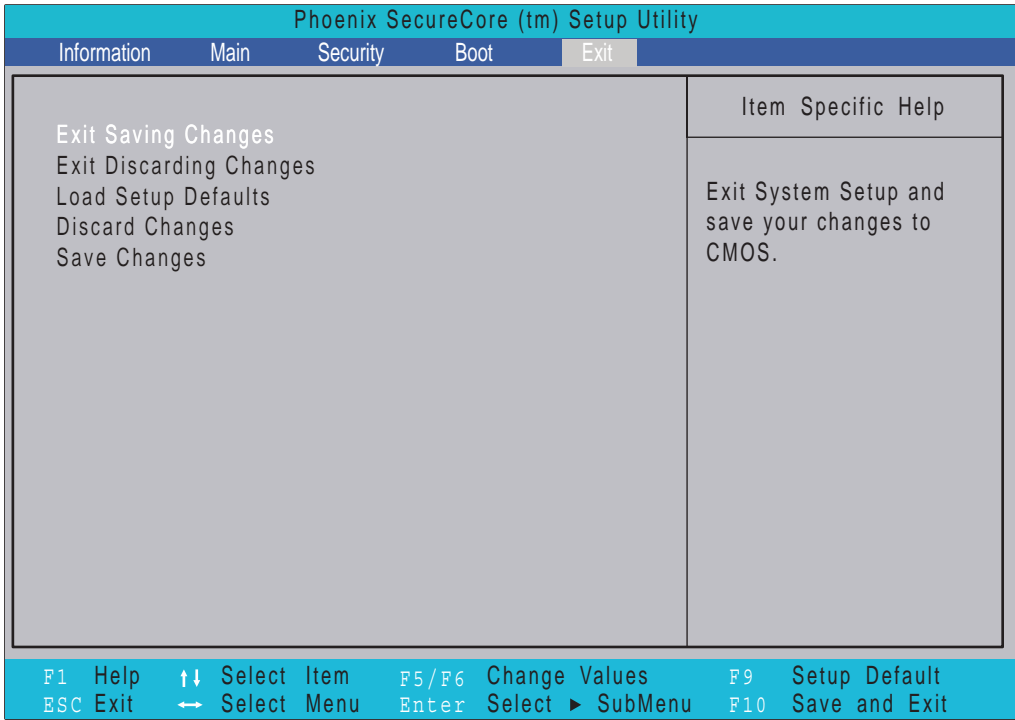

The table below describes the parameters in this screen.

Parameter	Description
Exit Saving Changes	Exit System Setup and save your changes to CMOS.
Exit Discarding Changes	Exit utility without saving setup data to CMOS.
Load Setup Default	Load default values for all SETUP item.
Discard Changes	Load previous values from CMOS for all SETUP items.
Save Changes	Save Setup Data to CMOS.

BIOS Flash Utility

The BIOS flash memory update is required for the following conditions:

- New versions of system programs
- New features or options
- Restore a BIOS when it becomes corrupted.

DOS Flash Utility

Perform the following steps to use the DOS Flash Utility:

1. Press F2 during boot to enter the Setup Menu.
2. Select **Boot Menu** to modify the boot priority order, for example, if using USB HDD to Update BIOS, move USB HDD to position 1.

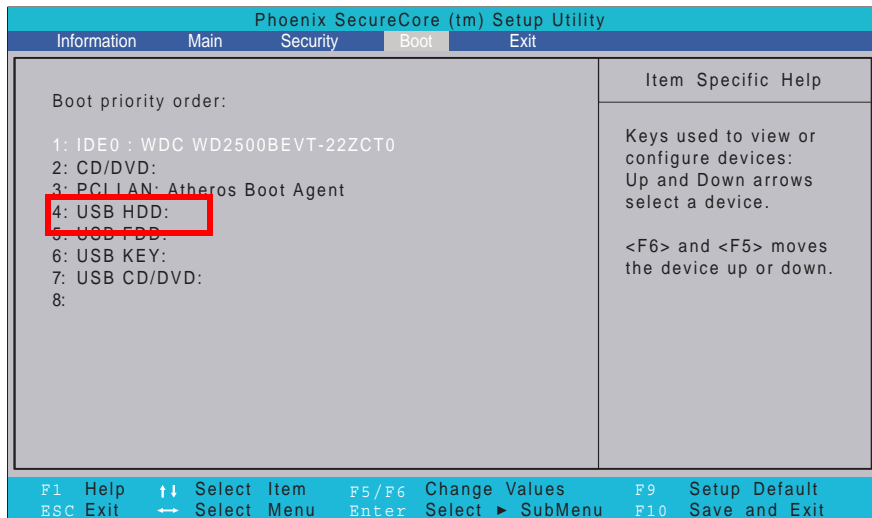

3. Execute the **FLASH.BAT** batch file to update BIOS.

The flash process begins as shown.



4. In flash BIOS, the message **Please do not remove AC Power Source** displays.

NOTE: If the AC power is not connected, the following message displays.



Plug in the AC power to continue.

5. Flash is complete when the message Flash programming complete displays.

WinFlash Utility

Perform the following steps to use the WinFlash Utility:

1. In Windows run **ZH6_xxxx_win.exe** where xxxx is the bios version. For example, ZH6_3102_win.exe
2. When the process is complete, close all programs and applications and reboot the system.

Remove HDD/BIOS Password Utilities

This section provide you with removing HDD/BIOS method:

Remove HDD Password:

When the user keys in the wrong password three times, the system reports the following error code to user.

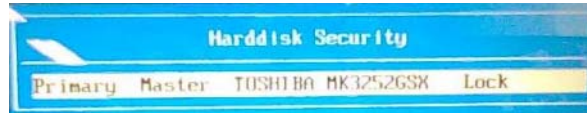

To unlock the HDD password, perform the following steps:

1. Press **Enter** to display the Select Item screen.

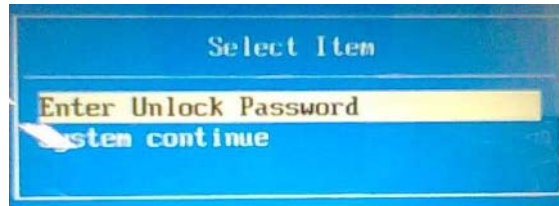

2. Select **Enter Unlock Password** and press **Enter**.

An Unlock Password displays.



3. Make a note of the key, **76943488** in the example.
4. Boot up the system to a removable bootable drive containing DOS and the UnlockHD.EXE program and open a DOS prompt. For instructions on changing boot priority see "Boot" on page 29.
5. Enter the **UnlockHD.EXE** command and input the key to create an unlock code. Make a note of the result, for example **46548274**.
6. Reboot to the hard disk and wait for the error code to reappear.
7. Press **Enter** to display the Select Item screen.
8. Select **Enter Unlock Password** and press **Enter**.
9. Enter the unlock code generated by UnlockHD.EXE.
10. Save and exit the BIOS to complete the process.

Removing BIOS Passwords:

If you key in the wrong Supervisor Password three times, System Disabled displays on the screen. See the image below.

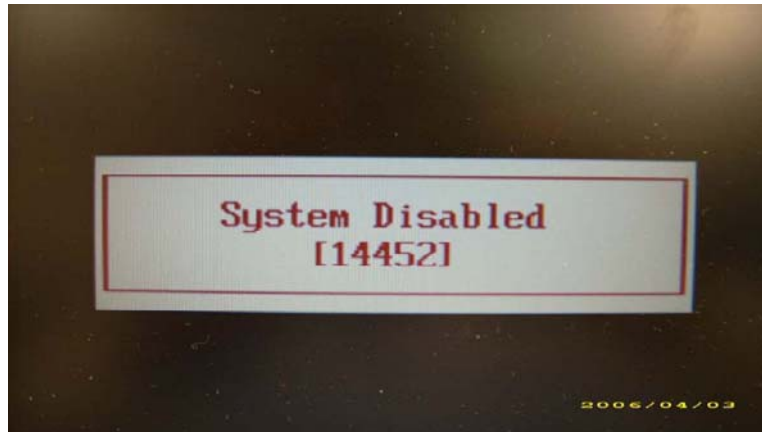

1. Make a note of the number displayed: 14452 in this instance.
2. Boot up the system to a removable bootable drive containing DOS and open a DOS prompt. For instructions on changing boot priority see "Boot" on page 29.
3. Enter the **BIOS_PW.EXE** command.
4. Enter **bios_pw 14452 0**

NOTE: 1. in the image below where 14452 is the number noted previously from the System Disabled message.

```
C:\WINDOWS\system32\cmd.exe
Microsoft Windows XP [Version 5.1.2600]
(C) Copyright 1985-2001 Microsoft Corp.
C:\Documents and Settings\M54>d:
D:\>bios_pw 14452 0 1.
unlock6.exe v1.0 1 July 1997
qjgg9vy
07ygnjd
cjl14tn
6mbzjaj 2.
D:\>_
```

5. Reboot the computer in its original boot sequence. When the BIOS user password box appears enter one of the four strings of characters noted as 2. in the image above. For example: **qjgg9vy**
6. Press **Enter** to set the new password and enter the BIOS.

Miscellaneous Utilities

Using Boot Sequence Selector

Boot Sequence Selector allows the boot order to be changes without accessing the BIOS. To use Boot Sequence Selector, perform the following steps:

1. Enter into DOS.
2. Execute BS.exe to display the usage screen.

```
d:\B00TSEQ>bs
*** Boot Sequence Selector Version 0.03 ***
Create by Rockwell Chuang 10/01/2005.
Usage:
      BS [ 1 | 2 | 3 | 4 ]
BS 1 : [ Floppy ] => [ HardDisk ] => [ CD-ROM ] => [ LAN   ]
BS 2 : [ HardDisk ] => [ CD-ROM ] => [ LAN   ] => [ Floppy ]
BS 3 : [ CD-ROM ] => [ HardDisk ] => [ LAN   ] => [ Floppy ]
BS 4 : [ LAN   ] => [ Floppy ] => [ HardDisk ] => [ CD-ROM ]
d:\B00TSEQ>
```

3. Select the desired boot sequence by entering the corresponding sequence, for example, enter BS2 to change the boot sequence to HDD|CD ROM|LAN|Floppy.

Using DMITools

The DMI (Desktop Management Interface) Tool copies BIOS information to eeprom to be used in the DMI pool for hardware management.

When the BIOS displays **Verifying DMI pool data** it is checking the table correlates with the hardware before sending to the operating system (Windows, etc.).

To update the DMI Pool, perform the following steps:

1. Enter into DOS.
2. Execute **dmitools.exe**. The following messages show dmitools usage:

```
*** Compal DMI String R/W Utility Ver1.40 for 2006/03/14 ***

Usage:

DMITOOLS [ /R | /WP | /WS | /WU ] [ STRING ]

[R]   : Read DMI Information from Memory
[WM]  : Write Manufacturer Name to EEPROM. (Max.= 16 characters)
[WP]  : Write Product Name to EEPROM.      (Max.= 16 characters)
[WS]  : Write Serial Number to EEPROM     (Max.= 22 characters)
[WU]  : Write UUID to EEPROM.             (Ignore String   )
[WA]  : Write Asset Tag to EEPROM.        (Max.= 32 characters)
```

IMPORTANT:The following write examples (2 to 5) require a system reboot to take effect

Example 1: Read DMI Information from Memory

Input:

```
dmitools /r
```

Output:

```
Manufacturer (Type1, Offset04h): Acer  
Product Name (Type1, Offset05h): Aspire one xxxxx  
Serial Number (Type1, Offset07h): 01234567890123456789  
UUID String (Type1, Offset08h): xxxxxxxx-xxxx-xxxx-xxxx-xxxxxxxxxxxx  
Asset Tag (Type3, Offset04h): Acer Asstag
```

Example 2: Write Product Name to EEPROM

Input:

```
dmitools /wp Acer
```

Example 3: Write Serial Number to EEPROM

Input:

```
dmitools /ws 01234567890123456789
```

Example 4: Write UUID to EEPROM

Input:

```
dmitools /wu
```

Example 5: Write Asset Tag to EEPROM

Input:

```
dmitools /wa Acer Asstag
```

Using the LAN MAC Utility

Perform the following steps to write MAC information to eeprom:

1. Use a text editor, for example Notepad, to edit the MAC.CFG file as shown:

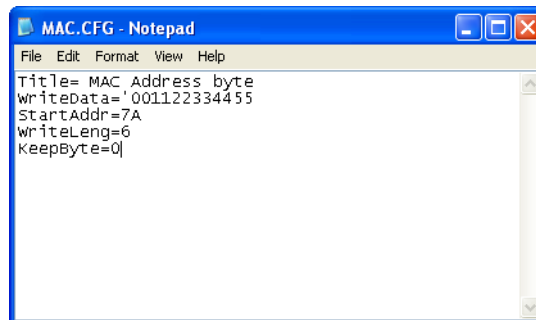

- WriteData= '001122334455' <----- MAC value
 - StartAddr=7A <----- MAC address
 - WriteLeng=6 <----- MAC value length
 - KeepByte=0 <----- can be any value
2. Boot into DOS.
 3. Execute **MAC.BAT** to write MAC information to eeprom.

Machine Disassembly and Replacement

This chapter contains step-by-step procedures on how to disassemble the notebook computer for maintenance and troubleshooting.

Disassembly Requirements

To disassemble the computer, you need the following tools:

- Wrist grounding strap and conductive mat for preventing electrostatic discharge
- Flat screwdriver
- Philips screwdriver
- Plastic flat screwdriver
- Plastic tweezers

NOTE: The screws for the different components vary in size. During the disassembly process, group the screws with the corresponding components to avoid mismatch when putting back the components.

Related Information

The product previews seen in the disassembly procedures may not represent the final product color or configuration.

IMPORTANT: Cable paths and positioning may not represent the actual model. During the removal and replacement of components, ensure all available cable channels and clips are used and that the cables are replaced in the same position.

Replacement Requirements

NOTE: Cabling and components require adhesive to be applied during the replacement and reassembly process.

NOTE: During manufacture a cyanoacrylate glue is used provided by Holdtite Adhesives LTD. This is not a specified requirement. The reassembler is free to select an alternative appropriate adhesive.

General Information

Pre-disassembly Instructions

Before proceeding with the disassembly procedure, make sure that you do the following:

1. Turn off the power to the system and all peripherals.

2. Unplug the AC adapter and all power and signal cables from the system.



3. Place the system on a flat, stable surface.
4. Remove the battery pack.

Disassembly Process

The disassembly process is divided into the following sections:

- External components disassembly
- Main unit disassembly
- LCD module disassembly

The flowcharts provided in the succeeding disassembly sections illustrate the entire disassembly sequence. Observe the order of the sequence to avoid damage to any of the hardware components. For example, if you want to remove the Mainboard, you must first remove the Keyboard, and LCD Module then disassemble the inside assembly frame in that order.

Main Screw List

Screw	Quantity	Part Number
M2*2.5 (silver)	5	86.TPK07.001
M3*3.5 (silver)	4	86.TDY07.003
M2*3	18	86.S0207.001
M2*4	1	86.W0107.003
M2*5	16	86.TG607.004
M2*8	5	86.FRC07.001
M2-0.4.5*2 FH	2	86.W4107.002

External Module Disassembly Process

NOTE: The product previews seen in the disassembly procedures may not represent the final product color or configuration.

External Modules Disassembly Flowchart

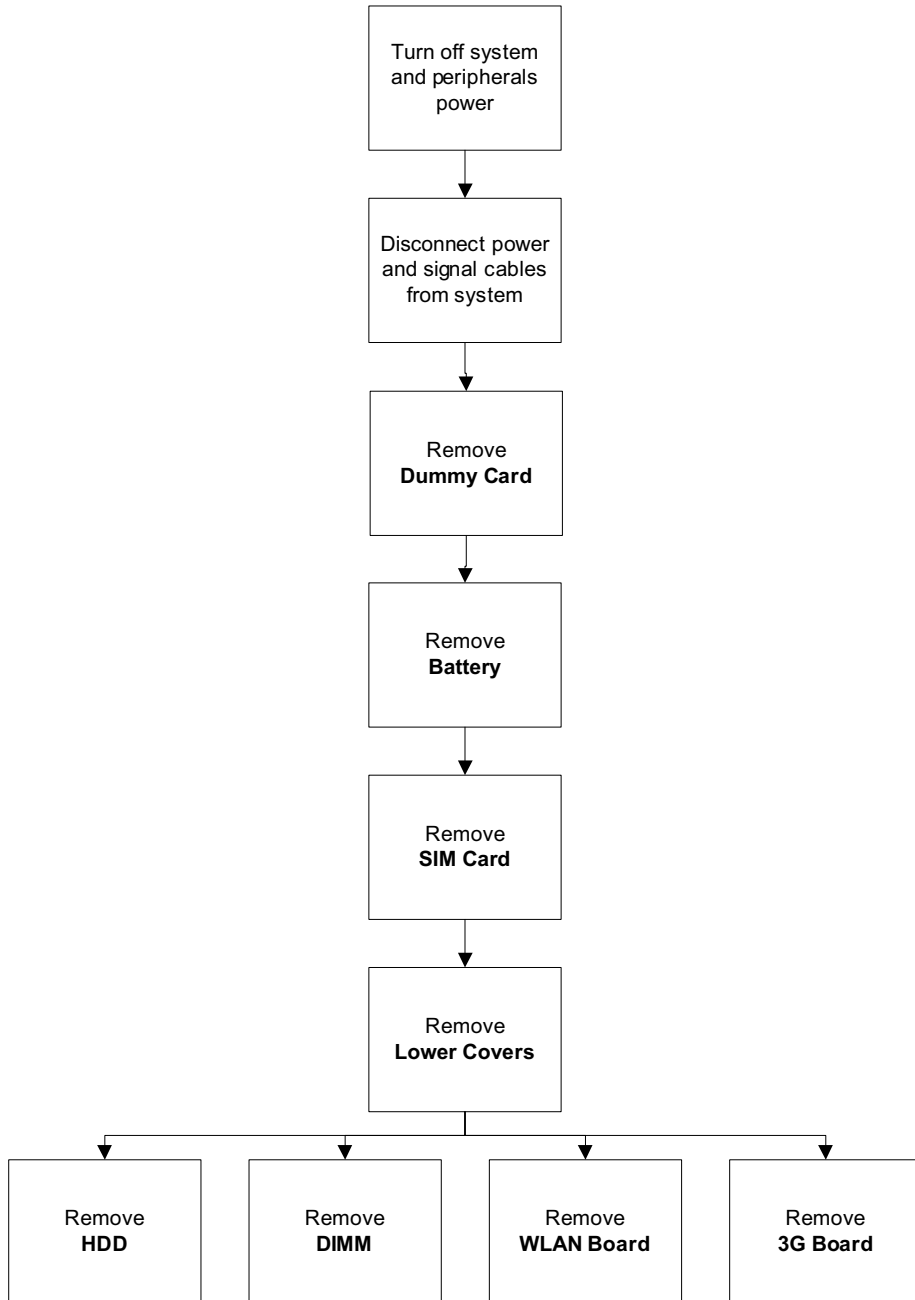

Screw List

Step	Screw	Quantity	Part No.
HDD Module	M3*3.5(silver)	4	86.TPK07.001
3G Module	M2*4	1	86.W0107.003
WLAN Module	M2*5	1	86.TG607.004

Removing the Battery Pack

1. Turn the computer over.
2. Slide the battery lock/unlock latch to the unlock position.



3. Slide and hold the battery release latch to the release position (1), then slide out the battery pack from the main unit (2).



Removing the Dummy Card

1. Press the dummy card to allow it to spring out.



2. Remove the dummy card.



Removing the SIM Card

1. See “Removing the Battery Pack” on page 42.
2. Press the SIM card to allow it to spring out.



3. Pull the SIM card out and store carefully.



Removing the Hard Disk Drive Module

1. See "Removing the Battery Pack" on page 42.
2. Loosen the two (2) captive screws on the HDD Cover.



3. Remove the HDD Cover from the inside edge.



4. Grasp the black tab.

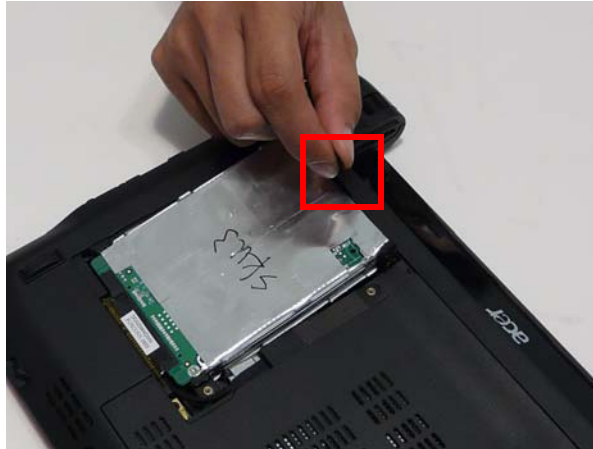

5. Lift up on the black tab to pull the HDD out but do not remove completely. Flip the HDD over to allow access to the HDD cable.

CAUTION: Do not pull the HDD out before disconnecting the HDD cable.

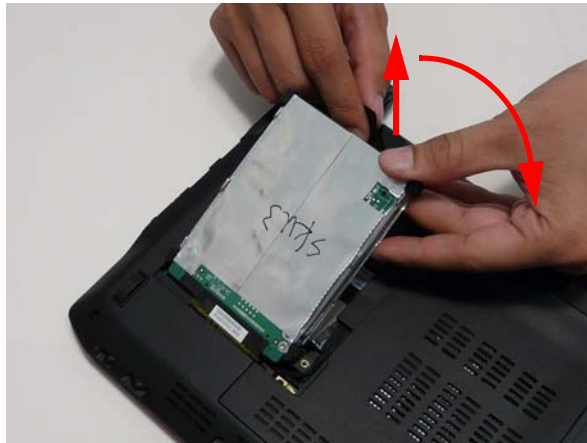

6. Grasp the HDD cable connector tab and pull up.

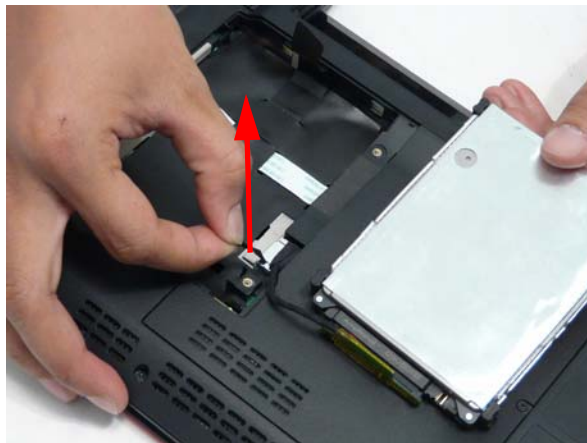

7. Remove the HDD cable from the HDD.

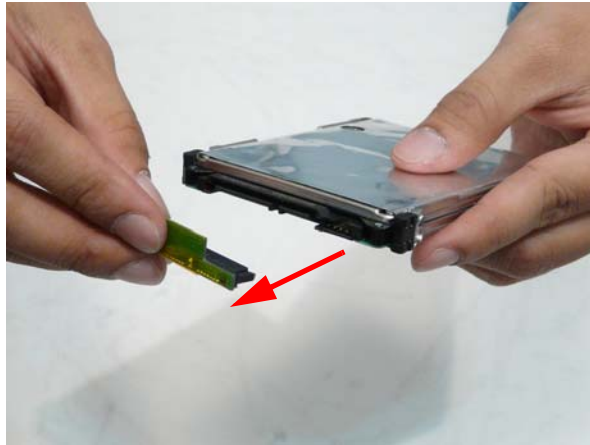

8. Remove the four (4) screws of the HDD rails.



Step	Screw	Quantity	Screw Type.
HDD Disassembly	3*3.5 (silver)	4	

9. Remove the rails from the HDD.



Removing the 3G Module

1. See "Removing the Battery Pack" on page 42.

2. Loosen the three (3) captive screws in the Memory Cover.



3. Lift the Memory Cover out from the rear edge.



4. Remove the cables from the 3G module.



5. Remove the one (1) screw from the 3G module.



Step	Screw	Quantity	Screw Type.
3G Disassembly	2*4	1	

6. Remove the 3G module.



Removing the DIMM Module

1. See “Removing the Battery Pack” on page 42.
2. Loosen the three (3) captive screws in the Memory Cover.



3. Remove the Memory Cover from the rear edge.



4. Pull open the two memory side clips.

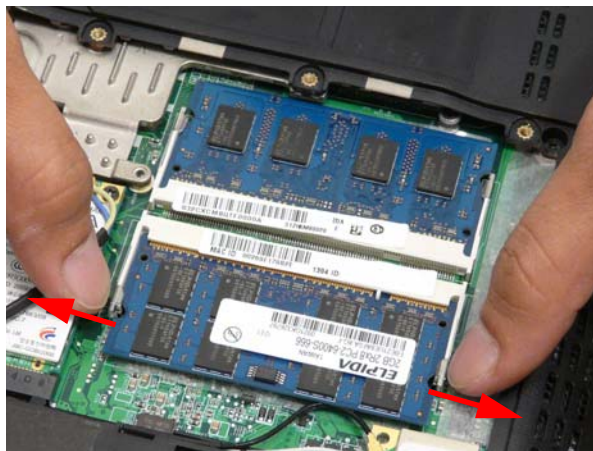

5. Lift the memory card out.

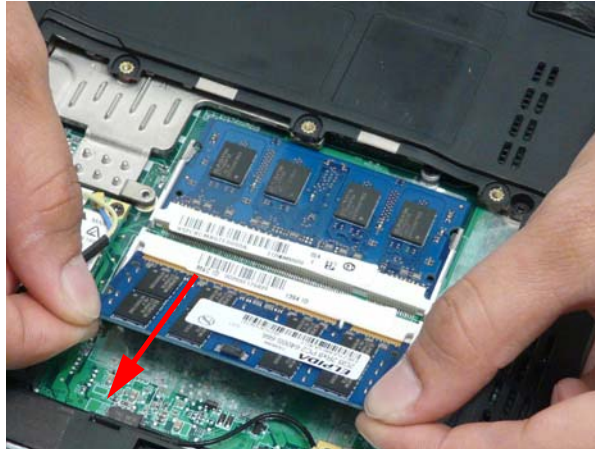

6. Repeat steps 4) and 5) for the second memory card.



Removing the WLAN Module

1. See “Removing the Battery Pack” on page 42.
2. Loosen the two (2) captive screws in the HDD Cover.



3. Remove the HDD Cover from the inside edge.



4. Loosen the three (3) captive screws in the Memory Cover.



- Remove the Memory Cover from the rear edge.



- Remove the cables on the WLAN module.



- Remove the one (1) screw on the WLAN module.



Step	Screw	Quantity	Screw Type.
WLAN Disassembly	2*5	1	

8. Remove the WLAN module.



Main Unit Disassembly Process

IMPORTANT: Cable paths and positioning may not represent the actual model. During the removal and replacement of components, ensure all available cable channels and clips are used and that the cables are replaced in the same position.

NOTE: The product previews seen in the disassembly procedures may not represent the final product color or configuration.

Main Unit Disassembly Flowchart

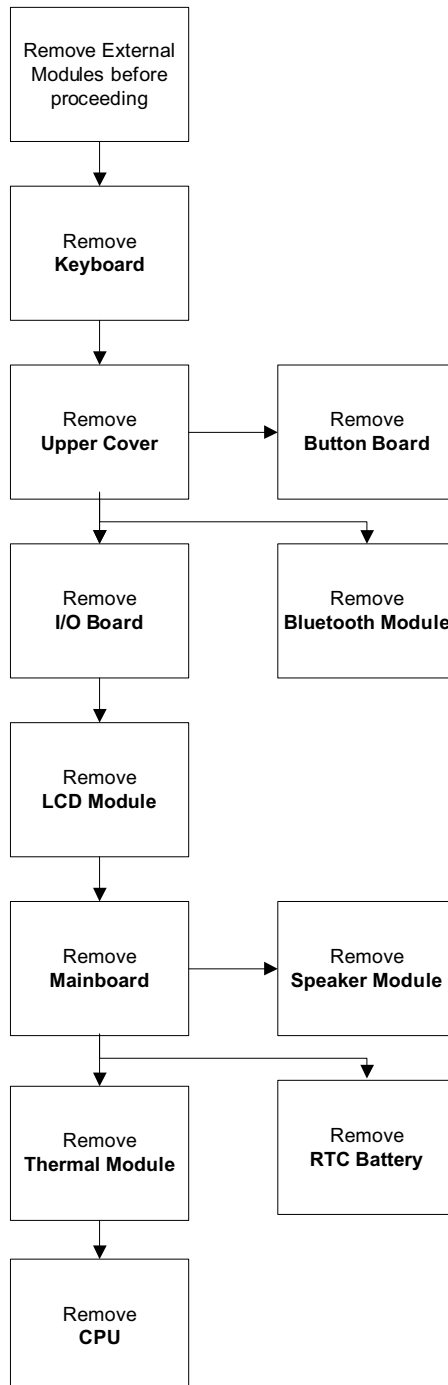

Screw List

Step	Screw	Quantity	Part No.
Lower Cover	2*3	4	86.S0207.001
Lower Cover	2*5	1	86.TG607.004
Lower Cover	2*8	5	86.FRC07.001
Upper Cover	2.0*2.5 (silver)	1	86.TG607.004
Upper Cover	2*3	1	86.S0207.001
Upper Cover	2*5	9	86.TG607.004
Button Board	M2-0.4*2	2	86.W4107.002
IO Board	2*5	1	86.TPK07.001
Main Board	2*3	1	86.S0207.001
LCD Hinge	2*5	2	86.TG607.004
Speaker Module	2*3	3	86.S0207.001

Removing the Keyboard

IMPORTANT: The keyboard is easily warped or damaged during the removal process. Take care not to use excessive force when removing the keyboard and replace if any damage occurs.

1. See “Removing the Battery Pack” on page 42.
2. Press the four (4) latches.

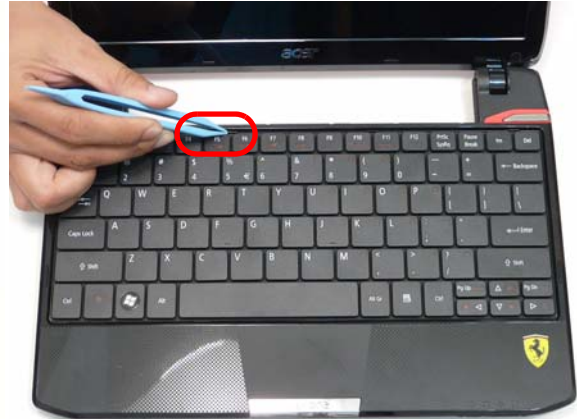

3. Pry up the keyboard.



4. Flip the keyboard over.



5. Unlock the keyboard cable.

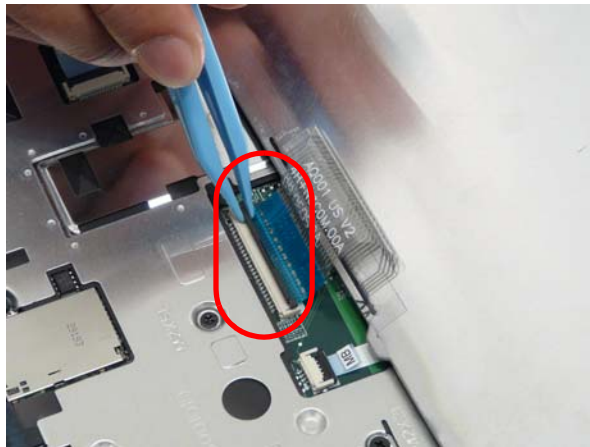



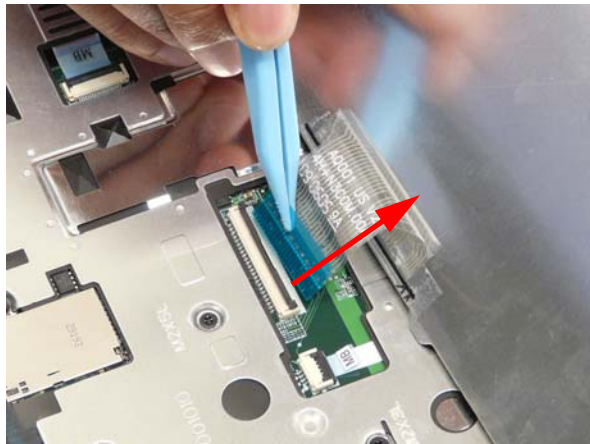

6. Remove the keyboard cable and keyboard.

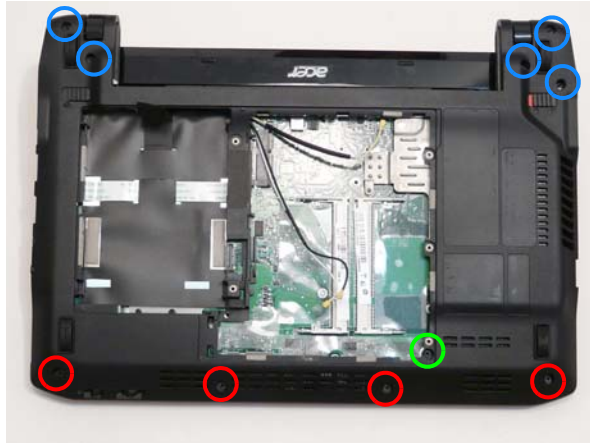

Removing the Upper Cover



1. See "Removing the Battery Pack" on page 42.
2. See "Removing the SIM Card" on page 43.
3. See "Removing the Hard Disk Drive Module" on page 44.
4. See "Remove the rails from the HDD." on page 46.
5. See "Removing the DIMM Module" on page 49.
6. See "Removing the WLAN Module" on page 51.
7. See "Removing the Keyboard" on page 56.
8. Remove the ten (10) screws in the lower cover

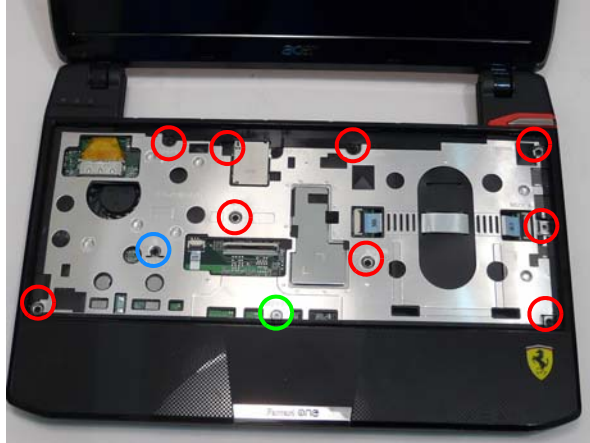

Step	Screw	Quantity	Screw Type.
Lower Cover Disassembly	2*3	4 (red call outs)	
	2*5	1 (green call out)	
	2*8	5 (blue call out)	

9. Turn the computer over and remove the eleven (11) screws in the upper cover.



Step	Screw	Quantity	Screw Type.
Upper Cover Disassembly	2.0*2.5 Silver	1 (green call out)	
	2*3	1 (blue call out)	
	2*5	9 (red call out)	

10. Unlock the I/O board to main board cable at both ends.

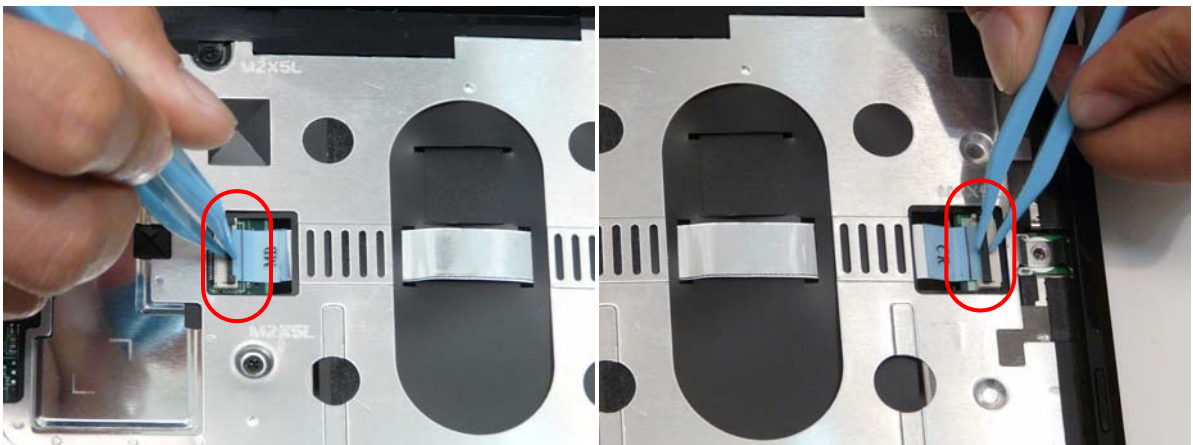

11. Disconnect the I/O board to main board cable at both ends.

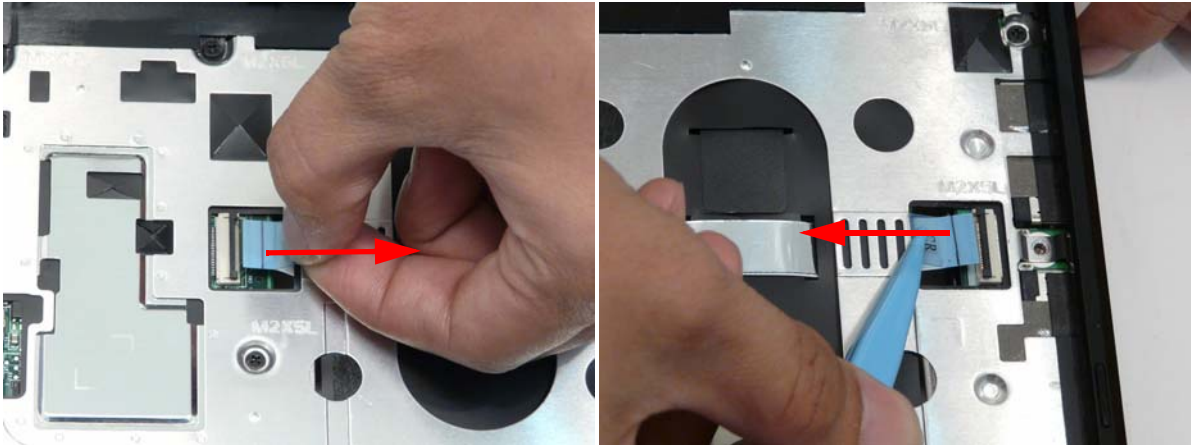

12. Unlock and disconnect the button board to main board cable.

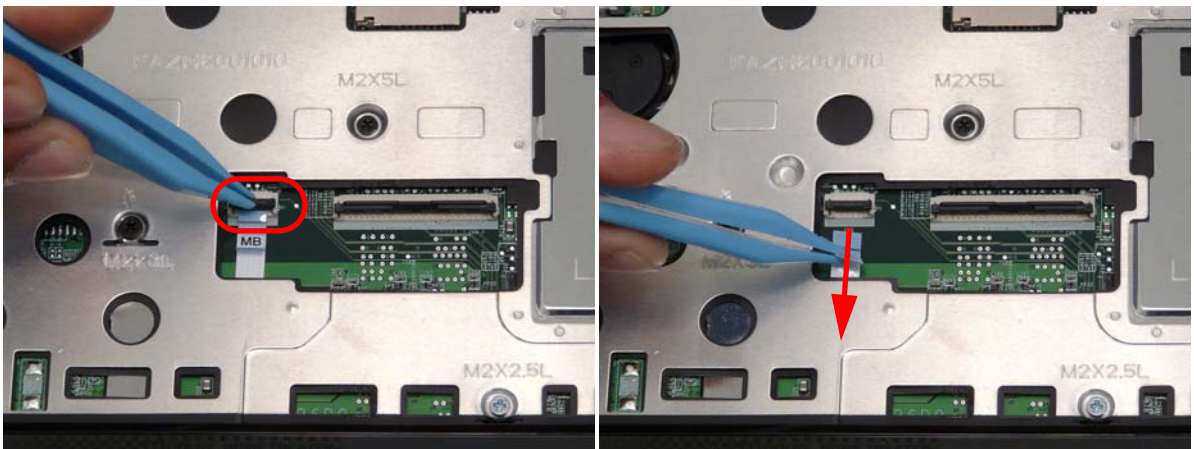

13. Pry up the Upper Cover starting from the side and lift away.



14. Remove the I/O board to main board cable.

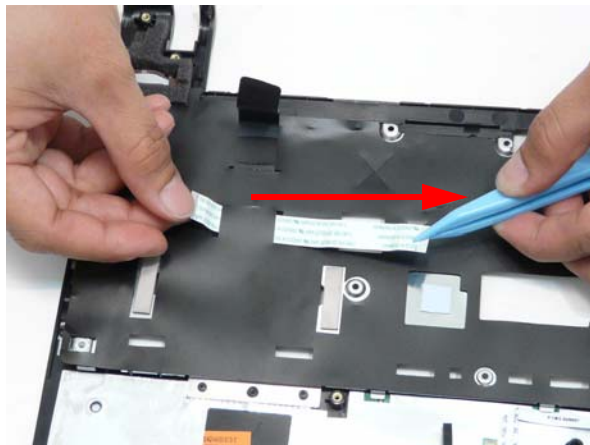

Removing the Button Board

IMPORTANT: The Touchpad Board cannot be removed individually. To replace the Button Board, replace the entire Upper Cover.

1. See "Removing the Upper Cover" on page 58.
2. Unlock the touchpad cable at both ends.

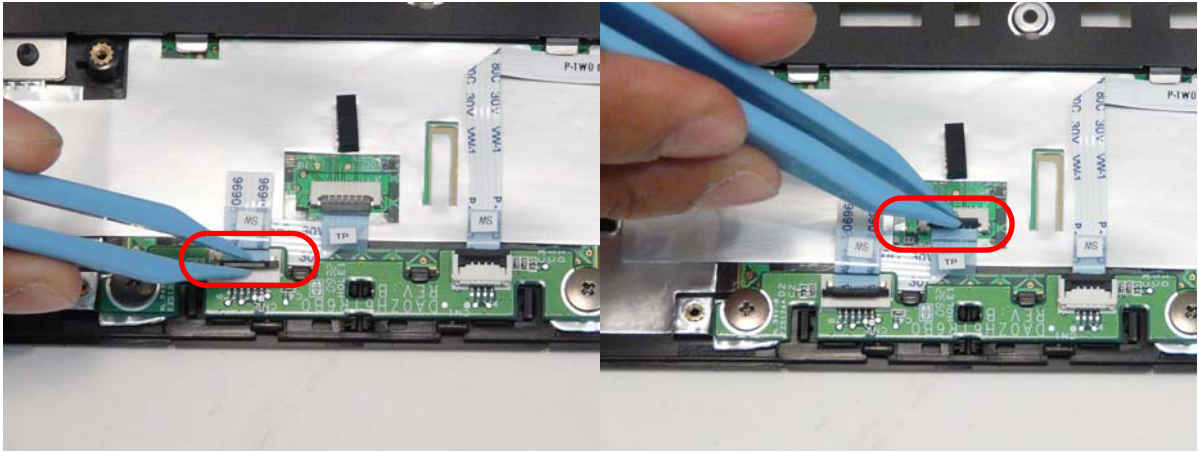

3. Remove the touchpad cable.

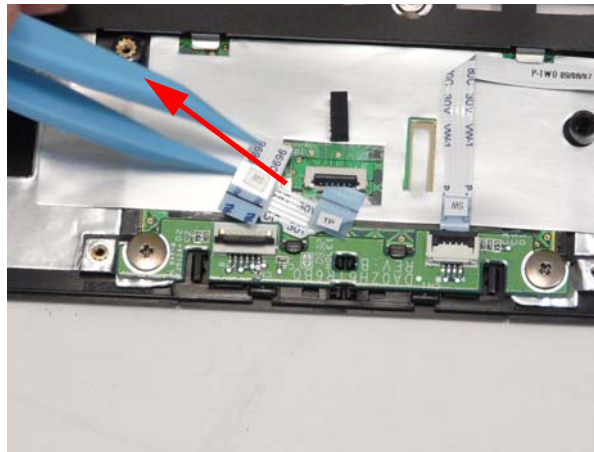

4. Disconnect the button board cable from the button board.

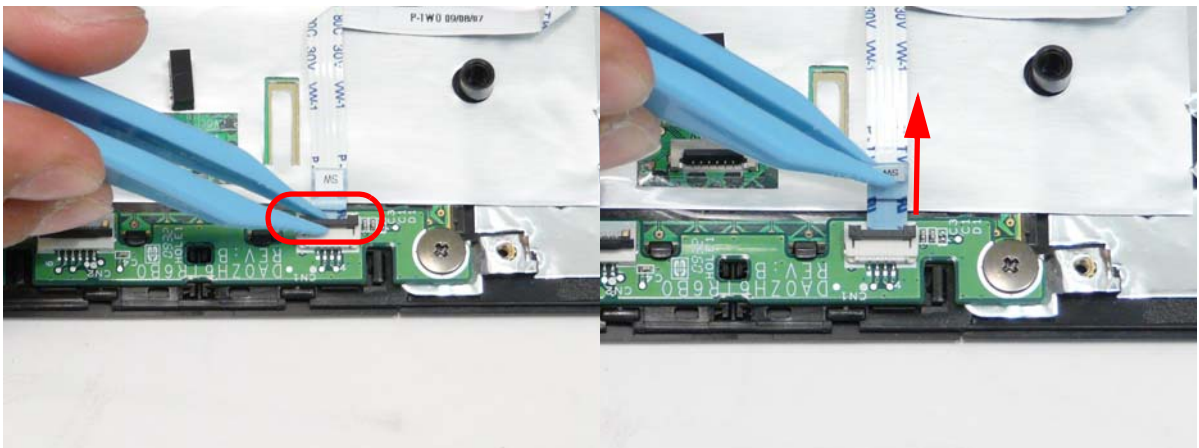

5. Pull the button board cable away from the adhesive.

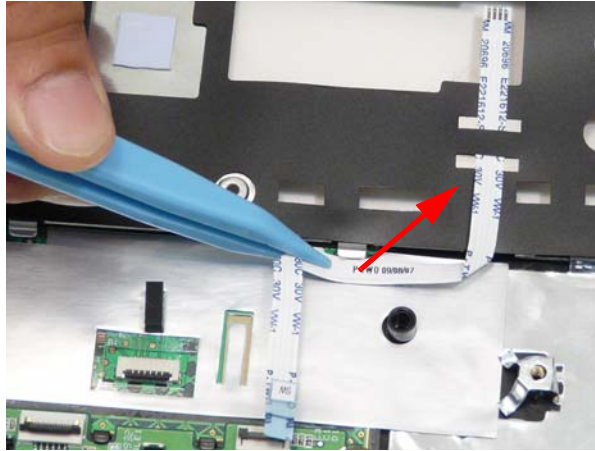

6. Remove the button board cable.

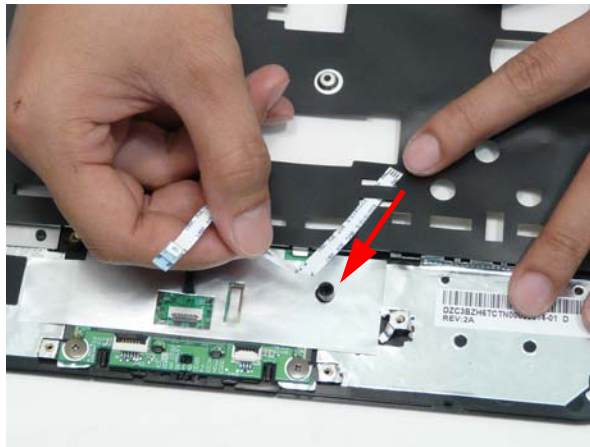

7. Remove the two (2) screws of the button board.

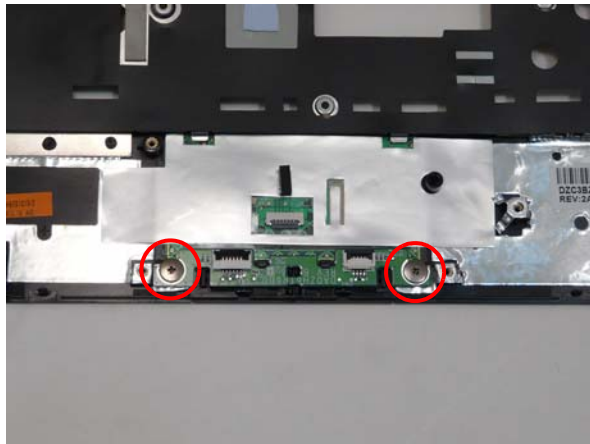

Step	Screw	Quantity	Screw Type.
Button Board Disassembly	M2-0.4*2	2	

8. Lift the button board away.

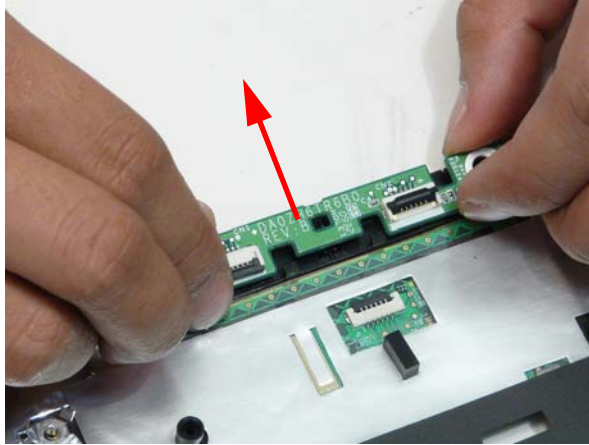

Removing the Bluetooth Module

1. See “Removing the Upper Cover” on page 58.
2. Disconnect the Bluetooth module to main board cable.

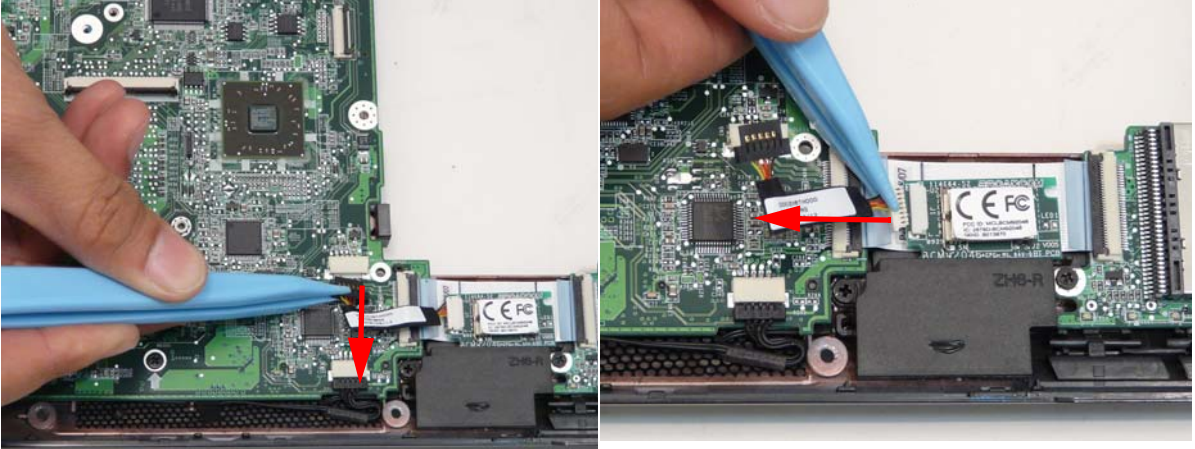

3. Pull the Bluetooth module away.

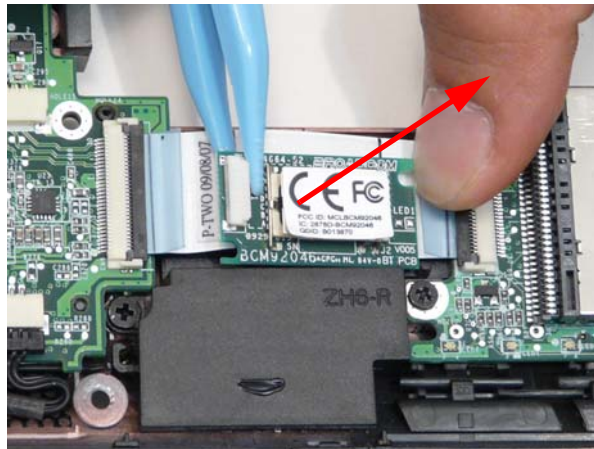

Removing the I/O Board

1. See "Removing the Upper Cover" on page 58.
2. Open the locking latch at both ends of the card reader cable connectors.

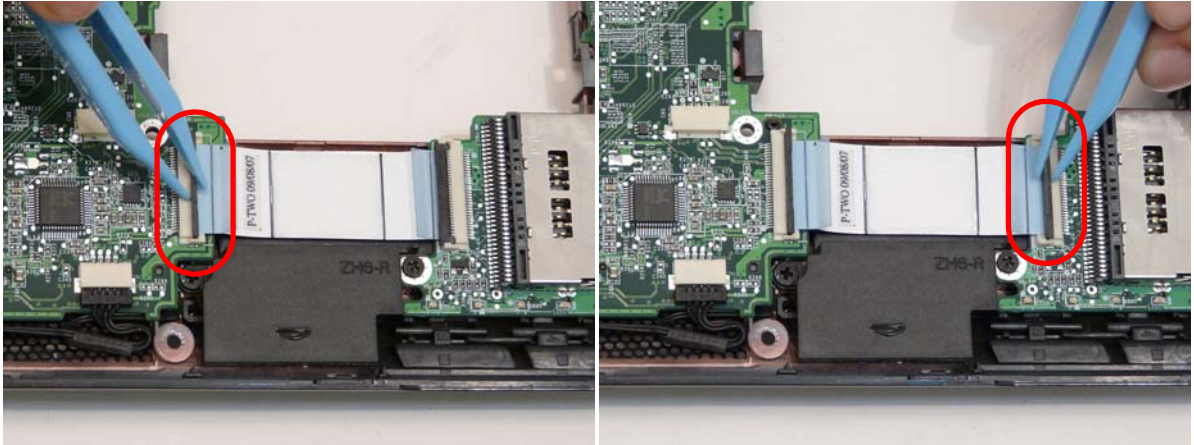

3. Remove the card reader cable.

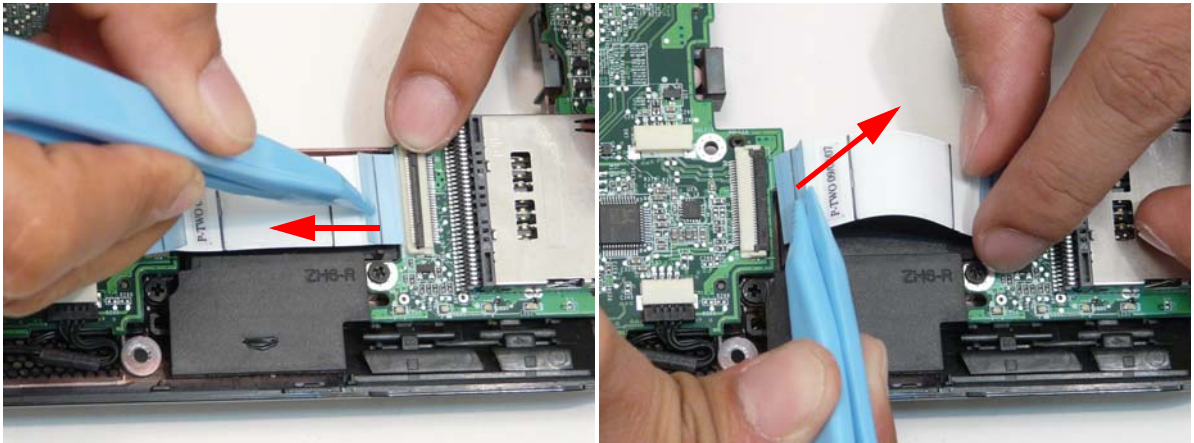

4. Disconnect the DC power cable connector from the mainboard.

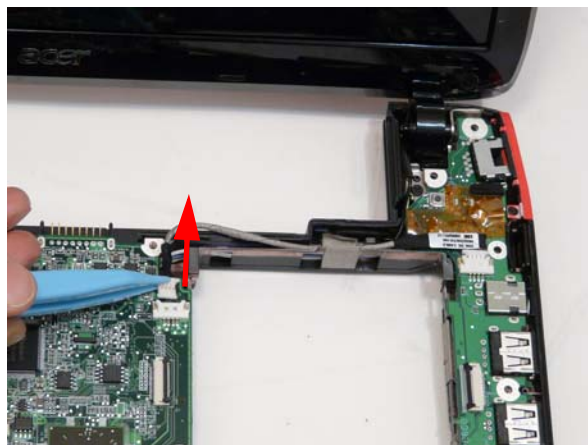

5. Remove the tape and lift the DC cable out of the cable guide.

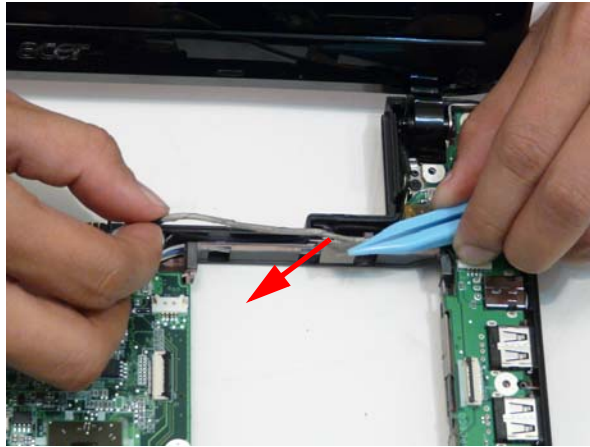

6. Disconnect the DC power cable from the I/O board.

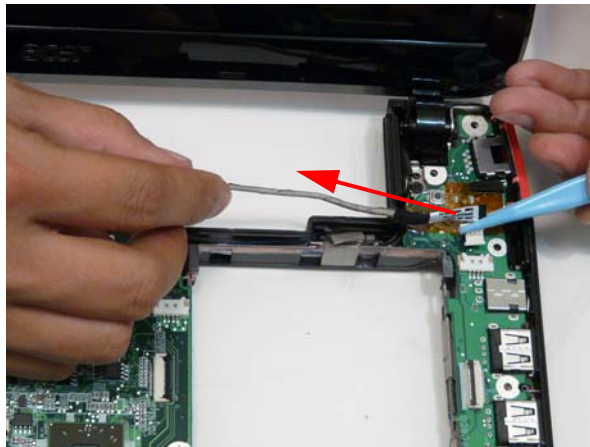

7. Remove the one (1) screw in the I/O board.

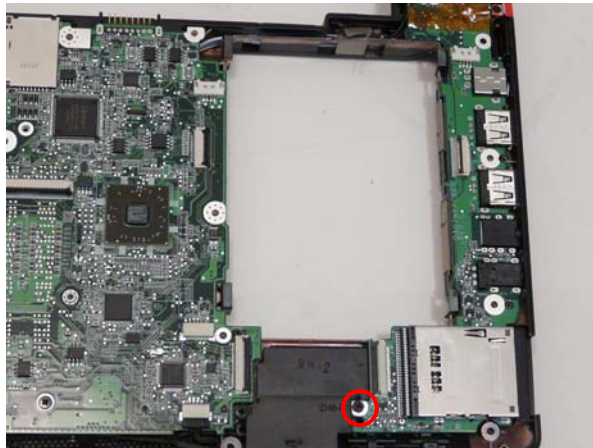

Step	Screw	Quantity	Screw Type.
IO Board Disassembly	2*5	1	

-
8. Lift the I/O board up by the inner edge and pull away on the angle.

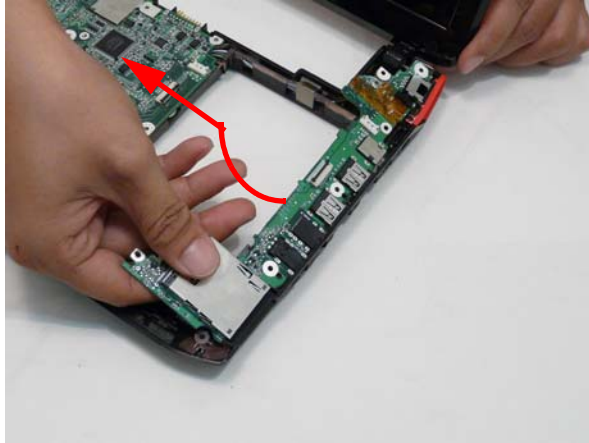

Removing the LCD Module

1. See “Removing the Upper Cover” on page 58.
2. See “Removing the I/O Board” on page 66.
3. Lift up the LCD cable protective over.

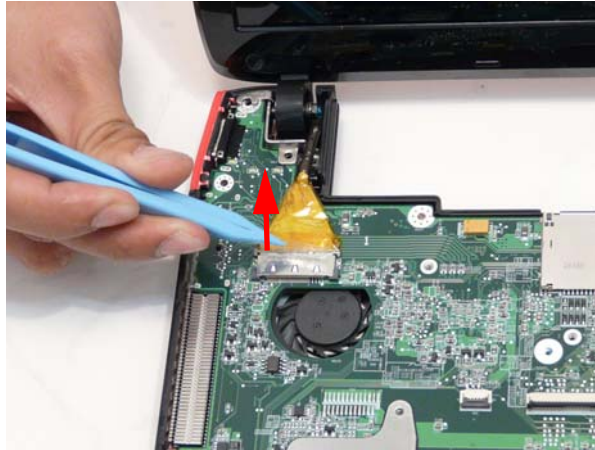

4. Disconnect the LCD cable connector.



- Remove the two (2) screws from the left and right hinges of the LCD module.

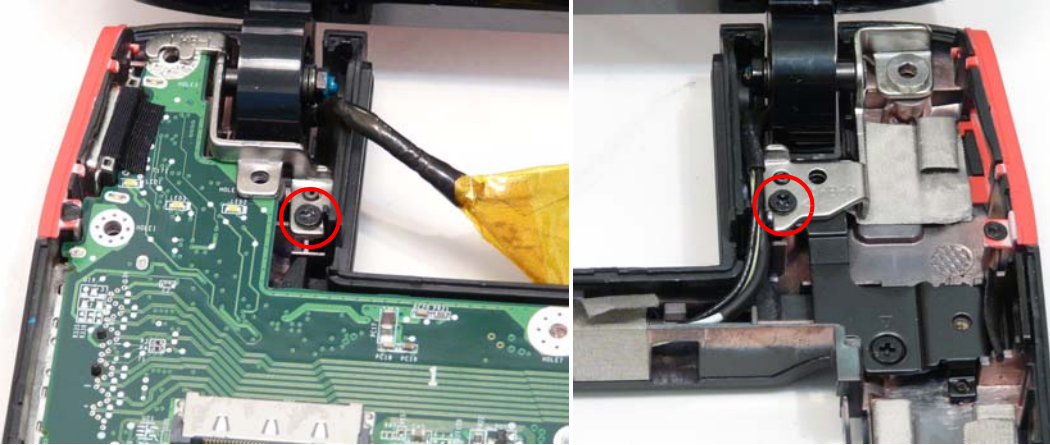

Step	Screw	Quantity	Screw Type.
LCD Disassembly	2*5	2	

- Lift away the LCD module and lay it down.

NOTE: Lay the LCD down on a clear smooth surface to prevent damage.

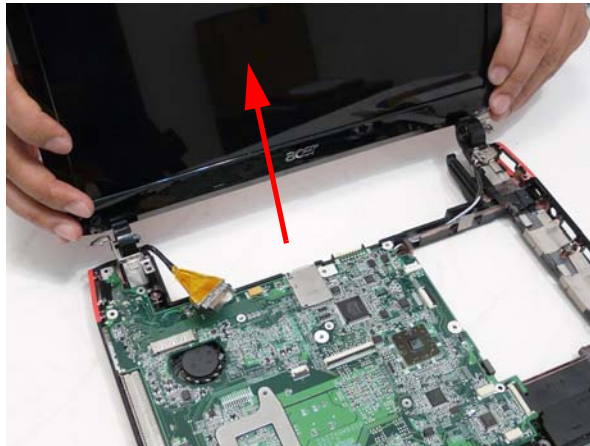

- Pull the antenna cables free of the chassis, threading the antenna cables through from the bottom side..

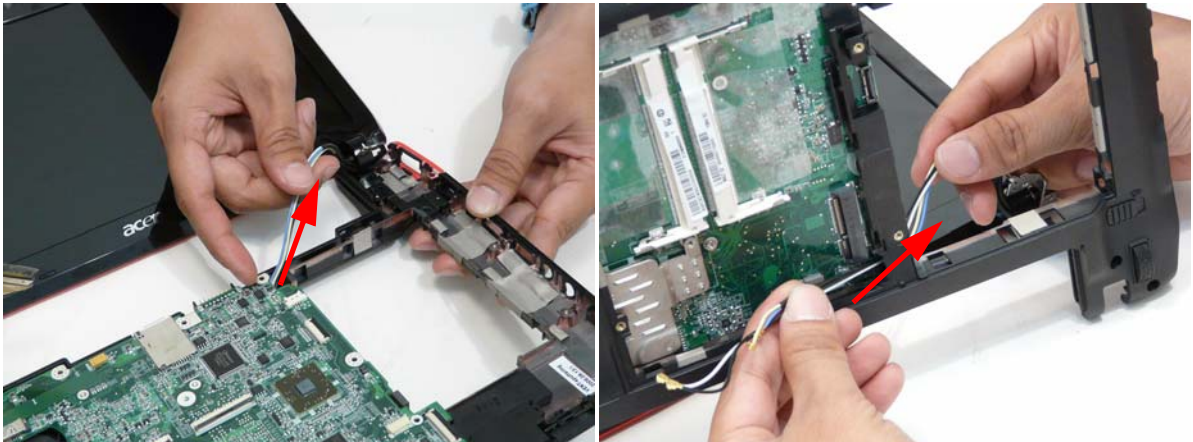

- Remove the LCD module completely.

Removing the Mainboard

1. See "Removing the Upper Cover" on page 58.
2. See "Removing the Bluetooth Module" on page 65.
3. See "Removing the I/O Board" on page 66.
4. See "Removing the LCD Module" on page 69.
5. Disconnect the speaker connector.

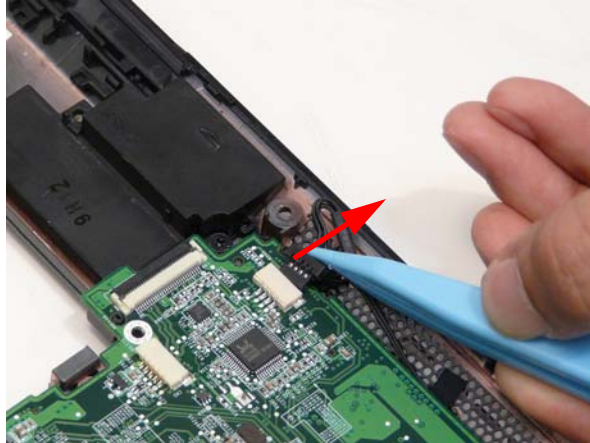

6. Remove the one (1) screw in the main board.

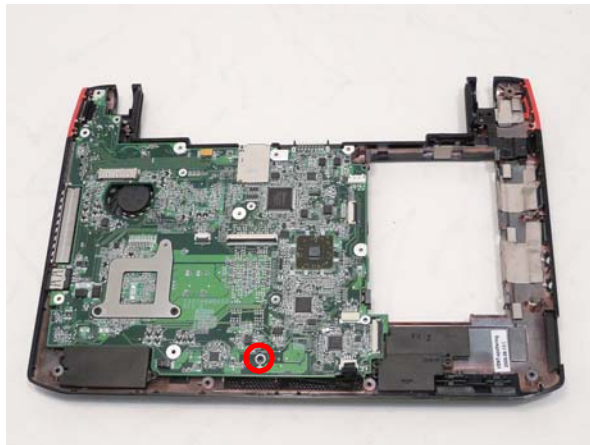

Step	Screw	Quantity	Screw Type.
Main Board Disassembly	2*3	1	

-
7. Lift out the main board from the inside edge.

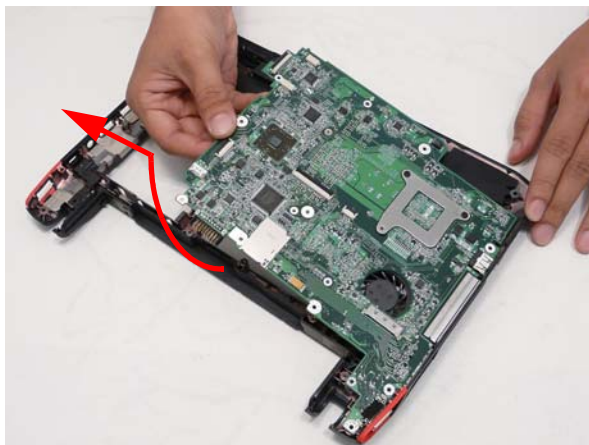

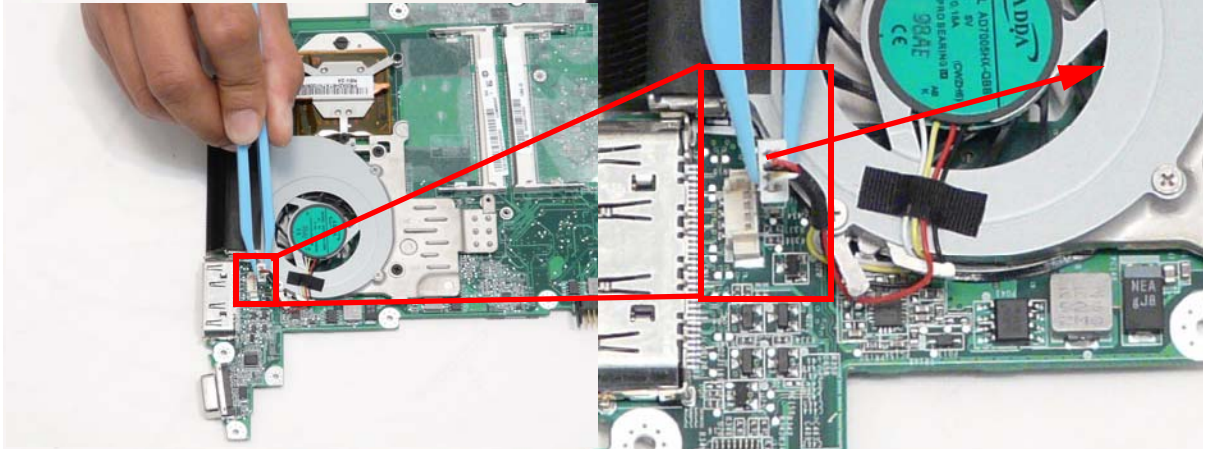

Removing the Thermal Module

1. See "Removing the Mainboard" on page 71.
2. Disconnect fan connector.

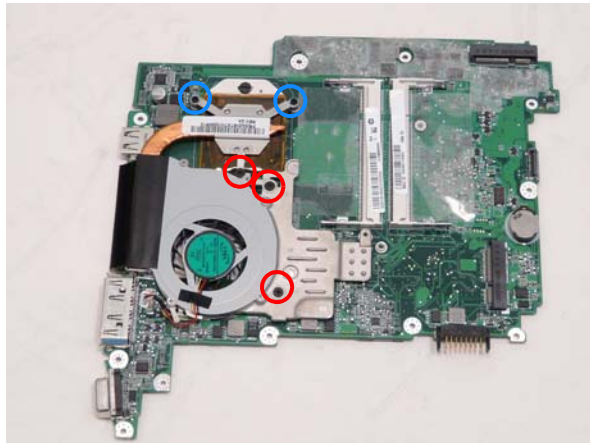

3. Remove the three (3) screws (red call outs) and loosen the two (2) captive screws (blue call outs).



Step	Screw	Quantity	Screw Type.
Thermal Module Disassembly	2*3	3	

-
- Lift the fan away from the main board.

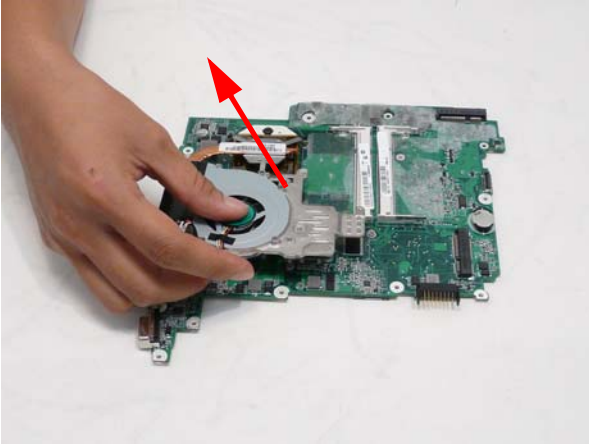

Removing the CPU

1. See “Removing the Thermal Module” on page 73.
2. Using a flat head screwdriver to turn the CPU mounting lock to the OFF position.

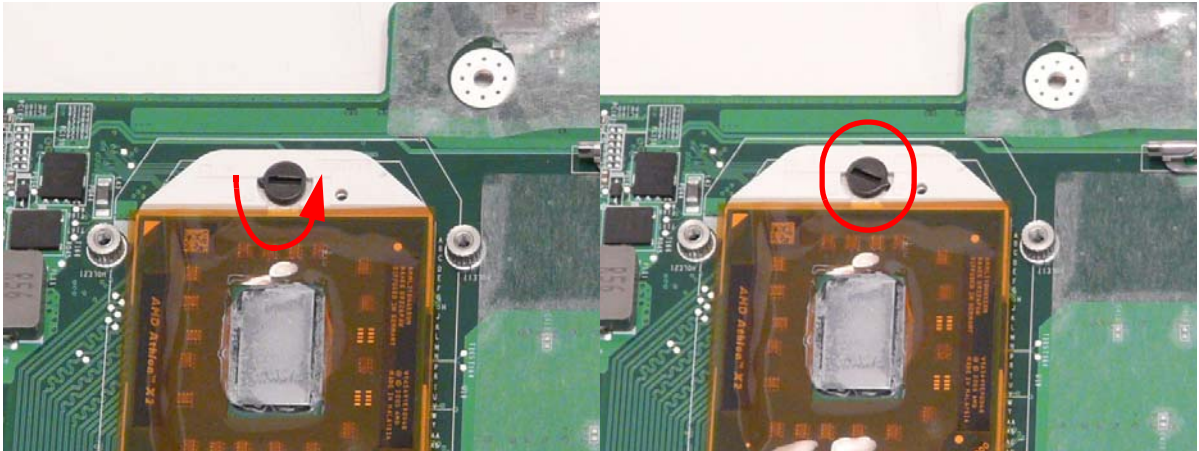

Locked CPU

Unlocked CPU

3. Lift the CPU out and store carefully.

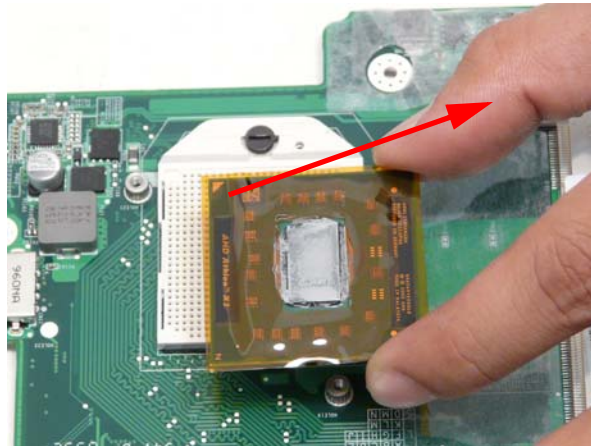

WARNING: Do not touch the thermal grease to prevent bodily harm.

Removing the RTC Battery.

1. See “Removing the Mainboard” on page 71.

-
2. Lift the RTC battery out of its holder.

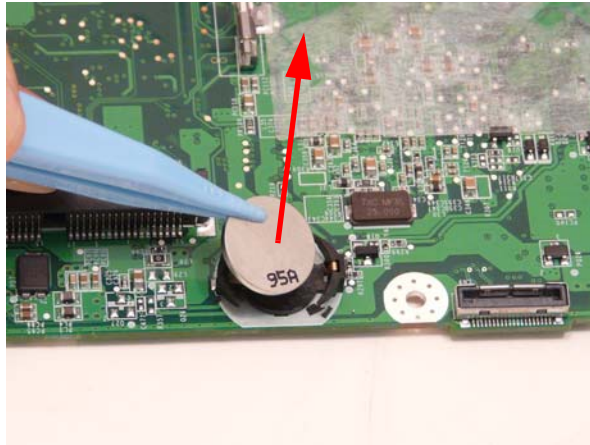

Removing the Speaker Modules

1. See "Removing the Mainboard" on page 71.
2. Remove the three (3) screws securing the Speakers to the lower cover.

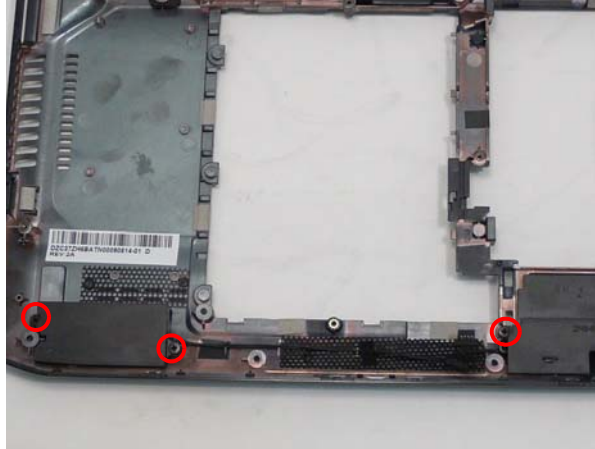

Step	Screw	Quantity	Screw Type.
Speaker Module Disassembly	2*3	3	

3. Remove the tape from the speaker cable.

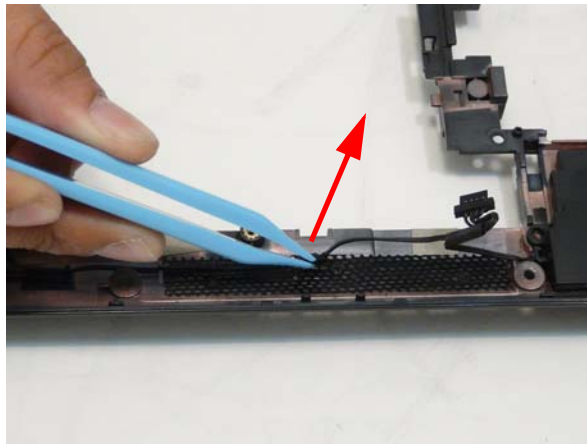

-
4. Lift the speaker module out of the lower cover.

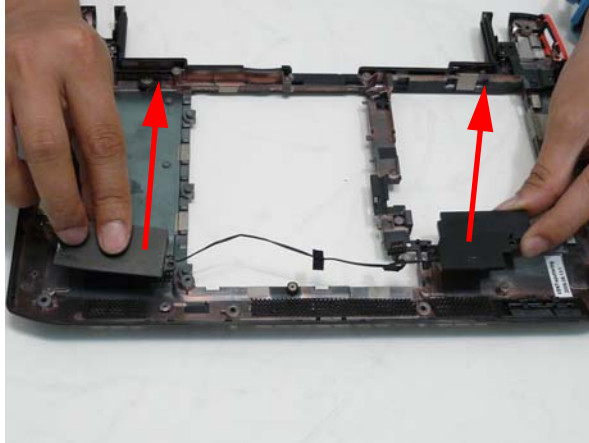

LCD Module Disassembly Process

IMPORTANT: Cable paths and positioning may not represent the actual model. During the removal and replacement of components, ensure all available cable channels and clips are used and that the cables are replaced in the same position.

NOTE: The product previews seen in the disassembly procedures may not represent the final product color or configuration.

LCD Module Disassembly Flowchart

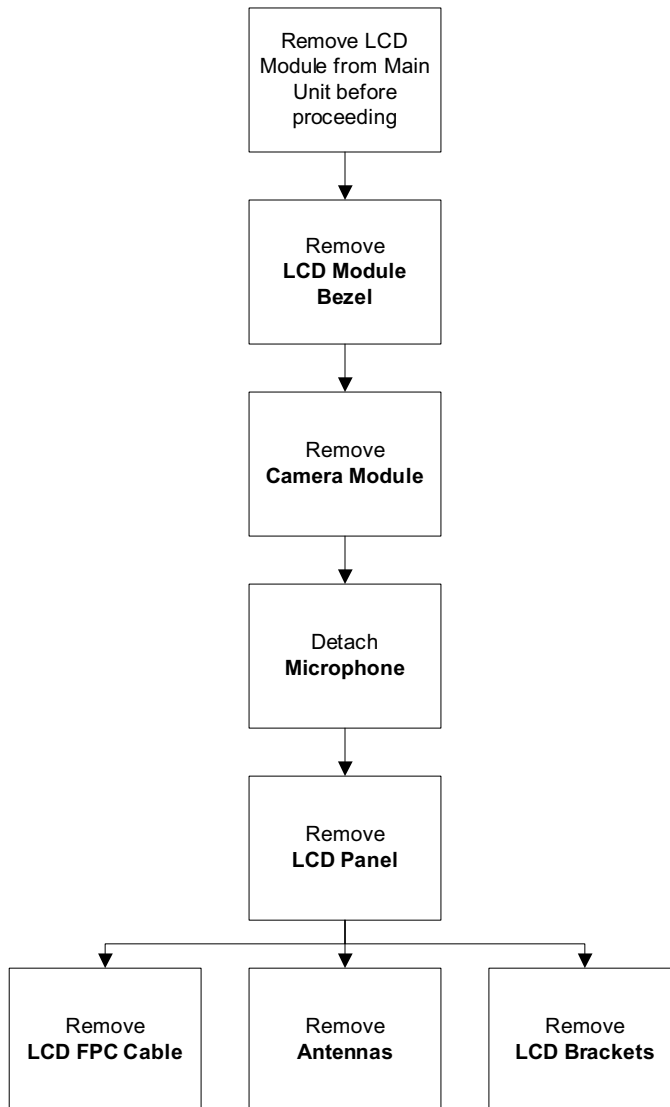

Screw List

Step	Screw	Quantity	Part No.
LCD Bezel Disassembly	2*5	2	86.TG607.004
LCD Panel Disassembly	2*3	4	86.S0207.001

Step	Screw	Quantity	Part No.
LCD Bracket Disassembly	2*2.5	4	86.TPK07.001

Removing the LCD Bezel

1. See "Removing the LCD Module" on page 69.
2. Remove the two (2) screw covers.



3. Remove the two (2) screws.



Step	Screw	Quantity	Screw Type.
Bezel Disassembly	2*5	2	

4. Pry the bezel free at the corner and lift the bezel off the hinge.

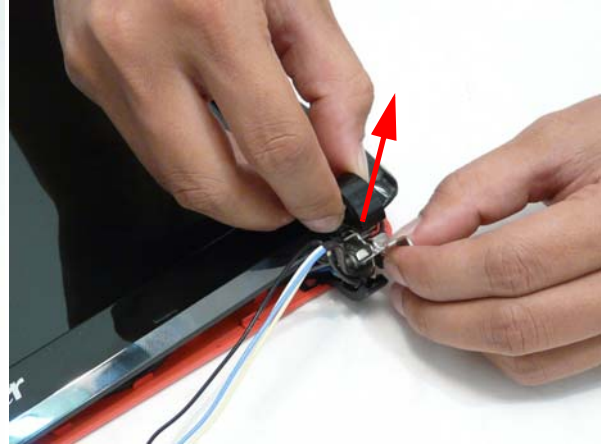
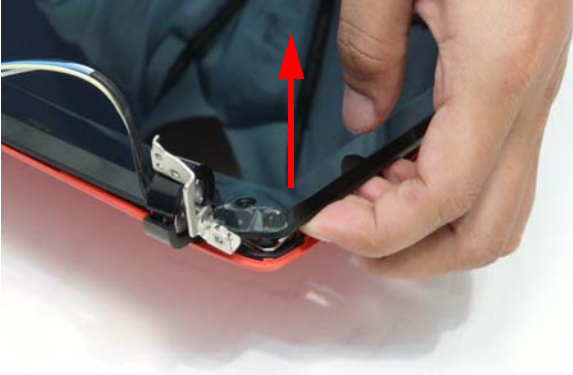

5. Pry the bezel free around the panel.

i)



ii)



iii)



iv)



Removing the Camera Board

1. See "Removing the LCD Bezel" on page 81.
2. Disconnect the camera board connector

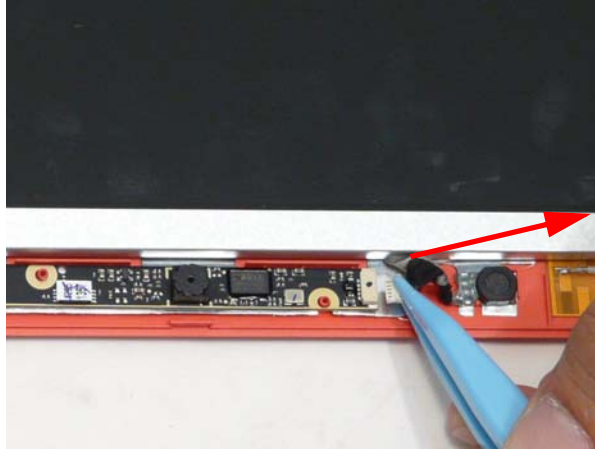

3. Lift the camera board out.

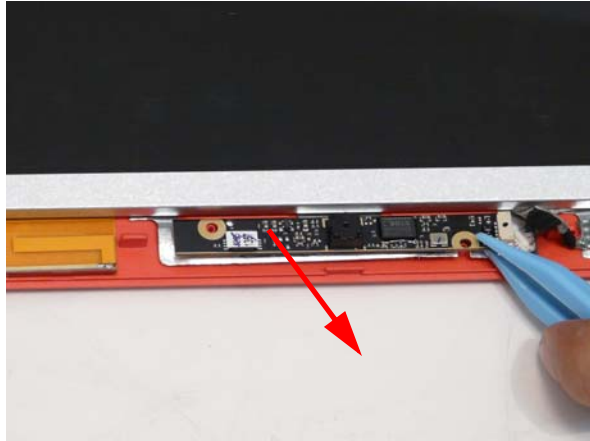

Removing the LCD Panel

1. See "Removing the Camera Board" on page 83.
2. Lift the microphone off the adhesive.

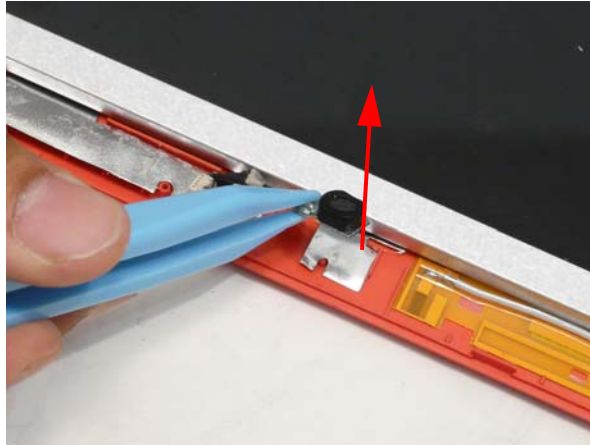

3. Remove the four (4) screws.



Step	Screw	Quantity	Screw Type.
LCD Panel Disassembly	2*3	4	

-
4. Lift the LCD panel out of the LCD module.



Removing the LCD Brackets

- 1. See "Removing the LCD Panel" on page 84.
- 2. Pick up the panel and remove the four (4) screws holding the brackets in place.

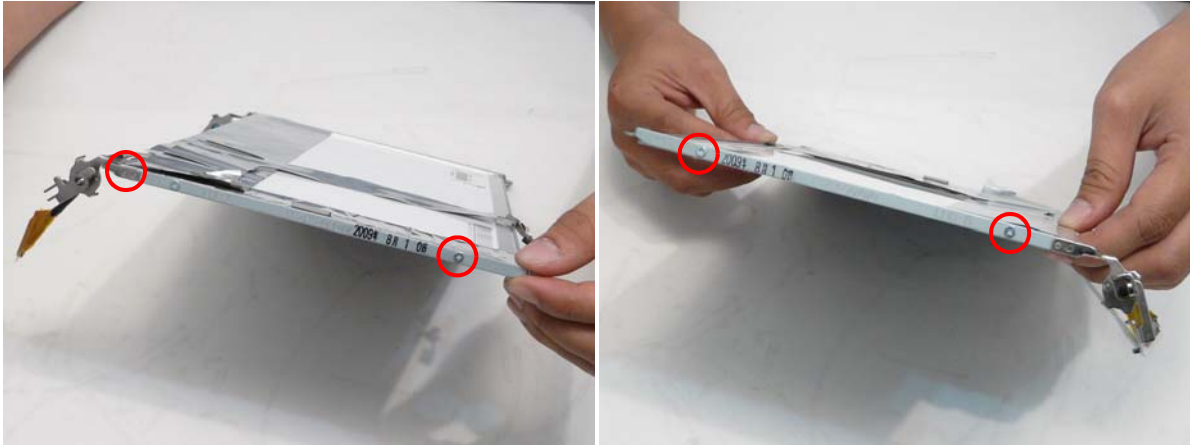

Step	Screw	Quantity	Screw Type.
LCD Panel Brackets Disassembly	2*2.5 (silver)	4	

Removing the FPC Cable

1. See "Removing the LCD Panel" on page 84.
2. Pull the vertical foil strip off the microphone cable.

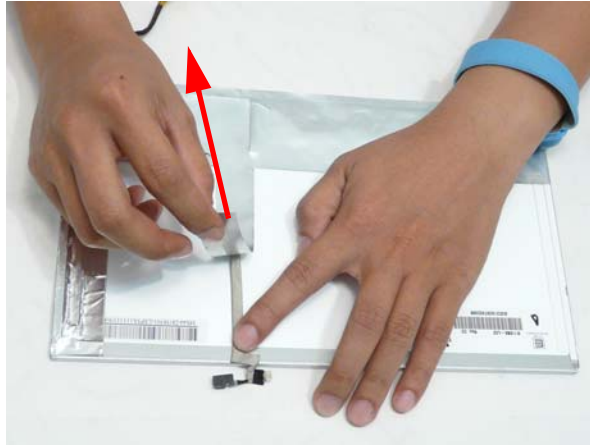

3. Pull off the horizontal foil strip till the FPC cable is completely exposed.

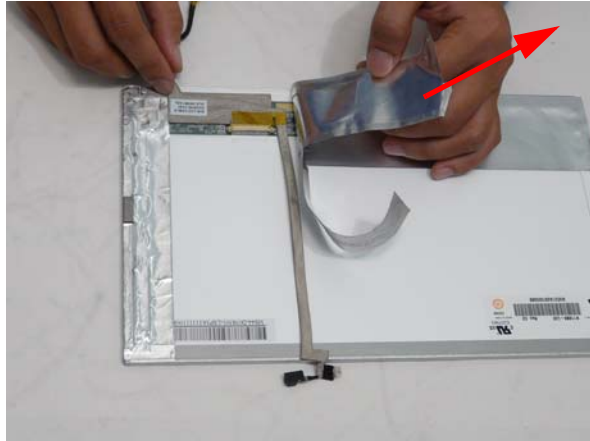

4. Pull the cable sleeve off the adhesive.

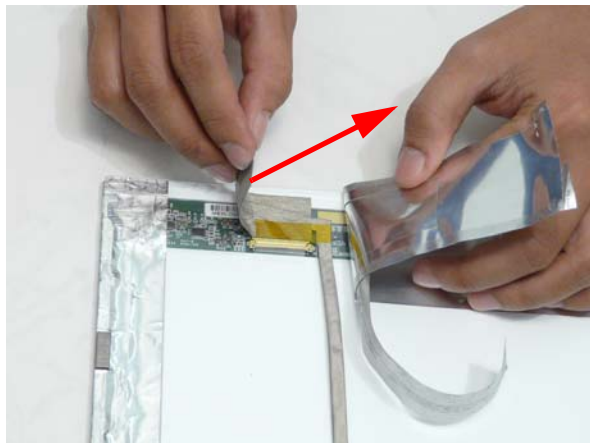

-
5. Lift up the clear connector protector.

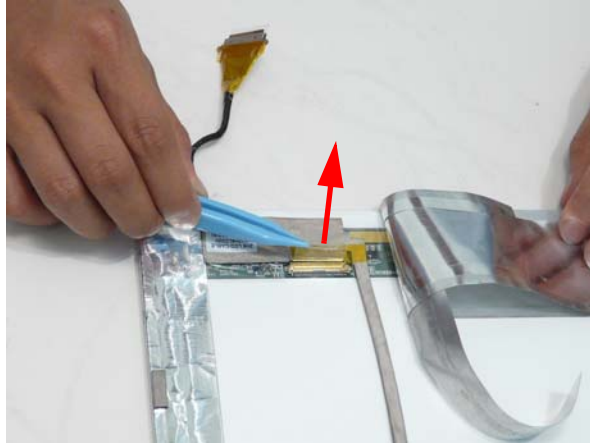

6. Disconnect the connector.

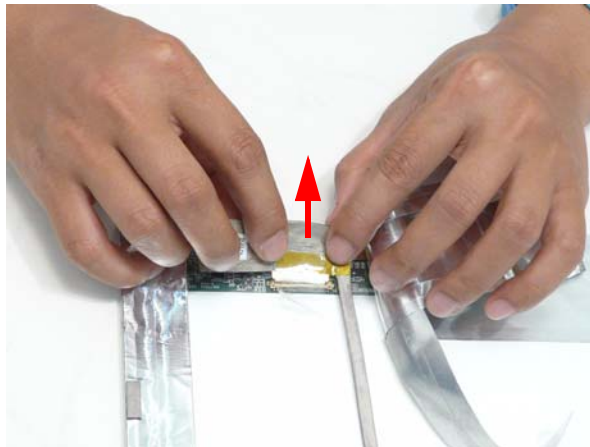

7. Pull the microphone cable free of the adhesive.

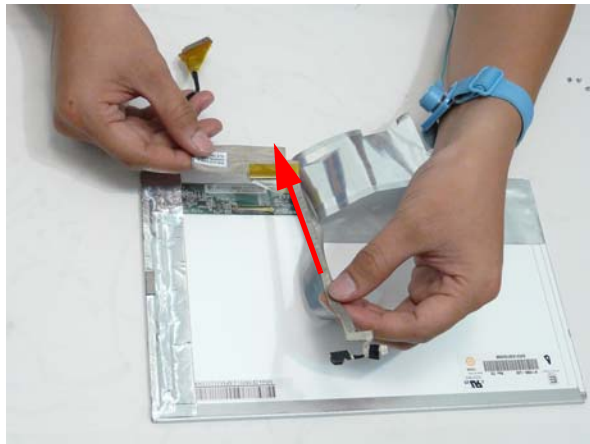

Removing the Antennas

1. See "Removing the LCD Panel" on page 84.
2. Lift up the four (4) foil tabs on each corner.

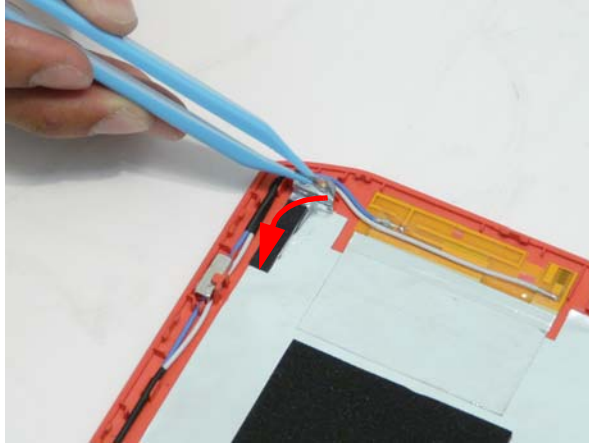

3. Pull the wiring free of the retention guides.

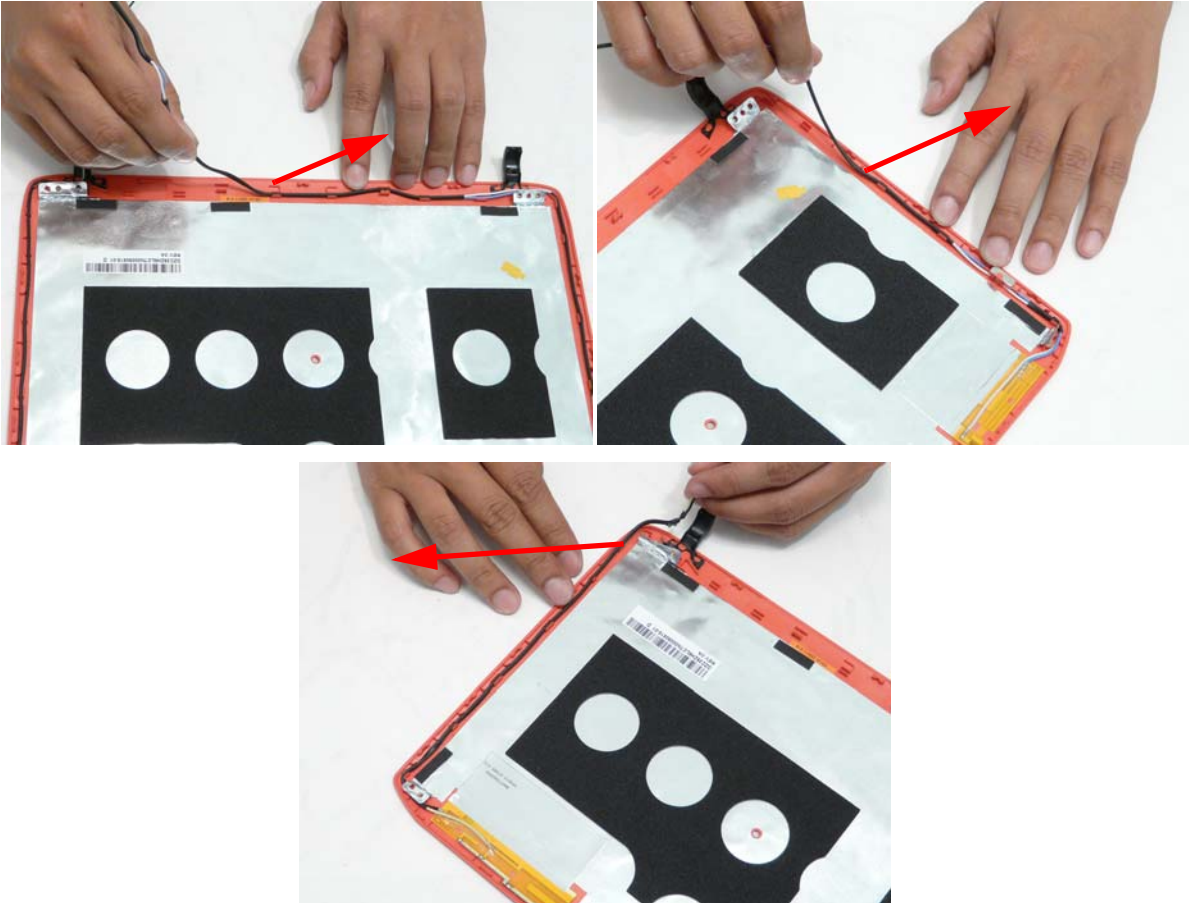

4. Remove the magnet.

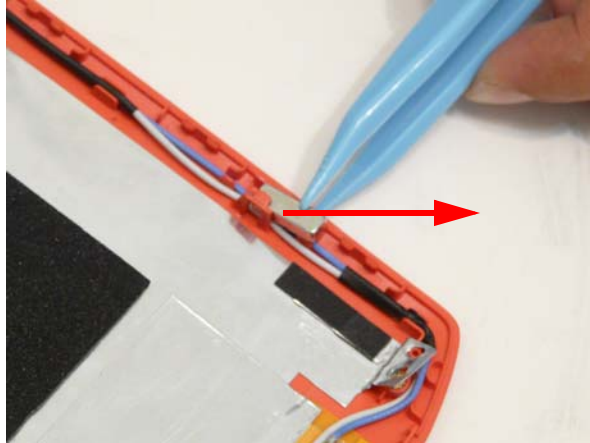

5. Pull the foil and antennas off the adhesive



LCD Reassembly Procedure

Replacing the Antennas

1. Adhere the Right Antenna Pad (yellow and blue cable) to the LCD cover.

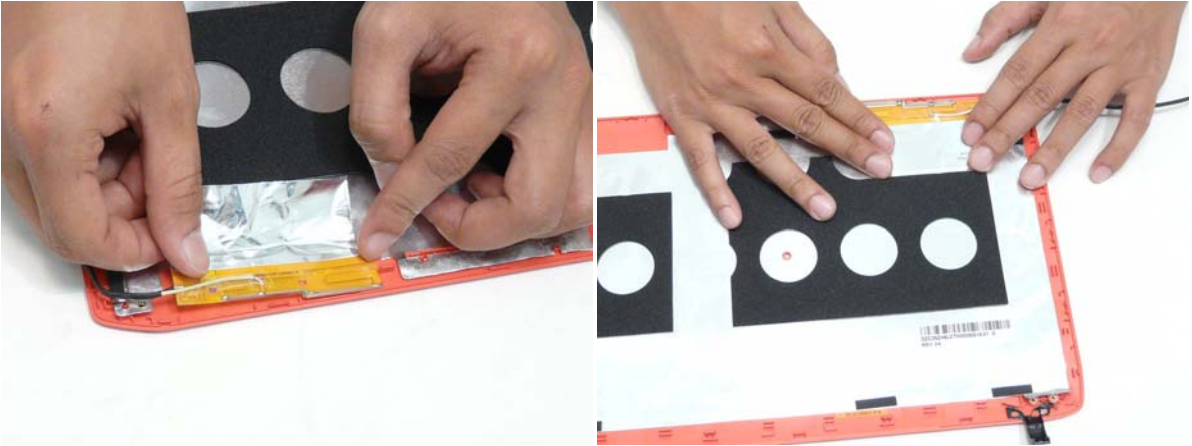

2. Adhere the Left Antenna Pad (white and blue cable) to the LCD Cover.

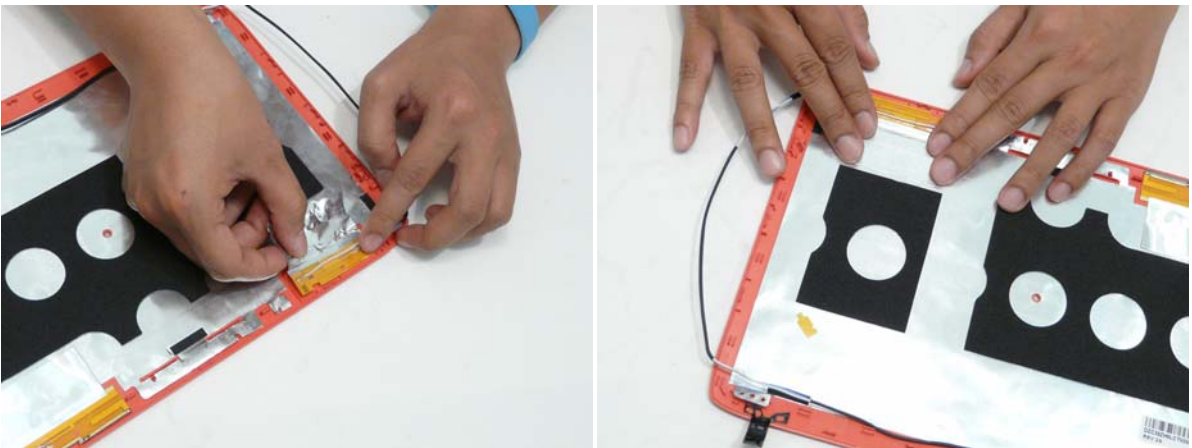

3. Insert the antenna cables into the retention guides around the top left corner of the LCD cover and then mount the magnet.

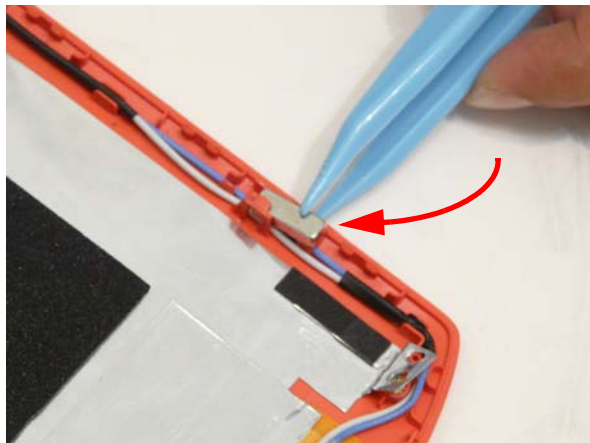

4. Insert the antenna cables into the retention guides around both sides.

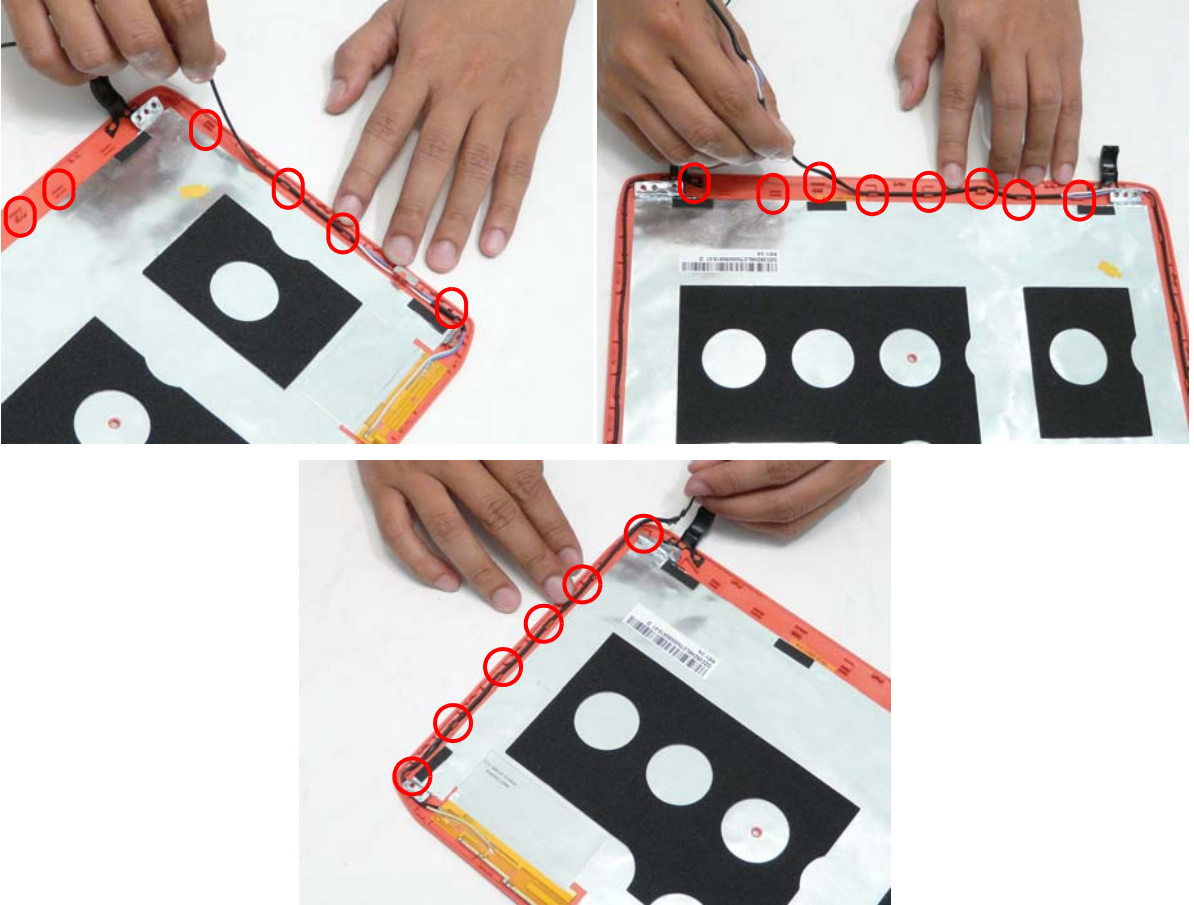

5. Flatten the four (4) foil tabs on each corner.

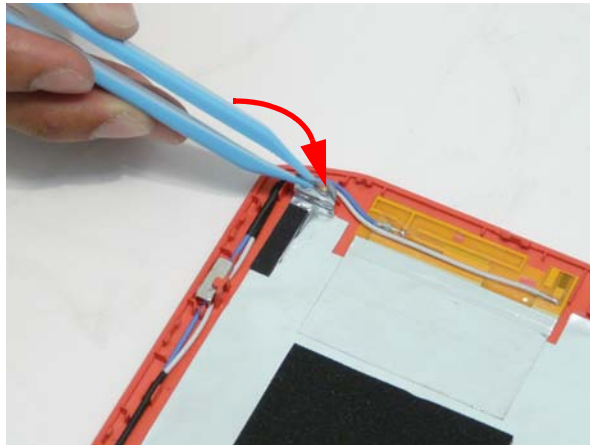

Replacing the FPC Cable

1. Pull back the foil from the panel and lay the FPC cable on the panel

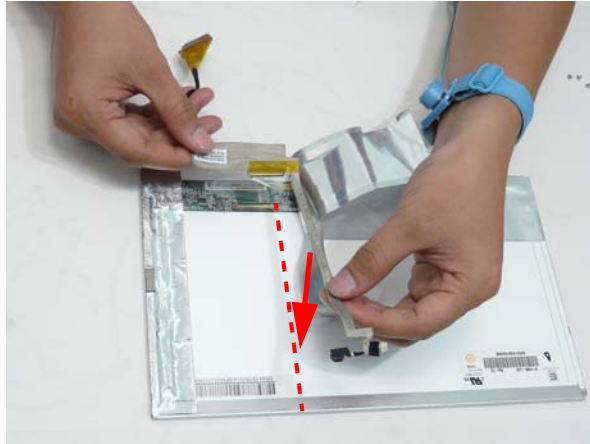

2. Apply adhesive and press down the FPC cable microphone extension.

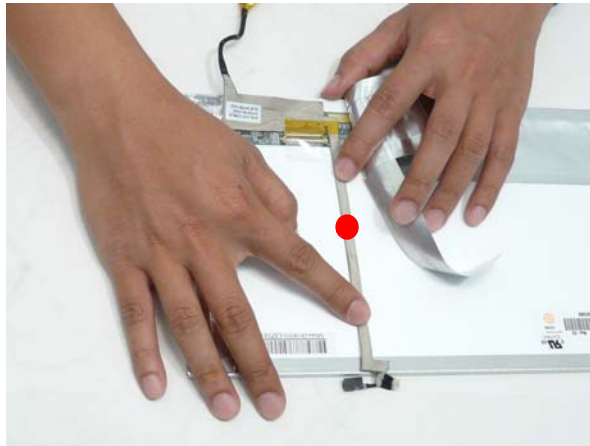

CAUTION: Ensure that the microphone is properly aligned with the top of the panel.

3. Connect the FPC cable connector.

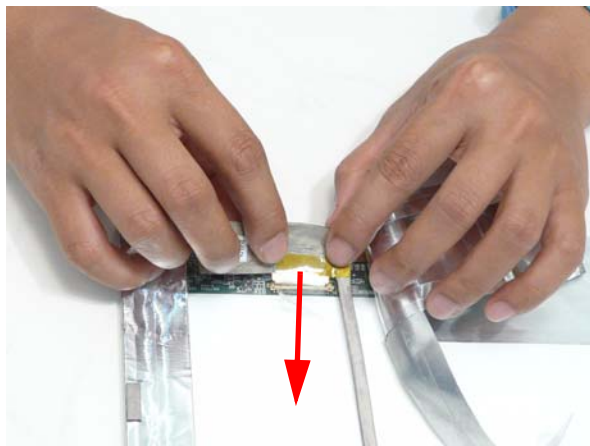

4. Press down the clear FPC connector protective cover.



5. Apply adhesive and press down the FPC cable sleeve.

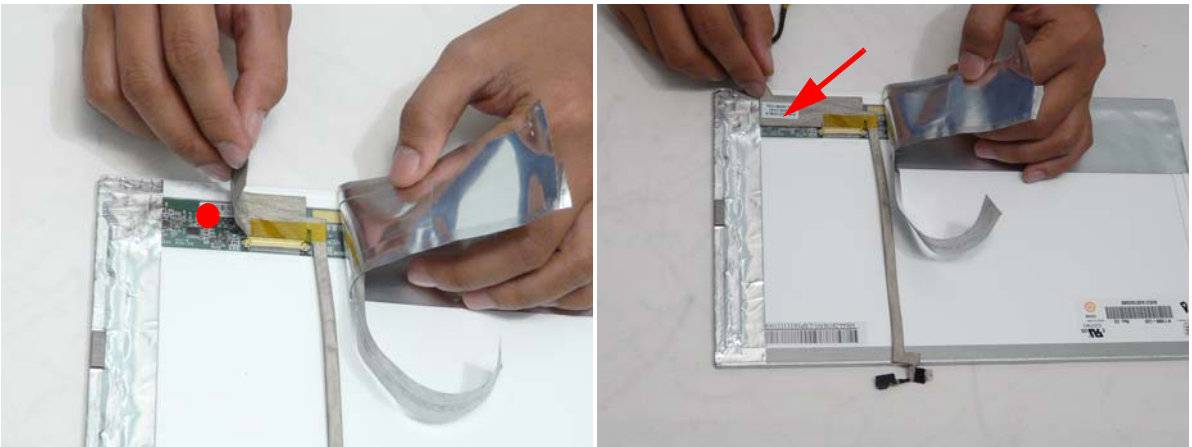

6. Press the foil back down on top of the FPC cable.

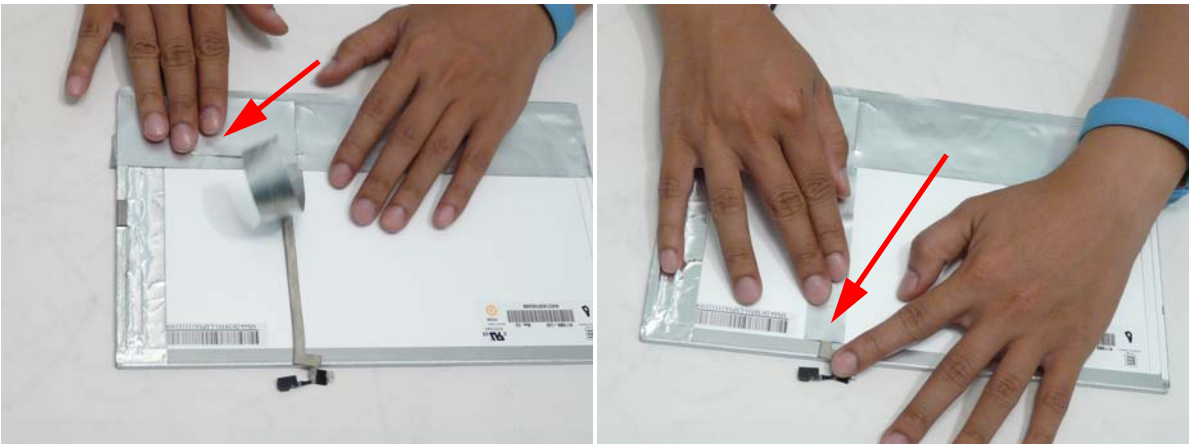

Replacing the LCD Brackets

- 1. Replace the four (4) screws in the left and right brackets.



Step	Screw	Quantity	Screw Type.
LCD Bracket Assembly	2*2.5 (silver)	4	

Replacing the LCD Panel

- 1. Place the LCD panel on the cover.



2. Replace the four (4) screws.



Step	Screw	Quantity	Screw Type.
LCD Panel Disassembly	2*3	4	

3. Apply adhesive and press the microphone into place.

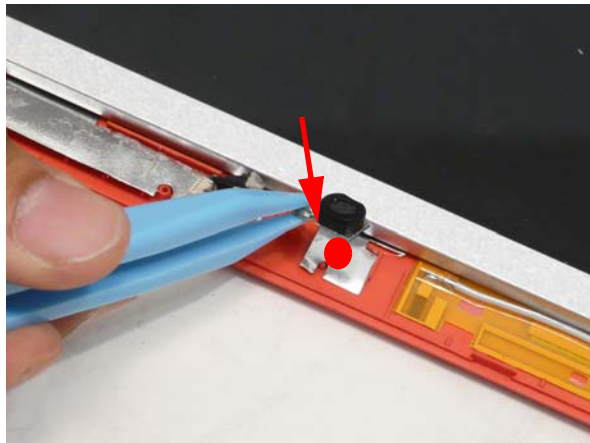

Replacing the Camera Board

1. Place the camera onto the LCD cover.

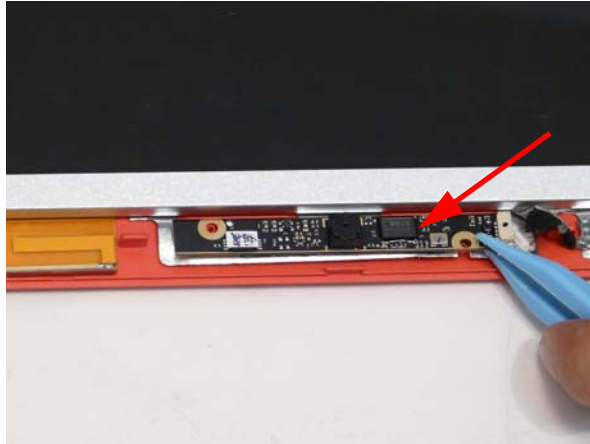

2. Connect the cable to the Camera Board

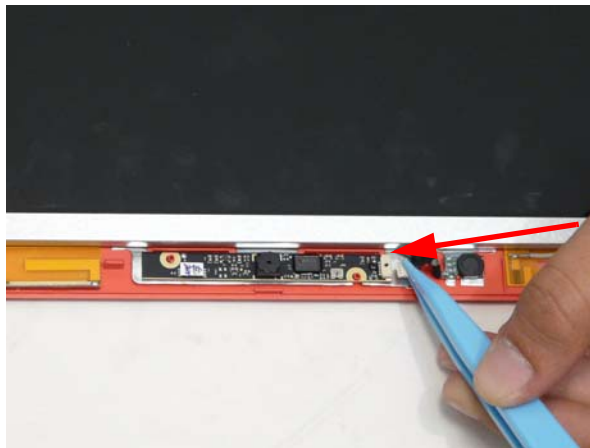

Replacing the LCD Bezel

1. Place the bezel hinge cover over the hinges and ensure the wiring is correctly routed under the center hinge pin.



2. Press the bezel down around the edges.



3. Replace the two (2) screws.



Step	Screw	Quantity	Screw Type.
LCD Bezel Assembly	2*5	2	

4. Replace the two screw covers.



Main Unit Reassembly Process

Replacing the Speaker Module

1. Place the speaker module onto the lower cover.

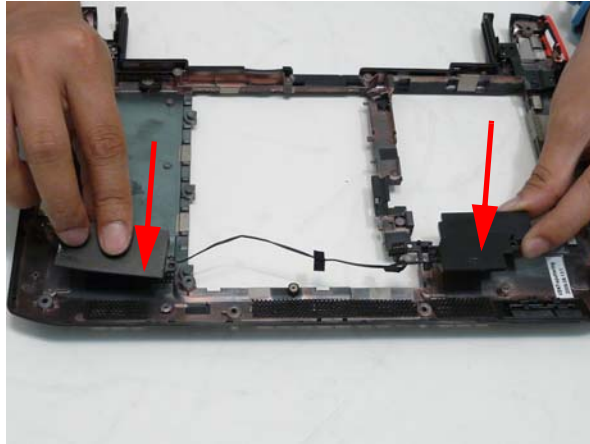

2. Replace the three (3) screws

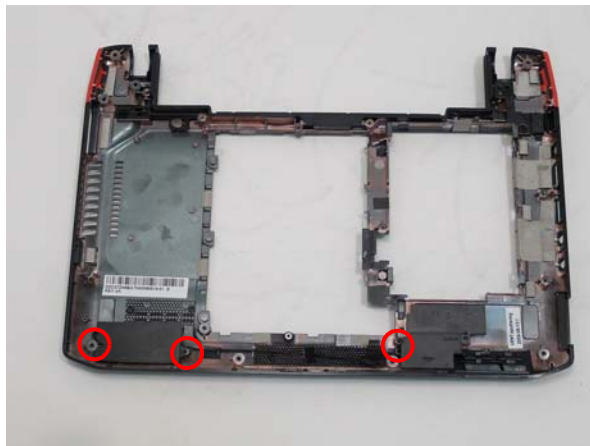

Step	Screw	Quantity	Screw Type.
Speaker Module Assembly	2*3	3	

3. Lay the cable into the retention guides and press down the adhesive tape.

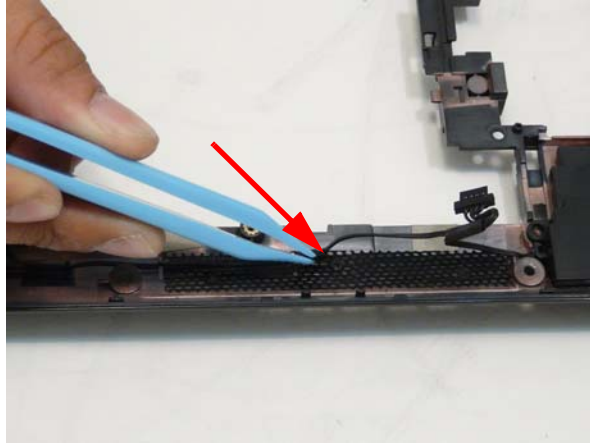

Replacing the RTC battery

1. Insert the RTC battery into the holding clips.

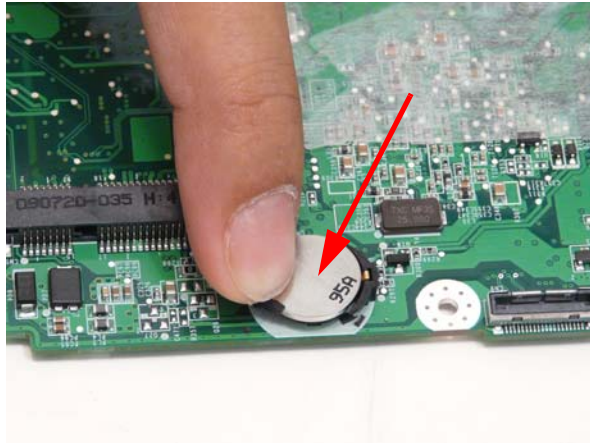

Replacing the CPU

1. Place the CPU into the socket paying attention to the correct alignment of the locating triangle in the corner.



2. Turn the CPU lock to the locked position.

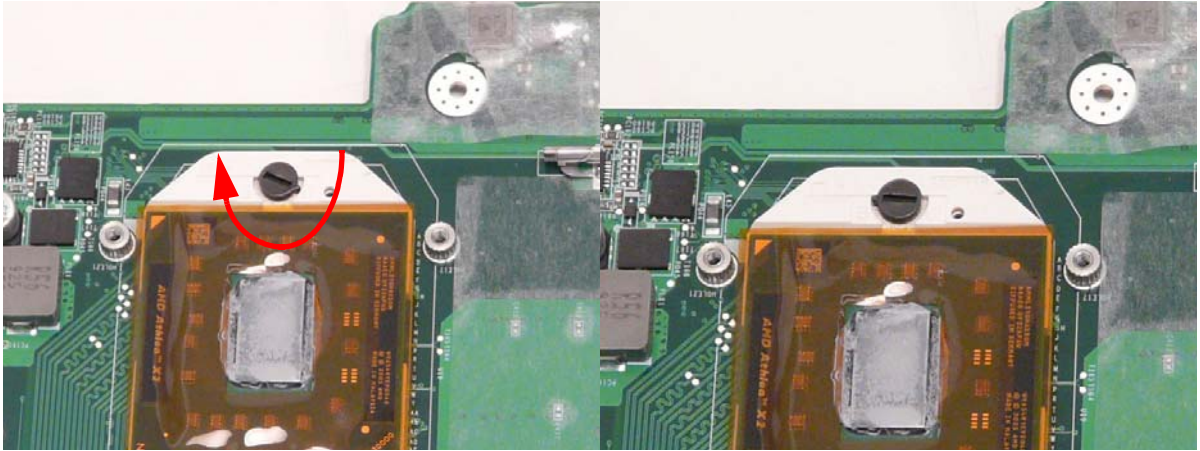

Replacing the Thermal Module

IMPORTANT: Ensure all heat pads are in place before replacing the Thermal Module.

The following TIM material and dimensions (mm) are approved for use:

CPU TIM PSX-D 18.3*12.3mm

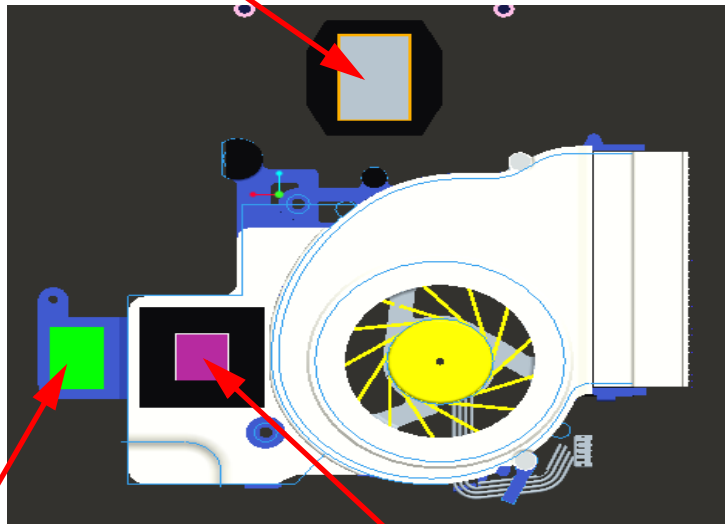

Vram TIM T-Flex-320 13*9*05mm

PCHNB TIM FSL-BS 9.5*9.5*1mm

1. Remove all traces of thermal grease or pad adhesive from the CPU and thermal module using a lint-free cloth or cotton swab and Isopropyl Alcohol, Acetone, or other approved cleaning agent.

- Place the thermal module on the main board.



- Tighten the two (2) captive screws (blue call outs) and replace the three (3) screws (red call outs) of the thermal module.



Step	Screw	Quantity	Screw Type.
Thermal Module Assembly	2*3	3	

- Connect the fan cable to the main board.



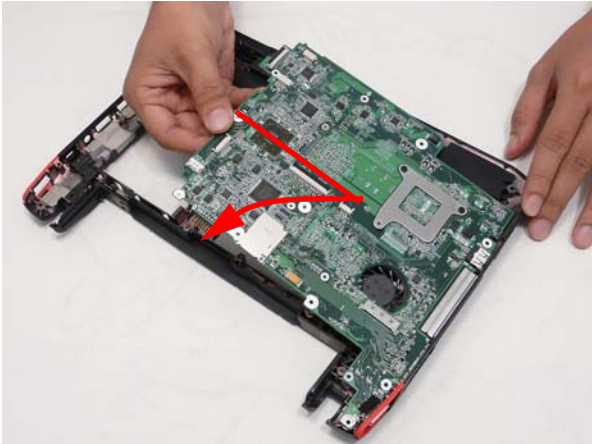

Replacing the Mainboard

1. Place the main board into the lower cover on an angle first aligning the I/O ports.

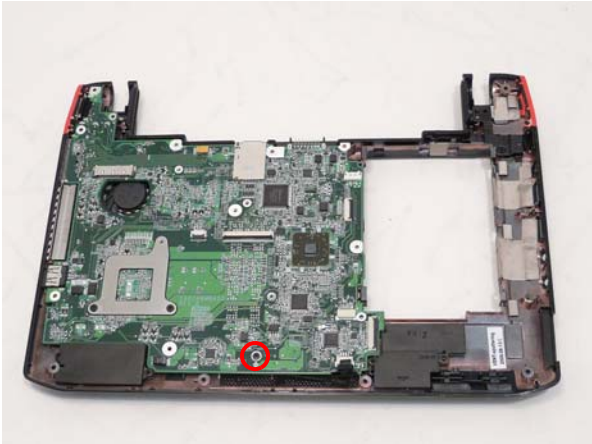

2. Replace the one (1) screw.



Step	Screw	Quantity	Screw Type.
Main Board Assembly	2*3	1	

3. Connect the speaker connector.

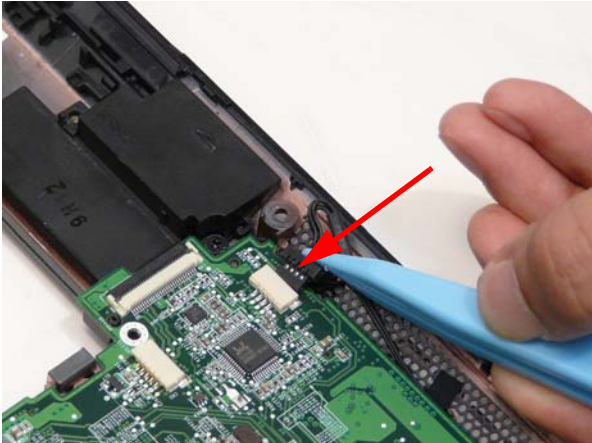

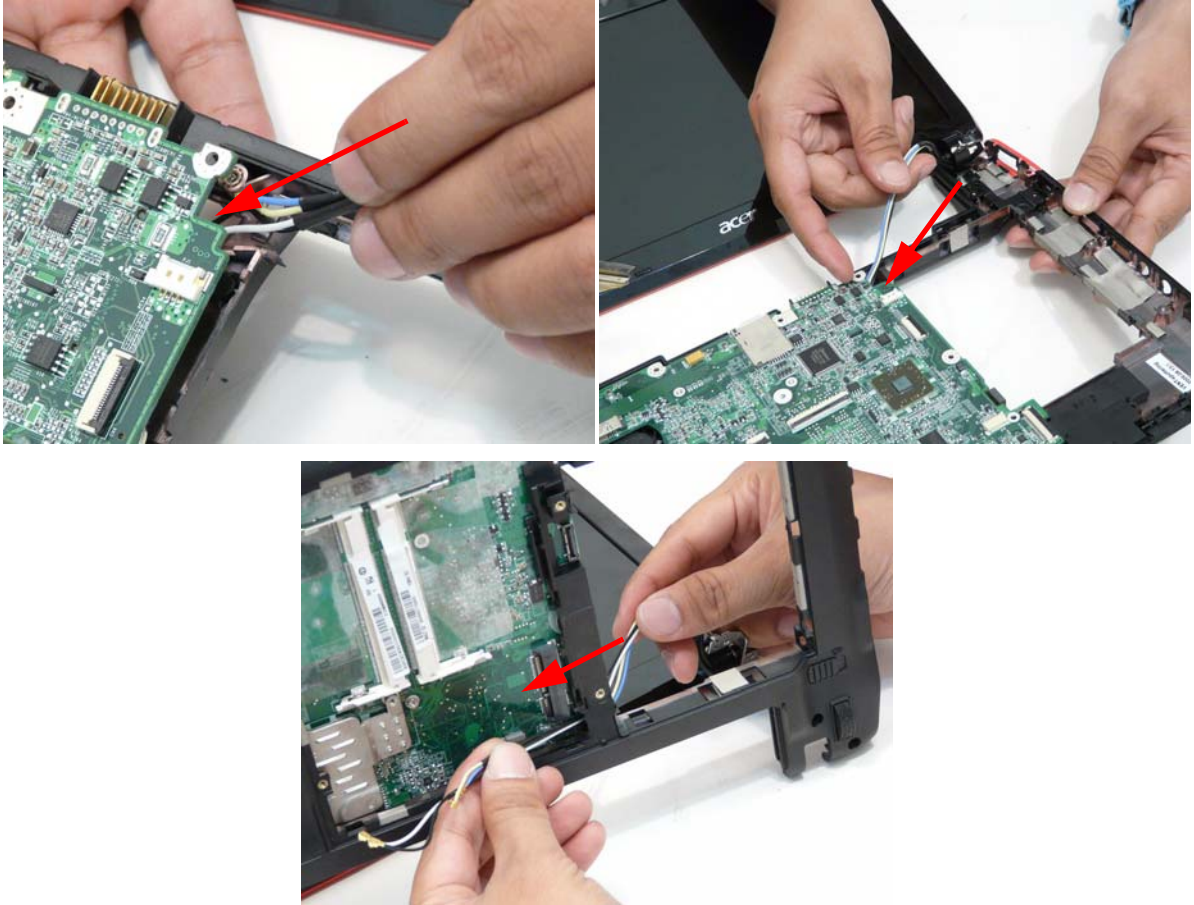

Replacing the LCD Module

1. Thread the antenna cables through to the bottom side of the lower cover and place in the retention guides.

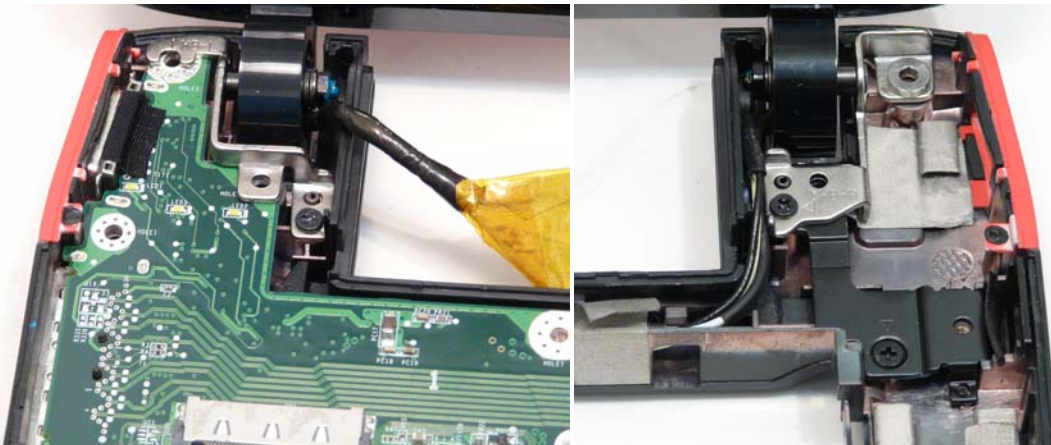

2. Place the hinges down on the lower case and ensure correct positioning of the antenna cables and the LCD cable and replace the two (2) screws.



Step	Screw	Quantity	Screw Type.
LCD Module Assembly	2*5	2	

3. Replace the LCD cable connector.

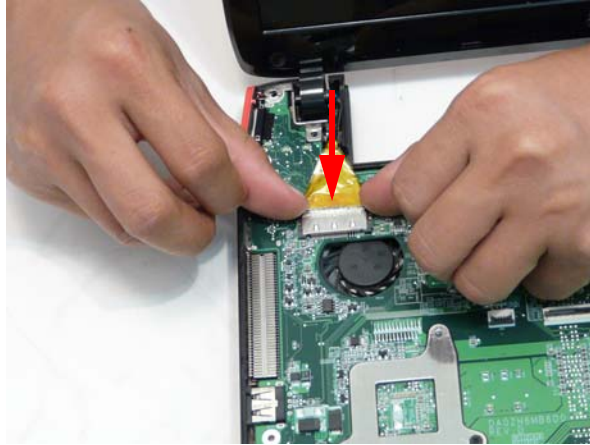

4. Press down the LCD cable connector protective cover.

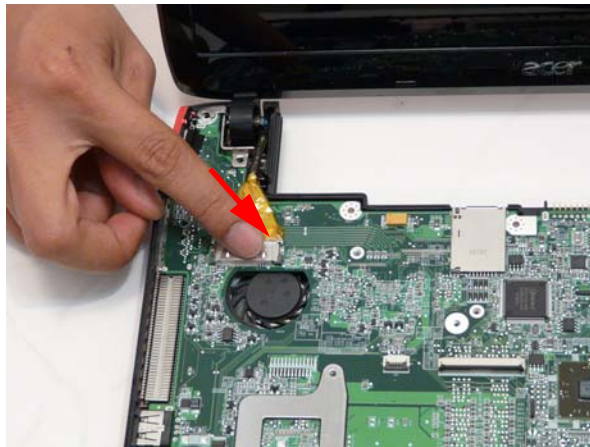

Replacing the I/O Board

1. Place the I/O board into the lower cover on an angle first aligning the I/O ports.

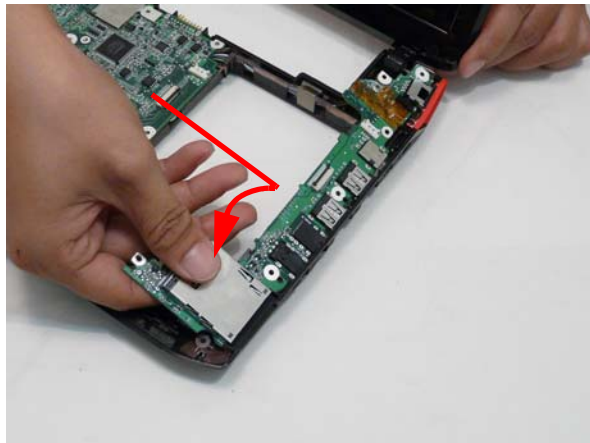

IMPORTANT: Ensure that the WLAN/3G switch and the Bluetooth switch are properly aligned in the plastic slide switch covers in the lower cover.

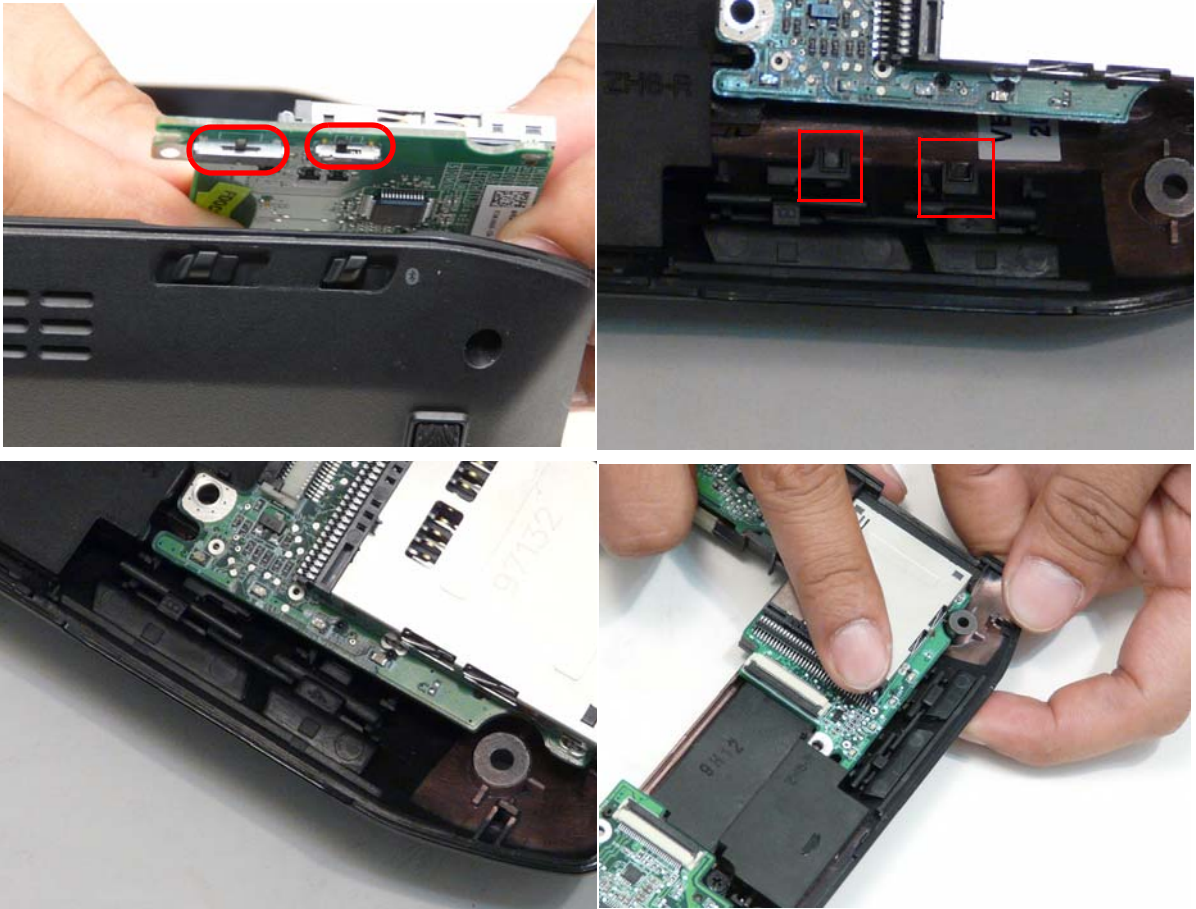

NOTE: You will feel the spring tension in the lower case sliders when the switches have been properly engaged.

2. Replace the one (1) screw.



Step	Screw	Quantity	Screw Type.
IO Board Assembly	2*5	1	

3. Reconnect the DC cable to the I/O board.

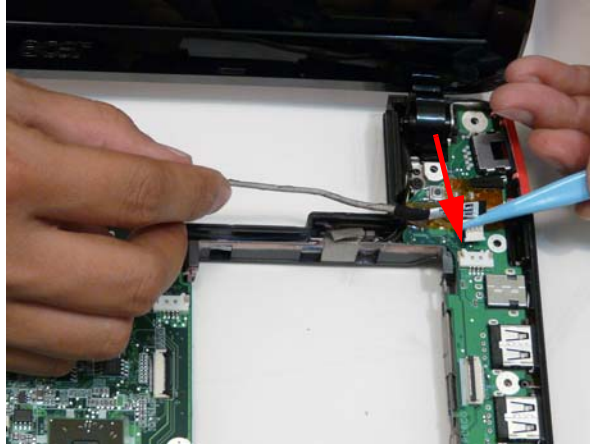

4. Lay the DC cable into the retention guide and press down the adhesive tape.

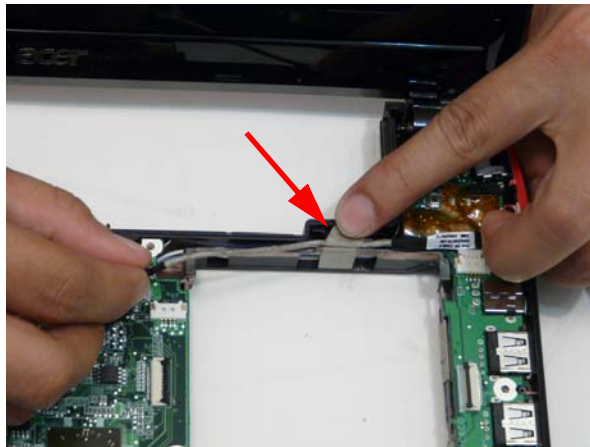

5. Reconnect the DC cable to the main board.

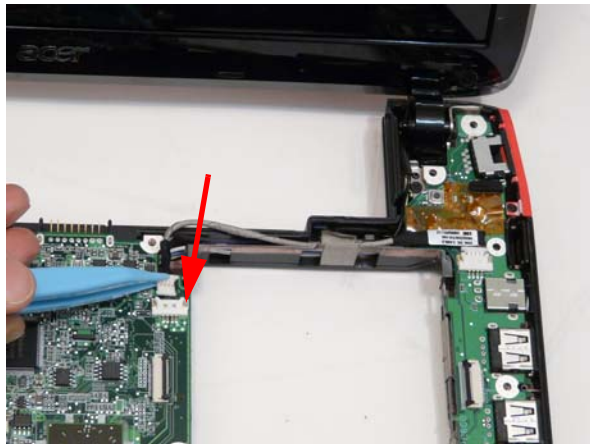

6. Reconnect the card reader cable.

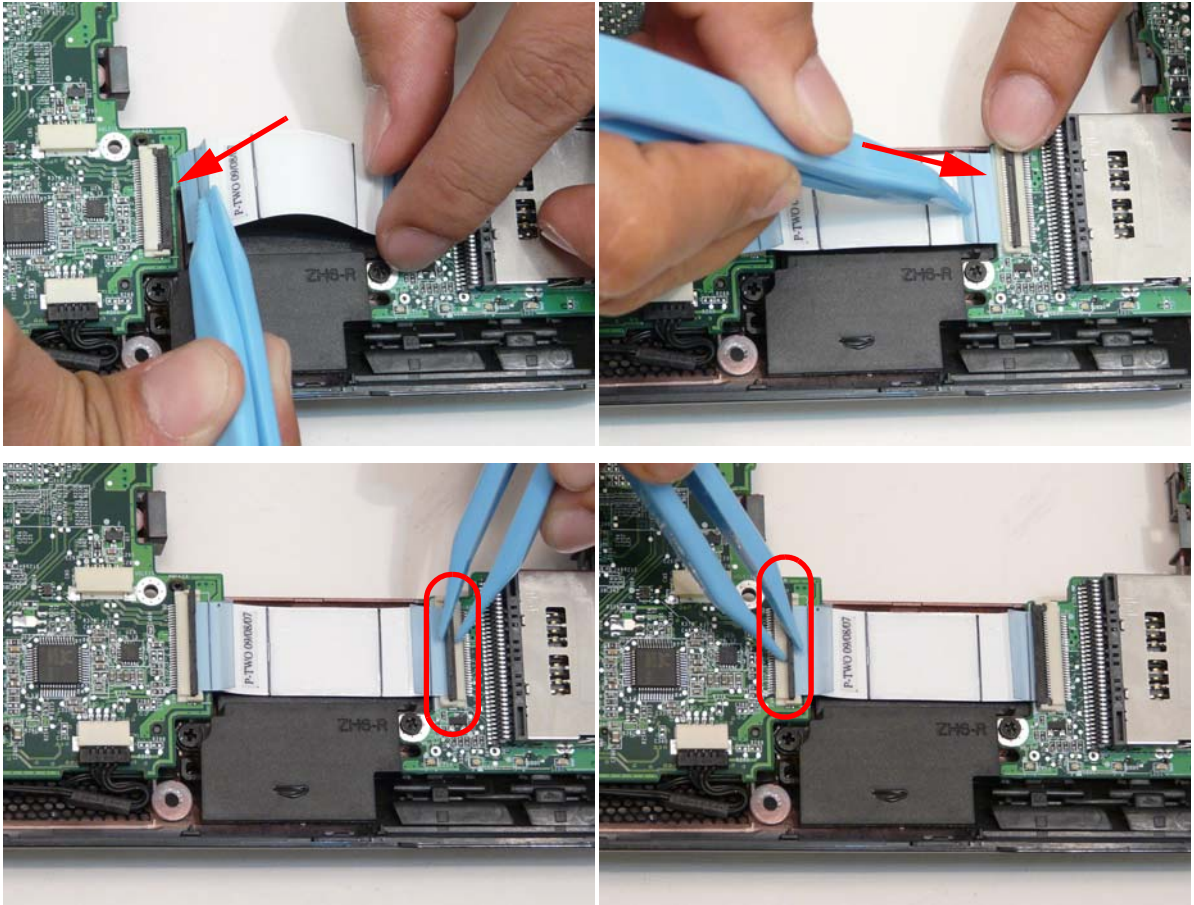

Replacing the Bluetooth Module

1. Place the Bluetooth module into position ensuring the board fits into the slot in the speaker module.

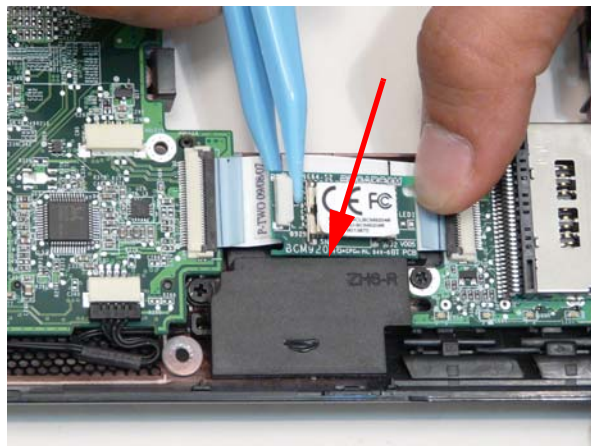

2. Reconnect the Bluetooth cable.

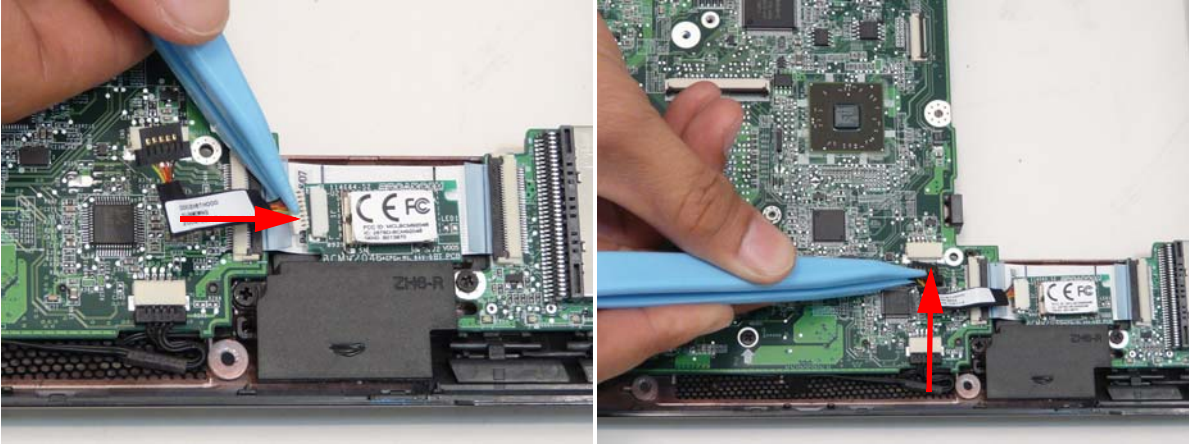

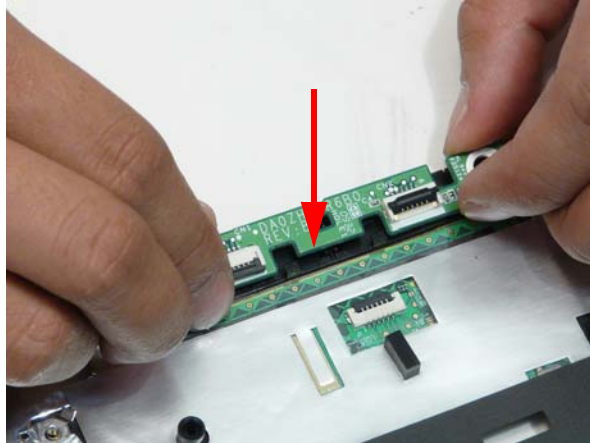

Replacing the Button Board

1. Place the button board on the upper cover.

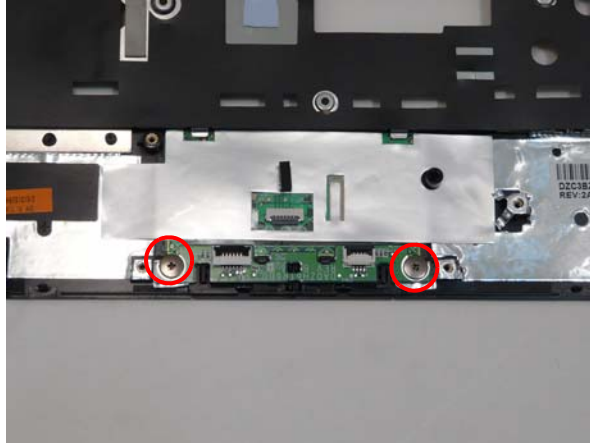

2. Replace the two (2) screws.



Step	Screw	Quantity	Screw Type.
Button Board Assembly	2-0.4*2	2	

3. Insert the button board cable into the upper cover.

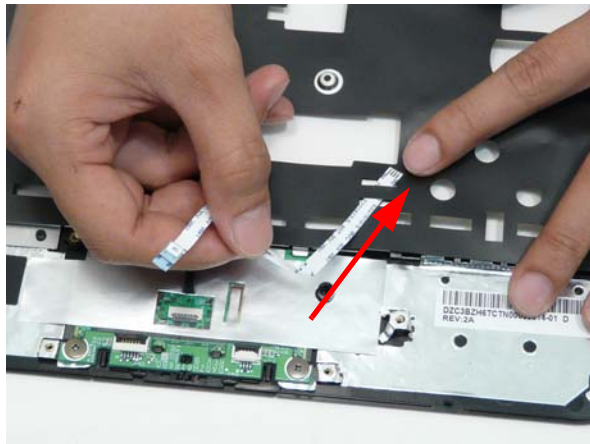

4. Apply adhesive and press the button board cable down.

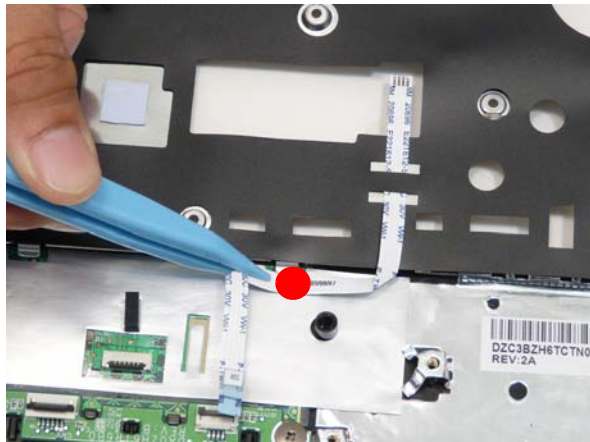

5. Connect the button board cable to the button board.

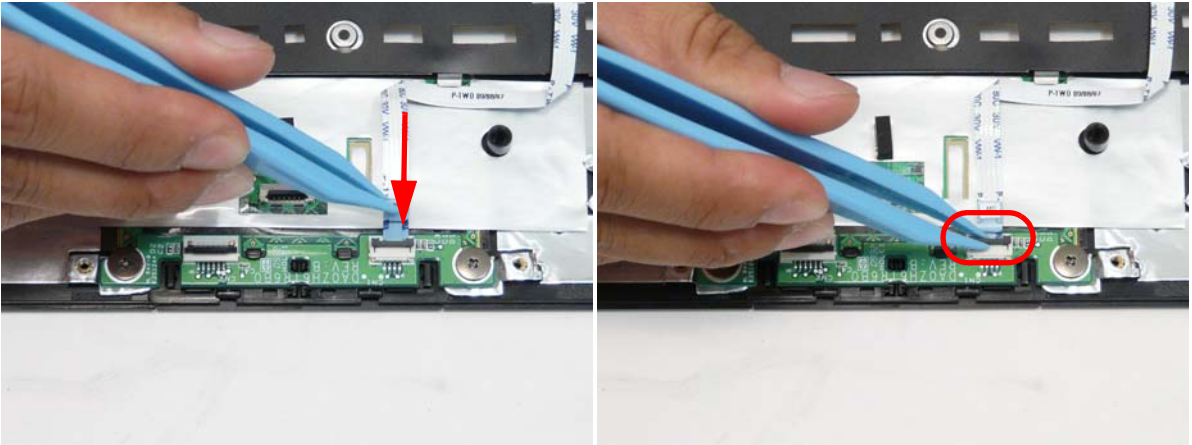

6. Connect the touch pad cable to the touch pad and the button board.

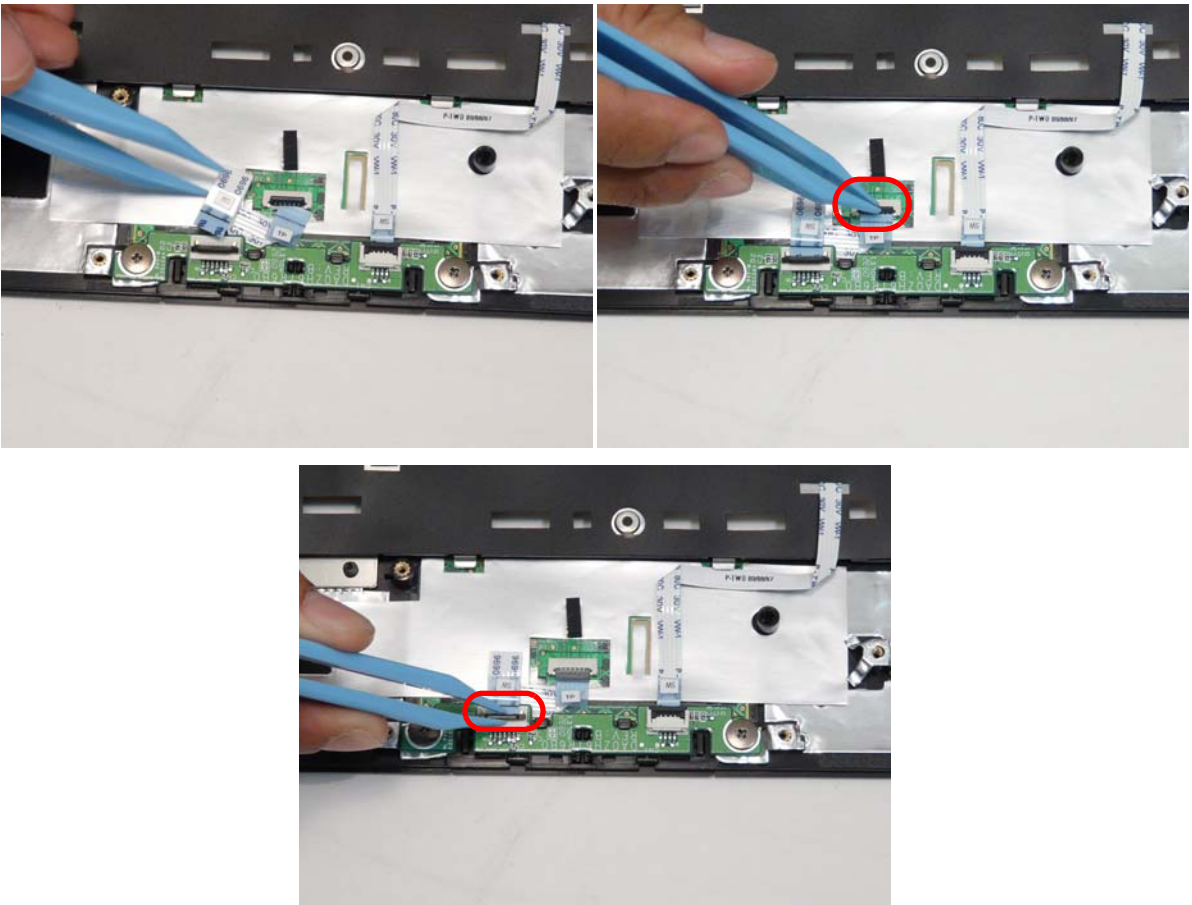

Replacing the Upper Cover

1. Insert the IO cable into the upper cover.

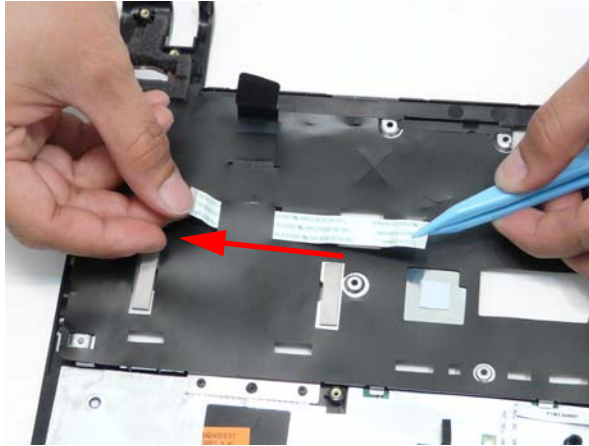

2. Place the upper cover onto the lower cover first aligning the hinges



3. Press around the edges of the upper cover.

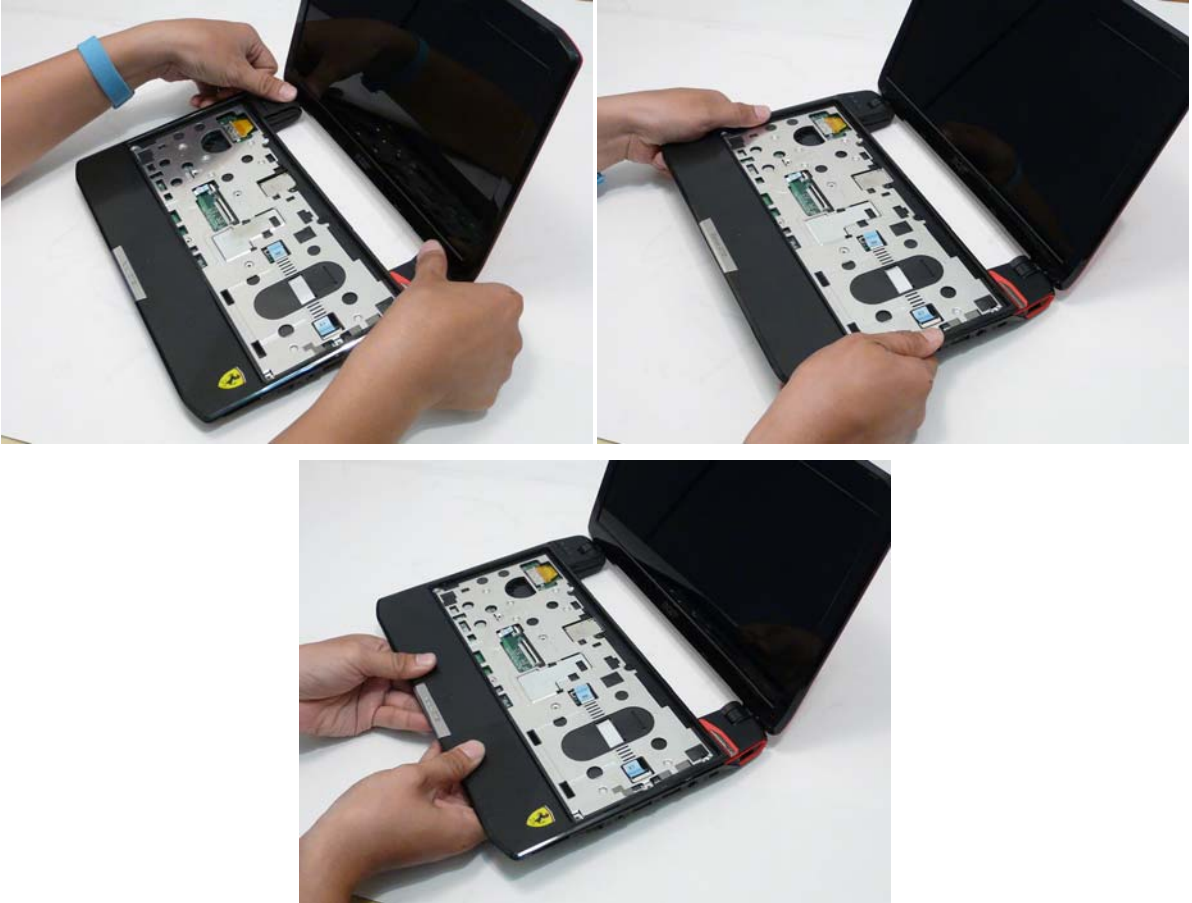

4. Connect the button board cable to the main board.

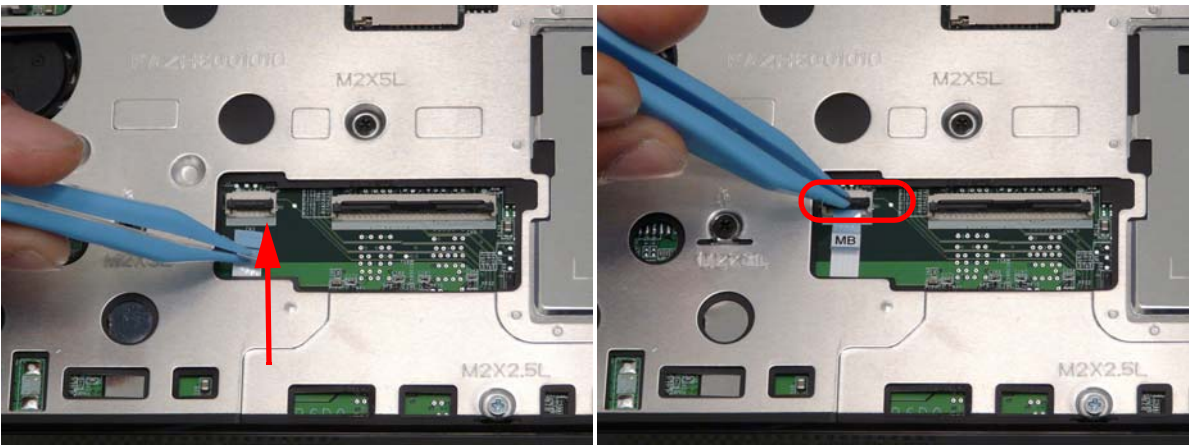

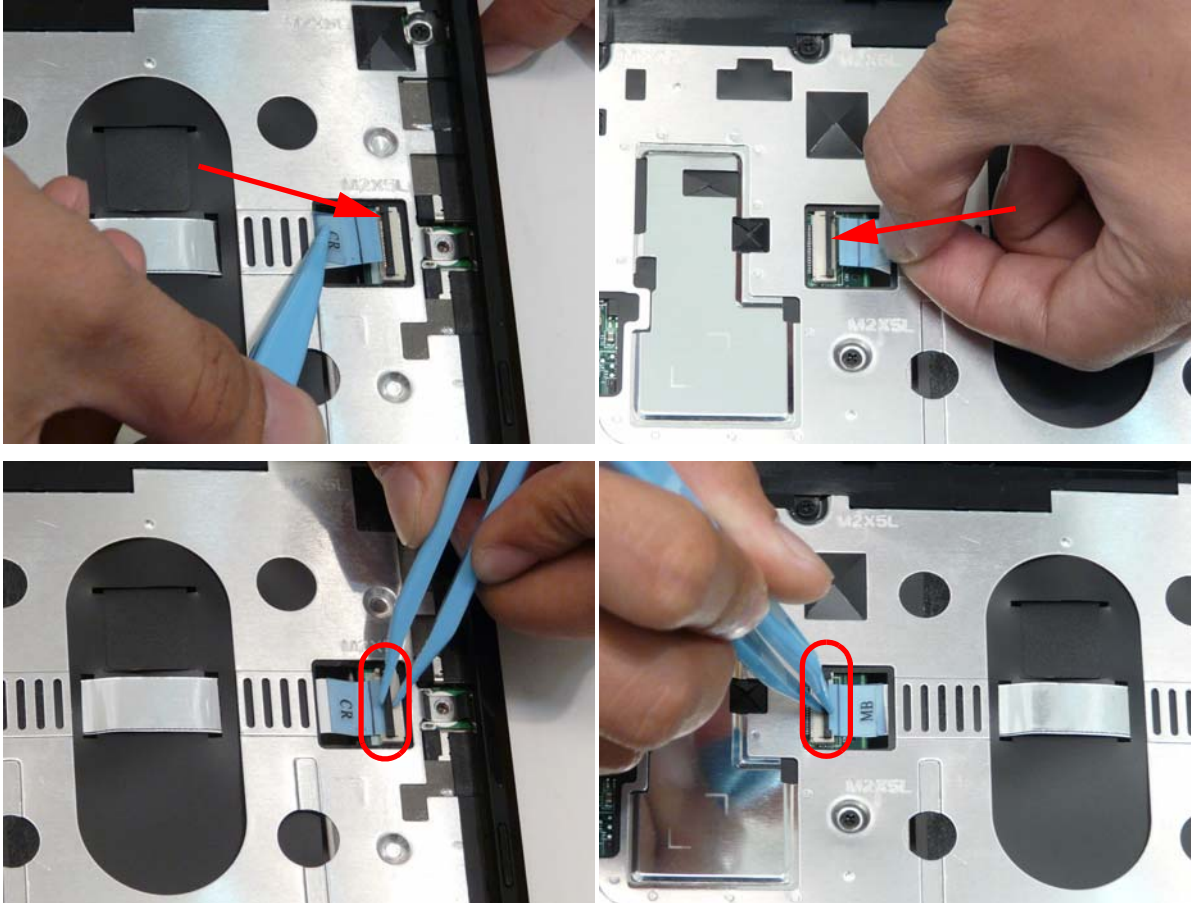

5. Connect the IO cable to the IO card and main board.



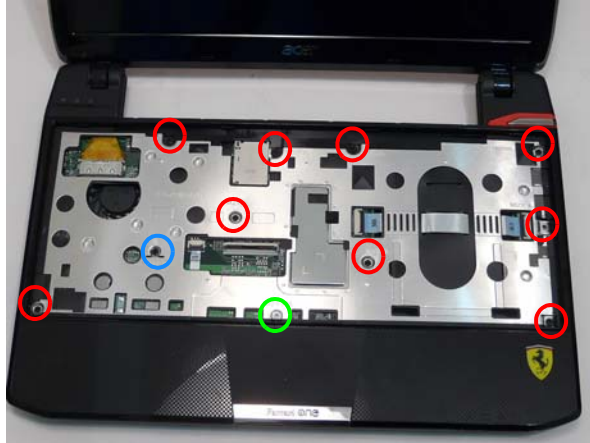



6. Replace the eleven (11) screws in the upper cover.

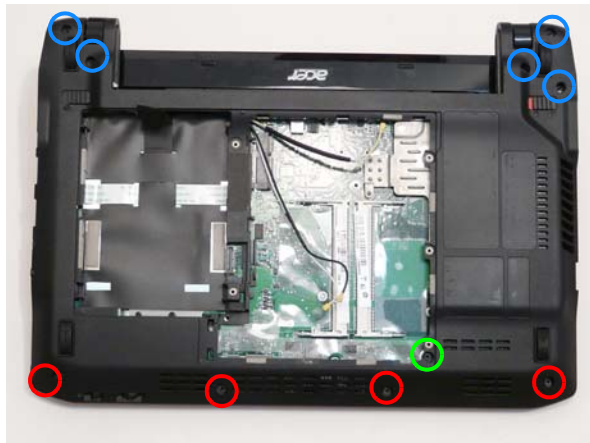

Step	Screw	Quantity	Screw Type.
Upper Cover Assembly	2.0*2.5 silver	1 (green call out)	
	2*3	1 (blue call out)	
	2*5	9 (red call out)	

7. Replace the ten (10) screws in the lower cover.



Step	Screw	Quantity	Screw Type.
Lower Cover Assembly	2*3	4 (red call out)	
	2*5	1 (green call out)	
	2*8	7 (red call out)	

Replacing the Keyboard

1. Connect the keyboard cable into the mainboard.

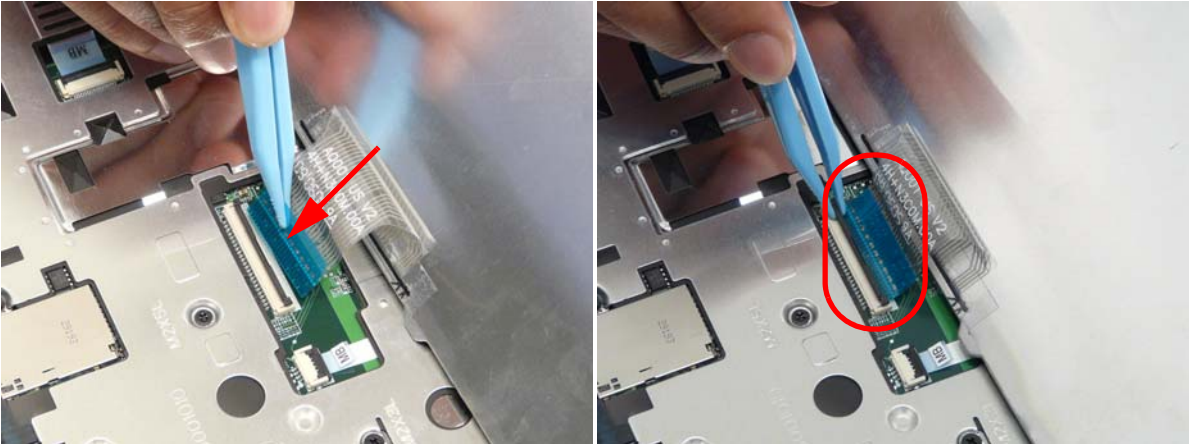

2. Turn the keyboard over and press the keyboard into place



Replacing the WLAN Module

1. Insert the WLAN module.



2. Replace the one (1) screw.



Step	Screw	Quantity	Screw Type.
WLAN Assembly	2*5	1	

3. Replace the two cables (white is MAIN, black AUX)



Replacing the DIMM Module

1. Insert the DIMM module.

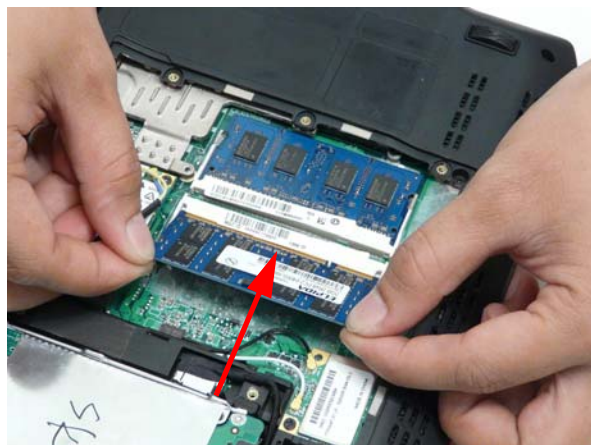

2. Press the DIMM module down.



Replacing the 3G Module

1. Insert the 3G module.

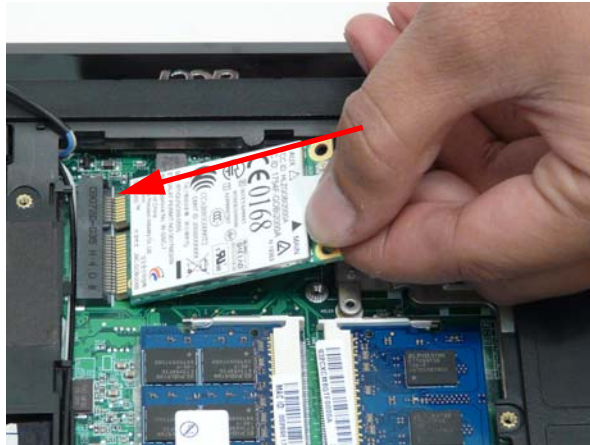

2. Replace the one (1) screw.



Step	Screw	Quantity	Screw Type.
3G Board Assembly	2*4	1	

3. Lay the 3G antenna cables into the retention guides.

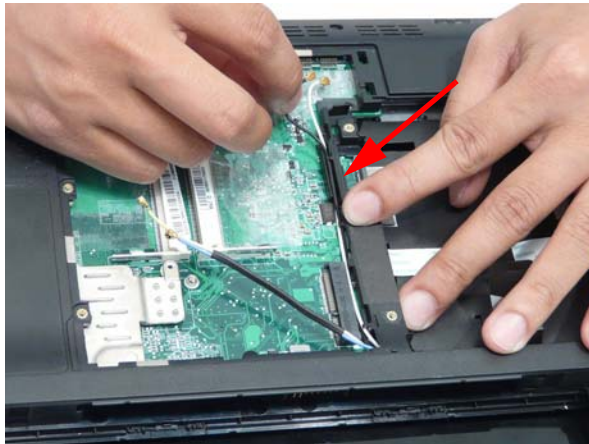



4. Connect the antenna cables (blue cable is MAIN, yellow cable is AUX).

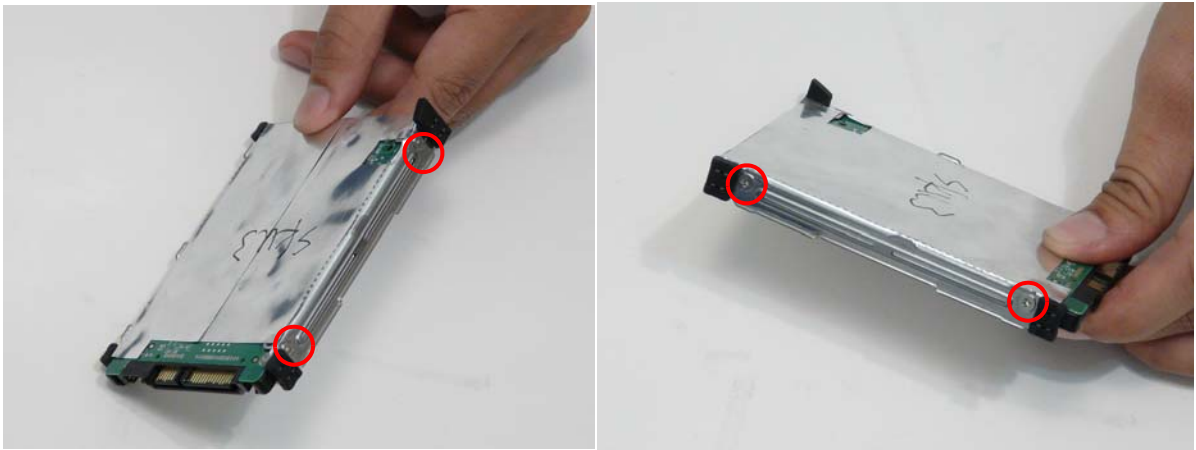

Replacing the HDD Module

1. Attach the rails and replace the four (4) screws in the HDD rails.



Step	Screw	Quantity	Screw Type.
HDD Assembly	3.0*3.5 (silver)	4	

2. Connect the HDD cable to the HDD.

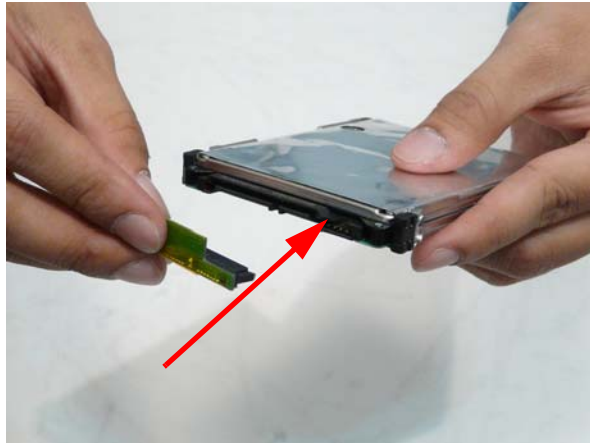

3. Connect the HDD cable to the main board.

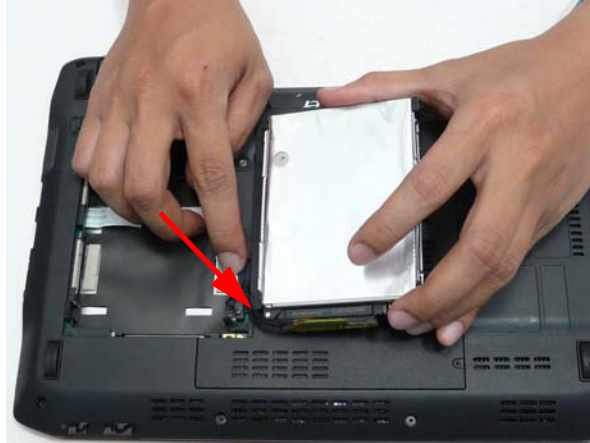

4. Lift up the black tab and place the HDD into the bay.



Replacing the Lower Covers

1. Replace the memory cover aligning the front tabs first.



-
2. Tighten the three (3) captive screws.



3. Replace the HDD cover, aligning the outside edge tabs first.



4. Tighten the two (2) captive screws.



Replacing the SIM Card

1. Insert the SIM card until it clicks into place.



Replacing the Battery

1. Insert the battery.



2. Slide the battery lock switch into the closed position.



Replacing the Dummy Card

1. Insert the dummy card until it clicks into place.



Troubleshooting

Common Problems

Use the following procedure as a guide for computer problems.

NOTE: The diagnostic tests are intended to test only Acer products. Non-Acer products, prototype cards, or modified options can give false errors and invalid system responses.

1. Obtain the failing symptoms in as much detail as possible.
2. Verify the symptoms by attempting to re-create the failure by running the diagnostic test or by repeating the same operation.
3. Use the following table with the verified symptom to determine which page to go to.

Symptoms (Verified)	Go To
Power On Issue	Page 128
No Display Issue	Page 129
LCD Failure	Page 131
Internal Keyboard Failure	Page 132
Touchpad Failure	Page 133
Internal Speaker Failure	Page 134
Internal Microphone Failure	Page 135
USB Failure	Page 137
Other Function Failure	Page 137

4. If the Issue is still not resolved, see "Online Support Information" on page 165.

Power On Issue

If the system doesn't power on, perform the following actions one at a time to correct the problem. Do not replace non-defective FRUs:

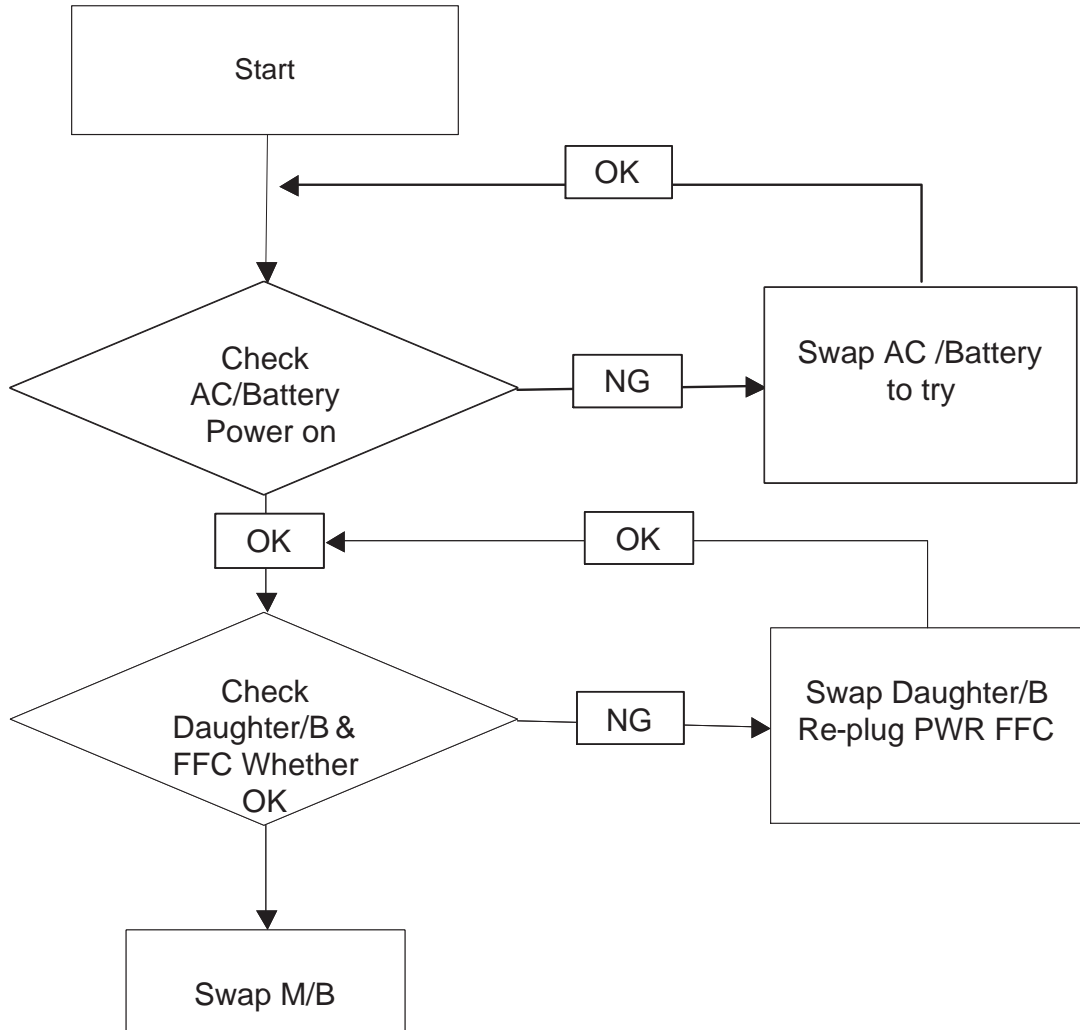

Computer Shuts down Intermittently

If the system powers off at intervals, perform the following actions one at a time to correct the problem.

1. Check the power cable is properly connected to the computer and the electrical outlet.
2. Remove any extension cables between the computer and the outlet.
3. Remove any surge protectors between the computer and the electrical outlet. Plug the computer directly into a known good electrical outlet.
4. Remove all external and non-essential hardware connected to the computer that are not necessary to boot the computer to the failure point.
5. Remove any recently installed software.
6. If the Issue is still not resolved, see "Online Support Information" on page 165.

No Display Issue

If the **Display** doesn't work, perform the following actions one at a time to correct the problem. Do not replace non-defective FRUs:

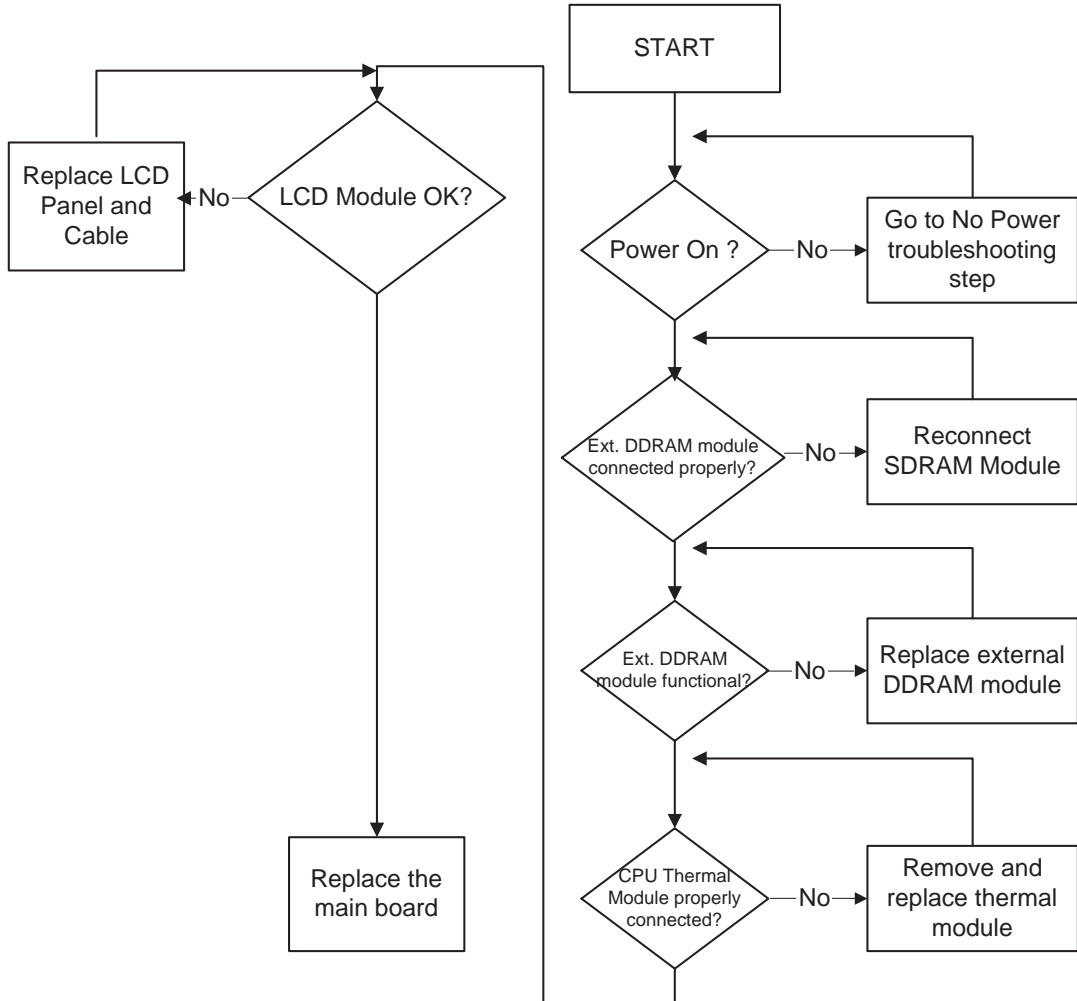

No POST or Video

If the POST or video doesn't display, perform the following actions one at a time to correct the problem.

1. Make sure that the internal display is selected. On this notebook model, switching between the internal display and the external display is done by pressing **Fn+F5**. Reference Product pages for specific model procedures.
2. Make sure the computer has power by checking at least one of the following occurs:
 - Fans start up
 - Status LEDs light up

If there is no power, see “Power On Issue” on page 128.

3. Drain any stored power by removing the power cable and battery and holding down the power button for 10 seconds. Reconnect the power and reboot the computer.
4. Connect an external monitor to the computer and switch between the internal display and the external display is by pressing **Fn+F5** (on this model).

If the POST or video appears on the external display, see “LCD Failure” on page 131.

-
5. Disconnect power and all external devices including port replicators or docking stations. Remove any memory cards and CD/DVD discs. Restart the computer.
If the computer boots correctly, add the devices one by one until the failure point is discovered.
 6. Reseat the memory modules.
 7. Remove the drives (see “Disassembly Process” on page 34).
 8. If the Issue is still not resolved, see “Online Support Information” on page 165.

Abnormal Video Display

If video displays abnormally, perform the following actions one at a time to correct the problem.

1. Reboot the computer.
2. If permanent vertical/horizontal lines or dark spots display in the same location, the LCD is faulty and should be replaced. See “Disassembly Process” on page 34.
3. If extensive pixel damage is present (different colored spots in the same locations on the screen), the LCD is faulty and should be replaced. See “Disassembly Process” on page 34.
4. Adjust the brightness to its highest level. See the User Manual for instructions on adjusting settings.
NOTE: Ensure that the computer is not running on battery alone as this may reduce display brightness.
If the display is too dim at the highest brightness setting, the LCD is faulty and should be replaced. See “Disassembly Process” on page 34.
5. Check the display resolution is correctly configured:
 - a. Minimize or close all Windows.
 - b. If display size is only abnormal in an application, check the view settings and control/mouse wheel zoom feature in the application.
 - c. If desktop display resolution is not normal, right-click on the desktop and select **Personalize**→ **Display Settings**.
 - d. Click and drag the Resolution slider to the desired resolution.
 - e. Click **Apply** and check the display. Readjust if necessary.
6. Roll back the video driver to the previous version if updated.
7. Remove and reinstall the video driver.
8. Check the Device Manager to determine that:
 - The device is properly installed. There are no red Xs or yellow exclamation marks.
 - There are no device conflicts.
 - No hardware is listed under Other Devices.
9. If the Issue is still not resolved, see “Online Support Information” on page 165.
10. Run the Windows Memory Diagnostic from the operating system DVD and follow the onscreen prompts.
11. If the Issue is still not resolved, see “Online Support Information” on page 165.

Random Loss of BIOS Settings

If the computer is experiencing intermittent loss of BIOS information, perform the following actions one at a time to correct the problem.

1. If the computer is more than one year old, replace the CMOS battery.
2. Run a complete virus scan using up-to-date software to ensure the computer is virus free.
3. If the computer is experiencing HDD or ODD BIOS information loss, disconnect and reconnect the power and data cables between devices.
If the BIOS settings are still lost, replace the cables.

4. If HDD information is missing from the BIOS, the drive may be defective and should be replaced.
5. Replace the Motherboard.
6. If the Issue is still not resolved, see “Online Support Information” on page 165.

LCD Failure

If the **LCD** fails, perform the following actions one at a time to correct the problem. Do not replace non-defective FRUs:

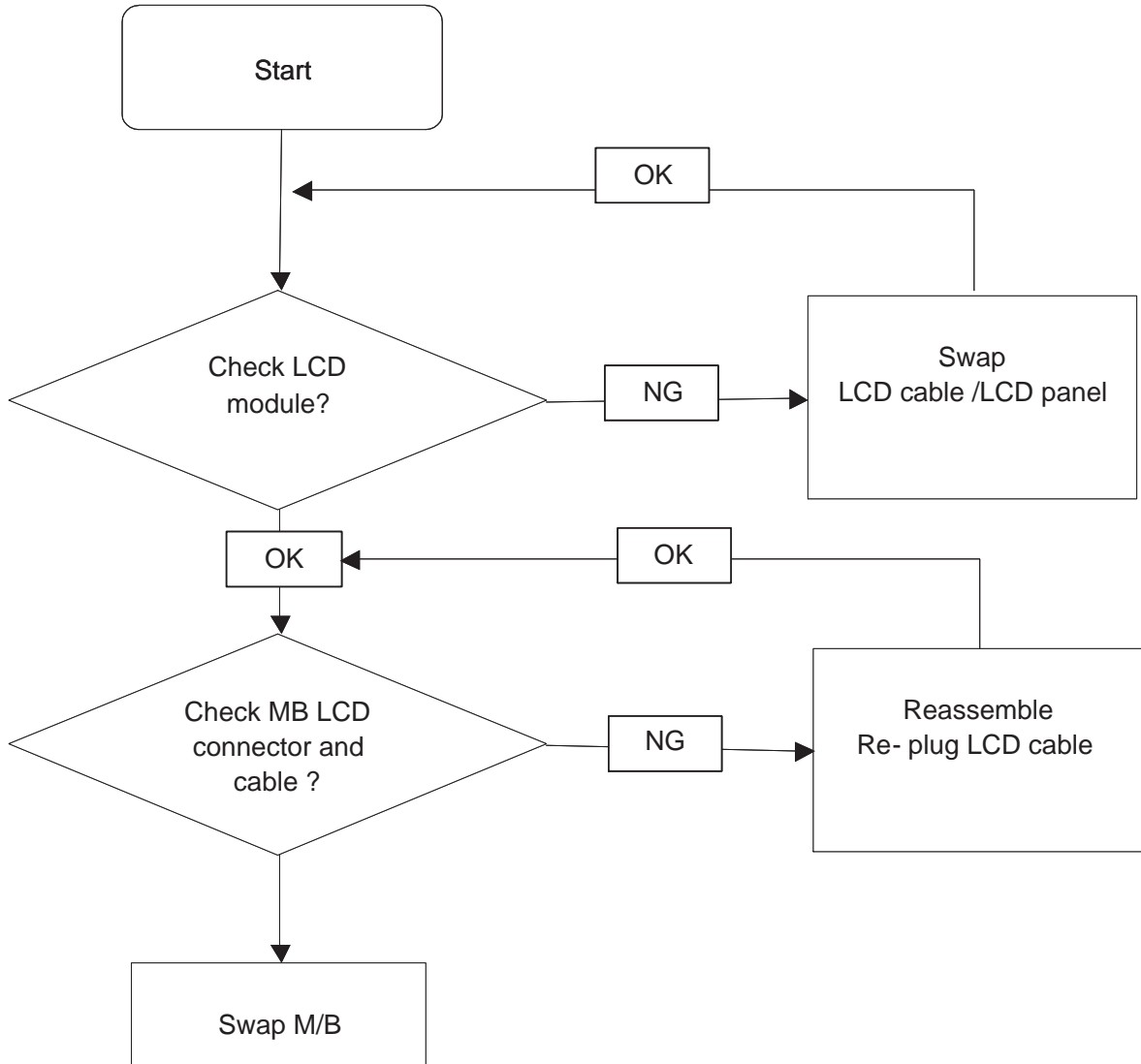

Built-In Keyboard Failure

If the built-in **Keyboard** fails, perform the following actions one at a time to correct the problem. Do not replace non-defective FRUs:

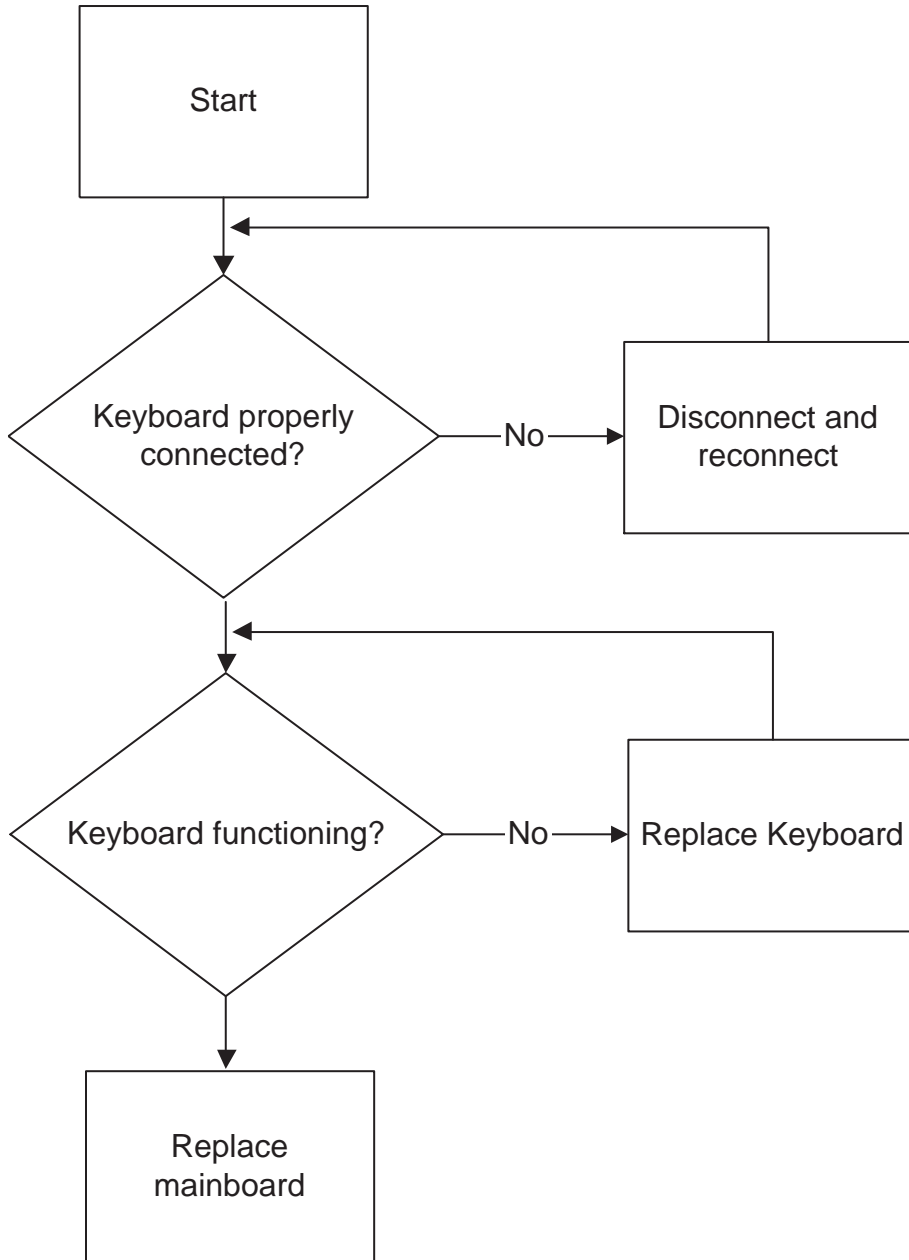

Touchpad Failure

If the **Touchpad** doesn't work, perform the following actions one at a time to correct the problem. Do not replace non-defective FRUs:

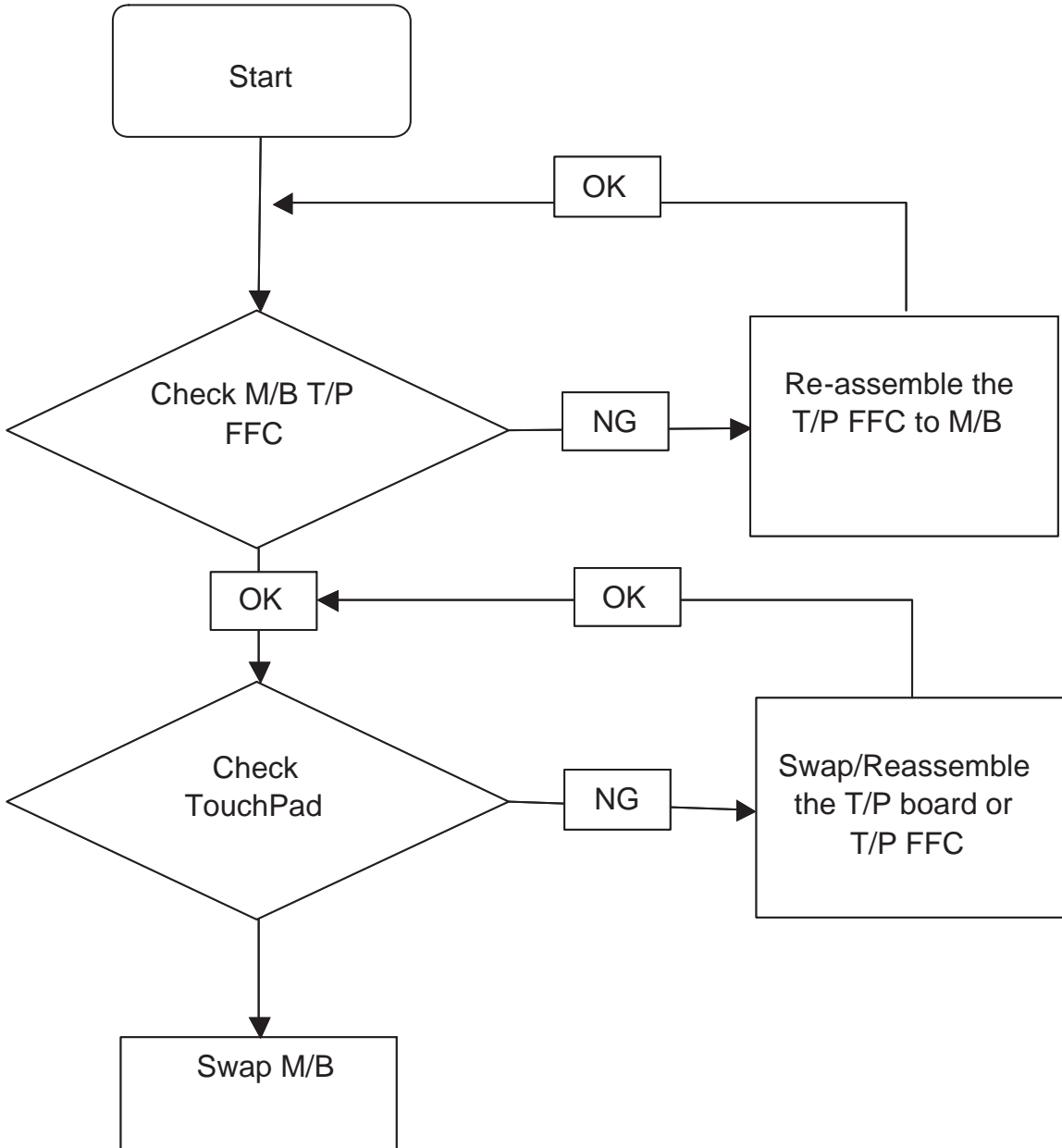

Internal Speaker Failure

If the internal **Speakers** fail, perform the following actions one at a time to correct the problem. Do not replace non-defective FRUs:

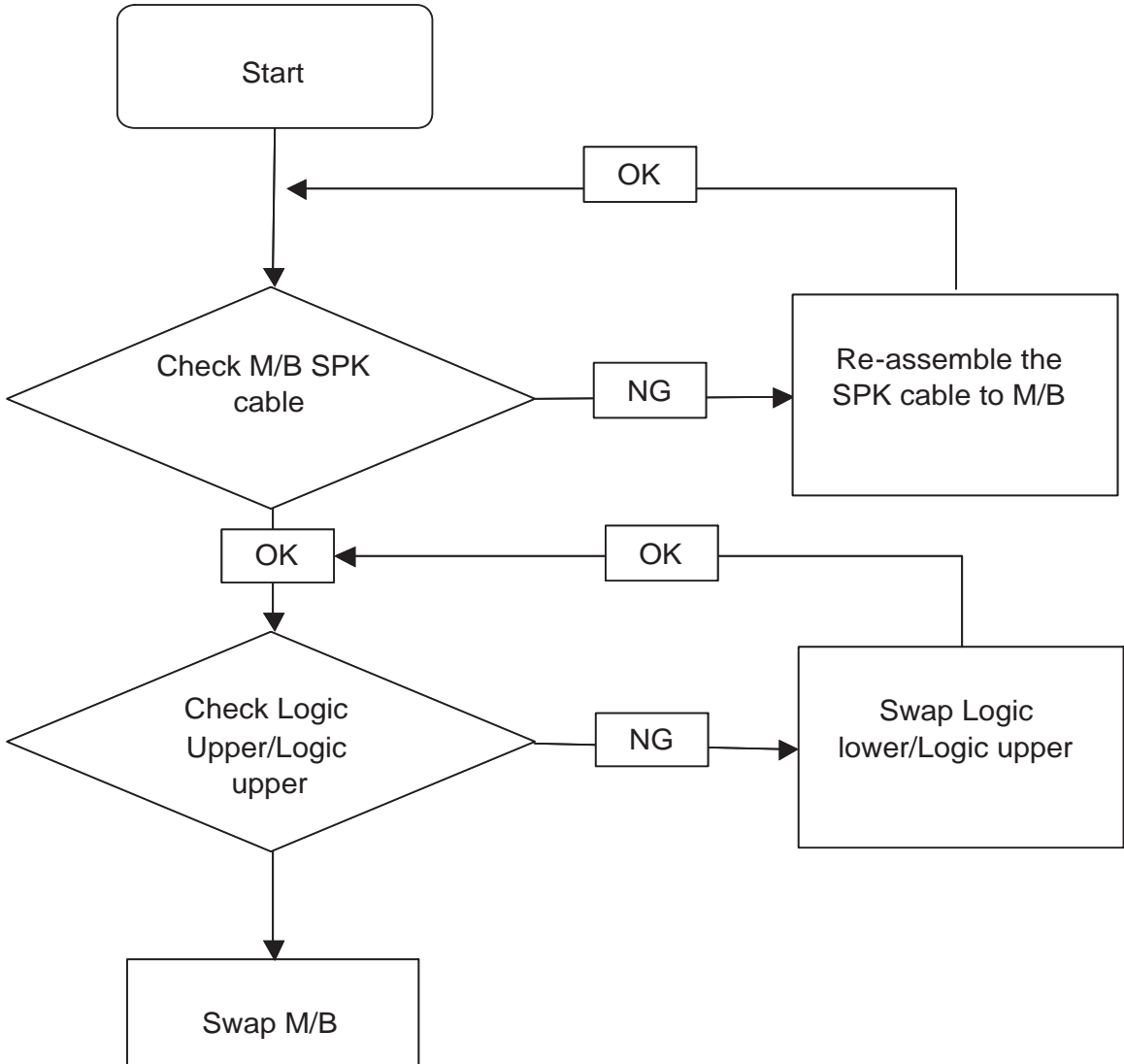

Sound Problems

If sound problems are experienced, perform the following actions one at a time to correct the problem.

1. Reboot the computer.
2. Navigate to **Start** → **Control Panel** → **System and Maintenance** → **System** → **Device Manager**. Check the Device Manager to determine that:
 - The device is properly installed.
 - There are no red Xs or yellow exclamation marks.
 - There are no device conflicts.
 - No hardware is listed under Other Devices.
3. Roll back the audio driver to the previous version, if updated recently.
4. Remove and reinstall the audio driver.

5. Ensure that all volume controls are set mid range:
 - a. Click the volume icon on the taskbar and drag the slider to 50. Ensure that the volume is not muted.
 - b. Click Mixer to verify that other audio applications are set to 50 and not muted.
6. Navigate to **Start** → **Control Panel** → **Hardware and Sound** → **Sound**. Ensure that Speakers are selected as the default audio device (green check mark).

NOTE: If Speakers does not show, right-click on the **Playback** tab and select **Show Disabled Devices** (clear by default).
7. Select Speakers and click **Configure** to start **Speaker Setup**. Follow the onscreen prompts to configure the speakers.
8. Remove and recently installed hardware or software.
9. Restore system and file settings from a known good date using **System Restore**.

If the issue is not fixed, repeat the preceding steps and select an earlier time and date.
10. Reinstall the Operating System.
11. If the Issue is still not resolved, see “Online Support Information” on page 165.

Internal Microphone Failure

If the internal **Microphone** fails, perform the following actions one at a time to correct the problem. Do not replace non-defective FRUs:

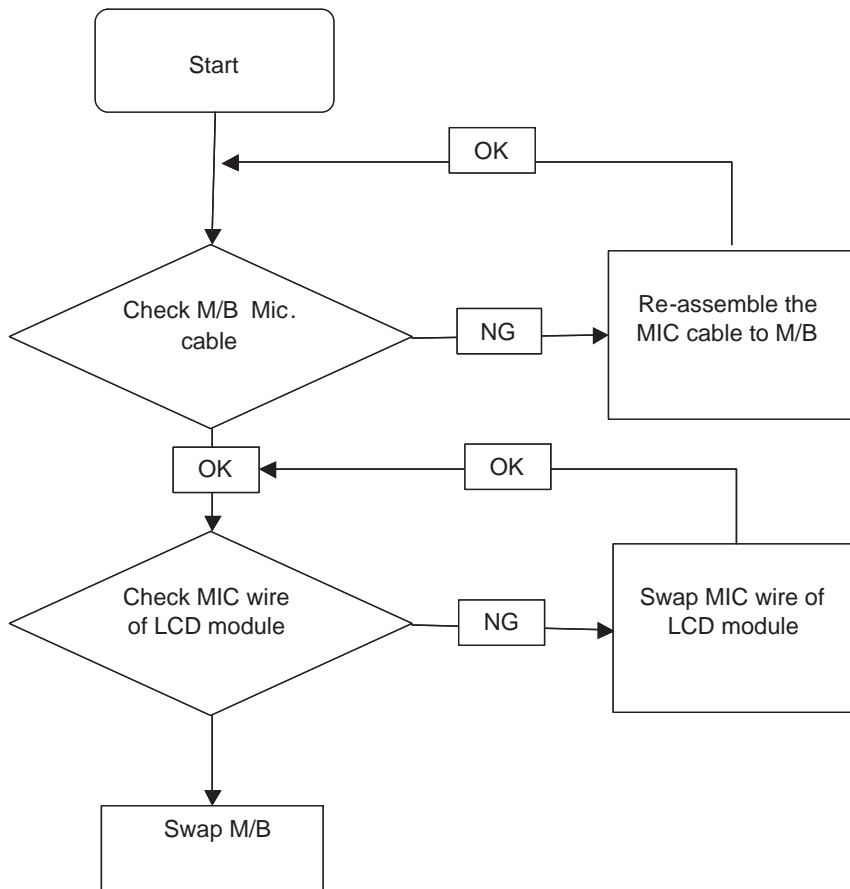

Microphone Problems

If internal or external **Microphones** do not operate correctly, perform the following actions one at a time to correct the problem.

-
1. Check that the microphone is enabled. Navigate to **Start**→ **Control Panel**→ **Hardware and Sound**→ **Sound** and select the **Recording** tab.
 2. Right-click on the **Recording** tab and select **Show Disabled Devices** (clear by default).
 3. The microphone appears on the **Recording** tab.
 4. Right-click on the microphone and select **Enable**.
 5. Select the microphone then click **Properties**. Select the **Levels** tab.
 6. Increase the volume to the maximum setting and click **OK**.
 7. Test the microphone hardware:
 - a. Select the microphone and click **Configure**.
 - b. Select **Set up microphone**.
 - c. Select the microphone type from the list and click **Next**.
 - d. Follow the onscreen prompts to complete the test.
 8. If the Issue is still not resolved, see “Online Support Information” on page 165.

HDD Not Operating Correctly

If the **HDD** does not operate correctly, perform the following actions one at a time to correct the problem.

1. Disconnect all external devices.
2. Run a complete virus scan using up-to-date software to ensure the computer is virus free.
3. Run the Windows Vista Startup Repair Utility:
 - a. insert the Windows Vista Operating System DVD in the ODD and restart the computer.
 - b. When prompted, press any key to start to the operating system DVD.
 - c. The **Install Windows** screen displays. Click **Next**.
 - d. Select **Repair your computer**.
 - e. The **System Recovery Options** screen displays. Click **Next**.
 - f. Select the appropriate operating system, and click **Next**.

NOTE: Click **Load Drivers** if controller drives are required.

- g. Select **Startup Repair**.
- h. Startup Repair attempts to locate and resolve issues with the computer.
- i. When complete, click **Finish**.

If an issue is discovered, follow the onscreen information to resolve the problem.

4. Run the Windows Memory Diagnostic Tool. For more information see Windows Help and Support.
5. Restart the computer and press F2 to enter the BIOS Utility. Check the BIOS settings are correct and that CD/DVD drive is set as the first boot device on the Boot menu.
6. Ensure all cables and jumpers on the HDD and ODD are set correctly.
7. Remove any recently added hardware and associated software.
8. Run the Windows Disk Defragmenter. For more information see Windows Help and Support.
9. Run Windows Check Disk by entering **chkdsk /r** from a command prompt. For more information see Windows Help and Support.
10. Restore system and file settings from a known good date using **System Restore**.

If the issue is not fixed, repeat the preceding steps and select an earlier time and date.
11. Replace the HDD. See “Disassembly Process” on page 34.

USB Failure (Right up/down side)

If the rightside **USB** port fails, perform the following actions one at a time to correct the problem. Do not replace non-defective FRUs:

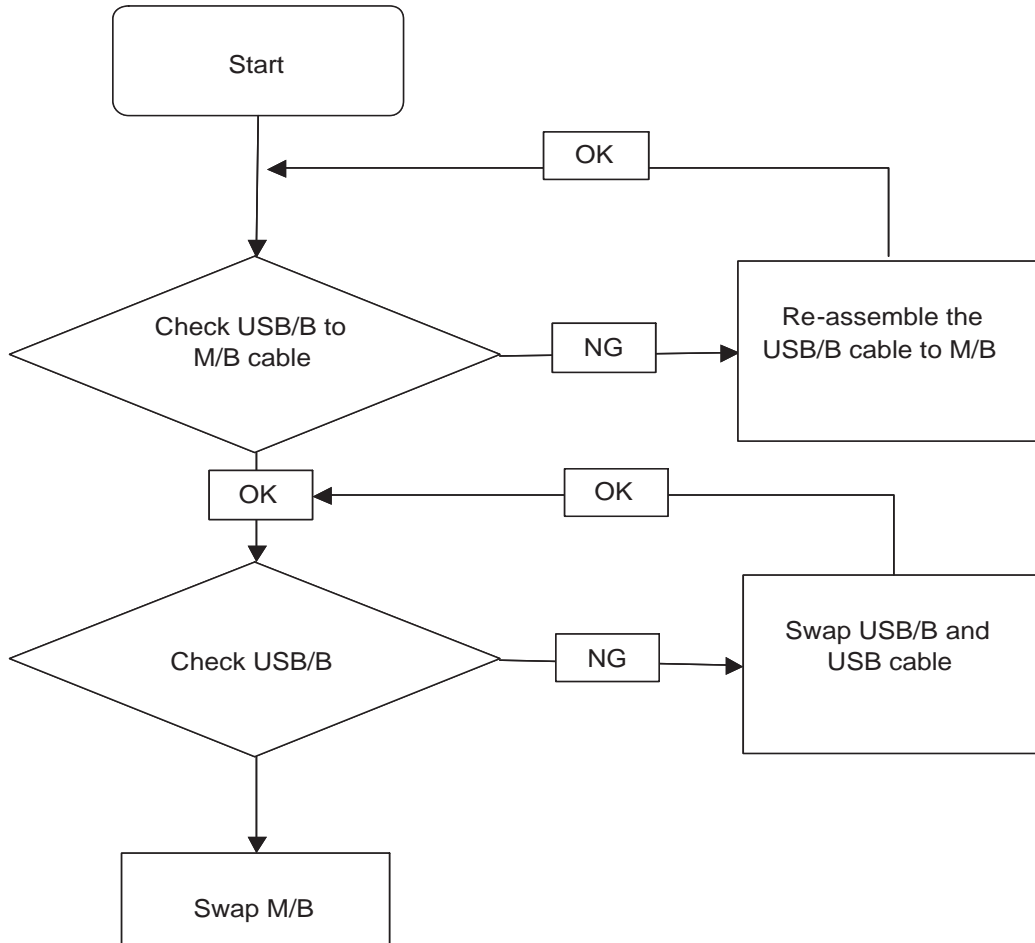

Other Failures

If the VGA board, LAN Port, external MIC or Speakers, PCI Express Card, 5-in-1 Card Reader or Volume Wheel fail, perform the following general steps to correct the problem. Do not replace non-defective FRUs:

1. Check whether the drive is OK.
2. Verify that the Test Fixture is ok.
3. Swap the mainboard and retest.

Intermittent Problems

Intermittent system hang problems can be caused by a variety of reasons that have nothing to do with a hardware defect, such as: cosmic radiation, electrostatic discharge, or software errors. FRU replacement should be considered only when a recurring problem exists.

When analyzing an intermittent problem, do the following:

1. Run the advanced diagnostic test for the system board in loop mode at least 10 times.
2. If no error is detected, do not replace any FRU.
3. If any error is detected, replace the FRU. Rerun the test to verify that there are no more errors.

Undetermined Problems

The diagnostic problems does not identify which adapter or device failed, which installed devices are incorrect, whether a short circuit is suspected, or whether the system is inoperative.

Follow these procedures to isolate the failing FRU (do not isolate non-defective FRU).

NOTE: Verify that all attached devices are supported by the computer.

NOTE: Verify that the power supply being used at the time of the failure is operating correctly. (See “Power On Issue” on page 128.):

1. Power-off the computer.
2. Visually check them for damage. If any problems are found, replace the FRU.
3. Remove or disconnect all of the following devices:
 - Non-Acer devices
 - Printer, mouse, and other external devices
 - Battery pack
 - Hard disk drive
 - DIMM
 - CD-ROM/Diskette drive Module
 - PC Cards
4. Power-on the computer.
5. Determine if the problem has changed.
6. If the problem does not recur, reconnect the removed devices one at a time until you find the failing FRU.
7. If the problem remains, replace the following FRU one at a time. Do not replace a non-defective FRU:
 - System board
 - LCD assembly

POST Code Reference Tables

These tables describe the POST codes and components of the POST process.

Code	Beeps	POST Routine Description
02h		Verify Real Mode
03h		Disable Non-Maskable Interrupt (NMI)
04h		Get CPU type
06h		Initialize system hardware
08h		Initialize chipset with initial POST values
09h		Set IN POST flag
0Ah		Initialize CPU registers
0Bh		Enable CPU cache
0Ch		Initialize caches to initial POST values
0Eh		Initialize I/O component
0Fh		Initialize the local bus IDE
10h		Initialize Power Management
11h		Load alternate registers with initial POST values
12h		Restore CPU control word during warm boot
13h		Initialize PCI Bus Mastering devices
14h		Initialize keyboard controller
16h	1-2-2-3	BIOS ROM checksum
17h		Initialize cache before memory autosize
18h		8254 timer initialization
1Ah		8237 DMA controller initialization
1Ch		Reset Programmable Interrupt Controller
20h	1-3-1-1	Test DRAM refresh
22h	1-3-1-3	Test 8742 Keyboard Controller
24h		Set ES segment register to 4 GB
26h		Enable A20 line
28h		Autosize DRAM
29h		Initialize POST Memory Manager
2Ah		Clear 512 KB base RAM
2Ch	1-3-4-1	RAM failure on address line xxxx*
2Eh	1-3-4-3	RAM failure on data bits xxxx* of low byte of memory bus
2Fh		Enable cache before system BIOS shadow
30h	1-4-1-1	RAM failure on data bits xxxx* of high byte of memory bus
32h		Test CPU bus-clock frequency
33h		Initialize Phoenix Dispatch Manager
36h		Warm start shut down
38h		Shadow system BIOS ROM
3Ah		Autosize cache
3Ch		Advanced configuration of chipset registers
3Dh		Load alternate registers with CMOS values
42h		Initialize interrupt vectors

Code	Beeps	POST Routine Description
45h		POST device initialization
46h	2-1-2-3	Check ROM copyright notice
48h		Check video configuration against CMOS
49h		Initialize PCI bus and devices
4Ah		Initialize all video adapters in system
4Bh		QuietBoot start (optional)
4Ch		Shadow video BIOS ROM
4Eh		Display BIOS copyright notice
50h		Display CPU type and speed
51h		Initialize EISA board
52h		Test keyboard
54h		Set key click if enabled
58h	2-2-3-1	Test for unexpected interrupts
59h		Initialize POST display service
5Ah		Display prompt "Press F2 to enter SETUP"
5Bh		Disable CPU cache
5Ch		Test RAM between 512 and 640 KB
60h		Test extended memory
62h		Test extended memory address lines
64h		Jump to UserPatch1
66h		Configure advanced cache registers
67h		Initialize Multi Processor APIC
68h		Enable external and CPU caches
69h		Setup System Management Mode (SMM) area
6Ah		Display external L2 cache size
6Bh		Load custom defaults (optional)
6Ch		Display shadow-area message
6Eh		Display possible high address for UMB recovery
70h		Display error messages
72h		Check for configuration errors
76h		Check for keyboard errors
7Ch		Set up hardware interrupt vectors
7Eh		Initialize coprocessor if present
80h		Disable onboard Super I/O ports and IRQs
81h		Late POST device initialization
82h		Detect and install external RS232 ports
83h		Configure non-MCD IDE controllers
84h		Detect and install external parallel ports
85h		Initialize PC-compatible PnP ISA devices
86h		Re-initialize onboard I/O ports.
87h		Configure Mainboard Configurable Devices (optional)
88h		Initialize BIOS Data Area
89h		Enable Non-Maskable Interrupts (NMIs)

Code	Beeps	POST Routine Description
8Ah		Initialize Extended BIOS Data Area
8Bh		Test and initialize PS/2 mouse
8Ch		Initialize floppy controller
8Fh		Determine number of ATA drives (optional)
90h		Initialize hard-disk controllers
91h		Initialize local-bus hard-disk controllers
92h		Jump to UserPatch2
93h		Build MPTABLE for multi-processor boards
95h		Install CD ROM for boot
96h		Clear huge ES segment register
97h		Fixup Multi Processor table
98h	1-2	Search for option ROMs. One long, two short beeps on checksum failure
99h		Check for SMART Drive (optional)
9Ah		Shadow option ROMs
9Ch		Set up Power Management
9Dh		Initialize security engine (optional)
9Eh		Enable hardware interrupts
9Fh		Determine number of ATA and SCSI drives
A0h		Set time of day
A2h		Check key lock
A4h		Initialize Typematic rate
A8h		Erase F2 prompt
AAh		Scan for F2 key stroke
ACh		Enter SETUP
A Eh		Clear Boot flag
B0h		Check for errors
B2h		POST done - prepare to boot operating system
B4h	1	One short beep before boot
B5h		Terminate QuietBoot (optional)
B6h		Check password (optional)
B9h		Prepare Boot
BAh		Initialize DMI parameters
BBh		Initialize PnP Option ROMs
BCh		Clear parity checkers
BDh		Display MultiBoot menu
BEh		Clear screen (optional)
BFh		Check virus and backup reminders
C0h		Try to boot with INT 19
C1h		Initialize POST Error Manager (PEM)
C2h		Initialize error logging
C3h		Initialize error display function
C4h		Initialize system error handler

Code	Beeps	POST Routine Description
C5h		PnPnd dual CMOS (optional)
C6h		Initialize notebook docking (optional)
C7h		Initialize notebook docking late
C8h		Force check (optional)
C9h		Extended checksum (optional)
D2h		Unknown interrupt

Code	Beeps	For Boot Block in Flash ROM
E0h		Initialize the chipset
E1h		Initialize the bridge
E2h		Initialize the CPU
E3h		Initialize system timer
E4h		Initialize system I/O
E5h		Check force recovery boot
E6h		Checksum BIOS ROM
E7h		Go to BIOS
E8h		Set Huge Segment
E9h		Initialize Multi Processor
EAh		Initialize OEM special code
EBh		Initialize PIC and DMA
ECh		Initialize Memory type
EDh		Initialize Memory size
EEh		Shadow Boot Block
EFh		System memory test
F0h		Initialize interrupt vectors
F1h		Initialize Run Time Clock
F2h		Initialize video
F3h		Initialize System Management Mode
F4h	1	Output one beep before boot
F5h		Boot to Mini DOS
F6h		Clear Huge Segment
F7h		Boot to Full DOS

Jumper and Connector Locations

Mainboard Top View

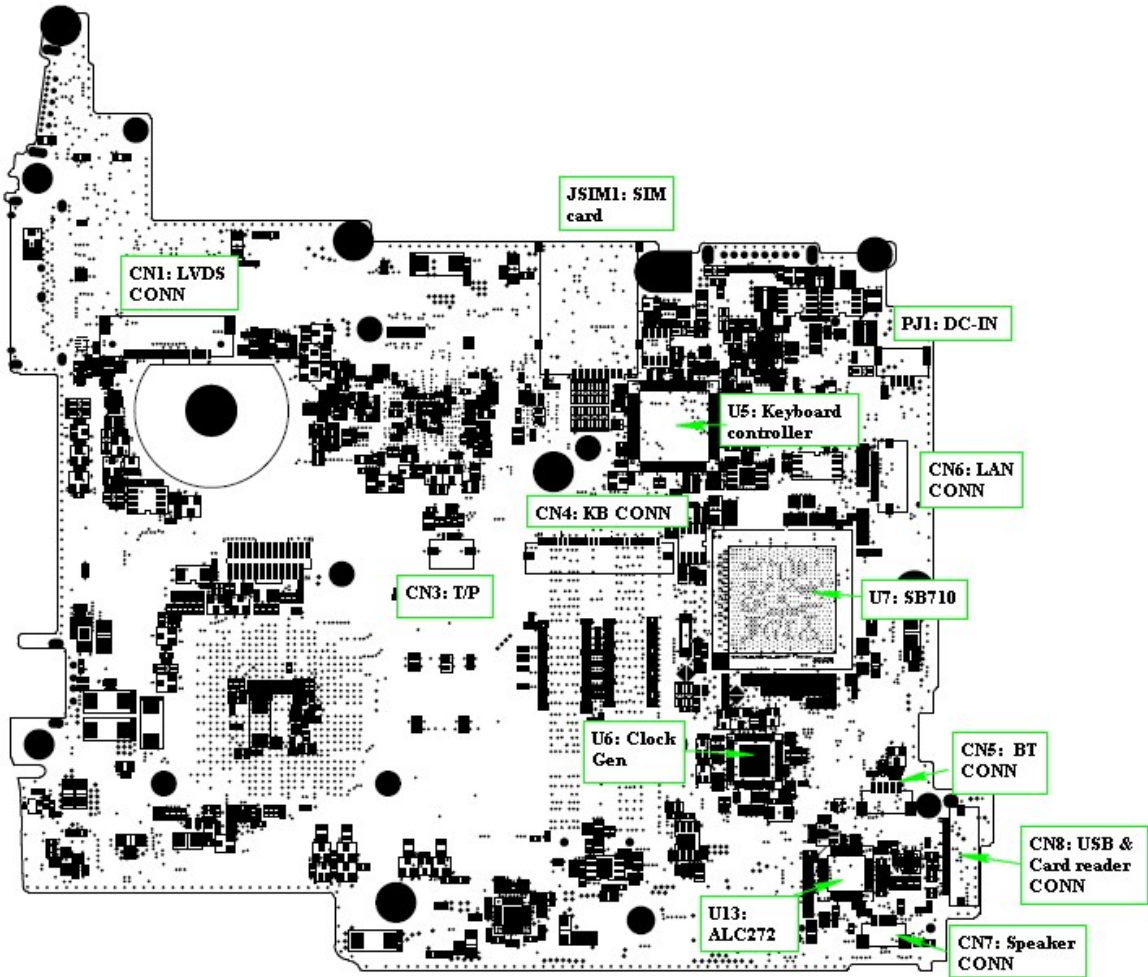

Item	Description	Item	Description
CN1	LVD Connector	CN8	ALC272
JSIMI	SIM Card	U6	Clock Generator
PJ1	DC In	CN3	Touch Pad Connector
CN6	Lan Connector	CN4	Keyboard Connector
CN5	Bluetooth Connector	U7	SB710
CN8	USB & Card Reader Connector	U5	Keyboard controller
CN7	Speaker Connector		

Mainboard Bottom View

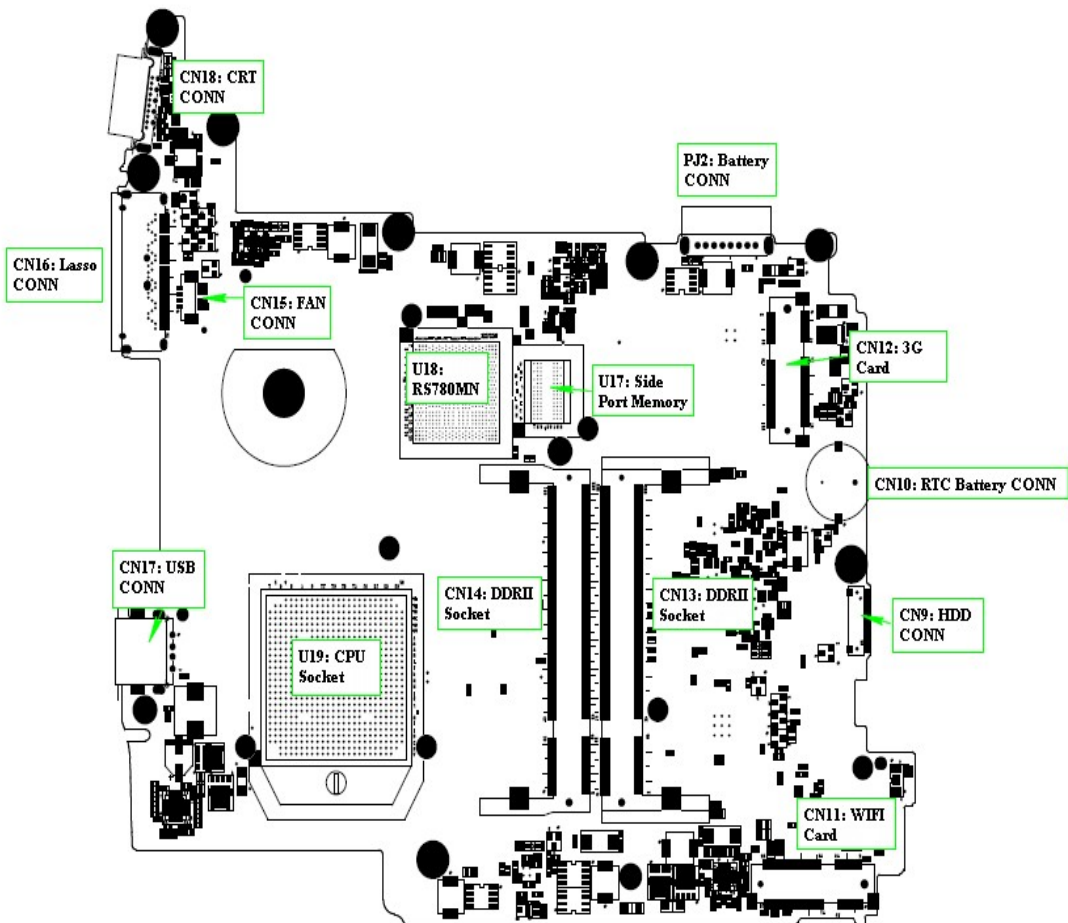

Item	Description	Item	Description
CN15	Fan Connector	CN11	WIFI Card
CN16	Lasso	CN13	DRII Socket
CN18	CRT	CN14	DRII Socket
PJ2	Battery Connector	U19	CPU Socket
CN12	3G Card	CN17	USB
CN10	RTC	U18	RS780MN
CN9	HDD Connector	U17	Side Port Memory

BIOS Recovery

BIOS Recovery by Crisis Disk

BIOS Recovery Boot Block

The BIOS Recovery Boot Block is a special block of BIOS. It is used to boot up the system with minimum BIOS initialization. Users can enable this feature to restore the BIOS firmware to the factory settings if a BIOS flash process fails.

BIOS Recovery Hotkey

The system provides a function hotkey: **Fn+Esc**, to enable the BIOS Recovery process when a system is powered on during BIOS POST. To use this function, it is strongly recommended to have the AC adapter and Battery present. If this function is enabled, the system will force the BIOS to enter a special BIOS block, called Boot Block.

Steps for BIOS Recovery from USB Storage

Before performing this procedure, prepare a Crisis USB key. The Crisis USB key can be made by executing the Crisis Disk program in a functioning system with a Windows XP, Windows 7 or Vista OS.

IMPORTANT:The Crisis Disk program will overwrite all data on any drive that you use as a crisis disk.

Follow the steps below:

1. Modify the archive name from "zh6 bios" to "ZH6X64.fd"
2. Save ROM file (file name: **ZH6X64.fd**) to the root directory of the USB storage.
3. Plug the USB storage into a USB port.
4. Press **Fn + ESC** button then plug in AC.
The Power button flashes once.
5. Press **Power** button to initiate system CRISIS mode.
When CRISIS is complete, the system auto restarts with a workable BIOS.
6. Update the latest version BIOS for this machine by the regular BIOS flashing process.

FRU (Field Replaceable Unit) List

This chapter gives you the FRU (Field Replaceable Unit) listing in global configurations of the computer. Refer to this chapter whenever ordering for parts to repair or for RMA (Return Merchandise Authorization).

Please note that WHEN ORDERING FRU PARTS, you should check the most up-to-date information available on your regional web or channel. For whatever reasons a part number change is made, it will not be noted on the printed Service Guide. For ACER AUTHORIZED SERVICE PROVIDERS, your Acer office may have a DIFFERENT part number code from those given in the FRU list of this printed Service Guide. You MUST use the local FRU list provided by your regional Acer office to order FRU parts for repair and service of customer machines.

NOTE: To scrap or to return the defective parts, you should follow the local government ordinance or regulations on how to dispose it properly, or follow the rules set by your regional Acer office on how to return it.

California Exploded Diagrams

Main Assembly

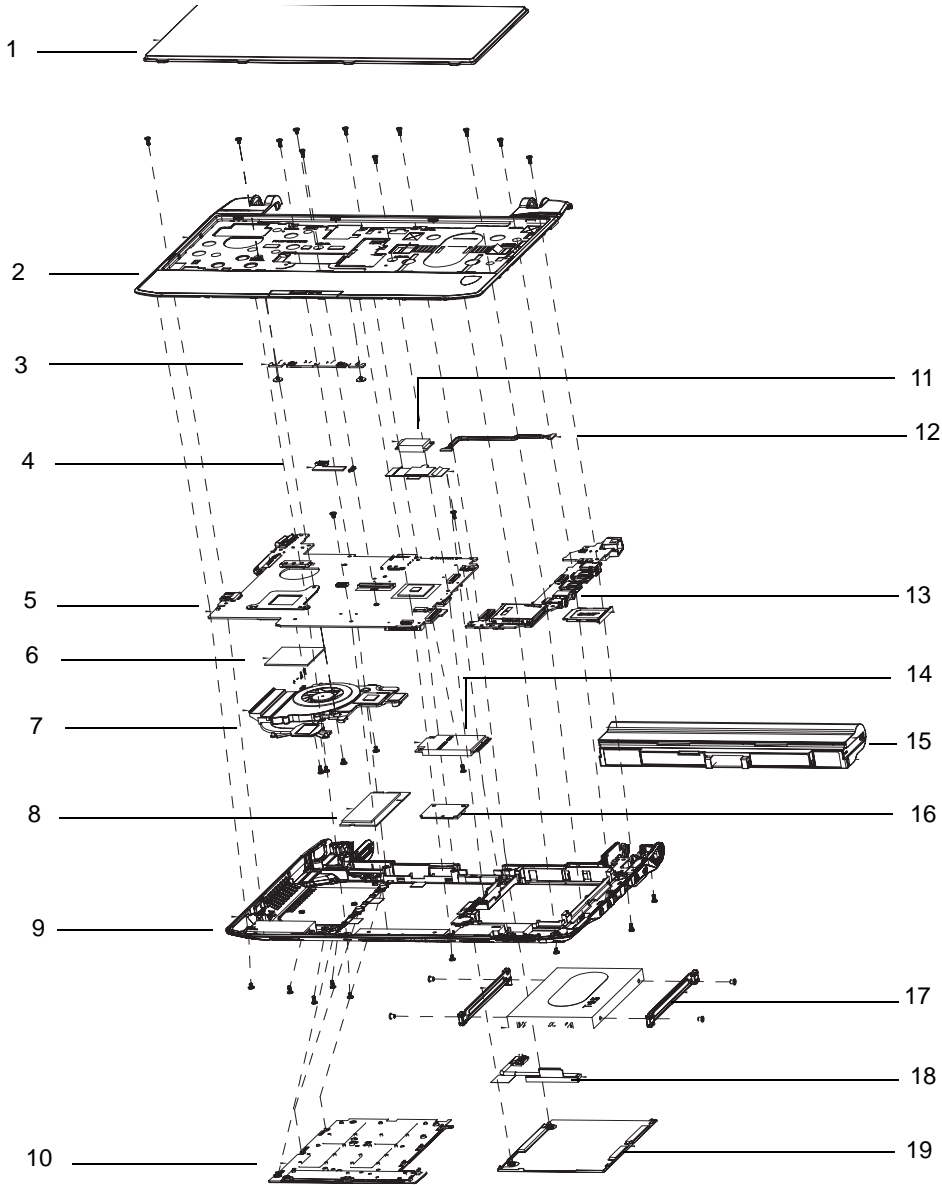

Item	Acer PN	Item	Acer PN
1. Keyboard	KB.I110A.085	11. Bluetooth Module	BH.21100.004
2. Upper Cover	60.FRC07.001	12. DC Power Cable	50.FRC07.002
3. TP board	55.FRC07.002	13. I/O Board	55.FRC07.001
4. IO Cable	TBC	14. 3G Module	LC.21300.011
5. Mainboard	MB.FRB06.001	15. Battery	BT.00603.098
6. Thermal Cable	TBC	16. WLAN Module	NI.23600.047
7. Thermal Module	60.FRC07.008	17. HDD Rails	33.FRC07.003 33.FRC07.004
8. Memory Module	KN.1GB09.013	18. HDD Cable	50.FRC07.003

Item	Acer PN	Item	Acer PN
9. Lower Cover	60.FRB07.001	19. HDD Door	42.FRC07.001
10. Memory Cover	42.FRC07.002		



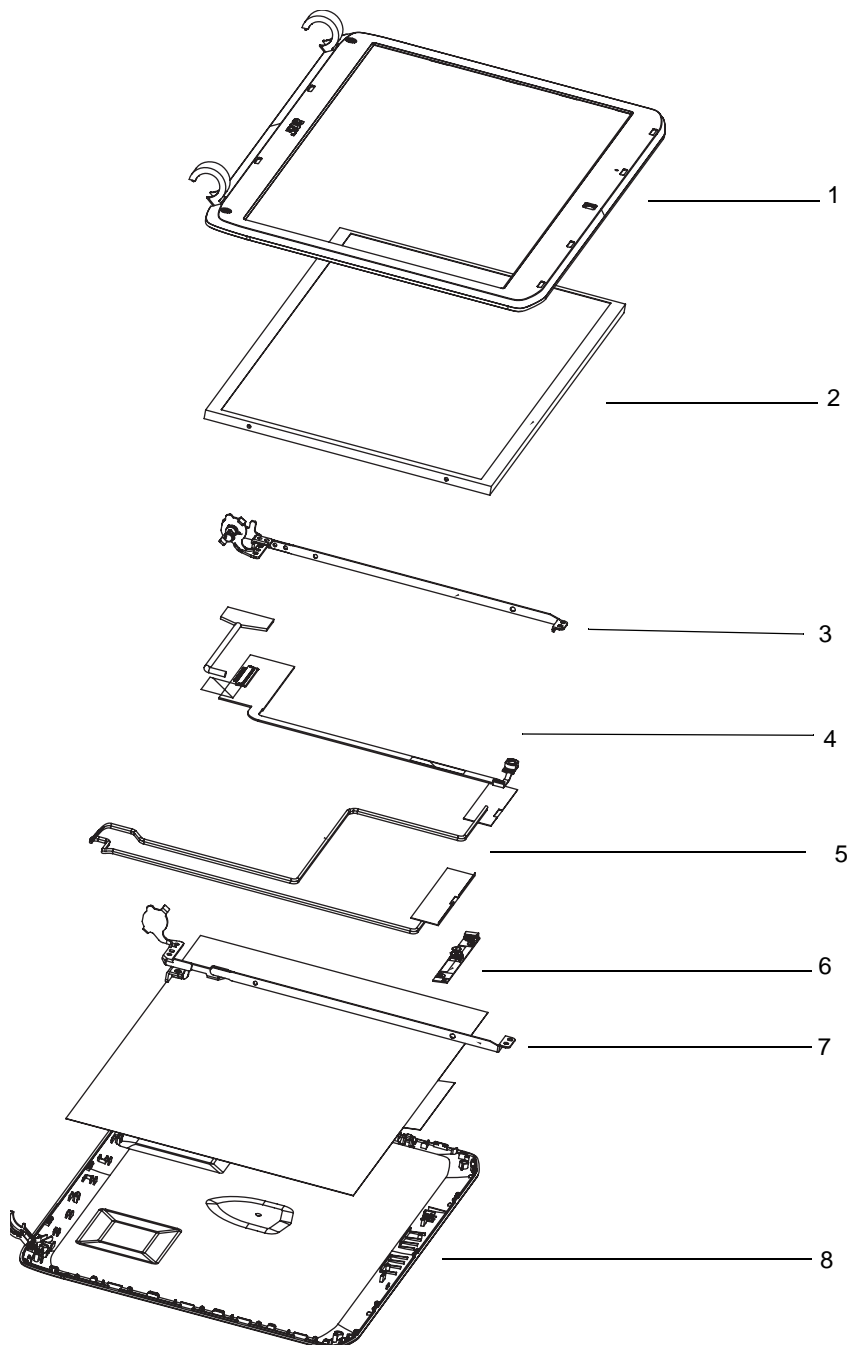



LCD Assembly











Item	Acer PN	Item	Acer PN
1. LCD Bezel	60.FRC07.007	5. Antennas w/cable	LZ.23500.006
2. LCD Panel	LK.11605.003	6. Camera module	57.S6507.001



Item	Acer PN	Item	Acer PN
3. LeftHinge	33.FRC07.002	7. Right hinge	33.FRC07.001
4.LCD FCP w/microphone	50.FRC07.004	8. LCD Module Case	60.FRB07.003

California FRU ListV



CATEGORY	PARTNAME	ACERPARTNO.
ADAPTER		
	ADAPTER DELTA 30W 19V 1.7X5.5X11 BLACK ADP-30JH BA LF	AP.03001.001
	ADAPTER LITE-ON 30W 1.7X5.5X11 BLACK PA-1300-04AC LF	AP.03003.001
	ADAPTER HIPRO 30W 19V 1.7X5.5X11 BLACK HP-A0301R3 B1LF LF	AP.0300A.001
	Adapter DELTA 65W 19V 1.7x5.5x11 Yellow ADP-65JH DB A, LV5 LED LF	AP.06501.026
	Adapter LITE-ON 65W 19V 1.7x5.5x11 Yellow PA-1650-22AC LV5 LED LF	AP.06503.024
	Adapter HIPRO 65W 19V 1.7x5.5x11 Yellow HP-A0652R3B 1LF, LV5 LED LF	AP.0650A.012
BATTERY		
	Battery SANYO UM-2009E Li-Ion 3S2P SANYO 6 cell 4400mAh Main COMMON ID: UM09E31	BT.00603.098
	Battery PANASONIC UM-2009E Li-Ion 3S2P PANASONIC 6 cell 4400mAh Main COMMON ID:UM09E51	BT.00605.052
	Battery SIMPLO UM-2009E Li-Ion 3S2P PANASONIC 6 cell 4400mAh Main COMMON ID:UM09E71	BT.00607.106
	Battery SIMPLO UM-2009E Li-Ion 3S2P SAMSUNG 6 cell 4400mAh Main COMMON ID:UM09E75	BT.00607.107
	Battery SANYO UM-2009E Li-Ion 3S2P SANYO 6 cell 5600mAh Main COMMON ID:UM09E36	BT.00603.096
	Battery SIMPLO UM-2009E Li-Ion 3S2P SAMSUNG 6 cell 5600mAh Main COMMON ID:UM09E70	BT.00607.102
	Battery SIMPLO UM-2009E Li-Ion 3S2P LGC 6 cell 5600mAh Main COMMON ID:UM09E78	BT.00607.103
	Battery PANASONIC UM-2009E Li-Ion 3S2P PANASONIC 6 cell 5800mAh Main COMMON ID:UM09E56	BT.00605.050
BOARD		
	Foxconn Bluetooth FOX BRM 2046 BT2.1	BH.21100.004
	Foxconn Wireless LAN Atheros HB95 BGN (HM)	NI.23600.047
	Foxconn Wireless LAN Atheros HB93 1x2 BGN (HM)	NI.23600.046
	Qualcomm Gobi2000	LC.21300.011
	LAN BOARD	55.FRC07.001
	TP BOARD	55.FRC07.002
CABLE		



CATEGORY	PARTNAME	ACERPARTNO.
	PWR CORD V943B30001218008 DANISH 3P	27.A03V7.006
	PWR CORD(ISR)1.8M 3PBLK FZ0I0008-038	27.TATV7.005
	PWR CORD V50CB3T3012180QD TW-110V,3P	27.A99V7.002
	POWER CORD(SWI)1.8M 3PBLACK FZ0I0008-011	27.A99V7.004
	POWER CORD(IT) 1.8M 3PBLACK FZ0I0008-008	27.A99V7.005
	POWER CORD(S.A) 1.8M 3BLACK FZ0I0008-006	27.T48V7.001
	POWER CORD US 3PIN ROHS	27.TAXV7.001
	POWER CORD(EU) 1.8M 3PBLACK FM0I0008-010	27.TATV7.001
	POWER CORD(UK) 1.8M 3PBLACK FP0I0008-013	27.TATV7.003
	POWER CORD BRAZIL IMETRO 3 PIN	27.S0607.001
	POWER CORD UK 3PIN	27.A03V7.004
	BLUETOOTH CABLE	50.FRC07.001
	DC-IN CABLE	50.FRC07.002
	HDD CABLE	50.FRC07.003
	LCD CABLE	50.FRC07.004
CASE/COVER/BRACKET ASSEMBLY		
	UPPER CASE ASSY BLACK FOR BT W/TP	60.FRC07.001
	UPPER CASE ASSY BLACK FOR NON BT W/TP	60.FRC07.002
	LOWER CASE ASSY BLACK FOR 3G/BT	60.FRB07.001
	LOWER CASE ASSY BLACK FOR 3G, NON BT	60.FRB07.002
	LOWER CASE ASSY BLACK FOR WF BT	60.FRC07.003
	LOWER CASE ASSY BLACK FOR WF , NONBT	60.FRC07.004

CATEGORY	PARTNAME	ACERPARTNO.
	LCD COVER ASSY UV RED W/3G ANTENNA	60.FRB07.003
	LCD COVER ASSY IMR RED W/3G ANTENNA	60.FRB07.004
	LCD COVER ASSY UV RED W/WF ANTENNA	60.FRC07.005
	LCD COVER ASSY IMR RED W/WF ANTENNA	60.FRC07.006
	LCD BEZEL ASSY - BLACK	60.FRC07.007
	HDD COVER - BLACK	42.FRC07.001
	RAM COVER - BLACK	42.FRC07.002
	HINGE - R	33.FRC07.001
	HINGE - L	33.FRC07.002
	SD DUMMY CARD	42.FRC07.003
Camera		
	Suyin Camera Rosa 2G, MODULE CN0316-S30C-OV06-1	57.S6507.001
	CAMERA CNF9011(CMOS,0.3M,VGA)	57.S6507.002
	CAMERA CNF9016(CMOS,0.3M,VGA)	57.FRC07.001
CPU/PROCESSOR		
	CPU AMD Athlon L310 PGA 1.2G 1M Dual Core	KC.AL002.310
HDD/HARD DISK DRIVE		

CATEGORY	PARTNAME	ACERPARTNO.
	HDD TOSHIBA 2.5" 5400rpm 160GB MK1655GSX Libra SATA LF F/W: FG011J	KH.16004.006
	HDD HGST 2.5" 5400rpm 160GB HTS545016B9A300 Panther B SATA LF F/W:C60F Disk imbalance criteria = 0.014g-cm	KH.16007.026
	HDD WD 2.5" 5400rpm 160GB WD1600BEVT-22ZCT0 ML160 SATA LF F/W:11.01A11	KH.16008.022
	HDD SEAGATE 2.5" 5400rpm 250GB ST9250315AS Wyatt SATA LF F/W:0001SDM1	KH.25001.016
	HDD TOSHIBA 2.5" 5400rpm 250GB MK2555GSX Libra SATA LF F/W:FG001J	KH.25004.003
	HDD HGST 2.5" 5400rpm 250GB HTS545025B9A300 Panther B SATA LF F/W:C60F Disk imbalance criteria = 0.014g-cm	KH.25007.016
	HDD WD 2.5" 5400rpm 250GB WD2500BEVT-22ZCT0 ML160 SATA LF F/W:11.01A11	KH.25008.021
	HDD SEAGATE 2.5" 5400rpm 320GB ST9320325AS Wyatt SATA LF F/W:0001SDM1	KH.32001.017
	HDD TOSHIBA 2.5" 5400rpm 320GB MK3255GSX Libra SATA LF F/W:FG011J	KH.32004.002
	HDD HGST 2.5" 5400rpm 320GB HTS545032B9A300 Panther B SATA LF F/W: C60F	KH.32007.007
	HDD HGST 2.5" 5400rpm 320GB HTS545032B9A300 Panther B SATA LF F/W:C60F Disk imbalance criteria = 0.014g-cm	KH.32007.008
	HDD WD 2.5" 5400rpm 320GB WD3200BEVT-22ZCT0 ML160 SATA LF F/W:11.01A11	KH.32008.013
	HDD SEAGATE 2.5" 5400rpm 500GB ST9500325AS Wyatt SATA LF F/W:0001SDM1	KH.50001.011
	HDD TOSHIBA 2.5" 5400rpm 500GB MK5055GSX Libra SATA LF F/W:FG001J	KH.50004.001
	HDD HGST 2.5" 5400rpm 500GB HTS545050B9A300 Panther B SATA LF F/W:C60F	KH.50007.009
	HDD HGST 2.5" 5400rpm 500GB HTS545050B9A300 Panther B SATA LF F/W:C60F Disk imbalance criteria = 0.014g-cm	KH.50007.010
	HDD WD 2.5" 5400rpm 500GB WD5000BEVT-22ZAT0 ML250 SATA LF F/W:01.01A01	KH.50008.013
	HDD BRACKET - R	33.FRC07.003
	HDD BRACKET - L	33.FRC07.004

CATEGORY	PARTNAME	ACERPARTNO.
KEYBOARD		
	Keyboard ACER NT1T Ferrari California 84KS Black Greek Texture	KB.I110A.069
	Keyboard ACER NT1T Ferrari California 84KS Black Thailand Texture	KB.I110A.082
	Keyboard ACER NT1T Ferrari California 85KS Black CZ/SK Texture	KB.I110A.063
	Keyboard ACER NT1T Ferrari California 85KS Black Hungarian Texture	KB.I110A.070
	Keyboard ACER NT1T Ferrari California 85KS Black Brazilian Portuguese Texture	KB.I110A.062
	Keyboard ACER NT1T Ferrari California 84KS Black Russian Texture	KB.I110A.077
	Keyboard ACER NT1T Ferrari California 85KS Black SLO/CRO Texture	KB.I110A.078
	Keyboard ACER NT1T Ferrari California 85KS Black Turkish Texture	KB.I110A.083
	Keyboard ACER NT1T Ferrari California 85KS Black Belgium Texture	KB.I110A.061
	Keyboard ACER NT1T Ferrari California 85KS Black Sweden Texture	KB.I110A.080
	Keyboard ACER NT1T Ferrari California 85KS Black French Texture	KB.I110A.067
	Keyboard ACER NT1T Ferrari California 85KS Black UK Texture	KB.I110A.084
	Keyboard ACER NT1T Ferrari California 85KS Black German Texture	KB.I110A.068
	Keyboard ACER NT1T Ferrari California 85KS Black Italian Texture	KB.I110A.071
	Keyboard ACER NT1T Ferrari California 88KS Black Japanese Texture	KB.I110A.072
	Keyboard ACER NT1T Ferrari California 85KS Black US w/ Canadian French Texture	KB.I110A.087
	Keyboard ACER NT1T Ferrari California 85KS Black Danish Texture	KB.I110A.065
	Keyboard ACER NT1T Ferrari California 85KS Black Nordic Texture	KB.I110A.074
	Keyboard ACER NT1T Ferrari California 84KS Black Arabic Texture	KB.I110A.060
	Keyboard ACER NT1T Ferrari California 85KS Black Spanish Texture	KB.I110A.079
	Keyboard ACER NT1T Ferrari California 85KS Black FR/ Arabic Texture	KB.I110A.066
	Keyboard ACER NT1T Ferrari California 84KS Black US International Texture	KB.I110A.085
	Keyboard ACER NT1T Ferrari California 85KS Black Swiss/G Texture	KB.I110A.081
	Keyboard ACER NT1T Ferrari California 85KS Black Portuguese Texture	KB.I110A.076

CATEGORY	PARTNAME	ACERPARTNO.
	Keyboard ACER NT1T Ferrari California 84KS Black US International w/ Hebrew Tex	KB.I110A.086
	Keyboard ACER NT1T Ferrari California 85KS Black Norwegian Texture	KB.I110A.075
	Keyboard ACER NT1T Ferrari California 84KS Black Korean Texture	KB.I110A.073
	Keyboard ACER NT1T Ferrari California 84KS Black Chinese Texture	KB.I110A.064
LCD		
	LED LCD AUO 11.6" WXGA Glare B116XW02 V0 1A (3G) LF 200nit 8ms 500:1	LK.11605.003
	LED LCD SAMSUNG 11.6" WXGA Glare LTN116AT01-A01 LF 200nit 8ms	LK.11606.001
	LED LCD LPL 11.6" WXGA Glare LP116WH1-TLA1 LF 200nit 8ms 500:1	LK.11608.001
	LED LCD CMO 11.6" WXGA Glare N116B6-L02 C2 LF 200nit 10ms 500:1	LK.1160D.005
	LED LCD AUO 11.6" WXGA Glare B116XW02 V0 2A LF 200nit 8ms 500:1	LK.11605.005
MAINBOARD		
	MAINBOARD UMA AMD RS780MN/SB710 FOR 3G W/O CPU RAM	MB.FRB06.001
	MAINBOARD UMA AMD RS780MN/SB710 FOR NON 3G W/O CPU RAM	MB.FRC06.001
MEMORY		
	Memory ELPIDA SO-DIMM DDRII 800 1GB EBE10UE8AFSA-8G-F LF 128*8 0.065um	KN.1GB09.013
	Memory SAMSUNG SO-DIMM DDRII 667 1GB M470T2864EH3-CE6 LF 64*16 0.055um	KN.1GB0B.027
	Memory HYNIX SO-DIMM DDRII 667 1GB HYMP112S64CP6-Y5 LF	KN.1GB0G.012
	Memory NANYA SO-DIMM DDRII 800 2GB NT2GT64U8HD0BN-AD LF 128*8 0.07um	KN.2GB03.010
	Memory ELPIDA SO-DIMM DDRII 800 2GB EBE21UE8AFSA-8G-F LF 128*8 0.065um	KN.2GB09.005
	Memory SAMSUNG SO-DIMM DDRII 667 2GB M470T5663EH3-CE6 LF 128*8 0.055um	KN.2GB0B.011
	Memory SAMSUNG SO-DIMM DDRII 800 2GB M470T5663EH3-CF7 LF 128*8 0.055um	KN.2GB0B.018
	Memory HYNIX SO-DIMM DDRII 667 2GB HYMP125S64CP8-Y5 LF	KN.2GB0G.004
	Memory HYNIX SO-DIMM DDRII 800 2GB HYMP125S64CP8-S6 LF 128*8 0.065um	KN.2GB0G.007
HEATSINK		

CATEGORY	PARTNAME	ACERPARTNO.
	THERMAL MODULE	60.FRC07.008
SPEAKER		
	SPEAKER MODULE ASSY(WITH L/R)	23.FRC07.001
MISCELLANEOUS		
	LCD BEZEL RUBBER	47.FRC07.001
	UPPER CASE RUBBER	47.FRC07.002
	FRONT LENS RUBBER	47.FRC07.003
	LOWER CASE RUBBER FOOT - BACK	47.FRC07.004
	LOWER CASE RUBBER FOOT - FRONT	47.FRC07.005
SCREW		
	SCREW M2*5-I(BZN)(NYLOK)	86.TG607.004
	SCREW M2.0*3.0-I,IRON SP	86.S0207.001
	SCREW M2-0.4*2-I(BNI)(NYLOK)(7,0.6)IRON	86.W4107.002
	SCREW M2.0*8.0-I(BZN)(NYLOK)	86.FRC07.001
	SCREW M2.0*2.5-I(BUWZN)	86.TPK07.001
	SCREW M3*0.5+3.5I	86.TDY07.003
	SCREW 2.0*4.0	86.W0107.003

Model Definition and Configuration

Ferrari one Series

Model	RO	Country	Acer Part No	Description
FO200-312G25n	EMEA	Greece	LX.FRC02.138	FO200-312G25n W7HP64FRGR1 MC UMACrk 1*2G/250/6L2.8/5R/ CB_bgn_0.3D_AU_EL32
FO200-313G25n	EMEA	Hungary	LX.FRC02.078	FO200-313G25n W7HP64FRHU1 MC UMACrk 2G+1G/250/6L2.2/5R/ CB_bgn_0.3D_AU_HU12
FO200-312G25n	CHINA	Hong Kong	LX.FRC02.151	FO200-312G25n W7HP64FRHK2 MC UMACrk 2*1G/250/BT/6L2.8/5R/ CB_bgn_0.3D_AU_ZH35
FO200-313G25n	EMEA	Portugal	LX.FRC02.080	FO200-313G25n W7HP64FRPT1 MC UMACrk 2G+1G/250/6L2.2/5R/ CB_bgn_0.3D_AU_PT12
FO200-312G25n	EMEA	Switzerland	LX.FRC02.154	FO200-312G25n W7HP64FRCH1 MC UMACrk 1*2G/250/BT/6L2.2/5R/ CB_bgn_0.3D_AU_IT42
FO200-312G25n	EMEA	Switzerland	LX.FRC02.153	FO200-312G25n W7HP64FRCH1 MC UMACrk 2*1G/250/BT/6L2.2/5R/ CB_bgn_0.3D_AU_IT42
FO200-313G25n	EMEA	Belgium	LX.FRC02.068	FO200-313G25n W7HP64FRBE1 MC UMACrk 2G+1G/250/6L2.2/5R/ CB_bgn_0.3D_AU_NL12
FO200-312G25n	EMEA	Germany	LX.FRC02.119	FO200-312G25n W7HP64FRDE1 MC UMACrk 2*1G/250/6L2.2/5R/ CB_bgn_0.3D_AU_DE62
FO200-314G32n	AAP	Japan	LX.FRC02.115	FO200-314G32n W7HP64FJP1 MC UMACrk 2*2G/320/BT/6L2.8/5R/ CB_bgn_0.3D_AU_JA12_Rb43
FO200-313G32n	EMEA	Middle East	LX.FRC02.006	FO200-313G32n W7HP64EMFRME2 MC UMACrk 2G+1G/320/BT/6L2.2/ 5R/CB_bgn_0.3D_AU_AR22
FO200-314G50n	CHINA	Hong Kong	LX.FRC02.152	FO200-314G50n W7HP64FRHK2 MC UMACrk 2*2G/500_L/BT/6L2.8/5R/ CB_bgn_0.3D_AU_ZH35
FO200-314G25n	EMEA	Spain	LX.FRC02.145	FO200-314G25n W7HP64FRES1 MC UMACrk 2*2G/250/BT/6L2.8/5R/ CB_bgn_0.3D_AU_ES52
FO200-313G25n	EMEA	Holland	LX.FRC02.069	FO200-313G25n W7HP64FRNL1 MC UMACrk 2G+1G/250/6L2.2/5R/ CB_bgn_0.3D_AU_NL12
FO200-312G25n	EMEA	Italy	LX.FRC02.137	FO200-312G25n W7HP64FRIT1 MC UMACrk 1*2G/250/6L2.8/5R/ CB_bgn_0.3D_AU_IT12
FO200-312G25i	EMEA	Russia	LX.FRC08.001	FO200-312G25i W7ST32RUFRRU1 MC UMACrk 1*2G/250/BT/6L2.2/5R/ CB_bg_0.3D_AU_RU11

Model	RO	Country	Acer Part No	Description
FO200-313G25n	EMEA	Denmark	LX.FRC02.065	FO200-313G25n W7HP64FRDK2 MC UMACrK 2G+1G/250/6L2.2/5R/ CB_bgn_0.3D_AU_ENS1
FO200-312G32n	AAP	Thailand	LX.FRC02.150	FO200-312G32n EM W7HP64EMFRTH1 MC UMACrK 1*2G/320/BT/6L2.8/5R/ CB_bgn_0.3D_AU_TH42
FO200-312G32n	AAP	Indonesia	LX.FRC02.149	FO200-312G32n EM W7HP64EMFRID1 MC UMACrK 1*2G/320/BT/6L2.2/5R/ CB_bgn_0.3D_AU_ID22
FO200-314G32n	AAP	Thailand	LX.FRC02.148	FO200-314G32n EM W7HP64EMFRTH1 MC UMACrK 2*2G/320/BT/6L2.8/5R/ CB_bgn_0.3D_AU_TH42
FO200-314G50n	AAP	Thailand	LX.FRC02.147	FO200-314G50n EM W7HP64EMFRTH1 MC UMACrK 2*2G/500_L/BT/6L2.8/5R/ CB_bgn_0.3D_AU_TH42
FO200-314G50n	EMEA	Czech	LX.FRC02.123	FO200-314G50n W7HP64FRCZ2 MC UMACrK 2*2G/500_L/BT/6L2.2/5R/ CB_bgn_0.3D_AU_SK12
FO200-314G25i	EMEA	Russia	LX.FRC01.002	FO200-314G25i W7HB64RUFRRU1 MC UMACrK 2*2G/250/6L2.2/5R/ CB_bg_0.3D_AU_RU11
FO200-314G50n	EMEA	Denmark	LX.FRC02.124	FO200-314G50n W7HP64FRDK2 MC UMACrK 2*2G/500_L/BT/6L2.8/5R/ CB_bgn_0.3D_AU_ENS1
FO200-314G50n	EMEA	Denmark	LX.FRC02.146	FO200-314G50n W7HP64FRDK2 MC UMACrK 2*2G/500_L/6L2.2/5R/ CB_bgn_0.3D_AU_ENS1
FO200-313G25n	EMEA	Ukraine	LX.FRC02.103	FO200-313G25n W7HP64RUFRRU1 MC UMACrK 2G+1G/250/6L2.2/5R/ CB_bgn_0.3D_AU_RU62
FO200-313G25n	EMEA	Serbia/ Macedonia	LX.FRC02.076	FO200-313G25n W7HP64FRCS1 MC UMACrK 2G+1G/250/6L2.2/5R/ CB_bgn_0.3D_AU_SL12
FO200-314G50n	EMEA	Denmark	LX.FRC02.129	FO200-314G50n W7HP64FRDK2 MC UMACrK 2*2G/500_L/BT/6L2.2/5R/ CB_bgn_0.3D_AU_ENS1
FO200-313G32n	EMEA	Denmark	LX.FRC02.130	FO200-313G32n W7HP64FRDK2 MC UMACrK 2G+1G/320/BT/6L2.2/5R/ CB_bgn_0.3D_AU_ENS1
FO200-312G25n	EMEA	Greece	LX.FRC02.144	FO200-312G25n W7HP64FRGR1 MC UMACrK 1*2G/250/BT/6L2.8/5R/ CB_bgn_0.3D_AU_EL32
FO200-312G25n	EMEA	Israel	LX.FRC02.143	FO200-312G25n W7HP64FRIL1 MC UMACrK 1*2G/250/BT/6L2.8/5R/ CB_bgn_0.3D_AU_HE32
FO200-312G25n	EMEA	Italy	LX.FRC02.142	FO200-312G25n W7HP64FRIT1 MC UMACrK 1*2G/250/BT/6L2.8/5R/ CB_bgn_0.3D_AU_IT12

Model	RO	Country	Acer Part No	Description
FO200-312G25n	EMEA	Cyprus	LX.FRC02.141	FO200-312G25n W7HP64FRCY1 MC UMACrk 1*2G/250/BT/6L2.8/5R/ CB_bgn_0.3D_AU_ES62
FO200-312G25n	EMEA	Israel	LX.FRC02.140	FO200-312G25n W7HP64FRIL1 MC UMACrk 1*2G/250/BT/6L2.8/5R/ CB_bgn_0.3D_AU_HE52
FO200-312G25n	EMEA	Israel	LX.FRC02.139	FO200-312G25n W7HP64FRIL1 MC UMACrk 1*2G/250/6L2.8/5R/ CB_bgn_0.3D_AU_HE32
FO200-312G25n	EMEA	Cyprus	LX.FRC02.136	FO200-312G25n W7HP64FRCY1 MC UMACrk 1*2G/250/6L2.8/5R/ CB_bgn_0.3D_AU_ES62
FO200-312G25n	EMEA	Israel	LX.FRC02.135	FO200-312G25n W7HP64FRIL1 MC UMACrk 1*2G/250/6L2.8/5R/ CB_bgn_0.3D_AU_HE52
FO200-312G25n	EMEA	Middle East	LX.FRC02.134	FO200-312G25n W7HP64EMFRME4 MC UMACrk 1*2G/250/BT/6L2.2/5R/ CB_bgn_0.3D_AU_RU62
FO200-313G25n	EMEA	Turkey	LX.FRC02.102	FO200-313G25n W7HP64EMFRTR1 MC UMACrk 2G+1G/250/6L2.2/5R/ CB_bgn_0.3D_AU_TR42
FO200-314G25i	EMEA	Russia	LX.FRC02.128	FO200-314G25i W7HP64RUFRRU1 MC UMACrk 2*2G/250/BT/6L2.2/5R/ CB_bg_0.3D_AU_RU62
FO200-314G25i	EMEA	Russia	LX.FRC02.133	FO200-314G25i W7HP64RUFRRU1 MC UMACrk 2*2G/250/6L2.2/5R/ CB_bg_0.3D_AU_RU62
FO200-313G25n	EMEA	Eastern Europe	LX.FRC02.132	FO200-313G25n W7HP64FREU5 MC UMACrk 2G+1G/250/BT/6L2.2/5R/ CB_bgn_0.3D_AU_RO12
FO200-313G25n	EMEA	Eastern Europe	LX.FRC02.131	FO200-313G25n W7HP64FREU4 MC UMACrk 2G+1G/250/BT/6L2.2/5R/ CB_bgn_0.3D_AU_SV22
FO200-312G16n	WW	WW	S2.FRC02.004	FO200-312G16n W7HP64FWW1 MC UMACrk 2*1G/160/BT/6L2.2/5R/ CB_bgn_0.3D_AU_ES64
FO200-314G50n	EMEA	Norway	LX.FRC02.127	FO200-314G50n W7HP64FRNO1 MC UMACrk 2*2G/500_L/BT/6L2.2/5R/ CB_bgn_0.3D_AU_NO12
FO200-314G50n	EMEA	Norway	LX.FRC02.126	FO200-314G50n W7HP64FRNO1 MC UMACrk 2*2G/500_L/6L2.2/5R/ CB_bgn_0.3D_AU_NO12
FO200-313G32n	EMEA	Denmark	LX.FRC02.125	FO200-313G32n W7HP64FRDK2 MC UMACrk 2G+1G/320/BT/6L2.8/5R/ CB_bgn_0.3D_AU_ENS1
FO200-312G25n	EMEA	UK	LX.FRC02.005	FO200-312G25n W7HP64FRGB1 MC UMACrk 1*2G/250/6L2.8/5R/ CB_bgn_0.3D_AU_ES62
FO200-312G25n	EMEA	Middle East	LX.FRC02.003	FO200-312G25n W7HP64EMFRME2 MC UMACrk 1*2G/250/BT/6L2.2/5R/ CB_bgn_0.3D_AU_AR22

Model	RO	Country	Acer Part No	Description
FO200-313G25n	EMEA	Middle East	LX.FRC02.098	FO200-313G25n W7HP64EMFRME2 MC UMACrk 2G+1G/250/6L2.2/5R/ CB_bgn_0.3D_AU_AR22
FO200-312G25n	CHINA	China	LX.FRC01.001	FO200-312G25n W7HB64SCFRCN1 MC UMACrk 1*2G/250/BT/6L2.8/5R/ CB_bgn_0.3D_AU_SC12
FO200-313G50n	AAP	Singapore	LX.FRC02.122	FO200-313G50n W7HP64FRSG1 MC UMACrk 2G+1G/500_L/BT/6L2.8/5R/ CB_bgn_0.3D_AU_ES62
FO200-314G50n	AAP	Singapore	LX.FRC02.121	FO200-314G50n W7HP64FRSG1 MC UMACrk 2*2G/500_L/BT/6L2.8/5R/ CB_bgn_0.3D_AU_ES62
FO200-314G50n	EMEA	Germany	LX.FRC02.120	FO200-314G50n W7HP64FRDE1 MC UMACrk 2*2G/500_L/BT/6L2.8/5R/ CB_bgn_0.3D_AU_DE62
FO200-312G32n	TWN	GCTWN	LX.FRC02.118	FO200-312G32n W7HP64FRTW1 MC UMACrk 1*2G/320/BT/6L2.8/5R/ CB_bgn_0.3D_AU_TC12
FO200-312G32n	AAP	Japan	LX.FRC02.117	FO200-312G32n W7HP64FJP1 MC UMACrk 1*2G/320/BT/6L2.8/5R/ CB_bgn_0.3D_AU_JA12_Rb23
FO200-312G50n	AAP	Japan	LX.FRC02.116	FO200-312G50n W7HP64FPJP1 MC UMACrk 1*2G/500_L/BT/6L2.8/5R/ CB_bgn_0.3D_AU_JA12Rb25F
FO200-314G32n	AAP	Japan	LX.FRC02.114	FO200-314G32n W7HP64FPJP1 MC UMACrk 2*2G/320/BT/6L2.8/5R/ CB_bgn_0.3D_AU_JA12_Rb43F
FO200-313G25n	AAP	Singapore	LX.FRC02.113	FO200-313G25n W7HP64FRSG1 MC UMACrk 2G+1G/250/BT/6L2.8/5R/ CB_bgn_0.3D_AU_ES62
FO200-313G32n	AAP	Singapore	LX.FRC02.112	FO200-313G32n W7HP64FRSG1 MC UMACrk 2G+1G/320/BT/6L2.8/5R/ CB_bgn_0.3D_AU_ES62
FO200-313G25n	EMEA	Turkey	LX.FRC02.101	FO200-313G25n W7HP64EMFRTR1 MC UMACrk 2G+1G/250/6L2.2/5R/ CB_bgn_0.3D_AU_TR32
FO200-313G25n	EMEA	Austria	LX.FRC02.072	FO200-313G25n W7HP64FRAT1 MC UMACrk 2G+1G/250/6L2.2/5R/ CB_bgn_0.3D_AU_DE62
FO200-313G25n	EMEA	Germany	LX.FRC02.012	FO200-313G25n W7HP64FRDE1 MC UMACrk 2G+1G/250/6L2.2/5R/ CB_bgn_0.3D_AU_DE62
FO200-313G25n	EMEA	Israel	LX.FRC02.085	FO200-313G25n W7HP64FRIL1 MC UMACrk 2G+1G/250/6L2.2/5R/ CB_bgn_0.3D_AU_HE52
FO200-313G25n	EMEA	Israel	LX.FRC02.084	FO200-313G25n W7HP64FRIL1 MC UMACrk 2G+1G/250/6L2.2/5R/ CB_bgn_0.3D_AU_HE32
FO200-313G25n	EMEA	Poland	LX.FRC02.087	FO200-313G25n W7HP64FRPL1 MC UMACrk 2G+1G/250/6L2.2/5R/ CB_bgn_0.3D_AU_PL72

Model	RO	Country	Acer Part No	Description
FO200-313G25n	EMEA	South Africa	LX.FRC02.091	FO200-313G25n W7HP64EMFRZA2 MC UMACrk 2G+1G/250/6L2.2/5R/ CB_bgn_0.3D_AU_ES62
FO200-313G25n	EMEA	Middle East	LX.FRC02.095	FO200-313G25n W7HP64EMFRME6 MC UMACrk 2G+1G/250/6L2.2/5R/ CB_bgn_0.3D_AU_ES62
FO200-313G25n	EMEA	Czech	LX.FRC02.074	FO200-313G25n W7HP64FRCZ2 MC UMACrk 2G+1G/250/6L2.2/5R/ CB_bgn_0.3D_AU_SK12
FO200-313G25n	EMEA	Italy	LX.FRC02.086	FO200-313G25n W7HP64FRIT1 MC UMACrk 2G+1G/250/6L2.2/5R/ CB_bgn_0.3D_AU_IT12
FO200-313G25n	EMEA	Middle East	LX.FRC02.093	FO200-313G25n W7HP64EMFRME2 MC UMACrk 2G+1G/250/6L2.2/5R/ CB_bgn_0.3D_AU_AR12
FO200-313G25n	EMEA	Middle East	LX.FRC02.094	FO200-313G25n W7HP64EMFRME2 MC UMACrk 2G+1G/250/6L2.2/5R/ CB_bgn_0.3D_AU_ES62
FO200-313G25n	EMEA	Sweden	LX.FRC02.073	FO200-313G25n W7HP64FRSE1 MC UMACrk 2G+1G/250/6L2.2/5R/ CB_bgn_0.3D_AU_FI12
FO200-313G25n	EMEA	Finland	LX.FRC02.077	FO200-313G25n W7HP64FRFI2 MC UMACrk 2G+1G/250/6L2.2/5R/ CB_bgn_0.3D_AU_FI12
FO200-313G25n	EMEA	Denmark	LX.FRC02.066	FO200-313G25n W7HP64FRDK1 MC UMACrk 2G+1G/250/6L2.2/5R/ CB_bgn_0.3D_AU_NO12
FO200-313G25n	EMEA	Portugal	LX.FRC02.079	FO200-313G25n W7HP64FRPT1 MC UMACrk 2G+1G/250/6L2.2/5R/ CB_bgn_0.3D_AU_EN61
FO200-313G25i	EMEA	Russia	LX.FRC02.104	FO200-313G25i W7HP64RUFRRU1 MC UMACrk 2G+1G/250/6L2.2/5R/ CB_bg_0.3D_AU_RU62
FO200-313G25n	EMEA	Latvia	LX.FRC02.075	FO200-313G25n W7HP64FRLV1 MC UMACrk 2G+1G/250/6L2.2/5R/ CB_bgn_0.3D_AU_RU22
FO200-313G25n	EMEA	Middle East	LX.FRC02.096	FO200-313G25n W7HP64EMFRME4 MC UMACrk 2G+1G/250/6L2.2/5R/ CB_bgn_0.3D_AU_RU62
FO200-313G25n	EMEA	UK	LX.FRC02.001	FO200-313G25n W7HP64FRGB1 MC UMACrk 2G+1G/250/6L2.8/5R/ CB_bgn_0.3D_AU_ES62
FO200-313G25n	EMEA	Greece	LX.FRC02.083	FO200-313G25n W7HP64FRGR1 MC UMACrk 2G+1G/250/6L2.2/5R/ CB_bgn_0.3D_AU_EL32
FO200-313G25n	EMEA	Switzerland	LX.FRC02.088	FO200-313G25n W7HP64FRCH1 MC UMACrk 2G+1G/250/6L2.2/5R/ CB_bgn_0.3D_AU_IT42
FO200-313G25n	EMEA	Cyprus	LX.FRC02.082	FO200-313G25n W7HP64FRCY1 MC UMACrk 2G+1G/250/6L2.2/5R/ CB_bgn_0.3D_AU_ES62

Model	RO	Country	Acer Part No	Description
FO200-313G25n	EMEA	UK	LX.FRC02.089	FO200-313G25n W7HP64FRGB1 MC UMACrk 2G+1G/250/6L2.2/5R/ CB_bgn_0.3D_AU_ES62
FO200-313G25n	EMEA	Algeria	LX.FRC02.092	FO200-313G25n EM W7HP64EMFRDZ1 MC UMACrk 2G+1G/250/6L2.2/5R/ CB_bgn_0.3D_AU_ES82
FO200-313G25n	EMEA	Middle East	LX.FRC02.099	FO200-313G25n W7HP64EMFRME9 MC UMACrk 2G+1G/250/6L2.2/5R/ CB_bgn_0.3D_AU_ES82
FO200-313G25n	EMEA	South Africa	LX.FRC02.090	FO200-313G25n W7HP64EMFRZA1 MC UMACrk 2G+1G/250/6L2.2/5R/ CB_bgn_0.3D_AU_ES82
FO200-313G25n	EMEA	Middle East	LX.FRC02.097	FO200-313G25n W7HP64EMFRME3 MC UMACrk 2G+1G/250/6L2.2/5R/ CB_bgn_0.3D_AU_ES82
FO200-313G25n	EMEA	Spain	LX.FRC02.081	FO200-313G25n W7HP64FRES1 MC UMACrk 2G+1G/250/6L2.2/5R/ CB_bgn_0.3D_AU_ES52
FO200-313G25n	EMEA	France	LX.FRC02.067	FO200-313G25n W7HP64FRFR1 MC UMACrk 2G+1G/250/6L2.2/5R/ CB_bgn_0.3D_AU_ES82
FO200-313G25n	EMEA	Norway	LX.FRC02.071	FO200-313G25n W7HP64FRNO1 MC UMACrk 2G+1G/250/6L2.2/5R/ CB_bgn_0.3D_AU_NO12
FO200-313G25n	EMEA	Luxembourg	LX.FRC02.070	FO200-313G25n W7HP64FRLU3 MC UMACrk 2G+1G/250/6L2.2/5R/ CB_bgn_0.3D_AU_IT42
FO200-312G16n	TWN	GCTWN	LX.FRC02.111	FO200-312G16n W7HP64FRTW1 MC UMACrk 1*2G/160/BT/6L2.2/5R/ CB_bgn_0.3D_AU_TC12
FO200-312G25n	TWN	GCTWN	LX.FRC02.110	FO200-312G25n W7HP64FRTW1 MC UMACrk 1*2G/250/BT/6L2.2/5R/ CB_bgn_0.3D_AU_TC12
FO200-314G32n	AAP	Australia/ New Zealand	LX.FRC02.109	FO200-314G32n W7HP64FRAU1 MC UMACrk 2*2G/320/BT/6L2.8/5R/ CB_bgn_0.3D_AU_ES62
FO200-312G25n	AAP	Singapore	LX.FRC02.108	FO200-312G25n W7HP64FRSG1 MC UMACrk 1*2G/250/BT/6L2.8/5R/ CB_bgn_0.3D_AU_ES62
FO200-314G50n	AAP	Australia/ New Zealand	LX.FRC02.107	FO200-314G50n W7HP64FRAU1 MC UMACrk 2*2G/500_L/BT/6L2.8/5R/ CB_bgn_0.3D_AU_ES62
FO200-314G32n	AAP	Singapore	LX.FRC02.106	FO200-314G32n W7HP64FRSG1 MC UMACrk 2*2G/320/BT/6L2.8/5R/ CB_bgn_0.3D_AU_ES62
FO200-312G32n	AAP	Singapore	LX.FRC02.105	FO200-312G32n W7HP64FRSG1 MC UMACrk 1*2G/320/BT/6L2.8/5R/ CB_bgn_0.3D_AU_ES62
FO200-314G50n	CHINA	China	LX.FRC02.009	FO200-314G50n W7HP64SCFRCN1 MC UMACrk 2*2G/500_L/BT/6L2.8/5R/ CB_bgn_0.3D_AU_SC12

Model	RO	Country	Acer Part No	Description
FO200-312G25n	EMEA	Spain	LX.FRC02.013	FO200-312G25n W7HP64FRES1 MC UMACrK 2*1G/250/BT/6L2.8/5R/ CB_bgn_0.3D_AU_ES52
FO200-312G25n	EMEA	France	LX.FRC02.010	FO200-312G25n W7HP64FRFR1 MC UMACrK 1*2G/250/BT/6L2.2/5R/ CB_bgn_0.3D_AU_ES82
FO200-314G25n	WW	WW	S2.FRC02.005	FO200-314G25n W7HP64FWW1 MC UMACrK 2*2G/250/BT/6L2.2/5R/ CB_bgn_0.3D_AU_ES64
FO200-312G25n	EMEA	UK	LX.FRC02.007	FO200-312G25n W7HP64FRGB1 MC UMACrK 1*2G/250/BT/6L2.2/5R/ CB_bgn_0.3D_AU_ES62
FO200-314G32n	EMEA	UK	LX.FRC02.002	FO200-314G32n W7HP64FRGB1 MC UMACrK 2*2G/320/6L2.8/5R/ CB_bgn_0.3D_AU_ES62
FO200-312G16n	CHINA	Hong Kong	LX.FRC02.004	FO200-312G16n W7HP64FRHK2 MC UMACrK 2*1G/160/BT/6L2.8/5R/ CB_bgn_0.3D_AU_ZH35
FO200-312G25n	TWN	GCTWN	LX.FRC02.008	FO200-312G25n W7HP64FRTW1 MC UMACrK 1*2G/250/BT/6L2.8/5R/ CB_bgn_0.3D_AU_TC12
FO200-312G16n	WW	GCTWN	S2.FRC02.003	FO200-312G16n W7HP64FWW1 MC UMACrK 2*1G/160/BT/6L2.2/5R/ CB_bgn_0.3D_AU_ES63
FO200-312G25n	WW	WW	S2.FRC02.002	FO200-312G25n W7HP64FWW1 MC UMACrK 1*2G/250/BT/6L2.8/5R/ CB_bgn_0.3D_AU_ES64
FO200-312G16n	WW	WW	S2.FRC02.001	FO200-312G16n W7HP64FWW1 MC UMACrK 1*2G/160/BT/6L2.8/5R/ CB_bgn_0.3D_AU_ES64
FO200-312G32n	AAP	Thailand	LX.FRB02.007	FO200-312G32n EM W7HP64EMFRTH1 MC UMAGCrK 1*2G/320/BT/6L2.8/5R/ CB_bgn_0.3D_G2K_AU_TH42
FO200-314G32n	AAP	Thailand	LX.FRB02.006	FO200-314G32n EM W7HP64EMFRTH1 MC UMAGCrK 2*2G/320/BT/6L2.8/5R/ CB_bgn_0.3D_G2K_AU_TH42
FO200-314G50n	AAP	Thailand	LX.FRB02.005	FO200-314G50n EM W7HP64EMFRTH1 MC UMAGCrK 2*2G/500_L/BT/6L2.8/5R/ CB_bgn_0.3D_G2K_AU_TH42
FO200-314G50n	WW	WW	S2.FRB02.004	FO200-314G50n W7HP64FWW1 MC UMAGCrK 2*2G/500_L/BT/6L2.2/5R/ CB_bgn_0.3D_G2K_AU_ES64
FO200-314G32n	AAP	Australia/ New Zealand	LX.FRB02.001	FO200-314G32n W7HP64FRAU1 MC UMAGCrK 2*2G/320/BT/6L2.8/5R/ CB_bgn_0.3D_G2K_AU_ES62
FO200-314G50n	AAP	Australia/ New Zealand	LX.FRB02.002	FO200-314G50n W7HP64FRAU1 MC UMAGCrK 2*2G/500_L/BT/6L2.8/5R/ CB_bgn_0.3D_G2K_AU_ES62

Model	RO	Country	Acer Part No	Description
FO200-312G25n	AAP	Australia/ New Zealand	LX.FRB02.003	FO200-312G25n W7HP64FRAU1 MC UMAGCrk 1*2G/250/BT/6L2.8/5R/ CB_bgn_0.3D_G2K_AU_ES62
FO200-312G32n	AAP	Australia/ New Zealand	LX.FRB02.004	FO200-312G32n W7HP64FRAU1 MC UMAGCrk 1*2G/320/BT/6L2.8/5R/ CB_bgn_0.3D_G2K_AU_ES62
FO200-314G50n	WW	WW	S2.FRB02.002	FO200-314G50n W7HP64FWW1 MC UMAGCrk 2*2G/500_L/BT/6L2.8/5R/ CB_bgn_0.3D_G2K_AU_ES64
FO200-314G32n	WW	WW	S2.FRB02.001	FO200-314G32n W7HP64FWW1 MC UMAGCrk 2*2G/320/BT/6L2.8/5R/ CB_bgn_0.3D_G2K_AU_ES64
FO200-314G32n	WW	WW	S2.FRB02.003	FO200-314G32n W7HP64FWW1 MC UMAGCrk 2*2G/320/BT/6L2.2/5R/ CB_bgn_0.3D_G2K_AU_ES64

Test Compatible Components

This computer's compatibility is tested and verified by Acer's internal testing department. All of its system functions are tested under Windows® XP Home, Windows® XP Pro environment.

Refer to the following lists for components, adapter cards, and peripherals which have passed these tests. Regarding configuration, combination and test procedures, please refer to the Aspire one series Compatibility Test Report released by the Acer Mobile System Testing Department.

BRAND	Type	Description
Adapter		
DELTA	65W	Adapter DELTA 65W 19V 1.7x5.5x11 Yellow ADP-65JH DB A, LV5 LED LF
Battery		
SANYO	6CELL2.8	Battery SANYO UM-2009E Li-Ion 3S2P SANYO 6 cell 5600mAh Main COMMON ID:UM09E36
SIMPLO	6CELL2.2	Battery SIMPLO UM-2009E Li-Ion 3S2P SAMSUNG 6 cell 4400mAh Main COMMON ID:UM09E75
CPU		
AMD	AAL310	CPU AMD Athlon L310 PGA 1.2G 1M Dual Core
HDD		
SEAGATE	N160GB5.4KS	HDD SEAGATE 2.5" 5400rpm 160GB ST9160314AS Wyatt SATA LF F/W:0001SDM1
SEAGATE	N250GB5.4KS	HDD SEAGATE 2.5" 5400rpm 250GB ST9250315AS Wyatt SATA LF F/W:0001SDM1
HGST	N320GB5.4KS	HDD HGST 2.5" 5400rpm 320GB HTS545032B9A300 Panther B SATA LF F/W: C60F
SEAGATE	N500GB5.4KS	HDD SEAGATE 2.5" 5400rpm 500GB ST9500325AS Wyatt SATA LF F/W:0001SDM1
TOSHIBA	N320GB5.4KS	HDD TOSHIBA 2.5" 5400rpm 320GB MK3255GSX Libra SATA LF F/W:FG011J
LCD		
AUO	NLED11.6WXGA G	LED LCD AUO 11.6" WXGA Glare B116XW02 V0 1A (3G) LF 200nit 8ms 500:1
MEM		
ELPIDA	SO1GBII8	Memory ELPIDA SO-DIMM DDRII 800 1GB EBE10UE8AFSA-8G-F LF 128*8 0.065um
NANYA	SO2GBII8	Memory NANYA SO-DIMM DDRII 800 2GB NT2GT64U8HD0BN-AD LF 128*8 0.07um
VGA Chip		
None	UMA	UMA (AMD)
NB Chipset		
AMD	AMDRS780MN	AMD RS780MN w/ HDCP EEPROM
SB Chipset		
AMD	AMDSB710	AMD SB710
Keyboard		

BRAND	Type	Description
ACER	NT1T Ferrari	Keyboard ACER NT-1T Ferrari California Internal 11 Standard Black NONE Texture
LAN		
Atheros	AR8131L	Atheros AR8131L
WiFi Antenna		
WNC	PIFA	PIFA
Audio Codec		
Realtek	ALC272X	Realtek Audio Codec ALC272X
A cover		
	ABS UV Red	ABS UV Red
B cover		
	Mirror w/Camera	Mirror w/Camera
Bluetooth		
Foxconn	BT 2.1	Foxconn Bluetooth BRM 2046 BT2.1 (T60H928.33) f/w:861
Camera		
Suyin	0.3M LDV	Suyin Camera Rose_2G
Card Reader		
	5 in 1-Build in	5 in 1-Build in MS, MS Pro, SD, SC, XD
Ferrari Royalty		
	Ferrari Royalty	Ferrari Royalty
Software		
	McAfee	Antivirus application McAfee
Wiping Cloth		
	Wiping Cloth	Wiping Clothes Wiping Cloth Wipng Cloth - California
Wireless LAN		
Foxconn	3rd WiFi 1x2 BGN	Foxconn Wireless LAN Atheros HB93 1x2 BGN (HM)
3G		
Qualcomm	Gobi2000	Qualcomm Gobi2000

Online Support Information

This section describes online technical support services available to help you repair your Acer Systems.

If you are a distributor, dealer, ASP or TPM, please refer your technical queries to your local Acer branch office. Acer Branch Offices and Regional Business Units may access our website. However some information sources will require a user i.d. and password. These can be obtained directly from Acer CSD Taiwan.

Acer's Website offers you convenient and valuable support resources whenever you need them.

In the Technical Information section you can download information on all of Acer's Notebook, Desktop and Server models including:

- Service guides for all models
- User's manuals
- Training materials
- Bios updates
- Software utilities
- Spare parts lists
- TABs (Technical Announcement Bulletin)

For these purposes, we have included an Acrobat File to facilitate the problem-free downloading of our technical material.

Also contained on this website are:

- Detailed information on Acer's International Traveler's Warranty (ITW)
- Returned material authorization procedures
- An overview of all the support services we offer, accompanied by a list of telephone, fax and email contacts for all your technical queries.

We are always looking for ways to optimize and improve our services, so if you have any suggestions or comments, please do not hesitate to communicate these to us.

A

- Antennas
 - Removing 89, 91

B

- Battery Pack
 - Removing 42
- BIOS
 - ROM type 18
 - vendor 18
 - Version 18
- BIOS Utility 23–31
 - Advanced 26
 - Boot 29
 - Exit 30
 - Navigating 23
 - Save and Exit 30
 - Security 26
 - System Security 30
- Bluetooth Module
 - Removing 65, 109, 118, 119, 121, 122, 124
- brightness
 - hotkeys 12
- Button Board
 - Removing 62

C

- Camera Board
 - Removing 83, 97
- caps lock
 - on indicator 8
- Common Problems 128
- CPU
 - Removing 75, 101
- CRT Cable
 - Removing 71, 104

D

- DIMM Module
 - Removing 49
- Display 3
- display
 - hotkeys 12

E

- Euro Key 13
- External Module Disassembly
 - Flowchart 40

F

- Features 1
- FLASH Utility 31
- Flash Utility 31
- FRU (Field Replaceable Unit) List 147

H

- Hard Disk Drive Module
 - Removing 44
- Hibernation mode
 - hotkey 12
- Hot Keys 10

I

- Indicators 8
- Intermittent Problems 138
- Internal Microphone Failure 135
- Internal Speaker Failure 134

J

- Jumper and Connector Locations 143

K

- Keyboard
 - Removing 56
- Keyboard Failure 132

L

- LCD Bezel
 - Removing 81, 97
- LCD Brackets
 - Removing 87, 93
- LCD Cable
 - Removing 87, 93
- LCD Failure 131
- LCD Module

Removing 69, 100, 105
LCD Module Disassembly
Flowchart 79
LCD Panel
Removing 84, 95

M

Main Unit Disassembly
Flowchart 54
Mainboard
Removing 71, 104
media access
on indicator 8
Memory Check 128
Microphone
Removing 84, 95
Model Definition 159

N

No Display Issue 129
num lock
on indicator 8

O

ODD Failure 137
Online Support Information 169
optical drive module 46

P

Panel 4
left 4
PC Card 8
Power On Failure 128

S

Speaker Module
Removing 77
speakers
hotkey 12
System
Block Diagram 3

T

Test Compatible Components 167
Thermal Module

Removing 102

Touch Pad Failure 133

Troubleshooting

Built-in KB Failure 132
Internal Microphone 135
Internal Speakers 134
LCD Failure 131
No Display 129
ODD 137
Other Failures 137
Power On 128
Touch Pad 133
USB 137

U

Undetermined Problems 138
Upper Cover
Removing 58
USB Failure (Rightside) 137
utility
BIOS 23–31

V

volume
hotkeys 12

W

Windows 2000 Environment Test 167
WLAN Board
Removing 51

