

# Acer TravelMate 2300/4000/4500 Series

## Service Guide

Service guide files and updates are available on the ACER/CSD web; for more information, please refer to <http://csd.acer.com.tw>

PRINTED IN TAIWAN

---

## Revision History

Please refer to the table below for the updates made on TravelMate 2300/4000/4500 service guide.

Date	Chapter	Updates
2004/10/13	Chapter 1	Specify core logic for TravelMate 2300 series
2005/01/07	Chapter 3	ODD module disassembling SOP

---

## Copyright

Copyright © 2004 by Acer Incorporated. All rights reserved. No part of this publication may be reproduced, transmitted, transcribed, stored in a retrieval system, or translated into any language or computer language, in any form or by any means, electronic, mechanical, magnetic, optical, chemical, manual or otherwise, without the prior written permission of Acer Incorporated.

## Disclaimer

The information in this guide is subject to change without notice.

Acer Incorporated makes no representations or warranties, either expressed or implied, with respect to the contents hereof and specifically disclaims any warranties of merchantability or fitness for any particular purpose. Any Acer Incorporated software described in this manual is sold or licensed "as is". Should the programs prove defective following their purchase, the buyer (and not Acer Incorporated, its distributor, or its dealer) assumes the entire cost of all necessary servicing, repair, and any incidental or consequential damages resulting from any defect in the software.

Acer is a registered trademark of Acer Corporation.

Intel is a registered trademark of Intel Corporation.

Pentium and Pentium II/III are trademarks of Intel Corporation.

Other brand and product names are trademarks and/or registered trademarks of their respective holders.

---

## Conventions

The following conventions are used in this manual:

<b>SCREEN MESSAGES</b>	Denotes actual messages that appear on screen.
<b>NOTE</b>	Gives bits and pieces of additional information related to the current topic.
<b>WARNING</b>	Alerts you to any damage that might result from doing or not doing specific actions.
<b>CAUTION</b>	Gives precautionary measures to avoid possible hardware or software problems.
<b>IMPORTANT</b>	Reminds you to do specific actions relevant to the accomplishment of procedures.

---

## Preface

Before using this information and the product it supports, please read the following general information.

1. This Service Guide provides you with all technical information relating to the BASIC CONFIGURATION decided for Acer's "global" product offering. To better fit local market requirements and enhance product competitiveness, your regional office MAY have decided to extend the functionality of a machine (e.g. add-on card, modem, or extra memory capability). These LOCALIZED FEATURES will NOT be covered in this generic service guide. In such cases, please contact your regional offices or the responsible personnel/channel to provide you with further technical details.
2. Please note WHEN ORDERING FRU PARTS, that you should check the most up-to-date information available on your regional web or channel. If, for whatever reason, a part number change is made, it will not be noted in the printed Service Guide. For ACER-AUTHORIZED SERVICE PROVIDERS, your Acer office may have a DIFFERENT part number code to those given in the FRU list of this printed Service Guide. You MUST use the list provided by your regional Acer office to order FRU parts for repair and service of customer machines.



# System Specifications

---

## Features

Below is a brief summary of the computer's many features:

### Performance

- Intel® Pentium M® processor 705, 715, 725, 735, 745, 755 or Intel® Celeron M® processor
- Intel® 855GME or 852GM chipset (manufacturing option; Intel® 855GME is for TM4000/4500 and Intel® 852GM is for TM2300)
- 256/512 MB of DDR333 SDRAM standard, upgradeable to 2048 MB with dual soDimm modules
- 30 GB and above high-capacity, Enhanced-IDE hard disk
- Advanced Configuration Power Interface (ACPI) power management system.
- Internal removable optical drive (AcerMedia bay)
- Li-ion main battery pack

### Display

- The TFT LCD panel providing a large viewing area for maximum efficiency and ease-of-use:
  - ▶ 14.1" XGA (1024x768) resolution
  - ▶ 15.0" XGA (1024x768) or SXGA+ (1400x1050) resolution
  - ▶ 15.4" WXGA (1200x800) or WSXGA+ (1680x1050) resolution
- ATI MOBILITY™ RADEON™ 9700 with 64MB of video memory (manufacturing option)
- 3D graphics support
- Simultaneous display on LCD and CRT monitor, and other display devices like projector support
- "Automatic LCD dim" feature that automatically decides the best settings for your display and conserves power
- Dual independent display

### Multimedia

- High-speed drive: DVD/CD-RW Combo, DVD-Dual or DVD-Super Multi
- 16-bit high-fidelity AC'97 stereo audio
- Built-in microphone and dual speakers
- Built-in microphone
- High-speed DVD/CD-RW Combo, DVD-Dual or DVD-Super Multi drive

### Connectivity

- Built-in 56Kbps fax/data modem
- Integrated 10/100/1000 Mbps Fast Ethernet connection (manufacturing option)
- Fast infrared wireless communication (manufacturing option)
- Three Universal Serial Bus (USB) 2.0 ports
- IEEE 1394 port
- InVilink™ 802.11b/g or Lnvilink™ 802.11a/b/g dual-band tri-mode Wireless LAN (manufacturing option)

- 
- Bluetooth® (manufacturing option)
  - SD/MMC/MS memory card reader (manufacturing option; for TravelMate 4500 only)
  - 100-pin port replicator connector (manufacturing option)

### **Human-centric design and ergonomics**

- Rugged, yet extremely portable design
- Stylish appearance
- Full-size keyboard with four programmable launch keys
- Ergonomically-centered touchpad pointing device
- Acer FineTouch keyboard with a 5-degree curve
- Internet 4-way scroll button

### **Keyboard and Pointing Device**

- 88/89-key Windows keyboard
- Ergonomically-centered touchpad pointing device with scroll function
- Acer FineTouch™ keyboard with a 5-degree curve

### **Expansion**

- One Type II CardBus PC Card slot
- Upgradeable memory modules
- Acer EasyPort (only in TravelMate 4500)

### **I/O Ports**

- One Type II PC Card slot
- One RJ-11 phone jack (V.92, 56Kbps modem)
- One RJ-45 network jack
- One DC-in jack (AC adapter)
- One 100-pin port replicator connector (manufacturing option) for TravelMate 4500 only
- One external monitor port
- One speaker/headphone-out jack (3.5mm mini jack)
- One audio line-in jack (3.5mm mini jack)
- One microphone-in jack (3.5mm mini jack)
- One Infrared (FIR) port (manufacturing option)
- One IEEE 1394 port (manufacturing option)
- One S-video TV-out port (manufacturing option)
- Three USB 2.0 ports
- 3-in-1 (MS/MMC/SD) memory card reader (manufacturing option; for TravelMate 4500 only)





# Board Layout

## Top View

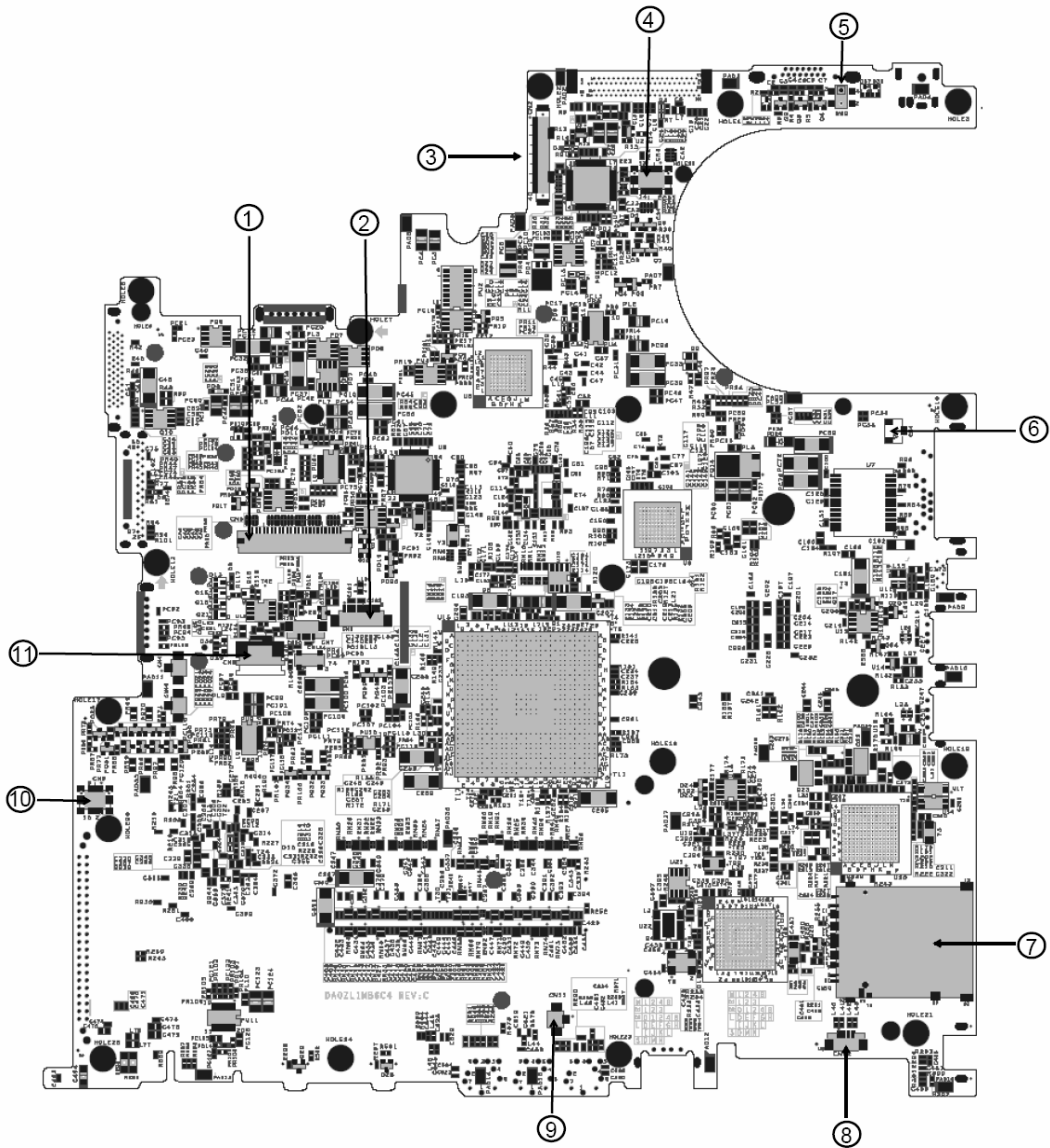

- |   |                           |    |                               |
|---|---------------------------|----|-------------------------------|
| 1 | Keyboard Connector        | 7  | 3 in 1 Connector              |
| 2 | Bluetooth Board Connector | 8  | Speaker Connector             |
| 3 | LCD Cable Connector       | 9  | Internal Microphone Connector |
| 4 | LED Board Connector       | 10 | Modem Board Connector         |
| 5 | Lid Switch                | 11 | Touchpad Board Connector      |
| 6 | Modem Cable Connector     |    |                               |

## Bottom View

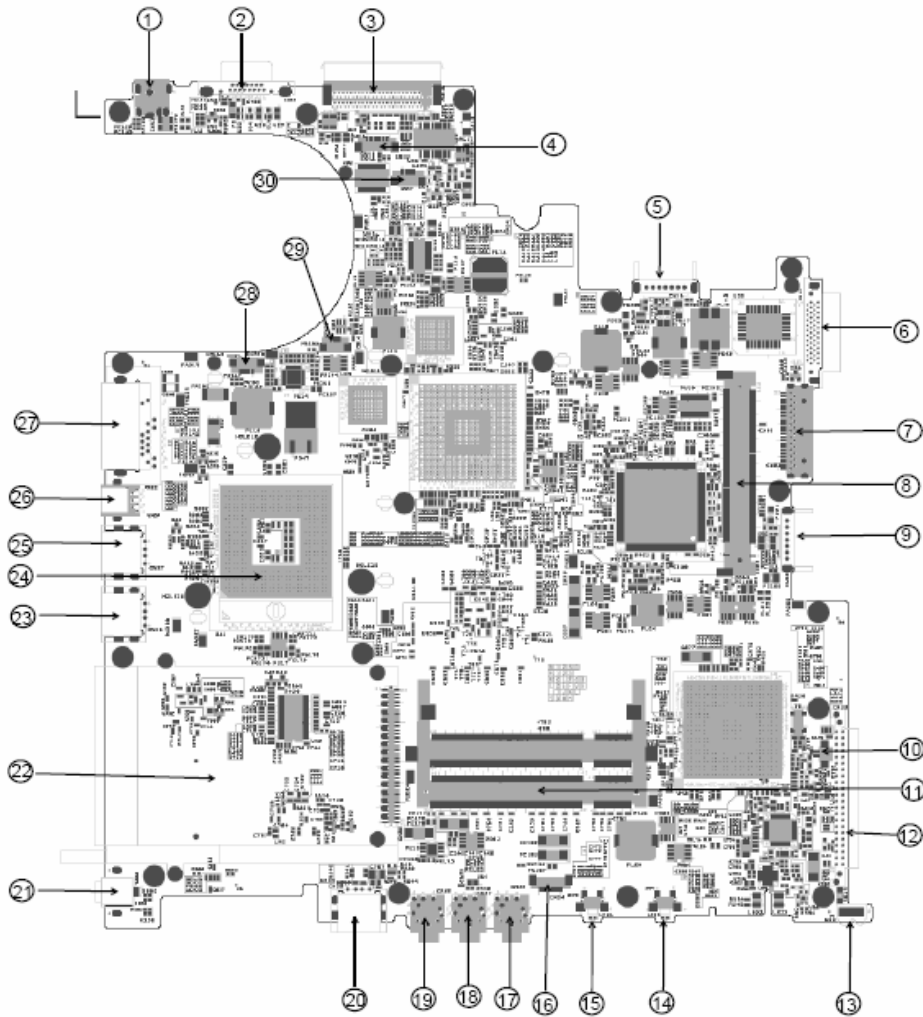

- |    |                          |    |                         |
|----|--------------------------|----|-------------------------|
| 1  | Power Jack               | 16 | Audio Cable Connector   |
| 2  | CRT                      | 17 | Line-in Connector       |
| 3  | Docking                  | 18 | Headphone Out Connector |
| 4  | Audio Cable Connector    | 19 | Microphone-in Connector |
| 5  | Main Battery Connector   | 20 | USB Connector           |
| 6  | ODD Connector            | 21 | IEEE 1394 Connector     |
| 7  | Media Bay Connector      | 22 | PCMCIA                  |
| 8  | Mini PCI Slot            | 23 | USB Connector           |
| 9  | Second Battery Connector | 24 | CPU Socket              |
| 10 | RTC Battery Connector    | 25 | USB Connector           |
| 11 | DDR DIMM Connector       | 26 | S-Video                 |
| 12 | HDD Connector            | 27 | RJ45 and RJ11 Connector |

---

13	IR	28	LAN Cable Connector
14	Bluetooth Switch	29	FAN Connector
15	Wireless Switch	30	LAN Cable Connector

---

## A TravelMate tour

After knowing your computer features, let us show you around your new TravelMate computer.

### Front Open View



#	Icon	Item	Description
1		Display screen	Also called LCD (liquid-crystal display), displays computer output.
2		Microphone	Internal microphone for sound recording.
3		Keyboard	Inputs data into your computer.
4		Palmrest	Comfortable support area for our hands when you use the computer.
5		Click buttons (Left, center and right)	The left and right buttons function like the left and right mouse buttons; the center button serves as a 4-way scroll button.
6		Touchpad	Touch-sensitive pointing device which functions like a computer mouse. Turns on the computer power.
7		Status indicators	Light-Emitting Diodes (LEDs) that turn on and off to show the status of the computer's function and components.
8		Launch keys	Buttons for launching frequently used programs.

---

9		Power button	Turns the computer on and off.
---	--	--------------	--------------------------------

## Front Closed View

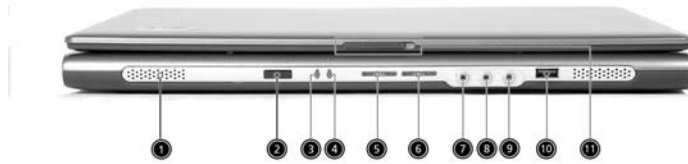

#	Icon	Item	Description
1		Speakers	Left and right speakers deliver stereo audio output.
2		Infrared port	Interfaces with infrared devices (e.g., infrared printer, IR-aware computer). The function is for TravelMate 4000 and TravelMate 4500.
3		Power indicator	Lights when the computer is on.
4		Battery indicator	Lights when the battery is being charged
5		Bluetooth® communications	Indicates that (optional) Bluetooth is enabled.
6		Wireless communication	Indicates status of wireless LAN communication.
7		Line-in/Mic-in jack	Accepts audio line-in devices (e.g., audio CD player, stereo walkman).
8		Line-in/Mic-in jack	Accepts audio line-in devices (e.g., audio CD player, stereo walkman).
9		Speaker/Line-Out/Headphone jack	Connects to audio line-out devices (e.g., speakers, headphones).
10		USB 2.0 port	Connects to Universal Serial Bus (USB) 2.0 devices (e.g., USB mouse, USB camera).
11		Latch	Locks and releases the lid.

## Left View







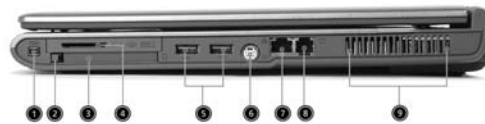

#	Icon	Item	Description
1		Optical drive	Internal optical drive; accepts CDs or DVDs depending on the optical drive type.
2		LED indicator	Lights up when the optical drive is active.
3		Emergency eject hole	Ejects the optical drive tray when the computer is turned off.
4		Optical drive eject button	Ejects the optical drive tray from the drive.
5		AcerMedia bay (Manufacturing option)	Houses an AcerMedia drive module.





## Right Panel



#	Icon	Item	Description
1		IEEE 1394 port (Manufacturing option)	Connects to IEEE 1394 devices. The function is for TravelMate 4000 and TravelMate 4500 only.
2		PC Card slot eject button	Ejects the PC Card from the slot.
3		PC Card slot	Connects to one Type II CardBus PC Card.
4		3-in-1 card reader	Accepts MS, MMC and SD card. Note: The 3-in-1 card reader is a manufacturing option, subject to configuration. Only one card can operate at any given time.
5		Two USB 2.0 ports	Connects to Universal Serial Bus (USB) 2.0 devices (e.g., USB mouse, USB camera).
6		S-video port	Connects to a television or display device with S-video input. This is for TravelMate 4000 and TravelMate 4500 only.
7		Network jack	Connect to an Ethernet 10/100-based network.
8		Modem jack	Connects to a phone line.
9		Ventilation slots	Enable the computer to stay cool, even after prolonged use.

## Rear Panel



#	Icon	Item	Description
1		Power jace	Connects to an AC adapter.
2		External display port	Connects a display device (e.g., external monitor, LCD projector).
3		100-pin port replicator connector (Manufacturing option)	Connects to an I/O port replicator, or Acer EasyPort expansion devices.(for TravelMate 4500 only)
4		Security keylock	Connects to a Kensington-compatible computer security lock.

## Bottom Panel

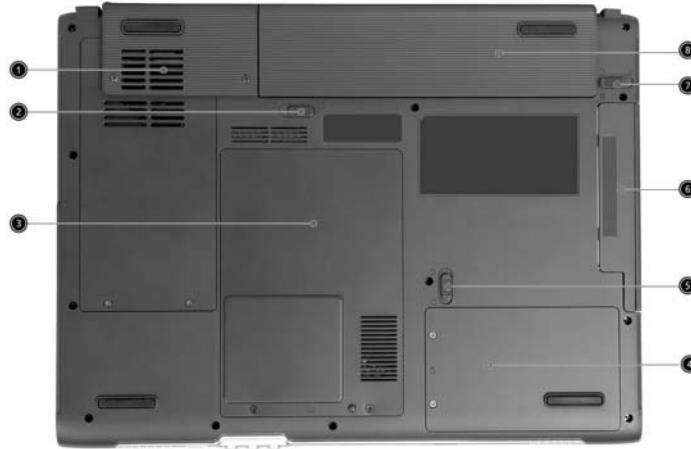



#	Item	Description
1	Cooling fan	Helps keep the computer cool. Note: Do not cover or obstruct the opening of the fan.
2	Battery lock	Locks the battery in place.
3	Memory compartment	Houses the computer's main memory.
4	Hard disk bay	Houses the computer's hard disk (secured by a screw).
5	AcerMedia bay release latch	Unlatches the AcerMedia drive for removing the optical drive. (Only in TravelMate 4500)
6	AcerMedia bay	Houses an AcerMedia drive module.
7	Battery release latch	Unlatches the battery to remove the battery pack.
8	Battery bay	Houses the computer's battery pack.

---

## Indicators



The computer has three easy-to-read status icons on the upper-right above the keyboard.



Icon	Function	Description
	Caps lock	Lights when Caps Lock is activated.
	Num lock	Lights when Num Lock is activated.
	Media Activity	Lights when the disc or AcerMedia is activated.

In addition, there are two indicators at the front panel. Even when the cover is closed, the state or features can still be seen.



Icon	Function	Description
	Power	Lights when the computer is on.
	Battery indicator	Lights when the battery is being charged.

---



## Using the Keyboard

The keyboard has full-sized keys and an embedded keypad, separate cursor keys, two Windows keys and twelve function keys.

### Lock Keys

The keyboard has three lock keys which you can toggle on and off.



Lock Key	Description
Caps Lock	When Caps Lock is on, all alphabetic characters typed are in uppercase.
Num lock (Fn-F11)	When Num Lock is on, the embedded keypad is in numeric mode. The keys function as a calculator (complete with the arithmetic operators +, -, *, and /). Use this mode when you need to do a lot of numeric data entry. A better solution would be to connect an external keypad.
Scroll lock (Fn-F12)	When Scroll Lock is on, the screen moves one line up or down when you press  and  respectively. Scroll Lock does not work with some applications.

---

## Embedded Numeric Keypad

The embedded numeric keypad functions like a desktop numeric keypad. It is indicated by small characters located on the upper right corner of the keycaps. To simplify the keyboard legend, cursor-control key symbols are not printed on the keys.









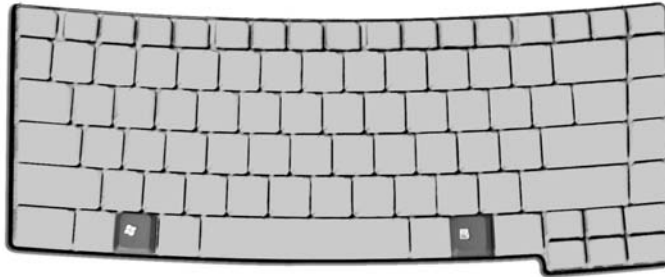

Desired Access	Num Lock On	Num Lock Off
Number keys on embedded keypad	Type numbers in a normal manner.	
Cursor-control keys on embedded keypad	Hold  while using cursor-control keys.	Hold Fn while using cursor-control keys.
Main keyboard keys	Hold Fn while typing letters on embedded keypad.	Type the letters in a normal manner.

## Windows Keys

The keyboard has two keys that perform Windows-specific functions.



Key	Icon	Description
Windows key 		Pressed alone, this key has the same effect as clicking on the Windows Start button; it launches the Start menu. It can also be used with other keys to provide a variety of function:  + Tab (Activates next taskbar button)  + E (Explores My Computer)  + F1 (Opens Help and Support)  + F (Opens the Find: All Files dialog box)  + M (Minimizes all windows)  +  + M (Undoes the minimize all windows)  + R (Displays the Run... dialog box)
Application key		This key has the same effect as clicking the right mouse button; it opens the application's context menu.









## Hot Keys

The computer employs hot keys or key combinations to access most of the computer's controls like screen brightness, volume output and the BIOS utility.

To activate hot keys, press and hold the **Fn** key before pressing the other key in the hot key combination.



Hot Key	Icon	Function	Description
Fn-F1	?	Hot key help	Displays help on hot keys.
Fn-F2		Acer eSetting	Launches the Acer eSetting in the Acer eManager set by the Acer Empowering key.
Fn-F3		Acer ePowerManagement	Launches the Acer ePowerManagement in the Acer eManager set by the Acer Empowering key.
Fn-F4	Z <sup>z</sup>	Sleep	Puts the computer in Sleep mode.
Fn-F5		Display toggle	Switches display output between the display screen, external monitor (if connected) and both the display screen and external monitor.
Fn-F6		Screen blank	Turns the display screen backlight off to save power. Press any key to return.
Fn-F7		Touchpad toggle	Turns the internal touchpad on and off.
Fn-F8		Speaker toggle	Turns the speakers on and off.
Fn-F9		Volume up	Increases the speaker volume.

Hot Key	Icon	Function	Description
Fn- 		Volume down	Decreases the speaker volume.
Fn- 		Brightness up	Increases the screen brightness.
Fn- 		Brightness down	Decreases the screen brightness
Alt Gr-\$		US dollar	Types the US dollar sign.
Alt Gr-Euro		Euro	Types the Euro symbol.

---

## Special Key

You can locate the Euro symbol and US dollar sign at the upper-center and/or bottom-right of your keyboard. To type:

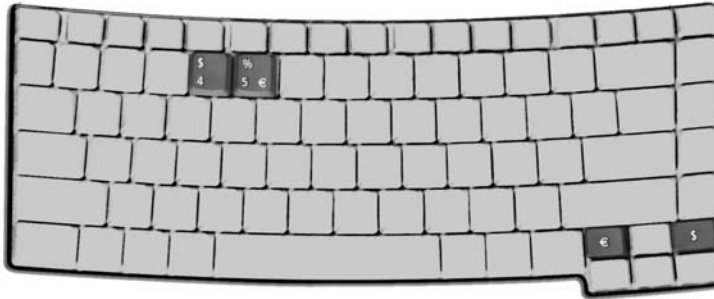

### The Euro symbol

1. Open a text editor or word processor.
2. Either directly press the **Euro** symbol at the bottom-right of the keyboard, or hold **Alt Gr** and then press the **Euro** symbol at the upper-center of the keyboard.

### The US dollar sign

1. Open a text editor or word processor.
2. Either directly press the **dollar** sign at the bottom-right of the keyboard, or hold **Alt Gr** and then press the **dollar** sign at the upper-center of the keyboard.

**NOTE:** This function varies by the operating system version.

---

## Launch Keys

Located at the upper-right above the keyboard are four buttons. These buttons are called launch keys. They are designated as the mail, Web browser, Empowering and programmable keys.



Press the Acer Empowering Key to run the Acer EManager. The mail and Web browser are default for Email and Internet programs, but can be reset by users. To set the mail, Web browser and programmable keys, run the acer Launch Manager.



Launch Key	Default application
Mail	Email application (user-programmable)
Web browser	Internet browser application (user programmable)
e	Acer eManager application (user-programmable)
P	User-programmable

In addition, there are two launch keys at the front panel. Even when the cover is closed, you can easily access the features of Wireless and Bluetooth®. However, the Wireless and Bluetooth keys cannot be set by users.



Description	Default application
Bluetooth® communications  	Lights to indicate the status of Bluetooth (optional) communications.
Wireless communications  	Lights to indicate the status of wireless LAN (optional) communications.

## Touchpad

The built-in touchpad is a PS/2-compatible pointing device that senses movement on its surface. This means the cursor responds as you move your finger on the surface of the touchpad. The central location on the palmrest provides optimum comfort and support.



**NOTE:** If you are using an external USB or serial mouse, you can press **Fn-F7** to disable the touchpad.

## Touchpad Basics

The following teaches you how to use the touchpad:



- Move your finger across the touchpad to move the cursor.
- Press the left (1) and right (3) buttons located on the edge of the touchpad to do selection and execution functions. These two buttons are similar to the left and right buttons on a mouse. Tapping on the touchpad produces similar results.
- Use the 4-way scroll (2) button (top/bottom/left/and right) to scroll.

Function	Left Button	Right Button	Scroll Button	Tap
Execute	Click twice quickly			Tap twice (at the same speed as double-clicking the mouse button)
Select	Click once			Tap once
Drag	Click and hold, then use finger to drag the cursor on the touchpad			Tap twice (at the same speed as double-clicking a mouse button) then hold finger to the touchpad on the second tap to drag the cursor
Access context menu		Click once		

---

Function	Left Button	Right Button	Scroll Button	Tap
Scroll			Click and hold the button in the desired direction (up/down/left/right)	

**NOTE:** Keep your fingers dry and clean when using the touchpad. Also keep the touchpad dry and clean. The touchpad is sensitive to finger movements. Hence, the lighter the touch, the better the response. Tapping too hard will not increase the touchpad's responsiveness.

# Hardware Specifications and Configurations

## Processor

Item	Specification
CPU type	Intel® Celeron M processor at 1.3GHz~1.4GHZ for TravelMate 2300 Intel® Pentium M processor at 1.5GHz~1.6GHz (Dothan) for TravelMate 4000 Intel® Pentium M processor at 1.8GHz (Dothan) for TravelMate 4500
Core logic	Intel® 855GME+ICH4 for TravelMate 4000/4500 Intel® 852GM+ICH4 for TravelMate 2300
CPU package	Intel socketable 478pin Micro-BGA
CPU core voltage	1.308V (highest frequency mode) to 0.956V (low frequency mode) 0.748V (deeper sleep mode)

## BIOS

Item	Specification
BIOS vendor	Phneoix
BIOS Version	3A03
BIOS ROM type	SST 39SF040A, 512KX8 CMOS Boot Block Flash Memory
BIOS ROM size	512KB
BIOS package	32-pin PLCC
Supported protocols	ACPI 1.0b, PC Card 95, SM BIOS 2.3, IEEE1284-ECP/EPP, PCI 2.2, PnP 1.0a, DMI 2.0, PS/2 keyboard and mouse, USB 2.0, VGA BIOS, CD-ROM bootable, IEEE 1394
BIOS password control	Set by setup manual

## Second Level Cache

Item	Specification
Cache controller	Built-in CPU
Cache size	512K for Intel® Celeron M processor at 1.3~1.4GHz-TravelMate 2300 2MB for Intel® Pentium M processor at 1.5~1.6GHz (Dothan)-TravelMate 4000 2MB for Intel® Pentium M processor at 1.8GHz (Dothan)-TravelMate 4500
1st level cache control	Always enabled
2st level cache control	Always enabled
Cache scheme control	Fixed in write-back

## System Memory

Item	Specification
Memory controller	Intel® 855GME built-in (TravelMate 4000/4500); Intel® 852GM built-in (TravelMate 2300)
Memory size	0MB (no on-board memory)
DIMM socket number	2 sockets
Supports memory size per socket	1024MB
Supports maximum memory size	2G (by two 1024MB SO-DIMM module)
Supports DIMM type	DDR Synchronous DRAM
Supports DIMM Speed	333 MHz
Supports DIMM voltage	2.5V and 1.25V



## System Memory

Item	Specification
Supports DIMM package	200-pin soDIMM
Memory module combinations	You can install memory modules in any combinations as long as they match the above specifications.

## Memory Combinations

Slot 1	Slot 2	Total Memory
0MB	128MB	128MB
0MB	256MB	256MB
0MB	512MB	512MB
0MB	1024MB	1024MB
128MB	128MB	256MB
128MB	256MB	384MB
128MB	512MB	640MB
128MB	1024MB	1152MB
256MB	128MB	384MB
256MB	256MB	512MB
256MB	512MB	768MB
256MB	1024MB	1280MB
512MB	128MB	640MB
512MB	256MB	768MB
512MB	512MB	1024MB
512MB	1024MB	1536MB
1024MB	0MB	1024MB
1024MB	128MB	1125MB
1024MB	256MB	1280MB
1024MB	512MB	1536MB
1024MB	1024MB	2048MB

**NOTE:** Above table lists some system memory configurations. You may combine DIMMs with various capacities to form other combinations. On above table, the configuration of slot 1 and slot 2 could be reversed.

## LAN Interface

Item	Specification
Chipset	Broadcom BCM4401 (10/100M) ; BroadCom BCM5788M (1G)- BroadCom BCM5788M chipset is manufacturing option
Supports LAN protocol	10/100/1000Mbps
LAN connector type	RJ45
LAN connector location	Right panel
Features	Integrated 10/100 BASE-T transceiver Wake on LAN support compliant with ACPI 2.0 PCI v2.2

## IR Interface

Item	Specification
Part name	VISHAY TFU6102F
Package	8-pin SMT type

### IR Interface

Item	Specification
Performance	4Mbit/s
Compliant	IrDA 1.1

### Modem Interface

Item	Specification
Data modem data baud rate (bps)	56K
Supports modem protocol	V.90/V.92
Modem connector type	RJ11
Modem connector location	Right panel

### Bluetooth Interface

Item	Specification
Chipset	Broadcom BCM2035
Data throughput	723 bps (full speed data rate)
Protocol	Bluetooth 1.1 (Upgradeable to Bluetooth 1.2 when SIG specification is ratified).
Interface	USB 1.1
Connector type	Mini-USB

### Wireless Module 802.11b/g (optional device)

Item	Specification
Chipset	Intel®
Data throughput	11~54 Mbps
Protocol	802.11b+g
Interface	Mini-PCI type II

### Wireless Module 802.11a/b/g (optional device)

Item	Specification
Chipset	Intel®
Data throughput	11~54 Mbps
Protocol	802.11 a+b+g
Interface	Mini-PCI type II

### 3-in-1 card reader

Item	Specification
Chipset	TI PC7411
Protocol	support Smart Media, Multi-Media Card and Security Digital

## Hard Disk Drive Interface

Item	Specification			
Vendor & Model Name	HGST HTS424030M9AT00/ Toshiba Pluto MK3025GAS/	HGST HTS424040M9AT00/ Toshiba Pluto MK4025GAS/	HGST MORAGA IC25N060ATMR04-0 Toshiba Pluto MK6025GAS	HGST MORAGA IC25N080ATMR04-0 Toshiba Pluto MK8025GAS
Capacity (MB)	30000	40000	60000	80000
Bytes per sector	512	512	512	512
Data heads	2	2	3/4 (for Toshiba)	4
Drive Format				
Disks	1	1	2	2
Spindle speed (RPM)	4200 RPM	4200 RPM	4200 RPM	4200 RPM
Performance Specifications				
Buffer size	2048KB/	2048KB	8192KB	8192KB
Interface	ATA/ATAPI-6; ATA-6	ATA/ATAPI-6; ATA-6	ATA/ATAPI-6; ATA-6	ATA/ATA-6; ATA-6
Max. media transfer rate (disk-buffer, Mbytes/s)	372	372	350	350
Data transfer rate (host~buffer, Mbytes/s)	100 MB/Sec. Ultra DMA mode-5	100 MB/Sec. Ultra DMA mode-5	100 MB/Sec. Ultra DMA mode-5	100 MB/Sec. Ultra DMA mode-5
DC Power Requirements				
Voltage tolerance	5V(DC) +/- 5%	5V(DC) +/- 5%	5V(DC) +/- 5%	5V(DC) +/- 5%

## Combo Drive Interface

Item	Specification	
Vendor & model name	DVD/CDRW KME UIDA760 (24x24x8x24x) DVD/CDRW QSI SBW-242C (24x24x8x24x)	
Performance Specification	With CD Diskette	With DVD Diskette
Transfer rate (KB/sec)	Sustained: Max 3.6Mbytes/sec	Sustained: Max 10.8Mbytes/sec
Buffer Memory	2MB	
Interface	Enhanced IDE(ATAPI) compatible	
Applicable disc format	DVD: DVD-ROM, (DVD-5, DVD-9, DVD-10, DVD-18),DVD-R (read, single border), DVD-RW, DVD-RAM (2.6GB, 4.7GB) CD: CD-DA, CD-ROM, CD-ROM XA, CD-R, CD-RW Photo (Multisession) Video CD, CD-Extra, (CD+), CD-test	
Loading mechanism	Load: Manual Release: (a) Electrical Release (Release Button) (b) Release by ATAPI command (c) Emergency Release	
Power Requirement		
Input Voltage	5 V +/- 5 % (Operating)	

## DVD-Dual Interface

Item	Specification	
Vendor & model name	DVD Dual HLDS GWA-4040N	
Performance Specification	With CD Diskette	With DVD Diskette
Transfer rate (KB/sec)	Sustained: Max 3.6Mbytes/sec	Sustained: Max 10.8Mbytes/sec
Buffer Memory	2MB	
Interface	Enhanced IDE(ATAPI) compatible	
Applicable disc format	Support disc formats 1. Reads data in each CD-ROM, CD-ROM XA, CD-1, Video CD, CD-Extra and CD-Text 2. Reads data in Photo CD (single and Multi-session) 3. Reads standard CD-DA 4. Reads and writes CD-R discs 5. Reads and writes CD-RW discs 6. Reads and writes in each dVD+R/RW (Ver. 1.1) 7. Reads data in each DVD-ROM and DVD-R (Ver. 2.0 for Authoring) 8. Reads and writes in each DVD-R (Ver. 2.0 for general), DVD-RW and DVD+R/RW (Ver1.1)	
Loading mechanism	Load: Manual Release: (a) Electrical Release (Release Button) (b) Release by ATAPI command (c) Emergency Release	
Power Requirement		
Input Voltage	5 V +/- 5 % (Operating)	

## Audio Interface

Item	Specification
Audio Controller	Conexant CX20468-31
Audio onboard or optional	Built-in
Mono or Stereo	Stereo
Resolution	18 bit stereo digital to analog converter 18 bit stereo analog to digital converter
Compatibility	AC97
Mixed sound source	Line-in, CD
Voice channel	8/16-bit, mono/stereo
Sampling rate	44,1 KHz (48K byte for AC97 interface)
Internal microphone	Yes
Internal speaker / Quantity	Yes/2

## Audio Jack

Item	Specification
Number of audio jack	Internal: 2 External:3
Rated input	1W
Connector type	Internal: two 1W speakers External: Headphone out, microphone in and line-in

## Video Interface

Item	Specification
Chipset	ATI Mobility RADEON 9700 (optional for TM4000/4500)
Package	MBGA 708 pin
Interface	AGP8X
Supports ZV (Zoomed Video) port	Yes

## Video Memory

Item	Specification
Chipset	TM4000 and TM4500 has two types of PCBAs. One is with Intel 855GME and the other is ATI M11 (ATI Mobility RADEON 9700) TM2300 Intel 852GM integrated
Memory size	UMA 16/32/64MB for TM2300 UMA 16/32/64MB or ATI M11-P 64MB for TM4000 UMA 16/32/64MB or ATI M11-P 64MB for TM4500
Interface	DDR

## USB Port

Item	Specification
Chipset	ICH4-M
USB Compliancy Level	2.0
OHCI	USB 1.1 and USB 2.0 Host controller
Number of USB port	3
Location	two on the right side; one on the front side
Serial port function control	Enable/Disable by BIOS Setup

## IEEE 1394 Port

Item	Specification
Chipset	TI PC7411
Number of IEEE 1394 port	1
Location	Right side
Connector type	IEEE 1394

## PCMCIA Port

Item	Specification
PCMCIA controller	TI PC7411
Supports card type	Type-II
Number of slots	One type-II
Access location	Right panel
Supports ZV (Zoomed Video) port	No ZV support
Supports 32 bit CardBus	Yes

## System Board Major Chips

Item	Controller
Core logic	Intel® 855GME+ICH4 (TravelMate 4000/4500) Intel® 852GM+ICH4 (TravelMate 2300)
VGA	ATI Mobility RADEON 9700 (optional for TravelMate 4000/4500)
LAN	BroadCom BCM4401 (10/100M); BCM5788M(1G)
IEEE 1394	TI PC7411
USB 2.0	ICH4-M
Super I/O controller	NS 87383
MODEM	Conexant RD01-D620
Bluetooth	Broadcom BCM2035
Wireless 802.11 b	Intel®
Wireless 802.11 b+g	Intel®
PCMCIA	TI PC7411
Audio	Conexant CX20468-31
3-in-1 card reader	TI PC7411

## Keyboard

Item	Specification
Keyboard controller	NS PC97551
Total number of keypads	88-/89-key
Windows logo key	Yes
Internal & external keyboard work simultaneously	1. Plug USB keyboard to the USB port directly: Yes 2. Use port replicator then plug a USB/PS 2 keyboard to the USB port/PS 2 port on the port replicator: Yes

## Battery

Item	Specification
Vendor & model name	Sanyo 4UR18650F-2-QC140 Panasonic CGR-B/8B5AE Simplo 916-3020
Battery Type	Li-ion
Pack capacity	4400 mAh
Number of battery cell	8
Package configuration	4 cells in series, 2 series in parallel
Normal voltage	14.4V
Charge voltage	16.8+-0.2v

## LCD 14.1 inch

Item	Specification		
Vendor & model name	AU B141XG05	CMO N141XB-L01	QDI QD141XLH12
Screen Diagonal (mm)	357(14.1inch)	14inch	360(14.1inch)
Active Area (mm)	285.7(H)x214.3(V)	285.7(H)x214.3(V)	285.7(H)x214.3(V)
Display resolution (pixels)	XGA (1024x768)	XGA (1024x768)	XGA (1024x768)

## LCD 14.1 inch

Item	Specification		
Pixel Pitch	0.279(H)x0.279(H) mm	0.279(H)x0.279(H) mm	0.279(H)x0.279(H) mm
Pixel Arrangement	RGB vertical stripe	RGB vertical stripe	RGB vertical stripe
Display Mode	Normally white	Normally white	Normally white
Typical White Luminance (cd/m <sup>2</sup> ) also called Brightness	150	130(min)/160(typ)	120
Luminance Uniformity	1.2(5 points) 1.5(13 points)	not show	1.45(5 points) 2(13 points)
Contrast Ratio	250 (min)/ 300 (typ)	300(min)/450(typ)	300(min)
Response Time (Optical Rise Time/Fall Time)msec	15/10	6/17(typ) 10/25(max)	12.5/22.5
Nominal Input Voltage VDD	+3.3V	not show	+3.3V
Typical Power Consumption (watt)	5.3	4.03 (for backlight unit)	N/A
Weight	400g (w/o inverter)	420g	460g
Physical Size(mm)	299(W)x228(H)x5.5 (D)	299(W)x228(H)x5.2 (D)	299(W)x228(H)x6.2 (D)
Electrical Interface	R/G/B Data, 3Sync, Signals, Clock (4 pairs LVDS)	1 channel LVDS	1 channel LVDS
Support Color	Native 262K colours	262K colours	262K colours
Viewing Angle (degree) Horizontal: Right/Left Vertical: Upper/Lower	45/45 15/35	45/45 15/35	40/40 10/30
Temperature Range(° C) Operating Storage (shipping)	0 to +50 -20 to +60	0 to +50 -20 to +60	0 to +50 -25 to +60

## LCD 15 inch

Item	Specification		
Vendor & model name	AU: B150XG01	QDI QD15XL06-01	Hannstar HSD150PX14-A07
Screen Diagonal (mm)	381	15.0 inches	15.0 inches
Active Area (mm)	304.1x228.1	304.1x228.1	304.1x228.1
Display resolution (pixels)	1024x768 XGA	1024x768 XGA	1024x768 XGA
Pixel Pitch	0.297x0.297	0.099x0.297	0.297x0.297
Pixel Arrangement	R.G.B. Vertical Stripe	R.G.B. Vertical Stripe	R.G.B. Vertical Stripe
Display Mode	Normally White	Normally White	Normally White
Typical White Luminance (cd/m <sup>2</sup> ) also called Brightness	180 (5 point average) 150 (5 point average)	160	150
Luminance Uniformity	N/A	N/A	70
Contrast Ratio	300	300	250
Response Time (Optical Rise Time/Fall Time)msec	24/11 15/35	8/17	10/25
Nominal Input Voltage VDD	+3.3V Typ.	+3.3V	3.3V

## LCD 15 inch

Item	Specification		
Typical Power Consumption (watt)	5.6/5.7	3.96	N/A
Weight	550	570	600
Physical Size(mm)	317.3x242.0x6.0	317.3x242.0x5.9	317.3x242.0x6.5
Electrical Interface	1 channel LVDS	1 channel LVDS	1 channel LVDS
Support Color	262K colors (RGB 6-bit data driver)	262,144	262,144
Viewing Angle (degree)			
Horizontal: Right/Left	40/40	45/45	40/40
Vertical: Upper/Lower	10/30	15/35	20/40
Temperature Range(° C)			
Operating	0 to +50	0 to +50	0 to +50
Storage (shipping)	-20 to +60	-25 to +60	-20 to +60

## LCD 15 inch and 15.4 inch

Item	Specification		
Vendor & model name	SAMSUNG LTN150XB-L03	Hitachi TX38D81VC1CAB	LCD 15.4" WXGA QDI
Screen Diagonal (mm)		15.0 inches, 381	390.1
Active Area (mm)	304.1x228.1	304.1x228.1	331.2x207.0
Display resolution (pixels)	1024x768 XGA	1024x768 XGA	1280x800 WXGA
Pixel Pitch	0.297x0.297	0.297x0.297	0.2588x0.2588
Pixel Arrangement	R.G.B. Vertical Stripe	R.G.B. Vertical Stripe	R.G.B. Vertical Stripe
Display Mode	Normally White	Transmissive & normally White	Normally White
Typical White Luminance (cd/m <sup>2</sup> ) also called Brightness	160	170	185
Luminance Uniformity	N/A	40	1.4 (5pts)
Contrast Ratio	200	200	400
Response Time (Optical Rise Time/Fall Time)msec	10/30(typ)	30/30	5/20
Nominal Input Voltage VDD	+3.3V	+3.3V	+3.3V Typ.
Typical Power Consumption (watt)	4.6 for backlight unit only	N/A	4.38
Weight	585	580	585
Physical Size(mm)	317.3x242.1x6.0	317.3x242.1x6.0	344x222.0x6.35 max
Electrical Interface	1 channel LVDS	1 channel LVDS	1 channel LVDS
Support Color	262K	262K	262K colors (RGB 6-bit data driver)
Viewing Angle (degree)			
Horizontal: Right/Left	45/45	40/40	15/35
Vertical: Upper/Lower	25/45	20/40	45/45
Temperature Range(° C)	N/A		
Operating		0 to +40	0 to +50
Storage (shipping)		-20 to +60	-25 to +60



### LCD Inverter

Item	Specification
Vendor & model name	SUMIDA TWS-449-147
Brightness conditions	V <sub>adj</sub> =3.3V
Input voltage (V)	8~20
Input current (mA)	350 (max)
Output voltage (V, rms)	1600 (no load)
Output current (mA, rms)	5.6~5.4
Output voltage frequency (k Hz)	55~58K Hz

### AC Adaptor

Item	Specification
Input rating	90V AC to 264V AC, 47Hz to 63Hz
Maximum input AC current	1.7A
Inrush current	220A@115VAC 220A@230VAC
Efficiency	82% min. @115VAC input full load

### System Power Management

ACPI mode	Power Management
Mech. Off (G3)	All devices in the system are turned off completely.
Soft Off (G2/S5)	OS initiated shutdown. All devices in the system are turned off completely.
Working (G0/S0)	Individual devices such as the CPU and hard disc may be power managed in this state.
Suspend to RAM (S3)	CPU set power down VGA Suspend PCMCIA Suspend Audio Power Down Hard Disk Power Down CD-ROM Power Down Super I/O Low Power mode
Save to Disk (S4)	Also called Hibernate state. System saves all system states and data onto the disc prior to power off the whole system.



## System Utilities

### BIOS Setup Utility

The BIOS Setup Utility is a hardware configuration program built into your computer's BIOS (Basic Input/Output System).

Your computer is already properly configured and optimized, and you do not need to run this utility. However, if you encounter configuration problems, you may need to run Setup. Please also refer to Chapter 4 Troubleshooting when problem arises.

To activate the BIOS Utility, press **F2** during POST (when "Press <F2> to enter Setup" message is prompted on the bottom of screen).

Press **F2** to enter setup. The default parameter of F12 Boot Menu is set to "disabled". If you want to change boot device without entering BIOS Setup Utility, please set the parameter to "enabled".

Press <F12> during POST to enter multi-boot menu. In this menu, user can change boot device without entering BIOS SETUP Utility.

PhoenixBIOS Setup Utility					
Info.	Main	Advanced	Security	Boot	Exit
CPU Type: Intel (R) Pentium (R) M processor 1.70Ghz CPU Speed: 1700 MHz  HDD1 Model Name: IC25N080ATMR04-0 HDD1 Serial Number: MPAA01Q2G0746A HDD2 Model Name: HDD2 Serial Number: ATAPI Device: MATSHITADVD-RAM UJ-825S System BIOS Ver: 3A01 VGA BIOS Ver: Montara-GME3360 KBC Ver: PQ1A24 Serial Number 1234567890123456789012 Asset Tag Number: 1234567890 Product Aspire1680 Manufacturer Name: Acer UUID: xxxxxxxxxxxxxxxxxxxxxxxxxxxxxxxxxxxx					
F1 Help	↑↓ Select Item	F5/F6 Change Values	F9 Setup Defaults		
Esc Exit	←→ Select Menu	Enter Select	▶ Sub-Menu	F10 Save and Exit	

---

## Navigating the BIOS Utility

There are six menu options: Info., Main, System Devices, Security, Boot, and Exit.

Follow these instructions:

- To choose a menu, use the cursor left/right keys (← →).
- To choose a parameter, use the cursor up/down keys (↑ ↓).
- To change the value of a parameter, press F5 or F6.
- A plus sign (+) indicates the item has sub-items. Press ENTER to expand this item.
- Press ESC while you are in any of the menu options to go to the Exit menu.
- In any menu, you can load default settings by pressing F9. You can also press F10 to save any changes made and exit the BIOS Setup Utility.

**NOTE:** You can change the value of a parameter if it is enclosed in square brackets. Navigation keys for a particular menu are shown on the bottom of the screen. Help for parameters are found in the Item Specific Help part of the screen. Read this carefully when making changes to parameter values. **Please note that system information vary in models.**

## Information

PhoenixBIOS Setup Utility

Info.	Main	Advanced	Security	Boot	Exit
-------	------	----------	----------	------	------

```

CPU Type:           Intel (R) Pentium (R) M processor 1.70Ghz
CPU Speed:          1700 MHz

HDD1 Model Name:    IC25N080ATMR04-0
HDD1 Serial Number: MPAA01Q2G0746A
HDD2 Model Name:
HDD2 Serial Number:
ATAPI Device:       MATSHITADVD-RAM UJ-825S
System BIOS Ver:    3A01
VGA BIOS Ver:       Montara-GME3360
KBC Ver:            PQ1A24
Serial Number       1234567890123456789012
Asset Tag Number:   1234567890
Product             Aspire1680
Manufacturer Name:  Acer
UUID:              xxxxxxxxxxxxxxxxxxxxxxxxxxxxxxxxxxxx
                    
```

F1 Help	↑↓ Select Item	F5/F6 Change Values	F9 Setup Defaults
Esc Exit	←→ Select Menu	Enter Select	▶ Sub-Menu F10 Save and Exit

**NOTE:** The system information is subject to different models.

Parameter	Description
Floppy Disk Drive	Shows floppy drive type information only when this model has floppy disk drive.
HDD Model Name	This field shows the model name of HDD installed on primary IDE master.
HDD Serial Number	This field displays the serial number of HDD installed on primary IDE master.
ATAPI Model Name	This field displays the model name of devices installed on secondary IDE master. The hard disk drive or optical drive model name is automatically detected by the system.
ATAPI Serial Number	This field shows the serial number of devices installed on secondary IDE master.
Serial Number	This field displays the serial number of this unit.
UUID Number	This will be visible only when an internal LAN device is presenting. UUID=32bytes

## Main

The Main screen displays a summary of your computer hardware information, and also includes basic setup parameters. It allows the user to specify standard IBM PC AT system parameters.

PhoenixBIOS Setup Utility					
Info.	Main	Advanced	Security	Boot	Exit
					Item Specific Help
System Time:	[05:34:07]				<Tab>, <Shift-Tab>, or <Enter> selects field.
System Date:	[07/23/2004]				
System Memory:	640 KB	Shows system base memory size			
Extended Memory:	238MB	Shows extended memory size			
Video Memory	[16MB]	VGA memory size			
Quiet Boot:	[Enabled]				
Power on Display:	[Auto ]				
Network boot:	[Enabled]				
F12 Boot Menu:	[Disabled]				
D2D recovery:	[Enabled]				
F1 Help	↑↓ Select Item	F5/F6 Change Values	F9 Setup Defaults		
Esc Exit	←→ Select Menu	Enter Select	▶ Sub-Menu	F10 Save and Exit	

**NOTE:** The screen above is for your reference only. Actual values may differ.

The table below describes the parameters in this screen. Settings in **boldface** are the default and suggested parameter settings.

Parameter	Description	Format/Option
System Time	Sets the system time. The hours are displayed with 24-hour format.	Format: HH:MM:SS (hour:minute:second) System Time
System Date	Sets the system date.	Format MM/DD/YYYY (month/day/year) System Date
System Memory	This field reports the memory size of the system. Memory size is fixed to 640MB	
Extended Memory	This field reports the memory size of the extended memory in the system. Extended Memory size=Total memory size-1MB	
VGA Memory	Shows the VGA memory size. VGA Memory size=64/128MB	
Fast Boot	Determines if Customer Logo will be displayed or not; shows Summary Screen is disabled or enabled.  Enabled: Customer Logo is displayed, and Summary Screen is disabled. Disabled: Customer Logo is not displayed, and Summary Screen is enabled.	Option: <b>Enabled</b> or Disabled
Power on display	Auto: During power process, the system will detect if any display device is connected on external video port. If any external display device is connected, the power on display will be in CRT (or projector) only mode. Otherwise it will be in LCD only mode.  Both: Simultaneously enable both the integrated LCD screen and the system's external video port (for an external CRT or projector).	Option: <b>Auto</b> or Both
LCD Auto Dim	Determines if the system will automatically dim the LCD brightness in order to save power when AC is not present.  The system will support an automatic dimming of the LCD backlight when the AC power is NOT available (running on battery power).	Option: <b>Enabled</b> or Disabled
Network Boot	Enables, disables the system boot from LAN (remote server).	Option: <b>Enabled</b> or Disabled
F12 Boot Menu	Enables, disables Boot Menu during POST.	Option: <b>Disabled</b> or Enabled
D2D Recovery	Enables, disables D2D Recovery function. The function allows the user to create a hidden partition on hard disc drive to store operation system and restore the system to factory defaults.	Option: <b>Enabled</b> or Disabled

**NOTE:** The sub-items under each device will not be shown if the device control is set to disable or auto. This is because the user is not allowed to control the settings in these cases.

## Advanced

The Advanced menu screen contains parameters involving your hardware devices. It also provides advanced settings of the system.

PhoenixBIOS Setup Utility					
Info.	Main	Advanced	Security	Boot	Exit
					Item Specific Help
Internal Touchpad:		[Both]			Configure Infrared Port using options: [Disable] No configuration  [Enabled] User configuration  [Auto] BIOS or OS chooses configuration  (OS Controlled) Displayed when controlled by OS
Infrared Port (FIR):		[Enabled]			
F1 Help	↑ ↓	Select Item	F5/F6	Change Values	F9 Setup Defaults
Esc Exit	← →	Select Menu	Enter	Select ▶ Sub-Menu	F10 Save and Exit

The table below describes the parameters in the screen. Settings in **boldface** are the default and suggested parameter settings.

Parameter	Description	Options
Infrared Port	Enables, disables or auto detects the infrared port.	<b>Disabled</b> /Disabled/Auto
Parallel Port	Enables, disables or auto detects the parallel port.	<b>Enabled</b> /Disabled/Auto
Mode	Sets the operation mode of the parallel port.	<b>ECP</b> , EPP, Output only or Bi-directional
Base I/O address	Sets the I/O address of the parallel port.	<b>378</b> /278
Interrupt	Sets the interrupt request of the parallel port.	<b>IRQ7</b> /IRQ5
DMA channel	Sets a DMA channel for the printer to operate in ECP mode. This parameter is enabled only if Mode is set to ECP.	<b>DMA3</b> /DMA1



---

Parameter	Description	Options
Legacy USB Support	Enables, disables USB interface devices support. (Enable for use with a non-USB aware Operating System such as DOS or UNIX).	Option: <b>Disabled</b> or Enabled
Hard Disk Recovery	Enables or disables Hard Disk to Hard Disk system Recovery by pressing Fn+F10 key during POST.	Option: <b>Disabled</b> or Enabled

## Security

The Security screen contains parameters that help safeguard and protect your computer from unauthorized use.

PhoenixBIOS Setup Utility			
Info.	Main	Advanced	Security
			Boot Exit
Supervisor Password Is: Clear User Password Is: Clear Primary HardDisk Security: Clear HDD Master ID: 43883445  Set Supervisor Password [Enter] Set User Passord [Enter] Set HDD Password [Enter]  Password on Boot [Disabled]			<b>Item Specific Help</b>  When shown as [Locked], the hard drive password currently can not be changed or disabled.  To change or disable it, turn off the system and enter Setup immediately after turning it back on.  Press [Enter] to input, change, or disable hard drive passwords.
F1 Help	↑↓ Select Item	F5/F6 Change Values	F9 Setup Defaults
Esc Exit	←→ Select Menu	Enter Select ▶ Sub-Menu	F10 Save and Exit

The table below describes the parameters in this screen. Settings in **boldface** are the default and suggested parameter settings.

Parameter	Description	Option
User Password is	Shows the setting of the user password.	<b>Clear</b> or Set
Supervisor Password is	Shows the setting of the Supervisor password	<b>Clear</b> or Set
Set User Password	Press Enter to set the user password. When user password is set, this password protects the BIOS Setup Utility from unauthorized access. The user can enter Setup menu only and does not have right to change the value of parameters.	
Set Supervisor Password	Press Enter to set the supervisor password. When set, this password protects the BIOS Setup Utility from unauthorized access. The user can not either enter the Setup menu nor change the value of parameters.	
Primary Harddisk Security	This feature is available to user when Supervisor password is set. Password can be written on HDD only when Supervisor password or user password is set and password on HDD is set to enabled. Supervisor Password is written to HDD only when Supervisor password is being set. User password is written to HDD when both passwords are set. When both Supervisor and user password are present, both passwords can unlock the HDD.	<b>Disabled</b> or Enabled
Password on Boot	Defines whether a password is required or not while the events defined in this group happened. The following sub-options are all requires the Supervisor password for changes and should be grayed out if the user password was used to enter setup.	<b>Disabled</b> or Enabled

**NOTE:** When you are prompted to enter a password, you have three tries before the system halts. Don't forget your password. If you forget your password, you may have to return your notebook computer to your dealer to reset it.

## Setting a Password

Follow these steps as you set the user or the supervisor password:

- Use the **↑** and **↓** keys to highlight the Set Supervisor Password parameter and press the **ENTER** key. The Set Supervisor Password box appears:

Set Supervisor Password

Enter New Password    [                    ]

Confirm New Password    [                    ]

- Type a password in the "Enter New Password" field. The password length can not exceeds 8 alphanumeric characters (A-Z, a-z, 0-9, not case sensitive). Retype the password in the "Confirm New Password" field.

**IMPORTANT:** Be very careful when typing your password because the characters do not appear on the screen.

3. Press **ENTER**.  
After setting the password, the computer sets the User Password parameter to "Set".
4. If desired, you can opt to enable the Password on boot parameter.
5. When you are done, press **F10** to save the changes and exit the BIOS Setup Utility.

## Removing a Password

Follow these steps:

1. Use the **↑** and **↓** keys to highlight the Set Supervisor Password parameter and press the **ENTER** key. The Set Password box appears:

Set Supervisor Password		
Enter current password	[	]
Enter New Password	[	]
Confirm New Password	[	]

2. Type the current password in the Enter Current Password field and press **ENTER**.
3. Press **ENTER** twice **without** typing anything in the Enter New Password and Confirm New Password fields. The computer then sets the Supervisor Password parameter to "Clear".
4. When you have changed the settings, press **F10** to save the changes and exit the BIOS Setup Utility.

## Changing a Password

1. Use the **↑** and **↓** keys to highlight the Set Supervisor Password parameter and press the **ENTER** key. The Set Password box appears:

Set Supervisor Password		
Enter current password	[	]
Enter New Password	[	]
Confirm New Password	[	]

2. Type the current password in the Enter Current Password field and press **ENTER**.
3. Type a password in the Enter New Password field. Retype the password in the Confirm New Password field.
4. Press **ENTER**. After setting the password, the computer sets the User Password parameter to "Set".
5. If desired, you can enable the Password on boot parameter.
6. When you are done, press **F10** to save the changes and exit the BIOS Setup Utility.

---

If the verification is OK, the screen will display as following.

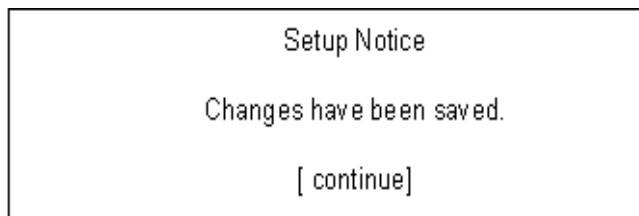

The password setting is complete after the user presses .

If the current password entered does not match the actual current password, the screen will show you the Setup Warning.

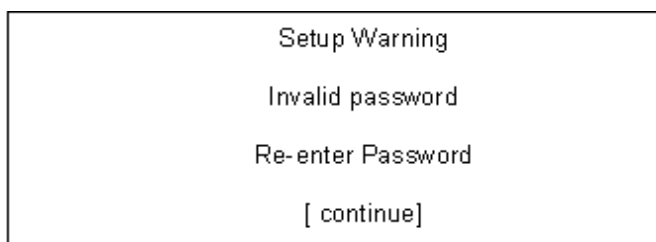

If the new password and confirm new password strings do not match, the screen will display the following message.

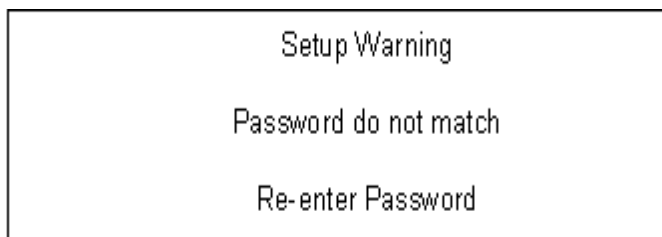

## Boot

This menu allows the user to decide the order of boot devices to load the operating system. Bootable devices includes the distette drive in module bay, the onboard hard disk drive and the CD-ROM in module bay.

PhoenixBIOS Setup Utility					
Info.	Main	Advanced	Security	Boot	Exit
CD-ROM/DVD Drive Floppy Devices +Hard Drive Network Boot				Item Specific Help	
				+ and - indicate device categories. Use <Enter> to expand/collapses.  Boot order is top-down using only the top device in each category.  Use <F6> and <F5> to move highlighted item up and down.	
F1 Help	↑↓ Select Item	F5/F6 Change Values	F9 Setup Defaults		
Esc Exit	←→ Select Menu	Enter Select	▶ Sub-Menu	F10 Save and Exit	

## Exit

The Exit screen contains parameters that help safeguard and protect your computer from unauthorized use.

PhoenixBIOS Setup Utility					
Info.	Main	Advanced	Security	Boot	Exit
Exit Saving Changes Exit Discarding Changes Load Setup Defaults Discard Changes Save Changes					Item Specific Help Exit System Setup and save your changes to CMOS.
F1 Help	↑↓ Select Item	F5/F6 Change Values	F9 Setup Defaults		
Esc Exit	←→ Select Menu	Enter Select ▶ Sub-Menu	F10 Save and Exit		

The table below describes the parameters in this screen.

Parameter	Description
Exit Saving Changes	Exit System Setup and save your changes to CMOS.
Exit Discarding Changes	Exit utility without saving setup data to CMOS.
Load Setup Default	Load default values for all SETUP item.
Discard Changes	Load previous values from CMOS for all SETUP items.
Save Changes	Save Setup Data to CMOS.

---

## BIOS Flash Utility

The BIOS flash memory update is required for the following conditions:

- New versions of system programs
- New features or options
- Restore a BIOS when it becomes corrupted.

Use the Phlash utility to update the system BIOS flash ROM.

**NOTE:** If you do not have a crisis recovery diskette at hand, then you should create a **Crisis Recovery Diskette** before you use the Phlash utility.

**NOTE:** Do not install memory-related drivers (XMS, EMS, DPMS) when you use the Phlash.

**NOTE:** Please use the AC adaptor power supply when you run the Phlash utility. If the battery pack does not contain enough power to finish BIOS flash, you may not boot the system because the BIOS is not completely loaded.

Follow the steps below to run the Phlash.

1. Prepare a bootable diskette.
2. Copy the Phlash utilities to the bootable diskette.
3. Then boot the system from the bootable diskette. The Phlash utility has auto-execution function.



## Machine Disassembly and Replacement

---

This chapter contains step-by-step procedures on how to disassemble the notebook computer for maintenance and troubleshooting.

To disassemble the computer, you need the following tools:

- Wrist grounding strap and conductive mat for preventing electrostatic discharge
- Small Philips screw driver
- Philips screwdriver
- Plastic flat head screw driver
- Tweezers

**NOTE:** The screws for the different components vary in size. During the disassembly process, group the screws with the corresponding components to avoid mismatch when putting back the components. When you remove the stripe cover, please be careful not to scrape the cover.

---

## General Information

### Before You Begin

Before proceeding with the disassembly procedure, make sure that you do the following:

1. Turn off the power to the system and all peripherals.
2. Unplug the AC adapter and all power and signal cables from the system.
3. Remove the battery pack.

**NOTE:** The screws used to secure bottom case and upper case are more than one type. Please group same type of screw together as you disassemble the system for service purpose. The image below is for your reference. Please pay attention to the explanation below.

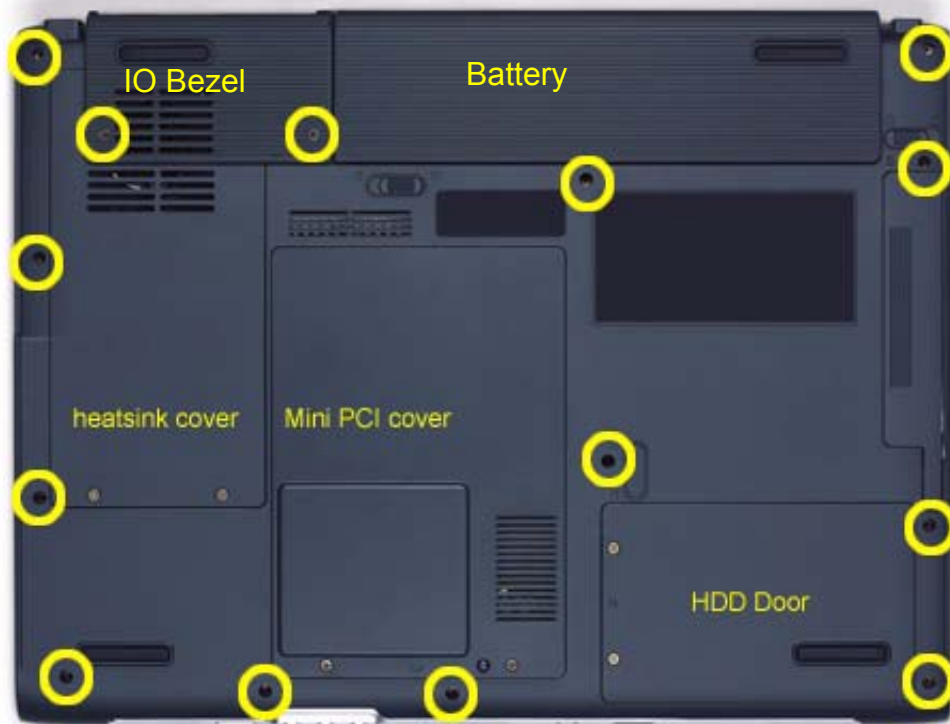

The screws that secure heatsink cover, Mini PCI cover and HDD cover are with the covers. There is no need to worry about mix them up. However, please notice that you have to group the screws on the following locations together. There are twenty screws holding the bottom case to upper case but some screws are inside the system. You may have to remove the HDD, the heatsink cover to see these screws. Mini PCI cover here also called RAM/Wireless cover.

Screw Type	Location	Quantity
M2.5*6 (Part number: 86.T23V7.010)	Bottom case and IO bezel (highlight with yellow circle)	14

---

Screw Type	Location	Quantity
M2.5*6 (Part number: 86.T23V7.010)	Remove the IO bezel then you will see.	2
M2.5*6 (Part number: 86.T23V7.010)	Remove the heatsink cover then you will see.	1
M2.5*6 (Part number: 86.T23V7.010)	Remove the HDD cover then you will see.	1
M2.5*3 (Part number: 86.T25V7.012)	Detach the HDD module then you will see.	1
M2.5*3 (Part number: 86.T25V7.012)	Remove the battery then you will see.	1

# Disassembly Procedure Flowchart

The flowchart on the succeeding page gives you a graphic representation on the entire disassembly sequence and instructs you on the components that need to be removed during servicing. For example, if you want to remove the system board, you must first remove the keyboard, then disassemble the inside assembly frame in that order.

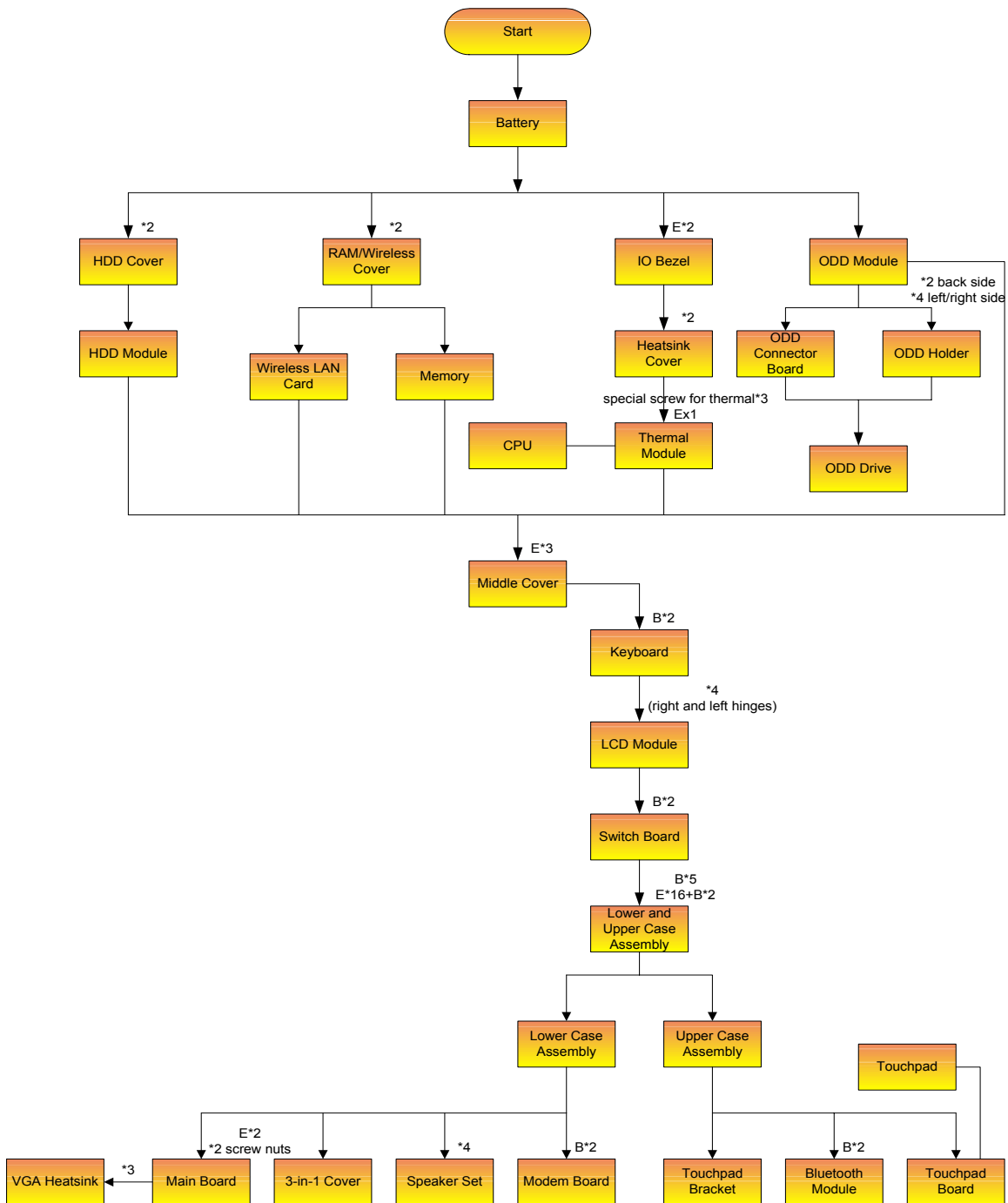

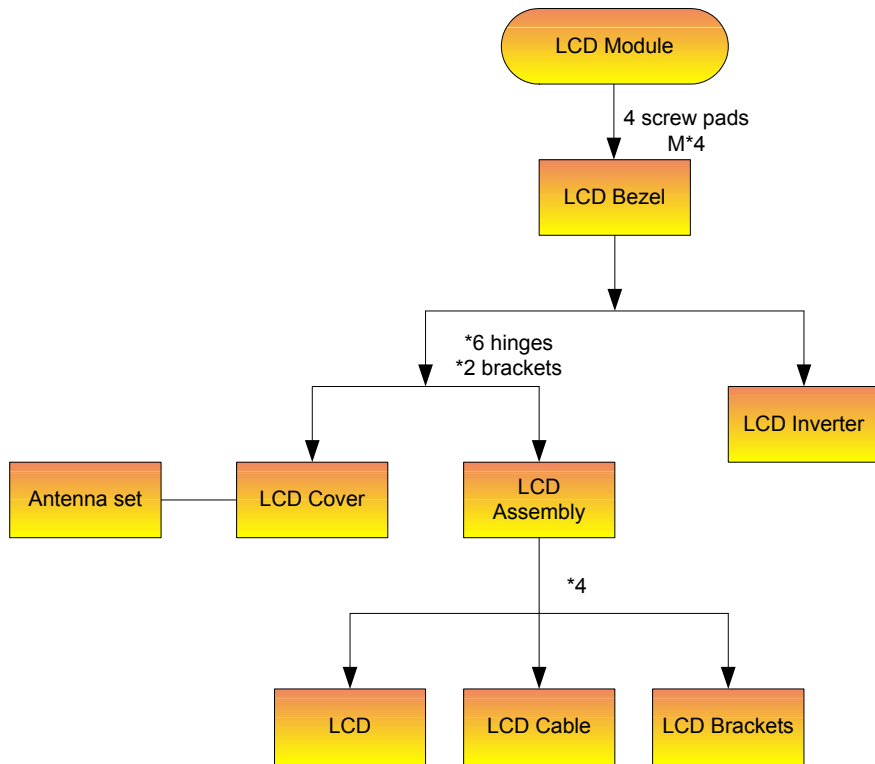

### Screw List

Item	Description
A	SCREW M2.0X3.0-I-NI-NYLOK
B	SCREW I2.5*3M-BNIH(M2.5L3)
C	SCREW M2.5*4L-BZN-NYLOK
D	SCREW M2.0X5-I-NI-NYLOK
E	SCREW MM25060IL69
F	SCREW M2.0*5-I(NI)(NYLOK)
G	SCREW M2.0X2.5-I-NI-NYLOK
H	SCREW I2*3M-NIHY (M2L3)
I	SCREW M1.7*3.0-I (BK)
J	SCREW I3*3.5M-NIH(M3L3.5)

---

## Removing the Battery Pack

1. Unlock the battery lock.
2. Slide the battery latch as shown then remove the battery pack.



---

# Removing the HDD Module/the Memory and the Wireless LAN Card/the Thermal Module and the CPU/ODD Module and LCD Module

## Removing the HDD Module

1. Remove the two screws holding the HDD cover.
2. Remove the HDD cover.
3. Detach the HDD module then remove it.



## Removing the Memory and the Wireless LAN Card

1. Remove the two screws that secure the RAM/Wireless cover.
2. Remove the RAM/Wireless cover.

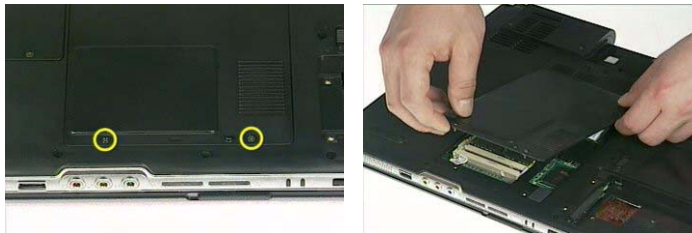

3. Pop up the memory then remove it.
4. Disconnect the auxiliary and the main wireless antennae.
5. Pop the wireless LAN card then remove it.



## Removing the Thermal Module and CPU

1. Remove the two screws holding the IO bezel.
2. Then remove the IO bezel.
3. Remove the two screws that secure the heatsink cover.

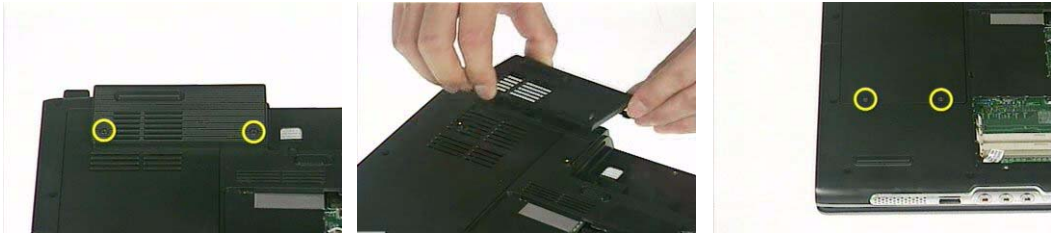

4. Remove the heatsink cover from the main unit.
5. Disconnect the fan cable.

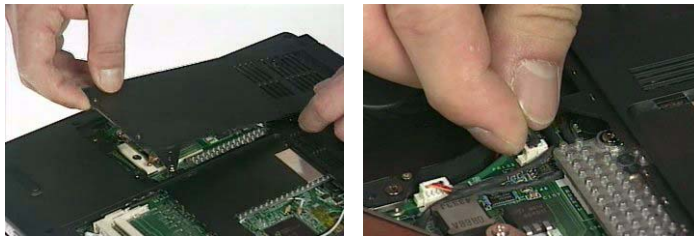

6. Remove the four screws that secure the thermal module.
7. Pull the thermal module outwards then remove it.

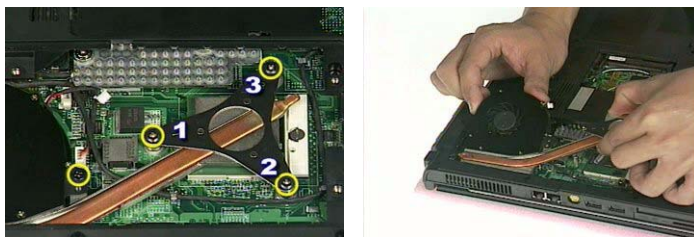

**NOTE:** The edge of the thermal module as shown is very sharp. Be very careful as you remove the thermal module.

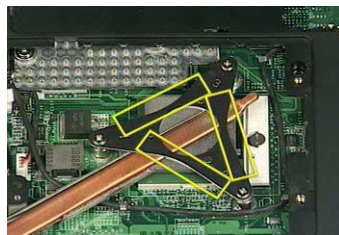

8. Use a flat-bladed screwdriver to release the CPU lock.
9. Remove the CPU from the socket carefully.



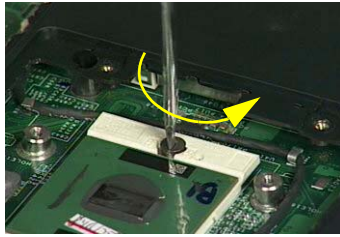

## Removing the ODD Module

1. Remove the three screws holding the middle cover.
2. Detach the middle cover carefully.

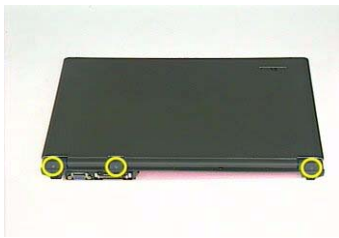

3. Turn over the keyboard as shown.
4. Disconnect the keyboard cable from the main board then remove the keyboard.

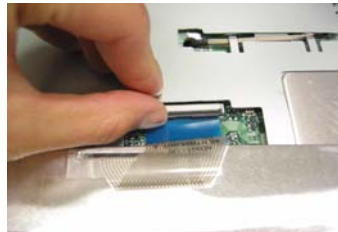

5. Remove the screw that fastens the ODD module.
6. Turn over the notebook computer then detach the ODD module carefully.

**NOTE:** When you reattach the ODD, please make sure you attach the ODD module completely to the main unit. Otherwise, you can not fasten the screw and the screw may damage the main board.

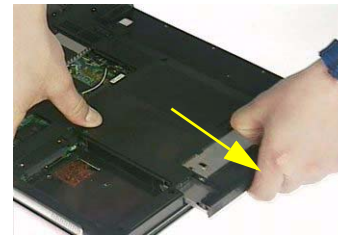
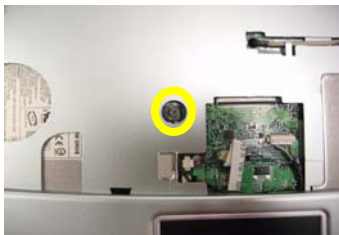

## Removing the LCD Module

1. Remove the three screws holding the keyboard cover.
2. Open the LCD module as the picture shown then detach the keyboard cover from the main unit.

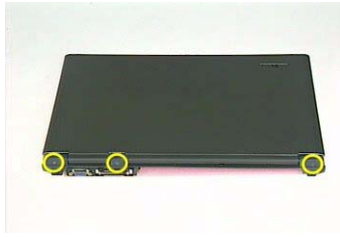

3. Remove the two screws that secure the keyboard as shown.
4. Turn over the keyboard as shown and disconnect the keyboard cable then remove the keyboard.
5. Pull out the antenna set with a tweezers then take out the antenna set from the main unit.

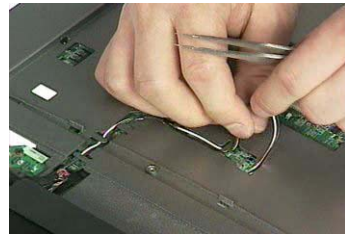
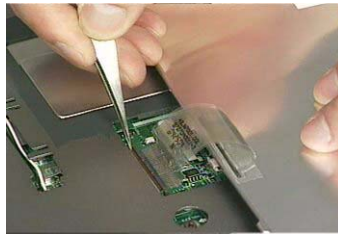

6. Disconnect the LCD coaxial cable.
7. Remove the four screws holding the right and the left hinge. Two on each side.
8. Then detach the LCD module from the main unit.

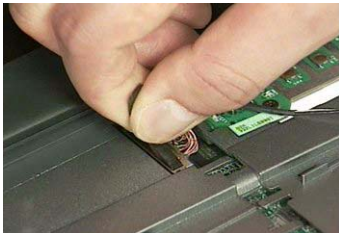

---

## Disassembling the Main Unit

### Separate the Main Unit Into the Upper and the Lower Case Assembly

1. Remove the two screws holding the switch board.
2. Remove the switch board.
3. Disconnect the touchpad FFC from the main board.



4. Disconnect the bluetooth cable.
5. Remove the five screws that secure the upper case.
6. Remove the eighteen screws on the bottom as shown.

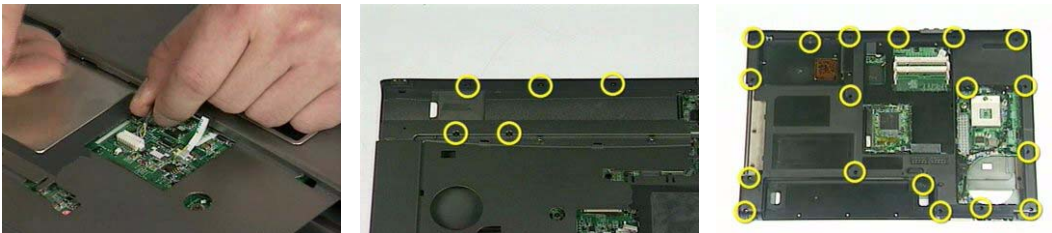

7. Detach the upper case assembly and place it next to the lower case assembly.
8. Disconnect the microphone cable then remove the upper case assembly.

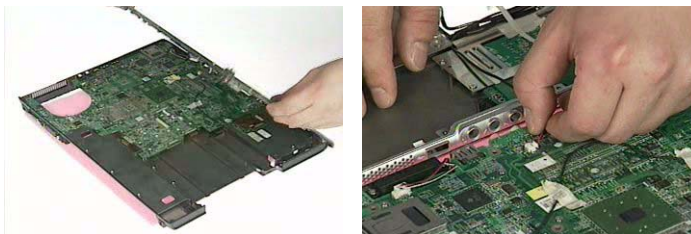

### Disassembling the Upper Case Assembly

1. Disconnect the touchpad board to touchpad FFC.
2. Disconnect the touchpad board to main board FFC.
3. Then detach the touchpad board to main board FFC from the touchpad board.



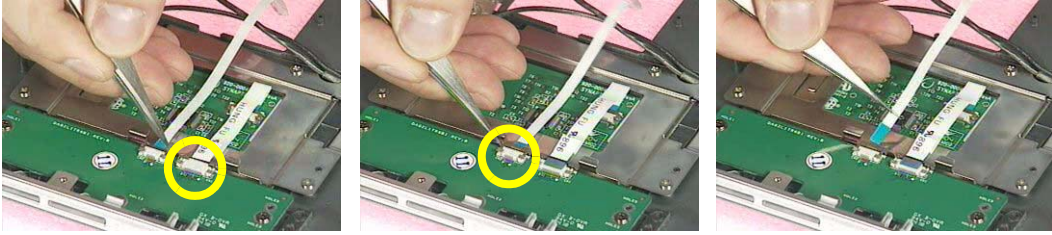

4. Remove the three screws that secure the touchpad board.
5. Remove the touchpad board from the upper case.
6. Disconnect the touchpad board to touchpad FFC.



7. Remove the touchpad board to touchpad FFC from the upper case assembly.
8. Remove the four screws holding the touchpad bracket.
9. Detach the touchpad bracket from the upper case assembly.

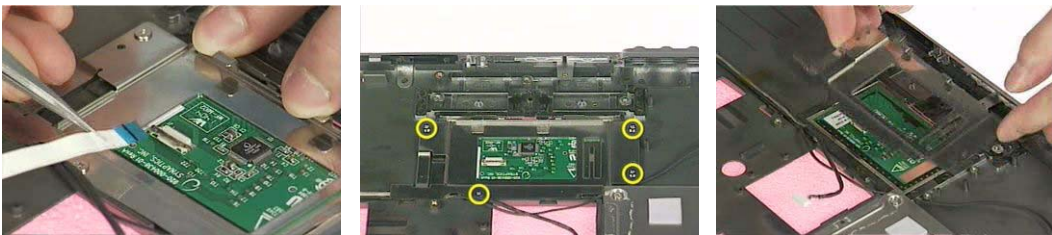

10. Remove the touchpad from the upper case.
11. Remove the two screws that secure the bluetooth module.
12. Disconnect the bluetooth module then remove it.



## Disassembling the Lower Case Assembly

1. Disconnect the MDC cable from the modem board.
2. Detach the MDC cable from the main board.
3. Remove the two screws holding the modem board.



4. Remove the modem board from the lower case.
5. Disconnect the speaker cable from the main board.
6. Remove the two screws that secure the main board.

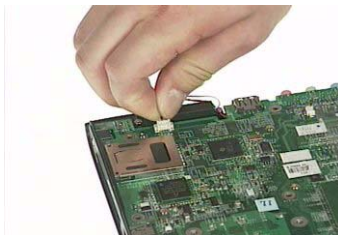

7. Remove the two screw nuts as shown.
8. The you can detach the main board from the upper case.
9. Remove the three screws that secure the VGA heatsink.

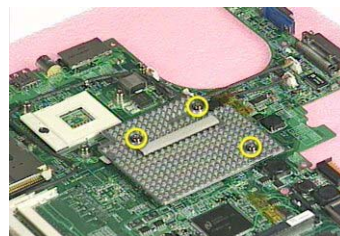
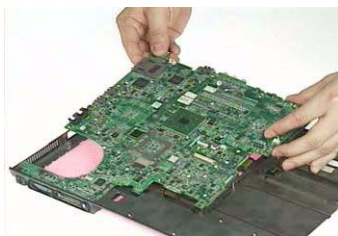
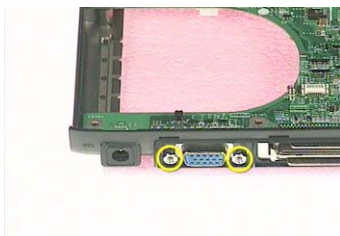

10. Remove the VGA heatsink from the main board as shown.
11. Remove the three in one cover from the lower case.
12. Remove the two screws that secure the speaker set on one side.

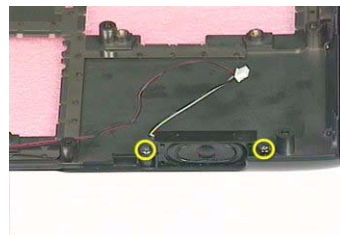
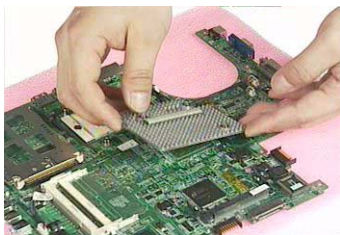

13. Then remove another two screws holding the speaker set on the other side.
14. Then take out the speaker set from the lower case.





## Disassembling the LCD Module

1. Remove the four screw caps as shown.
2. Remove the four screws holding the LCD bezel.
3. Then detach the LCD bezel from the LCD module.



4. Disconnect the inverter board then remove it.
5. Remove the three screws holding the right hinge.
6. Then remove the three screws that secure the left hinge.

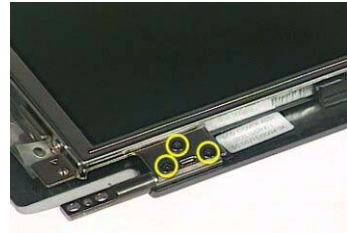
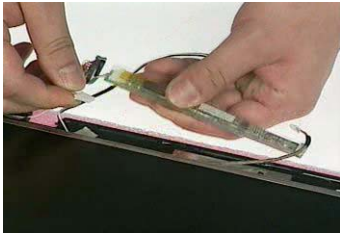

7. Remove one screw that secure the LCD bracket.
8. Remove another screw holding the LCD bracket on the other side.
9. Then detach the LCD panel from the LCD cover carefully.



10. Remove the two screws holding the right bracket.
11. Then remove the right bracket.
12. Remove another two screws that tighten the left bracket.



- 13.** Remove the left bracket as the picture shows.
- 14.** Tear off the tape fastening the LCD cable.
- 15.** Tear off the the LCD cable fastening the LCD cable, then remove it..





---

## Disassembling the External Modules

### Disassembling the HDD Module

1. Remove the two screws holding the HDD bracket on one side.
2. Remove another two screws holding the HDD bracket on the other side.
3. Then take the hard disc drive out from the HDD bracket.



### Disassembling the Optical Drive Module

1. Remove the four screws as the picture shows.
2. Remove the two screws that secure the optical disc drive and the ODD holder.

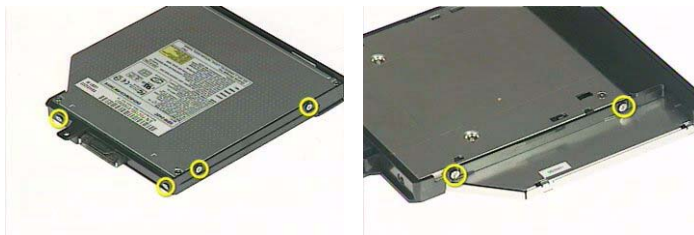

3. Push the ODD holder as shown.
4. Detach the ODD holder.
5. Disconnect the ODD connector board then remove it.

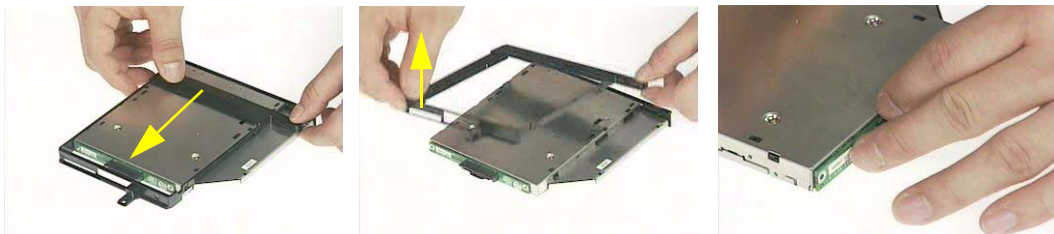



## Troubleshooting

Use the following procedure as a guide for computer problems.

**NOTE:** The diagnostic tests are intended to test this model. Non-Acer products, prototype cards, or modified options can give false errors and invalid system responses.

1. Duplicate symptom and obtain the failing symptoms in as much detail as possible.
2. Distinguish symptom. Verify the symptoms by attempting to re-create the failure by running the diagnostic test or by repeating the same operation.
3. Disassemble and assemble the unit without any power sources.
4. If any problem occurs, you can perform visual inspection before you follow this chapter's instructions. You can check the following:
  - power cords are properly connected and secured;
  - there are no obvious shorts or opens;
  - there are no obviously burned or heated components;
  - all components appear normal.
5. Use the following table with the verified symptom to determine which page to go to.

Symptoms (Verified)	Go To
Power failure. (The power indicator does not go on or stay on.)	"Power System Check" on page 71.
POST does not complete. No beep or error codes are indicated.	"Power-On Self-Test (POST) Error Message" on page 73 "Undetermined Problems" on page 85
POST detects an error and displayed messages on screen.	"Error Message List" on page 74
Other symptoms (i.e. LCD display problems or others).	"Power-On Self-Test (POST) Error Message" on page 73
Symptoms cannot be re-created (intermittent problems).	Use the customer-reported symptoms and go to "Power-On Self-Test (POST) Error Message" on page 73 "Intermittent Problems" on page 84 "Undetermined Problems" on page 85

---

# System Check Procedures

## External Diskette Drive Check

If an error occurs with the internal diskette drive, reconnect the diskette connector on the system board.

If the error still remains:

1. Reconnect the external diskette drive/DVD-ROM module.
2. Replace the external diskette drive/CD-ROM module.
3. Replace the main board.

## External CD-ROM Drive Check

Do the following to isolate the problem to a controller, drive, or CD-ROM. Make sure that the CD-ROM does not have any label attached to it. The label can cause damage to the drive or can cause the drive to fail.

Do the following to select the test device:

1. Boot from the diagnostics diskette and start the diagnostics program.
2. See if CD-ROM Test is passed when the program runs to CD-ROM Test.
3. Follow the instructions in the message window.

If an error occurs, reconnect the connector on the System board. If the error still remains:

1. Reconnect the external diskette drive/CD-ROM module.
2. Replace the external diskette drive/CD-ROM module.
3. Replace the main board.

## Keyboard or Auxiliary Input Device Check

Remove the external keyboard if the internal keyboard is to be tested.

If the internal keyboard does not work or an unexpected character appears, make sure that the flexible cable extending from the keyboard is correctly seated in the connector on the system board.

If the keyboard cable connection is correct, run the Keyboard Test.

If the tests detect a keyboard problem, do the following one at a time to correct the problem. Do not replace a non-defective FRU:

1. Reconnect the keyboard cables.
2. Replace the keyboard.
3. Replace the main board.

The following auxiliary input devices are supported by this computer:

- Numeric keypad
- External keyboard

If any of these devices do not work, reconnect the cable connector and repeat the failing operation.

## Memory check

Memory errors might stop system operations, show error messages on the screen, or hang the system.

1. Boot from the diagnostics diskette and start the doagmpstotics program (please refer to main board).
2. Go to the diagnostic memory in the test items.
3. Press F2 in the test items.
4. Follow the instructions in the message window.

**NOTE:** Make sure that the DIMM is fully installed into the connector. A loose connection can cause an error.

---

## Power System Check

To verify the symptom of the problem, power on the computer using each of the following power sources:

1. Remove the battery pack.
2. Connect the power adapter and check that power is supplied.
3. Disconnect the power adapter and install the charged battery pack; then check that power is supplied by the battery pack.

If you suspect a power problem, see the appropriate power supply check in the following list:

- “Check the Battery Pack” on page 72

---

## Check the Battery Pack

To check the battery pack, do the following:

From Software:

1. Check out the Power Management in control Panel
2. In Power Meter, confirm that if the parameters shown in the screen for Current Power Source and Total Battery Power Remaining are correct.
3. Repeat the steps 1 and 2, for both battery and adapter.
4. This helps you identify first the problem is on recharging or discharging.

From Hardware:

1. Power off the computer.
2. Remove the battery pack and measure the voltage between battery terminals 1(+) and 6(ground). See the following figure
3. If the voltage is still less than 7.5 Vdc after recharging, replace the battery.

To check the battery charge operation, use a discharged battery pack or a battery pack that has less than 50% of the total power remaining when installed in the computer.

If the battery status indicator does not light up, remove the battery pack and let it return to room temperature. Re-install the battery pack.

If the charge indicator still does not light up, replace the battery pack. If the charge indicator still does not light up, replace the DC/DC charger board.

## Touchpad check

If the touchpad doesn't work, do the following actions one at a time to correct the problem. Do not replace a non-defective FRU:

1. After rebooting, run Tracking Pad PS2 Mode Driver. For example, run Syn touch driver.
2. Run utility with the PS/2 mouse function and check if the mouse is working.
3. If the the PS/2 mouse does not work, then check if the main board to switch board FPC is connected O.K.
4. If the main board to switch board FPC is connected well, then check if the FCC on touch pad PCB connects properly.
5. If the FFC on touch pad PCB connects properly, then check if LS851 JP1 Pin6=5V are pulese. If yes, then replace switch board. If no, then go to next step.
6. Replace touch pad PCB.
7. If the touch pad still does not work, then replace FPC on Track Pad PCB.

After you use the touchpad, the pointer drifts on the screen for a short time. This self-acting pointer movement can occur when a slight, steady pressure is applied to the touchpad pointer. This symptom is not a hardware problem. No service actions are necessary if the pointer movement stops in a short period of time.

---

## Power-On Self-Test (POST) Error Message

The POST error message index lists the error message and their possible causes. The most likely cause is listed first.

**NOTE:** Perform the FRU replacement or actions in the sequence shown in FRU/Action column, if the FRU replacement does not solve the problem, put the original part back in the computer. Do not replace a non-defective FRU.

This index can also help you determine the next possible FRU to be replaced when servicing a computer.

If the symptom is not listed, see "Undetermined Problems" on page 85.

The following lists the error messages that the BIOS displays on the screen and the error symptoms classified by function.

**NOTE:** Most of the error messages occur during POST. Some of them display information about a hardware device, e.g., the amount of memory installed. Others may indicate a problem with a device, such as the way it has been configured.

**NOTE:** If the system fails after you make changes in the BIOS Setup Utility menus, reset the computer, enter Setup and install Setup defaults or correct the error.

---

## Index of Error Messages

### Error Message List

Error Messages	FRU/Action in Sequence
Struck Key	See "Keyboard or Auxiliary Input Device Check" on page 70
System CMOS checksum bad - Default configuration used	RTC battery Run BIOS Setup Utility to reconfigure system, then reboot system.
Real time clock error	RTC battery Run BIOS Setup Utility to reconfigure system time, then reboot system. Main board
Previous boot incomplete - Default configuration used	"Load Default Settings" in BIOS Setup Utility. RTC battery Main board
Invalid System Configuration Data	"Load Default Settings" in BIOS Setup Utility. Main board
Operating system not found	Enter Setup and see if fixed disk and drive A are properly identified. Dikette drive Hard disk drive Main board



## Error Message List

No beep Error Messages	FRU/Action in Sequence
Power-on indicator turns off and LCD is blank.	Power source (battery pack and power adapter.) See "Power System Check" on page 71 Ensure every connector is connected tightly and correctly. Reconnect the DIMM. Main board.
Power-on indicator turns on and LCD is blank.	Power source (battery pack and power adapter.) See "Power System Check" on page 71 Reconnect the LCD connector Hard disk drive LCD cable LCD inverter LCD Main board
Power-on indicator turns on and LCD is blank. But you can see POST on an external CRT.	Reconnect the LCD connectors. LCD cable LCD inverter LCD Main board
Power-on indicator turns on and a blinking cursor shown on LCD during POST.	Ensure every connector is connected tightly and correctly. Main board

## Phoenix BIOS Beep Codes

Code	Beeps	POST Routine Description
02h		Verify Real Mode
03h		Disable Non-Maskable Interrupt (NMI)
04h		Get CPU type
06h		Initialize system hardware
08h		Initialize chipset with initial POST values
09h		Set IN POST flag
0Ah		Initialize CPU registers
0Bh		Enable CPU cache
0Ch		Initialize caches to initial POST values
0Eh		Initialize I/O component
0Fh		Initialize the local bus IDE
10h		Initialize Power Management
11h		Load alternate registers with initial POST values
12h		Restore CPU control word during warm boot
13h		Initialize PCI Bus Mastering devices
14h		Initialize keyboard controller
16h	1-2-2-3	BIOS ROM checksum
17h		Initialize cache before memory autosize
18h		8254 timer initialization
1Ah		8237 DMA controller initialization
1Ch		Reset Programmable Interrupt Controller
20h	1-3-1-1	Test DRAM refresh
22h	1-3-1-3	Test 8742 Keyboard Controller
24h		Set ES segment register to 4 GB
26h		Enable A20 line
28h		Autosize DRAM
29h		Initialize POST Memory Manager
2Ah		Clear 215 KB base RAM
2Ch	1-3-4-1	RAM failure on address line xxxx
2Eh	1-3-4-3	RAM failure on data bits xxxx of low byte of memory bus
2Fh		Enable cache before system BIOS shadow
30h	1-4-1-1	RAM failure on data bits xxxx of high byte of memory bus
32h		Test CPU bus-clock frequency
33h		Initialize Phoenix Dispatch Manager
36h		Warm start shut down
38h		Shadow system BIOS ROM
3Ah		Autosize cache
3Ch		Advanced configuration of chipset registers
3Dh		Load alternate registers with CMOS values
42h		Initialize interrupt vectors
45h		POST device initialization
46h	2-1-2-3	Check ROM copyright notice

Code	Beeps	POST Routine Description
48h		Check video configuration against CMOS
49h		Initialize PCI bus and devices
4Ah		Initialize all video adapters in system
4Bh		QuietBoot start (optional)
4Ch		Shadow video BIOS ROM
4Eh		Display BIOS copyright notice
50h		Display CPU type and speed
51h		Initialize EISA board
52h		Test keyboard
54h		Set key click if enabled
58h	2-2-3-1	Test for unexpected interrupts
59h		Initialize POST display service
5Ah		Display prompt "Press F2 to enter SETUP"
5Bh		Disable CPU cache
5Ch		Test RAM between 512 and 640 KB
60h		Test extended memory
62h		Test extended memory address lines
64h		Jump to User Patch1
66h		Configure advanced cache registers
67h		Initialize Multi Processor APIC
68h		Enable external and CPU caches
69h		Setup System Management Mode (SMM) area
6Ah		Display external L2 cache size
6Bh		Load custom defaults (optional)
6Ch		Display shadow-area message
6Eh		Display possible high address for UMB recovery
70h		Display error messages
72h		Check for configuration errors
76h		Check for keyboard errors
7Ch		Set up hardware interrupt vectors
7Eh		Initialize coprocessor if present
80h		Disable onboard Super I/O ports and IRQs
81h		Late POST device initialization
82h		Detect and install external RS232 ports
83h		Configure non-MCD IDE controllers
84h		Detect and install external parallel ports
85h		Initialize PC-compatible PnP ISA devices
86h		Re-initialize onboard I/O ports
87h		Configure Motherboard Configurable Devices (optional)
88h		Initialize BIOS Area
89h		Enable Non-Maskable Interrupts (NMIs)
8Ah		Initialize Extended BIOS Data Area
8Bh		Test and initialize PS/2 mouse
8Ch		Initialize floppy controller

Code	Beeps	POST Routine Description
8Fh		Determine number of ATA drives (optional)
90h		Initialize hard-disk controllers
91h		Initialize local-bus hard-disk controllers
92h		Jump to UserPatch2
93h		Build MPTABLE for multi-processor boards
95h		Install CD ROM for boot
96h		Clear huge ES segment register
97h		Fixup Multi Processor table
98h	1-2	Search for option ROMs. One long, two short beeps on checksum failure.
99h		Check for SMART drive (optional)
9Ah		Shadow option ROMs
9Ch		Set up Power Management
9Dh		Initialize security engine (optional)
9Eh		Enable hardware interrupts
9Fh		Determine number of ATA and SCSI drives
A0h		Set time of day
A2h		Check key lock
A4h		Initialize Typematic rate
A8h		Erase F2 prompt
AAh		Scan for F2 key stroke
ACh		Enter SETUP
A Eh		Clear Boot flag
B0h		Check for errors
B2h		POST done- prepare to boot operating system
B4h	1	One short beep before boot
B5h		Terminate QuietBoot (optional)
B6h		Check password (optional)
B9h		Prepare Boot
BAh		Initialize DMI parameters
BBh		Initialize PnP Option ROMs
BCh		Clear parity checkers
BDh		Display MultiBoot menu
BEh		Clear screen (optional)
BFh		Check virus and backup reminders
C0h		Try to boot with INT 19
C1h		Initialize POST Error Manager (PEM)
C2h		Initialize error logging
C3h		Initialize error display function
C4h		Initialize system error handler
C5h		PnPnd dual CMOS (optional)
C6h		Initialize notebook docking (optional)
C7h		Initialize notebook docking late
C8h		Force check (optional)
C9h		Extended checksum (optional)
D2h		Unknown interrupt

Code	Beeps	POST Routine Description
E0h		Initialize the chipset
E1h		Initialize the bridge
E2h		Initialize the CPU
E3h		Initialize the system timer
E4h		Initialize system I/O
E5h		Check force recovery boot
E6h		Checksum BIOS ROM
E7h		Go to BIOS
E8h		Set Huge Segment
E9h		Initialize Multi Processor
EAh		Initialize OEM special code
EBh		Initialize PIC and DMA
ECh		Initialize Memory type
EDh		Initialize Memory size
EEh		Shadow Boot Block
EFh		System memory test
F0h		Initialize interrupt vectors
F1h		Initialize Run Time Clock
F2h		Initialize video
F3h		Initialize System Management Mode
F4h	1	Output one beep before boot
F5h		Boot to Mini DOS
F6h		Clear Huge Segment
F7h		Boot to Full DOS

# Index of Symptom-to-FRU Error Message

## LCD-Related Symptoms

Symptom / Error	Action in Sequence
LCD backlight doesn't work	First, plug a monitor to CRT port. Next, enter BIOS utility to running "Load Default Settings" then reboot the system. Reconnect the LCD connectors. Keyboard (if the brightness function key doesn't work). LCD cable LCD inverter LCD Main board
LCD is too dark LCD brightness cannot be adjusted	Enter BIOS Utility to execute "Load Setup Default Settings", then reboot system. Reconnect the LCD connectors. Keyboard (if the brightness function key doesn't work). LCD cable LCD inverter LCD Main board
Unreadable LCD screen Missing pels in characters Abnormal screen Wrong color displayed LCD has extra horizontal or vertical lines displayed.	Reconnect the LCD cable LCD cable LCD Main board

## Indicator-Related Symptoms

Symptom / Error	Action in Sequence
Indicator incorrectly remains off or on, but system runs correctly	Main board
HDD/CD-ROM active indicators cannot work	HDD/CD-ROM drive Device driver Main board

## Power-Related Symptoms

Symptom / Error	Action in Sequence
Power shuts down during operation	Power source (battery pack and power adapter). See "Power System Check" on page 71. Battery pack AC adapter See if the thermal module is overheat (Heat sink or fan). Main board
The system cannot power-on.	Power source (battery pack and power adapter). See "Power System Check" on page 71. Battery pack Power adapter CPU Main board
The system cannot power-off.	In Windows XP operating system, hold and press the power switch for more than 4 seconds. If the system can power off, then the main board is OK. Verify OS in the HDD. Main board

### Power-Related Symptoms

Symptom / Error	Action in Sequence
Battery can't be charged or discharged	See "Check the Battery Pack" on page 72. Battery pack Main board
System hang during POST	ODD/HDD/FDD/RAM module Main board

### PCMCIA-Related Symptoms

Symptom / Error	Action in Sequence
System cannot detect the PC Card (PCMCIA)	PCMCIA slot assembly Main board
PCMCIA slot pin is damaged.	PCMCIA slot assembly
PC Card cannot be inserted or ejected	Check if the PCMCIA slot is blocked Main board

### Memory-Related Symptoms

Symptom / Error	Action in Sequence
Memory count (size) appears different from actual size.	Enter BIOS Setup Utility to execute "Load Default Settings" then reboot system. RAM module Main board Check BIOS revision
System can power on, but you hear two long beeps: "B--, B--" and the LCD is blank.	Reinsert DIMM DIMM Main board

### Speaker-Related Symptoms

Symptom / Error	Action in Sequence
In Windows, multimedia programs, no sound comes from the computer.	OS volume control Audio driver Speaker Main board
Internal speakers make noise or emit no sound.	Speaker Main board
Microphone cannot work	Audio driver Volume control in Windows XP Main board

### Power Management-Related Symptoms

Symptom / Error	Action in Sequence
The system will not enter hibernation mode	Power option in Windows XP Hard disk drive Main board
The system doesn't enter standby mode after closing the lid of the portable computer.	Driver of Power Option Properties Lid close switch in upper case Main board

## Power Management-Related Symptoms

Symptom / Error	Action in Sequence
The system doesn't resume from hibernation/standby mode.	Connect AC adapter then check if the system resumes from Standby/Hibernation mode. Check if the battery is low. Hard disk drive Main board
The system doesn't resume from standby mode after opening the lid of the portable computer.	LCD cover switch Main board
Battery fuel gauge in Windows doesn't go higher than 90%.	Refresh battery (continue use battery until power off, then charge battery). Battery pack Main board
System hangs intermittently.	Reconnect hard disk/CD-ROM drives. Main board

## Peripheral-Related Symptoms

Symptom / Error	Action in Sequence
System configuration does not match the installed devices.	Enter BIOS Setup Utility to execute "Load Setup defaults", then reboot system. Reconnect hard disk/CD-ROM drives/FDD or other peripherals. Main board
External display does not work correctly.	Press Fn+F5, LCD/CRT/Both display switching Keyboard Main board
USB does not work correctly	Main board
Print problems.	Enter BIOS Setup Utility to execute "Load Default Settings" then reboot the system. Run printer self-test. Printer driver Printer cable Printer Main board
Parallel port device problems	Enter BIOS Setup Utility to execute "Load Default Settings" then reboot the system. Device driver Device cable Device Main board

## Keyboard/Touchpad-Related Symptoms

Symptom / Error	Action in Sequence
Keyboard (one or more keys) does not work.	Reconnect the keyboard cable. Keyboard Main board
Touchpad does not work.	Reconnect touchpad cable. Touchpad board Main board



---

### Modem/LAN-Related Symptoms

Symptom / Error	Action in Sequence
Internal modem does not work correctly.	Phone cable Driver Reconnect the Internal modem cable to the main board tightly. Main board
Internal LAN does not work correctly	Lan cable Driver Main board

**NOTE:** If you cannot find a symptom or an error in this list and the problem remains, see “Undetermined Problems” on page 85.

---

## Intermittent Problems

Intermittent system hang problems can be caused by a variety of reasons that have nothing to do with a hardware defect, such as: cosmic radiation, electrostatic discharge, or software errors. FRU replacement should be considered only when a recurring problem exists.

When analyzing an intermittent problem, do the following:

1. Run the diagnostic test for the system board in loop mode at least 10 times.
2. If no error is detected, do not replace any FRU.
3. If any error is detected, replace the FRU. Rerun the test to verify that there are no more errors.

---

## Undetermined Problems

The diagnostic problems does not identify which adapter or device failed, which installed devices are incorrect, whether a short circuit is suspected, or whether the system is inoperative.

Follow these procedures to isolate the failing FRU (do not isolate non-defective FRU).

**NOTE:** Verify that all attached devices are supported by the computer.

**NOTE:** Verify that the power supply being used at the time of the failure is operating correctly. (See "Power System Check" on page 71):

1. Power-off the computer.
2. Visually check them for damage. If any problems are found, replace the FRU.
3. Remove or disconnect all of the following devices:
  - Non-Acer devices
  - Printer, mouse, and other external devices
  - Battery pack
  - Hard disk drive
  - DIMM
  - PC Cards
4. Power-on the computer.
5. Determine if the problem has changed.
6. If the problem does not recur, reconnect the removed devices one at a time until you find the failing FRU.
7. If the problem remains, replace the following FRU one at a time. Do not replace a non-defective FRU:
  - System board
  - LCD assembly

---

# Use NAPP CD to Build Master Hard Disc Drive

## CD to Disk Recovery

1. Prepare NAPP CD, Recovery CD and System CD.
2. Put NAPP CD into the optical drive. Then boot up the system.
3. The system will ask you if you want to build NAPP Master HDD. Please press any key to continue.



4. NAPP CD will start to preload the system, please click [Y].

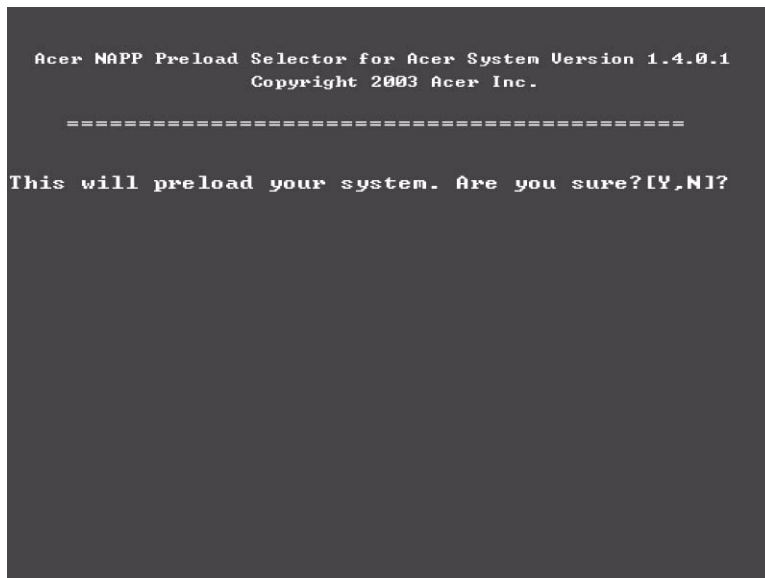

5. Select CD to Disk Recovery.

```
Method Selector
=====
1. Disk To Disk Recovery
2. CD to Disk Recovery
X. Quit

Please select your Choose...[1,2,x]?
```

6. Put the Recovery CD to the optical drive. This step is to create image files to the system, you do not have to put the Recovery CD to the optical drive in order. Place one Recovery CD to the drive at one time till you finish all Recovery CDs.

```
Please Insert Any Recovery CD

Please Press Any Key to Continue.
Press any key to continue...
_
```

After you place the Recovery CD to the optical drive, you will see the display below.

---

```
Please Wait for COPYING .....  
X:\images \70E40101.HDD
```

7. Then insert the System CD to the optical drive.

```
Please Insert the System CD  
  
Please Press Any Key to Continue.  
Press any key to continue...  
_
```

8. You will see the screen displaying "PASS" when the system has built NAPP Master hard disc drive.



## Disk to Disk Recovery

1. Prepare NAPP CD, Recovery CD and System CD.
2. Put NAPP CD into the optical drive. Then boot up the system.
3. The system will ask you if you want to build NAPP Master HDD. Please press any key to continue.



4. NAPP CD will start to preload the system, please click [Y].

```
Acer NAPP Preload Selector for Acer System Version 1.4.0.1
Copyright 2003 Acer Inc.

=====

This will preload your system. Are you sure?[Y,N]?
```

- 5. Select Disk to Disk Recovery. Then choose Single Language or Multi-Languages Recovery.  
**NOTE:** For Multi-Languages Recovery, not more than five languages could be loaded to the system.

```
Method Selector

=====

1. Single Language Recovery
2. Multi-Languages Recovery
X. Quit

Please select your Choose...[1,2,x]?
```

- 6. Put the Recovery CD to the optical drive. This step is to create image files to the system, you do not have to put the Recovery CD to the optical drive in order. Place one Recovery CD to the drive at one time till you finish all Recovery CDs.

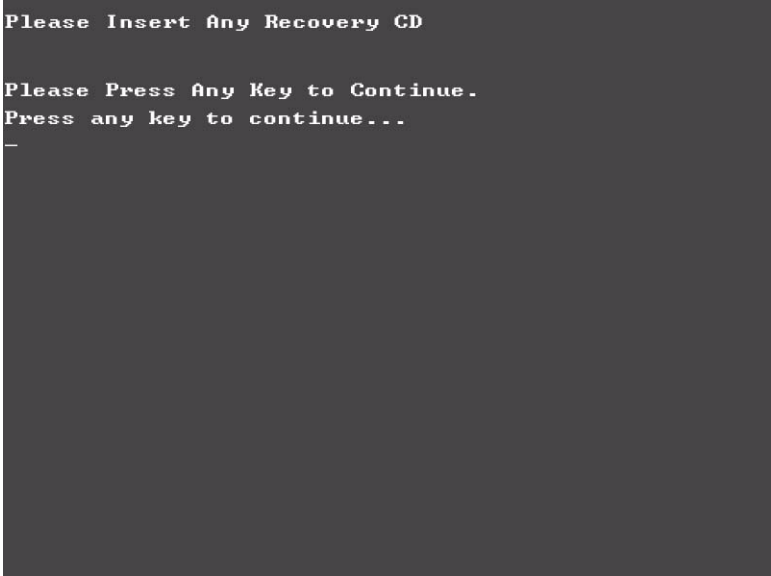

---

A dark gray rectangular area containing white text. The text reads: "Please Insert Any Recovery CD", "Please Press Any Key to Continue.", and "Press any key to continue...". There is a small horizontal line below the last line of text.

```
Please Insert Any Recovery CD

Please Press Any Key to Continue.
Press any key to continue...
_
```

After you place the Recovery CD to the optical drive, you will see the display below.

A dark gray rectangular area containing white text. The text reads: "Please Wait for COPYING .....", "X:\images \70E40101.HDD", and a large block of asterisks representing progress.

```
Please Wait for COPYING .....
X:\images \70E40101.HDD
*****
```

7. Then insert the System CD to the optical drive.

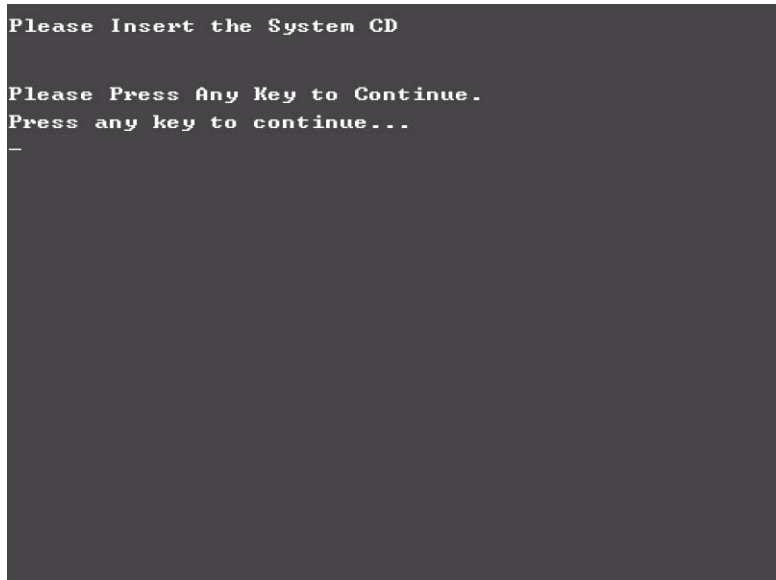

- 8. You will see the screen displaying "PASS" when the system has buit NAPP Master hard disc drive.



# Jumper and Connector Locations

## Top View

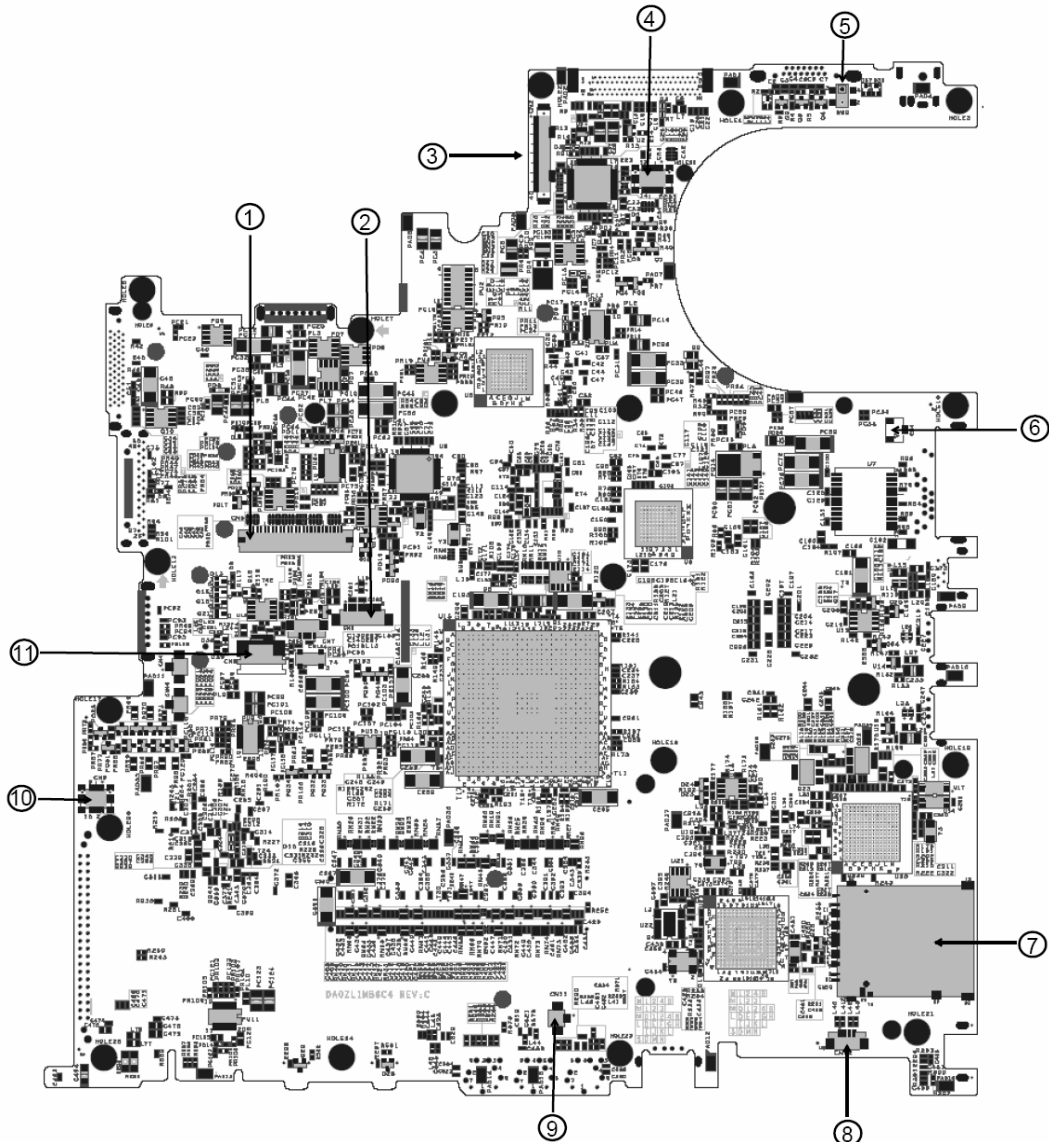

1	Keyboard Connector	CN5	7	3 in 1 Connector	CN10
2	Bluetooth Board Connector	CN6	8	Speaker Connector	CN12
3	LCD Cable Connector	CN2	9	Internal Microphone Connector	CN11
4	LED Board Connector	CN3	10	Modem Board Connector	CN9

---

5	Lid Switch	SW2	11	Touchpad Board Connector	CN8
6	Modem Cable Connector	CN4			

# Bottom View

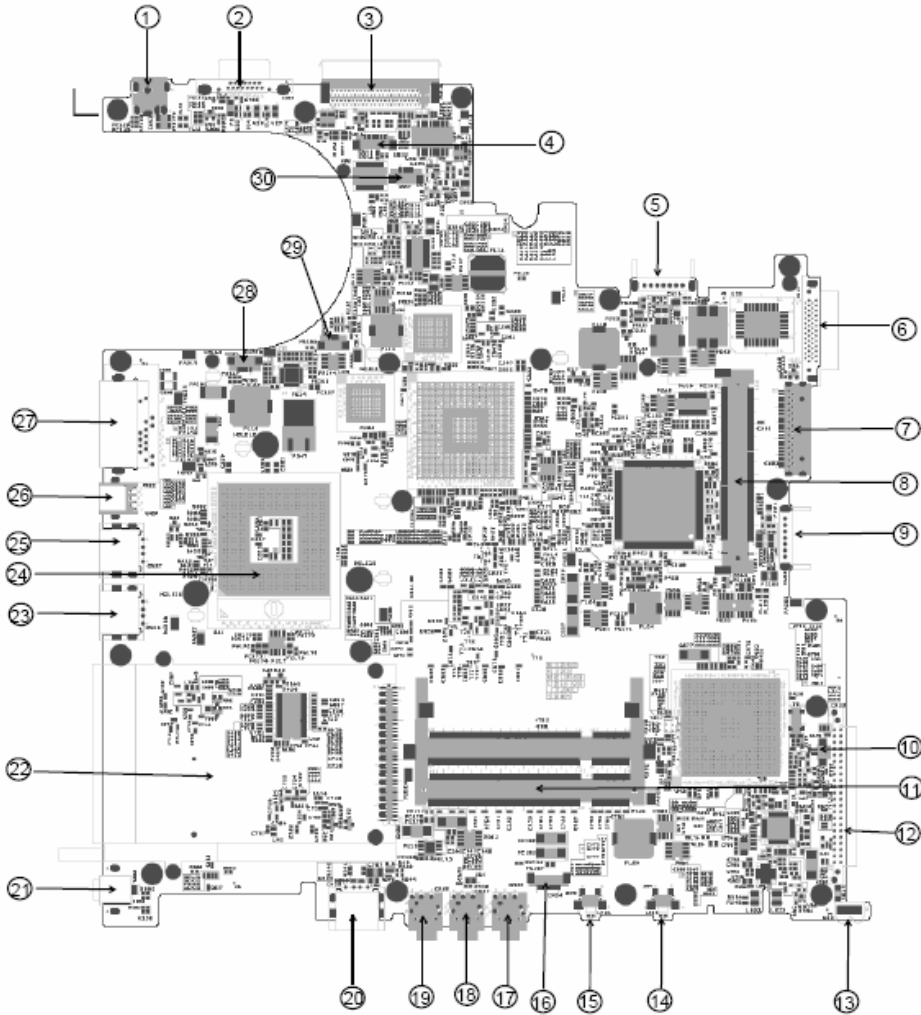

1	Power Jack	CN13	16	Audio Cable Connector	CN34
2	CRT	CN14	17	Line-in Connector	CN39
3	Docking	CN15	18	Headphone Out Connector	CN37
4	Audio Cable Connector	CN16	19	Microphone-in Connector	CN38
5	Main Battery Connector	CN18	20	USB Connector	CN36
6	ODD Connector	CN19	21	IEEE 1394 Connector	CN35
7	Media Bay Connector	CN23	22	PCMCIA	CN30
8	Mini PCI Slot	CN24	23	USB Connector	CN28
9	Second Battery Connector	CN26	24	CPU Socket	U41
10	RTC Battery Connector	CN31	25	USB Connector	CN27
11	DDR DIMM Connector	CN32	26	S-Video	CN25
12	HDD Connector	CN33	27	RJ45 and RJ11 Connector	CN22
13	IR	U53	28	LAN Cable Connector	CN21

---

14	Bluetooth Switch	SW4	29	FAN Connector	CN20
15	Wireless Switch	SW3	30	LAN Cable Connector	CN17

## FRU (Field Replaceable Unit) List

---

This chapter gives you the FRU (Field Replaceable Unit) listing in global configurations of TravelMate 4000/4500 series products. Refer to this chapter whenever ordering for parts to repair or for RMA (Return Merchandise Authorization).

Please note that WHEN ORDERING FRU PARTS, you should check the most up-to-date information available on your regional web or channel. For whatever reasons a part number change is made, it will not be noted on the printed Service Guide. For ACER AUTHORIZED SERVICE PROVIDERS, your Acer office may have a DIFFERENT part number code from those given in the FRU list of this printed Service Guide. You MUST use the local FRU list provided by your regional Acer office to order FRU parts for repair and service of customer machines.



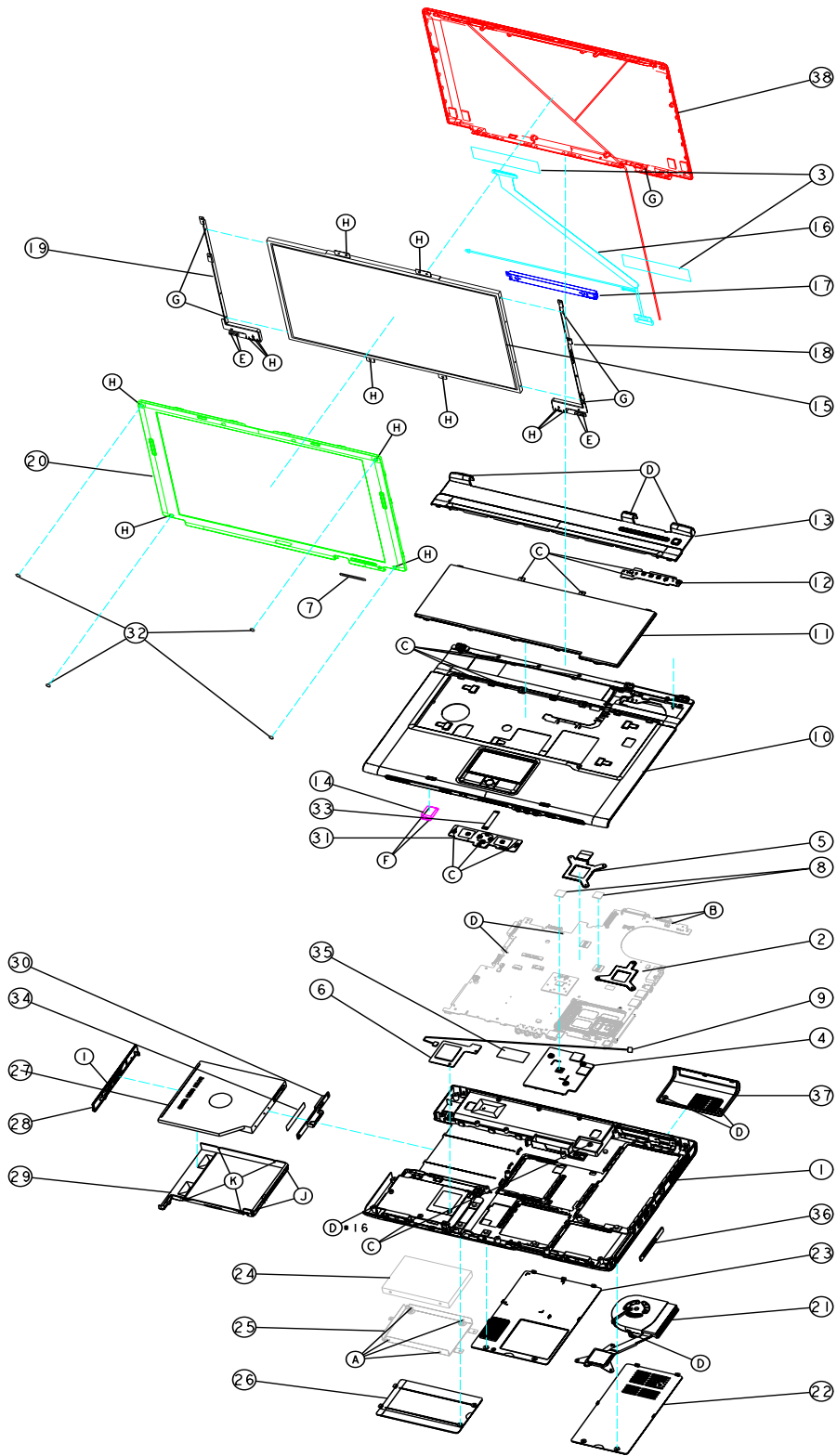

**NOTE:** To scrap or to return the defective parts, you should follow the local government ordinance or regulations on how to dispose it properly, or follow the rules set by your regional Acer office on how to return it.

# Exploded Diagram







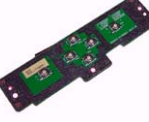



## TravelMate 4000

Picture	No.	Partname And Description	Part Number
<b>Adapter</b>			
	N/S	ADAPTER 65W 3 PIN DELTA SADP-65KB BF 19V	TBD
	N/S	ADAPTER 65W 3 PIN LITE-ON PA-1650-02 QA 19V	TBD
	N/S	ADAPTER 65W 3 PIN LI-SHIN SLS0335A 19V	TBD
<b>Battery</b>			
	N/S	BATTERY SANYO LI-ION 4S2P 4.4A 4UR18650F-2-QC140	TBD
		BATTERY PANASONIC LI-ION 4S2P 4.4A CGR-B/8B5AE	TBD
		BATTERY SIMPLO LI-ION 4S2P 4.4A 916-3020	TBD
<b>Boards</b>			
	9	MODEM BOARD	54.T50V7.001
	14	BLUETOOTH MODULE W/ANTENNA	54.T48V7.001
	N/S	WIRELESS LAN BOARD (802.11b+g) INTEL	KI.CAX01.005
	12	LAUNCH BOARD	55.T50V7.001
	31	TOUCH PAD BOARD	55.T50V7.002

## TravelMate 4000

Picture	No.	Partname And Description	Part Number
<b>Cables</b>			
	N/S	FFC CABLE - TP/B TO MB	50.T50V7.001
	N/S	MODEM CABLE	50.T50V7.002
	N/S	POWER CORD US (3 PIN)	27.A03V7.001
		POWER CORD PRC (3 PIN)	27.A03V7.003
		POWER CORD KOERA ( Pin)	27.T23V7.006
		POWER CORD EU (3 PIN)	27.A03V7.002
		POWER CORD UK (3 PIN)	27.A03V7.004
		POWER CORD ITALIAN (3 PIN)	27.A03V7.005
		POWER CORD- SWISS	27.A03V7.007
		POWER CORD AU (3 PIN)	27.A03V7.008
		POWER CORD DANISH (3 PIN)	27.A03V7.006
		POWER CORD AF (3 PIN)	27.T48V7.001
<b>Case/Cover/Bracket Assembly</b>			
	13	MIDDEL COVER ERGO W/BUTTON Note: The middle cover on the exploded diagram is non-ergo for Aspire series.	42.T50V7.001
	10	UPPER CASE ERGO W/TP, TP BRACKET, TP TO TP BOARD FFC CABLE Note: The upper case on the exploded diagram is non-ergo for Aspire series.	60.T50V7.001
	1	LOWER CASE W/SPEAKER	60.T51V7.001
	37	I/O BEZEL	42.T51V7.001
	23	DIMM/WIRELESS COVER	42.T50V7.002

## TravelMate 4000

Picture	No.	Partname And Description	Part Number
	22	HEATSINK COVER	42.T50V7.003
	26	HDD COVER	42.T50V7.004
	36	3 IN 1 DUMMY COVER Note: The image on the left is 3 in 1 cover. If that is 3 in 1 dummy cover, there is no card insert space on the cover.	42.T51V7.002
	25	HDD BRACKET	33.T50V7.001
<b>Communication Module</b>			
	N/S	WIRELESS LAN ANTENNA	50.T50V7.003
<b>CPU</b>			
	N/S	INTEL PENTIUM M 1.5G 2M 400FSB uFCPGA2 SL6F9 B-1 STEPPING	KC.N0001.715
		INTEL PENTIUM M 1.6G 2M 400FSB uFCPGA2 SL7EG B-1 STEPPING	KC.N0001.725
		INTEL PENTIUM M 1.7G 2M 400FSB uFCPGA2 SL7EP B-1 STEPPING	KC.N0001.735
		INTEL PENTIUM M 1.8G 2M 400FSB uFCPGA2 SL7EN B-1 STEPPING	KC.N0001.745
		INTEL PENTIUM M 2.0G 2M 400FSB uFCPGA2 SL7EM B-1 STEPPING	KC.N0001.755
<b>Optical Disc Drive Module</b>			
	N/S	DVD-ROM MODULE 8X QSI SDR-083	6M.T51V7.008
		DVD/CDRW COMBO MODULE 24X QSI SBW-242C	6M.T51V7.001
		DVD/CDRW COMBO MODULE KME UIDA-760	6M.T51V7.002
		DVD DUAL MODULE QSI SDW-042	6M.T51V7.003
		DVD DUAL MODULE PIONEER DVR-K14RA	6M.T51V7.004
		DVD DUAL MODULE LITE-ON SOSW-852S	6M.T51V7.005
		DVD SUPER MULTI MODULE KME UJ-830B	6M.T51V7.006
		DVD SUPER MULTI MODULE HLDS GSA-4080N	6M.T51V7.007



## TravelMate 4000

Picture	No.	Partname And Description	Part Number
	27	DVD-ROM DRIVE 8X QSI SDR-083	KV.00803.003
		DVD/CDRW COMBO DRIVE 24X QSI SBW-242C	KO.02407.014
		DVD/CDRW COMBO DRIVE 24X KME UIDA-760	KO.02406.008
		DVD DUAL DRIVE QSI SDW-042	KU.00403.001
		DVD DUAL DRIVE PIONEER DVR-K14RA	KU.00805.001
		DVD DUAL DRIVE LITE-ON SOSW-852S	KU.00805.001
		DVD SUPER MULTI DRIVE KME UJ-830B	KU.00807.003
		DVD SUPER MULTI DRIVE HLDS GSA-4080N	TBD
	29	OPTICAL DEVICE HOLDER-FIX	42.T51V7.003
	28	DVD-ROM BEZEL FOR QSI	42.T51V7.004
		DVD/CDRW BEZEL FOR QSI	42.T50V7.008
		DVD/CDRW BEZEL FOR KME	42.T50V7.009
		DVD DUAL BEZEL FOR QSI	42.T50V7.010
		DVD DUAL BEZEL FOR PIONEER	42.T50V7.011
		DVD DUAL BEZEL FOR LITE-ON	42.T50V7.012
		DVD SUPER MULTI BEZEL FOR KME	42.T50V7.013
		DVD SUPER MULTI BEZEL FOR HLDS	42.T50V7.014
HDD/Hard Disk Drive			
	24	30G HGST 2.5" 4200 Moraga+ HTS424030M9AT00 13G1486 fw:DA1017	KH.03007.006
		Toshiba Pluto 30G 4200rpm MK3025GAS	KH.03004.002
		Seagate 30G ST93015A,2MB F/W:4.05	KH.03001.001
		40G HGST 2.5" 4200 Moraga+ HTS424040M9AT00 13G1132 fw:DA1017	KH.04007.010
		Toshiba PLUTO 40G 4200rpm MK4025GAS ,KA100A F/W:KA100A	KH.04004.002
		SEAGATE 40G 4200rpm ST94019A, 2MB F/W:3.05	KH.04001.010
		HGST 60G 4200rpm MORAGA IC25N060ATMR04-0 08K0634 F/W:AD4A	KH.06007.006
		Toshiba PLUTO 60G 4200rpm MK6025GAS (phase in Mar/Apr) F/W:KA200A	KH.06004.003
		HGST 80G 4200rpm MORAGA IC25N080ATMR04-0 08K635 F/W:AD4A	KH.08007.007
		TOSHIBA PLUTO 80G 4200rpm MK8025GAS, 8MB F/W:KA023A	KH.08004.001
Keyboard			

## TravelMate 4000

Picture	No.	Partname And Description	Part Number
	11	TM4500/TM4000/TM2300 KEYBOARD DARFON US International Note: The keyboard on the exploded diagram is non-ergo for Aspire series.	KB.T5007.001
		TM4500/TM4000/TM2300 KEYBOARD DARFON Chinese	KB.T5007.002
		TM4500/TM4000/TM2300 KEYBOARD DARFON Spanish	KB.T5007.003
		TM4500/TM4000/TM2300 KEYBOARD DARFON Thai	KB.T5007.004
		TM4500/TM4000/TM2300 KEYBOARD DARFON Brazilian Protugese	KB.T5007.005
		TM4500/TM4000/TM2300 KEYBOARD DARFON Korea	KB.T5007.006
		TM4500/TM4000/TM2300 KEYBOARD DARFON UK	KB.T5007.007
		TM4500/TM4000/TM2300 KEYBOARD DARFON German	KB.T5007.008
		TM4500/TM4000/TM2300 KEYBOARD DARFON Italian	KB.T5007.009
		TM4500/TM4000/TM2300 KEYBOARD DARFON French	KB.T5007.010
		TM4500/TM4000/TM2300 KEYBOARD DARFON Swiss/G	KB.T5007.011
		TM4500/TM4000/TM2300 KEYBOARD DARFON Portuguese	KB.T5007.012
		TM4500/TM4000/TM2300 KEYBOARD DARFON Arabic	KB.T5007.013
		TM4500/TM4000/TM2300 KEYBOARD DARFON Belgium	KB.T5007.014
		TM4500/TM4000/TM2300 KEYBOARD DARFON Sweden	KB.T5007.015
		TM4500/TM4000/TM2300 KEYBOARD DARFON Czech	KB.T5007.016
		TM4500/TM4000/TM2300 KEYBOARD DARFON Hungaian	KB.T5007.017
		TM4500/TM4000/TM2300 KEYBOARD DARFON Norway	KB.T5007.018
		TM4500/TM4000/TM2300 KEYBOARD DARFON Danish	KB.T5007.019
		TM4500/TM4000/TM2300 KEYBOARD DARFON Turkish	KB.T5007.020
		TM4500/TM4000/TM2300 KEYBOARD DARFON Canadian French	KB.T5007.021
		TM4500/TM4000/TM2300 KEYBOARD DARFON Japanese	KB.T5007.022
		TM4500/TM4000/TM2300 KEYBOARD DARFON Greek	KB.T5007.023
		TM4500/TM4000/TM2300 KEYBOARD DARFON Hebrew	KB.T5007.024
		TM4500/TM4000/TM2300 KEYBOARD DARFON Russian	KB.T5007.025

## TravelMate 4000

Picture	No.	Partname And Description	Part Number
LCD Module			
	N/S	LCD MODULE 14.1 IN. XGA AU B141XG05	6M.T51V7.011
		LCD MODULE 14.1 IN. XGA QDI QD141XLH12	6M.T51V7.012
		LCD MODULE 14.1 IN. XGA CMO N141XB-L01	6M.T51V7.013
		LCD MODULE 15 IN. XGA AU B150XG01	6M.T50V7.011
		LCD MODULE 15 IN. XGA QDI QDI150XL06-01	6M.T50V7.012
		LCD MODULE 15 IN. XGA HANNSTAR HSD150PX14-A07	6M.T50V7.013
		LCD MODULE 15 IN. XGA SAMSUNG LTN150XB-L03	6M.T50V7.014
		LCD MODULE 15 IN. XGA HITACHI TX38D81VC1CAB	6M.T50V7.015
		LCD MODULE 15.4 IN. WXGA QDI QD15TL02-01	6M.T50V7.019
	20	LCD 14.1 IN. TFT XGA AU B141XG05	LK.14105.006
		LCD 14.1 IN. TFT XGA QDI QD141XLH12	LK.14109.003
		LCD 14.1 IN. TFT XGA CMO N141XB-L01	LK.1410D.003
		LCD 15" TFT XGA AU B150XG01 V2 (spwg-B)	LK.15005.001
		LCD 15 IN. XGA QDI QDI150XL06-01	LK.15009.002
		LCD 15 IN. XGA HANNSTAR HSD150PX14-A07	LK.15007.009
		LCD 15 IN. XGA SAMSUNG LTN150XB-L03	LK.15006.004
		LCD 15 IN. TFT XGA HITACHI TX38D81VC1CAB (SPWG-B)	LK.15004.006
		LCD 15.4 IN. WXGA QDI QD15TL02-01	LK.15409.001
	17	LCD INVERTER BOARD	19.T50V7.001

## TravelMate 4000

Picture	No.	Partname And Description	Part Number
	16	LCD CABLE - 14.1 IN. XGA	50.T51V7.001
		LCD CABLE - 15 IN. XGA	50.T50V7.004
		LCD CABLE - 15.4 IN. WXGA	50.T50V7.006
		LCD BRACKET W/HINGE 14 IN. - L	33.T51V7.001
		LCD BRACKET W/HINGE 14 IN. - R	33.T51V7.002
	19	LCD BRACKET W/HINGE 15 IN. - L	33.T50V7.002
	18	LCD BRACKET W/HINGE 15 IN. - R	33.T50V7.003
		LCD BRACKET W/HINGE 15.4 IN. - L	33.T50V7.004
		LCD BRACKET W/HINGE 15.4 IN. - R	33.T50V7.005
	38	LCD PANEL W/LOGO ANTENNA 14/15 IN.	60.T50V7.003
		LCD PANEL W/LOGO ANTENNA 15.4 IN.	60.T50V7.005
	20	LCD BEZEL W/RUBBER PAD 14 IN.	60.T51V7.002
		LCD BEZEL W/RUBBER PAD 15 IN.	60.T50V7.004
		LCD BEZEL W/RUBBER PAD 15.4 IN.	60.T50V7.006
<b>Main Board</b>			
	2	MAINBOARD 855GME M11 64MB W/PCMCIA SLOT W/O CPU MEMORY	LB.T5206.001
		MAINBOARD 855GME UMA W/PCMCIA SLOT W/O CPU MEMORY	LB.T5306.001
<b>Memory</b>			
	N/S	256MB NANYA SO-DIMM DDR333 256MB NT256D64SH8BAGM-6K (.14u)	KN.25603.009
		256M Infineon SO-DIMM DDR333 HYS64D32020GDL-6-C (.11u/B) (Sample April/M, 09/04' by firm PO)	KN.25602.022
		256M Infineon SO-DIMM DDR333 256MB HYS64D32020HDL-6-C 32x64 (.11u/G) (MP in Sept.)	KN.25602.012
		256M Micron SO-DIMM DDR333 256MB MT4VDDT3264HG-335C2	KN.25604.016
		256M Samsung SO-DIMM DDR333 256MB M470L3224FT0-CB3 (.13u)	KN.2560B.008
		256M Hynix SO-DIMM DDR333 256MB HYMD232M646D6-J AA	KN.2560G.001

## TravelMate 4000

Picture	No.	Partname And Description	Part Number
	N/S	512M Infineon SO-DIMM DDR333 512MB HYS64D64020GBDL-6-C (.11u/B)	KN.51202.013
	N/S	512MB NANYA SO-DIMM DDR333 512MB NT512D64SH8A0FM-6K	KN.51203.011
	N/S	512MB Micron SO-DIMM DDR333 512MB MT8VDDT6464HDG-335C1 (.11u),	KN.51204.013
<b>Speaker</b>			
	N/S	SPEAKER SET	23.T50V7.001
<b>Heatsink</b>			
	21	THERMAL MODULE	60.T50V7.007
	4	VGA HEATSINK W/PAD	34.T50V7.001
<b>Miscellaneous</b>			
	7	NAME PLATE	47.T51V7.001
	N/S	RUBBER FOOT	47.T50V7.002
	N/S	LCD SCREW RUBBER PAD	47.T50V7.003
	32	LCD BEZEL RUBBER PAD	47.T50V7.004
<b>Screw</b>			
	N/S	SCREW M2.0X3.0-I-NI-NYLOK	86.A03V7.012
	C	SCREW I2.5*3M-BNIH(M2.5L3)	86.T25V7.012
	N/S	SCREW M2.5*4L-BZN-NYLOK	86.A03V7.006
	N/S	SCREW M2.0X5-I-NI-NYLOK	86.T23V7.006
	D	SCREW MM25060IL69	86.A08V7.004
	N/S	SCREW M2.0*5-I(NI)(NYLOK)	86.T23V7.010
	K	SCREW M2.0X2.5-I-NI-NYLOK	86.A03V7.007
	G	SCREW I2*3M-NIHY (M2L3)	86.T25V7.008
	I	SCREW M1.7*3.0-I (BK)	86.T50V7.001
	A	SCREW I3*3.5M-NIH(M3L3.5)	86.A03V7.011



## TravelMate 4500

Picture	No.	Partname And Description	Part Number
<b>Adapter</b>			
		ADAPTER 65W 3 PIN DELTA SADP-65KB BF 19V	TBD
		ADAPTER 65W 3 PIN LITE-ON PA-1650-02 QA 19V	TBD
		ADAPTER 65W 3 PIN LI-SHIN SLS0335A 19V	TBD
<b>Battery</b>			
		BATTERY SANYO LI-ION 4S2P 4.4A 4UR18650F-2-QC140	TBD
		BATTERY PANASONIC LI-ION 4S2P 4.4A CGR-B/8B5AE	TBD
		BATTERY SIMPLO LI-ION 4S2P 4.4A 916-3020	TBD
<b>Boards</b>			
		MODEM BOARD	54.T50V7.001
		BLUETOOTH MODULE W/ANTENNA	54.T48V7.001
		WIRELESS LAN BOARD (802.11b+g) INTEL	KI.CAX01.005
		LAUNCH BOARD	55.T50V7.001
		TOUCH PAD BOARD	55.T50V7.002
<b>Cable</b>			
		FFC CABLE - TP/B TO MB	50.T50V7.001
		MODEM CABLE	50.T50V7.002
		POWER CORD US (3 PIN)	27.A03V7.001
		POWER CORD PRC (3 PIN)	27.A03V7.003
		POWER CORD KOERA ( Pin)	27.T23V7.006
		POWER CORD EU (3 PIN)	27.A03V7.002
		POWER CORD UK (3 PIN)	27.A03V7.004
		POWER CORD ITALIAN (3 PIN)	27.A03V7.005
		POWER CORD- SWISS	27.A03V7.007
		POWER CORD AU (3 PIN)	27.A03V7.008
		POWER CORD DANISH (3 PIN)	27.A03V7.006
		POWER CORD AF (3 PIN)	27.T48V7.001
<b>Case/Cover/Bracket Assembly</b>			
		MIDDEL COVER ERGO W/BUTTON	42.T50V7.001
		UPPER CASE ERGO W/TP, TP BRACKET, TP TO TP BOARD FFC CABLE	60.T50V7.001
		LOWER CASE FOR SWAP W/SPEAKER	60.T50V7.002
		I/O BEZEL FOR DOCKING	42.T50V7.005
		DIMM/WIRELESS COVER	42.T50V7.002
		HEATSINK COVER	42.T50V7.003
		HDD COVER	42.T50V7.004
		3 IN 1 COVER	42.T50V7.006
		HDD BRACKET	33.T50V7.001
<b>Communication Module</b>			
		WIRELESS LAN ANTENNA	50.T50V7.003
<b>CPU</b>			

**TravelMate 4500**

Picture	No.	Partname And Description	Part Number
		INTEL PENTIUM M 1.5G 2M 400FSB uFCPGA2 SL6F9 B-1 STEPPING	KC.N0001.715
		INTEL PENTIUM M 1.6G 2M 400FSB uFCPGA2 SL7EG B-1 STEPPING	KC.N0001.725
		INTEL PENTIUM M 1.7G 2M 400FSB uFCPGA2 SL7EP B-1 STEPPING	KC.N0001.735
		INTEL PENTIUM M 1.8G 2M 400FSB uFCPGA2 SL7EN B-1 STEPPING	KC.N0001.745
		INTEL PENTIUM M 2.0G 2M 400FSB uFCPGA2 SL7EM B-1 STEPPING	KC.N0001.755
Combo Module			
		DVD/CDRW COMBO MODULE 24X QSI SBW-242C SWAP	6M.T50V7.001
		DVD/CDRW COMBO DRIVE 24X QSI SBW- 242C	KO.02407.014
		OPTICAL DEVICE CONNECTOR BOARD W/ MYLARY	55.T50V7.003
		OPTICAL DEVICE HOLDER-SWAP	42.T50V7.007
		DVD/CDRW BEZEL FOR QSI	42.T50V7.008
		DVD/CDRW COMBO MODULE KME UID- 760 SWAP	6M.T50V7.002
		DVD/CDRW COMBO DRIVE 24X KME UID- 760	KO.02406.008
		OPTICAL DEVICE CONNECTOR BOARD W/ MYLARY	55.T50V7.003
		OPTICAL DEVICE HOLDER-SWAP	42.T50V7.007
		DVD/CDRW BEZEL FOR KME	42.T50V7.009
		DVD DUAL MODULE QSI SDW-042 SWAP	6M.T50V7.003
		DVD DUAL DRIVE QSI SDW-042	KU.00403.001
		OPTICAL DEVICE CONNECTOR BOARD W/ MYLARY	55.T50V7.003
		OPTICAL DEVICE HOLDER-SWAP	42.T50V7.007
		DVD DUAL BEZEL FOR QSI	42.T50V7.010
		DVD DUAL MODULE PIONEER DVR-K14RA SWAP	6M.T50V7.004
		DVD DUAL DRIVE PIONEER DVR-K14RA	KU.00805.001
		OPTICAL DEVICE CONNECTOR BOARD W/ MYLARY	55.T50V7.003
		OPTICAL DEVICE HOLDER-SWAP	42.T50V7.007
		DVD DUAL BEZEL FOR PIONEER	42.T50V7.011
		DVD DUAL MODULE LITE-ON SOSW-852S SWAP	6M.T50V7.005
		DVD DUAL DRIVE LITE-ON SOSW-852S	KU.00804.007
		OPTICAL DEVICE CONNECTOR BOARD W/ MYLARY	55.T50V7.003
		OPTICAL DEVICE HOLDER-SWAP	42.T50V7.007

## TravelMate 4500

Picture	No.	Partname And Description	Part Number
		DVD DUAL BEZEL FOR LITE-ON	42.T50V7.012
		DVD SUPER MULTI MODULE KME UJ-830B SWAP	6M.T50V7.006
		DVD SUPER MULTI DRIVE KME UJ-830B	KU.00807.003
		OPTICAL DEVICE CONNECTOR BOARD W/ MYLARY	55.T50V7.003
		OPTICAL DEVICE HOLDER-SWAP	42.T50V7.007
		DVD SUPER MULTI BEZEL FOR KME	42.T50V7.013
		DVD SUPER MULTI MODULE HLDS GSA-4080N SWAP	6M.T50V7.007
		DVD SUPER MULTI DRIVE HLDS GSA-4080N	TBD
		OPTICAL DEVICE CONNECTOR BOARD W/ MYLARY	55.T50V7.003
		OPTICAL DEVICE HOLDER-SWAP	42.T50V7.007
		DVD SUPER MULTI BEZEL FOR HLDS	42.T50V7.014
HDD/Hard Disk Drive			
		30G HGST 2.5" 4200 Moraga+ HTS424030M9AT00 13G1486 fw:DA1017	KH.03007.006
		Toshiba Pluto 30G 4200rpm MK3025GAS	KH.03004.002
		Seagate 30G ST93015A,2MB F/W:4.05	KH.03001.001
		40G HGST 2.5" 4200 Moraga+ HTS424040M9AT00 13G1132 fw:DA1017	KH.04007.010
		Toshiba PLUTO 40G 4200rpm MK4025GAS ,KA100A F/W:KA100A	KH.04004.002
		SEAGATE 40G 4200rpm ST94019A, 2MB F/W:3.05	KH.04001.010
		HGST 60G 4200rpm MORAGA IC25N060ATMR04-0 08K0634 F/W:AD4A	KH.06007.006
		Toshiba PLUTO 60G 4200rpm MK6025GAS (phase in Mar/Apr) F/W:KA200A	KH.06004.003
		HGST 80G 4200rpm MORAGA IC25N080ATMR04-0 08K635 F/W:AD4A	KH.08007.007
		TOSHIBA PLUTO 80G 4200rpm MK8025GAS, 8MB F/W:KA023A	KH.08004.001
Keyboard			
		TM4500/TM4000/TM2300 KEYBOARD DARFON US International	KB.T5007.001
		TM4500/TM4000/TM2300 KEYBOARD DARFON Chinese	KB.T5007.002
		TM4500/TM4000/TM2300 KEYBOARD DARFON Spanish	KB.T5007.003
		TM4500/TM4000/TM2300 KEYBOARD DARFON Thai	KB.T5007.004
		TM4500/TM4000/TM2300 KEYBOARD DARFON Brazilian Protugese	KB.T5007.005
		TM4500/TM4000/TM2300 KEYBOARD DARFON Korea	KB.T5007.006

## TravelMate 4500

Picture	No.	Partname And Description	Part Number
		TM4500/TM4000/TM2300 KEYBOARD DARFON UK	KB.T5007.007
		TM4500/TM4000/TM2300 KEYBOARD DARFON German	KB.T5007.008
		TM4500/TM4000/TM2300 KEYBOARD DARFON Italian	KB.T5007.009
		TM4500/TM4000/TM2300 KEYBOARD DARFON French	KB.T5007.010
		TM4500/TM4000/TM2300 KEYBOARD DARFON Swiss/G	KB.T5007.011
		TM4500/TM4000/TM2300 KEYBOARD DARFON Portuguese	KB.T5007.012
		TM4500/TM4000/TM2300 KEYBOARD DARFON Arabic	KB.T5007.013
		TM4500/TM4000/TM2300 KEYBOARD DARFON Belgium	KB.T5007.014
		TM4500/TM4000/TM2300 KEYBOARD DARFON Sweden	KB.T5007.015
		TM4500/TM4000/TM2300 KEYBOARD DARFON Czech	KB.T5007.016
		TM4500/TM4000/TM2300 KEYBOARD DARFON Hungarian	KB.T5007.017
		TM4500/TM4000/TM2300 KEYBOARD DARFON Norway	KB.T5007.018
		TM4500/TM4000/TM2300 KEYBOARD DARFON Danish	KB.T5007.019
		TM4500/TM4000/TM2300 KEYBOARD DARFON Turkish	KB.T5007.020
		TM4500/TM4000/TM2300 KEYBOARD DARFON Canadian French	KB.T5007.021
		TM4500/TM4000/TM2300 KEYBOARD DARFON Japanese	KB.T5007.022
		TM4500/TM4000/TM2300 KEYBOARD DARFON Greek	KB.T5007.023
		TM4500/TM4000/TM2300 KEYBOARD DARFON Hebrew	KB.T5007.024
		TM4500/TM4000/TM2300 KEYBOARD DARFON Russian	KB.T5007.025
LCD			
		LCD MODULE 15 IN. XGA AU B150XG01	6M.T50V7.011
		LCD 15" TFT XGA AU B150XG01 V2 (spwg- B)	LK.15005.001
		LCD INVERTER BOARD	19.T50V7.001
		LCD CABLE - 15 IN. XGA	50.T50V7.004
		LCD BRACKET W/HINGE 15 IN. - L	33.T50V7.002
		LCD BRACKET W/HINGE 15 IN. - R	33.T50V7.003
		LCD PANEL W/LOGO ANTENNA 14/15 IN.	60.T50V7.003
		LCD BEZEL W/RUBBER PAD 15 IN.	60.T50V7.004
		LCD MODULE 15 IN. XGA QDI QDI150XL06- 01	6M.T50V7.012

## TravelMate 4500

Picture	No.	Partname And Description	Part Number
		LCD 15 IN. XGA QDI QDI150XL06-01	LK.15009.002
		LCD INVERTER BOARD	19.T50V7.001
		LCD CABLE - 15 IN. XGA	50.T50V7.004
		LCD BRACKET W/HINGE 15 IN. - L	33.T50V7.002
		LCD BRACKET W/HINGE 15 IN. - R	33.T50V7.003
		LCD PANEL W/LOGO ANTENNA 14/15 IN.	60.T50V7.003
		LCD BEZEL W/RUBBER PAD 15 IN.	60.T50V7.004
		LCD MODULE 15 IN. XGA HANNSTAR HSD150PX14-A07	6M.T50V7.013
		LCD 15 IN. XGA HANNSTAR HSD150PX14-A07	LK.15007.009
		LCD INVERTER BOARD	19.T50V7.001
		LCD CABLE - 15 IN. XGA	50.T50V7.004
		LCD BRACKET W/HINGE 15 IN. - L	33.T50V7.002
		LCD BRACKET W/HINGE 15 IN. - R	33.T50V7.003
		LCD PANEL W/LOGO ANTENNA 14/15 IN.	60.T50V7.003
		LCD BEZEL W/RUBBER PAD 15 IN.	60.T50V7.004
		LCD MODULE 15 IN. XGA SAMSUNG LTN150XB-L03	6M.T50V7.014
		LCD 15 IN. XGA SAMSUNG LTN150XB-L03	LK.15006.004
		LCD INVERTER BOARD	19.T50V7.001
		LCD CABLE - 15 IN. XGA	50.T50V7.004
		LCD BRACKET W/HINGE 15 IN. - L	33.T50V7.002
		LCD BRACKET W/HINGE 15 IN. - R	33.T50V7.003
		LCD PANEL W/LOGO ANTENNA 14/15 IN.	60.T50V7.003
		LCD BEZEL W/RUBBER PAD 15 IN.	60.T50V7.004
		LCD MODULE 15 IN. XGA HITACHI TX38D81VC1CAB	6M.T50V7.015
		LCD 15 IN. TFT XGA HITACHI TX38D81VC1CAB (SPWG-B)	LK.15004.006
		LCD INVERTER BOARD	19.T50V7.001
		LCD CABLE - 15 IN. XGA	50.T50V7.004
		LCD BRACKET W/HINGE 15 IN. - L	33.T50V7.002
		LCD BRACKET W/HINGE 15 IN. - R	33.T50V7.003
		LCD PANEL W/LOGO ANTENNA 14/15 IN.	60.T50V7.003
		LCD BEZEL W/RUBBER PAD 15 IN.	60.T50V7.004
		LCD MODULE 15 IN. SXGA CMO N150P2-L04	6M.T50V7.016
		LCD 15" TFT SXGA+ CMO N150P2-L04	LK.1500D.003
		LCD INVERTER BOARD	19.T50V7.001
		LCD CABLE - 15 IN. SXGA	50.T50V7.005
		LCD BRACKET W/HINGE 15 IN. - L	33.T50V7.002
		LCD BRACKET W/HINGE 15 IN. - R	33.T50V7.003

## TravelMate 4500

Picture	No.	Partname And Description	Part Number
		LCD PANEL W/LOGO ANTENNA 14/15 IN.	60.T50V7.003
		LCD BEZEL W/RUBBER PAD 15 IN.	60.T50V7.004
		LCD MODULE 15 IN. SXGA AU B150PG01	6M.T50V7.017
		LCD 15" TFT SXGA+ AU B150PG01	LK.15005.002
		LCD INVERTER BOARD	19.T50V7.001
		LCD CABLE - 15 IN. SXGA	50.T50V7.005
		LCD BRACKET W/HINGE 15 IN. - L	33.T50V7.002
		LCD BRACKET W/HINGE 15 IN. - R	33.T50V7.003
		LCD PANEL W/LOGO ANTENNA 14/15 IN.	60.T50V7.003
		LCD BEZEL W/RUBBER PAD 15 IN.	60.T50V7.004
		LCD MODULE 15 IN. SXGA SAMSUNG LTN150P4-L03	6M.T50V7.018
		LCD 15 IN. TFT SXGA+ SAMSUNG LTN150P4-L03 (150nit)	LK.15006.006
		LCD INVERTER BOARD	19.T50V7.001
		LCD CABLE - 15 IN. SXGA	50.T50V7.005
		LCD BRACKET W/HINGE 15 IN. - L	33.T50V7.002
		LCD BRACKET W/HINGE 15 IN. - R	33.T50V7.003
		LCD PANEL W/LOGO ANTENNA 14/15 IN.	60.T50V7.003
		LCD BEZEL W/RUBBER PAD 15 IN.	60.T50V7.004
		LCD MODULE 15.4 IN. WXGA QDI QD15TL02-01	6M.T50V7.019
		LCD 15.4 IN. WXGA QDI QD15TL02-01	LK.15409.001
		LCD INVERTER BOARD	19.T50V7.001
		LCD CABLE - 15.4 IN. WXGA	50.T50V7.006
		LCD BRACKET W/HINGE 15.4 IN. - L	33.T50V7.004
		LCD BRACKET W/HINGE 15.4 IN. - R	33.T50V7.005
		LCD PANEL W/LOGO ANTENNA 15.4 IN.	60.T50V7.005
		LCD BEZEL W/RUBBER PAD 15.4 IN.	60.T50V7.006
<b>Mainboard</b>			
		MAINBOARD 855GME M11 64MB DOCKING 3 IN 1 W/PCMCIA SLOT W/O CPU MEMORY	LB.T5006.001
		MAINBOARD 855GME UMA DOCKING 3 IN 1 W/PCMCIA SLOT W/O CPU MEMORY	LB.T5106.001
<b>Memory</b>			
		256MB NANYA SO-DIMM DDR333 256MB NT256D64SH8BAGM-6K (.14u)	KN.25603.009
		256M Infineon SO-DIMM DDR333 HYS64D32020GDL-6-C (.11u/B) (Sample April/M, 09/04' by firm PO)	KN.25602.022
		256M Infineon SO-DIMM DDR333 256MB HYS64D32020HDL-6-C 32x64 (.11u/G) (MP in Sept.)	KN.25602.012
		256M Micron SO-DIMM DDR333 256MB MT4VDDT3264HG-335C2	KN.25604.016

## TravelMate 4500

Picture	No.	Partname And Description	Part Number
		256M Samsung SO-DIMM DDR333 256MB M470L3224FT0-CB3 (.13u)	KN.2560B.008
		256M Hynix SO-DIMM DDR333 256MB HYMD232M646D6-J AA	KN.2560G.001
		512M Infineon SO-DIMM DDR333 512MB HYS64D64020GBDL-6-C (.11u/B)	KN.51202.013
		512MB NANYA SO-DIMM DDR333 512MB NT512D64SH8A0FM-6K	KN.51203.011
		512MB Micron SO-DIMM DDR333 512MB MT8VDDT6464HDG-335C1 (.11u),	KN.51204.013
Speaker			
	SPEAKER	SPEAKER SET	23.T50V7.001
Heatsink			
		THERMAL MODULE	60.T50V7.007
		VGA HEATSINK W/PAD	34.T50V7.001
Miscellaneous			
		NAME PLATE	47.T50V7.001
		RUBBER FOOT	47.T50V7.002
		LCD SCREW RUBBER PAD	47.T50V7.003
		LCD BEZEL RUBBER PAD	47.T50V7.004
Weights Saver			
		WEIGHT SAVER	60.T50V7.008
2nd HDD Base			
		2nd HDD BASE W/CONNECT	60.T50V7.009
2nd HDD Cover			
		2nd HDD COVER	42.T50V7.015
2nd HDD Bracket Kit			
		2nd HDD BRACKET KIT	6K.T50V7.001
Screw			
		SCREW M2.0X3.0-I-NI-NYLOK	86.A03V7.012
		SCREW I2.5*3M-BNIH(M2.5L3)	86.T25V7.012
		SCREW M2.5*4L-BZN-NYLOK	86.A03V7.006
		SCREW M2.0X5-I-NI-NYLOK	86.T23V7.006
		SCREW MM25060IL69	86.A08V7.004
		SCREW M2.0*5-I(NI)(NYLOK)	86.T23V7.010
		SCREW M2.0X2.5-I-NI-NYLOK	86.A03V7.007
		SCREW I2*3M-NIHY (M2L3)	86.T25V7.008
		SCREW M1.7*3.0-I (BK)	86.T50V7.001
		SCREW I3*3.5M-NIH(M3L3.5)	86.A03V7.011







## Model Definition and Configuration

### TravelMate 4000 Series

Model Number	LCD	CPU	Memory	HDD	ODD	Wireless LAN	OS
4001WLCi	15.4" WXGA	PM 715 (1.5GHz/2M)	DDR333 1 or 2x256MB	40GB	24x Combo	11b/g	XPH
4001WLMi	15.4" WXGA	PM 715 (1.5GHz/2M)	DDR333 1 or 2x256MB	40/60GB	4x DVD-Dual	11b/g	XPH
4001WFLMi	15.4" WXGA	PM 715 (1.5GHz/2M)	DDR333 1x256MB	40GB	4x DVD-Dual	11b/g	IBM DOS
4001WFLCi	15.4" WXGA	PM 715 (1.5GHz/2M)	DDR333 1x256MB	40GB	24x Combo	11b/g	IBM DOS
4001WNLCi	15.4" WXGA	PM 715 (1.5GHz/2M)	DDR333 1x256MB	40GB	24x Combo	11b/g	Linux
4001WNLMi	15.4" WXGA	PM 715 (1.5GHz/2M)	DDR333 1x256MB	40GB	4x DVD-Dual	11b/g	Linux
4001LCi	15.0" XGA	PM 715 (1.5GHz/2M)	DDR333 2x256MB	40GB	24x Combo	11b/g	XPH
4001LMi	15.0" XGA	PM 715 (1.5GHz/2M)	DDR333 2x256MB	40/60GB	4x DVD-Dual	11b/g	XPH

## Test Compatible Components

---

This computer's compatibility is tested and verified by Acer's internal testing department. All of its system functions are tested under Windows® XP Home environment.

Refer to the following lists for components, adapter cards, and peripherals which have passed these tests. Regarding configuration, combination and test procedures, please refer to the TravelMate 2300/4000/4500 series Compatibility Test Report released by the Acer Mobile System Testing Department.

**NOTE:** Test Compatible List is **NOT** ready when the service guide is released. We will update test compatible list accordingly once we got test report.

# Microsoft® Windows® XP Pro Environment Test

Item	Specifications
Processor	Intel Celeron 1.3GHz Intel Celeron 1.4GHz Intel PMP 705Banias 1.5 GHz, Tj85 Intel Dothan 715/1.5GHz Intel Dothan 725/1.6GHz Intel Dothan 735/1.7GHz Intel Dothan 745/1.8GHz Intel Dothan 755/2.0GHz
Memory	256MB NANYA SO-DIMM DDR333 NT256D64SH8BAGM 256MB Infineon SO-DIMM DDR333 HYS64D32020GDL 256MB Infineon SO-DIMM DDR333 HYS64D32020HDL 256MB Micron SO-DIMM DDR333 MT4VDDT3264HG 256MB Samsung SO-DIMM DDR333 M470L3224FT0 256MB Hynix SO-DIMM DDR333 HYMD232M646D6 512M Infineon SO-DIMM DDR333 HYS64D64020GBDL 512MB Micron SO-DIMM DDR333 MT8VDDT6464HDG 1GMB Elpida SO-DIMM DDR333 EBD11UD8ADDA
LCD	14.1"XGA B141XG05 (AU) 14.1"XGA QD141X1LH12 (QDI) 14.1"XGA N141XB-L01 (CMO)
LCD	15.0"XGA B150XG01 V. 2 (AU) 15.0"XGA B150XG02 V.2 170 nits (AU) 15.0"XGA QD150XL06-01 160nits (QDI) 15.0"XGA LP150X08-A3 160nits (LG) 15.0"XGA HSD150PX14-A07 (Hannstar) 15.0"XGA LTN150XB-L03-C00 (Samsung) 15.0"XGA TX38D81VC1CAB Rev.B (Hitachi) 15.0"XGA N150X3-L07 (CMO/IDT) 15.0"XGA CLAA150XH01-N (CPT)
LCD	15.0" SXGA+ B150PG01 with NEC driver IC (AU) 15.0" SXGA+ N150P2-L04 (200nit) (IDT/CMO) 15.0" SXGA+ B150PG03 (200nit) (AU) 15.0" SXGA+ LTN150P4-L03 (Samsung) 15.0" SXGA+ QD15FL02 RV.01 (200nit) (QDI)
LCD	15.4" WXGA B154EW01 V.5 (170nit) (AU) 15.4" WXGA QD15TL02-01 (TN type) (185nit) (QDI) 15.4" WXGA N154I1-L09 (185nit) (CMO/IDT) 15.4" WXGA LTN154X2-L02 Low cost (Samsung) 15.4" WXGA Low cost TN TYPE (CPT) 15.4" WXGA Low Cost TN TYPE (LG) 15.4" WXGA TX39D85VC1FAA Low Cost (Hitachi) 15.4" WSXGA+ LP154W02-B1 (185nit) (LG) 15.4" WSXGA+ TX39D99VC1FAA (Hitachi) 15.4" WSXGA+ Low cost (Samsung)

Item	Specifications
Hard Disk Drive	30G HGST Moraga+ HTS424030M9AT00 30G Toshiba MK3025GAS30GB 30G Seagate 30G ST93015A  40G HGST Moraga+ HTS424040M9AT0040GB 40G Toshiba PLUTO MK4025GAS 40G SEAGATE ST94019A40G  60G HGST Moraga IC25N060ATMR04-0 60G TOSHIBA Neptune MK6021GAS  80G HGST Moraga IC25N080ATMR04 80G TOSHIBA Pluto MK8025GAS
DVD-ROM Drive 8X	DVD-ROM QSI SDR-083
DVD/CD-RW Combo	KME UJDA-760 QSI SBW-242C
DVD-dual	DVR-K14RA Lite-on SOSW-852S QSI SDW-042 QSI SDW-082
DVD-Super Multi	KME UJ-830B HLDS GSA-4080N
AC Adapter (3 pin)	Delta NB Asapter 65W, SADP-65KB BF Lite-on NB Adapter 65W, PA-1650-02 LSE NB Adapter 65W, P0335A1965
Power Cord	King Cord
Battery Li-Ion, 8 cells	Sanyo 4UR18650F-2-QC140 ZL1,4S2P,4.4A / AHA842223I4 Panasonic CGR-B/8B5AE,ZL1,4S2P,14.8V,4.4A / AHA84222050 Simplo 916-3020 4S2P,4.4A / AHA842221I0 Sanyo 4UR18650F-QC141 ZL1,4S1P,2.2A / AHA44122A01 Panasonic CGR-B/423AE,ZL1,4S1P,14.8V,2.2A / AHA441227I2 Simplo 916-2990 4S1P,2.2A / AHA44122909 Sanyo 3UF103450P-2-QC148 ZL1,3S2P,3.8A 6cell 2nd Bat / AHA632172I9
CRT Port	<b>CRT Monitor:</b> ViewSonic PF775 Philips Brilliance 109P 19" <b>LCD Monitor:</b> LCD Quanta ADT 20" LCD akia KX1 <b>Projector:</b> Panasonic PT-LC80U
Parallel Port	<b>Printer:</b> HP Desk Jet 840C HP Laser Jet 5M HP Deskjet 450 <b>Cable:</b> LL5 cable

Item	Specifications
1394 Port	<b>HDD:</b> IEEE 1394 (Fire Wire)/USB 1.1 Combo Hard Drive <b>CCD:</b> 1394 CCD (APLUX C102T) <b>1394 CardBus Card:</b> IEEE 1394 CardBus Card \DV Magician\UPMOST <b>Cable:</b> 1394 four to four cable
USB 2.0	<b>HUB:</b> Highspeed\4 Port UNION START UH-364 W-FORCE 4 Port USB2.0 Super Mini Hub <b>HDD:</b> USB HDD:VIPower(Smart Family Disk) <b>DVD/CD-RW:</b> Pioneer DVR-104 Ricoh MP5125A YAMAHA CD/RW-70 <b>Printer:</b> HP3425 Printer <b>Handy Drive:</b> SanDisk Cruzer USB 2.0 Handy Drive 256MB
USB Port	<b>USB Mouse:</b> BenQ M102-G80 Logitech Mouse M-BE58 Microsoft Wheel Mouse Optical USB & PS2 Compatible Acer MP0930 <b>USB Keyboard:</b> Microsoft Internet Keyboard Pro BenQ 6511-ME KILITEK <b>USB KeyPad:</b> LUNARIS TK-LU2BSV USB Keypad

Item	Specifications
USB Port	<b>USB CCD:</b> ViewQuest NB330 <b>USB HDD:</b> HD 530 Tested to comply with FCC Standards <b>USB FDD:</b> Teac USB FDD Yano USB FDD UFD-04 NEC USB FDD Mitsumi USB FDD D353FUE <b>USB Speaker:</b> J-S USB 3D Speaker /J1321 <b>USB Printer:</b> Canon BJC-3000 HD DeskJet 930C HP DeskJet 840C <b>USB Hub:</b> PCI_ USB HUB\UH-400 USB Hub /UH-9124Z <b>USB LAN:</b> BUFFALO USB-10/100M Ethernet LUX-TX <b>USB Handy Drive:</b> JMTEK USB 1.1 Handy Drive 128MB
GB LAN HUB	3COM SUPER STACK II \ 3C16611 24port
PS/2 Port	<b>Keyboard:</b> Microsoft Internet Keyboard Pro BTC Keyboard <b>PS/2 Keypad:</b> PC Keypad KB-5640 <b>Mouse:</b> Logitech M-C48
COM Port	<b>Mouse:</b> Logitech Serial Mouse M-MM43
S-Video	<b>TV:</b> SONY Trinitron 14"\PVM-14M2U
PC Card	<b>Modem Card:</b> Psion - Gold Card Global 56K+Fax <b>SyCard:</b> 16bit 32bit <b>16 bit LAN Card:</b> 3COM 10M LAN Card (3CCFE589ET) Xircom EtherNet 10/100+Modem56 CEM56-100 <b>CardBus LAN Card:</b> 3COM 10/100 CardBus LAN Card (3CCFE575CT) <b>SCSI:</b> Adaptec SlimSCSI APA-1460D Card Adaptec SlimSCSI 1480A CardBus UltraSCSI Card RATOC REX-CB80

Item	Specifications
PC Cards	<p><b>LAN+Modem card:</b> Xircom CreditCard Ethernet + Modem 56k (CEM56-100)</p> <p><b>ATA Card:</b> 4 in1 WIN&amp;MAC Card reader+Transcend 128MB Apapter CF Card Read + PNY CF CARD 128MB</p> <p><b>Wireless LAN Card:</b> CISCO AIRONET 350 SERIESAIR-PCM350 Linksys WPC11ver.4 Intel(R)PRO / Wireless 2011B LAN PC Card</p>
Memory Card	<p><b>MMC:</b> SanDisk 64MB</p> <p><b>Compact Flash Card:</b> PNY 128MB</p> <p><b>Memory Stick:</b> SONY 256MB</p> <p><b>SD Memory Card:</b> Apacer 128MB Toshiba 256MB</p> <p><b>Smart Media:</b> Transcend 128 MB Fuji 128 MB</p>
Audio Jacks	<p><b>Speaker:</b> J-S 3D Speaker /J-2202</p> <p><b>Headphone:</b> PHILIPS Stereo Headphone SBC HP090 Labtec Stereo Headphone Elite-840</p> <p><b>Earphone:</b> Philips Earphone</p> <p><b>Microphone:</b> Condenser MIC. EM-420T Labtec deskmic 524 Microphone</p>
Access Point	Intel 802.11B Linksys 54G
Bluetooth	HP Deskjet 450 with Ericsson bluetooth card
HDD	Toshiba 40G Toshiba 60G Toshiba 80G HITACHI 60G
ODD	MATSHITA UJDA755 DVD/CDRW



## Online Support Information

---

This section describes online technical support services available to help you repair your Acer Systems.

If you are a distributor, dealer, ASP or TPM, please refer your technical queries to your local Acer branch office. Acer Branch Offices and Regional Business Units may access our website. However some information sources will require a user i.d. and password. These can be obtained directly from Acer CSD Taiwan.

Acer's Website offers you convenient and valuable support resources whenever you need them.

In the Technical Information section you can download information on all of Acer's Notebook, Desktop and Server models including:

- Service guides for all models
- User's manuals
- Training materials
- Bios updates
- Software utilities
- Spare parts lists
- TABs (Technical Announcement Bulletin)

For these purposes, we have included an Acrobat File to facilitate the problem-free downloading of our technical material.

Also contained on this website are:

- Detailed information on Acer's International Traveler's Warranty (ITW)
- Returned material authorization procedures
- An overview of all the support services we offer, accompanied by a list of telephone, fax and email contacts for all your technical queries.

We are always looking for ways to optimize and improve our services, so if you have any suggestions or comments, please do not hesitate to communicate these to us.

