

Acer TravelMate 240/250 Series

Service Guide

SERVICE CD PART NO.: VD.T30V1.001

PRINTED IN TAIWAN

Revision History

Please refer to the table below for the updates made on HP Lapin service guide.

Date	Chapter	Updates

Copyright

Copyright © 2003 by Acer Incorporated. All rights reserved. No part of this publication may be reproduced, transmitted, transcribed, stored in a retrieval system, or translated into any language or computer language, in any form or by any means, electronic, mechanical, magnetic, optical, chemical, manual or otherwise, without the prior written permission of Acer Incorporated.

Disclaimer

The information in this guide is subject to change without notice.

Acer Incorporated makes no representations or warranties, either expressed or implied, with respect to the contents hereof and specifically disclaims any warranties of merchantability or fitness for any particular purpose. Any Acer Incorporated software described in this manual is sold or licensed "as is". Should the programs prove defective following their purchase, the buyer (and not Acer Incorporated, its distributor, or its dealer) assumes the entire cost of all necessary servicing, repair, and any incidental or consequential damages resulting from any defect in the software.

Intel is a registered trademark of Intel Corporation.

Pentium and Pentium II/III are trademarks of Intel Corporation.

Other brand and product names are trademarks and/or registered trademarks of their respective holders.

Conventions

The following conventions are used in this manual:

Screen messages	Denotes actual messages that appear on screen.
NOTE	Gives bits and pieces of additional information related to the current topic.
WARNING	Alerts you to any damage that might result from doing or not doing specific actions.
CAUTION	Gives precautionary measures to avoid possible hardware or software problems.
IMPORTANT	Reminds you to do specific actions relevant to the accomplishment of procedures.

Preface

Before using this information and the product it supports, please read the following general information.

1. This Service Guide provides you with all technical information relating to the BASIC CONFIGURATION decided for Acer "global" product offering. To better fit local market requirements and enhance product competitiveness, your regional office MAY have decided to extend the functionality of a machine (e.g. add-on card, modem, or extra memory capability). These LOCALIZED FEATURES will NOT be covered in this generic service guide. In such cases, please contact your regional offices or the responsible personnel/channel to provide you with further technical details.
2. Please note WHEN ORDERING FRU PARTS, that you should check the most up-to-date information available on your regional web or channel. If, for whatever reason, a part number change is made, it will not be noted in the printed Service Guide. For ACER AUTHORIZED SERVICE PROVIDERS, your Acer office may have a DIFFERENT part number code to those given in the FRU list of this printed Service Guide. You MUST use the list provided by your regional Acer office to order FRU parts for repair and service of customer machines.

Chapter 1	System Introduction	1
	Features	1
	System Block Diagram	3
	Board Layout	4
	Panel	6
	Indicators	12
	Keyboard	14
	Hot Keys	16
	Hardware Specifications and Configurations	19
Chapter 2	System Utilities	34
	BIOS Setup Utility	34
	BIOS Flash Utility	46
	System Diagnostic Diskette	46
Chapter 3	Machine Disassembly and Replacement	48
	General Information	49
	Disassembly Procedure Flowchart	50
	Removing the Battery	52
	Removing the Memory Module	53
	Removing the Modem Board	54
	Removing the Hard Disk Drive Module	55
	Removing the LCD Module	56
	Disassembling the LCD Module	59
	Disassembling the Main Unit	63
	System Upgrade Procedure	73
	Machine Disassembly and Replacement 74	
	Assembling the Main Unit	74
	Assembling the LCD Module	83
	Installing the LCD Module	87
	Installing the Hard Disk Drive Module	90
	Removing the Modem Board	91
	Installing the Memory Module	92
	Installing the Battery	93
Chapter 4	Troubleshooting	94
	System Check Procedures	95
	Power-On Self-Test (POST) Error Message	99
	Index of Error Messages	100
	Index of Symptom-to-FRU Error Message	103
	Intermittent Problems	106
	Undetermined Problems	107
Chapter 5	Jumper and Connector Locations	108
Chapter 6	FRU (Field Replaceable Unit) List	112
	TravelMate 240/250 Exploded Diagram	113
Appendix A	Model Definition and Configuration 126	
	Model Name Definition	126
Appendix B	Test Compatible Components 128	
	Microsoft Windows XP Environment Test	129

Table of Contents

Microsoft Windows 2000 Environment Test	133
Microsoft Windows 98 Environment Test	137
Appendix C Online Support Information	142
Index	144

Table of Contents

System Introduction

Features

This computer was designed with the user in mind. Here are just a few of its many features:

Performance

- Intel® Mobile Pentium® 4 series processors with 512 KB L2 cache or Intel® Mobile Celeron® processor with 256 KB L2 cache 64-bit memory bus
- 64-bit memory bus
- CD, DVD or DVD/CD-RW combo drive.
- Built-in floppy diskette drive
- High-capacity, Enhanced-IDE hard disk
- High-capacity battery pack
- Advanced Configuration Power Interface (ACPI) power management system

Multimedia

- 16-bit high-fidelity AC'97 stereo audio with 3D sound and wavetable synthesizer
- Built-in dual speakers
- High-speed CD, DVD, or DVD/CD-RW combo drive

Connectivity

- High-speed fax/data modem port
- Ethernet/Fast Ethernet port
- USB (Universal Serial Bus) 2.0 ports
- 802.11a+g/802.11b wireless LAN option
- Bluetooth option

Multimedia

- All-in-one design (CD-ROM, floppy disk drive, hard disk drive)
- Sleek, smooth and stylish design
- Full-sized keyboard
- Ergonomically centered touchpad pointing device with Internet scroll key

Expansion

- Two type II CardBus PC Card slots/ One Type III CardBus PC card slot
- Upgradeable memory

I/O Ports

- One VGA port (external CRT)
- One DC-in port (AC adapter)
- One microphone/line-in port
- One line-out port
- Two CardBus type II slot (3.3V and 5V support)

-
- Four USB ports (USB 2.0 compliant)
 - One RJ-11 port
 - One RJ-45 jack
 - One parallel port
 - One FIR

Display

- 14.1" or 15" Thin-Film Transistor (TFT) liquid crystal display (LCD) displaying 16M color at 1024x768 XGA (eXtended Graphics Array) resolution
- 3D capabilities
- Simultaneous LCD and CRT display support
- Supports other output display devices such as LCD projection panels for large audience presentations
- Dual display capacity

System Block Diagram

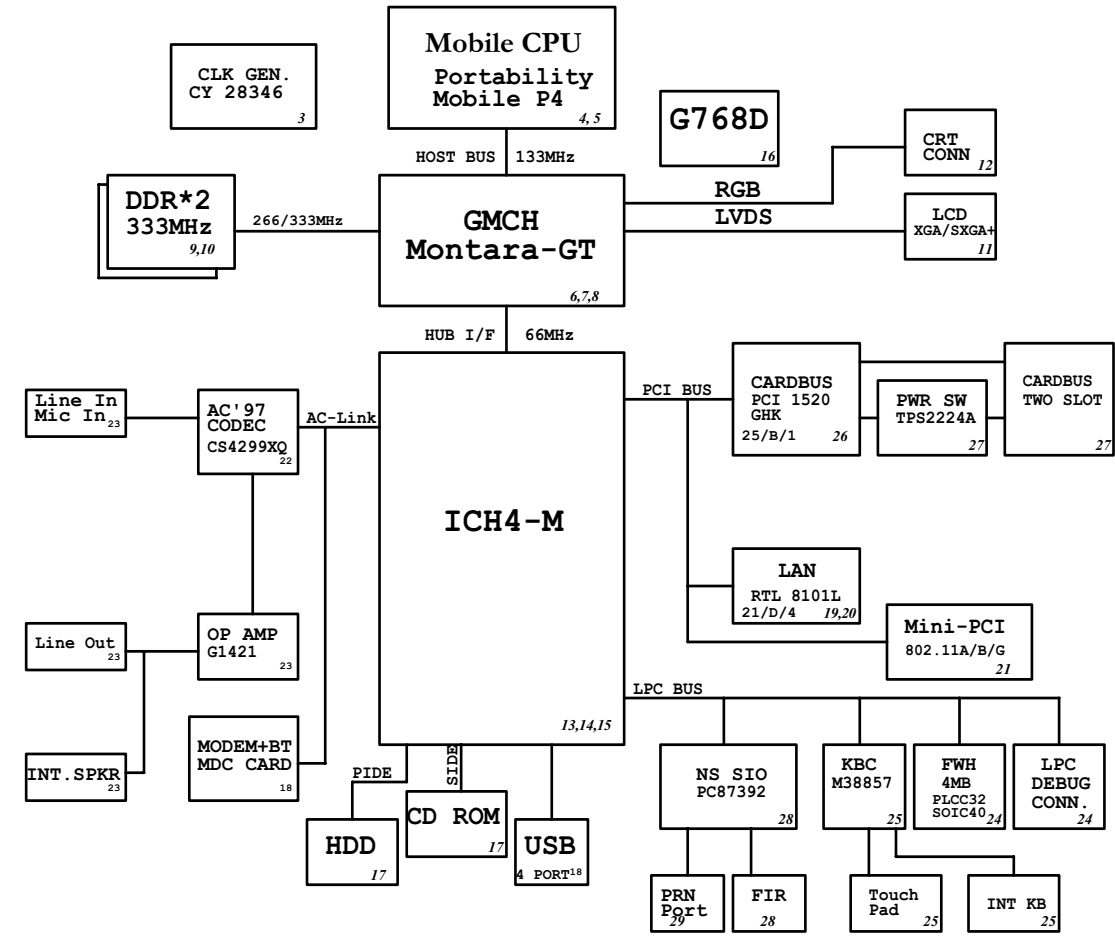

Board Layout

Top View

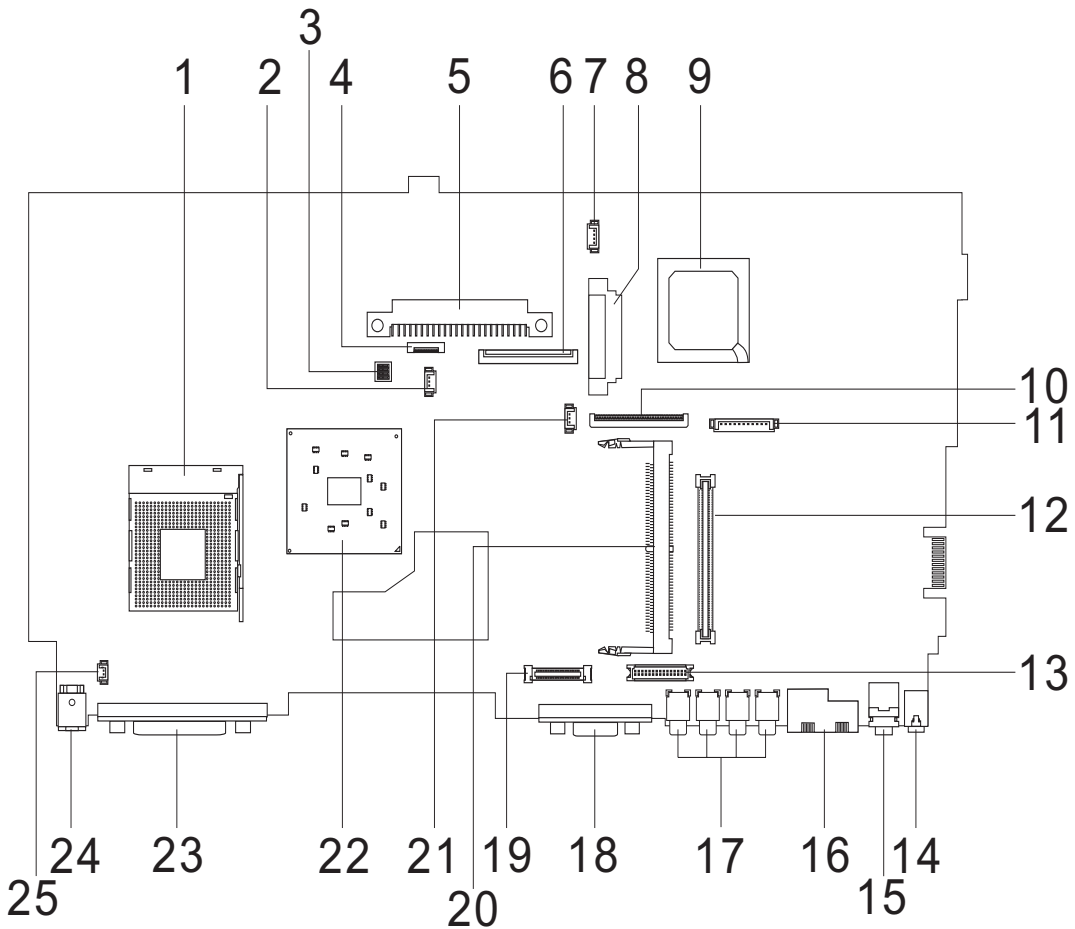

- | | | | |
|----|--|----|-----------------------------|
| 1 | CPU Socket | 14 | Line-in Port |
| 2 | Fan Connector | 15 | Line-out Port |
| 3 | SW1 (Please see Chapter 5 for detailed settings) | 16 | RJ45+RJ11 |
| 4 | Touchpad Cable Connector | 17 | Four USB Ports |
| 5 | HDD Connector | 18 | VGA Port |
| 6 | Keyboard Connector | 19 | LCD Coaxial Cable Connector |
| 7 | Speaker Cable Connector | 20 | Mini PCI Connector |
| 8 | Optical Drive Connector | 21 | RTC Battery Connector |
| 9 | South Bridge | 22 | North Bridge |
| 10 | FDD Connector | 23 | Parallel Port |
| 11 | Launch Cable Connector | 24 | DC-in Port |
| 12 | PCMCIA Slot | 25 | LCD Lid Switch |
| 13 | LCD Inverter Cable Connector | | |

Bottom View

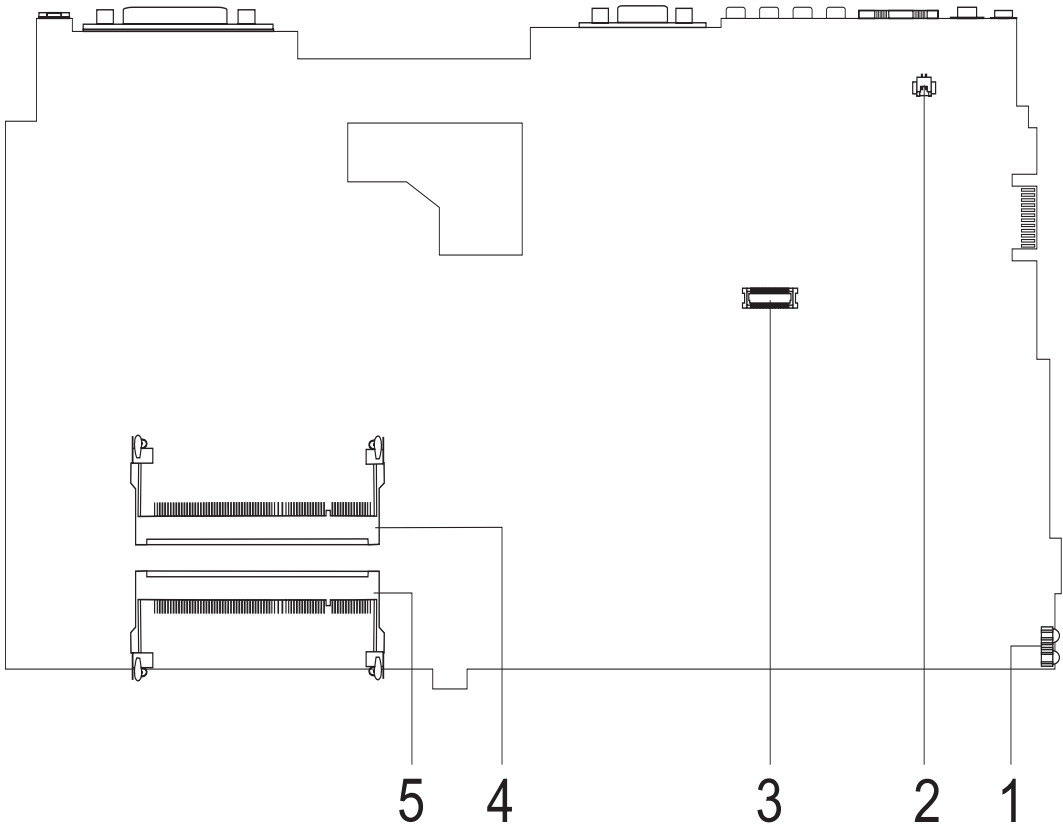

- 1 FIR Port
- 2 Modem Cable Connector
- 3 Modem Card Connector
- 4 DIMM Socket 2
- 5 DIMM Socket 1

Panel

Ports allow you to connect peripheral devices to your computer as you would with a desktop PC.

Front Panel



Left Panel

#	Item	Description
1	Display screen	Also called LCD (Liquid Crystal Display), displays computer output.
2	Status indicators	LEDs (Light Emitting Diodes) that turn on and off to show the status of the computer and its functions and components.
3	Launch Keys	Buttons for launching frequently used programs. See "Launch keys" on page 17 for more details.
4	Power switch	Turns on the computer power.
5	Palmrest	Comfortable support area for your hands when you use the computer.
6	Click buttons (left, center and right)	The left and right buttons function like the left and right mouse buttons, the center button serves as a scroll up/down button.
7	Touchpad	Touch-sensitive pointing device which functions like a computer mouse.
8	Keyboard	Inputs data into your computer.
9	Ventilation Slot	Enables the computer to stay cool, even after the prolonged use.

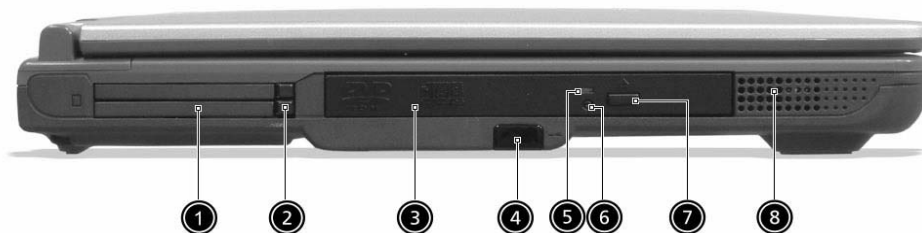

#	Icon	Item/ Port	Description
1		PCMCIA (PC card) Port	Connects to one Type III 16-bit PC card or 32-bit CardBus PC Card.
2		Eject button	Eject PC cards from the card slots.
3		Optical drive	Internal optical drive; accepts CDs or DVDs depending on the optical drive type.
4		Infrared port	Interfaces with infrared devices (e.g., infrared printer, IR-aware computer).
5		LED indicator	Lights up when the optical drive is active.
6		Emergency eject slot	Ejects the optical drive tray when the computer is turned off. There is a mechanical eject button on the CD-ROM or DVD-ROM drive. Simply insert the tip of a pen or paperclip and push to eject the tray.

#	Icon	Item/ Port	Description
7		Eject button	Ejects the optical drive tray from the drive.
8		Speaker	Delivers stereo audio output.

Right Panel

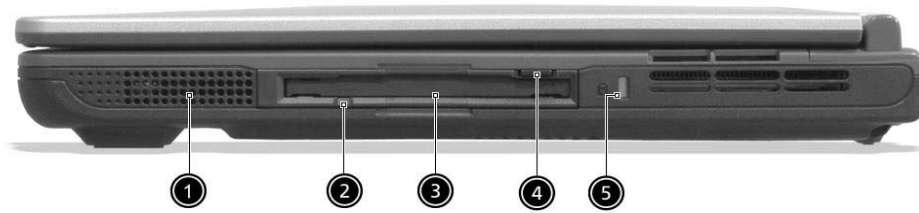

#	Icon	Item/ Port	Description
1		Speaker	Delivers stereo audio output.
2		Floppy activity indicator	LED (light-emitting diode) that turns on and off when the floppy is active.
3		Floppy drive	Internal diskette drive; accepts 3.5-inch diskettes.
4		Floppy disk eject button	Push this button to eject the floppy disk.
5		Security keylock	Connects to a Kensington-compatible computer security lock.

Rear Panel

I



#	Icon	Port	Description
1		Power Jack	Connects to an AC adapter
2		Parallel port	Connects to a parallel device (e.g., parallel printer)
3		External display port	Connects to a display device (e.g., external monitor, LCD projector) and displays up to 16M colors at 1024x768 resolution
4		USB port (four)	Connects to any Universal Serial Bus devices(e.g., USB mouse, USB camera).
5		Network jack	Connects to an Ethernet 10/100-based network
6		Modem jack	Connects to the phone line
7		Line-in jack	Accepts audio line-in devices (e.g., audio CD player, stereo walkman).
8		Speaker/Headphone-out jack	Connects to audio line-out devices (e.g., speakers, headphones).

Bottom Panel









#	Item	Description
1	Battery bay	Houses the computer's battery pack.
2	Battery release latch	Unlatches the battery to remove the battery pack.
3	Memory compartment	Houses the computer's main memory.

Indicators

The computer has six easy-to-read status icons on the right of the display screen.



The Power and Standby status icons are visible even when you close the display cover so you can see the status of the computer while the cover is closed.

#	Icon	Function	Description
1		Power	Lights when the computer is on.
2		Sleep	Lights when the computer enters Standby mode and blinks when it enters into or resumes from hibernation mode.
3		Media Activity	Lights when the floppy drive, hard disk or optical drive is active.
4		Battery Charge	Lights when the battery is being charged.
5		Caps Lock	Lights when Caps Lock is activated.
6		Num Lock (Fn-F11)	Lights when Numeric Lock is activated.

Understanding the icons

When the cover of your computer is closed, 2 easy-to-read icons are shown, indicating which state or feature is enabled or disabled.



#	Icon	Function	Description
1		Power	Lights up when the computer is on.
2	Z^Z	Sleep	Lights when the computer enters Standby mode and blinks when it enters into or resumes from hibernation mode.

Keyboard







The keyboard has full-sized keys and an embedded keypad, separate cursor keys, two Windows keys and twelve function keys.

Special keys

Lock keys

The keyboard has three lock keys which you can toggle on and off.



Lock key	Description
Caps Lock 	When  is on, all alphabetic characters typed are in uppercase.
Num Lock (Fn-F11) 	When  is on, the embedded keypad is in numeric mode. The keys function as a calculator (complete with the arithmetic operators), -, *, and /). Use this mode when you need to do a lot of numeric data entry. A better solution would be to connect an external keypad.
Scroll Lock (Fn-F12) 	When  is on, the screen moves one line up or down when you press the up or down arrow keys respectively.  does not work with some applications.

Embedded numeric keypad

The embedded numeric keypad functions like a desktop numeric keypad. It is indicated by small characters located on the upper right corner of the keycaps. To simplify the keyboard legend, cursor-control key symbols are not printed on the keys.

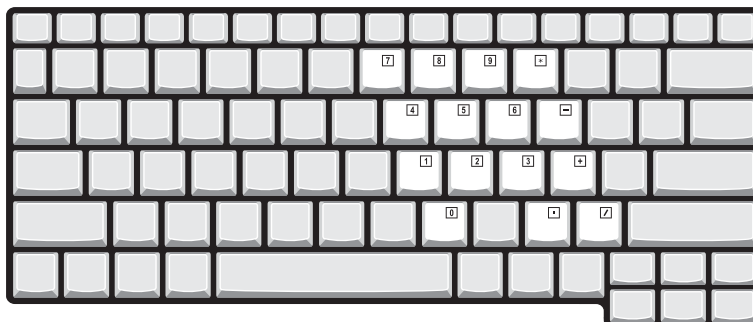









Desired access	Num lock on	Num lock off
Number keys on embedded keypad	Type numbers in a normal manner.	
Cursor-control keys on embedded keypad	Hold Shift while using cursor-control keys.	Hold Fn while using cursor-control keys.
Main keyboard keys	Hold Fn while typing letters on embedded keypad.	Type the letters in a normal manner.

NOTE: If an external keyboard or keypad is connected to the computer, the Num Lock feature automatically shifts from the internal keyboard to the external keyboard or keypad.

Windows keys

The keyboard has two keys that perform Windows-specific functions.



Keys	Description
<p>Windows logo key</p> 	<p>Start button. Combinations with this key perform shortcut functions. Below are a few examples:</p> <ul style="list-style-type: none">  + Tab (Activates next taskbar button)  + E (Explores My Computer)  + F (Finds Document)  + M (Minimizes All)  +  + M (Undoes Minimize All)  + R (Displays the Run... dialog box)
<p>Application key</p> 	<p>Opens a context menu (same as a right-click).</p>











Hot Keys

The computer employs hot keys or key combinations to access most of the computer's controls like screen contrast and brightness, volume output and the BIOS Utility.

To activate hot keys, press and hold the **Fn** key before pressing the other key in the hot key combination.



Hot Key	Icon	Function	Description
Fn-F1	?	Hotkey help	Displays a list of the hotkeys and their functions.
Fn-F2		Setup	Accesses the notebook configuration utility.
Fn-F3		Power Management Scheme Toggle	Switches between the power management scheme used by the computer (function available if supported by operating system).
Fn-F4	Z ^Z	Sleep	Puts the computer in Sleep mode.
Fn-F5		Display toggle	Switches display output between the display screen, external monitor (if connected) and both the display screen and external monitor.
Fn-F6		Screen blank	Turns the display screen backlight off to save power. Press any key to return.
Fn-F7		Touchpad Toggle	Turns the internal touchpad on and off.
Fn-F8		Speaker on/off	Turns the speakers on and off; mutes the sound.
Fn-↑		Volume up	Increases the sound volume.
Fn-↓		Volume down	Decreases the sound volume.
Fn-→		Brightness up	Increases the screen brightness.

Hot Key	Icon	Function	Description
Fn- 		Brightness down	Decreases the screen brightness.
Fn- 	Pg Up 	Home	Functions as the  key.
Fn- 	Pg Dn 	End	Functions as the  key.
 Gr-Euro		Euro	Types the Euro symbol.

The Euro symbol

If your keyboard layout is set to United States-International or United Kingdom or if you have a keyboard with a European layout, you can type the Euro symbol on your keyboard.

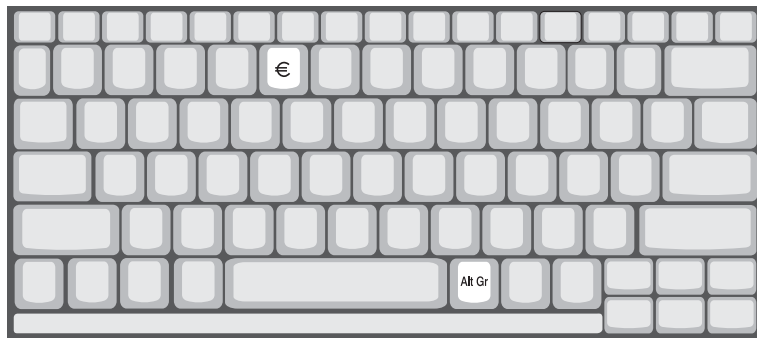

NOTE: for US keyboard users: The keyboard layout is set when you first set up Windows. For the Euro symbol to work, the keyboard layout has to be set to United States-international.

To verify the keyboard type:

1. Click on **Start, Control Panel**.
2. Double-click on **Regional and Language Options**.
3. Click on the **language** tab and click on **Details**.
4. Verify that the keyboard layout used for "EN English (United States) is set to United States-International.

If not, select and click on **ADD**, then select **United States-International** and click on **OK**.

5. Click on **OK**.





To type the Euro symbol:

1. Locate the Euro symbol on your keyboard.
2. Open a text editor or word processor.
3. Hold  Gr and press the Euro symbol.

Launch Keys

Located at the top of the keyboard are five buttons. These buttons are called launch keys. They are designated as wireless LAN/Bluetooth, Web Browser button, mail button, P1 and P2. By default, P1 and P2 are users programmable. The Web Browser button, by default, is used to launch the internet browser. The mail button is used to launch the e-mail application. The LED of the mail button will flash when the user has received an incoming email.



#	Icon	Function	Description
1		Mail	Email application
2		Web browser	Internet browser application
3	P1	P1	User-programmable
4	P2	P2	User-programmable
5		Bluetooth	Starts (optional) Bluetooth functionality and indicates that (optional) Bluetooth is enabled.
6		Wireless	Opens (optional) wireless connectivity and indicates status of (optional) wireless communication.

Hardware Specifications and Configurations

System Board Major Chips

Item	Controller
System core logic	Intel ICH4-M
Super I/O controller	NS PC87392
Audio controller	Cirrus logic CS4299-XQ
Video controller	Intel 852GME (Montara-GT)
Hard disk drive controller	Embedded in Intel ICH4
Keyboard controller	Mitsubishi LPC keyboard controller M38857
CardBus Controller	TI 1520
RTC	Intel ICH4

Processor (for TravelMate 240)

Item	Specification
CPU type	Intel Celeron processor
CPU package	To 2.0GHz uFCBGA
CPU core voltage	High speed: 1.525V or 1.55V Low speed: 1.2V
CPU I/O voltage	High speed: 1.525V or 1.55V Low speed: 1.2V

Processor (for TravelMate 250)

Item	Specification
CPU type	Intel Petium 4 processor
CPU package	To 2.4GHz uFCBGA
CPU core voltage	1.525V
CPU I/O voltage	1.525V

BIOS

Item	Specification
BIOS vendor	Phoenix BIOS
BIOS Version	TM240 V1.00 for TM240; TM250 V1.00 for TM250
BIOS ROM type	Flash ROM
BIOS ROM size	512KB
BIOS package	32 Pin PLCC
Supported protocols	ACPI 2.0 (if available, at least 1.0b), SMBIOS 2.3, PCI 2.2, Boot Block, PXE 2.0, Mobile PC2001, Hard Disk Password, INT 13h Extensions, PCI Bus Power Management interface Specification, EI Torito-Bootable CD-ROM Format Specification V1.0, Simple Boot Flag 1.0
BIOS password control	Set by switch, see SW1 settings

Second Level Cache

Item	Specification
Cache controller	Built-in CPU

Second Level Cache

Item	Specification
Cache size	128KB for TM240/512KB for TM250
1st level cache control	Always Enabled
2nd level cache control	Always Enabled
Cache scheme control	Fixed-in write back

System Memory

Item	Specification
Memory controller	Intel 852GME (Montara-GT)
Onboard memory size	0MB
DIMM socket number	2 Sockets
Supports memory size per socket	128MB
Supports maximum memory size	2048MB
Supports DIMM type	DDR-DRAM
Supports DIMM Speed	266 MHz/333 MHz
Supports DIMM voltage	2.5 V
Supports DIMM package	200-pin so-DIMM
Memory module combinations	You can install memory modules in any combinations as long as they match the above specifications .

Memory Combinations

Slot 1	Slot 2	Total Memory
0MB	128MB	128 MB
128MB	0MB	128 MB
128MB	128MB	256 MB
256MB	0MB	256MB
0MB	256MB	256MB
256MB	128MB	384MB
128MB	256MB	384MB
256MB	256MB	512MB
0MB	512MB	512MB
512MB	128MB	640MB
256MB	512MB	768MB
128MB	512MB	640MB
512MB	256MB	768MB
256MB	128MB	384MB
512MB	512MB	1024MB
0MB	512MB	512MB
1024MB	0MB	1024MB
1024MB	128MB	1152MB
1024MB	256MB	1280MB
1024MB	512MB	1536MB
0MB	1024MB	1024MB
128MB	1024MB	1152MB
256MB	1024MB	1280MB

Memory Combinations

Slot 1	Slot 2	Total Memory
512MB	1024MB	1536MB

Above table lists some system memory configurations. You may combine DIMMs with various capacities to form other combinations.

Modem Interface

Item	Specification
Chipset	Internal Agere Scorpio chipset (Scorpio+CSP1037B)
Fax modem data baud rate (bps)	14.4K
Data modem data baud rate (bps)	56K
Supports modem protocol	V.90/V.92MDC
Modem connector type	RJ11
Modem connector location	Rear side

Floppy Disk Drive Interface

Item	Specification		
Vendor & model name	Mitsumi D353G 4515 MCI JU-226A033FC		
Floppy Disk Specifications			
Media recognition	2DD (720KB)	2HD (1.2 MB, 3 mode)	2HD (1.44MB)
Sectors/track	9	15	18
Tracks	80	80	80
Data transfer rate (Kbit/s)	1 MB	1.6 MB	2 MB
Rotational speed (RPM)	300	360	300
Read/write heads	2		
Encoding method	MFM		
Power Requirement			
Input Voltage (V)	+5V		

Hard Disk Drive Interface

Item	Specification			
Vendor & Model Name	HITACHI EUCALYPTUS DK23EA-20/ HGST MORAGA IC25N020ATMR04-0 08K0632 IBM CASCADE IC25N020ATCS04-0 07N8325	HITACHI DK23EA-30 HGST MORAGA IC25N030ATMR04-0 TOSHIBA NEPTUNE MK3021GAS	HITACHI DK23EA-40 HGST MORAGA IC25N040ATMR04-0	HITACHI DK23EA-60 HGST MORAGA IC25N060ATMR04-0 TOSHIBA NEPTUNE MK6021GAS
Capacity (MB)	20000	30000	40000	60000
Bytes per sector	512	512	512	512
Logical heads	16	16	16	16
Logical sectors	63	63	63	63
Drive Format				
Logical cylinders	42091/16383/16383	42091/16383/47080	42091/16383	42091/16383/47080

Hard Disk Drive Interface

Item	Specification			
Physical read/write heads	2/1/2	3/2/2	2/2	4/3/4
Disks	1/1/1	2/1/1	1/1	2/2/2
Spindle speed (RPM)	4200RPM			
Performance Specifications				
Buffer size	2MB	2MB	2MB	2MB
Interface	ATA-5 for other vendors /ATA-6 for HGST			
Data transfer rate (disk-buffer, Mbytes/s)	19.4-37.1/350/245	22.1-42.8 for Hitachi/350 for HGST	19.4-37.1 for Hitachi/350 for HGST	22.1-42.8 for Hitachi/350 for HGST
Data transfer, rate (host~buffer, Mbytes/s)	100 MB/Sec			
DC Power Requirements				
Voltage tolerance	5 +/- 5%			

CD-ROM Interface

Items	Specification
Vendor & Model Name	Mitsumi SR-244W1
Performance Specification	
Transfer rate	Read Sustained: 1545~3600 KB/sec Programmed I/O: 16.7 MB/sec Max. (Mode 0~4) Multi-word DMA: 16.7 MB/sec Max. (Mode 0~2) Ultra DMA: 33.3MB/sec Max.
Access time (typ.)	Random: 115 ms Full Stroke: 250 ms
Rotation speed	5136 rpm
Data Buffer Capacity	128 KB
Interface	IDE
Applicable disc format	CD/CD-ROM(12cm,8cm), CD-R, CD-RW, CD-DA, CD-ROM (Mode 1, Mode2), CD-ROM XA (Mode 2, Form1 and Form 2), Photo CD (Single, Multi-session), Enhanced CD
Loading mechanism	Drawer with soft eject and emergency eject hole
Power Requirement	
Input Voltage	+5V[DC] +/-5%

DVD-ROM Interface

Item	Specification
Vendor & model name	MKE SR-8177-BAA6
Performance Specification	With CD Diskette With DVD Diskette

DVD-ROM Interface

Item	Specification	
Transfer rate (KB/sec)	Average Sustained: CAV mode 775~1800 blocks/sec (10.3X to 24X) 1550~3600kBytes/sec (Mode 1) 1768~4106 kBytes/sec (Mode 2)	DVD-5: Normal Speed (1X) 11.08 Mbits/sec CAV mode 36.67~88.64 Mbits/sec DVD-9/DVD-R: Normal Speed (1X) 11.08 Mbits/sec CAV mode 36.67~88.64 Mbits/sec
Average Full Access time (typ.)	Random (*1) CAV mode 110 msec typical 150 msec average max Full Stroke (*2) CAV mode 200 msec typical 260 msec average max	DVD-5: Random (*4) 120 msec typical 160 msec average max Full Stroke (*5) 270 msec typical 350 msec average max DVD-9: Random (*7) 150 msec typical 200 msec average max Full Stroke (*8) 340 msec typical 450 msec average max DVD-RAM (2.6G) Random (*7) 200 msec typical 300 msec average max Full Stroke (*8) 300 msec typical 600 msec average max DVD-RAM (4.7G) Random (*9) 180 msec typical 300 msec average max Full Stroke (*10) 320 msec typical 700 msec average max
Data Buffer Capacity	512 kBytes	
Interface	IDE	
Applicable disc format	DVD: DVD-5, DVD-9, DVD-10, DVD-R (3.95G), DVD-RAM (2.6G), DVD-RAM (4.7G) CD: CD-Audio, CD-ROM (mode 1 and mode 2), CD-ROM XA (mode 2, form 1 and form 2), CD-I (mode 2, form 1 and form 2), CD-I Ready, CD-I Bridge, CD-WO, CD-RW, Photo CD, Video CD, Enhanced Music CD, CD-TEXT	
Loading mechanism	Soft eject (with emergency eject hole)	
Power Requirement		
Input Voltage	+5V[DC]±5%	

(*1) Average of Data read over the whole area from 00 min. 02 sec. 00 block to 59 min. 58 sec. 74 block more than 2000 times including latency and layered error correction time.

(*2) From 00 min. 02 sec. 00 block to 59 min. 58 sec. 74 block including latency and layered error correction time.

(*3) Disc: MNSU-005

(*4) Average of Data read over the whole area from starting data recorded area (LBA:0) to maximum data recorded area (LBA:23197F), more than 2000 times including latency and layered error correction time.

(*5) from starting data recorded area (LBA:0) to maximum data recorded area (LBA:23197F) including latency and layered error correction time.

(*6) Disk: MKE-D551.

(*7) Average of Data read over the whole area from starting data recorded area (LBA:0) to maximum data recorded area (LBA:3FA0DF), more than 2000 times including latency and layered error correction time.

(*8) from starting data recorded area (LBA:0) to maximum data recorded area (LBA:3FA0DF) including latency and layered error correction time.

(*9) Disk: ODSC-PARA

Combo Drive Interface

Item	Specification
Vendor & model name	KME UJDA740
Performance Specification	
Transfer rate (KB/sec)	Read Sustained: DVD-ROM MAX 8X CAV (MAX 10800 KB/sec) CD-ROM MAX 24X CAV (MAX 3600 KB/sec) Write: CD-R 4X, 8X (CLV), Max 16X, MAX 24X (ZCLV) CD-RW 4X (CLV) HS-RW 4X,8X, 10X (CLV) ATAPI Interface: PIO mode 16.6 MB/sec :PIO Mode 4 DMA mode 16.6 MB/sec:Multi word mode 2 Ultra DMA mode 33.3MB/sec: Ultra DMA mode 2
Buffer rate	2MB
Access time	DVD-ROM 180 ms typ. (1/3 stroke) CD-ROM 130 ms typ. (1/3 stroke)
Start up time	less than 15s
Stop time	less than 6s
Acoustic noise	less than 50 dBA
Interface	Enhanced IDE (ATAPI) compatible
Master/Slave	Set by Cable Select (By host)
PC compatible	PC2001 compatible
Applicable disc format	CD: CD-DA, CD-ROM, CD-ROM XA, CD-R, CD-RW, PhotoCD (multiSession), Video CD, CD-Extra(CD+), CD-text DVD: DVD-ROM, DVD-R, DVD-RW (Ver.1.1)
Slope	15 degree (Any direction)
Dimensions, Weight	128X129X12.7mm (WXDXH) (except protrusion) 200g+- 10g
Eject	Soft Eject (with emergency eject hole)

Audio Interface

Item	Specification
Audio Controller	Cirrus Logic CS4299-XQ
Audio onboard or optional	Built-in
Mono or Stereo	Stereo
Resolution	20 bit stereo Digital to Analog converter 18 bit stereo Analog to Digital converter
Compatibility	Microsoft PC98/PC99, AC97 2.1
Mixed sound source	Line-in, CD, Video, AUX

Audio Interface

Item	Specification
Voice channel	8/16 bit, mono/stereo
Sampling rate	44.1 KHz
Internal microphone	Yes
Internal speaker / Quantity	Yes
Supports PnP DMA channel	DMA channel 0 DMA channel 1
Supports PnP IRQ	IRQ10, IRQ11

Video Interface

Item	Specification
Vendor & Model Name	Intel 845GME (Montara-GT)
Chip voltage	Core / 2.5V, 1.5V,
Supports ZV (Zoomed Video) port	NO
Graph interface	4X AGP (Accelerated Graphic Port) Bus
Maximum resolution (LCD)	1024 x768 (32bit colors)
Maximum resolution (CRT)	1024x768 (32 bit colors) 1280x1024 (32 bit colors) 1600x1200 (32 bit colors)

Video Memory

Item	Specification
Fixed or upgradeable	Fixed, share the system memory
Video memory size	8MB

Video Resolutions Mode

Resolution	Refresh Rate	
	CRT Only	LCD/CRT Simultaneous
640x480x256	90	60
640x480x64K	90	60
640x480x16M	90	60
800x600x256	90	60
800x600x64K	90	60
1024x768x256	90	60

Parallel Port

Item	Specification
Parallel port controller	NS PC87392
Number of parallel port	1
Location	Rear side
Connector type	25-pin D-type
Parallel port function control	Enable/Disable by BIOS Setup
Supports ECP/EPP	Yes (set by BIOS setup)
Optional ECP DMA channel (in BIOS Setup)	DMA channel 1 and 3

Parallel Port

Item	Specification
Optional parallel port I/O address (in BIOS Setup)	378, 278, 3BC
Optional parallel port IRQ (in BIOS Setup)	IRQ7, IRQ5

USB Port

Item	Specification
USB Compliancy Level	2.0
OHCI	USB 2.0
Number of USB port	4
Location	Rear side
Serial port function control	Enable/Disable by BIOS Setup

PCMCIA Port

Item	Specification
PCMCIA controller	TZ 1520
Supports card type	Type II, Tpye III
Number of slots	Two type II, one type III
Access location	Left side
Supports ZV (Zoomed Video) port	Yes
Supports 32 bit CardBus	Yes (IRQ17)

Keyboard

Item	Specification
Keyboard controller	Mitsubishi LPC keyboard controller M38857
Keyboard vendor & model name	API
Total number of keypads	84-/85- key
Windows 95 keys	Yes
Internal & external keyboard work simultaneously	Yes

Battery

Item	Specification
Vendor & model name	SIMPLO
Battery Type	Li-ION
Pack capacity	2000mAH
Cell voltage	3.8V / 1.2V
Number of battery cell	8
Package configuration	4529 / 8S
Package voltage	41.8V / 9.6V

DC-DC/Charger Converter

Item	Specification
Vendor & Model Name	MAX IM1645/MAXIM1715/MAX1 999/MAXI 545

DC-DC/Charger Converter

Item	Specification	
Input Voltage	AC Adapter or Battery: 8V - 19VDC	
DC-DC Converter Output		
Output Rating	+5V	3.3V
Current (w/load, A)	0~5A	0~4A
Charger Output	Li-ION	
Normal charge (charge while system is not operative)	2.8A	
Background charge (charge even system is still operative)	Constant power mode (2.8A~0A)	
Battery-low 2 level (V)	12.5V	
Battery-low 3 level (V)	11.5V	
Protection		
Charger protection	Over Current Protection	
DC/DC converter protection	OCP (Over Current Protection, A) OVP (Over Voltage Protection, V) UVP (Under Voltage Protection, V)	

DC-AC LCD Inverter

Item	Specification
Vendor & model name	Ambit
Input voltage (V)	8 ~ 21V
Input current (mA)	1A (max.)
Output voltage (Vrms, no load)	1400Vrms
Output voltage frequency (kHz)	40 ~ 70KHz
Output Current/Lamp	5.5 mA ~ 6.5mA

NOTE: DC-AC inverter is used to generate very high AC voltage, then support to LCD CCFT backlight user, and is also responsible for the control of LCD brightness. Avoid touching the DC-AC inverter area while the system unit is turned on.

NOTE: There is an EEPROM in the inverter, which stores its supported LCD type and ID code. If you replace a new inverter or replace the LCD with a different brand, use Inverter ID utility to update the ID information.

LCD

Item	Specification	
Vendor & model name	14.1" AU B141XN04 V2	15" Hitachi TX38D85VC1CAB
Mechanical Specifications		
LCD display area (diagonal, inch)	14.1	15
Display technology	TFT	TFT
Resolution	XGA (1024x768)	XGA (1024x768)
Support colors	262K	262K
Optical Specification		
Brightness control	Keyboard hotkey	Keyboard hotkey
Contrast control	None	None

LCD

Item	Specification	
Electrical Specification		
Supply voltage for LCD display (V)	3.3 (typ.)	3.3 (typ.)
Supply voltage for LCD backlight (Vrms)	650 (typ.)	650 (typ.)

AC Adapter

Item	Specification	
Vendor & model name	Liton	
Input Requirements		
Maximum input current (A, @90Vac, full load)	1.5 A @ 110Vac 1.0 A @ 240Vac	
Nominal frequency (Hz)	50-60	
Frequency variation range (Hz)	47-63	
Input voltage range (Vrms)	90-270	
Inrush current	The maximum inrush current will be less than 50A and 100A when the adapter is connected to 115Vac and 230Vac respectively.	
Efficiency	It should provide an efficiency of 80% minimum, when measured at maximum load under 115Vac.	
Output Ratings (CV mode)		
DC output voltage	19V	
Noise + Ripple	300mVp-pmax (20 MHz bandwidth)	
Load	0(min) 3.16A(max)	
Output Ratings (CC mode)		
DC output voltage	19V +/-1.0V for CV mode	
Constant current mode	3.6 +/- 0.3A	
Dynamic Output Characteristics		
Turn-on delay time	3 sec (@ 115Vac)	
Hold up time	5ms (@115Vac, Full load)	
Over Voltage Protection (OVP)	24V	
Short circuit protection	3.9A max can be protected and output can be shorted without damage	
Electrostatic discharge (ESD)	15KV (at air discharge) 8KV (at contact discharge)	
Dielectric Withstand Voltage		
Primary to secondary	3000Vac	
Leakage current	0.25 mA max. (@ 254Vac, 60Hz)	
Regulatory Requirements	<p>Safety Requirements:</p> <ol style="list-style-type: none">1.The subject product rated 100-120V 60Hz must be listed under UL 1950 and certified with SCA Standard C22.2 No.950.2.The subject product rated 200-240V 50Hz must comply with low voltage directive 73/23EEC. <p>EMI Requirements:</p> <ol style="list-style-type: none">1.The subject product rated 100-120V 60Hz must meet the EMI requirements of FCC part 15, Subpart B for Class B Digital Device and get FCC Certification before marketing into USA and Canada.2.The subject product rated 200-240V 50Hz must meet the EMC Directive 89/336/EEC.3.The subject product rated 100-120V must meet the VCCI-2 EMI requirements.	

Power Management

Power Saving Mode	Phenomenon
Standby Mode Enter Standby Mode when 1. Standby/Hibernation hot-key is pressed and system is not ready to enter Hibernation mode. 2. System standby/ Hibernation timer expires and system is not ready to enter Hibernation mode.	<input type="checkbox"/> The buzzer beeps <input type="checkbox"/> The Sleep indicator lights up
Hibernation Mode Enter Hibernation Mode (suspend to HDD) when 1. Hibernation hot-key is pressed and system is ready to enter Hibernation mode 2. System Hibernation timer expires and system is ready to enter Hibernation mode.	<input type="checkbox"/> All power shuts off
Display Standby Mode Keyboard, built-in touchpad, and an external PS/2 pointing device are idle for a specified period.	<input type="checkbox"/> The display shuts off
Hard Disk Standby Mode Hard disk is idle within a specified period of time.	<input type="checkbox"/> Hard disk drive is in standby mode. (spindle turned-off)

Environmental Requirements

Item	Specification
Temperature	
Operating	+5~+35 °C
Non-operating	-10~+60 °C
Package storage	-20~+60 °C
Humidity	
Operating	20% to 85% RH, non-condensing
Non-operating	20% to 80% RH, non-condensing (Unpacked)
Non-operating	20% to 90% RH, non-condensing (Storage package)
Vibration	
Operating (unpacked)	5~25.6Hz: 0.38mm (peak to peak) 25.6~250Hz: 0.5G
Non-operating (unpacked)	5~27.1Hz: 0.6G 27.1~50Hz: 0.04mm (peak to peak) 50~500Hz: 2.0G
Non-operating (packed)	5~62.6Hz: 0.51mm (peak to peak) 62.6~500Hz: 4.0G

Mechanical Specification

Item	Specification
Dimensions	322(W) x 294(D) x 39.4~39.9(H)mm
Weight	7.2 lbs for 14.1" TFT LCD model with battery/7.4 lbs for 15"LCD model with battery

Mechanical Specification

Item	Specification
I/O Ports	Two type II PCMCIA (PC Card) port, one RJ-11 port, one RJ-45 port, one DC-in port, one ECP parallel port, four USB ports, one microphone-in/line-in jack, one line-out (share with SP-DIF) jack, one VGA port, one FIR port.
Drive Bays	One
Material	Plastic
Indicators	Power-on, Standby, Battery Status, Media Access, CapsLock and NumLock
Switch	Power

Memory Address Map

Memory Address	Function
000A0000-000BFFFF E0000000-E007FFFF E0080000-E00FFFFFFF E8000000-EFFFFFFF F0000000-F7FFFFFFF	Intel (R) 82852/82855 GM/GME Graphics Controller
000A0000-000BFFFF 000D0000-000D3FFF 000D4000-000D7FFF 10000000-FEBFFFFFFF	PCI bus
000D6000-000D6FFF 000D7000-000D7FFF E4000000-E7FFFFFFF FABFA000-FABFBFFF FABFC000-FABFCFFF FABFD000-FEBFCFFF FEBFD000-FEBFDFFF FEBFE000-FEBFEFFF	Texas Instruments PCI-1520 CardBus Controller
E0100000-E01003FF	Intel (R) 82801DB/DBM USB 2.0 Enhanced Host Controller-24CD
E0100800-E01008FF E0100C00-E0100DFF	Crystal WDM AC'97 Driver for ICH4
E0200000-E02000FF	Realtek RTL8139/810x Family Fast Ethernet NIC
FEBFFC00-FEBFFFFFFF	Intel(R) 82801DBM Ultra ATA Storage Controller-24CA
FEC10000-FEC1FFFF	Motherboard resources
FF000000-FFFFFFFF	Intel(r) 82802 Firmware Hub Device

I/O Address Map

I/O Address	Function
00000000-0000000F	Direct Memory Access controller
00000000-00000CF7	PCI bus
00000020-00000021	Programmable interrupt controller
00000024-00000025	Programmable interrupt controller
00000028-00000029	Programmable interrupt controller
0000002C-0000002D	Programmable interrupt controller
0000002E-0000002F	Motherboard resources
00000030-00000031	Programmable interrupt controller

I/O Address Map

I/O Address	Function
00000034-00000035	Programmable interrupt controller
00000038-00000039	Programmable interrupt controller
0000003C-0000003D	Programmable interrupt controller
00000040-00000043	System Timer
00000050-00000053	System Timer
00000060-00000060	Standard 101/102-key or Microsoft Natural PS/2 keyboard
00000061-00000061	Motherboard resources
00000062-00000062	Microsoft ACPI-Compliant Embedded Controller
00000064-00000064	Standard 101/102-key or Microsoft Natural PS/2 keyboard
00000065-00000065	Motherboard resources
00000066-00000066	Microsoft ACPI-Compliant Embedded Controller
00000067-00000067	Motherboard resources
00000072-00000077	System CMOS/real time clock
00000080-00000080	Motherboard resources
00000081-0000008F	Direct memory access controller
00000090-00000091	Direct memory access controller
00000092-00000092	Motherboard resources
00000093-0000009F	Direct memory access controller
000000A0-000000A1	Programmable interrupt controller
000000A4-000000A5	Programmable interrupt controller
000000A8-000000A9	Programmable interrupt controller
000000AC-000000AD	Programmable interrupt controller
000000B0-000000B5	Programmable interrupt controller
000000B8-000000B9	Programmable interrupt controller
000000BC-000000BD	Programmable interrupt controller
000000C0-000000DF	Direct memory access controller
000000F0-000000F0	Numeric data processor
00000170-00000177	Secondary IDE channel
000001F0-000001F7	Primary IDE channel
00000274-00000277	ISAPNP Read Data Report
00000279-00000279	ISAPNP Read Data Report
00000376-00000376	Secondary IDE channel
00000378-0000037F	ECP Printer Port (LPT1)
000003B0-000003BB	Intel (R) 82845G Graphic Controller
000003C0-000003DF	Intel (R) 82845G Graphic Controller
000003F0-000003F5	Standard floppy disk controller
000003F6-000003F6	Primary IDE channel
000003F7-000003F7	Standard floppy disk controller
000004D0-000004D1	Programmable interrupt controller
00000600-0000060F	Motherboard resources
00000700-0000070F	Motherboard resources
00000778-0000077F	ECP Printer Port (LPT1)
00000800-0000080F	Motherboard resources
00000A79-00000A79	ISAPNP Read Data Report
00000D00-0000FFFF	PCI bus

I/O Address Map

I/O Address	Function
00001000-0000107F	Motherboard resources
00001180-000011BF	Motherboard resources
00001800-00001807	Intel (R) 82850/82855 GM/GME Graphics Controller
00001810-0000181F	Intel (R) 82801DB/DBM Ultra ATA Storage Controller-24CA
00001820-0000183F	Intel (R) 82801DB/DBM USB Universal Host Controller-24C2
00001840-0000185F	Intel (R) 82801DB/DBM USB Universal Host Controller-24C4
00001860-0000187F	Intel (R) 82801DB/DBM USB Universal Host Controller-24C7
00001880-0000189F	Intel (R) 82801DB/DBM SMBus Controller-24C3
000018C0-000018FF	Crystal WDM AC'97 Driver for ICH4
00001C00-00001CFF	Crystal WDM AC'97 Driver for ICH4
00002000-0000207F	Agere Systems AC'97 Modem
00002400-000024FF	Agere Systems AC'97 Modem
00003000-000030FF	Realtek RTL8139/810x Family Fast Ethernet NIC
0000FC00-0000FCFF	Texas Instruments PCI-1520 CardBus Controller
0000FD00-0000FDFF	Texas Instruments PCI-1520 CardBus Controller
0000FE00-0000FEFF	Texas Instruments PCI-1520 CardBus Controller
0000FF00-0000FFFF	Texas Instruments PCI-1520 CardBus Controller

IRQ Assignment Map

Interrupt Channel	Function
(ISA) 0	System timer
(ISA) 1	Keyboard
(ISA) 6	Keyboard
(ISA) 8	Standard floppy disk controller
(ISA) 9	System CMOS/real time clock
(ISA) 12	Synaptics PS/2 Port Pointing Device
(ISA) 13	Numeric data processor
(ISA) 14	Primary IDE Channel
(ISA) 15	Secondary IDE Channel
(PCI) 10	Agere Systems AC'97 Modem
(PCI) 10	Crystal WDM AC'97 Driver for ICH4
(PCI) 10	Intel (R) 82801DB/DBM SMBus Controller-24C3
(PCI) 10	Intel (R) 82801DB/DBM USB 2.0 Enhanced Host Controller-24CD
(PCI) 10	Texas Instruments PCI-1520 CardBus Controller
(PCI) 10	Texas Instruments PCI-1520 CardBus Controller
(PCI) 11	Intel (R) 82801DB/DBM USB Universal Host Controller-24C2
(PCI) 11	Intel (R) 82801DB/DBM USB Universal Host Controller-24C4
(PCI) 11	Intel (R) 82801DB/DBM USB Universal Host Controller-24C7
(PCI) 11	Intel (R) 82852/82855 GM/GME Graphics Controller
(PCI) 11	Realtek RTL8139/810x Family Fast Ethernet NIC

NOTE: IRQ settings may be changed by OS

DMA Channel Assignment

DMA Channel	Function
2	Standard floppy disk controller
3	ECP Printer Port (LPT1)
4	Direct memory access controller

System Utilities

BIOS Setup Utility

The BIOS Setup Utility is a hardware configuration program built into your computer's BIOS (Basic Input/Output System).

Your computer is already properly configured and optimized, and you do not need to run this utility. However, if you encounter configuration problems, you may need to run Setup. Please also refer to Chapter 4 Troubleshooting when problem arises.

To activate the BIOS Utility, press **F2** during POST (when "Press <F2> to enter Setup" message is prompted on the bottom of screen).

Press **F2** to enter setup. Press <F12> during POST to enter multi-boot menu. In this menu, user can change boot device without entering BIOS SETUP Utility.

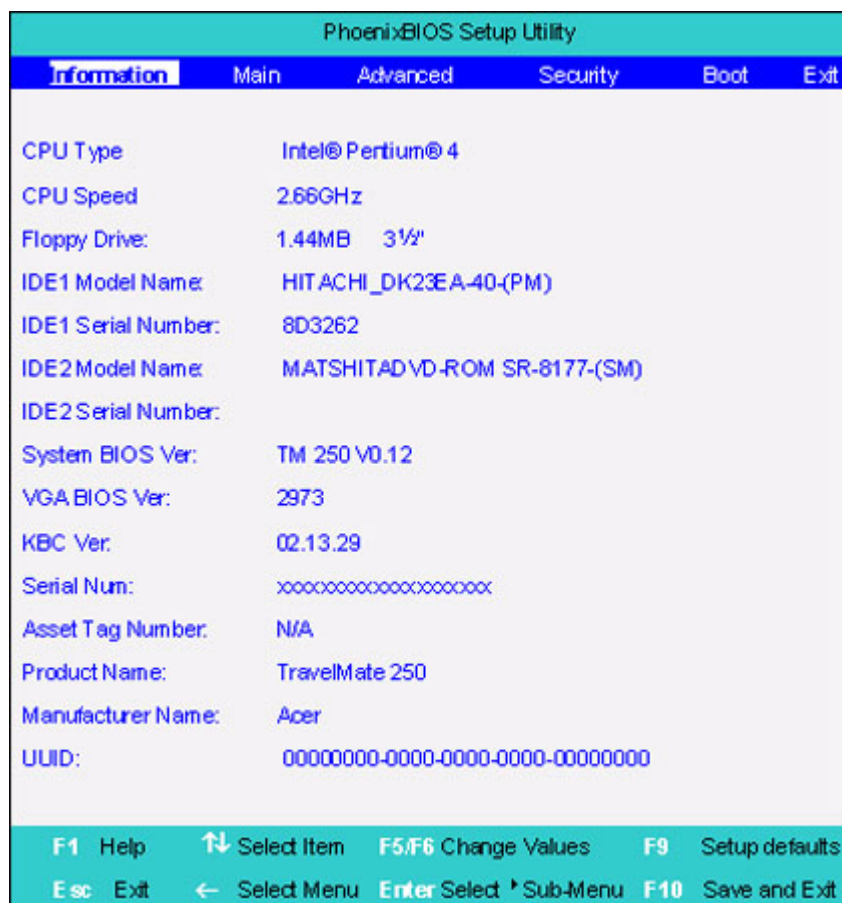

Navigating the BIOS Utility

There are six menu options: Info., Main, System Devices, Security, Boot, and Exit.

Follow these instructions:

- To choose a menu, use the cursor left/right keys (← →).
- To choose a parameter, use the cursor up/down keys (↑ ↓).
- To change the value of a parameter, press F5 or F6.
- A plus sign (+) indicates the item has sub-items. Press ENTER to expand this item.
- Press ESC while you are in any of the menu options to go to the Exit menu.
- In any menu, you can load default settings by pressing F9. You can also press F10 to save any changes made and exit the BIOS Setup Utility.

NOTE: You can change the value of a parameter if it is enclosed in square brackets. Navigation keys for a particular menu are shown on the bottom of the screen. Help for parameters are found in the Item Specific Help part of the screen. Read this carefully when making changes to parameter values.

This menu provides you the information of the system.

Information

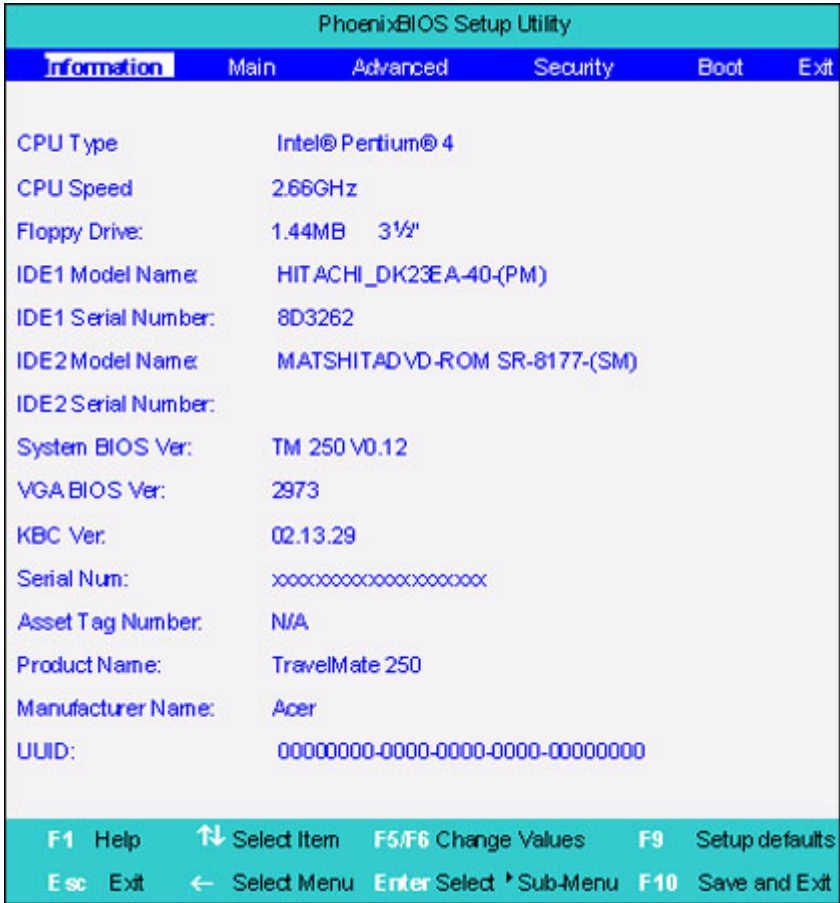

Parameter	Description
Floppy Disk Drive	Shows floppy drive type informaiton.
Serial Number	This field displays the serial number of this unit.
UUID Number	UUID=32bytes

Main

The Main screen displays a summary of your computer hardware information, and also includes basic setup parameters. It allows the user to specify standard IBM PC AT system parameters.

PhoenixBIOS Setup Utility		
Information	Main	Advanced Security Boot Exit
Item specific Help		
System Time:	[00:12:45]	
System Date:	[06/25/2003]	<Tab>, <Shift-Tab>, or <Enter> selects field.
System Memory:	640 KB	ShowSystem Memory Size
Extended Memory:	254 MB	ShowExtened Memory Size
VGA Memory:	16 MB	Video Memory Size
Fast Boot:	[Enabled]	
Power on display:	[Auto]	
LCD Auto Dim:	[Enabled]	
PXE Boot From LAN:	[Enabled]	
F12 Boot Menu:	[Disabled]	
F1 Help	↑↓ Select Item	F5/F6 Change Values F9 Setup defaults
Esc Exit	← Select Menu	Enter Select ↘ Sub-Menu F10 Save and Exit

NOTE: The screen above is for reference only. Actual values may differ.

The table below describes the parameters in this screen. Settings in **boldface** are the default and suggested parameter settings.

Parameter	Description	Format/Option
System Time	Sets the system time.	Format: HH:MM:SS (hour:minute:second) System Time
System Date	Sets the system date.	Format MM/DD/YYYY (month/day/year) System Date
System Memory	This field reports the memory size of the system. Memory size is fixed to 640MB	
Extended Memory	This field reports the memory size of the extended memory in the system. Extended Memory size=Total memory size-1MB	
Video Memory	Shows the VGA memory size.	
Fast Boot	Determines if Customer Logo will be displayed or not; shows Summary Screen is disabled or enabled. Enabled: Customer Logo is displayed, and Summary Screen is disabled. Disabled: Customer Logo is not displayed, and Summary Screen is enabled.	Option: Enabled or Disabled
Power on display	Auto: During power process, the system will detect if any display device is connected on external video port. If any external display device is connected, the power on display will be in CRT (or projector) only mode. Otherwise it will be in LCD only mode. Both: Simultaneously enable both the integrated LCD screen and the system's external video port (for an external CRT or projector).	Option: Auto or Both
LCD Auto Dim	Determines if the system will automatically dim the LCD brightness in order to save power when AC is not present.	Option: Enabled or Disabled
PXE Boot from LAN	Enables, disables the system boot from LAN (remote server). PXE is the protocol.	Option: Enabled or Disabled
F12 Boot Menu	Enables, disables Boot Menu during POST.	Option: Disabled or Enabled

NOTE: The sub-items under each device will not be shown if the device control is set to disable or auto. This is because the user is not allowed to control the settings in these cases.

Advanced

The Advanced menu screen contains parameters involving your hardware devices. It also provides advanced settings of the system.

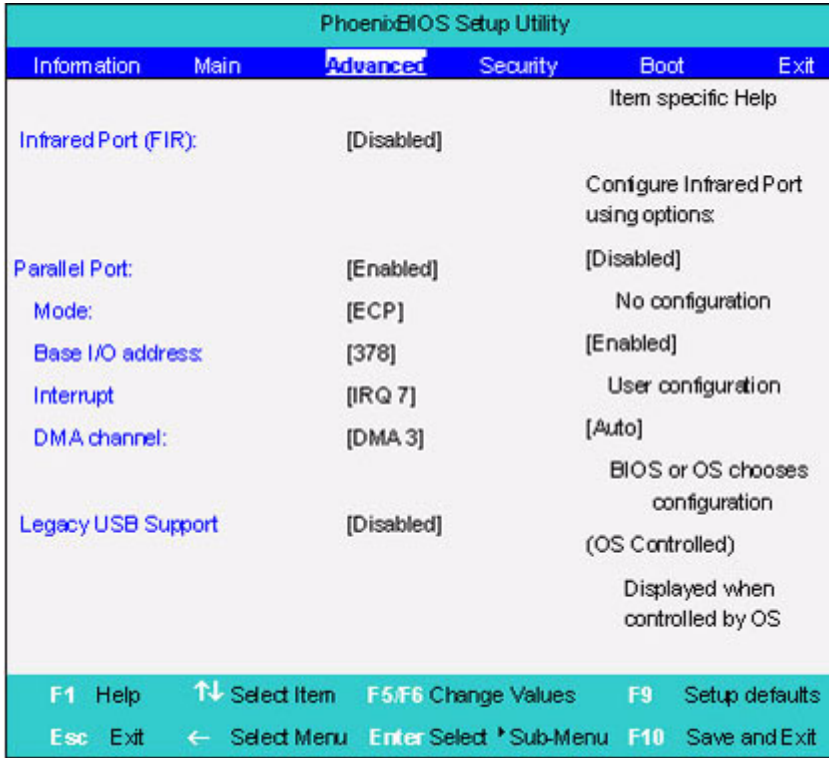

The table below describes the parameters in the screen. Settings in **boldface** are the default and suggested parameter settings.

Parameter	Description	Options
Infrared Port	Enables, disables or auto detects the infrared port.	Disabled /Disabled/Auto
Parallel Port	Enables, disables or auto detects the parallel port.	Enabled /Disabled/Auto
Mode	Sets the operation mode of the parallel port.	ECP , EPP, Normal or Bi-directional
Base I/O address	Sets the I/O address of the parallel port.	378h /278h/3BCH
Interrupt	Sets the interrupt request of the parallel port.	IRQ7 /IRQ5
DMA channel	Sets a DMA channel for the printer to operate in ECP mode. This parameter is enabled only if Mode is set to ECP.	DMA3 /DMA1
Legacy USB Support	Enables, disables USB interface devices support under DOS mode.	Option: Disabled or Enabled

Security

The Security screen contains parameters that help safeguard and protect your computer from unauthorized use.

PhoenixBIOS Setup Utility					
Information	Main	Advanced	Security	Boot	Exit
				Item specific Help	
User Password Is		Clear			
Supervisor Password Is		Clear		Supervisor Password controls access of the whole setup utility. It can be used to boot up when Password on boot enabled.	
Set User Password		[Enter]			
Set Supervisor Password		[Enter]			
Primary HardDisk Security		[Disabled]			
Password on Boot:		[Disabled]			
F1 Help	↑↓ Select Item	F5/F6 Change Values	F9 Setup defaults		
Esc Exit	← Select Menu	Enter Select Sub-Menu	F10 Save and Exit		

The table below describes the parameters in this screen. Settings in **boldface** are the default and suggested parameter settings.

Parameter	Description	Option
User Password is	Shows the setting of the user password.	Clear or Set
Supervisor Password is	Shows the setting of the Supervisor password	Clear or Set
Set User Password	Press Enter to set the user password. When set, this password protects the BIOS Setup Utility from unauthorized access.	
Set Supervisor Password	Press Enter to set the supervisor password. When set, this password protects the BIOS Setup Utility from unauthorized access.	
Primary Harddisk Security	This feature is available to user when Supervisor password is set. Password can be written on HDD only when Supervisor password or user password is set and password on HDD is set to enabled. Supervisor Password is written to HDD only when Supervisor password is being set. User password is written to HDD when both passwords are set. When both Supervisor and user password are present, both passwords can unlock the HDD.	Disabled or Enabled
Password on Boot	Defines whether a password is required or not while the events defined in this group happened. The following sub-options are all requires the Supervisor password for changes and should be grayed out if the user password was used to enter setup.	Disabled or Enabled

NOTE: When you are prompted to enter a password, you have three tries before the system halts. Don't forget your password. If you forget your password, you may have to return your notebook computer to your dealer to reset it.

Setting a Password

Follow these steps as you set the user or the supervisor password:

1. Use the **↑** and **↓** keys to highlight the Set Supervisor Password parameter and press the **ENTER** key. The Set Supervisor Password box appears:

Set Supervisor Password

Enter New Password []

Confirm New Password []

2. Type a password in the "Enter New Password" field. The password length can not exceeds 8 alphanumeric characters (A-Z, a-z, 0-9, not case sensitive). Retype the password in the "Confirm New Password" field.

IMPORTANT: Be very careful when typing your password because the characters do not appear on the screen.

3. Press **ENTER**.
After setting the password, the computer sets the User Password parameter to "Set".
4. If desired, you can opt to enable the Password on boot parameter.
5. When you are done, press **F10** to save the changes and exit the BIOS Setup Utility.

Removing a Password

Follow these steps:

1. Use the **↑** and **↓** keys to highlight the Set Supervisor Password parameter and press the **ENTER** key. The Set Password box appears:

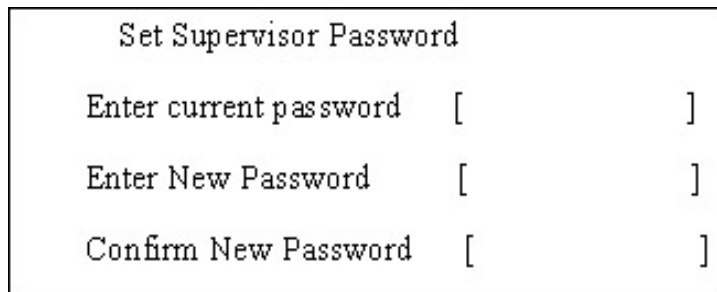

The screenshot shows a BIOS screen titled "Set Supervisor Password". It contains three input fields, each with a pair of square brackets to its right: "Enter current password []", "Enter New Password []", and "Confirm New Password []".

2. Type the current password in the Enter Current Password field and press **ENTER**.
3. Press **ENTER** twice **without** typing anything in the Enter New Password and Confirm New Password fields. The computer then sets the Supervisor Password parameter to "Clear".
4. When you have changed the settings, press **F10** to save the changes and exit the BIOS Setup Utility.

Changing a Password

1. Use the **↑** and **↓** keys to highlight the Set Supervisor Password parameter and press the **ENTER** key. The Set Password box appears:

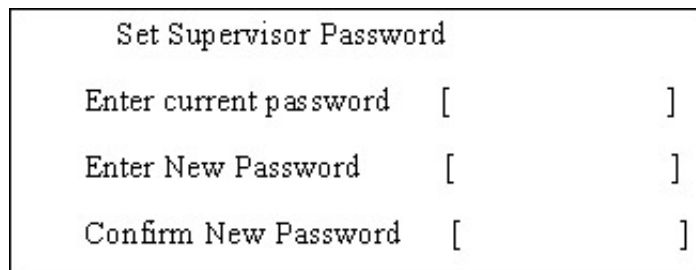

The screenshot shows a BIOS screen titled "Set Supervisor Password". It contains three input fields, each with a pair of square brackets to its right: "Enter current password []", "Enter New Password []", and "Confirm New Password []".

2. Type the current password in the Enter Current Password field and press **ENTER**.
3. Type a password in the Enter New Password field. Retype the password in the Confirm New Password field.
4. Press **ENTER**. After setting the password, the computer sets the User Password parameter to "Set".
5. If desired, you can enable the Password on boot parameter.
6. When you are done, press **F10** to save the changes and exit the BIOS Setup Utility.

If the verification is OK, the screen will display as following.

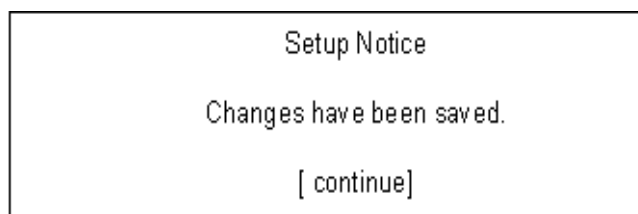

The screenshot shows a BIOS screen titled "Setup Notice". It displays the message "Changes have been saved." and a prompt "[continue]" at the bottom.

The password setting is complete after the user presses **F10**.

If the current password entered does not match the actual current password, the screen will show you the Setup Warning.

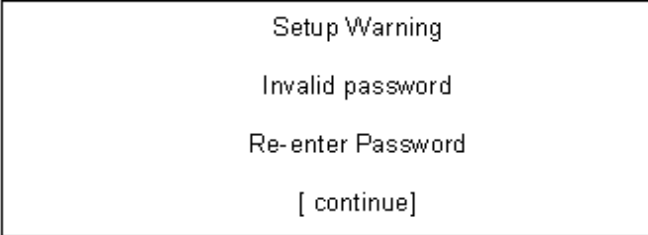

Setup Warning
Invalid password
Re-enter Password
[continue]

A rectangular dialog box with a black border containing four lines of text centered horizontally.

If the new password and confirm new password strings do not match, the screen will display the following message.

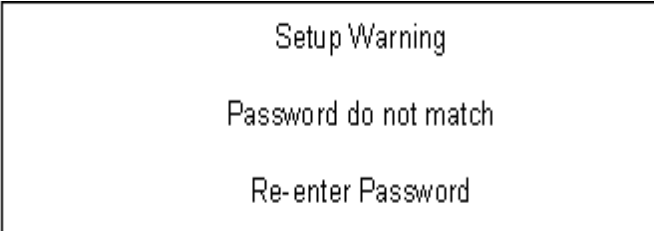

Setup Warning
Password do not match
Re-enter Password

A rectangular dialog box with a black border containing three lines of text centered horizontally.

Boot

This menu allows the user to decide the order of boot devices to load the operating system. Bootable devices includes the distette drive in module bay, the onboard hard disk drive and the CD-ROM in module bay.

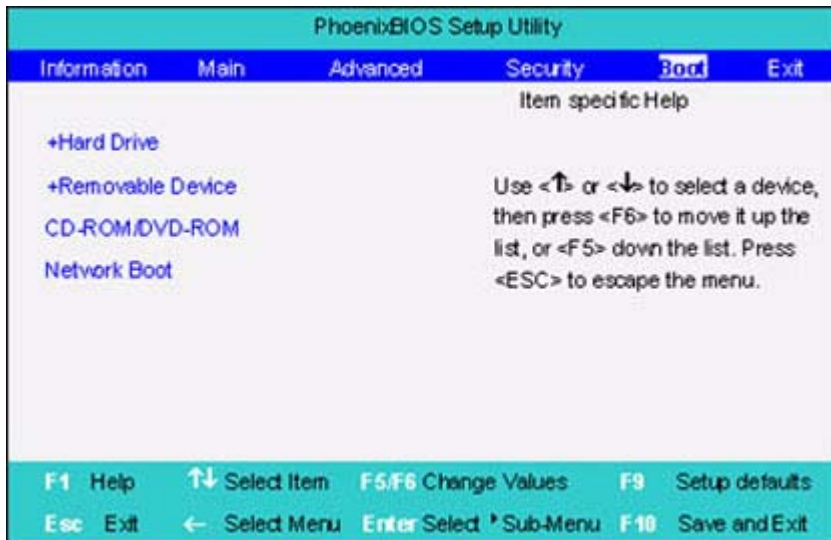

Exit

The Exit screen contains parameters that help safeguard and protect your computer from unauthorized use.

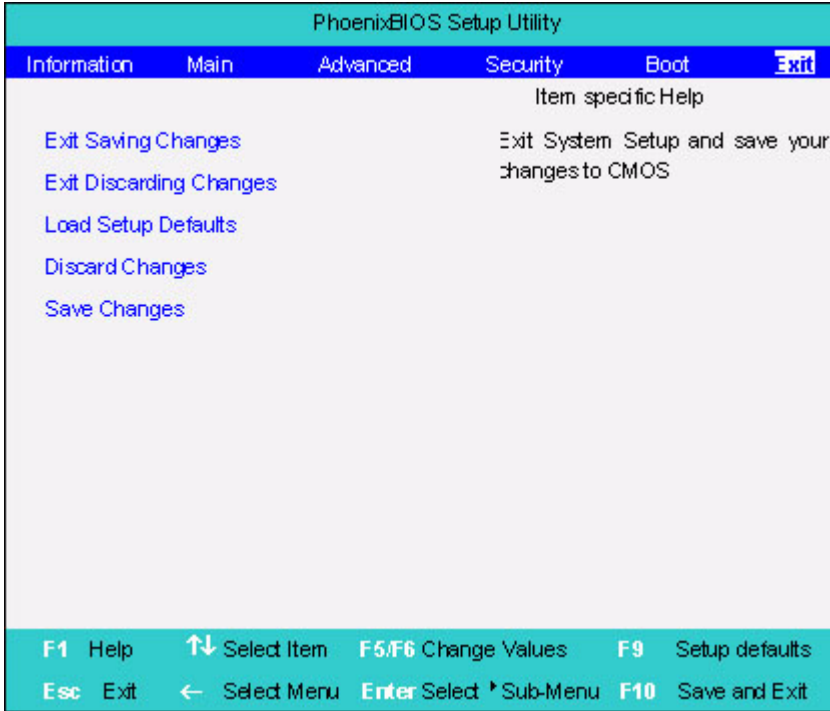

The table below describes the parameters in this screen.

Parameter	Description
Exit Saving Changes	Exit System Setup and save your changes to CMOS.
Exit Discarding Changes	Exit utility without saving setup data to CMOS.
Load Setup Default	Load default values for all SETUP item.
Discard Changes	Load previous values from CMOS for all SETUP items.
Save Changes	Save Setup Data to CMOS.

BIOS Flash Utility

The BIOS flash memory update is required for the following conditions:

- New versions of system programs
- New features or options
- Restore a BIOS when it becomes corrupted.

Use the Phlash utility to update the system BIOS flash ROM.

NOTE: If you do not have a crisis recovery diskette at hand, then you should create a **Crisis Recovery Diskette** before you use the Phlash utility.

NOTE: Do not install memory-related drivers (XMS, EMS, DPMS) when you use the Phlash.

NOTE: Please use the AC adaptor power supply when you run the Phlash utility. If the battery pack does not contain enough power to finish BIOS flash, you may not boot the system because the BIOS is not completely loaded.

Follow the steps below to run the Phlash.

1. Prepare a bootable diskette.
2. Copy the Phlash utilities to the bootable diskette.
3. Then boot the system from the bootable diskette. The Phlash utility has auto-execution function.

System Diagnostic Diskette

This diagnostic diskette is for the Acer TravelMate 240/250 series notebook machine. However, system diagnostic utility is not ready as service CD released. Acer HQ CSD will upload the utility to CSD website as soon as it is ready.

Machine Disassembly and Replacement

This chapter contains step-by-step procedures on how to disassemble the notebook computer for maintenance and troubleshooting.

To disassemble the computer, you need the following tools:

- Wrist grounding strap and conductive mat for preventing electrostatic discharge
- Flat-bladed screw driver
- Phillips screw driver
- Tweezers
- Plastic Flat-bladed screw driver
- Hexed Screw Driver

NOTE: The screws for the different components vary in size. During the disassembly process, group the screws with the corresponding components to avoid mismatch when putting back the components.

General Information

Before You Begin

Before proceeding with the disassembly procedure, make sure that you do the following:

1. Turn off the power to the system and all peripherals.
2. Unplug the AC adapter and all power and signal cables from the system.

Disassembly Procedure Flowchart

The flowchart on the succeeding page gives you a graphic representation on the entire disassembly sequence and instructs you on the components that need to be removed during servicing. For example, if you want to remove the main board, you must first remove the keyboard, then disassemble the inside assembly frame in that order.

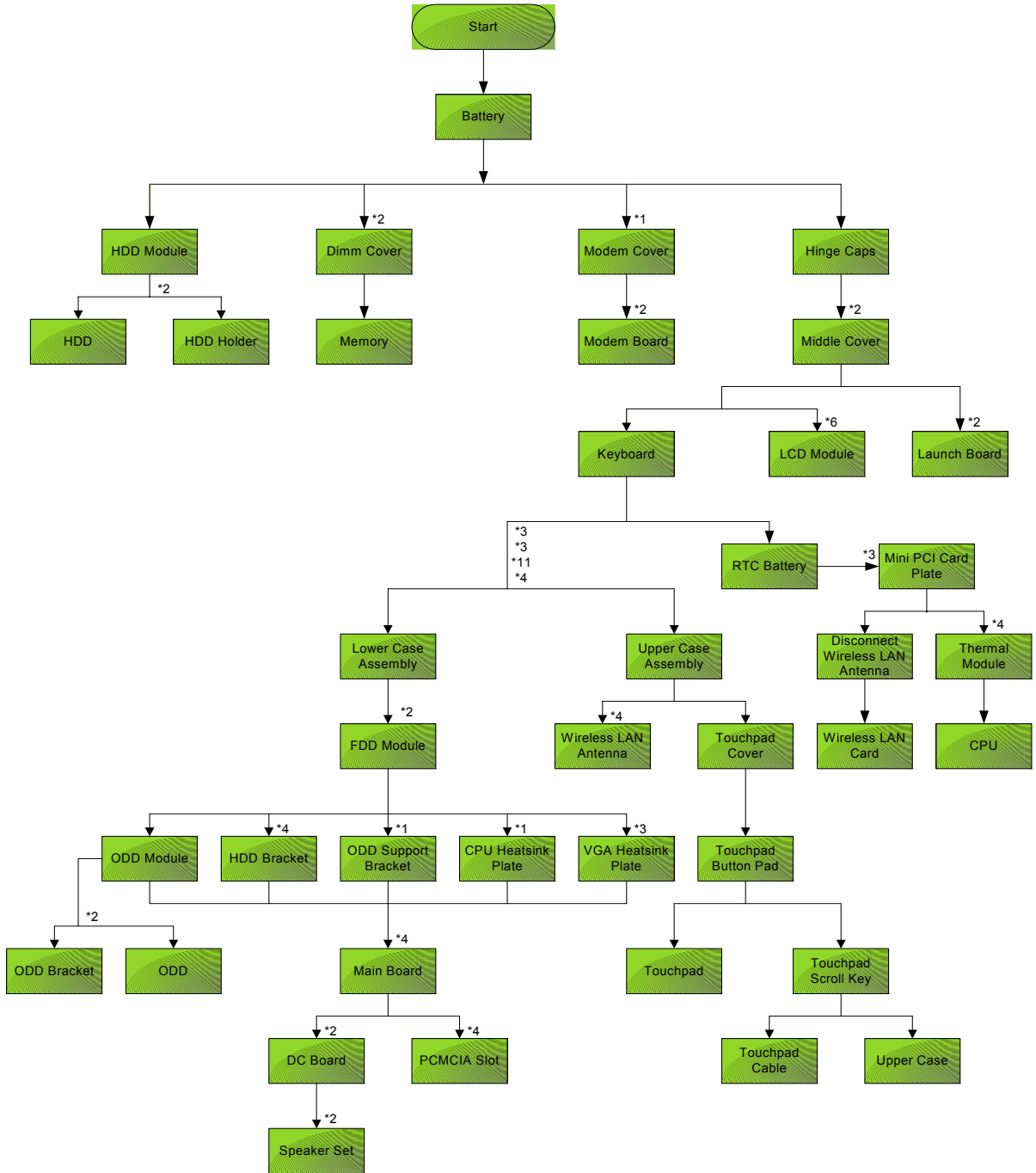

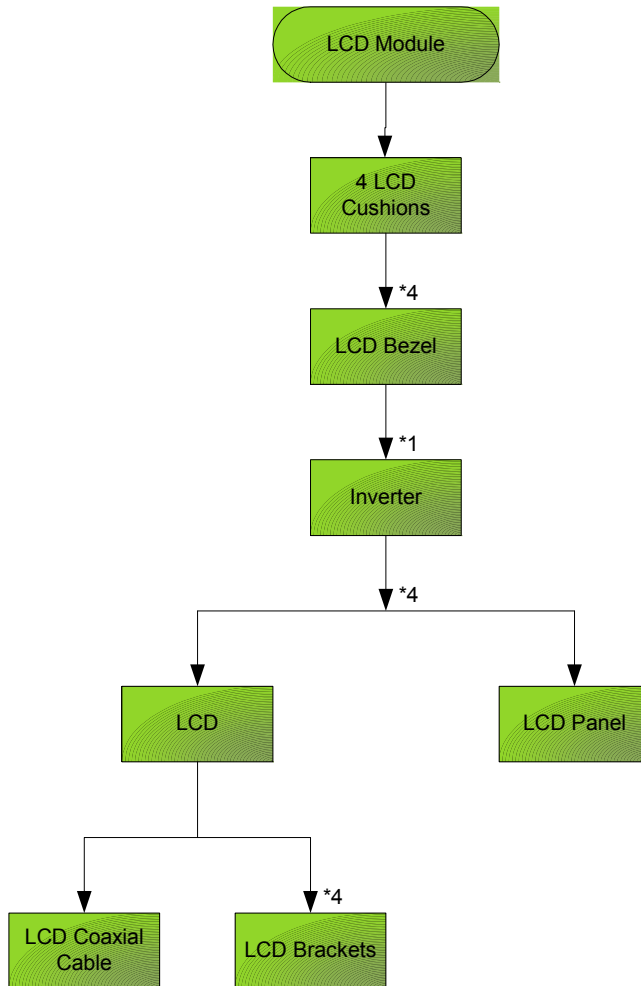

Screw List

Item	Description
A	SCREW MAC FLAT M2.5*L4 NI NYLOK (86.00123.630)
B	SCREW M2.0*L10 NYLOK(86.9A352.100)
C	SCREW M2*3 NYLON 1JMCP-420325(86.9A352.3R0)
D	SCREW M2.5X6(86.9A353.6R0)
E	SCREW M3x4 (86.9A524.4R0)
F	SCREW M2X2.0 (86.9A552.2R0)
G	SCREW WAFER NYLOK NI 2ML3 (86.9A552.3R0)
H	SCRW M2*4 WAFER NI (86.9A552.4R0)
I	SCRW M2.5*3 WAFER NI (86.9A553.3R0)
J	SCREW M2.5*4L NI (86.9A553.4R0)

Removing the Battery

1. To remove the battery, push the battery release latch.
2. Then slide the battery out from the machine.



Removing the Memory Module

1. See “Removing the Battery” on page 52.
2. To remove the memory module from the machine, first remove the two screws holding the dimm cover.



3. Remove the dimm cover.



4. Pop up the memory.
5. Then remove the memory.



Removing the Modem Board

1. See “Removing the Battery” on page 52.
2. To remove the modem board, first remove the screw from the modem cover.



3. Remove the modem cover from the machine.



4. Remove two screws from the modem board as shown. Please remove the screws according to the number on the picture indicate.
5. Then remove the modem board from the main unit carefully by using a plastic bladed screw driver.



6. Disconnect the modem cable from the modem board, then remove the modem board.



Removing the Hard Disk Drive Module

1. See “Removing the Battery” on page 52.
2. To remove the hard disk drive, pull the hard disk drive carefully.



3. Then take the hard disk drive out of the main unit.

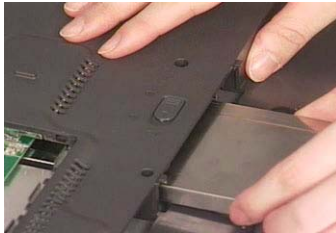

Disassembling the Hard Disk Drive Module

1. See “Removing the Battery” on page 52.
2. See “Removing the Hard Disk Drive Module” on page 55.
3. Remove the two screws that fasten the HDD holder.



4. Detach the hard disk drive from the HDD holder.



Removing the LCD Module

Removing the Middle Cover

1. See “Removing the Battery” on page 52.
2. To remove the middle cover, first use a plastic flat screwdriver to remove the right hinge cap.
3. Remove the screw that secures the middle cover.



4. Remove the left hinge cap.
5. Then remove the screw holding the middle cover on the other side.



6. Detach the middle cover from the machine.



7. Disconnect the launch board cable then remove the middle cover off the main unit.

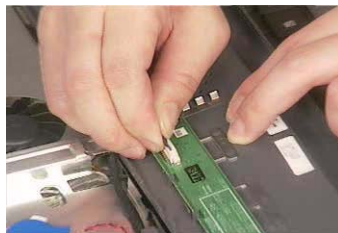

Removing the Launch Board

1. See “Removing the Battery” on page 52.
2. See “Removing the Middle Cover” on page 56.

3. Remove the two screws and then detach the launch board from the middle cover.



Removing the LCD Module

1. See “Removing the Battery” on page 52.
2. See “Removing the Middle Cover” on page 56.
3. See “Removing the Launch Board” on page 56.
4. Remove the screw that fastens the LCD coaxial cable and disconnect the cable. Then disconnect the LCD inverter cable.

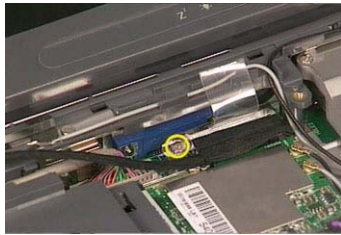

5. Remove the four screws holding the LCD hinge; two on the right and two on the left. Remove the four screws holding the LCD hinge; two on the right and two on the left.



6. Remove the two screws on the bottom; one on the right and the other on the left.



7. Then you can remove the entire LCD module from the main unit.

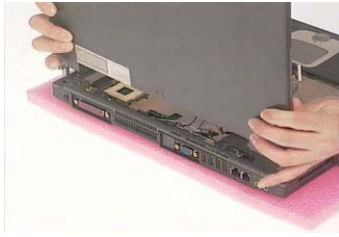

Disassembling the LCD Module

Removing the LCD Bezel

1. See “Removing the Battery” on page 52.
2. See “Removing the Middle Cover” on page 56.
3. See “Removing the Launch Board” on page 56.
4. See “Removing the LCD Module” on page 57.
5. Use plastic tweezers to remove the four screw pads, and then remove the four screws that fasten the LCD bezel.

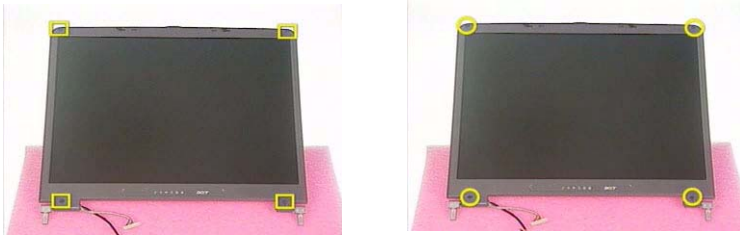

6. Snap off the bezel carefully, and then remove the LCD bezel from the LCD module.



Removing the Inverter Board (15” LCD)

1. See “Removing the Battery” on page 52.
2. See “Removing the Middle Cover” on page 56.
3. See “Removing the Launch Board” on page 56.
4. See “Removing the LCD Module” on page 57.
5. See “Removing the LCD Bezel” on page 59.
6. To remove the inverter board, first remove one screw from the inverter board.

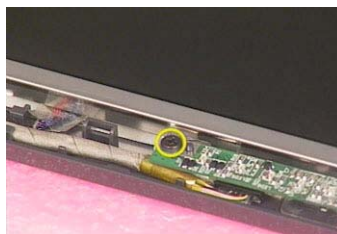

7. Disconnect the LCD power cable then disconnect the inverter cable from the inverter board.



NOTE: Please arrange the LCD inverter cable well to the LCD panel as the picture below shows when you reassemble the LCD module.



Removing the 15" TFT LCD

1. See "Removing the Battery" on page 52.
2. See "Removing the Middle Cover" on page 56.
3. See "Removing the Launch Board" on page 56.
4. See "Removing the LCD Module" on page 57.
5. See "Removing the LCD Bezel" on page 59.
6. See "Removing the Inverter Board (15" LCD)" on page 59.
7. To remove the LCD, first remove the four screws that secure the LCD hinges.



8. Then take the LCD out of the LCD panel.



Removing the LCD Brackets

1. See "Removing the Battery" on page 52.

2. See “Removing the Middle Cover” on page 56.
3. See “Removing the Launch Board” on page 56.
4. See “Removing the LCD Module” on page 57.
5. See “Removing the LCD Bezel” on page 59.
6. See “Removing the Inverter Board (15” LCD)” on page 59.
7. See “Removing the 15” TFT LCD” on page 60.
8. Remove the four screws holding the right LCD bracket. Then remove the right bracket.

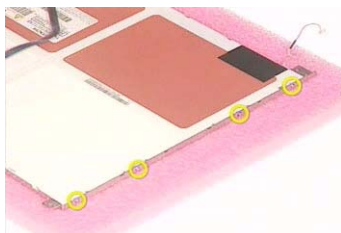

9. Remove the four screws holding the left LCD bracket. Then remove the left bracket.

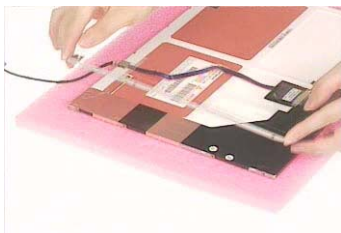
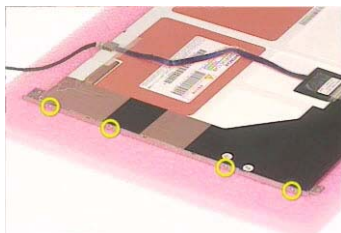

Removing the LCD Coaxial Cable

1. See “Removing the Battery” on page 52.
2. See “Removing the Middle Cover” on page 56.
3. See “Removing the Launch Board” on page 56.
4. See “Removing the LCD Module” on page 57.
5. See “Removing the LCD Bezel” on page 59.
6. See “Removing the Inverter Board (15” LCD)” on page 59.
7. See “Removing the 15” TFT LCD” on page 60.
8. Tear off the mylar fastening the LCD coaxial cable, then disconnect the coaxial cable.



Removing the LCD Hinges

1. See “Removing the Battery” on page 52.

-
2. See “Removing the Middle Cover” on page 56.
 3. See “Removing the Launch Board” on page 56.
 4. See “Removing the LCD Module” on page 57.
 5. See “Removing the LCD Bezel” on page 59.
 6. See “Removing the Inverter Board (15” LCD)” on page 59.
 7. See “Removing the 15” TFT LCD” on page 60.
 8. Remove the screw holding the right hinge, then remove the right hinge.

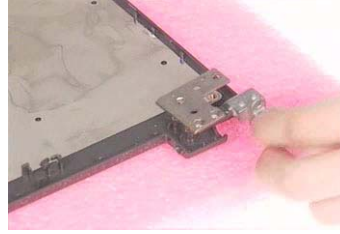

9. Remove the screw holding the left hinge, then remove the left hinge.



Disassembling the Main Unit

Removing the Keyboard

1. See “Removing the Battery” on page 52.
2. See “Removing the Middle Cover” on page 56.
3. To remove the keyboard, first pull out and upward to expose the keyboard.



4. Use a plastic tweezers or a plastic flat screwdriver to disconnect the keyboard cable from the main board carefully, then remove the keyboard from the main board.

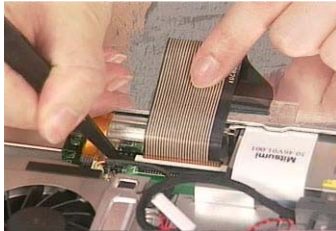

Removing the RTC Battery

1. See “Removing the Battery” on page 52.
2. See “Removing the Middle Cover” on page 56.
3. See “Removing the LCD Module” on page 57.
4. Disconnect the RTC battery cable then remove it.



Removing the MimiPCI Card Plate

1. See “Removing the Battery” on page 52.
2. See “Removing the Middle Cover” on page 56.
3. See “Removing the LCD Module” on page 57.
4. See “Removing the RTC Battery” on page 63.
5. Remove the three screws holding the mini PCI card plate and remove the mini PCI card plate.

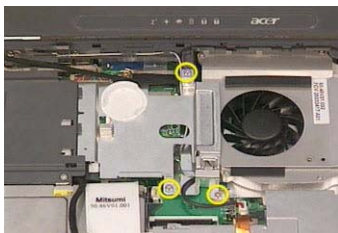

Removing the Thermal Module

1. See “Removing the Battery” on page 52.
2. See “Removing the Middle Cover” on page 56.
3. See “Removing the LCD Module” on page 57.
4. See “Removing the RTC Battery” on page 63.
5. See “Removing the MimiPCI Card Plate” on page 63.
6. Disconnect the fan cable then remove the four screws fastening the thermal module.

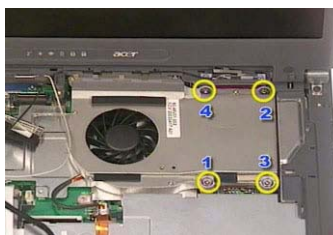
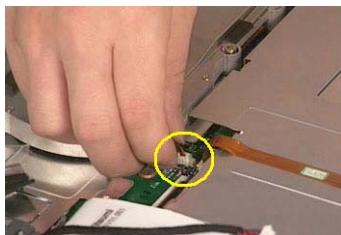

7. Then remove the thermal module.

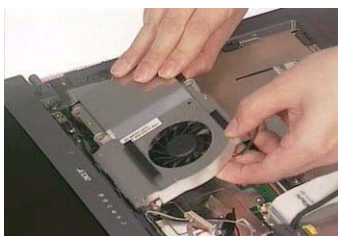

Removing the Processor

1. See “Removing the Battery” on page 52.
2. See “Removing the Middle Cover” on page 56.
3. See “Removing the Keyboard” on page 63.
4. See “Removing the RTC Battery” on page 63.
5. See “Removing the MimiPCI Card Plate” on page 63.
6. See “Removing the Thermal Module” on page 64.
7. Lift up the CPU socket lever. Then remove the CPU. Remember to press down the lever as the video shows after you remove the CPU.

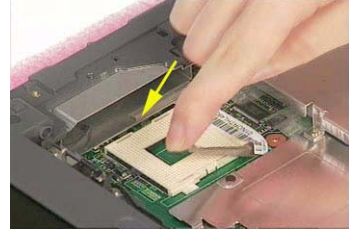
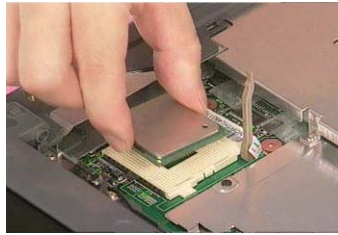
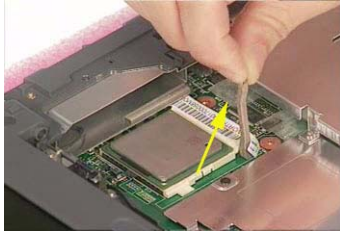

Installing the Processor

1. See “Removing the Battery” on page 52.
2. See “Removing the Middle Cover” on page 56.
3. See “Removing the Keyboard” on page 63.
4. See “Removing the RTC Battery” on page 63.
5. See “Removing the MimiPCI Card Plate” on page 63.
6. See “Removing the Thermal Module” on page 64.
7. Lift up the CPU lever, then place the CPU back to the CPU socket. Please remember to press the CPU lever after you put the CPU back to the socket.

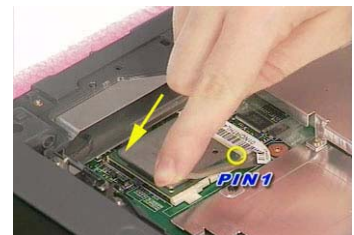
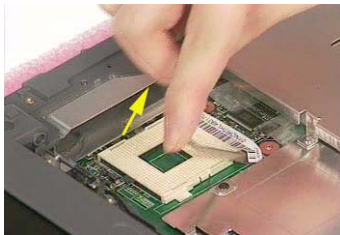

Removing the Upper Case Assembly

1. See “Removing the Keyboard” on page 63.
2. Disconnect the touchpad cable.

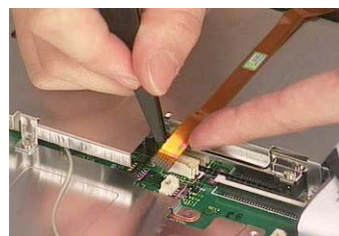
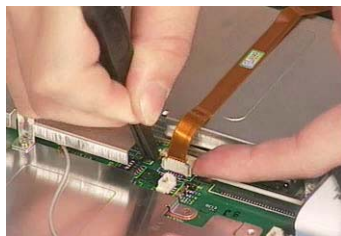

3. Remove the 6 screws that secure the upper case to the lower case. Then turn over the main unit and remove the 15 screws holding the lower case to the upper case.

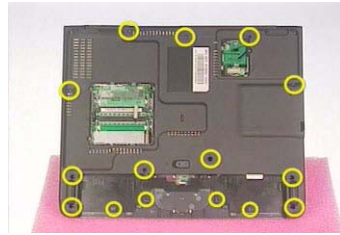
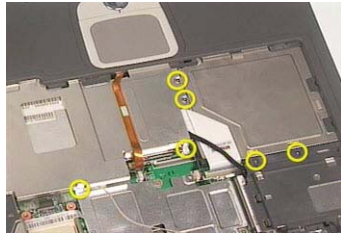

4. Then take the upper case assembly off the main unit.



Removing the Touchpad Board

1. See “Removing the Battery” on page 52.
2. See “Removing the Middle Cover” on page 56.
3. See “Removing the Keyboard” on page 63.
4. See “Removing the Upper Case Assembly” on page 65.
5. To detach the touch pad board, first disconnect the touch pad cable from the touch pad board with a plastic tweezers. Then release the touchpad cover lock on the back as the picture shows.

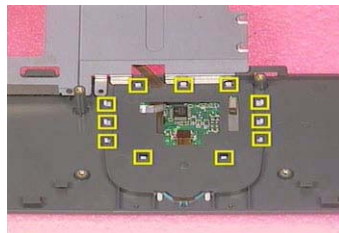

6. Remove the touchpad cover, then remove the touchpad button pad. Finally remove the touchpad board from the upper case.



Removing the Touchpad Cable

1. See “Removing the Battery” on page 52.
2. See “Removing the Middle Cover” on page 56.

3. See “Removing the LCD Module” on page 57.
4. See “Removing the Keyboard” on page 63.
5. See “Removing the Upper Case Assembly” on page 65.
6. See “Removing the Touchpad Board” on page 66.
7. Remove the touchpad scroll key then remove the touchpad cable.

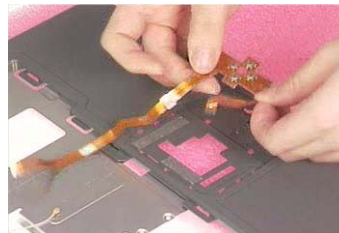

Removing the Floppy Disk Drive Module

1. See “Removing the Middle Cover” on page 56.
2. See “Removing the LCD Module” on page 57.
3. See “Removing the Keyboard” on page 63.
4. See “Removing the Upper Case Assembly” on page 65.
5. Disconnect the FDD cable from the main board.

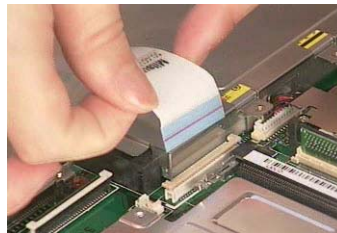

6. Remove the two screws hastening the FDD module. Detach the FDD module from the lower case.

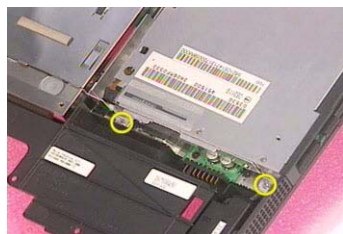

Disassembling the Floppy Disk Drive Module

1. Disconnect the FDD cable.
2. Remove the two screws that fasten the FDD bracket on one side.

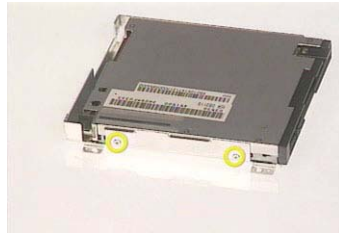
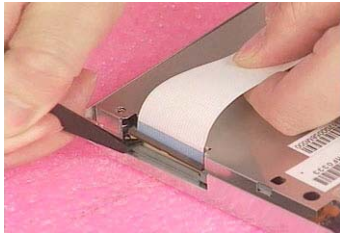

3. Remove another two screws holding the FDD bracket on the other side. Then take the FDD off the FDD bracket.

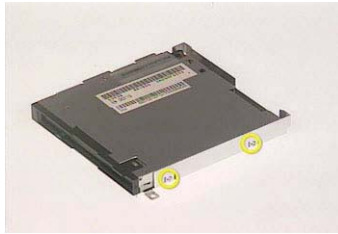

Removing the VGA Heatsink Plate

1. See “Removing the Battery” on page 52.
2. See “Removing the Middle Cover” on page 56.
3. See “Removing the Keyboard” on page 63.
4. See “Removing the Floppy Disk Drive Module” on page 67.
5. Remove the three screws that secure the VGA heatsink plate then remove the plate.

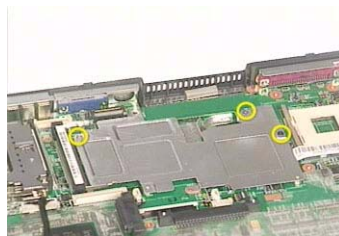

Removing the CPU Heatsink Plate

1. See “Removing the Battery” on page 52.
2. See “Removing the Middle Cover” on page 56.
3. See “Removing the Keyboard” on page 63.
4. See “Removing the Floppy Disk Drive Module” on page 67.
5. Remove the screw that fastens the CPU heatsink plate then remove it.

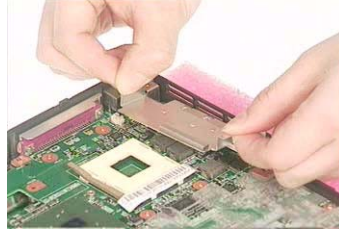

Removing the ODD Module(1)

1. See “Removing the Battery” on page 52.
2. Remove the screw that fastens the ODD bracket on the bottom. Push the ODD module at the point the red arrow indicates hard. Then remove the ODD module from the lower case.



NOTE: If you need to replace the ODD module only, you can remove the ODD module as the steps above.

Removing the ODD Module(2)

1. See “Removing the Battery” on page 52.
2. See “Removing the Middle Cover” on page 56.
3. See “Removing the Keyboard” on page 63.
4. See “Removing the Floppy Disk Drive Module” on page 67.
5. Push the ODD module outwards then take the ODD out of the support bracket. Remove the screw that fastens the ODD support bracket then remove it.

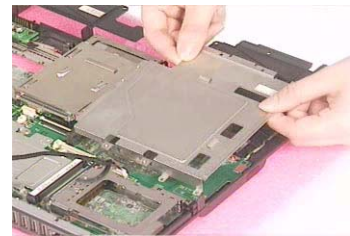
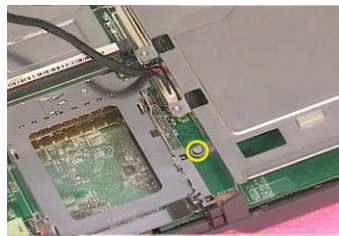
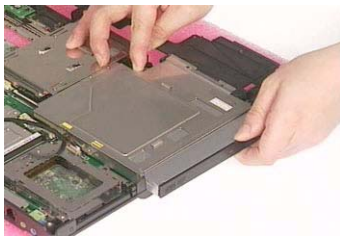

Removing the HDD Bracket

1. See “Removing the Battery” on page 52.
2. See “Removing the Middle Cover” on page 56.
3. See “Removing the Keyboard” on page 63.
4. See “Removing the Floppy Disk Drive Module” on page 67.
5. Remove the four screws holding the HDD bracket, then remove the HDD bracket.

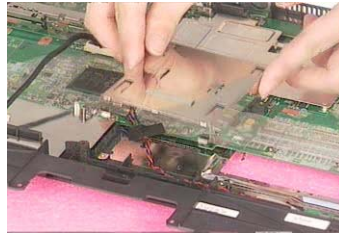
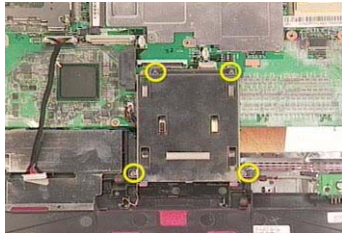

Removing the Main Board

1. See “Removing the Battery” on page 52.
2. See “Removing the Middle Cover” on page 56.
3. See “Removing the Keyboard” on page 63.
4. See “Removing the Floppy Disk Drive Module” on page 67.
5. See “Removing the VGA Heatsink Plate” on page 68.
6. See “Removing the CPU Heatsink Plate” on page 68.
7. See “Removing the ODD Module(1)” on page 69.
8. See “Removing the HDD Bracket” on page 69.
9. Disconnect the launch board cable. Tear off the tape that fastens the speaker set cable. Then disconnect the speaker set cable.

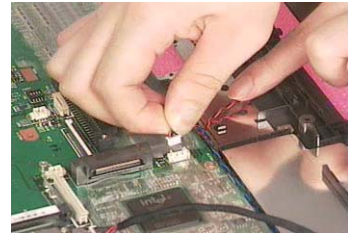
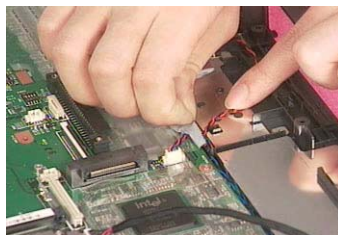
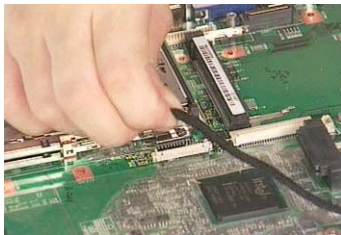

10. Remove the two screws holding the main board as the picture shows. Remove another two screws that fasten the main board. Then detach the main board from the lower case carefully.

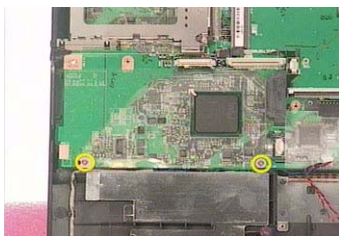

Removing the DC Board

1. See “Removing the Battery” on page 52.
2. See “Removing the Middle Cover” on page 56.
3. See “Removing the Keyboard” on page 63.
4. See “Removing the Floppy Disk Drive Module” on page 67.
5. See “Removing the VGA Heatsink Plate” on page 68.
6. See “Removing the CPU Heatsink Plate” on page 68.

7. See “Removing the ODD Module(1)” on page 69.
8. See “Removing the HDD Bracket” on page 69.
9. See “Removing the Main Board” on page 70.
10. Remove the two screws that fasten the DC board. Then detach the DC board from the lower case.

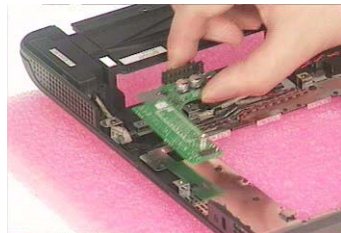

Removing the I/O Port Bracket

1. See “Removing the Battery” on page 52.
2. See “Removing the Middle Cover” on page 56.
3. See “Removing the Keyboard” on page 63.
4. See “Removing the Floppy Disk Drive Module” on page 67.
5. See “Removing the VGA Heatsink Plate” on page 68.
6. See “Removing the CPU Heatsink Plate” on page 68.
7. See “Removing the ODD Module(1)” on page 69.
8. See “Removing the HDD Bracket” on page 69.
9. See “Removing the Main Board” on page 70.
10. Remove the four hex screws to detach the I/O port bracket from the main board.



Removing the PCMCIA Slot

1. See “Removing the Battery” on page 52.
2. See “Removing the Middle Cover” on page 56.
3. See “Removing the Keyboard” on page 63.
4. See “Removing the Floppy Disk Drive Module” on page 67.
5. See “Removing the VGA Heatsink Plate” on page 68.
6. See “Removing the CPU Heatsink Plate” on page 68.
7. See “Removing the ODD Module(1)” on page 69.
8. See “Removing the HDD Bracket” on page 69.
9. See “Removing the Main Board” on page 70.

-
10. Remove the four screws that secure the PCMCIA slot, then remove the PCMCIA slot from the lower case.

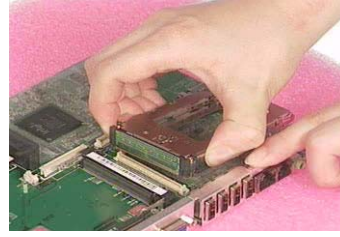
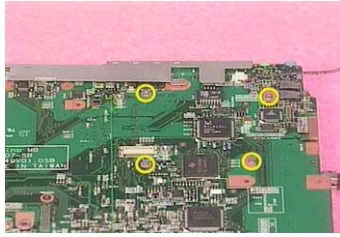

Removing the Speaker Set

1. See “Removing the Battery” on page 52.
2. See “Removing the Middle Cover” on page 56.
3. See “Removing the Keyboard” on page 63.
4. See “Removing the Floppy Disk Drive Module” on page 67.
5. See “Removing the VGA Heatsink Plate” on page 68.
6. See “Removing the CPU Heatsink Plate” on page 68.
7. See “Removing the ODD Module(1)” on page 69.
8. See “Removing the HDD Bracket” on page 69.
9. See “Removing the Main Board” on page 70.
10. See “Removing the DC Board” on page 70.
11. Tear off the tape fastening the speaker set cable. Then remove the four screws that secure the speaker set. Remove the speaker set from the lower case.

System Upgrade Procedure

Base Unit to Wireless Unit

1. See “Removing the Middle Cover” on page 56.
2. See “Removing the Keyboard” on page 63.
3. See “Removing the RTC Battery” on page 63.
4. See “Removing the MimiPCI Card Plate” on page 63.
5. Secure the wireless LAN card antenna by four screws. Insert the wireless LAN card to the socket then connect the wireless LAN card antenna to the wireless LAN card.

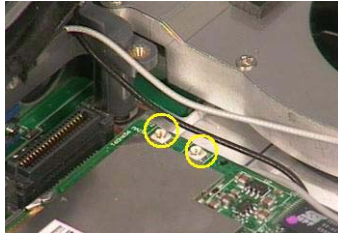

Assembling the Main Unit

Installing the Speaker Set

1. Attach the speaker set to the lower case. Secure the speaker set to the lower case with the four screws. Then stick the tape fastening the speaker set cable.

Installing the DC Board

1. See “Installing the Speaker Set” on page 86.
2. Attach the DC board to the lower case. Then secure the DC board to the lower case with two screws.

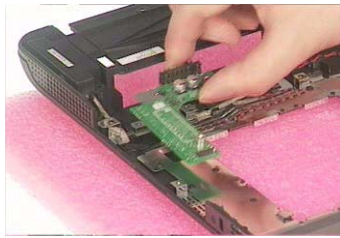

Installing the PCMCIA Slot

1. See “Installing the Speaker Set” on page 86.
2. See “Installing the DC Board” on page 86.
3. Attach the PCMCIA slot to the main board, and then fasten the PCMCIA slot to the main board with four screws

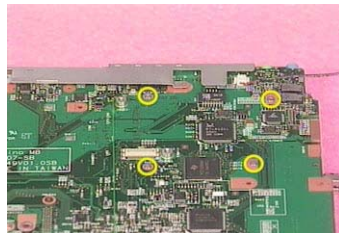
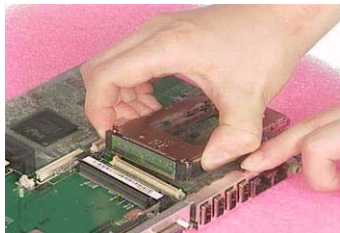

Installing the Main Board

1. See “Installing the Speaker Set” on page 86.
2. See “Installing the DC Board” on page 86.
3. See “Installing the PCMCIA Slot” on page 86.
4. Put the main board to the lower case. Secure the main board with the two screws as the picture shows. Fasten the main board to the lower case with another two screws.

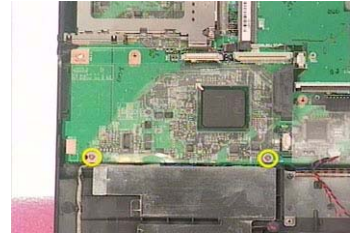
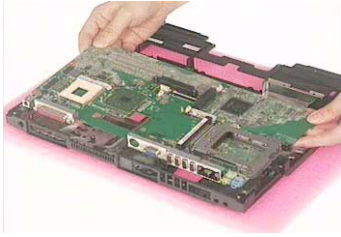

5. Connect the speaker set cable to the main board. Then stick the tape that fastens the speaker set cable. Connect the launch board cable to the main board.

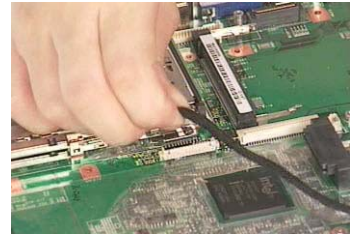
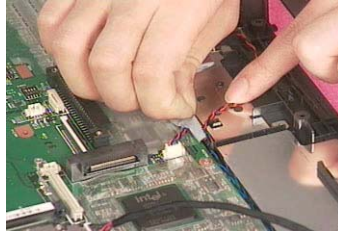
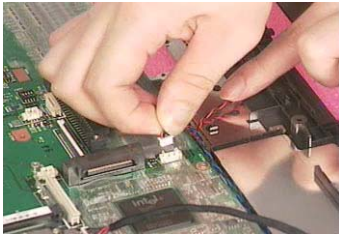

Installing the HDD Bracket

1. See "Installing the Speaker Set" on page 86.
2. See "Installing the DC Board" on page 86.
3. See "Installing the PCMCIA Slot" on page 86.
4. See "Installing the Main Board" on page 86.
5. Attach the HDD bracket. Then secure the HDD bracket with the four screws.

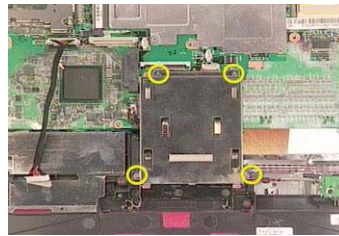
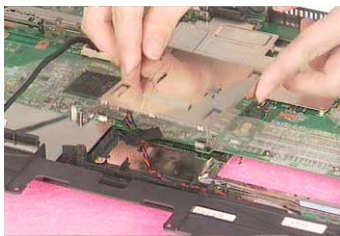

Installing the ODD Module

1. See "Installing the Speaker Set" on page 86.
2. See "Installing the DC Board" on page 86.
3. See "Installing the PCMCIA Slot" on page 86.
4. See "Installing the Main Board" on page 86.
5. See "Installing the HDD Bracket" on page 87.
6. Put the ODD support bracket to the lower case assembly, and then fasten the ODD support bracket with the one screw. Place the ODD back in the ODD support bracket, and then push the ODD to the original position.

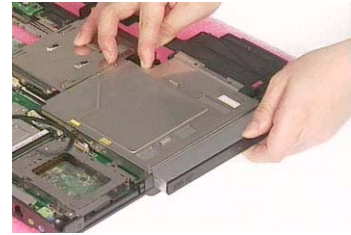
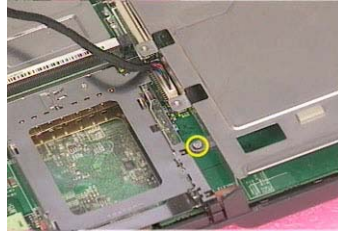
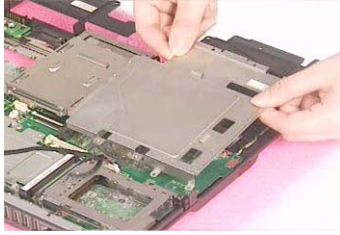

Installing the CPU Heatsink Plate

1. See “Installing the Speaker Set” on page 86.
2. See “Installing the DC Board” on page 86.
3. See “Installing the PCMCIA Slot” on page 86.
4. See “Installing the Main Board” on page 86.
5. Place the CPU heatsink plate to the main board. Then secure the CPU heatsink plate with one screws.

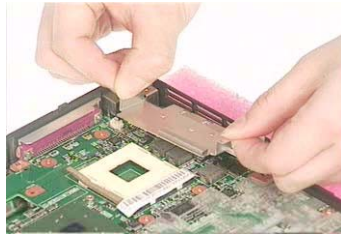

Installing the VGA Heatsink Plate

1. See “Installing the Speaker Set” on page 86.
2. See “Installing the DC Board” on page 86.
3. See “Installing the PCMCIA Slot” on page 86.
4. See “Installing the Main Board” on page 86.
5. Place the VGA heatsink plate to the main board. Then fasten the VGA heatsink plate with three screws.

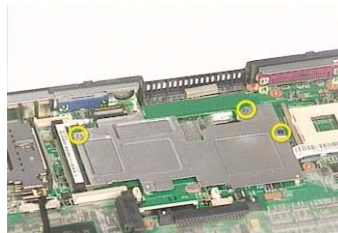

Installing the Floppy Disk Drive Module

1. See “Installing the Speaker Set” on page 86.
2. See “Installing the DC Board” on page 86.

3. See “Installing the PCMCIA Slot” on page 86.
4. See “Installing the Main Board” on page 86.
5. See “Installing the HDD Bracket” on page 87.
6. See “Installing the CPU Heatsink Plate” on page 88.
7. Put the FDD module to the main board. Secure the FDD module with two screws.

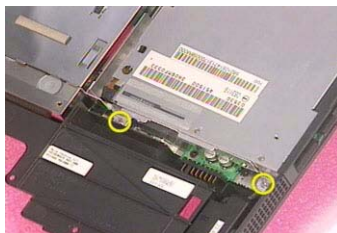

8. Connect the FDD cable to the main board.



Installing the Touchpad Cable

1. Attach the touchpad cable to the upper case, and then pull out the cable.
2. Place the touchpad scroll key to the upper case.

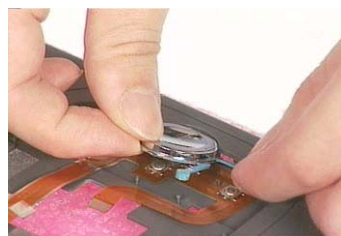
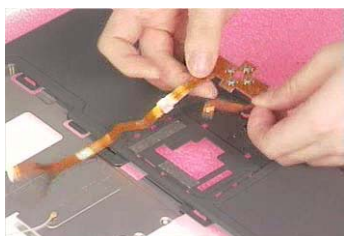

Installing the Touchpad Board

1. See “Installing the Touchpad Cable” on page 89.
2. Put the touchpad board and the touchpad button pad to the upper case. Then attach the touchpad cover to the upper case as the picture shows.



3. Connect the touch pad cable to the touchpad board with a plastic tweezers.



Installing the Upper Case Assembly

1. See "Installing the Speaker Set" on page 86.
2. See "Installing the DC Board" on page 86.
3. See "Installing the PCMCIA Slot" on page 86.
4. See "Installing the Main Board" on page 86.
5. See "Installing the HDD Bracket" on page 87.
6. See "Installing the ODD Module" on page 87.
7. See "Installing the CPU Heatsink Plate" on page 88.
8. See "Installing the VGA Heatsink Plate" on page 88.
9. See "Installing the Floppy Disk Drive Module" on page 88.
10. See "Installing the Touchpad Cable" on page 89.
11. See "Installing the Touchpad Board" on page 89.
12. Attach the upper case assembly to the lower case assembly.



13. Fasten the 15 screws on the bottom. Then secure the 6 screws as the picture shows.

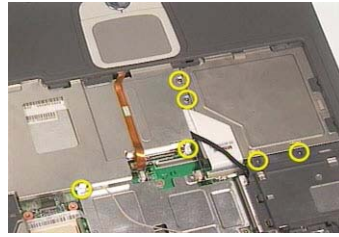
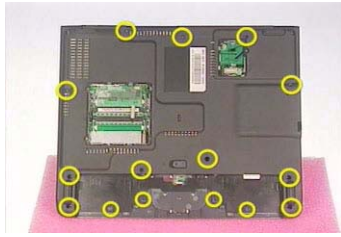

14. Connect the touchpad cable to the main board.

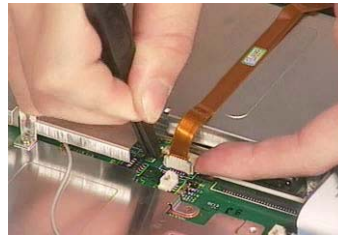
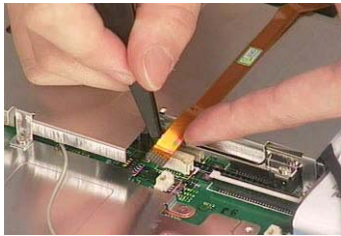

Installing the Processor

1. Lift up the CPU lever, then place the CPU back to the CPU socket carefully. Please remember to press the CPU lever after you put the CPU back to the socket.

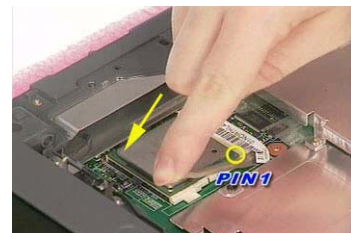
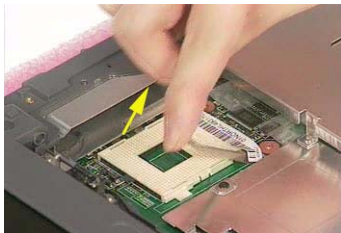

Installing the Thermal Module

1. See "Installing the Speaker Set" on page 86.
2. See "Installing the DC Board" on page 86.
3. See "Installing the PCMCIA Slot" on page 86.
4. See "Installing the Main Board" on page 86.
5. See "Installing the HDD Bracket" on page 87.
6. See "Installing the ODD Module" on page 87.
7. See "Installing the CPU Heatsink Plate" on page 88.
8. See "Installing the VGA Heatsink Plate" on page 88.
9. See "Installing the Floppy Disk Drive Module" on page 88.
10. See "Installing the Touchpad Cable" on page 89.
11. See "Installing the Touchpad Board" on page 89.
12. See "Installing the Upper Case Assembly" on page 90.

13. See “Installing the Processor” on page 91.
14. Place the thermal module to the main unit.

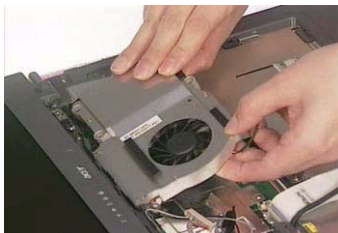

15. Secure the thermal module with the four screws. Then connect the thermal module cable to the main board.

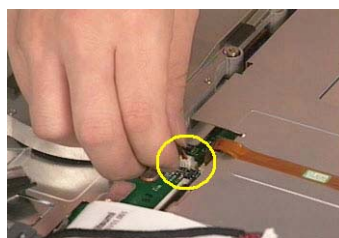
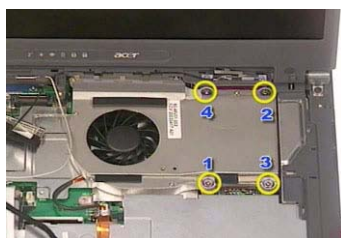

Installing the MimiPCI Card Plate

1. See “Installing the Speaker Set” on page 86.
2. See “Installing the DC Board” on page 86.
3. See “Installing the PCMCIA Slot” on page 86.
4. See “Installing the Main Board” on page 86.
5. See “Installing the HDD Bracket” on page 87.
6. See “Installing the ODD Module” on page 87.
7. See “Installing the CPU Heatsink Plate” on page 88.
8. See “Installing the VGA Heatsink Plate” on page 88.
9. See “Installing the Floppy Disk Drive Module” on page 88.
10. See “Installing the Touchpad Cable” on page 89.
11. See “Installing the Touchpad Board” on page 89.
12. See “Installing the Upper Case Assembly” on page 90.
13. See “Installing the Processor” on page 91.
14. See “Installing the Thermal Module” on page 91.
15. Place the mini PCI card plate to the main unit. Secure the mini PCI card plate with the three screws as the picture shows.

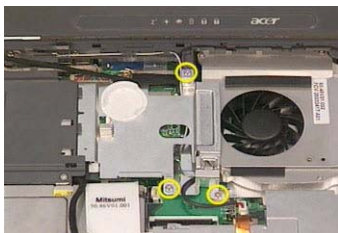

Installing the RTC Battery

1. See “Installing the Speaker Set” on page 86.
2. See “Installing the DC Board” on page 86.
3. See “Installing the PCMCIA Slot” on page 86.
4. See “Installing the Main Board” on page 86.
5. See “Installing the HDD Bracket” on page 87.
6. See “Installing the ODD Module” on page 87.
7. See “Installing the CPU Heatsink Plate” on page 88.
8. See “Installing the VGA Heatsink Plate” on page 88.
9. See “Installing the Floppy Disk Drive Module” on page 88.
10. See “Installing the Touchpad Cable” on page 89.
11. See “Installing the Touchpad Board” on page 89.
12. See “Installing the Upper Case Assembly” on page 90.
13. See “Installing the Processor” on page 91.
14. See “Installing the Thermal Module” on page 91.
15. See “Installing the MiniPCI Card Plate” on page 92.
16. Place the RTC battery to the RTC battery holder. Connect the RTC battery cable to the main board.



Installing the Keyboard

1. See “Installing the Speaker Set” on page 86.
2. See “Installing the DC Board” on page 86.
3. See “Installing the PCMCIA Slot” on page 86.
4. See “Installing the Main Board” on page 86.
5. See “Installing the HDD Bracket” on page 87.
6. See “Installing the ODD Module” on page 87.

-
7. See “Installing the CPU Heatsink Plate” on page 88.
 8. See “Installing the VGA Heatsink Plate” on page 88.
 9. See “Installing the Floppy Disk Drive Module” on page 88.
 10. See “Installing the Touchpad Cable” on page 89.
 11. See “Installing the Touchpad Board” on page 89.
 12. See “Installing the Upper Case Assembly” on page 90.
 13. See “Installing the Processor” on page 91.
 14. See “Installing the Thermal Module” on page 91.
 15. See “Installing the MiniPCI Card Plate” on page 92.
 16. See “Installing the RTC Battery” on page 93.
 17. Attach the keyboard cable to its connector on the main board. Connect the keyboard cable.

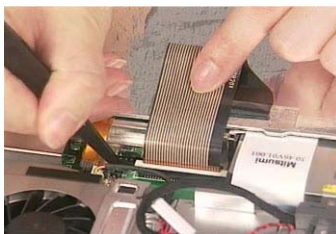

18. Turn over the keyboard and attach the keyboard to the main unit.



Assembling the LCD Module

Installing the LCD Hinges

1. Place the left hinge to the LCD panel. Secure the left hinge with one screw.



2. Place the right hinge to the LCD panel. Fasten the right hinge with one screw.

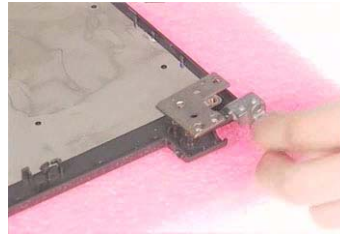

Installing the LCD Coaxial Cable

1. See "Installing the LCD Hinges" on page 95.
2. Connect the LCD coaxial cable and fasten with mylar. Fasten the LCD coaxial cable with mylar.



Installing the LCD Brackets

1. See "Installing the LCD Hinges" on page 95.
2. See "Installing the LCD Coaxial Cable" on page 95.
3. Attach the left bracket to the LCD. Then secure the left LCD bracket with four screws.

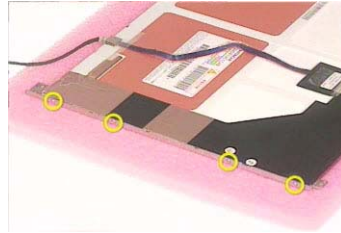
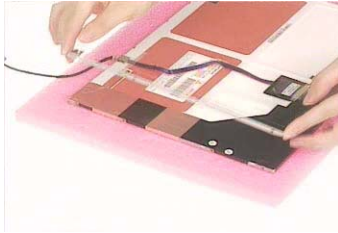

4. Attach the right bracket to the LCD. Fasten the right LCD bracket with four screws.

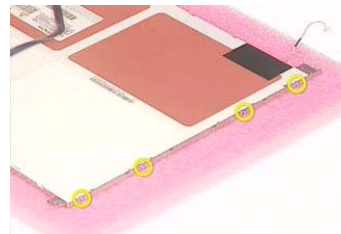

Installing the 15" TFT LCD

1. See "Installing the LCD Hinges" on page 95.
2. See "Installing the LCD Coaxial Cable" on page 95.
3. See "Installing the LCD Brackets" on page 95.
4. Place the LCD to the LCD panel.



5. Secure the left hinge with two screws. Fasten the right hinge with two screws.



Installing the Inverter Board (15" LCD)

1. See "Installing the LCD Hinges" on page 95.
2. See "Installing the LCD Coaxial Cable" on page 95.
3. See "Installing the LCD Brackets" on page 95.

4. See “Installing the 15” TFT LCD” on page 96.
5. Connect the inverter cable to the inverter board. Connect the inverter board to the LCD.

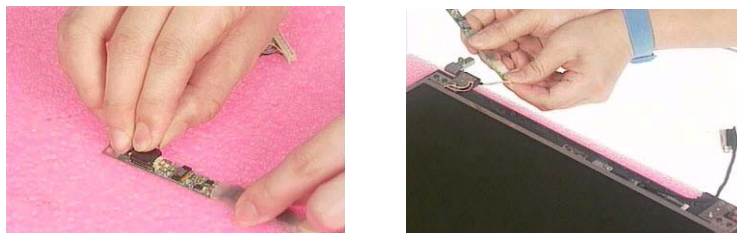

NOTE: Please arrange the LCD inverter cable well to the LCD panel as the picture below shows when you reassemble the LCD module.



6. Secure the inverter board with one screw.

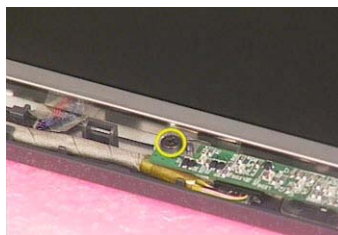

Installing the LCD Bezel

1. See “Installing the LCD Hinges” on page 95.
2. See “Installing the LCD Coaxial Cable” on page 95.
3. See “Installing the LCD Brackets” on page 95.
4. See “Installing the 15” TFT LCD” on page 96.
5. See “Installing the Inverter Board (15” LCD)” on page 96.
6. Attach the LCD bezel to the LCD module.



7. Fasten the LCD bezel with the four screws. Then cover the four screw pads.



Installing the LCD Module

Installing the LCD Module

1. Place the LCD module to the main unit.

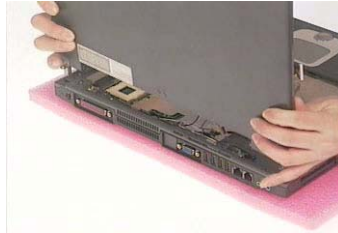

2. Fasten the LCD module with the two screws on the bottom; one on the right and another one on the left.



3. Secure the LCD hinge with the four screws; two on the right and two on the left.



4. Connect the inverter cable to the main board. Connect the LCD coaxial cable to the main board. Then fasten the LCD coaxial cable with one screw.

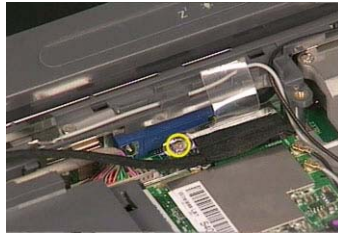

Installing the Launch Board

1. Attach the launch board to the middle cover. Then secure the launch board with the two screws as the picture shows.



Installing the Middle Cover

1. See "Installing the Launch Board" on page 99.
2. Connect the launch board cable to the launch board.

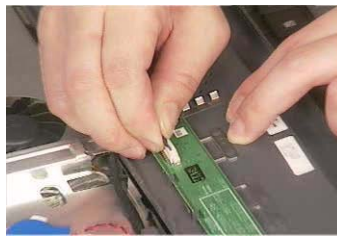

3. Attach the middle cover to the main unit carefully. Then close the LCD panel and fasten the middle cover with your fingers on its ridge.



4. Secure the middle cover with one screw as the picture shows.
5. Then attach the left hinge cap.



6. Secure the middle cover with one screw on another side as the picture shows.
7. Then attach the right hinge cap.



Installing the Hard Disk Drive Module

1. Insert the hard disk drive to the main unit. Then push it to the original position carefully.

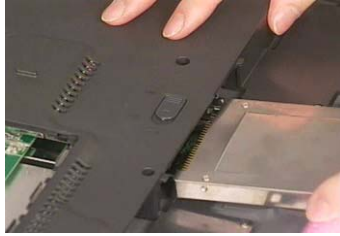

NOTE: Please attend the positive and negative of hard disk drive when insert the hard disk drive to the main unit.



Removing the Modem Board

1. Connect the modem cable to the modem board.

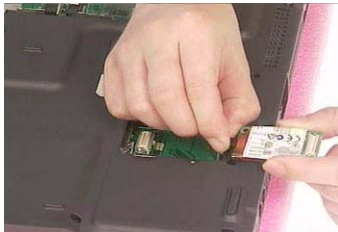

2. Place the modem board to the main unit carefully. Then fasten the modem board with the two screws.



3. Place the modem cover back to the machine. Then secure the modem cover with one screw.



Installing the Memory Module

1. Insert the memory module to the DIMM slot.



2. Put the DIMM cover back to the machine.



3. Fasten the DIMM cover with the two screws.

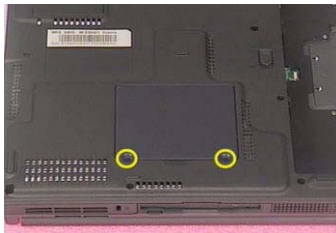

Installing the Battery

1. Place the the battery back to the machine.



Troubleshooting

Use the following procedure as a guide for computer problems.

NOTE: The diagnostic tests are intended to test only Acer products. Non-Acer products, prototype cards, or modified options can give false errors and invalid system responses.

1. Obtain the failing symptoms in as much detail as possible.
2. Verify the symptoms by attempting to re-create the failure by running the diagnostic test or by repeating the same operation.
3. Use the following table with the verified symptom to determine which page to go to.

Symptoms (Verified)	Go To
Power failure. (The power indicator does not go on or stay on.)	"Power System Check" on page 96.
POST does not complete. No beep or error codes are indicated.	"Power-On Self-Test (POST) Error Message" on page 99 "Undetermined Problems" on page 107
POST detects an error and displayed messages on screen.	"Error Message List" on page 100
Other symptoms (i.e. LCD display problems or others).	"Power-On Self-Test (POST) Error Message" on page 99
Symptoms cannot be re-created (intermittent problems).	Use the customer-reported symptoms and go to "Power-On Self-Test (POST) Error Message" on page 99 "Intermittent Problems" on page 106 "Undetermined Problems" on page 107

System Check Procedures

External Diskette Drive Check

Do the following to isolate the problem to a controller, driver, or diskette. A write-enabled, diagnostic diskette is required.

NOTE: Make sure that the diskette does not have more than one label attached to it. Multiple labels can cause damage to the drive or cause the drive to fail.

Do the following to select the test device.

1. Boot from the diagnostics diskette and start the diagnostics program.
2. See if FDD Test is passed as the program runs to FDD Test.
3. Follow the instructions in the message window.

If an error occurs with the internal diskette drive, reconnect the diskette connector on the system board.

If the error still remains:

1. Reconnect the external diskette drive/DVD-ROM module.
2. Replace the external diskette drive/CD-ROM module.
3. Replace the main board.

External CD-ROM Drive Check

Do the following to isolate the problem to a controller, drive, or CD-ROM. Make sure that the CD-ROM does not have any label attached to it. The label can cause damage to the drive or can cause the drive to fail.

Do the following to select the test device:

1. Boot from the diagnostics diskette and start the diagnostics program.
2. See if CD-ROM Test is passed when the program runs to CD-ROM Test.
3. Follow the instructions in the message window.

If an error occurs, reconnect the connector on the System board. If the error still remains:

1. Reconnect the external diskette drive/CD-ROM module.
2. Replace the external diskette drive/CD-ROM module.
3. Replace the main board.

Keyboard or Auxiliary Input Device Check

Remove the external keyboard if the internal keyboard is to be tested.

If the internal keyboard does not work or an unexpected character appears, make sure that the flexible cable extending from the keyboard is correctly seated in the connector on the system board.

If the keyboard cable connection is correct, run the Keyboard Test.

If the tests detect a keyboard problem, do the following one at a time to correct the problem. Do not replace a non-defective FRU:

1. Reconnect the keyboard cables.
2. Replace the keyboard.
3. Replace the main board.

The following auxiliary input devices are supported by this computer:

- Numeric keypad
- External keyboard

If any of these devices do not work, reconnect the cable connector and repeat the failing operation.

Memory check

Memory errors might stop system operations, show error messages on the screen, or hang the system.

1. Boot from the diagnostics diskette and start the doagmpstotics program (please refer to main board).
2. Go to the diagnostic memory in the test items.
3. Press F2 in the test items.
4. Follow the instructions in the message window.

NOTE: Make sure that the DIMM is fully installed into the connector. A loose connection can cause an error.

Power System Check

To verify the symptom of the problem, power on the computer using each of the following power sources:

1. Remove the battery pack.
2. Connect the power adapter and check that power is supplied.
3. Disconnect the power adapter and install the charged battery pack; then check that power is supplied by the battery pack.

If you suspect a power problem, see the appropriate power supply check in the following list:

- "Check the Power Adapter" on page 97
- "Check the Battery Pack" on page 98

Check the Power Adapter

Unplug the power adapter cable from the computer and measure the output voltage at the plug of the power adapter cable. See the following figure

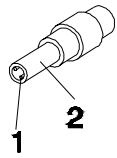

Pin 1: +19 to +20.5V
Pin 2: 0V, Ground

1. If the voltage is not correct, replace the power adapter.
2. If the voltage is within the range, do the following:
 - Replace the System board.
 - If the problem is not corrected, see “Undetermined Problems” on page 107.
 - If the voltage is not correct, go to the next step.

NOTE: An audible noise from the power adapter does not always indicate a defect.

3. If the power-on indicator does not light up, check the power cord of the power adapter for correct continuity and installation.
4. If the operational charge does not work, see “Check the Battery Pack” on page 98.

Check the Battery Pack

To check the battery pack, do the following:

From Software:

1. Check out the Power Management in control Panel
2. In Power Meter, confirm that if the parameters shown in the screen for Current Power Source and Total Battery Power Remaining are correct.
3. Repeat the steps 1 and 2, for both battery and adapter.
4. This helps you identify first the problem is on recharging or discharging.

From Hardware:

1. Power off the computer.
2. Remove the battery pack and measure the voltage between battery terminals 1(+) and 6(ground). See the following figure

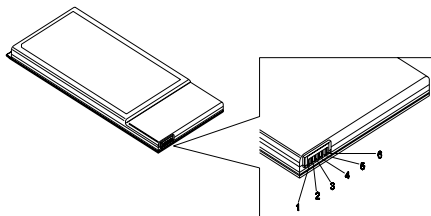

3. If the voltage is still less than 7.5 Vdc after recharging, replace the battery.

To check the battery charge operation, use a discharged battery pack or a battery pack that has less than 50% of the total power remaining when installed in the computer.

If the battery status indicator does not light up, remove the battery pack and let it return to room temperature. Re-install the battery pack.

If the charge indicator still does not light up, replace the battery pack. If the charge indicator still does not light up, replace the DC/DC charger board.

Touchpad Check

If the touchpad doesn't work, do the following actions one at a time to correct the problem. Do not replace a non-defective FRU:

1. Reconnect the touchpad cables.
2. Replace the touchpad.
3. Replace the system board.

After you use the touchpad, the pointer drifts on the screen for a short time. This self-acting pointer movement can occur when a slight, steady pressure is applied to the touchpad pointer. This symptom is not a hardware problem. No service actions are necessary if the pointer movement stops in a short period of time.

Power-On Self-Test (POST) Error Message

The POST error message index lists the error message and their possible causes. The most likely cause is listed first.

NOTE: Perform the FRU replacement or actions in the sequence shown in FRU/Action column, if the FRU replacement does not solve the problem, put the original part back in the computer. Do not replace a non-defective FRU.

This index can also help you determine the next possible FRU to be replaced when servicing a computer.

If the symptom is not listed, see “Undetermined Problems” on page 107.

The following lists the error messages that the BIOS displays on the screen and the error symptoms classified by function.

NOTE: Most of the error messages occur during POST. Some of them display information about a hardware device, e.g., the amount of memory installed. Others may indicate a problem with a device, such as the way it has been configured.

NOTE: If the system fails after you make changes in the BIOS Setup Utility menus, reset the computer, enter Setup and install Setup defaults or correct the error.

Index of Error Messages

Error Code List

Error Codes	Error Messages
006	Equipment Configuration Error Causes: 1. CPU BIOS Update Code Mismatch 2. IDE Primary Channel Master Drive Error (The causes will be shown before "Equipment Configuration Error")
010	Memory Error at xxxx:xxxx:xxxxh (R:xxxxh, W:xxxxh)
070	Real Time Clock Error
071	CMOS Battery Bad
072	CMOS Checksum Error
110	System disabled. Incorrect password is specified.
<No error code>	Battery critical LOW In this situation BIOS will issue 4 short beeps then shut down system, no message will show.
<No error code>	Thermal critical High In this situation BIOS will shut down system, not show message.

Error Message List

Error Messages	FRU/Action in Sequence
Failure Fixed Disk	Reconnect hard disk drive connector. "Load Default Settings" in BIOS Setup Utility. Hard disk drive System board
Stuck Key	see "Keyboard or Auxiliary Input Device Check" on page 95.
Keyboard error	see "Keyboard or Auxiliary Input Device Check" on page 95.
Keyboard Controller Failed	see "Keyboard or Auxiliary Input Device Check" on page 95.
Keyboard locked - Unlock key switch	Unlock external keyboard
Monitor type does not match CMOS - Run Setup	Run "Load Default Settings" in BIOS Setup Utility.
Shadow RAM Failed at offset: nnnn	BIOS ROM System board
System RAM Failed at offset: nnnn	DIMM System board
Extended RAM Failed at offset: nnnn	DIMM System board
System battery is dead - Replace and run Setup	Replace RTC battery and Run BIOS Setup Utility to reconfigure system time, then reboot system.
System CMOS checksum bad - Default configuration used	RTC battery Run BIOS Setup Utility to reconfigure system time, then reboot system.
System timer error	RTC battery Run BIOS Setup Utility to reconfigure system time, then reboot system. System board

Error Message List

Error Messages	FRU/Action in Sequence
Real time clock error	RTC battery Run BIOS Setup Utility to reconfigure system time, then reboot system. System board
Previous boot incomplete - Default configuration used	Run "Load Default Settings" in BIOS Setup Utility. RTC battery System board
Memory size found by POST differed from CMOS	Run "Load Default Settings" in BIOS Setup Utility. DIMM System board
Diskette drive A error	Check the drive is defined with the proper diskette type in BIOS Setup Utility See "External Diskette Drive Check" on page 95.
Incorrect Drive A type - run SETUP	Check the drive is defined with the proper diskette type in BIOS Setup Utility
System cache error - Cache disabled	System board
CPU ID:	System board
DMA Test Failed	DIMM System board
Software NMI Failed	DIMM System board
Fail-Safe Timer NMI Failed	DIMM System board
Device Address Conflict	Run "Load Default Settings" in BIOS Setup Utility. RTC battery System board
Allocation Error for device	Run "Load Default Settings" in BIOS Setup Utility. RTC battery System board
Failing Bits: nnnn	DIMM BIOS ROM System board
Fixed Disk n	None
Invalid System Configuration Data	BIOS ROM System board
I/O device IRQ conflict	Run "Load Default Settings" in BIOS Setup Utility. RTC battery System board
Operating system not found	Enter Setup and see if fixed disk and drive A: are properly identified. Diskette drive Hard disk drive System board

Error Message List

No beep Error Messages	FRU/Action in Sequence
No beep, power-on indicator turns off and LCD is blank.	Power source (battery pack and power adapter). See "Power System Check" on page 96. Ensure every connector is connected tightly and correctly. Reconnect the DIMM. LED board. System board.
No beep, power-on indicator turns on and LCD is blank.	Power source (battery pack and power adapter). See "Power System Check" on page 96. Reconnect the LCD connector Hard disk drive LCD inverter ID LCD cable LCD Inverter LCD System board
No beep, power-on indicator turns on and LCD is blank. But you can see POST on an external CRT.	Reconnect the LCD connectors. LCD inverter ID LCD cable LCD inverter LCD System board
No beep, power-on indicator turns on and a blinking cursor shown on LCD during POST.	Ensure every connector is connected tightly and correctly. System board
No beep during POST but system runs correctly.	Speaker System board

Index of Symptom-to-FRU Error Message

LCD-Related Symptoms

Symptom / Error	Action in Sequence
LCD backlight doesn't work LCD is too dark LCD brightness cannot be adjusted LCD contrast cannot be adjusted	Enter BIOS Utility to execute "Load Setup Default Settings", then reboot system. Reconnect the LCD connectors. Keyboard (if contrast and brightness function key doesn't work). LCD inverter ID LCD cable LCD inverter LCD System board
Unreadable LCD screen Missing pels in characters Abnormal screen Wrong color displayed	Reconnect the LCD connector LCD inverter ID LCD cable LCD inverter LCD System board
LCD has extra horizontal or vertical lines displayed.	LCD inverter ID LCD inverter LCD cable LCD System board

Indicator-Related Symptoms

Symptom / Error	Action in Sequence
Indicator incorrectly remains off or on, but system runs correctly	Reconnect the inverter board Inverter board System board

Power-Related Symptoms

Symptom / Error	Action in Sequence
Power shuts down during operation	Power source (battery pack and power adapter). See "Power System Check" on page 96. Battery pack Power adapter Hard drive & battery connection board System board
The system doesn't power-on.	Power source (battery pack and power adapter). See "Power System Check" on page 96. Battery pack Power adapter Hard drive & battery connection board System board
The system doesn't power-off.	Power source (battery pack and power adapter). See "Power System Check" on page 96. Hold and press the power switch for more than 4 seconds. System board
Battery can't be charged	See "Check the Battery Pack" on page 98. Battery pack System board

PCMCIA-Related Symptoms

Symptom / Error	Action in Sequence
System cannot detect the PC Card (PCMCIA)	PCMCIA slot assembly System board
PCMCIA slot pin is damaged.	PCMCIA slot assembly

Memory-Related Symptoms

Symptom / Error	Action in Sequence
Memory count (size) appears different from actual size.	Enter BIOS Setup Utility to execute "Load Default Settings, then reboot system. DIMM System board

Speaker-Related Symptoms

Symptom / Error	Action in Sequence
In Windows, multimedia programs, no sound comes from the computer.	Audio driver Speaker System board
Internal speakers make noise or emit no sound.	Speaker System board

Power Management-Related Symptoms

Symptom / Error	Action in Sequence
The system will not enter hibernation	Keyboard (if control is from the keyboard) Hard disk drive System board
The system doesn't enter hibernation mode and four short beeps every minute.	See "Hibernation Mode" on page 29. Press Fn+F4 and see if the computer enters hibernation mode. Touchpad Keyboard Hard disk connection board Hard disk drive System board
The system doesn't enter standby mode after closing the LCD	See "Hibernation Mode" on page 29. LCD cover switch System board
The system doesn't resume from hibernation mode.	See "Hibernation Mode" on page 29. Hard disk connection board Hard disk drive System board
The system doesn't resume from standby mode after opening the LCD.	See "Hibernation Mode" on page 29. LCD cover switch System board
Battery fuel gauge in Windows doesn't go higher than 90%.	Remove battery pack and let it cool for 2 hours. Refresh battery (continue use battery until power off, then charge battery). Battery pack System board

Power Management-Related Symptoms

Symptom / Error	Action in Sequence
System hangs intermittently.	Reconnect hard disk/CD-ROM drives. Hard disk connection board System board

Peripheral-Related Symptoms

Symptom / Error	Action in Sequence
System configuration does not match the installed devices.	Enter BIOS Setup Utility to execute "Load Default Settings", then reboot system. Reconnect hard disk/CD-ROM/diskette drives.
External display does not work correctly.	Press Fn+F5, LCD/CRT/Both display switching System board
USB does not work correctly	System board
Print problems.	Ensure the "Parallel Port" in the "Onboard Devices Configuration" of BIOS Setup Utility is set to Enabled. Onboard Devices Configuration Run printer self-test. Printer driver Printer cable Printer System Board
Serial or parallel port device problems.	Ensure the "Serial Port" in the Devices Configuration" of BIOS Setup Utility is set to Enabled. Device driver Device cable Device System board

Keyboard/Touchpad-Related Symptoms

Symptom / Error	Action in Sequence
Keyboard (one or more keys) does not work.	Reconnect the keyboard cable. Keyboard System board
Touchpad does not work.	Reconnect touchpad cable. Touchpad board System board

Modem-Related Symptoms

Symptom / Error	Action in Sequence
Internal modem does not work correctly.	Modem phone port modem combo board System board

NOTE: If you cannot find a symptom or an error in this list and the problem remains, see "Undetermined Problems" on page 107.

Intermittent Problems

Intermittent system hang problems can be caused by a variety of reasons that have nothing to do with a hardware defect, such as: cosmic radiation, electrostatic discharge, or software errors. FRU replacement should be considered only when a recurring problem exists.

When analyzing an intermittent problem, do the following:

1. Run the advanced diagnostic test for the system board in loop mode at least 10 times.
2. If no error is detected, do not replace any FRU.
3. If any error is detected, replace the FRU. Rerun the test to verify that there are no more errors.

Undetermined Problems

The diagnostic problems does not identify which adapter or device failed, which installed devices are incorrect, whether a short circuit is suspected, or whether the system is inoperative.

Follow these procedures to isolate the failing FRU (do not isolate non-defective FRU).

NOTE: Verify that all attached devices are supported by the computer.

NOTE: Verify that the power supply being used at the time of the failure is operating correctly. (See "Power System Check" on page 96):

1. Power-off the computer.
2. Visually check them for damage. If any problems are found, replace the FRU.
3. Remove or disconnect all of the following devices:
 - Non-Acer devices
 - Printer, mouse, and other external devices
 - Battery pack
 - Hard disk drive
 - DIMM
 - CD-ROM/Diskette drive Module
 - PC Cards
4. Power-on the computer.
5. Determine if the problem has changed.
6. If the problem does not recur, reconnect the removed devices one at a time until you find the failing FRU.
7. If the problem remains, replace the following FRU one at a time. Do not replace a non-defective FRU:
 - System board
 - LCD assembly

Jumper and Connector Locations

Top View

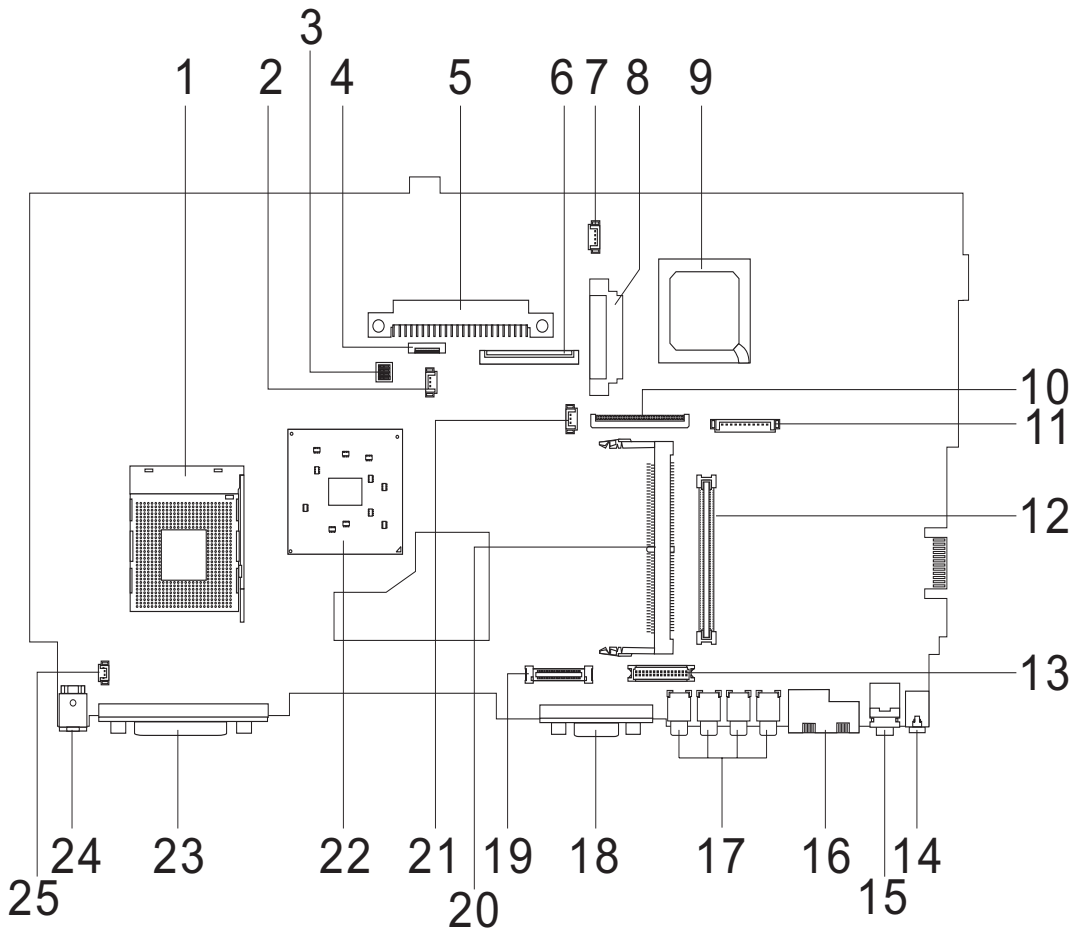

1	U12	CPU Socket	14	LIN1	Line-in Port
2	FAN1	Fan Connector	15	LOUT1	Line-out Port
3	SW1	SW1	16	RJ1	RJ45+RJ11
4	TPAD1	Touchpad Cable Connector	17	USB1-4	Four USB Ports
5	HDD1	HDD Connector	18	CRT1	VGA Port
6	KB1	Keyboard Connector	19	LCD1	LCD Coaxial Cable Connector
7	SPK1	Speaker Cable Connector	20	MINI1	Mini PCI Connector
8	IDE1	Optical Drive Connector	21	RTC1	RTC Battery Connector
9	U23	South Bridge	22	U15	North Bridge
10	FDD1	FDD Connector	23	PRT1	Parallel Port
11	CN1	Launch Cable Connector	24	DCIN1	DC-in Port
12	CBUS1,2	PCMCIA Slot	25	CVR1	LCD Lid Switch
13	INV1	LCD Inverter Cable Connector			

Bottom View

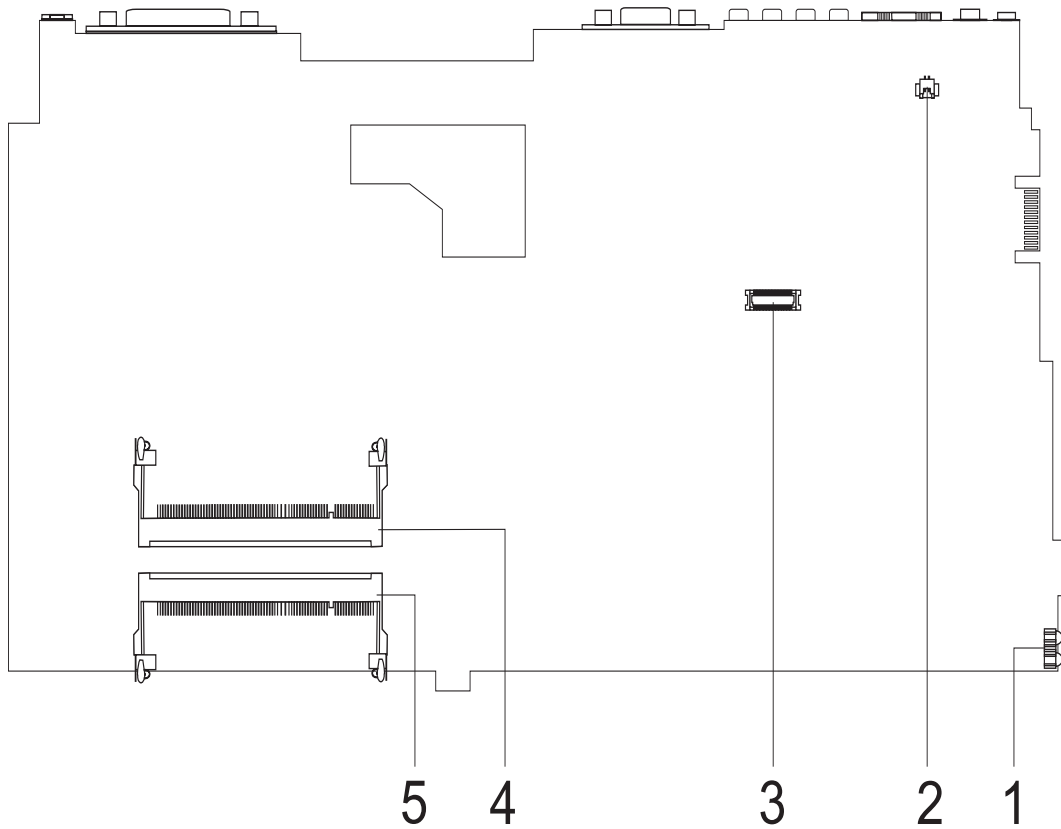

- 1 U7 FIR Port
- 2 RING1 Modem Cable Connector
- 3 MDC1 Modem Card Connector
- 4 DM1 DIMM Socket 1
- 5 DM2 DIMM Socket 2

SW1 Settings

	1	2	3	4
Password Enable	ON	X	X	X
Password Disable	OFF	X	X	X
Bootblock Enable	X	ON	X	X
Bootblock Disable	X	OFF	X	X
Adapter 90W	X	X	ON	X
Adapter 120W	X	X	OFF	X

FRU (Field Replaceable Unit) List





This chapter gives you the FRU (Field Replaceable Unit) listing in global configurations of TravelMate 240/250. Refer to this chapter whenever ordering for parts to repair or for RMA (Return Merchandise Authorization).

Please note that WHEN ORDERING FRU PARTS, you should check the most up-to-date information available on your regional web or channel. For whatever reasons a part number change is made, it will not be noted on the printed Service Guide. For ACER AUTHORIZED SERVICE PROVIDERS, your Acer office may have a DIFFERENT part number code from those given in the FRU list of this printed Service Guide. You MUST use the local FRU list provided by your regional Acer office to order FRU parts for repair and service of customer machines.

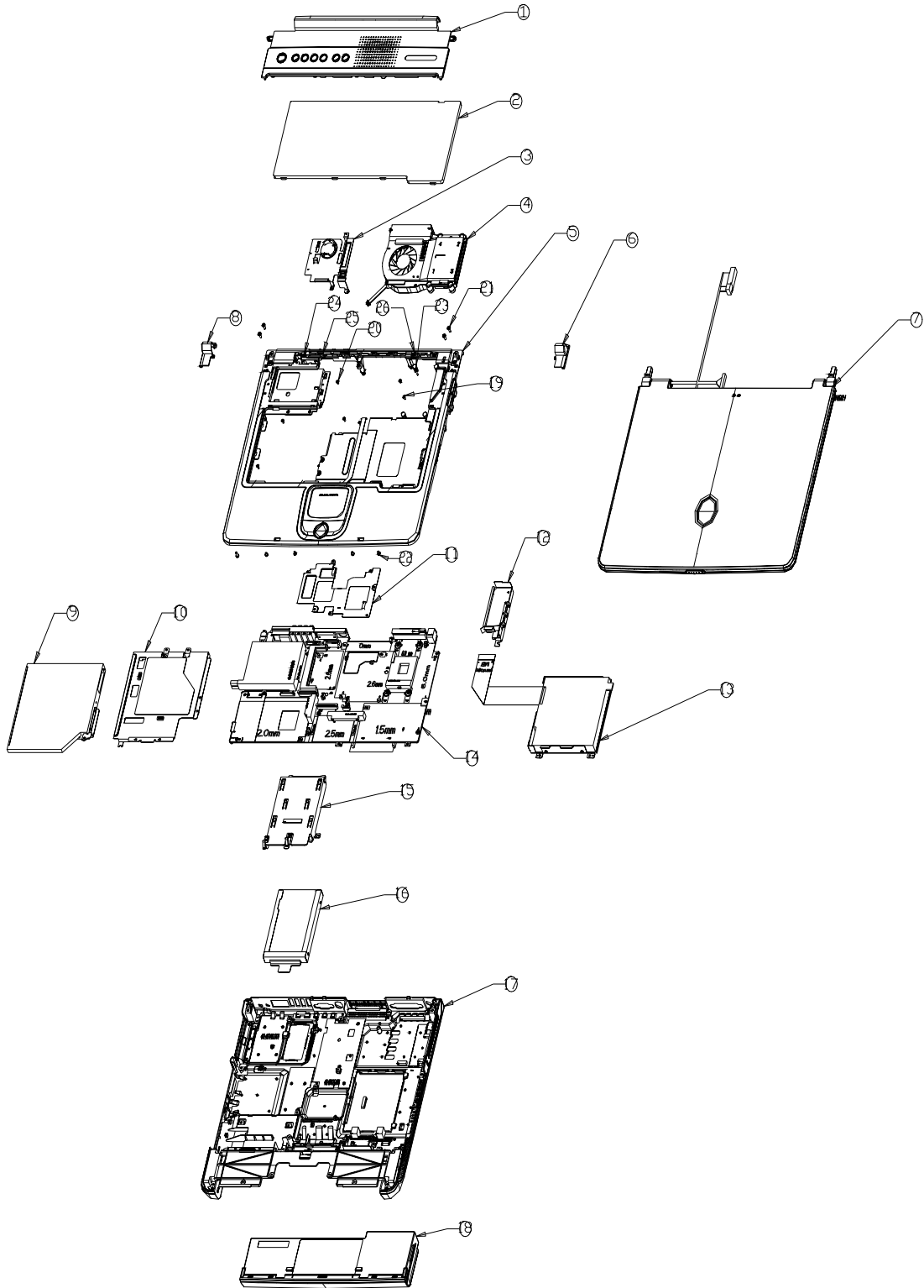





NOTE: To scrap or to return the defective parts, you should follow the local government ordinance or regulations on how to dispose it properly, or follow the rules set by your regional Acer office on how to return it.



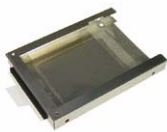

TravelMate 240/250 Exploded Diagram

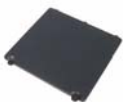

Picture	No.	Partname And Description	Part Number
Adapter			
		ADAPTER 120W 3PIN LITEON PA-1121-02AC REV.A	AP.T3003.002
Battery			
		RTC BATTERY	23.T30V1.001
	18	BATTERY MODULE LI-ION 8CELL 2.0 MAH SIMPLO W/ COVER	6M.T30V1.009
		BATTERY LI-ION 8CELL 2.0 MAH LI-ION SIMPLO BTP-58A1	BT.T3007.001
CASE/COVER/BRACKET ASSEMBLY			
		BATTERY COVER	42.T30V1.001
Boards			
		DC BOARD	55.T30V1.001
		WIRELESS LAN BOARD 802.11B AMBIT T60H656.02 REV.03	54.T30V1.001

Picture	No.	Partname And Description	Part Number
		LAUNCH BOARD	55.T30V1.002
		MODEM BOARD 56K AMBIT T60M283.10	54.09011.542
Cables			
		TOUCHPAD CABLE	50.T30V1.001
		COVER SWITCH CABLE	50.T30V1.002
		LAUNCH CABLE	50.T30V1.011
		MODEM CABLE	50.41T11.002
		POWER CORD US (3 pin)	27.01618.051
Case/Cover/Bracket Assembly			
	3	MINI PCI CARD PLATE W/RTC HOLDER	60.T30V1.003
	6	HINGE CAP RIGHT	42.T30V1.002









Picture	No.	Partname And Description	Part Number
	8	HINGE CAP LEFT	42.T30V1.003
	10	OPTICAL DRIVE SUPPORT BRACKET	33.T30V1.001
	15	HDD BRACKET	33.T30V1.002
	16	HDD HOLDER	33.T30V1.003
	17	LOWER CASE W/ DIMM COVER & MODEM COVER & SPEAKERS	60.T30V1.004
		MODEM COVER W/SCREW	42.T30V1.004
		DIMM COVER W/SCREW	42.T30V1.005
	19	UPPER CASE W/O COVER SWITCH CABLE & TOUCHPAD MODULE	60.T30V1.001

Picture	No.	Partname And Description	Part Number
		TOUCHPAD COVER	42.T30V1.006
		MIDDLE COVE W/LAUNCH BOARD	60.T30V1.005
Communication Module			
		WIRELESS ANTENNA RIGHT (BLACK)	50.T30V1.004
		WIRELESS ANTENNA LEFT (GRAY)	50.T30V1.005
CPU			
		INTEL CELERON PORTABILITY 2.6 GHZ 128K 400FSB for TM240	KC.NCP01.26G
		INTEL CELERON PORTABILITY 2.5 GHZ 128K 400FSB for TM240	KC.NCP01.25G
		INTEL CELERON PORTABILITY 2.4 GHZ 128K 400FSB for TM240	KC.NCP01.24G
		INTEL CELERON PORTABILITY 2.3 GHZ 128K 400FSB for TM240	KC.NCP01.23G
		INTEL CELERON PORTABILITY 2.2 GHZ 128K 400FSB for TM240	KC.NCP01.22G
		INTEL CELERON PORTABILITY 2.0GHZ 128K 400FSB for TM240	KC.NCP01.20G
		INTEL MOBILE PENTIUM 4 PORTABILITY 3.06GHZ 512K 1.53V for TM250	KC.NP001.306
		INTEL MOBILE PENTIUM 4 PORTABILITY 2.8GHZ 512K 1.53V for TM250	KC.NP001.2G8
		INTEL MOBILE PENTIUM 4 PORTABILITY 2.66GHZ 512K 1.53V for TM250	KC.NP001.266
		INTEL MOBILE PENTIUM 4 PORTABILITY 2.4GHZ 512K 1.53V for TM250	KC.NP001.2G4
FDD/Floppy Disk Drive			







Picture	No.	Partname And Description	Part Number
	13	FDD MODULE 1.44M MCI JU-226A033FC	6M.T30V1.003
		FDD MODULE 1.44M MITSUMI D353G 4515	6M.T30V1.004
		FDD DRIVE 1.44M MCI JU-226A033FC	KF.T3007.001
		FDD DRIVE 1.44M MITSUMI D353G 4515	KF.T3006.001
		FDD BRACKET	33.T30V1.005
		FDD CABLE	50.T30V1.003
HDD/ Hard Disk Drive			
		HDD 20GB 2.5" 4200RPM HGST MORAGA IC25N020ATMR04-0 08K0632	KH.02007.002
		HDD 20GB/2.5 IN./4200 RPM/IBM CASCADE IC25N020ATCS04-0 07N8325	KH.25202.001
		HDD 20GB/2.5 IN./4200RPM/ HITACHI EUCALYPTUS DK23EA	KH.32005.002
		HDD 20GB 2.5" 4200RPM TOSHIBA NEPTUNE V20 MK2023GAS	KH.02004.001
		HDD 30GB/2.5 IN./4200RPM/ HITACHI EUCALYPTUS DK23EA/ 30	KH.33005.002
		HDD 30GB 2.5" 4200RPM FUJITSU V-40 MHT2030AT	KH.03006.002
		HDD 30GB 2.5" 4200RPM HGST MORAGA IC25N030ATMR04-0	KH.03007.002
		HDD 30GB/2.5 IN./4200RPM/ TOSHIBA NEPTUNE MK3021GAS	KH.33004.001
		HDD 40GB/2.5 IN./4200RPM/ HITACHI EUCALYPTUS DK23EA-40	KH.34005.002

Picture	No.	Partname And Description	Part Number
		HDD 40GB 2.5" 4200RPM HGST MORAGA IC25N040ATMR04-0 08K0633	KH.04007.004
		HDD 40GB/2.5" IN./4200RPM/ TOSHIBA NEPTUNE MK4021GAS	KH.34004.001
		HDD 40GB 2.5" 5400RPM SEAGATE ST94011A	KH.04001.004
		HDD 40GB 2.5" 4200RPM FUJITSU V-40 MHT2040AT	KH.04006.002
		HDD 60GB/2.5 IN./4200RPM/ HITACHI EUCALYPTUS DK23EA-60	KH.06005.001
		HDD 60GB 2.5" 4200RPM HGST MORAGA IC25N060ATMR04-0 08K0634	KH.06007.002
		HDD 60GB/2.5 IN./4200RPM/ TOSHIBA NEPTUNE MK6021GAS	KH.36004.001
		HDD 60GB 2.5" 4200RPM FUJITSU V-40 MHT2060AT	KH.06006.002
		HDD 80GB 2.5" 4200RPM HGST MORAGA IC25N080ATMR04-0 08K0635	KH.08007.002
Heatsink			
	4	CPU FANSINK	34.T30V1.001
		VGA HEATSINK PLATE	34.T30V1.002
		CPU HEATSINK PLATE	34.T30V1.003
Keyboard			

Picture	No.	Partname And Description	Part Number
	2	KEYBOARD 84KEY DARFON NSK-AC61D US-INT	KB.T3007.001
		KEYBOARD 84KEY DARFON NSK-AC602 TAIWAN	KB.T3007.002
		KEYBOARD 85KEY DARFON NSK-AC60S SPANISH	KB.T3007.003
		KEYBOARD 84KEY DARFON NSK-AC603 THAI	KB.T3007.004
		KEYBOARD 85KEY DARFON NSK-AC60U UK	KB.T3007.006
		KEYBOARD 85KEY DARFON NSK-AC60G GERMAN	KB.T3007.007
		KEYBOARD 85KEY DARFON NSK-AC606 PORTUGUESE	KB.T3007.011
		KEYBOARD 84KEY DARFON NSK-AC60C CZECH	KB.T3007.015
LCD			
	7	LCD MODULE 14.1" TFT XGA CHIMEI N141X6-L01/08	6M.T30V1.005
		LCD MODULE 15" TFT XGA CHIMEI N150X3-L05	6M.T30V1.006
		LCD MODULE 15" TFT XGA HITACHI TX38D81VC1CAB	6M.T30V1.007
		LCD MODULE 15" TFT XGA AU B150XG01 V.2	6M.T30V1.008
		LCD 14.1" TFT XGA AU B141XN04 V2/5AXXX	LK.14105.005
		LCD 14.1" TFT XGA CHIMEI N141X6-L01/08	LK.1410D.001
		LCD 15" TFT XGA CHIMEI N150X3-L05	LK.1500H.001
		LCD 15" TFT XGA HITACHI TX38D81VC1CAB	LK.15004.004
		LCD 15" TFT XGA AU B150XG01 V.2	LK.15005.001
		INVERTER BOARD 14"/15" DARFON V0.21071.001	19.T30V1.001
		LCD BRACKET RIGHT FOR 14.1"	33.T30V1.006
		LCD BRACKET RIGHT FOR 15"	33.T30V1.009
	NS	LCD BRACKET LEFT FOR 14.1"	33.T30V1.007
		LCD BRACKET LEFT FOR 15"	33.T30V1.008

Picture	No.	Partname And Description	Part Number
		INVERTER CABLE	50.T30V1.007
		LCD COAXIAL CABLE	50.T30V1.008
	NS	LCD PANEL W/HINGE & LOGO	60.T30V1.008
	NS	LCD BEZEL 14.1" W/ICON LABEL	60.T30V1.006
		LCD BEZEL 15" W/ICON LABEL	60.T30V1.007
		HINGE PACK	6K.T30V1.001
Main Board			
		MAINBOARD W/LAUNCH CABLE & MODEM & MODEM CABLE & PCMCIA SLOT & RTC BATTERY	MB.T3001.001
Miscellaneous			
		LOGO	31.42S08.001
		ICON LABEL	40.T30V1.001
		TOUCHPAD SCROLL KEY	42.T30V1.007

Picture	No.	Partname And Description	Part Number
		TOUCHPAD KNOB	42.T30V1.008
		LCD SCREW RUBBER UPPER	47.T30V1.001
		LCD SCREW RUBBER LOWER	47.T30V1.002
		RUBBER FOOT	47.T30V1.003
		LCD BEZEL RUBBER UPPER	47.T30V1.004
		NAME PLATE TM250	40.T30V1.003
		NAME PLATE TM240	40.T30V1.002
Memory			
	NS	MEMORY SO-DIMM DDR266/ 128MB /INFINEON HYS64D16000GDL-7-B	KN.12802.004
		MEMORY SO-DIMM DDR266/ 128MB/0.14U /NANYA NT128D64SH4B0GM-75B	KN.12803.003
		MEMORY DDR266 128MB NANYA NT128D64SH4BBGM-75B	KN.12803.007
		MEMORY DDR266 128MB MICRON MT4VDDT1664HG- 265B2	KN.12804.004
		MEMORY DDR266 128MB MICRON MT4VDDT1664HG- 265C2	KN.12804.005
		MEMORY SO-DIMM DDR266/ 256MB/0.14U /INFINEON HYS64D32020 GDL-7-B	KN.25602.001
		MEMORY DDR266 256MB NANYA NT256D64SH8BAGM-75B	KN.25603.010
		MEMORY SO-DIMM DDR266/ 256MB/0.15U /MICRON MT8VDDT3264HDG-256B3	KN.25604.003
		MEMORY SO-DIMM DDR266 256MB MICRON MT8VDDT3264HDG-265C3	KN.25604.004
		MEMORY SO-DIMM DDR266/ 512MB/0.14U /INFINEON HYS64D64020GBDL-7-B	KN.51202.003
		MEMORY DDR333 128MB INFINEON HYS64D16000GDL-6-B	KN.12802.006
		MEMORY DDR333 256MB INFINEON HYS64D32020GDL-6-B	KN.25602.009
		MEMORY DDR333 256MB NANYA NT256D64SH8BAGM-6K	KN.25603.009

Picture	No.	Partname And Description	Part Number
		MEMORY DDR333 256MB ELPEDIA W30256AAEPI652A	KN.25609.002
		MEMORY DDR333 256MB MOCRON MT8VDDT3264HDG- 335C3	KN.25604.009
		MEMORY DDR333 512MB INFINEON HYS64D64020GBDL-6- B	KN.51202.007
Optical Drive			
		CD-ROM MODULE 24X MITSUMI SR244W1	6M.T30V1.001
		DVD-ROM MODULE 8X MKE SR- 8177	6M.T30V1.002
		CD-ROM DRIVE 24X W/ BEZEL MITSUMI SR244W1	KD.24X04.002
		DVD-ROM DRIVE 8X W/ BEZEL MKE SR-8177	KV.08X02.004
		OPTICAL DRIVE BRACKET	33.T30V1.004
PCMCIA slot/PC card slot			
		PCMCIA SLOT	22.T30V1.001
Pointing Device			
	NS	TOUCHPAD SYNAPTICS TM41P- 357	56.17001.001
Speaker			
		SPEAKER SET	23.T30V1.002
Screws			
	NS	SCREW	86.T30V1.001
	NS	SCREW	86.T30V1.002

Picture	No.	Partname And Description	Part Number
	NS	SCREW	86.9A352.3R0
	NS	SCREW	86.9A353.6R0
	NS	SCREW	86.9A524.4R0
	NS	SCREW	86.9A552.2R0
	NS	SCREW	86.9A552.3R0
	NS	SCREW	86.9A552.4R0
	NS	SCREW	86.9A553.3R0
	NS	SCREW	86.9A553.4R0
	NS	SCREW	34.00015.081

Model Definition and Configuration

Model Name Definition

Model Number	LCD	CPU	Memory	HDD	CD/DVD	Battery	Wireless LAN
242X	14.1"	ICP 2.4G	1x256M	20/ 30G	24x CD	Li-Ion	N
242XV	14.1"	ICP 2.4G	1x256M	30G	8x DVD	Li-Ion	N
242XC	14.1"	ICP 2.4G	1x256M	30G	24x CDRW+DVD	Li-Ion	N
242LMi	15.0"	ICP 2.4G	2x256M	40G	DVD-RW	Li-Ion	11b
244X	14.1"	ICP 2.6G	1x256M	20/ 30G	24x CD	Li-Ion	N
244XV	14.1"	ICP 2.6G	1x256M	30G	8x DVD	Li-Ion	N
244XC	14.1"	ICP 2.6G	1x256M	20/ 30G	24x CDRW+DVD	Li-Ion	N
244LM	15.0"	ICP 2.6G	1x256M	30G	DVD-RW	Li-Ion	N
244LC	15.0"	ICP 2.6G	1x256M	30G	24x CDRW+DVD	Li-Ion	N
250X	14.1"	P4P 2.4G	1x256M	20/ 30G	24X CD	Li-Ion	N
250XC	14.1"	P4P 2.4G	1x256M	30G	24x CDRW+DVD	Li-Ion	N
250LC	15.0"	P4P 2.4G	1x256M/ 2x256M	30/ 40G	24x CDRW+DVD	Li-Ion	N
251Xci	14.1	P4P 2.66G	1x256M	30G	24X CDRW+DVD/	Li-Ion	11b
251LC	14.1	P4P 2.66G	2x256M	40G	24X CDRW+DVD	Li-Ion	N
251LCi	14.1	P4P 2.66G	1x256M	40G	24X CDRW+DVD	Li-Ion	11b
251LM	15.0"	P4P 2.66G	2x256M	40G	DVD-RW	Li-Ion	N

Test Compatible Components

This computer's compatibility is a test plan released by Acer Internal Testing Department. Once the final report is available, this chapter will be revised accordingly.

Microsoft Windows XP Environment Test

Item	Specifications
Processor	Mobile Pentium 4 3.06GHz 512K, Mobile Pentium 4 2.8GHz 512K, Mobile Pentium 4 2.66GHz 512K, Mobile Pentium 4 2.4GHz 512K, Celeron (Portability) 2.6Ghz/128k/400FSB, Celeron (Portability) 2.5Ghz/128k/400FSB, Celeron (Portability) 2.4Ghz/128k/400FSB, Celeron (Portability) 2.3Ghz/128k/400FSB, Celeron (Portability) 2.2Ghz/128k/400FSB, Celeron (Portability) 2.0Ghz/128k/400FSB,
Memory	128MB Nan-Ya SO-DIMM DDR266 NT128D64SH4BBGM-75B (.14u) 128MB Infineon SO-DIMM DDR333 HYS64D16000GDL-6-B 256MB Nan-Ya SO-DIMM DDR266 NT256D64SH8BAGM-75B (.14u) 256MB Micron SO-DIMM DDR266 MT8VDDT3264HDG-265C3 256MB Infineon SO-DIMM DDR333 HYS64D32020GDL-6-B 256MB Elpedia SO-DIMM DDR333 W30256AAEPI652A 256MB Micron SO-DIMM DDR333 MT8VDDT3264HDG-335C3 (.13u) 512MB Infineon SO-DIMM DDR266 HYS64D64020GBDL-7-B 64Mx64 (.14u) 512MB Infineon SO-DIMM DDR333 HYS64D64020GBDL-6-B
LCD	14.1" XGA TFT AU B141XN04 V.2 Driver IC: 5Axxx CMO CMO N141X6-L01 Smasung LTN141X5 AU B141XN03 0Hxxx 15" XGA TFT AU B150XG01 V.2 Hitachi TX38D81VC1CAB CMO N150X3-L05
Hard Disk Drive	20GB IBM HGST Moraga IC25N020ATMR04-0 20GB Toshiba Neptune MK2023GAP 30GB IBM HGST Moraga IC25N030ATMR04-0 30GB Toshiba Neptune MK3021GAS 40GB IBM HGST Moraga IC25N040ATMR04-0 40GB Toshiba Neptune MK4021GAS 60GB IBM HGST Moraga IC25N060ATMR04-0 60GB Toshiba Neptune MK6021GAS 80GB IBM HGST Moraga IC25N080ATMR04
Floppy Disk Drive	Mitsumi D353G
DVD-ROM Drive 8X	MKE SR-8177 Liteon XJ-SD81D
CD-ROM Drive 24X	Mitsumi SR-224W1

Item	Specifications
DVD/CD-RW Combo	KME UJDA750-740 QSI SBW-242 Liteon LSC-240081
AC Adapter (3 pin)	Liteon TA 1121-02AW 120W Liteon
Power Cord	King Cord
Battery Li-Ion, 8 cells	SIMPLO BTP-58A1 ASSY BTY PK LI+2.0MAH 8C OPTION
Network Adapters	
LAN Ethernet/10baseT/100baseT	3Com Etherlink III 3C589D IBM EtherJet CardBus Adapter 10/100 Intel Ether Express Pro/100 Mobile Adapter MBLA3200 Xircom CardBus Ethernet 10/100 32 Bit CBE-10/100BTX
Multifunction Card (Combo)	3Com Megahertz 10/100 LAN + 56K Modem PC Card Xircom RealPort CardBus Ethenet 10/100 + Modem 56
LAN Token Ring	IBM Token Ring 16/4 Adapter II
Wireless LAN Card	IBM Wireless LAN Cardbus Adapter Intel Pro-Wireless LAN PC Card Proxim Skyline 802.11a Cardbus PC Card Cisco Aironet 350 series Wireless Lan Card NeWeb Wireless Lan Card 802.11b
Modem Adapters	
Modem (up to 56K)	3Com Megahertz 56K Modem PC Card Xircom Credit Card Modem 56 IBM 56K Double Jack Modem
ISDN	US Robotics Megahertz 128K ISDN Card 405R17T7117M IBM OBI International ISDN PC Card
I/O Peripheral	
I/O - Display	Acer 211c 21" Viewsonic PF790 19" Acer FP751 17" TFT LCD IBM Color TFT LCD 14" Compaq Color Monitor NET Color Monitor 20" Mozo 17" TFT LCD (DVI)
I/O - Projector	NEC MultiSync MT-1040
I/O - Parallel (Printer/Scanner)	Canon BJC-600J Epson Stylus Color 740 Parallel Interface HP DeskJet 890C HP DeskJet 880C Parallel Interface HP LaserJet 6MP HP LaserJet 2200
I/O - USB Keyboard/Mouse	Chicony USB Keyboard KU-8933 Microsoft Natural Keyboard Pro Acer Aspire USB mouse Logicool US Mouse Logitech Cordless Mouseman Wheel USB Interface Logitech USB Wheel Mouse M-BB48 Microsoft IntelliMouse Optical USB Interface

Item	Specifications
I/O - PS2 (Serial) Keyboard/Mouse	IBM 101 key keyboard IBM 109 key keyboard Acer PS2 keyboard Acer KB-101A IBM Numeric Keypad III IBM Numeric Keypad Acer Mouse IBM PS2 Mini Mouse IBM PS2 Mouse Logitech Cordless MouseMan Wheel PS2 interface Logitech Serial Mouse M-M35 Microsoft IntelliMouse PS2 interface Microsoft IntelliMouse Optical PS2 interface Logitech First Mouse Three Button Serial Mouse
I/O - USB (Printer/Scanner)	Epson Stylus Color 740 USB interface HP DeskJet 880C USB interface Canon CanonScan D1250 (USB 2.0, JP OS only) HP ScanJet 3300C Color Scanner
I/O - USB (Speaker/Joystick)	JS USB Digital Speaker Panasonic USB Speaker EAB-MPC57USB AIWA Multimedia Digital Speaker Microsoft SideWinder Precision Pro Joystick Logitech WingMan RumblePad
I/O - USB Camera	Intel Easy PC Camera Logitech QuickCam Express Internet Logitech QuickCam Home PC Video Camera Orange Micro USB 2.0 Web Cam
I/O - USB Storage Drive	Logitech CDRW +DVDROM combo USB interface Iomega USB Zip 250MB
I/O-USB Flash Drive	IBM 32MB USB Memory key Apacer USB Handy Drive 32MB Apacer USB Handy Drive 256MB
I/O - USB Hub	Belkin 4 Port USB Hub Eizo I Station USB Hub Elecom USB Hub 4 Port Sanwa USB Hub 4 Port 4 Port Hub USB 2.0
I/O - Access Point (802.11b)	Hitachi DC-CN3300 Lucent RG-1000 Lucent WavePoint-II Cisco Aironet 350 Orinoco AP-500
I/O Acss Point (802.11a/b)	Intel Dual Pro/Wireless 5000
I/O Acss Point (802.11a)	Intel Pro/Wireless 5000
PCMCIA	
PCMCIA - ATA	IBM Microdrive 340MB IBM Microdrive 1G Iomega Click! 40MB Sony Memory Stick 64MB Apacer SD Flash Card 128MB Transcedn SD Card 32MB

Item	Specifications
PCMCIA - USB 2.0	Apricom EZ-USB2.0 Cardbus PC Card DTK USB 2.0 2Port CardBus Host Controller Adaptec USB2CONNECT
PCMCIA - 1394	Buffalo 1394 Interface Cardbus IFC-ILCB/DV I-O Data 1394 Interface Cardbus CB1394/DVC Pixela 1394 Cardbus PC Card PIX-PCMC/FW1
PCMCIA-SCSI	Adaptec 1408 or B SCSI CB NewMedia Bus Toaster SCSI II
PCMCIA - Bluetooth	IBM Community Bluetooth PC Card Toshiba Bluetooth PC Card

Microsoft Windows 2000 Environment Test

Item	Specifications
Processor	Mobile Pentium 4 3.06GHz 512K, Mobile Pentium 4 2.8GHz 512K, Mobile Pentium 4 2.66GHz 512K, Mobile Pentium 4 2.4GHz 512K, Celeron (Portability) 2.6Ghz/128k/400FSB, Celeron (Portability) 2.5Ghz/128k/400FSB, Celeron (Portability) 2.4Ghz/128k/400FSB, Celeron (Portability) 2.3Ghz/128k/400FSB, Celeron (Portability) 2.2Ghz/128k/400FSB, Celeron (Portability) 2.0Ghz/128k/400FSB,
Memory	128MB Nan-Ya SO-DIMM DDR266 NT128D64SH4BBGM-75B (.14u) 128MB Infineon SO-DIMM DDR333 HYS64D16000GDL-6-B 256MB Nan-Ya SO-DIMM DDR266 NT256D64SH8BAGM-75B (.14u) 256MB Micron SO-DIMM DDR266 MT8VDDT3264HDG-265C3 256MB Infineon SO-DIMM DDR333 HYS64D32020GDL-6-B 256MB Elpedia SO-DIMM DDR333 W30256AAEPI652A 256MB Micron SO-DIMM DDR333 MT8VDDT3264HDG-335C3 (.13u) 512MB Infineon SO-DIMM DDR266 HYS64D64020GBDL-7-B 64Mx64 (.14u) 512MB Infineon SO-DIMM DDR333 HYS64D64020GBDL-6-B
LCD	14.1" XGA TFT AU B141XN04 V.2 Driver IC: 5Axxx CMO CMO N141X6-L01 Smasung LTN141X5 AU B141XN03 0Hxxx 15" XGA TFT AU B150XG01 V.2 Hitachi TX38D81VC1CAB CMO N150X3-L05
Hard Disk Drive	20GB IBM HGST Moraga IC25N020ATMR04-0 20GB Toshiba Neptune MK2023GAP 30GB IBM HGST Moraga IC25N030ATMR04-0 30GB Toshiba Neptune MK3021GAS 40GB IBM HGST Moraga IC25N040ATMR04-0 40GB Toshiba Neptune MK4021GAS 60GB IBM HGST Moraga IC25N060ATMR04-0 60GB Toshiba Neptune MK6021GAS 80GB IBM HGST Moraga IC25N080ATMR04
Floppy Disk Drive	Mitsumi D353G
DVD-ROM Drive 8X	MKE SR-8177 Liteon XJ-SD81D
CD-ROM Drive 24X	Mitsumi SR-224W1

Item	Specifications
DVD/CD-RW Combo	KME UJDA750-740 QSI SBW-242 Liteon LSC-240081
AC Adapter (3 pin)	Liteon TA 1121-02AW 120W Liteon
Power Cord	King Cord
Battery Li-Ion, 8 cells	SIMPLO BTP-58A1 ASSY BTY PK LI+2.0MAH 8C OPTION
Network Adapters	
LAN Ethernet/10baseT/100baseT	3Com Etherlink III 3C589D IBM EtherJet CardBus Adapter 10/100 Intel Ether Express Pro/100 Mobile Adapter MBLA3200 Xircom CardBus Ethernet 10/100 32 Bit CBE-10/100BTX
Multifunction Card (Combo)	3Com Megahertz 10/100 LAN + 56K Modem PC Card Xircom RealPort CardBus Ethenet 10/100 + Modem 56
LAN Token Ring	IBM Token Ring 16/4 Adapter II
Wireless LAN Card	IBM Wireless LAN Cardbus Adapter Intel Pro-Wireless LAN PC Card Proxim Skyline 802.11a Cardbus PC Card Cisco Aironet 350 series Wireless Lan Card NeWeb Wireless Lan Card 802.11b
Modem Adapters	
Modem (up to 56K)	3Com Megahertz 56K Modem PC Card Xircom Credit Card Modem 56 IBM 56K Double Jack Modem
ISDN	US Robotics Megahertz 128K ISDN Card 405R17T7117M IBM OBI International ISDN PC Card
I/O Peripheral	
I/O - Display	Acer 211c 21" Viewsonic PF790 19" Acer FP751 17" TFT LCD IBM Color TFT LCD 14" Compaq Color Monitor NET Color Monitor 20" Mozo 17" TFT LCD (DVI)
I/O - Projector	NEC MultiSync MT-1040
I/O - Parallel (Printer/Scanner)	Canon BJC-600J Epson Stylus Color 740 Parallel Interface HP DeskJet 890C HP DeskJet 880C Parallel Interface HP LaserJet 6MP HP LaserJet 2200
I/O - USB Keyboard/Mouse	Chicony USB Keyboard KU-8933 Microsoft Natural Keyboard Pro Acer Aspire USB mouse Logicool US Mouse Logitech Cordless Mouseman Wheel USB Interface Logitech USB Wheel Mouse M-BB48 Microsoft IntelliMouse Optical USB Interface

Item	Specifications
I/O - PS2 (Serial) Keyboard/Mouse	IBM 101 key keyboard IBM 109 key keyboard Acer PS2 keyboard Acer KB-101A IBM Numeric Keypad III IBM Numeric Keypad Acer Mouse IBM PS2 Mini Mouse IBM PS2 Mouse Logitech Cordless MouseMan Wheel PS2 interface Logitech Serial Mouse M-M35 Microsoft IntelliMouse PS2 interface Microsoft IntelliMouse Optical PS2 interface Logitech First Mouse Three Button Serial Mouse
I/O - USB (Printer/Scanner)	Epson Stylus Color 740 USB interface HP DeskJet 880C USB interface Canon CanonScan D1250 (USB 2.0, JP OS only) HP ScanJet 3300C Color Scanner
I/O - USB (Speaker/Joystick)	JS USB Digital Speaker Panasonic USB Speaker EAB-MPC57USB AIWA Multimedia Digital Speaker Microsoft SideWinder Precision Pro Joystick Logitech WingMan RumblePad
I/O - USB Camera	Intel Easy PC Camera Logitech QuickCam Express Internet Logitech QuickCam Home PC Video Camera Orange Micro USB 2.0 Web Cam
I/O - USB Storage Drive	Logitech CDRW +DVDROM combo USB interface Iomega USB Zip 250MB
I/O-USB Flash Drive	IBM 32MB USB Memory key Apacer USB Handy Drive 32MB Apacer USB Handy Drive 256MB
I/O - USB Hub	Belkin 4 Port USB Hub Eizo I Station USB Hub Elecom USB Hub 4 Port Sanwa USB Hub 4 Port 4 Port Hub USB 2.0
I/O - Access Point (802.11b)	Hitachi DC-CN3300 Lucent RG-1000 Lucent WavePoint-II Cisco Aironet 350 Orinoco AP-500
I/O Acss Point (802.11a/b)	Intel Dual Pro/Wireless 5000
I/O Acss Point (802.11a)	Intel Pro/Wireless 5000
PCMCIA	
PCMCIA - ATA	IBM Microdrive 340MB IBM Microdrive 1G Iomega Click! 40MB Sony Memory Stick 64MB Apacer SD Flash Card 128MB Transcedn SD Card 32MB

Item	Specifications
PCMCIA - USB 2.0	Apricom EZ-USB2.0 Cardbus PC Card DTK USB 2.0 2Port CardBus Host Controller Adaptec USB2CONNECT
PCMCIA - 1394	Buffalo 1394 Interface Cardbus IFC-ILCB/DV I-O Data 1394 Interface Cardbus CB1394/DVC Pixela 1394 Cardbus PC Card PIX-PCMC/FW1
PCMCIA-SCSI	Adaptec 1408 or B SCSI CB NewMedia Bus Toaster SCSI II
PCMCIA - Bluetooth	IBM Community Bluetooth PC Card Toshiba Bluetooth PC Card

Microsoft Windows 98 Environment Test

Item	Specifications
Processor	Mobile Pentium 4 3.06GHz 512K, Mobile Pentium 4 2.8GHz 512K, Mobile Pentium 4 2.66GHz 512K, Mobile Pentium 4 2.4GHz 512K, Celeron (Portability) 2.6Ghz/128k/400FSB, Celeron (Portability) 2.5Ghz/128k/400FSB, Celeron (Portability) 2.4Ghz/128k/400FSB, Celeron (Portability) 2.3Ghz/128k/400FSB, Celeron (Portability) 2.2Ghz/128k/400FSB, Celeron (Portability) 2.0Ghz/128k/400FSB,
Memory	128MB Nan-Ya SO-DIMM DDR266 NT128D64SH4BBGM-75B (.14u) 128MB Infineon SO-DIMM DDR333 HYS64D16000GDL-6-B 256MB Nan-Ya SO-DIMM DDR266 NT256D64SH8BAGM-75B (.14u) 256MB Micron SO-DIMM DDR266 MT8VDDT3264HDG-265C3 256MB Infineon SO-DIMM DDR333 HYS64D32020GDL-6-B 256MB Elpedia SO-DIMM DDR333 W30256AAEPI652A 256MB Micron SO-DIMM DDR333 MT8VDDT3264HDG-335C3 (.13u) 512MB Infineon SO-DIMM DDR266 HYS64D64020GBDL-7-B 64Mx64 (.14u) 512MB Infineon SO-DIMM DDR333 HYS64D64020GBDL-6-B
LCD	14.1" XGA TFT AU B141XN04 V.2 Driver IC: 5Axxx CMO CMO N141X6-L01 Smasung LTN141X5 AU B141XN03 0Hxxx 15" XGA TFT AU B150XG01 V.2 Hitachi TX38D81VC1CAB CMO N150X3-L05
Hard Disk Drive	20GB IBM HGST Moraga IC25N020ATMR04-0 20GB Toshiba Neptune MK2023GAP 30GB IBM HGST Moraga IC25N030ATMR04-0 30GB Toshiba Neptune MK3021GAS 40GB IBM HGST Moraga IC25N040ATMR04-0 40GB Toshiba Neptune MK4021GAS 60GB IBM HGST Moraga IC25N060ATMR04-0 60GB Toshiba Neptune MK6021GAS 80GB IBM HGST Moraga IC25N080ATMR04
Floppy Disk Drive	Mitsumi D353G
DVD-ROM Drive 8X	MKE SR-8177 Liteon XJ-SD81D
CD-ROM Drive 24X	Mitsumi SR-224W1

Item	Specifications
DVD/CD-RW Combo	KME UJDA750-740 QSI SBW-242 Liteon LSC-240081
AC Adapter (3 pin)	Liteon TA 1121-02AW 120W Liteon
Power Cord	King Cord
Battery Li-Ion, 8 cells	SIMPLO BTP-58A1 ASSY BTY PK LI+2.0MAH 8C OPTION
Network Adapters	
LAN Ethernet/10baseT/100baseT	3Com Etherlink III 3C589D IBM EtherJet CardBus Adapter 10/100 Intel Ether Express Pro/100 Mobile Adapter MBLA3200 Xircom CardBus Ethernet 10/100 32 Bit CBE-10/100BTX
Multifunction Card (Combo)	3Com Megahertz 10/100 LAN + 56K Modem PC Card Xircom RealPort CardBus Ethenet 10/100 + Modem 56
LAN Token Ring	IBM Token Ring 16/4 Adapter II
Wireless LAN Card	IBM Wireless LAN Cardbus Adapter Intel Pro-Wireless LAN PC Card Proxim Skyline 802.11a Cardbus PC Card Cisco Aironet 350 series Wireless Lan Card NeWeb Wireless Lan Card 802.11b
Modem Adapters	
Modem (up to 56K)	3Com Megahertz 56K Modem PC Card Xircom Credit Card Modem 56 IBM 56K Double Jack Modem
ISDN	US Robotics Megahertz 128K ISDN Card 405R17T7117M IBM OBI International ISDN PC Card
I/O Peripheral	
I/O - Display	Acer 211c 21" Viewsonic PF790 19" Acer FP751 17" TFT LCD IBM Color TFT LCD 14" Compaq Color Monitor NET Color Monitor 20" Mozo 17" TFT LCD (DVI)
I/O - Projector	NEC MultiSync MT-1040
I/O - Parallel (Printer/Scanner)	Canon BJC-600J Epson Stylus Color 740 Parallel Interface HP DeskJet 890C HP DeskJet 880C Parallel Interface HP LaserJet 6MP HP LaserJet 2200
I/O - USB Keyboard/Mouse	Chicony USB Keyboard KU-8933 Microsoft Natural Keyboard Pro Acer Aspire USB mouse Logicool US Mouse Logitech Cordless Mouseman Wheel USB Interface Logitech USB Wheel Mouse M-BB48 Microsoft IntelliMouse Optical USB Interface

Item	Specifications
I/O - PS2 (Serial) Keyboard/Mouse	IBM 101 key keyboard IBM 109 key keyboard Acer PS2 keyboard Acer KB-101A IBM Numeric Keypad III IBM Numeric Keypad Acer Mouse IBM PS2 Mini Mouse IBM PS2 Mouse Logitech Cordless MouseMan Wheel PS2 interface Logitech Serial Mouse M-M35 Microsoft IntelliMouse PS2 interface Microsoft IntelliMouse Optical PS2 interface Logitech First Mouse Three Button Serial Mouse
I/O - USB (Printer/Scanner)	Epson Stylus Color 740 USB interface HP DeskJet 880C USB interface Canon CanonScan D1250 (USB 2.0, JP OS only) HP ScanJet 3300C Color Scanner
I/O - USB (Speaker/Joystick)	JS USB Digital Speaker Panasonic USB Speaker EAB-MPC57USB AIWA Multimedia Digital Speaker Microsoft SideWinder Precision Pro Joystick Logitech WingMan RumblePad
I/O - USB Camera	Intel Easy PC Camera Logitech QuickCam Express Internet Logitech QuickCam Home PC Video Camera Orange Micro USB 2.0 Web Cam
I/O - USB Storage Drive	Logitech CDRW +DVDROM combo USB interface Iomega USB Zip 250MB
I/O-USB Flash Drive	IBM 32MB USB Memory key Apacer USB Handy Drive 32MB Apacer USB Handy Drive 256MB
I/O - USB Hub	Belkin 4 Port USB Hub Eizo I Station USB Hub Elecom USB Hub 4 Port Sanwa USB Hub 4 Port 4 Port Hub USB 2.0
I/O - Access Point (802.11b)	Hitachi DC-CN3300 Lucent RG-1000 Lucent WavePoint-II Cisco Aironet 350 Orinoco AP-500
I/O Acss Point (802.11a/b)	Intel Dual Pro/Wireless 5000
I/O Acss Point (802.11a)	Intel Pro/Wireless 5000
PCMCIA	
PCMCIA - ATA	IBM Microdrive 340MB IBM Microdrive 1G Iomega Click! 40MB Sony Memory Stick 64MB Apacer SD Flash Card 128MB Transcedn SD Card 32MB

Item	Specifications
PCMCIA - USB 2.0	Apricom EZ-USB2.0 Cardbus PC Card DTK USB 2.0 2Port CardBus Host Controller Adaptec USB2CONNECT
PCMCIA - 1394	Buffalo 1394 Interface Cardbus IFC-ILCB/DV I-O Data 1394 Interface Cardbus CB1394/DVC Pixela 1394 Cardbus PC Card PIX-PCMC/FW1
PCMCIA-SCSI	Adaptec 1408 or B SCSI CB NewMedia Bus Toaster SCSI II
PCMCIA - Bluetooth	IBM Community Bluetooth PC Card Toshiba Bluetooth PC Card

Online Support Information

This section describes online technical support services available to help you repair your Acer Systems.

If you are a distributor, dealer, ASP or TPM, please refer your technical queries to your local Acer branch office. Acer Branch Offices and Regional Business Units may access our website. However some information sources will require a user i.d. and password. These can be obtained directly from Acer CSD Taiwan.

Acer's Website offers you convenient and valuable support resources whenever you need them.

In the Technical Information section you can download information on all of Acer's Notebook, Desktop and Server models including:

- Service guides
- User's manuals
- Training materials
- Main manuals
- Bios updates
- Software utilities
- Spare parts lists
- Chips
- TABs (Technical Announcement Bulletin)

For these purposes, we have included an Acrobat File to facilitate the problem-free downloading of our technical material.

Also contained on this website are:

- Detailed information on Acer's International Traveller's Warranty (ITW)
- Returned material authorization procedures
- An overview of all the support services we offer, accompanied by a list of telephone, fax and email contacts for all your technical queries.

We are always looking for ways to optimize and improve our services, so if you have any suggestions or comments, please do not hesitate to communicate these to us.

A

- AC Adapter 28
- AFLASH Utility 46
- Audio 19

B

- Battery 26
- battery pack
 - charging indicator 12
- BIOS 19
 - package 19
 - ROM size 19
 - ROM type 19
 - vendor 19
 - Version 19
- BIOS Setup Utility 34
- BIOS Supports protocol 19
- BIOS Utility 34
 - Basic System Settings 39
 - Navigating 35
 - Onboard Device Configuration 41
 - Startup Configuration 40
 - System Information 35
 - System Security 45
- Board Layout 4
 - Bottom View 5, 110
 - Top View 4, 109
- brightness
 - hotkeys 16

C

- Cache
 - controller 19
 - size 20
- caps lock
 - on indicator 12
- CardBus 26
- CD-ROM Interface 22
- Chipsets 19
- computer
 - on indicator 12, 13
- contrast
 - hotkeys 16
- Controllers 19

- Core logic 19
- CPU
 - core voltage 19
 - I/O voltage 19
 - package 19
 - type 19

D

- DC-AC LCD Inverter 27
- DC-DC/Charger 26
- DIMM 20
 - Combinations 20
 - package 20
 - Speed 20
 - voltage 20
- Disassembly
 - Machine 48, 74
- Disassembly Flowchart 50
- Display 1
- display
 - hotkeys 16
- Display Standby Mode 29
- DMA Channel Assignment 33
- DVD-ROM Interface 22

E

- Environmental Requirements 29
- Error Symptom-to-Spare Part Index 99
- External CD-ROM Drive Check 95

F

- Features 1
- Flash Utility 46
- Floppy Disk Drive Interface 21
- FRU (Field Replaceable Unit) List 112

H

- Hard disk 19, 21
- Hard Disk Drive Module
 - Disassembly 55
- Hard Disk Standby Mode 29
- Hardware Specifications and Configurations 19
- HDD 19, 21
- Hibernation Mode 29

-
- Hibernation mode
 - hotkey 16
 - Hot Keys 16
 - I**
 - I/O Address Map 30
 - Indicators 12
 - Intermittent Problems 106
 - IRQ Assignment Map 32
 - J**
 - Jumper and Connector Locations 108
 - SW1 Settings 110
 - K**
 - Keyboard 19, 26
 - Keyboard or Auxiliary Input Device Check 95
 - L**
 - L2 cache 19
 - LCD 27
 - M**
 - Machine Disassembly 48, 74
 - Mechanical Specification 29
 - media access
 - on indicator 12
 - Memory
 - Address Map 30
 - Memory Address Map 30
 - Memory Check 96
 - Modem 21
 - N**
 - Notebook Manager
 - hotkey 16
 - num lock
 - on indicator 12
 - O**
 - Online Support Information 142
 - P**
 - Panel 5, 110
 - Bottom 11
 - right 9
 - Parallel Port 25
 - PC Card 12, 26
 - PCMCIA 26
 - Power Management 29
 - Power System Check 96
 - Battery Pack 98
 - Power Adapter 97
 - Processor 19
 - R**
 - Removing the Battery Pack 52
 - RTC 19
 - S**
 - Second Level Cache 19
 - speakers
 - hotkey 16
 - Standby Mode 29
 - Super I/O 19
 - System
 - Layout 4
 - System Check Procedures 95
 - System Diagnostic Diskette 46
 - System Memory 20
 - System Utilities 34
 - System Utility Diskette 46
 - T**
 - Temperature 29
 - Test Compatible Components 128
 - Touchpad 19
 - touchpad
 - hotkey 16
 - Touchpad Check 98
 - Troubleshooting 94
 - U**
 - Undetermined Problems 107
 - USB 26
 - utility
 - BIOS 34
 - V**
 - Video 25
 - Resolutions 25
 - Video controller 19
 - W**
 - Windows XP Environment Test 129,
 - Windows 2000 Environment Test 133,

