

# Acer TravelMate 3300/Extensa 3100 Series

## Service Guide

Service guide files and updates are available on the ACER/CSD web; for more information, please refer to <http://csd.acer.com.tw>

PRINTED IN TAIWAN

---

## Revision History

Please refer to the table below for the updates made on TravelMate 3300/Extensa 3100 service guide.

Date	Chapter	Updates
2005/11/25	All	Revise TravelMate 3300/Extensa 3100 battery spec. on page 25 and page 26.
2005/12/15	Chapter 1	Add "WFM" to BIOS support protocols on page 23.

---

## Copyright

Copyright © 2005 by Acer Incorporated. All rights reserved. No part of this publication may be reproduced, transmitted, transcribed, stored in a retrieval system, or translated into any language or computer language, in any form or by any means, electronic, mechanical, magnetic, optical, chemical, manual or otherwise, without the prior written permission of Acer Incorporated.

## Disclaimer

The information in this guide is subject to change without notice.

Acer Incorporated makes no representations or warranties, either expressed or implied, with respect to the contents hereof and specifically disclaims any warranties of merchantability or fitness for any particular purpose. Any Acer Incorporated software described in this manual is sold or licensed "as is". Should the programs prove defective following their purchase, the buyer (and not Acer Incorporated, its distributor, or its dealer) assumes the entire cost of all necessary servicing, repair, and any incidental or consequential damages resulting from any defect in the software.

Acer is a registered trademark of Acer Corporation.

Intel is a registered trademark of Intel Corporation.

Pentium and Pentium II/III are trademarks of Intel Corporation.

Other brand and product names are trademarks and/or registered trademarks of their respective holders.

---

## Conventions

The following conventions are used in this manual:

<b>SCREEN MESSAGES</b>	Denotes actual messages that appear on screen.
<b>NOTE</b>	Gives bits and pieces of additional information related to the current topic.
<b>WARNING</b>	Alerts you to any damage that might result from doing or not doing specific actions.
<b>CAUTION</b>	Gives precautionary measures to avoid possible hardware or software problems.
<b>IMPORTANT</b>	Reminds you to do specific actions relevant to the accomplishment of procedures.

---

## Preface

Before using this information and the product it supports, please read the following general information.

1. This Service Guide provides you with all technical information relating to the BASIC CONFIGURATION decided for Acer's "global" product offering. To better fit local market requirements and enhance product competitiveness, your regional office MAY have decided to extend the functionality of a machine (e.g. add-on card, modem, or extra memory capability). These LOCALIZED FEATURES will NOT be covered in this generic service guide. In such cases, please contact your regional offices or the responsible personnel/channel to provide you with further technical details.
2. Please note WHEN ORDERING FRU PARTS, that you should check the most up-to-date information available on your regional web or channel. If, for whatever reason, a part number change is made, it will not be noted in the printed Service Guide. For ACER-AUTHORIZED SERVICE PROVIDERS, your Acer office may have a DIFFERENT part number code to those given in the FRU list of this printed Service Guide. You MUST use the list provided by your regional Acer office to order FRU parts for repair and service of customer machines.



# System Specifications

---

## Features

This computer was designed with the user in mind. Here are just a few of its many features:

### Performance

- Intel® 915GM PCI Express chipset
- Intel® Pentium® M processor 740/750/760/770/780 (2MB L2 cache, 1.60/1.73/1.86/2/2.13/2.26 GHz, 533 MHz FSB)
- Intel® Celeron® M processor 360/370/380 (1MB L2 cache, 1.40/1.50/1.60 GHz, 400 MHz FSB)
- CPU Package is uFPGA 478 Package
- Integrated Intel® PRO/Wireless 2200BG network connection (dual-mode 802.11b/g) Wi-Fi CERTIFIED™ solution

### Memory

- 256MB or 512MB of DDRII 400/533
- Upgradeable to 2GB Memory by Dual channels of SODIMM
- 512KB flash ROM BIOS

### Display and graphics

- 14.1" WXGA Acer Crystallbrite color TFT LCD: 1280x 800 resolution
- 14.1" WXGA color TFT LCD: 1280x 800 resolution
- 16.7 million colors
- Intel® 915GM integrated 3D graphics, featuring Intel® Graphics Media Accelerator 900 and up to 128 MB of VRAM, supporting Microsoft® DirectX® 9.0 and dual independent display
- MPEG-2/DVD hardware-assisted capability

### Audio

- Audio system with two built-in speakers
- Intel® AC'97 audio support
- Sound Blaster Pro and MS Sound compatible
- Built-in microphone
- S/PDIF (Sony/Philips Digital interface)

### Storage

- 40/60/80/100/12060 GB ATA/100 hard disc drive
- Optical drive options: DVD-Dual double-layer or DVD/CD-RW combo
- 5-in-1 card reader (MS/MS PRO/MMC/SD/XD)

### Communication

- 56Kbps ITU V92 with PTT approval; Wake-on-Ring ready
- LAN: gigabit Ethernet; Wake-on-Ring ready

- 
- WLAN (optional):
    - Integrated Intel® PRO/Wireless 2200BG network connection (dual-band 802.11b/g) Wi-Fi CERTIFIED™ solution, supporting Acer SignalUp™ wireless technology, or
    - Integrated Acer InviLink™ 802.11b/g Wi-Fi CERTIFIED™ solution, supporting Acer SignalUp™ wireless technology
  - WPAN (optional): Integrated Bluetooth®

## **I/O Ports**

- Three USB 2.0 port
- 5-in-1 card reader (MS/MS PRO/MMC/SD/XD)
- One Type II PC Card slot
- IEEE 1394 port (6-pin)
- Fast infrared (FIR) port
- External display (VGA) port
- Headphones/speaker/line-out port with S/PDIF support
- Microphone-in jack
- Line-in jack
- Ethernet (RJ-45) port
- Modem (RJ-11) port
- DC-in jack (AC adapter)
- One external monitor port
- 124-pin Acer ezDock connector

## **Dimensions and weight**

- 330(W) x 240(D) x 23/31.3(H) mm (12.9 x 9.45 x 10.91/1.23 inches)
- 1.9Kg (4.23 lbs)

## **Environment**

- Temperature
  - Operating: 5° C ~ 35° C
  - Non-operating: -20° C ~ 65° C
- Humidity ( non-condensing)
  - Operating: 20% ~ 80% RH
  - Non-operating: 20% ~ 80% RH



# Mainboard Layout

## Top View

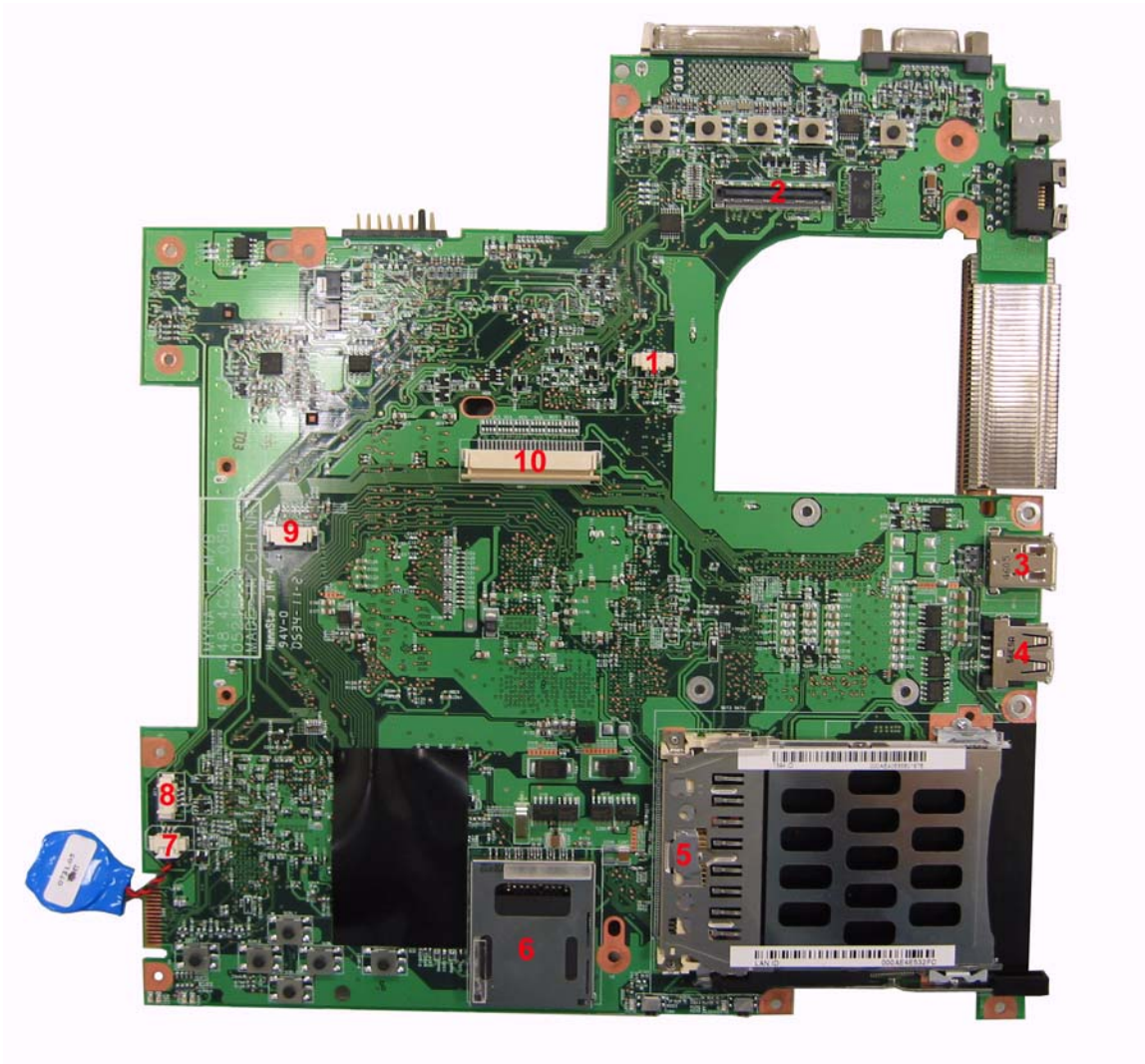

1	Fan Connector (FAN1)	6	5-in-1 Card Reader Slot (CARD1)
2	LCD Cable Connector (LCD1)	7	RTC Battery Connector (RTC1)
3	IEEE 1394 Connector (SKT1)	8	Bluetooth Module Connector (BT1)
4	USB Port (SKT2)	9	Touchpad FFC Connector (TPAD1)
5	PC Card Slot (PCH1 or U22)	10	Keyboard Connector (KB1)

## Bottom View

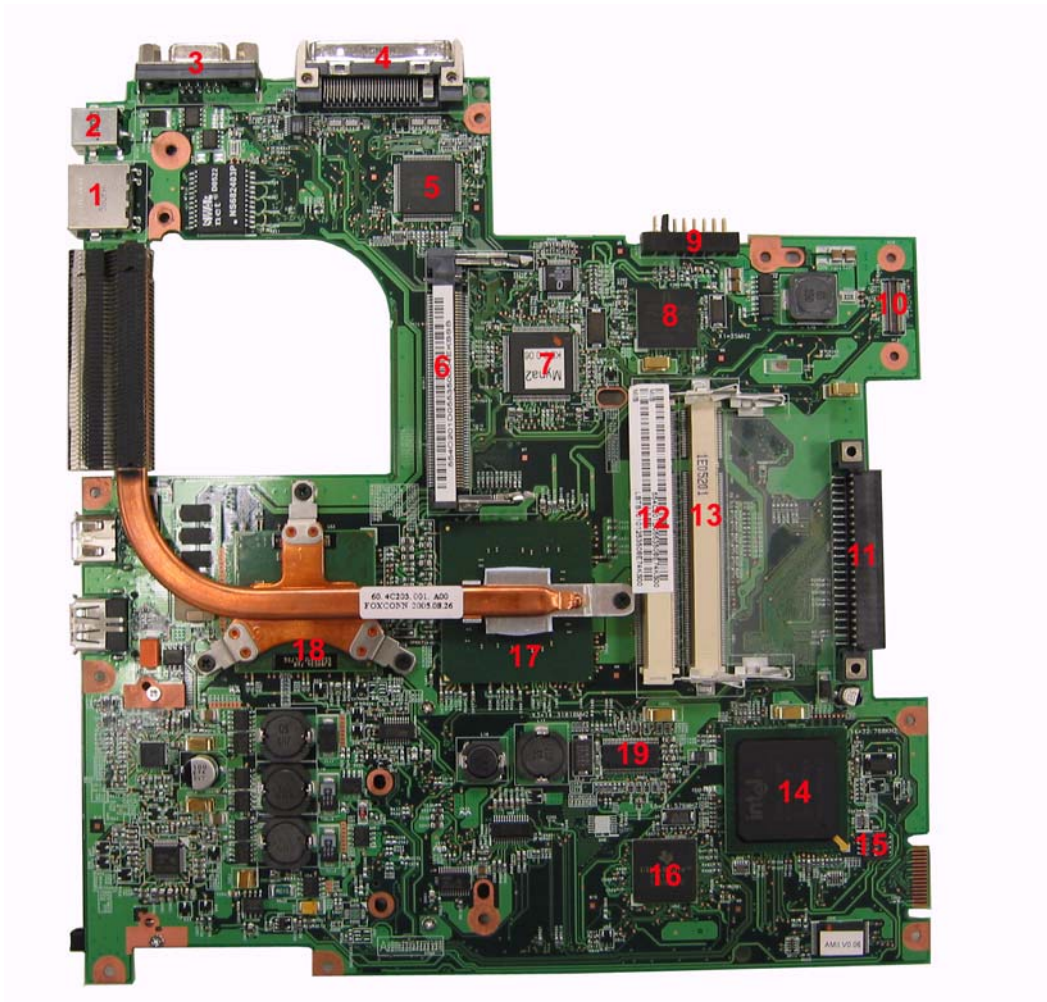

1	Giga LAN Port (JK1)	10	Main Board to IO Board Connector (IOB1)
2	Power Jack (DCIN1)	11	HDD Connector (HDD1)
3	VGA Port (CRT1)	12	DIMM Slot (DM2)
4	ezDock Port (DOCK1)	13	DIMM Slot (DM1)
5	IO Controller-PC 87392 (U27)	14	South Bridge-Intel ICH6-M (U44)
6	Wireless LAN Card Slot (WIN1)	15	Switch (SW8)
7	Keyboard Controller (U32)	16	Cardbus/1394/Card Reader Controller-UltraMedia PCI 7411 (U52)
8	LAN Controller-BROADCOM BCM5788M (U31)	17	North Bridge (U34)
9	Battery Connector (BAT1)	18	CPU (U33)
19	Power Generator-IDT CV125PA (U41)		

# IO Board Layout

## Top View

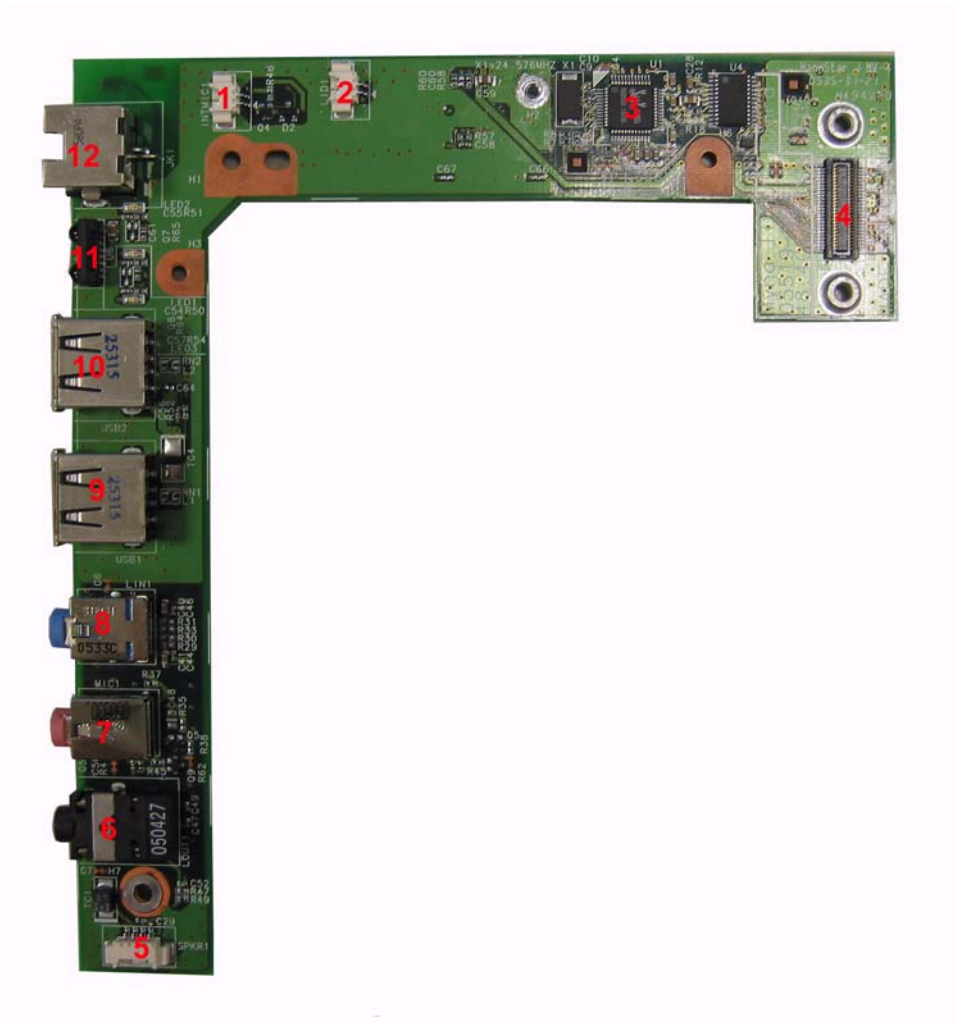

1	Microphone Connector (INTMIC1)	7	Microphone-in Port (MIC1)
2	Cover Switch Cable Connector (LID1)	8	Line-in Port (LINT1)
3	Audio Codec-Realtek ALC655 (U1)	9	USB Port (USB1)
4	IO Board to Main Board Connector (BTB1)	10	USB Port (USB2)
5	Speaker Set Connector (SPKR1)	11	FIR (U6)
6	Line-out Port (LOUT1)	12	RJ11 Modem Jack (JK1)

## Bottom View

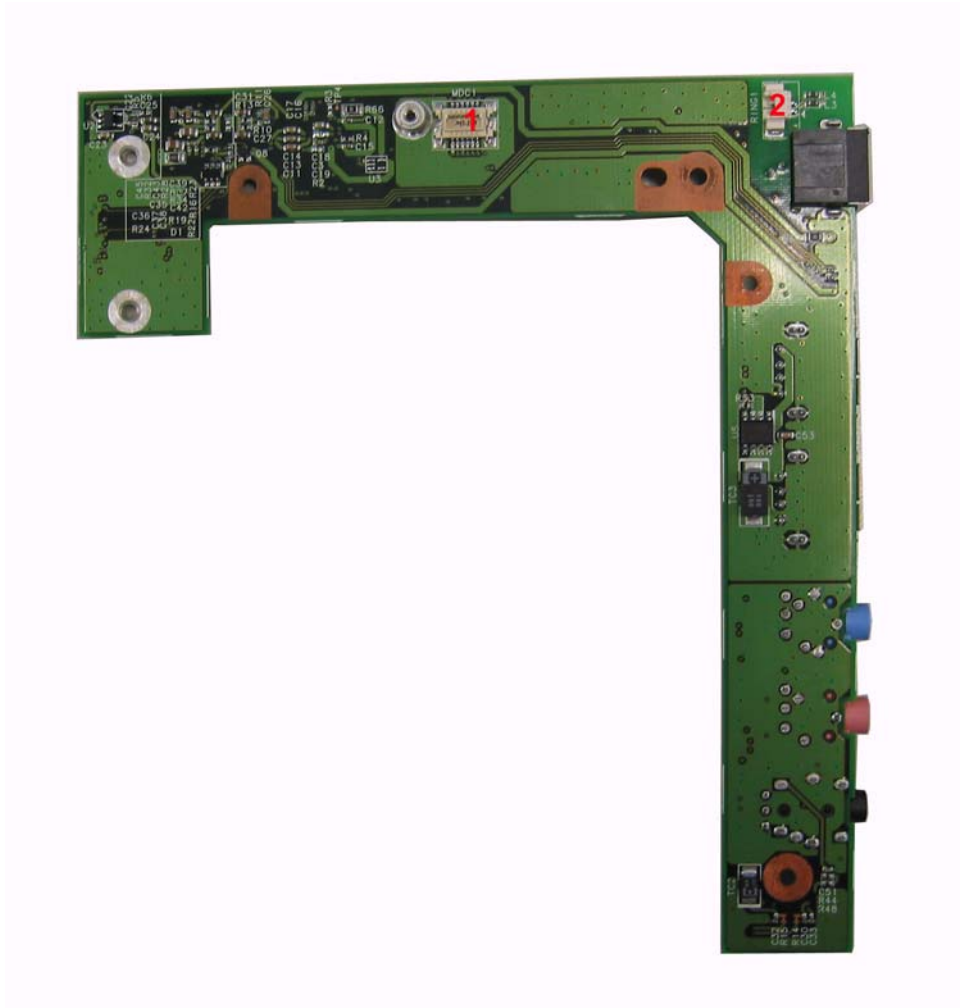

1

Modem Board Connector (MDC 1)

2

MDC Cable Connector (RING1)





# Outlook View

A general introduction of ports allow you to connect peripheral devices, as you would with a desktop PC.



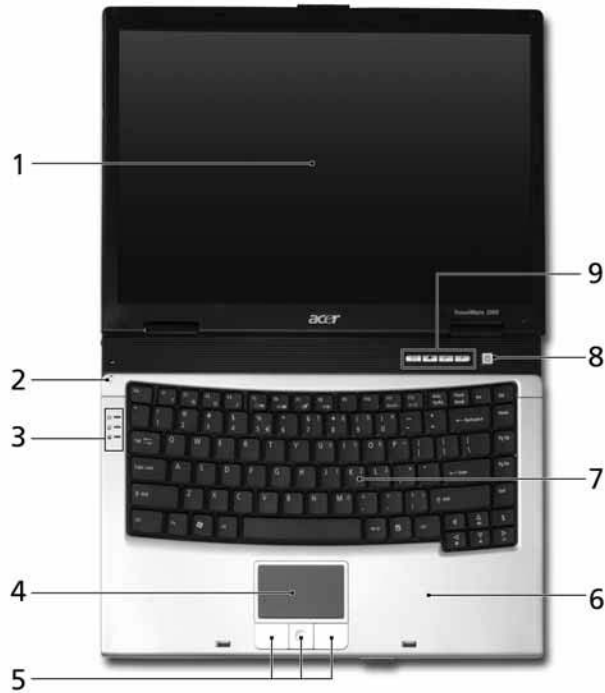

## Front View

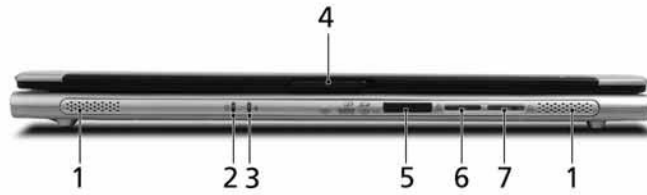

#	Item	Description
1	Display screen	Also called Liquid-Crystal Display (LCD), displaying computer output.
2	Microphone	Internal microphone for sound recording.
3	Status indicators	Light-Emitting Diodes (LEDs) that turn on and off to show the status of the computer's functions and components
4	Touchpad	Touch-sensitive pointing device which functions like a computer mouse.
5	Click buttons (Left, center and right)	The left and right buttons function like the left and right mouse buttons; the center button serves as a 4-way scroll button.
6	Palmrest	Comfortable support area for your hands when you use the computer.
7	Keyboard	For entering data into your computer.
8	Power button	Turns the computer on and off.
9	Easy-launch buttons	Buttons for launching frequently used programs.







## Closed front view



#	Icon	Item	Description
1		Speakers	Left and right speakers deliver stereo audio output.
2		Battery indicator	Lights up when the battery is being charged.
3		Power indicator	Lights up when the computer is on.
4		Latch	Locks and releases the lid.
5		5-in-1 card reader	Accepts Memory Stick, Memory stick Pro, MultiMedia card (MMC), Secure Digital (SD) and xD-Picture Card. Note: Only one card can operate at any given time.
6		Bluetooth communication button/indicator	Press to enable/disable Bluetooth function. Lights to indicate the status of Bluetooth communications. (for TM4600 only)
7		Wireless communications button/indicator	Press to enable/disable Wireless function. Lights to indicate the status of wireless LAN communications. (manufacturing option)

## Left View





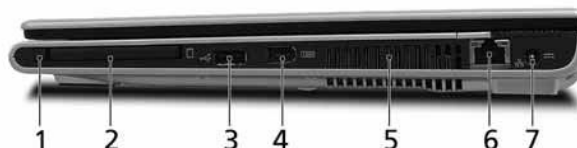

#		Item	Description
1		Kensington lock slot	Connects to a Kensington-compatible
2		Modem (RJ-11) port	Connects to a phone line.
3		Infrared port	Interfaces with infrared devices (e.g., infrared printer and IR-aware computer).
4		Two USB 2.0 ports	Connect to USB 2.0 devices (e.g., USB mouse, USB camera).
5		Line-in jack	Accepts audio line-in devices (e.g., audio CD player, stereo walkman).
6		Microphone jack	Accepts input from external microphones.
7		Headphones/speaker/line-out jack	Connects to audio line-out devices (e.g., speakers, headphones).

**NOTE:** The positions of the AcerMedia indicator, eject button and emergency eject hole may differ depending on the optical drive module installed.

## Right View







#	Icon	Item	Description
1		PC Card slot eject button	Ejects the PC Card from the slot.
2		PC Card slot	Connects to one Type II CardBus PC Card.
3		USB 2.0 ports	Connect to Universal Serial Bus (USB) 2.0 devices (e.g., USB mouse, USB camera).
4		IEEE 1394 port (6-pin)	Connects to IEEE 1394 devices.
5		Ventilation slots	Enable the computer to stay cool, even after prolonged use.
6		Network jack	Connects to an Ethernet 10/100/1000-based network (for selected models).
7		DC-in jack	Connects to an AC adapter.

## Rear View



#	Icon	Item	Description
1		External display port	Connects to a display device (e.g., external monitor, LCD projector).
		124-pin Acer ezDock connector	Connects to Acer ezDock.
		Battery bay	Houses the computer's battery pack.

## Bottom View

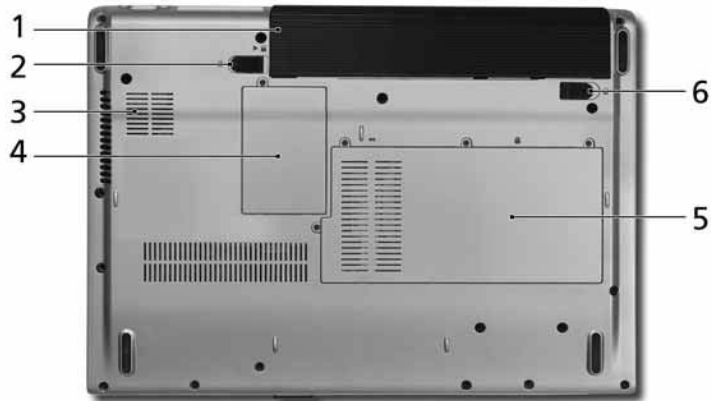

#	Item	Description
1	Battery bay	Houses the computer's battery pack.
2	Battery lock	Locks the battery in position.
3	Cooling fan	Helps keep the computer cool. Note: Do not cover or obstruct the opening of the fan.
4	Mini PCI card bay	Houses the computer's Mini PCI card.
5	Memory and hard disk bay	Houses the computer's main memory and hard disk (secured with screws).
6	Battery release latch	Release the battery for removal.

# Indicators

The computer has three easy-to-read status indicators on the left side of the keyboard, and four on the front panel.



The power, battery and wireless communication status indicators are visible even when the LCD display is closed.

Icon	Item	Description
	Caps Lock activity	Lights when Caps Lock is activated.
	Num Lock activity	Lights when Num Lock is activated.
	Media activity	Lights when the hard disk or optical drive is active.
	Battery	Lights up when the battery is being charged.
	Power	Lights up when the computer is on.
	Bluetooth	Indicates the status of Bluetooth communication.
	Wireless LAN	Indicates the status of wireless LAN communication.

**NOTE:** 1. **Charging:** The light shows amber when the battery is charging. 2. **Fully charged:** The light shows green when in AC mode.

---

## Easy-launch buttons

Located at the upper-right, above the keyboard are four buttons. These buttons are called easy-launch buttons. They are: mail, Web Browser, Empowering Key < *e* > and one user-programmable button.

Press < *e* > to run the Acer Empowering Technology. The mail and Web browser buttons are pre-set to email and Internet programs, but can be reset by users.



Easy-launch button	Default application
Mail	Email application (user-programmable)
Web browser	Internet browser (user-programmable)
<i>e</i>	Acer Empowering Technology (user-programmable)
P	User-programmable

# Touchpad

The build-in touchpad is pointing device that senses movement on its surface. This means the cursor responds as you move your finger across the surface of the touchpad. The central location on the palmrest provides optimum comfort and support.



## Touchpad Basics

Use the touchpad as follows:



- ❑ Move your finger across the touchpad **(2)** to move the cursor.
- ❑ Press the left **(1)** and right **(4)** buttons located on the edge of the touchpad to do selection and execution functions. These two buttons are similar to the left and right buttons on a mouse. Tapping on the touchpad is the same as clicking the left button
- ❑ Use the 4-way scroll **(3)** button to scroll up or down and move left or right a page. This button mimics your cursor pressing on the right scroll bar of windows applications.

Function	Left button (1)	Right button (4)	Main touchpad (2)	Center button (3)
Execute	Quickly click twice.		Tap twice (at the same speed as double-clicking a mouse button).	
Select	Click one.		Tap once.	

Function	Left button (1)	Right button (4)	Main touchpad (2)	Center button (3)
Drag	Click and hold, then use finger on the touchpad to drag the cursor.		Tap twice (at the same speed as double-clicking a mouse button); rest your finger on the touchpad on the second tap and drag the cursor.	
Access context menu		Click one.		
Scroll				Click and hold to move up/down/left/right.

---

## Using the Keyboard

The keyboard has full-sized keys and an embedded keypad, separate cursor keys, two Windows keys and twelve function keys.

### Lock Keys and embedded numeric keypad

The keyboard has three lock keys which you can toggle on and off.











Lock Key	Description
Caps Lock	When Caps Lock is on, all alphabetic characters typed are in uppercase.
Num lock <Fn>+<F11>	When Num Lock is on, the embedded keypad is in numeric mode. The keys function as a calculator (complete with the arithmetic operators +, -, *, and /). Use this mode when you need to do a lot of numeric data entry. A better solution would be to connect an external keypad.
Scroll lock <Fn>+<F12>	When Scroll Lock is on, the screen moves one line up or down when you press the up or down arrow keys respectively. Scroll Lock does not work with some applications.

The embedded numeric keypad functions like a desktop numeric keypad. It is indicated by small characters located on the upper right corner of the keycaps. To simplify the keyboard legend, cursor-control key symbols are not printed on the keys.

Desired Access	Num Lock On	Num Lock Off
Number keys on embedded keypad	Type numbers in a normal manner.	
Cursor-control keys on embedded keypad	Hold <Shift> while using cursor-control keys.	Hold <Fn> while using cursor-control keys.
Main keyboard keys	Hold <Fn> while typing letters on embedded keypad.	Type the letters in a normal manner.

### Windows Keys

The keyboard has two keys that perform Windows-specific functions.



Key	Icon	Description
Windows key 		<p>Pressed alone, this key has the same effect as clicking on the Windows Start button; it launches the Start menu. It can also be used with other keys to provide a variety of function:</p> <ul style="list-style-type: none"> <li> + &lt;Tab&gt; Activates next taskbar button.</li> <li> + &lt;E&gt; Opens the My Computer window</li> <li> + &lt;F1&gt; Opens Help and Support.</li> <li> + &lt;F&gt; Opens the Find: All Files dialog box.</li> <li> + &lt;R&gt; Opens the Run dialog box.</li> <li> + &lt;M&gt; Minimizes all windows.</li> </ul> <p>&lt;Shift&gt;+  + &lt;M&gt; Undoes the minimize all windows action.</p>
Application key		This key has the same effect as clicking the right mouse button; it opens the application's context menu.

## Hot Keys









The computer employs hotkeys or key combinations to access most of the computer's controls like screen brightness, volume output and the BIOS utility.

To activate hot keys, press and hold the <Fn> key before pressing the other key in the hotkey combination.



Hot Key	Icon	Function	Description
Fn-F1		Hot key help	Displays help on hot keys.
Fn-F2		Acer eSetting	Launches the Acer eSettings in Acer eManager.
Fn-F3		Acer ePowerManagement	Launches the Acer ePowerManagement in Acer eManager.



Hot Key	Icon	Function	Description
Fn-F4		Sleep	Puts the computer in Sleep mode.
Fn-F5		Display toggle	Switches display output between the display screen, external monitor (if connected) and both.
Fn-F6		Screen blank	Turns the display screen backlight off to save power. Press any key to return.
Fn-F7		Touchpad toggle	Turns the internal touchpad on and off.
Fn-F8		Speaker toggle	Turns the speakers on and off.
Fn-↑		Volume up	Increases the speaker volume.
Fn-↓		Volume down	Decreases the speaker volume.
Fn-☀		Brightness up	Increases the screen brightness.
Fn-☁		Brightness down	Decreases the screen brightness

## Special Key

You can locate the Euro symbol and US dollar sign at the upper-center and/or bottom-right of your keyboard. To type:



---

## The Euro symbol

1. Open a text editor or word processor.
2. Either directly press the <€> symbol at the bottom-right of the keyboard, or hold <Alt Gr> and then press the<5> symbol at the upper-center of the keyboard.

## The US dollar sign

1. Open a text editor or word processor.
2. Either directly press the <\$> key at the bottom-right of the keyboard, or hold <Shift> and then press the <4> key at the upper-center of the keyboard.

**NOTE:** This function varies by the operating system version.





**NOTE:** Some fonts and software do not support the Euro symbol. Please refer to [www.microsoft.com/typography/faq/faq12.htm](http://www.microsoft.com/typography/faq/faq12.htm) for more information.

# Using System Utilities

## Acer eManager

Innovative Acer eManagement software is designed for easy access to frequently used functions. At the press of Acer Empowering Key, the Acer eManager user interface appears, featuring four main settings -- Acer eSetting, Acer ePresentation, Acer ePowerManagement and Acer eRecovery.



Icon	Item	Description
	Acer eSetting	It is an easy way to manage the settings and security of your PC.
	Acer ePresentation	It takes the hassle out of making presentations.
	Acer ePowerManagement	It provides a central location from where to control all your PC's power schemes and maximise battery life.
	Acer eRecovery	It backs up your files preventing data loss in the event of a system crash.

# Launch Manager

Launch Manager allows you to set the two launch keys located above the keyboard.

You can access the Launch Manager by clicking on **Start, All Programs**, and then **Launch Manager** to start the application.

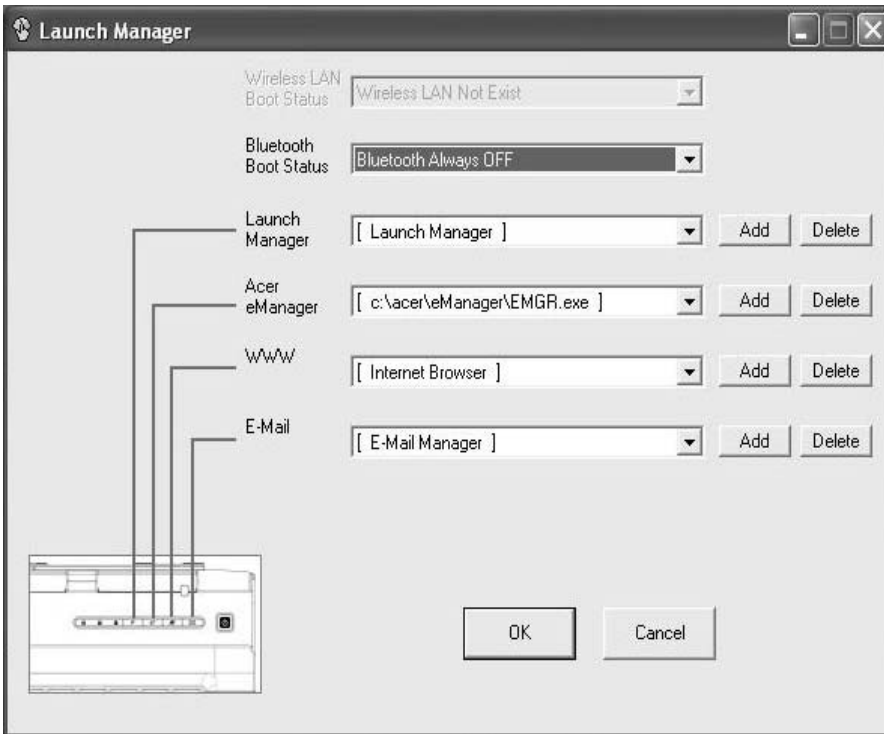

# Hardware Specifications and Configurations

## Processor

Item	Specification
CPU type	Intel® Pentium® M processor 740/750/760/770/780 (2MB L2 cache, 1.73/1.87/2.0/2.13/2.26 GHz, 533 MHz FSB) Intel® Celeron® M processor 360/370/380 (1MB L2 cache, 1.4/1.5/1.6 GHz, 400 MHz FSB)
CPU package	CPU on board no socket
CPU core voltage	Depend on DVI
CPU I/O voltage	1.2V

## System Board Major Chips

Item	Controller
System core logic	Intel® 915GM / ICH6-M
Super I/O controller	NS 87392, LPC interface
Audio controller	Codec ALC655
Video controller	UMA (built-in Intel® 915GM)
Hard disk drive controller	ICH6-M
Keyboard controller	Renesas RE144B
FIR controller	NS 87392
PCMCIA / card reader / 1394 controller	TI PCI7411
DDR-soDIMM controller	built-in Intel® 915GM

## BIOS

Item	Specification
BIOS vendor	Phoenix
BIOS Version	
BIOS ROM type	Flash ROM
BIOS ROM size	512KB
BIOS package	32 lead of TSSOP
Supported protocols	ACPI 2.0, PC Card 95, SMBIOS 2.3, IEEE1284-ECP/EPP, PCI 2.2, PnP 1.0a, DMI 2.0, PS/2 keyboard and mouse, USB 2.0, VGA BIOS, CD-ROM bootable, IEEE 1394, <b>WFM 2.0 (Wired for Management)</b>
BIOS password control	Set by setup manual

## L2 Cache

Item	
Cache controller	Built-in CPU
Cache size	2M (Intel® Pentium® M processor 740/750/760/770/780) 1M (Intel® Celeron® M processor 360/370/380)
1st level cache control	Always enabled
2nd level cache control	Always enabled
Cache scheme control	Always enabled

## System Memory

Item	Specification
Memory controller	Intel® 915GM
Memory size	256MB/512MB/1GB
DIMM socket number	2
Supports maximum memory size per slot	1024 MB
Supports maximum memory size	2GB
Supports DIMM type	DDRII SDRAM standard
Supports DIMM Speed	400/533 MHz
Supports DIMM voltage	1.8V
Memory module combinations	You can install memory modules in any combinations as long as they match the above specifications.

## LAN Interface

Item	Specification
Supports LAN protocol	10/100/1000 Mbps Fast Ethernet connection
LAN connector type	RJ45
Wireless LAN	InviLink. 802.11b/g dual-band
LAN connector location	Right side

## Modem/Bluetooth Interface

Item	Specification
Data modem data baud rate (bps)	56K ITU
Supports modem/bluetooth protocol	V.92 AC-Link modem with PTT approval Wake-on-Ring ready
Modem connector type	RJ11
Modem connector location	Left side

## VGA

Notice	UMA
Chipset for suitable VGA type	Intel (R) 915GM

## USB Port

Item	Specification
USB compliancy level	2.0
OHCI	USB 2.0
Number of USB port	3
Location	Right Side *1 Left Side *2

Item	Specification
Audio Controller	AC' 97 Codec (ALC 655)

Item	Specification
Audio onboard or optional	Built-in
Mono or Stereo	Stereo
Resolution	20 bit stereo Digital to analog converter 18 bit stereo Analog to Digital converter
Compatibility	Microsoft PC99/2100, AC97 2.3 & WHQL/WLP2.0
Mixed sound source	CD
Sampling rate	48 KHz
Internal microphone	Yes
Internal speaker / Quantity	Yes / 2

### PCMCIA Port

Item	Specification
PCMCIA controller	TI PCI 7411
Supports card type	Type II
Number of slots	One type-II
Access location	Right Side
Supports ZV (Zoomed Video) port	No
Supports 32 bit CardBus	Yes

### Keyboard

Item	Specification
Keyboard controller	Renesas RE144B
Keyboard vendor & model name	Darfon Standard keyboard with launch button embedded
Total number of keypads	<input type="checkbox"/> 88/85 keys PS/2 and AT-compatible keyboard
Touchpad with 4-way integrated scroll button	Yes
Function keys	<input type="checkbox"/> four inverted "T" cursor keys <input type="checkbox"/> Hot key controls (12 function keys) <input type="checkbox"/> two Windows functions <input type="checkbox"/> Lock keys and embedded numeric keypad <input type="checkbox"/> special keys <input type="checkbox"/> international language support
Four easy-launch buttons	<input type="checkbox"/> Web Browser <input type="checkbox"/> Mail <input type="checkbox"/> Empowering key <input type="checkbox"/> One user-programmable button
Two front access LED buttons	<input type="checkbox"/> WLAN LED button <input type="checkbox"/> Bluetooth LED button

## Battery

Item	Specification
Vendor & model name	Sony/Sanyo
Battery Type	Li-ion
Pack capacity	53Wh
Cell voltage	7200mAh for 9-cell
Number of battery cell	9-cell

**NOTE:** Extensa 3100 has second battery. When the battery is running out of power, the user can replace the battery with the second battery for prolong usage.

## LCD 14.1" WXGA

Item	Specification		
Vendor & model name	CMO: N141I1-L07 (non glare) N141I1-L05 (glare) N141C1-L02 (WXGA+)	QDI QD14TL0102	Hydis HT141WX1-100
Screen Diagonal (mm)	358.14	358.14	358.14
Active Area (mm)	303.36x189.6 303.48x189.675(for WXGA+)	303.7x189.8	303.36x189.6
Display resolution (pixels)	1280x800 WXGA 1440x900 WXGA+ for N141C1-L02	1280x800	1280x800
Pixel Pitch	0.237x0.237 0.21075x0.21075 (WXGA+)	0.237x0.237	0.237x0.237
Pixel Arrangement	R.G.B. Vertical Stripe	R.G.B. Vertical Stripe	R.G.B. Vertical Stripe
Display Mode (transmissive mode)	Normally White	Normally White	Normally White
Typical White Luminance (cd/m <sup>2</sup> ) also called Brightness	185 (typ) 220 (typ for WXGA+)	185	185
Luminance Uniformity	N/A	1.25	N/A
Contrast Ratio	400 (Typ) 500 (Typ)	300	300
Response Time (Optical Rise Time/Fall Time)msec	5/11	10/15	25
Power Supply Voltage	+3.3V Typ.	+3.3V	3.3V
Typical Power Consumption (watt)	4.02 for backlight unit only	N/A	
Weight	400	440 (max)	390
Physical Size(mm)	319.5x205.5x5.2	319.5x205.5x5.2	319.5x205.5x5.2
Electrical Interface	1 channel LVDS	1 channel LVDS	1 channel LVDS
Support Color	262K colors (RGB 6-bit data driver)	262,144	262,144
Viewing Angle (degree) Horizontal: Right/Left Vertical: Upper/Lower	45/45 20/45	40/40 15/30	45/45 20/45



## LCD 14.1" WXGA

Item	Specification		
Temperature Range(° C)			
Operating	0 to +50	0 to +50	0 to +50
Storage (shipping)	-20 to +60	-25 to +60	-20 to +60

## Hard Disk Drive Interface

Item				
Vendor & Model Name	HGST Hakone TOBHIBA Pluto MK4025GAS SEAGATE N2.1 ST9402112A	HGST Hakone TOBHIBA Pluto MK6025GAS SEAGATE N2.2 ST960812A	HGST Hakone TOSHIBA Pluto MK8025GAS SEAGATE N2.2 ST980829A	HGST Hakone TOSHIBA Aries MK 1031GAS SEAGATE N2.2 ST9100825A
Capacity (MB)	40000	60000	80000	100000
Bytes per sector	512	512	512	512
Data heads	HGST Hakone 2 (Toshiba) 1 (Seagate)	HGST Hakone 4 (Toshiba) 2 (Seagate)	HGST Hakone 4 (Toshiba) 3 (Seagate)	HGST Hakone 4 (Toshiba) 4 (Seagate)
Drive Format				
Disks	HGST Hakone/1/1	HGST Hakone/2/1	HGST Hakone/2/2	HGST Hakone/2/2
Spindle speed (RPM)	4200	4200	4200	4200
Performance Specifications				
Buffer size	HGST Hakone Toshiba 8192KB Seagate 2048KB	HGST Hakone Toshiba 8192KB Seagate 8192KB	HGST Hakone Toshiba 8192KB Seagate 8192KB	HGST Hakone Toshiba 8192KB Seagate 8192KB
Interface	HGST Hakone/ATA-6/Parallel ATA	HGST Hakone/ATA-6/Parallel ATA	HGST Hakone/ATA-6/Parallel ATA	HGST Hakone/ATA-6/Parallel ATA
Internal transfer rate (Mbytes/sec. max.)	HGST Hakone/42.71/ 56.25	HGST Hakone/38.43/ 56.25	HGST Hakone/42.71/ 56.25	HGST Hakone/46.62/ 56.25
I/O data transfer rate (Mbytes/sec. max.)	100 MB/Sec. Ultra DMA mode 5	100 MB/Sec. Ultra DMA mode 5	100 MB/Sec. Ultra DMA mode 5	100 MB/Sec. Ultra DMA mode 5
DC Power Requirements				
Allowable voltage	5V(DC) +/- 5%	5V(DC) +/- 5%	5V(DC) +/- 5%	5V(DC) +/- 5%

## AC Adapter

Item	Specification
Vendor & model name	LITEON PA-1650-02WR (3pin, 65W) LISHIN SLS0335A19A54LF (3pin, 65W)
Input Requirements	
Maximum input current (A, @100Vac, full load)	1.8A max@3.5A/100Vac and 240 Vac
Nominal frequency (Hz)	47 - 63
Frequency variation range (Hz)	47 - 63

## AC Adapter

Item	Specification
Nominal voltages (Vrms)	90 - 264
Inrush current	The maximum inrush current will be less than 50A and 100A when the adapter is connected to 100Vac(60Hz) and 240Vac(50Hz) respectively.
Efficiency	High efficiency 85% minimum, at 100~240Vac AC input, full load, warm-up condition.
Output Ratings (CV mode)	
DC output voltage	Offers constant voltage 19.0V output source with 150W max output power capacity.
Noise + Ripple	300mvp-pmax (20MHz bandwidth) for resistor load
Output current	0 A (min.) 3.5A (max.)
Output Ratings (CC mode)	
DC output voltage	18.0 ~ 20.0
Constant output	7.9A
Dynamic Output Characteristics	
Start-up time	3 sec. (@115 Vac and 230Vac full load)
Hold up time	5ms min. (@115 Vac input, full load)
Over Voltage Protection (OVP)	25V
Short circuit protection	Output can be shorted without damage, and auto recovery
Electrostatic discharge (ESD)	15kV (at air discharge) 8kV (at contact discharge)
Dielectric Withstand Voltage	
Primary to secondary	4242 Vdc for 1 second-
Leakage current	60uA at 240Vac/60Hz
Regulatory Requirements	1. FCC class B requirements (USA) 2. VDE class B requirements (German) 3. VCCI classII requirements (Japan)

## Power Management

ACPI Mode	Power Management
Mech. Off (G3)	All devices in the system are turned off completely.
Soft Off (G2/S5)	OS initiated shutdown. All devices in the system are turned off completely.
Working (G0/S0)	Individual devices such as the CPU and hard disk may be power managed in this state.
Sleeping State (S3)	CPU Power Down VGA Power Down PCMCIA Suspend Audio Power Down Hard Disk Power Down Super I/O Power Down
Sleeping State (S4)	Also called Hibernate state. System saves all system states and data onto the disk prior to power off the whole system.

## Dimensions and Weight

Item	Details
Deminsions	330(W) x 240(D) x 23/31.3(H) mm (12.9 x 9.45 x 10.91/1.23 inches)
Weight	1.9Kg (4.23 lbs)

## Environmental Requirements

Item	Specification
Temperature	
Operating	+5°C ~ +35°C
Non-operating	-10°C ~ +60°C
Package storage	-20°C ~ 60°C
Humidity	
Operating	20% ~ 85% RH
Non-operating	20% ~ 80% RH
Package storage	20% ~ 90% RH
Altitude	Operating sea level 0 to 10,000ft
	Storage sea level 0 to 40,000ft

## HDD Interface

Model Name	MK4025GAS ,KA100A, 40GB	Pluto MK6025GAS 60GB	Pluto MK8025GAS, 8MB, 80GB
Data Storage Physical			
Per drive, formatted	40.007GB	60.0116GB	80.012GB
Data Heads	2	4	4
Number of Disks	1	2	2
Logical Configuration			
Heads	16	16	16
Cylinders	16,383	16,383	16,383
User Sectors/Track at zone 0	63	63	63
Logical Blocks (LBA)	78,140,160	117,210,240	156,301,488
Data Transfer Rate			
Max transfer rate to host	100MB/sec	100MB/sec	100MB/sec
Seek Time			
Track-to-track	2ms	2ms	2ms
Average	12ms	12ms	12ms
Maximum	22ms	22ms	22ms



## System Utilities

### BIOS Setup Utility

The BIOS Setup Utility is a hardware configuration program built into your computer's BIOS (Basic Input/Output System).

Your computer is already properly configured and optimized, and you do not need to run this utility. However, if you encounter configuration problems, you may need to run Setup. Please also refer to Chapter 4 Troubleshooting when problem arises.

To activate the BIOS Utility, press **F2** during POST (when "Press <F2> to enter Setup" message is prompted on the bottom of screen).

The setup screen displays BIOS as follows: Navigating the BIOS Utility

Function	Item
Information	Display the system informations
Main	Allows the user to specify standard IBM PC AT system parameters
Advanced	Provides advanced settings of the system
Security	Provides security settings of the system
Boot	Allows the user to specify the boot options
Exit	Allows the user to save CMOS setting and exit Setup

During setup, all Fn function keys and power saving functions are disabled.

There are five menu options: Main, Advanced, Security, Boot and Exit.

Follow these instructions:

- To choose a menu, use the cursor left/right keys (**←** **→**).
- To choose a parameter, use the cursor up/down keys (**↑** **↓**).
- To change the value of a parameter, press **F5** or **F6**.
- Press **ESC** while you are in any of the menu options to go to the Exit menu.
- In any menu, you can load default settings by pressing **F9**. You can also press **F10** to save any changes made and exit the BIOS Setup Utility.

**NOTE:** You can change the value of a parameter if it is enclosed in square brackets. Navigation keys for a particular menu are shown on the bottom of the screen. Help for parameters are found in the Item Specific Help part of the screen. Read this carefully when making changes to parameter values.

# Information

**PhoenixBIOS Setup Utility**

Information
Main
Advanced
Security
Boot
Exit

```

CPU Type :           Intel (R) Pentium (R) M processor 2.0GHz
CPU Speed :          2000MHz
IDE1 Model Name :    ST9100825A - (PM)
IDE1 Serial Number : None
IDE2 Model Name :    None
IDE2 Serial Number : None
System BIOS Ver:     V0.08
VGA BIOS Ver         1232
KBC Ver              01.00
Serial Number         xxxxxxxxxxxxxxxxxxxxxxxx
Asset Tag Number      N/A
Produce Name          TravelMate 3300/Extensa 3100
Manufacturer Name:    Acer
UUID:                 xxxxxxxxxxxxxxxxxxxxxxxx
                    
```

F1 Help	↑↓ Select Item	F5/F6 Change Values	F9 Setup Defaults
Esc Exit	←→ Select Menu	Enter Select ▶ Sub-Menu	F10 Save and Exit

Parameter	Description
CPU Type	This field displays the system CPU type.
CPU Speed	This field displays the CPU speed of the system.
IDE1 Model Name	This item will show the Model name of HDD installed on Primary IDE master. The hard disk model name is automatically detected by the system. If there is no hard disk present or unknown type, "None" should be shown on this field
IDE1 Serial Number	This item will show the Serial number of HDD installed on Primary IDE master. If no Hard disk or other devices are installed on Primary IDE master, then it will display a blank line
IDE2 Model Name	This item will show the model name of DVD/CD-ROM drive installed on system. The DVD/CD-ROM model name is automatically detected by the system. If there is no DVD/CD-ROM model present or unknown type, "None" should be shown on this field
System BIOS Version	This field reports the BIOS version of system
VGA BIOS Version	This field reports the VGA version of the system
KBC Version	This field reports the KBC version of the system.

---

<b>Parameter</b>	<b>Description</b>
Serial Number	This item will show the Serial number of system.
Asset Tag Number	This item will show the Asset Tag number of the system.
Product Name	This field will show product name.
Manufacturer Name	This field will show manufacturer name.
UUID	This will be visible only when there is an internal LAN device present.

# Main

PhoenixBIOS Setup Utility					
Information	Main	Advanced	Security	Boot	Exit
System Time: [23:47:44] System Date: [11/23/2005]  System Memory: 640 KB Shows system base memory size Extended Memory: 1022 MB Shows extended memory size Video Memory [128MB] VGA memory size  Quiet Boot: [Enabled] Power on display: [Auto ] Network boot [Enabled] F12 Boot Menu [Disabled] D2D Recovery [Enabled]					Item Specific Help  <Tab>, <Shift-Tab>, or <Enter> selects field.
F1 Help	↑↓ Select Item	F5/F6 Change Values	F9 Setup Defaults		
Esc Exit	←→ Select Menu	Enter Select	▶ Sub-Menu	F10 Save and Exit	

This menu provides you the information of the system.

Parameter	Description
System Time / System Date	The hours are displayed with 24 hours format. The values set in these two fields take effect immediately.
System Memory	This field reports the memory size of system base memory. The size is fixed to 640KB.
Extended Memory	This field reports the memory size of the extended memory in the system. Extended Memory size = Total memory size - 1 MB
Video Memory	VGA Memory size = 128MB
Quiet Boot	Customer Logo display will be shown during POST when it is selected.
Power on display	<b>Auto:</b> During power on process, the system will detect if any display device is connected on external video port. If any external display device is connected, the power on display will be in CRT (or projector) only mode. Otherwise it will be in LCD only mode. <b>Both:</b> Simultaneously enable both the integrated LCD screen and the system's external video port (for an external CRT or projector).



---

<b>Parameter</b>	<b>Description</b>
Network boot	When this is selected, Boot from LAN feature is enabled. When this is not selected, Boot from LAN feature is then disabled.
F12 Boot Menu	When this is selected, users can modify device boot priority by pressing F12 key during POST. When this is not selected, device boot priority will not be adjustable during POST.
D2D Recovery	Allow user to enable/disable the Disk-to-Disk recovery

# Advanced

The Advanced screen contains parameters involving your hardware devices. It also provides advanced settings of the system.

PhoenixBIOS Setup Utility					
Info.	Main	Advanced	Security	Boot	Exit
Infrared Port (FIR)	[Enabled]				Item Specific Help
Parallel port:	[Enabled]				Configure Infrared Port using options: [Disable] No configuration  [Enabled] User configuration  [Auto] BIOS or OS chooses configuration  (OS Controlled) Displayed when controlled by OS
Serial port	[Enabled]				
F1 Help      ↑↓ Select Item      F5/F6 Change Values      F9 Setup Defaults Esc Exit      ←→ Select Menu      Enter Select      ▶ Sub-Menu      F10 Save and Exit					

The table below describes the parameters in the screen. Settings in **boldface** are the default and suggested parameter settings.

	Description	Option
Serial port A	Configure serial port A using options: [Disabled]: No configuration [Enabled]: User configuration [Auto]: BIOS or OS chooses configuration (OS Controlled) Displayed when controlled by OS	Disabled Enabled <b>Auto</b>

	Description	Option
Infrared Port	Configure serial port B using options: [Disabled]: No configuration [Enabled]: User configuration [Auto]: BIOS or OS chooses configuration (OS Controlled) Displayedd when controlled by OS	Disabled Enabled <b>Auto</b>
Parallel port	Configure serial port B using options: [Disabled]: No configuration [Enabled]: User configuration [Auto]: BIOS or OS chooses configuration (OS Controlled) Displayedd when controlled by OS	Disabled Enabled <b>Auto</b>
Mode	Set the mode for the parallel port using options: Output only Bi-directional EPP ECP	Output only Bi-directional EPP <b>ECP</b>

# Security

The Security screen contains parameters that help safeguard and protect your computer from unauthorized use.

PhoenixBIOS Setup Utility				
Information	Main	Security	Boot	Exit
User Password is : <b>Clear</b> Supervisor Password is : <b>Clear</b>  Set User Password [Enter] Set Supervisor Password [Enter]  Primary HardDisk Security [Disabled]  Password on Boot [Disabled]				<b>Item Specific Help</b>  Supervisor Password controls accesses of the whole setup utility. It can be used to boot up when Password on boot is enabled.
F1 Help	↑↓ Select Item	F5/F6 Change Values	F9 Setup Defaults	
Esc Exit	←→ Select Menu	Enter Select	▶ Sub-Menu	F10 Save and Exit

The table below describes the parameters in this screen. Settings in **boldface** are the default and suggested parameter settings.

Parameter	Description	Option
Supervisor Password Is	N/A	N/A
User Password Is	N/A	N/A
HDD Password Is	N/A	N/A
HDD Master ID	N/A	N/A
Set Supervisor Password	Press Enter to set the administrator password. When set, this password protects the BIOS Setup Utility from unauthorized access. [Set]: System password is set [Clear]: System password is not set	Length -- No more than 8 characters Characters -- 0-9, A-Z (not case sensitive)
Set User Password		

Parameter	Description	Option
Set HDD Password	When shown as [Locked], the hard drive password currently can not be changed or disabled. To change or disable it, turn off the system and enter Setup immediately after turning it back on. Press [Enter] to input change, or disable hard drive password.	<b>Enter</b>
Password on boot	Defines whether a password is required or not while the events defined in this group happened. The following sub-options are all requires the Supervisor password for changes and should be grayed out if the user password was used to enter setup. Allows the user to specify whether or not a password is required to boot.	<b>Disabled</b> Enabled

## Set Supervisor/User Password

If password on boot is required, the password must be set otherwise it cannot be enabled.

The formats of the password are as follows:

Length      No more than 8 characters

## Characters 0-9,A-Z (not case sensitive)

While these fields are highlighted and press "Enter", a window similar to the following is shown:

Set SupervisorPassword		
Enter New Password	[	]
Confirm New Password	[	]

If there is an old password then setup will prompt with the following window instead and a current password will be required to be entered at first:

Set Supervisor Password		
Enter current password	[	]
Enter New Password	[	]
Confirm New Password	[	]

---

User can now type password in field “Enter New Password”, and re-enter password in field “Confirm New Password” for verification.

If the verification is OK:

The password setting is complete after user presses enter.

Setup Notice

Changes have been saved.

[ continue]

If the current password entered does not match the actual current password:

Setup Warning

Invalid password

Re-enter Password

[ continue]

If the new password and confirm new password strings do not match:

Setup Warning

Password do not match

Re-enter Password

# Boot

This menu allows the user to decide the order of boot devices to load the operating system. Bootable devices includes the distette drive in module bay, the onboard hard disk drive and the CD-ROM in module bay and onboard LAN device.

PhoenixBIOS Setup Utility				
Information	Main	Security	Boot	Exit
+Hard Drive Floppy Devices CD-ROM/DVD Drive Network Boot			Item Specific Help  Keys used to view or configure devices: <Enter> to expands or collapses devices with a + or - <F5> and <F6> moves the device up or down.	
F1 Help	↑↓ Select Item	F5/F6 Change Values	F9 Setup Defaults	
Esc Exit	←→ Select Menu	Enter Select	▶ Sub-Menu	F10 Save and Exit

Parameter	Description
+Hard Drive	+ and - indicate device categories. Use <Enter> to expand/collapse.
Floppy Devices	
CD-ROM/DVD Drive	Boot order is top-down using only the top device in each category.
Network Boot	Use <F6> and <F5> to move highlighted item up and down.

# Exit

The Exit screen contains parameters that help safeguard and protect your computer from unauthorized use.

PhoenixBIOS Setup Utility				
Information	Main	Security	Boot	Exit
Exit Saving Changes Exit Discarding Changes Load Setup Defaults Discard Changes Save Changes				Item Specific Help  Exit System Setup and save your changes to CMOS.
F1 Help	↑↓ Select Item	F5/F6 Change Values	F9 Setup Defaults	
Esc Exit	←→ Select Menu	Enter Select	▶ Sub-Menu	F10 Save and Exit

The table below describes the parameters in this screen.

Parameter	Description
Exit Saving Changes	Exit System Setup and save your changes to CMOS
Exit Discarding Changes	Exit utility without saving Setup data to CMOS
Load Setup Default	Load default values for all SETUP items
Discard Changes	Load previous values from CMOS for all SETUP items
Save Changes	Save Setup Data to CMOS



## Machine Disassembly and Replacement

---

This chapter contains step-by-step procedures on how to disassemble the notebook computer for maintenance and troubleshooting.

To disassemble the computer, you need the following tools:

- Wrist grounding strap and conductive mat for preventing electrostatic discharge
- Small Philips screw driver
- Philips screwdriver
- Plastic flat head screw driver
- Tweezers

**NOTE:** The screws for the different components vary in size. During the disassembly process, group the screws with the corresponding components to avoid mismatch when putting back the components. When you remove the stripe cover, please be careful not to scrape the cover.

---

## General Information

### Before You Begin

Before proceeding with the disassembly procedure, make sure that you do the following:

1. Turn off the power to the system and all peripherals.
2. Unplug the AC adapter and all power and signal cables from the system.
3. Remove the battery pack.

# Disassembly Procedure Flowchart

The flowchart on the succeeding page gives you a graphic representation on the entire disassembly sequence and instructs you on the components that need to be removed during servicing. For example, if you want to remove the system board, you must first remove the keyboard, then disassemble the inside assembly frame in that order.

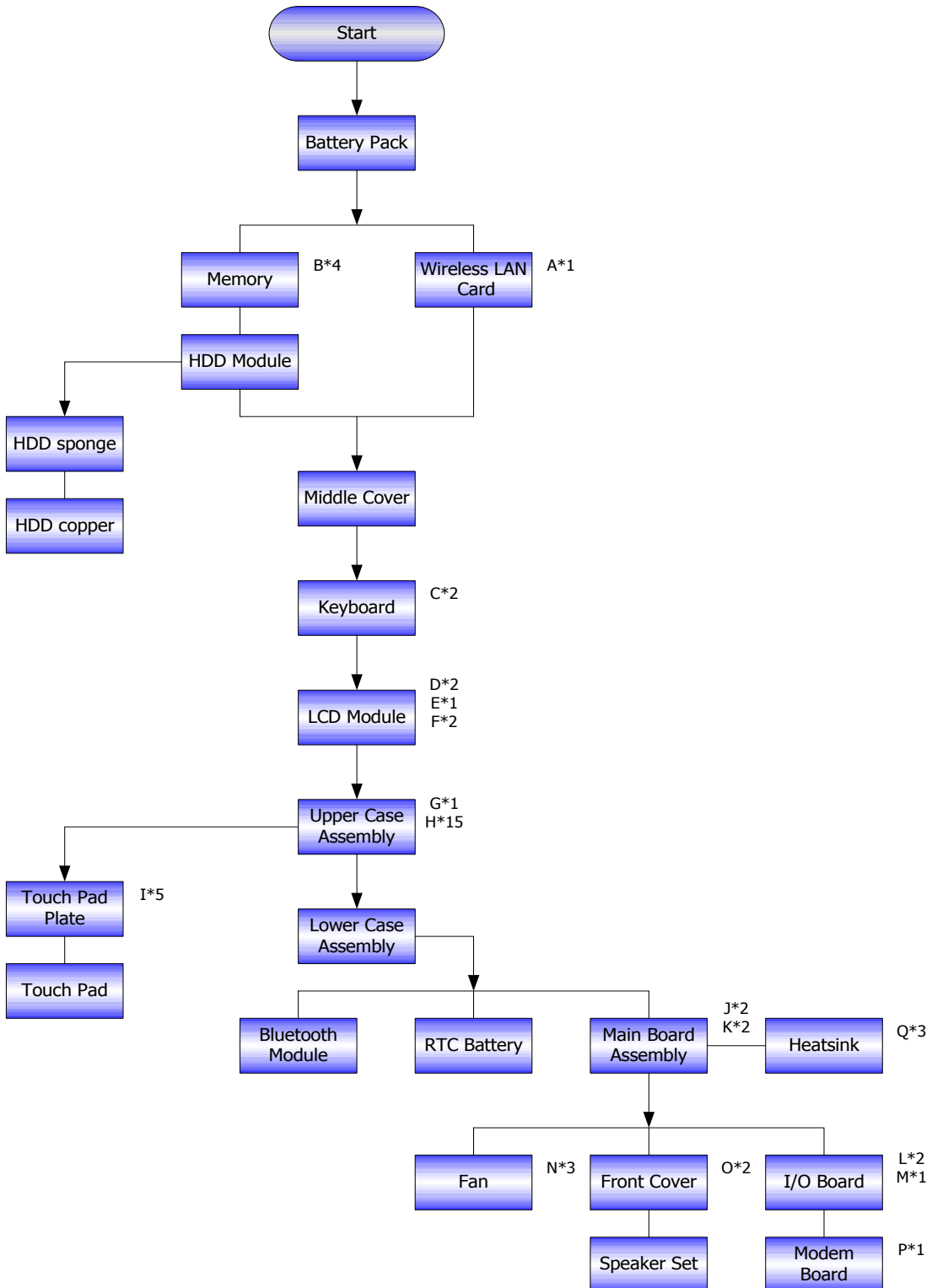

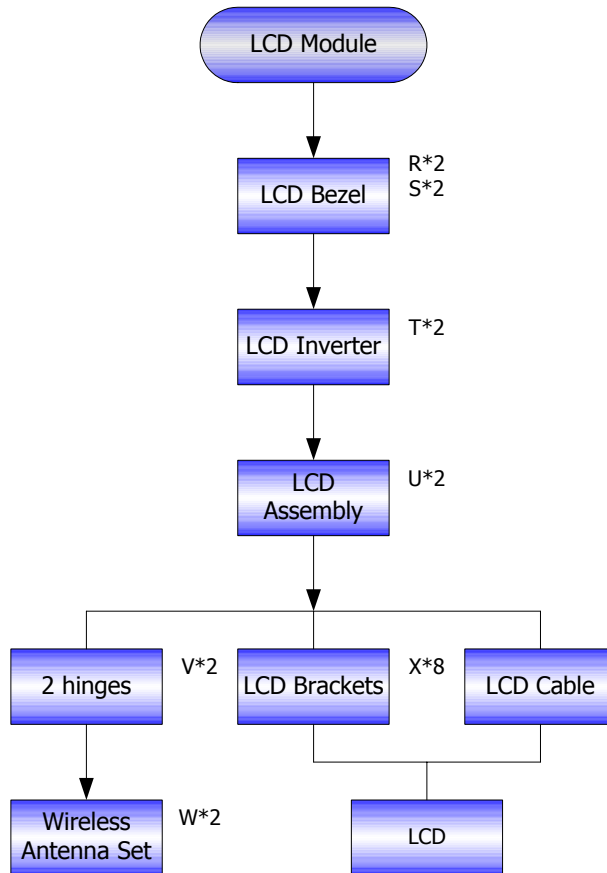

**Screw List**

Item	Description	Part Number
A	SCW HEX NYL I#R-40/O#4-40 L5.9	34.4C210.001
B	SCREW MACH WAFER M2*L4 NI	86.T39V1.002
C	SCREW M2*L9 NYLOK	86.00D38.520
D	SCRW WH MS+CBZ M2.5+L4 BLACK	86.9A323.4R0
E	SCREW M2.5-6	86.9A323.6R0
F	SCREW M2*3 NYLON 1JMCP-420325	86.9A352.3R0
G	SCREW M2.5*4L(NYLOCK)BLACK ZN	86.9A353.4R0
H	SCREW M2.5X6	86.9A353.6R0
I	SRW M2.5*8L B/ZN NYLOK 700	86.9A353.8R0
J	SCREW M2-3	86.9A522.3R0
K	SCRW M2*4 WAFER NI	86.9A552.4R0

---

## Removing the Battery Pack

1. Release the battery lock.
2. Slide the battery latch as shown then remove the battery pack.

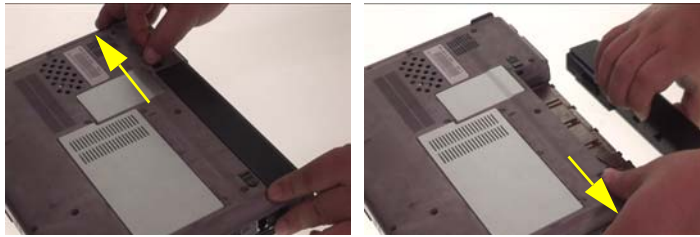

---

# Removing the Wireless LAN Card/the memory and the HDD Module and the LCD Module

## Removing the Wireless LAN Card

1. Remove the screw fastening the mini PCI cover.
2. Detach the mini PCI cover.
3. Disconnect the main and the auxiliary wireless antenna.
4. Pop out the wireless LAN card then remove it.

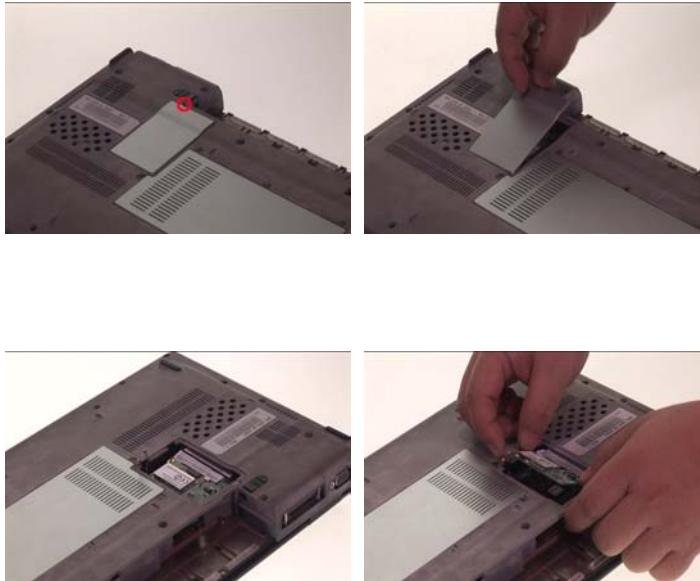

## Removing the Memory and the HDD Module

1. Remove the five screws that secure the HDD cover.
2. Detach the HDD cover from the main unit.

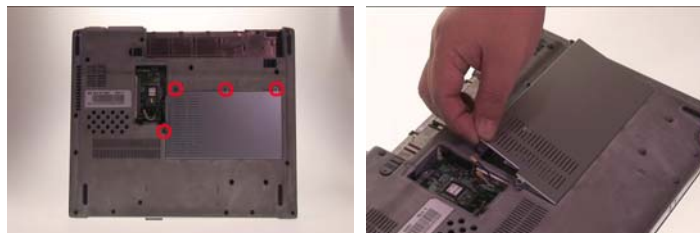

3. Pop up the memory then remove it.
4. Lift up the HDD module then pull the HDD module backwards and remove it.

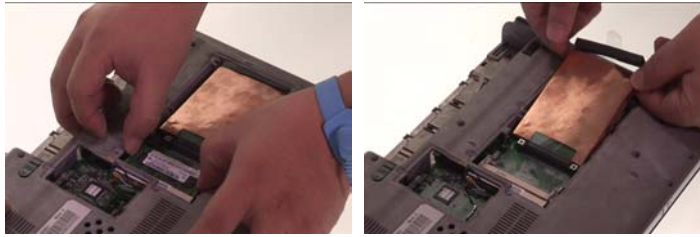

## Removing the LCD Module

1. Open the notebook as shown.
2. Detach the middle cover from the main unit.
3. Remove the two screws that secure the keyboard.



4. Turn over the keyboard as shown.
5. Disconnect the keyboard cable then remove the keyboard.



6. Tear off the tape fastening the wireless antenna, then pull out the antenna from the main unit.
7. Disconnect the LCD cable from the main board.
8. Close the LCD module and turn over the notebook, then remove two screws fastening the LCD module on the bottom as shown.



9. Remove one screw holding the LCD module on the rear side.

- 
10. Then remove two screws fastening the LCD module.
  11. Detach the LCD module from the main unit carefully.

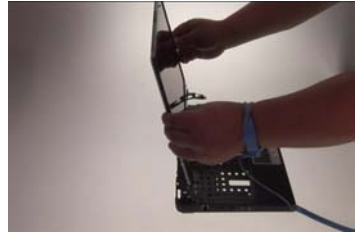
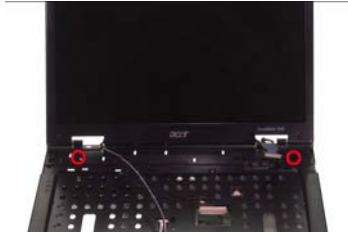



---

## Disassembling the Main Unit

### Separate the Main Unit Into the Upper and the Lower Case Assembly

1. Disconnect the touchpad FFC from the main board.
2. Disconnect the system fan cable from the main board.
3. Remove one screw fastening the upper and the lower case assembly as shown.



4. Remove 15 screws fastening the upper and the lower case assembly on the bottom.
5. Then detach the upper case assembly from the lower case assembly carefully.

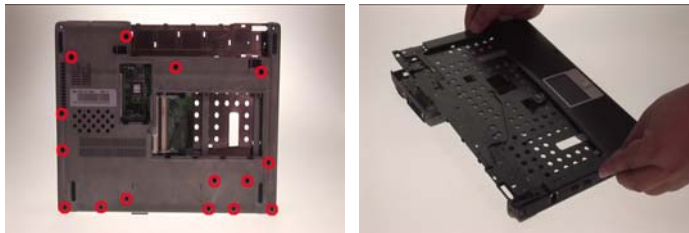

### Disassembling the Lower Case Assembly

1. Disconnect the bluetooth cable from the main board then detach the bluetooth module.
2. Disconnect the RTC battery cable from the main board then detach the RTC battery.
3. Disconnect the speaker cable from the IO board.



4. Disconnect the bluetooth cable from the bluetooth board.



5. Disconnect the microphone cable from the IO board then detach the microphone.
6. Disconnect the Lid switch cable from the IO board as shown.
7. Remove the four screws fastening the main board to the lower case.

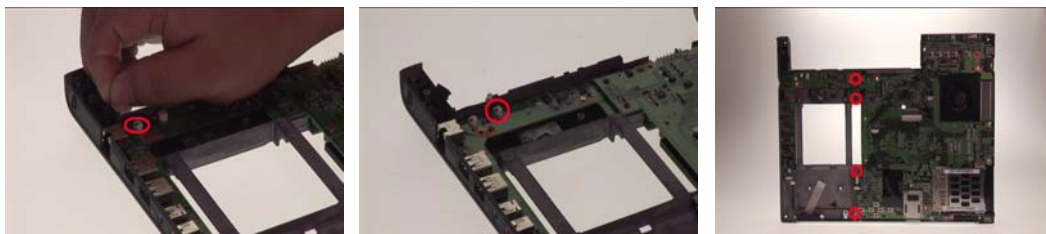

8. Remove two screws fastening the IO board and one screw holding the modem board.
9. Detach the IO board from the lower case (The IO board is with modem board).
10. Remove the three screws fastening the system fan.



11. Remove the system fan from the lower case.
12. Remove the two screws that fasten the speaker set.
13. Detach the front cover from the lower case.



14. Remove the speaker set from the lower case.
15. Remove the four screws fastening the heatsink to the main board.
16. Detach the heatsink from the main board.

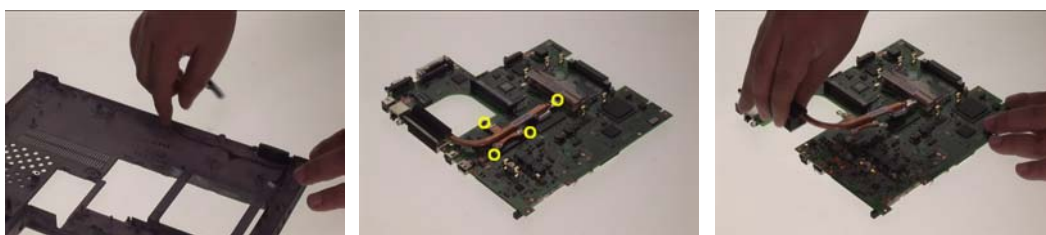

17. Remove the screw that fastens the modem board to the IO board.

18. Disconnect the modem board from the IO board.
19. Disconnect the modem board cable from the modem board.

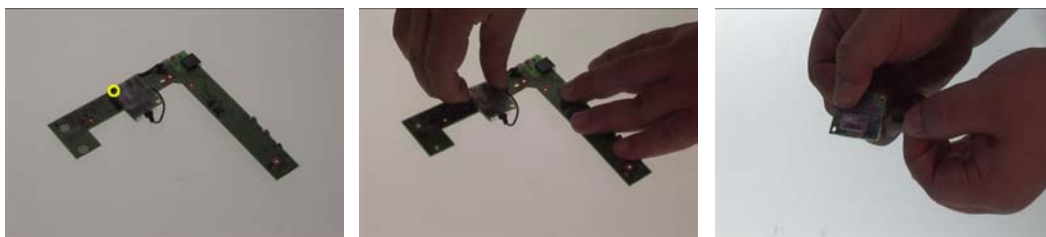

## Disassembling the Upper Case Assembly

1. Disconnect the touchpad FFC from the touchpad then remove it.
2. Remove the five screws fastening the touchpad plate.
3. Detach the scroll key rubber from the touchpad plate.

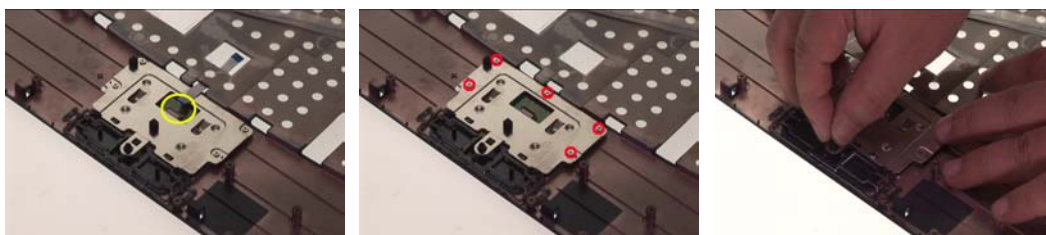

4. Remove the touchpad plate.
5. Then detach the touchpad from the upper case.

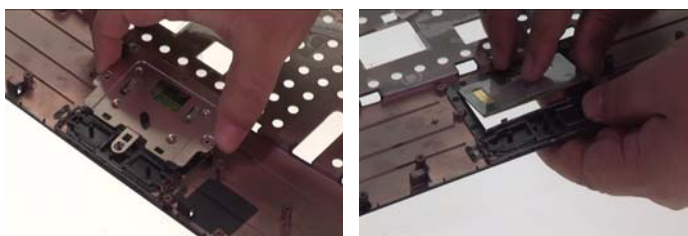

---

## Disassembling the LCD Module

1. Remove the four screw caps as shown.
2. Remove the four screws holding the LCD bezel.
3. Then detach the LCD bezel from the LCD module.



4. Remove the two screws fastening the inverter.
5. Take the inverter out of the LCD panel then disconnect the LCD cable.
6. Disconnect the LCD inverter cable on the other side then remove the inverter.



7. Remove two screws fastening the LCD to the LCD panel.
8. Detach the LCD from the LCD panel.
9. Remove the two screws fastening the hinges to the LCD panel.

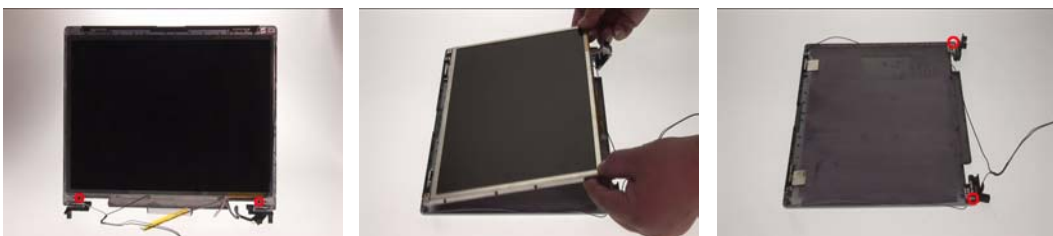

10. Remove the two hinges from the LCD panel.
11. Remove the two screws holding the wireless antenna set.
12. Then detach the wireless antenna set from the LCD panel.



- 13.** Remove the four screws fastening the LCD right bracket.
- 14.** Detach the LCD right bracket from the LCD.
- 15.** Remove the four screws fastening the LCD left bracket.



- 16.** Detach the LCD left bracket from the LCD.
- 17.** Tear off the tape fastening the LCD cable then disconnect the LCD cable.

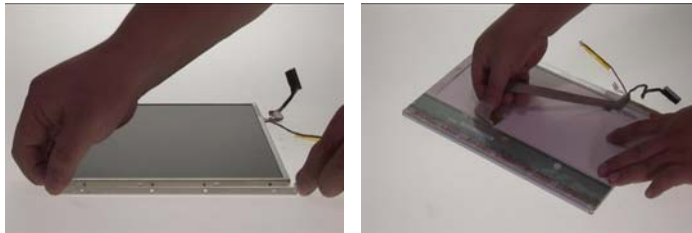

---

## Disassembling the External Modules

### Disassembling the HDD Module

1. Detach the HDD sponge.
2. Turn over the HDD module.

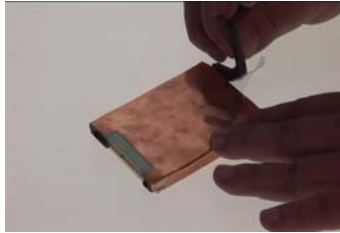

3. Tear off the HDD module copper (shielding).
4. Then detach the HDD from the HDD copper (shielding) as shown.

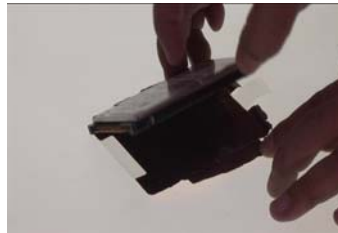

# Troubleshooting

---

Use the following procedure as a guide for computer problems.

**NOTE:** The diagnostic tests are intended to test only Acer products. Non-Acer products, prototype cards, or modified options can give false errors and invalid system responses.

1. Obtain the failing symptoms in as much detail as possible.
2. Verify the symptoms by attempting to re-create the failure by running the diagnostic test or by repeating the same operation.

---

# System Check Procedures

## External Diskette Drive Check

Do the following to isolate the problem to a controller, driver, or diskette. A write-enabled, diagnostic diskette is required.

**NOTE:** Make sure that the diskette does not have more than one label attached to it. Multiple labels can cause damage to the drive or cause the drive to fail.

Do the following to select the test device.

1. Boot from the diagnostics diskette and start the diagnostics program.
2. See if FDD Test is passed as the program runs to FDD Test.
3. Follow the instructions in the message window.

If an error occurs with the internal diskette drive, reconnect the diskette connector on the system board.

If the error still remains:

1. Reconnect the external diskette drive/DVD-ROM module.
2. Replace the external diskette drive/CD-ROM module.
3. Replace the main board.

## External CD-ROM Drive Check

Do the following to isolate the problem to a controller, drive, or CD-ROM. Make sure that the CD-ROM does not have any label attached to it. The label can cause damage to the drive or can cause the drive to fail.

Do the following to select the test device:

1. Boot from the diagnostics diskette and start the diagnostics program.
2. See if CD-ROM Test is passed when the program runs to CD-ROM Test.
3. Follow the instructions in the message window.

If an error occurs, reconnect the connector on the System board. If the error still remains:

1. Reconnect the external diskette drive/CD-ROM module.
2. Replace the external diskette drive/CD-ROM module.
3. Replace the main board.

## Keyboard or Auxiliary Input Device Check

Remove the external keyboard if the internal keyboard is to be tested.

If the internal keyboard does not work or an unexpected character appears, make sure that the flexible cable extending from the keyboard is correctly seated in the connector on the system board.

If the keyboard cable connection is correct, run the Keyboard Test.

If the tests detect a keyboard problem, do the following one at a time to correct the problem. Do not replace a non-defective FRU:

1. Reconnect the keyboard cables.
2. Replace the keyboard.
3. Replace the main board.

The following auxiliary input devices are supported by this computer:

- Numeric keypad
- External keyboard

If any of these devices do not work, reconnect the cable connector and repeat the failing operation.



---

## Memory check

Memory errors might stop system operations, show error messages on the screen, or hang the system.

1. Boot from the diagnostics diskette and start the doagmpstotics program (please refer to main board).
2. Go to the diagnostic memory in the test items.
3. Press F2 in the test items.
4. Follow the instructions in the message window.

**NOTE:** Make sure that the DIMM is fully installed into the connector. A loose connection can cause an error.

## Power System Check

To verify the symptom of the problem, power on the computer using each of the following power sources:

1. Remove the battery pack.
2. Connect the power adapter and check that power is supplied.
3. Disconnect the power adapter and install the charged battery pack; then check that power is supplied by the battery pack.

If you suspect a power problem, see the appropriate power supply check in the following list:

- “Check the Power Adapter” on page 59
- “Check the Battery Pack” on page 59

## Check the Power Adapter

Unplug the power adapter cable from the computer and measure the output voltage at the plug of the power adapter cable. See the following figure

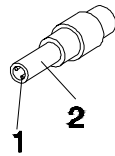

Pin 1: +19 to +20.5V  
Pin 2: 0V, Ground

1. If the voltage is not correct, replace the power adapter.
2. If the voltage is within the range, do the following:
  - Replace the System board.
  - If the problem is not corrected, see “Undetermined Problems” on page 73.
  - If the voltage is not correct, go to the next step.

**NOTE:** An audible noise from the power adapter does not always indicate a defect.

3. If the power-on indicator does not light up, check the power cord of the power adapter for correct continuity and installation.
4. If the operational charge does not work, see “Check the Battery Pack” on page 59.

## Check the Battery Pack

To check the battery pack, do the following:

From Software:

1. Check out the Power Management in control Panel
2. In Power Meter, confirm that if the parameters shown in the screen for Current Power Source and Total Battery Power Remaining are correct.
3. Repeat the steps 1 and 2, for both battery and adapter.

- 
4. This helps you identify first the problem is on recharging or discharging.

From Hardware:

1. Power off the computer.
2. Remove the battery pack and measure the voltage between battery terminals 1(+) and 6(ground). See the following figure

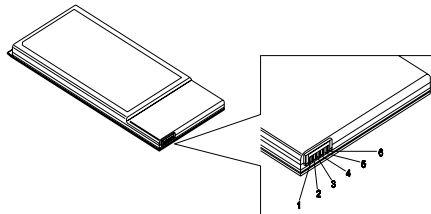

3. If the voltage is still less than 7.5 Vdc after recharging, replace the battery.

To check the battery charge operation, use a discharged battery pack or a battery pack that has less than 50% of the total power remaining when installed in the computer.

If the battery status indicator does not light up, remove the battery pack and let it return to room temperature. Re-install the battery pack.

If the charge indicator still does not light up, replace the battery pack. If the charge indicator still does not light up, replace the DC/DC charger board.

## Touchpad Check

If the touchpad doesn't work, do the following actions one at a time to correct the problem. Do not replace a non-defective FRU:

1. Reconnect the touchpad cables.
2. Replace the touchpad.
3. Replace the system board.

After you use the touchpad, the pointer drifts on the screen for a short time. This self-acting pointer movement can occur when a slight, steady pressure is applied to the touchpad pointer. This symptom is not a hardware problem. No service actions are necessary if the pointer movement stops in a short period of time.

---

## Power-on Self-Test Error Messages

The POST error message index lists the error message and their possible causes. The most likely cause is listed first.

**NOTE:** Perform the FRU replacement or actions in the sequence shown in FRU/Action column, if the FRU replacement does not solve the problem, put the original part back in the computer. Do not replace a non-defective FRU.

This index can also help you determine the next possible FRU to be replaced when servicing a computer.

If the symptom is not listed, see “Undetermined Problems” on page 73.

The following lists the error messages that the BIOS displays on the screen and the error symptoms classified by function.

**NOTE:** Most of the error messages occur during POST. Some of them display information about a hardware device, e.g., the amount of memory installed. Others may indicate a problem with a device, such as the way it has been configured.

**NOTE:** If the system fails after you make changes in the BIOS Setup Utility menus, reset the computer, enter Setup and install Setup defaults or correct the error.

# Index of Error Messages

## Error Code List

Error Codes	Error Messages
006	Equipment Configuration Error Causes: 1. CPU BIOS Update Code Mismatch 2. IDE Primary Channel Master Drive Error (The causes will be shown before "Equipment Configuration Error")
010	Memory Error at xxxx:xxxx:xxxxh (R:xxxxh, W:xxxxh)
070	Real Time Clock Error
071	CMOS Battery Bad
072	CMOS Checksum Error
110	System disabled. Incorrect password is specified.
<No error code>	Battery critical LOW In this situation BIOS will issue 4 short beeps then shut down system, no message will show.
<No error code>	Thermal critical High In this situation BIOS will shut down system, not show message.

## Error Message List

Error Messages	FRU/Action in Sequence
Failure Fixed Disk	Reconnect hard disk drive connector. "Load Default Settings" in BIOS Setup Utility. Hard disk drive System board
Stuck Key	see "Keyboard or Auxiliary Input Device Check" on page 58.
Keyboard error	see "Keyboard or Auxiliary Input Device Check" on page 58.
Keyboard Controller Failed	see "Keyboard or Auxiliary Input Device Check" on page 58.
Keyboard locked - Unlock key switch	Unlock external keyboard
Monitor type does not match CMOS - Run Setup	Run "Load Default Settings" in BIOS Setup Utility.
Shadow RAM Failed at offset: nnnn	BIOS ROM System board
System RAM Failed at offset: nnnn	DIMM System board
Extended RAM Failed at offset: nnnn	DIMM System board
System battery is dead - Replace and run Setup	Replace RTC battery and Run BIOS Setup Utility to reconfigure system time, then reboot system.
System CMOS checksum bad - Default configuration used	RTC battery Run BIOS Setup Utility to reconfigure system time, then reboot system.
System timer error	RTC battery Run BIOS Setup Utility to reconfigure system time, then reboot system. System board

## Error Message List

Error Messages	FRU/Action in Sequence
Real time clock error	RTC battery Run BIOS Setup Utility to reconfigure system time, then reboot system. System board
Previous boot incomplete - Default configuration used	Run "Load Default Settings" in BIOS Setup Utility. RTC battery System board
Memory size found by POST differed from CMOS	Run "Load Default Settings" in BIOS Setup Utility. DIMM System board
Diskette drive A error	Check the drive is defined with the proper diskette type in BIOS Setup Utility See "External Diskette Drive Check" on page 58.
Incorrect Drive A type - run SETUP	Check the drive is defined with the proper diskette type in BIOS Setup Utility
System cache error - Cache disabled	System board
CPU ID:	System board
DMA Test Failed	DIMM System board
Software NMI Failed	DIMM System board
Fail-Safe Timer NMI Failed	DIMM System board
Device Address Conflict	Run "Load Default Settings" in BIOS Setup Utility. RTC battery System board
Allocation Error for device	Run "Load Default Settings" in BIOS Setup Utility. RTC battery System board
Failing Bits: nnnn	DIMM BIOS ROM System board
Fixed Disk n	None
Invalid System Configuration Data	BIOS ROM System board
I/O device IRQ conflict	Run "Load Default Settings" in BIOS Setup Utility. RTC battery System board
Operating system not found	Enter Setup and see if fixed disk and drive A: are properly identified. Diskette drive Hard disk drive System board

## Error Message List

No beep Error Messages	FRU/Action in Sequence
No beep, power-on indicator turns off and LCD is blank.	Power source (battery pack and power adapter). See "Power System Check" on page 59. Ensure every connector is connected tightly and correctly. Reconnect the DIMM. LED board. System board.
No beep, power-on indicator turns on and LCD is blank.	Power source (battery pack and power adapter). See "Power System Check" on page 59. Reconnect the LCD connector Hard disk drive LCD inverter ID LCD cable LCD Inverter LCD System board
No beep, power-on indicator turns on and LCD is blank. But you can see POST on an external CRT.	Reconnect the LCD connectors LCD inverter ID LCD cable LCD inverter LCD System board
No beep, power-on indicator turns on and a blinking cursor shown on LCD during POST.	Ensure every connector is connected tightly and correctly System board
No beep during POST but system runs correctly.	Speaker System board

# Phoenix BIOS Beep Codes

Code	Beeps	POST Routine Description
02h		Verify Real Mode
03h		Disable Non-Maskable Interrupt (NMI)
04h		Get CPU type
06h		Initialize system hardware
08h		Initialize chipset with initial POST values
09h		Set IN POST flag
0Ah		Initialize CPU registers
0Bh		Enable CPU cache
0Ch		Initialize caches to initial POST values
0Eh		Initialize I/O component
0Fh		Initialize the local bus IDE
10h		Initialize Power Management
11h		Load alternate registers with initial POST values
12h		Restore CPU control word during warm boot
13h		Initialize PCI Bus Mastering devices
14h		Initialize keyboard controller
16h	1-2-2-3	BIOS ROM checksum
17h		Initialize cache before memory autosize
18h		8254 timer initialization
1Ah		8237 DMA controller initialization
1Ch		Reset Programmable Interrupt Controller
20h	1-3-1-1	Test DRAM refresh
22h	1-3-1-3	Test 8742 Keyboard Controller
24h		Set ES segment register to 4 GB
26h		Enable A20 line
28h		Autosize DRAM
29h		Initialize POST Memory Manager
2Ah		Clear 215 KB base RAM
2Ch	1-3-4-1	RAM failure on address line xxxx
2Eh	1-3-4-3	RAM failure on data bits xxxx of low byte of memory bus
2Fh		Enable cache before system BIOS shadow
30h	1-4-1-1	RAM failure on data bits xxxx of high byte of memory bus
32h		Test CPU bus-clock frequency
33h		Initialize Phoenix Dispatch Manager
36h		Warm start shut down
38h		Shadow system BIOS ROM
3Ah		Autosize cache
3Ch		Advanced configuration of chipset registers
3Dh		Load alternate registers with CMOS values
42h		Initialize interrupt vectors
45h		POST device initialization
46h	2-1-2-3	Check ROM copyright notice

Code	Beeps	POST Routine Description
48h		Check video configuration against CMOS
49h		Initialize PCI bus and devices
4Ah		Initialize all video adapters in system
4Bh		QuietBoot start (optional)
4Ch		Shadow video BIOS ROM
4Eh		Display BIOS copyright notice
50h		Display CPU type and speed
51h		Initialize EISA board
52h		Test keyboard
54h		Set key click if enabled
58h	2-2-3-1	Test for unexpected interrupts
59h		Initialize POST display service
5Ah		Display prompt "Press F2 to enter SETUP"
5Bh		Disable CPU cache
5Ch		Test RAM between 512 and 640 KB
60h		Test extended memory
62h		Test extended memory address lines
64h		Jump to User Patch1
66h		Configure advanced cache registers
67h		Initialize Multi Processor APIC
68h		Enable external and CPU caches
69h		Setup System Management Mode (SMM) area
6Ah		Display external L2 cache size
6Bh		Load custom defaults (optional)
6Ch		Display shadow-area message
6Eh		Display possible high address for UMB recovery
70h		Display error messages
72h		Check for configuration errors
76h		Check for keyboard errors
7Ch		Set up hardware interrupt vectors
7Eh		Initialize coprocessor if present
80h		Disable onboard Super I/O ports and IRQs
81h		Late POST device initialization
82h		Detect and install external RS232 ports
83h		Configure non-MCD IDE controllers
84h		Detect and install external parallel ports
85h		Initialize PC-compatible PnP ISA devices
86h		Re-initialize onboard I/O ports
87h		Configure Motherboard Configurable Devices (optional)
88h		Initialize BIOS Area
89h		Enable Non-Maskable Interrupts (NMIs)
8Ah		Initialize Extended BIOS Data Area
8Bh		Test and initialize PS/2 mouse
8Ch		Initialize floppy controller



Code	Beeps	POST Routine Description
8Fh		Determine number of ATA drives (optional)
90h		Initialize hard-disk controllers
91h		Initialize local-bus hard-disk controllers
92h		Jump to UserPatch2
93h		Build MPTABLE for multi-processor boards
95h		Install CD ROM for boot
96h		Clear huge ES segment register
97h		Fixup Multi Processor table
98h	1-2	Search for option ROMs. One long, two short beeps on checksum failure.
99h		Check for SMART drive (optional)
9Ah		Shadow option ROMs
9Ch		Set up Power Management
9Dh		Initialize security engine (optional)
9Eh		Enable hardware interrupts
9Fh		Determine number of ATA and SCSI drives
A0h		Set time of day
A2h		Check key lock
A4h		Initialize Typematic rate
A8h		Erase F2 prompt
AAh		Scan for F2 key stroke
ACh		Enter SETUP
A Eh		Clear Boot flag
B0h		Check for errors
B2h		POST done- prepare to boot operating system
B4h	1	One short beep before boot
B5h		Terminate QuietBoot (optional)
B6h		Check password (optional)
B9h		Prepare Boot
BAh		Initialize DMI parameters
BBh		Initialize PnP Option ROMs
BCh		Clear parity checkers
BDh		Display MultiBoot menu
BEh		Clear screen (optional)
BFh		Check virus and backup reminders
C0h		Try to boot with INT 19
C1h		Initialize POST Error Manager (PEM)
C2h		Initialize error logging
C3h		Initialize error display function
C4h		Initialize system error handler
C5h		PnPnd dual CMOS (optional)
C6h		Initialize notebook docking (optional)
C7h		Initialize notebook docking late
C8h		Force check (optional)
C9h		Extended checksum (optional)
D2h		Unknown interrupt

Code	Beeps	POST Routine Description
E0h		Initialize the chipset
E1h		Initialize the bridge
E2h		Initialize the CPU
E3h		Initialize the system timer
E4h		Initialize system I/O
E5h		Check force recovery boot
E6h		Checksum BIOS ROM
E7h		Go to BIOS
E8h		Set Huge Segment
E9h		Initialize Multi Processor
EAh		Initialize OEM special code
EBh		Initialize PIC and DMA
ECh		Initialize Memory type
EDh		Initialize Memory size
EEh		Shadow Boot Block
EFh		System memory test
F0h		Initialize interrupt vectors
F1h		Initialize Run Time Clock
F2h		Initialize video
F3h		Initialize System Management Mode
F4h	1	Output one beep before boot
F5h		Boot to Mini DOS
F6h		Clear Huge Segment
F7h		Boot to Full DOS

# Index of Symptom-to-FRU Error Message

## LCD-Related Symptoms

Symptom / Error	Action in Sequence
LCD backlight doesn't work LCD is too dark LCD brightness cannot be adjusted LCD contrast cannot be adjusted	Enter BIOS Utility to execute "Load Setup Default Settings", then reboot system. Reconnect the LCD connectors. Keyboard (if contrast and brightness function key doesn't work). LCD inverter ID LCD cable LCD inverter LCD System board
Unreadable LCD screen Missing pels in characters Abnormal screen Wrong color displayed	Reconnect the LCD connector LCD inverter ID LCD cable LCD inverter LCD System board
LCD has extra horizontal or vertical lines displayed.	LCD inverter ID LCD inverter LCD cable LCD System board

## Indicator-Related Symptoms

Symptom / Error	Action in Sequence
Indicator incorrectly remains off or on, but system runs correctly	Reconnect the inverter board Inverter board System board

## Power-Related Symptoms

Symptom / Error	Action in Sequence
Power shuts down during operation	Power source (battery pack and power adapter). See "Power System Check" on page 59. Battery pack Power adapter Hard drive & battery connection board System board
The system doesn't power-on.	Power source (battery pack and power adapter). See "Power System Check" on page 59. Battery pack Power adapter Hard drive & battery connection board System board
The system doesn't power-off.	Power source (battery pack and power adapter). See "Power System Check" on page 59. Hold and press the power switch for more than 4 seconds. System board
Battery can't be charged	See "Check the Battery Pack" on page 59. Battery pack System board

### PCMCIA-Related Symptoms

Symptom / Error	Action in Sequence
System cannot detect the PC Card (PCMCIA)	PCMCIA slot assembly System board
PCMCIA slot pin is damaged.	PCMCIA slot assembly

### Memory-Related Symptoms

Symptom / Error	Action in Sequence
Memory count (size) appears different from actual size.	Enter BIOS Setup Utility to execute "Load Default Settings, then reboot system. DIMM System board

### Speaker-Related Symptoms

Symptom / Error	Action in Sequence
In Windows, multimedia programs, no sound comes from the computer.	Audio driver Speaker System board
Internal speakers make noise or emit no sound.	Speaker System board

### Power Management-Related Symptoms

Symptom / Error	Action in Sequence
The system will not enter hibernation	Keyboard (if control is from the keyboard) Hard disk drive System board
The system doesn't enter hibernation mode and four short beeps every minute.	See "Sleeping State (S4)" on page 28. Press Fn+  and see if the computer enters hibernation mode. Touchpad Keyboard Hard disk connection board Hard disk drive System board
The system doesn't enter standby mode after closing the LCD	See "Sleeping State (S4)" on page 28. LCD cover switch System board
The system doesn't resume from hibernation mode.	See "Sleeping State (S4)" on page 28. Hard disk connection board Hard disk drive System board
The system doesn't resume from standby mode after opening the LCD.	See "Sleeping State (S4)" on page 28. LCD cover switch System board
Battery fuel gauge in Windows doesn't go higher than 90%.	Remove battery pack and let it cool for 2 hours Refresh battery (continue use battery until power off, then charge battery) Battery pack System board

### Power Management-Related Symptoms

Symptom / Error	Action in Sequence
System hangs intermittently.	Reconnect hard disk/CD-ROM drives. Hard disk connection board System board

### Peripheral-Related Symptoms

Symptom / Error	Action in Sequence
System configuration does not match the installed devices.	Enter BIOS Setup Utility to execute "Load Default Settings", then reboot system. Reconnect hard disk/CD-ROM/diskette drives.
External display does not work correctly.	Press Fn+F5, LCD/CRT/Both display switching System board
USB does not work correctly	System board
Print problems.	Ensure the "Parallel Port" in the "Onboard Devices Configuration" of BIOS Setup Utility is set to Enabled. Onboard Devices Configuration Run printer self-test. Printer driver Printer cable Printer System Board
Serial or parallel port device problems.	Ensure the "Serial Port" in the Devices Configuration" of BIOS Setup Utility is set to Enabled. Device driver Device cable Device System board

### Keyboard/Touchpad-Related Symptoms

Symptom / Error	Action in Sequence
Keyboard (one or more keys) does not work.	Reconnect the keyboard cable. Keyboard System board
Touchpad does not work.	Reconnect touchpad cable. Touchpad board System board

### Modem-Related Symptoms

Symptom / Error	Action in Sequence
Internal modem does not work correctly.	Modem phone port modem combo board System board

**NOTE:** If you cannot find a symptom or an error in this list and the problem remains, see "Undetermined Problems" on page 73.

---

## Intermittent Problems

Intermittent system hang problems can be caused by a variety of reasons that have nothing to do with a hardware defect, such as: cosmic radiation, electrostatic discharge, or software errors. FRU replacement should be considered only when a recurring problem exists.

When analyzing an intermittent problem, do the following:

1. Run the advanced diagnostic test for the system board in loop mode at least 10 times.
2. If no error is detected, do not replace any FRU.
3. If any error is detected, replace the FRU. Rerun the test to verify that there are no more errors.

---

## Undetermined Problems

The diagnostic problems does not identify which adapter or device failed, which installed devices are incorrect, whether a short circuit is suspected, or whether the system is inoperative.

Follow these procedures to isolate the failing FRU (do not isolate non-defective FRU).

**NOTE:** Verify that all attached devices are supported by the computer.

**NOTE:** Verify that the power supply being used at the time of the failure is operating correctly. (See “Power System Check” on page 59):

1. Power-off the computer.
2. Visually check them for damage. If any problems are found, replace the FRU.
3. Remove or disconnect all of the following devices:
  - Non-Acer devices
  - Printer, mouse, and other external devices
  - Battery pack
  - Hard disk drive
  - DIMM
  - CD-ROM/Diskette drive Module
  - PC Cards
4. Power-on the computer.
5. Determine if the problem has changed.
6. If the problem does not recur, reconnect the removed devices one at a time until you find the failing FRU.
7. If the problem remains, replace the following FRU one at a time. Do not replace a non-defective FRU:
  - System board
  - LCD assembly





# Jumper and Connector Locations

## Mainboard Layout

### Top View

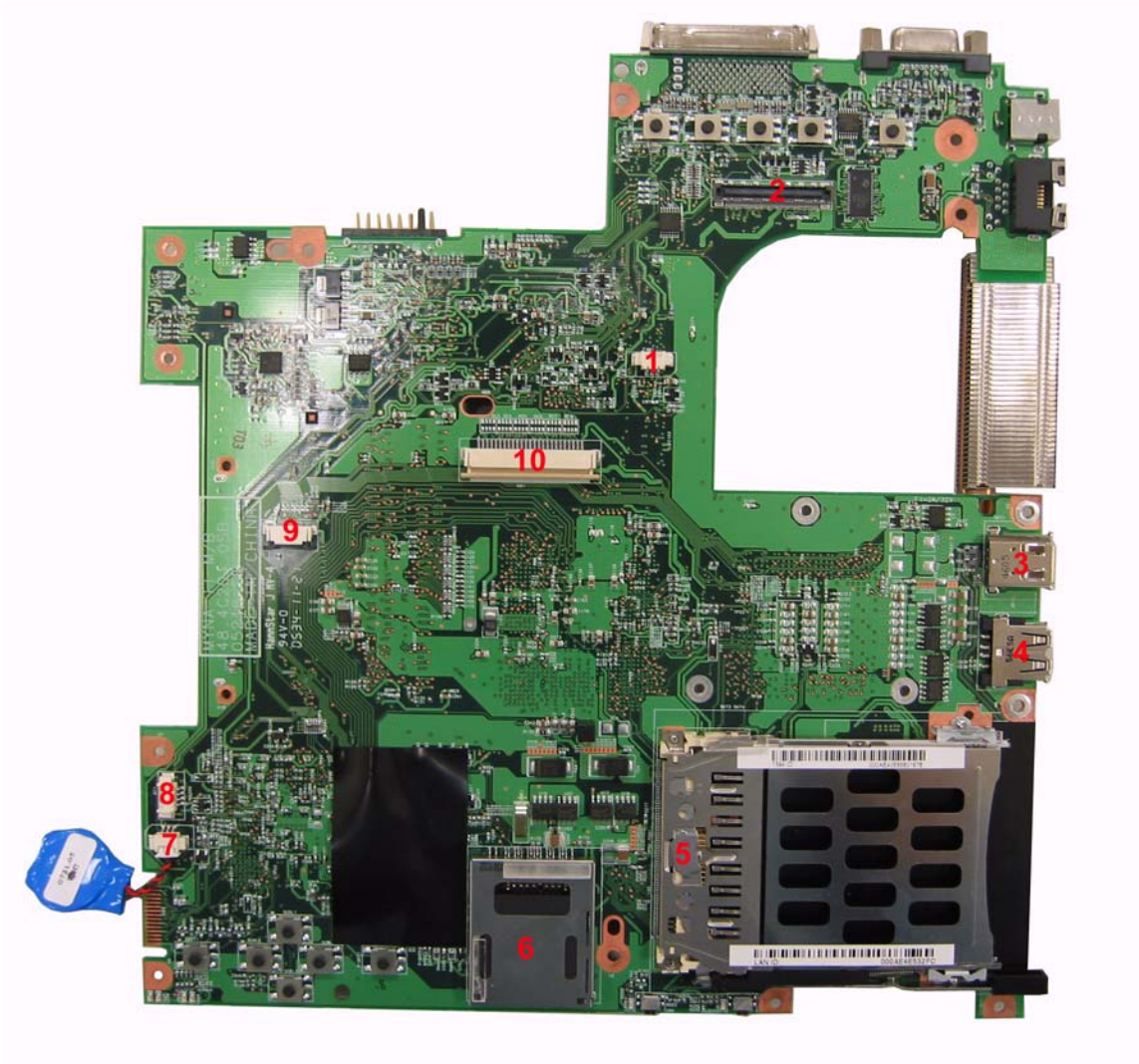

1	FAN1	Fan Connector	6	CARD1	5-in-1 Card Reader Slot
2	LCD1	LCD Cable Connector	7	RTC1	RTC Battery Connector
3	SKT1	IEEE 1394 Connector	8	BT1	Bluetooth Module Connector
4	SKT2	USB Port	9	TPAD1	Touchpad FFC Connector
5	U22 or PCH1? )	PC Card Slot	10	KB1	Keyboard Connector

# Bottom View

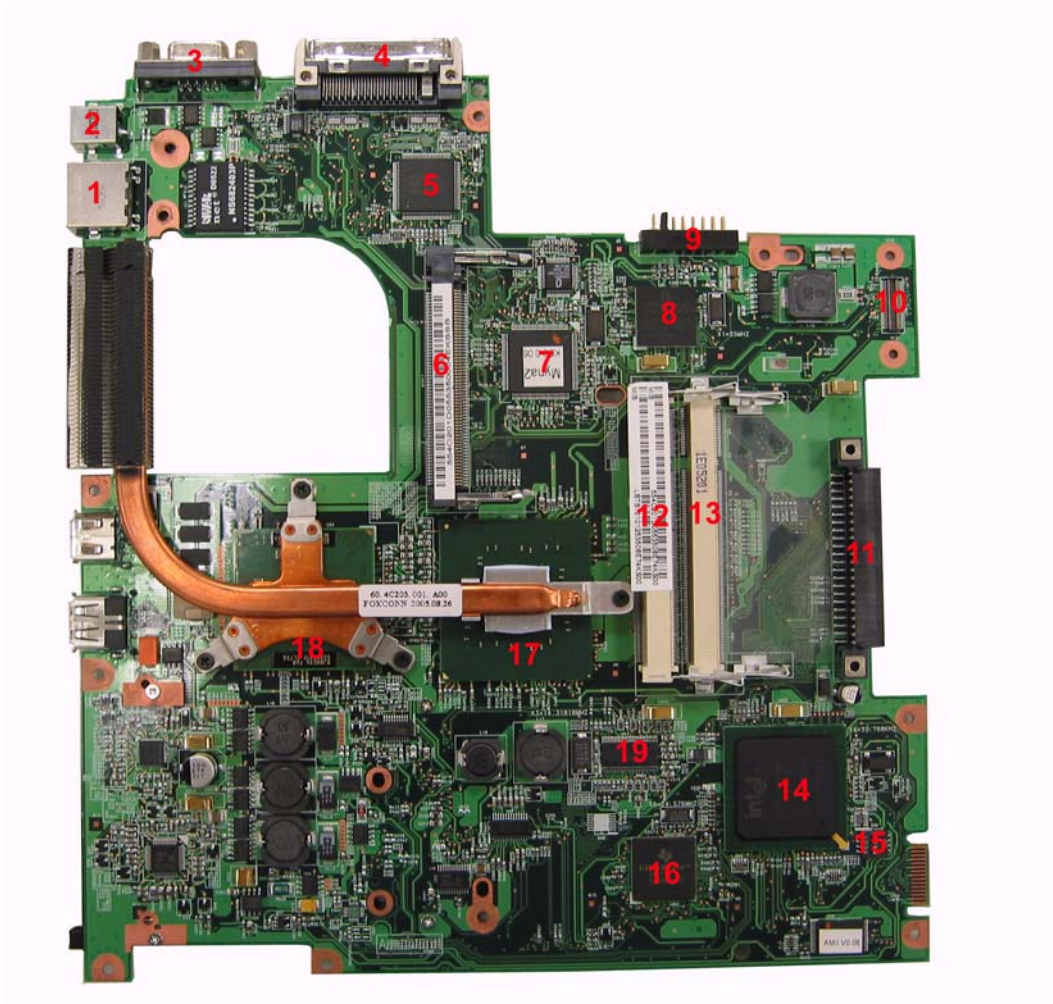

1	JK1	Giga LAN Port	10	IOB1	Main Board to IO Board Connector
2	DCIN1	Power Jack	11	HDD1	HDD Connector
3	CRT1	VGA Port	12	DM2	DIMM Slot
4	DOCK1	ezDock Port	13	DM1	DIMM Slot
5	U27	IO Controller-PC 87392	14	U44	South Bridge-Intel ICH6-M
6	WIN1	Wireless LAN Card Slot	15	SW8	Switch
7	U32	Keyboard Controller	16	U52	Cardbus/1394/Card Reader Controller-UltraMedia PCI 7411
8	U31	LAN Controller-BROADCOM BCM5788M	17	U34	North Bridge
9	BAT1	Battery Connector	18	U33	CPU
19	U41	Power Generator-IDT CV125PA			

# IO Board Layout

## Top View

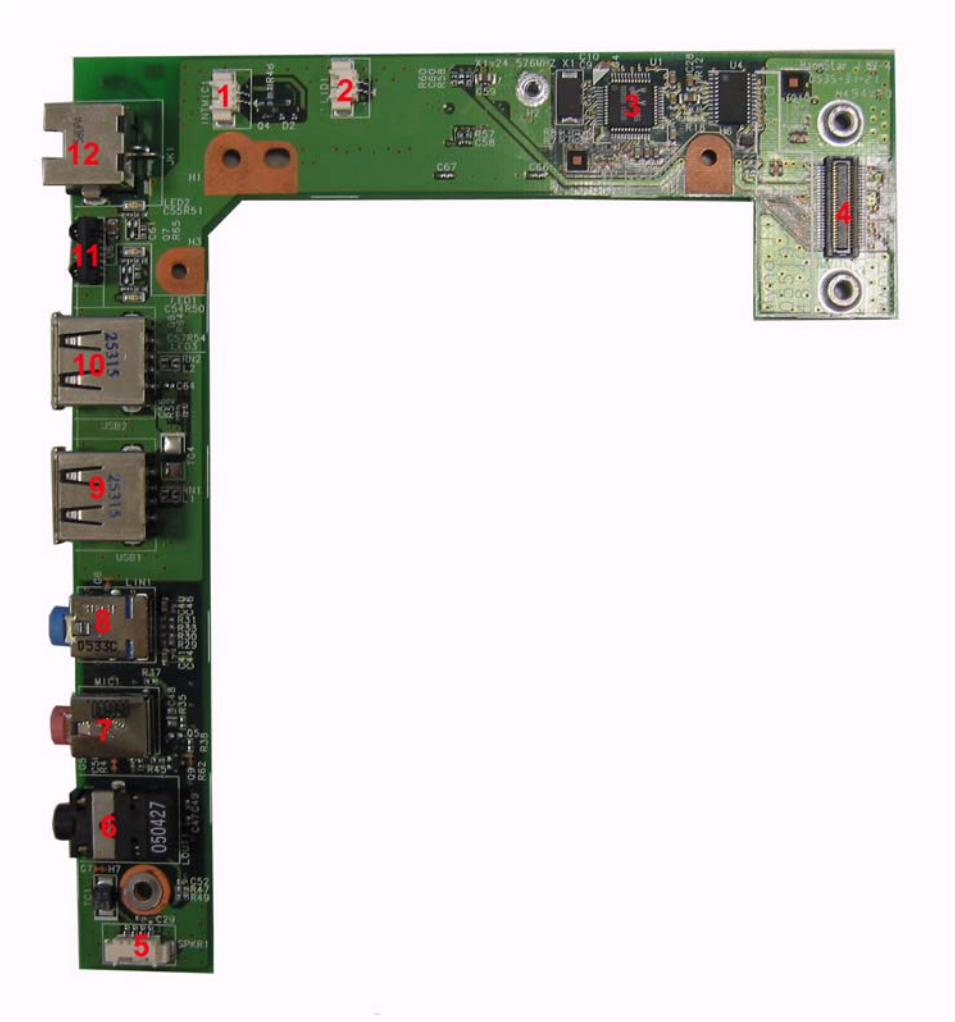

1	INTMIC1	Microphone Connector	7	MIC1	Microphone-in Port
2	LID1	Cover Switch Cable Connector	8	LINT1	Line-in Port
3	U1	Audio Codec-Realtek ALC655	9	USB1	USB Port
4	BTB1	IO Board to Main Board Connector	10	USB2	USB Port
5	SPKR1	Speaker Set Connector	11	U6	FIR
6	LOUT1	Line-out Port	12	JK1	RJ11 Modem Jack

## Bottom View

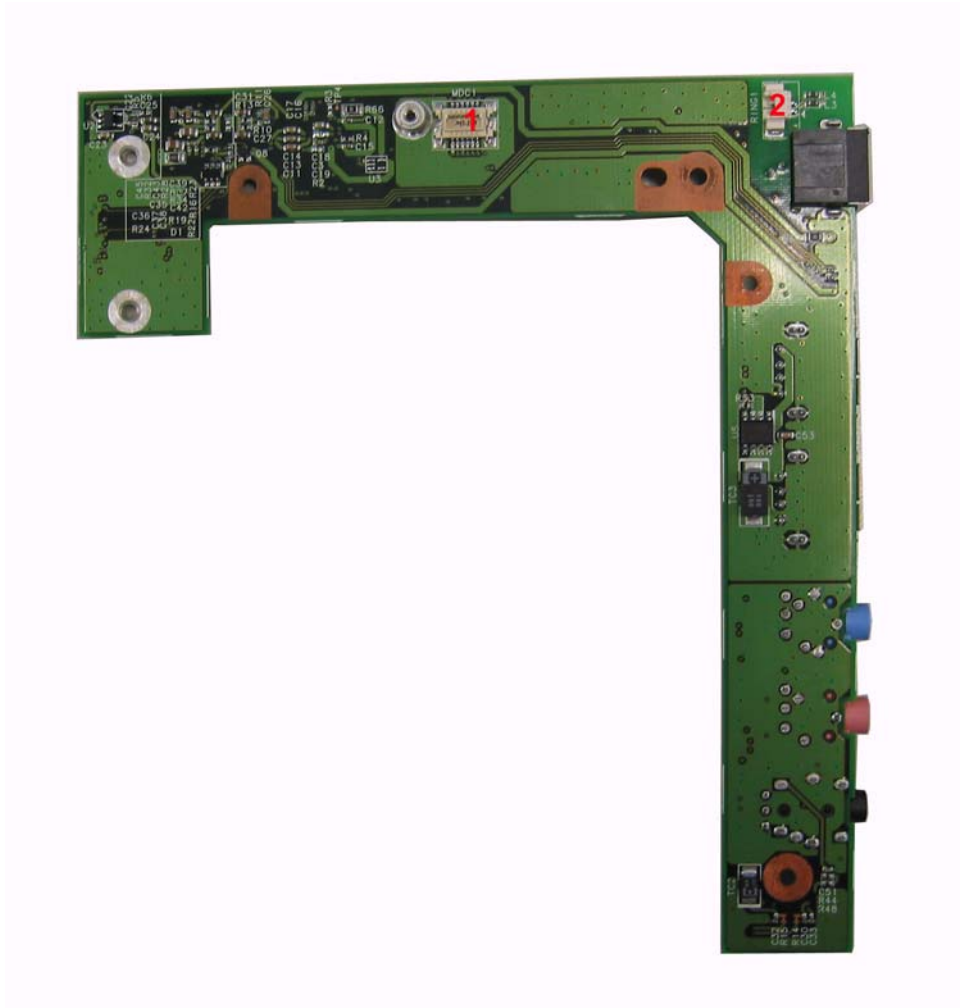

1 MDC1 Modem Board Connector

2 RING1 MDC Cable Connector







## FRU (Field Replaceable Unit) List

---

This chapter gives you the FRU (Field Replaceable Unit) listing in global configurations of TravelMate 3300/ Extensa 3100. Refer to this chapter whenever ordering for parts to repair or for RMA (Return Merchandise Authorization).

**Please note that WHEN ORDERING FRU PARTS, you should check the most up-to-date information available on your regional web or channel.** For whatever reasons a part number change is made, it will not be noted on the printed Service Guide. For ACER AUTHORIZED SERVICE PROVIDERS, your Acer office may have a DIFFERENT part number code from those given in the FRU list of this printed Service Guide. You MUST use the local FRU list provided by your regional Acer office to order FRU parts for repair and service of customer machines.

**NOTE:** To scrap or to return the defective parts, you should follow the local government ordinance or regulations on how to dispose it properly, or follow the rules set by your regional Acer office on how to return it.

# Exploded Diagram

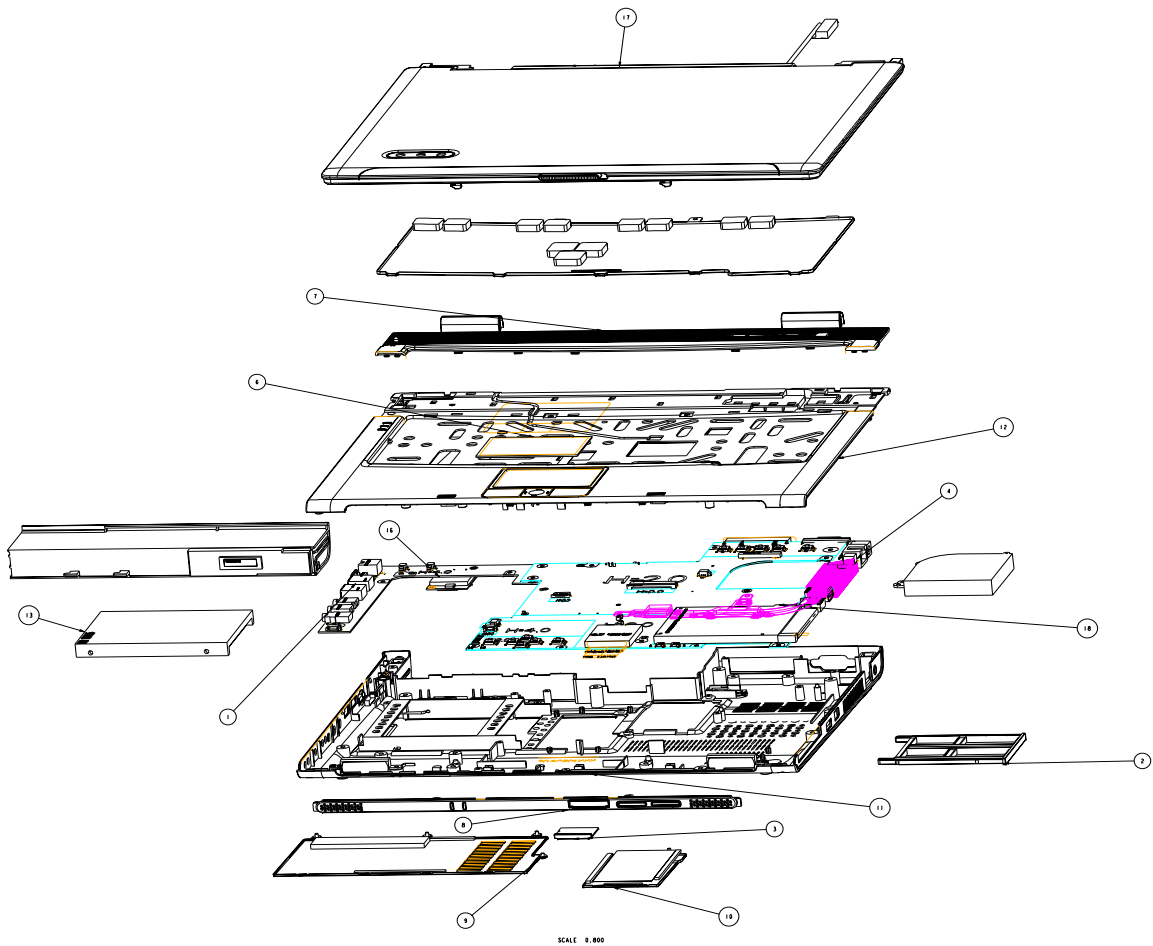



Image	Part Name	Description	Acer P/N
<b>ADAPTER</b>			
	ADAPTER 65W LITEON PA-1650-02WR	ADT 65W LITEON PA-1650-02WR	AP.06503.011
	ADAPTER 65W LISHIN SLS0335A19A54LF	ADT 65W LISHIN SLS0335A19A54LF	AP.06506.003
<b>BATTERY</b>			
	BATTERY PACK LI+ 6CELL 2.4MAH SONY	BTY PACK LI+ 6C 2.4AH SONY	BT.00604.005







Image	Part Name	Description	Acer P/N
	BATTERY PACK LI+ 6CELL 2.4MAH SANYO	BTY PACK LI+ 6C 2.4AH SANYO	BT.00603.012
	BATTERY PACK LI+ 9CELL 2.4MAH SANYO	BTY PACK LI+ 9C 2.4AH SANYO	BT.00903.004
BOARD			
	MODEM BOARD FOXCONN T60M845.01	MODEM MDC1.5 (AC97) T60M845.01	54.A56V1.001
	TOUCHPAD BOARD SYNAPTIC TM51-389	TOUCHPAD SYNAPTICS TM51-389	56.TB1V1.001
	WIRELESS LAN BOARD 802.11BG INTEL	WLAN 802.11BG INTEL867074 LF	KI.CAX01.013
	BLUETOOTH BOARD FOXCONN BCM2045	BT MODULE FOXCONN BCM2045	54.A74V1.003
	I/O BOARD	MYNA2 I/O BD 05519- SB (DIP)	55.TB1V1.001
CABLE			





Image	Part Name	Description	Acer P/N
	MODEM CABLE	CABLE MODEM US W/ RECYCLE	50.TB1V1.002
	TOUCHPAD CABLE	C.A. T/P FFC JH MYNA2	50.TB1V1.003
	POWER CODE 5A 250V 3P UK BK	CODE 5A 250V 3P UK BK	27.03118.001
	POWER CORD 2.5A 125V USA	CORD USA/W CNS 2.5A 125V 8121-	27.01518.781
	BLYETOOTH CABLE	B/T CABLE HT MYNA-2	50.TB1V1.010
CASE/COVER/BRAKET ASSEMBLY			
	PCMCIA DUMMY CARD	CARD-BUS DUMMY CARD	42.TB1V1.003
	SD MEMORY DUMMY CARD	SD DUMMY CARD MYNA2	42.TB1V1.004
	UPPER CASE	UPPER-CASE ASSY Note: This is engineering sample, and the color of the upper case is not correct.	60.TB1V1.002







Image	Part Name	Description	Acer P/N
	TOUCHPAD PLATE	ASSY T/P PLATE MYNA2	33.TB1V1.001
	LOWER CASE	ASSY L-CASE FOR CARD BUS MYNA2	60.TB1V1.001
	SPEAKER LEFT/ RIGHT	SPEAKER MYNA-2	23.TB1V1.001
	MICROPHONE	MICROPHONE MYNA2	23.TB1V1.002
	COVER SWITCH CABLE	C.A. COVER SWITCH MYNA2	50.TB1V1.001
	FRONT COVER	ASSY FRONT COVER MYNA2	60.TB1V1.004
	MIDDLE COVER	ASSY MIDDLE COVER MYNA2	60.TB1V1.003

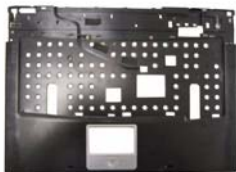



Image	Part Name	Description	Acer P/N
	HDD COVER	ASSY HDD COVER MYNA2	42.TB1V1.001
	MINI PCI COVER	ASSY MINIPCI COVER MYNA-2	42.TB1V1.002
COMBO MODULE			
	COMBO 24X PANASONIC UJDA770	COMBO 24X PAC/ UJDA770 MYNA EXT	KO.02406.014
	COMBO 24X LITEON SOSC-2483K	COMBO LIT/SOSC-2483K LF EXT	KO.02409.014
COMMUNICATION MODULE			
	WIRELESS ANTENNA LEFT/RIGHT	ANTENNA CABLE MYNA2	25.TB1V1.001
DVD MODULE			
	DVD-RW DRIVE 8X LITEON SOSW-833S DUAL	DUAL 8X LTN/SOSW-833S MYNA EXT	KU.00804.020

Image	Part Name	Description	Acer P/N
	DVD-RW DRIVE 8X PANASONIC UJ-840B DUAL	DUAL PAN/UJ-840B LF 8X DVD	KU.00807.030
FAN			
	FAN	FAN FORCECON MORAR	23.A74V1.001
HDD MODULE			
	HDD MODULE 40G	HDD MODULE 40G	TBD
	HDD MYLAR W/ CUPPER	ASSY HDD CHASSIS MYNA-2	33.TB1V1.002
	HDD 40G HITACHI HTS421240H9AT00	HDD 40GB HGST HTS421240H9AT00	KH.04007.013
	HDD 40G TOSHIBA MK4025GAS	HDD 40GB TOSHIBA MK4025GAS	KH.04004.005
	HDD 40G SEAGATE ST9402113A	HDD 40GB SEAGATE ST9402113A	KH.04001.016
	HDD MODULE 60G	ASSY HDD 60G SEAGATE MYNA-2	TBD
	HDD MYLAR W/ CUPPER	ASSY HDD CHASSIS MYNA-2	33.TB1V1.002
	HDD 60G HITACHI HTS421260H9AT00	HDD 60GB HGST HTS421260H9AT00	KH.06007.009
	HDD 60G TOSHIBA MK6025GAS	HDD 60GB TOSHIBA MK6025GAS	KH.06004.004
	HDD 60G SEAGATE ST960812A	HDD 60GB SEAGATE ST960812A	KH.06001.003
	HDD MODULE 80G	ASSY HDD 80G HGST MYNA-2	TBD
	HDD MYLAR W/ CUPPER	ASSY HDD CHASSIS MYNA-2	33.TB1V1.002
	HDD 80G TOSHIBA MK8025GAS	HDD 80GB TOSHIBA MK8025GAS	KH.08004.003
	HDD 80G HITACHI HTS421280H9AT00	HDD 80GB HGST HTS421280H9AT00	KH.08007.011
	HDD 80G SEAGATE ST980829A	HDD 80GB SEAGATE ST980829A	KH.08001.013
	HDD MODULE 100G	ASSY HDD 100G HGST MYNA-2	TBD

Image	Part Name	Description	Acer P/N
	HDD MYLAR W/ CUPPER	ASSY HDD CHASSIS MYNA-2	33.TB1V1.002
	HDD 100G HITACHI HTS421210H9AT00	HDD 100GB HGST HTS421210H9AT00	KH.10007.002
	HDD 100G TOSHIBA MK1031GAS	HDD 100GB TOSHIBA MK1031GAS	KH.10004.001
	HDD 100GB SEAGATE ST9100825A	HDD 100GB SEAGATE ST9100825A	KH.10001.003
KEYBOARD			
	KEYBOARD 88KEY DARFON NSK-AEN1D US-INT	KB DARFON NSK- AEN1D US-INT 88K	KB.TB107.001
	KEYBOARD DARFON NSK-AEN02 CHINESE 88	KB DARFON NSK- AEN02 CHINESE 88	KB.TB107.002
	TM3300 KEYBOARD SPANISH	TM3300 KEYBOARD SPANISH	KB.TB107.003
	TM3300 KEYBOARD THAI	TM3300 KEYBOARD THAI	KB.TB107.004
	TM3300 KEYBOARD BRAZILIAN PROTUGESE	TM3300 KEYBOARD BRAZILIAN PROTUGESE	KB.TB107.005
	TM3300 KEYBOARD KOREA	TM3300 KEYBOARD KOREA	KB.TB107.006
	TM3300 KEYBOARD UK	TM3300 KEYBOARD UK	KB.TB107.007
	TM3300 KEYBOARD GERMAN	TM3300 KEYBOARD GERMAN	KB.TB107.008
	TM3300 KEYBOARD ITALIAN	TM3300 KEYBOARD ITALIAN	KB.TB107.009
	TM3300 KEYBOARD FRENCH	TM3300 KEYBOARD FRENCH	KB.TB107.010
	TM3300 KEYBOARD SWISS/G	TM3300 KEYBOARD SWISS/G	KB.TB107.011
	TM3300 KEYBOARD PORTUGUESE	TM3300 KEYBOARD PORTUGUESE	KB.TB107.012
	TM3300 KEYBOARD ARABIC	TM3300 KEYBOARD ARABIC	KB.TB107.013
	TM3300 KEYBOARD BELGIUM	TM3300 KEYBOARD BELGIUM	KB.TB107.014
	TM3300 KEYBOARD SWEDEN	TM3300 KEYBOARD SWEDEN	KB.TB107.015
	TM3300 KEYBOARD CZECH	TM3300 KEYBOARD CZECH	KB.TB107.016
	TM3300 KEYBOARD HUNGAIAN	TM3300 KEYBOARD HUNGAIAN	KB.TB107.017
	TM3300 KEYBOARD NORWAY	TM3300 KEYBOARD NORWAY	KB.TB107.018



Image	Part Name	Description	Acer P/N
	TM3300 KEYBOARD DANISH	TM3300 KEYBOARD DANISH	KB.TB107.019
	TM3300 KEYBOARD TURKISH	TM3300 KEYBOARD TURKISH	KB.TB107.020
	TM3300 KEYBOARD TURKISH F TYPE	TM3300 KEYBOARD TURKISH F TYPE	KB.TB107.021
	TM3300 KEYBOARD CANADIAN FRENCH	TM3300 KEYBOARD CANADIAN FRENCH	KB.TB107.022
	TM3300 KEYBOARD JAPANESE	TM3300 KEYBOARD JAPANESE	KB.TB107.023
	TM3300 KEYBOARD GREEK	TM3300 KEYBOARD GREEK	KB.TB107.024
	TM3300 KEYBOARD HEBREW	TM3300 KEYBOARD HEBREW	KB.TB107.025
	TM3300 KEYBOARD RUSSIAN	TM3300 KEYBOARD RUSSIAN	KB.TB107.026
	TM3300 KEYBOARD SLOVENIA (SLO)	TM3300 KEYBOARD SLOVENIA (SLO)	KB.TB107.027
	TM3300 KEYBOARD CROATIA (CR )	TM3300 KEYBOARD CROATIA (CR )	KB.TB107.28
LCD MODULE			
	LCD MODULE 14.1" WXGA GLARE 400G	LCD 14" WXGA QD14TL02-04	6M.TB1V1.001
	INVERTER BOARD DARFON	INVERTER 17" ROHS VK.21189.401	19.TB1V1.001
	LCD CABLE 14.1 " WXGA	CABLE 14.1" WXGA HT MYNA2	50.TB1V1.004
	LCD BRACKET RIGHT	BRKT LCD 14.1" R MYNA2	33.TB1V1.003

Image	Part Name	Description	Acer P/N
	LCD BRACKET LEFT	BRKT LCD 14.1" L MYNA2	33.TB1V1.004
	LCD BEZEL 14.1"	ASSY LCD 14.1" BEZEL MYNA-2	60.TB1V1.005
	LCD BEZEL 14.1"	ASSY LCD 14.1" BEZEL MYNA-2 (for Extensa 3100) with model name printing on it	60.E31V1.001 (this is different item from TravelMate 3300)
	LCD PANEL 14.1"	ASSY LCD 14.1" PANEL MYNA-2	60.TB1V1.006
	HINGE PACK LEFT/ RIGHT	HINGE PACK LEFT/ RIGHT	6K.TB1V1.001
	LCD 14.1" WXGA N14111-L05 GLARE 400G	LCD 14" WXGA N14111-L05	LK.1410D.006
	LCD 14.1" WXGA QDI QD14TL02-04 400G	LCD 14" WXGA QD14TL02-04	LK.14109.006
	LCD MODULE 14.1" WXGA GLARE 420G	LCD 14.1" WXGA N141C1-L02	6M.TB1V1.002
	INVERTER BOARD DARFON	INVERTER 17" ROHS VK.21189.401	19.TB1V1.001
	LCD CABLE 14.1 " WXGA	CABLE 14.1" WXGA HT MYNA2	50.TB1V1.004



Image	Part Name	Description	Acer P/N
	LCD BRACKET RIGHT	BRKT LCD 14.1" R MYNA2	33.TB1V1.003
	LCD BRACKET LEFT	BRKT LCD 14.1" L MYNA2	33.TB1V1.004
	LCD BEZEL 14.1"	ASSY LCD 14.1" BEZEL MYNA-2	60.TB1V1.005
	LCD PANEL 14.1"	ASSY LCD 14.1" PANEL MYNA-2	60.TB1V1.006
	HINGE PACK LEFT/ RIGHT	HINGE PACK LEFT/ RIGHT	6K.TB1V1.001
	LCD 14.1" WXGA N141C1-L02 GLARE 420G	LCD 14.1" WXGA N141C1-L02	LK.1410D.008
	LCD MODULE 14.1" WXGA NONE GLARE 400G	ASSY QDI 14.1" WXGA (N-GLAR	6M.TB1V1.003
	INVERTER BOARD DARFON	INVERTER 17" ROHS VK.21189.401	19.TB1V1.001
	LCD CABLE 14.1 " WXGA	CABLE 14.1" WXGA HT MYNA2	50.TB1V1.004
	LCD BRACKET RIGHT	BRKT LCD 14.1" R MYNA2	33.TB1V1.003
	LCD BRACKET LEFT	BRKT LCD 14.1" L MYNA2	33.TB1V1.004
	LCD BEZEL 14.1"	ASSY LCD 14.1" BEZEL MYNA-2	60.TB1V1.005
	LCD PANEL 14.1"	ASSY LCD 14.1" PANEL MYNA-2	60.TB1V1.006
	HINGE PACK LEFT/ RIGHT	HINGE PACK LEFT/ RIGHT	6K.TB1V1.001
	LCD 14.1" WXGA N141I1-L07 NONE GLARE 400G	LCD 14.1" WXGA N141I1-L07	LK.1410D.007
	LCD 14.1" WXGA QDI QD14TL02-03 NONE GLARE 400G	LCD 14" WXGA QD14TL02-03	LK.14109.007
	LCD MODULE 14.1" WXGA NONE GLARE 420G	LCD MODULE 14.1" WXGA	6M.TB1V1.004
	INVERTER BOARD DARFON	INVERTER 17" ROHS VK.21189.401	19.TB1V1.001
	LCD CABLE 14.1 " WXGA	CABLE 14.1" WXGA HT MYNA2	50.TB1V1.004
	LCD BRACKET RIGHT	BRKT LCD 14.1" R MYNA2	33.TB1V1.003
	LCD BRACKET LEFT	BRKT LCD 14.1" L MYNA2	33.TB1V1.004
	LCD BEZEL 14.1"	ASSY LCD 14.1" BEZEL MYNA-2	60.TB1V1.005
	LCD PANEL 14.1"	ASSY LCD 14.1" PANEL MYNA-2	60.TB1V1.006
	HINGE PACK LEFT/ RIGHT	HINGE PACK LEFT/ RIGHT	6K.TB1V1.001





Image	Part Name	Description	Acer P/N
	LCD 14.1" WXGA N141C1-L03 NONE GLARE 420G	LCD 14.1" WXGA N141C1-L03	LK.1410D.009
	LCD 14.1" WXGA QDI QD14TL01-02 NONE GLARE 420G	LCD 14.1" WXGA QD14TL01-02	LK.14109.005
	LCD 14.1" WXGA QDI QD14TL01-03 NONE GLARE 420G	LCD 14" WXGA QDIQD14TL01-03	LK.14109.004
<b>MAIN BOARD</b>			
	MAINBOARD MYNA 2 4.4G 1.73MHZ(CPU ON BOARD) W/CPU HEATSINK & PCMCIA SLOT & RTC BATTERY	MB PM740 MYNA2 W/ O DIMM	LB.TB101.008
	MAINBOARD MYNA 2 2.13GMHZ(CPU ON BOARD) W/CPU HEATSINK & PCMCIA SLOT & RTC BATTERY	MYNA2 MB DOT-2.13G 05216SB DIP	LB.TB101.014
	MAINBOARD MYNA 2 2.0GMHZ(CPU ON BOARD) W/CPU HEATSINK & PCMCIA SLOT & RTC BATTERY	MYNA2 MB 2.0G 05216SB DIP	LB.TB101.012
	RTC BATTERY LI	BATTERY RTC CANARY	23.T28V1.001
	CPU HEATSINK W/O FAN	ASSY CPU HEAT SINK MYNA2	34.TB1V1.001
	PCMCIA SLOT 4PIN	CONN CARDBUS 4P 59330-00L0C	22.T28V1.001
	SDIMM 256M HYNIX HYMP532S64P6-C4	SODIMM 256M HYMP532S64P6-C4	KN.2560G.006
	SDIMM 256M INFINEON HYS64T32000HDL-3.7- A	SODIMM256MHYS64T 32000HDL-3.7-A	KN.25602.023





Image	Part Name	Description	Acer P/N
	SDIMM 512M INFINEON MHYS64T64020HDL- 3.7-A	SODIMM512MHYS64T 64020HDL-3.7-A	KN.51202.021
	SDIMM SAMSUNG M470T3354CZ3-CD5	Samsung M470T3354CZ3-CD5	KN.2560B.016
	SDIMM 512M NANYA NT512T64UH8A1FN- 37B	SODIMM512M NT512T64UH8A1FN- 37B	KN.51203.023
	SDIMM 512M SAMSUNG M470T6554CZ3-CD5	SODIMM 512M M470T6554CZ3-CD5	KN.5120B.015
	SDIMM 512M HYNIX HYMP564S64P6-C4	SODIMM 512M HYMP564S64P6-C4	KN.5120G.005
	LCD SCREW RUBBER	RUB LCD RUBBER CUSHION BOLSENA Note: See the upper two rubber cushion.	47.A46V1.002
	LCD SCREW RUBBER	RUBBER SCREW Note: See the lower two rubber	47.TB1V1.001
	SCROLL KEY RUBBER	KNOB SCROLL KEY MYNA2 Note: The picture below shows its location. It is put on the touchpad plate. 	47.TB1V1.002
	LOGO PLATE FOR BEZEL	PLT BEZEL PLATE "ACER " LOGO	31.A46V1.001
	LOGO PLATE FOR PANEL	PLT ACER LOGO ADHESIVE T.M.	31.T49V1.001

Image	Part Name	Description	Acer P/N
	HDD SPONGE	HDD SPONGE MYNA-2	47.TB1V1.003
	SCREW	SCW HEX NYL I#R-40/ O#4-40 L5.9	34.4C210.001
	SCREW	SCREW MACH WAFER M2*L4 NI	86.T39V1.002
	SCREW	SCREW M2*L9 NYLOK	86.00D38.520
	SCREW	SCRW WH MS+CBZ M2.5+L4 BLACK	86.9A323.4R0
	SCREW	SCREW M2.5-6	86.9A323.6R0
	SCREW	SCREW M2*3 NYLON 1JMCPC-420325	86.9A352.3R0
	SCREW	SCREW M2.5*4L(NYLOCK)BLA CK ZN	86.9A353.4R0
	SCREW	SCREW M2.5X6	86.9A353.6R0
	SCREW	SRW M2.5*8L B/ZN NYLOK 700	86.9A353.8R0
	SCREW	SCREW M2-3	86.9A522.3R0
	SCREW	SCRW M2*4 WAFER NI	86.9A552.4R0