

TravelMate4210/4270/4670&Aspire5620/5670
Service Guide

Service guide files and updates are available on the AIPG/CSD web; for more information, please refer to <http://csd.acer.com.tw>

Revision History

Please refer to the table below for the updates made on TravelMate4270/4670/4210 & Aspire5620/5670 service guide.

Date	Chapter	Updates

Copyright

Copyright © 2005 by Acer Incorporated. All rights reserved. No part of this publication may be reproduced, transmitted, transcribed, stored in a retrieval system, or translated into any language or computer language, in any form or by any means, electronic, mechanical, magnetic, optical, chemical, manual or otherwise, without the prior written permission of Acer Incorporated.

Disclaimer

The information in this guide is subject to change without notice.

Acer Incorporated makes no representations or warranties, either expressed or implied, with respect to the contents hereof and specifically disclaims any warranties of merchantability or fitness for any particular purpose. Any Acer Incorporated software described in this manual is sold or licensed "as is". Should the programs prove defective following their purchase, the buyer (and not Acer Incorporated, its distributor, or its dealer) assumes the entire cost of all necessary servicing, repair, and any incidental or consequential damages resulting from any defect in the software.

Acer is a registered trademark of Acer Corporation.

Intel is a registered trademark of Intel Corporation.

Pentium 4 and Celeron are trademarks of Intel Corporation.

Other brand and product names are trademarks and/or registered trademarks of their respective holders.

Conventions

The following conventions are used in this manual:

Screen messages	Denotes actual messages that appear on screen.
NOTE	Gives bits and pieces of additional information related to the current topic.
WARNING	Alerts you to any damage that might result from doing or not doing specific actions.
CAUTION	Gives precautionary measures to avoid possible hardware or software problems.
IMPORTANT	Reminds you to do specific actions relevant to the accomplishment of procedures.

Preface

Before using this information and the product it supports, please read the following general information.

1. This Service Guide provides you with all technical information relating to the BASIC CONFIGURATION decided for Acer's "global" product offering. To better fit local market requirements and enhance product competitiveness, your regional office MAY have decided to extend the functionality of a machine (e.g. add-on card, modem, or extra memory capability). These LOCALIZED FEATURES will NOT be covered in this generic service guide. In such cases, please contact your regional offices or the responsible personnel/channel to provide you with further technical details.
2. Please note WHEN ORDERING FRU PARTS, that you should check the most up-to-date information available on your regional web or channel. If, for whatever reason, a part number change is made, it will not be noted in the printed Service Guide. For ACER-AUTHORIZED SERVICE PROVIDERS, your Acer office may have a DIFFERENT part number code to those given in the FRU list of this printed Service Guide. You MUST use the list provided by your regional Acer office to order FRU parts for repair and service of customer machines.

Chapter1 System Specifications1

- Features 1
- Block Diagram 4
- TM 4670/4270/4210 Outlook View 5
- Aspire 5670/5620 Outlook View 11
- Indicators 17
- Easy-Launch Buttons 18
- Touchpad 19
- Using the Keyboard 20
- Using the System Utilities 25
- Acer Empowering Technology 28
- Hardware Specifications and Configurations 38

Chapter2 System Utilities48

- BIOS Setup Utility 48
- Information 49
- Main 51
- Advanced 53
- Security 54
- Boot 57
- Exit 58

Chapter3 Machine Disassembly and Replacement59

- General Information 60
- Disassembly Procedure Flowchart 61
- Removing the Adapter and Battery Pack 63
- Removing the TV Tuner, Heatsink Module, CPU, and HDD Module 64
- Removing the Memory and Wireless Card 67
- Removing the Bluetooth Module 68
- Disassembling the Main Unit into Upper Case and Lower Case 69
- Remove the Touchpad Board 72
- Remove the Mainboard 74
- Disassembling the LCD Module 77
- Reassembling the LCD Module 80
- HDD disassembly & Reassembly 82
- ODD disassembly & Reassembly 83
- Main Unit Reassembly 84

Chapter4 Troubleshooting93

- System Check Procedures 94
- Power-On Self-Test (POST) Error Message 97
- Index of Error Messages 98
- Phoenix BIOS Beep Codes 100
- Index of Symptom-to-FRU Error Message 104
- Intermittent Problems 108
- Undetermined Problems 109

Chapter5 Jumper and Connector Locations110

Top View	110
Bottom View	112

Chapter6 FRU (Field Replaceable Unit) List113

Exploded Diagram	114
Aspire 5670 Part List	117

System Specifications

Features

This computer was designed with the user in mind. Here are just a few of its many features:

Performance

- Intel® Pentium® M Yonah Processor dual core at 1.66~2.33 GHz or higher
- Intel® Pentium® M Yonah Processor single core at 1.66~1.83 GHz higher
- Intel® Celeron® M Yonah Processors 430/420/410

Chipset

- North Bridge:
 - 915GM/915PM
- South Bridge:
 - ICH7M-DH/ICH7M

Memory

- 256MB or 512MB of DDRII 533/667 SDRAM
- Two DDR SODIMM slots
- Upgradeable to 2GB Memory for 32bit OS, 4G for 64bit OS

Display

- 15.4" TFT WXGA, WXGAG, WSXGA+
- 15" TFT XGA

Graphics

- UMA
- Discrete
 - ATI MOBILITY™ RADEON® X1400(M54P), X1600(M56P)
 - ATI MOBILITY™ RADEON® X1300(M52P)

VRAM

- UMA
 - DVMT3.0, share 8MB, up to 128MB in OS
- Discrete
 - M56P: 64MB/128MB/256MB
 - M54P: 64MB/128MB/256MB
 - M52P: 64MB/128MB/256MB

TV Tuner (for Aspire only)

- MiniPCI type
- Reserve necessary thermal solution
- 3 TV tuner modules at lease
 - Analog w/ HW MPEG2
 - Analog+Digital w/ HS MPEG2(Hybrid)
 - Analog+Digital w/o HW MPEG2(Hybrid)
- Location of the TV tuner card has to be very close to the connector
- Worldwide version support

Audio

- Realtek ALC883 Audio Codec
- HD(High Definition) Audio
- SNR > 85
- Internal Microphone
- Two speakers, at least 1W/2.5cc for each
- Enable VoIP function

Storage

- PATA and SATA co-lay
- 9.5mm height, 2.5" HDD
- Easily removable
- 60/80/100/120GB
- PCI Bus Master Enhanced IDE
- Support Ultra DMA100, S.M.A.R.T

Communication

- 56Kbps V.90/V.92 AC-Link modem card (MDC1.5)
- 10/100Mbps or Giga LAN on board
- WLAN 802.11b/g or 802.11 a/b/g dual-band tri-mode Wireless with Mini-card/Mini-PCI interface
- Built-in 2 Antenna (which has to be placed on the top of LCD on the sides of LCD latch)

I/O Ports

- 4 external USB 2.0 ports
- IEEE 1394 port (4-pin)
- Ethernet (RJ-45) port
- Modem (RJ-11) port
- External display (VGA) port(15-pin)
- S-video port(7-pin)
- Microphones-in/Line-in jack
- Headphones/Speaker/Line-out jack with SPDIF support
- Infrared (FIR) port
- DC-in jack for AC adaptor

-
- 1 PCMCIA
 - 1 Express Card
 - 1 CIR(for Aspire)
 - 1 ezDock port
 - 1 DVI-D
 - 1 TV-in connector(for TV SKU)
 - 1 7-pin miniDin connector(for TV SKU)

Battery

- 8-cell of 18650 Li-ion battery pack, (2400mAh)
- 4-cell of 18650 Li-Ion battery pack, (2000mAh)
- 6-cell of 18650 Li-Ion battery pack, (2000mAh)
- 3-pin 90W AC adaptor

Block Diagram

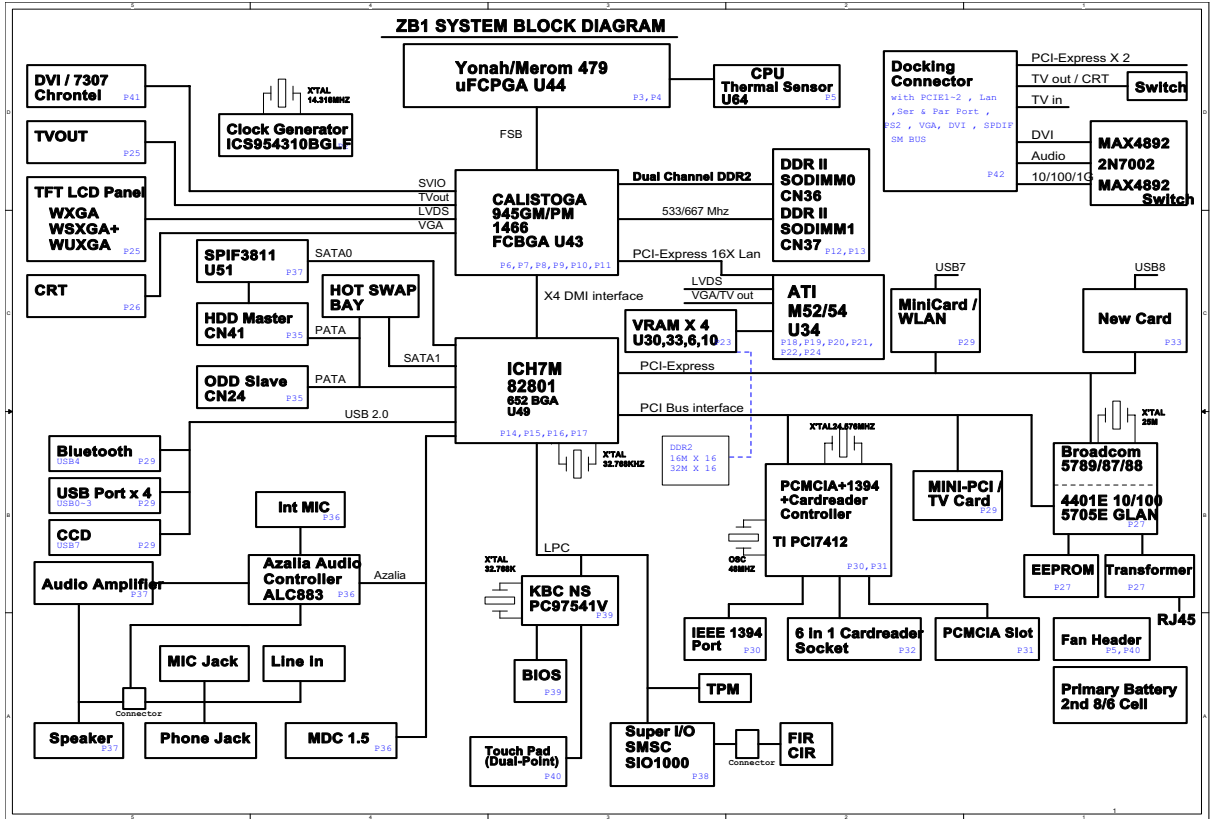

TM 4670/4270/4210 Outlook View

A general introduction of ports allow you to connect peripheral devices, as you would with a desktop PC.







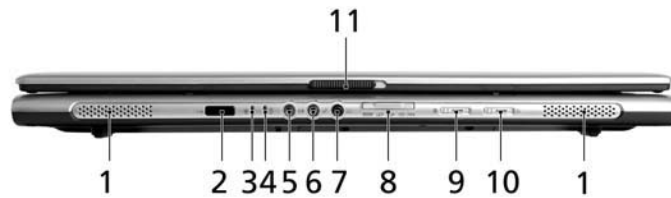

Open View



#	Item	Description
1	Display screen	Also called Liquid-Crystal Display (LCD), displaying computer output.
2	Microphone	Internal microphone for sound recording.
3	Keyboard	Inputs data into your computer.
4	Touchpad	Touch-sensitive pointing device which functions like a computer mouse.
5	Click buttons (Left, center and right)	The left and right buttons function like the left and right mouse buttons; the center button serves as a 4-way scroll button.
6	Palmrest	Comfortable support area for your hands when you use the computer.
7	Power button	Turns the computer on and off.
8	Easy-launch buttons	Buttons for launching frequently used programs.
9	Status indicators	Light-Emitting Diodes (LEDs) that turn on and off to show the status of the computer's functions and components.

Front View





#	Icon	Item	Description
1	N/A	Speakers	Left and right speakers deliver stereo audio output.
2		Infrared port	Interfaces with infrared devices(for TravelMate 4270/4670 Series)
3		Power indicator	Indicates the computer's power status.
4		Battery indicator	Indicates the computer's battery status.
5		Line-in jack	Accepts audio line-in devices (e.g., audio CD player, stereo walkman).
6		Mic-in jack	Accepts inputs from external microphones.
7		Headphones/ speaker/line-out jack with S/PDIF support	Connects to audio line-out devices(e.g., speakers, headphones)
8		5-in-1 card reader	Accepts Memory Stick(MS), Memory Stick PRO(MS PRO), MultiMediaCard(MMC), Secure Digital (SD) and xD-Picture Card(xD) (for TravelMate 4270/4670 Series) NOTE: Only one card can operate at any given time.
9		Bluetooth communication button/indicator	Press to enable/disable Bluetooth function. Lights to indicate the status of Bluetooth communications.
10		Wireless communications button/indicator	Press to enable/disable Wireless function. Lights to indicate the status of wireless LAN communications. (manufacturing option)

11	N/A	Latch	Locks and releases the lid.
----	-----	-------	-----------------------------

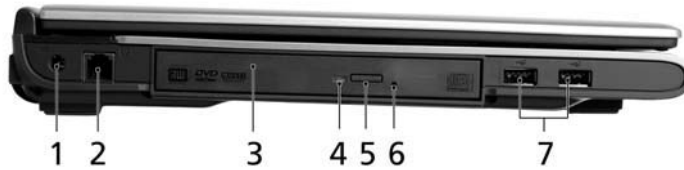





Left View

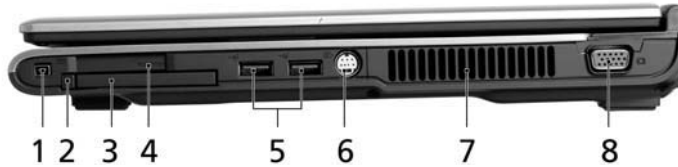

#	Icon	Item	Description
1		DC-in Jack	Connects to an AC adapter.
2		Modem(RJ-11) port	Connects to a phone line.
3		Acer MediaBay Optical drive	Houses an optical drive module, second battery pack or hard disk drive.(for TravelMate 4670 Series) Internal optical drive; accepts CDs or DVDs(for TravelMate 4210/4270 Series)
4		Optical disk access indicator	Lights up when the optical drive is active.
5		Optical drive eject button	Ejects the optical disk from the drive.
6		Emergency eject hole	Ejects the optical drive tray when the computer is turned off.
7		Two USB2.0 ports	Connect to USB 2.0 devices(e.g., USB mouse, USB camera)





Right View



#	Icon	Item	Description
1		IEEE 1394 port	Connects to IEEE 1394 devices.
2		PC Card slot eject button	Ejects the PC Card from the slot.
3		PC Card slot	Connects to one Type II CardBus PC Card.
4		ExpressCard/34 slot	Accepts one ExpressCard/34 module (for TravelMate 4670 Series)
5		Two USB 2.0 ports	Connect to Universal Serial Bus (USB) 2.0 devices (e.g., USB mouse, USB camera).
6		S-video port/TV-out (NTSC/PAL) port	Connects to a television or display device with S-video input. (for TravelMate 4270/4670 Series)
7		Ventilation slots	Enable the computer to stay cool, even after prolonged use.
8		External display (VGA) port	Connects to a display device (e.g., external monitor, LCD projector)

Rear View



#	Icon	Item	Description
1		Ethernet(RJ-45) port	Connects to an Ethernet 10/100/1000 based network.
2	DVI-D 	DVI-D port	Supports digital video connections(for TravelMate 4670 Series)
3		124-pin Acer ezDock connector	Connects to Acer ezDock(for TravelMate 4670 Series)
4		Battery	Powers the computer
5		Kensington lock slot	Connects to a Kensington-compatible computer security lock.

Bottom View



#	Item	Description
1	Battery release latch	Unlatches the battery to remove the battery pack.
2	Cooling fan	Helps keep the computer cool. NOTE: Do not cover or obstruct the opening of the fan.
3	Memory compartment	Houses the computer's main memory
4	Hard disk bay	Houses the computer's main memory
5	Acer MediaBay release latch	Releases the Acer MediaBay module for removal(for TravelMate 4670 Series)
6	Battery lock	Locks the battery in position.
7	Battery bay	Houses the computer's battery pack.

Aspire 5670/5620 Outlook View

Open View

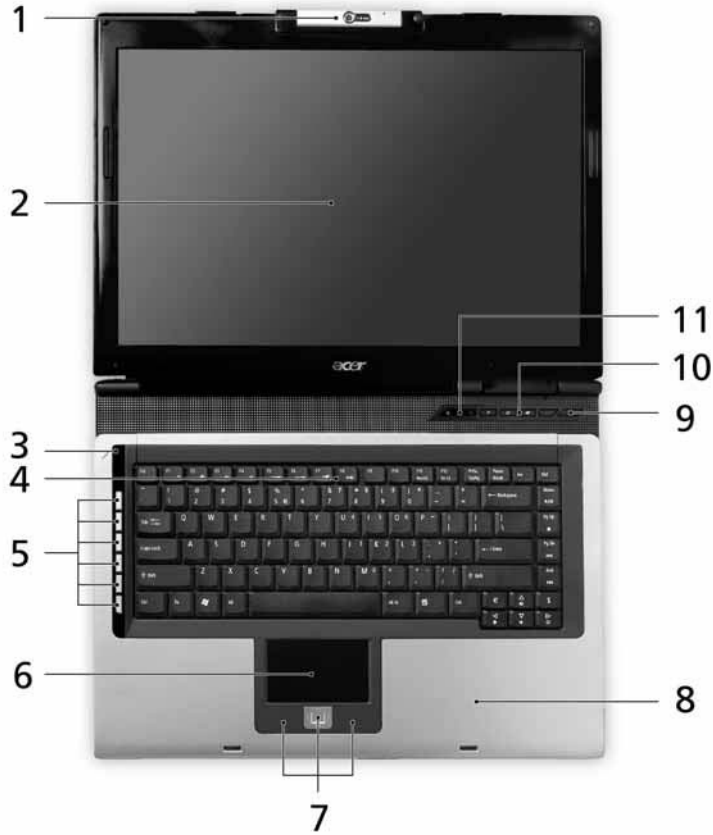









#	Item	Description
1	Built-in camera	1.3 megapixel web camera for video communication(for select models)
2	Display screen	Also called Liquid-Crystal Display (LCD), displaying computer output.
3	Microphone	Internal microphone for sound recording.
4	Keyboard	Inputs data into your computer.
5	Arcade/media/volume buttons	For use with Acer Arcade and other media playing programs.
6	Touchpad	Touch-sensitive pointing device which functions like a computer mouse.
7	Click buttons (Left, center and right)	The left and right buttons function like the left and right mouse buttons; the center button serves as a 4-way scroll button.
8	Palmrest	Comfortable support area for your hands when you use the computer.
9	Power button	Turns the computer on and off.

10	Easy-launch buttons	Buttons for launching frequently used programs.
11	Status indicators	Light-Emitting Diodes (LEDs) that turn on and off to show the status of the computer's functions and components.

Front View





#	Icon	Item	Description
1	N/A	Speakers	Left and right speakers deliver stereo audio output.
2		Infrared port	Interfaces with infrared devices(for Aspire 5670 Series)
3		Power indicator	Indicates the computer's power status.
4		Battery indicator	Indicates the computer's battery status.
5		Line-in jack	Accepts audio line-in devices (e.g., audio CD player, stereo walkman).
6		Mic-in jack	Accepts inputs from external microphones.
7		Headphones/ speaker/line-out jack with SPDIF support	Connects to audio line-out devices(e.g., speakers, headphones)
8		5-in-1 card reader	Accepts Memory Stick(MS), Memory Stick PRO(MS PRO), MultiMediaCard(MMC), Secure Digital (SD) and xD-Picture Card(xD) (for Aspire 5670 Series) NOTE: Only one card can operate at any given time.

9		Bluetooth communication button/indicator	Press to enable/disable Bluetooth function. Lights to indicate the status of Bluetooth communications.
10		Wireless communications button/indicator	Press to enable/disable Wireless function. Lights to indicate the status of wireless LAN communications. (manufacturing option)
11	N/A	Latch	Locks and releases the lid.







Left View



#	Icon	Item	Description
1		DC-in Jack	Connects to an AC adapter.
2		Modem(RJ-11) port	Connects to a phone line.
3		Slot-load optical drive eject button	Internal optical drive; accepts CDs or DVDs(slot-load or tray-load depending on model)
4		Optical disk access indicator	Lights up when the optical drive is active.
5		Slot-load Optical drive eject button	Ejects the optical disk from the drive.
6		Two USB2.0 ports	Connect to USB 2.0 devices(e.g., USB mouse, USB camera)





Right View



#	Icon	Item	Description
1		IEEE 1394 port(4-pin)	Connects to IEEE 1394 devices. (for Aspire 5670 Series)
2		PC Card slot eject button	Ejects the PC Card from the slot.
3		PC Card slot	Connects to one Type II CardBus PC Card.
4		ExpressCard/34 slot	Accepts one ExpressCard/34 module(for Aspire 5670 Series)
5		Two USB 2.0 ports	Connect to Universal Serial Bus (USB) 2.0 devices (e.g., USB mouse, USB camera).
6		S-video port/TV-out (NTSC/PAL) port	Connects to a television or display device with S-video input.(for Aspire 5670 Series)
7		Ventilation slots	Enable the computer to stay cool, even after prolonged use.
8		External display(VGA) port	Connects to a display device(e.g., external monitor, LCD projector)

Rear View



#	Icon	Item	Description
1		Ethernet(RJ-45) port	Connects to an Ethernet 10/100/1000 based network.
2	 DVI-D	DVI-D port	Supports digital video connections(for Aspire 5670 Series)
3		124-pin Acer ezDock connector	Connects to Acer ezDock(for selected models)
4		Battery	Powers the computer
5		Kensington lock slot	Connects to a Kensington-compatible computer security lock.

Bottom View









#	Item	Description
1	Battery release latch	Unlatches the battery to remove the battery pack.
2	Cooling fan	Helps keep the computer cool. NOTE: Do not cover or obstruct the opening of the fan.
3	Memory compartment	Houses the computer's main memory
4	Hard disk bay	Houses the computer's main memory(secured with screws)
5	Battery lock	Locks the battery in position.
6	Battery bay	Houses the computer's battery pack.

Indicators

Your computer provides an array of three indicators located above the keyboard, in addition to four indicators positioned at the front panel. These indicators show the status of the computer and its component.



The power, battery and wireless communication status indicators are visible even when the LCD display is closed.

Icon	Item	Description
	Caps Lock activity	Lights up when Caps Lock is activated.
	Num Lock activity	Lights up when Num Lock is activated.
	HDD	Indicate when the hard disk drive is active.
	Bluetooth	Indicates the status of Bluetooth communication.
	Wireless LAN	Indicates the status of wireless LAN communication.
	Power	Indicates the status of computer's power status.
	Battery	Indicates the computer's battery status. NOTE: The lights shows amber when the battery is charging. NOTE: The lights shows green when in AC mode.

Easy-Launch Buttons

Located at the upper-right, above the keyboard are four easy-launch buttons. They are User-Programmable Button, Mail, Web Browser, Acer Empowering Key from left to right.

TravelMate 4670/4270/4210



Aspire 5670/5620



Item	Default Application
P	User programmable
e	Acer Empowering Technology(User-programmable)
Web Browser	Internet browser(User -programmable)
Mail	Email application(User-programmable)

Touchpad

The build-in touchpad is a pointing device that senses movement on its surface.

This means the cursor responds as you move your finger across the surface of the touchpad.

The touchpad is located in the middle of the palm rest area, providing maximum comfort and efficiency.

Touchpad Basics

TravelMate 4670/4270/4210

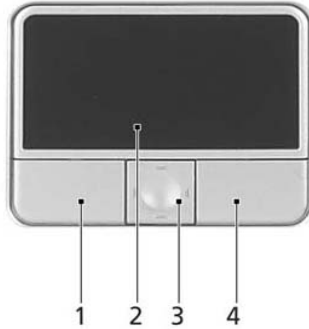

Aspire 5670/5620

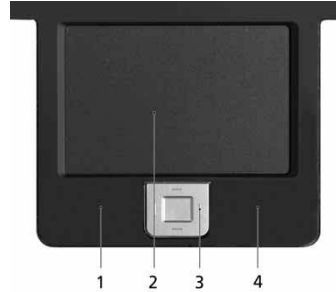

- Move your finger across the touchpad to move the cursor.
- Press the left **(1)** and right **(4)** buttons located beneath the touchpad to perform selection and execution functions. These two buttons are similar to the left and right buttons on a mouse. Tapping on the touchpad is the same as clicking the left button
- Use the 4-way scroll **(3)** button to scroll up or down and move left or right a page. This button mimics your cursor pressing on the right scroll bar of windows applications.

Function	Left Button(1)	Righ Button(4)	Main touchpad(2)	Center button(3)
Execute	Click twice quickly		Tap twice (at the same speed as double-clicking the mouse button)	
Select	Click once		Tap once	
Drag	Click and hold. Then slide your finger across the touchpad to drag the cursor over the selection.		Tap twice quickly; rest your finger on the touchpad on the second tap and drag the cursor.	
Access context menu		Click once		
Scroll				Click and hold to move up/down/left/right

NOTE: When using the touchpad, keep it-and your fingers-dry and clean. The touchpad is sensitive to finger movement; hence, the lighter the touch, the better the response. Tapping harder will not increase the touchpad's responsiveness.

Using the Keyboard

The full-sized keyboard includes an embedded numeric keypad, separate cursor keys, two Windows keys and twelve function keys.

Lock keys and Embedded Numeric Keypad

The keyboard has four lock keys which you can toggle on and off.

TravelMate 4670/4270/4210



Aspire 5670/5620



The computer features three lock keys, each with its own status indicator light.

Lock Key	Description
Caps Lock	When Caps Lock is on, all alphabetic characters are typed in uppercase. Toggle on and off by pressing the Caps Lock key on the left side of the keyboard.
Num lock <Fn+F11>	When Num Lock is on, the embedded keyboard is in numeric mode. The keys function as a calculator (complete with the arithmetic operators +, -, *, and /). Use this mode when you need to do a lot of numeric data entry. A better solution would be to connect an external keypad.
Scroll lock <Fn+F12>	When Scroll Lock is on, the screen moves one line up or down when you press the up or down arrow keys respectively. Scroll Lock does not work with some applications.









The embedded numeric keypad functions like a desktop numeric keypad. It is indicated by small characters located on the upper right corner of the keycaps. To simplify the keyboard legend, cursor-control key symbols are not printed on the keys.

Desired access	Num Lock on	Num Lock off
Numer keys on embedded keypad	Type numbers in a normal manner	

Desired access	Num Lock on	Num Lock off
Cursor-control keys on embedded keypad	Hold <Shift> while using cursor-control keys.	Hold <Fn> while using cursor-control keys.
Main keyboard keys	Hold <Fn> while typing letters on embedded keypad.	Type the letters in a normal manner.

Windows Keys

The keyboard has two keys that perform Windows-specific functions.

Windows logo key 	Pressed alone, this key has the same effect as clicking on the Windows Start button; it launches the Start menu. It can also be used with other keys to provide a variety of functions: <ul style="list-style-type: none">  + Tab (Activates the next Taskbar button)  + E (Opens the My Computer window)  + F1 (opens Help and Support)  + F (opens the Find: All Files dialog box)  + M (minimizes all windows) Ctrl + Windows logo key + M (undoes the minimize all windows action)  + R (opens the Run dialog box)
Application key 	This key has the same effect as clicking the right mouse button; it opens the application's context menu.

Hotkeys





The computer employs hotkeys or key combinations to access most of the computer's controls like screen brightness, volume output and the BIOS utility. To activate hotkeys, press and hold the <Fn> key before pressing the other key in the hotkey combination.







TravelMate 4670/4270/4210



Aspire 5670/5620



Hot Key	Icon	Item	Description
Fn+F1	?	Hot key help	This key will cause a help message to appear on the display device that describes the definition and functionality of the unit hot keys.
Fn+F2		Acer eSettings	Launches the Acer eSetting in Acer Empowering Technology. See "Acer Empowering Technology"
Fn+F3		Acer ePower Management	Launches the Acer ePower Management in Acer Empowering Technology. See "Acer Empowering Technology"
Fn+F4	Z ^z	Sleep	Puts the computer in Sleep mode
Fn+F5		Display toggle	Switches display output between the display screen, external monitor(if connected)and both .
Fn+F6		Screen blank	Turns the display screen backlight off to save power. Press any key to return

Hot Key	Icon	Item	Description
Fn+F7		Touchpad toggle	Turns the internal touchpad on and off
Fn+F8		Speaker toggle	Turns the speakers on and off
Fn+w		Volume up	Increases the sound volume
Fn+y		Volume down	Decreases the sound volume
Fn+x		Brightness up	Increases the screen brightness
Fn+z		Brightness down	Decrease the screen brightness

Special Keys

You can locate the Euro symbol and the US dollar sign at the upper-center and/or bottom-right of your keyboard.

TravelMate 4670/4270/4210



Aspire 5670/5620



The Euro Symbol

1. Open a text editor or word processor.
2. Either press < € > at the bottom-right of the keyboard, or hold <Alt Gr> and then press the <5> key at the upper-center of the keyboard.

NOTE: Some fonts and software do not support the Euro symbol. Please refer to www.microsoft.com/typography/faq/faq12.htm for more information.

The US Dollar Sign

1. Open a text editor or word processor.
2. Either press < \$ > at the bottom-right of the keyboard, or hold <Shift> and then press the <4> key at the upper-center of the keyboard.

NOTE: This function varies according to the language settings.

Using the System Utilities

Acer GridVista(dual-display compatible)

To enable the dual monitor feature of your notebook, first ensure that the second monitor is connected, then, select **Start, Control Panel, Display** and click on **Settings**. Select the secondary monitor (2) icon in the display box and then click the check box **Extend my Windows desktop onto this monitor**. Finally, click **Apply** to confirm the new settings and click **OK** to complete the process.

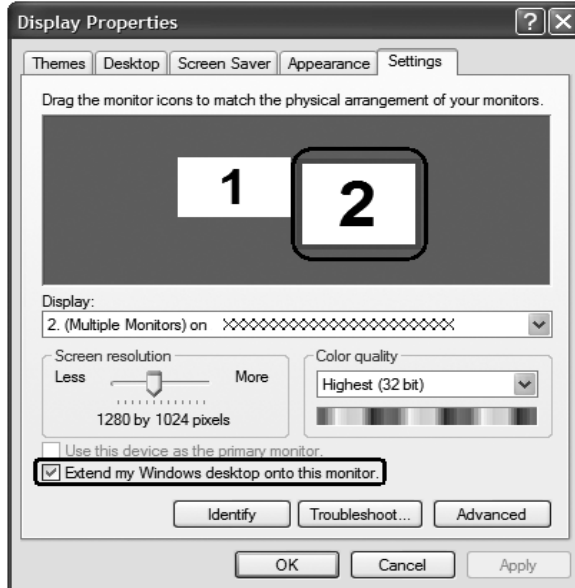

Acer GridVista is a handy utility that offers four pre-defined display settings so you can view multiple windows on the same screen. To access this function, please go to **Start, All Programs** and click on **Acer GridVista**. You may choose any one of the four display settings indicated below:

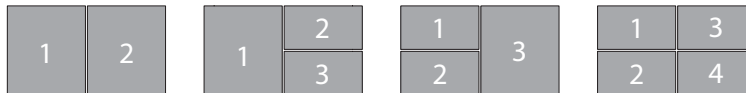

Double(vertical), Triple(primary at left), Triple(primary at right), or Quad Acer GridVista is dual-display compatible, allowing two displays to be partitioned independently.

Set up Procedure

1. Run Acer GridVista and select your preferred screen configuration for each display from the taskbar.
2. Drag and drop each window into the appropriate grid.
3. Enjoy the convenience of a well-organized desktop.

NOTE: The system utilities work under Microsoft Windows XP only.

Launch Manager

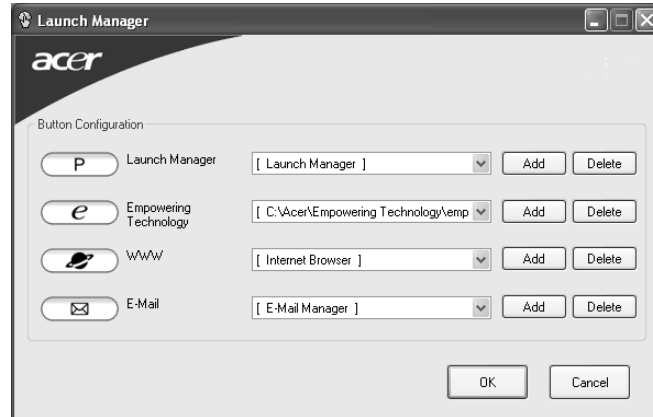

Launch Manager allows you to set the four easy-launch buttons located above the keyboard. You can access the Launch Manager by clicking on **Start, All Programs**, and then **Launch Manager** to start the application.

Norton AntiVirus

Norton AntiVirus is an anti-virus software that finds and repairs infected files, and protects against viruses to keep your computer data safe and secure.

How do I check for viruses?

A Full System Scan scans all files on your computer. To perform a system scan:

1. Start Norton AntiVirus.

Double click on the **Norton AntiVirus** icon on the desktop or click on the **Start** menu in the Windows taskbar, highlight **Programs**, and select **Norton AntiVirus**.

2. In the Norton AntiVirus main window, click **Scan for Viruses**.

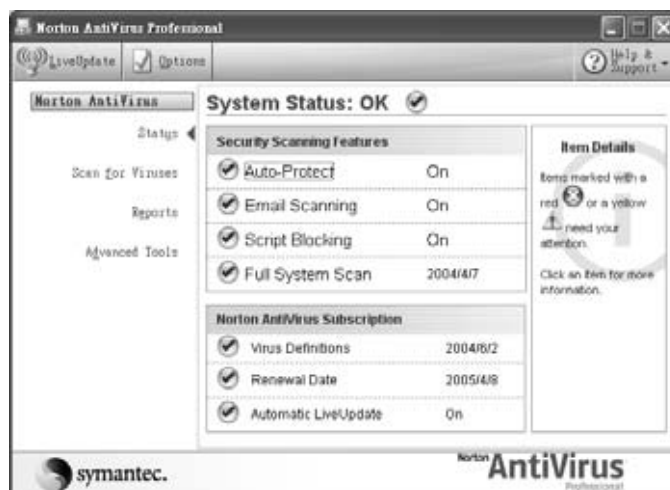

3. In the **Scan for Viruses** panel, click **Scan My Computer**.
4. Under **Actions**, click **Scan**.
5. When the scan is complete, a scan summary appears. Click **Finished**.

You can schedule customized virus scans that run unattended on specific dates and times or at periodic intervals. If you are using the computer when the scheduled scan begins, it runs in the background so that you do not have to stop working.

For more information refer to the Norton Antivirus Help menu.

Acer Empowering Technology

Acer's innovative Empowering Technology makes it easy for you to access frequently used functions and manage your new Acer notebook. It features the following handy utilities:

- ❑ **Acer eDataSecurity Management** protects data with passwords and advanced encryption algorithms.
- ❑ **Acer eLock Management** limits access to external storage media.
- ❑ **Acer ePerformance Management** improves system performance by optimizing disk space, memory and registry settings.
- ❑ **Acer eRecovery Management** backs up/recovers data flexibly, reliably and completely.
- ❑ **Acer eSettings Management** accesses system information and adjusts settings easily.
- ❑ **Acer ePower Management** extends battery power via versatile usage profiles.
- ❑ **Acer ePresentation Management** connects to a projector and adjusts display settings conveniently.



For more information, press the < *e* > key to launch the Empowering Technology menu, then click on the appropriate utility and select the Help function.

Acer eDataSecurity Management

Acer eDataSecurity Management is handy file encryption utility that protects your files from being accessed by unauthorized persons. It is conveniently integrated with Windows explorer as a shell extension for quick and

easy data encryption/decryption and also supports on-the-fly file encryption for MSN Messenger and Microsoft Outlook.

There are two passwords that can be used to encrypt/decrypt a file; the supervisor password and the file-specific password. The supervisor password is a “master” password that can decrypt any file on your system; the file-specific password will be used to encrypt files by default, or you can choose to enter your own file-specific password when encrypting a file.

NOTE: The password used to encrypt a file is the unique key that the system needs to decrypt it. If you lose the password, the supervisor password is the only other key capable of decrypting the file. If you lose both passwords, there will be no way to decrypt your encrypted file! **Be sure to safeguard all related passwords!**



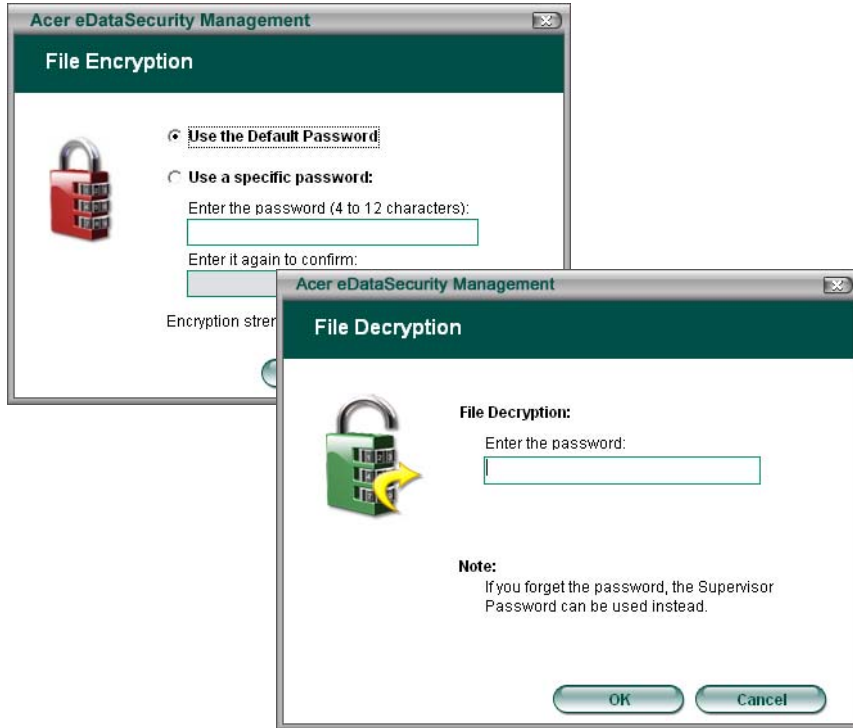

Acer eLock Management

Acer eLock Management is a security utility that allows you to lock up your removable data, optical and floppy drives to ensure that data can't be stolen while your notebook is unattended.

- ❑ Removable data devices - includes USB disk drives, USB pen drives, USB flash drives, USB MP3 drives, USB memory card readers, IEEE 1394 disk drives and any other removable disk drives that can be mounted as a file system when plugged into the system.
- ❑ Optical drive devices - includes any kind of CD-ROM or DVD-ROM drives.
- ❑ Floppy disk drives - 3.5-inch disks only.

To activate Acer eLock Management, a password must be set first. Once set, you may apply lock to any of the three kinds of devices. Lock(s) will immediately be set without any reboot necessary, and will remain locked after rebooting, until unlocked.

If you do not set a password, Acer eLock Management will reset back to the initial status with all locks removed.

NOTE: If you lose your password, there is no method to reset it except by reformatting your notebook or taking your notebook to an Acer Customer Service Center. Be sure to remember or write down your password.



Acer ePerformance Management

Acer ePerformance Management is a system optimization tool that boosts the performance of your Acer notebook. It provides you with the following options to enhance overall system performance:

- Memory optimization - releases unused memory and check usage.
- Disk optimization - removes unneeded items and files.
- Speed optimization - improves the usability and performance of your Windows XP system.



Acer eRecovery Management

Acer eRecovery Management is a powerful utility that does away with the need for recovery disks provided by the manufacturer. The Acer eRecovery Management utility occupies space in a hidden partition on your system's HDD. User-created backups are stored on D:\ drive. Acer eRecovery Management provides you with:

- Password protection.
- Recovery of applications and drivers.
- Image/data backup:
 - Back up to HDD (set recovery point).
 - Back up to CD/DVD.
- Image/data recovery tools:
 - Recover from a hidden partition (factory defaults).
 - Recover from the HDD (most recent user-defined recovery point).
 - Recover from CD/DVD.



NOTE: If your computer did not come with a Recovery CD or System CD, please use Acer eRecovery Management's "System backup to optical disk" feature to burn a backup image to CD or DVD. To ensure the best results when recovering your system using a CD or Acer eRecovery Management, detach all peripherals (except the external Acer ODD, if your computer has one), including your Acer ezDock.

Acer eSettings Management

Acer eSettings Management allows you to inspect hardware specifications and to monitor the system health status. Furthermore, Acer eSettings Management enables you to optimize your Windows operating system, so your computer runs faster, smoother and better.

Acer eSettings Management also:

- Provides a simple graphical user interface for navigating through the program effortlessly.
- Displays general system status and advanced monitoring for power users.
- Logs when a hardware component has been removed or replaced.
- Permits you to migrate personal settings.
- Keeps a history log of all alerts that were previously issued.

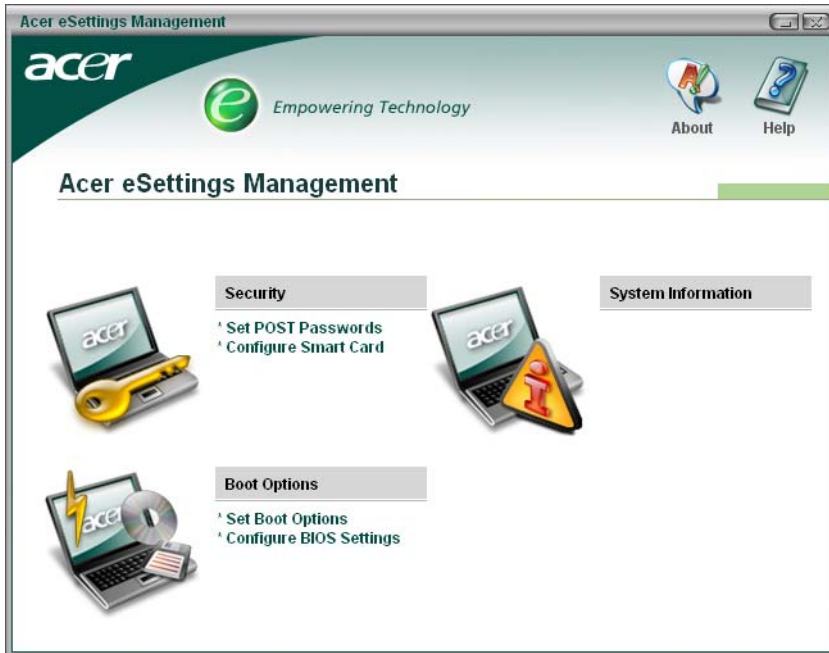

Acer eNet Management

Acer eNet Management helps you to quickly and easily connect to both wired and wireless networks in a variety of locations. To access this utility, either click on the “Acer eNet Management” icon on your notebook, or start the program from the Start menu. You also have the option to set Acer eNet Management to start automatically when you boot up your PC.

Acer eNet Management automatically detects the best settings for a new location, while offering you the freedom to manually adjust the settings to match your needs, simply by right-clicking on the icon in the taskbar.



Acer eNet Management can save network settings for a location to a profile, and automatically apply the appropriate profile when you move from one location to another. Settings stored include network connection

settings(IP and DNS settings, wireless AP details, etc.), as well as default printer settings. Security and safety concerns mean that Acer eNet Management does not store username and password information.

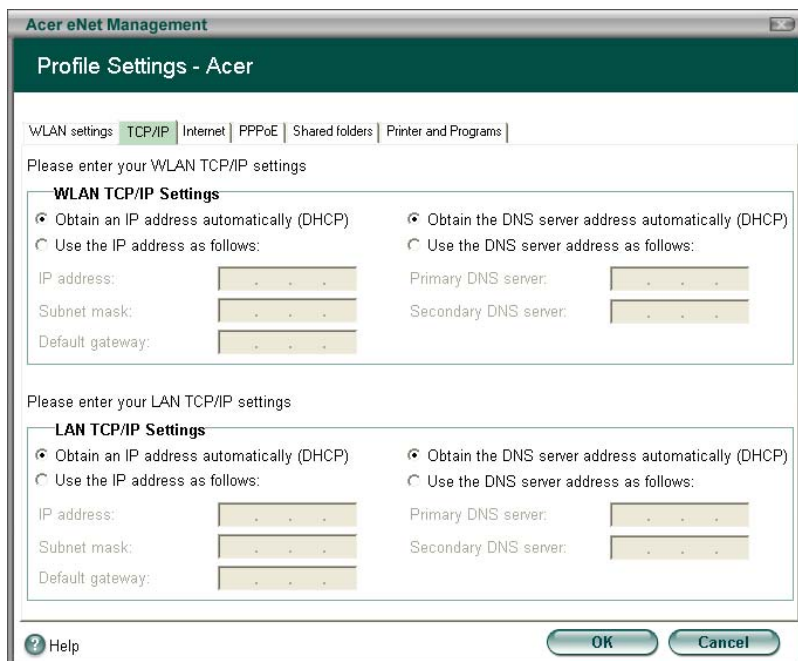

Acer ePower Management

Acer ePower Management features a straightforward user interface. To launch it, select Acer ePower Management from the Empowering Technology interface, or double-click the Acer ePower Management icon in the task tray.

Acer Mode

The default setting is “Maximum Performance.” You can adjust CPU speed, LCD brightness and other settings, or click on buttons to turn the following functions on/off: Wireless LAN, Bluetooth, CardBus, Memory Card, Audio, and Wired LAN.

DC Mode

To suit your usage, there are four pre-defined profiles - Entertainment, Presentation, Word Processing, and Maximum Battery. Or, you can define up to three of your own profiles.

Create new power scheme

1. Assign a name for the new scheme.
2. Choose existing scheme to use as a template.
3. Select whether used for mains (AC) or battery mode.
4. Choose which power options best fit your needs, then click OK.
5. The new profile will appear on the main screen.

Battery status

For real-time battery life estimates based on current usage, refer to the panel on the lower left-hand side of the window.

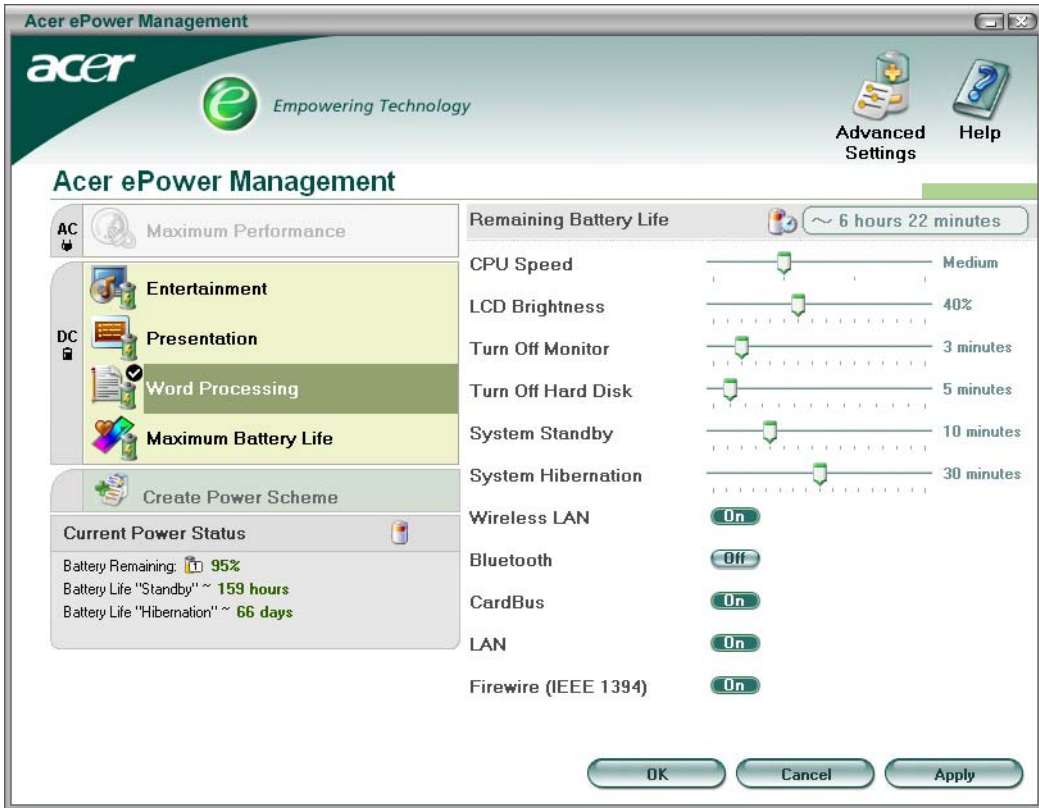

You can also click “Advanced Settings” to:

- Set alarms.
- Re-load factory defaults.
- Select what actions will be taken when the cover is closed, and set passwords for accessing the system after Hibernation or Standby.
- View information about Acer ePower Management.

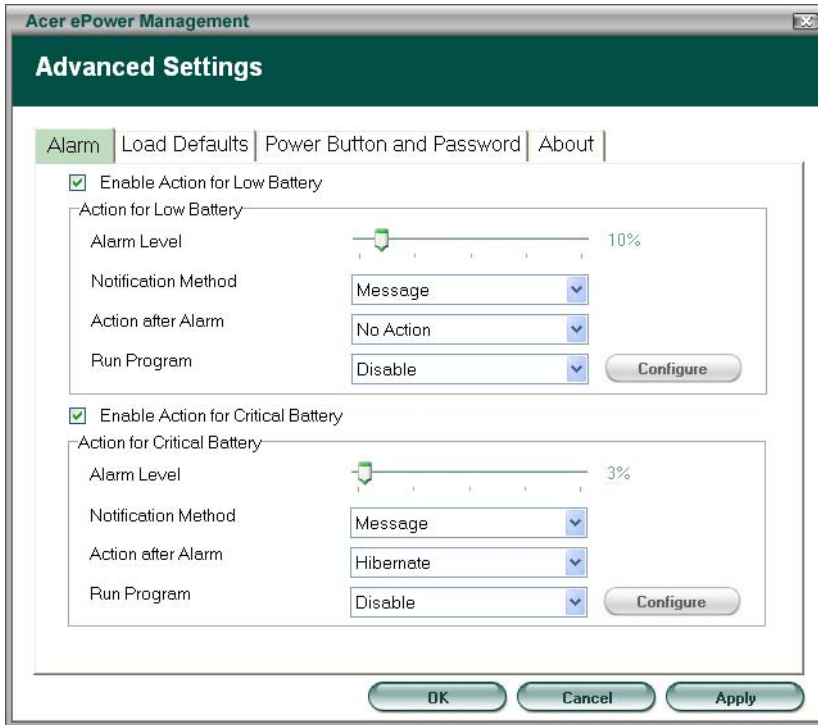

Acer ePresentation Management

Acer ePresentation Management lets you select from two of the most common projector resolutions: XGA and SVGA.

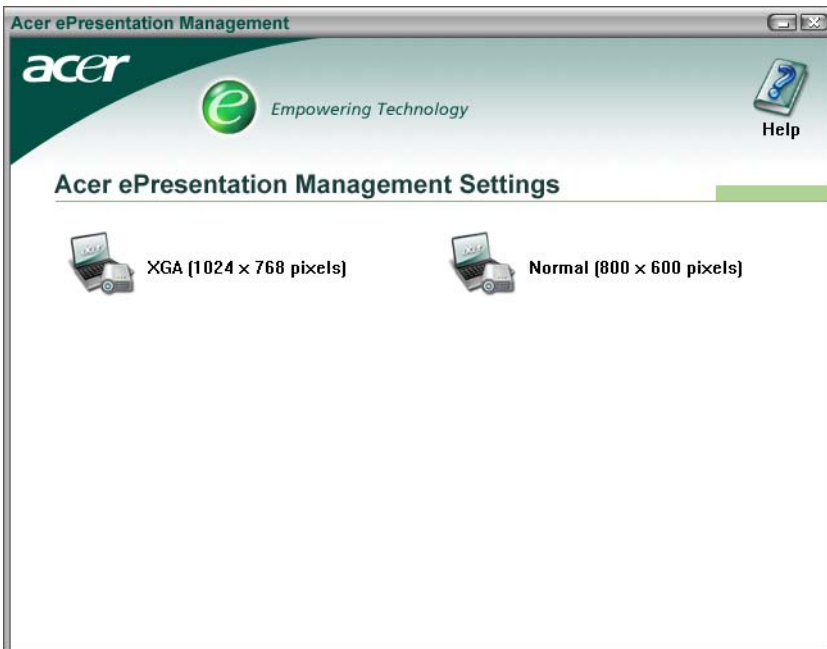

Hardware Specifications and Configurations

Processor

Item	Specification
CPU type	Intel® Pentium® M Yonah Processor dual core at 1.66~2.33 GHz or higher Intel® Pentium® M Yonah Processor single core at 1.66~1.83 GHz higher Intel® Celeron® M Yonah Processors 430/420/410
CPU package	uFCPGA
CPU core voltage	Depend on DVI
CPU I/O voltage	1.2V

System Board Major Chips

Item	Controller
System core logic	Intel® 945GM/ICH7M Intel® 945PM/ICH7M
Super I/O controller	SIO 1000, LPC interface
Audio controller	Azalia Audio Controller ALC883
Video controller	ATI M56P/54P/52P UMA
Hard disk drive controller	ICH7M
Keyboard controller	NS PC97541V
IrDA controller	SMSC SIO 1000
DVI controller	CH7307
PCMCIA/ card reader / 1394 controller	TI PCI7412
DDR-soDIMM controller	945PM/945GM

BIOS

Item	Specification
BIOS vendor	Phoenix
BIOS Version	Phoenix First BIOS
BIOS ROM type	Flash ROM
BIOS ROM size	512KB
BIOS package	32 lead of TSSOP
BIOS password control	Set by setup manual

Item	Specification
Cache controller	Built-in CPU
Cache size	2 MB
1st level cache control	Always enabled
2nd level cache control	Always enabled
Cache scheme control	Always enabled

System Memory

Item	Specification
Memory controller	945GM/945PM
Memory size	256MB/512MB
DIMM socket number	2
Supports memory size per slot	1024 MB
Supports maximum memory size	2GB (with dual soDIMM modules)
Supports DIMM type	DDRII SDRAM Standard
Supports DIMM Speed	533/667 MHz
Supports DIMM voltage	1.8V
Memory module combinations	You can install memory modules in any combinations as long as they match the above specifications.

LAN Interface

Item	Specification
Supports LAN protocol	10/100/1000 Mbps Fast Ethernet connection
LAN chip	Broadcom 5787/5789 PCI-E GbE Broadcom 5788E PCI GbE for selected model Broadcom 4401E PCI 10/100Mbps
LAN connector type	RJ45
LAN connector location	Rear side

Wireless LAN

Item	Specification
Card Type	Mini-card/Mini-PCI
Mode	802.11 a/b/g(Mini-Card) 802.11 b/g(Mini-Card) 802.11 b/g(Mini-PCI)
Antenna	Built in 2 antenna(PIFA type)
Support	Wi-Fi, WPA2, WMM, CCX V3/V4

Modem Interface

Item	Specification
Data modem data baud rate (bps)	56K ITU
Supports modem protocol	V.90/V.92 AC-Link modem with PTT approval Wake-on-Ring ready
Modem connector type	RJ11
Modem connector location	Left side
Bluetooth	Bluetooth 2.0 module(Mini USB module and built-in)

VGA

Notice	Discrete	UMA
Chipset for suitable VGA type	945PM	945GM
Video RAM	64/128MB	up to 128MB

USB Port

Item	Specification
USB compliancy level	2.0
OHCI	USB 2.0
Number of USB port	4
Location	Left Side *2 Right Side *1

Audio Port

Item	Specification
Audio Controller	Azalia Audio Controller (Realtek ALC883)
Audio onboard or optional	Built-in
Mono or Stereo	Stereo
Resolution	20 bit stereo Digital to analog converter 18 bit stereo Analog to Digital converter
Compatibility	Microsoft PC99/2100, AC97 2.3 & WHQL/WLP2.0
Mixed sound source	CD
Sampling rate	All DACs support 44.1K/48K/96K/192K sample rate All ADCs support 44.1K/48K/96K sample rate
Internal microphone	Yes
Internal speaker / Quantity	Yes / 2
Support	S/PDIF out / VoIP

PCMCIA Port

Item	Specification
PCMCIA controller	PCI7412
Supports card type	Type II
Number of slots	One
Access location	Right Side
Supports ZV (Zoomed Video) port	No
Supports 32 bit CardBus	Yes

Keyboard

Item	Specification
Keyboard controller	NS PC97541V
Keyboard vendor & model name	TravelMate series: New Acer Ergo Keyboard Aspire series: New Acer flat keyboard

Keyboard

Item	Specification
Total number of keypads	<input type="checkbox"/> 88-89 keys Acer Fine Touch™ keyboard
Touchpad with 4-way integrated scroll button	Yes
12 function keys	<input type="checkbox"/> two Windows keys <input type="checkbox"/> Hotkey controls <input type="checkbox"/> embedded numeric keypad <input type="checkbox"/> Multi-Langue support <input type="checkbox"/> Spill-proof
Four easy-launch buttons	<input type="checkbox"/> Internet browser <input type="checkbox"/> email with LED <input type="checkbox"/> Empowering key <input type="checkbox"/> one user-programmable button
Two front access LED buttons	<input type="checkbox"/> WLAN LED button <input type="checkbox"/> Bluetooth LED button

Battery

Item	Specification
Vendor & model name	Sony/Sanyo/Simplo
Battery Type	Li-ion
Pack capacity	65Wh
Number of battery cell	8-cell 2400mAh 8-cell 2000mAh 6-cell 2000mAh
Package configuration	
Pin 1 Pin 2	BATT+: Battery+, Battery Positive Terminal
Pin 3	ID : Identify Pin (Note 1)
Pin 4	B/I : Battery-In Pin
Pin 5	TS : Connect to Thermister
Pin 6	SMD : SMBus data interface I/O pin
Pin 7	SMC : SMBus clock interface I/O pin
Pin 8 Pin 9	GND : Battery Negative Terminal

LCD :15.4" WXGA LCD

Item	Specification				
Vendor & model name	CMO N15411-L0C GLARE TYPE/ N15411-L0B NON-GLARE	LPL LP154W01- TLB5 GLARE LEAD-FREE/ LP154W01- TLA1 NON- GLARE LEAD-FREE	Samsung LTN154X3- L01-H00 glare L6-G5/ L01-100 non- glare L6-G5/ LTN154P1- L02-V LEAD- FREE	AUO B154EW01 V9 16MS LEAD-FREE GLARE TYPE	QDI QD15TL07- 02 GLARE / QD15TL02- 03 NON- GLARE TYPE LEAD- FREE
Mechanical Specifications					
LCD display area (diagonal, inch)	15.4"	15.4"	15.4"	15.4"	15.4"
Active Area(mm)	331.2(H)x 207.0(V)	331.2(H)x 207.0(V)	331.2(H)x 207.0(V)	331.2(H)x20 7.0(V)	331.2(H)x20 7.0(V)
Display technology	TFT	TFT	TFT	TFT	TFT
Resolution	WXGA (1280*800)	WXGA (1280*800)	WXGA (1280*800)	WXGA (1280*800)	WXGA (1280*800)
Pixel Pitch	0.2588(H)x0 .2588(V)	0.2588(H)x0 .2588(V)	0.2588(H)x0 .2588(V)	0.2588(H)x0 .2588(V)	0.2588(H)x0 .2588(V)
Pixel Arrangement	RGB vertical stripe	RGB vertical stripe	RGB vertical stripe	RGB vertical stripe	RGB vertical stripe
Display Mode	Normally White	Normally White	Normally White	Normally White	Normally White
Typical White Luminance(cd/m ²) also called Brightness	200	200/170	200	180	185
Luminance Uniformity	N/A	N/A	N/A	1.25 max.	N/A
Contrast Ratio	400	550/300	300	400	400
Response Time(Optical Rise Time/Fall Time) msec	5/11	16(Tr+Tf)	25(Tr+Tf)	12/4	6/10
Power Supply Voltage	+3.3V	+3.3V	+3.0V	+3.3V	+3.3V
Typical Power Consumption(watt)	4.22	5.23	4.2	6.5	N/A
Weight	600 g	540/575 g	530 g	585 g	585 g
Physical Size(mm) (Typical)	344(H)x222 (V)x6.2(D)	344(H)x222 (V)x6.2(D)	344(H)x222 (V)x6.2(D)	344(H)x222 (V)x6.5(D)	344(H)x222 (V)x6.35(D)
Electrical Interface	LVDS with 1 pixel/clock	1 channel LVDS	3.3V LVDS	1 channel LVDS	
Support Color	262144	262144	262144	262K	262144
Viewing Angle(degree) Horizontal: Right/Left Vertical: Upper/Lower	45/45 15/35	45/45 15/35	45/45 15/35	45/45 15/35	45/45 15/35
Temperature Range(°C) Operating Storage(shipping)	0~+50 -20~+60	0~+50 -20~+60	0~+50 -20~+60	0~+50 -20~+60	0~+50 -20~+60

LCD :15.4" WXGA LCD

Item	Specification	
Vendor & model name	15.0" XGA NB LCD LPL LP150X08- TLA2 LEAD- FREE/CHINA MADE	15.0" XGA NB LCD CMO N150X3-L09 REV. C2
Mechanical Specifications		
LCD display area (diagonal, inch)	15.0"	15.0"
Active Area(mm)	304.1(H)x 228.1(V)	304.1(H)x 228.1(V)
Display technology	TFT	TFT
Resolution	XGA (1024*768)	XGA (1024*768)
Pixel Pitch(mm)	0.297(H)x 0.297(V)	0.297(H)x 0.297(V)
Pixel Arrangement	RGB Vertical stripe	RGB Vertical stripe
Display Mode	Normally White	Normally White
Typical White Luminance(cd/m ²) also called Brightness	170	200
Luminance Uniformity	N/A	N/A
Contrast Ratio	250	250
Response Time(Optical Rise Time/Fall Time) msec	10/20	5/11
Power Supply Voltage	+3.3V	+3.3V
Typical Power Consumption(watt)	4.76	3.96
Weight	530 g	550 g
Physical Size(mm) (Typical)	317(H)x241 (V)x5.9(D)	317(H)x242 (V)x5.7(D)
Electrical Interface	LVDS IS100- C30R-C15	LVDS with 1 pixel/clock
Support Color	262144	262144
Viewing Angle(degree) Horizontal: Right/Left Vertical: Upper/Lower	45/45 15/35	45/45 20/40
Temperature Range(°C) Operating Storage(shipping)	0~+50 -20~+60	0~+50 -20~+60

AC Adapter

Item	Specification
Vendor & model name	ROHS DELTA -90W ADP-90SB BBAHF BLACK 1.7X5.5X12.5 LITEON -90W PA-1900-04 QB BLUE 1.7X5.5X11 LF LSE-90W SLS0202C19A157 LF BLUE 1.7X5.5X11 LF
Input Requirements	
Maximum input current (A, @100Vac, full load)	1.5A @100Vac input and maximum load
Nominal(Rated) frequency (Hz)	50 or 60 and single phase
Frequency variation range (Hz)	47 - 63
Nominal voltages (Vrms)	90 - 265
Efficiency	High efficiency 85% minimum, at 100~240Vac AC input, full load, warm-up condition.
Output Ratings (CV mode)	
Rated output voltage	Offers rated output voltage 19.0V
Voltage Range	18.2V to 19.8V
Noise + Ripple	300mvp-pmax (20MHz bandwidth) for resistor load
Rated Power	90Watts continuously at all specified conditions
Output current	0 A (min.) to 4.74A (max.)
Dynamic Output Characteristics	
Start-up time	2 sec. (@115 Vac and 230Vac full load)
Hold up time	at least 10ms (@115 Vac input, full load)
Over Voltage Protection (OVP)	30V
Over Current Protection(OCP)	Output current limit is 6A(Max mode)
Short circuit protection	Output can be shorted without damage, and auto recovery
Electrostatic discharge (ESD)	15kV (at air discharge) 8kV (at contact discharge)
Dielectric Withstand Voltage	
Primary to secondary	3000 Vac for 1 second
Leakage current	less than 250uA at 240Vac, 50Hz
Regulatory Requirements	1. CISPR 22 Class B 2. VCCI Class B

Hard Disk Drive Interface

Item	Specification
Vendor & Model Name	Segate SATA ST9100824AS LF/ Toshiba MK1032GSX/ HGST NCQMORAGA+HTS 541010G9SA00
	Segate SATA ST9120821AS LF/ Toshiba SATA1.5G W/NCQ MK1234GSX
	Segate SATA ST9120821AS LF/ Toshiba SATA1.5G W/NCQ MK1234GSX

Hard Disk Drive Interface

Item	Specification		
Capacity (MB)	80000	100000	120000
Bytes per sector	1024/512	512	512
Data heads	3/4	4	4
Drive Format			
Disks	2	2	2
Spindle speed (RPM)	5400 RPM	5400 RPM	5400 RPM
Performance Specifications			
Buffer size	8192KB	8192KB	8192KB
Interface	Serial ATA	Serial ATA ATA7&SATA1.0&SAT All(for Toshiba)	Serial ATA
Max. media transfer rate (disk-buffer, Mbytes/s)	57.6/61.6	57.6/57.6/61.6	57.6
Data transfer rate (host~buffer, Mbytes/s)	150 MB/Sec. SATA 1.0	150 MB/Sec.	150 MB/Sec.
DC Power Requirements			
Voltage tolerance	5V(DC) +/- 5%	5V(DC) +/- 5%	5V(DC) +/- 5%

DVD-Dual Interface

Item	Specification	
Vendor & model name	PHILIPS SDVD8441	PIONEER DVR-K16RA
Performance Specification		
Transfer rate (KB/sec)	Sustained: Max 10.9Mbytes/sec	Sustained: Max 10.8Mbytes/sec
Access Time(DVD)	Random Access: 130 ms Full Stroke: 240 ms	Random Access: 150 ms Full Stroke: 300 ms
Buffer Memory	2MB	2MB
Interface	Compliant to ATA/ATAPI-5	ATAPI interface

DVD-Dual Interface

Item	Specification	
Applicable disc format	DVD(Read): DVD-ROM, DVD-Video, DVD-Audio, DVD-R, DVD-R 3.95GB, DVD-R Multi-Border, DVD-RW, DVD+R, DVD+R DL, DVD+R Multi-Session, DVD+RW CD(Read): CD-DA, CD-ROM Mode-1, CD-ROM/XA Mode-2 Form-1 and Mode-2 Form-2, CD-i, CD-i Bridge, Video-CD(MPEG-1), Karaoke CD, Photo-CD, Enhanced CD, CD Plus, CD Extra, i-trax CD, CD-Text, CD-R, and CD-RW DVD(Write): DVD Data&Video CD(Write): CD-DA, CD-ROM Mode-1, CD-ROM/XA Mode-2 Form-1 and Mode-2 Form-2, CD-i, Video-CD, CD-Text	DVD(Read): DVD-5/9/10/18, DVD-R 3.95G/4.7G, DVD-R DL, DVD-RW, DVD+R, DVD+R DL, DVD+RW, DVD+RW high speed, DVD-RAM v2.0/2.1 CD(Read): CD-DA, CD-ROM Mode-1, CD-ROM/XA Mode-2 Form-1 and Mode-2 Form-2, Photo CD, Video CD, CD-DA, CD-Extra, Mixed-CD, CD-Text, CD-R, CD-RW, HS CD-RW, US CD-RW, US+ CD-RW DVD(Write): DVD-R, DVD-RW, DVD+RW CD(Write): CD-DA, CD-i, Video-CD, CD-Text, Photo CD, CD-Extra, Mixed-CD, CD-R, CD-RW, HS CD-RW, US CD-RW, US+ CD-RW
Loading mechanism	Load: Manual	Drawer loading mechanism
Power Requirement		
Input Voltage	5 V +/- 5 % (Operating)	5 V +/- 5 % (Operating)

Combo Drive Interface

Item	Specification		
Vendor & model name	QSIPHILIPS SCB5265	PANASONIC UJDA-770	HLDS GCC-4244N
Performance Specification			
Transfer rate (KB/sec)(DVD)	Sustained: Max 11.2Mbytes/sec	Sustained: Max 10.8Mbytes/sec	Sustained: Max 11.8Mbytes/sec
Access Time	DVD: Random Access: 126 ms DVD:Full Stroke: 165 ms	DVD: Typical:180 ms	Average: CD-ROM110ms DVD-ROM 120ms
Buffer Memory	2MB	2MB	2MB
Interface	Compliant to ATA/ATAPI-5	ATAPI interface	ATAPI interface
Applicable disc format	DVD(Read): DVD 5/9/10/18, DVD-ROM, DVD-Video, DVD-R 3.95G/4.7G, DVD-RW, DVD+R, DVD+RW, Multi-Border DVD-R/ DVD-RW, Multi-Session DVD+R, DVD+RW and DVD-RAM CD(Read): CD-DA, CD-ROM Mode-1, CD-ROM/XA Mode-2 Form-1 and Mode-2 Form-2, CD-i Ready, Video-CD(MPEG-1), Karaoke CD, Super Video CD, Photo-CD, Enhanced CD, CD Plus, CD Extra, i-trax CD, CD-Text, CD-R, CD-RW CD(Write): CD-DA, CD-ROM Mode-1, CD-ROM/XA Mode-2 Form-1 and Mode-2 Form-2, CD-i, Video-CD, CD-Text	CD: CD-DA, CD-ROM, CD-R, CD-RW, CD-ROM XA, PhotoCD(MultiSession) DVD: DVD-ROM, DVD-Video, DVD-RAM(2.6GB/4.7GB), DVD-R, DVD-RW(Ver1.1), DVD+R, DVD+RW	1. Reads and writes data in each CD-ROM, CD-ROMXA, CD-I FMV, Video CD, and CD-EXTRA 2. Reads data in Photo CD(Single and Multi session) 3. Reads and writes standard CD-DA 4. Reads and writes CD-R 5. Reads and writes CD-RW 6. Reads data in DVD-ROM
Loading mechanism	Load: Manual	Load: Manual	Load: Manual
Power Requirement			
Input Voltage	5 V +/- 5 % (Operating)	5 V +/- 5 % (Operating)	5 V +/- 5 % (Operating)

Power Management

ACPI Mode	Power Management
Mech. Off (G3)	All devices in the system are turned off completely.
Soft Off (G2/S5)	OS initiated shutdown. All devices in the system are turned off completely.
Working (G0/S0)	Individual devices such as the CPU and hard disk may be power managed in this state.
Sleeping State (S3)	CPU Power Down VGA Power Down PCMCIA Suspend Audio Power Down Hard Disk Power Down Super I/O Power Down
Sleeping State (S4)	Also called Hibernate state. System saves all system states and data onto the disk prior to power off the whole system.

Dimensions and Weight

Item	Details	
	Model	Aspire 1690
Deminsions	364(W) x 274.75(D) with max. 28mm(H)	
Weight	<2950 g except TV SKU	

Environmental Requirements

Item	Specification
Temperature	
Operating	+5 ~ +35°C
Non-operating	-20 ~ +65°C (storage package)
Humidity	
Operating	20% ~ 80% without condensation
Altitude	Operating sea level 0 to 10,000ft
	Storage sea level 0 to 40,000ft

System Utilities

BIOS Setup Utility

The BIOS Setup Utility is a hardware configuration program built into your computer's BIOS (Basic Input/Output System).

Your computer is already properly configured and optimized, and you do not need to run this utility. However, if you encounter configuration problems, you may need to run Setup. Please also refer to Chapter 4 Troubleshooting when problem arises.

To activate the BIOS Utility, press **m** during POST (when "Press <F2> to enter Setup" message is prompted on the bottom of screen).

The setup screen displays BIOS as follows: Navigating the BIOS Utility

Function	Item
Information	Display the system informations
Main	Allows the user to specify standard IBM PC AT system parameters
Advanced	Provides advanced settings of the system
Security	Provides security settings of the system
Boot	Allows the user to specify the boot options
Exit	Allows the user to save CMOS setting and exit Setup

During setup, all Fn function keys and power saving functions are disabled.

There are five menu options: Main, Advanced, Security, Boot and Exit.

Follow these instructions:

- To choose a menu, use the cursor left/right keys (zx).
- To choose a parameter, use the cursor up/down keys (wy).
- To change the value of a parameter, press p or q.
- Press ^ while you are in any of the menu options to go to the Exit menu.
- In any menu, you can load default settings by pressing t. You can also press u to save any changes made and exit the BIOS Setup Utility.

NOTE: You can change the value of a parameter if it is enclosed in square brackets. Navigation keys for a particular menu are shown on the bottom of the screen. Help for parameters are found in the Item Specific Help part of the screen. Read this carefully when making changes to parameter values.

Information

PhoenixBIOS Setup Utility

Info.	Main	Advanced	Security	Boot	Exit
<p>CPU Type: Intel(R) Pentium(R) M processor 1.86GHz CPU Speed: 1866 MHz</p> <p>HDD Model Name: ST9100822A HDD Serial Number: 3LG0Y4FE HATAPI Device: Slimtype DVDRW S0SW-833S System BIOS Version: 3A02 VGA BIOS Version: ATi 009.010.002.023 KBC Version: 1A11 Serial Number: LXT123456705270008EF00 Asset Tag Number: Product Name: Aspire 5510 Manufacturer Name: Acer UUID: 003B4852C5630010A0EA00C09FAE9B34</p>					
F1 Help	↑↓ Select Item	F5/F6 Change Values	F9 Setup Defaults		
Esc Exit	←→ Select Menu	Enter Select	▶ Sub-Menu	F10 Save and Exit	

Parameter	Description
CPU Type	This item will show the CPU information of the system.
CPU Speed	This item will show the CPU clock speed.
HDD Model Name	This item will show the Model name of HDD installed on Primary IDE master. The hard disk model name is automatically detected by the system. If there is no hard disk present or unknown type, "None" should be shown on this field
HDD Serial Number	This item will show the Serial number of HDD installed on Primary IDE master. If no Hard disk or other devices are installed on Primary IDE master, then it will display a blank line
ATAPI Model Name	This item will show the model name of DVD/CD-ROM drive installed on system. The DVD/CD-ROM model name is automatically detected by the system. If there is no DVD/CD-ROM model present or unknown type, "None" should be shown on this field
System BIOS Version	This field reports the BIOS version of system
VGA BIOS Version	This field reports the VGA version of the system
KBC Version	This field reports the keyboard controller version of the system
Serial Number	This item will show the Serial number of system.
Asset Tag Number	This item will show the Asset Tag number of the system.

Parameter	Description
Product Name	This field will show product name.
Manufacturer Name	This field will show manufacturer name.
UUID	This will be visible only when there is an internal LAN device present.

Main

This menu provides you the information of the system.

PhoenixBIOS Setup Utility					
Info.	Main	Advanced	Security	Boot	Exit
System Time: [11:59:38] System Date: [07/27/2005] System Memory: 640 KB Extended Memory: 254 KB Video Memory: 128 MB Quiet Boot: [Enabled] Power on Display: [Auto] Network boot: [Enabled] F12 Boot Menu: [Disabled] D2D Recovery: [Enabled]					Item Specific Help <Tab>, <Shift-Tab>, or <Enter> selects field.
F1 Help	↑↓ Select Item	F5/F6 Change Values	F9 Setup Defaults		
Esc Exit	←→ Select Menu	Enter Select	▶ Sub-Menu	F10 Save and Exit	

Parameter	Description
System Time / System Date	The hours are displayed with 24 hours format. The values set in these two fields take effect immediately.
System Memory	This field reports the memory size of system base memory. The size is fixed to 640KB.
Extended Memory	This field reports the memory size of the extended memory in the system. Extended Memory size = Total memory size - 1 MB
Video Memory	VGA Memory size = 128MB
Quiet Boot	Customer Logo display will be shown during POST when it is selected.
Power on display	Auto: During power on process, the system will detect if any display device is connected on external video port. If any external display device is connected, the power on display will be in CRT (or projector) only mode. Otherwise it will be in LCD only mode. Both: Simultaneously enable both the integrated LCD screen and the system's external video port (for an external CRT or projector).
Network boot	When this is selected, Boot from LAN feature is enabled. When this is not selected, Boot from LAN feature is then disabled.

Parameter	Description
F12 Boot Menu	When this is selected, users can modify device boot priority by pressing F12 key during POST. When this is not selected, device boot priority will not be adjustable during POST.
D2D Recovery	Allow user to enable/disable the Disk-to-Disk recovery

Advanced

The Advanced screen contains parameters involving your hardware devices. It also provides advanced settings of the system.

PhoenixBIOS Setup Utility					
Info.	Main	Advanced	Security	Boot	Exit
Infrared Port:		[Auto]	Item Specific Help		
			Configure serial port B using options: [Disabled] No configuration [Enabled] User configuration [Auto] BIOS or OS chooses configuration (OS Controlled) Displayed when controlled by OS		
F1 Help	↑ ↓ Select Item	F5/F6 Change Values	F9 Setup Defaults		
Esc Exit	← → Select Menu	Enter Select ▶ Sub-Menu	F10 Save and Exit		

The table below describes the parameters in the screen. Settings in **boldface** are the default and suggested parameter settings.

	Description	Option
Infrared Port	Configure serial port B using options: [Disabled]: No configuration [Enabled]: User configuration [Auto]: BIOS or OS chooses configuration (OS Controlled) Displayedd when controlled by OS	Disabled Enabled Auto

Security

The Security screen contains parameters that help safeguard and protect your computer from unauthorized use.

PhoenixBIOS Setup Utility			
Info.	Main	Advanced	Security
Supervisor Password Is: Clear User Password Is: Clear HDD Password Is: Clear HDD Master ID: 19894480 Set Supervisor Password [Enter] Set User Password [Enter] Set HDD Password [Enter] Password on Boot: [Disabled]			Item Specific Help Supervisor Password controls accesses of the setup utility.
F1 Help	↑ ↓ Select Item	F5/F6 Change Values	F9 Setup Defaults
Esc Exit	← → Select Menu	Enter Select ▶ Sub-Menu	F10 Save and Exit

The table below describes the parameters in this screen. Settings in **boldface** are the default and suggested parameter settings.

Parameter	Description	Option
Supervisor Password Is	N/A	N/A
User Password Is	N/A	N/A
HDD Password Is	N/A	N/A
HDD Master ID	N/A	N/A
Set Supervisor Password	Press Enter to set the administrator password. When set, this password protects the BIOS Setup Utility from unauthorized access. [Set]: System password is set [Clear]: System password is not set	Length -- No more than 8 characters Characters -- 0-9, A-Z (not case sensitive)
Set User Password		

Parameter	Description	Option
Set HDD Password	When shown as [Locked], the hard drive password currently can not be changed or disabled. To change or disable it, turn off the system and enter Setup immediately after turning it back on. Press [Enter] to input change, or disable hard drive password.	Enter
Password on boot	Defines whether a password is required or not while the events defined in this group happened. The following sub-options are all requires the Supervisor password for changes and should be grayed out if the user password was used to enter setup. Allows the user to specify whether or not a password is required to boot.	Disabled Enabled

Set Supervisor/User Password

If password on boot is required, the password must be set otherwise it cannot be enabled.

The formats of the password are as follows:

Length No more than 8 characters

Characters 0-9,A-Z (not case sensitive)

While these fields are highlighted and press "Enter", a window similar to the following is shown:

Set SupervisorPassword		
Enter New Password	[]
Confirm New Password	[]

If there is an old password then setup will prompt with the following window instead and a current password will be required to be entered at first:

Set Supervisor Password		
Enter current password	[]
Enter New Password	[]
Confirm New Password	[]

User can now type password in field “Enter New Password”, and re-enter password in field “Confirm New Password” for verification.

If the verification is OK:

The password setting is complete after user presses enter.

Setup Notice
Changes have been saved.
[continue]

If the current password entered does not match the actual current password:

Setup Warning
Invalid password
Re-enter Password
[continue]

If the new password and confirm new password strings do not match:

Setup Warning
Password do not match
Re-enter Password

Boot

This menu allows the user to decide the order of boot devices to load the operating system. Bootable devices includes the distette drive in module bay, the onboard hard disk drive and the CD-ROM in module bay and onboard LAN device.

PhoenixBIOS Setup Utility									
Info.	Main	Advanced	Security	Boot	Exit				
+Hard Drive CD-ROM/DVD Drive Network Boot Floppy Devices				Item Specific Help + and - indicate device categories. Use <Enter> to expand/collapse. Boot order is top-down using only the top device in each category. Use <F6> and <F5> to move highlighted item up and down.					
F1	Help	↑↓	Select Item	F5/F6	Change Values	F9	Setup Defaults		
Esc	Exit	←→	Select Menu	Enter	Select	▶	Sub-Menu	F10	Save and Exit

Parameter	Description
+Hard Drive	+ and - indicate device categories. Use <Enter> to expand/collapse.
Floppy Devices	
CD-ROM/DVD Drive	Boot order is top-down using only the top device in each category.
Network Boot	Use <F6> and <F5> to move highlighted item up and down.

Exit

The Exit screen contains parameters that help safeguard and protect your computer from unauthorized use.

PhoenixBIOS Setup Utility					
Info.	Main	Advanced	Security	Boot	Exit
Exit Saving Changes Exit Discarding Changes Load Setup Defaults Discard Changes Save Changes					Item Specific Help Exit System Setup and save your changes to CMOS.
F1 Help	↑↓ Select Item	F5/F6 Change Values	F9 Setup Defaults		
Esc Exit	←→ Select Menu	Enter Select	▶ Sub-Menu	F10 Save and Exit	

The table below describes the parameters in this screen.

Parameter	Description
Exit Saving Changes	Exit System Setup and save your changes to CMOS
Exit Discarding Changes	Exit utility without saving Setup data to CMOS
Load Setup Default	Load default values for all SETUP items
Discard Changes	Load previous values from CMOS for all SETUP items
Save Changes	Save Setup Data to CMOS

Machine Disassembly and Replacement

This chapter contains step-by-step procedures on how to disassemble the notebook computer for maintenance and troubleshooting.

To disassemble the computer, you need the following tools:

- Wrist grounding strap and conductive mat for preventing electrostatic discharge
- Small Philips screw driver
- Philips screwdriver
- Plastic flat head screw driver
- Tweezers

NOTE: The screws for the different components vary in size. During the disassembly process, group the screws with the corresponding components to avoid mismatch when putting back the components. When you remove the stripe cover, please be careful not to scrape the cover.

General Information

Before You Begin

Before proceeding with the disassembly procedure, make sure that you do the following:

1. Turn off the power to the system and all peripherals.
2. Unplug the AC adapter and all power and signal cables from the system.
3. Remove the battery pack.

NOTE: There are several types of screws used to secure bottom case and upper case assembly. The screws vary in length. Please refer the picture below, group the same type of screws together during service disassembling. Please also remember the screw location for each screw type. If you fasten the screw to the wrong location, the screw may be too long to damage the main board.

Disassembly Procedure Flowchart

The flowchart on the succeeding page gives you a graphic representation on the entire disassembly sequence and instructs you on the components that need to be removed during servicing. For example, if you want to remove the main board, you must first remove the keyboard, then disassemble the inside assembly frame in that order.

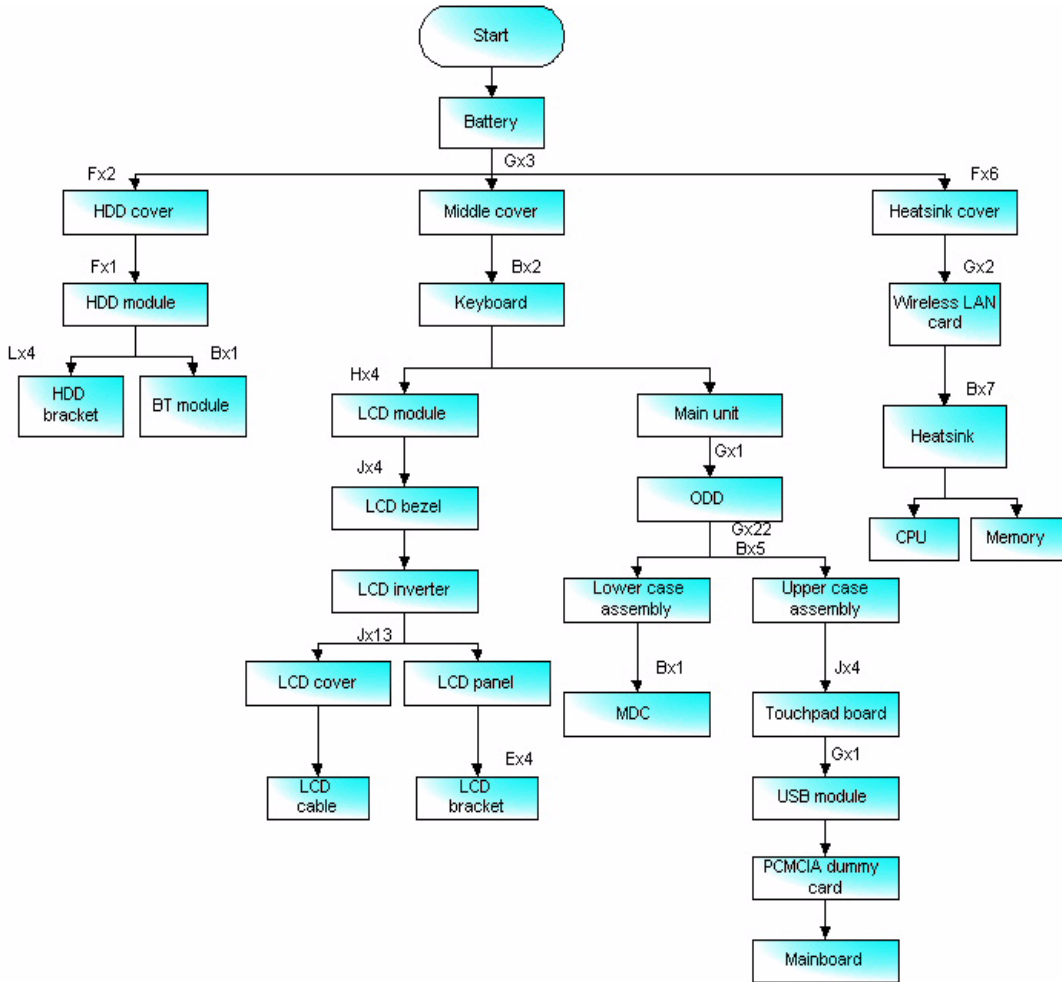

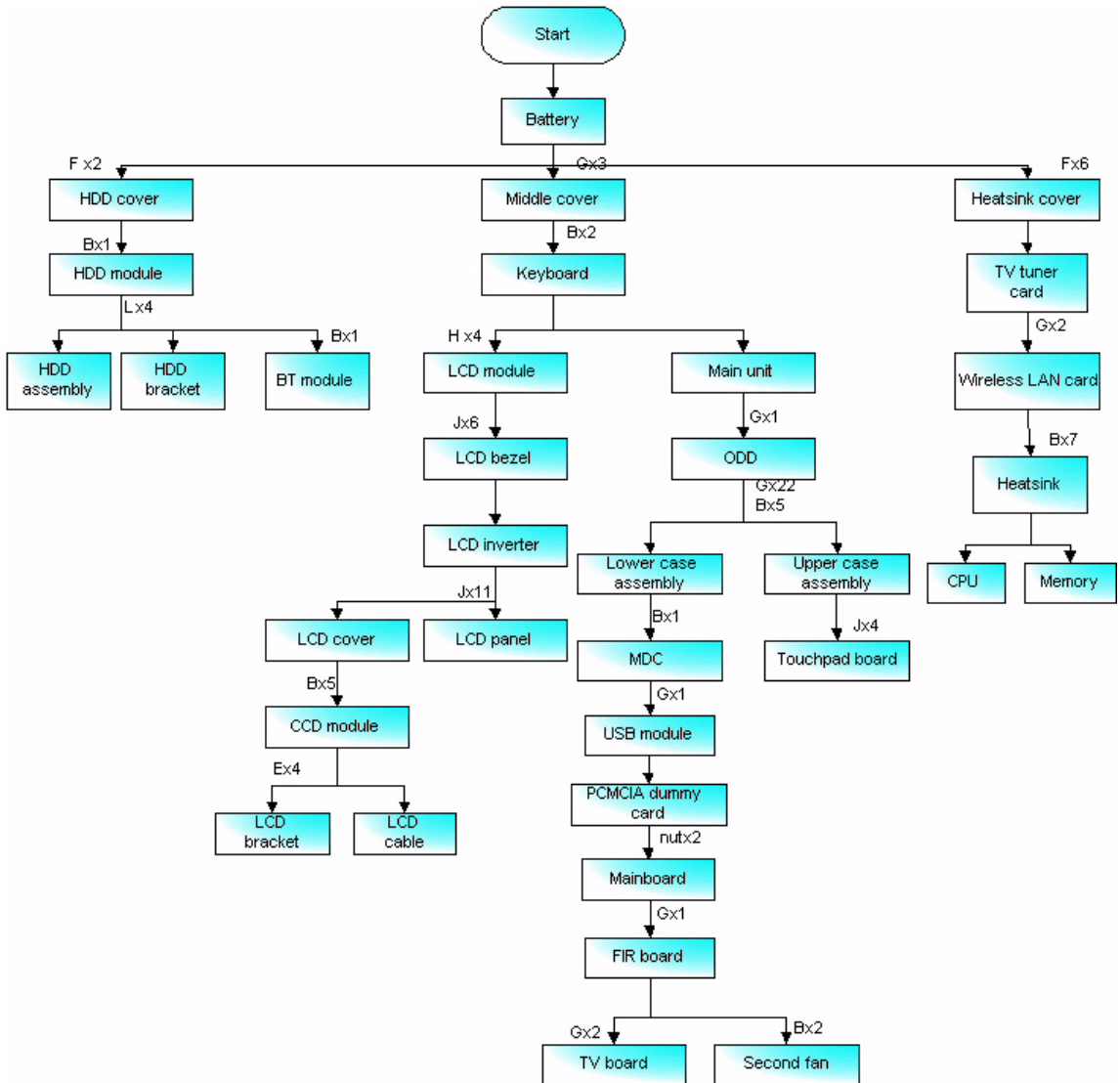

No	Partname	Part No
A	SCREW M2.5*3.5-I(NI)(NYLOK)	86.AAV7.001
B	SCWER M2.5*3.0I(BNI)(NYLOK)EP	86.T25V7.012
C	SCREW M2.0*5.0 I-(BNI)(NYLOK)	86.T23V7.015
D	SCREW M2.5-0.45*3.5-F(ANTI-LOOSE)	86.AA7V7.002
E	SCREW M2.0*3.0-I-NI-NYLOK	TBD
F	SCREW M2.5*4-I(BNI)	86.T23V7.019
G	SCREW M2.5*6-I(BNI)(NYLOK)	86.A08V7.004
H	SCREW M2.5*6.0-P(NI)(NYLOK)	86.AA7V7.003
I	SCREW M1.7*3.0-I(BK)	86.T50V7.001
J	SCREW M2.5*5.0-I(NI)(NYLOK)	86.T23V7.010
K	SCREW M2.0*5-I(NI)(NYLOK)	86.T23V7.006
L	SCREW M3*0.5+3.5I	TBD

Removing the Adapter and Battery Pack

1. Unplug the adapter.
2. Release the battery lock.
3. Slide the battery latch.
4. Remove the battery pack.



Removing the TV Tuner, Heatsink Module, CPU, and HDD Module

Remove the Heatsink Cover

1. Release the six screws securing the heatsink cover. (The six screws are attached to the heatsink cover)
2. Lift the heatsink cover up and remove it.



Remove the TV Tuner Card(for selected models)

1. Disconnect the TV tuner cable and antenna from the TV tuner card.
2. Press the left and right latch to release the TV tuner card.

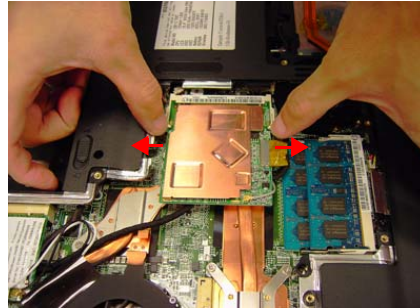
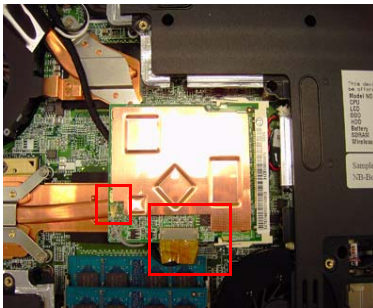

3. Disconnect the TV tuner cable and antenna from the TV board.

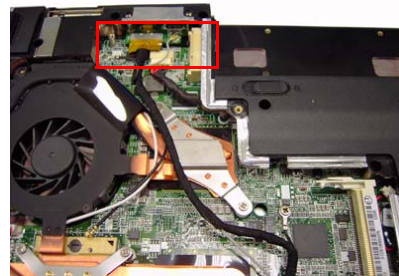

Remove the Heatsink Module

1. Disconnect the main fan cable from the mainboard.
2. Remove the seven screws securing the heatsink module.



3. Remove the heatsink module from the main unit.



Removing the HDD Module

1. Release the two screws securing the HDD cover. (One screw is attached to the HDD cover)
2. Remove the HDD cover.



3. Remove the screw securing the HDD.
4. Holding the mylar and pull the HDD module out of the main unit.



Removing the CPU

1. Use a flat screw driver and turn the screwdriver counterclockwise to unlock the CPU.
2. Remove the CPU from the mainboard.

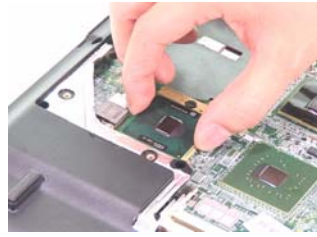
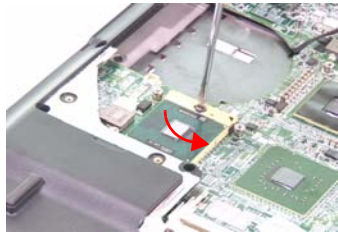

Removing the Memory and Wireless Card

Remove the Memory

1. Press the latch on left and right side to pop out the memory and remove it.
2. Remove the other memory.

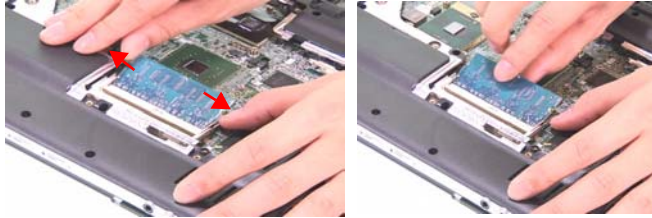

Removing the Wireless Card

1. Disconnect the wireless antenna from the wireless card.

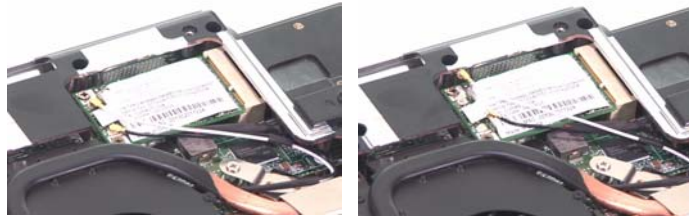

2. Remove the two screws securing the wireless card.
3. Remove the wireless card from the mainboard.



Removing the Bluetooth Module

1. Remove the screw securing the Bluetooth module.
2. Remove the Bluetooth connector from the mainboard.



3. Remove the Bluetooth cable from the Bluetooth wire groove.



4. Remove the Bluetooth module from the main unit.



5. Remove the two screws securing the Bluetooth bracket.
6. Remove the Bluetooth module from the Bluetooth bracket.
7. Disconnect the Bluetooth cable from the Bluetooth module.

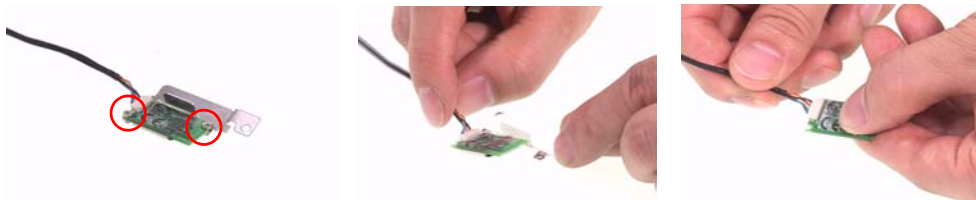

Disassembling the Main Unit into Upper Case and Lower Case

1. Disconnect the power cable from the mainboard.

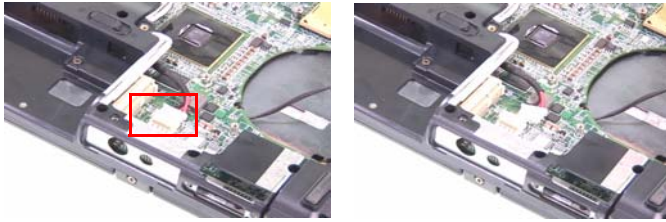

1. Remove the three screws securing the middle cover on the rear panel.
2. Open the notebook.



3. Release the clasp of middle cover and remove the middle cover from the main unit.



4. Remove the two screws securing the keyboard.
5. Turn the keyboard over.



6. Unlatch the keyboard FFC latch and remove the keyboard from the main unit.

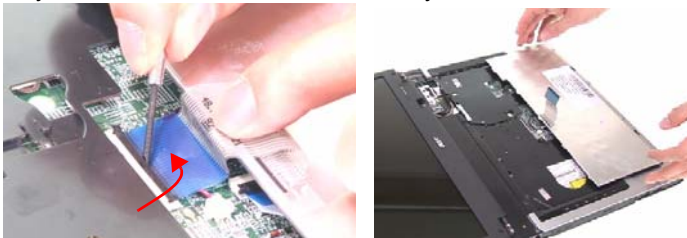

7. Disconnect the LCD cable from the mainboard as shown.

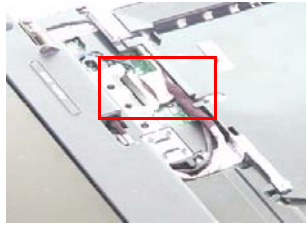

8. Remove the two screws on left and right hinges.
9. Remove the LCD module from the main unit and be careful to pull the antenna out.



10. Remove the screw securing the ODD module.
11. Push the ODD module out of the main unit.



12. Remove the five screws securing the upper case.
13. Remove the 22 screws securing the lower case.

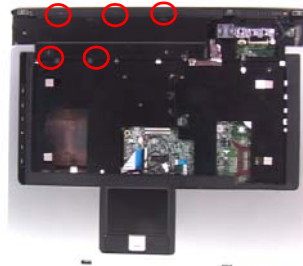

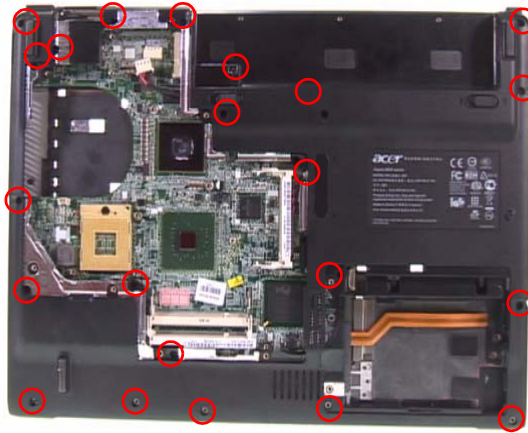

- 14. Disconnect the LID switch cable from the mainboard.
- 15. Disconnect the audio DJ cable from the mainboard. (Aspire series only)
- 16. Disconnect the MDC cables.

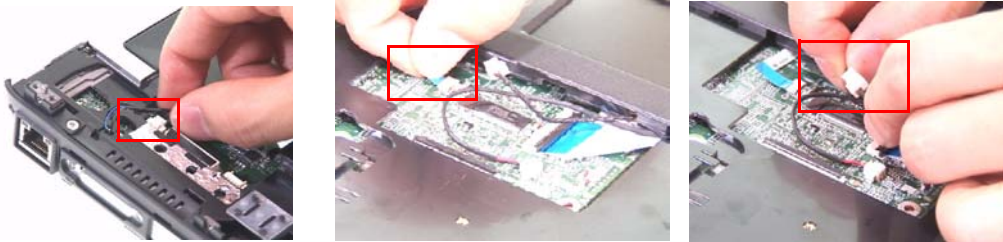

- 17. Disconnect the MIC wire cable from the mainboard.
- 18. Unlatch the touchpad board FFC and disconnect the touchpad board FFC from the mainboard.



- 19. Lift up the upper case to separate the upper and lower case.

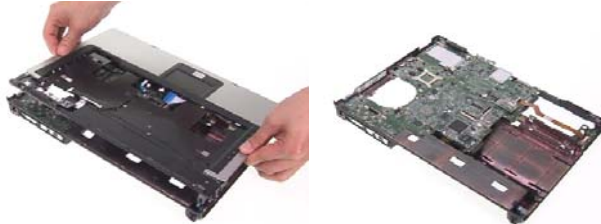

Remove the Touchpad Board

1. Remove the four screws securing the touchpad board and disconnect the touchpad FFC from touchpad board.

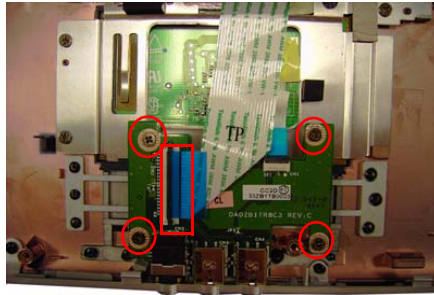

2. Remove the touchpad board from the upper case.

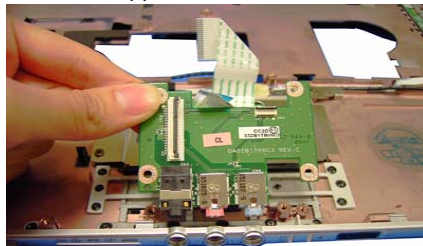

Remove the Second Fan(for selected model)

1. Disconnect the second fan cable from the mainboard.

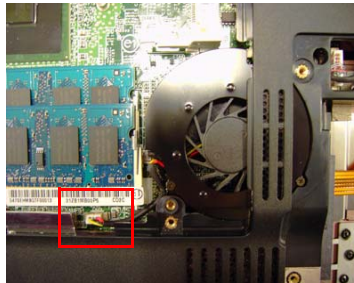

2. After removing the mainboard, remove the two screws securing the second fan.

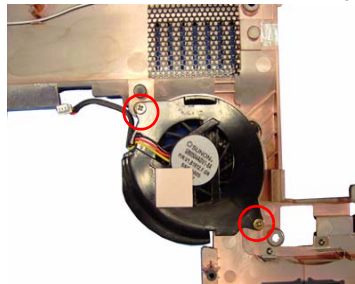

-
3. Remove the second fan from the lower case.

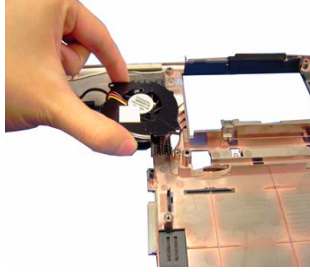

Remove the Mainboard

1. Disconnect the speaker cable from the mainboard.

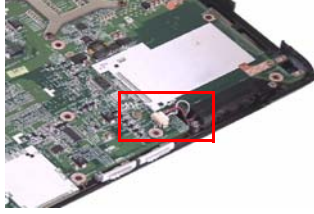

2. Remove the screw securing the MDC board.



3. Remove the MDC board from the mainboard.



4. Disconnect the MDC cable from the MDC board.

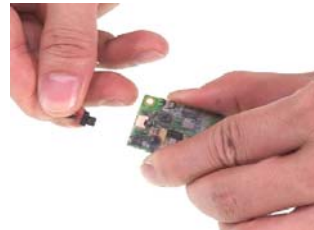

5. Unlatch the latch and disconnect the USB FFC from the mainboard.

6. Remove the screw securing the USB module.

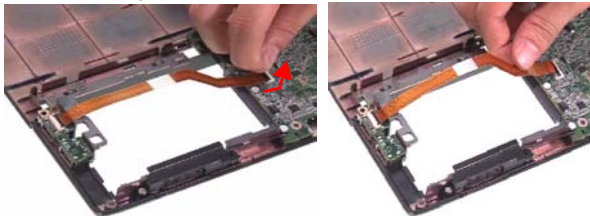

7. Remove the screw securing the USB module.

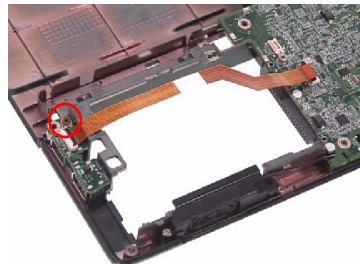

8. Remove the USB module from the lower case.



9. Unlatch the latch and disconnect the USB FFC from the USB module.



10. Remove the PCMCIA dummy card from the lower case.



11. Remove the mainboard from the lower case.



12. This completes the main unit disassembly.

NOTE: For models with CIR board and DVI-D port, please refer to following steps.

1. Use hex screw driver to release the two screw on the rear panel.



2. Release the screw securing the CIR board and remove the mainboard from the lower case.

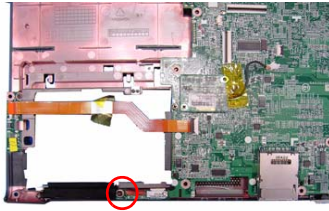

3. Disconnect the CIR cable from the CIR board to separate the CIR board and mainboard.

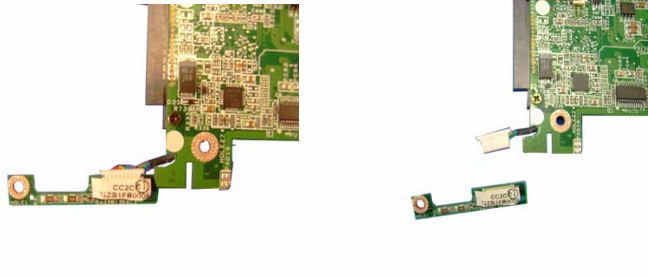

4. Remove the two screws securing the TV board.

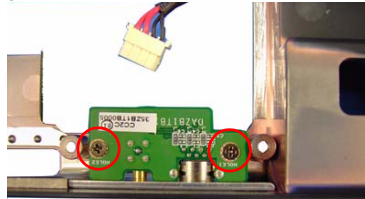

5. Remove the TV board from the lower case.

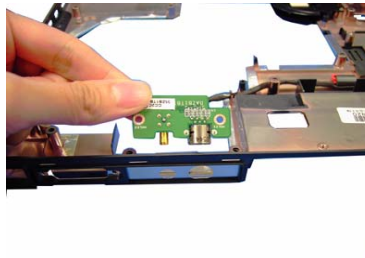

6. This completes the main unit disassembly.

Disassembling the LCD Module

1. Remove the four screw caps from the LCD module.
2. Remove the four screws securing the LCD bezel.

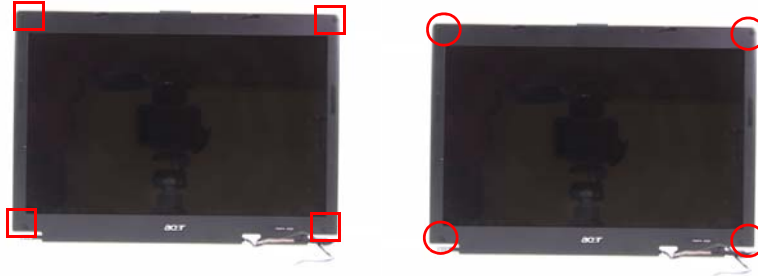

NOTE: For LCD module with CCD, please refer to following steps.

1. Remove the six screw caps for the LCD module.
2. Remove the six screws securing the LCD module.



3. Remove the LCD bezel.

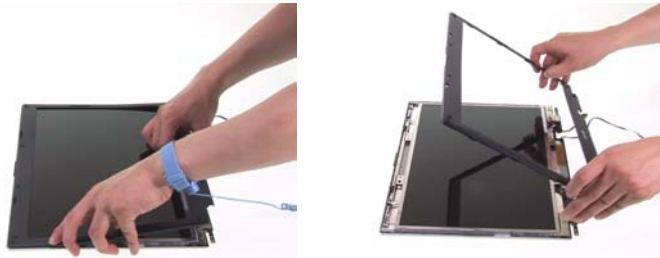

4. Remove the 13 screws securing the LCD panel.



5. For LCD with CCD, remove the 11 screws securing the LCD panel.

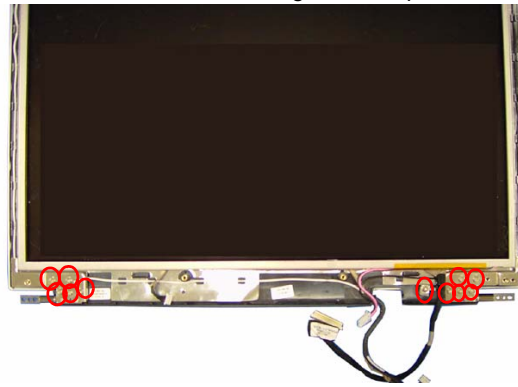

6. Lift up the inverter board.
7. Disconnect the inverter cables from the inverter board and remove the inverter board.

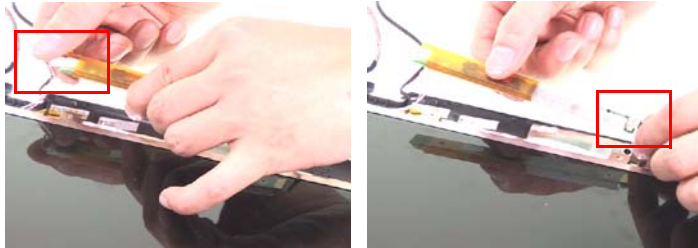

8. Remove the LCD panel from the LCD cover.

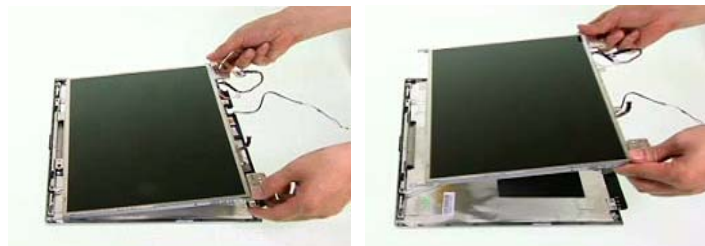

9. Remove the two screws securing the left LCD brackets.
10. Remove the left LCD bracket from the LCD panel.

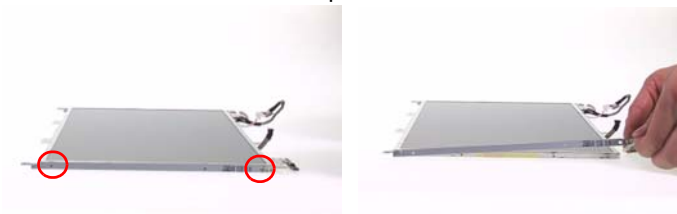

11. Remove the two screws securing the right LCD bracket.
12. Remove the right LCD bracket from the LCD panel.



13. Remove the tape on the LCD cable.

14. Disconnect the LCD cable and remove the LCD cable from the LCD panel.



15. This completes the LCD module disassembly.

Remove the CCD module

1. Remove the five screws securing the CCD brackets and remove the CCD brackets

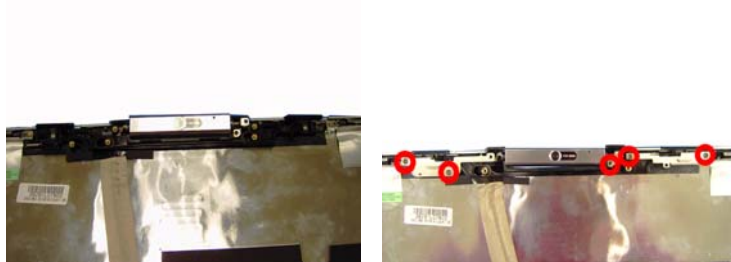

2. Lift the CCD plastic bracket up.



3. Remove the CCD module.

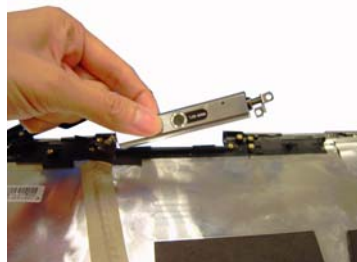

4. Be careful that the CCD cable is combined with the antenna.

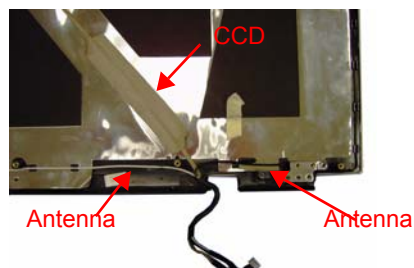

Reassembling the LCD Module

1. Connect the LCD cable to the LCD panel.
2. Place the tape on the LCD cable.

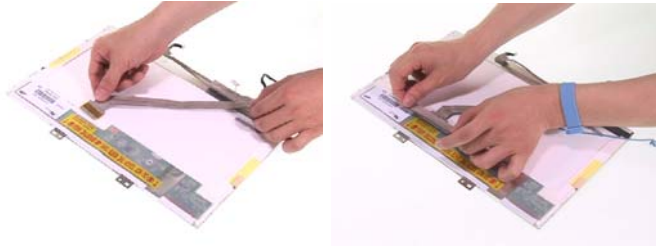

3. Place the right LCD bracket back to the LCD panel
4. Secure the right LCD bracket with the two screws.



5. Place the left LCD bracket back to the LCD panel
6. Secure the left LCD bracket with the two screws.

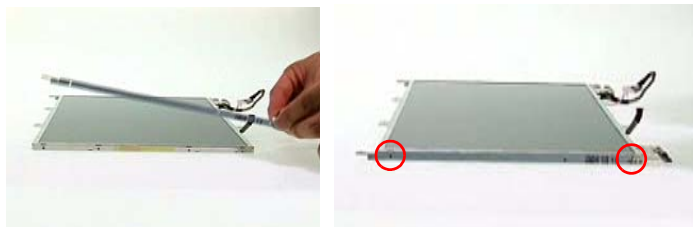

7. Place the LCD panel back to the LCD cover.
8. Place the inverter board back to the LCD module and connect the inverter cables to the inverter board.

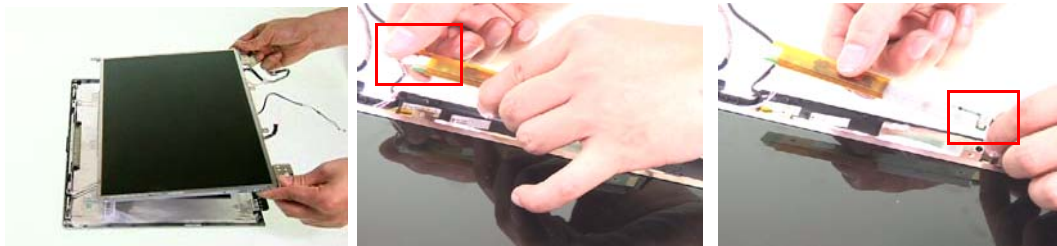

9. Secure the LCD panel with the 13 screws.



-
- 10.** Place the LCD bezel back to the LCD module. Push each side of the bezel to make it clip to the LCD cover well.

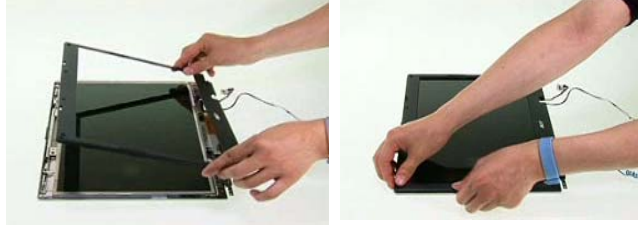

- 11.** Secure the LCD bezel with four screws.

- 12.** Place the four screw caps back.

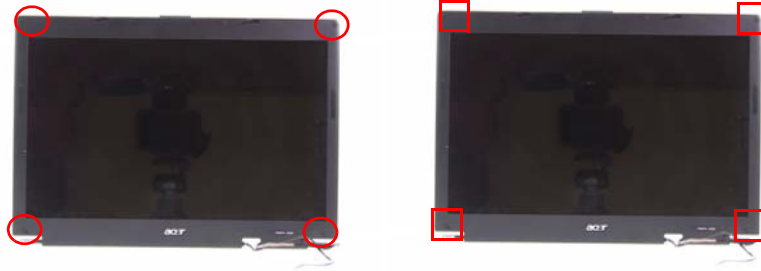

- 13.** This completes the LCD module reassembly.

HDD disassembly & Reassembly

1. Remove the four screws securing the HDD bracket.

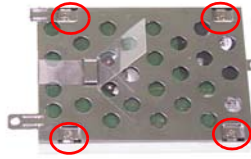

2. Remove the HDD bracket from the HDD.

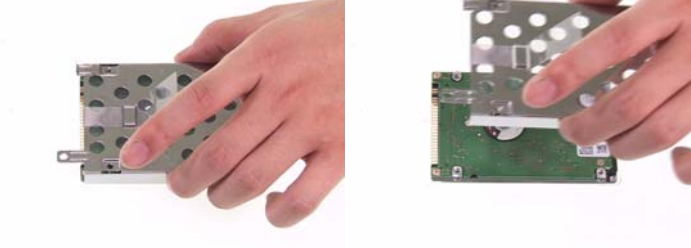

3. Place the HDD bracket back to the HDD.



4. Secure the HDD with the four screws.

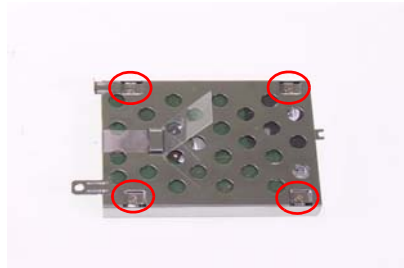

5. This completes HDD module disassembly and reassembly.

ODD disassembly & Reassembly

1. Remove the four screws securing the ODD module.



2. Remove the ODD bracket from the ODD.



3. Place the ODD bracket back to the ODD.



4. Secure the ODD with the four screw.



5. This completes ODD module disassembly and reassembly.

Main Unit Reassembly

Reassembling the Mainboard, Uppercase, and Lowercase

1. Place the mainboard back to the lower case.

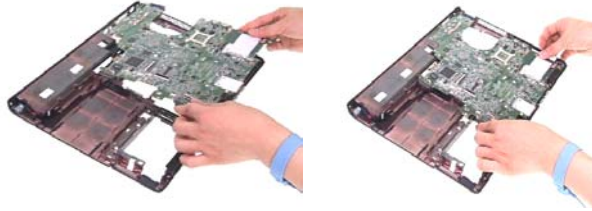

2. Insert the PCMCIA dummy card back to the lower case.



3. Connect the USB FFC to the USB module and latch it well.
4. Place the USB module back to the lower case.

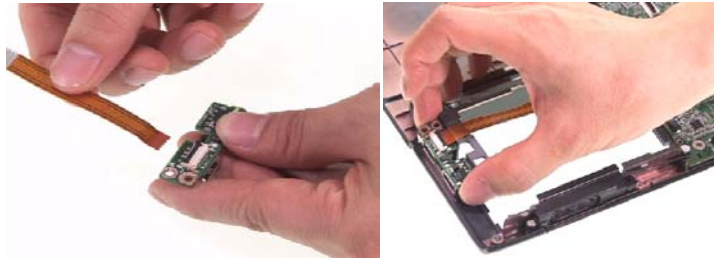

5. Secure the USB module with one screw.
6. Connect the USB FFC to the mainboard and latch it well.

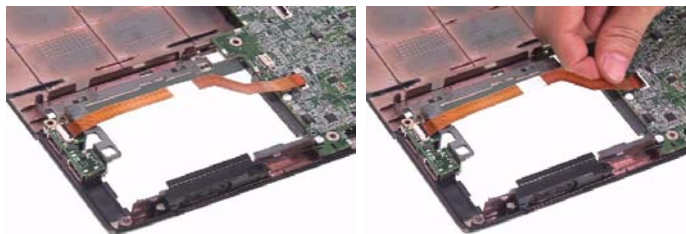

7. Connect the MDC cable to the MDC board.
8. Place the MDC board back to the mainboard.

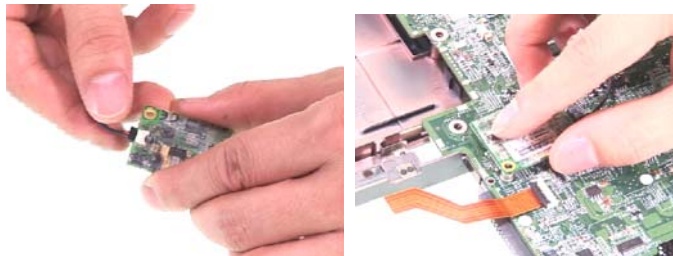

9. Secure the MDC board with one screw.

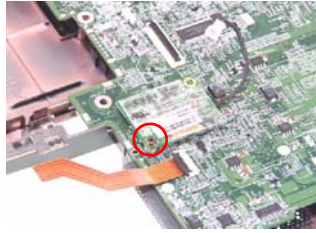

10. Connect the speaker cable to the mainboard.



11. Aim the location of Bluetooth and wireless launch button.

12. Place the upper case back to the lower case.

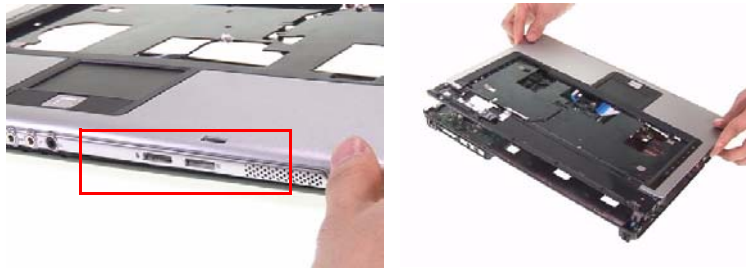

13. Connect the touchpad board FFC to the mainboard and latch it well.

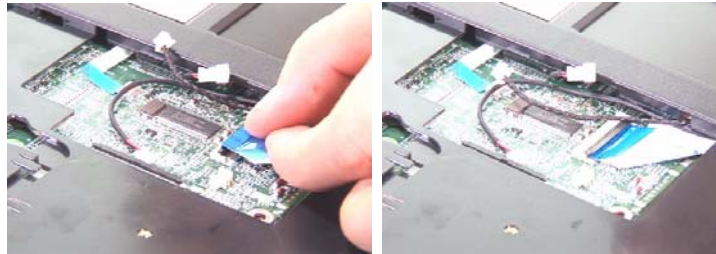

14. Connect the MIC wire cable to the mainboard.



15. Reconnect the MDC cables as shown.

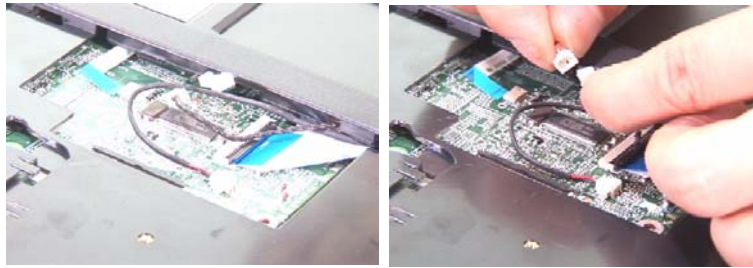

16. Connect the Audio DJ FFC to the mainboard.

17. Connect the LID switch cable back to the mainboard.



18. Secure the lower case with 22 screws.

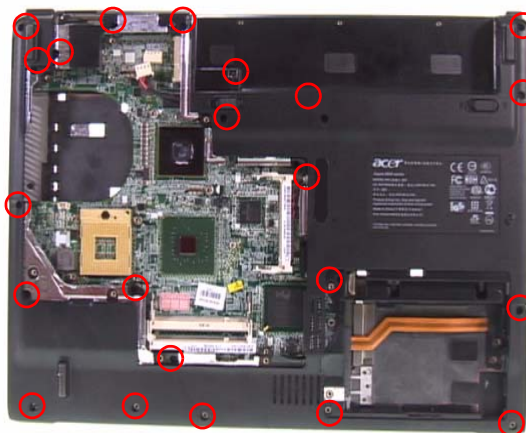

19. Secure the upper case with 5 screws.

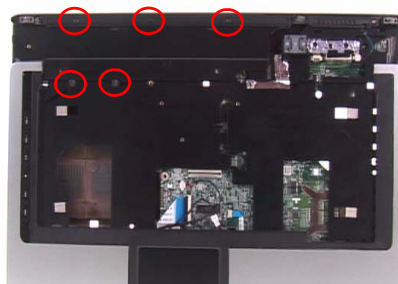

Reassembling the ODD

1. Place the ODD module back to the main unit.

2. Secure the ODD module with one screw.



Reassembling the LCD Module to Main Unit

1. Place the LCD module back to the main unit.
2. Put the antenna through the hole.

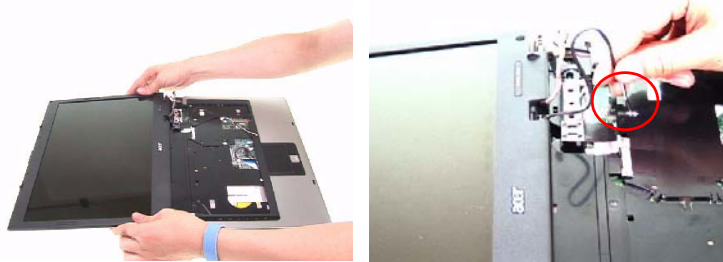

3. Secure the LCD module with two screws on left and right hinges.



4. Connect the LCD cable to the mainboard.

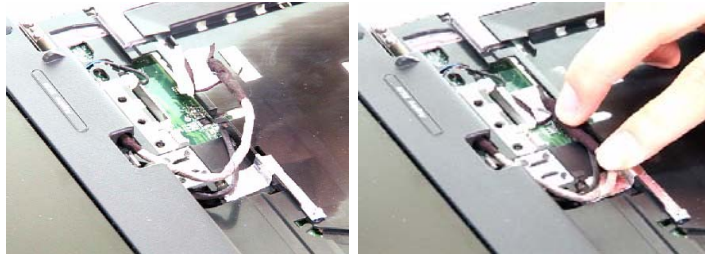

5. Place the keyboard back to the main unit.
6. Connect the keyboard FFC to the mainboard and latch it well.

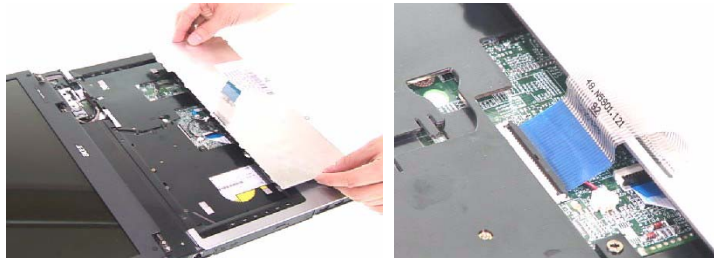

7. Turn the keyboard over.

- Secure the keyboard with two screws.



- Place the middle cover back to the main unit.
- Close the notebook.



- Secure the middle cover with three screws on the rear panel.



- Connect the power cable to the mainboard.

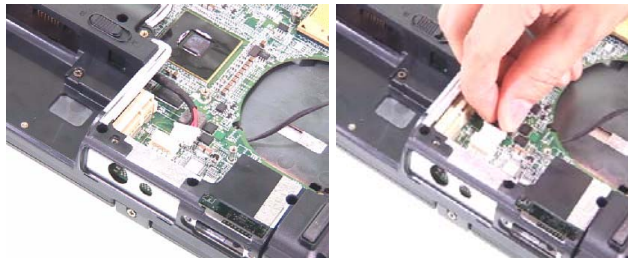

Reassembling the Bluetooth Module

- Connect the Bluetooth cable to the Bluetooth module.
- Place the Bluetooth module to the Bluetooth bracket.



- Secure the Bluetooth bracket with the two screws.

4. Place the Bluetooth module back to the main unit.

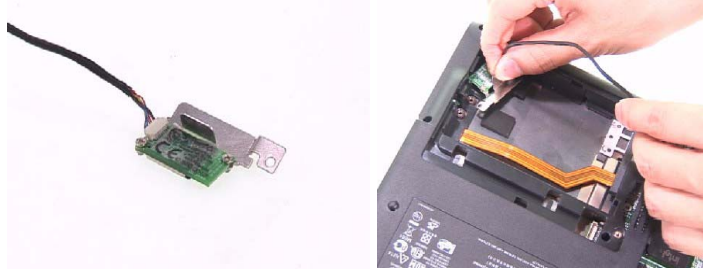

5. Secure the Bluetooth module with one screw.
6. Connect the Bluetooth cable to the mainboard.



7. Place the Bluetooth cable in the wire groove.



Reassembling the CPU

1. Aim the pin position on the CPU socket, then place the CPU back to the socket.
2. Use a flat screw driver and turn the screwdriver clockwise to lock the CPU.

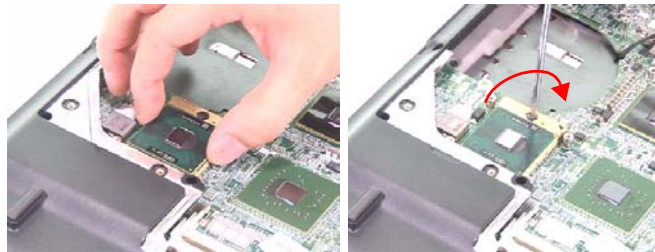

Reassembling the Memory

1. Place the DDR memory back to the mainboard as shown and press it down to latch it.

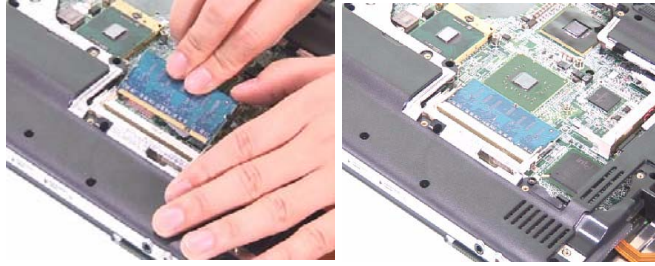

Reassembling the Heatsink module

1. Place the heatsink module back to the main unit.
2. Secure the heatsink module with the seven screws.

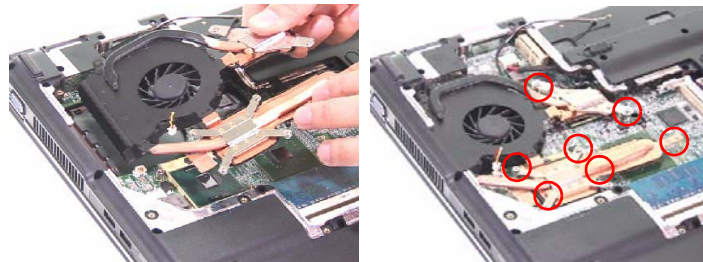

3. Connect the main fan cable to the mainboard.

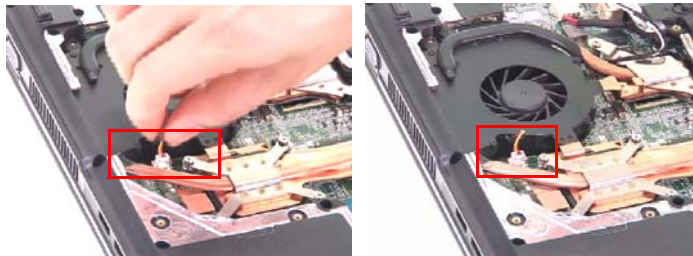

Reassembling the Wireless Card

1. Place the wireless card back to the mainboard as shown.
2. Secure the wireless card with two screws.

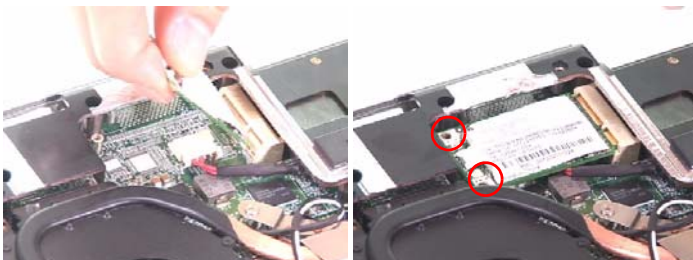

3. Connect the wireless antenna to the wireless card.

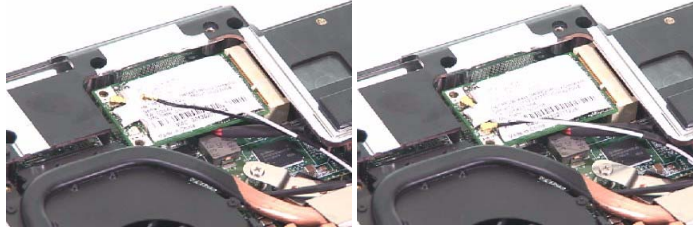

Reassembling the HDD

1. Place the HDD back to the main unit.
2. Secure the HDD with one screw.



3. Place the HDD cover back to the main unit.
4. Secure the HDD cover with the two screws.



Reassembling the heatsink cover & Battery

1. Aim the three hooks to the holes on the rear panel and place the heatsink cover back to the lower case.



2. Secure the heatsink cover with six screws.

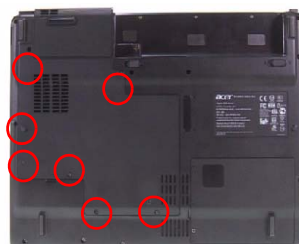

-
3. Place the battery back.



4. This completes the main unit reassembly.

Troubleshooting

Use the following procedure as a guide for computer problems.

NOTE: The diagnostic tests are intended to test this model. Non-Acer products, prototype cards, or modified options can give false errors and invalid system responses.

1. Duplicate symptom and obtain the failing symptoms in as much detail as possible.
2. Distinguish symptom. Verify the symptoms by attempting to re-create the failure by running the diagnostic test or by repeating the same operation.
3. Disassemble and assemble the unit without any power sources.
4. If any problem occurs, you can perform visual inspection before you follow this chapter's instructions. You can check the following:
 - power cords are properly connected and secured;
 - there are no obvious shorts or opens;
 - there are no obviously burned or heated components;
 - all components appear normal.
5. Use the following table with the verified symptom to determine which page to go to.

Symptoms (Verified)	Go To
Power failure. (The power indicator does not go on or stay on.)	"Power System Check" on page 95.
POST does not complete. No beep or error codes are indicated.	"Power-On Self-Test (POST) Error Message" on page 97 "Undetermined Problems" on page 109
POST detects an error and displayed messages on screen.	"Error Message List" on page 98
Other symptoms (i.e. LCD display problems or others).	"Power-On Self-Test (POST) Error Message" on page 97
Symptoms cannot be re-created (intermittent problems).	Use the customer-reported symptoms and go to "Power-On Self-Test (POST) Error Message" on page 97 "Intermittent Problems" on page 108 "Undetermined Problems" on page 109

System Check Procedures

External Diskette Drive Check

If an error occurs with the internal diskette drive, reconnect the diskette connector on the system board.

If the error still remains:

1. Reconnect the external diskette drive/DVD-ROM module.
2. Replace the external diskette drive/CD-ROM module.
3. Replace the main board.

External CD-ROM Drive Check

Do the following to isolate the problem to a controller, drive, or CD-ROM. Make sure that the CD-ROM does not have any label attached to it. The label can cause damage to the drive or can cause the drive to fail.

Do the following to select the test device:

1. Boot from the diagnostics diskette and start the diagnostics program.
2. See if CD-ROM Test is passed when the program runs to CD-ROM Test.
3. Follow the instructions in the message window.

If an error occurs, reconnect the connector on the System board. If the error still remains:

1. Reconnect the external diskette drive/CD-ROM module.
2. Replace the external diskette drive/CD-ROM module.
3. Replace the main board.

Keyboard or Auxiliary Input Device Check

Remove the external keyboard if the internal keyboard is to be tested.

If the internal keyboard does not work or an unexpected character appears, make sure that the flexible cable extending from the keyboard is correctly seated in the connector on the system board.

If the keyboard cable connection is correct, run the Keyboard Test.

If the tests detect a keyboard problem, do the following one at a time to correct the problem. Do not replace a non-defective FRU:

1. Reconnect the keyboard cables.
2. Replace the keyboard.
3. Replace the main board.

The following auxiliary input devices are supported by this computer:

- Numeric keypad
- External keyboard

If any of these devices do not work, reconnect the cable connector and repeat the failing operation.

Memory check

Memory errors might stop system operations, show error messages on the screen, or hang the system.

1. Boot from the diagnostics diskette and start the doagmpstotics program (please refer to main board).
2. Go to the diagnostic memory in the test items.
3. Press F2 in the test items.
4. Follow the instructions in the message window.

NOTE: Make sure that the DIMM is fully installed into the connector. A loose connection can cause an error.

Power System Check

To verify the symptom of the problem, power on the computer using each of the following power sources:

1. Remove the battery pack.
2. Connect the power adapter and check that power is supplied.
3. Disconnect the power adapter and install the charged battery pack; then check that power is supplied by the battery pack.

If you suspect a power problem, see the appropriate power supply check in the following list:

- “Check the Battery Pack” on page 96

Check the Battery Pack

To check the battery pack, do the following:

From Software:

1. Check out the Power Management in control Panel
2. In Power Meter, confirm that if the parameters shown in the screen for Current Power Source and Total Battery Power Remaining are correct.
3. Repeat the steps 1 and 2, for both battery and adapter.
4. This helps you identify first the problem is on recharging or discharging.

From Hardware:

1. Power off the computer.
2. Remove the battery pack and measure the voltage between battery terminals 1(+) and 6(ground). See the following figure
3. If the voltage is still less than 7.5 Vdc after recharging, replace the battery.

To check the battery charge operation, use a discharged battery pack or a battery pack that has less than 50% of the total power remaining when installed in the computer.

If the battery status indicator does not light up, remove the battery pack and let it return to room temperature. Re-install the battery pack.

If the charge indicator still does not light up, replace the battery pack. If the charge indicator still does not light up, replace the DC/DC charger board.

Touchpad check

If the touchpad doesn't work, do the following actions one at a time to correct the problem. Do not replace a non-defective FRU:

1. After rebooting, run Tracking Pad PS2 Mode Driver. For example, run Syn touch driver.
2. Run utility with the PS/2 mouse function and check if the mouse is working.
3. If the PS/2 mouse does not work, then check if the main board to switch board FPC is connected O.K.
4. If the main board to switch board FPC is connected well, then check if the FCC on touch pad PCB connects properly.
5. If the FFC on touch pad PCB connects properly, then check if LS851 JP1 Pin6=5V are pulse. If yes, then replace switch board. If no, then go to next step.
6. Replace touch pad PCB.
7. If the touch pad still does not work, then replace FPC on Track Pad PCB.

After you use the touchpad, the pointer drifts on the screen for a short time. This self-acting pointer movement can occur when a slight, steady pressure is applied to the touchpad pointer. This symptom is not a hardware problem. No service actions are necessary if the pointer movement stops in a short period of time.

Power-On Self-Test (POST) Error Message

The POST error message index lists the error message and their possible causes. The most likely cause is listed first.

NOTE: Perform the FRU replacement or actions in the sequence shown in FRU/Action column, if the FRU replacement does not solve the problem, put the original part back in the computer. Do not replace a non-defective FRU.

This index can also help you determine the next possible FRU to be replaced when servicing a computer.

If the symptom is not listed, see “Undetermined Problems” on page 109.

The following lists the error messages that the BIOS displays on the screen and the error symptoms classified by function.

NOTE: Most of the error messages occur during POST. Some of them display information about a hardware device, e.g., the amount of memory installed. Others may indicate a problem with a device, such as the way it has been configured.

NOTE: If the system fails after you make changes in the BIOS Setup Utility menus, reset the computer, enter Setup and install Setup defaults or correct the error.

Index of Error Messages

Error Message List

Error Messages	FRU/Action in Sequence
Struck Key	See "Keyboard or Auxiliary Input Device Check" on page 94
System CMOS checksum bad - Default configuration used	RTC battery Run BIOS Setup Utility to reconfigure system, then reboot system.
Real time clock error	RTC battery Run BIOS Setup Utility to reconfigure system time, then reboot system. Main board
Previous boot incomplete - Default configuration used	"Load Default Settings" in BIOS Setup Utility. RTC battery Main board
Invalid System Configuration Data	"Load Default Settings" in BIOS Setup Utility. Main board
Operating system not found	Enter Setup and see if fixed disk and drive A are properly identified. Dikette drive Hard disk drive Main board

Error Message List

No beep Error Messages	FRU/Action in Sequence
Power-on indicator turns off and LCD is blank.	Power source (battery pack and power adapter.) See "Power System Check" on page 95 Ensure every connector is connected tightly and correctly. Reconnect the DIMM. Main board.
Power-on indicator turns on and LCD is blank.	Power source (battery pack and power adapter.) See "Power System Check" on page 95 Reconnect the LCD connector Hard disk drive LCD cable LCD inverter LCD Main board
Power-on indicator turns on and LCD is blank. But you can see POST on an external CRT.	Reconnect the LCD connectors. LCD cable LCD inverter LCD Main board
Power-on indicator turns on and a blinking cursor shown on LCD during POST.	Ensure every connector is connected tightly and correctly. Main board

Phoenix BIOS Beep Codes

Code	Beeps	POST Routine Description
02h		Verify Real Mode
03h		Disable Non-Maskable Interrupt (NMI)
04h		Get CPU type
06h		Initialize system hardware
07h		Disable shadow and execute code from the ROM.
08h		Initialize chipset with initial POST values
09h		Set IN POST flag
0Ah		Initialize CPU registers
0Bh		Enable CPU cache
0Ch		Initialize caches to initial POST values
0Eh		Initialize I/O component
0Fh		Initialize the local bus IDE
10h		Initialize Power Management
11h		Load alternate registers with initial POST values
12h		Restore CPU control word during warm boot
13h		Initialize PCI Bus Mastering devices
14h		Initialize keyboard controller
16h	1-2-2-3	BIOS ROM checksum
17h		Initialize cache before memory autosize
18h		8254 timer initialization
1Ah		8237 DMA controller initialization
1Ch		Reset Programmable Interrupt Controller
20h	1-3-1-1	Test DRAM refresh
22h	1-3-1-3	Test 8742 Keyboard Controller
24h		Set ES segment register to 4 GB
28h		Autosize DRAM
29h		Initialize POST Memory Manager
2Ah		Clear 215 KB base RAM
2Ch	1-3-4-1	RAM failure on address line xxxx
2Eh	1-3-4-3	RAM failure on data bits xxxx of low byte of memory bus
2Fh		Enable cache before system BIOS shadow
32h		Test CPU bus-clock frequency
33h		Initialize Phoenix Dispatch Manager
36h		Warm start shut down
38h		Shadow system BIOS ROM
3Ah		Autosize cache
3Ch		Advanced configuration of chipset registers
3Dh		Load alternate registers with CMOS values
41h		Initialize extended memory for RomPilot.
42h		Initialize interrupt vectors
45h		POST device initialization
46h	2-1-2-3	Check ROM copyright notice

Code	Beeps	POST Routine Description
47h		Initialize I20 support
48h		Check video configuration against CMOS
49h		Initialize PCI bus and devices
4Ah		Initialize all video adapters in system
4Bh		QuietBoot start (optional)
4Ch		Shadow video BIOS ROM
4Eh		Display BIOS copyright notice
50h		Display CPU type and speed
51h		Initialize EISA board
52h		Test keyboard
54h		Set key click if enabled
55h		Enable USB devices
58h	2-2-3-1	Test for unexpected interrupts
59h		Initialize POST display service
5Ah		Display prompt "Press F2 to enter SETUP"
5Bh		Disable CPU cache
5Ch		Test RAM between 512 and 640 KB
60h		Test extended memory
62h		Test extended memory address lines
64h		Jump to User Patch1
66h		Configure advanced cache registers
67h		Initialize Multi Processor APIC
68h		Enable external and CPU caches
69h		Setup System Management Mode (SMM) area
6Ah		Display external L2 cache size
6Bh		Load custom defaults (optional)
6Ch		Display shadow-area message
6Eh		Display possible high address for UMB recovery
70h		Display error messages
72h		Check for configuration errors
76h		Check for keyboard errors
7Ch		Set up hardware interrupt vectors
7Eh		Initialize coprocessor if present
80h		Disable onboard Super I/O ports and IRQs
81h		Late POST device initialization
82h		Detect and install external RS232 ports
83h		Configure non-MCD IDE controllers
84h		Detect and install external parallel ports
85h		Initialize PC-compatible PnP ISA devices
86h		Re-initialize onboard I/O ports
87h		Configure Motherboard Configurable Devices (optional)
88h		Initialize BIOS Data Area
89h		Enable Non-Maskable Interrupts (NMI)
8Ah		Initialize Extended BIOS Data Area

Code	Beeps	POST Routine Description
8Bh		Test and initialize PS/2 mouse
8Ch		Initialize floppy controller
8Fh		Determine number of ATA drives (optional)
90h		Initialize hard-disk controllers
91h		Initialize local-bus hard-disk controllers
92h		Jump to UserPatch2
93h		Build MPTABLE for multi-processor boards
95h		Install CD ROM for boot
96h		Clear huge ES segment register
97h		Fixup Multi Processor table
98h	1-2	Search for option ROMs. One long, two short beeps on checksum failure.
99h		Check for SMART drive (optional)
9Ah		Shadow option ROMs
9Ch		Set up Power Management
9Dh		Initialize security engine (optional)
9Eh		Enable hardware interrupts
9Fh		Determine number of ATA and SCSI drives
A0h		Set time of day
A2h		Check key lock
A4h		Initialize Typematic rate
A8h		Erase F2 prompt
AAh		Scan for F2 key stroke
ACh		Enter SETUP
A Eh		Clear Boot flag
B0h		Check for errors
B1h		Inform RomPilot about the end of POST.
B2h		POST done- prepare to boot operating system
B4h	1	One short beep before boot
B5h		Terminate QuietBoot (optional)
B6h		Check password (optional)
B7h		Initialize ACPI BIOS
B9h		Prepare Boot
BAh		Initialize SMBIOS
BBh		Initialize PnP Option ROMs
BCh		Clear parity checkers
BDh		Display MultiBoot menu
BEh		Clear screen (optional)
BFh		Check virus and backup reminders
C0h		Try to boot with INT 19
C1h		Initialize POST Error Manager (PEM)
C2h		Initialize error logging
C3h		Initialize error display function
C4h		Initialize system error handler
C5h		PnPnd dual CMOS (optional)
C6h		Initialize notebook docking (optional)

Code	Beeps	POST Routine Description
C7h		Initialize notebook docking late
C8h		Force check (optional)
C9h		Extended checksum (optional)
CAh		Redirect Int 15h to enable remote keyboard
CBh		Redirect Int 13h to Memory Technologies Devices such as ROM, RAM, PCMCIA, and serial disk.
CCh		Redirect Int 10h to enable remote serial video
CDh		Re-map I/O and memory for PCMCIA
CEh		Initialize digitizer and display message.
D2h		Unknown interrupt
The following are for boot block in Flash ROM		
E0h		Initialize the chipset
E1h		Initialize the bridge
E2h		Initialize the CPU
E3h		Initialize the system timer
E4h		Initialize system I/O
E5h		Check force recovery boot
E6h		Checksum BIOS ROM
E7h		Go to BIOS
E8h		Set Huge Segment
E9h		Initialize Multi Processor
EAh		Initialize OEM special code
EBh		Initialize PIC and DMA
ECh		Initialize Memory type
EDh		Initialize Memory size
EEh		Shadow Boot Block
EFh		System memory test
F0h		Initialize interrupt vectors
F1h		Initialize Run Time Clock
F2h		Initialize video
F3h		Initialize System Management Mode
F4h	1	Output one beep
F5h		Clear Huge Segment
F6h		Boot to Mini DOS
F7h		Boot to Full DOS

Index of Symptom-to-FRU Error Message

LCD-Related Symptoms

Symptom / Error	Action in Sequence
LCD backlight doesn't work	First, plug a monitor to CRT port. Next, enter BIOS utility to running "Load Default Settings" then reboot the system. Reconnect the LCD connectors. Keyboard (if the brightness function key doesn't work). LCD cable LCD inverter LCD Main board
LCD is too dark LCD brightness cannot be adjusted	Enter BIOS Utility to execute "Load Setup Default Settings", then reboot system. Reconnect the LCD connectors. Keyboard (if the brightness function key doesn't work). LCD cable LCD inverter LCD Main board
Unreadable LCD screen Missing pels in characters Abnormal screen Wrong color displayed LCD has extra horizontal or vertical lines displayed.	Reconnect the LCD cable LCD cable LCD Main board

Indicator-Related Symptoms

Symptom / Error	Action in Sequence
Indicator incorrectly remains off or on, but system runs correctly	Main board
HDD/CD-ROM active indicators cannot work	HDD/CD-ROM drive Device driver Main board

Power-Related Symptoms

Symptom / Error	Action in Sequence
Power shuts down during operation	Power source (battery pack and power adapter). See "Power System Check" on page 95. Battery pack AC adapter See if the thermal module is overheat (Heat sink or fan). Main board
The system cannot power-on.	Power source (battery pack and power adapter). See "Power System Check" on page 95. Battery pack Power adapter CPU Main board
The system cannot power-off.	In Windows XP operating system, hold and press the power switch for more than 4 seconds. If the system can power off, then the main board is OK. Verify OS in the HDD. Main board

Power-Related Symptoms

Symptom / Error	Action in Sequence
Battery can't be charged or discharged	See "Check the Battery Pack" on page 96. Battery pack Main board
System hang during POST	ODD/HDD/FDD/RAM module Main board

PCMCIA-Related Symptoms

Symptom / Error	Action in Sequence
System cannot detect the PC Card (PCMCIA)	PCMCIA slot assembly Main board
PCMCIA slot pin is damaged.	PCMCIA slot assembly
PC Card cannot be inserted or ejected	Check if the PCMCIA slot is blocked Main board

Memory-Related Symptoms

Symptom / Error	Action in Sequence
Memory count (size) appears different from actual size.	Enter BIOS Setup Utility to execute "Load Default Settings" then reboot system. RAM module Main board Check BIOS revision
System can power on, but you hear two long beeps: "B--, B--" and the LCD is blank.	Reinsert DIMM DIMM Main board

Speaker-Related Symptoms

Symptom / Error	Action in Sequence
In Windows, multimedia programs, no sound comes from the computer.	OS volume control Audio driver Speaker Main board
Internal speakers make noise or emit no sound.	Speaker Main board
Microphone cannot work	Audio driver Volume control in Windows XP Main board

Power Management-Related Symptoms

Symptom / Error	Action in Sequence
The system will not enter hibernation mode	Power option in Windows XP Hard disk drive Main board
The system doesn't enter standby mode after closing the lid of the portable computer.	Driver of Power Option Properties Lid close switch in upper case Main board

Power Management-Related Symptoms

Symptom / Error	Action in Sequence
The system doesn't resume from hibernation/standby mode.	Connect AC adapter then check if the system resumes from Standby/Hibernation mode. Check if the battery is low. Hard disk drive Main board
The system doesn't resume from standby mode after opening the lid of the portable computer.	LCD cover switch Main board
Battery fuel gauge in Windows doesn't go higher than 90%.	Refresh battery (continue use battery until power off, then charge battery). Battery pack Main board
System hangs intermittently.	Reconnect hard disk/CD-ROM drives. Main board

Peripheral-Related Symptoms

Symptom / Error	Action in Sequence
System configuration does not match the installed devices.	Enter BIOS Setup Utility to execute "Load Setup defaults", then reboot system. Reconnect hard disk/CD-ROM drives/FDD or other peripherals. Main board
External display does not work correctly.	Press Fn+F5, LCD/CRT/Both display switching Keyboard Main board
USB does not work correctly	Main board
Print problems.	Enter BIOS Setup Utility to execute "Load Default Settings" then reboot the system. Run printer self-test. Printer driver Printer cable Printer Main board
Parallel port device problems	Enter BIOS Setup Utility to execute "Load Default Settings" then reboot the system. Device driver Device cable Device Main board

Keyboard/Touchpad-Related Symptoms

Symptom / Error	Action in Sequence
Keyboard (one or more keys) does not work.	Reconnect the keyboard cable. Keyboard Main board
Touchpad does not work.	Reconnect touchpad cable. Touchpad board Main board

Modem/LAN-Related Symptoms

Symptom / Error	Action in Sequence
Internal modem does not work correctly.	Phone cable Driver Reconnect the Internal modem cable to the main board tightly. Main board
Internal LAN does not work correctly	Lan cable Driver Main board

NOTE: If you cannot find a symptom or an error in this list and the problem remains, see “Undetermined Problems” on page 109.

Intermittent Problems

Intermittent system hang problems can be caused by a variety of reasons that have nothing to do with a hardware defect, such as: cosmic radiation, electrostatic discharge, or software errors. FRU replacement should be considered only when a recurring problem exists.

When analyzing an intermittent problem, do the following:

1. Run the diagnostic test for the system board in loop mode at least 10 times.
2. If no error is detected, do not replace any FRU.
3. If any error is detected, replace the FRU. Rerun the test to verify that there are no more errors.

Undetermined Problems

The diagnostic problems does not identify which adapter or device failed, which installed devices are incorrect, whether a short circuit is suspected, or whether the system is inoperative.

Follow these procedures to isolate the failing FRU (do not isolate non-defective FRU).

NOTE: Verify that all attached devices are supported by the computer.

NOTE: Verify that the power supply being used at the time of the failure is operating correctly. (See “Power System Check” on page 95):

1. Power-off the computer.
2. Visually check them for damage. If any problems are found, replace the FRU.
3. Remove or disconnect all of the following devices:
 - Non-Acer devices
 - Printer, mouse, and other external devices
 - Battery pack
 - Hard disk drive
 - DIMM
 - PC Cards
4. Power-on the computer.
5. Determine if the problem has changed.
6. If the problem does not recur, reconnect the removed devices one at a time until you find the failing FRU.
7. If the problem remains, replace the following FRU one at a time. Do not replace a non-defective FRU:
 - System board
 - LCD assembly

Jumper and Connector Locations

Top View

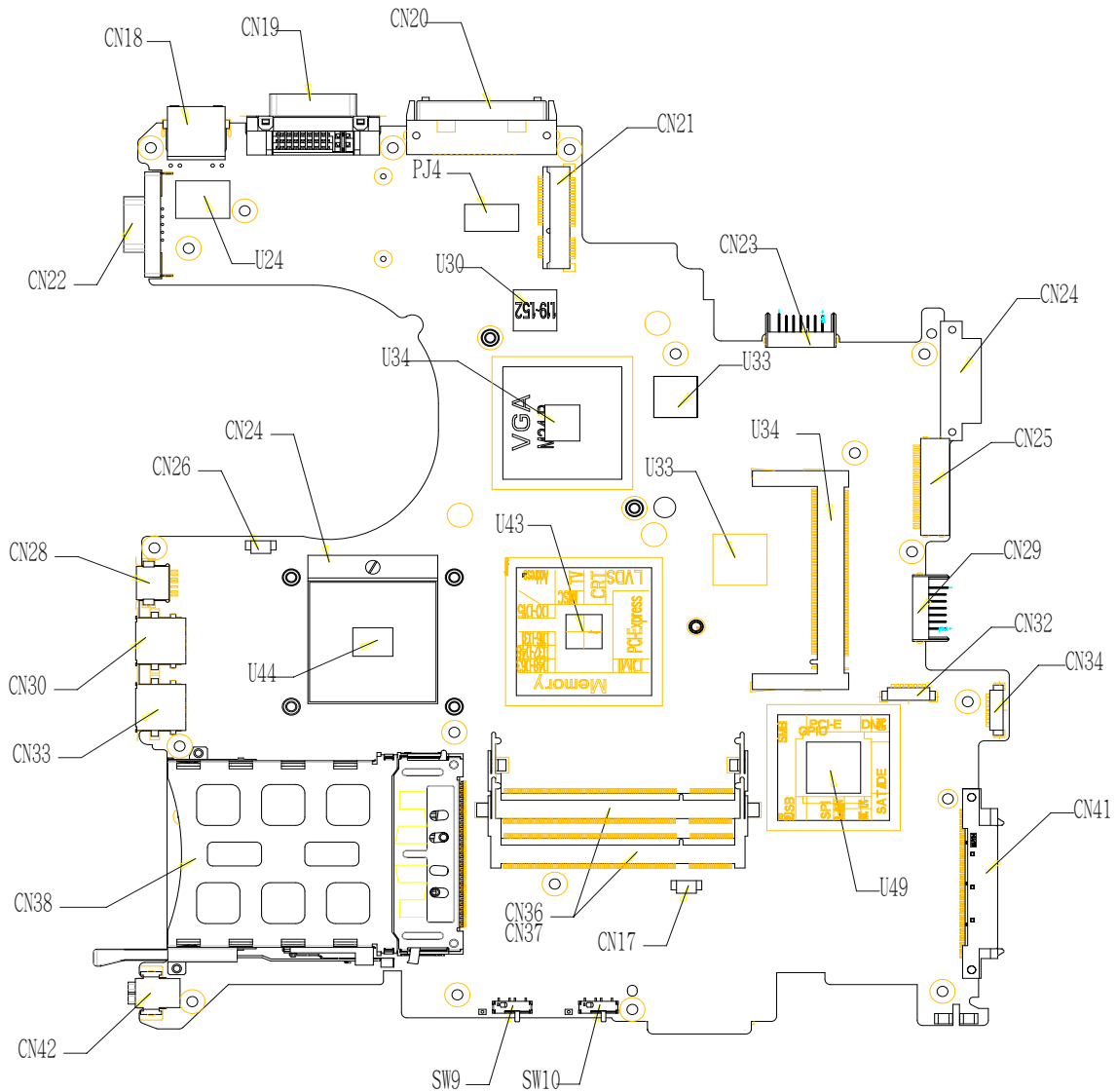

Item	Description	Item	Description
CN18	RJ45 connector	CN19	DVI connector
CN20	Docking connector	PJ4	DC wire connector

Item	Description	Item	Description
CN21	Mini card connector	CN23	Main battery connector
CN24	ODD fix connector	CN25	ODD media connector
CN29	Sub-battery/HDD connector	CN27	Mini PCI connector
CN32	CIR wire connector	CN34	Bluetooth wire connector
CN41	PATA HDD connector	CN41	SATA HDD connector
CN36	DDR connector	CN37	DDR connector
CN39	2nd fan connector	CN42	Mini 1394 connector
CN38	PCMCIA connector	CN33	USB connector
CN30	USB connector	CN28	S-Video connector
CN26	Main fan connector	CN24	CPU socket
CN22	CRT connector	U44	CPU
U34	VGA	U30	VGA RAM
U33	VGA RAM	U34	LAN chip
U49	South bridge	U43	North bridge
U24	LAN transformer	SW9	Wireless switch connector
SW10	Bluetooth switch connector		

Bottom View

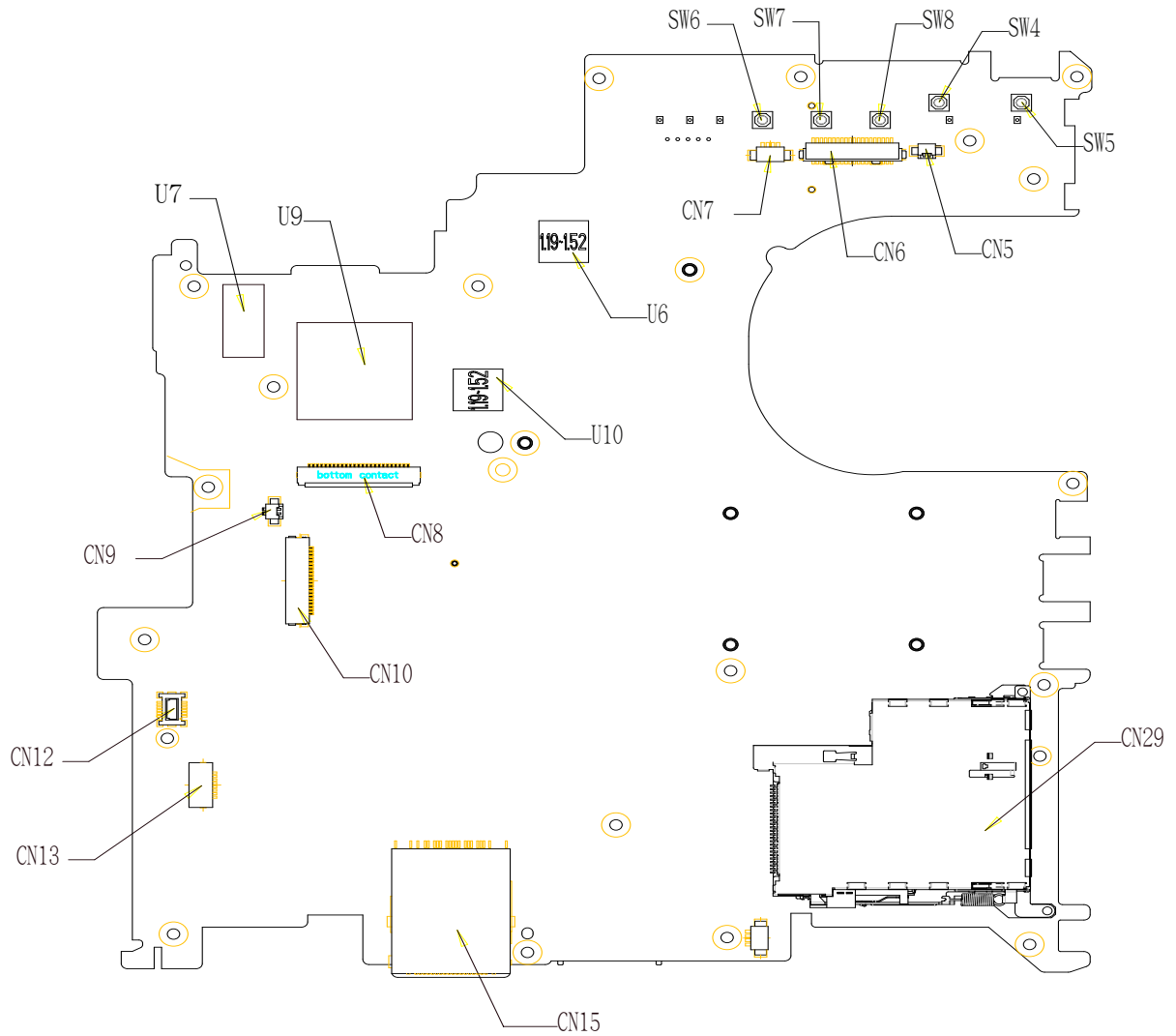

Item	Description	Item	Description
CN5	LID wire connector	CN6	LCD wire connector
CN7	CCD wire connector	CN29	Express card connector
CN15	3 in 1 connector	CN13	USB FFC connector
CN12	MDC connector	CN10	Touchpad board FFC connector
CN9	MIC wire connector	CN8	Keyboard connector
U6	VGA RAM	U10	VGA RAM
U9	EC	U7	BIOS ROM
SW6	Quick switch	SW7	Quick switch
SW8	IE switch	SW4	E-mail switch
SW5	Power switch		

FRU (Field Replaceable Unit) List

This chapter gives you the FRU (Field Replaceable Unit) listing in global configurations of Aspire 5670

Refer to this chapter whenever ordering for parts to repair or for RMA (Return Merchandise Authorization).

Please also note that there are some common parts for Aspire 5620, TravelMate 4210/4270/4670

Please note that WHEN ORDERING FRU PARTS, you should check the most up-to-date information available on your regional web or channel. For whatever reasons a part number change is made, it will not be noted on the printed Service Guide. For ACER AUTHORIZED SERVICE PROVIDERS, your Acer office may have a DIFFERENT part number code from those given in the FRU list of this printed Service Guide. You MUST use the local FRU list provided by your regional Acer office to order FRU parts for repair and service of customer machines.

NOTE: To scrap or to return the defective parts, you should follow the local government ordinance or regulations on how to dispose it properly, or follow the rules set by your regional Acer office on how to return it.

NOTE: Please visit website <http://aicsl.acer.com.tw/spl/> for the up to date SPL

Exploded Diagram

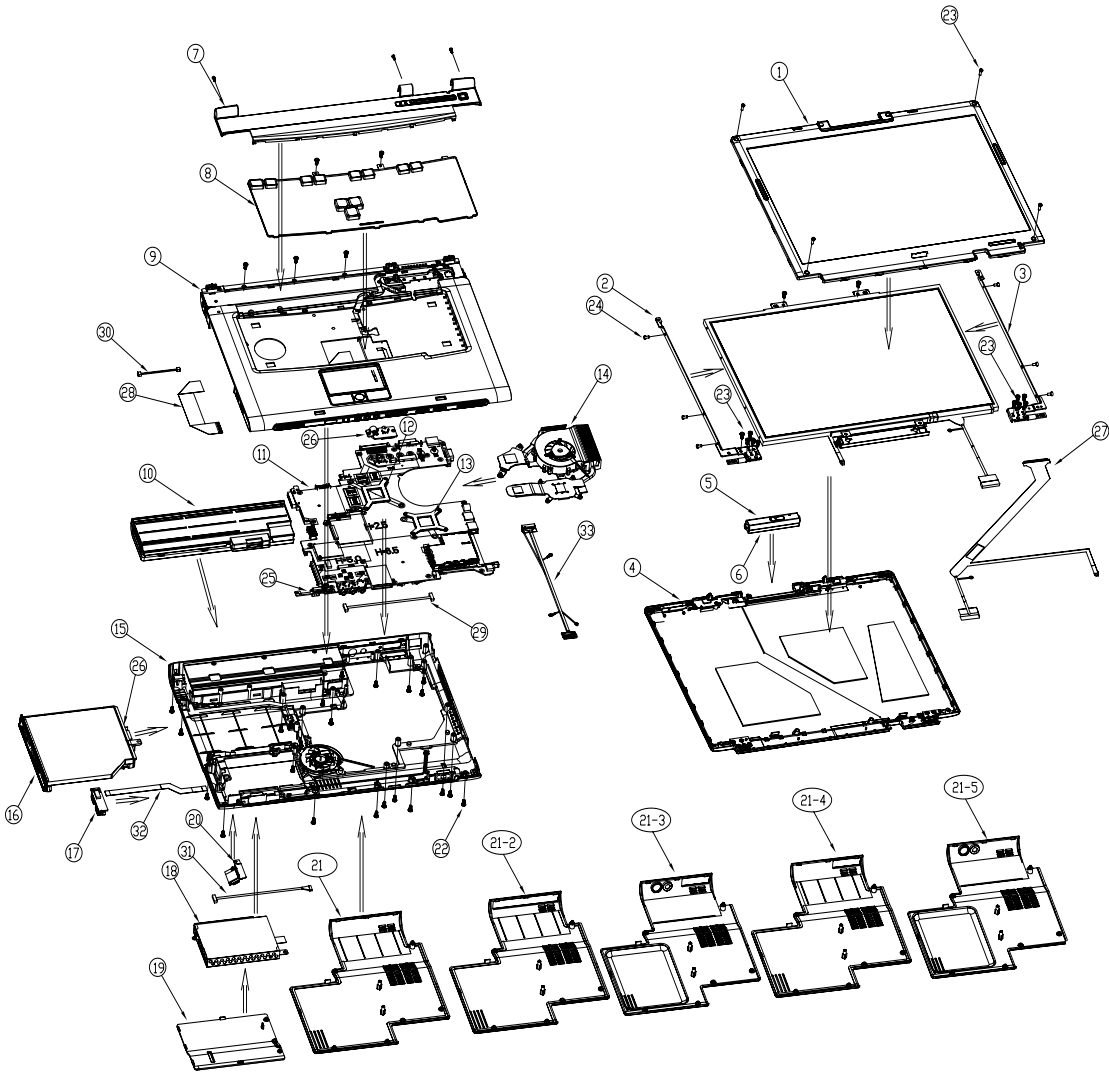

Item	Description	Item	Description
1	LCD bezel	21-4	Heatsink cover w/ DVI
2	LCD hinge-left	21-5	Heatsink cover w/ TV
3	LCD hinge-right	22	Screw M2.5*6-I(BNI)(NYLOK)
4	LCD cover	23	Screw M2.5*5.0-I(NI)(NYLOK)
5	CCD module	24	Screw M2.0*3.0-I-NI-NYLOK
6	CCD cover	25	FIR/CIR PCB
7	Middle cover	26	ODD bracket
8	Keyboard	27	LCD cable
9	Upper case	28	Touchpad board to mainboard cable
10	Battery	29	CIR cable
11	Mainboard	30	RJ11 cable
12	VGA support	31	Bluetooth cable
13	CPU support	32	USB cable
14	Heatsink module	33	TV cable
15	Lower case		
16	ODD module		
17	USB module		
18	HDD module		
19	HDD bracket		
20	Bluetooth bracket		
21	Heatsink cover		
21-2	Heatsink cover w/ docking, DVI		
21-3	Heatsink cover w/ TV, DVI		

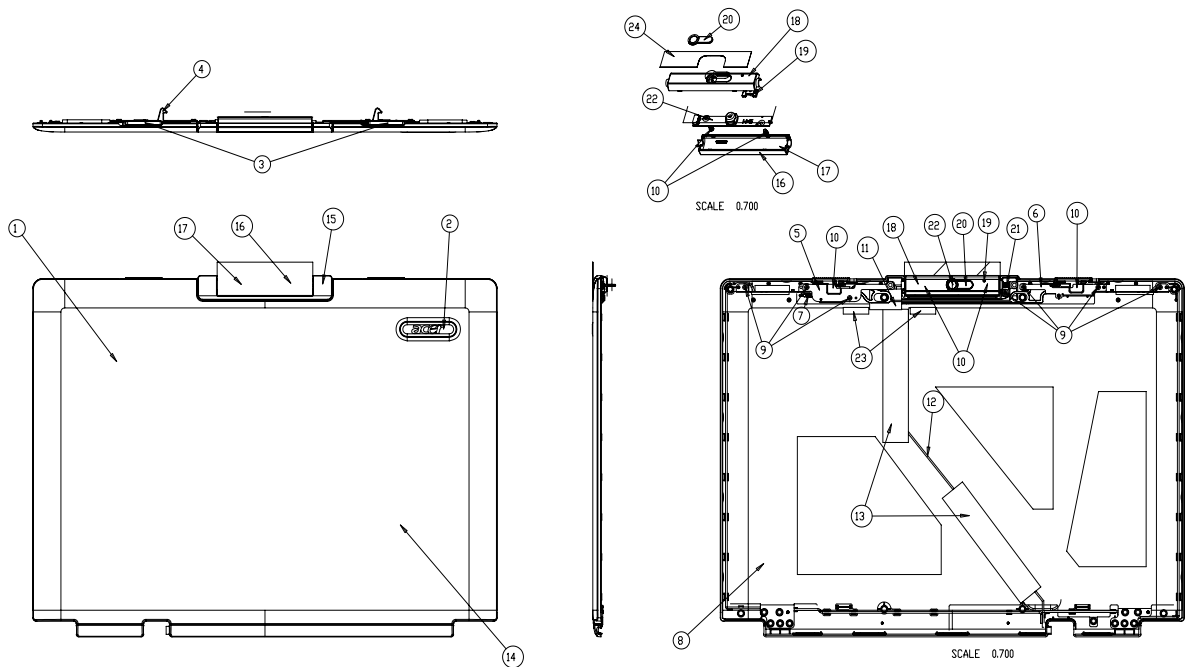

Item	Part Name	Item	Part Name
1	15.4" w/ CCD LCD cover(Aspire)	13	Conductive tape EP
2	ACER logo(Aspire)	14	LCD cover protect sheet
3	15.4" wide w/ CCD LCD knob	15	LCD CCD cover mylar
4	15.4" wide w/ CCD LCD latch	16	CCD cover protect
5	CCD latch BK-L	17	CCD cover
6	CCD latch BK-R	18	CCD bezel
7	LCD spring	19	CCD LED lens
8	15.4 w/ CCD cover shield	20	CCD name plate assy
9	screw M2.5*3.0-I(BNIXNYLOK)EP	21	CCD hinge
10	screw M2.0*3.0-I(NIXNYLOK)	22	camera V-UBDOEM1(CMOS module, 1.3M)
11	CCD cable maylar	23	LCD rubber-1
12	cable assy CCD (5P/4P/R2A) L-F	24	CCD bezel rotect

Aspire 5670 Part List

PHOTO	PARTNAME	DESCRIPTION	ACER PART NO.
ADAPTER			
N/A	ADAPTER 90W 3 PIN DELTA ADP-90SB BBAHF ROHS	ZB1 ADP 19V Delta S/P	AP.09001.005
	ADAPTER 90W 3 PIN LITEON PA-1900-04QB ROHS	ZB1 ADP 19V Lite-on S/P	AP.09003.009
BATTERY			
	"BATTER SONY LI LIP4084QUPC SY6(ZL5,4S1P,2.0A)LF"	ZB1 BAT(Lite-on 4 cell w/Sony pack) S/P	
	"BATTERY PACK SANYO LI 4CELL2.0 (4UR18650Y-QC219 4S1P,2.0A) ROHS "	ZB1 SANYO 4CELL 2.0 (W/ Sony) S/P	
	"BATTERY PACK SANYO LI 8CELLI2.4 4.8Ah (4UR18650F-2-QC218,4S2P) ROHS"	ZB1 LITE ON 8CELL 4.4A S/P	BT.00803.014
	MODEM BOARD	ZB1 MODEM 56K(MDC) EU S/P	54.AA7V7.001
	BLUETOOTH MODULE FOXCONN T60H928.00 LF		54.AA7V7.002
	MINI PCI WIRELESS BOARD 802.11 A/B/G ROW INTEL MM874511	ZB1 WLAN 3945ABG(WM3945ABGM2GE N) S/P	KI.GLN01.003
	MINI PCI WIRELESS BOARD 802.11 A/B/G MOW1 INTEL MM872612	ZB1 WLAN 3945ABG(WM3945ABGMOW1) S/P	KI.GLN01.001
	MINI PCI WIRELESS BOARD 802.11 A/B/G MOW2 INTEL MM872659	WLAN 3945ABG(WM3945ABGMOW2) S/P	KI.GLN01.002
	TOUCHPAD BOARD W/AUDIO PORT	ZB1 TP&AUDIO BOARD ASSY S/P	55.AA7V7.001



PHOTO	PARTNAME	DESCRIPTION	ACER PART NO.
	USB BOARD	ZB1 USB BOARD ASSY S/P	55.AA7V7.002
	SWITCH BOARD	ZB1 SWITCH BOARD ASSY S/P	55.AA7V7.003
	FIR BOARD	ZB1 FIR BOARD ASSY S/P	55.AA7V7.004
DIGITAL LIGHT DEVICE			
N/A	CCD MODULE W/CABLE		57.AA7V7.001
CABLE			
N/A	POWER CORD US 3PIN ROHS	ZB1 PWR CORD US S/P	
	POWER CORD EU 3 PIN ROHS	ZB1 PWR CORD (CEE) S/P	
	POWER CORD UK 3 PIN ROHS		
	POWER CORD ITALIAN 3 PIN ROHS		
	POWER CORD DANISH 3 PIN ROHS		
	POWER CORD SWISS 3 PIN ROHS		
	POWER CORD PRC 3 PIN ROHS		
	POWER CORD US-110V (BSMI) ROHS		
	POWER CORD AU W/LABEL 3 PIN ROHS		
	POWER CORD AF 3 PIN ROHS		
	POWER CORD AF-S INDIA ROHS		
	POWER CORD KOERA 2PIN ROHS		
	POWER CORD (JAPANESE) ROHS		
	POWER CORD ISRAEL 3 PIN ROHS		



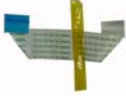



PHOTO	PARTNAME	DESCRIPTION	ACER PART NO.
	MODEM CABLE	ZB1 MODEM CABLE S/P	50.AA7V7.001
	BLUETOOTH CABLE	ZB1 BLUETOOTH CABLE S/P	50.AA7V7.002
	FFC CABLE - TP TO MB	ZB1 CABLE TP/MB FFC S/P	50.AA7V7.003
	FFC CABLE - TP TO TP BOARD	ZB1 CABLE TP/B FFC S/P	50.AA7V7.004
	PFC CABLE - USB	ZB1 CABLE ASSY USB S/P	50.AA7V7.005
	FIR/CIR WIRE CABLE	ZB1 CABLE ASSY CIR S/P	50.AA7V7.006
N/A	DC IN CABLE	ZB1 CABLE ASSY DC POWER S/P	50.AA7V7.007
N/A	SWITCH/AUDIO CABLE	ZB1 CABLE AUDIO FFC S/P	50.AA7V7.008
	CABLE ASSY ZB1 TV-TUNER	ZB1 CABLE ASSY TV-TUNER S/P	

PHOTO	PARTNAME	DESCRIPTION	ACER PART NO.
N/A	CABLE ASSY ZB1 TV/B	ZB1 CABLE ASSY TV/B S/P	
CASE/COVER/BACKET ASSEMBLY			
	MIDDLE COVER	ZB1 AS K/B COVER ASSY S/P	42.AA7V7.001
	"UPPER CASE W/TP,TP CABLE,MIC,LID CABLE W/O TV"	ZB1 AS TOP ASSY W/O TV S/ P	60.AA7V7.001
	"LOWER CASE W/READER COVER,NEW CARD COVER, DC CABLE, SPEAKER"	ZB1 BASE ASSY W/O MEDIA BAY S/P	60.AA7V7.002
	HEATSINK COVER W/DVI W/O DUCKING	ZB1 HS COVER ASSY W-DVI S/P	42.AA7V7.001
	BLUETOOTH BRACKET	ZB1 BLUETOOTH HOLDER S/ P	33.AA7V7.001
	DUMMY CARD	ZB1 CARDBUS DUMMY CARD S/P	42.AA7V7.011



PHOTO	PARTNAME	DESCRIPTION	ACER PART NO.
	CARD READER COVER	ZB1 CARD READER COVER S/P	42.AA7V7.012
CPU/PROCESSOR			
N/A	CPU INTEL YONAH CORE DUO FSB-667 1.66G 2M L8VR		KC.23001.DTP
	CPU INTEL YONAH CORE DUO FSB-667 1.83G 2M L8VQ		KC.24001.DTP
	CPU INTEL YONAH CORE DUO FSB-667 2.0G 2M L8VP		KC.25001.DTP
	CPU INTEL YONAH CORE DUO FSB-667 2.16G 2M L8VN		KC.26001.DTP
DVD RW/COMBO DRIVE			
DVD RW DRIVE	DVD SUPER MULTI MODULE PANASONIC UJ-845 SLOT IN		6M.AA7V7.001
DVD RW DRIVE	DVD SUPER MULTI PANASONIC UJ-845 DL SLOT IN LF		KU.00807.029
	OPTICAL DEVICE HOLDER FIX	ZB1 ODD HOLDER FIX S/P	42.AA7V7.002
N/A	SUPER MULTI BEZEL PANASONIC SLOT IN		42.AA7V7.003
DVD RW DRIVE	DVD DUAL MODULE PIONEER DVR-K06RA SLOT IN		6M.AA7V7.002
DVD RW DRIVE	DVD SUPER MULTI PIONEER DVR-K06RA DL SLOT IN LF		KU.00805.027
CASE/COVER/BRACKET ASSEMBLY	OPTICAL DEVICE HOLDER FIX	ZB1 ODD HOLDER FIX S/P	42.AA7V7.002
CASE/COVER/BRACKET ASSEMBLY	SUPER MULTI BEZEL PIONEER SLOT IN		42.AA7V7.004
COMBO DRIVE	DVD/CDRW COMBO MODULE 24X PHILIPS SCB5265	ZB1 COMBO MODULE (SCB5265) F/W:TX07 S/P	TBA
COMBO DRIVE	CDRW/DVD COMBO MODULE 24X PHILIPS SCB5265 W/O BEZEL	ZB1 COMBO (SCB5265) F/W:TX07 LF S/P	KO.02403.007
CASE/COVER/BRACKET ASSEMBLY	OPTICAL DEVICE HOLDER FIX	ZB1 ODD HOLDER FIX S/P	42.AA7V7.002
CASE/COVER/BRACKET ASSEMBLY	DVD COMBO G BASE BEZEL	ZB1 ODD BEZEL ASSY G/B S/P	42.AA7V7.005
DVD RW DRIVE	DVD DUAL MODULE PIONEER DVR-K16RA F/W:1.11	ZB1 DUAL MODULE DVR-K16RA F/W:1.11S/P	TBA
DVD RW DRIVE	DVD DUAL PIONEER DVR-K16RA F/W:1.11 LF	ZB1 DUAL DVDRW DVR-K16RA F/W:1.11S/P	TBA



PHOTO	PARTNAME	DESCRIPTION	ACER PART NO.
CASE/COVER/BRACKET ASSEMBLY	OPTICAL DEVICE HOLDER FIX	ZB1 ODD HOLDER FIX S/P	42.AA7V7.002
CASE/COVER/BRACKET ASSEMBLY	DVD DUAL G BASE BEZEL	ZB1 ODD PIONEER BEZEL ASSY G/B S/P	42.AA7V7.006
DVD RW DRIVE	DVD SUPER MULTI MODULE HLDS GSA-4082N LF	ZB1 DVD SUP MODULE DL4X GSA-4082N S/P	TBA
DVD RW DRIVE	DVD SUPER MULTI HLDS GSA-4082N LF	ZB1 DVD SUPER MULTI DL4X GSA-4082N S/P	TBA
CASE/COVER/BRACKET ASSEMBLY	OPTICAL DEVICE HOLDER FIX	ZB1 ODD HOLDER FIX S/P	42.AA7V7.002
CASE/COVER/BRACKET ASSEMBLY	DVD SUPER MULTI G BASE BEZEL	ZB1 ODD BEZEL ASSY G/B SUPER MULTI S/P	42.AA7V7.007
HARD DISK DRIVE			
	HDD 80G SEAGATE 5.4K SATAST98823AS MERCURY 2 FW:3.06 LF	80G SEAGATE 2.5 IN. 5400RPM SATAST98823AS LF MERCURY 2 FW:3.06	KH.08001.023
	"HDD 80G HGST 5.4K SATA 1.5G NCQ MORAGA+HTS541080G9SA00,C60D"	"80G HGST 2.5 IN. 5.4K SATA 1.5G NCQ MORAGA+HTS541080G9SA00,C60D"	KH.08007.015
	HDD 100G SEAGATE 5.4K SATA ST9100824AS MERCURY 2 FW:3.06 LF	100G SEAGATE 2.5 IN. 5400RPM SATA ST9100824AS LF MERCURY 2 FW:3.06	KH.10001.008
	HDD 100G TOSHIBA SATA 5.4K ARES-B_S MK1032GSX F/W AS021G	100G TOSHIBA 2.5 IN. SATA 5400RPM ARES-B_S MK1032GSX F/W AS021G	KH.10004.003
	HDD 100G HGST SATA 1.5G NCQMORAGA+HTS541010G9SA00 FW:S60D	100G HGST 2.5 IN. SATA 1.5G NCQMORAGA+HTS541010G9SA00 FW:S60D	KH.10007.005
	HDD 120G SEAGATE 5.4K SATA ST9120821AS LF MERCURY 2 FW:3.06	120G SEAGATE 2.5 IN. 5400RPM SATA ST9120821AS LF MERCURY 2 FW:3.06	KH.12001.025
	HDD 120G TOSHIBA 5.4K SATA1.5G W/NCQ MK1234GSX LF TAURUS FW:AH001A	120G TOSHIBA 2.5 IN. 5.4K SATA1.5G W/NCQ MK1234GSX LF TAURUS FW:AH001A	KH.12004.003
	HDD BRACKET		33.AA7V7.002
	HDD COVER W/RUBBER	ZB1 HDD COVER ASSY W/O COUSION S/P	42.AA7V7.008

PHOTO	PARTNAME	DESCRIPTION	ACER PART NO.
	KEYBOARD AS DARFON TC CHINESE	ZB1 K/B (TAIWAN) API S/P	KB.ASP07.070
	KEYBOARD AS DARFON US INTERNATIONAL	ZB1 K/B (UI) API S/P	KB.ASP07.071
	KEYBOARD AS DARFON THAILAND	ZB1 K/B (THAI) API S/P	KB.ASP07.072
	KEYBOARD AS DARFON GERMAN	ZB1 K/B (GERMAN) API S/P	KB.ASP07.073
	KEYBOARD AS DARFON UK	ZB1 K/B (UK) API S/P	KB.ASP07.074
	KEYBOARD AS DARFON ITALY	ZB1 K/B (ITALIAN) API S/P	KB.ASP07.075
	KEYBOARD AS DARFON FRENCH	ZB1 K/B (FRENCH) API S/P	KB.ASP07.076
	KEYBOARD AS DARFON SWISS/ G	ZB1 K/B (SWISS) API S/P	KB.ASP07.077
	KEYBOARD AS DARFON BELGIUM	ZB1 K/B (BELGIUM) API S/P	KB.ASP07.078
	KEYBOARD AS DARFON SPANISH	ZB1 K/B (SPANISH) API S/P	KB.ASP07.079
	KEYBOARD AS DARFON PORTUGUEES	ZB1 K/B (PORTU) API S/P	KB.ASP07.080
	KEYBOARD AS DARFON CZECH	ZB1 K/B (CZECH) API S/P	KB.ASP07.081
	KEYBOARD AS DARFON HUNGARY	ZB1 K/B (HUNG) API S/P	KB.ASP07.082
	KEYBOARD AS DARFON RUSSIAN	ZB1 K/B (RUSSIAN) API S/P	KB.ASP07.083
	KEYBOARD AS DARFON SWEDEN	ZB1 K/B (SWEDISH) API S/P	KB.ASP07.084
	KEYBOARD AS DARFON NORWAY	ZB1 K/B (NORW) API S/P	KB.ASP07.085
	KEYBOARD AS DARFON DANISH	ZB1 K/B (DANISH) API S/P	KB.ASP07.086
	KEYBOARD AS DARFON ARABIC	ZB1 K/B (ARAB-EN) API S/P	KB.ASP07.087
	KEYBOARD AS DARFON BRAZILIAN PROTUGESE	ZB1 K/B (BRAZIL) API S/P	KB.ASP07.088
	KEYBOARD AS DARFON CANADIAN FRENCH	ZB1 K/B (FRA-CAN) API S/P	KB.ASP07.089
	KEYBOARD AS DARFON GREEK	ZB1 K/B (GREEK) API S/P	KB.ASP07.090
	KEYBOARD AS DARFON TURKISH	ZB1 K/B (TURKISH) API S/P	KB.ASP07.091
	KEYBOARD AS DARFON TURKEY 1	ZB1 K/B (TURKEY)1 API S/P	
	KEYBOARD AS DARFON HEBREW	ZB1 K/B (HEBREW) API S/P	KB.ASP07.092
	KEYBOARD AS DARFON POLAND	ZB1 K/B (POLAND) API S/P	
	KEYBOARD AS DARFON SLOVAK	ZB1 K/B (SLOVAK) API S/P	
	KEYBOARD AS DARFON CHINA	ZB1 K/B (CHINA) API S/P	
	KEYBOARD AS DARFON DUTCH	ZB1 K/B (DUTCH) API S/P	
	KEYBOARD AS DARFON LA	ZB1 K/B (LA) API S/P	
	KEYBOARD AS DARFON US	ZB1 K/B (USA) API S/P	
	KEYBOARD AS DARFON ICELAND	ZB1 K/B (ICELAND) API S/P	





PHOTO	PARTNAME	DESCRIPTION	ACER PART NO.
	ASSY LCD MODULE 15.4 IN. WXGA GLARE W/ANTENNA CCD MODULE	ZB1 LCD ATI QDI(15.4 WXGAG) AS W/CCD S/P	6M.AA7V7.011
	LCD 15.4 IN. WXGA QDI QD15TL07-02 GLARE LF	ZB1 LCD15.4QDI15TL02 REV.04 (G) S/P	LK.15409.009
	LCD 15.4 IN. WXGA CMO N15411-L0C GLARE LF	ZB1 LCD 15.4(WXGA)N15411-LOC B/S LF S/P	LK.1540D.006
	LCD INVERTER BOARD	ZB1 INV MODULE S/P	19.AA7V7.001
	LCD CABLE - 15.4 IN.	ZB1 CABLE ASSY S/P	50.AA7V7.011
CASE/COVER/BRACKET ASSEMBLY	LCD COVER - 15.4 IN. W/ ANTENNA CCD MODULE	"ZB1 AS 15.4" LCD COVER ASSY W/CCD S/P"	60.AA7V7.003
CASE/COVER/BRACKET ASSEMBLY	LCD BEZEL - 15.4 IN. FOR CCD	"ZB1 15.4" LCD BEZEL ASSY W/CCD S/P"	60.AA7V7.004
	LCD BRACKET W/HINGE - L	"ZB1 15.4" HINGE-L ASSY S/P"	33.AA7V7.003
	LCD BRACKET W/HINGE - R	"ZB1 15.4" HINGE-R ASSY S/P"	33.AA7V7.004

PHOTO	PARTNAME	DESCRIPTION	ACER PART NO.
	ASSY LCD MODULE 15.4 IN. WXGA GLARE W/ANTENNA	ZB1 LCD ATI QDI(15.4 WXGA G) AS S/P	6M.AA7V7.012
	LCD 15.4 IN. WXGA QDI QD15TL07-02 GLARE LF	ZB1 LCD15.4QDI15TL02 REV.04 (G) S/P	LK.15409.009
	LCD 15.4 IN. WXGA CMO N15411-L0C GLARE LF	ZB1 LCD 15.4(WXGA)N15411-LOC B/S LF S/P	LK.1540D.006
	LCD INVERTER BOARD	ZB1 INV MODULE S/P	19.AA7V7.001
	LCD CABLE - 15.4 IN.	ZB1 CABLE ASSY S/P	50.AA7V7.011
	LCD COVER - 15.4 IN. W/ ANTENNA	"ZB1 AS 15.4" LCD COVER ASSY S/P"	60.AA7V7.005
	LCD BEZEL - 15.4 IN. UV	"ZB1 15.4" LCD BEZEL ASSY W-UV S/P"	60.AA7V7.004
	LCD BRACKET W/HINGE - L	"ZB1 15.4" HINGE-L ASSY S/P"	33.AA7V7.003





PHOTO	PARTNAME	DESCRIPTION	ACER PART NO.
	LCD BRACKET W/HINGE - R	"ZB1 15.4"" HINGE-R ASSY S/P"	33.AA7V7.004
	MAINBOARD 945PM M54P128 GLAN SATA NO-TV W/READER W/O CPU MEMORY	ZB1J MB ASSY(PM/M54P-128/SATA/5789/6IN1)S/P	MB.AA700.001
	SO-DIMM DDRII533 256M HYS64T32000HDL-3.7-A 32X64 LF (0.11u)		KN.25602.023
	SO-DIMM DDRII533 256MB NT256T64UH4A1FN-37B LF		KN.25603.029
	SO-DIMM DDRII533 256MB MT4HTF3264HY-53EB3 LF (512Mb*4)		KN.25604.027
	SO-DIMM DDRII533 256MB M470T3354CZ3-CD5 LF (Pb-free)		KN.2560B.017
	SO-DIMM DDRII533 256MB HYMP532S64P6-C4 LF		KN.2560G.006
	SO-DIMM DDRII 533 512MB HYS64T64020HDL-3.7-A LF (0.11u)		KN.51202.021
	SO-DIMM DDRII533 512MB NT512T64UH8A1FN-37B LF	ZB1 RAM(512M)DDR2 NANYA S/P	KN.51203.023
	SO-DIMM DDRII533 512MB M470T6554CZ3-CD500 LF		KN.5120B.015
	SO-DIMM DDRII533 512MB HYMP564S64P6-C4 LF	ZB1RAM(512M)DDR2 HY S/P	KN.5120G.005
	SO-DIMM DDRII533 1GB NT1GT64UH8A0BN-37B LF		KN.1GB03.006
	THERMAL MODULE - DISCRETE	ZB1 THERMAL MODULE ATI ASSY S/P	60.AA7V7.006
N/A	THERMAL MODULE - UMA	ZB1 THERMAL MODULE ASSY(UMA) S/P	60.AA7V7.007
MISCELLANEOUS			

PHOTO	PARTNAME	DESCRIPTION	ACER PART NO.
MISCELLANEOUS	NAME PLATE AS5670	ZB1H NAME PLATE (AS5670) S/P	40.AA7V7.001
MISCELLANEOUS	RUBBER FOOT - LOWER CASE	ZL1A RUBBER FOOT S.P.	47.T50V7.002
MISCELLANEOUS	RUBBER FOOT - HEATSINK COVER	ZB1 BASE RUBBER FOOT S/P	47.AA7V7.001
MISCELLANEOUS	LCD RUBBER PAD-UP	ZL1A RUBBER PAD-UP S.P.	47.AA7V7.002
SPEAKER			
SPEAKER	SPEAKER SET	ZB1 SPEAKER ASSY S/P	23.AA7V7.001
SCREW	SCREW M2.5*3.5-I(NI)(NYLOK)	ZB1 SCREW M2.5*3.5-I(NI)(NYLOK) S/P	86.AAV7.001
SCREW	SCREW M2.5*3.0-I(BNI)(NYLOK)EP	ZB1 SCREW M2.5*3.0-I(BNI)(NYLOK)EP S/P	86.T25V7.012
SCREW	SCREW M2.0*5.0 I-(BNI)(NYLOK)	ZI1S SCREW M2.0X5.0-I-BNI-NYLOK S/P	86.T23V7.015
SCREW	SCREW M2.5-0.45*3.5-F(ANTI-LOOSE)	ZB1 SCREW M2.5-0.45*3.5-F(ANTI-LOOSE)S/P	86.AA7V7.002
SCREW	SCREW M2.0*3.0-I-NI-NYLOK	ZI3 LCD LATCH KIT W/O SPRING S/P-F	
SCREW	SCREW M2.5*4-I(BNI)	ZI1S SCREW M2.5X4-I-BNI S/P	86.T23V7.019
SCREW	SCREW M2.5*6-I(BNI)(NYLOK)	ZB1 SCREW M2.5*6-I(BNI)(NYLOK)S/P	86.A08V7.004
SCREW	SCREW M2.5*6.0-P(NI)(NYLOK)	ZB1 SCREW M2.5*6.0-P(NI)(NYLOK)S/P	86.AA7V7.003
SCREW	SCREW M1.7*3.0-I(BK)	ZL1A SCREW (M1.7*3.1-I(BK) S.P.	86.T50V7.001
SCREW	SCREW M2.5*5.0-I(NI)(NYLOK)	ZB1 SCREW M2.5*5.0-I(NI)(NYLOK) S/P	86.T23V7.010
SCREW	SCREW M2.0*5-I(NI)(NYLOK)	ZB1 SCREW M2.0*5-I(NI)(NYLOK) S/P	86.T23V7.006

