

TravelMate 5730/Extensa 5630 Series Service Guide

Service guide files and updates are available on the ACER/CSD web; for more information, please refer to <http://csd.acer.com.tw>

PRINTED IN TAIWAN

Revision History

Please refer to the table below for the updates made on TravelMate 5730/Extensa 5630 Series service guide.

| Date | Chapter | Updates |
|------|---------|---------|
| | | |
| | | |
| | | |

Copyright

Copyright © 2008 by Acer Incorporated. All rights reserved. No part of this publication may be reproduced, transmitted, transcribed, stored in a retrieval system, or translated into any language or computer language, in any form or by any means, electronic, mechanical, magnetic, optical, chemical, manual or otherwise, without the prior written permission of Acer Incorporated.

Disclaimer

The information in this guide is subject to change without notice.

Acer Incorporated makes no representations or warranties, either expressed or implied, with respect to the contents hereof and specifically disclaims any warranties of merchantability or fitness for any particular purpose. Any Acer Incorporated software described in this manual is sold or licensed "as is". Should the programs prove defective following their purchase, the buyer (and not Acer Incorporated, its distributor, or its dealer) assumes the entire cost of all necessary servicing, repair, and any incidental or consequential damages resulting from any defect in the software.

Acer is a registered trademark of Acer Corporation.

Intel is a registered trademark of Intel Corporation.

Pentium and Pentium II/III are trademarks of Intel Corporation.

Other brand and product names are trademarks and/or registered trademarks of their respective holders.

Conventions

The following conventions are used in this manual:

| | |
|------------------------|--|
| SCREEN MESSAGES | Denotes actual messages that appear on screen. |
| NOTE | Gives bits and pieces of additional information related to the current topic. |
| WARNING | Alerts you to any damage that might result from doing or not doing specific actions. |
| CAUTION | Gives precautionary measures to avoid possible hardware or software problems. |
| IMPORTANT | Reminds you to do specific actions relevant to the accomplishment of procedures. |

Preface

Before using this information and the product it supports, please read the following general information.

1. This Service Guide provides you with all technical information relating to the BASIC CONFIGURATION decided for Acer's "global" product offering. To better fit local market requirements and enhance product competitiveness, your regional office MAY have decided to extend the functionality of a machine (e.g. add-on card, modem, or extra memory capability). These LOCALIZED FEATURES will NOT be covered in this generic service guide. In such cases, please contact your regional offices or the responsible personnel/channel to provide you with further technical details.
2. Please note WHEN ORDERING FRU PARTS, that you should check the most up-to-date information available on your regional web or channel. If, for whatever reason, a part number change is made, it will not be noted in the printed Service Guide. For ACER-AUTHORIZED SERVICE PROVIDERS, your Acer office may have a DIFFERENT part number code to those given in the FRU list of this printed Service Guide. You MUST use the list provided by your regional Acer office to order FRU parts for repair and service of customer machines.

Table of Contents

| | |
|---|-----------|
| System Specifications | 1 |
| Features | 1 |
| System Block Diagram | 3 |
| Your Acer Notebook tour | 4 |
| Right View | 7 |
| Indicators | 11 |
| Easy-Launch Buttons | 11 |
| Touchpad Basics (with fingerprint reader) | 12 |
| Touchpad basics (with two-click buttons) | 12 |
| Using the Keyboard | 14 |
| Lock Keys and embedded numeric keypad | 14 |
| Windows Keys | 15 |
| Hot Keys | 16 |
| Special Key (only for certain models) | 17 |
| Acer Empowering Technology | 18 |
| Launching Acer Empowering Technology | 18 |
| Empowering Technology password | 19 |
| Acer ePower Management | 20 |
| Acer eDataSecurity Management (only for certain models) | 21 |
| Acer eRecovery Management | 22 |
| Acer eSettings Management | 24 |
| Windows Mobility Center | 25 |
| Using the System Utilities | 26 |
| Acer GridVista (dual-display compatible) | 27 |
| Hardware Specifications and Configurations | 29 |
| System Utilities | 37 |
| BIOS Setup Utility | 37 |
| Navigating the BIOS Utility | 38 |
| Information | 39 |
| Main | 40 |
| Security | 42 |
| Boot | 46 |
| Exit | 47 |
| BIOS Flash Utility | 48 |
| Remove HDD/BIOS Utility | 49 |
| Machine Disassembly and Replacement | 53 |
| Disassembly Requirements | 53 |
| General Information | 54 |
| Pre-disassembly Instructions | 54 |
| Disassembly Process | 54 |
| External Module Disassembly Process | 55 |
| External Modules Disassembly Flowchart | 55 |
| Removing the Battery Pack | 56 |
| Removing the SD dummy card | 57 |
| Removing the PC and ExpressCard dummy cards | 58 |
| Removing the Lower Cover | 59 |
| Removing the DIMM | 60 |
| Removing the WLAN Board Modules | 61 |
| Removing the Hard Disk Drive Module | 63 |
| Removing the Optical Drive Module | 64 |
| Main Unit Disassembly Process | 67 |
| Main Unit Disassembly Flowchart | 67 |

Table of Contents

| | |
|---|------------|
| Removing the Middle Cover | 68 |
| Removing the Power Board | 69 |
| Removing the Keyboard | 71 |
| Removing the Heatsink Fan Module | 72 |
| Removing the CPU and VGA Heatsink Module | 73 |
| Removing the CPU | 74 |
| Removing the VGA Board (Discrete Model only) | 75 |
| Removing the LCD Module | 76 |
| Separating the Upper Case from the Lower Case | 78 |
| Removing the Speaker Module | 82 |
| Removing the Launch Board | 83 |
| Removing the Fingerprint and Touchpad Module | 84 |
| Removing the Modem Board | 87 |
| Removing the USB Board Module | 89 |
| Removing the Main Board | 90 |
| LCD Module Disassembly Process | 93 |
| LCD Module Disassembly Flowchart | 93 |
| Removing the LCD Bezel | 94 |
| Removing the LCD module with the Brackets | 96 |
| Removing the FPC Cable | 97 |
| Removing the LCD Brackets | 99 |
| Removing the Antennas | 100 |
| Removing the Web Camera | 101 |
| Troubleshooting | 103 |
| System Check Procedures | 104 |
| External Diskette Drive Check | 104 |
| External CD-ROM Drive Check | 104 |
| Keyboard or Auxiliary Input Device Check | 104 |
| Memory check | 105 |
| Power System Check | 105 |
| Touchpad Check | 107 |
| Power-On Self-Test (POST) Error Message | 108 |
| Index of Error Messages | 109 |
| Phoenix BIOS Beep Codes | 112 |
| Index of Symptom-to-FRU Error Message | 117 |
| Intermittent Problems | 121 |
| Undetermined Problems | 122 |
| Jumper and Connector Locations | 123 |
| Top and Bottom View | 123 |
| Clearing Password Check and BIOS Recovery | 125 |
| Clearing Password Check | 125 |
| BIOS Recovery by Crisis Disk | 126 |
| FRU (Field Replaceable Unit) List | 127 |
| TravelMate 5730 Series Exploded Diagram | 128 |
| TravelMate 5730 Series | 136 |
| Model Definition and Configuration | 136 |
| Test Compatible Components | 159 |
| Microsoft® Windows® Vista Environment Test | 160 |

Table of Contents

Online Support Information

163

Index

165

Table of Contents

System Specifications

Features

Below is a brief summary of the computer's many features:

Platform

Intel® Centrino® processor technology, featuring:

- Intel® Core™2 Duo mobile processor
- Mobile Intel® PM45/GM45 Express Chipset*
- Intel® Wireless WiFi Link 5100/5300*

System Memory

- Dual-Channel DDR2 SDRAM support
- Up to 2 GB of DDR2 667 MHz memory, upgradeable to 4 GB using two soDIMM modules*

Display and graphics

- 15.4" WXGA 1280 x 800
- Mobile Intel® GM45 Express Chipset
- ATI Mobility Radeon™ HD 3470*
- NVIDIA® GeForce® 9300M GS*

Storage subsystem

- 2.5" hard disk drives
- Optical drive options:
 - ▶ Blu-ray Disc™/DVD-Super Multi double-layer drive
 - ▶ DVD-Super Multi double-layer drive
 - ▶ DVD/CD-RW combo drive
- 5-in-1 card reader

Special keys and controls

- 88-/89-/93-key keyboard
- Touchpad pointing device
- Empowering Key
- Easy-launch buttons: WLAN, Internet, email, Bluetooth, Acer Arcade™
- Acer MediaTouch keys: play/pause, stop, previous, next
- Volume wheel
- Acer Media Center remote control*

Audio

- Two built-in Acer 3DSonic stereo speakers
- High-definition audio support
- MS-Sound compatible

-
- Acer PureZone technology with two built-in stereo microphones

Communication

- Acer Video Conference, featuring:
 - ✦ Integrated Acer Crystal Eye webcam
 - ✦ Optional Acer Xpress VoIP phone
- WLAN:
 - ✦ Intel® Wireless WiFi Link 5100/5300*
- WPAN: Bluetooth® 2.0+EDR (Enhanced Data Rate)
- LAN: Gigabit Ethernet; Wake-on-LAN ready
- Modem: 56K ITU V.92

I/O Ports

- Acer EasyPort IV connector
- ExpressCard™/54 slot
- PC Card slot (Type II)
- Acer Bio-Protection fingerprint reader
- 5-in-1 card reader (SD/MMC/MS/MS PRO/xD)
- 3 USB 2.0 ports
- HDMI™ port with HDCP support*
- USB 2.0/ eSATA port *

NOTE: If you plug an eSATA device you will have three USB ports available in the mean time.

- External display (VGA) port
- Headphones/speaker/line-out jack
- Microphone-in jack
- Line-in jack
- Ethernet (RJ-45) port
- Modem (RJ-11) port
- DC-in jack for AC adapter

Environment

- Temperature:
 - ✦ Operating: 5 °C to 35 °C
 - ✦ Non-operating: -20 °C to 65 °C
- Humidity (non-condensing):
 - ✦ Operating: 20% to 80%
 - ✦ Non-operating: 20% to 80%

NOTE: "*" "Only for certain models"

NOTE: The specifications listed above are for reference only. The exact configuration of your PC depends on the model purchased.

System Block Diagram

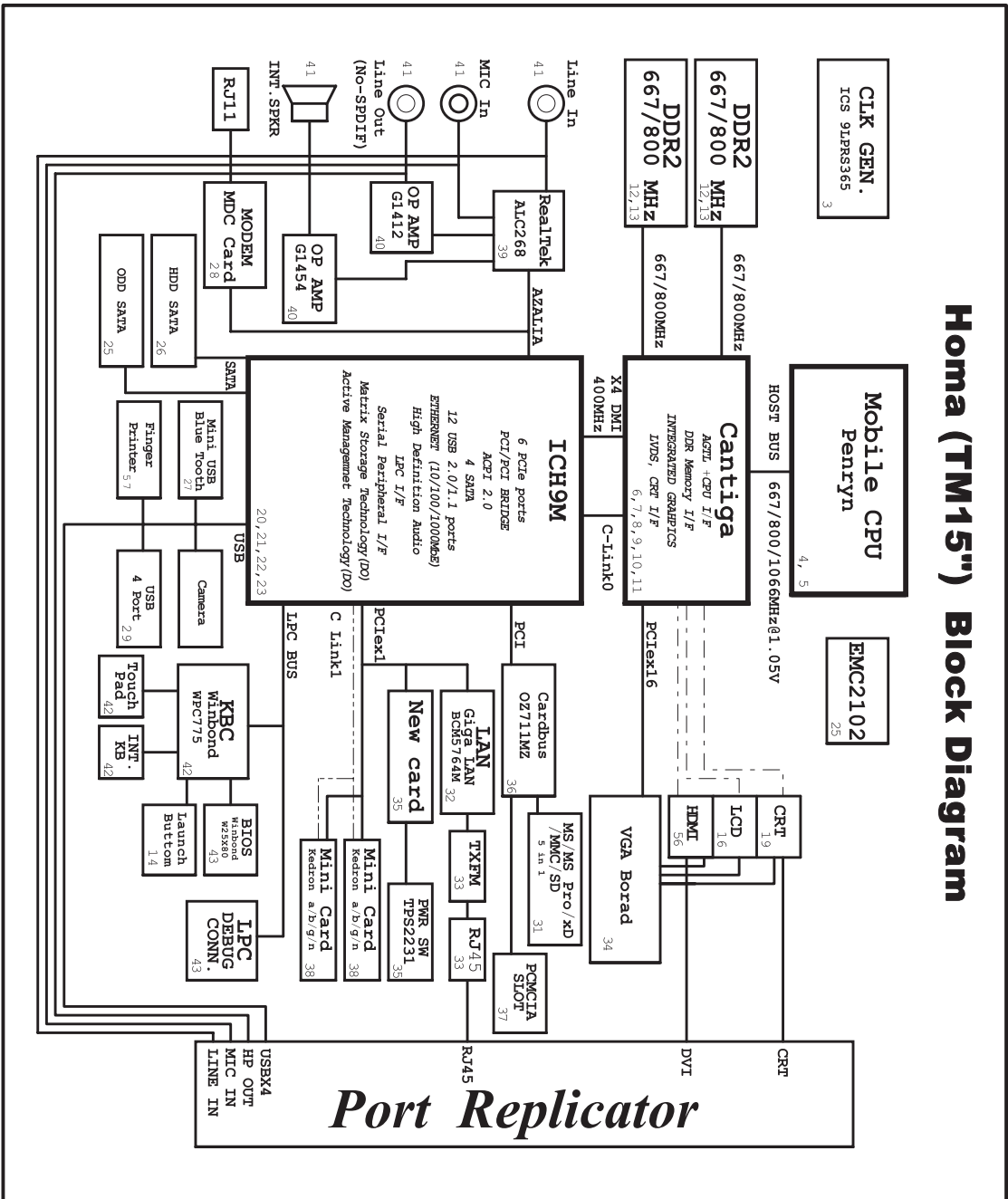

Your Acer Notebook tour

After knowing your computer features, let us show you around your new computer.

Front View



| | Icon | Item | Description |
|---|------|-------------------|---|
| 1 | | Acer Crystal Eye | Web camera for video communication (only for certain models). |
| 2 | | Acer PureZone | Two internal stereo microphones for sound recording (only for certain models). |
| 3 | | Display screen | Also called Liquid-Crystal Display (LCD), displays computer output. |
| 4 | | Speakers | Left and right speakers deliver stereo audio output. |
| 5 | | Empowering key | Launch Acer Empowering Technology |
| 6 | | Productivity keys | Three productivity keys give users one-touch access to protection and manageability features for a more secure, smarter and easier way to work. |

| | Icon | Item | Description |
|-------|---|---|--|
| 7 | | Easy-launch buttons | Buttons for launching frequently used programs. |
| 8 | | Palmrest | Comfortable support area for your hands when you use the computer. |
| 9 | | Touchpad | Touch-sensitive pointing device which functions like a computer mouse. |
| 10 | | Click buttons (left, center* and right) | The left and right buttons function like the left and right mouse buttons. *The center button serves as Acer BioProtect fingerprint reader supporting Acer FingerNav 4-way control function (manufacturing option). |
| 11 | | Acer Bio-Protection fingerprint reader | The center button serves as Acer Bio-Protection fingerprint reader supporting Acer FingerNav 4-way control function (only for certain models). |
| 12/15 | | Status indicators | Light-Emitting Diodes (LEDs) that light up to show the status of the computer's functions and components. |
| 13 | | Keyboard | For entering data into your computer. |
| 14 |  | Power button | Turns the computer on and off. |



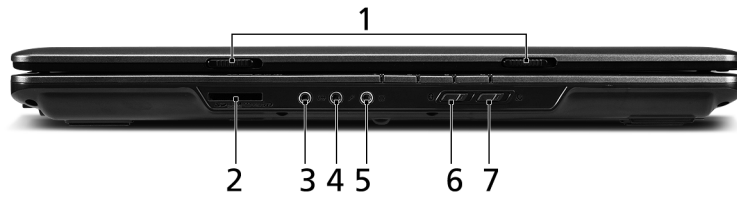



Closed Front View

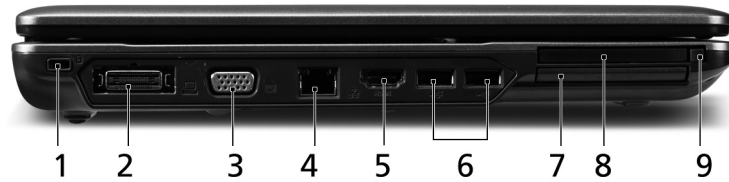

| | Icon | Item | Description |
|---|------|--|--|
| 1 | | Latch | Locks and releases the lid. |
| 2 | | 5-in-1 card reader | Accepts Secure Digital (SD), MultiMediaCard (MMC), Memory Stick (MS), Memory Stick Pro (MS PRO), and xD-Picture Card. Note: Only one card can operate at any given time. |
| 3 | | Line-in jack | Accepts audio line-in devices (e.g., audio CD player, stereo walkman, mp3 player) |
| 4 | | Microphone jack | Accepts inputs from external microphones. |
| 5 | | Headphones/ speaker/line-out jack. | Connects to audio line-out devices (e.g., speakers, headphones). |
| 6 | | Bluetooth communication switch | Enable/disable the Bluetooth function. (manufacturing option). |
| 7 | | Wireless communication switch | Enable/disable the wireless function. (manufacturing option). |

Left View



| # | Icon | Item | Description |
|---|---|-----------------------------|---|
| 1 |  | Kensington lock slot | Connects to a Kensington-compatible computer security lock. |
| 2 |  | Acer EasyPort IV connector | Connects to Acer EasyPort IV (only for certain models). |
| 3 |  | External display (VGA) port | Connects to a display device (e.g., external monitor, LCD projector). |
| 4 |  | Ethernet (RJ-45) port | Connects to an Ethernet 10/100/1000-based network. |
| 5 | HDMI | HDMI port | Supports high definition digital video connections (only for certain models). |
| 6 |  | Two USB 2.0 ports | Connect to USB 2.0 devices (e.g., USB mouse, USB camera). |
| 7 |  | PC Card slot | Accepts one Type II PC Card. |
| 8 | ExpressCard / 54 | ExpressCard/54 slot | Accepts one ExpressCard/54 module. |
| 9 | | PC Card slot eject button | Ejects the PC Card from the slot. |

Right View





| | Icon | Item | Description |
|---|------|-------------------------------|--|
| 1 | | Optical drive | Internal optical drive; accepts CDs or DVDs. |
| 2 | | Optical disk access indicator | Lights up when the optical drive is active. |
| 3 | | Optical drive eject button | Ejects the optical disk from the drive. |

| | Icon | Item | Description |
|---|------|----------------------|--|
| 4 | | Emergency eject hole | Ejects the optical drive tray when the computer is turned off. Note: Insert a paper clip to the emergency eject hole to eject the optical drive tray when the computer is off. |



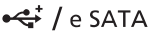

Rear View

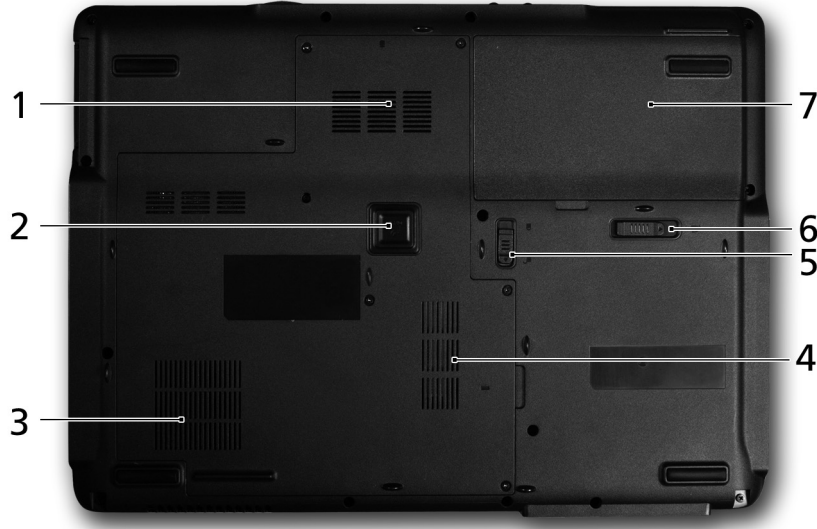

| # | Icon | Item | Description |
|---|---|---------------------|---|
| 1 |  | USB 2.0 port | Connects to USB 2.0 devices (e.g., USB mouse, USB camera). |
| 2 |  | USB 2.0/ eSATA port | Connects to USB 2.0 or eSATA devices (only for certain models). Note: If you plug an eSATA device you will have three USB ports available in the mean time. |
| 3 |  | Modem (RJ-11) port | Connects to a phone line. |
| 4 |  | DC-in jack | Connects to an AC adapter. |
| 5 | | Ventilation slots | Enable the computer to stay cool, even after prolonged use. |







Bottom View



| | Icon | Item | Description |
|---|---|--|---|
| 1 |  | Hard disk bay | Houses the computer's hard disk (secured with screws). |
| 2 | | Acer DASP (Disk Anti-Shock Protection) | Protects the hard disk drive from shocks and bumps (only for certain models). |
| 3 | | Ventilation slots | Enable the computer to stay cool, even after prolonged use. |
| 4 |  | Memory compartment | Houses the computer's main memory. |
| 5 |  | Battery lock | Locks the battery in position. |
| 6 |  | Battery release latch | Releases the battery for removal. |
| 7 |  | Battery bay | Houses the computer's battery pack. |

Indicators

The computer has several easy-to-read status indicators. The front panel indicators are visible even when the computer cover is closed.



| Icon | Function | Description |
|---|--|---|
|  | HDD | Indicates when the hard disk drive is active. |
|  | Num Lock | Lights up when Num Lock is activated. |
|  | Caps Lock | Lights up when Caps Lock is activated. |
|  | Power | Indicates the computer's power status. |
|  | Battery | Indicates the computer's battery status. |
|  | Bluetooth (Manufacturing option) | Indicates the status of Bluetooth communication. |
|  | Wireless LAN (Manufacturing option) | Indicates the status of wireless LAN communication. |

NOTE: 1. **Charging:** The light shows amber when the battery is charging. 2. **Fully charged:** The light shows green when in AC mode.

Easy-Launch Buttons

Located beside the keyboard are application buttons. These buttons are called easy-launch buttons. They are: WLAN, Internet, email, Bluetooth, Arcade and Acer Empowering Technology.

The mail and Web browser buttons are pre-set to email and Internet programs, but can be reset by users. To set the Web browser, mail and programmable buttons, run the Acer Launch Manager. You can access the Launch Manager by clicking on Start, All Programs, and then Launch Manager to start the application.

| Icon | Function | Description |
|---|----------------------------|---|
|  | Acer Empowering Technology | Launch Acer Empowering Technology (user-programmable) |
|  | Web browser | Internet browser (user-Programmable) |
|  | Mail | Email application (user-Programmable) |
| P | Programmable key | User-programmable |

Touchpad Basics (with fingerprint reader)

The following items show you how to use the touchpad with Acer Bio-Protection fingerprint reader.

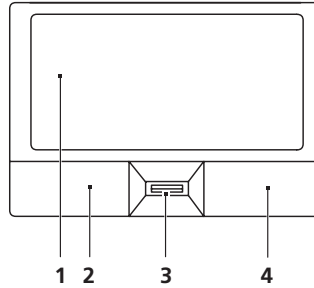

- Move your finger across the touchpad (2) to move the cursor.
- Press the left (1) and right (4) buttons located beneath the touchpad to perform selection and execution functions. These two buttons are similar to the left and right buttons on a mouse. Tapping on the touchpad is the same as clicking the left button.
- Use Acer Bio-Protection fingerprint reader (3) supporting Acer FingerNav 4-way control function (only for certain models) to scroll up or down and move left or right a page. This fingerprint reader or button mimics your cursor pressing on the right scroll bar of Windows applications.

| Function | Left button (1) | Right button (4) | Main touchpad (2) | Center button (3) |
|---------------------|---|------------------|--|--|
| Execute | Quickly click twice. | | Tap twice (at the same speed as double-clicking a mouse button). | |
| Select | Click once. | | Tap once. | |
| Drag | Click and hold, then use finger on the touchpad to drag the cursor. | | Tap twice (at the same speed as double-clicking a mouse button); rest your finger on the touchpad on the second tap and drag the cursor. | |
| Access context menu | | Click once. | | |
| Scroll | | | | Swipe up/down/left/right using Acer FingerNav 4-way control function (Manufacturing option). |

Touchpad basics (with two-click buttons)

The following items show you how to use the touchpad with two-click buttons.

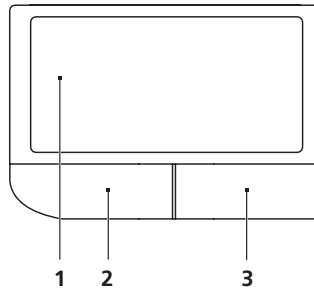

- Move your finger across the touchpad (1) to move the cursor.

-
- Press the left **(2)** and right **(3)** buttons located beneath the touchpad to perform selection and execution functions. These two buttons are similar to the left and right buttons on a mouse. Tapping on the touchpad is the same as clicking the left button.

| Function | Left button (2) | Right button (3) | Main touchpad (1) |
|---------------------|---|------------------|--|
| Execute | Quickly click twice. | | Tap twice (at the same speed as double-clicking a mouse button). |
| Select | Click once. | | Tap once. |
| Drag | Click and hold, then use finger on the touchpad to drag the cursor. | | Tap twice (at the same speed as double-clicking a mouse button); rest your finger on the touchpad on the second tap and drag the cursor. |
| Access context menu | | Click once. | |

NOTE: Illustrations for reference only. The exact configuration of your PC depends on the model purchased.

NOTE: When using the touchpad, keep it — and your fingers — dry and clean. The touchpad is sensitive to finger movement; hence, the lighter the touch, the better the response. Tapping harder will not increase the touchpad's responsiveness.

NOTE: By default, vertical and horizontal scrolling is enabled on your touchpad. It can be disabled under Mouse settings in Windows Control Panel.

Using the Keyboard

The keyboard has full-sized keys and an embedded numeric keypad, separate cursor, lock, Windows, function and special keys.

Lock Keys and embedded numeric keypad

The keyboard has three lock keys which you can toggle on and off.



















| Lock key | Description |
|--------------------------|--|
| Caps Lock | When Caps Lock is on, all alphabetic characters typed are in uppercase. |
| Num Lock <Fn> + <F11> | When Num Lock is on, the embedded keypad is in numeric mode. The keys function as a calculator (complete with the arithmetic operators +, -, *, and /). Use this mode when you need to do a lot of numeric data entry. A better solution would be to connect an external keypad. NOTE: <Fn> + <F11> works only for certain models. |
| Scroll Lock <Fn> + <F12> | When Scroll Lock is on, the screen moves one line up or down when you press the up or down arrow keys respectively. Scroll Lock does not work with some applications. |

The embedded numeric keypad functions like a desktop numeric keypad. It is indicated by small characters located on the upper right corner of the key caps. To simplify the keyboard legend, cursor-control key symbols are not printed on the keys.

| Desired access | Num Lock on | Num Lock off |
|--|--|--|
| Number keys on embedded keypad | Type numbers in a normal manner. | |
| Cursor-control keys on embedded keypad | Hold <Shift> while using cursor-control keys. | Hold <Fn> while using cursor-control keys. |
| Main keyboard keys | Hold <Fn> while typing letters on embedded keypad. | Type the letters in a normal manner. |

Windows Keys











The keyboard has two keys that perform Windows-specific functions.

| Key | Description |
|---|---|
|  Windows key | <p>Pressed alone, this key has the same effect as clicking on the Windows Start button; it launches the Start menu.</p> <p>It can also be used with other keys to provide a variety of functions:</p> <p><  >: Open or close the Start menu</p> <p><  > + <D>: Display the desktop</p> <p><  > + <E>: Open Windows Explore</p> <p><  > + <F>: Search for a file or folder</p> <p><  > + <G>: Cycle through Sidebar gadgets</p> <p><  > + <L>: Lock your computer (if you are connected to a network domain), or switch users (if you're not connected to a network domain)</p> <p><  > + <M>: Minimizes all windows</p> <p><  > + <R>: Open the Run dialog box</p> <p><  > + <T>: Cycle through programs on the taskbar</p> <p><  > + <U>: Open Ease of Access Center</p> <p><  > + <X>: Open Windows Mobility Center</p> <p><  > + <BREAK>: Display the System Properties dialog box</p> <p><  > + <SHIFT+M>: Restore minimized windows to the desktop</p> <p><  > + <TAB>: Cycle through programs on the taskbar by using Windows Flip 3-D</p> <p><  > + <SPACEBAR>: Bring all gadgets to the front and select Windows Sidebar</p> <p><CTRL> + <  > + <F>: Search for computers (if you are on a network)</p> <p><CTRL> + <  > + <TAB>: Use the arrow keys to cycle through programs on the taskbar by using Windows Flip 3-D</p> <p>Note: Depending on your edition of Windows Vista, some shortcuts may not function as described.</p> |
|  Application key | <p>This key has the same effect as clicking the right mouse button; it opens the application's context menu.</p> |

Hot Keys

The computer employs hotkeys or key combinations to access most of the computer's controls like screen brightness, volume output and the BIOS utility.

To activate hot keys, press and hold the <Fn> key before pressing the other key in the hotkey combination.

| Hotkey | Icon | Function | Description |
|-------------|---|------------------------|---|
| <Fn> + <F1> | ? | Hotkey help | Displays help on hotkeys. |
| <Fn> + <F2> |  | Acer eSettings | Launches Acer eSettings in Acer Empowering Technology. |
| <Fn> + <F3> |  | Acer ePower Management | Launches Acer ePower Management in Acer Empowering Technology. |
| <Fn> + <F4> | Z ^z | Sleep | Puts the computer in Sleep mode. |
| <Fn> + <F5> |  | Display toggle | Switches display output between the display screen, external monitor (if connected) and both. |
| <Fn> + <F6> |  | Screen blank | Turns the display screen backlight off to save power. Press any key to return. |
| <Fn> + <F7> |  | Touchpad toggle | Turns the internal touchpad on and off. |
| <Fn> + <F8> |  | Speaker toggle | Turns the speakers on and off. |
| <Fn> + <↑> |  | Brightness up | Increases the screen brightness. |
| <Fn> + <↓> |  | Brightness down | Decreases the screen brightness. |
| <Fn> + <△> |  | Volume up | Increases the sound volume (only for certain models). |
| <Fn> + <▽> |  | Volume down | Decreases the sound volume (only for certain models). |

Special Key (only for certain models)

You can locate the Euro symbol and the US dollar sign at the upper-center and/or bottom-right of your keyboard.

The Euro symbol

1. Open a text editor or word processor.
2. Either press < € > at the bottom-right of the keyboard, or hold <Alt Gr> and then press the <5> key at the upper-center of the keyboard.

NOTE: Some fonts and software do not support the Euro symbol. Please refer to www.microsoft.com/typography/faq/faq12.htm for more information.

The US dollar sign

1. Open a text editor or word processor.
2. Either press < \$ > at the bottom-right of the keyboard, or hold <Shift> and then press the <4> key at the upper-center of the keyboard.

NOTE: This function varies according to the language settings.

Acer Empowering Technology

The Empowering Technology toolbar makes it easy for you to access frequently used functions and manage your new Acer system. Activated by pressing the Empowering Key, it provides access to the following utilities:

NOTE: The following content is for general reference only. Actual product specifications may vary.



- Acer eDataSecurity Management** protects data with passwords and encryption (only for certain models).
- Acer ePower Management** optimizes battery usage via customizable power plans.
- Acer eRecovery Management** backs up and recovers data flexibly, reliably and completely.
- Acer eSettings Management** accesses system information and adjusts settings easily.



For more information, right-click on the Empowering Technology toolbar, then select **Help**. For help with a particular utility, launch the utility and click the  icon at the bottom of the active window.

Launching Acer Empowering Technology

To launch Acer Empowering Technology:

1. Press the Empowering Key to display the Acer Empowering Technology toolbar on the desktop.
 2. To hide the toolbar, press the Empowering Key again or click the hide button  on the toolbar.
- You may also launch Acer Empowering Technology by running the program from the Acer Empowering Technology program group in the Start menu, or by double-clicking the  icon if you have created a desktop shortcut.

To launch Acer Empowering Technology applications:

1. On the Acer Empowering Technology toolbar, click the icon that corresponds to the application you want to launch.
2. When you mouse over an application icon, a quick menu appears below the toolbar. The quick menu allows you to perform certain tasks simply and quickly.

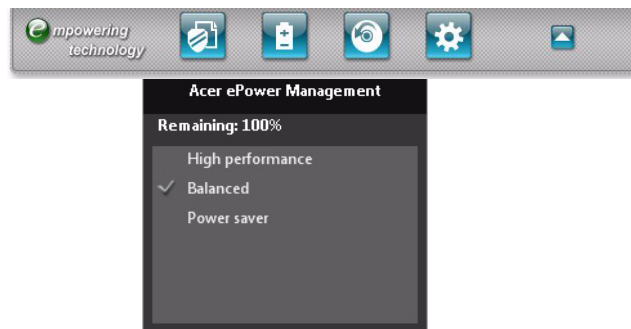

3. You may also run the application by selecting it from the Acer Empowering Technology program group in the Start menu.

Empowering Technology password

You must set the Empowering Technology password to use the password protection feature of Acer eRecovery Management to protect your data.

To set the Empowering Technology password:

1. Launch Acer eRecovery Management.
2. Click the Restore tab.
3. Click **Password settings**. The Empowering Technology Password Center dialogue box pops up.
4. Click **Create a new password**.

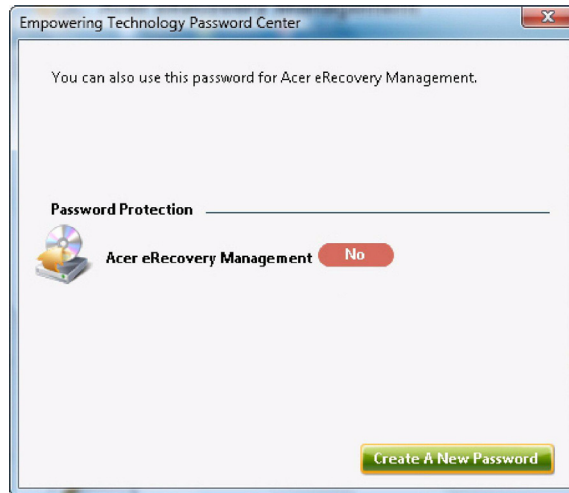

5. In the Create a New Password dialogue box, key in and confirm your password in the appropriate boxes. Your password should have a minimum of 4 and a maximum of 12 characters.
6. Enter a password hint that will help you remember your password.
7. Make sure the box **Use for Acer eRecovery Management** is checked.
8. Click **OK** to set the password.



Acer ePower Management



Acer ePower Management features a straightforward user interface for configuring your power management options. To access this utility, select **Acer ePower Management** from the Empowering Technology toolbar, run the program from the Acer Empowering Technology program group in Start menu, or right-click the Windows power icon in the system tray and select **Acer ePower Management**.

Using power plans

Acer ePower Management comes with three predefined power plans: Balanced, High performance and Power saver. You can also create customized power plans. You can create, switch between, edit, delete and restore power plans, as described below.

View and adjust settings for On Battery and Plugged In modes by clicking the appropriate tabs. For more power options, click  in the Acer ePower Management utility, or right-click the Windows power icon in the system tray and select **Power Options**.

NOTE: You cannot delete the predefined power plans.

To create a new power plan:

Creating customized power plans allows you to save and quickly switch to a personalized set of power options.

1. Click the **New power plan** option or icon .
2. Enter a name for your new power plan.
3. Choose a predefined power plan to base your customized plan on.
4. If necessary, change the display, sleep and hibernation settings you want your computer to use.
5. Click **OK** to save your new power plan.

To switch between power plans:

1. Mouse over the Acer ePower Management application on the Acer Empowering Technology toolbar. The quick menu appears. Select the power plan you want to switch to.
2. You may also switch between power plans by launching the Acer ePower Management application. Select the power plan you wish to switch to, then click **Apply**.

To edit a power plan:

Editing a power plan allows you to adjust system settings like LCD brightness and CPU speed.

1. Switch to the power plan you wish to edit.
2. Adjust settings as required.
3. Click **Apply** to save your new settings.

To delete a power plan:

You cannot delete the power plan you are currently using. If you want to delete the active power plan, switch to another one first.

1. Select the power plan you wish to delete.
2. Click the Delete Power Plan icon. 

Battery status

1. The quick menu shows the remaining battery life based on current usage.
2. You can also launch the Acer ePower Management application and refer to the Battery status panel located just below the power plans.

3. Click the Battery tab to view remaining battery life, battery status, and remaining battery life in standby and hibernate modes.



Acer eDataSecurity Management (only for certain models)

Acer eDataSecurity Management is an encryption utility that protects your files from being accessed by unauthorized persons. It is conveniently integrated with Windows Explorer as a shell extension for quick data encryption/decryption and also supports on-the-fly file encryption for Lotus Notes and Microsoft Outlook.

On first use, the Acer eDataSecurity Management setup wizard will prompt you to create the Master Password. You will use this password to access the Personal Secure Disk (PSD). The Master Password may also be used to encrypt/decrypt files by default.

If you set a different password to encrypt a file, but you forgot the encryption password, you can use the Master Password to decrypt the file.

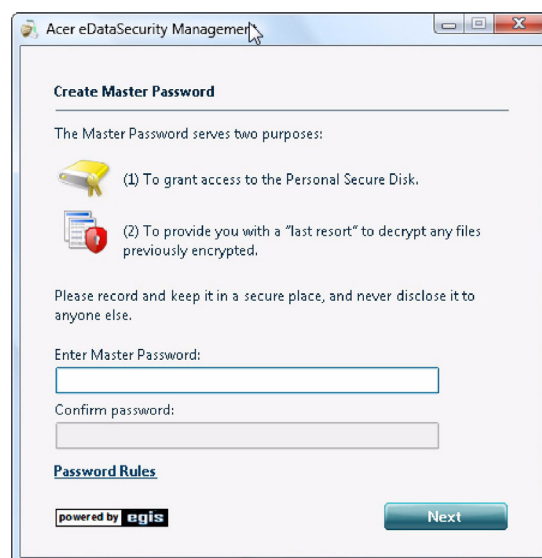

NOTE: The password used to encrypt a file is the unique key that the system needs to decrypt it. If you lose the password, the Master Password is the only other key capable of decrypting the file. If you lose both

passwords, there will be no way to decrypt your encrypted file! **Be sure to safeguard all related passwords!**



Acer eRecovery Management



Acer eRecovery Management is a versatile backup utility. It allows you to create full or incremental backups, burn the factory default image to optical disc, and restore from previously created backups or reinstall applications and drivers. By default, user-created backups are stored to the D:\ drive.

Acer eRecovery Management provides you with:

- Backup:
 - Back up factory default to CD/DVD
 - Back up drivers and applications to CD/DVD
 - Create user backup
 - Manage user backups
- Restore:
 - Restore system to factory default
 - Reinstall applications/drivers
 - Restore system from user backup
 - Password settings

To use the password protection feature of Acer eRecovery Management to protect your data, you must first set the Empowering Technology password. To set the password, refer to the section "**Empowering Technology password**".

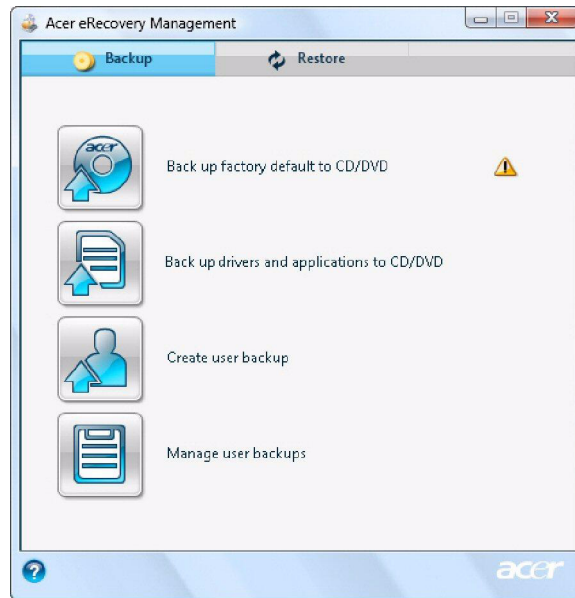

NOTE: If your computer did not come with a Recovery CD or System CD, please use Acer eRecovery Management's Backup factory default to CD/DVD feature to burn a backup image to CD or DVD. To ensure the best results when recovering your system using a CD or Acer eRecovery Management, detach all peripherals (except the external Acer ODD, if your computer has one), including your Acer ezDock.

Acer eSettings Management



Acer eSettings Management allows you to inspect hardware specifications, set BIOS passwords and modify boot options.

Acer eSettings Management also:

- Provides a simple graphical user interface for navigation.
- Prints and saves hardware specifications.
- Lets you set an asset tag for your system.

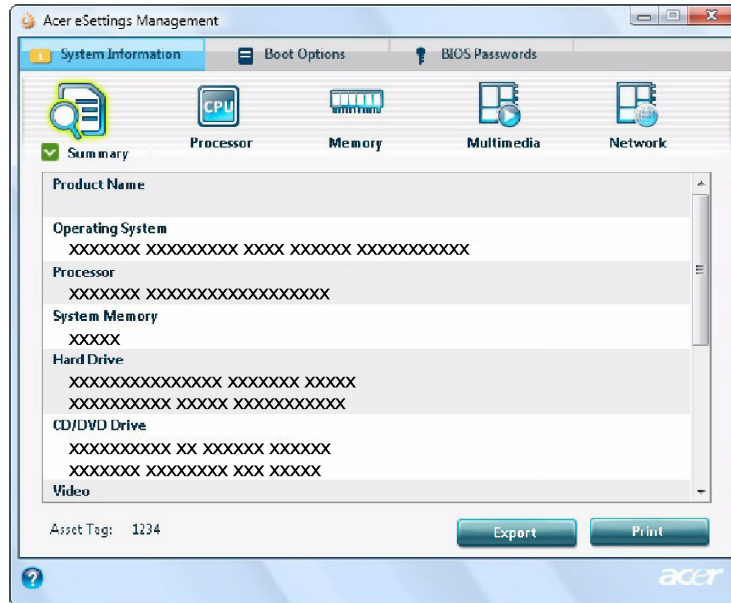

Windows Mobility Center

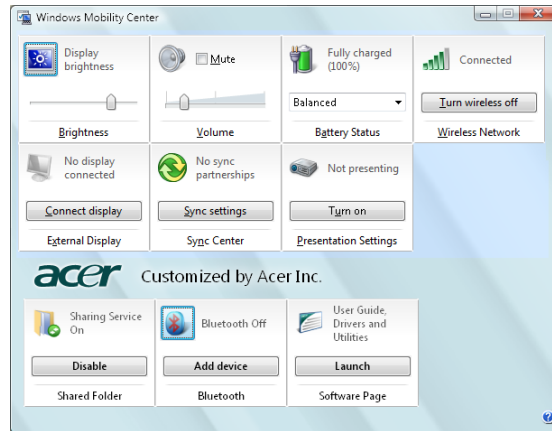

The Windows Mobility Center collects key mobile-related system settings in one easy-to-find place, so you can quickly configure your Acer system to fit the situation as you change locations, networks or activities. Settings include display brightness, volume, power plan, wireless networking on/off, external display settings, synchronization status and presentation settings.

Windows Mobility Center also includes Acer-specific settings like sharing folders overview/sharing service on or off, Bluetooth Add Device (if applicable), and a shortcut to the Acer user guide, drivers and utilities.

To launch Windows Mobility Center:

- Use the shortcut key + <X>.
- Start Windows Mobility Center from the Control panel.
- Start Windows Mobility Center from the Accessories program group in the Start menu.
- Launch Windows Mobility Center by right-clicking  in the system tray and select **Windows Mobility Center**.

Using the System Utilities

Acer Bio-Protection (only for certain models)

Acer Bio-Protection Fingerprint Solution is a multi-purpose fingerprint software package integrated with the Microsoft Windows operating system. Utilizing the uniqueness of one's fingerprint features, Acer Bio-Protection Fingerprint Solution has incorporated protection against unauthorized access to your computer with centralized password management with Password Bank, easy music player launching with Acer MusicLaunch, secure Internet favorites via Acer MyLaunch, and fast application/website launching and login with Acer FingerLaunch, while Acer ProfileLaunch can launch up to three applications/websites from a single finger swipe.

Acer Bio-Protection Fingerprint Solution also allows you to navigate through web browsers and documents using Acer FingerNav. With Acer Bio-Protection Fingerprint Solution, you can now enjoy an extra layer of protection for your personal computer, as well as the convenience of accessing your daily tasks with a simple swipe of your finger!

For more information refer to the Acer Bio-Protection help files.

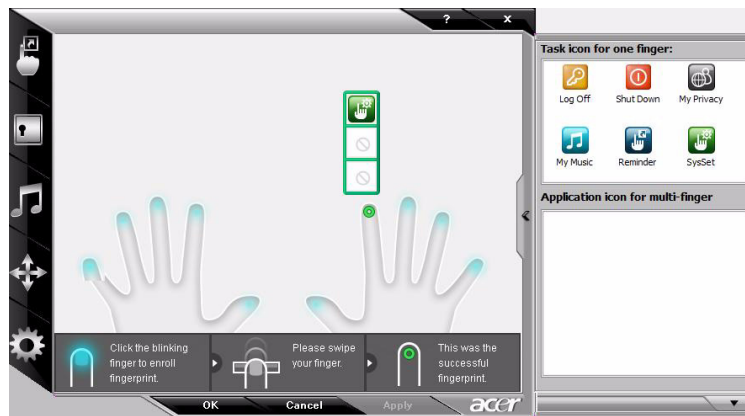

Acer GridVista (dual-display compatible)

NOTE: This feature is only available on certain models.

To enable the dual monitor feature of the notebook, first ensure that the second monitor is connected, then select **Start, Control Panel, Display** and click on **Settings**. Select the secondary monitor (**2**) icon in the display box and then click the check box **Extend my windows desktop onto this monitor**. Finally, click **Apply** to confirm the new settings and click **OK** to complete the process.

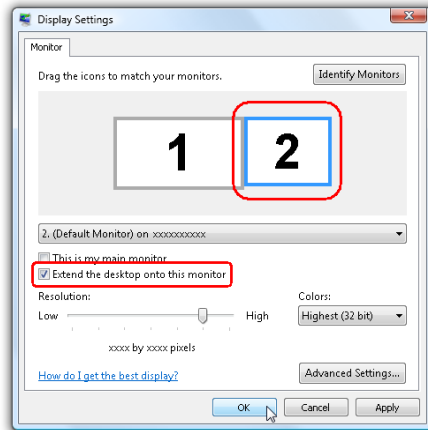

Acer GridVista is a handy utility that offers four pre-defined display settings so you can view multiple windows on the same screen. To access this function, please go to **Start>All Programs** and click on **Acer GridVista**. You may choose any one of the four display settings indicated below:

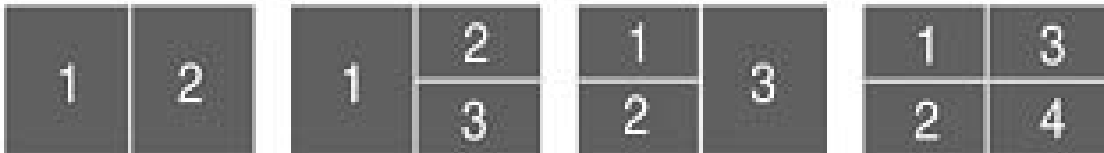

Double (vertical), Triple (primary at left), Triple (primary at right), or Quad Acer GridVista is dual-display compatible, allowing two displays to be partitioned independently.

Acer GridVista is dual-display compatible, allowing two displays to be partitioned independently.

AcerGridVista is simple to set up:

1. Run Acer GridVista and select your preferred screen configuration for each display from the task bar.
2. Drag and drop each window into the appropriate grid.
3. Enjoy the convenience of a well-organized desktop.

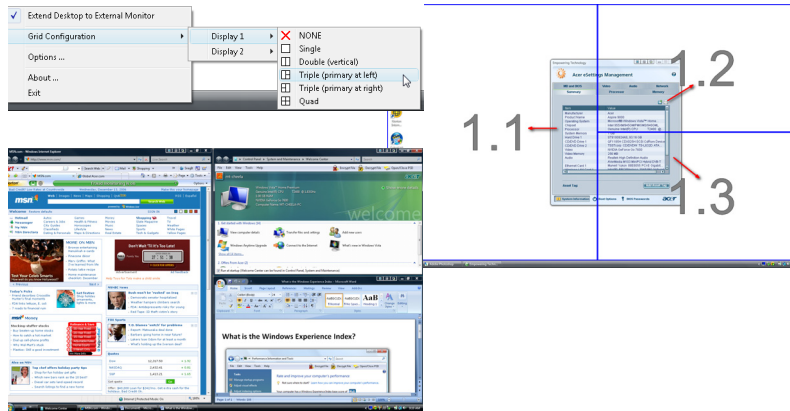

NOTE: Please ensure that the resolution setting of the second monitor is set to the manufacturer's recommended value.

Hardware Specifications and Configurations

Processor

| Item | Specification |
|------------------|---|
| CPU type | Intel® Core™2 Duo Mobile Processor P8400 (2.26G), P8600 (2.4 G), P9500 (2.53G), T9400 (2.53G), T9600 (2.8G) |
| Core logic | Mobile Intel® 945 Express Chipset |
| CPU package | Socket B (P8400, P8600, P9500) and Socket P (T9400, T9600) |
| CPU core voltage | 1.0375V to 1.3V |

CPU Fan True Value Table

| DTS(degree C) | Fan Speed (rpm) | Acoustic Level (dBA) |
|---------------|-----------------|----------------------|
| 45-50 | 0-3000 | 29 |
| 55-66 | 0-3300 | 33 |
| 68-74 | 3300-3800 | 38 |
| 78-83 | 3800-4100 | 40 |
| 86-91 | 4100-4800 | 40 |

Throttling 50%: On= 99° C; OFF=93° C

OS shut down at 105° C; H/W shot down at 110° .C

BIOS

| Item | Specification |
|--------------|---------------|
| BIOS vendor | Phoenix |
| BIOS Version | 1.04c |

System Memory

| Item | Specification |
|---------------------------------|--|
| Memory controller | Built-in |
| Memory size | 0MB (no on-board memory) |
| DIMM socket number | 2 sockets |
| Supports memory size per socket | 2048MB |
| Supports maximum memory size | 4G for 64bit OS (with two 2GB SODIMM) |
| Supports DIMM type | DDR 2 Synchronous DRAM |
| Supports DIMM Speed | 667 MHz |
| Supports DIMM voltage | 1.8V and 0.9V |
| Supports DIMM package | 200-pin soDIMM |
| Memory module combinations | You can install memory modules in any combinations as long as they match the above specifications. |

Memory Combinations

| Slot 1 | Slot 2 | Total Memory |
|--------|--------|--------------|
| 0MB | 256MB | 256MB |
| 0MB | 512MB | 512MB |
| 0MB | 1024MB | 1024MB |
| 0MB | 2048MB | 2048MB |
| 256MB | 256MB | 512MB |
| 256MB | 512MB | 768MB |
| 256MB | 1024MB | 1280MB |
| 256MB | 2048MB | 2304MB |
| 512MB | 256MB | 768MB |
| 512MB | 512MB | 1024MB |
| 512MB | 1024MB | 1536MB |
| 512MB | 2048MB | 2560MB |
| 1024MB | 0MB | 1024MB |
| 1024MB | 256MB | 1280MB |
| 1024MB | 512MB | 1536MB |
| 1024MB | 1024MB | 2048MB |
| 1024MB | 2048MB | 3072MB |
| 2048MB | 0MB | 2048MB |
| 2048MB | 256MB | 2304MB |
| 2048MB | 512MB | 2560MB |
| 2048MB | 1024MB | 3072MB |
| 2048MB | 2048MB | 4096MB |

NOTE: Above table lists some system memory configurations. You may combine DIMMs with various capacities to form other combinations. On above table, the configuration of slot 1 and slot 2 could be reversed.

| Item | Specification |
|------------------------|---|
| LAN Chipset | Broadcom BCM5764/Broadcom BCM5765 |
| Supports LAN protocol | 10/100/1000 Mbps |
| LAN connector type | RJ45 |
| LAN connector location | Left side |
| Features | Integrated 10/100 BASE-T transceiver Wake on LAN support compliant with ACPI 2.0 PCI v2.2 |

Bluetooth Interface

| Item | Specification |
|-----------------|--|
| Chipset | Foxconn Bluetooth FOX_BRM_2.0 F/W 300 |
| Data throughput | 723 bps (full speed data rate) |
| Protocol | Bluetooth 1.1 (Upgradeable to Bluetooth 1.2 when SIG specification is ratified). |
| Interface | USB 1.1 |

Bluetooth Interface

| Item | Specification |
|----------------|---------------|
| Connector type | USB |

Wireless Module 802.11b/g

| Item | Specification |
|-----------------|---|
| Chipset | WLAN 802.11ABGN SHIRLEYPEAK1*2 |
| Data throughput | 11~54 Mbps, up to 270 Mbps for Draft-N |
| Protocol | 802.11b+g, Draft-N |
| Interface | PCI bus (mini PCI socket for wireless module) |

Hard Disk Drive Interface

| Item | | | | |
|--|--|---|---|--------------------------------|
| Vendor & Model Name | HGST HTS542512K9SA00 BRONCO-B LF SEAGATE ST9120817AS LF TOSHIBA MK1246GSX LF WD1200BEVS- 22UST0 ML125 LF | WD1600BEVT- 22ZCT0 HITACHI HTS541616J9SA00 LF SEAGATE SATA ST9160827AS TOSHIBA MK1646GSX LF | SEAGATE SATA ST9250827AS TOSHIBA MK2546GSX LF HGST HTS542525K9SA00 LF WD WD2500BEVS- 22UST0 ML125 | WD WD3200BEVT- 22ZCT0 ML125 |
| Capacity (MB) | 120000 | 160000 | 250000 | 320000 |
| Bytes per sector | 512 | 512 | 512 | N/A |
| Data heads | 3 | 3/4 | 4 | N/A |
| Drive Format | | | | |
| Disks | 2 | 2 | 2 | N/A |
| Spindle speed (RPM) | 5400 RPM | 5400 RPM | 5400 RPM | 5400 RPM |
| Performance Specifications | | | | |
| Buffer size | 8MB | 8MB | 8MB | 8MB |
| Interface | SATA | SATA | SATA | SATA |
| Max. media transfer rate (disk-buffer, Mbytes/s) | 540 | 540 | 540 | 850 |
| DC Power Requirements | | | | |
| Voltage tolerance | 5V(DC) +/- 5% | 5V(DC) +/- 5% | 5V(DC) +/- 5% | 5V(DC) +/- 5% |

Optical Disc Drive

| Item | Specification | |
|---------------------------|--|-----------------------------------|
| Vendor & model name | TOSHIBA SUPER-MULTI DRIVE DL 8X TS-L633A LF PIONEER SUPER-MULTI DRIVE 8X DVR-TD08RS LF PANASONIC SUPER-MULTI DRIVE DL 8X UJ-870A LF HLDS SUPER-MULTI DRIVE TRAY DL 8X GSA-T50N LF HLDS SUPER-MULTI DRIVE DL 8X GSA-T50N LF SONY SUPER-MULTI DRIVE DL 8X AD-7560S LF PLDS SUPER-MULTI DRIVE DL 8X DS-8A2S LF | |
| Performance Specification | With CD Diskette | With DVD Diskette |
| Transfer rate (KB/sec) | Sustained: Max 3.6Mbytes/sec | Sustained: Max 10.08Mbytes/sec |
| Buffer Memory | 2MB | |
| Interface | SATA | |
| Applicable disc format | <p>Applicable disc format</p> <p>CD: CD-DA, CD-ROM, CD-ROM XA, Photo CD (multi-session), Video CD, Cd-Extra (CD+), CD-text</p> <p>DVD: DVD-VIDEO, DVD-ROM, DVD-R (3.9GB, 4.7GB) DVD-R DL, DVD-RW, DVD-RAM, DVD+R, DVD+R DL, DVD+RW</p> <p>CD:</p> <p>CD-DA (Red Book) - Standard Audio CD & CD-TEXT</p> <p>CD-ROM (Yellow Book Mode1 & 2) - Standard Data</p> <p>CD-ROM XA (Mode2 Form1 & 2) - Photo CD, Multi-Session</p> <p>CD-I (Green Book, Mode2 Form1 & 2, Ready, Bridge)</p> <p>CD-Extra/ CD-Plus (Blue Book) - Audio & Text/Video</p> <p>Video-CD (White Book) - MPEG1 Video</p> <p>CD-R (Orange Book Part)</p> <p>CD-RW & HSRW (Orange Book Part Volume1 & Volume 2)</p> <p>Super Audio CD (SACD) Hybrid type</p> <p>US & US+ RW</p> <p>DVD:</p> <p>DVD-ROM (Book 1.02), DVD-Dual</p> <p>DVD-Video (Book 1.1)</p> <p>DVD-R (Book 1.0, 3.9G)</p> <p>DVD-R (Book 2.0, 4.7G) - General & Authoring</p> <p>DVD+R (Version 1.0)</p> <p>DVD+RW</p> <p>DVD-RW (Non CPRM & CPRM)</p> <p>DVD²R Dual</p> | |
| Loading mechanism | <p>Load: Manual</p> <p>Release: (a) Electrical Release (Release Button)</p> <p style="padding-left: 40px;">(b) Release by ATAPI command</p> <p style="padding-left: 40px;">(c) Emergency Release</p> | |
| Power Requirement | | |
| Input Voltage | 5 V +/- 5% (Operating) | |

Audio Interface

| Item | Specification |
|-----------------------------|---|
| Audio Controller | Realtek ALC883 Azalia and Amplifier Maxim MAX9710 & MAX4411 |
| Audio onboard or optional | Built-in |
| Mono or Stereo | Stereo |
| Resolution | 18 bit stereo full duplex |
| Compatibility | HD audio Interface; S/PDIF output for PCM or AC-3 content |
| Sampling rate | 1Hz resolution VSR (Variable Sampling Rate) |
| Internal microphone | Yes |
| Internal speaker / Quantity | Yes/2 (1.5W speakers) |

Video Memory

| Item | Specification |
|-------------|-----------------------------------|
| Chipset | VGA CARD NB9P-GS/Intel GMA970 VGA |
| Memory size | 512M GDDR3/ |

| Item | Specification |
|------------------------------|--|
| Chipset | ICH8M |
| USB Compliancy Level | 2.0 |
| OHCI | USB 1.1 and USB 2.0 Host controller |
| Number of USB port | 3 |
| Location | Two on the right side/one on the front |
| Serial port function control | Enable/Disable by BIOS Setup |

System Board Major Chips

| Item | Controller |
|----------------------------|---|
| Core logic | Mobile Intel® GM945/PM945 + ICH8M Express Chipset |
| VGA | nVidia GeForce 9300 GS/ATI Mobility HD 3470/UMA |
| USB 2.0 | Intel ICH8M |
| Super I/O controller | N/A |
| MODEM | ALC 883 |
| Bluetooth | FOXCONN BCM2045 V2 |
| Wireless 802.11 b+g | WLAN 802.11ABGN SHIRLEYPEAK1*2 |
| PCMCIA/ 5 in 1 Card Reader | JMicron Cardreader JMB385 |
| Audio Codec | Audio Azalia(ALC888S) |

Keyboard

| Item | Specification |
|---------------------|---------------|
| Keyboard controller | NS PC97541V |

Keyboard

| Item | Specification |
|--|---|
| Total number of keypads | 84-/85-key |
| Windows logo key | Yes |
| Internal & external keyboard work simultaneously | Plug USB keyboard to the USB port directly: Yes |

Battery

| Item | Specification |
|------------------------|--|
| Vendor | Panasonic/Sanyo/Sony/Simplo |
| Battery Type | Li-ion |
| Pack capacity | 6Cell 4400 MAH/8Cell 4800 MAH |
| Number of battery cell | 6/8 |
| Package configuration | 3 cells in series, 2 series in parallel 4 cells in series, 2 series in parallel |

LCD 15.4" inch

| Item | Specification |
|---|------------------------|
| Vendor & model name | CMO/AUO/LG |
| Screen Diagonal (mm) | 15.4 inches |
| Display resolution (pixels) | 1280 x 800 WXGA |
| Pixel Pitch | 0.204 x 0.204 |
| Pixel Arrangement | R.G.B. Vertical Stripe |
| Display Mode | Normally White |
| Typical White Luminance (NIT) also called Brightness | 220 |
| Luminance Uniformity | 1.25 max. |
| Contrast Ratio | 400 typical |
| Response Time msec | 8 |
| Nominal Input Voltage VDD | +3.3V |
| Viewing Angle (degree) Horizontal: Right/Left Vertical: Upper/Lower | 45/45 15/35 |
| Temperature Range(° C) Operating Storage (shipping) | 0 to +50 -40 to +60 |

AC Adaptor

| Item | Specification |
|--------|-----------------------------|
| Input | 100-240V~ 1.5A, 50-60Hz/ |
| Output | 19V 4.74A 90W/19V 3.42A 65W |

System Power Management

| ACPI mode | Power Management |
|---------------------|--|
| Mech. Off (G3) | All devices in the system are turned off completely. |
| Soft Off (G2/S5) | OS initiated shutdown. All devices in the system are turned off completely. |
| Working (G0/S0) | Individual devices such as the CPU and hard disc may be power managed in this state. |
| Suspend to RAM (S3) | CPU set power down VGA Suspend PCMCIA Suspend Audio Power Down Hard Disk Power Down CD-ROM Power Down Super I/O Low Power mode |
| Save to Disk (S4) | Also called Hibernation Mode. System saves all system states and data onto the disc prior to power off the whole system. |

System Utilities

BIOS Setup Utility

The BIOS Setup Utility is a hardware configuration program built into your computer's BIOS (Basic Input/Output System).

Your computer is already properly configured and optimized, and you do not need to run this utility. However, if you encounter configuration problems, you may need to run Setup. Please also refer to Chapter 4 Troubleshooting when problem arises.

To activate the BIOS Utility, press **F2** during POST (when "Press <F2> to enter Setup" message is prompted on the bottom of screen).

Press **F2** to enter setup. The default parameter of F12 Boot Menu is set to "disabled". If you want to change boot device without entering BIOS Setup Utility, please set the parameter to "enabled".

Press <F12> during POST to enter multi-boot menu. In this menu, user can change boot device without entering BIOS SETUP Utility.

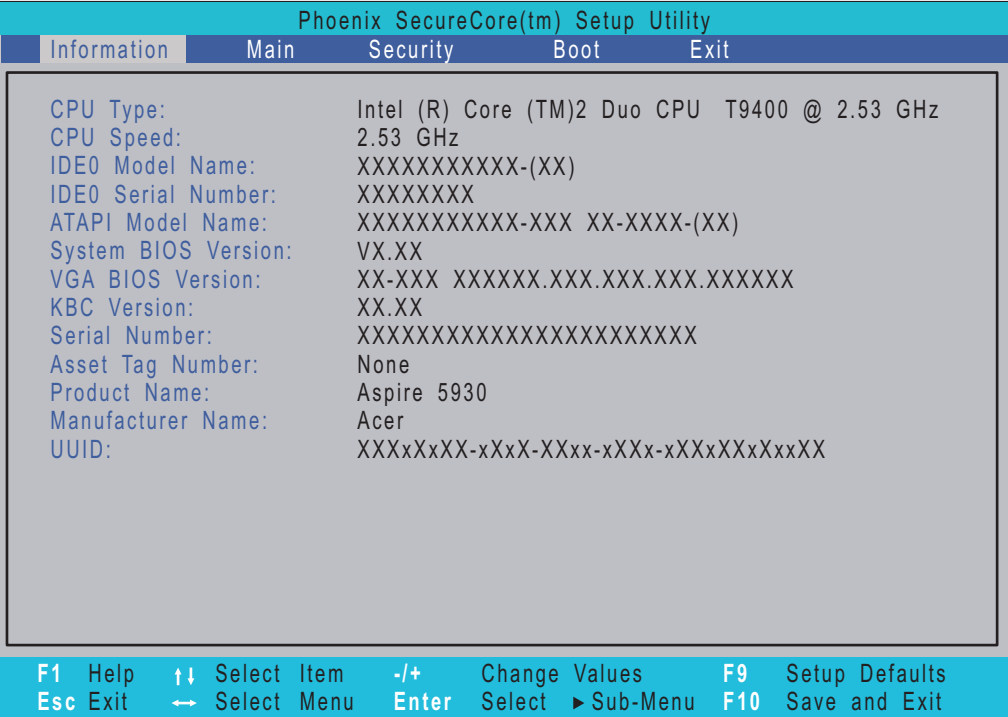

Navigating the BIOS Utility

There are six menu options: Information, Main, Security, Boot, and Exit.

Follow these instructions:

- To choose a menu, use the left and right arrow keys.
- To choose an item, use the up and down arrow keys.
- To change the value of a parameter, press **F5** or **F6**.
- A plus sign (+) indicates the item has sub-items. Press **Enter** to expand this item.
- Press **Esc** while you are in any of the menu options to go to the Exit menu.
- In any menu, you can load default settings by pressing **F9**. You can also press **F10** to save any changes made and exit the BIOS Setup Utility.

NOTE: You can change the value of a parameter if it is enclosed in square brackets. Navigation keys for a particular menu are shown on the bottom of the screen. Help for parameters are found in the Item Specific Help part of the screen. Read this carefully when making changes to parameter values. **Please note that system information is subject to different models.**

Information

The Information screen displays a summary of your computer hardware information.

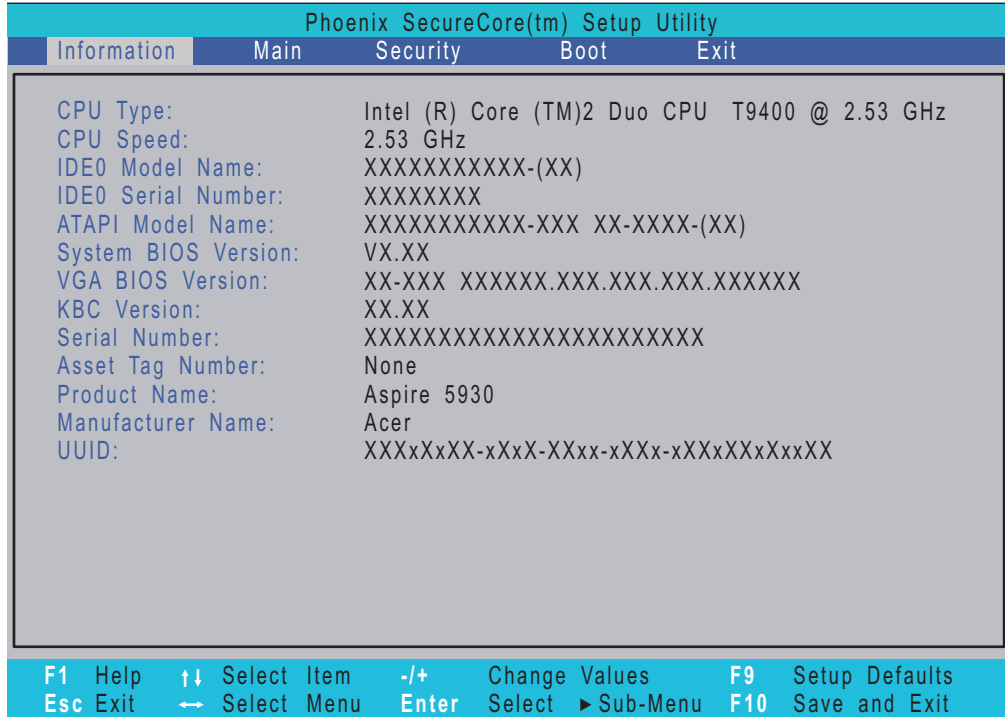

NOTE: The system information is subject to different models.

| Parameter | Description |
|---------------------|--|
| CPU Type | This field shows the CPU type and speed of the system. |
| CPU Speed | This field shows the speed of the CPU. |
| IDE0 Model Name | This field shows the model name of HDD installed on primary IDE master. |
| IDE0 Serial Number | This field displays the serial number of HDD installed on primary IDE master. |
| ATAPI Model Name | This field shows the model name of the Optical device installed in the system. |
| System BIOS Version | Displays system BIOS version. |
| VGA BIOS Version | This field displays the VGA firmware version of the system. |
| KBC Ver | This field shows the keyboard |
| Serial Number | This field displays the serial number of this unit. |
| Asset Tag Number | This field displays the asset tag number of the system. |
| Product Name | This field shows product name of the system. |
| Manufacturer Name | This field displays the manufacturer of this system. |
| UUID Number | Universally Unique Identifier (UUID) is an identifier standard used in software construction, standardized by the Open Software Foundation (OSF) as part of the Distributed Computing Environment (DCE). |

Main

The Main screen allows the user to set the system time and date as well as enable and disable boot option and recovery.

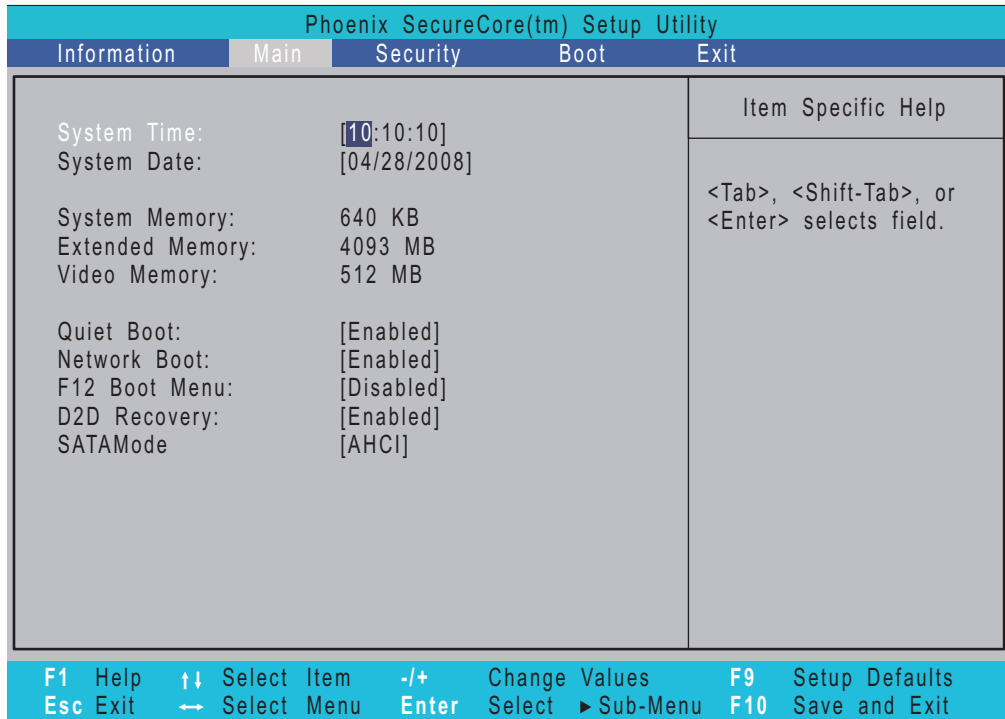

NOTE: The screen above is for your reference only. Actual values may differ.

The table below describes the parameters in this screen. Settings in **boldface** are the default and suggested parameter settings.

| Parameter | Description | Format/Option |
|-----------------|--|--|
| System Time | Sets the system time. The hours are displayed with 24-hour format. | Format: HH:MM:SS (hour:minute:second) System Time |
| System Date | Sets the system date. | Format MM/DD/YYYY (month/day/year) System Date |
| System Memory | This field reports the memory size of the system. Memory size is fixed to 640MB | |
| Extended Memory | This field reports the memory size of the extended memory in the system. Extended Memory size=Total memory size-1MB | |
| VGA Memory | Shows the VGA memory size. | |
| Quiet Boot | Determines if Customer Logo will be displayed or not; shows Summary Screen is disabled or enabled. Enabled: Customer Logo is displayed, and Summary Screen is disabled. Disabled: Customer Logo is not displayed, and Summary Screen is enabled. | Option: Enabled or Disabled |
| Network Boot | Enables, disables the system boot from LAN (remote server). | Option: Enabled or Disabled |
| F12 Boot Menu | Enables, disables Boot Menu during POST. | Option: Disabled or Enabled |
| D2D Recovery | Enables, disables D2D Recovery function. The function allows the user to create a hidden partition on hard disc drive to store operation system and restore the system to factory defaults. | Option: Enabled or Disabled |
| SATA Mode | Control the mode in which the SATA controller should operate. | Option: AHCI or IDE |

NOTE: The sub-items under each device will not be shown if the device control is set to disable or auto. This is because the user is not allowed to control the settings in these cases.

Security

The Security screen contains parameters that help safeguard and protect your computer from unauthorized use.

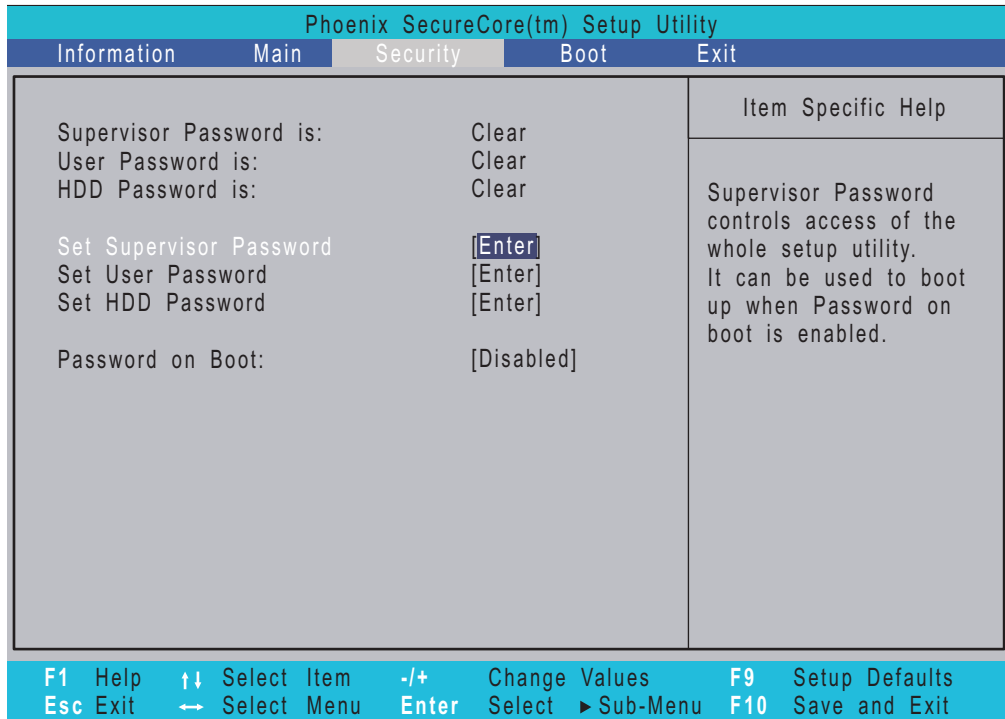

NOTE: Please refer to "Remove HDD/BIOS Password" section if you need to know how to remove HDD/BIOS Password.

The table below describes the parameters in this screen. Settings in **boldface** are the default and suggested parameter settings.

| Parameter | Description | Option |
|-------------------------|--|----------------------------|
| Supervisor Password Is | Shows the setting of the Supervisor password | Clear or Set |
| User Password Is | Shows the setting of the user password. | Clear or Set |
| HDD Password Is | Shows the setting of the hard disk password. | Clear or Set |
| Set Supervisor Password | Press Enter to set the supervisor password. When set, this password protects the BIOS Setup Utility from unauthorized access. The user can not either enter the Setup menu nor change the value of parameters. | |
| Set User Password | Press Enter to set the user password. When user password is set, this password protects the BIOS Setup Utility from unauthorized access. The user can enter Setup menu only and does not have right to change the value of parameters. | |
| Set HDD Password | Enter HDD Password. | |
| Password on Boot | Defines whether a password is required or not while the events defined in this group happened. The following sub-options are all requires the Supervisor password for changes and should be grayed out if the user password was used to enter setup. | Disabled or Enabled |

NOTE: When you are prompted to enter a password, you have three tries before the system halts. Don't forget your password. If you forget your password, you may have to return your notebook computer to your dealer to reset it.

Setting a Password

Follow these steps as you set the user or the supervisor password:

1. Use the "w" and "y" keys to highlight the Set Supervisor Password parameter and press the e key. The Set Supervisor Password box appears:

Set Supervisor Password

Enter New Password []

Confirm New Password []

2. Type a password in the "Enter New Password" field. The password length can not exceeds 8 alphanumeric characters (A-Z, a-z, 0-9, not case sensitive). Retype the password in the "Confirm New Password" field.

IMPORTANT: Be very careful when typing your password because the characters do not appear on the screen.

3. Press e.
After setting the password, the computer sets the User Password parameter to "Set".
4. If desired, you can opt to enable the Password on boot parameter.
5. When you are done, press u to save the changes and exit the BIOS Setup Utility.

Removing a Password

Follow these steps:

1. Use the **w** and **y** keys to highlight the Set Supervisor Password parameter and press the **e** key. The Set Password box appears:

| | | |
|-------------------------|---|---|
| Set Supervisor Password | | |
| Enter current password | [|] |
| Enter New Password | [|] |
| Confirm New Password | [|] |

2. Type the current password in the Enter Current Password field and press **e**.
3. Press **e** twice **without** typing anything in the Enter New Password and Confirm New Password fields. The computer then sets the Supervisor Password parameter to "Clear".
4. When you have changed the settings, press **u** to save the changes and exit the BIOS Setup Utility.

Changing a Password

1. Use the **w** and **y** keys to highlight the Set Supervisor Password parameter and press the **e** key. The Set Password box appears:

| | | |
|-------------------------|---|---|
| Set Supervisor Password | | |
| Enter current password | [|] |
| Enter New Password | [|] |
| Confirm New Password | [|] |

2. Type the current password in the Enter Current Password field and press **e**.
3. Type a password in the Enter New Password field. Retype the password in the Confirm New Password field.
4. Press **e**. After setting the password, the computer sets the User Password parameter to "Set".
5. If desired, you can enable the Password on boot parameter.
6. When you are done, press **u** to save the changes and exit the BIOS Setup Utility.

If the verification is OK, the screen will display as following.

| |
|--------------------------|
| Setup Notice |
| Changes have been saved. |
| [continue] |

The password setting is complete after the user presses **u**.

If the current password entered does not match the actual current password, the screen will show you the Setup Warning.

Setup Warning
Invalid password
Re-enter Password
[continue]

If the new password and confirm new password strings do not match, the screen will display the following message.

Setup Warning
Password do not match
Re-enter Password

Boot

This menu allows the user to decide the order of boot devices to load the operating system. Bootable devices includes the diskette drive in module bay, the onboard hard disk drive and the CD-ROM in module bay.

| Phoenix SecureCore(tm) Setup Utility | | | | |
|---|----------------|-------------------|--|-------------------|
| Information | Main | Security | Boot | Exit |
| Boot priority order: 1: IDE HDD: XXXXXXXXXXXX-(XX) 2: IDE CD: XXXXXXXXXXXX-XXX XX-XXXX-XX 3: PCI LAN: Network Boot 4: USB HDD: 5: USB FDD: 6: USB Key: 7: USB CDROM: | | | Item Specific Help Use <↑> or <↓> to select a device, then press <F6> to move it up the list, or <F5> to move it down the list. Press <Esc> to escape the menu. | |
| F1 Help | ↑↓ Select Item | -/+ Change Values | F9 Setup Defaults | |
| Esc Exit | ↔ Select Menu | Enter Select | ▶ Sub-Menu | F10 Save and Exit |

Exit

The Exit screen contains parameters that confirmed or discard the changes made to the parameters in the BIOS Setup Utility.

Phoenix SecureCore(tm) Setup Utility

Information Main Security Boot Exit

Exit Saving Changes
Exit Discarding Changes
Load Setup Defaults
Discard Changes
Save Changes

Item Specific Help

Exit System Setup and save your changes to CMOS.

F1 Help ↑↓ Select Item -/+ Change Values F9 Setup Defaults
Esc Exit ←→ Select Menu Enter Select ► Sub-Menu F10 Save and Exit

The table below describes the parameters in this screen.

| Parameter | Description |
|-------------------------|---|
| Exit Saving Changes | Exit System Setup and save your changes to CMOS. |
| Exit Discarding Changes | Exit utility without saving setup data to CMOS. |
| Load Setup Default | Load default values for all SETUP item. |
| Discard Changes | Load previous values from CMOS for all SETUP items. |
| Save Changes | Save Setup Data to CMOS. |

BIOS Flash Utility

The BIOS flash memory update is required for the following conditions:

- New versions of system programs
- New features or options
- Restore a BIOS when it becomes corrupted.

Use the Flash utility to update the system BIOS flash ROM.

NOTE: If you do not have a crisis recovery diskette at hand, then you should create a **Crisis Recovery Diskette** before you use the Flash utility.

NOTE: Do not install memory-related drivers (XMS, EMS, DPMS) when you use the Flash.

NOTE: Please use the AC adaptor power supply when you run the Flash utility. If the battery pack does not contain enough power to finish BIOS flash, you may not boot the system because the BIOS is not completely loaded.

Follow the steps below to run the Flash.

1. Prepare a bootable diskette.
2. Copy the flash utilities to the bootable diskette.
3. Then boot the system from the bootable diskette. The flash utility has auto-execution function.

Remove HDD/BIOS Utility

This section provide you with removing HDD/BIOS method:

Remove HDD Password:

- ❑ If you key in wrong HDD password for three time, "HDD password error code" would display on the screen. See the image below.

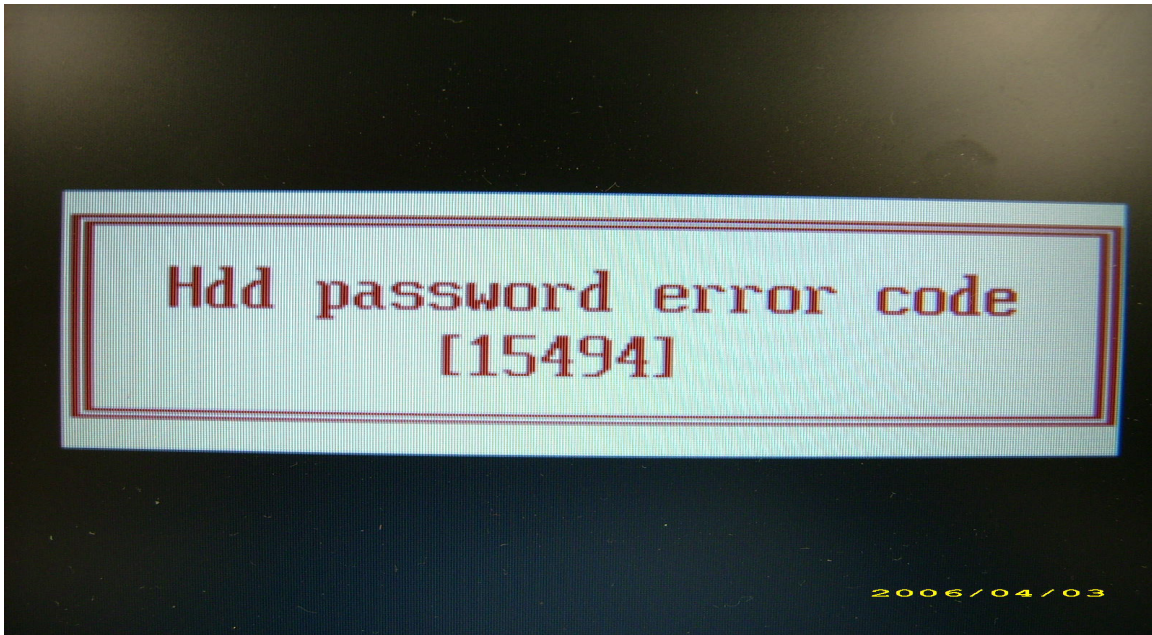

- ❑ If you need to solve HDD password locked problem, you can run HDD_PW.EXE
 1. Key in "hdd_pw 15494 0"
 2. Select "2"
 3. Choose one upper-case string

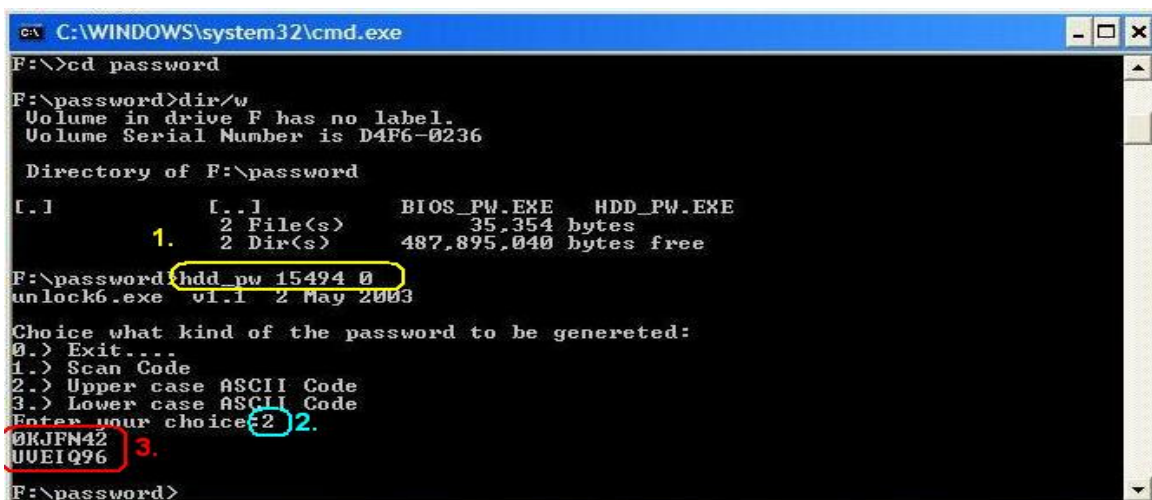

- ❑ Reboot system and key in "0KJFN42" or "UVEIQ96" to HDD user password.

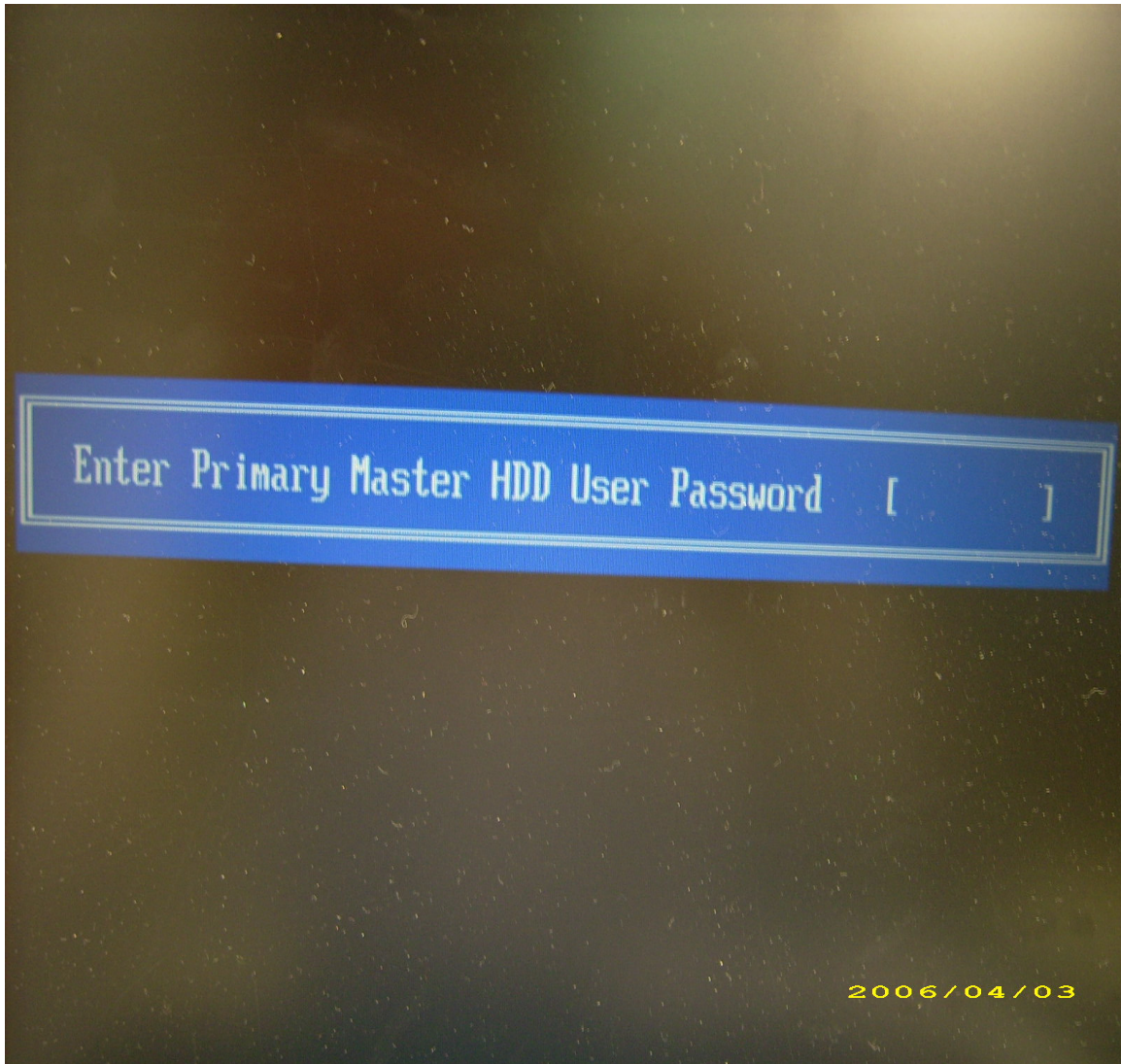

Remove BIOS Password:

- If you key in wrong Supervisor Password for three time, "System Disabled" would display on the screen. See the image below.

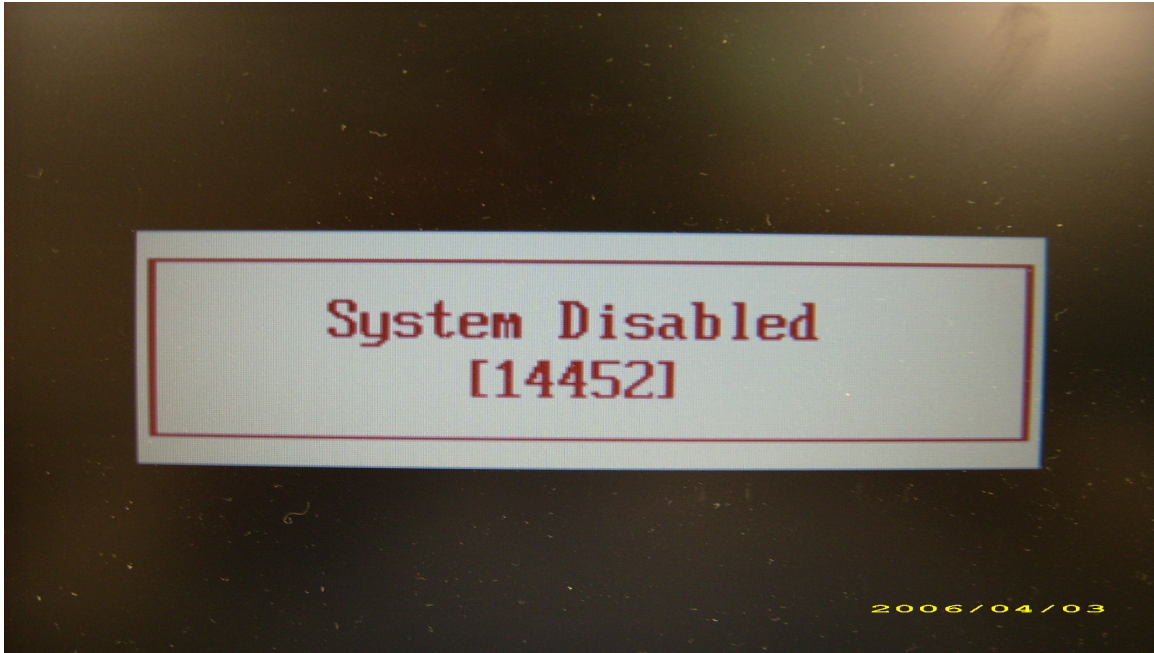

- If you need to solve BIOS password locked problem, you can run BIOS_PW.EXE
 1. Key in "bios_pw 14452 0"
 2. Choose one upper-case string

```
C:\WINDOWS\system32\cmd.exe
Microsoft Windows XP [Version 5.1.2600]
(C) Copyright 1985-2001 Microsoft Corp.
C:\Documents and Settings\M54>d:
D:\>bios_pw 14452 0
unlock6.exe v1.0 1 July 1997
qjjg9vy
07yqmjd
cjl14tm
6mbzjaj
D:\>_
```

- Reboot the system and key in "qjjg9vy" or "07yqmjd" to BIOS user password.



Machine Disassembly and Replacement

This chapter contains step-by-step procedures on how to disassemble the notebook computer for maintenance and troubleshooting.

Disassembly Requirements

To disassemble the computer, you need the following tools:

- Wrist grounding strap and conductive mat for preventing electrostatic discharge
- Flat screwdriver
- Philips screwdriver
- Hex screwdriver
- Plastic flat screwdriver
- Plastic tweezers

NOTE: The screws for the different components vary in size. During the disassembly process, group the screws with the corresponding components to avoid mismatch when putting back the components.

General Information

Pre-disassembly Instructions

Before proceeding with the disassembly procedure, make sure that you do the following:

1. Turn off the power to the system and all peripherals.
2. Unplug the AC adapter and all power and signal cables from the system.



3. Place the system on a flat, stable surface.
4. Remove the battery pack.

Disassembly Process

The disassembly process is divided into the following stages:

- External module disassembly
- Main unit disassembly
- LCD module disassembly

The flowcharts provided in the succeeding disassembly sections illustrate the entire disassembly sequence. Observe the order of the sequence to avoid damage to any of the hardware components. For example, if you want to remove the main board, you must first remove the keyboard, then disassemble the inside assembly frame in that order.

Main Screw List

| Item | Screw | Color | Part No. |
|------|-----------|--------|--------------|
| A | M2 x L3 | Black | 86.9A552.3R0 |
| B | M2 x L4 | Silver | 86.9A552.4R0 |
| C | M2.5 x L5 | Black | 86.00E33.736 |
| D | M2 x L8 | Black | 86.00E34.738 |
| E | M3 x L4 | Silver | 86.9A554.4R0 |
| F | M2 x L3 | Silver | 86.00E13.524 |
| G | M2.5 x L5 | Black | 86.00F87.735 |
| H | M2 x L3 | Silver | 86.00C07.220 |

External Module Disassembly Process

External Modules Disassembly Flowchart

The flowchart below gives you a graphic representation on the entire disassembly sequence and instructs you on the components that need to be removed during servicing. For example, if you want to remove the main board, you must first remove the keyboard, then disassemble the inside assembly frame in that order.

EXTERNAL MODULE DISASSEMBLY

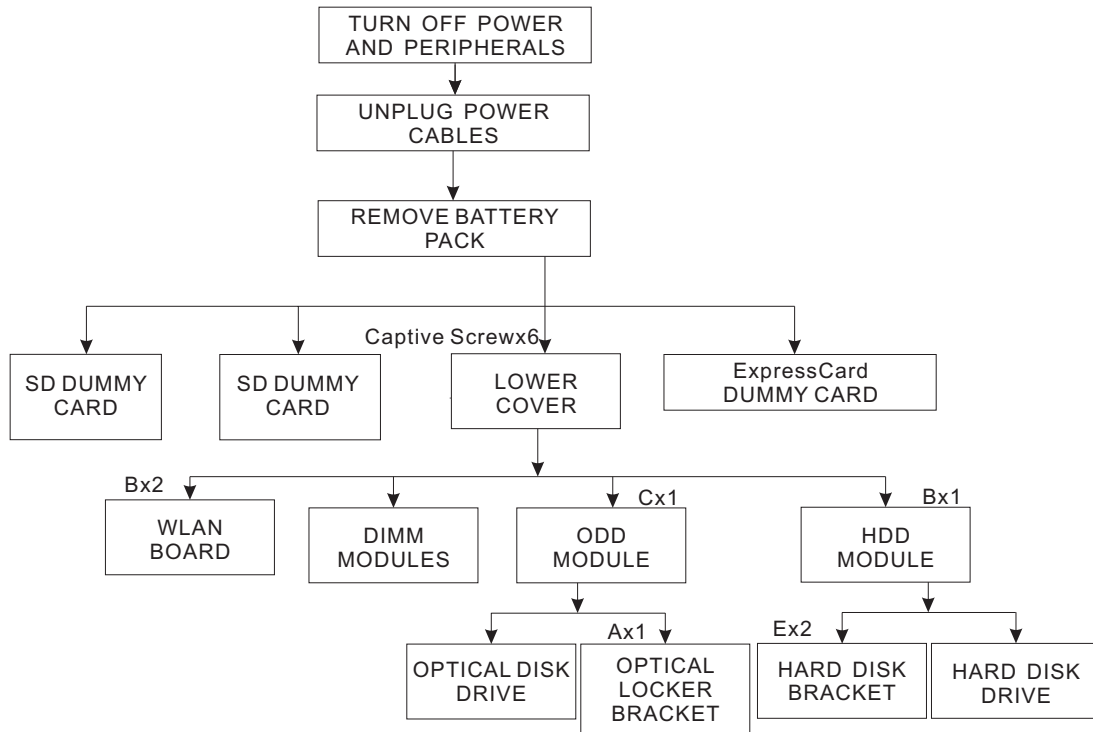

Screw List

| Item | Screw | Color | Part No. |
|------|-----------|--------|--------------|
| A | M2 x L3 | Silver | 86.9A552.3R0 |
| B | M2 x L4 | Silver | 86.9A552.4R0 |
| C | M2.5 x L5 | Black | 86.00E33.736 |
| E | M3 x L4 | Silver | 86.9A554.4R0 |

Removing the Battery Pack

1. Turn base unit over.
2. Slide the battery lock/unlock latch to the unlock position.



3. Slide and hold the battery release latch to the release position.

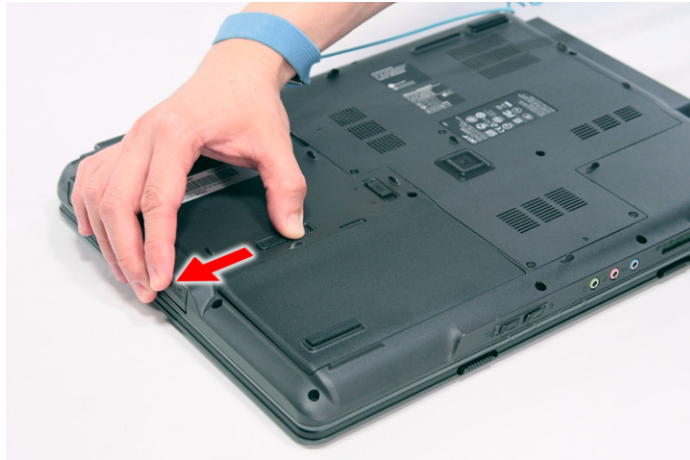

4. Then remove the battery from the main unit.



Removing the SD dummy card

1. Push the SD dummy card all the way in to eject it.



2. Pull it out from the slot.



Removing the PC and ExpressCard dummy cards

1. Press the eject button to pop out the button.



2. Press it again to pop out the PC dummy card.



3. Remove the PC dummy card from the slot.



-
4. Push the ExpressCard dummy card all the way in to eject it.



5. Pull it out from the slot.



Removing the Lower Cover

1. See "Removing the Battery Pack" on page 56.
2. Remove the six captive screws securing the lower cover.

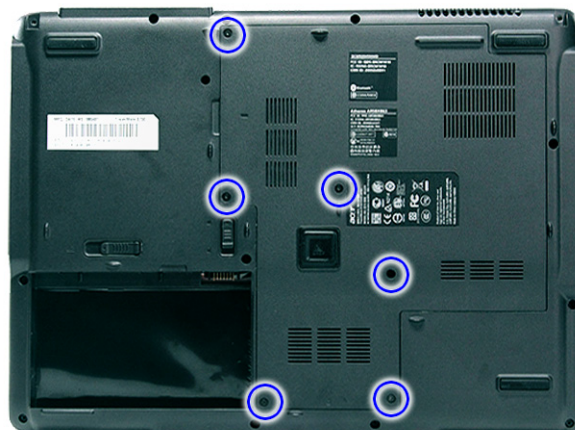

-
3. Use a plastic screw driver to carefully pry open the lower cover.



4. Remove the lower cover from the lower case.

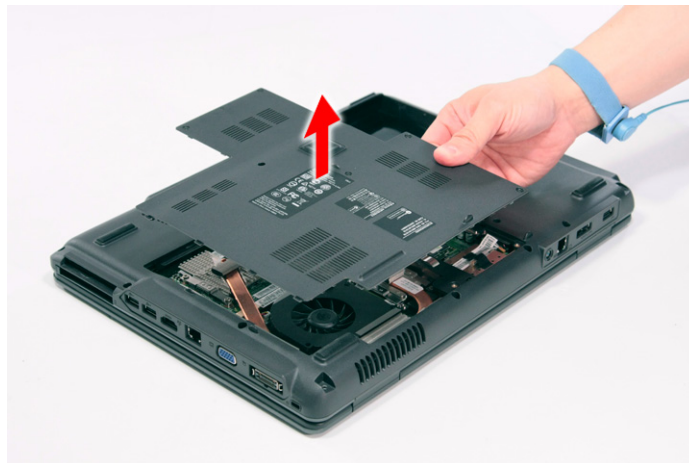

Removing the DIMM

1. See "Removing the Battery Pack" on page 56.
2. See "Removing the Lower Cover" on page 59..
3. Push out the latches on both sides of the DIMM socket to release the DIMM.

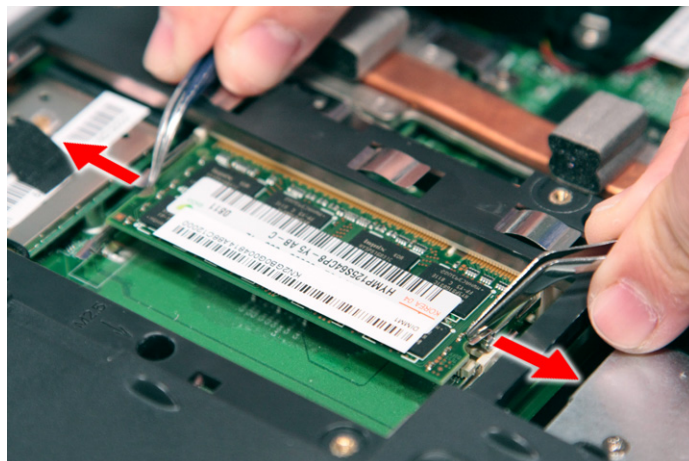

-
4. Remove the DIMM module.

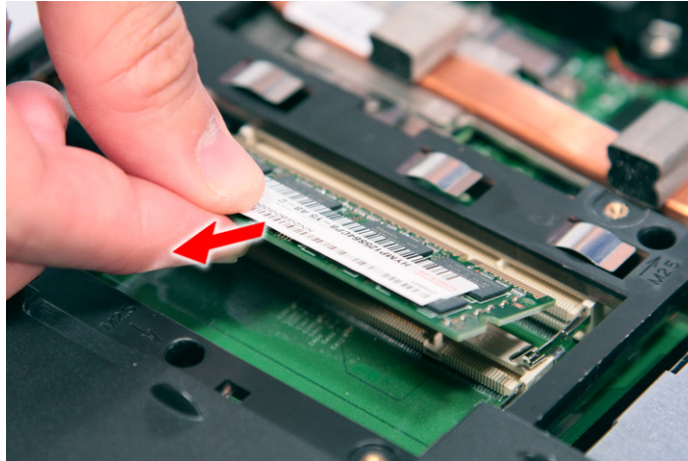

Removing the WLAN Board Modules

1. See “Removing the Battery Pack” on page 56.
2. See “Removing the Lower Cover” on page 59.
3. Disconnect the antenna cables from the WLAN board.



NOTE: There are 2 antenna cables connected to the WLAN board. The Black antenna cable is connected to MAIN connector and the White antenna cable is connected to AUX connector.

4. Remove the Gray antenna that is taped to the WLAN board and move the antenna cables away from the WLAN board.

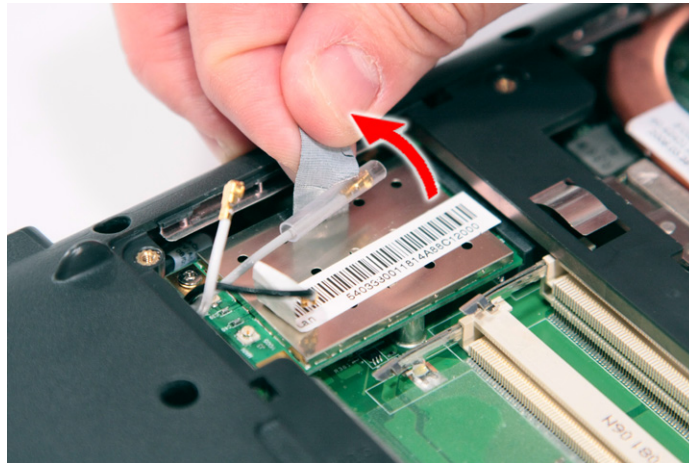

5. Remove the two screws (B) on the WLAN board to release the WLAN board.



| Step | Size (Quantity) | Color | Torque |
|------|-----------------|--------|------------|
| 1~2 | M2 x L4 (2) | Silver | 1.6 kgf-cm |

6. Detach the WLAN board from the WLAN socket.

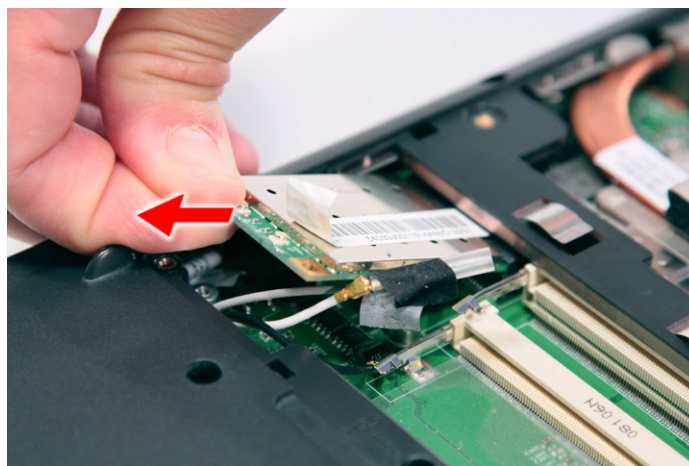

NOTE: When attaching the antenna back to the WLAN board, make sure the cable are arranged properly.

Removing the Hard Disk Drive Module

1. See “Removing the Battery Pack” on page 56.
2. See “Removing the Lower Cover” on page 59.
3. Remove the one screw (B) securing the hard disk drive module.



| Step | Size (Quantity) | Color | Torque |
|------|-----------------|--------|------------|
| 1 | M2 x L4 (1) | Silver | 1.6 kgf-cm |

4. Using the plastic tab, slide the hard disk drive module away from the connector; lift up the hard disk module to remove from the bay.

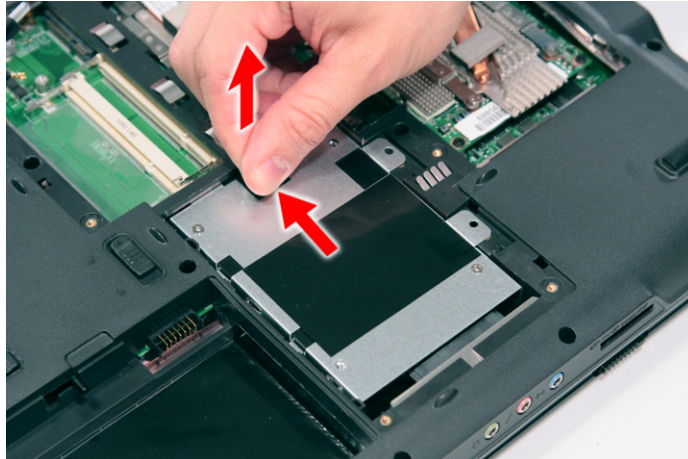

NOTE: To prevent damage to device, avoid pressing down on it or placing heavy objects on top of it.

-
5. Remove the two screws (E) securing the hard disk to the bracket and remove the hard disk from the bracket.

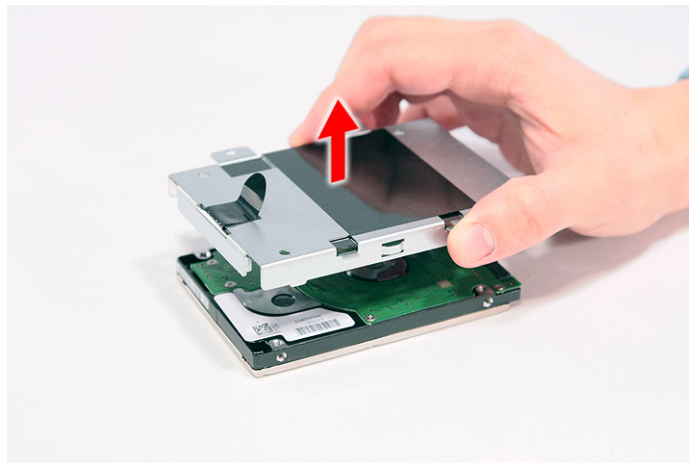
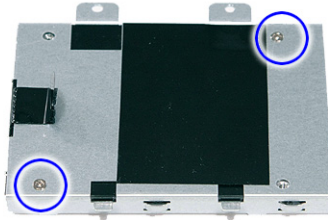

| Step | Size (Quantity) | Color | Torque |
|------|-----------------|--------|------------|
| 1~2 | M3 x L4 (2) | Silver | 3.0 kgf-cm |

Removing the Optical Drive Module

1. See "Removing the Battery Pack" on page 56.
2. See "Removing the Lower Cover" on page 59.

3. Remove the one screw (C) from the bottom panel.

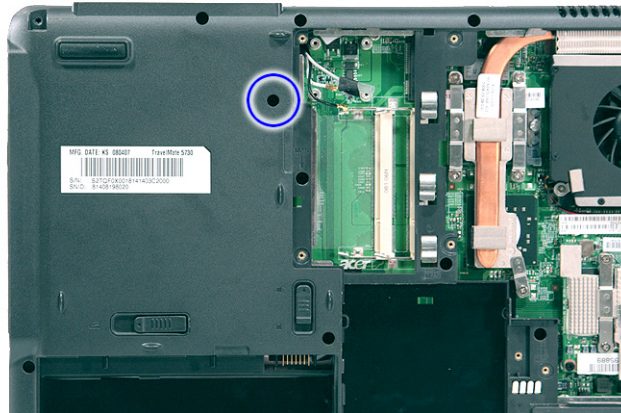

| Step | Size (Quantity) | Color | Torque |
|------|-----------------|-------|------------|
| 1 | M2.5 x L6 (1) | Black | 3.0 kgf-cm |

4. Use a screw driver to carefully push the odd drive tray out as shown.



5. Slowly pull out the odd module from the odd drive bay.

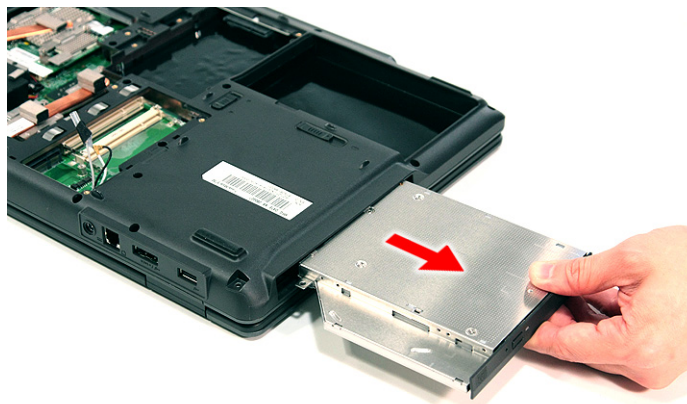

-
6. Remove the one screw (A) securing the locker bracket and remove the locker bracket from the optical disk drive module.



| Step | Size (Quantity) | Color | Torque |
|------|-----------------|--------|------------|
| 1 | M2 x L3 (1) | Silver | 1.6 kgf-cm |

Main Unit Disassembly Process

Main Unit Disassembly Flowchart

MAIN UNIT DISASSEMBLY

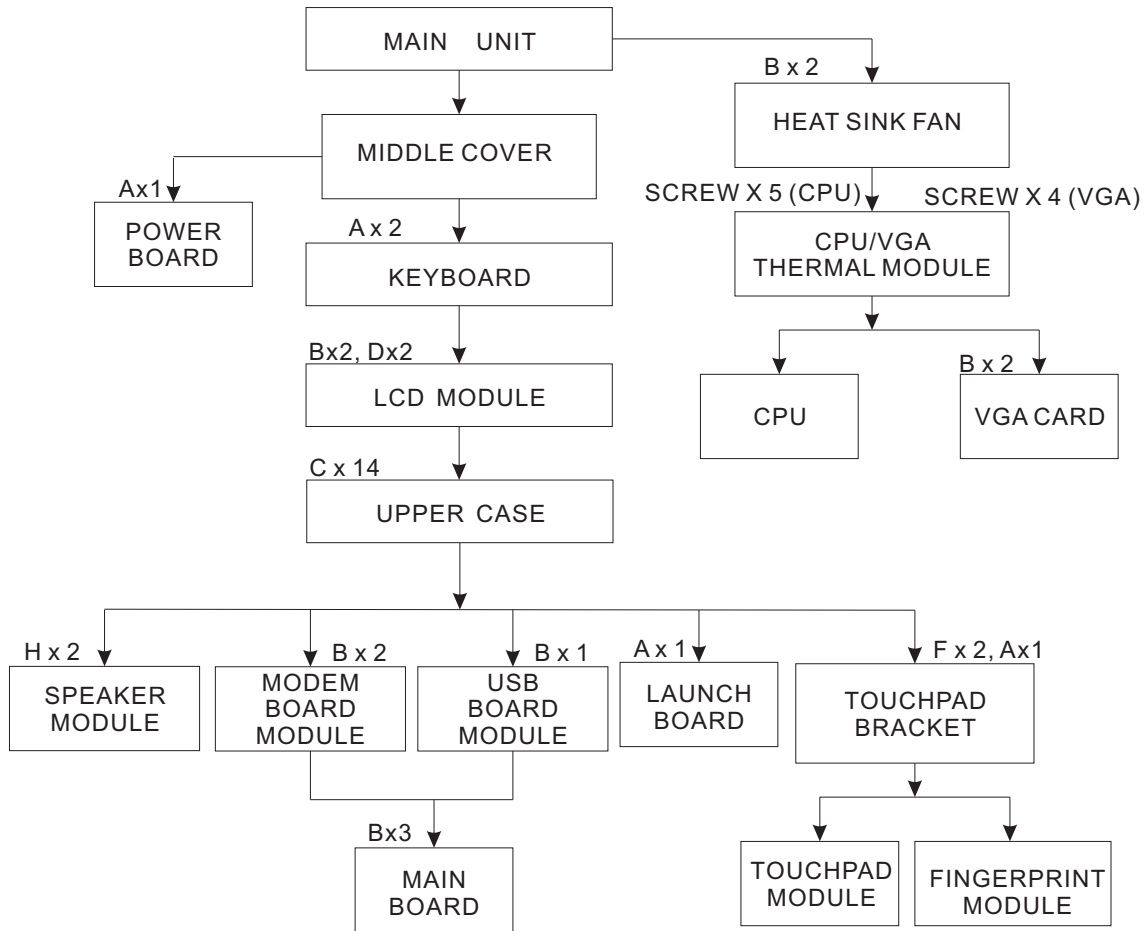

Screw List

| Item | Screw | Color | Part No. |
|------|-----------|--------|--------------|
| A | M2 x L3 | Silver | 86.9A552.3R0 |
| B | M2 x L4 | Silver | 86.9A552.4R0 |
| C | M2.5 x L5 | Black | 86.00E33.736 |
| D | M2 x L8 | Black | 86.00E34.738 |
| F | M2 x L3 | Silver | 86.00E13.524 |
| H | M2 x L3 | Silver | 86.00C07.220 |

Removing the Middle Cover

1. See "Removing the Battery Pack" on page 56.
2. Use a plastic screw driver to pry loose the side of the middle cover.



3. Carefully pry loose the middle cover from the latches securing it and turn it over on the keyboard to gain access to the cable connected to the power board.



4. Disconnect the cable connected to the power board and remove the middle cover from the system.

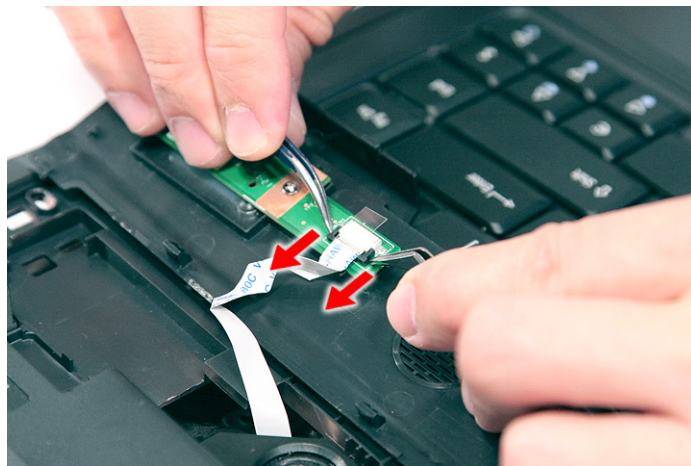

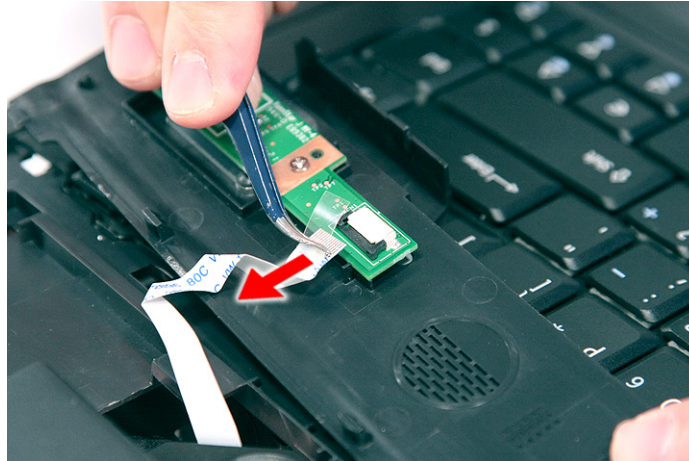

Removing the Power Board

1. See “Removing the Battery Pack” on page 56.
2. See “Removing the Middle Cover” on page 68.

-
3. Remove the one screw (A) securing the power board to the middle cover.



| Step | Size (Quantity) | Color | Torque |
|------|-----------------|--------|------------|
| 1 | M2 x L3 (1) | Silver | 1.6 kgf-cm |

4. Release the power board from the latches and remove it from the middle cover.

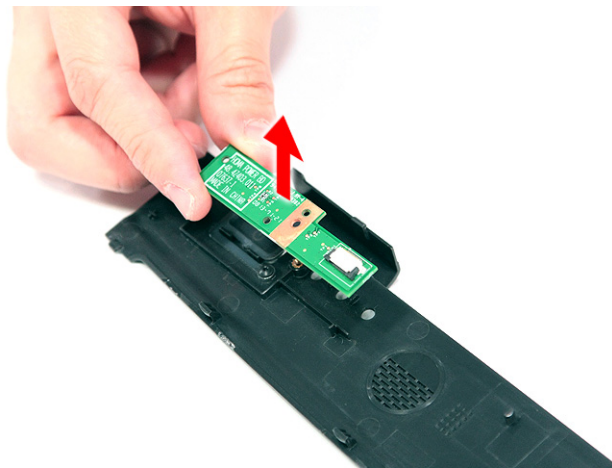

Removing the Keyboard

1. See “Removing the Battery Pack” on page 56.
2. See “Removing the Middle Cover” on page 68.
3. Remove the two screws (A) securing the keyboard.

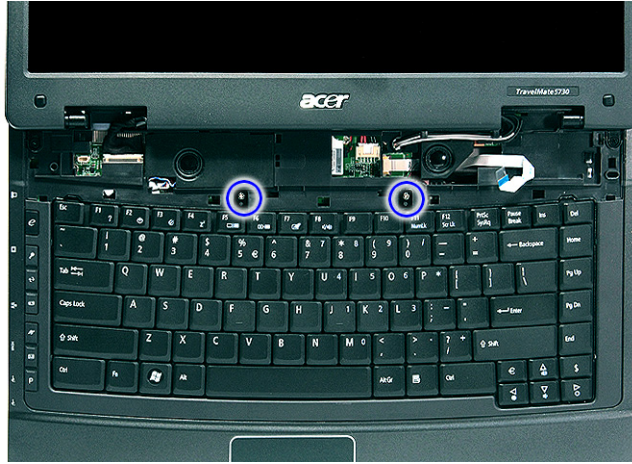

| Step | Size (Quantity) | Color | Torque |
|------|-----------------|--------|------------|
| 1~2 | M2 x L3 (2) | Silver | 1.6 kgf-cm |

4. Carefully pry loose the keyboard and turn it over on the touchpad area.



-
5. Disconnect the keyboard cable from the main board to remove the keyboard.

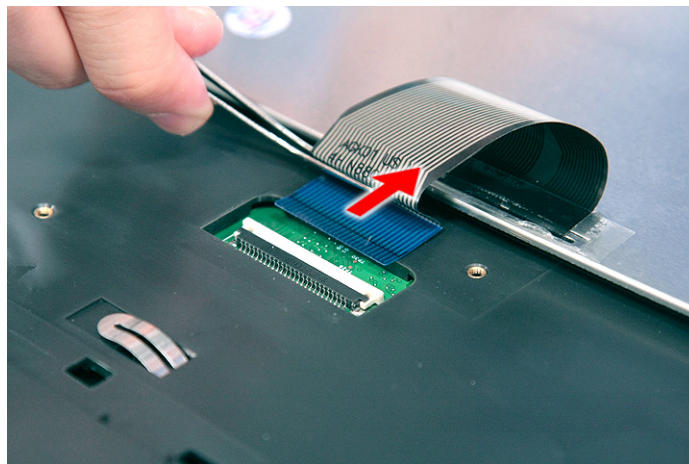
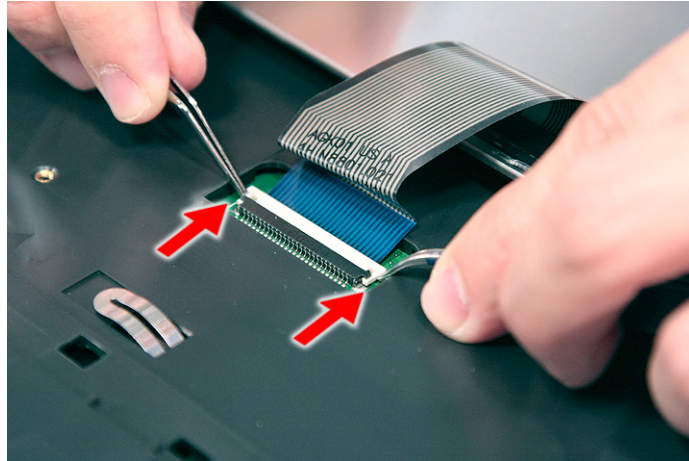

Removing the Heatsink Fan Module

1. See “Removing the Battery Pack” on page 56.
2. See “Removing the Lower Cover” on page 59.
3. Disconnect the heat sink fan connector from the main board.

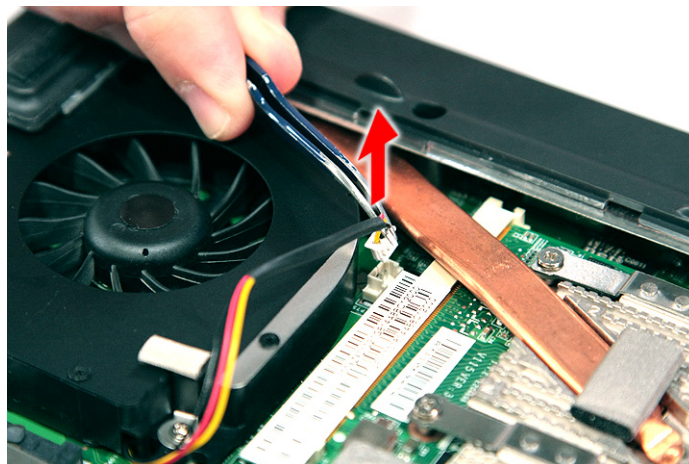

-
4. Remove the two screws (B) securing the heatsink fan module in place.

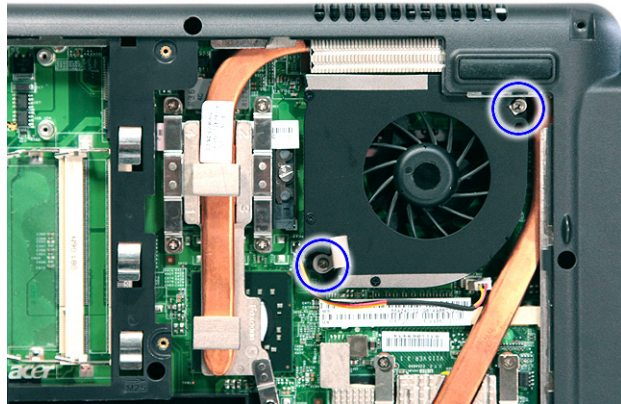

| Step | Size (Quantity) | Color | Torque |
|------|-----------------|--------|------------|
| 1~2 | M2 x L4 (2) | Silver | 1.6 kgf-cm |

5. Carefully lift up the heatsink fan module.

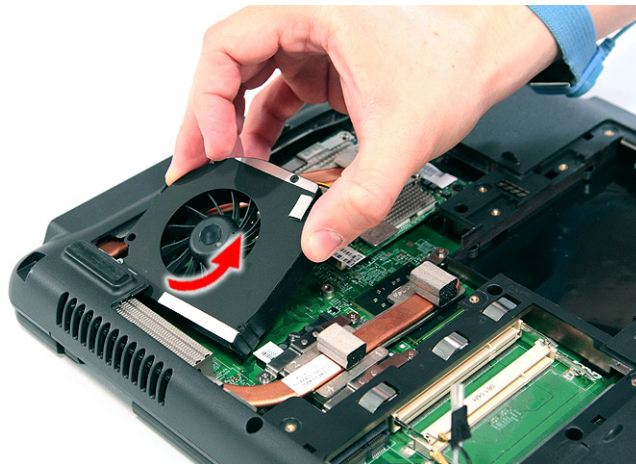

Removing the CPU and VGA Heatsink Module

1. See "Removing the Battery Pack" on page 56.
2. See "Removing the Lower Cover" on page 59.
3. See "Removing the Heatsink Fan Module" on page 72.

-
4. Remove the four screws securing the VGA board heatsink module (Discrete Model only) and the five screws securing the CPU heatsink module.

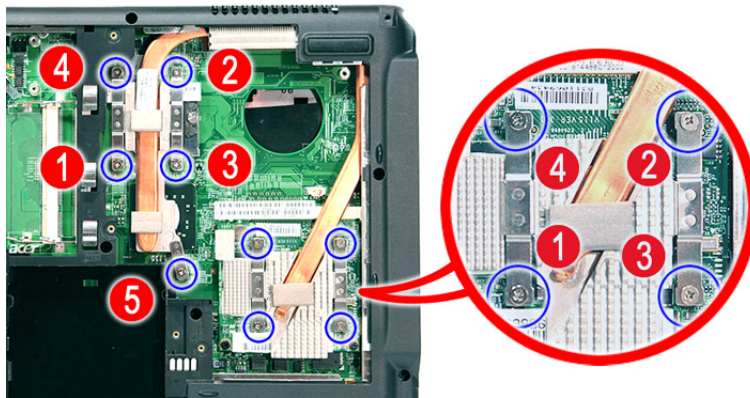

5. Carefully remove the heatsink module from the system.

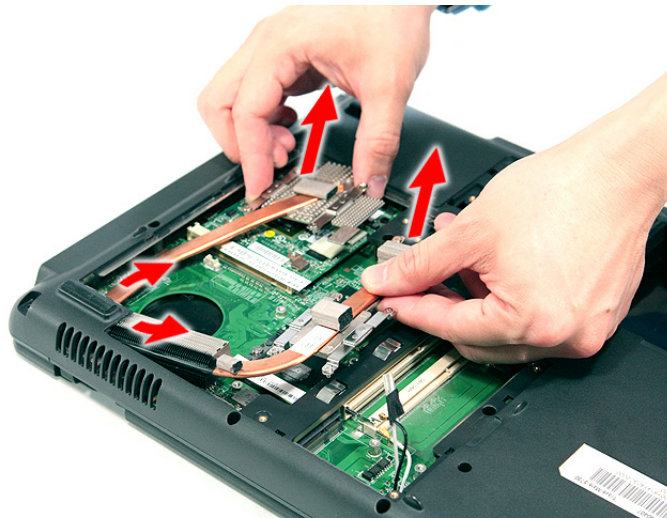

Removing the CPU

1. See "Removing the Battery Pack" on page 56.
2. See "Removing the Lower Cover" on page 59.
3. See "Removing the Heatsink Fan Module" on page 72.
4. See "Removing the CPU and VGA Heatsink Module" on page 73.

-
- Using a flat screwdriver, turn the CPU socket latch counter-clockwise to release the CPU.

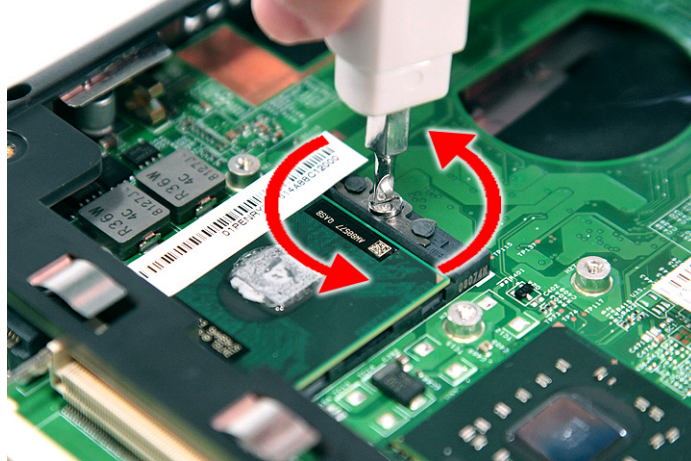

- Lift up carefully to remove the CPU.

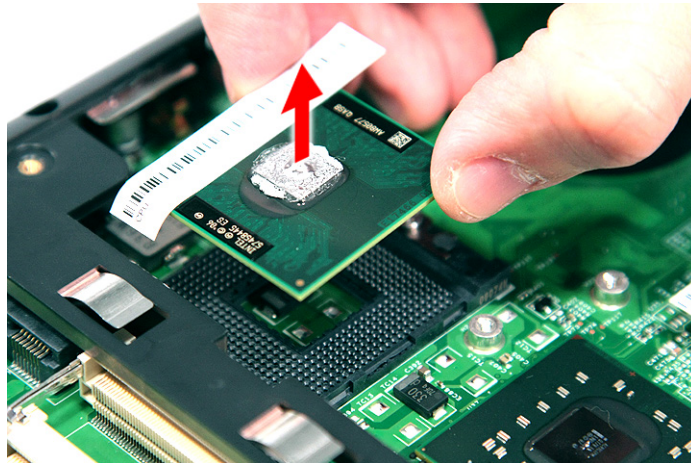

NOTE: When installing the CPU, make sure to install the CPU with PIN 1 at the corner as shown.



Removing the VGA Board (Discrete Model only)

- See “Removing the Battery Pack” on page 56.
- See “Removing the Lower Cover” on page 59.

3. See “Removing the Heatsink Fan Module” on page 72.
4. See “Removing the CPU and VGA Heatsink Module” on page 73.
5. Remove the two screws (B) securing the VGA board to the main board.

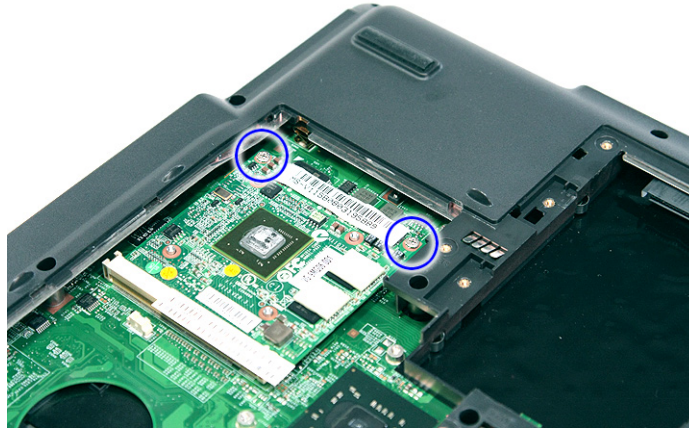

| Step | Size (Quantity) | Color | Torque |
|------|-----------------|--------|------------|
| 1~2 | M2 x L4 (2) | Silver | 1.6 kgf-cm |

6. Remove the VGA board from the main board.



Removing the LCD Module

1. See “Removing the Battery Pack” on page 56.
2. See “Removing the SD dummy card” on page 57.
3. See “Removing the PC and ExpressCard dummy cards” on page 58.
4. See “Removing the Lower Cover” on page 59.
5. See “Removing the WLAN Board Modules” on page 61.
6. See “Removing the Middle Cover” on page 68.
7. See “Removing the Keyboard” on page 71.

-
8. Turn over the system and remove the two screws (B) from the bottom of the left and right hinges.



| Step | Size (Quantity) | Color | Torque |
|------|-----------------|-------|------------|
| 1~2 | M2.5 x L6 (2) | Black | 3.0 kgf-cm |

9. Carefully pull out the wireless antenna cables from the hole and release the cables from the latches.



10. Disconnect the LCD cable connector from the main board.



11. Remove the two screws (D) from the left and right hinge of the LCD module.



| Step | Size (Quantity) | Color | Torque |
|------|-----------------|-------|------------|
| 1~2 | M2 x L8 (2) | Black | 4.0 kgf-cm |

12. Carefully remove the LCD module from the base unit.



NOTE: When connecting the cable back to the unit, please note that the cable should be routed well.

Separating the Upper Case from the Lower Case

1. See "Removing the Battery Pack" on page 56.
2. See "Removing the SD dummy card" on page 57.
3. See "Removing the PC and ExpressCard dummy cards" on page 58.
4. See "Removing the Lower Cover" on page 59.
5. See "Removing the DIMM" on page 60.
6. See "Removing the WLAN Board Modules" on page 61.
7. See "Removing the Hard Disk Drive Module" on page 63.
8. See "Removing the Optical Drive Module" on page 64.
9. See "Removing the Middle Cover" on page 68.
10. See "Removing the Keyboard" on page 71.
11. See "Removing the Heatsink Fan Module" on page 72.
12. See "Removing the CPU and VGA Heatsink Module" on page 73.

-
13. See “Removing the CPU” on page 74.
 14. See “Removing the VGA Board (Discrete Model only)” on page 75.
 15. See “Removing the LCD Module” on page 76.
 16. Disconnect the touchpad cable from the TPAD1 connector on the main board.

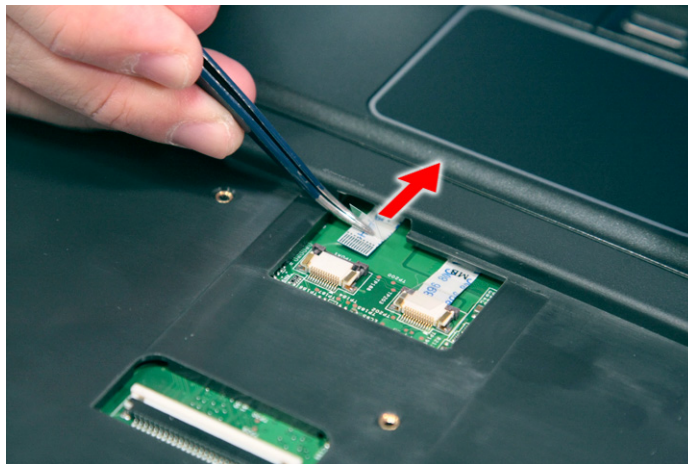
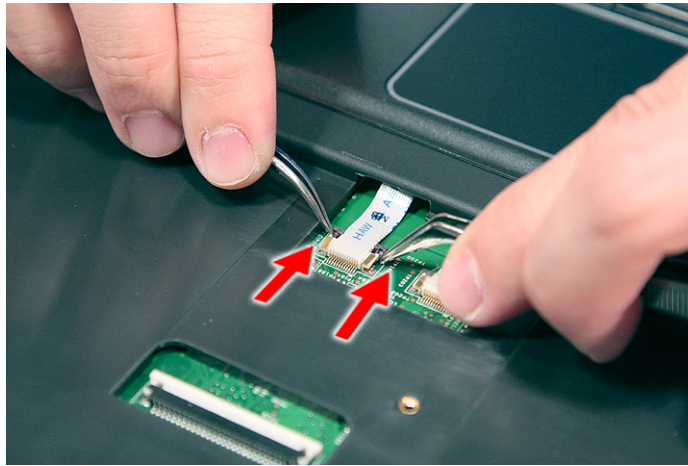

17. Disconnect the fingerprint cable from the FPCN1 connector on the main board.

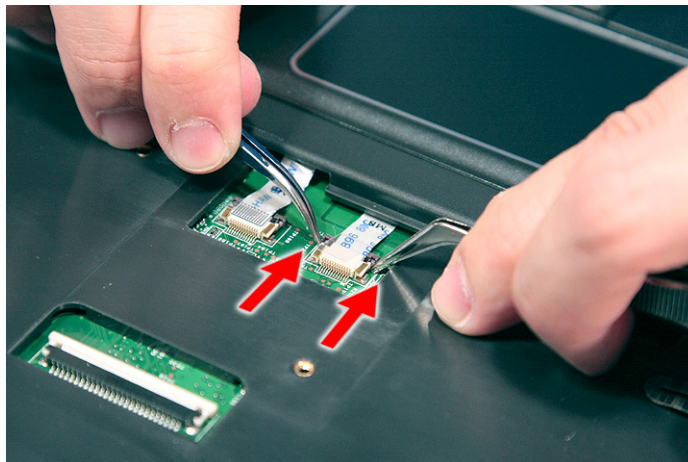

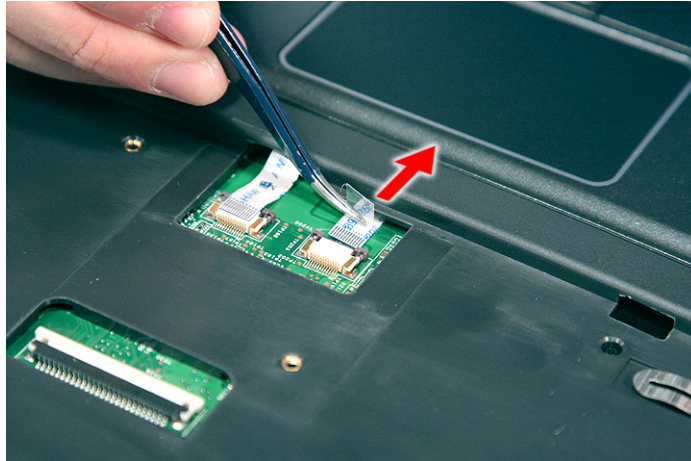

18. Disconnect the launch board cable from the SWITCHCN1 connector on the main board.

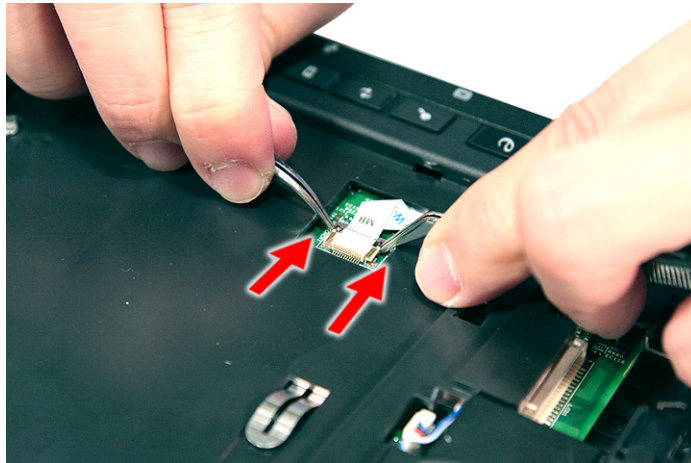

19. Disconnect the speaker cable from the INTSPK1 connector on the main board.

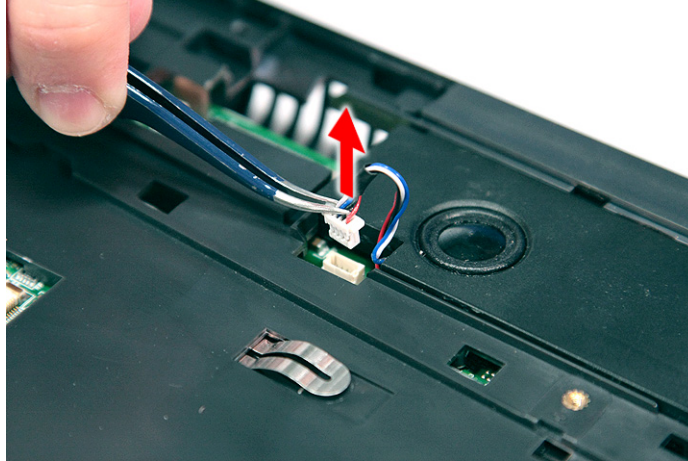

20. Remove the fourteen screws (14 x C) from the bottom panel.

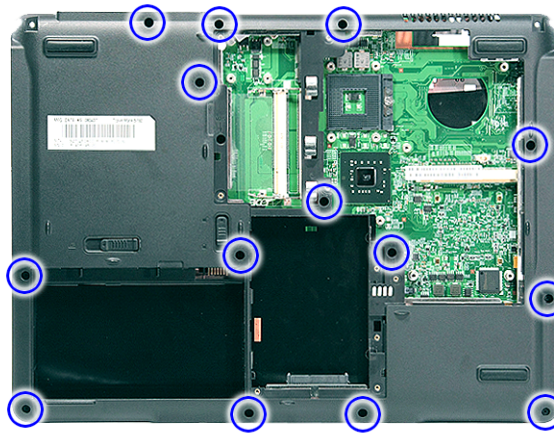

| Step | Size (Quantity) | Color | Torque |
|------|-----------------|-------|------------|
| 1~14 | M2.5 x L5 (14) | Black | 2.5 kgf-cm |

21. Turn the unit over and gently remove the upper case from the lower case.

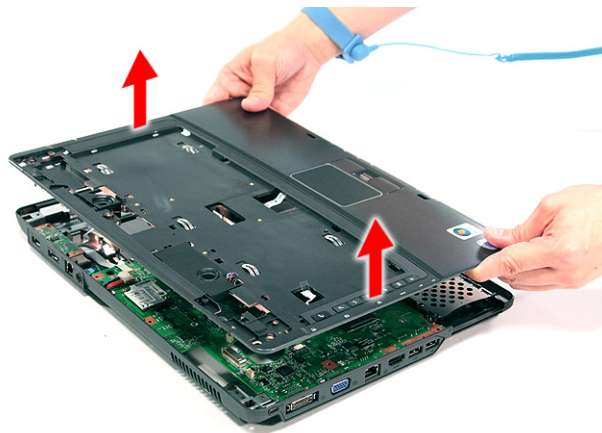

Removing the Speaker Module

1. See “Removing the Battery Pack” on page 56.
2. See “Removing the SD dummy card” on page 57.
3. See “Removing the PC and ExpressCard dummy cards” on page 58.
4. See “Removing the Lower Cover” on page 59.
5. See “Removing the DIMM” on page 60.
6. See “Removing the WLAN Board Modules” on page 61.
7. See “Removing the Hard Disk Drive Module” on page 63.
8. See “Removing the Optical Drive Module” on page 64.
9. See “Removing the Middle Cover” on page 68.
10. See “Removing the Keyboard” on page 71.
11. See “Removing the Heatsink Fan Module” on page 72.
12. See “Removing the CPU and VGA Heatsink Module” on page 73.
13. See “Removing the CPU” on page 74.
14. See “Removing the VGA Board (Discrete Model only)” on page 75.
15. See “Removing the LCD Module” on page 76.
16. See “Separating the Upper Case from the Lower Case” on page 78.
17. Remove the two screws (2 x H) securing the left and right speaker modules.

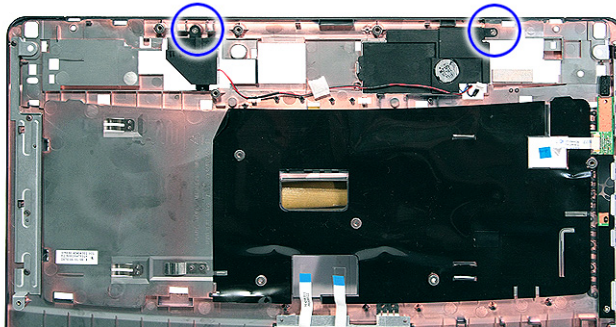

| Step | Size (Quantity) | Color | Torque |
|------|-----------------|--------|------------|
| 1~2 | M2 x L3 (2) | Silver | 1.6 kgf-cm |

-
18. Remove the left and right speaker modules from the upper case.

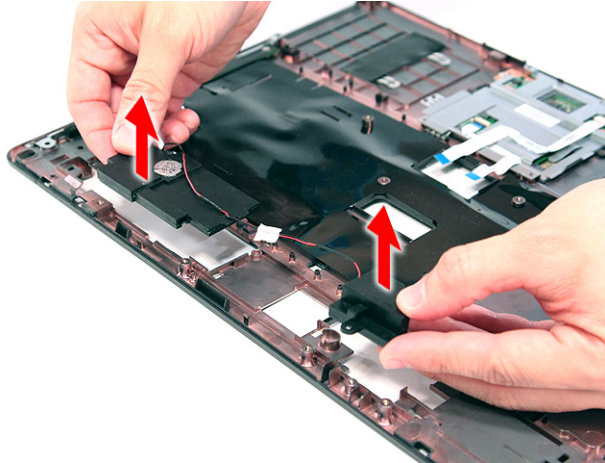

Removing the Launch Board

1. See "Removing the Battery Pack" on page 56.
2. See "Removing the SD dummy card" on page 57.
3. See "Removing the PC and ExpressCard dummy cards" on page 58.
4. See "Removing the Lower Cover" on page 59.
5. See "Removing the DIMM" on page 60.
6. See "Removing the WLAN Board Modules" on page 61.
7. See "Removing the Hard Disk Drive Module" on page 63.
8. See "Removing the Optical Drive Module" on page 64.
9. See "Removing the Middle Cover" on page 68.
10. See "Removing the Keyboard" on page 71.
11. See "Removing the Heatsink Fan Module" on page 72.
12. See "Removing the CPU and VGA Heatsink Module" on page 73.
13. See "Removing the CPU" on page 74.
14. See "Removing the VGA Board (Discrete Model only)" on page 75.
15. See "Removing the LCD Module" on page 76.
16. See "Separating the Upper Case from the Lower Case" on page 78.

17. Remove the one screw (1 x A) securing the launch board module.

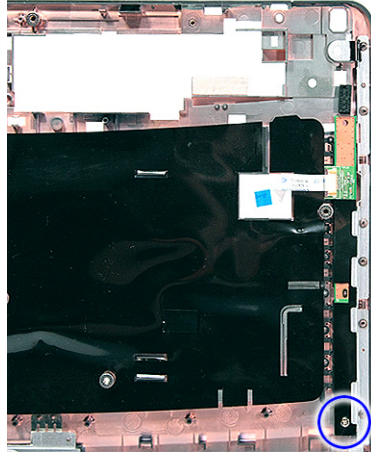

| Step | Size (Quantity) | Color | Torque |
|------|-----------------|--------|------------|
| 1 | M2 x L3 (1) | Silver | 1.6 kgf-cm |

18. Remove the launch board module from the upper case.

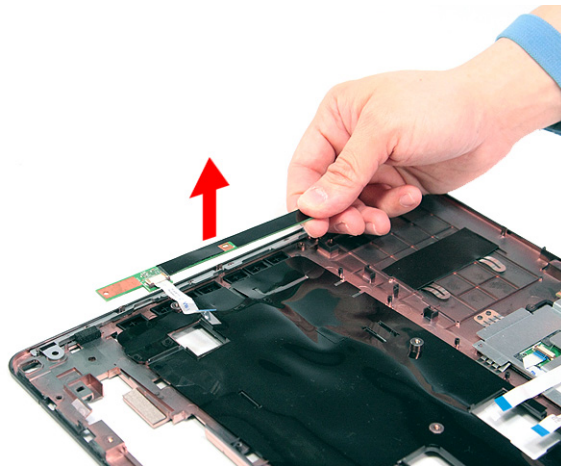

Removing the Fingerprint and Touchpad Module

1. See "Removing the Battery Pack" on page 56.
2. See "Removing the SD dummy card" on page 57.
3. See "Removing the PC and ExpressCard dummy cards" on page 58.
4. See "Removing the Lower Cover" on page 59.
5. See "Removing the DIMM" on page 60.
6. See "Removing the WLAN Board Modules" on page 61.
7. See "Removing the Hard Disk Drive Module" on page 63.
8. See "Removing the Optical Drive Module" on page 64.
9. See "Removing the Middle Cover" on page 68.
10. See "Removing the Keyboard" on page 71.
11. See "Removing the Heatsink Fan Module" on page 72.
12. See "Removing the CPU and VGA Heatsink Module" on page 73.
13. See "Removing the CPU" on page 74.

-
14. See “Removing the VGA Board (Discrete Model only)” on page 75.
 15. See “Removing the LCD Module” on page 76.
 16. See “Separating the Upper Case from the Lower Case” on page 78.
 17. Disconnect the touchpad cable from the touchpad board.

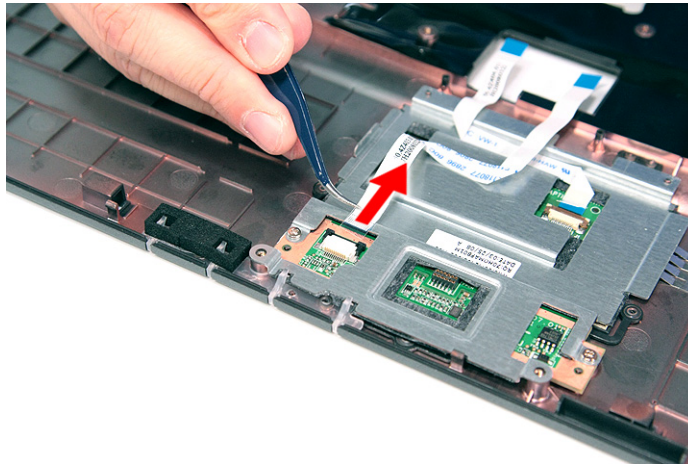
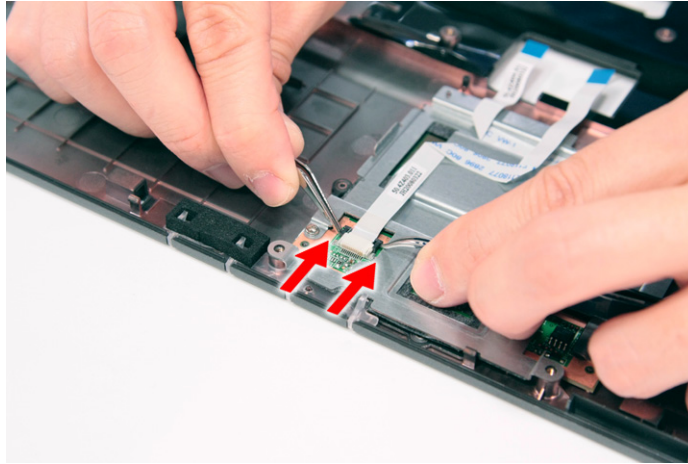

18. Disconnect the fingerprint cable from the fingerprint board.

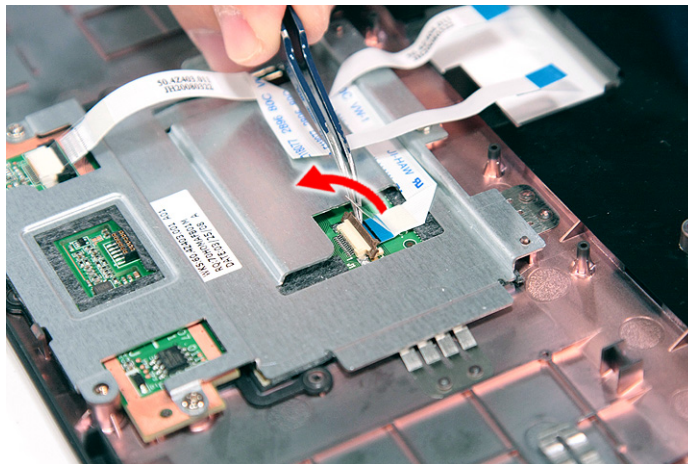

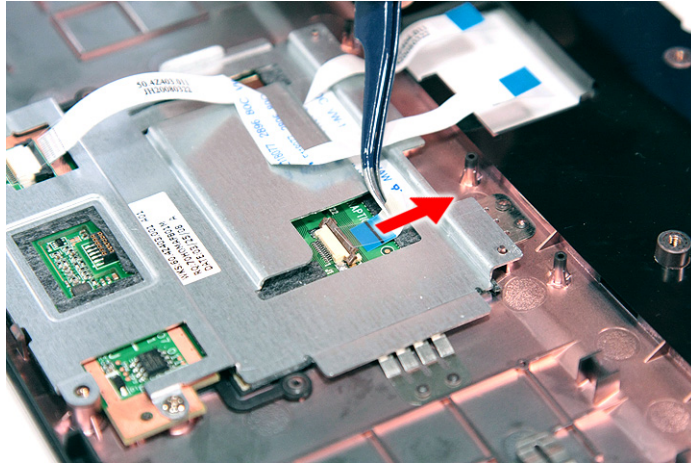

19. Remove the three screws (2 x F, 1 x A) securing the bracket to the upper case.

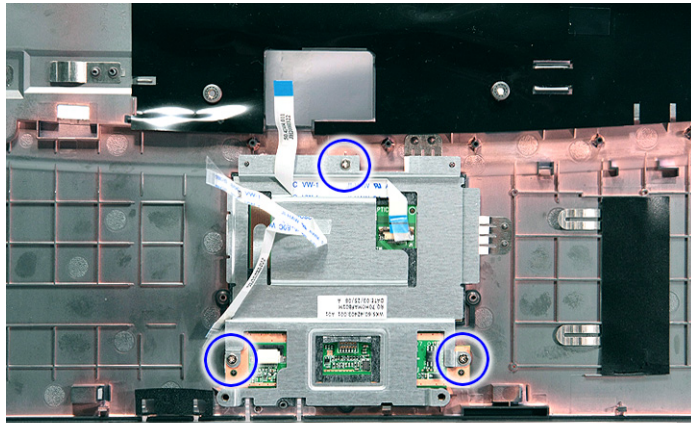

| Step | Size (Quantity) | Color | Torque |
|------|-----------------|--------|------------|
| 1~2 | M2 x L3 (2) | Silver | 1.6 kgf-cm |
| 3 | M2 x L3 (2) | Silver | 1.6 kgf-cm |

20. Remove the touchpad bracket.

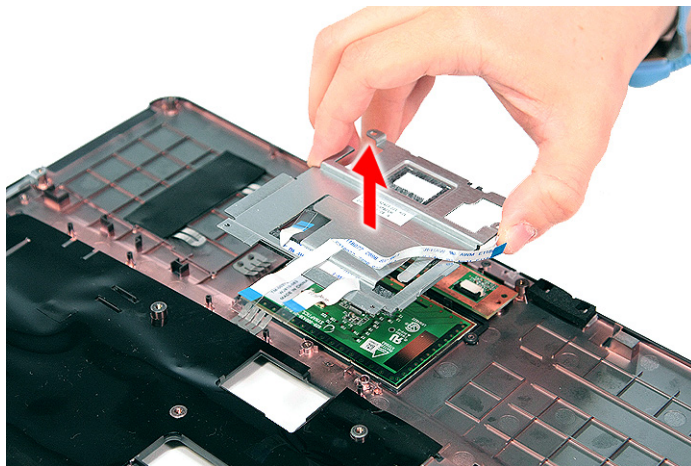

21. Remove the fingerprint board module.



22. Carefully pry loose and remove the touch pad board.

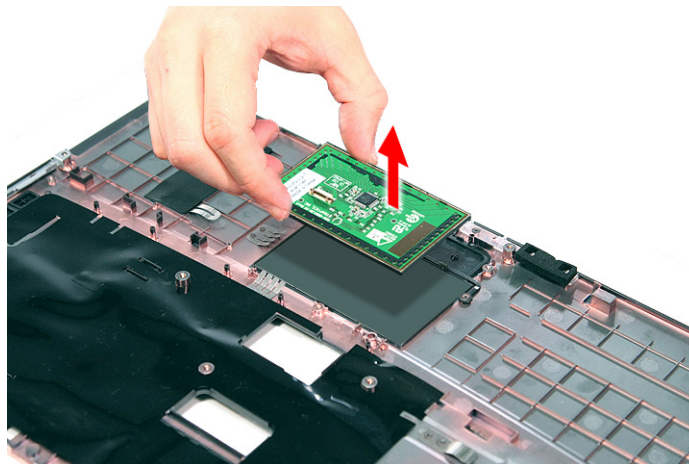
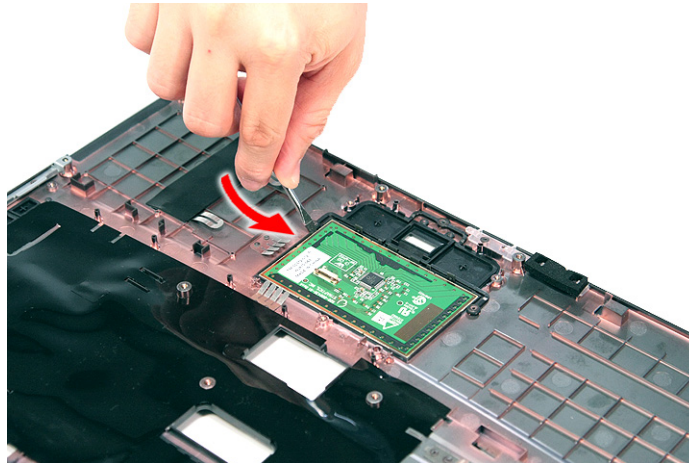

WARNING:The touchpad board is glued to the upper case, only remove the touchpad board if it is defective.

Removing the Modem Board

1. See "Removing the Battery Pack" on page 56.
2. See "Removing the SD dummy card" on page 57.

3. See “Removing the PC and ExpressCard dummy cards” on page 58.
4. See “Removing the Lower Cover” on page 59.
5. See “Removing the DIMM” on page 60.
6. See “Removing the WLAN Board Modules” on page 61.
7. See “Removing the Hard Disk Drive Module” on page 63.
8. See “Removing the Optical Drive Module” on page 64.
9. See “Removing the Middle Cover” on page 68.
10. See “Removing the Keyboard” on page 71.
11. See “Removing the Heatsink Fan Module” on page 72.
12. See “Removing the CPU and VGA Heatsink Module” on page 73.
13. See “Removing the CPU” on page 74.
14. See “Removing the VGA Board (Discrete Model only)” on page 75.
15. See “Removing the LCD Module” on page 76.
16. See “Separating the Upper Case from the Lower Case” on page 78.
17. Remove the two screws (B) securing the modem card.

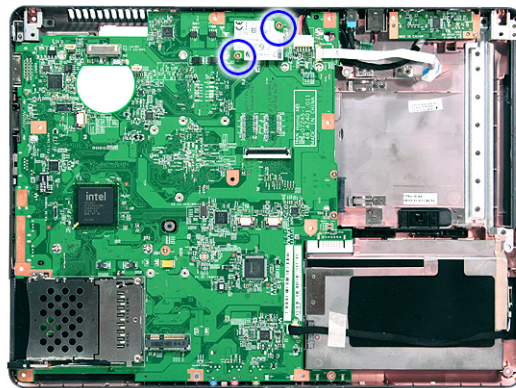

| Step | Size (Quantity) | Color | Torque |
|------|-----------------|--------|------------|
| 1~2 | M2 x L4 (2) | Silver | 1.6 kgf-cm |

18. Lift the modem board from the system.

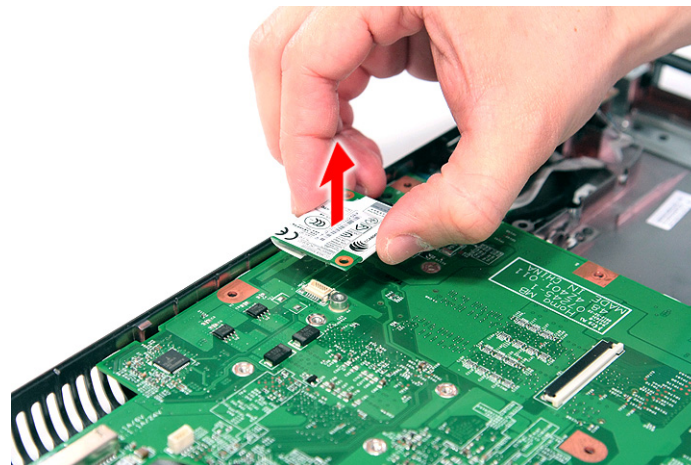

-
19. Disconnect the cable from the modem board.

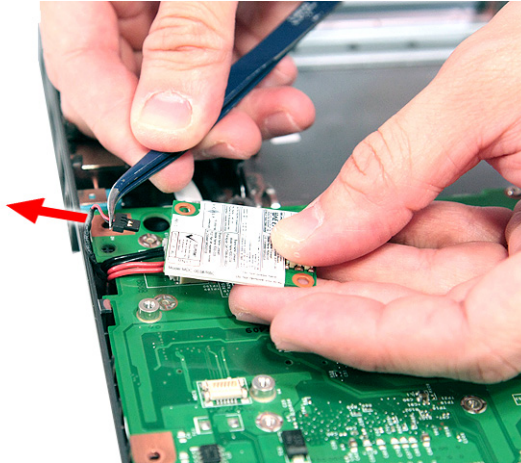

Removing the USB Board Module

1. See “Removing the Battery Pack” on page 56.
2. See “Removing the SD dummy card” on page 57.
3. See “Removing the PC and ExpressCard dummy cards” on page 58.
4. See “Removing the Lower Cover” on page 59.
5. See “Removing the DIMM” on page 60.
6. See “Removing the WLAN Board Modules” on page 61.
7. See “Removing the Hard Disk Drive Module” on page 63.
8. See “Removing the Optical Drive Module” on page 64.
9. See “Removing the Middle Cover” on page 68.
10. See “Removing the Keyboard” on page 71.
11. See “Removing the Heatsink Fan Module” on page 72.
12. See “Removing the CPU and VGA Heatsink Module” on page 73.
13. See “Removing the CPU” on page 74.
14. See “Removing the VGA Board (Discrete Model only)” on page 75.
15. See “Removing the LCD Module” on page 76.
16. See “Separating the Upper Case from the Lower Case” on page 78.

17. Remove the one screw (B) securing the USB board to the lower case.

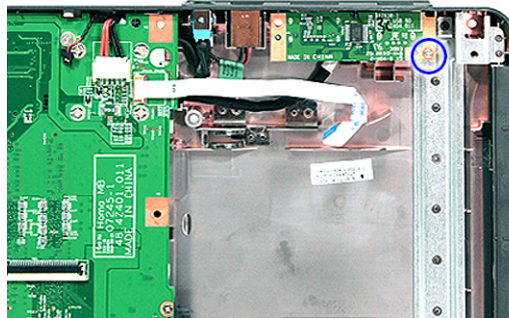

| Step | Size (Quantity) | Color | Torque |
|------|-----------------|--------|------------|
| 1 | M2 x L4 (1) | Silver | 1.6 kgf-cm |

18. Lift the USB board and disconnect the cable from USBCN1 on the USB board.

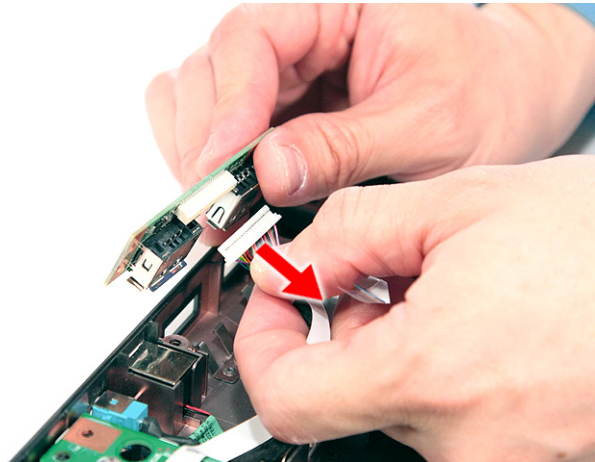

Removing the Main Board

1. See "Removing the Battery Pack" on page 56.
2. See "Removing the SD dummy card" on page 57.
3. See "Removing the PC and ExpressCard dummy cards" on page 58.
4. See "Removing the Lower Cover" on page 59.
5. See "Removing the DIMM" on page 60.
6. See "Removing the WLAN Board Modules" on page 61.
7. See "Removing the Hard Disk Drive Module" on page 63.
8. See "Removing the Optical Drive Module" on page 64.
9. See "Removing the Middle Cover" on page 68.
10. See "Removing the Keyboard" on page 71.
11. See "Removing the Heatsink Fan Module" on page 72.
12. See "Removing the CPU and VGA Heatsink Module" on page 73.
13. See "Removing the CPU" on page 74.

-
14. See “Removing the VGA Board (Discrete Model only)” on page 75.
 15. See “Removing the LCD Module” on page 76.
 16. See “Separating the Upper Case from the Lower Case” on page 78.
 17. See “Removing the Modem Board” on page 87.
 18. See “Removing the USB Board Module” on page 89.
 19. Disconnect the Bluetooth cable from BLUE1 on the main board.

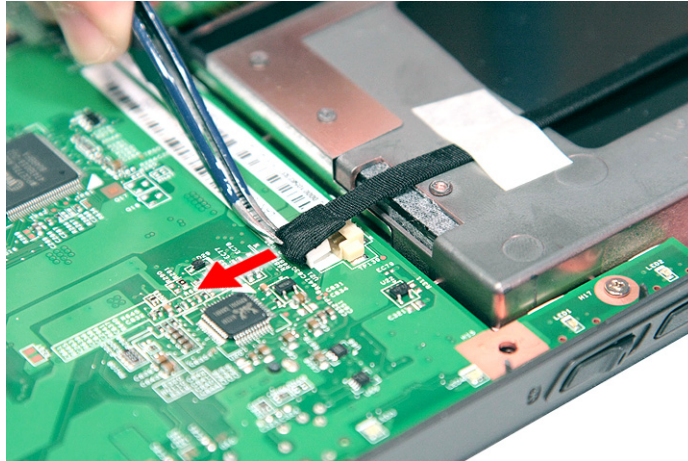

20. Disconnect the DC cable from the DC1 connector on the main board.

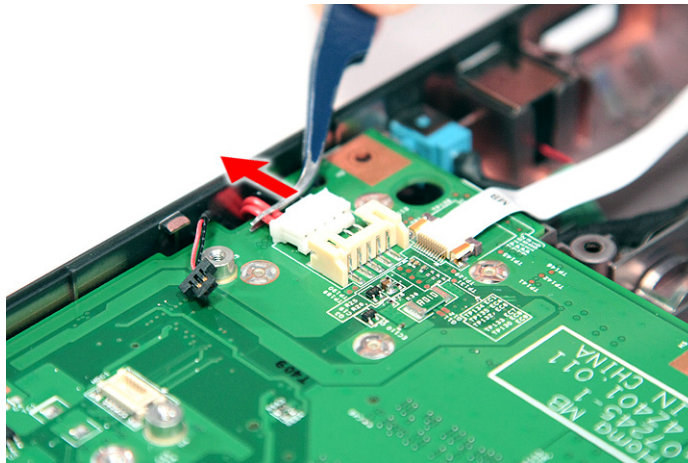

21. Remove the three screws (B) securing the main board in place.

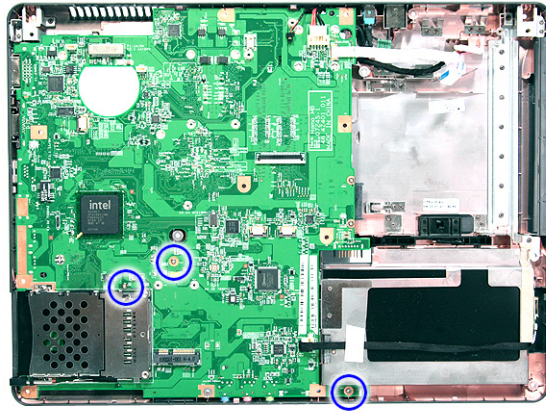

| Step | Size (Quantity) | Color | Torque |
|------|-----------------|--------|------------|
| 1~3 | M2 x L4 (3) | Silver | 1.6 kgf-cm |

22. Carefully remove the main board.

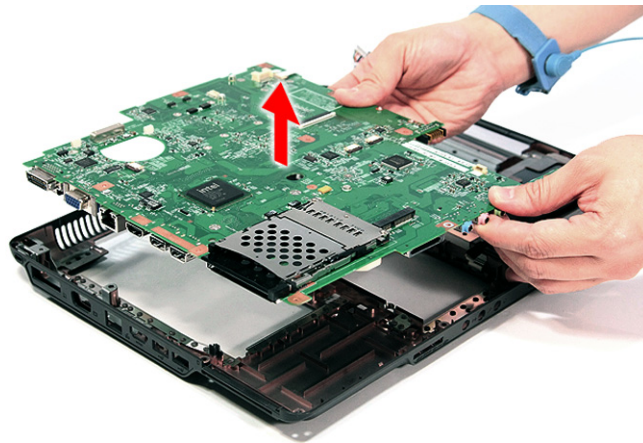

LCD Module Disassembly Process

LCD Module Disassembly Flowchart

LCD MODULE DISASSEMBLY

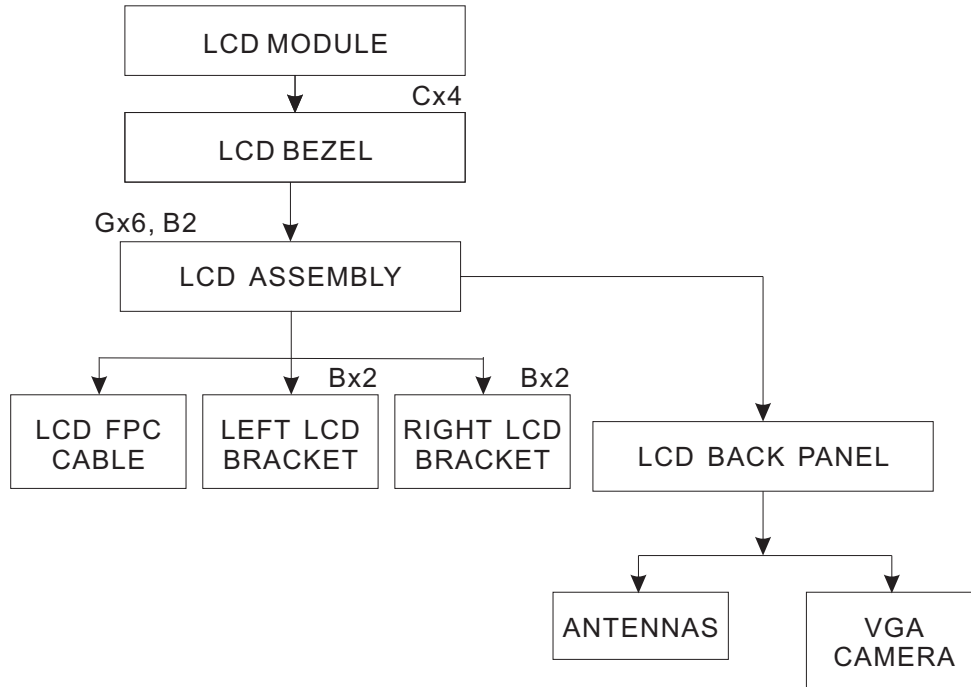

Screw List

| Item | Screw | Color | Part No. |
|------|-----------|--------|--------------|
| B | M2 x L4 | Silver | 86.9A552.4R0 |
| C | M2.5 x L5 | Black | 86.00E33.736 |
| G | M2.5 x L5 | Black | 86.00F87.735 |

Removing the LCD Bezel

1. See “Removing the Battery Pack” on page 56.
2. See “Removing the SD dummy card” on page 57.
3. See “Removing the PC and ExpressCard dummy cards” on page 58.
4. See “Removing the Lower Cover” on page 59.
5. See “Removing the WLAN Board Modules” on page 61.
6. See “Removing the Middle Cover” on page 68.
7. See “Removing the Keyboard” on page 71.
8. See “Removing the LCD Module” on page 76.
9. Remove the four screw covers from the LCD bezel.

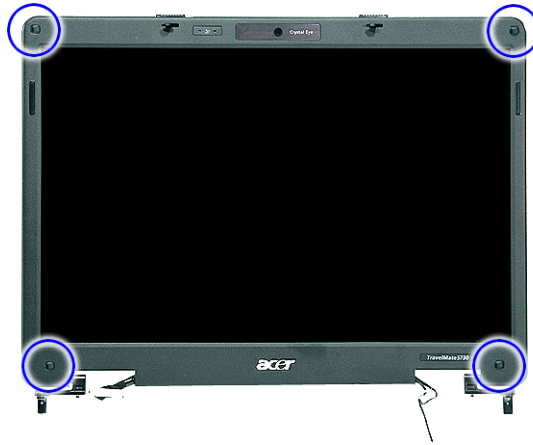

10. Remove the four screws (C) on the LCD module as shown.



| Step | Size (Quantity) | Color | Torque |
|------|-----------------|-------|------------|
| 1~4 | M2.5 x L6 (4) | Black | 3.0 kgf-cm |

11. Carefully pry open the LCD bezel and place the bezel on top of the LCD panel.

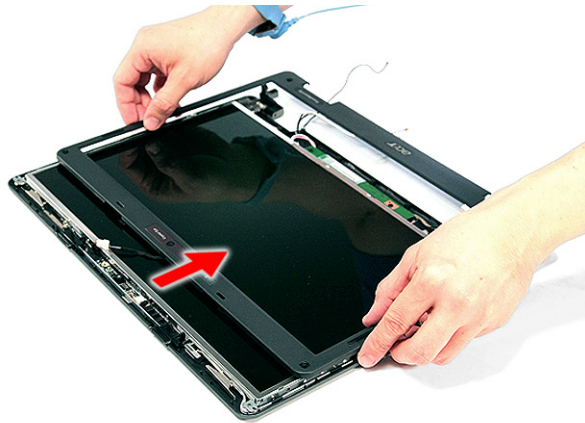

12. Disconnect the microphone cable and remove the bezel from the LCD panel.



Removing the LCD module with the Brackets

1. See “Removing the Battery Pack” on page 56.
2. See “Removing the SD dummy card” on page 57.
3. See “Removing the PC and ExpressCard dummy cards” on page 58.
4. See “Removing the Lower Cover” on page 59.
5. See “Removing the WLAN Board Modules” on page 61.
6. See “Removing the Middle Cover” on page 68.
7. See “Removing the Keyboard” on page 71.
8. See “Removing the LCD Module” on page 76.
9. See “Removing the LCD Bezel” on page 94.
10. Disconnect the cable from the web camera.

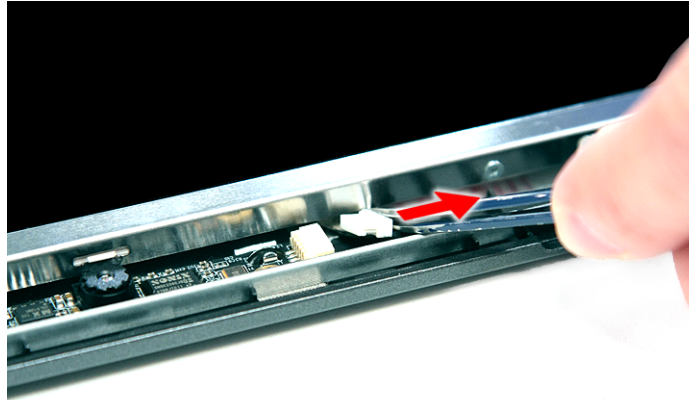

11. Remove the eight screws (6 x G, 2 x B) securing the LCD module.

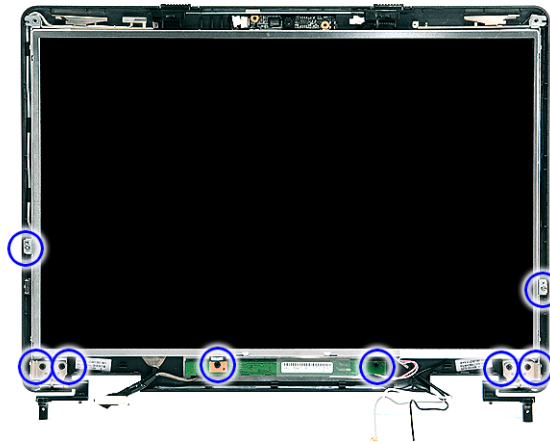

| Step | Size (Quantity) | Color | Torque |
|------|-----------------|--------|------------|
| 1~6 | M2.5 x L6 (6) | Black | 2.5 kgf-cm |
| 7~8 | M2 x L4 (2) | Silver | 1.6 kgf-cm |

-
12. Remove the LCD with the brackets from the back cover.



Removing the FPC Cable

1. See "Removing the Battery Pack" on page 56.
2. See "Removing the SD dummy card" on page 57.
3. See "Removing the PC and ExpressCard dummy cards" on page 58.
4. See "Removing the Lower Cover" on page 59.
5. See "Removing the WLAN Board Modules" on page 61.
6. See "Removing the Middle Cover" on page 68.
7. See "Removing the Keyboard" on page 71.
8. See "Removing the LCD Module" on page 76.
9. See "Removing the LCD Bezel" on page 94.
10. See "Removing the LCD module with the Brackets" on page 96.
11. Disconnect the cables from the inverter board.

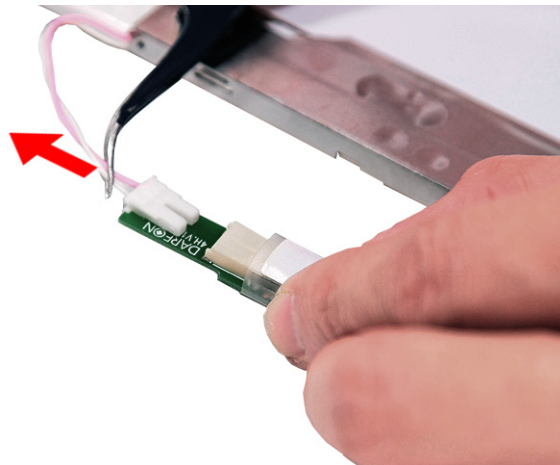

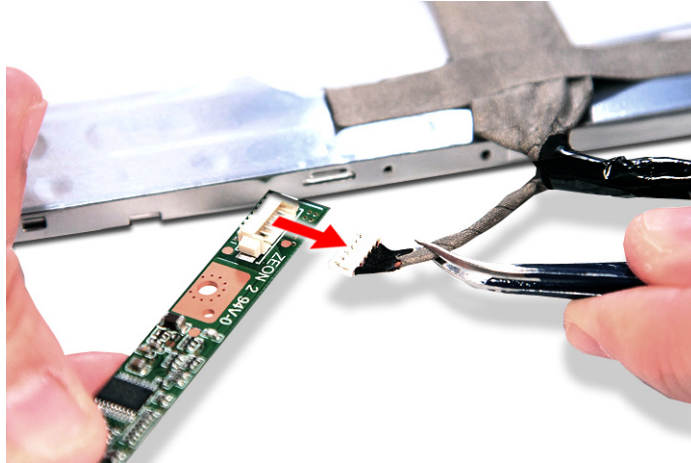

12. Detach any adhesive tapes and any cable that is glued to the LCD panel.





13. Disconnect the FPC cable from the LCD panel.

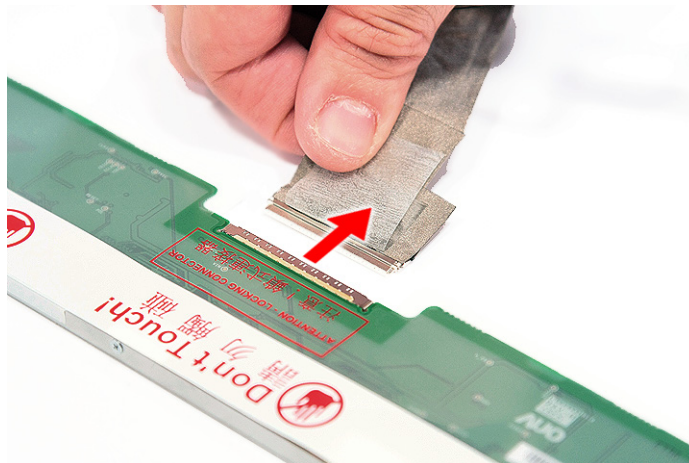

Removing the LCD Brackets

1. See "Removing the Battery Pack" on page 56.
2. See "Removing the Lower Cover" on page 59.
3. See "Removing the WLAN Board Modules" on page 61.
4. See "Removing the Keyboard" on page 71.
5. See "Removing the Middle Cover" on page 68.
6. See "Removing the LCD Module" on page 76.
7. See "Removing the LCD Bezel" on page 94.
8. See "Removing the LCD module with the Brackets" on page 96.
9. See "Removing the FPC Cable" on page 97.

10. Remove the four screws (4 x B) securing the left and right LCD brackets to remove the brackets.

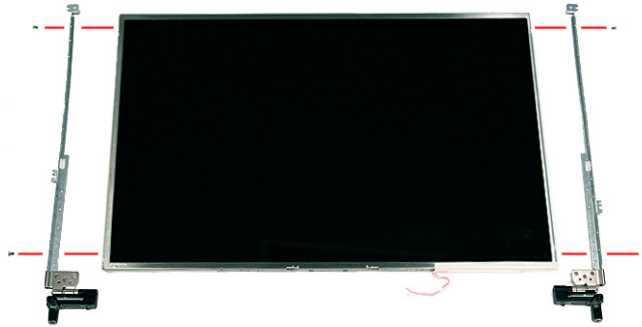

| Step | Size (Quantity) | Color | Torque |
|------|-----------------|--------|------------|
| 1~4 | M2 x L4 (4) | Silver | 1.6 kgf-cm |

Removing the Antennas

1. See “Removing the Battery Pack” on page 56.
2. See “Removing the Lower Cover” on page 59.
3. See “Removing the WLAN Board Modules” on page 61.
4. See “Removing the Keyboard” on page 71.
5. See “Removing the Middle Cover” on page 68.
6. See “Removing the LCD Module” on page 76.
7. See “Removing the LCD Bezel” on page 94.
8. See “Removing the LCD module with the Brackets” on page 96.
9. Release the antenna cables from the aluminium tapes.

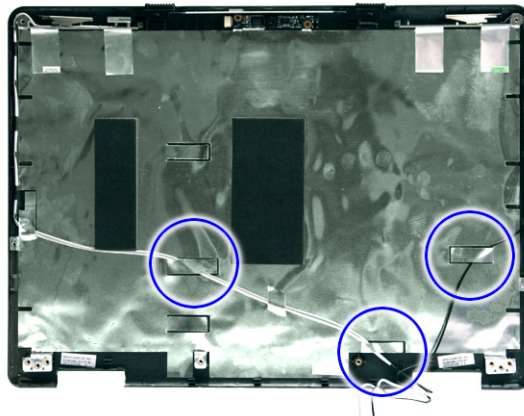

-
10. Remove the tapes together holding the antenna in place.



NOTE: There is no need to remove the antenna unless you really need to replace it.

Removing the Web Camera

1. See “Removing the Battery Pack” on page 56.
2. See “Removing the Lower Cover” on page 59.
3. See “Removing the WLAN Board Modules” on page 61.
4. See “Removing the Keyboard” on page 71.
5. See “Removing the Middle Cover” on page 68.
6. See “Removing the LCD Module” on page 76.
7. See “Removing the LCD Bezel” on page 94.
8. See “Removing the LCD module with the Brackets” on page 96.

-
9. Remove the Web camera from the back cover.

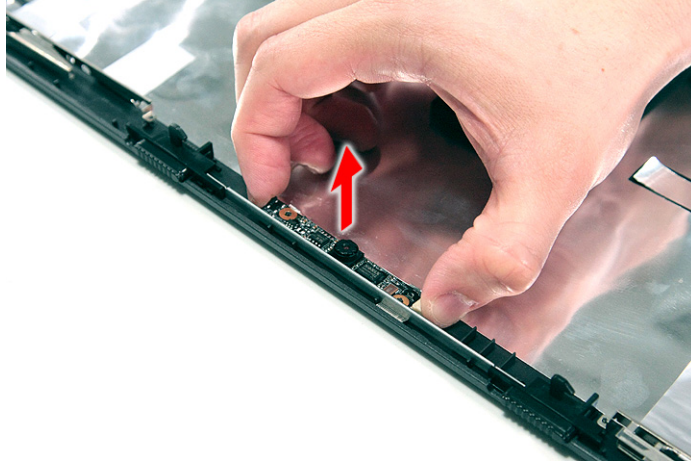

Troubleshooting

Use the following procedure as a guide for computer problems.

NOTE: The diagnostic tests are intended to test only Acer products. Non-Acer products, prototype cards, or modified options can give false errors and invalid system responses.

1. Obtain the failing symptoms in as much detail as possible.
2. Verify the symptoms by attempting to re-create the failure by running the diagnostic test or by repeating the same operation.
3. Use the following table with the verified symptom to determine which page to go to.

| Symptoms (Verified) | Go To |
|---|--|
| Power failure. (The power indicator does not go on or stay on.) | "Power System Check" on page 105. |
| POST does not complete. No beep or error codes are indicated. | "Power-On Self-Test (POST) Error Message" on page 108 "Undetermined Problems" on page 122 |
| POST detects an error and displayed messages on screen. | "Error Message List" on page 109 |
| Other symptoms (i.e. LCD display problems or others). | "Power-On Self-Test (POST) Error Message" on page 108 |
| Symptoms cannot be re-created (intermittent problems). | Use the customer-reported symptoms and go to "Power-On Self-Test (POST) Error Message" on page 108 "Intermittent Problems" on page 121 "Undetermined Problems" on page 122 |

System Check Procedures

External Diskette Drive Check

Do the following to isolate the problem to a controller, driver, or diskette. A write-enabled, diagnostic diskette is required.

NOTE: Make sure that the diskette does not have more than one label attached to it. Multiple labels can cause damage to the drive or cause the drive to fail.

Do the following to select the test device.

1. Boot from the diagnostics diskette and start the diagnostics program.
2. See if FDD Test is passed as the program runs to FDD Test.
3. Follow the instructions in the message window.

If an error occurs with the internal diskette drive, reconnect the diskette connector on the system board.

If the error still remains:

1. Reconnect the external diskette drive/DVD-ROM module.
2. Replace the external diskette drive/CD-ROM module.
3. Replace the main board.

External CD-ROM Drive Check

Do the following to isolate the problem to a controller, drive, or CD-ROM. Make sure that the CD-ROM does not have any label attached to it. The label can cause damage to the drive or can cause the drive to fail.

Do the following to select the test device:

1. Boot from the diagnostics diskette and start the diagnostics program.
2. See if CD-ROM Test is passed when the program runs to CD-ROM Test.
3. Follow the instructions in the message window.

If an error occurs, reconnect the connector on the System board. If the error still remains:

1. Reconnect the external diskette drive/CD-ROM module.
2. Replace the external diskette drive/CD-ROM module.
3. Replace the main board.

Keyboard or Auxiliary Input Device Check

Remove the external keyboard if the internal keyboard is to be tested.

If the internal keyboard does not work or an unexpected character appears, make sure that the flexible cable extending from the keyboard is correctly seated in the connector on the system board.

If the keyboard cable connection is correct, run the Keyboard Test.

If the tests detect a keyboard problem, do the following one at a time to correct the problem. Do not replace a non-defective FRU:

1. Reconnect the keyboard cables.
2. Replace the keyboard.
3. Replace the main board.

The following auxiliary input devices are supported by this computer:

- Numeric keypad

-
- External keyboard

If any of these devices do not work, reconnect the cable connector and repeat the failing operation.

Memory check

Memory errors might stop system operations, show error messages on the screen, or hang the system.

1. Boot from the diagnostics diskette and start the diagnostic program (please refer to main board).
2. Go to the diagnostic memory in the test items.
3. Press F2 in the test items.
4. Follow the instructions in the message window.

NOTE: Make sure that the DIMM is fully installed into the connector. A loose connection can cause an error.

Power System Check

To verify the symptom of the problem, power on the computer using each of the following power sources:

1. Remove the battery pack.
2. Connect the power adapter and check that power is supplied.
3. Disconnect the power adapter and install the charged battery pack; then check that power is supplied by the battery pack.

If you suspect a power problem, see the appropriate power supply check in the following list:

- "Check the Power Adapter" on page 106
- "Check the Battery Pack" on page 107

Check the Power Adapter

Unplug the power adapter cable from the computer and measure the output voltage at the plug of the power adapter cable. See the following figure

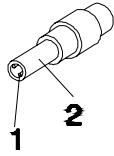

Pin 1: +19 to +20.5V

Pin 2: 0V, Ground

1. If the voltage is not correct, replace the power adapter.
2. If the voltage is within the range, do the following:
 - Replace the System board.
 - If the problem is not corrected, see “Undetermined Problems” on page 122.
 - If the voltage is not correct, go to the next step.

NOTE: An audible noise from the power adapter does not always indicate a defect.

3. If the power-on indicator does not light up, check the power cord of the power adapter for correct continuity and installation.
4. If the operational charge does not work, see “Check the Battery Pack” on page 107.

Check the Battery Pack

To check the battery pack, do the following:

From Software:

1. Check out the Power Management in control Panel
2. In Power Meter, confirm that if the parameters shown in the screen for Current Power Source and Total Battery Power Remaining are correct.
3. Repeat the steps 1 and 2, for both battery and adapter.
4. This helps you identify first the problem is on recharging or discharging.

From Hardware:

1. Power off the computer.
2. Remove the battery pack and measure the voltage between battery terminals 1(+) and 6(ground).
3. If the voltage is still less than 7.5 Vdc after recharging, replace the battery.

To check the battery charge operation, use a discharged battery pack or a battery pack that has less than 50% of the total power remaining when installed in the computer.

If the battery status indicator does not light up, remove the battery pack and let it return to room temperature. Re-install the battery pack.

If the charge indicator still does not light up, replace the battery pack. If the charge indicator still does not light up, replace the DC/DC charger board.

Touchpad Check

If the touchpad doesn't work, do the following actions one at a time to correct the problem. Do not replace a non-defective FRU:

1. Reconnect the touchpad cables.
2. Replace the touchpad.
3. Replace the system board.

After you use the touchpad, the pointer drifts on the screen for a short time. This self-acting pointer movement can occur when a slight, steady pressure is applied to the touchpad pointer. This symptom is not a hardware problem. No service actions are necessary if the pointer movement stops in a short period of time.

Power-On Self-Test (POST) Error Message

The POST error message index lists the error message and their possible causes. The most likely cause is listed first.

NOTE: Perform the FRU replacement or actions in the sequence shown in FRU/Action column, if the FRU replacement does not solve the problem, put the original part back in the computer. Do not replace a non-defective FRU.

This index can also help you determine the next possible FRU to be replaced when servicing a computer.

If the symptom is not listed, see “Undetermined Problems” on page 122.

The following lists the error messages that the BIOS displays on the screen and the error symptoms classified by function.

NOTE: Most of the error messages occur during POST. Some of them display information about a hardware device, e.g., the amount of memory installed. Others may indicate a problem with a device, such as the way it has been configured.

NOTE: If the system fails after you make changes in the BIOS Setup Utility menus, reset the computer, enter Setup and install Setup defaults or correct the error.

Index of Error Messages

Error Code List

| Error Codes | Error Messages |
|-----------------|--|
| 006 | Equipment Configuration Error Causes: 1. CPU BIOS Update Code Mismatch 2. IDE Primary Channel Master Drive Error (The causes will be shown before "Equipment Configuration Error") |
| 010 | Memory Error at xxxx:xxx:xxxxh (R:xxxxh, W:xxxxh) |
| 070 | Real Time Clock Error |
| 071 | CMOS Battery Bad |
| 072 | CMOS Checksum Error |
| 110 | System disabled. Incorrect password is specified. |
| <No error code> | Battery critical LOW In this situation BIOS will issue 4 short beeps then shut down system, no message will show. |
| <No error code> | Thermal critical High In this situation BIOS will shut down system, not show message. |

Error Message List

| Error Messages | FRU/Action in Sequence |
|---|---|
| Failure Fixed Disk | Reconnect hard disk drive connector. "Load Default Settings" in BIOS Setup Utility. Hard disk drive System board |
| Stuck Key | see "Keyboard or Auxiliary Input Device Check" on page 104. |
| Keyboard error | see "Keyboard or Auxiliary Input Device Check" on page 104. |
| Keyboard Controller Failed | see "Keyboard or Auxiliary Input Device Check" on page 104. |
| Keyboard locked - Unlock key switch | Unlock external keyboard |
| Monitor type does not match CMOS - Run Setup | Run "Load Default Settings" in BIOS Setup Utility. |
| Shadow RAM Failed at offset: nnnn | BIOS ROM System board |
| System RAM Failed at offset: nnnn | DIMM System board |
| Extended RAM Failed at offset: nnnn | DIMM System board |
| System battery is dead - Replace and run Setup | Replace RTC battery and Run BIOS Setup Utility to reconfigure system time, then reboot system. |
| System CMOS checksum bad - Default configuration used | RTC battery Run BIOS Setup Utility to reconfigure system time, then reboot system. |

Error Message List

| Error Messages | FRU/Action in Sequence |
|---|--|
| System timer error | RTC battery Run BIOS Setup Utility to reconfigure system time, then reboot system. System board |
| Real time clock error | RTC battery Run BIOS Setup Utility to reconfigure system time, then reboot system. System board |
| Previous boot incomplete - Default configuration used | Run "Load Default Settings" in BIOS Setup Utility. RTC battery System board |
| Memory size found by POST differed from CMOS | Run "Load Default Settings" in BIOS Setup Utility. DIMM System board |
| Diskette drive A error | Check the drive is defined with the proper diskette type in BIOS Setup Utility See "External Diskette Drive Check" on page 104. |
| Incorrect Drive A type - run SETUP | Check the drive is defined with the proper diskette type in BIOS Setup Utility |
| System cache error - Cache disabled | System board |
| CPU ID: | System board |
| DMA Test Failed | DIMM System board |
| Software NMI Failed | DIMM System board |
| Fail-Safe Timer NMI Failed | DIMM System board |
| Device Address Conflict | Run "Load Default Settings" in BIOS Setup Utility. RTC battery System board |
| Allocation Error for device | Run "Load Default Settings" in BIOS Setup Utility. RTC battery System board |
| Failing Bits: nnnn | DIMM BIOS ROM System board |
| Fixed Disk n | None |
| Invalid System Configuration Data | BIOS ROM System board |
| I/O device IRQ conflict | Run "Load Default Settings" in BIOS Setup Utility. RTC battery System board |
| Operating system not found | Enter Setup and see if fixed disk and drive A: are properly identified. Diskette drive Hard disk drive System board |

Error Message List

| No beep Error Messages | FRU/Action in Sequence |
|---|--|
| No beep, power-on indicator turns off and LCD is blank. | Power source (battery pack and power adapter). See "Power System Check" on page 105.. Ensure every connector is connected tightly and correctly. Reconnect the DIMM. LED board. System board. |
| No beep, power-on indicator turns on and LCD is blank. | Power source (battery pack and power adapter). See "Power System Check" on page 105.. Reconnect the LCD connector Hard disk drive LCD inverter ID LCD cable LCD Inverter LCD System board |
| No beep, power-on indicator turns on and LCD is blank. But you can see POST on an external CRT. | Reconnect the LCD connectors. LCD inverter ID LCD cable LCD inverter LCD System board |
| No beep, power-on indicator turns on and a blinking cursor shown on LCD during POST. | Ensure every connector is connected tightly and correctly. System board |
| No beep during POST but system runs correctly. | Speaker System board |

Phoenix BIOS Beep Codes

| Code | Beeps | POST Routine Description |
|------|---------|--|
| 02h | | Verify Real Mode |
| 03h | | Disable Non-Maskable Interrupt (NMI) |
| 04h | | Get CPU type |
| 06h | | Initialize system hardware |
| 08h | | Initialize chipset with initial POST values |
| 09h | | Set IN POST flag |
| 0Ah | | Initialize CPU registers |
| 0Bh | | Enable CPU cache |
| 0Ch | | Initialize caches to initial POST values |
| 0Eh | | Initialize I/O component |
| 0Fh | | Initialize the local bus IDE |
| 10h | | Initialize Power Management |
| 11h | | Load alternate registers with initial POST values |
| 12h | | Restore CPU control word during warm boot |
| 13h | | Initialize PCI Bus Mastering devices |
| 14h | | Initialize keyboard controller |
| 16h | 1-2-2-3 | BIOS ROM checksum |
| 17h | | Initialize cache before memory autosize |
| 18h | | 8254 timer initialization |
| 1Ah | | 8237 DMA controller initialization |
| 1Ch | | Reset Programmable Interrupt Controller |
| 20h | 1-3-1-1 | Test DRAM refresh |
| 22h | 1-3-1-3 | Test 8742 Keyboard Controller |
| 24h | | Set ES segment register to 4 GB |
| 26h | | Enable A20 line |
| 28h | | Autosize DRAM |
| 29h | | Initialize POST Memory Manager |
| 2Ah | | Clear 215 KB base RAM |
| 2Ch | 1-3-4-1 | RAM failure on address line xxxx |
| 2Eh | 1-3-4-3 | RAM failure on data bits xxxx of low byte of memory bus |
| 2Fh | | Enable cache before system BIOS shadow |
| 30h | 1-4-1-1 | RAM failure on data bits xxxx of high byte of memory bus |
| 32h | | Test CPU bus-clock frequency |
| 33h | | Initialize Phoenix Dispatch Manager |
| 36h | | Warm start shut down |
| 38h | | Shadow system BIOS ROM |
| 3Ah | | Autosize cache |

| Code | Beeps | POST Routine Description |
|------|---------|--|
| 3Ch | | Advanced configuration of chipset registers |
| 3Dh | | Load alternate registers with CMOS values |
| 42h | | Initialize interrupt vectors |
| 45h | | POST device initialization |
| 46h | 2-1-2-3 | Check ROM copyright notice |
| 48h | | Check video configuration against CMOS |
| 49h | | Initialize PCI bus and devices |
| 4Ah | | Initialize all video adapters in system |
| 4Bh | | QuietBoot start (optional) |
| 4Ch | | Shadow video BIOS ROM |
| 4Eh | | Display BIOS copyright notice |
| 50h | | Display CPU type and speed |
| 51h | | Initialize EISA board |
| 52h | | Test keyboard |
| 54h | | Set key click if enabled |
| 58h | 2-2-3-1 | Test for unexpected interrupts |
| 59h | | Initialize POST display service |
| 5Ah | | Display prompt "Press F2 to enter SETUP" |
| 5Bh | | Disable CPU cache |
| 5Ch | | Test RAM between 512 and 640 KB |
| 60h | | Test extended memory |
| 62h | | Test extended memory address lines |
| 64h | | Jump to User Patch1 |
| 66h | | Configure advanced cache registers |
| 67h | | Initialize Multi Processor APIC |
| 68h | | Enable external and CPU caches |
| 69h | | Setup System Management Mode (SMM) area |
| 6Ah | | Display external L2 cache size |
| 6Bh | | Load custom defaults (optional) |
| 6Ch | | Display shadow-area message |
| 6Eh | | Display possible high address for UMB recovery |
| 70h | | Display error messages |
| 72h | | Check for configuration errors |
| 76h | | Check for keyboard errors |
| 7Ch | | Set up hardware interrupt vectors |
| 7Eh | | Initialize coprocessor if present |
| 80h | | Disable onboard Super I/O ports and IRQs |
| 81h | | Late POST device initialization |

| Code | Beeps | POST Routine Description |
|------|-------|--|
| 82h | | Detect and install external RS232 ports |
| 83h | | Configure non-MCD IDE controllers |
| 84h | | Detect and install external parallel ports |
| 85h | | Initialize PC-compatible PnP ISA devices |
| 86h | | Re-initialize onboard I/O ports |
| 87h | | Configure Motherboard Configurable Devices (optional) |
| 88h | | Initialize BIOS Area |
| 89h | | Enable Non-Maskable Interrupts (NMIs) |
| 8Ah | | Initialize Extended BIOS Data Area |
| 8Bh | | Test and initialize PS/2 mouse |
| 8Ch | | Initialize floppy controller |
| 8Fh | | Determine number of ATA drives (optional) |
| 90h | | Initialize hard-disk controllers |
| 91h | | Initialize local-bus hard-disk controllers |
| 92h | | Jump to UserPatch2 |
| 93h | | Build MPTABLE for multi-processor boards |
| 95h | | Install CD ROM for boot |
| 96h | | Clear huge ES segment register |
| 97h | | Fixup Multi Processor table |
| 98h | 1-2 | Search for option ROMs. One long, two short beeps on checksum failure. |
| 99h | | Check for SMART drive (optional) |
| 9Ah | | Shadow option ROMs |
| 9Ch | | Set up Power Management |
| 9Dh | | Initialize security engine (optional) |
| 9Eh | | Enable hardware interrupts |
| 9Fh | | Determine number of ATA and SCSI drives |
| A0h | | Set time of day |
| A2h | | Check key lock |
| A4h | | Initialize Typematic rate |
| A8h | | Erase F2 prompt |
| AAh | | Scan for F2 key stroke |
| ACh | | Enter SETUP |
| A Eh | | Clear Boot flag |
| B0h | | Check for errors |
| B2h | | POST done- prepare to boot operating system |
| B4h | 1 | One short beep before boot |
| B5h | | Terminate QuietBoot (optional) |
| B6h | | Check password (optional) |

| Code | Beeps | POST Routine Description |
|------|-------|--|
| B9h | | Prepare Boot |
| BAh | | Initialize DMI parameters |
| BBh | | Initialize PnP Option ROMs |
| BCh | | Clear parity checkers |
| BDh | | Display MultiBoot menu |
| BEh | | Clear screen (optional) |
| BFh | | Check virus and backup reminders |
| C0h | | Try to boot with INT 19 |
| C1h | | Initialize POST Error Manager (PEM) |
| C2h | | Initialize error logging |
| C3h | | Initialize error display function |
| C4h | | Initialize system error handler |
| C5h | | PnPnd dual CMOS (optional) |
| C6h | | Initialize notebook docking (optional) |
| C7h | | Initialize notebook docking late |
| C8h | | Force check (optional) |
| C9h | | Extended checksum (optional) |
| D2h | | Unknown interrupt |

| Code | Beeps | POST Routine Description |
|------|-------|-----------------------------------|
| E0h | | Initialize the chipset |
| E1h | | Initialize the bridge |
| E2h | | Initialize the CPU |
| E3h | | Initialize the system timer |
| E4h | | Initialize system I/O |
| E5h | | Check force recovery boot |
| E6h | | Checksum BIOS ROM |
| E7h | | Go to BIOS |
| E8h | | Set Huge Segment |
| E9h | | Initialize Multi Processor |
| EAh | | Initialize OEM special code |
| EBh | | Initialize PIC and DMA |
| ECh | | Initialize Memory type |
| EDh | | Initialize Memory size |
| EEh | | Shadow Boot Block |
| EFh | | System memory test |
| F0h | | Initialize interrupt vectors |
| F1h | | Initialize Run Time Clock |
| F2h | | Initialize video |
| F3h | | Initialize System Management Mode |
| F4h | 1 | Output one beep before boot |

| Code | Beeps | |
|------|-------|--------------------|
| F5h | | Boot to Mini DOS |
| F6h | | Clear Huge Segment |
| F7h | | Boot to Full DOS |

Index of Symptom-to-FRU Error Message

LCD-Related Symptoms

| Symptom / Error | Action in Sequence |
|---|--|
| LCD backlight doesn't work LCD is too dark LCD brightness cannot be adjusted LCD contrast cannot be adjusted | Enter BIOS Utility to execute "Load Setup Default Settings", then reboot system. Reconnect the LCD connectors. Keyboard (if contrast and brightness function key doesn't work). LCD inverter ID LCD cable LCD inverter LCD System board |
| Unreadable LCD screen Missing pels in characters Abnormal screen Wrong color displayed | Reconnect the LCD connector LCD inverter ID LCD cable LCD inverter LCD System board |
| LCD has extra horizontal or vertical lines displayed. | LCD inverter ID LCD inverter LCD cable LCD System board |

Indicator-Related Symptoms

| Symptom / Error | Action in Sequence |
|--|--|
| Indicator incorrectly remains off or on, but system runs correctly | Reconnect the inverter board Inverter board System board |

Power-Related Symptoms

| Symptom / Error | Action in Sequence |
|-----------------------------------|--|
| Power shuts down during operation | Power source (battery pack and power adapter). See "Power System Check" on page 105. Battery pack Power adapter Hard drive & battery connection board System board |
| The system doesn't power-on. | Power source (battery pack and power adapter). See "Power System Check" on page 105. Battery pack Power adapter Hard drive & battery connection board System board |

Power-Related Symptoms

| Symptom / Error | Action in Sequence |
|-------------------------------|--|
| The system doesn't power-off. | Power source (battery pack and power adapter). See "Power System Check" on page 105. Hold and press the power switch for more than 4 seconds. System board |
| Battery can't be charged | See "Check the Battery Pack" on page 107. Battery pack System board |

PCMCIA-Related Symptoms

| Symptom / Error | Action in Sequence |
|---|--------------------------------------|
| System cannot detect the PC Card (PCMCIA) | PCMCIA slot assembly System board |
| PCMCIA slot pin is damaged. | PCMCIA slot assembly |

Memory-Related Symptoms

| Symptom / Error | Action in Sequence |
|---|---|
| Memory count (size) appears different from actual size. | Enter BIOS Setup Utility to execute "Load Default Settings, then reboot system. DIMM System board |

Speaker-Related Symptoms

| Symptom / Error | Action in Sequence |
|--|---|
| In Windows, multimedia programs, no sound comes from the computer. | Audio driver Speaker System board |
| Internal speakers make noise or emit no sound. | Speaker System board |

Power Management-Related Symptoms

| Symptom / Error | Action in Sequence |
|--|--|
| The system will not enter hibernation | See "Save to Disk (S4)" on page 35. Keyboard (if control is from the keyboard) Hard disk drive System board |
| The system doesn't enter hibernation mode and four short beeps every minute. | Press Fn+0 and see if the computer enters hibernation mode. Touchpad Keyboard Hard disk connection board Hard disk drive System board |
| The system doesn't enter standby mode after closing the LCD | See "Save to Disk (S4)" on page 35. LCD cover switch System board |

Power Management-Related Symptoms

| Symptom / Error | Action in Sequence |
|--|--|
| The system doesn't resume from hibernation mode. | See "Save to Disk (S4)" on page 35. Hard disk connection board Hard disk drive System board |
| The system doesn't resume from standby mode after opening the LCD. | See "Save to Disk (S4)" on page 35. LCD cover switch System board |
| Battery fuel gauge in Windows doesn't go higher than 90%. | Remove battery pack and let it cool for 2 hours. Refresh battery (continue use battery until power off, then charge battery). Battery pack System board |
| System hangs intermittently. | Reconnect hard disk/CD-ROM drives. Hard disk connection board System board |

Peripheral-Related Symptoms

| Symptom / Error | Action in Sequence |
|--|---|
| System configuration does not match the installed devices. | Enter BIOS Setup Utility to execute "Load Default Settings", then reboot system. Reconnect hard disk/CD-ROM/diskette drives. |
| External display does not work correctly. | Press Fn+F5, LCD/CRT/Both display switching System board |
| USB does not work correctly | System board |
| Print problems. | Ensure the "Parallel Port" in the "Onboard Devices Configuration" of BIOS Setup Utility is set to Enabled. Onboard Devices Configuration Run printer self-test. Printer driver Printer cable Printer System Board |
| Serial or parallel port device problems. | Ensure the "Serial Port" in the Devices Configuration" of BIOS Setup Utility is set to Enabled. Device driver Device cable Device System board |

Keyboard/Touchpad-Related Symptoms

| Symptom / Error | Action in Sequence |
|--|---|
| Keyboard (one or more keys) does not work. | Reconnect the keyboard cable. Keyboard System board |

Keyboard/Touchpad-Related Symptoms

| Symptom / Error | Action in Sequence |
|-------------------------|---|
| Touchpad does not work. | Reconnect touchpad cable. Touchpad board System board |

Modem-Related Symptoms

| Symptom / Error | Action in Sequence |
|---|---|
| Internal modem does not work correctly. | Modem phone port modem combo board System board |

NOTE: If you cannot find a symptom or an error in this list and the problem remains, see “Undetermined Problems” on page 122.

Intermittent Problems

Intermittent system hang problems can be caused by a variety of reasons that have nothing to do with a hardware defect, such as: cosmic radiation, electrostatic discharge, or software errors. FRU replacement should be considered only when a recurring problem exists.

When analyzing an intermittent problem, do the following:

1. Run the advanced diagnostic test for the system board in loop mode at least 10 times.
2. If no error is detected, do not replace any FRU.
3. If any error is detected, replace the FRU. Rerun the test to verify that there are no more errors.

Undetermined Problems

The diagnostic problems does not identify which adapter or device failed, which installed devices are incorrect, whether a short circuit is suspected, or whether the system is inoperative.

Follow these procedures to isolate the failing FRU (do not isolate non-defective FRU).

NOTE: Verify that all attached devices are supported by the computer.

NOTE: Verify that the power supply being used at the time of the failure is operating correctly. (See "Power System Check" on page 105.):

1. Power-off the computer.
2. Visually check them for damage. If any problems are found, replace the FRU.
3. Remove or disconnect all of the following devices:
 - Non-Acer devices
 - Printer, mouse, and other external devices
 - Battery pack
 - Hard disk drive
 - DIMM
 - CD-ROM/Diskette drive Module
 - PC Cards
4. Power-on the computer.
5. Determine if the problem has changed.
6. If the problem does not recur, reconnect the removed devices one at a time until you find the failing FRU.
7. If the problem remains, replace the following FRU one at a time. Do not replace a non-defective FRU:
 - System board
 - LCD assembly

Jumper and Connector Locations

Top and Bottom View

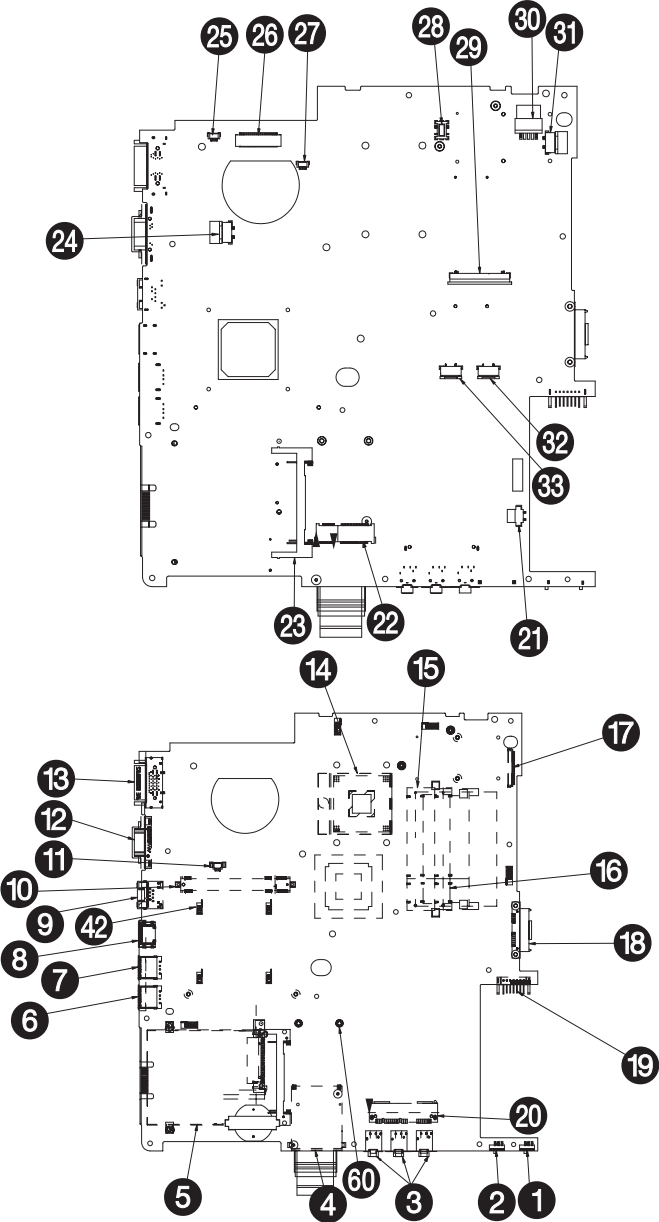

| ITEM | POSITION | PIN |
|------|----------------------------|-----|
| 1 | wirless switch | |
| 2 | bluetooth switch | |
| 3 | Audio Jack | |
| 4 | card reader | |
| 5 | new card | |
| 6 | USB | |
| 7 | USB | |
| 8 | HDMI | |
| 9 | RJ-45 | |
| 10 | MXM card connector | |
| 11 | FAN connector | |
| 12 | D-sub | |
| 13 | P/R connector | |
| 14 | CPU connector | |
| 15 | Dimm 1 connector | |
| 16 | Dimm 2 connector | |
| 17 | USB BD to M/B connector | |
| 18 | ODD connector | |
| 19 | BTY connector | |
| 20 | HDD connector | |
| 21 | bluetooth connector | |
| 22 | robin connector | |
| 23 | card bus | |
| 24 | Latch BD to M/B connector | |
| 25 | MIC connector | |
| 26 | LCD connector | |
| 27 | speaker connector | |
| 28 | moden connector | |
| 29 | K/B connector | |
| 30 | DC-IN connector | |
| 31 | power BD to M/B connector | |
| 32 | T/P connector | |
| 33 | finger bd to M/B connector | |
| 34 | 34.15F09.001 | |

Clearing Password Check and BIOS Recovery

This section provide you the standard operating procedures of clearing password and BIOS recovery for TravelMate 5730 Series. TravelMate 5730 Series provide one Hardware Open Gap on main board for clearing password check, and one Hotkey for enabling BIOS Recovery.

Clearing Password Check

Hardware Open Gap Description

| Hardware | Default Setting | Operation Description |
|----------|-----------------|---------------------------------|
| Gap | Open (Normal) | Short (Clearing Password Check) |

HW Gap position on M/B space:

Gap name in TravelMate 5730 Series is G77

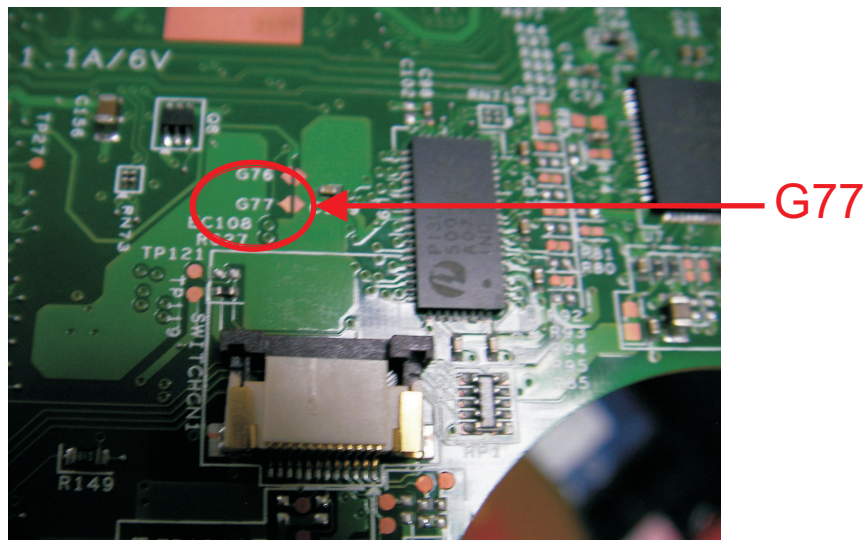

Steps for Clearing BIOS Password Check

If users set BIOS Password (Supervisor Password and/or User Password) for a security reason, BIOS will ask the password during systems POST or when systems enter to BIOS Setup menu. However, once it is necessary to bypass the password check, users need to short the HW Gap to clear the password by the following steps:

- Power Off a system, and remove HDD, AC and Battery from the machine.
- Open the back cover of the machine, and find out the HW Gap on M/B as picture.
- Use an electric conductivity tool to short the two points of the HW Gap.
- Plug in AC, keep the short condition on the HW Gap, and press Power Button to power on the system till BIOS POST finish. Then remove the tool from the HW Gap.
- Restart system. Press F2 key to enter BIOS Setup menu.
- If there is no Password request, BIOS Password is cleared. Otherwise, please follow the steps and try again.

NOTE: The steps are only for clearing BIOS Password (Supervisor Password and User Password).

BIOS Recovery by Crisis Disk

BIOS Recovery Boot Block:

BIOS Recovery Boot Block is a special block of BIOS. It is used to boot up the system with minimum BIOS initialization. Users can enable this feature to restore the BIOS firmware to a successful one once the previous BIOS flashing process failed.

BIOS Recovery Hotkey:

The system provides a function hotkey: **Fn+Esc**, for enable BIOS Recovery process when system is powered on during BIOS POST. To use this function, it is strongly recommended to have the AC adapter and Battery present. If this function is enabled, the system will force the BIOS to enter a special BIOS block, called Boot Block.

Steps for BIOS Recovery by Crisis Disk:

Before doing this, one Crisis Disk should be prepared ready in hand. The Crisis Disk could be made by executing the Crisis Disk program in another system with Windows XP OS.

Follow the steps below:

1. Power Off system.
2. Insert the Crisis Disk to a USB floppy drive which is attached to the BIOS flash failed machine.
3. In the power-off state, press **Fn+Esc** and hold them and then press Power Button. The system should be powered on with Crisis BIOS Recovery process.
4. BIOS Boot Block starts to restore the BIOS code from the Crisis floppy disk to BIOS ROM on the failed machine.
5. If the Crisis flashing process is finished, the system will restart.

If the Crisis Recovery process is finished, the system should be powered on with successful and workable BIOS. Then a person can update the latest version BIOS for this machine by regular BIOS flashing process.

FRU (Field Replaceable Unit) List

This chapter gives you the FRU (Field Replaceable Unit) listing in global configurations of 5930/5930Z/5730Z Series. Refer to this chapter whenever ordering for parts to repair or for RMA (Return Merchandise Authorization).

Please note that WHEN ORDERING FRU PARTS, you should check the most up-to-date information available on your regional web or channel. For whatever reasons a part number change is made, it will not be noted on the printed Service Guide. For ACER AUTHORIZED SERVICE PROVIDERS, your Acer office may have a DIFFERENT part number code from those given in the FRU list of this printed Service Guide. You MUST use the local FRU list provided by your regional Acer office to order FRU parts for repair and service of customer machines.

NOTE: To scrap or to return the defective parts, you should follow the local government ordinance or regulations on how to dispose it properly, or follow the rules set by your regional Acer office on how to return it.

TravelMate 5730 Series Exploded Diagram

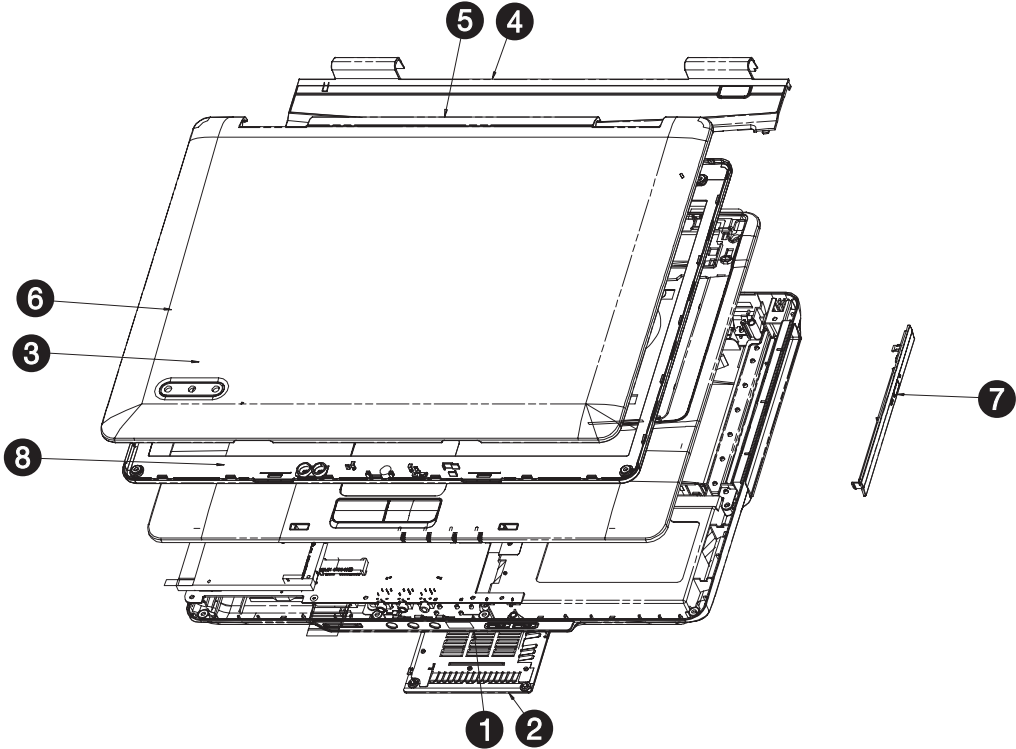



| NO | PART NO | DESCRIPTION | Q'TY | REV | REMARK |
|----|--------------|------------------------|------|-----|--------|
| 1 | 60.4Z401.001 | TBD | 1 | 0A | |
| 2 | 60.4Z402.001 | TBD | 1 | 0A | |
| 3 | 60.4Z404.001 | 60.4Z404.001 | 1 | 0A | |
| 4 | 60.4Z405.001 | ASSY MIDDLE COVER HDMA | 1 | 0A | |
| 5 | 60.4Z406.001 | Homa LCD Panel Assy | 1 | 0A | |
| 6 | 60.4Z408.001 | Homa LCD Bezel Assy | 1 | 0A | |
| 7 | 60.4Z431.001 | ASSY ODD BEZEL Blu-Ray | 1 | 0A | |
| 8 | HD.A_MB_AY1 | HDMA MB Layout ASSY | 1 | 0A | |

TravelMate 5730 Series FRU List

| Category | No. | Part Name and Description | Acer Part No. |
|---|-----|--|---------------|
| ACCESSORY | | | |
| | | REMOTE CONTROLLER FORMOSA21 RC804V-B EN | RT.22700.011 |
| | | REMOTE CONTROLLER FORMOSA21 RC804V-B EU | RT.22700.008 |
| Adapter | | | |
| | | ADAPTER 90W LITEON PA-1900-24AR | AP.09003.011 |
| | | ADAPTER 90W DELTA ADP-90SB BBEA LF | AP.09001.013 |
| | | ADAPTER 90W 3PIN DELTA ADP-90SB | AP.09001.014 |
| | | ADT 90W 19V 3P HP-OL093B13P LF | AP.0900A.001 |
| | | ADAPTER 65W 3PIN DELTA SADP-65KB BFJA LF | AP.06501.014 |
| | | ADAPTER 65W LITEON PA-1650-02AC LF | AP.06503.016 |
| | | ADAPTER 65W HIPRO HP-OK065B13 LF | AP.0650A.010 |
| | | ADAPTER 65W DELTA SADP-65KB DFA LF | AP.06501.013 |
| Battery- | | | |
| | | SANYO AS-2007B LI-ION 3S2P SANYO 6 CELL 4400MAH | BT.00603.042 |
| | | SONY AS-2007B LI-ION 3S2P SONY 6 CELL 4400MAH | BT.00604.025 |
| | | PANASONIC AS-2007B LI-ION 3S2P PANASONIC 6 CELL 4400MAH | BT.00605.021 |
| | | SIMPLO AS-2007B LI-ION 3S2P PANASONIC 6 CELL 4400MAH | BT.00607.016 |
| | | SIMPLO AS-2007B LI-ION 4S2P PANASONIC 8 CELL 4800MAH | BT.00807.015 |
| Boards | | | |
| | | EIGER AUDIO BD 07629-2M (D) | 55.AR501.001 |
| | | EIGER PD E KEY BD (D) | 55.AR501.006 |
| | | EIGER PD LAUNCH BD (D) | 55.AR501.002 |
| | | EIGER PD POWER BD (D) | 55.AR501.007 |
| | | EIGER PD USB BD WITH TV (D) | 55.AQE01.001 |
|  | | TOUCHPAD SYNAPTICS TM00540-001 | 56.AGV01.001 |
| | | BT MOD FOXCONN BCM2045 V2 | BT.21100.005 |
| | | WLAN 802.11ABGN SHIRLEYPEAK1*2 | KI.SPM01.003 |
|  | | VGA MXM CARD NVIDIA 9PGSHM DDRIII 512MB W/HDCP (MSI MADE) VGA CARD NB9P-GS/512M GDDR3 | 55.AQ301.001 |
| | | BIWA MINI SENSOR BD 07522-2M | 55.TKJ01.001 |
| | | EIGER PD FP BD WITH MINI (D) | 55.AQ301.002 |

| Category | No. | Part Name and Description | Acer Part No. |
|----------|-----|---|---------------|
| | | TV TUNCER DVB-T MINI TT-1260DA | TU.23100.015 |
| | | CAPACITIVE BUTTON TM-01119-001 | 55.AR501.005 |
| | | MODEM BOARD FOXCONN DELPHI-AM5 V2H 1.5_3.3V | FX.22500.022 |
| Cables | | | |
| | | LAUNCH BOARD CABLE | 50.AR501.002 |
| | | MEDIA BOARD CABLE | 50.AR501.005 |
| | | TOUCHPAD BOARD CABLE | 50.AR501.006 |
| | | USB BOARD CABLE | 50.AR501.003 |
| | | BLUETOOTH BOARD CABLE | 50.AR501.007 |
| | | AUDIO BOARD CABLE | 50.AR501.001 |
| | | DC-IN CABLE 90W | 50.AQ301.001 |
| | | TV TUNER BOARD CABLE | 50.AQE01.001 |
| | | TOUCHPAD BUTTON BOARD CABLE | 50.AR501.004 |
| | | DC-IN CABLE 65W | 50.AR501.008 |
| | | LCD/CAMERA CABLE 15.4" WXGA | 50.AR501.009 |
| | | POWER CORD 10A 125V US | 27.T30V1.001 |
| | | POWER CORD 10A 125V 3PIN US BK | 27.01518.641 |
| | | POWER CORD 2.5A 125V 8121- USA/ W CNS | 27.01518.781 |
| | | POWER CORD 220V 3PIN EUR | 27.T30V1.004 |
| | | POWER CABLE 16A 250V 3PIN EUR UK | 27.01518.731 |
| | | POWER CORD 3A 250V 3PIN UK | 27.01518.541 |
| | | POWER CORD 5A 250V 3PIN UK BK | 27.03118.001 |
| | | POWER CORD 10A 3PIN BK DENMARK | 27.01518.561 |
| | | POWER CORD 10A 250V 3PIN DENMARK BK | 27.01518.671 |
| | | POWER CORD 10A 250V 3PIN BK SOUTH AFRICA | 27.01518.571 |
| | | POWER CORD 16A 250V SOUTH AFRICA BK | 27.01518.681 |
| | | POWER CORD 10A 250V SWISS | 27.01518.581 |
| | | POWER CORD 10A 250V 3PIN SWISS BK | 27.01518.691 |
| | | POWER CORD 10A 250V 3PIN CHINA | 27.01518.591 |
| | | POWER CORD 10A 250V 3PIN CHINA BK | 27.01518.701 |
| | | POWER CORD 10A 250V 3PIN ITALY | 27.01518.611 |
| | | POWER CORD 10A 250V 3PIN ITALY BK | 27.01518.711 |
| | | POWER CORD 2.5A 250V SOUTH AFRICA BK (INDIA) | 27.01518.631 |
| | | POWER CORD 10A 250V SOUTH AFRICA BK (INDIA) | 27.01518.721 |
| | | POWER CORD 2.5A 250V AUSTRALIA | 27.01518.621 |
| | | POWER CORD ACA/ACNZ | 27.03218.021 |
| | | POWER CORD 7A 125V 2PIN JAPEN | 27.01518.551 |
| | | POWER CORD 7A 125V 2PIN JAPAN | 27.03518.161 |

| Category | No. | Part Name and Description | Acer Part No. |
|---|-----|--|---------------|
| | | POWER CORD 7A 250V 2PIN KOREA | 27.01518.531 |
| | | POWER CORD 250V 10A 3PIN ISRAEL | 27.01518.761 |
| Case/Cover/Bracket/Assembly | | | |
| | | LOWER CASE W/MODEM CABLE&FAN BRACKET&SPEAKER FOR TV | 60.AQE01.001 |
| | | SPEAKER SUB WOFFER | 23.AR501.001 |
| | | SPEAKER SET | 23.AR501.002 |
| | | EXPRESS DUMMY CARD | 42.AR501.004 |
| | | NEW CARD DUMMY CARD | 42.TK901.005 |
| | | SD DUMMY CARD | 42.TK901.006 |
| | | MIDDLE COVER | 42.AR501.001 |
| | | UNITLOAD COVER | 42.AR501.002 |
| | | E-KEY COVER | 42.AR501.003 |
| | | TOUCHPAD BRACKET | 33.AR501.001 |
| | | VGA BOARD BARCKET FOR NVIDIA | 33.TPE01.001 |
| | | UPPER CASE W/SPEAKER&E KEY CABLE&POWER CABLE&FINGERPRINT HOLE | 60.AQ301.002 |
| | | OPTICAL BRACKET | 33.AR501.002 |
| | | BD COMBO BEZEL | 42.AR501.005 |
| | | SUPER MULIT BEZEL | 42.AGV01.005 |
| | | HDD BRACKET | 33.AR501.003 |
| | | LCD COVER 15.4" W/BACKLIGHT MODULE&ANTENNA | 60.AR501.005 |
| | | LCD BEZEL 15.4" W/MICROPHONE | 60.AR501.004 |
| | | LCD BRACKET W/HINGE LEFT | 33.AR501.004 |
| | | LCD BRACKET W/HINGE RIGHT | 33.AR501.005 |
| Combo Module | | | |
|  | | COMBO MODULE BLU-RAY 2X | 6M.AR501.001 |
|  | | ODD SONY BD COMBO 12.7MM TRAY DL 2X BC-5500S LF W/O BEZEL SATA | KO.0020E.002 |
| Communication Module | | | |
| | | EXTERNAL ANTENNA SET | 25.AQE01.001 |
| CPU/Processor | | | |

| Category | No. | Part Name and Description | Acer Part No. |
|---|-----|---|---------------|
|  | | CPU INTEL CORE2DUAL P8400 PGA 2.26G 3M 1066 25W | KC.84001.DPP |
| | | CPU INTEL CORE2DUAL P8600 PGA 2.4G 1066 25W 3M | KC.86001.DPP |
| | | CPU INTEL CORE2DUAL P9500 PGA 2.53G 6M 1066 25W | KC.95001.DPP |
| | | CPU INTEL CORE2DUAL T9400 PGA 2.53G 6M 1066 35W | KC.94001.DTP |
| | | CPU INTEL CORE2DUAL T9600 PGA 2.8G 6M 1066 35W | KC.96001.DTP |
| DVD Module | | | |
|  | | ODD TOSHIBA SUPER-MULTI DRIVE 12.7MM TRAY DL 8X TS-L633A LF W/O BEZEL SATA | KU.00801.021 |
| | | ODD PIONEER SUPER-MULTI DRIVE 12.7MM TRAY DL 8X DVR-TD08RS LF W/O BEZEL SATA | KU.00805.044 |
| | | ODD PANASONIC SUPER-MULTI DRIVE 12.7MM TRAY DL 8X UJ-870A LF W/O BEZEL SATA | KU.00807.059 |
| | | ODD HLDS SUPER-MULTI DRIVE 12.7MM TRAY DL 8X GSA-T50N LF W/ O BEZEL SATA | KU.0080D.029 |
| | | ODD HLDS SUPER-MULTI DRIVE 12.7MM TRAY DL 8X GSA-T50N LF W/ O BEZEL SATA MALAYSIA | KU.0080D.034 |
| | | ODD SONY SUPER-MULTI DRIVE 12.7MM TRAY DL 8X AD-7560S LF W/O BEZEL SATA | KU.0080E.009 |
| | | ODD PLDS SUPER-MULTI DRIVE 12.7MM TRAY DL 8X DS-8A2S LF W/O BEZEL SATA | KU.0080F.001 |
| Fan | | | |
|  | | FAN SUNON | 23.AR501.003 |
| Heatsink | | | |
| | | CPU HEATSINK AVC NB9 W/O FAN | 60.AQ301.003 |
| HDD/Hard Disk Drive | | | |

| Category | No. | Part Name and Description | Acer Part No. |
|---|-----|---|---------------|
|  | | HDD 120GB 5400RPM SATA II HGST HTS542512K9SA00 BRONCO-B LF | KH.12007.014 |
| | | HDD 120GB 5400RPM SATA SEAGATE ST9120817AS LF | KH.12001.032 |
| | | HDD 120GB 5400RPM SATA TOSHIBA MK1246GSX LF | KH.12004.007 |
| | | HDD 120GB 5400RPM SATA WD WD1200BEVS-22UST0 ML125 LF | KH.12008.019 |
| | | HDD 160GB WD WD1600BEVT-22ZCT0 | KH.16008.022 |
| | | HDD 160GB 5400RPM SATA II HITACHI HTS541616J9SA00 LF | KH.16007.016 |
| | | HDD 160GB SEAGATE SATA ST9160827AS | KH.16001.029 |
| | | HDD 160GB 5400RPM SATA TOSHIBA MK1646GSX LF | KH.16004.002 |
| | | HDD 250GB SEAGATE SATA ST9250827AS | KH.25001.011 |
| | | HDD 250GB 5400RPM SATA TOSHIBA MK2546GSX LF | KH.25004.001 |
| | | HDD 250GB 5400RPM SATA II HGST HTS542525K9SA00 LF | KH.25007.011 |
| | | HDD 250GB 5400RPM SATA WD WD2500BEVS-22UST0 ML125 | KH.25008.018 |
| | | HDD 320GB 5400RPM SATA WD WD3200BEVT-22ZCT0 ML125 | KH.32008.013 |
| Keyboard | | | |
| | | KEYBOARD 14_15KB-FV3 BLACK E88KS US INTERNATIONAL (ASPIRE BLACK) | KB.INT00.442 |
| | | KEYBOARD 14_15KB-FV3 BLACK E88KS US INTERNATIONAL HEBREW (ASPIRE BLACK) | KB.INT00.443 |
| | | KEYBOARD 14_15KB-FV3 BLACK E89KS UK (ASPIRE BLACK) | KB.INT00.444 |
| | | KEYBOARD 14_15KB-FV3 BLACK E89KS TURKISH (ASPIRE BLACK) | KB.INT00.445 |
| | | KEYBOARD 14_15KB-FV3 BLACK E88KS THAILAND (ASPIRE BLACK) | KB.INT00.446 |
| | | KEYBOARD 14_15KB-FV3 BLACK E89KS SWISS/G (ASPIRE BLACK) | KB.INT00.447 |
| | | KEYBOARD 14_15KB-FV3 BLACK E89KS SWEDISH (ASPIRE BLACK) | KB.INT00.448 |
| | | KEYBOARD 14_15KB-FV3 BLACK E89KS SPANISH (ASPIRE BLACK) | KB.INT00.449 |
| | | KEYBOARD 14_15KB-FV3 BLACK 89KS SLO/CRO (ASPIRE BLACK) | KB.INT00.451 |
| | | KEYBOARD 14_15KB-FV3 BLACK E88KS RUSSIAN (ASPIRE BLACK) | KB.INT00.452 |
| | | KEYBOARD 14_15KB-FV3 BLACK E89KS PORTUGUESE (ASPIRE BLACK) | KB.INT00.453 |
| | | KEYBOARD 14_15KB-FV3 BLACK E89KS POLISH (ASPIRE BLACK) | KB.INT00.454 |

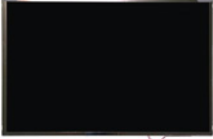
| Category | No. | Part Name and Description | Acer Part No. |
|---|-----|---|---------------|
| | | KEYBOARD 14_15KB-FV3 BLACK E89KS NORWEGIAN (ASPIRE BLACK) | KB.INT00.455 |
| | | KEYBOARD 14_15KB-FV3 BLACK E88KS KOREAN (ASPIRE BLACK) | KB.INT00.457 |
| | | KEYBOARD 14_15KB-FV3 BLACK E93KS JAPANESE (ASPIRE BLACK) | KB.INT00.458 |
| | | KEYBOARD 14_15KB-FV3 BLACK E89KS ITALIAN (ASPIRE BLACK) | KB.INT00.459 |
| | | KEYBOARD 14_15KB-FV3 BLACK E89KS HUNGARIAN (ASPIRE BLACK) | KB.INT00.462 |
| | | KEYBOARD 14_15KB-FV3 BLACK E88KS GREEK (ASPIRE BLACK) | KB.INT00.463 |
| | | KEYBOARD 14_15KB-FV3 BLACK E89KS GERMAN (ASPIRE BLACK) | KB.INT00.464 |
| | | KEYBOARD 14_15KB-FV3 BLACK E89KS FRENCH (ASPIRE BLACK) | KB.INT00.465 |
| | | KEYBOARD 14_15KB-FV3 BLACK E89KS DUTCH (ASPIRE BLACK) | KB.INT00.467 |
| | | KEYBOARD 14_15KB-FV3 BLACK E89KS DANISH (ASPIRE BLACK) | KB.INT00.468 |
| | | KEYBOARD 14_15KB-FV3 BLACK E89KS CZECH (ASPIRE BLACK) | KB.INT00.469 |
| | | KEYBOARD 14_15KB-FV3 BLACK E88KS TRADITIONAL CHINESE (ASPIRE BLACK) | KB.INT00.470 |
| | | KEYBOARD 14_15KB-FV3 BLACK E89KS CANADIAN FRENCH (ASPIRE BLACK) | KB.INT00.471 |
| | | KEYBOARD 14_15KB-FV3 BLACK E89KS BRAZILIAN PORTUGUESE (ASPIRE BLACK) | KB.INT00.472 |
| | | KEYBOARD 14_15KB-FV3 BLACK E89KS BELGIUM (ASPIRE BLACK) | KB.INT00.473 |
| | | KEYBOARD 14_15KB-FV3 BLACK E88KS ARABIC/ENGLISH (ASPIRE BLACK) | KB.INT00.474 |
| | | KEYBOARD 14_15KB-FV3 BLACK E89KS ARABIC/FRENCH (ASPIRE BLACK) | KB.INT00.475 |
| | | KEYBOARD 14_15KB-FV3 BLACK E89KS NORDIC (ASPIRE BLACK) | KB.INT00.476 |
| | | KEYBOARD 14_15KB-FV3 BLACK E89KS ENGLISH/CANADIAN FRENCH (ASPIRE BLACK) | KB.INT00.477 |
| LCD Module | | | |
|  | | LCD CMO 15.4" WXGA GLARE N154I3-L03 LF 220NIT 8MS | LK.1540D.022 |
| | | LCD AUO 15.4" WXGA GLARE B154EW02-V7 W/O BRACKET, H/W CODE 3A LF 220NIT 8MS | LK.15405.028 |
| | | LCD AUO 15.4" WXGA GLARE B154EW08-V1 W/O BRACKET, HW 3A LF 220NIT 8MS | LK.15405.029 |
| | | LCD LPL 15.4" WXGA GLARE LP154WX4-TLB4 LF 220NIT 8MS | LK.15408.029 |

| Category | No. | Part Name and Description | Acer Part No. |
|---------------|-----|--|---------------|
| MAINBOARD | | | |
| | | MAINBOARD AS5930G INTEL LF PGM45 ICH9 LF FOR MONTEVINA CPU WITH PR_ESATA | MB.AQ201.001 |
| | | MAINBOARD AS5930 INTEL LF GM45 ICH9 LF FOR MONTEVINA CPU WITH PR_ESATA | MB.AR501.001 |
| MEMORY | | | |
| | | SODIMM 1GB DDRII667 HYNIX HYMP112S64CP6-Y5 LF | KN.1GB0G.012 |
| | | SODIMM 1GB DDRII667 SAMSUNG M470T2864QZ3-CE6 | KN.1GB0B.016 |
| | | SODIMM 1GB DDRII667 INFINEON HYS64T128021EDL-3S LF | KN.1GB02.036 |
| | | SODIMM 1GB DDRII667 NANYA NT1GT64U8HB0BN-3C LF (0.09U) | KN.1GB03.014 |
| | | SODIMM 2GB DDRII667 ELPIDA EBE21UE8ACUA-6E-E LF | KN.2GB09.001 |
| | | SODIMM 2GB DDRII667 HYNIX HYMP125S64CP8-Y5 LF | KN.2GB0G.004 |
| | | SODIMM 2GB DDRII667 SAMSUNG M470T5663QZ3-CE6 LF | KN.2GB0B.003 |
| | | SODIMM 2GB DDRII667 MICRON MT16HTF25664HY-667E1 LF | KN.2GB04.001 |
| | | SODIMM 512MB DDRII667 HYNIX HYMP164S64CP6-Y5 LF | KN.5120G.024 |
| | | SODIMM 512MB DDRII667 NANYA NT512T64UH8B0FN-3C LF | KN.51203.032 |
| | | SODIMM 512MB DDRII667 SAMSUNG M470T6464QZ3-CE6 LF | KN.5120B.026 |
| MISCELLANEOUS | | | |
| | | NAME PLATE AS5930 | 47.AR501.001 |
| | | LOGO PLATE FOR LCD PANEL | 47.AR501.002 |
| SCREW | | | |
| | | IMS M2X4(H=0.3) | 86.00E13.524 |
| | | SCREW M2*L3 NYLOK CR 3+ | 86.00E25.723 |
| | | SCREW M2-3 | 86.9A522.3R0 |
| | | ISO M2.5X6(H=0.7~0.8MM) | 86.00E12.536 |
| | | M2.5*L10 BLACK ZN | 86.00F84.73A |
| | | SCREW MACH WAFER M3*L4 NI | 86.9A524.4R0 |

Model Definition and Configuration

TravelMate 5730 Series

| Model | RO | Country | Acer Part no | Description | CPU | LCD | DIMM 1 | DIMM 2 | HDD 1 (GB) | ODD | Wireless LAN | Bluetooth | VOIP Phone |
|--------------|-----|-------------|--------------|---|--------|------------|------------|--------|------------|-------|---------------|-----------|------------|
| AS5051ANWXMi | AAP | India | LX.AV30C.002 | AS5051ANWXMi LINPUSIL1 UMAC 1*512/80/ 6L/5R/ CB_bg_0.3 C_AN | ATMK36 | N14.1WXGAG | SO512MBII5 | N | N80GB5.4K | NSM8X | ABT_ATH5413BG | N | N |
| AS5051ANWXMi | AAP | Indonesia | LX.AV30C.003 | AS5051ANWXMi LINPUSIN1 UMAC 1*512/80/ 6L/5R/ CB_bg_0.3 C_AN | ATMK36 | N14.1WXGAG | SO512MBII5 | N | N80GB5.4K | NSM8X | ABT_ATH5413BG | N | N |
| AS5051ANWXMi | AAP | Malaysia | LX.AV30C.005 | AS5051ANWXMi LINPUSMA2 UMAC 1*512/80/ 6L/5R/ CB_bg_0.3 C_AN | ATMK36 | N14.1WXGAG | SO512MBII5 | N | N80GB5.4K | NSM8X | ABT_ATH5413BG | N | N |
| AS5051ANWXMi | AAP | Philippines | LX.AV30C.004 | AS5051ANWXMi LINPUSPH1 UMAC 1*512/80/ 6L/5R/ CB_bg_0.3 C_AN | ATMK36 | N14.1WXGAG | SO512MBII5 | N | N80GB5.4K | NSM8X | ABT_ATH5413BG | N | N |
| AS5051ANWXMi | AAP | Singapore | LX.AV30C.001 | AS5051ANWXMi LINPUSSG1 UMAC 1*512/80/ 6L/5R/ CB_bg_0.3 C_AN | ATMK36 | N14.1WXGAG | SO512MBII5 | N | N80GB5.4K | NSM8X | ABT_ATH5413BG | N | N |
| AS5051ANWXMi | AAP | Thailand | LX.AV30C.006 | AS5051ANWXMi LINPUSTH2 UMAC 1*512/80/ 6L/5R/ CB_bg_0.3 C_AN | ATMK36 | N14.1WXGAG | SO512MBII5 | N | N80GB5.4K | NSM8X | ABT_ATH5413BG | N | N |
| AS5051ANWXMi | AAP | Vietnam | LX.AV30C.007 | AS5051ANWXMi LINPUSVN1 UMAC 1*512/80/ 6L/5R/ CB_bg_0.3 C_AN | ATMK36 | N14.1WXGAG | SO512MBII5 | N | N80GB5.4K | NSM8X | ABT_ATH5413BG | N | N |

| Model | RO | Country | Acer Part no | Description | CPU | LCD | DIMM 1 | DIMM 2 | HDD 1 (GB) | ODD | Wireless LAN | Bluetooth | VOIP Phone |
|--------------|-----|------------------------------|---------------|--|---------|--------------|-------------|-------------|--------------|--------|----------------|-----------|------------|
| AS5051AWX Mi | PA | USA/Canada - Canadian French | LX.AV 30J.001 | AS5051AW XMi MCECF UMAC 2*512/120/6L/5R/ CB_bg_0.3 C_AN | ATMK 36 | N14.1 WXGA G | SO512 MBII5 | SO512 MBII5 | N120 GB5.4 K | NSM8 X | ABT_ATH54 13BG | N | N |
| AS5051AWX Mi | PA | USA/Canada - Canadian French | LX.AV 30J.002 | AS5051AW XMi MCEUS UMAC 2*512/120/6L/5R/ CB_bg_0.3 C_AN | ATMK 36 | N14.1 WXGA G | SO512 MBII5 | SO512 MBII5 | N120 GB5.4 K | NSM8 X | ABT_ATH54 13BG | N | N |
| AS5051AWX Mi | AAP | Australia/New Zealand | LX.AV 305.001 | AS5051AW XMi XPHAU1 UMAC 1*512/120/6L/5R/ CB_bg_0.3 C_AN | ATMK 36 | N14.1 WXGA G | SO512 MBII5 | N | N120 GB5.4 K | NSM8 X | ABT_ATH54 13BG | N | N |
| AS5051AWX Mi | PA | USA/Canada | LX.AV 305.008 | AS5051AW XMi XPHEN1 UMAC 1*512/120/6L/5R/ CB_bg_0.3 C_AN | ATMK 36 | N14.1 WXGA G | SO512 MBII5 | N | N120 GB5.4 K | NSM8 X | ABT_ATH54 13BG | N | N |
| AS5051AWX Mi | PA | ACLA-Spanish | LX.AV 305.010 | AS5051AW XMi XPHES1 UMAC 1*512/120/6L/5R/ CB_bg_0.3 C_AN | ATMK 36 | N14.1 WXGA G | SO512 MBII5 | N | N120 GB5.4 K | NSM8 X | ABT_ATH54 13BG | N | N |
| AS5051AWX Mi | PA | USA/Canada | LX.AV 305.009 | AS5051AW XMi XPHFR1 UMAC 1*512/120/6L/5R/ CB_bg_0.3 C_AN | ATMK 36 | N14.1 WXGA G | SO512 MBII5 | N | N120 GB5.4 K | NSM8 X | ABT_ATH54 13BG | N | N |
| AS5051AWX Mi | AAP | Indonesia | LX.AV 305.007 | AS5051AW XMi XPHIN1 UMAC 1*512/120/6L/5R/ CB_bg_0.3 C_AN | ATMK 36 | N14.1 WXGA G | SO512 MBII5 | N | N120 GB5.4 K | NSM8 X | ABT_ATH54 13BG | N | N |
| AS5051AWX Mi | AAP | Malaysia | LX.AV 305.003 | AS5051AW XMi XPHMA2 UMAC 1*512/120/6L/5R/ CB_bg_0.3 C_AN | ATMK 36 | N14.1 WXGA G | SO512 MBII5 | N | N120 GB5.4 K | NSM8 X | ABT_ATH54 13BG | N | N |
| AS5051AWX Mi | AAP | Philippines | LX.AV 305.002 | AS5051AW XMi XPHPH1 UMAC 1*512/120/6L/5R/ CB_bg_0.3 C_AN | ATMK 36 | N14.1 WXGA G | SO512 MBII5 | N | N120 GB5.4 K | NSM8 X | ABT_ATH54 13BG | N | N |

| Model | RO | Country | Acer Part no | Description | CPU | LCD | DIMM 1 | DIMM 2 | HDD 1 (GB) | ODD | Wireless LAN | Bluetooth | VOIP Phone |
|--------------|-------|-----------------|---------------|--|---------|-------------|-------------|-------------|---------------|---------|----------------|-------------|------------|
| AS5051AWX Mi | AAP | Thailand | LX.AV 305.004 | AS5051AW XMi XPHTH2 UMAC 1*512/120/6L/5R/ CB_bg_0.3 C_AN | ATMK 36 | N14.1 WXGAG | SO512 MBII5 | N | N120 GB5.4 K | NSM8 X | ABT_ATH54 13BG | N | N |
| AS5051AWX Mi | AAP | Vietnam | LX.AV 305.005 | AS5051AW XMi XPHVN1 UMAC 1*512/120/6L/5R/ CB_bg_0.3 C_AN | ATMK 36 | N14.1 WXGAG | SO512 MBII5 | N | N120 GB5.4 K | NSM8 X | ABT_ATH54 13BG | N | N |
| AS5051AWX Mi | AAP | Singapore | LX.AV 305.006 | AS5051AW XMi XPHWSG2 1W UMAC 1*512/120/6L/5R/ CB_bg_0.3 C_AN | ATMK 36 | N14.1 WXGAG | SO512 MBII5 | N | N120 GB5.4 K | NSM8 X | ABT_ATH54 13BG | N | N |
| AS5051AWX Mi | PA | ACLA-Portuguese | LX.AV 305.011 | AS5051AW XMi XPHXC1 UMAC 1*512/120/6L/5R/ CB_bg_0.3 C_AN | ATMK 36 | N14.1 WXGAG | SO512 MBII5 | N | N120 GB5.4 K | NSM8 X | ABT_ATH54 13BG | N | N |
| AS5051AWX Mi | TWN | GCTWN | S2.AV 305.001 | AS5051AW XMi XPHTC1 UMAC 2*512/120/BT/6L/5R/ CB_bg_0.3 C_AN | ATMK 36 | N14.1 WXGAG | SO512 MBII6 | SO512 MBII6 | N120 GB5.4 K | NSM8 X | ABT_ATH54 13BG | FOX_BRM_2.0 | N |
| AS5052WXM i | TWN | GCTWN | S2.AV 305.002 | AS5052WX Mi XPHTC1 UMAC 2*512/100/BT/6L/5R/ CB_bg_0.3 C_AN | ATTL5 0 | N14.1 WXGAG | SO512 MBII6 | SO512 MBII6 | N100 GB5.4 K | NSM8 X | ABT_ATH54 13BG | FOX_BRM_2.0 | N |
| AS5055WXM i | TWN | GCTWN | S2.AV 305.003 | AS5055WX Mi XPHTC1 UMAC 2*1G/160/BT/6L/5R/ CB_bg_0.3 C_AN | ATTL6 0 | N14.1 WXGAG | SO1G BII5 | SO1G BII5 | N160 GB5.4 KS | NSM8 X | ABT_BRM4 318BG | FOX_BRM_2.0 | N |
| AS5051AWX Ci | China | Hong Kong | LX.AV 305.016 | AS5051AW XCi XPHHK9 UMAC 1*512/120/6L/5R/ CB_bg_0.3 C_AN | ATMK 36 | N14.1 WXGAG | SO512 MBII5 | N | N120 GB5.4 K | NCB2 4X | ABT_ATH54 13BG | N | N |
| AS5051AWX Ci | China | China | LX.AV 305.015 | AS5051AW XCi XPHSC7 UMAC 1*512/120/6L/5R/ CB_bg_0.3 C_AN | ATMK 36 | N14.1 WXGAG | SO512 MBII5 | N | N120 GB5.4 K | NCB2 4X | ABT_ATH54 13BG | N | N |

| Model | RO | Country | Acer Part no | Description | CPU | LCD | DIMM 1 | DIMM 2 | HDD 1 (GB) | ODD | Wireless LAN | Bluetooth | VOIP Phone |
|--------------|-----|------------------------|---------------|--|---------|-------------|-------------|--------|--------------|--------|----------------|-------------|------------|
| AS5051AWX Mi | TWN | GCTWN | LX.AV 305.012 | AS5051AW XMi XPHTC1 UMAC 1*512/120/ BT/6L/5R/ CB_bg_0.3 C_AN | ATMK 36 | N14.1 WXGAG | SO512 MBII5 | N | N120 GB5.4 K | NSM8 X | ABT_ATH54 13BG | FOX_BRM_2.0 | N |
| AS5051AWX Mi | TWN | GCTWN | LX.AV 305.014 | AS5051AW XMi XPHTC1 UMAC 1*512/60/ BT/6L/5R/ CB_bg_0.3 C_AN | ATMK 36 | N14.1 WXGAG | SO512 MBII5 | N | N60G B5.4K | NSM8 X | ABT_ATH54 13BG | FOX_BRM_2.0 | N |
| AS5051AWX Mi | TWN | GCTWN | LX.AV 305.013 | AS5051AW XMi XPHTC1 UMAC 1*512/80/ BT/6L/5R/ CB_bg_0.3 C_AN | ATMK 36 | N14.1 WXGAG | SO512 MBII5 | N | N80G B5.4K | NSM8 X | ABT_ATH54 13BG | FOX_BRM_2.0 | N |
| AS5051AWX Mi | AAP | Australia/ New Zealand | LX.AV 30J.011 | AS5051AW XMi MCEAU1 UMAC 1*1G/120/ 6L/5R/ CB_bg_0.3 C_AN | ATMK 36 | N14.1 WXGAG | SO1G BII6 | N | N120 GB5.4 K | NSM8 X | ABT_ATH54 13BG | N | N |
| AS5051AWX Mi | AAP | Singapore | LX.AV 30J.012 | AS5051AW XMi MCESG1 UMAC 1*1G/120/ 6L/5R/ CB_bg_0.3 C_AN | ATMK 36 | N14.1 WXGAG | SO1G BII6 | N | N120 GB5.4 K | NSM8 X | ABT_ATH54 13BG | N | N |
| AS5051AWX Mi | AAP | India | LX.AV 30J.013 | AS5051AW XMi MCEIL1 UMAC 1*1G/120/ 6L/5R/ CB_bg_0.3 C_AN | ATMK 36 | N14.1 WXGAG | SO1G BII6 | N | N120 GB5.4 K | NSM8 X | ABT_ATH54 13BG | N | N |
| AS5051AWX Mi | AAP | Indonesia | LX.AV 30J.014 | AS5051AW XMi MCEIN1 UMAC 1*1G/120/ 6L/5R/ CB_bg_0.3 C_AN | ATMK 36 | N14.1 WXGAG | SO1G BII6 | N | N120 GB5.4 K | NSM8 X | ABT_ATH54 13BG | N | N |
| AS5051AWX Mi | AAP | Philippines | LX.AV 30J.015 | AS5051AW XMi MCEPH1 UMAC 1*1G/120/ 6L/5R/ CB_bg_0.3 C_AN | ATMK 36 | N14.1 WXGAG | SO1G BII6 | N | N120 GB5.4 K | NSM8 X | ABT_ATH54 13BG | N | N |
| AS5051AWX Mi | AAP | Malaysia | LX.AV 30J.016 | AS5051AW XMi MCEMA1 UMAC 1*1G/120/ 6L/5R/ CB_bg_0.3 C_AN | ATMK 36 | N14.1 WXGAG | SO1G BII6 | N | N120 GB5.4 K | NSM8 X | ABT_ATH54 13BG | N | N |

| Model | RO | Country | Acer Part no | Description | CPU | LCD | DIMM 1 | DIMM 2 | HDD 1 (GB) | ODD | Wireless LAN | Bluetooth | VOIP Phone |
|--------------|-----|---------------------------|---------------|---|---------|-------------|-----------|--------|--------------|--------|----------------|-----------|------------|
| AS5051AWX Mi | AAP | Thailand | LX.AV 30J.017 | AS5051AWXMi MCETH1 UMAC 1*1G/120/ 6L/5R/ CB_bg_0.3 C_AN | ATMK 36 | N14.1 WXGAG | SO1G BII6 | N | N120 GB5.4 K | NSM8 X | ABT_ATH54 13BG | N | N |
| AS5051AWX Mi | AAP | Vietnam | LX.AV 30J.018 | AS5051AWXMi MCEVN1 UMAC 1*1G/120/ 6L/5R/ CB_bg_0.3 C_AN | ATMK 36 | N14.1 WXGAG | SO1G BII6 | N | N120 GB5.4 K | NSM8 X | ABT_ATH54 13BG | N | N |
| AS5051AWX Mi | AAP | Australia/ New Zealand | LX.AV 306.002 | AS5051AWXMi XPPAU1 UMAC 1*1G/120/ 6L/5R/ CB_bg_0.3 C_AN | ATMK 36 | N14.1 WXGAG | SO1G BII6 | N | N120 GB5.4 K | NSM8 X | ABT_ATH54 13BG | N | N |
| AS5052WXM i | AAP | Australia/ New Zealand | LX.AV 30J.003 | AS5052WXM i MCEAU1 UMAC 1*1G/120/ 6L/5R/ CB_bg_0.3 C_AN | ATTL5 0 | N14.1 WXGAG | SO1G BII6 | N | N120 GB5.4 K | NSM8 X | ABT_ATH54 13BG | N | N |
| AS5052WXM i | AAP | India | LX.AV 30J.005 | AS5052WXM i MCEIL1 UMAC 1*1G/120/ 6L/5R/ CB_bg_0.3 C_AN | ATTL5 0 | N14.1 WXGAG | SO1G BII6 | N | N120 GB5.4 K | NSM8 X | ABT_ATH54 13BG | N | N |
| AS5052WXM i | AAP | Indonesia | LX.AV 30J.006 | AS5052WXM i MCEIN1 UMAC 1*1G/120/ 6L/5R/ CB_bg_0.3 C_AN | ATTL5 0 | N14.1 WXGAG | SO1G BII6 | N | N120 GB5.4 K | NSM8 X | ABT_ATH54 13BG | N | N |
| AS5052WXM i | AAP | Singapore | LX.AV 30J.004 | AS5052WXM i MCESG1 UMAC 1*1G/120/ 6L/5R/ CB_bg_0.3 C_AN | ATTL5 0 | N14.1 WXGAG | SO1G BII6 | N | N120 GB5.4 K | NSM8 X | ABT_ATH54 13BG | N | N |
| AS5052WXM i | AAP | Philippines | LX.AV 30J.007 | AS5052WXM i MCEPH1 UMAC 1*1G/120/ 6L/5R/ CB_bg_0.3 C_AN | ATTL5 0 | N14.1 WXGAG | SO1G BII6 | N | N120 GB5.4 K | NSM8 X | ABT_ATH54 13BG | N | N |
| AS5052WXM i | AAP | Malaysia | LX.AV 30J.008 | AS5052WXM i MCEMA1 UMAC 1*1G/120/ 6L/5R/ CB_bg_0.3 C_AN | ATTL5 0 | N14.1 WXGAG | SO1G BII6 | N | N120 GB5.4 K | NSM8 X | ABT_ATH54 13BG | N | N |

| Model | RO | Country | Acer Part no | Description | CPU | LCD | DIMM 1 | DIMM 2 | HDD 1 (GB) | ODD | Wireless LAN | Bluetooth | VOIP Phone |
|----------------|-----|---------------------------|--------------|--|--------|--------------------|----------------|--------|--------------------|-----------|-----------------------|---------------------|------------|
| AS5052WXM i | AAP | Thailand | LX.AV30J.009 | AS5052WXM i MCETH1 UMAC 1*1G/120/ 6L/5R/ CB_bg_0.3 C_AN | ATTL50 | N14.1 WXGA G | SO1G BII6 | N | N120 GB5.4 K | NSM8 X | ABT_ ATH54 13BG | N | N |
| AS5052WXM i | AAP | Vietnam | LX.AV30J.010 | AS5052WXM i MCEVN1 UMAC 1*1G/120/ 6L/5R/ CB_bg_0.3 C_AN | ATTL50 | N14.1 WXGA G | SO1G BII6 | N | N120 GB5.4 K | NSM8 X | ABT_ ATH54 13BG | N | N |
| AS5052WXM i | AAP | Australia/ New Zealand | LX.AV306.001 | AS5052WXM i XPPAU1 UMAC 1*1G/120/ 6L/5R/ CB_bg_0.3 C_AN | ATTL50 | N14.1 WXGA G | SO1G BII6 | N | N120 GB5.4 K | NSM8 X | ABT_ ATH54 13BG | N | N |
| AS5051ANW XM i | AAP | India | LX.AV30C.015 | AS5051ANW XM i LINPUSIL1 UMAC 1*256/60/ 6L/5R/ CB_bg_0.3 C_AN | ATMK36 | N14.1 WXGA G | SO256 MBII5 | N | N60G B5.4K | NSM8 X | ABT_ ATH54 13BG | N | N |
| AS5051ANW XM i | AAP | Vietnam | LX.AV30C.014 | AS5051ANW XM i LINPUSVN1 UMAC 1*512/60/ 6L/5R/ CB_bg_0.3 C_AN | ATMK36 | N14.1 WXGA G | SO512 MBII5 | N | N60G B5.4K | NSM8 X | ABT_ ATH54 13BG | N | N |
| AS5051ANW XM i | AAP | Thailand | LX.AV30C.016 | AS5051ANW XM i LINPUSTH2 UMAC 1*512/80/ BT/6L/5R/ CB_bg_0.3 C_AN | ATMK36 | N14.1 WXGA G | SO512 MBII5 | N | N80G B5.4K | NSM8 X | ABT_ ATH54 13BG | FOX_ BRM_ 2.0 | N |
| AS5051ANW XM i | AAP | Singapore | LX.AV30C.008 | AS5051ANW XM i LINPUSSG1 UMAC 1*512/60/ 6L/5R/ CB_bg_0.3 C_AN | ATMK36 | N14.1 WXGA G | SO512 MBII5 | N | N60G B5.4K | NSM8 X | ABT_ ATH54 13BG | N | N |
| AS5051ANW XM i | AAP | India | LX.AV30C.009 | AS5051ANW XM i LINPUSIL1 UMAC 1*512/60/ 6L/5R/ CB_bg_0.3 C_AN | ATMK36 | N14.1 WXGA G | SO512 MBII5 | N | N60G B5.4K | NSM8 X | ABT_ ATH54 13BG | N | N |
| AS5051ANW XM i | AAP | Indonesia | LX.AV30C.010 | AS5051ANW XM i LINPUSIN1 UMAC 1*512/60/ 6L/5R/ CB_bg_0.3 C_AN | ATMK36 | N14.1 WXGA G | SO512 MBII5 | N | N60G B5.4K | NSM8 X | ABT_ ATH54 13BG | N | N |

| Model | RO | Country | Acer Part no | Description | CPU | LCD | DIMM 1 | DIMM 2 | HDD 1 (GB) | ODD | Wireless LAN | Bluetooth | VOIP Phone |
|---------------|------|-------------|---------------|---|---------|--------------|-------------|-------------|--------------|--------|----------------|-------------|------------|
| AS5051ANW XMi | AAP | Philippines | LX.AV 30C.011 | AS5051AN WXM LINPUSPH1 UMAC 1*512/60/6L/5R/ CB_bg_0.3 C_AN | ATMK 36 | N14.1 WXGA G | SO512 MBII5 | N | N60G B5.4K | NSM8 X | ABT_ATH54 13BG | N | N |
| AS5051ANW XMi | AAP | Malaysia | LX.AV 30C.012 | AS5051AN WXM LINPUSMA2 UMAC 1*512/60/6L/5R/ CB_bg_0.3 C_AN | ATMK 36 | N14.1 WXGA G | SO512 MBII5 | N | N60G B5.4K | NSM8 X | ABT_ATH54 13BG | N | N |
| AS5051ANW XMi | AAP | Thailand | LX.AV 30C.013 | AS5051AN WXM LINPUSHT2 UMAC 1*512/60/6L/5R/ CB_bg_0.3 C_AN | ATMK 36 | N14.1 WXGA G | SO512 MBII5 | N | N60G B5.4K | NSM8 X | ABT_ATH54 13BG | N | N |
| AS5052WXM i | AAP | Thailand | LX.AV 30J.019 | AS5052WXM MCETH1 UMAC 1*1G/120/BT/6L/5R/ CB_bg_0.3 C_AN | ATTL50 | N14.1 WXGA G | SO1G BII6 | N | N120 GB5.4 K | NSM8 X | ABT_ATH54 13BG | FOX_BRM_2.0 | N |
| AS5051AWX Mi | EMEA | Belgium | LX.AV 30J.032 | AS5051AW XMi MCEBE6 UMAC 2*512/100/6L/ 5R_bg_0.3 C_AN | ATMK 36 | N14.1 WXGA | SO512 MBII6 | SO512 MBII6 | N100 GB5.4 K | NSM8 X | ABT_BRM4 318BG | N | N |
| AS5051AWX Mi | EMEA | Middle East | LX.AV 30J.043 | AS5051AW XMi MCEAR1 UMAC 2*512/100/6L/ 5R_bg_0.3 C_AN | ATMK 36 | N14.1 WXGA | SO512 MBII6 | SO512 MBII6 | N100 GB5.4 K | NSM8 X | ABT_BRM4 318BG | N | N |
| AS5051AWX Mi | EMEA | Middle East | LX.AV 30J.044 | AS5051AW XMi MCEAR2 UMAC 2*512/100/6L/ 5R_bg_0.3 C_AN | ATMK 36 | N14.1 WXGA | SO512 MBII6 | SO512 MBII6 | N100 GB5.4 K | NSM8 X | ABT_BRM4 318BG | N | N |
| AS5051AWX Mi | EMEA | Italy | LX.AV 30J.040 | AS5051AW XMi MCEIT7 UMAC 2*512/100/6L/ 5R_bg_0.3 C_AN | ATMK 36 | N14.1 WXGA | SO512 MBII6 | SO512 MBII6 | N100 GB5.4 K | NSM8 X | ABT_BRM4 318BG | N | N |
| AS5051AWX Mi | EMEA | Spain | LX.AV 30J.039 | AS5051AW XMi MCEESJ UMAC 2*512/100/6L/ 5R_bg_0.3 C_AN | ATMK 36 | N14.1 WXGA | SO512 MBII6 | SO512 MBII6 | N100 GB5.4 K | NSM8 X | ABT_BRM4 318BG | N | N |

| Model | RO | Country | Acer Part no | Description | CPU | LCD | DIMM 1 | DIMM 2 | HDD 1 (GB) | ODD | Wireless LAN | Bluetooth | VOIP Phone |
|--------------|------|----------------|---------------|---|---------|------------|-------------|-------------|--------------|--------|----------------|-----------|------------|
| AS5051AWX Mi | EMEA | Eastern Europe | LX.AV 30J.030 | AS5051AWXMi MCECS5 UMAC 2*512/100/6L/ 5R_bg_0.3 C_AN | ATMK 36 | N14.1 WXGA | SO512 MBII6 | SO512 MBII6 | N100 GB5.4 K | NSM8 X | ABT_BRM4 318BG | N | N |
| AS5051AWX Mi | EMEA | Denmark | LX.AV 30J.024 | AS5051AWXMi MCEDK6 UMAC 2*512/100/6L/ 5R_bg_0.3 C_AN | ATMK 36 | N14.1 WXGA | SO512 MBII6 | SO512 MBII6 | N100 GB5.4 K | NSM8 X | ABT_BRM4 318BG | N | N |
| AS5051AWX Mi | EMEA | France | LX.AV 30J.025 | AS5051AWXMi MCEFRF UMAC 2*512/100/6L/ 5R_bg_0.3 C_AN | ATMK 36 | N14.1 WXGA | SO512 MBII6 | SO512 MBII6 | N100 GB5.4 K | NSM8 X | ABT_BRM4 318BG | N | N |
| AS5051AWX Mi | EMEA | Germany | LX.AV 30J.027 | AS5051AWXMi MCEDEA UMAC 2*512/100/6L/ 5R_bg_0.3 C_AN | ATMK 36 | N14.1 WXGA | SO512 MBII6 | SO512 MBII6 | N100 GB5.4 K | NSM8 X | ABT_BRM4 318BG | N | N |
| AS5051AWX Mi | EMEA | Germany | LX.AV 30J.028 | AS5051AWXMi MCEDEB UMAC 2*512/100/6L/ 5R_bg_0.3 C_AN | ATMK 36 | N14.1 WXGA | SO512 MBII6 | SO512 MBII6 | N100 GB5.4 K | NSM8 X | ABT_BRM4 318BG | N | N |
| AS5051AWX Mi | EMEA | Holland | LX.AV 30J.033 | AS5051AWXMi MCENL6 UMAC 2*512/100/6L/ 5R_bg_0.3 C_AN | ATMK 36 | N14.1 WXGA | SO512 MBII6 | SO512 MBII6 | N100 GB5.4 K | NSM8 X | ABT_BRM4 318BG | N | N |
| AS5051AWX Mi | EMEA | Norway | LX.AV 30J.034 | AS5051AWXMi MCENO5 UMAC 2*512/100/6L/ 5R_bg_0.3 C_AN | ATMK 36 | N14.1 WXGA | SO512 MBII6 | SO512 MBII6 | N100 GB5.4 K | NSM8 X | ABT_BRM4 318BG | N | N |
| AS5051AWX Mi | EMEA | Russia | LX.AV 30J.035 | AS5051AWXMi MCERU9 UMAC 2*512/100/6L/ 5R_bg_0.3 C_AN | ATMK 36 | N14.1 WXGA | SO512 MBII6 | SO512 MBII6 | N100 GB5.4 K | NSM8 X | ABT_BRM4 318BG | N | N |
| AS5051AWX Mi | EMEA | Eastern Europe | LX.AV 30J.036 | AS5051AWXMi MCEPL7 UMAC 2*512/100/6L/ 5R_bg_0.3 C_AN | ATMK 36 | N14.1 WXGA | SO512 MBII6 | SO512 MBII6 | N100 GB5.4 K | NSM8 X | ABT_BRM4 318BG | N | N |

| Model | RO | Country | Acer Part no | Description | CPU | LCD | DIMM 1 | DIMM 2 | HDD 1 (GB) | ODD | Wireless LAN | Bluetooth | VOIP Phone |
|--------------|------|------------------|---------------|---|---------|------------|-------------|-------------|--------------|--------|----------------|-----------|------------|
| AS5051AWX Mi | EMEA | Slovenia/Croatia | LX.AV 30J.037 | AS5051AW XMi MCE511 UMAC 2*512/100/6L/ 5R_bg_0.3 C_AN | ATMK 36 | N14.1 WXGA | SO512 MBII6 | SO512 MBII6 | N100 GB5.4 K | NSM8 X | ABT_BRM4 318BG | N | N |
| AS5051AWX Mi | EMEA | Portugal | LX.AV 30J.038 | AS5051AW XMi MCEPT6 UMAC 2*512/100/6L/ 5R_bg_0.3 C_AN | ATMK 36 | N14.1 WXGA | SO512 MBII6 | SO512 MBII6 | N100 GB5.4 K | NSM8 X | ABT_BRM4 318BG | N | N |
| AS5051AWX Mi | EMEA | Sweden/Finland | LX.AV 30J.029 | AS5051AW XMi MCE5V5 UMAC 2*512/100/6L/ 5R_bg_0.3 C_AN | ATMK 36 | N14.1 WXGA | SO512 MBII6 | SO512 MBII6 | N100 GB5.4 K | NSM8 X | ABT_BRM4 318BG | N | N |
| AS5051AWX Mi | EMEA | Turkey | LX.AV 30J.041 | AS5051AW XMi MCETR5 UMAC 2*512/100/6L/ 5R_bg_0.3 C_AN | ATMK 36 | N14.1 WXGA | SO512 MBII6 | SO512 MBII6 | N100 GB5.4 K | NSM8 X | ABT_BRM4 318BG | N | N |
| AS5051AWX Mi | EMEA | Switzerland | LX.AV 30J.045 | AS5051AW XMi MCE5W8 UMAC 2*512/100/6L/ 5R_bg_0.3 C_AN | ATMK 36 | N14.1 WXGA | SO512 MBII6 | SO512 MBII6 | N100 GB5.4 K | NSM8 X | ABT_BRM4 318BG | N | N |
| AS5051AWX Mi | EMEA | UK | LX.AV 30J.046 | AS5051AW XMi MCEUK5 UMAC 2*512/100/6L/ 5R_bg_0.3 C_AN | ATMK 36 | N14.1 WXGA | SO512 MBII6 | SO512 MBII6 | N100 GB5.4 K | NSM8 X | ABT_BRM4 318BG | N | N |
| AS5051AWX Mi | EMEA | UK | LX.AV 30J.047 | AS5051AW XMi MCEWUK1 1W UMAC 2*512/100/6L/ 5R_bg_0.3 C_AN | ATMK 36 | N14.1 WXGA | SO512 MBII6 | SO512 MBII6 | N100 GB5.4 K | NSM8 X | ABT_BRM4 318BG | N | N |
| AS5051AWX Mi | EMEA | Italy | LX.AV 30J.042 | AS5051AW XMi MCEWIT11 W UMAC 2*512/100/6L/ 5R_bg_0.3 C_AN | ATMK 36 | N14.1 WXGA | SO512 MBII6 | SO512 MBII6 | N100 GB5.4 K | NSM8 X | ABT_BRM4 318BG | N | N |
| AS5051AWX Mi | EMEA | Germany | LX.AV 30J.031 | AS5051AW XMi MCEWDE1 1W UMAC 2*512/100/6L/ 5R_bg_0.3 C_AN | ATMK 36 | N14.1 WXGA | SO512 MBII6 | SO512 MBII6 | N100 GB5.4 K | NSM8 X | ABT_BRM4 318BG | N | N |

| Model | RO | Country | Acer Part no | Description | CPU | LCD | DIMM 1 | DIMM 2 | HDD 1 (GB) | ODD | Wireless LAN | Bluetooth | VOIP Phone |
|--------------|------|----------------|---------------|---|---------|------------|-------------|-------------|--------------|--------|----------------|-----------|------------|
| AS5051AWX Mi | EMEA | France | LX.AV 30J.026 | AS5051AW XMi MCEWFR1 1W UMAC 2*512/100/6L/ 5R_bg_0.3 C_AN | ATMK 36 | N14.1 WXGA | SO512 MBII6 | SO512 MBII6 | N100 GB5.4 K | NSM8 X | ABT_BRM4 318BG | N | N |
| AS5051AWX Mi | EMEA | Belgium | LX.AV 305.019 | AS5051AW XMi XPHBE1 UMAC 2*512/100/6L/ 5R_bg_0.3 C_AN | ATMK 36 | N14.1 WXGA | SO512 MBII6 | SO512 MBII6 | N100 GB5.4 K | NSM8 X | ABT_BRM4 318BG | N | N |
| AS5051AWX Mi | EMEA | Middle East | LX.AV 305.038 | AS5051AW XMi XPHAR1 UMAC 2*512/100/6L/ 5R_bg_0.3 C_AN | ATMK 36 | N14.1 WXGA | SO512 MBII6 | SO512 MBII6 | N100 GB5.4 K | NSM8 X | ABT_BRM4 318BG | N | N |
| AS5051AWX Mi | EMEA | Eastern Europe | LX.AV 305.027 | AS5051AW XMi XPHCS2 UMAC 2*512/100/6L/ 5R_bg_0.3 C_AN | ATMK 36 | N14.1 WXGA | SO512 MBII6 | SO512 MBII6 | N100 GB5.4 K | NSM8 X | ABT_BRM4 318BG | N | N |
| AS5051AWX Mi | EMEA | Germany | LX.AV 305.023 | AS5051AW XMi XPHDE7 UMAC 2*512/100/6L/ 5R_bg_0.3 C_AN | ATMK 36 | N14.1 WXGA | SO512 MBII6 | SO512 MBII6 | N100 GB5.4 K | NSM8 X | ABT_BRM4 318BG | N | N |
| AS5051AWX Mi | EMEA | Greece | LX.AV 305.033 | AS5051AW XMi XPHL1 UMAC 2*512/100/6L/ 5R_bg_0.3 C_AN | ATMK 36 | N14.1 WXGA | SO512 MBII6 | SO512 MBII6 | N100 GB5.4 K | NSM8 X | ABT_BRM4 318BG | N | N |
| AS5051AWX Mi | EMEA | Israel | LX.AV 305.034 | AS5051AW XMi XPHIS1 UMAC 2*512/100/6L/ 5R_bg_0.3 C_AN | ATMK 36 | N14.1 WXGA | SO512 MBII6 | SO512 MBII6 | N100 GB5.4 K | NSM8 X | ABT_BRM4 318BG | N | N |
| AS5051AWX Mi | EMEA | Italy | LX.AV 305.035 | AS5051AW XMi XPHIT1 UMAC 2*512/100/6L/ 5R_bg_0.3 C_AN | ATMK 36 | N14.1 WXGA | SO512 MBII6 | SO512 MBII6 | N100 GB5.4 K | NSM8 X | ABT_BRM4 318BG | N | N |
| AS5051AWX Mi | EMEA | Denmark | LX.AV 305.018 | AS5051AW XMi XPHDK1 UMAC 2*512/100/6L/ 5R_bg_0.3 C_AN | ATMK 36 | N14.1 WXGA | SO512 MBII6 | SO512 MBII6 | N100 GB5.4 K | NSM8 X | ABT_BRM4 318BG | N | N |

| Model | RO | Country | Acer Part no | Description | CPU | LCD | DIMM 1 | DIMM 2 | HDD 1 (GB) | ODD | Wireless LAN | Bluetooth | VOIP Phone |
|--------------|------|------------------|---------------|--|---------|------------|-------------|-------------|--------------|--------|----------------|-----------|------------|
| AS5051AWX Mi | EMEA | Holland | LX.AV 305.020 | AS5051AW XMi XPHNL1 UMAC 2*512/100/6L/ 5R_bg_0.3 C_AN | ATMK 36 | N14.1 WXGA | SO512 MBII6 | SO512 MBII6 | N100 GB5.4 K | NSM8 X | ABT_BRM4 318BG | N | N |
| AS5051AWX Mi | EMEA | France | LX.AV 305.021 | AS5051AW XMi XPHFRA UMAC 2*512/100/6L/ 5R_bg_0.3 C_AN | ATMK 36 | N14.1 WXGA | SO512 MBII6 | SO512 MBII6 | N100 GB5.4 K | NSM8 X | ABT_BRM4 318BG | N | N |
| AS5051AWX Mi | EMEA | Eastern Europe | LX.AV 305.028 | AS5051AW XMi XPHHU6 UMAC 2*512/100/6L/ 5R_bg_0.3 C_AN | ATMK 36 | N14.1 WXGA | SO512 MBII6 | SO512 MBII6 | N100 GB5.4 K | NSM8 X | ABT_BRM4 318BG | N | N |
| AS5051AWX Mi | EMEA | Spain | LX.AV 305.031 | AS5051AW XMi XPHESA UMAC 2*512/100/6L/ 5R_bg_0.3 C_AN | ATMK 36 | N14.1 WXGA | SO512 MBII6 | SO512 MBII6 | N100 GB5.4 K | NSM8 X | ABT_BRM4 318BG | N | N |
| AS5051AWX Mi | EMEA | Slovenia/Croatia | LX.AV 305.030 | AS5051AW XMi XPHSLO2 UMAC 2*512/100/6L/ 5R_bg_0.3 C_AN | ATMK 36 | N14.1 WXGA | SO512 MBII6 | SO512 MBII6 | N100 GB5.4 K | NSM8 X | ABT_BRM4 318BG | N | N |
| AS5051AWX Mi | EMEA | Eastern Europe | LX.AV 305.029 | AS5051AW XMi XPHPL6 UMAC 2*512/100/6L/ 5R_bg_0.3 C_AN | ATMK 36 | N14.1 WXGA | SO512 MBII6 | SO512 MBII6 | N100 GB5.4 K | NSM8 X | ABT_BRM4 318BG | N | N |
| AS5051AWX Mi | EMEA | Portugal | LX.AV 305.032 | AS5051AW XMi XPHPT1 UMAC 2*512/100/6L/ 5R_bg_0.3 C_AN | ATMK 36 | N14.1 WXGA | SO512 MBII6 | SO512 MBII6 | N100 GB5.4 K | NSM8 X | ABT_BRM4 318BG | N | N |
| AS5051AWX Mi | EMEA | Switzerland | LX.AV 305.039 | AS5051AW XMi XPHSW5 UMAC 2*512/100/6L/ 5R_bg_0.3 C_AN | ATMK 36 | N14.1 WXGA | SO512 MBII6 | SO512 MBII6 | N100 GB5.4 K | NSM8 X | ABT_BRM4 318BG | N | N |
| AS5051AWX Mi | EMEA | Turkey | LX.AV 305.036 | AS5051AW XMi XPHTR1 UMAC 2*512/100/6L/ 5R_bg_0.3 C_AN | ATMK 36 | N14.1 WXGA | SO512 MBII6 | SO512 MBII6 | N100 GB5.4 K | NSM8 X | ABT_BRM4 318BG | N | N |

| Model | RO | Country | Acer Part no | Description | CPU | LCD | DIMM 1 | DIMM 2 | HDD 1 (GB) | ODD | Wireless LAN | Bluetooth | VOIP Phone |
|--------------|------|------------------------------|---------------|--|---------|--------------|-------------|-------------|--------------|--------|----------------|-----------|------------|
| AS5051AWX Mi | EMEA | South Africa | LX.AV 305.017 | AS5051AW XMi XPHSA1 UMAC 2*512/100/6L/5R_bg_0.3 C_AN | ATMK 36 | N14.1 WXGA | SO512 MBII6 | SO512 MBII6 | N100 GB5.4 K | NSM8 X | ABT_BRM4 318BG | N | N |
| AS5051AWX Mi | EMEA | Norway | LX.AV 305.024 | AS5051AW XMi XPHNO1 UMAC 2*512/100/6L/5R_bg_0.3 C_AN | ATMK 36 | N14.1 WXGA | SO512 MBII6 | SO512 MBII6 | N100 GB5.4 K | NSM8 X | ABT_BRM4 318BG | N | N |
| AS5051AWX Mi | EMEA | Russia | LX.AV 305.025 | AS5051AW XMi XPHRU2 UMAC 2*512/100/6L/5R_bg_0.3 C_AN | ATMK 36 | N14.1 WXGA | SO512 MBII6 | SO512 MBII6 | N100 GB5.4 K | NSM8 X | ABT_BRM4 318BG | N | N |
| AS5051AWX Mi | EMEA | Sweden/Finland | LX.AV 305.026 | AS5051AW XMi XPHSV1 UMAC 2*512/100/6L/5R_bg_0.3 C_AN | ATMK 36 | N14.1 WXGA | SO512 MBII6 | SO512 MBII6 | N100 GB5.4 K | NSM8 X | ABT_BRM4 318BG | N | N |
| AS5051AWX Mi | EMEA | France | LX.AV 305.022 | AS5051AW XMi XPHWFRB 1W UMAC 2*512/100/6L/5R_bg_0.3 C_AN | ATMK 36 | N14.1 WXGA | SO512 MBII6 | SO512 MBII6 | N100 GB5.4 K | NSM8 X | ABT_BRM4 318BG | N | N |
| AS5051AWX Mi | EMEA | Italy | LX.AV 305.037 | AS5051AW XMi XPHWIT21 W UMAC 2*512/100/6L/5R_bg_0.3 C_AN | ATMK 36 | N14.1 WXGA | SO512 MBII6 | SO512 MBII6 | N100 GB5.4 K | NSM8 X | ABT_BRM4 318BG | N | N |
| AS5051AWX Mi | EMEA | UK | LX.AV 305.040 | AS5051AW XMi XPHUK1 UMAC 2*512/100/6L/5R_bg_0.3 C_AN | ATMK 36 | N14.1 WXGA | SO512 MBII6 | SO512 MBII6 | N100 GB5.4 K | NSM8 X | ABT_BRM4 318BG | N | N |
| AS5051AWX Mi | EMEA | UK | LX.AV 305.041 | AS5051AW XMi XPHWUK2 1W UMAC 2*512/100/6L/5R_bg_0.3 C_AN | ATMK 36 | N14.1 WXGA | SO512 MBII6 | SO512 MBII6 | N100 GB5.4 K | NSM8 X | ABT_BRM4 318BG | N | N |
| AS5052WXM i | PA | USA/Canada - Canadian French | LX.AV 30J.020 | AS5052WXM i MCECF UMAC 2*512/120/6L/5R/CB_bg_0.3 C_AN | ATTL5 0 | N14.1 WXGA G | SO512 MBII5 | SO512 MBII5 | N120 GB5.4 K | NSM8 X | ABT_ATH54 13BG | N | N |

| Model | RO | Country | Acer Part no | Description | CPU | LCD | DIMM 1 | DIMM 2 | HDD 1 (GB) | ODD | Wireless LAN | Bluetooth | VOIP Phone |
|----------------|------|-------------------------------|----------------|---|---------|--------------|-------------|-------------|--------------|---------|-----------------|---------------|-----------------|
| AS505 2WXM i | PA | USA/ Canada - Canadian French | LX.AV 30J.02 1 | AS5052WX Mi MCEUS UMAC 2*512/120/ 6L/5R/ CB_bg_0.3 C_AN | ATTL5 0 | N14.1 WXGA G | SO512 MBII5 | SO512 MBII5 | N120 GB5.4 K | NSM8 X | ABT_ ATH54 13BG | N | N |
| AS505 2WXM i | PA | ACLA-Spanish | LX.AV 30J.02 2 | AS5052WX Mi MCEES1 UMAC 2*512/120/ 6L/5R/ CB_bg_0.3 C_AN | ATTL5 0 | N14.1 WXGA G | SO512 MBII5 | SO512 MBII5 | N120 GB5.4 K | NSM8 X | ABT_ ATH54 13BG | N | N |
| AS505 1AWX Mi | PA | ACLA-Spanish | LX.AV 30J.04 8 | AS5051AW XMi MCEES1 UMAC 2*512/120/ 6L/5R/ CB_bg_0.3 C_AN | ATMK 36 | N14.1 WXGA G | SO512 MBII5 | SO512 MBII5 | N120 GB5.4 K | NSM8 X | ABT_ BRM4 318BG | N | N |
| AS505 1ANW XCi | AAP | Australia/ New Zealand | LX.AV 30C.0 17 | AS5051AN WXCi LINPUSAU 1 UMAC 1*512/80/ 6L/5R/ CB_bg_0.3 C_AN | ATMK 36 | N14.1 WXGA G | SO512 MBII5 | N | N80G B5.4K | NCB2 4X | ABT_ BRM4 318BG | N | N |
| AS505 1AWX Ci | AAP | Malaysia | LX.AV 305.04 2 | AS5051AW XCi XPHMA2 UMAC 1*512/80/ 6L/5R/ CB_bg_0.3 C_AN | ATMK 36 | N14.1 WXGA G | SO512 MBII5 | N | N80G B5.4K | NCB2 4X | ABT_ BRM4 318BG | N | N |
| AS505 1ANW XCi | AAP | Malaysia | LX.AV 30C.0 18 | AS5051AN WXCi LINPUSMA 2 UMAC 1*512/80/ 6L/5R/ CB_bg_0.3 C_AN | ATMK 36 | N14.1 WXGA G | SO512 MBII5 | N | N80G B5.4K | NCB2 4X | ABT_ BRM4 318BG | N | N |
| AS505 1AWX Mi | EMEA | Sweden/ Finland | LX.AV 30J.04 9 | AS5051AW XMi MCESV5 UMAC 1*512/100/ BT/6L/5R/ CB_bg_VP _0.3C_AN | ATMK 36 | N14.1 WXGA G | SO512 MBII6 | N | N100 GB5.4 K | NSM8 X | ABT_ BRM4 318BG | FOX_ BRM_ 2.0 | BT VoIP PCMC IA |
| AS505 1AWX Mi | EMEA | Slovenia/ Croatia | LX.AV 30J.05 0 | AS5051AW XMi MCESI1 UMAC 1*512/100/ BT/6L/5R/ CB_bg_VP _0.3C_AN | ATMK 36 | N14.1 WXGA G | SO512 MBII6 | N | N100 GB5.4 K | NSM8 X | ABT_ BRM4 318BG | FOX_ BRM_ 2.0 | BT VoIP PCMC IA |
| AS505 1AWX Mi | EMEA | Holland | LX.AV 30J.05 1 | AS5051AW XMi MCENL6 UMAC 1*512/100/ BT/6L/5R/ CB_bg_VP _0.3C_AN | ATMK 36 | N14.1 WXGA G | SO512 MBII6 | N | N100 GB5.4 K | NSM8 X | ABT_ BRM4 318BG | FOX_ BRM_ 2.0 | BT VoIP PCMC IA |

| Model | RO | Country | Acer Part no | Description | CPU | LCD | DIMM 1 | DIMM 2 | HDD 1 (GB) | ODD | Wireless LAN | Bluetooth | VOIP Phone |
|---------------|------|-------------------|----------------|---|---------|--------------|-------------|--------|--------------|--------|----------------|-------------|-----------------|
| AS5051AWX Mi | EMEA | Russia | LX.AV 30J.05 2 | AS5051AW XMi MCERU9 UMAC 1*512/100/ BT/6L/5R/ CB_bg_VP_0.3C_AN | ATMK 36 | N14.1 WXGA G | SO512 MBII6 | N | N100 GB5.4 K | NSM8 X | ABT_BRM4 318BG | FOX_BRM_2.0 | BT VoIP PCMC IA |
| AS5051AWX Mi | EMEA | Holland | LX.AV 30J.05 4 | AS5051AW XMi MCENL6 UMAC 1*512/100/ BT/6L/ 5R_bg_VP_0.3C_AN | ATMK 36 | N14.1 WXGA | SO512 MBII6 | N | N100 GB5.4 K | NSM8 X | ABT_BRM4 318BG | FOX_BRM_2.0 | BT VoIP PCMC IA |
| AS5051AWX Mi | EMEA | Russia | LX.AV 305.04 3 | AS5051AW XMi XPHRU2 UMAC 1*512/100/ 6L/ 5R_bg_0.3 C_AN | ATMK 36 | N14.1 WXGA | SO512 MBII6 | N | N100 GB5.4 K | NSM8 X | ABT_BRM4 318BG | N | N |
| AS5051AWX Mi | EMEA | Sweden/ Finland | LX.AV 30J.05 5 | AS5051AW XMi MCESV5 UMAC 1*512/100/ BT/6L/ 5R_bg_VP_0.3C_AN | ATMK 36 | N14.1 WXGA | SO512 MBII6 | N | N100 GB5.4 K | NSM8 X | ABT_BRM4 318BG | FOX_BRM_2.0 | BT VoIP PCMC IA |
| AS5051AWX Mi | EMEA | Slovenia/ Croatia | LX.AV 30J.05 3 | AS5051AW XMi MCESI1 UMAC 1*512/100/ BT/6L/ 5R_bg_VP_0.3C_AN | ATMK 36 | N14.1 WXGA | SO512 MBII6 | N | N100 GB5.4 K | NSM8 X | ABT_BRM4 318BG | FOX_BRM_2.0 | BT VoIP PCMC IA |
| AS5052NWX Mi | AAP | Thailand | LX.AV 30C.0 19 | AS5052N WXM Mi LINPUSH 2 UMAC 1*512/120/ BT/6L/5R/ CB_bg_0.3 C_AN | ATTL5 0 | N14.1 WXGA G | SO512 MBII5 | N | N120 GB5.4 K | NSM8 X | ABT_BRM4 318BG | FOX_BRM_2.0 | N |
| AS5053WXM i | AAP | Thailand | LX.AV 30J.05 6 | AS5053WXM i MCETH1 UMAC 1*1G/120/ BT/6L/5R/ CB_bg_0.3 C_AN | ATTL5 2 | N14.1 WXGA G | SO1G BII6 | N | N120 GB5.4 K | NSM8 X | ABT_BRM4 318BG | FOX_BRM_2.0 | N |
| AS5051ANW XMi | EMEA | Middle East | LX.AV 30C.0 22 | AS5051AN WXM i LINPUSAR 9 UMAC 1*512/60/ BT/6L/ 5R_bg_0.3 C_AN | ATMK 36 | N14.1 WXGA | SO512 MBII5 | N | N60G B5.4K | NSM8 X | ABT_BRM4 318BG | FOX_BRM_2.0 | N |
| AS5051ANW XMi | EMEA | Middle East | LX.AV 30C.0 24 | AS5051AN WXM i LINPUSAR 9 UMAC 1*512/60/ BT/6L/5R/ CB_bg_0.3 C_AN | ATMK 36 | N14.1 WXGA G | SO512 MBII5 | N | N60G B5.4K | NSM8 X | ABT_BRM4 318BG | FOX_BRM_2.0 | N |

| Model | RO | Country | Acer Part no | Description | CPU | LCD | DIMM 1 | DIMM 2 | HDD 1 (GB) | ODD | Wireless LAN | Bluetooth | VOIP Phone |
|---------------|------|----------------|----------------|---|---------|--------------|-------------|-------------|--------------|--------|-----------------|---------------|-----------------|
| AS5051ANW XMi | EMEA | Middle East | LX.AV 30C.0 20 | AS5051AN WXMi LINPUSAR 7 UMAC 1*512/60/ BT/6L/ 5R_bg_0.3 C_AN | ATMK 36 | N14.1 WXGA | SO512 MBII5 | N | N60G B5.4K | NSM8 X | ABT_ BRM4 318BG | FOX_ BRM_ 2.0 | N |
| AS5051ANW XMi | EMEA | France | LX.AV 30C.0 21 | AS5051AN WXMi LINPUSFR A UMAC 1*512/60/ 6L/ 5R_bg_0.3 C_AN | ATMK 36 | N14.1 WXGA | SO512 MBII5 | N | N60G B5.4K | NSM8 X | ABT_ BRM4 318BG | N | N |
| AS5051ANW XMi | EMEA | Russia | LX.AV 30C.0 23 | AS5051AN WXMi LINPUSRU 5 UMAC 1*512/60/ 6L/ 5R_bg_0.3 C_AN | ATMK 36 | N14.1 WXGA | SO512 MBII5 | N | N60G B5.4K | NSM8 X | ABT_ BRM4 318BG | N | N |
| AS5051AWX Mi | EMEA | Middle East | LX.AV 305.04 4 | AS5051AW XMi XPHAR8 UMAC 1*512/60/ BT/6L/5R/ CB_bg_0.3 C_AN | ATMK 36 | N14.1 WXGA G | SO512 MBII5 | N | N60G B5.4K | NSM8 X | ABT_ BRM4 318BG | FOX_ BRM_ 2.0 | N |
| AS5051AWX Mi | EMEA | Eastern Europe | LX.AV 30J.05 7 | AS5051AW XMi MCEPL7 UMAC 1*512/100/ BT/6L/ 5R_bg_VP _0.3C_AN | ATMK 36 | N14.1 WXGA | SO512 MBII6 | N | N100 GB5.4 K | NSM8 X | ABT_ BRM4 318BG | FOX_ BRM_ 2.0 | BT VoIP PCMC IA |
| AS5051AWX Mi | EMEA | Russia | LX.AV 305.04 5 | AS5051AW XMi XPHRU1 UMAC 1*512/100/ BT/6L/ 5R_bg_VP _0.3C_AN | ATMK 36 | N14.1 WXGA | SO512 MBII6 | N | N100 GB5.4 K | NSM8 X | ABT_ BRM4 318BG | FOX_ BRM_ 2.0 | BT VoIP PCMC IA |
| AS5052WXM i | TWN | GCTWN | LX.AV 30J.05 8 | AS5052WXM i MCETC9 UMAC 1*512/120/ BT/6L/5R/ CB_bg_0.3 C_AN | ATTL5 0 | N14.1 WXGA G | SO512 MBII5 | N | N120 GB5.4 K | NSM8 X | ABT_ BRM4 318BG | FOX_ BRM_ 2.0 | N |
| AS5052WXM i | TWN | GCTWN | LX.AV 305.04 6 | AS5052WXM i XPHTC1 UMAC 1*512/120/ BT/6L/5R/ CB_bg_0.3 C_AN | ATTL5 0 | N14.1 WXGA G | SO512 MBII5 | N | N120 GB5.4 K | NSM8 X | ABT_ ATH54 13BG | FOX_ BRM_ 2.0 | N |
| AS5051AWX Mi | EMEA | Switzerland | LX.AV 30J.05 9 | AS5051AW XMi MCESW8 UMAC 2*512/120/ BT/6L/5R/ CB_bg_0.3 C_AN | ATMK 36 | N14.1 WXGA G | SO512 MBII5 | SO512 MBII5 | N120 GB5.4 K | NSM8 X | ABT_ BRM4 318BG | FOX_ BRM_ 2.0 | N |

| Model | RO | Country | Acer Part no | Description | CPU | LCD | DIMM 1 | DIMM 2 | HDD 1 (GB) | ODD | Wireless LAN | Bluetooth | VOIP Phone |
|--------------|------|----------------|---------------|--|---------|-------------|-------------|-------------|--------------|--------|----------------|-----------|------------|
| AS5051AWX Mi | EMEA | Switzerland | LX.AV 30J.060 | AS5051AW XMi MCEW8 UMAC 2*512/120/6L/5R/CB_bg_0.3 C_AN | ATMK 36 | N14.1 WXGAG | SO512 MBII5 | SO512 MBII5 | N120 GB5.4 K | NSM8 X | ABT_BRM4 318BG | N | N |
| AS5051AWX Mi | EMEA | Portugal | LX.AV 30J.061 | AS5051AW XMi MCEPT6 UMAC 2*512/120/6L/5R_bg_0.3 C_AN | ATMK 36 | N14.1 WXGAG | SO512 MBII5 | SO512 MBII5 | N120 GB5.4 K | NSM8 X | ABT_BRM4 318BG | N | N |
| AS5051AWX Mi | EMEA | Spain | LX.AV 30J.062 | AS5051AW XMi MCEESJ UMAC 2*512/120/6L/5R_bg_0.3 C_AN | ATMK 36 | N14.1 WXGAG | SO512 MBII5 | SO512 MBII5 | N120 GB5.4 K | NSM8 X | ABT_BRM4 318BG | N | N |
| AS5051AWX Mi | EMEA | Germany | LX.AV 30J.064 | AS5051AW XMi MCEDEA UMAC 2*512/120/6L/5R_bg_0.3 C_AN | ATMK 36 | N14.1 WXGAG | SO512 MBII5 | SO512 MBII5 | N120 GB5.4 K | NSM8 X | ABT_BRM4 318BG | N | N |
| AS5051AWX Mi | EMEA | Germany | LX.AV 30J.065 | AS5051AW XMi MCEDEB UMAC 2*512/120/6L/5R_bg_0.3 C_AN | ATMK 36 | N14.1 WXGAG | SO512 MBII5 | SO512 MBII5 | N120 GB5.4 K | NSM8 X | ABT_BRM4 318BG | N | N |
| AS5051AWX Mi | EMEA | Middle East | LX.AV 30J.070 | AS5051AW XMi MCEAR1 UMAC 2*512/120/6L/5R_bg_0.3 C_AN | ATMK 36 | N14.1 WXGAG | SO512 MBII5 | SO512 MBII5 | N120 GB5.4 K | NSM8 X | ABT_BRM4 318BG | N | N |
| AS5051AWX Mi | EMEA | Middle East | LX.AV 30J.084 | AS5051AW XMi MCEAR2 UMAC 2*512/120/6L/5R_bg_0.3 C_AN | ATMK 36 | N14.1 WXGAG | SO512 MBII5 | SO512 MBII5 | N120 GB5.4 K | NSM8 X | ABT_BRM4 318BG | N | N |
| AS5051AWX Mi | EMEA | Belgium | LX.AV 30J.066 | AS5051AW XMi MCEBE6 UMAC 2*512/120/6L/5R_bg_0.3 C_AN | ATMK 36 | N14.1 WXGAG | SO512 MBII5 | SO512 MBII5 | N120 GB5.4 K | NSM8 X | ABT_BRM4 318BG | N | N |
| AS5051AWX Mi | EMEA | Eastern Europe | LX.AV 30J.079 | AS5051AW XMi MCECS5 UMAC 2*512/120/6L/5R_bg_0.3 C_AN | ATMK 36 | N14.1 WXGAG | SO512 MBII5 | SO512 MBII5 | N120 GB5.4 K | NSM8 X | ABT_BRM4 318BG | N | N |

| Model | RO | Country | Acer Part no | Description | CPU | LCD | DIMM 1 | DIMM 2 | HDD 1 (GB) | ODD | Wireless LAN | Bluetooth | VOIP Phone |
|--------------|------|------------------|---------------|---|---------|------------|-------------|-------------|--------------|--------|----------------|-----------|------------|
| AS5051AWX Mi | EMEA | Holland | LX.AV 30J.069 | AS5051AW XMi MCENL6 UMAC 2*512/120/6L/ 5R_bg_0.3 C_AN | ATMK 36 | N14.1 WXGA | SO512 MBII5 | SO512 MBII5 | N120 GB5.4 K | NSM8 X | ABT_BRM4 318BG | N | N |
| AS5051AWX Mi | EMEA | Italy | LX.AV 30J.071 | AS5051AW XMi MCEIT7 UMAC 2*512/120/6L/ 5R_bg_0.3 C_AN | ATMK 36 | N14.1 WXGA | SO512 MBII5 | SO512 MBII5 | N120 GB5.4 K | NSM8 X | ABT_BRM4 318BG | N | N |
| AS5051AWX Mi | EMEA | Denmark | LX.AV 30J.074 | AS5051AW XMi MCEDK6 UMAC 2*512/120/6L/ 5R_bg_0.3 C_AN | ATMK 36 | N14.1 WXGA | SO512 MBII5 | SO512 MBII5 | N120 GB5.4 K | NSM8 X | ABT_BRM4 318BG | N | N |
| AS5051AWX Mi | EMEA | France | LX.AV 30J.063 | AS5051AW XMi MCEFRF UMAC 2*512/120/6L/ 5R_bg_0.3 C_AN | ATMK 36 | N14.1 WXGA | SO512 MBII5 | SO512 MBII5 | N120 GB5.4 K | NSM8 X | ABT_BRM4 318BG | N | N |
| AS5051AWX Mi | EMEA | Norway | LX.AV 30J.073 | AS5051AW XMi MCENO5 UMAC 1*512/80/6L/ 5R_bg_0.3 C_AN | ATMK 36 | N14.1 WXGA | SO512 MBII6 | N | N80G B5.4K | NSM8 X | ABT_BRM4 318BG | N | N |
| AS5051AWX Mi | EMEA | Norway | LX.AV 30J.075 | AS5051AW XMi MCENO5 UMAC 2*512/120/6L/ 5R_bg_0.3 C_AN | ATMK 36 | N14.1 WXGA | SO512 MBII5 | SO512 MBII5 | N120 GB5.4 K | NSM8 X | ABT_BRM4 318BG | N | N |
| AS5051AWX Mi | EMEA | Russia | LX.AV 30J.080 | AS5051AW XMi MCERU9 UMAC 2*512/120/6L/ 5R_bg_0.3 C_AN | ATMK 36 | N14.1 WXGA | SO512 MBII5 | SO512 MBII5 | N120 GB5.4 K | NSM8 X | ABT_BRM4 318BG | N | N |
| AS5051AWX Mi | EMEA | Slovenia/Croatia | LX.AV 30J.085 | AS5051AW XMi MCES11 UMAC 2*512/120/6L/ 5R_bg_0.3 C_AN | ATMK 36 | N14.1 WXGA | SO512 MBII5 | SO512 MBII5 | N120 GB5.4 K | NSM8 X | ABT_BRM4 318BG | N | N |
| AS5051AWX Mi | EMEA | Switzerland | LX.AV 30J.086 | AS5051AW XMi MCESW8 UMAC 2*512/120/6L/ 5R_bg_0.3 C_AN | ATMK 36 | N14.1 WXGA | SO512 MBII5 | SO512 MBII5 | N120 GB5.4 K | NSM8 X | ABT_BRM4 318BG | N | N |

| Model | RO | Country | Acer Part no | Description | CPU | LCD | DIMM 1 | DIMM 2 | HDD 1 (GB) | ODD | Wireless LAN | Bluetooth | VOIP Phone |
|--------------|------|-----------------|---------------|---|---------|------------|-------------|-------------|--------------|--------|----------------|-----------|------------|
| AS5051AWX Mi | EMEA | Eastern Europe | LX.AV 30J.068 | AS5051AW XMi MCEPL7 UMAC 2*512/120/6L/ 5R_bg_0.3 C_AN | ATMK 36 | N14.1 WXGA | SO512 MBII5 | SO512 MBII5 | N120 GB5.4 K | NSM8 X | ABT_BRM4 318BG | N | N |
| AS5051AWX Mi | EMEA | Sweden/ Finland | LX.AV 30J.067 | AS5051AW XMi MCESV5 UMAC 2*512/120/6L/ 5R_bg_0.3 C_AN | ATMK 36 | N14.1 WXGA | SO512 MBII5 | SO512 MBII5 | N120 GB5.4 K | NSM8 X | ABT_BRM4 318BG | N | N |
| AS5051AWX Mi | EMEA | UK | LX.AV 30J.081 | AS5051AW XMi MCEUUK1 1U UMAC 2*512/120/6L/ 5R_bg_0.3 C_AN | ATMK 36 | N14.1 WXGA | SO512 MBII5 | SO512 MBII5 | N120 GB5.4 K | NSM8 X | ABT_BRM4 318BG | N | N |
| AS5051AWX Mi | EMEA | UK | LX.AV 30J.087 | AS5051AW XMi MCEUK5 UMAC 2*512/120/6L/ 5R_bg_0.3 C_AN | ATMK 36 | N14.1 WXGA | SO512 MBII5 | SO512 MBII5 | N120 GB5.4 K | NSM8 X | ABT_BRM4 318BG | N | N |
| AS5051AWX Mi | EMEA | Turkey | LX.AV 30J.072 | AS5051AW XMi MCETR5 UMAC 2*512/120/6L/ 5R_bg_0.3 C_AN | ATMK 36 | N14.1 WXGA | SO512 MBII5 | SO512 MBII5 | N120 GB5.4 K | NSM8 X | ABT_BRM4 318BG | N | N |
| AS5051AWX Mi | EMEA | Italy | LX.AV 30J.076 | AS5051AW XMi MCEWIT11 W UMAC 2*512/120/6L/ 5R_bg_0.3 C_AN | ATMK 36 | N14.1 WXGA | SO512 MBII5 | SO512 MBII5 | N120 GB5.4 K | NSM8 X | ABT_BRM4 318BG | N | N |
| AS5051AWX Mi | EMEA | UK | LX.AV 30J.088 | AS5051AW XMi MCEUK6 UMAC 2*512/120/6L/ 5R_bg_0.3 C_AN | ATMK 36 | N14.1 WXGA | SO512 MBII5 | SO512 MBII5 | N120 GB5.4 K | NSM8 X | ABT_BRM4 318BG | N | N |
| AS5051AWX Mi | EMEA | France | LX.AV 30J.077 | AS5051AW XMi MCEWFR1 1W UMAC 2*512/120/6L/ 5R_bg_0.3 C_AN | ATMK 36 | N14.1 WXGA | SO512 MBII5 | SO512 MBII5 | N120 GB5.4 K | NSM8 X | ABT_BRM4 318BG | N | N |
| AS5051AWX Mi | EMEA | Germany | LX.AV 30J.078 | AS5051AW XMi MCEWDE1 1W UMAC 2*512/120/6L/ 5R_bg_0.3 C_AN | ATMK 36 | N14.1 WXGA | SO512 MBII5 | SO512 MBII5 | N120 GB5.4 K | NSM8 X | ABT_BRM4 318BG | N | N |

| Model | RO | Country | Acer Part no | Description | CPU | LCD | DIMM 1 | DIMM 2 | HDD 1 (GB) | ODD | Wireless LAN | Bluetooth | VOIP Phone |
|--------------|------|----------------|---------------|---|---------|------------|-------------|-------------|--------------|--------|----------------|-----------|------------|
| AS5051AWX Mi | EMEA | Germany | LX.AV 305.057 | AS5051AW XMi XPHDE7 UMAC 2*512/120/6L/ 5R_bg_0.3 C_AN | ATMK 36 | N14.1 WXGA | SO512 MBII5 | SO512 MBII5 | N120 GB5.4 K | NSM8 X | ABT_BRM4 318BG | N | N |
| AS5051AWX Mi | EMEA | Middle East | LX.AV 305.061 | AS5051AW XMi XPHAR1 UMAC 2*512/120/6L/ 5R_bg_0.3 C_AN | ATMK 36 | N14.1 WXGA | SO512 MBII5 | SO512 MBII5 | N120 GB5.4 K | NSM8 X | ABT_BRM4 318BG | N | N |
| AS5051AWX Mi | EMEA | Denmark | LX.AV 305.047 | AS5051AW XMi XPHDK1 UMAC 2*512/120/6L/ 5R_bg_0.3 C_AN | ATMK 36 | N14.1 WXGA | SO512 MBII5 | SO512 MBII5 | N120 GB5.4 K | NSM8 X | ABT_BRM4 318BG | N | N |
| AS5051AWX Mi | EMEA | Belgium | LX.AV 305.056 | AS5051AW XMi XPHBE1 UMAC 2*512/120/6L/ 5R_bg_0.3 C_AN | ATMK 36 | N14.1 WXGA | SO512 MBII5 | SO512 MBII5 | N120 GB5.4 K | NSM8 X | ABT_BRM4 318BG | N | N |
| AS5051AWX Mi | EMEA | Eastern Europe | LX.AV 305.052 | AS5051AW XMi XPHCS2 UMAC 2*512/120/6L/ 5R_bg_0.3 C_AN | ATMK 36 | N14.1 WXGA | SO512 MBII5 | SO512 MBII5 | N120 GB5.4 K | NSM8 X | ABT_BRM4 318BG | N | N |
| AS5051AWX Mi | EMEA | UK | LX.AV 30J.083 | AS5051AW XMi MCEWUK1 1W UMAC 2*512/120/6L/ 5R_bg_0.3 C_AN | ATMK 36 | N14.1 WXGA | SO512 MBII5 | SO512 MBII5 | N120 GB5.4 K | NSM8 X | ABT_BRM4 318BG | N | N |
| AS5051AWX Mi | EMEA | UK | LX.AV 30J.082 | AS5051AW XMi MCEWUK2 1W UMAC 2*512/120/6L/ 5R_bg_0.3 C_AN | ATMK 36 | N14.1 WXGA | SO512 MBII5 | SO512 MBII5 | N120 GB5.4 K | NSM8 X | ABT_BRM4 318BG | N | N |
| AS5051AWX Mi | EMEA | Eastern Europe | LX.AV 305.051 | AS5051AW XMi XPHHU6 UMAC 2*512/120/6L/ 5R_bg_0.3 C_AN | ATMK 36 | N14.1 WXGA | SO512 MBII5 | SO512 MBII5 | N120 GB5.4 K | NSM8 X | ABT_BRM4 318BG | N | N |
| AS5051AWX Mi | EMEA | Spain | LX.AV 305.059 | AS5051AW XMi XPHESA UMAC 2*512/120/6L/ 5R_bg_0.3 C_AN | ATMK 36 | N14.1 WXGA | SO512 MBII5 | SO512 MBII5 | N120 GB5.4 K | NSM8 X | ABT_BRM4 318BG | N | N |

| Model | RO | Country | Acer Part no | Description | CPU | LCD | DIMM 1 | DIMM 2 | HDD 1 (GB) | ODD | Wireless LAN | Bluetooth | VOIP Phone |
|--------------|------|----------------|---------------|---|---------|--------------|-------------|-------------|--------------|--------|----------------|-----------|------------|
| AS5051AWX Mi | EMEA | Greece | LX.AV 305.054 | AS5051AWXMi XPHEL1 UMAC 2*512/120/6L/ 5R_bg_0.3 C_AN | ATMK 36 | N14.1 WXGA | SO512 MBII5 | SO512 MBII5 | N120 GB5.4 K | NSM8 X | ABT_BRM4 318BG | N | N |
| AS5051AWX Mi | EMEA | Israel | LX.AV 305.069 | AS5051AWXMi XPHIS1 UMAC 2*512/120/6L/ 5R_bg_0.3 C_AN | ATMK 36 | N14.1 WXGA | SO512 MBII5 | SO512 MBII5 | N120 GB5.4 K | NSM8 X | ABT_BRM4 318BG | N | N |
| AS5051AWX Mi | EMEA | France | LX.AV 305.048 | AS5051AWXMi XPHFRA UMAC 2*512/120/6L/ 5R_bg_0.3 C_AN | ATMK 36 | N14.1 WXGA | SO512 MBII5 | SO512 MBII5 | N120 GB5.4 K | NSM8 X | ABT_BRM4 318BG | N | N |
| AS5051AWX Mi | EMEA | Italy | LX.AV 305.055 | AS5051AWXMi XPHIT1 UMAC 2*512/120/6L/ 5R_bg_0.3 C_AN | ATMK 36 | N14.1 WXGA | SO512 MBII5 | SO512 MBII5 | N120 GB5.4 K | NSM8 X | ABT_BRM4 318BG | N | N |
| AS5051AWX Mi | EMEA | Eastern Europe | LX.AV 305.053 | AS5051AWXMi XPHPL6 UMAC 2*512/120/6L/ 5R_bg_0.3 C_AN | ATMK 36 | N14.1 WXGA | SO512 MBII5 | SO512 MBII5 | N120 GB5.4 K | NSM8 X | ABT_BRM4 318BG | N | N |
| AS5051AWX Mi | EMEA | Holland | LX.AV 305.067 | AS5051AWXMi XPHNL1 UMAC 2*512/120/6L/ 5R_bg_0.3 C_AN | ATMK 36 | N14.1 WXGA | SO512 MBII5 | SO512 MBII5 | N120 GB5.4 K | NSM8 X | ABT_BRM4 318BG | N | N |
| AS5051AWX Mi | AAP | Malaysia | LX.AV 305.066 | AS5051AWXMi XPHMA2 UMAC 1*512/80/6L/5R/ CB_bg_0.3 C_AN | ATMK 36 | N14.1 WXGA G | SO512 MBII5 | N | N80G B5.4K | NSM8 X | ABT_ATH54 13BG | N | N |
| AS5051AWX Mi | EMEA | Norway | LX.AV 305.058 | AS5051AWXMi XPHNO1 UMAC 2*512/120/6L/ 5R_bg_0.3 C_AN | ATMK 36 | N14.1 WXGA | SO512 MBII5 | SO512 MBII5 | N120 GB5.4 K | NSM8 X | ABT_BRM4 318BG | N | N |
| AS5051AWX Mi | EMEA | South Africa | LX.AV 305.062 | AS5051AWXMi XPHSA1 UMAC 2*512/120/6L/ 5R_bg_0.3 C_AN | ATMK 36 | N14.1 WXGA | SO512 MBII5 | SO512 MBII5 | N120 GB5.4 K | NSM8 X | ABT_BRM4 318BG | N | N |

| Model | RO | Country | Acer Part no | Description | CPU | LCD | DIMM 1 | DIMM 2 | HDD 1 (GB) | ODD | Wireless LAN | Bluetooth | VOIP Phone |
|--------------|------|------------------|---------------|--|---------|--------------|-------------|-------------|--------------|--------|----------------|-----------|------------|
| AS5051AWX Mi | EMEA | Russia | LX.AV 305.049 | AS5051AWXMi XPHRU2 UMAC 2*512/120/6L/ 5R_bg_0.3 C_AN | ATMK 36 | N14.1 WXGA | SO512 MBII5 | SO512 MBII5 | N120 GB5.4 K | NSM8 X | ABT_BRM4 318BG | N | N |
| AS5051AWX Mi | EMEA | Sweden/Finland | LX.AV 305.050 | AS5051AWXMi XPHSV1 UMAC 2*512/120/6L/ 5R_bg_0.3 C_AN | ATMK 36 | N14.1 WXGA | SO512 MBII5 | SO512 MBII5 | N120 GB5.4 K | NSM8 X | ABT_BRM4 318BG | N | N |
| AS5051AWX Mi | EMEA | Slovenia/Croatia | LX.AV 305.063 | AS5051AWXMi XPHSLO2 UMAC 2*512/120/6L/ 5R_bg_0.3 C_AN | ATMK 36 | N14.1 WXGA | SO512 MBII5 | SO512 MBII5 | N120 GB5.4 K | NSM8 X | ABT_BRM4 318BG | N | N |
| AS5051AWX Mi | EMEA | Portugal | LX.AV 305.068 | AS5051AWXMi XPHPT1 UMAC 2*512/120/6L/ 5R_bg_0.3 C_AN | ATMK 36 | N14.1 WXGA | SO512 MBII5 | SO512 MBII5 | N120 GB5.4 K | NSM8 X | ABT_BRM4 318BG | N | N |
| AS5051AWX Mi | EMEA | Switzerland | LX.AV 305.064 | AS5051AWXMi XPHSW5 UMAC 2*512/120/6L/ 5R_bg_0.3 C_AN | ATMK 36 | N14.1 WXGA | SO512 MBII5 | SO512 MBII5 | N120 GB5.4 K | NSM8 X | ABT_BRM4 318BG | N | N |
| AS5051AWX Mi | EMEA | UK | LX.AV 305.065 | AS5051AWXMi XPHUK1 UMAC 2*512/120/6L/ 5R_bg_0.3 C_AN | ATMK 36 | N14.1 WXGA | SO512 MBII5 | SO512 MBII5 | N120 GB5.4 K | NSM8 X | ABT_BRM4 318BG | N | N |
| AS5051AWX Mi | EMEA | Turkey | LX.AV 305.070 | AS5051AWXMi XPHTR1 UMAC 2*512/120/6L/ 5R_bg_0.3 C_AN | ATMK 36 | N14.1 WXGA | SO512 MBII5 | SO512 MBII5 | N120 GB5.4 K | NSM8 X | ABT_BRM4 318BG | N | N |
| AS5051ANWXMi | EMEA | Turkey | LX.AV 30C.025 | AS5051ANWXMi LINPUSTR1 UMAC 1*512/60/6L/5R/ CB_bg_0.3 C_AN | ATMK 36 | N14.1 WXGA G | SO512 MBII5 | N | N60G B5.4K | NSM8 X | ABT_BRM4 318BG | N | N |
| AS5051AWX Mi | EMEA | Turkey | LX.AV 305.071 | AS5051AWXMi XPHTR1 UMAC 1*512/60/6L/5R/ CB_bg_0.3 C_AN | ATMK 36 | N14.1 WXGA G | SO512 MBII5 | N | N60G B5.4K | NSM8 X | ABT_BRM4 318BG | N | N |

| Model | RO | Country | Acer Part no | Description | CPU | LCD | DIMM 1 | DIMM 2 | HDD 1 (GB) | ODD | Wireless LAN | Bluetooth | VOIP Phone |
|-------------|-----|---------|--------------|---|--------|----------------|----------------|--------|------------|-------|---------------|-------------|------------|
| AS5052NWXMi | AAP | India | LX.AV30C.026 | AS5052N WXMi LINPUSIL1 UMAC 1*512/80/ BT/6L/5R/ CB_bg_0.3 C_AN | ATTL50 | N14.1 WXGAG | SO512 MBII5 | N | N80GB5.4K | NSM8X | ABT_ATH5413BG | FOX_BRM_2.0 | N |

Test Compatible Components

This computer's compatibility is tested and verified by Acer's internal testing department. All of its system functions are tested under Windows® XP Home, Windows® XP Pro environment.

Refer to the following lists for components, adapter cards, and peripherals which have passed these tests. Regarding configuration, combination and test procedures, please refer to the TravelMate 5730 series Compatibility Test Report released by the Acer Mobile System Testing Department.

Microsoft® Windows® Vista Environment Test

| Item | Specification |
|----------------------|--|
| CRT Port Test | |
| CRT Monitor | Acer 211c 21", ViewSonic G220F, ViewSonic PF790 19" |
| LCD Monitor | Acer FP751 17" TFT LCD, Acer AL1521, Acer AL1721, ViewSonic VD201b, Westinghouse W37G, HP LP2065, HP S9500 |
| Projector | Dell 3300MP |
| USB Port Test | |
| USB Keyboard/Mouse | Microsoft Natural Keyboard Pro Dell USB Keyboard Logicool USB Mouse (OWCM-USB) Logitech USB Wheel Mouse Logitech First Wheel Mouse Dell by Logitech Dell Internet Navigator Keyboard Dell Smart Card Keyboard HP USB Optical Austin Mouse Belkin Miniglow Optical USB Mouse HP USB Optical Mouse (RB129AA) |
| USB Speaker/Joystick | Aiwa Multimedia Digital Speaker (SC-UC78) Panasonic USB Speaker EAB-MPC57USB |
| USB Storage Drive | Iomega USB Zip 250MB Transcend 80G HDD Plextor DVD+R/RW LG DVD+R/RW Sony DVD+R/RW |
| USB Camera | Intel Easy PC Camera (A20953-001) Orange Micro USB 2.0 Web Cam |
| USB HUB and Others | A TEN UH-204 IOGEAR 4-Port Hub Corega CG-WLUSBST11 |
| USB Printer/Scanner | HP 450WBT Deskjet Printer |
| USB Flash Drive | Sony Memory Key 128MB Sony Micro Vault Pro USD-5G IBM 128MB Memory Key IBM 512MB Memory Key Apacer Handy Drive Apacer The USB Flash Drive 256MB |
| USB ODD | Logitec CDRW+DVDROM combo LG DVD+R/RW Sony DVD+R/RW |
| 1394 Camera | Sony DV-TRV10 |
| Access Point 802.11a | Intel Pro/Wireless 5000 NetGear HE 102 |
| Access Point 802.11g | D-Link Building Networks People WiFi Certified a/b/g Wireless 108AG |
| Access Point 802.11n | Belkin N1MIMO Wireless Router High Performance wireless 802.11n |
| Bluetooth Device | Sony Ericsson Wireless Headset Sony Ericsson T610 X Bridge Bluetooth Access Point BT300 |

| Item | Specification |
|---|--|
| PCMCIA Test | |
| LAN/Modem Card | TDK CardBus Ethernet 10/100 32-Bit CBE-10/100BTX |
| Storage Card | Hitachi Microdrive 4G |
| 1394 Card | Buffalo 1394 Interface Cardbus (IFC-ILCB/DV) |
| USB2.0 Card | IBM EtherJet CardBus Adapter 10/100 |
| Wireless Lan Card (Not recommended for wireless ready model) | Cisco Wireless LAN Card 802.11a NETGEAR Wireless LAN card 802.11a |
| ISDN Card | Toshiba Type B for Bluetooth 128K ISDN Card |
| GPRS Card | Vodafone QL1ACC-21581 3G/GPRS card Sony Ericsson GC83 GPRS card Sony Ericsson GC89 GPRS card |
| ExpressCard Test | |
| Express Card | Abcom 5-in-1 Adapter ExpressCard Reader Abcom GigaLan ExpressCard Sunix ECF2400 2 Ports 1394A ExpressCard |
| Memory Card Test (SD/MS/MMC/SM/CF/Microdrive/XD) | |
| SD Card | Apacer 128/256MB SanDisk 256MB Apacer 2GB (150x Hi-Speed) KINGMAX 1GB (66x Hi-Speed) SanDisk 1GB RiDATA 4GB SD PRO Memory Card |
| MS Card | Sony 512 MS PRO Lexar 512MB MS PRO Lexar 1GB MS PRO Sony 2GB MS PRO |
| MMC Card | SanDisk 32MB Transcend 64/128MB Transcend 256MB SanDisk RS-MMC 128MB PQI RS-MMC 256MB Transcend 512MB A-DATA Turbo 200X 2GB MMC Card |
| XD Card | Apacer 256/512MB SanDisk 2GB Olympus 512MB |
| CF Card | Apacer 256/512 SanDisk 2GB |

Online Support Information

This section describes online technical support services available to help you repair your Acer Systems.

If you are a distributor, dealer, ASP or TPM, please refer your technical queries to your local Acer branch office. Acer Branch Offices and Regional Business Units may access our website. However some information sources will require a user i.d. and password. These can be obtained directly from Acer CSD Taiwan.

Acer's Website offers you convenient and valuable support resources whenever you need them.

In the Technical Information section you can download information on all of Acer's Notebook, Desktop and Server models including:

- Service guides for all models
- User's manuals
- Training materials
- Bios updates
- Software utilities
- Spare parts lists
- TABs (Technical Announcement Bulletin)

For these purposes, we have included an Acrobat File to facilitate the problem-free downloading of our technical material.

Also contained on this website are:

- Detailed information on Acer's International Traveller's Warranty (ITW)
- Returned material authorization procedures
- An overview of all the support services we offer, accompanied by a list of telephone, fax and email contacts for all your technical queries.

We are always looking for ways to optimize and improve our services, so if you have any suggestions or comments, please do not hesitate to communicate these to us.

A

AFLASH Utility 48
Antennas 100
Audio 33

B

Battery Pack 56
BIOS 29
 vendor 29
 Version 29
BIOS Utility 37–48
 Navigating 38
 Onboard Device Configuration 43
 Security 41, 42
 System Security 47
Board Layout
 Top View 123
brightness
 hotkeys 16

C

caps lock
 on indicator 11
computer
 on indicator 11
CPU 74
CPU Fan True Value Table 29

D

DIMM Module 60
Display 3
display
 hotkeys 16

E

Error Symptom-to-Spare Part Index 108
Euro 17
External CD-ROM Drive Check 104
External Module Disassembly
 Flowchart 55

F

Features 1
Fingerprint Board 84
Flash Utility 48
fpc cable 97
FRU (Field Replaceable Unit) List 127

H

Hard disk 31
Hard Disk Drive Module 63
HDD 31
Hibernation mode
 hotkey 16
Hot Keys 14

I

Indicators 11
Intermittent Problems 121

J

Jumper and Connector Locations 123
 Top View 123

K

Keyboard 33, 71
Keyboard or Auxiliary Input Device Check
 104

L

Launch Board 83
LCD Bezel 94
LCD Brackets 99
LCD Module Disassembly
 Flowchart 93
LCD with the Brackets 96
lower cover 59

M

Main Unit Disassembly
 Flowchart 67
Mainboard 90

media access
 on indicator 11
Memory Check 105
Model Definition 136
Modem Board 87

N

Notebook Manager
 hotkey 16
num lock
 on indicator 11

O

Online Support Information 163

P

Panel 4
 Bottom 10
 left 4
PC Card 11
Power System Check 105
 Battery Pack 107
 Power Adapter 106
Processor 29

S

Screw List 54
speakers
 hotkey 16
System
 Block Diagram 3
System Check Procedures 104
System Memory 29
System Utilities 37

T

Test Compatible Components 159
Top 123
touchpad
 hotkey 16
 using 12
Touchpad Check 107
Troubleshooting 103

U

Undetermined Problems 122
utility
 BIOS 37–48

V

view
 left 7
 rear 9
 right 7

W

Windows 2000 Environment Test 160
WLAN Board 61