

# Acer

## TravelMate 6460/6410 Service Guide

Service guide files and updates are available on the ACER/CSD web. For more information, please refer to <http://csd.acer.com.tw>

PRINTED IN TAIWAN

---

# Revision History

Please refer to the table below for the updates of notebook TravelMate 6460/6410 service guide.

Date	Chapter	Updates
September 26, 2006		first release

---

# Copyright

Copyright© 2006 by Acer Incorporated. All rights reserved. No part of this publication may be reproduced, transmitted, transcribed, stored in a retrieval system, or translated into any language or computer language, in any form or by any means, electronic, mechanical, magnetic, optical, chemical, manual or otherwise, without the prior written permission of Acer Incorporated.

---

# Disclaimer

The information in this guide is subject to change without notice.

Acer Incorporated makes no representations or warranties, either expressed or implied, with respect to the contents hereof and specifically disclaims any warranties of merchantability or fitness for any particular purpose. Any Acer Incorporated software described in this manual is sold or licensed "as is". Should the programs prove defective following their purchase, the buyer (and not Acer Incorporated, its distributor, or its dealer) assumes the entire cost of all necessary servicing, repair, and any incidental or consequential damages resulting from any defect in the software.

Acer is a registered trademark of Acer Incorporated.

Other brand and product names are trademarks and/or registered trademarks of their respective holders.

---

# Conventions

The following conventions are used in this manual:

SCREEN MESSAGES	Denotes actual messages that appear on screen.
NOTE	Gives bits and pieces of additional information related to the current topic.
WARNING	Alerts you to any damage that might result from doing or not doing specific actions.
CAUTION	Gives precautionary measures to avoid possible hardware or software problems.
IMPORTANT	Reminds you to do specific actions relevant to the accomplishment of procedures.

---

# Preface

Before using this information and the product it supports, please read the following general information.

1. This Service Guide provides you with all technical information relating to the BASIC CONFIGURATION decided for Acer's "global" product offering. To better fit local market requirements and enhance product competitiveness, your regional office MAY have decided to extend the functionality of a machine (e.g. add-on card, modem, or extra memory capability). These LOCALIZED FEATURES will NOT be covered in this generic service guide. In such cases, please contact your regional offices or the responsible personnel/channel to provide you with further technical details.
2. Please note WHEN ORDERING FRU PARTS, you should check the most up-to-date information available on your regional web or channel. For whatever reason, if a part number change is made, it will not be noted in the printed Service Guide. For ACER-AUTHORIZED SERVICE PROVIDERS, your Acer office may have a DIFFERENT part number code to those given in the FRU list of this printed Service Guide. You MUST use the list provided by your regional Acer office to order FRU parts for repair and service of customer machines.

# System Specification

---

## Specification

### Operating System

- Windows® Vista™ Capable
- Windows® Vista™ Premium Ready (for selected models)
- Genuine Windows® XP Professional x 64 Edition
- Genuine Windows® XP Professional (Service Pack 2)
- Genuine Windows® XP Home Edition (Service Pack 2)

### Platform

- Intel® Centrino® Duo mobile technology, featuring:
  - Intel® Core™ 2 Duo processor T7200/T7400/T7600 (4MB L2 cache, 2/2.16/2.33GHz, 667MHz FSB), or T5500/T5600 (2MB L2 cache, 1.66/1.83GHz, 667MHz FSB), supporting Intel® Extended Memory 64 Technology (Intel® EM64T)
  - Mobile Intel® 945GM/PM Express chipset (for selected model)
  - Intel® PRO/Wireless 3945ABG network connection (dual-band tri-mode 802.11a/b/g) or Intel® PRO/Wireless 3945BG network connection (dual-mode 802.11b/g) Wi-Fi CERTIFIED™ solution, supporting Acer SignalUp™ wireless technology

### System Memory

- Up to 2GB of DDR2 533/667MHz memory, upgradeable to 4GB using two soDIMM modules (dual-channel support)

### Display and Graphics

- 15.4" WSXGA + high-brightness TFT LCD, 1680 x 1050 pixel resolution, 16 ms response time, supporting simultaneous multi-window viewing via Acer GridVista™
- 15.4" WXGA + high-brightness TFT LCD, 1280 x 800 pixel resolution, 16 ms response time, supporting simultaneous multi-window viewing via Acer GridVista™
- 15" SXGA + high-brightness TFT LCD, 1400 x 1050 pixel resolution
- 15" XGA + high-brightness TFT LCD, 1024 x 768 pixel resolution
- ATI Mobility™ Radeon® X1300 with up to 512MB HyperMemory™ (128MB of dedicated GDDR2 VRAM, up to 384MB of shared system memory), supporting ATI PowerPlay™ 5.0, Microsoft® DirectX® 9.0 and DualView™ (for selected models)  
or
- Mobile Intel® 945GM Express chipset with integrated 3D graphics, featuring Intel® Graphics Media Accelerator (GMA) 950, up to 224MB of shared memory supporting Microsoft® DirectX® 9.0 and dual independent display (for selected models)
- Up to 2048 x 1536 resolution via non-integrated CRT display
- MPEG-2/DVD hardware-assisted capability
- 16.7 million colors
- S-video/TV-out (NTSC/PAL) support (for selected models)

- 
- DVI-D (true digital video interface) support (for selected models)

## Audio

- Intel® High-Definition audio support
- Two built-in Acer 3D Sonic (1.5W) stereo speakers
- Built-in microphone
- SoundBlaster Pro™ and MS Sound compatible

## Storage Subsystem

- 60/80/100/120/160GB or higher Serial ATA hard disk driver with Acer DASP (Disk Anti-Shock Protection)
- Acer Media Bay hot-swappable 80/100/120/160GB Serial ATA second hard disk drive
- Acer Media Bay hot-swappable optical drive:
  - 8X DVD Super Multi double layer drive
  - DVD/CD-RW combo drive
- 5-in-1 card reader, supporting Secure Digital (SD), MultiMediaCard (MMC), Memory Stick® (MS), Memory Stick PRO™ (MS PRO), xD-Picture Card™ (xD) (for selected models)

## Communication

- Acer Video Conference featuring Voice and Video over Internet Protocol (VoIP) support via Acer OrbiCam™ and optional Acer Bluetooth® VoIP phone (for selected models)
- Acer OrbiCam™ integrated 1.3 megapixel CMOS camera (for selected models), featuring:
  - 225 degree ergonomic rotation
  - Acer VisageON™ technology
  - Acer PrimaLite™ technology
- Modem: 56K ITU V.92 with PTT approval; Wake-on-Ring ready
- LAN: Gigabit Ethernet; ASF 2.0 support; Wake-on-LAN ready
- WPAN: Bluetooth® 2.0 + EDR (Enhanced Data Rate)
- WLAN: integrated Intel® PRO/Wireless 3945ABG network connection (dual-band tri-mode 802.11a/b/g) or 3945BG network connection (dual-mode 802.11b/g) Wi-Fi CERTIFIED™ solution, supporting Acer SignalUp™ wireless technology

## Input Devices

- Security access via TravelMate TPM-based fingerprint reader / TravelMate SmartCard reader (for selected models)
- 88/89-key Acer FineTouch™ keyboard with five degree curve, inverted “T” cursor layout, 2.5 mm (minimum) key travel
- 12 function keys, four cursor keys, two Windows® keys, hotkey controls, embedded numeric keypad, international language support
- Dual navigation control, featuring Acer FineTrack™ with two FineTrack™ buttons and touch pad with 4-way scroll button
- Four easy-launch buttons: Empowering Key, email, Internet and user-programmable button
- Two communication LED switches: WLAN and Bluetooth®

## I/O Interface

- Acer ezDock II and ezDock II+ connector



- 
- ExpressCard™/34 slot (for selected models)
  - PC Card slot (Type II)
  - TravelMate fingerprint reader (for selected models)
  - 5-in-1 card reader (SD, MMC, MS, MS PRO, xD) (for selected models)
  - Three USB 2.0 ports
  - DVI-D port (for selected models)
  - IEEE 1394 port (for selected models)
  - Fast Infrared (FIR) port (for selected models)
  - External display (VGA) port
  - S-video/TV-out (NTSC/PAL) port (for selected models)
  - Headphones/speaker/line-out jack
  - Serial port
  - Microphone-in jack
  - Line-in jack
  - Ethernet (RJ-45) port
  - Modem (RJ-11) port
  - DC-in jack for AC adapter

## Power Subsystem

- ACPI 2.0 CPU power management standards: Stand-by and Hibernation power-saving modes support
- 71W 4800mAh 8-cell Li-Ion battery pack and 44.4W 4000mAh 6-cell Li-Ion battery pack
- Acer QuicCharge™ technology:
  - 80% charge in 1 hour
  - 2-hour rapid charge system-off
  - 2.5-hour charge-in-use
- 3-pin 90W AC adapter

## Security

- Acer DASP (Disk Anti-Shock Protection)
- Acer GraviSense and Acer Anti-Theft HDD protection technologies (for selected models)
- TravelMate TPM-based fingerprint solution (for selected models)
- TravelMate SmartCard solution (for selected models)
- TravelMate TPM (Trusted Platform Module) solution, Acer eDataSecurity Management support (for selected models)
- Kensington lock slot
- BIOS user, HDD and supervisor passwords

## Dimensions and Weight

- 360 (W) x 271 (D) x 35.5 (H) mm (14.2 x 10.6 x 1.4 inches)
- 3.12 kg (6.88 lbs.) with 8-cell battery pack and Acer Media Bay 6-cell second battery pack
- 2.85 kg (6.27 lbs.) with 8-cell battery pack and optical drive
- 2.7 kg (5.94 lbs.) with 6-cell battery pack and optical drive

## Environment

- Temperature:
  - Operating: 5 °C to 35 °C

- 
- Non-operating: -20 °C to 65 °C
  - Humidity (non-condensing):
    - Operating: 20% to 80%
    - Non-operating: 20% to 80%

**Warning!**For safety reasons, do not use non-compliant parts when you add or change components.



# Outlook Tour

## Front View

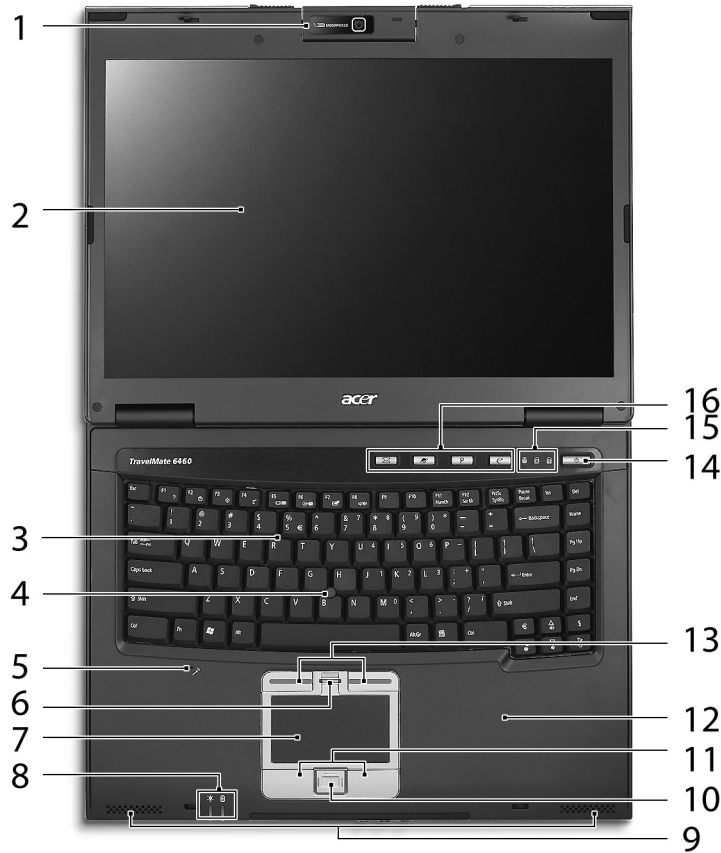

#	Item	Description
1	Acer Orbicam	1.3 megapixel web camera for video communication. (for selected models)
2	Display screen	Also called Liquid-Crystal Display (LCD), displays computer output.
3	Acer FineTouch Keyboard	Serves to enter data into the computer.
4	Acer FineTrack	Touch-sensitive pointing device which functions like a computer mouse when used together with the click buttons.
5	Microphone	Internal microphone for sound recording.
6	Fingerprint reader	Security identification. (for selected models)
7	Touch pad	Touch-sensitive pointing device which functions like a computer mouse.
8	Status indicators	Light-Emitting Diodes (LEDs) that light up to show the status of the computer's functions and components.
9	3D sonic speakers	Left and right speakers deliver stereo audio output.
10 11	Click buttons (left, center and right)	The left and right buttons work like the left and right mouse buttons; the center button serves as a four-way scroll button.
12	Palmrest	Comfortable support area for your hands when you use the computer.

13	FineTrack buttons (left and right)	Work like the left and right mouse buttons when used together with the center-keyboard FineTrack.
14	Power button	Turns the computer on and off.
15	Status indicators	Light-Emitting Diodes (LEDs) that light up to show the status of the computer's functions and components.
16	Easy-launch buttons	Buttons for launching frequently used programs.



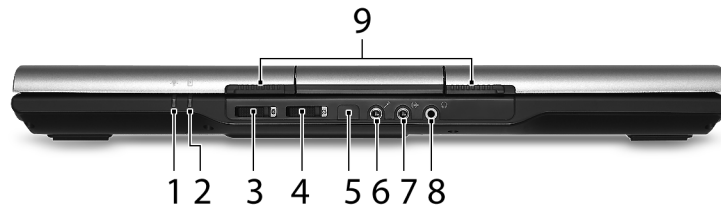

## Closed Front View

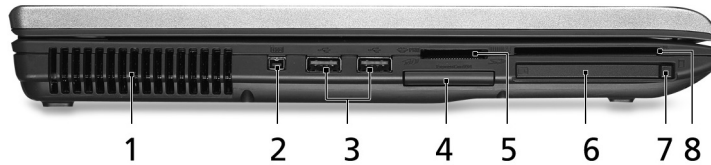

#	Icon	Item	Description
1		Power indicator	Indicates the computer's power status.
2		Battery indicator	Indicates the computer's battery status.
3		Bluetooth communication button/indicator	Enables/disables the Bluetooth communication. Indicates the status of Bluetooth communication.
4		Wireless communication button/indicator	Enables/disables the wireless function. Indicates the status of wireless LAN communication.
5		Infrared port	Interfaces with infrared devices (e.g., infrared printer and IR-aware computer). (for selected models)
6		Microphone-in jack	Accepts input from external microphones.
7		Line-in jack	Accepts audio line-in devices (e.g., audio CD player, stereo walkman).
8		Headphones/speaker/line-out jack	Connects to audio line-out devices (e.g., speakers, headphones).
9	N/A	Latch	Locks and releases the lid.

## Left View



#	Icon	Item	Description
1	N/A	Ventilation slots	Enable the computer to stay cool, even after prolonged use.
2		4-pin IEEE 1394 port	Connects to IEEE 1394 devices. (for selected models)
3		Two USB 2.0 ports	Connect to USB 2.0 devices (e.g., USB mouse, USB camera). (3 total)
4	ExpressCard/34	ExpressCard/34 slot	Accepts one ExpressCard module. (for selected models)
5		5-in-1 card reader	Accepts Memory Stick (MS), Memory Stick Pro (MS PRO), Multi Media Card (MMC), Secure Digital (SD) and xD-Picture Card (xD). (for selected models)
6		PC Card slot	Accepts one Type II PC Card.
7	N/A	PC Card slot eject button	Ejects the PC Card from the slot.
8	N/A	SmartCard	Accepts the TravelMate SmartCard. (for selected models)

## Right View



#	Item	Description
1	Acer Media Bay optical drive	Internal optical drive; accepts CDs or DVDs.
2	Optical disk access indicator	Lights up when the optical drive is active.
3	Optical drive eject button	Ejects the optical disk from the drive.
4	Emergency eject hole	Ejects the optical drive tray when the computer is turned off.
5	USB 2.0 port	Connects to USB 2.0 devices (e.g., USB mouse, USB camera). (3 total)

## Rear View

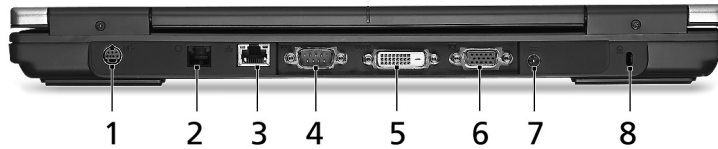

#	Icon	Item	Description
1		S-video port/TV out port (NTSC/PAL) port	Connects to a television or display device with S-video input. (for selected models)
2		Modem (RJ-11) port	Connects to a phone line.
2		Ethernet (RJ-45) port	Connects to an Ethernet 10/100/1000-based networks.
4		Serial port	Connects to serial devices.
5		Digital Video Interface - Digital port	Supports digital video connections. (for selected models)
6		External display (VGA) port	Connects to an external display device (e.g., external monitor, LCD projector).
7		DC-in jack	Connects to an AC adapter.
8		Kensington lock slot	Connects to a Kensington-compatible computers security lock.

## Base View

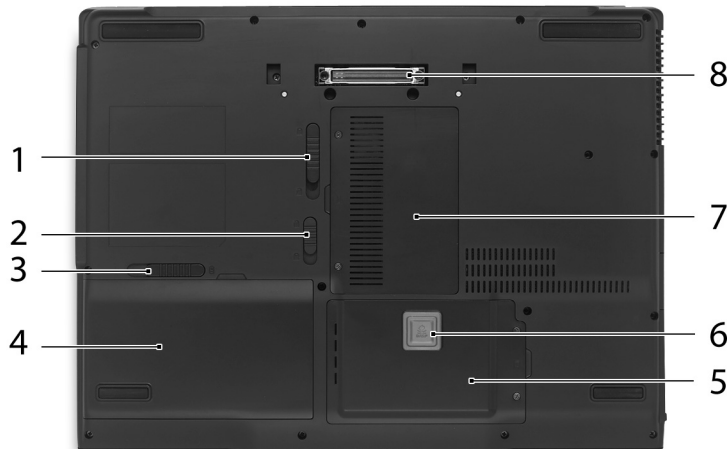

#	Item	Description
1	Acer Media Bay release latch	Locks or unlocks Acer Media Bay device.
2	Battery lock	Locks the battery in position.
3	Battery latch	Releases the battery for removal.

---

4	Battery bay	Houses the computer's battery pack.
5	Hard disk bay	Houses the computer's hard disk (secured with screws).
6	Acer DASP	Disk Anti-Shock Protection
7	Memory compartment	Houses the computer's main memory.
8	ezDock II/II+ connector	Connects to Acer ezDock II/II+.



# Indicators

The computer has eight several easy-to-read status indicators, including five on the front panel. The power, battery and wireless communication status indicators are visible even when the LCD display is closed.



Icon	Item	Description
	Num Lock	Lights up when Num Lock is activated.
	Caps Lock	Lights up when Caps Lock is activated.
	HDD	Indicates when the hard disk drive is active.
	Bluetooth	Indicates the status of Bluetooth communication
	Wireless LAN	Indicates the status of wireless LAN communication
	Power	Lights when the computer is on.
	Battery	Lights when the battery is being charged.

**Note:** The light shows amber when the battery is charging. The light shows green when the system is under AC mode.

---

# Easy-launch Buttons

There are several conveniently located easy-launch buttons. They are one user-programmable button, web browser button, mail button, and Acer Empowering Key *e*. Press *e* to run the Acer Empowering Technology. Although the mail and web browser buttons are pre-set to E-mail and Internet programs, they can be redefined by users. To set the web browser, mail and programmable buttons, run the Acer Launch Manager.



Easy-launch button	Default application
<i>e</i>	Acer Empowering Technology (user-programmable)
Mail	E-mail application (user-programmable)
Web browser	Internet browser (user-programmable)
P	User-programmable

---

# FineTrack and FineTrack buttons

The built-in FineTrack is a pointing device that senses movement on its surface. This means the cursor responds as you use your finger to move the FineTrack. Its central location on the keyboard provides optimum comfort and support.



## FineTrack Basics

The following items show you how to use the FineTrack and FineTrack buttons:

- Using your finger, apply light, steady force on the FineTrack **(1)** to move the cursor.
- Press the FineTrack left **(2)** and the right **(3)** buttons located below the keyboard to perform selection and execution functions. These two FineTrack buttons are similar to the left and right buttons on a mouse.

# Touchpad

The built-in touchpad is a pointing device that senses movement on its surface. This means the cursor responds as you move your finger across the surface of the touchpad. The central location on the palmrest provides optimum comfort and support.

## Touchpad Basics

The following items will show you how to use the touchpad.

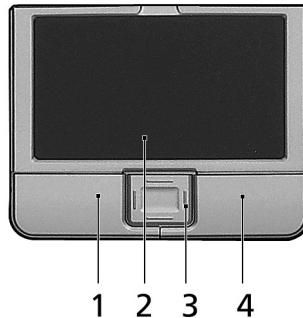

- Move your finger across the touchpad **(2)** to move the cursor.
- Press the left **(1)** and right **(4)** buttons to perform selection and execution functions. These two buttons are similar to the left and right buttons on a mouse. Tapping on the touchpad is the same as clicking the left button.
- Use the 4-way scroll **(3)** button to scroll up or down and move left or right a page. This button mimics the cursor pressing on the right scroll bar of Windows applications.

Function	Left button (1)	Right button (4)	Main touchpad (2)	Center button (3)
Execute	Quickly click twice.		Tap twice (at the same speed as double-clicking a mouse button).	
Select	Click once		Tap once.	
Drag	Click and hold, then use finger on the touchpad to drag the cursor.		Tap twice (at the same speed as double-clicking a mouse button); rest your finger on the touchpad on the second tap and drag the cursor.	
Access context menu		Click once.		
Scroll				Click and hold to move up/down/left/right.

**Note:** Keep your fingers, as well as the surface of the touchpad dry and clean. The touchpad is sensitive to your finger movement; hence, the lighter the touch, the better the response. Tapping hard will not increase the touchpad's responsiveness.

**Note:** By default, vertical and horizontal scrolling is enabled on your touch pad. It can be disabled under Mouse settings in Windows Control Panel.

# Using Acer FineTouch Keyboard

The full-sized keyboard includes an embedded numeric keypad, separate cursor, lock, Windows, function and special keys.

## Lock Keys and Embedded Numeric Keypad

The keyboard has three lock keys which you can toggle on and off.











Lock Key	Description
Caps Lock	When Caps Lock is on, all alphabetic characters are typed in uppercase.
Num Lock <Fn> + <F11>	When Num Lock is on, the right hand side numeric keypad is in numeric mode. The keys function as a calculator (complete with the arithmetic operators +, -, *, and /). When Num Lock is off, the keys assume cursor and other shortcut functions.
Scroll Lock <Fn> + <F12>	When Scroll Lock is on, the screen moves one line up or down when you press the up or down arrow keys respectively. scroll Lock does not work with some applications.

The embedded numeric keypad functions like a desktop numeric keypad. It is indicated by small characters located on the upper right corner of the keycaps. To simplify the keyboard legend, cursor-control key symbols are not printed on the keys.

Desired access	Num Lock on	Num Lock off
Number keys on embedded keypad	Type numbers in a normal manner.	N/A
Cursor-control keys on embedded keypad	Hold <Shift> while using cursor-control keys.	Hold <Fn> while using cursor-control keys.
Main keyboard keys	Hold <Fn> while typing letters on embedded keypad.	Type the letters in a normal manner.

# Windows keys





The keyboard has two keys that perform Windows-specific functions.









Key	Icon	Description
Windows key		<p>Press alone. This key has the same effect as clicking on the Windows Start button. It launches the Start menu. It can also be used with other keys to provide a variety of functions:</p> <ul style="list-style-type: none"> <li> + &lt;Tab&gt;: Activates the next Taskbar button.</li> <li> + &lt;E&gt;: Opens the My Computer window.</li> <li> + &lt;F1&gt;: Opens Help and Support.</li> <li> + &lt;F&gt;: Opens the Find (All Files dialog box).</li> <li> + &lt;R&gt;: Opens the Run dialog box.</li> <li> + &lt;M&gt;: Minimizes all windows.</li> <li>&lt;Shift&gt; +  + &lt;M&gt;: Undoes the minimize all windows action.</li> </ul>
Application key		This key has the same effect as clicking the right mouse button. It opens the application's context menu.

# Hotkeys

The computer employs hotkeys or key combinations to access most of the computer's controls like screen brightness, volume output and the BIOS utility. To activate hotkeys, press and hold the <Fn> key before pressing the other key in the hotkey combination.



Hot Key	Icon	Function	Description
<Fn> + <F1>		Hot key help	Displays help on hotkeys.
<Fn> + <F2>		Acer eSettings	Launches the Acer eSettings in Acer Empowering Technology.
<Fn> + <F3>		Acer ePower Management	Launches the Acer ePower Management in Acer Empowering Technology.
<Fn> + <F4>		Sleep	Leads the computer to Sleep mode.

Hot Key	Icon	Function	Description
<Fn> + <F5>		Display toggle	Switches the display output between the display screen, external monitor (if connected) and both.
<Fn> + <F6>		Screen blank	Turns off the display screen backlight to save power. Press any key to return.
<Fn> + <F7>		Touchpad toggle	Turns the internal touchpad on and off.
<Fn> + <F8>		Speaker toggle	Turns the speakers on and off.
<Fn> + <↑>		Volume up	Increases the sound volume.
<Fn> + <↓>		Volume down	Decreases the sound volume.
<Fn> + <→>		Brightness up	Increases the screen brightness.
<Fn> + <←>		Brightness down	Decreases the screen brightness.

## Special keys

You can locate the Euro symbol and the US dollar sign on the upper-center and/or bottom-right side of the keyboard.

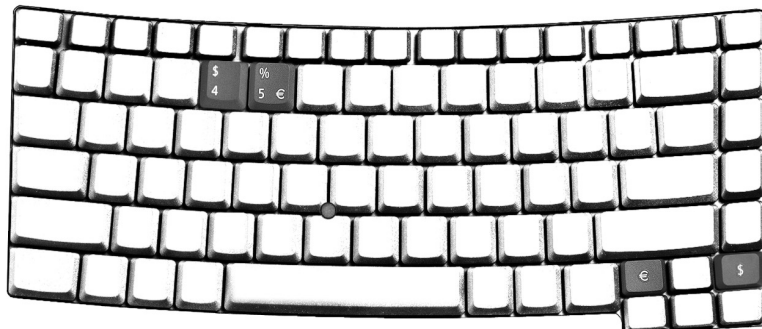

### The Euro Symbol

1. Open a text editor or word processor.
2. Either press Euro key on the bottom-right edge of the keyboard, or hold **<Alt Gr>** key then press the number **<5>** key on the upper-center edge of the keyboard.

**Note:** Some fonts and software do not support the Euro symbol. Please refer to [www.microsoft.com/typography/faq/faq12.htm](http://www.microsoft.com/typography/faq/faq12.htm) for more information.

### The US Dollar Sign

1. Open a text editor or word processor.
2. Either press Dollar key on the bottom-right edge of the keyboard, or hold **<Shift>** and then press the **<4>** key on the upper-center edge of the keyboard.

**Note:** This function varies according to the language settings.

---

# Acer OrbiCam

The Acer OrbiCam is a 1.3 megapixel CMOS camera appropriately mounted on top of the LCD panel. The camera's 225-degree ergonomic rotation allows you to capture high-resolution photos or videos up front or at the back of the LCD panel. The Acer OrbiCam fully supports the Acer Video Conference technology so you transmit the best video conference quality over an instant messenger service.

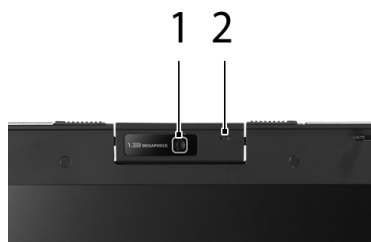

#	Item
1	Lens
2	Power indicator

## Rotating the Acer OrbiCam

The Acer OrbiCam rotates 225 degrees counterclockwise to achieve the desired angle. Refer to the illustrations below:



**Note:** Do NOT rotate the camera clockwise to prevent damage to the device.

For your convenience, the camera snaps 45 degrees to match the position of your face in front or at the back of the LCD panel.



---

# Launching the Acer OrbiCam

To launch the Acer OrbiCam, double-click on the Acer OrbiCam icon on the desktop, or click Start > All Programs > Acer > Acer OrbiCam. The Acer OrbiCam capture window will appear as below.



## Changing the Acer OrbiCam Settings

### Resolution

To change the capture resolution, click the displayed resolution at the bottom right corner of the capture window, then select the desired resolution.

**Note:** Setting the camera resolution to 640 x 480 or larger does not change the capture window size.

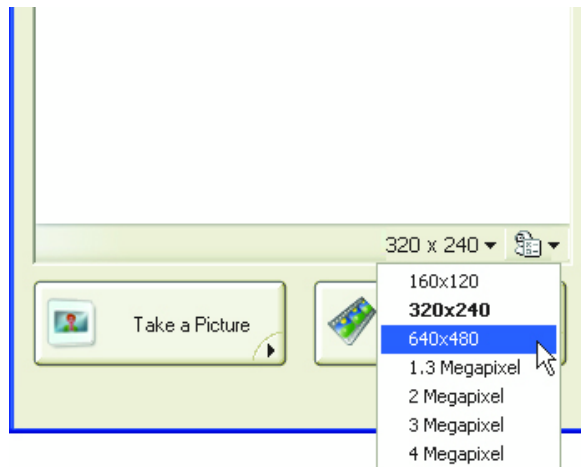

---

## Options

Click **Options** to display the **Window**, **Preview**, and **Folder** tabs. Use the options to change the capture window size, preview settings, and the folder for captured photos or videos.

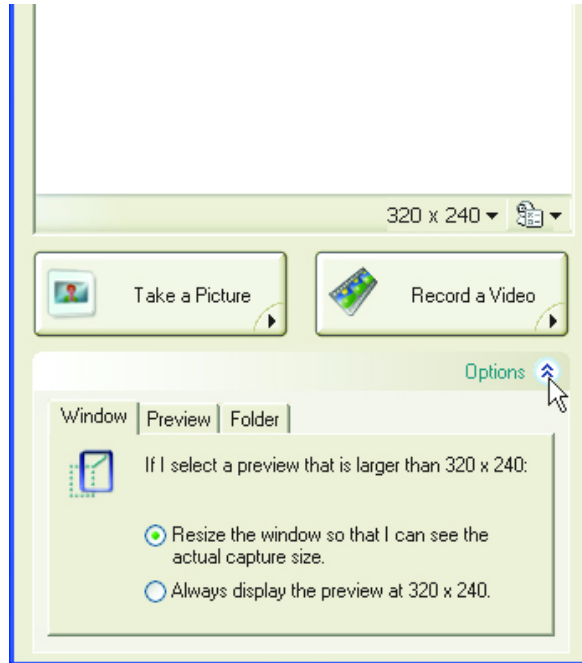

---

## Camera Settings

### Basic Settings

Click the Camera Settings icon on the bottom right corner of the capture display, then select **Camera Settings** from the pop-up menu. You can adjust the **Video**, **Audio**, and **Zoom/Face tracking** options from this window.

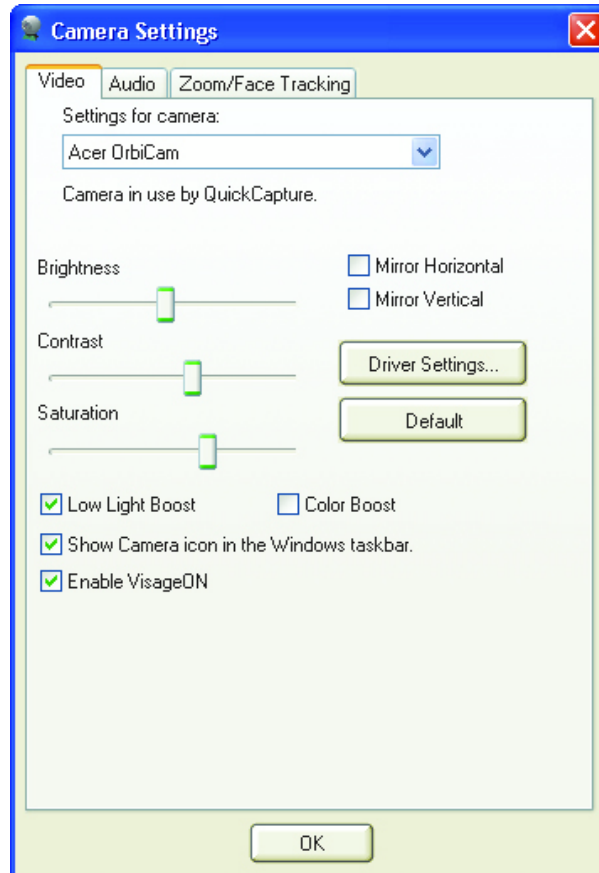

## Capture Settings

From the Camera Settings window, click the **Driver Settings** button. The **Properties** window will appear.

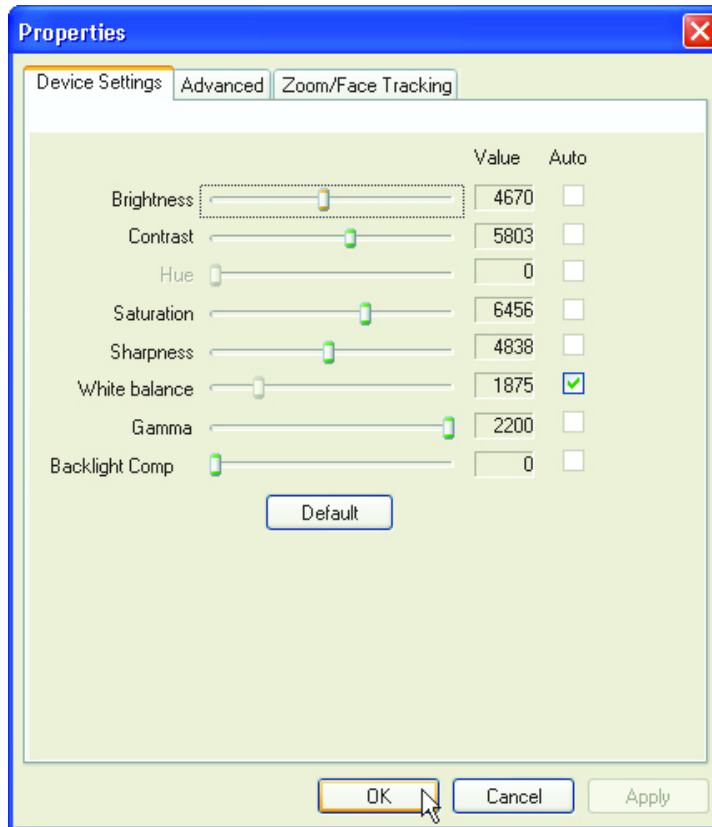

**Device Settings** allows you to change the camera brightness, contrast, hue, saturation, sharpness, etc.

**Advanced Settings** allows you to achieve gain control, implement image mirror, select image enhancements and anti-flicker settings, and turn on/off the camera indicator.

**Zoom/Face Track Settings** allows you to adjust the zoom level and turn the face tracking feature on or off.

## Capturing Photos/Videos

To capture a photo or a video clip, rotate the Acer OrbiCam to get the desired angle, then click the **Take a Picture** or **Record a Video** button. The **Windows Picture and Fax Viewer** or the **Windows Media Player** automatically launches to display or play a preview of the photo/video clip.

**Note:** By default, all photos and videos are saved in the **My Pictures** and **My Videos** folder.

---

## Using the Acer OrbiCam as Webcam

The Acer OrbiCam is automatically selected as the capture device of any instant messenger (IM) application. To use the Acer OrbiCam as a webcam, open the IM service, then select the video/webcam feature. You can now broadcast from your location to an IM partner anywhere in the world.

## Enabling the Acer VisageON (for 1.3 megapixel camera models only)

The **Acer VisageON** technology comes with two features: **Face tracking**. The face tracking feature tracks your head movement and automatically centers your face in the capture window.

**Note:** The face tracking feature is not capable of centering your face beyond the capture window frame. Minimal head movements are tracked more efficiently.

Please follow the steps below to enable the Acer VisageON.

1. Right click on this icon, then select **VisageON** from the pop-up menu.

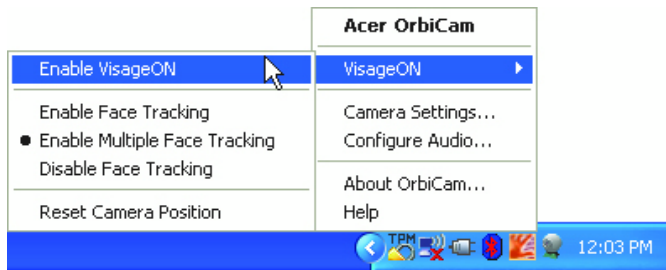

The VisageON window will appear as below:



2. Select and apply a video effect in the left section of the VisageON window. Change the face tracking settings and options in the right section.

## Using the Face Tracking Feature

To use the face tracking feature:

1. Click the left icon down arrow button, then select Single User or Multiple Users from the pop-up menu. For multiple users, the face tracking feature automatically centers all the users' face in the capture window, otherwise the utility centers the face of the user closest to the camera.

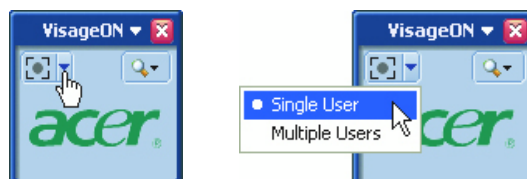

2. Click the right icon to zoom in/out or reset the current view.

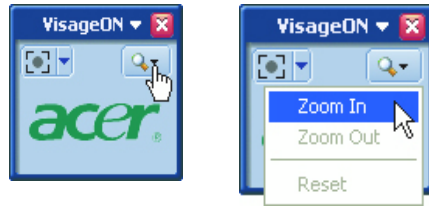

3. Click VisageON to display a menu that allows to change the configuration of the camera, face tracking and video effects settings.

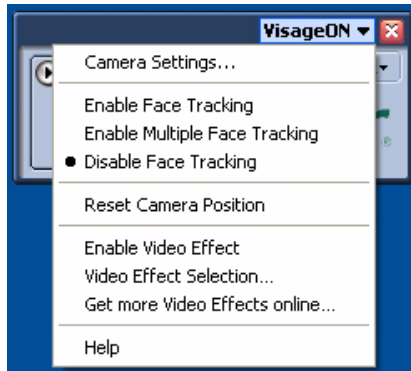

---

# Acer Empowering Technology

Acer's innovative Empowering Technology toolbar makes it easy to have access to the frequently used functions and manage the notebook. Displayed by default in the upper-right corner of the screen, it features the following handy utilities:

- Acer eNet Management hooks up to location-based networks intelligently.
- **Acer ePower Management** extends battery power via versatile usage profiles.
- **Acer ePresentation Management** connects to a projector and adjusts display settings conveniently.
- **Acer TPM-based eDataSecurity Management** protects data with passwords and advanced encryption algorithms in TPM.
- Acer eLock Management limits access to external storage media and removable data devices.
- **Acer eRecovery Management** backs up and recovers data flexibly, reliably and completely.
- **Acer eSettings Management** accesses system information and adjusts settings easily.
- **Acer ePerformance Management** improves system performance by optimizing disk space, memory and registry setting.



For more information, right click on the Empowering Technology toolbar, then select the Help or Tutorial function.

## Empowering Technology Password

Before using Acer eLock Management and Acer eRecovery Management, You must initialize the Empowering Technology password. Right click on the Empowering Technology toolbar and select **Password Setup** to do so. If you do not initialize the Empowering Technology password, you will be prompted to do so when running Acer eLock Management or Acer eRecovery Management for the first time.

**Note:** If you lose your password, there is no method to reset it except by reformatting your notebook or taking your notebook to an Acer Customer Service Center. Be sure to remember or write down your password.

# Acer eNet Management

Acer eNet Management helps you to quickly and easily connect to both wired and wireless networks in a variety of locations. To access this utility, either click on the **Acer eNet Management** icon on your notebook, or start the program from the Start menu. You also have the option to set Acer eNet Management to start automatically when you boot up your PC.

Acer eNet Management automatically detects the best settings for a new location, while offering you the freedom to manually adjust the settings to meet your needs.

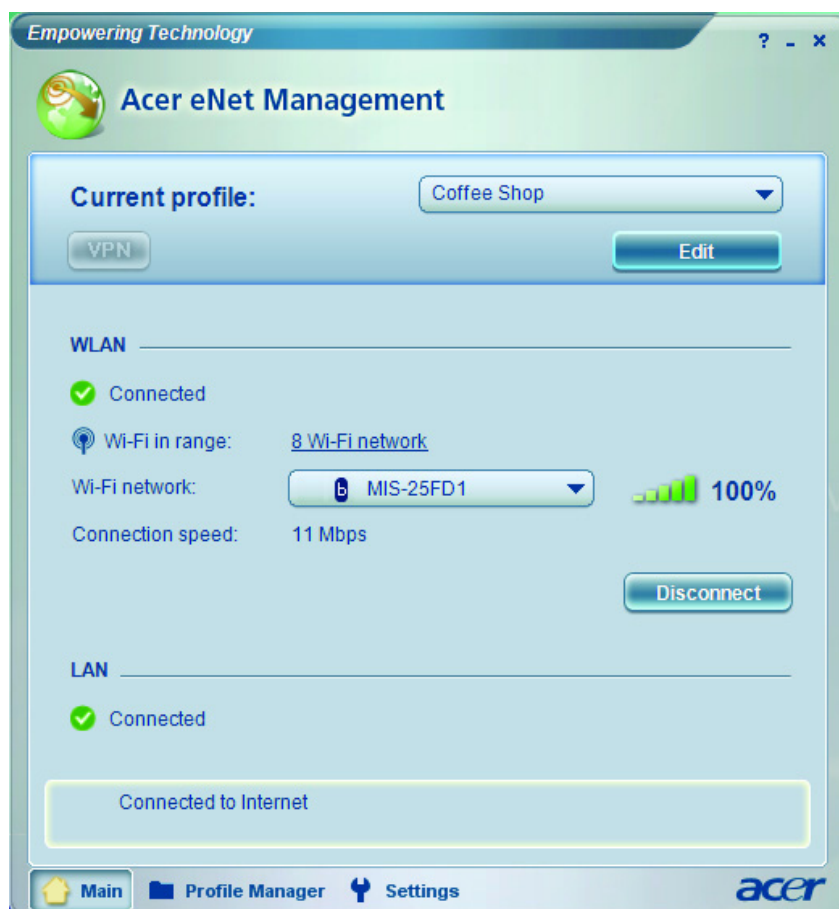

Acer eNet Management can save network settings for a location to a profile, and automatically switch to the appropriate profile when you move from one location to another. Settings stored include network connection settings (IP and DNS settings, wireless AP details, etc.), as well as default printer settings.

Security and safety concerns mean that Acer eNet Management does not store username and password information.



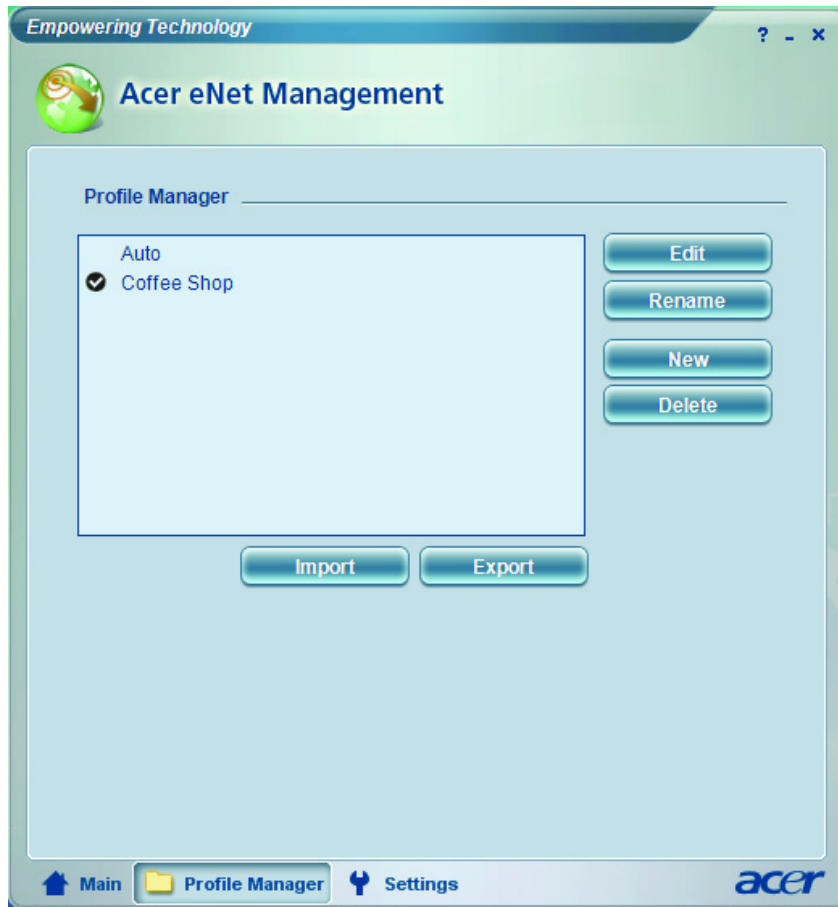

## Acer ePower Management

Acer ePower Management features a straightforward user interface. To launch it, select Acer ePower Management from the Empowering Technology interface.

### AC Mode (Adapter Mode)

The default setting is Maximum Performance. You can adjust CPU speed, LCD brightness and other settings, or click on buttons to turn the following functions on/off: wireless LAN, Bluetooth, CardBus, firewire (1394), wired LAN and optical device if supported.

### DC Mode (Battery Mode)

There are four pre-defined profiles: Entertainment, Presentation, Word Processing, and Battery Life. You can also define up to three of your own.

### To Create a New Power Profile

1. Change power settings as desired.
2. Click **Save as...** to save to a new power profile.
3. Name the newly created profile.
4. Select whether this profile is for Adapter or Battery mode, then click **OK**.
5. The new profile will appear in the profile list.

### Battery Status

For real-time battery life estimates based on current usage, refer to the panel on the upper half side of the window.



For additional options, click **Settings** to:

- Set alarms.
- Reload factory defaults.
- Select what actions to be taken when the cover is closed or the power button is pressed.
- Set passwords for accessing the system after Hibernation or Stand-by.
- View information about Acer ePower Management.



# Acer ePresentation Management

Acer ePresentation Management lets you project your computer's display to an external device or projector using the hotkey: <Fn> + <F5>. If auto-detection hardware is implemented in the system and the external display supports it, your system display will be automatically switched out when an external display is connected to the system. For projectors and external devices that are not auto-detected, launch Acer ePresentation Management to choose an appropriate display setting.

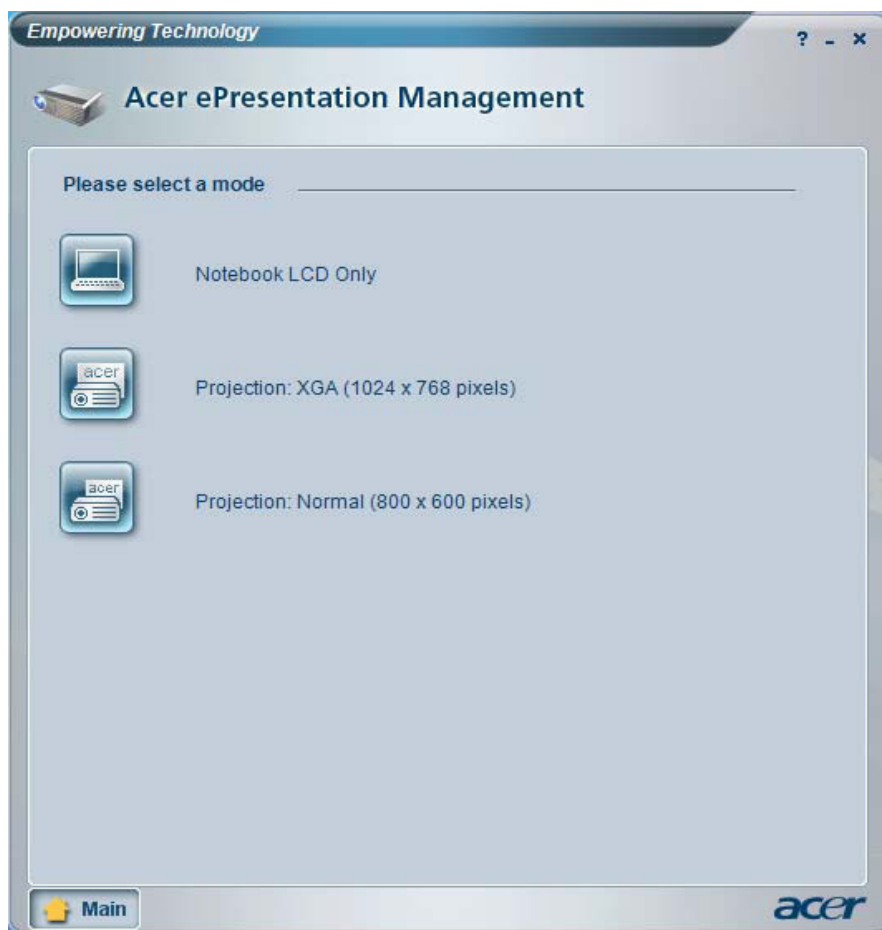

**Note:** If the restored resolution is not correct after disconnecting a projector, or you need to use an external resolution that is not supported by Acer ePresentation Management, adjust your display settings using Display Properties or the utility provided by the graphics vendor.

---

## Acer TPM-Based eDataSecurity Management

Acer TPM-based eDataSecurity Management is a handy file encryption utility that protects the files from being accessed by unauthorized persons. It is conveniently integrated with Windows Explorer as a shell extension for quick and easy data encryption/decryption and also supports on-the-fly file encryption for MSN Messenger and Microsoft Outlook.

The Acer eDataSecurity Management setup wizard will prompt you for a supervisor password and default encryption. This encryption will be used to encrypt files by default, or you can choose to enter your own file-specific password when encrypting a file.

Acer eDataSecurity Management can be integrated with TPM on computers equipped with the TPM hardware. On computers equipped with the TPM hardware, there will be additional Acer eDataSecurity Management system setup and administration procedures which allow the user to utilize TPM for the PSD and the File/Folder encryption functions. If the **Use TPM** option is selected during Acer eDataSecurity Management's initial system setup or system administration, the PSD and the File/Folder encryption functions will be protected by TPM.



**Note:** The password used to encrypt a file is the unique key that the system needs to decrypt it. If you lose the password, the supervisor password is the only other key capable of decrypting the file. **If you lose both passwords, there will be no way to decrypt your encrypted file! Be sure to safeguard all related passwords!**

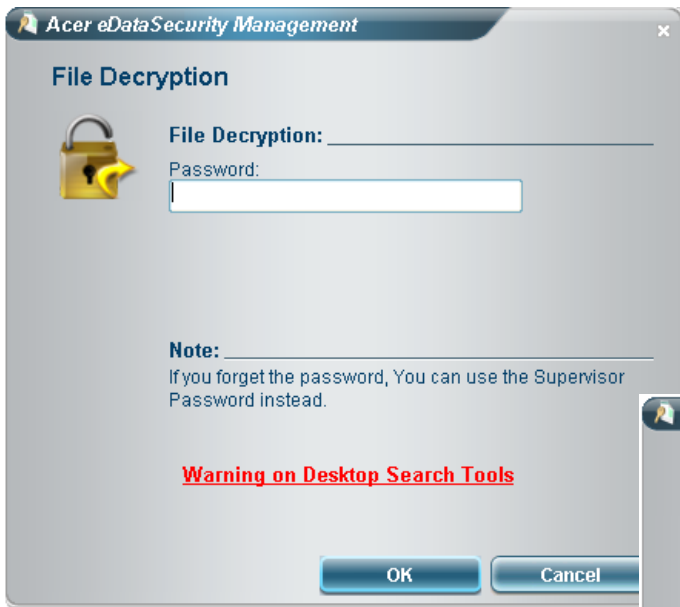
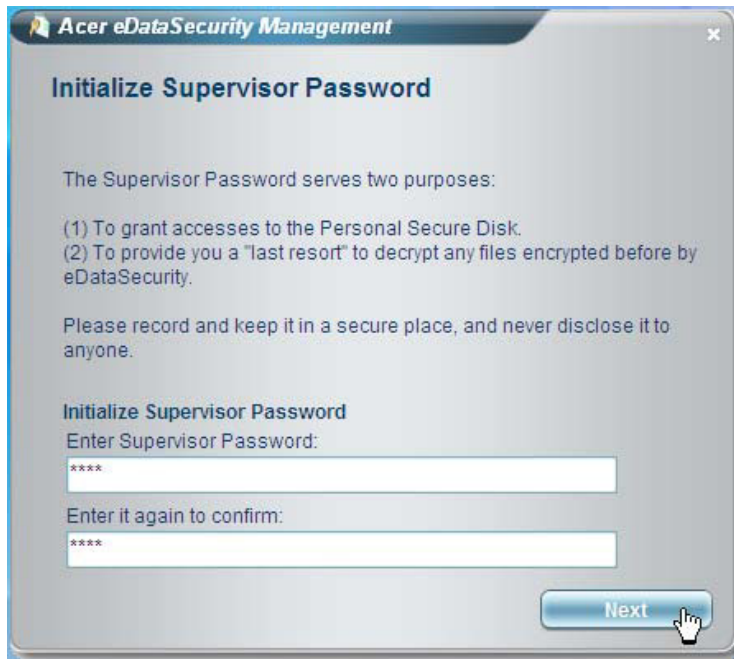

# Acer eRecovery Management

Acer eRecovery Management is a powerful utility with the need for recovery disks provided by the manufacturer. The Acer eRecovery Management utility occupies space in a hidden partition on the system's HDD. By default, user-created backups are stored on D:\ drive. Acer eRecovery Management provides:

- Password protection
- Recovery of applications and drives
- Image or data backup:
  - Backup to HDD (set recovery point)
  - Backup to CD or DVD
- Image/data recovery tools:
  - Recovery from a hidden partition (factory defaults)
  - Recovery from the HDD (most recent user-defined recovery point)
  - Recovery from CD or DVD

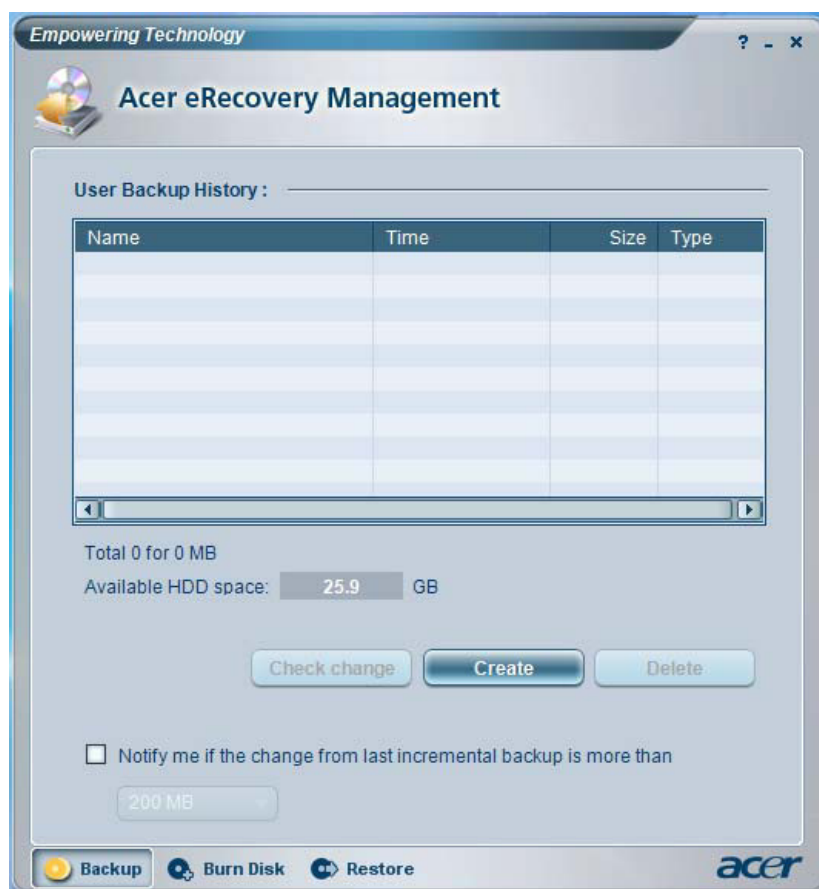

**Note:** If the computer did not come with a Recovery CD or System CD, please use Acer eRecovery Management's **System backup to optical disk** feature to burn a backup image to CD or DVD. To ensure the best results when recovering the system using a CD or Acer eRecovery Management, detach all peripherals (except external Acer ODD, if equipped), including the Acer ezDock.

# Acer eSettings Management

Acer eSettings Management allows you to inspect hardware specification, change BIOS passwords or other Windows settings, and to monitor the system health status.

Acer eSettings Management also:

- Provides a simple graphical user interface for navigation.
- Displays general system status and advanced monitoring for power users on Acer computer.





---

# Acer ePerformance Management

Acer ePerformance Management is a system optimization tool that boosts the performance of the Acer notebook. It provides an express optimization method to release unused memory and disk space quickly. The user can also enable advanced options for full control over the following options:

- Disk optimization: removes unneeded items and files.
- Speed optimization: improves the usability and performance of the Windows XP system.
- Memory optimization: releases unused memory and check usage.



# Using the System Utilities

**Note:** The system utilities work under Microsoft Windows XP only.

## Acer GridVista (dual-display compatible)

**Note:** This feature is only available on certain models.

To enable the dual monitor feature of the notebook, first ensure that the second monitor is connected, then select **Start, Control Panel, Display** and click on **Settings**. Select the secondary monitor (**2**) icon in the display box and then click the check box **Extend my windows desktop onto this monitor**. Finally, click **Apply** to confirm the new settings and click **OK** to complete the process.

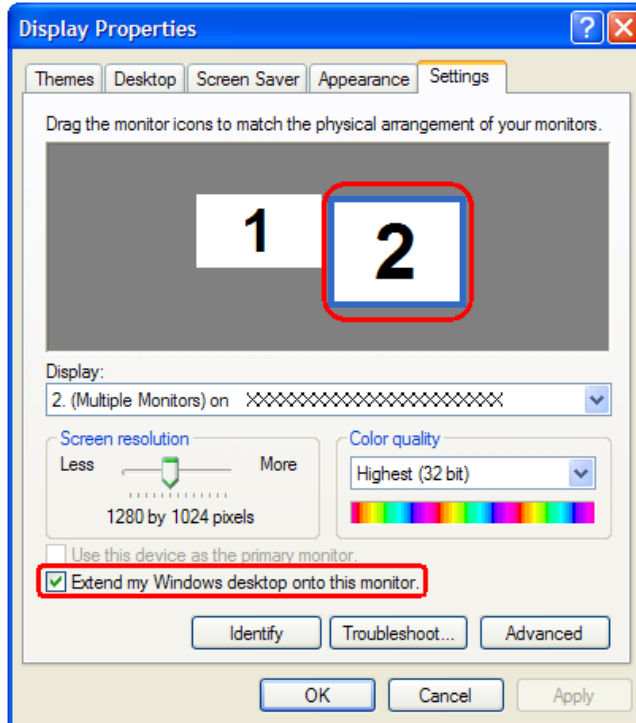

Acer GridVista is a handy utility that offers four pre-defined display settings so you can view multiple windows on the same screen. To access this function, please go to **Start > All Programs** and click on **Acer GridVista**. You may choose any one of the four display settings indicated below:



Double (vertical), Triple (primary at left), Triple (primary at right), or Quad

Acer GridVista is dual-display compatible, allowing two displays to be partitioned independently. Acer GridVista is simple to set up:

1. Run Acer GridVista and select your preferred screen configuration for each display from the task bar.
2. Drag and drop each window into the appropriate grid.
3. Enjoy the convenience of a well-organized desktop.

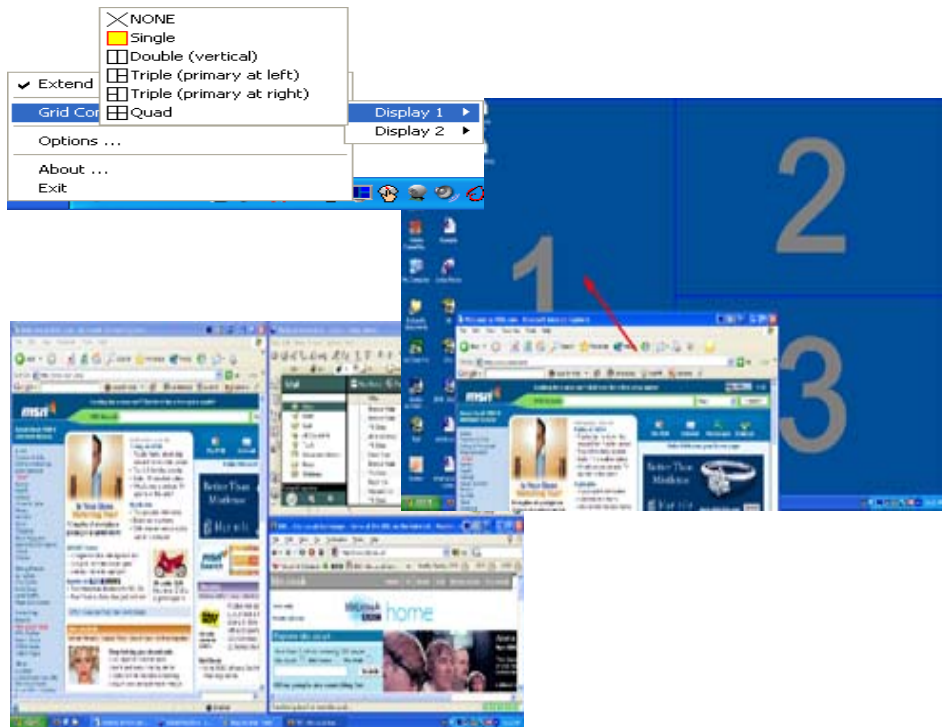

**Note:** Please ensure that the resolution setting of the second monitor is set to the manufacturer's recommended value.

## Launch Manager

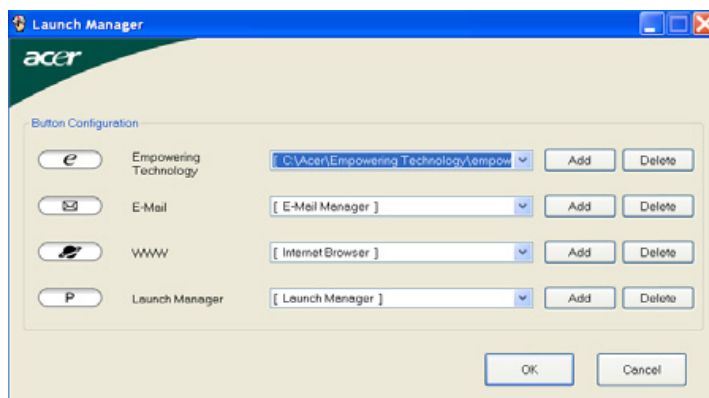

Launch Manager allows you to set the four easy-launch buttons located above the keyboard. You can access the Launch Manager by clicking on Start > All Programs > Launch Manager to start the application.

---

# Norton AntiVirus

Norton AntiVirus is an anti-virus software that finds and repairs infected files, and protects against viruses to keep you computer data safe and secure.

## How do I check for viruses?

A Full System Scan scans all files on your computer. To perform a system scan:

1. Start Norton Antivirus: Double click on the **Norton AntiVirus** Icon on the desktop or click on the **Start** menu in the Windows task bar, highlight **Programs**, and select **Norton Antivirus**.
2. In the Norton Antivirus main window, click **Scans**.

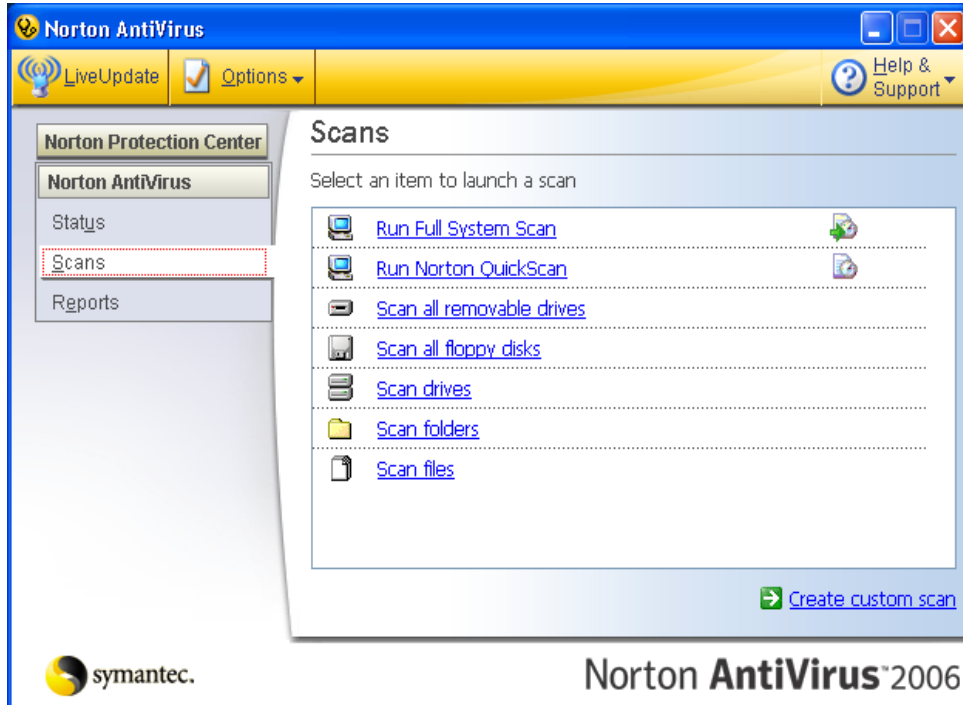

3. In the **Scans** panel, click **Run Full System Scan**.
4. When the scan is complete, a scan summary appears. Click **Finished**.

You can schedule customized virus scans that run unattended on specific dates and times or at periodic intervals. If you are using the computer when the scheduled scan begins, it runs in the background so that you do not have to stop working.

For more information, please refer to the Norton AntiVirus Help menu.

# Hardware Specification and Configuration

## Processor

Item	Specification
Type	Intel® Core™ 2 Duo processor T7200/T7400/T7600 (4MB L2 cache, 2/2.16/2.33GHz, 667MHz FSB), or T5500/T5600 (2MB L2 cache, 1.66/1.83GHz, 667MHz FSB), supporting Intel® Extended Memory 64 Technology (Intel® EM64T)
Feature	<ul style="list-style-type: none"> <li>• Dual core processor for mobile with enhanced performance</li> <li>• Intel® 64 architecture</li> <li>• Intel Architecture with Dynamic Execution support</li> <li>• On-die, primary 32KB instruction cache and 32KB write-back data cache per core</li> <li>• On-die, up to 4MB second level shared cache with Advanced Transfer Cache Architecture</li> <li>• Data Prefetch Logic</li> <li>• Streaming SIMD Extensions 2 (SSE2), Streaming SIMD Extensions 3 (SSE3) and Supplemental Streaming SIMD Extensions 3 (SSSE3)</li> <li>• 667MHz, Source-Synchronous FSB for Standard Voltage processors</li> <li>• Advanced Power Management features including Enhanced Intel SpeedStep® Technology</li> <li>• Intel® Enhanced Deeper Sleep state and Dynamic Cache Sizing</li> <li>• Digital Thermal Sensor</li> <li>• Micro-FCPGA and Micro-FCBGA packaging technologies</li> <li>• Intel® Visualization Technology</li> <li>• Execute Disable Bit support for enhanced security</li> </ul>

## North Bridge

Item	Specification
Chipset	Intel® 945GM/PM
Feature	<ul style="list-style-type: none"> <li>• 667/533MHz Front Side Bus: Intel® Core™ Duo and Intel® Core™ Solo processors with up to 25% faster data transfer rate compared to the previous generation bus speed</li> <li>• Two SODIMMs up to 4GB max. system memory</li> <li>• Memory Type: DDR2 667/533MHz</li> <li>• Memory Channels: dual/single channel</li> <li>• ECC Parity: No for both</li> <li>• Integrated Graphics: Intel GMA 950 for 945GM only</li> <li>• PCI Express x16 Interface: delivers greater than 3.5 times the bandwidth over the traditional AGP interface and supports the latest high performance graphics cards.</li> <li>• Integrated TV out for 945GM only</li> <li>• LVDS: up to UXGA (1600 x 1200) for 945GM only</li> <li>• Dual Display Options: concurrent/simultaneous</li> <li>• Intel® High Definition (HD) Audio 24 bits 192KHz, AC'97 2.3 audio, integrated audio support enables premium sound and delivers advanced features such as multiple audio streams and jack re-tasking.</li> <li>• Integrated high speed USB 2.0: supports for eight USB 2.0 peripherals</li> <li>• North Hub Package: 1466 FCBGA 37.5 mm x 37.5 mm</li> <li>• South Hub Package: 652 FCBGA 31 mm x 31 mm</li> </ul>

## South Bridge

Item	Specification
Chipset	ICH7M
Feature	<ul style="list-style-type: none"> <li>• Direction Media Interface 10GB/s each direction, full duplex</li> <li>• Four PCI Express root ports, PCI Express 1.0a support</li> <li>• PCI 2.3 specification at 33MHz</li> <li>• Bus master IDE controller (Ultra 100/66/33 support)</li> <li>• Integrated Serial ATA controller</li> <li>• USB 2.0 host controllers</li> <li>• Compliant with AC'97 2.3 interface</li> <li>• Intel® Matrix Storage Technology: configures the ICH7 SATA controller as a RAID controller supporting RAID 0/1</li> <li>• AC'97 2.3 Codec support</li> <li>• Low pin count (LPC) interface</li> <li>• Enhanced DMA controller, two cascaded 8237 DMA controllers, LPC DMA support</li> <li>• ACPI 3.0 Power management</li> </ul>

## System Memory

Item	Specification
Feature	<ul style="list-style-type: none"> <li>• Built-in 945GM/PM</li> <li>• DDRII 533/667MHz SDRAM memory interface design</li> <li>• 0MB DDR RAM on board</li> <li>• Two SODIMMS slots</li> <li>• Maximum memory up to 4GB (with two 2GB SODIMMs)</li> </ul>

## BIOS

Item	Description
Vendor	Phoenix
Version	0.94.06
ROM type	Flash ROM
Feature	<ul style="list-style-type: none"> <li>• Acer UI support</li> <li>• Multi-boot support</li> <li>• Suspend to RAM (S3) / Disk (S4)</li> <li>• Various hot keys for system control</li> <li>• Support boot option: HDD / Removable device (media bay device) / all USB ports</li> <li>• Support protocols: SMBIOS 2.4, PCI 2.2, WFM 2.0</li> <li>• ACPI 2.0 compliance with Speedstep, C1, C2, C3, C4 and S3, S4 support for mobile CPU</li> <li>• DMI utility for BIOS serial number configurable/asset tag</li> <li>• PXE support</li> <li>• BIOS virus protection</li> <li>• WinFlash support</li> <li>• Wake on LAN from S3</li> <li>• Wake on LAN from S4 and S5 in AC mode</li> <li>• TPM 1.2 BIOS support</li> <li>• D to D recovery support</li> </ul>

## Keyboard

Item	Description
Chip	KBC1122
Features	<ul style="list-style-type: none"><li>• 88/89 keys</li><li>• Windows logo key: yes</li><li>• Internal and external keyboard work simultaneously: plug USB keyboard to the USB port directly support</li></ul>

## Modem

Item	Description
Features	<ul style="list-style-type: none"><li>• 56K, V.90/V.92, WWDA</li><li>• Wake-on-Ring support</li><li>• Apply CISPR22</li><li>• MDC 1.5 card</li></ul>
Connector type	RJ-11

## Audio Codec & Amplifier

Item	Description
Controller	Realtek ALC883D
Feature	<ul style="list-style-type: none"><li>• HD audio</li><li>• SNR &gt; 85, high-performance DACs with 95dB SNR (A-weighting), ADCs with 85dB SNR (A-weighting)</li><li>• Internal microphone</li><li>• Two speakers, at least 1.5W/30cc for each</li></ul>

## Wireless LAN

Item	Description
Controller	ICH7M
Card type	Mini-PCI
Features	<ul style="list-style-type: none"><li>• 802.11a/b/g or 802.11b/g</li><li>• Built-in two antennae</li><li>• WiFi, WPA2, WMM</li><li>• CCX V4 and above</li><li>• Placed on the top of LCD or on the sides of LCD latches</li></ul>

## LAN Interface

Item	Description
LAN controller	BCM5787MKMLG
Feature	<ul style="list-style-type: none"><li>• PCI-E GbE LAN</li><li>• WOL from S5 (AC mode) support</li><li>• LDCM support</li><li>• ASF2.0 support</li></ul>

## IEEE 1394

Item	Description
Controller	TSB43AB22

Item	Description
Feature	<ul style="list-style-type: none"> <li>• PCI single chip solution with PCI 2.2 compliant</li> <li>• OHCI V1.1</li> <li>• 4-pin IEEE 1394</li> </ul>

## PCMCIA Express Card & Express Card

Item	Description
Chip	OZ601 + OZ27 C10
Feature	<ul style="list-style-type: none"> <li>• One type II PC card</li> <li>• PCI-Express narrow type card</li> </ul>

## VRAM

Item	Description
Chip	ATI M54P
Feature	<ul style="list-style-type: none"> <li>• GDDR2 VRAM speed <math>\geq</math> 350MHz</li> <li>• Discrete 64MB/128MB with Hyper Memory technology, up to 512 MB in OS</li> <li>• UMA: DVMT3.0, up to maximum DVMT (default 64MB)</li> </ul>

## Hard Disk Drive

SEAGATE				
Model				
ST9160821AS	ST9120821AS	ST9100824AS	ST98823AS	ST96812AS
Formatted Gbytes (512 bytes/sector): 160 / 120 / 100 / 80 / 60				
Physical read/write head: 4 / 4 / 4 / 3 / 2				
Discs: 2 / 2 / 2 / 1 / 1				
Spindle Speed (RPM): 5400 / 5400 / 5400 / 5400 / 5400				
I/O data transfer rate (Mbytes/sec. max.): 150 / 150 / 150 / 150 / 150				
Internal transfer rate (Mbytes/sec. max.): 57.6 / 57.6 / 57.6 / 57.6 / 57.6				
ATA data transfer mode supported: SATA 1.0, SATA II, PIO modes 0-4, Multiword DMA modes 0-2, Ultra DMA modes 0-6				
Cache buffer: 8MB				
Bytes per sector: 1024 / 1024 / 1024 / 1024 / 1024				
Voltage tolerance: +5.0V +/- 5%				

TOSHIBA		
Model		
MK1234GSX	MK1032GSX	MK8032GSX
Formatted Gbytes (512 bytes/sector): 120 / 100 / 80		
Physical read/write head: 4 / 4 / 4		
Discs: 2 / 2 / 2		
Spindle Speed (RPM): 5400 / 5400 / 5400		
Internal transfer rate (Mbytes/sec. max.): 244.7~474.4 / 236.1~456.0 / 214~422		
I/O data transfer rate (Mbytes/sec. max.): 150 / 150 / 150		
ATA data transfer mode supported: ATA7, SATA 1.0a, SATA II 1.2, Multi word DMA, Ultra DMA modes, Advanced PIO mode settings and commands		



TOSHIBA			
Cache buffer (MB): 8 / 16 / 8			
Bytes per sector: 512 / 512 / 512			
Voltage tolerance: +5.0V +/- 5%			

HGST			
Model			
HTS541616J9SA00	HTS541010G9SA00	HTS541080G9SA00	HTS541060G9SA00
Formatted Gbytes: 160 / 100 / 80 / 60			
Physical read/write head: 4 / 4 / 4 / 3			
Discs: 2 / 2 / 2 / 2			
Spindle Speed (RPM): 5400 / 5400 / 5400 / 5400			
Internal transfer rate: N/A			
I/O data transfer rate: 150 (MB/sec.) / 493 (Mbps) / 493 (Mbps) / 493 (Mbps)			
ATA data transfer mode supported: N/A			
Cache buffer (MB): 8 /			
Bytes per sector: 512 / 512 / 512 / 512			
Voltage tolerance: +5.0V +/- 5%			

WD			
Model			
WD1200BEVS	WD1000BEVS	WD800BEVS	WD600BEVS
Formatted Gbytes: 120 / 100 / 80 / 60			
Interface: SATA 150MB/s			
RoHS compliant: Yes / Yes / Yes / Yes			
Spindle Speed (RPM): 5400 / 5400 / 5400 / 5400			
Average read seek: 12.0 ms (average)			
Track-to-track seek: 2.0 ms (average)			
Average latency: 5.5 ms			
Cache buffer (MB): 8 / 8 / 8 / 8			
Bytes per sector: 512 / 512 / 512 / 512			
Voltage tolerance: +5.0V +/- 5%			

## Optical Disk Drive: Combo 24X

Item	Description	
Model	PHILIPS SCB5265	PANASONIC UJDA-770
Buffer memory	2MB	2MB
Interface	IDE/ATAPI interface (compliant to ATA/ATAPI-5)	ATAPI interface (PIO mode, DMA mode, Ultra DMA mode)
Applicable disc format	<ul style="list-style-type: none"> <li>DVD (read): DVD 5, 9, 10, 18, DVD-ROM, DVD-Video, DVD-R 4.7GB, DVD-R 3.95GB, DVD-RW, DVD+R, DVD+RW, Multi-Border DVD-R/DVD-RW, Multi-Session DVD+R, DVD+RW, DVD-RAM</li> <li>CD (read): CD-DA, CD-ROM Mode-1, CD-ROM/XA Mode-2 Form-1 and Mode-2 Form-2, CD-i ready, Video-CD (MPEG-1), Karaoke CD, Super Video CD, Photo-CD, Enhanced CD, CD Plus, CD Extra, i-tax CD, CD-Text, CD-R, CD-RW</li> <li>CD (write): CD-DA, CD-ROM Mode-1, CD-ROM/XA Mode-2 Form-1 and Mode-2 Form-2, CD-i, Video-CD, CD-Text</li> </ul>	<ul style="list-style-type: none"> <li>DVD: DVD-ROM, DVD-Video, DVD-RAM (2.6GB/4.7GB), DVD-R, DVD-RW (Ver. 1.1, Multi-Border support), DVD+RW, DVD+R</li> <li>CD: CD-DA, CD-ROM, CD-R, CD-RW, CD-ROM XA, Photo (Multi-Session), Video CD, CD-Extra (CD+), CD-text</li> </ul>
Power requirement	max. 1300mA	max. 1800mA
Input voltage	+5V +/- 5% (Operating)	5V +/- 0.25V (operating)

## Optical Disk Drive: DVD Super Multi 8X

Item	Description		
Model	TSST TS-L632D	PANASONIC UJ850 UAA	8X Super Multi (DL) PHILIPS SDVD-8821
Buffer memory	2MB	2MB	2MB
Interface	IDE/ATAPI interface (compliant to ATA/ATAPI-5)	ATAPI interface (PIO mode, DMA mode, Ultra DMA mode)	IDE/ATAPI interface (compliant to ATA/ATAPI-5)

Item	Description		
Applicable disc format	<p>Media Compatibility</p> <ul style="list-style-type: none"> <li>DVD: 5/9/10/18 G DVD-Single / Dual (read only), 4.7GB DVD+R (read &amp; write), 4.7GB DVD-R (read &amp; write), 4.7GB DVD+RW (read &amp; write), 4.7GB DVD-RW (read &amp; write), DVD+R dual (read &amp; write), DVD-R dual (read &amp; write), DVD-RAM (read &amp; write), 80mm DVD</li> <li>CD: 650MB CD-ROM (read only), 80 mm CD, 800/700/650 CD-R (read &amp; write), 700/650MB CD-RW (read &amp; write), 700/650MB High Speed CD-RW (read &amp; write), 700/650MB Ultra &amp; Ultra+ speed CD-RW (read &amp; write)</li> </ul> <p>Format Compatibility</p> <ul style="list-style-type: none"> <li>DVD: DVD-ROM, DVD-Dual, DVD-Video, 3.9G DVD-R, 4.7G DVD-R, DVD+R, DVD+RW, DVD-RW, DVD+R dual, DVD-R dual, DVD-RAM</li> <li>CD: CD-DA, CD-ROM, CD-ROM XA photo CD, CD-ROM Multi-Session, CD-I, CD Plus, CD Extra, Video-CD, CD-R, CD-RW &amp; HSRW Super Audio CD, US &amp; US+RW</li> </ul>	<ul style="list-style-type: none"> <li>DVD: DVD-Video, DVD-ROM, DVD-R (3.9GB, 4.7GB), DVD-R DL, DVD-RW (Ver. 1.1), DVD-RAM, DVD+R, DVD+R DL, DVD+RW, DVD-R 3.9GB (read only), DVD-RAM 2.6GB (read only)</li> <li>CD: CD-DA, CD-ROM, CD-ROM XA, Photo CD (Multi-Session), Video CD, CD-Extra, CD-Text</li> </ul>	<ul style="list-style-type: none"> <li>DVD (read): DVD-ROM (DVD-5/9/10/18), DVD-Video, DVD-Audio, SACD (Hybrid), DVD-R, DVD-R DL, DVD-R 3.95GB, DVD-R Authoring, DVD-R Multi-Border, DVD-RW, DVD+R, DVD+R DL, DVD+R Multi-Session, DVD+RW, DVD-RAM V1.0, DVD-RAM V2.1</li> <li>DVD (write): DVD Data &amp; Video</li> <li>CD (read): CD-DA, CD-ROM Mode-1, CD-ROM/XA Mode-2 Form-1 and Mode-2 Form-2, CD-i, CD-i Bridge, Enhanced CD, CD Plus, CD-Extra, i-trax CD, CD-Text, Video-CD (MPEG1), Karaoke CD, CD-R, CD-RW</li> <li>CD (write): CD-DA, CD-ROM Mode-1, CD-ROM/XA Mode-2 Form-1 and Mode-2 Form-2, CD-i, Video-CD, CD-Text</li> </ul>
Power requirement	max. 1600mA	max. 1800 mA	max. 2100mA
Input voltage	+5V +/- 5% (Operating)	+5V +/- 0.25V	5V +/- 5% (Operating)

## LCD 15.4"

Item	Specification	
Vendor & Model name	QDI QD15AL02-01	QDI QD15TL07-01
Screen Diagonal	15.4" WSXGA	15.4" WXGA
Active area	331.2 (W) x 207.0 (H)	331.2 (W) x 207.0 (H)
Display resolution	1680 x 3 (RGB) x 1050	1280 x 3 (RGB) x 800
Display mode	normally white	normally white
Surface treatment	QD15AL02-01 non-glare + Hardness 3H	QD15TL07-01 non-glare + Hardness 3H
Pixel arrangement	RGB vertical stripe	RGB vertical stripe
Pixel pitch (mm)	0.1971 (H) x 0.1971 (V)	0.2588 (H) x 0.2588 (V)
Typical white luminance (cd/m <sup>2</sup> ) also called brightness	200 (typical)	185 (typical)
Contrast ratio	400 (typical)	400 (typical)
Respond time (msec.)	Rise: 6 Decay: 10	Rise: 6 Decay: 10
Normal input voltage of power supply	+3.3V (typical)	+3.3V (typical)
Power consumption (watt)	4.38 (typical)	4.38 (typical)
Weight	585g	585g
Physical size (mm)	344.5 (W) x 222.5 (V) x 6.5 (T)	344.0 (H) x 222.0 (V) x 6.35 (T)
Electrical interface	2 channels LVDS	1 channel LVDS
Color support	262,144 colors	262,144 colors
Item	Specification	
Vendor & Model name	CMO N154I2-L01	CMO N154Z1-L01
Screen Diagonal	15.4" WXGA	15.4" WSXGA
Active area	335.0 (W) x 210.7 (H)	331.2 (W) x 207.0 (H)
Display resolution	1280 x 3 (RGB) x 800	1680 x 3 (RGB) x 1050
Display mode	normally white	normally white
Surface treatment	non-glare + Hard Coating 3H	non-glare + Hard Coating 3H
Pixel arrangement	RGB vertical stripe	RGB vertical stripe
Pixel pitch (mm)	0.2588 (H) x 0.2588 (V)	0.1971 (H) x 0.1971 (V)
Typical white luminance (cd/m <sup>2</sup> ) also called brightness	200 (typical)	185 (typical)
Contrast ratio	400 (typical)	350 (typical)
Respond time (msec.)	Rise: 5 Decay: 11	Rise:4 Decay: 12
Normal input voltage of power supply	+3.3V (typical)	+3.3V (typical)
Power consumption (watt)	4.2 (typical)	4.2 (typical)
Weight	540g	580g
Physical size (mm)	344.0 (W) x 222.0 (H) x 6.2 (D)	344.0 (W) x 222.0 (H) x 6.2 (D)
Electrical interface	30-pin LVDS interface	LVDS
Color support	262,144 colors	262,144 colors

## LCD 15.4"

Item	Specification	
Vendor & Model name	CMO N154C2-L03	AUO B154PW02 V03
Screen Diagonal	15.4" WXGA	15.4" WXGA
Active area	331.56 (H) x 207.225 (V)	331.2 (W) x 207.0 (H)
Display resolution	1440 x 3 (RGB) x 900	1440 x 3 (RGB) x 900
Display mode	normally white	normally white
Surface treatment	anti-glare + hard coating 3H	anti-glare + Hardness 3H
Pixel arrangement	RGB vertical stripe	RGB vertical stripe
Pixel pitch (mm)	0.23025 x 0.23025	0.23025 x 0.23025
Typical white luminance (cd/m <sup>2</sup> ) also called brightness	175 (typical)	250 (typical)
Contrast ratio	400 (typical)	400 (typical)
Respond time (msec.)	Rise: 3 Decay: 7	Rise: 4 Decay: 12
Normal input voltage of power supply	+3.3V (typical)	+3.3V (typical)
Power consumption (watt)	4.2 (typical)	4.2 (typical)
Weight	530g	535g max.
Physical size (mm)	344.0 (W) x 222.0 (H) x 6.2 (D)	344.0 (W) x 222.0 (H) x 6.1 (D)
Electrical interface	30-pin LVDS interface	2-channel LVDS
Color support	262,144 colors	262,144 colors
Item	Specification	
Vendor & Model name	AUO B154EW02-V0	LPL LP154W01-TLE1 LP154W01-TLE3
Screen Diagonal	15.4" WXGA	15.4" WXGA
Active area	331.2 (W) x 207.0 (H)	331.2 (W) x 207.0 (H)
Display resolution	1280 x 3 (RGB) x 800	1280 x 3 (RGB) x 800
Display mode	normally white	normally white
Surface treatment	anti-glare + hardness 3H	non-glare + Hard Coating 3H
Pixel arrangement	RGB vertical stripe	RGB vertical stripe
Pixel pitch (mm)	0.2588 x 0.2588	0.25875 (H) x 0.25875 (V)
Typical white luminance (cd/m <sup>2</sup> ) also called brightness	200	200 (typical)
Contrast ratio	400 (typical)	400 (typical)
Respond time (msec.)	Rise: 4 Decay: 12	Rise: 6 Decay: 10
Normal input voltage of power supply	+3.3V (typical)	+3.3V (typical)
Power consumption (watt)	4.2 (typical)	4.2 (typical)
Weight	500g	560g
Physical size (mm)	344.0 (W) x 222.0 (H) x 6.1 (D)	344.0 (W) x 222.0 (H) x 6.5 (D)
Electrical interface	1-channel LVDS	LVDS
Color support	262,144 colors	262,144 colors

## LCD 15.4"

Item	Specification	
Vendor & Model name	SAMSUNG 154P4-L01-0	SAMSUNG 154XA-L01-0
Screen Diagonal	15.4" WXGA	15.4" WXGA
Active area	331.38 (H) x 207.1125 (H)	331.2 (W) x 207.0 (H)
Display resolution	1680 x 3 (RGB) x 1050	1280 x 3 (RGB) x 800
Display mode	normally white	normally white
Surface treatment	anti-glare + hard coating 3H	anti-glare + hard Coating 3H
Pixel arrangement	RGB vertical stripe	RGB vertical stripe
Pixel pitch (mm)	0.19725 (H) x 0.19725 (V)	0.25875 (H) x 0.25875 (V)
Typical white luminance (cd/m <sup>2</sup> ) also called brightness	200	200 (typical)
Contrast ratio	300 (typical)	300 (minimum)
Respond time (msec.)	Rise + Decay: 16	Rise + Decay: 16
Normal input voltage of power supply	+3.3V (typical)	+3.3V (typical)
Power consumption (watt)	4.2 (typical)	4.2 (typical)
Weight	570g	560g
Physical size (mm)	344.0 (W) x 222.0 (H) x 6.1 (D)	344.0 (W) x 222.0 (H) x 6.1 (D)
Electrical interface	1-channel LVDS	LVDS
Color support	262,144 colors	262,144 colors

## LCD 15"

Item	Specification	
Vendor & Model name	QDI QD150XL06-03-01	LPL LP150X08-TLA2
Screen Diagonal	15" XGA	15" XGA
Active area	304.13 (W) x 228.1 (H)	304.128 (W) x 228.096 (H)
Display resolution	1024 x 3 (RGB) x 768	1024 x 3 (RGB) x 768
Display mode	normally white	normally white
Surface treatment	glare + Hardness 3H	non-glare + Hard Coating 3H
Pixel arrangement	RGB vertical stripe	RGB vertical stripe
Pixel pitch (mm)	0.297 (H) x 0.297 (V)	0.297 (H) x 0.297 (V)
Typical white luminance (cd/m <sup>2</sup> ) also called brightness	160 (typical)	170 (typical)
Contrast ratio	300 (typical)	250 (typical)
Respond time (msec.)	Rise: 8 Decay: 17	Rise: 10 Decay: 20
Normal input voltage of power supply	+3.3V (typical)	+3.3V (typical)
Power consumption (watt)	3.96 (typical)	4.76 (typical)
Weight	570g	530g
Physical size (mm)	317.3 (W) x 242.0 (H) x 5.9 (D)	317.3 (W) x 241.5 (H) x 5.9 (D)
Electrical interface	1 channel LVDS	LVDS
Color support	262,144 colors	262,144 colors

## LCD 15"

Item	Specification	
Vendor & Model name	CMO N150X3-L9	AUO B150XG02 V4
Screen Diagonal	15" XGA	15" XGA
Active area	304.1 (W) x 228.1 (H)	304.1 (W) x 228.1 (H)
Display resolution	1024 x 3 (RGB) x 768	1024 x 3 (RGB) x 768
Display mode	normally white	normally white
Surface treatment	non-glare + Hard Coating 3H	non-glare + Hardness 3H
Pixel arrangement	RGB vertical stripe	RGB vertical stripe
Pixel pitch (mm)	0.297 (H) x 0.297 (V)	0.297 (H) x 0.297 (V)
Typical white luminance (cd/m <sup>2</sup> ) also called brightness	200 (typical)	170 (typical)
Contrast ratio	250 (typical)	300 (typical)
Respond time (msec.)	Rise: 5 Decay: 11	Rise: 16 Decay: 9
Normal input voltage of power supply	+3.3V (typical)	+3.3V (typical)
Power consumption (watt)	3.96 (typical)	3.9 (typical)
Weight	550g	585g
Physical size (mm)	317.3 (W) x 242 (H) x 5.7 (D)	317.3 (W) x 242 (H) x 5.7 (D)
Electrical interface	LVDS	1 channel LVDS
Color support	262,144 colors	262,144 colors
Item	Specification	
Vendor & Model name	AUO B150PG03 V0	SAMSUNG LTN150XB-L03-V
Screen Diagonal	15" SXGA	15" XGA
Active area	304.5 (W) x 228.375 (H)	304.128 (H) x 228.096 (V)
Display resolution	1400 x 3 (RGB) x 1050	1024 x 3 (RGB) x 768
Display mode	normally white	normally white
Surface treatment	non-glare + Hardness 3H	Haze 25, Hard coating 3H
Pixel arrangement	RGB vertical stripe	RGB vertical stripe
Pixel pitch (mm)	0.2175 (H) x 0.2175 (V)	0.297 (H) x 0.297 (V)
Typical white luminance (cd/m <sup>2</sup> ) also called brightness	200 (typical)	160 (typical)
Contrast ratio	300 (typical)	200 (minimum)
Respond time (msec.)	Rise: 16 Decay: 9	Rise: 10 Decay: 30
Normal input voltage of power supply	+3.3V (typical)	+3.3V (typical)
Power consumption (watt)	5.9W	4.26W
Weight	575g	585g
Physical size (mm)	317.3 (W) x 242.0 (H) x 6.5 (D)	317.8 (W) x 242.6 (H) x 6.5 (D)
Electrical interface	2-channel LVDS	3.3V LVDS
Color support	262,144 colors	262,144 colors

## Battery

Item	Specification	
Model	SONY LIP8216IVPC PACK 4800 mAh 8 CELL	SONY LIP6219IVPC PACK 4000mAh 6 CELL
Rating Specification	<ul style="list-style-type: none"> <li>Nominal capacity: 4800 mAh</li> <li>Nominal voltage: 14.8V</li> <li>Rated charge voltage: 16.8V</li> <li>Discharge cutoff voltage: 12.0V</li> <li>Rated charge current: 3.84A</li> <li>Discharge loading: 10W ~ 78W</li> <li>Max. discharge current: 6.5A</li> <li>Inrush current 30A (0.4mS)</li> <li>Discharge cell temperature: -20°C ~ 70°C</li> <li>Initial charge temperature: 0°C ~ 50°C</li> <li>Charge continuous temperature: 0°C ~ 60°C</li> </ul>	<ul style="list-style-type: none"> <li>Nominal capacity: 4000 mAh</li> <li>Nominal voltage: 11.1V</li> <li>Rated charge voltage: 12.6V</li> <li>Discharge cutoff voltage 9.0V</li> <li>Rated charge current 3.2A</li> <li>Discharge loading: 10W ~ 67W</li> <li>Max. discharge current: 6.0A</li> <li>Inrush current: 30A (0.4mS)</li> <li>Discharge cell temperature: -20°C ~ 70°C</li> <li>Initial charge temperature: 0°C ~ 50°C</li> <li>Charge continuous temperature: 0°C ~ 60°C</li> </ul>
Charge specification	<ul style="list-style-type: none"> <li>Charge voltage: 16.8A</li> <li>Charge current: 3.84A</li> <li>Charge initial temperature: 0°C ~ 50°C</li> <li>Charge method: CC-CV mode</li> <li>Charge suspension: &lt; 0°C or 60°C &gt;; Charging current = 0; Bad battery; Communication lost</li> <li>Charging time: 150 min. (25°C ~ 40°C); 180 mins. (5°C)</li> </ul>	<ul style="list-style-type: none"> <li>Charge voltage: 12.6V</li> <li>Charge current: 3.2A</li> <li>Charge initial temperature: 0°C ~ 50°C</li> <li>Charge mode: CC-CV mode</li> <li>Charge suspension: &lt; 0°C or 60°C &gt;; Charging current = 0; Bad battery; Communication lost</li> <li>Charging time: 150 mins. (25°C ~ 40°C); 180 mins. (5°C)</li> </ul>
Environment	<ul style="list-style-type: none"> <li>Storage temperature range: max. 1 month (-20°C ~ 60°C); max. 3 months (-20°C ~ 45°C); max. 6 months (-20°C ~ 30°C)</li> <li>Humidity: 10% ~ 90% RH</li> </ul>	<ul style="list-style-type: none"> <li>Storage temperature range: max. 1 month (-20°C ~ 60°C); max. 3 months (-20°C ~ 45°C); max. 6 months (-20°C ~ 30°C)</li> <li>Humidity: 10% ~ 90% RH</li> </ul>
Item	Specification	
Model	SANYO 4UR18650F-2-INV-6 4800mAh 8 CELL	SANYO 3UR18650Y-2-INV-10 4000mAh 6 CELL
Nominal specification	<ul style="list-style-type: none"> <li>Nominal capacity: 4600mAh</li> <li>Typical capacity: 4800mAh</li> <li>Nominal voltage: 14.8V</li> <li>End voltage: 12.0V</li> <li>Charging voltage: 3840mA (typical); 4080mA (max.)</li> <li>Charging voltage: 16.80+/-0.12V (CC-CV charge mode)</li> <li>Charging time (standard): 3.0 hours at 25°C</li> <li>Max. discharging loading: 92W</li> <li>Max. internal resistance: 185 mOmega</li> <li>Max. weight: 420g</li> </ul>	<ul style="list-style-type: none"> <li>Nominal capacity: 3800mAh</li> <li>Typical capacity: 4000mAh</li> <li>Nominal voltage: 11.1V</li> <li>End voltage: 9.0V</li> <li>Charging current: 3200mA (typical); 3400mA (max.)</li> <li>Charging voltage: 12.6+/-0.09V (CC-CV charge mode)</li> <li>Charging time (standard): 3.0 hours at 25°C</li> <li>Max. discharging loading: 67W</li> <li>Max. internal resistance: 178 mOmega</li> <li>Max. weight: 330g</li> </ul>



Item	Specification	
Environment	<ul style="list-style-type: none"> <li>Storage temperature range: max. 1 month (-20°C ~ 60°C); max. 3 months (-20°C ~ 45°C); max. 12 months (-20°C ~ 25°C)</li> </ul>	<ul style="list-style-type: none"> <li>Storage temperature range: max. 1 month (-20°C ~ 60°C); max. 3 months (-20°C ~ 45°C); max. 12 months (-20°C ~ 25°C)</li> </ul>

### AC Adaptor

Item	Specification
Feature	<ul style="list-style-type: none"> <li>Normal AC adaptor, 90 ~ 264V AC, 47 ~ 63Hz</li> <li>3-pin 90W with 19V DC output</li> <li>Normal DC jack (diameter 1.7 mm)</li> </ul>

### System Fan True Value Table

Test Condition: 35W@ambient 25°C			
CPU Temperature		Fan Speed	Acoustic
DTS_0	DTS_1	(RPM)	(dBA)
85	85	4000	43
86	86	3800	40
88	88	3500	38
92	92	3100	34
94	94	2700	31

# System Utilities

## BIOS Setup Utility

The BIOS Setup Utility is a hardware configuration program built into your computer's BIOS (Basic Input/Output System). Your computer is already properly configured and optimized, and you do not need to run this utility. However, if you encounter configuration problems, you may need to run Setup. Please also refer to Chapter 4 Troubleshooting when problem arises.

To activate the BIOS Utility, press **F2** during POST (when "Press <F2> to enter Setup" message is prompted on the bottom of screen). The setup screen displays BIOS as follows:

Function	Item
Information	Display the system informations
Main	Allows the user to specify standard IBM PC AT system parameters
Advanced	Provides advanced settings of the system
Security	Provides security settings of the system
Boot	Allows the user to specify the boot options
Exit	Allows the user to save CMOS setting and exit Setup

During setup, all Fn function keys and power saving functions are disabled. There are five menu options: Main, Advanced, Security, Boot and Exit. Follow these instructions below

- To choose a menu, use the cursor left/right keys (**←** **→**).
- To choose a parameter, use the cursor up/down keys (**↑** **↓**).
- To change the value of a parameter, press **F5** or **F6**.
- Press **ESC** while you are in any of the menu options to go to the Exit menu.
- In any menu, you can load default settings by pressing **F9**. You can also press **F10** to save any changes made and exit the BIOS Setup Utility.

**Note:** You can change the value of a parameter if it is enclosed in square brackets. Navigation keys for a particular menu are shown on the bottom of the screen. Help for parameters are found in the Item Specific Help part of the screen. Read this carefully when making changes to parameter values.

# Information

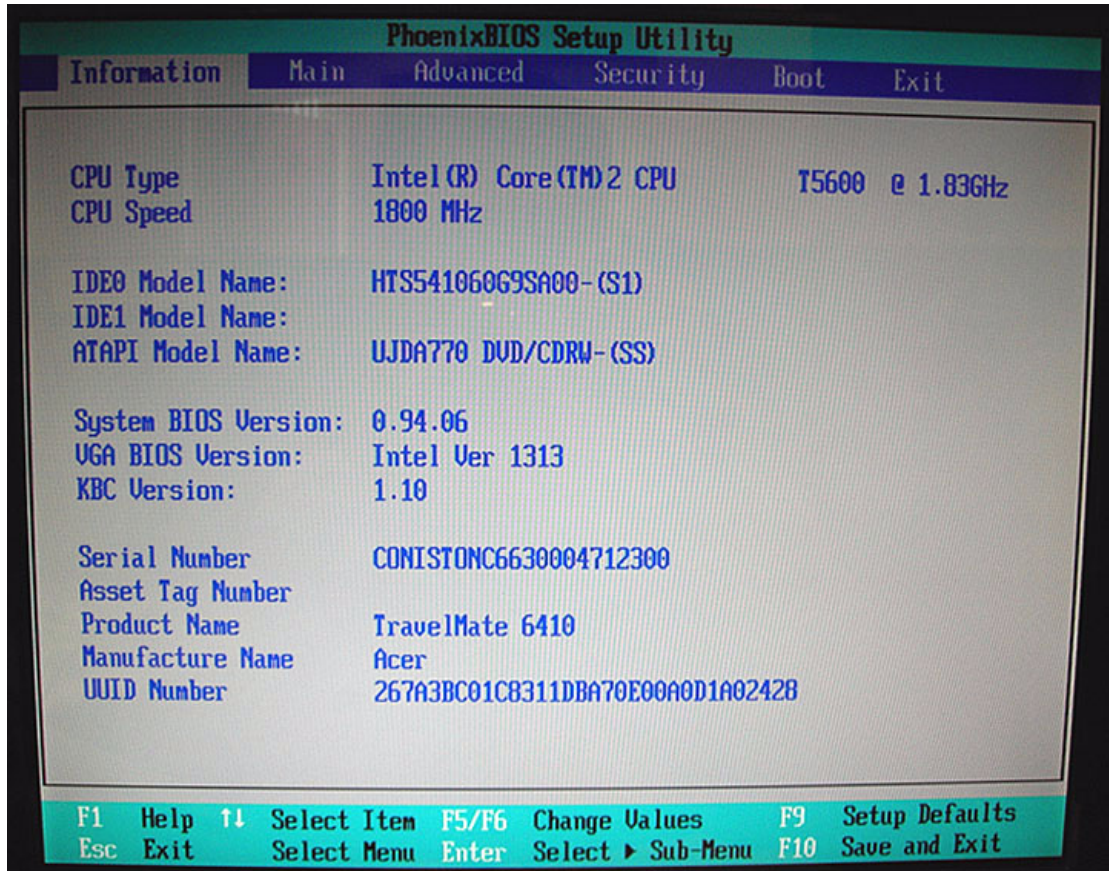

Parameter	Description
CPU Type	This item will show the CPU information of the system.
CPU Speed	This item will show the CPU clock speed.
IDE1 Model Name	This item will show the Model name of HDD installed on Primary IDE master. The hard disk model name is automatically detected by the system. If there is no hard disk present or unknown type, "None" should be shown on this field
IDE1 Serial Number	This item will show the Serial number of HDD installed on Primary IDE master. If no Hard disk or other devices are installed on Primary IDE master, then it will display a blank line
System BIOS Version	This field reports the BIOS version of system
VGA BIOS Version	This field reports the VGA version of the system
KBC Version	This field reports the keyboard controller version of the system
Serial Number	This item will show the Serial number of system.
Asset Tag Number	This item will show the Asset Tag number of the system.
Product Name	This field will show product name.
Manufacturer Name	This field will show manufacturer name.
UUID	This will be visible only when there is an internal LAN device present.

# Main

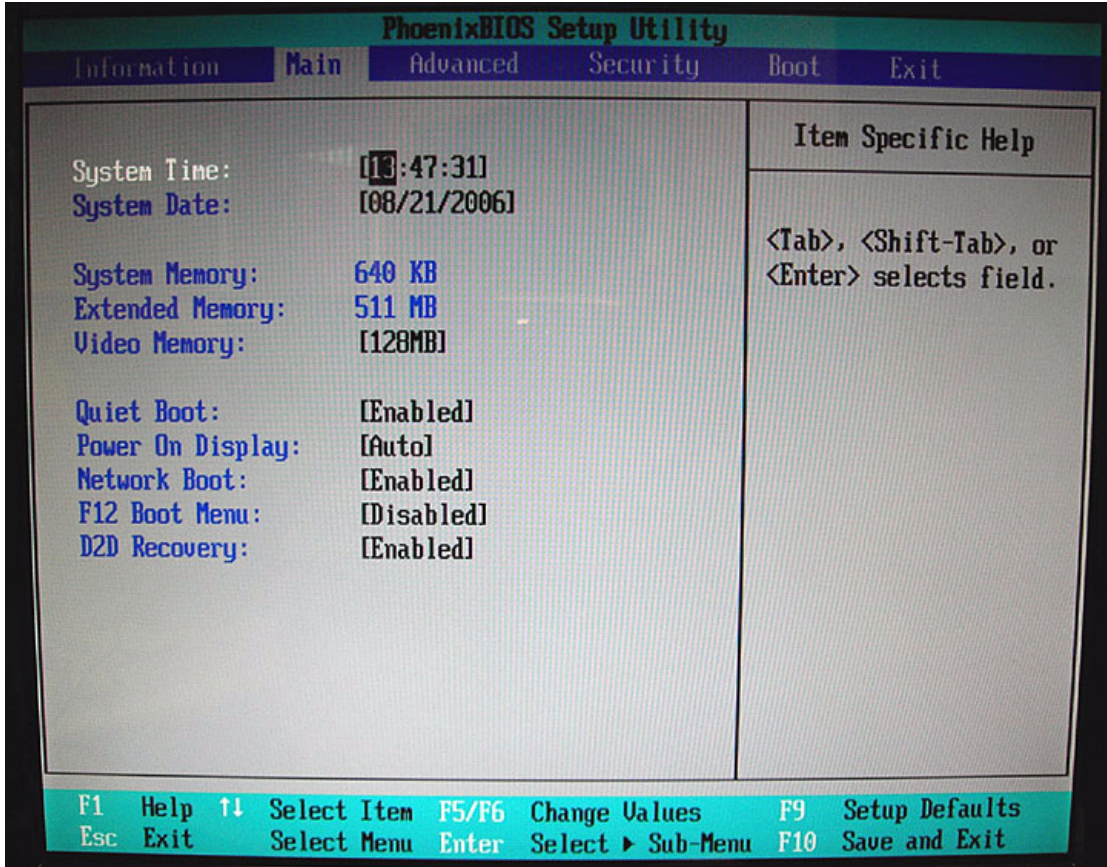

Parameter	Description
System Time / System Date	The hours are displayed with 24 hours format. The values set in these two fields take effect immediately.
System Memory	This field reports the memory size of system base memory. The size is fixed to 640KB.
Extended Memory	This field reports the memory size of the extended memory in the system. Extended Memory size = Total memory size - 1 MB
Video Memory	VGA Memory size = 128MB
Quiet Boot	Customer Logo display will be shown during POST when it is selected.
Power on display	<b>Auto:</b> During power on process, the system will detect if any display device is connected on external video port. If any external display device is connected, the power on display will be in CRT (or projector) only mode. Otherwise it will be in LCD only mode. <b>Both:</b> Simultaneously enable both the integrated LCD screen and the system's external video port (for an external CRT or projector).
Network boot	When this is selected, Boot from LAN feature is enabled. When this is not selected, Boot from LAN feature is then disabled.
F12 Boot Menu	When this is selected, users can modify device boot priority by pressing F12 key during POST. When this is not selected, device boot priority will not be adjustable during POST.
D2D Recovery	Allow user to enable/disable the Disk-to-Disk recovery

# Advanced

The Advanced menu screen contains parameters involving your hardware devices. It also provides advanced settings of the system.

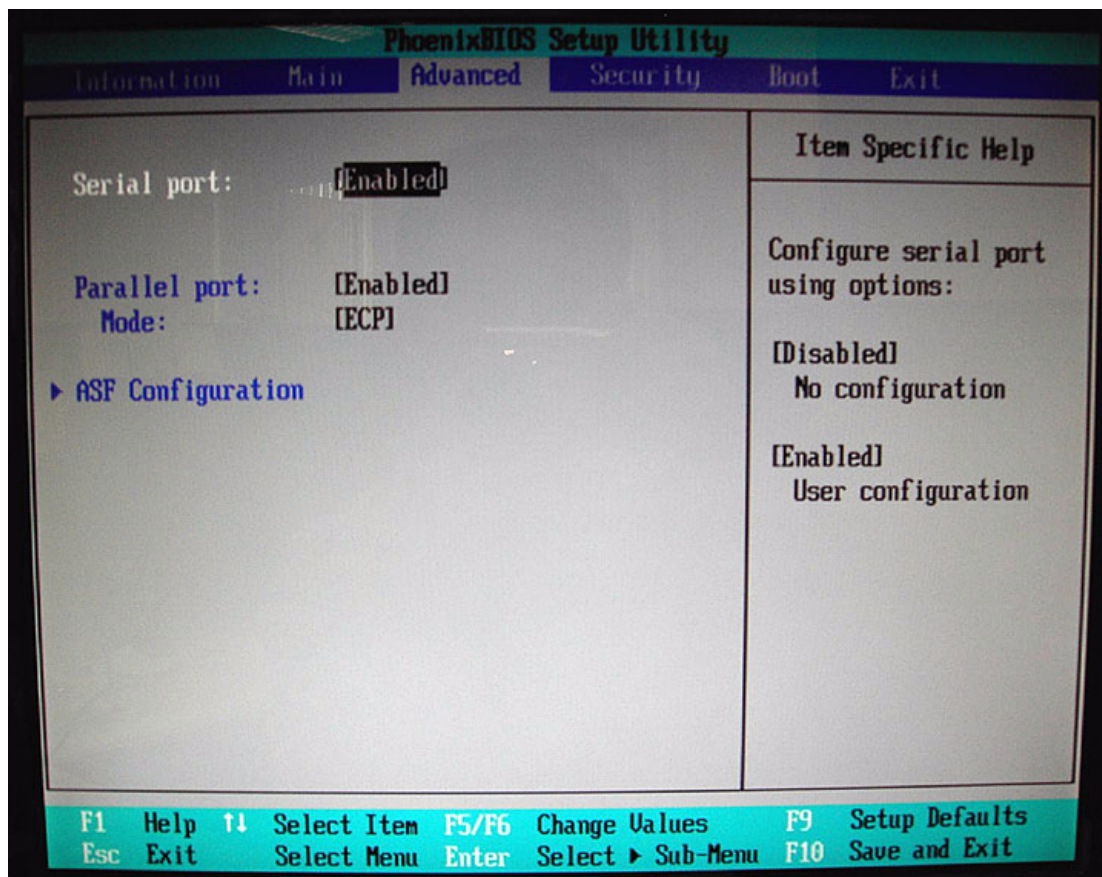

Parameter	Description	Option
Serial Port	Configure serial port A using options: [Disabled]: No configuration [Enabled]: User configuration [Auto]: BIOS or OS chooses configuration (OS Controlled) Displayed when controlled by OS	Disabled Enabled Auto
Infrared Port	Configure serial port B using options: [Disabled]: No configuration [Enabled]: User configuration [Auto]: BIOS or OS chooses configuration (OS Controlled) Displayed when controlled by OS	Disabled Enabled Auto
Parallel Port	Configure serial port B using options: [Disabled]: No configuration [Enabled]: User configuration [Auto]: BIOS or OS chooses configuration (OS Controlled) Displayed when controlled by OS	Disabled Enabled Auto
Mode	Set the mode for the parallel port	Output only Bi-directional EPP ECP

# Security

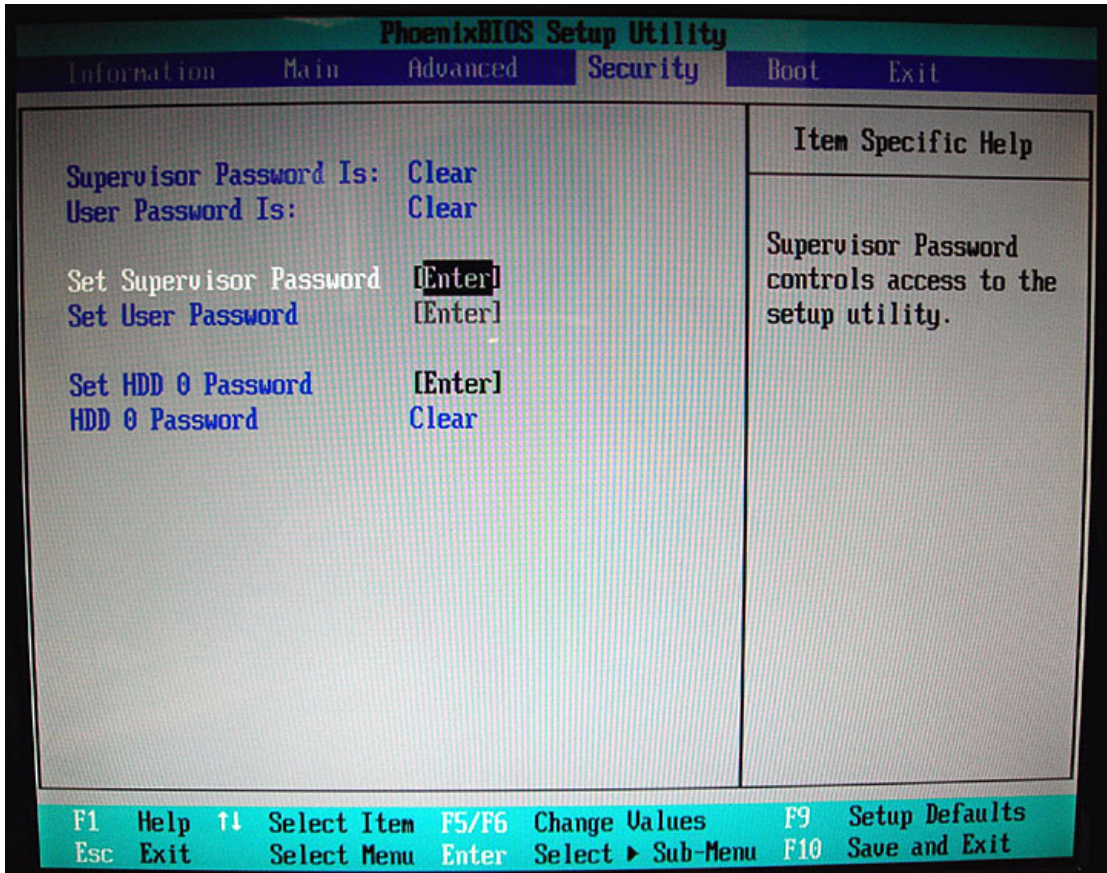

The system supports three levels of password protection. The password support consists of a Supervisor Password, User Password, and Hard Disk Password. All the passwords are stored in a non-volatile storage device (EEPROM).

All the passwords obeys the following rules:

- Password Policy
  - All the passwords can be set or cleared in BIOS Setup Security screen.
  - The password entry consists of eight alphanumeric characters. At least one character must be assigned.
  - The valid keys are listed in the table below:

Symbol Character	Symbol Name
A-Z	letters A to Z (not case sensitive)
0-9	numerical characters
-	dash
=	equal sign
[	left bracket
]	right bracket
.	period
,	comma
;	semi-colon

Symbol Character	Symbol Name
/	slash
\	back slash

- The users can not change or remove password during resuming from S4.
- The max. number of times to retry the password is limited to three.
- Supervisor Password:
  - Supervisor Password controls the access of the whole BIOS Setup Utility. If the Supervisor Password is set, the system will pop up the password dialog box to ask for the password when the users press <F2> for entering BIOS Setup Utility.
  - If the Supervisor Password is set and Password on boot is enabled, the system will pop up the password dialog box to ask for the password when the system is powered on or resumes for S4 state.
  - **If the users fail three times consecutively in password verification, the system will be hung up and the users need to manually power off the system.**
- User Password:
  - If the User Password is set, the system will pop up the password dialog box to ask for the password when the users press <F2> for entering BIOS Setup Utility.
  - If the Supervisor Password is not set at first, the User Password can not be set. If the Supervisor Password is cleared, the User Password will be cleared, too.
  - If the User Password is set and Password on boot is enabled, the system will pop up the password dialog box to ask for the password when the system is powered on or resumes for S4 state.
  - **If the users fail three times consecutively in password verification, the system will be hung up and the users need to manually power off the system.**
- Set Supervisor Password / User Password:
  - Highlight the item and press “Enter”, a dialog box will be shown to ask the users to enter new password and confirm new password.
  - If the users want to reset password, a current password will be required to be tapped in at first. If the current password is correct, the users are permitted to enter new password and confirm new password for verification. If the verification is OK, the password setting will be complete after the users press “Enter”.
  - If the password entered does not match the current password, a dialog box will be shown to ask to re-enter the password.
- Set HDD Password: When shown as “Locked”, the hard drive password currently can not be changed or disabled. To change or disable it, turn off the system and enter Setup immediately after turning it back on. Press “Enter” to input change, or disable hard drive password.
- Password on Boot: It allows the user to specify whether or not a password is required to boot.

# Boot

This menu allows the users to decide the order of bootable devices to load the operating system. It identifies all the bootable devices in the system and attempts to boot them in the order specified. Bootable devices include the diskette drive in module bay, the hard disk and the CD-ROM/DVD drive in module bay and onboard LAN device.

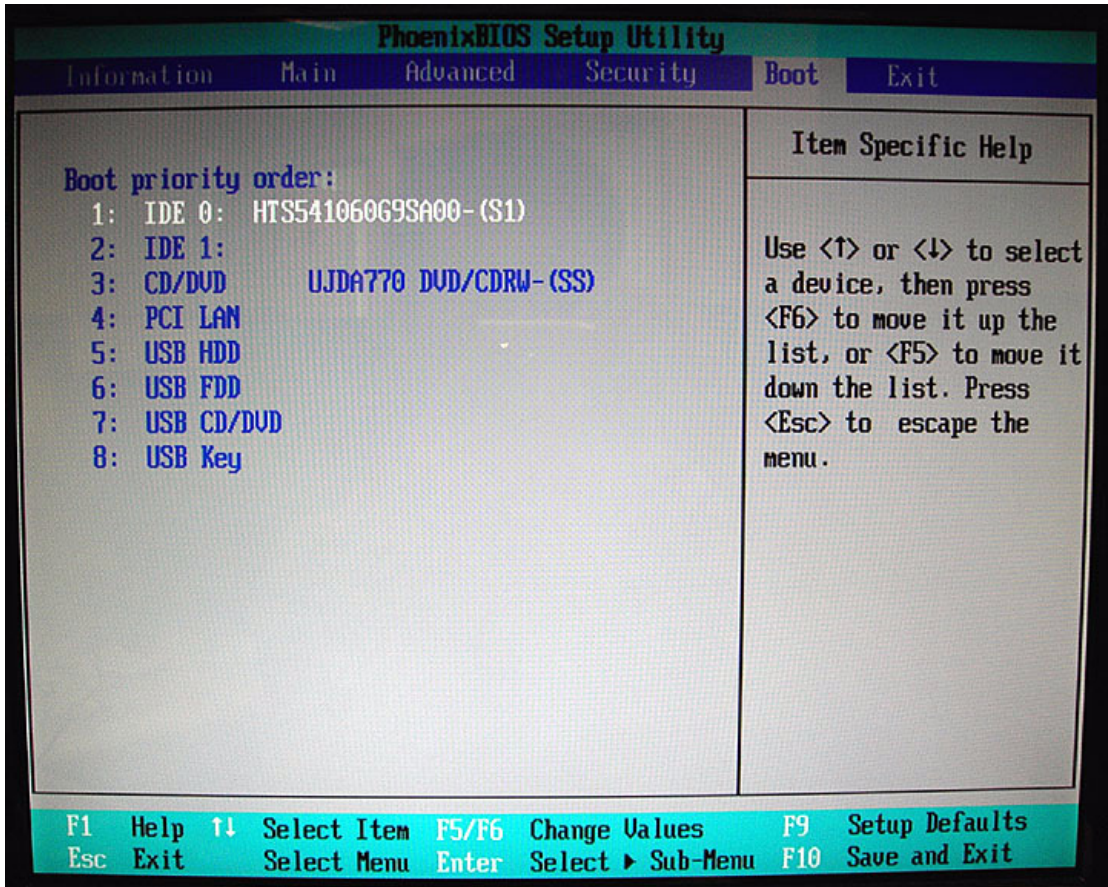

Parameter	Description
Boot priority order	Keys used to view or configure devices: Up and Down arrows select a device. <+> and <-> move the device up or down. <f> and <r> specifies the device fixed or removable. <x> exclude or include the device to boot. <Shift +1> enables or disables a device. <1-4> Loads default boot sequence.



# Exit

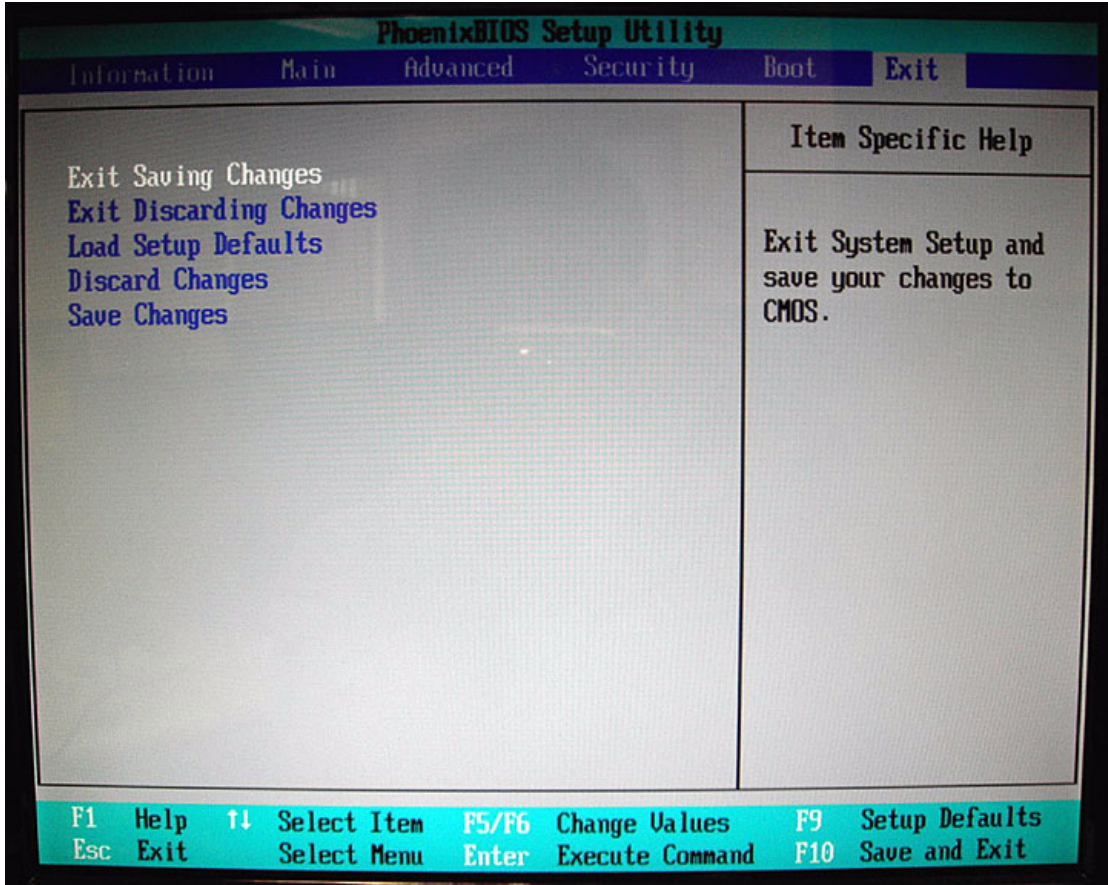

Parameter	Description
Exit Saving Changes	Exit System Setup and save your changes to CMOS
Exit Discarding Changes	Exit utility without saving Setup data to CMOS
Load Setup Default	Load default values for all SETUP items
Discard Changes	Load previous values from CMOS for all SETUP items
Save Changes	Save Setup Data to CMOS

# Machine Disassembly and Replacement

---

## General Information

This chapter contains step-by-step procedures on how to disassemble the Aspire 6460/6410 for maintenance and troubleshooting.

To disassemble the notebook, you need the tools below:

- Wrist ground strap and conductive mat for preventing electrostatic discharge
- Small Philips screw driver
- Flat headed screw driver
- Tweezers

**Note:** The screws for the different components vary in size. During the disassembly process, group the screws with the corresponding components to avoid mismatch when putting back the components. When you remove the stripe cover, please be careful not to scrape the cover.

## Before You Begin

Before proceeding with the disassembly procedure, you have to make sure that:

- The system and all peripherals are powered off.
- The AC adaptor and all power and signal cables from the system are unplugged.
- The battery pack is removed.

**Note:** There are several types of screws used to secure the main unit. The screws vary in length. Please refer to the screws table after the flowchart. Group the same type of screws together during service disassembling. Please also remember the screw location for each screw type. If you fasten the screws on the wrong location, the long screws may cause irrecoverable damage to the main board.

# Disassembly Procedure Flowchart

The flowchart gives you a graphic representation on the entire disassembly and reassembly and instructs you how to remove the components.

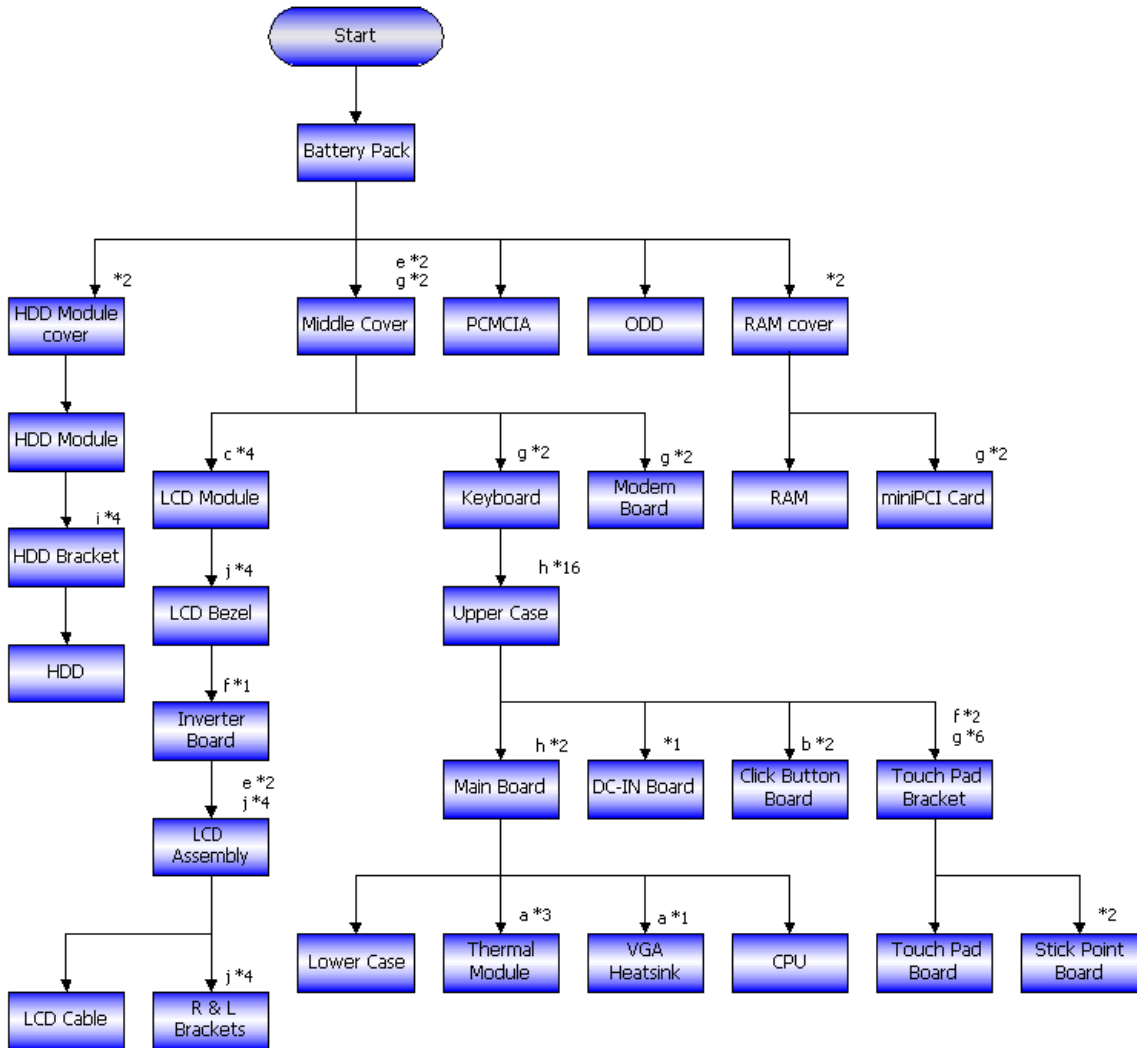

#	Description	Acer Part No.
a1	SCREW-I20040M-BK-PATCH	86.TCXVN.001
b	SCREW-I25025M (4.5Dx0.8T) -BK-PATCH	86.TCXVN.002
c	SCREW-I250100M (4.5DX0.8T) -BK-PATCH	86.TCXVN.003
d	SCREW-I20050M (4.5Dx0.5T) -BK-PATCH	86.TCXVN.004
e	SCREW-I25040M (4.5Dx0.8T) -BK-PATCH	86.TCXVN.005
f	SCREW-I-M2.0-3.0-M-4.0Dx0.3T-BK-PATCH	86.TCXVN.006
g	SCREW, I, M2.5, 3.0mm, M, 4.5mm, 0.8mm, BNI, PAT	86.TCXVN.007
h	SCREW, I, M2.5, 5mm, M, 0.45mm, 0.8mm, BNI, PATC	86.D03VN.004
i	SCREW-WI30030M (5.0Dx1.5T) -NI-HARDEN	86.AAMVN.001
j	SCREW-I25060M (4.5Dx0.8T) -BK-PATCH	86.AAMVN.002

---

# Disassembly Procedure

## Removing Battery Pack

1. Unlock the battery lock to the end as the arrow indicates.
2. Slide the battery latch to the end as the arrow indicates and hold it. The battery pack will pop up then remove the battery pack.

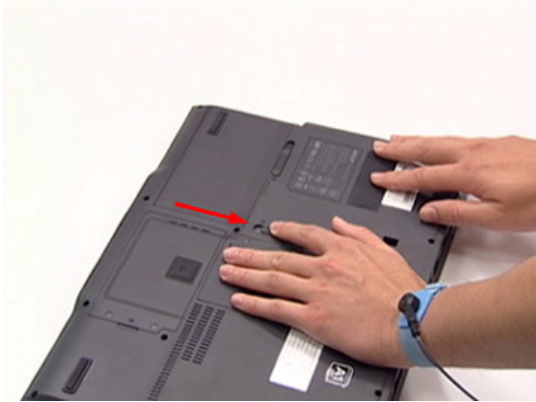

## Removing HDD Module

1. Release the two screws fastening the HDD module cover then detach the HDD module cover.
2. Pull the HDD module backwards as the arrow indicates then detach the HDD module.

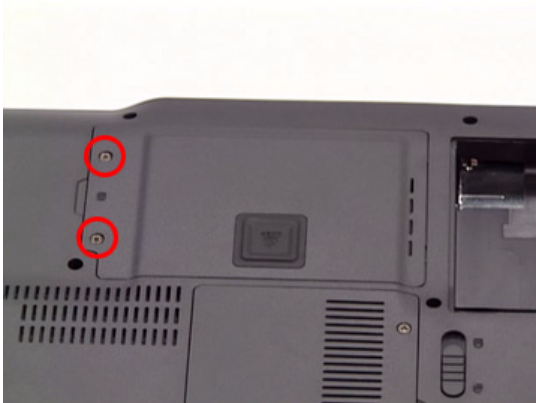

# Removing RAM Modules and Mini PCI Card

1. Release the two screws holding the RAM modules and mini PCI card cover then remove the cover.
2. Disconnect the wireless LAN antennae. Release the two screws holding the mini PCI card then detach the mini PCI card as the arrow indicates.
3. Press the RAM module locks at the same time as the arrows indicate. The RAM module will pop up then detach the RAM module. Repeat this step to detach another RAM module.

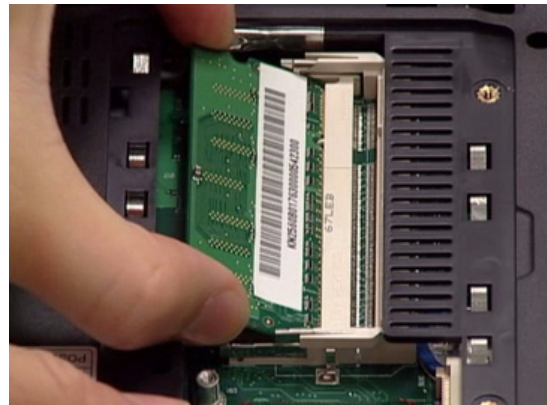
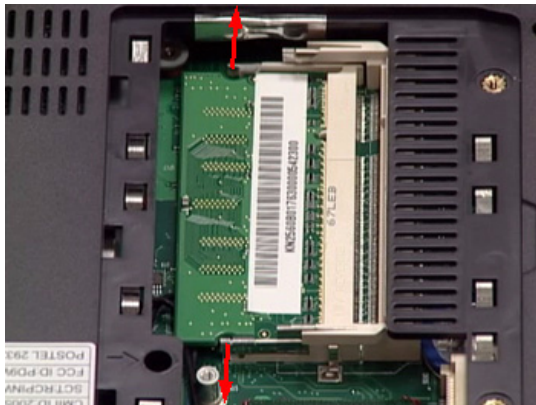
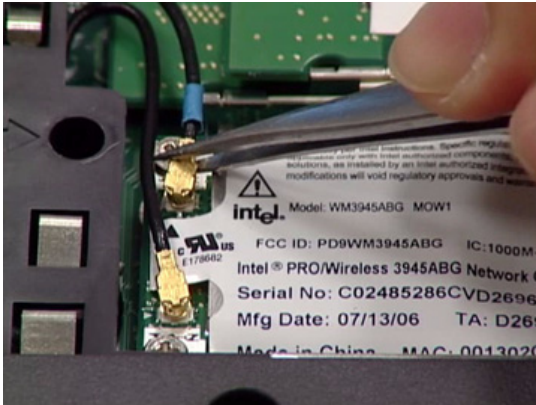
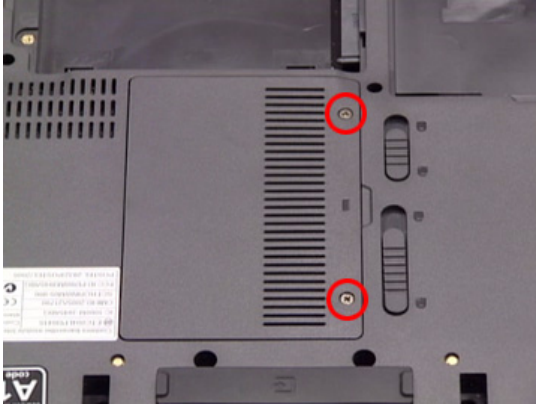

---

## Removing Optical Disk Drive and PCMCIA

1. Push the optical disk drive latch forwards to bring out the optical disk drive.
2. Remove the optical disk drive.
3. Push the PCMCIA eject button to bring out the PCMCIA. Then detach the PCMCIA. When you do the assembly, at first you have to push the eject button to the end then insert the PCMCIA into the slot.

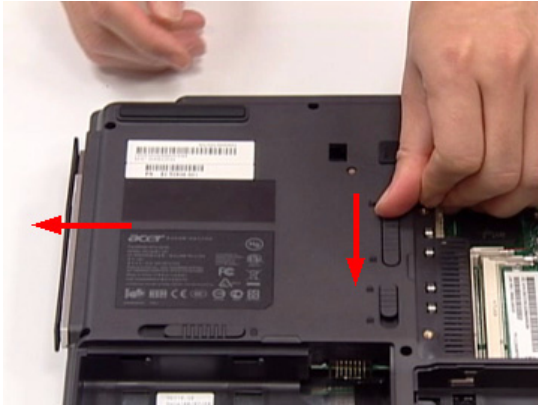

# Removing Keyboard

1. Release the four screws holding the middle cover, two on the rear side and the other two on the bottom side.
2. Then detach the middle cover.
3. Release the two screws fastening the keyboard plate.
4. Detach the keyboard plate slightly then have it reversed as shown.
5. Slightly release the keyboard plate FFC latch with the nail then disconnect that FFC.
6. Slightly release the point device FFC latch then disconnect that FFC. Keep in mind that these two latches are fragile.
7. Then remove the keyboard plate.

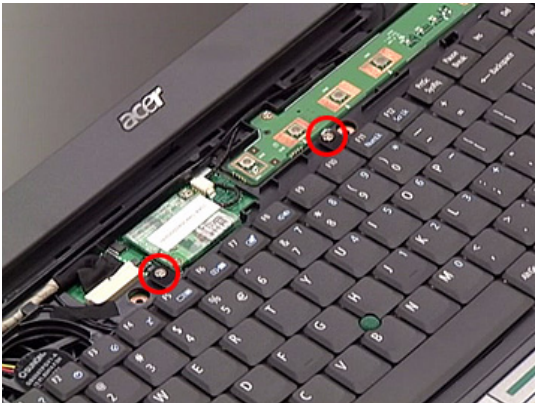
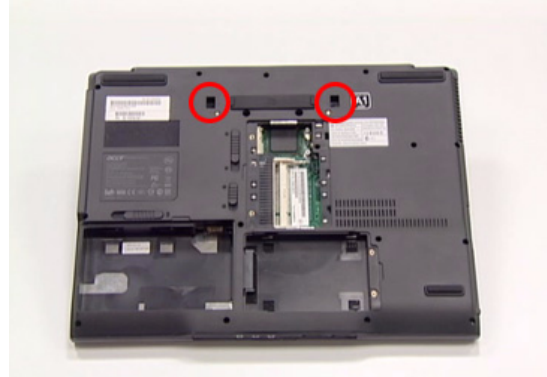
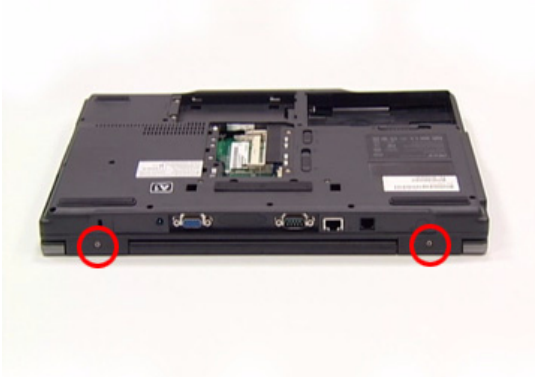

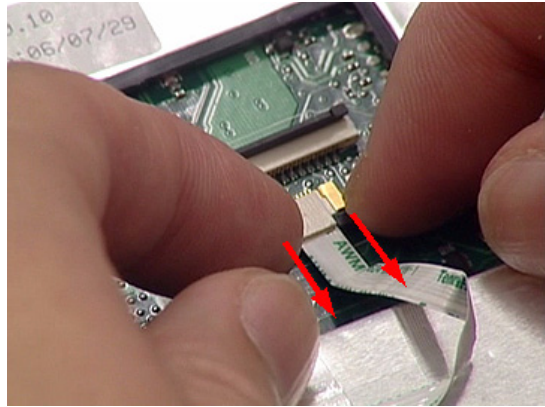
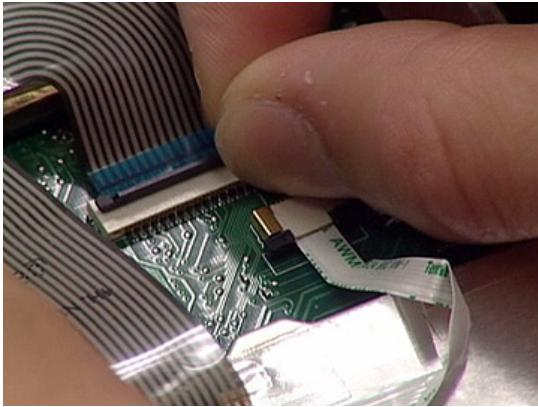

## Removing Power Board and Modem Board

1. Release the two screws fastening the power board then detach it from the main unit.
2. Release the two screws holding the modem board. Disconnect the modem board cable then detach the modem board from the main unit.

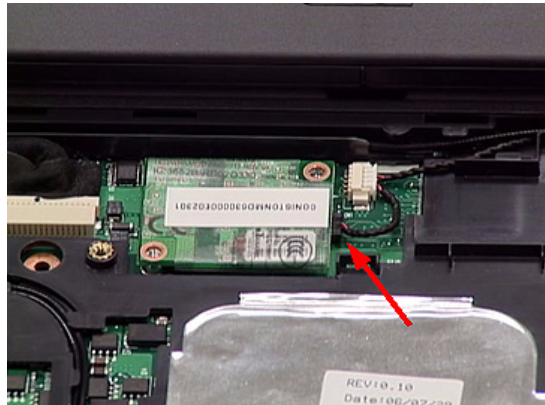
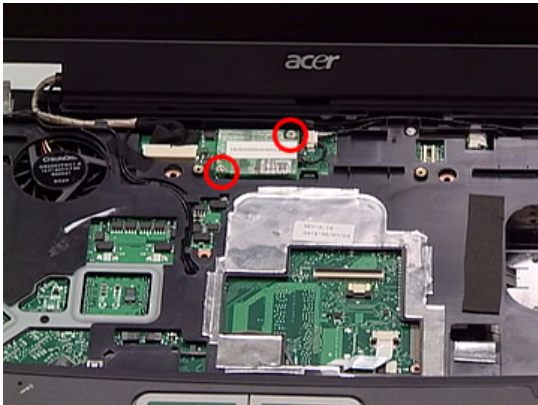
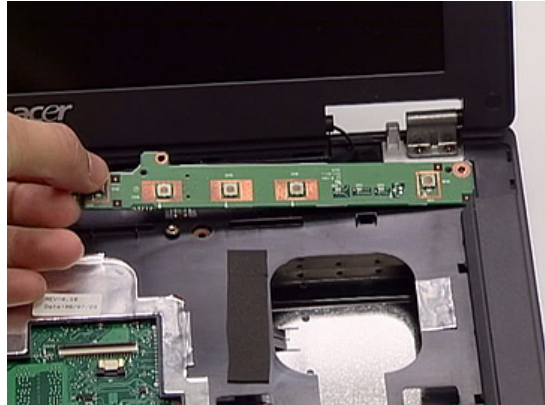
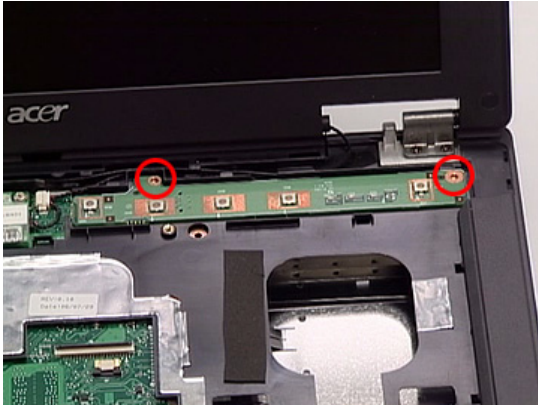



## Removing LCD module from Main Unit

1. Disconnect the LCD module cable and slightly pull out the wireless LAN antennae.
2. Then disconnect the RJ-11 port cable.
3. Hold the top edge of LCD module and release the four screws holding the LCD module on the main unit.
4. Remove the LCD module from the main unit.
5. When you do the assemble, remember to have the ground wire locked on the LCD left hinge.

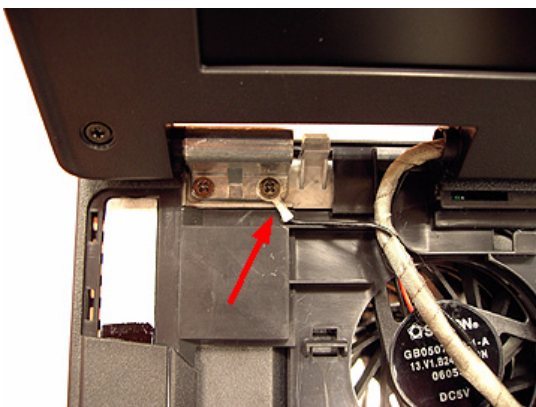
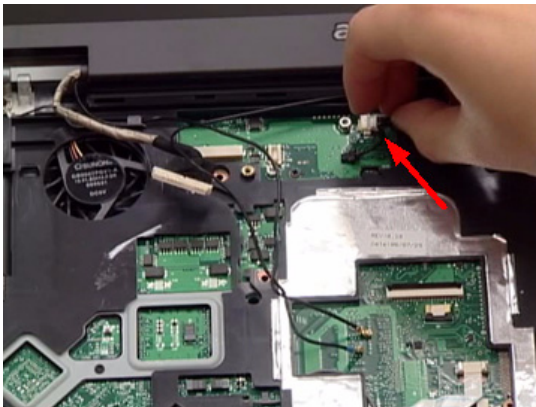
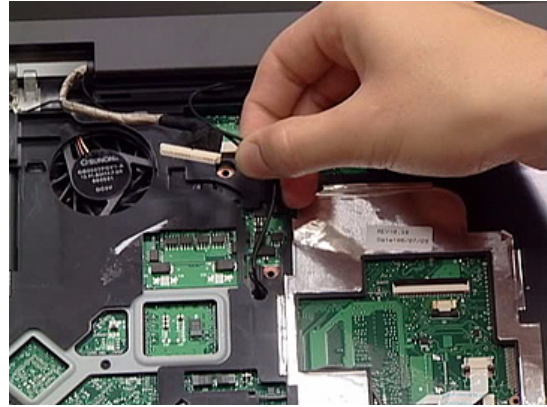
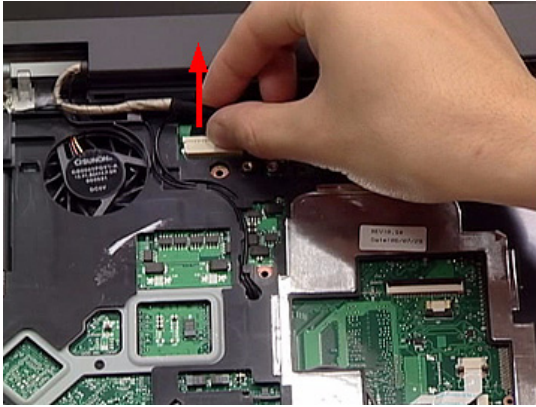

## Separating Upper Case and Lower Case

1. Carefully release the touch pad board FFC lock then disconnect the touch pad board FFC.
2. Slightly disconnect the microphone cable connector.
3. Release the 16 screws securing the upper case and the lower case on the bottom side.
4. Then detach the upper case from the main unit.

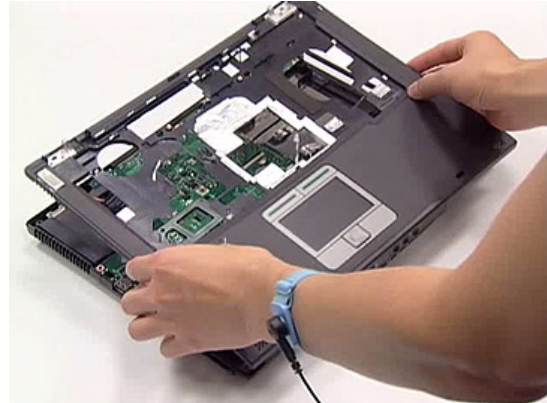
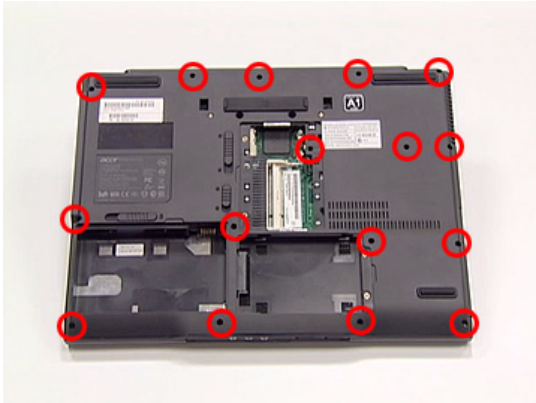
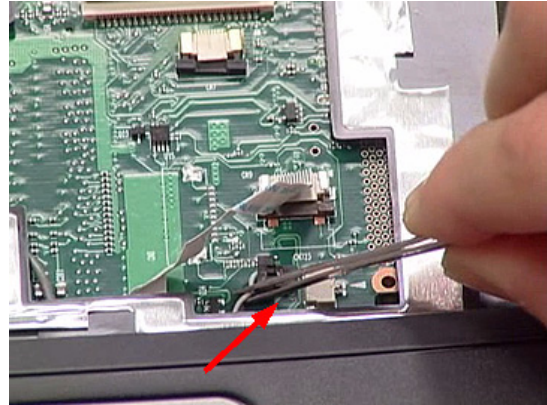
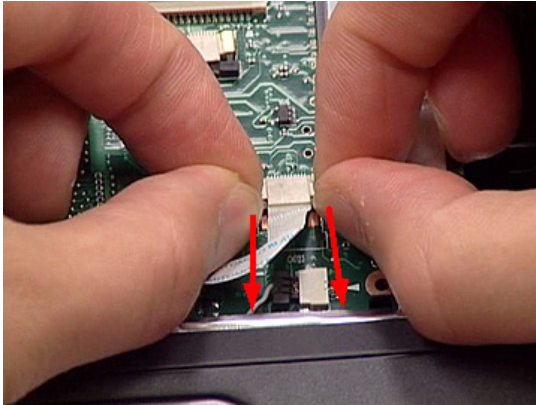

# Removing Main Board

1. Disconnect the right and the left speaker cables.
2. Release the DC-in board FFC latch then disconnect the DC-in board FFC.
3. Release the two screws fastening the main board.
4. Detach the main board from edge of the lower case carefully for not causing irreversible damage. Then remove the main board from the lower case as the arrow indicates.
5. Release the screw holding the DC-in board then detach the DC-in board from the lower case.

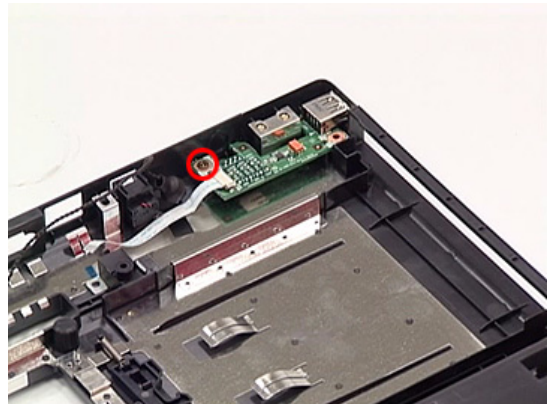
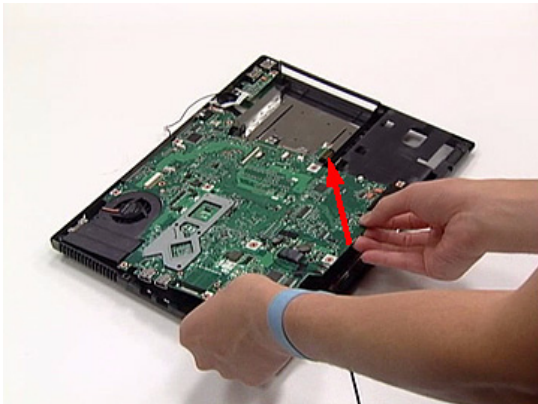
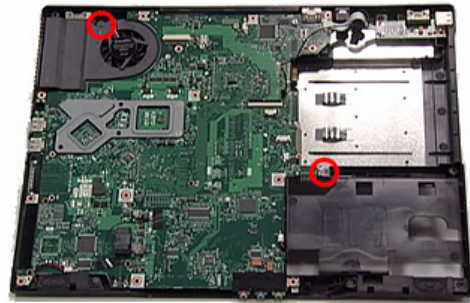
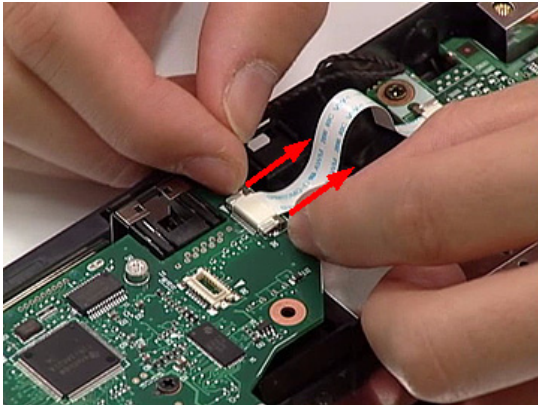
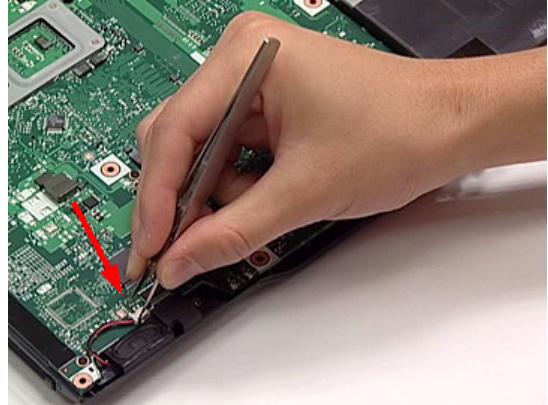
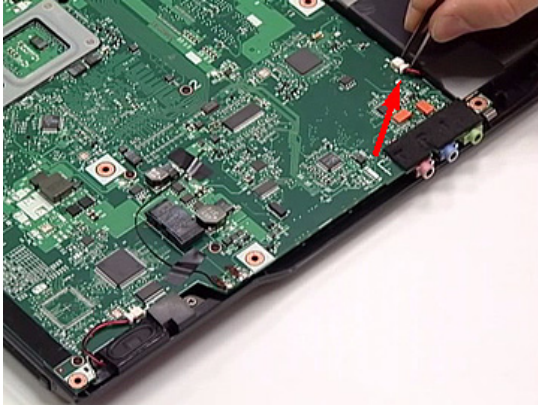

---

## Removing Thermal Module

1. Disconnect the CPU fan cable.
2. Release the three screws fastening the thermal module.
3. Remove the thermal module holder then detach the thermal module.

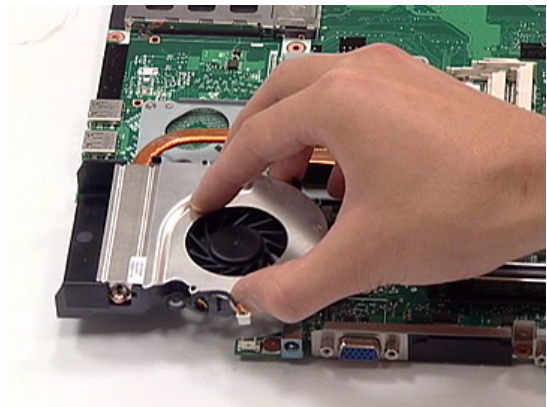
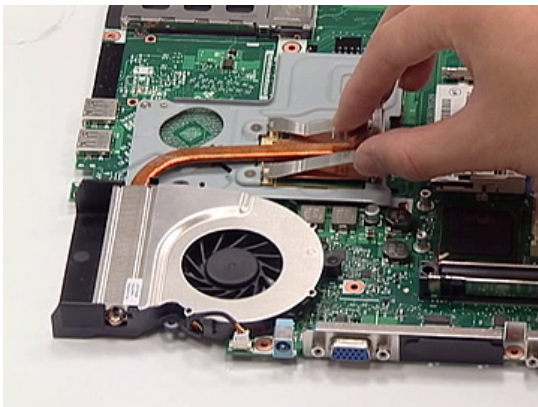
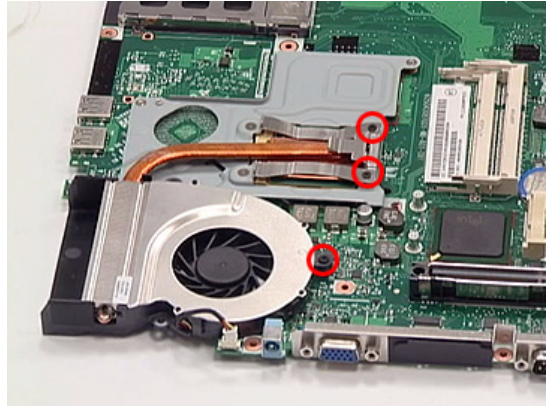
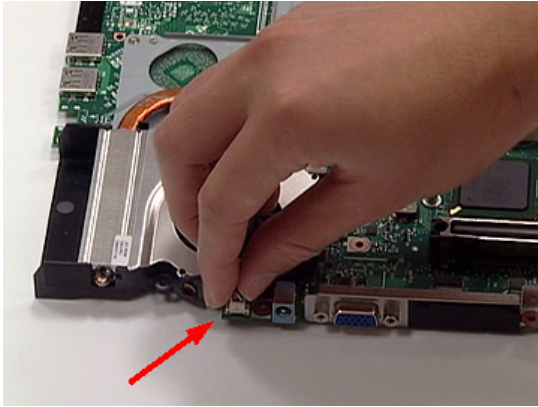

## Detaching CPU

1. Release the CPU socket lock by turning a flat headed screw driver **counter clockwise**.
2. Keep in mind that CPU pins are fragile so please carefully detach the CPU from the socket with tips of fingers.

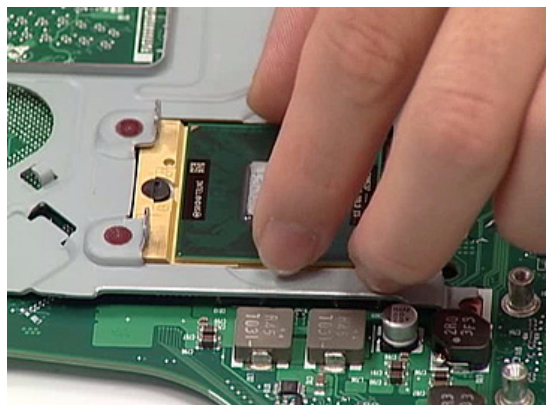
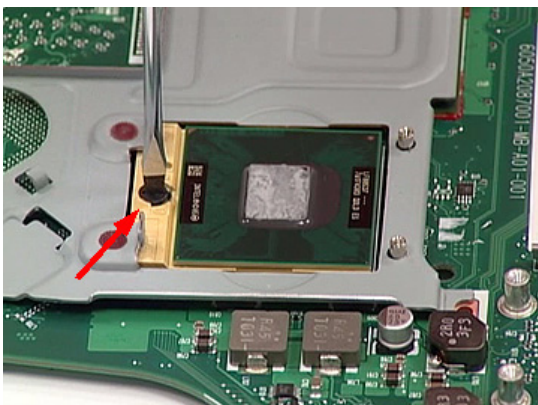

# Removing Touch Pad Board

1. Release the FFC latches then disconnect the following FFCs in sequence as shown: 1) click button board to touch pad board FFC; 2) stick point board to main board FFC; 3) click button board to stick point board FFC; 4) the other end of click button board to stick point board FFC.
2. Release the eight screws holding the touch pad board bracket then remove the touch pad board bracket.
3. Remove the touch pad board.
4. Remove the stick point board.
5. Release the two screws holding the click button board then remove the click button board.

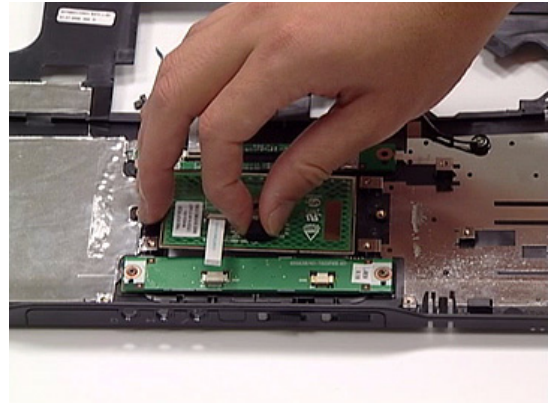
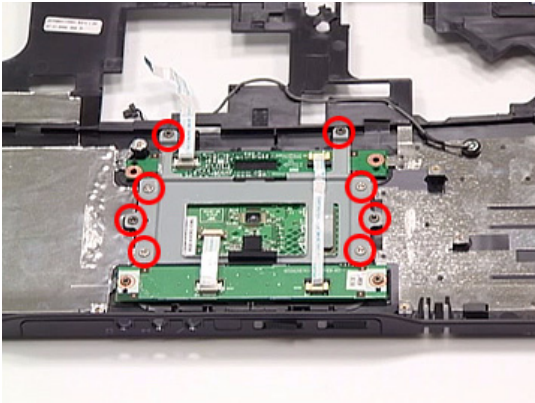
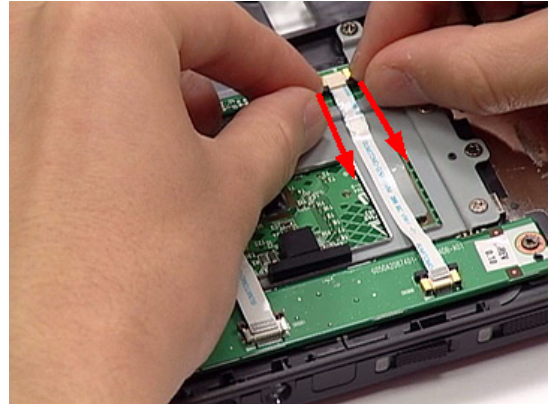
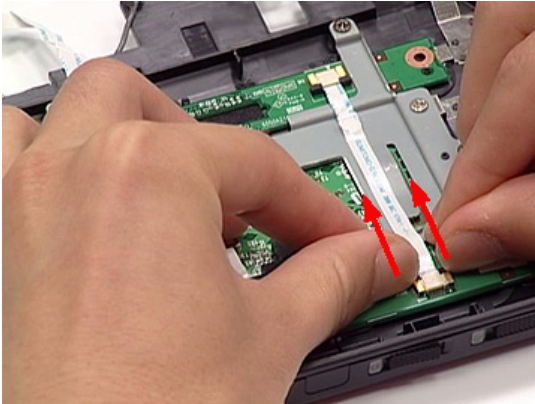
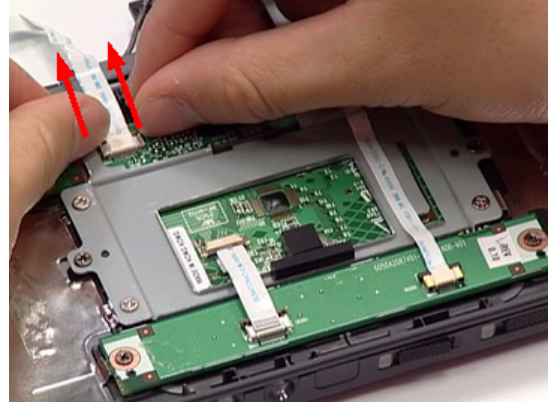
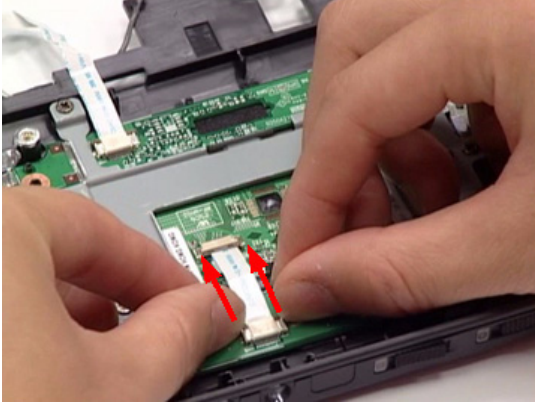

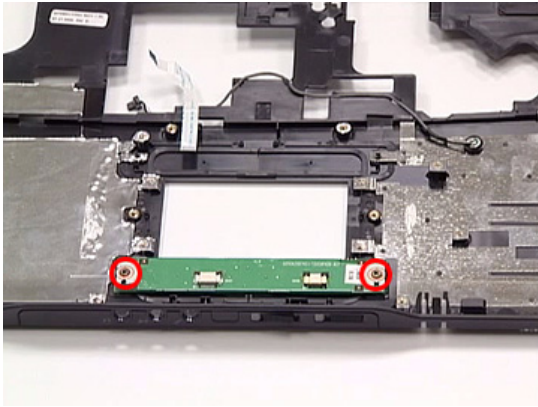

## Removing LCD Bezel

**Note:** Please do not press the LCD panel through the whole procedure when you disassemble the LCD module.

1. Detach the mylars and the rubber cushions covered on the screws then release the four screws securing the LCD bezel.
2. Carefully detach the LCD bezel from the LCD module as shown till the LCD bezel is total removed.

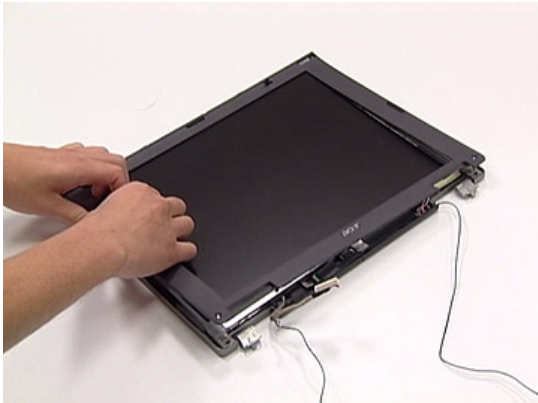

---

## Removing Inverter Board

1. Release the screw holding the inverter board.
1. Carefully disconnect the backlight cable.
2. Carefully disconnect the LCD cable then remove the inverter board.

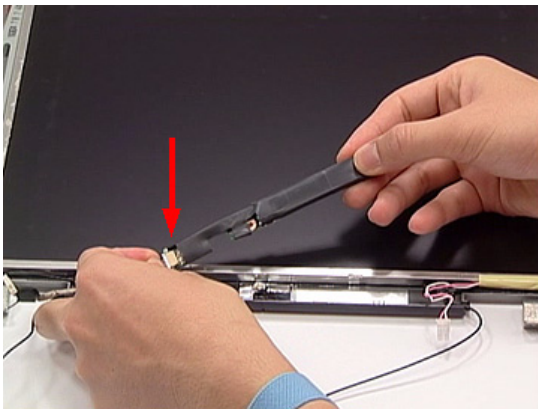
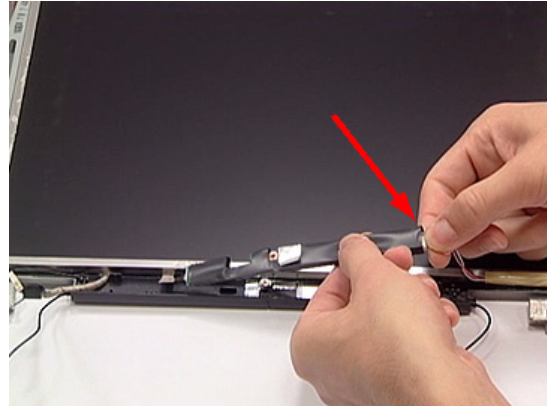
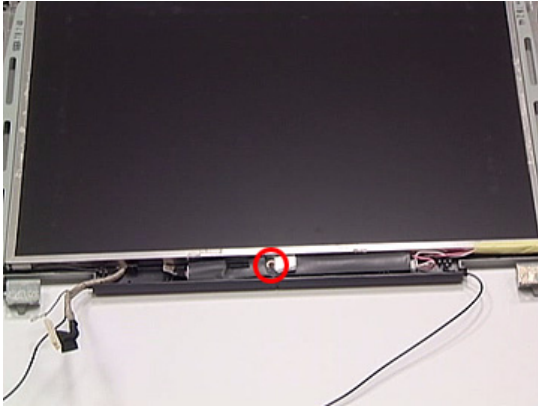

## Detaching LCD Panel

1. Release the six screws securing the LCD panel.
2. Then detach the LCD panel from the LCD cover.

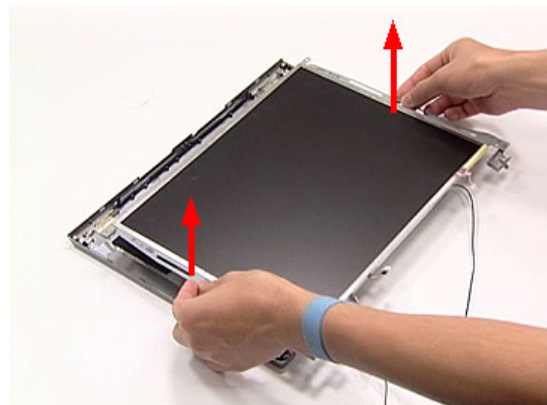
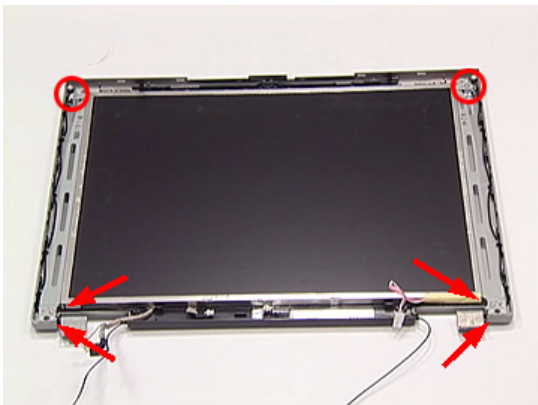

---

## Removing LCD Brackets

1. Release the four screws securing the left and the right LCD brackets.
2. Then remove the left and the right LCD brackets.

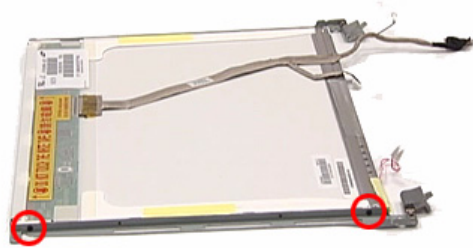
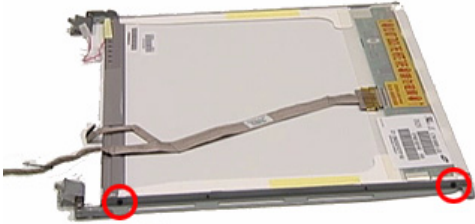

## Removing LCD Cable

1. Slight tear off the tape holding the LCD cable connector then disconnect the LCD cable connector.

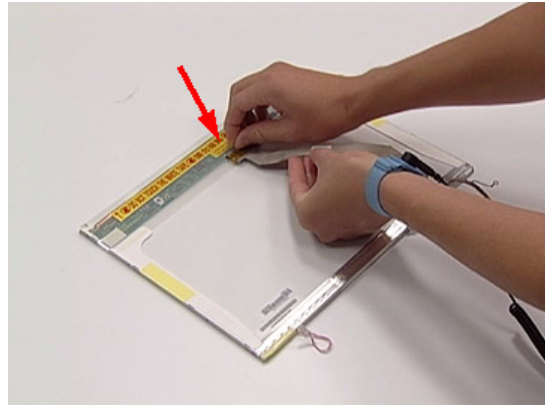
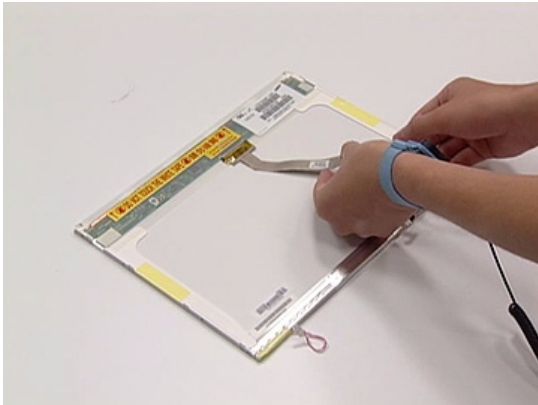



# Troubleshooting

---

Please use the following procedures as a guide for computer problems.

**Note:** The diagnostic tests are intended to test only Acer products. Non-Acer products, prototype cards, or modified options may occur errors or invalid responses.

1. Obtain the detailed fail symptoms as many as possible.
2. Verify the symptoms by attempting to recreate, running the diagnostic tests or repeating the same operation.

---

# System Check Procedures

## External Diskette Drive Check

Do the following procedures to isolate the possible effects from a controller, driver, or diskette. A writable, diagnostic diskette is required.

**Note:** Make sure that the diskette does not have more than one label attached. Multiple labels may cause damage to the drive or make the drive fail.

1. Boot from the diagnostic diskette and start the diagnostic programs.
2. See if FDD test is passed as the programs run the FDD test.
3. Follow the instructions in the message window.

If errors occur with the internal diskette driver, reconnect the diskette connector on the system board. If the errors still remain:

1. Reconnect the external diskette drive.
2. Replace the external diskette driver.
3. Replace the main board.

## External CD-ROM Drive Check

Do the following procedures to isolate the possible effects from a controller, driver, or CD-ROM.

**Note:** Make sure that the CD-ROM does not have any label attached. The label may cause damage to the drive or make the drive fail.

1. Boot from the diagnostic diskette and start the diagnostic programs.
2. See if CD-ROM test is passed when the programs run the CD-ROM test.
3. Follow the instructions in the message window.

If errors occur, reconnect the connector on the system board. If the errors still remain:

1. Reconnect the external CD-ROM drive.
2. Replace the external CD-ROM drive.
3. Replace the main board.

## Keyboard or Auxiliary Input Device Check

Remove the external keyboard if the internal keyboard is under test. If the internal keyboard does not work or an unexpected error appears, make sure that the flexible cable extending from the internal keyboard is correctly connected on the system board. If the keyboard is correctly connected, run the Keyboard test.

If errors occur, do the following procedures in sequence to correct the problems. Do not replace a non-defective FRU.

1. Reconnect the keyboard cable.
2. Replace the keyboard.
3. Replace the main board.

The following auxiliary input devices are supported by this computer.

- Numeric keypad
- External keyboard

If any of these devices do not function, reconnect the cable and repeat the anterior procedures.

## Memory Check

Follow the procedures below to correct the memory errors.

1. Boot from the diagnostic diskette and start the diagnostic programs.

2. Go to the diagnostic memory in the test items.
3. Press F2 in the test items.
4. Follow the instructions in the message window.

**Note:** Make sure that the DIMM is correctly inserted into the connector. A wrong connection will cause errors.

## Power System Check

To verify the symptoms, power on the computer by using the following power sources separately.

1. Remove the battery pack.
2. Connect the power adaptor and check the power supply.
3. Disconnect the power adaptor and install the battery pack, then check the power supply.

If you think there is a power supply problem, please go to **Check the Power Adaptor** and **Check the Battery Pack** in this chapter.

## Check the Power Adaptor

Unplug the power adaptor cable from the computer and measure the output voltage at the plug of the power adaptor cable. See the illustration and follow the procedures below.

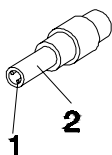

pin 1: +19V to +20.5V  
pin 2: 0V, ground

1. If the voltage is not correct, replace the power adaptor.
2. If the voltage is within the range:
  - (1) Replace the system board.
  - (2) If the problem is still not resolved, see **Undetermined Problems**.
  - (3) If the voltage is not correct, go to the next step.

**Note:** An audible noise from the power adaptor does not always indicate a defect.

3. If the power-on indicator does not light up, check the power cord of the power adaptor for continuity and correct installation.
4. If the operational charge does not work, see **Check the Battery Pack**.

## Check the Battery Pack

Follow the procedures below to check the battery pack.

From software, this helps to identify the problem is on recharging or discharging.

1. Check the Power Management in Control Panel.
2. Then confirm that the parameters shown in the screen for Current Power Source and Total Battery Power Remaining are correct.
3. Repeat the step 1 and step 2 for both battery and adaptor.

From hardware, this helps to identify whether you should replace the battery pack or not.

1. Power off the system.
2. Remove the battery pack and measure the voltage between terminals one (+) and seven (-). There are seven terminals totally. See the illustration below.
3. If the voltage is still less than 7.5V after recharging, replace the battery.

If the battery status indicator does not light up, remove the battery pack. After the battery pack returns to room temperature, reinstall it to the system.

---

If the charge indicator does not light up, replace the battery pack. If the charge indicator still does not light up, replace the AC / DC charger board.

## Touchpad Check

If the touchpad does not work, follow the procedures one at a time to correct the problem. Do not replace a non-defective FRU.

1. Reconnect the touchpad cables.
2. Replace the touchpad.
3. Replace the system board.

After you use the touchpad, the pointer drifts on the screen for a short time. This self-acting pointer movement will occur when a slight, steady pressure is applied to the touchpad pointer. This symptom is not a hardware problem.

# Power-On Self-Test (POST) Error Message

The POST error message index lists the error message and their possible causes.

**Note:** Perform the FRU replacement or actions in the sequence shown in Error Message List, if the FRU replacement does not solve the problem, put the original part back in the computer. Do not replace a non-defective FRU.

The error messages are listed in the coming pages to indicate the BIOS signals on the screen and the error symptoms classified by functions. If the symptom is not included on the list, please refer to **Undetermined Problems**.

**Note:** Most of the error messages occur during POST. Some of them show information about a hardware device, for example, the size of memory installed. Others may indicate problems with a device, such as the way it has been configured.

**Note:** If the system fails after you make changes in the BIOS Setup Utility menus, please reset the computer. Enter Setup and install Setup defaults to correct the errors.

## Index of Error Messages

### Error Code List

Error Code	Error Message
006	Equipment Configuration Error Causes: <ul style="list-style-type: none"><li>• CPU BIOS Update Code Mismatch</li><li>• IDE Primary Channel Master Drive Error</li></ul> The causes will be shown before <b>Equipment Configuration Error</b> .
010	Memory Error at xxxx:xxxx:xxxxh (R: xxxxh, W: xxxxh)
070	Real Time Clock Error
071	CMOS Battery Bad
072	CMOS Checksum Error
110	System disabled. Incorrect password is specified.
No error code	Battery critical low: In this situation BIOS will issue four short beeps then shut down system, no message will be shown.
No error code	Thermal critical high: In this situation BIOS will shut down the system, no message will be shown.

### Error Message List

Error Message	FRU/Action in Sequence
Failure Fixed Disk	Reconnect hard disk drive connector. Run <b>Load Default Settings</b> in BIOS Setup Utility. Hard disk drive System board
Stuck Key	see <b>Keyboard or Auxiliary Input Device Check</b> .
Keyboard error	see <b>Keyboard or Auxiliary Input Device Check</b> .
Keyboard Controller Failed	see <b>Keyboard or Auxiliary Input Device Check</b> .
Keyboard locked - Unlock key switch	Unlock external keyboard
Monitor type does not match CMOS - Run Setup	Run <b>Load Default Settings</b> in BIOS Setup Utility.

Error Message	FRU/Action in Sequence
Shadow RAM Failed at offset: nnnn	BIOS ROM System board
System RAM Failed at offset: nnnn	DIMM System board
Extended RAM Failed at offset: nnnn	DIMM System board
System battery is dead - Replace and run Setup	Replace RTC battery and Run BIOS Setup Utility to reconfigure system time, then reboot system.
System CMOS checksum bad - Default configuration used	RTC battery Run BIOS Setup Utility to reconfigure system time, then reboot system.
System timer error	RTC battery Run BIOS Setup Utility to reconfigure system time, then reboot system. System board
Real time clock error	RTC battery Run BIOS Setup Utility to reconfigure system time, then reboot system. System board
Previous boot incomplete - Default configuration used	Run <b>Load Default Settings</b> in BIOS Setup Utility. RTC battery System board
Memory size found by POST differed from CMOS	Run <b>Load Default Settings</b> in BIOS Setup Utility. DIMM System board
Diskette drive A error	Check the drive is defined with the proper diskette type in BIOS Setup Utility. <b>See External Diskette Drive Check.</b>
Incorrect Drive A type - run Setup	Check the drive is defined with the proper diskette type in BIOS Setup Utility.
System cache error - Cache disabled	System board
CPU ID:	System board
DMA Test Failed	DIMM System board
Software NMI Failed	DIMM System board
Fail-Safe Timer NMI Failed	DIMM System board
Device Address Conflict	Run <b>Load Default Settings</b> in BIOS Setup Utility. RTC battery System board
Allocation Error for device	Run <b>Load Default Settings</b> in BIOS Setup Utility. RTC battery System board
Failing Bits: nnnn	DIMM BIOS ROM System board
Fixed Disk n	None

Error Message	FRU/Action in Sequence
Invalid System Configuration Data	BIOS ROM System board
I/O device IRQ conflict	Run <b>Load Default Settings</b> in BIOS Setup Utility. RTC battery System board
Operating system not found	Enter Setup and see if fixed disk and drive A: are properly identified. Diskette drive Hard disk drive System board
No beep, power-on indicator turns off and LCD is blank.	Power source (battery pack and power adapter). See <b>Power System Check</b> . Ensure every connector is connected correctly. Reconnect the DIMM. LED board System board
No beep, power-on indicator turns on and LCD is blank.	Power source (battery pack and power adapter). See <b>Power System Check</b> . Reconnect the LCD connector. Hard disk drive LCD inverter ID LCD cable LCD Inverter LCD System board
No beep, power-on indicator turns on and LCD is blank. But you can see POST on an external CRT.	Reconnect the LCD connectors. LCD inverter ID LCD cable LCD inverter LCD System board
No beep, power-on indicator turns on and a blinking cursor shown on LCD during POST.	Ensure every connector is connected tightly and correctly. System board
No beep during POST but system runs correctly.	Speaker System board

# Phoenix BIOS Beep Codes

Beep Code	Post Code	Description	What to Check (Recommended)
1-1-1-3	02h	Verify Real Mode.	<ul style="list-style-type: none"> <li>• Check the processor.</li> <li>• Check the main board.</li> </ul>
1-1-2-1	04h	Get CPU type.	<ul style="list-style-type: none"> <li>• Check the processor.</li> <li>• Check the main board.</li> </ul>
1-1-2-3	06h	Initialize system hardware.	<ul style="list-style-type: none"> <li>• Check the main board.</li> </ul>
1-1-3-1	08h	Initialize cache to initial POST values.	<ul style="list-style-type: none"> <li>• Check the main board.</li> </ul>
1-1-3-2	09h	Set in POST flag.	<ul style="list-style-type: none"> <li>• Check the main board.</li> </ul>
1-1-3-3	0Ah	Initialize CPU registers.	<ul style="list-style-type: none"> <li>• Check the processor.</li> <li>• Check the main board.</li> </ul>
1-1-4-1	0Ch	Initialize cache to initial POST values.	<ul style="list-style-type: none"> <li>• Check the secondary cache.</li> <li>• Check the processor.</li> <li>• Check the main board.</li> </ul>
1-1-4-3	0Eh	Initialize I/O.	<ul style="list-style-type: none"> <li>• Make sure all the cards are securely inserted into the system.</li> <li>• Make sure that there are no physical problems with the main board or internal connections.</li> <li>• Disable all shadowing of expansion adapter ROMs and see if that fixes the problem.</li> <li>• Remove all unnecessary expansion cards (basically, everything but the video card) and see if the problem goes away. If it does, the problem is probably one of the expansion cards you removed. If not, your problem lies elsewhere. Try to isolate the problem by inserting one expansion card at a time back into the system and seeing which one triggers the problem.</li> </ul>
1-2-1-1	10h	Initialize Power Management.	<ul style="list-style-type: none"> <li>• Check the main board.</li> </ul>
1-2-1-2	11h	Load alternate registers with initial POST values.	<ul style="list-style-type: none"> <li>• Check the main board.</li> </ul>
1-2-1-3	12h	Jump to UserPatch0.	<ul style="list-style-type: none"> <li>• Check the main board.</li> </ul>
1-2-2-1	14h	Initialize keyboard controller.	<ul style="list-style-type: none"> <li>• Check the keyboard.</li> <li>• Check the keyboard controller.</li> <li>• Check the main board.</li> </ul>
1-2-2-3	16h	BIOS ROM checksum.	<ul style="list-style-type: none"> <li>• Check the main board.</li> </ul>
1-2-3-1	18h	8254 timer initialization.	<ul style="list-style-type: none"> <li>• Check the main board.</li> </ul>
1-2-3-3	1Ah	8237 DMA controller initialization	<ul style="list-style-type: none"> <li>• Treat as an expansion card problem.</li> <li>• Check the main board.</li> </ul>
1-2-4-1	1Ch	Reset Programmable Interrupt Controller	<ul style="list-style-type: none"> <li>• Treat as an expansion card problem.</li> <li>• Check the main board.</li> </ul>
1-3-1-1	20h	Test DRAM refresh.	<ul style="list-style-type: none"> <li>• Check the system memory.</li> <li>• Check the main board.</li> </ul>



Beep Code	Post Code	Description	What to Check (Recommended)
1-3-1-3	22h	Test 8742 keyboard controller.	<ul style="list-style-type: none"> <li>• Check the keyboard.</li> <li>• Check the keyboard controller.</li> <li>• Check the main board.</li> </ul>
1-3-2-1	24h	Set ES segment register to 4GB.	<ul style="list-style-type: none"> <li>• Check the main board.</li> </ul>
1-3-3-1	28h	Autosize DRAM.	<ul style="list-style-type: none"> <li>• Check the system memory.</li> <li>• Check the main board.</li> </ul>
1-3-3-3	2Ah	Clear 512K base RAM.	<ul style="list-style-type: none"> <li>• Check the system memory.</li> <li>• Check the main board.</li> </ul>
1-3-4-1	2Ch	RAM failure on address line xxxx.	<ul style="list-style-type: none"> <li>• Check the system memory.</li> <li>• Check the main board.</li> </ul>
1-3-4-3	2Eh	RAM failure on data bits xxxx of low byte of memory bus.	<ul style="list-style-type: none"> <li>• Check the system memory.</li> <li>• Check the main board.</li> </ul>
1-4-1-3	32h	Test CPU bus-clock frequency.	<ul style="list-style-type: none"> <li>• Check the processor.</li> <li>• Check the main board.</li> </ul>
1-4-2-1	34h	COMS RAM read/write failure.	<ul style="list-style-type: none"> <li>• Check the main board.</li> </ul>
1-4-2-4	37h	Reinitialize the chipset.	<ul style="list-style-type: none"> <li>• Check the main board.</li> </ul>
1-4-3-1	38h	Shadow system BIOS ROM.	<ul style="list-style-type: none"> <li>• Check the expansion cards.</li> <li>• Check the system memory.</li> <li>• Check the main board.</li> </ul>
1-4-3-2	39h	Reinitialize the cache.	<ul style="list-style-type: none"> <li>• Check the secondary cache.</li> <li>• Check the processor.</li> <li>• Check the main board.</li> </ul>
1-4-3-3	3Ah	Autosize cache.	<ul style="list-style-type: none"> <li>• Check the secondary cache.</li> <li>• Check the processor.</li> <li>• Check main board.</li> </ul>
1-4-4-1	3Ch	Configure advanced chipset registers.	<ul style="list-style-type: none"> <li>• Check the main board.</li> </ul>
1-4-4-2	3Dh	Load alternate registers with CMOS values.	<ul style="list-style-type: none"> <li>• Check the main board.</li> </ul>
2-1-1-1	40h	Set Initial CPU speed.	<ul style="list-style-type: none"> <li>• Check the main board.</li> </ul>
2-1-1-3	42h	Initialize interrupt vector.	<ul style="list-style-type: none"> <li>• Treat as an expansion card problem.</li> <li>• Check the main board.</li> </ul>
2-1-2-1	44h	Initialize BIOS interrupt.	<ul style="list-style-type: none"> <li>• Treat as an expansion card problem.</li> <li>• Check the main board.</li> </ul>
2-1-2-3	46h	Check ROM copyright notice.	<ul style="list-style-type: none"> <li>• Check the main board.</li> </ul>
2-1-2-4	47h	Initialize manager for PCI Options ROMs.	<ul style="list-style-type: none"> <li>• Treat as an expansion card problem.</li> <li>• Check the serial port(s).</li> <li>• Check the parallel port(s).</li> <li>• Check the main board.</li> </ul>
2-1-3-1	48h	Check video configuration against CMOS.	<ul style="list-style-type: none"> <li>• Check the video card.</li> <li>• Make sure the system memory is working properly.</li> <li>• Check the main board.</li> </ul>

Beep Code	Post Code	Description	What to Check (Recommended)
2-1-3-2	49h	Initialize PCI bus and devices.	<ul style="list-style-type: none"> <li>• Treat as an expansion card problem.</li> <li>• Check the serial port(s).</li> <li>• Check the parallel port(s).</li> <li>• Check the main board.</li> </ul>
2-1-3-3	4Ah	Initialize all video adapters in system.	<ul style="list-style-type: none"> <li>• Check the video card.</li> <li>• Make sure the system memory is working properly.</li> </ul>
2-1-4-1	4Ch	Shadow video BIOS ROM.	<ul style="list-style-type: none"> <li>• Check the expansion cards.</li> <li>• Check the system memory.</li> <li>• Check the main board.</li> </ul>
2-1-4-3	4Eh	Display copyright notice.	<ul style="list-style-type: none"> <li>• Check the video card.</li> <li>• Check the main board.</li> </ul>
2-2-1-1	50h	Display CPU type and speed.	<ul style="list-style-type: none"> <li>• Check the video card.</li> </ul>
2-2-1-3	52h	Test keyboard.	<ul style="list-style-type: none"> <li>• Check the keyboard.</li> <li>• Check the keyboard controller.</li> <li>• Check the main board.</li> </ul>
2-2-2-1	54h	Set key click if enabled.	<ul style="list-style-type: none"> <li>• Check the keyboard.</li> <li>• Check the keyboard controller.</li> <li>• Check the main board.</li> </ul>
2-2-2-3	56h	Enable keyboard.	<ul style="list-style-type: none"> <li>• Check the keyboard.</li> <li>• Check the keyboard controller.</li> <li>• Check the main board.</li> </ul>
2-2-3-1	58h	Test for unexpected interrupts.	<ul style="list-style-type: none"> <li>• Treat as an expansion card problem.</li> <li>• Check the main board.</li> </ul>
2-2-3-3	5Ah	Display prompt "Press F2 to enter SETUP".	<ul style="list-style-type: none"> <li>• Check the video card.</li> <li>• Check the main board.</li> </ul>
2-2-4-1	5Ch	Test RAM between 512 and 640K.	<ul style="list-style-type: none"> <li>• Check the system memory.</li> <li>• Check the main board.</li> </ul>
2-3-1-1	60h	Test expanded memory.	<ul style="list-style-type: none"> <li>• Check the system memory.</li> <li>• Check the main board.</li> </ul>
2-3-1-3	62h	Test extended memory address lines.	<ul style="list-style-type: none"> <li>• Check the system memory.</li> <li>• Check the main board.</li> </ul>
2-3-2-1	64h	Jump to UserPatch1.	<ul style="list-style-type: none"> <li>• Check the main board.</li> </ul>
2-3-2-3	66h	Configure advanced cache registers.	<ul style="list-style-type: none"> <li>• Check the secondary cache.</li> <li>• Check the processor.</li> <li>• Check the main board.</li> </ul>
2-3-3-1	68h	Enable external and CPU caches.	<ul style="list-style-type: none"> <li>• Check the secondary cache.</li> <li>• Check the processor.</li> <li>• Check the main board.</li> </ul>
2-3-3-2	69h	Initialize SMI handler.	<ul style="list-style-type: none"> <li>• Check the main board.</li> </ul>
2-3-3-3	6Ah	Display external cache size.	<ul style="list-style-type: none"> <li>• Check the video card.</li> <li>• Check the main board.</li> </ul>
2-3-4-1	6Ch	Display shadow message.	<ul style="list-style-type: none"> <li>• Check the video card.</li> <li>• Check the main board.</li> </ul>
2-3-4-3	6Eh	Display non-disposable segments.	<ul style="list-style-type: none"> <li>• Check the video card.</li> <li>• Check the main board.</li> </ul>

Beep Code	Post Code	Description	What to Check (Recommended)
2-4-1-1	70h	Display error messages.	<ul style="list-style-type: none"> <li>• Check the video card.</li> <li>• Check the main board.</li> </ul>
2-4-1-3	72h	Check for configuration errors.	<ul style="list-style-type: none"> <li>• Check the main board.</li> </ul>
2-4-2-1	74h	Test real-time clock.	<ul style="list-style-type: none"> <li>• Check the main board.</li> </ul>
2-4-2-3	76h	Check for keyboard errors.	<ul style="list-style-type: none"> <li>• Check the keyboard.</li> <li>• Check the keyboard controller.</li> <li>• Check the main board.</li> </ul>
2-4-4-1	7Ch	Set up hardware interrupts vectors.	<ul style="list-style-type: none"> <li>• Treat as an expansion card problem.</li> <li>• Check the main board.</li> </ul>
2-4-4-3	7Eh	Test coprocessor if present.	<ul style="list-style-type: none"> <li>• Check the processor.</li> <li>• Check the main board.</li> </ul>
3-1-1-1	80h	Disable onboard I/O ports.	<ul style="list-style-type: none"> <li>• Treat as an expansion card problem.</li> <li>• Check the serial port(s).</li> <li>• Check the parallel port(s).</li> <li>• Check the main board.</li> </ul>
3-1-1-3	82h	Detect and install external RS232 ports.	<ul style="list-style-type: none"> <li>• Treat as an expansion card problem.</li> <li>• Check the serial port(s).</li> <li>• Check the parallel port(s).</li> <li>• Check the main board.</li> </ul>
3-1-2-1	84h	Detect and install external parallel ports.	<ul style="list-style-type: none"> <li>• Treat as an expansion card problem.</li> <li>• Check the serial port(s).</li> <li>• Check the parallel port(s).</li> <li>• Check the main board.</li> </ul>
3-1-2-3	86h	Reinitialize onboard I/O ports.	<ul style="list-style-type: none"> <li>• Treat as an expansion card problem.</li> <li>• Check the serial port(s).</li> <li>• Check the parallel port(s).</li> <li>• Check the main board.</li> </ul>
3-1-3-1	88h	Initialize BIOS data area.	<ul style="list-style-type: none"> <li>• Check the main board.</li> </ul>
3-1-3-3	8Ah	Initialize extended BIOS data area.	<ul style="list-style-type: none"> <li>• Check the main board.</li> </ul>
3-1-4-1	8Ch	Initialize floppy controller.	<ul style="list-style-type: none"> <li>• Check the HDD.</li> <li>• Check the floppy disk drive(s).</li> <li>• Check the main board.</li> </ul>
3-2-1-1	90h	Initialize hard disk controller.	<ul style="list-style-type: none"> <li>• Check the HDD.</li> <li>• Check the floppy disk drive(s).</li> <li>• Check the main board.</li> </ul>
3-2-1-2	91h	Initialize local bus hard disk controller.	<ul style="list-style-type: none"> <li>• Check the HDD.</li> <li>• Check the floppy disk drive(s).</li> <li>• Check the main board.</li> </ul>
3-2-1-3	92h	Jump to UserPatch2.	<ul style="list-style-type: none"> <li>• Check the main board.</li> </ul>
3-2-2-1	94h	Disable A20 address line.	<ul style="list-style-type: none"> <li>• Check the keyboard.</li> <li>• Check keyboard controller.</li> <li>• Check the main board.</li> </ul>
3-2-2-3	96h	Clear huge ES segment register.	<ul style="list-style-type: none"> <li>• Check the main board.</li> </ul>
3-2-3-1	98h	Search for option ROMs.	<ul style="list-style-type: none"> <li>• Check the main board.</li> </ul>

Beep Code	Post Code	Description	What to Check (Recommended)
3-2-3-3	9Ah	Shadow for option ROMs.	<ul style="list-style-type: none"> <li>• Check the expansion cards.</li> <li>• Check the system memory.</li> <li>• Check the main board.</li> </ul>
3-2-4-1	9Ch	Set up Power Management.	<ul style="list-style-type: none"> <li>• Check the main board.</li> </ul>
3-2-4-3	9Eh	Enable hardware interrupts.	<ul style="list-style-type: none"> <li>• Treat as an expansion card problem.</li> <li>• Check the main board.</li> </ul>
3-3-1-1	A0h	Set time of day.	<ul style="list-style-type: none"> <li>• Check the main board.</li> </ul>
3-3-1-3	A2h	Check key lock.	<ul style="list-style-type: none"> <li>• Unlock the key lock if it is locked.</li> <li>• Investigate possible problem with the key lock switch. If it is either unlocked already or not present on the system case.</li> <li>• Check the main board.</li> </ul>
3-3-3-1	A8h	Erase F2 prompt.	<ul style="list-style-type: none"> <li>• Check the video card.</li> <li>• Check the main board.</li> </ul>
3-3-3-3	AAh	Scan for F2 key stroke.	<ul style="list-style-type: none"> <li>• Check the main board.</li> </ul>
3-3-4-1	ACh	Enter SETUP.	<ul style="list-style-type: none"> <li>• Check the main board.</li> </ul>
3-3-4-3	A Eh	Clear in-POST flag.	<ul style="list-style-type: none"> <li>• Check the main board.</li> </ul>
3-4-1-1	B0h	Check for errors.	<ul style="list-style-type: none"> <li>• Check the main board.</li> </ul>
3-4-1-3	B2h	POST done - prepare to boot operating system.	<ul style="list-style-type: none"> <li>• Check the main board.</li> </ul>
3-4-2-1	B4h	One beep.	<ul style="list-style-type: none"> <li>• Check the main board.</li> </ul>
3-4-2-3	B6h	Check password (optional).	<ul style="list-style-type: none"> <li>• Check the main board.</li> </ul>
3-4-3-1	B8h	Clear global descriptor table.	<ul style="list-style-type: none"> <li>• Check the main board.</li> </ul>
3-4-4-1	BCh	Clear parity checkers.	<ul style="list-style-type: none"> <li>• Check the main board.</li> </ul>
3-4-4-3	BEh	Clear screen (optional).	<ul style="list-style-type: none"> <li>• Check the video card.</li> <li>• Check the main board.</li> </ul>
3-4-4-4	BFh	Check virus and backup reminders.	<ul style="list-style-type: none"> <li>• Check the main board.</li> </ul>
4-1-1-1	C0H	Try to boot with INT 19.	<ul style="list-style-type: none"> <li>• Check the HDD.</li> <li>• Check the floppy disk drive(s).</li> <li>• Check the main board.</li> </ul>
4-2-1-1	D0H	Interrupt handler error.	<ul style="list-style-type: none"> <li>• Treat as an expansion card problem.</li> <li>• Check the main board.</li> </ul>
4-2-1-3	D2h	Unknown interrupt.	<ul style="list-style-type: none"> <li>• Treat as an expansion card problem.</li> <li>• Check the main board.</li> </ul>
4-2-2-1	D4h	Pending interrupt error.	<ul style="list-style-type: none"> <li>• Treat as an expansion card problem.</li> <li>• Check the main board.</li> </ul>
4-2-2-3	D6h	Initialize option ROM error.	<ul style="list-style-type: none"> <li>• Check the main board.</li> </ul>
4-2-3-1	D8h	Shutdown error.	<ul style="list-style-type: none"> <li>• Check the main board.</li> </ul>
4-2-3-3	DAh	Extended Block Move.	<ul style="list-style-type: none"> <li>• Check the main board.</li> </ul>
4-2-4-1	DCh	Shutdown error.	<ul style="list-style-type: none"> <li>• Check the main board.</li> </ul>

Beep Code	Post Code	Description	What to Check (Recommended)
4-2-4-3	DEh	Keyboard controller failure.	<ul style="list-style-type: none"> <li>• Check the keyboard.</li> <li>• Check the keyboard controller.</li> <li>• Check the main board.</li> </ul>
4-3-1-3	E2h	Initialize the chipset.	<ul style="list-style-type: none"> <li>• Check the main board.</li> </ul>
4-3-1-4	E3h	Initialized refresh counter.	<ul style="list-style-type: none"> <li>• Check the main board.</li> </ul>
4-3-2-1	E4h	Check for Forced Flash.	<ul style="list-style-type: none"> <li>• Check the main board.</li> </ul>
4-3-2-2	E5h	Check HW status of ROM.	<ul style="list-style-type: none"> <li>• Check the main board.</li> </ul>
4-3-2-3	E6h	BIOS ROM is OK.	<ul style="list-style-type: none"> <li>• Check the main board.</li> </ul>
4-3-2-4	E7h	Do a complete RAM test.	<ul style="list-style-type: none"> <li>• Check the system memory.</li> <li>• Check the main board.</li> </ul>
4-3-3-1	E8h	Do OEM initialization.	<ul style="list-style-type: none"> <li>• Check the main board.</li> </ul>
4-3-3-2	E9h	Initialize interrupt controller.	<ul style="list-style-type: none"> <li>• Treat as an expansion card problem.</li> <li>• Check the main board.</li> </ul>
4-3-3-3	EAh	Read in bootstrap code.	<ul style="list-style-type: none"> <li>• Check the HDD.</li> <li>• Check the floppy disk drive.</li> <li>• Check the main board.</li> </ul>
4-3-3-4	EBh	Initialize all vectors.	<ul style="list-style-type: none"> <li>• Treat as an expansion card problem.</li> <li>• Check the main board.</li> </ul>
4-3-4-1	ECh	Boot the Flash program.	<ul style="list-style-type: none"> <li>• Check the main board.</li> </ul>
4-3-4-2	EDh	Initialize the boot device.	<ul style="list-style-type: none"> <li>• Check the HDD.</li> <li>• Check the floppy disk drive(s).</li> <li>• Check the main board.</li> </ul>
4-3-4-3	EEh	Boot code was read OK.	<ul style="list-style-type: none"> <li>• Check the HDD.</li> <li>• Check the floppy disk drive(s).</li> <li>• Check the main board.</li> </ul>

# Index of Symptom-to-FRU Error Message

## LCD-Related Symptoms

Symptom/Error	Action in Sequence
LCD backlight doesn't work. LCD is too dark. LCD brightness cannot be adjusted. LCD contrast cannot be adjusted.	Enter BIOS Utility to execute <b>Load Setup Default Settings</b> , then reboot system. Reconnect the LCD connectors. Keyboard (if contrast and brightness function key do not work). LCD inverter ID LCD cable LCD inverter LCD System board
Unreadable LCD screen Missing pels in characters Abnormal screen Wrong color displayed	Reconnect the LCD connector. LCD inverter ID LCD cable LCD inverter LCD System board
LCD has extra horizontal or vertical lines displayed.	LCD inverter ID LCD inverter LCD cable LCD System board

## Indicator-Related Symptoms

Symptom/Error	Action in Sequence
Indicator incorrectly remains off or on, but system runs correctly.	Reconnect the inverter board Inverter board System board

## Power-Related Symptoms

Symptom/Error	Action in Sequence
Power shuts down during operation.	Power source (battery pack and power adapter). See <b>Power System Check</b> . Battery pack Power adapter Hard drive & battery connection board System board
The system doesn't power on.	Power source (battery pack and power adapter). See <b>Power System Check</b> . Battery pack Power adapter Hard drive & battery connection board System board
The system doesn't power-off.	Power source (battery pack and power adapter). See <b>Power System Check</b> . Hold and press the power switch for more than 4 seconds. System board

---

Symptom/Error	Action in Sequence
Battery can't be charged.	See <b>Check the Battery Pack</b> . Battery pack System board

## PCMCIA-Related Symptoms

Symptom/Error	Action in Sequence
System cannot detect the PC Card (PCMCIA).	PCMCIA slot assembly System board
PCMCIA slot pin is damaged.	PCMCIA slot assembly

## Memory-Related Symptoms

Symptom / Error	Action in Sequence
Memory count (size) appears different from actual size.	Enter BIOS Setup Utility to execute <b>Load Default Settings</b> , then reboot system. DIMM System board

## Speaker-Related Symptoms

Symptom/Error	Action in Sequence
In Windows, multimedia programs, no sound comes from the computer.	Audio driver Speaker System board
Internal speakers make noise or emit no sound.	Speaker System board

## Power Management-Related Symptoms

Symptom/Error	Action in Sequence
The system will not enter hibernation.	Keyboard (if control is from the keyboard) Hard disk drive System board
The system does not enter hibernation mode and four short beeps every minute.	Press Fn + F4 and see if the computer enters hibernation mode. Touchpad Keyboard Hard disk connection board Hard disk drive System board
The system does not enter standby mode after closing the LCD.	LCD cover switch System board
The system does not resume from hibernation mode.	Hard disk connection board Hard disk drive System board
The system does not resume from standby mode after opening the LCD.	LCD cover switch System board
Battery fuel gauge in Windows does not go higher than 90%.	Remove battery pack and let it cool for two hours. Refresh battery (continue to use battery until power off, then charge battery). Battery pack System board
System hangs intermittently.	Reconnect hard disk/CD-ROM drives. Hard disk connection board System board



## Peripheral-Related Symptoms

Symptom/Error	Action in Sequence
System configuration does not match the installed devices.	Enter BIOS Setup Utility to execute <b>Load Default Settings</b> , then reboot system. Reconnect hard disk/CD-ROM/diskette drives.
External display does not work correctly.	Press Fn + F5, LCD/CRT/Both display switching System board
USB does not work correctly.	System board
Print problems	Ensure the <b>Parallel Port</b> in the "Onboard Devices Configuration" of BIOS Setup Utility is set to Enabled. Onboard Devices Configuration Run printer self-test. Printer driver Printer cable Printer System Board
Serial or parallel port device problems.	Ensure the <b>Serial Port</b> in the Devices Configuration" of BIOS Setup Utility is set to Enabled. Device driver Device cable Device System board

## Keyboard/Touchpad-Related Symptoms

Symptom/Error	Action in Sequence
Keyboard (one or more keys) does not work.	Reconnect the keyboard cable. Keyboard System board
Touchpad does not work.	Reconnect touchpad cable. Touchpad board System board

## Modem-Related Symptoms

Symptom/Error	Action in Sequence
Internal modem does not work correctly.	Modem phone port Modem combo board System board

**Note:** If you can not correct the problems according to the anterior tables, see **Undetermined Problems**.

---

# Intermittent Problems

Intermittent system hang problems can be caused by a variety of reasons that have nothing to do with a hardware defect, such as cosmic radiation, electrostatic discharge, or software errors. FRU replacement should be considered only when a recurring problem exists.

When analyzing an intermittent problems, follow the procedures below:

1. Run the advanced diagnostic test for the system board in loop mode at least 10 times.
2. If no error is detected, do not replace any FRU.
3. If any error is detected, replace the FRU. Rerun the test to verify that there are no more errors.

---

# Undetermined Problems

The diagnostic problems does not identify which devices fail, which devices are incorrectly installed, whether a short circuit happens, or whether the system is inoperative.

**Note:** Verify if all devices attached are supported by the computer.

**Note:** Verify if the power supply used at the time of failure is operating correctly. You can refer to **Power System Check**.

Follow the procedures below to isolate the failing FRU. Do not isolate non-defective FRU.

1. Power off the computer.
2. Visually check the devices. If any problems are found, replace the FRU.
3. Remove or disconnect all of the following devices:
  - Non-Acer devices
  - Printer, mouse, and other external devices
  - Battery Pack
  - Hard disk drive
  - DIMM
  - CD-ROM / Diskette drive module
  - PC cards
4. Power on the computer.
5. Determine if the problem has been resolved.
6. If the problem does not recur, reconnect the removed devices one at a time until you find the failed FRU.
7. If the problem remains, replace the following FRU one at a time. Do not replace a non-defective FRU.
  - System board
  - LCD assembly

# Jumper and Connector Location

## Top view

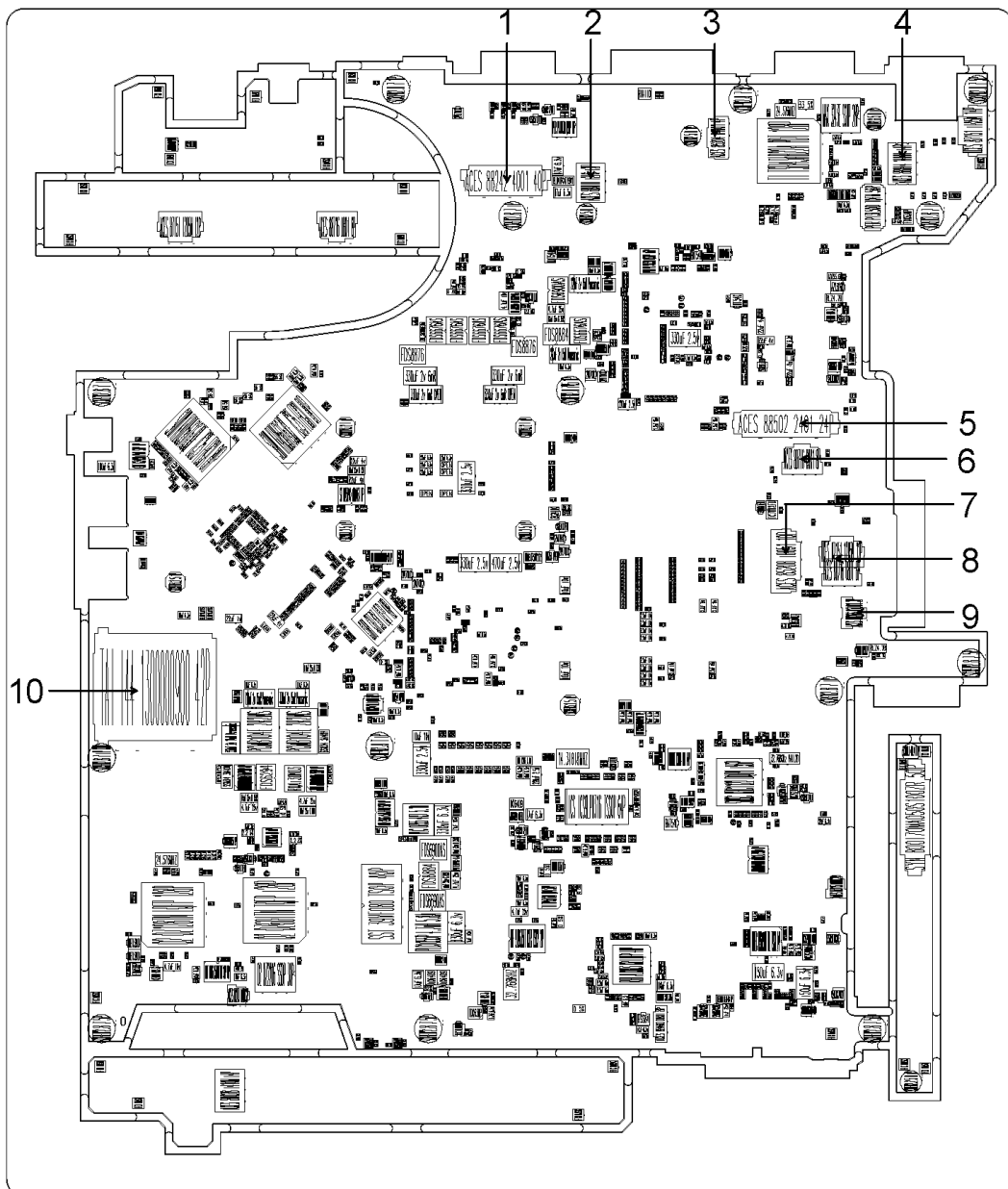

#	Name	Description	#	Name	Description
1	CN3	LCD cable connector	2	CN4	Modem board connector
3	CN1	RJ11 connector	4	CN5	Launch board connector
5	CN6	Keyboard connector	6	CN7	Acer FineTrack connector

---

#	Name	Description	#	Name	Description
7	CN8	Smart card connector	8	CN9	Touchpad connector
9	CN722	Microphone connector	10	CN10	5-in-1 card reader connector

# Bottom view

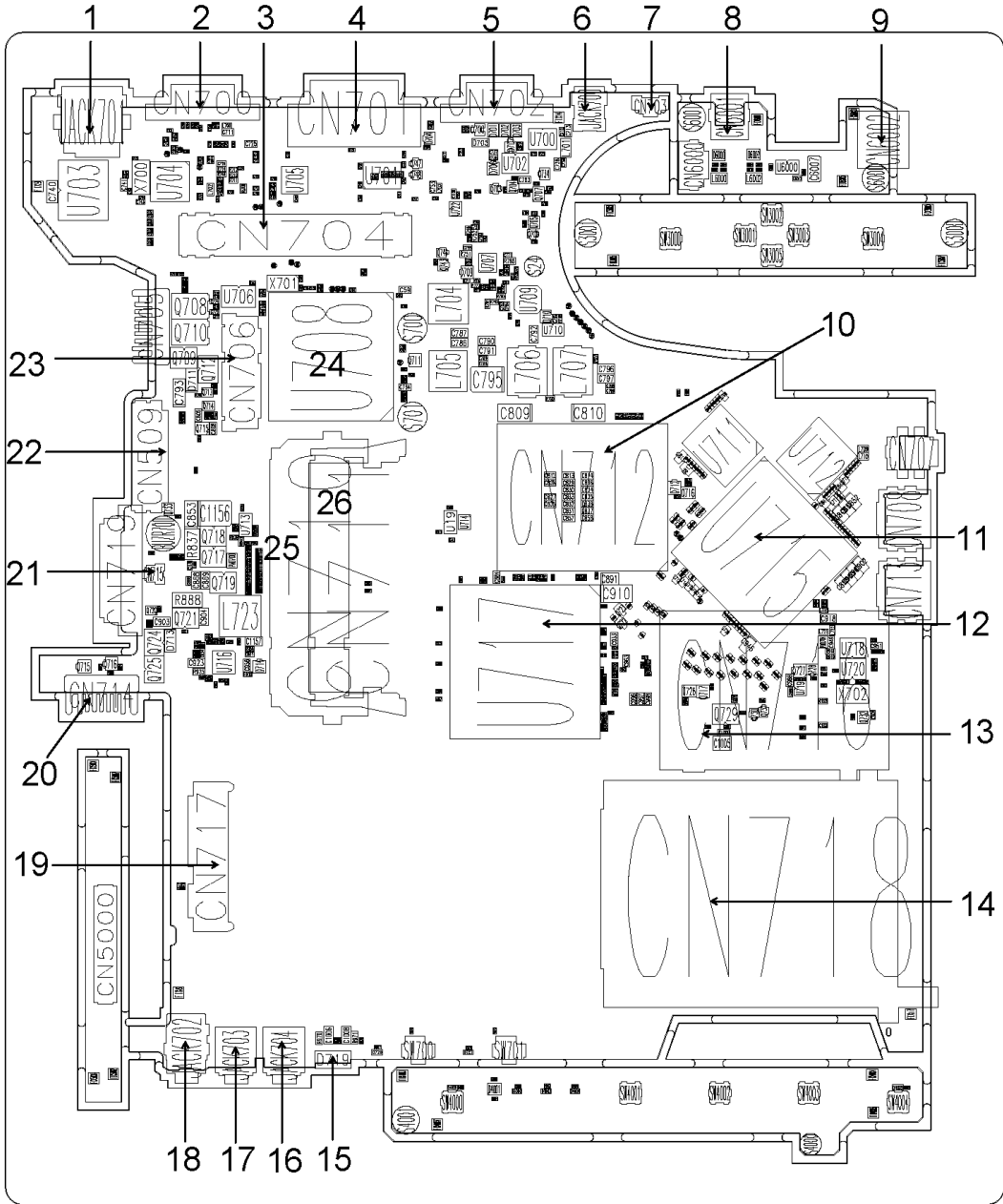

#	Name	Description	#	Name	Description
1	JACK701	Ethernet jack	2	CN700	Serial port
3	CN704	Docking connector	4	CN701	Digital video interface-digital port
5	CN702	External VGA port	6	JACK700	DC-in jack
7	CN703	Fan cable connector	8	CN6001	Modem jack
9	CN6002	S-video port	10	CN712	CPU socket
11	U715	Graphic controller	12	U717	North bridge
13	CN716	New card socket	14	CN718	PCMCIA socket

#	Name	Description	#	Name	Description
15	D719	IR receiver	16	JACK704	Microphone jack
17	JACK703	Line-in jack	18	JACK702	Headphones/speaker/line-out jack
19	CN717	HDD connector	20	CN714	Battery connector
21	CN715	RTC battery connector	22	CN509	ODD connector
23	CN706	PCI-E socket	24	U708	South bridge
25	CN710	DIMM socket	26	CN711	DIMM socket

**Note:** CN6002 (S-video port) and CN6001 (Modem jack) locate on IO board which is the apposite direction from the bottom view.

# Jumper and Connector Location

## Top view

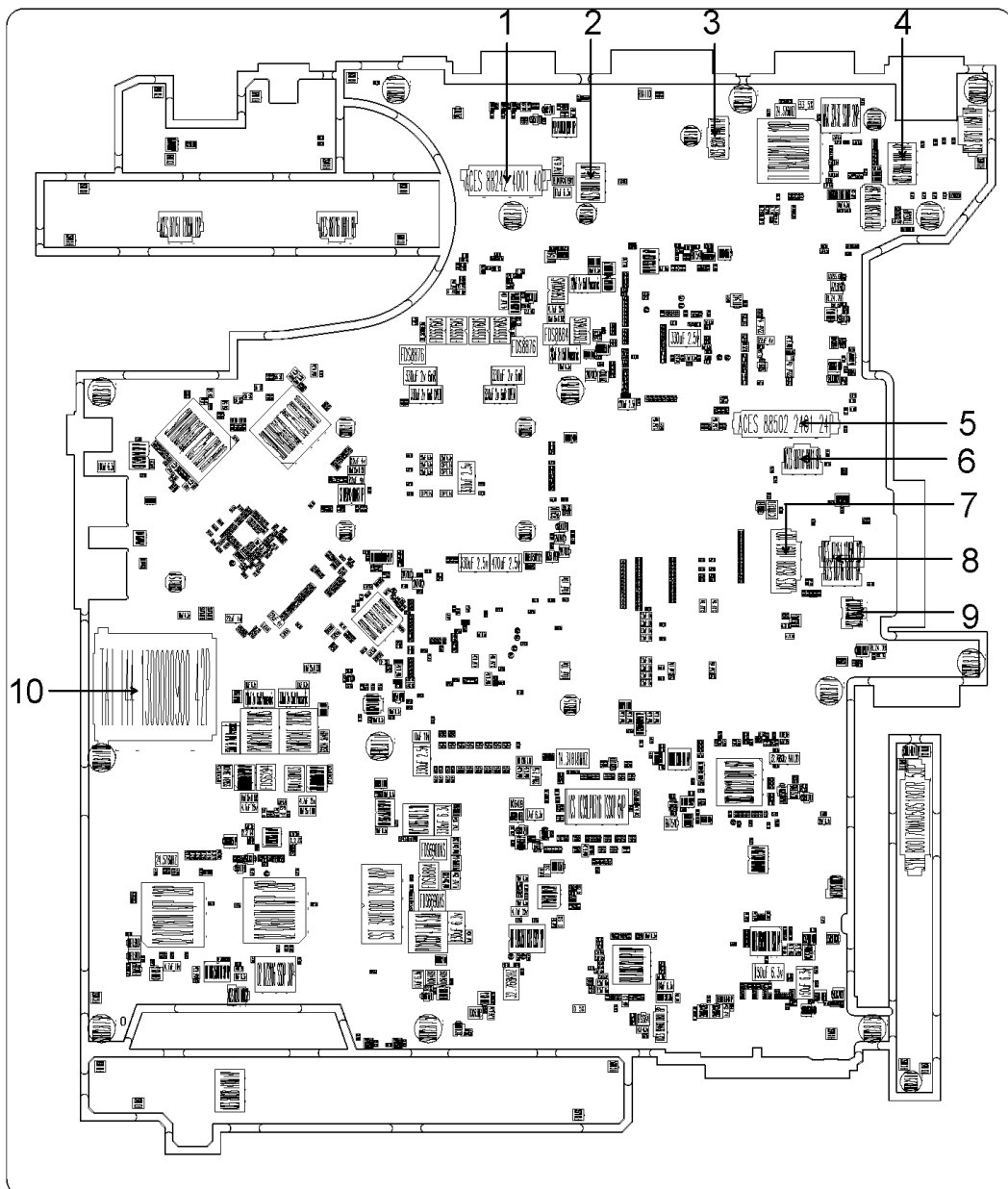

#	Name	Description	#	Name	Description
1	CN3	LCD cable connector	2	CN4	Modem board connector
3	CN1	RJ11 connector	4	CN5	Launch board connector
5	CN6	Keyboard connector	6	CN7	Acer FineTrack connector



---

#	Name	Description	#	Name	Description
7	CN8	Smart card connector	8	CN9	Touchpad connector
9	CN722	Microphone connector	10	CN10	5-in-1 card reader connector

# Bottom view

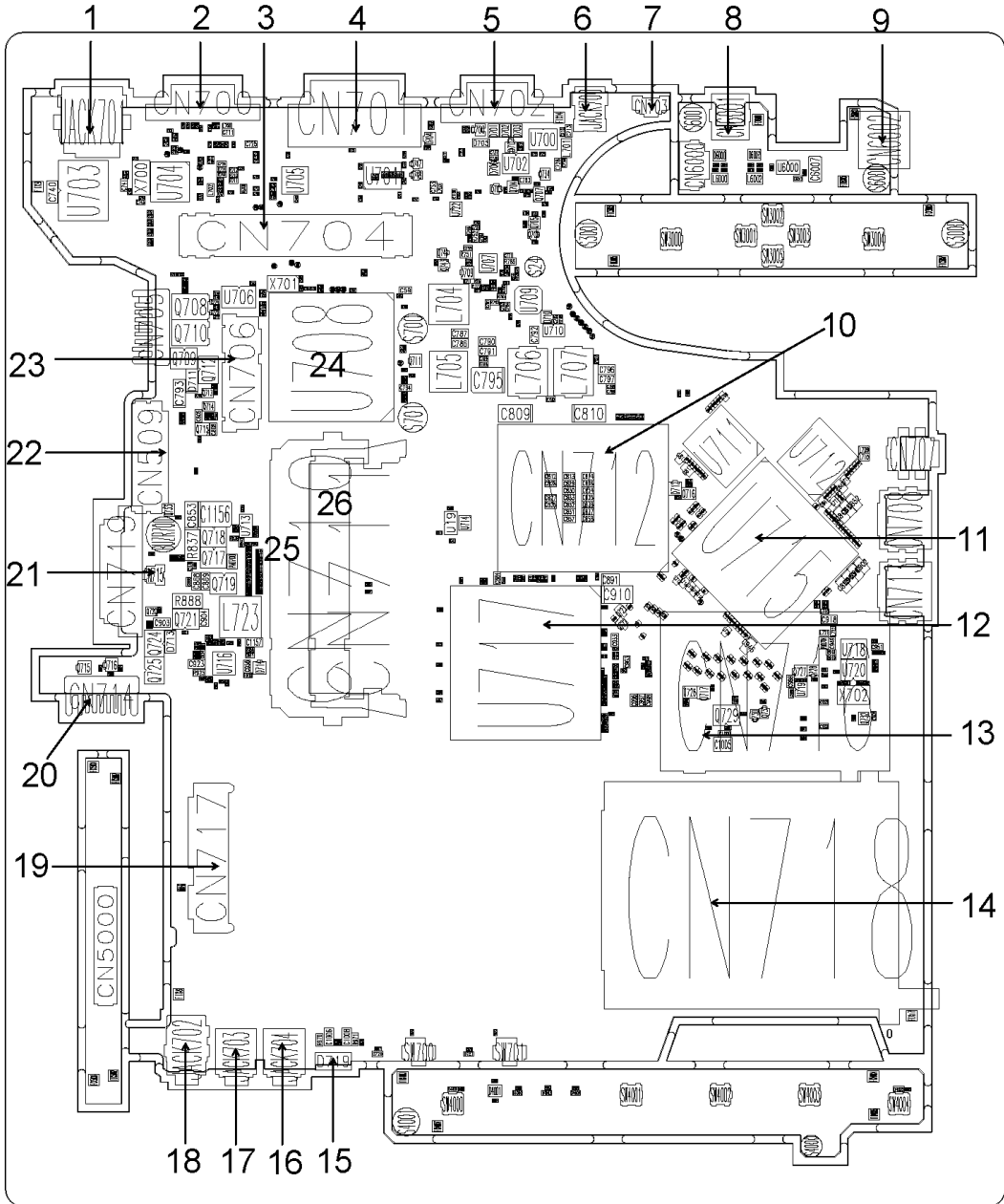

#	Name	Description	#	Name	Description
1	JACK701	Ethernet jack	2	CN700	Serial port
3	CN704	Docking connector	4	CN701	Digital video interface-digital port
5	CN702	External VGA port	6	JACK700	DC-in jack
7	CN703	Fan cable connector	8	CN6001	Modem jack
9	CN6002	S-video port	10	CN712	CPU socket
11	U715	Graphic controller	12	U717	North bridge
13	CN716	New card socket	14	CN718	PCMCIA socket

#	Name	Description	#	Name	Description
15	D719	IR receiver	16	JACK704	Microphone jack
17	JACK703	Line-in jack	18	JACK702	Headphones/speaker/line-out jack
19	CN717	HDD connector	20	CN714	Battery connector
21	CN715	RTC battery connector	22	CN509	ODD connector
23	CN706	PCI-E socket	24	U708	South bridge
25	CN710	DIMM socket	26	CN711	DIMM socket

**Note:** CN6002 (S-video port) and CN6001 (Modem jack) locate on IO board which is the apposite direction from the bottom view.

## FRU (Field Replaceable Unit)

---

This chapter offers the FRU (Field Replaceable Unit) listing in global configuration of TravelMate 6460/6410. Please refer to this chapter whenever you order the parts to repair or for RMA (Return Merchandise Authorization).

Please note that when ordering FRU part, you should check the most-up-to-date information available on your regional web or channel. For whatever reasons, a part number is changed, it will NOT be noted on the printed service guide. For Acer authorized service providers, your Acer office may have a different part number code from those given in the FRU list of this printed service guide. You MUST use the local FRU list provided by your regional Acer office to order FRU parts for service.

**Note:** To scrap or to return the defective parts, you should follow the local government ordinance or regulations on how to dispose them properly, or follow the rules set by your regional Acer office on how to return it.

# Parts and Exploded Diagram

PHOTO	PARTNAME	DESCRIPTON	ACER PART NO.
<b>ADAPTER</b>			
N/A	ADAPTER 90W DELTA ADP-90SB BBDEF BLUE 1.7X5.5X11 LF	"ADAPTOR,3PIN,90W,19 VDC,4.74A,240VAC"	AP.09001.009
N/A	ADAPTER 90W LITE-ON PA-1900-04 RI YELLOW 1.7X5.5X11 LF	"ADAPTOR,3PIN,90W,19 VDC,4.74A,240VAC"	AP.09003.010
N/A	"ADAPTER 90W LSE SLS0202C19A20LF, BLACK, 1.7X5.5X11 LF"	"ADAPTOR,3PIN,90W,19 VDC,4.74A,240VAC"	AP.09006.004
N/A	ADAPTER 90W LITE-ON PA-1900-24 AR BLUE 1.7X5.5X11 LF	"ADAPTOR,3PIN,90W,19 VDC,4.74A,240VAC"	AP.09003.011
<b>BATTERY</b>			
N/A	"BATTERY SANYO LI-ION 3S2P 6CELL 2.0AHR (4,000MAH Y CELL)"	"BATTERY PACK,LI- ION,11.1V,4000mAH,2P3 S"	BT.00603.024
N/A	"BATTERY SONY LI-ION 3S2P 6CELL 2.0AHR (4,000MAH G4E CELL)"	"BATTERY PACK,LI- ION,11.1V,4000mAH,3S2 P"	BT.00604.011
N/A	"BATTERY SANYO LI-ION 4S2P 8CELL 2.4AHR (4,800MAH CELL)"	"BATTERY PACK,LI- ION,14.8V,4800mAH,2P4 S"	BT.00803.020
	"BATTERY SONY LI-ION 4S2P 86CELL 2.4AHR (4,800MAH CELL)"	"BATTERY PACK,LI- ION,14.8V,4800mAH,2P4 S"	BT.00804.017
N/A	BATTERY SANYO LI-ION 3S2P 6CELL 2ND	"BATTERY PACK,LI- ION,11.1V,3800mAH,2P3 S"	BT.00603.026
N/A	RTC BATTERY 3V	"BATTERY SET,LI,3V,90mAH,CELL,2 1X20.5,30m"	23.TCXV1.004
<b>CPU</b>			
	CPU INTEL MEROM CORE 2 DUO T5500 FSB667 2M 1.66G SL9SH	"CPU,1.66GHZ,DUAL CORE,667MHZ,2M,UFCP GA,478P,TAP"	KC.55001.DTP
N/A	CPU INTEL MEROM CORE 2 DUO T5600 FSB667 2M 1.83G SL9SG	"CPU,1.83GHZ,DUAL CORE,667MHZ,2M,UFCP GA,478P,TAP"	KC.56001.DTP
N/A	CPU INTEL MEROM CORE 2 DUO T7200 FSB667 4M 2.0G SL9SF	"CPU,2.0GHZ,DUAL CORE,667MHZ,4M,UFCP GA,478P,TAP"	KC.72001.DTP

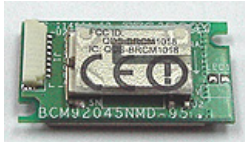
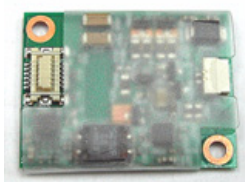

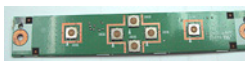

PHOTO	PARTNAME	DESCRIPTION	ACER PART NO.
N/A	CPU INTEL MEROM CORE 2 DUO T7200 FSB667 4M 2.16G SL9SE	"CPU,2.16GHZ,DUAL CORE,667MHZ,4M,UFCP GA,478P,TAP"	KC.74001.DTP
N/A	CPU INTEL MEROM CORE 2 DUO T7200 FSB667 4M 2.33G SL9SD	"CPU,2.33GHZ,DUAL CORE,667MHZ,4MB,UFC PGA,478P,TAP"	KC.76001.DTP
<b>BOARD</b>			
	MINI WIRELESS BOARD 802.11 A/B/G MOW1 INTEL MM872612	"MODULE,WIRELESS LAN,PCI EXP 802.11A/G"	KI.GLN01.001
N/A	MINI WIRELESS BOARD 802.11 A/B/G MOW2 INTEL MM872659	"MODULE,WIRELESS LAN,PCI EXP 802.11A/G"	KI.GLN01.002
N/A	MINI WIRELESS BOARD 802.11 A/B/G ROW INTEL MM874511	"MODULE,WIRELESS LAN,PCI EXP 802.11B/G"	KI.GLN01.003
N/A	MINI WIRELESS BOARD 802.11 A/B/G JP INTEL MM874740	"MODULE,WIRELESS LAN,PCI EXP 802.11A/G"	KI.GLN01.004
N/A	MINI WIRELESS LAN BOARD 802.11BG INTEL WM3945AGBG	"MODULE,WIRELESS LAN,PCI EXP 802.11B/G"	KI.GLN01.005
	BLUETOOTH BOARD FOXCONN T60H928.01	"MODULE,BLUE TOOTH,USB2.0"	54.AAMVN.004
	MODEM BOARD FOXCONN T60M955.00	"MODEM,MDC,56K,AZALI A"	54.TCXVN.001
	TOUCHPAD SYNAPTICS TM51PDF1R226	"TOUCH PAD,NO BUTTON,12P,79.7X47.7,B LK"	56.TCXVN.001
	TOUCHPAD BOTTON BOARD	"FRU,I/O BOARD ASSEMBLY,TOUCH PAD BUTTON BOARD"	55.TCXVN.003
	STICK POINT BOARD WITH FINGER PRINTER (TravelMate 6460 only)	"FRU,I/O BOARD ASSEMBLY,STICK POINT/B WITH FINGER PRINTER CHIP"	55.TEDVN.001
N/A	STICK POINT BOARD W/ O FINGER PRINTER	"FRU,I/O BOARD ASSEMBLY,STICK POINT BOARD W/O FINGER PRINTER CHIP"	55.TCXVN.001

PHOTO	PARTNAME	DESCRIPTION	ACER PART NO.
	I/O BOARD WITH S-VIDEO	"FRU,I/O BOARD ASSEMBLY"	55.TEDVN.002
N/A	I/O BOARD W/O S-VIDEO (TravelMate 6410 only)	"FRU,I/O BOARD ASSEMBLY,W/O S-VIDEO CONNECTOR"	55.TCXVN.002
	LAUNCH BOARD	"FRU,I/O BOARD ASSEMBLY,HOTKEY BOARD"	55.TCXVN.004
	OPTICAL BOARD	"FRU,I/O BOARD ASSEMBLY,ODD MULTI INTERFACE"	55.TCXVN.005
	INVERTER BOARD NEC/ TOKIN 7312S2	"INVERTER,5VDC,AC690 V,65KHz,130X12.5"	19.TCXVN.001
<b>CABLE</b>			
N/A	TOUCHPAD CABLE	"FFC,12P,1L,1.772X0.256 X0.006,PET,S"	50.TCXVN.001
N/A	BUTTON BOARD CABLE 8 PINS TO STICK POINT BOARD	"FFC,8P,1L,3.27X0.177X0.006,PET,S"	50.TCXVN.002
N/A	BUTTON BOARD CABLE 8 PINS TO MAINBOARD	"FFC,8P,1L,7.95X0.177X0.006,PET,S"	50.TCXVN.003
N/A	STICK POINT BOARD CABLE 12PINS TO MB	"FFC,12P,1L,2.847X0.256 X0.006,PET,S"	50.TCXVN.004
N/A	I/O BOARD CABLE	"FFC,14P,1L,2.638X0.295 X0.006,PET,S"	50.TCXVN.005
	BLUETOOTH CABLE	"CABLE,ROUND,8POS,14 0mm,I,BLUETOOTH,32 AW"	50.TCXVN.006
	MODEM CABLE WITH RJ11 CONNECTOR	"CABLE,ROUND,4POS,17 5mm,I,RJ11"	50.TCXVN.007
	"LCD CABLE 15"" XGA"	"CABLE,FIBER,40POS,33 9.898mm,I,LCM"	50.TCXVN.011
N/A	"LCD CABLE 15"" SXGA+"	"CABLE,FLAT,40POS,314 mm,I,LCM"	50.TCXVN.012
N/A	"LCD CABLE 15.4"" WXGA"	"CABLE,FIBER,40POS,29 3.23mm,I,LCM"	50.TCXVN.021
N/A	"LCD CABLE 15.4"" WXGA W/CCD"	"CABLE,FIBER,40POS,35 3.091mm,I,LCM"	50.TCXVN.022
N/A	"LCD CABLE 15.4"" WSXGA+"	"CABLE,FLAT,40POS,304 mm,I,LCM"	50.TCXVN.031
N/A	"LCD CABLE 15.4"" WSXGA+ W/CCD"	"CABLE,FIBER,40POS,35 3.091mm,I,LCM"	50.TCXVN.032
<b>POWER CORD</b>			
N/A	POWER CORD 3PIN USA	CORD-ROUND-3POS-1828mm-E-POWER-USA	27.AAMVN.001

PHOTO	PARTNAME	DESCRIPTION	ACER PART NO.
N/A	POWER CORD 3PIN EUR	CORD-ROUND-3POS-1850mm-E-POWER-EUR	27.AAMVN.002
N/A	POWER CORD AUSTRALIA W/LABEL	CORD-ROUND-3POS-1850mm-E-POWER-AUL	27.AAMVN.003
N/A	POWER CORD 3PIN UK	CORD-ROUND-3POS-1828mm-E-POWER-UK	27.AAMVN.004
N/A	POWER CORD 3PIN CHINA	"CORD,ROUND,3POS,1800mm,E,POWER,PRC"	27.AAMVN.005
N/A	POWER CORD 3PIN SWISS	"CORD,ROUND,3POS,1830mm,E,POWER,SWITZERLAND"	27.AAMVN.006
N/A	POWER CORD SOUTH AFRICA (AIL)	"CORD,ROUND,3POS,1830mm,E,POWER,S.AFRICAN"	27.AAMVN.007
N/A	POWER CORD 3PIN SOUTH AFRICA	"CORD,ROUND,3POS,1800mm,E,SOUTH AFRICA"	27.AAMVN.008
N/A	POWER CORD 3PIN ITALIAN	"CORD,ROUND,3POS,1800mm,E,ITL"	27.AAMVN.009
N/A	POWER CORD 3PIN DENMARK	"CORD,ROUND,3POS,1800mm,E,DANISH"	27.AAMVN.010
N/A	POWER CORD ISRAEL	"CORD,ROUND,3POS,1800mm,E,ISRAEL"	27.AAMVN.011
<b>CASE/COVER/BACKET ASSEMBLY</b>			
	TOUCHPAD BRACKET	"BRACKET,TOP,TOUCHPAD,SECC"	33.TCXVN.011
	DIMM COVER	"SET,COVER,MEMORY"	42.TCXVN.001
	HDD COVER	"SET,COVER,HDD"	42.TCXVN.002
N/A	PCMCIA DUMMY CARD	"DUMMY,PCMCIA CARD,PC+ABS"	42.TCXVN.003
N/A	MINI DUMMY CARD	"DUMMY,EXPRESS CARD,PC+ABS"	42.TCXVN.004
N/A	LOWER CASE (TravelMate 6410 only)	"FRU,BOTTOM CASE ASSEMBLY"	60.TCXVN.001
N/A	UPPER CASE (TravelMate 6410 only)	"FRU,TOP CASE ASSEMBLY"	60.TCXVN.002
N/A	MIDDLE COVER (TravelMate 6410 only)	"SET,COVER,SWITCH"	60.TCXVN.003







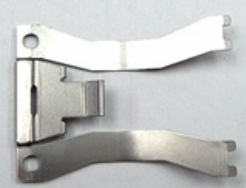

PHOTO	PARTNAME	DESCRIPTION	ACER PART NO.
	LOWER CASE (TravelMate 6460 only)	"FRU,BOTTOM CASE ASSEMBLY"	60.TEDVN.001
N/A	UPPER CASE W/O FINGER PRINTER (TravelMate 6460 only)	"FRU, TOP CASE ASSEMBLY"	60.TEDVN.002
	UPPER CASE WITH FINGER PRINTER (TravelMate 6460 only)	"FRU, TOP CASE ASSEMBLY"	60.TEDVN.012
	MIDDLE COVER (TravelMate 6460 only)	"SET,COVER,SWITCH"	60.TEDVN.003
N/A	CONNECTOR 2ND HDD	"E.SET,FPC+CONN,50P/20P,38.06MM"	22.D03VN.001
N/A	BRACKET 2ND HDD	"BRACKET,HDD,BOTTOM,SECC"	33.D03VN.002
N/A	UPPER CASE 2ND HDD	"CASE,HDD,BOTTOM,PC+ABS"	60.D03VN.003
N/A	LOWER CASE 2ND HDD	"CASE,HDD,TOP,PC+ABS"	60.D03VN.004
N/A	COMBO BEZEL GBASE	"SET,BEZEL,ODD"	42.TCXVN.005
N/A	SUPER MULTI BEZEL GBASE	"SET,BEZEL,ODD"	42.TCXVN.007
	OPTICAL RAIL HOLDER	"HOLDER,ODD,PC+ABS"	42.TCXVN.006
	HDD HOLDER	"FRAME,HDD,AL"	42.TCXVN.008
	CPU HEATSINK FINGER	"FINGER,CPU,SUS301"	33.TCXVN.001
	VGA HEATSINK FINGER	"FINGER,VGA,SUS301"	33.TCXVN.002

PHOTO	PARTNAME	DESCRIPTION	ACER PART NO.
N/A	NORTH BRIDGE THERMAL BRACKET LOWER	"BRACKET,THERMAL,BOTTOM,SECC"	33.TCXVN.008
N/A	NORTH BRIDGE THERMAL BRACKET UPPER	"BRACKET,THERMAL,TOP,SECC"	33.TCXVN.009
N/A	I/O PORT BRACKET	"BRACKET,PCB,DISUB,SUS 301"	33.TXCVN.010
N/A	"LCD COVER 15""	"FRU,LCD TOP CASE ASSEMBLY"	60.TCXVN.004
N/A	"LCD BEZEL 15"" W/ LOGO"	"FRU,LCD BOTTOM CASE ASSEMBLY"	60.TCXVN.005
N/A	"LCD BRACKET 15"" L"	"HINGE-W BRACKET,DISPLAY,LEFT, 7.9~8.9KGF-"	33.TCXVN.003
N/A	"LCD BRACKET 15"" R"	"HINGE-W BRACKET,DISPLAY,RIGHT, 7.9~8.9KGF"	33.TCXVN.004
N/A	"LCD BEZEL 15.4"" W/ LOGO"	"FRU,LCD TOP CASE ASSEMBLY"	60.TCXVN.006
N/A	"LCD COVER 15.4"" W/ LOGO"	"FRU,LCD BOTTOM CASE ASSEMBLY"	60.TCXVN.007
N/A	"LCD BRACKET 15.4"" L"	"HINGE-W BRACKET,DISPLAY,LEFT, 8.1~9.1KGF-"	33.TCXVN.005
N/A	"LCD BRACKET 15.4"" R"	"HINGE-W BRACKET,DISPLAY,RIGHT, 8.1~9.1KGF"	33.TCXVN.006
N/A	CAMERA LATCH	"HINGE-W BRACKET,CCD,0.6~0.7KGF-CM"	33.TCXVN.007
N/A	"LCD BEZEL 15.4"" CCD W/LOGO"	"FRU,LCD TOP CASE ASSEMBLY"	60.TCXVN.008
N/A	"LCD COVER 15.4"" CCD W/LOGO"	"FRU,LCD BOTTOM CASE ASSEMBLY"	60.TCXVN.009
N/A	CCD BEZEL	"SET,BEZEL,CCD"	60.TCXVN.010
N/A	CCD COVER	"CASE,CCD,REAR,PC+ABS,COAT"	60.TCXVN.011
N/A	CCD BEZEL W/LOGO 0.3M	"SET,BEZEL,CCD"	60.TXCVN.012
<b>COMBO DRIVE</b>			
N/A	CDRW/DVD COMBO MODULE 24X	CDRW/DVD COMBO MODULE 24X	6M.TCXVN.001
N/A	DVD/CDRW COMBO 24X DRIVE PANASONIC UJDA-770 G-BASE LF	"DVD,COMBO,8X,24X,24X,24X,AMBER,M2,128X12.7X126.1mm,SLIM"	KO.02406.013
N/A	"DVD/CDRW COMBO 24X DRIVE PHILIPS SCB5265 ,GB,LF FW#TX13"	"DVD,COMBO,8X,24X,24X,24X,M2,128X12.7X126.1mm,SLIM"	KO.02408.011
<b>DVD RW DRIVE</b>			

PHOTO	PARTNAME	DESCRIPTION	ACER PART NO.
N/A	DVD-RW DRIVE 8X SUPER MULTI GBASE W/ BEZEL	DVD-RW DRIVE 8X SUPER MULTI GBASE W/ BEZEL	6M.TCXVN.002
N/A	DVD-RW DRIVE 8X SUPER MULTI TOSHIBA TS-L632D W/O BEZEL	"DVD,SUPER MULTI,5X,8X,6X,8X,8X,8X ,24X,24X,24X, GREEN,12 8X12.7X126.1mm,SLIM"	KU.00801.014
N/A	DVD-RW DRIVE 8X SUPER MULTI PANASONIC UJ-850 LF W/O BEZEL	"DVD,SUPER MULTI,5X,8X,6X,8X,8X,8X ,24X,16X,24X,AMBER,M2, 128X12.7X126.1mm,SLIM "	KU.00807.047
N/A	DVD-RW DRIVE 8X SUPER MULTI PHI SDVD- 8821 LF W/O BEZEL	"DVD,SUPER MULTI,5X,8X,6X,8X,8X,8X ,24X,24X,24X,M2,128X12. 7X126.1mm,SLIM"	KU.00809.005
<b>FAN</b>			
N/A	FAN	"FAN.SET,VERTICAL,5V,0 .2A,3650RPM,"	23.TCXVN.003
<b>HDD/HARD DISK DRIVE</b>			
N/A	HDD 60G SEAGATE 5.4K SATA 8M ST96812AS (- 189) MERCURY 2 LF FW:3.06	"HDD,SATA,60GB,5.4KRP M,22P,12.5ms,5.5ms,SAT A II,2.5X0.37,M3"	KH.06001.009
N/A	"HDD 60G HGST 5.4K SATA 1.5G NCQ MORAGA+HTS541060G9 SA00,C60D"	"HDD,SATA,60GB,5.4KRP M,22P,12ms,5.5ms,SATA1 .0,2.5X0.37,M3"	KH.06007.012
N/A	HDD 60G WD 5.4K SATA 8M WD600BEVS-22LAT0 ML60 LF FW:T0	"HDD,SATA,60GB,5.4KRP M,22P,12ms,5.5ms,SATA1 .0,2.5X0.37,M3"	KH.06008.005
	HDD 80G SEAGATE 5.4K SATA ST98823AS MERCURY 2 FW:3.06 LF	"HDD,SATA,80GB,5.4KRP M,22P,12.5ms,5.5ms,SAT A II,2.5X0.37,M3"	KH.08001.023
N/A	HDD 80G SEAGATE 5.4K SATA 8M ST98823AS (- 189) MERCURY 2 LF FW:3.06	"HDD,SATA,80GB,5.4KRP M,22P,12.5ms,5.5ms,SAT A II,2.5X0.37,M3"	KH.08001.027
N/A	HDD 80GB TOSHIBA 5.4K SATA MK8032GSX ARIES-B FREE-FALL LF FW:AS111J	"HDD,SATA,80GB,5.4KRP M,22P,12ms,5.6ms,SATA1 .0,2.5X0.37,M3"	KH.08004.007
N/A	"HDD 80G HGST 5.4K SATA 1.5G NCQ MORAGA+HTS541080G9 SA00,C60D"	"HDD,SATA,80GB,5.4KRP M,22P,12ms,5.5ms,SATA1 .0,2.5X0.37,M3"	KH.08007.015
N/A	HDD 80G WD 5.4K SATA 8M WD800BEVS-22LAT0 ML60 LF FW:T0	"HDD,SATA,80GB,5.4KRP M,22P,12ms,5.5ms,SATA1 .0,2.5X0.37,M3"	KH.08008.031

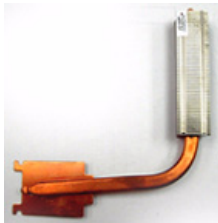

PHOTO	PARTNAME	DESCRIPTION	ACER PART NO.
N/A	HDD 100G SEAGATE 5.4K SATA ST9100824AS MERCURY 2 FW:3.06 LF	"HDD,SATA,100GB,5.4KR PM,22P,12.5ms,5.6ms,SA TA1.0,2.5X0.37,M3"	KH.10001.008
N/A	HDD 100G SEAGATE 5.4K SATA 8M ST9100824AS (-189) MERCURY 2 FW:3.06 LF	"HDD,SATA,100GB,5.4KR PM,22P,12.5ms,5.5ms,SA TA II,2.5X0.37,M3"	KH.10001.009
N/A	HDD 100G TOSHIBA 5.4K SATA MK1032GSX ARIES-B FREE-FALL LF FW:AS021J	"HDD,SATA,100GB,5.4KR PM,22P,12ms,5.6ms,SATA 1.0,2.5X0.37,M3"	KH.10004.004
N/A	HDD 100G HGST SATA 1.5G NCQMORAGA+HTS5410 10G9SA00 FW:S60D	"HDD,SATA,100GB,5.4KR PM,22P,12ms,5.5ms,SATA 1.0,2.5X0.37,M3"	KH.10007.005
N/A	HDD 100G WD 5.4K SATA 8M WD1000BEVS- 22LAT0 ML60 LF FW:T0	"HDD,SATA,100GB,5.4KR PM,22P,12ms,5.5ms,SATA 1.0,2.5X0.37,M3"	KH.10008.002
N/A	HDD 120G SEAGATE 5.4K SATA ST9120821AS LF MERCURY 2 FW:3.06	"HDD,SATA,120GB,5.4KR PM,22P,12.5ms,5.6ms,SA TA1.0,2.5X0.37,M3"	KH.12001.025
N/A	HDD 120G SEAGATE 5.4K SATA 8M ST9120821AS (-189) MERCURY 2 LF FW:3.06	"HDD,SATA,120GB,5.4KR PM,22P,12.5ms,5.5ms,SA TA II,2.5X0.37,M3"	KH.12001.026
N/A	HDD 120G TOSHIBA 5.4K SATA1.5G W/NCQ MK1234GSX ARIES-B FREE-FALL LF FW:AH001J	"HDD,SATA,120GB,5.4KR PM,22P,12ms,5.6ms,SATA 1.0,2.5X0.37,M3"	KH.12004.004
N/A	HDD 120G WD 5.4K SATA WD1200BEVS- 22LAT0 ML60 LF FW:T0	"HDD,SATA,120GB,5.4KR PM,22P,12ms,5.5ms,SATA 1.0,2.5X0.37,M3"	KH.12008.016
N/A	HDD 160G SEAGATE 5.4K ST9160821AS VENUS SATA LF FW:3.ALA	"HDD,SATA,160GB,5.4KR PM,22P,12.5ms,5.5ms,SA TA II,2.5X0.37,M3"	KH.16001.021
N/A	HDD 160G HGST 5.4K SATA HTS541616J9SA00 SURUGA-B LF F/W: C70P	"HDD,SATA,160GB,5.4KR PM,22P,12ms,5.5ms,SATA 1.0,2.5X0.37,M3"	KH.16007.011
<b>HEATSINK</b>			
	CPU HEATSINK	"THERMAL MODULE,CPU"	34.TCXVN.001
	VGA HEATSINK	"THERMAL MODULE,VGA False 1 PRD"	34.TCXVN.002
<b>KEYBOARD</b>			

PHOTO	PARTNAME	DESCRIPTION	ACER PART NO.
	KEYBOARD DARFON TM6410/TM6460 US INTERNATIONAL	"KEYBOARD/W ST,88,24P,BLACK,US- INTL,310X115.52, 5.5mm"	KB.TCX07.001
N/A	KEYBOARD DARFON TM6410/TM6460 CHINESE	"KEYBOARD/W ST,88,24P,BLACK,PRC,31 0X115.52,5.5mm"	KB.TCX07.002
N/A	KEYBOARD DARFON TM6410/TM6460 SPANISH	"KEYBOARD/W ST,89,24P,BLACK,SPN,31 0X115.52,5.5mm"	KB.TCX07.003
N/A	KEYBOARD DARFON TM6410/TM6460 THAILAND	"KEYBOARD/W ST,88,24P,BLACK,THAI,3 10X115.52,5.5mm"	KB.TCX07.004
N/A	KEYBOARD DARFON TM6410/TM6460 BRAZILIAN PORTUGUESE	"KEYBOARD/W ST,89,24P,BLACK,BRZ,31 0X115.52,5.5mm"	KB.TCX07.005
N/A	KEYBOARD DARFON TM6410/TM6460 KORAEAN	"KEYBOARD/W ST,88,24P,BLACK,KOR,31 0X115.52,5.5mm"	KB.TCX07.006
N/A	KEYBOARD DARFON TM6410/TM6460 UK	"KEYBOARD/W ST,89,24P,BLACK,UK,310 X115.52,5.5mm"	KB.TCX07.007
N/A	KEYBOARD DARFON TM6410/TM6460 GERMAN	"KEYBOARD/W ST,89,24P,BLACK,GER,31 0X115.52,5.5mm"	KB.TCX07.008
N/A	KEYBOARD DARFON TM6410/TM6460 ITALIAN	"KEYBOARD/W ST,89,24P,BLACK,ITA,310 X115.52,5.5mm"	KB.TCX07.009
N/A	KEYBOARD DARFON TM6410/TM6460 FRENCH	"KEYBOARD/W ST,89,24P,BLACK,FRE,31 0X115.52,5.5mm"	KB.TCX07.010
N/A	KEYBOARD DARFON TM6410/TM6460 SWISS/ G	"KEYBOARD/W ST,89,24P,BLACK,SWI,31 0X115.52,5.5mm"	KB.TCX07.011
N/A	KEYBOARD DARFON TM6410/TM6460 PORTUGUESE	"KEYBOARD/W ST,89,24P,BLACK,POU,31 0X115.52,5.5mm"	KB.TCX07.012
N/A	KEYBOARD DARFON TM6410/TM6460 ARABIC	"KEYBOARD/W ST,88,24P,BLACK,ARA,31 0X115.52,5.5mm"	KB.TCX07.013
N/A	KEYBOARD DARFON TM6410/TM6460 BELGIUM	"KEYBOARD/W ST,89,24P,BLACK,BEL,31 0X115.52,5.5mm"	KB.TCX07.014
N/A	KEYBOARD DARFON TM6410/TM6460 SWEDISH	"KEYBOARD/W ST,89,24P,BLACK,SWE,3 10X115.52,5.5mm"	KB.TCX07.015
N/A	KEYBOARD DARFON TM6410/TM6460 CZECH	"KEYBOARD/W ST,89,24P,BLACK,CZE,31 0X115.52,5.5mm"	KB.TCX07.016
N/A	KEYBOARD DARFON TM6410/TM6460 HUNGARIAN	"KEYBOARD/W ST,89,24P,BLACK,HUN,31 0X115.52,5.5mm"	KB.TCX07.017

PHOTO	PARTNAME	DESCRIPTION	ACER PART NO.
N/A	KEYBOARD DARFON TM6410/TM6460 NORWEGIAN	"KEYBOARD/W ST,89,24P,BLACK,NOR,31 0X115.52,5.5mm"	KB.TCX07.018
N/A	KEYBOARD DARFON TM6410/TM6460 DANISH	"KEYBOARD/W ST,89,24P,BLACK,DEN,31 0X115.52,5.5mm"	KB.TCX07.019
N/A	KEYBOARD DARFON TM6410/TM6460 TURKISH	"KEYBOARD/W ST,89,24P,BLACK,TUR,31 0X115.52,5.5mm"	KB.TCX07.020
N/A	KEYBOARD DARFON TM6410/TM6460 CANADIAN FRENCH	"KEYBOARD/W ST,89,24P,BLACK,FR.CA NADIAN,310X115.52,5.5m m"	KB.TCX07.021
N/A	KEYBOARD DARFON TM6410/TM6460 JAPANESE	TBD	KB.TCX07.022
N/A	KEYBOARD DARFON TM6410/TM6460 GREEK	"KEYBOARD/W ST,88,24P,BLACK,GRK,31 0X115.52,5.5mm"	KB.TCX07.023
N/A	KEYBOARD DARFON TM6410/TM6460 RUSSIAN	"KEYBOARD/W ST,88,24P,BLACK,RUS,31 0X115.52,5.5mm"	KB.TCX07.024
N/A	KEYBOARD DARFON TM6410/TM6460 SLOVENIAN	"KEYBOARD/W ST,89,24P,BLACK,SLOVE NIA,310X115.52,5.5mm"	KB.TCX07.025
N/A	KEYBOARD DARFON TM6410/TM6460 SLO/ CRO	"KEYBOARD/W ST,89,24P,BLACK,CROAT IAN,310X115.52,5.5mm"	KB.TCX07.026
N/A	TBD	"KEYBOARD/W ST,88,24P,BLACK,HEBRE W,310X115.52,5.5mm"	TBD
<b>COMMUNICATION MODULE</b>			
	WIRELESS ANTENNA LEFT/RIGHT	"ANTENNA,DUAL,2.4/ 5.2G,770mm,1.37mm"	25.TCXVN.001
<b>LCD</b>			
N/A	"LCD MODULE 15"" XGA W/ ANTENNA"	"LCD MODULE 15"" XGA W/ ANTENNA"	6M.TCXV1.011
N/A	"LCD MODULE 15"" SXGA+ W/ ANTENNA"	"LCD MODULE 15"" SXGA+ W/ ANTENNA"	6M.TCXVN.012
N/A	LCD 15 IN . SXGA+ AU B150PG03 200 NITS SPWG-B	"LCM,15,TFT,SXGA+,LVD S,575g"	LK.15005.008
N/A	LCD 15 IN. XGA AUO B150XG02. V4 LEAD- FREE	"LCM,15,TFT,XGA,LVDS,5 85g"	LK.15005.010
N/A	LCD MODULE 15.4IN. WXGA NON-GLARE W/ ANTENNA	LCD MODULE 15.4IN. WXGA NON-GLARE W/ ANTENNA	6M.TCXVN.021

PHOTO	PARTNAME	DESCRIPTION	ACER PART NO.
N/A	LCD MODULE 15.4IN. WXGA NON-GLARE W/ ANTENNA &CCD 1.3M	LCD MODULE 15.4IN. WXGA NON-GLARE W/ ANTENNA &CCD 1.3M	6M.TCXVN.022
N/A	LCD MODULE 15.4IN. WXGA NON-GLARE W/ ANTENNA &CCD 0.3M	LCD MODULE 15.4IN. WXGA NON-GLARE W/ ANTENNA &CCD 0.3M	6M.TCXVN.023
N/A	"LCD 15.4 WXGA AUO B154EW02-V0 NON- GLARE 200NITS, 16MS (LF)"	"LCM,15.4,TFT,WXGA,LV DS,500g"	LK.15405.013
N/A	"15.4"" WXGA LPL LP154W01-TLE1NO N- GLARE 16MS, 200NITS"	"LCM,15.4,TFT,WXGA,LV DS,560g"	LK.15408.019
N/A	LCD MODULE 15.4IN. WSXGA+ NON-GLARE W/ANTENNA	LCD MODULE 15.4IN. WSXGA+ NON-GLARE W/ANTENNA	6M.TCXVN.031
N/A	LCD MODULE 15.4IN. WSXGA+ NON-GLARE W/ANTENNA &CCD 1.3M	LCD MODULE 15.4IN. WSXGA+ NON-GLARE W/ANTENNA &CCD 1.3M	6M.TCXVN.032
N/A	LCD 15.4 IN. WSXGA+ QDI QD15AL02-01 NON GLARE LF	"LCM,15.4,TFT,WSXGA+, LVDS,585g"	LK.15409.014
N/A	LCD MODULE 15.4IN. WXGA+ NON-GLARE W/ ANTENNA	LCD MODULE 15.4IN. WXGA+ NON-GLARE W/ ANTENNA	6M.TCXVN.041
N/A	LCD MODULE 15.4IN. WXGA+ NON-GLARE W/ ANTENNA & CCD 1.3M	LCD MODULE 15.4IN. WXGA+ NON-GLARE W/ ANTENNA & CCD 1.3M	6M.TCXVN.042
N/A	"LCD 15.4"" WXGA+ CMO N154C2-L03 NON-GLARE 10MS 200NITS"	"LCM,15.4,TFT,WXGA+,L VDS,530g"	LK.1540D.013
<b>CAMERA</b>			
N/A	CCD CAMERA 1.3M LOGITECH SHAGGY2	"DIGITAL CAMERA,1.3M"	56.AAMVN.003
<b>MAINBOARD</b>			
N/A	MAINBOARD TM6410 INTEL 945GM LF UMA <b>(TravelMate 6410)</b>	"FRU,MAIN BOARD ASSEMBLY"	MB.TCX0B.001
	"MAINBOARD TM6460 INTEL 945PM M52P128M LF W/CARD READER, SMART CARD, DVI, & TV- OUT" <b>(TravelMate 6460)</b>	"FRU,MAIN BOARD ASSEMBLY"	MB.TED0B.001
<b>MEMORY</b>			
N/A	SO-DIMM DDRII533 256MB NANYA NT256T64UH4A1FN-37B LF	"MEMORY MODULE,256MB,PC2- 4200,SODIMM,200P,32M X64,"	KN.25603.029
N/A	SO-DIMM DDRII533 256MB SAMSUNG M470T3354CZ3-CD5 LF	"MEMORY MODULE,256MB,PC2- 4200,200P,32MX64,"	KN.2560B.017

PHOTO	PARTNAME	DESCRIPTION	ACER PART NO.
N/A	SO-DIMM DDRII533 256M HYNIX HYMP532S64BP6- C4	"MEMORY MODULE,256MB,PC2- 4200,SODIMM,200P,32M X64,"	KN.2560G.012
N/A	SO-DIMM DDRII533 512MB NANYA NT512T64UH8A1FN-37B LF	"MEMORY MODULE,512MB,PC2- 4200,SODIMM,200P,64M X64,"	KN.51203.023
N/A	SO-DIMM DDRII533 512MB SAMSUNG M470T6554CZ3-CD500 LF	"MEMORY MODULE,512MB,PC2- 4200,200P,64MX64,"	KN.5120B.015
N/A	SO-DIMM DDRII533512M HYNIX HYMP564S64BP6- C4	"MEMORY MODULE,512MB,PC2- 4200,SODIMM,200P,64M X64,"	KN.5120G.013
N/A	SO-DIMM DDRII533 1GB INFINEON HYS64T128021HDL-3.7-B	"MEMORY MODULE,1GB,PC2- 4200,SODIMM,200P,128M X64,"	KN.1GB02.030
N/A	SO-DIMM DDRII533 1GB MANYA NT1GT64UH8A0BN-37B LF	"MEMORY MODULE,1024MB,PC2- 4200,DDR2,200P,128MX6 4,"	KN.1GB03.006
N/A	SO-DIMM DDRII533 1GB SAMSUNG M470T2953CZ3-CD5 LF	"MEMORY MODULE,1GB,PC2- 4200,DDR2,200P,128MX6 4,"	KN.1GB0B.004
N/A	SO-DIMM DDRII667 256MB NANYA NT256T64UH4A1FN-3C LF	"MEMORY MODULE,256MB,PC2- 5300,DDR2,200P,32MX64 ,"	KN.25603.027
N/A	SO-DIMM DDRII667 256MB SAMSUNG M470T3354CZ3-CE6 LF	"MEMORY MODULE,256MB,PC2- 5300,DDR2,200P,32MX64 ,"	KN.2560B.018
N/A	SO-DIMM DDRII667 256MB HYNIX HYMP532S64BP6-Y5 LF (.09UM)	"MEMORY MODULE,256MB,PC2- 5300,DDR2,200P,32MX64 ,"	KN.2560G.013
N/A	SO-DIMM DDRII667 512MB INFINEON HYS64T64020HDL-3S-B (.09U/G)	"MEMORY MODULE,512MB,PC2- 5300,DDR2,200P,64MX64 ,"	KN.51202.035
N/A	SO-DIMM DDRII667 512MB NANYA NT512T64UH8A1FN-3C LF	"MEMORY MODULE,512MB,PC2- 5300,DDR2,200P,64MX64 ,"	KN.51203.025
N/A	SO-DIMM DDRII667 512MB SAMSUNG M470T6554CZ3-CE6 LF	"MEMORY MODULE,512MB,PC2- 5300,DDR2,200P,64MX64 ,"	KN.5120B.018

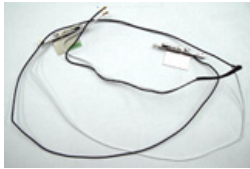

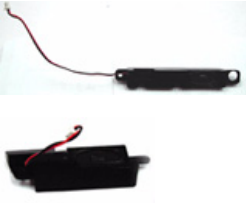
PHOTO	PARTNAME	DESCRIPTON	ACER PART NO.
N/A	SO-DIMM DDRII667 512MB HYNIX HYMP564S64BP6-Y5 LF (.09UM)	"MEMORY MODULE,512MB,PC2- 5300,DDR2,200P,64MX64 ,"	KN.5120G.014
N/A	SO-DIMM DDRII667 1GB NANYA NT1GT64U8HA0BN-3C LF	"MEMORY MODULE,1GB,PC2- 5300,DDR2,200P,128MX6 4,"	KN.1GB03.009
N/A	SO-DIMM DDRII667 1GB SAMSUNG M470T2953CZ3-CE6	"MEMORY MODULE,1GB,PC2- 5300,DDR2,200P,128MX6 4,"	KN.1GB0B.005
<b>MISCELLANEOUS</b>			
N/A	LCD CUSHION LEFT	"BUMPER,DISPLAY,LEFT, SILICONE"	47.TCXV1.001
N/A	LCD CUSHION RIGHT	"BUMPER,DISPLAY,RIGH T,SILICONE"	47.TCXV1.002
N/A	BUMPER DOCK	"BUMPER,BOTTOM,DOC K,SILICONE"	47.TCXV1.003
N/A	BUMPER CARDREADER	"BUMPER,TOP,CARDRE ADER,SILICONE"	47.TCXV1.004
N/A	KNOB WLAN & BT	"KNOB,TOP,WIFI,PC+AB S,COAT"	47.TCXVN.005
<b>MICROPHONE</b>			
N/A	MICROPHONE	"BUZZER,9X5.5 False 1 PRD"	23.TCXVN.001
<b>SPEAKER</b>			
	SPEAKER SET	"SPEAKER.SET,40HM,1. 5W,9.5mm,25X12X4.6mm, 55/110mm"	23.TCXVN.002
N/A	SPEAKER SET	"SPEAKER.SET,80HM,2 W,24mm,62X13X13- 94X12X14mm,55/110mm"	6039B0009801
<b>SCREW</b>			
N/A	SCREW	"SCREW,I,M2.5,5mm,M,0. 45mm,0.8mm,BNI,PATC"	86.D03VN.004
N/A	SCREW	SCREW- WI30030M(5.0Dx1.5T)-NI- HARDEN	86.AAMVN.001
N/A	SCREW	SCREW- I25060M(4.5Dx0.8T)-BK- PATCH	86.AAMVN.002
N/A	SCREW	SCREW-I20040M-BK- PATCH	86.TCXVN.001
N/A	SCREW	SCREW- I25025M(4.5Dx0.8T)-BK- PATCH	86.TCXVN.002

PHOTO	PARTNAME	DESCRIPTON	ACER PART NO.
N/A	SCREW	SCREW-I250100M(4.5DX0.8T)-BK-PATCH	86.TCXVN.003
N/A	SCREW	SCREW-I20050M(4.5Dx0.5T)-BK-PATCH	86.TCXVN.004
N/A	SCREW	SCREW-I25040M(4.5Dx0.8T)-BK-PATCH	86.TCXVN.005
N/A	SCREW	SCREW-I-M2.0-3.0-M-4.0Dx0.3T-BK-PATCH	86.TCXVN.006
N/A	SCREW	"SCREW,I,M2.5,3.0mm,M,4.5mm,0.8mm,BNI,PAT"	86.TCXVN.007