

TravelMate 7530/7230 Series Service Guide

Service guide files and updates are available on the ACER/CSD web; for more information, please refer to <http://csd.acer.com.tw>

PRINTED IN TAIWAN

Revision History

Please refer to the table below for the updates made on TravelMate 7530/7230 Series service guide.

Date	Chapter	Updates

Copyright

Copyright © 2008 by Acer Incorporated. All rights reserved. No part of this publication may be reproduced, transmitted, transcribed, stored in a retrieval system, or translated into any language or computer language, in any form or by any means, electronic, mechanical, magnetic, optical, chemical, manual or otherwise, without the prior written permission of Acer Incorporated.

Disclaimer

The information in this guide is subject to change without notice.

Acer Incorporated makes no representations or warranties, either expressed or implied, with respect to the contents hereof and specifically disclaims any warranties of merchantability or fitness for any particular purpose. Any Acer Incorporated software described in this manual is sold or licensed "as is". Should the programs prove defective following their purchase, the buyer (and not Acer Incorporated, its distributor, or its dealer) assumes the entire cost of all necessary servicing, repair, and any incidental or consequential damages resulting from any defect in the software.

Acer is a registered trademark of Acer Corporation.

Intel is a registered trademark of Intel Corporation.

Pentium and Pentium II/III are trademarks of Intel Corporation.

Other brand and product names are trademarks and/or registered trademarks of their respective holders.

Conventions

The following conventions are used in this manual:

SCREEN MESSAGES	Denotes actual messages that appear on screen.
NOTE	Gives bits and pieces of additional information related to the current topic.
WARNING	Alerts you to any damage that might result from doing or not doing specific actions.
CAUTION	Gives precautionary measures to avoid possible hardware or software problems.
IMPORTANT	Reminds you to do specific actions relevant to the accomplishment of procedures.

Preface

Before using this information and the product it supports, please read the following general information.

1. This Service Guide provides you with all technical information relating to the BASIC CONFIGURATION decided for Acer's "global" product offering. To better fit local market requirements and enhance product competitiveness, your regional office MAY have decided to extend the functionality of a machine (e.g. add-on card, modem, or extra memory capability). These LOCALIZED FEATURES will NOT be covered in this generic service guide. In such cases, please contact your regional offices or the responsible personnel/channel to provide you with further technical details.
2. Please note WHEN ORDERING FRU PARTS, that you should check the most up-to-date information available on your regional web or channel. If, for whatever reason, a part number change is made, it will not be noted in the printed Service Guide. For ACER-AUTHORIZED SERVICE PROVIDERS, your Acer office may have a DIFFERENT part number code to those given in the FRU list of this printed Service Guide. You MUST use the list provided by your regional Acer office to order FRU parts for repair and service of customer machines.

System Specifications	1
Features	1
System Block Diagram	4
Your Acer Notebook tour	5
Front View	5
Closed Front View	6
Left View	7
Right View	8
Rear View	8
Bottom View	9
Indicators	10
Easy-Launch Buttons	10
Productivity Keys (only for certain models)	11
TouchPad Basics (with fingerprint reader)	12
Using the Keyboard	13
Lock Keys and embedded numeric keypad	13
Windows Keys	14
Hot Keys	15
Special Key (only for certain models)	15
Using the System Utilities	16
Acer GridVista (dual-display compatible)	16
Hardware Specifications and Configurations	18
 System Utilities	 27
BIOS Setup Utility	27
Navigating the BIOS Utility	27
Information	28
Main	29
Advanced	30
Security	33
Boot	36
Power	37
Exit	39
BIOS Flash Utility	40
Remove HDD/BIOS Utility	41
 Machine Disassembly and Replacement	 45
Disassembly Requirements	45
General Information	46
Pre-disassembly Instructions	46
Disassembly Process	46
External Module Disassembly Process	47
External Modules Disassembly Flowchart	47
Removing the Battery Pack	48
Removing the SD dummy card	49
Removing the ExpressCard dummy card	50
Removing the Lower Covers	51
Removing the Turbo RAM module	52
Removing the WLAN Module	53
Removing the Hard Disk Drive2 Module	54
Removing the Hard Disk Drive1 Module	56
Removing the Optical Drive Module	58
Main Unit Disassembly Process	60
Main Unit Disassembly Flowchart	60

Table of Contents

Removing the Switch Cover	62
Removing the Keyboard	64
Removing the DIMM Modules	65
Removing the Antenna	67
Removing the LCD Module	68
Removing the Switch Board	70
Removing the Upper Cover	71
Removing the Finger Print Reader	75
Removing the Speaker Module	76
Removing the TouchPad	78
Removing the Launch Board	79
Removing the Bluetooth Module	81
Removing the Modem Module	82
Removing the ExpressCard Module	83
Removing the Mainboard	84
Removing the CPU Fan	86
Removing the CPU	87
LCD Module Disassembly Process	88
LCD Module Disassembly Flowchart	88
Removing the LCD Bezel	89
Removing the Inverter Board	91
Removing the Camera Module	92
Removing the LCD Panel	93
Removing the LCD Brackets and FPC Cable	94
LCD Module Reassembly Procedure	96
Replacing the LCD Panel	96
Replacing the LCD Bezel	99
Main Module Reassembly Procedure	100
Replacing the CPU	100
Replacing the CPU Fan Module	100
Replacing the Mainboard	101
Replacing the Bluetooth Board	103
Replacing the Modem Module	103
Replacing the Finger Print Reader	105
Replacing the Launch Board	106
Replacing the Speaker Module	107
Replacing the TouchPad	108
Replacing the Upper Cover	108
Replacing the LCD Module	112
Replacing the Switch Board	114
Replacing the DIMM Modules	115
Replacing the Keyboard	116
Replacing the Switch Cover	116
Replacing the Turbo RAM Module	117
Replacing the WLAN Module	118
Replacing the Hard Disk Drive Module	118
Replacing the ODD Module	120
Replacing the Lower Covers	121
Replacing the Express and SD Card Trays	122

Troubleshooting

123

Common Problems	123
Power On Issue	124
No Display Issue	125
Random Loss of BIOS Settings	126

Table of Contents

LCD Failure	127
Built-In Keyboard Failure	127
TouchPad Failure	128
Internal Speaker Failure	128
Internal Microphone Failure	130
HDD Not Operating Correctly	131
ODD Failure	132
USB Failure (Rightside)	135
Modem Function Failure	135
Wireless Function Failure	136
EasyTouch Button Failure	136
MediaTouch Button Failure	137
Fingerprint Reader Failure	137
Thermal Unit Failure	138
HDTV Switch Failure	138
External Mouse Failure	139
Other Failures	139
Intermittent Problems	140
Undetermined Problems	140
POST Codes Tables	141
Chipset POST Codes	141
Jumper and Connector Locations	145
Top View	145
Bottom View	146
Clearing Password Check and BIOS Recovery	147
Clearing Password Check	147
BIOS Recovery by Crisis Disk	148
FRU (Field Replaceable Unit) List	149
TravelMate 7530/7230 Exploded Diagrams	150
Upper/ Lower Cover	150
LCD Panel	151
TravelMate 7530/7230 FRU List	153
Screw List	164
Model Definition and Configuration	166
TravelMate 7530/7230 Series	166
Test Compatible Components	167
Microsoft® Windows® Vista Environment Test	168
Online Support Information	173
Index	175

Table of Contents

System Specifications

Features

Below is a brief summary of the computer's many feature:

NOTE: Items marked with * denote only selected models.

Operating System

- Genuine Windows® Vista™

Platform

- AMD Better by Design program, featuring:
 - AMD Turion™ X2 dual-core mobile processor
 - AMD Athlon™ X2 dual-core mobile processor
 - Mobile AMD Sempron™ processor (TravelMate 7230 only)
 - AMD RS780MN/SB700 Chipset
 - Acer InviLink™ 802.11b/g

System Memory

- Dual-Channel DDR2 SDRAM support
- Up to 2 GB of DDR2 667 MHz memory, upgradeable to 4 GB using two soDIMM modules*

Display and graphics

- 17" WXGA+ 1440 x 900
- ATI Radeon™ HD 3200 Graphics*
- ATI Mobility Radeon™ HD 3470 Hybrid x 2*

Storage subsystem

- 2.5" hard disk drive
- Optical drive options:
 - Blu-ray Disc™/DVD-Super Multi double-layer drive*
 - DVD-Super Multi double-layer drive*
 - DVD/CD-RW combo drive*
- 5-in-1 card reader

Audio

- Two built-in Acer 3DSonic stereo speakers
- High-definition audio support
- MS-Sound compatible
- Built-in microphone

Communication

- Acer Video Conference, featuring:
 - Integrated Acer Crystal Eye webcam*
 - Optional Acer Xpress VoIP phone*
- WLAN: Acer InviLink™ 802.11b/g
- WPAN: Bluetooth® 2.0+Enhanced Data Rate (EDR)*
- LAN: Gigabit Ethernet, Wake-on-LAN ready
- Modem: 56K ITU V.92

Privacy control

- Enhanced Acer DASP (Disk Anti-Shock Protection)*
- • Acer Bio-Protection fingerprint solution*
- • BIOS user, supervisor, HDD passwords
- • Kensington lock slot

Dimensions

- 396 (W) x 286 (D) x 35.2/44 (H) mm (15.59 x 11.261 x 1.39/1.73 inches)
- 3.60 kg (7.93 lbs.) with 2 HDDs and 8-cell battery pack*
- 3.40 kg (7.48 lbs.) with one HDD and 6-cell battery pack*

Power subsystem

- ACPI 3.0
- 71 W 4800 mAh*
- 48.8W 4400 mAh*
- 3-pin 65 W AC adapter*
- 3-pin 90W AC adapter*
- Energy Star 4.0

Input Devices

- 105-/106-key keyboard
- Touchpad pointing device

I/O interface

- Acer EasyPort IV connector
- ExpressCard™/54 slot
- PC Card slot (Type II)
- Acer Bio-Protection fingerprint reader*
- 5-in-1 card reader (SD™, MMC, MS, MS PRO, xD)
- Four USB 2.0 ports
- HDMI™ port with HDCP support*
- External display (VGA) port

-
- Headphone/speaker/line-out jack
 - Microphone-in jack
 - Line-in jack
 - Ethernet (RJ-45) port
 - Modem (RJ-11) port
 - DC-in jack for AC adapter

Environment

- Temperature:
 - Operating: 5 °C to 35 °C (41°F to 95°F)
 - Non-operating: -20 °C to 65 °C (-4°F to 149°F)
- Humidity (non-condensing):
 - Operating: 20% to 80%
 - Non-operating: 20% to 80%

NOTE: Items marked with * denote only selected models.

NOTE: The specifications listed above are for reference only. The exact configuration of your PC depends on the model purchased.



Your Acer Notebook tour

After knowing your computer features, let us show you around your new computer.

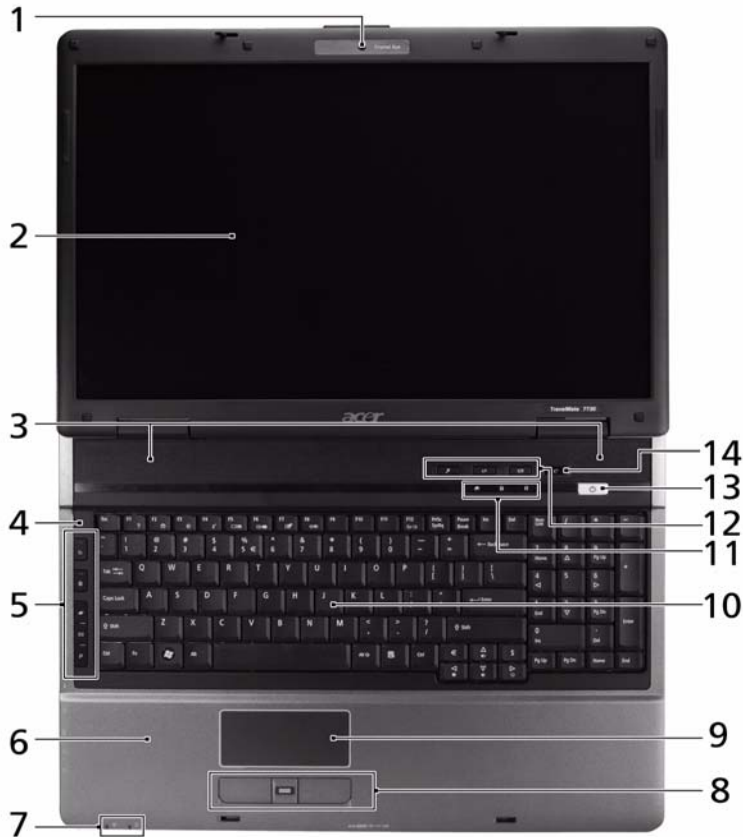
Front View



No.	Icon	Item	Description
1		Acer Crystal Eye	Web camera for video communication (only for certain models).
2		Display screen	Also called Liquid-Crystal Display (LCD), displays computer output.
3		Speakers	Left and right speakers deliver stereo audio output.
4		Microphone	Internal microphone for sound recording.
5		Easy-launch buttons	Buttons for launching frequently used programs.
6		Palmrest	Comfortable support area for your hands when you use the computer.
7		Status indicators	Light-Emitting Diodes (LEDs) that light up to show the status of the computer's functions and components.

No.	Icon	Item	Description
8		Click buttons (left, center* and right)	The left and right buttons function like the left and right mouse buttons. *The center button serves as Acer Bio-Protection fingerprint reader supporting Acer FingerNav 4-way control function.
9		TouchPad	Touch-sensitive pointing device which functions like a computer mouse.
10		Keyboard	For entering data into your computer.
11		Status indicators	Light-Emitting Diodes (LEDs) that light up to show the status of the computer's functions and components.
12		Productivity Keys	Three productivity keys give users one-touch access to protection and manageability features for a more secure, smarter and easier way to work.
13		Power button	Turns the computer on and off.
14		Empowering key	Launch Acer Empowering Technology







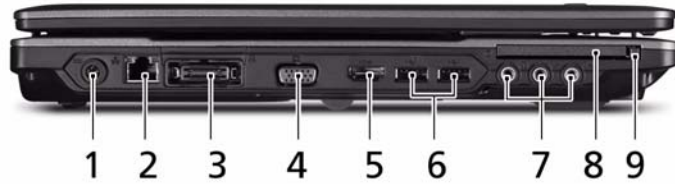

Closed Front View



No.	Icon	Item	Description
1		5-in-1 card reader	Accepts Secure Digital (SD), MultiMediaCard (MMC), Memory Stick (MS), Memory Stick Pro (MS PRO), xD-Picture Card. Note: Push to remove/install the card. Only one card can operate at any given time.
2		Latch	Locks and releases the lid





Left View

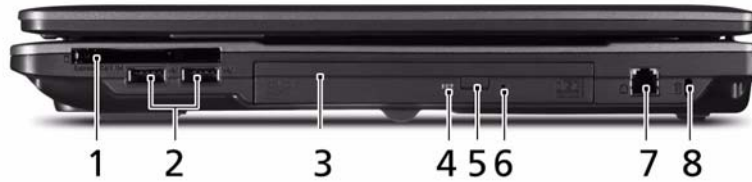

No.	Icon	Item	Description
1		DC-in jack	Connects to an AC adapter
2		Ethernet (RJ-45) port	Connects to an Ethernet 10/100/1000-based network.
3		Acer EasyPort IV connector	Connects to Acer EasyPort IV (only for certain models).
4		External display (VGA) port	Connects to a display device (e.g. external monitor, LCD projector).
5	HDMI	HDMI	Supports high definition digital video connections (only for certain models).
6		USB 2.0 ports	Connect to USB 2.0 devices (e.g. USB mouse, USB camera).
7		Headphones/speaker/line-out jack	Connects to audio line-out devices (e.g. speakers, headphones).
		Microphone-in jack	Accepts input from external microphones.
		Line-in jack	Accepts audio line-in devices (e.g. audio CD player, stereo walkman, mp3 player).
8		PC Card slot	Accepts one Type II PC Card.
9		PC Card slot eject button	Ejects the PC Card from the slot.

Right View



No.	Icon	Item	Description
1		ExpressCard/54 slot	Accepts one ExpressCard/54 module. Note: Push to remove/install the card.
2		USB 2.0 ports	Connect to USB 2.0 devices (e.g. USB mouse, USB camera).
3		Optical drive	Internal optical drive; accepts CDs or DVDs.
4		Optical disk access indicator	Lights up when the optical drive is active.
5		Optical drive eject button	Ejects the optical disk from the drive.
6		Emergency eject hole	Ejects the optical drive tray when the computer is turned off. Note: Insert a paper clip into the emergency eject hole to eject the optical drive tray when the computer is off.
7		Modem (RJ-11) port	Connects to a phone line.
8		Kensington lock slot	Connects to a Kensington-compatible computer security lock.







Rear View

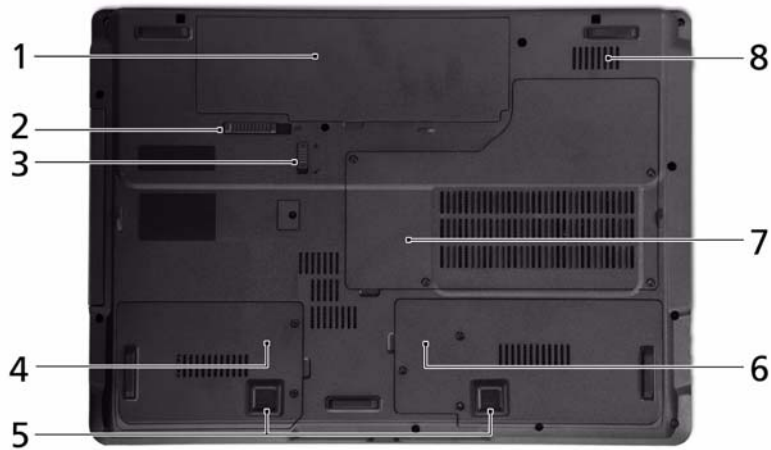

No.	Item	Description
1	Ventilation slots	Enable the computer to stay cool, even after prolonged use.







Bottom View



No.	Icon	Item	Description
1		Battery bay	Houses the computer's battery pack.
2		Battery release latch	Releases the battery for removal.
3		Battery lock	Locks the battery in position.
4		Hard disk bay - Main	Houses the computer's hard disk (secured with screws).
5		Acer DASP (Disk Anti-Shock Protection)	Protects the hard disk drive from shocks and bumps (only for certain models).
6		Hard disk bay - Secondary	Houses the computer's hard disk (secured with screws) (only for certain models).
7		Memory compartment	Houses the computer's main memory.
8		Ventilation slots	Enable the computer to stay cool, even after prolonged use.

Indicators

The computer has several easy-to-read status indicators. The front panel indicators are visible even when the computer cover is closed.





Icon	Function	Description
	HDD	Indicates when the hard disk drive is active.
	Num Lock	Lights up when Num Lock is activated.
	Caps Lock	Lights up when Caps Lock is activated.
	Power	Indicates the computer's power status.
	Battery	Indicates the computer's battery status.
	Bluetooth communication button/indicator	Enables/disables the Bluetooth function. Indicates the status of Bluetooth communication.
	Wireless communication button/indicator	Enables/disables the wireless function. Indicates the status of wireless LAN communication.

NOTE: 1. **Charging:** The light shows amber when the battery is charging. 2. **Fully charged:** The light shows green when in AC mode.

Easy-Launch Buttons

Located beside the keyboard are application buttons. These buttons are called easy-launch buttons. They are: WLAN, Internet, email, Bluetooth and Acer Empowering Technology.



The mail and Web browser buttons are pre-set to email and Internet programs, but can be reset by users. To set the Web browser, mail and programmable buttons, run the Acer Launch Manager, you can access the Launch Manager by clicking on Start, All Programs, and then Launch Manager to start the application.

Icon	Function	Description
	Empowering Technology	Launch Acer Empowering Technology. (user-programmable)
	Web browser	Internet browser (user-Programmable)
	Mail	Email application (user-Programmable)
	Programmable key	User-programmable

Productivity Keys (only for certain models)

Three productivity keys give users one-touch access to protection and manageability features for a more secure, smarter and easier way to work.

- Lock key - runs the Windows® lock function to lock the notebook when you step out. If the laptop is equipped with Acer Bio-Protection, you only need to swipe your finger to log into Windows® again.
- Presentation key - minimizes open application windows and prepares the display for impressive presentations.
- Sync key - instantly synchronizes your computer system to an external storage device, for convenient and secure backup.

Icon	Function	Description
	Lock	Launch Windows Lock function
	Presentation	Minimizes your open windows and prepares your display for presenting
	Sync	Launch NTI Shadow

TouchPad Basics (with fingerprint reader)

The following items show you how to use the TouchPad with Acer Bio-Protection fingerprint reader:

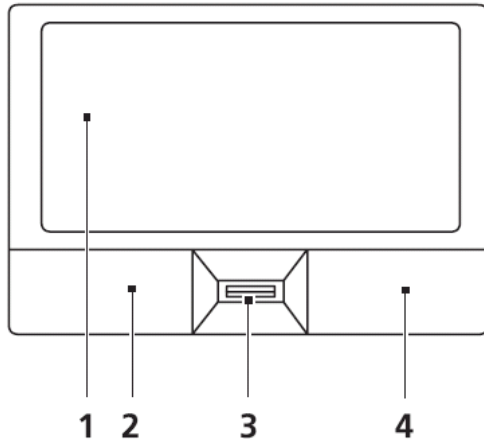

- Move your finger across the touchpad (1) to move the cursor.
- Press the left (2) and right (4) buttons located beneath the touchpad to perform selection and execution functions. These two buttons are similar to the left and right buttons on a mouse. Tapping on the touchpad is the same as clicking the left button.
- Use Acer Bio-Protection fingerprint reader (3) supporting Acer FingerNav 4-way control function (only for certain models) to scroll up or down and move left or right a page. This fingerprint reader or button mimics your cursor pressing on the right scroll bar of Windows applications.

Function	Left Button (2)	Right Button (4)	Main TouchPad (1)	Center button (3)
Execute	Quickly click twice.		Tap twice (at the same speed as double-clicking a mouse button).	
Select	Click once.		Tap once.	
Drag	Click and hold, then use finger on the touchpad to drag the cursor.		Tap twice (at the same speed as double-clicking a mouse button); rest your finger on the touchpad on the second tap and drag the cursor.	
Access context menu		Click once.		
Scroll				Swipe up/down/left/right using Acer FingerNav 4-way control function (Manufacturing option).

NOTE: When using the TouchPad, keep it - and your fingers - dry and clean. The TouchPad is sensitive to finger movement; hence, the lighter the touch, the better the response. Tapping too hard will not increase the TouchPad's responsiveness.

Using the Keyboard

The keyboard has full-sized keys and an embedded numeric keypad, separate cursor, lock, Windows, function and special keys.

Lock Keys and embedded numeric keypad

The keyboard has three lock keys which you can toggle on and off.



















Lock key	Description
Caps Lock	When Caps Lock is on, all alphabetic characters typed are in uppercase.
Num Lock <Fn> + <F11>	When Num Lock is on, the embedded keypad is in numeric mode. The keys function as a calculator (complete with the arithmetic operators +, -, *, and /). Use this mode when you need to do a lot of numeric data entry. A better solution would be to connect an external keypad. Note: <Fn> + <F11> only for certain models.
Scroll Lock <Fn> + <F12>	When Scroll Lock is on, the screen moves one line up or down when you press the up or down arrow keys respectively. Scroll Lock does not work with some applications.

The embedded numeric keypad functions like a desktop numeric keypad. It is indicated by small characters located on the upper right corner of the keycaps. To simplify the keyboard legend, cursor-control key symbols are not printed on the keys.

Desired access	Num Lock on	Num Lock off
Number keys on embedded keypad	Type numbers in a normal manner.	
Cursor-control keys on embedded keypad	Hold <Shift> while using cursor-control keys.	Hold <Fn> while using cursor-control keys.
Main keyboard keys	Hold <Fn> while typing letters on embedded keypad.	Type the letters in a normal manner.

Windows Keys











The keyboard has two keys that perform Windows-specific functions.

Key	Description
 Windows key	<p>Pressed alone, this key has the same effect as clicking on the Windows Start button; it launches the Start menu. It can also be used with other keys to provide a variety of functions:</p> <ul style="list-style-type: none"> <  >: Open or close the Start menu <  > + <D>: Display the desktop <  > + <E>: Open Windows Explore <  > + <F>: Search for a file or folder <  > + <G>: Cycle through Sidebar gadgets <  > + <L>: Lock your computer (if you are connected to a network domain), or switch users (if you're not connected to a network domain) <  > + <M>: Minimizes all windows <  > + <R>: Open the Run dialog box <  > + <T>: Cycle through programs on the taskbar <  > + <U>: Open Ease of Access Center <  > + <X>: Open Windows Mobility Center <  > + <BREAK>: Display the System Properties dialog box <  > + <SHIFT+M>: Restore minimized windows to the desktop <  > + <TAB>: Cycle through programs on the taskbar by using Windows Flip 3-D <  > + <SPACEBAR>: Bring all gadgets to the front and select Windows Sidebar <CTRL> + <  > + <F>: Search for computers (if you are on a network) <CTRL> + <  > + <TAB>: Use the arrow keys to cycle through programs on the taskbar by using Windows Flip 3-D <p>Note: Depending on your edition of Windows Vista or Windows XP, some shortcuts may not function as described.</p>
 Application key	<p>This key has the same effect as clicking the right mouse button; it opens the application's context menu.</p>

Hot Keys

The computer employs hotkeys or key combinations to access most of the computer's controls like screen brightness, volume output and the BIOS utility.

To activate hot keys, press and hold the <Fn> key before pressing the other key in the hotkey combination.

Hotkey	Icon	Function	Description
<Fn> + <F1>	?	Hotkey help	Displays help on hotkeys.
<Fn> + <F2>		Acer eSettings Management	Launches Acer eSettings Management in Acer Empowering Technology.
<Fn> + <F3>		Acer ePower Management	Launches Acer ePower Management in Acer Empowering Technology.
<Fn> + <F4>	Z ^z	Sleep	Puts the computer in Sleep mode.
<Fn> + <F5>		Display toggle	Switches display output between the display screen, external monitor (if connected) and both.
<Fn> + <F6>		Screen blank	Turns the display screen backlight off to save power. Press any key to return.
<Fn> + <F7>		TouchPad toggle	Turns the internal TouchPad on and off.
<Fn> + <F8>		Speaker toggle	Turns the speakers on and off.
<Fn> + <Δ>		Volume up	Increases the sound volume.
<Fn> + <∇>		Volume down	Decreases the sound volume.
<Fn> + <▷>		Brightness up	Increases the screen brightness.
<Fn> + <◁>		Brightness down	Decreases the screen brightness.

Special Key (only for certain models)

You can locate the Euro symbol and the US dollar sign at the upper-center and/or bottom-right of your keyboard.

The Euro symbol

1. Open a text editor or word processor.
2. Press € at the bottom-right of the keyboard, or hold <Alt Gr> and then press the <5> key at the upper-center of the keyboard.

NOTE: Some fonts and software do not support the Euro symbol. Please refer to www.microsoft.com/typography/faq/faq12.htm for more information.

The US dollar sign

1. Open a text editor or word processor.
2. Press \$ at the bottom-right of the keyboard, or hold <Shift> and then press the <4> key at the upper-center of the keyboard.

NOTE: This function varies by the operating system version.

Using the System Utilities

Acer Bio-Protection (only for certain models) Acer Bio-Protection Fingerprint Solution is a multi-purpose fingerprint software package integrated with the Microsoft Windows operating system. Utilizing the uniqueness of one's fingerprint features, Acer Bio-Protection Fingerprint Solution has incorporated protection against unauthorized access to your computer with centralized password management with Password Bank, easy music player launching with Acer MusicLaunch, secure Internet favorites via Acer MyLaunch, and fast application/website launching and login with Acer FingerLaunch, while Acer ProfileLaunch can launch up to three applications/websites from a single finger swipe.

Acer Bio-Protection Fingerprint Solution also allows you to navigate through web browsers and documents using Acer FingerNav. With Acer Bio-Protection Fingerprint Solution, you can now enjoy an extra layer of protection for your personal computer, as well as the convenience of accessing your daily tasks with a simple swipe of your finger!

For more information refer to the Acer Bio-Protection help files.



Acer GridVista (dual-display compatible)

NOTE: This feature is only available on certain models.

To enable the dual monitor feature of the notebook, first ensure that the second monitor is connected, then select **Start, Control Panel, Display** and click on **Settings**. Select the secondary monitor (**2**) icon in the display box and then click the check box **Extend my windows desktop onto this monitor**. Finally, click **Apply** to confirm the new settings and click **OK** to complete the process.

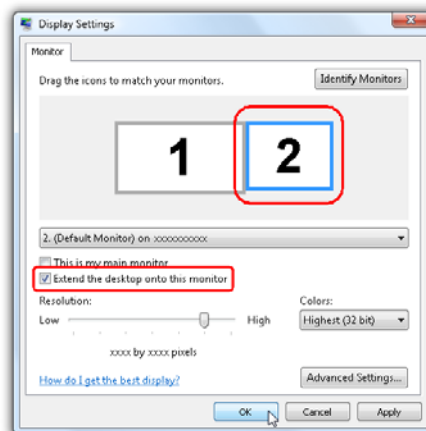

Acer GridVista is a handy utility that offers four pre-defined display settings so you can view multiple windows on the same screen. To access this function, please go to **Start → All Programs** and click on **Acer GridVista**. You may choose any one of the four display settings indicated below:



Double (vertical), Triple (primary at left), Triple (primary at right), or Quad Acer GridVista is dual-display compatible, allowing two displays to be partitioned independently.

Acer GridVista is dual-display compatible, allowing two displays to be partitioned independently.

AcerGridVista is simple to set up:

1. Run Acer GridVista and select your preferred screen configuration for each display from the task bar.
2. Drag and drop each window into the appropriate grid.
3. Enjoy the convenience of a well-organized desktop.

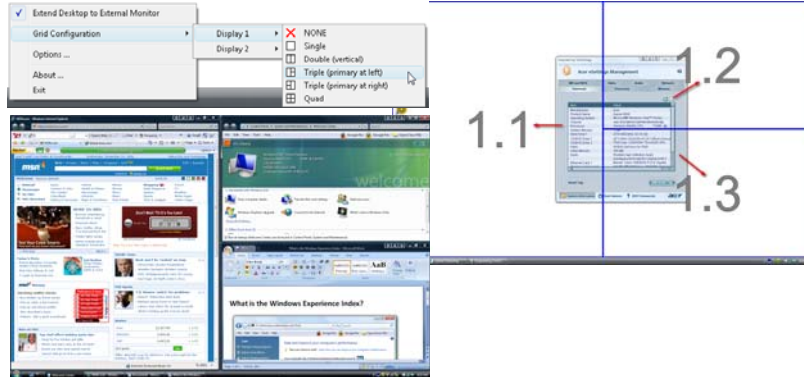

NOTE: Please ensure that the resolution setting of the second monitor is set to the manufacturer's recommended value.

Hardware Specifications and Configurations

Processor

Item	Specification
CPU	AMD CPU S1g2 Processor (Griffin Series - Turion / Sempron); HT3 (1.2~2.6 GT/s) (Bandwidth: 9.6GB/S to 20.8GB/s)
Type	1.8GHZ~2.3GHZ
CPU package	AMD 638 pin Micro-PGA
Features	<ul style="list-style-type: none"> Hyper Transport 3.0 Technology: Designed to support HT Gen3 speeds from 1.2GHZ to 2.6GHZ. 64-bit or 128-bit DDR2 Memory Interface: Two independent 64-bit DDR2 channels. Split Power Planes: Separate power planes provided for each CPU core and on die Northbridge Up to 2 processor cores per die, Up to 1MB L2 cache per die. Each CPU core supports up to 8 P-states: P0 (Highest performance) and P7
CPU Power	<ul style="list-style-type: none"> VDD0, VDD1 set according to the respective P-state control when core VDD are isolated and VDD set according to the CPU core in the highest performance P-state when VDD is common. CPU_VDDNB; VLDT 1.2V_HT; VDD I/O 1.8VSUS; CPU Memory Interface

North Bridge

Item	Specification
Type	AMD RS780M (North Bridge)
Package	FCBGA 528-pin
Features	<ul style="list-style-type: none"> CPU Hyper Transport Interface: Support 16-bit up/down Hyper Transport 3.0 interface up to 5.2GT/S. PCI Express Interface: Support PCI-E GEN2; Optimized peer to peer and general purpose link performance; Highly flexible PCI Express implementation to suit a variety of platform needs. A-Link Express II interface: one x4 A-Link Express II Interface for connection
Power	1.1V, 1.2V, 1.8V, 3.3V

South Bridge

Item	Specification
Type	AMD SB700 (South Bridge)
Package	FCBGA 528-pin
Features	<ul style="list-style-type: none"> A-Link Express II interface to AMD Northbridge: High data transfer Bandwidth up to 2.5GT/s/Lane. PCI bus support Rev 2.3 USB controllers: 5 OHCI and 2 EHCI Host controllers to support 12 USB 2.0 Ports and 2 dedicated USB 1.1 ports. SATA controllers: Supports six SATA ports with transfer rates up to 3Gb/s Supports both SATA 1.5 and SATA 3.0 compliance devices; Supports e-SATA. AMD RAID support and AMD AHCI support. Interrupt controller: Support IOAPIC/X APIC mode for 24 channels of interrupt. High definition Audio supports up to 4 codec's and up to 192 KHZ sample rate and 32-bit Audio. Flash controller supports ReadyBoost and ReadyDrive features of windows Vista.
Power	1.2V,3.3V,5V, 1.8V

CPU Fan True Value Table

CPU Temp (°C)	Fan Speed (rpm)	dB (A)
<48	0	0
52	3100	31
60	3500	34
70	4100	37
90	4500	40

- Throttling 50%: On = 97°C; Off = 88°C
- OS Shut down: 105°C
- H/W Shut down: 110°C
- Fan default 3.5V

System Clock

Item	Specification
System clock chip	SLG8SP628VTR or pin compatible device
Package	64 pin QFN
Clock Synthesizer	<ul style="list-style-type: none"> 200Mhz for CPU, RS780M 100MHz clock buffer for RS780M, SB700 and PCI-E devices 96MHz for RS780M 48Mhz for USB clock inside SB700 33Mhz PCI clock for PC devices, SIO, LPC
Power	3.3V,1.2V
Features	Support spread spectrum function for reducing EMI

Crystal and Oscillator

Item	Specification
Features	<ul style="list-style-type: none"> • 14.318Mhz crystal for clock Gen chip • 32.768Khz crystal for RTC inside SB700 and WPCE775C • 25Mhz for SATA controller inside SB700 • 25MHZ crystal for BroadCom Lan controller BCM5764M

System Memory

Item	Specification
Memory controller	Built-in
Memory size	0MB (no on-board memory)
DIMM socket number	2 sockets
Supports memory size per socket	2 GB
Supports maximum memory size	2GB for 32bit OS, 4G for 64bit OS (with two 1GB/2GB SODIMM)
Supports DIMM type	DDR II 533/677 Mhz RVS SODIMM memory interface design
Supports DIMM Speed	533/667 MHz
Memory module combinations	You can install memory modules in any combinations as long as they match the above specifications.

Memory Combinations

Slot 1	Slot 2	Total Memory
0MB	256MB	256MB
0MB	512MB	512MB
0MB	1024MB	1024MB
0MB	2048MB	2048MB
256MB	256MB	512MB
256MB	512MB	768MB
256MB	1024MB	1280MB
256MB	2048MB	2304MB
512MB	256MB	768MB
512MB	512MB	1024MB
512MB	1024MB	1536MB
512MB	2048MB	2560MB
1024MB	0MB	1024MB
1024MB	256MB	1280MB
1024MB	512MB	1536MB
1024MB	1024MB	2048MB
1024MB	2048MB	3072MB
2048MB	0MB	2048MB
2048MB	256MB	2304MB
2048MB	512MB	2560MB
2048MB	1024MB	3072MB
2048MB	2048MB	4096MB

Hard Disk Drive Interface

Item				
Vendor & Model Name				
Capacity (MB)				
Bytes per sector				
Data heads				
Drive Format				
Disks				
Spindle speed (RPM)				
Performance Specifications				
Buffer size				
Interface				
Max. media transfer rate (disk-buffer, Mbytes/s)				
Data transfer rate (host-buffer, Mbytes/s)				
DC Power Requirements				
Voltage tolerance				

Combo Drive Module

Item	Specification
Vendor & model name	
Performance Specification	
Transfer rate (KB/sec)	
Buffer Memory	
Interface	
Applicable disc format	
Loading mechanism	
Power Requirement	
Input Voltage	

Thermal Sensor Control

Item	Specification
Thermal Sensor Chip	GMT-781
Package	8-pin SSOP
Features	Thermal sensor control
Interface	I ² C bus, address: 98h

BIOS

Item	Specification
BIOS Type	WND W25X80VSSIG or pin compatible device One 8-pin SOP package 1Mbyte FLASH ROM W25X80VSSIG is used for BIOS, keyboard encoder and power controller codes. It occupies system memory area E0000-FFFF. After posting system, the shadow RAM function will be enabled.
BIOS ROM Type	WND 4MB CMOS Boot Block Flash Memory
Package	8 pin SOP
Block Size	64kbytes per block
Supply Current	Active current = 5 mA (Typical) Standby current= 1 μ A (Typical)

LCD 17.1"

Item	Specification
Vendor/model name	
Screen Diagonal (mm)	
Active Area (mm)	
Display resolution (pixels)	
Pixel Pitch	
Pixel Arrangement	
Display Mode	
Typical White Luminance (cd/m^2) also called Brightness	
Luminance Uniformity	
Contrast Ratio	
Response Time (Optical Rise Time/Fall Time) msec	
Nominal Input Voltage VDD	
Typical Power Consumption (watt)	
Weight (without inverter)	
Physical Size (mm)	
Electrical Interface	
Support Color	
Viewing Angle (degree) Horizontal: Right/Left Vertical: Upper/Lower	
Temperature Range ($^{\circ}\text{C}$) Operating Storage (shipping)	

VGA Subsystem

Item	Specification
Internal Graphic Chipset	RS780M
Features	<ul style="list-style-type: none">• Integrated dual-link 24-bit LVDS interface• Integrated HD audio codec supports linear PCM and AC3(5.1) audio formats for HDMI output• An integrated TV encoder from AMD's Xilleon products, with an on-chip DAC• DirectX 10 support
Discrete Graphic (MXM card)	MS-V122A3-M82ME-XT, GPU AMD M82ME-XT
Features	<ul style="list-style-type: none">• 16 Lane PCI Express support• LVDS Interface support• VGA support• HDMI support

KBC

Item	Specification
Chipset	Winbond WPCE775CA0DG
Package	128Pin LQFP
Features	<ul style="list-style-type: none">• Shared SPI BIOS flash memory with page programming support• Media center compliant CIR port• Fast infrared port• High-accuracy, high-speed ADC• Up to 95 GPIO ports (including KB scanning) with a variety of wake-up events• 16 bit RISC core, with up to 4 Mbytes of external address space, running at up to 25MHz• 128 pin LQFP package

PCMCIA, and Memory Card Reader

Item	Specification
PCMCIA	OZ601TN
Memory Card Features	<ul style="list-style-type: none">• Support 5-in-1 Card Reader (MS, MS pro, SD, MMC, xD)• JMB385-LGEZ0B

Audio Interface

Item	Specification
Audio Controller	ALC268-VB1-GR Azalia Codec and Amplifier GMT G1441 and G1412
Features	<ul style="list-style-type: none">• HD Audio• SNR > 85, High-performance DACs with 95dB SNR (A-Weighting), ADCs with 85dB SNR (A-Weighting)• Internal Microphone• Two speakers, at least 1.5W/10cc for each• Enable Universal jack function• Enable VOIP function

LAN Interface

Item	Specification
LAN Chipset	BroadCom Lan controller BCM5764MKMLG
Features	<ul style="list-style-type: none">• PCI-E bus• Support Wake on Lan from S4,S5 in AC mode• Support ASF2.0• File deployment support• Meet ViiV dependent

Bluetooth Interface

Item	Specification
Chipset	FOXCONN T60H928.11 BlueTooth miniUSB module
Features	<ul style="list-style-type: none">• Bluetooth 1.2 qualified Embedded USB Module• Extremely small size• Class 2 specification RF output power (max + 4 dBm)• Full piconet and scatternet operation• Support 3Mbps enhanced data rate• USB 2.0 full-speed compliant interface• Very low power consumption• Led indicator built-in

Keyboard

Item	Specification
Type	New Acer proprietary keyboard (TM Flat Number KB)
Total number of keypads	88/89 keys with 101/102 key emulation
Windows logo key	Support Windows keys and Application keys
Features	<ul style="list-style-type: none">• Standard pitch, 2.5 mm travel length• Multi-Langue support• Spill-proof• (Hotkey control → ID)• 26 pin connector

MDC Card

Item	Specification
Type	Liteon-Conexant (AVAP)
Features	<ul style="list-style-type: none">• V.90/V.92, WWDAA• MDC 3.3V card (HD)• Apply CISPR22• Wake-on-Ring support by S3

Camera

Item	Specification	
Vendor	Chicony	Suyin
Model Name	CNF701721004971L	CN0314-SN30-OV03-1
Type	Fixed	Fixed
Dimension (L x W x H mm)	65±0.2 * 9±0.1 * 5.4±0.25 mm	65* 9.0 * 5.30+/-0.20 mm
Sensor	VGA CMOS sensor	OV7725 CMOS Sensor 350K Pixel

Item	Specification	
Optical Size	1/4" CMOS	F/2.0
Pixel Resolution	640 X 480	640X480
Pixel Size	6.0µm X6.0µm	6.0µm X6.0µm

Finger Print Board

Item	Specification
Vendor and Model	Authentec AES1610-C-DF-TR-GO00-AC
Features	<ul style="list-style-type: none"> • TruePrint® and TrueMatch® Technology. • TrueNav® Cursor and Menu Navigation Technology • High Definition 128 x 8 Pixel Array • Multiple battery-friendly operating modes @ 3.3V • Built-in low power Finger Detection w/ remote wakeup capability • USB 2.0 Full Speed Interface

WLAN

Item	Specification
Features	<ul style="list-style-type: none"> • The wireless LAN is compliant to IEEE 802.11b and IEEE 802.11g standard. • Dynamic data rate switching with 54, 48, 36, 24, 18, 12, 9, 6Mbps with 802.11g • Dynamic data rate switching with 11, 5.5, 2, 1Mbps with 802.11b • Support Ad-hoc mode and infrastructure mode communications • Allow auto fallback data rate for optimized reliability, throughput and transmission range.

Battery

Item	Specification
Vendor	SANYO/Panasonic
Battery Type	Li-ion
Pack capacity	4400mAH/4800mAH
Number of battery cell	6 cell/8 cell
Package configuration	3S2P/4S2P

System Utilities

BIOS Setup Utility

The BIOS Setup Utility is a hardware configuration program built into your computer's BIOS (Basic Input/Output System).

Your computer is already properly configured and optimized, and you do not need to run this utility. However, if you encounter configuration problems, you may need to run Setup. Please also refer to Chapter 4 Troubleshooting when problem arises.

To activate the BIOS Utility, press **F2** during POST (when "Press <F2> to enter Setup" message is prompted on the bottom of screen).

Press **F2** to enter setup. The default parameter of F12 Boot Menu is set to "disabled". If you want to change boot device without entering BIOS Setup Utility, please set the parameter to "enabled".

Press <F12> during POST to enter multi-boot menu. In this menu, user can change boot device without entering BIOS SETUP Utility.

Navigating the BIOS Utility

There are six menu options: Information, Main, Advanced, Security, Boot, and Exit.

Follow these instructions:

- To choose a menu, use the left and right arrow keys.
- To choose an item, use the up and down arrow keys.
- To change the value of a parameter, press **F5** or **F6**.
- A plus sign (+) indicates the item has sub-items. Press **Enter** to expand this item.
- Press **Esc** while you are in any of the menu options to go to the Exit menu.
- In any menu, you can load default settings by pressing **F9**. You can also press **F10** to save any changes made and exit the BIOS Setup Utility.

NOTE: You can change the value of a parameter if it is enclosed in square brackets. Navigation keys for a particular menu are shown on the bottom of the screen. Help for parameters are found in the Item Specific Help part of the screen. Read this carefully when making changes to parameter values. **Please note that system information is subject to different models.**

Information

The Information screen displays a summary of your computer hardware information.

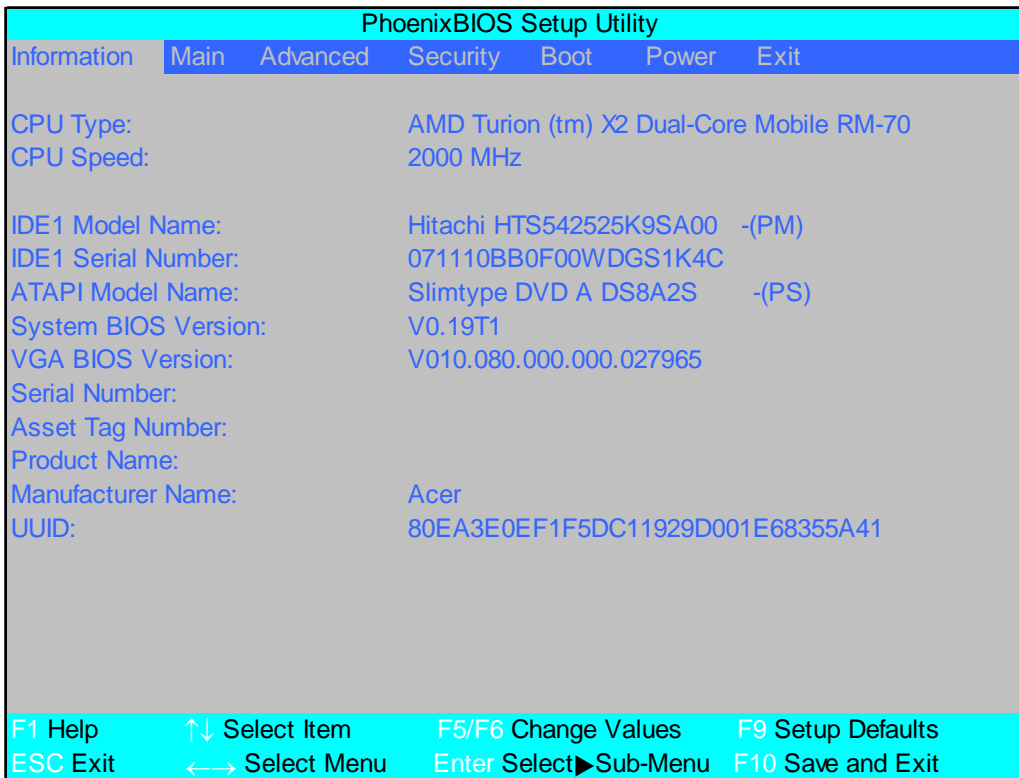

NOTE: The system information is subject to different models.

Parameter	Description
CPU Type	This field shows the CPU type and speed of the system.
CPU Speed	This field shows the speed of the CPU.
IDE1 Model Name	This field shows the model name of HDD installed on primary IDE master.
IDE1 Serial Number	This field displays the serial number of HDD installed on primary IDE master.
ATAPI Model Name	This field shows the model name of the Optical device installed in the system.
System BIOS Version	Displays system BIOS version.
VGA BIOS Version	This field displays the VGA firmware version of the system.
Serial Number	This field displays the serial number of this unit.
Asset Tag Number	This field displays the asset tag number of the system.
Product Name	This field shows product name of the system.
Manufacturer Name	This field displays the manufacturer of this system.
UUID Number	Universally Unique Identifier (UUID) is an identifier standard used in software construction, standardized by the Open Software Foundation (OSF) as part of the Distributed Computing Environment (DCE).

Main

The Main screen allows the user to set the system time and date as well as enable and disable boot option and recovery.

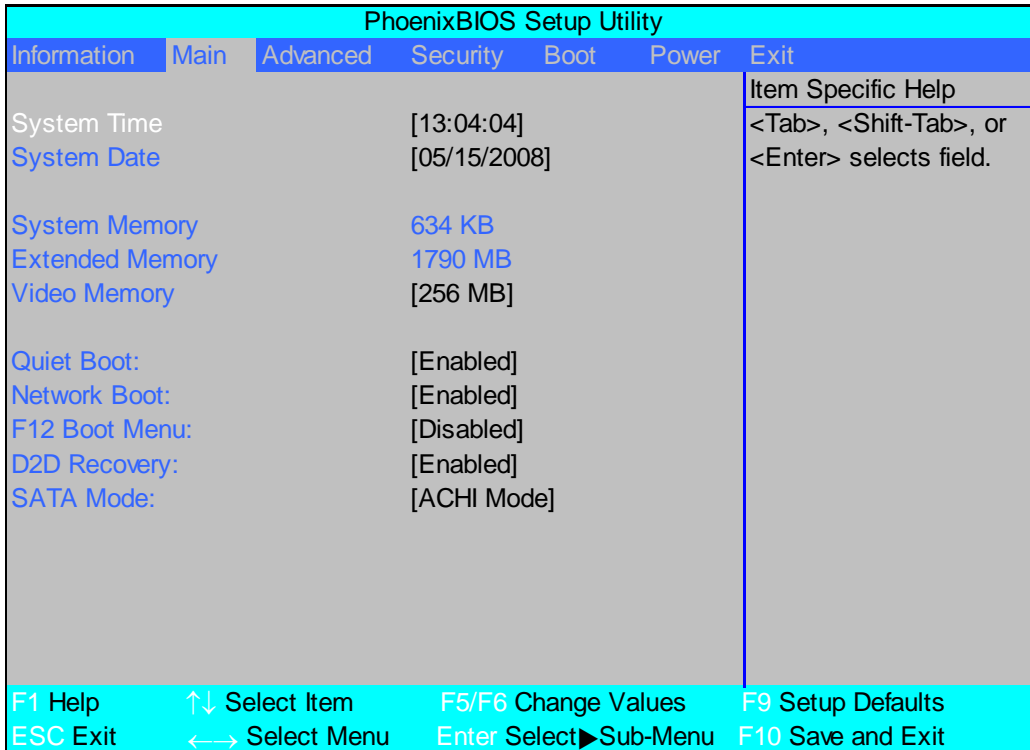

NOTE: The screen above is for your reference only. Actual values may differ.

The table below describes the parameters in this screen. Settings in **boldface** are the default and suggested parameter settings.

Parameter	Description	Format/Option
System Time	Sets the system time. The hours are displayed with 24-hour format.	Format: HH:MM:SS (hour:minute:second)
System Date	Sets the system date.	Format MM/DD/YYYY (month/day/year)
System Memory	This field reports the memory size of the system. Memory size is fixed to 3071 MB.	N/A
Extended Memory	This field reports the Extended Memory size. Memory size is fixed to 4094 MB.	N/A
Video Memory	Shows the video memory size. VGA Memory size=32 MB	N/A
Quiet Boot	Displays the logo screen while booting.	Option: Enabled or Disabled
Network Boot	Enables, disables the system boot from LAN (remote server).	Option: Enabled or Disabled
F12 Boot Menu	Enables, disables Boot Menu during POST.	Option: Disabled or Enabled
D2D Recovery	Enables, disables D2D Recovery function. The function allows the user to create a hidden partition on hard disc drive to store operation system and restore the system to factory defaults.	Option: Enabled or Disabled
SATA Mode	Control the mode in which the SATA controller should operate.	Option: AHCI Mode or IDE Mode

Advanced

The Advanced screen allows the user to configure the various advanced BIOS options.

IMPORTANT: Making incorrect settings to items on these pages may cause the system to malfunction. Unless you have experience adjusting these items, we recommend that you leave these settings at the default values. If making settings to items on these pages causes your system to malfunction or prevents the system from booting, open BIOS and choose Load Optimal Defaults in the Exit menu to boot up normally.

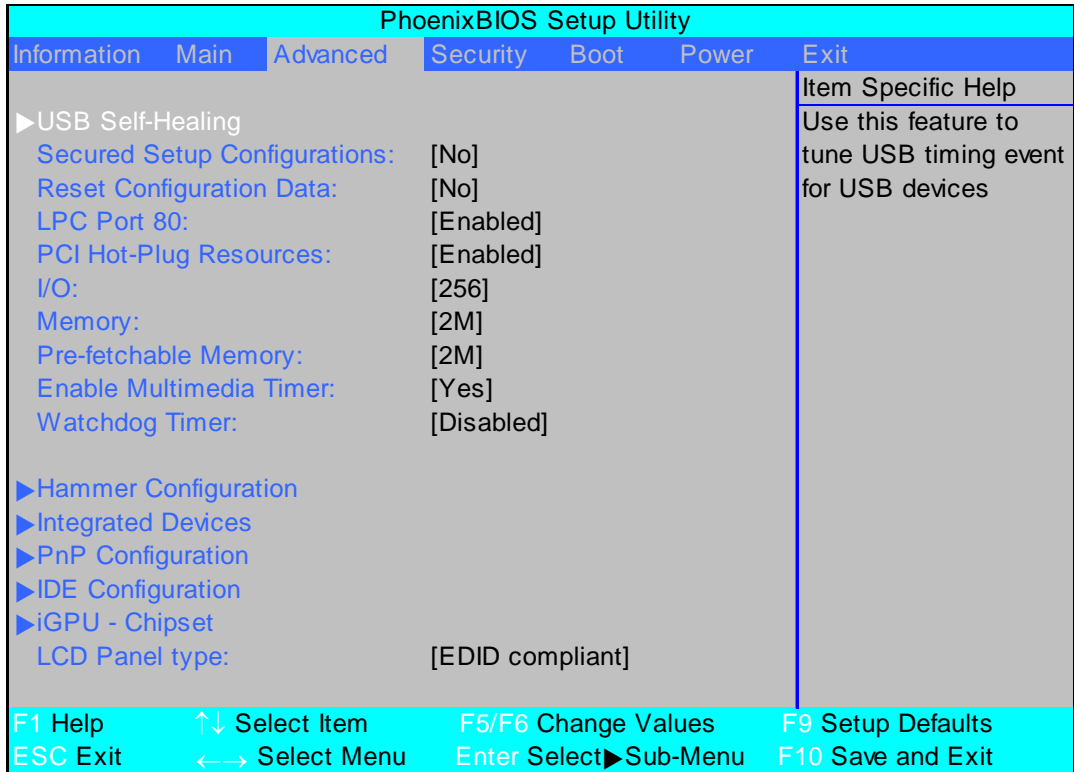

The table below describes the items, menus, and submenus in this screen. Settings in **boldface** are the default and suggested parameter settings.

Parameter	Description	Submenu Items
USB Self-Healing	Enter the USB Self-Healing menu.	<ul style="list-style-type: none"> • Self-Healing ▶ OCHI Self-Healing ▶ EHCI Self-Healing
Secured Setup Configuration	Prevents Plug and Play devices from changing system settings.	N/A
Reset Configuration Data	Clear the Extended System Configuration Data (ESCD) area using this option.	N/A
LPC Port 80	Enable or Disable LPC Port 80.	N/A
PCI Hot-Plug Resources	Enable or Disable Hot-Plug support.	N/A
I/O	Set the amount of I/O (in bytes) available to the Hot-Plug slots.	N/A
Memory	Set the amount of Memory (in bytes) available to Hot-Plug slots.	N/A
Pre-fetchable Memory	Set the amount of Pre-fetchable Memory (in bytes) available to the Hot-Plug slots.	N/A

Parameter	Description	Submenu Items
Enable Multimedia Timer	Enable [Yes] or Disable [No] Multimedia Timer support.	N/A
Watchdog Timer	Disable or Enable the OS Watchdog Timer using ACPI WDAT.	N/A
Hammer Configuration	Enter the Hammer Configuration menu.	<ul style="list-style-type: none"> • HT-LDT Frequency • HT-LDT Width • DDR2 Memory Frequency • LS Table loading • ISO Flow Control • Hi Priority Channel • Display Refresh • Sync Flood Detection
Integrated Devices	Enter the Integrated Devices menu.	<ul style="list-style-type: none"> • USB Control • USB2 Control • USB BIOS Legacy Support • MAC LAN • MAC Address • Azalia Codec • Integrated Codec • SATA Mode • SATA AHCI Mode • SATA Hotplug • Power on options • Interrupt Mode • PCI Express MSI • S5 WOL • Software Based PMU FW Loading • SMU • Dynamic Crush Voltage • PMU iGPU Stutter Mode • PMU System Stutter Mode • PMU LMM Mode • Dynamic FPCI Clock
PnP Configuration	Enter the PnP Configuration menu.	<ul style="list-style-type: none"> ▶ PCI Device, Slot #1 ▶ PCI/PNP ISA UMB Region Exclusion ▶ PCI/PNP IRQ UMB Resource Exclusion
IDE Configuration	Enter the IDE Configuration menu.	<ul style="list-style-type: none"> • Large Disk Access Mode • Local Bus IDE adapter ▶ Primary Master ▶ Primary Slave

Parameter	Description	Submenu Items
iGPU - Chipset	Enter the iGPU - Chipset menu.	<ul style="list-style-type: none">• Integrated Graphic• Video Memory• Hybrid Graphics• mGPU nPW• MXM LVDS/TV• MXM CRT/DVI• Panel Scaling• Boot Display• Preferred TV Connector• TV Format
LCD Panel type	Select the correct LCD panel type for testing purposes.	N/A

Security

The Security screen contains parameters that help safeguard and protect your computer from unauthorized use.

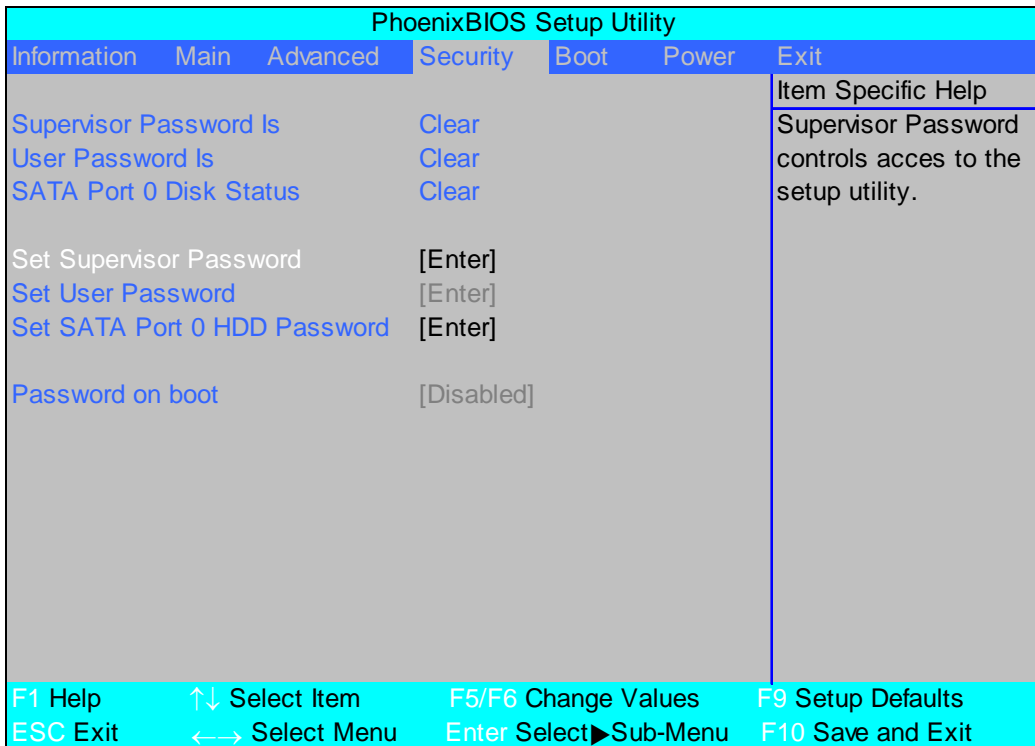

The table below describes the parameters in this screen. Settings in **boldface** are the default and suggested parameter settings.

Parameter	Description	Option
Supervisor Password Is	Shows the setting of the Supervisor password	Clear or Set
User Password Is	Shows the setting of the user password.	Clear or Set
SATA Port 0 Disk Status	Shows the setting of the hard disk password.	Clear or Set
Set Supervisor Password	Press Enter to set the supervisor password. When set, this password protects the BIOS Setup Utility from unauthorized access. The user can not either enter the Setup menu nor change the value of parameters.	N/A
Set User Password	Press Enter to set the user password. When user password is set, this password protects the BIOS Setup Utility from unauthorized access. The user can enter Setup menu only and does not have right to change the value of parameters.	N/A
Set SATA Port 0 HDD Password	Enter HDD Password.	N/A
Password on boot	Defines whether a password is required or not while the events defined in this group happened. The following sub-options are all requires the Supervisor password for changes and should be grayed out if the user password was used to enter setup.	Disabled or Enabled

NOTE: When you are prompted to enter a password, you have three tries before the system halts. Don't forget your password. If you forget your password, you may have to return your notebook computer to your dealer to reset it.

Setting a Password

Follow these steps as you set the user or the supervisor password:

1. Use the ↑ and ↓ keys to highlight the Set Supervisor Password parameter and press the **Enter** key. The Set Supervisor Password box appears:

Set Supervisor Password		
Enter New Password	[]
Confirm New Password	[]

2. Type a password in the “Enter New Password” field. The password length can not exceeds 8 alphanumeric characters (A-Z, a-z, 0-9, not case sensitive). Retype the password in the “Confirm New Password” field.

IMPORTANT: Be very careful when typing your password because the characters do not appear on the screen.

3. Press **Enter**. After setting the password, the computer sets the User Password parameter to “Set”.
4. If desired, you can opt to enable the Password on boot parameter.
5. When you are done, press F10 to save the changes and exit the BIOS Setup Utility.

Removing a Password

Follow these steps:

1. Use the w and y keys to highlight the Set Supervisor Password parameter and press the **Enter** key. The Set Password box appears:

Set Supervisor Password		
Enter current password	[]
Enter New Password	[]
Confirm New Password	[]

2. Type the current password in the Enter Current Password field and press **Enter**.
3. Press e twice **without** typing anything in the Enter New Password and Confirm New Password fields. The computer then sets the Supervisor Password parameter to “Clear”.
4. When you have changed the settings, press u to save the changes and exit the BIOS Setup Utility.

Changing a Password

1. Use the ↑ and ↓ keys to highlight the Set Supervisor Password parameter and press the **Enter** key. The Set Password box appears.

Set Supervisor Password		
Enter current password	[]
Enter New Password	[]
Confirm New Password	[]

2. Type the current password in the Enter Current Password field and press **Enter**.
3. Type a password in the Enter New Password field. Retype the password in the Confirm New Password field.
4. Press **Enter**. After setting the password, the computer sets the User Password parameter to “Set”.
5. If desired, you can enable the Password on boot parameter.
6. When you are done, press F10 to save the changes and exit the BIOS Setup Utility.

If the verification is OK, the screen will display as following.

Setup Notice
Changes have been saved.
[continue]

The password setting is complete after the user presses **Enter**.

If the current password entered does not match the actual current password, the screen will show you the Setup Warning.

Setup Warning
Invalid password
Re-enter Password
[continue]

If the new password and confirm new password strings do not match, the screen will display the following message.

Setup Warning
Password do not match
Re-enter Password

Power

The Power screen allows the user to configure various CPU and power management options and device wakeup behavior.

PhoenixBIOS Setup Utility						
Information	Main	Advanced	Security	Boot	Power	Exit
C1E Configuration [Griffin Mode] CPU Throttle: [Disabled] CPU Spread Spectrum: [Enabled] iGPU Spread Spectrum: [2.00% Triangular Centre] PCIE Spread Spectrum: [Disabled] SATA Spread Spectrum: [Linear Down] PState Configuration [Enabled] USB CSC Resume [Disabled] Cannot_Find_String [Disabled] HIPM [Disabled] SATA FPCI Clock: [133Mhz] PCI Clocks: [Enabled] AltVid [Disabled] ASPM (L0s/L1s) [Disabled L0s] PCIE Lane Swizzle: [Disabled]						Item Specific Help Enable or Disable C1E Dual-Core related CPU power State. Auto enables C1E if dual core is detected and disables C1E if single core is detected.
F1 Help ↑↓ Select Item F5/F6 Change Values F9 Setup Defaults ESC Exit ←→ Select Menu Enter Select▶Sub-Menu F10 Save and Exit						

The table below describes the items, menus, and submenus in this screen. Settings in **boldface** are the default and suggested parameter settings.

Parameter	Description	Option
C1E Configuration	Enable or Disable C1E Dual-Core related CPU power State.	Griffin Mode or Disabled
CPU Throttle	Enable or disable CPU Throttle.	Disabled or Enabled
CPU Spread Spectrum	Enable or disable CPU Spread Spectrum.	Disabled or Enabled
iGPU Spread Spectrum	Set the iGPU Spread Spectrum percentage.	1.00%, 2.00% , 3.00%, 4.00%, 5.00% or Disabled
PCIE Spread Spectrum	Enable or disable PCIE Spread Spectrum.	Disabled or Enabled
SATA Spread Spectrum	Enable or disable SATA Spread Spectrum.	Disabled or Linear Down
PState Configuration	Enable or disable ACPI PState Support	Enabled or Disabled
USB CSC Resume	Enable or disable wake up from S3 by USB plug or unplug.	Disabled or Enabled
Cannot_Find_String	Enable or disable the Cannot_Find_String message during boot.	Disabled or Enabled
HIPM	Enable or disable Aggressive Link Power Management (HIPM).	Disabled or Enabled
SATA FPCI Clock	Set the SATA low power control level.	133 MHz or 200 MHz
PCI Clocks	Enable all PCI clocks or lock down all PCI clocks to Port 80.	Enabled or Auto

Parameter	Description	Option
AltVid	Enable or disable AltVid functionality.	Disabled or Enabled
ASPM (L0s/L1s)	Enable or disable Active State Power Management (ASPM) states for L0s and L1.	Disable L0s , Disable L1, Enabled, or Disabled
PCIE Lane Swizzle	Enable or disable PCIE Lane Swizzle for PCIE x 16 slot.	Disabled or Enabled

Exit

The Exit screen allows you to save or discard any changes you made and quit the BIOS Utility.

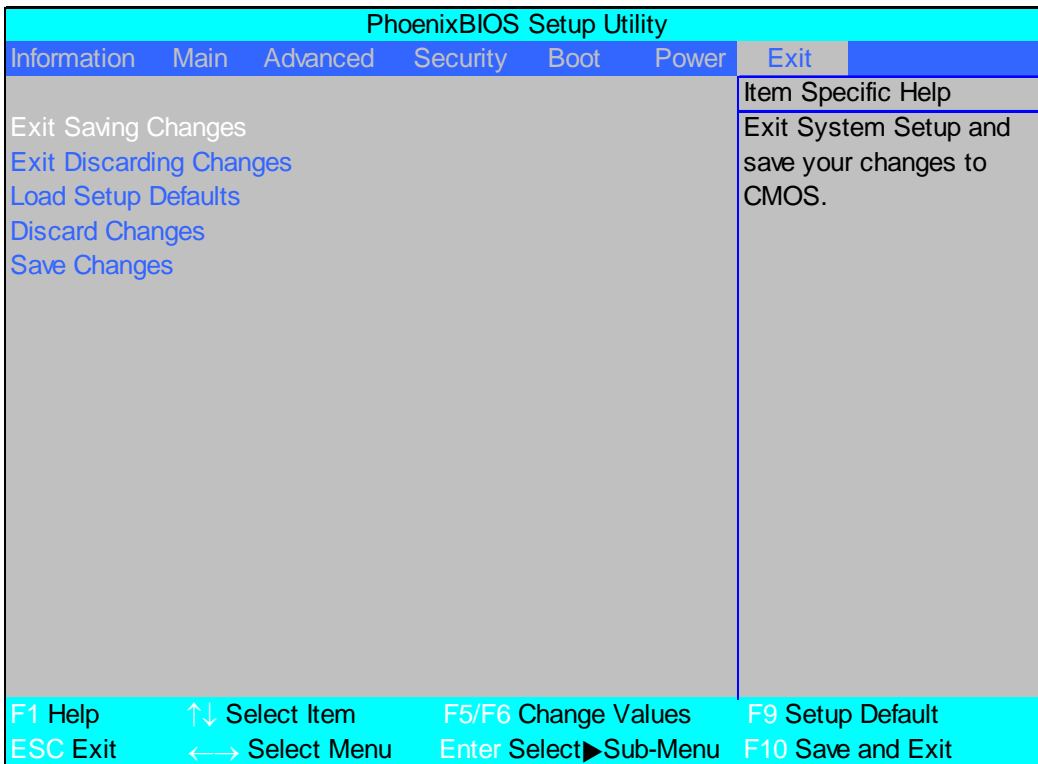

The table below describes the parameters in this screen.

Parameter	Description
Exit Saving Changes	Exit System Setup and save your changes to CMOS.
Exit Discarding Changes	Exit utility without saving setup data to CMOS.
Load Setup Default	Load default values for all SETUP item.
Discard Changes	Load previous values from CMOS for all SETUP items.
Save Changes	Save Setup Data to CMOS.

BIOS Flash Utility

The BIOS flash memory update is required for the following conditions:

- New versions of system programs
- New features or options
- Restore a BIOS when it becomes corrupted.

Use the Phlash utility to update the system BIOS flash ROM.

NOTE: If you do not have a crisis recovery diskette at hand, then you should create a **Crisis Recovery Diskette** before you use the Phlash utility.

NOTE: Do not install memory-related drivers (XMS, EMS, DPMI) when you use the Phlash.

NOTE: Please use the AC adaptor power supply when you run the Phlash utility. If the battery pack does not contain enough power to finish BIOS flash, you may not boot the system because the BIOS is not completely loaded.

Follow the steps below to run the Phlash.

1. Prepare a bootable diskette.
2. Copy the flash utilities to the bootable diskette.
3. Then boot the system from the bootable diskette. The flash utility has auto-execution function.

Remove HDD/BIOS Utility

This section provide you with removing HDD/BIOS method:

Remove HDD Password:

- If you key in wrong HDD password for three time, "HDD password error code" would display on the screen. See the image below.



- If you need to solve HDD password locked problem, you can run HDD_PW.EXE
 1. Key in "hdd_pw 15494 0"
 2. Select "2"
 3. Choose one upper-case string

```
C:\WINDOWS\system32\cmd.exe
F:\>cd password
F:\password>dir/w
Volume in drive F has no label.
Volume Serial Number is D4F6-0236

Directory of F:\password

[. ]          [..]          BIOS_PW.EXE  HDD_PW.EXE
           2 File(s)          35,354 bytes
           2 Dir(s)          487,895,040 bytes free
F:\password>hdd_pw 15494 0
unlock6.exe  v1.1  2 May 2003

Choice what kind of the password to be generated:
0.) Exit....
1.) Scan Code
2.) Upper case ASCII Code
3.) Lower case ASCII Code
Enter your choice: 2
0KJFN42
UVEIQ96
F:\password>
```

- Reboot system and key in "0KJFN42" or "UVEIQ96" to HDD user password.



Enter Primary Master HDD User Password []

Remove BIOS Password:

- If you key in wrong Supervisor Password for three time, "System Disabled" would display on the screen. See the image below.

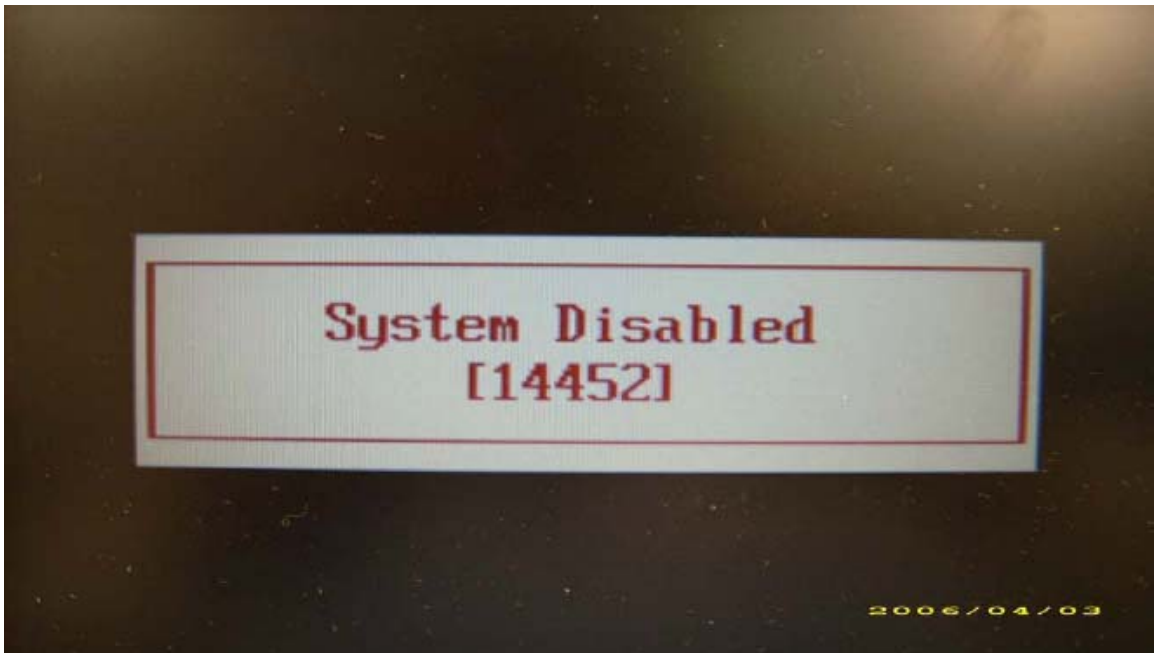

- If you need to solve BIOS password locked problem, you can run BIOS_PW.EXE
 1. Key in "bios_pw 14452 0"
 2. Choose one upper-case string

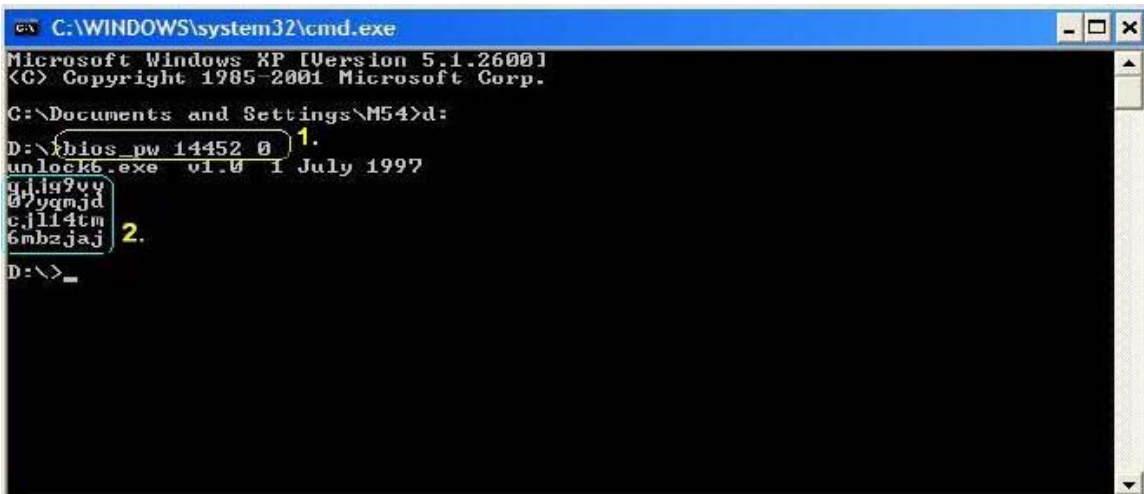

- Reboot the system and key in "qjjg9vy" or "07yqmjd" to BIOS user password.



Machine Disassembly and Replacement

This chapter contains step-by-step procedures on how to disassemble the notebook computer for maintenance and troubleshooting.

Disassembly Requirements

To disassemble the computer, you need the following tools:

- Wrist grounding strap and conductive mat for preventing electrostatic discharge
- Flat screwdriver
- Philips screwdriver
- Plastic flat screwdriver
- Plastic tweezers

NOTE: The screws for the different components vary in size. During the disassembly process, group the screws with the corresponding components to avoid mismatch when putting back the components.

General Information

Pre-disassembly Instructions

Before proceeding with the disassembly procedure, make sure that you do the following:

1. Turn off the power to the system and all peripherals.
2. Unplug the AC adapter and all power and signal cables from the system.



3. Place the system on a flat, stable surface.
4. Remove the battery pack.

Disassembly Process

The disassembly process is divided into the following stages:

- External module disassembly
- Main unit disassembly
- LCD module disassembly

The flowcharts provided in the succeeding disassembly sections illustrate the entire disassembly sequence. Observe the order of the sequence to avoid damage to any of the hardware components. For example, if you want to remove the main board, you must first remove the keyboard, then disassemble the inside assembly frame in that order.

Main Screw List

Screw Type	Number	Part Number
M2.0*2.5		86.TPK07.001
M3.0*3.5		86.TPK07.002
M3*0.5+3.5		86.A03V7.006
M2.5*6.5		86.ARE07.001
M2.5*5.0		86.ARE07.003
M2.5*3.0		86.TPK07.003

External Module Disassembly Process

External Modules Disassembly Flowchart

The flowchart below gives you a graphic representation on the entire disassembly sequence and instructs you on the components that need to be removed during servicing. For example, if you want to remove the main board, you must first remove the keyboard, then disassemble the inside assembly frame in that order.

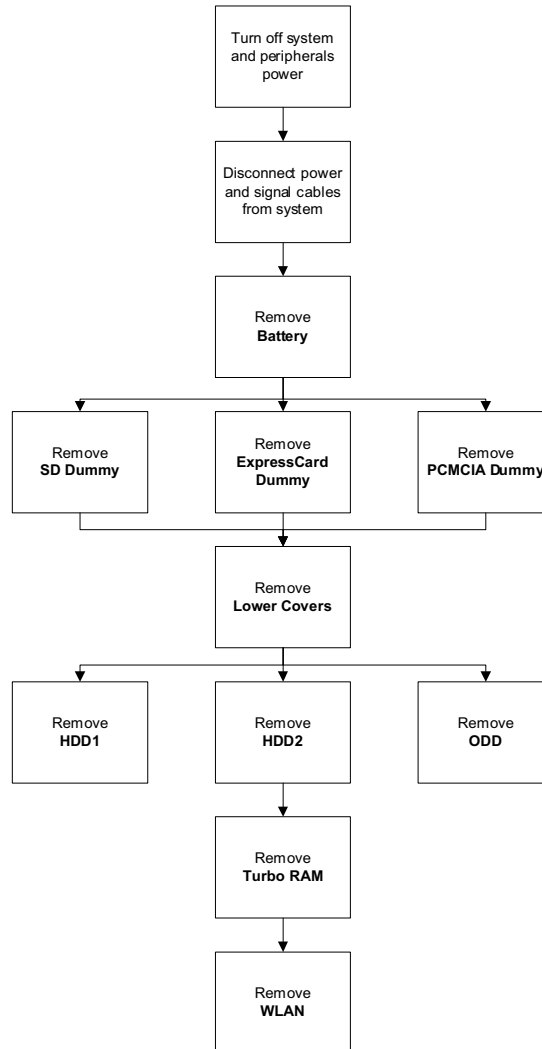

Screw List

Step	Screw	Quantity	Part No.
WLAN Module	M2*L3.5 (NL)	2	
HDD2 Carrier	M3*L3.5 (NL)	4	
HDD1 Carrier	M3*L3.5 (NL)	4	
ODD Bracket	M2*L2.5 (NL)	2	

Removing the Battery Pack

1. Turn computer over.
2. Slide the battery lock/unlock latch to the unlock position.



3. Slide and hold the battery release latch to the release position (1), then slide out the battery pack from the main unit (2).

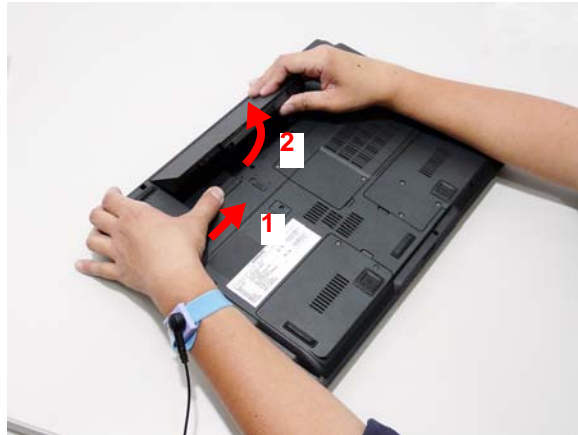

Removing the SD dummy card

1. Push the SD dummy card all the way in to eject it.



2. Pull it out from the slot.



Removing the ExpressCard dummy card

1. Push the ExpressCard dummy card all the way in to eject it.



2. Pull it out from the slot.



Removing the Lower Covers

1. See “Removing the Battery Pack” on page 48.
2. See “Removing the SD dummy card” on page 49.
3. See “Removing the ExpressCard dummy card” on page 50.
4. Loosen the 9 captive screws on the HDD1, HDD2, and Memory covers.

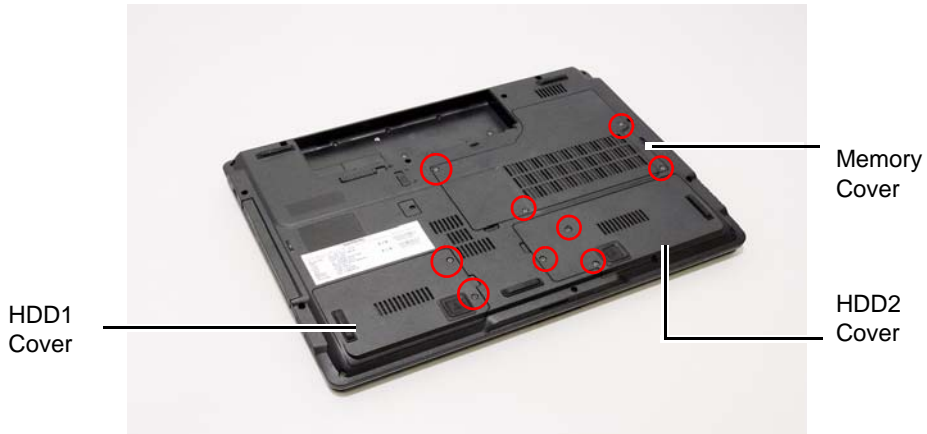

5. Carefully open the memory cover.



6. Remove the HDD2 cover as shown.



7. Remove the HDD1 cover as shown.



Removing the Turbo RAM module

1. See "Removing the Battery Pack" on page 48.
2. Remove the HDD2 cover. See "Removing the Lower Covers" on page 51.
3. Remove the Turbo RAM module as shown.





Removing the WLAN Module

1. See "Removing the Turbo RAM module" on page 52.
2. Disconnect the 3 antenna cables from the WLAN board.

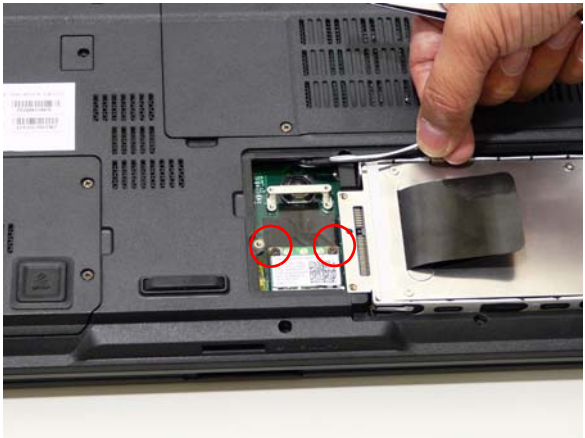

3. Move the antenna cables away and remove the two screws on the WLAN board to release the WLAN board.



Step	Size	Quantity	Screw Type
WLAN Module	M2*L3.5 (NL)	2	

4. Detach the WLAN board from the WLAN socket.



Removing the Hard Disk Drive2 Module

1. See “Removing the Battery Pack” on page 48.
2. Remove the HDD2 cover. See “Removing the Lower Covers” on page 51.
3. Use the pull-tab to slide and lift up the hard disk drive module to remove.



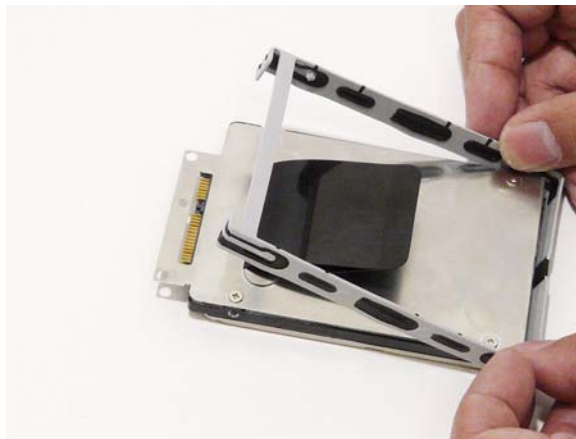

NOTE: To prevent damage to device, avoid pressing down on it or placing heavy objects on top of it.

4. Remove the HDD2 holder by easing the sides outward to clear the carrier.

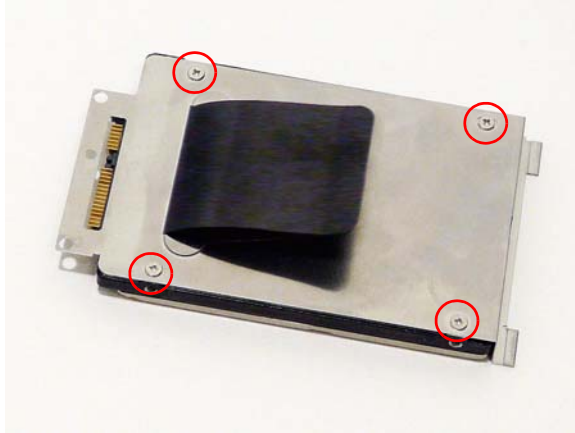

5. Remove the four screws securing the hard disk to the carrier.



Step	Size	Quantity	Screw Type
HDD Carrier	M3*L3.5 (NL)	4	

6. Remove the HDD from the carrier.

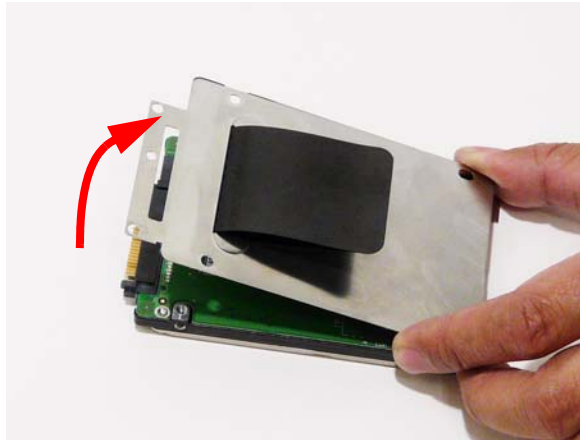

7. Remove the connector from the HDD.

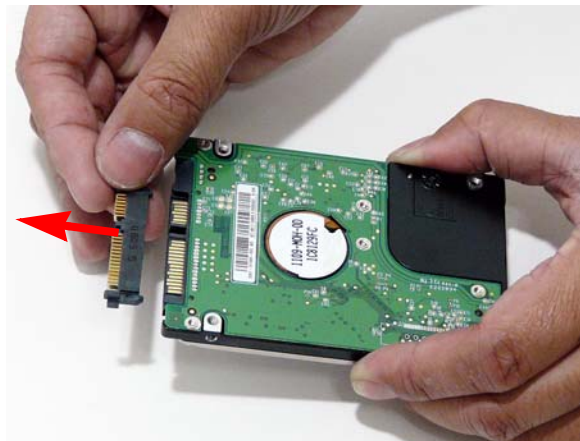

Removing the Hard Disk Drive1 Module

1. See “Removing the Battery Pack” on page 48.
2. Remove the HDD1 cover. See “Removing the Lower Covers” on page 51.
3. Use the pull-tab to slide and lift up the hard disk drive module to remove.



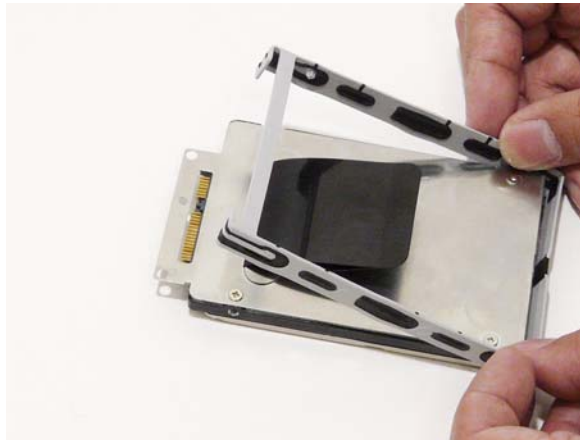

NOTE: To prevent damage to device, avoid pressing down on it or placing heavy objects on top of it.

4. Remove the HDD1 holder by easing the sides outward to clear the carrier.

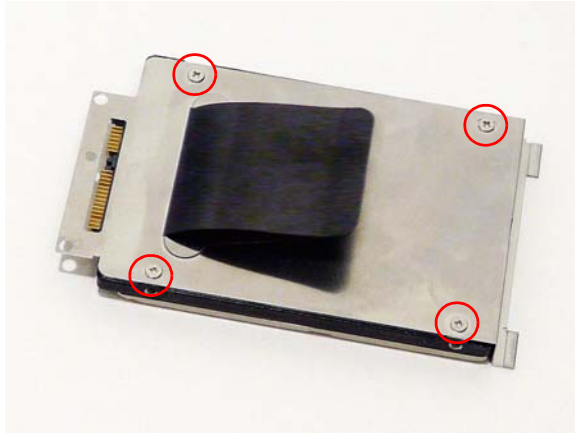

5. Remove the four screws securing the hard disk to the carrier.



Step	Size	Quantity	Screw Type
HDD Carrier	M3*L3.5 (NL)	4	

6. Remove the HDD from the carrier.

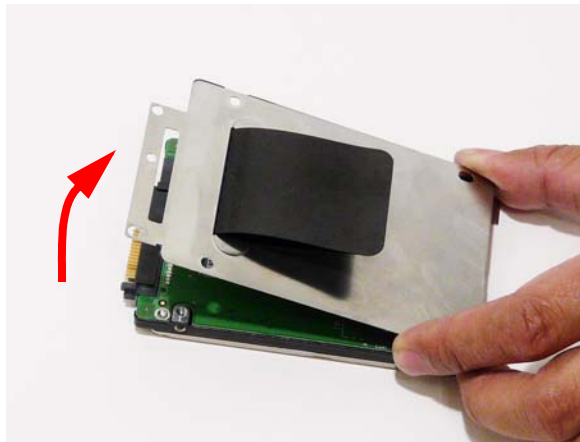

7. Remove the connector from the HDD.

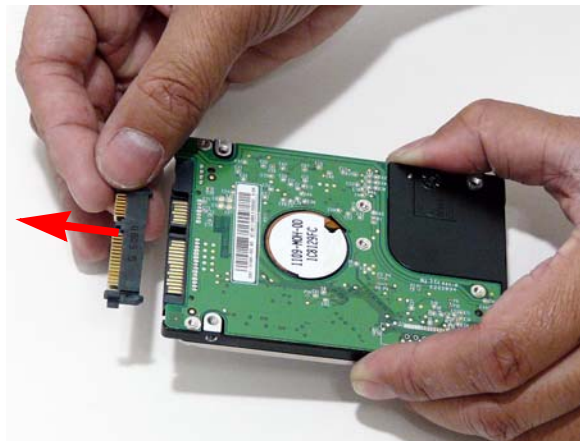

Removing the Optical Drive Module

1. See "Removing the Battery Pack" on page 48.
2. Loosen the screw to remove the ODD cap.
3. Remove the ODD cap.



4. Using a screw driver, push the ODD module and grasp the front panel to remove from the computer.

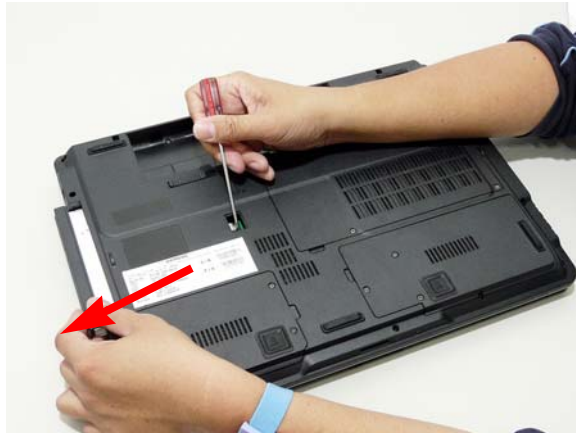

5. Remove the two screws securing the ODD bracket and remove the ODD bracket from the optical disk drive module.

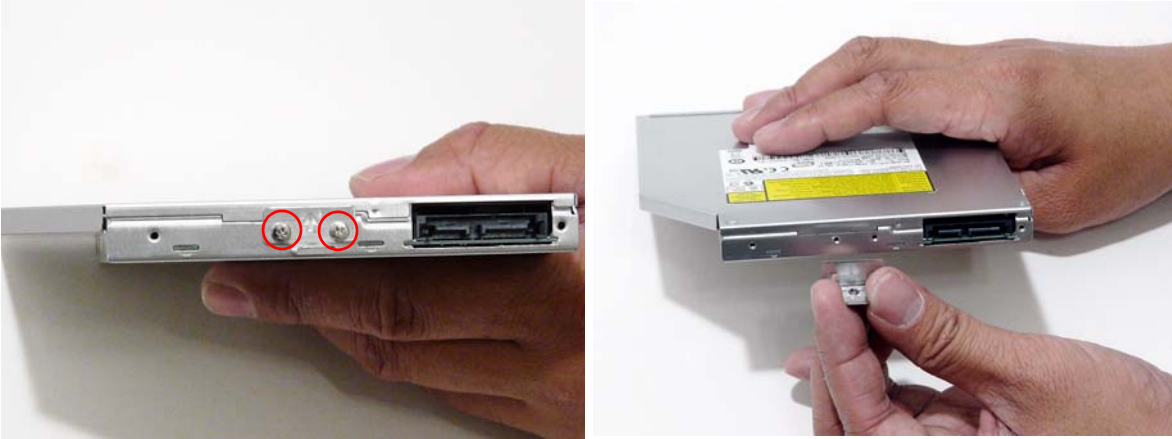

Step	Size	Quantity	Screw Type
ODD Bracket	M2*L2.5 (NL)	2	

6. Insert a pin in the eject hole of the ODD to eject the ODD tray.



7. Press down on the locking catch to release the ODD bezel and remove.

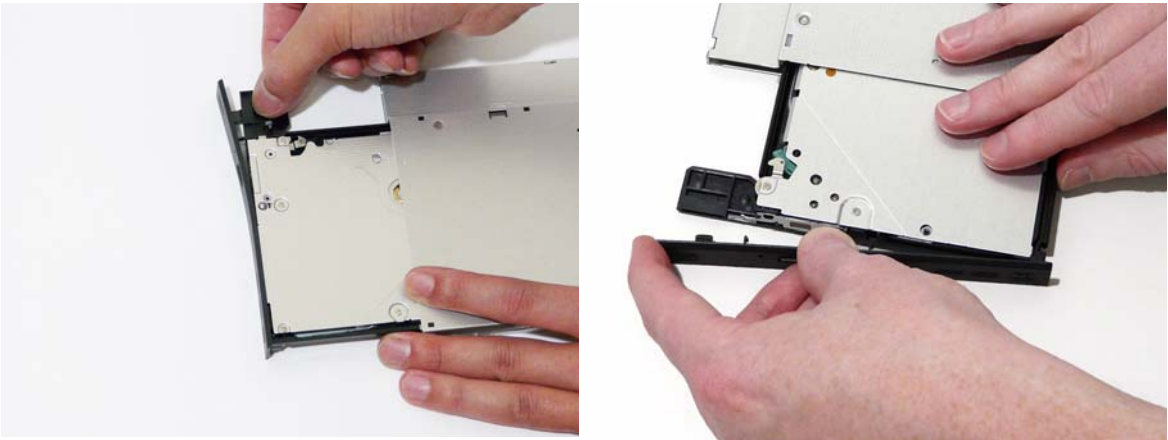

Main Unit Disassembly Process

Main Unit Disassembly Flowchart

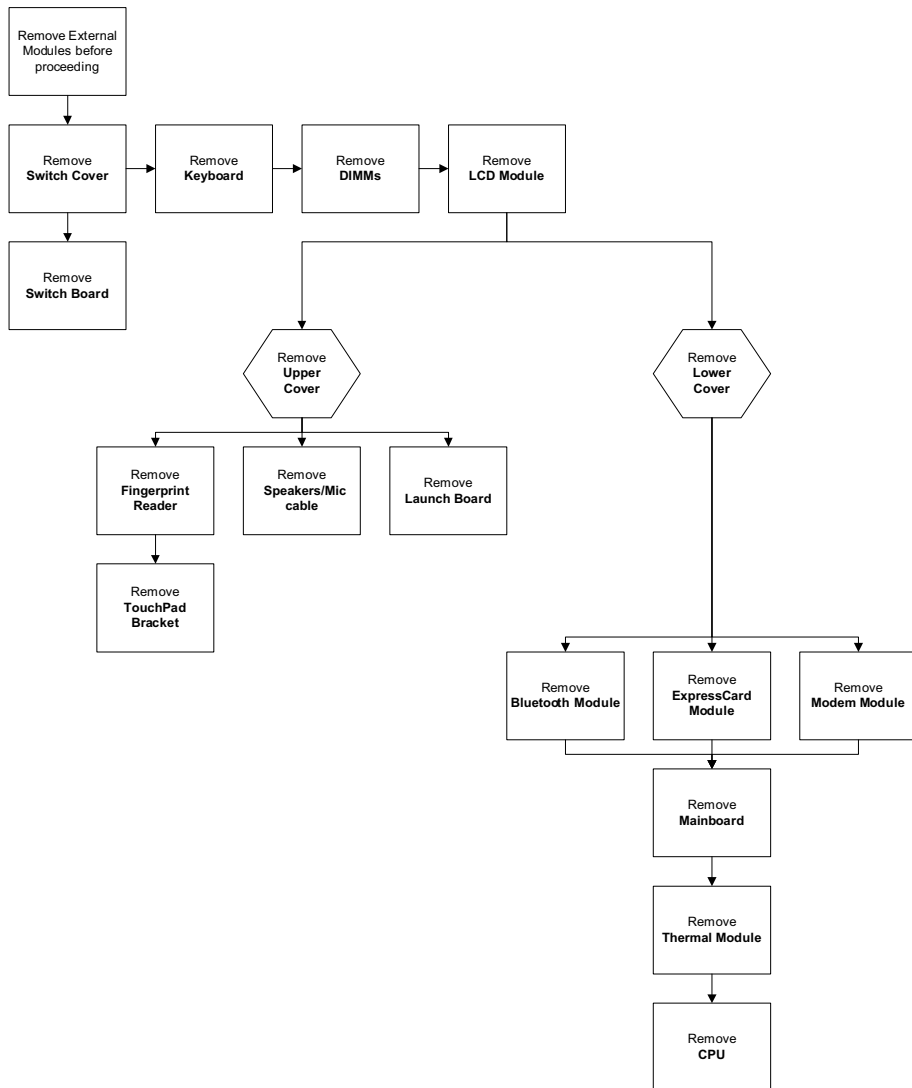

Screw List

Step	Screw	Quantity	Part No.
Switch Cover	M2.5*L5 (NL)	2	
LCD Module	M2.5*L6.5 (NL)	2	
	M2.5*L6.5 (NL)	4	
Switch Board	M2.5*L4 (NL)	3	
Upper Cover	M2.5*3	2	
	M2.5*L5 (NL)	3	
	M2.5*L6.5 (NL)	12	
Finger Print Reader	M2.5*L4 (NL)	2	
Speaker Module	M2*L6 (NL)	5	
Launch Board	M2.5*L4 (NL)	3	

Step	Screw	Quantity	Part No.
Modem Module	M2.5*L4 (NL)	1	
ExpressCard Module	M2.5*L4 (NL)	3	
Mainboard	M2.5*L6.5 (NL)	2	

Removing the Switch Cover

CAUTION: Using tools to remove the Switch Cover may cause damage to the outer casing. It is recommended that only fingers are used to remove the Switch Cover.

1. See "Removing the Battery Pack" on page 48.
2. Locate and remove the two securing screws as shown.



Step	Size	Quantity	Screw Type
Switch Cover	M2.5*L5 (NL)	2	

3. Turn the computer over and open the LCD module fully to expose the Switch Cover.
4. Starting from the right side, lift the Switch Cover and move left as shown.

IMPORTANT: Do not remove both sides of the Switch Cover together to prevent damage to the cover. Instead, lift one end first and follow the instructions as directed.



5. Lift the Switch Cover clear of the chassis.



Removing the Keyboard

1. See “Removing the Switch Cover” on page 62.
2. Grasp the keyboard and firmly lift up to remove.



3. Turn the keyboard over and disconnect both sides of the keyboard cable from the mainboard to remove the keyboard.

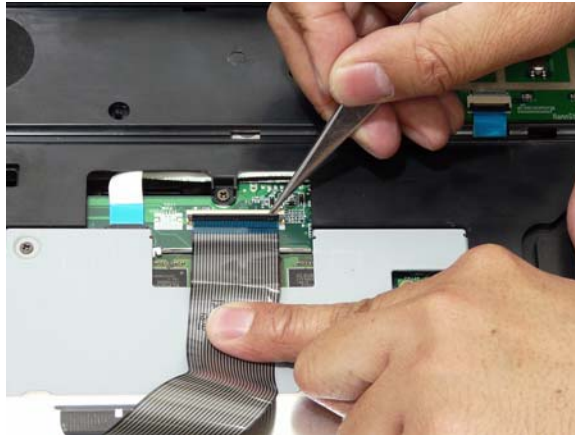

Removing the DIMM Modules

1. See "Removing the Keyboard" on page 64.
2. Loosen the captive screw on the keyboard plate.



3. Remove the plate to access the DIMM modules.

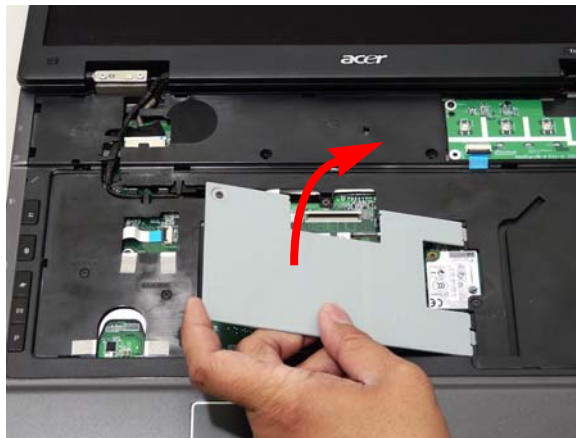

4. Push out the release latches on both sides of the DIMM socket to release the DIMM module.

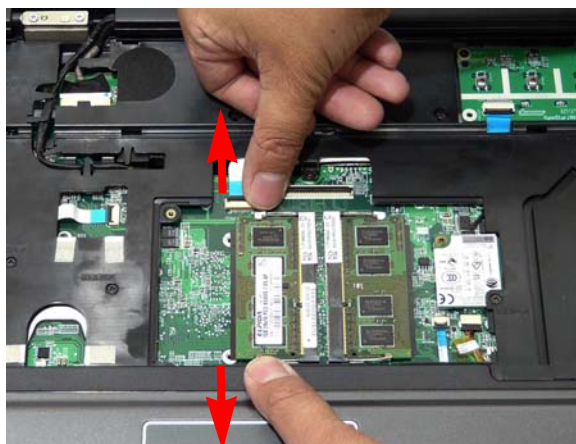

5. Remove the DIMM module.



6. Repeat steps for the second DIMM module.

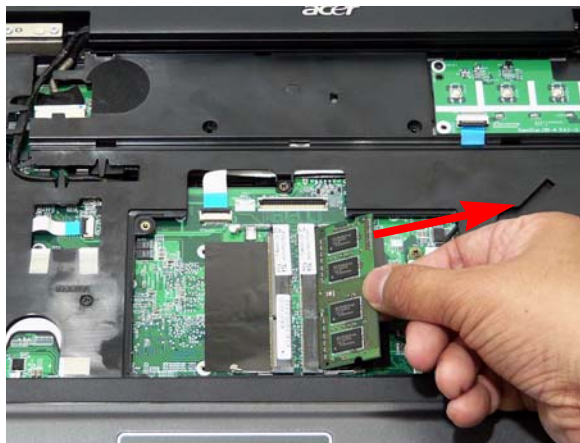

Removing the Antenna

1. Remove the Memory Cover. See “Removing the Lower Covers” on page 51.
2. Remove the HDD2 Cover. See “Removing the Lower Covers” on page 51.
3. Remove the WLAN Module. See “Removing the WLAN Module” on page 53.
4. Disconnect the Antenna Cables from the securing guides as shown.



5. Pull the cables completely through the housing.

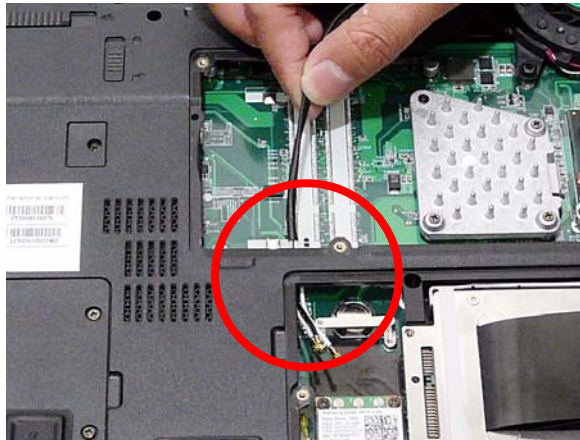

6. While pushing the cables through the underside, pull them completely through the upper cover.

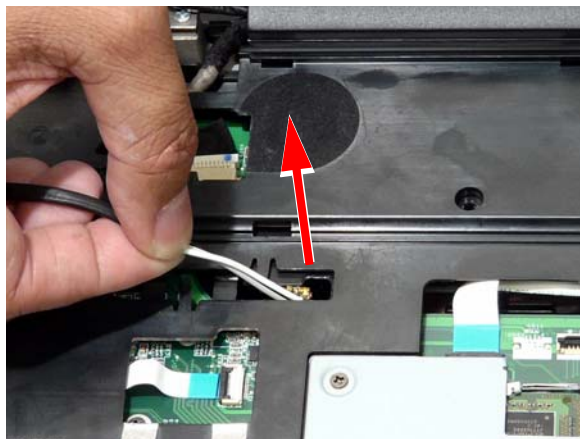

Removing the LCD Module

1. See "Removing the Battery Pack" on page 48.
2. See "Removing the Lower Covers" on page 51.
3. See "Removing the Keyboard" on page 64.
4. See "Removing the Antenna" on page 67.
5. Remove the two securing screws from the bottom of the chassis.



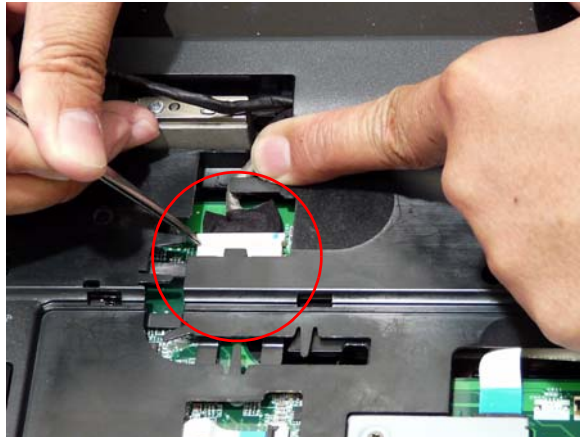

Step	Size	Quantity	Screw Type
LCD Module	M2.5*L6.5 (NL)	2	

6. Turn the computer over. Disconnect the LCD cable from the top panel.

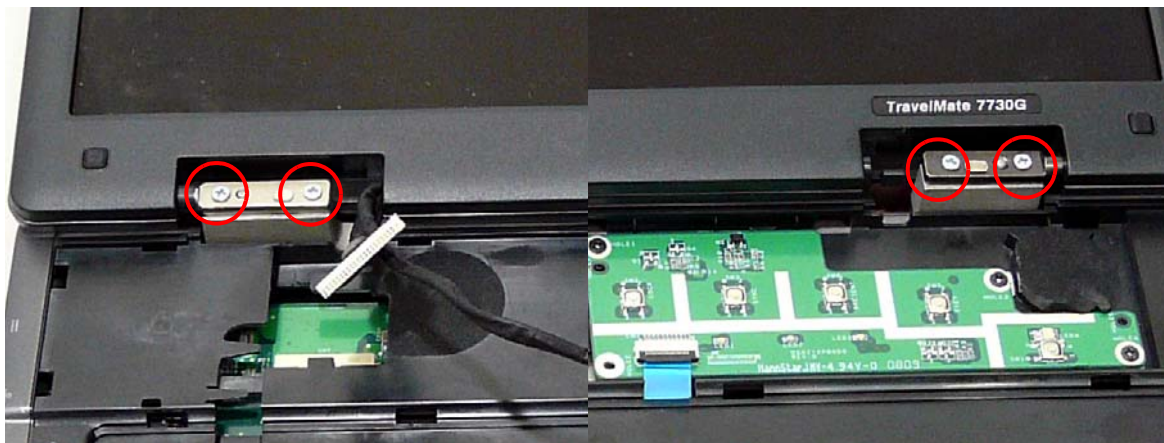

7. Remove the four securing screws (two on each side) from the LCD module.



Step	Size	Quantity	Screw Type
LCD Module	M2.5*L6.5 (NL)	4	

8. Carefully remove the LCD module from the chassis.

IMPORTANT:Place the LCD module face up on a clean surface to prevent scratching or damage.



Removing the Switch Board

- 1. See "Removing the Upper Cover" on page 71.
- 2. Remove the three securing screws.

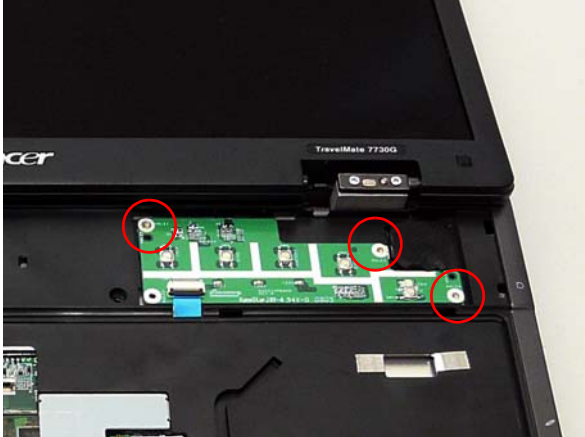

Step	Size	Quantity	Screw Type
Switch Board	M2.5*L4 (NL)	3	

- 3. Disconnect the FFC and remove the Switch Board from the upper cover.

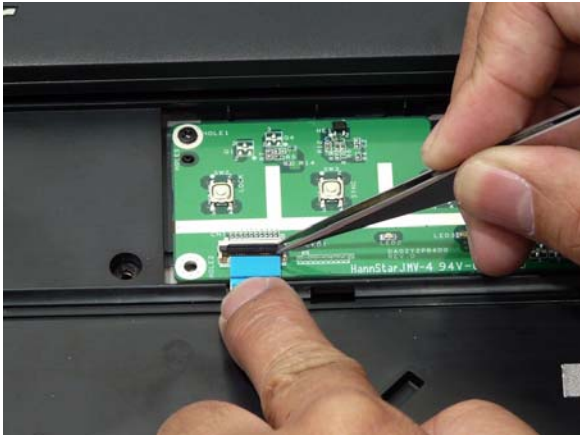

Removing the Upper Cover

1. See "Removing the Battery Pack" on page 48.
2. See "Removing the LCD Module" on page 68.
3. See "Removing the Switch Board" on page 70.
4. Turn the computer over. Remove the sixteen (16) screws on the bottom panel.

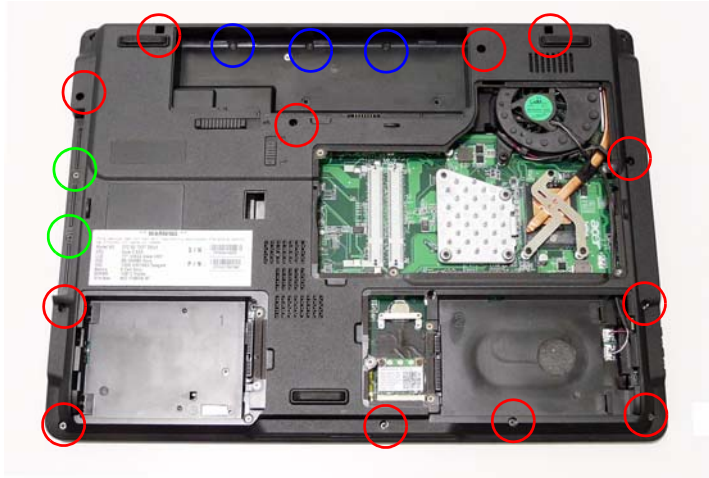

Step	Size	Quantity	Screw Type
Upper Cover	M2.5*3 Green Callout	2	
Upper Cover	M2.5*5 Blue Callout	3	
Upper Cover	M2.5*L6.5 (NL) Red Callout	12	

5. Turn the computer over. Remove the four screws on the top panel.

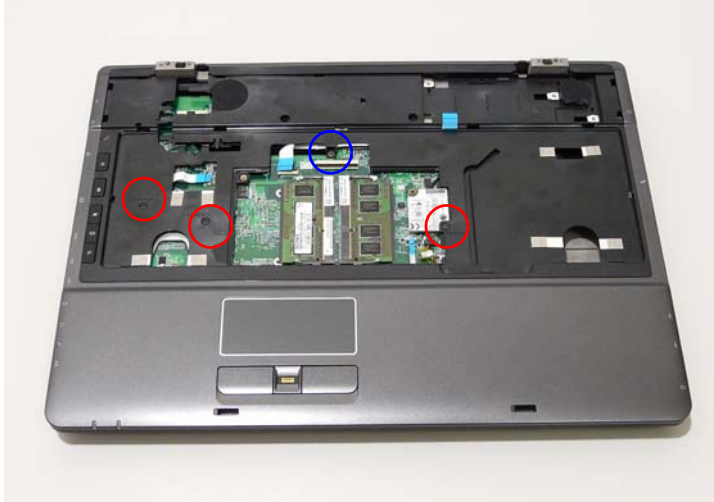

Step	Size	Quantity	Screw Type
Upper Cover	Blue Callout	1	
Upper Cover	Red Callout	3	

6. Disconnect the MIC and speaker cables and carefully pull through the HDD housing.

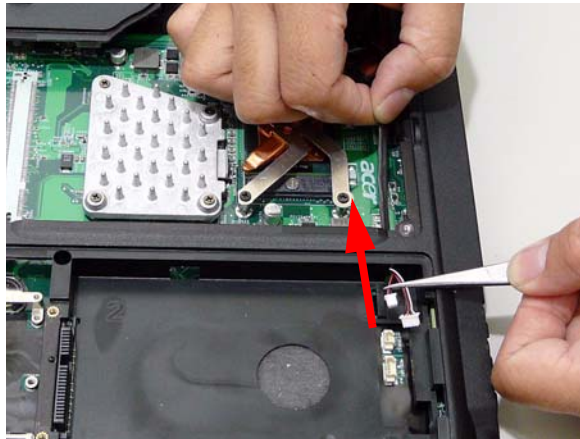

7. Pull the cables under and through the thermal module.

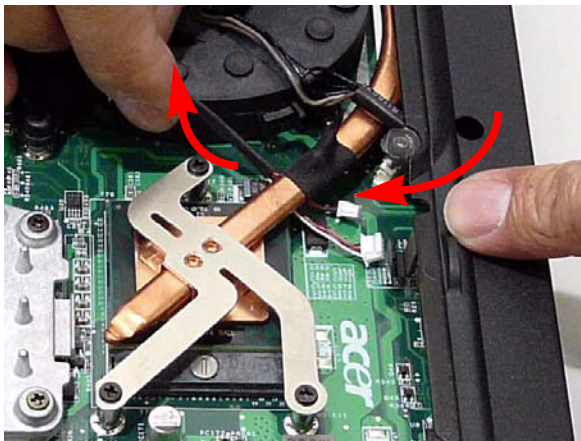

8. Turn the computer over, and disconnect the four cables from the mainboard as shown.

B

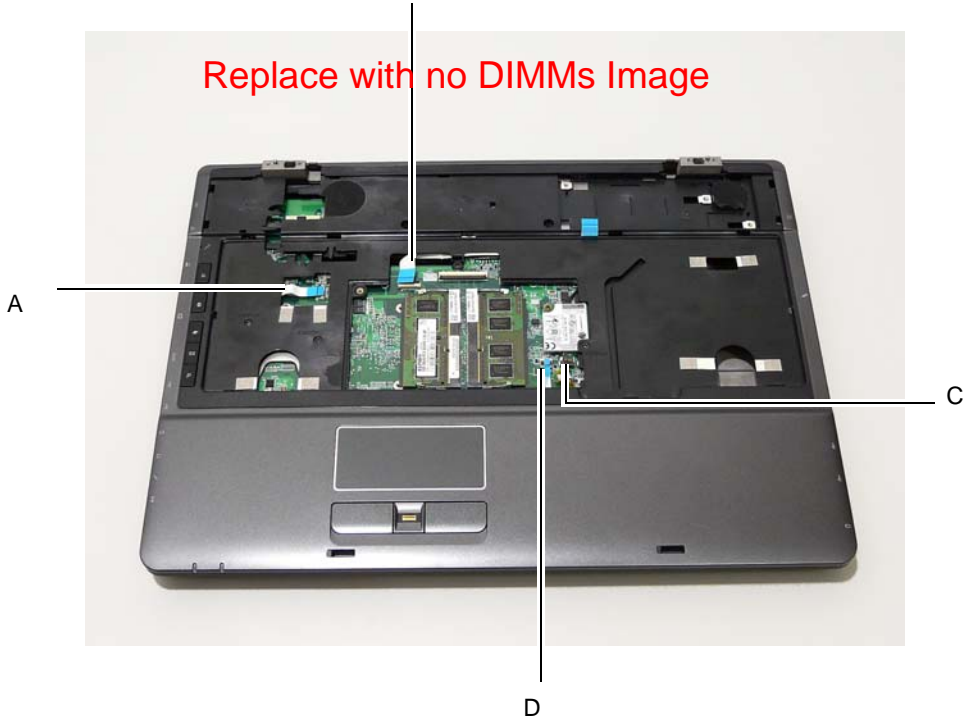

NOTE: The image depicts installed DIMM modules. The DIMM modules must be removed before proceeding.

See "Removing the DIMM Modules" on page 65.

Release the securing latch and disconnect (A) as shown.

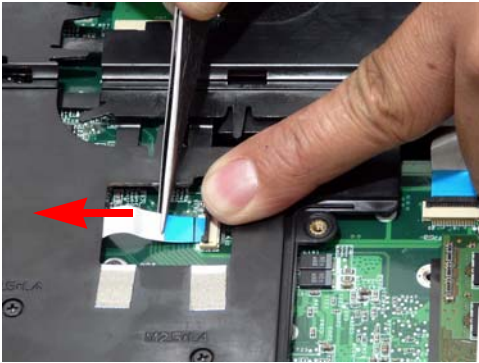

Release the securing latch and disconnect (B) as shown.

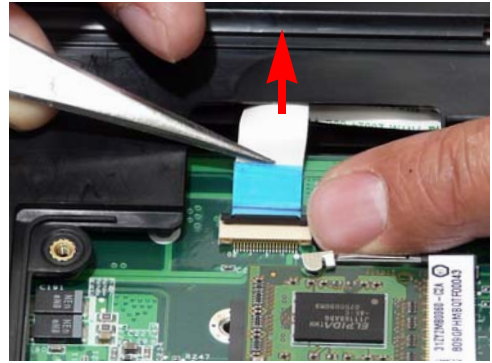

Disconnect (C) as shown.



Release the securing latch and disconnect (D) as shown.



9. Remove the upper cover by lifting upward from the chassis, rear edge first.

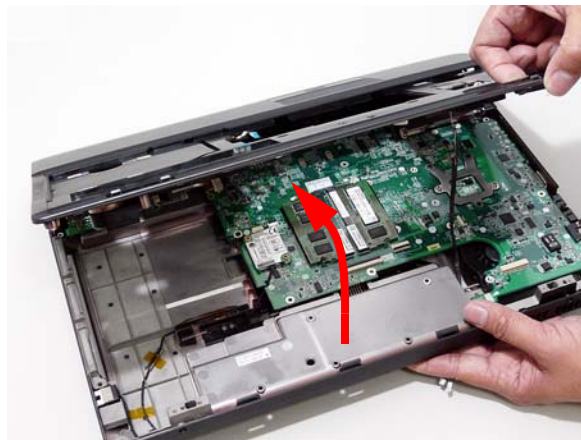

Removing the Finger Print Reader

1. See "Removing the Upper Cover" on page 71.
2. Disconnect the touchpad to switch FFC.

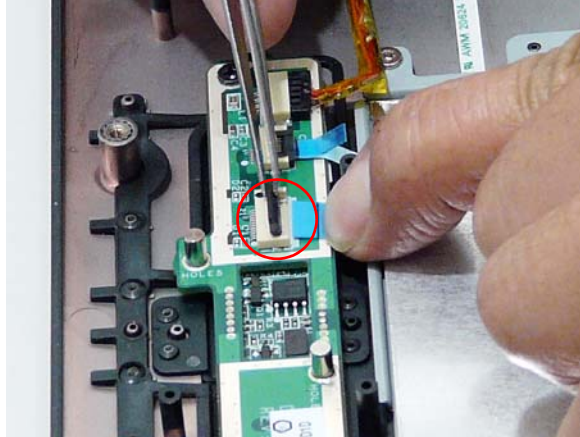

3. Disconnect the switch to mainboard FFC.

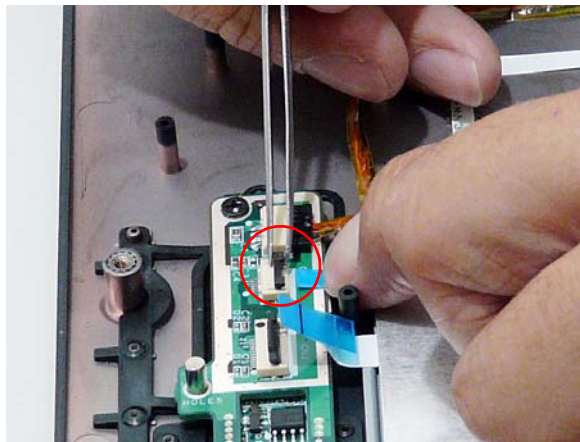

4. Disconnect the finger print cable.

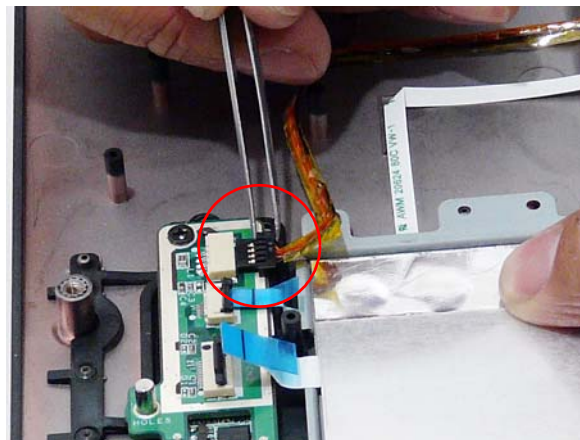

5. Remove the two securing screws from the Finger Print Reader board.

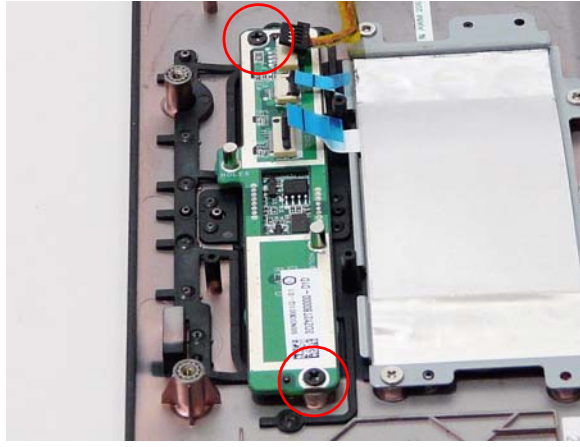

Step	Size	Quantity	Screw Type
Finger Print Reader	M2.5*L4 (NL)	2	

6. Using your fingers, gently lift the Finger Print Reader board from the Upper Cover.

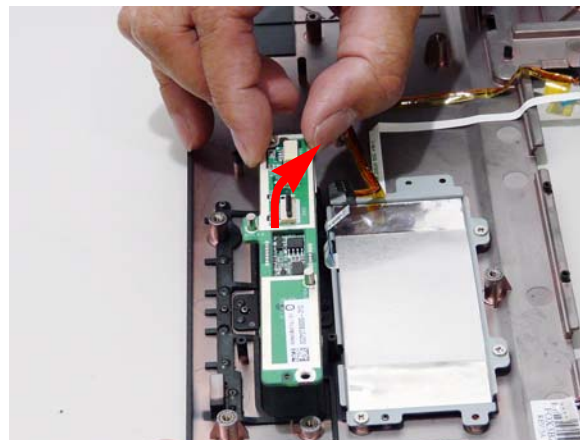

Removing the Speaker Module

1. See "Removing the Upper Cover" on page 71.
2. Remove the two securing screws from the left speaker.

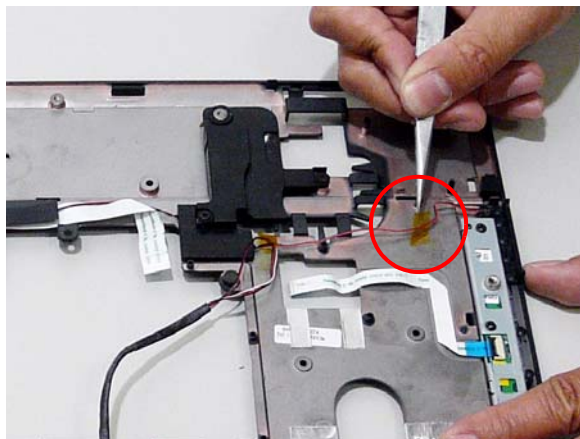

3. Disconnect the Mic cable.



4. Remove the five securing screws.

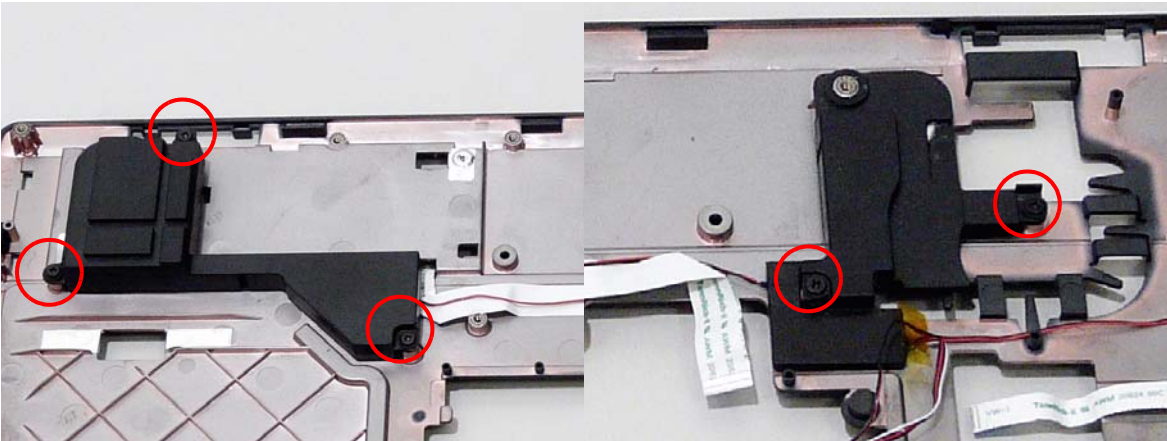

Step	Size	Quantity	Screw Type
Speaker Module	M2*L6 (NL)	5	

5. Remove the Speaker Modules as shown.

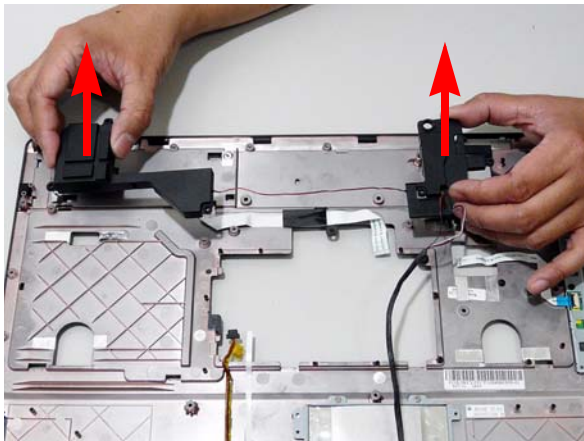

Removing the TouchPad

1. Remove the Upper Cover. See “Removing the Upper Cover” on page 71.
2. Remove the Speaker Module. See “Removing the Speaker Module” on page 76.
3. Remove the Finger Print Reader. See “Removing the Finger Print Reader” on page 75.
4. Disconnect the TouchPad FFC from the TouchPad board.

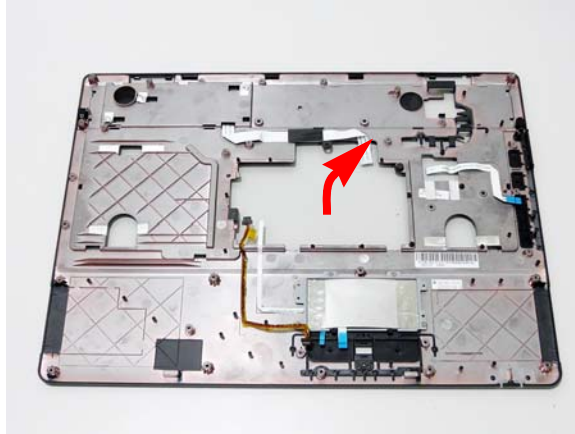

Take note of any items that may remain on the upper cover, and remove them. To replace the TouchPad, the upper cover module must be replaced.

Removing the Launch Board

1. See "Removing the Upper Cover" on page 71.
2. Lift the locking lever and disconnect the FFC.

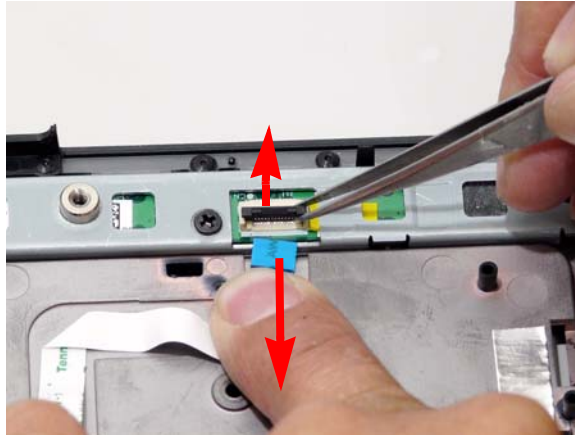

3. Remove the three securing screws.

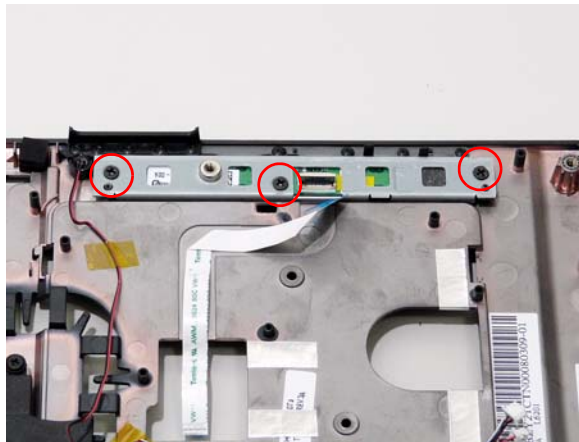

Step	Size	Quantity	Screw Type
Launch Board	M2.5*L4 (NL)	3	

4. Remove the Launch Board from the upper cover.

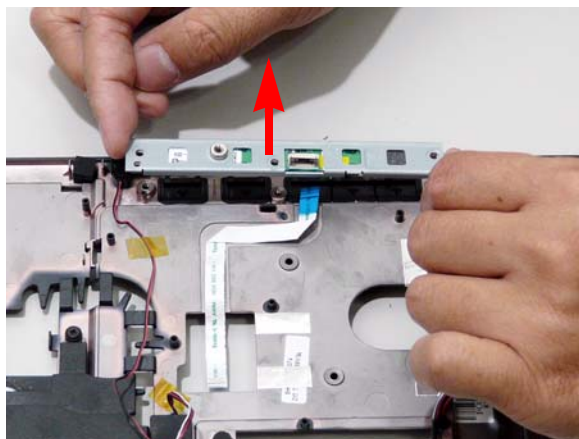

5. Remove the Launch Board from the bracket.

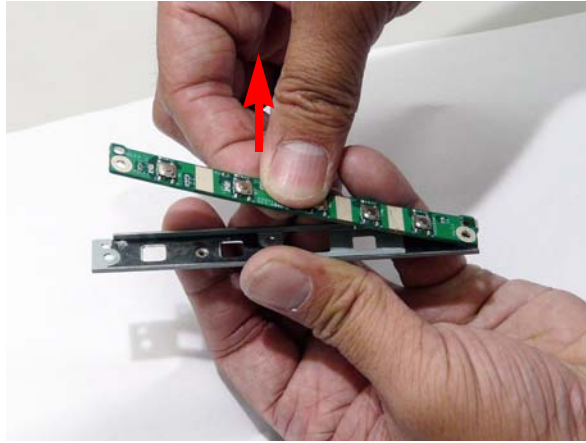

Removing the Bluetooth Module

1. See "Removing the Upper Cover" on page 71.
2. Disconnect the Bluetooth cable connecting the Bluetooth module.



3. Lift the Bluetooth module away from the base.

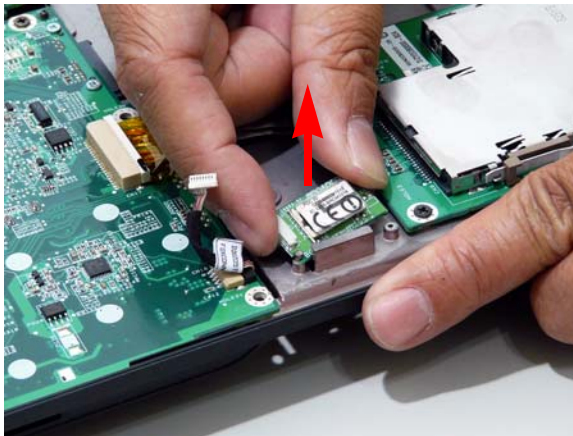

Removing the Modem Module

1. See "Removing the Upper Cover" on page 71.
2. Locate the modem module and disconnect the cable.

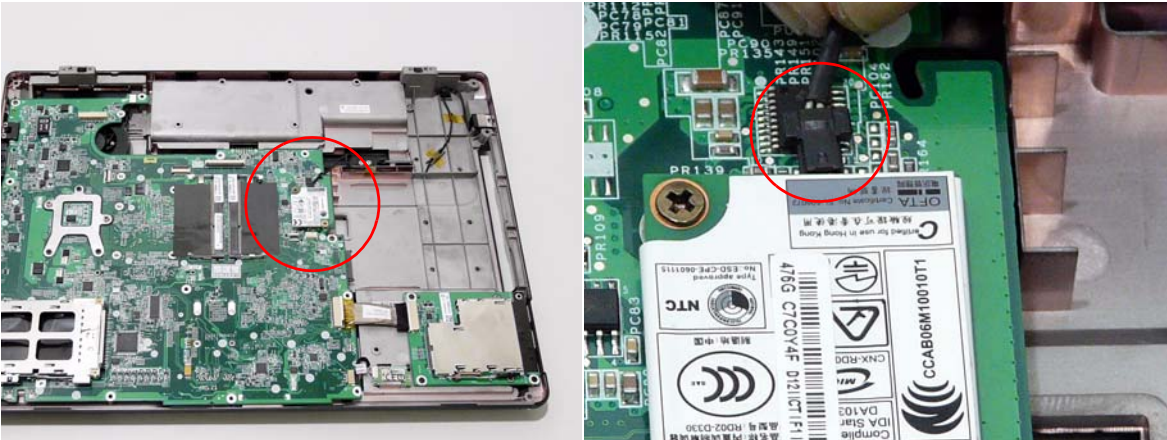

3. Remove the securing screw from the modem module.



Step	Size	Quantity	Screw Type
Modem Module	M2.5*L4 (NL)	1	

4. Lift the module from the mainboard.





Removing the ExpressCard Module

1. See "Removing the Upper Cover" on page 71.
2. Disconnect the cable connecting the ExpressCard module.

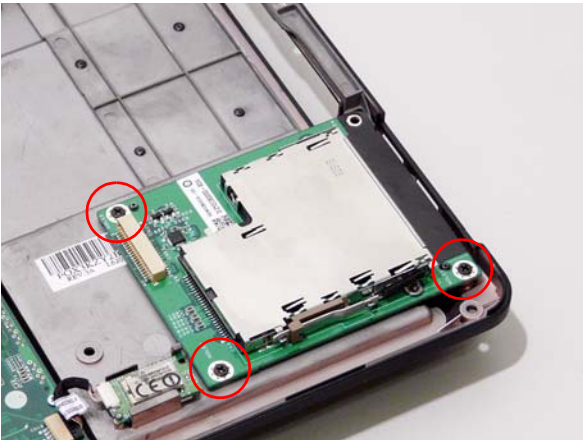

3. Remove the three securing screws.



Step	Size	Quantity	Screw Type
ExpressCard Module	M2.5*L4 (NL)	3	

4. Lift the ExpressCard module away from the upper cover.



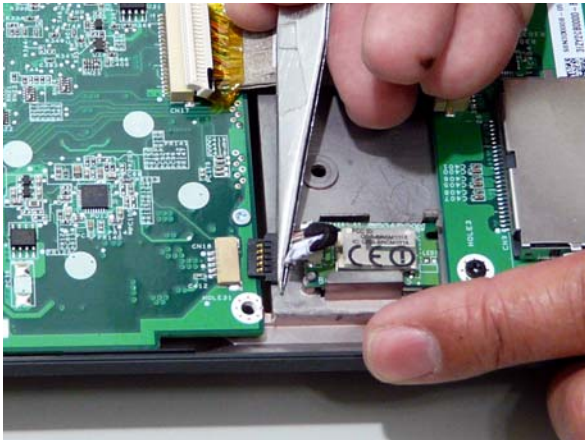
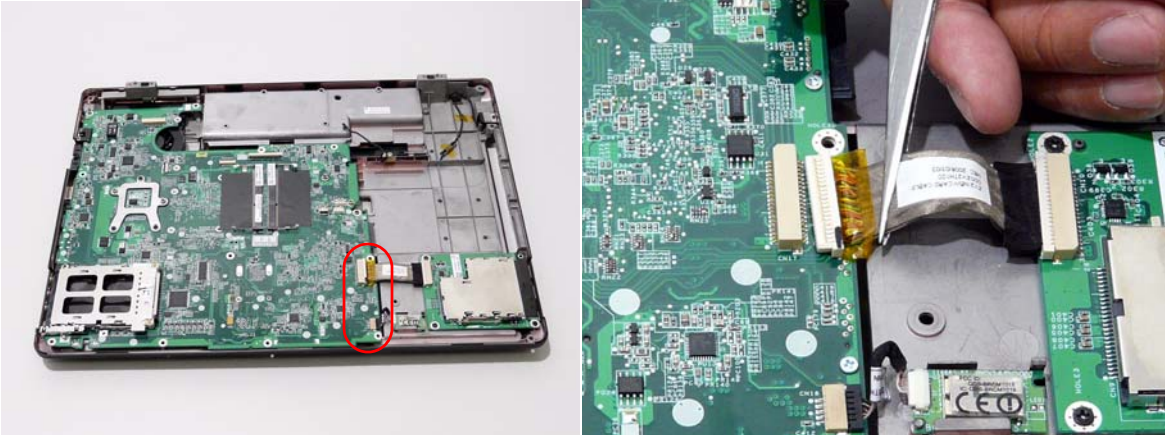

Removing the Mainboard

1. See "Removing the Upper Cover" on page 71.
2. See "Removing the Modem Module" on page 82.
3. Disconnect ExpressCard and Bluetooth cables attached to the mainboard.

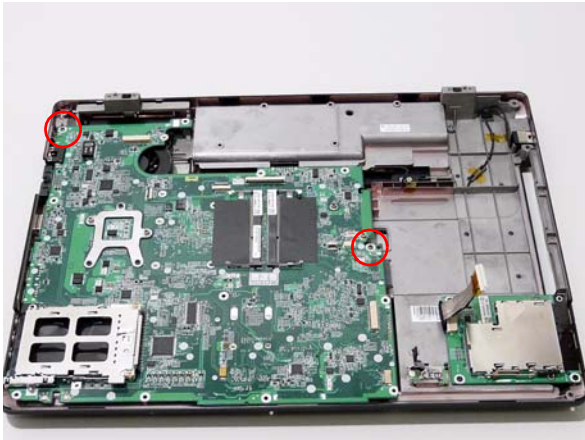

4. Remove the two securing screws on the mainboard.



Step	Size	Quantity	Screw Type
Mainboard	M2.5*L6.5 (NL)	2	

5. Remove the mainboard from the lower base.



Removing the CPU Fan

1. Remove the Mainboard. See “Removing the Mainboard” on page 84.
2. Loosen the three captive screws.



3. Disconnect the Fan cable from the mainboard.

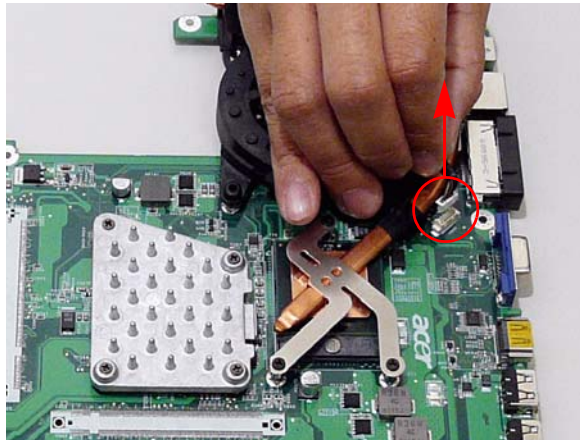

4. Lift the Fan module clear of the mainboard.

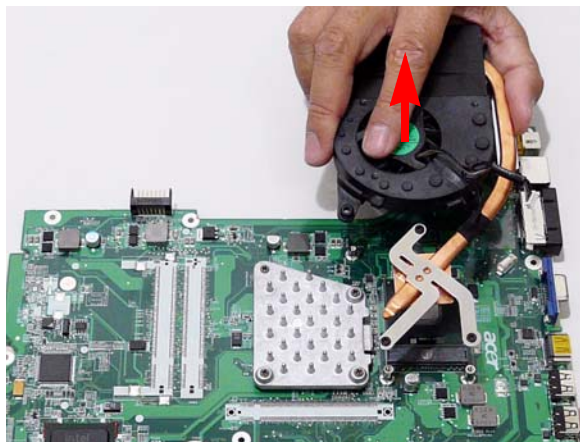

Removing the CPU

1. Remove the Mainboard. See “Removing the Mainboard” on page 84.
2. Take note of the indicators on the socket cam screw. Using a flat screwdriver, turn the CPU socket screw counter-clockwise until it indicates unlocked.

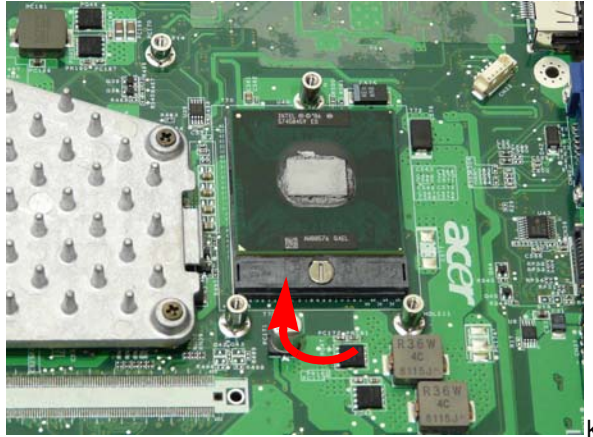

3. Lift the CPU clear of the Mainboard.

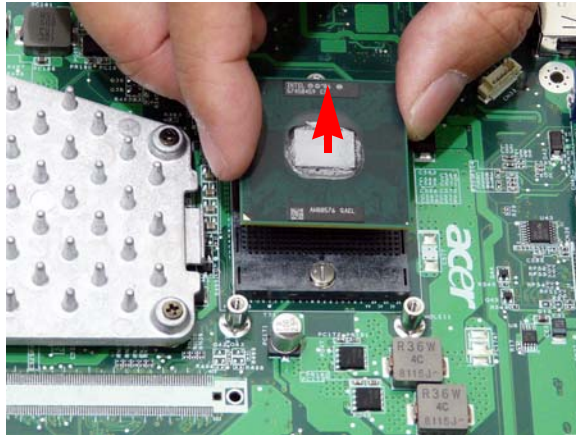

LCD Module Disassembly Process

LCD Module Disassembly Flowchart

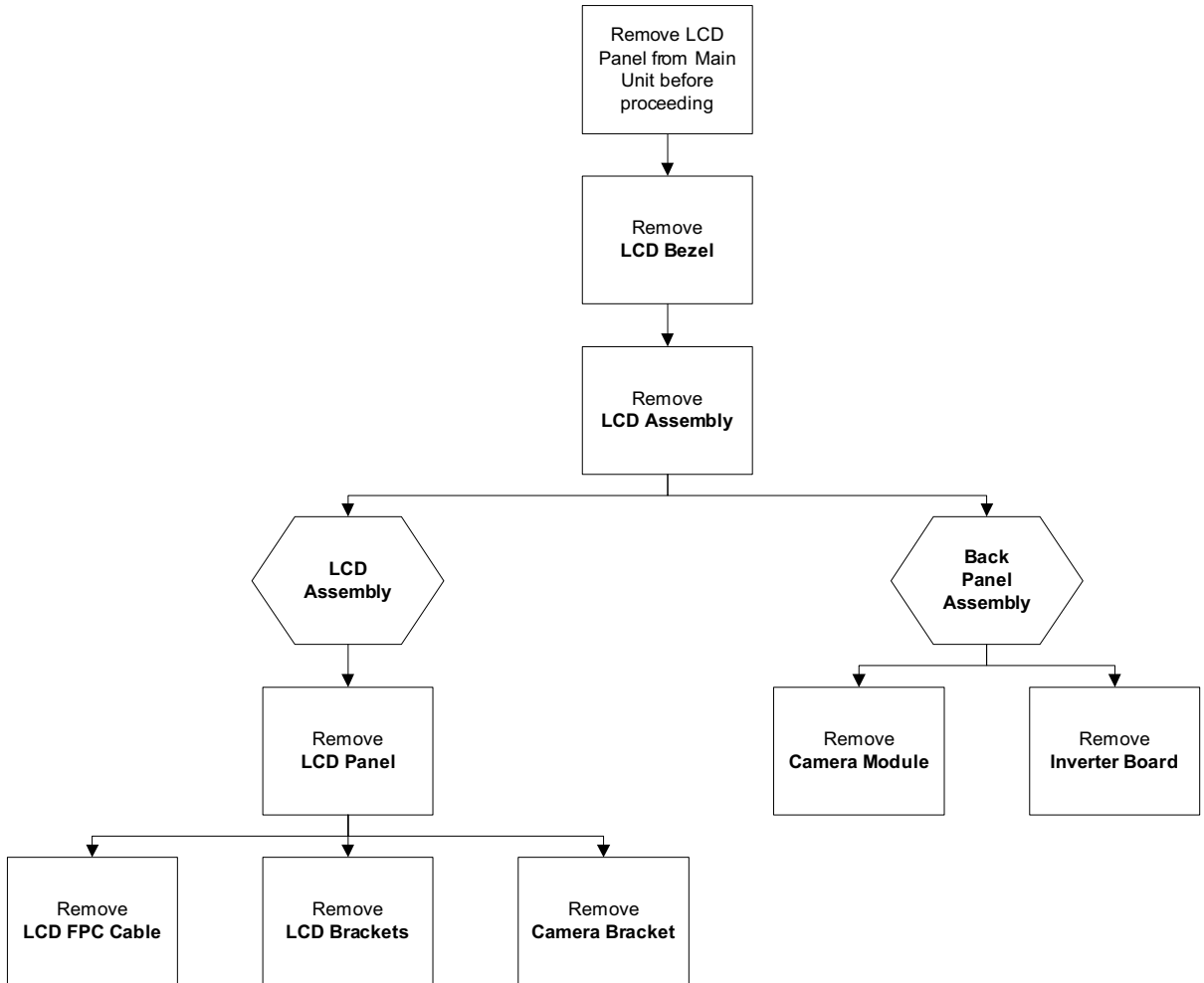

Screw List

Step	Screw	Quantity	Part No.
LCD Bezel	M2.5*L5 (NL)	6	
LCD Panel	M2.5*L5 (NL)	9	
LCD Brackets	M2*L3 (NL)	8	
Camera Bracket	M2*L3 (NL)	2	

Removing the LCD Bezel

- 1. Remove the LCD Module. See "Removing the LCD Module" on page 68.
- 2. Remove the six rubber covers and screws.



Step	Size	Quantity	Screw Type
LCD Bezel	M2.5*L5 (NL)	6	

- 3. Starting from the inside edges, pry the inside of the bezel upwards from the panel. Continue moving left until the bezel is removed. If necessary, use a plastic pry to release the corners of the bezel.

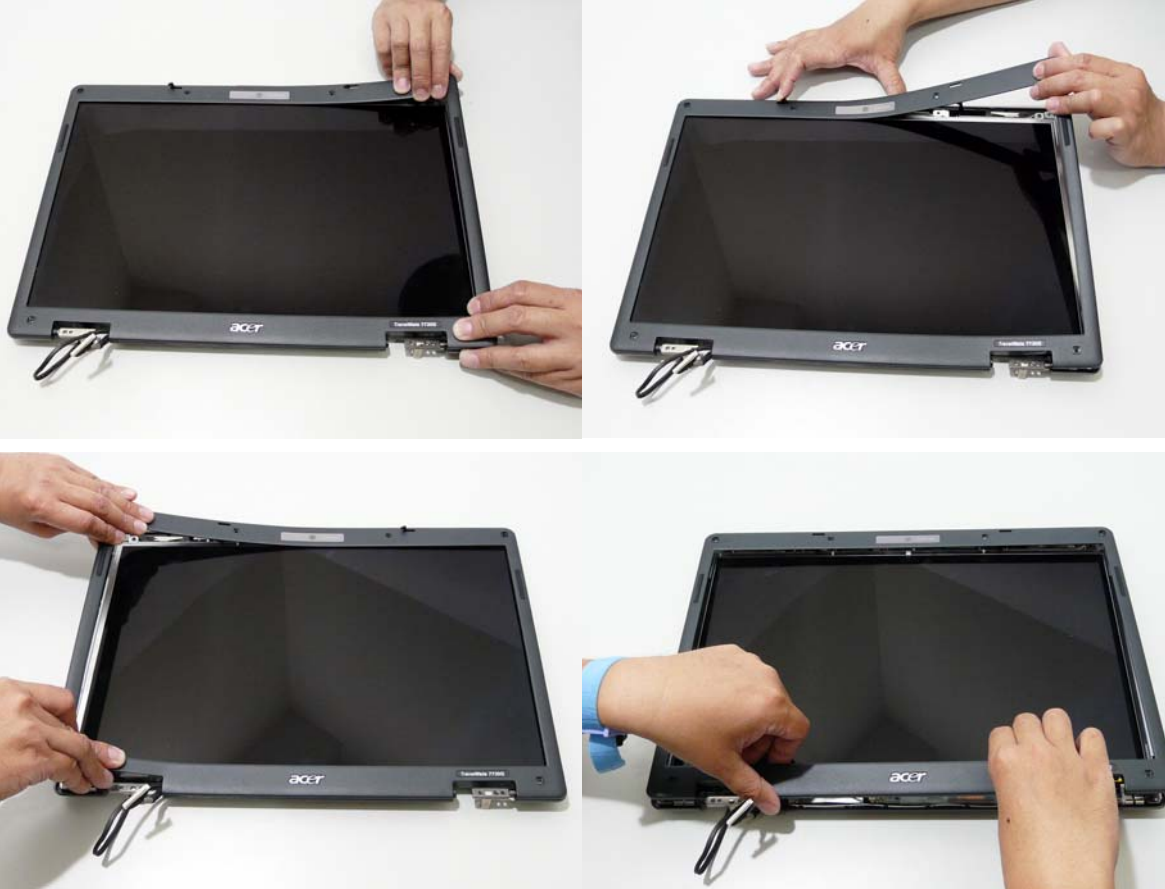

-
4. Lift up the bezel and remove it from the LCD Module.



Removing the Inverter Board

1. Remove the LCD Bezel. See "Removing the LCD Bezel" on page 89.
2. Disconnect the left and right Inverter board cables as shown.



3. Lift the Inverter board clear of the LCD Module.

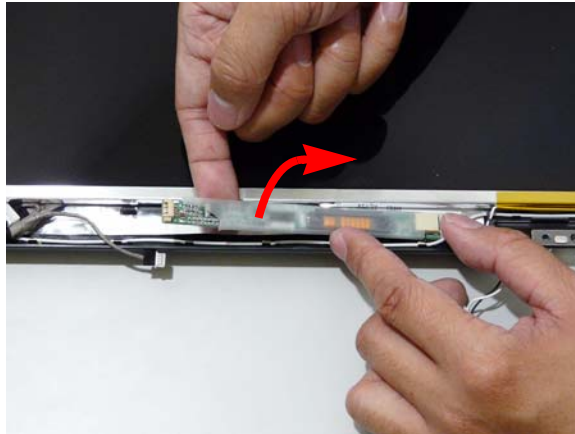

Removing the Camera Module

1. Remove the LCD Bezel. See "Removing the LCD Bezel" on page 89.
2. Disconnect the Camera Module cable as shown.

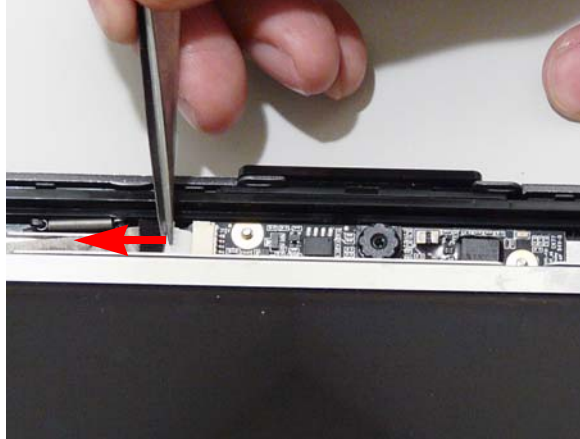

IMPORTANT: Be careful when using a sharp tool to remove the cable or camera module. The surface of the LCD panel can be easily scratched.

3. Remove the module from its securing pins and lift away from the bracket.

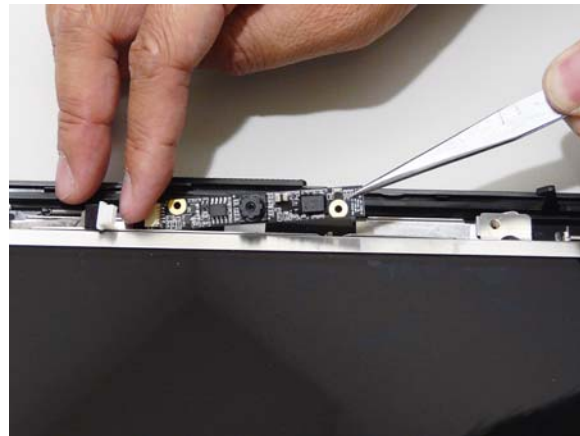

Removing the LCD Panel

1. Remove the LCD Bezel. See "Removing the LCD Bezel" on page 89.
2. Remove the nine securing screws from the LCD Panel.

IMPORTANT:The leftside screw holds the ground connector in place. Ensure that the ground is replaced during reassembly.

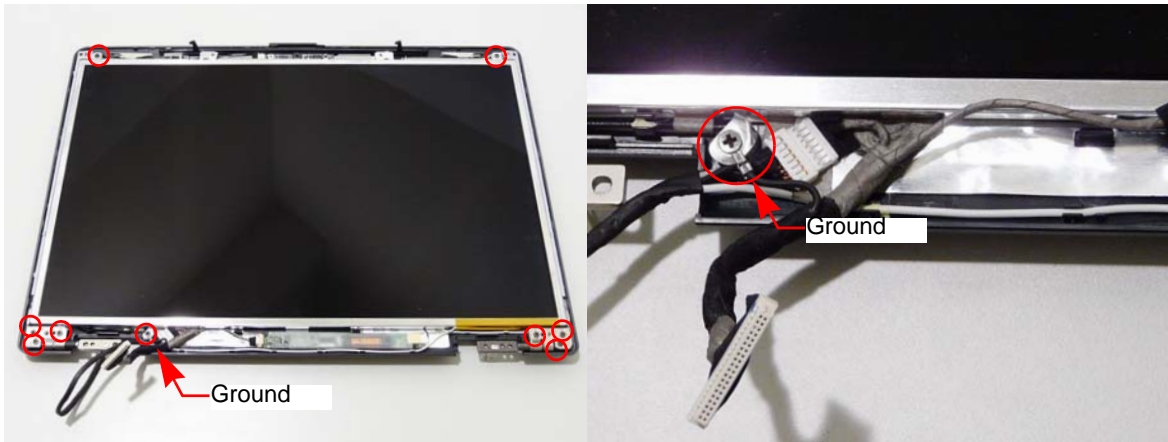

Step	Size	Quantity	Screw Type
LCD Panel	M2.5*L5 (NL)	9	

3. Lift the LCD Panel clear of the LCD Module.



Removing the LCD Brackets and FPC Cable

1. Remove the LCD Panel. See “Removing the LCD Panel” on page 93.
2. Turn the LCD panel over to expose the rear. Remove the mylar strips securing the FPC cable.

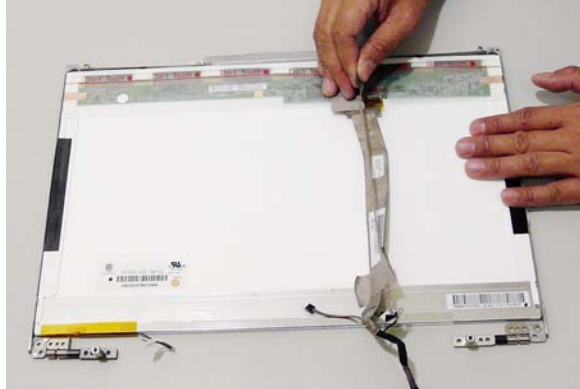

3. Disconnect the cable from the panel and remove.

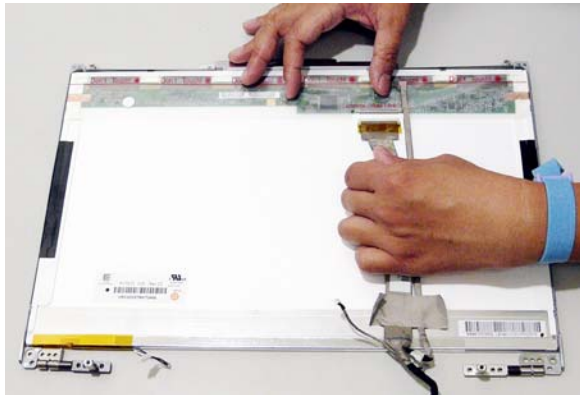

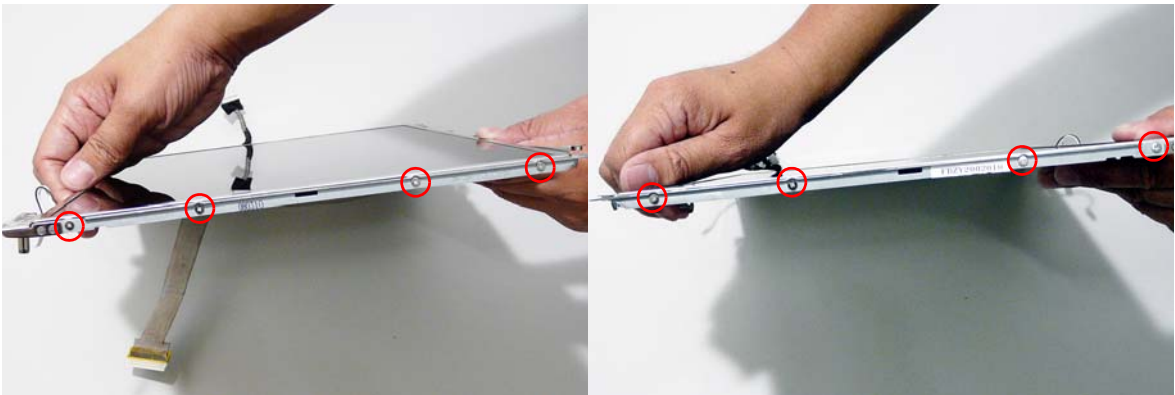

4. Remove the eight securing screws (four on each side) from the LCD Panel brackets.

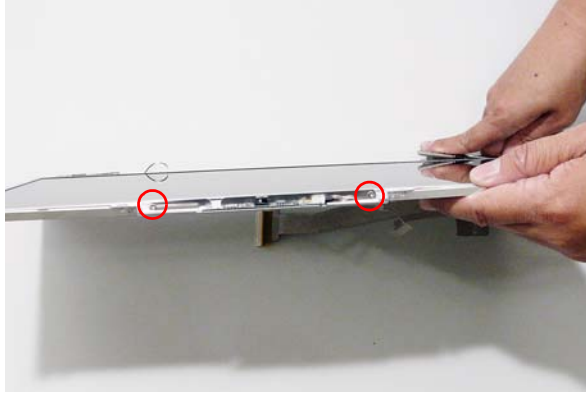

Step	Size	Quantity	Screw Type
LCD Brackets	M2*L3 (NL)	8	

5. Remove the two securing screws from the camera bracket (top of LCD Panel).



Step	Size	Quantity	Screw Type
Camera Bracket	M2*L3 (NL)	2	

6. Remove the camera and LCD brackets by pulling away from the LCD Panel as shown.



LCD Module Reassembly Procedure

Replacing the LCD Panel

1. Align the LCD brackets and the camera bracket in place.

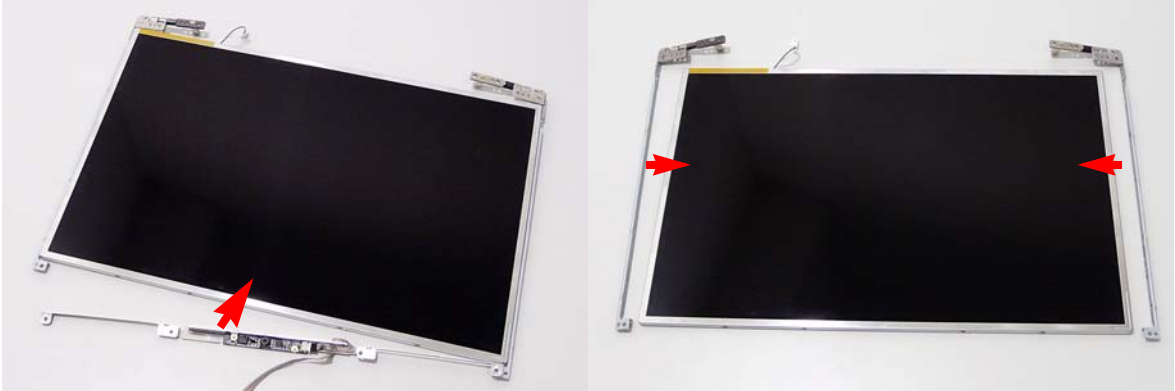

2. Replace the two securing screws on the camera bracket (top of LCD panel).

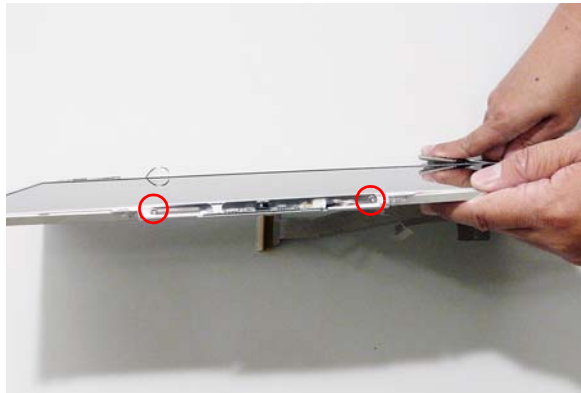

3. Replace the eight securing screws (four on each side) on the LCD Panel brackets.

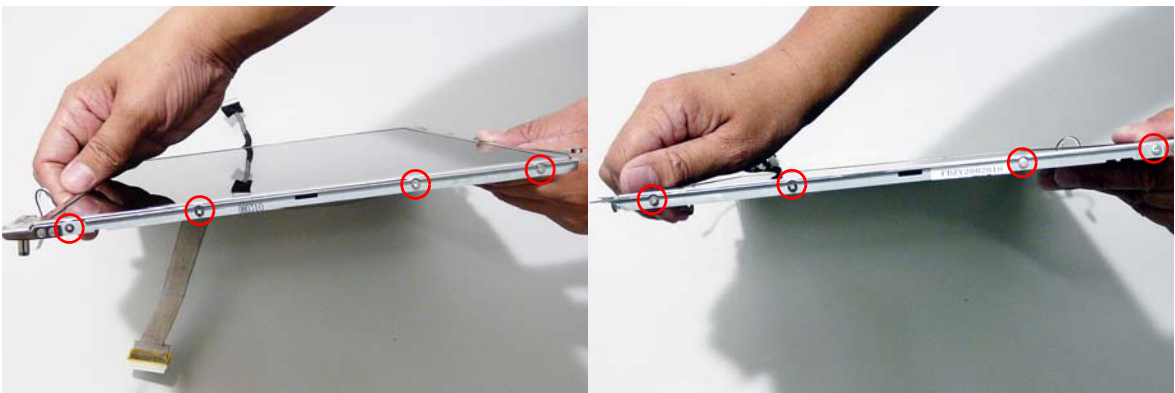

4. Align the LCD Panel cable as shown. Conenct the LCD cable and press down to engage the adhesive pads.

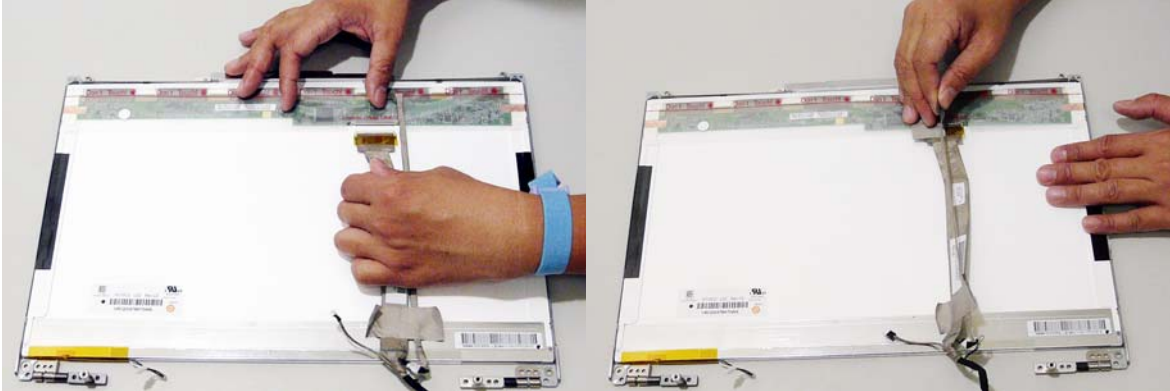

5. Ensure that all cables are positioned out of the way, and place the LCD Panel in the back cover.

6. Replace the ground cable and secure with the screw.

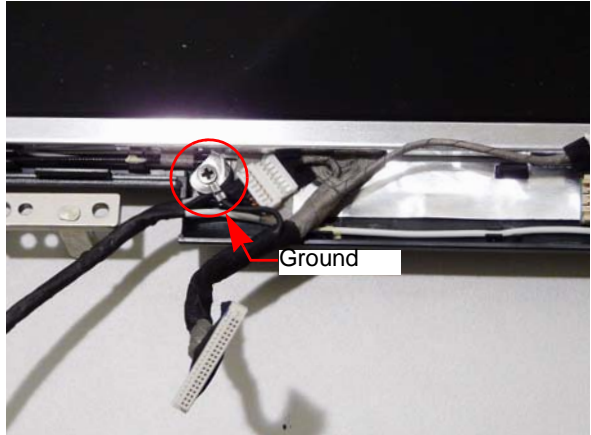

7. Secure the LCD module with the eight securing screws.

8. Align the Camera Module over the guide pins and insert it in place (adhesive side down). Secure by pressing down to insure cohesion.

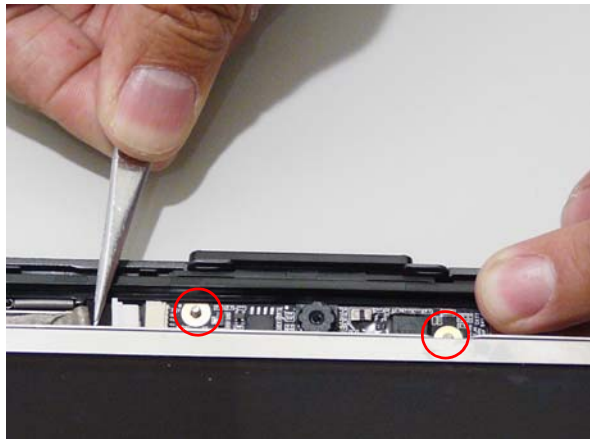

9. Connect the Camera Module cable.

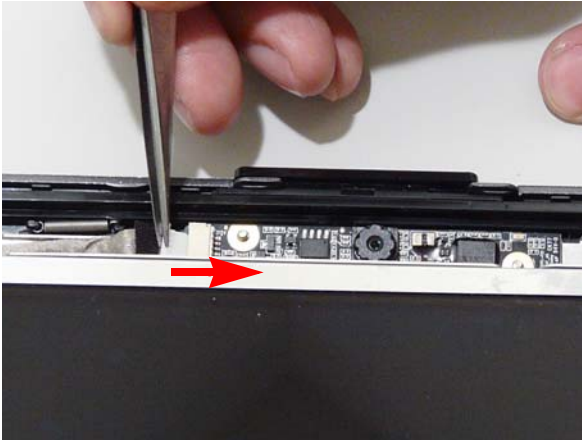

10. Insert the Inverter board in place. Press down to ensure cohesion.

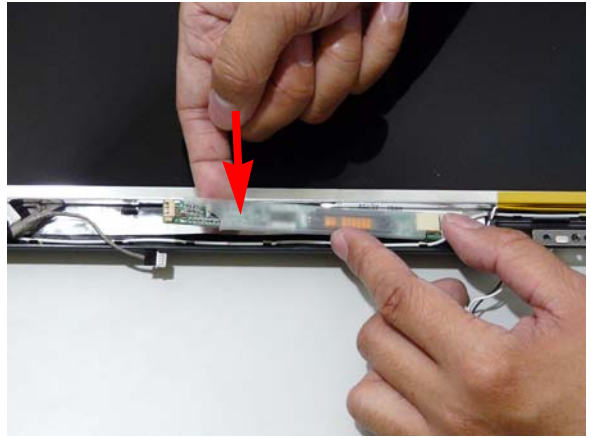

11. Connect the left and right Inverter board cables as shown.

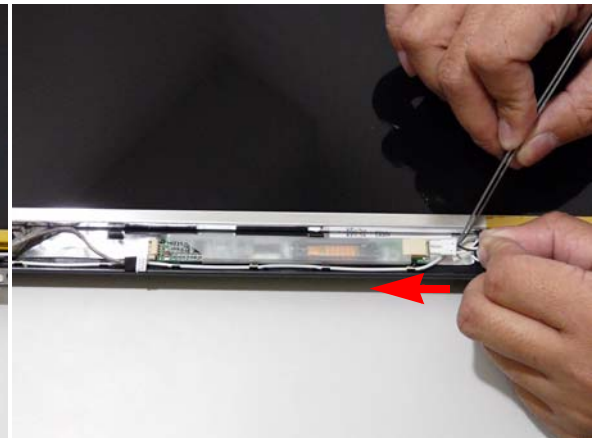

Replacing the LCD Bezel

1. Locate the bezel correctly and press down the edges until there are no gaps between the bezel and the LCD Module.



2. Starting from left to right, firmly press down to ensure the bezel is situated correctly (four locations on each side).



3. Replace the six screws and the rubber caps provided.

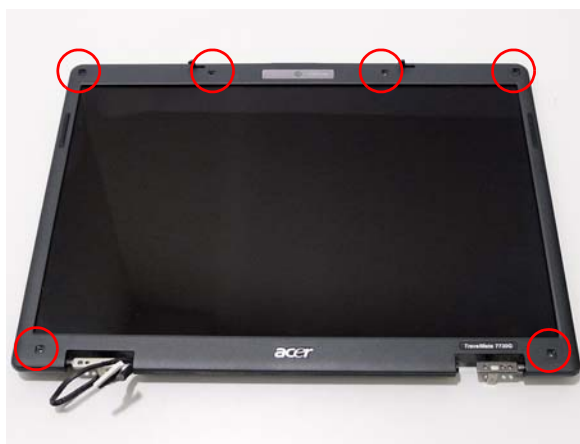

Main Module Reassembly Procedure

Replacing the CPU

1. Carefully turn the mainboard upside down (CPU side up), and insert the CPU into the CPU bracket as shown.
2. Using a plastic screw driver, lock the CPU in the socket as shown.

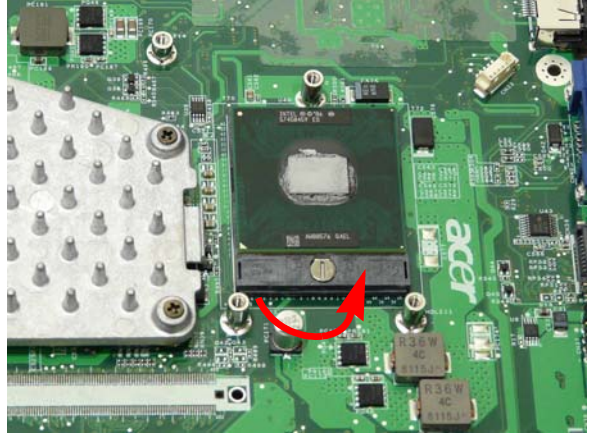
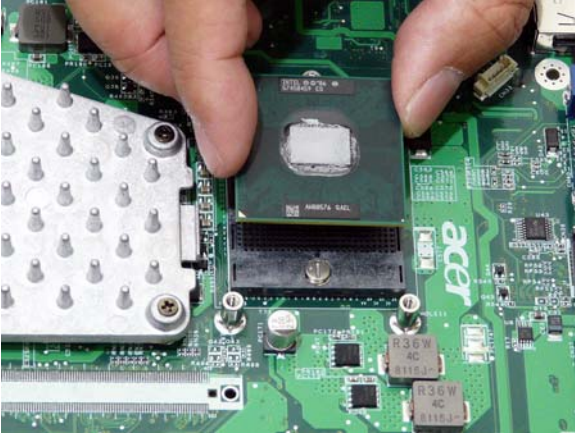

Replacing the CPU Fan Module

1. Align the Fan Module on the screw brackets.
2. Secure the 3 screws according to the following numbered order.

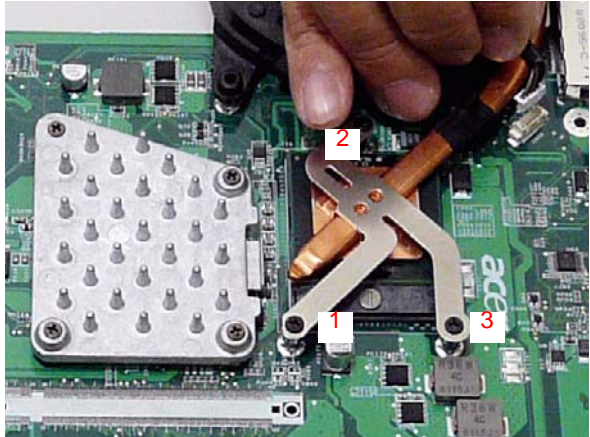
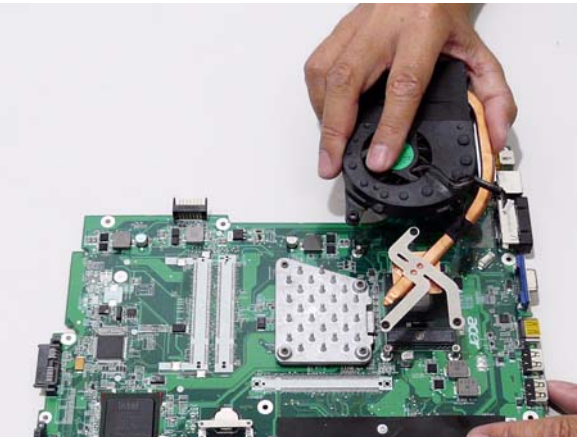

3. Connect the Fan cable to the Mainboard.

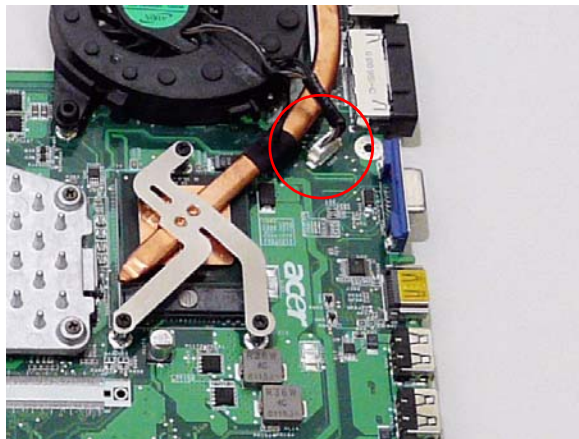

Replacing the Mainboard

1. Ensure that the Mainboard is face up (the Heatsink and CPU are not visible). Place the Mainboard in the chassis, rear edge first, and press down to install. Replace the two securing screws as shown.

NOTE: Make sure the I/O ports are positioned correctly through the lower cover, and the screw sockets are visible through the mainboard.

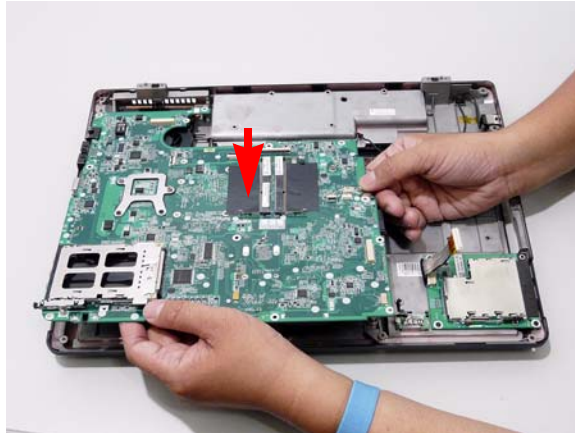

2. Replace the two securing screws on the mainboard.

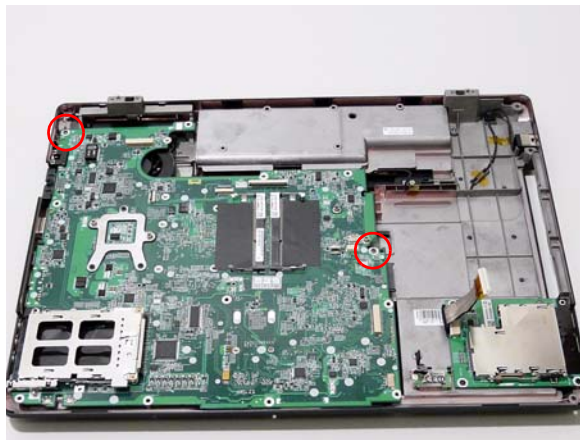

3. Connect the ExpressCard and Bluetooth cables attached to the mainboard.

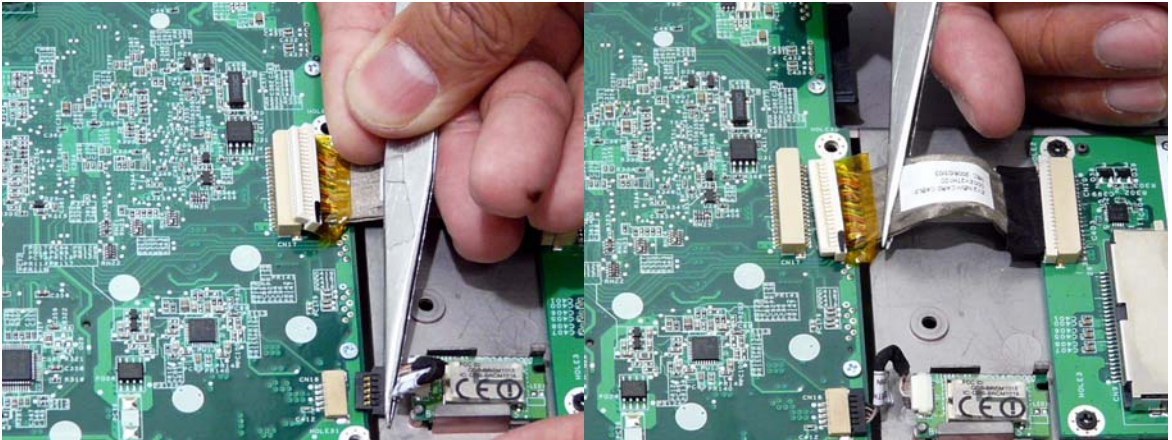

Replacing the Bluetooth Board

1. Start by inserting the notch into the retaining pin.
2. Press the module down to secure in place.

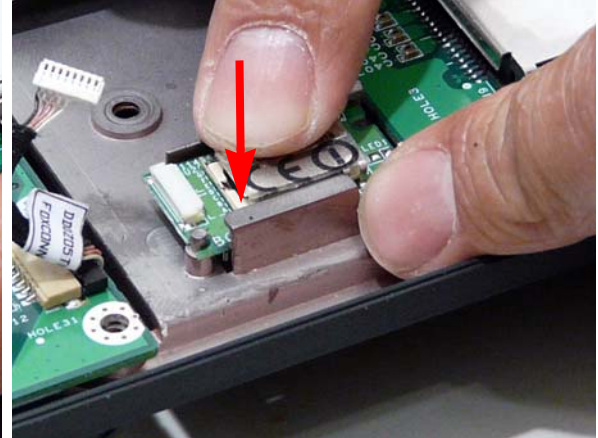
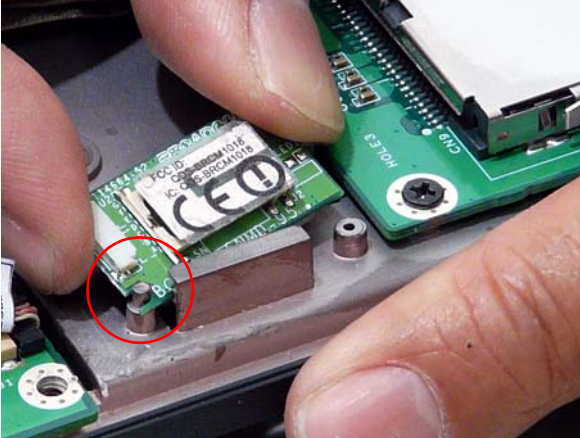

3. Connect the Bluetooth cable to the Bluetooth module.

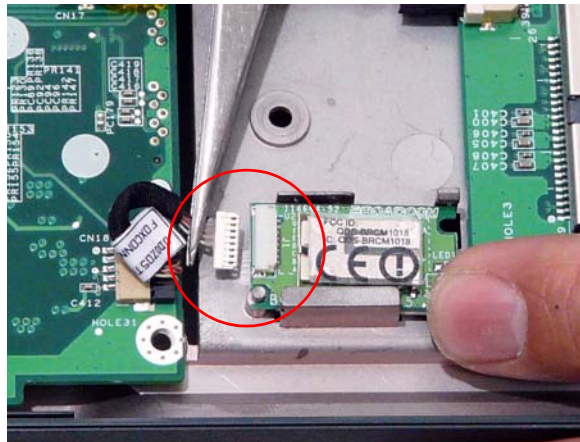

Replacing the Modem Module

1. Replace the Modem Module taking note of the connector location.
2. Replace the securing screw on the modem module.

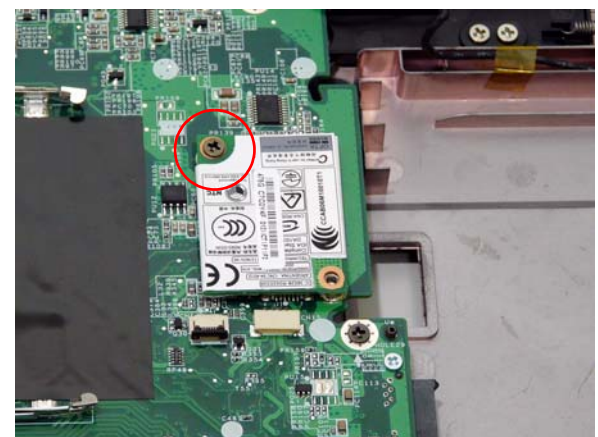
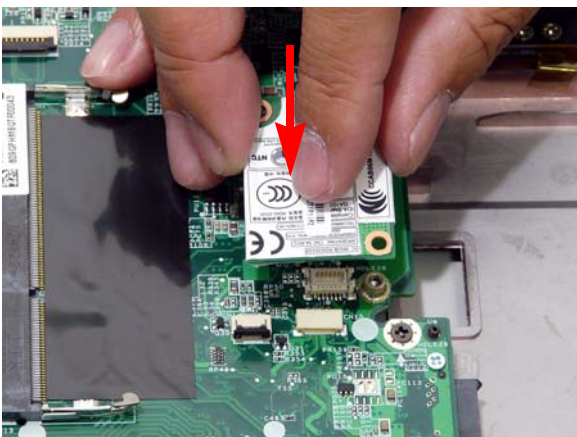

3. Connect the modem cable to the module.

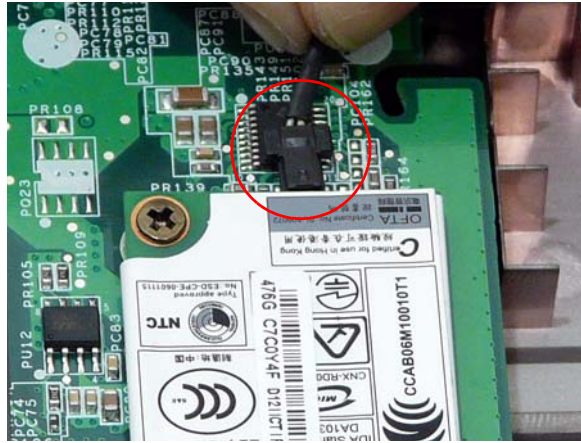

Replacing the Finger Print Reader

1. Replace the Finger Print Reader board in the upper cover.

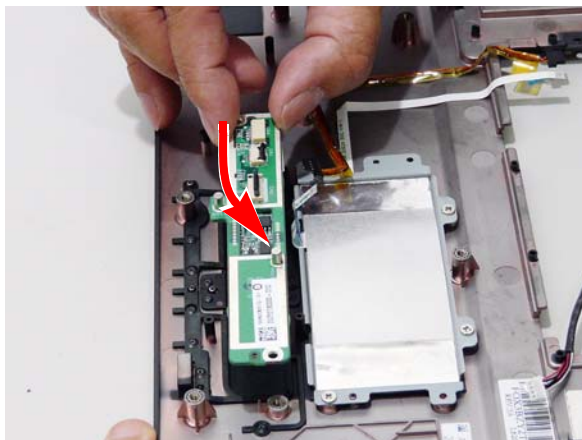

2. Replace the two securing screws.



3. Connect the finger print cable.

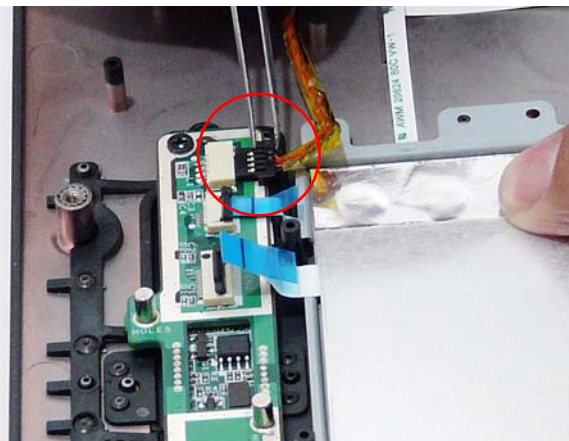

4. Connect the switch to mainboard FFC

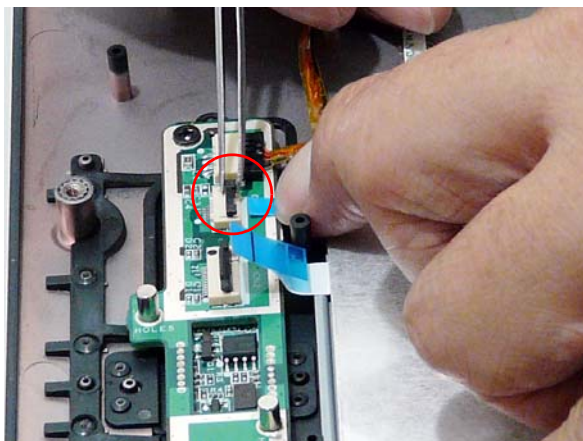

5. Connect the touchpad to switch FFC.

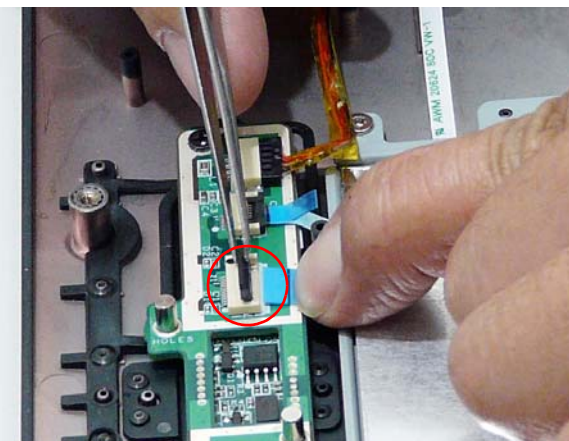

NOTE: Carefully insert the FFC cable ends fully into the connector. Take care to line up the cable square with the connector before securing the FFC connector latch.

Replacing the Launch Board

1. Replace the Launch Board in the bracket.

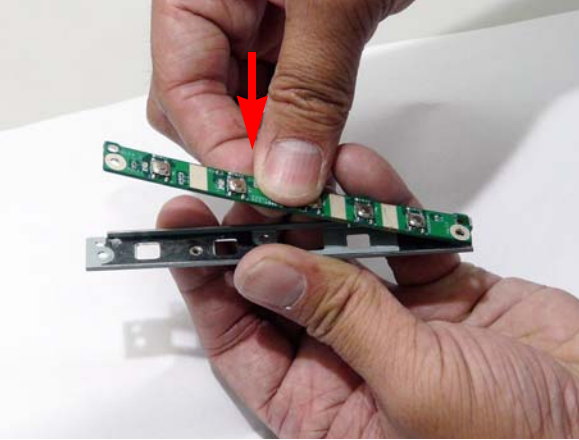

2. Replace the Launch Board on the upper cover.

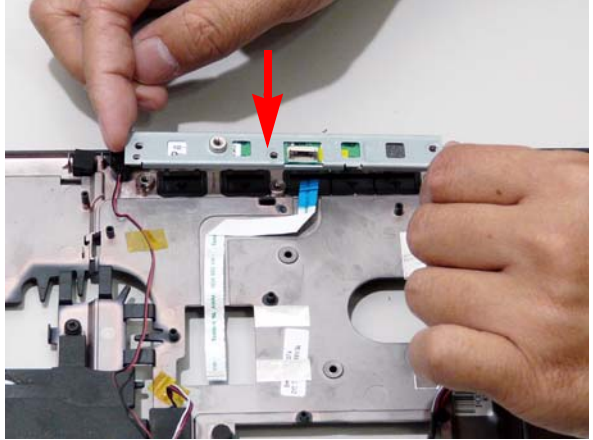

3. Replace the three securing screws.

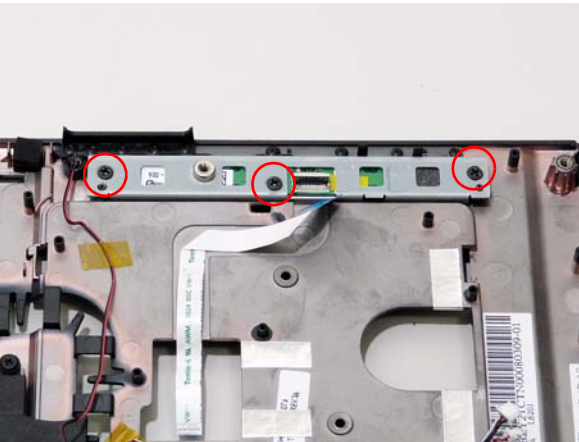

4. Line up the FFC square with the connector. Hold the cable in place and press lever down to secure.

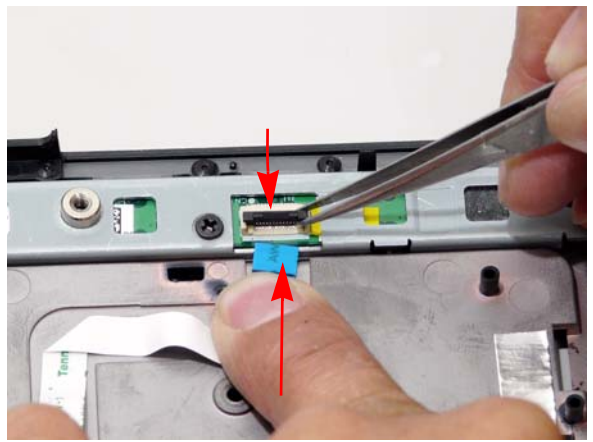

Replacing the Speaker Module

1. Replace the speaker modules as shown.

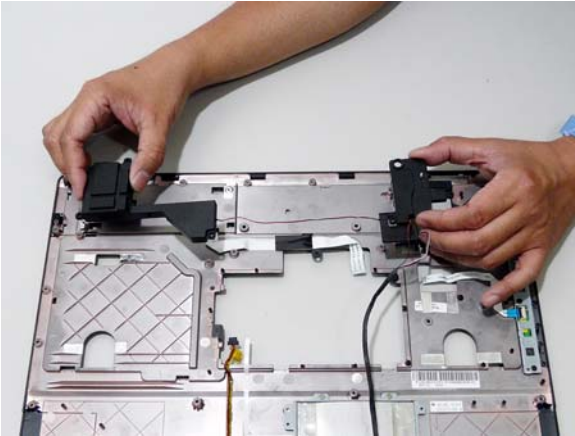

2. Replace the five securing screws, three on the left module and two on the right module.

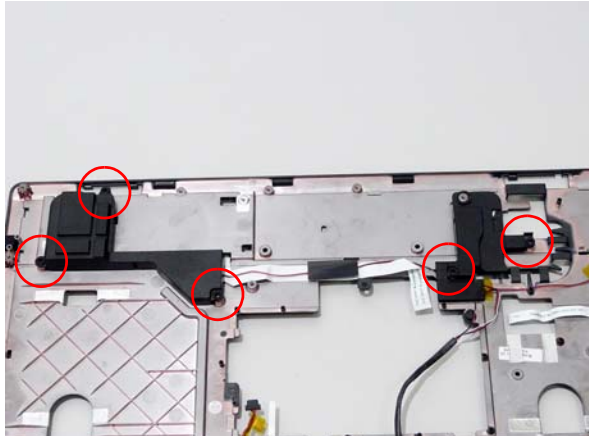

3. Secure the speaker cable as shown with the adhesive tape.

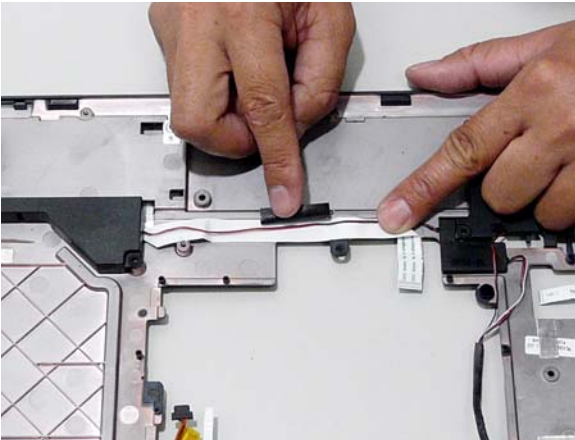

4. Replace the Microphone as shown.

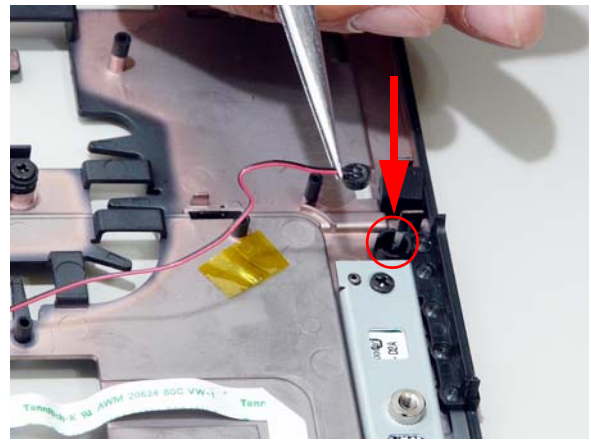

5. Secure the microphone cable as shown with the adhesive tape.

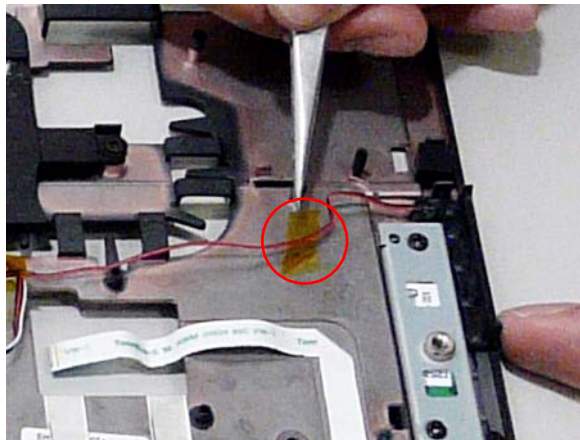

Replacing the TouchPad

1. Connect the TouchPad cable to the TouchPad board.

IMPORTANT:The TouchPad cannot be removed individually. To replace the TouchPad, replace the entire Upper Cover.

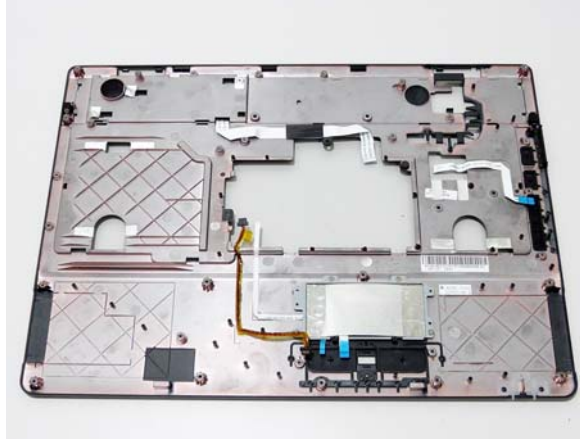

Replacing the Upper Cover

1. Tilt the Upper cover and insert the back of the cover into place.
2. While holding the Upper Cover at an angle, insert the MIC cable through the lower base taking care to ensure that the cable is accessible from the bottom cover.

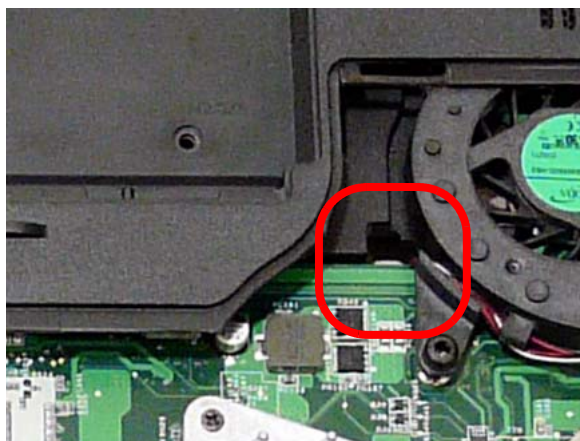
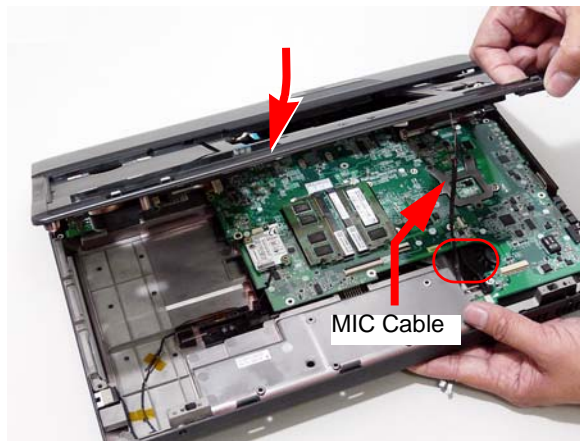

3. Connect the four cables from the mainboard as shown in the following image.

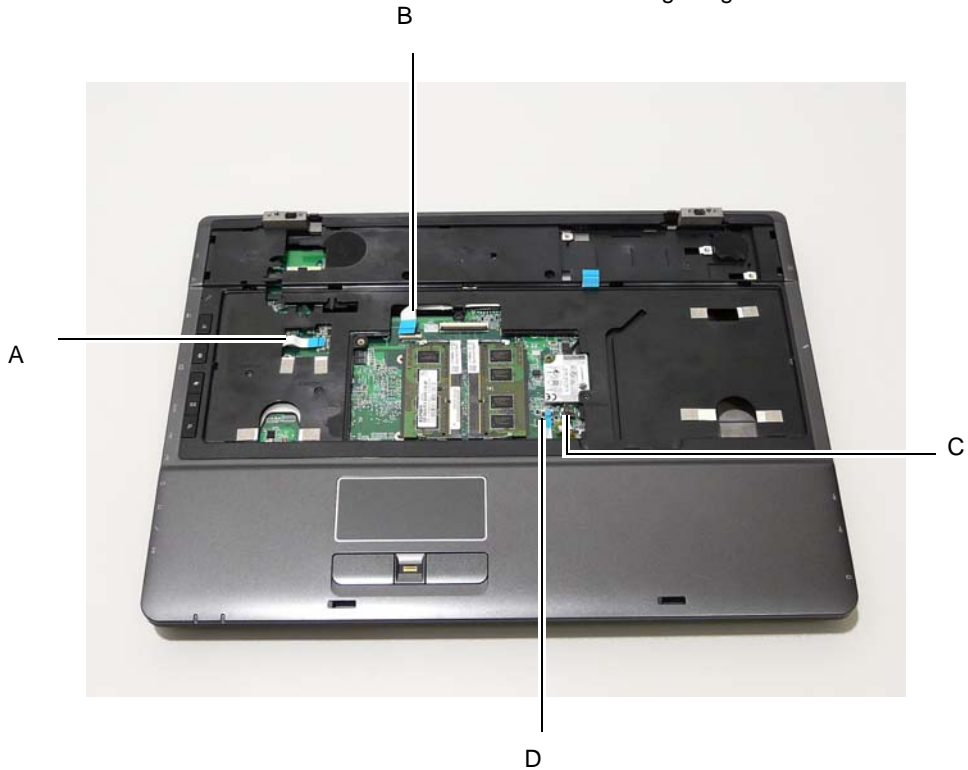

4. Align (A) and secure by securing the FFC connector latch.

5. Align (B) and secure by securing the FFC connector latch.

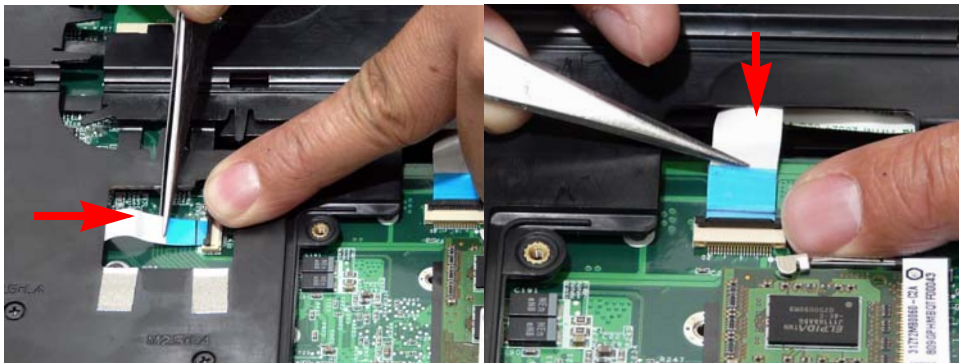

6. Align (D) and secure by securing the FFC connector latch.

7. Connect (C) as shown.



NOTE: Carefully insert the FFC cable ends fully into the connector. Take care to line up the cable square with the connector before securing the FFC connector latch.

8. Insert the Antenna Cables completely through the upper cover.

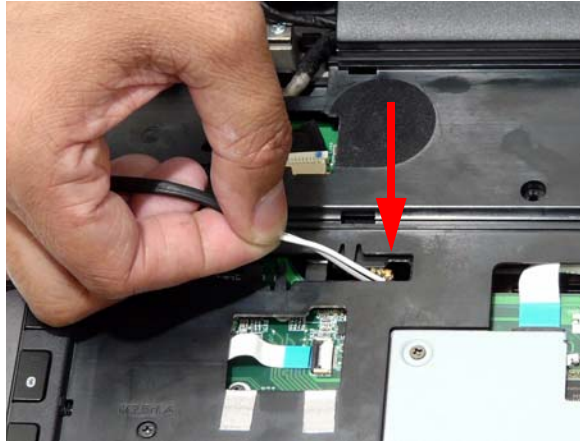

9. Pull the cables through and locate them in the housing guides as shown in the following image.

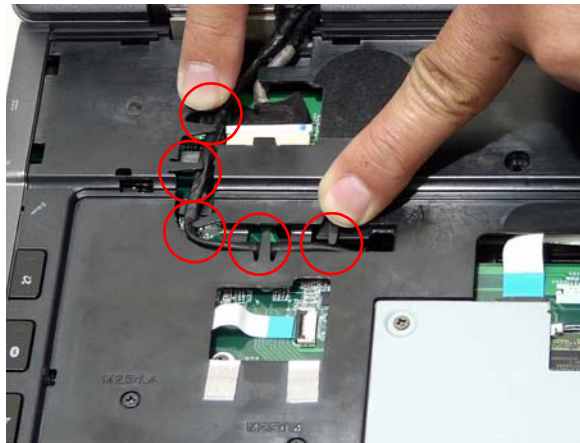

10. Turn the computer over and locate the MIC/Speaker cables.

11. Insert the cables under the thermal module as shown.

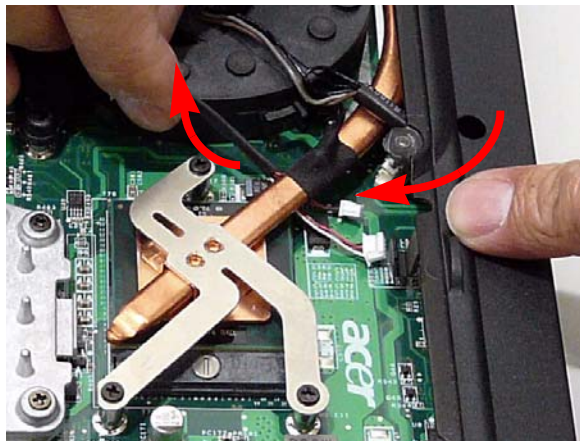

12. Continue to insert the cables through the HDD2 housing and pull the cable taunt.

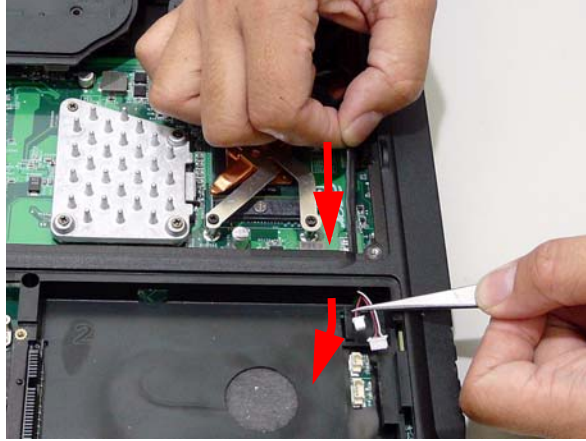

13. Locate the cables in the housing guides located by the CPU Fan module.

14. Connect the cables.

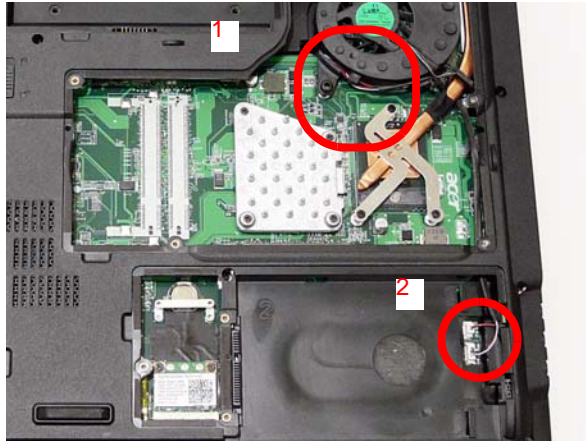

15. Replace the sixteen (16) screws as marked in the following image.

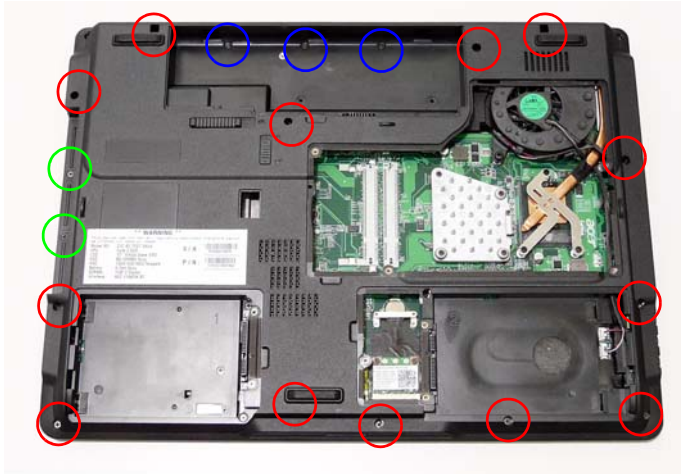

16. Turn the chassis over and replace the four securing screws.

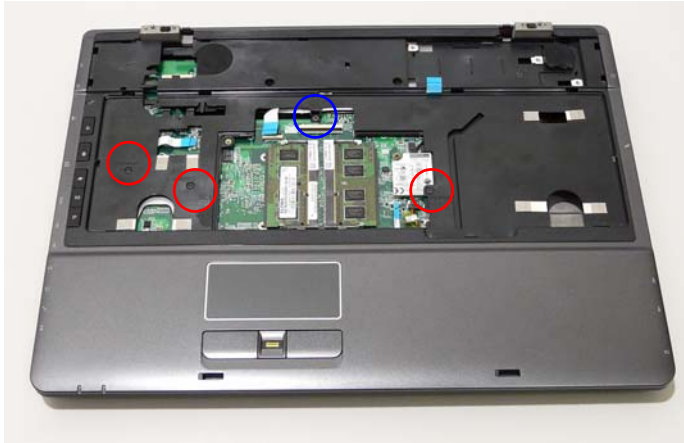

Replacing the LCD Module

1. Align the LCD Module hinges with the alignment pins and gently set down.

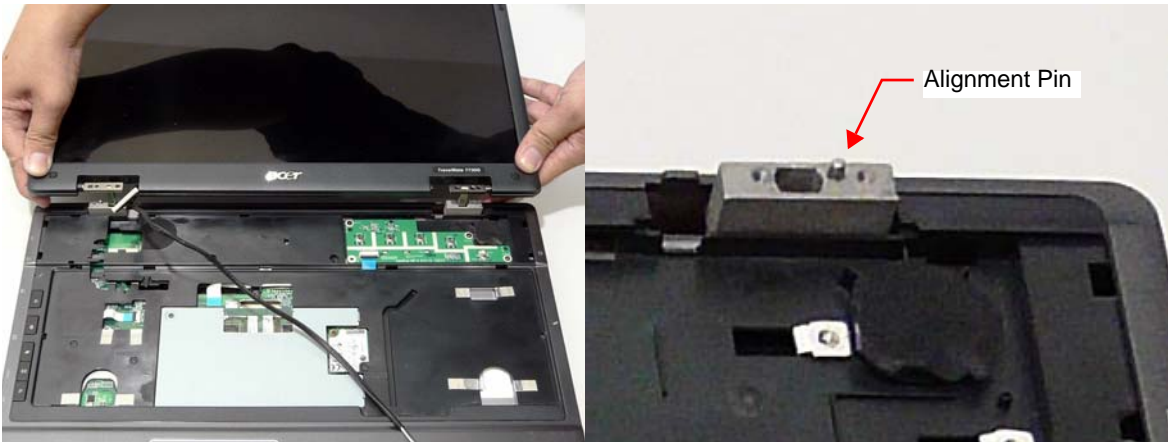

2. Replace the four securing screws (two on each side) on the LCD module.

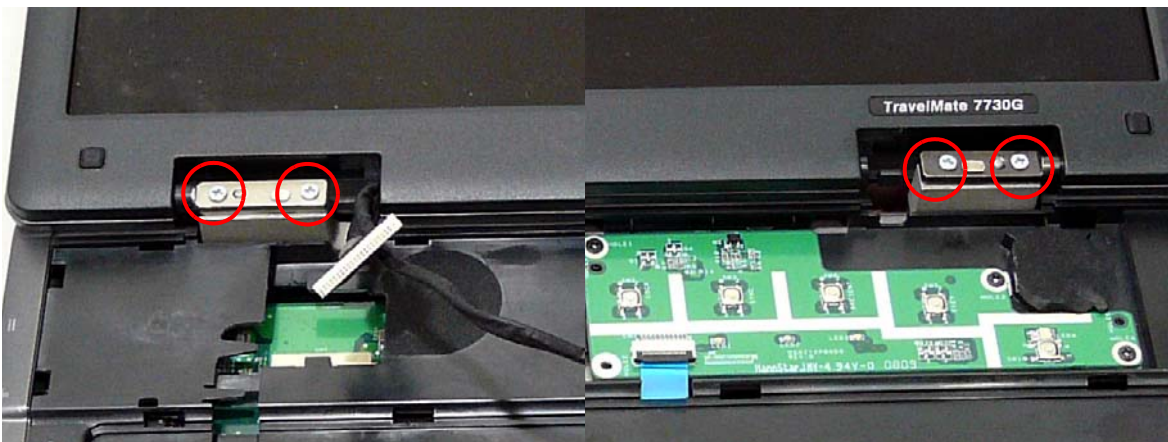

3. Connect the LCD cable on the top panel.

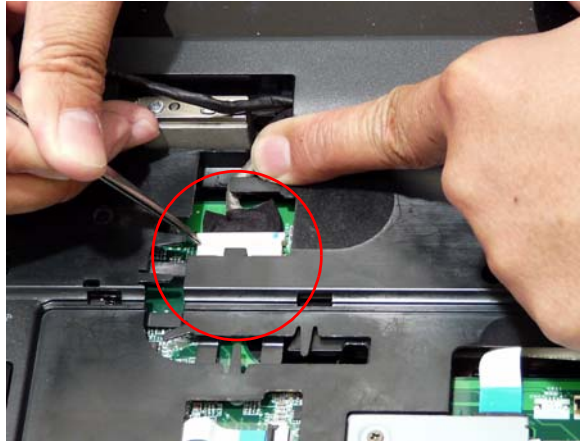

4. Insert the Antenna Cables through the Upper Cover. Make sure they are accessible from the underside.



5. Secure the cables in place as shown.

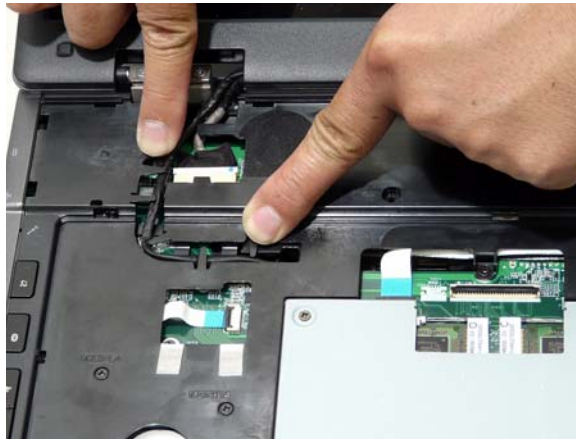

6. Turn the computer over and pull the antenna cables until it is taut.

7. Grasp the cable and insert it through the HDD2 housing.

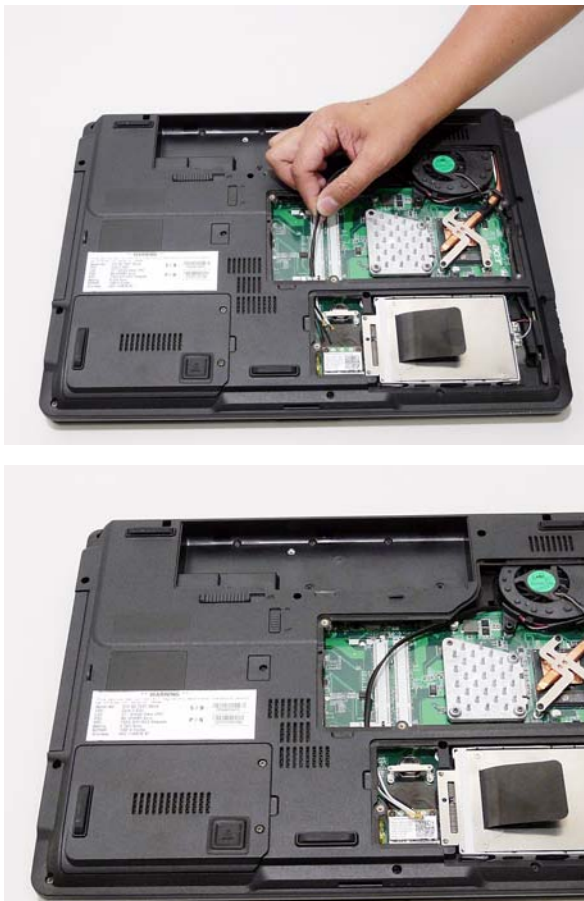

Replacing the Switch Board

1. Replace the three securing screws.
2. Place the Switch Board in its location and replace the three screws.
3. Replace the FFC and ensure the cable is flush with the connector. Secure by locking the latch.

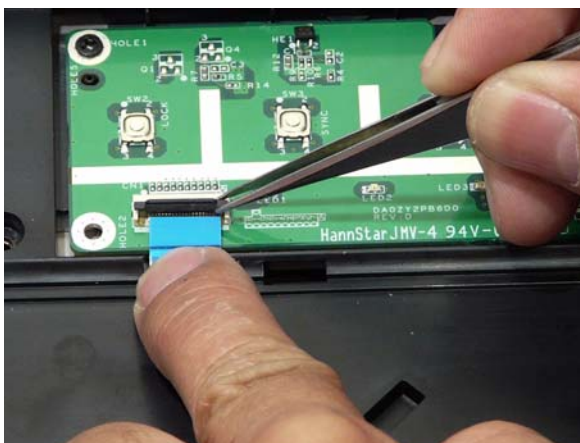
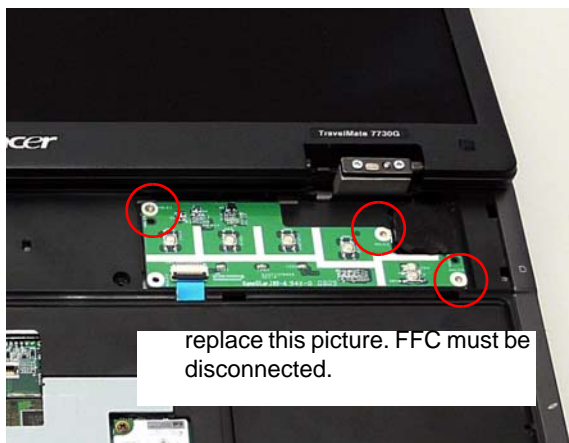

Replacing the DIMM Modules

1. Insert the right-hand DIMM module and press down to lock in place.
The module clicks in place.

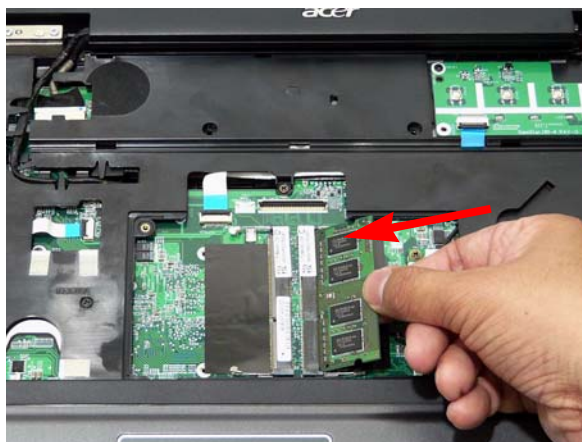

2. Insert the left-hand DIMM module and press down to lock in place.
The module clicks in place.



3. Replace the keyboard plate taking care to pay attention to the installation guides on the left side of the plate.



4. Tighten the captive screw on the keyboard plate.

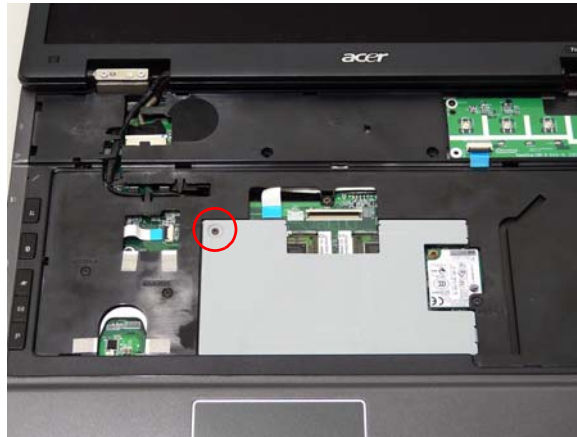

Replacing the Keyboard

1. Replace keyboard cable to the mainboard, and secure the locking latch.
2. Turn the keyboard over and place the front edge first in the mounting.

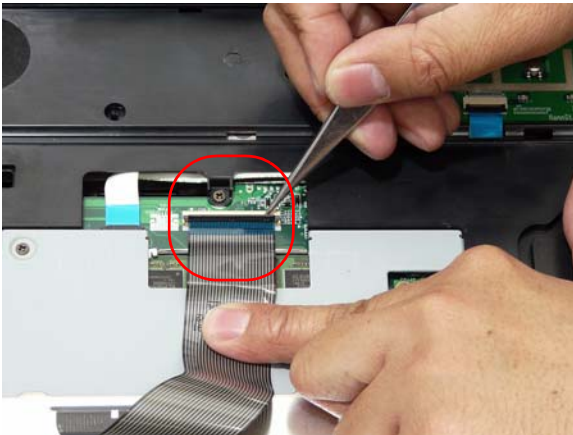

Replacing the Switch Cover

1. Insert one side of the Switch Cover into the chassis.
2. While holding the inserted side in place, grasp the Switch Cover in the middle and bend slightly to allow for the other side to be inserted.



3. Secure the Switch Cover in place by pressing on all sides until the Switch Cover clicks in place.

Replacing the Turbo RAM Module

Insert the Turbo RAM Module and ensure it is flush with the connector.



Replacing the WLAN Module

1. Insert the WLAN board into the WLAN socket.
2. Replace the two screws to secure the module.



3. Connect the three antenna cables to the module.



Replacing the Hard Disk Drive Module

1. Replace the connector on the HDD.
2. Replace the HDD in the carrier.

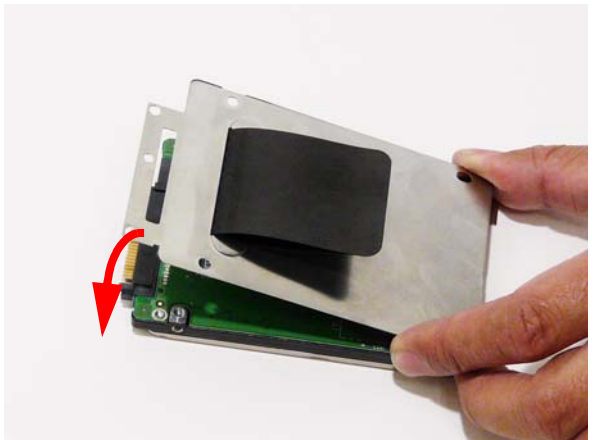
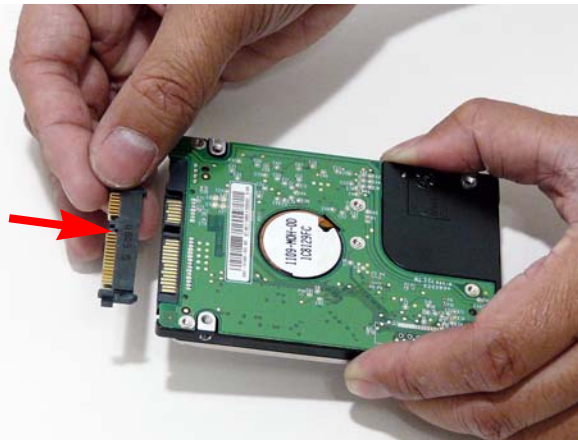

3. Replace the four screws securing the hard disk to the carrier.
4. Replace the HDD holder.

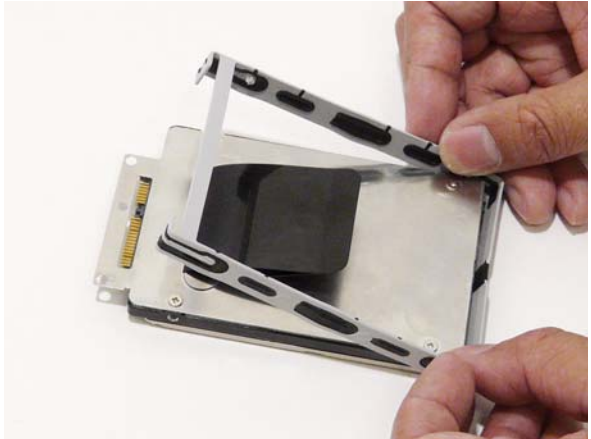
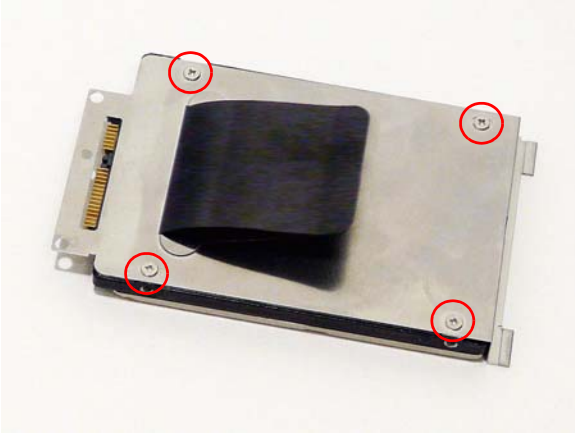

5. Place the HDD in the bay and slide into the connector. Ensure the HDD is secure before replacing the cover.



Replacing the ODD Module

1. With the ODD tray in the eject position, replace the ODD cover on the new ODD Module.
2. Turn the ODD Module around and replace the bracket.



3. Secure the bracket with the two screws.

IMPORTANT: Take note of the arrow on the bracket. The arrow designates the bottom of the ODD.

4. Slide Module in chassis and press until Module is flush with chassis.

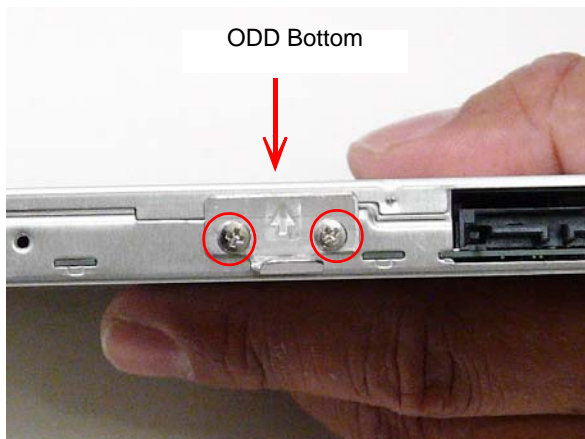

5. Replace the ODD cap and secure with the single screw.



Replacing the Lower Covers

1. Replace the Memory Cover.



2. Replace the four screws to secure in place.

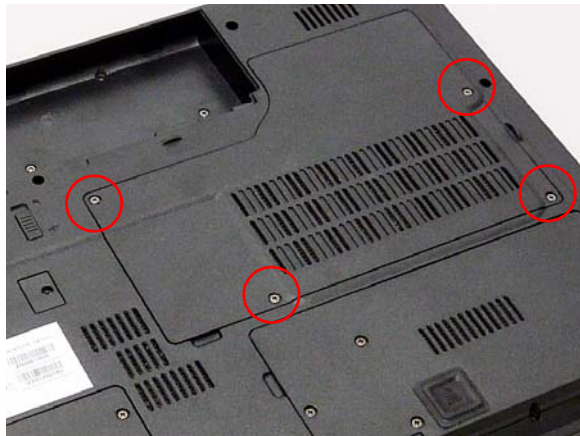

3. Replace the HDD2 Cover.



4. Replace the three securing screws.

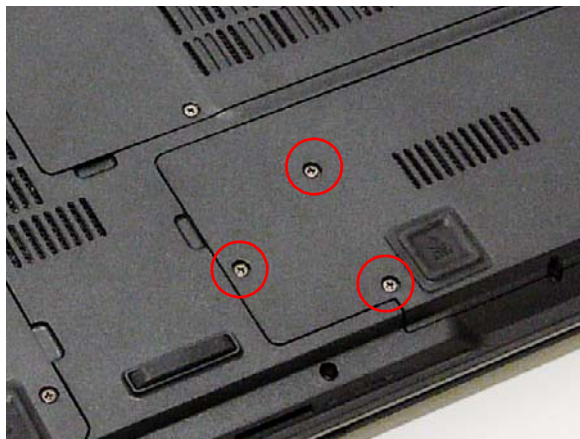

5. Replace HDD Cover.



6. Replace the two screws to secure in place.



Replacing the Express and SD Card Trays

1. Insert the Express Card and push into the slot until flush with the chassis cover.
2. Insert the SD Card and push into the slot until flush with the chassis cover.



Troubleshooting

Common Problems

Use the following procedure as a guide for computer problems.

NOTE: The diagnostic tests are intended to test only Acer products. Non-Acer products, prototype cards, or modified options can give false errors and invalid system responses.

1. Obtain the failing symptoms in as much detail as possible.
2. Verify the symptoms by attempting to re-create the failure by running the diagnostic test or by repeating the same operation.
3. Use the following table with the verified symptom to determine which page to go to.

Symptoms (Verified)	Go To
Power On Issue	Page 124
No Display Issue	Page 125
LCD Failure	Page 127
Internal Keyboard Failure	Page 127
TouchPad Failure	Page 128
Internal Speaker Failure	Page 128
Internal Microphone Failure	Page 130
ODD Failure	Page 132
Rightside USB Failure	Page 135
Modem Failure	Page 135
WLAN Failure	Page 136
Acer EasyLaunch Button Failure	Page 136
Acer MediaTouch Failure	Page 137
Fingerprint Reader Failure	Page 137
Thermal Unit Failure	Page 138
HDTV Switch Failure	Page 138
Other Functions Failure	Page 139
Intermittent Failures	Page 140
Undermined Failures	Page 140

4. If the Issue is still not resolved, see "Online Support Information" on page 173.

Power On Issue

If the system doesn't power on, perform the following actions one at a time to correct the problem. Do not replace a non-defective FRUs:

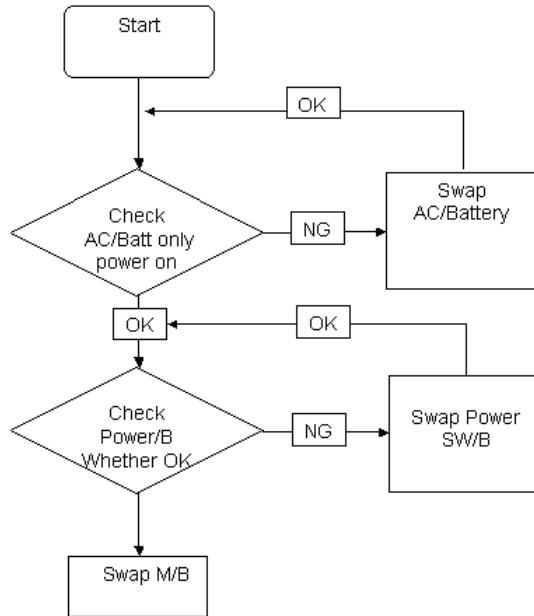

Computer Shutdown Intermittently

If the system powers off at intervals, perform the following actions one at a time to correct the problem.

1. Check the power cable is properly connected to the computer and the electrical outlet.
2. Remove any extension cables between the computer and the outlet.
3. Remove any surge protectors between the computer and the electrical outlet. Plug the computer directly into a known good electrical outlet.
4. Disconnect the power and open the casing to check the Thermal Unit (see "Thermal Unit Failure" on page 138) and fan airways are free of obstructions.
5. Disable the power management settings in the BIOS to ensure they are not the cause of the problem (see "Boot" on page 36).
6. Remove all external and non-essential hardware connected to the computer that are not necessary to boot the computer to the failure point.
7. Remove any recently installed software.
8. If the Issue is still not resolved, see "Online Support Information" on page 173.

No Display Issue

If the **Display** doesn't work, perform the following actions one at a time to correct the problem. Do not replace a non-defective FRUs:

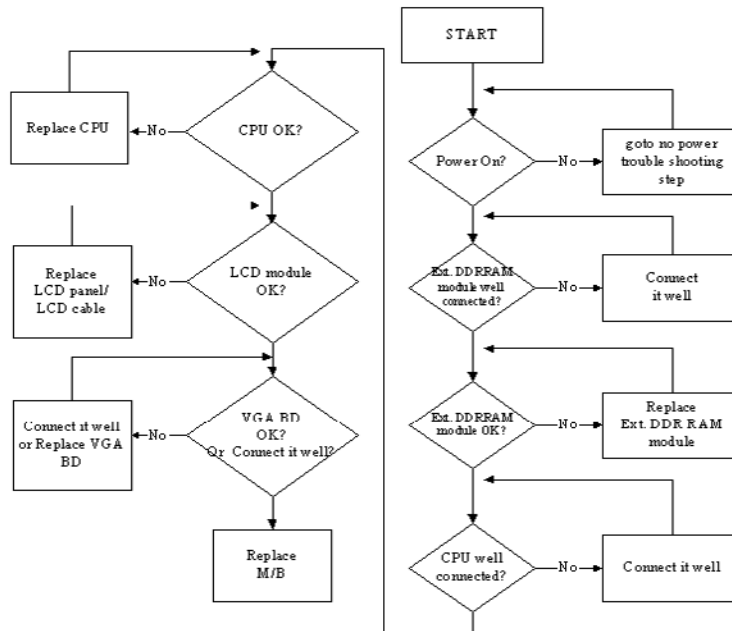

No POST or Video

If the POST or video doesn't display, perform the following actions one at a time to correct the problem.

1. Make sure that the internal display is selected. On this notebook model, switching between the internal display and the external display is done by pressing **Fn+F5**. Reference Product pages for specific model procedures.
2. Make sure the computer has power by checking at least one of the following occurs:
 - Fans start up
 - Status LEDs light up

If there is no power, see "Power On Issue" on page 124.

3. Drain any stored power by removing the power cable and battery and holding down the power button for 10 seconds. Reconnect the power and reboot the computer.
4. Connect an external monitor to the computer and switch between the internal display and the external display is by pressing **Fn+F5** (on this model).

If the POST or video appears on the external display, see "LCD Failure" on page 127.

5. Disconnect power and all external devices including port replicators or docking stations. Remove any memory cards and CD/DVD discs. Restart the computer.

If the computer boots correctly, add the devices one by one until the failure point is discovered.

6. Reseat the memory modules.
7. Remove the drives (see "Disassembly Process" on page 46).
8. If the Issue is still not resolved, see "Online Support Information" on page 173.

Abnormal Video Display

If video displays abnormally, perform the following actions one at a time to correct the problem.

1. Reboot the computer.
2. If permanent vertical/horizontal lines or dark spots display in the same location, the LCD is faulty and should be replaced. See “Disassembly Process” on page 46.
3. If extensive pixel damage is present (different colored spots in the same locations on the screen), the LCD is faulty and should be replaced. See “Disassembly Process” on page 46.
4. Adjust the brightness to its highest level. See the User Manual for instructions on adjusting settings.
NOTE: Ensure that the computer is not running on battery alone as this may reduce display brightness.
If the display is too dim at the highest brightness setting, the LCD is faulty and should be replaced. See “Disassembly Process” on page 46.
5. Check the display resolution is correctly configured:
 - a. Minimize or close all Windows.
 - b. If display size is only abnormal in an application, check the view settings and control/mouse wheel zoom feature in the application.
 - c. If desktop display resolution is not normal, right-click on the desktop and select **Personalize**→ **Display Settings**.
 - d. Click and drag the Resolution slider to the desired resolution.
 - e. Click **Apply** and check the display. Readjust if necessary.
6. Roll back the video driver to the previous version if updated.
7. Remove and reinstall the video driver.
8. Check the Device Manager to determine that:
 - The device is properly installed. There are no red Xs or yellow exclamation marks.
 - There are no device conflicts.
 - No hardware is listed under Other Devices.
9. If the Issue is still not resolved, see “Online Support Information” on page 173.
10. Run the Windows Memory Diagnostic from the operating system DVD and follow the onscreen prompts.
11. If the Issue is still not resolved, see “Online Support Information” on page 173.

Random Loss of BIOS Settings

If the computer is experiencing intermittent loss of BIOS information, perform the following actions one at a time to correct the problem.

1. If the computer is more than one year old, replace the CMOS battery.
2. Run a complete virus scan using up-to-date software to ensure the computer is virus free.
3. If the computer is experiencing HDD or ODD BIOS information loss, disconnect and reconnect the power and data cables between devices.
If the BIOS settings are still lost, replace the cables.
4. If HDD information is missing from the BIOS, the drive may be defective and should be replaced.
5. Replace the Motherboard.
6. If the Issue is still not resolved, see “Online Support Information” on page 173.

LCD Failure

If the **LCD** fails, perform the following actions one at a time to correct the problem. Do not replace a non-defective FRUs:

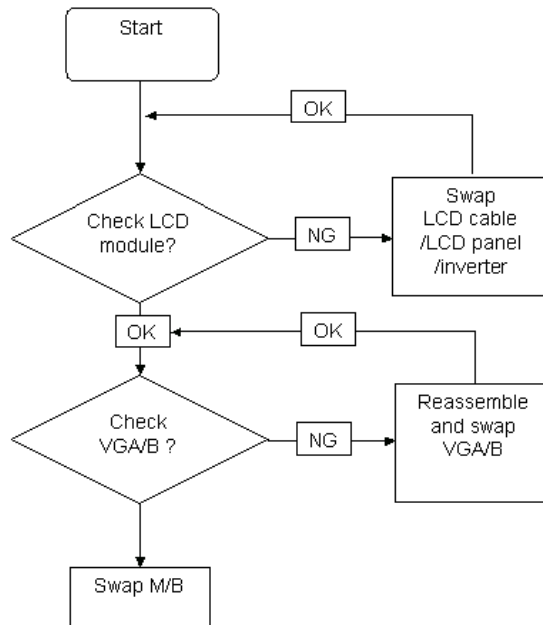

Built-In Keyboard Failure

If the built-in **Keyboard** fails, perform the following actions one at a time to correct the problem. Do not replace a non-defective FRUs:

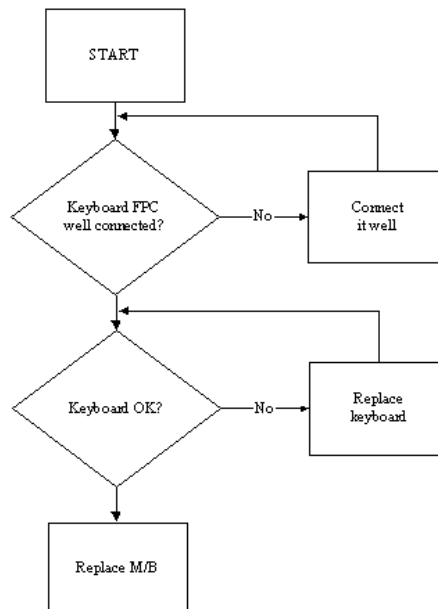

TouchPad Failure

If the **TouchPad** doesn't work, perform the following actions one at a time to correct the problem. Do not replace a non-defective FRUs:

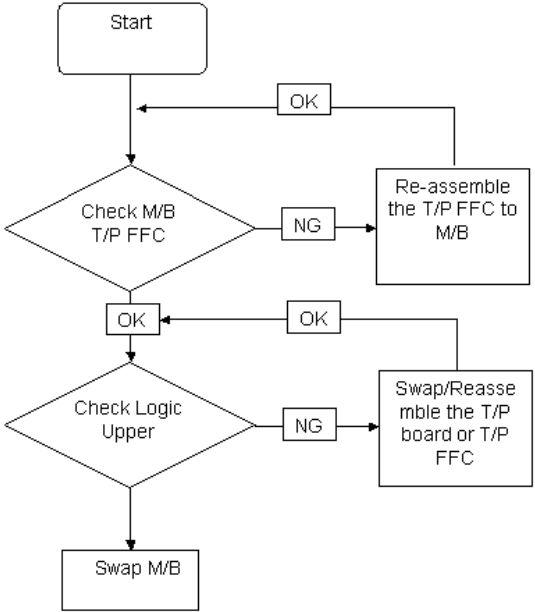

Internal Speaker Failure

If the internal **Speakers** fail, perform the following actions one at a time to correct the problem. Do not replace a non-defective FRUs:

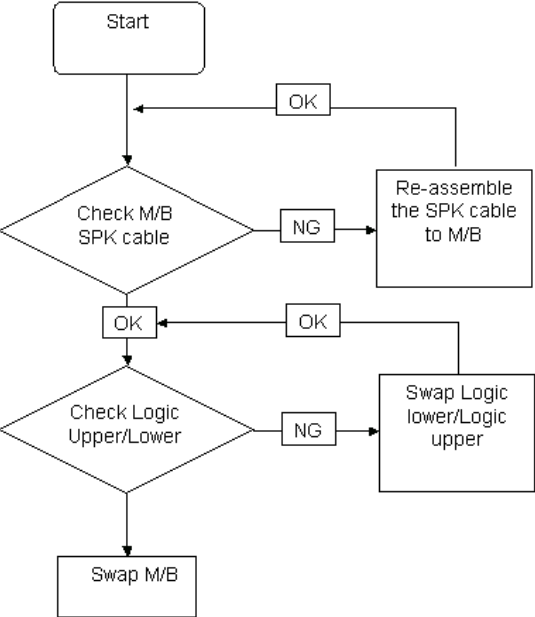

Sound Problems

If sound problems are experienced, perform the following actions one at a time to correct the problem.

1. Reboot the computer.
2. Navigate to **Start** → **Control Panel** → **System and Maintenance** → **System** → **Device Manager**. Check the Device Manager to determine that:
 - The device is properly installed.
 - There are no red Xs or yellow exclamation marks.
 - There are no device conflicts.
 - No hardware is listed under Other Devices.
3. Roll back the audio driver to the previous version, if updated recently.
4. Remove and reinstall the audio driver.
5. Ensure that all volume controls are set mid range:
 - a. Click the volume icon on the taskbar and drag the slider to 50. Ensure that the volume is not muted.
 - b. Click Mixer to verify that other audio applications are set to 50 and not muted.
6. Navigate to **Start** → **Control Panel** → **Hardware and Sound** → **Sound**. Ensure that Speakers are selected as the default audio device (green check mark).

NOTE: If Speakers does not show, right-click on the **Playback** tab and select **Show Disabled Devices** (clear by default).
7. Select Speakers and click **Configure** to start **Speaker Setup**. Follow the onscreen prompts to configure the speakers.
8. Remove and recently installed hardware or software.
9. Restore system and file settings from a known good date using **System Restore**.

If the issue is not fixed, repeat the preceding steps and select an earlier time and date.
10. Reinstall the Operating System.
11. If the Issue is still not resolved, see “Online Support Information” on page 173.

Internal Microphone Failure

If the internal **Microphone** fails, perform the following actions one at a time to correct the problem. Do not replace a non-defective FRUs:

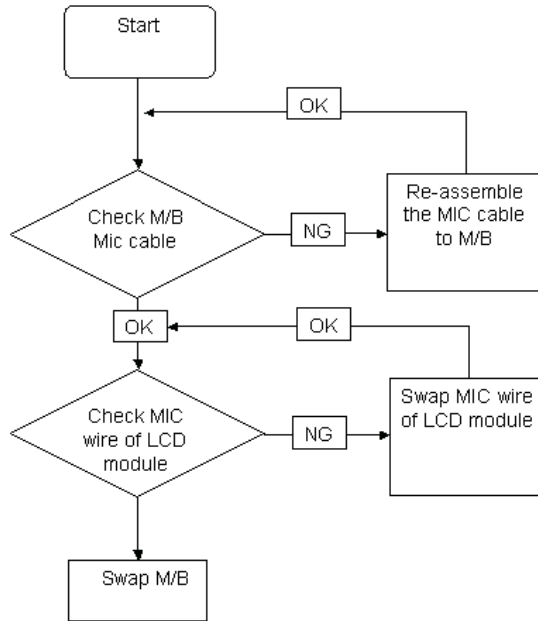

Microphone Problems

If internal or external **Microphones** do not operate correctly, perform the following actions one at a time to correct the problem.

1. Check that the microphone is enabled. Navigate to **Start** → **Control Panel** → **Hardware and Sound** → **Sound** and select the **Recording** tab.
2. Right-click on the **Recording** tab and select **Show Disabled Devices** (clear by default).
3. The microphone appears on the **Recording** tab.
4. Right-click on the microphone and select **Enable**.
5. Select the microphone then click **Properties**. Select the **Levels** tab.
6. Increase the volume to the maximum setting and click **OK**.
7. Test the microphone hardware:
 - a. Select the microphone and click **Configure**.
 - b. Select **Set up microphone**.
 - c. Select the microphone type from the list and click **Next**.
 - d. Follow the onscreen prompts to complete the test.
8. If the Issue is still not resolved, see "Online Support Information" on page 173.

HDD Not Operating Correctly

If the **HDD** does not operate correctly, perform the following actions one at a time to correct the problem.

1. Disconnect all external devices.
2. Run a complete virus scan using up-to-date software to ensure the computer is virus free.
3. Run the Windows Vista Startup Repair Utility:
 - a. insert the Windows Vista Operating System DVD in the ODD and restart the computer.
 - b. When prompted, press any key to start to the operating system DVD.
 - c. The **Install Windows** screen displays. Click **Next**.
 - d. Select **Repair your computer**.
 - e. The **System Recovery Options** screen displays. Click **Next**.
 - f. Select the appropriate operating system, and click **Next**.

NOTE: Click **Load Drivers** if controller drives are required.

- g. Select **Startup Repair**.
- h. Startup Repair attempts to locate and resolve issues with the computer.
- i. When complete, click **Finish**.

If an issue is discovered, follow the onscreen information to resolve the problem.

4. Run the Windows Memory Diagnostic Tool. For more information see Windows Help and Support.
5. Restart the computer and press F2 to enter the BIOS Utility. Check the BIOS settings are correct and that CD/DVD drive is set as the first boot device on the Boot menu.
6. Ensure all cables and jumpers on the HDD and ODD are set correctly.
7. Remove any recently added hardware and associated software.
8. Run the Windows Disk Defragmenter. For more information see Windows Help and Support.
9. Run Windows Check Disk by entering **chkdsk /r** from a command prompt. For more information see Windows Help and Support.
10. Restore system and file settings from a known good date using **System Restore**.

If the issue is not fixed, repeat the preceding steps and select an earlier time and date.
11. Replace the HDD. See "Disassembly Process" on page 46.

ODD Failure

If the **ODD** fails, perform the following actions one at a time to correct the problem. Do not replace a non-defective FRUs:

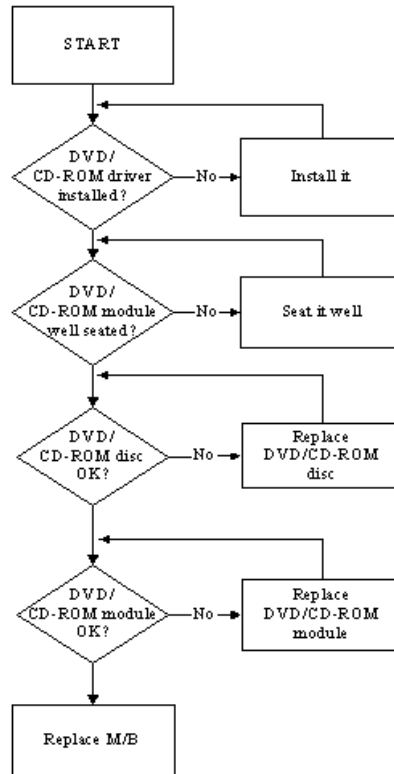

ODD Not Operating Correctly

If the **ODD** exhibits any of the following symptoms it may be faulty:

- Audio CDs do not play when loaded
- DVDs do not play when loaded
- Blank discs do not burn correctly
- DVD or CD play breaks up or jumps
- Optical drive not found or not active:
 - Not shown in My Computer or the BIOS setup
 - LED does not flash when the computer starts up
 - The tray does not eject
- Access failure screen displays
- The ODD is noisy

Perform the following general solutions one at a time to correct the problem.

1. Reboot the computer and retry the operation.
2. Try an alternate disc.
3. Navigate to **Start** → **Computer**. Check that the ODD device is displayed in the **Devices with Removable Storage** panel.
4. Navigate to **Start** → **Control Panel** → **System and Maintenance** → **System** → **Device Manager**.

-
- a. Double-click **IDE ATA/ATAPI controllers**. If a device displays a down arrow, right-click on the device and click **Enable**.
 - b. Double-click **DVD/CD-ROM drives**. If the device displays a down arrow, right-click on the device and click **Enable**.
 - c. Check that there are no yellow exclamation marks against the items in **IDE ATA/ATAPI controllers**. If a device has an exclamation mark, right-click on the device and uninstall and reinstall the driver.
 - d. Check that there are no yellow exclamation marks against the items in **DVD/CD-ROM drives**. If a device has an exclamation mark, right-click on the device and uninstall and reinstall the driver.
 - e. If the exclamation marker is not removed from the item in the lists, try removing any recently installed software and retrying the operation.

Discs Do Not Play

If discs do not play when inserted in the drive, perform the following actions one at a time to correct the problem.

1. Check that the disc is correctly seated in the drive tray and that the label on the disc is visible.
2. Check that the media is clean and scratch free.
3. Try an alternate disc in the drive.
4. Ensure that **AutoPlay** is enabled:
 - a. Navigate to **Start** → **Control Panel** → **Hardware and Sound** → **AutoPlay**.
 - b. Select **Use AutoPlay for all media and devices**.
 - c. In the Audio CD and DVD Movie fields, select the desired player from the drop down menu.
5. Check that the Regional Code is correct for the selected media:

IMPORTANT:Region can only be changed a limited number of times. After Changes remaining reaches zero, the region cannot be changed even Windows is reinstalled or the drive is moved to another computer.

- a. Navigate to **Start** → **Control Panel** → **System and Maintenance** → **System** → **Device Manager**.
- b. Double-click **DVD/CD-ROM drives**.
- c. Right-click **DVD drive** and click **Properties**, then click the **DVD Region** tab.
- d. Select the region suitable for the media inserted in the drive.

Discs Do Not Burn Properly

If discs can not be burned, perform the following actions one at a time to correct the problem.

1. Ensure that the default drive is record enabled:
 - a. Navigate to **Start** → **Computer** and right-click the writable ODD icon. Click **Properties**.
 - b. Select the **Recording** tab. In the **Desktop disc recording** panel, select the writable ODD from the drop down list.
 - c. Click **OK**.
2. Ensure that the software used for burning discs is the factory default. If using different software, refer to the software's user manual.

Playback is Choppy

If playback is choppy or jumps, perform the following actions one at a time to correct the problem.

1. Check that system resources are not running low:
 - a. Try closing some applications.
 - b. Reboot and try the operation again.
2. Check that the ODD controller transfer mode is set to DMA:
 - a. Navigate to **Start** → **Control Panel** → **System and Maintenance** → **System** → **Device Manager**.

-
- b. Double-click **IDE ATA/ATAPI controllers**, then right-click ATA Device 0.
 - c. Click **Properties** and select the **Advanced Settings** tab. Ensure that the **Enable DMA** box is checked and click **OK**.
 - d. Repeat for the other ATA Devices shown if applicable.

Drive Not Detected

If Windows cannot detect the drive, perform the following actions one at a time to correct the problem.

1. Restart the computer and press F2 to enter the BIOS Utility.
2. Check that the drive is detected in the **ATAPI Model Name** field on the Information page.
NOTE: Check that the entry is identical to one of the ODDs specified in “Hardware Specifications and Configurations” on page 18.
3. Turn off the power and remove the cover to inspect the connections to the ODD. See “Disassembly Process” on page 46.
 - a. Check for broken connectors on the drive, motherboard, and cables.
 - b. Check for bent or broken pins on the drive, motherboard, and cable connections.
 - c. Try an alternate cable, if available. If the drive works with the new cable, the original cable should be replaced.
4. Reseat the drive ensuring and all cables are connected correctly.
5. Replace the ODD. See “Disassembly Process” on page 46.

Drive Read Failure

If discs cannot be read when inserted in the drive, perform the following actions one at a time to correct the problem.

1. Remove and clean the failed disc.
2. Retry reading the CD or DVD.
 - d. Test the drive using other discs.
 - e. Play a DVD movie
 - f. Listen to a music CD

If the ODD works properly with alternate discs, the original disc is probably defective and should be replaced.

3. Turn off the power and remove the cover to inspect the connections to the ODD. See “Disassembly Process” on page 46.
 - a. Check for broken connectors on the drive, motherboard, and cables.
 - b. Check for bent or broken pins on the drive, motherboard, and cable connections.
 - c. Try an alternate cable, if available. If the drive works with the new cable, the original cable should be replaced.
4. Replace the ODD. See “Disassembly Process” on page 46.

USB Failure (Rightside)

If the rightside **USB** port fails, perform the following actions one at a time to correct the problem. Do not replace a non-defective FRUs:

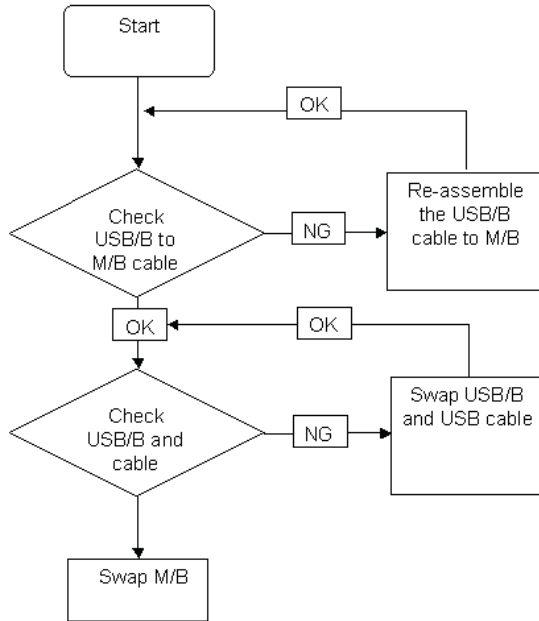

Modem Function Failure

If the internal **Modem** fails, perform the following actions one at a time to correct the problem. Do not replace a non-defective FRUs:

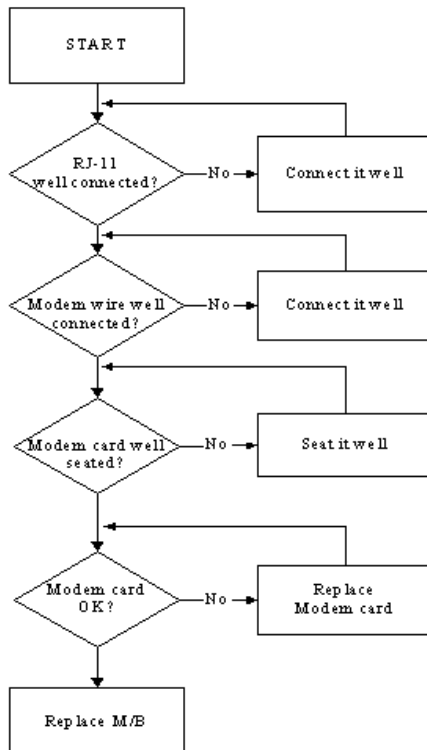

Wireless Function Failure

If the **WLAN** fails, perform the following actions one at a time to correct the problem. Do not replace a non-defective FRUs:

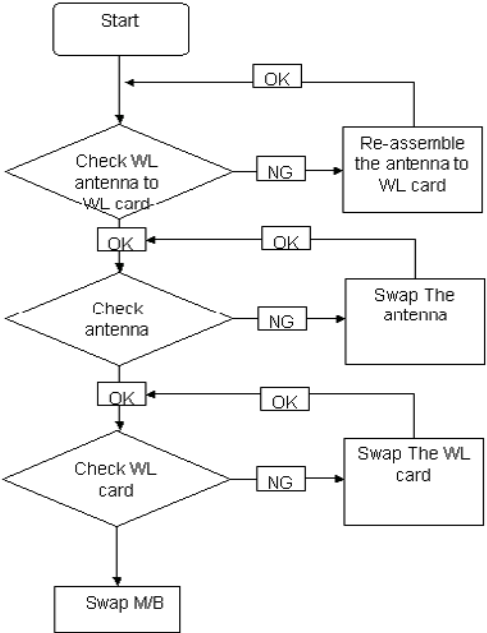

EasyTouch Button Failure

If the **Acer EasyTouch** buttons fail, perform the following actions one at a time to correct the problem. Do not replace a non-defective FRUs:

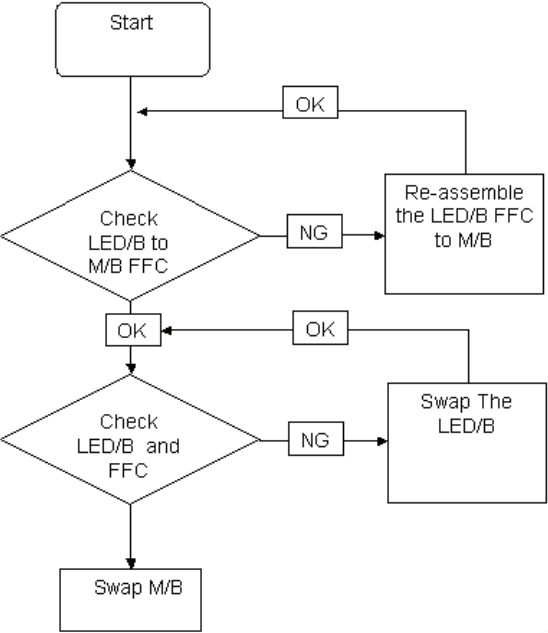

MediaTouch Button Failure

If the **Acer MediaTouch** buttons fail, perform the following actions one at a time to correct the problem. Do not replace a non-defective FRUs:

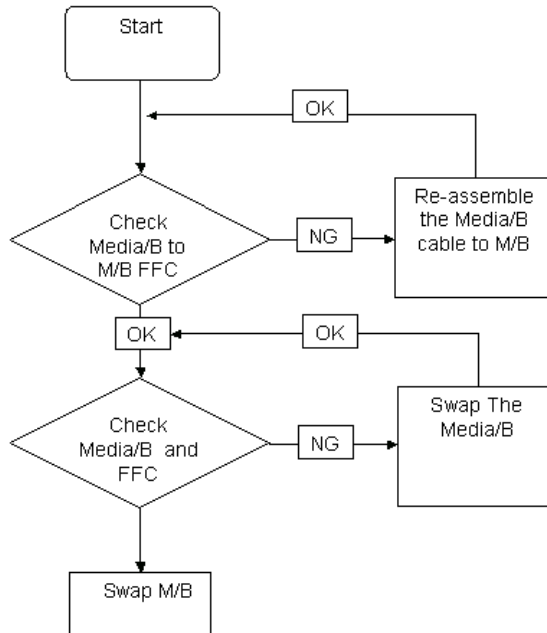

Fingerprint Reader Failure

If the **Fingerprint Reader** fails, perform the following actions one at a time to correct the problem. Do not replace a non-defective FRUs:

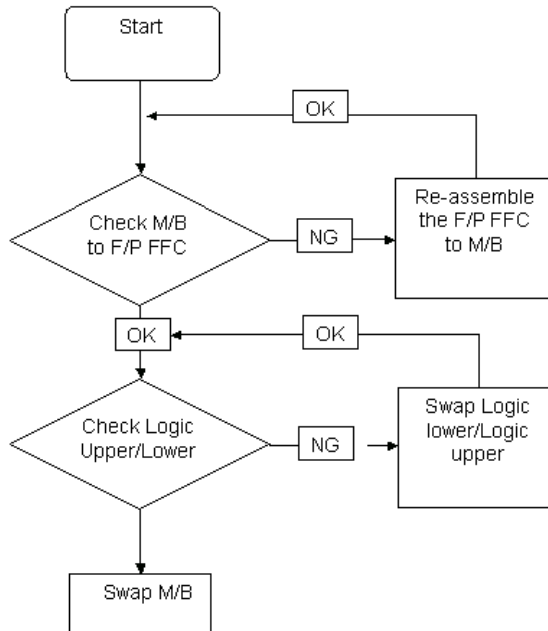

Thermal Unit Failure

If the **Thermal Unit** fails, perform the following actions one at a time to correct the problem. Do not replace a non-defective FRUs:

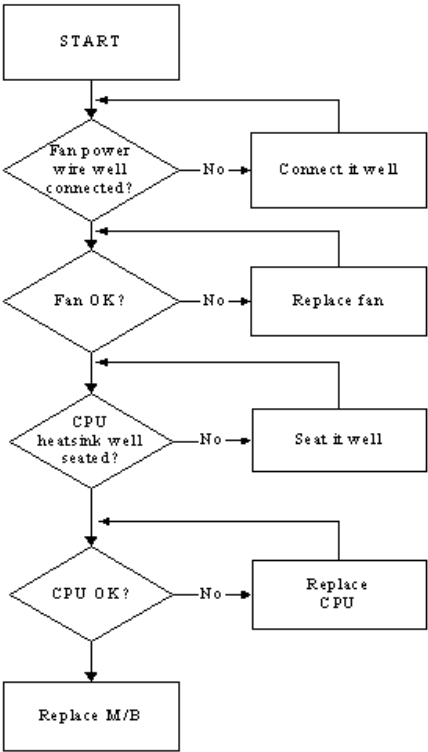

HDTV Switch Failure

If the **HDTV Switch** fails, perform the following actions one at a time to correct the problem. Do not replace a non-defective FRUs:

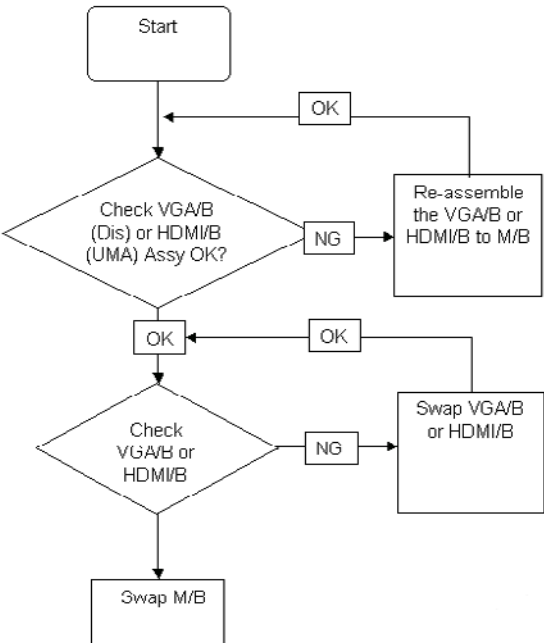

External Mouse Failure

If an external **Mouse** fails, perform the following actions one at a time to correct the problem.

1. Try an alternative mouse.
2. If the mouse uses a wireless connection, insert new batteries and confirm there is a good connection. See the mouse user manual.
3. If the mouse uses a USB connection, try an alternate USB port.
4. Try an alternative program to verify mouse operation. Reinstall the program experiencing mouse failure.
5. Restart the computer.
6. Remove any recently added hardware and associated software.
7. Remove any recently added software and reboot.
8. Restore system and file settings from a known good date using **System Restore**.

If the issue is not fixed, repeat the preceding steps and select an earlier time and date.

9. Run the Event Viewer to check the events log for errors. For more information see Windows Help and Support.
10. Roll back the mouse driver to the previous version if updated recently.
11. Remove and reinstall the mouse driver.
12. Check the Device Manager to determine that:
 - The device is properly installed. There are no red Xs or yellow exclamation marks.
 - There are no device conflicts.
 - No hardware is listed under Other Devices.
13. If the Issue is still not resolved, see "Online Support Information" on page 173.

Other Failures

If the CRT Switch, Dock, LAN Port, external MIC or Speakers, PCI Express Card, 5-in-1 Card Reader or Volume Wheel fail, perform the following general steps to correct the problem. Do not replace a non-defective FRUs:

1. Check Drive whether is OK.
2. Check Test Fixture is ok.
3. Swap M/B to Try.

Intermittent Problems

Intermittent system hang problems can be caused by a variety of reasons that have nothing to do with a hardware defect, such as: cosmic radiation, electrostatic discharge, or software errors. FRU replacement should be considered only when a recurring problem exists.

When analyzing an intermittent problem, do the following:

1. Run the advanced diagnostic test for the system board in loop mode at least 10 times.
2. If no error is detected, do not replace any FRU.
3. If any error is detected, replace the FRU. Rerun the test to verify that there are no more errors.

Undetermined Problems

The diagnostic problems does not identify which adapter or device failed, which installed devices are incorrect, whether a short circuit is suspected, or whether the system is inoperative.

Follow these procedures to isolate the failing FRU (do not isolate non-defective FRU).

NOTE: Verify that all attached devices are supported by the computer.

NOTE: Verify that the power supply being used at the time of the failure is operating correctly. (See “Power On Issue” on page 124.):

1. Power-off the computer.
2. Visually check them for damage. If any problems are found, replace the FRU.
3. Remove or disconnect all of the following devices:
 - Non-Acer devices
 - Printer, mouse, and other external devices
 - Battery pack
 - Hard disk drive
 - DIMM
 - CD-ROM/Diskette drive Module
 - PC Cards
4. Power-on the computer.
5. Determine if the problem has changed.
6. If the problem does not recur, reconnect the removed devices one at a time until you find the failing FRU.
7. If the problem remains, replace the following FRU one at a time. Do not replace a non-defective FRU:
 - System board
 - LCD assembly

POST Codes Tables

These tables describe the chipset and core POST codes, functions, phases, and components for the POST.

Chipset POST Codes

The following table details the chipset POST codes and functions used in the POST.

Code	Beeps	POST Routine Description
02h		Verify Real Mode
03h		Disable Non-Maskable Interrupt (NMI)
04h		Get CPU type
06h		Initialize system hardware
08h		Initialize chipset with initial POST values
09h		Set IN POST flag
0Ah		Initialize CPU registers
0Bh		Enable CPU cache
0Ch		Initialize caches to initial POST values
0Eh		Initialize I/O component
0Fh		Initialize the local bus IDE
10h		Initialize Power Management
11h		Load alternate registers with initial POST values
12h		Restore CPU control word during warm boot
13h		Initialize PCI Bus Mastering devices
14h		Initialize keyboard controller
16h	1-2-2-3	BIOS ROM checksum
17h		Initialize cache before memory autosize
18h	8254	timer initialization
1Ah	8237	DMA controller initialization
1Ch		Reset Programmable Interrupt Controller
20h	1-3-1-1	Test DRAM refresh
22h	1-3-1-3	Test 8742 Keyboard Controller
24h		Set ES segment register to 4 GB
26h		Enable A20 line
28h		Autosize DRAM
29h		Initialize POST Memory Manager
2Ah		Clear 512 KB base RAM
2Ch	1-3-4-1	RAM failure on address line xxxx*
2Eh	1-3-4-3	RAM failure on data bits xxxx* of low byte of memory bus
2Fh		Enable cache before system BIOS shadow
30h	1-4-1-1	RAM failure on data bits xxxx* of high byte of memory bus
32h		Test CPU bus-clock frequency
33h		Initialize Phoenix Dispatch Manager
36h		Warm start shut down
38h		Shadow system BIOS ROM
3Ah		Autosize cache

Code	Beeps	POST Routine Description
3Ch		Advanced configuration of chipset registers
3Dh		Load alternate registers with CMOS values
42h		Initialize interrupt vectors
45h		POST device initialization
46h	2-1-2-3	Check ROM copyright notice
48h		Check video configuration against CMOS
49h		Initialize PCI bus and devices
4Ah		Initialize all video adapters in system
4Bh		QuietBoot start (optional)
4Ch		Shadow video BIOS ROM
4Eh		Display BIOS copyright notice
50h		Display CPU type and speed
51h		Initialize EISA board
52h		Test keyboard
54h		Set key click if enabled
58h	2-2-3-1	Test for unexpected interrupts
59h		Initialize POST display service
5Ah		Display prompt Press F2 to enter SETUP
5Bh		Disable CPU cache
5Ch		Test RAM between 512 and 640 KB
60h		Test extended memory
62h		Test extended memory address lines
64h		Jump to UserPatch1
66h		Configure advanced cache registers
67h		Initialize Multi Processor APIC
68h		Enable external and CPU caches
69h		Setup System Management Mode (SMM) area
6Ah		Display external L2 cache size
6Bh		Load custom defaults (optional)
6Ch		Display shadow-area message
6Eh		Display possible high address for UMB recovery
70h		Display error messages
72h		Check for configuration errors
76h		Check for keyboard errors
7Ch		Set up hardware interrupt vectors
7Eh		Initialize coprocessor if present
80h		Disable onboard Super I/O ports and IRQs
81h		Late POST device initialization
82h		Detect and install external RS232 ports
83h		Configure non-MCD IDE controllers
84h		Detect and install external parallel ports
85h		Initialize PC-compatible PnP ISA devices
86h		Re-initialize onboard I/O ports.

Code	Beeps	POST Routine Description
87h		Configure Motherboard Configurable Devices (optional)
88h		Initialize BIOS Data Area
89h		Enable Non-Maskable Interrupts (NMIs)
8Ah		Initialize Extended BIOS Data Area
8Bh		Test and initialize PS/2 mouse
8Ch		Initialize floppy controller
8Fh		Determine number of ATA drives (optional)
90h		Initialize hard-disk controllers
91h		Initialize local-bus hard-disk controllers
92h		Jump to UserPatch2
93h		Build MPTABLE for multi-processor boards
95h		Install CD ROM for boot
96h		Clear huge ES segment register
97h		Fixup Multi Processor table
98h	1-2	Search for option ROMs. One long, two short beeps on checksum failure
99h		Check for SMART Drive (optional)
9Ah		Shadow option ROMs
9Ch		Set up Power Management
9Dh		Initialize security engine (optional)
9Eh		Enable hardware interrupts
9Fh		Determine number of ATA and SCSI drives
A0h		Set time of day
A2h		Check key lock
A4h		Initialize Typematic rate
A8h		Erase F2 prompt
AAh		Scan for F2 key stroke
ACh		Enter SETUP
A Eh		Clear Boot flag
B0h		Check for errors
B2h		POST done - prepare to boot operating system
B4h	1	One short beep before boot
B5h		Terminate QuietBoot (optional)
B6h		Check password (optional)
B9h		Prepare Boot
BAh		Initialize DMI parameters
BBh		Initialize PnP Option ROMs
BCh		Clear parity checkers
BDh		Display MultiBoot menu
BEh		Clear screen (optional)
BFh		Check virus and backup reminders
C0h		Try to boot with INT 19
C1h		Initialize POST Error Manager (PEM)
C2h		Initialize error logging

Code	Beeps	POST Routine Description
C3h		Initialize error display function
C4h		Initialize system error handler
C5h		PnPnd dual CMOS (optional)
C6h		Initialize notebook docking (optional)
C7h		Initialize notebook docking late
C8h		Force check (optional)
C9h		Extended checksum (optional)
D2h		Unknown interrupt

Code	Beeps	For Boot Block in Flash ROM
E0h		Initialize the chipset
E1h		Initialize the bridge
E2h		Initialize the CPU
E3h		Initialize system timer
E4h		Initialize system I/O
E5h		Check force recovery boot
E6h		Checksum BIOS ROM
E7h		Go to BIOS
E8h		Set Huge Segment
E9h		Initialize Multi Processor
EAh		Initialize OEM special code
EBh		Initialize PIC and DMA
ECh		Initialize Memory type
EDh		Initialize Memory size
EEh		Shadow Boot Block
EFh		System memory test
F0h		Initialize interrupt vectors
F1h		Initialize Run Time Clock
F2h		Initialize video
F3h		Initialize System Management Mode
F4h	1	Output one beep before boot
F5h		Boot to Mini DOS
F6h		Clear Huge Segment
F7h		Boot to Full DOS

* If the BIOS detects error 2C, 2E, or 30 (base 512K RAM error), it displays an additional word-bitmap (xxxx) indicating the address line or bits that failed. For example, **2C 0002** means address line 1 (bit one set) has failed. **2E 1020** means data bits 12 and 5 (bits 12 and 5 set) have failed in the lower 16 bits. Note that error 30 cannot occur on 386SX systems because they have a 16 rather than 32-bit bus. The BIOS also sends the bitmap to the port-80 LED display. It first displays the check point code, followed by a delay, the high-order byte, another delay, and then the low-order byte of the error. It repeats this sequence continuously.

Jumper and Connector Locations

Top View

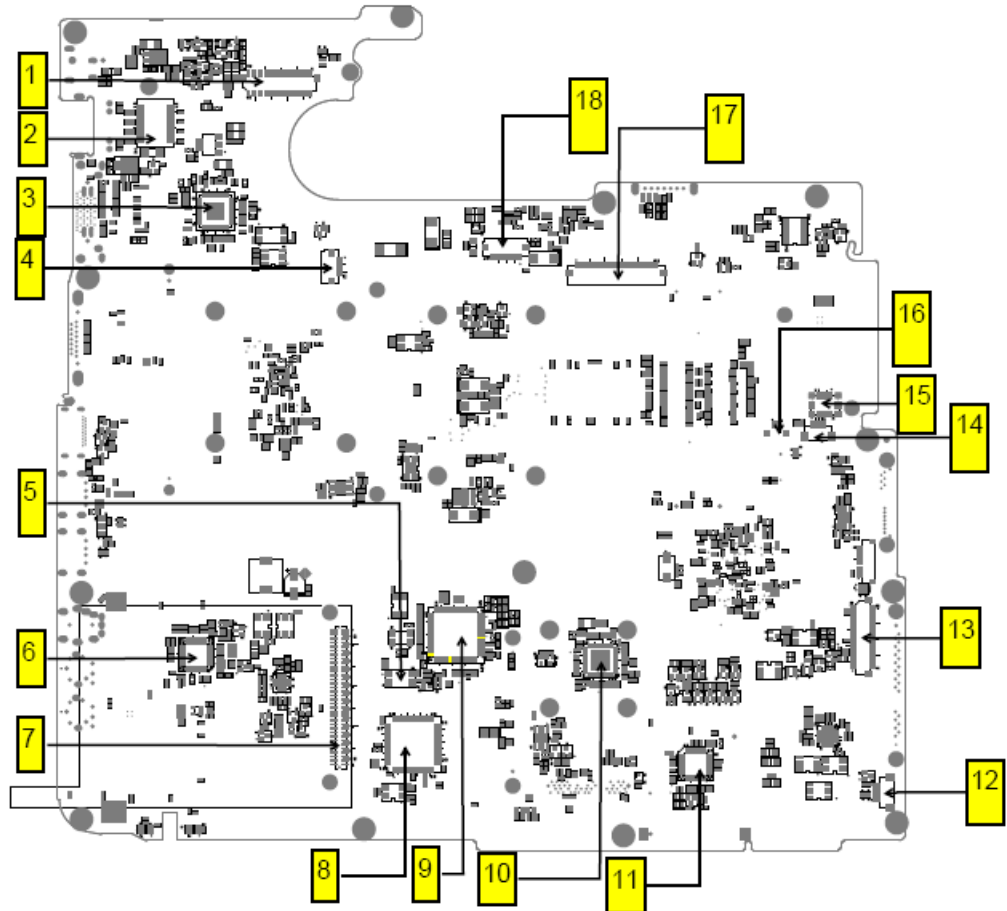

No.	Name	Description	No.	Name	Description
1	CN1	LVDS Connector	10	U14	Clock Generator
2	U1	LAN Transformer	11	U17	Card Reader Controller
3	U2	LAN Chip	12	CN11	Bluetooth Connector
4	CN3	Switch Board Connector	13	CN9	NewCard Board Connector
5	U15	BIOS Chip	14	CN7	Finger Print
6	U13	Audio Codec	15	CN5	Modem Board Connector
7	CN10	Card Bus Connector	16	CN6	TouchPad
8	U16	Card Bus Controller	17	CN4	Keyboard Connector
9	U12	EC	18	CN2	Power Board Connector

Bottom View

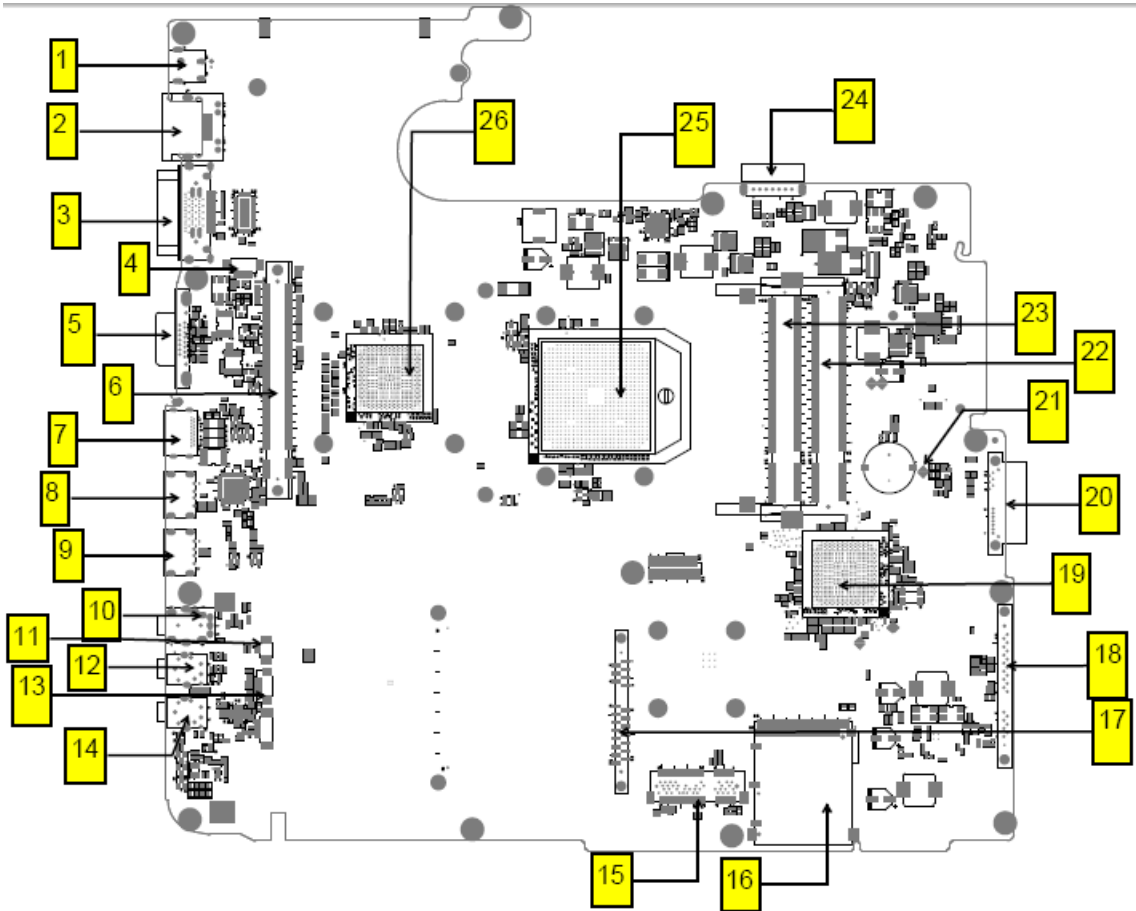

No.	Name	Description	No.	Name	Description
1	PJ1	Power Jack	14	CN23	Line In Connector
2	CN12	RJ45 Connector	15	CN33	Wireless Connector
3	CN13	Docking Connector	16	CN31	Card Reader
4	CN14	Fan Connector	17	CN26	HDD Connector
5	CN15	CRT Connector	18	CN28	HDD Connector
6	CN16	MXM Card Connector	19	U30	South Bridge
7	CN17	HDMI Connector	20	CN20	ODD Connector
8	CN19	USB Connector	21	G1	CMOS Clear Jumper
9	CN21	USB Connector	22	J1	RAM Connector
10	CN29	HP Out Connector	23	J2	RAM Connector
11	CN24	Internal Microphone Connector	24	PCN1	Battery Connector
12	CN24	Microphone Connector	25	U25	CPU Socket
13	CN27	Internal Speaker Connector	26	U24	North Bridge

Clearing Password Check and BIOS Recovery

This section provide you the standard operating procedures of clearing password and BIOS recovery for TravelMate 7530/7230. TravelMate 7530/7230s provide one Hardware Open Gap on main board for clearing password check, and one Hotkey for enabling BIOS Recovery.

Clearing Password Check

Hardware Open Gap Description

Item	Description
R347 (RTC_RST)	Clear CMOS Jumper



Steps for Clearing BIOS Password Check

If users set BIOS Password (Supervisor Password and/or User Password) for a security reason, BIOS will ask the password during systems POST or when systems enter to BIOS Setup menu. However, once it is necessary to bypass the password check, users need to short the HW Gap to clear the password by the following steps:

- Power Off a system, and remove HDD, AC and Battery from the machine.
- Open the back cover of the machine, and find out the HW Gap on M/B as picture.
- Use an electric conductivity tool to short the two points of the HW Gap.
- Plug in AC, keep the short condition on the HW Gap, and press Power Button to power on the system till BIOS POST finish. Then remove the tool from the HW Gap.
- Restart system. Press F2 key to enter BIOS Setup menu.
- If there is no Password request, BIOS Password is cleared. Otherwise, please follow the steps and try again.

NOTE: The steps are only for clearing BIOS Password (Supervisor Password and User Password).

BIOS Recovery by Crisis Disk

BIOS Recovery Boot Block:

BIOS Recovery Boot Block is a special block of BIOS. It is used to boot up the system with minimum BIOS initialization. Users can enable this feature to restore the BIOS firmware to a successful one once the previous BIOS flashing process failed.

BIOS Recovery Hotkey:

The system provides a function hotkey: **Fn+Esc**, for enable BIOS Recovery process when system is powered on during BIOS POST. To use this function, it is strongly recommended to have the AC adapter and Battery present. If this function is enabled, the system will force the BIOS to enter a special BIOS block, called Boot Block.

Steps for BIOS Recovery from USB Storage:

Before doing this, prepare the Crisis USB key. The Crisis USB key could be made by executing the Crisis Disk program in another system with Windows XP OS.

Follow the steps below:

1. Save ROM file (file name: **JAL90x64.fd**) to the root directory of USB storage.
2. Plug USB storage into USB port.
3. Press **Fn + ESC** button then plug in AC.
The Power button flashes once.
4. Press **Power** button to initiate system CRISIS mode.
When CRISIS is complete, the system auto restarts with a workable BIOS.
5. Update the latest version BIOS for this machine by regular BIOS flashing process.

FRU (Field Replaceable Unit) List

This chapter gives you the FRU (Field Replaceable Unit) listing in global configurations of TravelMate 7530/7230. Refer to this chapter whenever ordering for parts to repair or for RMA (Return Merchandise Authorization).

Please note that WHEN ORDERING FRU PARTS, you should check the most up-to-date information available on your regional web or channel. For whatever reasons a part number change is made, it will not be noted on the printed Service Guide. For ACER AUTHORIZED SERVICE PROVIDERS, your Acer office may have a DIFFERENT part number code from those given in the FRU list of this printed Service Guide. You MUST use the local FRU list provided by your regional Acer office to order FRU parts for repair and service of customer machines.

NOTE: To scrap or to return the defective parts, you should follow the local government ordinance or regulations on how to dispose it properly, or follow the rules set by your regional Acer office on how to return it.

TravelMate 7530/7230 Exploded Diagrams

Upper/ Lower Cover

Number	Description	Part Number

Number	Description	Part Number

LCD Panel

Number	Description	Part Number

Number	Description	Part Number

TravelMate 7530/7230 FRU List

Category	Description	Part Number
Adapter		
	ADAPTER 65W 3PIN DELTA SADP-65KB DFA	AP.06501.013
	ADAPTER 65W LITEON PA-1650-02AC LF	AP.06503.016
	ADAPTER 65W 3PIN HIPRO AC-OK065B13	AP.0650A.010
	ADAPTER DELTA 90W ADP-90SB BBEA LF	AP.09001.013
	ADAPTER LITE-ON 90W 19V BLUE PA-1900-24AR LED LF	AP.09003.011
	ADAPTER HIPRO 90W 19V BLUE HP-OL093B13P LED LF LEVEL 4	AP.0900A.001
	Adapter DELTA 65W SADP-65KB BFJA LV4 LF for OBL	AP.06501.014
	Adapter DELTA 90W ADP-90SB BBEN (for OBL Spec.) LV4 LF	AP.09001.014
Battery		
	Battery SANYO AS-2007B Li-Ion 3S2P SANYO 6 cell 4400mAh Main COMMON Normal Type	BT.00603.042
	Battery SONY AS-2007B Li-Ion 3S2P SONY 6 cell 4400mAh Main COMMON Normal Type	BT.00604.025
	Battery SIMPLO AS-2007B Li-Ion 3S2P PANASONIC 6 cell 4400mAh Main COMMON PSS	BT.00607.016
	Battery SANYO AS-2007B Li-Ion 4S2P SANYO 8 cell 4800mAh Main COMMON	BT.00803.024
	Battery SONY AS-2007B Li-Ion 4S2P SONY 8 cell 4800mAh Main COMMON	BT.00804.020
	Battery PANASONIC AS-2007B Li-Ion 4S2P PANASONIC 8 cell 4800mAh Main COMMON	BT.00805.011
	Battery SIMPLO AS-2007B Li-Ion 4S2P PANASONIC 8 cell 4800mAh Main COMMON PSS	BT.00807.015
	Battery PANASONIC AS-2007B Li-Ion 3S2P PANASONIC 6 cell 4400mAh Main COMMON PSS	BT.00605.021
Board		
	Lite-On Conexant -Unizion 1.5_3.3v AUS RD02-D330 B85247600G	FX.22500.021
	BLUETOOTH MODULE (T60H928.11)	BT.21100.005
	WIRELESS LAN CARD FOXCONN T60h976.00 MINI	54.AZL07.001
	WIRELESS LAN BOARD 802.11BG FOXCONN BCM4312 T77H030.00	NI.23600.029
	TOUCHPAD BOARD W/O FP	55.TQ407.001
	TOUCHPAD BOARD W/ FP	55.TPK07.001

Category	Description	Part Number
	POWER BOARD	55.TPK07.002
	SWITCH BOARD	55.TPK07.003
	NEWCARD BOARD	55.TPK07.004
	MSI VGA Card AMD M82ME-XT DDRII 256M 400MHz 32*16 MXM II w/ HDCP w/ O2 PowerIC	VG.82M06.001
Cables		
	PWR CORD V943B30001218008 DANISH 3P	27.A03V7.006
	PWR CORD(ISR)1.8M 3PBLK FZ0I0008-038	27.TATV7.005
	PWR CORD V50CB3T3012180QD TW-110V,3P	27.A99V7.002
	POWER CORD(SWI)1.8M 3PBLACK FZ010008-011	27.A99V7.004
	POWER CORD(IT) 1.8M 3PBLACK FZ010008-008	27.A99V7.005
	POWER CORD(S.A) 1.8M 3BLACK FZ010008-006	27.T48V7.001
	POWER CORD US 3PIN ROHS	27.TAXV7.001
	POWER CORD(EU) 1.8M 3PBLACK FM010008-010	27.TATV7.001
	POWER CORD(UK) 1.8M 3PBLACK FP010008-013	27.TATV7.003
	BLUETOOTH CABLE	50.TPK07.001
	NEW CARD CABLE	50.TPK07.002
Case/Cover/Bracket Assembly		
	MIDDLE COVER	42.TPK07.001
	UPPER CASE ASSY W/TP,SPEAKER,MIC,FFC CABLE W/O FP	60.TQ407.001
	UPPER CASE ASSY W/TP,SPEAKER,MIC,FFC CABLE FOR FP	60.TPK07.001
	LOWER CASE ASSY W/RJ11	60.TPK07.002

Category	Description	Part Number
	RAM COVER	42.TPK07.002
	KB PLATE FOR DDR2	33.TPK07.007
	SWITCH BOARD BRACKET	33.TPK07.008
	BASE ODD CAP	42.TG607.002
CPU/Processor		
	CPU AMD Athlon64X2 QL60 PGA 1.9G 1M 638 35W Griffin B1	KC.AQL02.600
	CPU AMD TurionX2 RM70 PGA 2.0G 1M 638 35W Griffin B1	KC.TRM02.700
	CPU AMD TurionX2 ZM80 PGA 2.1G 2M 638 35W Griffin B1	KC.TZM02.800
	CPU AMD TurionX2 ZM82 PGA 2.2G 2M 638 35W Griffin B1	KC.TZM02.820
	CPU AMD TurionX2 ZM84 PGA 2.3G 2M 638 35W Griffin B1	KC.TZM02.840
	CPU AMD SempronM SI40 PGA 2.0G 512K 638 25W Griffin B1	KC.SSI02.400
Combo Module		
	DVD/CDRW COMBO MODULE	6M.TPK07.001
	TOSHIBA COMBO Tray DL 24X TS-L463A LF W/O bezel SATA	KO.02401.006
	SONY COMBO Tray DL 24X CRX890S LF W/O bezel SATA	KO.0240E.009
	OPTICAL BRACKET	33.TPK07.001
	DVD/CDRW COMBO BEZEL	42.TPK07.005
	DVD/RW SUPER MULTI SATA MODULE	6M.TR807.001
	PIONEER Super-Multi DRIVE Tray DL 8X DVR-TD08RS LF W/O bezel SATA	KU.00805.044
	ODD PLDS Super-Multi DRIVE 12.7mm Tray DL 8X DS-8A2S LF W/O bezel SATA	KU.0080F.001
	SONY SUPER-MULTI DRIVE TRAY DL 8X AD-7560S LF W/O BEZEL SATA	KU.0080E.009

Category	Description	Part Number
	OPTICAL BRACKET	33.TPK07.001
	ODD BEZEL - SUPER MULTI	42.TPK07.006
	BLUE RAY COMBO MODULE	6M.TPL07.001
	BLUE RAY COMBO TRAY 2X SONY BC-5500S-AR	KO.0020E.002
	OPTICAL BRACKET	33.TPK07.001
	BD COMBO BEZEL	42.TPL07.001

Category	Description	Part Number
HDD		
	HDD SEAGATE 2.5" 5400rpm 120GB ST9120817AS Corsair SATA LF F/ W:3.AAA	KH.12001.032
	HDD TOSHIBA 5400rpm 120GB MK1246GSX Leo BS SATA I LF F/ W:LB213J	KH.12004.007
	HDD HGST 5400rpm 120GB HTS542512K9SA00 Bronco-B SATA II LF F/ W:C31P	KH.12007.014
	HDD WD 5400rpm 120GB WD1200BEVS-22UST0 ML125 SATA LF F/ W:01.01A01	KH.12008.019
	HDD(160G) ST9160827AS 9DG133-188 STN B/S SEAGATE F/W:3.AAA	KH.16001.029
	HDD TOSHIBA 2.5" 5400rpm 160GB MK1652GSX Virgo - BS SATA LF F/ W:LV010J	KH.16004.003
	HDD HGST 2.5" 5400rpm 160GB HTS542516K9SA00 Bronco-B SATA II LF F/W:C31P	KH.16007.016
	HDD HGST 2.5" 5400rpm 160GB HTS543216L9A300 Falcon-B SATA LF F/W:C40C	KH.16007.019
	HDD WD 2.5" 5400rpm 160GB WD1600BEVT-22ZCT0 ML160 SATA LF F/ W:11.01A11	KH.16008.022
	HDD TOSHIBA 2.5" 5400rpm 250GB MK2546GSX Leo BS SATA I LF F/ W:LB013J	KH.25004.001
	HDD 250GB 5400RPM SATA II HGST HTS542525K9SA00 LF F/W:C31P	KH.25007.011
	HDD HGST 2.5" 5400rpm 250GB HTS543225L9A300 Falcon-B SATA LF F/W:C40C	KH.25007.013
	HDD WD 2.5 IN. 5400rpm 250GB WD2500BEVS-22UST0 ML125 SATA LF F/W:01.01A01	KH.25008.018
	HDD TOSHIBA 2.5" 5400rpm 320GB MK3252GSX Virgo BS SATA LF F/ W:LV010J	KH.32004.001
	HDD HGST 2.5" 5400rpm 320GB HTS543232L9A300 Falcon-B SATA LF F/W:C40C	KH.32007.004
	HDD WD 2.5" 5400rpm 320GB WD3200BEVT-22ZCT0 ML160 SATA LF F/ W:11.01A11	KH.32008.013
	HDD BRACKET ASSY	33.TPK07.002
	HDD COVER-1 ASSY W/RUBBER	42.TPK07.003
	HDD COVER-2 ASSY W/RUBBER	42.TPK07.004
	HDD CONNECTOR	20.TPK07.001

Category	Description	Part Number
Keyboard		
	Keyboard 17KB-FV4 Black Monserrat 104KS Black US International	KB.INT00.627
	Keyboard 17KB-FV4 Black Monserrat 104KS Black US International Hebrew	KB.INT00.628
	Keyboard 17KB-FV4 Black Monserrat 105KS Black UK	KB.INT00.629
	Keyboard 17KB-FV4 Black Monserrat 105KS Black Turkish	KB.INT00.630
	Keyboard 17KB-FV4 Black Monserrat 104KS Black Thailand	KB.INT00.631
	Keyboard 17KB-FV4 Black Monserrat 105KS Black Swiss/G	KB.INT00.632
	Keyboard 17KB-FV4 Black Monserrat 105KS Black Swedish	KB.INT00.633
	Keyboard 17KB-FV4 Black Monserrat 105KS Black Spanish	KB.INT00.634
	Keyboard 17KB-FV4 Black Monserrat 105KS Black Slovak	KB.INT00.635
	Keyboard 17KB-FV4 Black Monserrat 105KS Black SLO/CRO	KB.INT00.636
	Keyboard 17KB-FV4 Black Monserrat 104KS Black Russian	KB.INT00.637
	Keyboard 17KB-FV4 Black Monserrat 105KS Black Portuguese	KB.INT00.638
	Keyboard 17KB-FV4 Black Monserrat 105KS Black Polish	KB.INT00.639
	Keyboard 17KB-FV4 Black Monserrat 105KS Black Norwegian	KB.INT00.640
	Keyboard 17KB-FV4 Black Monserrat 104KS Black Korean	KB.INT00.642
	Keyboard 17KB-FV4 Black Monserrat 104KS Black Japanese	KB.INT00.643
	Keyboard 17KB-FV4 Black Monserrat 105KS Black Italian	KB.INT00.644
	Keyboard 17KB-FV4 Black Monserrat 105KS Black Hungarian	KB.INT00.647
	Keyboard 17KB-FV4 Black Monserrat 104KS Black Greek	KB.INT00.648
	Keyboard 17KB-FV4 Black Monserrat 105KS Black German	KB.INT00.649
	Keyboard 17KB-FV4 Black Monserrat 105KS Black French	KB.INT00.650
	Keyboard 17KB-FV4 Black Monserrat 105KS Black Danish	KB.INT00.653
	Keyboard 17KB-FV4 Black Monserrat 105KS Black Czech	KB.INT00.654
	Keyboard 17KB-FV4 Black Monserrat 104KS Black Traditional Chinese	KB.INT00.655
	Keyboard 17KB-FV4 Black Monserrat 105KS Black Canadian French	KB.INT00.656
	Keyboard 17KB-FV4 Black Monserrat 105KS Black Brazilian Portuguese	KB.INT00.657
	Keyboard 17KB-FV4 Black Monserrat 105KS Black Belgium	KB.INT00.658
	Keyboard 17KB-FV4 Black Monserrat 104KS Black Arabic/English	KB.INT00.659
	Keyboard 17KB-FV4 Black Monserrat 105KS Black Luxembourgian	KB.INT00.641
	Keyboard 17KB-FV4 Black Monserrat 104KS Black Israel	KB.INT00.645
	Keyboard 17KB-FV4 Black Monserrat 105KS Black Irish	KB.INT00.646
	Keyboard 17KB-FV4 Black Monserrat 105KS Black Finnish	KB.INT00.651
	Keyboard 17KB-FV4 Black Monserrat 105KS Black Dutch	KB.INT00.652
	Keyboard 17KB-FV4 Black Monserrat 105KS Black Arabic/French	KB.INT00.660
	Keyboard 17KB-FV4 Black Monserrat 105KS Black Nordic	KB.INT00.661
	Keyboard 17KB-FV4 Black Monserrat 105KS Black English/Canadian French	KB.INT00.662
	Keyboard 17KB-FV4 Black Monserrat 109KS Black Japanese	KB.INT00.663
LCD		
	LCD MODULE ASSY MIMO (3WIRE) GLARE W/CCD	6M.TR807.002
	LCD SAMSUNG 17.1" WXGA+ Glare LTN170BT07-G01 LF 220nit 8ms 500:1	LK.17106.004
	LCD LPL 17.1" WXGA+ Glare LP171WP4-TLR1 LF 220nit 8ms	LK.17108.011
	LCD CMO 17" WXGA+ Glare N170C2-L02 LF 200nit 10ms	LK.1700D.009
	INVERTER BOARD	19.TPK07.001

Category	Description	Part Number
	LCD CABLE FOR CCD	50.TPK07.003
	LCD COVER ASSY W/ANTENNA * 3	60.TPK07.003
	LCD BEZEL FOR CCD	60.TPK07.004
	LCD BRACKET W/HINGE - R	33.TPK07.003
	LCD BRACKET W/HINGE - L	33.TPK07.004
	CCD MODULE 0.3M	57.ARE07.001
	CAMERA CNF701721004971L CNY	57.TPK07.002
	CCD BRACKET	33.TPK07.005
	CCD CABLE	50.TPK07.004
	LCD MODULE ASSY MIMO (3WIRE) NON-GLARE W/CCD	6M.TR807.003
	LCD LPL 17.1" WXGA+ None Glare LP171WP4-TLR2 LF 220nit 8ms	LK.17108.012
	INVERTER BOARD	19.TPK07.001
	LCD CABLE FOR CCD	50.TPK07.003
	LCD COVER ASSY W/ANTENNA * 3	60.TPK07.003
	LCD BEZEL FOR CCD	60.TPK07.004
	LCD BRACKET W/HINGE - R	33.TPK07.003
	LCD BRACKET W/HINGE - L	33.TPK07.004

Category	Description	Part Number
	CCD MODULE 0.3M	57.ARE07.001
	CAMERA CNF701721004971L CNY	57.TPK07.002
	CCD BRACKET	33.TPK07.005
	CCD CABLE	50.TPK07.004
	LCD MODULE ASSY MIMO (2WIRE) GLARE W/CCD	6M.TR807.004
	LCD SAMSUNG 17.1" WXGA+ Glare LTN170BT07-G01 LF 220nit 8ms 500:1	LK.17106.004
	LCD LPL 17.1" WXGA+ Glare LP171WP4-TLR1 LF 220nit 8ms	LK.17108.011
	LCD CMO 17" WXGA+ Glare N170C2-L02 LF 200nit 10ms	LK.1700D.009
	INVERTER BOARD	19.TPK07.001
	LCD CABLE FOR CCD	50.TPK07.003
	LCD COVER ASSY W/ANTENNA * 2	60.TPK07.005
	LCD BEZEL FOR CCD	60.TPK07.004
	LCD BRACKET W/HINGE - R	33.TPK07.003
	LCD BRACKET W/HINGE - L	33.TPK07.004
	CCD MODULE 0.3M	57.ARE07.001
	CAMERA CNF701721004971L CNY	57.TPK07.002
	CCD BRACKET	33.TPK07.005
	CCD CABLE	50.TPK07.004
	LCD MODULE ASSY MIMO (2WIRE) NON-GLARE W/CCD	6M.TR807.005
	LCD LPL 17.1" WXGA+ None Glare LP171WP4-TLR2 LF 220nit 8ms	LK.17108.012
	INVERTER BOARD	19.TPK07.001
	LCD CABLE FOR CCD	50.TPK07.003

Category	Description	Part Number
	LCD COVER ASSY W/ANTENNA * 2	60.TPK07.005
	LCD BEZEL FOR CCD	60.TPK07.004
	LCD BRACKET W/HINGE - R	33.TPK07.003
	LCD BRACKET W/HINGE - L	33.TPK07.004
	CCD MODULE 0.3M	57.ARE07.001
	CAMERA CNF701721004971L CNY	57.TPK07.002
	CCD BRACKET	33.TPK07.005
	CCD CABLE	50.TPK07.004
	LCD MODULE ASSY MIMO (3WIRE) AUO GLARE W/CCD	6M.TPK07.006
	LCD AUO 17.1" WXGA+ Glare B170PW06 V2 LF 220nit 8ms	LK.17105.009
	INVERTER BOARD	19.TPK07.001
	LCD CABLE FOR CCD	50.TPK07.003
	LCD COVER ASSY W/ANTENNA * 3 FOR AUO	60.TPK07.008
	LCD BEZEL FOR CCD	60.TPK07.004
	LCD BRACKET W/HINGE - R	33.TPK07.003
	LCD BRACKET W/HINGE - L	33.TPK07.004
	CCD MODULE 0.3M	57.ARE07.001
	CAMERA CNF701721004971L CNY	57.TPK07.002
	CCD BRACKET	33.TPK07.005

Category	Description	Part Number
	CCD CABLE	50.TPK07.004
	LCD MODULE ASSY MIMO (3WIRE) AUO NON-GLARE W/CCD	6M.TPK07.007
	LCD AUO 17.1" WXGA+ None Glare B170PW06 V3 LF 220nit 8ms	LK.17105.008
	INVERTER BOARD	19.TPK07.001
	LCD CABLE FOR CCD	50.TPK07.003
	LCD COVER ASSY W/ANTENNA * 3 FOR AUO	60.TPK07.008
	LCD BEZEL FOR CCD	60.TPK07.004
	LCD BRACKET W/HINGE - R	33.TPK07.003
	LCD BRACKET W/HINGE - L	33.TPK07.004
	CCD MODULE 0.3M	57.ARE07.001
	CAMERA CNF701721004971L CNY	57.TPK07.002
	CCD BRACKET	33.TPK07.005
	CCD CABLE	50.TPK07.004
	LCD MODULE ASSY MIMO (2WIRE) AUO GLARE W/CCD	6M.TPK07.008
	LCD AUO 17.1" WXGA+ Glare B170PW06 V2 LF 220nit 8ms	LK.17105.009
	INVERTER BOARD	19.TPK07.001
	LCD CABLE FOR CCD	50.TPK07.003
	LCD COVER ASSY W/ANTENNA * 2 FOR AUO	60.TPK07.009

Category	Description	Part Number
	LCD BEZEL FOR CCD	60.TPK07.004
	LCD BRACKET W/HINGE - R	33.TPK07.003
	LCD BRACKET W/HINGE - L	33.TPK07.004
	CCD MODULE 0.3M	57.ARE07.001
	CAMERA CNF701721004971L CNY	57.TPK07.002
	CCD BRACKET	33.TPK07.005
	CCD CABLE	50.TPK07.004
	LCD MODULE ASSY MIMO (2WIRE) AUO NON-GLARE W/CCD	6M.TPK07.009
	LCD AUO 17.1" WXGA+ None Glare B170PW06 V3 LF 220nit 8ms	LK.17105.008
	INVERTER BOARD	19.TPK07.001
	LCD CABLE FOR CCD	50.TPK07.003
	LCD COVER ASSY W/ANTENNA * 2 FOR AUO	60.TPK07.009
	LCD BEZEL FOR CCD	60.TPK07.004
	LCD BRACKET W/HINGE - R	33.TPK07.003
	LCD BRACKET W/HINGE - L	33.TPK07.004
	CCD MODULE 0.3M	57.ARE07.001
	CAMERA CNF701721004971L CNY	57.TPK07.002
	CCD BRACKET	33.TPK07.005
	CCD CABLE	50.TPK07.004

Category	Description	Part Number
Mainboard		
	MAINBOARD UMA AMDRS780MN W/CARD READER W/O CPU RAM LF	
	MAINBOARD DIS AMDRS780MN W/CARD READER W/O CPU RAM LF	
Memory		
	1GB NANYA DDRII 667 1GB NT1GT64U8HB0BN-3C (0.09U)	KN.1GB03.014
	Memory SAMSUNG SO-DIMM DDRII 667 1GB M470T2864QZ3-CE6 LF	KN.1GB0B.016
	Memory MICRON SO-DIMM DDRII 667 2GB MT16HTF25664HY-667E1 LF	KN.2GB04.001
	Memory SAMSUNG SO-DIMM DDRII 667 2GB M470T5663QZ3-CE6 LF	KN.2GB0B.003
	MEMORY HYNIX SO-DIMM DDRII 667 2GB HYMP125S64CP8-Y5 LF	KN.2GB0G.004
	Memory SAMSUNG SO-DIMM DDRII 667 512MB M470T6464QZ3-CE6 LF	KN.5120B.026
	Memory HYNIX SO-DIMM DDRII 667 512MB HYMP164S64CP6-Y5 LF	KN.5120G.024
Heatsink		
	THERMAL MODULE FOR UMA	60.TR807.001
	THERMAL MODULE FOR VGA	60.TQC07.001
Miscellaneous		
	LCD RUBBER-1	47.TPK07.001
	LCD RUBBER-2	47.TPK07.002
	LOWER CASE FOOT STAND	47.AGW07.004
Speaker		
	SPEAKER	23.TPK07.001

Screw List

Category	Description	Part Number
Screw List		
	SCREW M2.0*2.5-I (BUWZN)	86.TPK07.001
	SCREW M3.0*3.5-I (BUWZN) IRON	86.TPK07.002
	SCREW M3*0.5+3.5I	86.A03V7.006
	SCREW M2.5*6.5-I (BZN(NYLOK-RED)	86.ARE07.001
	SCREW M2.5*5.0-I (BZN)	86.ARE07.003
	SCREW M2.5*3.0-I (BZN)	86.TPK07.003

Model Definition and Configuration

TravelMate 7530/7230 Series

Model	RO	Country	Acer Part no	Description	CPU	LCD	DIMM 1	DIMM 2	HDD 1 (GB)	ODD	Wireless LAN	Bluetooth	VOIP Phone

Test Compatible Components

This computer's compatibility is tested and verified by Acer's internal testing department. All of its system functions are tested under Windows® XP Home, Windows® XP Pro environment.

Refer to the following lists for components, adapter cards, and peripherals which have passed these tests. Regarding configuration, combination and test procedures, please refer to the TravelMate 7530/7230 series Compatibility Test Report released by the Acer Mobile System Testing Department.

Microsoft® Windows® Vista Environment Test

Vendor	Type	Description
Adapter Test		
F0000183 DELTA CN	90W	Adapter DELTA 90W 1.7x5.5x11 ADP-90SB BBEA LF level 4
10001023 LITE-ON	90W	Adapter LITE-ON 90W 19V 1.7x5.5x11 Blue PA-1900-24AR LED LF level 4
60002015 HIPRO	90W	Adapter HIPRO 90W 19V 1.7x5.5x11 Blue HP-OL093B13P LED LF level 4
F0000183 DELTA CN	90W-DE	Adapter DELTA 90W 1.7x5.5x11 ADP-90SB BBEN (for OBL Spec.) LV4 LF
F0000183 DELTA CN	65W-DE	Adapter DELTA 65W 1.7x5.5x11 SADP-65KB BFJA LV4 LF for OBL only
10001023 LITE-ON	65W	Adapter LITE-ON 65W 1.7x5.5x11 PA-1650-02AC LF level 4
60002015 HIPRO	65W	Adapter HIPRO 65W 19V 1.7x5.5x11 Yellow HP-OK065B13 LED LF level 4
F0000183 DELTA CN	65W	Adapter DELTA 65W 1.7x5.5x11 SADP-65KB DFA LF level 4
Audio Codec Test		
9999995 ONE TIME VENDER	ALC268	ALC268
Battery Test		
60001921 SANYO	6CELL2.2	Battery SANYO AS-2007B Li-Ion 3S2P SANYO 6 cell 4400mAh Main COMMON Normal Type
60001535 PANASONI C	6CELL2.2	Battery PANASONIC AS-2007B Li-Ion 3S2P PANASONIC 6 cell 4400mAh Main COMMON PSS
10001063 SONY	8CELL2.4	Battery SONY AS-2007B Li-Ion 4S2P SONY 8 cell 4800mAh Main COMMON
60002162 SIMPLO	8CELL2.4	Battery SIMPLO AS-2007B Li-Ion 4S2P PANASONIC 8 cell 4800mAh Main COMMON PSS
10001063 SONY	6CELL2.2	Battery SONY AS-2007B Li-Ion 3S2P SONY 6 cell 4400mAh Main COMMON Normal Type
60002162 SIMPLO	6CELL2.2	Battery SIMPLO AS-2007B Li-Ion 3S2P PANASONIC 6 cell 4400mAh Main COMMON PSS
60001921 SANYO	8CELL2.4	Battery SANYO AS-2007B Li-Ion 4S2P SANYO 8 cell 4800mAh Main COMMON
60001535 PANASONI C	8CELL2.4	Battery PANASONIC AS-2007B Li-Ion 4S2P PANASONIC 8 cell 4800mAh Main COMMON
CPU Test		
22554573 AMD	GFNQS	CPU AMD TurionX2 Griffin QS PGA
22554573 AMD	ATUZM86	CPU AMD TurionX2 ZM86 PGA 2.4G 2M 638 35W Griffin B1
22554573 AMD	AAQL60	CPU AMD Athlon64X2 QL60 PGA 1.9G 1M 638 35W Griffin B1

Vendor	Type	Description
22554573 AMD	ATRM70	CPU AMD TurionX2 RM70 PGA 2.0G 1M 638 35W Griffin B1
22554573 AMD	ATUZM80	CPU AMD TurionX2 ZM80 PGA 2.1G 2M 638 35W Griffin B1
22554573 AMD	ATUZM82	CPU AMD TurionX2 ZM82 PGA 2.2G 2M 638 35W Griffin B1
22554573 AMD	SMPSI4025W	CPU AMD SempronM SI40 PGA 2.0G 512K 638 25W Griffin B1
22554573 AMD	ATUZM84	CPU AMD TurionX2 ZM84 PGA 2.3G 2M 638 35W Griffin B1
HDD Test		
60002036 SEAGATE	N120GB5.4KS	HDD SEAGATE 2.5" 5400rpm 120GB ST9120817AS Corsair SATA LF F/W:3.AAA
60001994 WD	N120GB5.4KS	HDD WD 2.5" 5400rpm 120GB WD1200BEVS-22UST0 ML125 SATA LF F/W:01.01A01
60001922 TOSHIBA DIGI	N250GB5.4KS	HDD TOSHIBA 2.5" 5400rpm 250GB MK2546GSX Leo BS SATA I LF F/W:LB013J
60002005 HGST SG	N160GB5.4KS	HDD HGST 2.5" 5400rpm 160GB HTS542516K9SA00 Bronco-B SATA II LF F/W:C31P
60001922 TOSHIBA DIGI	N320GB5.4KS	HDD TOSHIBA 2.5" 5400rpm 320GB MK3252GSX Virgo BS SATA LF F/W:LV010J
60001922 TOSHIBA DIGI	N120GB5.4KS	HDD TOSHIBA 2.5" 5400rpm 120GB MK1246GSX Leo BS SATA I LF F/W:LB213J
60002036 SEAGATE	N160GB5.4KS	HDD SEAGATE 2.5" 5400rpm 160GB ST9160827AS Corsair SATA LF F/W:3.AAA
60001994 WD	N160GB5.4KS	HDD WD 2.5" 5400rpm 160GB WD1600BEVT-22ZCT0 ML160 SATA LF F/W:11.01A11
60002005 HGST SG	N250GB5.4KS	HDD HGST 2.5" 5400rpm 250GB HTS542525K9SA00 Bronco-B SATA II LF F/W:C31P
60001994 WD	N320GB5.4KS	HDD WD 2.5" 5400rpm 320GB WD3200BEVT-22ZCT0 ML160 SATA LF F/W:11.01A11
60002005 HGST SG	N120GB5.4KS	HDD HGST 2.5" 5400rpm 120GB HTS542512K9SA00 Bronco-B SATA II LF F/W:C31P
60001922 TOSHIBA DIGI	N160GB5.4KS	HDD TOSHIBA 2.5" 5400rpm 160GB MK1652GSX Virgo - BS SATA LF F/W:LV010J
60002036 SEAGATE	N250GB5.4KS	HDD SEAGATE 2.5" 5400rpm 250GB ST9250827AS Corsair SATA LF F/W:3.AAA
60001994 WD	N250GB5.4KS	HDD WD 2.5" 5400rpm 250GB WD2500BEVS-22UST0 ML125 SATA LF F/W:01.01A01
60002036 SEAGATE	N320GB5.4KS	HDD SEAGATE 2.5" 5400rpm 320GB ST9320320AS Crockett SATA LF F/W:0303
60002005 HGST SG	N160GB5.4KS	HDD HGST 2.5" 5400rpm 160GB HTS543216L9A300 Falcon-B SATA LF F/W:C40C
60002036 SEAGATE	N160GB5.4KS	HDD SEAGATE 2.5" 5400rpm 160GB ST9160310AS Crockett SATA LF F/W:0303

Vendor	Type	Description
60002005 HGST SG	N320GB5.4KS	HDD HGST 2.5" 5400rpm 320GB HTS543232L9A300 Falcon-B SATA LF F/W:C40C
60001922 TOSHIBA DIGI	N120GB5.4KS	HDD TOSHIBA 2.5" 5400rpm 120GB MK1252GSX Virgo BS SATA LF F/W:LV010J
60002005 HGST SG	N250GB5.4KS	HDD HGST 2.5" 5400rpm 250GB HTS543225L9A300 Falcon-B SATA LF F/W:C40C
60001922 TOSHIBA DIGI	N250GB5.4KS	HDD TOSHIBA 2.5" 5400rpm 250GB MK2552GSX Virgo BS SATA LF F/W:LV010J
60002005 HGST SG	N120GB5.4KS	HDD HGST 2.5" 5400rpm 120GB HTS543212L9A300 Falcon-B SATA LF F/W:C40C
LCD Test		
60003316 AUO	N17WXGA+	LCD AUO 17.1" WXGA+ None Glare B170PW06 V3 LF 220nit 8ms
60002215 SAMSUNG	N17WXGA+G	LCD SAMSUNG 17.1" WXGA+ Glare LTN170BT07-G01 LF 220nit 8ms 500:1
60003089 LG	N17WXGA+G	LCD LPL 17.1" WXGA+ Glare LP171WP4-TLR1 LF 220nit 8ms
10001038 CMO	N17WXGA+G	LCD CMO 17" WXGA+ Glare N170C2-L02 LF 200nit 10ms
60003316 AUO	N17WXGA+G	LCD AUO 17.1" WXGA+ Glare B170PW06 V2 LF 220nit 8ms
60002215 SAMSUNG	N17WXGA+	LCD SAMSUNG 17.1" WXGA+ None Glare LTN170BT-001 LF 220nit 8ms 500:1
60003089 LG	N17WXGA+	LCD LPL 17.1" WXGA+ None Glare LP171WP4-TLR2 LF 220nit 8ms
10001038 CMO	N17WXGA+	LCD CMO 17" WXGA+ None Glare N170C2-L01 LF 200nit 10ms
60003089 LG	N17WXGA+	LCD LPL 17.1" WXGA+ None Glare LP171WP4-TLR2 LF 220nit 8ms
10001038 CMO	N17WXGA+	LCD CMO 17" WXGA+ None Glare N170C2-L01 LF 200nit 10ms
10001038 CMO	N17WXGA+	LCD CMO 17" WXGA+ None Glare N170C2-L01 LF 200nit 10ms
60003089 LG	N17WXGA+	LCD LPL 17.1" WXGA+ None Glare LP171WP4-TLR2 LF 220nit 8ms
60003089 LG	N17WXGA+	LCD LPL 17.1" WXGA+ None Glare LP171WP4-TLR2 LF 220nit 8ms
Memory Test		
60001993 NANYA	SO1GBII6	SO-DIMM DDRII 667 1GB NT1GT64U8HB0BN-3C (0.09U)
16081942 MICRON	U2GBII6	Memory MICRON UNB-DIMM DDRII 667 2GB MT16HTF25664AY-667E1 LF
60002215 SAMSUNG	SO512MBII6	Memory SAMSUNG SO-DIMM DDRII 667 512MB M470T6464QZ3-CE6 LF
610092 INFINEON	SO1GBII6	Memory INFINEON SO-DIMM DDRII 667 1GB HYS64T128021EDL-3S LF
60002045 HYNIX	SO1GBII6	Memory HYNIX SO-DIMM DDRII 667 1GB HYMP112S64CP6-Y5 LF

Vendor	Type	Description
60002045 HYNIX	U2GBII6	Memory HYNIX UNB-DIMM DDRII 667 2GB HYMP125U64CP8-Y5 LF 128*8 0.065um
60002215 SAMSUNG	U2GBII6	Memory SAMSUNG UNB-DIMM DDRII 667 2GB M378T5663QZ3-CE6 LF 128*8 0.065um
60002045 HYNIX	SO512MBII6	Memory HYNIX SO-DIMM DDRII 667 512MB HYMP164S64CP6-Y5 LF 64*16 0.065um
60002215 SAMSUNG	SO1GBII6	Memory SAMSUNG SO-DIMM DDRII 667 1GB M470T2864QZ3-CE6 LF
610092 INFINEON	SO1GBII6	Memory INFINEON SO-DIMM DDRII 667 1GB HYS64T128021EDL-3S LF
610092 INFINEON	SO1GBII6	Memory INFINEON SO-DIMM DDRII 667 1GB HYS64T128021EDL-3S LF
60002045 HYNIX	U2GBII6	Memory HYNIX UNB-DIMM DDRII 667 2GB HYMP125U64CP8-Y5 LF 128*8 0.065um
60002045 HYNIX	SO2GBII6	Memory HYNIX SO-DIMM DDRII 667 2GB HYMP125S64CP8-Y5 LF
60002215 SAMSUNG	U2GBII6	Memory SAMSUNG UNB-DIMM DDRII 667 2GB M378T5663QZ3-CE6 LF 128*8 0.065um
16081942 MICRON	U2GBII6	Memory MICRON UNB-DIMM DDRII 667 2GB MT16HTF25664AY-667E1 LF
60002045 HYNIX	U2GBII6	Memory HYNIX UNB-DIMM DDRII 667 2GB HYMP125U64CP8-Y5 LF 128*8 0.065um
60002215 SAMSUNG	U2GBII6	Memory SAMSUNG UNB-DIMM DDRII 667 2GB M378T5663QZ3-CE6 LF 128*8 0.065um
16081942 MICRON	U2GBII6	Memory MICRON UNB-DIMM DDRII 667 2GB MT16HTF25664AY-667E1 LF
60002215 SAMSUNG	SO2GBII6	Memory SAMSUNG SO-DIMM DDRII 667 2GB M470T5663QZ3-CE6 LF
16081942 MICRON	SO2GBII6	Memory MICRON SO-DIMM DDRII 667 2GB MT16HTF25664HY-667E1 LF
60001993 NANYA	SO1GBII6	Memory NANYA SO-DIMM DDRII 667 1GB NT1GT64UH8D0FN-3C LF 64*16 0.07um
Modem Test		
10001023 LITE-ON	Lite+Con MC4Z 1.5_3.3V Aus	Lite-On Conexant -Unizion 1.5_3.3v AUS RD02-D330
Northbridge Chipset Test		
22554573 AMD	AMDRS780MN	AMD RS780MN w/ HDCP EEPROM
ODD Test		
10001070 PHILIPS	NSM8XS	ODD PLDS Super-Multi DRIVE 12.7mm Tray DL 8X DS-8A2S LF W/O bezel SATA
60001939 PIONEER	NSM8XS	ODD PIONEER Super-Multi DRIVE 12.7mm Tray DL 8X DVR-TD08RS LF W/O bezel SATA
10001063 SONY	NBDCB2XS	ODD SONY BD COMBO 12.7mm Tray DL 2X BC-5500S LF W/O bezel SATA
60001535 PANASONI C	NBDCB2X	ODD PANASONIC BD COMBO 12.7mm Tray DL 2X UJ-120B LF W/O bezel PATA
10001063 SONY	NSM8XS	ODD SONY Super-Multi DRIVE 12.7mm Tray DL 8X AD-7560S LF W/O bezel SATA

Vendor	Type	Description
10001063 SONY	NCB24XS	ODD SONY COMBO 12.7mm Tray DL 24X CRX890S LF W/O bezel SATA
60001922 TOSHIBA DIGI	NCB24XS	ODD TOSHIBA COMBO 12.7mm Tray DL 24X TS-L463A LF W/O bezel SATA
Southbridge Chipset Test		
22554573 AMD	AMDSB700	AMD SB700
VGA Chip Test		
22554573 AMD	82MEXTHM	AMD 82MEXTHM w/ HDCP w/o Macrovision
10001024 MSI	82MEXTHM256 M	MSI VGA Card AMD M82ME-XT DDRII 256M 400MHz 32*16 MXM II w/ HDCP w/ O2 PowerIC
9999995 ONE TIME VENDER	UMA	UMA
WLAN Test		
23707801 FOXCONN TW	3rd WiFi BG	Foxconn FOX_ATH_XB63 Foxconn Atheros XB63 minicard b/g
9999995 ONE TIME VENDER	3rd WiFi BG	Foxconn Wireless LAN Broadcom 4312 minicard b/g

Online Support Information

This section describes online technical support services available to help you repair your Acer Systems.

If you are a distributor, dealer, ASP or TPM, please refer your technical queries to your local Acer branch office. Acer Branch Offices and Regional Business Units may access our website. However some information sources will require a user i.d. and password. These can be obtained directly from Acer CSD Taiwan.

Acer's Website offers you convenient and valuable support resources whenever you need them.

In the Technical Information section you can download information on all of Acer's Notebook, Desktop and Server models including:

- Service guides for all models
- User's manuals
- Training materials
- Bios updates
- Software utilities
- Spare parts lists
- TABs (Technical Announcement Bulletin)

For these purposes, we have included an Acrobat File to facilitate the problem-free downloading of our technical material.

Also contained on this website are:

- Detailed information on Acer's International Traveler's Warranty (ITW)
- Returned material authorization procedures
- An overview of all the support services we offer, accompanied by a list of telephone, fax and email contacts for all your technical queries.

We are always looking for ways to optimize and improve our services, so if you have any suggestions or comments, please do not hesitate to communicate these to us.

A

AFLASH Utility 40

B

Battery Pack 48

BIOS

ROM type 22
vendor 22

BIOS Utility 27–40

Advanced 30
Boot 36
Exit 39
Navigating 27
Onboard Device Configuration 34
Power 36, 37
Save and Exit 39
Security 33
System Security 39

Bluetooth module 81

Board Layout

Top View 145

brightness

hotkeys 15

C

Camera Module 92

caps lock

on indicator 10

Chipset POST Codes 141

Common Problems 124

computer

on indicator 10

CPU 87

D

DIMM Module 65

Display 4

display

hotkeys 15

E

EasyTouch Failure 136

Euro 15

ExpressCard Module 83

External Module Disassembly

Flowchart 47

F

Features 1

Fingerprint Reader Failure 137

Flash Utility 40

FPC Cable 94

FRU (Field Replaceable Unit) List 149

H

Hard Disk Drive1 Module 54

Hard Disk Drive2 Module 56

HDTV Switch Failure 138

Hibernation mode

hotkey 15

Hot Keys 13

I

Indicators 10

Intermittent Problems 140

Internal Microphone Failure 130

Internal Speaker Failure 128

inverter board 91

J

Jumper and Connector Locations 145

Top View 145

K

Keyboard 64

Keyboard Failure 127

L

Launch Board 79

LCD Bezel 89

LCD Brackets 94

LCD Failure 127

LCD Module Disassembly
 Flowchart 88
LCD Panel 93
lower cover 51

M

Main Unit Disassembly
 Flowchart 60
Mainboard 84
media access
 on indicator 10
MediaTouch Button Failure 137
Memory Check 124
Model Definition 166
Modem Failure 135
Modem Module 82

N

No Display Issue 125
Notebook Manager
 hotkey 15
num lock
 on indicator 10

O

ODD Failure 132
Online Support Information 173
optical drive module 58

P

Panel 5
 Bottom 9
 left 5
PC Card 10
POST Codes
 Chipset 141
Power On Failure 124

S

speakers
 hotkey 15
System
 Block Diagram 4

T

Test Compatible Components 167
Thermal Unit Failure 138
Top 145
TouchPad 78
 hotkey 15
TouchPad Failure 128
Troubleshooting
 Built-in KB Failure 127
 EasyTouch Buttons 136
 Fingerprint Reader 137
 HDTV Switch 138
 Internal Microphone 130
 Internal Speakers 128
 LCD Failure 127
 MediTouch Buttons 137
 Modem 135
 No Display 125
 ODD 132
 Other Failures 139
 Power On 124
 Thermal Unit 138
 TouchPad 128
 USB 135
 WLAN 136
Turbo RAM module 52

U

Undetermined Problems 140
USB Failure (Rightside) 135
utility
 BIOS 27–40

W

Windows 2000 Environment Test 168
Wireless Function Failure 136
WLAN Board 53