

Acer TravelMate 8100 Series

Service Guide

Service guide files and updates are available on the ACER/CSD web; for more information, please refer to <http://csd.acer.com.tw>

PRINTED IN TAIWAN

Revision History

Please refer to the table below for the updates made on TravelMate 3200 service guide.

Date	Chapter	Updates
2005/1/7		First Released Version
2005/1/28		Update S/PDIF out on Page7

Copyright

Copyright © 2004 by Acer Incorporated. All rights reserved. No part of this publication may be reproduced, transmitted, transcribed, stored in a retrieval system, or translated into any language or computer language, in any form or by any means, electronic, mechanical, magnetic, optical, chemical, manual or otherwise, without the prior written permission of Acer Incorporated.

Disclaimer

The information in this guide is subject to change without notice.

Acer Incorporated makes no representations or warranties, either expressed or implied, with respect to the contents hereof and specifically disclaims any warranties of merchantability or fitness for any particular purpose. Any Acer Incorporated software described in this manual is sold or licensed "as is". Should the programs prove defective following their purchase, the buyer (and not Acer Incorporated, its distributor, or its dealer) assumes the entire cost of all necessary servicing, repair, and any incidental or consequential damages resulting from any defect in the software.

Acer is a registered trademark of Acer Corporation.

Intel is a registered trademark of Intel Corporation.

Pentium and Pentium II/III are trademarks of Intel Corporation.

Other brand and product names are trademarks and/or registered trademarks of their respective holders.

Conventions

The following conventions are used in this manual:

SCREEN MESSAGES	Denotes actual messages that appear on screen.
NOTE	Gives bits and pieces of additional information related to the current topic.
WARNING	Alerts you to any damage that might result from doing or not doing specific actions.
CAUTION	Gives precautionary measures to avoid possible hardware or software problems.
IMPORTANT	Reminds you to do specific actions relevant to the accomplishment of procedures.

Preface

Before using this information and the product it supports, please read the following general information.

1. This Service Guide provides you with all technical information relating to the BASIC CONFIGURATION decided for Acer's "global" product offering. To better fit local market requirements and enhance product competitiveness, your regional office MAY have decided to extend the functionality of a machine (e.g. add-on card, modem, or extra memory capability). These LOCALIZED FEATURES will NOT be covered in this generic service guide. In such cases, please contact your regional offices or the responsible personnel/channel to provide you with further technical details.
2. Please note WHEN ORDERING FRU PARTS, that you should check the most up-to-date information available on your regional web or channel. If, for whatever reason, a part number change is made, it will not be noted in the printed Service Guide. For ACER-AUTHORIZED SERVICE PROVIDERS, your Acer office may have a DIFFERENT part number code to those given in the FRU list of this printed Service Guide. You MUST use the list provided by your regional Acer office to order FRU parts for repair and service of customer machines.

Chapter 1 System Specifications	1
Features	1
System Block Diagram	3
Board Layout	4
Outlook View	6
Using the Keyboard	13
Hardware Specifications and Configurations	23
Chapter 2 System Utilities	32
BIOS Setup Utility	32
BIOS Flash Utility	44
Chapter 3 Machine Disassembly and Replacement	45
General Information	46
Disassembly Procedure Flowchart	47
Removing the Battery Pack	49
Removing the HDD Module and the miniPCI	50
Disassembling the Main Unit into Upper Case and Lower Case	52
Disassembling the Lower Case	54
Disassembling the LCD Module and Upper Case	57
Disassembling the LCD Module	60
Disassembling the External Modules	62
Chapter 4 Troubleshooting	63
System Check Procedures	64
Power-On Self-Test (POST) Error Message	67
Index of Error Messages	68
Phoenix BIOS Beep Codes	70
Index of Symptom-to-FRU Error Message	74
Intermittent Problems	78
Undetermined Problems	79
Chapter 5 Jumper and Connector Locations	80
Top View	80
Bottom View	81
Main Board Layout	82
Chapter 6 FRU(Field Replaceable Unit)List	84
Exploded Diagram	85
FRU List	87
Appendix A Model Definition and Configuration	95
TravelMate 8100 Series	95
Appendix B Test Compatible Components	96
Microsoft® Windows® XP Pro Environment Test	97
Appendix C Online Support Information	99

System Specifications

Features

Below is a brief summary of Kingfisher's features:

Performance

- Intel Dothan processor 730,740,750,760,770
- Intel® 915PM Express chipset
- 256/512 MB of DDRII 533 standard, upgradeable to 2GB* with dual soDimm modules
- 60/80 GB and above high-capacity, Enhanced-IDE hard disk

Display

- The 15.4" Wide SWXGA(1680 x 1050 pixel resolution) + TFT LCD panel providing a large viewing area for maximum efficiency and ease-of-use
- DualView™ support
- Employs ATI MOBILITY™ RADEON™ x700 with 128MB DDR video memory
- MPEG-2/DVD hardware-assisted capability
- S-video/TV-out (NTSC/PAL), DVI-D (digital) interface supported.

Multimedia

- Built-in dual speakers
- Internal Microphone x1 which combines
- Sound Blaster® Pro and MS-Sound compatible
- Azalia stereo, SPDIF supported

Communication

- 56K ITU V.92 modem with PTT approval, Wake-in-Ring ready
- Integrated 10/100/1000 Mbps Fast Ethernet connection, Wake-on-LAN ready
- Integrated Intel® PRO/Wireless 2915ABG network connection 802.11a/b/g tri-mode Wi-Fi CERTIFIED™ solution,2200BGRW 802.11 b/g, supporting Acer SignalUp wireless technology
- Integrated Bluetooth®
- Built-in 2 Antenna
- Mini-PCI(Manufacturing option)

Keyboard and Pointing Device

- 84/85/88 keys Windows keyboard
- Built-in touchpad pointing device
- 12 function keys, four cursor keys, two Windows® keys, hotkey controls, embedded numeric keypad
- 6 easy-launch buttons (internet, email, wireless LAN, Bluetooth®, Empowering key and one user-programmable button)

* The 1024MB memory has not been tested yet.

Expansion

- One Type II CardBus PC Card slot
- Upgradeable memory modules
- Acer EasyPort

I/O Ports

- One Type II PC Card slot
- Modem (RJ-11) port
- One RJ-45 jack for LAN (Ethernet 10/100/1000 Base-T)
- One external display (VGA) port, one DVI port
- One Microphone/line-in port
- One Headphone/speaker/line-out port
- One Infrared (FIR) port
- One IEEE 1394 port
- Four USB 2.0 ports
- One 5-in-1 card reader (Only support MS/MS Pro/MMC/SD/xD)
- 124-pin Easy Dock connector
- DC-in jack for AC adaptor

Security

- Smart Card support
- Kensington lock slot
- BIOS user and supervisor password support

Software

- Acer Launch Manager
- Acer eManager
- Acer System Recovery CD
- Acer disc-to-disc recovery³
- Norton AntiVirus™
- Adobe® Reader®
- CyberLink® PowerDVD®
- MTI CD-Maker™
- GridVista

System Block Diagram

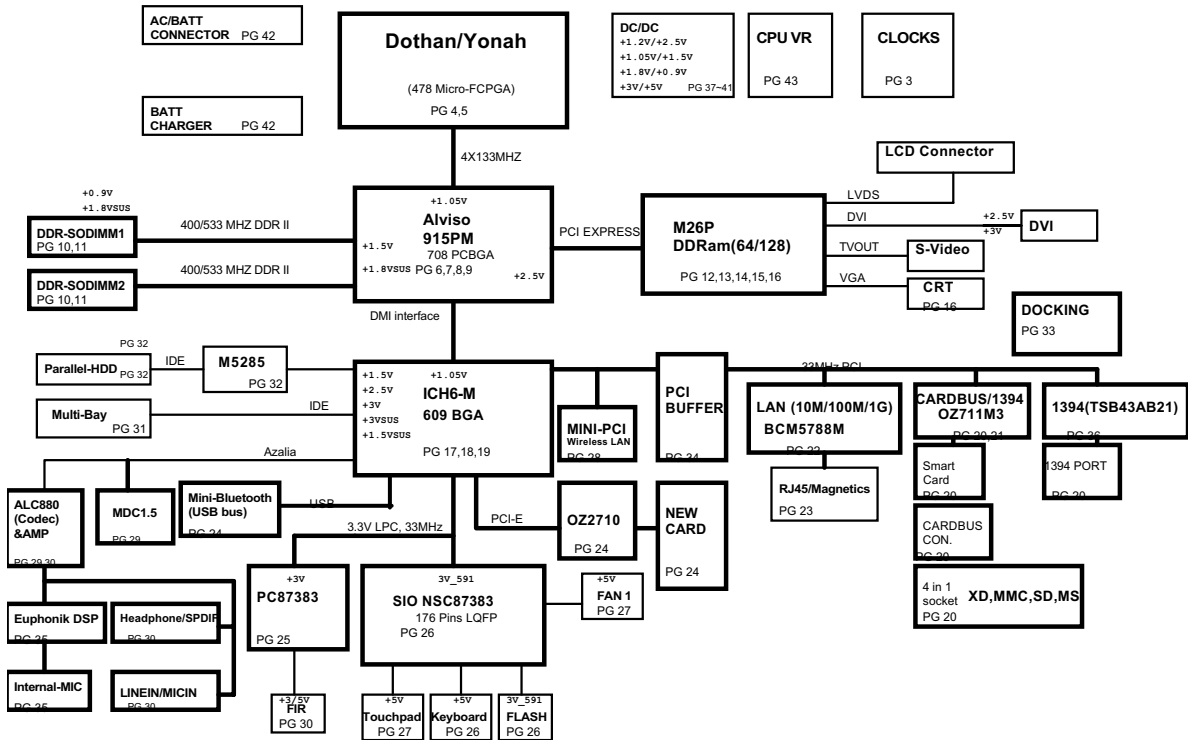

Board Layout

Top View

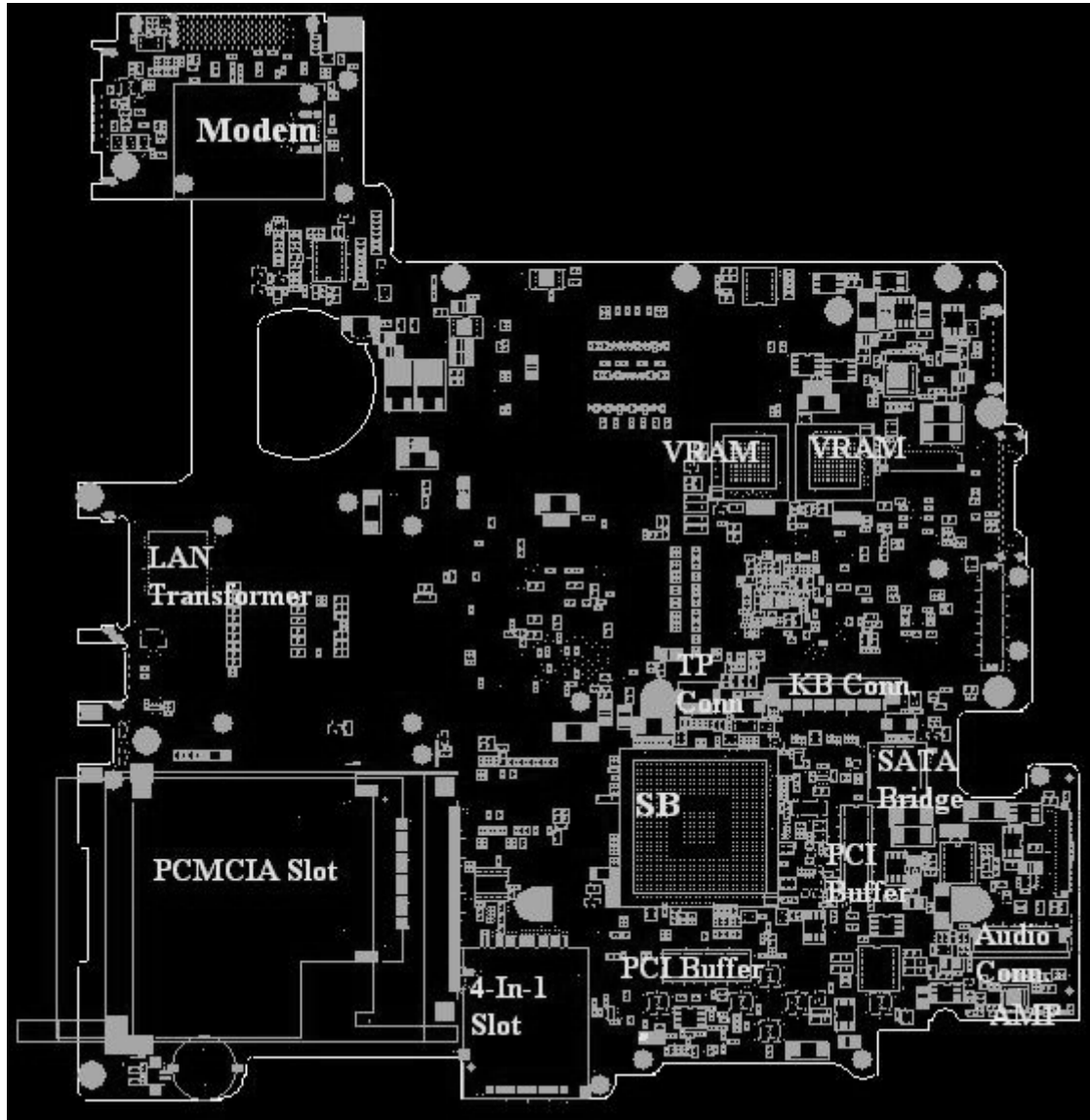

Bottom View

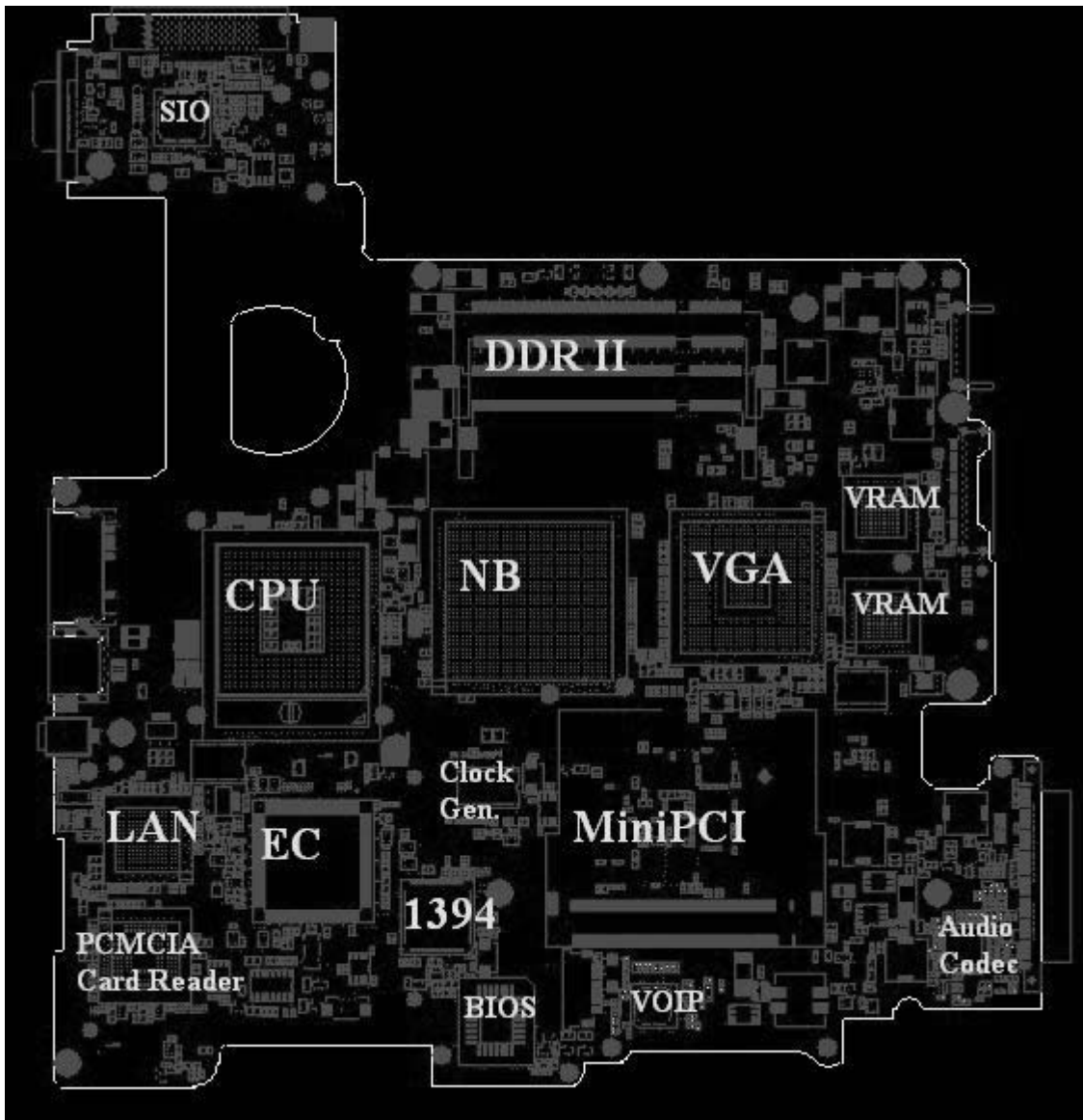

Outlook View

A general introduction of ports allow you to connect peripheral devices, as you would with a desktop PC.

Front Open View



#	Icon	Item	Description
1		Display screen	Also called LCD (liquid-crystal display), displays computer output.
2		Power button	Turns the computer on and off
3		Status indicators	Light-Emitting Diodes (LEDs) that turn on and off to show the status of the computer's functions and components.
4		Keyboard	Inputs data into your computer.
5		Palmrest	Comfortable support area for your hands when you use the computer.
6		Click buttons (left, center and right)	The left and right buttons function like the left and right mouse buttons; the center button serves as a 4-way scroll button.
7		Launch keys	Special keys for launching E-mail, Internet browser, eManager and frequently used programs.
8		Touchpad	Touch-sensitive pointing device which functions like a computer mouse. Turns on the computer power.

Front Closed View

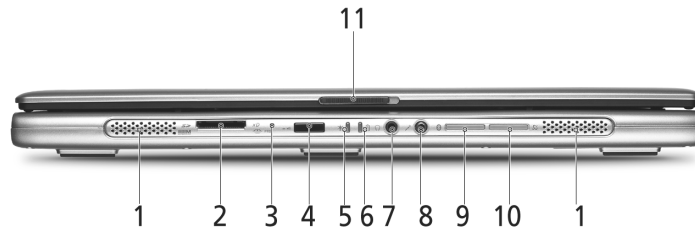





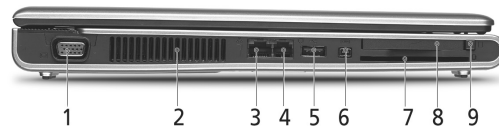

#	Icon	Item	Description
1	N/A	Speakers	Left and right speakers deliver stereo audio output.
2		5-in-1 card reader	Only accepts MS, MMC, MS PRO, xD and SD cards. Note: Only one card can operate at any given time.
3		Microphone	Internal microphone for sound recording.
4		Infrared port	Interfaces with infrared devices(e.g. infrared printer and IR-aware computer)
5		Power indicator	Lights when the computer is on.
6		Battery indicator	Lights when the battery is being charged
7		Speaker/Line-Out/ Headphone jack S/PDIF out *	Connects to audio line-out devices(e.g. speakers, headphones)
8		Line-in/Mic-in jack	Accepts audio line-in devices(e.g. audio CD player, stereo walkman)
9		Bluetooth communications	Indicates that (optional) Bluetooth is enabled.
10		Wireless communication	Indicates status of wireless LAN communication.
11	N/A	Latch	Locks and releases the lid.

NOTE: The Bluetooth and Wireless buttons and indicators only work on models with Bluetooth and Wireless features, respectively.

* Please reference to <http://www.techweb.com/encyclopedia/defineterm.jhtml?term=S%2FPDIF> for more information of S/PDIF.



Left View



#	Icon	Item	Description
1	N/A	External display port	Connects to a display device(e.g. external monitor, LCD projector)
2	N/A	Ventilation Slots	Enable the TravelMate to stay cool.
3		Network LAN Jack	Connects to an Ethernet 10/100/1000 based network.
4		RJ-11 Modem jack	Connects to a phone line.
5		USB port	Connect to Universal Serial Bus (USB) 2.0 devices (e.g., USB mouse, USB camera).
6		IEEE 1394 port	Connects to IEEE 1394 devices.
7	N/A	Smart Card Slot	Accepts Smart Cards for added security.
8		PC Card slot	Connects to one Type II CardBus PC Card.
9	N/A	PC Card slot eject button	Ejects the PC Card from the slot.



Right Panel



#	Icon	Item	Description
1		USB 2.0 port	Connects to Universal Serial Bus (USB) 2.0 devices (e.g., USB mouse, USB camera).
2	N/A	Optical drive	Internal optical drive; accepts CDs or DVDs depending on the optical drive type.
3	N/A	LED indicator	Lights up when the optical drive is active.
4	N/A	Optical drive eject button	Ejects the optical drive tray from the drive.
5	N/A	Emergency Eject hole	Ejects the optical drive tray when the computer is turned off.
6		Power jack	Connects to an AC adapter.
7		Security keylock	Connects to a Kensington-compatible computer security lock.

Rear Panel



#	Icon	Item	Description
1	N/A	DVI-D port	Supports digital video connections
2		S-video port	Connects to a television or display device with S-video input.
3		124-pin port replicator connector	Connects to I/O port replicator or EasyPort expansion devices.

Bottom Panel

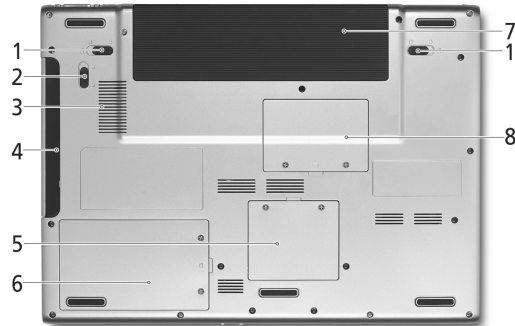

#	Icon	Item	Description
1	N/A	Battery lock latches	Lock the battery in place.
2	N/A	AcerMedia bay release latch	Unlatches the AcerMEDIA drive for removal of drive(optional)
3	N/A	cooling fan	Helps keep th ecomputer cool. Note: Do not cover or obstruct the opening of the fan.
4	N/A	AcerMedia bay	Houses an AcerMedia drive module.
5	N/A	Wireless LAN bay	Houses the computer's wireless LAN.
6	N/A	Hard disk bay	Houses the computer's hard disk
7	N/A	Battery bay	Houses the computer's battery pack.
8	N/A	Memory compartment	Houses the computer's main memory.

Indicators

The computer has three easy-to-read status icons on the upper-left above the keyboard, and four located on the front of the computer.



Icon	Function	Description
	Caps lock	Lights when Caps Lock is activated.
	Num lock	Lights when Num Lock is activated.
	Media Activity	Lights when the disc or AcerMedia is activated.
	Power indicator	Lights when the computer is on.
	Battery indicator	Lights when the battery is being charged
	Bluetooth communications	Indicates that (optional) Bluetooth is enabled.
	Wireless communication	Indicates status of wireless LAN communication.

Launch Keys

Located at the upper-right above the keyboard are four buttons. These buttons are called launch keys. They are designated as the mail, Web browser, Empowering and programmable keys.



Press the Acer Empowering Key to run the Acer EManager. The mail and Web browser are default for Email and Internet programs, but can be reset by users. To set the mail, Web browser and programmable keys, run the acer Launch Manager.



Launch Key	Default application
Email	Email application (user programmable)
Web browser	Internet browser application (user programmable)
e	Acer EManager application (user-programmable)
P	User-programmable

In addition, there are two launch keys at the front panel. Even when the cover is closed, you can easily access the features of Wireless and Bluetooth. However, the Wireless and Bluetooth keys cannot be set by users.



Description	Default application
Bluetooth communications 	Lights to indicate the status of Bluetooth (optional) communications.
Wireless communication 	Lights to indicate the status of wireless LAN (optional) communications.

Using the Keyboard

The keyboard has full-sized keys and an embedded keypad, separate cursor keys, two Windows keys and twelve function keys.

Lock Keys

The keyboard has three lock keys which you can toggle on and off.



Lock Key	Description
Caps Lock	When Caps Lock is on, all alphabetic characters typed are in uppercase.
Num lock (Fn-F11)	When Num Lock is on, the embedded keypad is in numeric mode. The keys function as a calculator (complete with the arithmetic operators +, -, *, and /). Use this mode when you need to do a lot of numeric data entry. A better solution would be to connect an external keypad.
Scroll lock (Fn-F12)	When Scroll Lock is on, the screen moves one line up or down when you press \uparrow and \downarrow respectively. Scroll Lock does not work with some applications.

Embedded Numeric Keypad

The embedded numeric keypad functions like a desktop numeric keypad. It is indicated by small characters located on the upper right corner of the keycaps. To simplify the keyboard legend, cursor-control key symbols are not printed on the keys.





Desired Access	Num Lock On	Num Lock Off
Number keys on embedded keypad	Type numbers in a normal manner.	
Cursor-control keys on embedded keypad	Hold j while using cursor-control keys.	Hold Fn while using cursor-control keys.
Main keyboard keys	Hold Fn while typing letters on embedded keypad.	Type the letters in a normal manner.

Windows Keys

The keyboard has two keys that perform Windows-specific functions.









Key	Icon	Description
Windows logo key		Pressed alone, this key has the same effect as clicking on the Windows Start button; it launches the Start menu. It can also be used with other keys to provide a variety of function: + Tab (Activates next taskbar button) + E (Explores My Computer) + F (Finds Document) + M (Minimizes All) j + Windows logo key + M (Undoes Minimize All) + R (Displays the Run... dialog box)
Application key		This key has the same effect as clicking the right mouse button; it opens the application's context menu.



Hot Keys

The computer employs hot keys or key combinations to access most of the computer's controls like screen brightness, volume output and the BIOS utility.

To activate hot keys, press and hold the **Fn** key before pressing the other key in the hot key combination.



Hot Key	Icon	Function	Description
Fn-F1	?	Hot key help	Displays help on hot keys.
Fn-F2		Acer eSetting	Launches the Acer eSetting in the Acer eManager set by the Acer Empowering key.
Fn-F3		Acer ePowerManagement	Launches the Acer ePowerManagement in the Acer eManager set by the Acer Empowering key.
Fn-F4	Z ^z	Sleep	Puts the computer in Sleep mode.
Fn-F5		Display toggle	Switches display output between the display screen, external monitor (if connected) and both the display screen and external monitor.
Fn-F6		Screen blank	Turns the display screen backlight off to save power. Press any key to return.
Fn-F7		Touchpad toggle	Turns the internal touchpad on and off.
Fn-F8		Speaker toggle	Turns the speakers on and off.
Fn-vv		Volume up	Increases the speaker volume.

Hot Key	Icon	Function	Description
Fn-y		Volume down	Decreases the speaker volume.
Fn-x		Brightness up	Increases the screen brightness.
Fn-z		Brightness down	Decreases the screen brightness

The Euro Symbol

If your keyboard layout is set to United States-International or United Kingdom or if you have a keyboard with a European layout, you can type the Euro symbol on your keyboard.



NOTE: For US keyboard users: The keyboard layout is set when you first set up Windows. For the Euro symbol to work, the keyboard layout has to be set to United States-International.

To verify the keyboard type in Windows XP, follow the steps below:

1. Click on **Start, Control Panel**.
2. Double-click on **Regional and Language Options**.
3. Click on the **Language** tab and click on **Details**.
4. Verify that the keyboard layout used for "En English (United States)" is set to United States-International. If not, select and click on **ADD**; then select **United States-International** and click on **OK**.
5. Click on **OK**.

To type the Euro symbol:

1. Locate the Euro symbol on your keyboard.
2. Open a text editor or word processor.
3. Hold **Alt Gr** and press the Euro symbol.

NOTE: Some fonts and software do not support the Euro symbol. Please refer to www.microsoft.com/typography/faq/faq12.htm for more information.

Touchpad

The built-in touchpad is a pointing device that senses movement on its surface. This means the cursor responds as you move your finger on the surface of the touchpad. The central location on the palmrest provides optimal comfort and support.



NOTE: If you are using an external USB mouse, you can press **Fn-F7** to disable the touchpad.

Touchpad Basics

The following teaches you how to use the touchpad:



- Move your finger across the touchpad to move the cursor.
- Press the left (1) and right (3) buttons located on the edge of the touchpad to do selection and execution functions. These two buttons are similar to the left and right buttons on a mouse. Tapping on the touchpad produces similar results.
- Use the 4-way scroll (2) button (top/bottom/left/and right) to scroll.

Function	Left Button(1)	Right Button(4)	Scroll Button(3)	Main Touchpad(2)
Execute	Click twice quickly			Tap twice (at the same speed as double-clicking the mouse button)
Select	Click once			Tap once
Drag	Click and hold, then use finger to drag the cursor on the touchpad			Tap twice (at the same speed as double-clicking a mouse button) then hold finger to the touchpad on the second tap to drag the cursor
Access context menu		Click once		

Function	Left Button(1)	Right Button(4)	Scroll Button(3)	Main Touchpad(2)
Scroll			Click and hold the button in the desired direction (up/down/left/right)	

NOTE: Keep your fingers dry and clean when using the touchpad. Also keep the touchpad dry and clean. The touchpad is sensitive to finger movements. Hence, the lighter the touch, the better the response. Tapping too hard will not increase the touchpad's responsiveness.

Hardware Specifications and Configurations

Processor

Item	Specification
CPU type	Intel Pentium M processor at 1.6~2.13GHz (Dothan)
Core logic	Intel 915PM
CPU package	LGA775
CPU core voltage	0.8~1.5V

BIOS

Item	Specification
BIOS vendor	PhneoiX
BIOS Version	S3C11
BIOS ROM type	Flash ROM
BIOS ROM size	512KB
BIOS package	32-pin PLCC
Supported protocols	ACPI 1.0b/2.0, PCI 2.2, PnP BIOS 1.0a SMBIOS 2.3.1 WFM2.0, Intel AC97 CNR Specification, IrDA1.0, USB Specification 1.1/2.0PCMCIA 3.0 compliant, PC 99a and Mobile PC2001 compliant, Simple Boot Flag 1.0
BIOS password control	Set by setup manual

Second Level Cache

Item	Specification
Cache controller	Built-in CPU
Cache size	Advanced Transfer Cache 2048KB
1st level cache control	Always enabled
2st level cache control	Always enabled
Cache scheme control	Fixed in write-back

System Memory

Item	Specification
Memory controller	Intel 915PM
Memory size	0MB (no on-board memory)
DIMM socket number	2 sockets
Supports memory size per socket	512MB
Supports maximum memory size	1G (by two 512MB SO-DIMM module)
Supports DIMM type	DDRII SODIMM
Supports DIMM Speed	533 MHz
Supports DIMM voltage	+1.8VSUS
Supports DIMM package	200 pin
Memory module combinations	You can install memory modules in any combinations as long as they match the above specifications.

Slot 1	Slot 2	Total Memory
0MB	128MB	128MB
0MB	256MB	256MB
0MB	512MB	512MB
0MB	1024MB	1024MB
128MB	128MB	256MB
128MB	256MB	384MB
128MB	512MB	640MB
128MB	1024MB	1152MB
256MB	128MB	384MB
256MB	256MB	512MB
256MB	512MB	768MB
256MB	1024MB	1280MB
512MB	128MB	640MB
512MB	256MB	768MB
512MB	512MB	1024MB
512MB	1024MB	1536MB
1024MB	0MB	1024MB
1024MB	128MB	1125MB
1024MB	256MB	1280MB
1024MB	512MB	1536MB
1024MB	1024MB	2048MB

NOTE: Above table lists some system memory configurations. You may combine DIMMs with various capacities to form other combinations. On above table, the configuration of slot 1 and slot 2 could be reversed. Please note that the 1GB is still under testing.

LAN Interface

Item	Specification
Chipset	BroadCom BCM5788M
Supports LAN protocol	10/100/1000Mbps
LAN connector type	RJ45
LAN connector location	left panel
Features	Integrated 10/100/1000 BASE-T transceiver Wake on LAN support compliant with ACPI 2.0 PCI v2.2

IR Interface

Item	Specification
Part name	VISHAY TFU6102F
Package	8-pin SMT type
Performance	Up to 4Mbit/s transfer rate
Compliant	IrDA standard

Modem Interface

Item	Specification
Data modem data baud rate (bps)	56K
Supports modem protocol	V.90/V.92/WWDAA

Modem Interface

Item	Specification
Modem connector type	RJ11
Modem connector location	Left panel

Mini-Bluetooth

Item	Specification
Controller	ICH6-M
Interface	USB bus

MiniPCI

Item	Specification
Controller	ICH6-M
Data throughput	11M/54M bps
Protocol	802.11 a/b/g, 802.11b/g
Interface	Mini-PCI type 3A

Hard Disk Drive Interface

Item				
Vendor & Model Name	HGST Moraga HTS541060G9AT00/ HTS541080G9AT00	TOSHIBA Proteus 80G MK8026GAS	FUJITSU Mercury MHT2060BH A1/ MHT2080BH A1	Seagate N2 ST9808210A ST960821A
Capacity (GB)	80/100	80	60/80	80/60
Bytes per sector	512	512	512	512
Logical heads	16	16	16	16
Logical sectors	63	63	63	63
Drive Format				
Logical cylinders	16383	16383	16383	16383
Physical read/write heads	3/4	4	3/4	3/3
Disks	2/2	2	2	2
Spindle speed (RPM)	5400RPM	5400RPM	4200RPM	4200RPM
Performance Specifications				
Buffer size	8MB	16MB	8MB 16MB(option)	8MB
Interface	ATA/ATAPI-6	ATA/ATAPI-6	PATA	PATA
Data transfer rate (buffer to/from media, Mbytes/s)	Max. 61	Max. 56	Max. 46.6/54.8	Max. 48.25
Data transfer rate (host-buffer, Mbytes/s)	Ultra DMA mode: 100 MB/Sec	Ultra DMA mode:100 MB/Sec PIO mode: 16.6 MB/Sec	Max. 150MB/Sec	Max. 100MB/Sec
DC Power Requirements				

Hard Disk Drive Interface

Item				
Voltage tolerance	5V +/- 5%	5V +/- 5%	5V +/- 5%	5V +/- 5%

Combo Drive Interface

Item	Specification	
Vendor & model name	UJDA-760QT1-A	HLDS GCC-4243N
Performance Specification		
Transfer rate (KB/sec)		
(1) Read DVD-ROM	MAX 8X CAV (MAX 10800 KB/s)	MAX 8X CAV (MAX 10800 KB/s)
DVD-R	MAX 4X CVA(MAX 5400 KB/s)	MAX 4X CVA(MAX 5400 KB/s)
CD-ROM	MAX 24X CAV (MAX 3600 KB/s)	MAX 24X CAV (MAX 3600 KB/s)
(2) Write CD-R	4X,8X(CLV), 16XZCLV, MAX. 24X CAV	4XCLV, 10XCLV, 10-16XPCAV, 24XMAX.CAV
CD-RW	4X (CLV)	4XCLV,
HS-RW	4X,8X,10X CLV(at 640-700MB disc))	4XCLV,10XCLV,
US-RW	10XCLV, MAX. 24X CAV	10XCLV, 10-16XPCAV, 24XMAX. CAV
(3) ATAPI Interface		
PIO mode	16.6MB/s: PIO mode4	16.6MB/s: PIO mode4
DMA mode	16.6MB/s: Multi word mode2	16.6MB/s: Multi word mode2
Ultra DMA mode	33.3MB/s: Ultra DMA mode2	33.3MB/s: Ultra DMA mode2
Buffer Memory	2MB	2MB
Interface	Enhanced IDE(ATAPI) compatible	Enhanced IDE(ATAPI) compatible
Applicable disc format	DVD: DVD-ROM, DVD-Video, DVD-RAM, (2/6GB/4.7GB), DVD-R, DVD-RW (ver1.1) (supporting Multi Border) CD: CD-DA, CD-ROM, CD-R/W CD-ROM XA(except ADPCM), PhotoCD (Multi Session), Video CD, CD-Extra (CD+), CD-text	DVD: DVD-ROM, DVD-RAM(2.6GB/4.7GB), DVD-R, DVD-RW (4.7GB) (supporting Multi Border) CD: CD-Audio, CD-ROM, CD-R/RW CD-ROM XA, CD-ROM Mode-1, PhotoCD (Single and Multi Session), Video CD, CD-Extra (CD+), Mixed Mode CD-ROM, CD-Text, CD-I
Loading mechanism	Load: Manual Release: (a) Electrical Release (Release Button) (b) Release by ATAPI command (c) Emergency Release	Load: Manual Release: (a) Electrical Release
Power Consumption		
Input Voltage	5 V +/- 5 % (Operating)	5 V +/- 5 % (Operating)

Super Multi Interface

Item	Specification	
Vendor & model name	KME UJ-831BQB	Super HLDS, GMA-4080N, 0H35
Performance Specification		

Super Multi Interface

Item	Specification	
Transfer rate (KB/sec)		
(1) Read DVD-ROM	8X CAV(MAX 10800 kB/s)	8X CAV(MAX 10800 kB/s)
CD-ROM	24X CAV(MAX 3600 kB/s)	24X CAV(MAX 3600 kB/s)
DVD-Video		4X (MAX 5540 kB/s)
DVD-R		8X (MAX 11080 kB/s)
DVD-RW		6X (MAX 8320 kB/s)
DVD-RAM		4160 kB/s(Ver 1.0/2.1)
DVD+R		8X (MAC 11080 kB/s)
DVD+R DL		4X (MAC 5540 kB/s)
DVD+RW		6X (MAC 8310 kB/s)
CD-R/RW/ROM		24X (MAC 3600 kB/s)
CD-DA(DAE)		20X (MAC 3000 kB/s)
CD-DA(Audio out)/CD-I/ Video CD		10X (MAC 1500 kB/s)
(2) Write CD-R	4X, 8X(CLV), MAC 12X, 16X, 24X(ZCLV)	
CD-RW	4X(CLV)	
HS-RW	4X,8X,10X(CLV)	
US-RW	8X,10X(CLV)	
DVD-R	1X,2X(CLV), MAX.4X,6X,8X(ZCLV)	2XCLV, 4X, 8XZCLV
DVD-RW	1X,2X(CLV),MAX.4X(ZCLV)	1X,2XCLV, 4XZCLV
DVD+R	2.4X(CLV),MAX.4X,6X,8X(ZCLV)	2XCLV, 4X, 8XZCLV
DVD+R DL	2.4X(CLV)	2.4XCLV
DVD+RW	2.4X(CLV),MAX.4X(ZCLV)	2.4XCLV, 4XZCLV
DVD-RAM	2X,3X(ZCLV)	3XZCLV
(3) ATAPI Interface		
PIO mode	16.6MB/s: PIO mode4	16.6MB/s: PIO mode4
DMA mode	16.6MB/s: Multi word mode2	16.6MB/s: Multi word mode2
Ultra DMA mode	33.3MB/s: Ultra DMA mode2	33.3MB/s: Ultra DMA mode2
Buffer Memory	2MB	2MB
Interface	ATAPI	ATAPI
Applicable disc format	CD: CD-DA,CD-ROM,CD-R,CD- RW,CD-ROMXA,photoCD, Video CD, CD-EXTRA(CD+), CD-Text DVD: DVD-VIDEO, DVD-ROM, DVD- R(3.9GB,4.7GB), DVD- RW(Ver1.1), DVD-RAM, DVD+R,DVD+R DL, DVD+RW	CD: CD-DA,CD-ROM,CD-R,CD- RW,CD-ROMXA,photoCD, Video CD, CD-EXTRA(CD+), CD-Text DVD: DVD-VIDEO, DVD-ROM, DVD- R(3.9GB,4.7GB), DVD- RW(Ver1.1), DVD-RAM, DVD+R,DVD+R DL, DVD+RW
Loading mechanism	Tray	Tray
Power Consumption	Max. 1800 mA	Max. 1.9A
Operating Voltage	+5V+/-0.25V	+5V+/-5%

Audio Interface

Item	Specification
Audio Controller	Realtek ALC880
Audio onboard or optional	Built-in
Mono or Stereo	Stereo
Resolution	16/20/24-bit S/PDIF-OUT supoprts 44.1/48/96 kHz sample rate 16/20/24-bit S/PDIF-IN supoprts 44.1/48/96 kHz sample rate

Audio Interface

Item	Specification
Compatibility	Microsoft PC99/2001, AC97 2.3 & WHQL/WLP2.0
Power support	Digital: 3.3V Analog: 3.3V/5.0V
Sampling rate	Up to 96 KHz
Sound Quality	Max. 100dB
Internal speaker / Quantity	Yes / 2

Video Interface

Item	Specification
Chipset	ATI M26 with 128MB VRAM
package	708PCBGA
interface	PCIE x16
Compatibility	DirectX®9

USB Port

Item	Specification
Chipset	ICH6-M
USB Compliancy Level	2.0
OHCI	USB 2.0
Number of USB port	4
Location	Three on the right side; one on the left side
Serial port function control	Enable/Disable by BIOS Setup

IEEE 1394 Port

Item	Specification
Chipset	TI TSB43AB21
Number of IEEE 1394 port	1
Location	Left side
Interface	33MHz PCI
Compatibility	ACPI2.0, PCI Local Bus Specification V2.2, PC 98/99 and PC 2001

PCMCIA Port

Item	Specification
PCMCIA controller	OZ711M3
Supports card type	PC Card 95 with 1x Type II / PCI CardBus
Number of slots	One type-II
Access location	left Side
Data Throughput	Max. 132 MB/s
IRQ Support	Supports serialized IRQ with PCI interrupts

System Board Major Chips

Item	Controller
System core logic	Intel 915PM Express Chipset
Super I/O controller	NSC87383, 3.3V LPC interface
Audio controller	Realtek ALC880 Codec
Video controller	ATI M26P
Hard disk drive controller	ICH6-M
Keyboard controller	NS PC87591
USB 2.0	ICH6-M
MODEM	V.92, Ambit MDC 1.5
Wireless 802.11a+b/a+b+g	ICH6-M
PCMCIA	OZ711M3
5-in-1 card reader	OZ711M3

Keyboard

Item	Specification
Keyboard controller	SIO NSC97551
Keyboard vendor & model name	Standard keyboard
Total number of keypads	84 keys(US),85 keys(EU), 88keys(JP)
Windows logo key and Application key	Yes
Multi-Language	Yes

Battery

Item	Specification
Vendor & model name	Sanyo
Battery Type	Li-ion
Typical capacity	2400mAh
Cell voltage	3.7V
Number of battery cell	8
Package configuration	
Pin 1	GND
Pin 2	SDA
Pin 3	SCL
Pin 4	TH
Pin 5	BAT+

LCD

Item	Specification	
Vendor & model name	SAMSUNG LTN154P1-L02	HITACHI TX39D99VC1FAA
Screen Diagonal (mm)	15.4 inch	

LCD

Item	Specification	
Active Area (mm)	331.38(H)x207.1125(V)	331.38(H)207.11(V)
Display resolution (pixels)	Wide SXGA(1680x1050)	Wide SXGA(1680x1050)
Pixel Pitch	0.19725(H)x0.19725(v)	0.19725(H)x0.19725(v)
Pixel Arrangement	RGB vertical stripe	RGB vertical stripe
Display Mode	Normally white	Transmissive&Normally White
Typical White Luminance (cd/m ²) also called Brightness	185(Typical)	185(Typical)
Contrast Ratio	300 (Typical)	200(Typical)
Response Time (Optical Rise Time+Fall Time)msec	25(Typical) 35(Max)	50(Typical)
Voltage of Power Supply	+3.3V(Typical)	+3.3V(Typical)
Power Consumption (watt)	5.5(Max)	Not show
Weight	610 g	640 g
Physical Size(mm)	344(W)x222(H)x6.5(D) (Max)	344(W)x222(H)x6.5(D) (Max)
Electrical Interface	R/G/B Data, 3Sync, Signals, Clock (4 pairs LVDS)	2 channel LVDS
Support Color	Native 262K colours	262K colours
Viewing Angle (degree) Horizontal: Right/Left Vertical: Upper/Lower	65/65 50/50	Lower side of 6 o'clock (Azimuth $\phi = 270^\circ$)
Temperature Range(° C) Operating Storage (shipping)	0 to 50 -25 to 65	10 to 40 -20 to -60

LCD Inverter

Item	Specification
Vendor & model name	SUMIDA TWS-449-171
Brightness conditions	Duty 30~100%
Input voltage (V)	9~21V
Input current (mA)	330mA typ
Output voltage (V, rms)	650Vrms typ
Output current (mA, rms)	3.0~6.0mA
Output voltage frequency (k Hz)	45~65KHz

AC Adaptor

Item	Specification
Vendor & model name	Lite-On PA-1650-02Q2
Input Voltage	Normal: 100 to 127 (VAC)
input power rating	<= 80 (watts)
Frequency	50/60 Hz
Maximum input AC current	1.6A Max@90V/47Hz

AC Adaptor

Item	Specification
Inrush current	220A@240VAC/50Hz(hot start) 220A@100VAC/60Hz(cold start)
Efficiency	85% (Min), 88%(Typical) with the AC input set at the normal voltage.

System Power Management

ACPI mode	Power Management
Mech. Off (G3)	All devices in the system are turned off completely.
Soft Off (G2/S5)	OS initiated shutdown. All devices in the system are turned off completely.
Working (G0/S0)	Individual devices such as the CPU and hard disc may be power managed in this state.
Suspend to RAM (S3)(Sleeping State)	CPU set Power Down VGA Suspend PCMCIA Suspend Audio Power Down Hard Disk Power Down CD-ROM Power Down Super I/O Low Power mode
Save to Disk (S4)(Sleeping State)	Also called Hibernate state. System saves all system states and data onto the disc prior to power off the whole system.

System Utilities

BIOS Setup Utility

The BIOS Setup Utility is a hardware configuration program built into your computer's BIOS (Basic Input/Output System).

Your computer is already properly configured and optimized, and you do not need to run this utility. However, if you encounter configuration problems, you may need to run Setup. Please also refer to Chapter 4 Troubleshooting when problem arises.

To activate the BIOS Utility, press **m** during POST (when "Press <F2> to enter Setup" message is prompted on the bottom of screen).

Press **m** to enter setup. Press <F12> during POST to enter multi-boot menu. In this menu, user can change boot device without entering BIOS SETUP Utility.

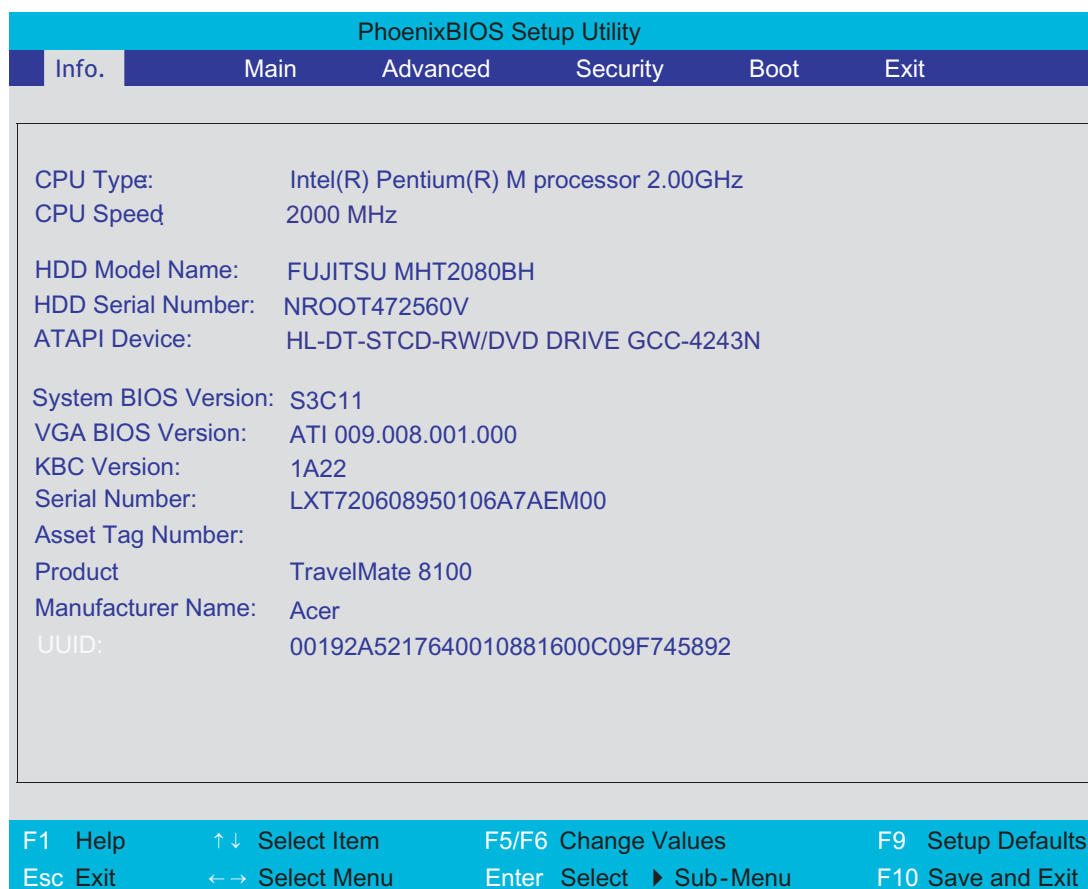

Navigating the BIOS Utility

There are six menu options: Info., Main, System Devices, Security, Boot, and Exit.

Follow these instructions:

- ❑ To choose a menu, use the cursor left/right keys (\left \right).
- ❑ To choose a parameter, use the cursor up/down keys (\uparrow \downarrow).
- ❑ To change the value of a parameter, press ρ or σ .
- ❑ A plus sign (+) indicates the item has sub-items. Press \ominus to expand this item.
- ❑ Press \wedge while you are in any of the menu options to go to the Exit menu.
- ❑ In any menu, you can load default settings by pressing τ . You can also press \cup to save any changes made and exit the BIOS Setup Utility.

NOTE: You can change the value of a parameter if it is enclosed in square brackets. Navigation keys for a particular menu are shown on the bottom of the screen. Help for parameters are found in the Item Specific Help part of the screen. Read this carefully when making changes to parameter values.

This menu provides you the information of the system.

Information

PhoenixBIOS Setup Utility

Info.	Main	Advanced	Security	Boot	Exit
<p>CPU Type: Intel(R) Pentium(R) M processor 2.00GHz CPU Speed: 2000 MHz</p> <p>HDD Model Name: FUJITSU MHT2080BH HDD Serial Number: NROOT472560V ATAPI Device: HL-DT-STCD-RW/DVD DRIVE GCC-4243N</p> <p>System BIOS Version: S3C11 VGA BIOS Version: ATI 009.008.001.000 KBC Version: 1A22 Serial Number: LXT720608950106A7AEM00 Asset Tag Number: Product: TravelMate 8100 Manufacturer Name: Acer UUID: 00192A5217640010881600C09F745892</p>					
F1 Help	↑↓ Select Item	F5/F6 Change Values	F9 Setup Defaults		
Esc Exit	←→ Select Menu	Enter Select	▶ Sub-Menu	F10 Save and Exit	

Parameter	Description
HDD Model Name	This field displays the model name of HDD installed on Primary IDE master. The system can automatically detect the hard disc model name. If there is no hard disc drive or unknown type, this field would display "None".
HDD Serial Number	This field shows the serial number of HDD installed on Primary IDE master. If no hard disc drive or other devices are installed, this field would display a blank line.
Serial Number	This field shows the serial number of HDD installed on Secondary IDE master. If no hard disc drive or other devices are installed, this field would display a blank line.
UUID	This will be visible only when there is an internal LAN device present.

Main

The Main screen displays a summary of your computer hardware information, and also includes basic setup parameters. It allows the user to specify standard IBM PC AT system parameters.

PhoenixBIOS Setup Utility		
Info.	Main	Advanced Security Boot Exit
System Time: [11:59:38] System Date: [08/05/2004] System Memory: 640 KB Extended Memory: 766 KB Video Memory 128 KB Quiet Boot: [Enabled] Power on Display: [Auto] Network boot [Enabled] F12 Boot Menu: [Disabled] D2D Recovery: [Enabled]		Item Specific Help <Tab>, <Shift-Tab>, or <Enter> selects field.
F1 Help ↑↓ Select Item F5/F6 Change Values F9 Setup Defaults Esc Exit ←→ Select Menu Enter Select ▶ Sub-Menu F10 Save and Exit		

NOTE: The screen above is for reference only. Actual values may differ.

The table below describes the parameters in this screen. Settings in **boldface** are the default and suggested parameter settings.

Parameter	Description	Format/Option
System Time	Sets the system time.	Format: HH:MM:SS (hour:minute:second) System Time
System Date	Sets the system date.	Format MM/DD/YYYY (month/day/ year) System Date
System Memory	This field reports the memory size of the system. Memory size is fixed to 640KB	
Extended Memory	This field reports the memory size of the extended memory in the system. Extended Memory size=Total memory size-2MB	
Video Memory	Shows the VGA memory size. The default value is set to 64MB	

Parameter	Description	Format/Option
Quiet Boot	Determines if Customer Logo will be displayed or not; shows Summary Screen is disabled or enabled. Enabled: Customer Logo is displayed, and Summary Screen is disabled. Disabled: Customer Logo is not displayed, and Summary Screen is enabled.	Option: Enabled or Disabled
Power on display	Auto: During power process, the system will detect if any display device is connected on external video port. If any external display device is connected, the power on display will be in CRT (or projector) only mode. Otherwise it will be in LCD only mode. Both: Simultaneously enable both the integrated LCD screen and the system's external video port (for an external CRT or projector).	Option: Auto or Both
Network Boot	Allows user to enable/disable the Network boot function.	Option: Enabled or Disabled
F12 Boot Menu	Allow user to enable/disable the F12 boot meny function.	Option: Enabled or Disabled
D2D Recovery	Enables, disables D2D Recovery function. The function allows the user to create a hidden partition on hard disc drive to store operation system and restore the system to factory defaults.	Option: Enabled or Disabled

NOTE: The sub-items under each device will not be shown if the device control is set to disable or auto. This is because the user is not allowed to control the settings in these cases.

Advanced

The Advanced menu screen contains parameters involving your hardware devices. It also provides advanced settings of the system.

PhoenixBIOS Setup Utility					
Info.	Main	Advanced	Security	Boot	Exit
Serial port A:		[Auto]			Item Specific Help
Infrared Port:		[Auto]			Configure serial port A using options: [Disabled] No configuration [Enabled] User configuration [Auto] BIOS or OS chooses configuration (OS Controlled) Displayed when controlled by OS
Parallel port:		[Auto]			
Mode:		[ECP]			
F1 Help	↑↓ Select Item	F5/F6 Change Values	F9 Setup Defaults		
Esc Exit	←→ Select Menu	Enter Select	▶ Sub-Menu	F10 Save and Exit	

The table below describes the parameters in the screen. Settings in **boldface** are the default and suggested parameter settings.

Parameter	Description	Options
Serial port A	Configure serial port A using options	Auto /Enabled/Disabled
Infrared Port	Enables, disables or auto detects the Infrared port.	Auto /Enabled/Disabled
Parallel Port	Enables, disables or auto detects the parallel port.	Enabled /Disabled/Auto
Mode	Sets the operation mode of the parallel port.	ECP , EPP, Output only or Bi-directional

Security

The Security screen contains parameters that help safeguard and protect your computer from unauthorized use.

PhoenixBIOS Setup Utility					
Info.	Main	Advanced	Security	Boot	Exit
Supervisor Password Is:			Clear	Item Specific Help	
User Password Is:			Clear	Supervisor Password controls accesses of the setup utility.	
HDD Password Is:			Clear		
HDD Master ID:			49888545		
Set Supervisor Password			[Enter]		
Set User Passord			[Enter]		
Set HDD Password			[Enter]		
Password on Boot:			[Disabled]		
F1 Help	↑ ↓ Select Item	F5/F6 Change Values	F9 Setup Defaults		
Esc Exit	← → Select Menu	Enter Select ▶ Sub-Menu	F10 Save and Exit		

The table below describes the parameters in this screen. Settings in **boldface** are the default and suggested parameter settings.

Parameter	Description	Option
Supervisor Password is	Shows the setting of the supervisor password.	Clear or Set
User Password is	Shows the setting of the user password.	Clear or Set
Set Supervisor Password	Press Enter to set the supervisor password. When set, this password protects the BIOS Setup Utility from unauthorized access. The user can not either enter the Setup menu nor change the value of parameters.	
Set User Password	Press Enter to set the user password. When user password is set, this password protects the BIOS Setup Utility from unauthorized access. The user can enter Setup menu only and does not have right to change the value of parameters.	
HDD Password	This feature is available to user when Supervisor password is set. Password can be written on HDD only when Supervisor password or user password is set and password on HDD is set to enabled. Supervisor Password is written to HDD only when Supervisor password is being set. User password is written to HDD when both passwords are set. When both Supervisor and user password are present, both passwords can unlock the HDD.	
Password on Boot	Defines whether a password is required or not while the events defined in this group happened. The following sub-options are all requires the Supervisor password for changes and should be grayed out if the user password was used to enter setup.	Disabled or Enabled

NOTE: When you are prompted to enter a password, you have three tries before the system halts. Don't forget your password. If you forget your password, you may have to return your notebook computer to your dealer to reset it.

Setting a Password

Follow these steps as you set the user or the supervisor password:

1. Use the **w** and **y** keys to highlight the Set Supervisor Password parameter and press the **e** key. The Set Supervisor Password box appears:

Set Supervisor Password

Enter New Password []

Confirm New Password []

2. Type a password in the "Enter New Password" field. The password length can not exceeds 8 alphanumeric characters (A-Z, a-z, 0-9, not case sensitive). Retype the password in the "Confirm New Password" field.

IMPORTANT: Be very careful when typing your password because the characters do not appear on the screen.

3. Press **e** .

-
- After setting the password, the computer sets the User Password parameter to “Set”.
 - If desired, you can opt to enable the Password on boot parameter.
 - When you are done, press **u** to save the changes and exit the BIOS Setup Utility.

Removing a Password

Follow these steps:

- Use the **w** and **y** keys to highlight the Set Supervisor Password parameter and press the **e** key. The Set Password box appears:

Set Supervisor Password		
Enter current password	[]
Enter New Password	[]
Confirm New Password	[]

- Type the current password in the Enter Current Password field and press **e**.
- Press **e** twice **without** typing anything in the Enter New Password and Confirm New Password fields. The computer then sets the Supervisor Password parameter to “Clear”.
- When you have changed the settings, press **u** to save the changes and exit the BIOS Setup Utility.

Changing a Password

- Use the **w** and **y** keys to highlight the Set Supervisor Password parameter and press the **e** key. The Set Password box appears:

Set Supervisor Password		
Enter current password	[]
Enter New Password	[]
Confirm New Password	[]

- Type the current password in the Enter Current Password field and press **e**.
- Type a password in the Enter New Password field. Retype the password in the Confirm New Password field.
- Press **e**. After setting the password, the computer sets the User Password parameter to “Set”.
- If desired, you can enable the Password on boot parameter.
- When you are done, press **u** to save the changes and exit the BIOS Setup Utility.

If the verification is OK, the screen will display as following.

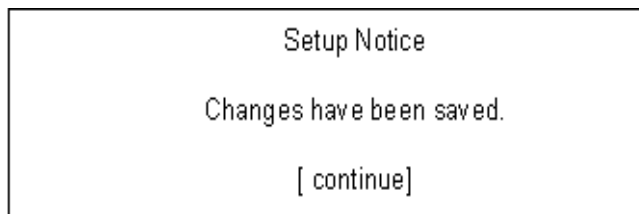

The password setting is complete after the user presses \cup .

If the current password entered does not match the actual current password, the screen will show you the Setup Warning.

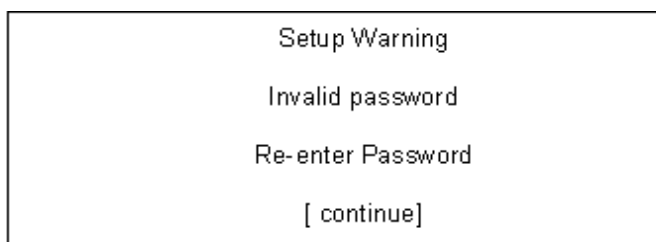

If the new password and confirm new password strings do not match, the screen will display the following message.

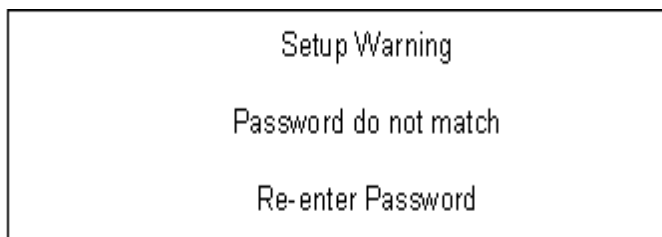

Boot

This menu allows the user to decide the order of boot devices to load the operating system. Bootable devices includes the distette drive in module bay, the onboard hard disk drive and the CD-ROM in module bay.

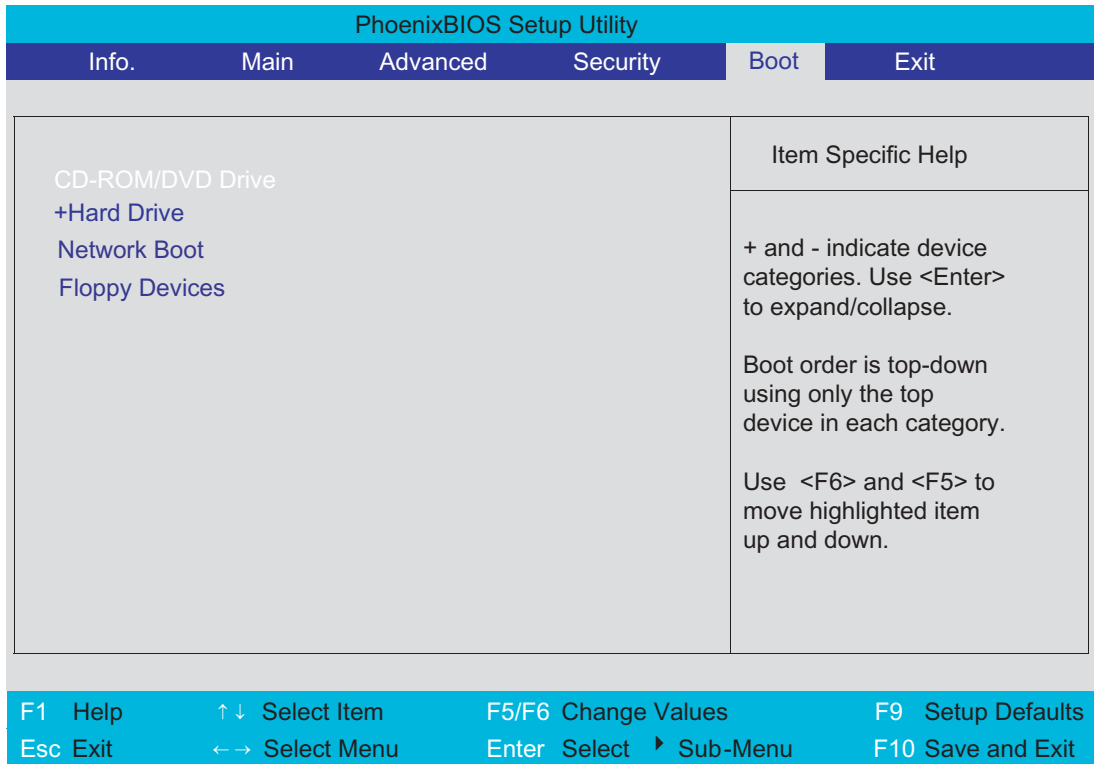

Exit

The Exit screen contains parameters that help safeguard and protect your computer from unauthorized use.

PhoenixBIOS Setup Utility						
Info.	Main	Advanced	Security	Boot	Exit	
<table border="1"> <tr> <td> Exit Saving Changes Exit Discarding Changes Load Setup Defaults Discard Changes Save Changes </td> <td> Item Specific Help Exit System Setup and save your changes to CMOS. </td> </tr> </table>					Exit Saving Changes Exit Discarding Changes Load Setup Defaults Discard Changes Save Changes	Item Specific Help Exit System Setup and save your changes to CMOS.
Exit Saving Changes Exit Discarding Changes Load Setup Defaults Discard Changes Save Changes	Item Specific Help Exit System Setup and save your changes to CMOS.					
F1 Help	↑↓ Select Item	F5/F6 Change Values	F9 Setup Defaults			
Esc Exit	←→ Select Menu	Enter Select	▶ Sub-Menu	F10 Save and Exit		

The table below describes the parameters in this screen.

Parameter	Description
Exit Saving Changes	Exit System Setup and save your changes to CMOS.
Exit Discarding Changes	Exit utility without saving setup data to CMOS.
Load Setup Default	Load default values for all SETUP item.
Discard Changes	Load previous values from CMOS for all SETUP items.
Save Changes	Save Setup Data to CMOS.

BIOS Flash Utility

The BIOS flash memory update is required for the following conditions:

- New versions of system programs
- New features or options
- Restore a BIOS when it becomes corrupted.

Use the Phlash utility to update the system BIOS flash ROM.

NOTE: If you do not have a crisis recovery diskette at hand, then you should create a **Crisis Recovery Diskette** before you use the Phlash utility.

NOTE: Do not install memory-related drivers (XMS, EMS, DPMS) when you use the Phlash.

NOTE: Please use the AC adaptor power supply when you run the Phlash utility. If the battery pack does not contain enough power to finish BIOS flash, you may not boot the system because the BIOS is not completely loaded.

Follow the steps below to run the Phlash.

1. Prepare a bootable diskette.
2. Copy the Phlash utilities to the bootable diskette.
3. Then boot the system from the bootable diskette. The Phlash utility has auto-execution function.

Machine Disassembly and Replacement

This chapter contains step-by-step procedures on how to disassemble the notebook computer for maintenance and troubleshooting.

To disassemble the computer, you need the following tools:

- Wrist grounding strap and conductive mat for preventing electrostatic discharge
- Small Philips screw driver
- Philips screwdriver
- Plastic flat head screw driver
- Tweezers

NOTE: The screws for the different components vary in size. During the disassembly process, group the screws with the corresponding components to avoid mismatch when putting back the components. When you remove the stripe cover, please be careful not to scrape the cover.

General Information

Before You Begin

Before proceeding with the disassembly procedure, make sure that you do the following:

1. Turn off the power to the system and all peripherals.
2. Unplug the AC adapter and all power and signal cables from the system.
3. Remove the battery pack.

NOTE: TravelMate 3200 series product uses mylar or tape to fasten the FFC/FPC/connectors/cable, you may need to tear the tape or mylar before you disconnect different FFC/FPC/connectors.

NOTE: There are several types of screws used to secure bottom case and upper case assembly. The screws vary in length. Please refer the picture below, group the same type of screws together during service disassembling. Please also remember the screw location for each screw type. If you fasten the screw to the wrong location, the screw may be too long to damage the main board.

Disassembly Procedure Flowchart

The flowchart on the succeeding page gives you a graphic representation on the entire disassembly sequence and instructs you on the components that need to be removed during servicing. For example, if you want to remove the main board, you must first remove the keyboard, then disassemble the inside assembly frame in that order.

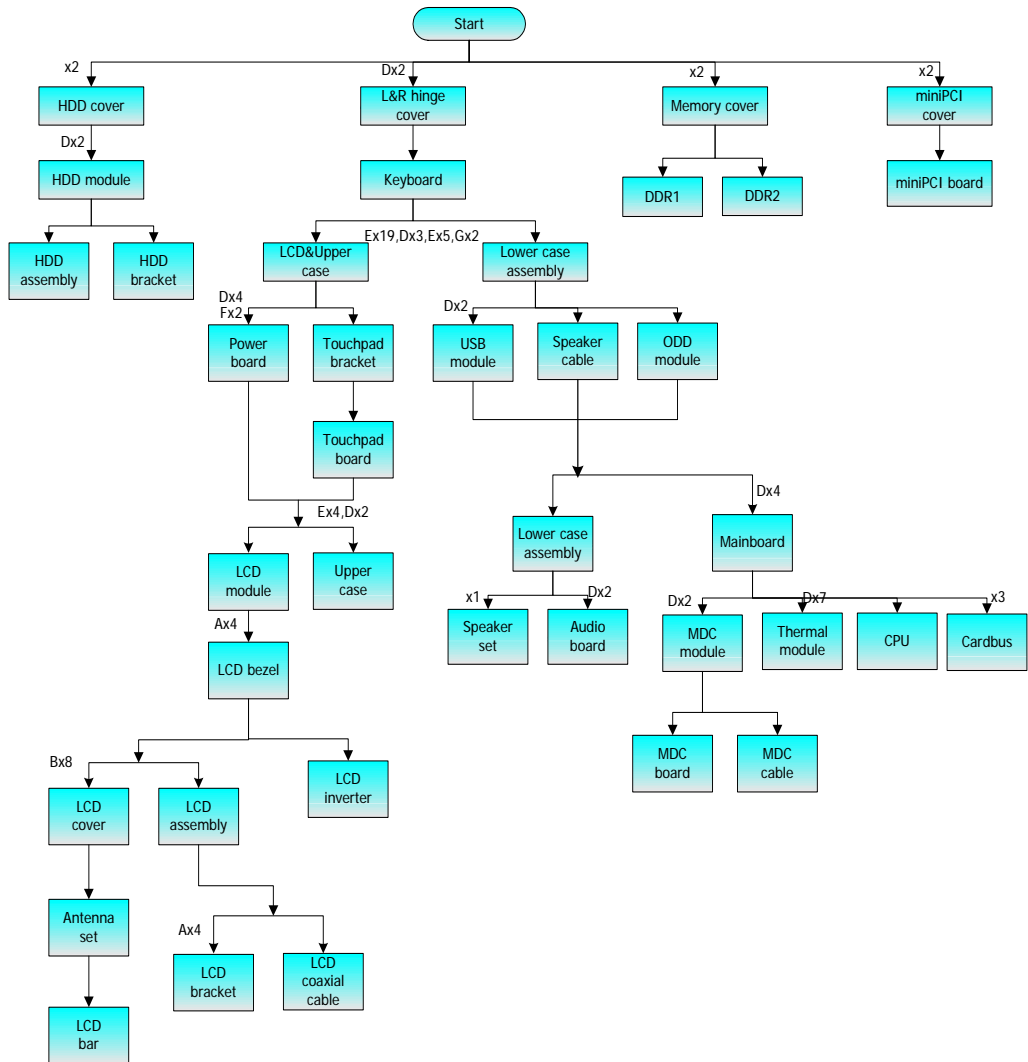

Screw List

Item	Description	Acer part No.
A	SCREW M2.0*2.5-I(NI)(NYLOK)	86.A03V7.012
B	SCREW I2.5*4M-BKAGHY(M2.5L4)	86.T25V7.013
C	SCREW M2.5*6-I(BNI)(NYLOK)	86.T25V7.012
D	SCREW M2.5*3-I(NI,NYLOK)	86.T23V7.010
E	SCREW M2.5*7-I(NI,NYLOK)	86.T25V7.008
F	SCREW NUT IO EA1(MBEA1001,REV3 B)	86.T23V7.001
G	SCREW M2.0*4-I(BNI)(NYLOK)	86.A03V7.007

Removing the Battery Pack

1. Release the battery lock.
2. Slide the battery latch.
3. Remove the battery pack.



Removing the HDD Module and the miniPCI

Removing the HDD Module

1. Remove two screws that secure the HDD cover.
2. Remove the HDD cover.
3. Remove the two screws that secure the HDD.
4. Holding the mylar and pull the HDD module out of the main unit.



Removing the Memory

1. Remove the two screws that secure the memory cover.
2. Remove the memory cover.
3. Press the latch on left and right side to pop out the memory and remove it.
4. Remove the other memory.



Removing the miniPCI

1. Remove the two screws that secure the miniPCI cover.
2. Remove the miniPCI cover.

-
3. Release the wireless antenna.
 4. Press the latch on left and right side to pop out the miniPCI and remove it.



Disassembling the Main Unit into Upper Case and Lower Case

1. Remove the two screws that secure the left and right hinge cover.
2. Remove the left and right hinge cover. Detach the right and the left hinge cover from the main unit.



3. Remove the three screws on the rear of the main unit.
4. Remove the nineteen screws that secure the lower case..



5. Release the keyboard latch with tweezers
6. Release another keyboard latch with tweezers.
7. Pull the keyboard out.
8. Unlatch the keyboard FFC latch and remove the keyboard from the main unit.



9. Remove the seven screws that secure the upper case.
10. Disconnect the power board cable.
11. Disconnect the thermal lid switch cable.
12. Disconnect the touchpad FFC from the mainboard.
13. Pull the wireless antenna from the hole.

14. Close the LCD and remove the upper case from the main unit.

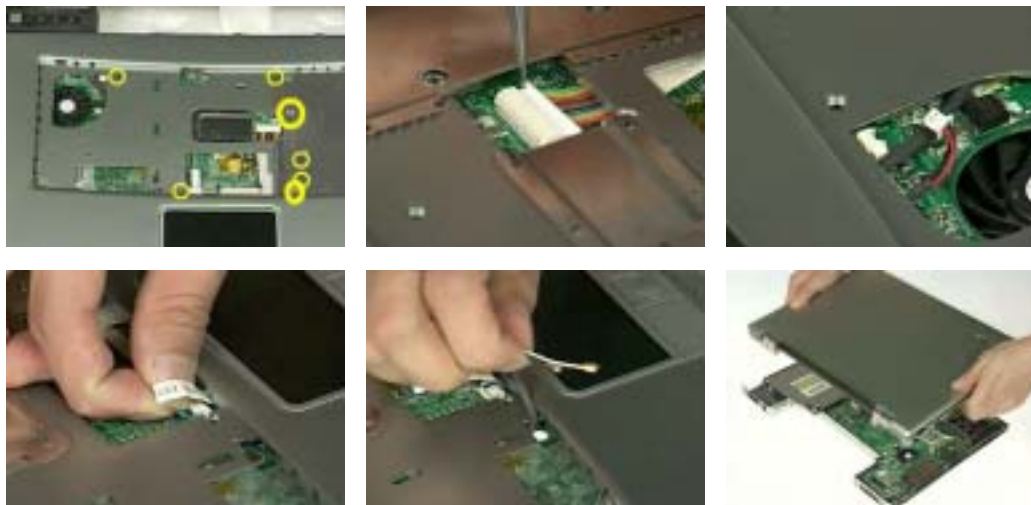

Disassembling the Lower Case

1. Remove the ODD from the lower case.



2. Disconnect the right speaker cable from USB cable and disconnect the USB cable from the mainboard.



3. Remove the two screws that secure the USB module.
4. Remove the USB module from the lower case.
5. Disconnect the USB module from the USB module.



6. Disconnect the left speaker cable from the mainboard.
7. Disconnect the Audio cable from the mainboard and remove the audio cable from the audio board.



8. Remove the four screws that secure the mainboard.
9. Detach the mainboard from the lower case assembly.



10. Tear off the mylar on the MDC cable.
11. Disconnect the MDC cable from the mainboard.
12. Remove the two screws that secure the MDC module.
13. Remove the MDC module from the mainboard.
14. Disconnect the cable from MDC board.



15. Disconnect the fan cable from the mainboard.



16. Remove the seven screws that secure the thermal module.
17. Remove the screw that secures the CPU
18. Turn the screw that secures the CPU.
19. Remove the CPU from the mainboard.



20. Disconnect the cardbus cable from the mainboard.
21. Remove the three screws that secure the cardbus.
22. Remove the cardbus from the mainboard.



23. Tear off the mylar on the right speaker cable.
24. Remove the right speaker from the lower case.
25. Remove the screw that secure the left speaker.
26. Remove the left speaker from the lower case.



27. Remove the two screws that secure the audio board.
28. Remove the audio board from the lower case.



Disassembling the LCD Module and Upper Case

1. Disconnect the LCD cable from the power board.
2. Remove the two screws that secure the power board.
3. Remove another four screws that secure the power board.
4. Remove the power board from the upper case.



5. Tear off the mylar on the touchpad FFC.
6. Disconnect the touchpad FFC from the touchpad board.
7. Remove the three screws that secure the touchpad bracket.
8. Remove the touchpad bracket from the upper case.
9. Remove the touchpad board from the upper case.



10. Tear off the mylar on the wireless antenna.
11. Remove the wireless antenna from the wire groove.
12. Remove the three screws that secure the LCD hinge on both sides.

13. Detach the LCD panel from the upper case assembly.



14. Remove the four screw caps of the LCD bezel.

15. Remove the four screws that secure the LCD bezel.

16. Remove the LCD bezel from the LCD module.



17. Disconnect the inverter power cable and the LVDS cable from the inverter board.

18. Remove the eight screws that secure the LCD.

19. Remove the LCD from the LCD cover.



20. Tear off the tapes on the antenna cable.

21. Tear off the tapes on the antenna brackets.

22. Remove the two screws that secure the left and right antenna bracket.

23. Remove the left and right antenna brackets and antenna cable from the LCD cover.



24. Remove the two screws that secure the LCD bar.

25. Remove the LCD bar from the LCD cover.



26. Remove the four screws that secure the right LCD bracket.

27. Remove the right LCD bracket.

28. Remove the four screws that secure the left LCD bracket.

29. Remove the left LCD bracket.



30. Tear off the tape on the LCD cable.

31. Disconnect the LCD cable from the LCD.

32. This completes the LCD module and upper case disassembly.



Disassembling the LCD Module

1. Remove the four screw caps as shown.
2. Then remove the four screws tightening the LCD bezel.



3. Detach the LCD bezel from the LCD module.
4. Then turn the LCD bezel over and remove the microphone.



5. Tear off the type fastening the inverter cable then disconnect the inverter cable then remove the inverter.
6. Remove the six screws holding the LCD to the LCD cover.
7. Then remove the LCD from the LCD cover.



8. Remove the two screws holding the right bracket then remove the bracket.
9. Remove the two screws holding the left bracket then remove the bracket.
10. Tear off the tape that fastens the LCD cable.



11. Disconnect the LCD cable from the LCD.

-
12. Tear off the tape fastening the antennae set.
 13. Then detach the antennae set from the LCD cover.



Disassembling the External Modules

Disassembling the ODD Module

1. Remove the two screws holding the ODD bracket on one side.
2. Remove the two screws holding the ODD bracket on the other side.
3. Remove another two screws on the rear side.



4. Slide the ODD bracket out of the ODD module.
5. Remove the ODD connector from the ODD module.



Disassembling the Optical Drive Module

1. Remove the four screws that secure the HDD holder.
2. Remove the HDD holder from the HDD module.



Troubleshooting

Use the following procedure as a guide for computer problems.

NOTE: The diagnostic tests are intended to test this model. Non-Acer products, prototype cards, or modified options can give false errors and invalid system responses.

1. Duplicate symptom and obtain the failing symptoms in as much detail as possible.
2. Distinguish symptom. Verify the symptoms by attempting to re-create the failure by running the diagnostic test or by repeating the same operation.
3. Disassemble and assemble the unit without any power sources.
4. If any problem occurs, you can perform visual inspection before you follow this chapter's instructions. You can check the following:
 - power cords are properly connected and secured;
 - there are no obvious shorts or opens;
 - there are no obviously burned or heated components;
 - all components appear normal.
5. Use the following table with the verified symptom to determine which page to go to.

Symptoms (Verified)	Go To
Power failure. (The power indicator does not go on or stay on.)	"Power System Check" on page 65.
POST does not complete. No beep or error codes are indicated.	"Power-On Self-Test (POST) Error Message" on page 67 "Undetermined Problems" on page 79
POST detects an error and displayed messages on screen.	"Error Message List" on page 68
Other symptoms (i.e. LCD display problems or others).	"Power-On Self-Test (POST) Error Message" on page 67
Symptoms cannot be re-created (intermittent problems).	Use the customer-reported symptoms and go to "Power-On Self-Test (POST) Error Message" on page 67 "Intermittent Problems" on page 78 "Undetermined Problems" on page 79

System Check Procedures

External Diskette Drive Check

If an error occurs with the internal diskette drive, reconnect the diskette connector on the system board.

If the error still remains:

1. Reconnect the external diskette drive/DVD-ROM module.
2. Replace the external diskette drive/CD-ROM module.
3. Replace the main board.

External CD-ROM Drive Check

Do the following to isolate the problem to a controller, drive, or CD-ROM. Make sure that the CD-ROM does not have any label attached to it. The label can cause damage to the drive or can cause the drive to fail.

Do the following to select the test device:

1. Boot from the diagnostics diskette and start the diagnostics program.
2. See if CD-ROM Test is passed when the program runs to CD-ROM Test.
3. Follow the instructions in the message window.

If an error occurs, reconnect the connector on the System board. If the error still remains:

1. Reconnect the external diskette drive/CD-ROM module.
2. Replace the external diskette drive/CD-ROM module.
3. Replace the main board.

Keyboard or Auxiliary Input Device Check

Remove the external keyboard if the internal keyboard is to be tested.

If the internal keyboard does not work or an unexpected character appears, make sure that the flexible cable extending from the keyboard is correctly seated in the connector on the system board.

If the keyboard cable connection is correct, run the Keyboard Test.

If the tests detect a keyboard problem, do the following one at a time to correct the problem. Do not replace a non-defective FRU:

1. Reconnect the keyboard cables.
2. Replace the keyboard.
3. Replace the main board.

The following auxiliary input devices are supported by this computer:

- Numeric keypad
- External keyboard

If any of these devices do not work, reconnect the cable connector and repeat the failing operation.

Memory check

Memory errors might stop system operations, show error messages on the screen, or hang the system.

1. Boot from the diagnostics diskette and start the doagmpstotics program (please refer to main board).
2. Go to the diagnostic memory in the test items.
3. Press F2 in the test items.
4. Follow the instructions in the message window.

NOTE: Make sure that the DIMM is fully installed into the connector. A loose connection can cause an error.

Power System Check

To verify the symptom of the problem, power on the computer using each of the following power sources:

1. Remove the battery pack.
2. Connect the power adapter and check that power is supplied.
3. Disconnect the power adapter and install the charged battery pack; then check that power is supplied by the battery pack.

If you suspect a power problem, see the appropriate power supply check in the following list:

- "Check the Battery Pack" on page 66

Check the Battery Pack

To check the battery pack, do the following:

From Software:

1. Check out the Power Management in control Panel
2. In Power Meter, confirm that if the parameters shown in the screen for Current Power Source and Total Battery Power Remaining are correct.
3. Repeat the steps 1 and 2, for both battery and adapter.
4. This helps you identify first the problem is on recharging or discharging.

From Hardware:

1. Power off the computer.
2. Remove the battery pack and measure the voltage between battery terminals 1(+) and 6(ground). See the following figure
3. If the voltage is still less than 7.5 Vdc after recharging, replace the battery.

To check the battery charge operation, use a discharged battery pack or a battery pack that has less than 50% of the total power remaining when installed in the computer.

If the battery status indicator does not light up, remove the battery pack and let it return to room temperature. Re-install the battery pack.

If the charge indicator still does not light up, replace the battery pack. If the charge indicator still does not light up, replace the DC/DC charger board.

Touchpad check

If the touchpad doesn't work, do the following actions one at a time to correct the problem. Do not replace a non-defective FRU:

1. After rebooting, run Tracking Pad PS2 Mode Driver. For example, run Syn touch driver.
2. Run utility with the PS/2 mouse function and check if the mouse is working.
3. If the the PS/2 mouse does not work, then check if the main board to switch board FPC is connected O.K.
4. If the main board to switch board FPC is connected well, then check if the FCC on touch pad PCB connects properly.
5. If the FFC on touch pad PCB connects properly, then check if LS851 JP1 Pin6=5V are pulese. If yes, then replace switch board. If no, then go to next step.
6. Replace touch pad PCB.
7. If the touch pad still does not work, then replace FPC on Track Pad PCB.

After you use the touchpad, the pointer drifts on the screen for a short time. This self-acting pointer movement can occur when a slight, steady pressure is applied to the touchpad pointer. This symptom is not a hardware problem. No service actions are necessary if the pointer movement stops in a short period of time.

Power-On Self-Test (POST) Error Message

The POST error message index lists the error message and their possible causes. The most likely cause is listed first.

NOTE: Perform the FRU replacement or actions in the sequence shown in FRU/Action column, if the FRU replacement does not solve the problem, put the original part back in the computer. Do not replace a non-defective FRU.

This index can also help you determine the next possible FRU to be replaced when servicing a computer.

If the symptom is not listed, see “Undetermined Problems” on page 79.

The following lists the error messages that the BIOS displays on the screen and the error symptoms classified by function.

NOTE: Most of the error messages occur during POST. Some of them display information about a hardware device, e.g., the amount of memory installed. Others may indicate a problem with a device, such as the way it has been configured.

NOTE: If the system fails after you make changes in the BIOS Setup Utility menus, reset the computer, enter Setup and install Setup defaults or correct the error.

Index of Error Messages

Error Message List

Error Messages	FRU/Action in Sequence
Struck Key	See "Keyboard or Auxiliary Input Device Check" on page 64
System CMOS checksum bad - Default configuration used	RTC battery Run BIOS Setup Utility to reconfigure system, then reboot system.
Real time clock error	RTC battery Run BIOS Setup Utility to reconfigure system time, then reboot system. Main board
Previous boot incomplete - Default configuration used	"Load Default Settings" in BIOS Setup Utility. RTC battery Main board
Invalid System Configuration Data	"Load Default Settings" in BIOS Setup Utility. Main board
Operating system not found	Enter Setup and see if fixed disk and drive A are properly identified. Dikette drive Hard disk drive Main board

Error Message List

No beep Error Messages	FRU/Action in Sequence
Power-on indicator turns off and LCD is blank.	Power source (battery pack and power adapter.) See "Power System Check" on page 65 Ensure every connector is connected tightly and correctly. Reconnect the DIMM. Main board.
Power-on indicator turns on and LCD is blank.	Power source (battery pack and power adapter.) See "Power System Check" on page 65 Reconnect the LCD connector Hard disk drive LCD cable LCD inverter LCD Main board
Power-on indicator turns on and LCD is blank. But you can see POST on an external CRT.	Reconnect the LCD connectors. LCD cable LCD inverter LCD Main board
Power-on indicator turns on and a blinking cursor shown on LCD during POST.	Ensure every connector is connected tightly and correctly. Main board

Phoenix BIOS Beep Codes

Code	Beeps	POST Routine Description
02h		Verify Real Mode
03h		Disable Non-Maskable Interrupt (NMI)
04h		Get CPU type
06h		Initialize system hardware
07h		Disable shadow and execute code from the ROM.
08h		Initialize chipset with initial POST values
09h		Set IN POST flag
0Ah		Initialize CPU registers
0Bh		Enable CPU cache
0Ch		Initialize caches to initial POST values
0Eh		Initialize I/O component
0Fh		Initialize the local bus IDE
10h		Initialize Power Management
11h		Load alternate registers with initial POST values
12h		Restore CPU control word during warm boot
13h		Initialize PCI Bus Mastering devices
14h		Initialize keyboard controller
16h	1-2-2-3	BIOS ROM checksum
17h		Initialize cache before memory autosize
18h		8254 timer initialization
1Ah		8237 DMA controller initialization
1Ch		Reset Programmable Interrupt Controller
20h	1-3-1-1	Test DRAM refresh
22h	1-3-1-3	Test 8742 Keyboard Controller
24h		Set ES segment register to 4 GB
28h		Autosize DRAM
29h		Initialize POST Memory Manager
2Ah		Clear 215 KB base RAM
2Ch	1-3-4-1	RAM failure on address line xxxx
2Eh	1-3-4-3	RAM failure on data bits xxxx of low byte of memory bus
2Fh		Enable cache before system BIOS shadow
32h		Test CPU bus-clock frequency
33h		Initialize Phoenix Dispatch Manager
36h		Warm start shut down
38h		Shadow system BIOS ROM
3Ah		Autosize cache
3Ch		Advanced configuration of chipset registers
3Dh		Load alternate registers with CMOS values
41h		Initialize extended memory for RomPilot.
42h		Initialize interrupt vectors
45h		POST device initialization
46h	2-1-2-3	Check ROM copyright notice

Code	Beeps	POST Routine Description
47h		Initialize I20 support
48h		Check video configuration against CMOS
49h		Initialize PCI bus and devices
4Ah		Initialize all video adapters in system
4Bh		QuietBoot start (optional)
4Ch		Shadow video BIOS ROM
4Eh		Display BIOS copyright notice
50h		Display CPU type and speed
51h		Initialize EISA board
52h		Test keyboard
54h		Set key click if enabled
55h		Enable USB devices
58h	2-2-3-1	Test for unexpected interrupts
59h		Initialize POST display service
5Ah		Display prompt "Press F2 to enter SETUP"
5Bh		Disable CPU cache
5Ch		Test RAM between 512 and 640 KB
60h		Test extended memory
62h		Test extended memory address lines
64h		Jump to User Patch1
66h		Configure advanced cache registers
67h		Initialize Multi Processor APIC
68h		Enable external and CPU caches
69h		Setup System Management Mode (SMM) area
6Ah		Display external L2 cache size
6Bh		Load custom defaults (optional)
6Ch		Display shadow-area message
6Eh		Display possible high address for UMB recovery
70h		Display error messages
72h		Check for configuration errors
76h		Check for keyboard errors
7Ch		Set up hardware interrupt vectors
7Eh		Initialize coprocessor if present
80h		Disable onboard Super I/O ports and IRQs
81h		Late POST device initialization
82h		Detect and install external RS232 ports
83h		Configure non-MCD IDE controllers
84h		Detect and install external parallel ports
85h		Initialize PC-compatible PnP ISA devices
86h		Re-initialize onboard I/O ports
87h		Configure Motherboard Configurable Devices (optional)
88h		Initialize BIOS Data Area
89h		Enable Non-Maskable Interrupts (NMIs)
8Ah		Initialize Extended BIOS Data Area

Code	Beeps	POST Routine Description
8Bh		Test and initialize PS/2 mouse
8Ch		Initialize floppy controller
8Fh		Determine number of ATA drives (optional)
90h		Initialize hard-disk controllers
91h		Initialize local-bus hard-disk controllers
92h		Jump to UserPatch2
93h		Build MPTABLE for multi-processor boards
95h		Install CD ROM for boot
96h		Clear huge ES segment register
97h		Fixup Multi Processor table
98h	1-2	Search for option ROMs. One long, two short beeps on checksum failure.
99h		Check for SMART drive (optional)
9Ah		Shadow option ROMs
9Ch		Set up Power Management
9Dh		Initialize security engine (optional)
9Eh		Enable hardware interrupts
9Fh		Determine number of ATA and SCSI drives
A0h		Set time of day
A2h		Check key lock
A4h		Initialize Typematic rate
A8h		Erase F2 prompt
AAh		Scan for F2 key stroke
ACh		Enter SETUP
A Eh		Clear Boot flag
B0h		Check for errors
B1h		Inform RomPilot about the end of POST.
B2h		POST done- prepare to boot operating system
B4h	1	One short beep before boot
B5h		Terminate QuietBoot (optional)
B6h		Check password (optional)
B7h		Initialize ACPI BIOS
B9h		Prepare Boot
BAh		Initialize SMBIOS
BBh		Initialize PnP Option ROMs
BCh		Clear parity checkers
BDh		Display MultiBoot menu
BEh		Clear screen (optional)
BFh		Check virus and backup reminders
C0h		Try to boot with INT 19
C1h		Initialize POST Error Manager (PEM)
C2h		Initialize error logging
C3h		Initialize error display function
C4h		Initialize system error handler
C5h		PnPnd dual CMOS (optional)
C6h		Initialize notebook docking (optional)

Code	Beeps	POST Routine Description
C7h		Initialize notebook docking late
C8h		Force check (optional)
C9h		Extended checksum (optional)
CAh		Redirect Int 15h to enable remote keyboard
CBh		Redirect Int 13h to Memory Technologies Devices such as ROM, RAM, PCMCIA, and serial disk.
CCh		Redirect Int 10h to enable remote serial video
CDh		Re-map I/O and memory for PCMCIA
CEh		Initialize digitizer and display message.
D2h		Unknown interrupt
The following are for boot block in Flash ROM		
E0h		Initialize the chipset
E1h		Initialize the bridge
E2h		Initialize the CPU
E3h		Initialize the system timer
E4h		Initialize system I/O
E5h		Check force recovery boot
E6h		Checksum BIOS ROM
E7h		Go to BIOS
E8h		Set Huge Segment
E9h		Initialize Multi Processor
EAh		Initialize OEM special code
EBh		Initialize PIC and DMA
ECh		Initialize Memory type
EDh		Initialize Memory size
EEh		Shadow Boot Block
EFh		System memory test
F0h		Initialize interrupt vectors
F1h		Initialize Run Time Clock
F2h		Initialize video
F3h		Initialize System Management Mode
F4h	1	Output one beep
F5h		Clear Huge Segment
F6h		Boot to Mini DOS
F7h		Boot to Full DOS

Index of Symptom-to-FRU Error Message

LCD-Related Symptoms

Symptom / Error	Action in Sequence
LCD backlight doesn't work	First, plug a monitor to CRT port. Next, enter BIOS utility to running "Load Default Settings" then reboot the system. Reconnect the LCD connectors. Keyboard (if the brightness function key doesn't work). LCD cable LCD inverter LCD Main board
LCD is too dark LCD brightness cannot be adjusted	Enter BIOS Utility to execute "Load Setup Default Settings", then reboot system. Reconnect the LCD connectors. Keyboard (if the brightness function key doesn't work). LCD cable LCD inverter LCD Main board
Unreadable LCD screen Missing pels in characters Abnormal screen Wrong color displayed LCD has extra horizontal or vertical lines displayed.	Reconnect the LCD cable LCD cable LCD Main board

Indicator-Related Symptoms

Symptom / Error	Action in Sequence
Indicator incorrectly remains off or on, but system runs correctly	Main board
HDD/CD-ROM active indicators cannot work	HDD/CD-ROM drive Device driver Main board

Power-Related Symptoms

Symptom / Error	Action in Sequence
Power shuts down during operation	Power source (battery pack and power adapter). See "Power System Check" on page 65. Battery pack AC adapter See if the thermal module is overheat (Heat sink or fan). Main board
The system cannot power-on.	Power source (battery pack and power adapter). See "Power System Check" on page 65. Battery pack Power adapter CPU Main board
The system cannot power-off.	In Windows XP operating system, hold and press the power switch for more than 4 seconds. If the system can power off, then the main board is OK. Verify OS in the HDD. Main board

Power-Related Symptoms

Symptom / Error	Action in Sequence
Battery can't be charged or discharged	See "Check the Battery Pack" on page 66. Battery pack Main board
System hang during POST	ODD/HDD/FDD/RAM module Main board

PCMCIA-Related Symptoms

Symptom / Error	Action in Sequence
System cannot detect the PC Card (PCMCIA)	PCMCIA slot assembly Main board
PCMCIA slot pin is damaged.	PCMCIA slot assembly
PC Card cannot be inserted or ejected	Check if the PCMCIA slot is blocked Main board

Memory-Related Symptoms

Symptom / Error	Action in Sequence
Memory count (size) appears different from actual size.	Enter BIOS Setup Utility to execute "Load Default Settings" then reboot system. RAM module Main board Check BIOS revision
System can power on, but you hear two long beeps: "B--, B--" and the LCD is blank.	Reinsert DIMM DIMM Main board

Speaker-Related Symptoms

Symptom / Error	Action in Sequence
In Windows, multimedia programs, no sound comes from the computer.	OS volume control Audio driver Speaker Main board
Internal speakers make noise or emit no sound.	Speaker Main board
Microphone cannot work	Audio driver Volume control in Windows XP Main board

Power Management-Related Symptoms

Symptom / Error	Action in Sequence
The system will not enter hibernation mode	Power option in Windows XP Hard disk drive Main board
The system doesn't enter standby mode after closing the lid of the portable computer.	Driver of Power Option Properties Lid close switch in upper case Main board

Power Management-Related Symptoms

Symptom / Error	Action in Sequence
The system doesn't resume from hibernation/standby mode.	Connect AC adapter then check if the system resumes from Standby/Hibernation mode. Check if the battery is low. Hard disk drive Main board
The system doesn't resume from standby mode after opening the lid of the portable computer.	LCD cover switch Main board
Battery fuel gauge in Windows doesn't go higher than 90%.	Refresh battery (continue use battery until power off, then charge battery). Battery pack Main board
System hangs intermittently.	Reconnect hard disk/CD-ROM drives. Main board

Peripheral-Related Symptoms

Symptom / Error	Action in Sequence
System configuration does not match the installed devices.	Enter BIOS Setup Utility to execute "Load Setup defaults", then reboot system. Reconnect hard disk/CD-ROM drives/FDD or other peripherals. Main board
External display does not work correctly.	Press Fn+F5, LCD/CRT/Both display switching Keyboard Main board
USB does not work correctly	Main board
Print problems.	Enter BIOS Setup Utility to execute "Load Default Settings" then reboot the system. Run printer self-test. Printer driver Printer cable Printer Main board
Parallel port device problems	Enter BIOS Setup Utility to execute "Load Default Settings" then reboot the system. Device driver Device cable Device Main board

Keyboard/Touchpad-Related Symptoms

Symptom / Error	Action in Sequence
Keyboard (one or more keys) does not work.	Reconnect the keyboard cable. Keyboard Main board
Touchpad does not work.	Reconnect touchpad cable. Touchpad board Main board

Modem/LAN-Related Symptoms

Symptom / Error	Action in Sequence
Internal modem does not work correctly.	Phone cable Driver Reconnect the Internal modem cable to the main board tightly. Main board
Internal LAN does not work correctly	Lan cable Driver Main board

NOTE: If you cannot find a symptom or an error in this list and the problem remains, see “Undetermined Problems” on page 79.

Intermittent Problems

Intermittent system hang problems can be caused by a variety of reasons that have nothing to do with a hardware defect, such as: cosmic radiation, electrostatic discharge, or software errors. FRU replacement should be considered only when a recurring problem exists.

When analyzing an intermittent problem, do the following:

1. Run the diagnostic test for the system board in loop mode at least 10 times.
2. If no error is detected, do not replace any FRU.
3. If any error is detected, replace the FRU. Rerun the test to verify that there are no more errors.

Undetermined Problems

The diagnostic problems does not identify which adapter or device failed, which installed devices are incorrect, whether a short circuit is suspected, or whether the system is inoperative.

Follow these procedures to isolate the failing FRU (do not isolate non-defective FRU).

NOTE: Verify that all attached devices are supported by the computer.

NOTE: Verify that the power supply being used at the time of the failure is operating correctly. (See "Power System Check" on page 65):

1. Power-off the computer.
2. Visually check them for damage. If any problems are found, replace the FRU.
3. Remove or disconnect all of the following devices:
 - Non-Acer devices
 - Printer, mouse, and other external devices
 - Battery pack
 - Hard disk drive
 - DIMM
 - PC Cards
4. Power-on the computer.
5. Determine if the problem has changed.
6. If the problem does not recur, reconnect the removed devices one at a time until you find the failing FRU.
7. If the problem remains, replace the following FRU one at a time. Do not replace a non-defective FRU:
 - System board
 - LCD assembly

Jumper and Connector Locations

Top View

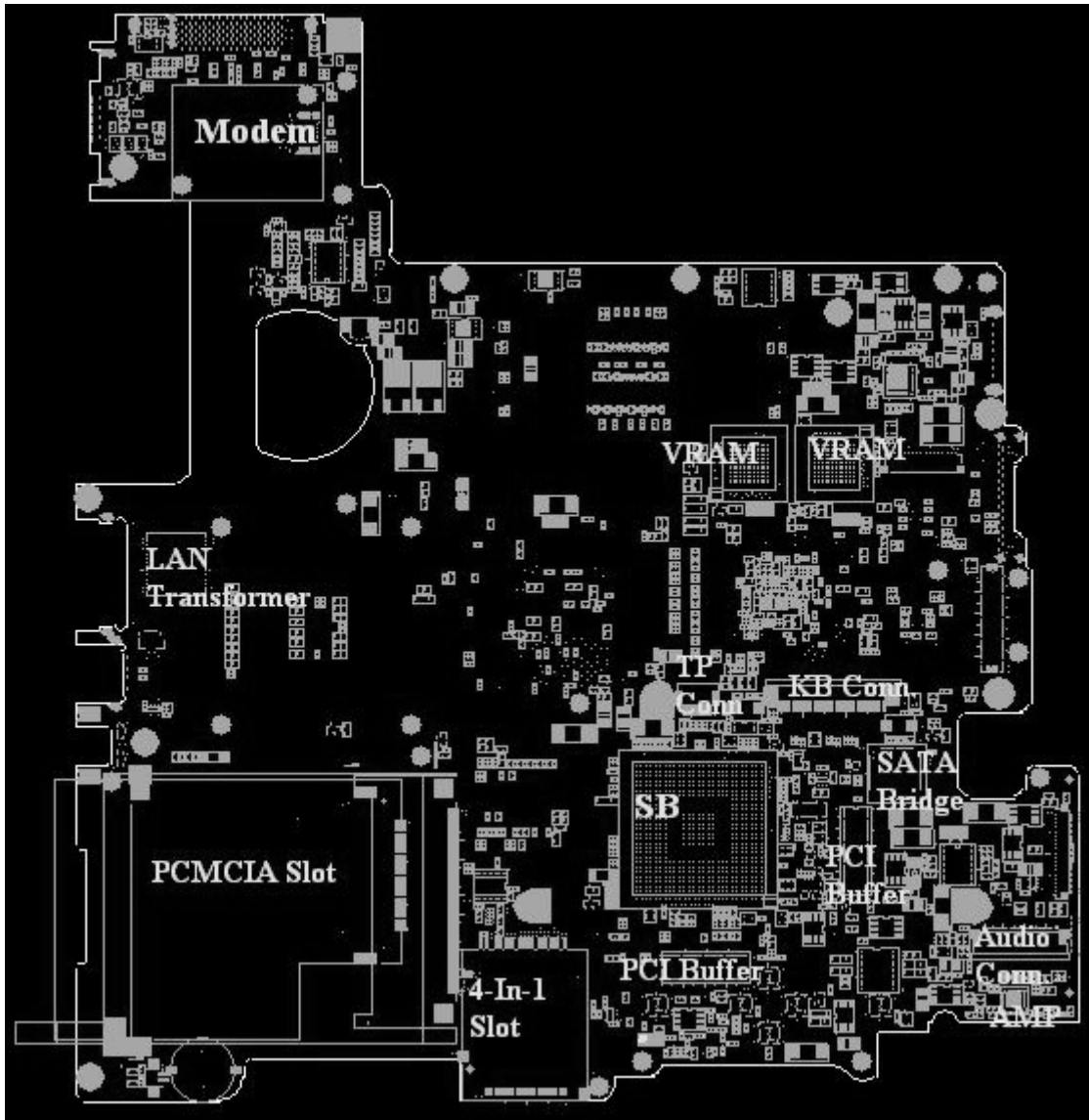

Bottom View

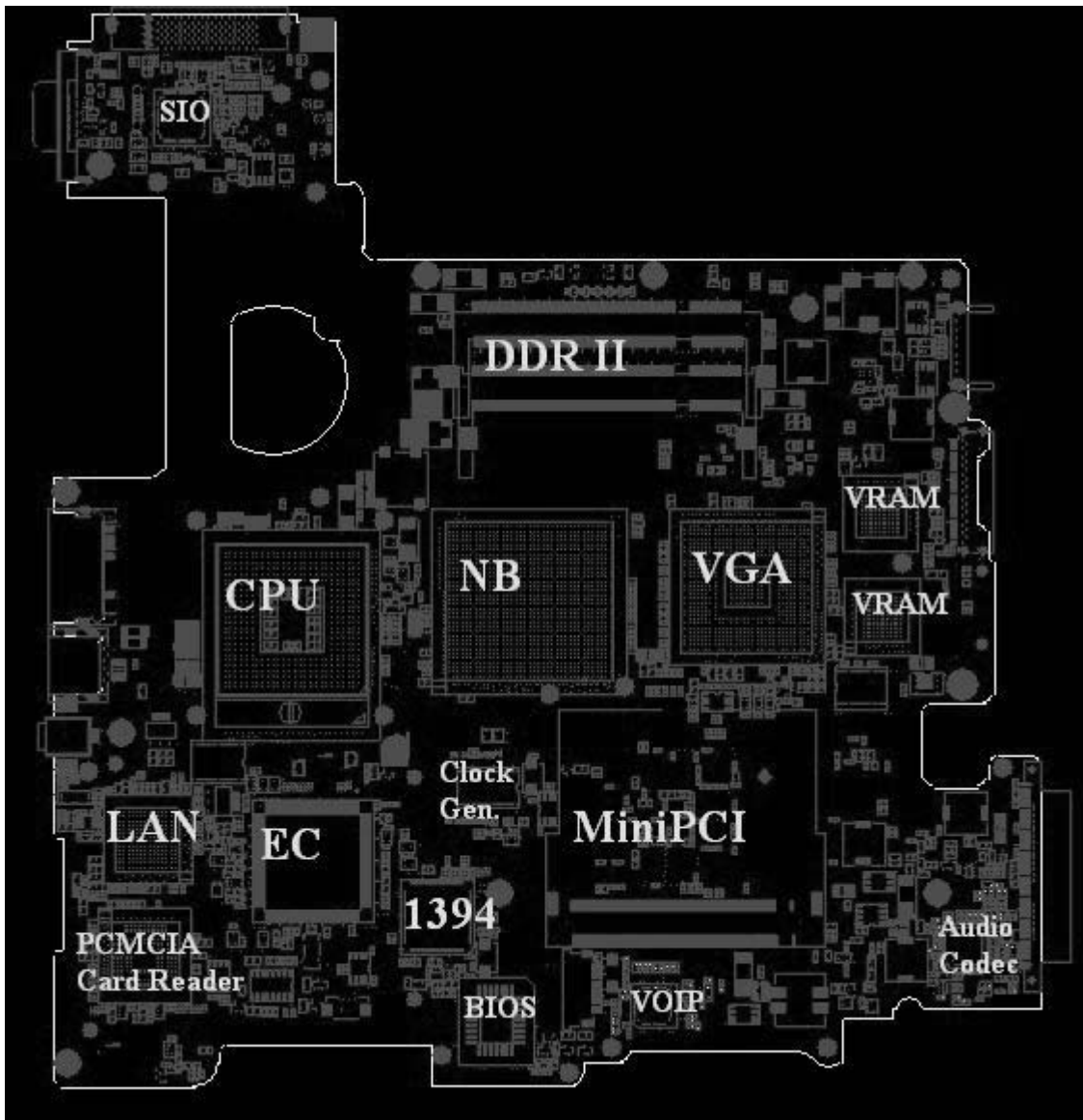

Main Board Layout

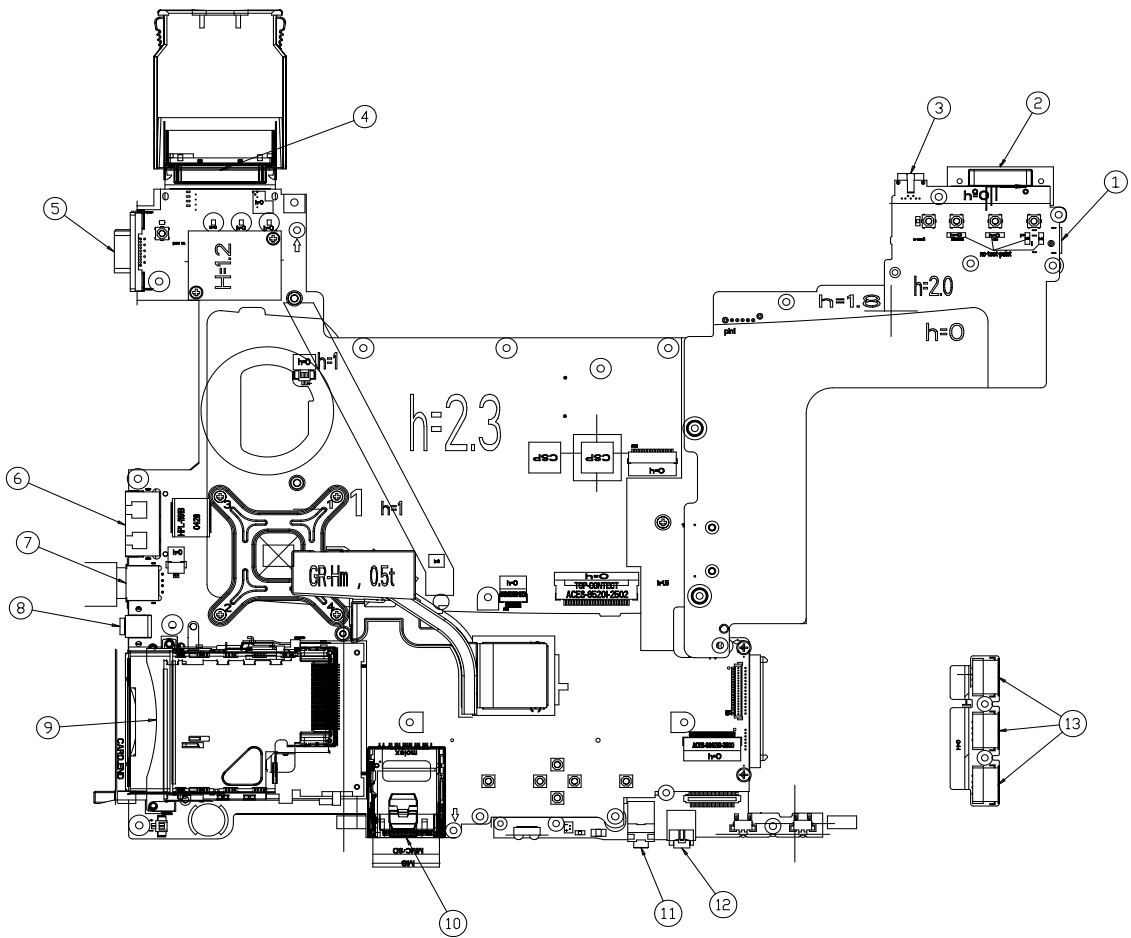

Number	Item
1	DC JACK
2	DVI
3	S-VIDEO
4	DOCKING
5	CRT
6	RJ11RJ45
7	USB
8	IEEE1394
9	PCMCIA
10	4 IN 1
11	SPDIF
12	PHONE-JACK
13	USB

FRU (Field Replaceable Unit) List

This chapter gives you the FRU (Field Replaceable Unit) listing in global configurations of TravelMate 8100 series products. Refer to this chapter whenever ordering for parts to repair or for RMA (Return Merchandise Authorization).

Please note that WHEN ORDERING FRU PARTS, you should check the most up-to-date information available on your regional web or channel. For whatever reasons a part number change is made, it will not be noted on the printed Service Guide. For ACER AUTHORIZED SERVICE PROVIDERS, your Acer office may have a DIFFERENT part number code from those given in the FRU list of this printed Service Guide. You MUST use the local FRU list provided by your regional Acer office to order FRU parts for repair and service of customer machines.

NOTE: To scrap or to return the defective parts, you should follow the local government ordinance or regulations on how to dispose it properly, or follow the rules set by your regional Acer office on how to return it.

Exploded Diagram

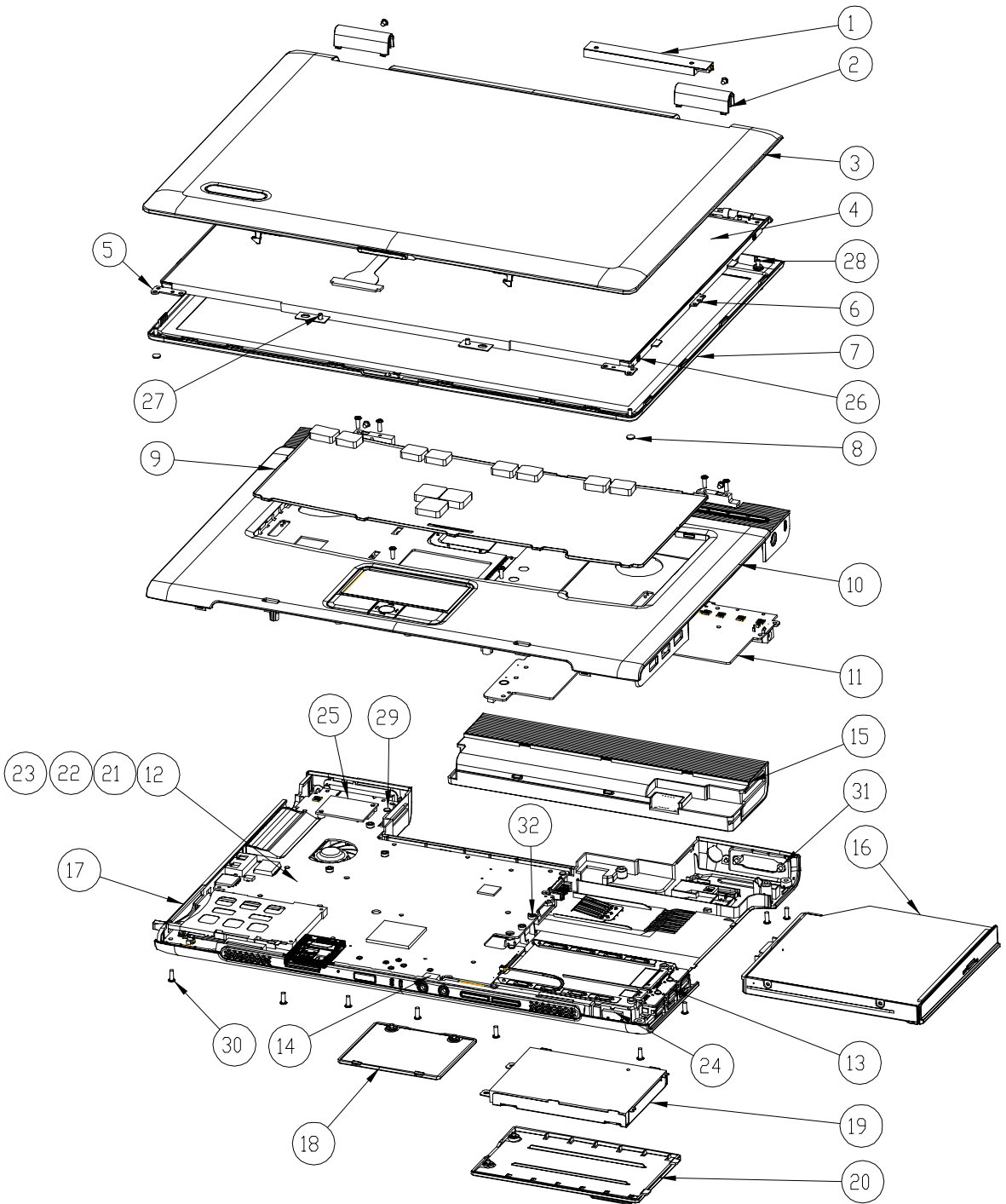

Item List

Item	Description
1	IVC MODULE PM2 (8-20V, V=700V, REV : A1A)
2	HINGE COVER-L
3	ZF1 15.4 LCD COVER ASSY
4	LCD LTN154P1-L02(15.4", WSXGA)STN B/S
5	HINGE-L
6	HINGE-R
7	ZF1 15.4 LCD BEZEL ASSY
8	LCD-RUBER-UP
9	K/B MODULE(UI) ZF1(AEZF1TNR,REV3A)
10	TOP SUB ASSY
11	ZF1 CHARGER/B ASSY
12	ZF1 M/B ASSY(M26-128MB/HDD-PATA)
13	ZF1 USB/B ASSY
14	ZF1 AUDIO/B ASSY
15	BATT LI 916-3270(ZF1,4S2P, 4.8A)
16	ZF1 DVD MULTI ASSY(HLD GMA-4080N)STN B/S
17	ZF1 BASE ASSY
18	ZF1 MINI-PCI DOOR ASSY
19	ZF1 HDD ASSY(TOS MK8026GAX 80G)STN B/S
20	ZF1 HDD DOOR ASSY
21	CPU(478P)DOTHAN 2.0G C0(UFCPGA4)STN B/S
22	RAM(512M)DDR HYS64T6420HDL-3.7-A L-F
23	ZF1 W/L 802.11A/B/G(WM3B2915ABGEU) ASSY
24	ZF1 BLUETOOTH MODULE 91.BU513.002 ASSY
25	ZF1 MODEM MODULE T60M893.T00 ASSY
26	SCREW M2.0*L2.5 NI-NYLOK
27	SCREW-M2.5-4-BK-NYLOK
28	SCREW M2.5*L6.0-I
29	SCREW M2.5*3-I(NI,NULOK)
30	SCREW M2.5*7NI (NULOK)
31	NUT IO
32	SCREW M2.0*4 (BNI)(NULOK)

FRU List

TravelMate 8100 FRU List

Picture	No.	Partname And Description	Part Number
Adapter			
		ADAPTER 65W 3 PIN DELTA SADP-65KB	AP.06501.005
		ADAPTER 65W 3 PIN LITE-ON PA-1650-02Q2 19V	AP.06503.006
Battery			
		BATTERY SANYO LI-ION 4S2P 4.8A 4UR18650F-2-QC-ZF1	BT.00803.006
		BATTERY SIMPLO LI-ION 4S2P 4.8A 916-3270	BT.00807.002
Boards			
		MODEM BOARD 56K(MDC) T60M893.T00 S.P.	54.T72V5.001
		BLUETOOTH MODULE MINI-USB 91.BU513.002 S.P. WITH ANTENNA	54.T72V5.002
		WIRELESS LAN BOARD (802.11a/b/g) INTEL EU	KI.CAX01.009
		WIRELESS LAN BOARD (802.11a/b/g) INTEL NA	KI.CAX01.010
		WIRELESS LAN BOARD (802.11a/b/g) INTEL RW	KI.CAX01.011
		WIRELESS LAN BOARD (802.11b/g) INTEL 2200BGRW	KI.CAX01.006
		CHARGER BOARD	55.T72V7.001
		USB BOARD	55.T72V7.002
		AUDIO BOARD	55.T72V7.003
Cables			
		FFC CABLE - TP/B TO TP	50.T72V7.001

TravelMate 8100 FRU List

Picture	No.	Partname And Description	Part Number
		MODEM CABLE	50.T72V7.002
		CHARGER CABLE - 16/16 PIN	50.T72V7.003
		FFC CABLE - AUDIO BOARD 35 PIN	50.T72V7.004
		USB CABLE - 19/20 PIN	50.T72V7.005
		POWER CORD US (3 pin)	27.A03V7.001
		POWER CORD PRC (3 Pin)	27.A03V7.003
		POWER CORD KOERA (Pin)	27.T23V7.006
		POWER CORD EU (3 PIN)	27.A03V7.002
		POWER CORD UK (3 PIN)	27.A03V7.004
		POWER CORD ITALIAN (3 PIN)	27.A03V7.005
		POWER CORD- SWISS	27.A03V7.007
		POWER CORD AU (3 PIN)	27.A03V7.008
		POWER CORD DANISH (3 PIN)	27.A03V7.006
		POWER CORD AF (3 PIN)	27.T48V7.001
Case/Cover/Bracket Assembly			
		UPPER CASE W/LIP SWITCH CABLE, BUTTON, HINGE	60.T72V7.001
		LOWER CASE W/SPEAKER	60.T72V7.002

TravelMate 8100 FRU List

Picture	No.	Partname And Description	Part Number
		RAM DOOR W/SCREW	42.T72V7.001
		MINIPCI DOOR W/SCREW	42.T72V7.002
		TOUCHPAD BRACKET	33.T72V7.001
		SMART CARD BRACKET	33.T72V7.002
		HINGE COVER - R	42.T72V7.003
		HINGE COVER - L	42.T72V7.004
		HDD COVER W/RUBBER	42.T72V5.010
		HDD BRACKET W/MYLAR	33.T72V7.003
Communication Module			
		WIRELESS LAN ANTENNA	50.T72V7.006
CPU/PROCESSOR			
		INTEL PENTIUM M 1.6G 2M 533FSB uFCPGA2 SL86G C-1 STEPPING	KC.N0001.730
		INTEL PENTIUM M 1.73G 2M 533FSB uFCPGA2 SL7SA C-1 STEPPING	KC.N0001.740

TravelMate 8100 FRU List

Picture	No.	Partname And Description	Part Number
		INTEL PENTIUM M 1.87G 2M 533FSB uFCPGA2 SL7S9 C-1 STEPPING	KC.N0001.750
		INTEL PENTIUM M 2.0G 2M 533FSB uFCPGA2 SL7SM C-1 STEPPING	KC.N0001.760
		INTEL PENTIUM M 2.13G 2M 533FSB uFCPGA2 SL7SL C-1 STEPPING	KC.N0001.770
HDD/ Hard Disk Drive			
		HGST MORAGA 60GB 4200RPM, IC25N060ATMR04-0 08K0634	KH.06007.006
		TOSHIBA PLUTO 60GB 4200RPM, MK6025GAS	KH.06004.003
		SEAGATE N2 (50) 60GB 4200RPM, ST960821A	KH.06001.002
		FJ 60GB 5400RPM, MERCURY, MHT2060BH A1, SATA	KH.06006.005
		HGST MORAGA 80GB 4200RPM, IC25N080ATMR04-0 08K635	KH.08007.007
		TOSHIBA PLUTO 80GB 4200RPM, MK8025GAS, 8MB	KH.08004.001
		SEAGATE N2 (50) 80GB 4200RPM, ST9808210A	KH.08001.012
		FJ 80GB 5400RPM, MERCURY, MHT2080BH A1, SATA	KH.08006.003
		HGST MORAGA+ 80GB 5400RPM, HTS541080G9AT00	KH.08007.009
		TOSHIBA PROTEUS 80GB 5400RPM, MK8026GAX	KH.08004.002
		HGST MORAGA+ 100GB 5400RPM, HTS541060G9AT00	KH.10007.001
		SEAGATE MERCURY 100GB 5400RPM, ST9100823A	KH.10001.002
Keyboard			
		TM4500/TM4000/TM2300 KEYBOARD DARFON US INTERNATIONAL	KB.T5007.001
		TM4500/TM4000/TM2300 KEYBOARD DARFON CHINESE	KB.T5007.002
		TM4500/TM4000/TM2300 KEYBOARD DARFON SPANISH	KB.T5007.003
		TM4500/TM4000/TM2300 KEYBOARD DARFON THAI	KB.T5007.004
		TM4500/TM4000/TM2300 KEYBOARD DARFON BRAZILIAN PROTUGESE	KB.T5007.005
		TM4500/TM4000/TM2300 KEYBOARD DARFON KOREA	KB.T5007.006
		TM4500/TM4000/TM2300 KEYBOARD DARFON UK	KB.T5007.007
		TM4500/TM4000/TM2300 KEYBOARD DARFON GERMAN	KB.T5007.008

TravelMate 8100 FRU List

Picture	No.	Partname And Description	Part Number
		TM4500/TM4000/TM2300 KEYBOARD DARFON ITALIAN	KB.T5007.009
		TM4500/TM4000/TM2300 KEYBOARD DARFON FRENCH	KB.T5007.010
		TM4500/TM4000/TM2300 KEYBOARD DARFON SWISS/G	KB.T5007.011
		TM4500/TM4000/TM2300 KEYBOARD DARFON PORTUGUESE	KB.T5007.012
		TM4500/TM4000/TM2300 KEYBOARD DARFON ARABIC	KB.T5007.014
		TM4500/TM4000/TM2300 KEYBOARD DARFON BELGIUM	KB.T5007.015
		TM4500/TM4000/TM2300 KEYBOARD DARFON SWEDEN	KB.T5007.016
		TM4500/TM4000/TM2300 KEYBOARD DARFON CZECH	KB.T5007.017
		TM4500/TM4000/TM2300 KEYBOARD DARFON HUNGAIAN	KB.T5007.018
		TM4500/TM4000/TM2300 KEYBOARD DARFON NORWAY	KB.T5007.019
		TM4500/TM4000/TM2300 KEYBOARD DARFON DANISH	KB.T5007.020
		TM4500/TM4000/TM2300 KEYBOARD DARFON TURKISH	KB.T5007.021
		TM4500/TM4000/TM2300 KEYBOARD DARFON CANADIAN FRENCH	KB.T5007.022
		TM4500/TM4000/TM2300 KEYBOARD DARFON JAPANESE	KB.T5007.023
		TM4500/TM4000/TM2300 KEYBOARD DARFON GREEK	KB.T5007.024
		TM4500/TM4000/TM2300 KEYBOARD DARFON HEBREW	KB.T5007.025
		TM4500/TM4000/TM2300 KEYBOARD DARFON RUSSIAN	KB.T5007.026
LCD			
		LCD MODULE 15.4 IN. WSXGA+ HITACHI TX39D99VC1FAA 185NITS	6M.T72V7.011
		LCD MODULE 15.4 IN. WSXGA+ SAMSUNG LTN154P1-L02 185NITS	6M.T72V7.012
		LCD MODULE 15.4 IN. WSXGA+ LG LP154W02-B1K1 185NITS	6M.T72V7.013
		LCD 15.4 IN. WSXGA+ HITACHI TX39D99VC1FAA 185NITS	LK.15404.002
		LCD 15.4 IN. WSXGA+ SAMSUNG LTN154P1- L02 185NITS	LK.15406.002
		LCD 15.4 IN. WSXGA+ LG LP154W02-B1K1 185NITS	LK.15408.003

TravelMate 8100 FRU List

Picture	No.	Partname And Description	Part Number
		LCD INVERTER BOARD W/ TYPE	19.T72V7.001
		LCD CABLE - 15.4 IN. WXGA	50.T72V7.007
		LCD PANEL W/LOGO ANTENNA 15.4 IN.	60.T72V7.003
		LCD BEZEL W/RUBBER PAD 15.4 IN.	60.T72V7.004
		LCD BRACKET W/HINGE 15.4 IN. - L	33.T72V7.004
		LCD BRACKET W/HINGE 15.4 IN. - R	33.T72V7.005
Main Board			
		MAINBOARD 915PM M26-128MB W/PCMCIA SLOT, SMART CARD, 5 IN 1 W/O CPU MEMORY	LB.T7206.001

TravelMate 8100 FRU List

Picture	No.	Partname And Description	Part Number
		SMART READER	55.T72V7.005
		PCMCIA SLOT	22.T72V7.001
Memory			
		MEMORY MICRON 256MB/ 533MHZ, MT8HTF3264HDY-53EB2	KN.25604.023
		MEMORY IFX 256MB/ 533MHZ, HYS64T32000HDL-3.7-A	KN.25602.023
		MEMORY ELPIDA 256MB/ 533MHZ, U33512AGEPQ662A	KN.25609.003
		MEMORY MICRON 512MB/ 533MHZ, MT8HTF6464HDY-53EA2	KN.51204.015
		MEMORY IFX 512MB/ 533MHZ, HYS64T64020HDL-3.7-A	KN.51202.021
		MEMORY ELPIDA 512MB/ 533MHZ, U33512AGEPQ672A	KN.51209.004
		MEMORY IFX 1GB/533 MHZ, HYS64T128021HDL-3.7-A	KN.1GB02.012
Optical Drive			
		DVD/CDRW COMBO MODULE KME UJDA-760	6M.T72V7.001
		COMBO MODULE HLDS GCC-4243N FOR KINGFISHER	6M.T72V7.002
		DVD SUPER MULTI 8X HLDS GMA-4080N DL G BASE	6M.T72V7.003
		DVD SUPER MULTI 8X MODULE KME UJ-831BQB	6M.T72V7.004
		COMBO UJDA-760QT1-A, 24/24/24,8X	KO.02406.008
		COMBO DRIVE HLDS GCC-4243N FOR KINGFISHER	KO.02405.006
		DVD SUPER MULTI DRIVE HLDS GMA-4080N 0H35 DL G BASE	KU.0080D.007
		DVD SUPER MULTI DRIVE KME UJ-831B F/W : 1.50	KU.00807.006
		OPTICAL CONNECTOR BOARD	55.T72V7.004
		OPTICAL DEVICE HOLDER-FIX	42.T72V7.005
		DVD/CDRW BEZEL FOR KME	42.T72V7.006
		DVD/CDRW BEZEL FOR HLDS	42.T72V7.007
		DVD SUPER MULTI BEZEL FOR HLDS	42.T72V7.008
		DVD SUPER MULTI BEZEL FOR PANASONIC	42.T72V7.009

TravelMate 8100 FRU List

Picture	No.	Partname And Description	Part Number
Pointing Device			
		TOUCHPAD	55.T72V7.006
Speaker			
		SPEAKER R	23.T72V7.002
		SPEAKER L	23.T72V7.001
Heatsink			
		THERMAL MODULE	60.T72V7.005
Miscellaneous			
		NAME PLATE - TM8100	40.T72V7.001
		LCD BEZEL RUBBER PAD UP	47.T72V7.001
		LCD BEZEL RUBBER PAD MIDDLE	47.T72V7.002
		RUBBER FOOT	47.T72V7.003
Screws			
		SCREW M2.0*2.5-I(NI)(NYLOK)	86.A03V7.012
		SCREW M2.5*6-I(BNI)(NYLOK)	86.T25V7.012
		SCREW M3*0.5+3.5I	86.A03V7.006
		SCREW M2.0*3.0-I-NI-NYLOK	86.T23V7.006
		SCREW M2.0*6.0-I-NI-NYLOK	86.A08V7.004
		SCREW M2.5*3-I(NI,NYLOK)	86.T23V7.010
		SCREW M2.0*4-I(BNI)(NYLOK)	86.A03V7.007
		SCREW M2.5*7-I(NI,NYLOK)	86.T25V7.008
		SCREW M2.0*4.0-NI(NYLOK)	86.T50V7.001
		SCREW I3*3.5M-NIH(M3L3.5)	86.A03V7.011
		SCREW NUT IO EA1(MBEA1001,REV3B)	86.T23V7.001
		SCREW I2.5*4M-BKAGHY(M2.5L4)	86.T25V7.013

Model Definition and Configuration

TravelMate 8100 Series

Model Number	CPU	LCD	Memory	HDD (GB)	ODD	BT	Wireless LAN
8105WLMi	PM770	15.4" WSXGA+	SOII512MB *2	80GB (5400rpm)	8x DVD-SMulti (DL)	FoxcoMo +WNCUS BT	Intel2915A BG(SKU1)
8104WLMi	PM760	15.4" WSXGA+	SOII512MB *2/ SOII256MB *2	80GB/100GB (5400rpm)	8x DVD-SMulti (DL)	FoxcoMo +WNCUS BT	Intel2915A BG(SKU1/ SKU2)/ Intel2200BG
8103WLMi	PM750	15.4" WSXGA+	SOII256MB *2/ SOII512MB	80GB/100GB (5400rpm)	8x DVD-SMulti (DL)	FoxcoMo +WNCUS BT	Intel2915A BG(SKU1/ SKU2)/ Intel2200BG
8102WLCi	PM740	15.4" WSXGA+	SOII256MB *2	60GB/80GB	24x Combo	FoxcoMo +WNCUS BT	Intel2915A BG(SKU1// SKU2/ SKU4)/ Intel2200BG
8101WLMi	PM730	15.4" WSXGA+	SOII256MB *2	60GB	8x DVD-SMulti (DL)	FoxcoMo +WNCUS BT	Intel2915A BG(SKU1/ SKU2)/ Intel2200BG

Test Compatible Components

This computer's compatibility is tested and verified by Acer's internal testing department. All of its system functions are tested under Windows® XP Home environment.

Refer to the following lists for components, adapter cards, and peripherals which have passed these tests. Regarding configuration, combination and test procedures, please refer to the TravelMate8100 series Compatibility Test Report released by the Acer Mobile System Testing Department.

Microsoft® Windows® XP Pro Environment Test

Item	Specifications
CPU	Dothan CPU 2.13 Dothan CPU 2.0A Dothan CPU 1.86 Dothan CPU 1.73 Dothan CPU 1.6B
LCD	SAMSUNG, LTN154P1-L02, 185nits, 185nits/25ms/CR300 HITACHI, TX39D99VC1FAA, 185nits, 185/50/200 LG, LP154W02-B1K1, 185 nits
Memory DDR333	Micron 256MB/ 533MHz, MT8HTF3264HDY-53EB2 Elpida 256MB/ 533MHz, U33256AGEPQ662A Micron 512MB/ 533MHz, MT8HTF6464HDY-53EA2 Elpida 512MB/ 533MHz, U33512AGEPQ672A IFX 256MB/ 533MHz, HYS64T32000HDL-3.7-A (256MB X2) IFX 512MB/ 533MHz, HYS64T64020HDL-3.7-A(512MBX2) Infineon 1GB/ 533MHz, HYS64T128021HDL-3.7-A
HDD	FJ 80GB 5400rpm, Mercury, MHT2080BH A1, SATA FJ 60GB 5400rpm, Mercury, MHT2060BH A1, SATA HGST Moraga 80GB 4200rpm, IC25N080ATMR04-0 08K635 TOSHIBA Pluto 80GB 4200rpm, MK8025GAS, 8MB Seagate N2 (50) 80GB 4200rpm, ST9808210A HGST Moraga 60GB 4200rpm, IC25N060ATMR04-0 08K0634 TOSHIBA Pluto 60GB 4200rpm, MK6025GAS Seagate N2 (50) 60GB 4200rpm, ST960821A HGST Moraga+ 100GB 5400rpm, HTS541060G9AT00 Seagate Mercury 100GB 5400rpm, ST9100823A HGST Moraga+ 80GB 5400rpm, HTS541080G9AT00 Toshiba Proteus 80GB 5400rpm, MK8026GAX
Combo	COMBO UJDA-760QT1-A, 24/24/24,8X COMBO HLDS GCC-4243N,
SuperMulti	DVD SuperMulti KME UJ-831BQB, Dual Layer DVD Super HLDS, 8x/4x/8x/4x/3x GMA-4080N (D. Layer)
WLAN	Intel 802.11a/b/g (NA)C51962-010, (MM#860871) Intel 802.11a/b/g (EU)C67261-002, (MM#861736) Intel 802.11a/b/g (RW)C67275-001, (MM#861738) Intel 802.11b/g WLAN module- 2200BGRW 802.11b/g
AC Adapter	Lite-On NB Adapter 65W, PA-1650-02Q2, 19V 3 pins Delta NB Adapter 65W, SADP-65KB BFD, 19V, 3 pins
Battery	Sanyo Lilon 4.8Ahr 8 cell (Sanyo) Simple Panasonic Lilon 4.8Ahr 8 cell (Panasonic)
Mainboard	TM8100 Mainboard with 915PM Chipset and M26-128MB VRAM

Item	Specifications
Keyboard	TM4500/TM4000/TM2300 KEYBOARD DARFON US International TM4500/TM4000/TM2300 KEYBOARD DARFON Chinese TM4500/TM4000/TM2300 KEYBOARD DARFON Spanish TM4500/TM4000/TM2300 KEYBOARD DARFON Thai TM4500/TM4000/TM2300 KEYBOARD DARFON Brazilian Protugese TM4500/TM4000/TM2300 KEYBOARD DARFON Korea TM4500/TM4000/TM2300 KEYBOARD DARFON UK TM4500/TM4000/TM2300 KEYBOARD DARFON German TM4500/TM4000/TM2300 KEYBOARD DARFON Italian TM4500/TM4000/TM2300 KEYBOARD DARFON French TM4500/TM4000/TM2300 KEYBOARD DARFON Swiss/G TM4500/TM4000/TM2300 KEYBOARD DARFON Portuguese TM4500/TM4000/TM2300 KEYBOARD DARFON Arabic TM4500/TM4000/TM2300 KEYBOARD DARFON Belgium TM4500/TM4000/TM2300 KEYBOARD DARFON Sweden TM4500/TM4000/TM2300 KEYBOARD DARFON Czech TM4500/TM4000/TM2300 KEYBOARD DARFON Hungaian TM4500/TM4000/TM2300 KEYBOARD DARFON Norway TM4500/TM4000/TM2300 KEYBOARD DARFON Danish TM4500/TM4000/TM2300 KEYBOARD DARFON Turkish TM4500/TM4000/TM2300 KEYBOARD DARFON Canadian French TM4500/TM4000/TM2300 KEYBOARD DARFON Japanese TM4500/TM4000/TM2300 KEYBOARD DARFON Greek TM4500/TM4000/TM2300 KEYBOARD DARFON Hebrew TM4500/TM4000/TM2300 KEYBOARD DARFON Russian TM4500/TM4000/TM2300 KEYBOARD DARFON Slovenia (SLO) TM4500/TM4000/TM2300 KEYBOARD DARFON Croatia (CR)
SmartCard	TravelMate Smart Card TravelMate Smart Card Sheet Smart Card Kit
5-in-1 module (SD/MMS/MS/MS-Pro/xD)	Integrated in O2 711M3
MODEM + Bluetooth daughter Card	Ambit S/W MODEM V.92 Scorpio
Bluetooth	Bluetooth module with antenna(Mini USB),MINI USB,Broadcom 2035 NMD
Inverter	SUMIDA TWS-449-171
Touchpad	Synaptic TM42P-372

Online Support Information

This section describes online technical support services available to help you repair your Acer Systems.

If you are a distributor, dealer, ASP or TPM, please refer your technical queries to your local Acer branch office. Acer Branch Offices and Regional Business Units may access our website. However some information sources will require a user i.d. and password. These can be obtained directly from Acer CSD Taiwan.

Acer's Website offers you convenient and valuable support resources whenever you need them.

In the Technical Information section you can download information on all of Acer's Notebook, Desktop and Server models including:

- Service guides for all models
- User's manuals
- Training materials
- Bios updates
- Software utilities
- Spare parts lists
- TABs (Technical Announcement Bulletin)

For these purposes, we have included an Acrobat File to facilitate the problem-free downloading of our technical material.

Also contained on this website are:

- Detailed information on Acer's International Traveler's Warranty (ITW)
- Returned material authorization procedures
- An overview of all the support services we offer, accompanied by a list of telephone, fax and email contacts for all your technical queries.

We are always looking for ways to optimize and improve our services, so if you have any suggestions or comments, please do not hesitate to communicate these to us.

