

Acer TravelMate C210 Series

Service Guide

Service guide files and updates are available on the ACER/CSD web; for more information, please refer to <http://csd.acer.com.tw>

PRINTED IN TAIWAN

Revision History

Please refer to the table below for the updates made on TravelMate C210 service guide.

Date	Chapter	Updates

Copyright

Copyright © 2006 by Acer Incorporated. All rights reserved. No part of this publication may be reproduced, transmitted, transcribed, stored in a retrieval system, or translated into any language or computer language, in any form or by any means, electronic, mechanical, magnetic, optical, chemical, manual or otherwise, without the prior written permission of Acer Incorporated.

Disclaimer

The information in this guide is subject to change without notice.

Acer Incorporated makes no representations or warranties, either expressed or implied, with respect to the contents hereof and specifically disclaims any warranties of merchantability or fitness for any particular purpose. Any Acer Incorporated software described in this manual is sold or licensed "as is". Should the programs prove defective following their purchase, the buyer (and not Acer Incorporated, its distributor, or its dealer) assumes the entire cost of all necessary servicing, repair, and any incidental or consequential damages resulting from any defect in the software.

Acer is a registered trademark of Acer Corporation.

Intel is a registered trademark of Intel Corporation.

Pentium and Pentium II/III are trademarks of Intel Corporation.

Other brand and product names are trademarks and/or registered trademarks of their respective holders.

Conventions

The following conventions are used in this manual:

SCREEN MESSAGES	Denotes actual messages that appear on screen.
NOTE	Gives bits and pieces of additional information related to the current topic.
WARNING	Alerts you to any damage that might result from doing or not doing specific actions.
CAUTION	Gives precautionary measures to avoid possible hardware or software problems.
IMPORTANT	Reminds you to do specific actions relevant to the accomplishment of procedures.

Preface

Before using this information and the product it supports, please read the following general information.

1. This Service Guide provides you with all technical information relating to the BASIC CONFIGURATION decided for Acer's "global" product offering. To better fit local market requirements and enhance product competitiveness, your regional office MAY have decided to extend the functionality of a machine (e.g. add-on card, modem, or extra memory capability). These LOCALIZED FEATURES will NOT be covered in this generic service guide. In such cases, please contact your regional offices or the responsible personnel/channel to provide you with further technical details.
2. Please note WHEN ORDERING FRU PARTS, that you should check the most up-to-date information available on your regional web or channel. If, for whatever reason, a part number change is made, it will not be noted in the printed Service Guide. For ACER-AUTHORIZED SERVICE PROVIDERS, your Acer office may have a DIFFERENT part number code to those given in the FRU list of this printed Service Guide. You MUST use the list provided by your regional Acer office to order FRU parts for repair and service of customer machines.

Chapter 1	System Specifications	1
	Features	1
	System Block Diagram	3
	Board Layout	4
	Top View	4
	Bottom View	5
	A TravelMate Tour	7
	Top View	7
	Open front view	8
	Closed front view	8
	Left view	9
	Right view	10
	Rear view	11
	Base view	11
	Indicators	13
	Easy-launch buttons	14
	Trackpoint and click buttons	15
	Trackpoint basics	15
	Scrolling basics	15
	Using the keyboard	16
	Lock keys and embedded numeric keypad	16
	Windows Keys	16
	Hot Keys	17
	Special keys	18
	Acer Empowering Technology	20
	Empowering Technology password	20
	Acer eNet Management (for selected models)	20
	Acer ePower Management	22
	Acer ePresentation Management	24
	Acer eDataSecurity Management (for selected models)	25
	Acer eLock Management	27
	Acer eRecovery Management	28
	Acer eSettings Management	29
	Acer ePerformance Management	29
	Hardware Specifications and Configurations	31
Chapter 2	System Utilities	35
	BIOS Setup Utility	41
	Navigating the BIOS Utility	42
	Information	43
	Main	44
	Advanced	45
	Security	46
	Boot	49
	Exit	50
	BIOS Flash Utility	51
	Remove HDD/BIOS Utility	52
Chapter 3	Machine Disassembly and Replacement	47
	General Information	58
	Before You Begin	58
	Disassembly Procedure Flowchart	59
	Removing the Battery Pack	60
	Removing the HDD Module/ODD Module/Memory/	

Table of Contents

Wireless LAN Card/ LCD Module and the Keyboard	.61
Removing the Hard Disk Drive Module	.61
Removing the Optical Disk Drive Module	.61
Removing the Memory	.61
Removing the Wireless LAN Card	.61
Removing the LCD Module	.62
Removing the Keyboard	.63
Disassembling the Main Unit	.64
Separating the Main Unit into the Upper Case And the Lower Case Assembly	.64
Disassembling the Upper Case, the Lower Case and the Main Board Assembly	.65
Disassembling the LCD Module	.67
Disassembling the External Modules	.69
Disassembling the HDD Module	.69
Disassembling the Optical Disc Drive Module	.69
Chapter 4 Troubleshooting	63
System Check Procedures	.72
External Diskette Drive Check	.72
External CD-ROM Drive Check	.72
Keyboard or Auxiliary Input Device Check	.72
Memory check	.73
Power System Check	.73
Touchpad check	.74
Power-On Self-Test (POST) Error Message	.75
Index of Error Messages	.76
POST Codes	.78
Index of Symptom-to-FRU Error Message	.82
Intermittent Problems	.86
Undetermined Problems	.87
Chapter 5 Jumper and Connector Locations	81
Top View	.89
Bottom View	.90
Chapter 6 FRU (Field Replaceable Unit) List	83
Appendix A Model Definition and Configuration	94
TravelMate C210 Series	.106
Appendix B Test Compatible Components	95
Microsoft® Windows® XP Pro Environment Test	.112
Microsoft® Windows® XP Home Environment Test	.115
Appendix C Online Support Information	103

System Specifications

Features

This computer was designed with the user in mind. Here are just a few of its many features:

Performance

- Intel® Centrino® Duo mobile technology, featuring
 - ▶ Intel® Core 2 Duo processor T5500/T5600 (2MB L2 cache, 1.66/1.83 GHz, 667 MHz FSB) and T7200/T7400 (4 MB L2 cache, 2/2.16 GHz, 667 MHz FSB)
 - ▶ Intel® Core Duo processor T2300/T2400/T2500/T2600 (2MB L2 cache, 1.66/1.83/2/2.16 GHz, 667 MHz FSB)
 - ▶ Mobile Intel® 945GM /945PM +ICH7M
- Intel® PRO/Wireless 3945ABG network connection (dual-band tri-mode 802.11a/b/g) or Intel® PRO/Wireless 3945BG network connection (dual-mode 802.11b/g) Wi-Fi CERTIFIED™ solution, supporting Acer SignalUp™ wireless technology
- Up to 2 GB of DDR2 533/677 MHz system memory, upgradeable to 4 GB using two soDIMM modules (dual-channel support)

Display

- 12.1" XGA Thin-Film Transistor (TFT) liquid-crystal display (LCD) supporting pen-based input, with 16.7 million color at 1024X768 resolution
- LCD slides to convert from notebook to tablet mode
- NVIDIA® GeForce® Go 7300 up to 256 MB TurboCache (128 MB of dedicated GDDR2 VRAM, up to 128 MB of shared system memory), supporting Microsoft® DirectX 9.0, Shader Model 3.0, OpenEXR High Dynamic Range (HDR) technology, NVIDIA® PowerMizer™ 6.0 PCI Express® (for discrete models)
- Mobile Intel® 945GM Express chipset with integrated 3D graphics, featuring Intel® Graphics Media Accelerator (GMA) 950, up to 224 MB of shared system memory, supporting Microsoft® DirectX® 9.0 dual independent display (for UMA models)
- Up to 2048 x 1536 resolution via non-interlaced CRT display
- 16.7 million colors
- Simultaneous LCD and CRT display, with LCD panel refresh rate at 70Hz
- MPEG-2/DVD hardware-assisted capability
- DualView™ support

Storage subsystem

- 60/80/100/120/160 GB hard disk drive
- Optical drive options:
 - ▶ 8X DVD-Super Multi double-layer, slot-loaded
 - ▶ DVD/CD-RW combo (for selected models)
- 4-in 1 card reader, supporting Memory Stick™ (MS), Memory Stick PRO™ (MS PRO), MultiMediaCard (MMC) and Secure Digital (SD)

Communication

- Modem: 56K ITU V.92 with PTT approval; Wake-on-Ring ready

-
- LAN: gigabit Ethernet; Wake-on-LAN ready
 - WLAN: Intel® PRO/Wireless 3945ABG network connection (dual-band tri-mode 802.11a/b/g) or Intel® PRO/Wireless 3945BG network connection (dual-mode 802.11b/g) Wi-Fi CERTIFIED™ solution, supporting Acer SignalUp™ wireless technology
 - WPAN: integrated Bluetooth® 2.0+EDR (Enhanced Data Rate)

Input devices

- Biometric fingerprint reader provides the notebook with advanced security protection
- 84-/85-key keyboard with inverted “T” cursor layout
- Built-in trackpoint with two buttons
- 12 function keys, four cursor keys, two Windows® key, hotkey controls, embedded numeric keypad, international language support
- Four easy-launch buttons: Internet, email, Empowering Key, user-programmable button
- Four tablet-mode buttons: Windows Security, Screen Rotate, Function, Escape
- 3-way scroll wheel (up/down/enter)
- Electromagnetic Resonance (EMR) pen with eraser

Audio

- Audio system with one built-in 1W speaker and microphone
- Sound Blaster Pro™ and MS-Sound compatible
- Intel® High-Definition audio support

I/O interface

- 124-pin Acer ezDock connector
- PC card slot (Type II)
- Biometric fingerprint reader
- 4-in-1 card reader (MS/MS PRO/MMC/SD)
- Three USB 2.0 ports
- IEEE 1394 port
- Fast infrared (FIR) port
- External display (VGA) port
- Headphones/speaker/line-out jack
- Microphone jack
- Line-in jack
- Ethernet (RJ-45) port
- Modem (RJ-11) port
- DC-in jack for AC adapter

Environment

- Temperature:
 - ▶operating: 5° C to 35° C
 - ▶Non-operating: -20° C to 65° C
- Humidity (non-condensing):
 - ▶operating: 20%~80%
 - ▶Non-operating: 20%~80%

System Block Diagram

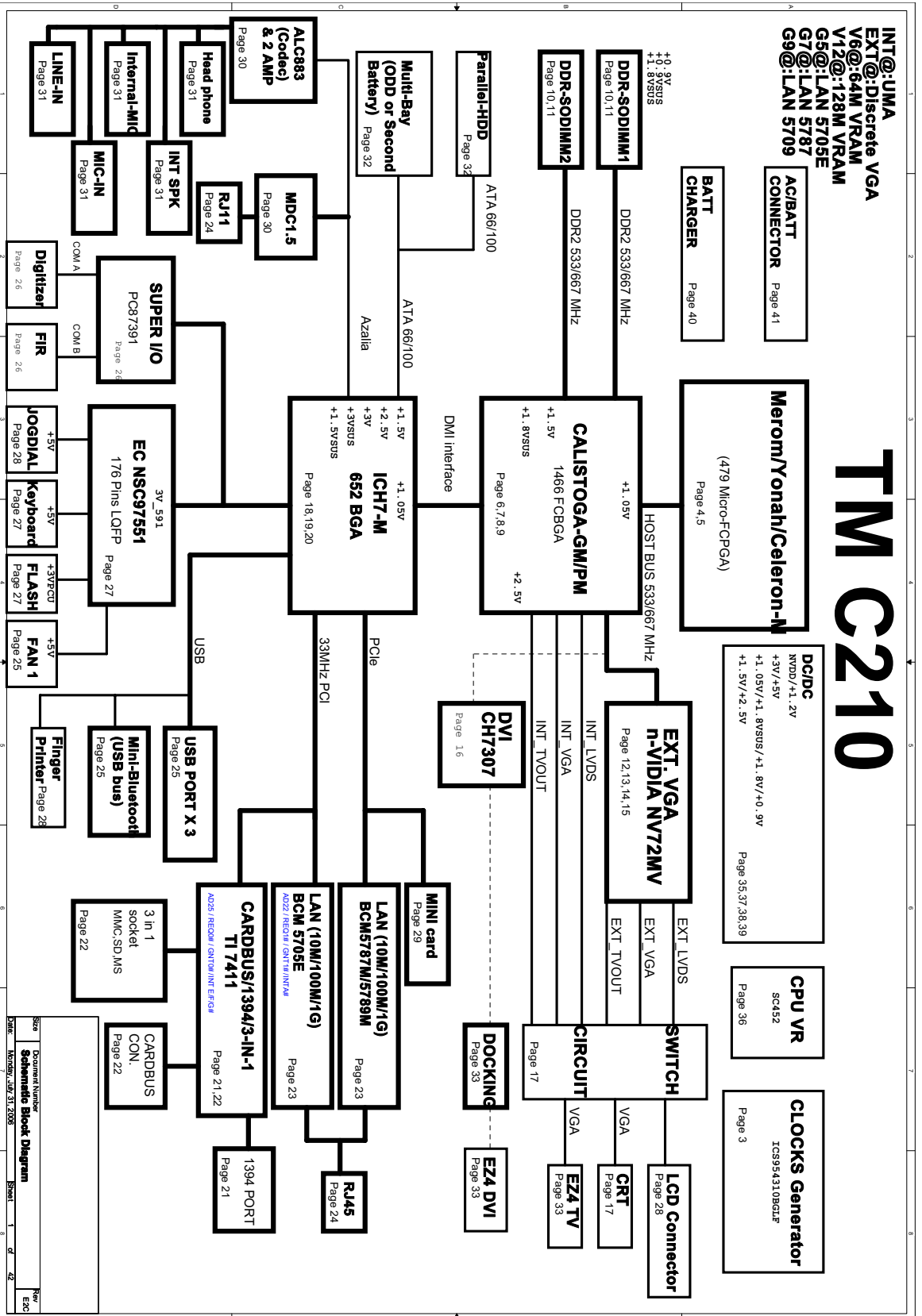

Board Layout

Top View

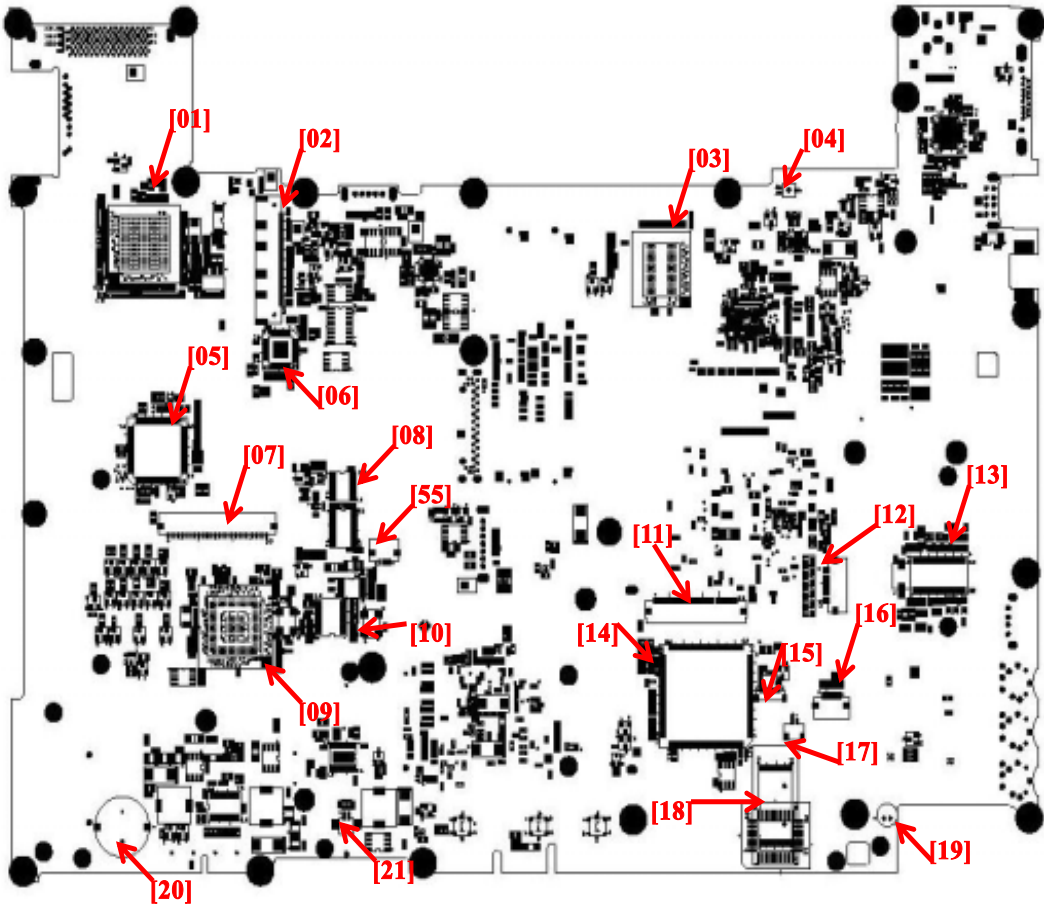

1	U3	Lan Controller	12	CN5	Quick Button Board Connector
2	CN2	LCD Connector	13	U20	Clock Generator
3	U4	VRAM1	14	U29	EC (Keyboard Controller)
4	CN1	Lid Switch	15	CN7	BT Connector
5	U16	Super I/O Controller	16	CN8	Jogdial Board Connector
6	U10	DVI Trasmitter	17	CN9	Pen Switch Board Connector
7	CN3	PCI Debug Card Connector (Reserved)	18	CON1/ U34	BIOS ROM
8	U17/ U19	IDE Buffer	19	CN10	Internal MIC
9	U23	PCMCIA/1394/Card Reader Controller	20	BT1	RTC Battery Connector
10	U22	Track Point Controller	21	CN11	Intetnal Speaker
11	CN6	Keyboard Connector	55	CN4	Track Point Connector

Bottom View

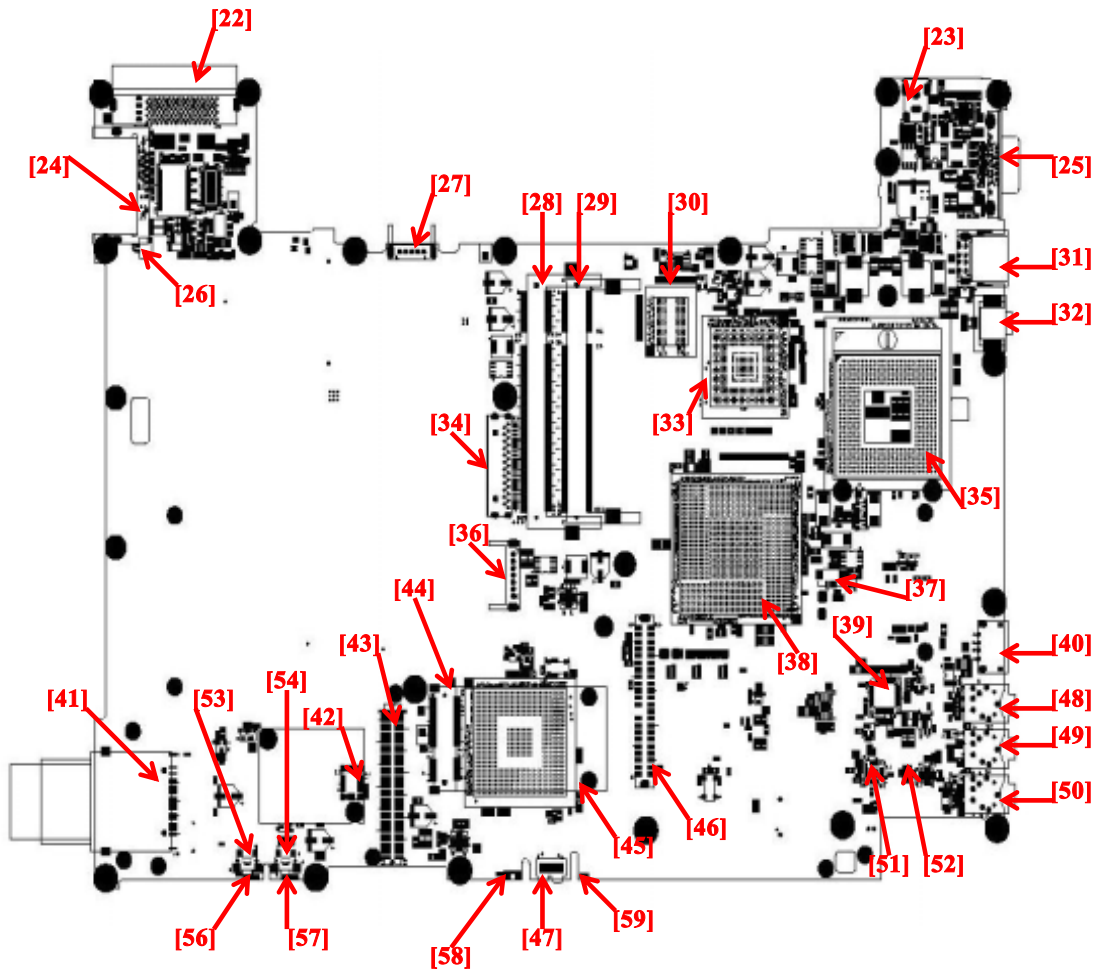

22	CN13	EZ Docking Connector	41	CN30	Memory Card Reader
23	CN12	AC Power Jack	42	J1	MDC Connector
24	CN15	RJ11/RJ45 Connector	43	CN28	PCMCIA Board Connector
25	CN14	CRT Connector	44	CN26	MINI Card Connector
26	CN16	Modem Connector	45	U54	South Bridge (ICH7)
27	CN17	Main Battery Connector	46	CN24	PATA HDD Connector
28	JDIM1	DDR Socket 1	47	U57	FIR
29	JDIM2	DDR Socket 2	48	CN25	External Line In
30	U44	VRAM2	49	CN27	External MIC In
31	CN18	USB Dual Connector	50	CN29	External Headphone
32	CN19	1394 Connector	51	U55	Speaker Amplifier (MAX9710)
33	U45	VGA Chip (NV72MV)	52	U56	Headphone (MAX4411)
34	CN20	CD-ROM Board Connector	53	SW4	Bluetooth Enable Switch
35	U46	CPU Socket	54	SW5	WLAN Enable Swtich
36	CN22	Second Battery Connector	56	LED3	BT LED

37	CN21	FAN Connector	57	LED4	WLAN LED
38	U48	North Bridge (945GM/PM)	58	LED1	Battery LED
39	U52	Audio Codec Controller	59	LED2	HDD LED
40	CN23	USB Connector			

A TravelMate Tour

Now let us show you around the new TravelMate computer.

Top View



#	Item	Description
1	Display screen	Also called LCD (liquid-crystal display), displays computer output. Electromagnetic resonance (EMR) stylus is used to input data in tablet mode. Use only an EMR-compatible stylus to input data on the screen.
2	Tablet-mode button	Escape button for use in tablet PC mode.
3	Tablet-mode button	Function button for use in tablet PC mode.
4	Tablet-mode button	Screen rotate button for use in tablet PC mode.
5	Biometric fingerprint reader	Provides fingerprint-verified access to operating system applications.
6	Windows Security lock button	A tablet-mode button, it functions like CLT-ALT-DEL to lock the access to the operating system.
7	Power switch	Turns the computer on and off.

Open front view

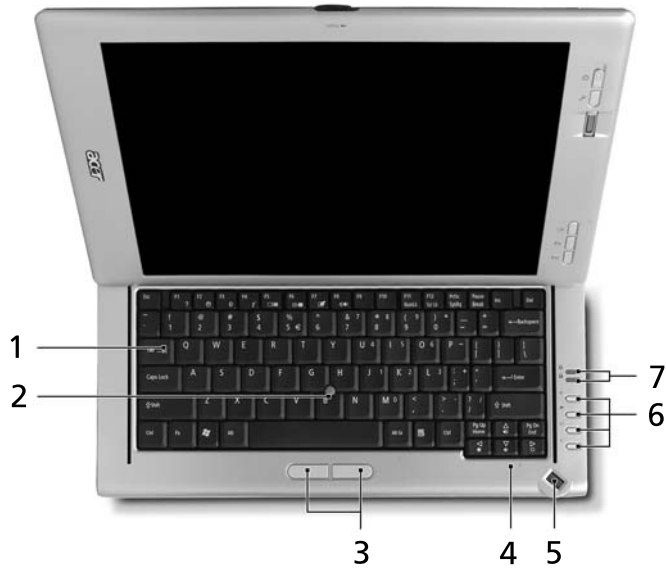





#	Item	Description
1	Keyboard	For entering data in notebook PC mode.
2	Built-in trackpoint	Touch-sensitive pointing device which functions like a computer mouse when used together with the click buttons.
3	Click buttons (left and right)	Function like the left and right mouse buttons when used together with the center-keyboard trackpoint.
4	Built-in microphone	Internal microphone for sound recording.
5	Scroll wheel	For up, down and one-touch accelerated scrolling.
6	Easy-launch buttons	Buttons for launching frequently used programs.
7	Indicator lights	Light up when Caps Lock or Num Lock are activated.

Closed front view





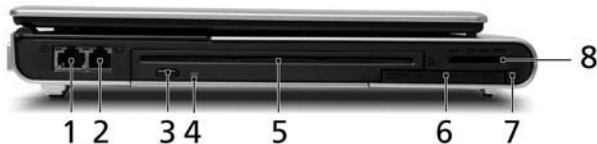

#	Icon	Item	Description
---	------	------	-------------

1		Wireless communication button/indicator	Press to enable/disable the wireless function. Lights to indicated the status of wireless LAN communication.
2		Bluetooth communication button/indicator	Press to enable/disable Bluetooth functions. Lights to indicated the status of Bluetooth communications.
3		Speaker	Provides sound.
4		Battery indicator	Lights up when battery is being charged.
5		Fast infrared (FIR) port	Interfaces with infrared printers, computers and other FIR-aware devices.
6		HDD indicator	Indicates when the hard disk drive is active.
7		Electromagnetic resonance (EMR) pen with eraser	For entering data in tablet PC mode.

Left view







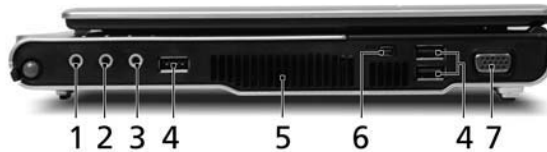

#	Icon	Item	Description
1		Ethernet (RJ-45) port	Connects to a gigabit Ethernet network.
2		Modem (RJ-11) port	Connects to a phone line.
3		Optical drive eject button	Ejects the optical drive tray.
4		LED indicator	Lights up when the optical drive is active.
5		Optical drive	Accepts recordable DVDs and CDs, depending on the drive type.
6		PC Card slot	Accepts one Type II PC Card.

7		PC Card slot eject button	Eject the PC Card from the slot.
8		4-in-1 card reader	Accepts Memory Stick, Memory Stick Pro, MultiMediaCard (MMC), Secure Digital (SD). Note: Only one card can operate at any given time.



Right view

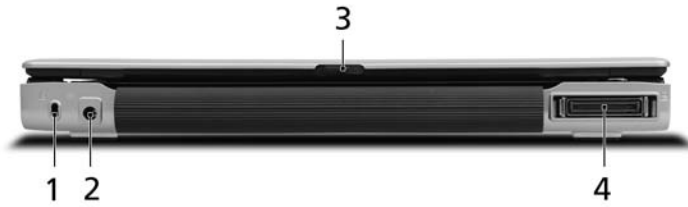

#	Icon	Item	Description
1		Headphone/speakers line-out jack	Connects to audio line-out devices.
2		Microphone/line-in jack	Accepts audio line-in devices (e.g. microphone or audio CD player).
3		IEEE 1394 port	Connects to IEEE 1394 devices.
4		USB 2.0 port	Connects to USB 2.0 devices (e.g. USB mouse or camera).
5		Ventilation slots	Keep computer cool during use.
6		USB 2.0 port	Connects to USB 2.0 devices (e.g. USB mouse or camera).
7		External display (VGA) port	Connects to a display device (e.g. monitor or projector).

Rear view



#	Icon	Item	Description
1		Kensington lock slot	Connects to a Kensington-compatible computer security lock.
2		DC-in jack	Connects to an AC adapter.
3		Latch	Locks and release the LCD unit to convert from tablet to notebook mode.
4		Acer ezDock port	Connects to an Acer ezDock (optional).

Base view

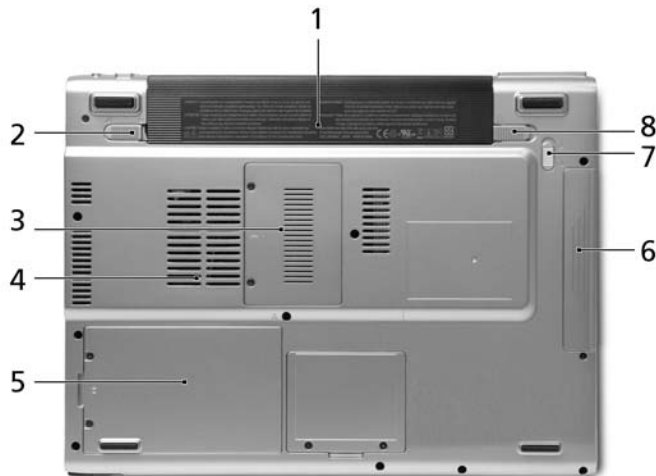

#	Item	Description
1	Battery bay	Houses the computer's battery pack.
2	Battery lock latch	Locks the battery in place.
3	Memory compartment	Houses the computer's main memory (secured with two screws).

4	Cooling fan	Cools computer during use. Note: Do not cover or obstruct the opening of the fan.
5	Hard disk bay	Houses the computer's hard disk (secured with two screws).
6	Optical drive	Internal optical drive (hot -swappable Acer MediaBay drive model is optional).
7	Optical drive release latch	Release the optical drive module for removal.
8	Battery lock latch	Locks the battery in place.

Indicators

The computer has two easy-to-read status indicators to the right of the keyboard, and four on the front panel.



The power, media, Bluetooth and wireless communication status indicators are visible even when the LCD display is closed.

Icon	Function	Description
	Caps Lock	Lights up when Caps Lock is activated.
	Num Lock	Lights up when Num Lock is activated.
	HDD activity	Indicates when the hard disk or optical drive is active.
	Battery indicator	Lights up when the computer is on.
	Bluetooth	Indicates the status of Bluetooth communication.
	Wireless LAN	Indicates the status of wireless LAN communication.

Easy-launch buttons

Located to the right of the keyboard are four buttons. These buttons are called easy-launch buttons. They are: mail, Web browser, Acer Empowering Key < *e* > and one user-programmable button.

Press < *e* > to run the Acer Empowering Technology. The mail and Web browser buttons are pre-set to email and Internet programs, but can be reset by users. To set the Web browser, mail and programmable buttons, run the Acer Launch Manager.



Easy-launch button	Default application
P	User-programmable
<i>e</i>	Acer Empowering Technology (user-programmable)
	Internet browser (user-programmable)
Mail	Email application (user-programmable)

Trackpoint and click buttons

The built-in trackpoint is a pointing device that senses movement on its surface. This means the cursor responds as you use your finger to move the trackpoint. Its central location on the move your finger on the surface of the touchpad. The central location on the palmrest provides optimal comfort and support.



NOTE: If you are using an external USB mouse, you can press **Fn-F7** to disable the touchpad.

Trackpoint basics

The following items show you how to use the trackpoint and click buttons:

- Using your finger, apply light, steady pressure on the trackpoint (1) to move the cursor.
- Press the left (2) and right (3) buttons located below the keyboard to perform selection and execution functions. These two buttons are similar to the left and right buttons on a mouse.

Scrolling basics

The 3-way scroll wheel is enabled for tablet-and keyboard-mode use.

- Use the job wheel (4) to scroll up or down on a page. A click on the job wheel executes the Enter function, similar to clicking the left click button or the left button of a mouse.

Function	Left Button	Right Button	Scroll Wheel
Execute	Quickly click twice		Click on the job wheel.
Select	Click once		
Drag	Click and hold, then use finger on the trackpoint to drag the cursor.		
Access context menu		Click once	
Scroll			Use finger to roll scroll wheel lightly up or down in tablet or notebook mode.

NOTE: When using these inputs, keep them - and your fingers - dry and and clean. The scroll wheel is sensitive to finger movement; hence, the lighter the touch, the better the response. Tapping harder will not increase click button responsiveness.

Using the keyboard

Lock keys and embedded numeric keypad

The keyboard has full-sized keys with an embedded numeric keypad, as well as separate lock, cursor and Windows keys, and hotkey controls.











Lock Key	Description
Caps Lock	When Caps Lock is on, all alphabetic characters typed are in uppercase.
Num Lock <Fn> + <F11>	When Num Lock is on, the embedded keypad is in numeric mode. The keys function as a calculator (complete with the arithmetic operators +, -, *, and /). Use this mode when you need to do a lot of numeric data entry. Another solution would be connect an external keypad.
Scroll Lock <Fn> + <F12>	When Scroll Lock is on, the screen moves one line up or down when you press the up or down arrow keys respectively. Scroll Lock does not work with some applications.

The embedded numeric keypad functions like a desktop numeric keypad. It is indicated by small characters located on the upper right corner of the keycaps. To simplify the keyboard legend, cursor-control key symbols are not printed on the keys.

Desired access	Num Lock on	Num Lock off
Number keys on embedded keypad	Type numbers in a normal manner.	
Cursor-control keys on embedded keypad	Hold <Shift> while using cursor-control keys.	Hold <Fn> while using cursor-control keys.
Main keyboard keys	Hold <Fn> while typing letters on embedded keypad.	Type the letters in a normal manner.

Windows Keys

The keyboard has two keys that perform Windows-specific functions.



Key	Icon	Description
Windows key		<p>Pressed alone, this key has the same effect as clicking on the Windows Start button; it launches the Start menu. It can also be used with other keys to provides a variety of functions:</p> <ul style="list-style-type: none">  + <Tab>: Activates the next taskbar button  + <E>: Opens the My Computer window.  + <F1>: Opens Help and Support Center.  + <F>: Opens the Search Results window.  + <R>: Opens the Run dialog box.  + <M>: Minimizes all windows. <p><Shift> +  + <M>: Undoes the minimize all windows action.</p>
Application key		This key has the same effect as clicking the right mouse button; it opens the application's context menu.









Hot Keys

The computer employs hotkeys or key combinations to access many computer controls, including screen brightness, volume output and the BIOS utility.

To activate hotkeys, press and hold the **<Fn>** key before pressing the other key in the hotkey combination.



Hot Key	Icon	Function	Description
<Fn> + <F1>		Hotkey help	Displays help on hotkeys.
<Fn> + <F2>		Acer eSettings	Launches Acer eSettings in Acer Empowering Technology.
<Fn> + <F3>		Acer ePower Management or Power management	Display the Power Options Properties used by the computer (function available if supported by operating system). See "Power management" on page 25.

Hot Key	Icon	Function	Description
<Fn> + <F4>		Sleep	Puts the computer in Sleep mode. See "Power management" on page 25.
<Fn> + <F5>		Display toggle	Switches display output between the display screen, external monitor (if connected) and both the display screen and external monitor.
<Fn> + <F6>		Screen blank	Turns the display screen backlight off to save power. Press any key to return.
<Fn> + <F7>		Touchpad toggle	Turns the internal touchpad on and off.
<Fn> + <F8>		Speaker toggle	Turns the speakers on and off.
<Fn>+< ↑ >		Volume up	Increases the speaker volume.
<Fn>+< ↓ >		Volume down	Decreases the speaker volume.
<Fn>+< → >		Brightness up	Increases the screen brightness.
<Fn>+< ← >		Brightness down	Decreases the screen brightness

Special keys

You can locate the Euro symbol and the US dollar sign at the upper-center and/or bottom-right of your keyboard.



The Euro symbol

1. Open a text editor or word processor.

-
2. Either press <€> at the bottom-right of the keyboard, or hold <Alt Gr> and then press the <5> key at the upper-center of the keyboard.

NOTE: Some fonts and software do not support the Euro symbol. Please refer to www.microsoft.com/typography/faq/faq12.htm for more information.

The US dollar sign

1. Open a text editor or word processor.
2. Either press <\$> at the bottom-right of the keyboard, or hold <shift> and then press the <4> key at the upper-center of the keyboard.

NOTE: This function varies according to the language settings.

Acer Empowering Technology

Acer's innovative Empowering Technology makes it easy for you to access frequently used functions and manage your new Acer notebook. It features the following handy utilities:

- ❑ **Acer eNet Management (for selected models)** hooks up to location-based networks intelligently.
- ❑ **Acer ePower Management** extends battery power via versatile usage profiles.
- ❑ **Acer ePresentation Management** connects to a projector and adjusts display settings conveniently.
- ❑ **Acer eDataSecurity Management (for selected models)** protects data with passwords and advanced encryption algorithms.
- ❑ **Acer eLock Management (for selected models)** limits access to external storage media.
- ❑ **Acer eRecovery Management** backs up and recovers data flexibly, reliably and completely.
- ❑ **Acer eSettings Management** accesses system information and adjusts settings easily.
- ❑ **Acer ePerformance Management** improves system performance by optimizing disk space, memory and registry settings.



For more information, press the < *e* > key to launch the Empowering Technology menu, then click on the appropriate utility and select the Help or Tutorial function.

Empowering Technology password

Before using Acer eLock Management and Acer eRecovery Management, you must initialize the Empowering Technology password. Right-click on the Empowering Technology toolbar and select "Password Setup" to do so. If you do not initialize the Empowering Technology password, you will be prompted to do so when running Acer eLock Management or Acer eRecovery Management for the first time.

Acer eNet Management (for selected models)

Acer eNet Management helps you to quickly and easily connect to both wired and wireless networks in a variety of locations. To access this utility, either click on the "**Acer eNet Management**" icon on your netebook, or start the program from the Start menu. You also have the option to set Acer eNet Management to start automatically when you boot up your PC.

Acer eNet Management automatically detects the best settings for a new location, while offering you the freedom to manually adjust the settings to match your needs.



Acer eNet Management can save network settings for a location to a profile, and automatically switch to the appropriate profile when you move from one location to another. Settings stored include network connection settings (IP and DNS settings, wireless AP details, etc.), as well as default printer settings.

Security and safety concerns mean that Acer eNet Management does not store username and password information.

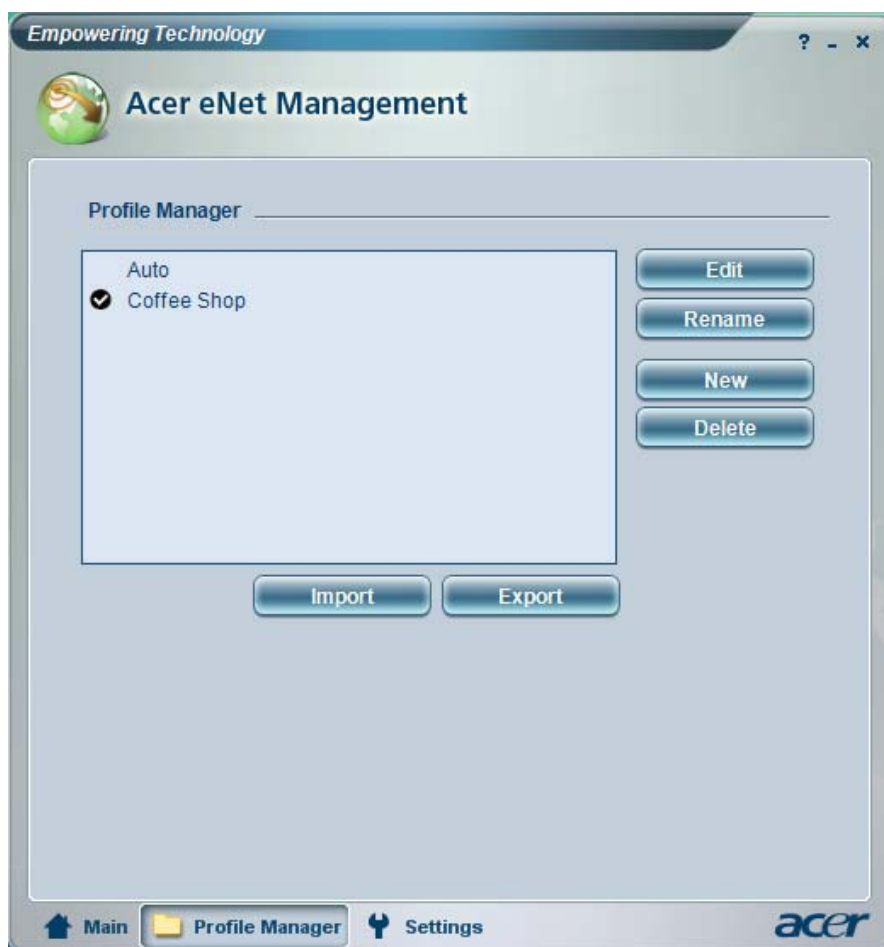

Acer ePower Management

Acer ePower Management features a straightforward user interface. To launch it, select Acer ePower Management from the Empowering Technology interface.

AC Mode (Adapter mode)

The default setting is “Maximum Performance.” You can adjust CPU speed, LCD brightness and other settings, or click on buttons to turn the following functions on/off: Wireless LAN, Bluetooth, CardBus, FireWire (1394), Wired LAN and Optical Device if supported.

DC Mode (Battery mode)

There are four pre-defined profiles - Entertainment, Presentation, Word Processing, and Battery Life. You can also define up to three of your own.

To create new power profile

1. Change power settings as desired.
2. Click “Save as...” to save to a new power profile.
3. Name the newly created profile.
4. Select whether this profile is for Adapter or Battery mode, then click OK.
5. The new profile will appear in the profile list.

Battery status

For real-time battery life estimates based on current usage, refer to the panel on the lower left-hand side of the window.



For additional options, click **“Settings”** to:

- Set alarms.
- Re-load factory defaults.
- Select what actions will be taken when the cover is closed or the power button is pressed.
- View information about Acer ePower Management.

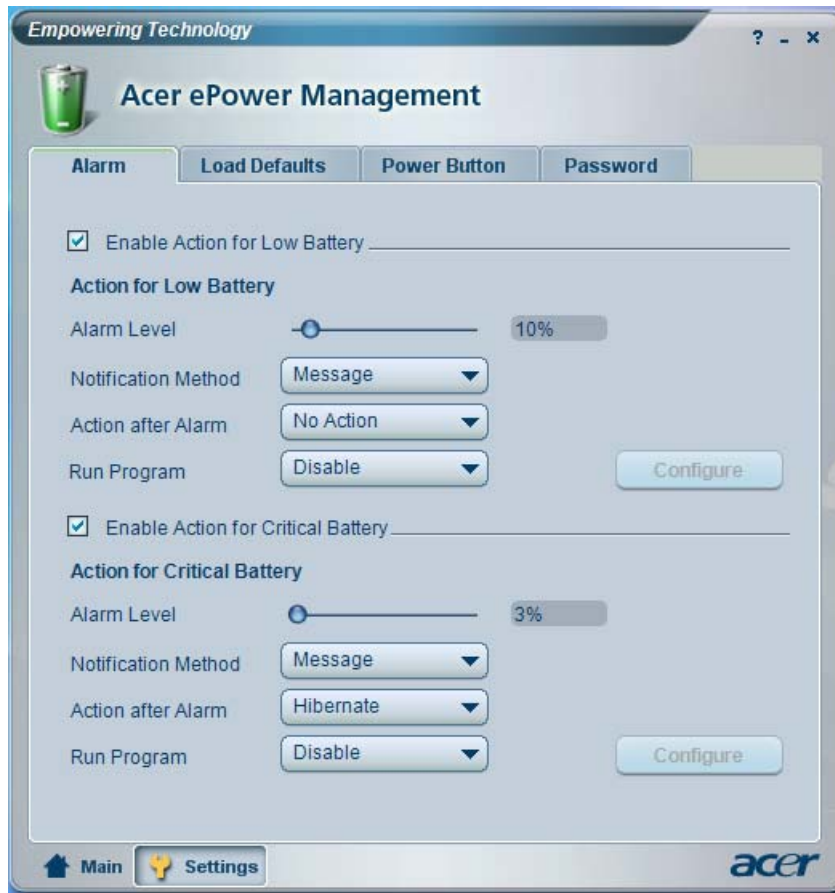

Acer ePresentation Management

Acer ePresentation Management lets you project your computer's display to an external device or project using the hot key: Fn + F5. If auto-detection hardware is implemented in the system, your system display will be automatically switched out when an external display is connected to the system.

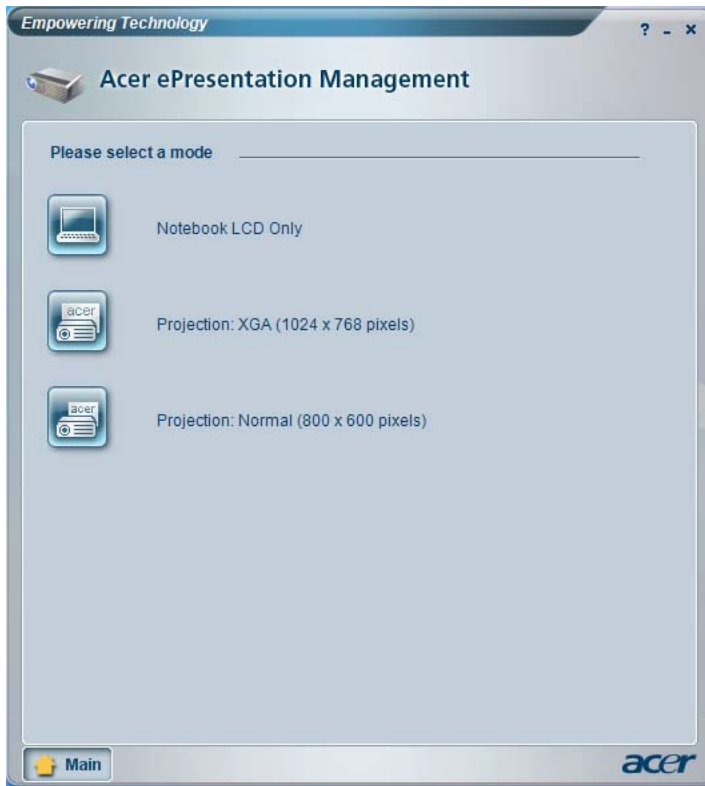

Acer eDataSecurity Management (for selected models)

Acer eDataSecurity Management is handy file encryption utility that protects your files from being accessed by unauthorized persons. It is conveniently integrated with Windows explorer as a shell extension for quick and easy data encryption/decryption and also supports on-the-fly file encryption for MSN Messenger and Microsoft Outlook.

The Acer eDataSecurity Management setup wizard will prompt you for a supervisor password and default encryption. This encryption will be used to encrypt files by default, or you can choose to enter your own file-specific password when encrypting a file.

NOTE: The password used to encrypt a file is the unique key that the system needs to decrypt it. If you lose the password, the supervisor password is the only other key capable of decrypting the file. If you lose both passwords, there will be no way to decrypt your encrypted file! **Be sure to safeguard all related passwords!**

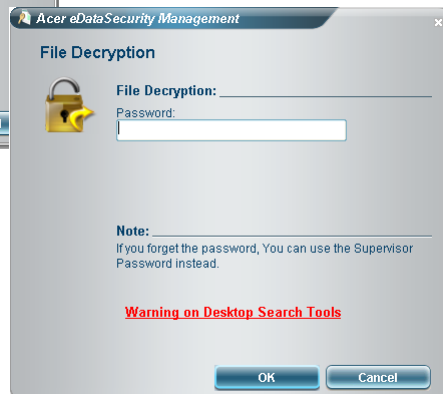
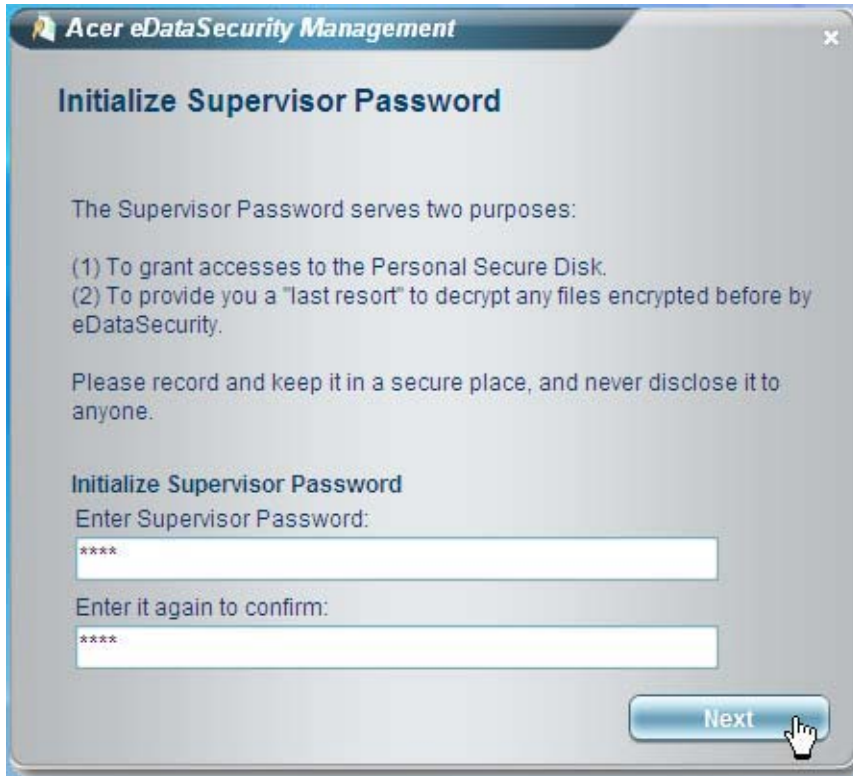

Acer eLock Management

Acer eLock Management is a security utility that allows you to lock your removable data, optical and floppy drives to ensure that data can't be stolen while your notebook is unattended.

- Removable data devices - includes USB disk drives, USB pen drives, USB flash drives, USB MP3 drives, USB memory card readers, IEEE 1394 disk drives and any other removable disk drives that can be mounted as a file system when plugged into the system.
- Optical drive devices - includes any kind of CD-ROM or DVD-ROM drives.
- Floppy disk drives - 3.5-inch disks only.
- Interfaces - includes serial ports, parallel port, infrared (IR), and Bluetooth.

To activate Acer eLock Management, a password must be set first. Once set, you can apply locks to any of the devices. Lock(s) will immediately be set without any reboot necessary, and will remain locked after rebooting, until unlocked.

NOTE: If you lose your password, there is no method to reset it except by reformatting your notebook or taking your notebook to an Acer Customer Service Center. Be sure to remember or write down your password.

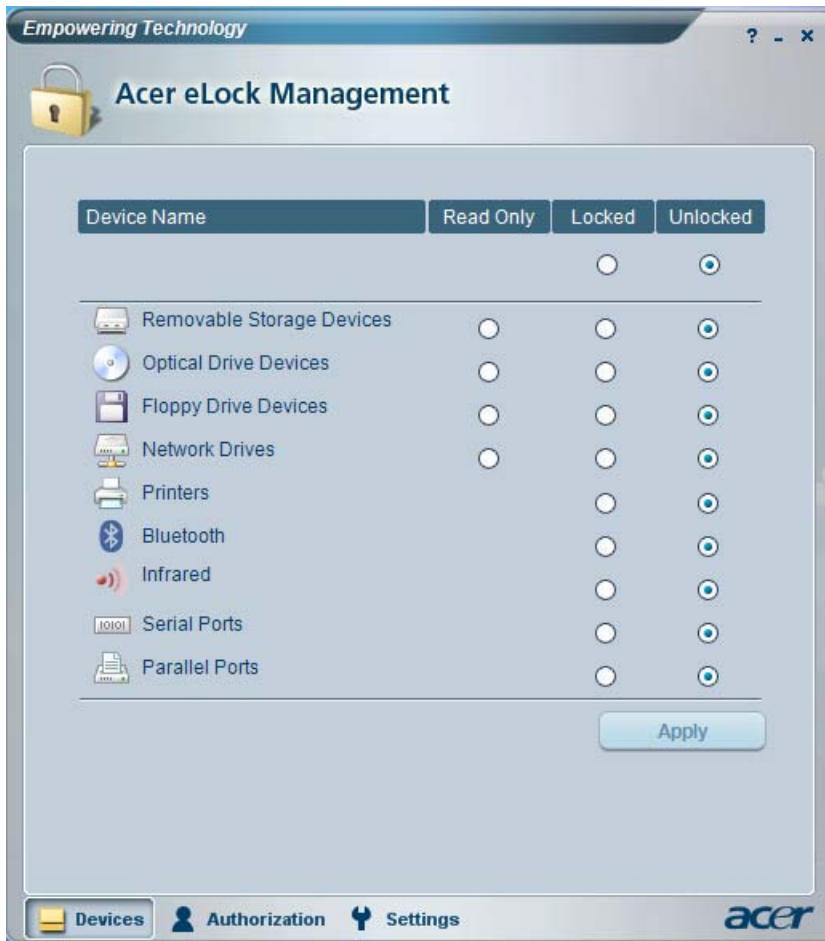

Acer eRecovery Management

Acer eRecovery Management is a powerful utility that does away with the need for recovery disks provided by the manufacturer. The Acer eRecovery Management utility occupies space in a hidden partition on your system's HDD. User-created backups are stored on D:\ drive. Acer eRecovery Management provides you with:

- Password protection.
- Recovery of applications and drivers.
- Image/data backup:
 - Back up to HDD (set recovery point).
 - Back up to CD/DVD.
- Image/data recovery tools:
 - Recover from a hidden partition (factory defaults).
 - Recover from the HDD (most recent user-defined recovery point).
 - Recover from CD/DVD.

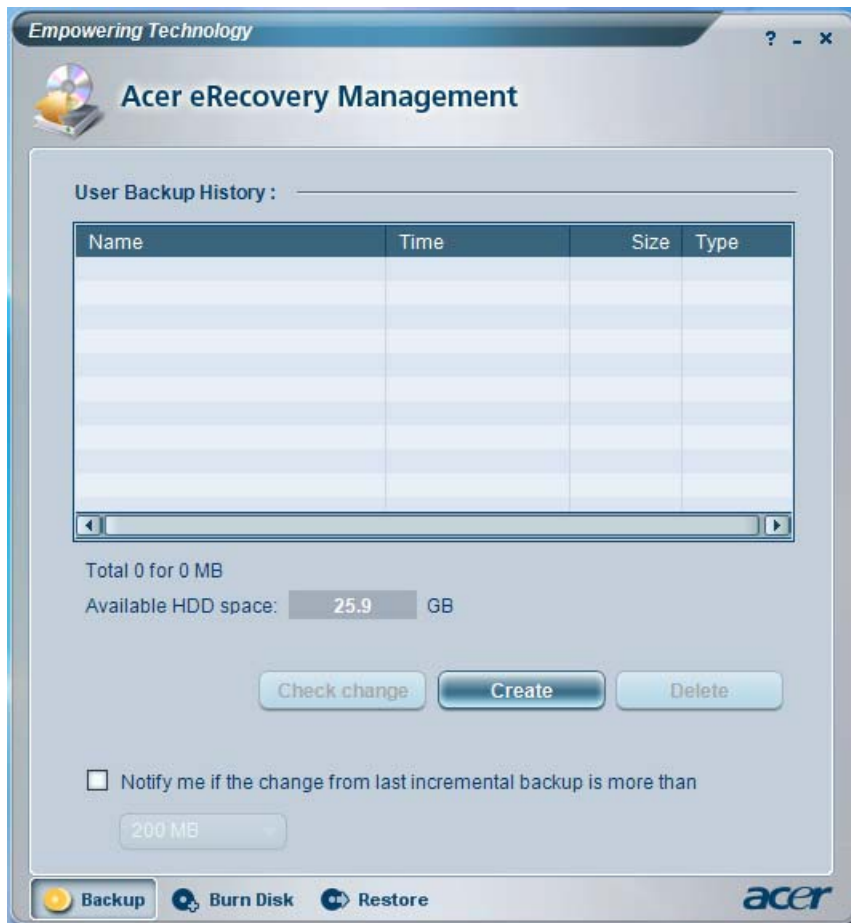

For more information, please refer to “Acer eRecovery Management”

NOTE: If your computer did not come with a Recovery CD or System CD, please use Acer eRecovery Management’s “System backup to optical disk” feature to burn a backup image to CD or DVD. To ensure the best results when recovering your system using a CD or Acer eRecovery Management, detach all peripherals (except the external Acer ODD, if your computer has one), including your Acer ezDock.

Acer eSettings Management

Acer eSettings Management allows you to inspect hardware specifications and to monitor the system health status. Furthermore, Acer eSettings Management enables you to optimize your Windows operating system, so your computer runs faster, smoother and better.

Acer eSettings Management also:

- Provides a simple graphical user interface for navigating.
- Displays general system status and advanced monitoring for power users.



Acer ePerformance Management

Acer ePerformance Management is a system optimization tool that boosts the performance of your Acer notebook. It provides an express optimization method to release unused memory and disk space quickly. The user can also enable advanced options for full control over the following option:

- Memory optimization - releases unused memory and check usage.
- Disk optimization - removes unneeded items and files.
- Speed optimization - improves the usability and performance of your Windows XP system.

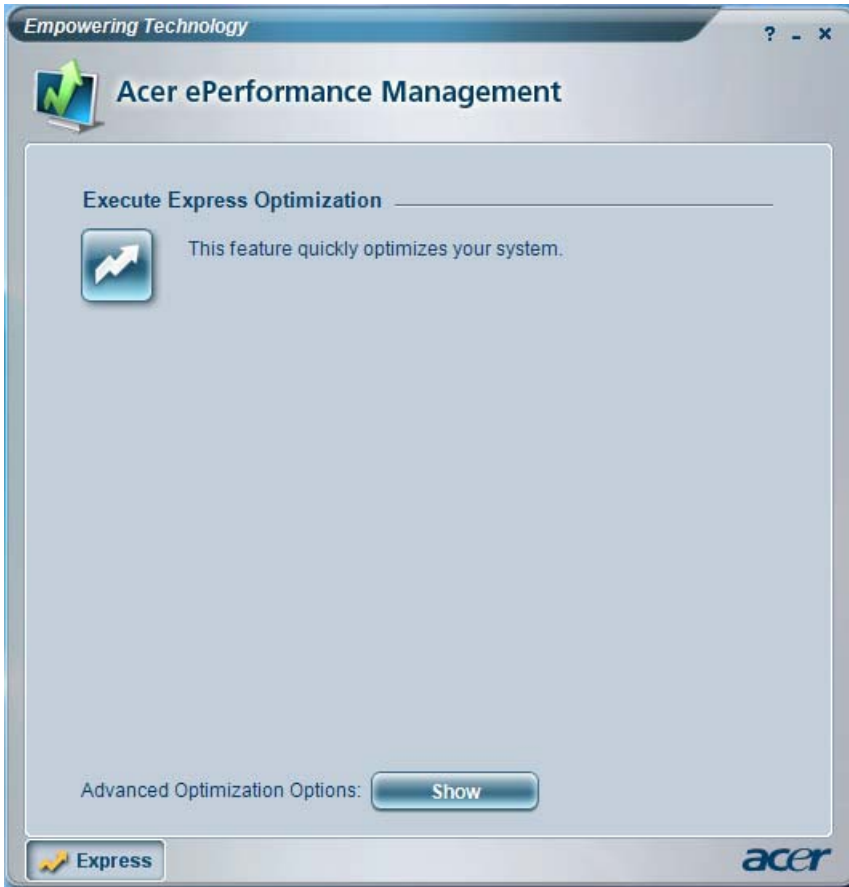

Hardware Specifications and Configurations

Processor

Item	Specification
CPU type	Intel® Core 2 Duo processor T5500/T5600 (2MB L2 cache, 1.66/1.83 GHz, 667 MHz FSB) and T7200/T7400 (4 MB L2 cache, 2/2.16 GHz, 667 MHz FSB) Intel® Core Duo processor T2300/T2400/T2500/T2600 (2MB L2 cache, 1.66/1.83/2/2.16 GHz, 667 MHz FSB)
CPU package	Intel 479 pin Micro-FCBGA
CPU core voltage	Vcc-Core:1.2875V (highest frequency mode) to 0.8375V (low frequency mode) Vcc-Core: 0.75V (Deep sleep mode)

CPU Fan True Value Table

Level	Fan Speed (rpm)	Temperature	Sound pressure level (dBA)		
			Average	Left	Right
BGN	0	0	15.0	14.9	15.0
Fan-off	0	0	17.0	16.6	17.3
Low	3380	50	28.5	26.1	30.9
Middle	3910	66	28.7	31.0	26.3
High	4510	78	38.0	35.8	40.2
Full	4800	90	39.9	37.7	42.0

Performance Mode

Throttling

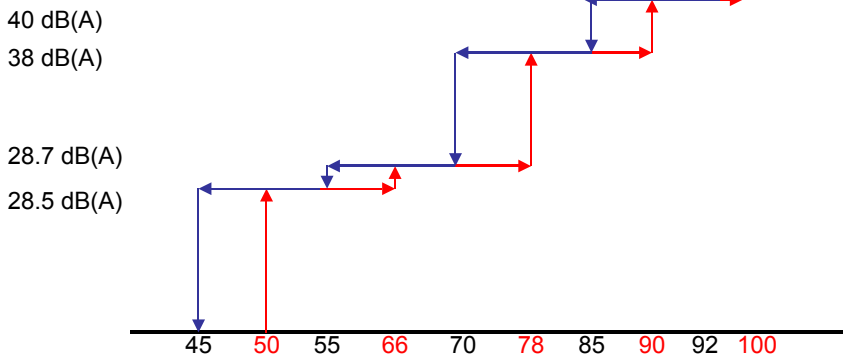

- Level 0 : Fan on =50C ; Fan Off =45C , Fan RPM= 3380
- Level 1 : Fan on =66C ; Fan Off =55C , Fan RPM= 3910
- Level 2 : Fan on =78C ; Fan Off =70C , Fan RPM= 4510
- Level 3 : Fan on =90C ; Fan Off =85C , Fan RPM= 4800

Sound Pressure Level

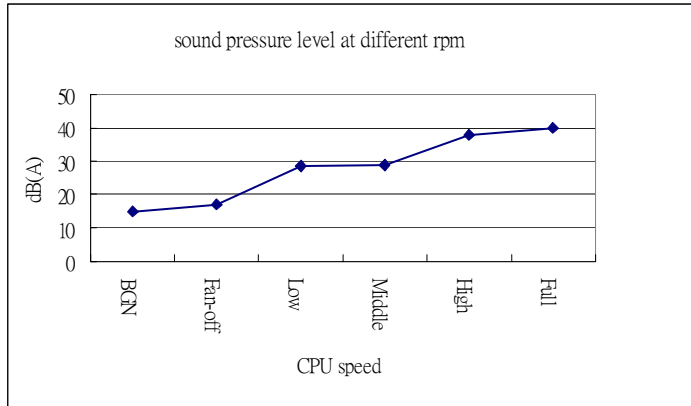

Low : 3380 rpm
Middle: 3910 rpm
High:4510 rpm
Full:4800 rpm

BIOS

Item	Specification
BIOS vendor	Phoenix
BIOS Version	V1.00
BIOS ROM type	Flash ROM (SST SST39VF080)
BIOS ROM size	1Mbytes
BIOS package	TSOP
Supported protocols	ACPI 1.0b, PC Card 95, SM BIOS 2.3, EPP/IEEE 1284, ECP/IEEE 1284 1.7 & 1.9, PCI 2.2, PnP 1.0a, DMI 2.0, PS/2 keyboard and mouse, USB 2.0, VGA BIOS, CD-ROM bootable, IEEE 1394
BIOS password control	Set by setup manual

Second Level Cache

Item	Specification
Cache controller	Built-in CPU
Cache size	2MB for Intel® Pentium® M processor 1MB for Intel® Celeron® M processor
1st level cache control	Always enabled
2st level cache control	Always enabled
Cache scheme control	Fixed in write-back

System Memory

Item	Specification
Memory controller	Built in Intel 945PM/GM
Memory size	0MB (no on-board memory)
DIMM socket number	2 sockets
Supports memory size per socket	256MB, 512MB, 1024MB
Supports maximum memory size	2GB (by two 1024MB DDRII RAM module)
Supports DIMM type	soDIMM
Supports DIMM Speed	533/677 MHz
Supports DIMM voltage	1.8V and 0.9V
Supports DIMM package	200-pin soDIMM

Memory Combinations

Slot 1	Slot 2	Total Memory
0MB	256MB	256MB
0MB	512MB	512MB
0MB	1024MB	1024MB
256MB	0MB	256MB
256MB	256MB	512MB
256MB	512MB	768MB
256MB	1024MB	1280MB
512MB	0MB	512MB
512MB	256MB	768MB
512MB	512MB	1024MB
512MB	1024MB	1536MB
1024MB	0MB	1024MB
1024MB	256MB	1280MB
1024MB	512MB	1536MB
1024MB	1024MB	2048MB

NOTE: Above table lists some system memory configurations. You may combine DIMMs with various capacities to form other combinations. On above table, the configuration of slot 1 and slot 2 could be reversed.

Modem Interface

Item	Specification
Data modem data baud rate (bps)	56K
Supports modem protocol	V92 MDC
Modem connector type	RJ11
Modem connector location	Left side

LAN Interface

Item	Specification
Chipset	BroadCom BCM5787M/5789M
Supports LAN protocol	10/100/1000 Mbps
LAN connector type	RJ45
LAN connector location	Left side

Bluetooth Interface

Item	Specification
Chipset	Built-in ICH7M
Data throughput	723 bps (full speed data rate)
Protocol	Bluetooth 1.1 (Upgradeable to Bluetooth 1.2 when SIG specification is ratified).
Interface	USB 1.1
Connector type	Mini-USB

Wireless Module 802.11a/b/g

Item	Specification
Chipset	Built-in ICH7M
Data throughput	11~54 Mbps
Protocol	802.11a+b+g or 802.11b+g
Interface	PCI bus

Four-in-One Card Reader

Item	Specification
Chipset	Integrated on TI PC7411
Data throughput	USB 1.1
Protocol	Memory Stick (MS), MS PRO, MultiMediaCard, Secure Digital (SD)

Hard Disk Drive Interface

Item	Specification			
Vendor & Model Name	HGST MORAGA+ HTS541060G9AT00 SEAGATE ST96812A LF MERCURY TOSHIBA MK6034GAX	HGST MORAGA+ HTS541080G9AT00 ROHS F/W:A60A SEAGATE ST98823A LF MERCURY 2 TOSHIBA MK8032GAX	HGST MORAGA+ HTS541010G9AT00 SEAGATE ST9100824A LF MERCURY TOSHIBA MK1032GAX	SEAGATE ST9120821A TOSHIBA MK1234GAX WD WD1200UE
Capacity (GB)	60	80	100	120
Bytes per sector	512	512	512	512
Data heads	2	2/3	3/4 for Toshiba	4
Logical heads	16	16	16	16
Logical sectors	63	63	63	63
Drive Format				
Disks	1	1/2	2/3 for Toshiba	2
Logical cylinders	16383	16383	16383	16383
Spindle speed (RPM)	5400 RPM	5400 RPM	5400 RPM	5400 RPM
Performance Specifications				
Buffer size	2MB	2MB	8MB/2MB for Toshiba	8MB
AT Interface	ATA/ATAPI-6 ATA-5 for Toshiba	ATA/ATAPI-6 ATA-5 for Toshiba	ATA/ATAPI-6 ATA-5 for Toshiba	ATA/ATAPI-6
Data transfer rate (buffer to/from media Mbytes/s)	350	350	350/450	350
Data transfer rate (host~buffer, Mbytes/s)	100 MB/Sec. Ultra DMA mode-5	100 MB/Sec. Ultra DMA mode-5	100 MB/Sec. Ultra DMA mode-5	100 MB/Sec. Ultra DMA mode-5
DC Power Requirements				

Hard Disk Drive Interface

Item	Specification			
Voltage tolerance	5V(DC) +/- 5%	5V(DC) +/- 5%	5V(DC) +/- 5%	5V(DC) +/- 5%

DVD/CDRW Interface

Item	Specification	
Vendor & model name	LITEON SSC-2485K,GBAS PANASONIC UJDA-770, GBASE	
Performance Specification	With CD Diskette	With DVD Diskette
Transfer rate (KB/sec)	Sustained: Max 3.6Mbytes/sec	Sustained: Max 10.8Mbytes/sec
Data Buffer Capacity	128 KBytes	
Interface	IDE/ATAPI (ATA/ATAPI-5)	
Applicable disc format (for SONY)	For Panasonic UJDA770: CD: CD-DA, CD-ROM, CD-R, CD-RW, CD-ROM XA, Photo CD (Multi session), Video CD, CD-Extra (CD+), CD-text DVD: DVD-ROM, DVD-Video, DVD-RAM (2.6GB/4.7GB), DVD-R, DVD-RW (ver. 1.1) (Supporting Multi Border) DVD+R, DVD+RW (Supporting Multi Session)	
Applicable disc format (for QSI)	DVD: DVD-ROM (DVD-5, DVD-9, DVD-10, DVD-18), DVD-R, DVD-RW, DVD+R, DVD+RW, DVD-RAM (optional) CD: CD-DA, CD-ROM/XA, CD-i, Karaoke CD, Video CD, Multi-session Photo CD, Enhanced CD, itrax CD, CD extra, CD Plus, CD-Text, CD-R and CD-RW discs	
Loading mechanism	Load: Manual Release: (a) Electrical Release (Release Button) (b) Release by ATAPI command (c) Emergency Release	
Power Requirement		
Input Voltage	5 V +/- 5 % (Operating)	

DVD Super Multi Interface

Item	Specification	
Vendor & model name	PANASONIC UJ-85J	
Performance Specification	With CD Diskette	With DVD Diskette
Transfer rate (KB/sec)	Sustained: Max 3.6Mbytes/sec	Sustained: Max 10.8Mbytes/sec
Data Buffer Capacity	128 KBytes	
ATAPI Interface	SFF-8020i, SFF8090 Ver5	
Applicable disc format	Applicable disc format CD: CD-DA, CD-ROM, CD-ROM XA, PhotoCD (multi-session), Video CD, Cd-Extra (CD+), CD-text DVD: DVD-VIDEO, DVD-ROM, DVD-R (3.9GB, 4.7GB) DVD-R DL, DVD-RW, DVD-RAM, DVD+R, DVD+R DL, DVD+RW	
Loading mechanism	Load: Manual Release: (a) Electrical Release (Release Button) (b) Release by ATAPI command (c) Emergency Release	
Power Requirement		
Input Voltage	5 V +/- 5 % (Operating)	

Speaker

Item	Specification
Number of speaker	1
Rated input	1W
Connector type	Headphone out, microphone in and line-in

Video Interface

Item	Specification
Chipset	Intel 945GM (UMA) or Nvidia NV72MV (NVIDIA® GeForce™ Go 7300)
Interface	PCI-E
Supports ZV (Zoomed Video) port	No
Maximum resolution LCD	1600X1200 (UXGA)
Maximum resolution CRT	2048X1536@75HZ

Audio Interface

Item	Specification
Audio Controller	Realtek ALC883 Azalia and Amplifier Maxim MAX9710 (for internal speaker) & MAX4411 (for headphone)
Audio onboard or optional	Built-in
Mono or Stereo	Stereo
Resolution	18 bit stereo full duplex
Compatibility	HD audio Interface; S/PDIF output for PCM or AC-3 content
Sampling rate	1Hz resolution VSR (Variable Sampling Rate)
Internal microphone	Yes
Internal speaker / Quantity	Yes/2 (1.5W speakers)

Video Memory

Item	Specification
Fixed or Upgradeable	Fixed for UMA Upgradeable for NVIDIA® NV44M-V (NVIDIA® GeForce™ Go 6200)
Vendor	Intel/NVIDIA®
Memory size	UMA: up to 224MB (of system shared memory) NVIDIA: up to 256MB turbocache(128 MB of dedicated GDDR2 VRAM, up to 128 MB of shared system meory)
Interface	PCI-E

USB Port

Item	Specification
Chipset	built-in ICH7-M
USB Compliancy Level	2.0
EHCI	USB 2.0 (supporting data transfer rate up to 60MB per second)
Number of USB port	3
Location	Right side

USB Port

Item	Specification
Serial port function control	Enable/Disable by BIOS Setup

IEEE 1394 Port

Item	Specification
Chipset	TI 7411
InterfaceUSB Compliancy Level	IEEE 1394 1.0
Number of IEEE 1394 port	1
Location	Right side
Connector type	IEEE 1394

PCMCIA Port

Item	Specification
PCMCIA controller	TI PC7411
Supports card type	Type-II
Number of slots	One type-II
Access location	Left panel
Supports ZV (Zoomed Video) port	No ZV support
Supports 32 bit CardBus	Yes (IRQ10)

System Board Major Chips

Item	Controller
Core logic	Intel® 945GM/PM+ ICH7-M
VGA	Intel® 945GM (UMA) NVIDIA® NV72MV (NVIDIA® GeForce™ Go 7300)
LAN	Broad Com 5787M/5789M
IEEE 1394	TI PC7411
USB 2.0	ICH7-M intergrated
Super I/O controller	PC 87391
MODEM	Conexant MC3Z MDC1.5_Azalia
Blue tooth	FOX_BRM_2.0
Wireless 802.11 b	Intel 3945abg/Intel 3945bg
PCMCIA	TI PC7411
Audio	Codec: Realtek ALC883
Four-in-one card reader	TI PC7411
Trackpoint	EC NCD97551

Keyboard

Item	Specification
Keyboard controller	EC NSC97551
Keyboard vendor & model name	DARFON
Total number of keypads	84/85/88
Windows logo key	Yes

Keyboard

Item	Specification
Internal & external keyboard work simultaneously	No Note: Internal and external keyboard can not work simultaneously by software specification.

Battery

Item	Specification
Vendor & model name	Sanyo Sony
Battery Type	Li-ion
Pack capacity	4000 MAH or 4800 MAH
Cell voltage	3.7V/cell
Number of battery cell	6
Package configuration	3 cells in series, 2 series in parallel
Package voltage	14.8V

LCD

Item	Specification
Vendor & model name	12.1XGA TABLET HYDIS HT12X21
Mechanical Specifications	
LCD display area (diagonal, inch)	12.1
Display technology	TFT
Resolution	XGA (1024x768)
Supports colors	262K
Optical Specification	
Brightness control	keyboard hotkey
Contrast control	No
Typical White Luminance	180
Contrast ratio	450
Response time (msec)	40 (Tr+Td)
Electrical Specification	
Supply voltage for LCD display (V)	3.0 (Min.), 3.3 (Typ.), 3.6 (Max.)
Viewing Angle Range	80 (left/right/down/up)

AC Adaptor

Item	Specification
Model number	LiteOn PA-1650 19V 65W (3 PIN)
AC input	90~264V, 47Hz to 63Hz
Output power	65W, 19V@3.42V

System Power Management

ACPI mode	Power Management
Mech. Off (G3)	All devices in the system are turned off completely.
Soft Off (G2/S5)	OS initiated shutdown. All devices in the system are turned off completely.
Working (G0/S0)	Individual devices such as the CPU and hard disk may be power managed in this state.
Suspend to RAM (S3)	CPU set power down VGA Suspend PCMCIA Suspend

Memory Address Map

Memory Address	Size	Function
00100000h-000F0000h	512 KB	System BIOS
000CFFFFh-000C0000h		VGA BIOS
00009FFFFh-00000000h	640KB	Conventional memory

I/O Address Map

I/O Address	Function
0000-001F, 0081-008F, 0090-0091, 0093-009F, 00C0-00DF, 040B, 04D6	DMA controller
0D00-FFFF	PCI bus
0020-0021, 0024-0025, 0028-0029, 002C-002D, 0030-0031, 0034-0035, 0038-0039, 003C-003D, 00A0-00A1, 00A4-00A5, 00A8-00A9, 00AC-00AD, 00B0-00B1, 00B4-00B5, 00B8-00B9, 00BC-00BD, 00C0-00DF	Programmable interrupt controller
0040-0043, 0050-0053	System timer
0060, 0064	Acer Tablet PC Keyboard Buttons (101/102 key)
002E-002F, 004E-004F, 0061, 0063, 0065, 0067, 0080, 0092, 00B2-00B3, 0200-020F, 0600-060F, 0700-070F, 0800-080F, 1000-107F, 1180-11BF,	Main board resources
0066	Microsoft ACPI-Compliant Embedded Controller
0070-0077	System CMOS/real time clock
00F0	Numeric data processor
0170-0177, 0376	Secondary IDE Channel
01F0-01F7, 03F6	Primary IDE Channel
0274-0277, 0279, 0A79,	ISAPNP Read Data Port
0378-037F, 0778-077B	Printer Port (LPT1)
03B0-03BB, 03C0-03DF, 1800-1807,	Intel (R) 82852/82855 GM/GME Graphics Controller
06F8-06FF	Wacom Serial Pen Tablet
1810-181F	Intel (R) 82801DBM Ultra ATA Storage Controller-24CA
1820-183F	Intel (R) 82801DB/DBM USB Universal Host Controller-24C2
1840-185F	Intel (R) 82801DB/DBM USB Universal Host Controller-24C4
1860-187F	Intel (R) 82801DB/DBM USB Universal Host Controller-24C7
1880-189F	Intel (R) 82801DB/DBM SMBus Controller-24C3

I/O Address Map

I/O Address	Function
18C0-18FF, 1C00-1CFF	Crystal WDM AC97 Driver for ICH4
2000-207F, 2400-24FF	Agere System AC97 Modem
FB00-FBFE	O2Micro SmartCardBus Reader
FC00-FCFF, FD00-FDFF, FE00-FEFF, FF00-FFFF	Generic Cardbus Controller

IRQ Assignment Map

Interrupt Channel	System timer
IRQ00	System time
IRQ01	Keyboard
IRQ02	Programmable Interrupt Controller
IRQ03	FIR
IRQ04	Communications Port (COM1)
IRQ05	Free
IRQ06	Wacom Serial Pen Tablet/Standard Floppy Disk Controller
IRQ07	ECP Printer Port (LPT1)/O2Micro Smart CardBus Reader
IRQ08	Real Time Clock
IRQ09	SCI
IRQ10	PCI Device (LAN, Audio, Modem...)
IRQ11	USB 1.1, USB 2.0, VGA
IRQ12	PS/2 Mouse
IRQ13	Numeric data processor
IRQ14	1st EIDE device (hard disk)
IRQ15	2nd EIDE device (optical drive)

DMA Channel Assignment

Item	Specification
00	PnP Audio System CODEC
01	Free
02	Standard Floppy Disk Controller
03	ECP Printer Port

System Utilities

BIOS Setup Utility

The BIOS Setup Utility is a hardware configuration program built into your computer's BIOS (Basic Input/Output System).

Your computer is already properly configured and optimized, and you do not need to run this utility. However, if you encounter configuration problems, you may need to run Setup. Please also refer to Chapter 4 Troubleshooting when problem arises.

To activate the BIOS Utility, press **F2** during POST (when "Press <F2> to enter Setup" message is prompted on the bottom of screen).

Press **F2** to enter setup. Press <F12> during POST to enter multi-boot menu. In this menu, user can change boot device without entering BIOS SETUP Utility.

Navigating the BIOS Utility

There are six menu options: Information, Main, Advanced, Security, Boot, and Exit.

Follow these instructions:

- To choose a menu, use the cursor left/right keys (← →).
- To choose a parameter, use the cursor up/down keys (↑ ↓).
- To change the value of a parameter, press F5 or F6.
- A plus sign (+) indicates the item has sub-items. Press ENTER to expand this item.
- Press ESC while you are in any of the menu options to go to the Exit menu.
- In any menu, you can load default settings by pressing F9. You can also press F10 to save any changes made and exit the BIOS Setup Utility.

NOTE: You can change the value of a parameter if it is enclosed in square brackets. Navigation keys for a particular menu are shown on the bottom of the screen. Help for parameters are found in the Item Specific Help part of the screen. Read this carefully when making changes to parameter values.

This menu provides you the information of the system.

Information

Parameter	Description
IDE1 Model Name	Shows the Model name of HDD installed on Primary IDE master. The hard disk model name is automatically detected by the system. If there is no hard disk present or unknown type, " None " should be shown on this field.
IDE1 Serial #	This field display the Serial number of HDD installed on Primary IDE master. If no Hard disk or other devices are installed on Primary IDE master, then it will display a blank line.
IDE2 Model Name	This item will show the Model name of device installed on Secondary IDE master. The hard disk or CD-ROM model name is automatically detected by the system. If there is no hard disk or CD-ROM present or unknown type, " None " should be shown on this field.
IDE2 Serial #	This item will show the Serial number of HDD installed on Secondary IDE master. If no hard disk or other devices are installed on Primary IDE master, then it will display a blank line.
Serial Number	This field displays the serial number of this unit.
UUID Number	UUID=32bytes

Main

The Main screen displays a summary of your computer hardware information, and also includes basic setup parameters. It allows the user to specify standard IBM PC AT system parameters.

NOTE: The screen above is for reference only. Actual values may differ.

The table below describes the parameters in this screen. Settings in **boldface** are the default and suggested parameter settings.

Parameter	Description	Format/Option
System Time	Sets the system time.	Format: HH:MM:SS (hour:minute:second) System Time
System Date	Sets the system date.	Format MM/DD/YYYY (month/day/ year) System Date
System Memory	This field reports the memory size of the system. Memory size is fixed to 640MB	
Extended Memory	This field reports the memory size of the extended memory in the system. Extended Memory size=Total memory size-1MB	
VGA Memory	Shows the VGA memory size. The default value is set to 8MB. Note: 8MB is VGA memory size under DOS mode. Dynamic video memory allocation up to 64MB in Windows mode.	
Quiet Boot	Determines if Customer Logo will be displayed or not; shows Summary Screen is disabled or enabled. Enabled: Customer Logo is displayed, and Summary Screen is disabled. Disabled: Customer Logo is not displayed, and Summary Screen is enabled.	Option: Enabled or Disabled
Power on display	Auto: During power process, the system will detect if any display device is connected on external video port. If any external display device is connected, the power on display will be in CRT (or projector) only mode. Otherwise it will be in LCD only mode. Both: Simultaneously enable both the integrated LCD screen and the system's external video port (for an external CRT or projector).	Option: Auto or Both
LCD Auto Dim	Determines if the system will automatically dim the LCD brightness in order to save power when AC is not present.	Option: Enabled or Disabled
PXE (Preboot Execution Environment) Boot From LAN	Indicates that whether the notebook can boot from LAN or not.	Option: Enabled or Disabled
F12 Boot Menu	Determines if the OEM POST screen will have "Press <F12> Change Boot Device" or not during user's quiet boot.	Option: Enabled or Disabled

NOTE: The sub-items under each device will not be shown if the device control is set to disable or auto. This is because the user is not allowed to control the settings in these cases.

Advanced

The Advanced menu screen contains parameters involving your hardware devices. It also provides advanced settings of the system.

PhoenixBIOS Setup Utility					
Information	Main	Advanced	Security	Boot	Exit
Infrared/Serial port: :					Item Specific Help
[Disabled]					
F1 Help	↑ ↓	Select Item	F5/F6	Change Values	F9 Setup Defaults
Esc Exit	← →	Select Menu	Enter	Select ▶ Sub-Menu	F10 Save and Exit

The table below describes the parameters in the screen. Settings in **boldface** are the default and suggested parameter settings.

Parameter	Description	Options
Infrared/Serial port	Enables, disables the infrared/serial port.	Enabled /Disabled

Security

The Security screen contains parameters that help safeguard and protect your computer from unauthorized use.

PhoenixBIOS Setup Utility					
Information	Main	Advanced	Security	Boot	Exit
User Password is Clear Supervisor Password is Clear Set User Password [Enter] Set Supervisor Password [Enter] Password on boot: [Enabled]				Item Specific Help Supervisor Password controls accesses of the whole setup utility. It can be used to boot up when Password on boot is enabled.	

F1 Help	↑ ↓ Select Item	F5/F6 Change Values	F9 Setup Defaults
Esc Exit	← → Select Menu	Enter Select ▶ Sub-Menu	F10 Save and Exit

The table below describes the parameters in this screen. Settings in **boldface** are the default and suggested parameter settings.

Parameter	Description	Option
User Password is	Shows the setting of the user password.	Clear or Set
Supervisor Password is	Shows the setting of the Supervisor password	Clear or Set
Set User Password	Press Enter to set the user password. When set, this password protects the BIOS Setup Utility from unauthorized access.	
Set Supervisor Password	Press Enter to set the supervisor password. When set, this password protects the BIOS Setup Utility from unauthorized access.	
Password on Boot	Defines whether a password is required or not while the events defined in this group happened. The following sub-options are all requires the Supervisor password for changes and should be grayed out if the user password was used to enter setup.	Disabled or Enabled

NOTE: When you are prompted to enter a password, you have three tries before the system halts. Don't forget your password. If you forget your password, you may have to return your notebook computer to your dealer to reset it.

Setting a Password

Follow these steps as you set the user or the supervisor password:

1. Use the **↑** and **↓** keys to highlight the Set Supervisor Password parameter and press the **ENTER** key. The Set Supervisor Password box appears:

Set Supervisor Password	
Enter New Password	[]
Confirm New Password	[]

2. Type a password in the “Enter New Password” field. The password length can not exceeds 8 alphanumeric characters (A-Z, a-z, 0-9, not case sensitive). Retype the password in the “Confirm New Password” field.

IMPORTANT: Be very careful when typing your password because the characters do not appear on the screen.

3. Press **ENTER**.
After setting the password, the computer sets the User Password parameter to “Set”.
4. If desired, you can opt to enable the Password on boot parameter.
5. When you are done, press **F10** to save the changes and exit the BIOS Setup Utility.

Removing a Password

Follow these steps:

1. Use the **↑** and **↓** keys to highlight the Set Supervisor Password parameter and press the **ENTER** key. The Set Password box appears:

Set Supervisor Password	
Enter current password	[]
Enter New Password	[]
Confirm New Password	[]

2. Type the current password in the Enter Current Password field and press **ENTER**.
3. Press **ENTER** twice **without** typing anything in the Enter New Password and Confirm New Password fields. The computer then sets the Supervisor Password parameter to “Clear”.
4. When you have changed the settings, press **F10** to save the changes and exit the BIOS Setup Utility.

Changing a Password

1. Use the **↑** and **↓** keys to highlight the Set Supervisor Password parameter and press the **ENTER** key. The Set Password box appears:

Set Supervisor Password		
Enter current password	[]
Enter New Password	[]
Confirm New Password	[]

2. Type the current password in the Enter Current Password field and press **ENTER**.
3. Type a password in the Enter New Password field. Retype the password in the Confirm New Password field.
4. Press **ENTER**. After setting the password, the computer sets the User Password parameter to "Set".
5. If desired, you can enable the Password on boot parameter.
6. When you are done, press **F10** to save the changes and exit the BIOS Setup Utility.

If the verification is OK, the screen will display as following.

Setup Notice
Changes have been saved.
[continue]

The password setting is complete after the user presses **F10**.

If the current password entered does not match the actual current password, the screen will show you the Setup Warning.

Setup Warning
Invalid password
Re-enter Password
[continue]

If the new password and confirm new password strings do not match, the screen will display the following message.

Setup Warning
Password do not match
Re-enter Password

Boot

This menu allows the user to decide the order of boot devices to load the operating system. Bootable devices includes the distette drive in module bay, the onboard hard disk drive and the CD-ROM in module bay.

PhoenixBIOS Setup Utility					
Information	Main	Advanced	Security	Boot	Exit
Hard Drive Removable Device CD-ROM Drive				Item Specific Help	
				Keys used to view or configure devices: <Enter> expands or Collapses Devices with a + or - <Ctrl+Enter> expands all <Shift + 1> enables or disables a device. <+> and <-> moves the device up or down. <n> May move removable device between Hard Disk or Removable Disk. <d> Remove a device that is not installed.	
F1 Help	↑↓ Select Item	F5/F6 Change Values	F9 Setup Defaults		
Esc Exit	←→ Select Menu	Enter Select	▶ Sub-Menu	F10 Save and Exit	

Exit

The Exit screen contains parameters that help safeguard and protect your computer from unauthorized use.

PhoenixBIOS Setup Utility					
Information	Main	Advanced	Security	Boot	Exit
Exit Saving Changes Exit Discarding Changes Load Setup Defaults Discard Changes Save Changes				Item Specific Help Exit System Setup and save your changes to CMOS.	
F1	Help	↑↓	Select Item	F5/F6	Change Values
Esc	Exit	←→	Select Menu	Enter	Select ▶ Sub-Menu
				F9	Setup Defaults
				F10	Save and Exit

The table below describes the parameters in this screen.

Parameter	Description
Exit Saving Changes	Exit System Setup and save your changes to CMOS.
Exit Discarding Changes	Exit utility without saving setup data to CMOS.
Load Setup Default	Load default values for all SETUP item.
Discard Changes	Load previous values from CMOS for all SETUP items.
Save Changes	Save Setup Data to CMOS.

BIOS Flash Utility

The BIOS flash memory update is required for the following conditions:

- New versions of system programs
- New features or options
- Restore a BIOS when it becomes corrupted.

Use the Phlash utility to update the system BIOS flash ROM.

NOTE: If you do not have a crisis recovery diskette at hand, then you should create a **Crisis Recovery Diskette** before you use the Phlash utility.

NOTE: Do not install memory-related drivers (XMS, EMS, DPMI) when you use the Phlash.

NOTE: Please use the AC adaptor power supply when you run the Phlash utility. If the battery pack does not contain enough power to finish BIOS flash, you may not boot the system because the BIOS is not completely loaded.

Follow the steps below to run the Phlash.

1. Prepare a bootable diskette.
2. Copy the Phlash utilities to the bootable diskette.
3. Then boot the system from the bootable diskette. The Phlash utility has auto-execution function.

Remove HDD/BIOS Utility

This section provide you with removing HDD/BIOS method:

Remove HDD Password:

- If you key in wrong HDD password for three time, "HDD password error code" would display on the screen. See the image below.

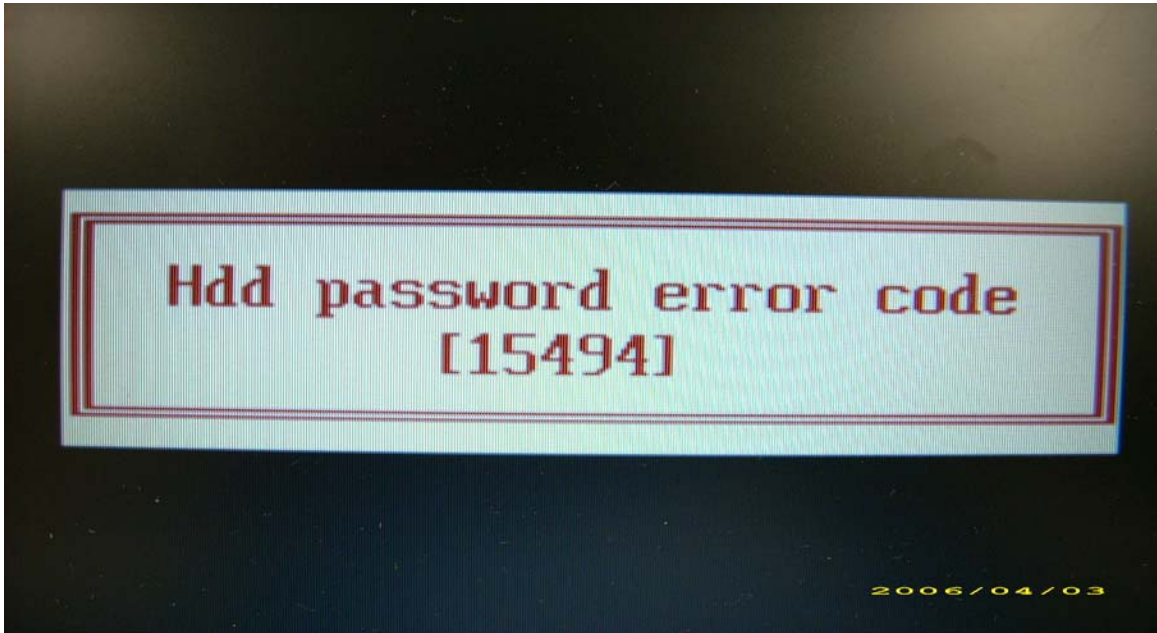

- If you need to solve HDD password locked problem, you can run HDD_PW.EXE
 1. Key in "hdd_pw 15494 0"
 2. Select "2"
 3. Choose one upper-case string

```
C:\WINDOWS\system32\cmd.exe
F:\>cd password
F:\password>dir/w
Volume in drive F has no label.
Volume Serial Number is D4F6-0236

Directory of F:\password

[.]          [..]      BIOS_PW.EXE  HDD_PW.EXE
             2 File(s)      35,354 bytes
             2 Dir(s)      487,895,040 bytes free
F:\password>hdd_pw 15494 0
unlock6.exe v1.1 2 May 2003

Choice what kind of the password to be generated:
0.) Exit....
1.) Scan Code
2.) Upper case ASCII Code
3.) Lower case ASCII Code
Enter your choice: 2
0KJFN42
UVEIQ96
F:\password>
```

- Reboot system and key in "0KJFN42" or "UVEIQ96" to HDD user password.

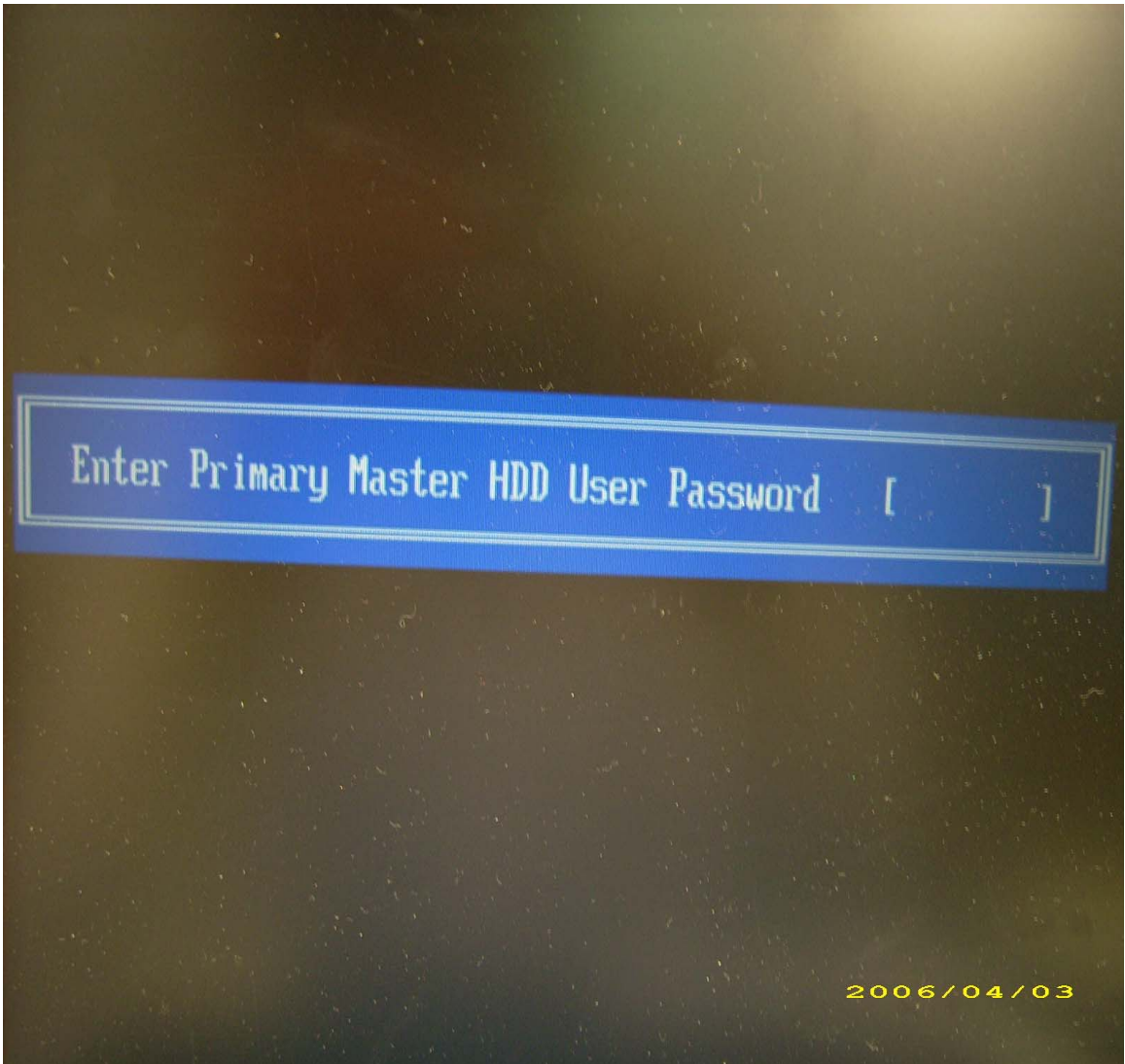

Remove BIOS Password:

- If you key in wrong Supervisor Password for three time, "System Disabled" would display on the screen. See the image below.

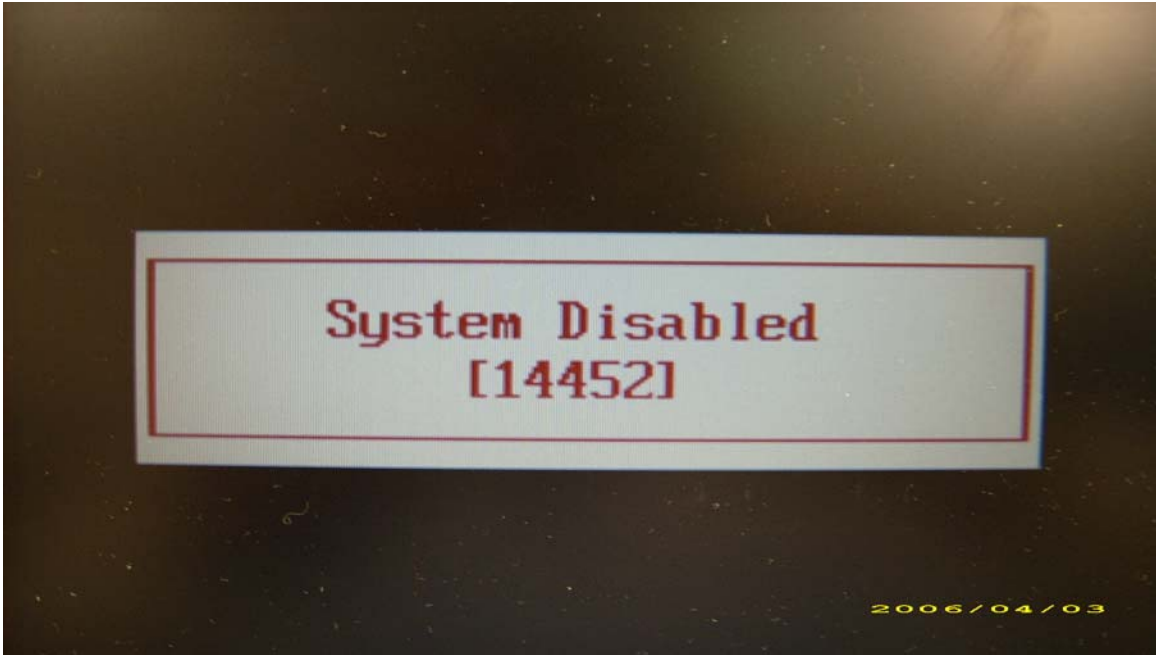

- If you need to solve BIOS password locked problem, you can run BIOS_PW.EXE
 1. Key in "bios_pw 14452 0"
 2. Choose one upper-case string

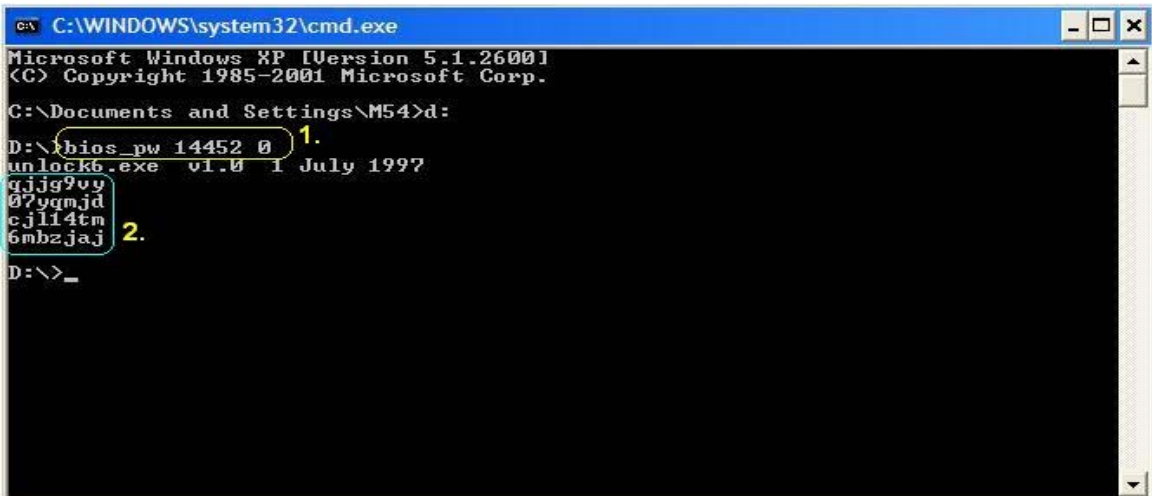

- Reboot the system and key in "qjjg9vy" or "07yqmjd" to BIOS user password.



Machine Disassembly and Replacement

This chapter contains step-by-step procedures on how to disassemble the notebook computer for maintenance and troubleshooting.

To disassemble the computer, you need the following tools:

- Wrist grounding strap and conductive mat for preventing electrostatic discharge
- Philips screw drivers
- Flat head screwdriver

NOTE: The screws for the different components vary in size. During the disassembly process, group the screws with the corresponding components to avoid mismatch when putting back the components. When you remove the middle cover, please be careful not to scrape the cover.

General Information

Before You Begin

Before proceeding with the disassembly procedure, make sure that you do the following:

1. Turn off the power to the system and all peripherals.
2. Unplug the AC adapter and all power and signal cables from the system.
3. Remove the battery pack.

NOTE: TravelMate C210 series product uses tape to fasten the antenna/cable, you may need to tear the tape before you remove the antenna.

NOTE: The disassembly is based on an engineering sample, therefore, the number of the screws and the color of the system may differ from a finish-good unit.

Disassembly Procedure Flowchart

The flowchart on the succeeding page gives you a graphic representation on the entire disassembly sequence and instructs you on the components that need to be removed during servicing. For example, if you want to remove the system board, you must first remove the then disassemble the inside assembly frame in that order.

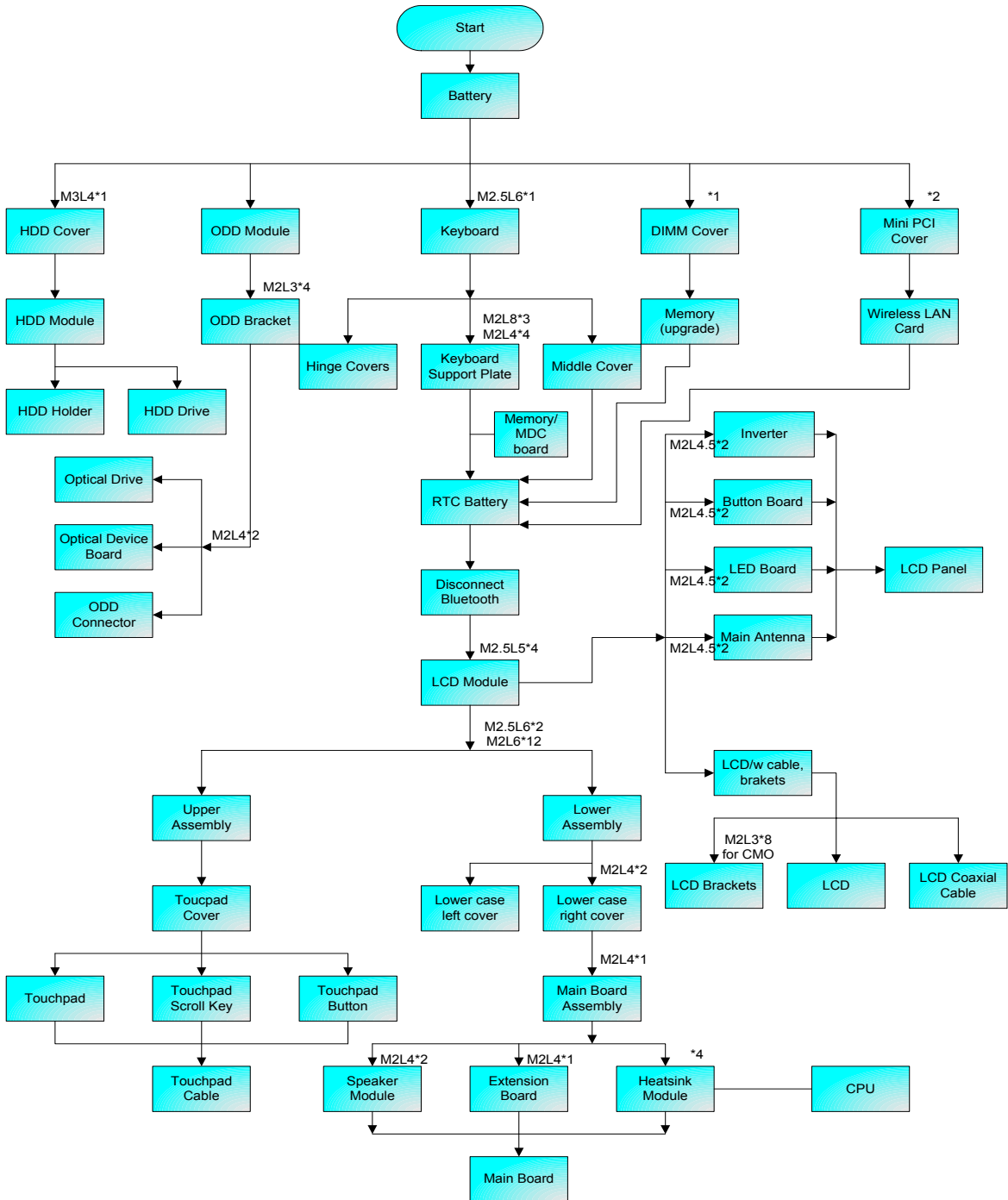

Removing the Battery Pack

1. Release the battery lock.
2. Slide the battery latch then remove the battery.



Removing the HDD Module/ODD Module/Memory/Wireless LAN Card/ LCD Module and the Keyboard

Removing the Hard Disk Drive Module

1. Remove the two screws fastening the HDD cover.
2. Detach the HDD cover from the notebook.
3. Pull out the hard disk drive then detach it from the main unit.



Removing the Optical Disk Drive Module

1. Slide the ODD latch then remove the ODD module from the main unit carefully.



Removing the Memory

1. Remove the two screws that fasten the DIMM door.
2. Detach the DIMM door.
3. Pop out the memory then remove it.



Removing the Wireless LAN Card

1. Remove the two screws holding the wireless LAN cover.
2. Detach the wireless cover.



3. Disconnect wireless main and auxiliary antenna.
4. Pop out the wireless LAN card then remove it.



Removing the LCD Module

1. Remove two screws holding the left and the right hinge cover.
2. Remove the right hinge cover.



3. Remove the left hinge cover.
4. Turn over the entire LCD module as shown.
5. Disconnect the six screws fastening the middle cover.



6. Detach the middle cover carefully.
7. Then disconnect the LCD cable.

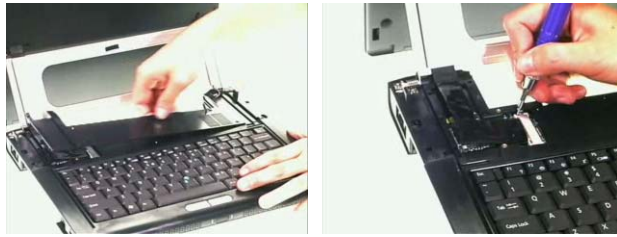

8. Disconnect the wireless LAN antenna.
9. Remove the four screws fastening the LCD module to the main unit.
10. Detach the LCD module from the main unit.



Removing the Keyboard

1. Remove the screw fastening the keyboard on the bottom.
2. Disconnect the trackpoint cable.
3. Disconnect the keyboard cable then remove the keyobar.



Disassembling the Main Unit

Separating the Main Unit into the Upper Case And the Lower Case Assembly

1. Remove the 11 screws fastening the upper case and the lower case assembly.
2. Then remove the 10 screws holding the upper case and the lower case assembly on bottom side.
3. Disconnect the launch board FFC.



4. Disconnect the joystick board FFC as shown.
5. Disconnect the bluetooth cable from the main board as shown.
6. Tear off the capton fastening the wireless LAN antenna set then pull out the wireless LAN antenna set.



7. Detach the upper case assembly carefully.
8. Disconnect the dynamic board cable from the main board then remove it.
9. Remove the two screws fastening the dynamic board then detach the dynamic board from the main board.

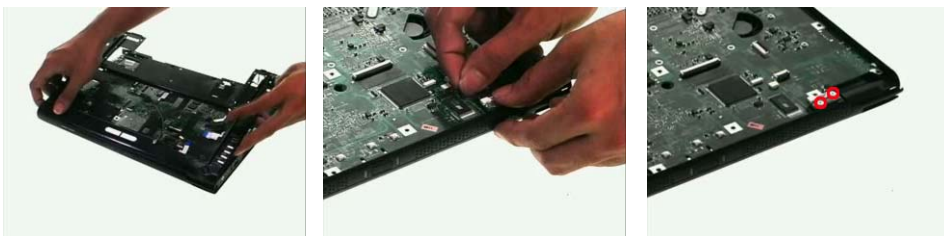

10. Disconnect the speaker cable from the main board.
11. Detach the main board assembly from the lower case carefully.

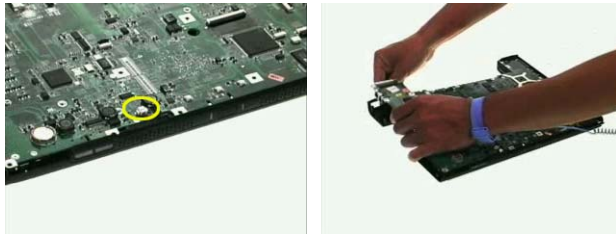

Disassembling the Upper Case, the Lower Case and the Main Board Assembly

1. Remove the speaker from the lower case.
2. Remove the three screws fastening the launch board.
3. Then detach the launch board from the lower case.



4. Disconnect the launch board FFC.
5. Remove the two screws fastening the joystick board.
6. Remove the joystick board assembly from the lower case.



7. Disconnect the joystick board FFC.
8. Remove the two screws fastening the Bluetooth module.
9. Remove the Bluetooth module from the lower case carefully.

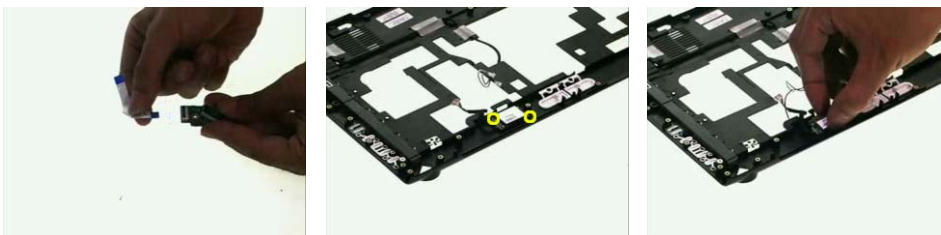

10. Disconnect the Bluetooth cable from the Bluetooth module.
11. Remove the eight screws fastening the thermal module.

12. Detach the thermal module from the main board and disconnect the fan cable then remove the thermal module.

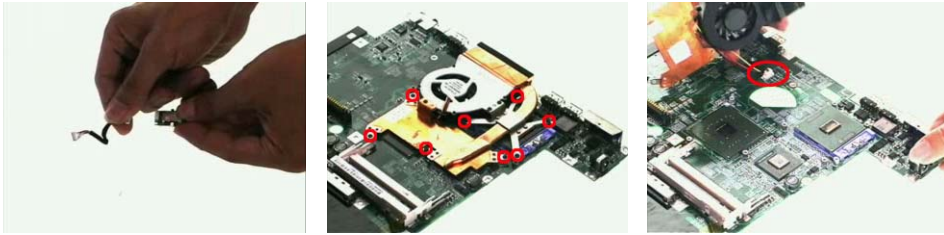

13. Use a flat-headed screwdriver to release the CPU lock.
14. Remove the CPU from the socket carefully.
15. Remove the three screws fastening the PCMCIA slot.

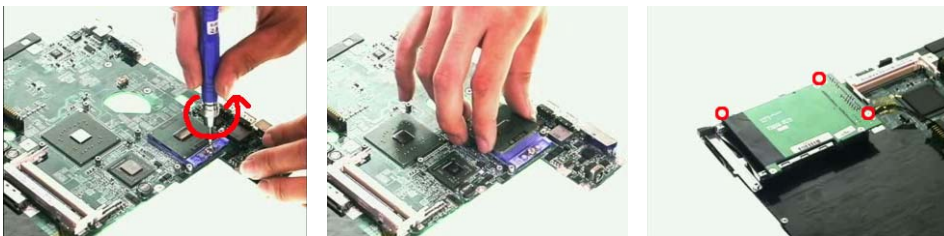

16. Detach the PCMCIA slot from the main board.
17. Remove the two screws fastening the modem board.
18. Disconnect the modem board from then main board and disconnect the modem board cable then remove the board.

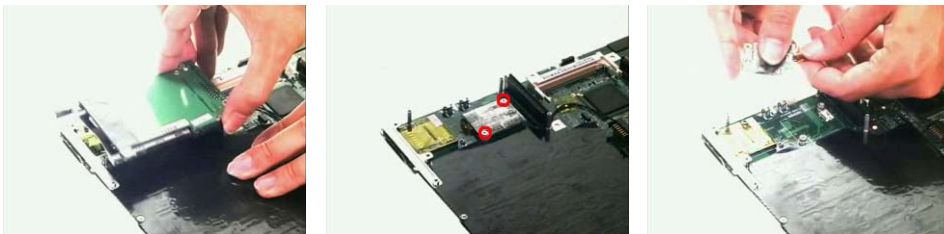

Disassembling the LCD Module

1. Remove the four LCD screw caps.
2. Then remove the six screws fastening the LCD bezel.
3. Remove one screw holding the LCD support on one side.

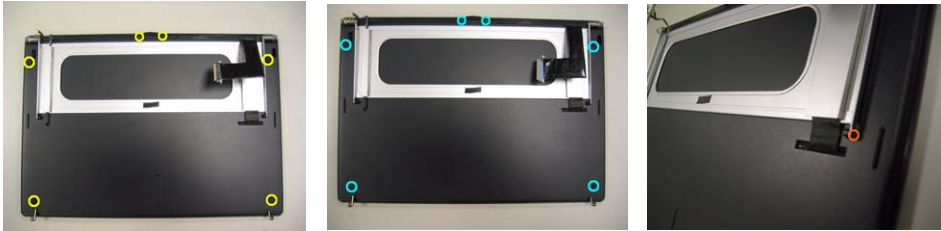

4. Remove another screw holding the LCD support on the other side as shown.
5. Open the cover as shown.
6. Open the other cover protecting antenna set as shown then remove the LCD support.



7. Detach the LCD bezel from the LCD module carefully.
8. Remove the four screws fastening the LCD assembly.
9. Remove the two screws fastening the finger board.

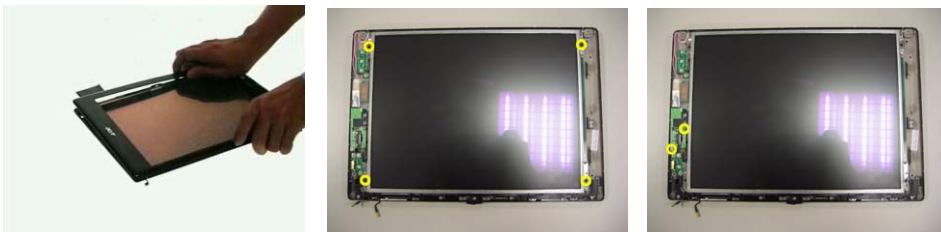

10. Turn over the finger board and disconnect the cable then remove the finger board.
11. Remove the two screws fastening the power board.
12. Lift the LCD as shown to take out the power board.



13. Turn over the power board and disconnect the cable then remove the board.
14. Remove the two screws fastening the launch board.
15. Disconnect the launch board cable then remove the launch board.



16. Disconnect the inverter cable then remove the inverter.
17. Take out LCD assembly from the LCD panel (The LCD support has been removed in step 3 to step 6).
18. Disconnect the LCD cable from the LCD then remove the cable.

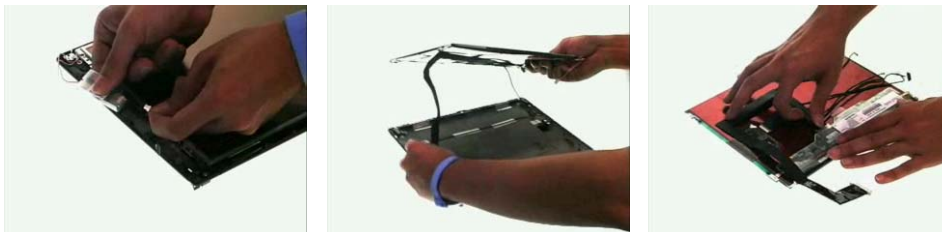

19. Remove the three screws fastening the digitizer.
20. Then detach the digitizer as shown.



Disassembling the External Modules

Disassembling the HDD Module

1. Remove two screws fastening the HDD bracket on one side.
2. Remove another two screws holding the HDD bracket on another side.
3. Then remove the last screws fastening the HDD bracket.



4. Detach the HDD from the HDD bracket carefully.
5. Disconnect the HDD connector as shown.



Disassembling the Optical Disc Drive Module

1. Remove two screws fastening the ODD holder on one side.
2. Remove another two screws holding the ODD holder on its rear side.
3. Then remove the last screws fastening the ODD holder.



4. Remove the ODD holder from the ODD.
5. Disconnect the ODD connector from the ODD.

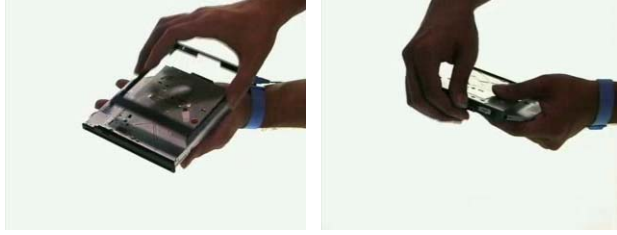

Troubleshooting

Use the following procedure as a guide for computer problems.

NOTE: The diagnostic tests are intended to test this model. Non-Acer products, prototype cards, or modified options can give false errors and invalid system responses.

1. Duplicate symptom and obtain the failing symptoms in as much detail as possible.
2. Distinguish symptom. Verify the symptoms by attempting to re-create the failure by running the diagnostic test or by repeating the same operation.
3. Disassemble and assemble the unit without any power sources.
4. If any problem occurs, you can perform visual inspection before you follow this chapter's instructions. You can check the following:
 - power cords are properly connected and secured;
 - there are no obvious shorts or opens;
 - there are no obviously burned or heated components;
 - all components appear normal.
5. Use the following table with the verified symptom to determine which page to go to.

Symptoms (Verified)	Go To
Power failure. (The power indicator does not go on or stay on.)	"Power System Check" on page 73.
POST does not complete. No beep or error codes are indicated.	"Power-On Self-Test (POST) Error Message" on page 75 "Undetermined Problems" on page 87
POST detects an error and displayed messages on screen.	"Error Message List" on page 76
Other symptoms (i.e. LCD display problems or others).	"Power-On Self-Test (POST) Error Message" on page 75
Symptoms cannot be re-created (intermittent problems).	Use the customer-reported symptoms and go to "Power-On Self-Test (POST) Error Message" on page 75 "Intermittent Problems" on page 86 "Undetermined Problems" on page 87

System Check Procedures

External Diskette Drive Check

Do the following to isolate the problem to a controller, driver, or diskette. A write-enabled, diagnostic diskette is required.

NOTE: Make sure that the diskette does not have more than one label attached to it. Multiple labels can cause damage to the drive or cause the drive to fail.

Do the following to select the test device.

1. Boot from the diagnostics diskette and start the diagnostics program.
2. See if FDD Test is passed as the program runs to FDD Test.
3. Follow the instructions in the message window.

If an error occurs with the internal diskette drive, reconnect the diskette connector on the system board.

If the error still remains:

1. Reconnect the external diskette drive/DVD-ROM module.
2. Replace the external diskette drive/CD-ROM module.
3. Replace the main board.

External CD-ROM Drive Check

Do the following to isolate the problem to a controller, drive, or CD-ROM. Make sure that the CD-ROM does not have any label attached to it. The label can cause damage to the drive or can cause the drive to fail.

Do the following to select the test device:

1. Boot from the diagnostics diskette and start the diagnostics program.
2. See if CD-ROM Test is passed when the program runs to CD-ROM Test.
3. Follow the instructions in the message window.

If an error occurs, reconnect the connector on the System board. If the error still remains:

1. Reconnect the external diskette drive/CD-ROM module.
2. Replace the external diskette drive/CD-ROM module.
3. Replace the main board.

Keyboard or Auxiliary Input Device Check

Remove the external keyboard if the internal keyboard is to be tested.

If the internal keyboard does not work or an unexpected character appears, make sure that the flexible cable extending from the keyboard is correctly seated in the connector on the system board.

If the keyboard cable connection is correct, run the Keyboard Test.

If the tests detect a keyboard problem, do the following one at a time to correct the problem. Do not replace a non-defective FRU:

1. Reconnect the keyboard cables.
2. Replace the keyboard.
3. Replace the main board.

The following auxiliary input devices are supported by this computer:

- Numeric keypad
- External keyboard

If any of these devices do not work, reconnect the cable connector and repeat the failing operation.

Memory check

Memory errors might stop system operations, show error messages on the screen, or hang the system.

1. Boot from the diagnostics diskette and start the doagmpstotics program (please refer to main board).
2. Go to the diagnostic memory in the test items.
3. Press F2 in the test items.
4. Follow the instructions in the message window.

NOTE: Make sure that the DIMM is fully installed into the connector. A loose connection can cause an error.

Power System Check

To verify the symptom of the problem, power on the computer using each of the following power sources:

1. Remove the battery pack.
2. Connect the power adapter and check that power is supplied.
3. Disconnect the power adapter and install the charged battery pack; then check that power is supplied by the battery pack.

If you suspect a power problem, see the appropriate power supply check in the following list:

- "Check the Battery Pack" on page 74

Check the Battery Pack

To check the battery pack, do the following:

From Software:

1. Check out the Power Management in control Panel
2. In Power Meter, confirm that if the parameters shown in the screen for Current Power Source and Total Battery Power Remaining are correct.
3. Repeat the steps 1 and 2, for both battery and adapter.
4. This helps you identify first the problem is on recharging or discharging.

From Hardware:

1. Power off the computer.
2. Remove the battery pack and measure the voltage between battery terminals 1(+) and 6(ground). See the following figure
3. If the voltage is still less than 7.5 Vdc after recharging, replace the battery.

To check the battery charge operation, use a discharged battery pack or a battery pack that has less than 50% of the total power remaining when installed in the computer.

If the battery status indicator does not light up, remove the battery pack and let it return to room temperature. Re-install the battery pack.

If the charge indicator still does not light up, replace the battery pack. If the charge indicator still does not light up, replace the DC/DC charger board.

Touchpad check

If the touchpad doesn't work, do the following actions one at a time to correct the problem. Do not replace a non-defective FRU:

1. After rebooting, run Tracking Pad PS2 Mode Driver. For example, run Syn touch driver.
2. Run utility with the PS/2 mouse function and check if the mouse is working.
3. If the the PS/2 mouse does not work, then check if the main board to switch board FPC is connected O.K.
4. If the main board to switch board FPC is connected well, then check if the FCC on touch pad PCB connects properly.
5. If the FFC on touch pad PCB connects properly, then check if LS851 JP1 Pin6=5V are pulese. If yes, then replace switch board. If no, then go to next step.
6. Replace touch pad PCB.
7. If the touch pad still does not work, then replace FPC on Track Pad PCB.

After you use the touchpad, the pointer drifts on the screen for a short time. This self-acting pointer movement can occur when a slight, steady pressure is applied to the touchpad pointer. This symptom is not a hardware problem. No service actions are necessary if the pointer movement stops in a short period of time.

Power-On Self-Test (POST) Error Message

The POST error message index lists the error message and their possible causes. The most likely cause is listed first.

NOTE: Perform the FRU replacement or actions in the sequence shown in FRU/Action column, if the FRU replacement does not solve the problem, put the original part back in the computer. Do not replace a non-defective FRU.

This index can also help you determine the next possible FRU to be replaced when servicing a computer.

If the symptom is not listed, see “Undetermined Problems” on page 87.

The following lists the error messages that the BIOS displays on the screen and the error symptoms classified by function.

NOTE: Most of the error messages occur during POST. Some of them display information about a hardware device, e.g., the amount of memory installed. Others may indicate a problem with a device, such as the way it has been configured.

NOTE: If the system fails after you make changes in the BIOS Setup Utility menus, reset the computer, enter Setup and install Setup defaults or correct the error.

Index of Error Messages

Error Message List

Error Messages	FRU/Action in Sequence
Struck Key	See "Keyboard or Auxiliary Input Device Check" on page 72
System CMOS checksum bad - Default configuration used	RTC battery Run BIOS Setup Utility to reconfigure system, then reboot system.
Real time clock error	RTC battery Run BIOS Setup Utility to reconfigure system time, then reboot system. Main board
Previous boot incomplete - Default configuration used	"Load Default Settings" in BIOS Setup Utility. RTC batter Main board.
Invalid System Configuration Data	"Load Default Settings" in BIOS Setup Utility. Main board.
Operating system not found	Enter Setup and see if fixed disk and drive A are properly identified. Dikette drive Hard disk drive Main board.

Error Message List

No beep Error Messages	FRU/Action in Sequence
Power-on indicator turns off and LCD is blank.	Power source (battery pack and power adapter.) See "Power System Check" on page 73 Ensure every connector is connected tightly and correctly. Reconnect the DIMM. Main board.
Power-on indicator turns on and LCD is blank.	Power source (battery pack and power adapter.) See "Power System Check" on page 73 Reconnect the LCD connector Hard disk drive LCD cable LCD inverter LCD Main board
Power-on indicator turns on and LCD is blank. But you can see POST on an external CRT.	Reconnect the LCD connectors. LCD cable LCD inverter LCD Main board
Power-on indicator turns on and a blinking cursor shown on LCD during POST.	Ensure every connector is connected tightly and correctly. Main board

POST Codes

Code	Beeps	POST Routine Description
02h		Verify Real Mode
03h		Disable Non-Maskable Interrupt (NMI)
04h		Get CPU type
06h		Initialize system hardware
08h		Initialize chipset with initial POST values
09h		Set IN POST flag
0Ah		Initialize CPU registers
0Bh		Enable CPU cache
0Ch		Initialize caches to initial POST values
0Eh		Initialize I/O component
0Fh		Initialize the local bus IDE
10h		Initialize Power Management
11h		Load alternate registers with initial POST values
12h		Restore CPU control word during warm boot
13h		Initialize PCI Bus Mastering devices
14h		Initialize keyboard controller
16h	1-2-2-3	BIOS ROM checksum
17h		Initialize cache before memory autosize
18h		8254 timer initialization
1Ah		8237 DMA controller initialization
1Ch		Reset Programmable Interrupt Controller
20h	1-3-1-1	Test DRAM refresh
22h	1-3-1-3	Test 8742 Keyboard Controller
24h		Set ES segment register to 4 GB
26h		Enable A20 line
28h		Autosize DRAM
29h		Initialize POST Memory Manager
2Ah		Clear 215 KB base RAM
2Ch	1-3-4-1	RAM failure on address line xxxx
2Eh	1-3-4-3	RAM failure on data bits xxxx of low byte of memory bus
2Fh		Enable cache before system BIOS shadow
30h	1-4-1-1	RAM failure on data bits xxxx of high byte of memory bus
32h		Test CPU bus-clock frequency
33h		Initialize Phoenix Dispatch Manager
36h		Warm start shut down
38h		Shadow system BIOS ROM
3Ah		Autosize cache
3Ch		Advanced configuration of chipset registers
3Dh		Load alternate registers with CMOS values
42h		Initialize interrupt vectors
45h		POST device initialization
46h	2-1-2-3	Check ROM copyright notice

Code	Beeps	POST Routine Description
48h		Check video configuration against CMOS
49h		Initialize PCI bus and devices
4Ah		Initialize all video adapters in system
4Bh		QuietBoot start (optional)
4Ch		Shadow video BIOS ROM
4Eh		Display BIOS copyright notice
50h		Display CPU type and speed
51h		Initialize EISA board
52h		Test keyboard
54h		Set key click if enabled
58h	2-2-3-1	Test for unexpected interrupts
59h		Initialize POST display service
5Ah		Display prompt "Press F2 to enter SETUP"
5Bh		Disable CPU cache
5Ch		Test RAM between 512 and 640 KB
60h		Test extended memory
62h		Test extended memory address lines
64h		Jump to User Patch1
66h		Configure advanced cache registers
67h		Initialize Multi Processor APIC
68h		Enable external and CPU caches
69h		Setup System Management Mode (SMM) area
6Ah		Display external L2 cache size
6Bh		Load custom defaults (optional)
6Ch		Display shadow-area message
6Eh		Display possible high address for UMB recovery
70h		Display error messages
72h		Check for configuration errors
76h		Check for keyboard errors
7Ch		Set up hardware interrupt vectors
7Eh		Initialize coprocessor if present
80h		Disable onboard Super I/O ports and IRQs
81h		Late POST device initialization
82h		Detect and install external RS232 ports
83h		Configure non-MCD IDE controllers
84h		Detect and install external parallel ports
85h		Initialize PC-compatible PnP ISA devices
86h		Re-initialize onboard I/O ports
87h		Configure Motherboard Configurable Devices (optional)
88h		Initialize BIOS Area
89h		Enable Non-Maskable Interrupts (NMIs)
8Ah		Initialize Extended BIOS Data Area
8Bh		Test and initialize PS/2 mouse
8Ch		Initialize floppy controller

Code	Beeps	POST Routine Description
8Fh		Determine number of ATA drives (optional)
90h		Initialize hard-disk controllers
91h		Initialize local-bus hard-disk controllers
92h		Jump to UserPatch2
93h		Build MPTABLE for multi-processor boards
95h		Install CD ROM for boot
96h		Clear huge ES segment register
97h		Fixup Multi Processor table
98h	1-2	Search for option ROMs. One long, two short beeps on checksum failure.
99h		Check for SMART drive (optional)
9Ah		Shadow option ROMs
9Ch		Set up Power Management
9Dh		Initialize security engine (optional)
9Eh		Enable hardware interrupts
9Fh		Determine number of ATA and SCSI drives
A0h		Set time of day
A2h		Check key lock
A4h		Initialize Typematic rate
A8h		Erase F2 prompt
AAh		Scan for F2 key stroke
ACh		Enter SETUP
A Eh		Clear Boot flag
B0h		Check for errors
B2h		POST done- prepare to boot operating system
B4h	1	One short beep before boot
B5h		Terminate QuietBoot (optional)
B6h		Check password (optional)
B9h		Prepare Boot
BAh		Initialize DMI parameters
BBh		Initialize PnP Option ROMs
BCh		Clear parity checkers
BDh		Display MultiBoot menu
BEh		Clear screen (optional)
BFh		Check virus and backup reminders
C0h		Try to boot with INT 19
C1h		Initialize POST Error Manager (PEM)
C2h		Initialize error logging
C3h		Initialize error display function
C4h		Initialize system error handler
C5h		PnPnd dual CMOS (optional)
C6h		Initialize notebook docking (optional)
C7h		Initialize notebook docking late
C8h		Force check (optional)
C9h		Extended checksum (optional)
D2h		Unknown interrupt

Code	Beeps	For Boot Block in Flash ROM
E0h		Initialize the chipset
E1h		Initialize the bridge
E2h		Initialize the CPU
E3h		Initialize the system timer
E4h		Initialize system I/O
E5h		Check force recovery boot
E6h		Checksum BIOS ROM
E7h		Go to BIOS
E8h		Set Huge Segment
E9h		Initialize Multi Processor
EAh		Initialize OEM special code
EBh		Initialize PIC and DMA
ECh		Initialize Memory type
EDh		Initialize Memory size
EEh		Shadow Boot Block
EFh		System memory test
F0h		Initialize interrupt vectors
F1h		Initialize Run Time Clock
F2h		Initialize video
F3h		Initialize System Management Mode
F4h	1	Output one beep before boot
F5h		Boot to Mini DOS
F6h		Clear Huge Segment
F7h		Boot to Full DOS

Index of Symptom-to-FRU Error Message

LCD-Related Symptoms

Symptom / Error	Action in Sequence
LCD backlight doesn't work	First, plug a monitor to CRT port. Next, enter BIOS utility to running "Load Default Settings" then reboot the system. Reconnect the LCD connectors. Keyboard (if the brightness function key doesn't work). LCD cable LCD inverter LCD Main board
LCD is too dark LCD brightness cannot be adjusted	Enter BIOS Utility to execute "Load Setup Default Settings", then reboot system. Reconnect the LCD connectors. Keyboard (if the brightness function key doesn't work). LCD cable LCD inverter LCD Main board
Unreadable LCD screen Missing pels in characters Abnormal screen Wrong color displayed LCD has extra horizontal or vertical lines displayed.	Reconnect the LCD cable LCD cable LCD Main board

Indicator-Related Symptoms

Symptom / Error	Action in Sequence
Indicator incorrectly remains off or on, but system runs correctly	Main board
HDD/CD-ROM active indicators cannot work	HDD/CD-ROM drive Device driver Main board

Power-Related Symptoms

Symptom / Error	Action in Sequence
Power shuts down during operation	Power source (battery pack and power adapter). See "Power System Check" on page 73. Battery pack AC adapter See if the thermal module is overheat (Heat sink or fan). Main board
The system cannot power-on.	Power source (battery pack and power adapter). See "Power System Check" on page 73. Battery pack Power adapter CPU Main board
The system cannot power-off.	In Windows XP operating system, hold and press the power switch for more than 4 seconds. If the system can power off, then the main board is OK. Verify OS in the HDD. Main board

Power-Related Symptoms

Symptom / Error	Action in Sequence
Battery can't be charged or discharged	See "Check the Battery Pack" on page 74. Battery pack Main board
System hang during POST	ODD/HDD/FDD/RAM module Main board

PCMCIA-Related Symptoms

Symptom / Error	Action in Sequence
System cannot detect the PC Card (PCMCIA)	PCMCIA slot assembly Main board
PCMCIA slot pin is damaged.	PCMCIA slot assembly
PC Card cannot be inserted or ejected	Check if the PCMCIA slot is blocked Main board

Memory-Related Symptoms

Symptom / Error	Action in Sequence
Memory count (size) appears different from actual size.	Enter BIOS Setup Utility to execute "Load Default Settings" then reboot system. RAM module Main board Check BIOS revision
System can power on, but you hear two long beeps: "B--, B--" and the LCD is blank.	Reinsert DIMM DIMM Main board

Speaker-Related Symptoms

Symptom / Error	Action in Sequence
In Windows, multimedia programs, no sound comes from the computer.	OS volume control Audio driver Speaker Main board
Internal speakers make noise or emit no sound.	Speaker Main board
Microphone cannot work	Audio driver Volume control in Windows XP Main board

Power Management-Related Symptoms

Symptom / Error	Action in Sequence
The system will not enter hibernation mode	Power option in Windows XP Hard disk drive Main board
The system doesn't enter standby mode after closing the lid of the portable computer.	Driver of Power Option Properties Lid close switch in upper case Main board

Power Management-Related Symptoms

Symptom / Error	Action in Sequence
The system doesn't resume from hibernation/standby mode.	Connect AC adapter then check if the system resumes from Standby/Hibernation mode. Check if the battery is low. Hard disk drive Main board
The system doesn't resume from standby mode after opening the lid of the portable computer.	LCD cover switch Main board
Battery fuel gauge in Windows doesn't go higher than 90%.	Refresh battery (continue use battery until power off, then charge battery). Battery pack Main board
System hangs intermittently.	Reconnect hard disk/CD-ROM drives. Main board

Peripheral-Related Symptoms

Symptom / Error	Action in Sequence
System configuration does not match the installed devices.	Enter BIOS Setup Utility to execute "Load Setup defaults", then reboot system. Reconnect hard disk/CD-ROM drives/FDD or other peripherals. Main board
External display does not work correctly.	Press Fn+F5, LCD/CRT/Both display switching Keyboard Main board
USB does not work correctly	Main board
Print problems.	Enter BIOS Setup Utility to execute "Load Default Settings" then reboot the system. Run printer self-test. Printer driver Printer cable Printer Main board
Parallel port device problems	Enter BIOS Setup Utility to execute "Load Default Settings" then reboot the system. Device driver Device cable Device Main board

Keyboard/Touchpad-Related Symptoms

Symptom / Error	Action in Sequence
Keyboard (one or more keys) does not work.	Reconnect the keyboard cable. Keyboard Main board
Touchpad does not work.	Reconnect touchpad cable. Touchpad board Main board

Modem/LAN-Related Symptoms

Symptom / Error	Action in Sequence
Internal modem does not work correctly.	Phone cable Driver Reconnect the Internal modem cable to the main board tightly. Main board
Internal LAN does not work correctly	Lan cable Driver Main board

NOTE: If you cannot find a symptom or an error in this list and the problem remains, see “Undetermined Problems” on page 87.

Intermittent Problems

Intermittent system hang problems can be caused by a variety of reasons that have nothing to do with a hardware defect, such as: cosmic radiation, electrostatic discharge, or software errors. FRU replacement should be considered only when a recurring problem exists.

When analyzing an intermittent problem, do the following:

1. Run the diagnostic test for the system board in loop mode at least 10 times.
2. If no error is detected, do not replace any FRU.
3. If any error is detected, replace the FRU. Rerun the test to verify that there are no more errors.

Undetermined Problems

The diagnostic problems does not identify which adapter or device failed, which installed devices are incorrect, whether a short circuit is suspected, or whether the system is inoperative.

Follow these procedures to isolate the failing FRU (do not isolate non-defective FRU).

NOTE: Verify that all attached devices are supported by the computer.

NOTE: Verify that the power supply being used at the time of the failure is operating correctly. (See “Power System Check” on page 73):

1. Power-off the computer.
2. Visually check them for damage. If any problems are found, replace the FRU.
3. Remove or disconnect all of the following devices:
 - Non-Acer devices
 - Printer, mouse, and other external devices
 - Battery pack
 - Hard disk drive
 - DIMM
 - PC Cards
4. Power-on the computer.
5. Determine if the problem has changed.
6. If the problem does not recur, reconnect the removed devices one at a time until you find the failing FRU.
7. If the problem remains, replace the following FRU one at a time. Do not replace a non-defective FRU:
 - System board
 - LCD assembly

Jumper and Connector Locations

Top View

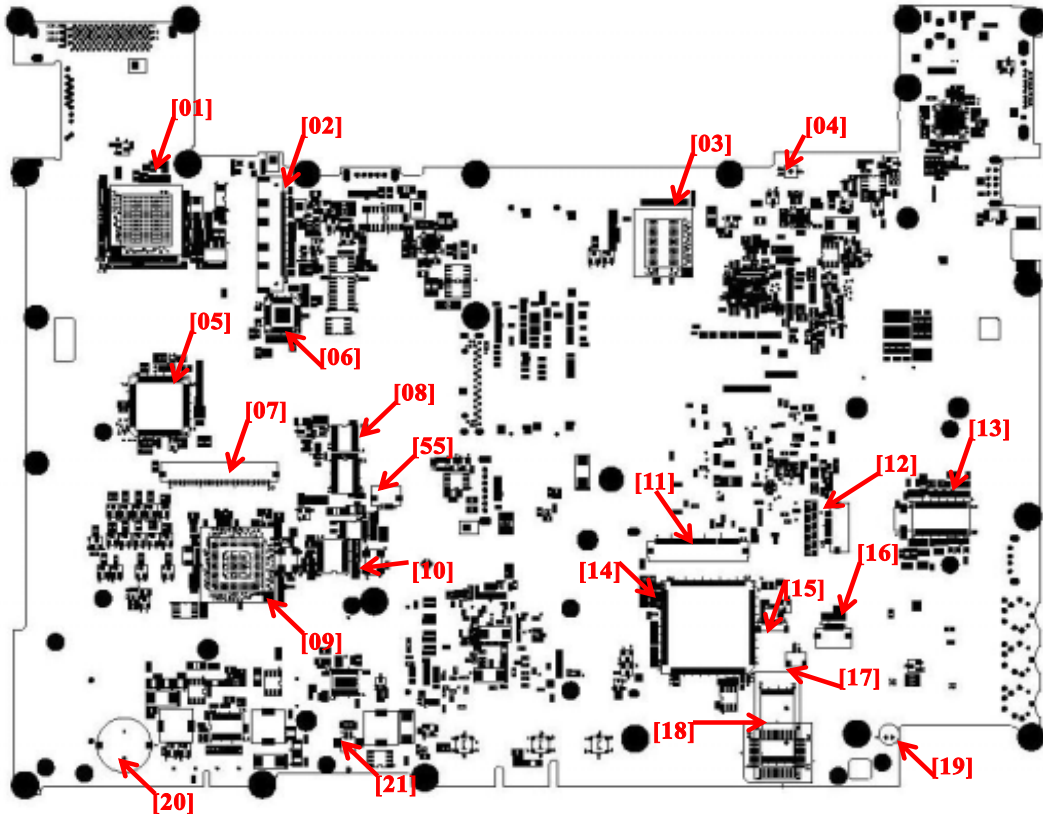

1	U3	Lan Controller	12	CN5	Quick Button Board Connector
2	CN2	LCD Connector	13	U20	Clock Generator
3	U4	VRAM1	14	U29	EC (Keyboard Controller)
4	CN1	Lid Switch	15	CN7	BT Connector
5	U16	Super I/O Controller	16	CN8	Jogdial Board Connector
6	U10	DVI Trasmitter	17	CN9	Pen Switch Board Connector
7	CN3	PCI Debug Card Connector (Reserved)	18	CON1/ U34	BIOS ROM
8	U17/ U19	IDE Buffer	19	CN10	Internal MIC
9	U23	PCMCIA/1394/Card Reader Controller	20	BT1	RTC Battery Connector
10	U22	Track Point Controller	21	CN11	Intetnal Speaker
11	CN6	Keyboard Connector	55	CN4	Track Point Connector

Bottom View

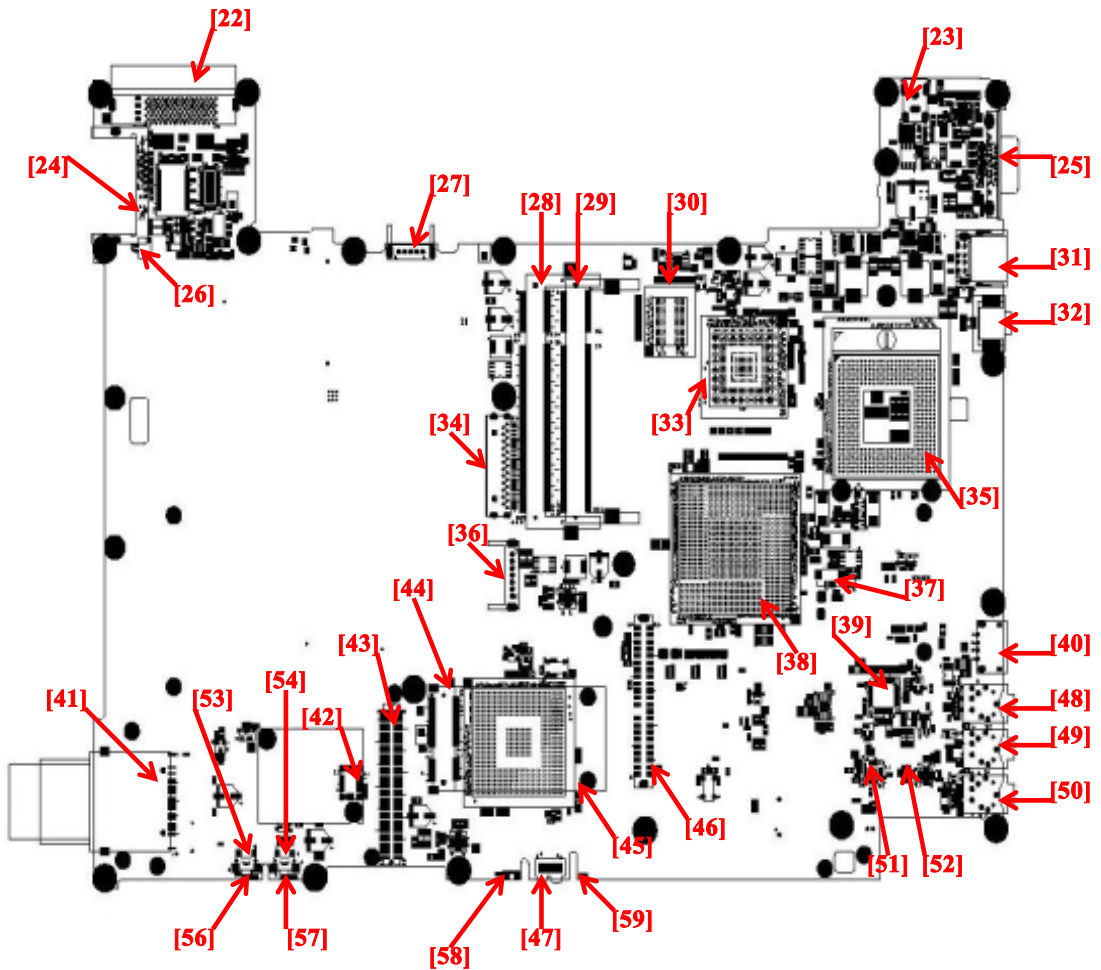

22	CN13	EZ Docking Connector	41	CN30	Memory Card Reader
23	CN12	AC Power Jack	42	J1	MDC Connector
24	CN15	RJ11/RJ45 Connector	43	CN28	PCMCIA Board Connector
25	CN14	CRT Connector	44	CN26	MINI Card Connector
26	CN16	Modem Connector	45	U54	South Bridge (ICH7)
27	CN17	Main Battery Connector	46	CN24	PATA HDD Connector
28	JDIM1	DDR Socket 1	47	U57	FIR
29	JDIM2	DDR Socket 2	48	CN25	External Line In
30	U44	VRAM2	49	CN27	External MIC In
31	CN18	USB Dual Connector	50	CN29	External Headphone
32	CN19	1394 Connector	51	U55	Speaker Amplifier (MAX9710)
33	U45	VGA Chip (NV72MV)	52	U56	Headphone (MAX4411)
34	CN20	CD-ROM Board Connector	53	SW4	Bluetooth Enable Switch
35	U46	CPU Socket	54	SW5	WLAN Enable Swtich
36	CN22	Second Battery Connector	56	LED3	BT LED

37	CN21	FAN Connector	57	LED4	WLAN LED
38	U48	North Bridge (945GM/PM)	58	LED1	Battery LED
39	U52	Audio Codec Controller	59	LED2	HDD LED
40	CN23	USB Connector			

FRU (Field Replaceable Unit) List

This chapter gives you the FRU (Field Replaceable Unit) listing in global configurations of TravelMate C210 series products. Refer to this chapter whenever ordering for parts to repair or for RMA (Return Merchandise Authorization).

Please note that WHEN ORDERING FRU PARTS, you should check the most up-to-date information available on your regional web or channel. For whatever reasons a part number change is made, it will not be noted on the printed Service Guide. For ACER AUTHORIZED SERVICE PROVIDERS, your Acer office may have a DIFFERENT part number code from those given in the FRU list of this printed Service Guide. You MUST use the local FRU list provided by your regional Acer office to order FRU parts for repair and service of customer machines.

NOTE: To scrap or to return the defective parts, you should follow the local government ordinance or regulations on how to dispose it properly, or follow the rules set by your regional Acer office on how to return it.

Exploded Diagram

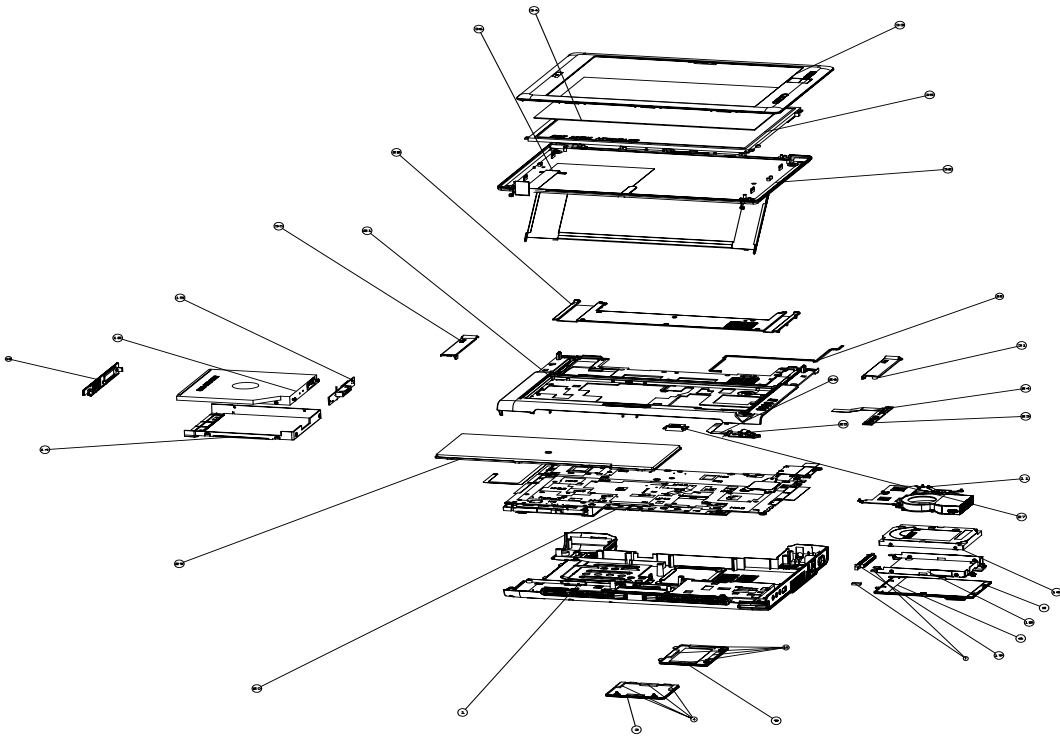



NOTE: The exploded diagram is not ready as the service guide released. We will update the section later.







NOTE: The photos below are taken from an engineering sample. The cover of the engineering sample's case is not what you would see on the finish-good shipping product.

NOTE: TravelMate C210 FRU list is not ready as the service guide released. We will update the FRU list as soon as we got the spare part list.

TravelMate C200 FRU List

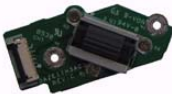
Picture	No.	Partname And Description	Part Number
Adapter			
		LITE-ON NB ADAPTER PA-1650-02QR, 19V, 3 PINS, 65W	AP.06503.010
		LSE NB ADAPTER SLS0335A19A57LF 19V 3 PINS 65W	AP.06506.002
Battery			
		LI-ION SANYO 3S1P 2.0AH high rate W/O IND (W/Z SANYO PACK CELLS)	BT.00303.003
		LI-ION SANYO 3S2P 4.8AH W/O IND (W/Z SANYO PACK CELLS)	BT.T4803.001
		LI-ION SANYO 3S3P 4.8AH W/O IND (W/Z SANYO PACK CELLS)	BT.00903.001

TravelMate C200 FRU List

Picture	No.	Partname And Description	Part Number
		MODEM BOARD	54.TAKV7.001
		BLUETOOTH MODULE W/ANTENNA	54.TADV7.001
		WIRELESS LAN BOARD (802.11b+g) INTEL	KI.CAX01.008
		WIRELESS LAN BOARD (802.11a/b/g) INTEL EU	KI.CAX01.010
		WIRELESS LAN BOARD (802.11a/b/g) INTEL NA	KI.CAX01.009
		WIRELESS LAN BOARD (802.11a/b/g) INTEL RW	KI.CAX01.011
		JOYSTICK BOARD	55.TADV7.001
		PCMCIA SLOT MODULE	55.TADV7.002
		LAUNCH BOARD	55.TADV7.003
		PEN SENSOR BOARD	55.TADV7.004

TravelMate C200 FRU List

Picture	No.	Partname And Description	Part Number
		PEN SENSOR BOARD CABLE	50.TADV7.001
		FFC- JOYSTICK BOARD TO MB	50.TADV7.002
		FFC - LAUNCH BOARD TO MB	50.TADV7.003
		BLUETOOTH CABLE	50.TADV7.004
		MODEM CABLE LEAD FREE	50.TADV7.005
		POWER CORD AF (3 PIN)	27.T48V7.001
		POWER CORD DANISH (3 PIN)	27.A03V7.006
		POWER CORD AU W/LABEL (3 PIN)	27.A50V7.003
		POWER CORD AF-S (INDIA)	27.A50V7.001
		POWER CORD UK (3 PIN)	27.A03V7.004
		POWER CORD PRC (3 PIN)	27.A03V7.003
		POWER CORD US (3 PIN)	27.A03V7.001
		POWER CORD KOERA (Pin)	27.T23V7.006
		POWER CORD EU (3 PIN)	27.A03V7.002
		POWER CORD ITALIAN (3 PIN)	27.A03V7.005
		POWER CORD- SWISS	27.A03V7.007
		POWER CORD ISRAEL (3 PIN)	27.A50V7.002

TravelMate C200 FRU List

Picture	No.	Partname And Description	Part Number
		MIDDLE COVER	42.TADV7.001
		HINGE COVER R	42.TADV7.002
		HINGE COVER L	42.TADV7.003
		UPPER CASE W/ ANTENNA	60.TADV7.001
		LOWER CASE W/ SPEAKER	60.TADV7.002
		PCI DOOR	42.TADV7.004
		RAM DOOR	42.TADV7.005
		PCMCIA SUPPORT BRACKET	33.TADV7.001





TravelMate C200 FRU List

Picture	No.	Partname And Description	Part Number
		ZE1 PCMCIA DUMMY Card	42.TADV7.006
CPU			
		Celeron M 350 (1.3G 1M) C0	KC.NC001.350
		Celeron M 360 (1.4G 1M) C0	KC.NC001.360
		Celeron M 370 (1.5G 1M) C0	KC.NC001.370
		CELERON M 380 (1.6G 1M) C0	KC.NC001.380
		Pentium M 725 (1.6G 2M 400FSB)	KC.N0001.725
		Pentium M 730 (1.6G 2M 533FSB)	KC.N0001.730
		Pentium M 740 (1.73G 2M 533FSB)	KC.N0001.740
		Pentium M 750 (1.87G 2M 533FSB)	KC.N0001.750
		Pentium M 760 (2.0G 2M 533FSB)	KC.N0001.760
	Pentium M 770 (2.13G 2M 533FSB)	KC.N0001.770	
		DVD CDRW COMBO ASSY(PANASONIC)STNB/S	6M.TADV7.001
		DVD/CDRW (COMBO) UJDA770AC-A	KO.02406.013
		ODD CONNECTOR BOARD	55.TADV7.005
		ODD HOLDER	42.TADV7.007
		DVD COMBO BEZEL ASSY	42.TADV7.008





TravelMate C200 FRU List

Picture	No.	Partname And Description	Part Number
			6M.TADV7.002
		DVD DUAL(DL), LITEON SOLW-831S, SLOT-IN, F/W:WRT9	KU.00804.016
		ODD CONNECTOR BOARD	55.TADV7.005
		ODD HOLDER	42.TADV7.007
		DVD DUAL LITE-ON SLOT IN BEZEL ASSY	42.TADV7.009
		100G SEAGATE 2.5' 4200RPM N2.2ST9100825A F/W:3.04	KH.10001.003
		100G TOSHIBA 2.5' 4200RPM ARES MK1031GAS (ROHS) F/W AA204A	KH.10004.001
		100G HGST 2.5' 4200RPM HAKONE-A F/W:A70G	KH.10007.002
		40G TOSHIBA 2.5' 4200RPM PLUTO MK4025GAS (ROHS) F/W KA100A	KH.04004.005
		40G HGST 2.5' 4200RPM HAKONA-A F/W :A70G	KH.04007.013
		60G SEAGATE 2.5' 4200RPM N2.2ST960812A F/W:3.04	KH.06001.003
		60G HGST 2.5' 4200RPM HAKONE-A F/W :A70G	KH.06007.009

TravelMate C200 FRU List

Picture	No.	Partname And Description	Part Number
		80G SEAGATE 2.5' 4200RPM N2.2ST980829A F/W:3.04	KH.08001.013
		80G HGST 2.5' 4200RPM HAKONE-A F/ W:A70G	KH.08007.011
		40G SEAGATE 2.5 IN. 4200RPM N2.1ST9402113A F/W:3.01	KH.04001.016
		60G TOSHIBA 2.5 IN. 4200RPM PLUTO MK6025GAS CZK(ROHS) F/W:KA200A	KH.06004.004
		80G TOSHIBA 2.5 IN. 4200RPM PLUTO MK8025GAS (ROHS) F/W:KA023A	KH.08004.003
		HDD CONNECTOR	55.TADV7.006
		HDD COVER	42.TADV7.010
		HDD BRACKET	33.TADV7.002
Keyboard			
		TMC200 KEYBOARD DARFON US International	KB.TAD07.001
		TMC200 KEYBOARD DARFON Chinese	KB.TAD07.002
		TMC200 KEYBOARD DARFON Thai	KB.TAD07.004
		TMC200 KEYBOARD DARFON Czech	KB.TAD07.016
		TMC200 KEYBOARD DARFON Brazilian Protugese	KB.TAD07.005
		TMC200 KEYBOARD DARFON Russian	KB.TAD07.025
		TMC200 KEYBOARD DARFON Turkish	KB.TAD07.020
		TMC200 KEYBOARD DARFON Belgium	KB. TAD07.014
		TMC200 KEYBOARD DARFON Sweden	KB.TAD07.015
		TMC200 KEYBOARD DARFON UK	KB.TAD07.007
		TMC200 KEYBOARD DARFON French	KB.TAD07.010
		TMC200 KEYBOARD DARFON German	KB.TAD07.008
		TMC200 KEYBOARD DARFON Italian	KB.TAD07.009
		TMC200 KEYBOARD DARFON Japanese	KB.TAD07.022

TravelMate C200 FRU List

Picture	No.	Partname And Description	Part Number
		TMC200 KEYBOARD DARFON Danish	KB.TAD07.019
		TMC200 KEYBOARD DARFON Spanish	KB.TAD07.003
		TMC200 KEYBOARD DARFON Arabic	KB.TAD07.013
		TMC200 KEYBOARD DARFON Swiss/G	KB.TAD07.011
		TMC200 KEYBOARD DARFON Portuguese	KB.TAD07.012
		TMC200 KEYBOARD DARFON Norway	KB.TAD07.018
		TMC200 KEYBOARD DARFON Korea	KB.TAD07.006
		TMC200 KEYBOARD DARFON Hungaian	KB.TAD07.017
		TMC200 KEYBOARD DARFON Canadian French	KB.TAD07.021
		TMC200 KEYBOARD DARFON Hebrew	KB.TAD07.024
		TMC200 KEYBOARD DARFON Greek	KB.TAD07.023
		ZE1 LCD 12.1 IN. XGA ASSY HYDIS HT12X21	6M.TADV7.011
		LCD(TFT) 12.1 IN. HYDIS HT12X21-220(XGA) LF W/PROTECT COVER	56.TADV7.001
		INVERTER BOARD LF	19.TADV7.001
		POWER BUTTON/B ASSY	55.TADV7.007
		TABLET BUTTON/B ASSY	55.TADV7.008
		FINGER PRINT BOARD	55.TADV7.009





TravelMate C200 FRU List

Picture	No.	Partname And Description	Part Number
		CABLE ASSY - FINGER12.1(50/55P,1A)LF	50.TADV7.006
		LCD STAND	33.TADV7.003
		LCD BEZEL	60.TADV7.003
		LCD COVER W/ANTENNA - HYDIS	60.TADV7.004
		DIGITIZER PANEL -WACOM SU-1201E-02X	56.TADV7.002
		ZE1 LCD 12.1 IN. XGA ASSY HYDIS HT12X21 W/O FINGER	6M.TADV7.021
		LCD(TFT) 12.1 IN. HYDIS HT12X21-220(XGA) LF W/PROTECT COVER	56.TADV7.001
		INVERTER BOARD LF	19.TADV7.001
		POWER BUTTON/B ASSY	55.TADV7.007
		TABLET BUTTON/B ASSY	55.TADV7.008
		CABLE ASSY - W/O FINGER12.1(50/55P,1A)LF	50.TADV7.007
		LCD STAND	33.TADV7.003
		LCD BEZEL W/O FINGER	60.TADV7.008
		LCD COVER W/ANTENNA - HYDIS	60.TADV7.004
		DIGITIZER PANEL -WACOM SU-1201E-02X	56.TADV7.002
		ZE1 LCD 12.1 IN. XGA ASSY TOSHIBA LTD121KA0Q	6M.TADV7.012
		LCD(TFT)12.1 IN. TOSHIBA LTD121KA0Q LF W/PROTECT COVER	56.TADV7.002
		INVERTER BOARD LF	19.TADV7.001

TravelMate C200 FRU List

Picture	No.	Partname And Description	Part Number
		POWER BUTTON/B ASSY	55.TADV7.007
		TABLET BUTTON/B ASSY	55.TADV7.008
		FINGER PRINT BOARD	55.TADV7.009
		CABLE ASSY - FINGER12.1(50/55P,1A)LF	50.TADV7.006
		LCD STAND	33.TADV7.003
		LCD BEZEL	60.TADV7.003
		LCD COVER W/ANTENNA - TOSHIBA	60.TADV7.009
		DIGITIZER PANEL -WACOM SU-1201E-02X	56.TADV7.002
		ZE1 LCD 12.1 IN. XGA ASSY TOSHIBA LTD121KA0Q W/O FINGER	6M.TADV7.022
		LCD(TFT)12.1 IN. TOSHIBA LTD121KA0Q LF W/PROTECT COVER	56.TADV7.002
		INVERTER BOARD LF	19.TADV7.001
		POWER BUTTON/B ASSY	55.TADV7.007
		TABLET BUTTON/B ASSY	55.TADV7.008
		CABLE ASSY - W/O FINGER12.1(50/55P,1A)LF	50.TADV7.007
		LCD STAND	33.TADV7.003
		LCD BEZEL W/O FINGER	60.TADV7.008
		LCD COVER W/ANTENNA - TOSHIBA	60.TADV7.009
		DIGITIZER PANEL -WACOM SU-1201E-02X	56.TADV7.002
		MAINBOARD UMA W/MODEM CABLE, 4 IN 1 W/O CPU MEMORY	LB.TAD06.001
		MAINBOARD NVIDIA NV44M64 W/MODEM CABLE, 4 IN 1 W/O CPU MEMORY	LB.TAU06.001
		RTC BATTERY - ML1220	23.T42V7.001
		MEMORY INFINEON DDRII533256M HYS64T32000HDL-3.7-A 32X64 CL4	KN.25602.023
		SO-DIMM DDRII533 256MB NT256T64UH4A0FN-37B LF	KN.25603.020
		SO-DIMM DDRII533 256MB MT8HTF3264HDY-53EB3 LF	KN.25604.023
		MEMORY DDRII 533 256MB M470T3354CZ3-CD5 (PB-FREE), SAMSUNG	KN.2560B.016
		SO-DIMM DDRII533 256MB HYMP532S64P6-C4 LF	KN.2560G.006
		MEMORY SO-DIMM DDRII 533 256MB HYMP532S64P6-C4, HYNIX	KN.51202.021

TravelMate C200 FRU List

Picture	No.	Partname And Description	Part Number
		MEMORY SO-DIMM DDRII 533 512MB NT512T64UH8A0FN-37B, NANYA	KN.51203.018
		SO-DIMM DDRII533 512MB M470T6554CZ3- CD500 LF	KN.5120B.015
		SO-DIMM DDRII533 512MB HYMP564S64P6- C4 LF	KN.5120G.005
		SPEAKER SET	23.TADV7.001
		THERMAL MODULE	60.TADV7.005
		STYLUS	60.TADV7.006
		LATCH RUBBER	47.TADV7.001
		LCD RUBBER Note: Larger one is LCD rubber.	47.TADV7.002
		LCD RUBBER MID Note: Smaller one is LCD rubber mid.	47.TADV7.003
		LOWER CASE RUBBER FOOT	47.TADV7.004
		WEIGHT SAVER	
		SCREW M2.0*2.5-I(NI)(NYLOK)	
		SCREW M2.0*5-I(NI)(NYLOK)	
		SCREW M2.5*4.0-I(NI)(NYLOK)	
		SCREW M2.0*6 I-BNI	
		SCREW M2.5*3-I(NI,NYLOK)	
		SCREW M2*5-I(BNI)(NYLOK)(D3H0.3)LF	

Model Definition and Configuration

TravelMate C210 Series

Model	RO	Country	Acer Part no	Description	Group1	CPU
TMC213TMi	China	China	LX.TDG0E.003	TMC213TMi XPTSC8 G72MV128 2*512/ 100/BT/6L+3H/ 4R_abg	TMC213T	C2DT5500
TMC213TMi	China	Hong Kong	LX.TDG0E.001	TMC213TMi XPCHK6 G72MV128 2*512/ 100/BT/6L+3H/ 4R_abg	TMC213T	C2DT5500
TMC213TMi	China	China	LX.TDG0E.004	TMC213TMi XPTSC8 G72MV128 2*512/ 100/BT/6L+3H/ 4R_abg_FP	TMC213T	C2DT5500
TMC213TMi	China	Hong Kong	LX.TDG0E.002	TMC213TMi XPCHK6 G72MV128 2*512/ 100/BT/6L+3H/ 4R_abg_FP	TMC213T	C2DT5500
TMC213TMi	AAP	Australia/New Zealand	LX.TDG0E.006	TMC213TMi XPTAU1 G72MV128 2*512/ 100/BT/6L+3H/ 4R_abg	TMC213T	C2DT5500
TMC213TMi	AAP	Singapore	LX.TDG0E.013	TMC213TMi XPTSG1 G72MV128 2*512/ 100/BT/6L+3H/ 4R_abg	TMC213T	C2DT5500
TMC213TMi	AAP	India	LX.TDG0E.009	TMC213TMi XPTIL1 G72MV128 2*512/ 100/BT/6L+3H/ 4R_abg	TMC213T	C2DT5500
TMC213TMi	AAP	Indonesia	LX.TDG0E.010	TMC213TMi XPTIN1 G72MV128 2*512/ 100/BT/6L+3H/ 4R_abg	TMC213T	C2DT5500
TMC213TMi	AAP	Philippines	LX.TDG0E.012	TMC213TMi XPPTH1 G72MV128 2*512/ 100/BT/6L+3H/ 4R_abg	TMC213T	C2DT5500
TMC213TMi	AAP	Thailand	LX.TDG0E.015	TMC213TMi XPTTH2 G72MV128 2*512/ 100/BT/6L+3H/4R_bg	TMC213T	C2DT5500
TMC213TMi	AAP	Vietnam	LX.TDG0E.016	TMC213TMi XPTVN1 G72MV128 2*512/ 100/BT/6L+3H/ 4R_abg	TMC213T	C2DT5500
TMC213TMi	AAP	Malaysia	LX.TDG0E.011	TMC213TMi XPTMA2 G72MV128 2*512/ 100/BT/6L+3H/ 4R_abg	TMC213T	C2DT5500

Model	RO	Country	Acer Part no	Description	Group1	CPU
TMC213Tmi	PA	USA/Canada	LX.TDG0E.007	TMC213Tmi XPTEN4 G72MV128 2*512/ 100/BT/6L+3H/ 4R_abg	TMC213T	C2DT5500
TMC213Tmi	PA	ACLA- Spanish	LX.TDG0E.008	TMC213Tmi XPTES4 G72MV128 2*512/ 100/BT/6L+3H/ 4R_abg	TMC213T	C2DT5500
TMC215Tmi	PA	USA/Canada	LX.TDG0E.018	TMC215Tmi XPTEN4 G72MV128 2*1G/160/ BT/6L+3H/ 4R_abg_FP	TMC215T	C2DT7200
TMC215Tmi	PA	ACLA- Spanish	LX.TDG0E.019	TMC215Tmi XPTES4 G72MV128 2*1G/160/ BT/6L+3H/ 4R_abg_FP	TMC215T	C2DT7200
TMC215Tmi	AAP	Australia/New Zealand	LX.TDG0E.017	TMC215Tmi XPTAU1 G72MV128 2*1G/160/ BT/6L+3H/ 4R_abg_FP	TMC215T	C2DT7200
TMC215Tmi	AAP	Thailand	LX.TDG0E.025	TMC215Tmi XPTTH2 G72MV128 2*1G/160/ BT/6L+3H/4R_bg_FP	TMC215T	C2DT7200
TMC215Tmi	AAP	Singapore	LX.TDG0E.024	TMC215Tmi XPTSG1 G72MV128 2*1G/160/ BT/6L+3H/ 4R_abg_FP	TMC215T	C2DT7200
TMC215Tmi	AAP	India	LX.TDG0E.020	TMC215Tmi XPTIL1 G72MV128 2*1G/160/ BT/6L+3H/ 4R_abg_FP	TMC215T	C2DT7200
TMC215Tmi	AAP	Indonesia	LX.TDG0E.021	TMC215Tmi XPTIN1 G72MV128 2*1G/160/ BT/6L+3H/ 4R_abg_FP	TMC215T	C2DT7200
TMC215Tmi	AAP	Philippines	LX.TDG0E.023	TMC215Tmi XPTPH1 G72MV128 2*1G/160/ BT/6L+3H/ 4R_abg_FP	TMC215T	C2DT7200
TMC215Tmi	AAP	Malaysia	LX.TDG0E.022	TMC215Tmi XPTMA2 G72MV128 2*1G/160/ BT/6L+3H/ 4R_abg_FP	TMC215T	C2DT7200
TMC215Tmi	AAP	Vietnam	LX.TDG0E.026	TMC215Tmi XPTVN1 G72MV128 2*1G/160/ BT/6L+3H/ 4R_abg_FP	TMC215T	C2DT7200
TMC213Tmi	EMEA	Germany	LX.TDG0E.060	TMC213Tmi XPTDEC G72MV128 2*512/ 100/BT/6L+3H/ 4R_abg_FP	TMC213T	C2DT5500
TMC213Tmi	EMEA	Belgium	LX.TDG0E.061	TMC213Tmi XPTBE7 G72MV128 2*512/ 100/BT/6L+3H/ 4R_abg_FP	TMC213T	C2DT5500

Model	RO	Country	Acer Part no	Description	Group1	CPU
TMC213TMi	EMEA	Middle East	LX.TDG0E.049	TMC213TMi XPTARA G72MV128 2*512/ 100/BT/6L+3H/ 4R_abg_FP	TMC213T	C2DT5500
TMC213TMi	EMEA	Germany	LX.TDG0E.043	TMC213TMi XPTDEC G72MV128 1*512/80/ BT/6L+3H/4R_abg	TMC213T	C2DT5500
TMC213TMi	EMEA	Belgium	LX.TDG0E.038	TMC213TMi XPTBE7 G72MV128 1*512/80/ BT/6L+3H/4R_abg	TMC213T	C2DT5500
TMC213TMi	EMEA	Denmark	LX.TDG0E.041	TMC213TMi XPTDK5 G72MV128 1*512/80/ BT/6L+3H/4R_abg	TMC213T	C2DT5500
TMC213TMi	EMEA	Middle East	LX.TDG0E.030	TMC213TMi XPTARA G72MV128 1*512/80/ BT/6L+3H/4R_abg	TMC213T	C2DT5500
TMC213TMi	EMEA	France	LX.TDG0E.042	TMC213TMi XPTFRD G72MV128 1*512/80/ BT/6L+3H/4R_abg	TMC213T	C2DT5500
TMC213TMi	EMEA	Spain	LX.TDG0E.032	TMC213TMi XPTESI G72MV128 1*512/80/ BT/6L+3H/4R_abg	TMC213T	C2DT5500
TMC213TMi	EMEA	Italy	LX.TDG0E.034	TMC213TMi XPTIT5 G72MV128 1*512/80/ BT/6L+3H/4R_abg	TMC213T	C2DT5500
TMC213TMi	EMEA	Holland	LX.TDG0E.039	TMC213TMi XPTNL7 G72MV128 1*512/80/ BT/6L+3H/4R_abg	TMC213T	C2DT5500
TMC213TMi	EMEA	Norway	LX.TDG0E.040	TMC213TMi XPTNO4 G72MV128 1*512/80/ BT/6L+3H/4R_abg	TMC213T	C2DT5500
TMC213TMi	EMEA	Italy	LX.TDG0E.047	TMC213TMi XPTIT5 G72MV128 2*512/ 100/BT/6L+3H/ 4R_abg_FP	TMC213T	C2DT5500
TMC213TMi	EMEA	Holland	LX.TDG0E.056	TMC213TMi XPTNL7 G72MV128 2*512/ 100/BT/6L+3H/ 4R_abg_FP	TMC213T	C2DT5500
TMC213TMi	EMEA	Denmark	LX.TDG0E.055	TMC213TMi XPTDK5 G72MV128 2*512/ 100/BT/6L+3H/ 4R_abg_FP	TMC213T	C2DT5500
TMC213TMi	EMEA	France	LX.TDG0E.050	TMC213TMi XPTFRD G72MV128 2*512/ 100/BT/6L+3H/ 4R_abg_FP	TMC213T	C2DT5500
TMC213TMi	EMEA	Spain	LX.TDG0E.051	TMC213TMi XPTESI G72MV128 2*512/ 100/BT/6L+3H/ 4R_abg_FP	TMC213T	C2DT5500
TMC213TMi	EMEA	Portugal	LX.TDG0E.052	TMC213TMi XPTPT4 G72MV128 2*512/ 100/BT/6L+3H/ 4R_abg_FP	TMC213T	C2DT5500

Model	RO	Country	Acer Part no	Description	Group1	CPU
TMC213TMi	EMEA	Norway	LX.TDG0E.057	TMC213TMi XPTNO4 G72MV128 2*512/ 100/BT/6L+3H/ 4R_abg_FP	TMC213T	C2DT5500
TMC213TMi	EMEA	Russia	LX.TDG0E.058	TMC213TMi XPTRU7 G72MV128 2*512/ 100/BT/6L+3H/ 4R_abg_FP	TMC213T	C2DT5500
TMC213TMi	EMEA	Sweden/ Finland	LX.TDG0E.053	TMC213TMi XPTSV4 G72MV128 2*512/ 100/BT/6L+3H/ 4R_abg_FP	TMC213T	C2DT5500
TMC213TMi	EMEA	Russia	LX.TDG0E.035	TMC213TMi XPTRU7 G72MV128 1*512/80/ BT/6L+3H/4R_abg	TMC213T	C2DT5500
TMC213TMi	EMEA	Sweden/ Finland	LX.TDG0E.036	TMC213TMi XPTSV4 G72MV128 1*512/80/ BT/6L+3H/4R_abg	TMC213T	C2DT5500
TMC213TMi	EMEA	South Africa	LX.TDG0E.059	TMC213TMi XPTSA3 G72MV128 2*512/ 100/BT/6L+3H/ 4R_abg_FP	TMC213T	C2DT5500
TMC213TMi	EMEA	South Africa	LX.TDG0E.046	TMC213TMi XPTSA3 G72MV128 1*512/80/ BT/6L+3H/4R_abg	TMC213T	C2DT5500
TMC213TMi	EMEA	Portugal	LX.TDG0E.033	TMC213TMi XPTPT4 G72MV128 1*512/80/ BT/6L+3H/4R_abg	TMC213T	C2DT5500
TMC213TMi	EMEA	Switzerland	LX.TDG0E.031	TMC213TMi XPTSW5 G72MV128 1*512/80/ BT/6L+3H/4R_abg	TMC213T	C2DT5500
TMC213TMi	EMEA	UK	LX.TDG0E.028	TMC213TMi XPTUK6 G72MV128 1*512/80/ BT/6L+3H/4R_abg	TMC213T	C2DT5500
TMC213TMi	EMEA	Turkey	LX.TDG0E.029	TMC213TMi XPTTR4 G72MV128 1*512/80/ BT/6L+3H/4R_abg	TMC213T	C2DT5500
TMC213TMi	EMEA	Eastern Europe	LX.TDG0E.037	TMC213TMi XPTWW3 G72MV128 1*512/80/BT/6L+3H/ 4R_abg	TMC213T	C2DT5500
TMC213TMi	EMEA	Turkey	LX.TDG0E.048	TMC213TMi XPTTR4 G72MV128 2*512/ 100/BT/6L+3H/ 4R_abg_FP	TMC213T	C2DT5500
TMC213TMi	EMEA	Switzerland	LX.TDG0E.044	TMC213TMi XPTSW5 G72MV128 2*512/ 100/BT/6L+3H/ 4R_abg_FP	TMC213T	C2DT5500
TMC213TMi	EMEA	UK	LX.TDG0E.045	TMC213TMi XPTUK6 G72MV128 2*512/ 100/BT/6L+3H/ 4R_abg_FP	TMC213T	C2DT5500
TMC213TMi	EMEA	Eastern Europe	LX.TDG0E.054	TMC213TMi XPTWW3 G72MV128 2*512/100/BT/6L+3H/ 4R_abg_FP	TMC213T	C2DT5500

Model	RO	Country	Acer Part no	Description	Group1	CPU
TMC213Tmi	AAP	Singapore	LX.TDG0E.062	TMC213Tmi XPTSG1 G72MV128 1*512/80/ BT/6L+3H/ 4R_abg_FP	TMC213T	C2DT5500
TMC213Tmi	AAP	Australia/New Zealand	LX.TDG0E.063	TMC213Tmi XPTAU1 G72MV128 1*1G/120/ BT/6L+3H/4R_abg	TMC213T	C2DT5500
TMC213Tmi	AAP	Australia/New Zealand	LX.TDG0E.064	TMC213Tmi XPTAU1 G72MV128 1*1G/120/ BT/6L+3H/ 4R_abg_FP	TMC213T	C2DT5500
TMC215Tmi	AAP	Philippines	LX.TDG0E.065	TMC215Tmi XPTPH1 G72MV128 1*1G/160/ BT/6L+3H/ 4R_abg_FP	TMC215T	C2DT7200

Test Compatible Components

This computer's compatibility is tested and verified by Acer's internal testing department. All of its system functions are tested under Windows® XP Home, Windows® XP Pro environment.

Refer to the following lists for components, adapter cards, and peripherals which have passed these tests. Regarding configuration, combination and test procedures, please refer to the TravelMate C210 series Compatibility Test Report released by the Acer Mobile System Testing Department.

Microsoft® Windows® XP Pro Environment Test

Item	Specification
CRT Port Test	
CRT Monitor	View Sonic E72f 17" PerfectFlat color CRT Area with 1280*1024
LCD Monitor	COMPAQ FP 7317 17" LCD area with 1024*768 Gateway FPD1730 17"(1280*1024)
DVI Monitor	CMV CM-930D (1280*1024)
Projector	BenQ FB8225
TV	FERGUSON DV3
Audio Jacks Port Test	
Microphone	V008
Head Phone	TP-M06 R
Printer	HP Deskjet 840C
USB Port Test	
USB 1.1-Mouse	Logitech Wheel Mouse(Optical, USB PS/2) Huaerte USB Stroll Mouse 2-button HM-28 Microsoft Track Ball Explorer(USB PS/2) USB Stroll Mouse 2-button HM-28(Scroll, wheel) Logitech(Optical) Microsoft IntelliMouse optical ps2/USB Microsoft IntelliMouse Explorer ps2/USB Microsoft Optical Mouse Blue USB and PS/2 Compatible Logitech Cordless TrackMan Fx(Trackball, Optical) Microsoft Wireless Optical Mouse Blue(USB PS/2) Microsoft Wheel Mouse Optical(USB PS/2)
USB 1.1-keyboard	NewMen TECHNOLOGY Basic Keyboard HP USB Keyboard ViewSonic ViewMate Internet/Multimedia Keyboard Chang yang Kb-MED-U T3A158 NMB The Right Touch! SILITEK SK-6000 USB KeyPad: ZIPPY USB Keyboard TK323
USB 2.0-Speaker	JAZZ HIPSTER CORRPORATION MODELGJ 1301 USB OZAKI USB206 USB J-S J1321
USB 1.1-FDD	TEAC FD-05PUB USB1.0 Device YE-DATA USB1.1 Floppy Disk Drvie YU-8U10 SMSC USB1.1 external Floppy Drive IBM USB1.1 external Floppy Drive
USB 1.1-Camera / CCD	Logitech USB1.1 QuickCam for Notebooks pro
USB 1.1-HUB	UNIONSTAR USB1.1 HUB 4 Port
USB 1.1-Gamepad	Logitech WingMan Stike forcee 3D Microsoft Gamepad Logitech WingMan Force J-UA9
USB 1.1-Card Reader	IWILL 6in1 USB1.1 Card Reader/Writer HP USB 1.0 digital drive

Item	Specification
USB 2.0-HDD	Istyle USB2.0/1394 HDD NEWMAN USB2.0 HDD ViPower SmartFamily USB2.0 HDD
USB 2.0-DVD/CD-RW	VP-6228V2 CDROMBOX
USB 2.0-HUB	Highlight High-Speed 4-port USB 2.0 hub D-Link DUB-H4 4-Port Hi-SPEED USB 2.0 Hub Hi-Speed 4-Port USB 2.0 HUB(IOGEAR)
USB 2.0-Cable	GoodMan USB Turbo Link
USB to LAN Cable	BUFFALD USB-10/100M Ethernet LUA-TX
USB 2.0-Handy Drive	Apacer USB2.0 Handy Drive
USB 2.0-Camera/CCD	Logitech QuickCam 5.0.1(USB2.0)
USB 2.0-Scanner	HP ScanJet 3500C USB2.0 digital flatbed Scanner
PCMCIA Test	
PCI Express Card	Express card 5in1 adapter (YE-DATA YD-8V30) Express Gigabit Lan Card (AboCom)
SCSI Card	Ultra Slim SCSI 1480B Ultra Slim SCSI 1460D
Modem Card	billionton 56Kbps FAX Modem PC Card Xircom CreditCard Modem 56-GlobalAccess
32 bit Lan Card	NETGEAR Gigabit PC card GA511 TDK10/100 Lan CardBus LAC-CB100x D-Link DFE-690TXD 32bit 10/100Mb PC Card
1394 CardBus Card	VIA OHCI Compliant IEEE 1394 Host Controller e-sense PCMCIA 1394d CardBus 2 Ports
USB2.0 CardBus Card	IOGEAR USB 2.0 2-Port CardBus Card USB 2.0 Hi-speed CardBus Adapter INTOPIC USB 2.0 4-Port Notebook Card(CardBus)
Wireless Lan Card	BUFFALD 54M Wireless LAN PC Card WLI-CB-G54A GIGABYTE GN-WMGA 802.11 b/g Wireless LAN PC Card Gemtek Wireless LAN PC Card WL-211F 802.11b 2.4GHz LINKSYS Wireless-B Notebook Adapter 2.4GHz
ATA Card	SanDisk 1G ATA PC Card IBM Microdrive 1GB
PS/2 Port Test	
Mouse	Microsoft FCC ID:C3KKZB1 GS S100 TECH SWW-25 Logitech Serial Mouse M-M35
Keyboard	DELL PS2 keyboard
COM/Serial Port Test	
Mouse	Logitech Serial Mouse M-M35
Memory Card Test (SD/MS/MMC/SM/CF/Microdrive/XD)	
MMC Card	ScanDisk 32MB MMC Card Transcend 512MB MMC Card Transcend 1GB MMC Card

Item	Specification
SD Card	Panasonic 2.0G SD Card Transcend 2.0G SD Card Sandisk 256MB SD Card Simpletech 128MB SD Card Sandisk 1.0G SD Card X Digital Media SD 256MB Simpletech 512MB SD Card
MS Card	Sony 128MB MS Card SanDisk stick Pro 1GB LEXAR 256MB MS Card Sandisk 64MB MS Card SONY 32MB MS Card SONY 256MB MS Card
XD Card	OLYMPUS XD Picture Card 256MB OLYMPUS XD Picture Card 1GB
CF Card	Protec 256MB CF Card Compact Flash Adapter 128MB
Card Reader	POW four-in-one memory media PCMCIA

Microsoft® Windows® XP Home Environment Test

Item	Specification
CRT Port Test	
CRT Monitor	View Sonic E72f 17" PerfectFlat color CRT Area with 1280*1024
LCD Monitor	COMPAQ FP 7317 17" LCD area with 1024*768 Gateway FPD1730 17"(1280*1024)
DVI Monitor	CMV CM-930D (1280*1024)
Projector	BenQ FB8225
TV	FERGUSON DV3
Audio Jacks Port Test	
Microphone	V008
Head Phone	TP-M06 R
Printer	HP Deskjet 840C
USB Port Test	
USB 1.1-Mouse	Logitech Wheel Mouse(Optical, USB PS/2) Huaerte USB Stroll Mouse 2-button HM-28 Microsoft Track Ball Explorer(USB PS/2) USB Stroll Mouse 2-button HM-28(Scroll, wheel) Logitech(Optical) Microsoft IntelliMouse optical ps2/USB Microsoft IntelliMouse Explorer ps2/USB Microsoft Optical Mouse Blue USB and PS/2 Compatible Logitech Cordless TrackMan Fx(Trackball, Optical) Microsoft Wireless Optical Mouse Blue(USB PS/2) Microsoft Wheel Mouse Optical(USB PS/2)
USB 1.1-keyboard	NewMen TECHNOLOGY Basic Keyboard HP USB Keyboard ViewSonic ViewMate Internet/Multimedia Keyboard Chang yang Kb-MED-U T3A158 NMB The Right Touch! SILITEK SK-6000 USB KeyPad: ZIPPY USB Keyboard TK323
USB 2.0-Speaker	JAZZ HIPSTER CORRPORATION MODELGJ 1301 USB OZAKI USB206 USB J-S J1321
USB 1.1-FDD	TEAC FD-05PUB USB1.0 Device YE-DATA USB1.1 Floppy Disk Drvie YU-8U10 SMSC USB1.1 external Floppy Drive IBM USB1.1 external Floppy Drive
USB 1.1-Camera / CCD	Logitech USB1.1 QuickCam for Notebooks pro
USB 1.1-HUB	UNIONSTAR USB1.1 HUB 4 Port
USB 1.1-Gamepad	Logitech WingMan Stike forcee 3D Microsoft Gamepad Logitech WingMan Force J-UA9
USB 1.1-Card Reader	IWILL 6in1 USB1.1 Card Reader/Writer HP USB 1.0 digital drive

Item	Specification
USB 2.0-HDD	Istyle USB2.0/1394 HDD NEWMAN USB2.0 HDD ViPower SmartFamily USB2.0 HDD
USB 2.0-DVD/CD-RW	VP-6228V2 CDROMBOX
USB 2.0-HUB	Highlight High-Speed 4-port USB 2.0 hub D-Link DUB-H4 4-Port Hi-SPEED USB 2.0 Hub Hi-Speed 4-Port USB 2.0 HUB(IOGEAR)
USB 2.0-Cable	GoodMan USB Turbo Link
USB to LAN Cable	BUFFALD USB-10/100M Ethernet LUA-TX
USB 2.0-Handy Drive	Apacer USB2.0 Handy Drive
USB 2.0-Camera/CCD	Logitech QuickCam 5.0.1(USB2.0)
USB 2.0-Scanner	HP ScanJet 3500C USB2.0 digital flatbed Scanner
PCMCIA Test	
PCI Express Card	Express card 5in1 adapter (YE-DATA YD-8V30) Express Gigabit Lan Card (AboCom)
SCSI Card	Ultra Slim SCSI 1480B Ultra Slim SCSI 1460D
Modem Card	billionton 56Kbps FAX Modem PC Card Xircom CreditCard Modem 56-GlobalAccess
32 bit Lan Card	NETGEAR Gigabit PC card GA511 TDK10/100 Lan CardBus LAC-CB100x D-Link DFE-690TXD 32bit 10/100Mb PC Card
1394 CardBus Card	VIA OHCI Compliant IEEE 1394 Host Controller e-sense PCMCIA 1394d CardBus 2 Ports
USB2.0 CardBus Card	IOGEAR USB 2.0 2-Port CardBus Card USB 2.0 Hi-speed CardBus Adapter INTOPIC USB 2.0 4-Port Notebook Card(CardBus)
Wireless Lan Card	BUFFALD 54M Wireless LAN PC Card WLI-CB-G54A GIGABYTE GN-WMGA 802.11 b/g Wireless LAN PC Card Gemtek Wireless LAN PC Card WL-211F 802.11b 2.4GHz LINKSYS Wireless-B Notebook Adapter 2.4GHz
ATA Card	SanDisk 1G ATA PC Card IBM Microdrive 1GB
PS/2 Port Test	
Mouse	Microsoft FCC ID:C3KKZB1 GS S100 TECH SWW-25 Logitech Serial Mouse M-M35
Keyboard	DELL PS2 keyboard
COM/Serial Port Test	
Mouse	Logitech Serial Mouse M-M35
Memory Card Test (SD/MS/MMC/SM/CF/Microdrive/XD)	
MMC Card	ScanDisk 32MB MMC Card Transcend 512MB MMC Card Transcend 1GB MMC Card

Item	Specification
SD Card	Panasonic 2.0G SD Card Transcend 2.0G SD Card Sandisk 256MB SD Card Simpletech 128MB SD Card Sandisk 1.0G SD Card X Digital Media SD 256MB Simpletech 512MB SD Card
MS Card	Sony 128MB MS Card SanDisk stick Pro 1GB LEXAR 256MB MS Card Sandisk 64MB MS Card SONY 32MB MS Card SONY 256MB MS Card
XD Card	OLYMPUS XD Picture Card 256MB OLYMPUS XD Picture Card 1GB
CF Card	Prtec 256MB CF Card Compact Flash Adapter 128MB
Card Reader	POW four-in-one memory media PCMCIA

Online Support Information

This section describes online technical support services available to help you repair your Acer Systems.

If you are a distributor, dealer, ASP or TPM, please refer your technical queries to your local Acer branch office. Acer Branch Offices and Regional Business Units may access our website. However some information sources will require a user i.d. and password. These can be obtained directly from Acer CSD Taiwan.

Acer's Website offers you convenient and valuable support resources whenever you need them.

In the Technical Information section you can download information on all of Acer's Notebook, Desktop and Server models including:

- Service guides for all models
- User's manuals
- Training materials
- Bios updates
- Software utilities
- Spare parts lists
- TABs (Technical Announcement Bulletin)

For these purposes, we have included an Acrobat File to facilitate the problem-free downloading of our technical material.

Also contained on this website are:

- Detailed information on Acer's International Traveler's Warranty (ITW)
- Returned material authorization procedures
- An overview of all the support services we offer, accompanied by a list of telephone, fax and email contacts for all your technical queries.

We are always looking for ways to optimize and improve our services, so if you have any suggestions or comments, please do not hesitate to communicate these to us.

A

ACPI 1.0a 32
 AFLASH Utility 51
 Audio 36

B

Battery Pack 60
 BIOS 32

- package 32
- password control 32
- ROM size 32
- ROM type 32
- vendor 32
- Version 32

 BIOS Setup Utility 41
 BIOS Supports protocol 32
 BIOS Utility 41

- Basic System Settings 45
- Navigating 42
- Onboard Device Configuration 47
- Startup Configuration 46
- System Information 42
- System Security 50

 Board Layout 4

- Bottom View 5
- Top View 4, 89

C

Cache

- controller 32
- size 32

 CardBus 37
 CPU

- core voltage 31
- package 31
- type 31

 CPU Fan True Value Table 31

D

DIMM

- Combinations 33
- external 61, 64
- removing 61, 64

 Disassembly

- Battery Pack 59

LCD Module 67
 Procedure Flowchart 59

Display 3

E

Easy-launch buttons 14
 Error Symptom-to-Spare Part Index 75
 External CD-ROM Drive Check 72
 External Diskette Drive Check 72

F

Features 1
 Flash Utility 51
 Floppy Disk

- removing the 67

 FRU (Field Replaceable Unit) List 93

H

Hard disk 34
 HDD 34

I

Indicators 13
 Intermittent Problems 86

J

Jumper and Connector Locations 89

- Top View 89
- Bottom View 90

K

Keyboard 37
 Keyboard or Auxiliary Input Device Check 72

L

L2 cache 32

M

Memory Check 73
 Model Definition 106
 Modem 33

O

Online Support Information 119

P

Panel

right 8

PC Card 37

PCMCIA 37

Power System Check 73

Battery Pack 74

Processor 31

R

RMA 93

S

Second Level Cache 32

System

Block Diagram 3

Layout 4

System Memory 32

System Utilities 41

T

Test Compatible Components 111

Touchpad Check 74

Troubleshooting 71

U

Undetermined Problems 87

USB 36, 37

utility

BIOS 41

V

View

Base view 11

Closed front view 8

Left view 9

Open front view 8

Rear view 11

Right view 10

Top View 7

W

Windows XP Pro Environment Test 112

Windows XP Home Environment test 115

