



- STAEDTLER guarantees:
- Perfect writing performance
  - High reliability
  - Superb writing comfort

Edition  
2005 / 2006

Edition 2005 / 2006



0K205 A6000 / 1204

© STAEDTLER Mars GmbH & Co. KG  
 Manufacturers of writing and drawing instruments  
 Moosaeckerstrasse 3  
 90427 Nuernberg  
 Germany  
 eMail: info@staedtler.de  
 www.staedtler.com

Printed in Germany / Subject to change

A historic brand shapes its future.



## STAEDTLER

Pages 6 – 7

- Brand profile
- Tradition – company and brand
- Environment
- Quality – Made in Germany
- STAEDTLER Foundation



## STAEDTLER Lumocolor®

Pages 8 – 29

- Universal pens
- All-rounders
- Permanent markers
- Special markers
- CD/DVD pens
- Dry markers
- OHP pens
- Whiteboard markers
- Flipchart markers
- Film



## STAEDTLER Textsurfer®

Pages 30 – 35

- Highlighter pens
- Highlighter pencils



## STAEDTLER triplus®

Pages 36 – 45

- Fineliners
- Rollerballs
- Gel rollers
- Fibre-tip pens
- Ballpoint pens
- Mechanical pencils
- Highlighters



## Writing instruments

Pages 46 – 55

- Rollerballs
- Gel rollers
- Ballpoint pens
- Ballpoint pen refills
- Fineliners

## Pencils and accessories

Pages 56 – 69

- Mechanical pencils
- Mechanical pencil leads
- Leadholders
- Leads
- Pencils
- Erasers
- Sharpeners



## STAEDTLER karat® aquarell

Pages 70 – 73

- Watercolour pencils



## STAEDTLER ergosoft®

Pages 74 – 81

- Watercolour pencils
- Coloured pencils
- Pencils



## STAEDTLER school range

Pages 82 – 91

- Coloured pencils
- Sharpeners
- Pencils
- Erasers
- Fibre-tip pens
- Wax crayons
- Poster colours
- Compasses

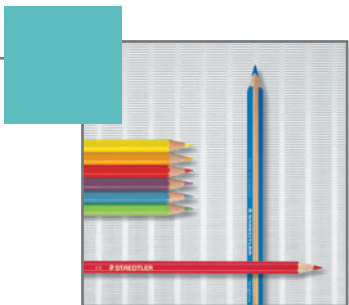

## Technical drawing

Pages 92 – 111

- Mars professional
- Technical pens
- Drawing inks
- Leadholder
- Drawing boards
- Rulers
- Set squares
- Lettering guides
- Compasses





## Brand profile

STAEDTLER is one of the world's leading manufacturers and suppliers of writing and drawing instruments and its name vouches for highest brand quality.

### STAEDTLER guarantees

- perfect writing performance
- high reliability
- superb writing comfort

This follows the company's many decades of experience in the development and manufacture of professional writing and drawing instruments.

### Tradition – company and brand

Both the STAEDTLER brand and the product lines 'Mars' and 'Noris' can look back on a long tradition. Already in the year 1900, the product name 'Mars' was registered at the imperial patent office, followed, only one year later, by 'Noris'.

Today, both product lines are still of great importance to STAEDTLER and are registered trademarks in more than 100 countries. The product name 'Minerva' is even older. It was registered in the trademark ledger in 1896 and is still used in the present day.

The company itself is rich in tradition too. One of Johann Sebastian Staedtler's ancestors, Friedrich Staedtler, had been active in the pencil-making trade long before the foundation of the company J.S. Staedtler in 1835.

Indeed, first references to him in the city annals date back as far as 1662.



## Responsibility for the environment

As an internationally active manufacturing company, environmental protection is something that STAEDTLER has always taken very seriously. For years already, the company has been implementing numerous publicly recognised pollution control measures and has received a number of environmental awards as a result – not only at the head office in Nuremberg.

STAEDTLER is particularly active in the areas of waste water treatment, reusable material sorting, raw material recycling and energy conservation by means of heat recycling. Worldwide, top priority is given to a careful use of resources and

an efficient and environmentally friendly manufacturing process in order to conserve our ecosystem for future generations.

When it comes to global ecology, STAEDTLER has gone still one step further. In the year 2000, the company's management started a joint research project together with the Malaysian government on the reforestation of jelutong (*Dyera costulata*). In doing so, STAEDTLER is making an active contribution to the research, cultivation and growth of a type of wood commonly used for the manufacture of pencils.



## Quality – Made in Germany and international

Tradition is value, quality is tradition – not only in the company’s German production plants where the majority of STAEDTLER products are manufactured. The words **MADE IN GERMANY** are regarded as a guarantee for top quality all over the world. STAEDTLER is proud of its long manufacturing history in Germany – and will, of course, continue this tradition in the future as well.

A continuous striving for top performance is something that is very much anchored in the STAEDTLER workforce on a worldwide level. This principle is actively enforced by the company’s more than 3,000 employees at eleven production plants and 24 sales subsidiaries all over the globe. STAEDTLER is the largest manufacturer of blacklead and coloured pencils and erasers in Europe.

### Innovation secures success – both now and in the future

Know-how stimulates innovation – innovation stimulates success. Ground-breaking inventions – today standards for the entire branch – provide the foundation for STAEDTLER’s outstanding market positioning in many product segments. This already began in 1834 with Johann Sebastian Staedtler’s invention of the **coloured pencil**. The first **OHP pen** – STAEDTLER Lumocolor – set another milestone in the writing instruments market. The development of the **DRY SAFE feature** for permanent and non-permanent inks is another example of STAEDTLER’s pioneering spirit.

High investments in R&D secure STAEDTLER’s innovative power well into the future. For products offering a perfect synthesis of functionality and design, in line with the high standards of the STAEDTLER brand.



## STAEDTLER Foundation

All shares of the STAEDTLER Group are held by the STAEDTLER Foundation. On 16th April 1997, the foundation was officially recognised and certified as a non-profit organisation by the regional government of Central Franconia. The purpose of the foundation is to

support scientific research at national universities and polytechnics. Every year, profits from the STAEDTLER Foundation are allocated to generously fund research projects and to finance highly remunerative awards for outstanding PhD theses.







STAEDTLER whiteboard marker

Lumocolor

DRY SAFE



STAEDTLER Lumocolor

permanent compact

DRY SAFE

1-2 mm





## Lumocolor® – perfect all-rounders

Suitable for a whole variety of uses and offering a perfect solution for just about every imaginable application – the pens and markers of the Lumocolor range are true standard-setters. Thanks to the innovative ink technology, products remain ready for use at all times, even when really put to the test, and excel with their long service life and superb writing and marking performance on all kinds

of different materials. For over 50 years now, Lumocolor has stood for excellent product quality MADE IN GERMANY. The characteristic design of the Lumocolor OHP pen, market leader in many countries, is today common to all products in the assortment. What's more, the unique, prize-winning STAEDTLER box keeps pens ready to hand at all times. What more could you want?

Universal pens  
All-rounders  
Permanent markers  
Special markers  
CD/DVD pens  
Dry markers  
OHP pens  
Whiteboard markers  
Flipchart markers  
Film



**Lumocolor –  
write on whatever you like!**

## The comprehensive Lumocolor range ...



### Permanent / non-permanent

- Permanent / waterproof: dark barrel colour
- Non-permanent / water-soluble: light barrel colour



### Colour range

- Up to 8 different colours are available

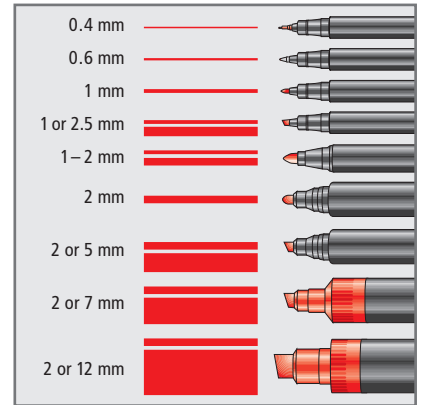

### Line widths

- The right line width whatever the application

## ... with its ingenious packaging ...



### STAEDTLER box

- Practical pen stand for desks
- Quick to assemble
- Patented in Germany, Japan and the USA (US Pat 6,364,100 B1); patents pending in Europe



- Perfect alignment of products
- The exact moulding of the STAEDTLER box enables easy removal and replacement of pens
- Sturdy material protects pens during transport



red dot design award  
winner 2003

- 2003 distinguished with the internationally acclaimed red dot design award for exceptional product design

... and outstanding characteristics



**ONE FOR ALL**

- For almost all surfaces, such as glass, plastic, metal, porcelain, wood etc.
- For labelling CDs/DVDs
- For overhead film, whiteboards and flipcharts



**DRY SAFE – Say goodbye to dried-up pens!**

- Thanks to the DRY SAFE feature, pens can be left uncapped for days at a time without drying up
- When left open during breaks in writing, they remain ready for action without delay
- The DRY SAFE permanent ink is patented in Germany, France, Great Britain, Italy and Japan; the DRY SAFE non-permanent ink is patented in Germany, France, Great Britain, the Netherlands, Spain, Italy and the USA (US 6,364,100).

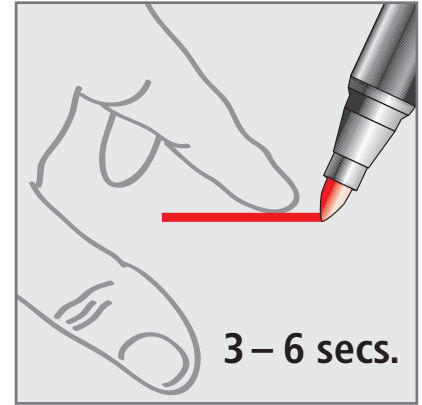

**Dry in seconds**

- Lumocolor permanent ink takes only 3 – 6 seconds to dry, making it ideal for left-handed users

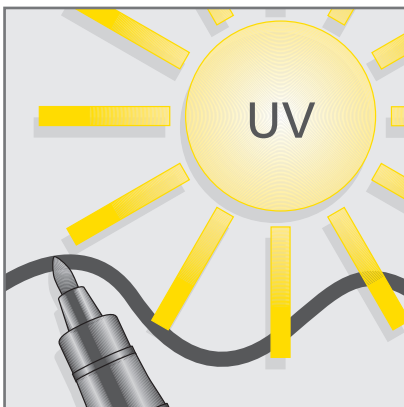

**Lightfast**

- Lumocolor permanent markers, Lumocolor permanent compact and 4 of the Lumocolor permanent pen colours excel by their high level of lightfastness
- Writing is still clearly legible years later
- Some of the inks are lightfast for more than 7 years

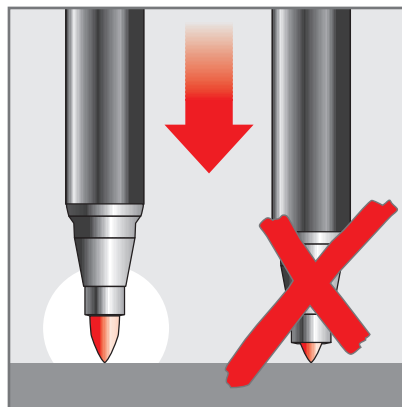

**Locked tip**

- Even when subjected to extremely heavy writing pressure, the tip remains locked in place and cannot be pushed back into the barrel

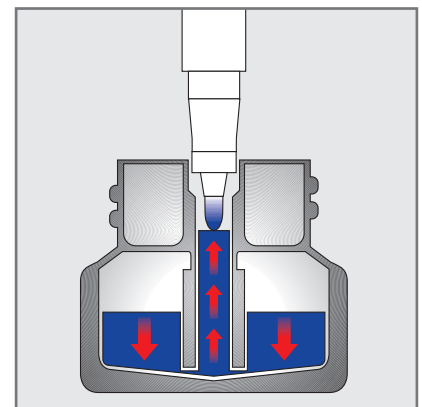

**Refill station**

- For easy and clean refilling
- Simply insert pen or marker into the refill station
- Minutes later the pen is ready for use, after 3 – 4 hours it is completely refilled
- An overfilling is impossible as the pen can only draw its own maximum ink content out of the refill station

**Permanent / Waterproof**

						
	<b>313/314 317/318</b>	<b>319 S / F / M</b>	<b>310 CD</b>	<b>342</b>	<b>350 352</b>	<b>385 388</b>

**For writing on:**

Paper / cardboard	—	—	—	—	—	—
Film / foil / plastic / metal	—	—	—	—	—	—
Overhead film	—					
Flipcharts						
Whiteboards						
Polystyrene	—	—	—	—	—	—
Glass / porcelain	—	—	—	—	—	—
Wood / leather / stone	—	—	—	—	—	—
CDs / DVDs	313/317		—	—		
Coated surfaces		—				

**Ink / lead characteristics:**

Fast-drying	—	—	—	—	—	—
DRY SAFE – can be left uncapped for days without drying up	—		—	—	—	—
Lightfast	4 colours	—	black	—	—	—
Smudge-proof	—	—	—	—	—	—
No bleeding through paper						
Weatherproof	black	black		black	black	black

**Range:**

Number of colours	8	2	4	4	8	4
Refillable	—				—	—
Page	15	19	19	16	17	18





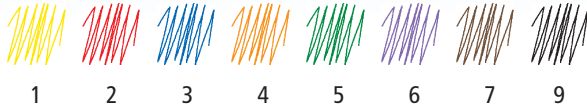

Colour

1 2 3 4 5 6 7 9

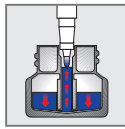

## Lumocolor® non-permanent

- Universal pen for use on overhead film and almost all surfaces
- Can be wiped off film using a damp cloth
- Water-soluble ink
- Fast-drying
- Superb colour brilliancy
- With clip
- PP barrel and cap guarantee long service life
- Easy to refill with refill station 487 15
- Stand-up STAEDTLER box
- 4 line widths, 8 colours

10 pieces per box

Set of 4, 6 or 8 colours in STAEDTLER box



316 WP4



316 WP6



316 WP8

**S** \_\_\_\_\_  
approx. 0.4 mm



**Superfine** 8 colours  
311- 1 2 3 4 5 6 7 9  
311 WP4 STAEDTLER box with 4 colours  
311 WP6 STAEDTLER box with 6 colours  
311 WP8 STAEDTLER box with 8 colours

**F** \_\_\_\_\_  
approx. 0.6 mm



**Fine** 8 colours  
316- 1 2 3 4 5 6 7 9  
316 WP4 STAEDTLER box with 4 colours  
316 WP6 STAEDTLER box with 6 colours  
316 WP8 STAEDTLER box with 8 colours

**M** \_\_\_\_\_  
approx. 1.0 mm



**Medium** 8 colours  
315- 1 2 3 4 5 6 7 9  
315 WP4 STAEDTLER box with 4 colours  
315 WP6 STAEDTLER box with 6 colours  
315 WP8 STAEDTLER box with 8 colours

**B** \_\_\_\_\_  
approx. 1.0 or 2.5 mm



**Broad** 8 colours  
312- 1 2 3 4 5 6 7 9  
312 WP4 STAEDTLER box with 4 colours  
312 WP6 STAEDTLER box with 6 colours  
312 WP8 STAEDTLER box with 8 colours

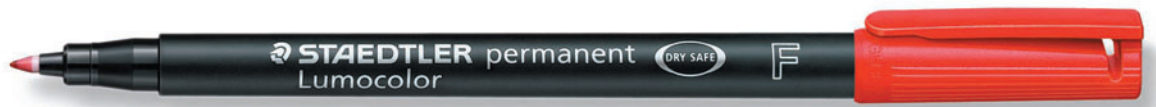

## Lumocolor® permanent

- Universal pen for use on overhead film and almost all surfaces; S and M also suitable for use on CDs/DVDs
- DRY SAFE – can be left uncapped for days without drying up (test ISO 554)
- Excellent smudge-proof and waterproof qualities on almost all surfaces
- Dries in seconds, therefore ideal for left-handed users
- Permanent, low-odour ink
- Superb colour brilliancy
- Black, yellow, orange and brown are lightfast
- Black is weatherproof
- With clip
- PP barrel and cap guarantee long service life
- Easy to refill with refill station 487 17
- Stand-up STAEDTLER box
- 4 line widths, 8 colours

10 pieces per box

Set of 4, 6 or 8 colours in STAEDTLER box

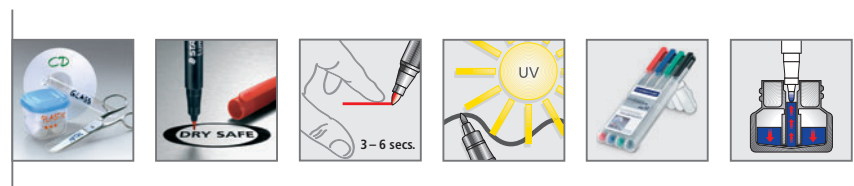
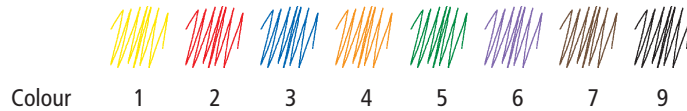

318 WP4



318 WP6



318 WP8

**S** \_\_\_\_\_ **Superfine** 8 colours  
 approx. 0.4 mm  
**313-** 1 2 3 4 5 6 7 9  
**313 WP4** STAEDTLER box with 4 colours  
**313 WP6** STAEDTLER box with 6 colours  
**313 WP8** STAEDTLER box with 8 colours



**M** \_\_\_\_\_ **Medium** 8 colours  
 approx. 1.0 mm  
**317-** 1 2 3 4 5 6 7 9  
**317 WP4** STAEDTLER box with 4 colours  
**317 WP6** STAEDTLER box with 6 colours  
**317 WP8** STAEDTLER box with 8 colours



**F** \_\_\_\_\_ **Fine** 8 colours  
 approx. 0.6 mm  
**318-** 1 2 3 4 5 6 7 9  
**318 WP4** STAEDTLER box with 4 colours  
**318 WP6** STAEDTLER box with 6 colours  
**318 WP8** STAEDTLER box with 8 colours



**B** \_\_\_\_\_ **Broad** 8 colours  
 approx. 1.0 or 2.5 mm  
**314-** 1 2 3 4 5 6 7 9  
**314 WP4** STAEDTLER box with 4 colours  
**314 WP6** STAEDTLER box with 6 colours  
**314 WP8** STAEDTLER box with 8 colours



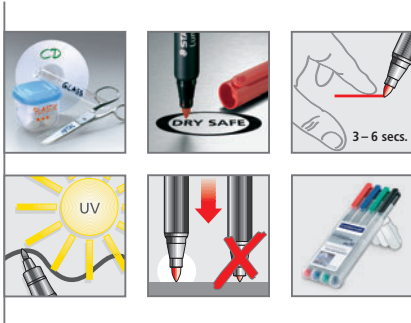

342 WP4

## Lumocolor® permanent compact

### 342

- Handy-sized all-rounder for labelling and marking
- With sturdy universal tip for variable line widths
- DRY SAFE – can be left uncapped for days without drying up (test ISO 554)
- Excellent smudge-proof and waterproof qualities on almost all surfaces and on CDs/DVDs
- Dries in seconds, therefore ideal for left-handed users
- Lightfast (black and green for over 10 years on paper)
- Black and green are weatherproof
- Colour-intensive, low odour, xylene-free
- Locked tip
- With clip
- PP barrel and cap guarantee long service life
- Stand-up STAEDTLER box
- 4 colours

10 pieces per box

Set of 4 colours in STAEDTLER box

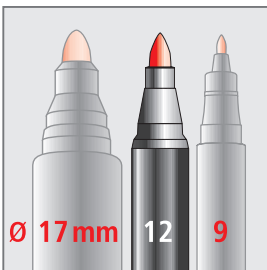

### Compact size

- Feels like a pen – performs like a marker when writing or labelling
- Lumocolor permanent compact – the universal all-rounder

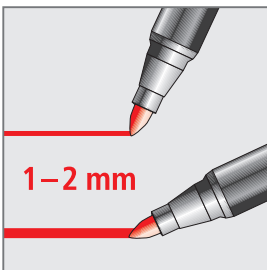

### Universal tip

- The sturdy universal tip for variable line widths offers a consistent line width performance even during intensive use
- By altering the way the pen is held, line widths of between 1 – 2 mm are possible: steep angle for fine lines and shallow angle for broad lines

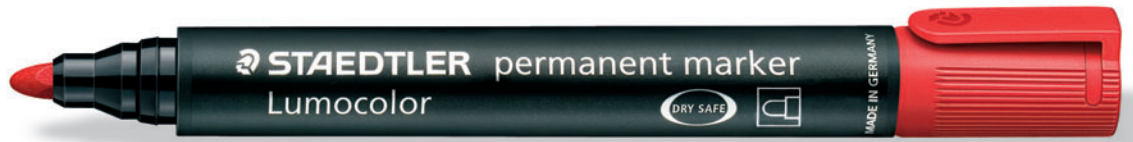

## Lumocolor® permanent marker

350/352

- DRY SAFE – can be left uncapped for days without drying up (test ISO 554)
- Excellent smudge-proof and waterproof qualities on almost all surfaces
- Dries in seconds, therefore ideal for left-handed users
- Lightfast (black and green for over 10 years on paper)
- Black and green are weatherproof
- Colour-intensive, low odour, xylene-free
- Locked tip
- With clip
- PP barrel and cap guarantee long service life
- Easy to refill with refill station 488 50
- Stand-up STAEDTLER box
- 8 colours
- 2 line widths:  
 Bullet tip approx. 2 mm  
 Chisel tip approx. 2 or 5 mm

10 pieces per box

Set of 4 colours in STAEDTLER box

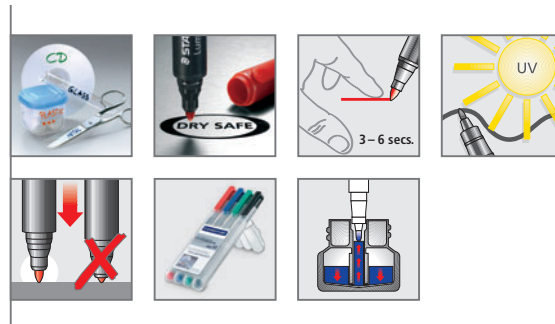
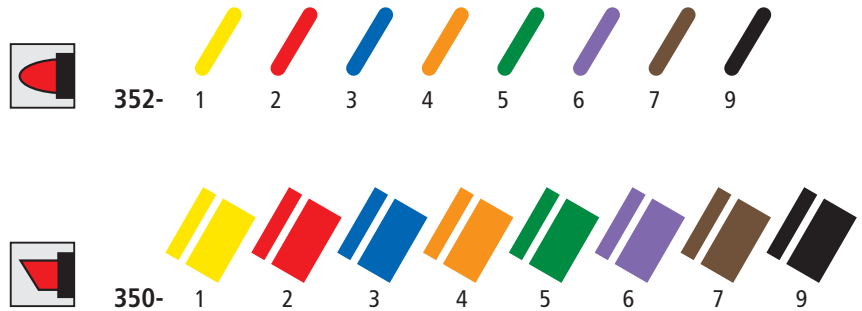

352 WP4 (bullet tip)

350 WP4 (chisel tip)



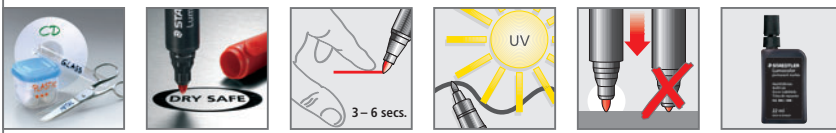
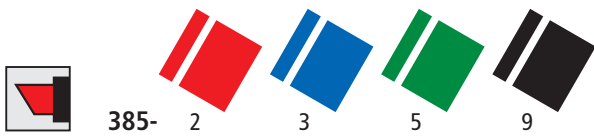

## Lumocolor® permanent marker

385

- DRY SAFE – can be left uncapped for days without drying up (test ISO 554)
- Excellent smudge-proof and waterproof qualities on almost all surfaces
- Dries in seconds, therefore ideal for left-handed users
- Lightfast (black and green for over 10 years on paper)
- Black and green are weatherproof
- Colour-intensive, low odour, xylene-free
- Locked tip
- With clip
- PE barrel and PP cap guarantee long service life
- Refillable with bottle 485 23
- 4 colours
- Broad chisel tip approx. 2 or 7 mm

5 pieces per box

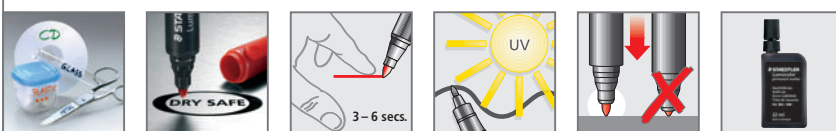
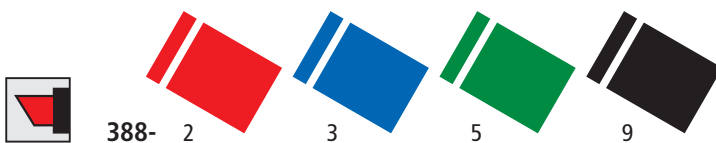

## Lumocolor® permanent marker

388

- Characteristics as for Lumocolor permanent marker 385, but with:
- Extra-broad chisel tip approx. 2 or 12 mm

5 pieces per box

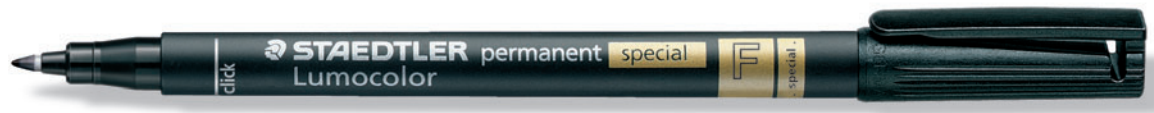





## Lumocolor® permanent special

319 S / 319 F / 319 M

- For many special applications such as coated surfaces, nano coatings, optical glass, laboratory glass
- Adheres to many special surfaces which other fine markers do not adhere to
- The black Lumocolor permanent special F and M can also be used for marking laundry with and for a variety of outdoor applications, e.g. as a "garden marker"
- Excellent smudge-proof and waterproof qualities on almost all surfaces
- Dries in seconds, therefore ideal for left-handed users
- Colour-intensive, low odour
- Extremely lightfast (on smooth surfaces: black for 7 years, red for 1 year; on paper: much longer)
- Black is weatherproof
- With clip
- PP barrel and cap guarantee long service life
- 3 line widths, 2 colours

10 pieces per box

-  **319 S-9** — approx. 0.4 mm
-  **319 F-2** — approx. 0.6 mm
-  **319 F-9** — approx. 0.6 mm
-  **319 M-9** — approx. 1.0 mm

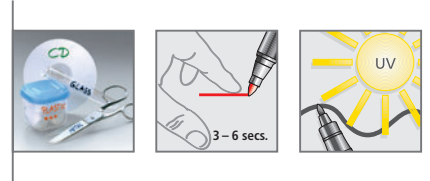

### Example of application on a nano-coated surface:



The Lumocolor permanent special adheres perfectly without beading or smudging.

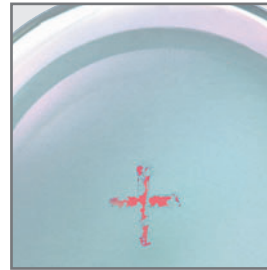

Conventional markers do not adhere well, ink beads and smudges.

CD/DVD pens . Special markers

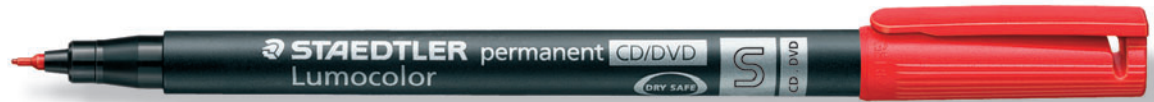

## Lumocolor® CD/DVD pen

310 CDS

- Extra-soft tip does not damage sensitive CD/DVD surfaces
- Ink does not penetrate data storage layer
- DRY SAFE – can be left uncapped for days without drying up (test ISO 554)
- Excellent smudge-proof and waterproof qualities on almost all surfaces
- Dries in seconds, therefore ideal for left-handed users
- Superb colour brilliancy, low odour
- Black is lightfast
- With clip
- PP barrel and cap guarantee long service life
- Stand-up STAEDTLER box

10 pieces per box of black colour

Set of 4 colours in STAEDTLER box

-  **310 CDS-9** — approx. 0.4 mm



310 CDSWP4



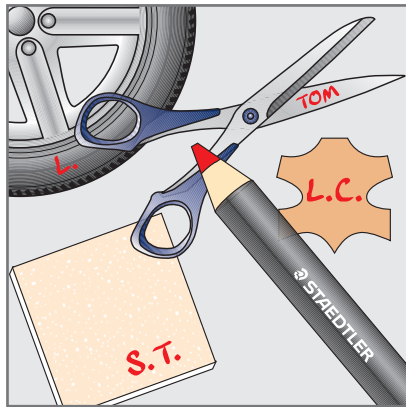

## Lumocolor® dry markers

- Ideal tool for users in industry and trade
- For use on almost all surfaces, e.g. glass, leather, textiles, stone, metal, wood and plastic
- For opaque marking even on dark and transparent surfaces
- No bleeding through paper
- Colour-intensive and lightfast
- Non-corrosive colour pigments
- No drying up
- Odourless

### Waterproof

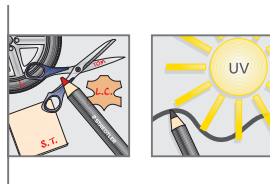
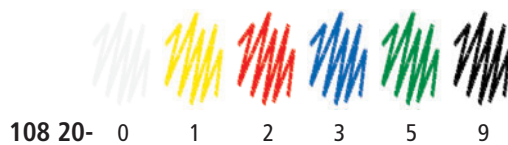

## Lumocolor® permanent glasochrom

108 20

- Wood-cased pencil in 6 colours
- Waterproof
- Recommended sharpener:  
tub sharpener 512 002

12 pieces per box

### Waterproof

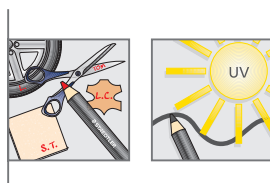
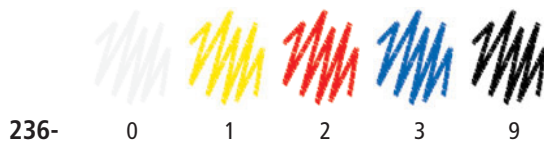

## Lumocolor® permanent omnigraph

236

- Universal crayon in 5 colours
- Also for use on wet wood
- Waterproof
- Length 113 mm, hexagonal shape,  
approx. Ø 12 mm

12 pieces per box

Water-soluble



Lumocolor®  
non-permanent  
omnichrom

108

- Wood-cased pencil in 6 colours
- Water-soluble
- Can be wiped off many smooth surfaces such as plastic, metal, lacquer, leather etc.
- Washes out of many textiles
- Recommended sharpener: tub sharpener 512 002

12 pieces per box

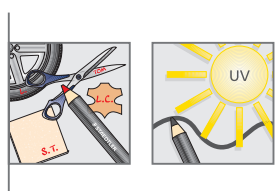

Water-soluble . Refillable

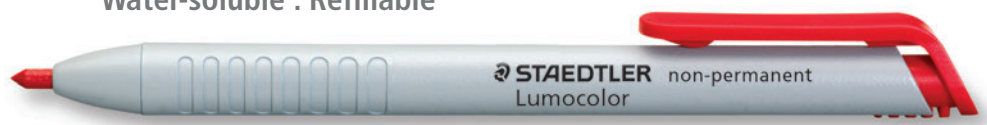

Lumocolor®  
non-permanent  
omnichrom

768N

- Convenient single-hand use leadholder
- No sharpening necessary
- Lead can be retracted after use for protection
- Refillable with refill lead 218
- Water-soluble
- Can be wiped off many smooth surfaces such as plastic, metal, lacquer, leather etc.
- Washes out of many textiles
- 4 colours

5 pieces per box

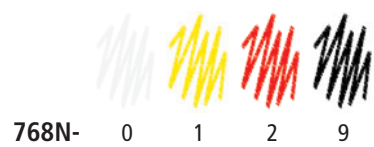
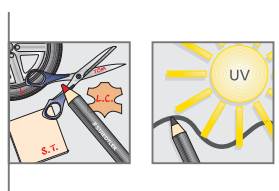

Lumocolor®  
non-permanent  
omnichrom

218

- Refill lead for Lumocolor non-permanent 768N in 4 colours, length 70 mm

12 pieces per box

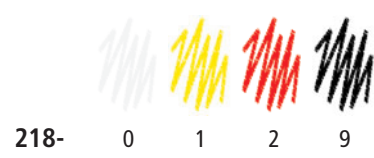
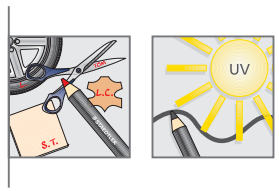

Dry markers

# Lumocolor® – for impressive presentations

Add a striking visual dimension to speeches, give presentations a clear structure, develop and convey ideas in meetings. A strong visualisation is essential for getting your point across. Whether on overhead film, whiteboards, flipcharts or presentation boards – Lumocolor pens and markers communicate thoughts and ideas both clearly and precisely.

Available in four different line widths and eight high-contrast colours, the OHP pens are ideal for drawing up clear structures and coherent charts with. When it comes to the markers, the bullet tip ensures a consistent writing performance, whilst the chisel tip is ideal for emphasising headlines and individual words. True leaders in quality, offering outstanding expertise.

**OHP permanent and non-permanent pens**

**Whiteboard markers and accessories**

**Flipchart markers**



## Overhead presentations

- An overhead projector is almost always to hand; transparencies are quick, easy and inexpensive to make
- Notes made with Lumocolor non-permanent can be wiped off using a damp cloth
- Lumocolor permanent can be removed quickly and easily using STAEDTLER Mars plastic erasers

Lumocolor OHP permanent and non-permanent pens can be found on pages 14 and 15.



## Whiteboard presentations

- A whiteboard is more versatile than a conventional blackboard
- Text can be quickly dry-wiped from the board and changed
- Non-dry-wipe lines – e.g. for charts and timetables – can be made with Lumocolor non-permanent universal pens

Whiteboard markers and accessories can be found on pages 23 – 25.

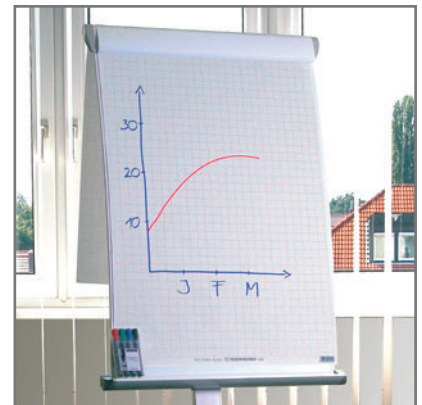

## Flipchart presentations

- A flipchart is versatile and not dependent on other equipment, such as a plug or screen
- It can also be used in daylight conditions
- Individual sheets can be prepared in advance
- Notes remain unchanged; pages can be turned backwards or forwards

Flipchart markers can be found on page 26.



## Lumocolor® whiteboard compact

341

- Handy-sized whiteboard marker
- With universal tip for variable line widths of approx. 1 – 2 mm
- DRY SAFE – can be left uncapped for days without drying up (test ISO 554)
- Can be dry-wiped from whiteboards and surfaces such as glass and porcelain without leaving a trace
- Fast-drying, low odour
- Locked tip
- With clip
- PP barrel and cap guarantee long service life
- Stand-up STAEDTLER box
- 4 colours

10 pieces per box

Set of 4 colours in STAEDTLER box

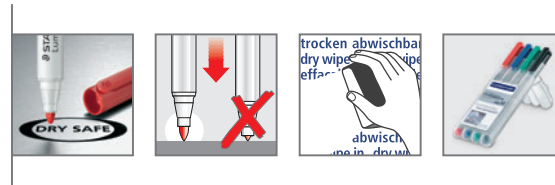

341 WP4

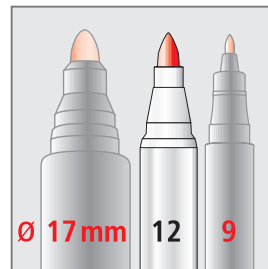

### Compact size

- Feels like a pen – performs like a marker when jotting down notes or making presentations
- Lumocolor whiteboard compact – the ideal marker for small whiteboards

## Lumocolor® memo board

641 A5

- Reusable notice board
- Self-adhesive
- Removable
- Dry wipe
- Handy size: A5 (210 x 148 mm)

Cellophane bag containing 10 pieces

641 SBKD / 641 SBKE

Set containing 1 Lumocolor memo board, 1 blue Lumocolor whiteboard compact and pen holder

Single pack



641 A5



641 SBKD (German / English / French)

641 SBKE (Italian / Portuguese / Spanish)

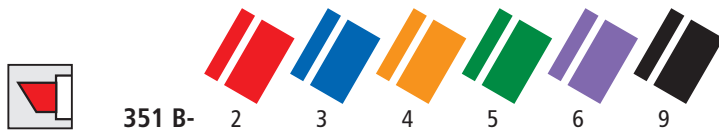
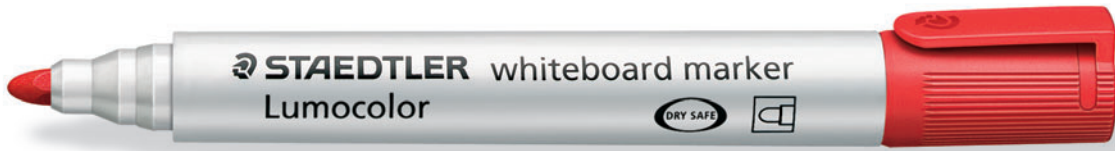

## Lumocolor® whiteboard marker

351 / 351 B

- DRY SAFE – can be left uncapped for days without drying up (test ISO 554)
- Can be dry-wiped from whiteboards and surfaces such as glass and porcelain without leaving a trace
- Fast-drying, low odour
- Improved colour intensity
- Locked tip
- With clip
- PP barrel and cap guarantee long service life
- Easy to refill with refill station 488 51
- Stand-up STAEDTLER box
- 6 colours
- 2 line widths:  
 Bullet tip approx. 2 mm  
 Chisel tip approx. 2 or 5 mm

10 pieces per box

Set of 4 or 6 colours in STAEDTLER box



351 WP4 (bullet tip)  
351 B WP4 (chisel tip)



351 WP6 (bullet tip)  
351 B WP6 (chisel tip)



## Lumocolor® park + write set

611 S

- Fixed to a whiteboard, the park + write set makes an ideal parking place for Lumocolor whiteboard markers
- The park + write set keeps Lumocolor whiteboard markers filled and ready for use at all times – markers cannot be overfilled
- Contents:  
2 adapter units with double-sided adhesive tape for affixing to whiteboards,  
4 whiteboard markers 351 and refill station 488 51 in red, blue, green and black

Single pack



611 S

## Lumocolor® whiteboard-system wiper

651

- For dry-wiping of whiteboards
- Soft pad with magnetic inlay and micro-fibre cleaning cloth

Single pack



651

## Lumocolor® whiteboard cleaner

681

- For thorough cleaning of whiteboards
- CFC-free pump spray, non-inflammable
- Content 250 ml

Single pack



681

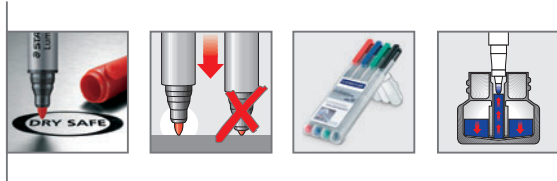
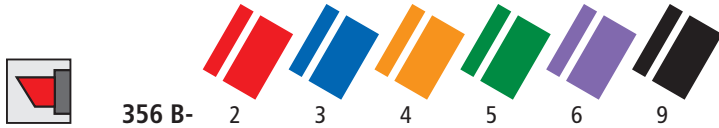

## Lumocolor® flipchart marker

356 / 356 B

- DRY SAFE – can be left uncapped for days without drying up (test ISO 554)
- Ideal for use on paper as ink does not bleed through
- Washes out of many textiles
- Colour-intensive, odourless
- Water-based ink
- Dries in seconds, therefore ideal for left-handed users
- Locked tip
- With clip
- PP barrel and cap guarantee long service life
- Easy to refill with refill station 488 56
- Stand-up STAEDTLER box
- 6 colours
- 2 line widths:
  - Bullet tip approx. 2 mm
  - Chisel tip approx. 2 or 5 mm

10 pieces per box

Set of 4 or 6 colours in STAEDTLER box



356 WP4 (bullet tip)  
356 B WP4 (chisel tip)



356 WP6 (bullet tip)  
356 B WP6 (chisel tip)



## Lumocolor® refill stations

- Practical PP (polypropylene) refill stations for easy and clean refilling of Lumocolor pens and markers
- Simply insert pen or marker into the refill station
- Minutes later the pen is ready for use, after 3 – 4 hours it is completely refilled
- Impossible to overfill as the pen can only draw its own maximum ink content out of the refill station

4 pieces per box

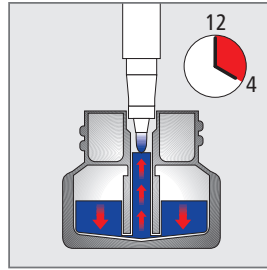

Each available in the colours

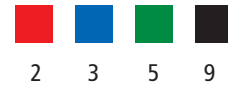

### 487 15

- For the refilling of Lumocolor non-permanent universal pens
- Content 15 ml



487 15



487 17

### 487 17

- For the refilling of Lumocolor permanent universal pens
- Content 15 ml

### 488 50

- For the refilling of Lumocolor permanent markers 350, 352
- Content 30 ml



488 50



488 56

### 488 56

- For the refilling of Lumocolor flipchart markers 356, 356 B
- Content 30 ml

### 488 51

- For the refilling of Lumocolor whiteboard markers 351, 351 B
- Content 20 ml



488 51

## Lumocolor® refill ink

### 485 23

- Refill ink for Lumocolor permanent markers 385, 388
- PE bottle, content 22 ml
- 4 colours

Single pack



485 23



632 10-21



638 30-20

## Lumicolor® write-on film

### 632 10-21

- For true colour projection, tear-resistant
- 0.10 mm, A4 format

100 sheets per box

### 638 30-20

- Film roll
- 0.03 mm, 297 mm wide, 20 m long

Single pack



636 10 DLT

## Lumicolor® photocop film

- Available in 5 different versions (see table)
- Photocopy film for use with almost all photocopiers
- 0.10 mm, A4 format

100 sheets per box

Article no.	636 10 DLT	636 10 DT1	636 10 DT4	636 10 DT5	636 10 DT6
<b>Film characteristics</b>					
heat-resistant	•	•		•	•
antistatic	•	•			
coated	on one side	on both sides			
removable sensor strip along the side	•				
backing sheet				attached along the side	attached along the top
<b>Machine characteristics</b>					
single sheet intake	•	•	•	•	•
stacked intake	•	•		•	•
optical sheet detection	•			•	•
b/w copier	•	•	•	•	•
b/w laser printer	•	•			

## Lumocolor® colour laser printer film

### 634 10 CLP

- For use with almost all colour laser printers
- Suitable for single sheet and stacked intake
- 0.125 mm, A4 format

50 sheets per box



634 10 CLP

## Lumocolor® inkjet film

- For use with almost all inkjet printers up to 720/1440 dpi
- Suitable for single sheet and stacked intake
- Crystal clear and heat-resistant
- A4 format

### 639 30 A4

50 sheets per box

### 639 31 A4

- With attached backing sheet

50 sheets per box



639 30 A4



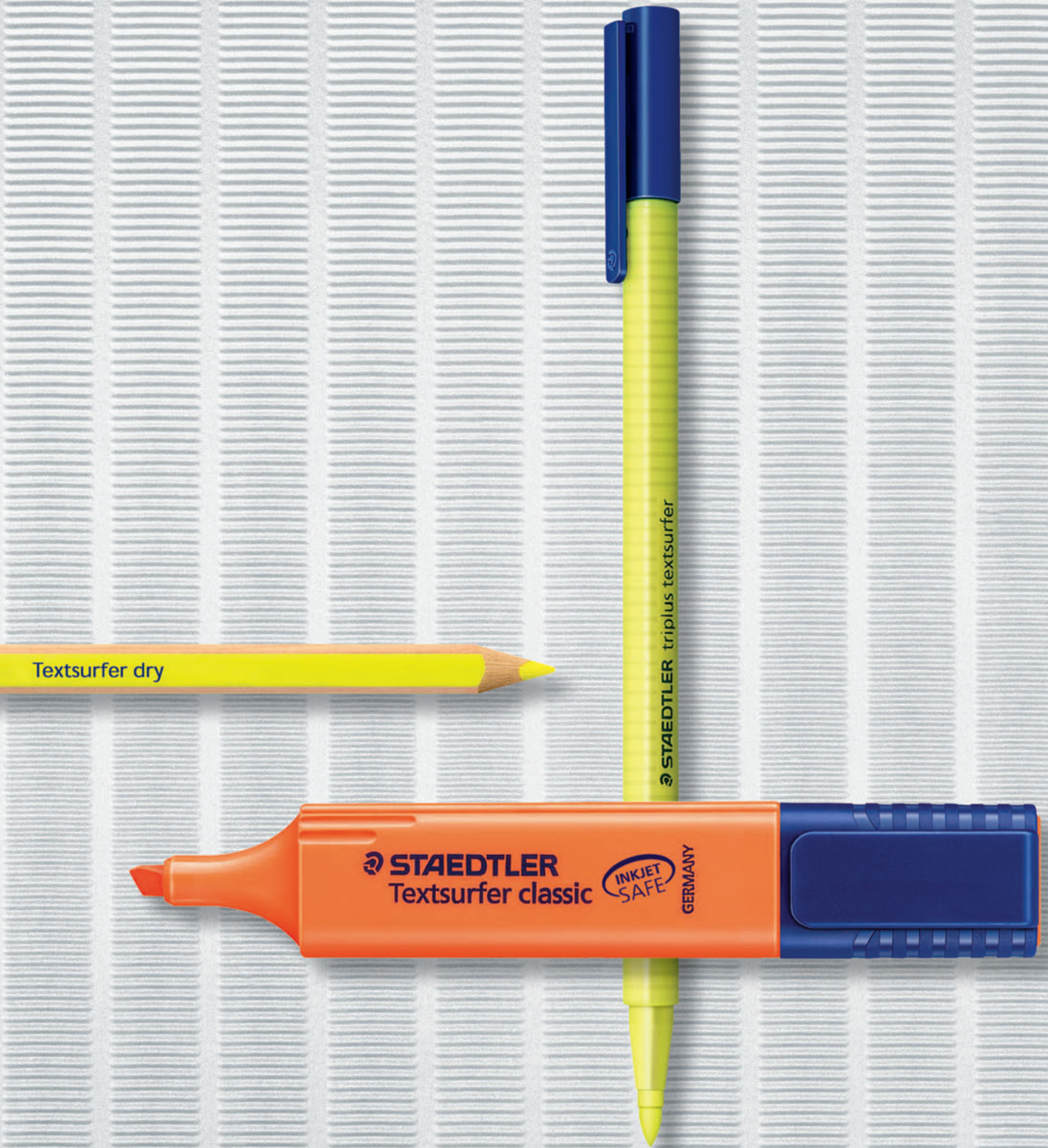

Textsurfer dry

STAEDTLER triplus textsurfer

STAEDTLER Textsurfer classic  
INKJET SAFE  
GERMANY



# Outstanding highlighters – for a better transparency of texts

STAEDTLER highlighters enable you to focus on the essentials. Whether classic, innovative designer or wood-cased version – all STAEDTLER highlighters can be relied upon to put the spotlight on what’s important. Textsurfer classic even performs perfectly on inkjet print-outs, without smudging the ink; its violet and turquoise colours are truly amazing too, with highlights still remaining visible after photocopying.

The dry markers are ideal for use on thin paper and the triplus textsurfer, with its ergonomic design and soft tip, guarantees an exceptional highlighting experience every time. The innovative refill station is not only environmentally-friendly, it also offers an easy, clean and cost-efficient refilling solution for Textsurfer classic. Truly outstanding!

Highlighter pens  
Highlighter pencils



### INKJET SAFE

- All Textsurfer classic colours do not smudge inkjet print-outs

# Textsurfer® classic – perfect performance even on inkjet print-outs

In contrast to conventional highlighters, which are usually only suitable for use on normal paper, photocopies and fax, STAEDTLER Textsurfer classic is just perfect for all kinds of paper and applications. These innovative experts offer impressive colour brilliancy while maintaining excellent legibility of highlighted text.

Set colourful highlights on normal paper, photocopies, carbon copies, autcopy paper, fax and even inkjet print-outs! All eight colours do not smudge inkjet print-outs. What's more, with violet and turquoise, both highlights and text remain visible when photocopied. Innovation and quality MADE IN GERMANY – simply brilliant!

paper . copy . fax  
inkjet safe  
copy proof

**PAPER**  
Normal paper

**COPY**  
Autocopy paper

**FAX**  
Fax paper

**NEW**  
All colours do not smudge  
inkjet print-outs

**COPY PROOF**  
With violet and turquoise,  
both highlights and text remain  
visible when photocopied

# Inkjet safe

The new generation of STAEDTLER Textsurfer classic was developed especially for use with pigmented inkjet inks, as are common in inkjet printers.

Conventional highlighters loosen pigments from the paper, causing them to smudge. The new STAEDTLER Textsurfer classic fixes the pigments. Highlights without smudging!

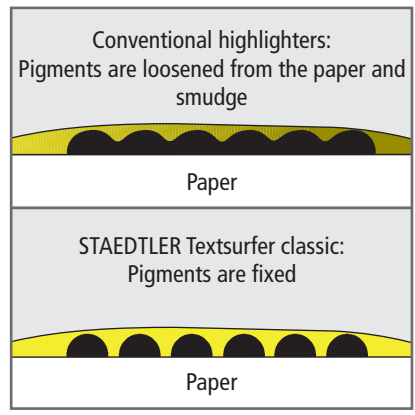

# Copy proof

The majority of highlighter colours either don't get recognised by photocopiers at all, meaning that highlights simply don't show up on the copies, or they merely appear as a thick black line, covering the text.

However, with the STAEDTLER Textsurfer classic in violet (364-6) and turquoise (364-35), both highlights and text remain clearly visible on the photocopies too.





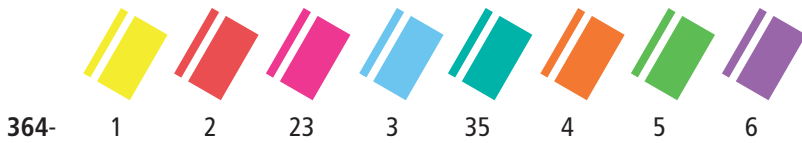

364 WP4



364 WP6



364 WP8

## Textsurfer® classic

364

- Highlighter with large ink reservoir for extra-long highlighting performance
- Lightfast pigment ink
- For paper, fax and copies
- INKJET SAFE – all colours do not smudge inkjet print-outs
- Violet and turquoise for documents which are to be photocopied
- Fast-drying
- Washes out of most textiles
- With clip
- Twist cap for easy opening
- PP barrel and cap guarantee long service life
- Easy to refill with refill station 488 64
- 8 neon colours
- Ultra-soft chisel tip approx. 1 – 5 mm

10 pieces per box

364 WP4

364 WP6

364 WP8

Wallet containing 4, 6 or 8 colours

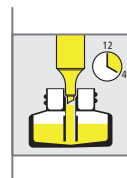

488 64-

1

2

23

3

4

5

## Textsurfer® classic refill station

488 64

- Refill station for easy and clean refilling of Textsurfer classic highlighters
- Impossible to overfill the highlighters
- PP tank, content 30 ml
- 6 neon colours

4 pieces per box

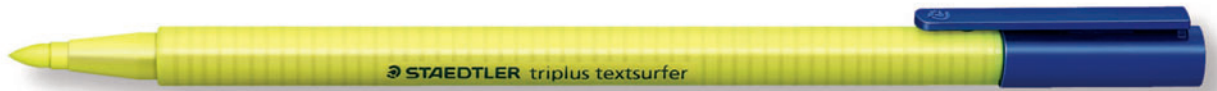

## tripus® textsurfer®

362

- Highlighter with pleasantly soft, variable tip for very fine to broad highlighting
- Ergonomic triangular barrel for effortless, fatigue-free highlighting
- Lightfast pigment ink
- For paper, fax and copies
- Water-based fluorescent ink
- With clip
- PP barrel guarantees long service life
- 4 neon colours
- Variable line width from approx. 1 – 4 mm
- Also available in the triplus multi-set (see page 39)

10 pieces per box

### 362 SB4

STAEDTLER box containing 4 colours  
See triplus range, page 45



362 SB4



## Textsurfer® dry

128 64

- Wood-cased highlighter pencil
- Ergonomic triangular shape
- Fluorescent, lightfast wax lead, Ø 4.0 mm
- For paper, fax and copies
- No bleeding through thin paper, e.g. law texts, newspapers, bible passages
- No smudging of inkjet print-outs
- 4 neon colours
- Recommended sharpener: double-hole sharpener 510 20 (see page 69)

12 pieces per box







STAEDTLER triplus ball M

STAEDTLER triplus micro 0.5 mm

STAEDTLER triplus fineliner DRY SAFE

REFILL



# triplus® – for fatigue-free writing

The name triplus stands for an innovative product concept with all features designed specifically with one goal in mind: fatigue-free writing, drawing, colouring and highlighting. This is reflected in the ergonomic triangular shape, slip-resistant pen surface, DRY SAFE ink feature – rendering it unnecessary to keep

replacing pen caps all the time – and the STAEDTLER box – the ingenious storage solution that keeps products ready to hand whenever and wherever they're needed. Taken together, these features offer ideal conditions for a stress and fatigue-free use of the triplus articles – whether at home, at school or at work.

- Fineliners**
- Rollerballs**
- Gel rollers**
- Fibre-tip pens**
- Ballpoint pens**
- Mechanical pencils**
- Highlighters**

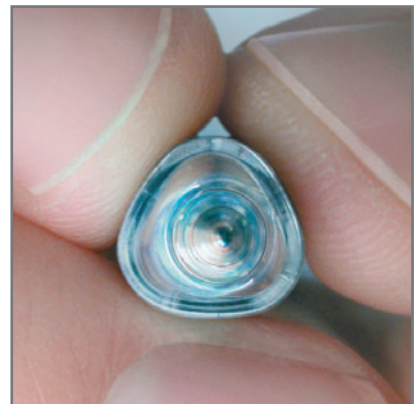

### Triangular shape

- Recommended by the Technical University of Munich
- For effortless, fatigue-free writing, drawing, colouring and highlighting
- Products fit perfectly in the hand so they cannot turn or slip around whilst in use
- The grip remains relaxed and unstrained – even when used over longer periods of time, the hand does not tire



Fineliner    Gel roller    Rollerball    Fibre-tip pen    Ballpoint pen    Mechanical pencil    Highlighter

### Writing systems

- With the triplus concept, STAEDTLER has succeeded in developing an extensive range of products for fatigue-free writing, drawing, colouring and highlighting

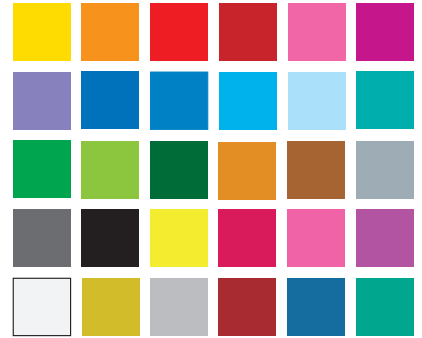

### Awards

- The triplus products have been distinguished for outstanding, innovative product design
- The STAEDTLER box has been awarded the red dot design award for exceptional packaging design and superb functionality

### DRY SAFE

- No more dried-up pens!
- The unique DRY SAFE feature of the inks enables pens to be left uncapped for days at a time without drying up
- Even when left open during long breaks in writing, they remain ready for action without delay

### Colour range

- The range includes a wide array of brilliant colours and effect colours for a whole variety of applications



### STAEDTLER box

- An exceptional packaging for exceptional products
- It can be transformed into a practical pen stand for desks in no time at all
- Patented in Germany, Japan and the USA (US 6,364,100 B1); patents pending in Europe



### Pen slots

- The exact moulding of the STAEDTLER box ensures an optimal alignment of products and keeps them perfectly in place
- Easy removal and replacement of products
- Sturdy box for safe transport



### STAEDTLER box tray

- Exceedingly practical and extremely attractive
- This space-saving display for 10 STAEDTLER boxes not only looks good, it is also very sturdy

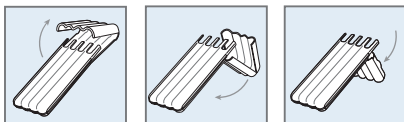



# triplus® multi-set

34 SB4

## The mobile office

- The practical STAEDTLER triplus multi-set comprises:
  - 1 triplus fineliner, black
  - 1 triplus roller, blue
  - 1 triplus micro, 0.5 mm
  - 1 triplus textsurfer, fluorescent yellow
- This set of products in the stand-up STAEDTLER box ensures that you always have the right pen to hand – whenever and wherever you need it
- See pages 40,41 and 45 for descriptions of the individual products



34 SB4

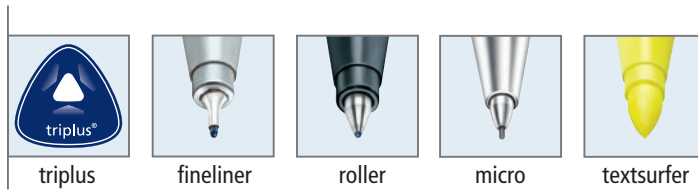



## tripus® fineliner

### 334

- Fineliner with superfine, metal-clad tip
- Ergonomic triangular barrel for effortless, fatigue-free writing
- DRY SAFE – can be left uncapped for days without drying up (test ISO 554)
- Washes out of most textiles
- Water-based ink
- With clip
- PP barrel guarantees long service life
- Stand-up STAEDTLER box
- 20 brilliant colours
- Line width approx. 0.3 mm
- Also available in the triplus multi-set (see page 39)

10 pieces per box

### 334 SB4

### 334 SB10

### 334 SB20

Set of 4, 10 or 20 colours in STAEDTLER box



334 SB4



334 SB10



334 SB20



## triplus® roller

403

- Rollerball with ink reservoir
- Ergonomic triangular barrel for effortless, fatigue-free writing
- DRY SAFE – can be left uncapped for days without drying up (test ISO 554)
- Sturdy, durable metal tip
- Suitable for carbon copies
- Water-based ink
- With clip
- PP barrel guarantees long service life
- Stand-up STAEDTLER box
- 10 brilliant colours
- Line width approx. 0.3 mm
- Also available in the triplus multi-set (see page 39)

10 pieces per box

403 SB4

403 SB10

Set of 4 or 10 colours in STAEDTLER box

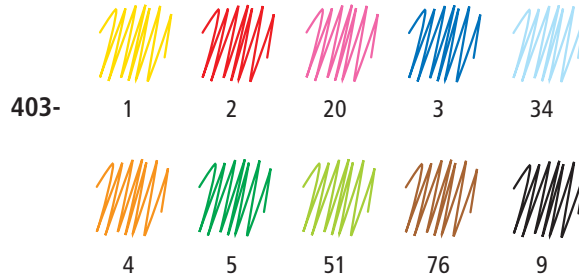

403 SB4



403 SB10

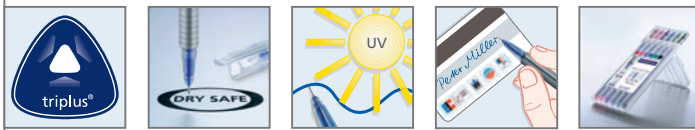
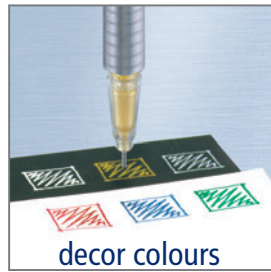
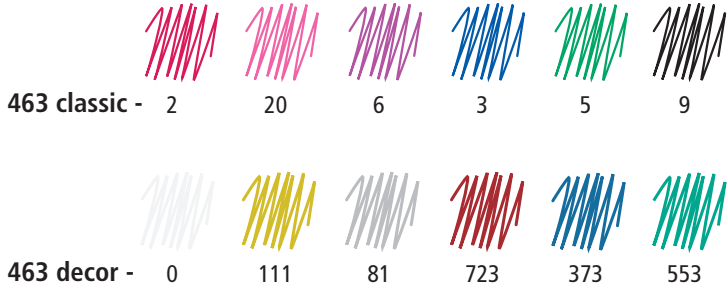

## triplus® gel-liner

### 463

- Gel roller with fine needle tip
- Ergonomic triangular barrel for effortless, fatigue-free writing
- DRY SAFE – can be left uncapped for days without drying up (test ISO 554)
- Lightfast, waterproof, indelible (except silver) in accordance with ISO 14145-2
- Decor colours for opaque coverage even on dark and coloured paper
- Water-based gel
- With clip
- PP barrel guarantees long service life
- Stand-up STAEDTLER box
- 12 brilliant colours:
  - 6 classic colours,
  - 6 decor colours
- Line widths:
  - classic 0.3 mm
  - decor 0.4 mm

10 pieces per box

### 463 CSB6

Set of 6 classic colours in STAEDTLER box, line width 0.3 mm

### 463 DSB6

Set of 6 decor colours in STAEDTLER box, line width 0.4 mm



463 CSB6



463 DSB6





## triplus® color

323

- Fibre-tip pen with sturdy, pressure-resistant tip
- Ergonomic triangular barrel for effortless, fatigue-free writing and colouring
- DRY SAFE – can be left uncapped for days without drying up (test ISO 554)
- Washes out of most textiles
- Water-based ink
- Ventilated cap conforming to ISO 11540 and BS 7272-1/2
- With clip
- PP barrel guarantees long service life
- Stand-up STAEDTLER box
- 20 brilliant colours
- Line width approx. 1.0 mm

10 pieces per box

323 SB10

323 SB20

Set of 10 or 20 colours in STAEDTLER box

323-



323 SB10



323 SB20





431 FSB4  
431 MSB4

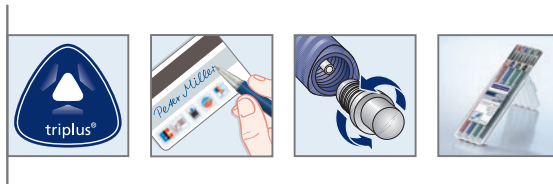
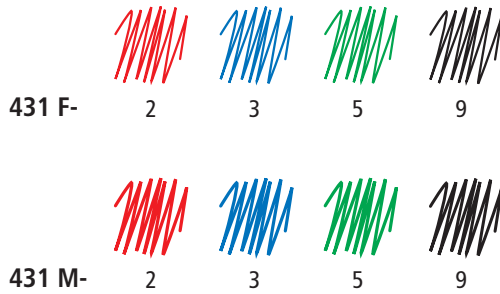

## tripus® ball

### 431

- Ballpoint pen with cap and clip
- Ergonomic triangular barrel for effortless, fatigue-free writing
- Rubberised barrel
- Particularly smooth writing performance
- Indelible ink conforming to ISO 12757-2
- Metal tip, metal screw end plug
- Refillable with standard refill conforming to ISO 12757, type "F"
- Stand-up STAEDTLER box

- 4 colours
  - 2 line widths
- 10 pieces per box

### 431 FSB4

Set of 4 colours in STAEDTLER box, line width F

### 431 MSB4

Set of 4 colours in STAEDTLER box, line width M

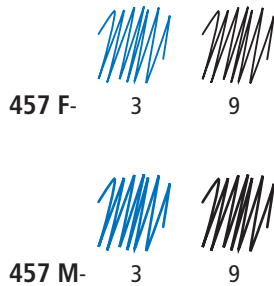

## refill 457

### 457

- Refill for triplus ball and other ballpoint pens with type "F" refill
- Indelible ink conforming to ISO 12757-2
- 2 colours
- 2 line widths

2 pieces per pack

### 457 F

Pack containing 2 pieces of the same colour, line width F

### 457 M

Pack containing 2 pieces of the same colour, line width M



## tripus® micro

774

- Mechanical pencil for writing
- Ergonomic triangular barrel for effortless, fatigue-free writing
- Chrome-plated metal tip
- Pocket-safe thanks to retractable metal lead sleeve
- Extra-long screw in/out eraser for very good erasing results
- HB leads
- Minimal lead wastage – even better writing performance as 95% lead usage
- 2 line widths
- Also available in the triplus multi-set (see page 39)

10 pieces per box

- 774 25 0.5 mm
- 774 27 0.7 mm

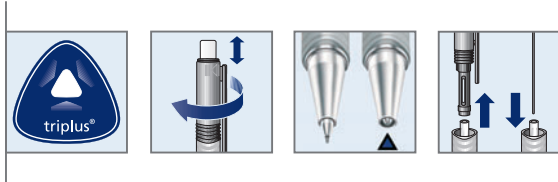

## Spare eraser

77 R56

- For triplus micro mechanical pencils
- 3 pieces per pack



77 R56



## tripus® textsurfer®

362

- Highlighter with pleasantly soft, variable tip for very fine to broad highlighting
- Ergonomic triangular barrel for effortless, fatigue-free highlighting
- Lightfast pigment ink
- For paper, fax and copies
- Water-based fluorescent ink
- With clip
- PP barrel guarantees long service life
- 4 neon colours
- Variable line width from approx. 1 – 4 mm
- Also available in the triplus multi-set (see page 39)

10 pieces per box

- 362- 1 (yellow)
- 362- 4 (orange)
- 362- 23 (pink)
- 362- 5 (green)

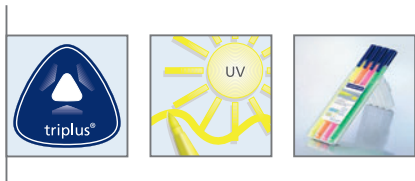

362 SB4

362 SB4

STAEDTLER box containing 4 colours







# Designed with attention to detail – for sheer writing comfort!

Superb writing comfort is created not by chance, but by a combination of know-how, technology and design – with STAEDTLER writing instruments, you can experience this first-hand. Thanks to the company’s extensive experience in the field of ink tech-

nology, this impressive range has a variety of truly outstanding technical details to offer.

Users profit from the continuous research and development activities. A smooth writing experience and excellent performance are the result.

- Rollerballs
- Gel rollers
- Ballpoint pens
- Ballpoint pen refills
- Fineliners



## Indelible

- STAEDTLER products with indelible ink or paste (corresponding to ISO 14145-2 and ISO 12757-2 resp.) are lightfast, waterproof, chemical and solvent-resistant, smudge-proof and non-erasable
- Ideal for use on cheques, documents and contracts

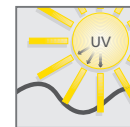

Lightfast

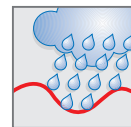

Waterproof

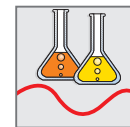

Chemical-resistant

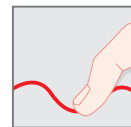

Smudge-proof

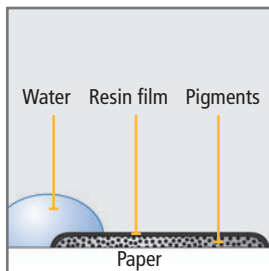

## Pigment ink

- High-grade pigments as colouring agents
- Resin is necessary in order to obtain the desired water repellency
- Extremely lightfast colourfast, waterproof and chemical-resistant



## DRY SAFE

- No more dried-up pens!
- The unique DRY SAFE feature of the inks enables pens to be left uncapped for days at a time without drying up
- Even when left open during long breaks in writing, they remain ready for action without delay

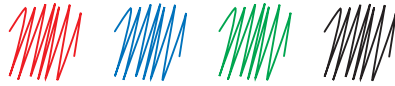

416 / 417-

2

3

5

9

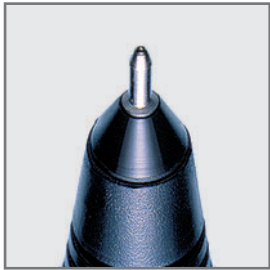

416



417



416 WP4

417 WP4

## liquid point 5

416

## liquid point 7

417 (not illustrated)

- Rollerball with visible ink level
- High-tech needle tip for effortless writing
- Suitable for carbon copies
- Ink feed system
- With metal clip
- PP barrel guarantees long service life
- 4 colours
- 2 line widths  
liquid point 5 approx. 0.25 mm  
liquid point 7 approx. 0.30 mm

10 pieces per box

416 WP4

417 WP4

Wallet containing 4 colours



411-

2

3

5

9

## cool roller

411

- Rollerball with visible ink level
- Needle tip for effortless writing
- Suitable for carbon copies
- Ink feed system
- With clip
- PP barrel guarantees long service life
- 4 colours
- Line width approx. 0.25 mm

10 pieces per box





## silver ball

404

- Rollerball with ink reservoir
- Sturdy, durable metal tip
- Suitable for carbon copies
- With clip
- PP barrel guarantees long service life
- 10 brilliant colours
- Line width approx. 0.3 mm

10 pieces per box

404 WP4

404 WP10

Wallet containing 4 or 10 colours

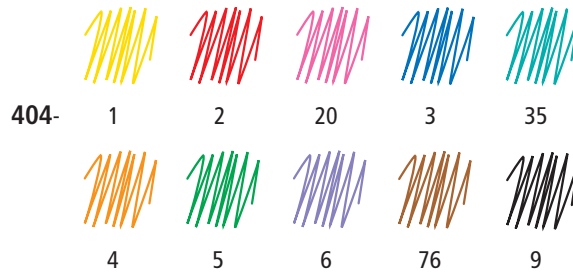

404 WP4



404 WP10



## tripus<sup>®</sup> roller

403

- Rollerball in ergonomic triangular shape
- See triplus range, page 41



## tripus<sup>®</sup> gel-liner

463

- Gel roller in ergonomic triangular shape
- See triplus range, page 42



421 25 S



## elance ice colours

421 25 S

- Refillable, retractable ballpoint pen
- Non-slip grip zone
- Metal tip and push-button clip
- Plastic jumbo refill
- Indelible ink conforming to ISO 12757-2
- 5 translucent barrel colours
- Blue ink
- Line width M

10 pieces per box, assorted colours



421 25 S1



## elance silk colours

421 25 S1

- Refillable, retractable ballpoint pen
- Non-slip grip zone
- Metal tip and push-button clip
- Plastic jumbo refill
- Indelible ink conforming to ISO 12757-2
- 4 silky barrel colours
- Blue ink
- Line width M

10 pieces per box, assorted colours



## elance

### 421 25

- Refillable, retractable ballpoint pen
- Non-slip grip zone
- Metal tip and push-button clip
- Metal jumbo refill
- Indelible ink conforming to ISO 12757-2
- 2 barrel colours
- Blue ink
- Line width M

10 pieces per box



421 25-3



421 25-9



## elance

### 421 15

- Refillable, retractable ballpoint pen
- Non-slip grip zone
- Black metallic barrel, grip zone grooves and push-button clip in ink colour
- Metal jumbo refill
- Indelible ink conforming to ISO 12757-2
- 4 colours
- Line width M

10 pieces per box



421 15-

2

3

5

9

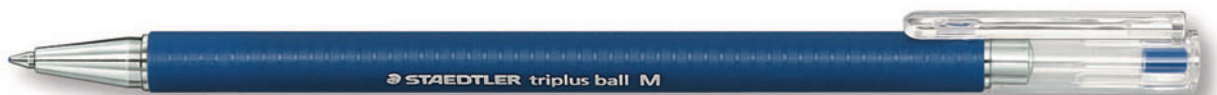

## triplus® ball

### 431

- Ballpoint pen in ergonomic triangular shape
- See triplus range, page 44

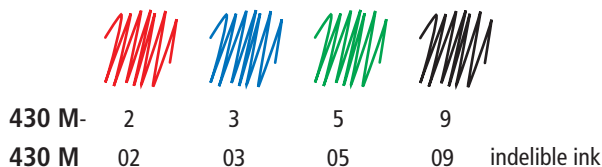

## stick 430

### 430

- Ballpoint pen with cap and clip
- 4 colours
- 2 line widths, F and M
- M also available with indelible ink conforming to ISO 12757-2

10 pieces per box

50 pieces per box with indelible ink

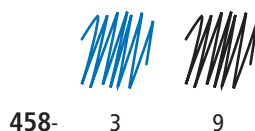
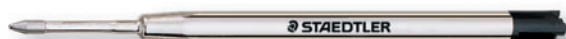

## refill 458

### 458

- Metal jumbo refill, type "G2"
- For elance and other retractable ballpoint pens
- Indelible ink conforming to ISO 12757-2
- 2 colours
- Line width M

10 pieces per box

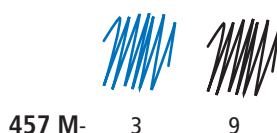
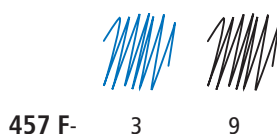

## refill 457

### 457

- Refill for triplus ball and other ballpoint pens with type "F" refill
- Indelible ink conforming to ISO 12757-2
- 2 colours
- 2 line widths

2 pieces per pack

### 457 F

Pack containing 2 pieces of the same colour, line width F

### 457 M

Pack containing 2 pieces of the same colour, line width M



# Mars® professional

With the Mars professional, STAEDTLER has come up with a real highlight for the world of writing and drawing. The Mars professional satisfies even the highest demands when it comes to technical drawing

and makes writing a real experience. Its unique tip and indelible ink are most impressive. Superb prize-winning design and technical finesse. Quality MADE IN GERMANY!



## Mars® professional

712

712

- Indelible pigment ink conforming to ISO 14145-2
- Water-based, fast-drying, acid-free black pigment ink
- Unique tip encased in solid metal sleeve
- Perfectly designed ink feed system
- Refill system including new tip
- 10 line widths
- The line widths 0.18 mm, 0.25 mm, 0.35 mm, 0.5 mm, 0.7 mm conform to ISO 128 and 3098
- Line width indication at base of barrel
- Suitable for use with templates (e.g. 572 FL)
- High-class aluminium finish
- Ergonomic grip zone with integrated roll-stop
- Safety cap with fine-pitch thread
- With shiny, chrome-plated metal clip

Single pack

### For writing and drawing



### Indelible

- Conforms to ISO 14145-2



### Safety cap



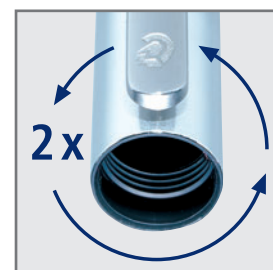









- The cap is equipped with a high-quality, fine-pitch thread which prevents unintended opening – the tip is optimally protected



2002 awarded with:  
**DESIGN PLUS**





			
approx. 0.05 mm <b>308 005-9</b>	approx. 0.1 mm <b>308 01-9</b>	approx. 0.2 mm <b>308 02-9</b>	approx. 0.3 mm <b>308 03-9</b>
			
approx. 0.4 mm <b>308 04-9</b>	approx. 0.5 mm <b>308 05-2</b>	approx. 0.5 mm <b>308 05-3</b>	approx. 0.5 mm <b>308 05-5</b>
			
approx. 0.5 mm <b>308 05-9</b>	approx. 0.6 mm <b>308 06-9</b>	approx. 0.7 mm <b>308 07-9</b>	approx. 0.8 mm <b>308 08-9</b>

## pigment liner

### 308

- Fineliner for writing, sketching and drawing
- Long metal tip, ideal for use with rulers, templates (e.g. 572 FL)
- Pigment ink, indelible (in accordance with ISO 14145-2), lightfast, waterproof
- Erasable when used on tracing paper, no bleeding when highlighted
- With metal clip
- PP barrel guarantees long service life
- 9 line widths, black ink
- Line width 0.5 mm available in 4 colours

10 pieces per box

### 308 WP4

Wallet containing  
4 line widths (0.1/0.3/0.5/0.7),  
black ink

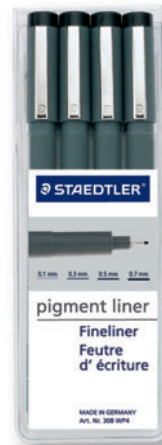
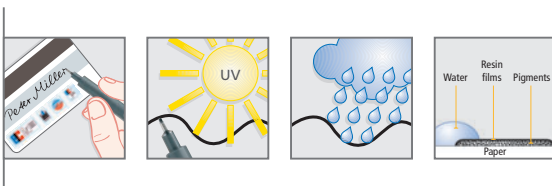

308 WP4

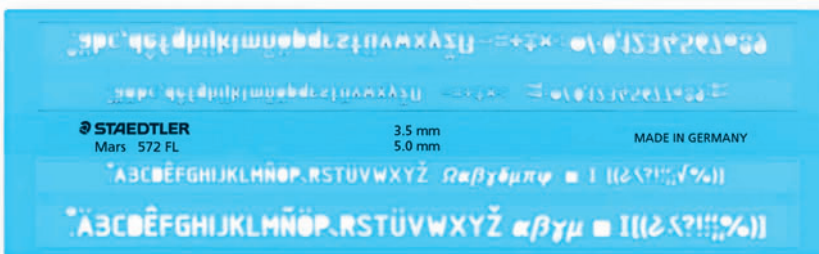

572 FL

## Mars® lettering guide

### 572 FL

- For pigment liner, Mars professional, fineliners, mechanical pencils and Lumocolor S
- Plastic, transparent blue

Single pack



## fineliner 306 S

### 306 S

- Fineliner with superfine, metal-clad tip
- DRY SAFE – can be left uncapped for several days without drying up (test ISO 554)
- With clip
- PP barrel guarantees long service life
- 4 colours
- Line width approx. 0.3 mm

10 pieces per box

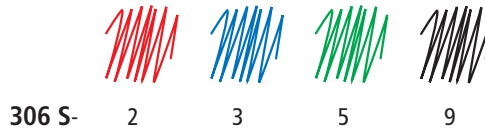

## fineliner 321 S

### 321 S

- Fineliner with superfine, metal-clad tip
- PP barrel guarantees long service life
- 4 colours available individually, 10 colours in wallet
- Line width approx. 0.3 mm

10 pieces per box

### 321 S WP10

Wallet containing 10 colours

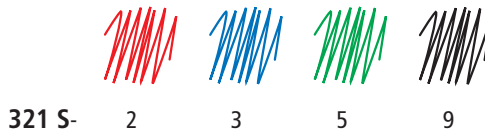

321 S WP10



## triplus® fineliner

### 334

- Fineliner in ergonomic triangular shape
- See triplus range, page 40





MADE IN GERMANY

STAEDTLER Noris HB 2





## The graphite experience – at STAEDTLER competence is traditional

The history of the company and success of the STAEDTLER brand is inextricably linked with the invention of the pencil. The name STAEDTLER stands for established competence. The current assortment reflects the company's progressive orientation: a perfectly-balanced range of 16 degrees, refined mechanical

pencil technology and comprehensive line of accessories all make writing with STAEDTLER pencils and mechanical pencils an unforgettable experience. Future needs tradition – at STAEDTLER, the pencil has been writing history for centuries already!

Mechanical pencils  
Mechanical pencil leads  
Leadholders  
Leads  
Pencils  
Erasers  
Sharpeners





775 05 (0.5 mm)

775 03 (0.3 mm)

775 07 (0.7 mm)

775 09 (0.9 mm)



775 SC WP3



## Mars® micro

### 775

- Mechanical pencil for drawing and writing
- ISO colour coding
- Non-slip rubber grip zone
- With metal clip, push-button and tip
- Pocket-safe thanks to retractable metal lead sleeve
- Cylindrical lead sleeve, ideal for use with rulers and templates
- Cushioned lead for high level of break resistance
- Easy to refill with "12-a-go" Mars micro carbon mechanical pencil leads
- Eraser and HB leads
- 4 line widths

10 pieces per box

### 775 SC WP3

- Wallet containing 3 mechanical pencils Mars micro 775 in college colours
- 3 different line widths (0.3 / 0.5 / 0.7 mm)

### Pocket-safe

- The tip of the mechanical pencil is retractable at the mere push of a button

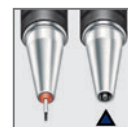
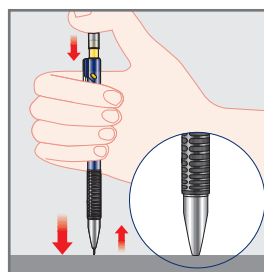

### Break-resistant

- The mechanical pencil lead is cushioned, protecting it from breakage

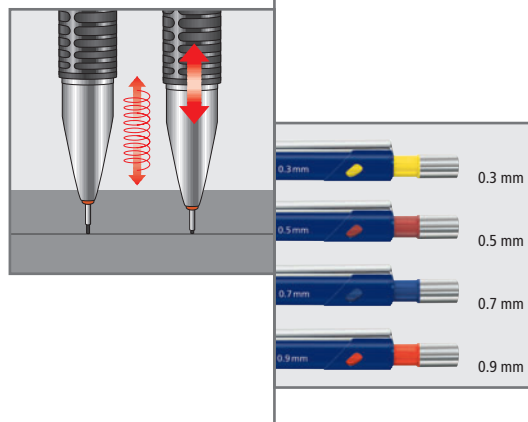

### ISO colour coding

- The identical colour coding of mechanical pencils, mechanical pencil leads and technical pens facilitates recognition of the different line widths



## graphite 779

779 05/07

- Mechanical pencil for writing
- Ergonomic rubber grip zone in leather look
- With metal clip, push-button and tip
- Pocket-safe thanks to retractable metal lead sleeve
- Cushioned lead for high level of break resistance
- Easy to refill with "12-a-go" Mars micro carbon mechanical pencil leads
- Eraser and HB leads
- 2 line widths, 3 barrel colours

10 pieces per box

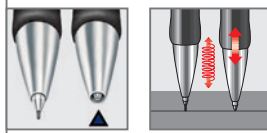

779 05-3 (0.5 mm)

779 07-3 (0.7 mm)



779 05-2 (0.5 mm)

779 07-2 (0.7 mm)

779 05-9 (0.5 mm)

779 07-9 (0.7 mm)



## graphite 779

779 15/17

- Mechanical pencil for writing
- Barrel colours in transparent design
- Ergonomic rubber grip zone
- With metal clip
- Pocket-safe thanks to retractable metal lead sleeve
- Cushioned lead for high level of break resistance
- Easy to refill with "12-a-go" Mars micro carbon mechanical pencil leads
- Eraser and HB leads
- 2 line widths, 3 barrel colours

10 pieces per box

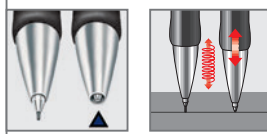

779 15-33 (0.5 mm)

779 17-33 (0.7 mm)



779 15-61 (0.5 mm)

779 17-61 (0.7 mm)

779 15-8 (0.5 mm)

779 17-8 (0.7 mm)

## Spare eraser

77N R52

- For mechanical pencils 775 and 779

5 pieces per pack



77N R52



777 05-33 (0.5 mm)  
777 07-33 (0.7 mm)

## graphite 777

- 777
- Mechanical pencil for writing
  - Rubberised barrel in frosted transparent design
  - Extra-large eraser and HB leads
  - 2 line widths, 6 barrel colours
- 10 pieces per box



777 05-8 (0.5 mm)  
777 07-8 (0.7 mm)

777 05-61 (0.5 mm)  
777 07-61 (0.7 mm)



777 05-3 (0.5 mm)  
777 07-3 (0.7 mm)



777 05-4 (0.5 mm)  
777 07-4 (0.7 mm)

777 05-5 (0.5 mm)  
777 07-5 (0.7 mm)



## tripus<sup>®</sup> micro

- 774
- Mechanical pencil in ergonomic triangular shape
- See triplus range, page 45





## Mars® technico

780 C

### 780 C

- Leadholder for drawing, sketching and writing
- For 2 mm leads
- With metal clip, push-button and grip zone
- Lead pointer integrated in push-button
- HB lead

5 pieces per box

### Integrated lead pointer

- Simply remove the push-button, insert the lead into the metal opening and sharpen

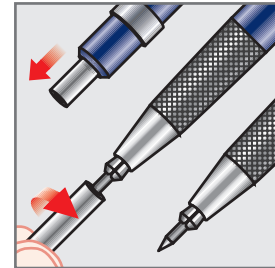

## Mars® technico

788 C

### 788 C

- Leadholder for drawing, sketching and writing
- For 2 mm leads
- With metal clip
- HB lead

10 pieces per box



## Mars® carbon

### 200

- 2 mm lead for use on paper and drawing card
- 130 mm long
- 7 degrees

12 leads per plastic box

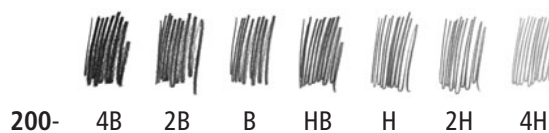

# STAEDTLER mechanical pencil leads – evolution at its best

STAEDTLER mechanical pencil leads possess outstanding product characteristics. Made up of over 90%, carefully-selected, natural raw materials and manufactured in a unique, ecological production process – no PVC and no softening agents –,

the mechanical pencil leads offer users a soft, smooth-gliding writing performance and, thanks to their high graphite content, jet black lines. The high flexibility of the leads (bend not break) makes them extremely break-resistant. Last but not least, good

erasability rounds off this range of features which make writing and technical drawing with STAEDTLER mechanical pencil leads so special. Tried and tested for over 30 years already – quality MADE IN GERMANY.



255 05-	2B	HB	0.5 mm
255 07-	2B	HB	0.7 mm

## Innovative push-button mechanism

- Easy single-handed refilling – hold tube, press push-button, one lead is released
- If the push-button is pressed accidentally, the lead can be pushed back in by turning the tube upside-down and pressing the push-button a second time

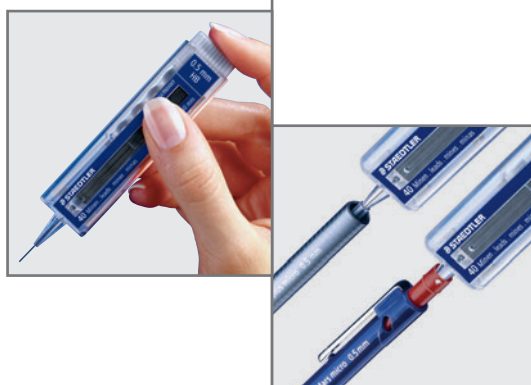

## STAEDTLER mechanical pencil lead

### 255

- Mechanical pencil lead for use on paper and drawing card
- Innovative push-button mechanism for single-handed use and refilling of individual leads
- Funnel-shaped tip for easy refilling
- Lead content window
- Smooth-gliding lead
- Jet black lines
- Highly flexible – extremely break-resistant
- Easy to erase
- Suitable for use with all mechanical pencils
- 2 line widths, 2 degrees

40 leads per tube

### Funnel-shaped tip

- Easy insertion of tip – irrespective of lead tube diameter
- Lead cannot fall between barrel and lead tube
- Advantages:
  - No touching of lead
  - No dropping of lead
  - No breaking of lead

## Mars® micro carbon

250

- Mechanical pencil lead for use on paper and drawing card
- Easy "12-a-go" refilling for Mars micro and graphite 779
- Smooth-gliding lead
- Jet black lines
- Highly flexible – extremely break-resistant
- Easy to erase
- ISO colour coding
- Suitable for use with all mechanical pencils
- 4 line widths, up to 7 degrees

12 leads per tube

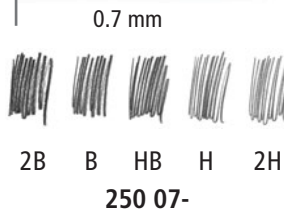
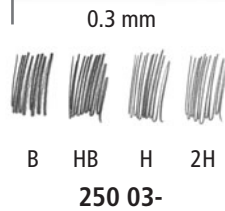
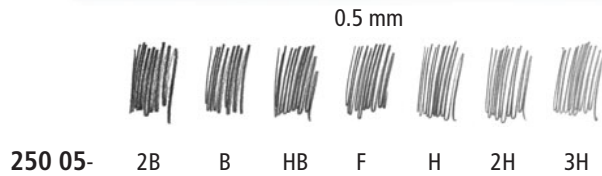
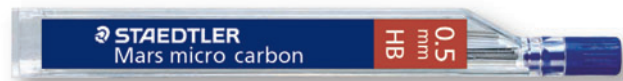

### 12-a-go

- The neck of the lead tube is simply inserted into the end of the mechanical pencil – all twelve leads can be filled into Mars micro or graphite 779 in one go
- Advantages:
  - No touching of lead
  - No dropping of lead
  - No breaking of lead

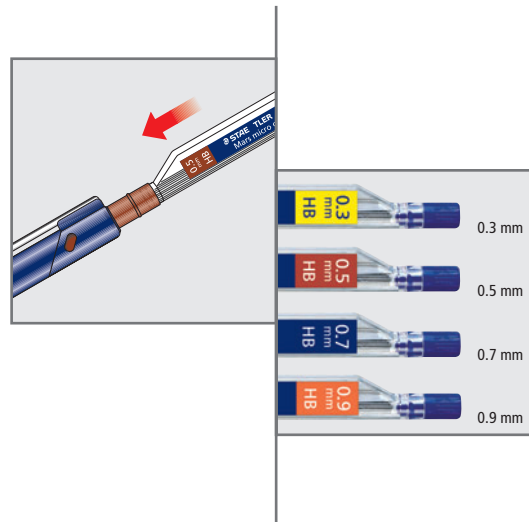

### ISO colour coding

- The identical colour coding of mechanical pencils, mechanical pencil leads and technical pens facilitates recognition of the different line widths

## Mars® micro color

254

- Coloured mechanical pencil lead also for use on matt drafting film and tracing paper
- Easy "12-a-go" refilling for Mars micro
- Suitable for use with all mechanical pencils
- Line width 0.5 mm, 3 colours

12 leads per tube

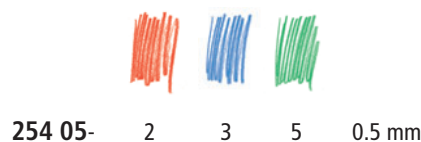

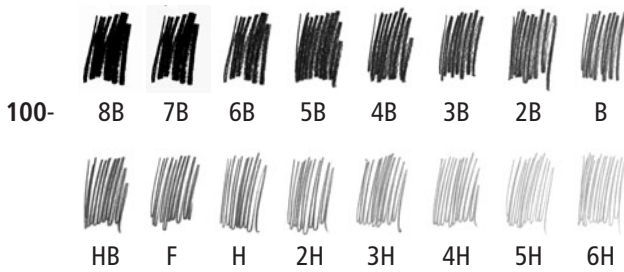

100 G6



100 G12

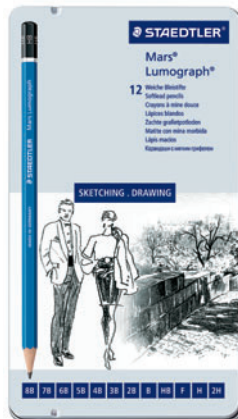

100 G12 S

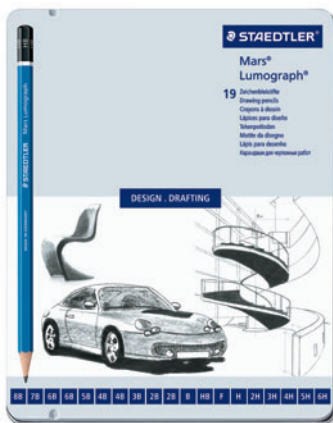

100 G19

## Mars® Lumograph®

100

- Premium-quality pencil for writing, drawing and sketching on paper and matt drafting film
- The wide range of degrees makes Lumograph the ideal tool for artists and graphic designers
- Especially break-resistant thanks to super-bonded lead
- Lines reproduce well
- Easy to erase
- Easy to sharpen with any quality sharpener, e.g. 511 001
- 16 degrees

12 pieces per box

100 G6

Tin containing 6 soft degrees:  
8B, 7B, 6B, 4B, 2B, HB

100 G12

Tin containing 12 medium degrees:  
6B, 5B, 4B, 3B, 2B, B, HB, F, H, 2H, 3H, 4H

100 G12 S

Tin containing 12 soft degrees:  
8B, 7B, 6B, 5B, 4B, 3B, 2B, B, HB, F, H, 2H

100 G19

Tin containing all degrees  
(2 pieces each of 2B, 4B, 6B)



101- HB

## Mars® stenofix

101

- Shorthand pencil
- Especially break-resistant thanks to super-bonded lead
- Easy to erase
- Easy to sharpen with any quality sharpener, e.g. 511 001

12 pieces per box





## Noris®

### 120/122

- High-quality pencil
- The 5 degrees make it ideal for school and office use
- Especially break-resistant thanks to super-bonded lead
- Easy to erase
- Easy to sharpen with any quality sharpener, e.g. 511 004
- Noris 122 with eraser tip
- Up to 5 degrees

12 pieces per box

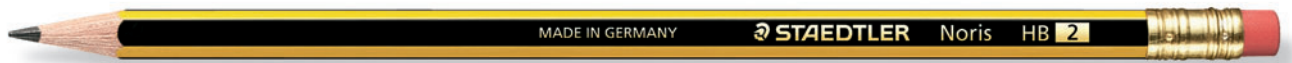
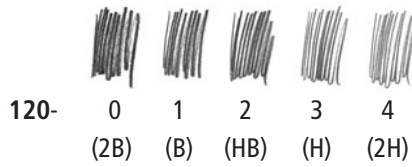

## tradition

### 110

- High-quality pencil
- The 12 degrees make it ideal for school and office use
- Especially break-resistant thanks to super-bonded lead
- Easy to erase
- Easy to sharpen with any quality sharpener, e.g. 511 005
- 12 degrees

12 pieces per box

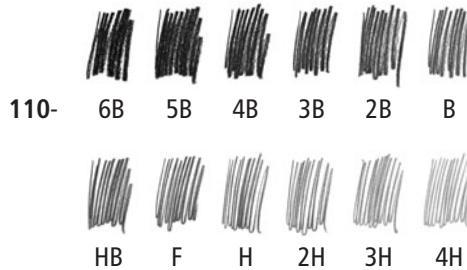

## minerva

### 130 60

- Pencil in 3 degrees, 1 (B), 2 (HB) and 3 (H)

12 pieces per box

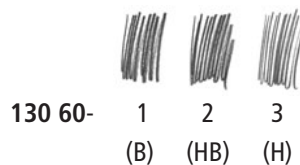

# STAEDTLER eraser blocks

With Mars plastic and rasoplast, STAEDTLER offers a range of erasers which not only satisfies the very highest demands but also sets new standards. The formula guarantees superb erasing performance at all times on a whole variety of materials such as paper, matt drafting film and OHP film – extremely clean and

practically residue-free results thanks to significantly less crumbling! What's more, not only does the cellophane wrap with practical tear strip offer protection against dirt, the slide sleeve ensures convenient handling too. Simply perfect – all the way down the line!



- Some erasers leave traces of graphite when erasing soft pencil degrees

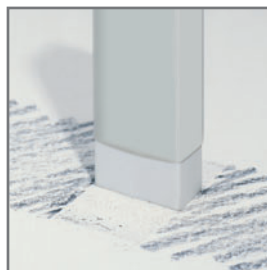

## Eraser performance Mars plastic

- Mars plastic erasers ensure superb erasing performance at all times
- For practically residue-free erasing – precise and clean

## Crumbling

- The formula of Mars plastic results in significantly less crumbling
- The eraser waste twists itself up into long strands which can be easily removed

### Conventional



Mars plastic



526 50



526 508

## Mars® plastic

### 526 50

- Premium quality
- 65 x 23 x 13 mm

20 pieces per box

## Mars® plastic combi

### 526 508

- Premium quality
- Blue part of eraser for drawing ink on paper and matt drafting film
- 65 x 23 x 13 mm

20 pieces per box

## rasoplast

### 526 B20

- Comfort quality
- 65 x 23 x 13 mm

20 pieces per box



526 B20

### 526 B30

- Comfort quality
- 43 x 19 x 13 mm

30 pieces per box



526 B30



526 B40

### 526 B40

- Comfort quality
- 33 x 16 x 13 mm

40 pieces per box

## rasoplast combi

### 526 BT30

- Comfort quality
- Blue part of eraser for writing ink on paper
- 43 x 19 x 13 mm

30 pieces per box



526 BT30

## Mars® plastic

### 528 50

- Eraser holder for graphite on paper and matt drafting film
- With core sliding mechanism and clip
- Eraser core refill art. no. 528 55

10 pieces per box



528 50



526 61

## Mars® rasor

### 526 61

- Eraser pencil for ballpoint pen, writing and drawing inks
- For pinpoint erasing
- With brush

12 pieces per box

# The new STAEDTLER sharpeners

There are many dimensions to writing and drawing with blacklead and coloured pencils. Whether used for jotting down notes with, sketching, outlining or colouring – different applications require different degrees and lead diameters and that means different pencil sizes. All that's needed then is creativity and the right pencil sharpener. For writing purposes, a

cone which sharpens standard-sized pencils to a long, sharp point is ideal, thereby ensuring fine, accurate results. Colouring applications, on the other hand, demand a sharpener with a blunt cone which gives coloured pencils a shorter, broader point, able to withstand higher pressure and suitable for colouring in large areas with. When it comes to quality, the

new STAEDTLER sharpener range is most impressive. The three-point fixing of sharpener blades and extra-long pencil guiding slot to prevent wedging guarantee superb sharpener performance. All sharpener inserts are made out of die-cast zinc which guarantees stability, precision and an exceptionally long service life.

STAEDTLER sharpeners – to the point!



511 001



511 004



511 005



512 001

## STAEDTLER / Noris® / tradition tub sharpeners

511 001 / 511 004 / 511 005

- For standard-sized blacklead pencils up to 8.2 mm Ø
- Metal sharpener insert
- Hinged cover prevents shavings from spilling
- Lid with safety lock to avoid accidental opening

10 pieces per box

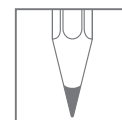

23°

## STAEDTLER double-hole tub sharpener

512 001

- Same features as for STAEDTLER tub sharpener 511 001, and:
- For thick blacklead and coloured pencils up to 10.2 mm Ø

10 pieces per box

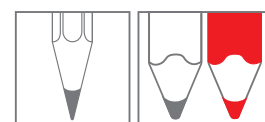

23°

30°



## Metal sharpener

510 10

- For standard-sized blacklead pencils up to 8.2 mm Ø
- Extra-long pencil guiding slot to prevent wedging

20 pieces per box

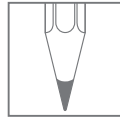

23°



510 10

## Metal double-hole sharpener

510 20

- For standard-sized blacklead pencils up to 8.2 mm Ø and thick blacklead and coloured pencils up to 10.2 mm Ø
- Extra-long pencil guiding slot to prevent wedging

20 pieces per box

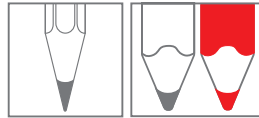

23°

30°



510 20

## Mars® rotary sharpener

501 20-3

- For all round, triangular and hexagonal blacklead and coloured pencils up to Ø 12 mm
- Point adjuster: sharp and long for blacklead pencils, blunt and short for coloured pencils
- Automatic sharpening stop
- Desk clamp
- Blue plastic housing

Single pack



501 20-3

## Mars® lead pointer tub

502

- For 2 mm leads

Single pack



502



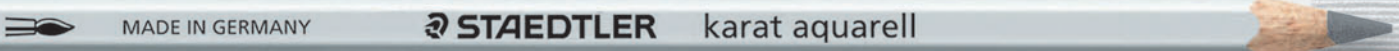



## karat® aquarell – variations in impressions

An effective play of light and shadow, transparency and colour, subtlety and vehemence can be created by both hobby and professional artists alike using the high-quality, water-soluble STAEDTLER karat aquarell watercolour pencils. They offer infinite creative potential – even making it possible to combine fine detail with large area washes. Their break-resistant leads in

60 brilliant, lightfast colours are now even softer and more colour-intensive and retain their vibrancy even when blended with water. Whether used for making quick sketches with when out-and-about or for doing more detailed work back home, STAEDTLER karat aquarell watercolour pencils can always be relied upon to bring your ideas to paper perfectly.

### Watercolour pencils



## Dry techniques

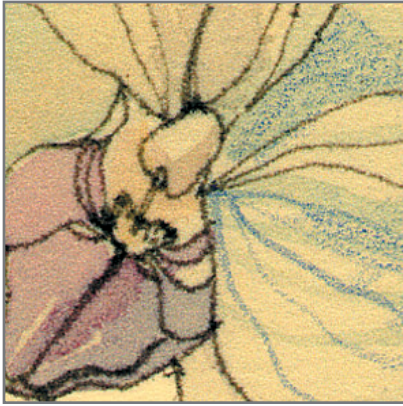

### Sketching

Creation of contours

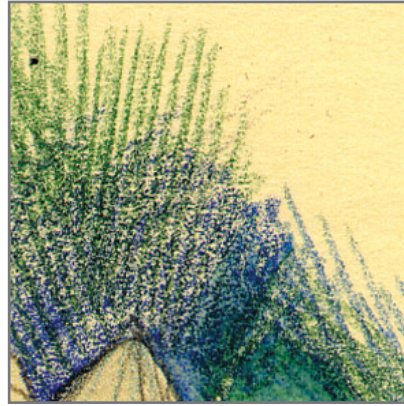

### Hatching

Drawing of a series of parallel lines closely together – for special light and shadow effects



### Overlaying

Blending by overlaying of different colours

## Wet techniques



### Watercolouring

Washing of colours using a brush



### Dry-on-wet

Use of dry lead on wet paper – strokes remain visible



### Wet-on-wet

Use of wet lead on already wet paper – for smooth, soft transitions of colour

## Special techniques



### Reproduction

Creation of a print by pressing a piece of dry paper on top of a wet watercolour

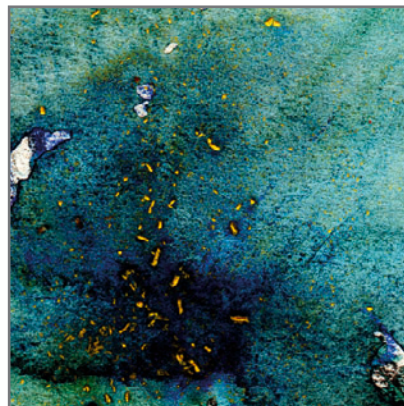

### Scraping

Scattering of fine, scraped lead particles over a wet wash – for impressive effects

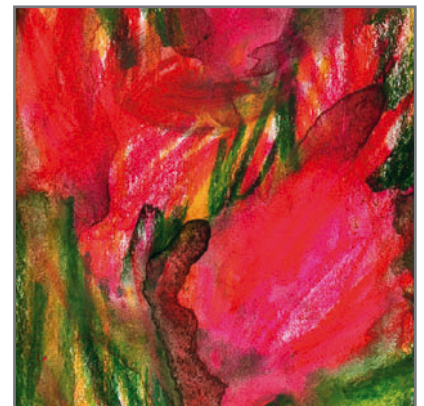

### Smudging and blotting

Reduction of colour density or creation of colour transitions using a dry or moist cloth





# karat® aquarell watercolour pencil

125

- High-quality watercolour pencil
- For a wide range of creative effects when colouring, drawing or watercolouring with water and brush
- 60 brilliant, lightfast colours
- Excellent blending quality
- Break-resistant lead
- Smooth, colour-intensive performance
- Watercolour lead – for dry and wet blending
- Easy to sharpen with any quality metal sharpener

6 pieces per box

125 M12

125 M24

125 M36

125 M48

125 M60

Set of 12, 24, 36, 48 or 60 colours in tin

## Colour code / Colour

0 White	302 Pastel blue	57 Olive green
1 Yellow	31 Glacier blue	59 Hooker's green
10 Light yellow	33 Cobalt blue	6 Violet
11 Sand	330 Powder blue	602 Pastel violet
110 Bright yellow	35 Turquoise	61 Dark mauve
12 Lemon	36 Indigo	62 Lavender
16 Golden ochre	37 Cyan	63 Delft blue
17 Light ochre	38 Sea green	703 Rose wood
19 Dark ochre	4 Orange	72 Dark sand
2 Red	42 Light orange	73 Burnt sienna
20 Magenta	43 Peach	76 Van Dyke brown
21 Light carmine	49 Fawn	77 Warm sepia
222 Salmon	5 Green	8 Grey
23 Bordeaux	50 Willow green	80 Light grey
24 Scarlet	52 Sap green	800 Cool grey
25 Pink	53 Lime green	805 Warm grey 5
260 Tuscan red	54 French green	83 Dove grey
29 Carmine	55 Green earth	85 Warm grey
3 Blue	550 Pale green	890 Cool grey 13
30 Light blue	56 Light olive	9 Black

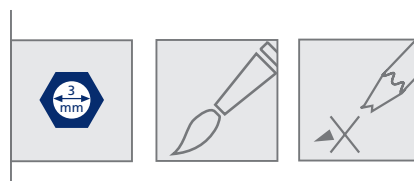

125 M12



125 M24 (not illustrated)  
125 M36



125 M48 (not illustrated)  
125 M60



MADE IN GERMANY STAEDTLER Mars ergo-soft

MADE IN GERMANY

STAEDTLER

MADE IN GERMANY

STAEDTLER

ergo-soft



ergo-

STAEDTLER ergo-soft Jumbo

MADE IN GERMANY

aquarell



## ergo soft® – fun included

The high-quality STAEDTLER ergo soft range has been distinguished with the 'spiel gut' seal of approval and 'product of the year 2004' award. And not without good reason either, as the assortment possesses a number of advantageous features designed to offer users fatigue-free writing, drawing and colouring. The triangular shape – recommended by the

Technical University of Munich – guarantees natural ergonomics and the non-slip, ultra-soft surface ensures superb handling.

Additional comfort is offered by the permanent and water-soluble, break-resistant, easy-to-sharpen leads in 24 brilliant colours – fun galore whether for school, office or recreational use.

Watercolour pencils

Coloured pencils

Pencils



### Perfect ergonomics with innovative soft surface

- The pencil's triangular shape offers optimal writing comfort; its non-slip surface ensures a good grip and prevents fingers from slipping



### Unique STAEDTLER box

- Protection for coloured pencils
- Stand-up box
- Convenient handling
- Re-closable
- Easy to open
- Ideal for school, home and office use
- Multi-purpose
- Refillable
- Patented in Germany, Japan and the USA (US Pat 6,364,100 B1); patents pending in Europe

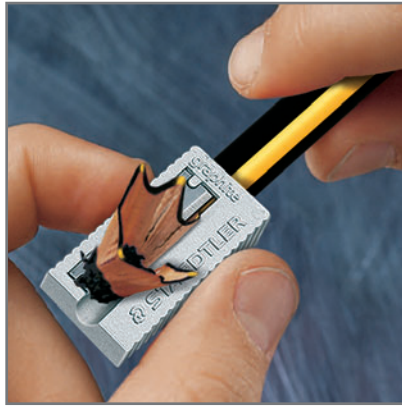
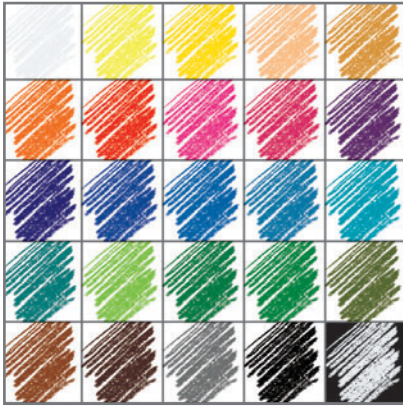

### Writing and drawing quality

- Soft leads
- Up to 24 brilliant, opaque colours
- Permanent and water-soluble

### Lead quality

- Break-resistant leads
- Easy to sharpen

### Pencil sizes

- Jumbo pencils and coloured pencils
- Standard pencils and coloured pencils
- Standard watercolour pencils
- All pencils in ergonomic triangular design

### The ergosoft range

STAEDTLER has combined outstanding manufacturing competence in the field of wood-cased pencils with state-of-the-art technology in order to enhance the haptics – for fatigue-free writing and drawing.

	ergosoft aquarell watercolour pencil 156	ergosoft coloured pencil 157	ergosoft jumbo coloured pencil 158	Mars ergosoft pencil 150	Mars ergosoft jumbo pencil 151	Noris ergosoft pencil 152	Noris ergosoft jumbo pencil 153
Number of colours	24	24	12	1	1	1	1
Lead diameter	3 mm	3 mm	4 mm	2 mm	3 mm	2 mm	3 mm
Degrees	–	–	–	2B/B/HB	2B	HB	2B
Packaging	STAEDTLER box	STAEDTLER box	STAEDTLER box	–	–	–	–
Packing unit	12/24	12/24	6/12	individually	individually	individually	individually
Soft surface	•	•	•	•	•	•	•
Triangular shape	•	•	•	•	•	•	•





## ergosoft® aquarell watercolour pencil

156

- Watercolour pencil
- For a wide range of creative possibilities when colouring, drawing or watercolouring with water and brush
- Unique, non-slip soft surface
- Perfect ergonomics thanks to triangular shape
- Stand-up STAEDTLER box
- 24 brilliant colours
- Soft, break-resistant lead
- Lead diameter 3 mm
- Watercolour lead – for dry and wet blending
- Easy to sharpen with any quality sharpener, e.g. 512 002

12 pieces per box

156 SB12

156 SB24

STAEDTLER box containing 12 or 24 colours

### Colour code / Colour

0 White	30 Light blue	52 Sap green
1 Yellow	33 Cobalt blue	57 Olive green
10 Light yellow	35 Turquoise	6 Violet
16 Golden ochre	37 Cyan	61 Dark mauve
2 Red	4 Orange	73 Burnt sienna
20 Magenta	43 Peach	76 Van Dyke brown
23 Bordeaux	5 Green	80 Light grey
3 Blue	50 Willow green	9 Black



156 SB12



156 SB24



**Colour code / Colour**

 0 White	 30 Light blue	 52 Sap green
 1 Yellow	 33 Cobalt blue	 57 Olive green
 10 Light yellow	 35 Turquoise	 6 Violet
 16 Golden ochre	 37 Cyan	 61 Dark mauve
 2 Red	 4 Orange	 73 Burnt sienna
 20 Magenta	 43 Peach	 76 Van Dyke brown
 23 Bordeaux	 5 Green	 80 Light grey
 3 Blue	 50 Willow green	 9 Black

**ergosoft®  
coloured pencil**

**157**

- Slim coloured pencil for all age groups
- Unique, non-slip soft surface
- Perfect ergonomics thanks to triangular shape
- Stand-up STAEDTLER box
- 24 brilliant colours
- Soft, break-resistant lead
- Lead diameter 3 mm
- Name box
- Easy to sharpen with any quality sharpener, e.g. 512 002

12 pieces per box

**157 SB12**

**157 SB24**

STAEDTLER box containing 12 or 24 colours



**157 SB12**



**157 SB24**



## ergosoft® jumbo coloured pencil

158

- Jumbo coloured pencil
- Unique, non-slip soft surface
- Perfect ergonomics thanks to triangular shape
- Stand-up STAEDTLER box
- 12 brilliant colours
- Soft, break-resistant lead
- Lead diameter 4 mm
- Name box
- Easy to sharpen with any quality sharpener, e.g. 512 002













12 pieces per box

158 SB6-GB

158 SB12

STAEDTLER box containing 6 or 12 colours

### Colour code / Colour

 0 White	 30 Light blue	 50 Willow green
 1 Yellow	 4 Orange	 6 Violet
 2 Red	 43 Peach	 76 Van Dyke brown
 3 Blue	 5 Green	 9 Black

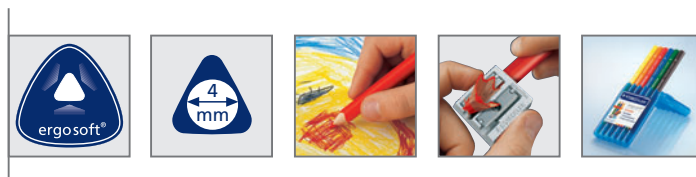

158 SB6



158 SB12

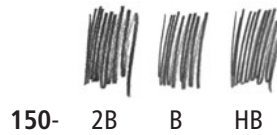

## Mars® ergosoft®

150

- Pencil for writing and drawing
- Premium quality
- Unique, non-slip soft surface
- Perfect ergonomics thanks to triangular shape
- Especially break-resistant thanks to super-bonded lead
- Easy to erase
- Easy to sharpen with any quality sharpener, e.g. 510 10 or 511 001
- 3 degrees for all applications
- Superb writing performance
- Suitable for artists
- Lead diameter 2 mm
- Degrees 2B/B/HB

12 pieces per box

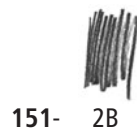

## Mars® ergosoft®

151

- Thick pencil for writing and drawing
- Premium quality
- Unique, non-slip soft surface
- Perfect ergonomics thanks to triangular shape
- Especially break-resistant thanks to super-bonded lead
- Easy to erase
- Easy to sharpen with any quality sharpener, e.g. 510 20 or 512 001
- Superb writing performance
- Ideal degree for writing
- Lead diameter 3 mm
- Degree 2B

12 pieces per box





## Noris® ergo soft®

152

- High-quality pencil
- Unique, non-slip soft surface
- Perfect ergonomics thanks to triangular shape
- Especially break-resistant thanks to super-bonded lead
- Easy to erase
- Easy to sharpen with any quality sharpener, e.g. 510 10 or 511 004
- Ideal degree for school use
- Lead diameter 2 mm
- Degree HB
- Name box

12 pieces per box

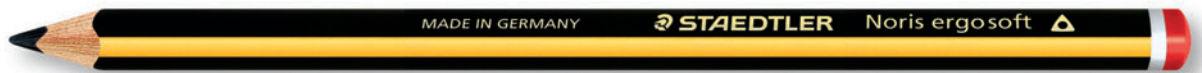

## Noris® ergo soft®

153

- Thick learner's pencil
- Unique, non-slip soft surface
- Perfect ergonomics thanks to triangular shape
- Especially break-resistant thanks to super-bonded lead
- Easy to erase
- Easy to sharpen with any quality sharpener, e.g. 510 20 or 512 001
- Ideal learner's pencil
- Lead diameter 3 mm
- Degree 2B
- Name box

12 pieces per box









# Noris Club® – the school-goers choice the world over!

STAEDTLER Noris Club offers a wide range of attractive school products, popular with pupils all over the world. Noris Club pens and pencils combine superb writing comfort with perfect writing, drawing and colouring results and a high level of reliability. The innovative ergonomic triangular-

shaped pencils with extra-thick diameter for fatigue-free writing, drawing and colouring are indispensable for school-beginners. For more experienced users, standardized ergonomic triangular-shaped pencils are also available, as are classic hexagonal-shaped products.

- Coloured pencils
- Sharpeners
- Pencils
- Erasers
- Fibre-tip pens
- Wax crayons
- Poster colours
- Compasses



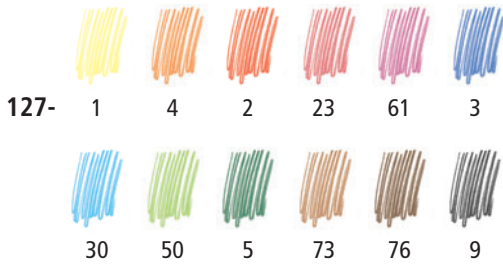

127- 1 4 2 23 61 3  
30 50 5 73 76 9



## triplus® slim coloured pencil

127

- Standard-sized triangular coloured pencil for all age groups
- Ergonomic triangular design fosters correct grip for fatigue-free, effortless writing, drawing and colouring
- Sturdy lead in vibrant colours
- Easy to sharpen with any quality sharpener, e.g. tub sharpener 512 128
- 24 brilliant colours
- Lead diameter 3 mm
- 12 colours available individually
- Conforms to EN 71

12 pieces/colour per box

127 NC6

127 NC12

127 NC24

Set of 6, 12 or 24 colours in cardboard box



127 NC6



127 NC12



127 NC24

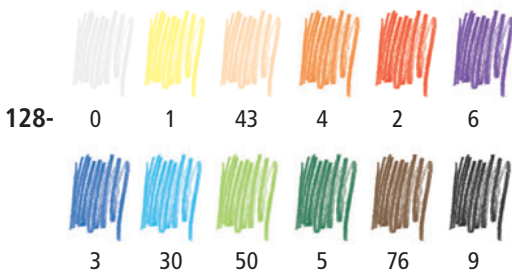

128- 0 1 43 4 2 6  
3 30 50 5 76 9



## triplus® jumbo coloured pencil

128

- Jumbo-sized coloured pencil in ergonomic triangular design
- Fosters correct grip for fatigue-free, effortless writing, drawing and colouring
- Ideal for first writing and drawing exercises
- Especially break-resistant, sturdy lead
- Easy to sharpen with any quality sharpener for thick coloured pencils, e.g. 512 128
- 12 vibrant colours
- Lead diameter 4 mm
- 12 colours available individually
- Conforms to EN 71

12 pieces/colour per box

128 NC6, 128 NC12

Set of 6 or 12 colours in cardboard box

128 NKP48

Cup containing 48 pencils



128 NC6



128 NC12



128 NKP48





## Coloured pencil

**144**

- Classic hexagonal coloured pencil
- Lacquered in lead colour for easier identification and differentiation of colours
- Break-resistant lead for smooth, colour-intensive results
- Easy to sharpen with any quality sharpener, e.g. tub sharpener 510 002
- Lead diameter 3 mm
- 26 colours available individually
- Conforms to EN 71

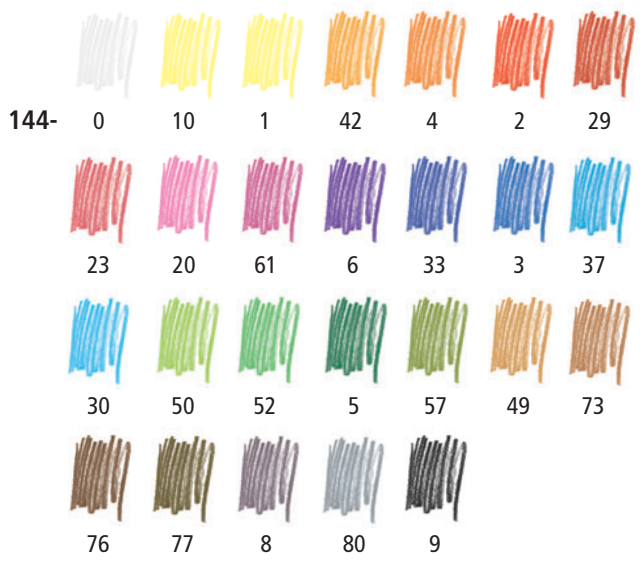

12 pieces/colour per box

**144 NC6**

**144 NC12**

**144 NC24**

Set of 6, 12 or 24 colours in cardboard box

**144 01NC12**

Set of 12 colours (half-length) in cardboard box



144 01NC12

144 NC6

144 NC12

144 NC24



## Natural coloured pencil

**144**

- Classic hexagonal coloured pencil in unlacquered, natural wood casing
- Imprint in lead colour for easier colour identification
- Break-resistant lead for smooth, colour-intensive results
- Easy to sharpen with any quality sharpener, e.g. 512 002
- 12 brilliant colours
- Lead diameter 3 mm
- Conforms to EN 71



144 NNC12

**144 NNC12**

Set of 12 colours in cardboard box



145 AM12



145 AM24

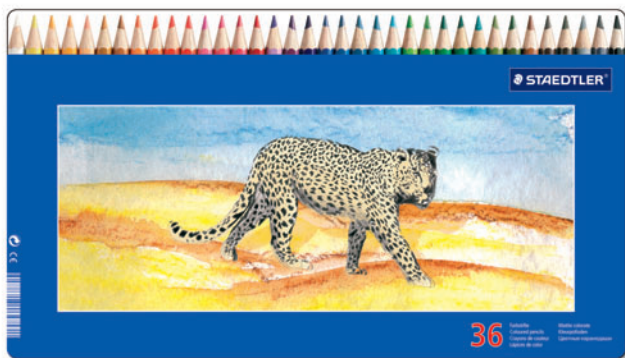

145 AM36



145 CM12



145 CM24



145 CM36

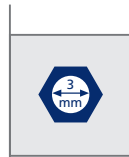

## Coloured pencils in motif tin sets

### 145

- Tin sets in 9 attractive motifs
- Coloured pencils lacquered in lead colour
- Break-resistant lead for smooth, colour-intensive results
- Easy to sharpen with any quality sharpener, e.g. 512 002
- 36 brilliant colours
- Lead diameter 3 mm
- Conform to EN 71

### 145 AM

- 3 different animal motifs

### 145 AM12

### 145 AM24

### 145 AM36

Set of 12, 24 or 36 colours in tin

### 145 CM

- 3 different historical castle motifs

### 145 CM12

### 145 CM24

### 145 CM36

Set of 12, 24 or 36 colours in tin



### 145 SPM

- 3 different trend sport motifs

### 145 SPM12

### 145 SPM24

### 145 SPM36

Set of 12, 24 or 36 colours in tin



145 SPM12



145 SPM24



145 SPM36

## Double-hole tub sharpener

### 512 002

- For standard-sized coloured pencils up to 8.2 mm Ø, 30° sharpening angle for smooth, colour-intensive results and user info "colour" under sharpener hole
- For thick blacklead and coloured pencils up to 10.2 mm Ø, 30° sharpening angle for a smooth performance
- Metal sharpener insert
- Better sharpening results and longer service life thanks to 3-point fixing of sharpener blades and extra-long pencil guiding slot
- Hinged cover prevents shavings from spilling
- Lid with safety lock to avoid accidental opening

10 pieces per box

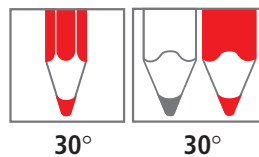

512 002

## Triangular double-hole tub sharpener

### 512 128

- Same features as for 512 002, but:
- In handy triangular shape



512 128

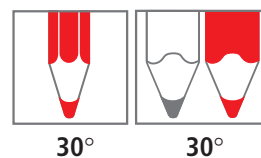





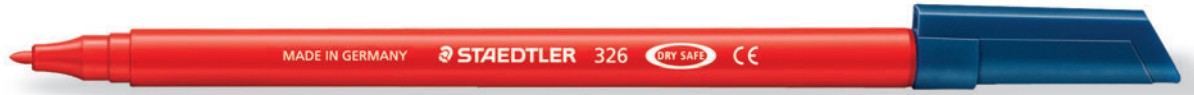

## Fibre-tip pen

326

- Water-based ink, contains food colouring
- DRY SAFE ink – can be left uncapped for days without drying up (test ISO 554)
- Sturdy, pressure-resistant tip
- Washes out of most textiles easily
- Ventilated cap in accordance with ISO 11540 and BS 7272-1/2
- PP barrel guarantees long service life
- 20 brilliant colours
- Line width approx. 1.0 mm
- 13 colours available individually
- Conforms to EN 71

10 pieces/colour per box

326 WP6

326 WP10

326 WP20

Set of 6, 10, or 20 colours in plastic wallet

326 NKP40

Cup containing 40 pens

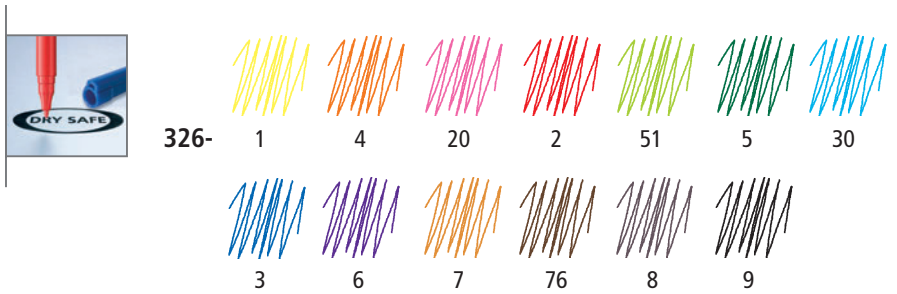

326 WP6



326 WP10



326 WP20



326 NKP40



## triplus® color

323

- Fibre-tip pen in ergonomic triangular shape
- See triplus range, page 40



340 WP12

## Jumbo colouring marker

340

- Ink contains food colouring
- Sturdy, pressure-resistant tip
- Ventilated cap in accordance with ISO 11540 and BS 7272-1/2
- Washes out of most textiles easily
- 12 brilliant colours
- Line width approx. 3 mm
- Conforms to EN 71

340 WP12

Set of 12 colours in plastic wallet



228 M10



## triplus® wax crayon

228

- Ergonomic triangular wax crayon
- Ideal for first writing and drawing exercises
- Fosters correct grip for fatigue-free drawing and colouring
- Especially suitable for scraping technique
- Can be blended using water and brush
- Highly break-resistant, paper-wrapped
- 10 vibrant, brilliant colours
- Crayon diameter 9 mm
- Conforms to EN 71

228 M10

Set of 10 colours and 1 scraper in tin



220 NC8



220 NC16



220 NC24

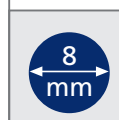

## Wax crayon

220

- Waterproof wax crayon
- Break-resistant, paper-wrapped
- 24 vibrant colours
- Crayon diameter approx. 8 mm
- Conforms to EN 71

220 NC8

220 NC16

220 NC24

Set of 8, 16 or 24 colours in cardboard box

## Poster colours

885

- Opaque poster paint in plastic pots
- Vibrant, lightfast colours
- Can be diluted with water
- Excellent opaque coverage
- Easy to blend
- Suitable for a variety of painting techniques
- 18 ml in plastic pot
- Conforms to EN 71

Set of 6 colours



885

## School compasses \*

- Precision compasses with obtuse-angled safety needle for first circle-drawing exercises at school
- Maximum circle Ø approx. 300 mm
- Length 124.2 mm

550 50

School compass with lead part and lead box in case with hinged lid

550 55

School compass with universal adapter\*\* in case with hinged lid

550 60

School compass with lead part, universal adapter\*\* and lead box in case with hinged lid



550 50



550 55

## School compasses with centre wheel \*

- Precision compasses with centre wheel and quick-setting mechanism
- Interchangeable lead part and needle
- Hinged lead and needle legs
- With shouldered/pointed needle
- Maximum circle Ø approx. 260 mm with extension bar approx. 395 mm
- Length 156 mm

550 01

School compass with universal adapter\*\* and lead box in case with hinged lid

550 02

School compass with extension bar, universal adapter\*\* and lead box in case with hinged lid



550 01

\* Available November 2005

\*\* For pens and pencils up to 11 mm diameter







## Precision for perfectionists and future visionaries

High precision and accurate results are of vital importance to anyone who uses a drawing board on a daily basis. STAEDTLER's professional equipment is designed to provide exactly that and to offer extensive support so that rooms can be planned right down to

the last millimetre and visions can be filled with life. The range also includes drafting instruments tailor-made to meet the demands of semi-professional users, career-beginners and school-goers.

**Mars professional**

**Technical pens**

**Drawing inks**

**Leadholder**

**Drawing boards**

**Accessories**

- Rulers
- Set squares
- Lettering guides

**Compasses**

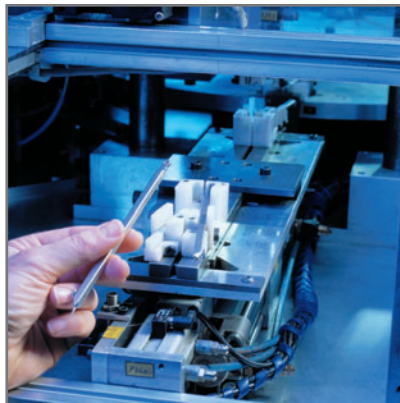

# Mars® professional

With the Mars professional, STAEDTLER has come up with a real highlight for the world of writing and drawing. The Mars professional satisfies even the highest demands when it comes to technical drawing

and makes writing a real experience. Its unique tip and indelible ink are most impressive. Superb prize-winning design and technical finesse. Quality MADE IN GERMANY!

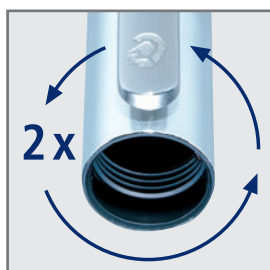
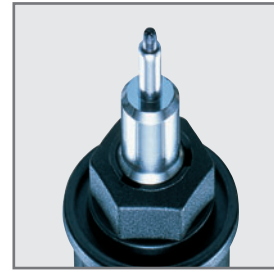

712



## Mars® professional

712

- Indelible pigment ink conforming to ISO 14145-2
- Water-based, fast-drying, acid-free black pigment ink
- Unique tip encased in solid metal sleeve
- Perfectly designed ink feed system
- Refill system including new tip
- 10 line widths
- The line widths 0.18 mm, 0.25 mm, 0.35 mm, 0.5 mm, 0.7 mm conform to ISO 128 and 3098
- Line width indication at base of barrel
- Suitable for use with templates (e.g. 572 FL)
- High-class aluminium finish
- Ergonomic grip zone with integrated roll-stop
- Safety cap with fine-pitch thread
- With shiny, chrome-plated metal clip

Single pack

2002 awarded with:  
**DESIGN PLUS**

 The Baden-Württemberg  
International Design Award

# Mars® professional refill unit

716

- For easy and clean refilling of Mars professional 712
- Guide notches for exact fit in pen
- Singly-packed in sealed, airtight protective sleeve
- Protector cap for solid metal clad tip
- Line width indication at base of refill unit

Single pack



716

Line width			Pen	Refill unit
0.18 mm			712 018	716 018
0.25 mm			712 025	716 025
0.35 mm			712 035	716 035
0.5 mm			712 05	716 05
0.7 mm			712 07	716 07
0.2 mm			712 02	716 02
0.3 mm			712 03	716 03
0.4 mm			712 04	716 04
0.6 mm			712 06	716 06
0.8 mm			712 08	716 08

Mars professional

## Set of 3

712 C3 05

Line widths 0.25 mm, 0.35 mm, 0.5 mm

712 C3 06

Line widths 0.2 mm, 0.4 mm, 0.6 mm



712 C3 05 / 712 C3 06

## Technical set

712 775

Mars professional in line widths 0.35 mm, 0.5 mm and 0.7 mm, mechanical pencil Mars micro 775 05, Mars micro carbon mechanical pencil leads 250 05-HB, eraser Mars plastic combi 526 508, in high-quality case with hinged lid



712 775





700

## Mars® matic technical pen

700

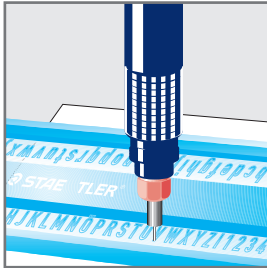

- Standard-conforming use of technical pen with lettering guides

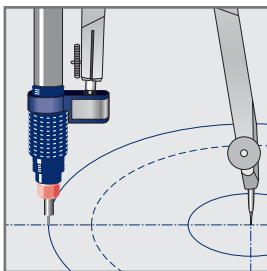

- Use of technical pen with compass

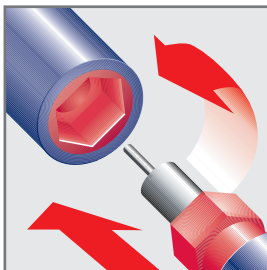

- Easy changing of drafting point

- For maximum precision
- With hard chrome-plated drafting tube
- No drying up of ink thanks to double sealing system in cap
- Steady ink flow thanks to ink collector system
- Triple line width colour indication according to ISO and DIN resp.
- For use on drafting and tracing paper and on matt drafting film
- Easy to refill from bottle or with cartridge
- 14 line widths

Single pack



750









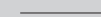
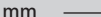

## Mars® matic spare drafting point

750





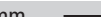
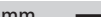





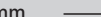
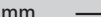

- For technical pen Mars matic 700
- With hard chrome-plated drafting tube
- Easy replacement
- 14 line widths

Single pack

## Technical pens and spare drafting points conforming to ISO 9175-1/DIN 15

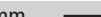
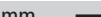
			
Technical pen	<b>700 M013</b>	<b>700 M018</b>	<b>700 M025</b>
Spare drafting point	<b>750 M013</b>	<b>750 M018</b>	<b>750 M025</b>
Line width	0.13 mm 	0.18 mm 	0.25 mm 
			
Technical pen	<b>700 M035</b>	<b>700 M05</b>	<b>700 M07</b>
Spare drafting point	<b>750 M035</b>	<b>750 M05</b>	<b>750 M07</b>
Line width	0.35 mm 	0.5 mm 	0.7 mm 
			
Technical pen	<b>700 M10</b>		
Spare drafting point	<b>750 M10</b>		
Line width	1.0 mm 		

## Technical pens and spare drafting points conforming to DIN 15 and DIN 16

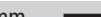
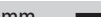
			
Technical pen	<b>700 01</b>	<b>700 02</b>	<b>700 03</b>
Spare drafting point	<b>750 01</b>	<b>750 02</b>	<b>750 03</b>
Line width	0.1 mm 	0.2 mm 	0.3 mm 
			
Technical pen	<b>700 04</b>	<b>700 M05</b>	<b>700 06</b>
Spare drafting point	<b>750 04</b>	<b>750 M05</b>	<b>750 06</b>
Line width	0.4 mm 	0.5 mm 	0.6 mm 
			
Technical pen	<b>700 08</b>	<b>700 M10</b>	<b>700 12</b>
Spare drafting point	<b>750 08</b>	<b>750 M10</b>	<b>750 12</b>
Line width	0.8 mm 	1.0 mm 	1.2 mm 



700 S4 M



700 S7



700 S9

## Mars® matic technical pen sets

- With Mars matic 700 in different line widths
- With technical pen compass adapter
- With template attachment for facilitating work with templates
- Drawing ink bottle 745 R-9
- Plastic case with removable transparent lid, non-slip feet and technical pen holder

Single pack

Technical pen set conforming to ISO 9175-1 and DIN 15

700 S4 M 

0.25	0.35	0.5	0.7
------	------	-----	-----

Technical pen sets conforming to DIN 15 and DIN 16

700 S4 

0.2	0.3	0.4	0.5
-----	-----	-----	-----

700 S7 

0.2	0.3	0.4	0.5	0.6
0.8	1.0			

700 S9 

0.1	0.2	0.3	0.4	0.5
0.6	0.8	1.0	1.2	

## Mars® matic pen cleaner

746 C 100 (not illustrated)

- Cleaning concentrate for drafting points (mixing ratio 1:10)
- Plastic bottle containing approx. 100 ml

Single pack

## Mars® matic drawing ink

745

- 7 colours
- For use on drafting and tracing paper and on matt drafting film
- Excellent reproduction qualities
- Bottle content approx. 22 ml

1 bottle per box



### Refilling from bottle



## Mars® matic drawing ink

- Black drawing ink with anti-clogging additive
- For use on drafting and tracing paper
- Jet black for well-defined lines

745 R-9

- Bottle content approx. 22 ml

1 bottle per box



745 R-9



745 R 00-9

745 R 00-9

- Cartridge content approx. 0.9 ml

5 cartridges per box

### Refilling with cartridge

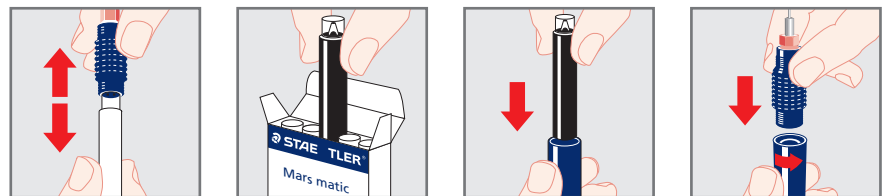

## Mars® matic drawing ink

745 M2-9

- Black twin media drawing ink
- Jet black for well-defined lines
- For use on drafting and tracing paper and on matt drafting film
- Bottle content approx. 22 ml

1 bottle per box



745 M2-9





780 C

## Mars® technico

780 C

- Leadholder for drawing, sketching and writing
- See pencil range, page 61

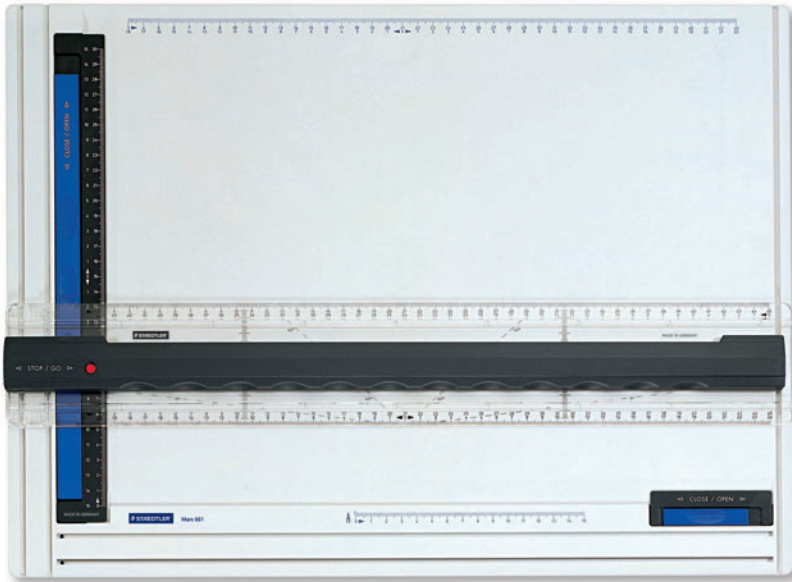

661 A3

## Mars® drawing boards

- With parallel drafting arm with double-sided scale
- Convenient single-hand double locking mechanism for setting at any position on the rail
- Twin rail for especially smooth, even gliding of the ruler
- Colour indicator shows whether locked or unlocked
- Sheet clamping strips on both sides of the drawing board for fastening of paper – securely holds more than one sheet at a time
- Scale with needle hole for precise compass radius setting
- Made out of sturdy, break-resistant plastic
- With non-slip rubber feet
- In 2 sizes: A3 and A4

### 661 A3

A3 drawing board

### 661 A4

A4 drawing board

Single pack



661 A4

## Mars® drafting head

660 20

- For use with the drawing boards 661 A3 and A4
- Single-handed use
- Stop-and-go push-button for easy setting at desired angle and freewheeling
- Two transparent ruler arms with double-sided opposite-running scales
- Parallel guide lines serve as hatching aid
- Opposite-running protractor scales from 0° – 90° with additional marks at 7° and 42° for dimetric projection
- Automatic settings at 15° intervals
- Uninterrupted drawing of right angles possible

Single pack

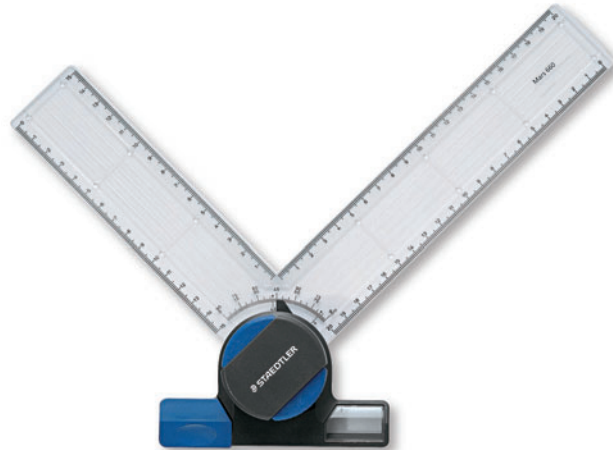

660 20

## Mars® drawing board bags

- For safe transportation of drawing boards and drawings
- Water-repellent
- With removable cell phone case
- With handle and adjustable shoulder strap
- Made out of durable nylon
- In 2 sizes: for A3 and A4

LR 661 13

For A3 drawing boards



LR 661 14



LR 661 13

LR 661 14

For A4 drawing boards

Single pack



561 98

## Mars® reduction scale ruler

561 98

- 4 divisions 1, 2, 4, DIN (see table)
- Colour-coded grooves for easy identification of scales
- Plastic, white

Single pack

Article no.	Mars 561 reduction scale table														
	Scale														
561 98	1:2.5	1:5	1:10	1:20	1:25	1:33.3	1:50	1:75	1:100	1:125	1:200	1:250	1:300	1:400	1:500
-DIN	•	•	•	•			•		•						
-1				•	•		•			•					
-2				•	•	•	•		•						
-4									•		•	•	•	•	•



### 572 S

Article no.	Letter height	Line width	Technical pen
572 025 S	2.5 mm	0,25	700 M025
572 035 S	3.5 mm	0,35	700 M035
572 05 S	5.0 mm	0,5	700 M05
572 07 S	7.0 mm	0,7	700 M07

## Mars® lettering guides

### 572 S

- With vertical standard letters conforming to ISO 3098/1B
- "H" profile for smudge-free working with technical pens
- Plastic, transparent blue

Single pack



### 572 FL

## Mars® lettering guide

### 572 FL

- For pigment liner, Mars professional, fineliners, mechanical pencils and Lumocolor S
- Plastic, transparent blue

Single pack



### 562 00

Article no.	Length
562 00-20	20 cm
562 00-30	30 cm

## Mars® school rulers

### 562 00

- With inking edge
- Plastic, transparent blue

Single pack

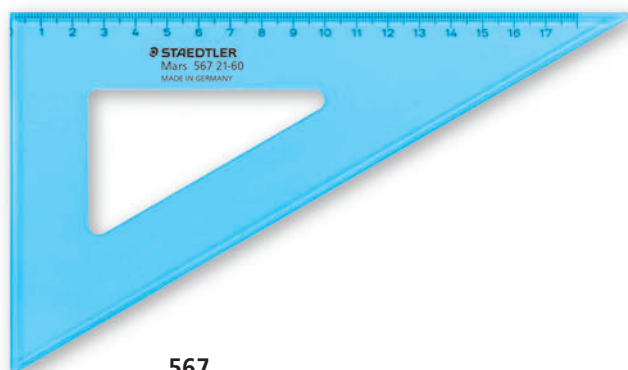
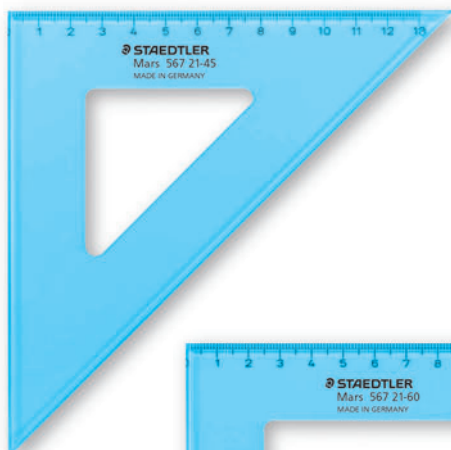

### 567

## Mars® set squares

- With inking edge
- Scale begins directly at the edge
- Plastic, transparent blue

45°/45°	60°/30°	Length*
567 21-45,	21-60	21 cm
567 26-45,	26-60	26 cm
567 31-45,	31-60	31 cm
567 36-45,	36-60	36 cm

Single pack

\*For 45° set squares, the length of the hypotenuse is indicated; for 30°/60° set squares, the length of the long cathetus.

## Mars® standard parabola ( $y = x^2$ )

576 34

- With sine, cosine and tangent curves
- Plastic, transparent

Single pack

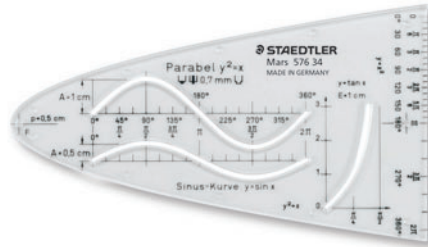

576 34

## Mars® geometry set squares

- Removable grip
- With ink studs

568 35

- 22 cm
- Acrylic, transparent

568 36

- 16 cm
- Polystyrene, transparent

Single pack



568 35



568 36

## Mars® French curves

571 40 WP

- 3 shapes A, B and C
- With inking edge
- Plastic, transparent blue

Wallet containing 3 shapes

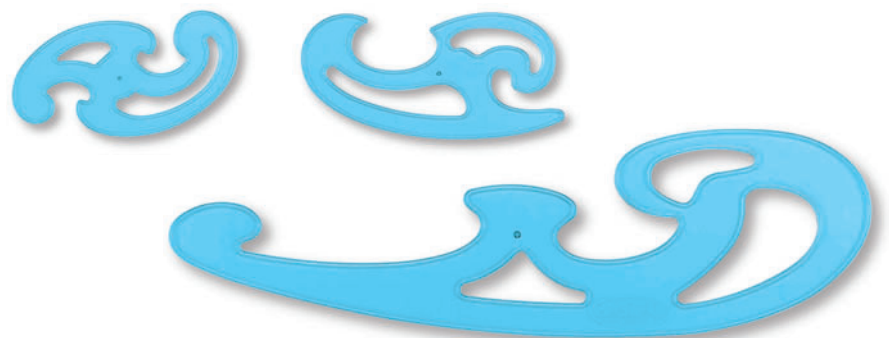

571 40 WP



# Perfection in precision

For the past 75 years already, the STAEDTLER brand has stood for top technological performance in the field of high-precision drafting instruments. STAEDTLER compasses enjoy a superb reputation the world over and today continue to remain indispensable tools on the drawing boards of professional users.

The STAEDTLER compass range is clearly structured:

- Professional for specialists
- Comfort for use in education and at the workplace
- Basic for primary school and hobby users

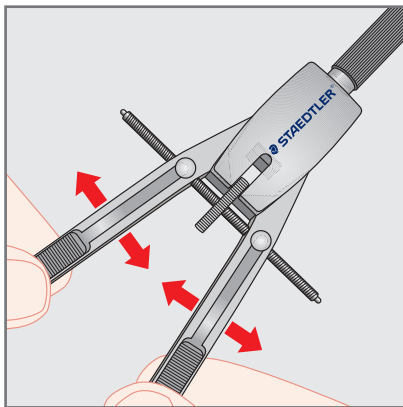
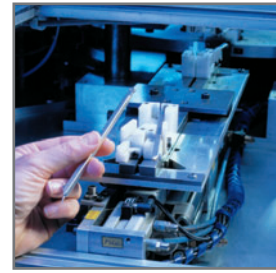

## Push-button mechanism

- Convenient quick setting using sturdy, push-button mechanism
- Easy to use thanks to large push-buttons

## Centre wheel

- Precise setting using centre wheel
- Prevents unintended setting adjustments

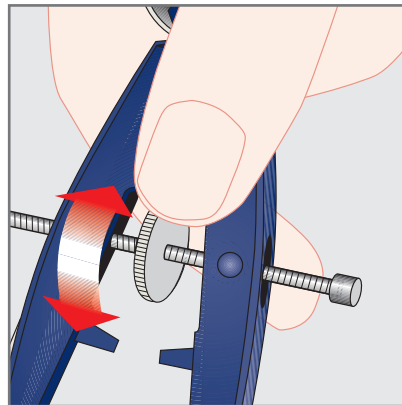

## Hinged legs

- For parallel leg positioning
- Facilitates exact drawing of particularly large radii

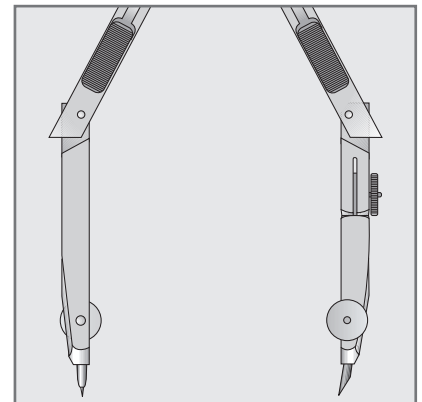

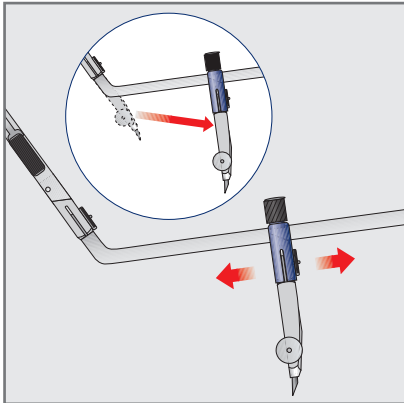

### Extension bar

- Enlarges the possible circle diameter by up to max. 235 mm
- Exact fit for needle leg

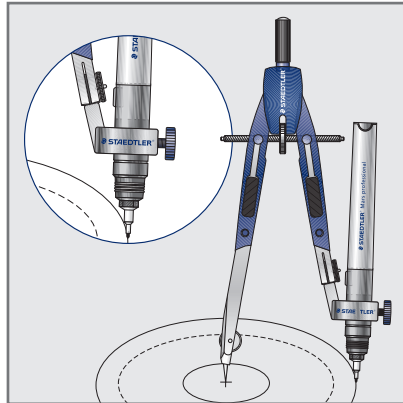

### Universal adapter

- For drawing precise circles with all common writing and drafting instruments
- Easy to use with all compasses with interchangeable lead part

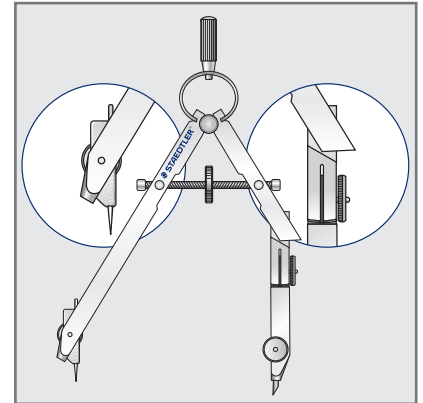

### Adjustable leg and needle shoe

- For parallel positioning
- Facilitates exact drawing of large radii

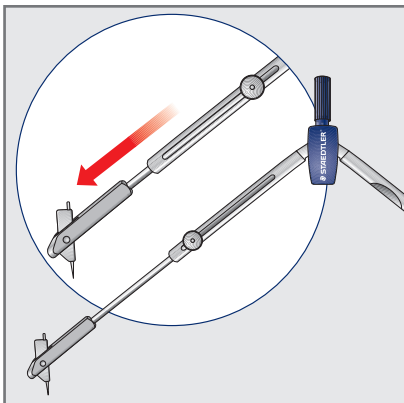

### Telescopic extension bar

- Integrated in needle leg
- Enlarges the possible circle diameter by up to max. 110 mm

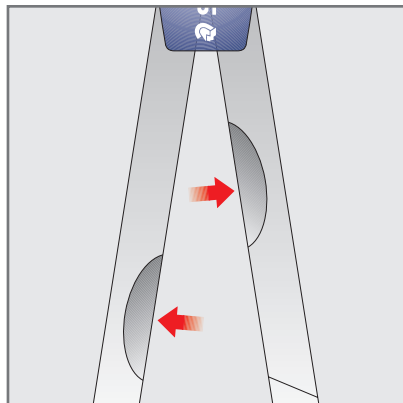

### Grip zones

- Ergonomic grip zones for optimal handling

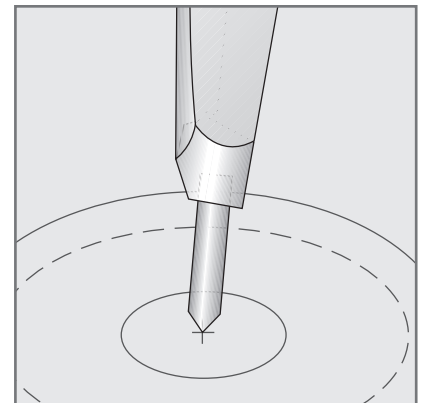

### Safety needle

## All STAEDTLER compasses have the following standard features:

- Precision compasses conforming to ISO/DIN 12753-2
- Resilient surfaces thanks to sandblasting and nickel-plating of metal parts
- Plastic parts reinforced with glass-fibre to keep them distortion-free
- Non-slip grooved grips

- Interchangeable needles
- Break-resistant, sturdy, hang-sell plastic cases with transparent, hinged lids
- All compasses come equipped with a high-quality universal metal adapter<sup>(1)</sup> and spares box<sup>(2)</sup>

(exception Mars 556<sup>(1)</sup> and Mars 559<sup>(1)+(2)</sup>)



Mars 555

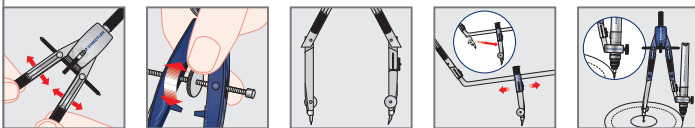

555 03

## Professional

The STAEDTLER Professional solid metal compass fully satisfies all the demanding requirements expected by professional users of a high-grade drafting instrument. The compass set also comprises high-quality accessories for perfect drafting results.

## Professional

### Mars 555

- High-quality solid metal compass
- With quick-setting push-button mechanism and centre wheel
- Hinged lead and needle legs
- Interchangeable lead part with shank  $\varnothing$  4 mm
- Interchangeable shouldered/pointed needle
- Max. circle  $\varnothing$  approx. 400 mm, with extension bar approx. 635 mm
- Length 170 mm

### 555 03

Compass, extension bar, technical pen adapter, universal adapter and spares box in high-quality plastic case with transparent lid

# Comfort

The range for advanced school-goers, apprentices and students. Whatever the schooling level, these products have the right features.



Mars 552

## Comfort

### Mars 552

- Quick-setting compass with push-button mechanism and centre wheel
- Hinged lead and needle legs
- Interchangeable lead part with shank Ø 4 mm
- Interchangeable needle
- Max. circle Ø approx. 350 mm, with extension bar approx. 585 mm
- Length 170 mm

### 552 01

Compass, universal adapter and spares box in case with hinged lid

### 552 02

Compass, extension bar, universal adapter and spares box in case with hinged lid

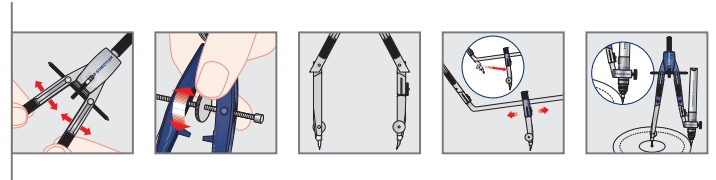

552 01



552 02





Mars 551



551 01

551 02

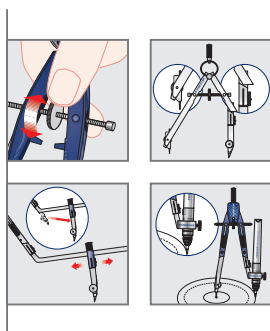

## Comfort

### Mars 551

- Precision compass with spring-bow head and centre wheel
- Solid metal compass
- Hinged leg joint and needle shoe
- Interchangeable lead part with shank  $\varnothing$  4 mm
- Interchangeable shouldered needle
- Max. circle  $\varnothing$  approx. 265 mm, with extension bar approx. 500 mm
- Length 154 mm

### 551 01

Compass, universal adapter and spares box in case with hinged lid

### 551 02

Compass, extension bar, universal adapter and spares box in case with hinged lid



Mars 556



556 00

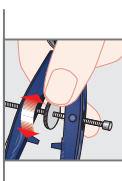

## Comfort

### Mars 556

- Precision geometry compass with spring-bow head and centre wheel
- Sturdy plastic/metal compass
- Interchangeable needle
- Max. circle  $\varnothing$  approx. 225 mm
- Length 154 mm

### 556 00

Compass and spares box in case with hinged lid

# Basic

The core assortment for primary school-goers and hobby and creative users with helpful product features for all beginners.

## Basic

### Mars 554

- Precision compass with telescopic extension bar
- Friction head for precise, smooth radius setting
- Hinged lead leg and needle shoe
- Interchangeable lead part with shank  $\varnothing$  4.0 mm
- Interchangeable needle
- Max. circle  $\varnothing$  approx. 360 mm, with telescopic extension bar approx. 470 mm
- Length 146 mm



Mars 554

### 554 T01

Compass, universal adapter and spares box in case with hinged lid

### 554 T11

Compass, dividers, universal adapter and spares box in case with hinged lid

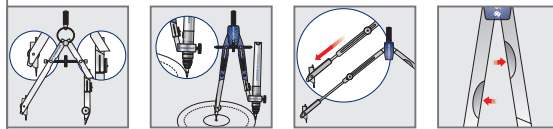

554 T01



554 T11



Mars 558



558 01

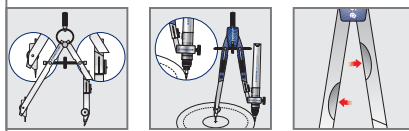

## Basic

### Mars 558

- Precision compass with friction head for precise, smooth radius setting
- Hinged lead leg and needle shoe
- Interchangeable lead part with shank  $\varnothing$  4.0 mm
- Interchangeable needle
- Max. circle  $\varnothing$  approx. 400 mm
- Length 145 mm

### 558 01

Compass with universal adapter and spares box in case with hinged lid



Mars 559



559 WP 00

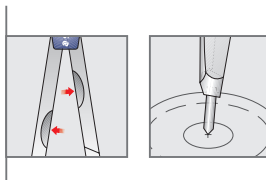

## Basic

### Mars 559

- Precision compass with friction head for precise, smooth radius setting
- With obtuse-angled safety needle
- Max. circle  $\varnothing$  approx. 340 mm
- Length 128 mm

### 559 WP 00

Compass with lead box in plastic wallet

## Universal adapter

557 02

- For drawing precise circles with all common writing and drafting instruments up to 11 mm Ø
- Easy to use with all compasses with interchangeable lead part
- Shank Ø 4 mm

5 pieces per box



557 02

## Spares set

557 ET

- Contains all spares required for STAEDTLER Professional, Comfort and Basic compasses

Single pack



557 ET

## Lead box

556 E4-HB

- 4 leads
- Degree HB

20 lead boxes



556 E4-HB



## Alphabetical index

### A

All-rounders.....16  
aquarell watercolour pencils.....73, 77

### B

Ballpoint pen refills.....44, 52  
Ballpoint pens.....44, 50, 51, 52  
Basic compasses.....109, 110

### C

CD/DVD pen.....19  
Colour laser printer film.....29  
Coloured pencils in motif tin sets.....86, 87  
Coloured pencils.....  
.....73, 77, 78, 79, 84, 85, 86, 87  
Comfort compasses.....107, 108  
Compass accessories.....111  
Compasses.....91, 106 – 110  
cool roller rollerballs.....48

### D

Double-hole tub sharpener.....68, 87  
Drawing board bags.....101  
Drawing boards.....100  
Drafting head.....101  
Drawing accessories.....101, 102, 103  
Drawing inks.....99  
Dry markers.....20, 21

### E

elance retractable ballpoint pens..... 50, 51  
Erasers.....66, 67, 88  
Eraser holder.....67  
Eraser pencil.....67  
ergosoft aquarell watercolour pencils.....77  
ergosoft coloured pencils.....77, 78, 79  
ergosoft pencils.....80, 81

### F

Fibre-tip pens.....43, 89, 90  
Film roll.....28  
Film.....28, 29  
Fineliner 306 S.....55  
Fineliner 321 S.....55  
Fineliners.....40, 53, 54, 55  
Flipchart markers.....26  
French curves.....103

### G

Gel rollers.....42  
Geometry set squares.....103  
glasochrom dry markers.....20  
graphite mechanical pencils.....59, 60

### H

Highlighters.....34, 35, 45  
Highlighter pencils.....35

### I

Inkjet film.....29

### J

Jumbo coloured pencils.....79, 84  
Jumbo colouring markers.....90  
Jumbo learner's pencil.....88

### K

karat aquarell watercolour pencils.....73

### L

Lead box.....111  
Leadholders.....61, 100  
Lead pointer tub.....69  
Lead for leadholders.....61  
Learner's pencil.....88

Lettering guides.....102  
liquid point rollerballs.....48  
Lumocolor CD/DVD pen.....19  
Lumocolor colour laser printer film.....29  
Lumocolor dry markers.....20, 21  
Lumocolor film roll.....28  
Lumocolor flipchart markers.....26  
Lumocolor inkjet film.....29  
Lumocolor memo board.....23  
Lumocolor non-permanent omnichrom  
dry marker leadholders.....21  
Lumocolor non-permanent omnichrom  
dry markers.....21  
Lumocolor non-permanent  
universal pens.....14  
Lumocolor park+write set.....25  
Lumocolor permanent compact.....16  
Lumocolor permanent glasochrom  
dry markers.....20  
Lumocolor permanent markers.....17, 18  
Lumocolor permanent omnigraph  
universal crayons.....20  
Lumocolor permanent special.....19  
Lumocolor permanent universal pens.....15  
Lumocolor photocopy film.....28  
Lumocolor refill ink.....27  
Lumocolor refill stations.....27  
Lumocolor whiteboard cleaner.....25  
Lumocolor whiteboard compact.....23  
Lumocolor whiteboard markers.....24  
Lumocolor whiteboard-system wiper.....25  
Lumocolor write-on film.....28

### M

Mars carbon leads.....61  
Mars compasses.....106 – 110  
Mars drafting head.....101  
Mars drawing board bags.....101  
Mars drawing boards.....100  
Mars ergosoft pencils.....80  
Mars French curves.....103  
Mars geometry set squares.....103  
Mars lead pointer tub.....69  
Mars lettering guides.....54, 102  
Mars Lumograph pencils.....64

Mars matic drawing inks .....	99
Mars matic pen cleaner .....	98
Mars matic spare drafting points.....	96, 97
Mars matic technical pen sets .....	98
Mars matic technical pens .....	96
Mars micro carbon mechanical pencil leads.....	63
Mars micro color mechanical pencil leads.....	63
Mars micro mechanical pencils.....	58
Mars plastic combi eraser.....	66
Mars plastic eraser holder .....	67
Mars plastic erasers.....	66
Mars professional refill units .....	95
Mars professional set of 3 .....	95
Mars professional technical set .....	95
Mars professional .....	53, 94, 95
Mars razor eraser pencil .....	67
Mars reduction scale ruler .....	101
Mars rotary sharpener .....	69
Mars school rulers .....	102
Mars set squares.....	102, 103
Mars standard parabola .....	103
Mars stenofix shorthand pencil .....	64
Mars technico leadholders.....	61, 100
Mechanical pencil leads.....	62, 63
Mechanical pencils.....	45, 58, 59, 60
memo board .....	23
Metal double-hole sharpener .....	69
Metal sharpeners.....	69
Minerva pencils .....	65

## N

Natural coloured pencils.....	85
Noris ergosoft pencils .....	81
Noris pencils .....	65
Noris tub sharpener .....	68

## O

OHP pens.....	14, 15
omnichrom dry markers .....	21
omnichrom leads .....	21
omnichrom leadholders .....	21
omnigraph universal crayons.....	20

## P

park + write set.....	25
Pen cleaner .....	98
Pencils .....	64, 65, 80, 81, 88
Permanent markers .....	17, 18
Photocopy film .....	28
pigment liner fineliners.....	54
Poster colours .....	91
Precision compasses .....	108, 109, 110
Professional compass .....	106

## Q

Quick-setting compass .....	107
-----------------------------	-----

## R

rasoplast combi eraser.....	67
rasoplast erasers.....	67
Reduction scale ruler .....	101
refill 457 .....	52
refill 458 .....	52
Refill leads for dry marker leadholders .....	21
Refill ink for Lumocolor .....	27
refill stations.....	27, 34
refill units mars professional .....	95
Retractable ballpoint pens .....	50, 51
Rollerballs .....	41, 48, 49
Rotary sharpener .....	69

## S

School compasses.....	91
School rulers.....	102
Set squares .....	102
Sharpeners.....	68, 69
Shorthand pencil .....	64
silver ball rollerballs.....	49
Solid metal compass.....	106
Spare drafting points .....	96, 97
Spare eraser for triplus micro mechanical pencils .....	45
Spare eraser for mechanical pencils .....	59
Spares set for compasses.....	111
Special markers .....	19
STAEDTLER mechanical pencil lead .....	62
STAEDTLER tub sharpeners.....	68
Standard parabola .....	103
stick 430 ballpoint pens.....	52

## T

Technical pens.....	96, 97, 98
Technical pen sets.....	98
Technical set Mars professional.....	95
Textsurfer classic highlighters .....	34
Textsurfer classic refill stations .....	34
Textsurfer dry highlighter pencils.....	35
Tin sets for coloured pencils .....	56, 87
tradition pencils.....	65
tradition tub sharpener.....	68
Triangular eraser .....	88
tripus ball ballpoint pens .....	44
tripus ball refills.....	44
tripus color fibre-tip pens .....	43
tripus fineliners.....	40
tripus gel-liner gel rollers.....	42
tripus jumbo coloured pencils.....	84
tripus jumbo learner's pencil.....	88
tripus micro mechanical pencils.....	45
tripus multi-set .....	39
tripus roller rollerballs.....	41
tripus slim coloured pencils .....	84
tripus slim pencil .....	88
tripus textsurfer highlighters.....	35, 45
tripus wax crayons.....	90
Tub sharpeners.....	68, 69, 87

## U

Universal adapter for compasses.....	111
Universal crayons .....	20
Universal pens .....	14, 15

## W

Watercolour pencils .....	73, 77
Wax crayons .....	90
Whiteboard cleaner .....	25
Whiteboard wiper.....	25
Whiteboard marker accessories.....	25
Whiteboard markers .....	23, 24
Write-on film .....	28
Writing set.....	39

### 1

100	Mars Lumograph pencil .....	64
101	Mars stenofix shorthand pencil.....	64
108	Lumocolor non-permanent omnichrom dry marker.....	21
108 20	Lumocolor permanent glasochrom dry marker.....	20
110	tradition pencil.....	65
118	triplus slim pencil.....	88
119	triplus jumbo learner's pencil.....	88
120	Noris pencil.....	65
122	Noris pencil with eraser tip.....	65
125	karat aquarell coloured pencil .....	73
127	triplus slim coloured pencil .....	84
128	triplus jumbo coloured pencil.....	84
128 64	Textsurfer dry highlighter pencil.....	35
130 60	minerva pencil .....	65
144 NNC12	Natural coloured pencil.....	85
144	Coloured pencil.....	85
145	Coloured pencils in motif tin sets.....	86, 87
150	Mars ergosoft pencil .....	80
151	Mars ergosoft thick pencil .....	80
152	Noris ergosoft pencil.....	81
153	Noris ergosoft thick learner's pencil.....	81
156	ergosoft aquarell watercolour pencil .....	77
157	ergosoft coloured pencil .....	78
158	ergosoft jumbo coloured pencil .....	79

### 2

200	Mars carbon lead .....	61
218	Lumocolor non-permanent omnichrom refill lead.....	21
220	Wax crayon .....	90
228 M10	triplus wax crayon.....	90
236	Lumocolor permanent omnigraph universal crayon.....	20
250	Mars micro carbon mechanical pencil lead .....	63
254	Mars micro color coloured mechanical pencil lead .....	63
255	STAEDTLER mechanical pencil lead.....	62

### 3

306 S	fineliner 306 S.....	55
308	pigment liner fineliner.....	54
310 CDS	Lumocolor CD/DVD pen .....	19
311	Lumocolor non-permanent S universal pen.....	14
312	Lumocolor non-permanent B universal pen .....	14
313	Lumocolor permanent S universal pen.....	15
314	Lumocolor permanent B universal pen.....	15
315	Lumocolor non-permanent M universal pen .....	14

316	Lumocolor non-permanent F universal pen.....	14
317	Lumocolor permanent M universal pen .....	15
318	Lumocolor permanent F universal pen.....	15
319	Lumocolor permanent special marker .....	19
321 S	fineliner 321 S.....	55
323	triplus color fibre-tip pen .....	43
326	Fibre-tip pen.....	89
334	triplus fineliner.....	40
34 SB4	triplus multi-set writing set.....	39
340	Jumbo colouring marker .....	90
341	Lumocolor whiteboard compact .....	23
342	Lumocolor permanent compact all-rounder.....	16
350	Lumocolor permanent marker with chisel tip.....	17
351	Lumocolor whiteboard marker with bullet tip.....	24
351 B	Lumocolor whiteboard marker with chisel tip.....	24
352	Lumocolor permanent marker with bullet tip.....	17
356	Lumocolor flipchart marker with bullet tip.....	26
356 B	Lumocolor flipchart marker with chisel tip.....	26
362	triplus textsurfer highlighter .....	35, 45
364	Textsurfer classic highlighter.....	34
385	Lumocolor permanent marker.....	18
388	Lumocolor permanent marker .....	18

### 4

403	triplus roller rollerball .....	41
404	silver ball rollerball .....	49
411	cool roller rollerball.....	48
416	liquid point 5 rollerball .....	48
417	liquid point 7 rollerball .....	48
421 15	elance retractable ballpoint pen .....	51
421 25 S	elance ice colours retractable ballpoint pen.....	50
421 25 S1	elance silk colours retractable ballpoint pen.....	50
421 25	elance retractable ballpoint pen .....	51
430	stick 430 ballpoint pen .....	52
431	triplus ball ballpoint pen .....	44
457	refill 457 ballpoint pen refill.....	44, 52
458	refill 458 ballpoint pen refill.....	52
463	triplus gel-liner gel roller.....	42
485 23	Lumocolor refill ink .....	27
487 15	Lumocolor non-permanent refill station.....	27
487 17	Lumocolor permanent refill station.....	27
488 50	Lumocolor permanent marker refill station .....	27
488 51	Lumocolor whiteboard marker refill station.....	27
488 56	Lumocolor flipchart marker refill station .....	27
488 64	Textsurfer classic refill station .....	34

5

501 20-3 Mars rotary sharpener .....69

502 Mars lead pointer tub .....69

510 10 Metal sharpener .....69

510 20 Metal double-hole sharpener .....69

511 001 STAEDTLER tub sharpener .....68

511 004 Noris tub sharpener .....68

511 005 tradition tub sharpener .....68

512 001 STAEDTLER double-hole tub sharpener .....68

512 002 Double-hole tub sharpener .....87

512 128 Triangular double-hole tub sharpener .....87

526 002 Triangular eraser .....88

526 50 Mars plastic eraser .....66

526 508 Mars plastic combi eraser .....66

526 61 Mars rasor eraser pencil .....67

526 B20 rasoplast eraser .....67

526 B30 rasoplast eraser .....67

526 B40 rasoplast eraser .....67

526 BT30 rasoplast combi eraser .....67

528 50 Mars plastic eraser holder .....67

550 School compass .....91

551 Mars 551 Comfort precision compass .....108

552 Mars 552 Comfort quick-setting compass .....107

554 Mars 554 Basic precision compass .....109

555 Mars 555 Professional solid metal compass .....106

556 Mars 556 Comfort precision geometry compass .....108

556 E4-HB Lead box for compasses .....111

557 02 Universal adapter for compasses .....111

557 ET Spares set for compasses .....111

558 Mars 558 Basic precision compass .....110

559 Mars 559 Basic precision compass .....110

561 98 Mars reduction scale ruler .....101

562 00 Mars school ruler .....102

567 Mars set square .....102

568 35 Mars geometry set square 22 cm .....103

568 36 Mars geometry set square 16 cm .....103

571 40 WP Mars french curves .....103

572 FL Mars lettering guide .....54, 102

572 S Mars lettering guide .....102

576 34 Mars standard parabola .....103

6

611 S Lumocolor park + write set .....25

632 10-21 Lumocolor write-on film .....28

634 10 CLP Lumocolor colour laser printer film .....29

636 10 Lumocolor photocopy film .....28

638 30-20 Lumocolor film roll .....28

639 30 A4 Lumocolor inkjet film .....29

639 31 Lumocolor inkjet film .....29

641 A5 Lumocolor memo board .....23

641 SBK Lumocolor memo board set .....23

651 Lumocolor whiteboard-system wiper .....25

660 20 Mars drafting head .....101

661 A3 Mars drawing board A3 .....100

661 A4 Mars drawing board A4 .....100

LR 661 13 Mars drawing board bag A4 .....101

LR 661 14 Mars drawing board bag A3 .....101

681 Lumocolor whiteboard cleaner .....25

7

700 S Mars matic technical pen sets .....98

700 Mars matic technical pen .....96, 97

712 775 Mars professional Technical set .....95

712 C3 Mars professional set of 3 .....95

712 Mars professional .....53, 94

716 Mars professional refill unit .....95

745 M2-9 Mars matic twin media drawing ink .....99

745 R Mars matic anti-clogging drawing ink .....99

745 Mars matic drawing ink .....99

746 C 100 Mars matic pen cleaner .....98

750 Mars matic spare drafting point .....96, 97

768N Lumocolor non-permanent omnichrom dry marker leadholder .....21

774 triplus micro mechanical pencil .....45

775 Mars micro mechanical pencil .....58

777 graphite 777 mechanical pencil .....60

779 graphite 779 mechanical pencil .....59

77N R52 Spare eraser for mechanical pencils .....59

77 R56 Spare eraser for triplus micro mechanical pencils .....45

780 C Mars technico leadholder .....61, 100

788 C Mars technico leadholder .....61

8

885 Poster colours .....91



### Head office

STAEDTLER Mars GmbH & Co. KG  
Manufacturers of writing and drawing instruments  
Moosaeckerstrasse 3  
90427 Nuernberg  
Germany  
eMail: [info@staedtler.de](mailto:info@staedtler.de)  
[www.staedtler.com](http://www.staedtler.com)



### Australia

STAEDTLER (Pacific) Pty. Ltd.  
1 Inman Road  
Dee Why NSW 2099  
Sydney  
eMail: [claforest@staedtler.com.au](mailto:claforest@staedtler.com.au)

### France

STAEDTLER (France) S.A.R.L.  
64, rue Ernest Renan  
92022 Nanterre Cedex  
eMail: [info@staedtler.fr](mailto:info@staedtler.fr)  
[www.staedtler.fr](http://www.staedtler.fr)

### Indonesia

P.T. STAEDTLER Indonesia  
Jalan Raya Serang Km. 80,  
Cimiung Serang  
Jawa Barat, Indonesia  
eMail: [staindo@cbn.net.id](mailto:staindo@cbn.net.id)

### Austria

STAEDTLER Schreib- und  
Zeichengeraeete-Vertriebs GmbH  
Puchgasse 10  
1222 Wien  
eMail: [info@at.staedtler.com](mailto:info@at.staedtler.com)  
[www.staedtler.at](http://www.staedtler.at)

### Germany

STAEDTLER Deutschland Vertriebs-GmbH  
Moosaeckerstrasse 3  
D-90427 Nuernberg  
eMail: [vertriebd@staedtler.de](mailto:vertriebd@staedtler.de)  
[www.staedtler.de](http://www.staedtler.de)

### Iran

STAEDTLER (Iran) pjsc  
27, Shahid Hossein Atefi St.  
Opp. Park Mellat  
Vali Asr Ave.  
Tehran 19679, Iran  
eMail: [info@staedtler.ir](mailto:info@staedtler.ir)  
[www.staedtler.ir](http://www.staedtler.ir)

### Benelux

STAEDTLER Benelux N.V./S.A.  
Pedro Colomalaan 9  
2880 Bornem, België  
eMail: [info@staedtler.be](mailto:info@staedtler.be)  
[www.staedtler.be](http://www.staedtler.be)

### Great Britain and Republic of Ireland

STAEDTLER (U.K.) LTD.  
Cowbridge Road  
Pontyclun  
Rhondda Cynon Taff CF72 8YJ  
eMail: [sales@uk.staedtler.com](mailto:sales@uk.staedtler.com)  
[www.staedtler.com](http://www.staedtler.com)

### Italy

STAEDTLER Italia S.p.A.  
Via Privata Archimede 5/7/9  
20094 Corsico/ Milano  
eMail: [informazioni@it.staedtler.com](mailto:informazioni@it.staedtler.com)  
[www.staedtler.it](http://www.staedtler.it)

### Canada

STAEDTLER-MARS LTD.  
5725 McLaughlin Road  
Mississauga, ON L5R 3K5 Toronto  
eMail: [info@staedtler.ca](mailto:info@staedtler.ca)  
[www.staedtler.ca](http://www.staedtler.ca)

### Hong Kong

STAEDTLER (HK) Ltd.  
Kwai Bo Ind. Bldg.  
40, Wong Chuk Hang Road.  
22nd Floor, Flat C&D  
Aberdeen, Hong Kong  
eMail: [info@staedtler.com.hk](mailto:info@staedtler.com.hk)

### Japan

STAEDTLER Nippon K.K.  
1-6-3, Iwamoto-cho  
Chiyoda-ku  
Tokyo, Japan  
eMail: [info@staedtler.co.jp](mailto:info@staedtler.co.jp)  
[www.staedtler.co.jp](http://www.staedtler.co.jp)

### Korea

STAEDTLER (Korea) Co. Ltd.  
1st Floor ASO Bldg.  
Yangjae-dong 103-5, Secho-Ku  
Seoul  
Korea 137-130  
eMail: webmaster@staedtler.co.kr  
www.staedtler.co.kr

### Malaysia

STAEDTLER (Malaysia) Berhad  
6/6A Jalan Kilan 9, Dato Onn Ind. Estate  
80350 Johore Bahru, Malaysia  
eMail: co@staedtler.com.my  
www.staedtler.com.my

### Mexico

STAEDTLER de Mexico, S.A. de C.V.  
Km. 3 de la Av. de las Partidas  
Carr. Lerma El Cerillo, Lote 6,  
Manzana 2  
Parque Industrial Cerillo II  
52000 Lerma de Villada,  
Estado de Mexico  
eMail: mmueller@staedtler.com.mx

### New Zealand

STAEDTLER (NZ) LTD.  
9, Ashfield Road, P.O. Box 100640  
North Shore Mail Centre  
Auckland  
eMail: wayne@staedtler.co.nz

### Philippines

Pecton Marcantile Inc.  
15 Gilmore Ave., Corner 1st St.  
New Manila, Quezon City  
Philippines 2800  
eMail: pecton@netasia.net

### Portugal

STAEDTLER Portuguesa, Lda.  
Rua de São Sebastião  
Lote 11, Pavilhão 1 – 2  
Cabra Figa, Albarraque  
2635-047 Rio de Mouro  
eMail: comercial@staedtler.pt  
www.staedtler.pt

### Singapore

STAEDTLER Singapore Pte. Ltd.  
17 Mandai Estate, #06-02A,  
Hwa Yew Industrial Building,  
Singapore 729934  
eMail: info@staedtler.com.sg

### South Africa

STAEDTLER (SA) (PTY) Ltd.  
Postnet Suite 31  
Private Bag X10010  
Edenvale, 1610  
eMail: sales@staedtler.co.za

### Spain

STAEDTLER Española, S.A.  
Comunicacions 12  
Polígono Industrial Agripina  
08755 Castellbisbal (Barcelona)  
eMail: sesa@staedtler.es  
www.staedtler.es

### Thailand

STAEDTLER (Thailand) Ltd.  
59 Soi Barbos 2  
Sukhumvit 42, Prakanong Klongtoey  
Bangkok 10110  
eMail: smtl@inet.co.th  
www.staedtler.co.th

### USA

STAEDTLER Inc.  
21900 Plummer Street  
Chatsworth, CA 91311-4001  
eMail: info@staedtler-usa.com  
www.staedtler-usa.com



