

Wboss®

Handle of Design

HANDLES & ACCESSORIES



Handles Perfection...





Büyükoğlu firmasının sektöre girişi 2007 yılında Pvc ve Alüminyum profil kapı ve pencere aksesuarları pazarlaması ile başlamıştır. 2010 yılında Wboss markasını oluşturarak, müşterilerine hizmet vermeye devam etmiştir. 2014 Yılında kendi üretim tesisini kurup, ürün kalitesini, müşteri memnuniyetine göre yükselterek yoluna devam etmiştir. Günümüzde 4000m2 kapalı alan fabrikasında dünya çapında kaliteli üretici firma olmanın sağlam adımlarını atmaya her zaman gelişim göstererek devam etmektedir. Sektörün genç üreticisi olmasını avantaja dönüştürerek, tüm üretim hattında modern makineler ve robotlar kullanarak kalitesini sektöre kabul ettirmiştir. Ürünlerin hammaddeden bitmiş ürün haline gelene kadar, imalatın her aşaması sıkı bir kalite kontrol kademesinden geçmektedir.

Araştırma-Geliştirme, Kalite-Yüksek Standart'ta Müşteri Memnuniyeti, Özveri-Sorumluluk ve Disiplin Büyükoğlu'nun vazgeçilmez ilkeleri olmuştur.

Buyukoglu enters to market with the marketing of accessories for Pvc and Aluminium profile window and doors in 2007. Established Wboss brand in 2010, and keep serving his customers with quality products. during 2014, Buyukoglu has established his own producing plant and improve the quality of products. Today, in a modern investment of 4000 m2 plant, keep producing and keep walking strongly to be one of the well known brands in the World on his own sector. From the raw material income to the finished product, all the steps are subject to strong quality control.

The R&O, Quality. Customer Satisfaction. Devotion, Responsibility, Discipline and respect is became basis principles of Buyukoglu.





Kapı Kolları
Door Handels

02 - 26

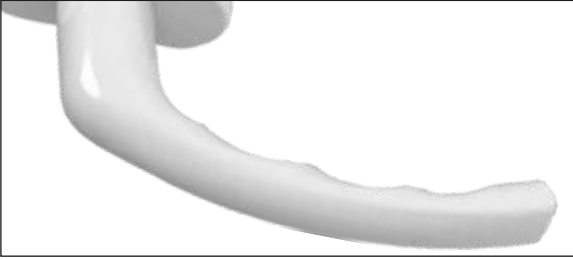

Pencere Kolları
Window Handels

28 - 36

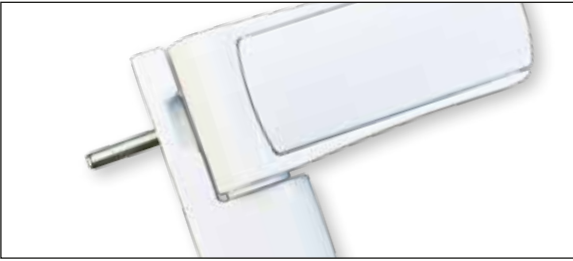

Menteşeler
Hinges

38 - 42



İspanyoletler
Espagnolettes

44 - 47



Kapı Sistemi
Door System

48 - 56



Aksesuarlar
Accessories

58 - 66



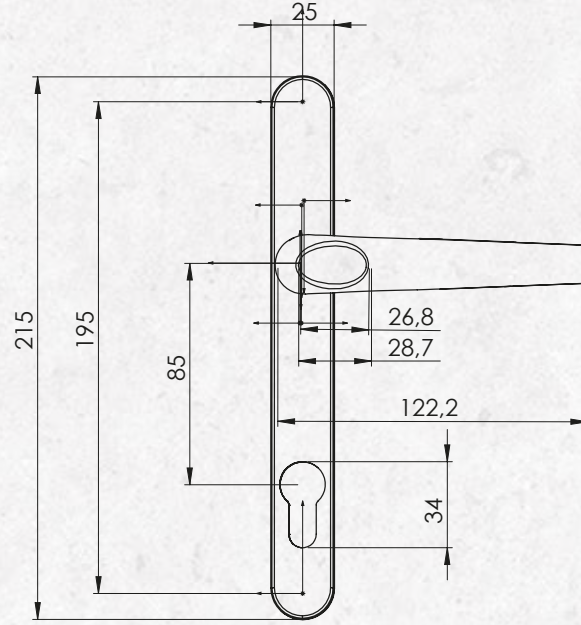

Ayna Tipleri / Plate Types

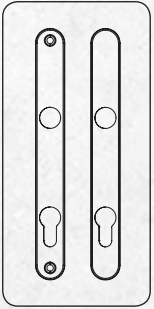

Silindirli
Cylindrical

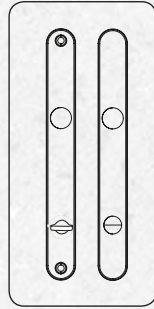



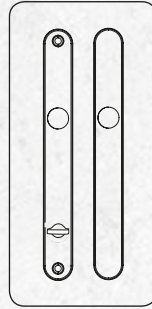



WC



Balkon
Balcony

Teknik Özellikler / Technical Specifications

Kod Code	Kilit Şekli Keyhole	Yay Spring	Merkez Mesafesi Axis Distance	A	B	Kare Square	Vida Boyu Screws Lenght (mm)		
22550		✓	25 / 85 mm	215	195	8*8	M5*70 M5*80 M5*90	2	40
22560		✓	25 / 92 mm						
22570		✓	25 / 90 mm						
22580		✓	25 / 85 mm						

Asos Serisi Alüminyum Yaylı Kapı Kolu Silindirli 25/85 mm

Asos Series Aluminium Door Handle with Spring, Cylindrical 25/85 mm



RAL 9016



RAL 8017



RAL 8022

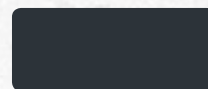

RAL 7016



RAL 8003



RAL 8019



RAL 9005



Gri / Grey

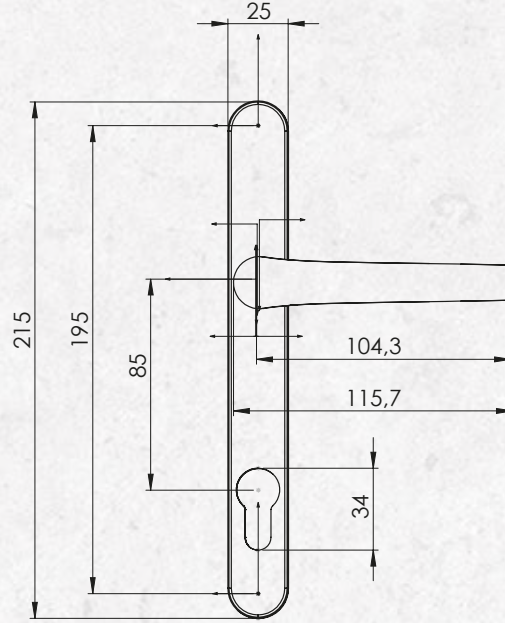

Ayna Tipleri / Plate Types

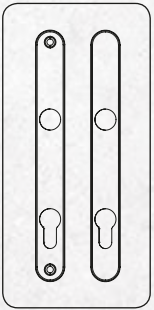

Silindirli
Cylindrical

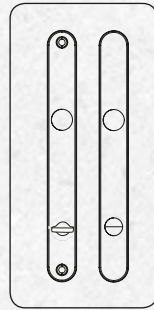



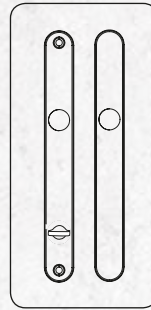



WC



Balkon
Balcony

Teknik Özellikler / Technical Specifications

Kod Code	Kilit Şekli Keyhole	Yay Spring	Merkez Mesafesi Axis Distance	A	B	Kare Square	Vida Boyu Screws Lenght (mm)		
32550		✓	25 / 85 mm	215	195	8*8	M5*70 M5*80 M5*90	2	40
32560		✓	25 / 92 mm						
32570		✓	25 / 90 mm						
32580		✓	25 / 85 mm						

Malta

Serisi / Series

wboss®
Handle of Design

MALTA Serisi Alüminyum Yaylı Kapı Kolu Silindirli 25/85 mm

MALTA Series Aluminium Door Handle with Spring, Cylindrical 25/85 mm



RAL 9016



RAL 8017



RAL 8022



RAL 7016



RAL 8003



RAL 8019



RAL 9005



Gri / Grey

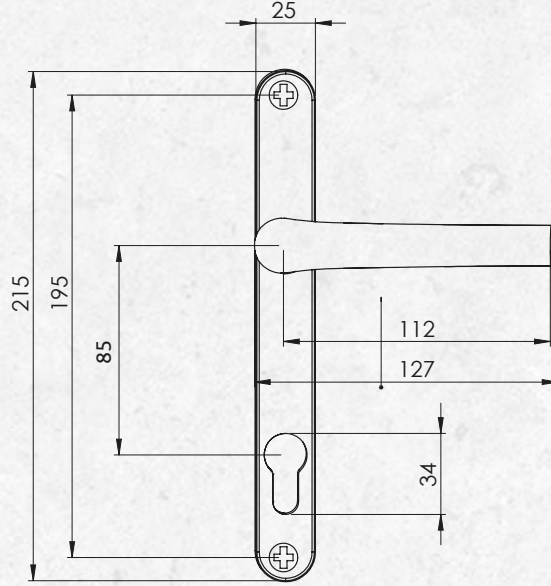

Ayna Tipleri / Plate Types

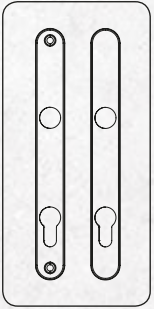

Silindirli
Cylindrical

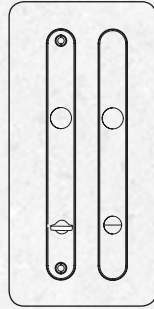



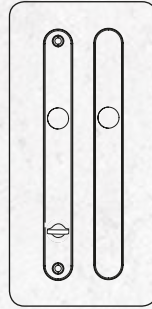



WC



Balkon
Balcony

Teknik Özellikler / Technical Specifications

Kod Code	Kilit Şekli Keyhole	Yay Spring	Merkez Mesafesi Axis Distance	A	B	Kare Square	Vida Boyu Screws Lenght (mm)		
42550		✓	25 / 85 mm	215	195	8*8	M5*70 M5*80 M5*90	2	40
42560		✓	25 / 92 mm						
42570		✓	25 / 90 mm						
42580		✓	25 / 85 mm						

Varna

Serisi / Series

wboss®
Handle of Design

Varna Serisi Alüminyum Yaylı Kapı Kolu Silindirli 25/85 mm

Varna Series Aluminium Door Handle with Spring, Cylindrical 25/85 mm

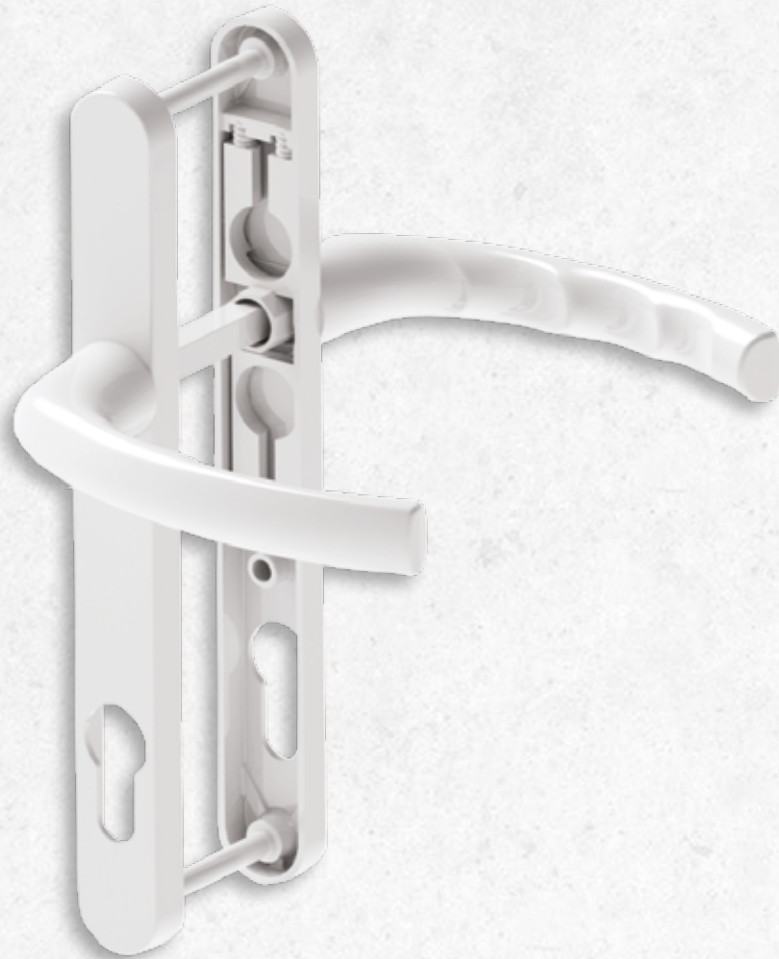

RAL 9016



RAL 8017



RAL 8022

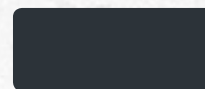

RAL 7016



RAL 8003



RAL 8019



RAL 9005



Gri / Grey

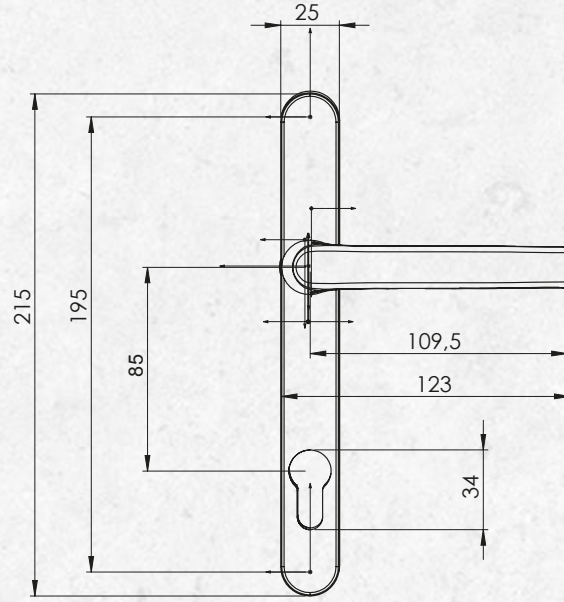

Ayna Tipleri / Plate Types

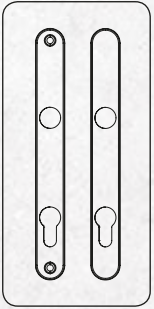

Silindirli
Cylindrical

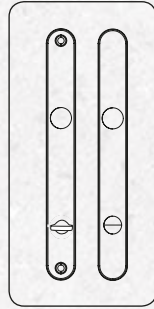



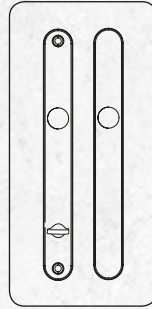



WC



Balkon
Balcony

Teknik Özellikler / Technical Specifications

Kod Code	Kilit Şekli Keyhole	Yay Spring	Merkez Mesafesi Axis Distance	A	B	Kare Square	Vida Boyu Screws Lenght (mm)		
52550		✓	25 / 85 mm	215	195	8*8	M5*70 M5*80 M5*90	2	40
52560		✓	25 / 92 mm						
52570		✓	25 / 90 mm						
52580		✓	25 / 85 mm						

Revma Serisi Alüminyum Yaylı Kapı Kolu Silindirli 25/85 mm

Revma Series Aluminium Door Handle with Spring, Cylindrical 25/85 mm



RAL 9016



RAL 8017



RAL 8022



RAL 7016



RAL 8003



RAL 8019



RAL 9005



Gri / Grey

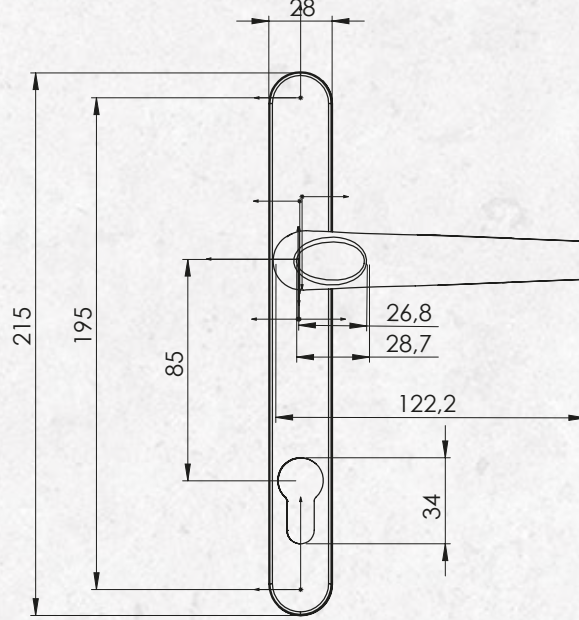

Ayna Tipleri / Plate Types

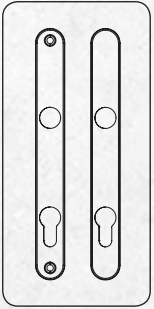

Silindirli
Cylindrical

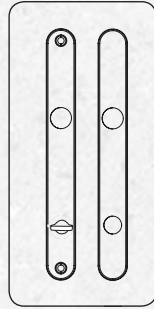



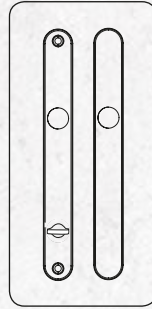



WC



Balkon
Balcony

Teknik Özellikler / Technical Specifications

Kod Code	Kilit Şekli Keyhole	Yay Spring	Merkez Mesafesi Axis Distance	A	B	Kare Square	Vida Boyu Screws Lenght (mm)		
22850		✓	28 / 85 mm	215	195	8*8	M5*70 M5*80 M5*90	2	40
22860		✓	28 / 92 mm						
22870		✓	28 / 90 mm						
22880		✓	28 / 85 mm						

Asos Serisi Alüminyum Yaylı Kapı Kolu Silindirli 28/85 mm

Asos Series Aluminium Door Handle with Spring, Cylindrical 28/85 mm



RAL 9016



RAL 8017



RAL 8022



RAL 7016



RAL 8003



RAL 8019



RAL 9005



Gri / Grey

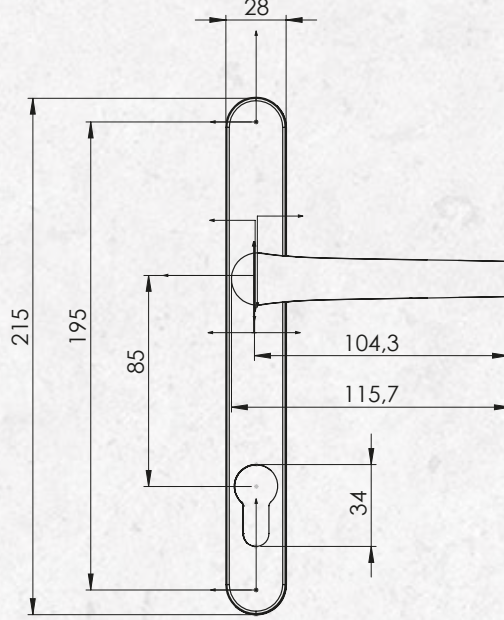

Ayna Tipleri / Plate Types

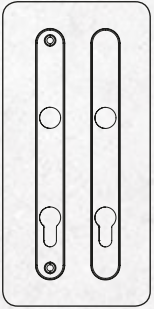

Silindirli
Cylindrical

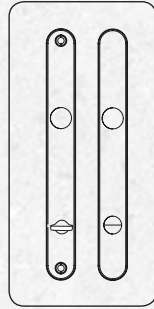



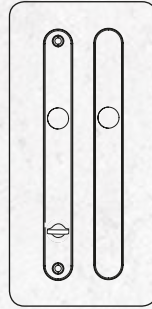



WC



Balkon
Balcony

Teknik Özellikler / Technical Specifications

Kod Code	Kilit Şekli Keyhole	Yay Spring	Merkez Mesafesi Axis Distance	A	B	Kare Square	Vida Boyu Screws Lenght (mm)		
32850		✓	28 / 85 mm	215	195	8*8	M5*70 M5*80 M5*90	2	40
32860		✓	28 / 92 mm						
32870		✓	28 / 90 mm						
32880		✓	28 / 85 mm						

Malta

Serisi / Series

wboss®
Handle of Design

MALTA Serisi Alüminyum Yaylı Kapı Kolu Silindirli 28/85 mm

MALTA Series Aluminium Door Handle with Spring, Cylindrical 28/85 mm



RAL 9016



RAL 8017



RAL 8022



RAL 7016



RAL 8003



RAL 8019



RAL 9005



Gri / Grey

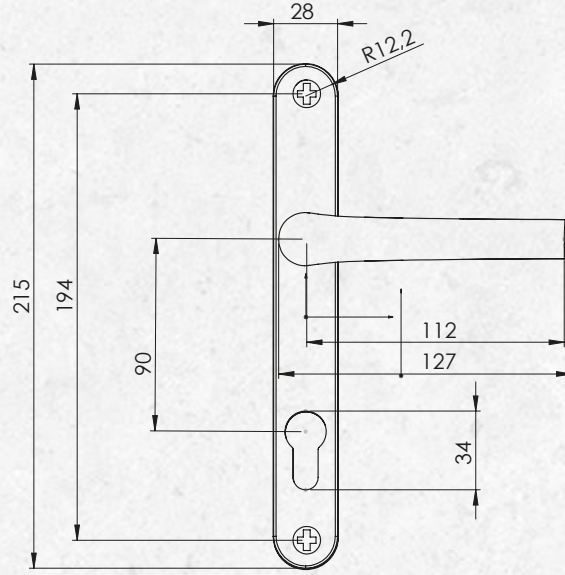

Ayna Tipleri / Plate Types

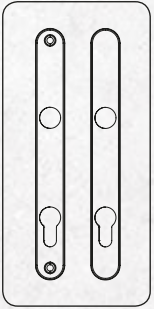

Silindirli
Cylindrical

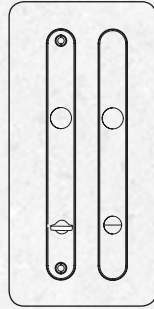



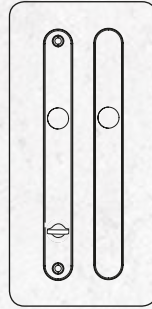



WC



Balkon
Balcony

Teknik Özellikler / Technical Specifications

Kod Code	Kilit Şekli Keyhole	Yay Spring	Merkez Mesafesi Axis Distance	A	B	Kare Square	Vida Boyu Screws Lenght (mm)		
42850		✓	28 / 85 mm	215	195	8*8	M5*70 M5*80 M5*90	2	40
42860		✓	28 / 92 mm						
42870		✓	28 / 90 mm						
42880		✓	28 / 85 mm						

Varna

Serisi / Series

Wboss®
Handle of Design

Varna Serisi Alüminyum Yaylı Kapı Kolu Silindirli 28/85 mm

Varna Series Aluminium Door Handle with Spring, Cylindrical 28/85 mm



RAL 9016



RAL 8017



RAL 8022



RAL 7016



RAL 8003



RAL 8019



RAL 9005



Gri / Grey

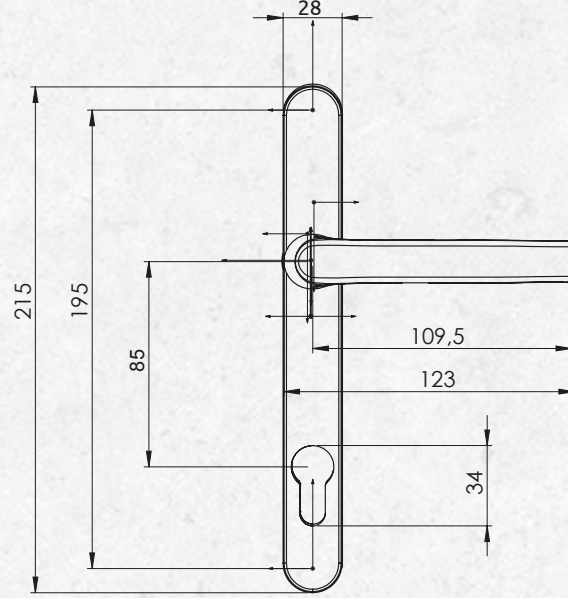

Ayna Tipleri / Plate Types

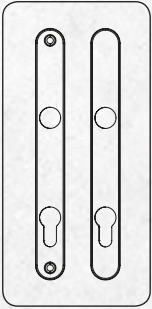

Silindirli
Cylindrical

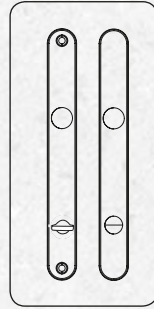



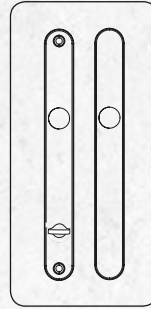



WC



Balkon
Balcony

Teknik Özellikler / Technical Specifications

Kod Code	Kilit Şekli Keyhole	Yay Spring	Merkez Mesafesi Axis Distance	A	B	Kare Square	Vida Boyu Screws Lenght (mm)		
52850		✓	28 / 85 mm	215	195	8*8	M5*70 M5*80 M5*90	2	40
52860		✓	28 / 92 mm						
52870		✓	28 / 90 mm						
52880		✓	28 / 85 mm						

Revma Serisi Alüminyum Yaylı Kapı Kolu Silindirli 28/85 mm

Revma Series Aluminium Door Handle with Spring, Cylindrical 28/85 mm

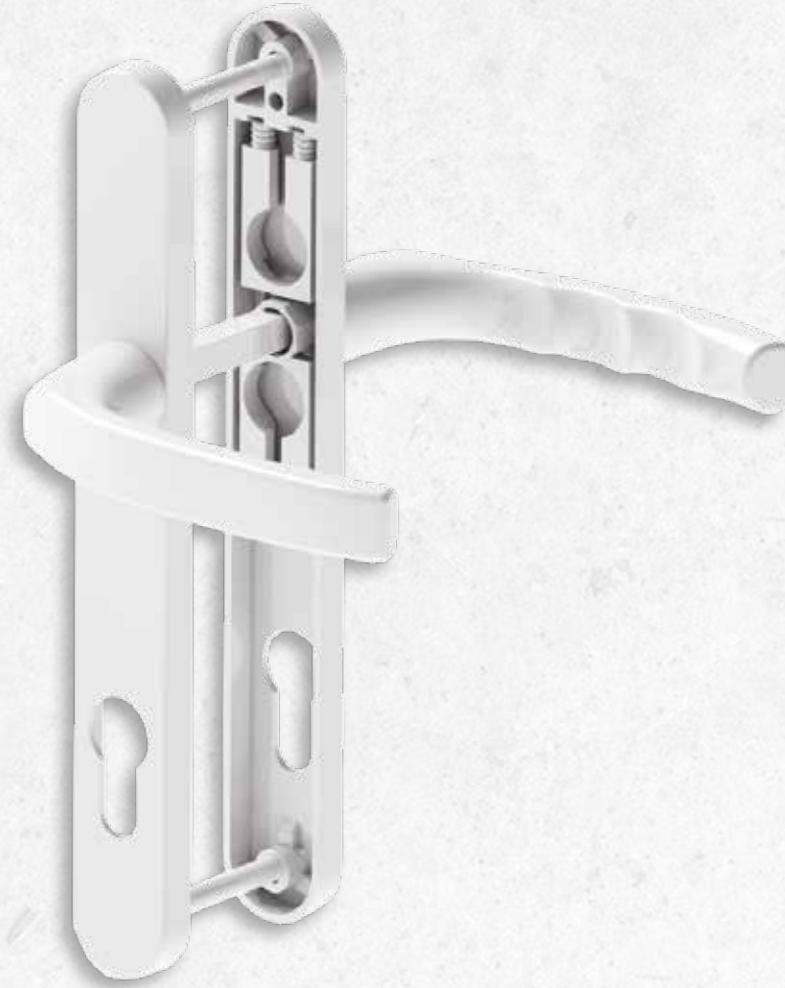

RAL 9016



RAL 8017



RAL 8022



RAL 7016



RAL 8003



RAL 8019



RAL 9005



Gri / Grey

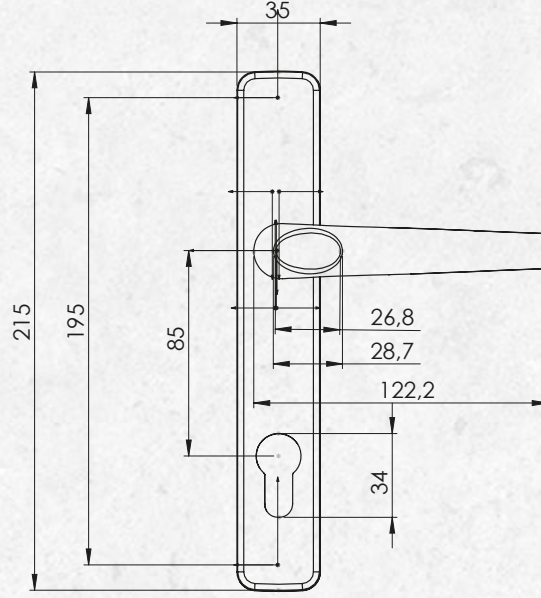

Ayna Tipleri / Plate Types

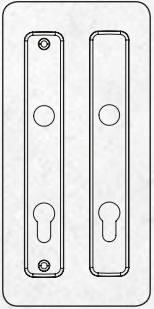

Silindirli
Cylindrical

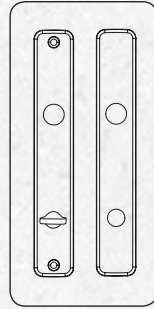

WC

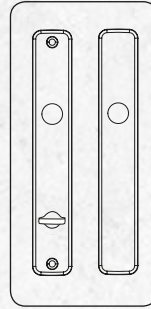



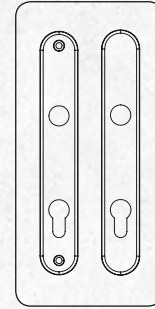



Balkon
Balcony



***Oval Seçenek**
Round Option

Teknik Özellikler / Technical Specifications

Kod Code	Kilit Şekli Keyhole	Yay Spring	Merkez Mesafesi Axis Distance	A	B	Kare Square	Vida Boyu Screws Lenght (mm)		
23550		✓	35 / 85 mm	215	195	8*8	M5*70 M5*80 M5*90	2	40
23560		✓	35 / 92 mm						
23570		✓	35 / 90 mm						
23580		✓	35 / 85 mm						

Asos Serisi Alüminyum Yaylı Kapı Kolu Silindirli 35/85 mm

Asos Series Aluminium Door Handle with Spring, Cylindrical 35/85 mm



RAL 9016



RAL 8017



RAL 8022



RAL 7016



RAL 8003



RAL 8019



RAL 9005



Gri / Grey

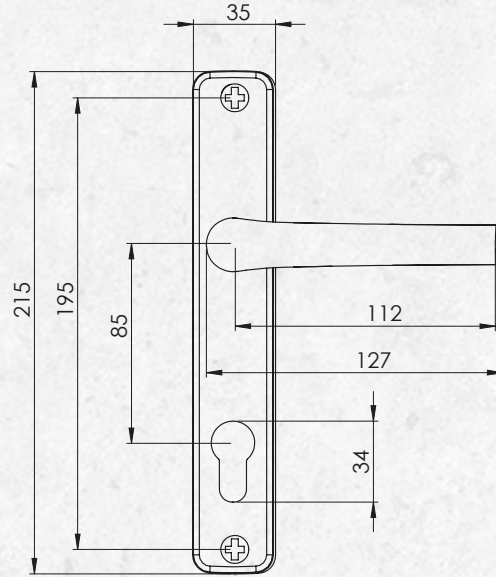

Ayna Tipleri / Plate Types

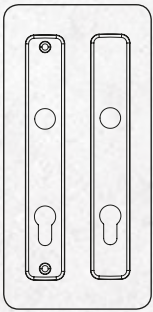

Silindirli
Cylindrical

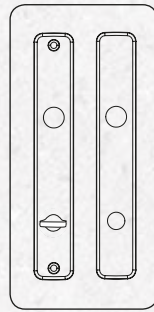

WC

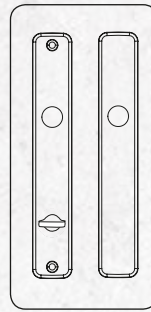



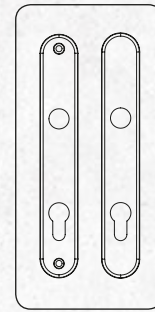



Balkon
Balcony



***Oval Seçenek**
Round Option

Teknik Özellikler / Technical Specifications

Kod Code	Kilit Şekli Keyhole	Yay Spring	Merkez Mesafesi Axis Distance	A	B	Kare Square	Vida Boyu Screws Lenght (mm)		
33550		✓	35 / 85 mm	215	195	8*8	M5*70 M5*80 M5*90	2	40
33560		✓	35 / 92 mm						
33570		✓	35 / 90 mm						
33580		✓	35 / 85 mm						

MALTA Serisi Alüminyum Yaylı Kapı Kolu Silindirli 35/85 mm

MALTA Series Aluminium Door Handle with Spring, Cylindrical 35/85 mm



RAL 9016



RAL 8017



RAL 8022



RAL 7016



RAL 8003



RAL 8019



RAL 9005



Gri / Grey

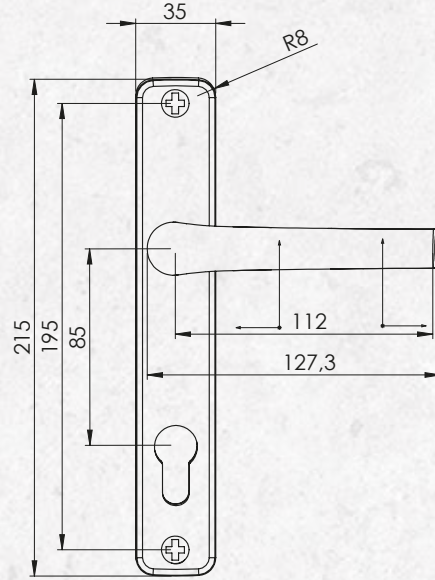

Ayna Tipleri / Plate Types

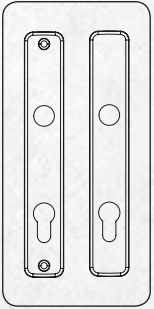

Silindirli
Cylindrical

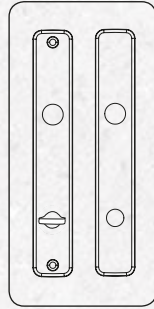

WC

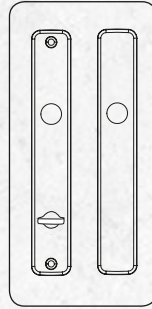



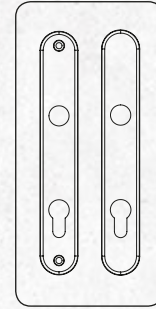



Balkon
Balcony



***Oval Seçenek**
Round Option

Teknik Özellikler / Technical Specifications

Kod Code	Kilit Şekli Keyhole	Yay Spring	Merkez Mesafesi Axis Distance	A	B	Kare Square	Vida Boyu Screws Lenght (mm)		
43550		✓	35 / 85 mm	215	195	8*8	M5*70 M5*80 M5*90	2	40
43560		✓	35 / 92 mm						
43570		✓	35 / 90 mm						
43580		✓	35 / 85 mm						

Varna

Serisi / Series

Wboss®
Handle of Design

Varna Serisi Alüminyum Yaylı Kapı Kolu Silindirli 35/85 mm

Varna Series Aluminium Door Handle with Spring, Cylindrical 35/85 mm



RAL 9016



RAL 8017



RAL 8022



RAL 7016



RAL 8003



RAL 8019



RAL 9005



Gri / Grey

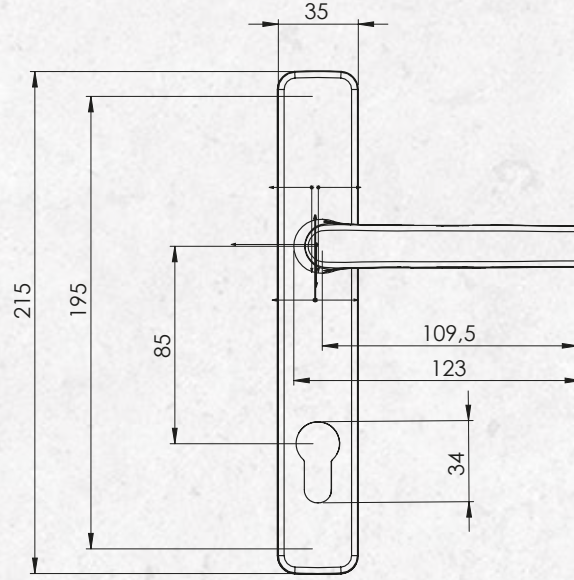

Ayna Tipleri / Plate Types

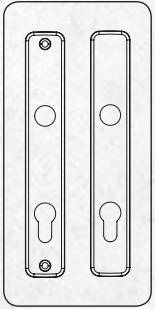

Silindirli
Cylindrical

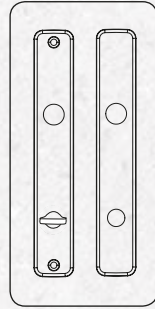

WC

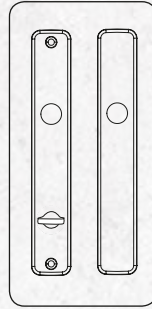



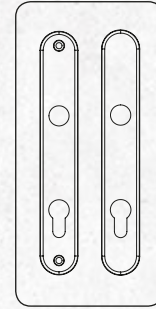



Balkon
Balcony



***Oval Seçenek**
Round Option

Teknik Özellikler / Technical Specifications

Kod Code	Kilit Şekli Keyhole	Yay Spring	Merkez Mesafesi Axis Distance	A	B	Kare Square	Vida Boyu Screws Lenght (mm)		
53550		✓	35 / 85 mm	215	195	8*8	M5*70 M5*80 M5*90	2	40
53560		✓	35 / 92 mm						
53570		✓	35 / 90 mm						
53580		✓	35 / 85 mm						

Revma Serisi Alüminyum Yaylı Kapı Kolu Silindirli 35/85 mm

Revma Series Aluminium Door Handle with Spring, Cylindrical 35/85 mm



RAL 9016



RAL 8017



RAL 8022



RAL 7016



RAL 8003



RAL 8019



RAL 9005



Gri / Grey

Çekme Model Alüminyum Yaylı Kapı Kolu Silindirli 35/85 mm

Pull Type Aluminium Door Handle with Spring, Cylindrical 35/85 mm

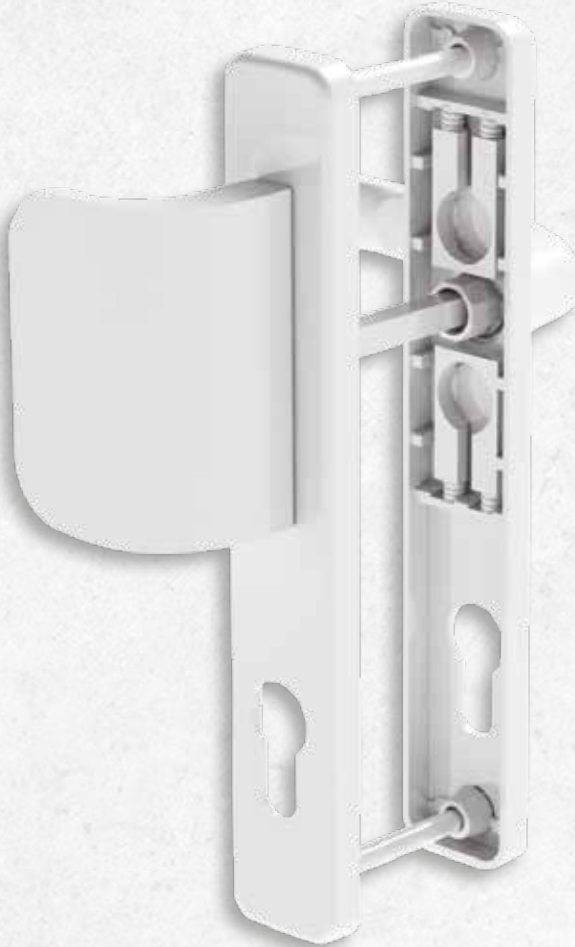

RAL 9016



RAL 8003



RAL 8017



RAL 8019







RAL 8022



RAL 9005



Teknik Özellikler / Technical Specifications

Kod Code	Kilit Şekli Keyhole	Yay Spring	Merkez Mesafesi Axis Distance	A	B	Kare Square	Vida Boyu Screws Length (mm)		
53550C		✓	35 / 85 mm	215	195	8*8	M5*70 M5*80 M5*90	2	40
53560C		✓	35 / 92 mm						

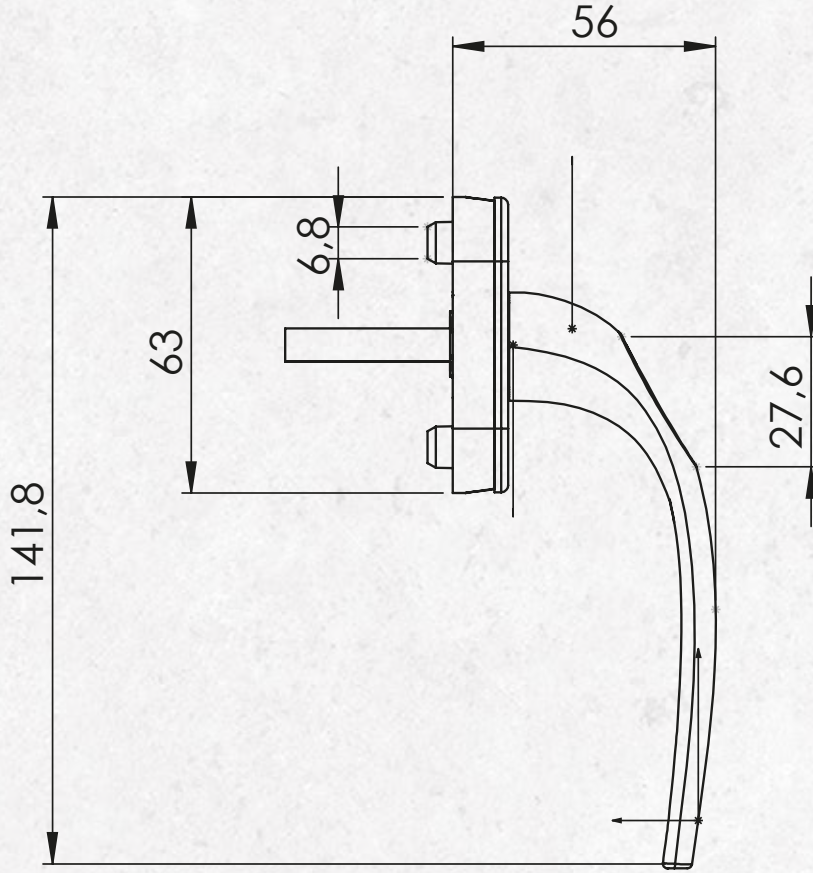



Teknik Özellikler / Technical Specifications

Kod Code	Demir Uzunluk Iron Bar	Kare Square	Vida Boyu Screws Lenght (mm)	Kilit Pozisyonu Locking Position		
20010	33/35	7*7	M5*40 M5*45	45° 90° 180°	2	100
20020	38/40					
20080	40/45 45/52					

Asos Serisi Alüminyum Pencere Kolu

Asos Series Aluminium Window Handle



RAL 9016



RAL 8017



RAL 8022



RAL 7016



RAL 8003



RAL 8019





RAL 9005

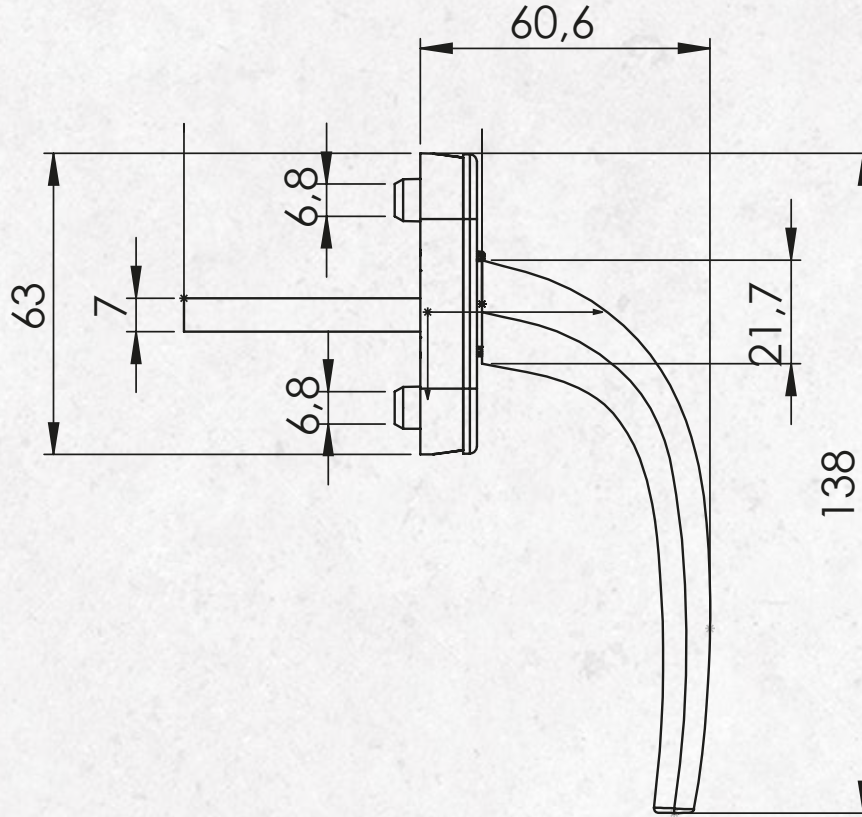

Gri / Grey



Teknik Özellikler / Technical Specifications

Kod Code	Demir Uzunluk Iron Bar	Kare Square	Vida Boyu Screws Lenght (mm)	Kilit Pozisyonu Locking Position		
30010	33/35	7*7	M5*40 M5*45	45° 90° 180°	2	100
30020	38/40					
30080	40/45 45/52					

Malta Serisi Alüminyum Pencere Kolu

Malta Series Aluminium Window Handle



RAL 9016



RAL 8017



RAL 8022



RAL 7016



RAL 8003



RAL 8019





RAL 9005

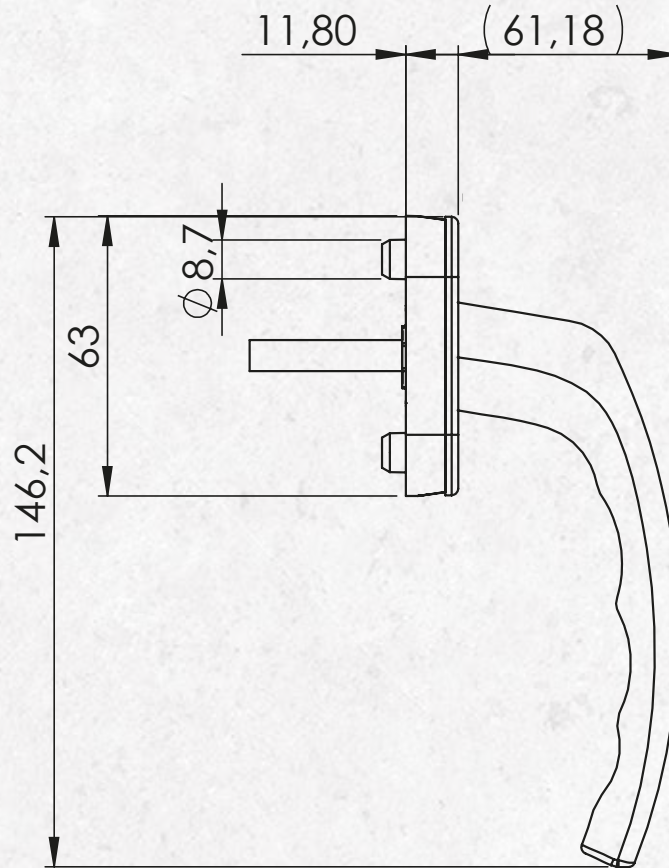

Gri / Grey



Teknik Özellikler / Technical Specifications

Kod Code	Demir Uzunluk Iron Bar	Kare Square	Vida Boyu Screws Lenght (mm)	Kilit Pozisyonu Locking Position		
40010	33/35	7*7	M5*40 M5*45	45° 90° 180°	2	100
40020	38/40					
40080	40/45 45/52					

Varna Serisi Alüminyum Pencere Kolu

Varna Series Aluminium Window Handle



RAL 9016



RAL 8017



RAL 8022



RAL 7016



RAL 8003



RAL 8019



RAL 9005



Gri / Grey

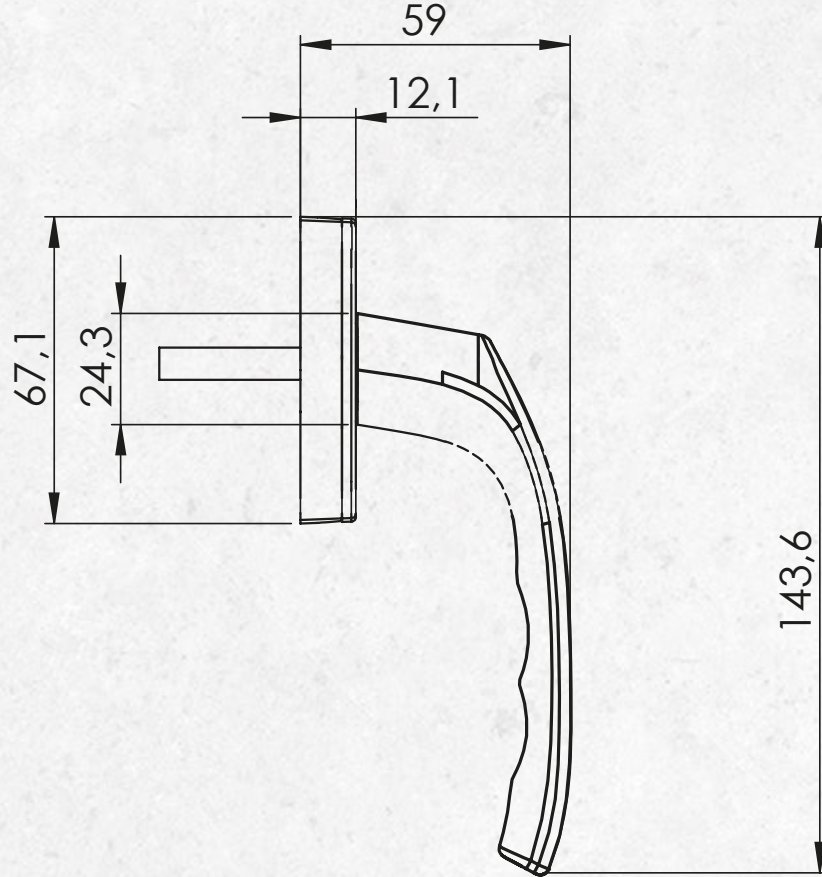

Teknik Özellikler / Technical Specifications

Kod Code	Demir Uzunluk Iron Bar	Kare Square	Vida Boyu Screws Lenght (mm)	Kilit Pozisyonu Locking Position		
50010	33/35	7*7	M5*40 M5*45	45° 90° 180°	2	100
50020	38/40					
50080	40/45 45/52					

Revma Serisi Alüminyum Pencere Kolu

Revma Series Aluminium Window Handle



RAL 9016



RAL 8017



RAL 8022



RAL 7016



RAL 8003



RAL 8019



RAL 9005



Gri / Grey

Plastik Pencere Kolu

Plastic Window Handle



RAL 9016



RAL 8003



RAL 8017



RAL 8019





RAL 8022



RAL 9005

Teknik Özellikler / Technical Specifications

Kod Code	Demir Uzunluk Iron Bar	Kare Square	Vida Boyu Screws Lenght (mm)	Kilit Pozisyonu Locking Position		
PPK-01	33/35 38/40 40/45 45/52	7*7	M5*40 M5*45	45° 90° 180°	2	200



Menteşe

Hinge

wboss®
Handle of Design

75 mm Zamak Mentese

75 mm Zinc Hinge

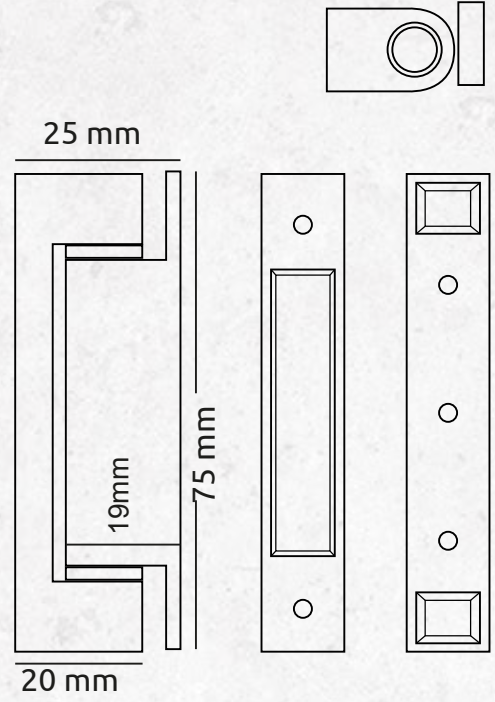

Teknik Özellikler Technical Specifications

Kod Code	Uzunluk (mm) Length	
HN-75-01	75	200



RAL 9016



RAL 8017



RAL 8022



RAL 7016



RAL 8003



RAL 8019



RAL 9005



Gri / Grey

Menteşe

Hinge

wboss®
Handle of Design

95 mm Zamak Mentese

95 mm Zinc Hinge

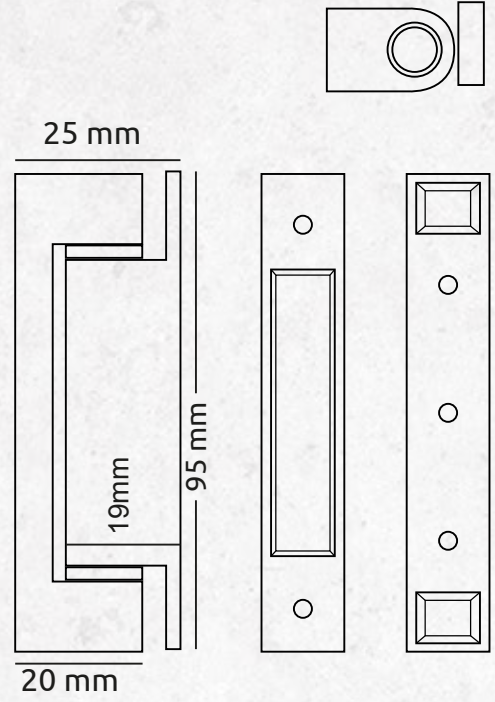

Teknik Özellikler Technical Specifications

Kod Code	Uzunluk (mm) Length	
HN-95-01	95	150



RAL 9016



RAL 8017



RAL 8022



RAL 7016



RAL 8003



RAL 8019



RAL 9005



Gri / Grey

100 mm Zamak Mentese

100 mm Zinc Hinge

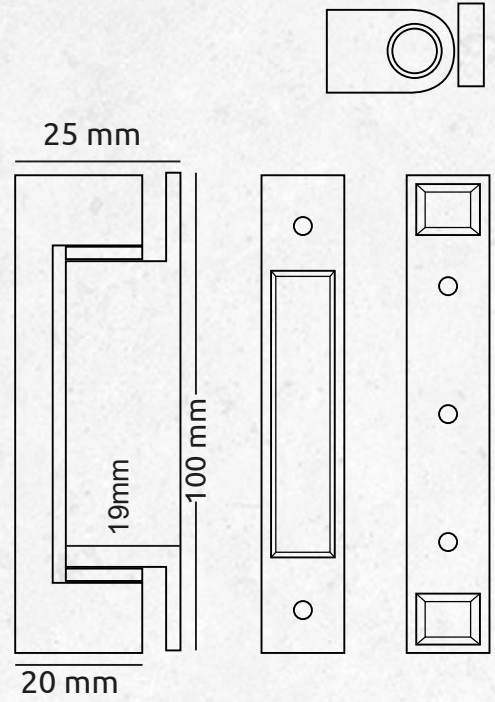

Teknik Özellikler Technical Specifications

Kod Code	Uzunluk (mm) Length	
HN-100-01	100	150



RAL 9016



RAL 8017



RAL 8022



RAL 7016



RAL 8003



RAL 8019



RAL 9005



Gri / Grey

Menteşe

Hinge

90 mm Plastik Mentеше

90 mm Plastic Hinge

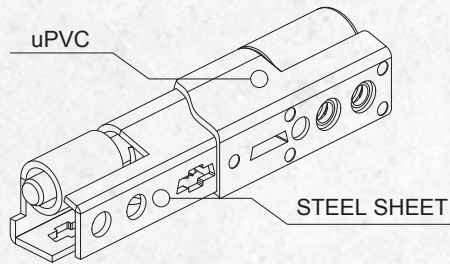
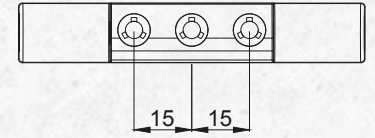
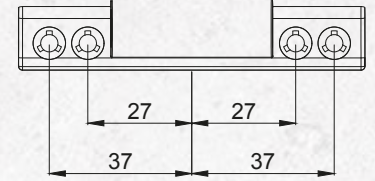
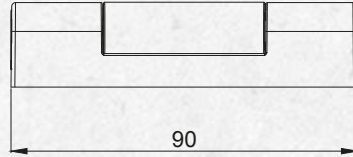

Teknik Özellikler Technical Specifications

Kod Code	Uzunluk (mm) Length	
HN-90-01	90	150



RAL 9016



RAL 8017



RAL 8022



RAL 7016



RAL 8003



RAL 8019



RAL 9005



Gri / Grey

Menteşe

Hinge

Wboss®
Handle of Design

3D Alüminyum Ayarlı Kapı Mentese

3D Aluminium Adjustable Door Hinge

Winboss®

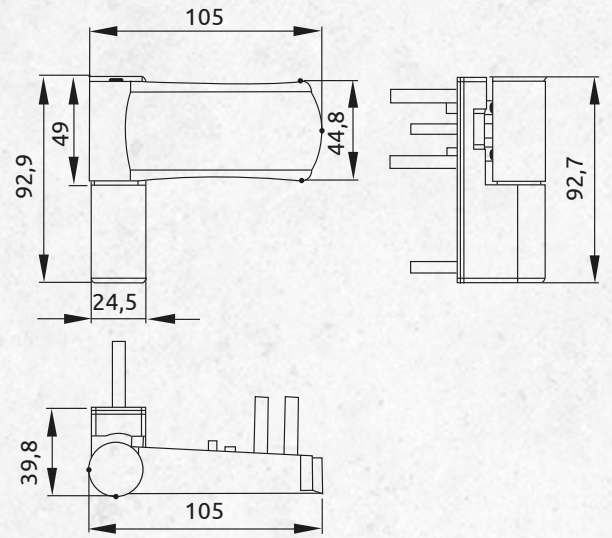
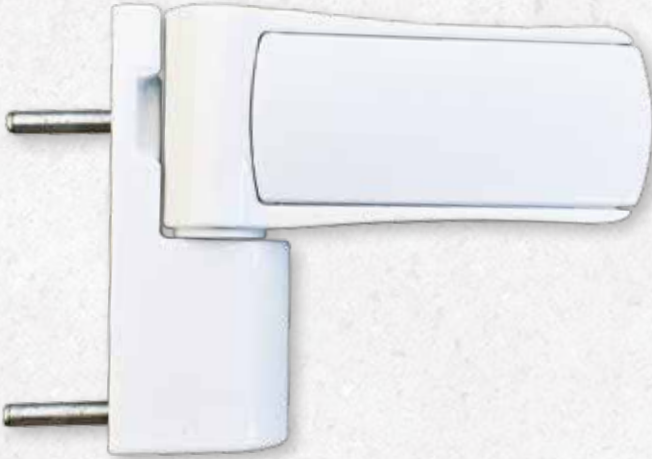

Teknik Özellikler Technical Specifications

Kod Code	Kapak Cover	
WN-01	Alüminyum Aluminium	24
WNZ-01	Zamak Zinc	24



RAL 9016



RAL 8017



RAL 8022



RAL 7016



RAL 8003



RAL 8019



RAL 9005



Gri / Grey

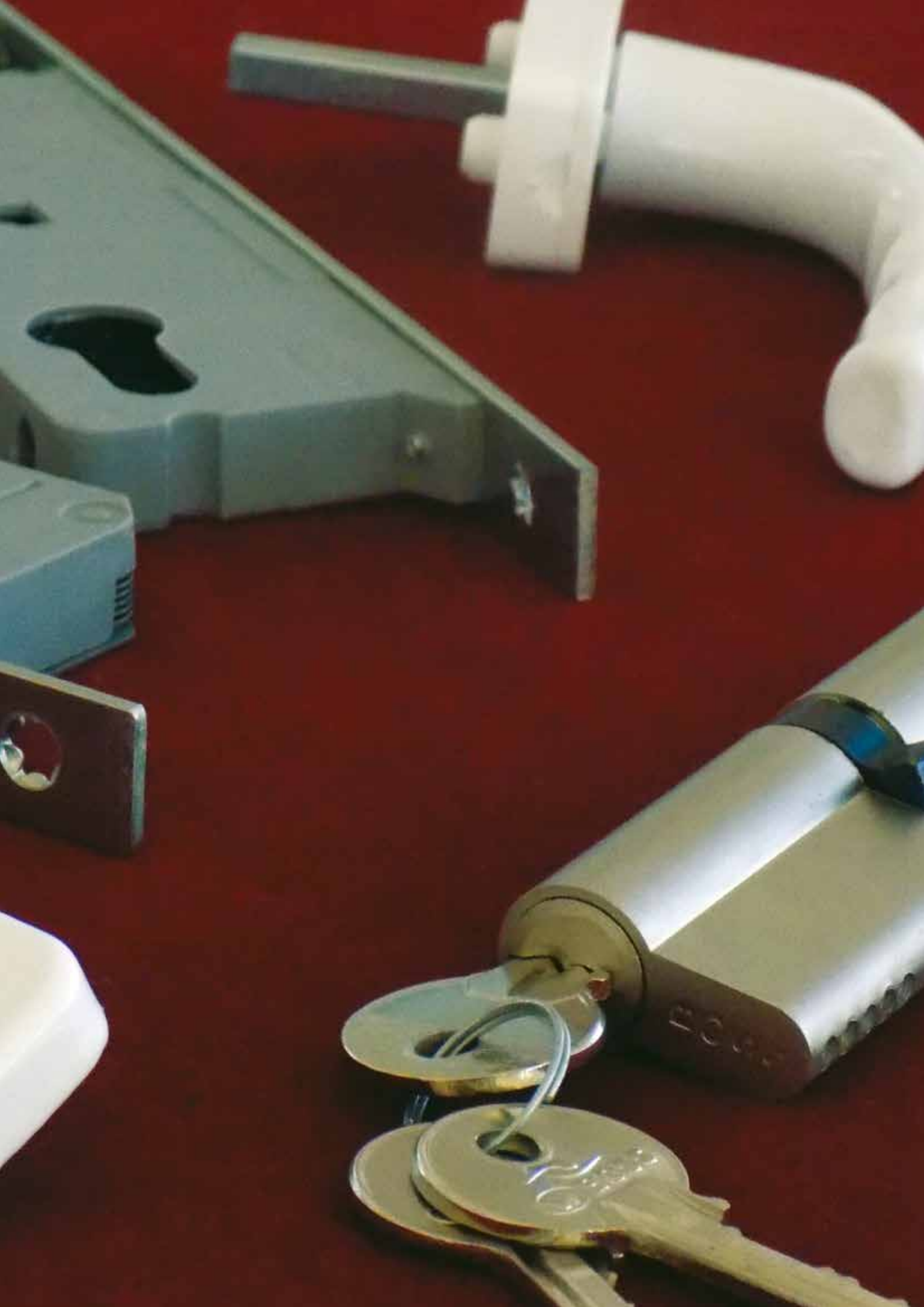

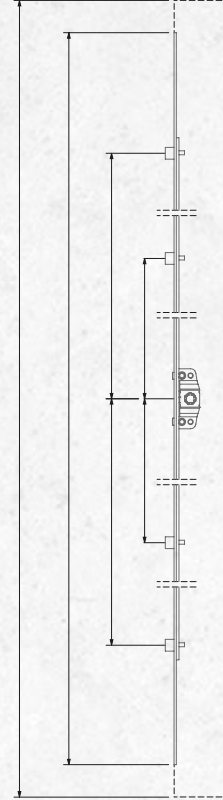

Tek Açılım İspanyolet Sac Göbek

Side hung espagnolette steel body



Teknik Özellikler

Technical Specifications

Kod Code	Uzunluk Length (mm)	Merkez Center (mm)		
ESC 15-01	300	15	2	40
ESC 15-02	400	15	2	40
ESC 15-03	600	15	2	40
ESC 15-04	800	15	2	40
ESC 15-05	1000	15	3	40
ESC 15-06	1200	15	3	40
ESC 15-07	1400	15	4	20
ESC 15-08	1600	15	4	20
ESC 15-09	1800	15	4	20
ESC 15-10	2000	15	4	20
ESC 15-11	2200	15	4	20

Tek Açılım İspanyolet Zamak Göbek

Side hung espagnolette zinc body

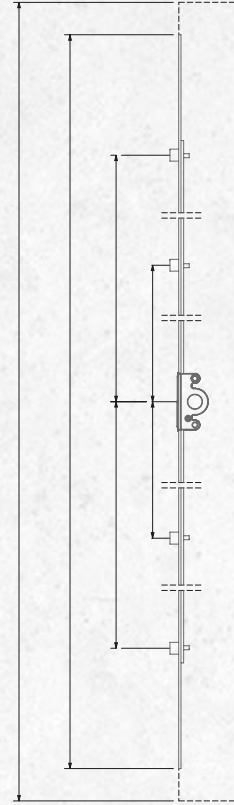

Teknik Özellikler *Technical Specifications*

Kod Code	Uzunluk Length (mm)	Merkez Center (mm)		
EZC 15-01	300	15	2	40
EZC 15-02	400	15	2	40
EZC 15-03	600	15	2	40
EZC 15-04	800	15	2	40
EZC 15-05	1000	15	3	40
EZC 15-06	1200	15	3	40
EZC 15-07	1400	15	4	20
EZC 15-08	1600	15	4	20
EZC 15-09	1800	15	4	20
EZC 15-10	2000	15	4	20
EZC 15-11	2200	15	4	20

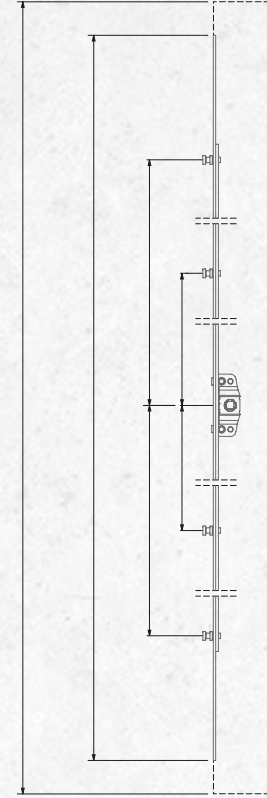

Tek Açılım Sürme İspanyolet Sac Göbek

Side hung sliding espagnolette steel body



Teknik Özellikler

Technical Specifications

Kod Code	Uzunluk Length (mm)	Merkez Center (mm)		
ESC 15-01 S	300	15	2	40
ESC 15-02 S	400	15	2	40
ESC 15-03 S	600	15	2	40
ESC 15-04 S	800	15	2	40
ESC 15-05 S	1000	15	3	40
ESC 15-06 S	1200	15	3	40
ESC 15-07 S	1400	15	4	20
ESC 15-08 S	1600	15	4	20
ESC 15-09 S	1800	15	4	20
ESC 15-10 S	2000	15	4	20
ESC 15-11 S	2200	15	4	20

Tek Açılım Sürme İspanyolet Zamak Göbek

Side hung sliding espagnolette zinc body

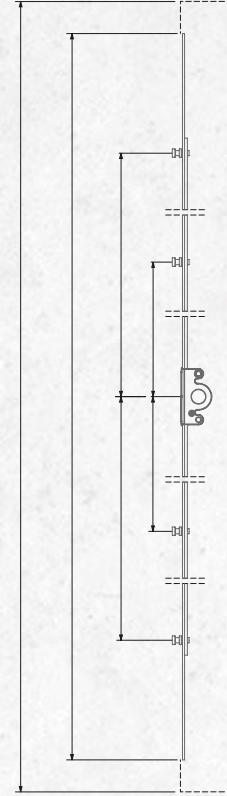

Teknik Özellikler

Technical Specifications



Kod Code	Uzunluk Length (mm)	Merkez Center (mm)		
EZC 15-01 S	300	15	2	40
EZC 15-02 S	400	15	2	40
EZC 15-03 S	600	15	2	40
EZC 15-04 S	800	15	2	40
EZC 15-05 S	1000	15	3	40
EZC 15-06 S	1200	15	3	40
EZC 15-07 S	1400	15	4	20
EZC 15-08 S	1600	15	4	20
EZC 15-09 S	1800	15	4	20
EZC 15-10 S	2000	15	4	20
EZC 15-11 S	2200	15	4	20

Kilitli Kapı İspanyoleti

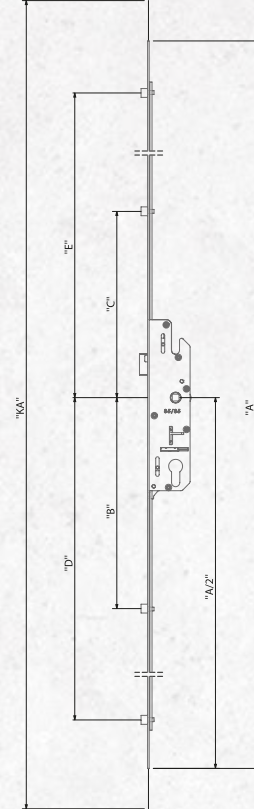
Lockable Door Espagnolette



Teknik Özellikler / Technical Specifications

Kod Code	Uzunluk Length (mm)	A	B		
KKI 25-160	1600	25	85	4	20
KKI 25-180	1800		85	4	20
KKI 25-200	2000		85	4	20
KKI 25-92-160	1600		92	4	20
KKI 25-92-180	1800		92	4	20
KKI 25-92-200	2000		92	4	20
KKI 35-160	1600	35	85	4	20
KKI 35-180	1800		85	4	20
KKI 35-200	2000		85	4	20
KKI 35-92-160	1600		92	4	20
KKI 35-92-180	1800		92	4	20
KKI 35-92-200	2000		92	4	20

Kapı Sistemi

Door System



wboss®
Handle of Design

Kilitli Kapı İspanyoleti Çift Dilli

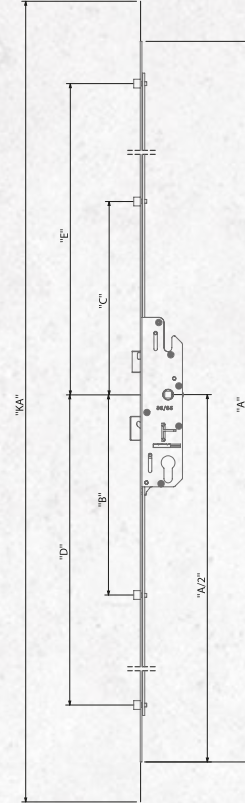
Lockable Door Espagnolette with latch



Teknik Özellikler / Technical Specifications

Kod Code	Uzunluk (mm) Length	A	B		
KKI 25-160 CD	1600	25	85	4	20
KKI 25-180 CD	1800		85	4	20
KKI 25-200 CD	2000		85	4	20
KKI 25-92-160 CD	1600		92	4	20
KKI 25-92-180 CD	1800		92	4	20
KKI 25-92-200 CD	2000		92	4	20
KKI 35-160 CD	1600	35	85	4	20
KKI 35-180 CD	1800		85	4	20
KKI 35-200 CD	2000		85	4	20
KKI 35-92-160 CD	1600		92	4	20
KKI 35-92-180 CD	1800		92	4	20
KKI 35-92-200 CD	2000		92	4	20

Kapı Kilidi

Door Lock

wboss®
Handle of Design

PVC Kapı Kilidi Silindirli Metal Gövde

PVC Door Lock Cylindrical Metal Body

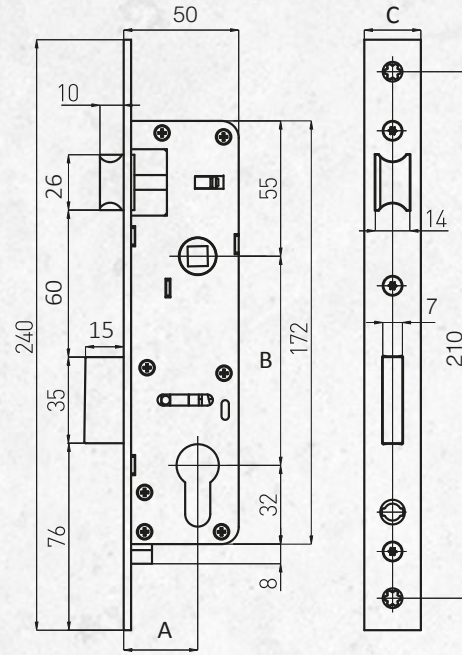

Teknik Özellikler

Technical Specifications

Kod Code	A	B	C	
PVC 20-85M	20	85	16	30
PVC 25-85M	25	85	16	30
PVC 30-85M	30	85	16	30
PVC 35-85M	35	85	16	30

Kapı Kilidi

Door Lock

wboss®
Handle of Design

PVC Kapı Kilidi WC Metal Gövde

PVC Door Lock WC Metal Body

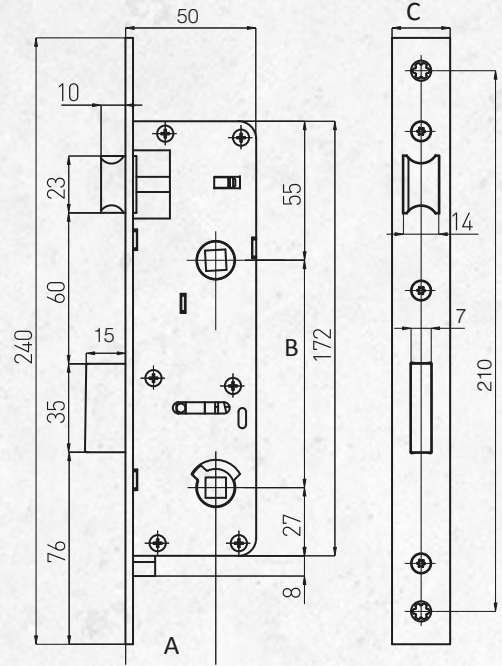

Teknik Özellikler

Technical Specifications

Kod Code	A	B	C	
WC-20M	20	90	16	30
WC-25M	25	90	16	30
WC-30M	30	90	16	30
WC-35M	35	90	16	30

Kapı Kilidi

Door Lock

wboss®
Handle of Design

PVC Kapı Kilidi Silindirli 35/85 mm

PVC Door Lock Cylindrical 35/85 mm

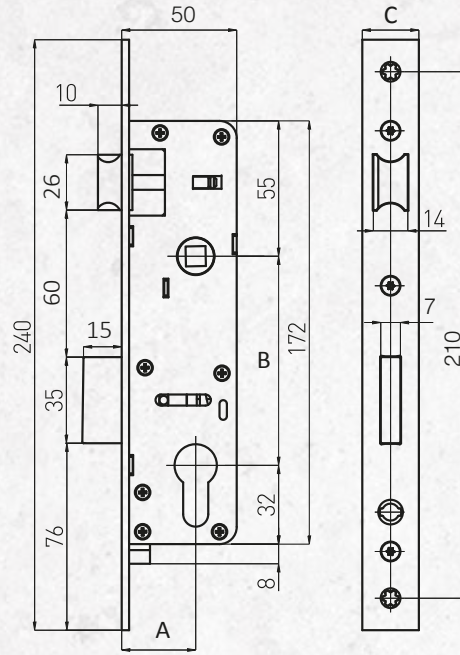

Teknik Özellikler

Technical Specifications

Kod Code	A	B	C	
PVC 35-85	35	85	16	40

Kapı Kilidi

Door Lock

wboss®
Handle of Design

PVC Kapı Kilidi WC 35/90 mm

PVC Door Lock WC 35/90 mm

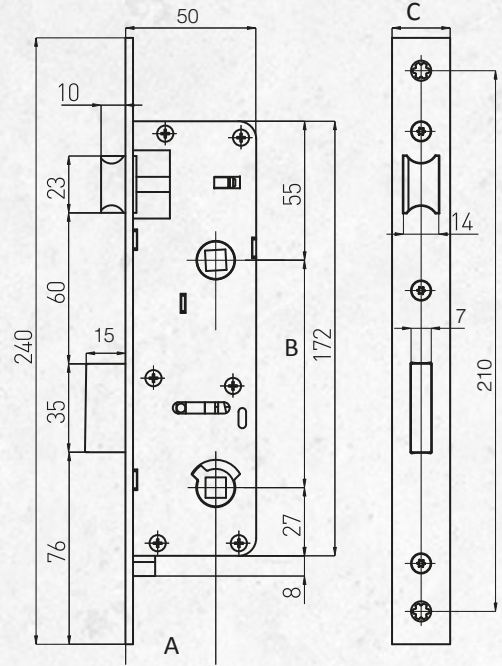

Teknik Özellikler Technical Specifications

Kod Code	A	B	C	
WC-35	35	90	16	40

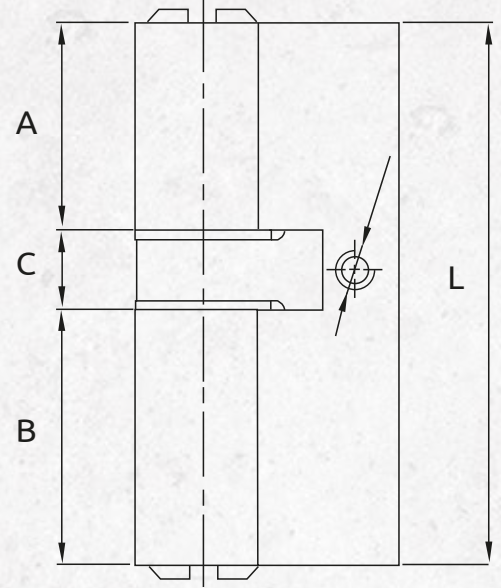

Pirinç Barel

Brass Cylinder



Teknik Özellikler

Technical Specifications

Kod Code	L	A	B	C			
BB 001	68	26	32	10	1	3	96
BB 002	83	35	38	10	1	3	96
BB 003	90	35	45	10	1	3	96
BB 004	100	40	50	10	1	3	96

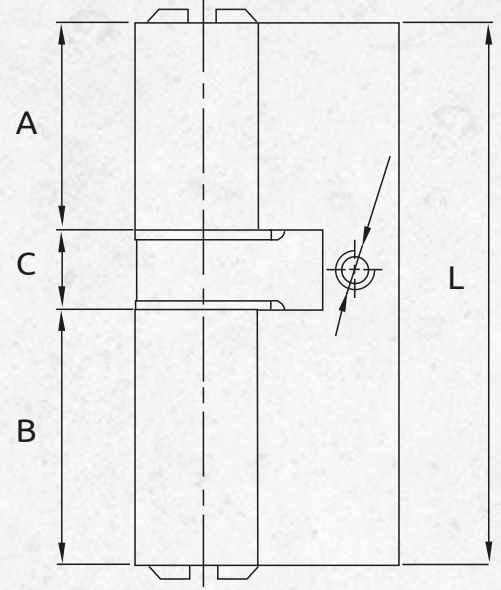

Zamak Barel

Zinc Cylinder



Teknik Özellikler

Technical Specifications

Kod Code	L	A	B	C			
BZ 001	68	26	32	10	1	3	120
BZ 002	83	35	38	10	1	3	120
BZ 003	90	35	45	10	1	3	120
BZ 004	100	40	50	10	1	3	120

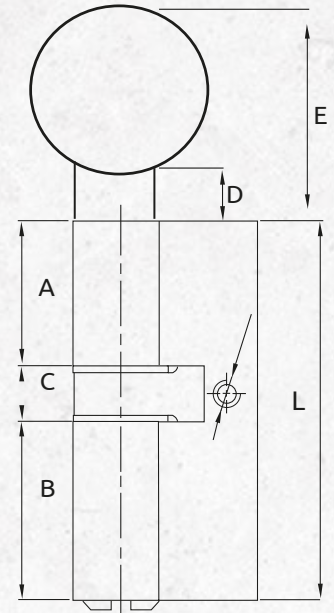

Zamak Barel Topuzlu

Zinc Cylinder with Knob



Teknik Özellikler

Technical Specifications

Kod Code	L	A	B	C	D	E			
BZ 012	68	26	32	10	12	44	1	3	60
BZ 013	83	35	38	10	12	44	1	3	60
BZ 014	90	35	45	10	12	44	1	3	60
BZ 015	100	40	50	10	12	44	1	3	60

Kilit Karşılığı - Uzun

Adjustable Door Lock Striker - Long



Teknik Özellikler / Technical Specifications

Kod Code	A	B	C	D	E	
KK 001	176	159	80	24	10	250

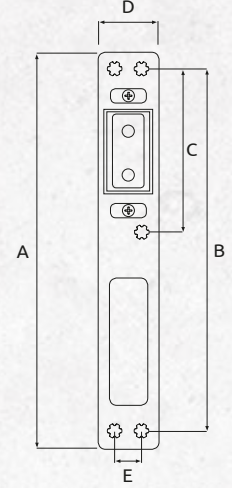

Kilit Karşılığı - Kısa

Adjustable Door Lock Striker - Short



Teknik Özellikler / Technical Specifications

Kod Code	A	B	C	D	E	
KK 002	100	82	25	12	400	250

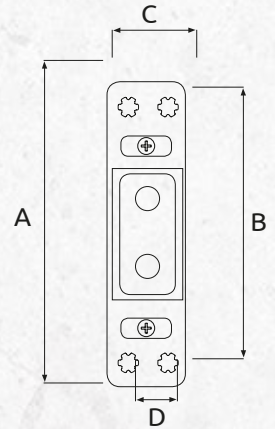

Kilit Karşılığı - Uzun

Adjustable Door Lock Striker - Long



Teknik Özellikler / Technical Specifications

Kod Code	A	B	C	D	E	
KK 005	176	159	80	24	10	250

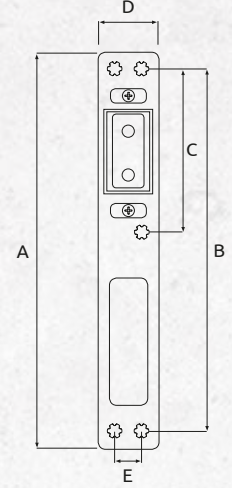

Kilit Karşılığı - Kısa

Adjustable Door Lock Striker - Short



Teknik Özellikler / Technical Specifications

Kod Code	A	B	C	D	E	
KK 006	100	82	25	12	400	250

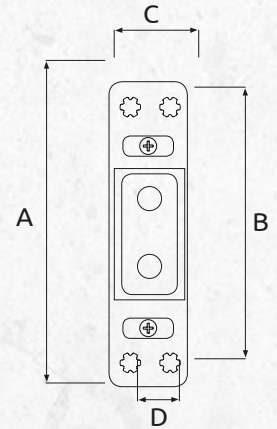

Vasistas Makas 13 cm

Transom Scissors 13 cm

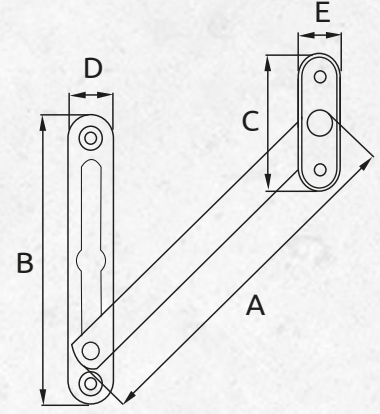

Teknik Özellikler / Technical Specifications

Kod Code	A	B	C	D	E	
BA 801	130	108	51	16,20	16,30	300

Vasistas Makas 22 cm

Transom Scissors 22 cm

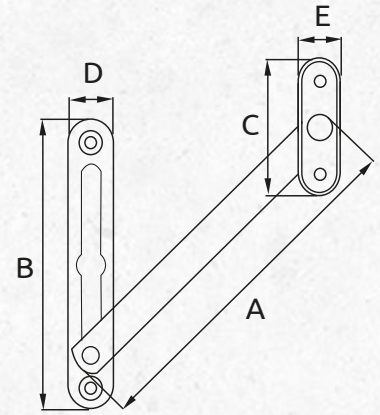

Teknik Özellikler / Technical Specifications

Kod Code	A	B	C	D	E	
BA 802	220	108	51	16,20	16,30	300

Plastik arpma

Plastical Transom Locked



Teknik zellikler *Technical Specifications*

Kod Code	
1043.B	600

Emniyet Kilidi

Security Locked



Teknik zellikler *Technical Specifications*

Kod Code	
EMN03	100

Sürme Rulman - Çift Teker

Sliding Roller - Double



Teknik Özellikler *Technical Specifications*

Kod Code	
SA028	200

Sürme Rulman - Tek Teker

Sliding Roller - Single



Teknik Özellikler *Technical Specifications*

Kod Code	
SA029	200

Universal Rozetli Kapı Kolu

Universal Door Handle with Rosette



Teknik Özellikler *Technical Specifications*

Kod Code	
AA-259	40

Fabia Rozetli Kapı Kolu

Fab Door Handle with Rosette



Teknik Özellikler *Technical Specifications*

Kod Code	
AA-256	40

Elit Rozetli Kapı Kolu

Elit Door Handle with Rosette



Teknik Özellikler *Technical Specifications*

Kod Code	
AA-258-1	40

Axis Rozetli Kapı Kolu

Axis Door Handle with Rosette



Teknik Özellikler *Technical Specifications*

Kod Code	
AA-258	40

Euroline 2'li Menteşe

Euroline Hinge's Double



Teknik Özellikler

Technical Specifications

Kod Code	
AA-186	160

Euroline 3'lü Menteşe

Euroline Hinge's Triple



Teknik Özellikler

Technical Specifications

Kod Code	
AA-188	100

Eksenel Kol Çift Dilli

Aluminium Axial Window Handle



Teknik Özellikler Technical Specifications

Kod Code	
AA-278	50

Sürme Tetik Kol

Sliding Window Handle



Teknik Özellikler Technical Specifications

Kod Code	
AA-272	100



future is today ...



BÜYÜKOĞLU İNŞ. MALZ. SAN. VE DIŞ TİC. LTD. ŞTİ.

Merkez : Arnavutköy Mah. Sucubahçe Sk. No.1
Beşiktaş - İstanbul / TÜRKİYE

Fabrika : Çerkeşli Mah. İMES OSB 16. Cadde No.10
Dilovası - Kocaeli / TÜRKİYE

Tel : +90 262 502 03 43 - Faks : +90 262 502 03 45
www.wboss.com.tr - info@wboss.com.tr



Made in Turkey