

Course 445

# CompTIA A+ Certification Exam Prep

Customer  
Management  
Standard  
Development  
Consistency  
Business  
Optimal

Customer  
Management  
Standard  
Development  
Consistency  
Business  
Optimal

# Acknowledgments

The author would like to thank the following people for their valuable help with this course:

- **Teresa Shinn**
- **Carl Waldron**
- **Tim Watts**
- **Esteban Delgado**
- **Dave O'Neal**
- **Shirley Auguste**
- **Alicia Richardson**



© LEARNING TREE INTERNATIONAL, INC.  
All rights reserved.

All trademarked product and company names are the property of their respective trademark holders.

No part of this publication may be reproduced, stored in a retrieval system, or transmitted in any form or by any means, electronic, mechanical, photocopying, recording or otherwise, or translated into any language, without the prior written permission of the publisher.

Copying software used in this course is prohibited without the express permission of Learning Tree International, Inc. Making unauthorized copies of such software violates federal copyright law, which includes both civil and criminal penalties.

# Introduction and Overview

Customer  
Management  
Standard  
Development  
Consistency  
Business  
Optimal

# Course Objectives

The main objective of this course is to

- Prepare you to pass the CompTIA A+ 220-901 and 220-902 exams

To accomplish this goal, you will learn how to

- Safely disassemble and reassemble a complete PC system
- Install and configure common PC motherboards and adapter cards
- Use an organized strategy to identify and troubleshoot common PC problems
- Select and install the correct type of RAM memory needed to upgrade a PC system
- Install and configure data storage systems, including hard disks, solid state drives (SSD), CD, and DVD-ROM drives
- Identify fundamental components of laptops and mobile devices and describe how to troubleshoot common problems



# Course Objectives

- **Identify basic components of printer/scanner technologies and describe configuration/troubleshooting procedures**
- **Explain the fundamentals of using Windows, Mac OS, and Linux operating systems**
- **Describe procedures for installing and upgrading operating systems**
- **Explain methods for managing, optimizing, and troubleshooting Windows**
- **Identify and explain basic principles of computer networking**
- **List fundamental protocols and technologies of the Internet**
- **Describe fundamental principles of computer security**
- **Describe the use of effective communication skills and professional behavior on the job**



# Course Contents

## Introduction and Overview

### Chapter 1

### CompTIA A+ Exam Overview

### Chapter 2

### Introduction to the PC and Safe Disassembly Practices

### Chapter 3

### The Motherboard

### Chapter 4

### Microprocessors

### Chapter 5

### The Power Supply

### Chapter 6

### Preventive Maintenance and a Troubleshooting Strategy for PCs

### Chapter 7

### Displays and Input Devices

### Chapter 8

### PC Connection Interfaces and Custom PC Configurations

### Chapter 9

### Expanding and Troubleshooting Memory

### Chapter 10

### Data Storage Systems

### Chapter 11

### Laptops and Mobile Devices



# Course Contents

- Chapter 12**     **Printers and Scanners**
- Chapter 13**     **Windows Operating Systems**
- Chapter 14**     **Other Operating Systems and Technologies**
- Chapter 15**     **Installing and Upgrading Windows**
- Chapter 16**     **Managing, Optimizing, and Troubleshooting Windows**
- Chapter 17**     **Introduction to Networking**
- Chapter 18**     **Internet Technologies**
- Chapter 19**     **Computer Security**
- Chapter 20**     **Effective Communication and Professionalism on the Job**
- Chapter 21**     **Course Summary**
- Next Steps**
- Appendix A**     **CompTIA 2015 A+ Exam Objectives**
- Appendix B**     **Chapter Review Answers**





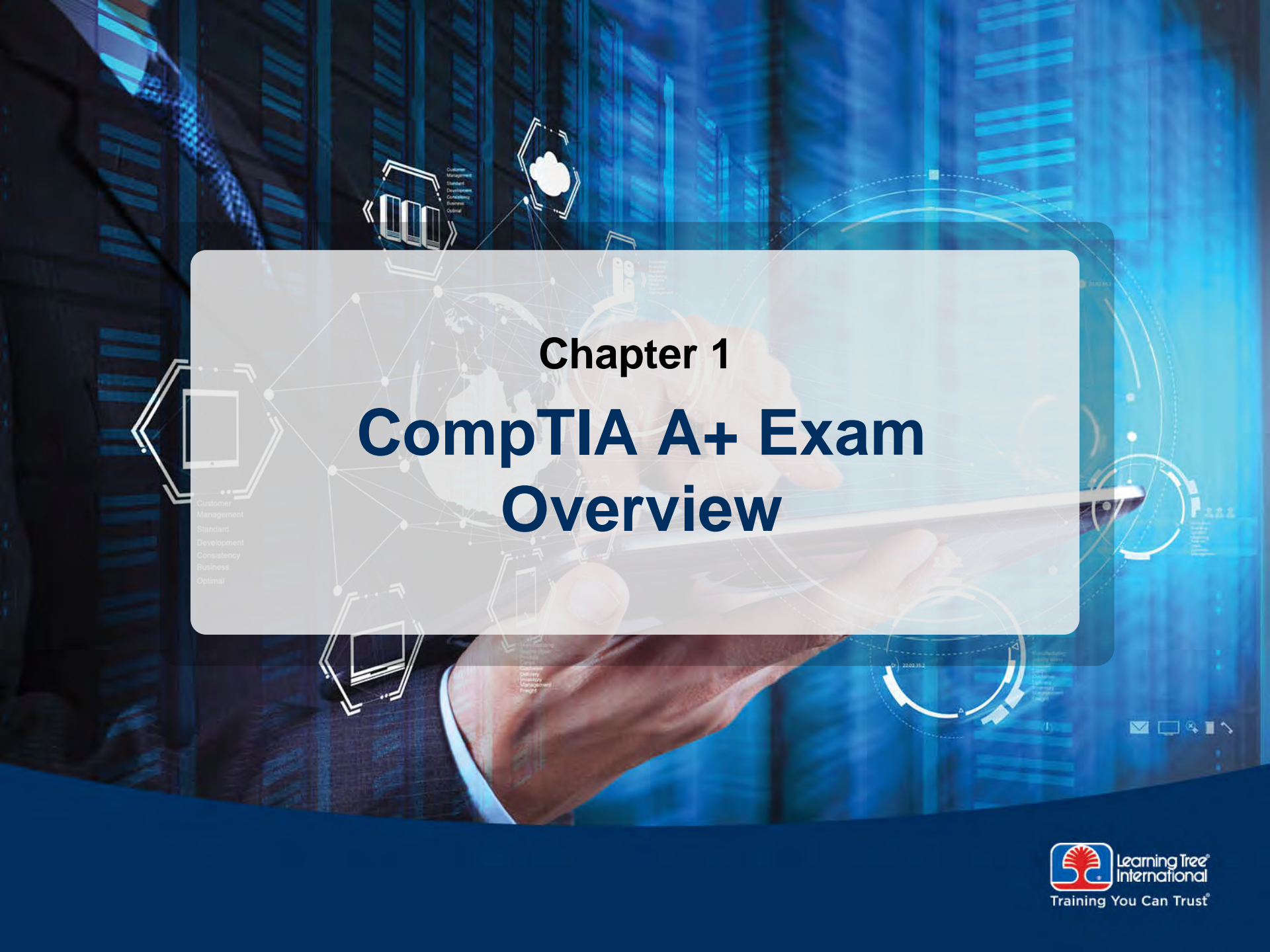

# Chapter 1

# CompTIA A+ Exam Overview

Customer  
Management  
Standard  
Development  
Consistency  
Business  
Optimal

# Chapter Objectives

---

**In this chapter, you will learn how to**

- **Describe the format and requirements of the CompTIA A+ exam**
- **Explain the methods you should use to prepare for the CompTIA A+ exam**



- **Overview of CompTIA A+ Certification**
  - **A+ Exam Format and Requirements**
  - **Exam Preparation and Test-Taking Tips**
  - **Sample Questions**



# Who Is CompTIA?

- **Computing Technology Industry Association**
- **Industry trade group of major computer and peripheral manufacturers**
  - Adobe Systems
  - AMD
  - Canon
  - Cisco Systems
  - Intel
  - IBM
  - Microsoft
  - Fujitsu
  - Hewlett-Packard
  - Siemens
  - Best Buy
  - Thousands of other companies

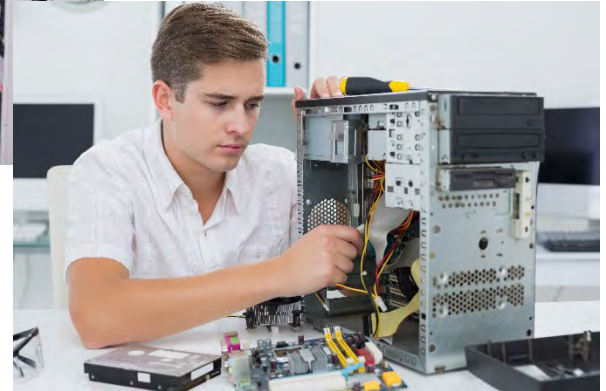

# A+ Certification

## ➤ A+ certification goal

- “The CompTIA A+ Essentials Examination measures necessary competencies for an entry-level IT professional with the equivalent knowledge of at least 12 months of hands-on experience in the lab or field”
  - CompTIA 2015 A+ Exam Objectives

## ➤ Benefits of A+ certification

- Validate basic skills in support of microcomputers and peripherals
- Provides baseline skill assurance for companies
- Provides assurance of quality care for customers
- Career advancement for PC support personnel



- **Overview of CompTIA A+ Certification**
- **A+ Exam Format and Requirements**
- **Exam Preparation and Test-Taking Tips**
- **Sample Questions**



## ➤ A+ certification exams

- CompTIA A+ 220-901
  - Fundamentals of computer technology; installation and configuration of PCs, laptops, and related hardware; and basic networking
- CompTIA A+ 220-902
  - Skills required to install, configure, and troubleshoot PC operating systems as well as configuring common features for mobile operating systems

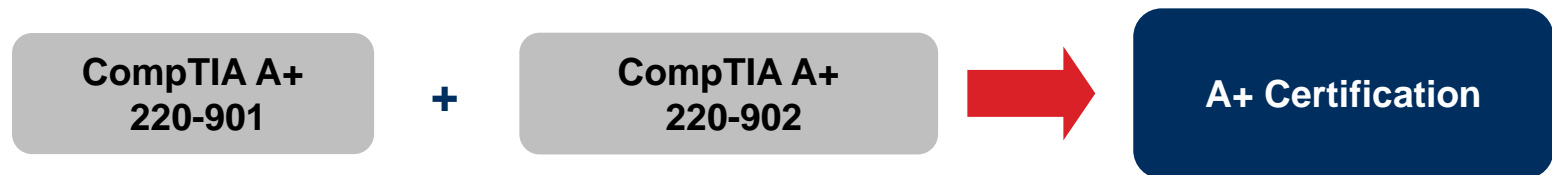

# Exam Format

## ➤ Exam format

- Linear format, computer-based test
  - Multiple choice and some performance-based (simulation) questions
- 90 minutes to complete each exam

Exam	Number of questions	Passing score (out of 900 points)
CompTIA A+ 220-901	90	675
CompTIA A+ 220-902	90	700





# Testing Services

## ➤ Pearson VUE

- [www.pearsonvue.com](http://www.pearsonvue.com)



- **Overview of CompTIA A+ Certification**
- **A+ Exam Format and Requirements**
- **Exam Preparation and Test-Taking Tips**
- **Sample Questions**



# Preparing for the A+ Exam

## ➤ Course requirements

- Reasonable previous experience in PC configuration and troubleshooting

## ➤ Course preparation method

- The A+ exam covers a large amount of information
- It has been divided into digestible sections, but coverage will be fairly quick
  - Some hands-on for illustration
  - Representative key questions at the end of each chapter
- Stick to topics included—they have been selected because they are exam topics
  - Our goal is to prepare you well!



# Preparing for the A+ Exam

- **Real experience is required**
  - Gain as much practical experience as you can in areas you are less familiar with
- **Be familiar with the objectives for the exams you will be taking**
- **Practice with sample questions in each area**
  - There are sample questions at the end of each chapter in this course
- **Study for one to two weeks in addition to this course before taking the exams**



# Test-Taking Tips

- **Read questions carefully**
  - There are no trick questions—the answer is there somewhere
- **Answer questions you know first, then go back and do the unanswered questions**
- **Don't leave any questions unanswered—they will be counted as incorrect**
- **Keep track of time**
  - You have 90 minutes per exam



- **Overview of CompTIA A+ Certification**
- **A+ Exam Format and Requirements**
- **Exam Preparation and Test-Taking Tips**
- **Sample Questions**



# Sample Questions

- 1. The practice of modern CPUs automatically reducing their speed during times of low demand, or when overheating is detected, is called \_\_\_\_\_.**
  - A. Hyperthreading
  - B. Throttling
  - C. Overclocking
  - D. Underclocking
  
- 2. When upgrading memory on a computer with a front-side bus speed of 400 MHz, what memory module has the necessary data transfer rate to support this speed?**
  - A. PC1200
  - B. PC2100
  - C. PC3200
  - D. PC4000



# Sample Questions

3. The standard connector for a UTP Ethernet cable is a:

- A. DB-9 male
- B. DB-25 female
- C. RJ-45
- D. RJ-11

4. Which connector is highlighted?

- A. PCI
- B. PCIe x1
- C. IDE
- D. AGP

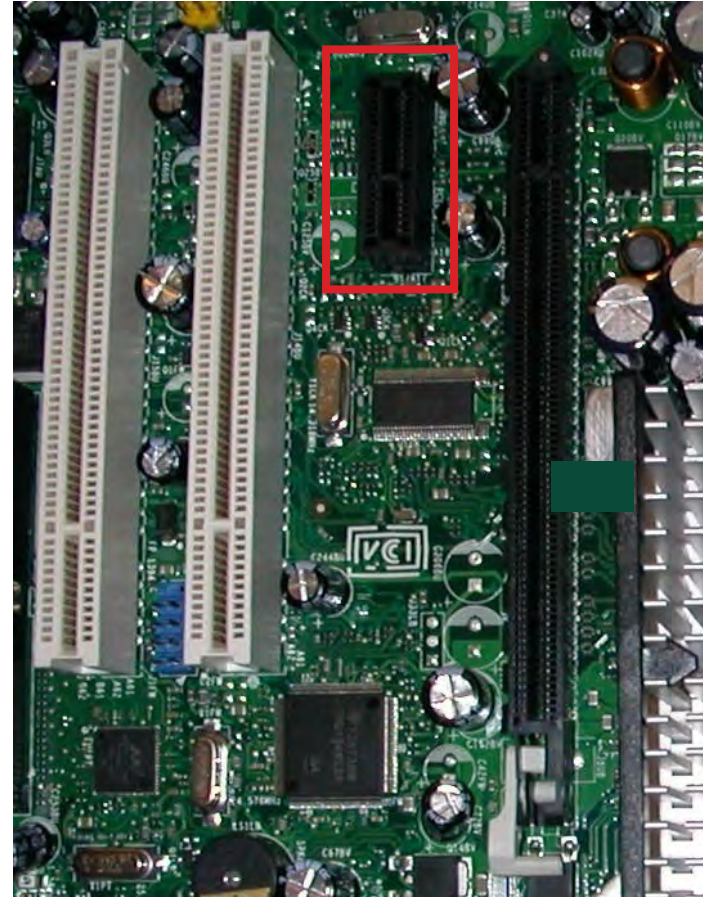



# Sample Questions

5. In Windows Device Manager, a device is shown with a down arrow. This indicates that the device is \_\_\_\_\_.
- A. Overheating
  - B. Defective
  - C. Uncertified
  - D. Disabled
6. A user complains that the type smears on documents output from a laser printer. What is the most likely cause of the problem?
- A. Broken primary corona wire
  - B. Defective laser scanner
  - C. Defective fuser
  - D. The toner cartridge is out of toner



# Sample Questions

- 7. Joanne, a network technician, wants to run a quick check on the network adapter card of a computer she is servicing. What IP address can she use as a local loopback address?**
- A. 10.1.1.1
  - B. 127.0.0.1
  - C. 132.0.0.1
  - D. 192.168.1.1
- 8. Which Windows 7 version supports BitLocker drive encryption?**
- A. Starter
  - B. Home Premium
  - C. Professional
  - D. Ultimate



# Sample Questions

## ? How did you do with these sample questions?

- They are representative of the type and scope of questions you'll encounter on the A+ exam
  - Several of them are variants of sample questions provided by CompTIA
- **If you got them all correct, great!**
- **If not, don't worry—we'll cover the topics for each of them so you'll know the right answers for these types of questions**



# Chapter Summary

---

**In this chapter, you have learned how to**

- **Describe the format and requirements of the CompTIA A+ exam**
- **Explain the methods you should use to prepare for the CompTIA A+ exam**



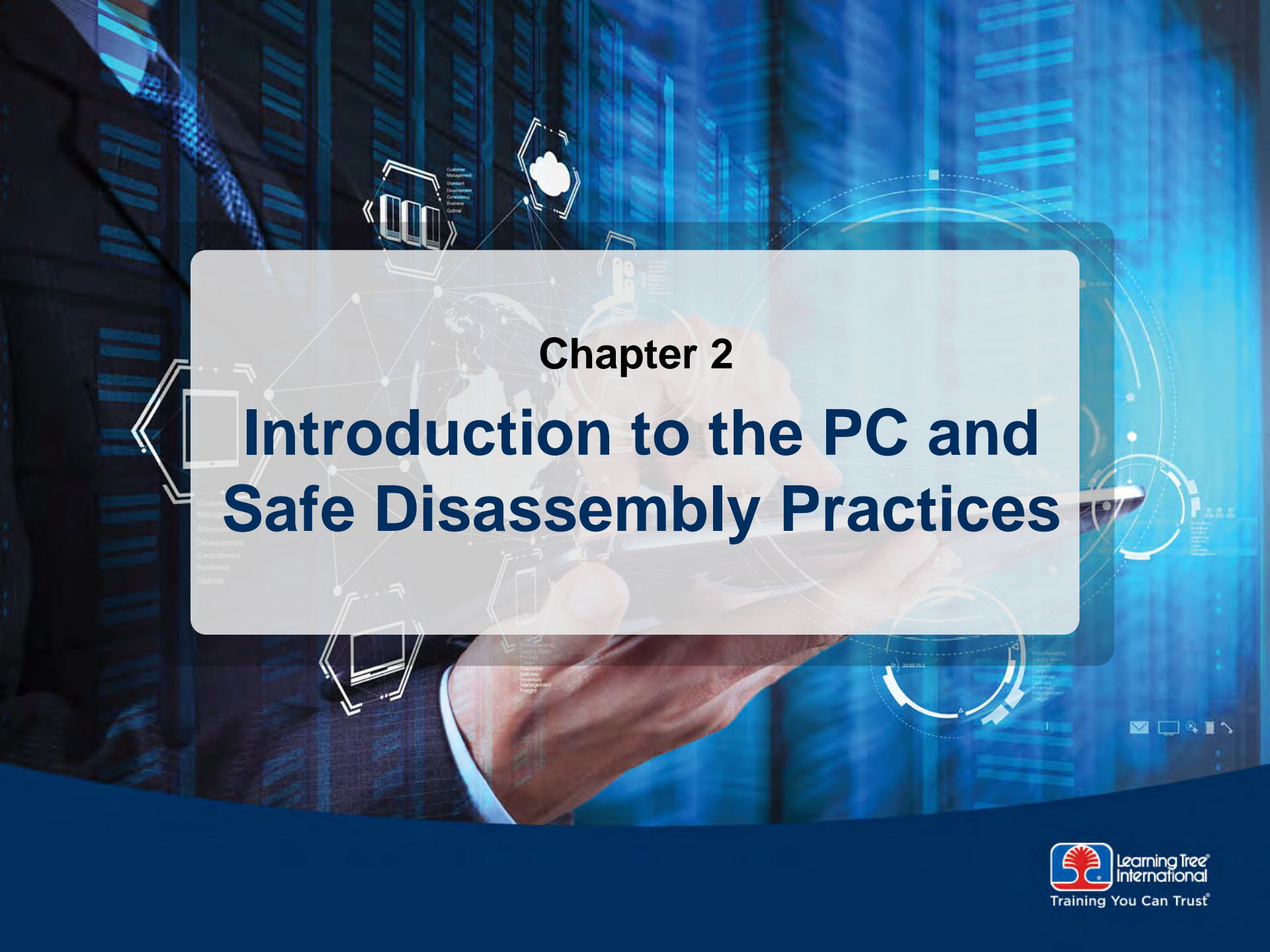

**Chapter 2**

# **Introduction to the PC and Safe Disassembly Practices**

# Chapter Objectives

---

**In this chapter, you will learn how to**

- **Safely disassemble a PC**
- **Draw a reference diagram of the PC cards and connections**
- **Identify and remove adapter cards**
- **Disconnect the system hard drives**
- **Disconnect and remove the DVD-ROM drive**
- **Disconnect and remove the power supply**



## ➤ **Taking Apart the PC**

- **Hands-On Exercise 2.1**
- **Optional Hands-On Exercise 2.2**
- **Hands-On Exercise 2.3**
- **Optional Hands-On Exercise 2.4**
- **Optional Hands-On Exercise 2.5**
- **Hands-On Exercise 2.6**



# PC Disassembly Procedure

- **In this section, we'll examine the PC disassembly procedure**
  - How to do it safely
    - Best practices (helpful for the exam)
  - Tips for real-world work
  
- **In this course, we will be using short video clips to provide real-world examples of PC**
  - Hardware disassembly
  - Hardware configuration
  - Hardware installation and testing
  
- **Course PC**
  - Core i7 desktop PC
  - Custom built for the course
    - Contains representative common hardware components





# Introduction to the In-Class PC

## ➤ Core i7 PC



ATA = Advanced Technology Attachment  
LCD = liquid-crystal display



# PC Major Components

## ➤ **Motherboard**

- Main circuit board containing CPU, memory, main control circuitry

## ➤ **Microprocessor**

- Intel Core i7

## ➤ **Memory**

- RAM
- ROM

## ➤ **Data storage devices**

- Disk drives
- CD/DVD-ROM

## ➤ **Input devices**

- Keyboard
- Mouse

## ➤ **Display monitor**

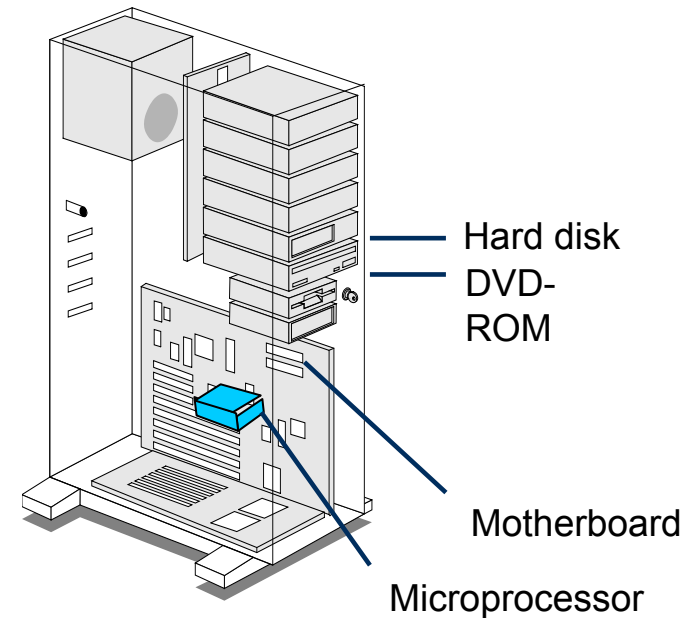
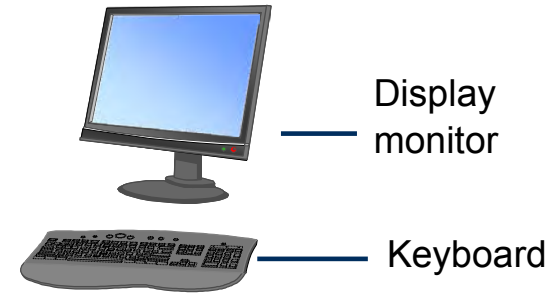

# Required Equipment

- **Most PC upgrades and repairs can be performed using only a screwdriver**
  - Case removal
  - Motherboard replacement
  - Power-supply replacement
  - Memory replacement/installation
  - Disk drive replacement/installation
  - Adapter card replacement/installation
  
- **Specialized test or soldering equipment is *not* required**
  - Troubleshooting to component (chip) level is not cost-effective
  - Majority of PC problems have simple causes: loose connections, incorrect settings, etc.
  
- **Antistatic protection should always be used**
  - Antistatic wrist strap protects against ElectroStatic Discharge (ESD) and should always be used when working on PCs
    - The only exception is when working around high-voltage equipment
  - Antistatic bags protect sensitive components from damage



# Required Equipment



# Guidelines for Safe PC Disassembly

## ➤ Objectives

In this section, you will learn how to

- Safely disassemble a PC
- Identify and remove adapter cards (PCI Express display adapter card, PCI network interface card, PCI Express USB 3.0 USB adapter card)
- Disconnect system hard drives
- Disconnect and remove the DVD-ROM drive
- Disconnect and remove the system power supply

## ➤ Exercise procedure

- We will cover the disassembly process in phases
- For each phase, we will watch a short video clip that provides a real-world example of the steps being covered
  - As you watch the video, answer the questions and fill out the worksheets as requested
  - Your Instructor will collect answers from the group after the video has finished



- **Taking Apart the PC**
- **Hands-On Exercise 2.1**
- **Optional Hands-On Exercise 2.2**
- **Hands-On Exercise 2.3**
- **Optional Hands-On Exercise 2.4**
- **Optional Hands-On Exercise 2.5**
- **Hands-On Exercise 2.6**



# Hands-On Exercise 2.1

## Video: Setting the PC's Configuration to a Known State

### ➤ Objective

- In this exercise you will learn how to set the PC's configuration to a known state

### ➤ Exercise procedure

- As you watch the video clip, write your answers to the questions in this exercise

1. What utility is used to set the PC to a known state?

---

2. What key is used to enter the utility?

---



# Hands-On Exercise 2.1

## Video: Setting the PC's Configuration to a Known State

3. Using the BIOS setup screen on the next page as a guide, how can the system be set back to default settings?

---

4. What type of CPU is used in this system?

---

5. How much memory is installed in this system?

---

BIOS = basic input/output system





# Hands-On Exercise 2.1

## Video: Setting the PC's Configuration to a Known State

The screenshot displays the BIOS System Setup utility. The title bar reads "System Setup" and the menu bar includes "Main", "Advanced", "Performance", "Security", "Power", "Boot", and "Exit". The "Main" menu is selected. The screen shows various system configuration options and their current values. On the right side, there is a legend for navigation keys.

Option	Value
BIOS Version	SDX5810J.86A.4598.2009.1211.1321
Processor Type	Intel(R) Core(TM) i7 CPU 930 @ 2.80GHz Intel® 64 Architecture Capable
Active Processor Cores	<ALL>
Intel® Hyper-Threading Technology	<Enable>
Host Clock Frequency	133 MHz
Overridden Processor Turbo Speed	3.33 GHz
Memory Speed	1067 MHz
QPI Data Rate	4.800 GT/s
L2 Cache RAM	256 KB
L3 Cache RAM	8192 KB
Total Memory	8192 MB
Memory Channel A Slot 1	2048 MB
Memory Channel A Slot 0	2048 MB
Memory Channel B Slot 0	2048 MB
Memory Channel C Slot 0	2048 MB
Language	<English>
Additional System Information	
System Date	[08/09/2010]
System Time	[22:16:26]

Number of cores enable in each processor.

Legend:  
←→=Select Screen  
↑↓=Select Item  
Enter=Select Submenu  
F9=Setup Defaults  
F10=Save and Exit  
Esc=Previous Page



# Hands-On Exercise 2.1

## Video: Setting the PC's Configuration to a Known State

6. Using the setup screen on the next screen as a guide, which option can be used to set the PC to boot from an external USB device?

---

7. In the current boot order, which device is set to boot first (if present)?

---



# Hands-On Exercise 2.1

## Video: Setting the PC's Configuration to a Known State

The screenshot shows a BIOS System Setup screen with the following configuration:

Option	Value
Boot Menu Type	<Normal>
Boot Device Priority	<CD/DVD-ROM Drive> <Floppy Drive> <Hard Disk Drives> <Ethernet>
Hard Drive Order	<Hitachi HDS72105> <Hitachi HDS72105>
CD/DVD-ROM Drive Order	<ATAPI iHAS124 >
Removable Drive Order	No Removable Drive
Boot to Optical Devices	<Enable>
Boot to Removable Devices	<Enable>
Boot to Network	<Enable>
USB Boot	<Enable>
Boot USB Devices First	<Disable>
USB Mass Storage Emulation Type	<Auto>
UEFI Boot	<Disable>

Change style of this boot menu page.

←→=Select Screen  
↑↓=Select Item  
Enter=Select Submenu  
F9=Setup Defaults  
F10=Save and Exit  
Esc=Previous Page



# Hands-On Exercise 2.1

## Video: Setting the PC's Configuration to a Known State

8. Using the setup screen on the next screen as a guide, which key should we press to save the system settings?

---

9. (Extra credit): Where are the system settings saved?

---



# Hands-On Exercise 2.1

## Video: Setting the PC's Configuration to a Known State

The screenshot shows the BIOS System Setup screen with the following configuration:

Item	Value
BIOS Version	SOX5810J.86A.4598.2009.1211.1321
Processor Type	Intel(R) Core(TM) i7 CPU 930 @ 2.80GHz Intel® 64 Architecture Capable
Active Processor Cores	<ALL>
Intel® Hyper-Threading Technology	<Enable>
Host Clock Frequency	133 MHz
Overridden Processor Turbo Speed	3.33 GHz
Memory Speed	1067 MHz
QPI Data Rate	4.800 GT/s
L2 Cache RAM	256 KB
L3 Cache RAM	8192 KB
Total Memory	8192 MB
Memory Channel A Slot 1	2048 MB
Memory Channel A Slot 0	2048 MB
Memory Channel B Slot 0	2048 MB
Memory Channel C Slot 0	2048 MB
Language	<English>
Additional System Information	
System Date	[08/09/2010]
System Time	[22:16:26]

Number of cores enable in each processor.

Legend:  
←→=Select Screen  
↑↓=Select Item  
Enter=Select Submenu  
F9=Setup Defaults  
F10=Save and Exit  
Esc=Previous Page



- Taking Apart the PC
- Hands-On Exercise 2.1
- **Optional Hands-On Exercise 2.2**
- Hands-On Exercise 2.3
- Optional Hands-On Exercise 2.4
- Optional Hands-On Exercise 2.5
- Hands-On Exercise 2.6



# Optional Hands-On Exercise 2.2

## Video: Drawing Reference Diagrams and Initial Disassembly

### ➤ Objectives

- In this exercise, you will learn how to
  - Draw reference diagrams
  - Perform initial system disassembly

### ➤ Exercise procedure

- In your course materials, locate Handout HO1 (445 Worksheets)
- In the handout, turn to Worksheet 1: External Cable Connection
- Watching the video, draw in the connections for the following cables:
  - AC power cord
  - Keyboard
  - Mouse
  - Display monitor
  - Network

AC = alternating current



# Optional Hands-On Exercise 2.2

## Video: Drawing Reference Diagrams and Initial Disassembly

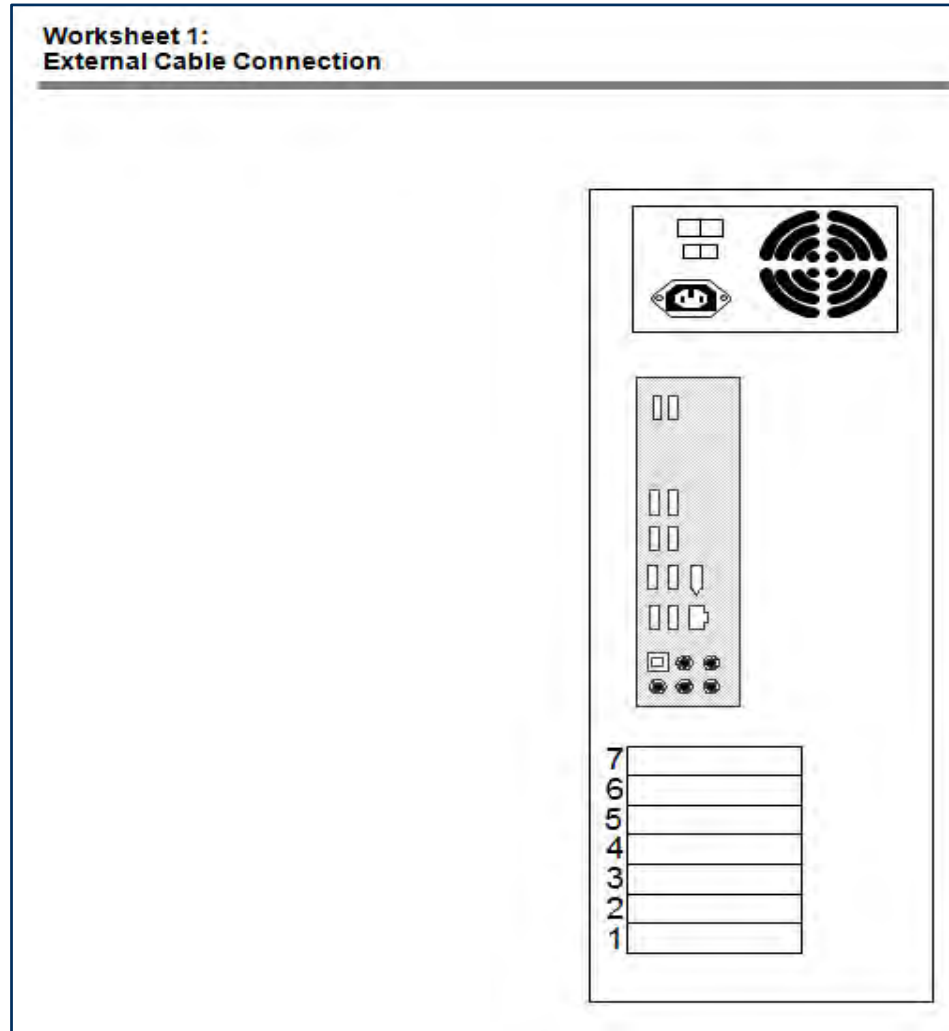



# Hands-On Exercise 2.3

## Video: Initial PC Disassembly and Identifying Adapter Cards

### ➤ Objective

- In this exercise, you will learn how to perform initial system disassembly

### ➤ Exercise procedure

- In your course materials, locate Handout HO1 (445 Worksheets)
- In the handout, turn to Worksheet 2: Adapter Card Position
- While watching the video, answer the questions and fill out in the adapter card names and connector types as instructed in the video

#### Worksheet 2: Adapter Card Position

Slot 7:

Card: \_\_\_\_\_

Connector(s): \_\_\_\_\_

Slot 6:

Card: \_\_\_\_\_

Connector(s): \_\_\_\_\_

Slot 5:

Card: \_\_\_\_\_

Connector(s): \_\_\_\_\_

Slot 4:

Card: \_\_\_\_\_

Connector(s): \_\_\_\_\_

Slot 3:

Card: \_\_\_\_\_

Connector(s): \_\_\_\_\_

Slot 2:

Card: \_\_\_\_\_

Connector(s): \_\_\_\_\_

Slot 1:

Card: \_\_\_\_\_

Connector(s): \_\_\_\_\_

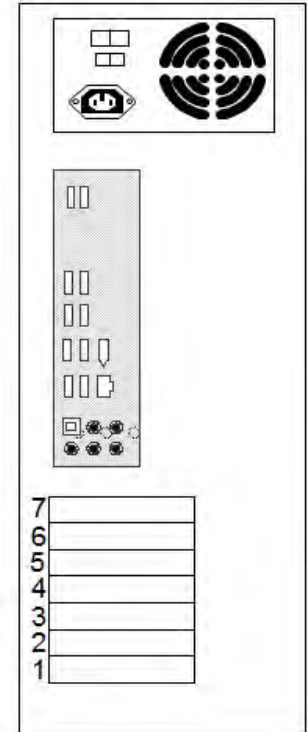

# Hands-On Exercise 2.3

## Video: Initial PC Disassembly and Identifying Adapter Cards

### ➤ Finding the display adapter card

- In Worksheet 2, write “Display Adapter Card” in the appropriate slot number
- Then record the three connectors on the card

### ➤ High-Definition Multimedia Interface (**HDMI**)

- Used for both PCs and televisions

### ➤ Vide Graphics Array (**VGA**)

- Uses an HDB-15 female connector
  - (High-density D-shaped connector, 15 socket holes)

### ➤ Digital Visual Interface (**DVI**)

- Newer interface for digital monitors



# Hands-On Exercise 2.3

## Video: Initial PC Disassembly and Identifying Adapter Cards

### ➤ Finding the network interface card

- In Worksheet 2, write “Network Interface Card” in the appropriate slot number
- Then record the connector on the card

### ➤ RJ-45 connector

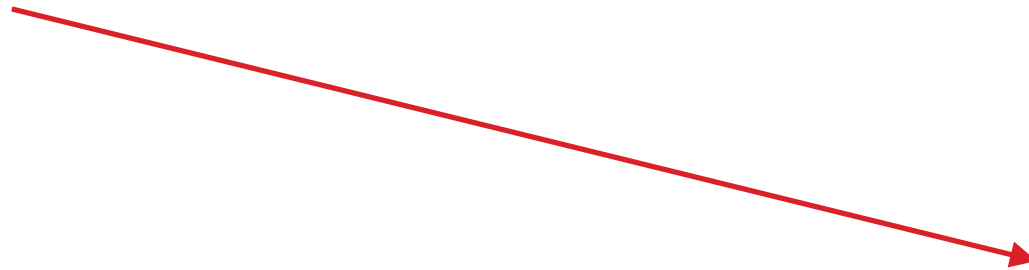

# Hands-On Exercise 2.3

## Video: Initial PC Disassembly and Identifying Adapter Cards

### ➤ Finding the USB 3.0 adapter card

- In Worksheet 2, write “USB 3.0 Adapter Card” in the appropriate slot number
- Then record the connectors on the card

### ➤ USB 3.0 connectors

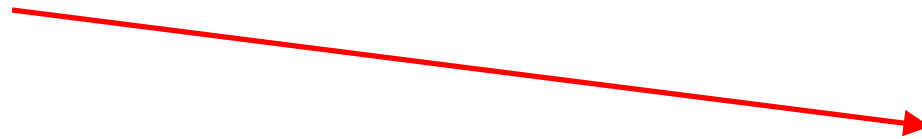

- Taking Apart the PC
- Hands-On Exercise 2.1
- Optional Hands-On Exercise 2.2
- Hands-On Exercise 2.3
- **Optional Hands-On Exercise 2.4**
- Optional Hands-On Exercise 2.5
- Hands-On Exercise 2.6



# Optional Hands-On Exercise 2.4

## Video: Removing Adapter Cards

### ➤ Objectives

- In this exercise, you will learn how to remove the adapter cards in the course PC
  - Display adapter card
  - Network interface card
  - USB 3.0 adapter card

### ➤ Exercise procedure

- While watching the video, answer the questions on the following slides

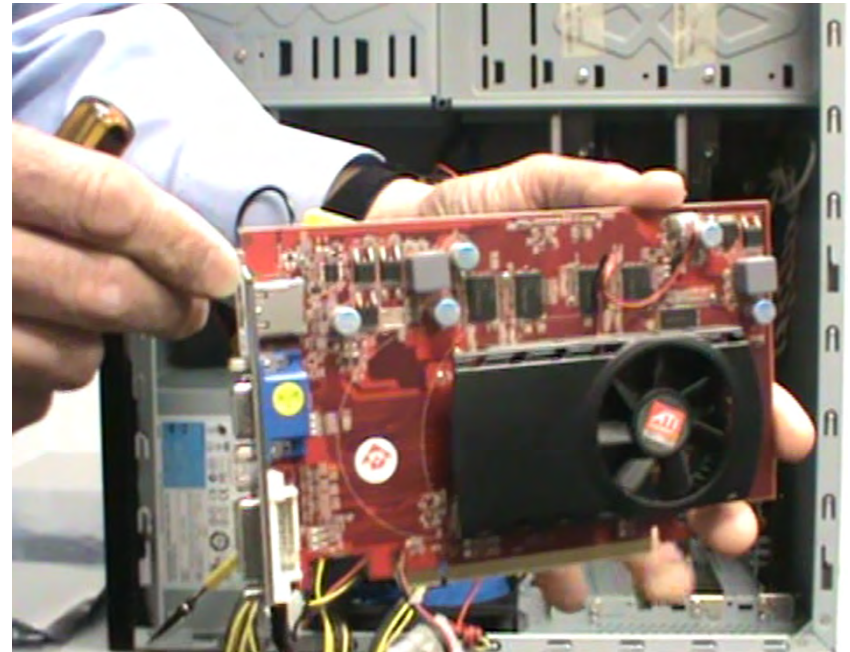

# Optional Hands-On Exercise 2.4

## Video: Removing Adapter Cards

1. What is an important safety measure to help protect PC components from damage?

---

2. Where should this device be attached to?

---

3. What type of damage does it protect the PC components from?

---



# Optional Hands-On Exercise 2.4

## Video: Removing Adapter Cards

4. What is the best way to handle adapter cards and why?

---

---

5. Where should adapter cards be placed after removal?

---

6. How can you identify a USB 3.0 connector?

---





- **Taking Apart the PC**
- **Hands-On Exercise 2.1**
- **Optional Hands-On Exercise 2.2**
- **Hands-On Exercise 2.3**
- **Optional Hands-On Exercise 2.4**
- **Optional Hands-On Exercise 2.5**
- **Hands-On Exercise 2.6**



## Video: Labeling and Disconnecting Drive Cables

### ➤ Objectives

- In this exercise, you will
  - Identify and label drive cables
  - Disconnect drive cables
    - SATA data cables
    - Power cables

### ➤ Procedure

- While watching the video, answer the questions on the following slides

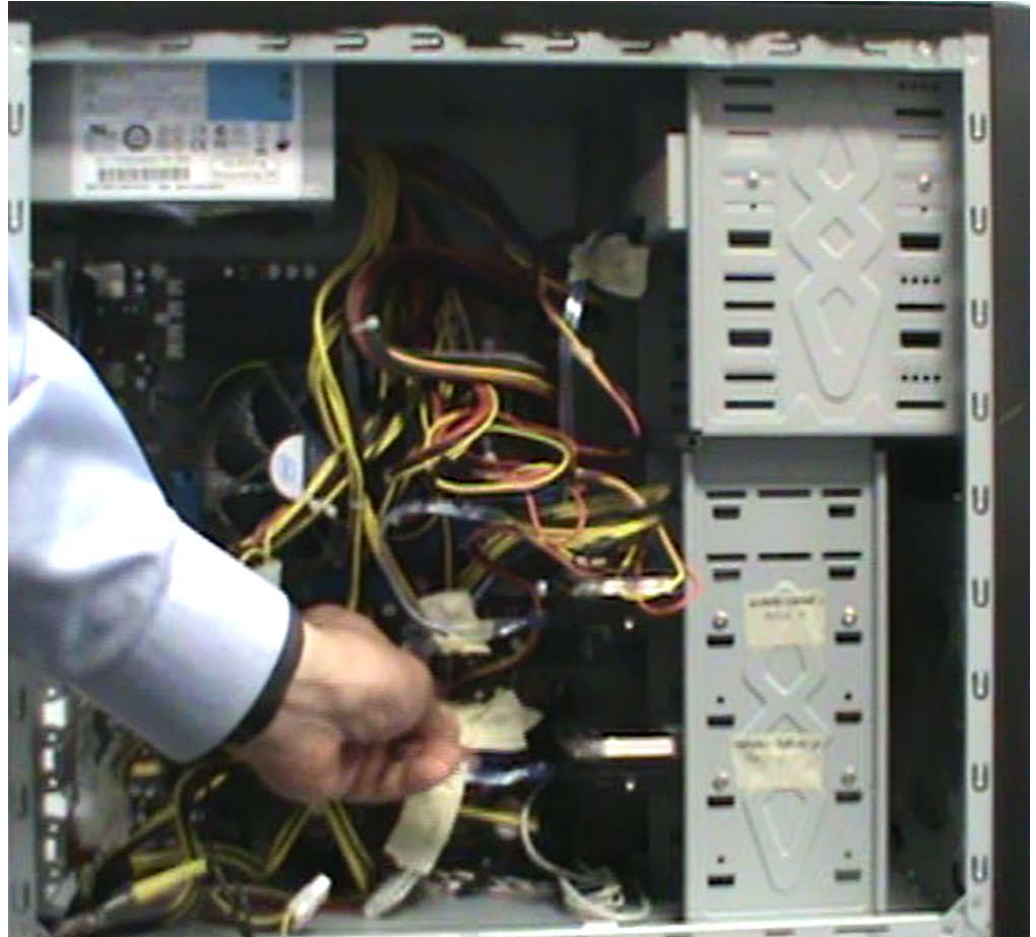

# Optional Hands-On Exercise 2.5

## Video: Labeling and Disconnecting Drive Cables

### ➤ Labeling drive cables

1. What's the benefit of labeling drive cables before disconnecting them?

---

2. In the space below, record where the two hard drives in the system are mounted:

Bay 2: \_\_\_\_\_

Bay 4: \_\_\_\_\_



# Optional Hands-On Exercise 2.5

## Video: Labeling and Disconnecting Drive Cables

### ➤ Labeling drive cables

3. What is a reason to label the power cables plugged into devices before disconnecting them?

---

4. When disconnecting SATA data cable from a hard drive, what should you check for?

---

5. What type of power connectors are used for the hard drives and DVD drive in the course PC?

---



- **Taking Apart the PC**
- **Hands-On Exercise 2.1**
- **Optional Hands-On Exercise 2.2**
- **Hands-On Exercise 2.3**
- **Optional Hands-On Exercise 2.4**
- **Optional Hands-On Exercise 2.5**
- **Hands-On Exercise 2.6**



## Video: Disconnecting Motherboard Power Cables and Removing the PC Power Supply

### ➤ Objectives

- In this exercise, you will
  - Disconnect motherboard power cables
  - Remove the PC power supply

### ➤ Procedure

- While watching the video, answer the questions on the following slides



# Hands-On Exercise 2.6

## Video: Disconnecting Motherboard Power Cables and Removing the PC Power Supply

### ➤ Removing motherboard power cables

1. How many pins are on the main power cable to the motherboard?
- 

2. On this system, what is the purpose of the second power cable to the motherboard (near the CPU)?
- 

### ➤ Identifying PC power supply connectors

- In the diagram on the next slide, fill in the labels to identify the different power supply connectors



# Hands-On Exercise 2.6

## Video: Disconnecting Motherboard Power Cables and Removing the PC Supply

### ➤ Identifying PC power supply connectors

- Fill in the labels to identify the power supply connector types

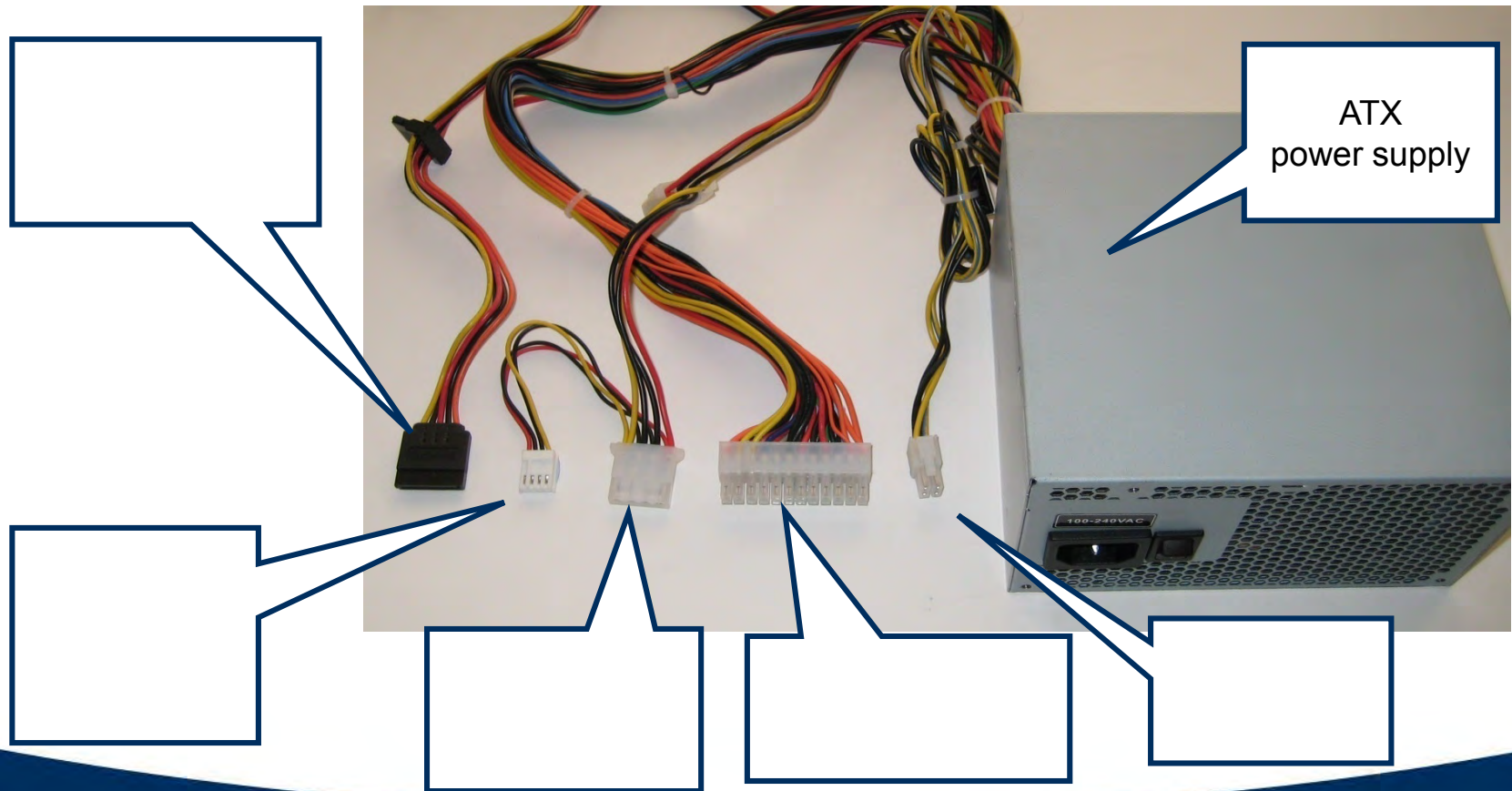



# Hands-On Exercises 2.1–2.6: Summary



## **Congratulations!**

- In this series of exercises, you have learned how to
  - Safely disassemble a PC
  - Identify and remove adapter cards (PCI Express display adapter card, PCI network interface card, PCI Express USB 3.0 USB adapter card)
  - Disconnect system hard drives
  - Disconnect and remove the DVD-ROM drive
  - Disconnect and remove the system power supply

**In subsequent chapters, you will learn how to configure, test, and reassemble these components into a working PC system**

**? What important techniques did you learn in these exercises?**

---

---

---



# Chapter Summary

---

**In this chapter, you have learned how to**

- **Safely disassemble a PC**
- **Draw a reference diagram of the PC cards and connections**
- **Identify and remove adapter cards**
- **Disconnect the system hard drives**
- **Disconnect and remove the DVD-ROM drive**
- **Disconnect and remove the power supply**





# Chapter 3

## The Motherboard

Customer  
Management  
Standard  
Development  
Consistency  
Business  
Optimal

# Chapter Objectives

In this chapter, you will learn how to

- **Identify and describe the following motherboard components:**
  - Microprocessor (CPU)
  - Chipset
  - System clock circuit
  - ROM and RAM memory devices
  - PC bus types and expansion slots
  - I/O (Input/Output) ports
  
- **Explain how the CMOS RAM and setup program are used to configure the PC**



## ➤ **Motherboard Components**

### ➤ **Basic Motherboard Components**

- Hands-On Exercise 3.1
  - Basic Computer Terminology
  - Microprocessor and Chipset
  - ROM and RAM
  - Expansion Slots
- 
- **Configuring the Motherboard**



# The Motherboard

## ➤ What is a PC motherboard?

- Main PC circuit board contains Central Processing Unit (CPU), control circuits that run entire system

## ➤ PC motherboard components

- CPU, or microprocessor
- Memory cards
- Chipset (high-integration chips containing main control circuits)
- Adapter card slots
- System clock
- Input/Output (I/O) ports



# The Motherboard

- **Motherboard example**
  - Intel DX58SO
    - Core i7 motherboard
- **In an upcoming exercise, you will get a chance to identify the major components on this motherboard**

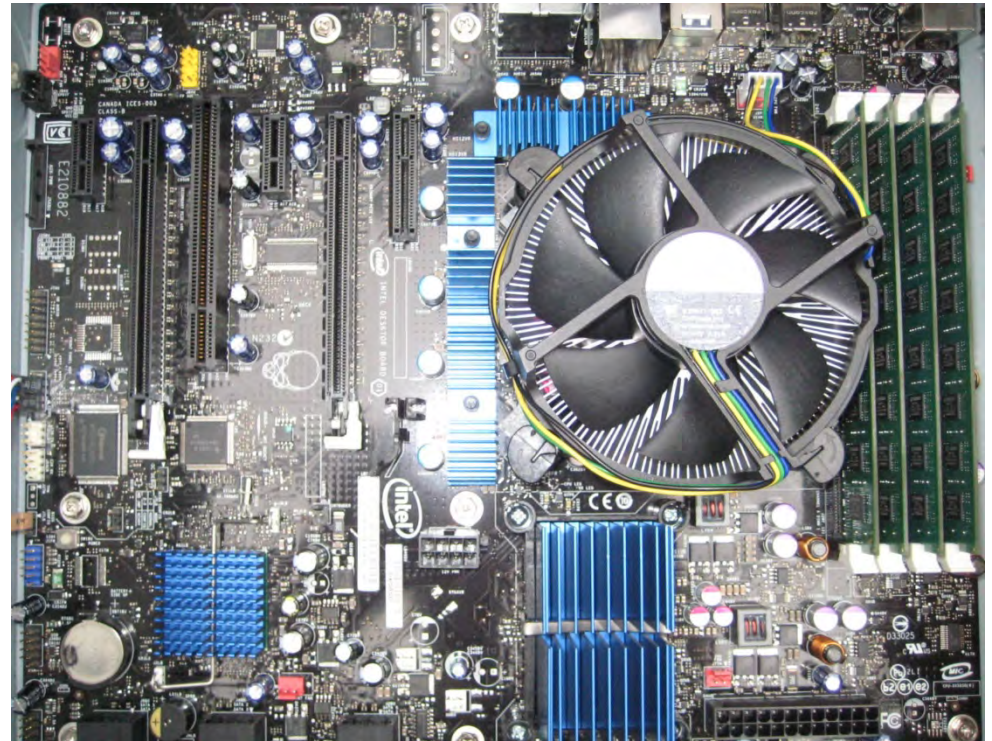

# Motherboard Types

- **PC motherboards come in several different form factors**
- **Advanced Technology Extended (ATX) and Micro-ATX style motherboards**
  - Motherboard form factor introduced by Intel
  - Designed to reduce manufacturing costs, improve service and reliability
  - Original ATX design includes five PCI slots—today's Micro-ATX design reduces board size and includes two to three PCI slots
- **ATX features**
  - Redesigned power supply used to cool both system and CPU
    - CPU is located near power-supply fan
  - Double-height I/O panel supports I/O device connectors directly on motherboard
    - Serial, Parallel port
    - Keyboard, mouse (PS/2 mini-DIN connectors)
    - VGA, MIDI, audio connectors

DIN = Deutsches Institut für Normung (German Institute for Standardization)

MIDI = musical instrument digital interface





# ATX and Micro-ATX Style Motherboard Features

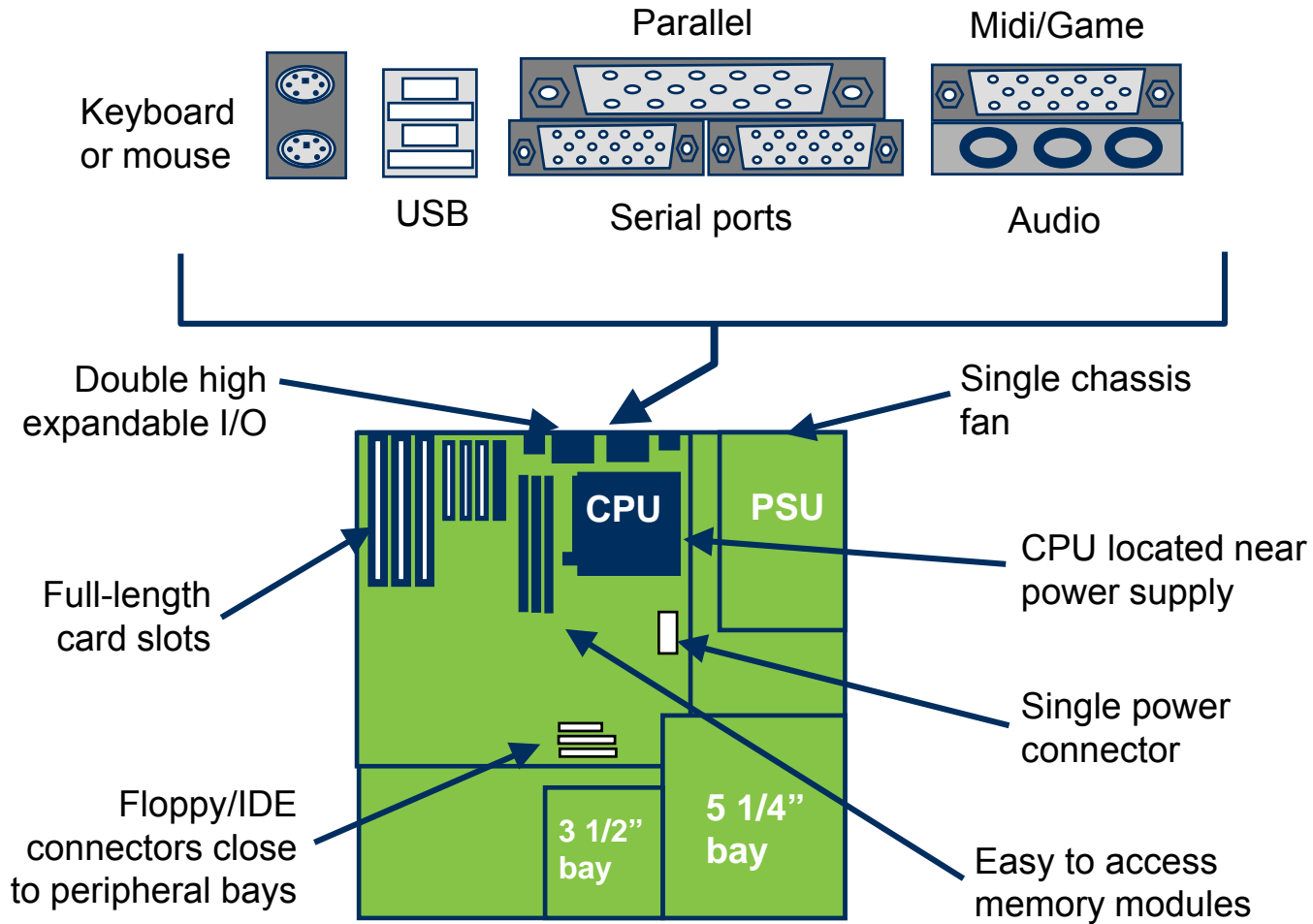

# Motherboard Types

## ➤ ITX-style motherboards

- Mini-ITX is slightly smaller than Micro- ATX, but mounting holes are compatible
  - Supports only one expansion slot
- Used in small form factor computers and home theater PCs
  - Low power consumption allows for quiet passive cooling (no fans)



# PC Connectors

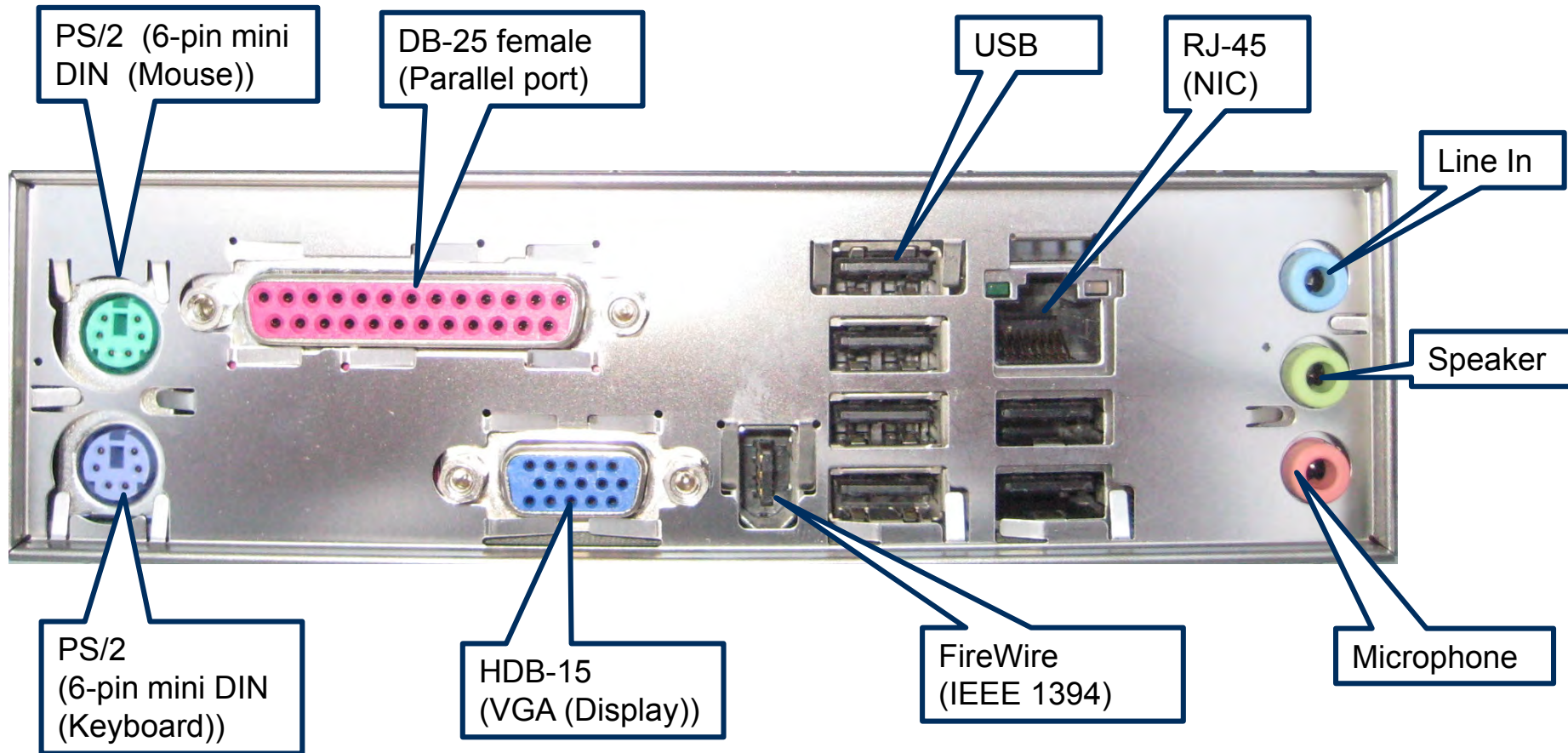

## ➤ **Motherboard Components**

- Basic Motherboard Components
  - **Hands-On Exercise 3.1**
  - Basic Computer Terminology
  - Microprocessor and Chipset
  - ROM and RAM
  - Expansion Slots
- **Configuring the Motherboard**



# Hands-On Exercise 3.1

---

*In your Exercise Manual, please refer to  
Hands-On Exercise 3.1: Identifying Motherboard PC Components*



## ➤ **Motherboard Components**

- Basic Motherboard Components
- Hands-On Exercise 3.1
- **Basic Computer Terminology**
  - Microprocessor and Chipset
  - ROM and RAM
  - Expansion Slots
- **Configuring the Motherboard**



# Quick Guide to Basic Computer Terminology

## ➤ Bits, bytes, and storage terms

Term	Definition	Decimal	Binary
Bit (b)	Binary digit		1 or 0
Byte (B)	8 bits		11110000
Kilo (K)	Thousand	1,000	
Mega (M)	Million	1,000,000	
Giga (G)	Billion	1,000,000,000	
Tera (T)	Trillion	1,000,000,000,000	

## ➤ Examples:

- 1 KB of memory = 1,000 Bytes
- 256 MB of memory = \_\_\_\_\_
- 500 GB hard disk = \_\_\_\_\_



# Quick Guide to Basic Computer Terminology

## ➤ Terms that describe speed

- Hertz (Hz)
  - Number of cycles per second



System clock



- Bits per second (bps)
  - Number of bits per second



11110000111100111





## ➤ **Motherboard Components**

- Basic Motherboard Components
- Hands-On Exercise 3.1
- Basic Computer Terminology
- **Microprocessor and Chipset**
  - ROM and RAM
  - Expansion Slots
- **Configuring the Motherboard**



# Microprocessor

## ➤ Microprocessor (CPU)

- “Brains” of the entire system (covered in detail in next chapter)
- High speed component generates large amounts of heat
  - Large heatsink/fan combination attached over CPU to keep cool

## ➤ CPU socket

- Motherboard contains LGA (Land Grid Array) socket for CPU
- Small leaf springs in socket contact metal hemispheres on CPU chip

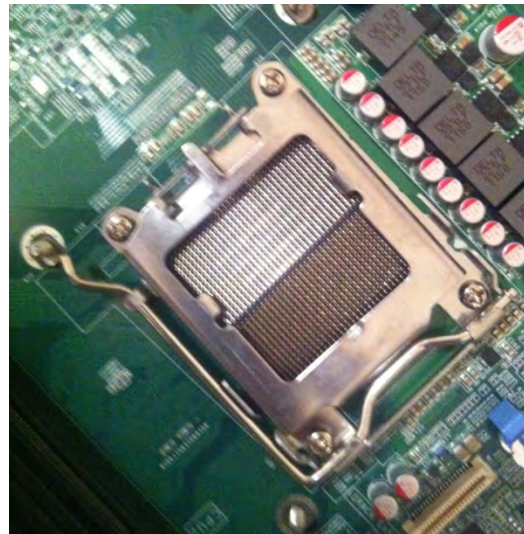

# Chipset

## ➤ System chipset

- Set of high-integration components that contain key motherboard support devices (covered in next chapter)
  - Memory controller
  - I/O controller
- Located near CPU
- Covered with high-efficiency aluminum heatsink to keep cool

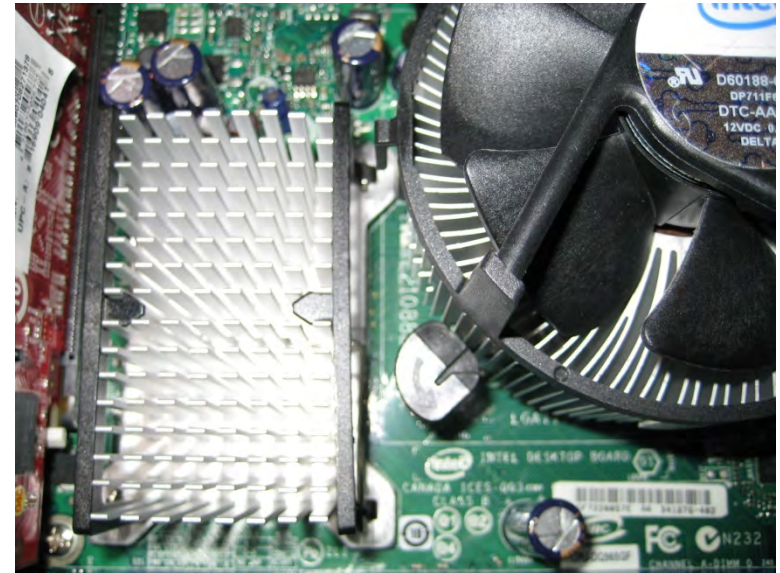

## ➤ **Motherboard Components**

- Basic Motherboard Components
- Hands-On Exercise 3.1
- Basic Computer Terminology
- Microprocessor and Chipset
- **ROM and RAM**
- Expansion Slots
  
- **Configuring the Motherboard**



## ➤ **What is ROM?**

- Read-Only Memory
- Provides permanent (“non-volatile”) storage of programs and data

## ➤ **System ROM programs**

- Contained in “Flash” BIOS ROM on motherboard
  - System initialization and power-on self-test (POST)
  - Basic input/output system (BIOS)

## ➤ **“Flash” BIOS ROM**

- “Semipermanent” memory used to store system programs on newer motherboards

## ➤ **Main advantage of “Flash” BIOS ROM**

- Allows system programs to be updated with newer releases provided by BIOS manufacturer
- Programs can be loaded from diskette or downloaded from the Internet



# RAM

## ➤ What is RAM?

- Random Access Memory
- Read/write memory
- Provides temporary (“volatile”) storage of programs and data
- RAM data is accessible while system power is on

## ➤ RAM (physical locations)

- Motherboard
- Display expansion card
- Network interface card

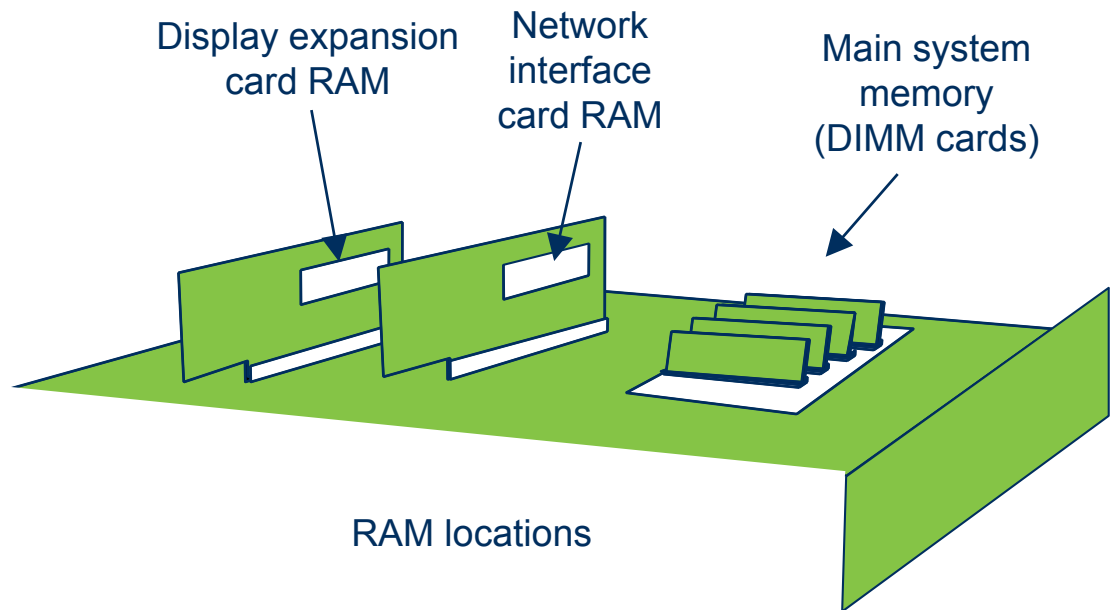

DIMM = dual in-line memory module



## ➤ **Motherboard Components**

- Basic Motherboard Components
- Hands-On Exercise 3.1
- Basic Computer Terminology
- Microprocessor and Chipset
- ROM and RAM
- **Expansion Slots**
- **Configuring the Motherboard**



# Expansion Slots

## ➤ What are expansion slots?

- Female edge connector sockets on the motherboard designed to receive expansion cards (also called adapter cards)
- Expansion slots provide access to system address, data, and control bus lines

## ➤ Expansion slot type is based on PC bus standard used in system

- The original IBM PC used the Industry Standard Architecture (ISA) expansion slot
- Although several types have been developed, modern motherboards typically use the following types of expansion slots
  - Accelerated Graphics Port (AGP)
  - Peripheral component interconnect (PCI)
  - PCI eXtended (PCI-X)
  - PCI express (PCIe)
  - Mini PCI used in laptops (covered later)





# Expansion Slots

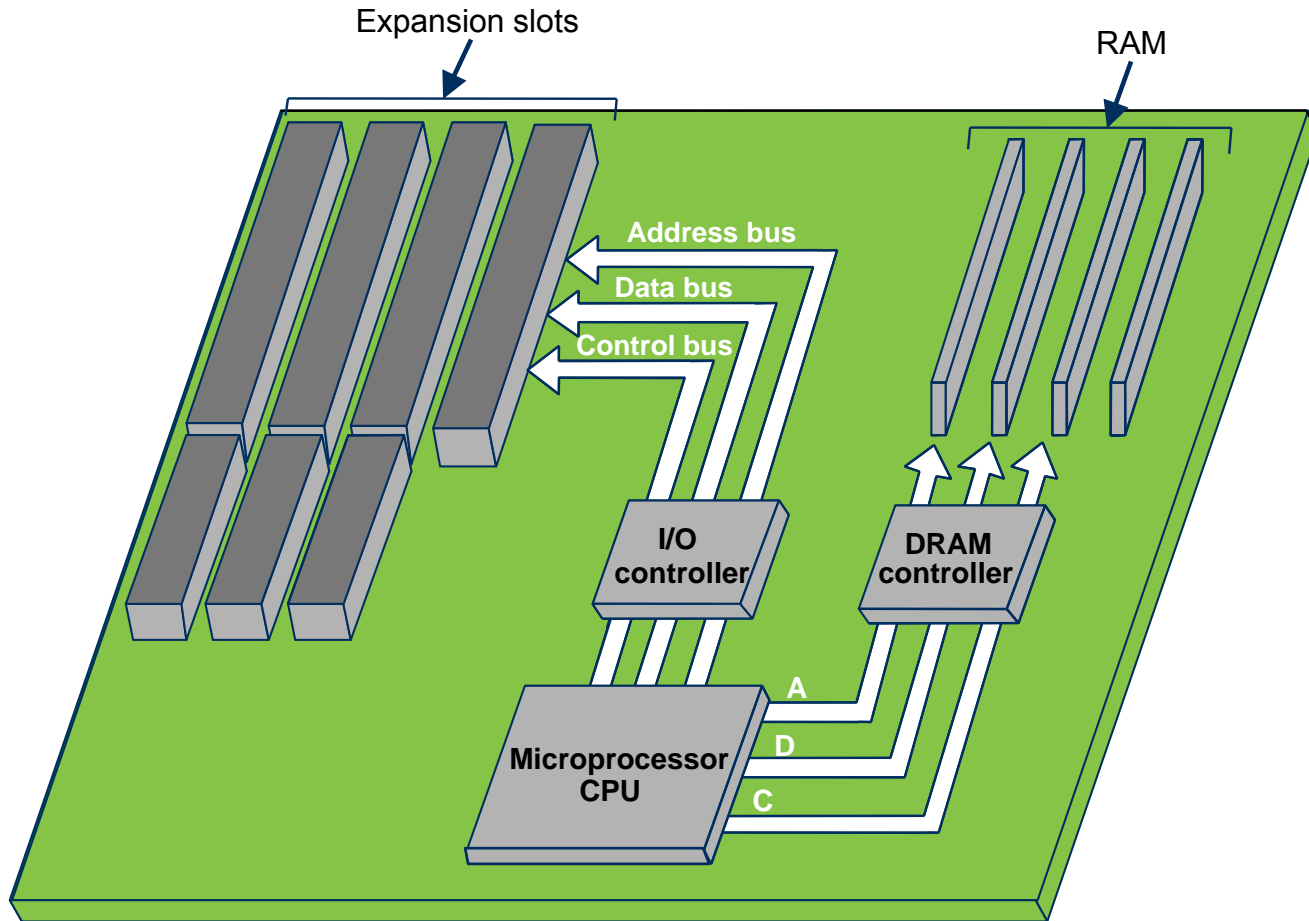

DRAM = dynamic random-access memory



# PCI Expansion Slots

## ➤ What is the PCI bus?

- Bus standard developed by Intel, with cooperation from Microsoft
- Provides increased bus performance and supports “plug-and-play” devices
- Increased size of data bus to 32 bits (and 64 bits in Version 2.1)

## ➤ PCI bus features

Feature	PCI Version 1.0	PCI Version 2.1
Data bus width	32 bits	64 bits
Bus speed	33 MHz	66 MHz
Bandwidth	132 MB/sec	533 MB/sec
Plug-and-play support	Yes	Yes

## ➤ PCI-X (PCI extended)

- Legacy PCI version designed for servers
- 64-bit card featured clock speed of 133 MHz for transfer rate of 1.06 GB/sec



# PCI Express (PCIe)

## ➤ What is the PCI Express bus?

- New PCI bus standard that uses “point-to-point” serial technology to dramatically increase data transfer rates
- Will replace AGP in new computers for display card interface

## ➤ PCI standard bus architecture

- All devices must share bandwidth of main bus

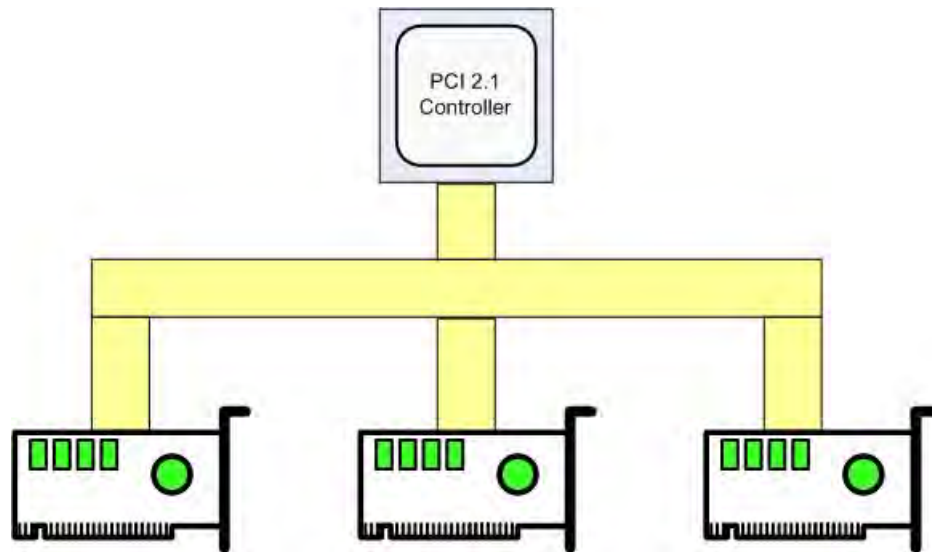

# PCI Express Architecture

- **PCI controller acts as a switch that can directly connect two devices “point-to-point”**
  - Connections to devices are called links
  - Each link consists of one or more “lanes”
    - A lane is a serial communication pathway with one send and one receive wire (up to 100 MB/sec/pin data transfer rate)
  - Each additional lane increases data transfer rate (x1, x2, x3 up to x32 [x256 in future])
    - The example shown below shows two lanes (x2)

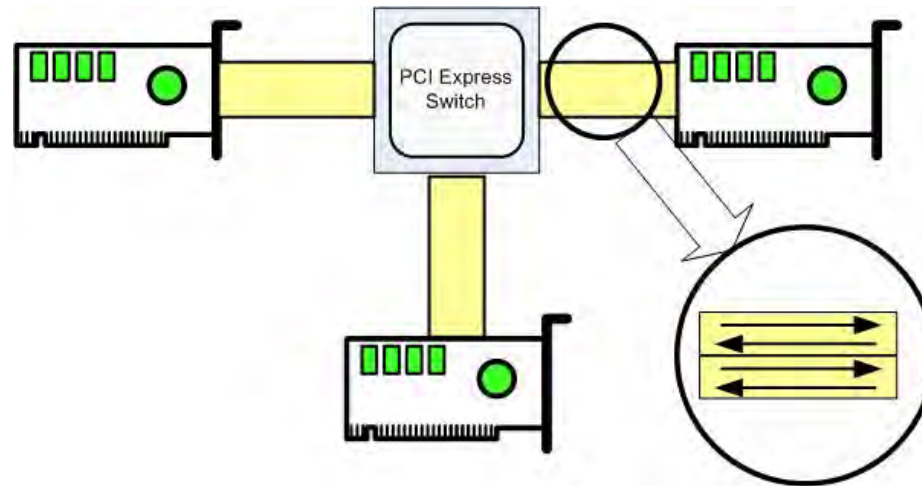

# PCI, PCIe Expansion Slot Examples

## ➤ PCI, PCIe expansion slots

- PCI
  - Note: can be white or black
- PCIe (1X)
- PCIe (16X)

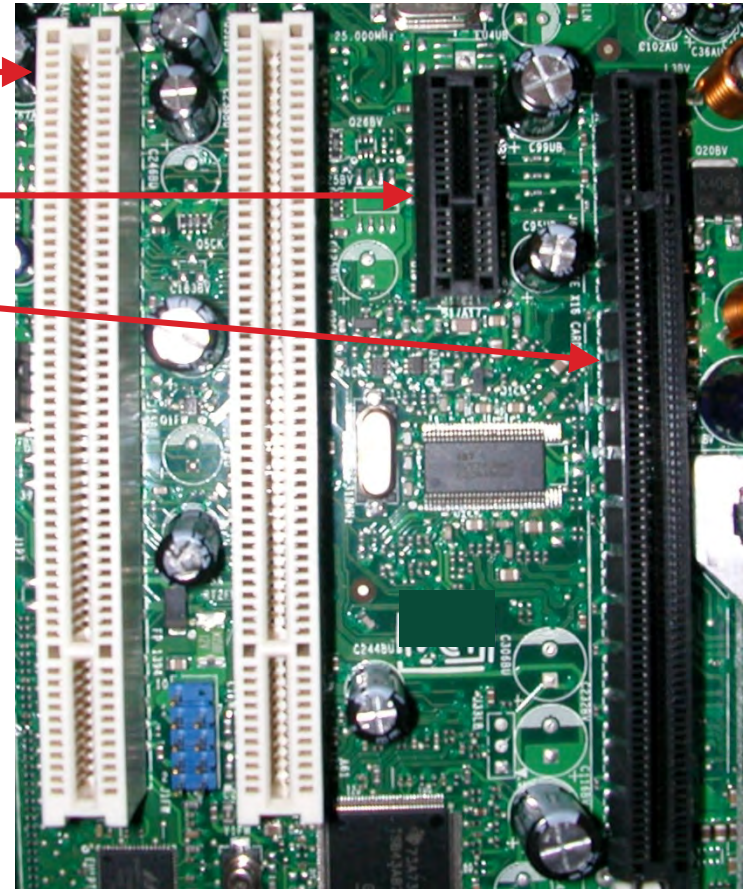

- **Motherboard Components**
- **Configuring the Motherboard**
  - **Setup Program**
    - CMOS RAM and Backup Battery



# Configuring the Motherboard

- **On most PCs, system settings are entered using a Setup program**
  - Setup program is contained in Flash BIOS ROM on motherboard
  - BIOS Setup Utility allows system configuration settings to be selected by menu
  - Settings are stored in battery-backed CMOS RAM
  
- **UEFI (Unified Extensible Firmware Interface)**
  - Newer replacement for BIOS found on some PCs
  - Provides
    - Increased boot security
    - Faster startup
    - Support for larger bootable GPT hard drives
  - PC will use either BIOS or UEFI

BIOS = Basic Input Output System

GPT = GUID (Globally Unique Identifier) Partition Table



# Invoking the BIOS Setup Program

- **The specific method for invoking the Setup program is defined by the manufacturer of the BIOS ROMs in the PC (AMI, Award, Phoenix, IBM, etc.)**
  - When PC is turned on, it runs initialization code contained in the BIOS ROMs
  - The initialization code checks for a certain key (or key combinations)
  - The activating key or key combination must be pressed within a few seconds after the PC is turned on or reset
- **Common key combinations used to invoke the BIOS Setup program**
  - <F2> key (Phoenix BIOS)
  - <Del> or <F1> key (AMI BIOS)





# BIOS Setup Program Information

## ➤ CPU

- Processor type, speed
- Architecture (32- or 64-bit)
- Hyperthreading status

## ➤ Clock speeds

- System bus speed

## ➤ RAM

- Memory size, speed
- Memory amount per slot

## ➤ BIOS/motherboard security features

- Supervisor/user password
- Hard drive encryption status
- Trusted Platform Module (TPM)
- Lo-jack (embedded program contacts security firm if computer is stolen)

## ➤ Hard drive

- Displays hard drive type
- Set boot hard drive

## ➤ Optical drive

- Displays optical drive type

## ➤ Virtualization support

- CPU hardware support for virtual hypervisors
- Intel VT (Virtualization Technology)

## ➤ Power management

- Fan speed



# BIOS Setup Program

**System Setup**

Main Advanced Performance Security Power Boot Exit

BIOS Version	SOX5810J.86A.4598.2009.1211.1321	Number of cores enabled in each processor.
Processor Type	Intel(R) Core(TM) i7 CPU 930 @ 2.80GHz Intel® 64 Architecture Capable	
Active Processor Cores	<ALL>	
Intel® Hyper-Threading Technology	<Enable>	
Host Clock Frequency	133 MHz	
Overridden Processor Turbo Speed	3.33 GHz	
Memory Speed	1067 MHz	
QPI Data Rate	4.800 GT/s	
L2 Cache RAM	256 KB	
L3 Cache RAM	8192 KB	
Total Memory	8192 MB	
Memory Channel A Slot 1	2048 MB	
Memory Channel A Slot 0	2048 MB	
Memory Channel B Slot 0	2048 MB	
Memory Channel C Slot 0	2048 MB	
Language	<English>	++=Select Screen ↑↓=Select Item Enter=Select Submenu F9=Setup Defaults F10=Save and Exit Esc=Previous Page
Additional System Information		
System Date	[02/11/2012]	
System Time	[08:44:41]	



# BIOS Setup Configuration Settings

- **The BIOS setup program can be used to configure computer hardware settings**
- **Boot sequence**
  - Set order of devices to boot from
  - Example: Boot from USB devices first
- **Enabling/disabling devices**
  - Example: Enable eSATA port
- **Set date/time**
- **Clock speeds**
  - CPU, System bus, Memory
  - Caution: Incorrectly setting these speeds can damage system hardware!
- **Virtualization support**
  - Example: Intel CPU VT (Virtualization Technology) hardware support



# BIOS Setup: Boot Order Configuration

**System Setup**

Main Advanced Performance Security Power **Boot** Exit

Boot Menu Type <Normal>  
Boot Device Priority <CD/DVD-ROM Drive>  
<Floppy Drive>  
<Hard Disk Drives>  
<Ethernet>  
Hard Drive Order <Hitachi HDS72105>  
<Hitachi HDS72105>  
<ATAPI iHAS124 >  
CD/DVD-ROM Drive Order  
Removable Drive Order  
Boot to Optical Devices  
Boot to Removable Devices  
Boot to Network  
USB Boot  
Boot USB Devices First  
USB Mass Storage Emulation Type  
UEFI Boot <Auto>  
<Disable>

Set boot order of media devices.

**CD/DVD-ROM Drive**  
Floppy Drive  
Hard Disk Drives  
Ethernet

+ = Move Selection Up  
- = Move Selection Down  
Enter=Change Setting  
Esc=Discard Changes



# BIOS Setup Program: Hardware Monitoring

- **The BIOS setup program can be used to monitor status of motherboard hardware components**
- **Temperature**
  - Embedded sensors display temperature
  - Can trigger alarms
- **Fan speeds**
  - Displays fan speed RPM (revolutions per minute)
  - Note: Some BIOS setup programs can also set fan speeds
- **Intrusion detection/notification**
  - Displays state of intrusion detection switches on case
- **Hardware component parameters**
  - Voltage
  - Clock speeds
  - Bus speed (main system bus)



# BIOS Setup Program: Hardware Monitoring

```

                                     System Setup
Main  Advanced Performance Security Power Boot Exit

Hardware Monitoring

Processor Fan Speed    1080
Aux Fan Speed         0000
Front Fan Speed       0000
Rear Fan Speed        0000

Processor Thermal Margin      42 C
IOH Temperature              63 C
Motherboard Ambient Temperature 45 C
Voltage Regulator Temperature 51 C

V12.0          12.250 U
V5.0           5.181 U
V3.3           3.248 U
V1.1           1.119 U
Vccp           1.242 U

Press Escape to continue

```



- **Motherboard Components**
- **Configuring the Motherboard**
  - Setup Program
  - **CMOS RAM and Backup Battery**



# CMOS RAM and Backup Battery

## ➤ What is CMOS RAM?

- Battery-backed memory used to store configuration settings
  - Set using BIOS Setup Utility program run from BIOS ROM
- CMOS devices consume very little power

## ➤ Backup battery

- Supplies power to CMOS RAM when system power is off
- Battery pack on motherboard or externally mounted
- Battery life: from two to three years

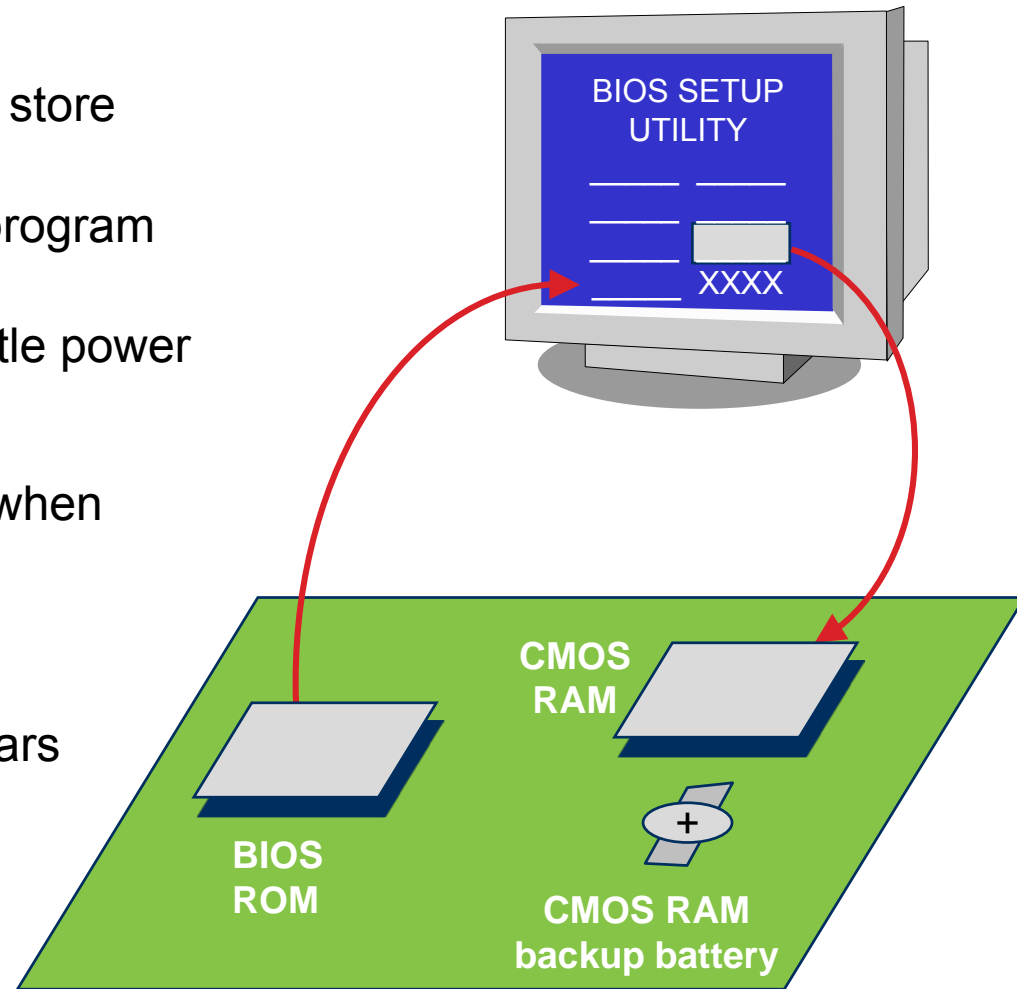

CMOS = complementary metal-oxide semiconductor





# Backup Battery Problems and Solutions

## ➤ Battery problems and solutions

- Loss of configuration setup information or erratic time and date is usually due to battery failure
- Solution: Replace battery, run Setup program to reconfigure system and restore settings in CMOS setup memory
  - This is also a trick method for resetting an unknown BIOS password!

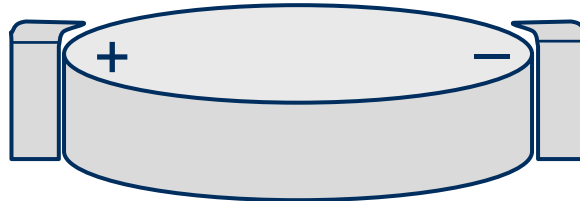

# Front Panel Connectors

## ➤ Front panel switches, lights, and connectors are connected to a header on the motherboard

- Power button
- Power light
- Drive activity lights
- Reset button
- Audio, USB connectors

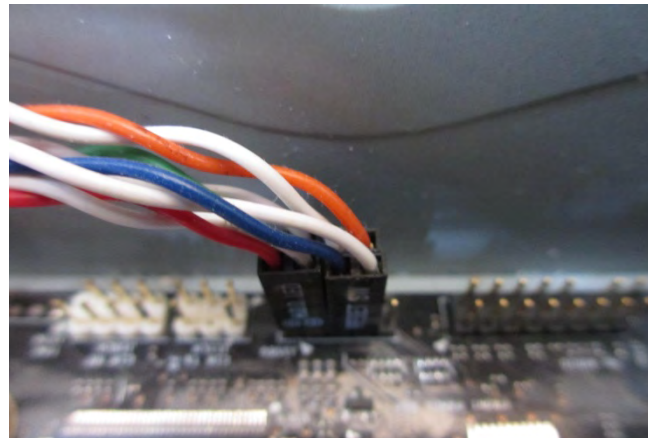
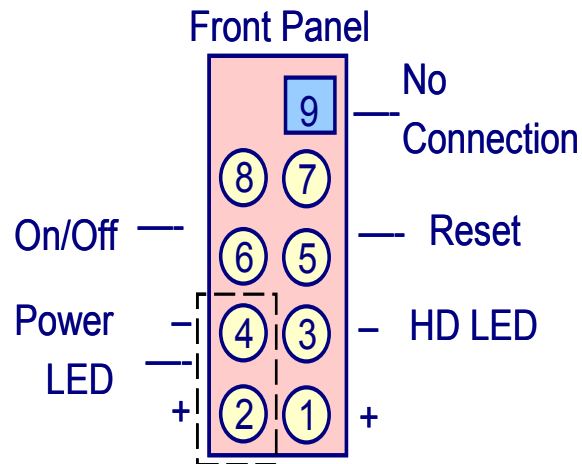

# Review Questions

Match the numbered items on the motherboard in the photo with the letter of the correct label in the list below

1. \_\_\_\_\_

2. \_\_\_\_\_

3. \_\_\_\_\_

4. \_\_\_\_\_

5. \_\_\_\_\_

6. \_\_\_\_\_

7. \_\_\_\_\_

8. \_\_\_\_\_

9. \_\_\_\_\_

A. CPU and heatsink

B. SATA port connector

C. DIMM memory cards

D. PCIe x16 display card socket

E. CMOS backup battery

F. Main motherboard power supply connector

G. PCIe x1 port connector

H. PCI expansion slot

I. Chipset and heatsink



# Review Questions

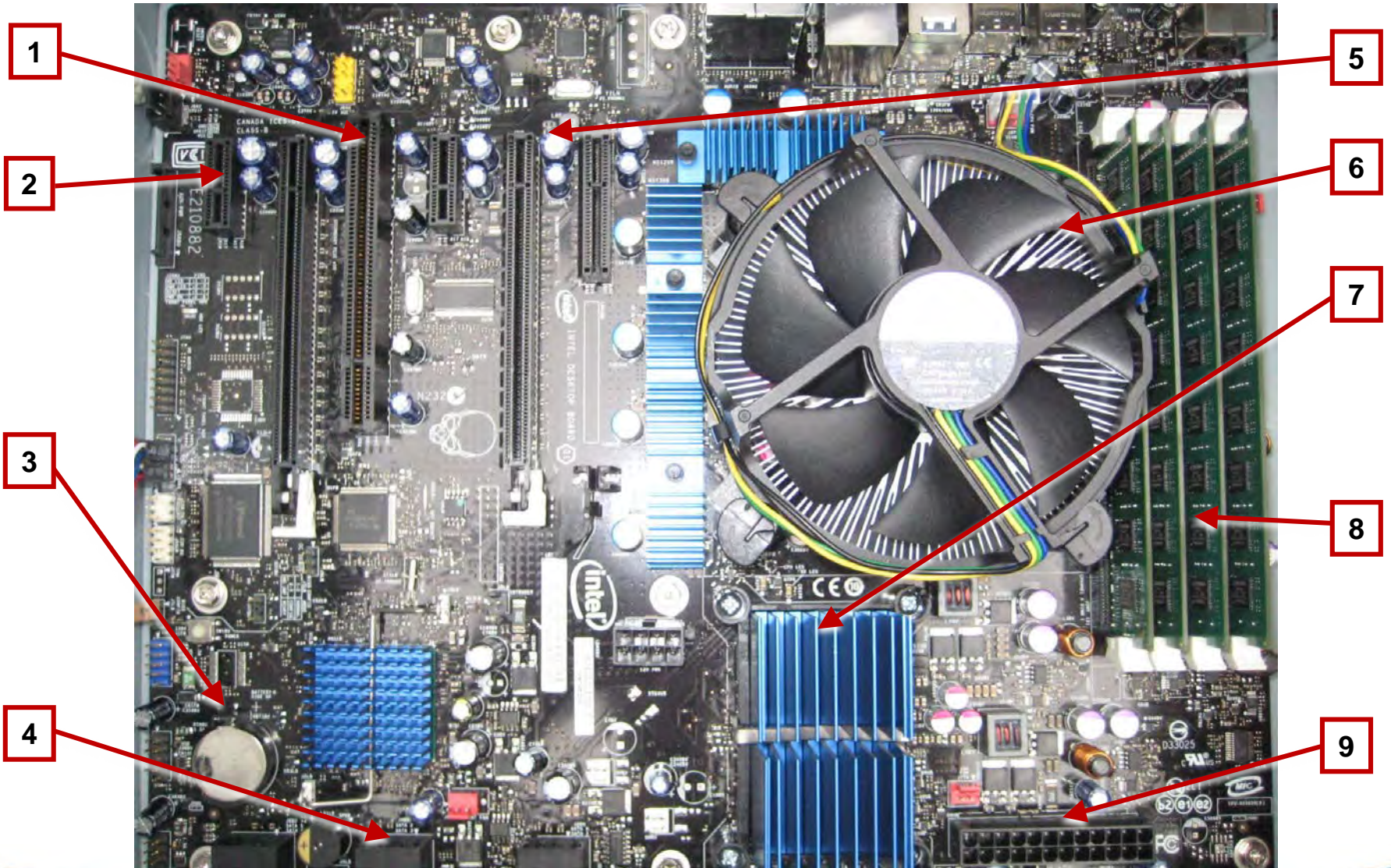

# Review Questions

- 1. When does the PnP BIOS scan peripheral devices to gather configuration information?**
  - A. During the initialization phase of the PC boot process
  - B. When the user types the PnP command
  - C. After the operating system has been loaded
  - D. When the PC is being shut down
- 2. Which type of program would benefit from enabling the VT feature in the BIOS setup program?**
  - A. Microsoft Office
  - B. Antivirus scanner
  - C. Virtualization program
  - D. Web design program



# Review Questions

- 3. A user complains that they have to keep resetting the time on their PC. What is the most likely cause of this problem?**
- A. Defective system RAM
  - B. Failing CMOS backup battery
  - C. Defective CPU
  - D. Failed power supply
- 4. Which type of PCIe slot would be best suited for a display adapter card?**
- A. PCIe 1X
  - B. PCIe 8X
  - C. PCIe 16X
  - D. PCIe slots cannot be used for display adapter cards



# Chapter Summary

In this chapter, you have learned how to

- **Identify and describe the following motherboard components:**
  - Microprocessor (CPU)
  - Chipset
  - System clock circuit
  - ROM and RAM memory devices
  - PC bus types and expansion slots
  - I/O (Input/Output) ports
  
- **Explain how the CMOS RAM and setup program are used to configure the PC**



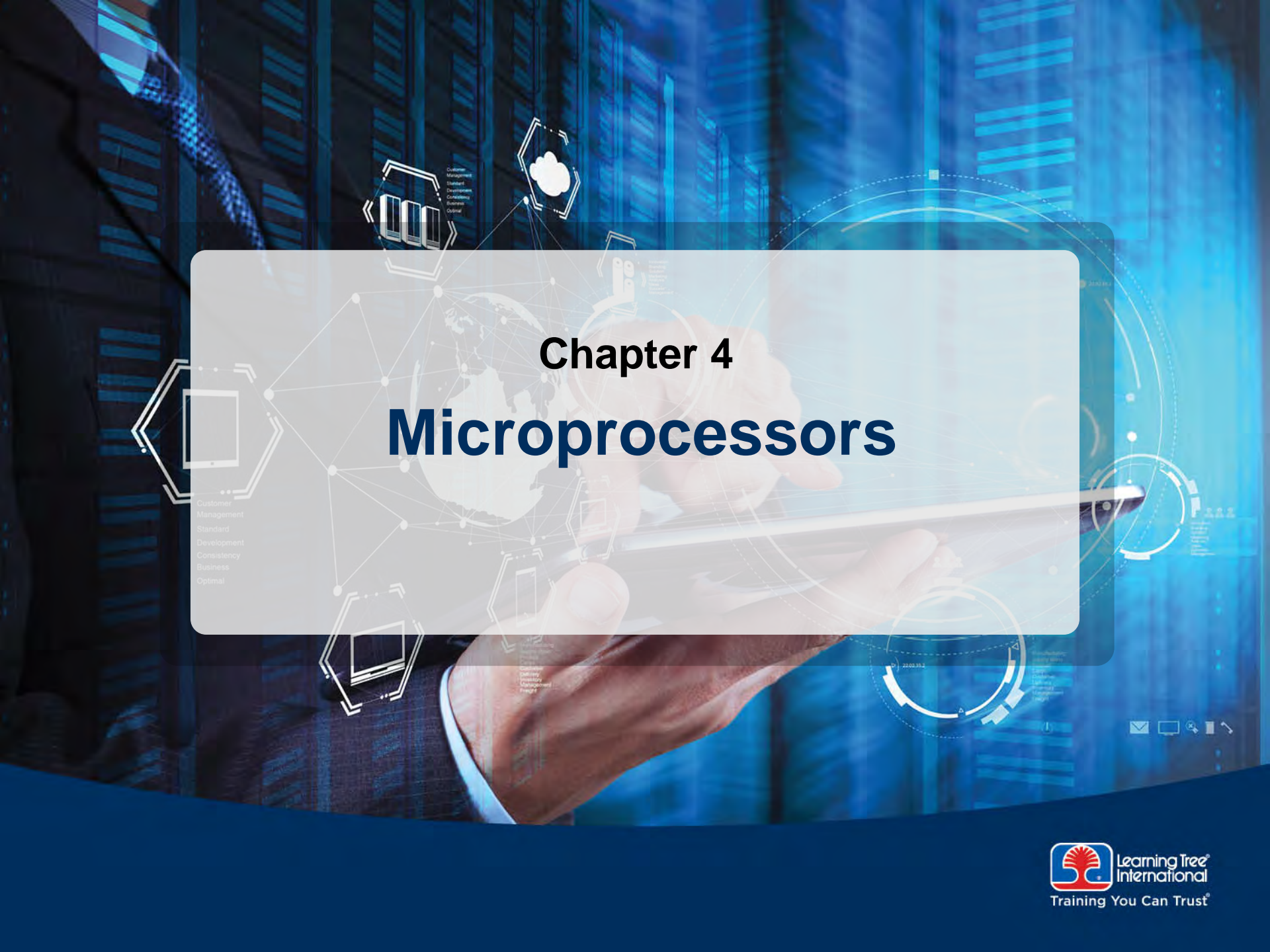

# Chapter 4

# Microprocessors

Customer  
Management  
Standard  
Development  
Consistency  
Business  
Optimal



# Chapter Objectives

In this chapter, you will learn how to

- **Describe the basic operation of a microprocessor (CPU)**
- **Define the following terms**
  - Address bus
  - Data bus
  - Clock circuit
- **Identify and describe the key features of microprocessors**
  - Intel
  - AMD
- **Describe the main functions of the system chipset and system clock**



## ➤ **How Microprocessor Systems Work**

- **Microprocessor Chips**
- **System Chipset**
- **Clock Circuits**



# How Microprocessor Systems Work

## ➤ Why study basic microprocessor operation?

- Key to understanding how the motherboard components work together
- Provides concrete illustrations of abstract terms used to distinguish different microprocessors (address bus size, external vs. internal data bus size, etc.)

## ➤ Simplified microprocessor system example

- The most common operation performed by any microprocessor is reading an instruction stored in memory
- The following section uses a simplified microprocessor system to explain how this operation works



# Simplified Microprocessor System Example

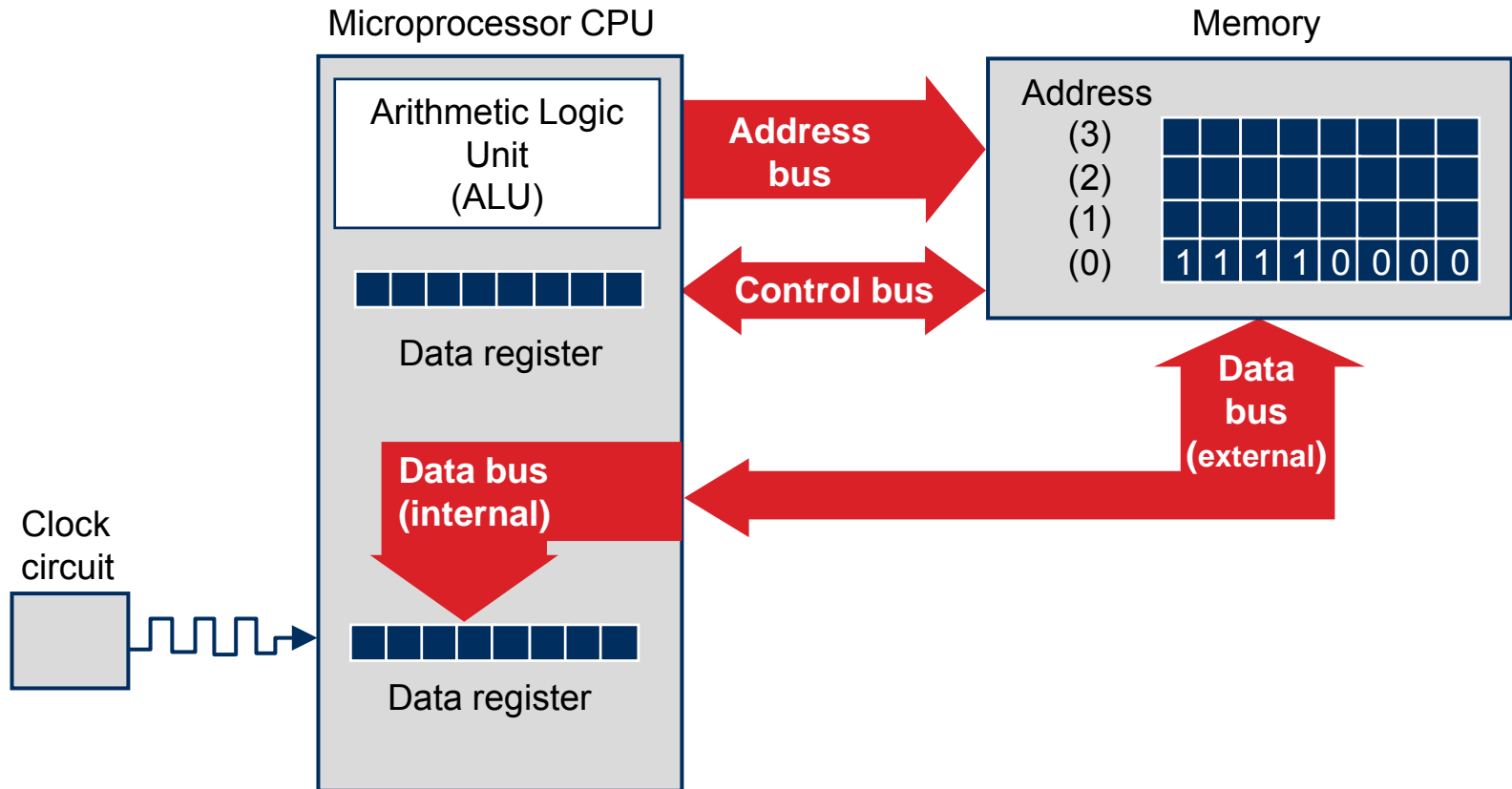

# Simplified Microprocessor System Example

## Overview of system components

### ➤ **Microprocessor = CPU (Central Processing Unit)**

- “Brains” of the computer system
  - Reads instruction stored in memory and executes specified operations
- Registers: temporary storage units that hold data before and after processing
- Arithmetic Logic Unit (ALU): main data processing unit of CPU

### ➤ **Memory**

- Semiconductor devices that store instructions and data that is processed by CPU

### ➤ **Busses**

- Sets of wires (printed-circuit tracks) that carry related groups of signals between the microprocessor and other devices in the system



# Simplified Microprocessor System Example

## Overview of system components

### ➤ Address bus

- Bus that carries the address information (location) from the CPU to or from memory or I/O devices
- The specified memory location is then activated and can be read or written by the microprocessor
- Key point: The size of the address bus determines *how many* memory locations can be accessed by the microprocessor

### ➤ Data bus

- Main data pathway between microprocessor and memory or I/O devices
- Key point: The size of the data bus determines *how much* data is transferred to or from the microprocessor on each memory access

### ➤ Clock circuit

- Crystal-based oscillator provides a precise timing signal to the microprocessor chip
- Determines basic speed of computer (2.4 GHz, 3.0 GHz, etc.)



# 32-Bit vs. 64-Bit CPU Architectures

- **What is the difference between 32-bit and 64-bit CPU architectures?**
  - This number refers to the size of the Data and Address registers used in a CPU
  - Larger registers can contain bigger numbers
- **Data bus**
  - 64-bit registers provide higher data processing capability
  - Also supports larger, more complex instruction sets
- **Address bus (theoretical limits)**
  - **32-bit** address registers can address  $2^{32}$  bytes of memory (**4 GB**)
  - **64-bit** address registers can address  $2^{64}$  bytes of memory (**17.2 billion GB!**)
  - Most CPUs (and operating systems) support less than the theoretical maximum addressing capabilities



- **How Microprocessor Systems Work**
- **Microprocessor Chips**
- **System Chipset**
- **Clock Circuits**





# Microprocessor Chips: Historical Overview

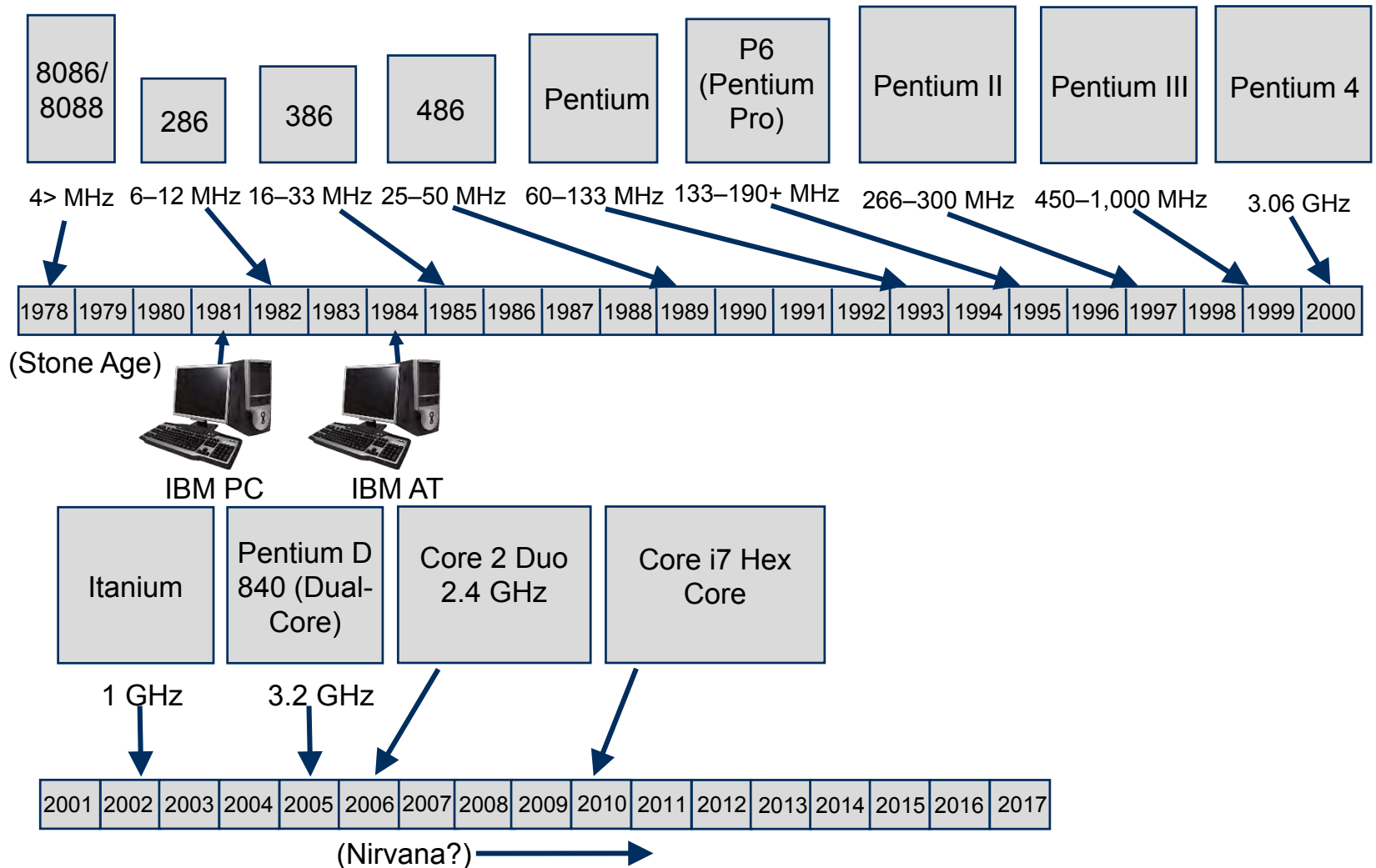

AT = advanced technology



# Intel Pentium

- **Internal register size is 32-bit addressing, 64-bit data path**
- **External data bus size is 64 bits**
  - This is double the size of many mainframe computers
- **Cache memory**
  - 8K Instruction
  - 8K Data



# Intel Pentium (80586)

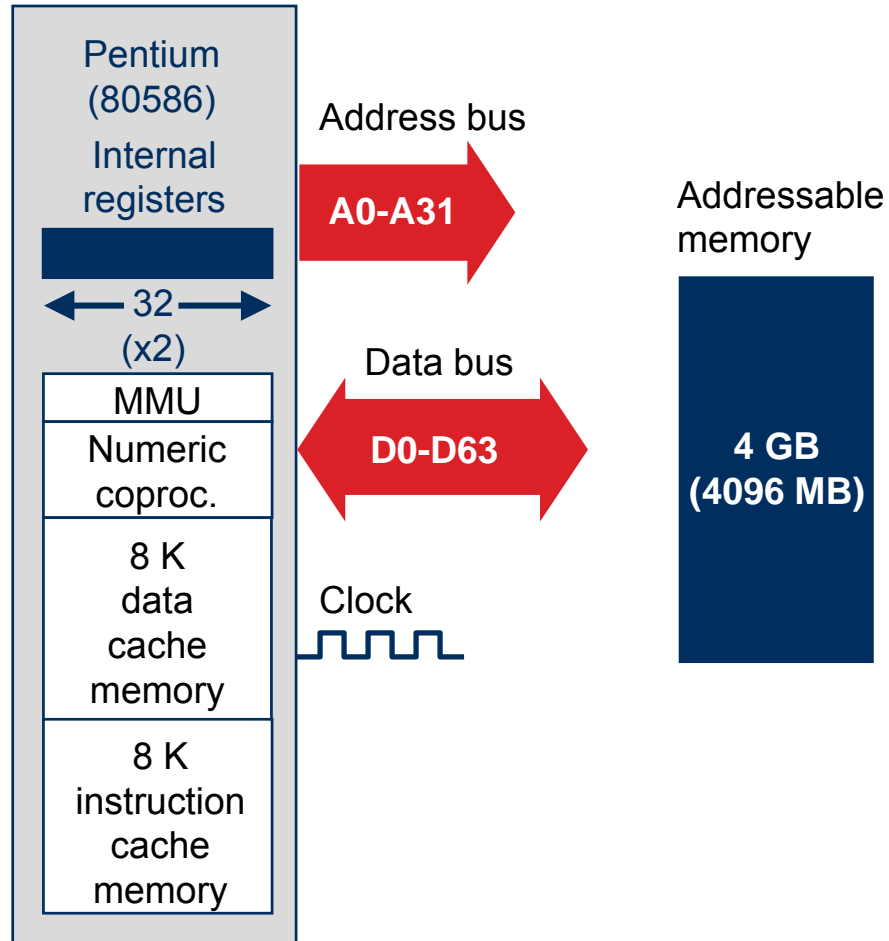

# Cache Memory

## ➤ What is cache memory?

- High-speed Static RAM (SRAM) is used to quickly load and store instructions (or data) from main memory
  - SRAM is fast, does not need refreshing, but is expensive and usually provided in relatively small amounts
- CPU can then execute instructions rapidly from cache memory without waiting for external bus fetches

## ➤ Types of cache memory

- L1 (Level 1) cache contained inside CPU (on same integrated circuit)
  - Runs at internal CPU clock speed
- L2 (Level 2) cache is located near CPU integrated circuit
  - May be another integrated circuit mounted on same chip as CPU
  - Runs at reduced speed



# Cache Memory

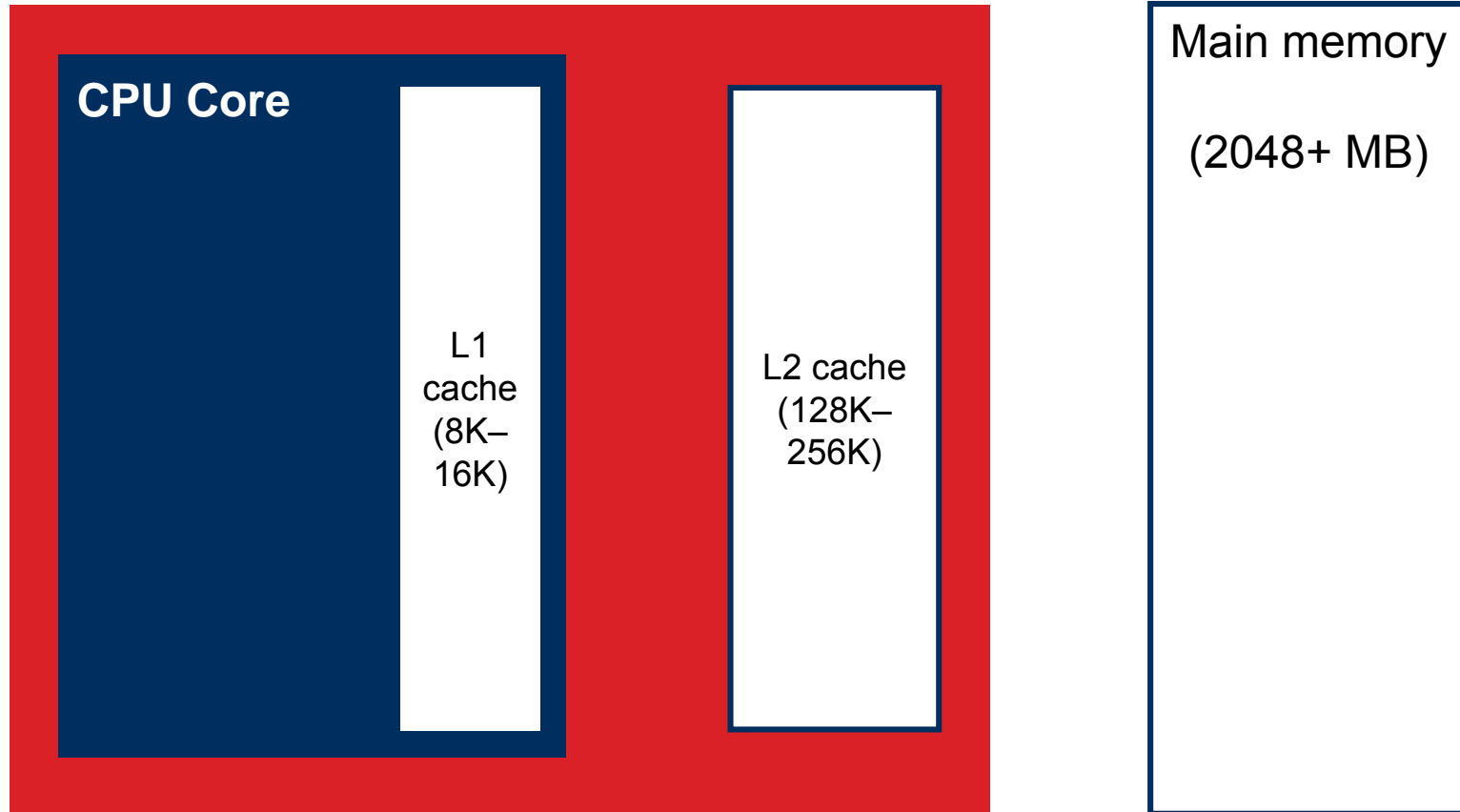

# Dual-Core CPUs

## ➤ What are dual-core CPUs?

- Chips that contain two complete CPU cores and L2 caches
  - Intel Core 2 Duo, AMD Athlon 64X2
- Able to execute two instruction streams completely independently

## ➤ Why are manufacturers beginning to produce dual-core CPUs?

- Until recently, manufacturers increased CPU performance by making denser chips (more transistors) and by increasing the clock speed
- CPU speed+density/heat ratios have finally hit a wall (chips melt), so manufacturers are opting to produce chips with multiple-CPU cores that run at current clock speeds

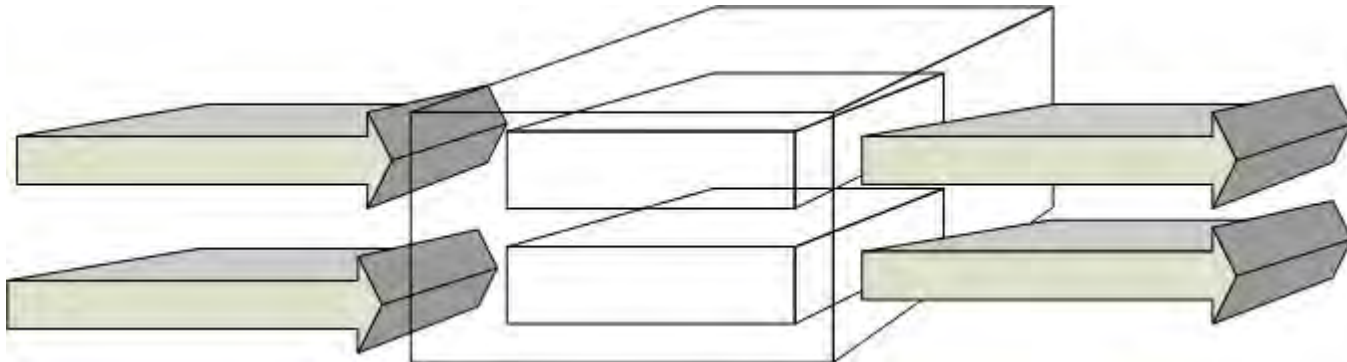

# Triple-Core and Quad-Core CPUs

## ➤ Intel quad-core CPUs contain two Core 2 duo CPU cores

- Includes 2 x 4MB L2 cache
- Able to execute four instruction streams completely independently

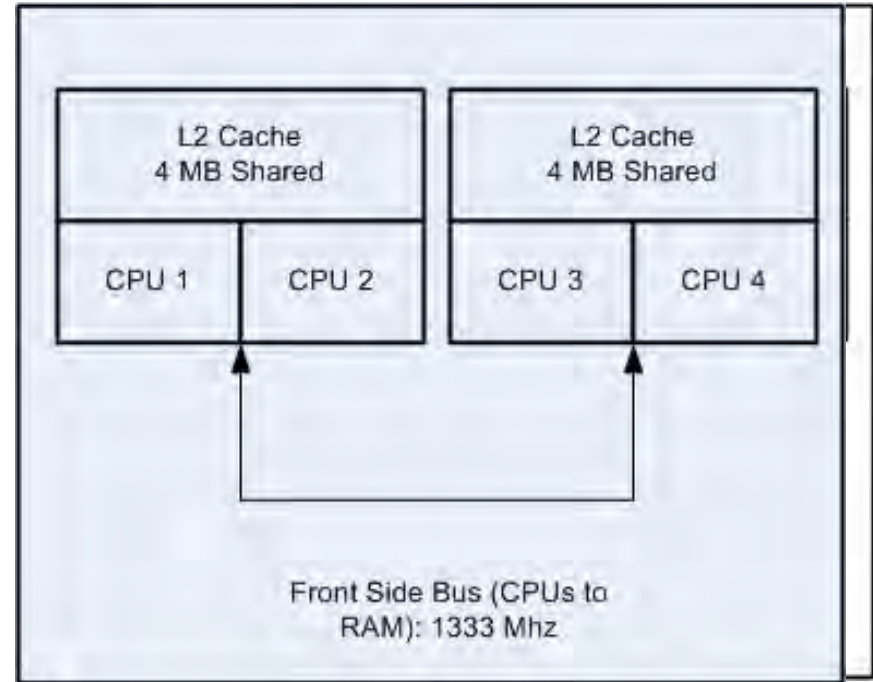

# Intel Core i CPUs

## ➤ Latest Intel CPU family

- Based on new microarchitecture (code named Nehalem)
- Includes Core i3, i5, i7 CPUs
  - Number no longer refers to number of cores
  - Indicates relative performance

## ➤ Core i CPU features

- Multicore (2, 4, 6)
- Integrated memory controller supports two or three channels DDR3 RAM
- Integrated Graphics Processor (IGP)
- 32 KB L1, 256 KB L2, 8-12 MB L3 cache memory

DDR = double data rate

## i7 Quad Core CPU

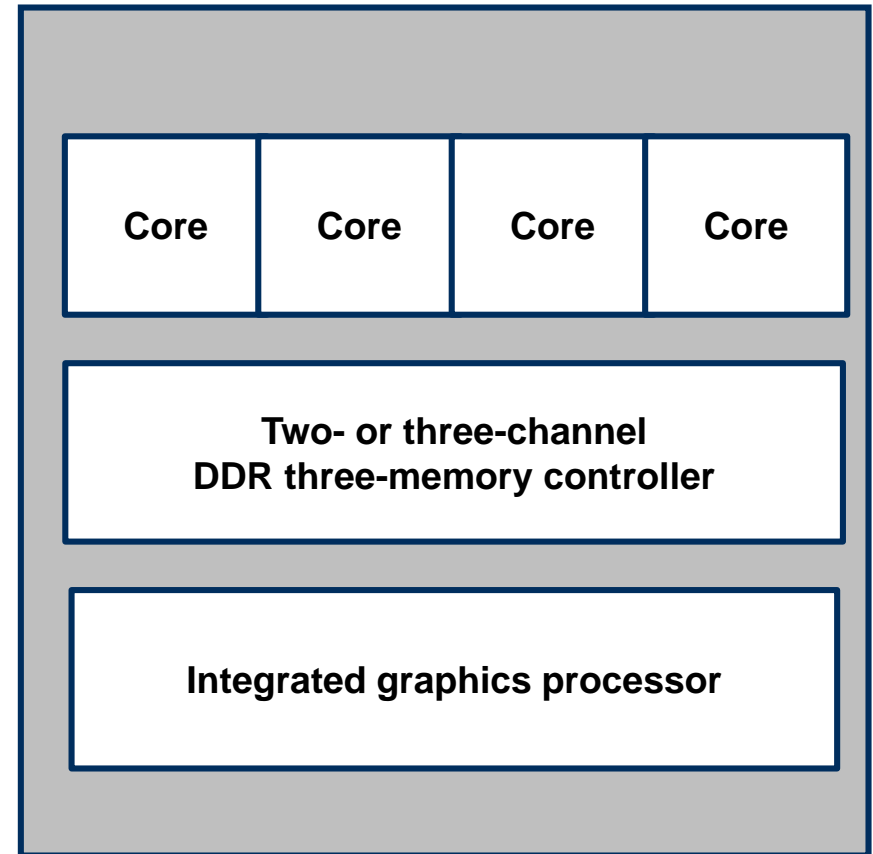



# Hyperthreading and Virtualization Support

## ➤ Hyperthreading

- Intel technology allows single CPU core to execute two program threads in parallel
  - Acts as if there are two cores
  - Switches between threads when one is waiting for I/O or other resource

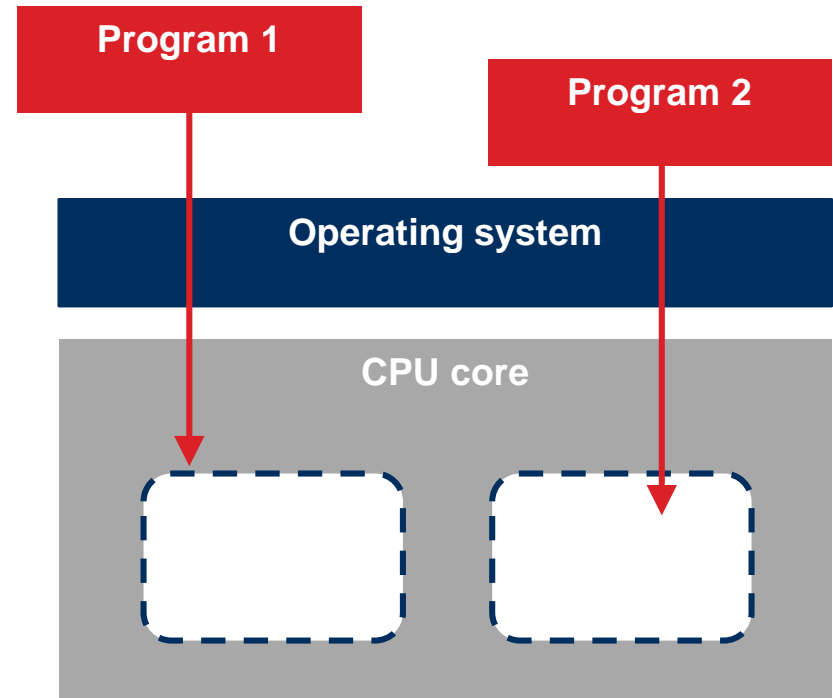

# CPU Virtualization Support

## ➤ What is virtualization?

- Technology that allows multiple operating systems to run on one CPU

## ➤ Software-only virtualization

- Uses Virtual Machine Monitor (VMM) program to run operating system environments

## ➤ Hardware-assisted virtualization support

- CPU hardware features to support running multiple operating systems on one CPU
  - Intel Virtualization Technology (VTx)
  - AMD Virtualization (AMD-V)

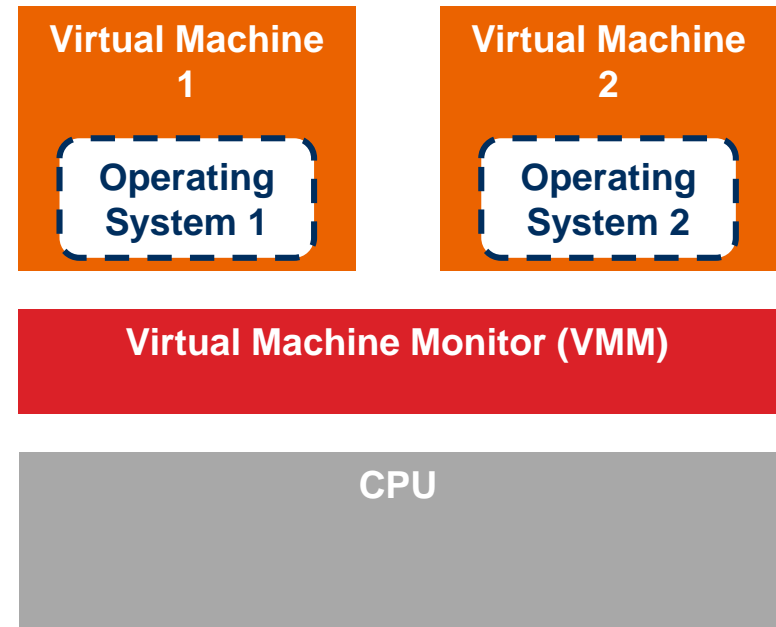

# Integrated Graphics Processing Unit (GPU)

## ➤ What is an integrated GPU?

- CPU containing a built-in graphics processing unit (GPU)
- Direct path between CPU and GPU increases video/graphics performance
- Intel Sandy Bridge, SkyLake CPU architecture
- AMD Accelerated Processing Unit (APU)

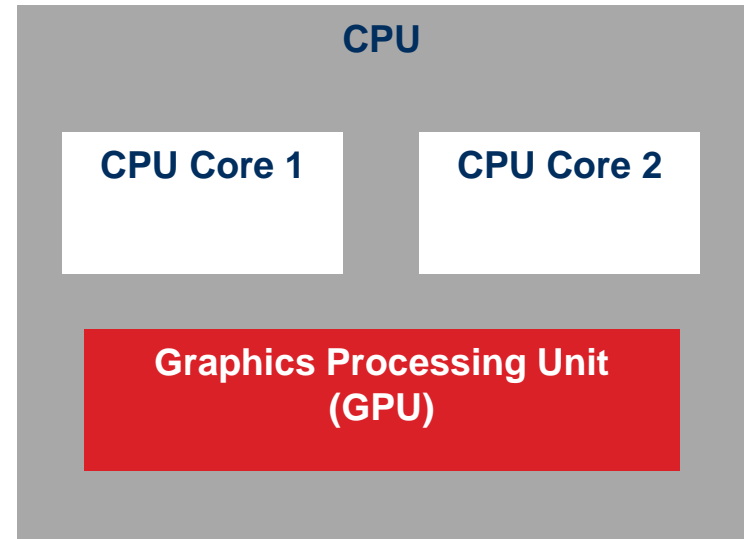

# Execute Disable Bit

## ➤ Intel CPU security feature

- Allows CPU to set a bit flag preventing execution of code in specified memory areas
- Prevents malware from loading code into memory buffers, then running malicious code

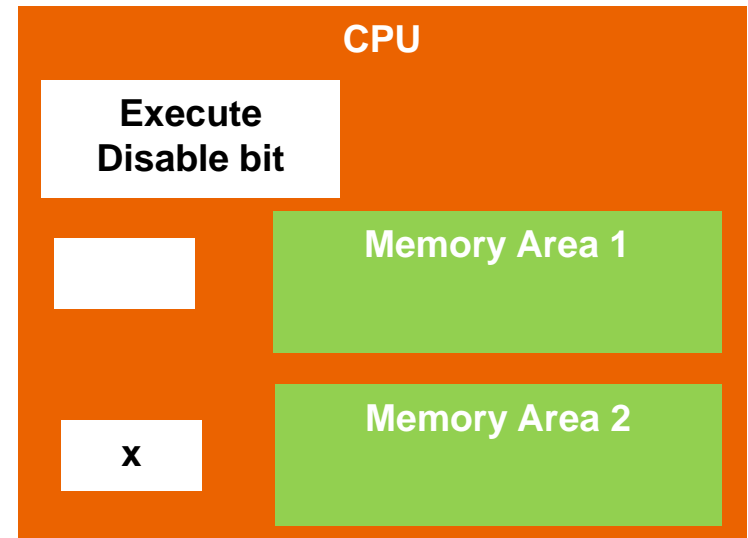

# CPU Socket Types: Intel

- **CPU sockets provide grid of electrical contacts that connect CPU contacts to motherboard**
  - Use a lever or plate to secure chip to socket
- **Land Grid Array (LGA)**
  - Features “Lands” (flexible leaf contacts) in socket that connect to gold-plated contacts on CPU chip
    - Many Intel CPUs use this socket
  - Socket name includes number of pins
  - Replaces Pin Grid Array (PGA) package

**PGA socket**

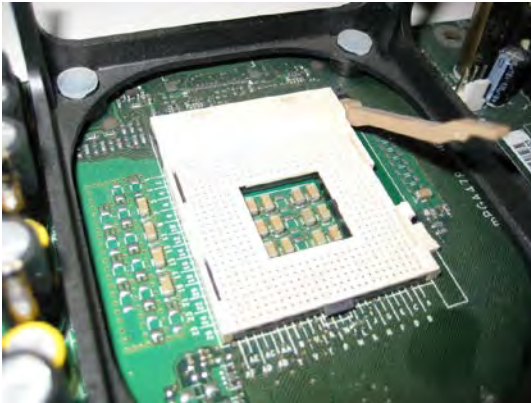

**LGA socket**

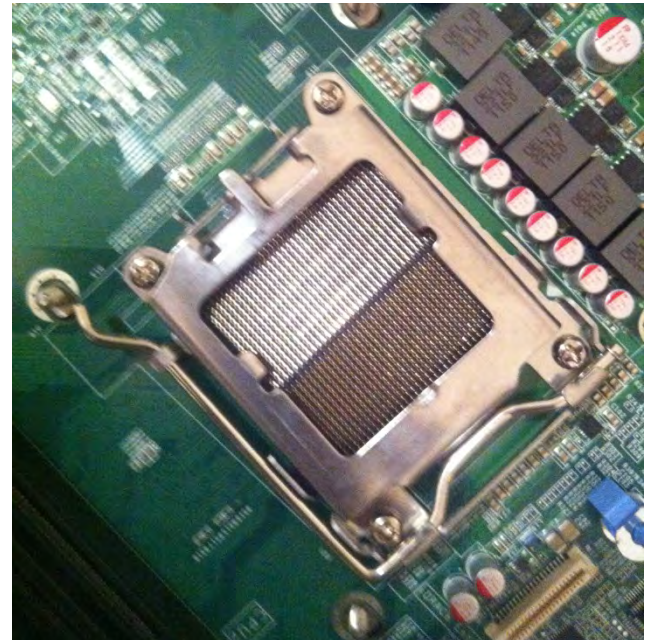

# Intel and AMD Multi-Core CPUs and Sockets

Manufacturer	CPU	Socket
Intel	Pentium 4 Core 2 Duo	LGA 775
	Core i3, i5, i7 Xeon, Pentium, Celeron	LGA 1155, 1156
	4 <sup>th</sup> generation Core CPUs	LGA 1366, 1150, 2011
AMD	Phenom II, Athlon II, Sempron	AM3
	Phenom II, Athlon II, Sempron Vishera, Zambezi	AM3+
	Llano	FM1
	Trinity	FM2
	Kaveri, Godavari	FM2+



# CPU Cooling Methods and Devices

## ➤ Heat sinks

- Multiple fins provide large surface area to radiate heat
- Thermal compound must be applied between heat sink and CPU to provide maximum heat transfer

## ➤ Fans

- Attached to CPU heat sink
- Mounted on PC case

## ➤ Fan connectors

- CPU heat sink fan connects to header on motherboard
- Case fans connect to 4-pin Molex power connector

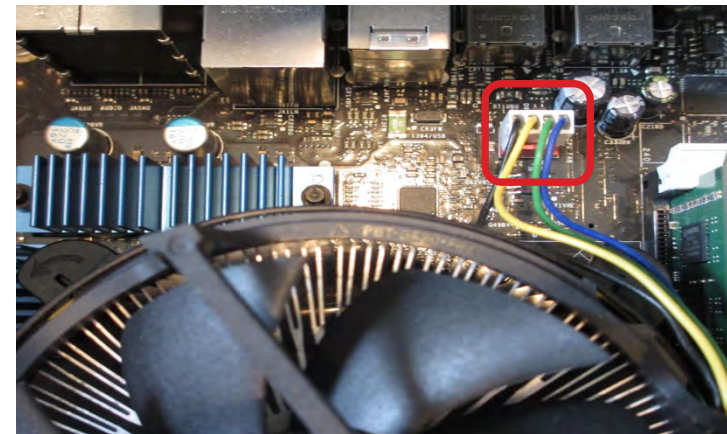

# Thermal Paste

## ➤ What is thermal paste?

- Special paste fills gaps between CPU and heat sink to maximize heat transfer
- Should always be applied to CPU before mounting heat sink

## ➤ Applying thermal paste

- Squeeze a small amount onto the CPU metal plate
- Spread out using applicator or small piece of cardboard

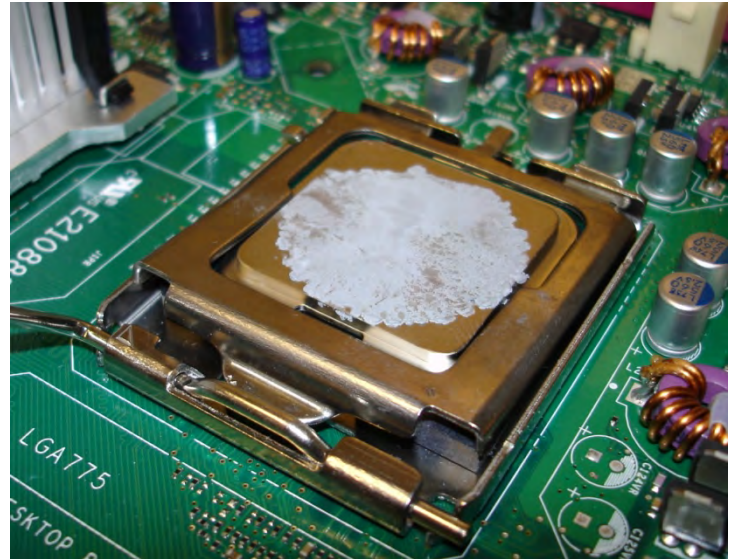



# CPU Cooling Methods and Devices

## ➤ Liquid-based cooling systems

- Water or other liquid flows through heat sink mounted to CPU; dissipates heat through radiator on rear of PC chassis

## ➤ Heat pipes

- Liquid coolant is vaporized by heat at one end of the pipe
- Heated vapor migrates to other end of pipe, where heat is radiated to outside of chassis

## ➤ Fanless/passive

- Heat sinks with multiple plates dissipate heat by radiating into air



CPU

Heat Pipe



- **How Microprocessor Systems Work**
- **Microprocessor Chips**
- **System Chipset**
- **Clock Circuits**



# Chipsets

## ➤ What is a chipset?

- Set of high-integration components that contain key motherboard support devices
- Current motherboards predominantly use Intel chipsets

## ➤ Chipset architecture

- Consists of two *bridge* chips
- *North bridge*
  - Main interface between CPU and memory
- *South bridge*
  - Interface between CPU and I/O, disk drives



# Chipset Example: Intel 850

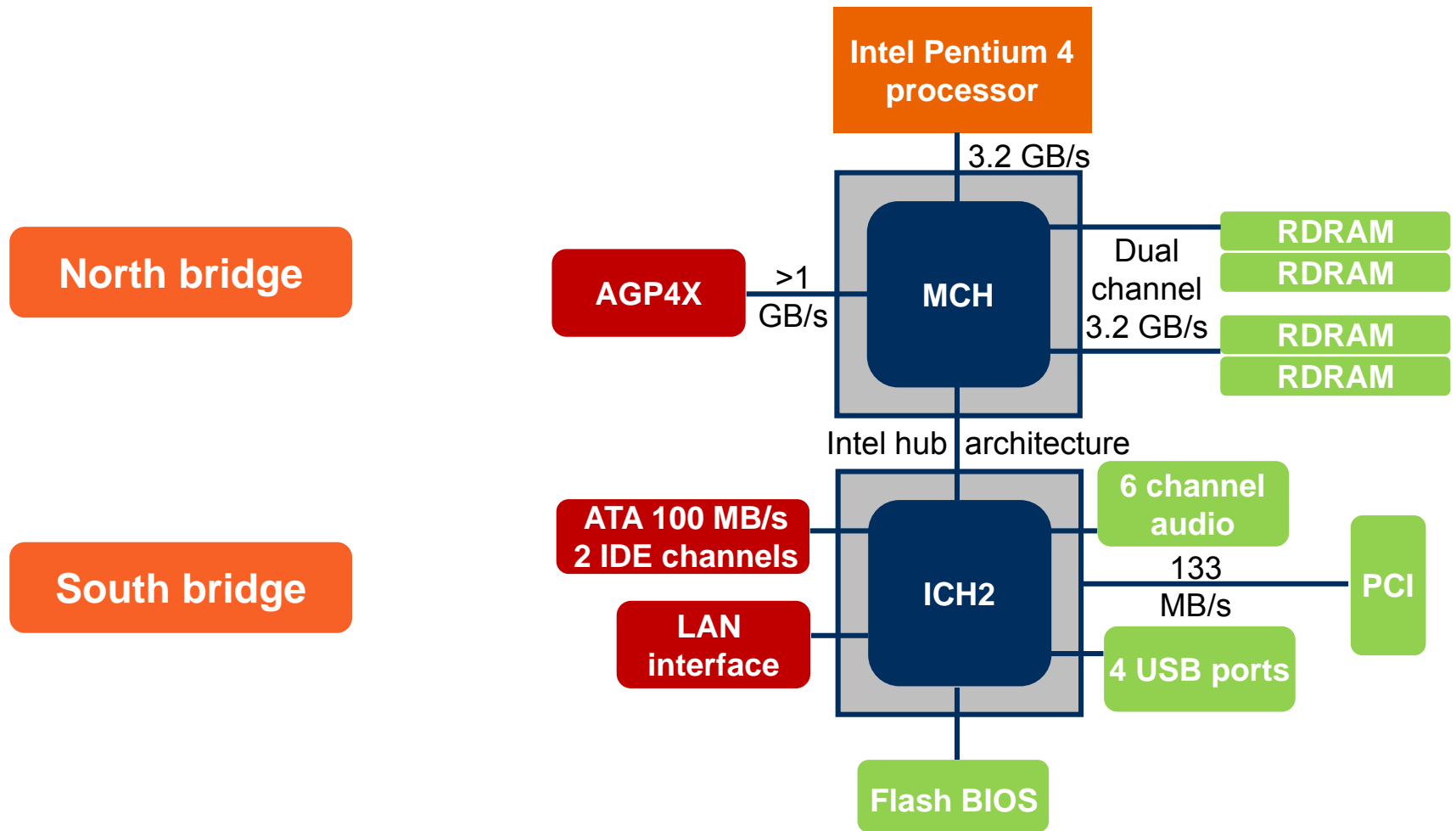

- **How Microprocessor Systems Work**
- **Microprocessor Chips**
- **System Chipset**
- **Clock Circuits**



# Clock Circuits and Bus Speeds

- **The clock circuit provides the basic clock signal to the microprocessor**
  - This clock rate determines the system's basic speed (System Bus speed)
  - The clock frequency is created by a crystal oscillator (encased in a small metal can)
  - The clock frequency may be multiplied inside the microprocessor to allow it to run at a higher speed
  - On some systems, the clock speed may be set to different speeds using the system BIOS
- **The maximum speed of a microprocessor chip is normally specified along with the part number**
  - Example: Core i7 at 3.2 Ghz



# Clock Circuits

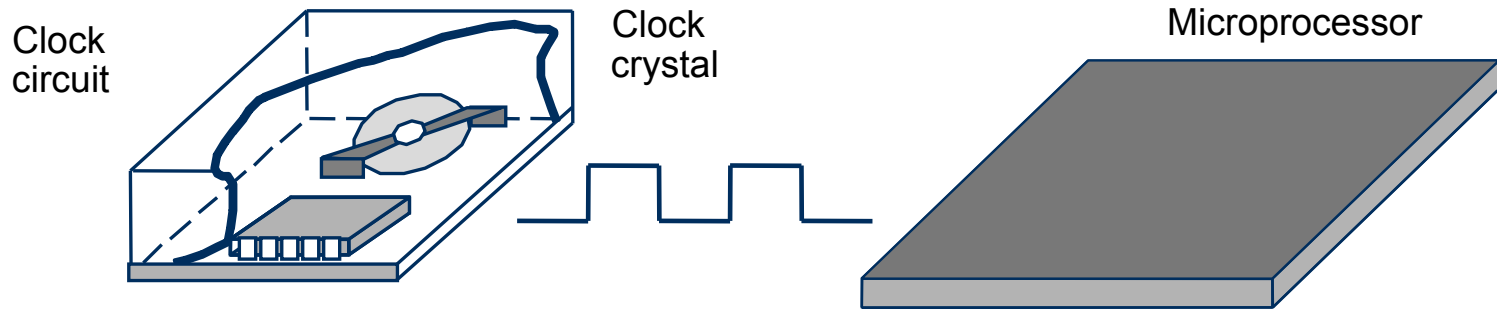

100-MHz clock frequency = 100 million cycles per second

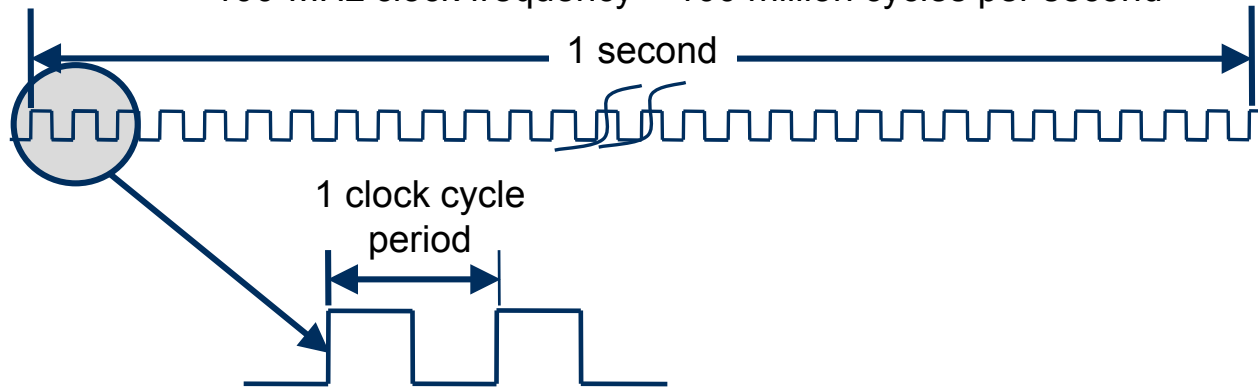

$$\frac{1}{\text{Frequency}} = \text{Period (1 clock cycle)}$$

$$\frac{1}{100,000,000} = .000000010 \text{ seconds}$$
$$= 10 \text{ nanoseconds (billionths of a second)}$$



# CPU Clock-Multiplier Technology

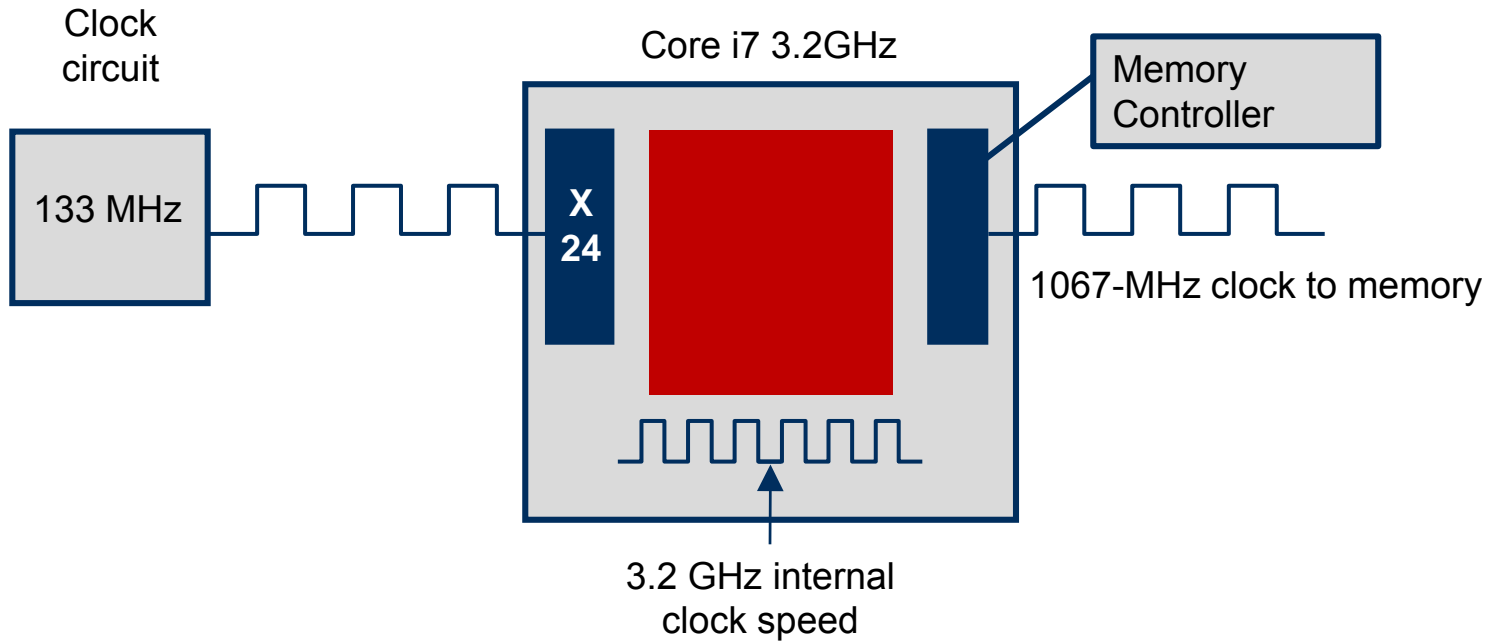

Note: The Core i7 features an integrated memory controller, instead of using the memory controller on a chipset





# Review Questions

- 1. Which type of cache memory is located near the CPU core (but not within)?**
  - A. L1
  - B. L2
  - C. L3
  - D. L4
  
- 2. Which technology allows multiple operating systems to run on one CPU?**
  - A. Hyperthreading
  - B. Virtualization
  - C. Graphics Processing Unit (GPU)
  - D. Multiple operating systems cannot be run on one CPU
  
- 3. The chipset on a PC motherboard is:**
  - A. The BIOS ROM device
  - B. The RAM memory on the display adapter card
  - C. The adapter card slots
  - D. A set of high-integration components that contain key motherboard support devices



# Review Questions

4. Which part of the chipset is the main interface between the CPU and I/O devices?
- A. North bridge
  - B. East bridge
  - C. South bridge
  - D. West bridge



# Chapter Summary

In this chapter, you have learned how to

- **Describe the basic operation of a microprocessor (CPU)**
- **Define the following terms**
  - Address bus
  - Data bus
  - Clock circuit
- **Identify and describe the key features of microprocessors**
  - Intel
  - AMD
- **Describe the main functions of the system chipset and system clock**





# Chapter 5

## The Power Supply



# Chapter Objectives

---

In this chapter, you will learn how to

- Describe the basic features of the ATX power supply
- Diagnose and troubleshoot power-supply problems
- Describe common power-line-related problems and their solutions
- Test AC power-outlet wiring
- Describe the function of an Uninterruptible Power Supply (UPS)



## ➤ **ATX Power Supply**

- **Troubleshooting Power Supply Problems**
- **Power-Line Problems**
- **Solutions to Power-Line Problems**



# ATX Power Supply

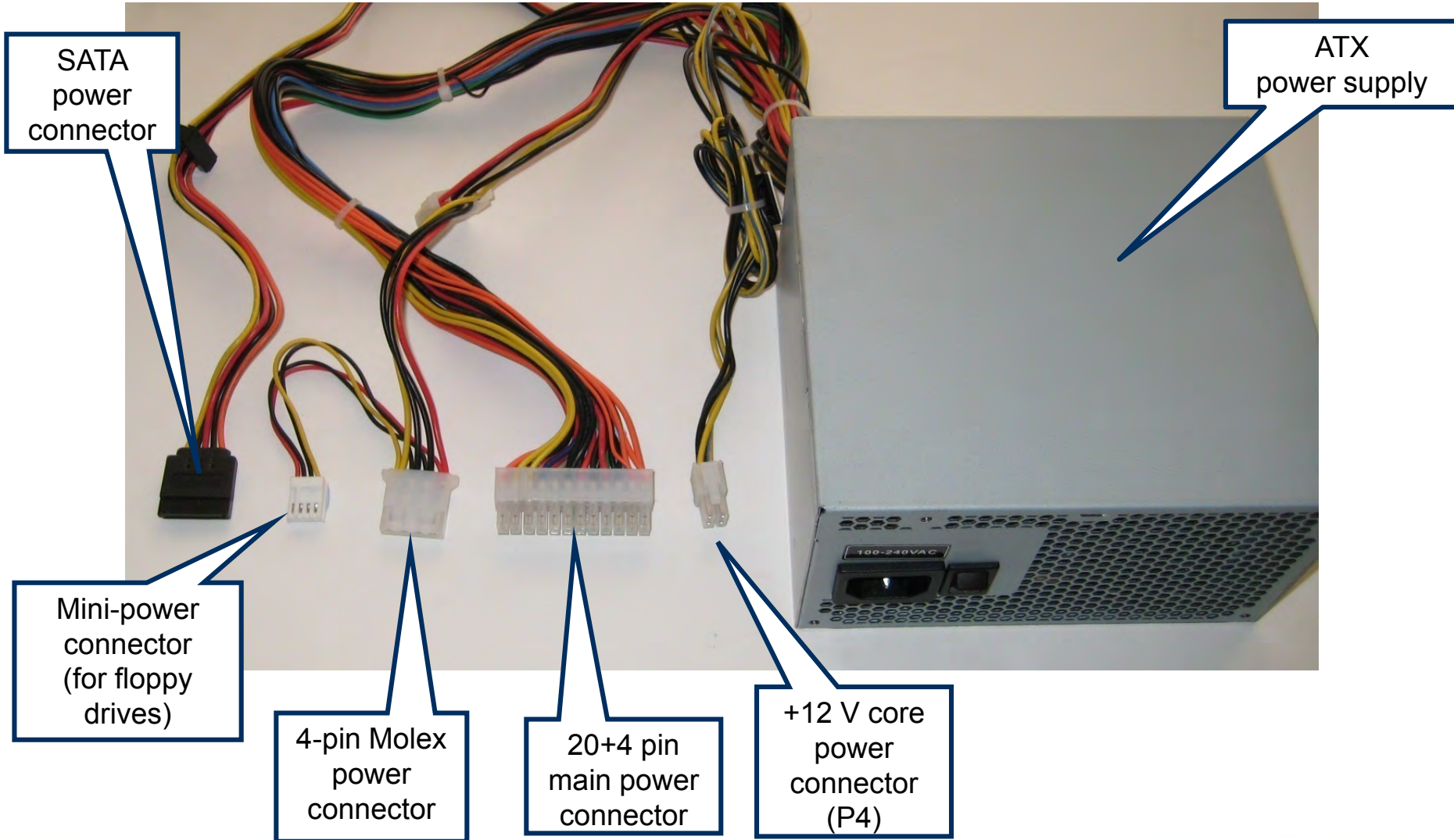

# ATX Power Supply

## ➤ ATX-style motherboard power connector

- Uses either a 20-pin single connector (P1), or a 20+4 pin connector

## ➤ Micro-ATX motherboards use same power connector

- But may use a low-profile power supply case

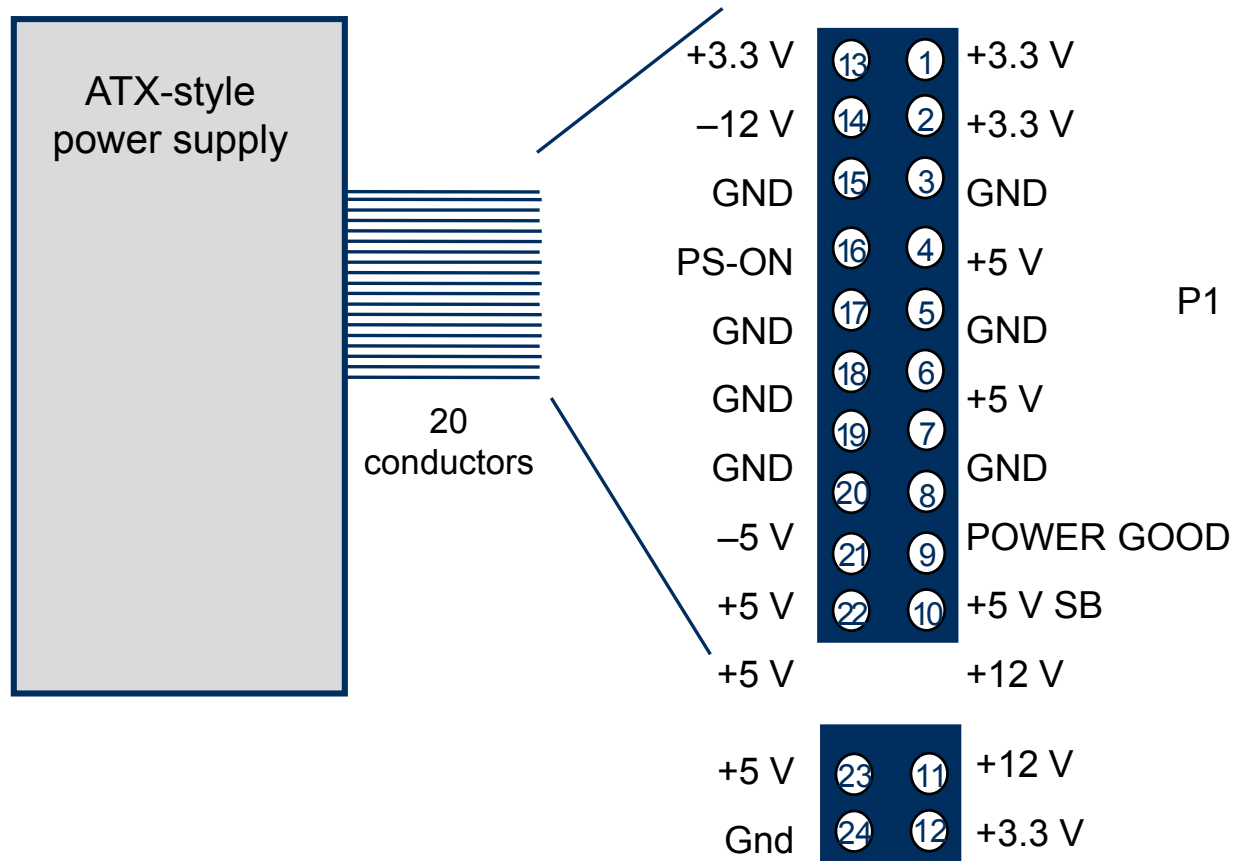



# ATX Power Supply: Device Power Connectors

## ➤ Molex (4-pin)

- Used for pre-SATA drives

Pin	Voltage	Color
1	+12 V	Yellow
2	GND	Black
3	GND	Black
4	+5	Red

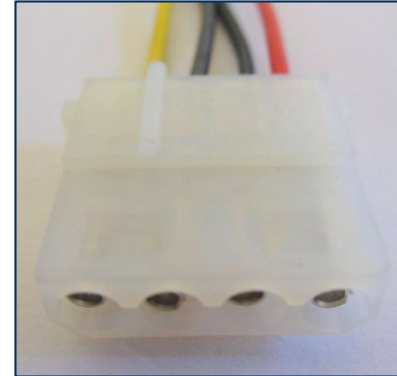

## ➤ Floppy drive connector (4-pin)

Pin	Voltage	Color
1	+12 V	Yellow
2	GND	Black
3	GND	Black
4	+5	Red



# ATX Power Supply: Device Power Connectors

## ➤ Sata (15-pin)

- Used for SATA devices

Pin	Voltage	Color	Pin	Voltage	Color
1	+3.3 V	Orange	9	+5 V	Red
2	+3.3 V	Orange	10	GND	Black
3	+3.3 V	Orange	11	GND	Black
4	GND	Black	12	GND	Black
5	GND	Black	13	+12 V	Yellow
6	GND	Black	14	+12 V	Yellow
7	+5 V	Red	15	+12 V	Yellow
8	+5 V	Red			

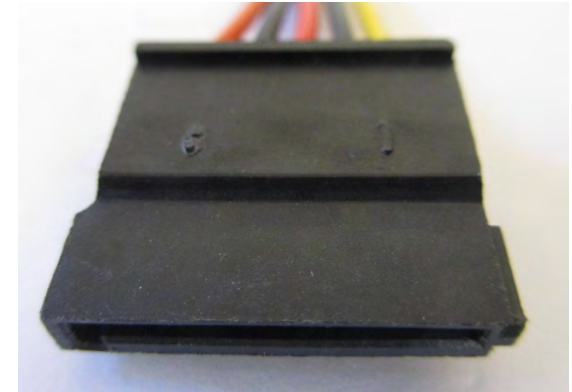

# ATX Power Supply: PCIe Auxiliary Power Connectors

## ➤ PCIe 6/8 pin 12 V

- Supplies extra +12 V power to PCIe expansion cards (high-end video cards, etc)
- PCIe 6-pin connector

Pin	Voltage	Color	Pin	Voltage	Color
1	+12 V	Yellow	4	+5 V	Red
2	+12 V	Yellow	5	GND	Black
3	+12 V	Yellow	6	GND	Black

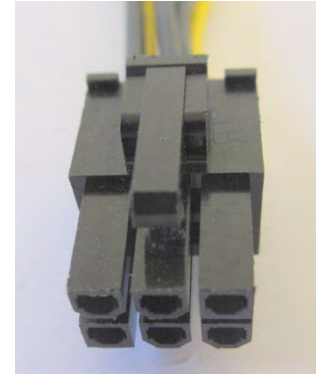

## ➤ PCIe 4/8 pin 12

- PCIe 8-pin connector

Pin	Voltage	Color	Pin	Voltage	Color
1	+12 V	Yellow	5	GND	Black
2	+12 V	Yellow	6	GND	Black
3	+12 V	Yellow	7	GND	Black
4	GND	Black	8	GND	Black



# ATX Power Supply

## ➤ ATX-style power supply auxiliary connectors

- Auxiliary power connector
  - Used on some server boards that require additional +3.3 V and +5 V power
- +12 V core power connector
  - Used on P4 motherboards that require additional +12 V power

## ➤ Dual rail

- Some power supplies internally provide two separate sources for certain voltages (+5, +12)
- Allows power supply to shut down if overcurrent is sensed on one rail
  - Instead of supplying all current on one rail, which could overheat

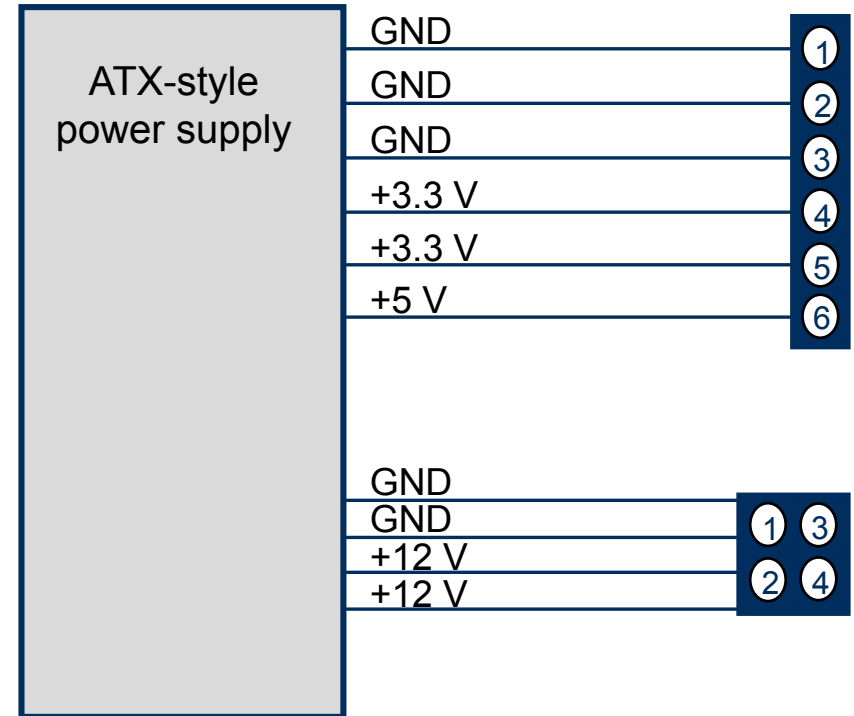

# Power-Supply Voltage and Current Ratings

## ➤ ATX-style power supplies

Voltage	Typical output current (amps)		
	235 W	300 W	400 W
+3.3	14	14	28
+5	22	30	30
-5	.5	.5	1
+12	8	12	14
-12	1	1	1



# Voltage, Current, and Power

## ➤ Voltage

- Amount of electrical potential (measured in volts [V])
- Examples: +1.5 V AA battery, +12 V auto battery

## ➤ Current

- Amount of electrical capacity (measured in amps)
- Direct Current (DC) flows in one direction
- Alternating current (AC) alternately reverses direction of flow
- Example: Typical wall outlets can supply 120 V AC at 15–20 amps

## ➤ Power

- Product of voltage x current, measured in watts (W)
- $P$  (in watts) = voltage x amps



# Upgrading the Power Supply

## ➤ **Upgrading the power supply is simple**

- Unplug power-supply cables connected to the motherboard and remove the power supply
- Install new supply and plug power-supply cables into the motherboard

## ➤ **Power supply specifications**

- Wattage
  - 350-to-1,350-watt power supplies are available from many third-party vendors at fairly low cost
- Size
  - Make sure power supply has correct dimensions for PC chassis
- Number of connectors
  - Choose appropriate number/type of connectors for all devices in PC
- ATX or Micro-ATX
  - Choose appropriate power supply for motherboard type



# Overseas Voltage Requirements

## ➤ AC power-line voltages and frequencies vary according to country

- United States: 120 V/60 Hz
- Canada: 120 V/60 Hz
- United Kingdom: 240 V/50 Hz
- Europe: 220 V/50 Hz
- Japan: 100 V/50 Hz

## ➤ Input power voltage selection methods

- None
- 110/220-V switch
- Automatic switching by power supply
  - Labeled 110/240VAC

## ➤ If in doubt, *don't experiment!*

- Plugging a 110-V power supply into a 220-V AC line has one result: smoke!





# Repairing the Power Supply

- **Are power supplies repairable?**
  - No!
- **Typical power-supply label:**

## **CAUTION! HAZARDOUS AREA**

Do not remove this cover under any circumstances.  
No serviceable components inside.  
Serious shock hazards are present inside this case.

- **They are not kidding! Besides, replacement power supplies are relatively cheap**



- **ATX Power Supply**
- **Troubleshooting Power Supply Problems**
- **Power-Line Problems**
- **Solutions to Power-Line Problems**



# Troubleshooting Power Supply Problems

## ➤ Symptoms of power supply problem

- No lights (external or standby LED on motherboard)
- No fan movement

## ➤ Troubleshooting steps

1. Check external connections to power supply
  - AC power cable, power strips
2. Check that wall socket is working (plug in a lamp or other device)
3. Check that power switch on rear of power supply is turned ON
4. Check that the 110V/220V switch on power supply is set correctly
5. Swap power supply with a known good power supply



# Troubleshooting Power Supply Problems

- **PC power-supply testers are designed specifically to test ATX power supply**
  - **Connectors**
    - 24-pin ATX main power connector
    - 4-pin device power connector
  - Contains connections to allow power supply to run, even though it's not plugged into motherboard



# Troubleshooting Power Supply Problems

## ➤ Power supply voltages can also be checked with a multimeter

- Note: power supply must be connected to the motherboard, and system turned on
- Set multimeter to measure voltage
- Gently insert black probe into power connector with black wire (ground)
- Gently insert red probe into power connector with colored wire:
  - Red = +5 V
  - Yellow = +12 V
  - Orange = +3.3 V

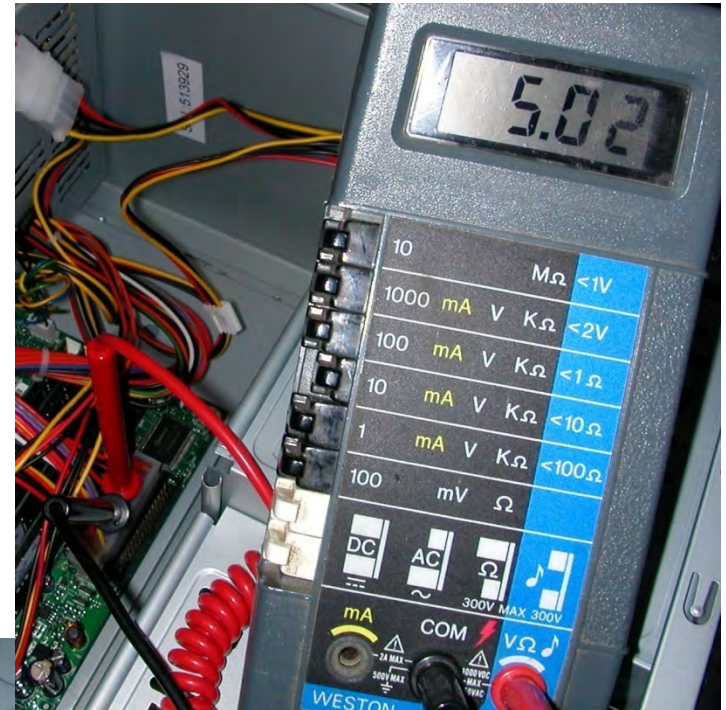

- **ATX Power Supply**
- **Troubleshooting Power Supply Problems**
- **Power-Line Problems**
- **Solutions to Power-Line Problems**



# Power Disturbances

## ➤ Complete power failure

- Power-line voltage drops to zero for extended periods of time
- Consequences: data loss

## ➤ Brownout

- Power-line voltage dips below voltage required by power supply (can be for extended periods of time)
- Consequences: data loss

## ➤ Voltage spikes

- Very fast high-voltage spikes on power line caused by lightning or electric motors
- Consequences: possible permanent system damage!



# Causes of Power-Line Disturbances

## ➤ **Power company**

- Disturbances in power supplied by utility company may be intentional or due to natural causes; e.g., lightning

## ➤ **Building-related**

- Power fluctuations may be caused by faulty or inadequate building wiring
- Building machinery; e.g., air conditioners, lighting, heating systems

## ➤ **User wiring**

- Multiple PCs plugged into the same power line
- PCs plugged into power line shared by high-current machines; e.g., laser printers, air conditioners, coffee makers, copiers
- PC plugged into an ungrounded power strip





- **ATX Power Supply**
- **Troubleshooting Power Supply Problems**
- **Power-Line Problems**
- **Solutions to Power-Line Problems**



# Surge Suppressors

## ➤ What is a surge suppressor?

- Power-distribution box that suppresses voltage spikes using a Metal Oxide Varistor (MOV)

## ➤ Metal oxide varistor

- Electrical circuit protection component placed across AC power-line inputs
- Short-circuits high-voltage spikes
- Effectiveness deteriorates with use (overvoltage conditions)

## ➤ Benefits

- Questionable, but provides added insurance at low cost (from U.S. \$30 to \$100)

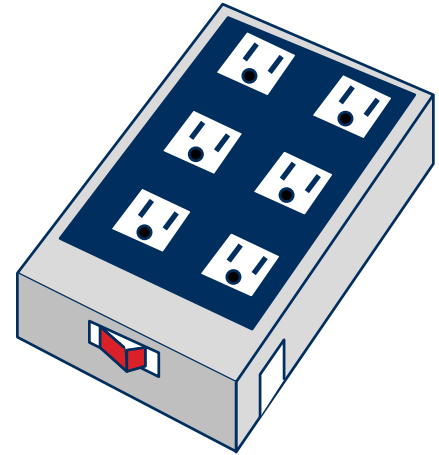

# Backup Power Supplies

## ➤ What is a backup power supply?

- Power supply incorporating a battery and an AC inverter circuit
- Provides continuous power when line power fails
  - Uses serial communication link to inform computer of power failure
    - Starts software routine that performs “graceful shutdown” of PC

## ➤ Uninterruptible power supply (UPS)

- Batteries always used to provide power to system
- Input power used to charge batteries while in use
- UPS will beep if AC power is unplugged, to alert user that it is not being charged

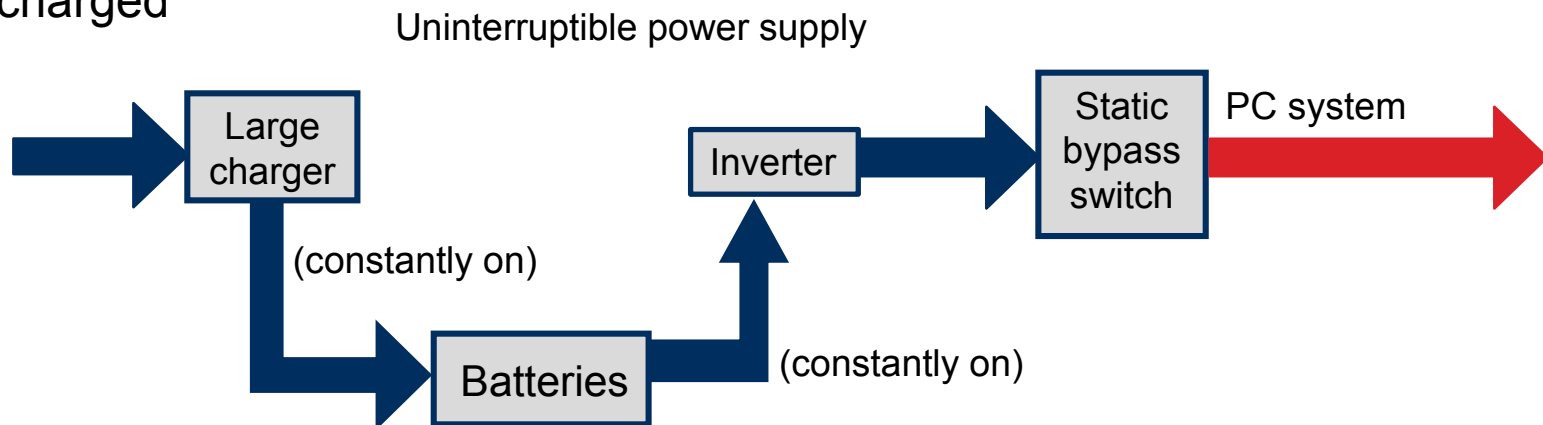

# Review Questions

- 1. The overall power capability of a power supply is expressed in:**
  - A. Volts
  - B. Amps
  - C. Watts
  - D. There is no overall measure of power capability
- 2. If a PC appears to be completely dead, you should first check:**
  - A. That the AC power cable is plugged into the power supply
  - B. The BIOS setup configuration
  - C. That the video cable to the monitor is plugged in
  - D. The fuse inside the power supply



# Review Questions

- 3. A multimeter is used to test the voltages on the main 20-pin connector from an ATX power supply that is connected to the motherboard. What voltages should be seen on the red and yellow wires?**
- A.  $-5\text{ V}$ ,  $-3.3\text{ V}$
  - B.  $+5\text{ V}$ ,  $+3.3\text{ V}$
  - C.  $-5\text{ V}$ ,  $-12\text{ V}$
  - D.  $+5\text{ V}$ ,  $+12\text{ V}$
- 4. If you suspect that a new adapter card is overloading the power supply, you should:**
- A. Replace the power supply
  - B. Replace all adapter cards
  - C. Remove the new adapter card and check the power supply status after powering up again
  - D. Replace the motherboard



# Chapter Summary

---

**In this chapter, you have learned how to**

- **Describe the basic features of the ATX power supply**
- **Diagnose and troubleshoot power-supply problems**
- **Describe common power-line-related problems and their solutions**
- **Test AC power-outlet wiring**
- **Describe the function of an uninterruptible power supply (UPS)**



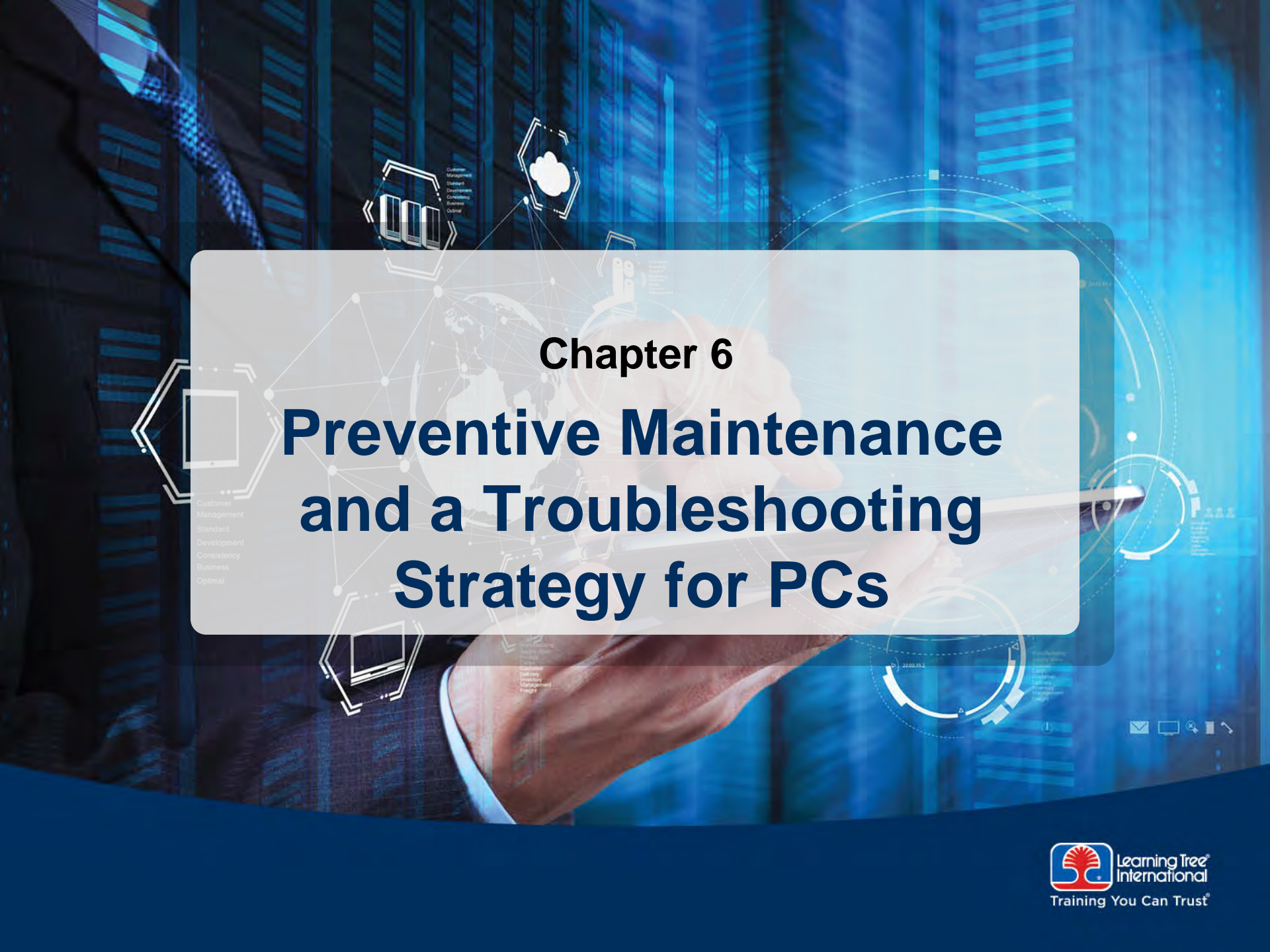

# Chapter 6

## Preventive Maintenance and a Troubleshooting Strategy for PCs

# Chapter Objectives

In this chapter, you will learn how to

- **Avoid PC problems using preventive maintenance procedures**
- **Use a top-down troubleshooting strategy to identify causes of PC faults quickly**
- **Determine which PC component is faulty through the use of symptom analysis and substitution techniques**
- **Describe the functions of the POST diagnostic test**





- **Avoiding Trouble:  
Preventative Maintenance**
  - **Safe Operating Environments**
    - Periodic Maintenance/Disposal Procedures
  - **Troubleshooting Strategy for PCs**
  - **POST**
  - **Optional Hands-On Exercise 6.1**
  - **Optional Hands-On Exercise 6.2**
  - **Optional Hands-On Exercise 6.3**



# Heat-Related Problems

## ➤ Heat-related problems

- Gradual chip destruction
- Thermal expansion causes connection and disk problems
- Exposure to direct sunlight can cause overheating of PCs, laptops
- Very high humidity can also exacerbate overheating

## ➤ Cooling the PC

- Temperature inside PC may be 40°F higher than ambient temperature
- Internal fan draws in cool air from system front and exhausts hot air out the rear
- For optimal airflow, missing expansion slot covers (in the rear of the PC) should always be replaced

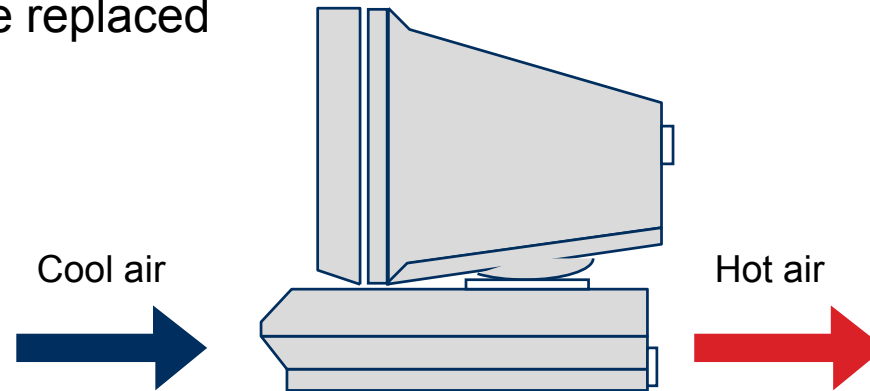

# Smoke, Dust, and Pollutants

## ➤ **A PC breathes the same air you do**

- Smoke and dust are drawn into the PC by its cooling system
- Expansion slot covers should be used to close any unused adapter card openings in rear of PC
  - Blocks dust, and allows cooling airflow in PC to work as designed

## ➤ **Air contaminant problems**

- Dust coating on boards acts as a thermal insulator, causing heat buildup
- Use enclosure to protect computer
- Use air filters to protect workers

## ➤ **Preventive maintenance procedures**

- No smoking near computer equipment
- Clean dust from internal boards and power-supply vent once a year



# Static Electricity

## ➤ **Electrostatic discharge (ESD)**

- Discharge of static from one substance to another
- Charge from your body to ground (through a doorknob) equals approximately 40,000 volts!
- Low-current static discharge will not hurt you, but it can kill computer chips

## ➤ **Protecting against ESD**

- When working on a PC, always use an antistatic wrist strap

 **Cautionary note:** The one time not to use an antistatic wrist strap is when working around high voltage devices (the inside of a CRT monitor)

- Only qualified personnel should work on CRT monitors due to the dangerous high voltages (25,000 volts)
- Place PC components in antistatic bags



# Anti-Static Wrist Strap

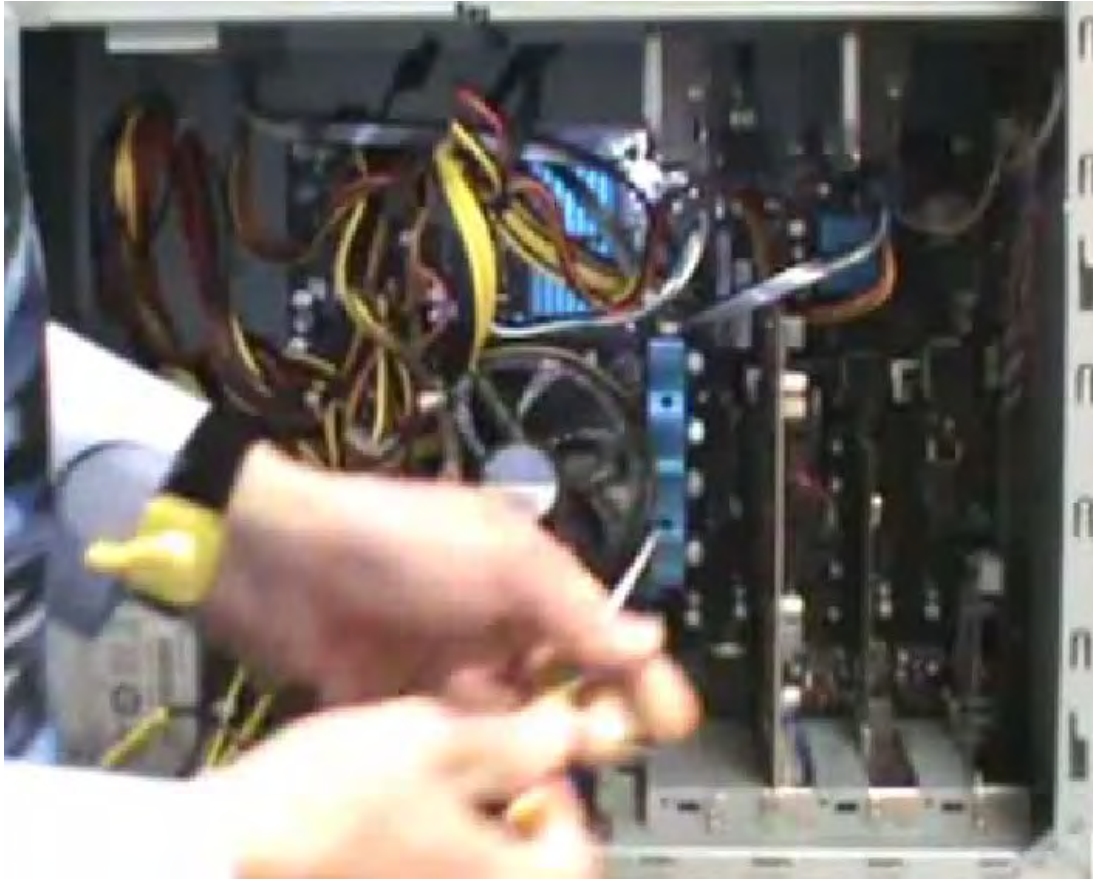

# Static Electricity

## ➤ **Protecting PCs from static discharge**

- ESD strap (antistatic wrist strap)
- ESD mats
  - Conductive mat connected to ground pin on wall socket
- Equipment grounding
  - Make sure that ground wire on AC cord makes good connection to ground pin on wall socket
- Use antistatic bags to store PC components during servicing

## ➤ **Self-grounding**

- Always ground yourself by touching PC case or chassis before removing or handling circuit boards
- This is true even when wearing an antistatic wrist strap, in case the grounding clip becomes detached from the chassis
- Touching a PC case or chassis with a key or coin will prevent the discharge spark from contacting your fingers directly



# Electrical Safety

- **Although most PC devices use low voltages, there are hazardous voltages found in a few devices**
  - *Disconnect AC power cord before working inside PCs*
- **Laptops**
  - Inverter for backlight panel produces high voltages
  - Be aware of inverter location and do not touch
- **Laser printers**
  - Contain high-voltage power supplies (up to 1,000 V)
  - Follow manufacturer's repair safety guidelines
- **Match the power requirement of computer equipment plugged into uninterruptable power supply (UPS) sources**
  - To prevent overloading the UPS



# EMI and RFI

## ➤ ElectroMagnetic Interference (EMI)

- Magnetic interference generated by electrical current
  - Fluorescent lights
  - High voltage transformers
- EMI can cause interference with network traffic
  - Route network cables away from EMI sources

## ➤ Radio Frequency Interference (RFI)

- High-frequency radio waves generated by electronic transmitters
  - Cordless phones
  - Microwave ovens
- Can cause interference with Wi-Fi equipment
  - Move away from RFI source
  - Try using a different Wi-Fi channel





# Personal Safety in the Workplace

- ***Disconnect power before working inside a PC***
  - Unplug AC power cord from power supply
- **Remove jewelry or metal bracelets before working on PC**
- **Use proper lifting techniques with heavy equipment**
  - Use lifting dollies or ask for assistance
  - Keep back straight; lift with legs
  - Observe weight limitations (50 pounds maximum)\*
- **Electrical fire safety**
  - Use Class C (nonconductive) fire extinguisher



\*U.S. National Institute for Occupational Safety and Health



# Personal Safety in the Workplace

## ➤ Cable management

- Secure loose cables (avoid trip hazard)
- Route cables away from high-traffic areas
- Use rubber cable guard or gaffer's tape to protect cables

## ➤ Personal safety equipment

- Safety goggles
- Air filter mask

## ➤ Compliance with local government regulations

- Follow regulatory guidelines



- **Avoiding Trouble:  
Preventative Maintenance**
  - Safe Operating Environments
  - **Periodic Maintenance/Disposal  
Procedures**
- **Troubleshooting Strategy for PCs**
- **POST**
- **Optional Hands-On Exercise 6.1**
- **Optional Hands-On Exercise 6.2**
- **Optional Hands-On Exercise 6.3**



# Periodic Preventive Maintenance: Best Practices

## ➤ **Scheduled backups**

- Data should be backed up nightly

## ➤ **Disk maintenance**

- Scheduled check disks (using CHKDSK utility)
- Scheduled defragmentation

## ➤ **Windows updates**

- For large installations
  - Use change control management
  - Evaluate and test before applying updates
- For smaller installations
  - Windows automatic updates may be appropriate

## ➤ **Windows patch management**

- Scan system for missing security patches
- Install as needed



# Periodic Preventive Maintenance: Best Practices

## ➤ **Driver/firmware updates**

- Usually update only if there is a problem
- Exception: Video card/sound card drivers may need to be upgraded more frequently for performance reasons

## ➤ **Antivirus/antimalware updates**

- Antivirus/antimalware programs should be configured to update signatures nightly



# Special Disposal Procedures

- **To protect the environment, computer components must be disposed of in a safe manner**
  - Many computer components contain harmful materials
- **Batteries**
  - Can contain lithium, mercury, nickel-cadmium, etc.
  - Never incinerate batteries—they can explode!
  - Take batteries to a recycling center
- **Display monitors: Cathode-Ray Tube (CRT)**
  - Often contain lead, a toxic metal
  - Send to a commercial recycler or contact city hazardous waste management department
- **Toner and inkjet cartridges**
  - Return to manufacturer or send to commercial recycler
- **Chemical solvents, canned products (canned air)**
  - Dispose according to regulations of city hazardous waste management department



# Special Disposal Procedures

## ➤ Material Safety Data Sheet (MSDS)

- Documents any safety warnings and safe disposal recommendations for chemicals
- Often supplied with chemicals, or can be obtained from manufacturer
- See also [www.msdssearch.com](http://www.msdssearch.com)



- **Avoiding Trouble: Preventative Maintenance**

- **Troubleshooting Strategy for PCs**

- **POST**
- **Optional Hands-On Exercise 6.1**
- **Optional Hands-On Exercise 6.2**
- **Optional Hands-On Exercise 6.3**





# The CompTIA PC Troubleshooting Strategy

## 1. Identify the problem

- Question user and identify user changes to computer
- Perform backups before making changes

## 2. Establish a theory of probable cause

- Question the obvious

## 3. Test theory to determine cause

- Once theory is confirmed, determine next steps
- If theory is not confirmed, re-establish new theory or escalate

## 4. Establish a plan of action to resolve the problem and implement solution

## 5. Verify full system functionality

- Implement preventative measures (if applicable)

## 6. Document findings, actions, and outcomes



# PC Troubleshooting Strategy Steps

## 1. Identify the problem

- Question the user; identify user changes to computer
  - “When was the last time the computer worked normally?”
  - “Have there been any recent changes to the system software or hardware?”
- Perform backups before making changes

## 2. Establish a theory of probable cause

- What could be causing the problem?
  - User error
  - External cable connection fault
  - Internal cable connection fault
  - Incorrect CMOS configuration
  - Hardware or software fault



# PC Troubleshooting Strategy Steps

## 3. Test theory to determine cause

- Ask user to perform checks (re-plug in cables, check power, etc.)
- Remove or replace suspect hardware
- Run diagnostic tests
- If theory not confirmed, establish new theory or escalate

## 4. Establish a plan of action

- Replace defective components
- Repair software problems
- Apply fix to other computers if necessary



# PC Troubleshooting Strategy Steps

## 5. Verify full system functionality and implement preventative measures

- Test system for full functionality
  - Confirm that the problem has been resolved
- Implement preventative measures
  - Provide any necessary information to user

## 6. Document findings, actions, and outcomes

- Document problem, solution, and comments
  - Provides help for other technicians
  - Provides help for you (now or later on)



- **Avoiding Trouble: Preventative Maintenance**
- **Troubleshooting Strategy for PCs**

➤ **POST**

- **Optional Hands-On Exercise 6.1**
- **Optional Hands-On Exercise 6.2**
- **Optional Hands-On Exercise 6.3**



# What Is POST?

## ➤ **Power-on self-test**

- Series of diagnostic tests performed at power-on
- POST program contained in BIOS ROMs

## ➤ **Advantages of POST diagnostics**

- Basic system components tested on every power-up
- POST diagnostics do not depend on disk drives to run
- Capable of isolating faults to board level

## ➤ **POST error messages are generated in two forms**

- Audio: A series of coded beeps
- Visual: Error codes or messages displayed on monitor

## ➤ **POSTs and error codes vary depending on manufacturer of BIOS ROMs**

- Original POST codes: IBM
- Third-party manufacturers: AMI, Award, Phoenix, DTK, etc.



# System Devices Tested by POST

- **Basic motherboard components**
  - CPU and motherboard support circuitry
  - Interrupt controller, DMA controller, and timer chip
  - System ROM chips
- **Display adapter**
  - Display controller and display memory
- **System RAM**
  - Tests base and extended memory
- **Keyboard**
  - Tests for keyboard response and stuck keys
- **Disk drives**
  - Checks for presence and status of disk drives



# Phoenix POST Audio Error Messages

Audio code	Problem area
None	Power supply
— — —	Defective or missing first 64K of system memory
— — — — Four alternating beeps: High tone, low tone, High tone, low tone	Thermal warning





# Intel DX58SO Core i7 POST Messages

- **Numerical POST codes are output to I/O port 80h**
  - Can be viewed using a third-party plug-in **POST card**
  - Some codes also output to lower right corner of display monitor screen during boot process
  - Excerpts from a typical boot sequence
    - Complete table available from Intel website (Intel Desktop Board DQ965GF Technical Product Specification)

POST code	Description
BA	Detecting presence of removable media
5A	Resetting PATA/SATA bus and all devices
EB	Calling video BIOS
E7	Waiting for user input
00	Ready to boot



# Troubleshooting System Faults With POST

## ➤ **Test minimal configuration first**

- Motherboard
- Power supply
- Display adapter
- Speaker

## ➤ **Test disk system next**

- Plug in disk controller and disks; run POST

## ➤ **Test other adapter cards last**

- Plug in I/O adapters and network cards, then run POST



- **Avoiding Trouble: Preventative Maintenance**
- **Troubleshooting Strategy for PCs**
- **POST**
- **Optional Hands-On Exercise 6.1**
- **Optional Hands-On Exercise 6.2**
- **Optional Hands-On Exercise 6.3**



# Optional Hands-On Exercise 6.1

## Video: POST and PC Startup Sequence

### ➤ Objective

- In this exercise, you will learn how to identify the POST and PC startup sequence for a PC

### ➤ Exercise procedure

- As you watch the video clip, write down the number of the startup steps as you see them occur



# Optional Hands-On Exercise 6.1

## Video: POST and PC Startup Sequence

### ➤ POST startup sequence

In the spaces below, write the number in which you see the startup steps occur as you watch PC start up

- \_\_\_\_\_ Intel logo screen is displayed
- \_\_\_\_\_ DVD drive light turns on (briefly)
- \_\_\_\_\_ System boots from boot DVD in DVD drive, loads operating system files
- \_\_\_\_\_ Display monitor pilot light turns blue



- **Avoiding Trouble: Preventative Maintenance**
- **Troubleshooting Strategy for PCs**
- **POST**
- **Optional Hands-On Exercise 6.1**
- **Optional Hands-On Exercise 6.2**
- **Optional Hands-On Exercise 6.3**



# Optional Hands-On Exercise 6.2

## Video: POST Troubleshooting Problem 1

### ➤ Objective

- In this exercise, you will use your knowledge of the PC startup sequence and the POST test to troubleshoot a PC problem

### ➤ Exercise procedure

- As you watch the video clip, record your observations about the PC on the following slide
- After the video clip has finished, write down what you think is the cause of the problem
- Discuss with your classmates



# Optional Hands-On Exercise 6.2

## Video: POST Troubleshooting Problem 1

### ➤ Observation notes

1. \_\_\_\_\_
2. \_\_\_\_\_
3. \_\_\_\_\_
4. \_\_\_\_\_

① What do you think is the cause of this problem?

---

---





- **Avoiding Trouble: Preventative Maintenance**
- **Troubleshooting Strategy for PCs**
- **POST**
- **Optional Hands-On Exercise 6.1**
- **Optional Hands-On Exercise 6.2**
- **Optional Hands-On Exercise 6.3**



# Optional Hands-On Exercise 6.3

## Video: POST Troubleshooting Problem 2

### ➤ Objective

- In this exercise, you will use your knowledge of the PC startup sequence and the POST test to troubleshoot a PC problem

### ➤ Exercise procedure

- As you watch the video clip, record your observations about the PC on the following slide
- After the video clip has finished, write down what you think is the cause of the problem
- Discuss with your classmates



# Optional Hands-On Exercise 6.3

## Video: POST Troubleshooting Problem 2

### ➤ Observation notes

1. \_\_\_\_\_
2. \_\_\_\_\_
3. \_\_\_\_\_
4. \_\_\_\_\_

① What do you think is the cause of this problem?

---

---



# Troubleshooting Motherboard, RAM, CPU, and Power Problems

- For these common symptoms, choose the number of the most likely cause

Symptom	Cause	Cause choices
Burning smell or smoke		1. Power cord not plugged in properly 2. Power supply overheating 3. CPU overheating 4. Damaged or shorted component 5. Incorrect BIOS setup
POST code beeps (alternating high-low beeps)		
Attempts to boot to incorrect device		
No power or indicator lights		
Unexpected shutdowns or system lockups		



# Troubleshooting Motherboard, RAM, CPU, and Power Problems

- For these common symptoms, choose the number of the most likely cause

Symptom	Cause	Cause choices
BIOS time and settings resets		1. Loose connections or board not seated properly
Blank screen on bootup		2. Cable hitting fan
Intermittent device failure		3. Memory card failure
<u>B</u> lue <u>S</u> creen <u>O</u> f <u>D</u> eath (BSOD)		4. Power supply defective (only +12V working)
Fans spin, no power to other devices		5. Video controller failure
Loud noise (clicking)		6. CMOS battery failure



# Review Questions

- 1. While working on a PC, Chris notices a couple of open expansion slots in the rear of the PC. What should Chris do?**
  - A. Nothing; open expansion slots provide more airflow to the PC
  - B. Install two expansion slot covers
  - C. Cover the open expansion slots with some masking tape
  - D. Push the PC up against the wall to make sure nothing gets into the open expansion slots
  
- 2. Which statement about ESD (electrostatic discharge) is not true?**
  - A. High voltages from ESD can damage computer parts
  - B. ESD is normal and shouldn't be worried about
  - C. An antistatic wrist strap helps protect against ESD damage
  - D. Walking across a nylon carpet can generate ESD



# Review Questions

- 3. The first step in troubleshooting a PC problem is to:**
  - A. Interview the user to identify the problem
  - B. Replace all adapter cards
  - C. Remove the PC cover
  - D. Run a diagnostic program
  
- 4. If a PC won't boot after being moved from one building to another, the most likely cause of the problem is a:**
  - A. Computer virus
  - B. Corrupted hard drive
  - C. Loose internal cable or adapter card
  - D. Burned-out CPU
  
- 5. When troubleshooting a computer problem, what should be done to prevent redundant steps and provide more accurate conclusions?**
  - A. Search the Web for accounts of similar problems
  - B. Use the BIOS setup program to reset the system to default settings
  - C. Unplug cables to all external peripheral devices first
  - D. Document all troubleshooting steps and results



# Chapter Summary

In this chapter, you have learned how to

- **Avoid PC problems using preventive maintenance procedures**
- **Use a top-down troubleshooting strategy to identify causes of PC faults quickly**
- **Determine which PC component is faulty through the use of symptom analysis and substitution techniques**
- **Describe the functions of the POST diagnostic test**





# Chapter 7

## Displays and Input Devices

Customer  
Management  
Standard  
Development  
Consistency  
Business  
Optimal

# Chapter Objectives

In this chapter, you will learn how to

- Describe how display monitors work and define the following terms: *pixel*, *resolution*, *analog vs. digital*, *aspect ratio*
- List characteristics of display standards: VGA, HD-Ready, WUXGA, HD
- Troubleshoot common display-related problems



- **Display Monitors**
  - **LCD and Active Matrix Displays**
    - Display System Technology
  - **Display Adapters**
  - **Troubleshooting Display Problems**



# LCD Monitors

## ➤ Liquid-crystal display (LCD)

- LCDs use an array of liquid-crystal cells to control amount of light transmitted from backlit fluorescent panel (or LED backlighting panel)
  - Low-voltage DC (direct current) control signals used to control liquid crystal cells

## ➤ LCD panel types

- TN—Twisted Nematic
  - Fast response, but color shifts at wide viewing angles
- IPS—In-Plane Switching
  - Provides accurate color from wide viewing angles



# Passive Matrix LCD Operation

## ➤ How do LCD screens work?

1. A backlit fluorescent panel supplies main light source
2. Horizontal polarizing filter passes through only light that vibrates horizontally
3. Control grid supplies voltages to LCD cells at each pixel location
  - The greater the charge, the more the LCD molecules spiral; at greatest charge, LCD molecules spiral 90 degrees from original orientation
  - Light follows path of LCD molecules
4. Light beams from each LCD cell pass through a red, green, or blue color filter
5. Colored light beams pass through vertical polarizing filter
  - The more the beams have been twisted toward the vertical orientation, the more light is passed through the filter
6. Brightness of each light beam depends on how much light is passed through filter
  - In the diagram on the next slide, the red beam has been twisted the most, so it is brightest; the blue beam has been twisted the least, so it is the dimmest



# Passive Matrix LCD Operation

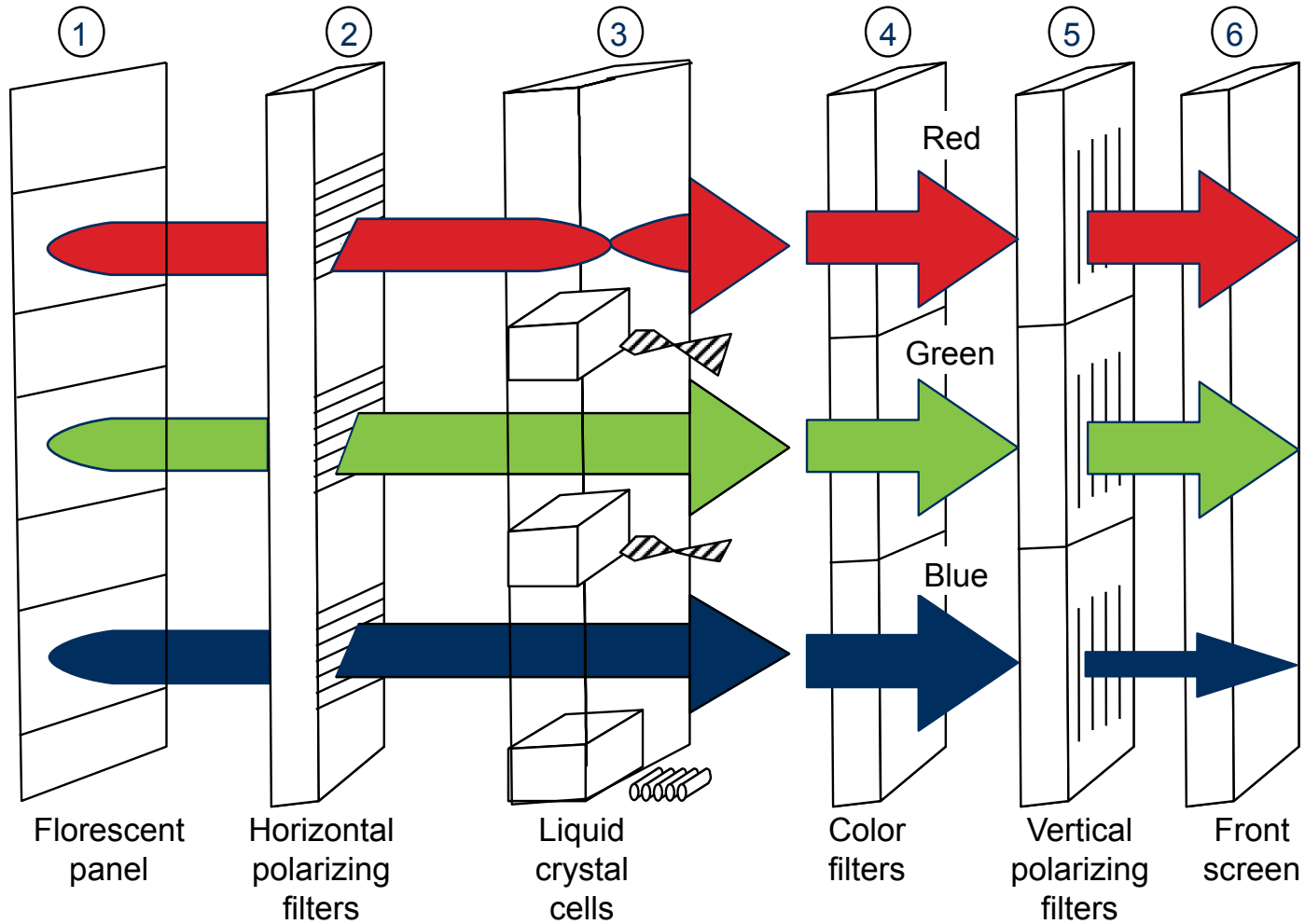

# LCD Terminology

## ➤ **Native resolution**

- LCDs are designed for a single, fixed resolution
  - Display is sharpest at this resolution
- Other resolutions require interpolation (scaling) of the image

## ➤ **Contrast ratio**

- Measures ratio of the brightest color (white) to the darkest color (black)
- Can be measure statically, or dynamically
  - Higher contrast ratio is better

## ➤ **Active Matrix LCD**

- LCD display that uses a transistor at every LCD pixel control point
  - Speeds up switching times
  - Results in brighter, faster display



# Projectors

- **Projectors allow display of large images on a screen or wall**
  - LCD projectors shine a bright light through LCD panel
- **Projector light source**
  - High-intensity projection bulb
  - Or, in LED projectors, an LED array
  - Light output measured in lumens
  - Typical projector brightness levels (1,000-2,000 lumens)





# Display Type Comparison

Display	Description
CRT (cathode-ray tube)	Legacy display type, large and heavy
Projector	Uses high-intensity bulb or LED array with LCD shutter for projection of large display areas
Flat-panel and laptop displays	
LCD (liquid-crystal display)	Uses white fluorescent panel backlight
LED ( <u>L</u> ight- <u>E</u> mitting Diode)	Uses LEDs as light source behind LCD panel
Plasma	Uses panel containing ionized gasses—has high contrast ratio
OLED ( <u>O</u> rganic <u>L</u> ED)	Uses OLEDs as light source—does not require backlight (produces high contrast ratios)



- **Display Monitors**
  - LCD and Active Matrix Displays
    - **Display System Technology**
  - **Display Adapters**
  - **Troubleshooting Display Problems**



# Understanding Display System Terminology

## ➤ Pixel (picture element)

- Smallest independently controllable screen area (dot)

## ➤ Resolution

- Maximum number of pixels that can be displayed in a given display mode
- Specified in (X,Y) format:
  - X = number of horizontal pixels
  - Y = number of vertical pixels

## ➤ Aspect ratio

- Relationship between display width and height
- Common PC display aspect ratios
  - 4:3, 16:9 (wide-screen)



# Understanding Display System Terminology

## ➤ Resolution example (VGA 640 x 480):

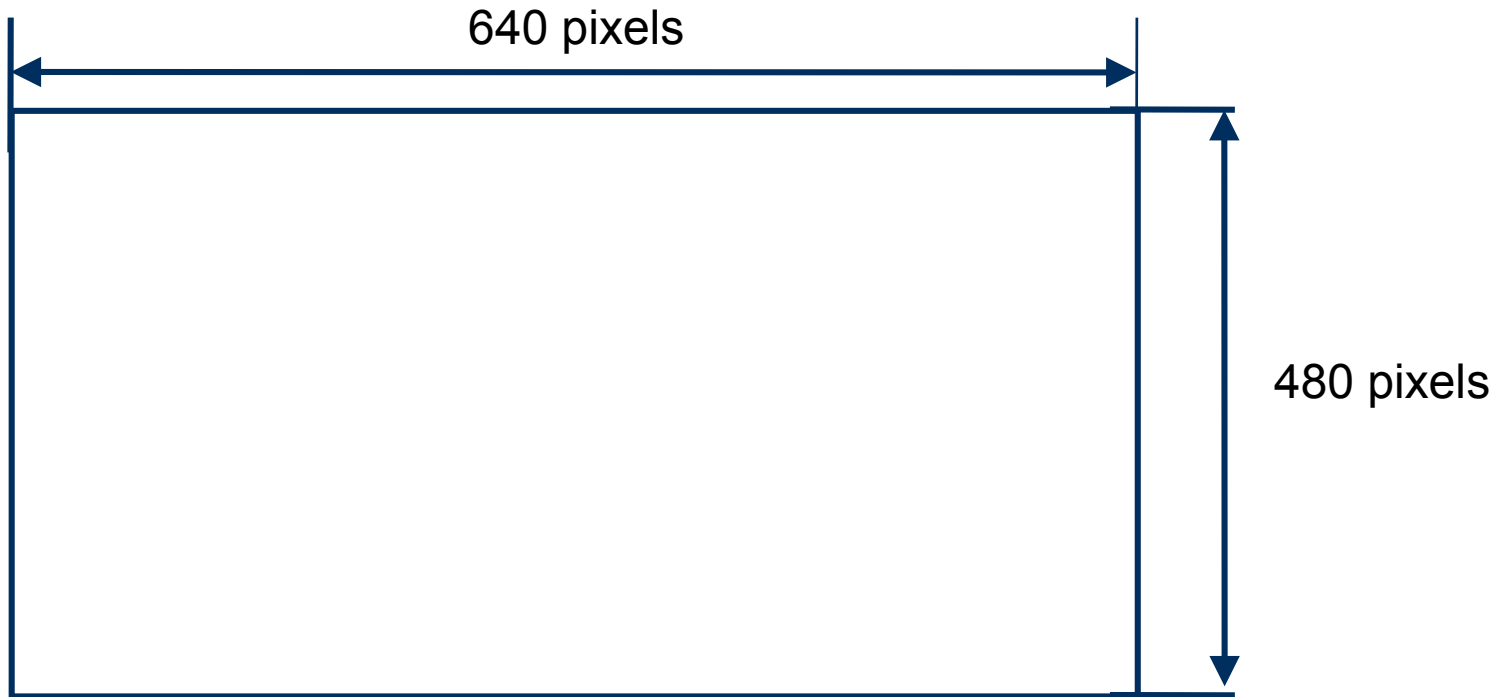

# Understanding Display System Terminology

## ➤ Refresh rate

- Number of times per second a screen image (frame) is drawn by electron beams
- Common refresh rates range from 50 to 75 Hz (frames per second)
- Higher refresh rates cause less discernible flicker

## ➤ Color depth

- Number of colors that can be displayed for each pixel
- Specified as number of bits (of video RAM) per color

Color depth	Number of colors
4-bit	16
8-bit	256
16-bit	65,536
24-bit	16,777,216
32-bit	4,294,967,296



# Understanding Display System Terminology

## ➤ Video RAM

- Dedicated RAM on video card that holds screen image
- Amount of video RAM required = Resolution x Color Depth (in bytes)

## ➤ Examples:

Resolution	Color depth	No. of colors	Memory required	Minimum video RAM size
800 x 600	24-bit	16,777,216	1,440,000 bytes	2 MB
1,024 x 768	24-bit	16,777,216	2,359,296 bytes	4 MB
1,280 x 1,024	32-bit	4,294,967,296	5,242,880 bytes	8 MB



# Configuring Multi-Monitor Settings

- **Windows supports configuration of multiple monitors**
  - Allows Windows desktop to be extended to another monitor
  
- **Configuring multi-monitor settings**
  1. Connect additional monitor to second video connector on display adapter card
  2. *Windows 7:* Right-click the desktop and select Screen Resolution, then Multiple Displays  
*Windows Vista:* Right-click the desktop and select Personalize, then Display Settings  
*Windows 8/8.1:* Invoke Windows Charm menu by swiping in from right, then Choose Devices | Second Screen
  3. Click the monitor symbol labeled 2; then select the checkbox “Extend the Desktop onto this Monitor”
  4. Click OK



# Configuring Multi-Monitor Settings

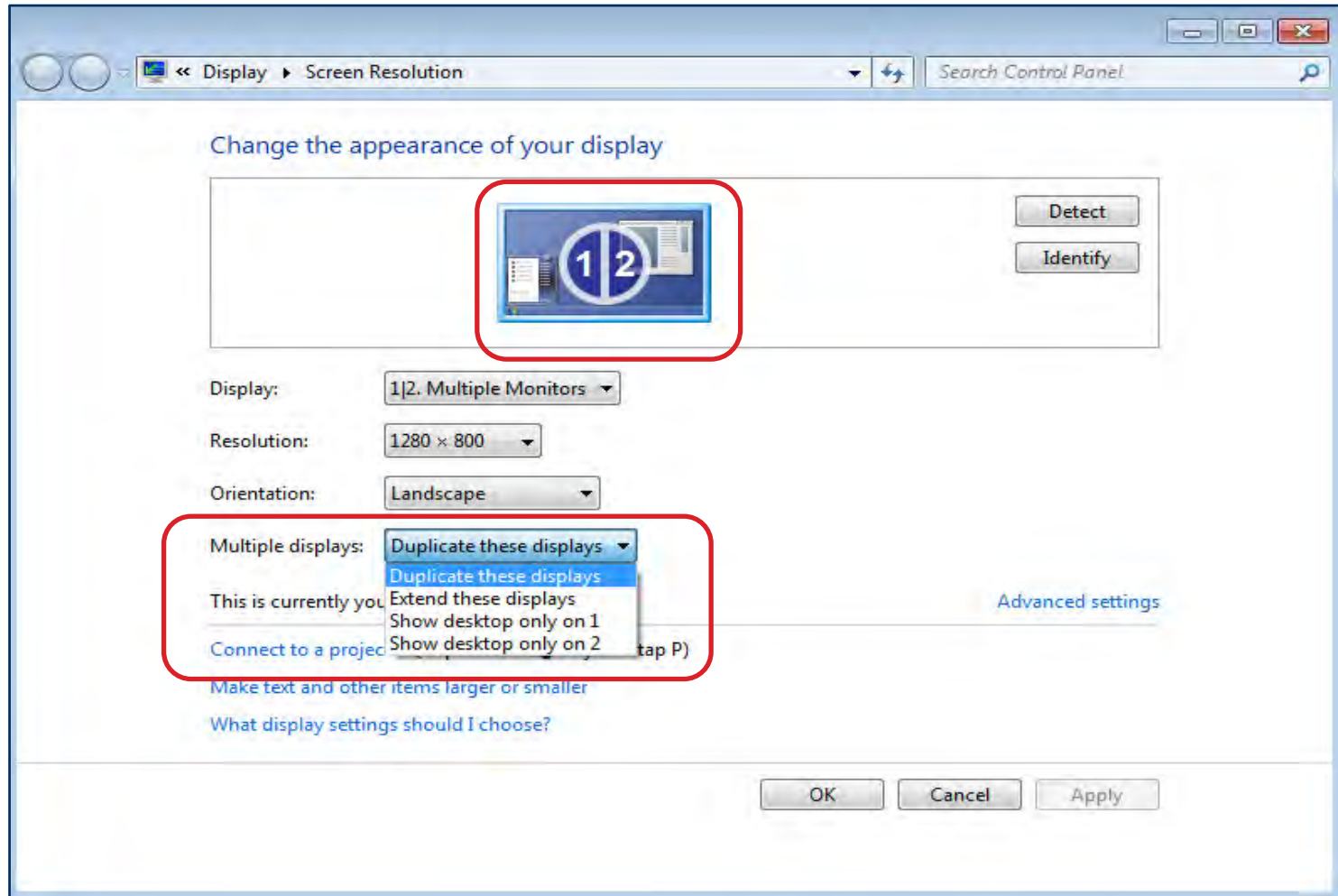



- **Display Monitors**
- **Display Adapters**
- **Troubleshooting Display Problems**



# Display Adapter Cards

## ➤ What does a display adapter do?

- Converts text or graphics data stored in display RAM into video signals that control display monitor

## ➤ Display adapter locations

- Plug-in display adapter card (PCI-e)
  - Multiple display adapters may be supported simultaneously
- Built into motherboard
  - Will auto-detect if a plug-in display adapter card is inserted, and will turn itself off
  - Uses part of system memory for video memory



# Display Adapter Cards

## ➤ Display adapter card block diagram:

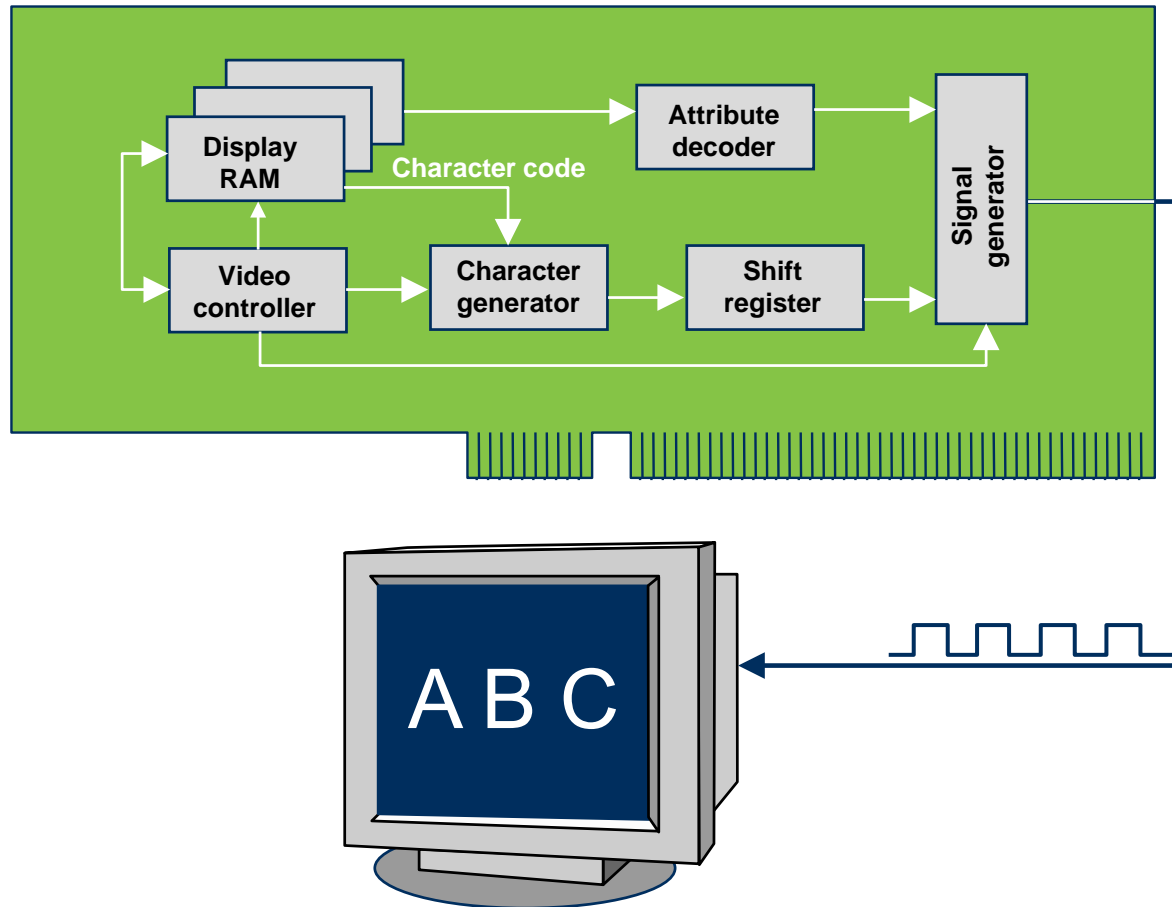

# Display Adapter Types

## ➤ Evolution of PC display adapter standards

Display adapter	Description	Max. graphics resolution	Aspect Ratio
<b>VGA</b>	<u>V</u> ideo <u>G</u> raphics <u>A</u> rray adapter	640 x 480	4:3
<b>XGA</b>	E <u>X</u> tended <u>G</u> raphics <u>A</u> rray	1024 x 768	4:3
<b>WXGA</b>	<u>W</u> idescreen e <u>X</u> tended <u>G</u> raphics <u>A</u> rray	1280 x 1024	16:10
<b>HD Ready</b>	Similar to WXGA (for laptops)	1366 x 768	16:9
<b>WUXGA</b>	<u>W</u> ide <u>U</u> ltra <u>XGA</u>	1920 x 1200	16:9
<b>HD 1080p</b>	<u>H</u> igh <u>D</u> efinition	1920 x 1080	16:9
<b>UHD 4K</b>	<u>U</u> ltra <u>H</u> igh <u>D</u> efinition	3840 x 2160	16:9



# VGA Display Adapter Connector

## ➤ VGA display adapter connector

- Can be identified by HDB-15 female connector
  - This connector can also be called a DB-15 female connector
- This video interface uses analog signals
- Supports VGA and later video standards

## ➤ Connectors:



VGA display  
(HDB-15 female)

# Analog vs. Digital Transmission

## ➤ Analog video signal

- Video signals use voltage level to control brightness of RGB signals
  - Higher voltage = higher brightness level

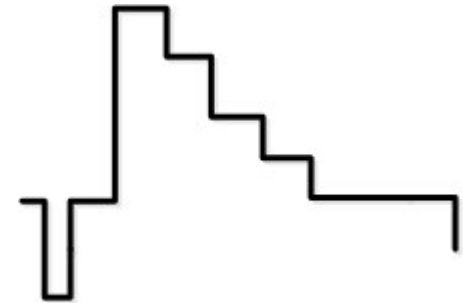

## ➤ Digital video signal

- Video signal brightness, color sent as encoded digital number (1s and 0s)
  - Digital monitor converts numbers to brightness/color signals



## ➤ VGA vs. HDMI

- VGA uses analog video signal
- DVI and HDMI use digital video signals



# Digital Visual Interface (DVI)

## ➤ Newer display interface standard

- Can be identified by DVI-I female connector
  - This version of the interface (29 pin, -I = Integrated) supports both digital and analog video signals
- Video only, no audio signals

## ➤ Connectors:

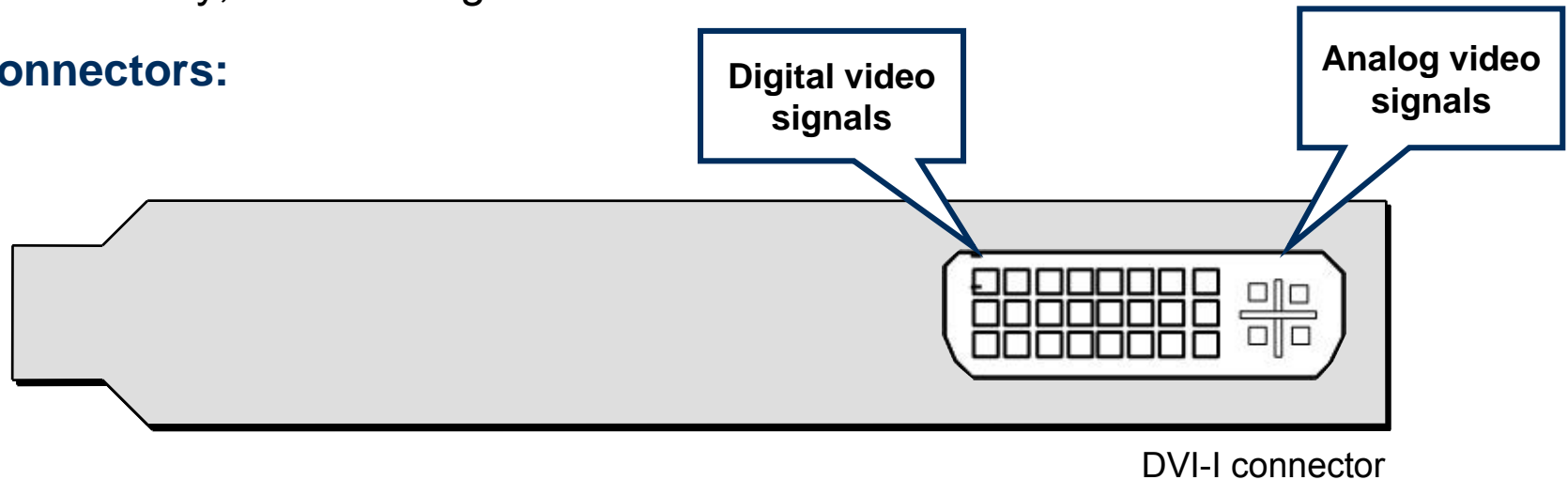

# DVI Connector Types (Male Connector)

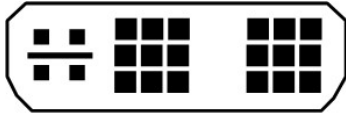

DVI-I (Integrated, Single Link)

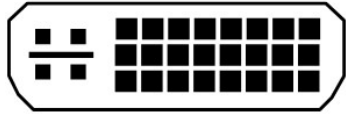

DVI-I (Integrated, Dual Link)

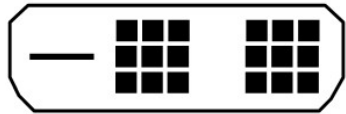

DVI-D (Digital, Single Link)



DVI-D (Digital, Dual Link)

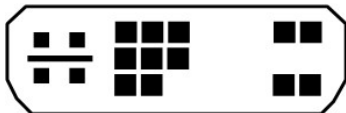

DVI-A (Analog)

Note: Dual-link connector provides additional pins for data signals (for HD resolution displays)





# TV Tuner/Capture Cards

---

- **Adapter card with TV reception/capture circuitry**
  - Receives television signals from cable/satellite provider
  - Able to capture video streams to hard disk
- **Windows Media Center allows control of TV tuner/capture card functions**



# Additional Display Connector Types

## ➤ S-Video

- Carries an analog video signal (no audio)
- 4- or 7-pin mini-DIN connector



## ➤ High-Definition Multimedia Interface (HDMI)

- Carries digital (HD) video and audio

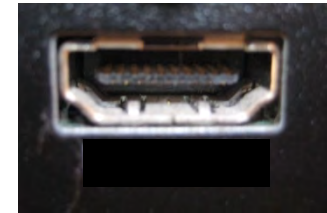

## ➤ DisplayPort

- Carries video and audio signals



# Additional Display Connector Types

## ➤ Composite Video + Audio

- Connector type: RCA
- Yellow = composite video
- Red/white = audio (left, right channels)



## ➤ Component/RGB

- Carries analog or digital video (no audio) over red, green, and blue wires
- Can carry standard and HD video signals

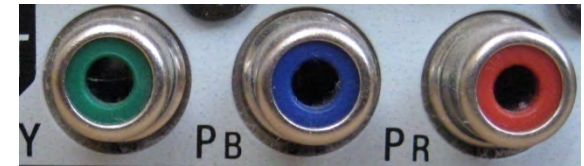

# Display Cable Types

## ➤ HDMI



## ➤ Component



## ➤ DVI



## ➤ Composite



## ➤ VGA



## ➤ S-Video



# Display Cable Types

## ➤ RGB



## ➤ Coaxial



## ➤ Ethernet



# Adapters and Convertors

## ➤ Adapters and converters

- Provide conversion between different connector types

## ➤ Display adapters

- DVI to HDMI
- DVI to VGA
- Thunderbolt to DVI
- HDMI to VGA
- DisplayPort to HDMI

HDMI to VGA



DisplayPort to HDMI



USB to Ethernet



## ➤ USB converters

- PS/2 to USB
- USB A to USB B
- USB to Ethernet

- **Display Monitors**
- **Display Adapters**
- **Troubleshooting Display Problems**



# Common Display Problems

## ➤ **Power-on self-test display failure**

- POST audio code indicates a defective, missing, or incorrectly configured display adapter
- Reseat display adapter board
- Check display adapter configuration settings

## ➤ **Dark display screen**

- Check power to display (is pilot light on?)
- Check display cable connection
- Adjust display brightness and contrast controls
- Display may be receiving power, but not video signal
  - Many new monitors use dual-color LEDs for pilot light (orange = power but no video signal, green = power + video signal)





# Troubleshooting Video and Display Issues

## ➤ Common display problem symptoms and causes

Symptom	Cause
Windows defaults to low-resolution VGA mode	Incorrect/incompatible display driver
No image on screen	Loose display cable or (laptop) <Fn> key for display port redirect pressed
Overheat shutdown	Blocked air vents, or insufficient cooling for display card
Dead pixels	Defective display monitor
Display artifacts	Graphics processing unit (GPU) overheating or failure



# Troubleshooting Video and Display Issues

Symptom	Cause
Color patterns incorrect	Incorrect color depth settings or bent pin in display cable
Dim image	Old (degraded) display monitor or (laptops) defective inverter or backlight
Flickering image	(Laptops) Defective inverter or backlight
BSOD (Blue Screen of Death)	Defective display adapter hardware



# Common Display Problems

- **Display not readable in Windows, but startup text messages displayed normally**
  - Indicates problem with Windows display driver
  - Restart system, press <F8> key when Starting Windows is displayed
  - Select Safe Mode
    - Runs display at lowest resolution (640x480)
    - Allows troubleshooting or replacement of display driver
  
- **“Off color” display**
  - One of the RGB signal pins is bent or pushed into the connector shell
  - Use pliers to straighten or reposition defective pin
  
- **Full set of colors not displayed**
  - Incorrect display driver
  - Use Device Manager | Update driver to replace driver



# Review Questions

- 1. The term that specifies the total number of pixels for a given display mode (expressed in X,Y format) is:**
  - A. Refresh rate
  - B. Dot pitch
  - C. Resolution
  - D. Multisync
  
- 2. Which type of display adapter connector supports both analog and digital signals?**
  - A. VGA
  - B. DVI-I
  - C. USB
  - D. IDE



# Review Questions

- 3. In Windows 7, which command will display the Windows screen to configure multiple monitors?**
- A. Right-click the desktop and select Personalize, then Display settings
  - B. Right-click the desktop and select Screen resolution
  - C. Right-click the desktop and select Properties, then Display settings
  - D. There is no screen to configure multiple monitors
- 4. A user calling in to the help desk complains that their display monitor is blank. When asked, they say that the pilot light on the display monitor is orange. What should you ask them to check next?**
- A. The display resolution setting in Windows
  - B. That the AC power cable is plugged into the display monitor
  - C. That the display monitor cable is plugged into the display adapter connector on the PC
  - D. That the power switch on the display monitor is turned on



# Review Questions

- 5. If the display is not readable in Windows, but startup text messages are displayed normally, this indicates:**
- A. A defective video cable
  - B. A problem with Windows display driver
  - C. A loose power connection to display monitor
  - D. An incorrect CMOS configuration



# Chapter Summary

---

In this chapter, you have learned how to

- Describe how display monitors work and define the following terms: *pixel*, *resolution*, *analog vs. digital*, *aspect ratio*
- List characteristics of display standards: VGA, HD-Ready, WUXGA, HD
- Troubleshoot common display-related problems



## Chapter 8

# PC Connection Interfaces and Custom PC Configurations

Customer  
Management  
Standard  
Development  
Consistency  
Business  
Optimal



# Chapter Objectives

---

In this chapter, you will learn how to

- Describe key characteristics of PC connection interfaces
- Explain features of network interface card (NIC)
- Describe the basic features of the Universal Serial Bus (USB), FireWire I/O, and Thunderbolt standards
- Select and configure appropriate devices for custom PC configurations



## ➤ **Network Interface Cards**

- **USB and FireWire**
- **PC Input Devices**
- **Custom PC Configurations**



# Serial Interface

## ➤ Serial interface characteristics

- Eight-bit data sent serially over a single conductor
- Offers high-speed data transfer

## ➤ Serial interface types

- Original PC serial port
- Ethernet network ports
- USB/FireWire ports

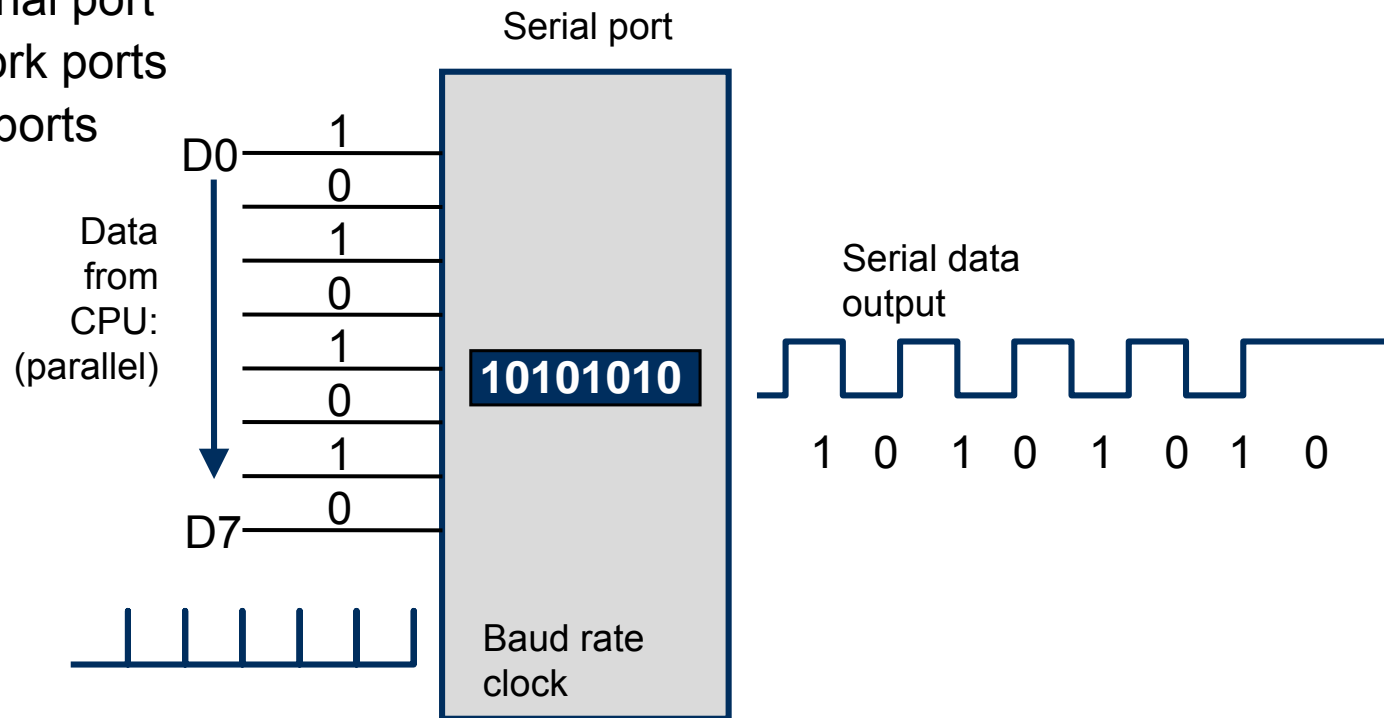

# Network Interface Cards (NICs)

- **What does a network interface card do?**
  - Converts data stored in network RAM buffer into serial stream of data conforming to several different network protocols

- **Network interface card status indicators**

- Link light
  - Indicates data link and data traffic
- Network speed indicator
  - Color indicates network speed
  - Example: Green = 100 Mbps  
Orange = 1 Gbps

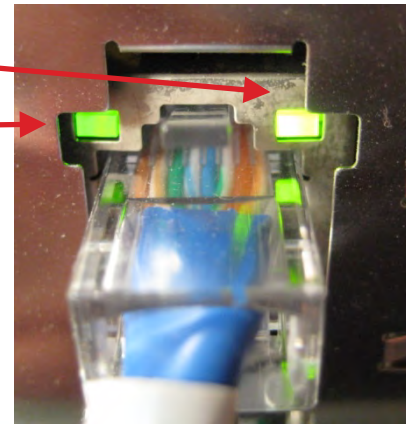

# Network Interface Card Connectors

- Over the years, network interface cards have used different connectors for different types of cables
- **RJ-45**
  - For Unshielded or Shielded Twisted Pair cable
  - Current standard
- **Bayonet Nut Connector (BNC)**
  - “Twist and lock” connector used for coaxial cable

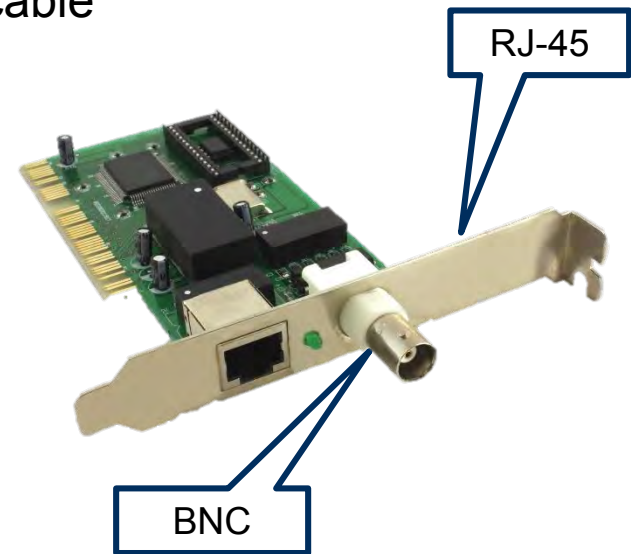

- **Network Interface Cards**
- **USB and FireWire**
- **PC Input Devices**
- **Custom PC Configurations**



# High-Speed Serial Buses: USB

## ➤ USB (Universal Serial Bus)

- Expandable serial bus designed for low/medium-speed devices (keyboards, monitors, digital audio speakers, etc.)

## ➤ USB advantages

- 480 Mbps maximum transfer rate (USB 2.0)
- 4800 Mbps = 4.8 Gbps maximum transfer rate (USB 3.0)
- Supports up to 127 USB devices
- Plug-and-play support
- Permits “hot-swapping” of USB devices

## ➤ USB cable

- 4-wire cable
  - D+, D– (differential data, twisted pair)
  - +5 V
  - Ground

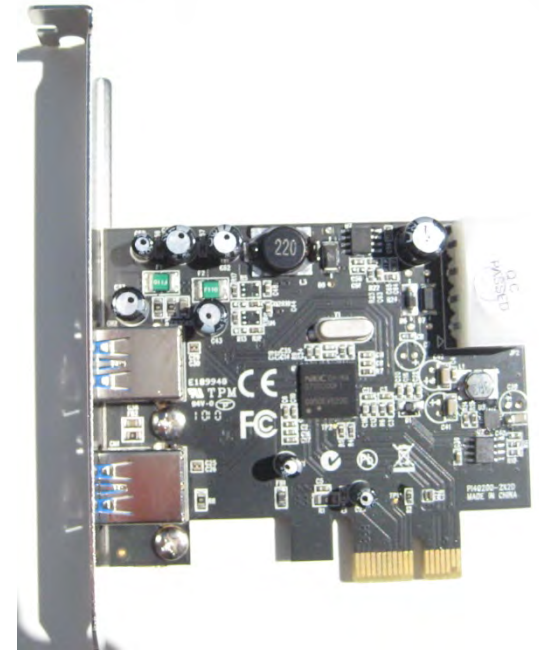

# High-Speed Serial Buses: USB

## ➤ USB connectors

- USB Type A
  - Connects to PC USB port
- USB Type B
  - Connects to peripheral device USB port
- Mini USB
  - Connects to peripheral device Mini-USB port
- Micro USB
  - Connects to peripheral device Micro-USB port

USB Type A



USB Type B



Mini USB



Micro USB





# High-Speed Serial Buses: USB

- **USB 2.0 supports high-speed transfers (480 Mbs)**
- **USB 3.0 supports very-high-speed transfers (4800 Mbps = 4.8 Gbps)**
  - Uses two separate controllers in each USB host, so connecting USB 2.0 devices to host will not slow down USB 3.0 devices
- **USB 3.1 supports super-speed transfers (10000 Mbps = 10 Gbps)**
  - Uses two separate controllers in each USB host, so connecting USB 2.0 devices to host will not slow down USB 3.0 devices

I/O bus type	Data rate (bytes/sec)	Max. cable length
USB 1.1 (low-speed mode: 1.5 Mbps)	187.5 KB/sec	3 meters
USB 1.1 (full-speed mode: 12 Mbps)	1.5 MB/sec	3 meters
USB 2.0 (480 Mbps)	60 MB/sec	5 meters
USB 3.0 (4.8 Gbps)	600 MB/sec	3 meters (practical limit)
USB 3.1 (10 Gbps)	1250 MB/sec	3 meters (recommended limit)



# High-Speed Serial Busses: USB

## ➤ How to identify the USB version on a PC

- Windows Device Manager lists USB 2.0 controller as “Enhanced”
- USB 3 controllers are usually labeled as USB 3.0

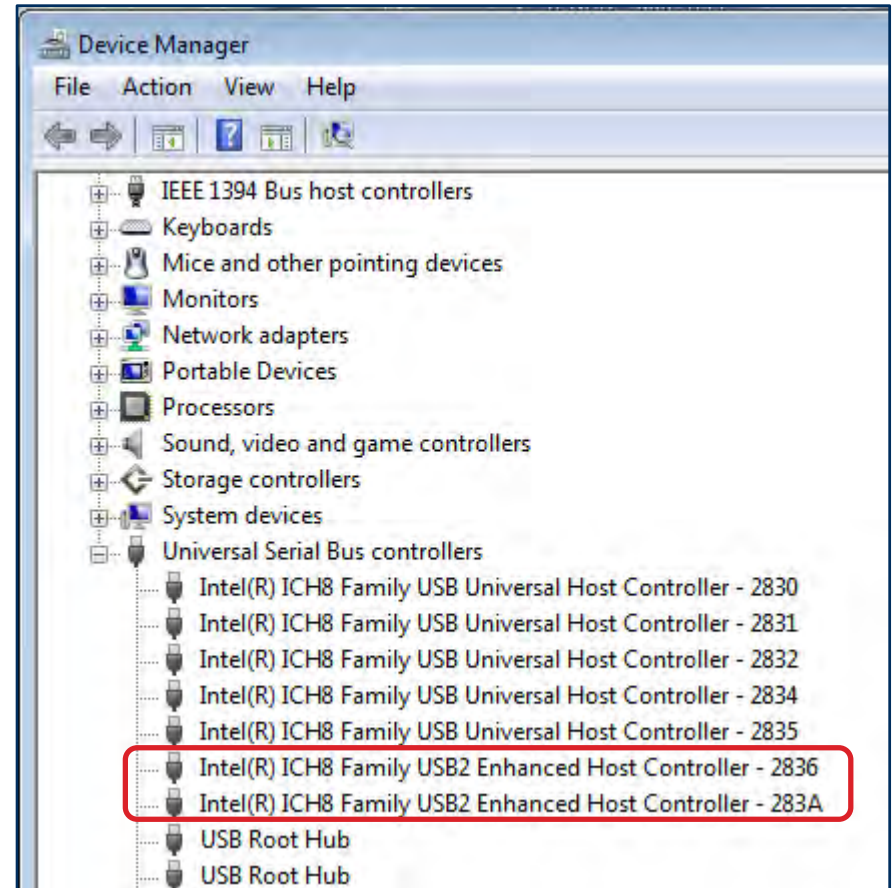

# High-Speed Serial Busses: USB

## ➤ How does the Universal Serial Bus support multiple devices?

- Star topology permits connection of one USB port to another device which can also act as a hub with multiple USB ports
- PC contains a single USB controller chip which typically supports between 8 and 10 USB connectors on the PC

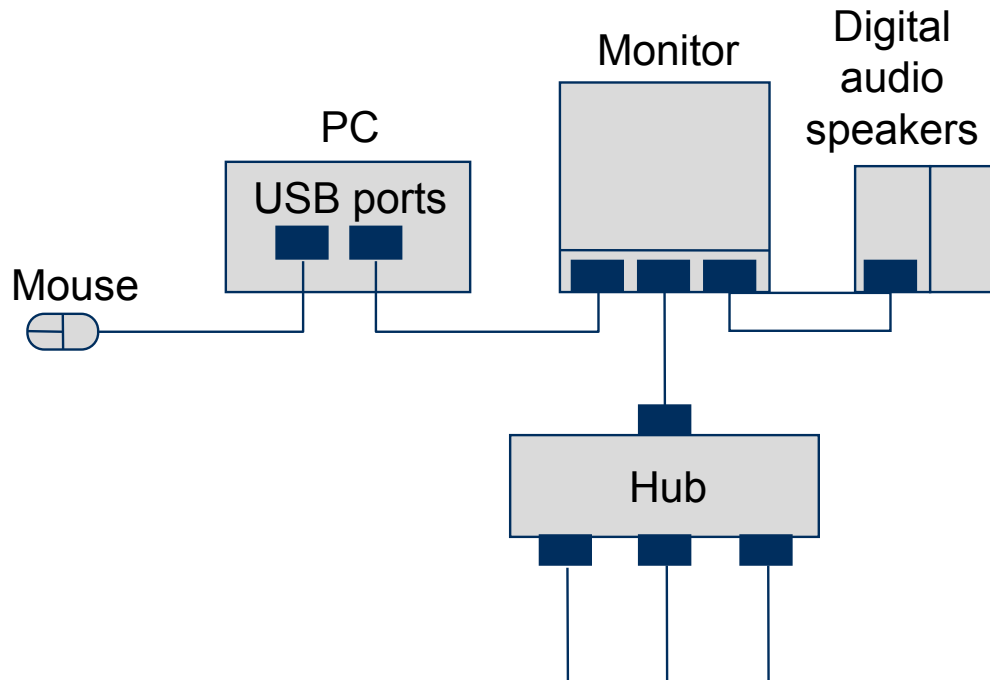

# High-Speed Serial Busses: IEEE 1394 FireWire

## ➤ What is IEEE 1394 FireWire?

- High-speed serial interface specification introduced by Apple computer under trade name *FireWire*
- Supports plug-and-play, “hot-swapping”
- Up to 63 FireWire devices supported via sets of up to 16 daisy-chained devices per node



FireWire 400 connector

FireWire type	Data rate (Mbits/sec)	Max. cable length per segment
FireWire 400 (IEEE 1394)	400 Mbps	4.5 meters
FireWire 800 (IEEE 1394b)	800 Mbps	4.5 meters
FireWire S3200 (IEEE 1394-2008)	3200 Mbps (3.2 Gbps)	4.5 meters



# High-Speed Serial Busses: IEEE 1394 FireWire

## ➤ What types of devices are good candidates for IEEE 1394?

- Devices that require high data rates
- Digital camcorders and VCRs, hard drives, DVD drives
- Digital audio recording and playback applications
- Videoconferencing support devices
- Cable TV set-top boxes



# High-Speed Serial Busses: IEEE 1394 FireWire

## ➤ How are multiple devices supported under IEEE 1394 FireWire?

- The FireWire bus is implemented as a network of branches
- Each branch (node) can support up to 16 daisy-chained devices (with a maximum distance of 4.5 M between devices)

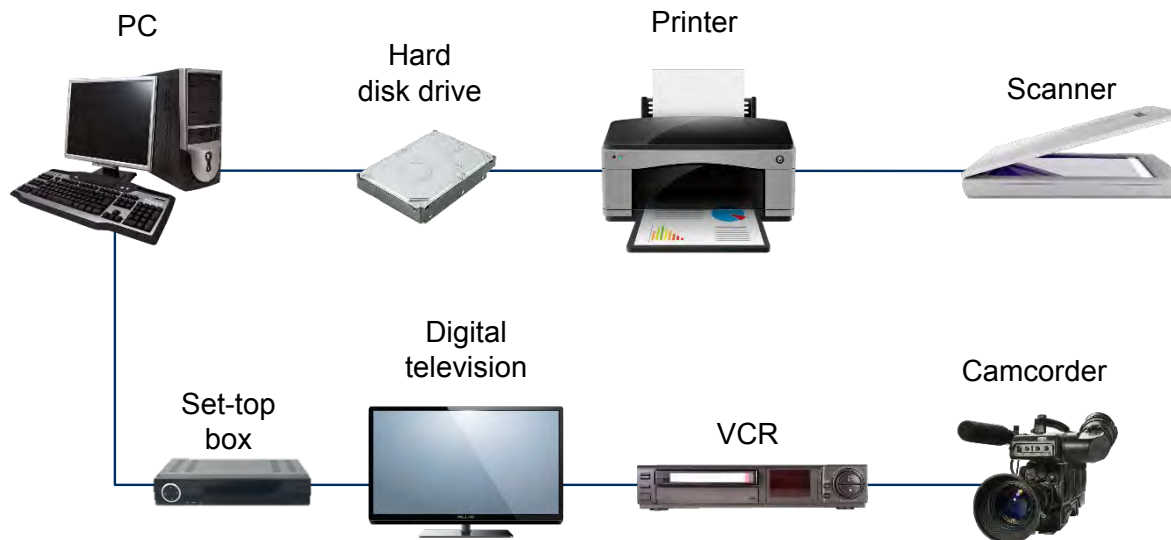

# High-Speed Serial Busses: Thunderbolt

## ➤ What is Thunderbolt?

- High-speed data transfer port/cable developed by Intel
- Featured on some Apple computers and a few PC platforms



Thunderbolt Version	Data rate (Mbits/sec)	Connector Type	Max. cable length per segment
Version 1	10 Gbs	Display port	4.5 meters
Version 2	20 Gbs	Display port	4.5 meters
Version 3	40 Gbs	USB Type C	4.5 meters





- **Network Interface Cards**
- **USB and FireWire**
- **PC Input Devices**
- **Custom PC Configurations**









# PC Input Devices: Mouse, Keyboard, Bar Code Reader

➤ **Note:** Devices that use PS/2 connector are *not* “hot-pluggable”

Input device	Description	Types	Connection	
Mouse	Provides point-and-click control of Windows desktop	Ball, optical	PS/2, USB, Wireless	
Keyboard	Main text entry and control	101-key	PS/2, USB, Wireless	
Bar-code reader	Reads standard bar code labels		USB	





# PC Input Devices: Multimedia

Input device	Description	Types	Connection	
Webcam	Captures video stream for broadcast over the web	Stand-alone or built-in	USB, wireless	
Digital camera	Provides still-image or video-image capture		USB, wireless	
Microphone	Records audio (voice or music) into PC		USB	
Motion sensor	Security systems		USB	



# PC Input Devices: Biometric, Touchscreen, KVM Switch

Input device	Description	Types	Connection	
Biometric devices	Captures individual's biometric information for authentication	Fingerprint reader, retinal scanner	USB, wireless	
Touchscreen	Video display with touch-sensitive matrix	Digital tablets, tablet PCs	Built-in, USB	
KVM switch	Switches <u>K</u> eyboard/ <u>V</u> ideo/ <u>M</u> ouse between multiple PCs		PS/2, USB	
MIDI-enabled devices	Musical Instrument Digital Interface		5-pin DIN	



- **Network Interface Cards**
- **USB and FireWire**
- **PC Input Devices**
- **Custom PC Configurations**



# Custom PC Configurations

- **It is common to build PCs for specific tasks**
  - Tasks determine PC components required

<b>PC type</b>	<b>Required components</b>
<b>Graphic/CAD/CAM design workstation</b>	Multicore processor High-end video Maximum RAM
<b>Audio/video editing workstation</b>	Specialized audio and video card Large, fast hard drive Dual monitors
<b>Virtualization workstation</b>	Maximum RAM and CPU cores
<b>Gaming PC</b>	Multicore processor High-end/specialized GPU (Graphics Processing Unit) High-definition sound card High-end cooling



# Custom PC Configurations

PC type	Required components
<b>Home theater PC</b>	Surround-sound audio HDMI output HTPC ( <u>H</u> ome <u>T</u> heater <u>P</u> C) compact form factor TV tuner
<b>Standard thick client</b>	Desktop applications Meets recommended requirements for selected OS
<b>Thin client</b>	Basic applications Meets minimum requirements for selected OS Network connectivity
<b>Home server PC</b>	Media streaming File sharing Print sharing Gigabit NIC (Network Interface Card) RAID ( <u>R</u> edundant <u>A</u> rray of <u>I</u> nexpensive <u>D</u> isks) array



# Evaluating/Selecting Components for Custom Configurations

- **The choice of components for a PC depends on the type of work it will be used for**
  - Match the component choice number to the PC type

PC type	Selection #	Computer component choices
Graphic/CAD/CAM design workstation		<ol style="list-style-type: none"><li>1. Maximum RAM and CPU cores</li><li>2. Powerful processor, high-end video/specialized GPU, high-definition sound card, high-end cooling</li><li>3. Specialized audio and video cards; large, fast hard drive; dual monitors</li><li>4. Powerful processor, high-end video, maximum RAM</li></ol>
Audio/video editing workstation		
Virtualization workstation		
Gaming PC		



# Evaluating/Selecting Components for Custom Configurations

PC type	Selection #	Computer component choices
Home theater PC		1. Media streaming, file sharing, print sharing, Gigabit NIC, RAID array
Standard thick client		2. Surround-sound audio, HDMI output, HTPC compact form factor, TV tuner
Thin client		3. Desktop applications (Microsoft Office), meets recommended requirements for running Windows
Home server PC		4. Basic applications only





# Review Questions

- 1. The type of I/O port that transmits 8 bits of data at exactly the same time is called a \_\_\_\_\_ port.**
  - A. Video
  - B. Serial
  - C. Parallel
  - D. USB
  
- 2. Which type of bus uses serial technology to support up to 127 devices?**
  - A. ISA
  - B. USB
  - C. PCI
  - D. Parallel
  
- 3. USB 2.0 has a maximum data transfer rate of:**
  - A. 12 Mbps
  - B. 60 Mbps
  - C. 480 Mbps
  - D. 4800 Mbps



# Review Questions

4. A type A USB connector is typically plugged into the USB connector on a:

- A. Peripheral device
- B. Small digital camera
- C. Mouse
- D. PC

5. Match the component choice number to the PC type

PC type	Selection #	Computer component choices
1. Home theater PC		A. Media streaming, file sharing, print sharing, Gigabit NIC, RAID array
2. Standard thick client		B. Surround-sound audio, HDMI output, HTPC compact form factor, TV tuner
3. Thin client		C. Desktop applications (Microsoft Office), meets recommended requirements for running Windows
4. Home server PC		D. Basic applications only



# Chapter Summary

---

**In this chapter, you have learned how to**

- **Describe key characteristics of PC connection interfaces**
- **Explain features of network interface card (NIC)**
- **Describe the basic features of the Universal Serial Bus (USB), FireWire I/O, and Thunderbolt standards**
- **Select and configure appropriate devices for custom PC configurations**



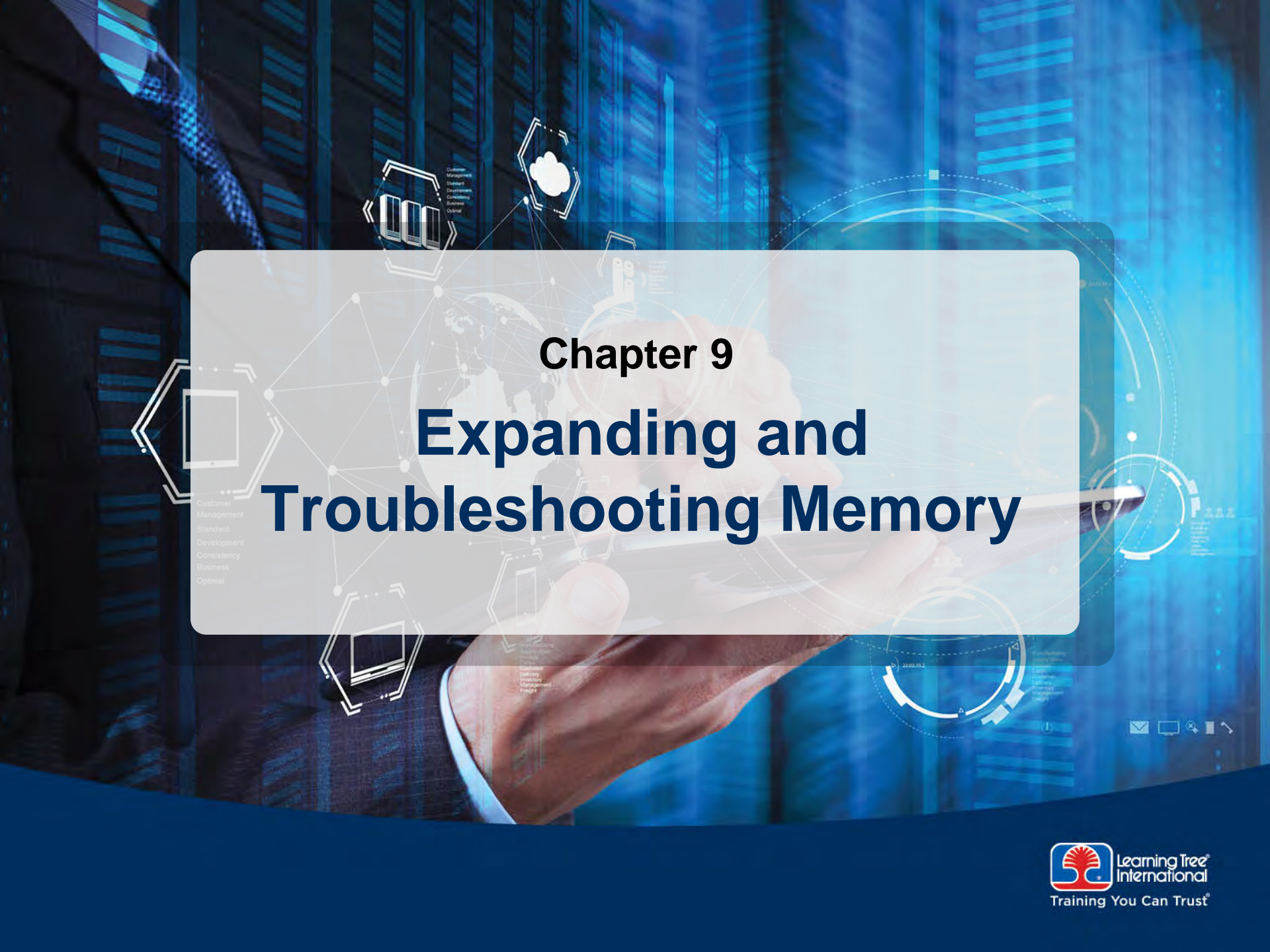

# Chapter 9

## Expanding and Troubleshooting Memory

Customer  
Management  
Standard  
Development  
Consistency  
Business  
Optimal

# Chapter Objectives

---

**In this chapter, you will learn how to**

- **Explain the following terms: DIMM, SODIMM, DRAM, SDRAM, DDR-SDRAM, DDR2-SDRAM, DDR3-SDRAM**
- **Identify the storage capacity, packaging format, and speeds of common PC RAM devices**
- **Select the correct RAM devices to upgrade your system memory**



- **Memory Overview and Error Checking Types**
  - **RAM Packaging Formats**
  - **RAM Device Types**
  - **Memory Speed**
  - **Optional Hands-On Exercise 9.1**
  - **Optional Hands-On Exercise 9.2**



# System RAM

## ➤ What is RAM?

- Read/write memory
- Provides temporary storage of programs and data
- RAM data is accessible while system power is on
  - Called “volatile” memory, because content is lost when power is turned off

## ➤ System RAM organization

- Organized as a number of SIMM or DIMM cards plugged into the motherboard
- Sizes for DIMM cards range from 1 GB to 16 GB

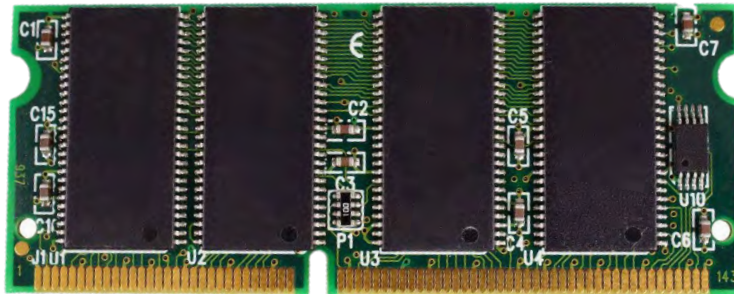

# Understanding PC RAM Memory

- **Adding more RAM memory is one of the easiest ways to increase the performance of a PC**
  - The performance of Windows systems increases linearly in proportion to the amount of RAM installed in the system!
  - For this reason, expanding the RAM memory on a PC is one of the most common tasks you will perform
- **The most difficult part of expanding a PC's RAM is selecting the correct type of RAM card to install**
  - Rapid progress in RAM technology has resulted in a large number of different types of RAM devices, packaging styles, speeds, etc...





# Understanding PC RAM Memory

- **To select and maintain the proper type of memory for your PC, you need to be familiar with the following terms and topics**
  - Parity, nonparity, ECC RAM operation
  - RAM packaging and logical organization (DIMM, SODIMM)
  - Types of RAM memory devices (DRAM, SDRAM, DDR-SDRAM)

ECC = error-correcting code

DDR-SDRAM = Double Data Rate SDRAM

SODIMM = small outline dual in-line memory module



# How RAM Works

## ➤ RAM organization

- Organized in units of eight or nine memory devices
- Each memory device stores 1 bit of data in each of its  $N$  (16 M, 32 M, 64 M, etc.) locations
- Eight memory devices are required to store 1 byte (8 bits) of data
- Optional ninth memory device stores parity bit (used for error checking—explained later)

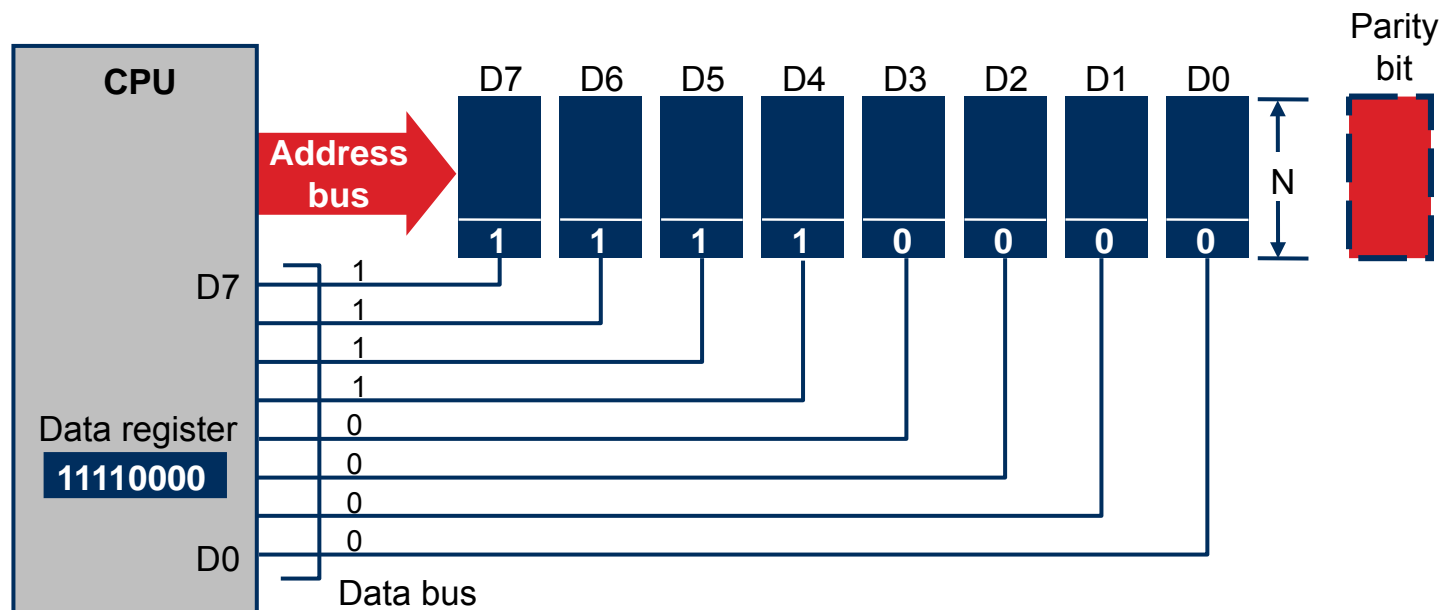

# How RAM Works: Parity Checking

## ➤ What is the parity bit?

- Additional (ninth) bit is stored with each byte of data written to memory
- Used to detect errors when data is read back from memory
  - System will generate a Non-Maskable Interrupt (NMI) signal, and usually display the error message `PARITY ERROR`

## ➤ How does parity checking work?

- IBM-type PCs use the odd-parity error-checking standard
- Value of parity bit is set to make the total number of 1s contained in the 9 bits written to memory an *odd* number
- Example:

D7	D6	D5	D4	D3	D2	D1	D0	Parity bit
1	1	1	1	0	0	0	0	1
1	1	1	1	1	0	0	0	0



# How RAM Works: Parity Checking

## ➤ How parity checking detects memory errors

### 1. Memory write process

- When a byte of data is written to memory, the CPU (or external circuitry) calculates the value of the parity bit and stores it with the byte of data

### 2. Memory read process

- Later, when the byte of data is read back from memory, the CPU (or external circuitry) checks the total number of 1s contained in the data byte + parity bit
- If the total number of 1s is an *odd* number, the data byte has been read successfully
- If the total number of 1s is an *even* number, an error has occurred and the system displays an error message:

PARITY ERROR



# How RAM Works: Parity Checking

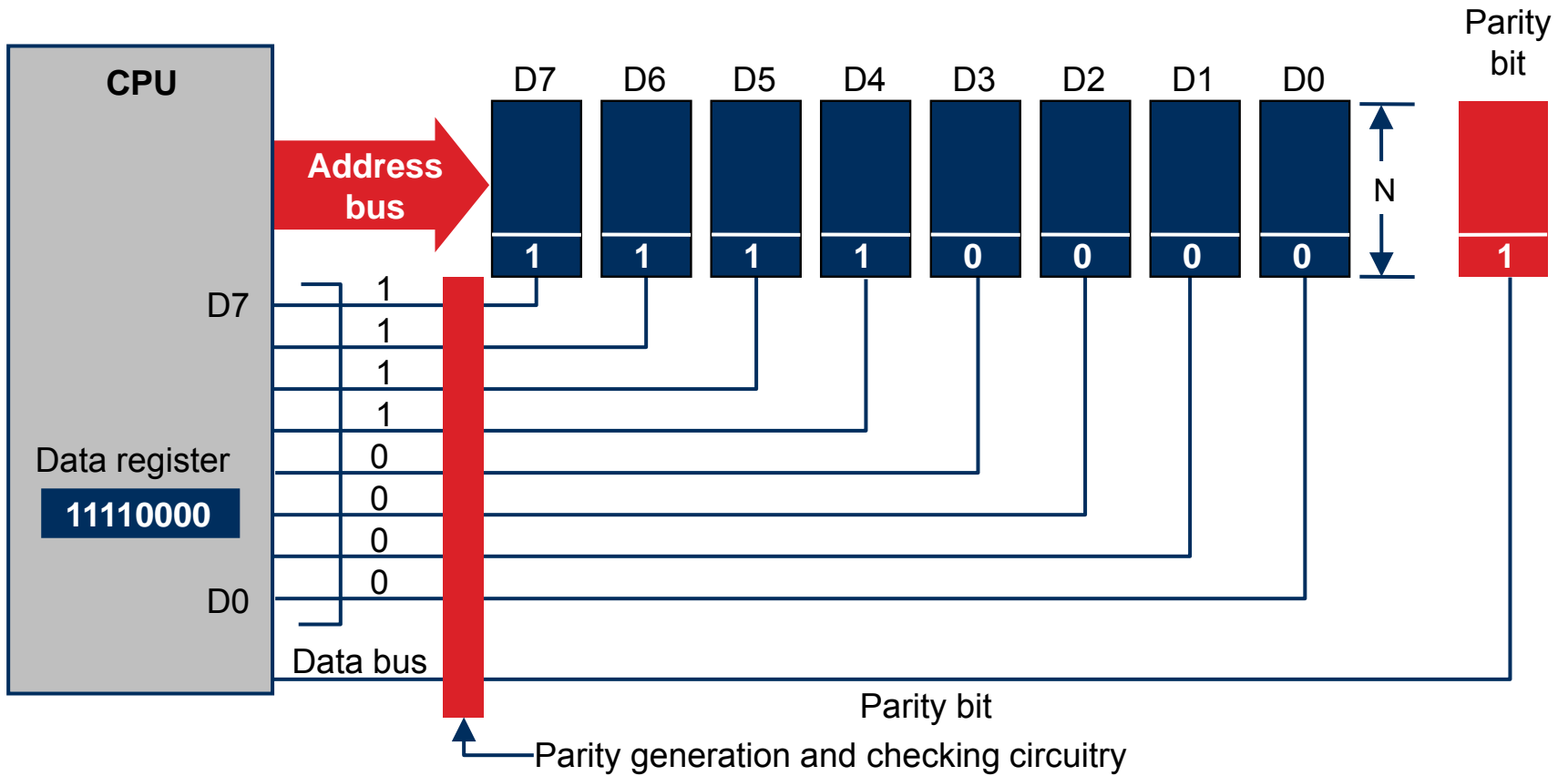

# How RAM Works: Nonparity RAM

## ➤ The RAM in my PC doesn't have a parity bit; is this bad?

- Current motherboard manufacturers have been designing systems that do not use parity checking
- This is done for two reasons
  - It reduces the overall cost of the system
  - RAM memory devices are becoming more and more reliable
- If your system is not designed to use parity checking, don't worry about it (unless you require extra-high reliability—see next slide)



# How RAM Works: ECC Memory

## ➤ What is Error-Correcting Code (ECC) memory?

- Special type of memory design capable of detecting and correcting 1-bit errors
- Designed for use in mission-critical systems (such as servers)
- Motherboard must be designed with memory controller that supports ECC memory scheme
- Memory cards must be built to support ECC memory operations

## ➤ How does ECC memory work?

- When data is written to memory, the ECC memory controller computes a checksum (ECC bits) and stores it along with the actual data
- When data is read from memory, the ECC memory controller decodes the ECC bits and determines if the data has been corrupted
- If a single-bit error is detected, the ECC memory controller corrects the error in the data
- If a multiple-bit error is detected, the ECC controller reports a parity error



- **Memory Overview and Error Checking Types**
- **RAM Packaging Formats**
- **RAM Device Types**
- **Memory Speed**
- **Optional Hands-On Exercise 9.1**
- **Optional Hands-On Exercise 9.2**





# RAM Packaging Formats

## ➤ Dual in-line memory module (DIMM)

- Gold or tin edge connectors on each side of card are electrically independent
  - This effectively doubles the available number of signal lines for a given number of pins (an 84-pin DIMM has 168 available signal lines)

## ➤ Dual in-line memory module (DDR-SDRAM/184 pins, DDR2/DDR3-SDRAM/240 pins DIMM):



**Note: DDR-SDRAM DIMM (184-pin) and DDR2/DDR3-SDRAM DIMM (240-pin) are not compatible, although they look similar; “keying” notch is located in a slightly different position between the two types of DIMM cards**



# RAM Packaging Formats

## ➤ Small Outline DIMM

- Small-form factor DIMM package used for laptops
- 204-pin SODIMM pictured below

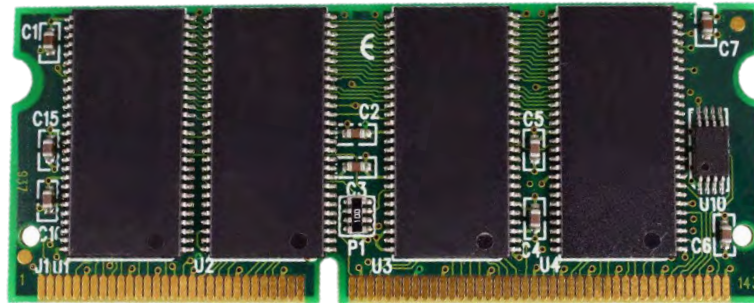

SODIMM type	Pins
DDR	200
DDR 2	200
DDR 3	204
DDR 4	260



# RAM Packaging: Single-Sided vs. Double-Sided

- **Refers to logical arrangement of memory on a DIMM card**
  - Independent of whether RAM chips are on one or both sides of card
- **Double-sided RAM**
  - RAM chips are divided into two groups (“ranks”)
  - CPU can only access one group at a time
  - Pins 33 and 45 are used to switch between groups
- **Single-sided RAM**
  - Higher-performance design
  - All RAM chips on memory card are accessible at any time



# DIMM Memory Card Installation

## ➤ Installing DIMM memory cards

- Orient card, then push straight down until ejector handle latches card into place

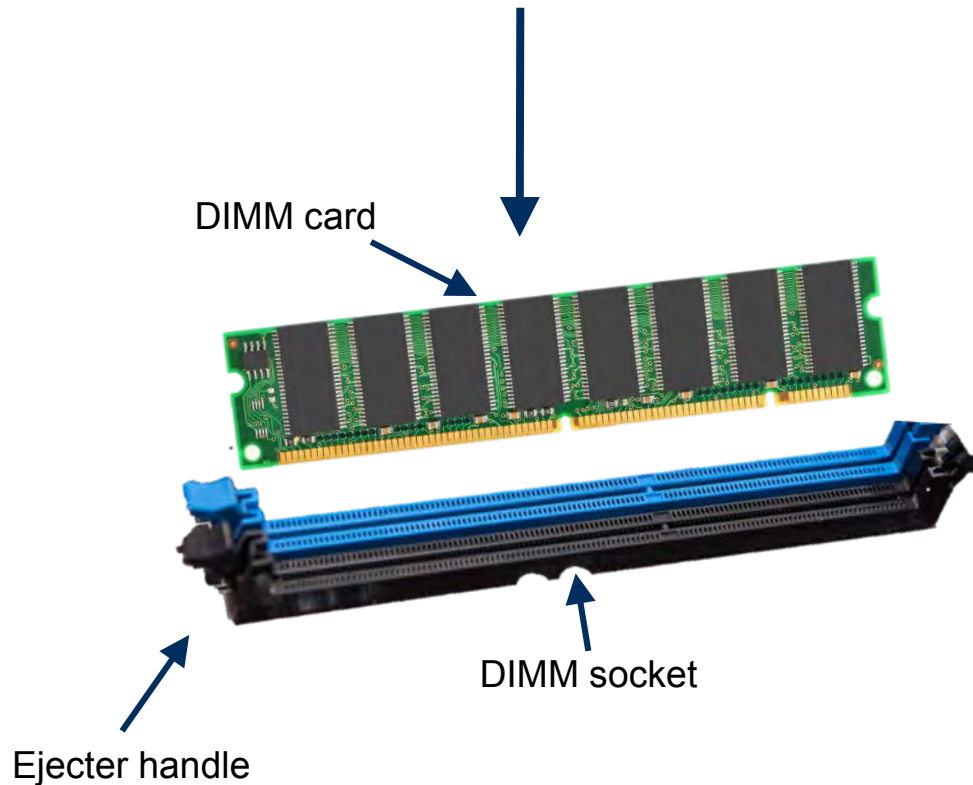

# SIMM/DIMM Memory Card Installation Precautions

- **Use antistatic protective devices when installing memory devices**
  - All CMOS memory devices are easily damaged by static electricity
- ***Never use force when installing memory cards!***
  - The plastic portions of the SIMM/DIMM memory sockets on the motherboard can easily be broken if excessive force is applied
  - Because these sockets cannot be easily repaired, a damaged socket usually requires *replacement of the entire motherboard!*



- **Memory Overview and Error Checking Types**
- **RAM Packaging Formats**
- **RAM Device Types**
  - **Memory Speed**
  - **Optional Hands-On Exercise 9.1**
  - **Optional Hands-On Exercise 9.2**



# RAM Device Types: DRAM

- **The hardware architecture of RAM devices continuously evolves from one generation to the next**
  - The main goal is speed at a reasonable price
- **Dynamic RAM (DRAM)**
  - Introduced in original PC, provided foundation for following RAM technologies
  - Each cell provides capacitive storage for a charge that represents a bit of data
  - The stored charge rapidly leaks away, so this type of RAM device must be constantly refreshed by memory support circuitry
- **Synchronous DRAM (SDRAM)**
  - A form of DRAM that uses a clock to synchronize memory transfers with the timing of the CPU
    - Transfers data on rising edge of clock signal



# RAM Device Types: DDR-SDRAM

## ➤ Double Data Rate (DDR) SDRAM

- Next-generation SDRAM transfers data on both edges of clock



- Doubles data transfer rate of standard SDRAM

## ➤ **DDR packaging format**

- DIMM card – 284 pins

## ➤ **DDR memory speed**

- Specified as Data Transfer Rate (in MB/sec)

Data Transfer Rate = Clock speed x 2 x number of bytes (64 bits = 8 bytes)

## ➤ **Example:**

- What is the data transfer rate for DDR memory using clock speed of 400Mhz?
- $400\text{Mhz} \times 2 \times \text{number of bytes (8)} = 6400 \text{ MB/sec}$
- This type of DDR memory card would be labeled:
  - DDR-PC6400





# RAM Device Types: DDR2

## ➤ DDR2-SDRAM

- Next-generation follow-up to DDR memory
- Higher clock speeds (up to 1200 MHz)
- Lower power consumption (1.8V), better thermal performance
- Not backward compatible with DDR memory systems and sockets
  - DIMM card – 240 pins

## ➤ Common DDR2 memory speeds

DDR2 type	Data transfer rate	DDR2 effective clock speed	Bus clock speed
PC2-3200	3.2 GB/s	DDR2 400	200 MHz
PC2-4300	4.25 GB/s	DDR2 533	266 MHz
PC2-5400	5.6 GB/s	DDR2 667	333 MHz
PC2-6400	6.4 GB/s	DDR2 800	400 MHz
PC2-9600	9.6 GB/s	DDR2 1200	600 Mhz



# RAM Device Types: DDR3

## ➤ DDR3-SDRAM

- Next generation in the DDR memory family
- Higher clock speeds (up to 1600 MHz)
- Lower power consumption than DDR2 modules (up to 40 percent less)
- DIMM card – 240 pins
  - Notch in slightly different position than DDR2 DIMM card

## ➤ DDR3 memory speeds

DDR3 type	Data transfer rate	DDR3 effective clock speed	Bus clock speed
PC3-6400	6.4 GB/s	DDR3 800	400 MHz
PC3-8500	8.53 GB/s	DDR3 1066	533 MHz
PC3-10600	10.67 GB/s	DDR3 1333	667 MHz
PC3-12800	12.80 GB/s	DDR3 1600	800 MHz



- **Memory Overview and Error Checking Types**
- **RAM Packaging Formats**
- **RAM Device Types**
- **Memory Speed**
  - **Optional Hands-On Exercise 9.1**
  - **Optional Hands-On Exercise 9.2**



# RAM Memory Speed

## ➤ Access time (latency)

- Time required for the memory device to locate and output stored data

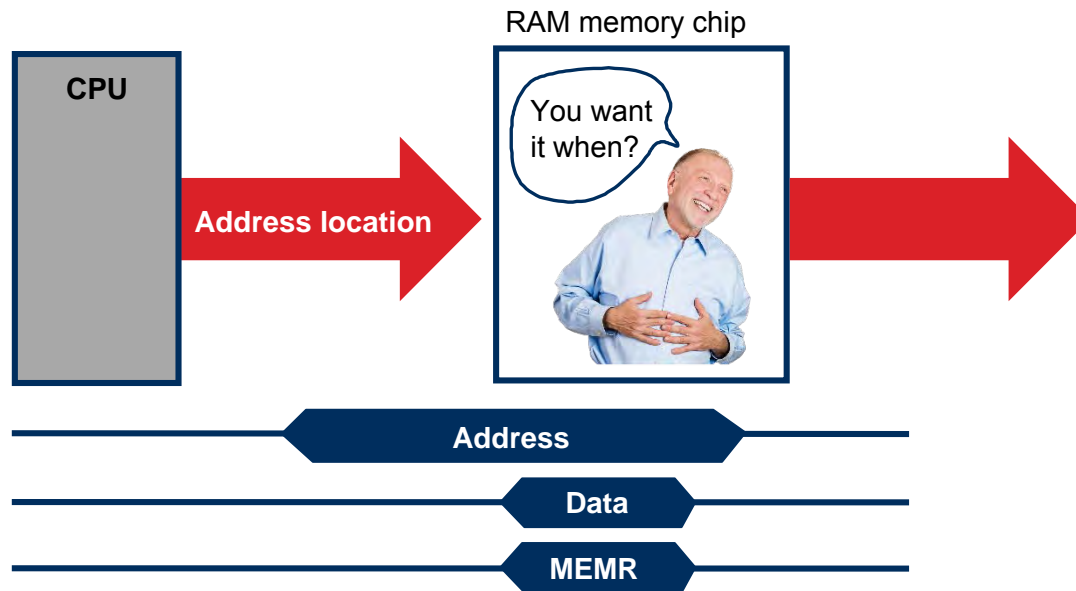

MEMR = Memory Read

# Buffered vs. Unbuffered Memory

- **Buffered memory is an older term for registered memory**
  - Registered memory contains registers that buffer the address and command signals going to memory
    - Instead of these signals going directly to the memory cells
    - Results in slight performance drop to latch these signals
  - Traditional memory without these registers is called *unbuffered memory*
- **What's the advantage of buffered (registered) memory?**
  - Provides more stability in systems with large amounts of memory
  - Typically used in servers (not in standard desktop computers)
    - Supported with special circuitry on motherboard



# Determining RAM Speed

- **When replacing or adding RAM, how do I determine the correct speed of the new memory devices?**
  - The safest way is to refer to the motherboard manual for the RAM speed specification
  - If the manual is not available, look at the speed of the RAM devices already installed (or the one that you are replacing)
- **Does the speed of the new RAM device need to be exactly the same as the RAM device being replaced?**
  - In general, yes
  - In some older systems, it is allowable to use faster memory as a substitute, but it is generally safer to only install memory specified by the motherboard documentation



# Memory Operation Modes: Dual-Channel

## ➤ Dual-Channel DDR SDRAM

- Memory architecture increases data throughput to DDR memory to match faster processor speeds
- Doubles data transfer rate of DDR memory by transferring 64 bits of data to two DDR DIMM cards at the same time (dual channel)

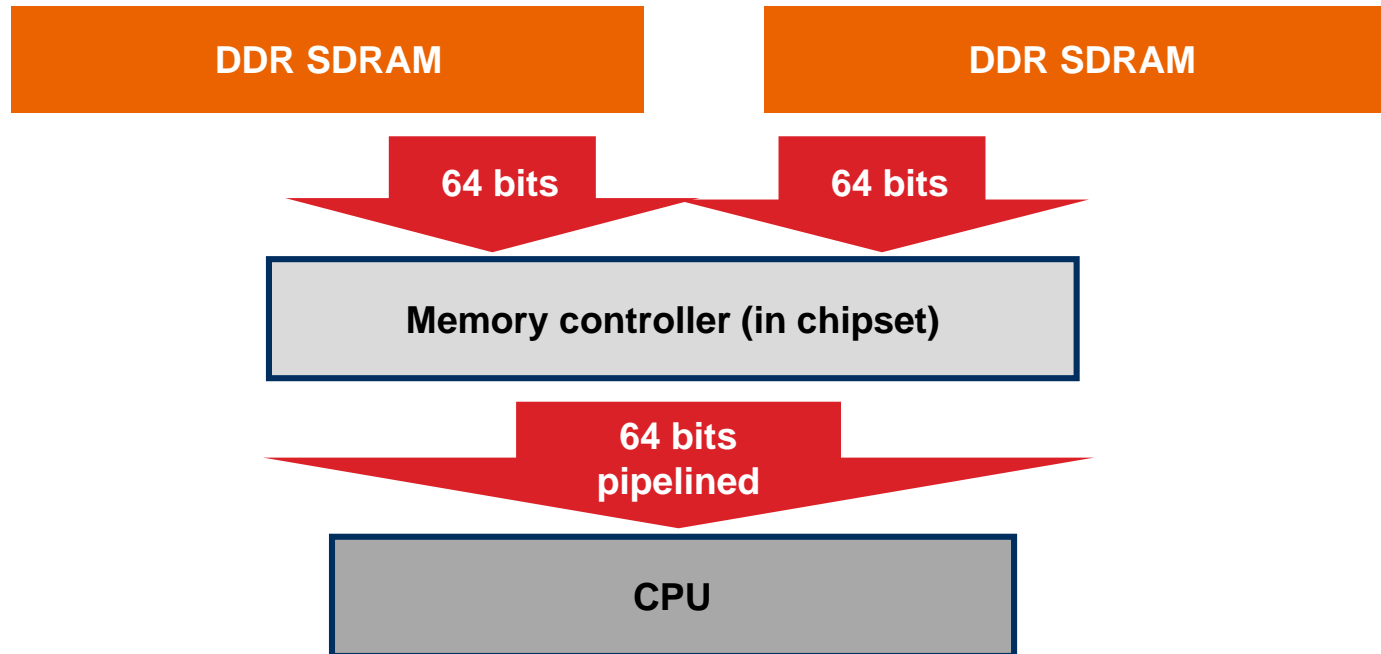

# Dual-Channel DDR Data Transfer Rates

## ➤ Dual-Channel DDR Data Transfer Rates

- Data transfer rate =
  - Memory speed (MHz)
  - x Data bus width (64 bits / 8 bytes)
  - x Number of channels

P4/400	P4/533	P4/800
3.2 GB/s	4.2 GB/s	6.4 GB/s

Memory	PC-133	PC2100	PC2700	PC3200
Peak data rate		DDR266	DDR333	DDR400
Single-channel	1.1 GB/s	2.1 GB/s	2.7 GB/s	3.2 GB/s
Dual-channel		4.2 GB/s	5.4 GB/s	6.4 GB/s

From Kingston Technology's "Intel Dual-Channel DDR Memory Architecture White Paper" on [www.kingston.com](http://www.kingston.com)





# Dual-Channel DDR Data Transfer Rates

- **To determine memory card speed (frequency) from data transfer rate, divide by 8**
  - Example:  $PC3200/8 = 400$  MHz
- **To operate in dual-channel mode, memory modules in each pair of sockets (Channel A DIMM0 and Channel B DIMM0) must**
  - Be the same size; e.g., both 512 MB
  - Be the same speed; e.g., both PC2700
  - Have the same number of chips on each side of the module
- **If memory modules are not exactly matched, system will default to (slower) single-channel operation**



# Memory Operation Modes: Triple-Channel

## ➤ Triple-Channel DDR SDRAM

- New Intel memory architecture increases data throughput to DDR memory to match faster processor speeds
- Triple-channel mode enabled when identical memory modules are installed in triple-channel memory slots (blue connectors)
- If only two identical memory modules are installed, dual-channel is enabled

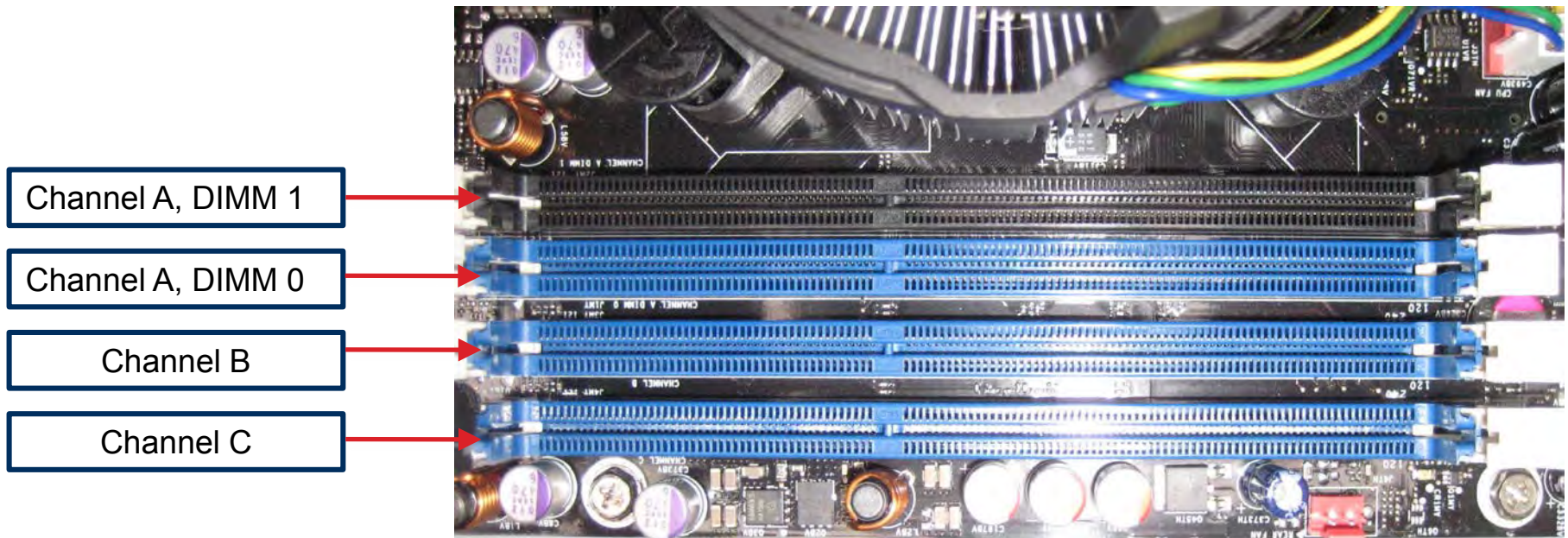

- **Memory Overview and Error Checking Types**
- **RAM Packaging Formats**
- **RAM Device Types**
- **Memory Speed**
- **Optional Hands-On Exercise 9.1**
- **Optional Hands-On Exercise 9.2**



# Optional Hands-On Exercise 9.1

## Video: Uninstalling System RAM Cards

### ➤ Objectives

In this exercise, you will learn how to

- Safely uninstall a system RAM card
- Use the RAM card part number to look up memory size, type and speed

### ➤ Exercise procedure

- As you watch the video clip, write your answers to the questions on the following slides



# Optional Hands-On Exercise 9.1

## Video: Uninstalling System RAM Cards

### ➤ Removing system RAM cards

1. What safety precaution should always be taken when working on system memory cards?

---

2. What is the purpose of the notch in the DIMM RAM card?

---



# Optional Hands-On Exercise 9.1

## Video: Uninstalling System RAM Cards

### ➤ Determining system RAM type

3. Record the name of the manufacturer of the DIMM RAM card below:

---

4. Record the part number of the DIMM RAM card below:

---

➤ **In the next exercise, you will use this information to look up the size, type, and speed of the DIMM RAM card**



- **Memory Overview and Error Checking Types**
- **RAM Packaging Formats**
- **RAM Device Types**
- **Memory Speed**
- **Hands-On Exercise 9.1**
- **Optional Hands-On Exercise 9.2**



*In your Exercise Manual, please refer to  
Optional Hands-On Exercise 9.2:  
Looking Up Memory Card Information*





# Review Questions

- 1. Which type of RAM can detect one-bit errors but cannot correct them?**
  - A. Nonparity
  - B. Parity
  - C. EDO
  - D. ECC
  
- 2. A motherboard has four memory slots, two of which are colored blue and the other two black. What type of memory architecture is used on this motherboard?**
  - A. Single-channel
  - B. Dual-channel
  - C. Triple-channel
  - D. Quad-channel



# Review Questions

- 3. Two memory cards are installed in the same bank of a dual-channel RAM system, but they are of different sizes. What will happen?**
- A. The memory will work in dual-channel mode
  - B. The memory will not work at all
  - C. The memory will default to working in single-channel mode
  - D. The power supply will shut down immediately
- 4. What is the clock speed for the DDR RAM in a PC3200 DIMM?**
- A. 100 MHz
  - B. 200 MHz
  - C. 300 MHz
  - D. 400 MHz



# Review Questions

5. The 240-pin memory card pictured below is a:

- A. SIMM
- B. SDRAM DIMM
- C. DDR2-SDRAM DIMM
- D. SODIMM



# Chapter Summary

---

**In this chapter, you have learned how to**

- **Explain the following terms: DIMM, SODIMM, DRAM, SDRAM, DDR-SDRAM, DDR2-SDRAM, DDR3-SDRAM**
- **Identify the storage capacity, packaging format, and speeds of common PC RAM devices**
- **Select the correct RAM devices to upgrade your system memory**



# Chapter 10

# Data Storage Systems

Customer  
Management  
Standard  
Development  
Consistency  
Business  
Optimal

# Chapter Objectives

In this chapter, you will learn how to

- List the main components of a hard disk, solid state, and optical drives and explain their functions
- Describe the meanings of the following hard disk drive parameters: *cylinders, heads, sectors, landing zone, capacity*
- Install and configure serial ATA hard drives
- Explain how to partition and format disk drives
- Describe the types and functions of RAID arrays



## ➤ **Hard Disk Drive Basics**

- **Interface Standards**
- **Preparing a Hard Drive for Use**
- **Optional Hands-On Exercise 10.1**
- **RAID**
- **Hands-On Exercise 10.2**
- **Solid-State Storage Devices and External Storage Devices**
- **CD-ROM/DVD Drives**
- **Troubleshooting Hard Drives and Disk Startup Issues**



# Hard Drive Construction

## ➤ Hard drive platters

- Hard drives use rigid metal or glass-ceramic disk platters coated with magnetic material
  - Thin-film magnetic media consists of cobalt alloy 3 microns in thickness
- Read/write heads “fly” over disk surface

## ➤ Hard drive components

- Disk platters
- Read/Write (R/W) heads
- Head actuator





# Hard Drive Construction

## ➤ Hard drive components

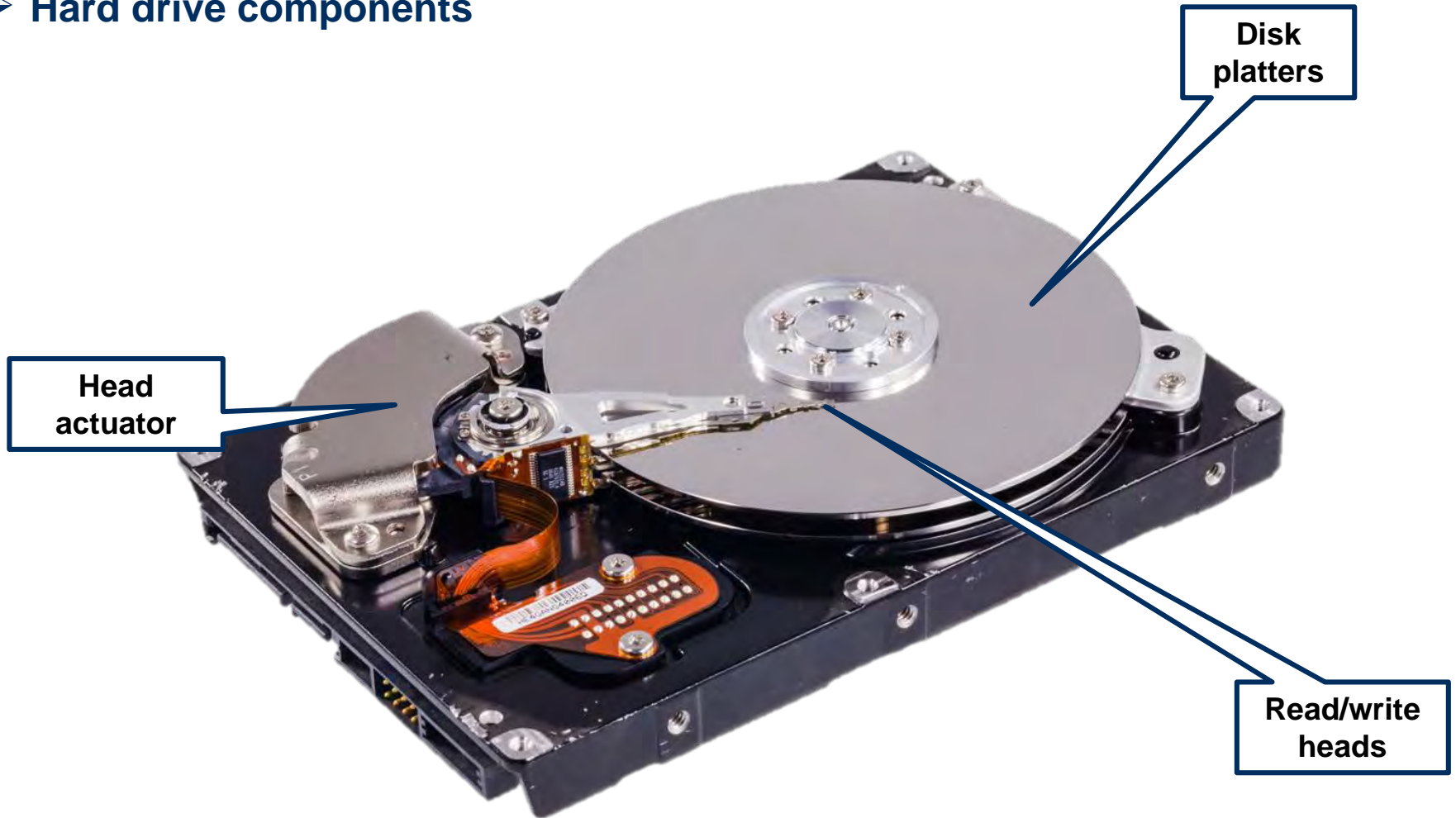

# Read/Write Heads and Platter Rotational Speed

## ➤ Hard disk read/write heads

- Read/write heads are specially shaped to fly over disk platter surface
- Heads are lifted by air currents on a spinning platter
- Flying height is between 3 and 10 microns (millionths of a meter)

## ➤ Platter rotational speed

- Measured in Revolutions Per Minute (RPM)
- Higher rotational speed = faster data transfer rate
- Common speeds: 5,400, 7,200, 10,000, 15,000 rpm

## ➤ Disk contaminants vs. head flying height

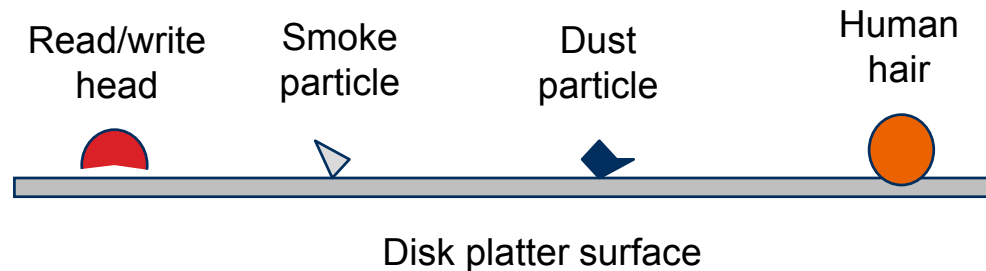

- Hard drives are assembled in a “clean room” to eliminate contaminants
- Drives are permanently sealed: *Never* attempt to open a hard drive case!



# Hard Disk Terminology

## ➤ Track

- Narrow, concentric circles of recorded data

## ➤ Cylinder

- One cylinder equals all of the tracks on disk platters that lie directly above each other (all tracks under read/write heads at one time)
- Number of cylinders depends on drive type and storage capacity

## ➤ Sector

- Pie-shaped sections of disk track
- Smallest unit of data that can be read/written by drive (512 bytes)
- Original PC hard drives used 17 sectors/track
  - Newer drives use many more sectors/track (36, 63, etc.)

## ➤ Cluster

- For hard disks, the operating system allocates space in groups of one, two, four, or eight sectors called *clusters*



# Basic Terms

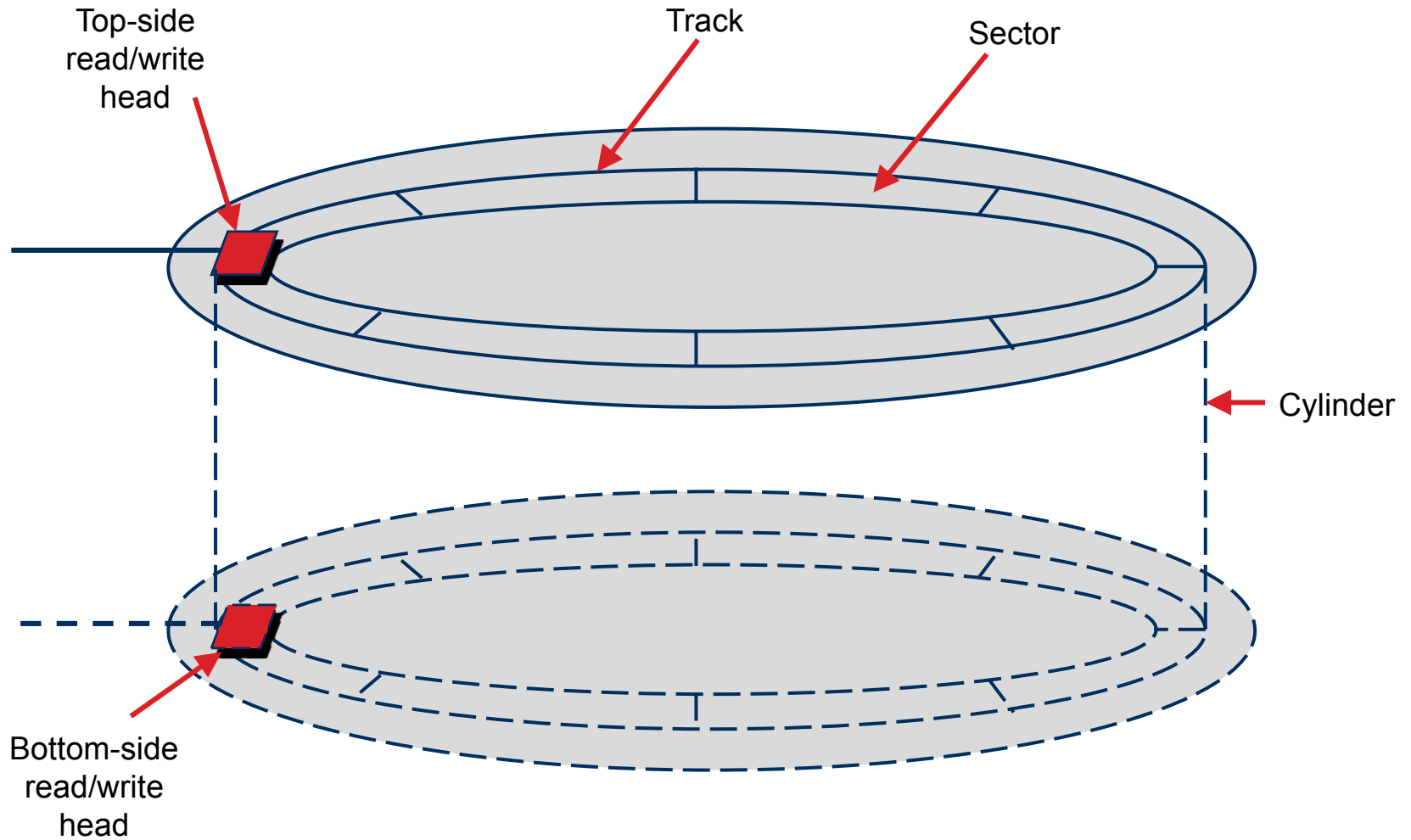

# Hard Disk Terminology

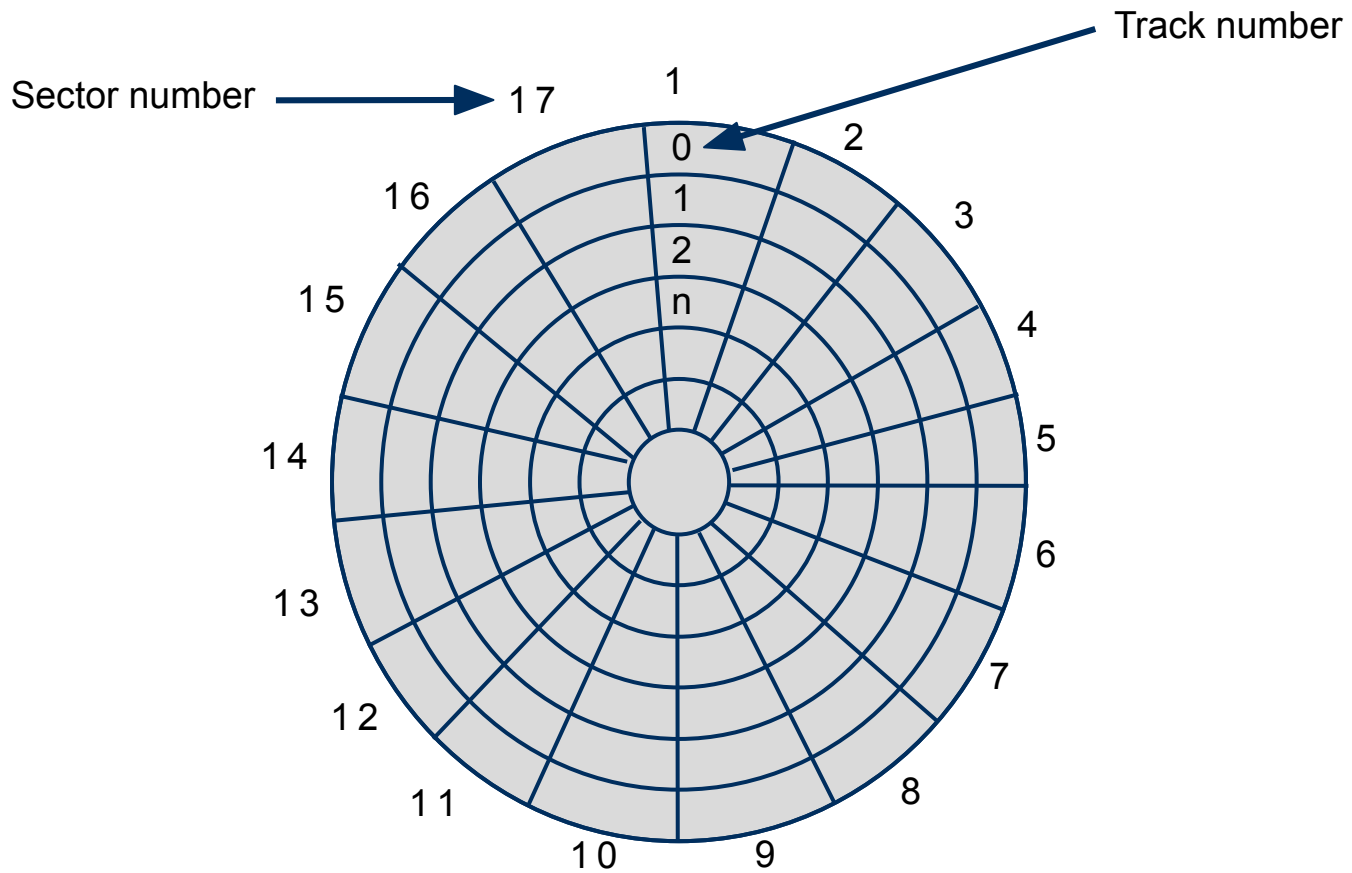

# Hard Disk Parameters

## ➤ What are hard disk parameters?

- Information describing low-level data organization (“geometry”) of drive
  - Used by BIOS to control drive and locate data
- Originally described actual physical characteristics of drive
  - Now used to describe logical organization of drive as it appears to BIOS

## ➤ Disk parameters

- Cylinders: Total number of cylinders on drive
- Heads: Number of read/write heads
- Sectors: Number of sectors per track
- Landing zone: Cylinder number where disk heads are parked
- Capacity: Formatted storage capacity of drive



- **Hard Disk Drive Basics**
- **Interface Standards**
- **Preparing a Hard Drive for Use**
- **Optional Hands-On Exercise 10.1**
- **RAID**
- **Hands-On Exercise 10.2**
- **Solid-State Storage Devices and External Storage Devices**
- **CD-ROM/DVD Drives**
- **Troubleshooting Hard Drives and Disk Startup Issues**



# Hard Drive Interface

## ➤ SATA (Serial ATA)

- Serial interface for ATA devices (hard drives, DVD-ROMS, etc.)

## ➤ Serial ATA speeds:

SATA type	Data rate (Gb/sec)	Data rate (MB/sec)	Max. cable length
SATA Rev. 1	1.5	150	1 meter
SATA Rev. 2	3	300	1 meter
SATA Rev. 3	6	600	1 meter
SATA Rev. 3.2	16	1969	1 meter

## ➤ SATA drive controller software includes S.M.A.R.T. diagnostic program

- S.M.A.R.T. = Self-Monitoring, Analysis and Reporting Technology
- Monitors and reports disk defects in advance of major disk failure

ATA = AT Attachment





# Serial ATA Data and Power Connectors

## ➤ Serial ATA connectors

- Uses 7-pin edge connector for data
  - Small, right-angle tab on edge of connector used for orienting power and data cables
- Uses 15-pin edge connector for power
  - Other side of power cable adapter goes to standard 4-pin male power connector

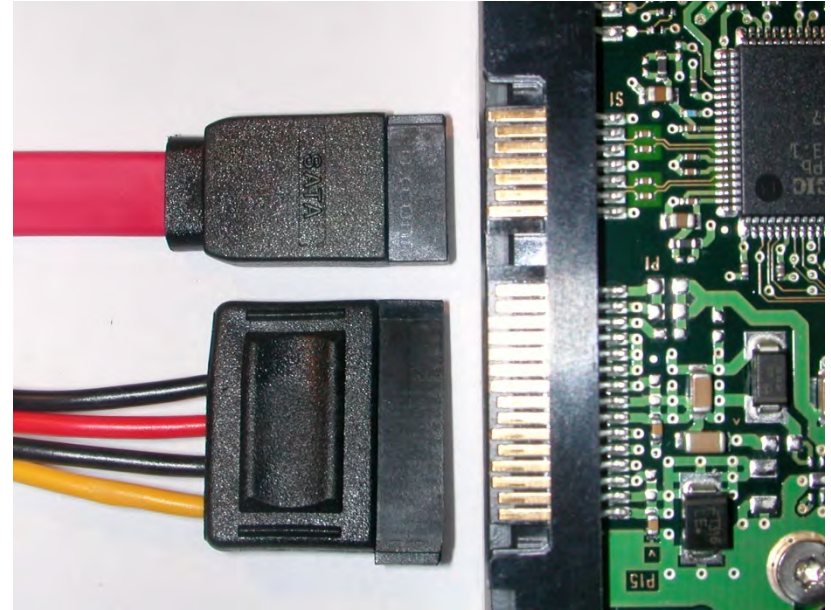

## ⚠ Warning!

- Serial data connector on motherboard is very fragile
- Damaging this connector permanently damages the motherboard



# eSATA and Thunderbolt

## ➤ What is eSATA?

- External Serial Advanced Technology Attachment
- Allows external connection of SATA drive to PC

## ➤ eSATA specifications

- Maximum cable length: 1 m (passive); 2 m (active)



Serial ATA type	Data rate (Gb/sec)	Data rate (MB/sec)	Max. cable length
eSATA	3	300	2 meters



# High-Speed Serial Busses: Thunderbolt

## ➤ What is Thunderbolt?

- High-speed serial interface specification introduced by Intel
- Also provides DC power: 18 V 550 mA
- Daisy chain up to six devices



Thunderbolt Version	Data rate (Mbits/sec)	Connector Type	Max. cable length per segment
Version 1	10 Gbs	Display port	4.5 meters
Version 2	20 Gbs	Display port	4.5 meters
Version 3	40 Gbs	USB Type C	4.5 meters

mA = milliamps



- **Hard Disk Drive Basics**
- **Interface Standards**
- **Preparing a Hard Drive for Use**
- **Optional Hands-On Exercise 10.1**
- **RAID**
- **Hands-On Exercise 10.2**
- **Solid-State Storage Devices and External Storage Devices**
- **CD-ROM/DVD Drives**
- **Troubleshooting Hard Drives and Disk Startup Issues**



# Hard Drive Logical Preparation

- **Three procedures must be performed on a hard drive to prepare it for data storage**
  1. Low-level formatting
  2. Disk partitioning
  3. High-level formatting



# Low-Level Formatting

## ➤ What is low-level formatting?

- Procedure that sets up original track and sector marks on disk platters
- All new hard drives are low-level formatted by the manufacturer (low-level format program can be downloaded for repair purposes)
- Low-level formatting can be used to completely wipe a disk (for security, or to remove viruses)

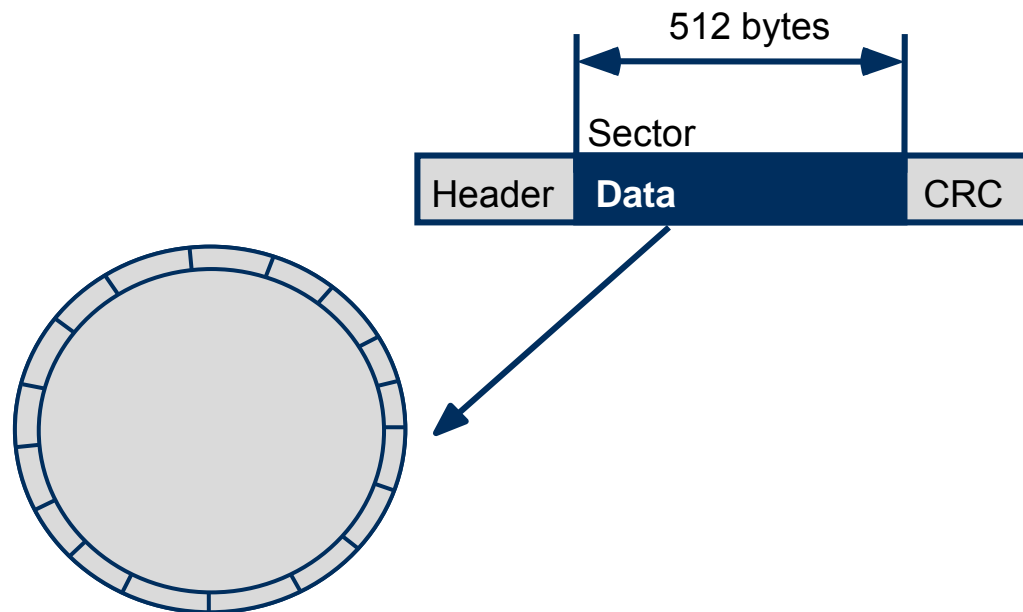

CRC = cyclic redundancy check



# Disk Partitioning

## ➤ What is disk partitioning?

- Process of dividing a disk into one or more logical partitions for use by operating systems
- Windows Disk Management utility can be used to partition a disk
- Partition information stored in partition table on disk

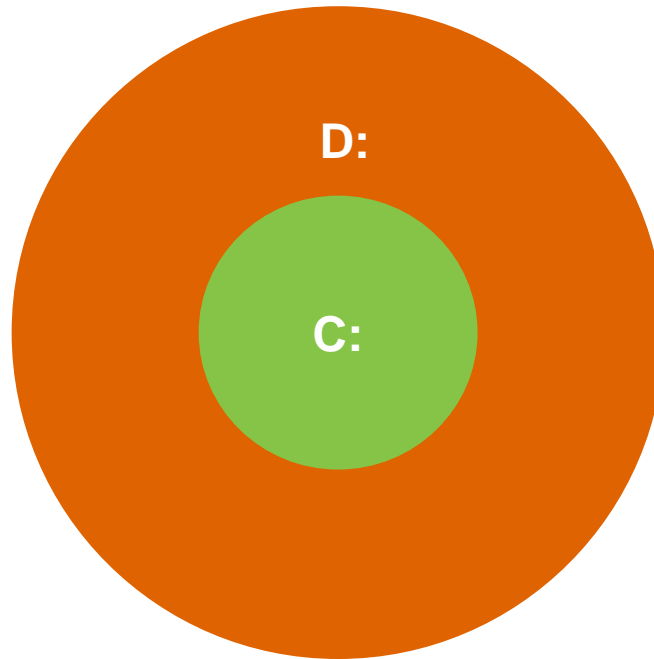

# Partition Types

## ➤ Basic disk/MBR partition

- Traditional partitioning scheme based on original IBM PC disk system
  - MBR (Master Boot Record) contains partition table
- Maximum of four Primary (bootable) partitions
  - Or three Primary and one Extended partition
- Extended partition
  - Special partition can hold multiple logical (non-bootable) partitions

## ➤ GPT (GUID Partition Table)

- Newer partitioning scheme labels each partition with a Globally Unique Identifier (GUID)
- Can have up to 128 partitions
  - Partitions are bootable
    - System must be running 64-bit version of Windows on a UEFI computer
- Partition maximum size = 16 EB (ExaBytes)
  - One exabyte = 1,000,000 terabytes





# Disk Partitioning

- **Windows Disk Management utility**
  - Right-click Computer, select Manage
  - In left pane, select Disk Management

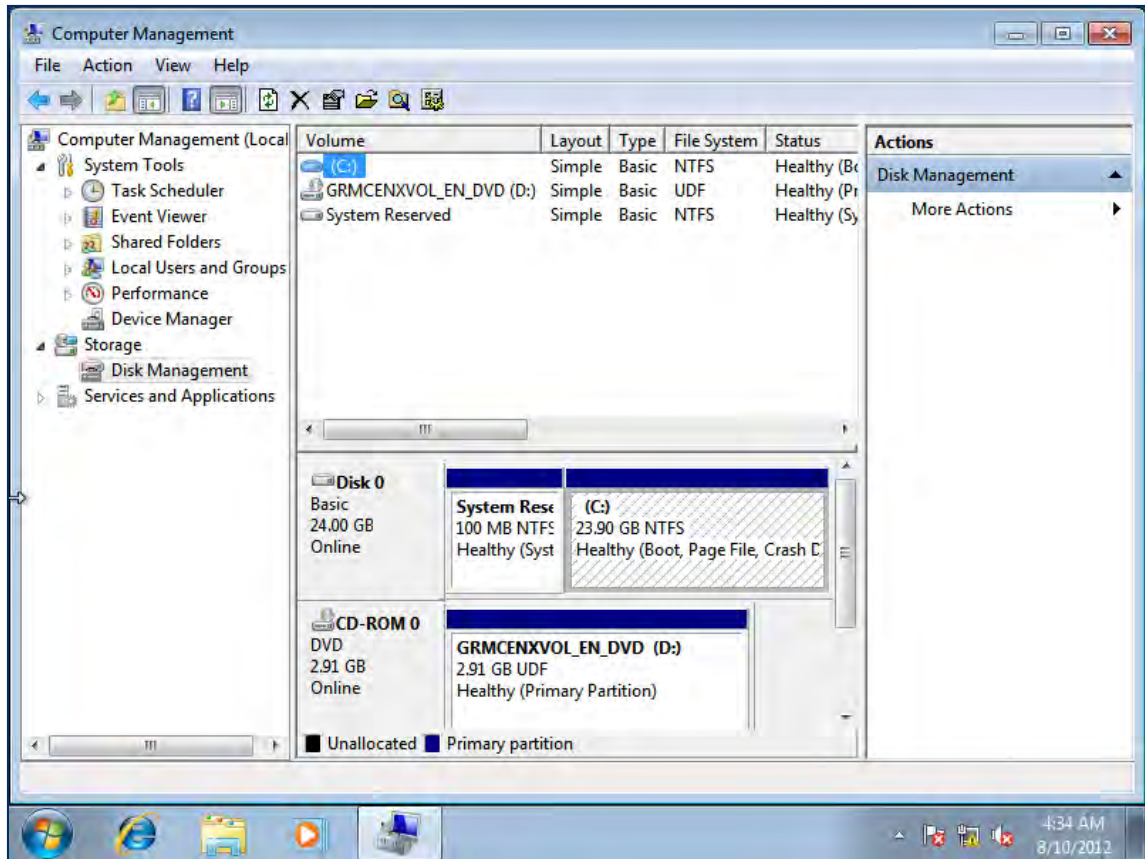

# Managing Partitions

- **Right-click a partition to display partition management options**
- **Extending partitions**
  - Select Extend Volume
- **Splitting partitions**
  - Select Shrink Volume, then create new partition from unallocated space
- **Assigning drive letters**
  - Select Change Drive Letter and Paths
- **Mounting**
  - Partitions can be mounted as NTFS folders

NTFS = New Technology File System

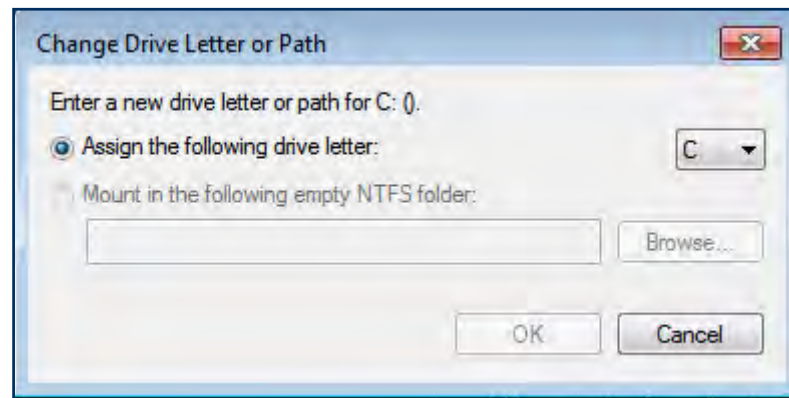
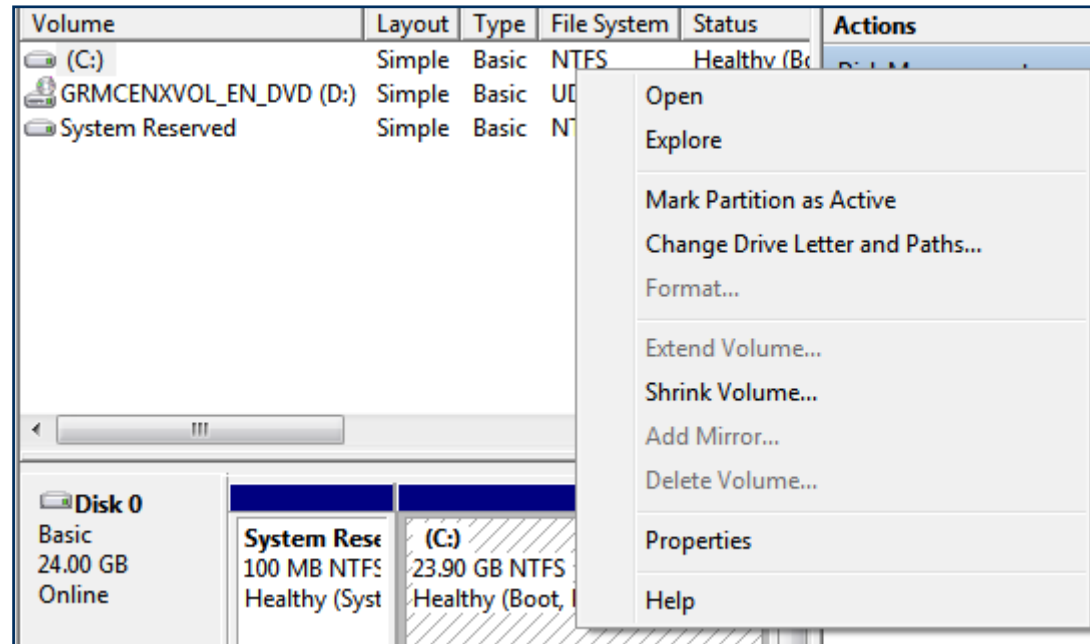

# Managing Partitions

## ➤ Adding drives

- Connect new drive power and data cables
- In Disk Management tool, select new drive
  - Right-click, then select New Simple Volume
- Use New Simple Volume wizard to partition and format new disk

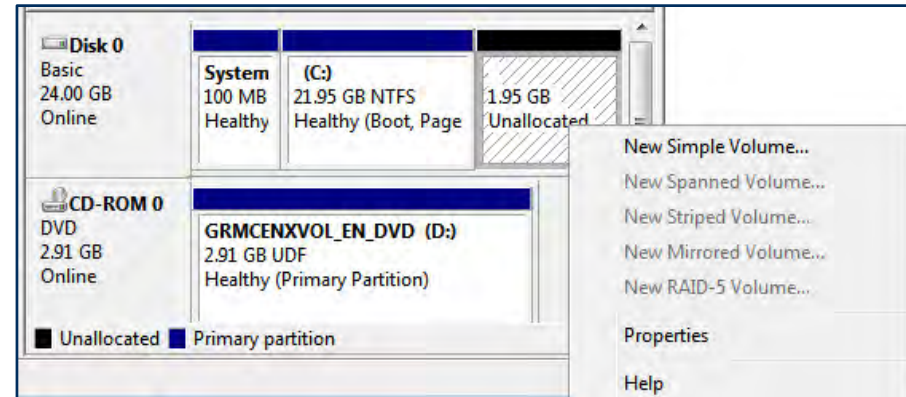

# High-Level Formatting

## ➤ What is high-level formatting?

- Creation of tables and structures used by operating system to manage disk
- Root directory, File Allocation Tables (FATs) or Master File Table (NTFS file system)
- Use Windows Disk Management utility, or `FORMAT` utility (from the command line)

## ➤ High-level format procedure (from the command line)

- Type `FORMAT C:`

## ➤ Formatting types

- Quick format (erases file system tables)
- Full format (erases file system tables and scans disk for bad sectors)



- **Hard Disk Drive Basics**
- **Interface Standards**
- **Preparing a Hard Drive for Use**
- **Optional Hands-On Exercise 10.1**
- **RAID**
- **Hands-On Exercise 10.2**
- **Solid-State Storage Devices and External Storage Devices**
- **CD-ROM/DVD Drives**
- **Troubleshooting Hard Drives and Disk Startup Issues**



*In your Exercise Manual, please refer to  
Optional Hands-On Exercise 10.1:  
Partitioning and Formatting System Hard Drives*



- **Hard Disk Drive Basics**
- **Interface Standards**
- **Preparing a Hard Drive for Use**
- **Optional Hands-On Exercise 10.1**

## ➤ **RAID**

- **Hands-On Exercise 10.2**
- **Solid-State Storage Devices and External Storage Devices**
- **CD-ROM/DVD Drives**
- **Troubleshooting Hard Drives and Disk Startup Issues**



# Redundant Array of Inexpensive Disks (RAID)

## ➤ What is a RAID system?

- System using an array of hard drives managed by a RAID controller
- RAID controller can be located on adapter card, or built into motherboard

## ➤ What does a RAID controller do?

- Organizes array of drives as a single unit
- Distributes data across drives
- RAID 0–5 levels provide different levels of data protection, increased performance

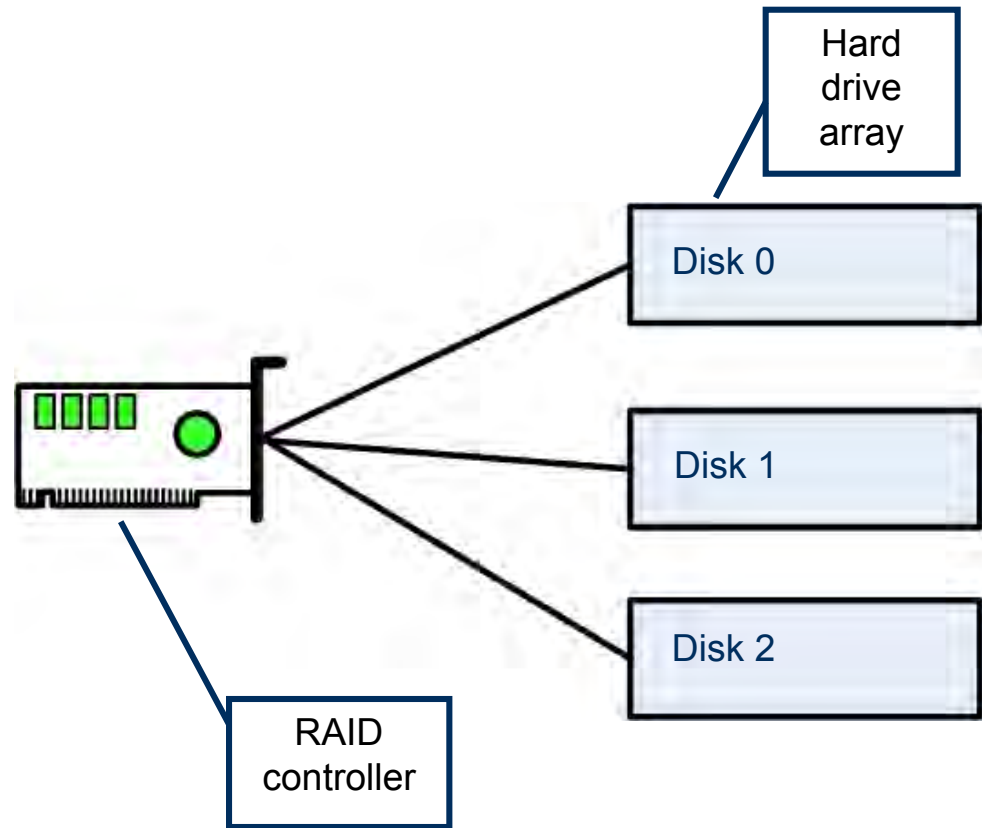



# RAID Levels

## ➤ RAID levels in common use

RAID Level	Name	Description	Minimum drives required
<b>RAID 0</b>	Disk striping	Stripes data across disks for higher performance	2
<b>RAID 1</b>	Disk mirroring	Duplicates data for safety	2
<b>RAID 5</b>	Disk striping with distributed parity	Stripes data across disks with error correcting data. Allows a damaged disk to be hot-swapped, with data rebuilt by system	3
<b>RAID 10 (RAID 1 + 0)</b>	Mirrored sets in a striped set	Uses sets of mirrored drives to create a striped set	4 (requires even number of drives)



# Advanced Disk Management

## ➤ Dynamic disks

- Allows multiple individual disks to be combined in various types of arrays

## ➤ Converting a basic disk to a dynamic disk

- In Disk Management tool, right-click on disk
  - Select Convert to Dynamic Disk

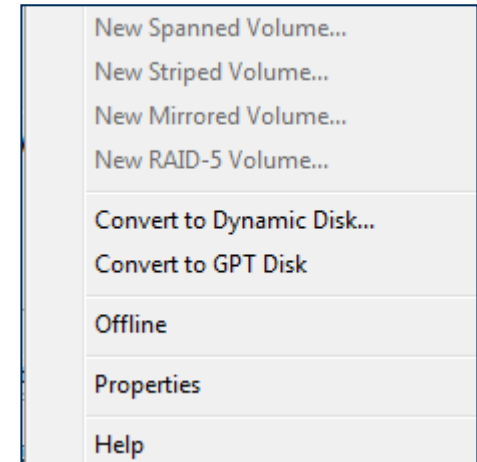

## ➤ Adding arrays

- Use Disk Management tool to delete all volumes to be included in array
  - Combined drives will be shown as unallocated space
- Right-click unallocated space, then select
  - New Spanned Volume
  - New Striped Volume
  - New Mirrored Volume
  - New RAID-5 Volume



# Example: Creating a RAID 1 Array (Mirrored Drives)

## ➤ This example system has:

- One primary boot disk with Windows installation (C :)
- Two additional blank drives
  - Basic disks, unallocated
  - Will be used to create RAID 1 (mirrored) disk array

## 1. In Computer Management console, start Disk Management tool



# Example: Creating a RAID 1 Array

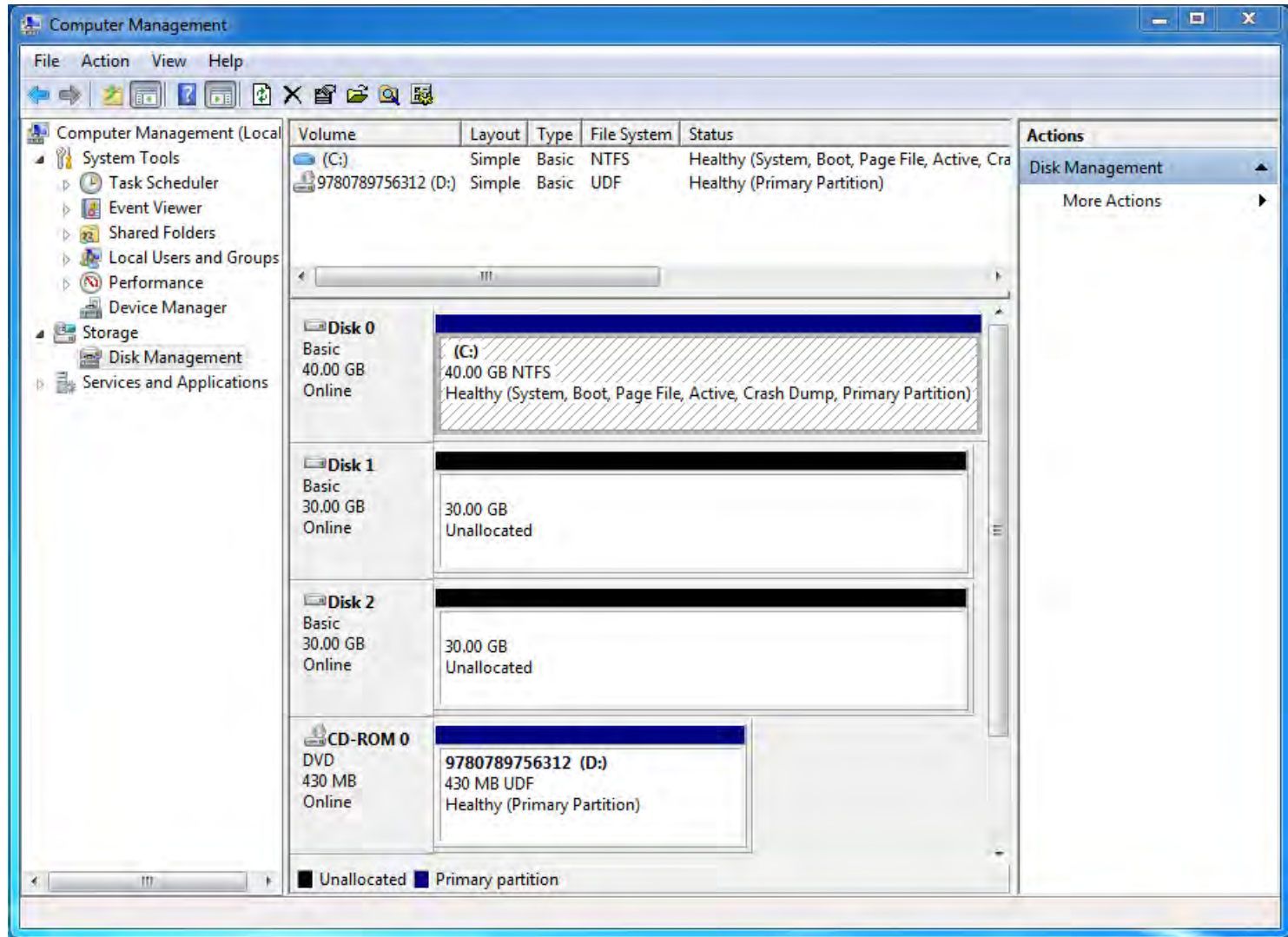

# Example: Creating a RAID 1 Array

- Before creating the array, we must convert the basic disks to dynamic disks

## 2. Right-click on Disk 1, then select Convert to Dynamic Disk

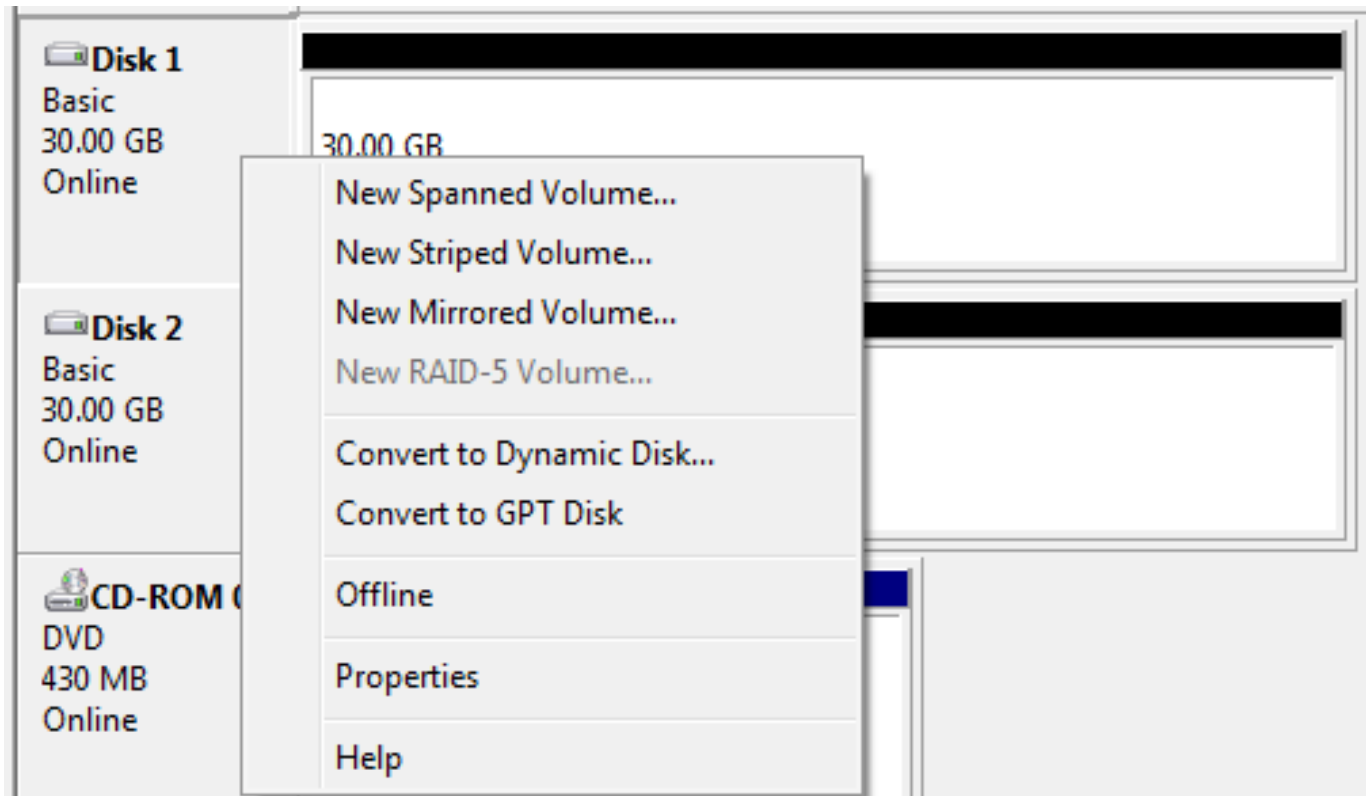

# Example: Creating a RAID 1 Array

- Before creating the array, we must convert the basic disks to dynamic disks
2. Right-click on Disk 1, then select Convert to Dynamic Disk
    - The Convert to Dynamic Disk window will be displayed

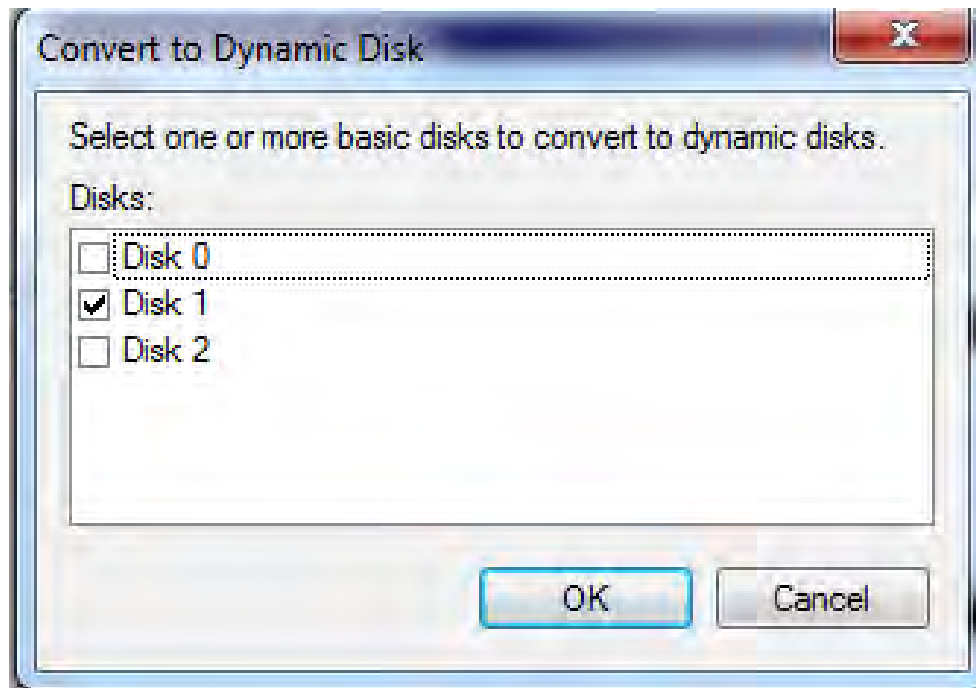

# Example: Creating a RAID 1 Array

3. In the Convert to Dynamic Disk window, select Disk 2 as well, then press OK

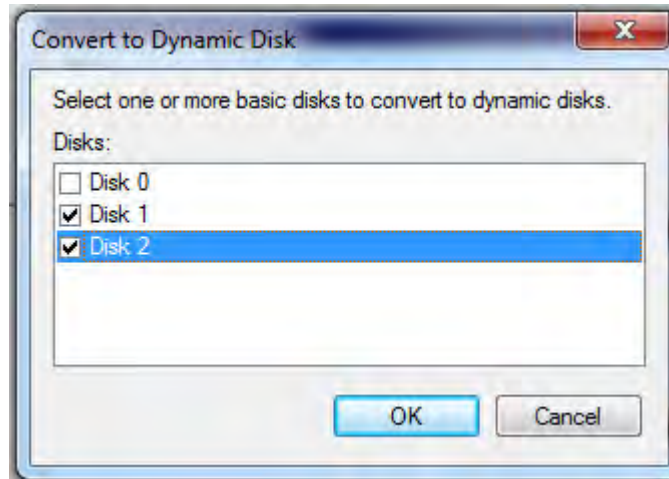

- Both Disk 1 and Disk 2 will be converted to dynamic disks

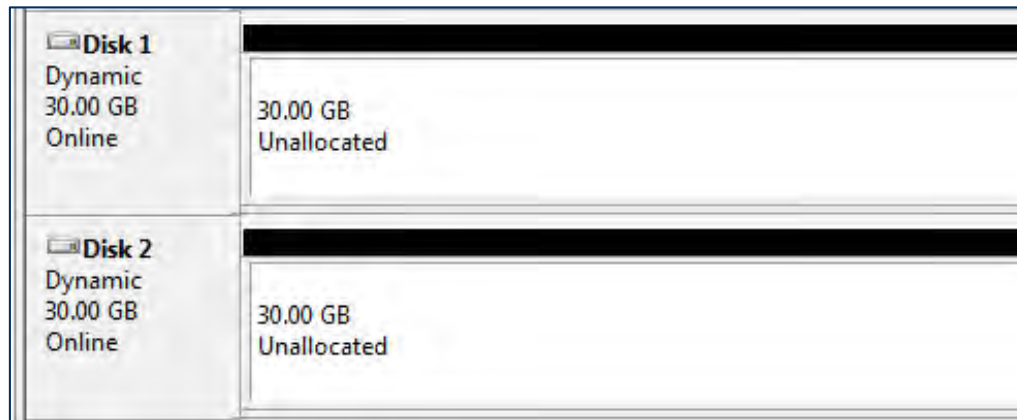

# Example: Creating a RAID 1 Array

## 4. Right-click on Disk 1, then select New Mirrored Volume

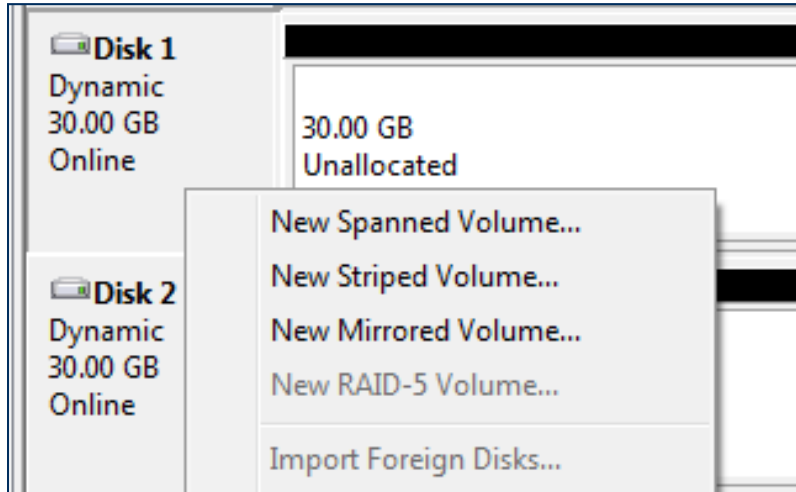

- The New Mirrored Volume Wizard will be displayed

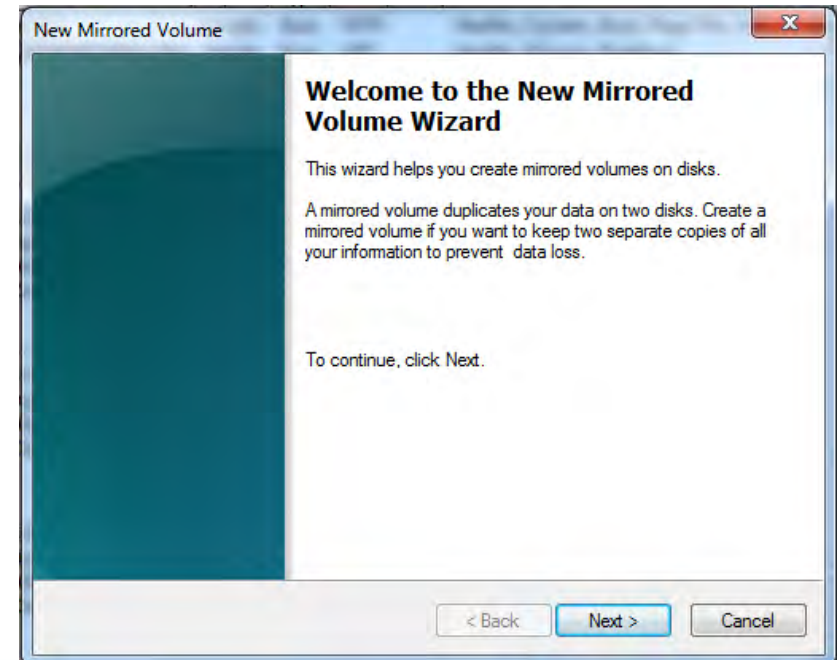



# Example: Creating a RAID 1 Array

## 5. In the New Mirrored Volume window, click Next

- The Select Disks dialog will be displayed

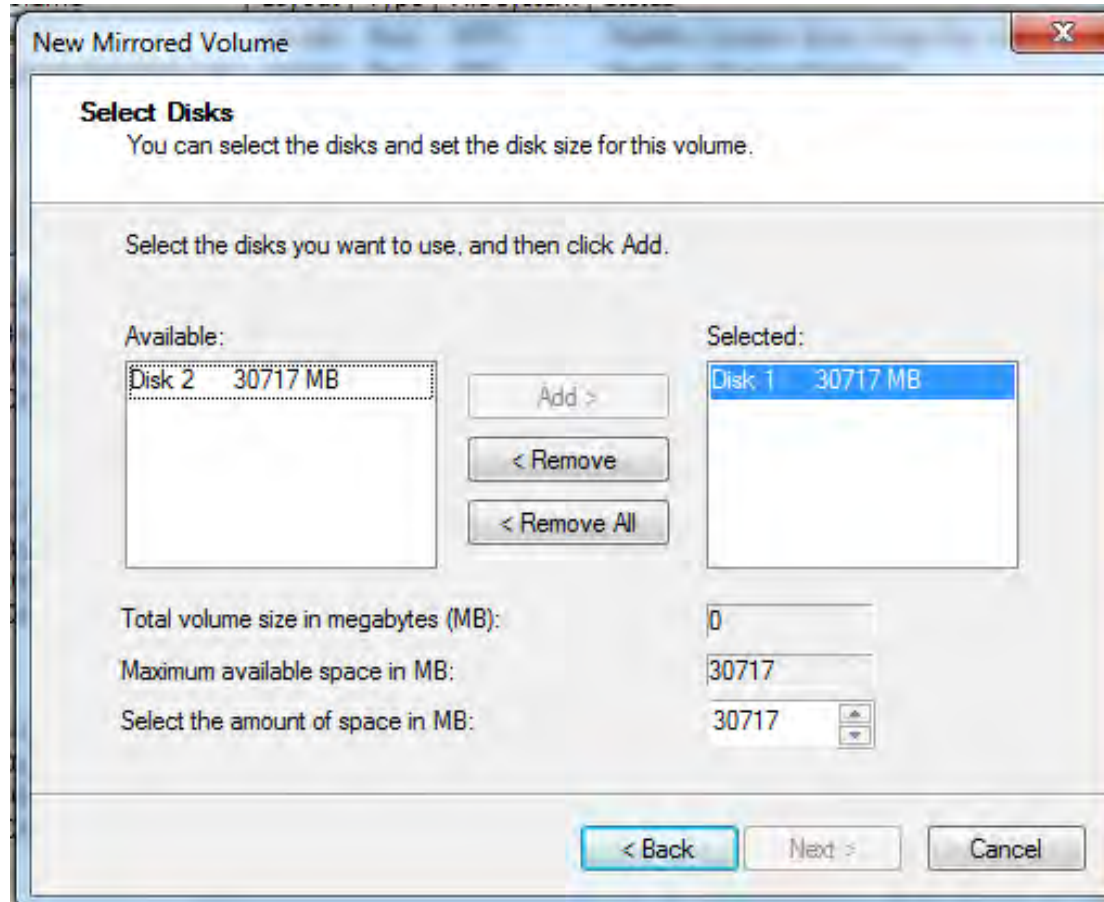

# Example: Creating a RAID 1 Array

## 6. In the Select Disks dialog, click Disk 2, then Add

- Disk 2 will be added to the array

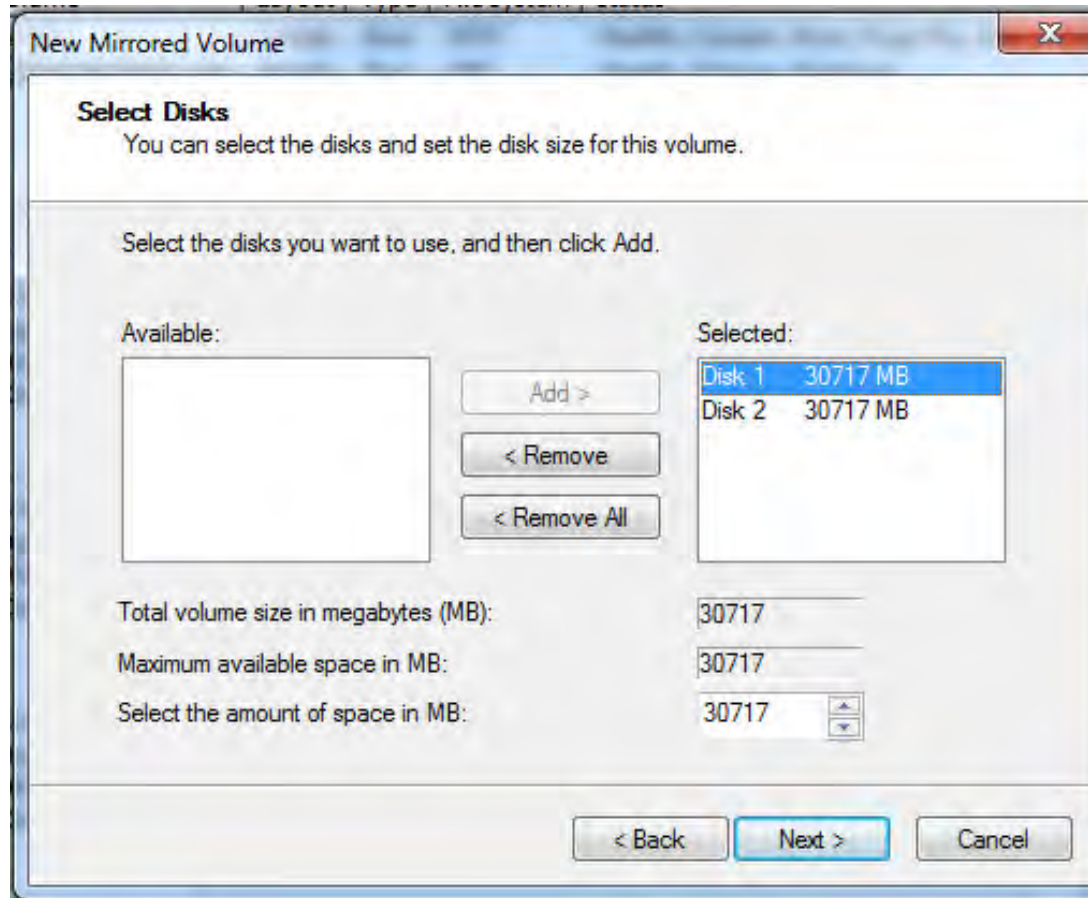

# Example: Creating a RAID 1 Array

## 7. In the Select Disks dialog, click Next

- The Assign Drive Letter or Path dialog will be displayed

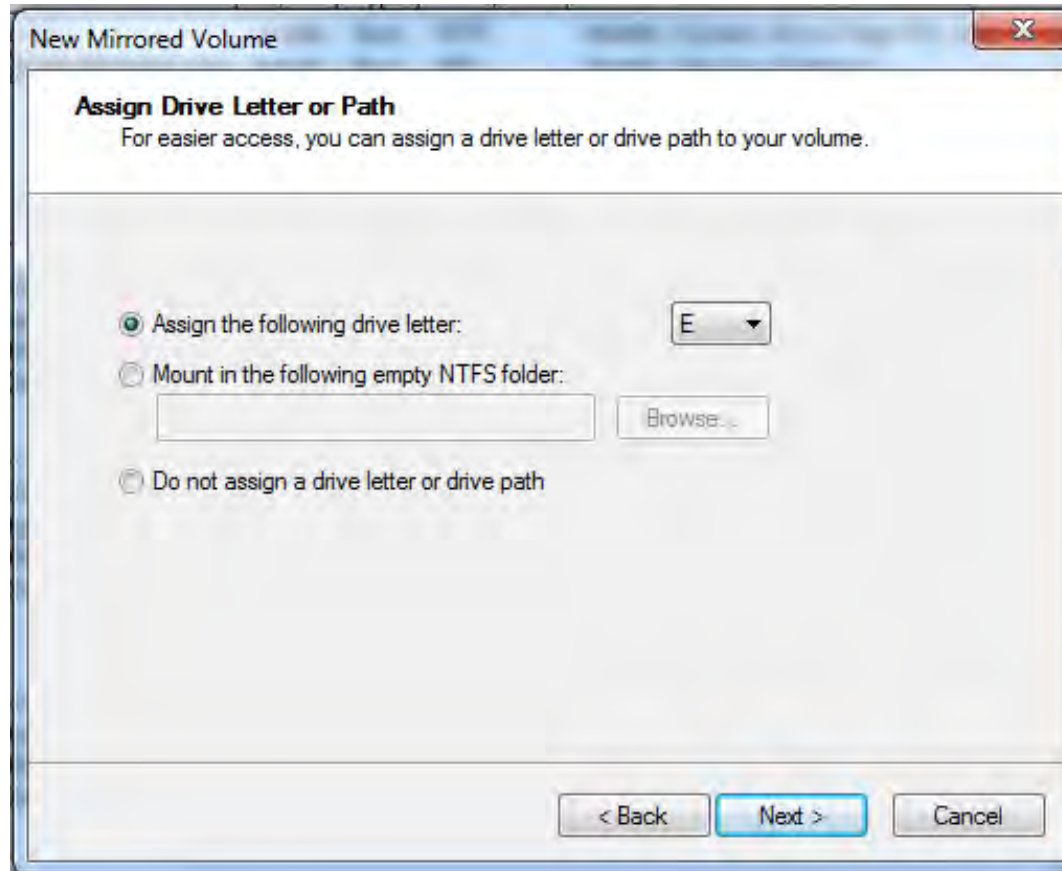

# Example: Creating a RAID 1 Array

## 8. In the Assign Drive Letter or Path dialog, keep the defaults, then click **Next**

- The Format Volume dialog will be displayed

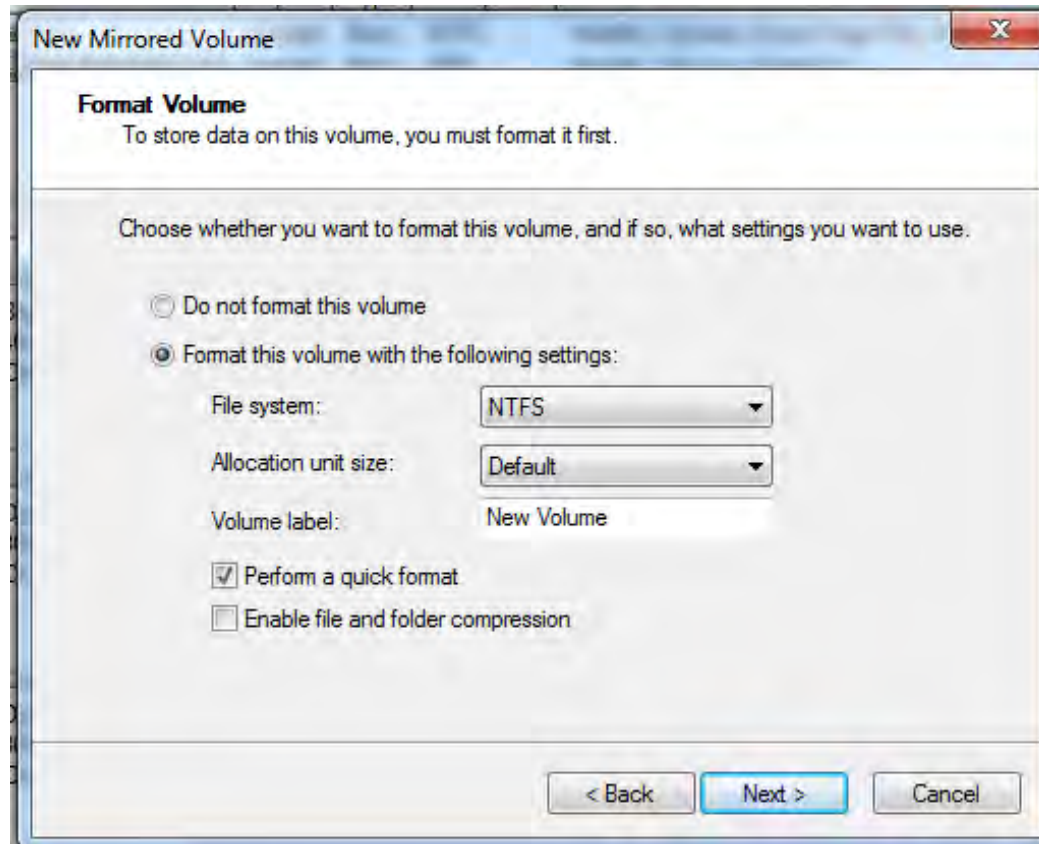

# Example: Creating a RAID 1 Array

## 9. In the Format Volume dialog, keep the defaults, then click Next



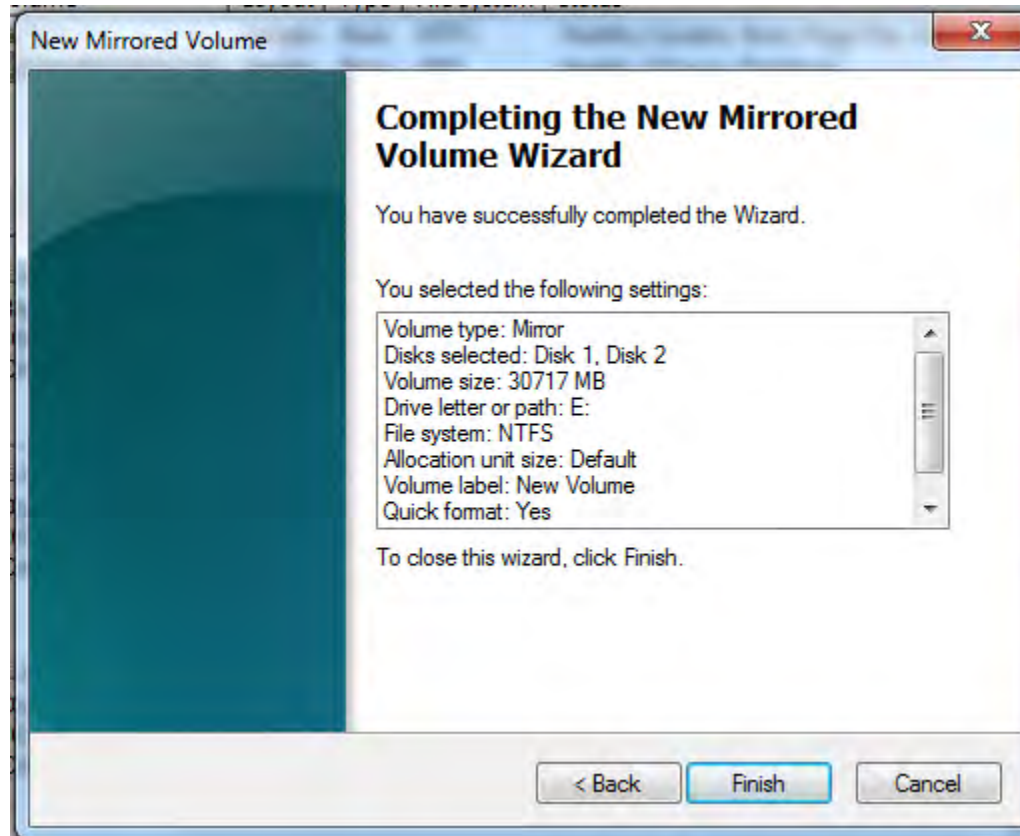



- The Completing the New Mirrored Volume wizard screen will be displayed



# Example: Creating a RAID 1 Array

## 10. In the Completing the New Mirrored Volume Wizard screen, click Finish

- Disk 1 and Disk 2 will be formatted, and will then be displayed as Drive E: (mirrored drive set)

 <b>Disk 0</b> Basic 40.00 GB Online	 <b>(C:)</b> 40.00 GB NTFS Healthy (System, Boot, Page File, Active, Crash Dump, Primary Partition)
 <b>Disk 1</b> Dynamic 30.00 GB Online	 <b>New Volume (E:)</b> 30.00 GB NTFS Healthy
 <b>Disk 2</b> Dynamic 30.00 GB Online	 <b>New Volume (E:)</b> 30.00 GB NTFS Healthy

- We have successfully created a RAID 1 (mirrored drive) array!



- **Hard Disk Drive Basics**
- **Interface Standards**
- **Preparing a Hard Drive for Use**
- **Optional Hands-On Exercise 10.1**
- **RAID**
- **Hands-On Exercise 10.2**
  - **Solid-State Storage Devices and External Storage Devices**
  - **CD-ROM/DVD Drives**
  - **Troubleshooting Hard Drives and Disk Startup Issues**



*In your Exercise Manual, please refer to  
Hands-On Exercise 10.2: Creating a RAID 1 Array (Mirrored Drives)*





- **Hard Disk Drive Basics**
- **Interface Standards**
- **Preparing a Hard Drive for Use**
- **Optional Hands-On Exercise 10.1**
- **RAID**
- **Hands-On Exercise 10.2**
- **Solid-State Storage Devices and External Storage Devices**
  - **CD-ROM/DVD Drives**
  - **Troubleshooting Hard Drives and Disk Startup Issues**



# Solid-State Storage Devices

## ➤ What are solid-state storage devices?

- Devices that use semiconductor memory to store data
- Typically use Flash (nonvolatile) memory

## ➤ USB Flash drive (“thumb drive”)

- Uses microcontroller to emulate a hard drive’s logical structure
- Provides portable storage in a low-cost, low-power device



# Solid-State Storage Devices

## ➤ Compact Flash cards

- Early generation of solid-state storage cards
- Still provides good storage/cost ratio
  - Can support capacities up to 128 GB

## ➤ Secure Digital (SD) cards

- Solid-state storage card features miniaturized packaging format (32x24x2.1 mm)
- Used in many digital cameras, audio recorders

## ➤ Mini-SD, Micro-SD

- Smaller form factor SD cards
- Mini-SD (21x20x1.4 mm)
- Micro-SD (15x11x1.0 mm)

## ➤ xD card

- Small (20x25x1.78 mm) solid-state storage card for cameras developed by Fuji/Olympus



# Solid-State Drives (SSDs)

## ➤ What is a solid-state drive?

- Data storage device that uses solid-state memory as the main storage media
- Emulates functionality of a magnetic hard drive

## ➤ Advantages

- Faster startup (does not require disk platters to spin up)
- Faster read/write access
- Less susceptible to mechanical shock

## ➤ Disadvantages

- Higher cost than magnetic HDDs
- Flash memory supports a finite number of read/write cycles
  - 1,000 to 10,000 depending on type
  - Can be mitigated by “wear-leveling” software that distributes writes across entire memory array

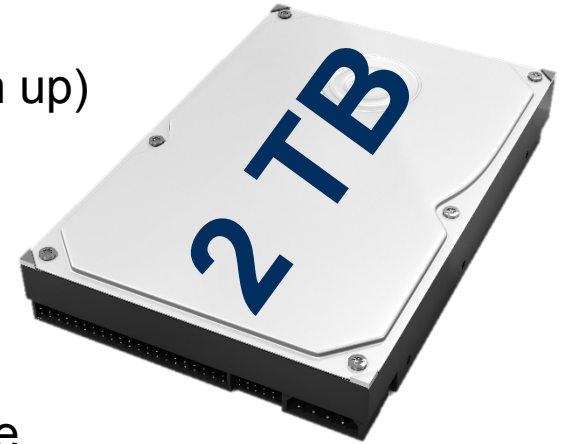

# SSHD and eMMC Devices

## ➤ SSHD (Solid-State Hybrid Drive)

- Combines solid-state memory storage with magnetic hard drive
- Provides
  - High speed of SSD (Solid-State Drive)
  - Large storage capacity of magnetic hard drive

## ➤ eMMC (eMBEDDED Multi-Media CONTROLLER)

- Single package combines
  - Flash memory
  - Flash memory controller
- Embedded in tablets, phones, cameras
- Faster than magnetic hard drive, but slower than SSD
- Typical sizes: 32 GB, 64 GB

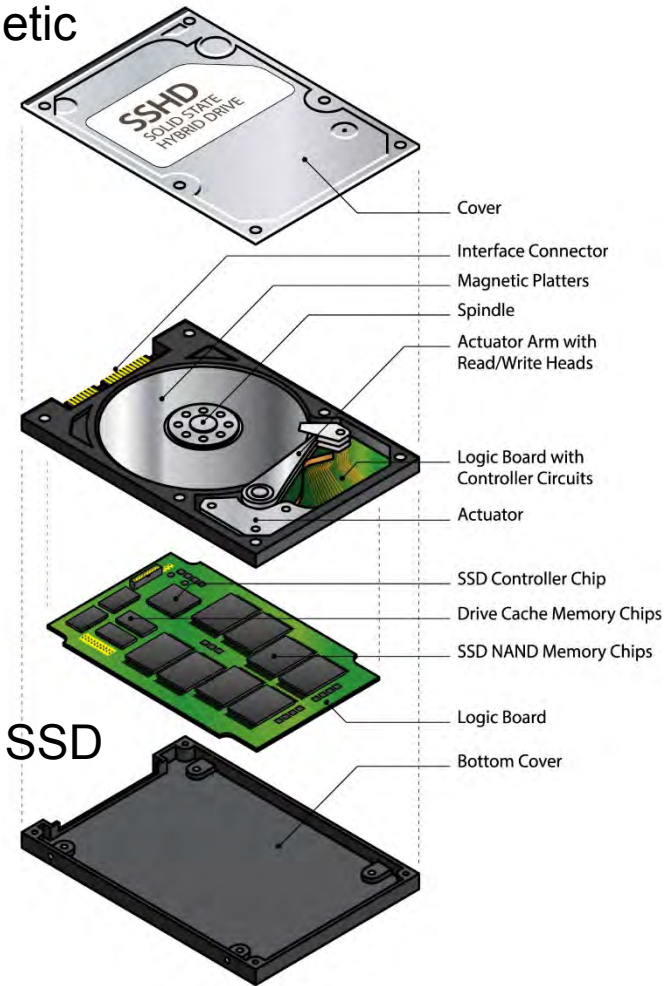

# External Storage Devices

## ➤ External storage device types

- Hard disk drives
- Optical disk drives
- Tape drives
  - Use data tape cartridges
  - Typical capacities: 250 GB to 1 TB



## ➤ Connection types

- USB, FireWire, eSATA (external SATA)

## ➤ Hot-swappable vs. Non-hot-swappable devices

- Hot-swappable devices can be plugged in or out of a system that is powered on
  - USB devices that do not have file systems
  - USB hard drives may be plugged into a system that is powered on, but the “Safely remove device feature” must be used before disconnecting drive
- Non-hot-swappable devices
  - Devices that plug into PS/2 style connectors
  - PS/2 keyboard, mouse



- **Hard Disk Drive Basics**
- **Interface Standards**
- **Preparing a Hard Drive for Use**
- **Optional Hands-On Exercise 10.1**
- **RAID**
- **Hands-On Exercise 10.2**
- **Solid-State Storage Devices and External Storage Devices**
- **CD-ROM/DVD Drives**
- **Troubleshooting Hard Drives and Disk Startup Issues**



# CD-ROM Fundamentals

## ➤ What is a CD-ROM?

- Compact disk read-only memory
- High-density (650/700 MB) optical storage disk
- Digital information is originally stamped onto CD as a series of “pits” (depressions) and “lands” (reflective raised areas)

## ➤ How does a CD-ROM drive work?

1. Laser diode projects light beam toward desired track
2. If light beam strikes a “land,” beam is reflected back toward prism; if light beam strikes a “pit,” beam is scattered and not reflected back
3. Prism directs reflected light beam pulses to light sensor
4. Light sensor circuitry generates digital pulse stream

## ➤ What file system does a CD/DVD disk use?

- CD/DVDs use CD File System (CDFS)





# CD-ROM Fundamentals

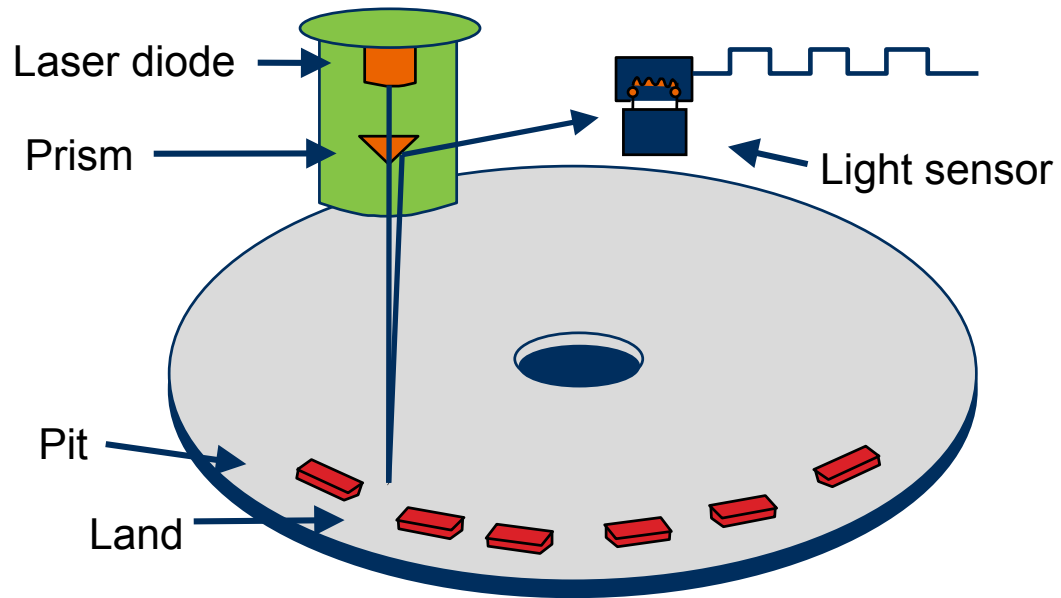

# DVD-ROM/Blu-Ray

## ➤ DVD-ROM

- Digital Versatile Disk (originally Digital Video Disk) Read-Only Memory
- Follow-up to CD-ROM featuring higher storage capacity (4.7 GB)

## ➤ DL-DVD

- Dual-Layer DVD uses two layers of optical material for data storage
- Expands capacity to 8.5 GB per side

## ➤ Blu-ray

- Next-generation format for optical storage drives
  - Proprietary standard developed by Sony
- Uses “Blue” laser (405 nm wavelength)
- Very large storage capacity
  - 25 GB (single layer, single-sided)
  - 50 GB (single layer, dual-sided)

nm = nanometer (one-billionth of a meter)



# Recordable CD/DVD Drives and Blu-ray Drives

## ➤ What are recordable drives?

- Recordable versions of CD/DVD/Blu-ray disks
- Some formats are Write Once, Read Many (WORM); others permit recording/erasing media

## ➤ Dual-Layer DVD-R and DVD-RW disks

- Two layers of optical dye coatings are used to provide higher storage densities

## ➤ Advantages of recordable CD/DVD drives

- Moderately large storage capacity (see chart on the next slide)
- Convenient media format (120-mm disk)
- CD/DVD drives can be used as large disk drives for backup purposes



# CD/DVD Disk Types

Disk type	Description	Capacity
CD-R	Write once, read many	650-700 MB
CD-RW	Read/writeable	650-700MB
DVD (DVD-ROM)	Read-only	4.7 GB (single-sided, single-layer) 8.5 GB (single-sided, dual-layer) 9.4 GB (dual-sided, single-layer) 17 GB (dual-sided, dual-layer)
DVD-R, DVD+R	Write once, read many	4.7 GB (single-sided, single-layer) 8.5 GB (single-sided, dual-layer)
DVD-RW, DVD+RW	Read/writable	4.7 GB (single-sided, single-layer)
Blu-ray	Uses a shorter-wavelength (450 nm) blue laser	25 GB (single-sided, single-layer) 50 GB (single-sided, dual-layer)
BD-R	Write once, read many	25 GB (single-sided, single-layer) 50 GB (single-sided, dual-layer)
BD-RE	Read/writeable (RE = Recordable-Erasable)	25 GB (single-sided, single-layer) 50 GB (single-sided, dual-layer)



- **Hard Disk Drive Basics**
- **Interface Standards**
- **Preparing a Hard Drive for Use**
- **Optional Hands-On Exercise 10.1**
- **RAID**
- **Hands-On Exercise 10.2**
- **Solid-State Storage Devices and External Storage Devices**
- **CD-ROM/DVD Drives**
- **Troubleshooting Hard Drives and Disk Startup Issues**



# Troubleshooting Hard Drives and RAID Arrays

- For these common symptoms, choose the number of the most likely cause:

Symptom	Cause	Cause choices
Read/write failure		<ol style="list-style-type: none"><li>1. Drive not partitioned</li><li>2. Damaged or missing boot files</li><li>3. Drive is fragmented</li><li>4. Corrupted sectors</li><li>5. Drive internal controller failure (can't find tracks)</li></ol>
Slow performance		
Loud clicking noise		
Failure to boot		
Drive not recognized		



# Troubleshooting Hard Drives and RAID Arrays

- For these common symptoms, choose the number of the most likely cause:

Symptom	Cause	Cause choices
OS (operating system) not found		1. Damaged Windows BCD (Boot Configuration Data) file
RAID stops working		2. Defective or incorrectly configured RAID controller
RAID not found		3. Defective drive in (non-RAID 5) drive array



## ➤ Reboot system, then press <F8> to enter Windows Recovery Environment

- Select Repair my Computer
  - System Recovery Options screen will be displayed
- Select Startup Repair
  - If this doesn't fix problem, start Command Prompt

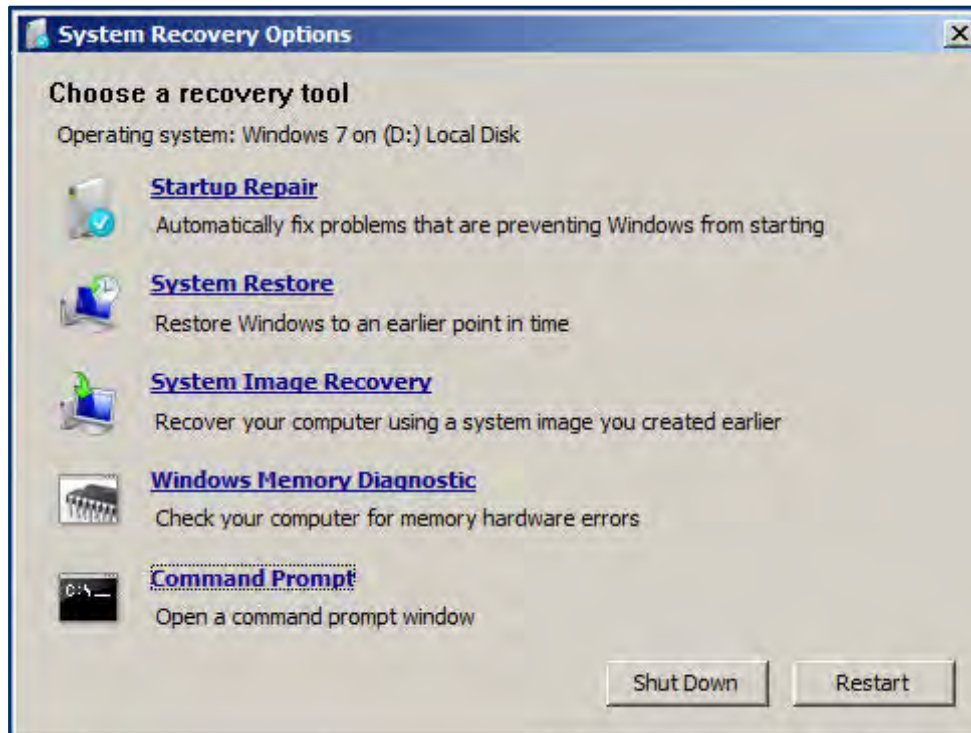



## ➤ **Bootrec.exe**

- Repair tool for disk boot structures
  - Master boot record (MBR for entire disk)
  - Boot record (for current active partition)
  - Bootmgr
  - BCD
- Bootrec uses switches (parameters) to fix specific problems

## ➤ **Bootrec /FixMbr**

- Writes a new MBR to system partition
- Does not overwrite partition table

## ➤ **Bootrec /FixBoot**

- Writes new boot sector to system partition
- Use if an earlier version of Windows was installed (one that uses NTLDR instead of Bootmgr)
  - Error message: Bootmgr is Missing

NTLDR = New Technology Loader



# Troubleshooting Hard Drives and Disk Startup Issues

## ➤ `Bootrec /ScanOs`

- Scans all disks for Windows installations
  - Select desired Windows installation to make bootable

## ➤ `Bootrec /RebuildBcd`

- Scans all disks for Windows installations, then completely rebuilds the BCD store



# Review Questions

- 1. On a hard drive, all of the tracks under the read/write heads at one time are called a:**
  - A. Track
  - B. Cylinder
  - C. Sector
  - D. Cluster
  
- 2. The maximum cable length for a SATA cable is:**
  - A. 1 foot
  - B. 2 feet
  - C. 1 meter
  - D. 2 meters



# Review Questions

3. The procedure that sets up original track and sector marks on disk platters is called:
- A. Low-level formatting
  - B. Partitioning
  - C. Allocating
  - D. High-level formatting
4. A Basic disk (MBR) partition can support up to \_\_\_\_\_ Primary (bootable) partitions.
- A. 1
  - B. 2
  - C. 4
  - D. 8



# Review Questions

5. \_\_\_\_\_ provides disk striping with distributed parity, and requires a minimum of \_\_\_\_\_ disks.

- A. RAID 1; 2
- B. RAID 1; 3
- C. RAID 5; 2
- D. RAID 5; 3



# Chapter Summary

In this chapter, you have learned how to

- List the main components of a hard disk, solid state, and optical drives and explain their functions
- Describe the meanings of the following hard disk drive parameters: *cylinders, heads, sectors, landing zone, capacity*
- Install and configure serial ATA hard drives
- Explain how to partition and format disk drives
- Describe the types and functions of RAID arrays



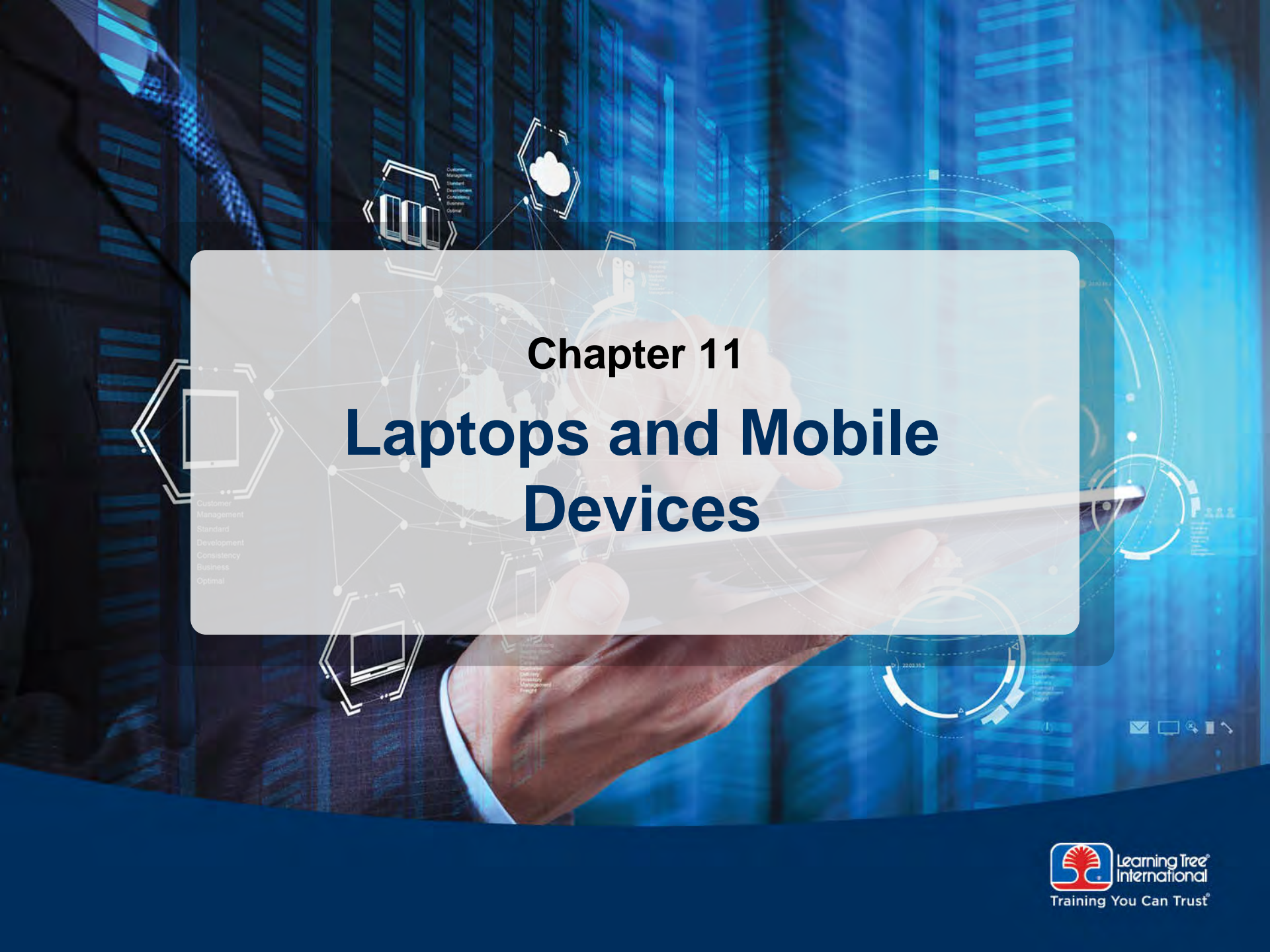

# Chapter 11

# Laptops and Mobile Devices

Customer  
Management  
Standard  
Development  
Consistency  
Business  
Optimal

# Chapter Objectives

---

**In this chapter, you will learn how to**

- **Identify the names and purposes of fundamental laptop components**
- **Describe types of laptop expansion options**
- **Describe techniques for troubleshooting common laptop problems**
- **Provide an overview of common mobile device features**
- **Describe how to configure and secure mobile devices**
- **List techniques for troubleshooting mobile device problems**





## ➤ **Laptop Components**

- **Expansion Options**
- **Troubleshooting Laptops**
- **Mobile Device Features**
- **Configuring Mobile Devices**
- **Securing Mobile Devices**



# Laptop Hardware/Device Replacement

## ➤ Replacing/installing laptop hardware devices

- Laptops usually use manufacturer-specific, proprietary hardware devices
- May require special tools
  - Manufacturer service manual
- Plastic/frames often have to be pried loose
  - Without breaking them!

## ➤ Disassembling processes for proper reassembly

- Document and label cable and screw locations
- Organize parts (place in sectioned container)
- Refer to manufacturer documentation
  - Service manuals available online



# Memory

## ➤ Small Outline DIMM (SODIMM)

## ➤ MicroDIMM

## ➤ Replacing/upgrading portable memory

- Unplug AC power adapter and remove battery from laptop
- Unscrew memory module cover from laptop
- Insert new memory module at 45-degree angle into memory slot, then press down until it clicks into place
- Notes:
  - Only use memory modules approved by laptop manufacturer; non-approved memory cards may cause intermittent errors
  - Many laptops use shared video memory, which uses part of the main system memory for the video display (causing the system to report less than the total amount of memory installed)
  - On some laptops, the second memory card slot may be located under the keyboard



# Disk Drives

- 1.8- or 2.5-inch IDE hard drive or SSD (solid-state drive)
- Replacing/upgrading portable hard drive
  1. Unscrew hard drive cover screw
  2. Slide drive out from chassis
  3. Remove IDE interface to custom slot adapter (if any)
  4. Unscrew and replace 2.5 in hard drive



3.5-inch IDE hard drive

2.5-inch IDE hard drive



2.5-inch SSD drive



# Keyboard

## ➤ Keyboard replacement

1. Pry loose top switch cover on laptop (near display)
2. Unscrew keyboard hold-down screws

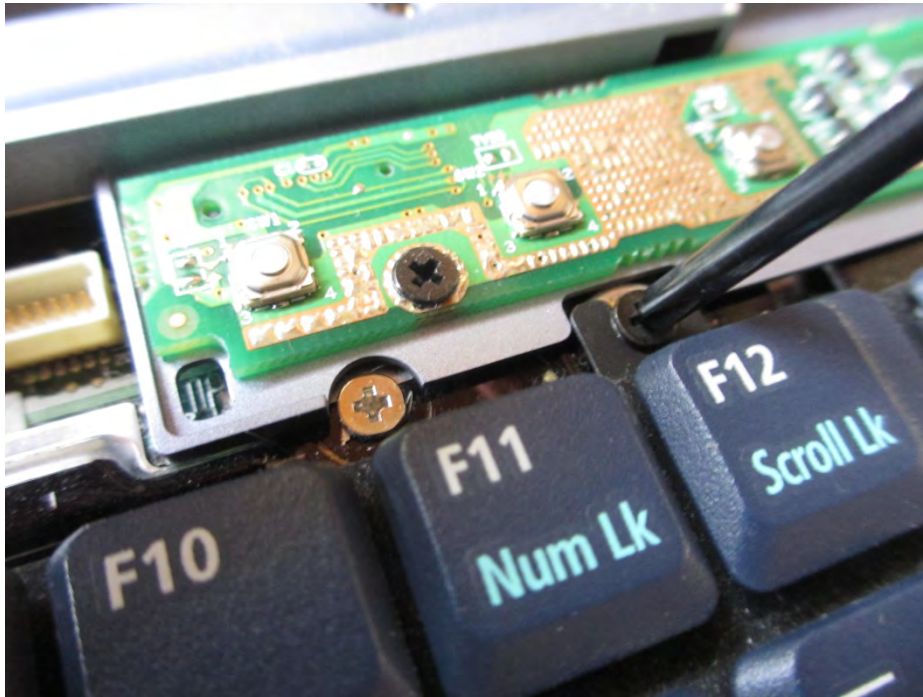

# Keyboard

3. Lift keyboard assembly up
4. Unplug keyboard connector
5. Replace with new keyboard assembly, plug in keyboard connector



# Screen

## ➤ Screen replacement

1. Pry loose top switch cover on laptop (near display)
2. Unplug antenna and display inverter connectors



# Battery and DC Jack

## ➤ Battery replacement

1. Slide battery lock lever to release
2. Replace with new battery

## ➤ DC jack replacement

1. Unsolder DC jack from motherboard
2. Insert new DC jack into motherboard
3. Solder in place

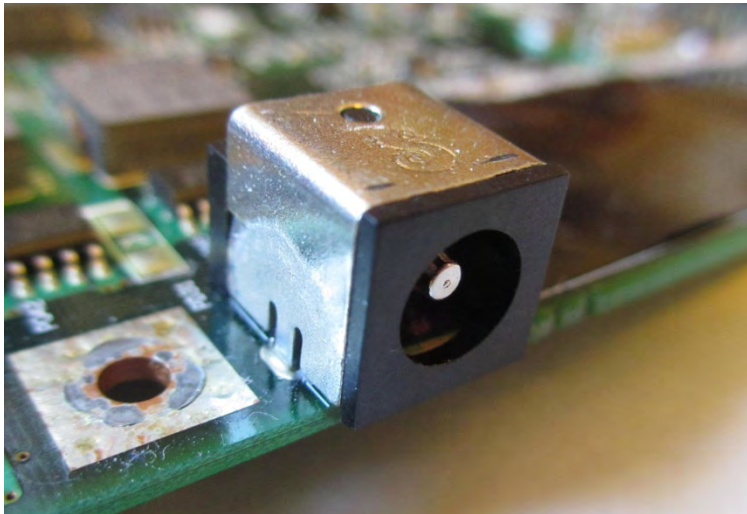



# Touchpad

## ➤ Touchpad replacement

1. Disassemble laptop, remove palm rest panel
2. Disconnect touchpad cable
3. Install replacement palm rest panel
4. Connect touchpad cable

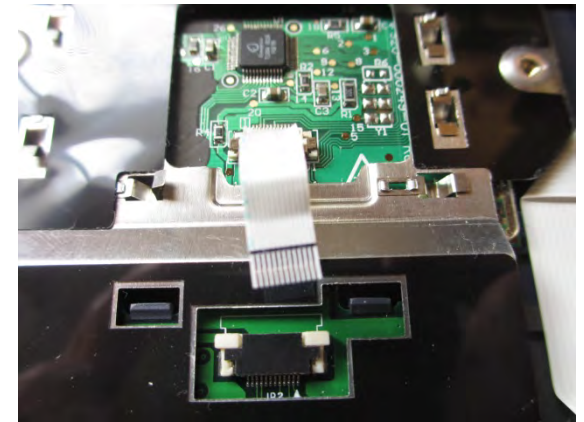

# Speaker

## ➤ Speaker replacement

- Some laptops use replaceable plug-in speaker assembly



# System Board

## ➤ System board replacement

1. Disassemble laptop to reveal system board
2. Unscrew system board mounting screws
3. Install replacement system board

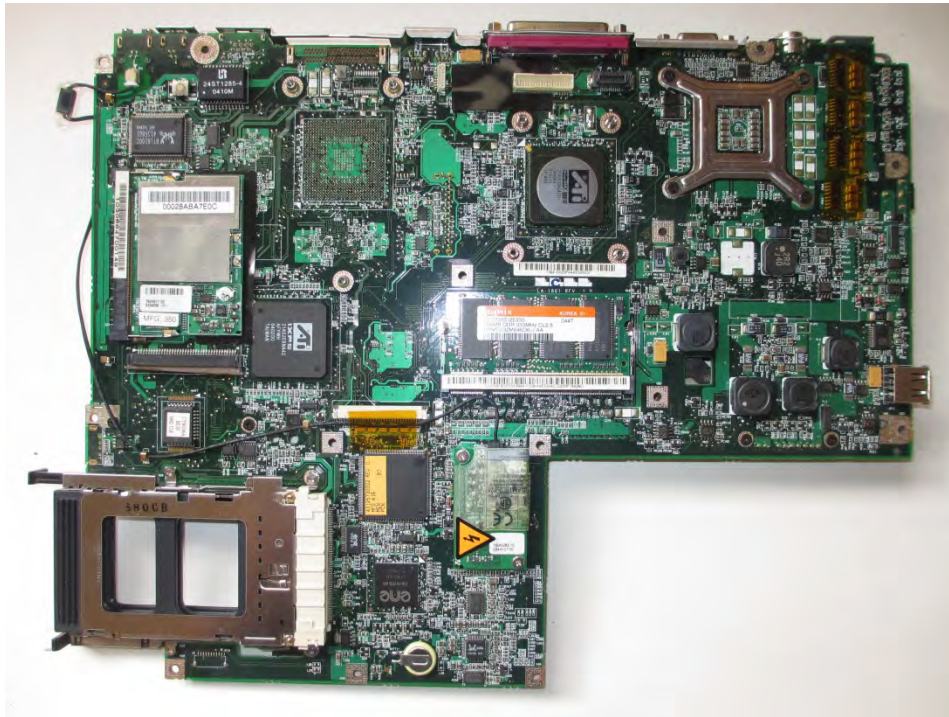

# CPU and Heat Sink Assembly

## ➤ CPU replacement

- On some laptops, CPU is pre-mounted with heat sink assembly
  1. Remove heat sink fans
  2. Install replacement CPU + heat sink assembly

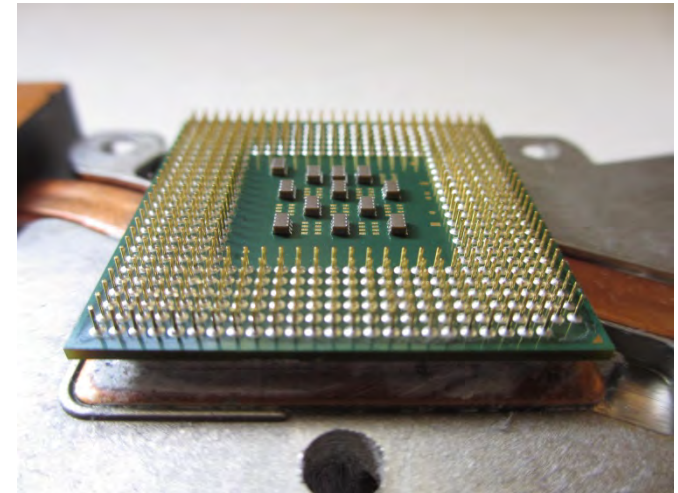
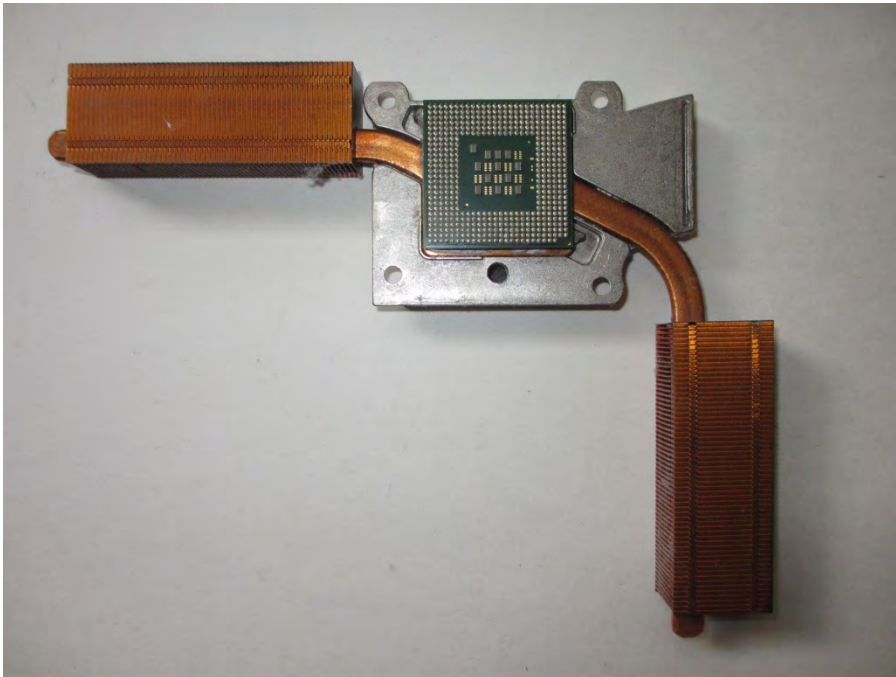

# Laptop Features: Special Function Keys

- To save keyboard space, laptops use a **Function key (<Fn>)** to provide dual use for certain keys
  - Function key is held down while additional key is pressed



- **Special function keys (Dell laptop)**
  - Dual displays
    - Invokes Windows Dual Display menu

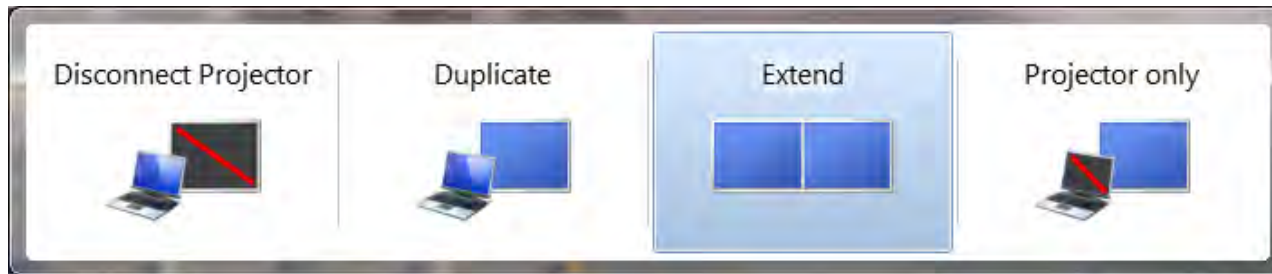

# Special Function Keys

## ➤ Wireless (On/Off)

- Function key is held down while additional key is pressed



## ➤ Volume settings:



Softer

Louder

Mute

## ➤ Screen brightness and keyboard backlight:



Dimmer

Brighter

Keyboard backlight

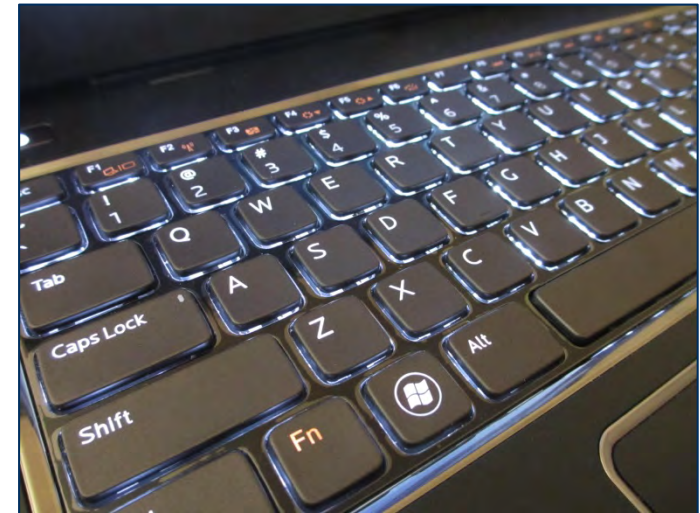

# Special Function Keys: Bluetooth

- **Some laptops feature a settings button that invokes the Windows Mobility Center**
  - Provides menu-driven control of laptop features
- **Bluetooth (On/Off):**

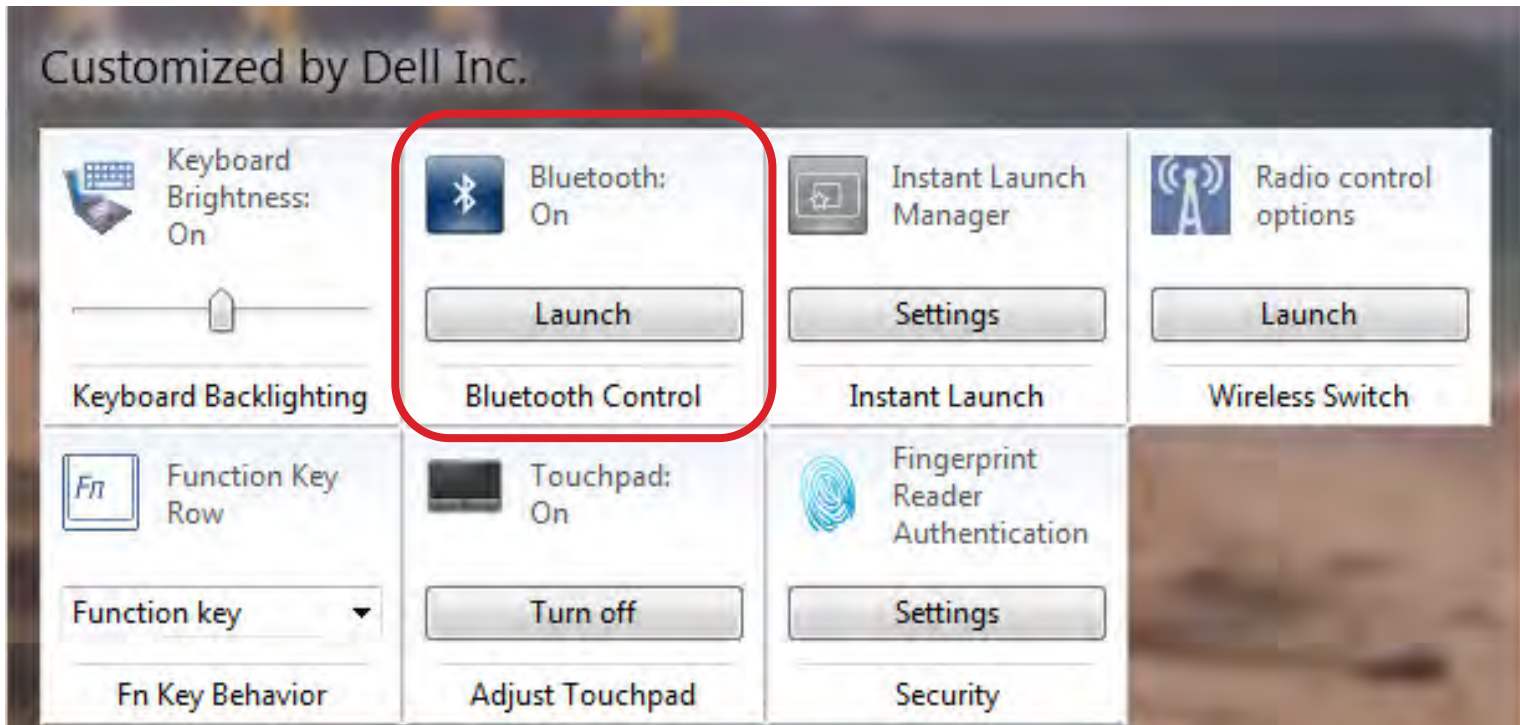
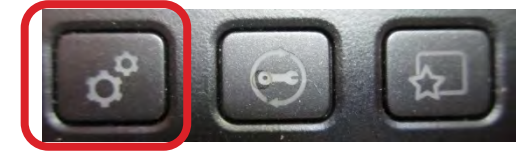

# Display Panel

## ➤ Display panel main components

- LCD panel (4)
- Backlight (4)
  - White light source, built into LCD panel
- Inverter (7)
  - Converts low-voltage DC to high-voltage AC for backlight
- Video cable (8)
  - Connects LCD panel to display adapter circuit

## ➤ Display panel types

- LCD (Liquid Crystal Display)
- OLED (Organic LED)

## ➤ Rotating/removable screens

- Featured on some laptops with touch-screen displays

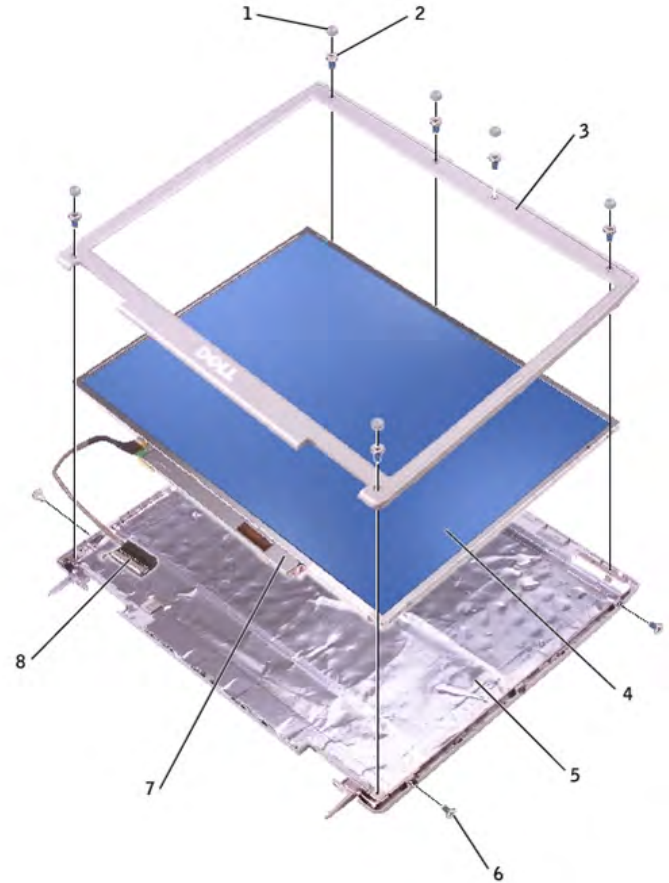

[http://downloads.dell.com/manuals/all-products/esuprt\\_laptop/esuprt\\_inspiron\\_laptop/inspiron-600m\\_service%20manual\\_en-us.pdf](http://downloads.dell.com/manuals/all-products/esuprt_laptop/esuprt_inspiron_laptop/inspiron-600m_service%20manual_en-us.pdf)





# Keyboards

- **Compact 84-key keyboard**
- **Function key (<Fn>)** used to define special functions for keys
  - Example (Dell Inspiron): <F2> = Enable Wireless, <F8> = LCD/Ext video
- **Windows Start key (<🏠>)** provides shortcuts for common Windows functions
  - <🏠><L> = lock Windows (displays logon dialog)
  - <🏠><R> = Run (displays Run dialog)

Windows key

Function key (<Fn>)



# Input Devices: Pointing Devices and Stylus/Digitizer

- **Touchpad uses capacitive array to sense finger position**
  - Mapped to screen X,Y coordinates to control mouse cursor
  - Buttons emulate left/right mouse buttons
  - Can be disabled for external mouse use
    - Function key
    - BIOS setting
- **Stylus/digitizer**
  - Penlike device used on digitizing screen or pad
  - Commonly used on tablet PCs



# Docking Stations and Physical Locks

## ➤ Docking station

- Allows laptop to be plugged into base that contains I/O ports and hardware peripherals (DVD drives, additional hard drives, etc.)

## ➤ Physical laptop lock and cable lock

- Slot in laptop contains metal reinforced hole
- Accepts mating cable locking device
  - Loop around fixed object to prevent theft of laptop



# Power Supplies

## ➤ External power supply

- Converts AC (alternating current) voltage from wall socket to lower DC (direct current) voltage
  - Example: 120VAC to 19.5VDC

## ➤ Input voltages

- Fixed input power supplies must be connected to specified input voltage (110 VAC or 240 VAC)
- Some external supplies are *autoswitching*, and can handle multiple input voltages

## ➤ Replacement external power supplies must supply same output voltage and current as original

- Information can be found on external power supply label



# Power Supplies

## ➤ Batteries

- Li-ion (lithium ion)
  - Current technology, largest capacity provides longest supply time between recharging



Lithium ion battery



# Power Management

## ➤ Windows Power Management

- Use Start | Control Panel | Power Options to open Power Options Properties window
  - Click **“Change plan settings”** to modify
- Or type **Power** in Control Panel Search box
  - List of Power Options will be displayed

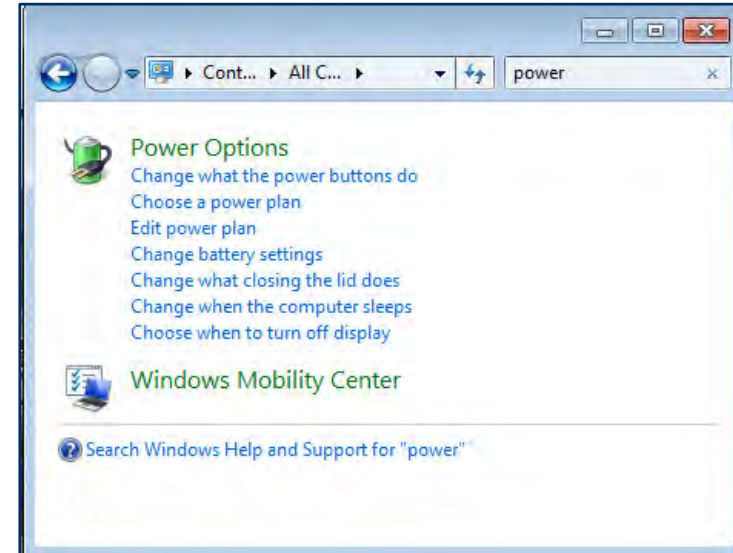
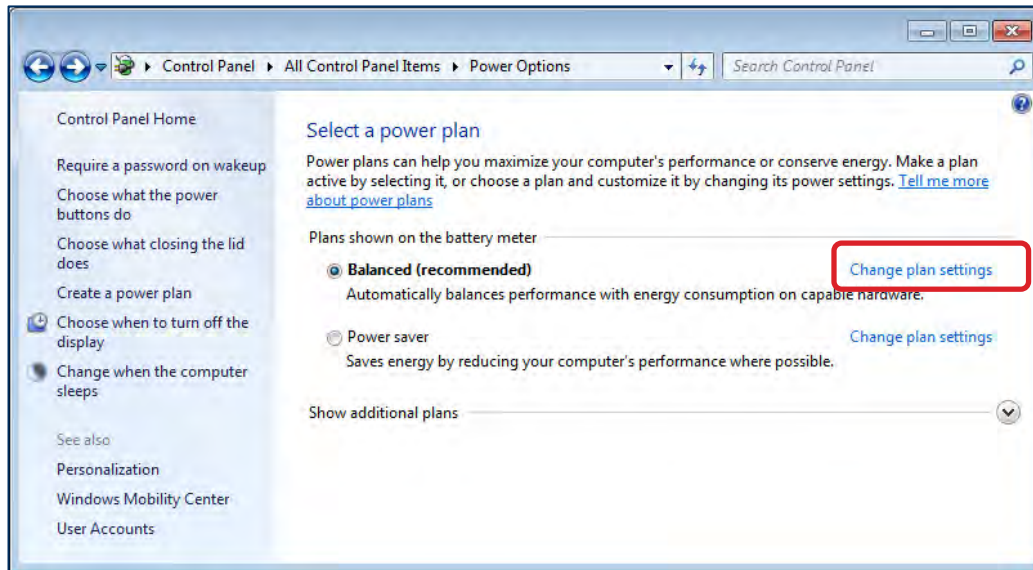

# Power Management

## ➤ Windows Power Management Options example:

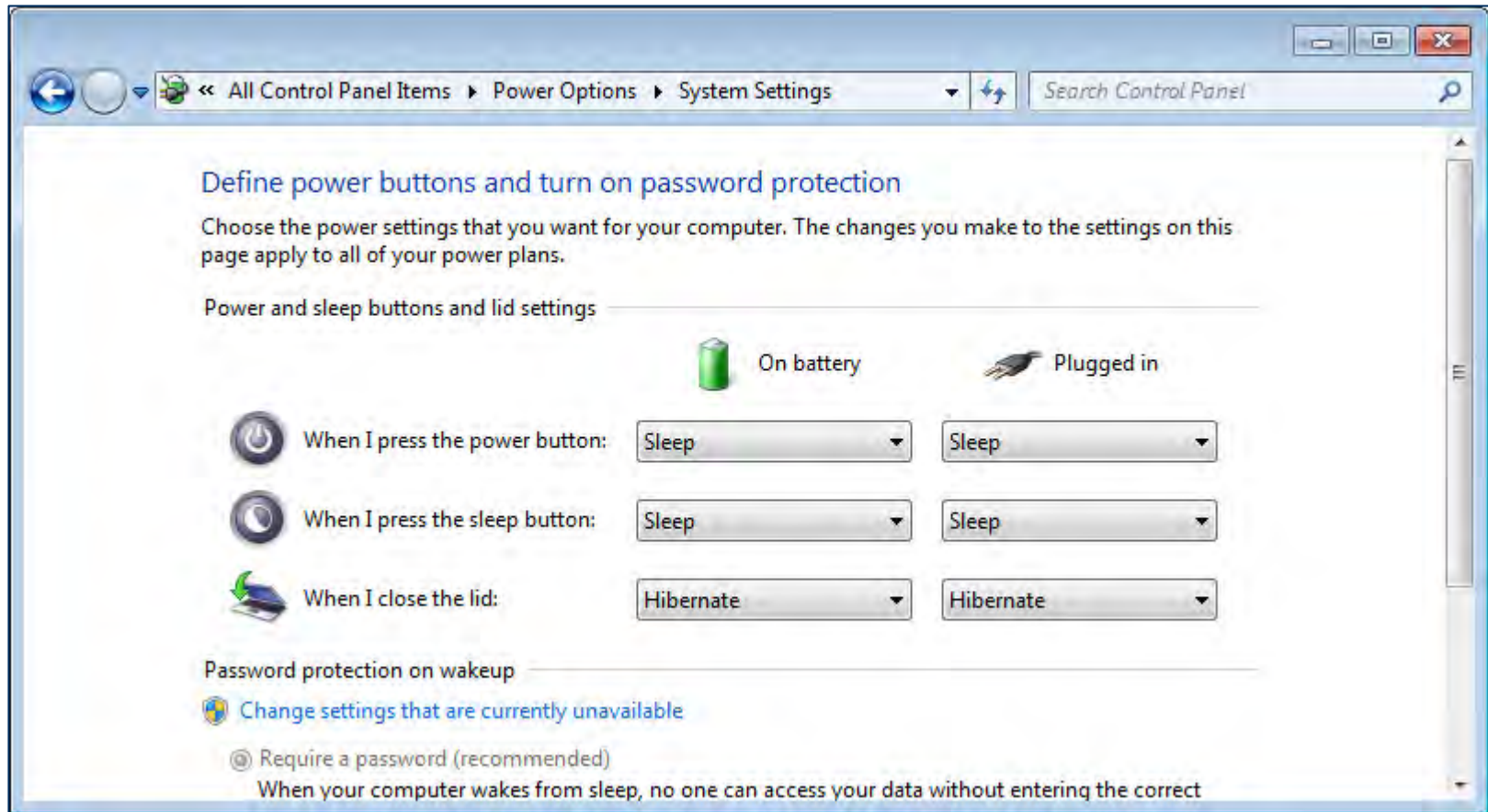

- **Laptop Components**
- **Expansion Options**
- **Troubleshooting Laptops**
- **Mobile Device Features**
- **Configuring Mobile Devices**
- **Securing Mobile Devices**





# Laptop Components: Expansion Options

- **Plug-in options that expand laptop functionality**
  - Do not require disassembly of laptop
- **Expansion options**
  - PCI Express Cards /34, /54
  - SODIMM memory cards
  - Disk drives
  - Flash memory devices



# PCI Express Card

## ➤ What is the PCI Express Card?

- Format for plug-in laptop cards
- Uses PCI Express bus to provide high-speed data transfers
- Often used for mobile broadband modems

34 mm

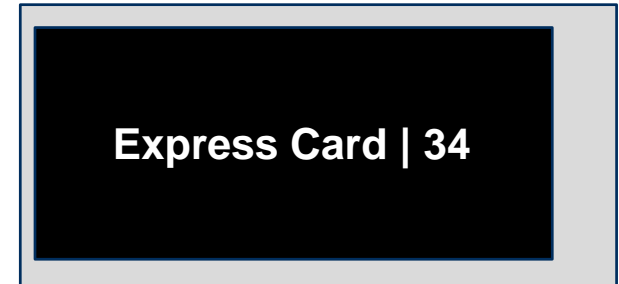

## ➤ Express Card formats

- Express Card /34 (34mm x 75 mm)
- Express Card /54 (54mm x XXX mm)
  - 54 mm slot accepts both /34 and /54 cards

75 mm

54 mm

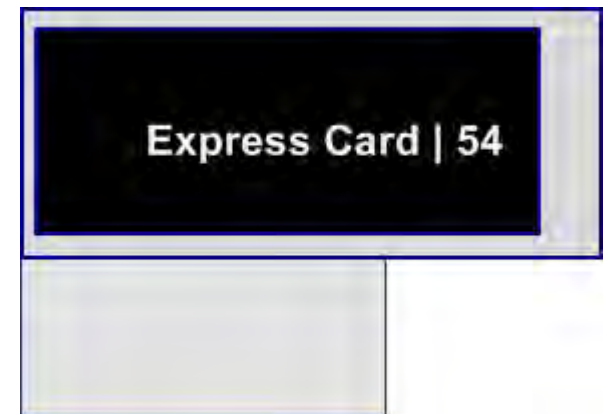

# Mini PCI Card

## ➤ Common platform for Wi-Fi cards used in laptops

- Wi-Fi can be turned ON/OFF using function key to conserve power or disable for airplane use
- Antenna wires routed up sides of laptop display panel



# Additional Laptop Components

## ➤ Laptops can contain built-in

- Webcam
- Microphone
- Digitizer (touchscreen)

## ➤ Example: Microsoft Surface Pro

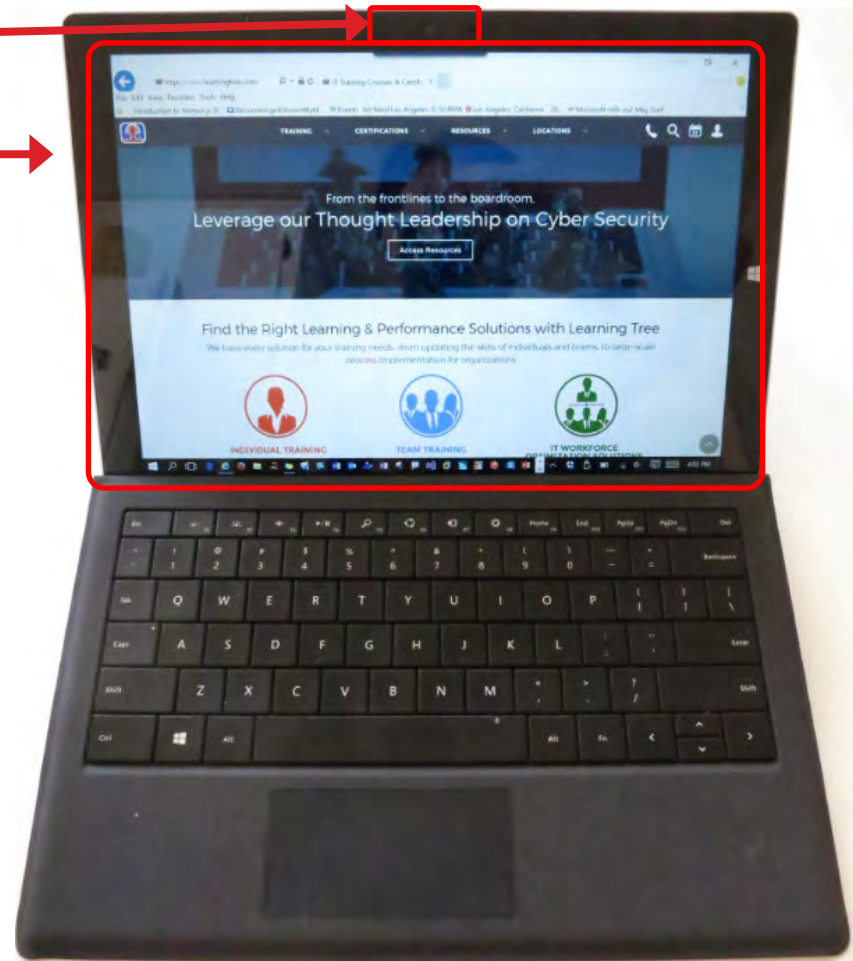

- **Laptop Components**
- **Expansion Options**
- **Troubleshooting Laptops**
- **Mobile Device Features**
- **Configuring Mobile Devices**
- **Securing Mobile Devices**



# Laptop Preventive Maintenance

## ➤ Protecting from thermal damage

- Make sure that laptop is on a hard, flat surface and has adequate ventilation, and that fan(s) are working
- Keep portable PC out of direct sunlight or freezing temperatures
- Use power management controls (Windows ACPI)



# Display Problems

## ➤ No display

- Check <Fn> key for display toggle to make sure display signal is not redirected to display port (with LCD display disabled)
- Check display cutoff switch (near hinge)
- Connect external monitor to verify display adapter circuitry

## ➤ Cannot display to external monitor

- Check <Fn> key for display toggle
- Display adapter or external display connector defective

## ➤ Dim display

- Can be caused by defective inverter or burned out backlight bulb
- Check connections to inverter, because a loose connection can cause the same symptom

## ➤ Flickering display

- Can be caused by defective inverter or backlight



# Power Problems

## ➤ Defective battery

- Confirm by unplugging AC power supply
  - If system shuts down, battery is defective

## ➤ Battery won't hold charge

- Run battery calibration program
- Old batteries need to be replaced

## ➤ No power—won't turn on

- Check that wall socket has power (plug in another device)
- Substitute known-good AC adapter
- Remove any extra peripherals (USB devices, etc...)





# Keyboard, Touchpad, and Stylus Problems

## ➤ Keyboard problems

- No operation
  - Check keyboard connector to main board
- Sticking keys
  - Clean with compressed air or replace key
- Num lock indicator lights on
  - Will produce numbers instead of letters

## ➤ Touchpad problems

- Check that touchpad sensor connection has not become dislodged
- Check BIOS configuration settings for mouse/touchpad

## ➤ “Ghost” cursor (on laptops using external mouse)

- Cursor seems to randomly jump to other positions
  - User is brushing against touchpad when typing—disable touchpad

## ➤ Stylus

- Run touchscreen digitizer calibration program



# Wireless Networking Problems

## ➤ No wireless connectivity or works intermittently

- Check for switch or special function key that enables/disables wireless networking
- Move laptop close to wireless access point to make sure that adequate signal strength is provided

## ➤ No Bluetooth connectivity

- Update Bluetooth driver
- Make sure that Bluetooth device is discoverable for pairing



# Removable Peripheral Problems

- **Click Safely Remove Hardware in taskbar before unplugging removable devices**
- **Check device status in Windows Device Manager**

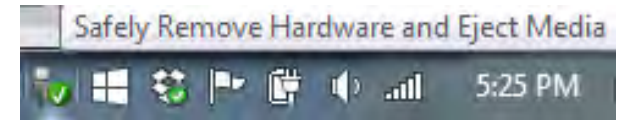

- **Laptop Components**
- **Expansion Options**
- **Troubleshooting Laptops**
- **Mobile Device Features**
  - **Configuring Mobile Devices**
  - **Securing Mobile Devices**



# Mobile Device Overview

## ➤ Mobile device types

- Smart phones
- Tablets
- Wearable technology devices

## ➤ Common features

- Touchscreens
- Apps (applications)
- Mobile operating systems
  - iOS (Apple)
  - Android (open-source)
- Many mobile devices use ARM CPU
  - CPU optimized for portable devices

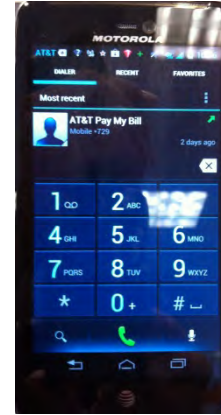

# Mobile Devices vs. Laptops: Hardware Differences

- **Mobile devices do not usually contain field-serviceable parts**
  - Due to small size, sealed systems

Item	Laptops	Mobile devices
Field-serviceable parts	Yes	No
Hardware upgradeable	Yes	No
Touch interface	On some models	Yes (on most models)  Apple: Multi-touch  Android: Touch flow
Solid state drives	Optional	Built-in flash memory



# Mobile Operating Systems: Android

## ➤ Android operating system

- Open-source (nonproprietary) software
- Developed by the Open Handset Alliance
  - Originally Android Inc., purchased by Google and released as open-source software in 2007
- Operating-system kernel based on Linux kernel
- Used by many mobile device manufacturers

## ➤ Android Market

- Source for Android applications
  - Android Market applications allows searching for Android apps
- Subset of Google Play

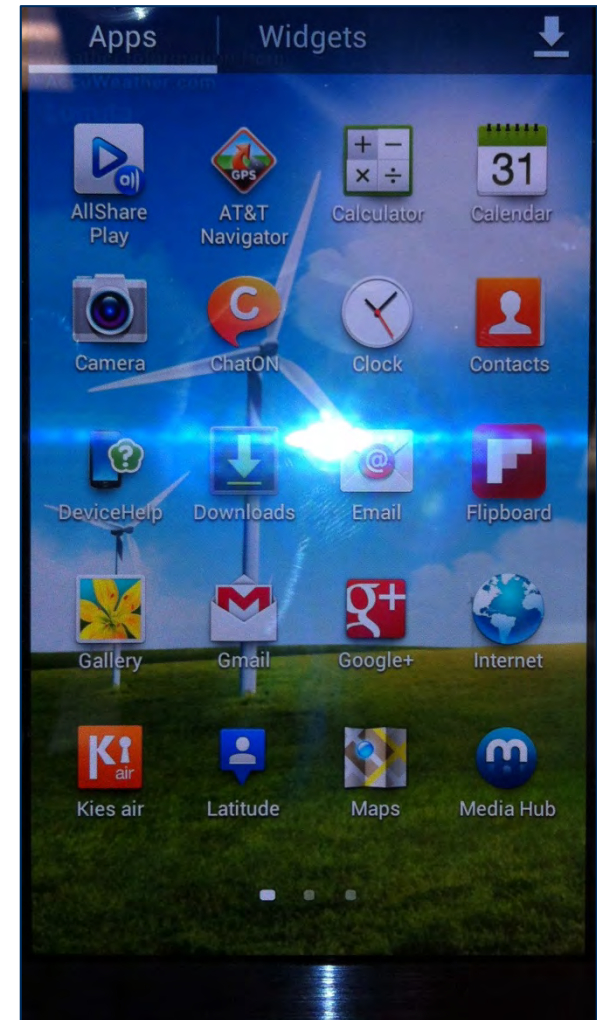

# Mobile Operating Systems: iOS (Apple)

## ➤ iOS (iPhone OS)

- Proprietary operating system developed by Apple
  - iPhone, iPad, iPod touch
- Closed-source software can only be used on Apple-manufactured products
  - Apple sponsors Apple Developers Network to support independent developers creating applications for iOS
- iCloud provides cloud-based backup storage

## ➤ Sources for iOS apps

- App Store
- iTunes





# Mobile Device Operating Systems: Common Features

## ➤ Screen orientation

- Mobile devices use an accelerometer/gyroscope to sense device orientation
- Display adjusts automatically for portrait or landscape orientation

## ➤ Screen calibration

- Some mobile devices allow calibration of touchscreen (usually in device Settings menu)
  - Allows adjustment for speed and location of finger or stylus



# Mobile Device Operating Systems: Common Features

## ➤ Global Positioning System (GPS) and geotracking

- Mobile devices use either GPS receiver or cell phone tower triangulation to determine position
- Allows “geotracking” (ability to determine mobile device location at any time)

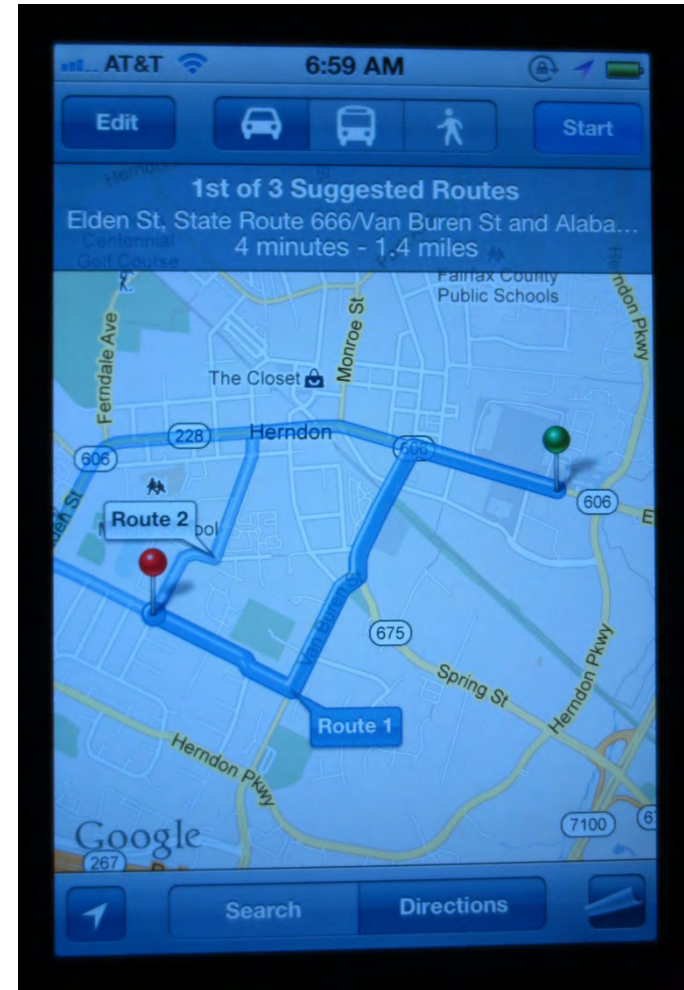

# Mobile Device Features: Wi-Fi Hotspot and Tethering

## ➤ Hotspot

- Mobile device acts as Wi-Fi access point using cellular Internet connection
  - Other wireless devices connect to Internet using Wi-Fi broadcast by mobile device



# Mobile Device Features: Wi-Fi Hotspot and Tethering

## ➤ Tethering

- Mobile device with cellular Internet connection connects with cable to computer
- Computer uses mobile device as a modem to connect to Internet



# Other Mobile Device Types

## ➤ e-readers

- Mobile devices optimized for reading books
- Example: Kindle Reader

## ➤ Phablets

- Phone + Tablet

## ➤ Wearable technology devices

- Smart watches
- Fitness monitors
- Glasses and headsets

## ➤ GPS (Global Positioning System)

- Navigation devices

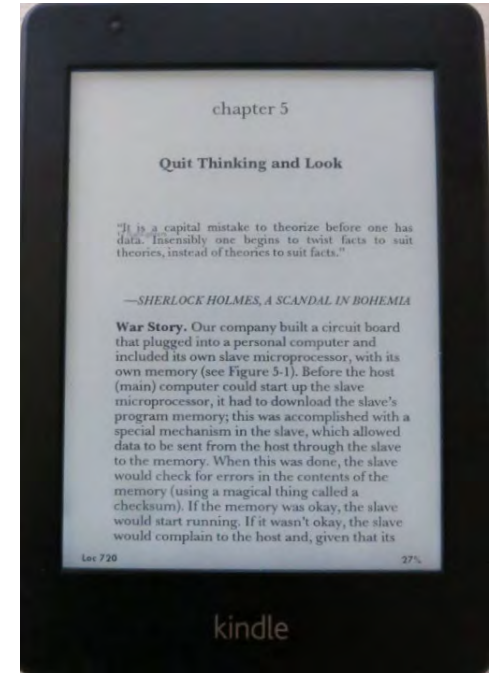

# Mobile Device Connection Types

## ➤ Non-proprietary

- Micro USB/Mini USB
  - Data and charging



## ➤ Proprietary vendor-specific ports

- Apple Lightning connector
  - Data and charging



# Mobile Device Connection Types

## ➤ **NFC (Near-Field Communication)**

- Wireless data transfer standard
  - Connects devices in close proximity (approximately 2 inches)
  - Allows mobile phones to be used for payment services
    - Example: Apple Pay

## ➤ **IR (Infrared)**

- Remote control of televisions

## ➤ **Bluetooth**

- Wireless standard for short-distance communication
  - Headsets, stylus

## ➤ **Hotspot**

- Mobile device acts as Wi-Fi access point using cellular Internet connection



# Mobile Device Accessories

## ➤ Credit card readers

- Plug-in attachment + processing service



## ➤ Memory/MicroSD

- Provide additional storage for tablets



## ➤ Battery packs/chargers

- Provide backup power for smartphones/tablets





- **Laptop Components**
- **Expansion Options**
- **Troubleshooting Laptops**
- **Mobile Device Features**
- **Configuring Mobile Devices**
- **Securing Mobile Devices**



# Establishing Basic Network Connectivity

## ➤ Wireless

- Configured through menu
  - iPhone: Settings | Wi-Fi
- View IP address using
  - iPhone: Settings | Wi-Fi | Network name (SSID)

## ➤ Cellular Data Network (3G)

- Enable/disable through menu
  - iPhone: Settings | Network

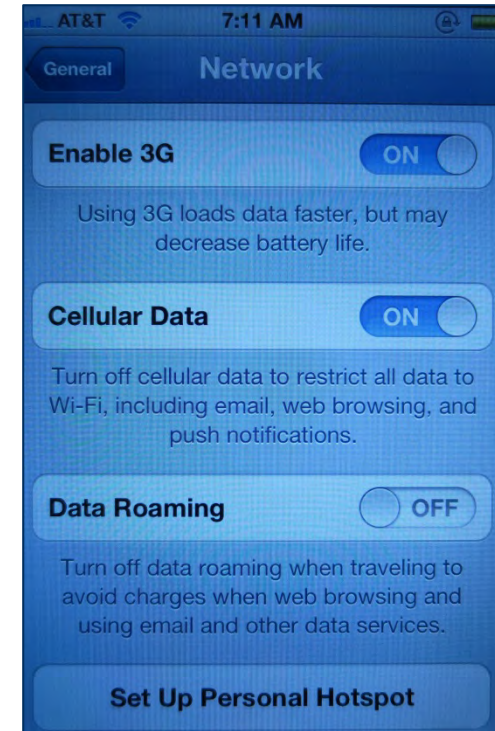
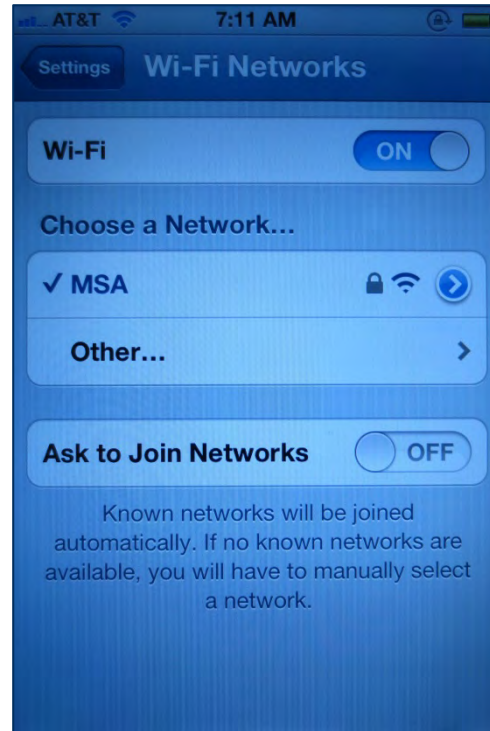

# Bluetooth

## ➤ Enable Bluetooth

- Configured through menu
  - iPhone: Settings | General | Bluetooth

## ➤ Bluetooth pairing

- Mobile device will find device for pairing
- Will prompt user to enter appropriate PIN code
- Will then test connectivity to Bluetooth device



# Hotspot/Tethering

## ➤ Hotspot

- iPhone: Settings | Personal Hotspot

## ➤ Tethering

- Connect mobile phone with Internet access to tethered device with USB cable
- Example: iPhone to laptop



# E-Mail Configuration

## ➤ Server address

- Configured through menu
  - iPhone: Settings | Mail, Contacts, Calendar | Mail
- POP3
  - Standard protocol for receiving e-mail messages
  - Example: bob\_tester@earthlink.net
- IMAP
  - More sophisticated e-mail protocol
- Port and SSL settings
  - E-mail port number (110)
  - Secure Socket Layer settings

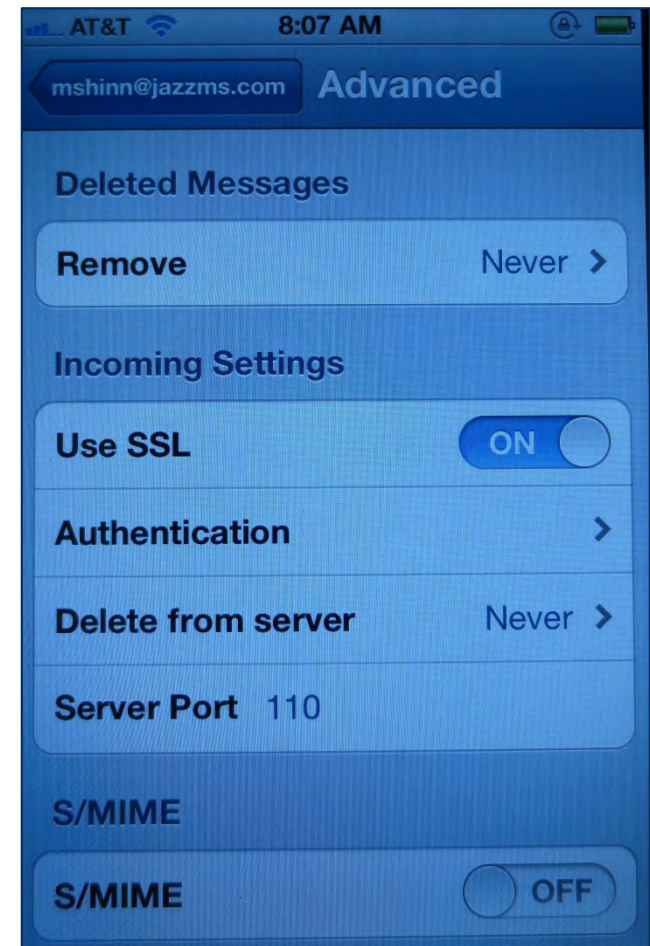

IMAP = Internet Message Access Protocol

POP = Post Office Protocol



# Exchange and Gmail

## ➤ Exchange

- Microsoft server-based mail service
- Configured through menu
  - iPhone: Settings | Mail, Contacts, Calendars | Add Account | Microsoft Exchange

## ➤ Gmail

- Google cloud-based e-mail service
- Configured through menu
  - iPhone: Settings | Mail, Contacts, Calendars | Add Account | Gmail

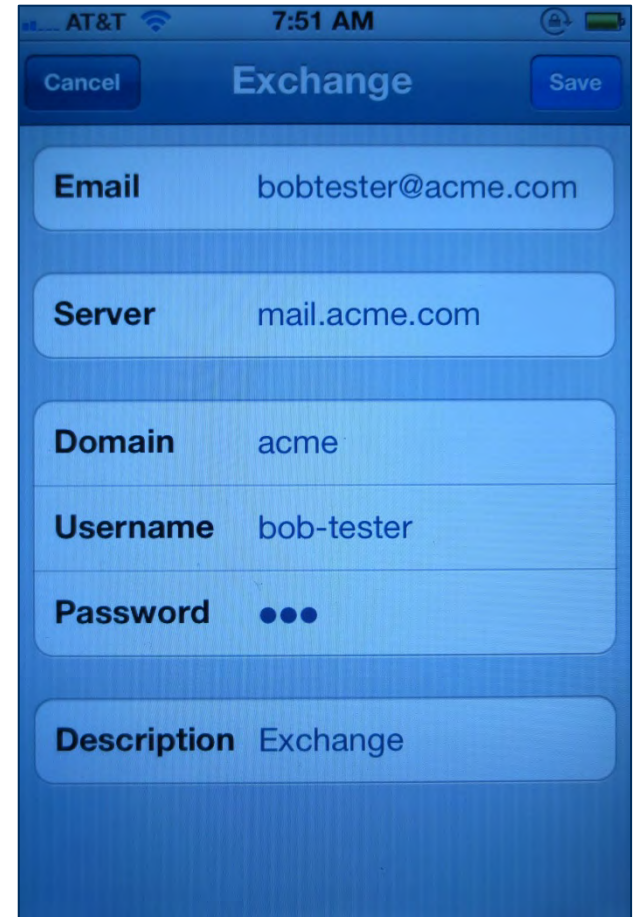

- **Laptop Components**
- **Expansion Options**
- **Troubleshooting Laptops**
- **Mobile Device Features**
- **Configuring Mobile Devices**
- **Securing Mobile Devices**



# Securing Mobile Devices

## ➤ Methods for securing mobile devices:

Method	Description
Passcode locks	User sets password required to unlock device
Remote wipes	Allows remote deletion of all user data (in case device is stolen)
Locator applications	Allows geotracking of phone in case of loss or theft
Remote backup applications	Provides backup of mobile device data to cloud based storage (ATT, Verizon, Carbonite)
Failed login attempts restrictions	Locks out access after set number of failed login attempts
Antivirus	Anti-malware protection for mobile devices (Norton, McAfee)
Patching/OS updates	Download latest security/operating system patches to protect mobile device





# Configuring Mobile Device Synchronization

## ➤ **What is mobile device synchronization?**

- Provides automatic synchronization between main computer and mobile devices
  - Example: Synchronize laptop files to mobile phone

## ➤ **Types of data to synchronize**

- Contacts, programs, e-mail, photos, etc...

## ➤ **Software requirements to install data synchronization software on PC**

- Specified by data synchronization software manufacturer



# Troubleshooting Mobile Device Problems

## ➤ Signal drop/weak signal

- In building, move closer to window (walls block signals)
- Turn on airplane mode briefly
  - Will cause a new connection to be made (possibly to a closer cell tower)

## ➤ Power drain

- Turn display brightness down
- Turn cellular data off (use Wi-Fi connection when available)
- Turn off geo-location services

## ➤ Slow data speeds

- Cellular data is subject to traffic volume and throttling by carriers
- Try switching to Wi-Fi connection, if available



# Troubleshooting Mobile Device Problems

- **Sluggishness, touch screen response, other minor issues**
  - Soft reset (power cycle device)
  - Preserves user data
  
- **Corrupted software, viruses, major software problems**
  - Hard reset (reset to factory defaults)
  - Removes user data, applications, and settings



# Troubleshooting Mobile Device Problems

## ➤ **Unintended Wi-Fi connection**

- Mobile devices will try to connect to previous Wi-Fi network connections
- Go into Wi-Fi settings for device and delete any unwanted/unused Wi-Fi networks

## ➤ **Leaked personal files/data**

- Make a list of all important online accounts
  - Change passwords and security questions
- Set up all sites for two-factor authentication
  - Will send a PIN code to your mobile phone for confirmation
- Alert any credit card/payment companies
- Encrypt personal data on all devices

## ➤ **Unauthorized account access**

- Same as above



# Review Questions

- 1. A laptop with 2 GB of memory installed reports only 1.7 GB of system memory. The probable cause of this is:**
  - A. One memory card is defective
  - B. Laptop uses shared video memory
  - C. Overheating
  - D. Power-saving mode
  
- 2. If a laptop display is visible, but very dim, a possible cause is:**
  - A. LCD panel is disconnected
  - B. Defective memory
  - C. Defective inverter
  - D. External monitor is connected
  
- 3. Susan has used a USB cable to connect her mobile phone and laptop so she can use the phone's Internet connection. This is called a \_\_\_\_\_ connection.**
  - A. USB
  - B. Local
  - C. Hotspot
  - D. Tethered



# Review Questions

4. **Which power-saving mode saves contents of memory to the hard drive, then shuts down the entire system?**
  - A. Standby
  - B. Suspend
  - C. Hibernate
  - D. There is no such power-saving mode
  
5. **Two security features provided on many mobile devices are (select two):**
  - A. Accelerometer
  - B. Passcode locks
  - C. Remote wipes
  - D. Bluetooth
  
6. **To configure wireless settings on an iPhone, use:**
  - A. Wireless Administration
  - B. Settings | Wi-Fi
  - C. Settings | General
  - D. You cannot configure wireless settings on an iPhone



# Chapter Summary

**In this chapter, you have learned how to**

- **Identify the names and purposes of fundamental laptop components**
- **Describe types of laptop expansion options**
- **Describe techniques for troubleshooting common laptop problems**
- **Provide an overview of common mobile device features**
- **Describe how to configure and secure mobile devices**
- **List techniques for troubleshooting mobile device problems**





# Chapter 12

## Printers and Scanners

Customer  
Management  
Standard  
Development  
Consistency  
Business  
Optimal



# Chapter Objectives

In this chapter, you will learn how to

- **Identify and describe the basic characteristics of printer technologies, including impact (dot-matrix), inkjet, thermal, and laser**
- **List basic printer installation and configuration steps**
- **Describe the Windows printing process and considerations for installing Windows printer drivers**
- **Describe troubleshooting procedures and solutions for common printer problems**
- **Identify basic components and describe configuration/troubleshooting procedures for scanners**



## ➤ **Printer Types**

- **Installing and Configuring Printers**
- **Configuring Printers in Windows**
- **Troubleshooting Printer Problems**
- **Scanners**



# Printer Types: Impact (Dot-Matrix)

- **Impact printer uses print head with matrix of printwires to print dot patterns that form characters and graphic symbols**
  - Impact printers are often used for multipart forms
  - Dot-matrix print heads can use 9, 18, or 24 printwires (for high-quality characters)
- **Paper movement mechanisms**
  - Friction feed (rubber rollers)
  - Tractor feed (sprockets grab perforations at paper edges)
- **Consumables**
  - Printer ribbon cartridge
  - Impact paper (fan-fold with perforations and sprocket holes)



# Printer Types: Impact (Dot-Matrix)

Main control board  
(inside printer)

Tractor feed mechanism

Dot-matrix print head

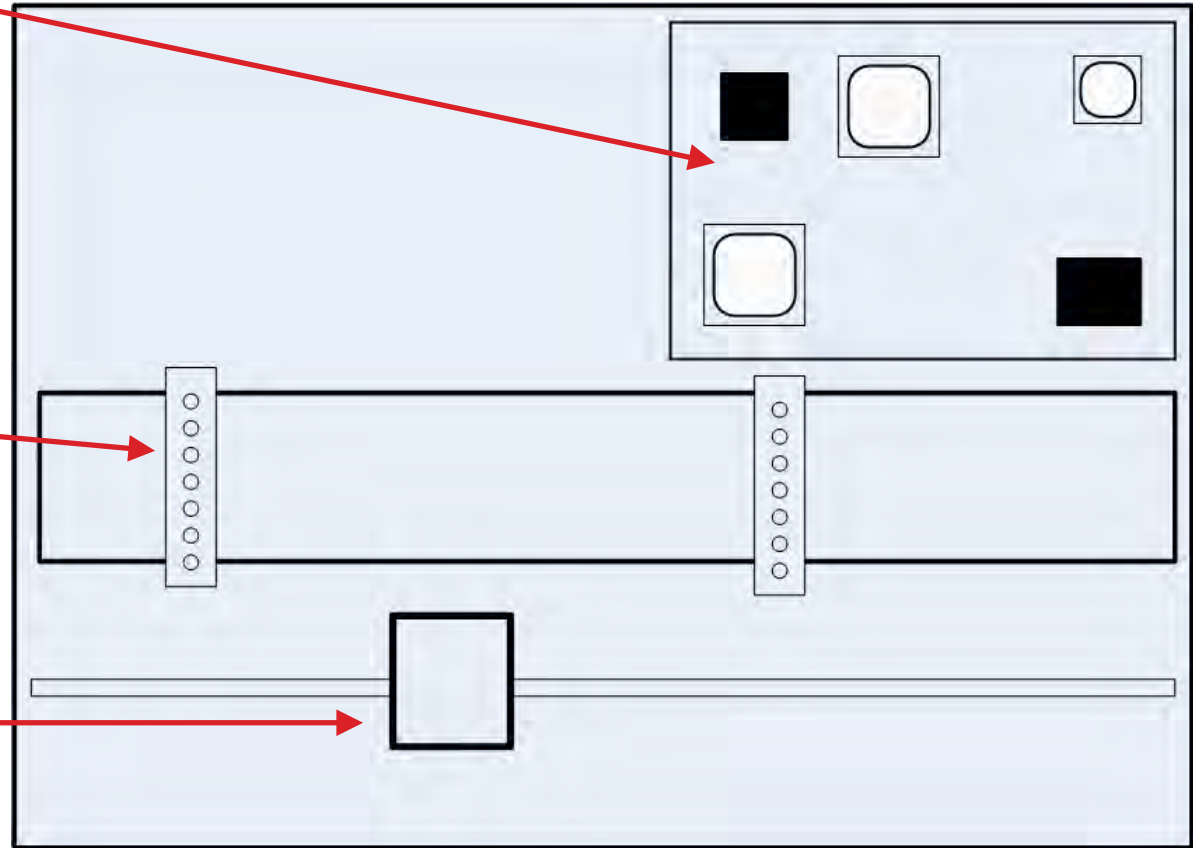

# Printer Types: Inkjet

- **Print head “squirts” precisely controlled ink drops using one of two methods**
  - Thermal: heat forces drop to shoot through nozzle with high velocity
  - Vibration: piezoelectric crystal flexes to move ink through nozzle
- **Print head nozzles require calibration**
  - Use calibration program from printer manufacturer
- **Consumables: ink cartridges**



# Inkjet Components

## ➤ Carriage and belt

- Carriage is main rubber cylinder that supports paper during printing
- Belt moves drum to position paper for printing

## ➤ Roller(s)

- Rubber rollers used for paper pickup, movement

## ➤ Feeder

## ➤ Duplexing assembly

- Mechanical paper-handling mechanism provides printing on both sides of paper



# Printer Types: Thermal

- **Print head uses a heating element to produce characters**
  - Heat changes color of small areas on special thermal paper
    - Note: Thermal paper can become discolored when stored for long periods or when exposed to heat
- **Feed assembly moves thermal paper through printer**
- **Direct-transfer thermal printers often used for printing receipts, bar codes, etc.**
- **Consumables: Thermal paper**



# Printer Types: Laser

- **Uses ElectroPhotographic (EP) process developed by Xerox and Canon**
  - Laser beam writes (positively charged) image on photosensitive drum
  - Negatively charged toner particles are attracted to positively charged image
  - Heated fuser fixes toner particles to paper
  - Provides fast, high-quality printing
- **Consumables: Toner cartridge (containing photosensitive drum)**
  - Note: Photosensitive drum can be damaged by exposure to sunlight or bright light





# Laser Printer Components

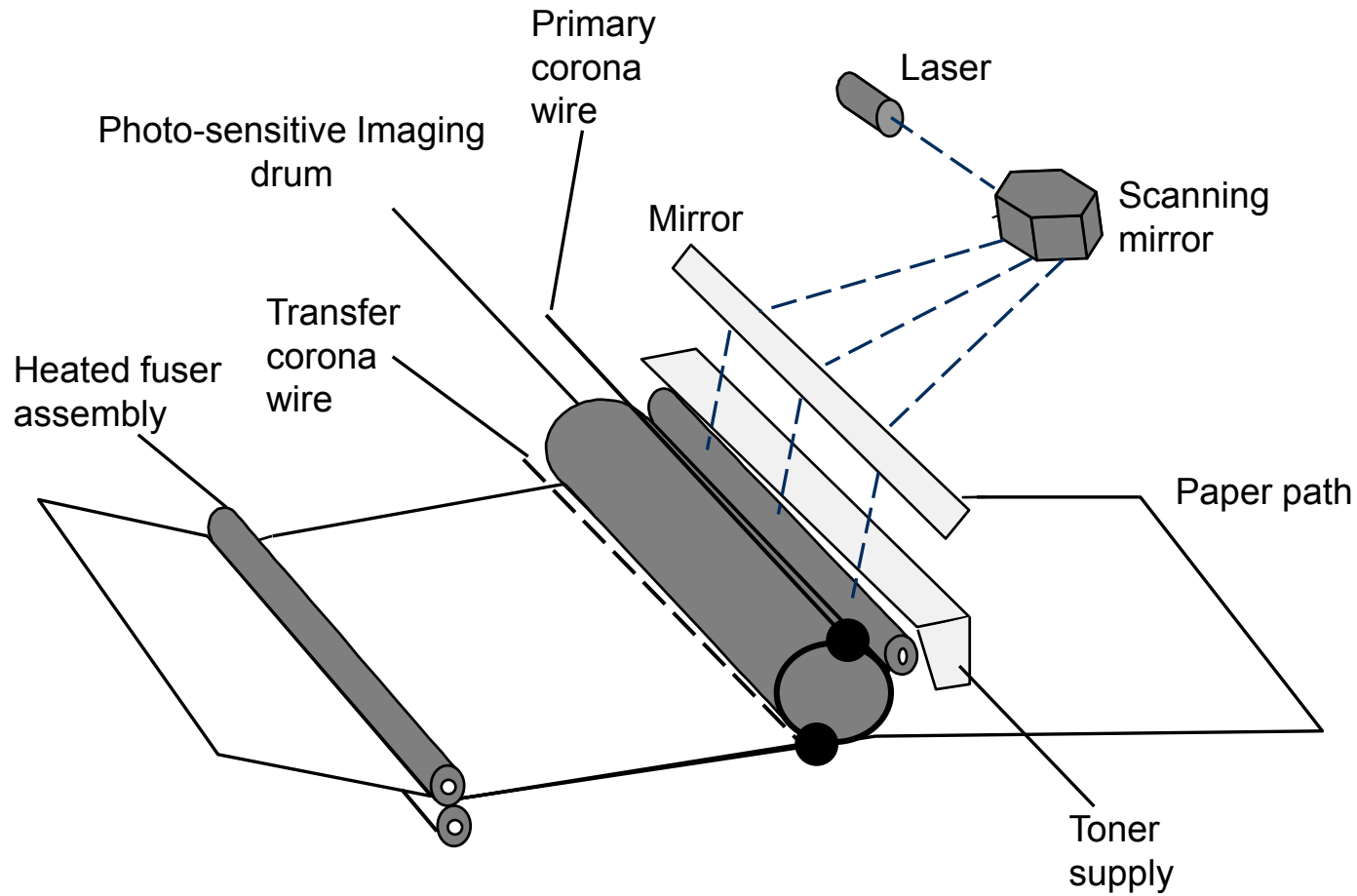

# Laser Printer Components

## ➤ Imaging drum

- Photosensitive drum holds electrostatic charge except where it is exposed to light

## ➤ Primary corona wire

- High voltage (–600 V) wire resets photosensitive drum by charging entire surface to –600 volts

## ➤ Laser and scanning mirror

- Laser beam is modulated to produce image
- High-speed rotating mirror sweeps beam across drum
- Note: Laser light can be damaging to eyes—do not look directly at beam

## ➤ Toner supply

- Fine iron particles bonded to printing powder are attracted to less negatively charged areas of drum



# Laser Printer Components

## ➤ **Transfer corona wire**

- High-voltage (+600 V) wire charges back of paper surface to +600 volts (to attract toner particles from drum)

## ➤ **Fuser assembly**

- High-temperature (165–180 degrees Celsius) rollers melt toner particles onto paper



# Additional Laser Printer Components

## ➤ Pickup rollers

- Rollers that pick up paper from paper tray

## ➤ Transfer roller

- Sponge-like roller positioned below toner cartridge
- Charged to high positive voltage to attract toner particles from drum to paper

## ➤ Transfer belt

- Large belt positioned near toner cartridge
- Helps ensure even application of toner to paper

## ➤ Separation pads (separate pads)

- Plastic pads that help ensure that only one page at a time is picked up from paper tray

## ➤ Duplexing assembly

- Mechanical assembly adds two-sided printing capability to laser printer



# Laser Printer Operational Steps

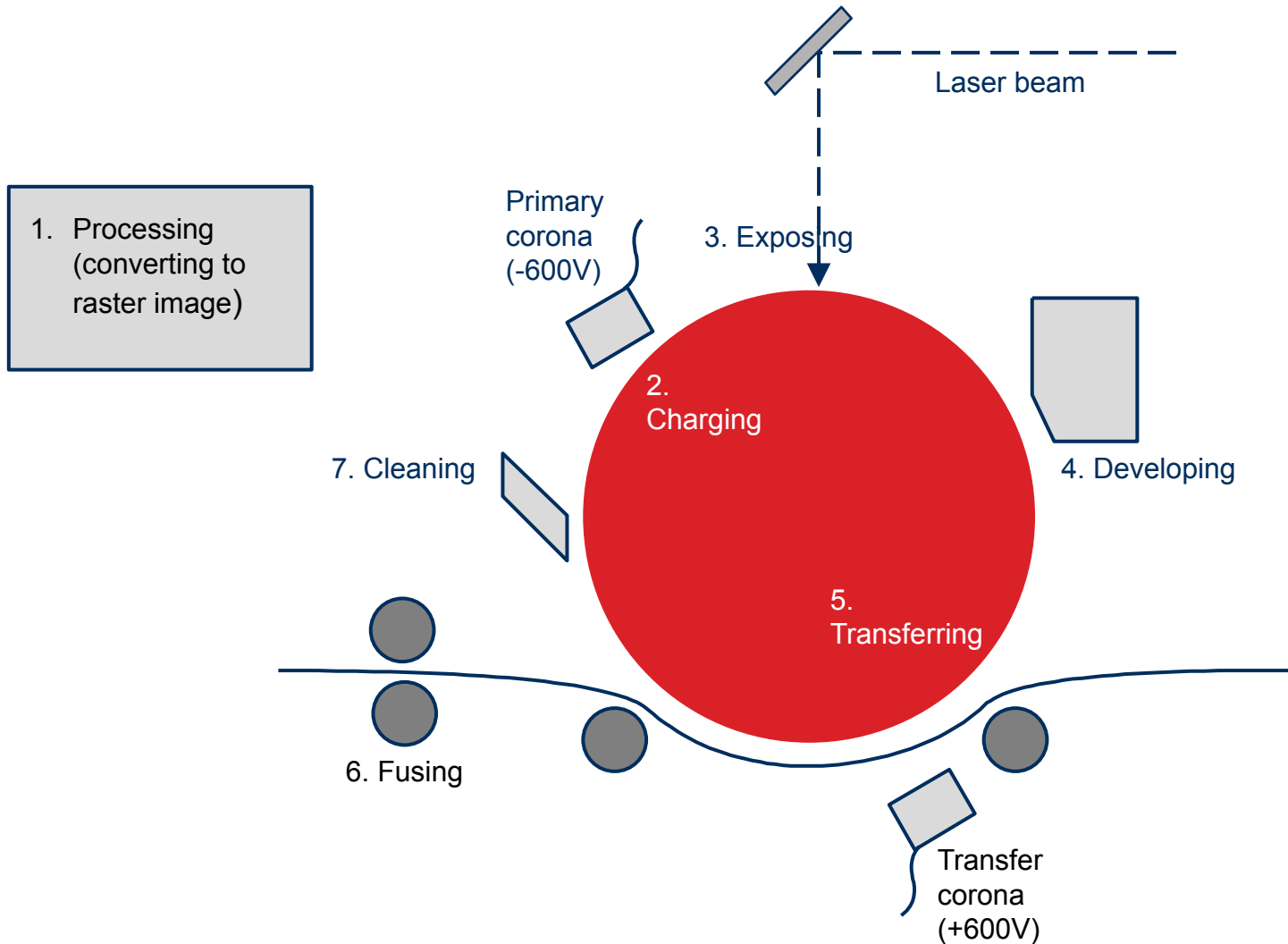

# Laser Printer Imaging Process

## 1. Processing

- Image to be printed is turned into series of lines by Raster Image Processor

## 2. Charging

- Drum is charged to  $-600\text{ V}$  by primary corona wire or primary charge roller

## 3. Exposing

- Laser beam/scanning mirror are used to write image to photosensitive drum
- Where laser beam strikes drum, charge is reduced to  $-100\text{ V}$



# Laser Printer Operational Steps

## 4. Developing

- Toner particles are attracted to exposed areas of drum (creating image)

## 5. Transferring

- Transfer corona wire charges paper to +600 volts to attract negatively charged particles from drum
- This transfers the image to be printed onto the paper

## 6. Fusing

- Fusing rollers melt toner onto paper, producing permanent image

## 7. Cleaning

- Plastic blade scrapes off any excess toner on drum



# Laser Printer Operational Steps Mnemonic

## ➤ “PC Educated Techs Fix Computers”

1. Processing
2. Charging
3. Exposing
4. Transferring
5. Fusing
6. Cleaning





# Printer Types: Virtual

## ➤ What is virtual printing?

- Printing to a file format that is stored on the computer (instead of paper)
  - Can be used for systems without access to a physical printer
- Can be selected from application like Word

## ➤ Print to file

- Print to a file that can be saved to a flash drive for printing on a different system

## ➤ Print to XPS (XML Paper Specification)

- Windows applications can print to XPS printer
  - File can be viewed on any computer that supports XPS format

## ➤ Print to image

- Print screen button captures screen as image file (.bmp)

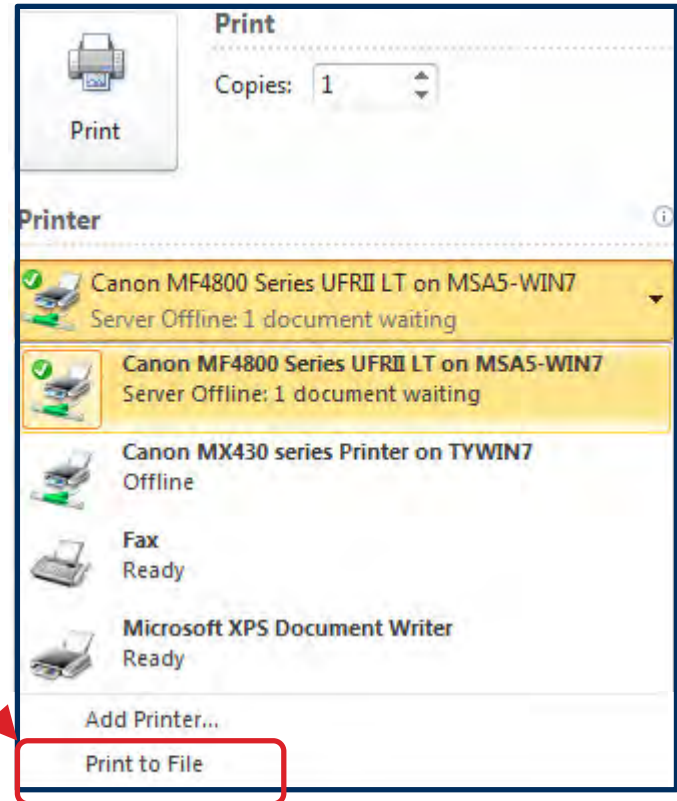

- **Printer Types**
- **Installing and Configuring Printers**
- **Configuring Printers in Windows**
- **Troubleshooting Printer Problems**
- **Scanners**



# Printer Driver Compatibility

## ➤ What is a printer driver?

- Software routine that converts data to be printed into correct format for a specific printer
- Necessary because printer mechanisms and hardware are unique to each model of printer

## ➤ Where are printer drivers located?

- Installation disk provided with new printer
- Manufacturer's website
- Windows internal driver library
  - Not as current, but many printers supported



Printer Driver



# Standalone Printer Installation Procedure

1. **Connect AC power cord**
2. **Connect (USB) printer cable**
3. **Install correct printer driver**
4. **Load paper**
5. **Run printer self-test to print test copy**
6. **Instruct users on printer operation specifics**



# Print Device Sharing: Wired

## ➤ USB

- Connect USB cable from printer to PC
- Use Found New Hardware Wizard to select correct driver from Windows internal library, or provide driver from manufacturer on CD (or download)

## ➤ Serial

- Serial cable (with DB-25 or DB-9 male connectors on both ends) connects printer to PC
- Configure PC and Printer to use same serial port settings
  - Baud rate, number of bits, parity

## ➤ Ethernet

- Printer contains built-in NIC and RJ-45 network connector
- Connect to network, configure network address



## ➤ Bluetooth

- In Windows, use Start | Devices and Printers
- Right-click printer, then select Bluetooth tab
- Configure Bluetooth settings

## ➤ 802.11x (Wi-Fi)

- Using control panel on printer, enter wireless network SSID and password
- Printer will automatically install driver
- Infrastructure (using Wi-Fi Access point)
- Ad-hoc (direct Wi-Fi connection)

## ➤ Printer hardware print server

- Connect printer to PC that will act as print server
- Install printer drivers
- In Windows, use Start | Devices and Printers
  - Right-click printer, select Printer Properties | Sharing
  - Share printer to make it available to other computers



# Print Device Sharing: Cloud/Public Shared Devices

## ➤ **Cloud printing**

- Users send documents to cloud-based printing services
  - Document then prints on the printer they have selected
  - Example: Google Cloud Print
- Advantages—print from any device, anywhere

## ➤ **Public/shared devices**

- Printers in public areas (libraries, meeting centers)
  - Shared using operating system sharing settings
    - TCP
    - Bonjour/AuPrint

## ➤ **Data privacy on shared printers**

- User must authenticate on device
  - One-time-use print code
- Hard drive caching
  - Printer hard drive should be set to delete print jobs after printing



- **Printer Types**
- **Installing and Configuring Printers**
- **Configuring Printers in Windows**
- **Troubleshooting Printer Problems**
- **Scanners**





# Basic Printer Configuration Settings

## ➤ Duplexing

- Print on both sides of paper
  - Default mode is normally set to print on one side of paper

## ➤ Collating

- Used when printing multiple copies of same document
  - Sorts into document sets

## ➤ Orientation

- Portrait (default) or Landscape

## ➤ Quality

- Print resolution in DPI (Dots Per Inch)
  - 600 DPI is acceptable
  - 1200+ DPI may be used for higher-resolution graphics

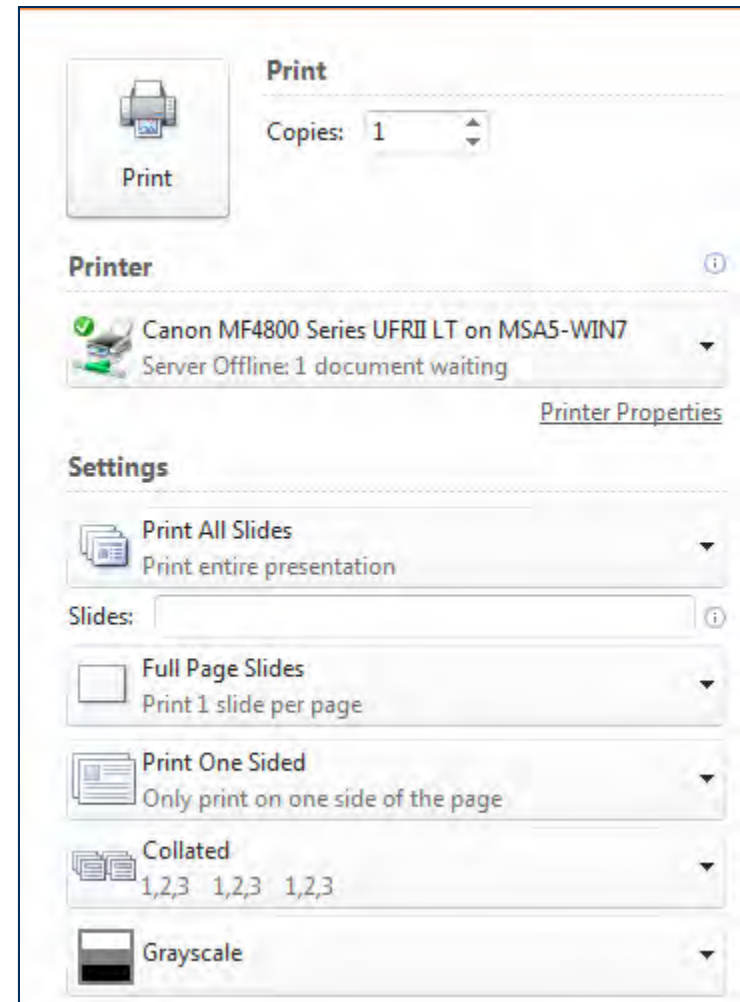

# Windows Printing Process

## ➤ How does Windows printing work?

- Windows applications call the Graphics Device Interface (GDI), which then calls the printer driver for target printer
- Printer driver renders print job and sends to local print spooler (disk buffer)
- Print spooler then sends job to printer or printer server

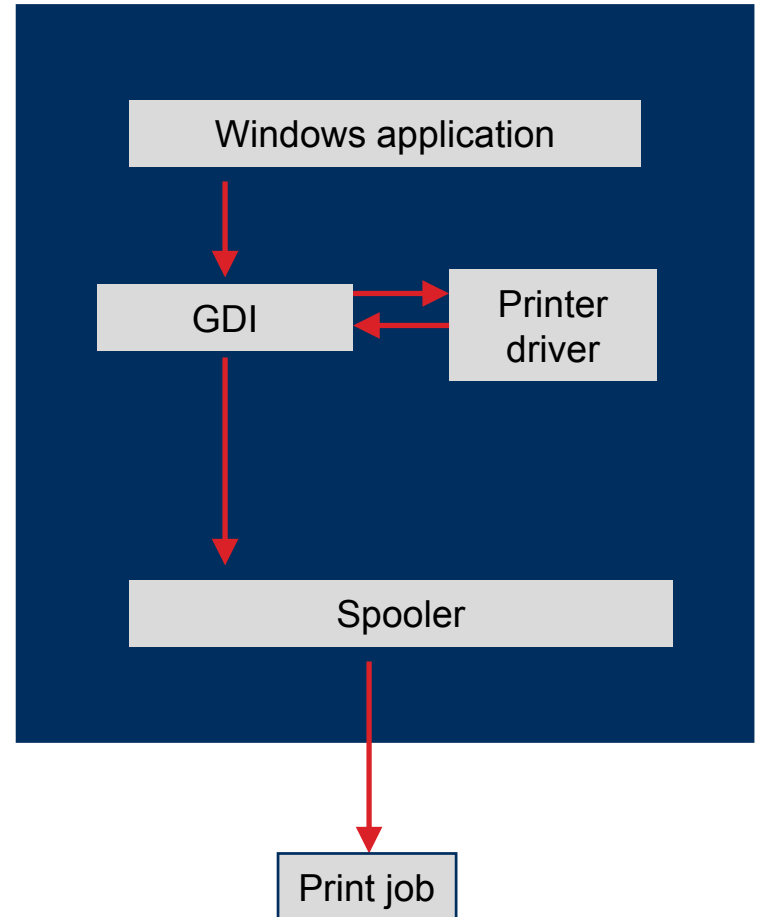

# Windows Printing Process

## ➤ Print spooler

- Windows driver that buffers data being sent to printer
- In a networked system
  - Spooler on client PC buffers print data being sent to spooler on print server
  - Print server sends data to printer, then requests more data from spooler on client PC
- Windows Print Spooler Properties used to control print spooler
  - Start | Control Panel | Administrative Tools | Services | Print Spooler

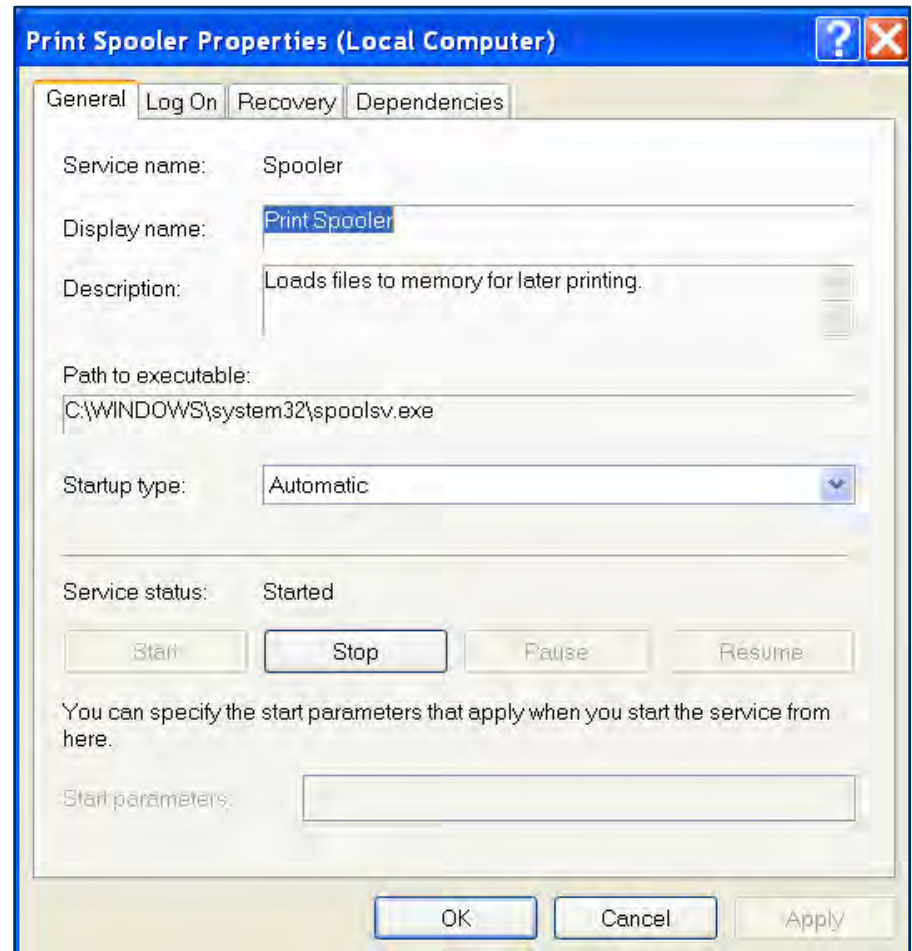

Note: SPOOL is an acronym for Simultaneous Peripheral Operations On Line



# Configuring Print Spooling Options

## ➤ Print spooler options

- Right-click printer, select **Properties**, then click **Advanced** tab
- Start printing immediately
  - One page at a time is spooled to hard disk, then printed
  - Default setting
- Start printing after last page is spooled
  - Spools entire document to hard disk, then prints
  - Slower, but may be used if stalling is a problem

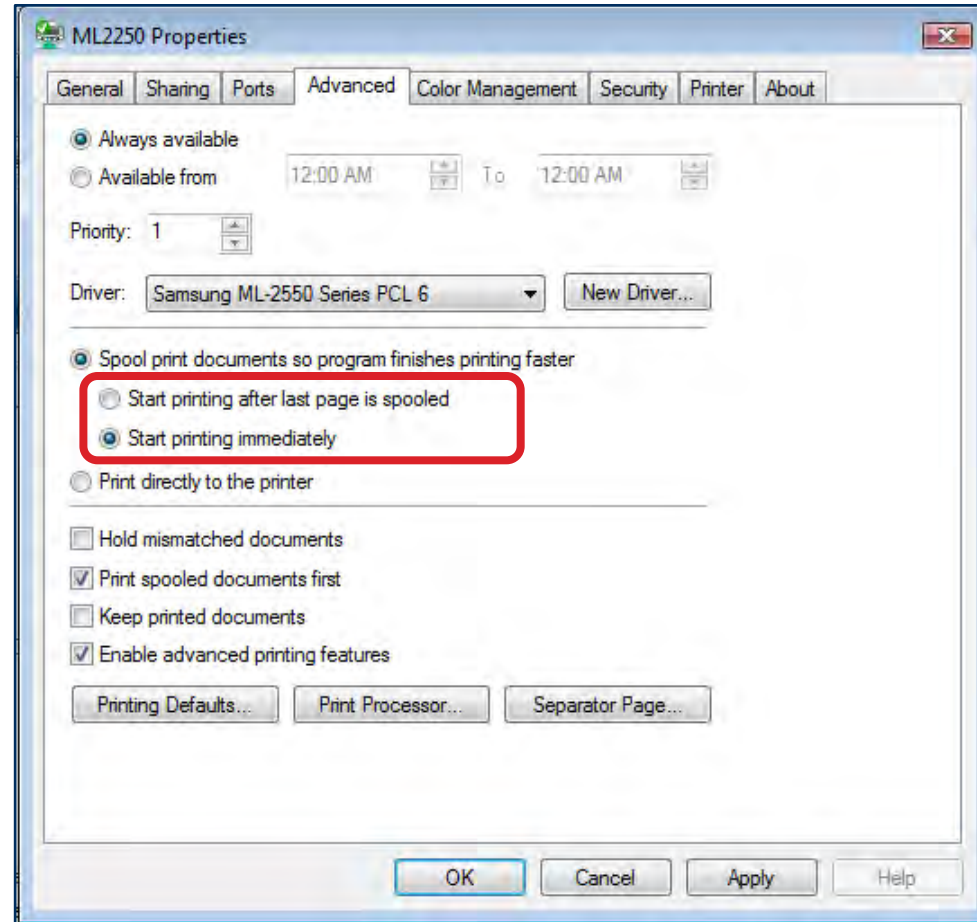

# Starting and Stopping Print Spooler Service (From Windows)

## ➤ Type *services* in Windows Search Box

- Select Print Spooler

## ➤ Start or stop print spooler service

- Right-click Print Spooler
  - Select Stop or Start

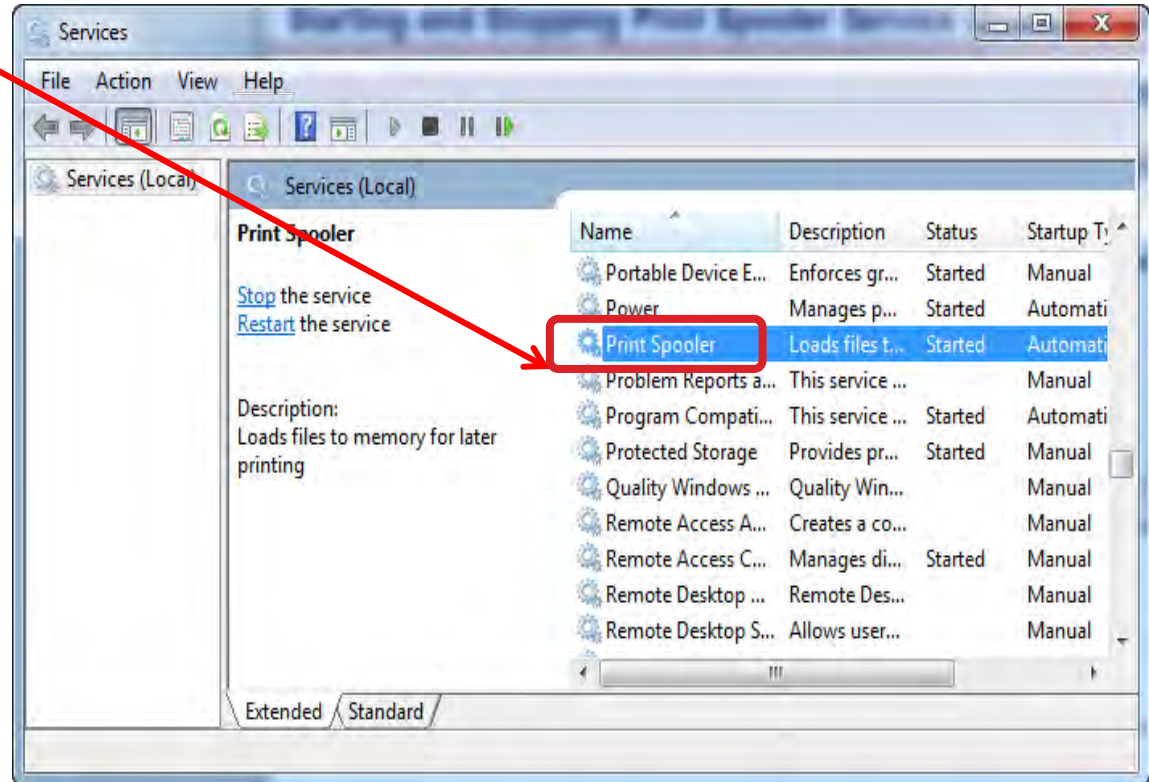

# Starting and Stopping Print Spooler Service

## From the command line

### ➤ Open a command window

- Press <Windows><R>, type **cmd**, then click **OK**

### ➤ Start or stop print spooler

- Use `net` command
- Example: `net start spooler`

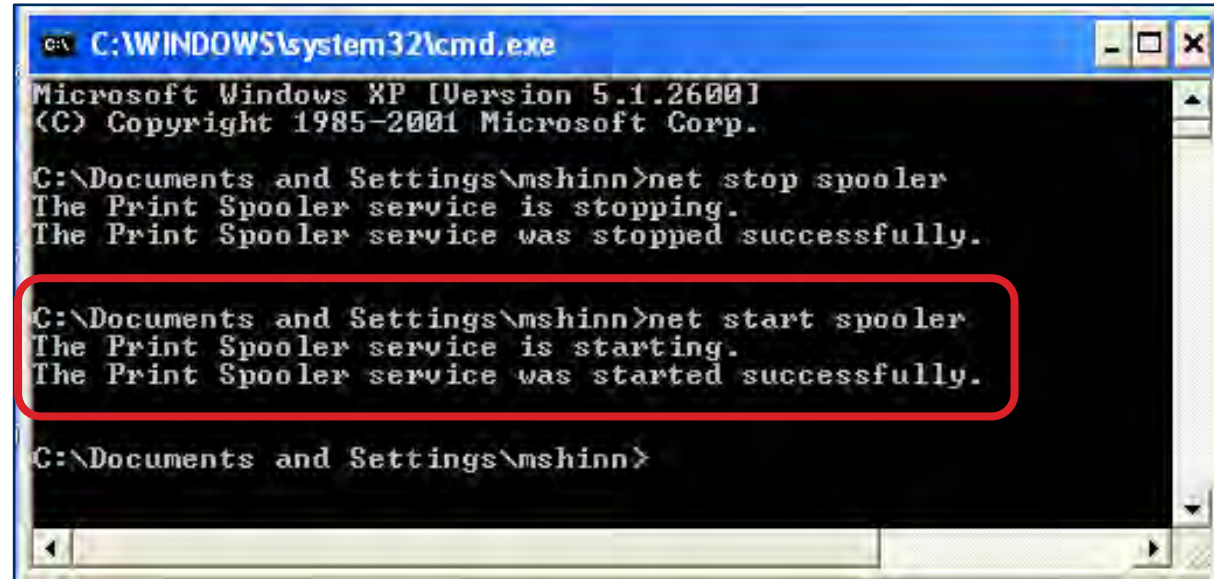

```
C:\WINDOWS\system32\cmd.exe
Microsoft Windows XP [Version 5.1.2600]
(C) Copyright 1985-2001 Microsoft Corp.

C:\Documents and Settings\mshinn>net stop spooler
The Print Spooler service is stopping.
The Print Spooler service was stopped successfully.

C:\Documents and Settings\mshinn>net start spooler
The Print Spooler service is starting.
The Print Spooler service was started successfully.

C:\Documents and Settings\mshinn>
```



# Windows Printing Process

## ➤ Windows print queue

- Stores multiple files that have been sent to printer
- Double-click printer icon in SysTray to display
- Allows starting, pausing, deleting of print jobs

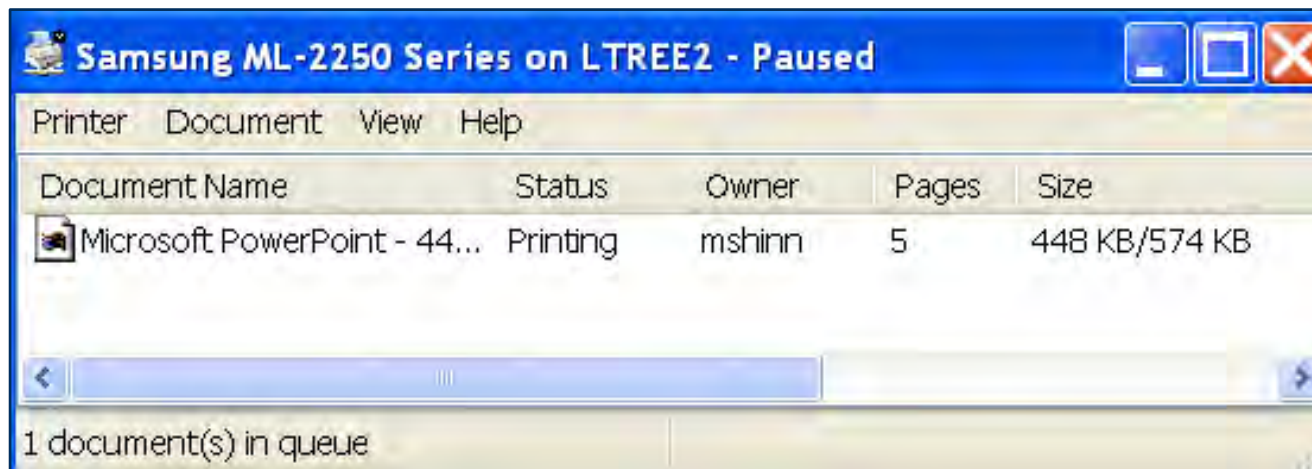

# Installing Printer Drivers

➤ **Printer drivers normally installed by Plug and Play process upon detection**

➤ **Manual installation of printer driver**

1. In Windows Search Box, type Devices and Printers
2. In Devices and Printers dialog, click Add a Printer
3. Follow steps in wizard to add driver

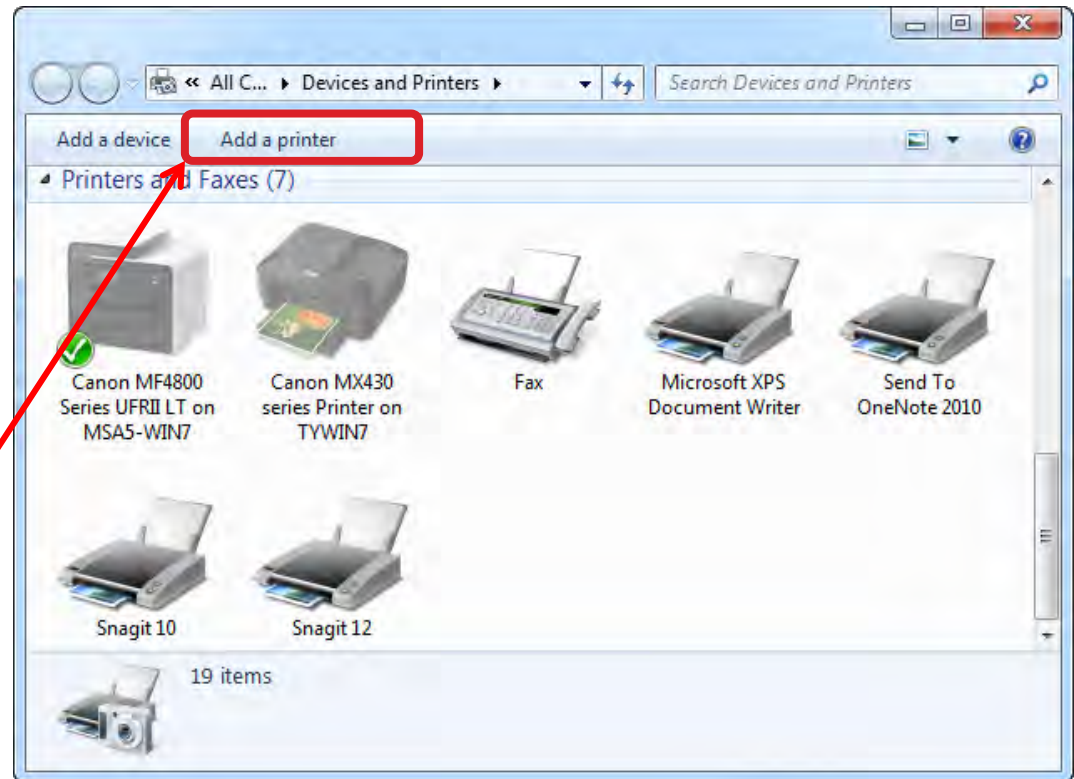



- **Printer Types**
- **Installing and Configuring Printers**
- **Configuring Printers in Windows**
- **Troubleshooting Printer Problems**
- **Scanners**



# Common Printer Problems

## ➤ **Connection faults**

- Loose printer cable or cable plugged into wrong connector
- Incorrect printer cable type

## ➤ **Printer configuration faults**

- Incorrect printer operation mode settings (page size, line width, line feeds, etc.)

## ➤ **Software faults**

- Printer driver used by application program does not match printer

## ➤ **Power-line faults**

- Power-line voltage fluctuation caused by high-current printer operation



# Basic Troubleshooting Method

## ➤ Preliminary checks

1. Make sure printer cable is connected securely to correct connectors
2. Check printer status: Online? Out of paper? Paper jam? etc.
3. Reset computer and printer; print test document

## ➤ Check printer interface configuration

4. Check that the computer interface matches the printer interface

## ➤ Check printer cables and path to printer (print-sharing devices)

5. Check that correct printer is set as default printer

## ➤ Test printer operation

6. Run printer self-test program (see printer manual)



# Basic Troubleshooting Method

## ➤ Test printer calibration

7. Print a test pattern (available from printer and ink manufacturers)
  - Graphics test patterns show black/white gradient bars and patterns
  - Color test patterns show reference bars of color
    - Cyan Magenta Yellow Key (black)

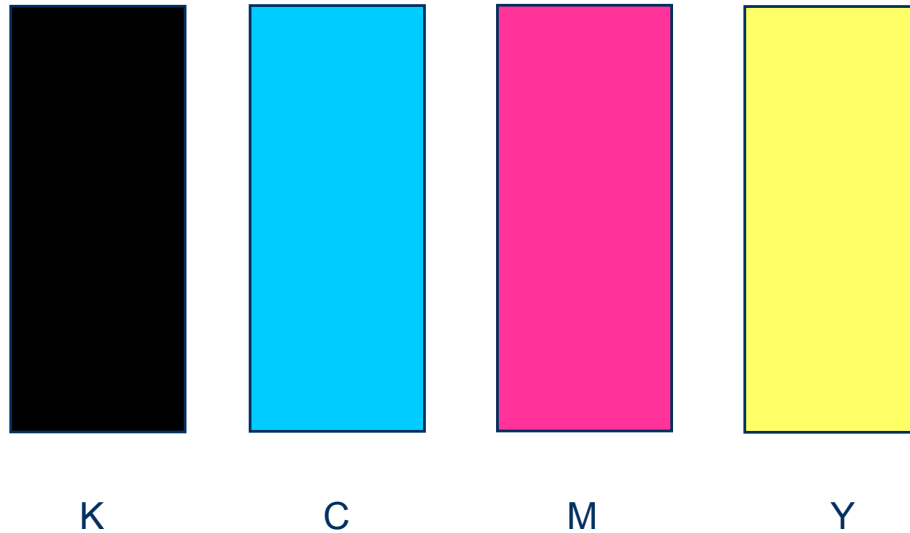

# Troubleshooting Impact (Dot-Matrix) Printers

Symptom or problem	Probable cause
No connectivity	Printer cable or configured for incorrect port
Printing is faded or uneven	Ribbon cartridge needs replacement
Paper jams or creased paper	Wrong paper type or weight (measure of paper thickness), or paper has been left in damp environment
Tops of characters missing or print fades from one side of paper to the other	Print head is misaligned with platten (main roller)
Single, thick black line of garbled characters	Paper advance mechanism not working
Print head moves slightly on startup, but does not move during printing	Main control board may be defective

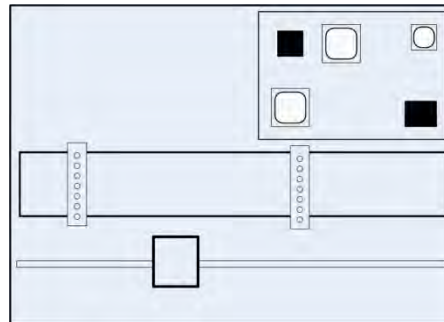

# Troubleshooting Inkjet Printers

Symptom or problem	Probable cause
Printing is faded or uneven	Ink jet nozzles are clogged  Run maintenance software provided with printer to clean nozzles, then print test page
Paper not feeding	Pick up rollers need replacement
Printing is very faint, or not visible at all	Ink cartridge needs replacement
Single, thick black line of garbled characters	Paper advance mechanism not working
Color prints in wrong color	Nozzle for one or more colors is clogged, or one or more ink cartridges need replacement



# Troubleshooting Laser Printers

Symptom or problem	Probable cause
Blank pages	Out of toner Failed power supply, laser or transfer corona wire
Paper wrinkles or jams	Wrong paper type or weight (measure of paper thickness), or paper has been left in damp environment
Ghost images	Cleaning blade needs replacement
Streaks	Clean excess toner from cartridge/replace cartridge (defective electrostatic drum)
White areas throughout printout or blotchy print	Toner is not evenly distributed in cartridge (shake toner cartridge)
Print can be smudged when touched	Fuser is dirty or damaged
Vertical lines on page	Drum is damaged



# Troubleshooting Computer Printing Problems

Symptom or problem	Probable cause
Backed up print queue	Printer is offline
Low memory errors	Insufficient memory installed on printer
Access denied	Network printer does not have proper permissions configured
Printer will not print	Missing or incorrect printer driver/mechanical error on printer
Unable to install printer	Wrong version of printer driver for operating system (32-bit vs. 64-bit)
Error codes	Google printer error codes to determine problem being reported





# Laser Printer Maintenance

- **Manufacturer's laser printer maintenance kits contain commonly replaced components**
  - Note: Kit content can vary according to specific printer
- **Common replacement components**
  - Fuser
  - Transfer roller
  - Pick-up rollers and separation rollers
- **Maintenance procedures**
  - Apply maintenance kit
  - Cleaning (use toner vacuum)
  - Calibration
  - Reset page count after maintenance is completed

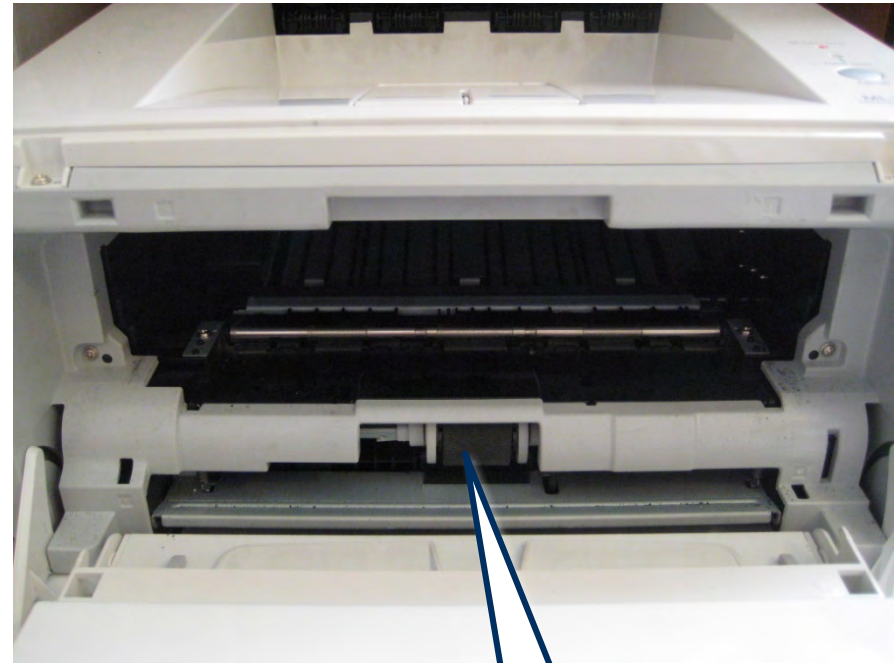

Pick-up roller



- **Printer Types**
- **Installing and Configuring Printers**
- **Configuring Printers in Windows**
- **Troubleshooting Printer Problems**
- **Scanners**



# Scanner Components

## ➤ Scanning head

- Contains high-intensity light source
- Stepper motor moves scanning head on rails to scan document on scanner bed

## ➤ Mirrors

- Reflect current line being illuminated by scanning head toward light sensor array

## ➤ Light sensor array

- Receives image of current line being illuminated, converts to digital data



# Installing Scanners

1. **Unpack and remove any locking devices on scanning head**
2. **Connect AC power**
3. **Install correct scanner driver**
4. **Connect (USB) scanner cable**



# Review Questions

1. A(n) \_\_\_\_\_ printer uses a tractor-feed drive to print continuous forms.
  - A. Impact (dot-matrix)
  - B. Inkjet
  - C. Thermal
  - D. Laser
  
2. Which is *not* one of the six stages in laser printer operation?
  - A. Cleaning
  - B. Fusing
  - C. Toning
  - D. Charging



# Review Questions

3. The \_\_\_\_\_ corona wire charges the photosensitive drum in a laser printer to a high negative voltage (-600 V).
- A. Primary
  - B. Secondary
  - C. Transfer
  - D. Final
4. A user complains that they are not able to print from a laptop using a printer's infrared IrDA link. What is the maximum and recommended distance the laptop can be from the printer?
- A. 2 meters (6 ft), 1 meter (3 ft)
  - B. 1 meter (3 ft), .5 meter (1.5 ft)
  - C. 5 meters (15 ft), 1 meter (3 ft)
  - D. 10 meters (30 ft), 5 meters (15 ft)



# Review Questions

5. To start or stop the Windows Print Spooler service, use Start | Control Panel | Administrative Tools | \_\_\_\_\_.
- A. Printer Queue, Print Spooler
  - B. Services, Print Spooler
  - C. Print Spooler, Administrative Tools
  - D. Set as Default Printer



# Chapter Summary

In this chapter, you have learned how to

- **Identify and describe the basic characteristics of printer technologies, including impact (dot-matrix), inkjet, thermal, and laser**
- **List basic printer installation and configuration steps**
- **Describe the Windows printing process and considerations for installing Windows printer drivers**
- **Describe troubleshooting procedures and solutions for common printer problems**
- **Identify basic components and describe configuration/troubleshooting procedures for scanners**





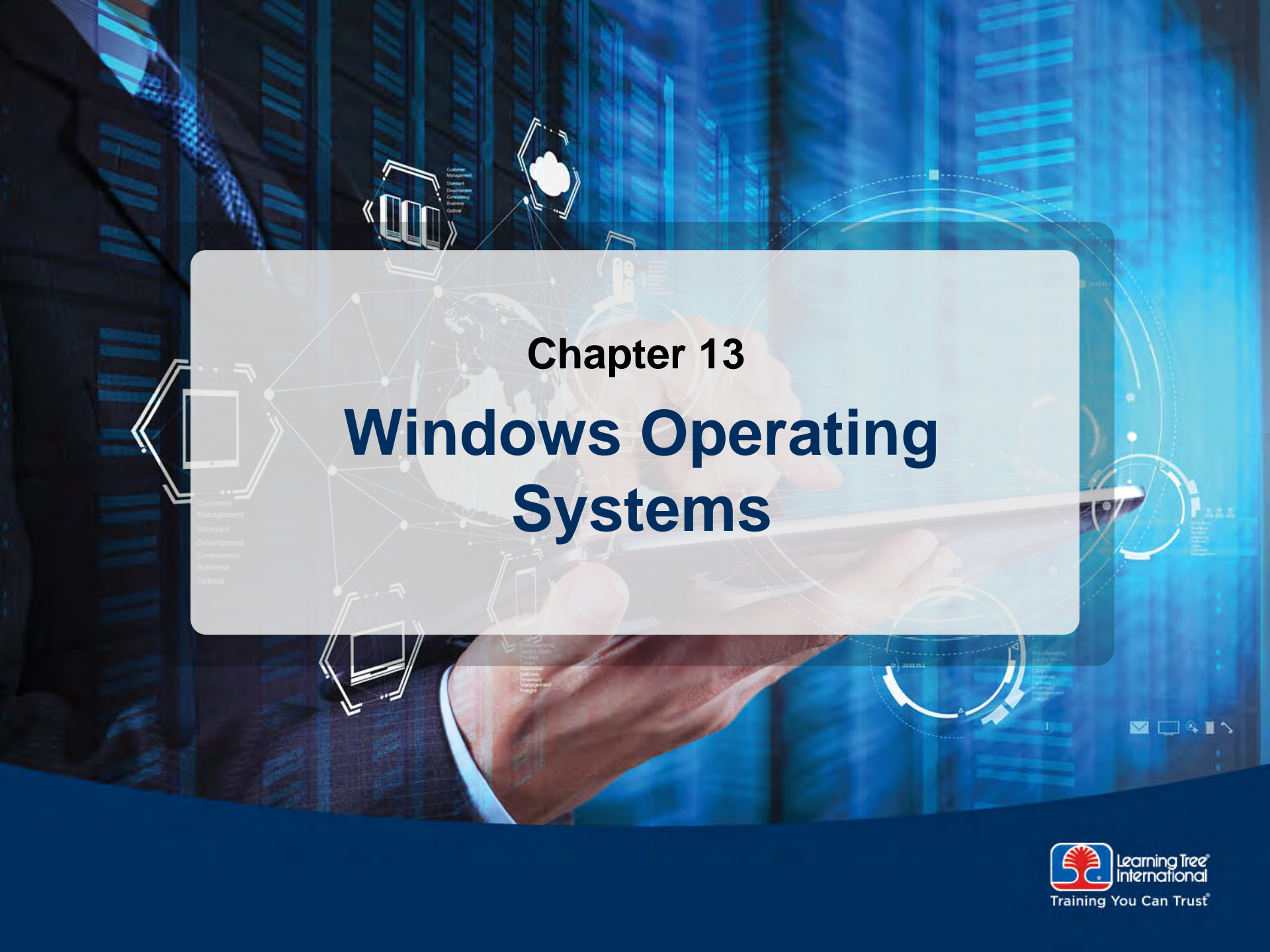

# Chapter 13

# Windows Operating Systems

Customer  
Management  
Standard  
Development  
Consistency  
Business  
Optimal

# Chapter Objectives

---

**In this chapter, you will learn how to**

- **Describe Windows desktop and command line features and commands**
- **Identify names and purposes of Windows boot files**
- **Describe the fundamental operation of Windows file systems and memory management**
- **Explain the basic structure of the Windows registry**



## ➤ **Operating Systems Introduction**

- **Windows Basic Features/Navigation**
- **Windows Building Blocks**
- **Troubleshooting Windows Operating System Problems**



## ➤ **Windows Versions (covered in A+ 2015 exam)**

- Windows Vista
- Windows 7
- Windows 8/8.1



# Windows 32- vs. 64-Bit Versions

- **Windows is available in 32- and 64-bit versions**
- **Windows 32-bit versions**
  - Utilize the x86 instruction set
    - Instruction set designed for 32-bit registers of Intel 8086 used in original IBM PC
  - Support up to 4 GB RAM (theoretical limit)
- **Windows 64-bit versions**
  - Utilize the x64 instruction set
    - Superset of x86 instruction set
    - Able to use 64-bit registers and also run 32-bit applications
  - Supports up to 128 GB RAM (theoretical limit)
- **Application compatibility considerations**
  - Windows 64-bit versions do not support 32-bit device drivers



# Application Compatibility

## ➤ Application compatibility considerations

- Windows 64-bit versions do not support
  - 16-bit (MS-DOS) applications
  - 32-bit device drivers

## ➤ Running older programs on Windows

- Windows compatibility mode supports previous Windows environments
- Right-click application
- Select **Properties**
- Click the **Compatibility** tab

## ➤ Running older programs on Windows 7

- Windows XP mode allows running older programs in a Windows XP virtual environment

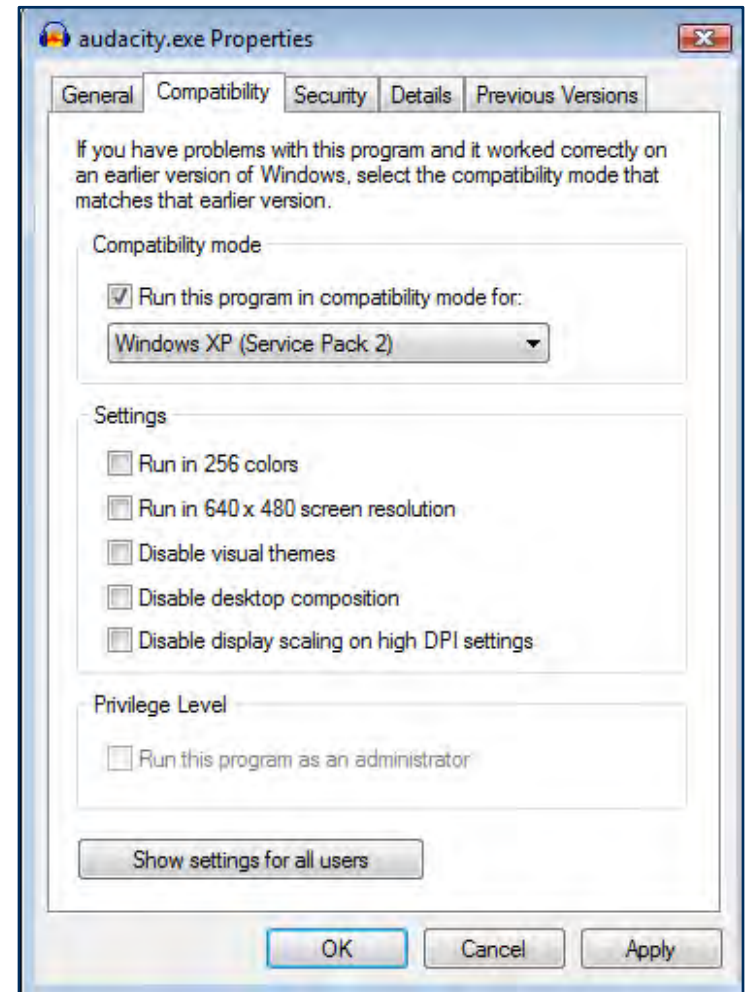

- **Operating Systems Introduction**
- **Windows Basic Features/Navigation**
- **Windows Building Blocks**
- **Troubleshooting Windows Operating System Problems**



# Windows Vista Desktop

## ➤ Windows Vista desktop includes Sidebar area

- Gadgets (mini-programs) can be docked in Sidebar area
  - Add gadgets by right-clicking **Sidebar**, then selecting **Add Gadgets**

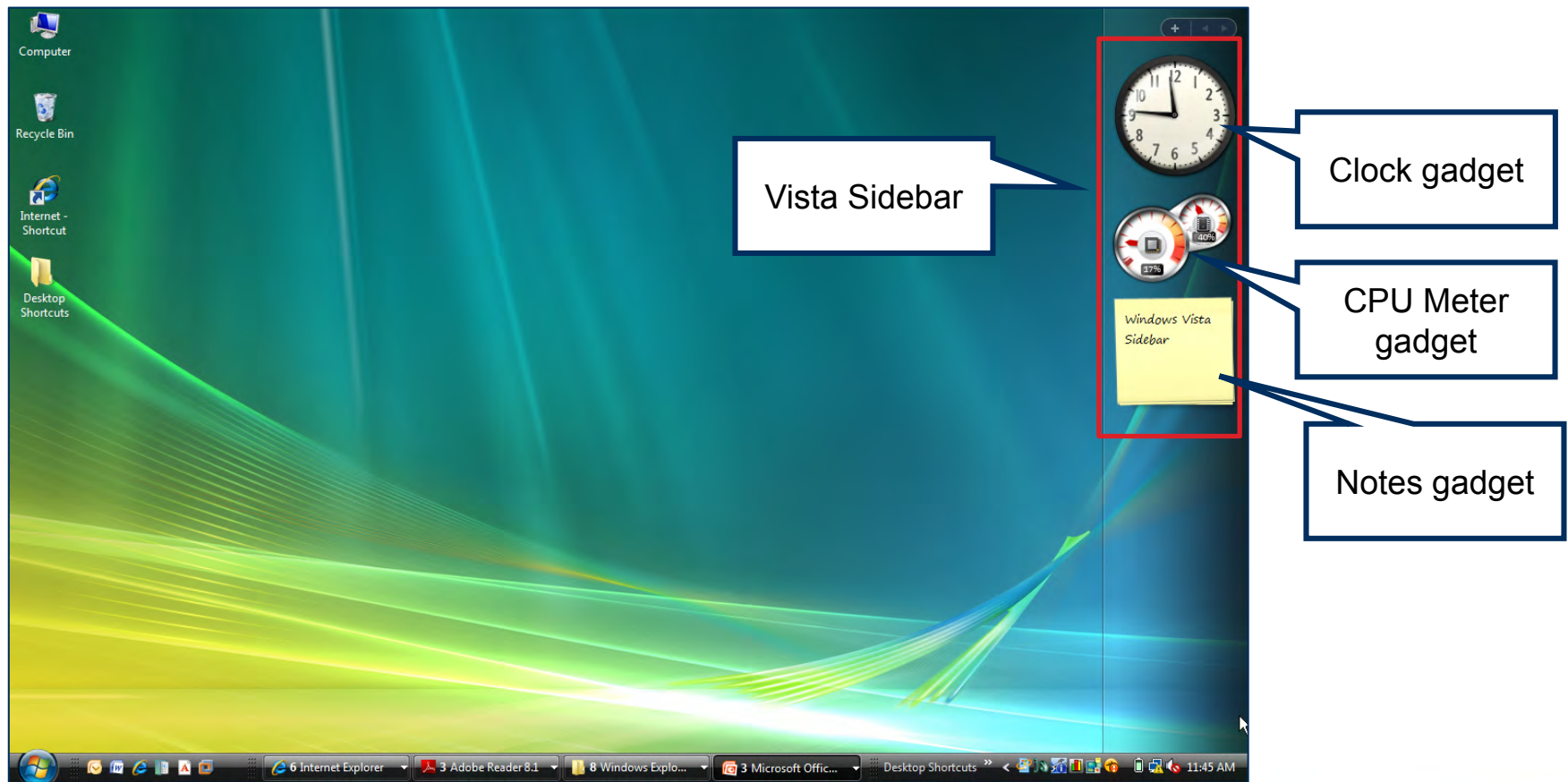



# Windows 7 Desktop

## ➤ Windows 7 desktop supports gadgets

- Gadgets (mini-programs) can be placed anywhere on desktop
  - Add gadgets by right-clicking desktop, then selecting **Gadgets**



# Windows 8.1 Desktop

- **Windows 8/8.1 Start Screen features tiles for Windows Apps**
  - Add gadgets by right-clicking desktop, then selecting Gadgets
  - Click on Desktop tile to switch to standard Windows desktop view

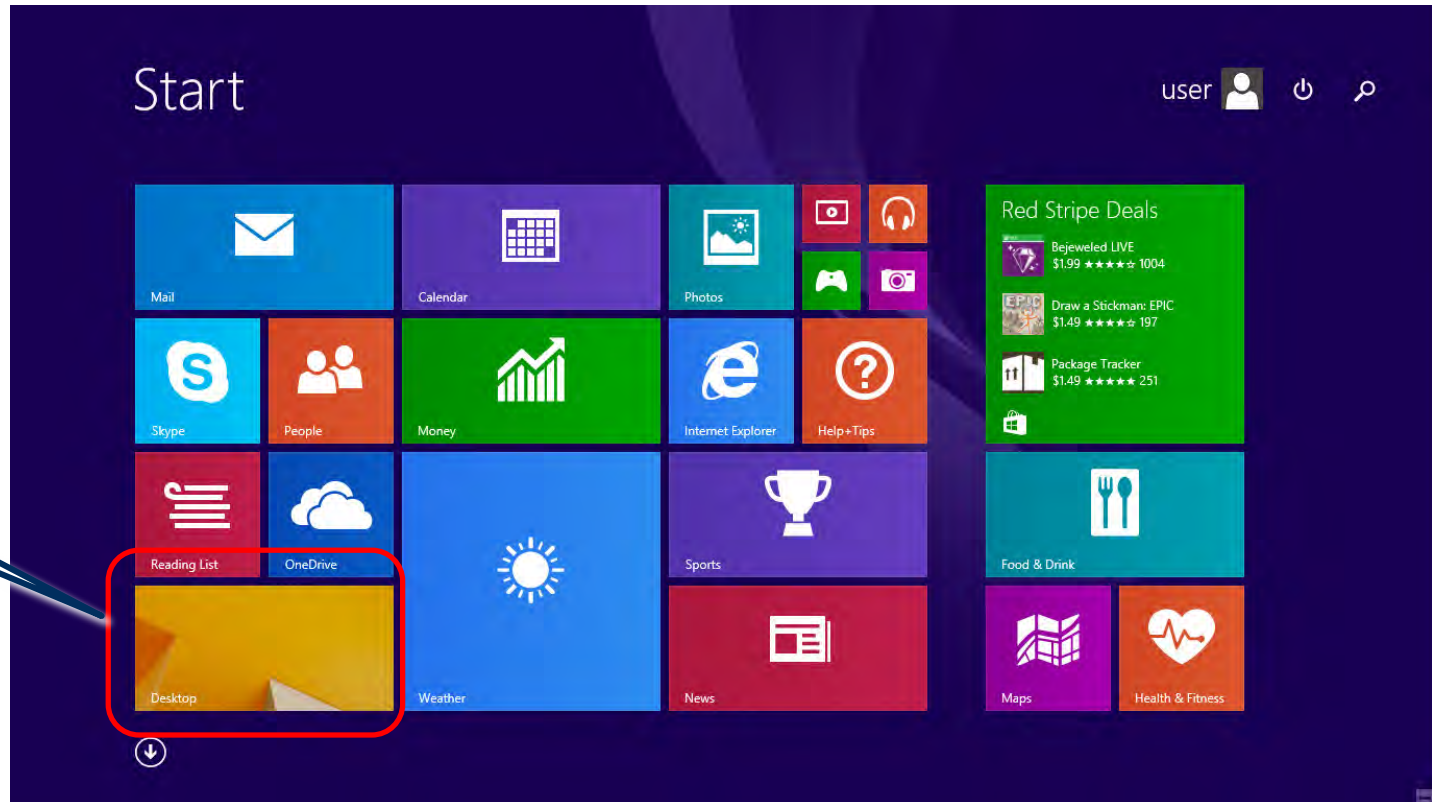

# Windows Features

## ➤ Aero user interface

- Modern display interface provides transparent windows
- Requires display adapter card with 128 MB RAM

## ➤ User Account Control (UAC)

- New security feature runs application programs with standard user privileges
- Requires elevation to Administrative level to make changes that affect system
  - Prevents malware from making unauthorized changes to systems

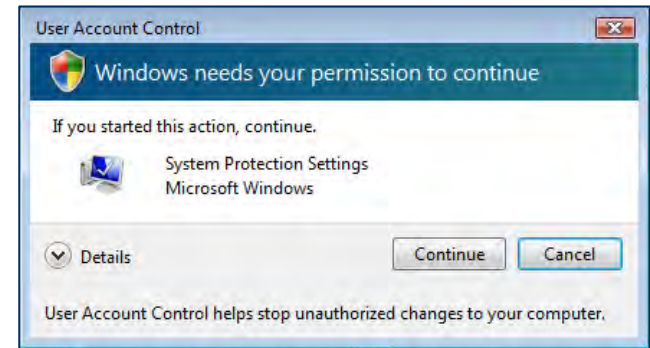

# Windows Display Configuration

## ➤ Setting display resolution

- Right-click desktop, then select **Screen Resolution**
  - Set display resolution
  - Configure multiple displays, etc...

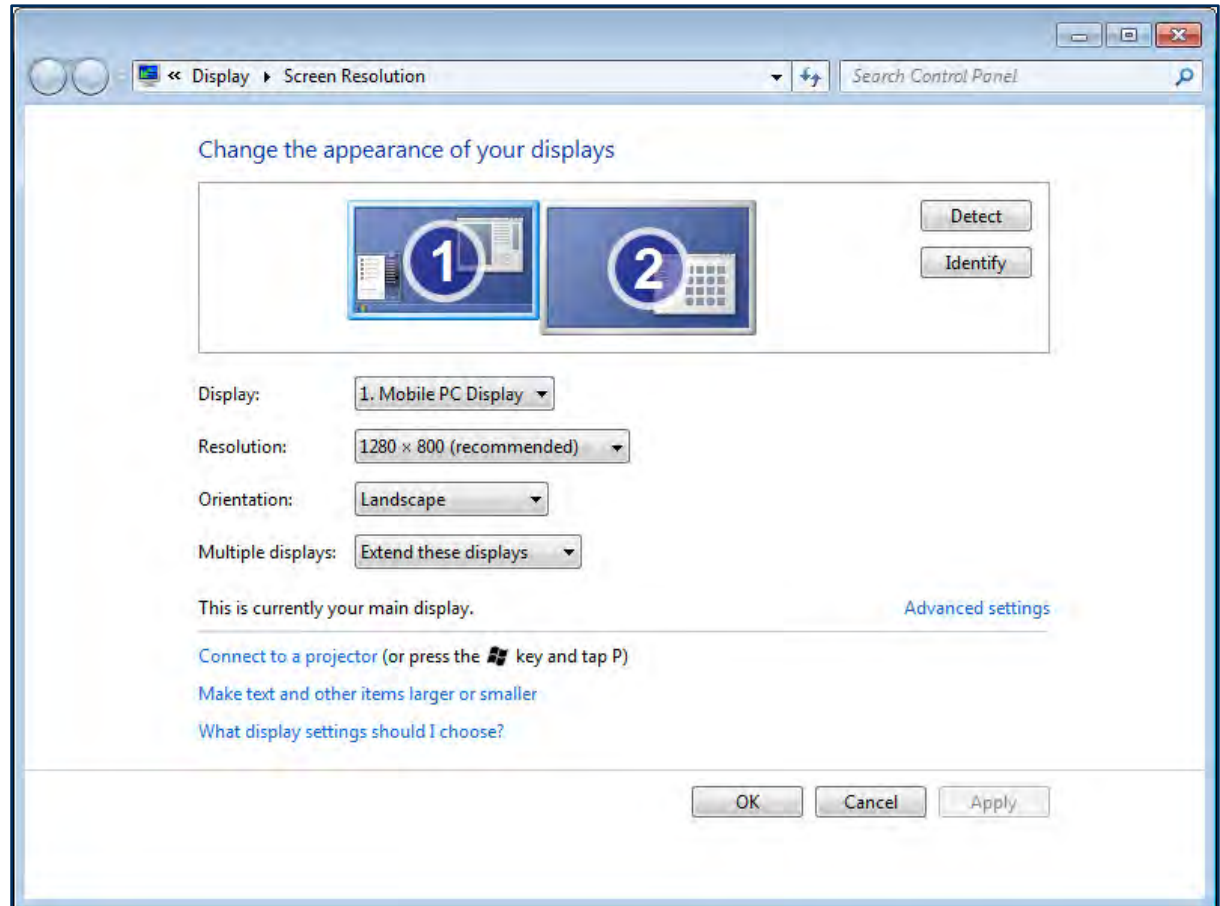

# Windows XP Mode

## ➤ What is Windows XP mode?

- A virtual machine package designed to run under Windows Virtual PC
  - Pre-installed, licensed version of Windows XP SP3
- Designed to support older applications that won't run under Windows 7

## ➤ Installing Windows XP mode on Windows 7

- Available as a free download from Microsoft site
- Install the following programs in order
  1. Windows XP Mode
  2. Windows Virtual PC
- Note: requires Intel VT (Virtualization Technology)
  - Must be supported by CPU and enabled in BIOS



SP3 = Service Pack 3



# Windows XP Mode

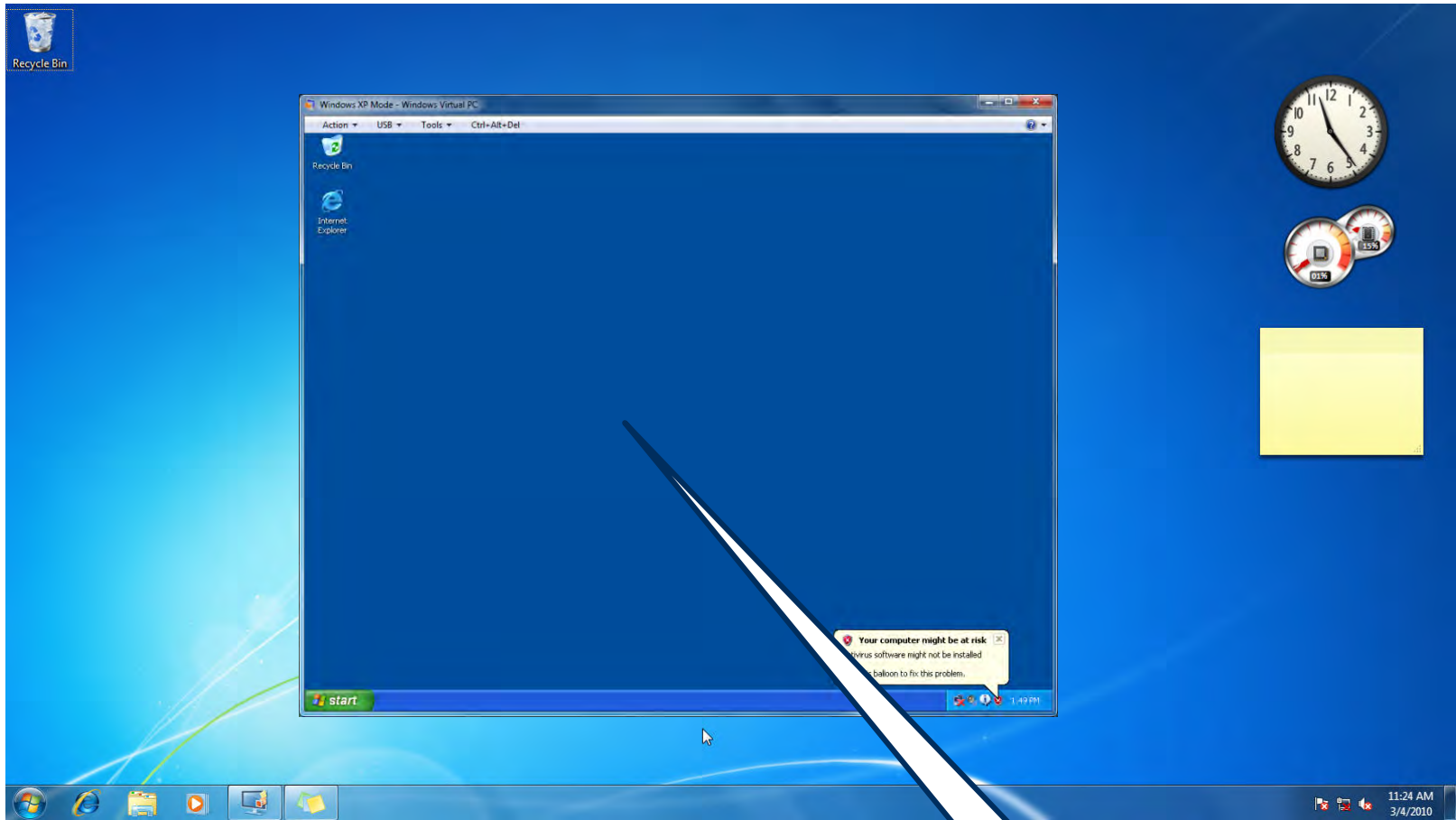

Windows XP  
Mode



# Windows Desktop Navigation Shortcut Keys









- **Shortcut keys provide a fast way to navigate through desktop items**
  - Also useful when mouse is unavailable or inoperable

Shortcut key(s)	Function
<Ctrl><Esc>	Toggle Start menu
<Tab>	Move forward through selection options
<Shift><Tab>	Move backward through selection options
<Alt><Tab>	Fast switch through open application windows
<Alt> double-click	Display properties of target object



# Windows Shortcut Keys

- The special Windows logo key (<

Windows key shortcuts	Function
<  <td>Toggle Start menu</td>	Toggle Start menu
<  <td>Minimize all windows and display desktop</td>	Minimize all windows and display desktop
<  <td>Display Windows Explorer</td>	Display Windows Explorer
<  <td>Find files or folders</td>	Find files or folders
<  <td>Lock Windows</td>	Lock Windows
<  <td>Minimize all windows</td>	Minimize all windows
<  <td>Open Run dialog</td>	Open Run dialog
<  <td>Display System Properties dialog</td>	Display System Properties dialog





# Windows Taskbar

## ➤ Windows 7 taskbar

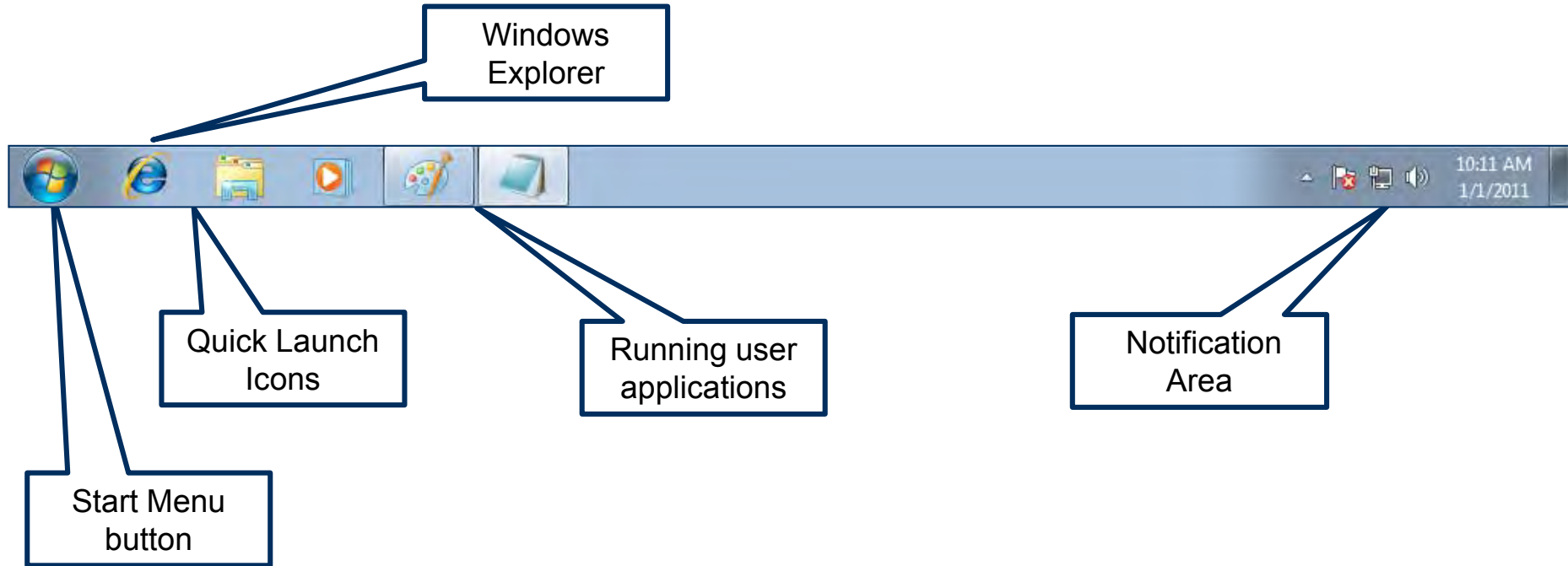

# Start Menu (Windows 7)

## ➤ Windows 7 Start menu

- Similar to Vista Start menu

## ➤ Windows 7 Search box

- Type in the program name or search item
  - Windows 7 Search files and contents, so search is very fast
- Enter **Indexing Options** to access dialog to configure Indexing settings

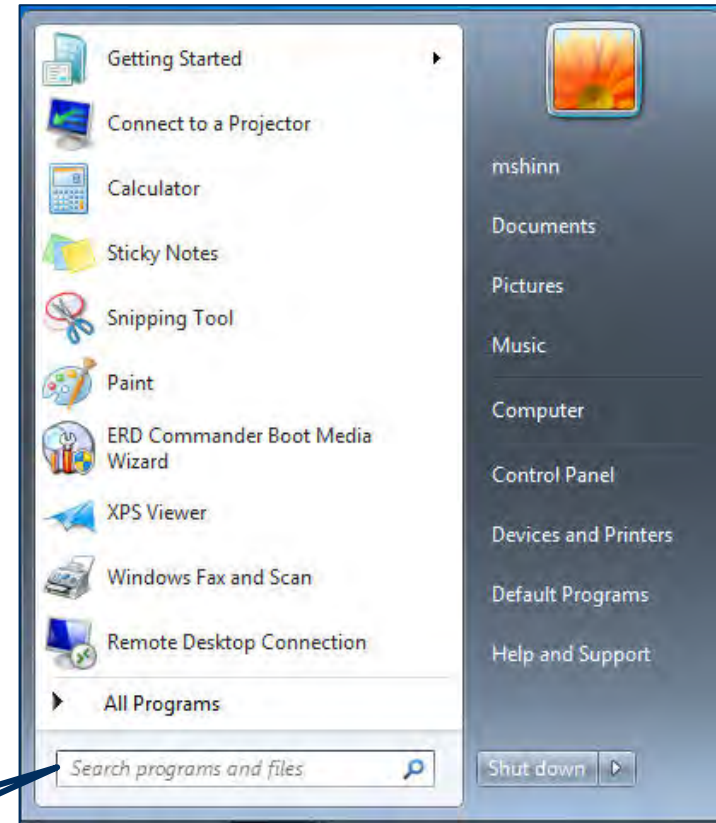
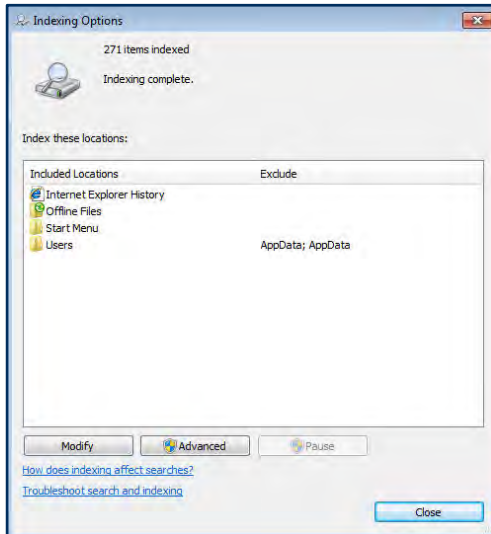

Windows  
Search box



# Windows Command-Line Environment

## ➤ Windows provides a command-line environment

- Invoked using Start | Run, then type `cmd`
- Or, press the start <img alt="Windows logo" data-bbox="342 181 376 215"/> <R>, then type `cmd`
- Or type `cmd` in Windows Search Box

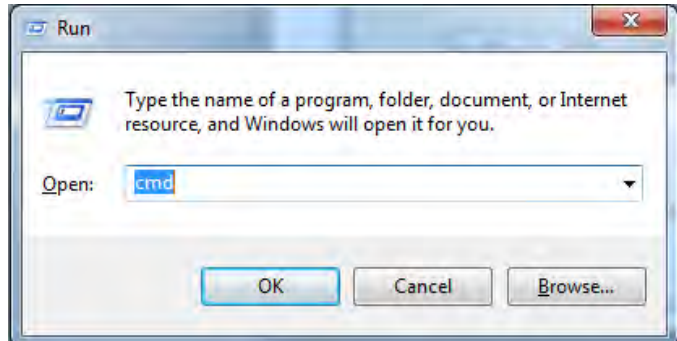

# Windows Command-Line Environment

## ➤ Obtaining help for commands

- Type `help` to obtain a list of all commands with descriptions
- Type `help <specific command>` or `<command name> /?` to obtain detailed help for a command
  - Example: `help attrib`

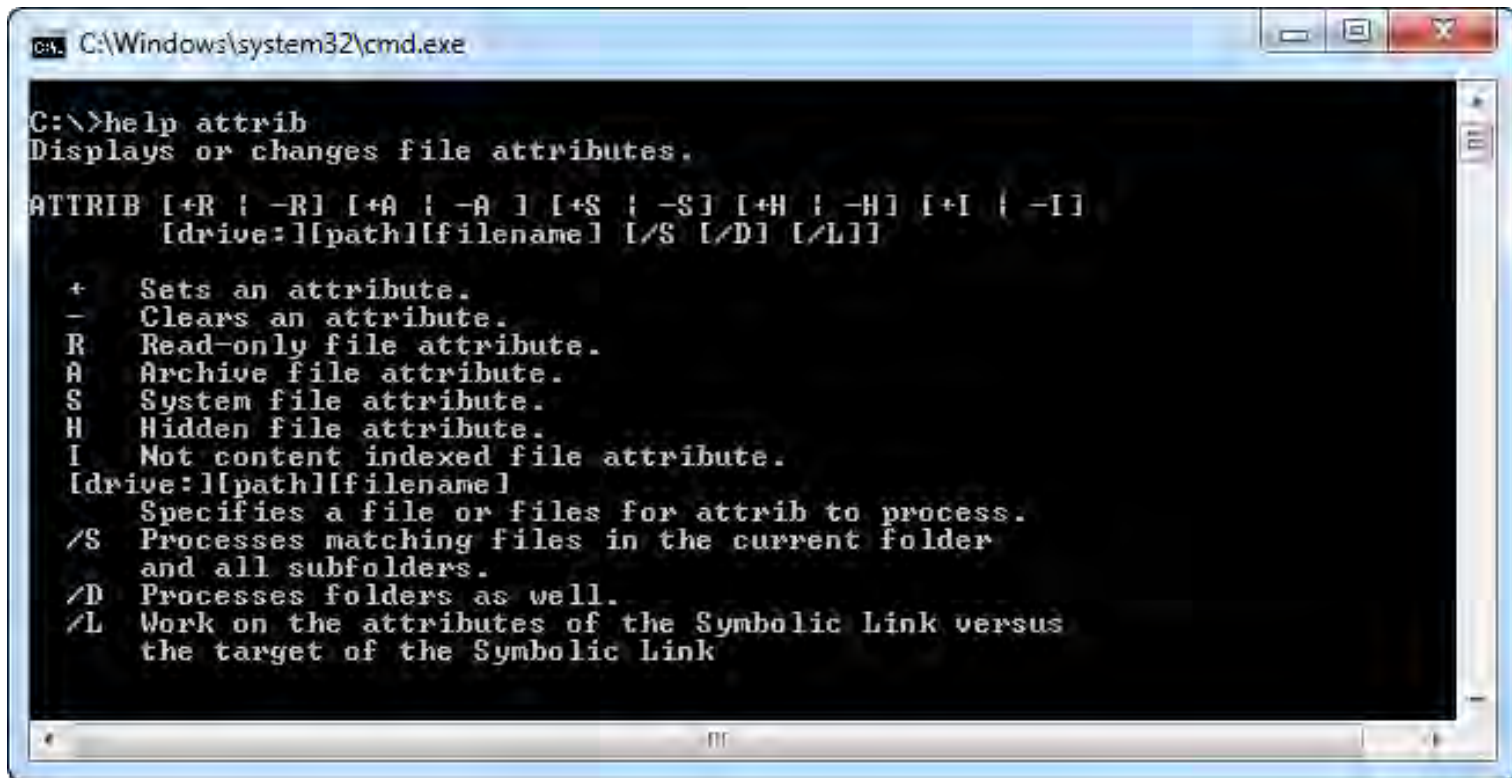

```
C:\Windows\system32\cmd.exe

C:\>help attrib
Displays or changes file attributes.

ATTRIB [+R | -R] [+A | -A ] [+S | -S] [+H | -H] [+I | -I]
      [drive:][path][filename] [/S [/D] [/L]]

+   Sets an attribute.
-   Clears an attribute.
R   Read-only file attribute.
A   Archive file attribute.
S   System file attribute.
H   Hidden file attribute.
I   Not content indexed file attribute.
[drive:][path][filename]
    Specifies a file or files for attrib to process.
/S  Processes matching files in the current folder
    and all subfolders.
/D  Processes folders as well.
/L  Work on the attributes of the Symbolic Link versus
    the target of the Symbolic Link
```



# Windows Command-Line Environment

## ➤ **Command switches**

- A command switch is a modifier that enhances or alters the behavior of a command
  - Command switches follow the command, and are preceded by a forward slash (/)

## ➤ **Example: command switches for the DIR command**

- /A Displays files with specified attributes
  - D Directories
  - H Hidden files
  - S System files
  - R Read-only files
  - A Files ready for archiving
- /S Displays files in specified directory and all subdirectories

## ➤ **Example: DIR /AR will display all files that are read-only**



# Windows Command-Line Environment

## ➤ **Example: Command switches for the XCOPY command**

- XCOPY can be used to copy both files and directories
  - /S Copy directories and subdirectories except for empty ones
  - /e Copy directories and subdirectories including empty ones

## ➤ **EXPAND command**

- Expands compressed Windows files
  - Windows compressed files end with underscore (.ex\_, for example)
- Example:
  - `EXPAND D:\i386\ntoskrnl.ex_`  
`C:\Windows\System32\ntoskrnl.exe`
  - Expands compressed file `ntoskrnl.ex_` on Windows installation disk to `ntoskrnl.exe` on hard disk



# Windows Command-Line Environment

## ➤ Common commands:

Command	Description
CD	Change directory
MD	Make directory
RD	Remove directory
DIR	List all files in directory
ATTRIB	Display/change file attributes
EDIT	Start full screen editor
COPY	Copy a file
XCOPY	Copy a file or directory
ROBOCOPY	Robust file copy (more sophisticated copy utility)
DEL	Delete a file
FORMAT	Format a disk
EXIT	Exits current batch script



# Windows Command-Line Environment

## ➤ Advanced commands:

Command	Description
TASKKILL	Stops process
BOOTREC	Repairs Win7 Master Boot Record
SHUTDOWN	Shuts down local or remote computer
TASKLIST	Displays Task List (list of running processes)
FDISK	Partitions disk (Win 9x)
DISKPART	Partitions disk (Vista, Win7)
CHKDSK	Check Disk
SFC	System File Checker (checks Windows system files)

Command	Description
GPUPDATE	Refreshes Active Directory Group Policy settings
GPRESULT	Displays Resultant Set of Policy for specified computer  - Group Policy Objects that have been applied and their settings
EXPAND	Expands compressed Windows update files





- **Operating Systems Introduction**
- **Windows Basic Features/Navigation**
  - **Hands-On Exercise 13.1**
    - Windows Control Panel
    - Hands-On Exercise 13.2
- **Windows Building Blocks**
- **Troubleshooting Windows Operating System Problems**



*In your Exercise Manual, please refer to  
Hands-On Exercise 13.1:  
Exploring the Windows Command-Line Environment*



- **Operating Systems Introduction**
- **Windows Basic Features/Navigation**
  - Hands-On Exercise 13.1
  - **Windows Control Panel**
  - Hands-On Exercise 13.2
- **Windows Building Blocks**
- **Troubleshooting Windows Operating System Problems**



# Windows Explorer (Windows 7)

- In Windows 7, click Windows 7 Explorer icon (looks like a folder) in taskbar
  - Note: Default view shows Windows 7 Libraries (collections of User Files)

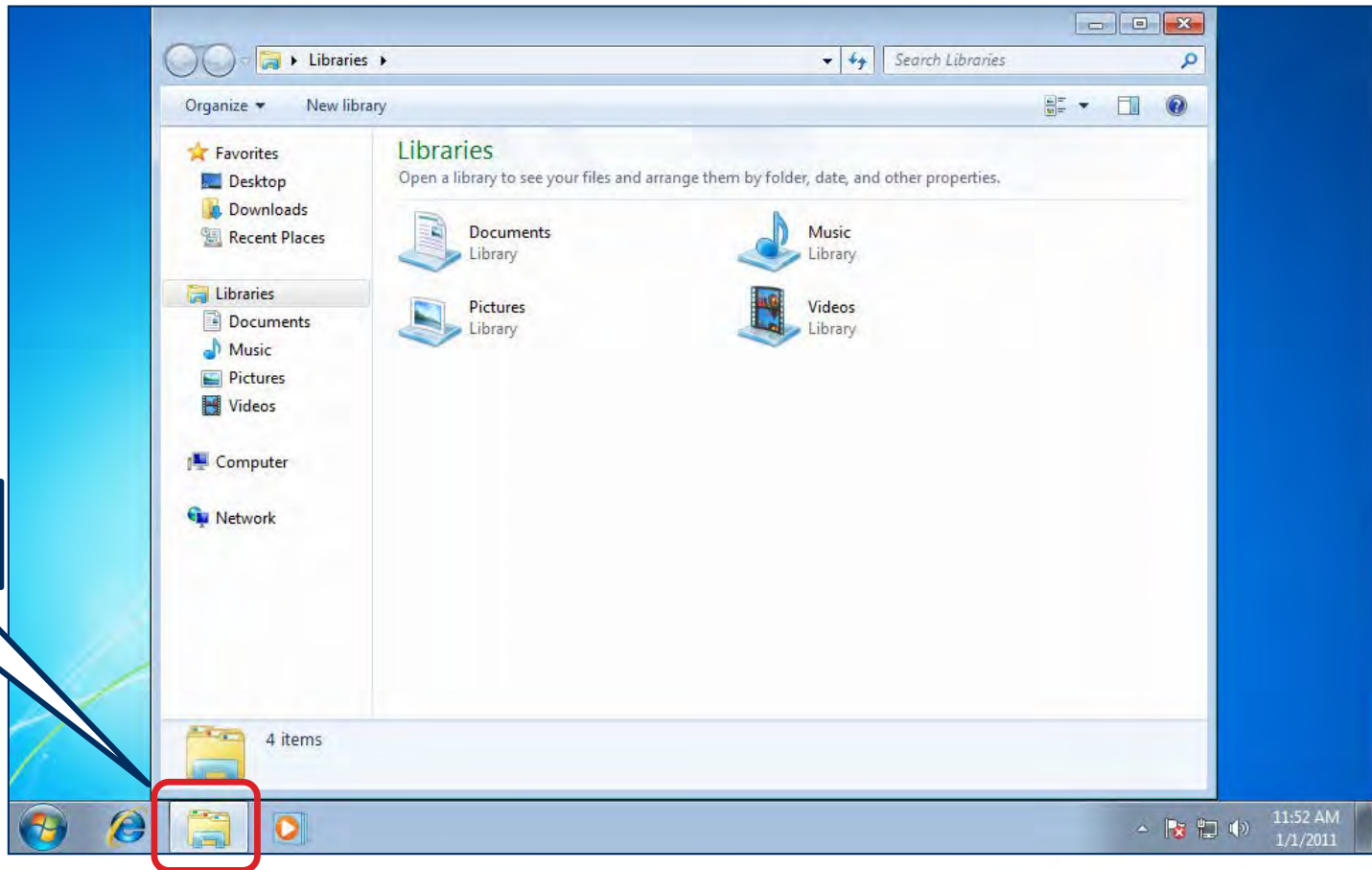

# Windows Explorer: Changing Views

## ➤ Changing views

- Click drop-down arrow of Views icon
- Select desired view (Thumbnails, Tiles, Details, etc.)

## Windows 7

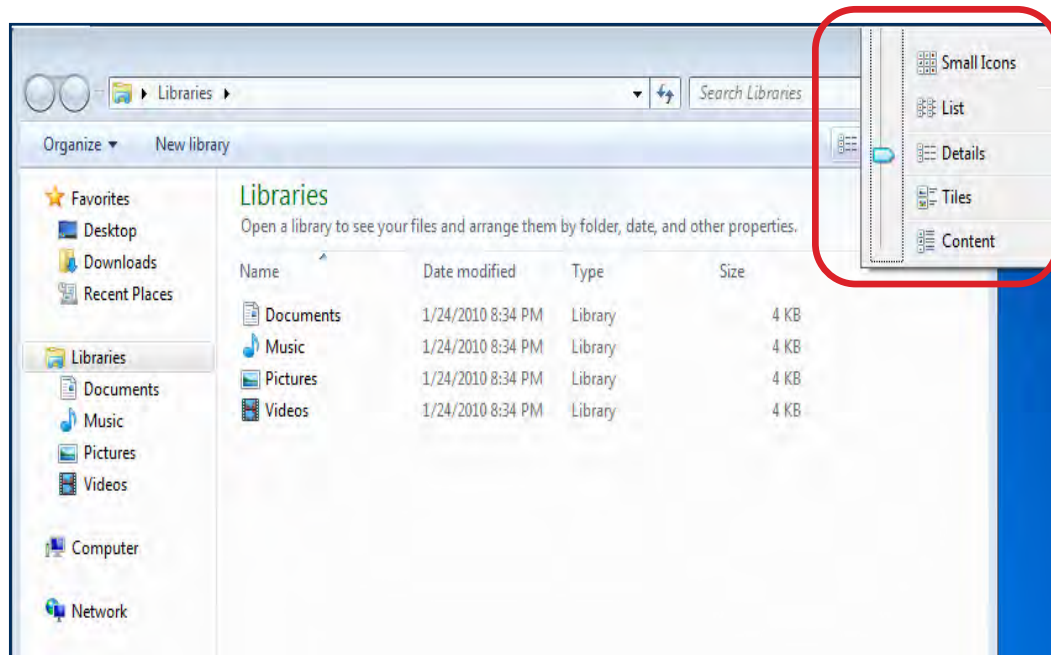

# Windows Folder and Search Options (Windows 7)

- **To display Windows Folder and Search options in Windows 7**
  - In Windows Explorer, click drop-down arrow next to Organize
    - Select **Folder and search options**

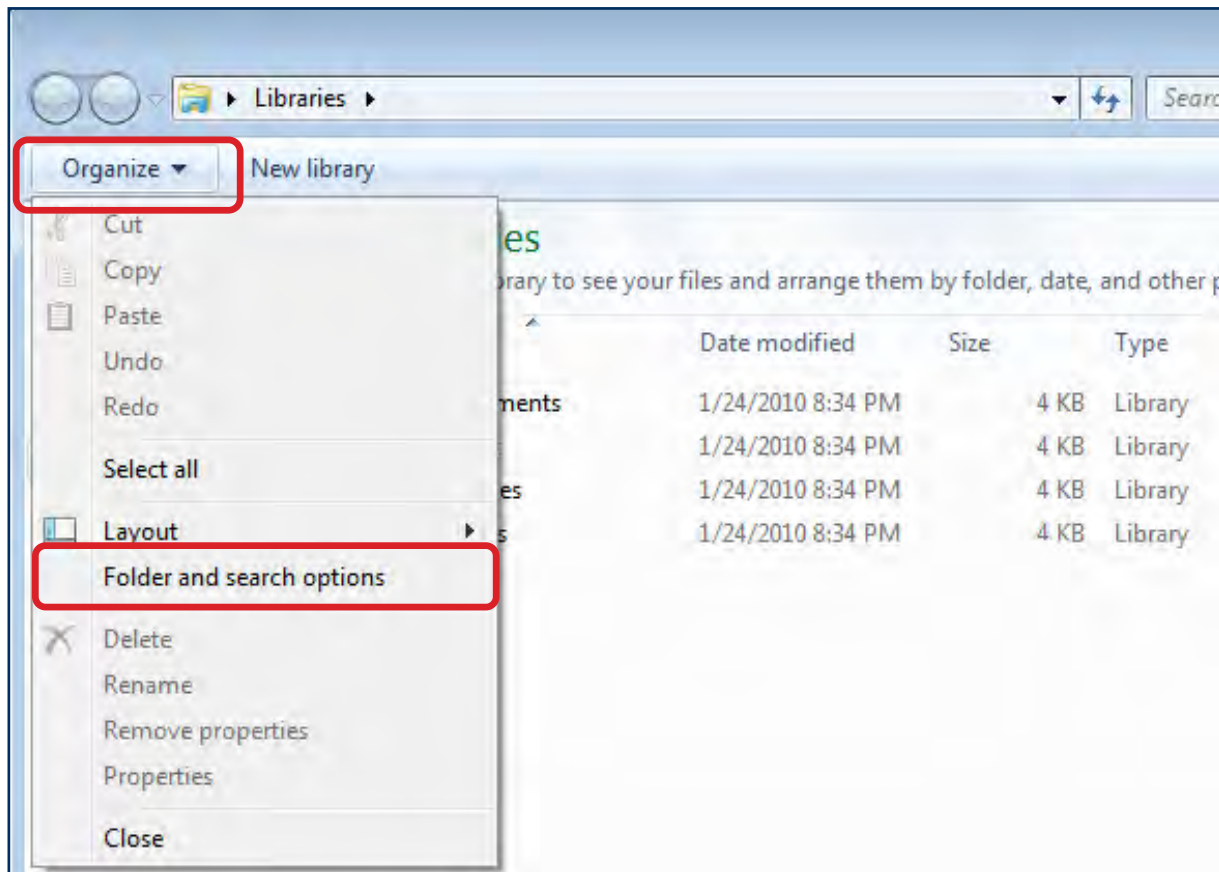

# Windows Explorer: Hidden File Types

- **System files and folders**
- **System files (.sys, .ini, .dat) are hidden by default**
  - From Windows Explorer or My Computer
    - Use Organize | Folder and Search Options
  - Click View tab
    - Select “Show hidden files and folders” to display hidden files
    - Clear the “Hide extensions for known file types” checkbox to display file extensions
  - Click “Apply to All Folders” to set for all folders
- **To display/change file attributes**
  - Right-click file and select Properties

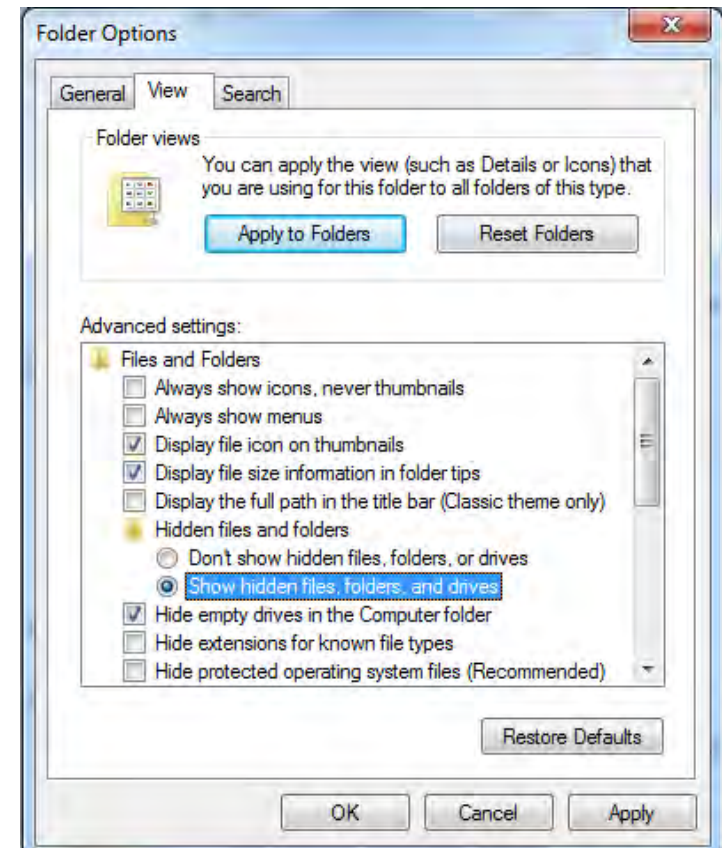

# Windows Control Panel

## ➤ Windows Control Panel

- Set of utilities (called applets) used to manage system hardware and software

## ➤ Displayed as

- Category view
- Icon view (classic view)

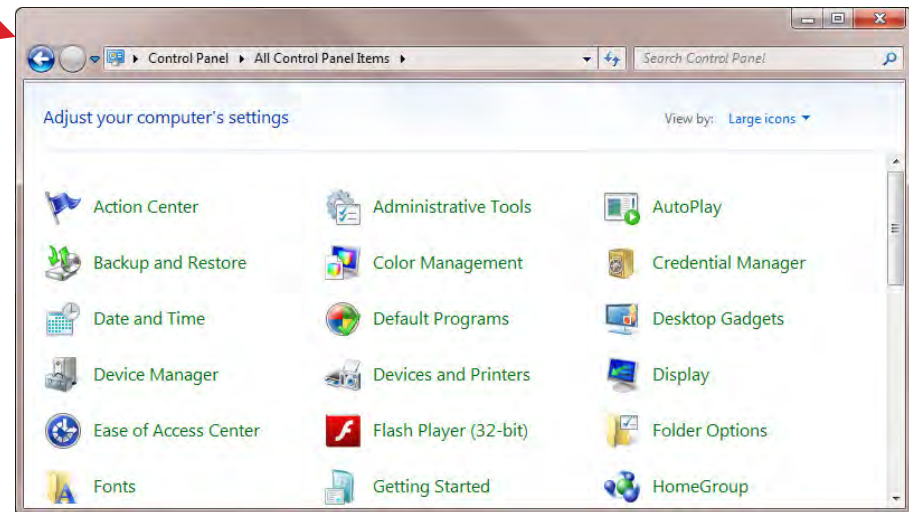



# Windows Control Panel: Internet Options

## ➤ Control panel (icon view)

- Click Internet Options

## ➤ General

- Set home page
- Manage browsing history

## ➤ Security

- Configure security levels
- Specify trusted sites

## ➤ Privacy

- Configure types of personal tracking information allowed (cookies)

## ➤ Content

- Configure parental controls
- Digital certificates

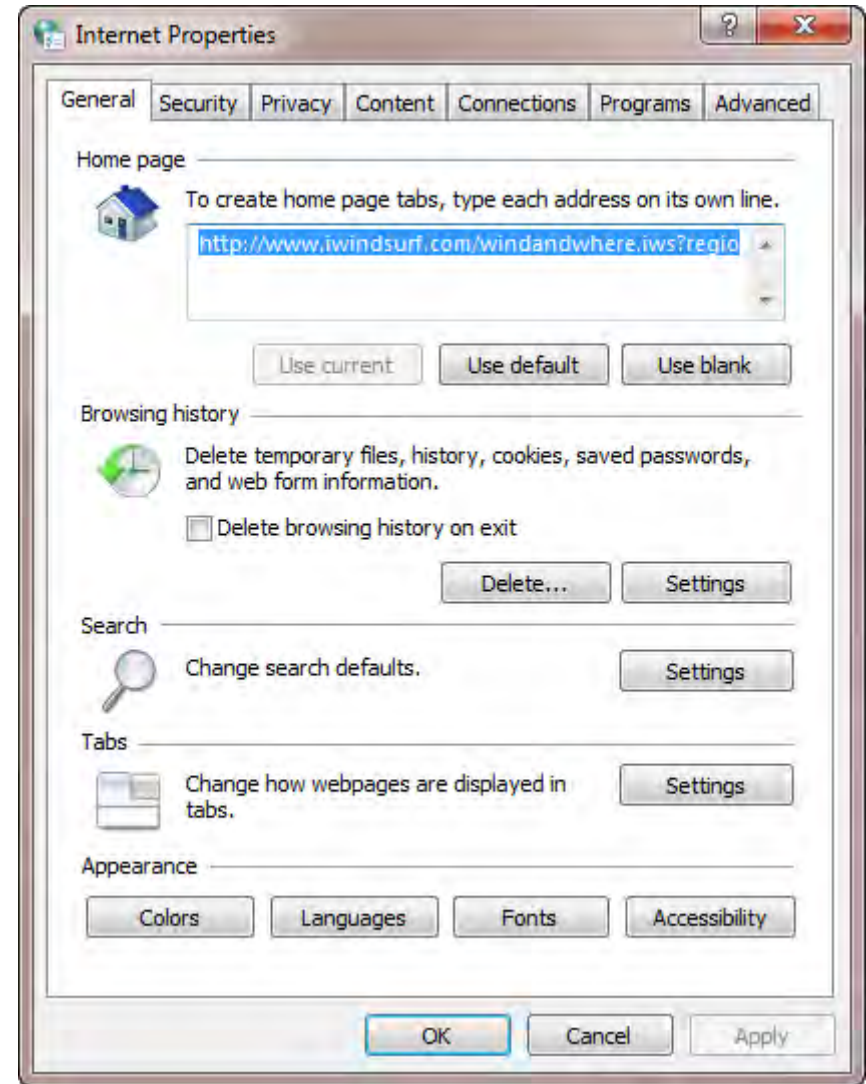

# Windows Control Panel: Internet Options

## ➤ Connections

- Set up Internet connections

## ➤ Programs

- Set default web browser
- Manage add-ons

## ➤ Advanced

- Configure advanced Internet settings
  - Additional settings for each tab category

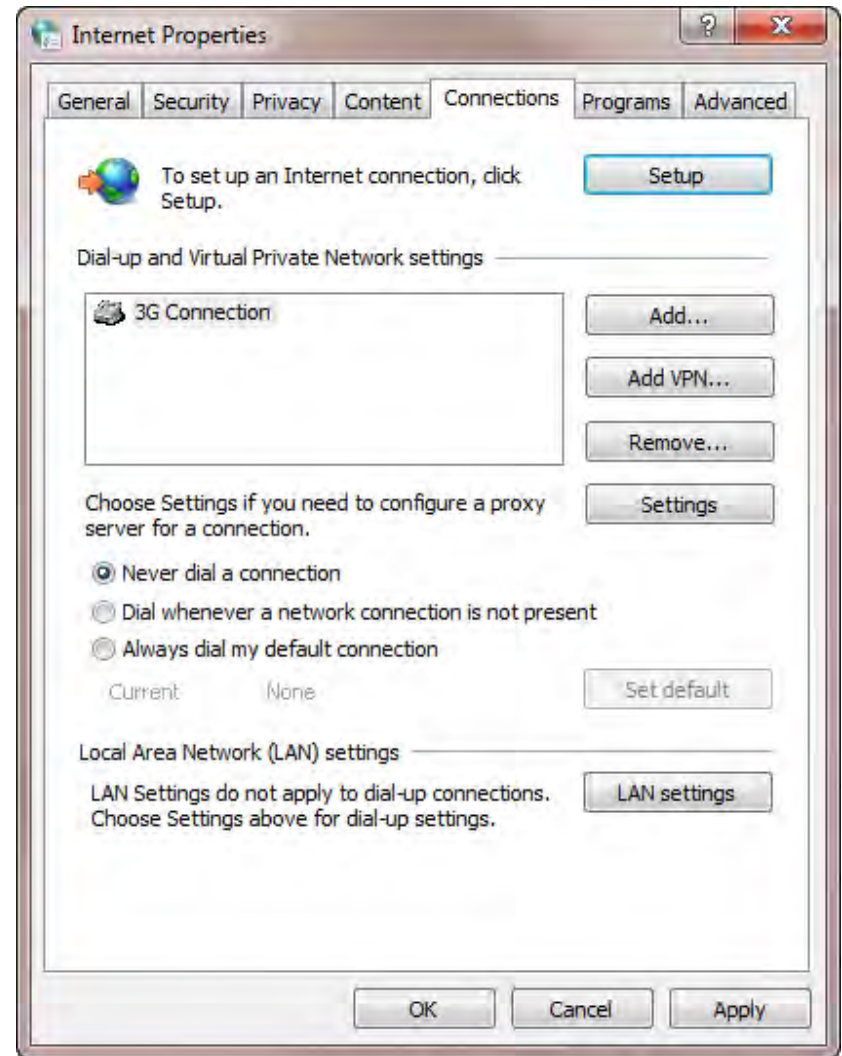

# Windows Control Panel: Display

- **Adjust screen resolution**
- **Configure multiple displays**
  - Extend
  - Duplicate
- **Calibrate color**

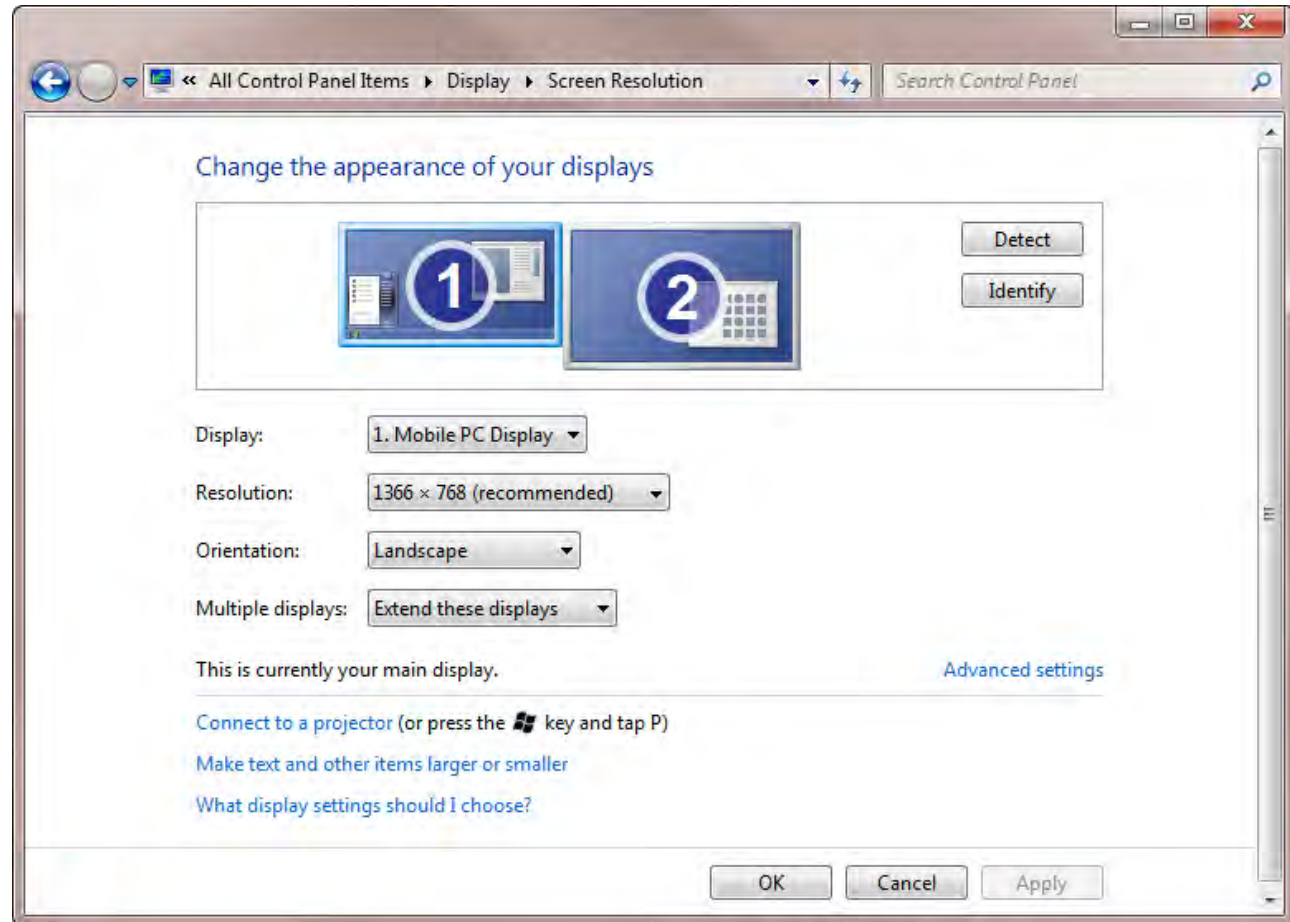

# Windows Control Panel: User Accounts

- Change password
- Change account name, type
- Manage other user accounts

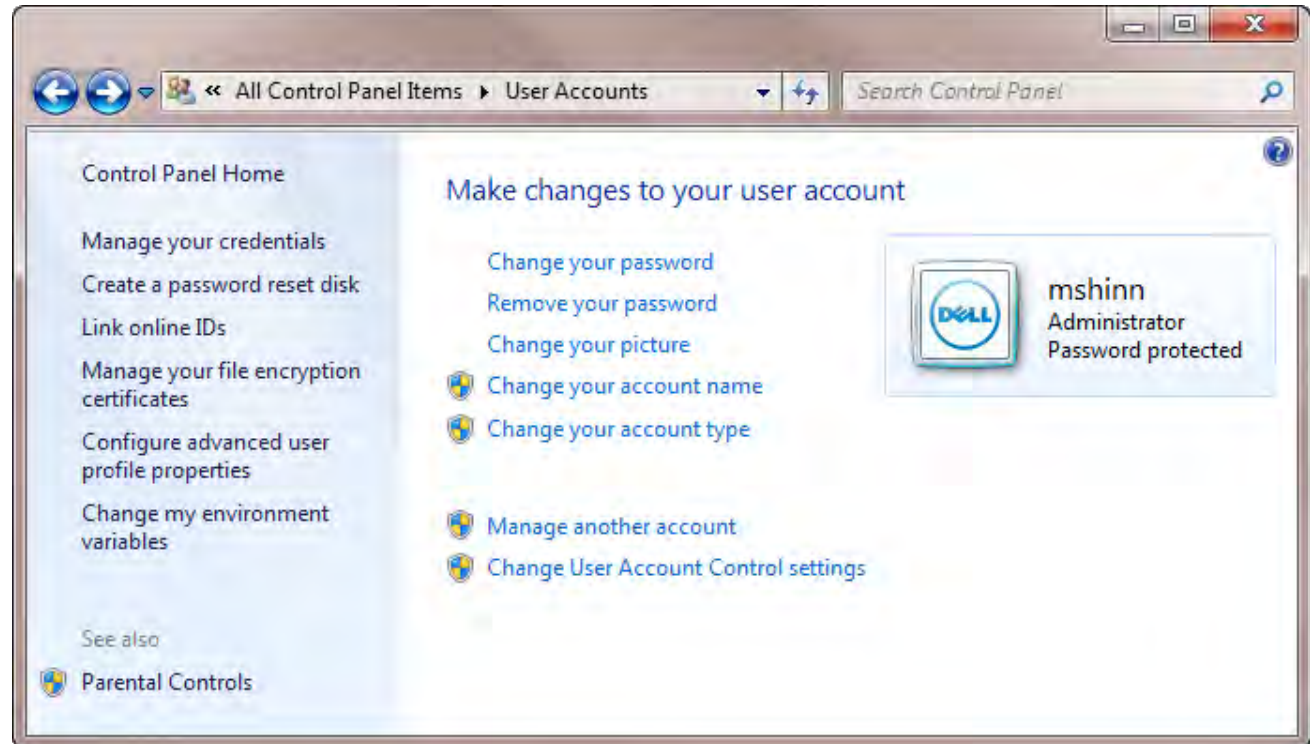

# Windows Control Panel: Folder Options

## ➤ General

- Set double-click or single-click to open items

## ➤ View

- Display file extensions, hidden files

## ➤ Search

- Specify search criteria
  - Example: “In indexed locations, search file names and contents”

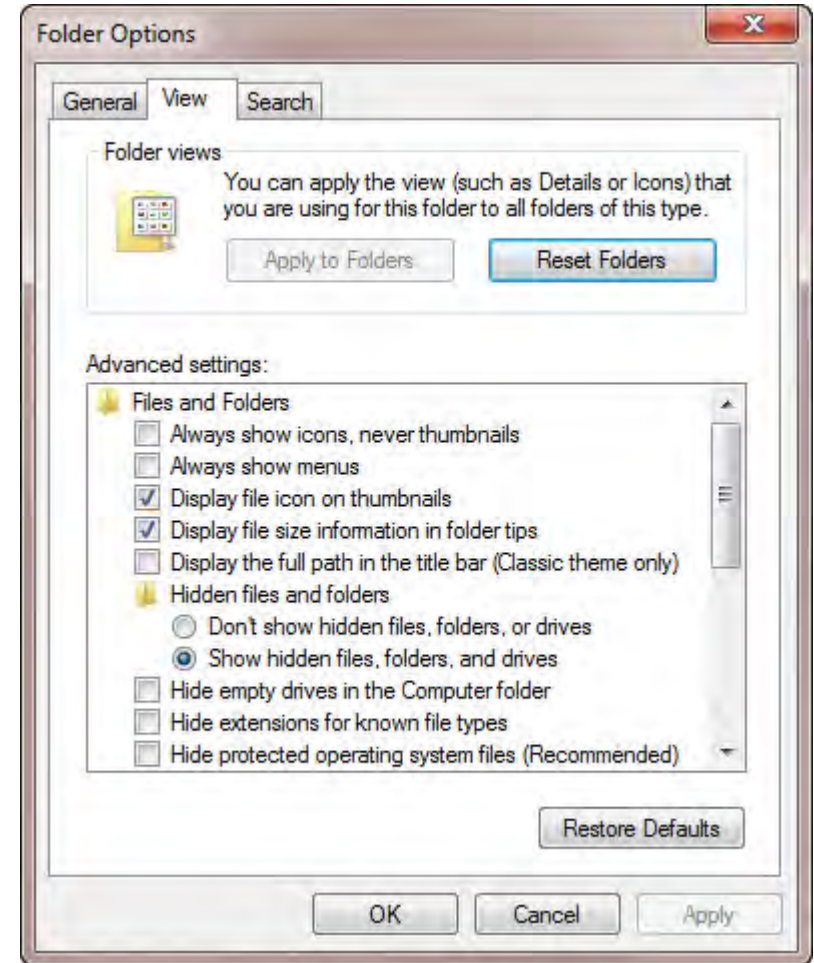

# Windows Control Panel: System

## ➤ Device Manager

- Hardware status and driver management

## ➤ Remote settings

- Allow remote connections

## ➤ System protection

- System restore

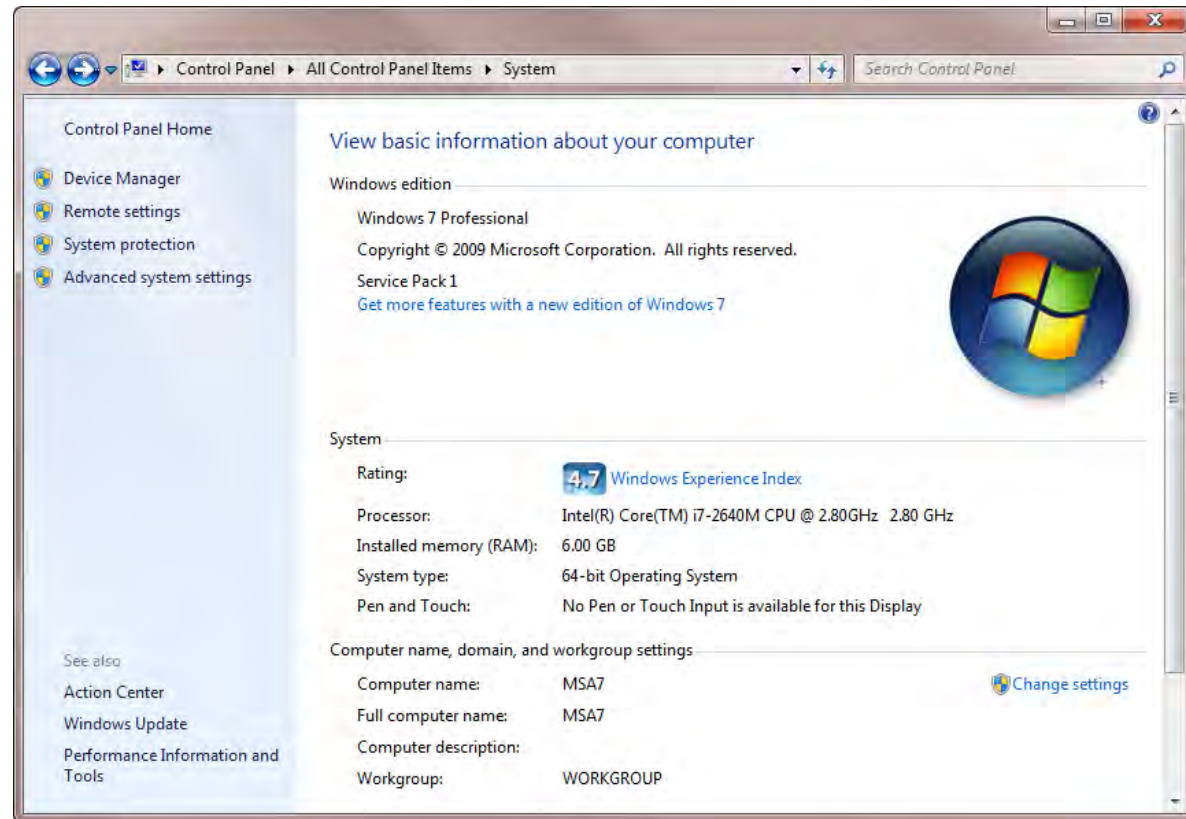

# Windows Control Panel: System

## ➤ Performance

- Rate and improve system performance
  - Indexing options
  - Disk cleanup

## ➤ Advanced system settings

- Brings up System Properties dialog
- Adjust virtual memory
  - **Select Performance | Settings | Advanced**

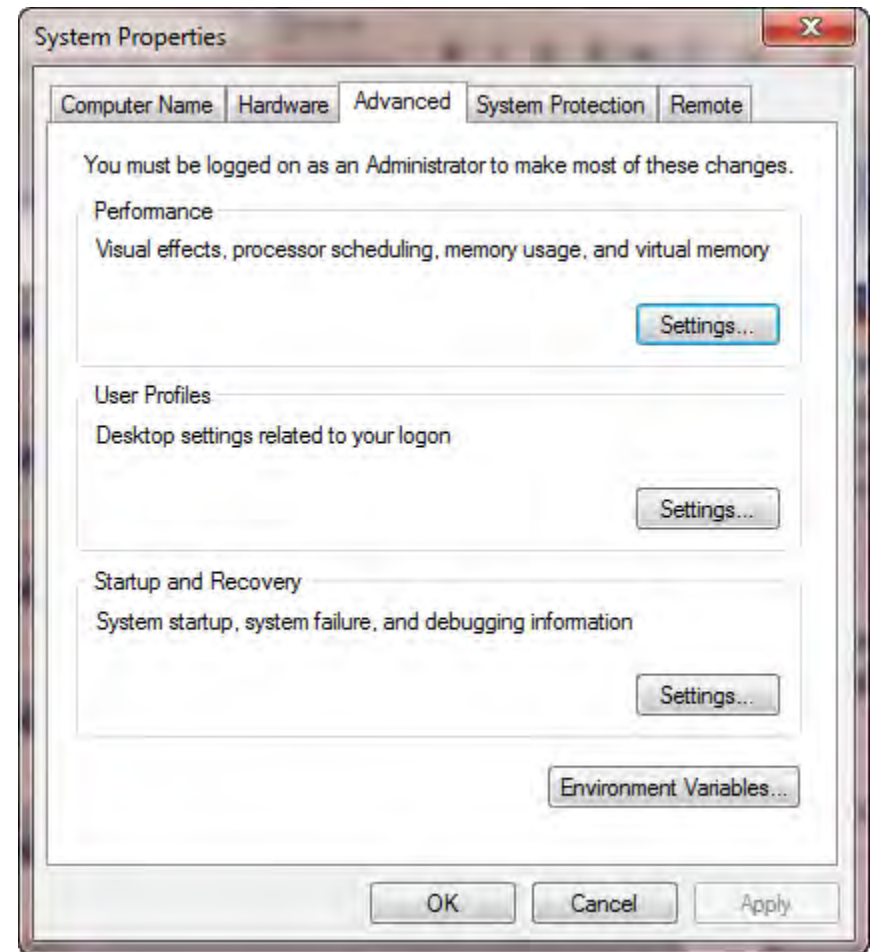
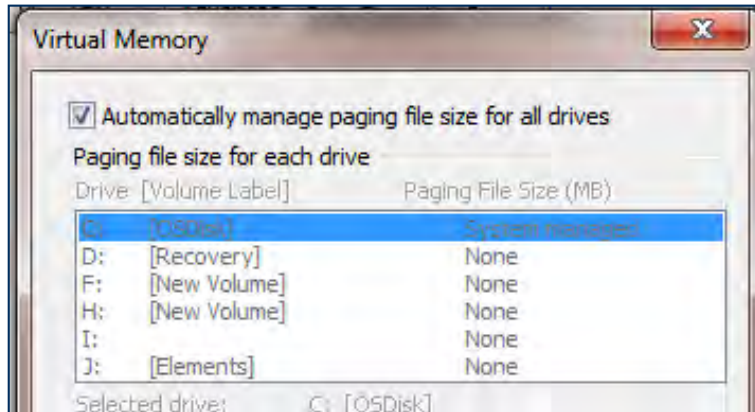

# Windows Control Panel: Action Center

## ➤ Action Center

- Central location for Windows alerts and recommended actions

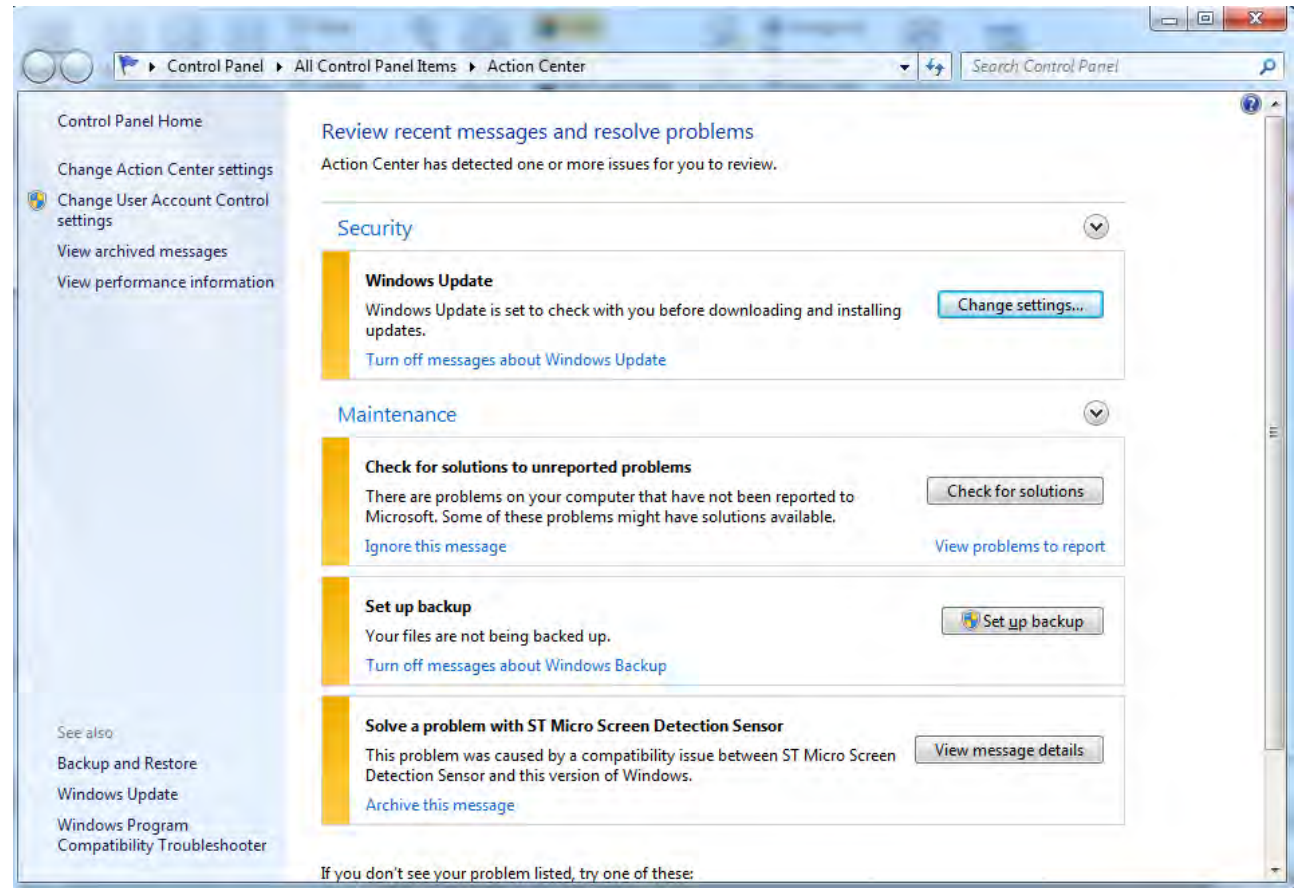



# Windows Control Panel: Network and Sharing Center

## ➤ Network and Sharing Center

- Manage and configure network hardware and protocols

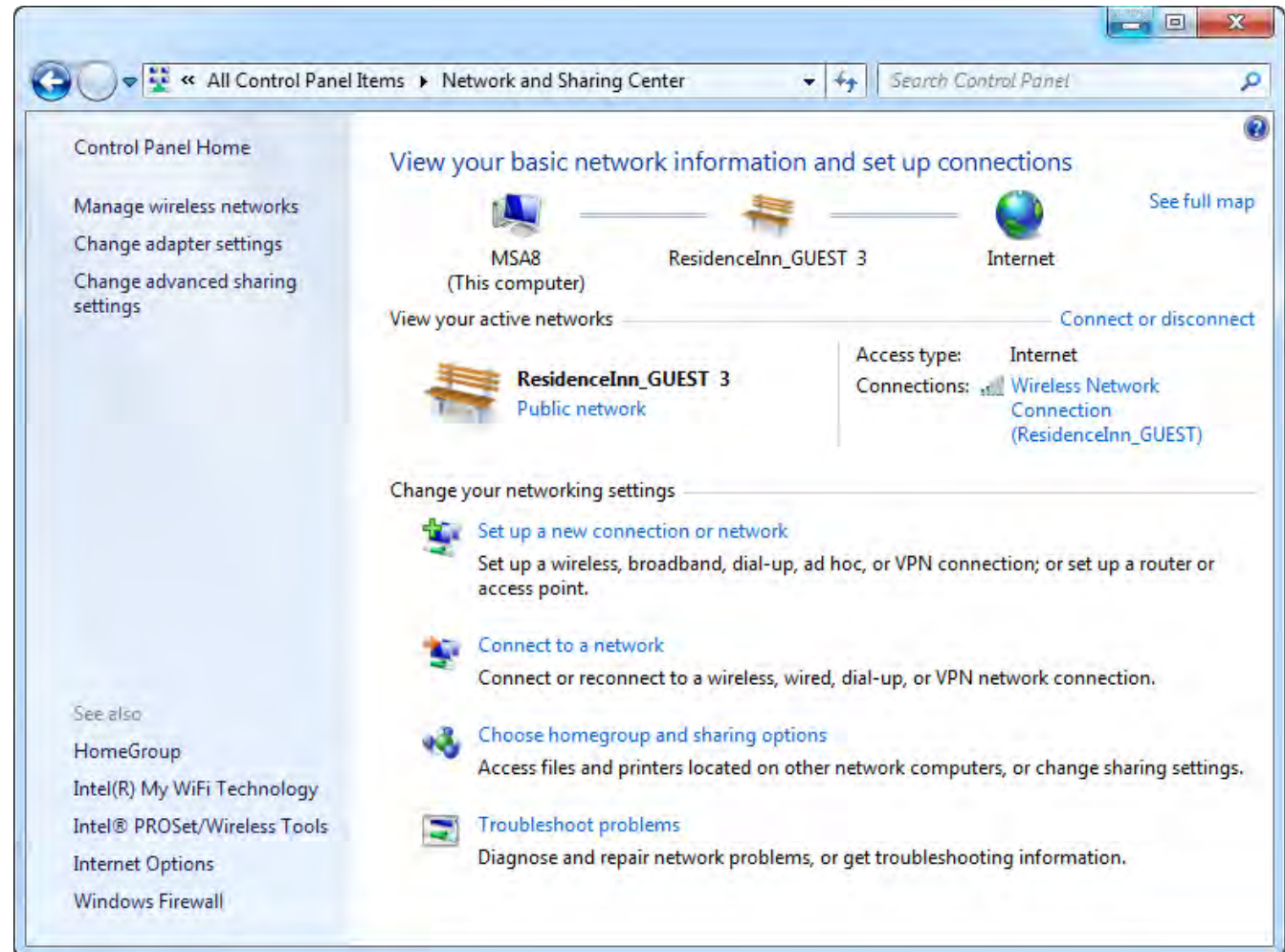

# Windows Control Panel Additional Controls

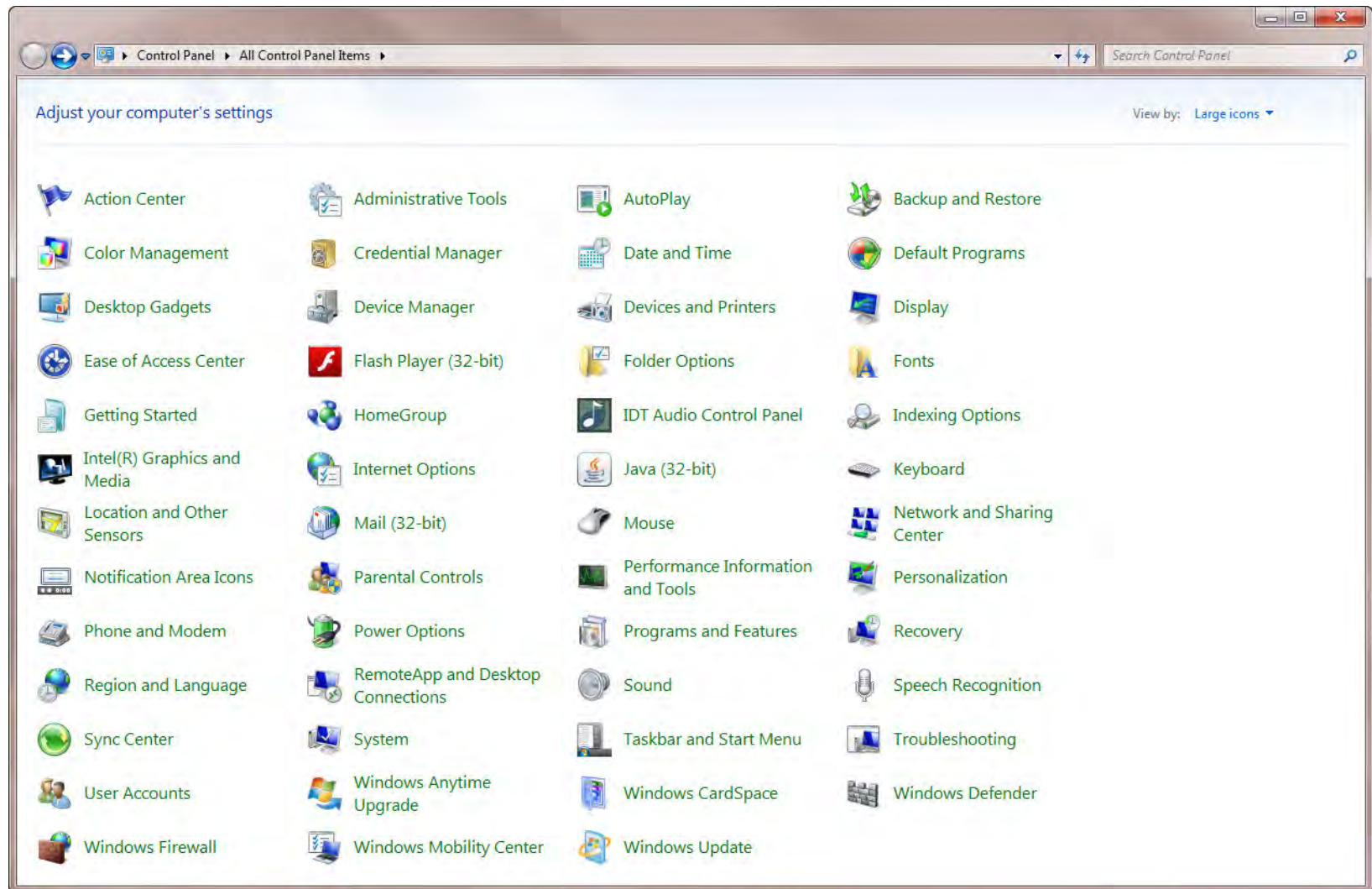

# Windows Control Panel Additional Controls

## ➤ Programs and Features

- Uninstall or change programs and Windows features

## ➤ HomeGroup

- Share computer with other computers (Networking wizard)

## ➤ Devices and Printers

- Add and manage external devices and printers

## ➤ Sound

- Manage audio devices (recording, playback)

## ➤ Troubleshooting

- Set of troubleshooting wizards (Networking and Internet, Security, etc.)

## ➤ Device Manager

- Manage and configure system hardware devices



- **Operating Systems Introduction**
- **Windows Basic Features/Navigation**
  - Hands-On Exercise 13.1
  - Windows Control Panel
  - **Hands-On Exercise 13.2**
- **Windows Building Blocks**
- **Troubleshooting Windows Operating System Problems**



# Hands-On Exercise 13.2

---

*In your Exercise Manual, please refer to  
Hands-On Exercise 13.2: Customizing the Desktop*



- **Operating Systems Introduction**
- **Windows Basic Features/Navigation**
- **Windows Building Blocks**
  - **Windows Startup Sequence and Boot Files**
    - Windows File Systems
    - Windows File and Folder Security
    - Windows Memory Management
    - Windows Registry
- **Troubleshooting Windows Operating System Problems**



# Windows Boot Sequence

- **Windows Vista/Windows 7/Windows 8/8.1 use two main files during the boot sequence**
- **Boot Manager (Bootmgr)**
  - Replacement for NTLDR (used in Windows XP and earlier)
    - Bootstrap loader loads operating system files
- **Boot Configuration Data (BCD)**
  - Replacement for Boot.ini
    - Contains operating system configuration information
  - Edit using bcdedit.exe utility



# Windows Boot Files

Filename	Description
Bootmgr	Bootstrap loader: loads the operating system files from the boot partition (replacement for NTLDR)
BCD (Boot Configuration Data)	File contains configuration information about the operating system on the computer (replacement for <code>BOOT.INI</code> ); edit using <code>BCDedit.exe</code>
BOOTSECT.DOS	Copy of MS-DOS or Windows 9x boot sector (used in dual-boot systems to restore DOS or Windows 9x environment)
NTDETECT.COM	Detects system hardware configuration on startup
NTBOOTDD.SYS	SCSI device driver, used only on systems with a SCSI boot drive
HAL.DLL	Hardware abstraction layer: contains platform-specific code used by the operating system
WIN.COM	Windows command file





# Windows User File Locations

## ➤ User profile and document locations

Description	Windows Vista/Windows 7
User Profiles	C:\Users\
User Documents	C:\Users\User_Name\ Documents
Start menu	C:\ProgramData\Microsoft \Windows\StartMenu



- **Operating Systems Introduction**
- **Windows Basic Features/Navigation**
- **Windows Building Blocks**
  - Windows Startup Sequence and Boot Files
  - **Windows File Systems**
    - Windows File and Folder Security
    - Windows Memory Management
    - Windows Registry
- **Troubleshooting Windows Operating System Problems**



# File System Types

## ➤ What is a file system?

- Data structures and methods used by operating system to manage files on disk

## ➤ FAT32 (File Allocation Table)

- File system used on earlier hard disks
- Also used on flash drives and memory cards
- 32-bit cluster pointer supports partition sizes up to 8 TB

## ➤ ExFAT (Extended File Allocation Table)

- Modern file system optimized for flash drives and memory cards
- Supports partition sizes up to 128 PB (petabyte = 1,000 TB)

BR	FAT1	FAT2	Root dir.	Data area
----	------	------	-----------	-----------



# File System Types: NTFS

## ➤ What is NTFS?

- New Technology File System
- First introduced with Windows NT; current version is NTFS5

## ➤ Reliable performance

- In the event of a system failure, uses a transaction log file to restore the file system to the previous state

## ➤ Security features

- Permissions can be set on files and folders
- Permits access only by approved users or groups

## ➤ Supports large volumes

- Up to 16 TB (using 4 K cluster size)
- Up to 256 TB (using maximum cluster size of 64 K)
- Additional volumes can be “mounted” (grafted) onto an existing volume

## ➤ Disk quotas

- Can set a quota limiting a user’s allocated space on a specific volume



# Other File System Types: CDFS, NFS, ext3, ext4

## ➤ **CDFS (CD-ROM File System)**

- File system for optical CD-ROM disks

## ➤ **NFS (Network File System)**

- Distributed file system allows client computer to access files over the network on another computer
- Used primarily on Unix, Linux systems
  - Windows Vista, 7, and Windows 8 Enterprise provide NFS client

## ➤ **ext3 (Third Extended File System)**

- File system commonly used by the Linux kernel
- Compatible with Windows

## ➤ **ext4 (Fourth Extended File System)**

- Linux file system (not compatible with Windows)
- Supports maximum filesystem size of 1 EB (exabyte)
  - Exabyte = 1,000,000 TB



# Disk Encryption: Encrypting File System (EFS)

## ➤ Encrypting File System (EFS)

- Built-in feature of NTFS
- Uses symmetric key encryption to encrypt files and folders
  - Key for the current user logged on to the system is used
- Data recovery is available through the designated recovery agent (system administrator)

## ➤ Using EFS

1. In Windows Explorer, right-click file or folder name, then select **Properties**
2. In Properties dialog, click **Advanced** button
3. In Advanced dialog, select “**Encrypt contents to secure data**” and click **OK**
  - Folder or file name will turn green



# NTFS Features: Encrypting File System (EFS)

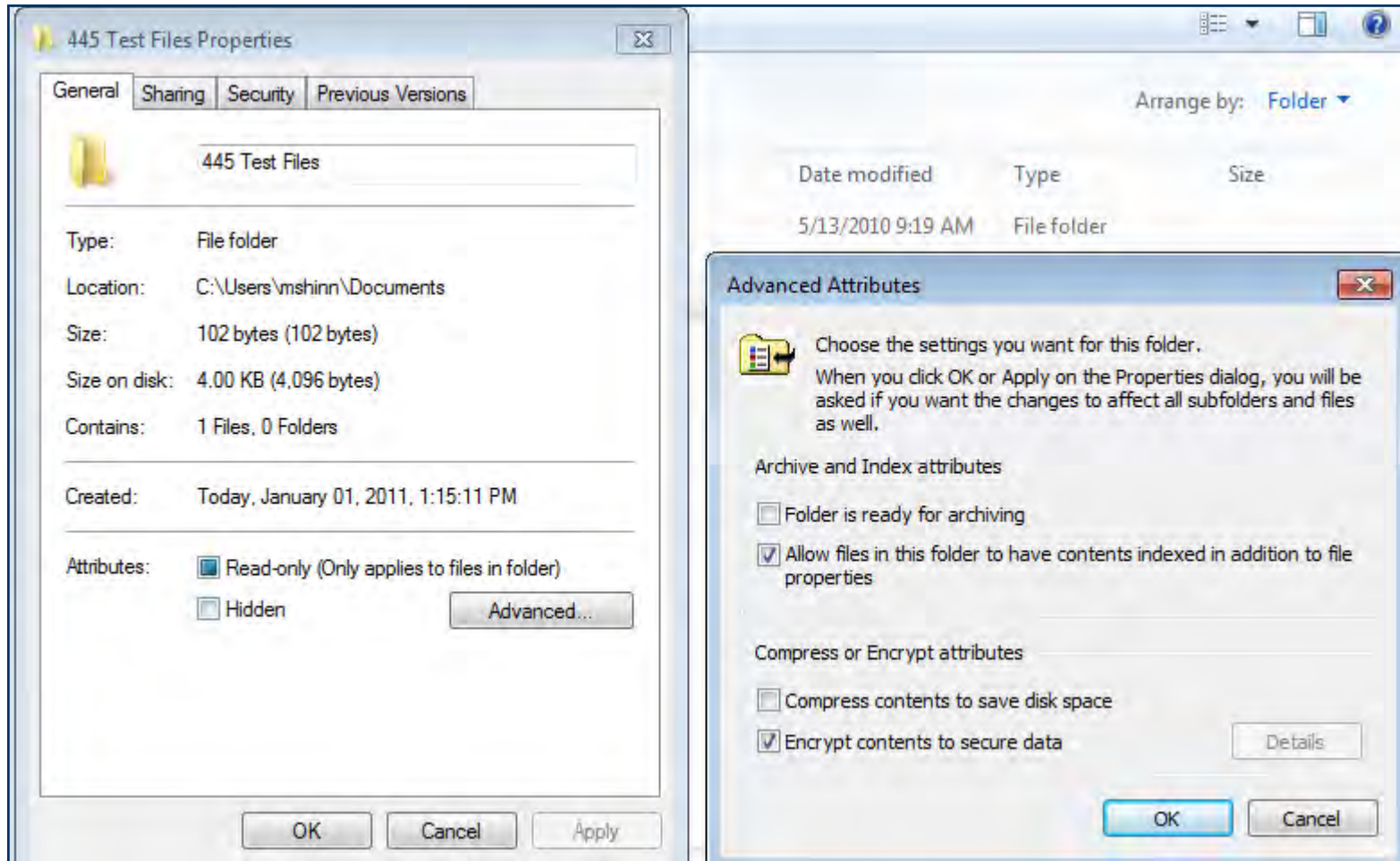

# Windows BitLocker

## ➤ Windows BitLocker

- Provides full disk encryption for hard drives
  - Windows Vista and 7 Ultimate and Enterprise
  - Windows 8 Pro and Enterprise
- Encryption key stored in Trusted Platform Module chip on motherboard
  - Or in flash drive or Active Directory server

## ➤ BitLocker To Go

- Encryption for USB Flash drives

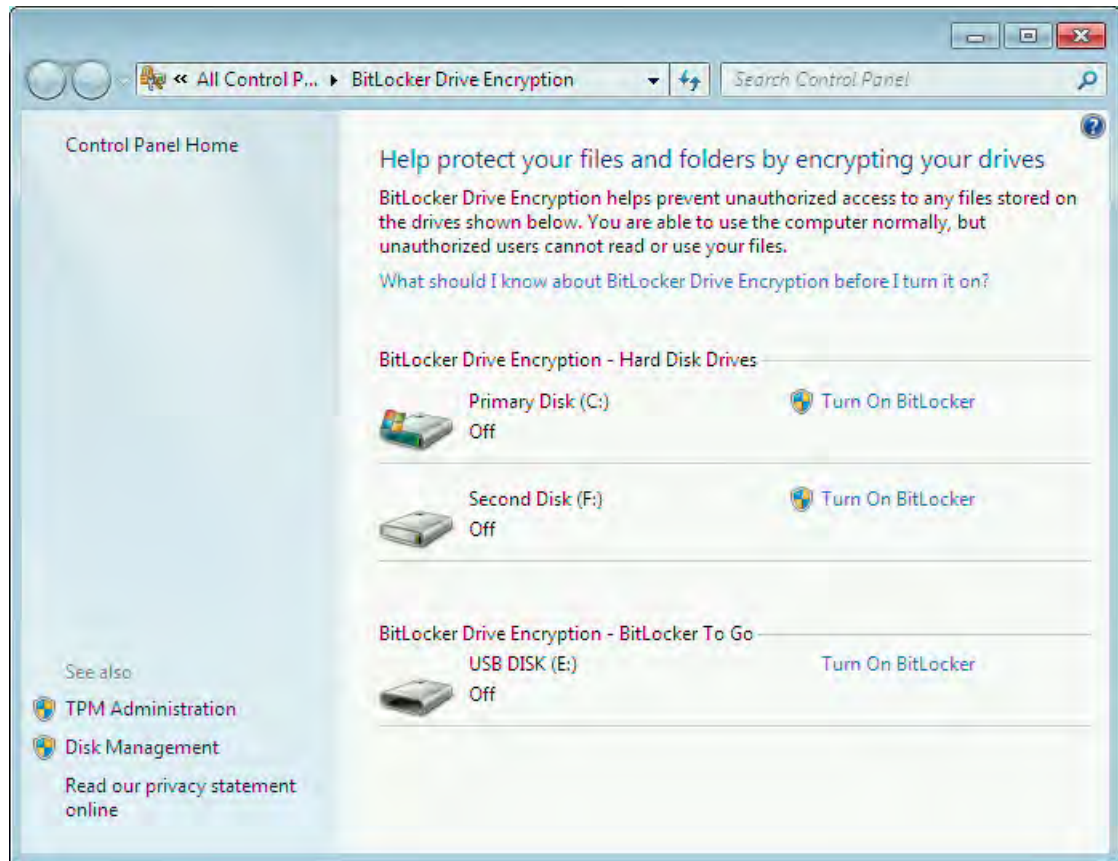



# Windows ReadyBoost

## ➤ Windows ReadyBoost

- Uses USB flash drive as fast disk cache to speed up performance
- Offered as an option when a USB flash drive is plugged into PC
- Available in Windows Vista, Windows 7, Windows 8/8.1

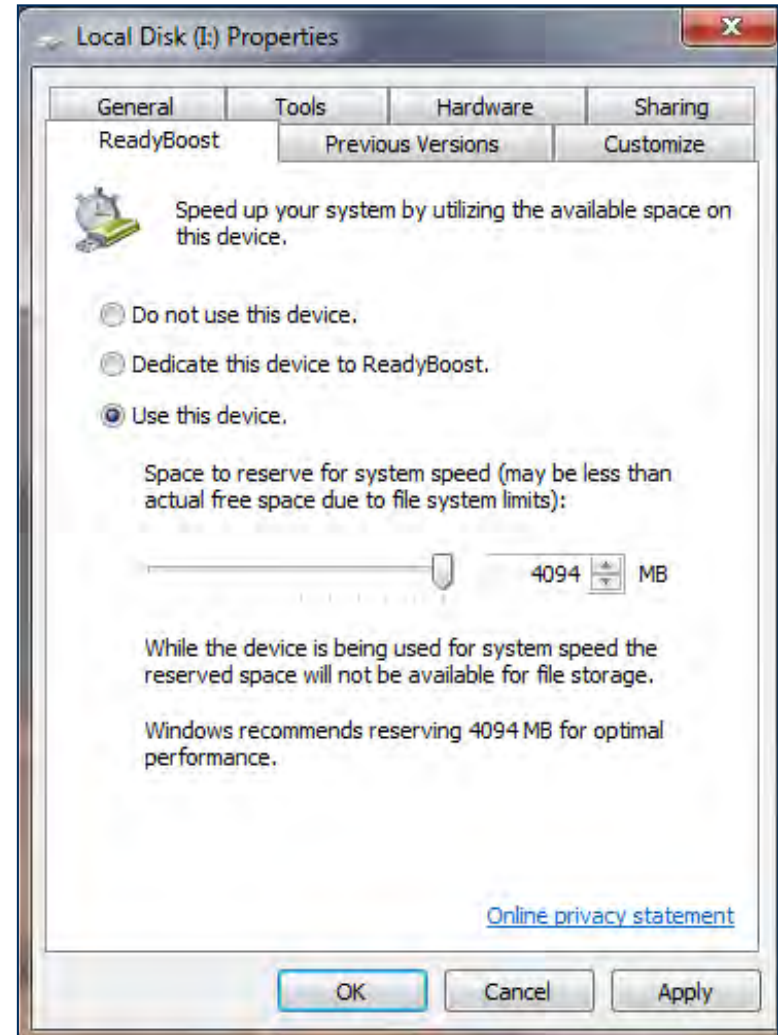
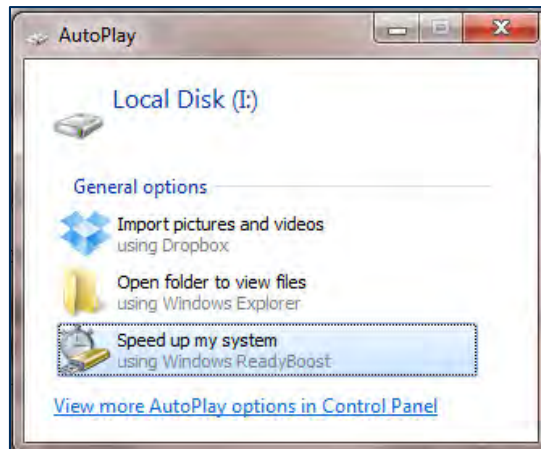

- **Operating Systems Introduction**
- **Windows Basic Features/Navigation**
- **Windows Building Blocks**
  - Windows Startup Sequence and Boot Files
  - Windows File Systems
  - **Windows File and Folder Security**
  - Windows Memory Management
  - Windows Registry
- **Troubleshooting Windows Operating System Problems**



# File and Folder Security

- **Windows provides two types of file/folder security**
- **NTFS permissions**
  - Controls access to files/folders at the file system level
  - Applies files/folders accessed *locally or from the network*
- **Share permissions**
  - Controls access to folders *only when accessed from the network*

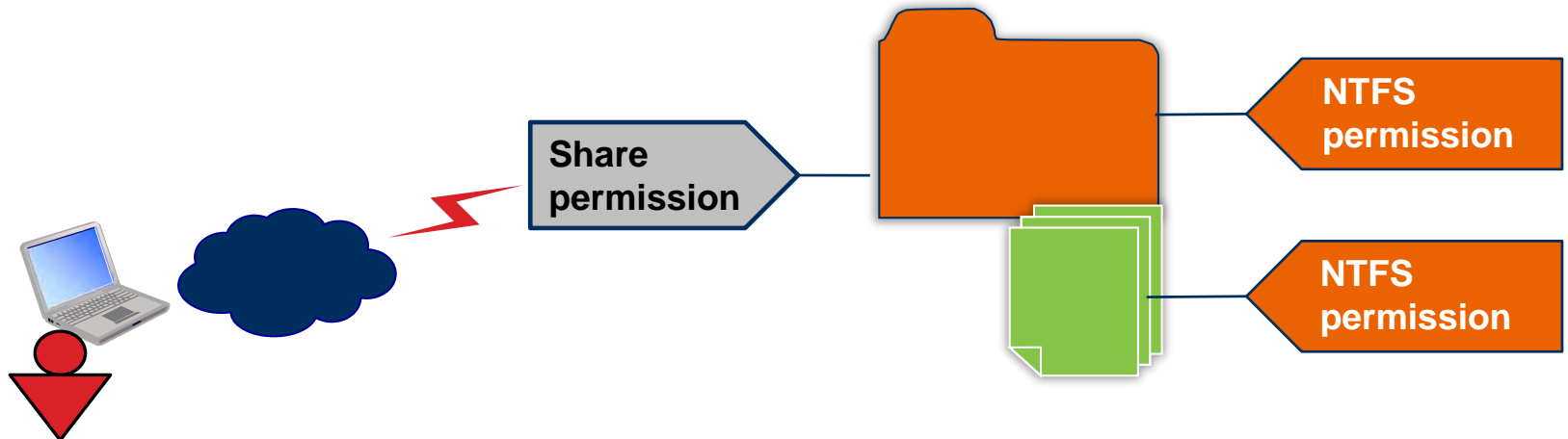

# File and Folder Security

## ➤ Accessing NTFS file and folder permissions

- Right-click the file or folder, select Properties, then click Security tab
- Click Edit to modify permissions

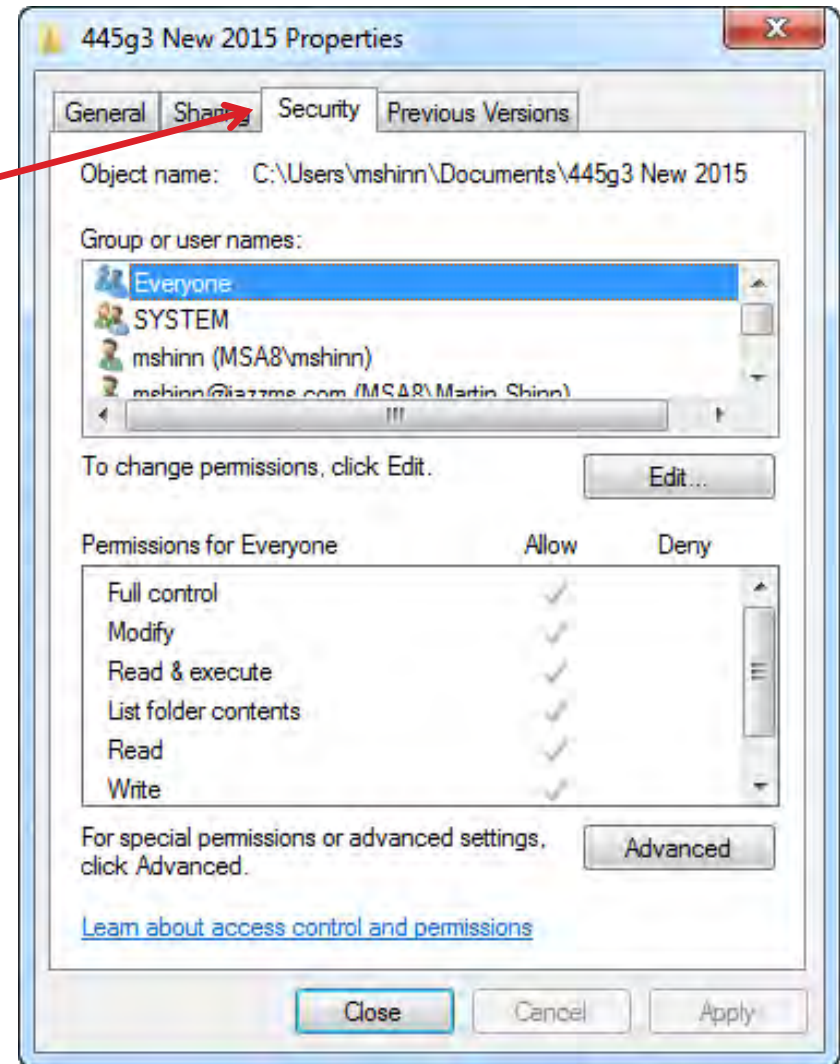

# NTFS File and Folder Permissions

NTFS permission	Description
Full Control	See, change, and create new files and folders; run programs in a folder
Modify	Change existing files and folders, but cannot create new ones
Read & Execute	See contents of files and folders; run programs in a folder
List Folder Contents (applies only to folders)	List content of folder and subfolders, but does not grant access to files in folder
Read	See contents of a folder; open files and folders
Write	Create new files and folders; make changes to existing files and folders



# Share Permissions

## ➤ Accessing folder Share Permissions

- Right-click file or folder, select Properties, and then click the Sharing tab
- Click Advanced Sharing, then select “Share this folder”

## ➤ Administrative shares

- Default shares created by Windows for use by Administrators
- By default created as a hidden share (denoted by \$ at end of name)
  - Example: C\$

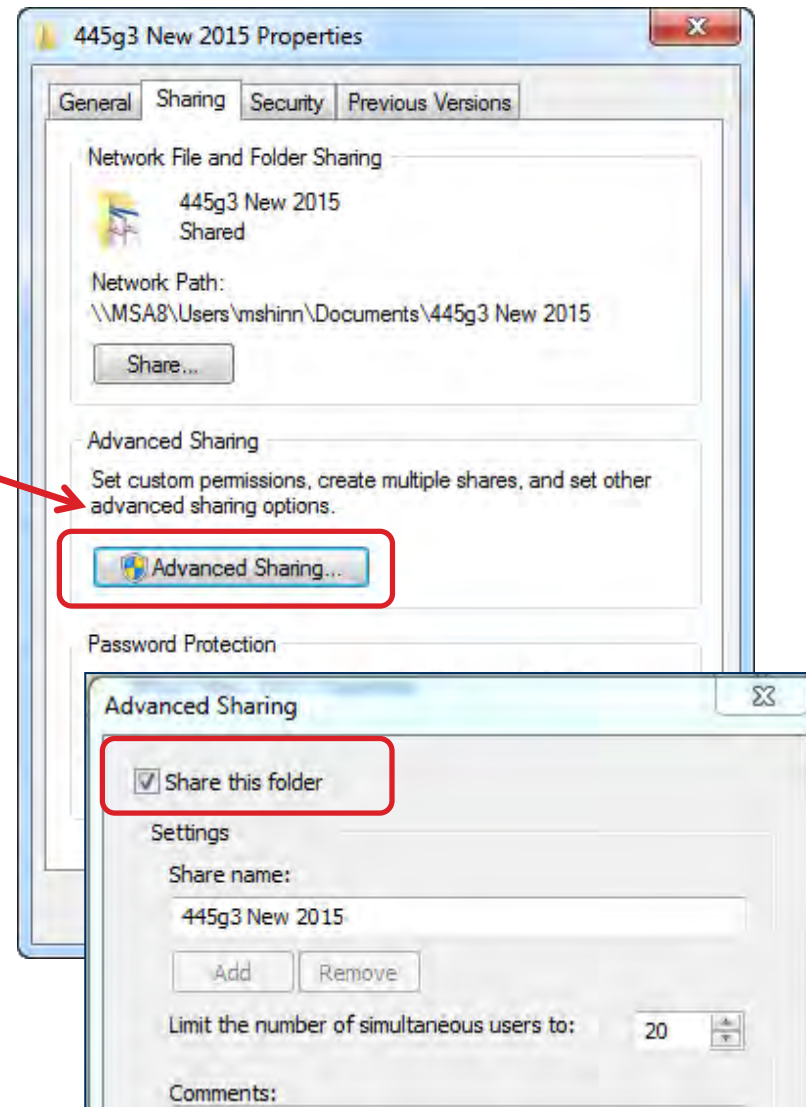

# Share Permissions

## ➤ Accessing folder Share Permissions (continued)

- Right-click file or folder, select **Properties**, click **Sharing** tab, and then click the “**Share this folder**” option
- To display permissions, click the **Permissions** button

Share permission	Description
Full Control	Can perform all functions on files and folders in share
Change	See, add, delete, or change files or folders in share
Read	See files and folders; execute applications

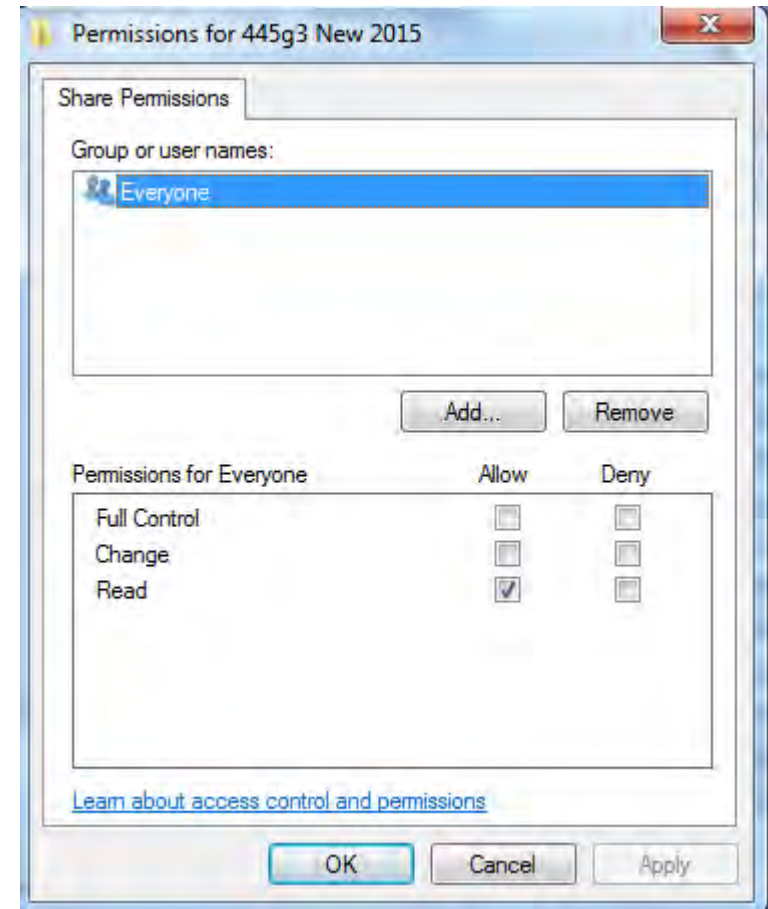

# Permission Propagation and Inheritance

## ➤ Allow vs. Deny

- Allow permits access
- Deny prohibits access
  - Use sparingly, because restrictive permissions override lenient permissions

## ➤ Inheritance

- When new folder is created, Full Control/Everyone is default NTFS permission
- All subfolders inherit permissions from parent folder

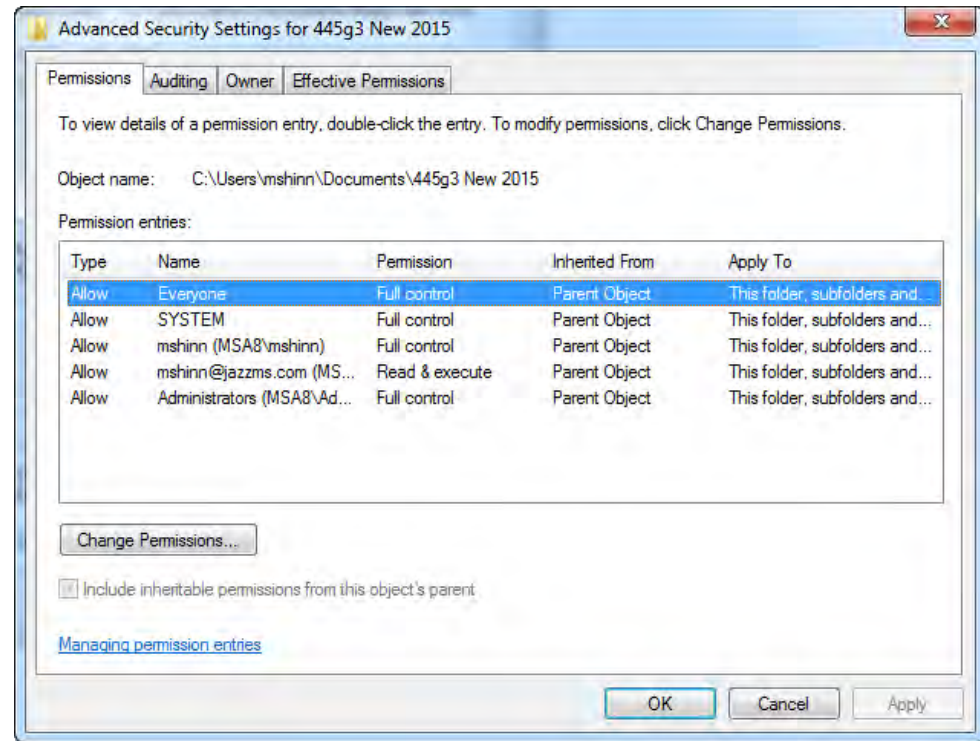



# Permission Control and Inheritance

- **Moving a folder to a different location on the same volume**
  - Retains original permissions
- **Copying a folder (to the same or different volume)**
  - Inherits permissions of new parent folder



- **Operating Systems Introduction**
- **Windows Basic Features/Navigation**
- **Windows Building Blocks**
  - Windows Startup Sequence and Boot Files
  - Windows File Systems
  - Windows File and Folder Security
  - **Windows Memory Management**
  - Windows Registry
- **Troubleshooting Windows Operating System Problems**



# Windows Memory Management

## ➤ What is virtual memory?

- Special file on hard disk (`pagefile.sys`) is used as a repository for data that is swapped with contents of system RAM
- Allows programs to use a much larger “virtual memory” space than supported in physical system memory
- `Pagefile.sys` recommended size: 1.5 x amount of system RAM

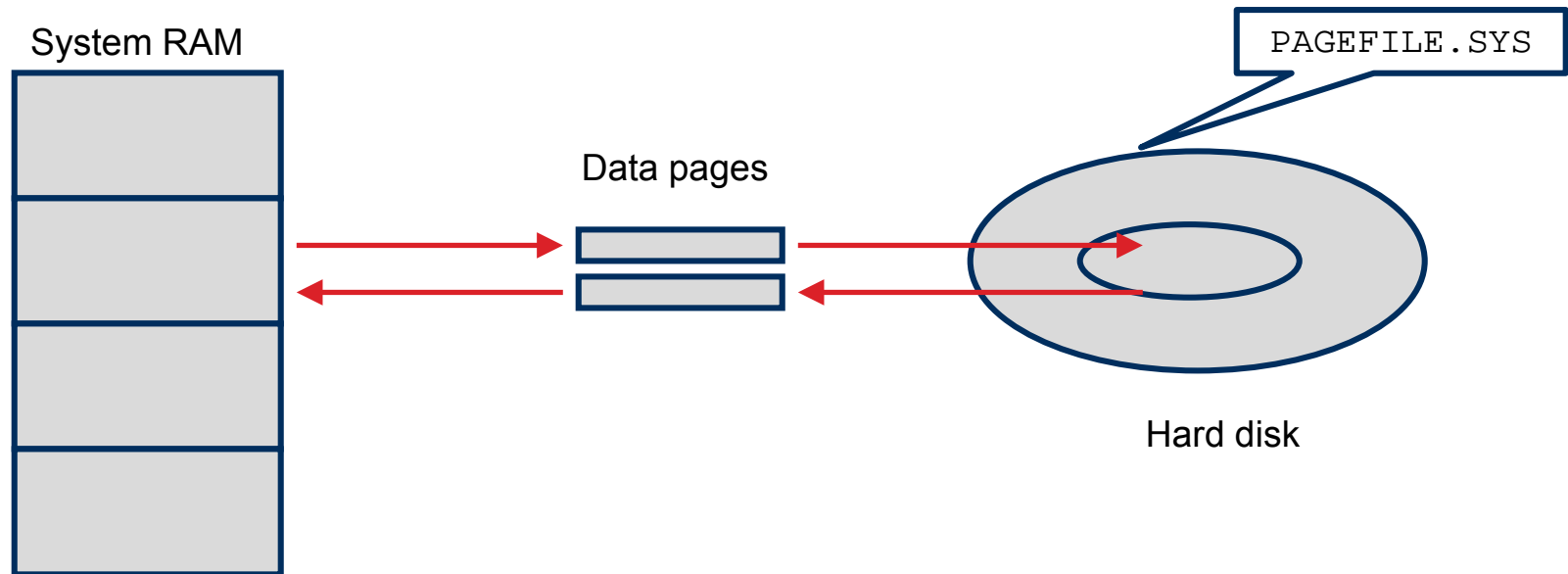

- **Operating Systems Introduction**
- **Windows Basic Features/Navigation**
- **Windows Building Blocks**
  - Windows Startup Sequence and Boot Files
  - Windows File Systems
  - Windows File and Folder Security
  - Windows Memory Management
  - **Windows Registry**
- **Troubleshooting Windows Operating System Problems**



# Introduction to the Windows Registry

## ➤ What is the Windows registry?

- A unified database that stores system and application configuration data
- Replaces configuration settings previously stored in `CONFIG.SYS`, `AUTOEXEC.BAT`, and `.INI` files
  - Exception: Some legacy applications may still require the use of these files

## ➤ Registry Editor (`Regedit.exe`) is used to edit the Windows registry

- Should only be used in special circumstances by experienced personnel



# Windows Registry Architecture

- **The registry is organized as a hierarchy of HKEYS**
  - In Microsoft terminology, an HKEY is a “handle to a key”
  - A registry key is similar to a Windows folder
    - Each registry key can contain multiple nested subkeys
- **The Windows registry consists of five main HKEYS**

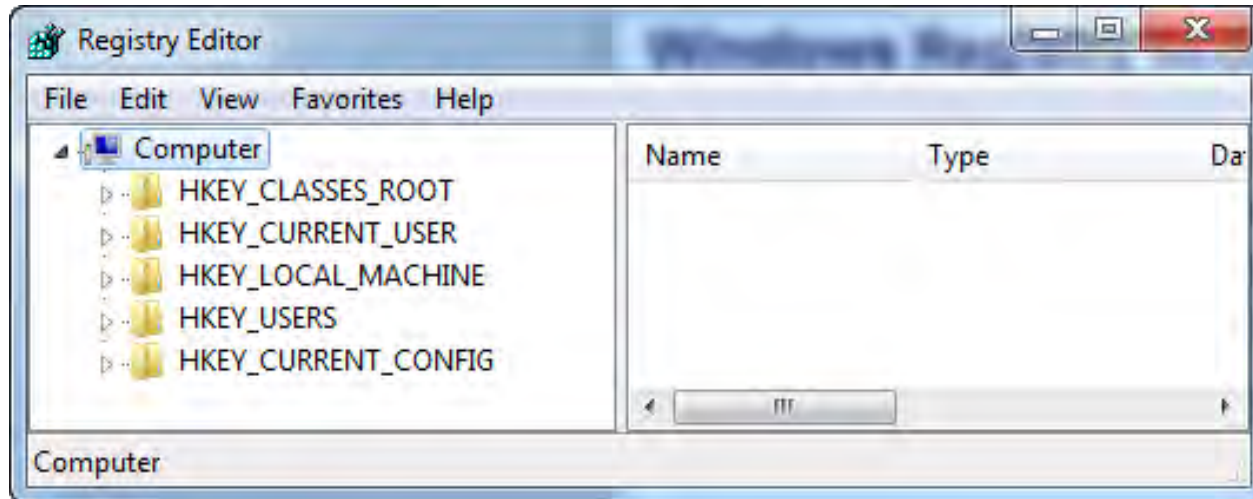

# Main Registry HKEYS

## ➤ HKEY\_LOCAL\_MACHINE

- Contains all hardware and Windows system configuration settings
- Information about devices and device drivers is here

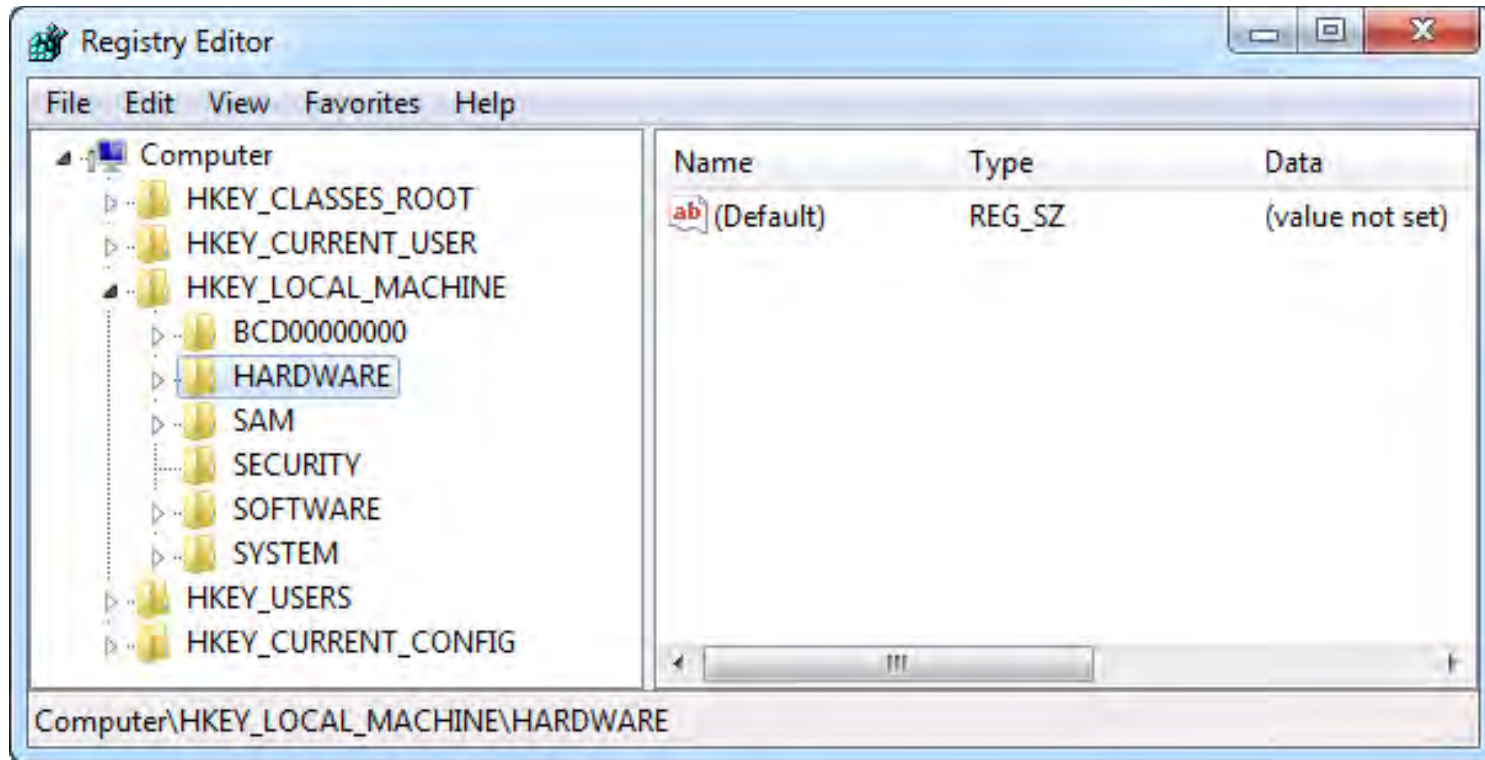

# Main Registry HKEYs

## ➤ HKEY\_CLASSES\_ROOT

- Contains information required to launch application programs
  - File extensions and associations
  - Microsoft foundation class ID numbers

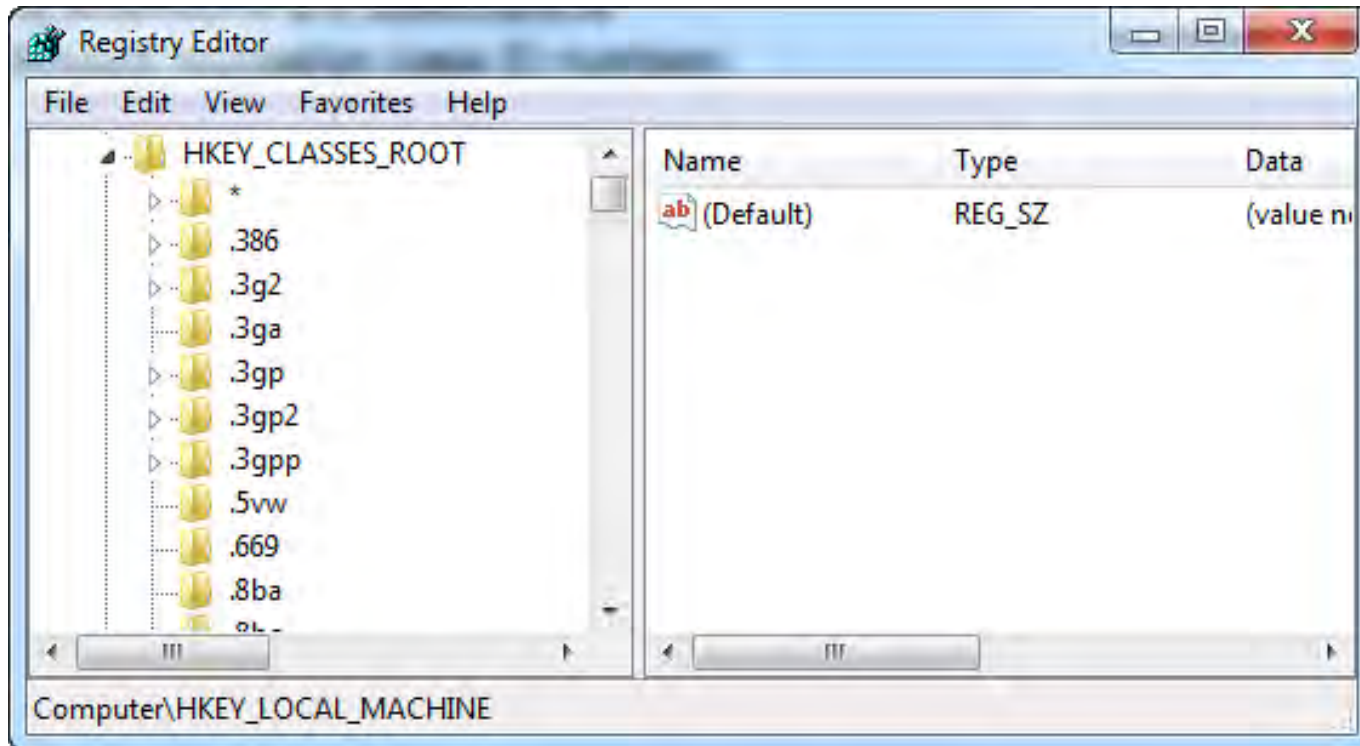



# Main Registry HKEYs

## ➤ HKEY\_CURRENT\_CONFIG

- Contains current hardware configuration information
- Extracted from HKEY\_LOCAL\_MACHINE

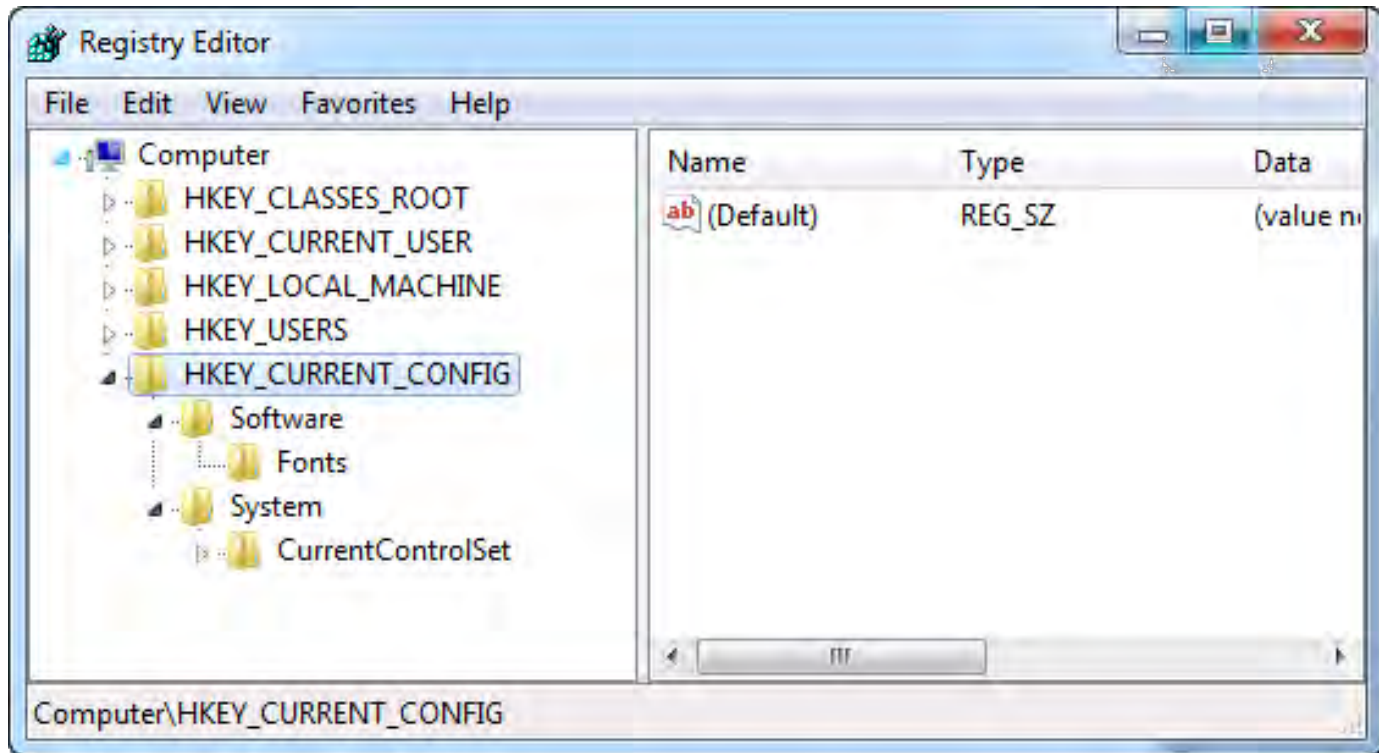

# Main Registry HKEYs

## ➤ HKEY\_USERS

- Contains a library of user settings used to build the logon screen and environment for the logged-in user
  - User desktop preferences, colors, icons, Start menu options, etc.

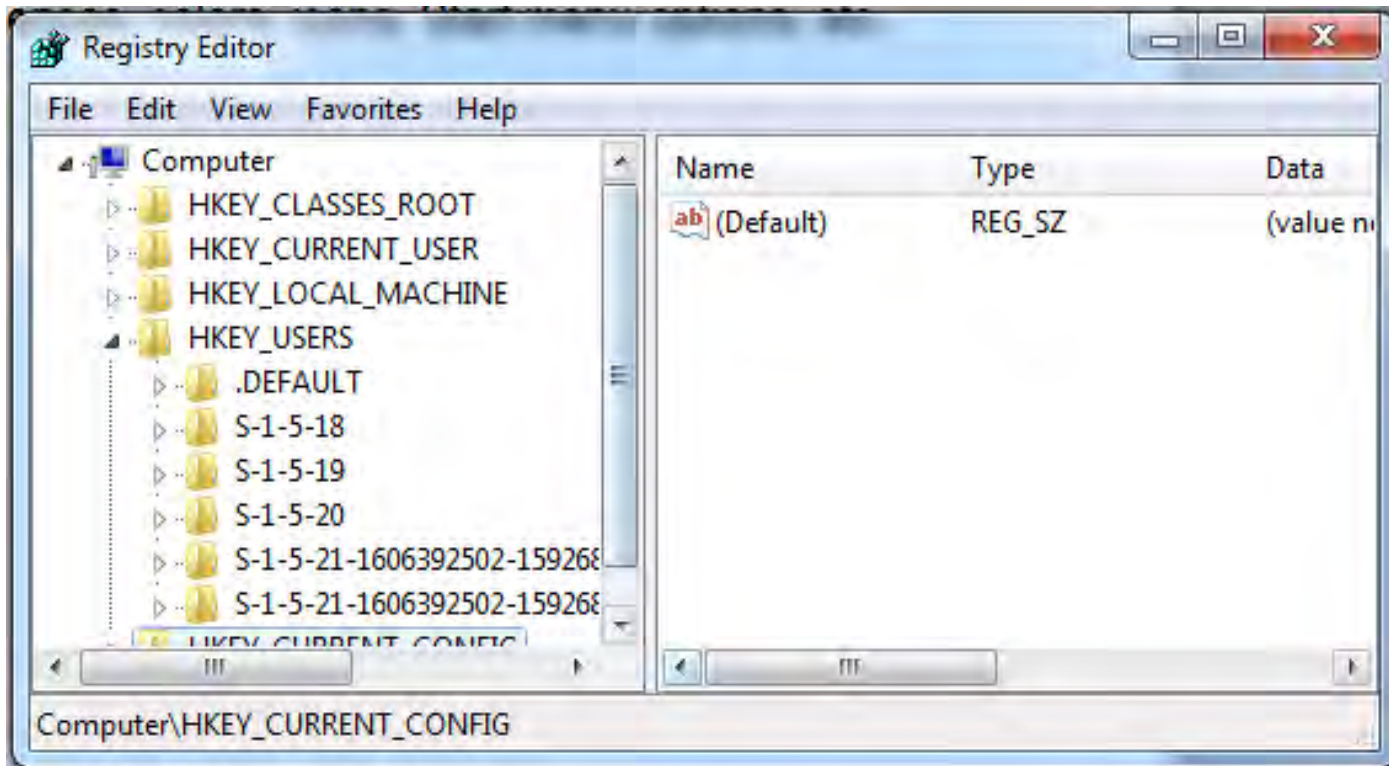

# Main Registry HKEYs

## ➤ HKEY\_CURRENT\_USER

- Contains information specific to the logged-in user
- If multiple user profiles are defined, information is copied from the profile of the logged-in user
  - Otherwise, the default user profile information is used

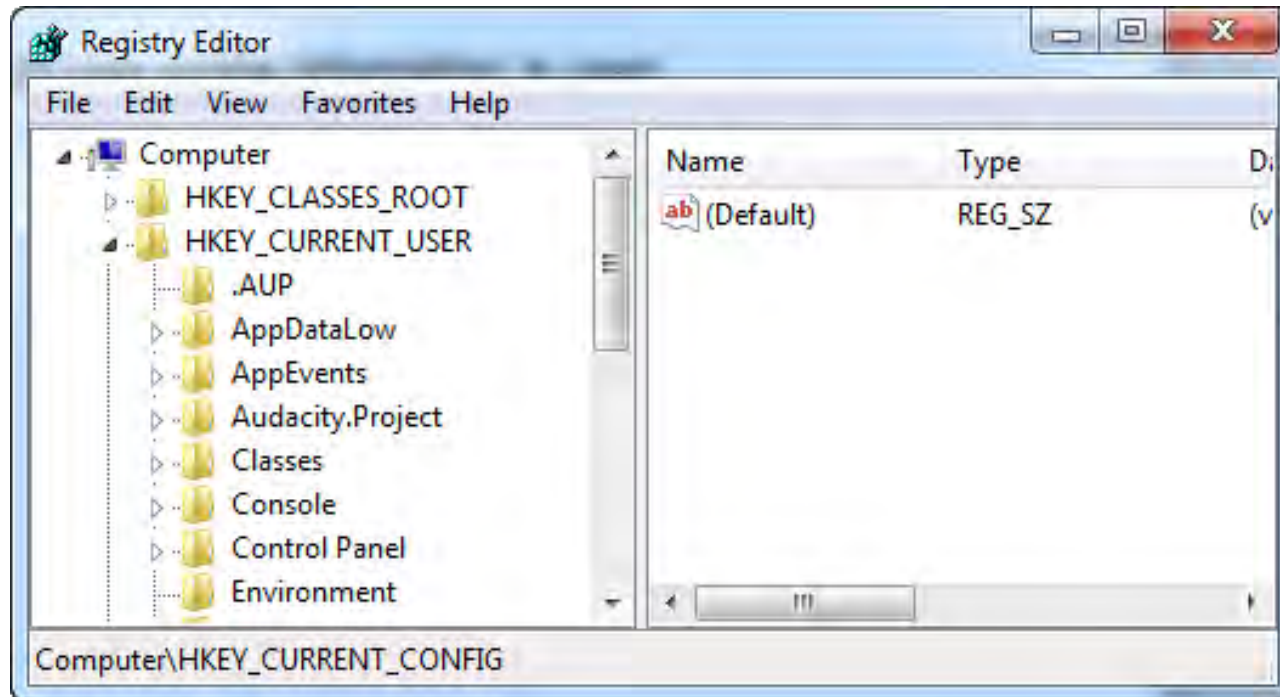

- **Operating Systems Introduction**
- **Windows Basic Features/Navigation**
- **Windows Building Blocks**
- **Troubleshooting Windows  
Operating System Problems**



# Troubleshooting Operating System Problems 1

- For these common symptoms, choose the number of the most likely cause

Symptom	Cause	Operating system faults
BSOD (Blue Screen Of Death)		1. RAID controller driver problem (requires firmware update)
Failure to boot		2. Hardware or driver problem
“Improper shutdown” message		3. System was not gracefully shut down (Windows Start   Shutdown)
RAID not detected during installation		4. Unwanted registry entry is calling .dll routine
“Missing .dll” message		5. Missing or damaged boot files



# Troubleshooting Operating System Problems 2

- For these common symptoms, choose the number of the most likely cause

Symptom	Cause	Operating system faults
Missing graphical interface		1. Registry entry to load <code>Explorer.exe</code> has been altered or damaged
File fails to open (example, <code>.xlsx</code> file)		2. Damaged or defective hard drive 3. Nonbootable disk left in boot drive (DVD drive)
Missing NTLDR		4. Attempt to open newer version of file (Excel 2007/2010) with older version of program
Missing operating system		



# Review Questions

- 1. Which Windows desktop shortcut key allows you to quickly cycle through open applications?**
  - A. <Ctrl><Esc>
  - B. <Tab>
  - C. <Shift><Tab>
  - D. <Alt><Tab>
  
- 2. In Windows 7+, what are two main boot files?**
  - A. NTLDR
  - B. Bootmgr
  - C. BCD
  - D. Boot.ini
  
- 3. In Windows Explorer, you can display or change a file's attributes by:**
  - A. Double-clicking the file, then selecting attributes
  - B. You cannot change a file's attributes from Windows Explorer
  - C. Right-clicking the file, then selecting Properties
  - D. Clicking the file, then selecting Properties



# Review Questions

**4. The Windows virtual memory swap file is named:**

- A. SWAP.SYS
- B. VIRTUAL.DAT
- C. PAGEFILE.SYS
- D. SWAPMEM.SYS

**5. Which registry key contains information about file extensions and associations?**

- A. HKEY\_LOCAL\_MACHINE
- B. HKEY\_CLASSES\_ROOT
- C. HKEY\_CURRENT\_CONFIGURATION
- D. HKEY\_USERS





# Chapter Summary

---

**In this chapter, you have learned how to**

- **Describe Windows desktop and command line features and commands**
- **Identify names and purposes of Windows boot files**
- **Describe the fundamental operation of Windows file systems and memory management**
- **Explain the basic structure of the Windows registry**



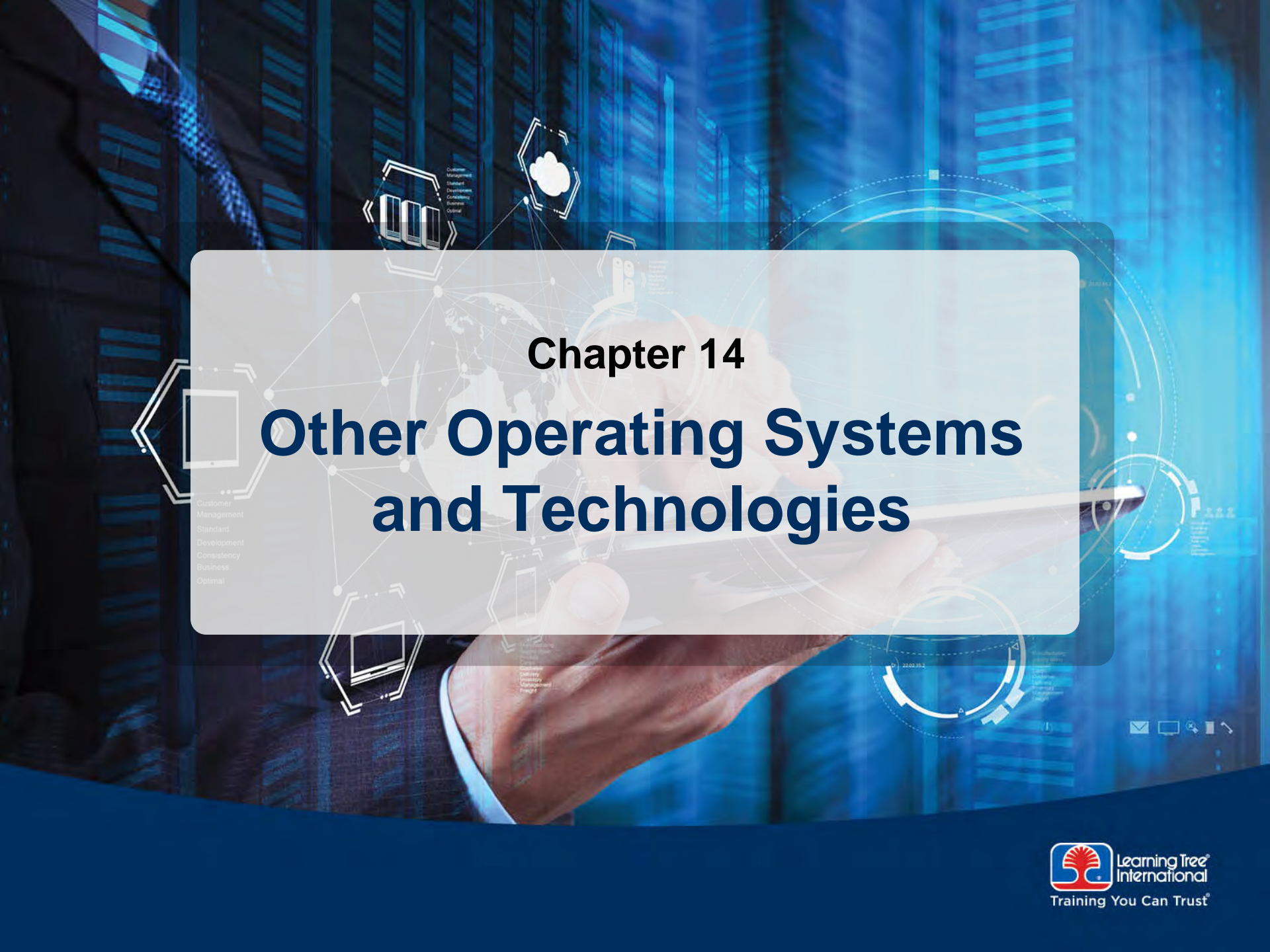

# Chapter 14

## Other Operating Systems and Technologies

Customer  
Management  
Standard  
Development  
Consistency  
Business  
Optimal

# Chapter Objectives

---

**In this chapter, you will learn how to**

- **Use basic features of Mac OS and Linux operating systems**
- **Describe best practices and tools for Mac OS and Linux**
- **List basic Linux commands**
- **Explain how to set up and use client-side virtualization**
- **Describe basic cloud concepts**



- **Mac OS and Linux Best Practices**
  - **Mac OS and Linux Tools**
  - **Mac OS and Linux Features**
  - **Basic Linux Commands**
  - **Client-side Virtualization**
  - **Cloud Computing**



- **What do the Mac OS and Linux operating systems have in common?**
  - Both based on a Unix operating system core
- **Mac OS**
  - Since 2001, Mac OS has been called Mac OS X
  - Features sophisticated Graphical User Interface (GUI)
- **Linux**
  - Open-source version of Unix
  - Used in both command-line and GUI versions (e.g., Ubuntu)



# Mac OS X



# Linux (Ubuntu)

## ➤ Opening a terminal window in Ubuntu

- Use <CTRL><ALT><T>

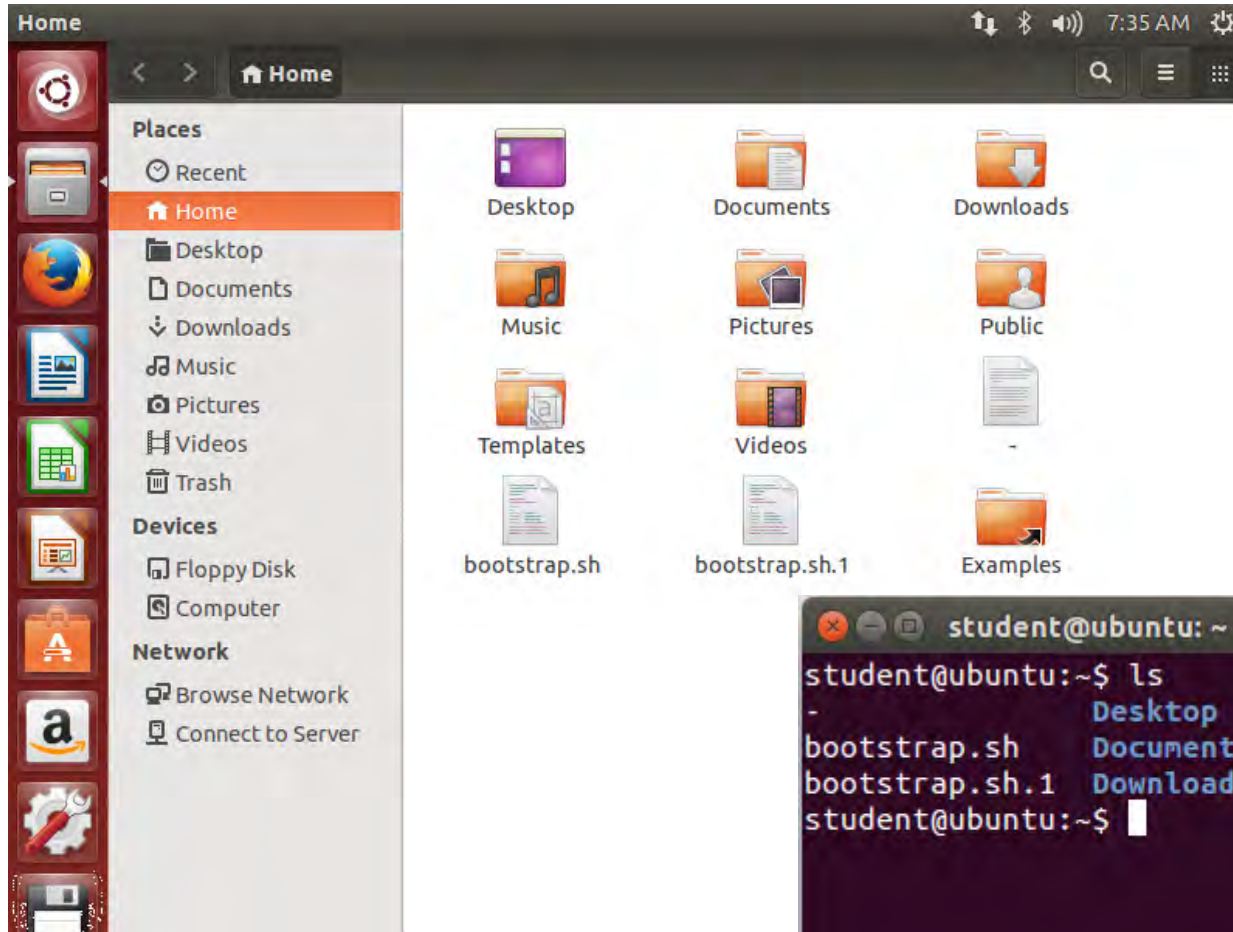

# Best Practices: Scheduled Disk Maintenance

## ➤ Linux disk maintenance

- Linux file systems do not require defragmentation
  - File system automatically moves file clusters to make them contiguous to avoid fragmentation
- fsck
  - Logical file system checker

## ➤ Mac OS disk maintenance

- Run Disk Utility once a month
  - Repairs disk permissions
  - Repairs disk boot problems
    - Boot from recovery partition by holding down <Command><R>, then run Disk Utility





# Best Practices: System Updates (Linux)

## ➤ Linux updates (command line)

1. Open terminal window
2. Use command: `sudo apt-get upgrade`
  - (sudo = SuperUser DO, apt-get = Advanced Packaging Tool GET)
3. Enter user password
4. Examine list of updates
5. Select updates to install

## ➤ Linux updates (GUI)

1. Open Dash
  - Click top left button in Launcher
2. Type Update
  - Software Updater will be displayed
3. Click “Details of updates”
  - Select updates to install
4. Click “Install Now”



# Best Practices: System Updates (Mac OS X)

## ➤ Mac OS X updates

- Updates available from the Mac App Store
  - Or “pushed” directly from Apple

## ➤ Updating from Mac App Store

1. Open App Store app on Mac
2. Click Updates icon in toolbar
3. Update individual Apps or Update All

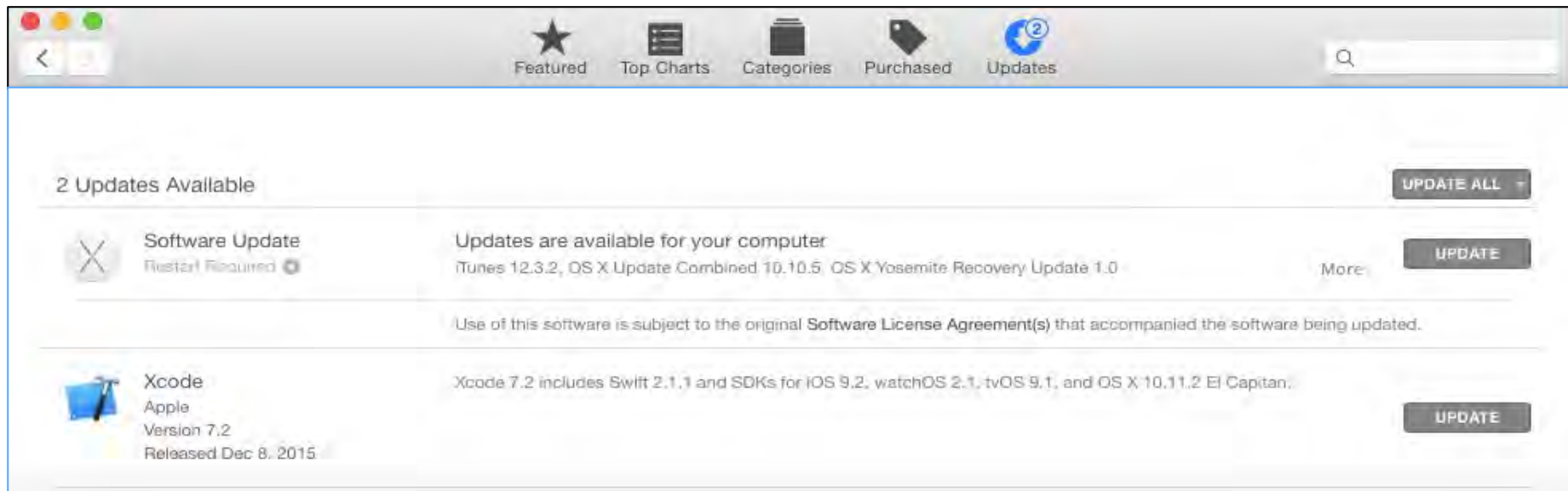

# Best Practices: Patch Management

## ➤ What is a patch?

- Software designed to fix problems or improve performance

## ➤ Linux and Mac OS patch management

- Main Windows patch management tool may also be used for Linux and Mac OS
  - System Center Configuration Manager (SCCM)

## ➤ Third-party patch management tools

- Casper Suite
  - Management tool built for Apple provides complete patch management solution



# Best Practices: Driver/Firmware Upgrades

## ➤ Linux hardware drivers

- Most drivers already included with Linux
  - Upgraded automatically with new upgrades of operating system

## ➤ Installing proprietary drivers for Linux

- Some drivers (e.g., video cards) may be proprietary
- Ubuntu
  - Open Dash, type Additional Drivers
  - Additional Drivers app will search for hardware that requires proprietary driver
  - Install proprietary drivers

## ➤ Max OS X drivers

- Obtain drivers from Apple Support website
  - [support.apple.com](http://support.apple.com)

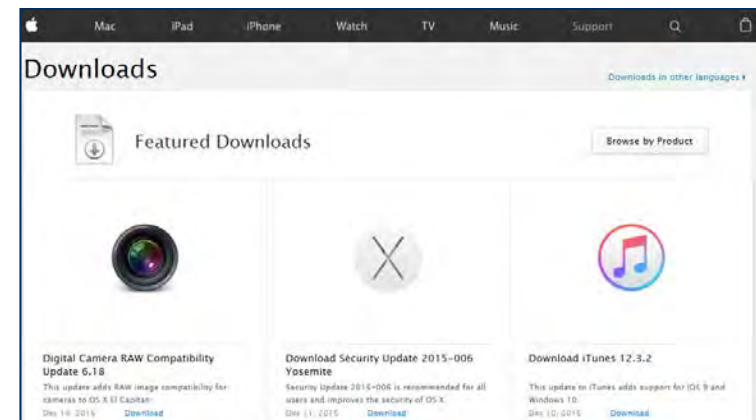
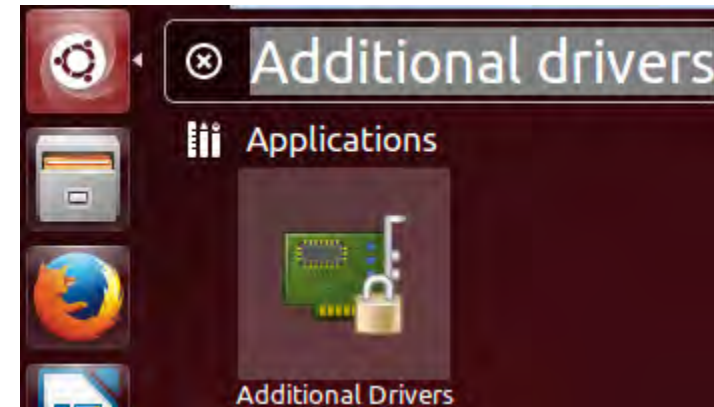

# Best Practices: Antivirus/Antimalware Updates

- **Antivirus/Antimalware programs for Linux and Mac OS X provided by major security program vendors**
  - Symantec
  - Avast!
  - AVG
  - F-PROT
- **Antivirus/antimalware programs include scheduling of automatic updates**



- **Mac OS and Linux Best Practices**
- **Mac OS and Linux Tools**
- **Mac OS and Linux Features**
- **Basic Linux Commands**
- **Client-side Virtualization**
- **Cloud Computing**



## ➤ **rsync**

- Command utility for synchronizing files/folders
- `rsync -a [source directory] [destination directory]`
  - `-a` (archive)

## ➤ **tar (tape archive)**

- Converts a group of files into an archive
  - Single file that contains multiple files + information to permit restoral by an extraction program
- Syntax
  - `tar option(s) archive file name`



# Backup Tools: Mac OS Time Machine

## ➤ Mac OS Time Machine

- Built-in backup program in OS X
  - Saves backup files to external hard drive

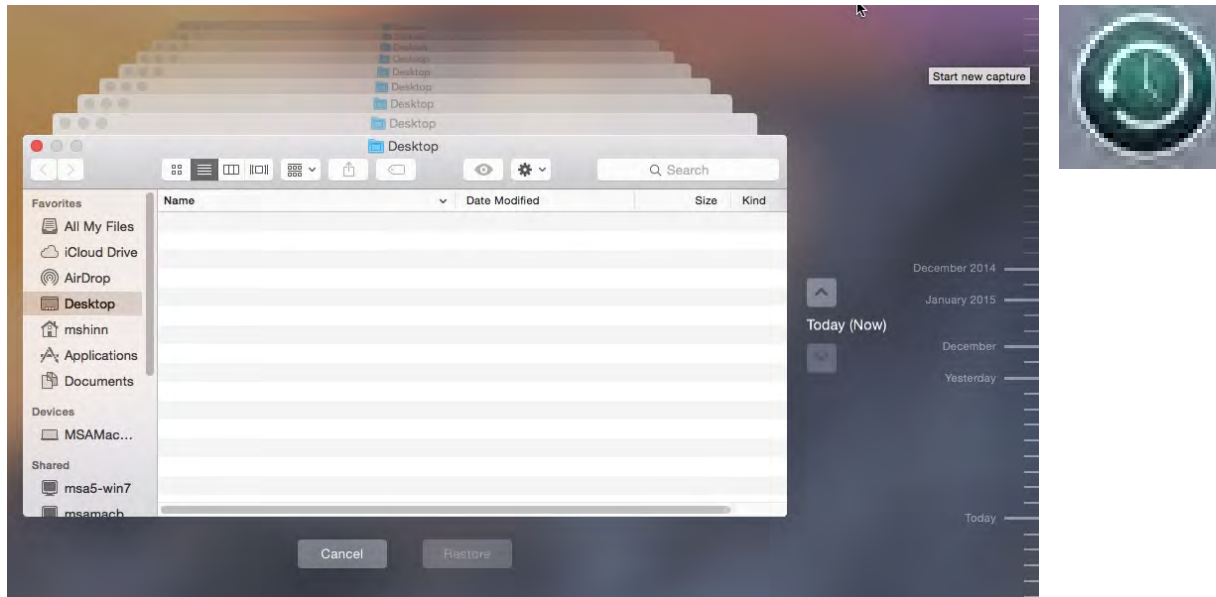



## ➤ What is a Linux Snapshot Volume?

- Image of a Linux disk volume taken at a particular time
- Use `lvcreate -s` to create snapshot volume

## ➤ Restoring Linux Snapshot Volume

- Use `lvconvert -merge` to merge snapshot volume
  - Merge takes place the next time volume is activated



# Restoring Snapshots in Mac OS X

## ➤ Use Time Machine to restore previous snapshots and files

1. Start Time Machine app
2. Select date of snapshot image
3. Select file to restore
4. Click Restore button

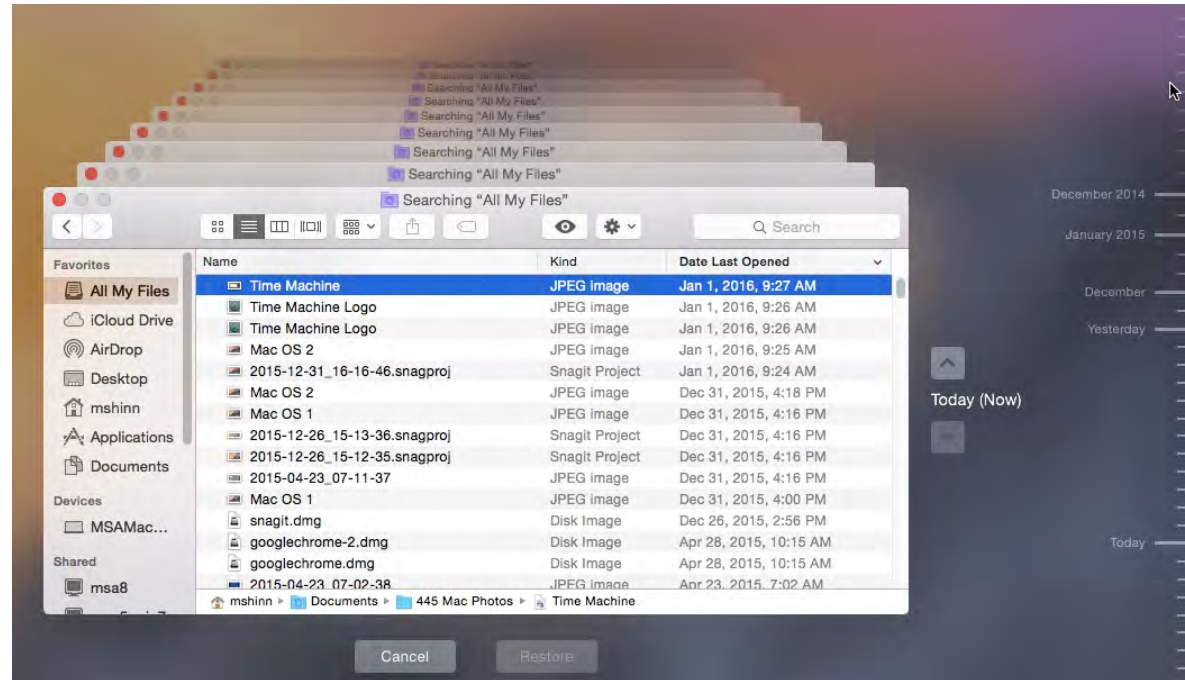

# Image Recovery: Linux

➤ **Linux image snapshots can be restored using the `rsync` command**

➤ **`rsync` restore syntax**

- `rsync -avz folder/snapshot_file destination_folder`
  - `a` = archive
  - `v` = verbose
  - `z` = compress



# Image Recovery: Mac OS X

- **A Mac computer can be restored using a previously saved image stored on an external hard drive**
- **Image recovery process**
  1. Connect external hard drive
  2. Boot Mac from OS X installation CD
    - Note: hold down <C> key when booting, then select language
  3. From menu bar, select Utilities | Disk Utilities
  4. From Disk Utilities app, select drive to restore image from
  5. Select Restore tab, click the Image button, then select external hard drive from left pane
  6. In the left pane, select the .dmg (disk image) file to restore
  7. In the left pane, select the Mac computer's hard drive, then drag it to the destination field in the Restore screen
  8. Click the Restore button
    - The disk image will be copied to the destination drive



# Disk Maintenance Utilities

- **Most disk utilities listed below can be used on both Linux and Mac OS X systems**

Disk Utility	Description
fsck	File system checker
rsync (recursive sync)	Synchronizes files between two systems—can be used for backup and restore of files (note: backs up only files that have changed since last backup)
tar (tape archive)	Backs up files to one archive file
lvcreate -s	Creates a snapshot of a disk volume
lvconvert -m	Merges snapshot image with current volume
Time Machine	Mac OS X backup and restore program
Disk Utilities	Mac OS X set of disk maintenance tools



# Shell/Terminal

## ➤ What is a shell?

- Command line interface
  - Like the command prompt in Windows

## ➤ Linux command shell

- Invoked using  
<CTRL><ALT><T>

## ➤ Mac OS command shell

- Use Applications | Utilities | Terminal

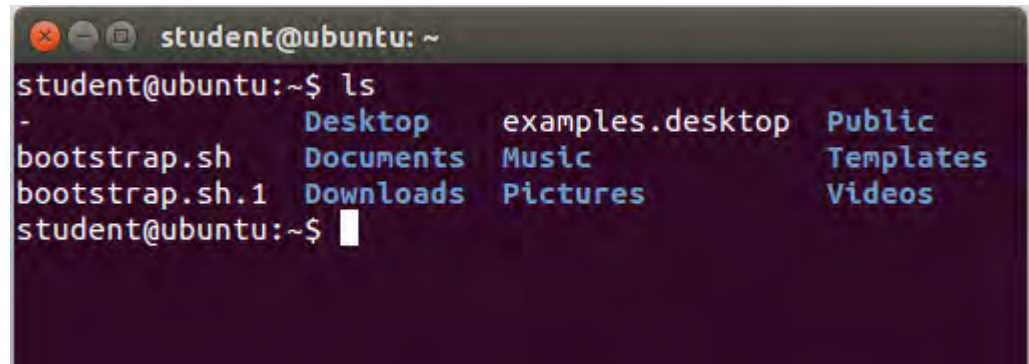

```
student@ubuntu: ~  
student@ubuntu:~$ ls  
- Desktop examples.desktop Public  
bootstrap.sh Documents Music Templates  
bootstrap.sh.1 Downloads Pictures Videos  
student@ubuntu:~$
```



```
mshinn - bash - 66x8  
Last login: Mon Jan 4 15:55:23 on ttys000  
MSAMacbook-2:~ mshinn$ ls  
Applications Downloads Movies Public  
Desktop Library Music Sites  
Documents MSA Projects Pictures Snagit Captures  
MSAMacbook-2:~ mshinn$
```



# Screen Sharing: Linux

- **Third-party screen sharing programs are available for Linux and Mac OS X**
  - LogMeIn
  - Webex
- **Ubuntu Linux contains built-in screen sharing app**
  - VNC (Virtual Network Computing)
- **Starting VNC**
  1. Open Dash, type `remote`
    - Remote Desktop and Desktop Sharing icons will be displayed
  2. Click Desktop Sharing icon
    - Desktop Sharing Preferences window will be displayed



# Screen Sharing: Linux

## ➤ Starting VNC (continued)

3. In Desktop Sharing preferences window, select “Allow other users to view your desktop”
4. Create a password, then close window
5. Users can connect to Computer using VNC Stand Alone Client

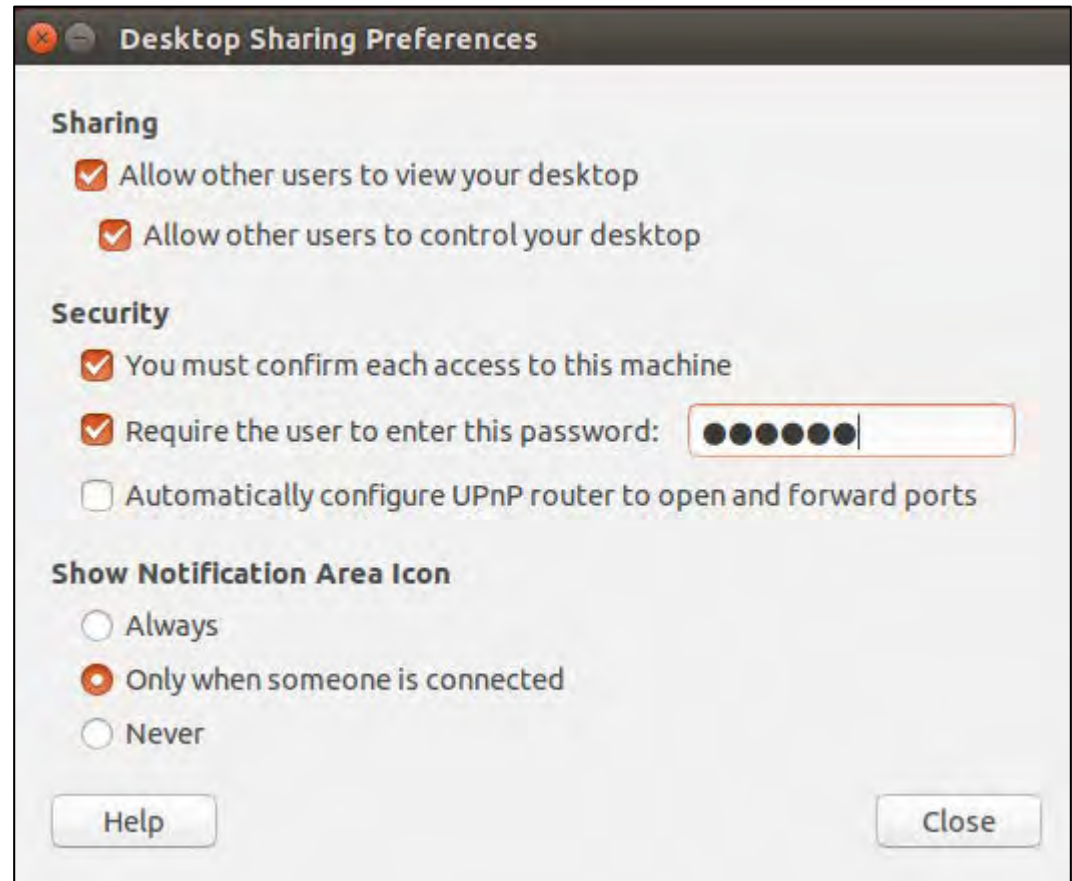



# Screen Sharing: Mac OS X

## ➤ Screen sharing is built into Mac OS X

1. Click Apple icon | System Preferences
2. In System Preferences window, click Sharing, then click the Screen Sharing checkbox
3. Select “All Users” or “Only these users”
  - If “Only these users” selected, click the + sign to specify users

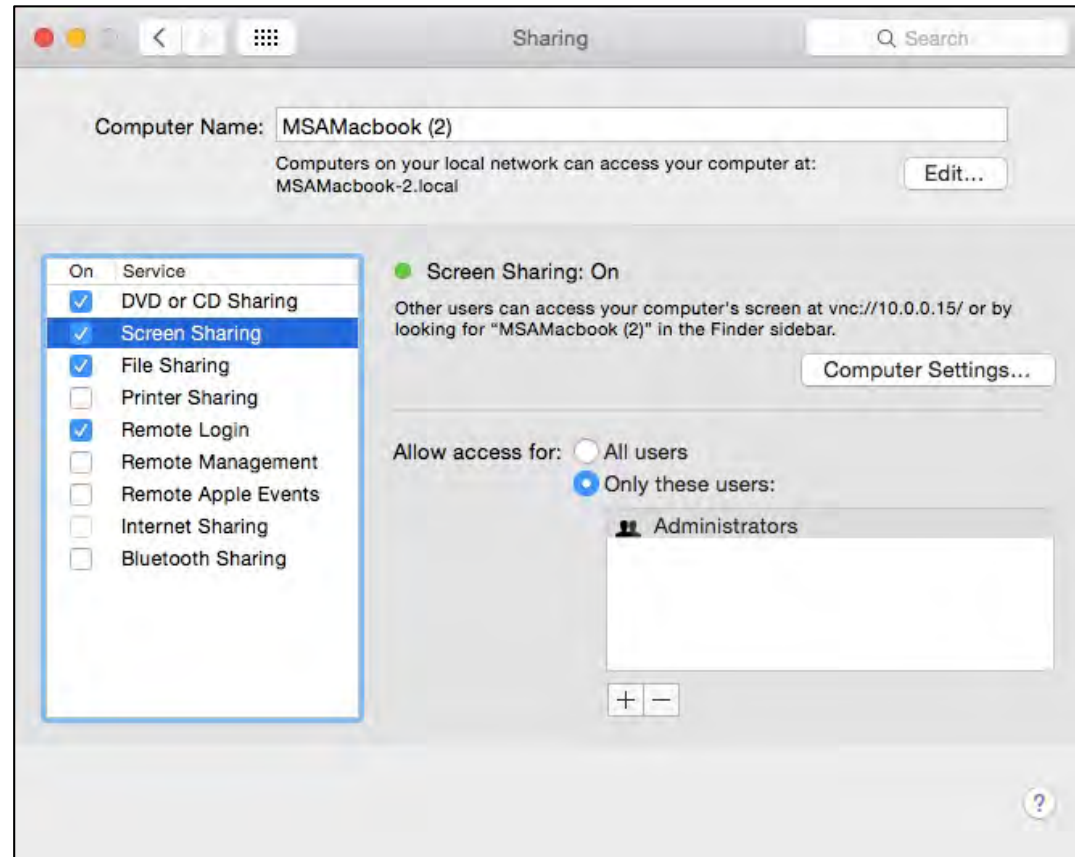

# Mac OS X Force Quit

## ➤ Used to terminate unresponsive applications

1. Click Apple icon | Force Quit
  - Force Quit Applications window will be displayed
2. In Force Quit Applications window, select application to terminate, then click Force Quit

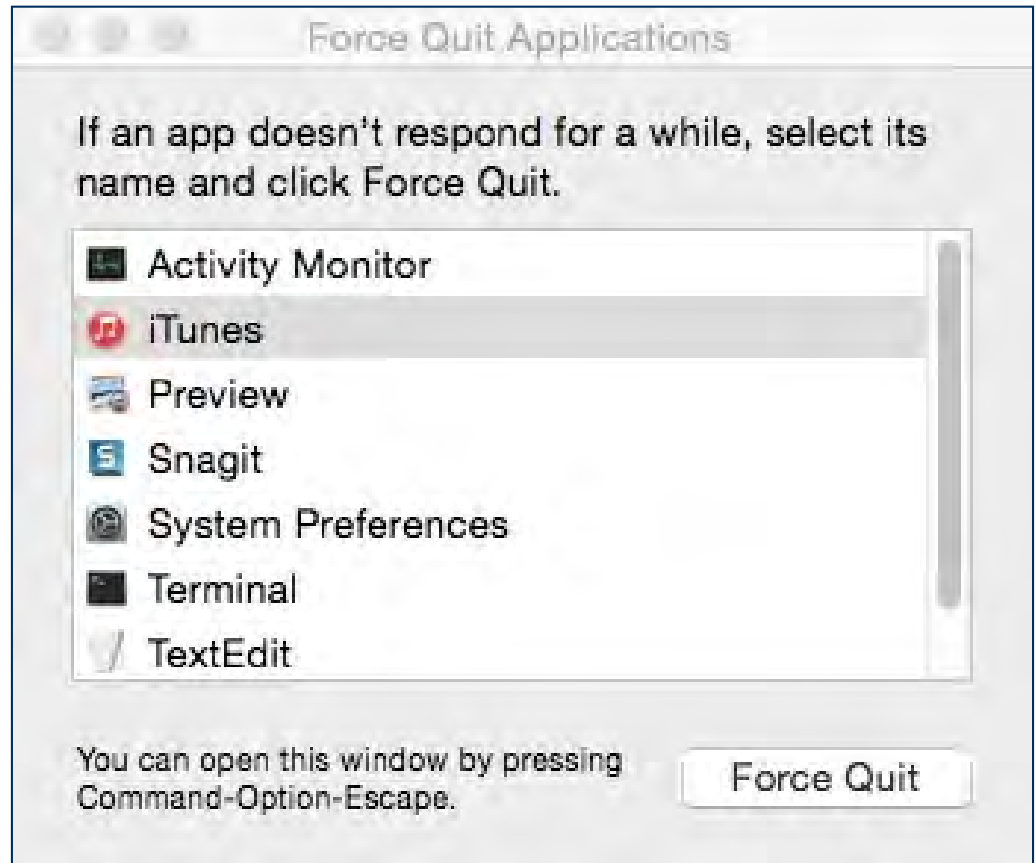

- **Mac OS and Linux Best Practices**
- **Mac OS and Linux Tools**
- **Mac OS and Linux Features**
  - **Basic Linux Commands**
  - **Client-side Virtualization**
  - **Cloud Computing**



# Mac OS X and Linux Features

- **Mac OS X and Linux have many features in common**
  - This section will cover several key Mac OS X features
  - Linux variants often have equivalent features
- **Mission Control (multiple desktops)**
  - Allows user to view and manage all open windows and applications
  - Multiple desktops can be switched to from within Mission Control window
- **Displaying Mission Control window**
  - Swipe up with three or four fingers on multi-touch trackpad
  - Click Mission Control icon in Dock
  - Press Mission Control key on Apple keyboard or press <CTRL><Up Arrow>



# Mac OS X Mission Control/Multiple Desktops

Multiple desktops

Open Windows and Applications

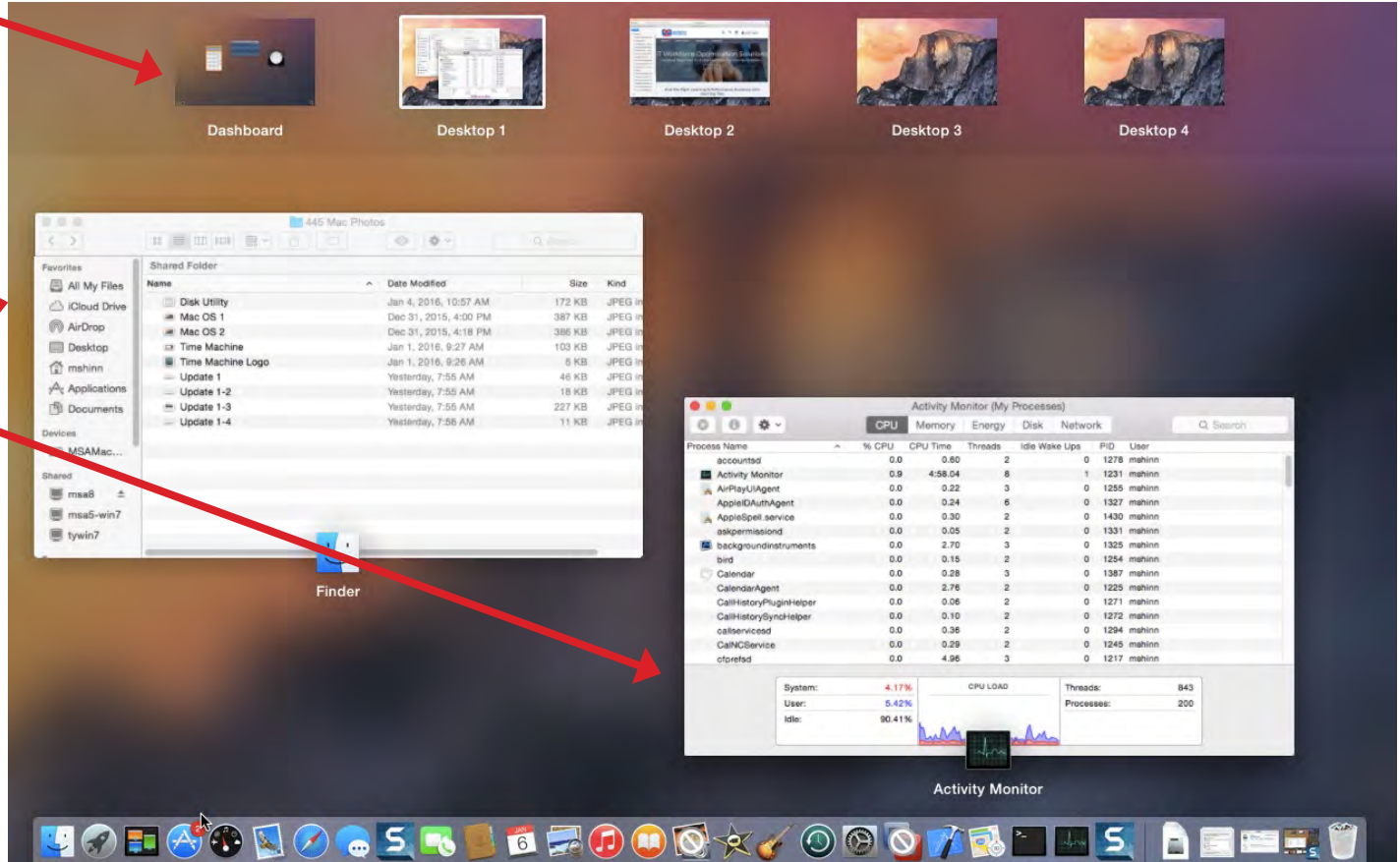

# Linux Multiple Desktops

➤ **Ubuntu Linux multiple workspace feature manages multiple desktops**

➤ **Activating multiple workspaces**

1. In Launcher, click System Settings 
2. In System Settings, click Appearance icon
3. In Appearance dialog, select Behavior tab, then click “Enable workspaces” checkbox

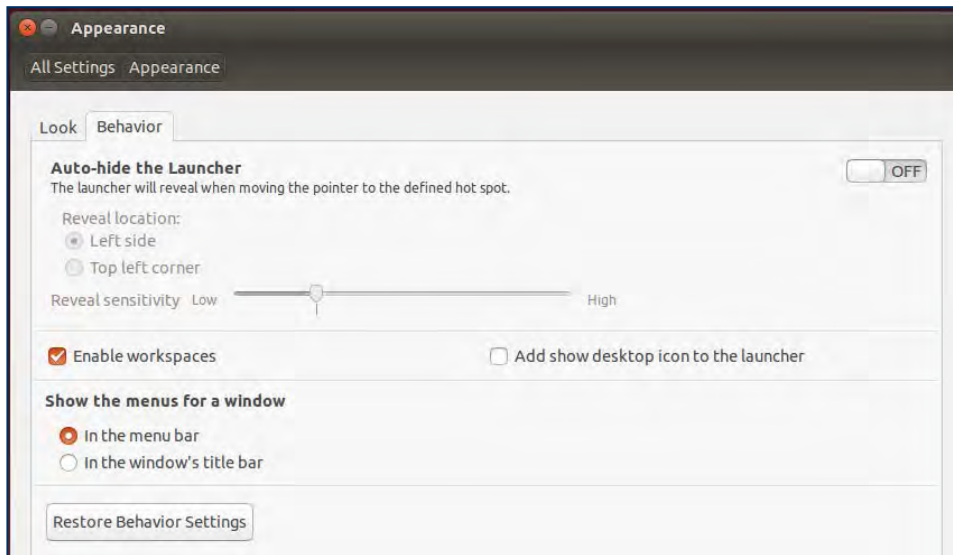
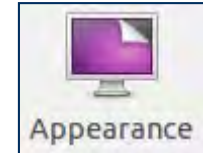

# Linux Multiple Desktops

## ➤ Activating multiple workspaces (continued)

4. In Launcher, click new Workspace Switcher icon to launch multiple workspace view

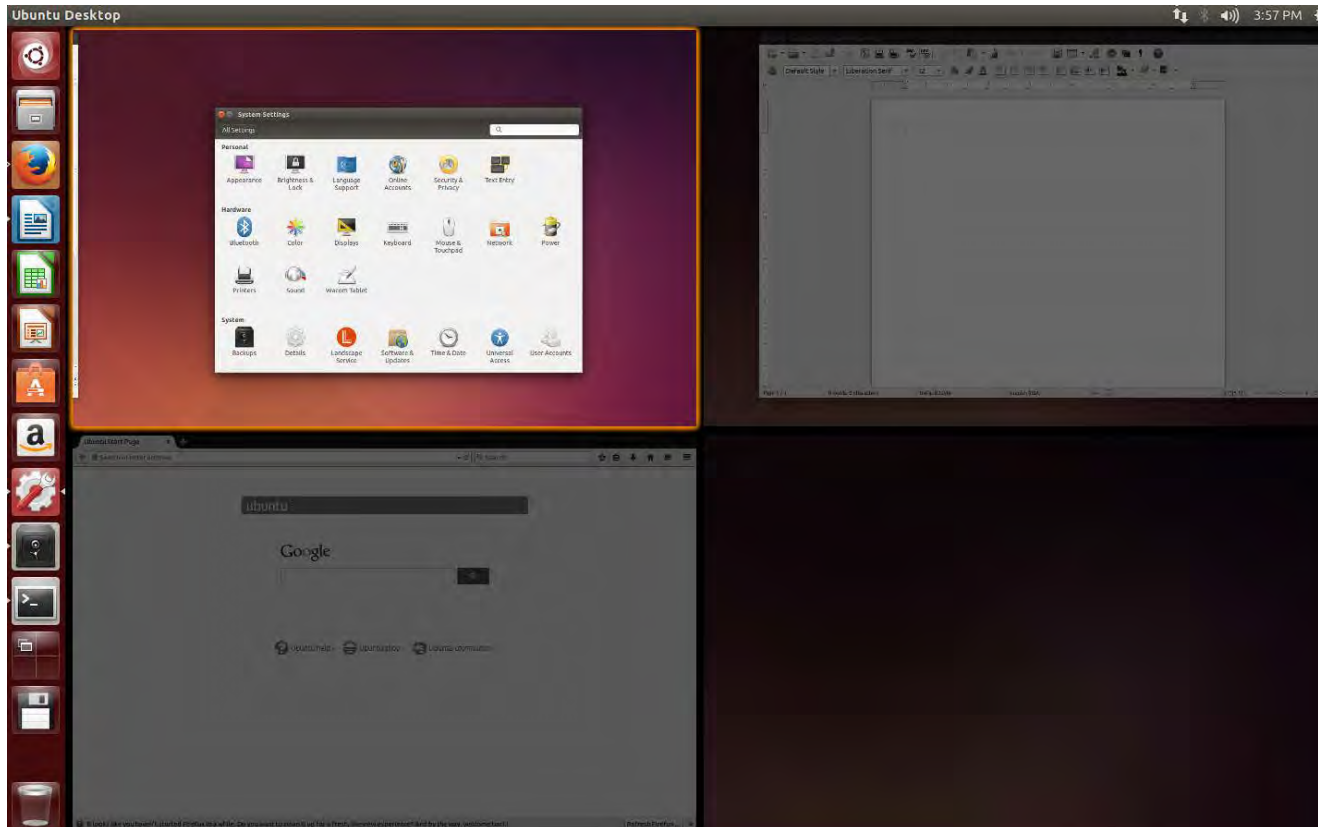
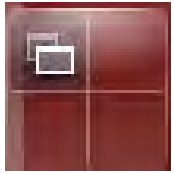

# Mac OS X Features

## ➤ Spotlight

- Built-in search tool for Mac OS X systems
- Open search box by clicking magnifying glass icon in upper right corner of menu bar
  - Or by pressing <Command><Spacebar>

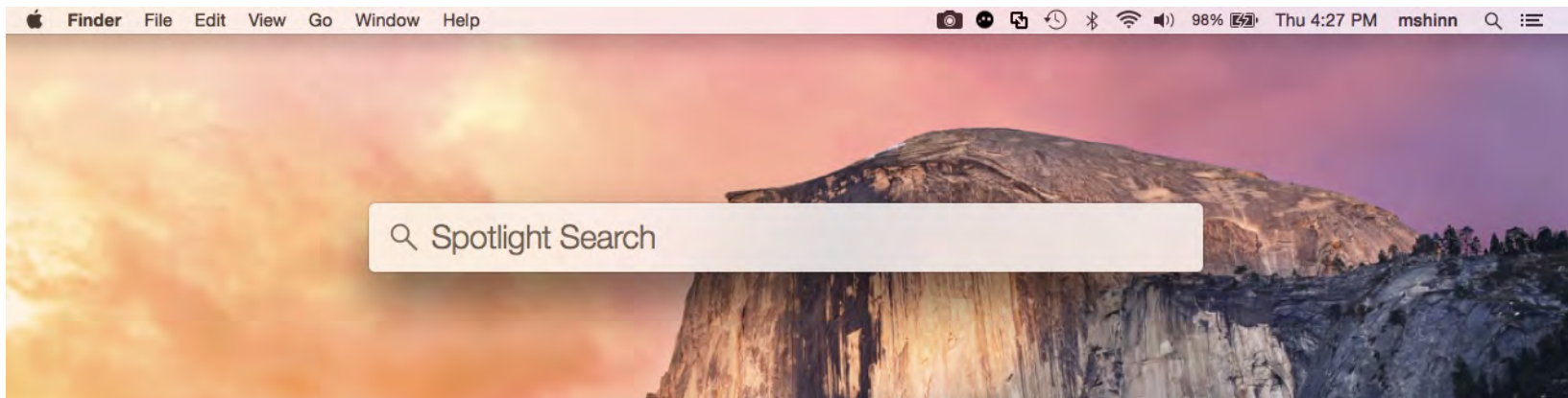

## ➤ Keychain

- Mac OS password management system
  - Stores passwords for applications, servers, websites
  - Stores digital certificates





# Mac OS X Features

## ➤ Keychain

- Mac OS password management system
  - Stores passwords, digital certificates for applications, servers, websites

## ➤ Accessing Keychain

- Click Spotlight icon, then type `Keychain`
  - Keychain window will be displayed

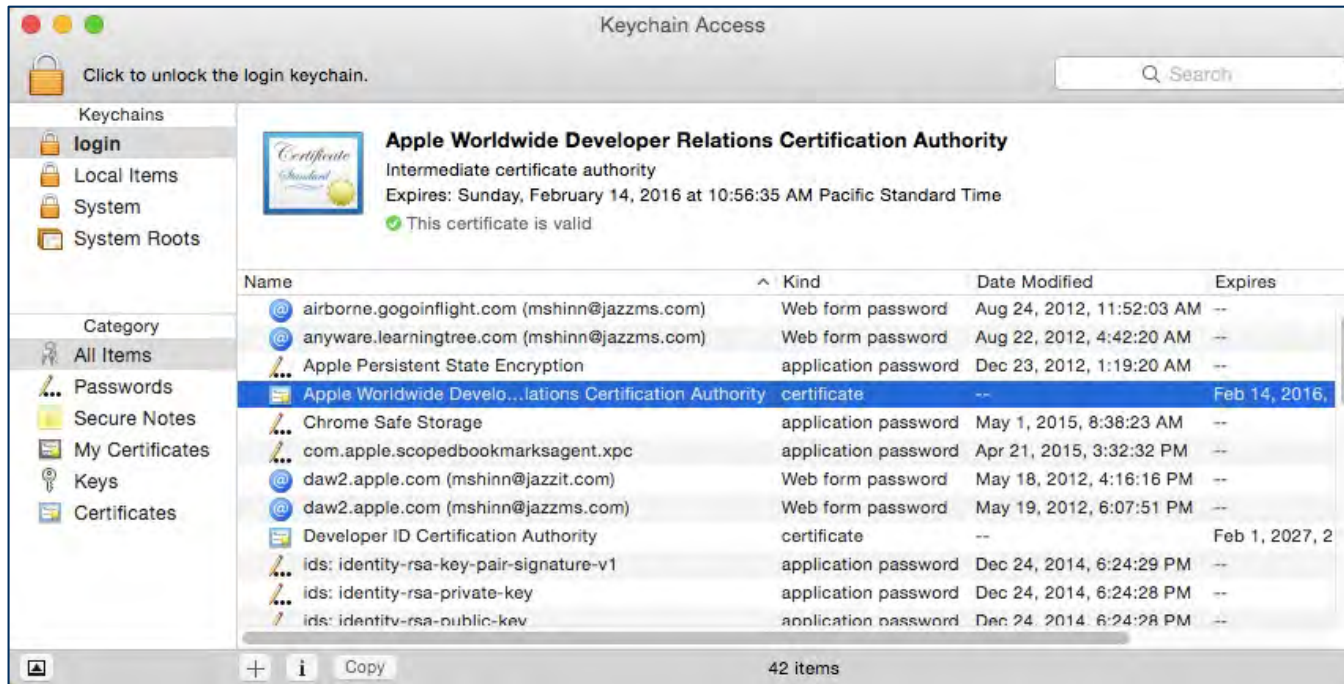

- **Mac OS and Linux Best Practices**
- **Mac OS and Linux Tools**
- **Mac OS and Linux Features**
- **Basic Linux Commands**
- **Client-side Virtualization**
- **Cloud Computing**



# Basic Linux Commands

- **Linux command-line interface is powerful and fast**
  - If you know basic commands...
- **From the Ubuntu desktop, press <CTRL><ALT><T> to open the Terminal window**
  - Command prompt will be displayed: `user name@machine:~$`

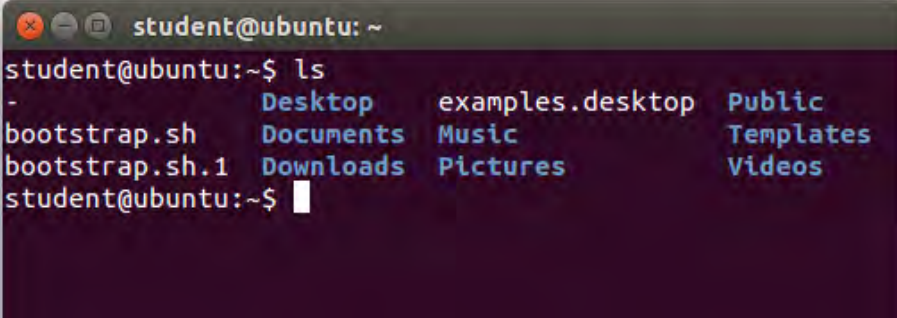

```
student@ubuntu: ~
student@ubuntu:~$ ls
-          Desktop      examples.desktop  Public
bootstrap.sh  Documents  Music             Templates
bootstrap.sh.1 Downloads  Pictures          Videos
student@ubuntu:~$
```

- **To get help**
  - `Help` – provides list of shell commands
  - `help` – provides specific help and syntax when typed after a command
    - Example: `ls -help`
  - `man` – provides detailed command information from manual when typed before a command
    - Example: `man help`



# Linux Basic Commands

Command	Description
<code>ls</code>	List (files in a directory)
<code>cd</code>	Change directory
<code>rm</code>	Remove files
<code>cp</code>	Copy files
<code>mv</code>	Move files
<code>chmod</code>	Change file permissions (change mode)
<code>chown</code>	Change file owner
<code>grep</code>	Search a line for a matching pattern (globally search a regular expression and print)
<code>pwd</code>	Prints full pathname of working directory
<code>passwd</code>	Modify a user password

Command	Description
<code>vi</code>	Visual editor
<code>q</code>	Quit (visual editor)
<code>ps</code>	Process status
<code>ifconfig</code>	Configure network interface
<code>iwconfig</code>	Configure wireless interface
<code>apt-get</code>	Install software packages (Advanced Packaging Tool)
<code>dd</code>	Copy and Convert a file (writes disk headers)
<code>su</code>	Substitute user
<code>sudo</code>	Execute a command as a different user (e.g., SuperUser)
<code>shutdown</code>	Shutdown Linux



## ➤ **Missing GRUB/LILO**

- GRUB (GRUB and Unified Bootloader) is the boot loader for UNIX/Linux
- LILO (Linux LOader) is an older boot loader for Linux
- Missing or corrupted files will cause boot problems

## ➤ **Repairing GRUB**

1. Mount partition containing Linux installation
2. Bind directories GRUB needs access to detect other operating systems
3. Use chroot (change root directory) to enter directory
4. Use grub –install to install and update GRUB
5. Exit and unmount all mounted files
6. Reboot system



## ➤ Kernel panic

- Fatal error in UNIX or Mac OS
  - Similar to “Blue Screen of Death” in Windows
  - Reboot computer as first measure
- If problem still occurs
  - Try safe boot (restart Mac while holding down <Shift> key)



- **Mac OS and Linux Best Practices**
- **Mac OS and Linux Tools**
- **Mac OS and Linux Features**
- **Basic Linux Commands**
- **Client-side Virtualization**
- **Cloud Computing**



# Client-side Virtualization

## ➤ Purpose of virtual machines

- Allows multiple operating systems to run on one physical computer

## ➤ Hypervisor

- Program that creates and manages virtual environments
  - Example: VMWare, HyperV

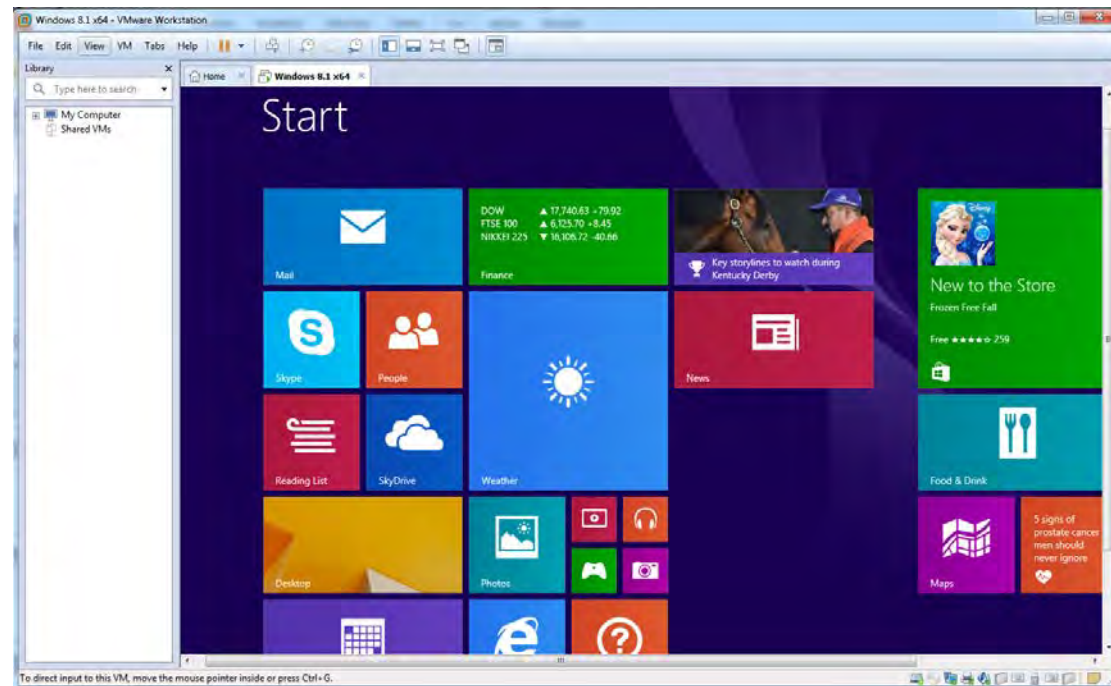
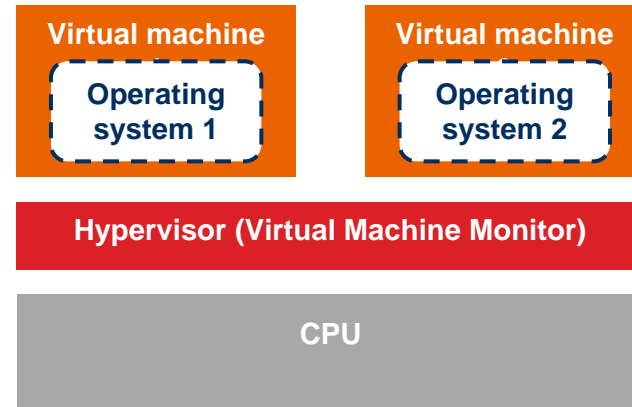



# Client-side Virtualization

## ➤ Resource requirements

- Increased memory
- Sufficient disk space
- High-performance CPU

## ➤ Emulator requirements

- Emulators simulate environment of a specific operating system
  - Example: Microsoft's XP Mode
- Require compatibility with Host operating system

## VMWare virtual machine settings

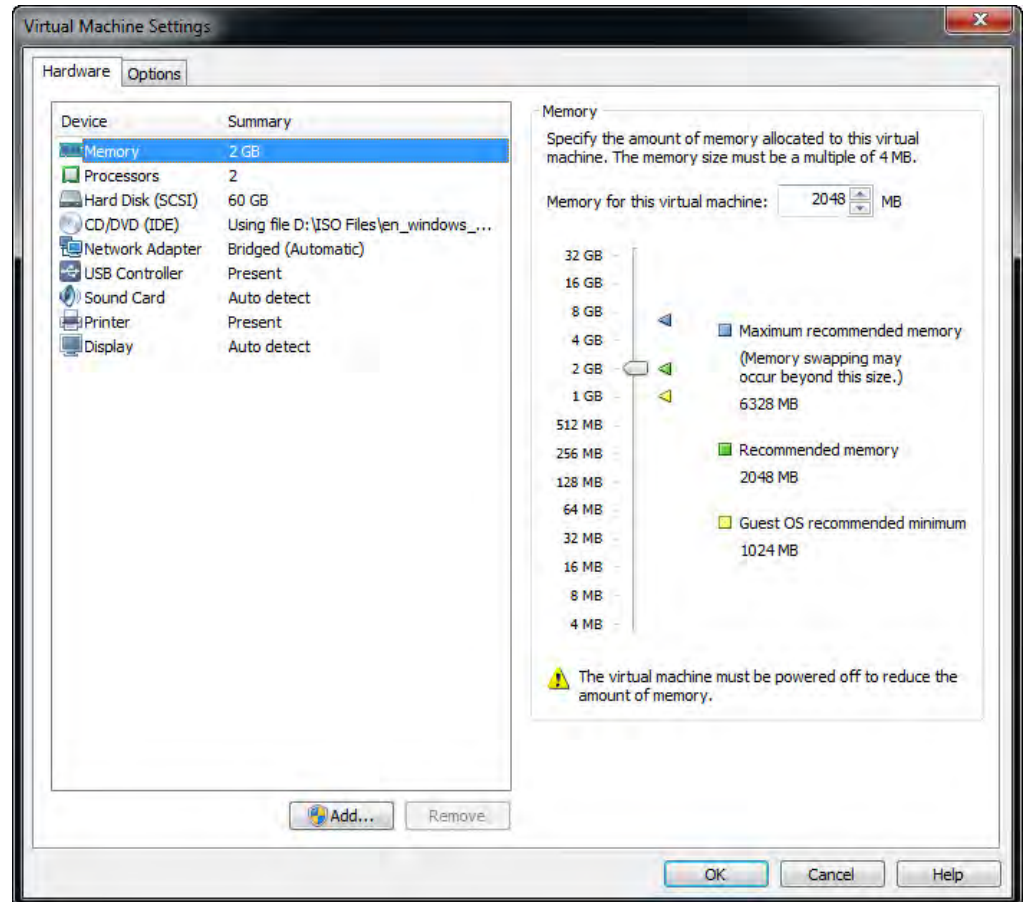

# Client-side Virtualization

## ➤ Security requirements

- Hackers may try to attack the hypervisor creating the virtual environment
- Both the host and guest operating system require protection
  - Antimalware
  - Latest operating system security patches

## ➤ Network requirements

- Depends on virtual machine use
- Can be configured to support
  - Internal networking (between virtual machines)
  - External networking (connection to computers outside virtual machine environment)



- **Mac OS and Linux Best Practices**
- **Mac OS and Linux Tools**
- **Mac OS and Linux Features**
- **Basic Linux Commands**
- **Client-side Virtualization**
- **Cloud Computing**



# Cloud Computing Models

- **Software as a Service (SaaS)**
- Applications provided to users from a centrally hosted computer source
- **Platform as a Service (PaaS)**
- Computing platform environments provided to users from a centrally hosted computer source
  - Operating systems, development environments
- **Infrastructure as a Service (IaaS)**
- Computer networking, storage, virtualization environments provided to users from a centrally hosted computer source

Software as a Service  
(SaaS)

Platform as a Service  
(PaaS)

Infrastructure as a Service  
(IaaS)



# Cloud Types

## ➤ Public

- Infrastructure and services offered to the general public over the Internet
  - Managed by third-party vendor
- Benefits
  - Minimized cost
  - Dynamic allocation of resources, scalability

## ➤ Private

- Infrastructure and services dedicated to a single organization
  - Managed by organization or third-party vendor
- Benefits
  - Provide more control over security

## ➤ Community

- Infrastructure and services shared by multiple organizations with similar needs
  - Managed by organization or third-party vendor
- Benefits
  - Leverage cost and resources across several organizations



# Cloud Computing Features

## ➤ **Rapid elasticity**

- Computing resources can be increased or decreased rapidly, based on demand
  - Example: an online department store

## ➤ **Resource pooling**

- Cloud providers pool computing, virtualization, and networking resources
  - Can be provided to many customers that use what they need

## ➤ **Measured service**

- Customer's use of computing resources is monitored and billed based on usage
  - Time used
  - Amount of storage, VMs, etc.



# Server Roles

- **Computer servers can function in different roles**
- **Web server**
  - Produces web pages in response to HTTP requests
  - Main hosting site for individual/company websites
- **File server**
  - Provides shared storage of files (documents, photographs, sound and video files, etc.)
- **Print server**
  - Provides centralized control for one or more printers
  - Allows multiple users to share printer resources
- **DHCP (Dynamic Host Configuration Protocol) server**
  - Provides IP addresses to networked computers dynamically



# Server Roles

## ➤ DNS server

- Resolves domain names to IP addresses
- Example: `microsoft.com = 172.20.0.1`

## ➤ Proxy server

- Acts as intermediary for requests from clients to other servers

## ➤ Mail server

- Sends and receives e-mail
- Example: Microsoft exchange server

## ➤ Authentication server

- Authenticates credentials from users (User Name, Password)
- Provides cryptographic ticket that provides access to resources





# Review Questions

- 1. In MAC OS, which utility can be used to repair disk permissions and boot problems?**
  - A. Disk Prep
  - B. Disk Manager
  - C. Partition Manager
  - D. Disk Utility
  
- 2. In Linux, which utility can be used for backup purposes?**
  - A. Time Machine
  - B. rsync
  - C. System Backup and Restore
  - D. chmod
  
- 3. In MAC OS, which command is used to open a command shell environment?**
  - A. <CTRL><Shift><T>
  - B. Hit Apple key, then type `command`
  - C. Use: Applications | Utilities | Terminal
  - D. There is no command shell environment in MAC OS



# Review Questions

4. **In MAC OS, which command can be used to search for items?**
  - A. Keychain
  - B. Search box
  - C. Spotlight
  - D. Detective
  
5. **Which type of cloud computing architecture has infrastructure and services dedicated to a single organization?**
  - A. Public
  - B. Private
  - C. Community
  - D. General



# Chapter Summary

---

**In this chapter, you have learned how to**

- **Use basic features of Mac OS and Linux operating systems**
- **Describe best practices and tools for Mac OS and Linux**
- **List basic Linux commands**
- **Explain how to set up and use client-side virtualization**
- **Describe basic cloud concepts**



# Chapter 15

# Installing and Upgrading Windows

Customer  
Management  
Standard  
Development  
Consistency  
Business  
Optimal

# Chapter Objectives

---

**In this chapter, you will learn how to**

- **Identify procedures for installing operating systems**
- **Explain procedures and considerations for upgrading operating systems**
- **Describe the minimum requirements and installation procedures for Windows Vista, Windows 7, and Windows 8/8.1**
- **Explain the purpose of Service Packs and updates**



- **Installing Windows**
  - **Upgrading Windows**
  - **Service Packs and Updates**



# Windows OS Upgrade Advisor

## ➤ What is the Windows Upgrade Advisor?

- Microsoft tool that analyzes computer to determine suitability for Windows upgrade
  - Free, downloadable from Microsoft website

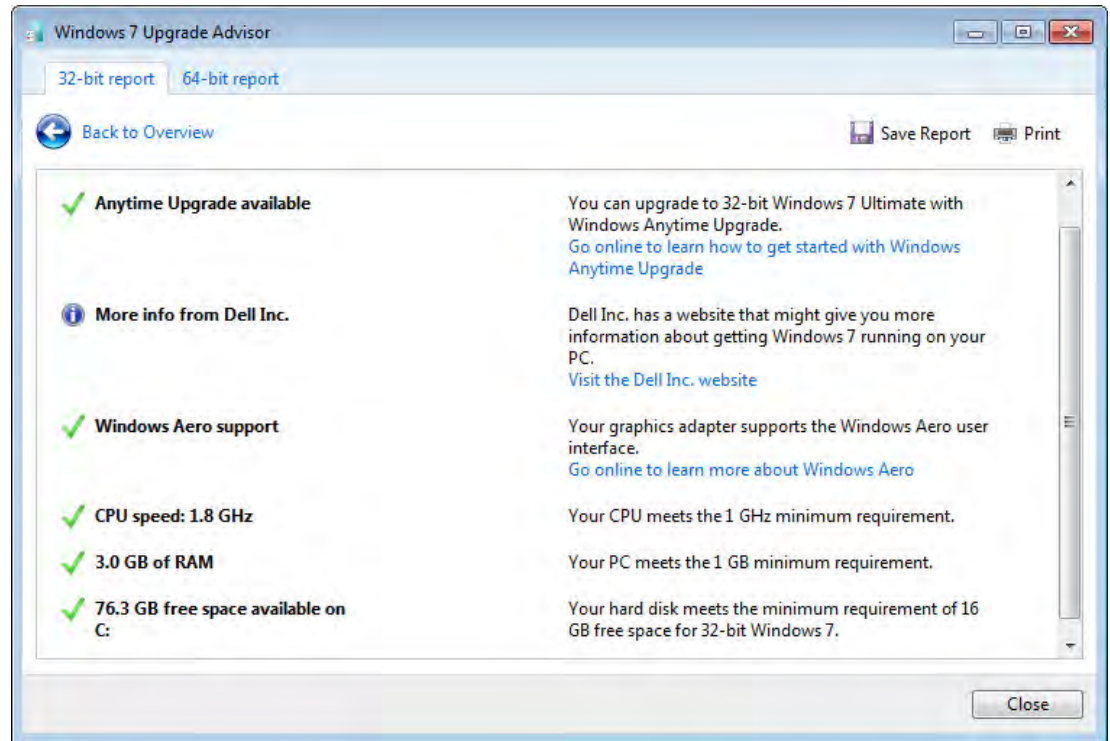

# Minimum Hardware Requirements: Windows Vista

- **Minimum hardware requirements for Windows Vista**
  - Note that these are minimal specifications

Component	Windows Vista
CPU	800 MHz
Memory	512 MB
Hard disk	15 GB free on a 20 GB drive
Display	Super VGA  Note: 128 MB required for Aero display feature
Installation drive	CD-ROM





# Minimum Hardware Requirements: Windows 7

- **Microsoft-specified minimum requirements for Windows 7**
  - Note that these are minimal specifications

Component	Windows 7 (32-bit)	Windows 7 (64-bit)
CPU	1 GHz	1 GHz
Memory	1 GB	2 GB
Hard disk	15 GB free	20 GB free
Display	Direct X 9 Support  <u>Windows Display Driver Model (WDDM 1.0)</u>	Direct X 9 Support  Windows Display Driver Model (WDDM 1.0)



# Minimum Hardware Requirements: Windows 8/8.1

- **Microsoft-specified minimum requirements for Windows 8/8.1**
- **CPU requirements**
  - PAE allows 32-bit processors to use more than 4 GB of memory
  - NX stops malicious software from executing from data areas
  - SSE2 standard instruction set used by third-party apps and drivers

Component	Windows 8/8.1 (32-bit)	Windows 8/8.1 (64-bit)
CPU	1 GHz with support for PAE, NX, SSE2	1 GHz with support for PAE, NX, SSE2
Memory	1 GB	2 GB
Hard disk	15 GB free	20 GB free
Display	Direct X 9 Support  Windows Display Driver Model (WDDM 1.0)	Direct X 9 Support  Windows Display Driver Model (WDDM 1.0)

PAE = Physical Address Extension; NX = No Execute; SSE2 = Streaming SIMD Extensions



# Windows Vista Versions

## ➤ Windows Vista versions available in 32- and 64-bit versions

Feature	Home Basic	Home Premium	Business	Ultimate	Enterprise
Instant Search	✓	✓	✓	✓	✓
Windows Aero display		✓	✓	✓	✓
Windows Media Center		✓		✓	✓
Domain Join			✓	✓	✓
Windows Complete Backup			✓	✓	✓
Remote Desktop Host			✓	✓	✓
Windows BitLocker Encryption				✓	✓

Source: [www.microsoft.com/windows/windows-vista/compare-editions/default.aspx](http://www.microsoft.com/windows/windows-vista/compare-editions/default.aspx)



# Windows 7 Versions

## ➤ Windows 7 versions available in 32- and 64-bit versions

Feature	Starter (NetBooks only)	Home Premium	Professional	Ultimate	Enterprise
Instant Search	✓	✓	✓	✓	✓
Windows Aero display		✓	✓	✓	✓
Windows Media Center		✓		✓	✓
Domain Join			✓	✓	✓
Windows Complete Backup			✓	✓	✓
Remote Desktop Host			✓	✓	✓
Windows BitLocker Encryption				✓	✓

Source: [www.microsoft.com/windows/windows-7/compare-editions/default.aspx](http://www.microsoft.com/windows/windows-7/compare-editions/default.aspx)



# Windows 8/8.1 Versions

## ➤ Windows 8/8.1 versions available in 32- and 64-bit versions

Feature	Windows 8/8.1	Windows 8/8.1 Professional	Windows 8/8.1 Enterprise
Instant Search	✓	✓	✓
Domain Join		✓	✓
Windows File History (backup utility)	✓	✓	✓
Remote Desktop Host	(Remote desktop client only)	✓	✓
Windows BitLocker Encryption		✓	✓
Hyper-V (virtual machine manager)		64-bit version	64-bit version
Windows to Go (Windows on a USB drive)			✓



# Installing Windows: Boot Methods

## ➤ **USB/external hot-swappable drive**

- Installation files can be stored on bootable USB flash drive or hard drive
- PC BIOS must be set to boot from USB device

## ➤ **CD-ROM/DVD**

- System can be booted from Windows Installation disk

## ➤ **Preboot Execution Environment (PXE)**

- PXE pronounced “Pixie”
- Allows booting from a network interface card
  - Network card obtains IP address from DHCP server
  - Downloads Network Boot Program (NBP) and executes
  - Optionally may require user to press <F12> to confirm



# Installing Windows: Boot Methods

## ➤ Solid State/Flash Drives

- Installation files can be stored on bootable USB solid state or flash drive
- PC BIOS must be set to boot from USB device

## ➤ NetBoot

- Apple technology allows computers to boot from network instead of hard disk
  - Computer locates PXE server and downloads operating system image

## ➤ Internal partition

- Copy of installation files can be stored in a hidden recovery partition



# Installation Methods

## ➤ **Attended installation**

- Windows installation files on bootable DVD
- Windows installation files on remote network server
  1. Boot local system with boot diskette or DVD that contains driver for network card in system
  2. Partition and format local disk
  3. Connect to remote server with installation files
  4. Run `WINNT.EXE` (if booting from a DOS disk) or `WINNT32.EXE` (if booting from a Windows PE DVD or USB drive)

## ➤ **Unattended installations**

- Via network, using Answer Files
  - Windows Setup Manager (available by download) can set up file with answers to Windows installation prompts
- Using disk images
  - Binary “snapshots” of complete Windows installations
  - Created by third-party utilities (Ghost, Acronis Disk Manager, etc.)





# Installation Methods

## ➤ Repair installation

- Reinstall Windows from installation disk to repair defective system
  - Use only if System Restore doesn't work
- Windows installation files on bootable DVD
  1. Boot local system with bootable Windows installation disk
  2. Partition and format local disk
  3. Install Windows

## ➤ Multiboot installation

- Install newer version of Windows on existing Windows system
  - Will install new version in separate partition
  - Will create boot selection menu to allow booting into selected operating system



# Remote Installation Methods

## ➤ Remote network installation and image deployment

- Windows image files can be remotely installed on client computers over the network
- Requires use of Windows Deployment Services
  - Runs on Windows Server 2012
- Client computers use PXE boot over network
  - They then load Windows installation image file

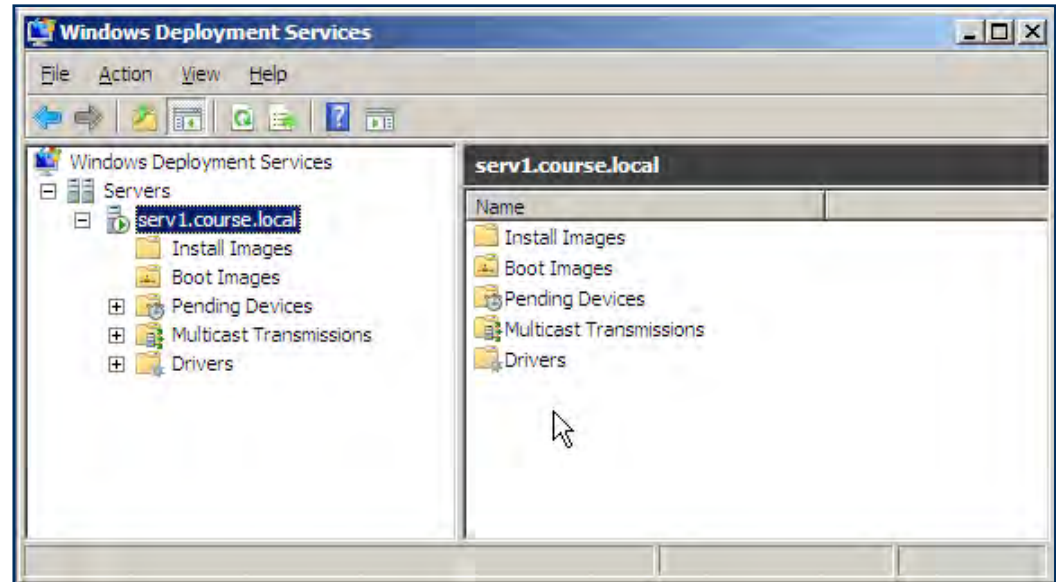

# Image Deployment

## ➤ Image deployment

- Windows images created with Sysprep can be deployed with Windows Automated Installation Kit (WAIK)
  - Microsoft suite of tools for deploying Windows images

## ➤ Factory recovery partition

- Installation files stored in hidden partition
- Preconfigured by manufacturer
- Provides self-contained recovery capability for damaged operating systems



# Refresh/Restore/Reset

## ➤ Windows 8/8.1 built-in recovery modes

- Press Windows key + <C> to display Charms menu
- Then use Change PC Settings | Update and Recovery | Recovery

## ➤ Refresh

- Returns operating system to factory default state
- User data is unaffected

## ➤ Restore

- Returns to an earlier restore point
  - Programs and configuration settings will be rolled back
  - User data is unaffected

## ➤ Reset

- Resets entire system to factory defaults
  - All user installed programs and data are removed

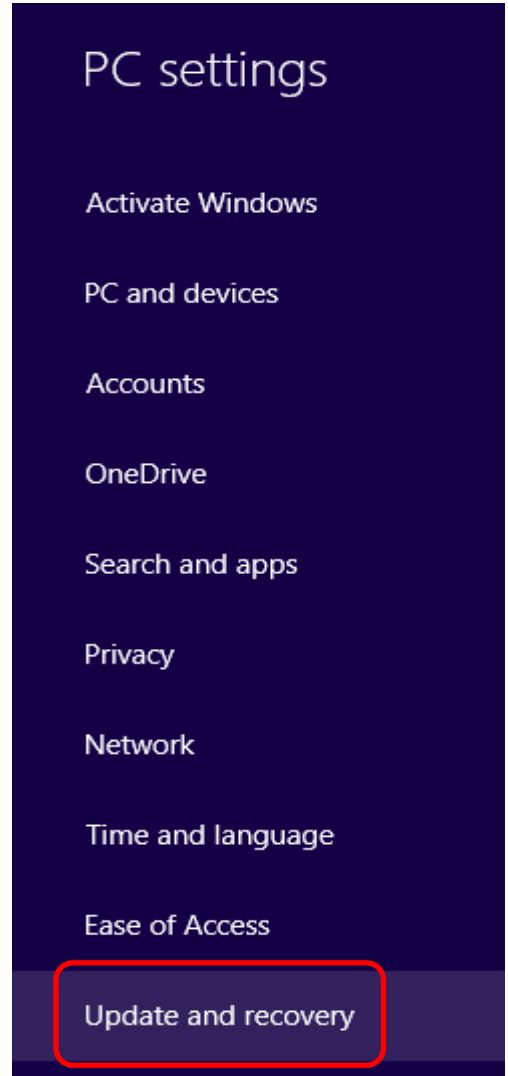

# Refresh/Restore/Reset

The image shows a Windows Settings window titled "Update and recovery". The left sidebar lists "Windows Update", "File History", and "Recovery", with "Recovery" selected. The main content area is divided into three sections:

- Refresh your PC without affecting your files**: A red arrow points from an orange "Refresh" box to this section. Below the title is a description: "If your PC isn't running well, you can refresh it without losing your photos, music, videos, and other personal files." and a "Get started" button.
- Remove everything and reinstall Windows**: A red arrow points from an orange "Reset" box to this section. Below the title is a description: "If you want to recycle your PC or start over completely, you can reset it to its factory settings." and a "Get started" button.
- Advanced startup**: A red arrow points from an orange "Restore" box to this section. Below the title is a description: "Start up from a device or disc (such as a USB drive or DVD), change Windows startup settings, or restore Windows from a system image. This will restart your PC." and a "Restart now" button.



# Clean vs. Upgrade Installation

- **What's the difference between a clean installation and an upgrade?**
  - A clean installation loads a fresh copy of Windows onto a blank disk
  - An upgrade installation upgrades the existing version of Windows on a disk
- **Clean vs. upgrade installation pros and cons:**

Installation type	Pros	Cons
Clean	Starts with clean registry, doesn't preserve existing problems	User programs must be reinstalled, user settings must be reconfigured
Upgrade	User programs and settings are maintained	Existing registry and problems carried over

- **Upgrading file systems**
  - The CONVERT command-line utility performs a one-way conversion from FAT32 to NTFS



# Disk Preparation

- **Installation from bootable DVD**
  1. Boot from DVD, start Windows installation process
  2. Partition disk
  3. Format disk
  4. Copy and install system files
  
- **Installation from network requires that target system have a partitioned, formatted disk**
  - In a domain-based network, you must also have Administrative rights to perform installation or upgrade functions



# Disk Partition Types

## ➤ **Dynamic Disk**

- Specialized partition type allows partitions that can span multiple disks
  - RAID arrays

## ➤ **Basic Disk**

- Most common partition type consists of Primary, Extended, Logical partitions

## ➤ **Primary partition**

- Bootable partition (four maximum on Basic Disk)

## ➤ **Extended partition**

- Hard disk may contain only one extended (non-bootable) partition
  - Can be subdivided into multiple Logical partitions

## ➤ **Logical partition**

- Extended partition can contain multiple Logical partitions

## ➤ **GPT (GUID Partition Table)**

- Newer partitioning scheme labels each partition with a globally unique identifier (GUID)





# Windows Installation Phases

## ➤ Boot from Windows installation disk

- PC will boot into Windows Preinstallation Environment (PE)
  - System runs from smaller version of Windows loaded into RAM
- Program will prompt for language, time and currency format, keyboard type



# Windows Installation Phases

## ➤ Next steps

1. Click Install to begin installation
2. Agree to license terms
3. Select **Upgrade** or **Custom** (clean) installation
4. Select disk partition (or create new one)
5. Start installation
  - Installation process will begin

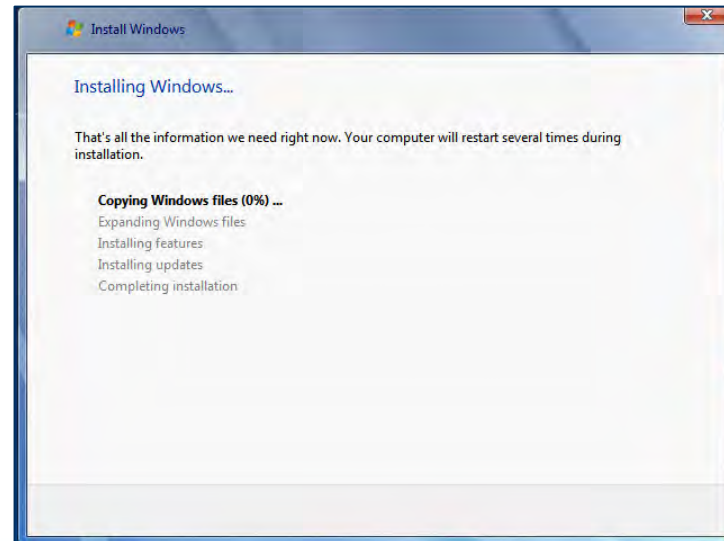
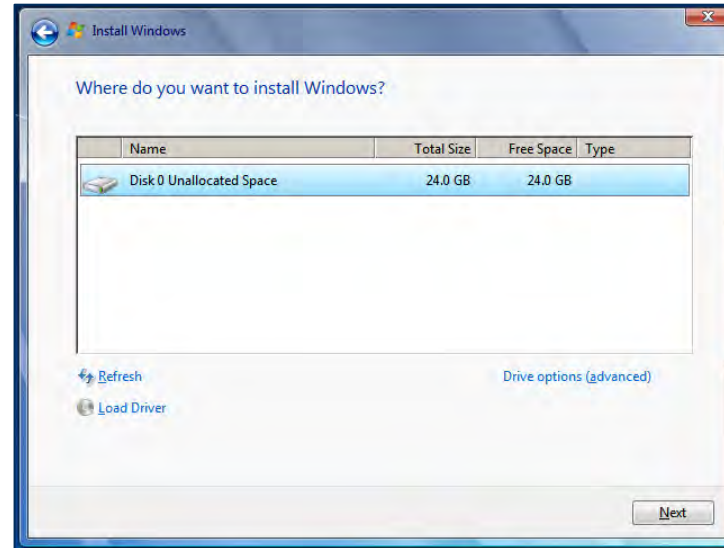

# Windows Installation Phases

- **Load alternate third-party drivers when necessary**
  - Third-party drivers can be added early in the installation process by pressing <F6>, then providing drivers (SCSI or SATA drivers, for example)
  
- **Workgroup vs. domain setup**
  - Configure network type
    - Workgroup name
    - Or domain name
  
- **Time/date/region/language settings**
  - Select during initial installation phase
  
- **Final steps (after Windows installation has completed)**
  1. Install necessary computer and peripheral drivers
  2. Install application software
  3. Install Windows updates



# What Does the Windows SETUP Program Do?

- **The Windows SETUP program uses a multistep process to install the new operating system on a PC**
- **Windows SETUP steps**
  1. Preparing to run Windows setup
  2. Collecting information about your computer
  3. Copying Windows files
  4. Restarting your computer
  5. Setting up hardware and finalizing settings
- **Windows activation**
  - Anti-piracy measure creates a unique code based on the installation CD's product key and a number of hardware-related features
  - Activation can be deferred, but must be completed within 30 days, or
    - Windows will not allow all features to be used
    - Windows will not be updated
    - Windows activation request messages will be frequently displayed



# Repair Installations

- **The Windows installation process can be used to repair a corrupted Windows system**
  - Note: always back up critical data files before performing a repair installation
  
- **Repair installation procedure (Windows 7)**
  - Option 1 (restore from previously created image file)
    1. Turn on computer, press <F8> to display Advanced Boot Options menu
    2. Select Repair Your Computer
    3. Select System Image Recovery
      - Recover your computer using an image you created earlier
  
  - Option 2 (repair in-place)
    1. Boot from Windows installation DVD
    2. Select Install
    3. Select Upgrade when prompted



- **Installing Windows**
- **Upgrading Windows**
- **Service Packs and Updates**



# Valid Upgrade Paths: Windows Vista

## ➤ Upgrading previous versions of Windows to Windows Vista:

Previous Windows version	Windows Vista version
Windows XP Home	Windows Vista Home Basic
Windows XP Home, Windows XP Media Center	Windows Vista Home Premium
Windows XP Home, Windows XP Pro	Windows Vista Business
Windows XP Home, Windows XP Pro, Windows XP Media Center	Windows Vista Ultimate

Note: Windows XP Pro (64-bit) and Windows 2000 Pro cannot be upgraded to any version of Vista



# Valid Upgrade Paths: Windows 7

## ➤ Upgrading previous versions of Windows to Windows 7:

Previous Windows version	Windows 7 version
Windows Vista Home Basic	Windows 7 Home Basic, Home Premium, or Ultimate
Windows Vista Home Premium	Windows 7 Home Premium, Ultimate
Windows Vista Business	Windows 7 Professional, Ultimate, Enterprise
Windows Vista Ultimate	Windows 7 Ultimate
Windows Vista Enterprise	Windows 7 Enterprise





# Valid Upgrade Paths: Windows 8

## ➤ Upgrading previous versions of Windows 7 to Windows 8:

Previous Windows version	Windows 8 version
Windows 7 Home Basic or Premium	Windows 8, Windows 8 Professional
Windows 7 Professional	Windows 8 Professional
Windows 7 Ultimate	Windows 8 Professional
Windows 7 Professional (Volume licensed) or Windows 7 Enterprise (Volume licensed)	Windows 8 Enterprise



# Valid Upgrade Paths: Windows 8.1

## ➤ Upgrading previous versions of Windows 8 to Windows 8.1:

Previous Windows version	Windows 8.1 version
Windows 8	Windows 8.1 or Windows 8.1 Professional
Windows 8 Professional	Windows 8.1 Professional or Windows 8.1 Enterprise
Windows 8 Enterprise	Windows 8.1 Enterprise  Note: cannot upgrade from Windows Store, must download Windows 8.1 Enterprise from Microsoft Volume Licensing Service Center, then do in-place upgrade



# Preparation Procedures for Upgrading

## ➤ Determine current version of Windows

- Right-click Computer and select Properties

## ➤ Back up user data

- Determine where user data is stored (locally, or on network drive)
- Back up any local user data
  - To network, tape, external hard drive, or optical media (DVD)

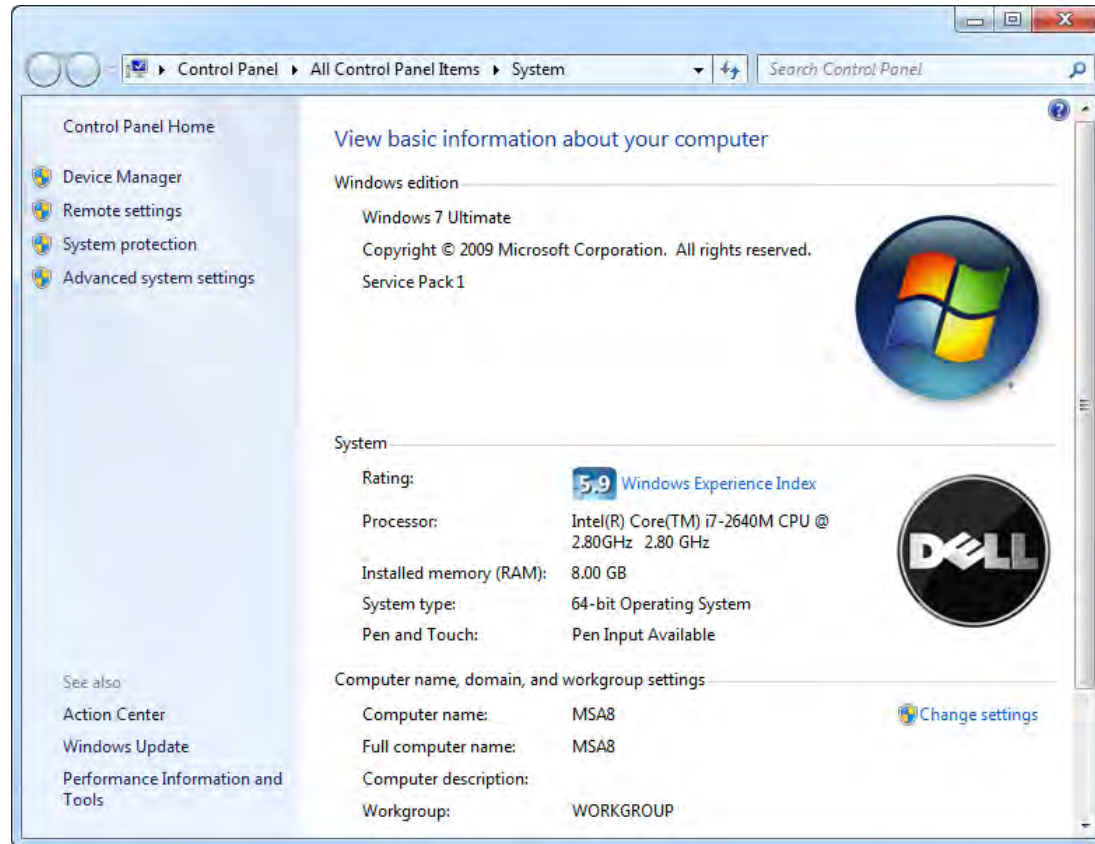

# Preparation Procedures for Upgrading

- **Defragment disk**
- **Run virus scan, then disable virus scanning program**
  - This is because the virus scanning program will complain when key system records (like the boot record) are accessed during the upgrade process
  - Note: If there is a virus detection option in the BIOS, this should also be disabled



# Migrating User Data

- **Windows includes the following migration tools for transferring user data and settings:**

Windows version	Migration tool	Description
Windows Vista/Windows 7/Windows 8/8.1	Windows Easy Transfer	Transfers user files and settings to a backup hard drive prior to doing a clean install
Windows Vista/Windows 7/Windows 8/8.1	User State Migration Tool	System administrator tool transfers user files and settings from old computer to new in a domain environment



- **Installing Windows**
- **Upgrading Windows**
- **Service Packs and Updates**



# Installing Service Packs

## ➤ What are Service Packs?

- Collections of Windows updates and patches
- Apply latest service pack (by number; e.g., SP1) after operating system has been installed
- Use System Properties to check version of installed Service Packs

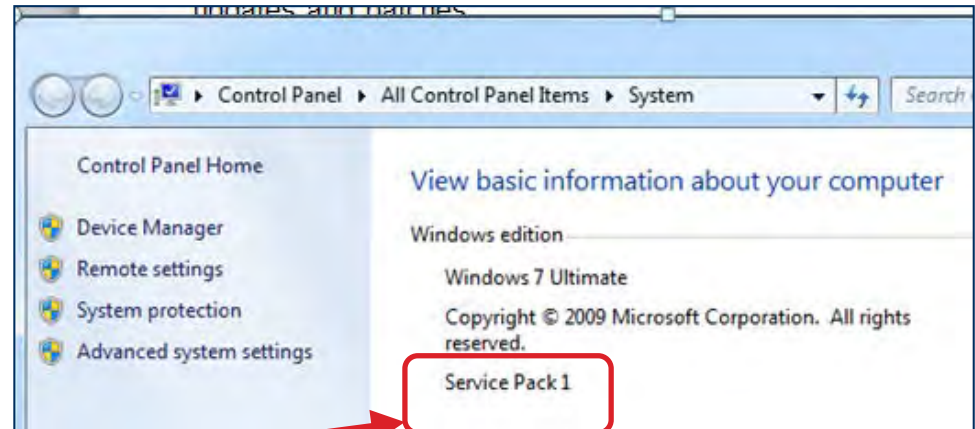

## ➤ Obtain latest updates, service packs from Microsoft Update site

- [www.update.microsoft.com](http://www.update.microsoft.com)



# Windows Automatic Updates

- **Windows automatic update service downloads install latest patches on a scheduled basis**
  - Can be set to “Check for updates but let me choose whether to download and install them”
- **Use Start | Control Panel | Automatic Updates**
  - Or, right-click My Computer, select Properties, click Automatic Updates tab, then select Automatic Update Options

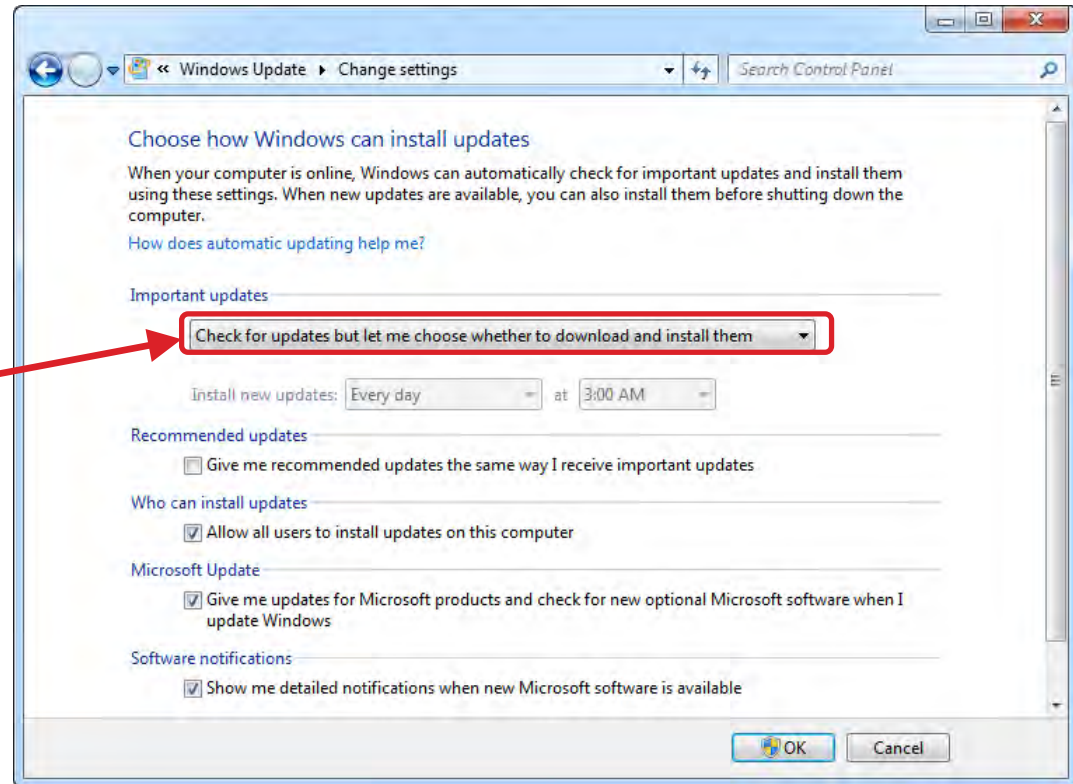



# Review Questions

- 1. When installing Windows from a network (without using a disk image), the target system must have:**
  - A. A partitioned, unformatted hard disk
  - B. An unpartitioned hard disk
  - C. An unpartitioned, unformatted hard disk
  - D. A partitioned, formatted hard disk
- 2. Which Windows version requires: 1 Ghz CPU with support for PAE, NX, SSE2, 2 GB of memory, and 20 GB of hard disk space?**
  - A. Windows Vista
  - B. Windows 7 (32-bit)
  - C. Windows 7 (64-bit)
  - D. Windows 8/8.1 (64-bit)



# Review Questions

- 3. How can third-party drivers be added during the Windows installation process?**
- A. They cannot be added until after Windows has been installed
  - B. Press <F6> when prompted during the text phase of the installation process, then supply drivers
  - C. During the graphical phase of the installation process, start the “Third-party Driver Wizard”
  - D. Third-party drivers must be added using the BIOS Setup program
- 4. What will happen if Windows 7 is not activated during the installation process?**
- A. The operating system will fail to boot
  - B. The operating system will boot but will halt until it has been activated
  - C. The operating system will work, but with reduced functionality and will not install Windows updates
  - D. The operating system will work normally but will be disabled after 30 days if not activated



# Review Questions

5. Jane is using Windows Vista Business; which two versions of Windows 7 are valid upgrades from this version of Windows Vista?
- A. Windows 7 Starter
  - B. Windows 7 Home Premium
  - C. Windows 7 Professional
  - D. Windows 7 Ultimate



# Chapter Summary

---

**In this chapter, you have learned how to**

- **Identify procedures for installing operating systems**
- **Explain procedures and considerations for upgrading operating systems**
- **Describe the minimum requirements and installation procedures for Windows Vista, Windows 7, and Windows 8/8.1**
- **Explain the purpose of Service Packs and updates**



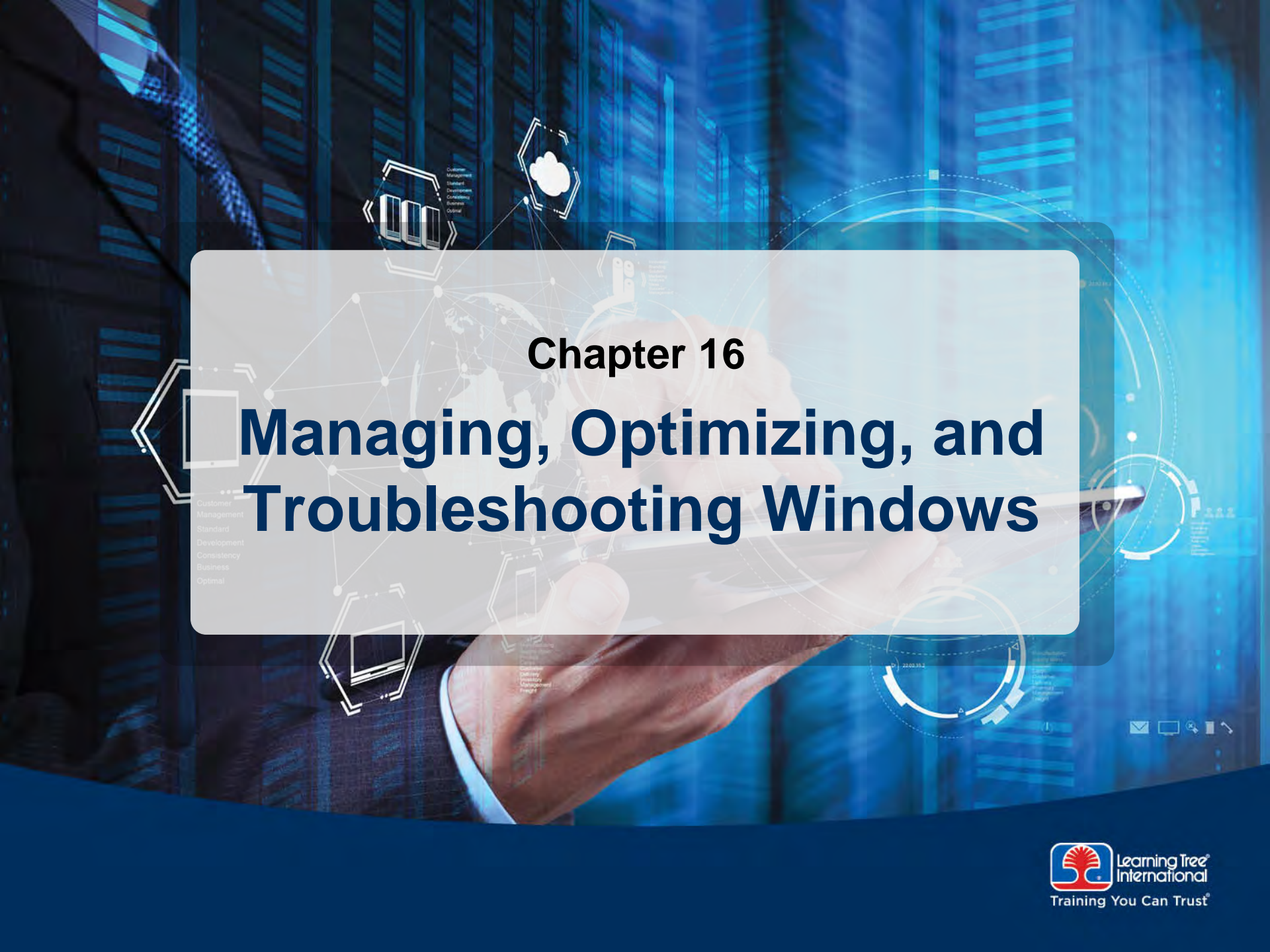

# Chapter 16

## Managing, Optimizing, and Troubleshooting Windows

Customer  
Management  
Standard  
Development  
Consistency  
Business  
Optimal

# Chapter Objectives

In this chapter, you will learn how to

- Describe strategies and tools for managing Windows (Windows BACKUP, Event Viewer, Task Manager, Windows disk management tools)
- Optimize Windows hard disk, virtual memory, and services
- Describe tools and techniques for troubleshooting Windows startup problems
- Troubleshoot Windows hardware and driver problems with Device Manager



## ➤ **Managing Windows**

- **Optimizing Windows**
- **Troubleshooting Windows Startup Problems**
- **Troubleshooting Windows Hardware Problems**



# Windows Computer Management

## ➤ Provides centralized administration for Windows

- Task scheduler
- Device manager
- Local Users and Groups (covered in a later chapter)
  - Local Security policies
- Disk Manager
- Services and applications
- Event Viewer

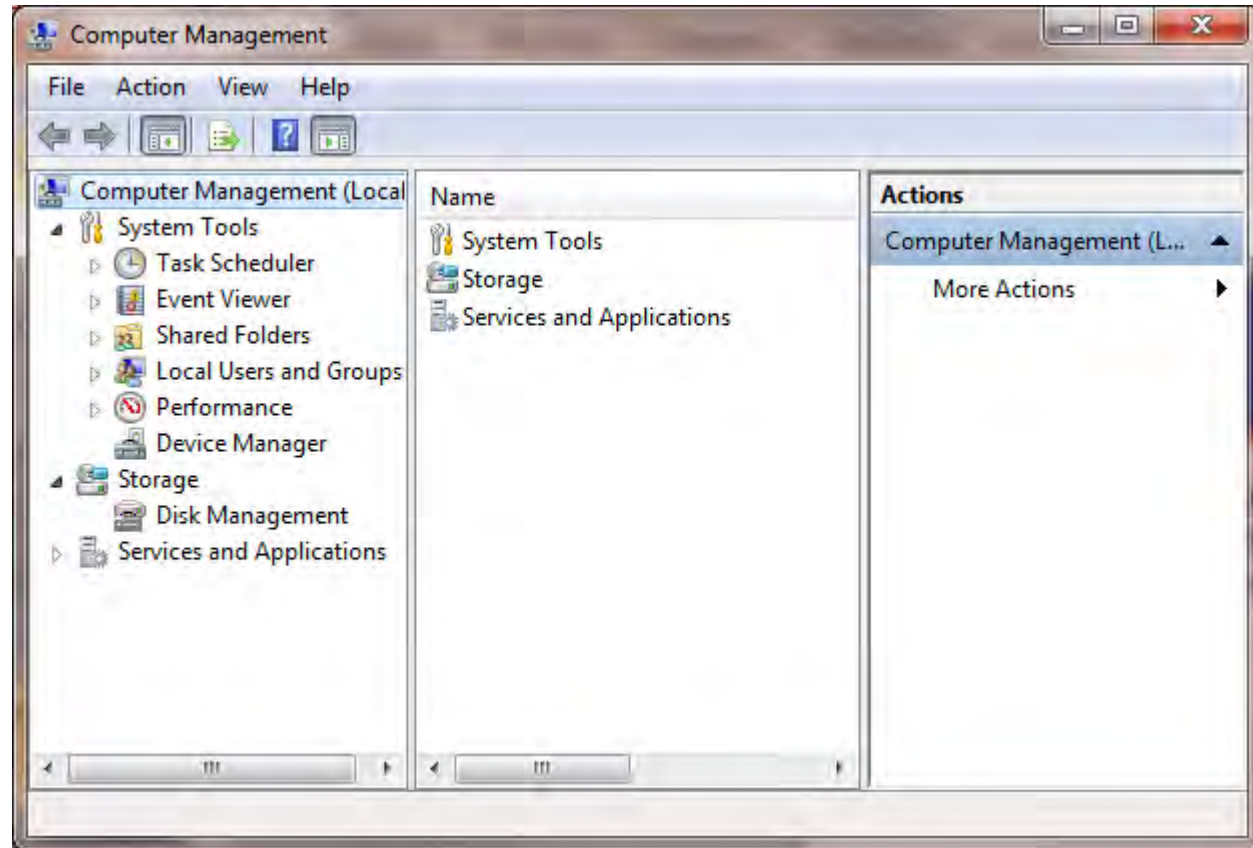

## ➤ To access, right-click Computer and select Manage





# Windows Administrative Tools

- **Provides centralized administration for Windows**
- **Component services**
  - Manage COM objects
- **Data sources**
  - Manage connections to databases
- **Print management**
  - Manage local and network printer settings, print jobs
- **Windows memory diagnostic**
- **Windows firewall**
  - Manage firewall ports, advanced configuration options
  - Basic Windows firewall settings managed through Firewall applet in Control panel
- **Advanced security (part of Windows firewall)**

COM = component object model



# Windows Administrative Tools

## ➤ Windows 7

- Type Administrative tools in search box

## ➤ Windows 8/8.1

- In upper right corner, click Search icon



- Then type Administrative tools in search box

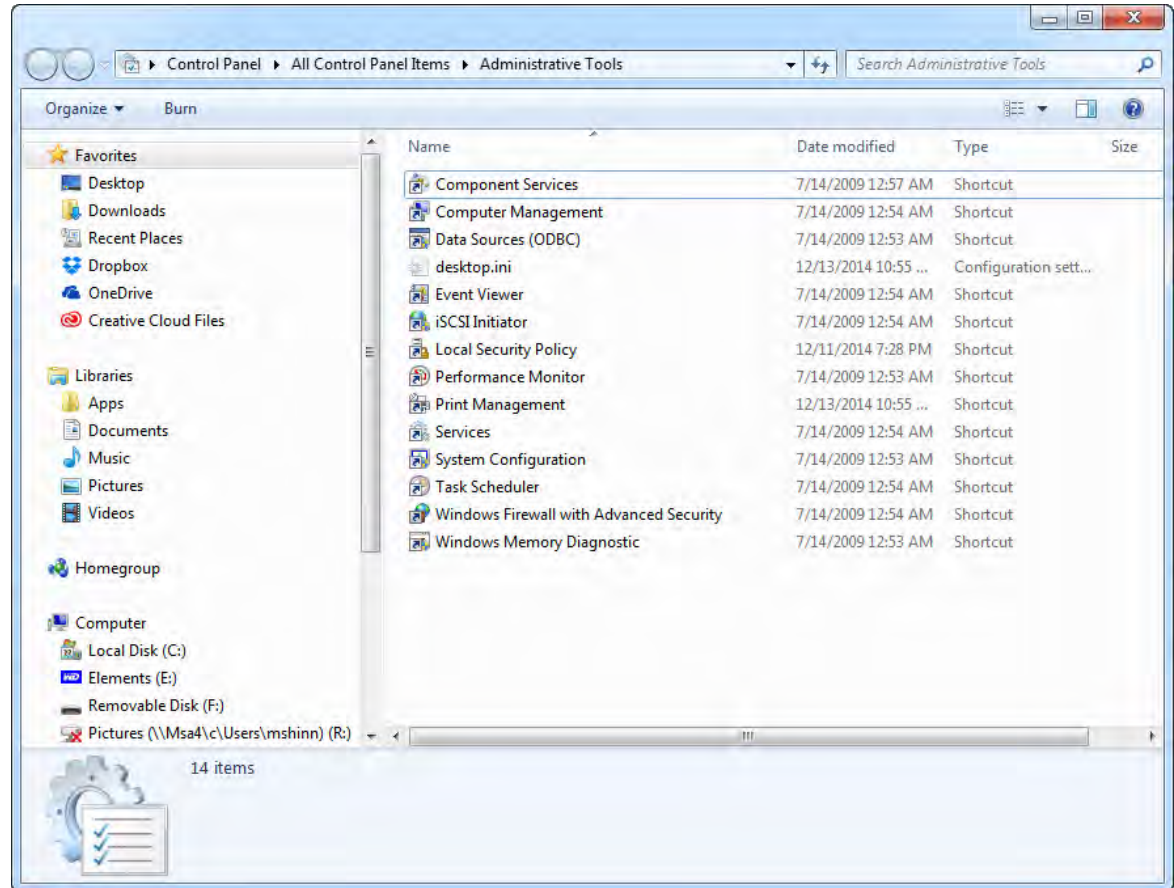

# Windows Backup Strategies

- **Frequent backups are the best solution to a catastrophic hard drive disaster**
  - Crashed hard disk
  - Stolen or destroyed PC system
  - Virus-infected system
  
- **Hard drive backup alternatives**
  - Network servers
  - Tape drives
  - Dedicated hard drives
  - Recordable CD, DVD drives



# Windows Backup Utility: Windows Vista and 7

- **Windows Vista and 7 also feature CD and DVD writing as part of the backup utility**
  - Use Control Panel | System and Security | Backup and Restore

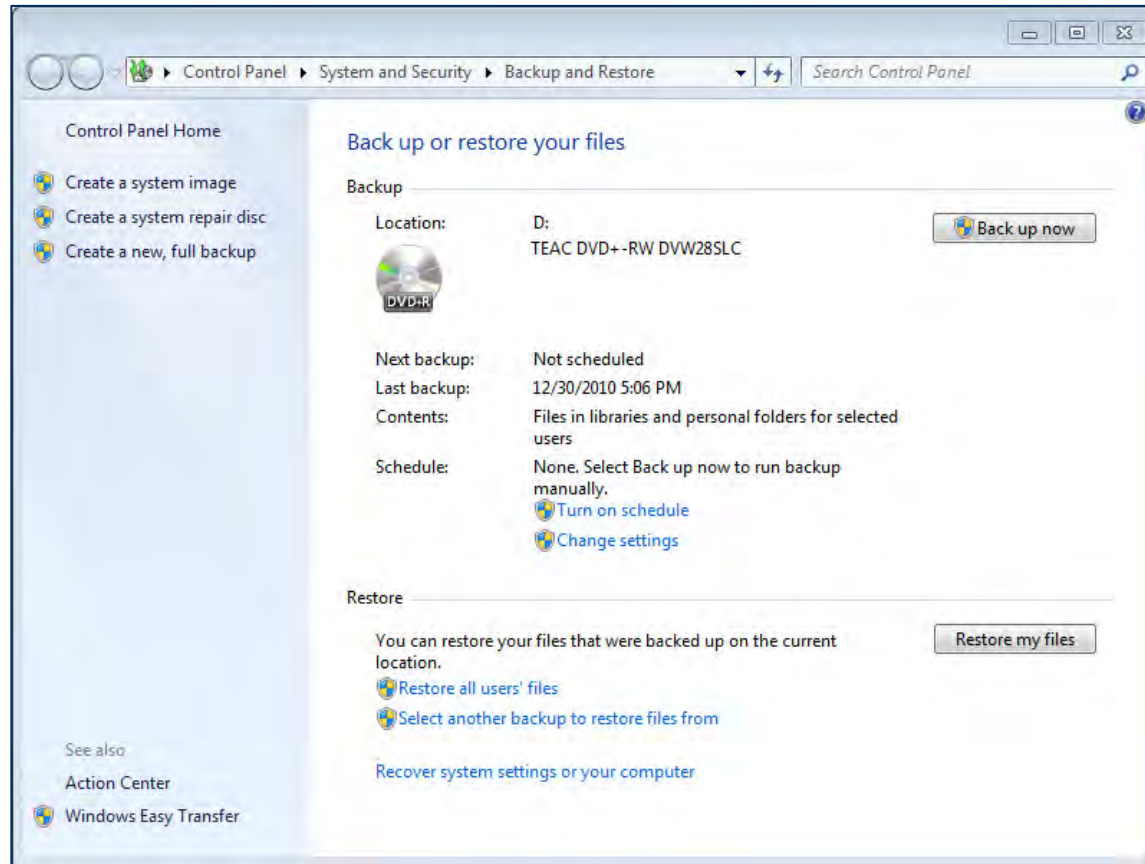

# Backup Types

- **Different backup types are used to make the backup process efficient**
- **Full**
  - Backs up everything on a computer's hard disk
  - Initial backup, used in conjunction with other backup types
- **Incremental**
  - Backs up only files that have been created or changed since last backup
  - Restoring files requires last full backup and each incremental backup since then
- **Differential**
  - Backs up only files that have changed since last full backup
  - Restoring requires last full backup and last differential backup



# Monitoring Windows With Event Viewer

- **Windows Event Viewer records log files of system events**
  - Valuable source of information for troubleshooting problems
  - Use Control Panel | Administrative Tools | Event Viewer
    - Or type `eventvwr.msc` in the Search box

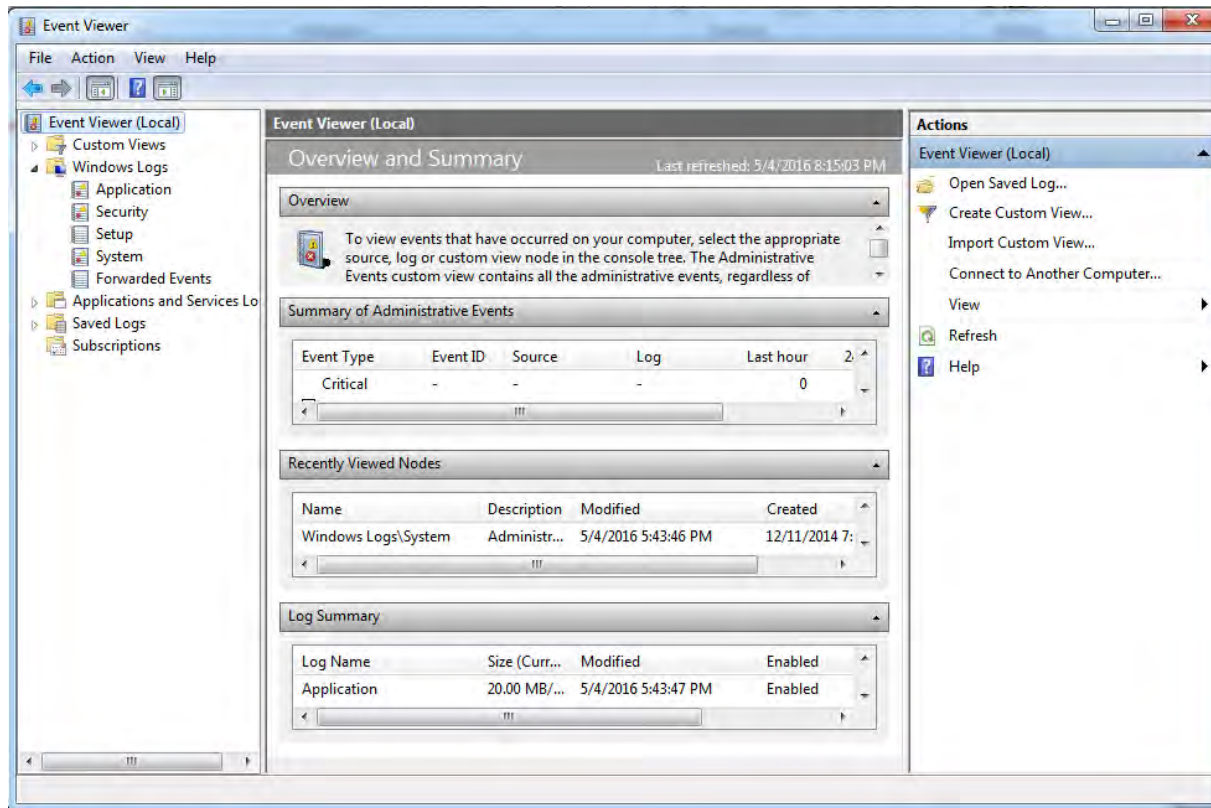

# Monitoring Windows With Event Viewer

## ➤ System Events log

- Select an event to view a detailed description in the pane below

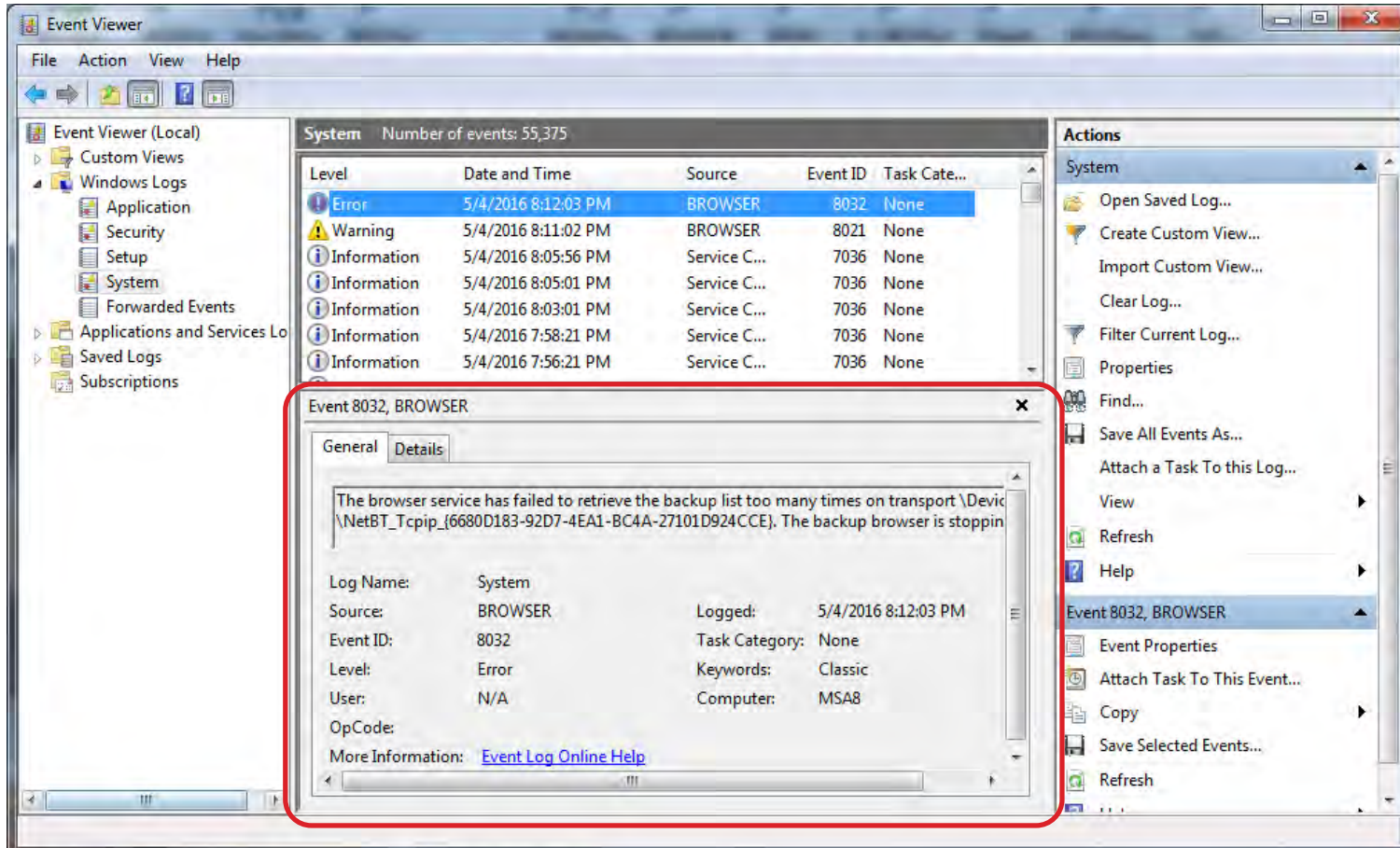

# Monitoring Windows With Event Viewer

## ➤ Managing log files

- Right-click an event log (System, for example) to display options
- Select **Properties** to manage event log parameters

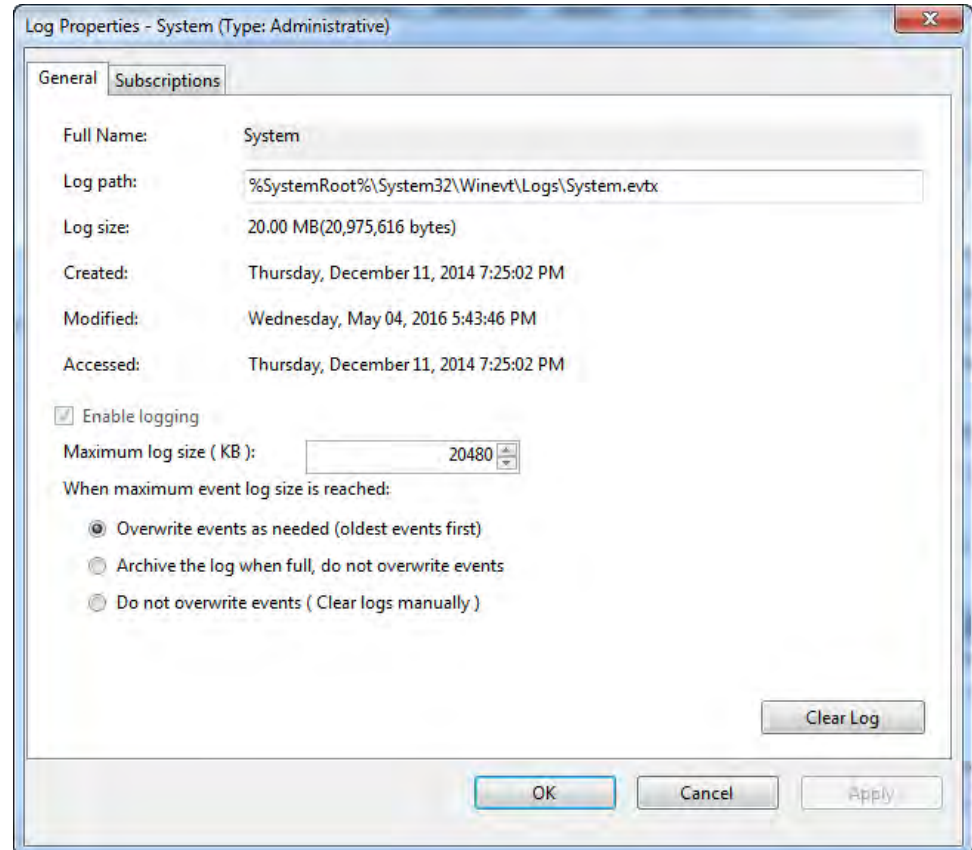
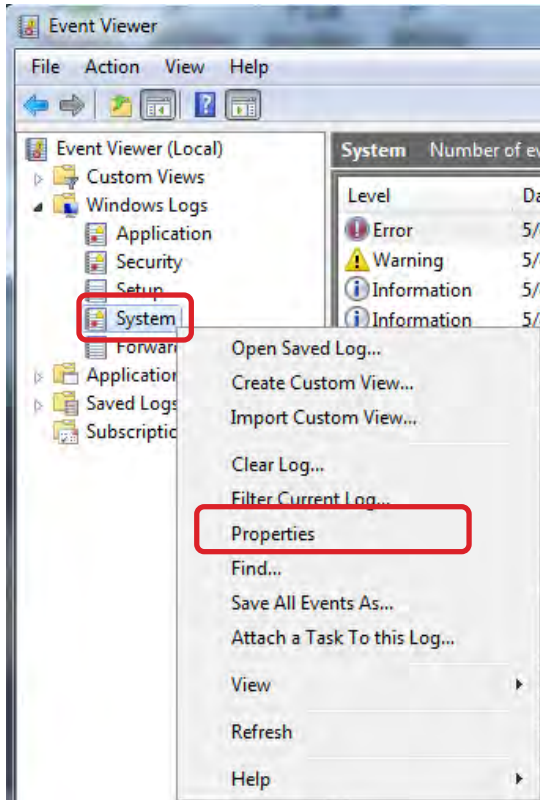



# Monitoring Windows With Task Manager

- **Windows Task Manager provides several useful management functions**
  - View running applications (Applications tab)
  - View running processes (Processes tab)
  - View CPU and memory usage (Performance tab)
  - View network resource usage (Networking tab)
  - Start/Stop applications, processes
  - Shut down Windows (Standby, Hibernate, Restart, etc.)
- **Press <Ctrl><Shift><Esc> or <Ctrl><Alt><Del> and click Task Manager if Windows logon dialog is displayed**



# Monitoring Windows With Task Manager

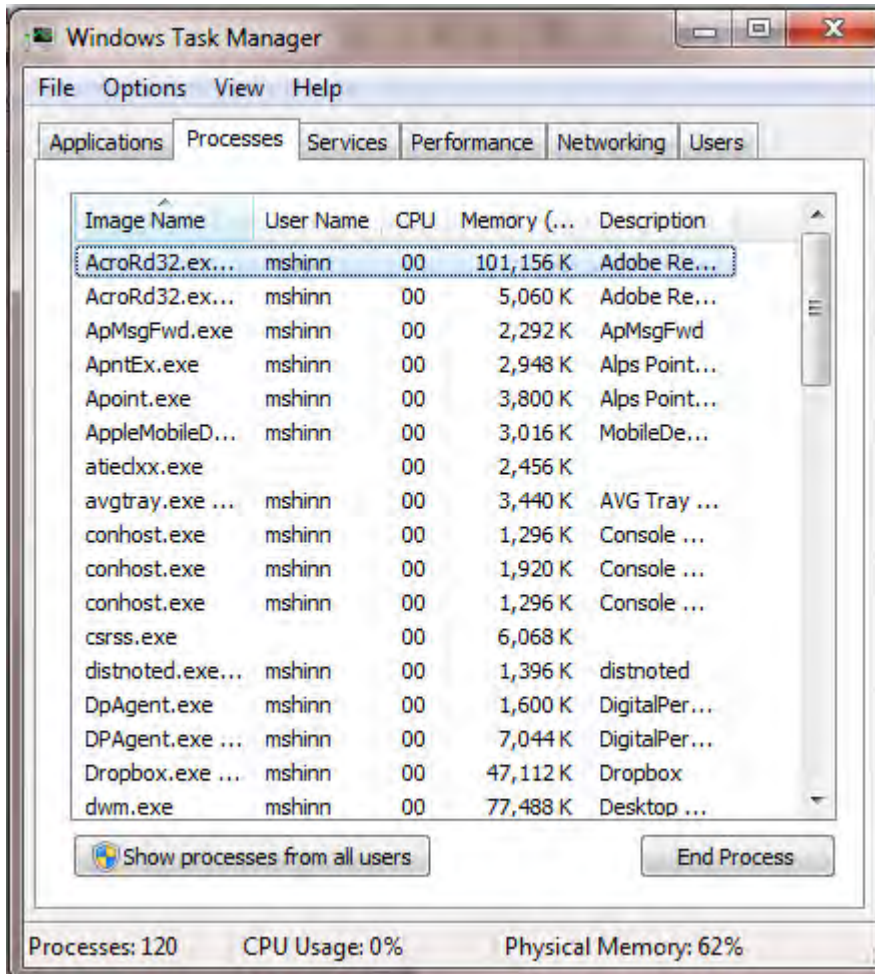

The screenshot shows the Windows Task Manager window with the 'Processes' tab selected. The window title is 'Windows Task Manager'. The menu bar includes 'File', 'Options', 'View', and 'Help'. The tabs at the top are 'Applications', 'Processes', 'Services', 'Performance', 'Networking', and 'Users'. The main area displays a list of processes with columns for 'Image Name', 'User Name', 'CPU', 'Memory (...)', and 'Description'. The status bar at the bottom shows 'Processes: 120', 'CPU Usage: 0%', and 'Physical Memory: 62%'.

Image Name	User Name	CPU	Memory (...)	Description
AcroRd32.ex...	mshinn	00	101,156 K	Adobe Re...
AcroRd32.ex...	mshinn	00	5,060 K	Adobe Re...
ApMsgFwd.exe	mshinn	00	2,292 K	ApMsgFwd
ApntEx.exe	mshinn	00	2,948 K	Alps Point...
Apoint.exe	mshinn	00	3,800 K	Alps Point...
AppleMobileD...	mshinn	00	3,016 K	MobileDe...
atiedxx.exe		00	2,456 K	
avgtray.exe ...	mshinn	00	3,440 K	AVG Tray ...
conhost.exe	mshinn	00	1,296 K	Console ...
conhost.exe	mshinn	00	1,920 K	Console ...
conhost.exe	mshinn	00	1,296 K	Console ...
csrss.exe		00	6,068 K	
distnoted.exe...	mshinn	00	1,396 K	distnoted
DpAgent.exe	mshinn	00	1,600 K	DigitalPer...
DPAgent.exe ...	mshinn	00	7,044 K	DigitalPer...
Dropbox.exe ...	mshinn	00	47,112 K	Dropbox
dwm.exe	mshinn	00	77,488 K	Desktop ...

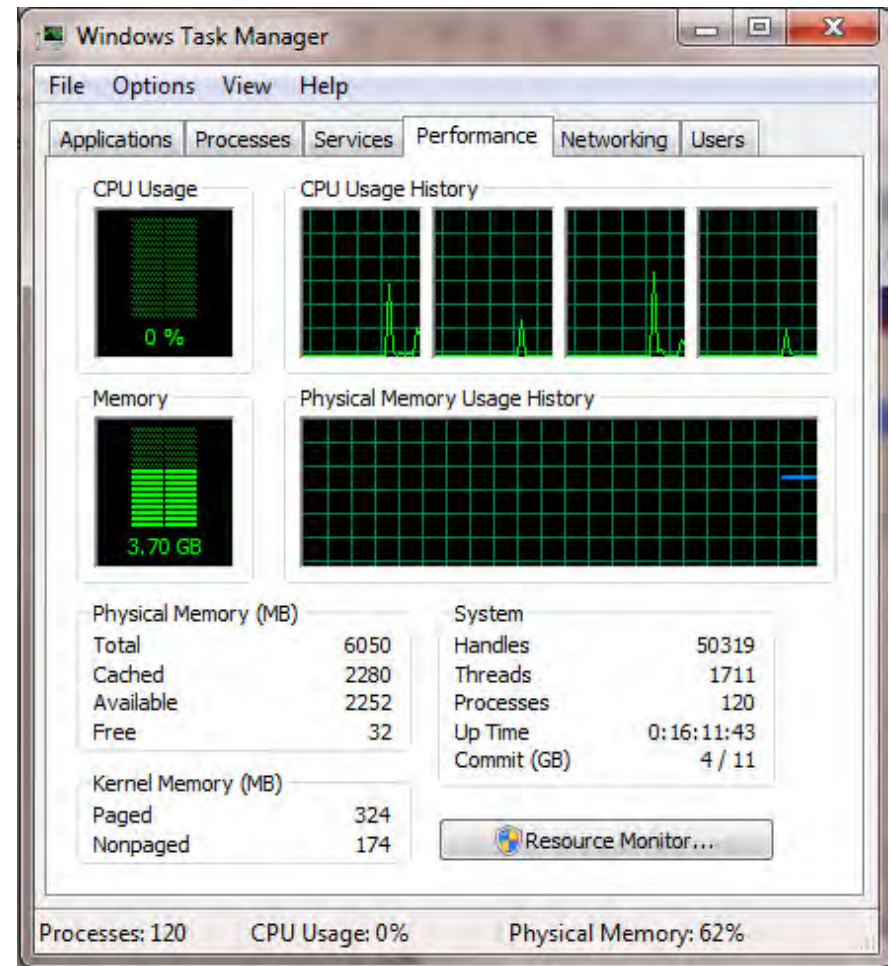

The screenshot shows the Windows Task Manager window with the 'Performance' tab selected. The window title is 'Windows Task Manager'. The menu bar includes 'File', 'Options', 'View', and 'Help'. The tabs at the top are 'Applications', 'Processes', 'Services', 'Performance', 'Networking', and 'Users'. The main area displays performance metrics and graphs. The status bar at the bottom shows 'Processes: 120', 'CPU Usage: 0%', and 'Physical Memory: 62%'.

**CPU Usage**  
0 %

**CPU Usage History**

**Memory**  
3.70 GB

**Physical Memory Usage History**

Physical Memory (MB)		System	
Total	6050	Handles	50319
Cached	2280	Threads	1711
Available	2252	Processes	120
Free	32	Up Time	0:16:11:43
Kernel Memory (MB)		Commit (GB)	4 / 11
Paged	324		
Nonpaged	174		

Resource Monitor...



# Troubleshooting Problem Processes With Task Manager

- **A problem process is one that is constantly consuming the majority of system resources**
  - Prevents other applications and processes from running, or causes them to run very slowly
  
- **Troubleshooting problem processes with Task Manager**
  1. Open Task Manager, click the Performance tab
  2. Check to see if CPU usage is very high (80%–100%) for extended periods of time
  3. Click the Processes tab and look under CPU column to identify process using majority of CPU time
  4. Use Google to look up process name
  5. If it is not a critical Windows process, click the End Process button
  6. Click the Performance tab to see if this has corrected the problem



# Windows Performance Monitor

## ➤ Windows Performance Monitor provides real-time performance monitoring of user selected objects

- Click the + button to add a selected object to monitor
  - Example: Network Interface

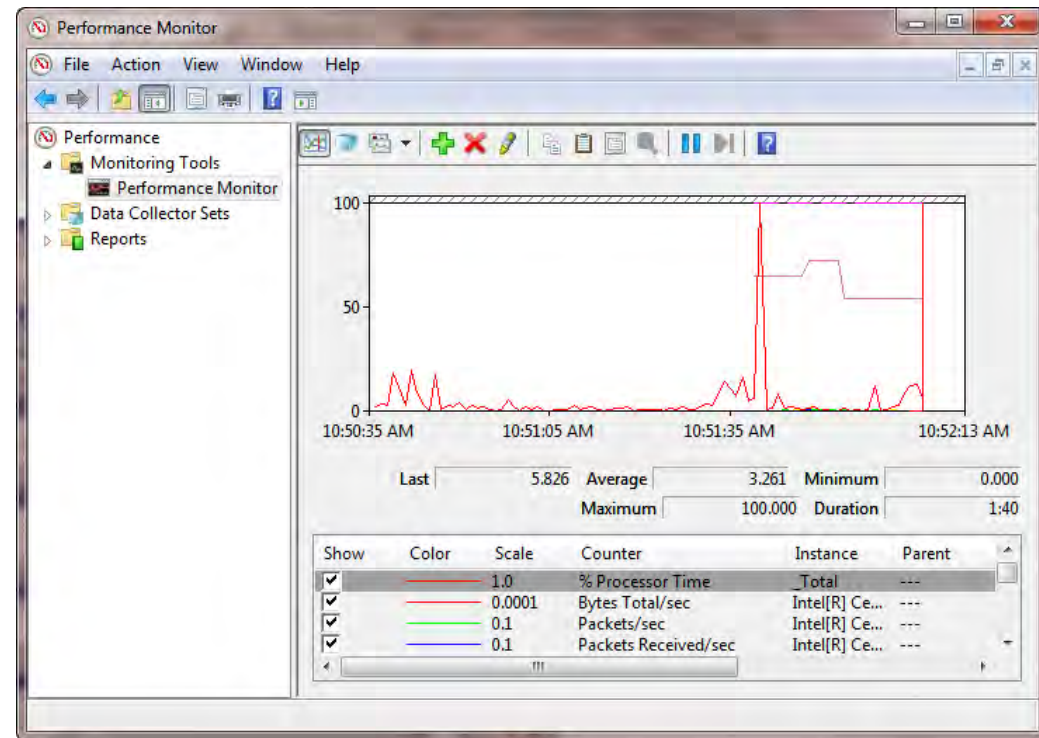
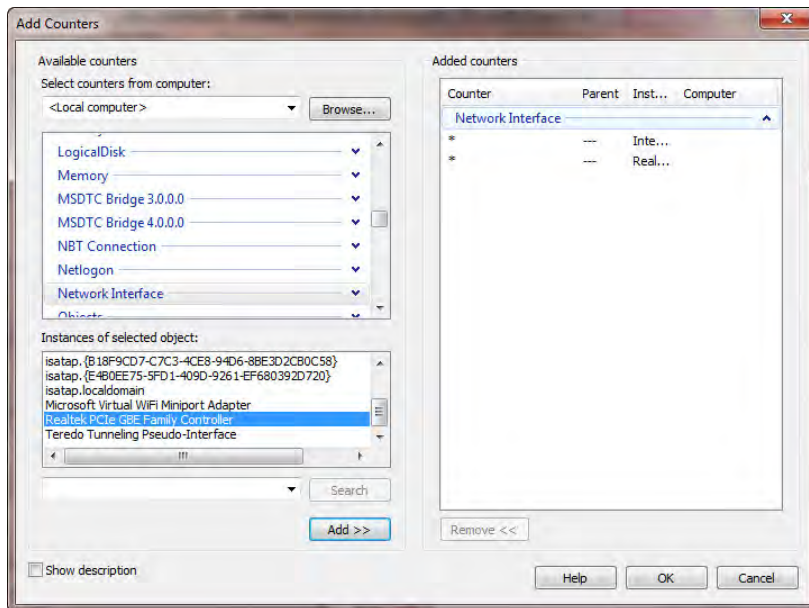

# Windows Reliability and Performance Monitor (Vista)

- **Windows Vista Reliability and Performance monitor provides real-time performance monitoring of CPU, Disk, Network, and Memory usage**
  - Click Start, right-click Computer, then click Manage
    - In the Microsoft Management Console navigation pane, select “Reliability and Performance,” then select Performance
    - Select Reliability to display a graph of system reliability

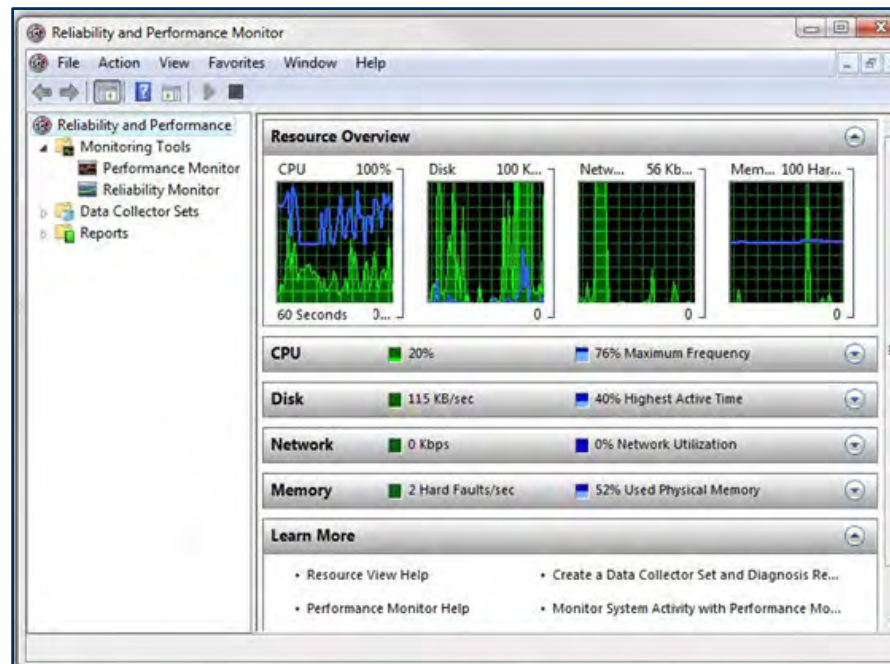

# Windows Performance Monitor (Windows 7)

- **Windows 7 Performance Monitor provides real-time monitoring of user-selected items (CPU, Disk, Memory, etc.)**
  - Click Start, right-click Computer, then click Manage
    - In the Microsoft Management Console navigation pane, select Performance, then select Monitoring Tools | Performance Monitor

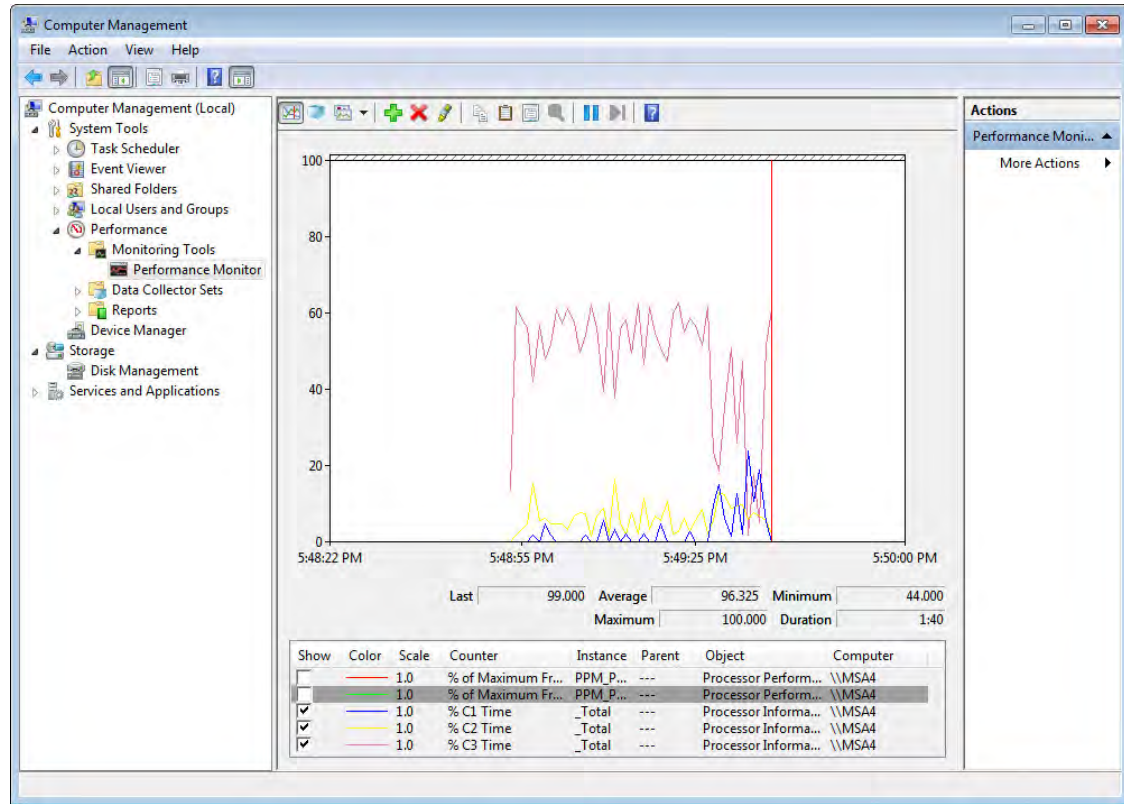

# Windows Reliability Monitor (Windows 7)

## ➤ Windows 7 Reliability Monitor displays a graph of computer's reliability and problem history

- Click Start, type reliability in Search box, then click "View reliability history"

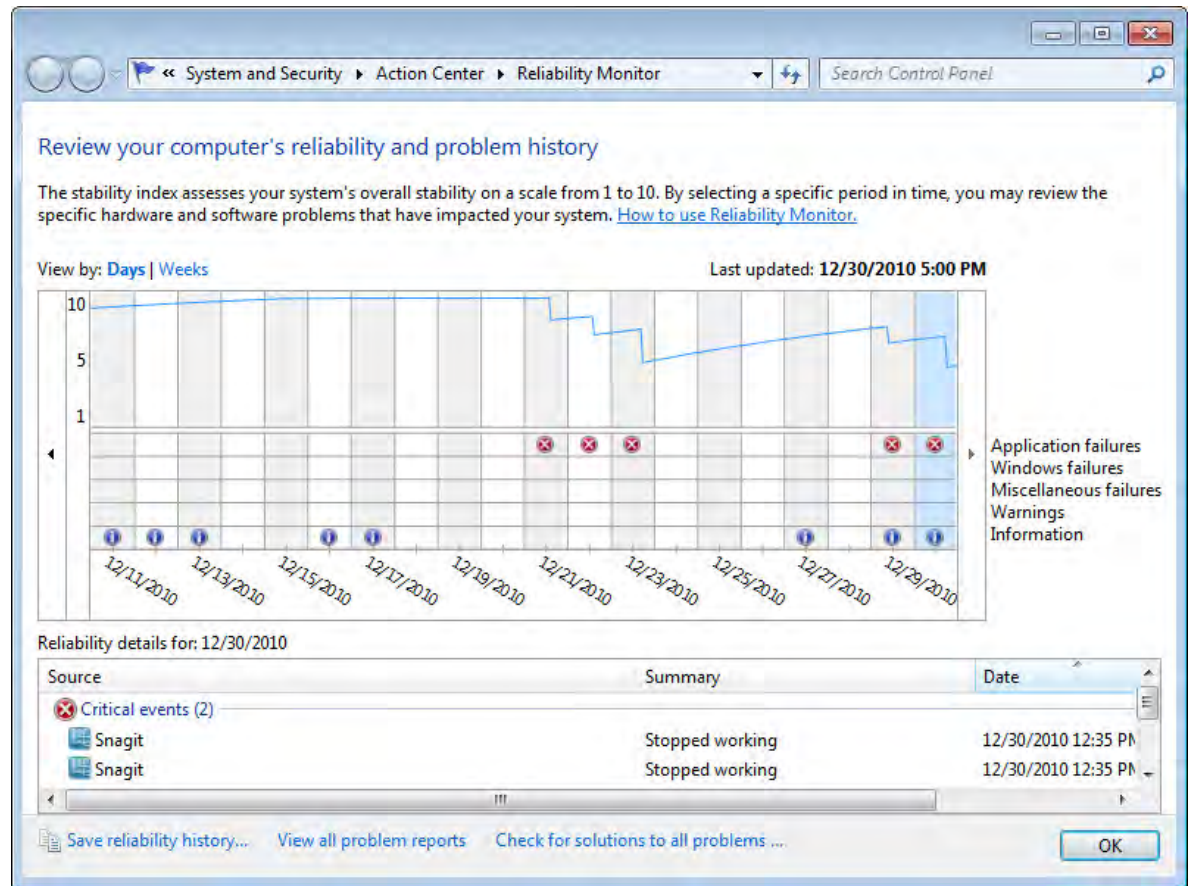

# Display System Configuration Information With Msinfo32

- **Msinfo32 provides a detailed list of system configuration information**
  - Hardware, Components, Software

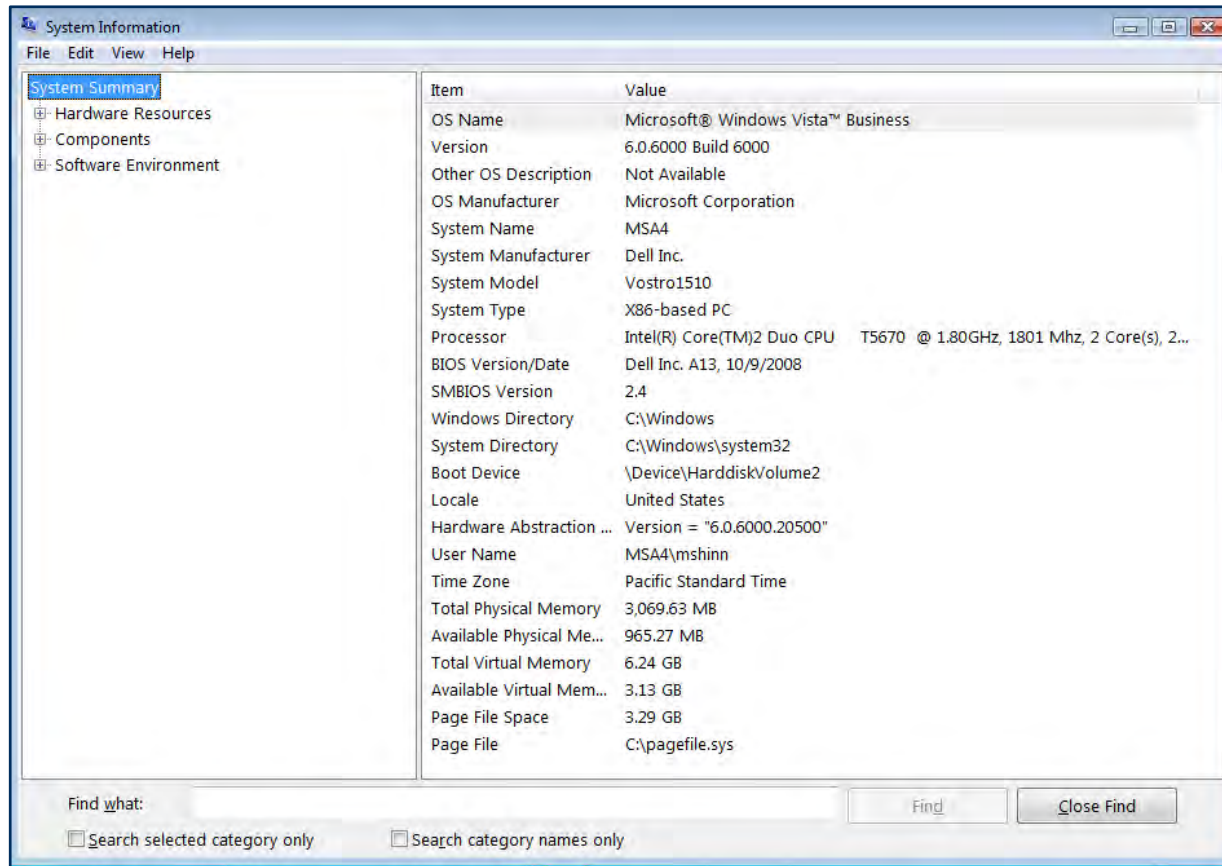



# Test DirectX Functionality With DxDiag

## ➤ What is DirectX?

- Set of display-related Application Programming Interfaces (APIs) used for multimedia and game programming

## ➤ DxDiag

- Reports detailed information about DirectX components
- Verifies that drivers have been signed by Microsoft

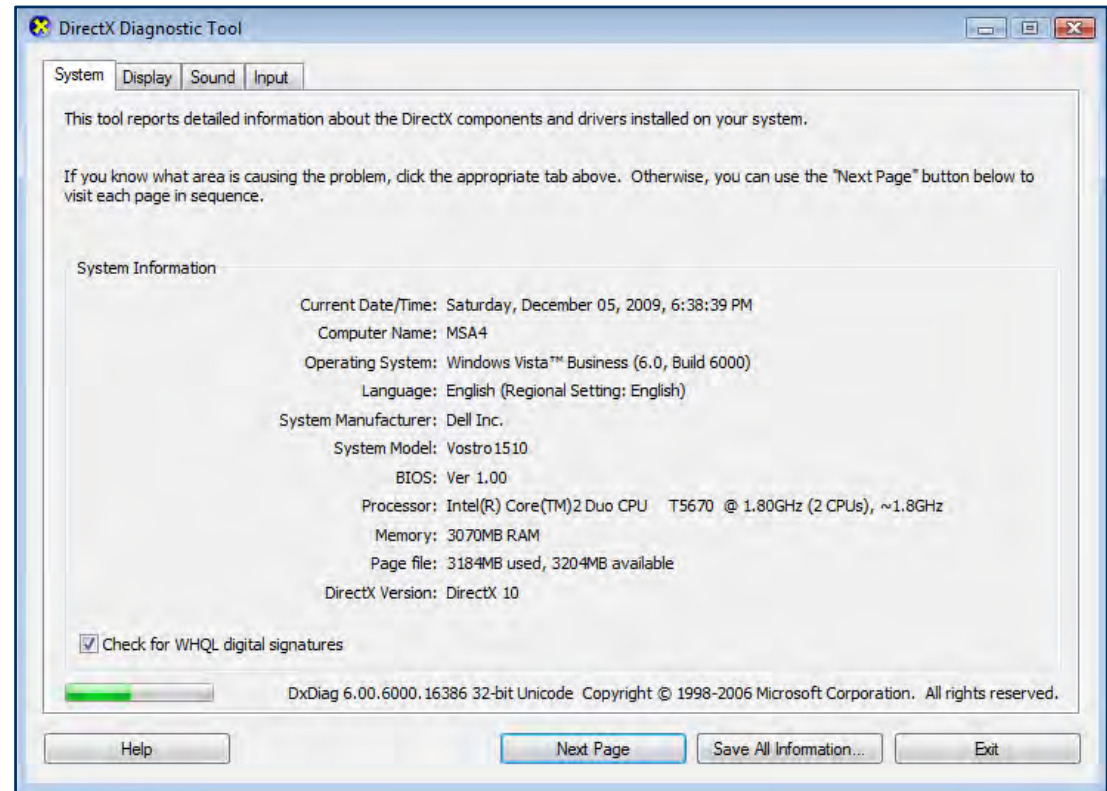

# Windows Command-Line Utilities

## Starting the command-line environment

- **Windows provides several management utilities that may be invoked from the command line**
  - Use Start | Run, then type `cmd` to open a command prompt

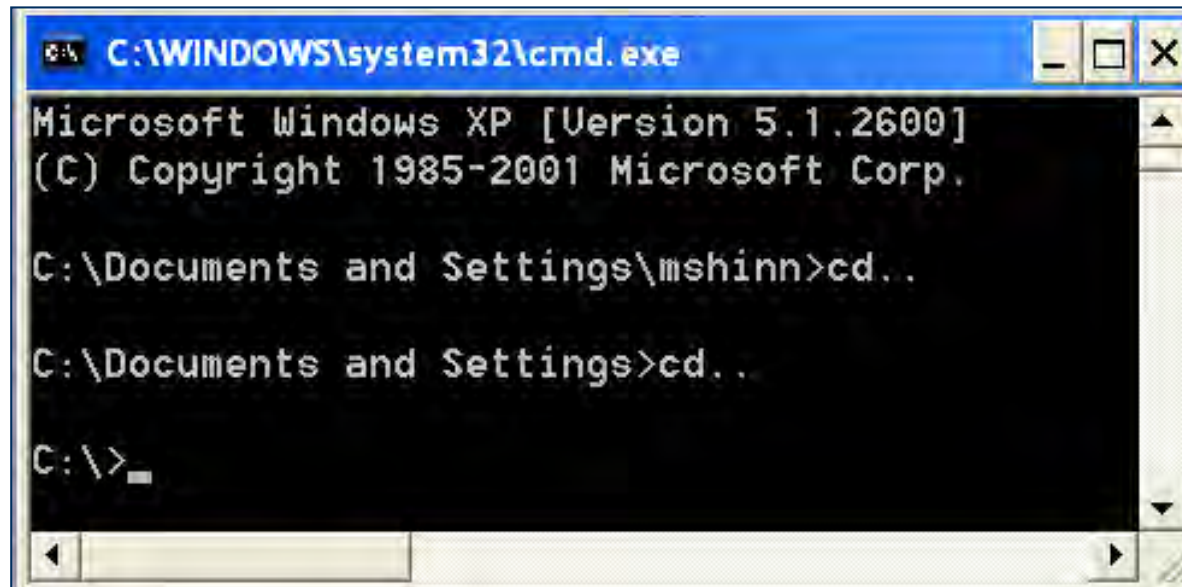

```
C:\WINDOWS\system32\cmd.exe
Microsoft Windows XP [Version 5.1.2600]
(C) Copyright 1985-2001 Microsoft Corp.

C:\Documents and Settings\mshinn>cd..

C:\Documents and Settings>cd..

C:\>_
```



# Windows Command-Line Utilities

## ➤ CHKDSK

- Scans disk for lost or cross-linked clusters (clusters containing data that have become “lost” to the file system)
- `chkdsk /F` (Fix) converts lost cluster chains to files for inspection
  - `FILE0001.CHK`

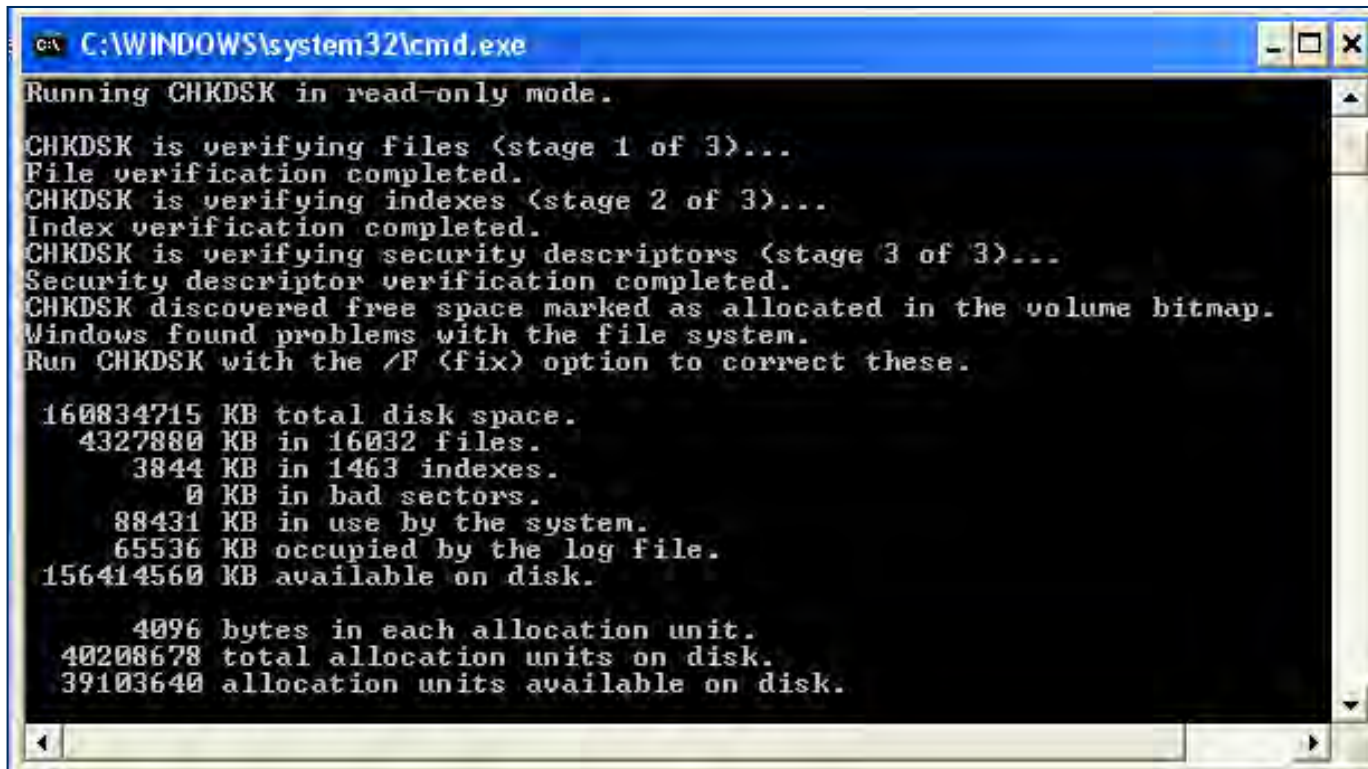

```
C:\WINDOWS\system32\cmd.exe
Running CHKDSK in read-only mode.

CHKDSK is verifying files (stage 1 of 3)...
File verification completed.
CHKDSK is verifying indexes (stage 2 of 3)...
Index verification completed.
CHKDSK is verifying security descriptors (stage 3 of 3)...
Security descriptor verification completed.
CHKDSK discovered free space marked as allocated in the volume bitmap.
Windows found problems with the file system.
Run CHKDSK with the /F (fix) option to correct these.

160834715 KB total disk space.
 4327880 KB in 16032 files.
  3844 KB in 1463 indexes.
   0 KB in bad sectors.
 88431 KB in use by the system.
 65536 KB occupied by the log file.
156414560 KB available on disk.

    4096 bytes in each allocation unit.
 40208678 total allocation units on disk.
39103640 allocation units available on disk.
```



# Windows Disk Management Utilities

## ➤ defrag

- Defragments files by rearranging files into contiguous clusters
- Increases disk performance because movement of disk heads to locate noncontiguous clusters is greatly reduced
- Note: Help file for all command-line utilities can be displayed by typing command name without any parameters

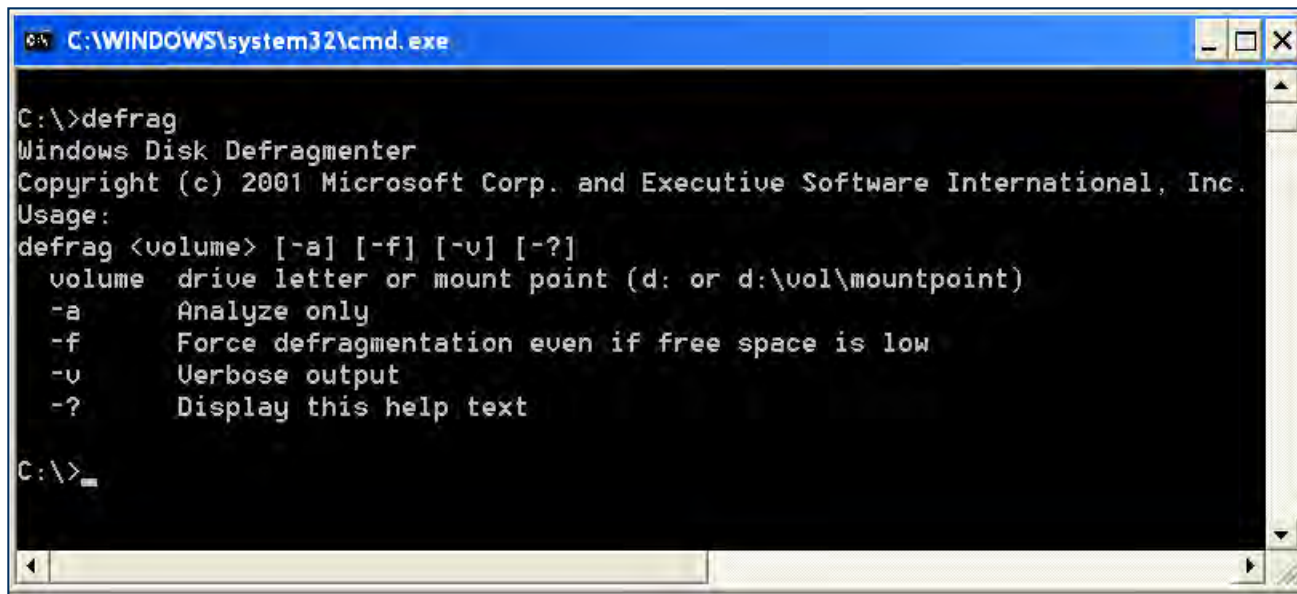

```
C:\WINDOWS\system32\cmd.exe

C:\>defrag
Windows Disk Defragmenter
Copyright (c) 2001 Microsoft Corp. and Executive Software International, Inc.
Usage:
defrag <volume> [-a] [-f] [-v] [-?]
  volume  drive letter or mount point (d: or d:\vol\mountpoint)
  -a      Analyze only
  -f      Force defragmentation even if free space is low
  -v      Verbose output
  -?      Display this help text

C:\>
```



# Windows Disk Management Utilities

## ➤ defrag example:

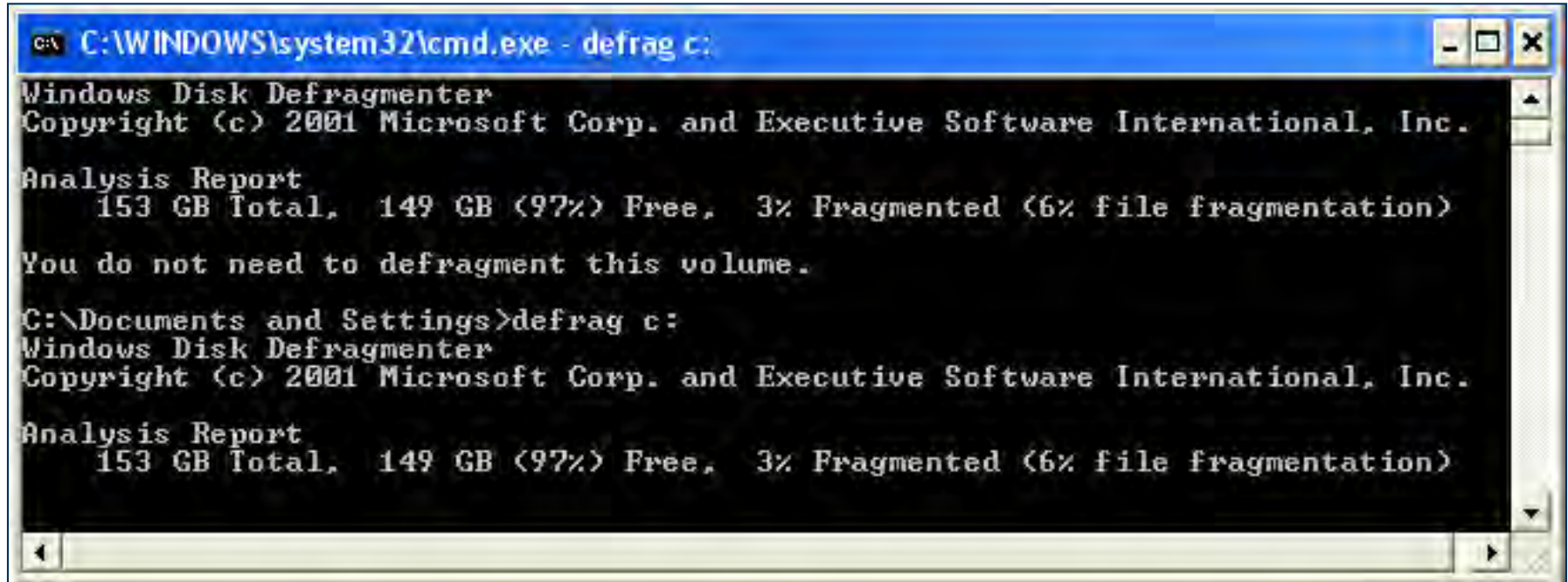

```
C:\WINDOWS\system32\cmd.exe - defrag c:
Windows Disk Defragmenter
Copyright (c) 2001 Microsoft Corp. and Executive Software International, Inc.

Analysis Report
  153 GB Total,  149 GB (97%) Free,  3% Fragmented (6% file fragmentation)

You do not need to defragment this volume.

C:\Documents and Settings>defrag c:
Windows Disk Defragmenter
Copyright (c) 2001 Microsoft Corp. and Executive Software International, Inc.

Analysis Report
  153 GB Total,  149 GB (97%) Free,  3% Fragmented (6% file fragmentation)
```



# Windows System File Checker

## ➤ sfc

- Checks integrity of all Windows system files
  - Used to detect corrupted, missing, or damaged system files
- `sfc /scannow` invokes immediate scan
- `sfc /scanonce` scans all protected system files at next boot

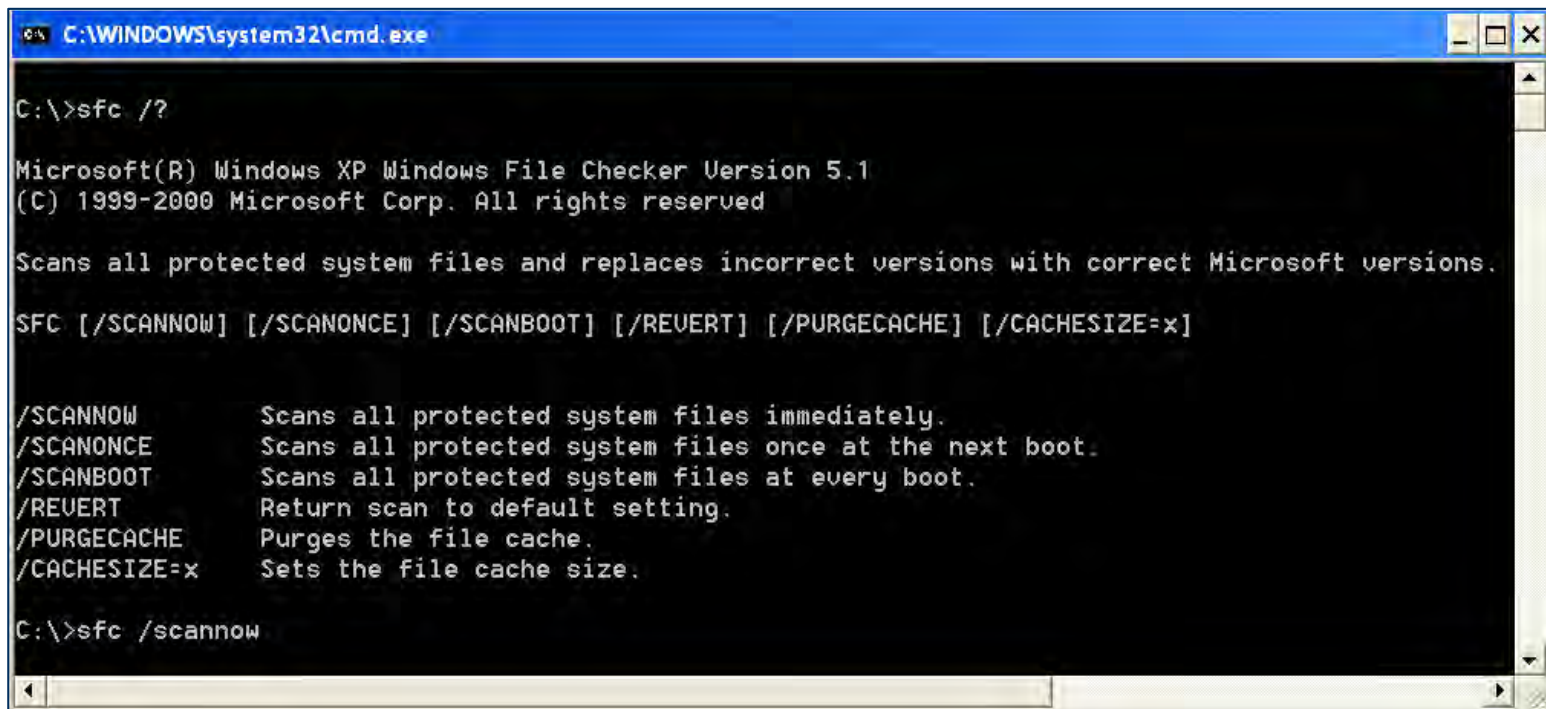

```
C:\WINDOWS\system32\cmd.exe

C:\>sfc /?

Microsoft(R) Windows XP Windows File Checker Version 5.1
(C) 1999-2000 Microsoft Corp. All rights reserved

Scans all protected system files and replaces incorrect versions with correct Microsoft versions.

SFC [/SCANNOW] [/SCANONCE] [/SCANBOOT] [/REVERT] [/PURGECACHE] [/CACHESIZE=x]

/SCANNOW           Scans all protected system files immediately.
/SCANONCE          Scans all protected system files once at the next boot.
/SCANBOOT          Scans all protected system files at every boot.
/REVERT            Return scan to default setting.
/PURGECACHE        Purges the file cache.
/CACHESIZE=x       Sets the file cache size.

C:\>sfc /scannow
```



# Windows Run Line Utilities

## ➤ What are Run Line utilities?

- Windows graphical utilities
  - Invoked by using Start | Run, then typing name of utility
  - Or, type name of utility in search box

## ➤ Example: msinfo32

- Starts Microsoft System Information utility

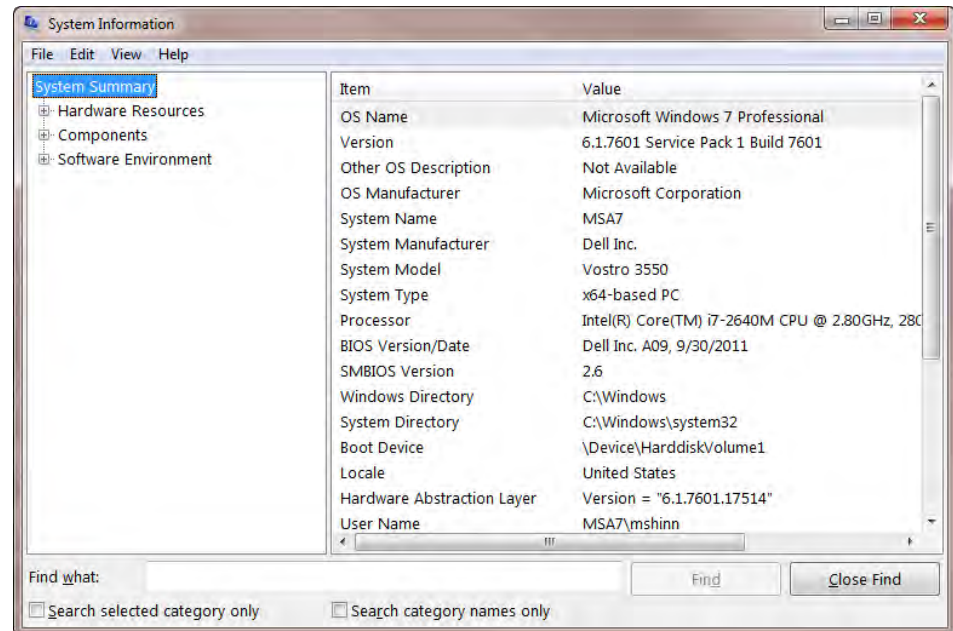
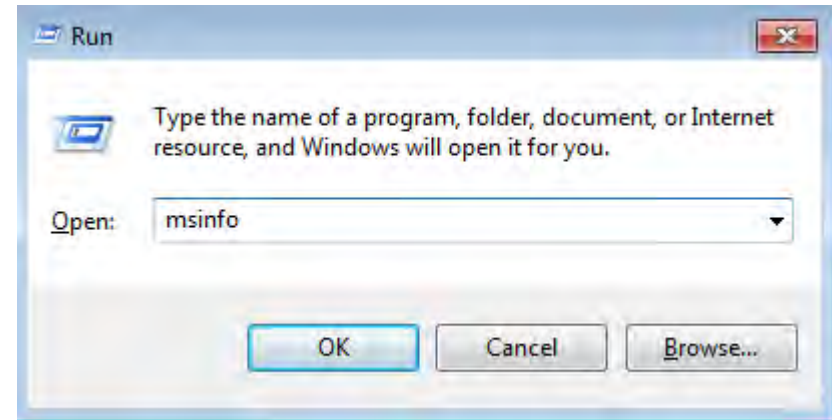

# Windows Run Line Utilities

Run Line utility	Name	Description
CMD	Command Prompt	Command-line environment
MMC	Microsoft Management Console	Centralized administration console—add snap-ins to configure (disk management, etc.)
SERVICES.MSC	Services console	Configure Windows services
MSCONFIG	Microsoft Configuration Manager	Configure startup programs and services
REGEDIT	Registry Editor	View, modify, create Windows Registry keys
MSTSC	Microsoft Terminal Services Connection	Windows Remote Desktop





# Windows Run Line Utilities

Run Line Utility	Name	Description
DXDIAG	DirectX Diagnostics	Test and troubleshoot Windows DirectX functionality
EXPLORER	Windows Explorer	Navigate Windows files and folders
NOTEPAD	Windows Notepad	Text editor



# Windows Remote Desktop

## ➤ What is Windows Remote Desktop?

- Windows service allows user to control a remote computer
  - *Remote computer must have Remote Desktop feature enabled*
- Requires only one party (initiating user)
- Not included in Windows Home editions

## ➤ Enabling Remote Desktop

1. Right-click Computer and select Properties
2. In System Properties dialog, select Remote tab
3. Select the checkbox “Allow users to connect remotely to this computer”

## ➤ Accessing remote computer

- Type Remote Desktop in Windows Search box

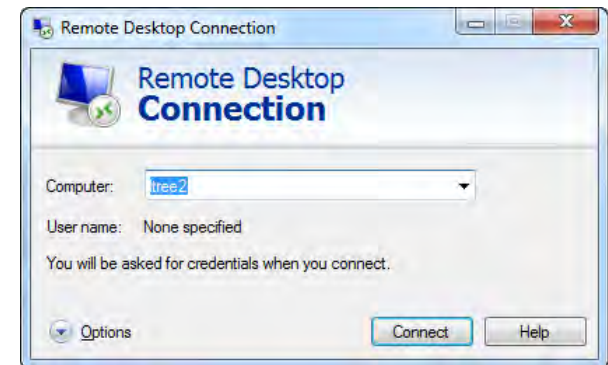
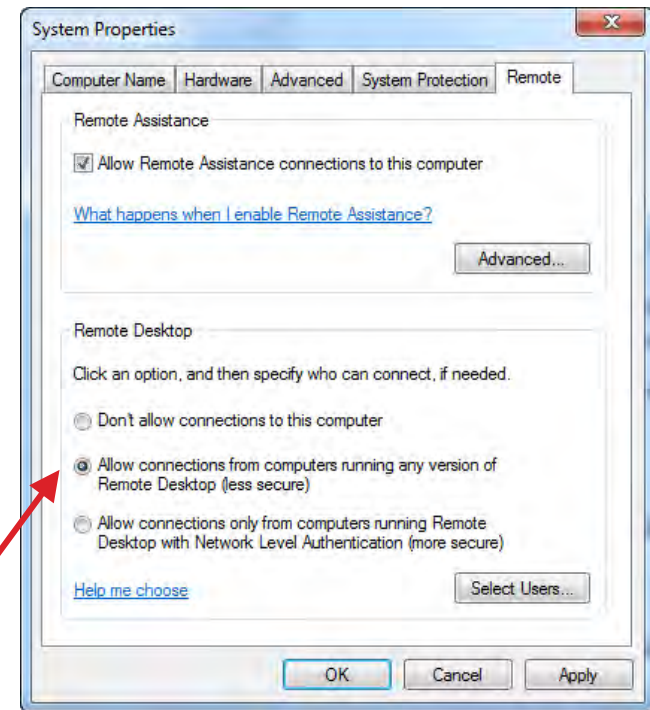

# Windows Remote Assistance

## ➤ What is Windows Remote Assistance?

- Windows service allows a remote user (PC technician) to control *your* computer
  - *Your computer must have remote assistance enabled (default setting)*
- **Requires two parties**
  - User requesting assistance
  - Technician providing assistance

## ➤ Enabling Remote Assistance

1. Right-click Computer and select Properties
2. In System Properties dialog, select Remote tab
3. Select checkbox “Allow Remote Assistance invitations to be sent from this computer”

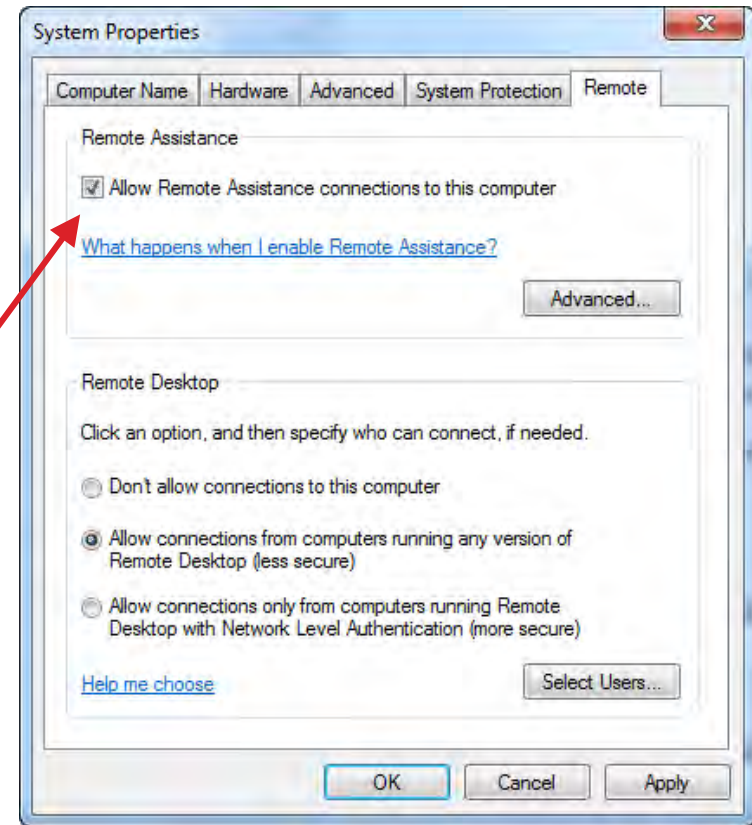

# Windows Remote Assistance

## ➤ Sending a request for Remote Assistance

- Type Remote Assistance in Windows Search box
- Click link labeled “Remote Assistance,” then click “Invite someone you trust to help you”
- In Remote Assistance dialog, choose method to send invitation
  - After helper clicks link provided in invitation, you will see a window with one-time password to give them

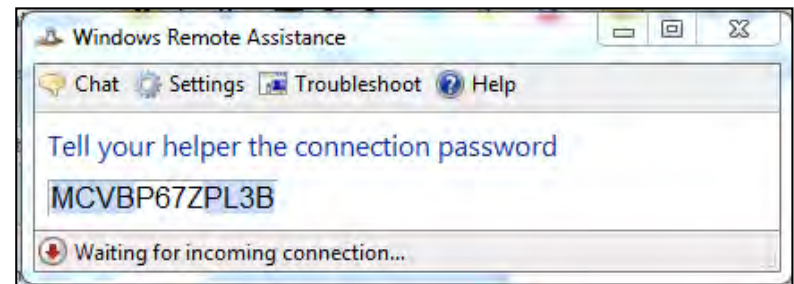
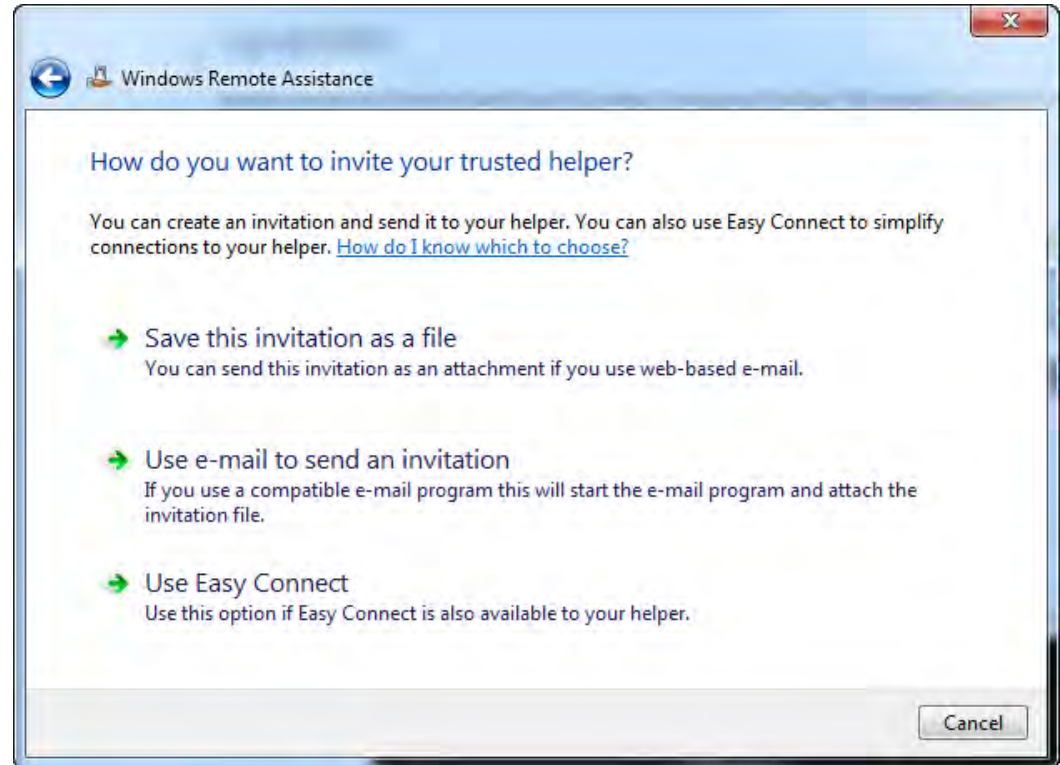

- **Managing Windows**
- **Optimizing Windows**
- **Troubleshooting Windows  
Startup Problems**
- **Troubleshooting Windows  
Hardware Problems**



# Optimizing Virtual Memory

## ➤ Virtual memory performance can be increased by distributing the swap file (PAGEFILE.SYS) among multiple hard drives

1. Use Start | Control Panel | System, then click Advanced system settings
2. Click the Settings button in the Performance section
  - The Performance Options window will be displayed
3. Click the Advanced tab, then click the Change button in the Virtual memory section
  - The Virtual Memory window will be displayed

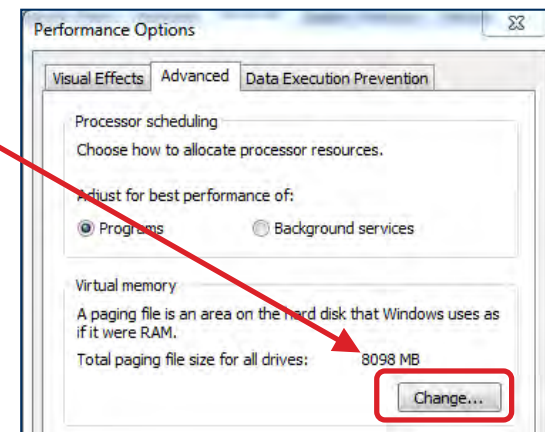
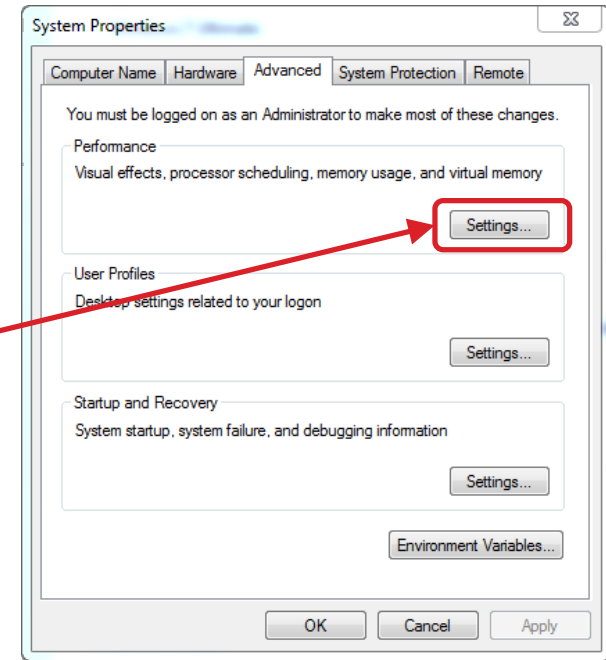

# Optimizing Virtual Memory

- **To change Virtual Memory settings**
  1. In Virtual Memory dialog, uncheck “Automatically manage paging file size for all drives”
  2. You can then manually configure virtual memory options

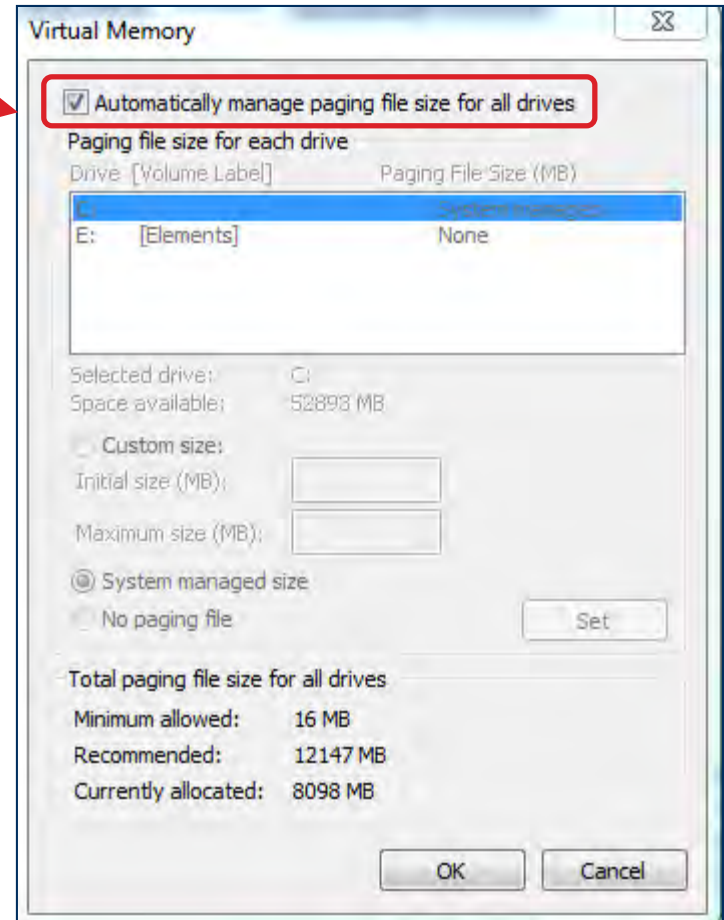

# Optimizing Hard Disk Performance

## ➤ Windows provides two utilities for optimizing hard disk performance

- Disk Defragment
- Disk Cleanup

## ➤ Disk Defragment

1. Type Disk Defragment in Windows Search box
2. In the Disk Defragmenter dialog, click the “Analyze disk” button to analyze disk fragmentation

Note: Starting with Windows Vista, the Disk Defragmenter runs as a low-priority task in the background

- Automatically keeps hard disk defragmented

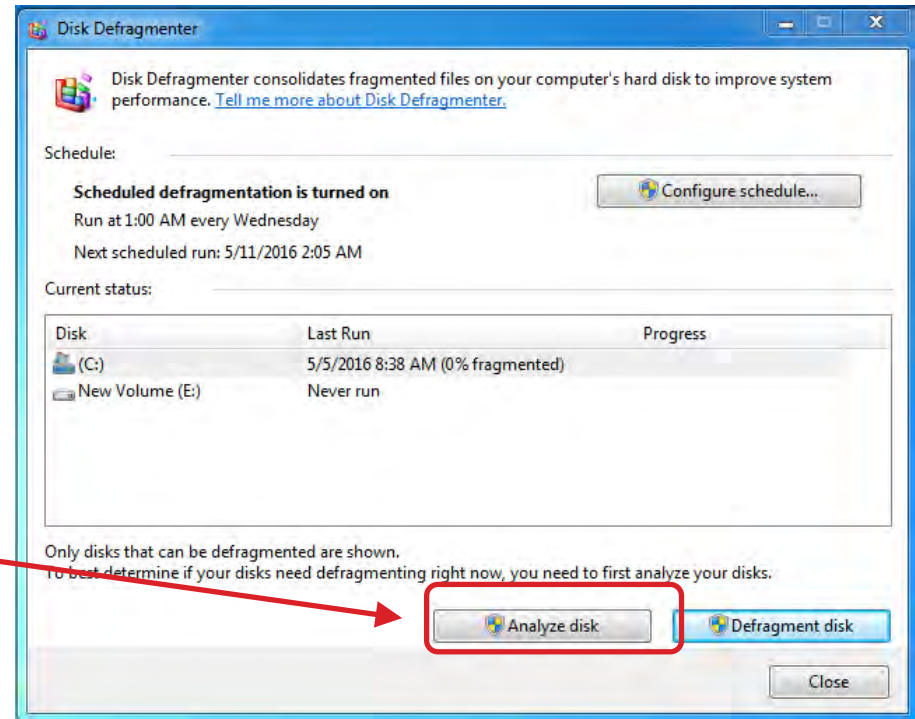



# Optimizing Hard Disk Performance

- **Disk Cleanup can free up disk space by**
  - Removing temporary files (Internet temp files, Windows temp files)
  - Emptying Recycle Bin
  - Compressing infrequently used files
- **Type Disk Cleanup in Windows Search box**
  - Disk Cleanup will scan disk, then report how much space can be gained

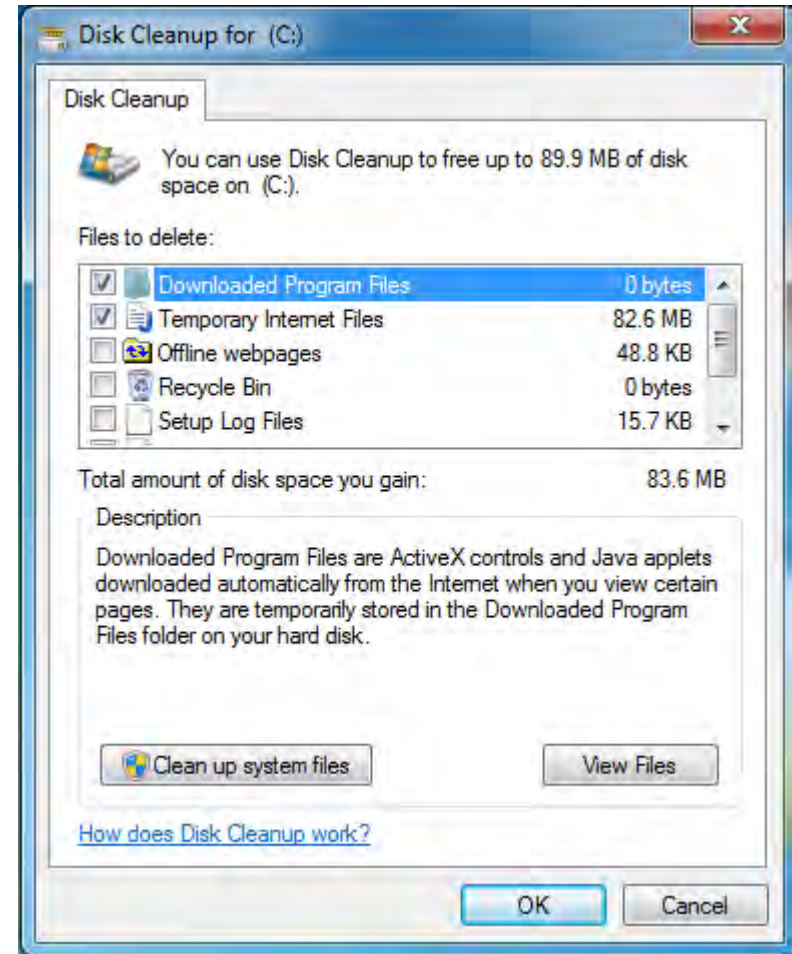

# Optimizing System Services

- **Stopping unused services can improve system performance**
  - Use Control Panel | Administrative Tools | Services (or type Services in Windows Search box) to view all services
  - Double-click selected service to Start, Stop, Pause, or Resume

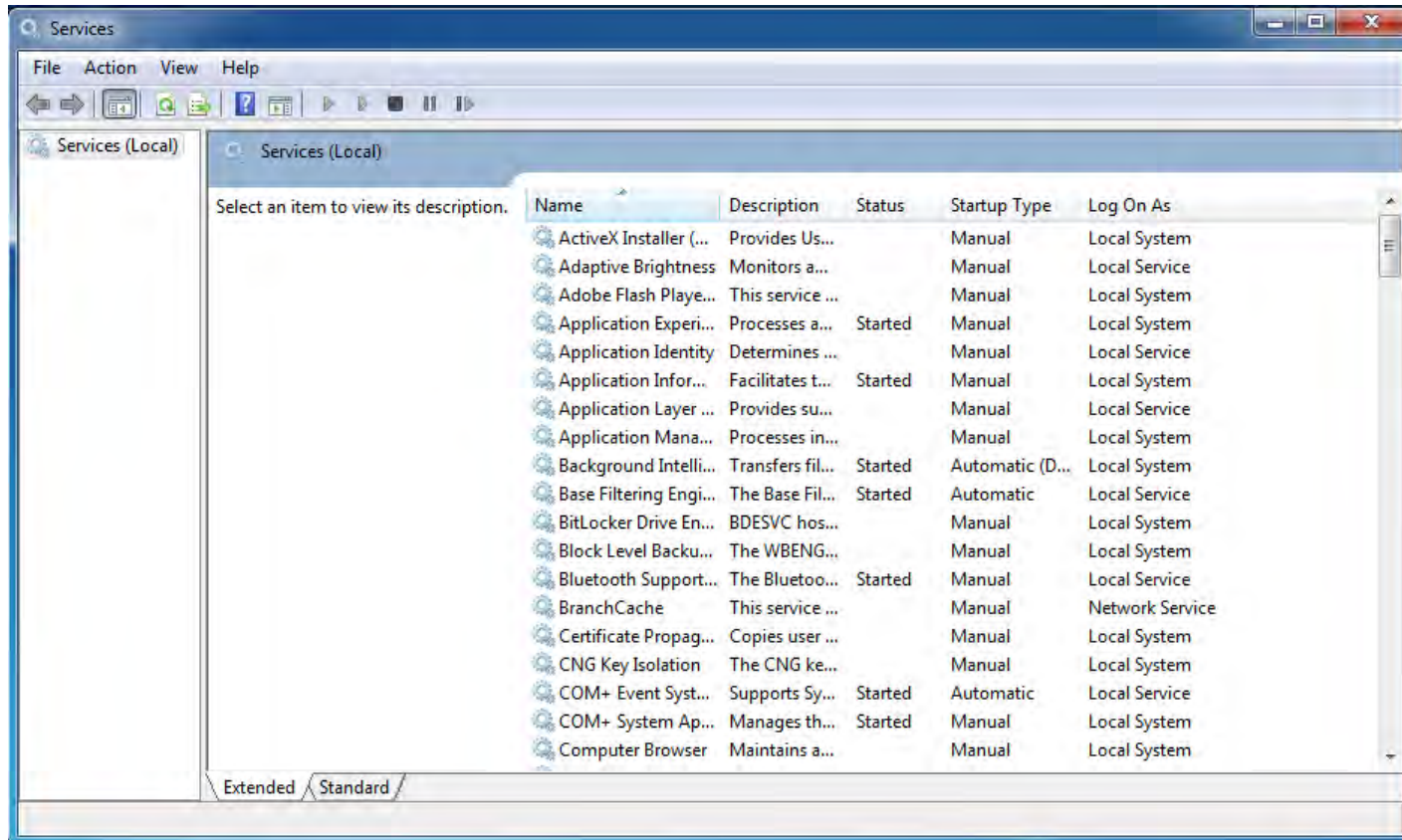

- **Managing Windows**
- **Optimizing Windows**
- **Troubleshooting Windows  
Startup Problems**
- **Troubleshooting Windows  
Hardware Problems**



# Troubleshooting Startup Problems

## ➤ Types of startup problems

- Noncatastrophic
  - Windows starts, but unwanted programs are launched automatically
- Catastrophic
  - Windows unable to start or display garbled

## ➤ Windows troubleshooting tools

- Windows `MSCONFIG.EXE` utility
- Advanced startup modes (Safe Mode)
- System Restore
- Windows Vista/Windows 7 tools
  - Windows System Recovery Options (Windows Vista/7)



# Troubleshooting Registry-Based Startup Problems

- **“I often have several unwanted programs start automatically—I’ve removed references to them from the Startup folder, but they keep launching—is there any way to solve this problem?”**
  - Devious programs often install themselves into registry keys that are designed to launch programs
  - One solution is to use the Registry Editor (`REGEDIT.EXE`) to find these keys, then delete references to the unwanted programs
    - In the Registry Editor, use Edit | Find, and press `<F3>` to find the next occurrence

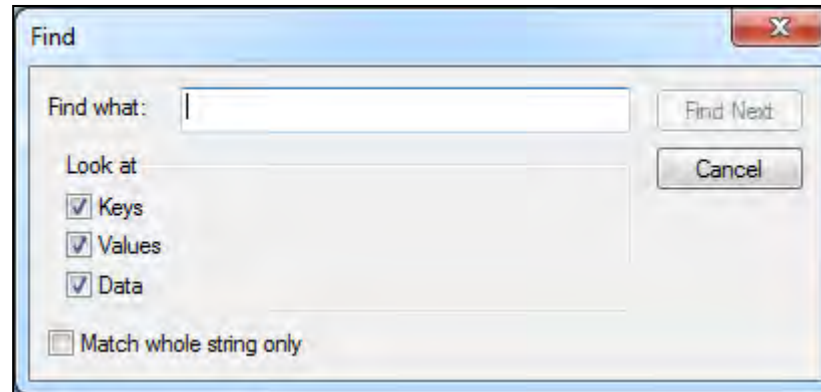

# Troubleshooting Registry-Based Startup Problems

## ➤ Common registry keys for launching programs and services

- HKEY\_LOCAL\_MACHINE\SOFTWARE\Microsoft\Windows\CurrentVersion\Run
- HKEY\_LOCAL\_MACHINE\SOFTWARE\Microsoft\Windows\CurrentVersion\RunOnce
- HKEY\_LOCAL\_MACHINE\SOFTWARE\Microsoft\Windows\CurrentVersion\RunServices
- HKEY\_CURRENT\_USER\SOFTWARE\Microsoft\Windows\CurrentVersion\Run
- HKEY\_CURRENT\_USER\SOFTWARE\Microsoft\Windows\CurrentVersion\RunOnce
- HKEY\_LOCAL\_MACHINE\SOFTWARE\Microsoft\WindowsNT\CurrentVersion\WinLogon\Userinit
- HKEY\_LOCAL\_MACHINE\SOFTWARE\Microsoft\WindowsNT\CurrentVersion\WinLogon\Shell
- HKEY\_LOCAL\_MACHINE\SYSTEM\CurrentControlSet\Services
- HKEY\_CLASSES\_ROOT\exefile\shell\open\command
- HKEY\_LOCAL\_MACHINE\SOFTWARE\Classes\exefile\shell\open\command



# Troubleshooting Startup Problems With MSConfig

## ➤ Windows MSConfig (System Configuration) utility

- Utility allows menu-driven control of startup programs and services
- Displays registry keys and allows activation and deactivation by checkbox
- Use Start | Run | `msconfig`, then click the **Startup** tab
- Clear checkboxes to disable programs from being loaded at startup

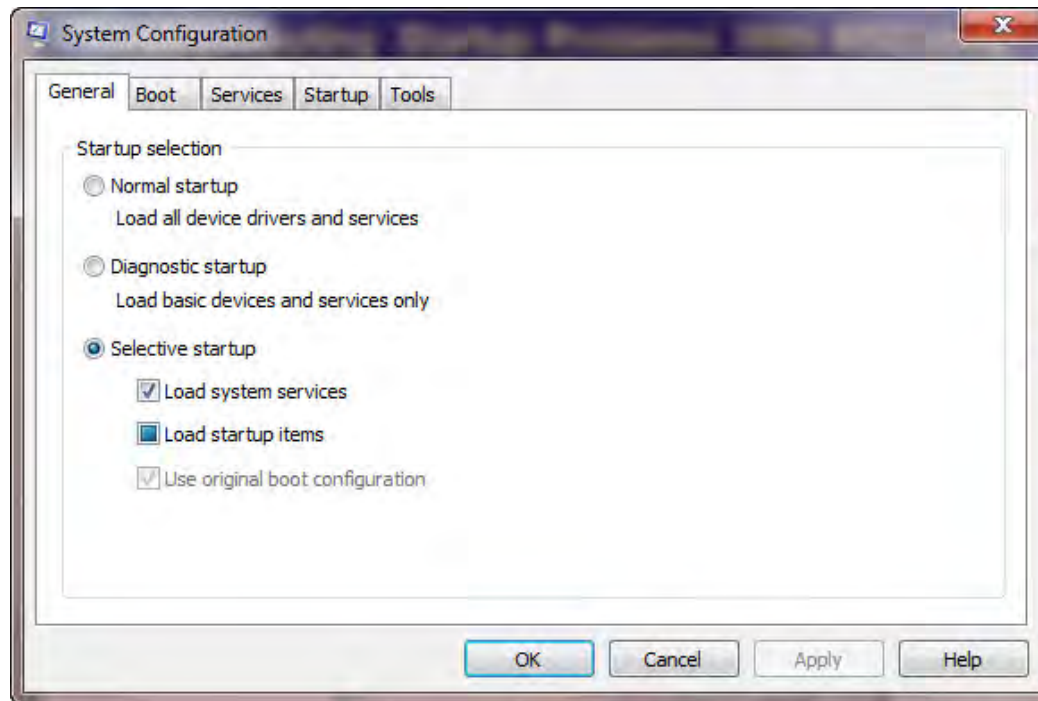

# Troubleshooting Registry-Based Startup Problems

## ➤ MSConfig provides selective control over programs and services

- General
- Boot
- Services
- Startup
- Tools

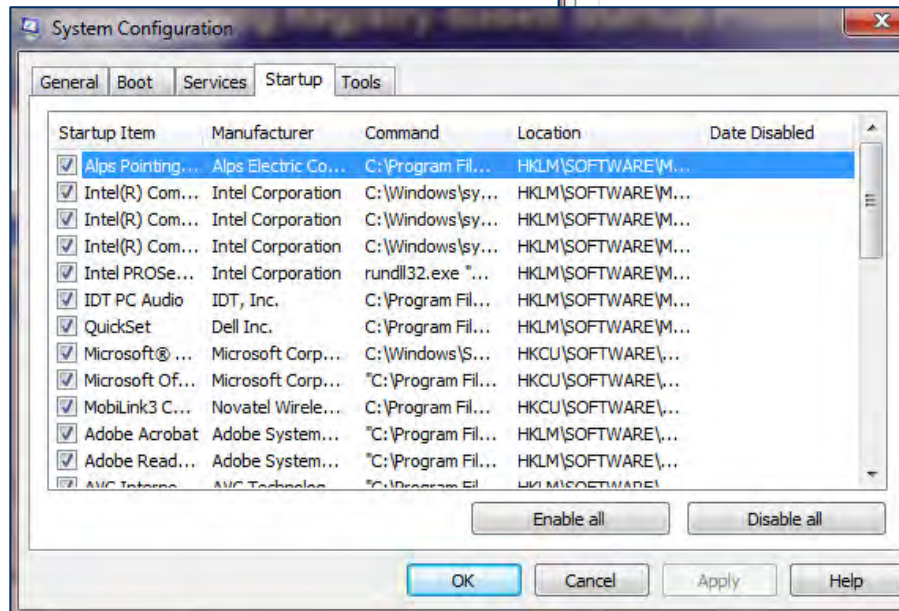
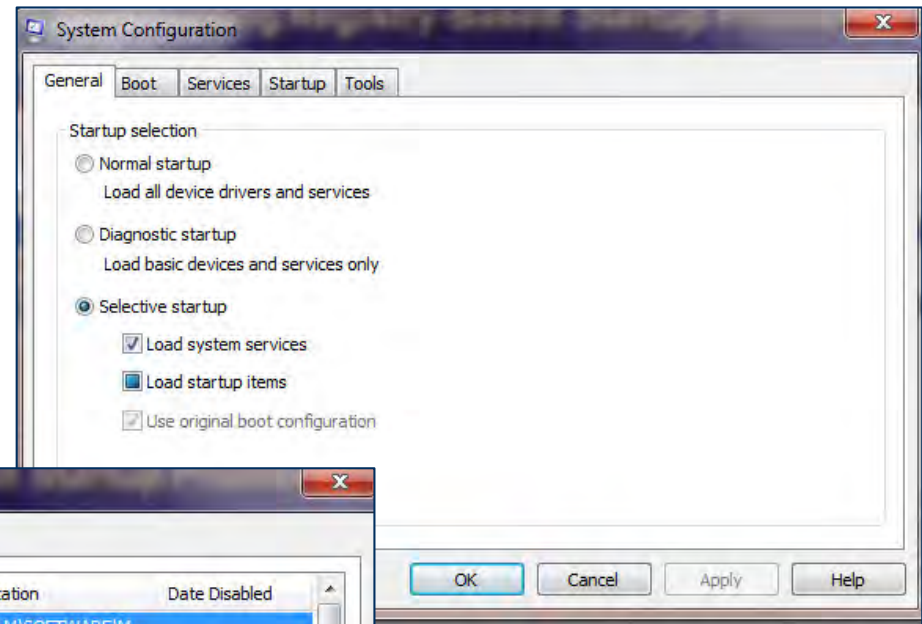



# Troubleshooting Noncatastrophic Startup Problems

## ➤ System Restore

- Allows restoration of system state to a previous point
- Windows monitors changes to the system and some application files, and automatically creates restore points (including daily restore point)
- User can also create a restore point at any time
- Use Start | Programs | Accessories | System Tools | System Restore to start System Restore utility
- System Restore Points are stored in (hidden) folder `C:\System Volume Information`

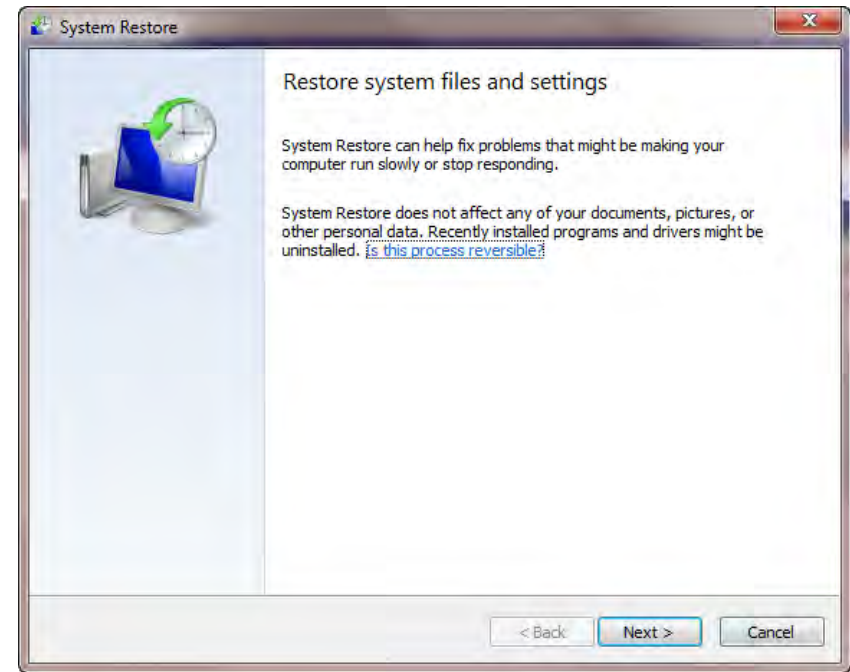

# Troubleshooting Noncatastrophic Startup Problems

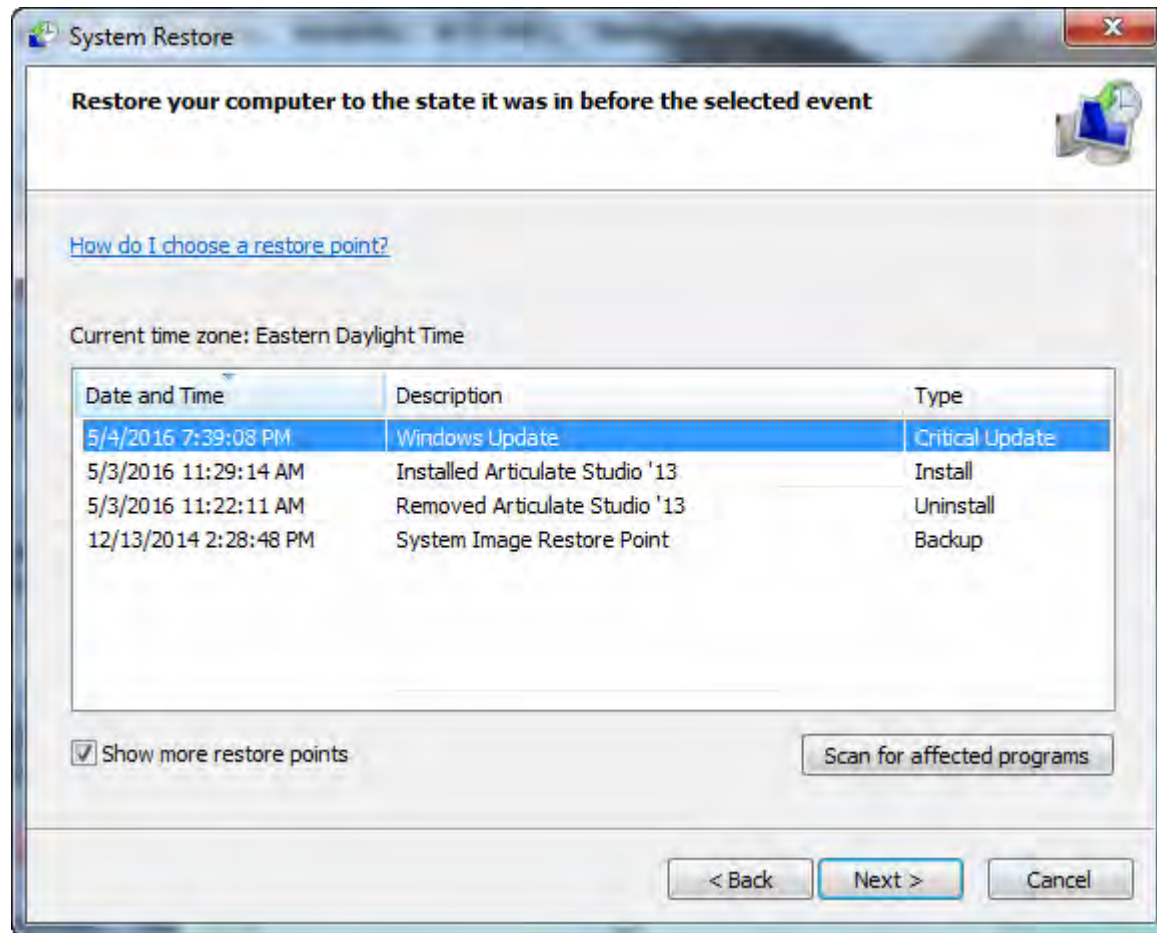

# Troubleshooting Catastrophic Startup Problems

## Startup mode (safe mode)

- **When a system cannot start, the Windows Advanced Options menu provides access to troubleshooting startup modes**
  - Turn system *on*, then press the <F8> key when “Starting Windows” message is displayed
  - The Windows Advanced Options menu will be displayed
- **Safe mode**
  - Loads minimal Windows components (keyboard, mouse, VGA display driver)
  - Allows Windows desktop to be displayed so troubleshooting can begin



# Windows Advanced Options Menu

Windows Advanced Options Menu

Please select an option

Safe Mode

Safe Mode with Networking

Safe Mode with Command Prompt

Enable Boot Logging

Enable VGA Mode

Last Known Good Configuration (your most recent settings that worked)

Directory Services Restore Mode (Windows domain controllers only)

Debugging Mode

Disable automatic restart on system failure

Start Windows normally

Reboot

Return to OS choices menu

Use the up and down arrow keys to move the highlight to your choice



# Troubleshooting Catastrophic Startup Problems

## ➤ Windows Recovery Console

- Microsoft's emergency repair utility program for Windows
  - Included on the original Windows XP installation media
- Note: Windows Vista, Windows 7, Windows 8/8.1 use Windows Recovery Environment instead of Recovery Console (covered in next section)

## ➤ Starting the Windows Recovery Console

1. Boot from Windows XP CD
2. After the startup process is completed, press <R> (Repair)
3. Press <C> (Console) to start the Recovery Console
4. Program will prompt for installation (partition) to repair and for the Administrator account password
5. The `C:\WINNT` (or `%systemroot%`) prompt will be displayed

## ➤ Installing the Windows Recovery Console on the system hard drive

1. Insert Windows installation media CD
2. Use Start | Run, then type: `D:\I386\winnt32.exe /cmdcons`



# Windows Recovery Console

## ➤ Displays a command-line prompt

- Allows user to perform repair operations on (NTFS) disk files

```
12/07/1999 05:00a      49,680 twunk_16.exe
12/07/1999 05:00a      26,384 twunk_32.exe
03/23/1999 01:12a     299,520 uninst.exe
12/07/1999 05:00a      15,120 upwizun.exe
01/22/2000 01:13p         36 vb.ini
01/22/2000 01:13p         37 vbaddin.ini
12/07/1999 05:00a     20,240 ummreg32.dll
11/06/2000 12:51p     481,792 WBDBI32I.DLL
12/07/1999 05:00a     366,864 welcome.exe
12/07/1999 05:00a         23 welcome.ini
09/05/2000 06:31a         327 win.ini
12/07/1999 05:00a     256,192 winhelp.exe
05/04/2001 12:05p     269,584 winhlp32.exe
11/06/2000 12:52p         820 wininit.ini
05/04/2001 12:05p     193,296 winrep.exe
09/05/2000 06:31a         107 wmsetup.log
Press any key to continue . . .
09/05/2000 06:31a     288,880 WMSysPrx.prx
12/07/1999 05:00a         9,522 Zapotec.bmp
12/07/1999 05:00a         707 _default.pif
        66 File(s)      4,884,433 bytes
        28 Dir(s)     542,586,880 bytes free

C:\WINNT>
C:\WINNT>
```



# Windows Recovery Environment (Windows RE)

## ➤ Windows Recovery Environment

- Repair environment for
  - Windows Vista
  - Windows 7
  - Windows 8/8.1

## ➤ Accessing Windows RE from startup

- Press <F8> on startup
  - Advanced Boot Options menu will be displayed
- Select Repair Your Computer

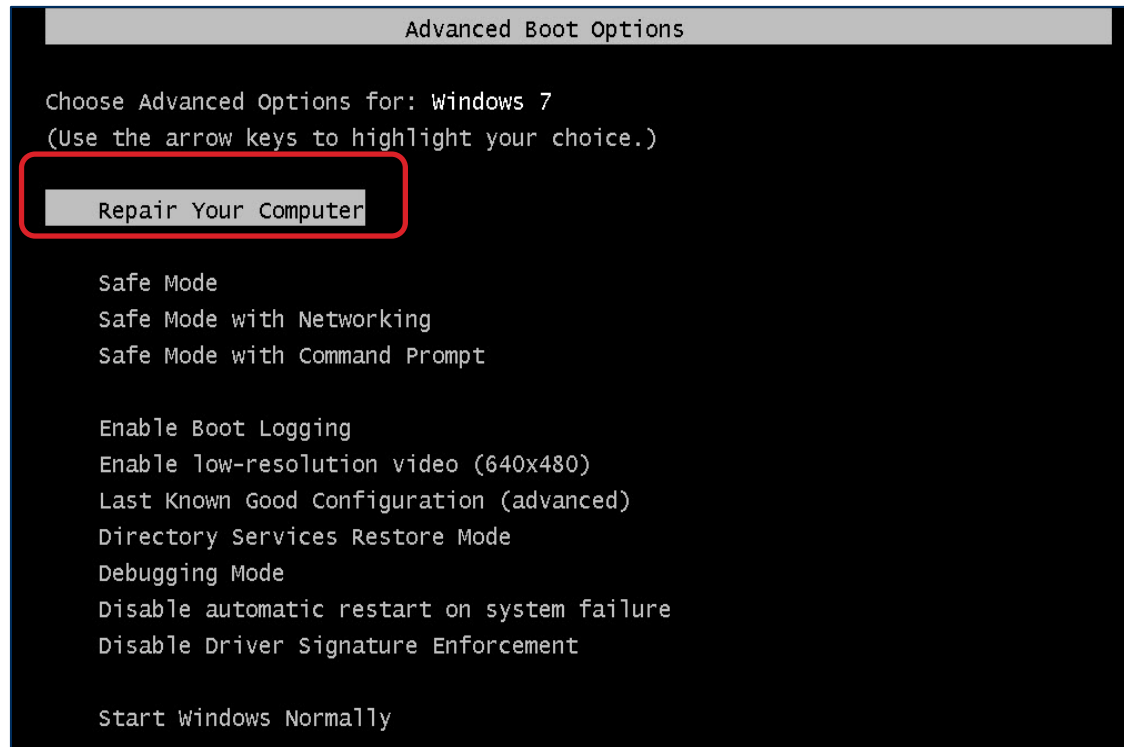

# Windows Recovery Environment (Windows RE)

## ➤ Accessing Windows Recovery Environment from the Windows Installation Disk

1. Boot system from Windows Installation Disk
  - The Install Windows screen will be displayed
2. Click Next
  - The Install Now screen will be displayed
3. Click “Repair your computer”
  - The System Recovery Options dialog will be displayed

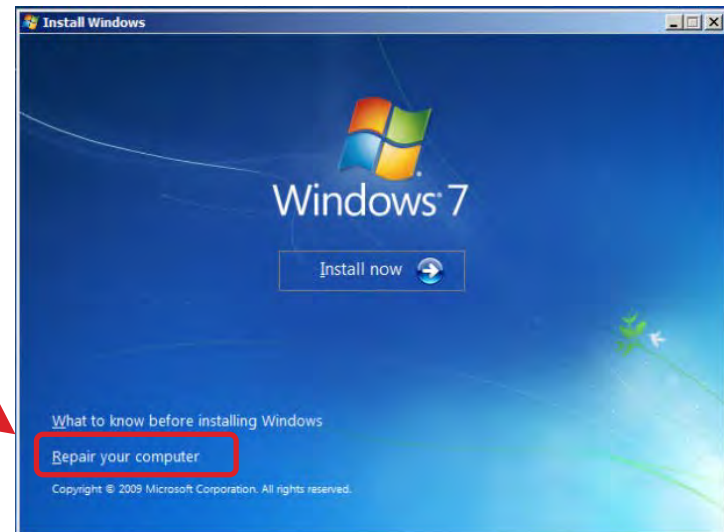

Repair your computer





# Windows Recovery Environment (Windows RE)

## ➤ Accessing Windows Recovery Environment from the Windows Installation Disk (continued)

4. In the System Recovery Options dialog, click Next
  - The System Recovery Options menu will be displayed

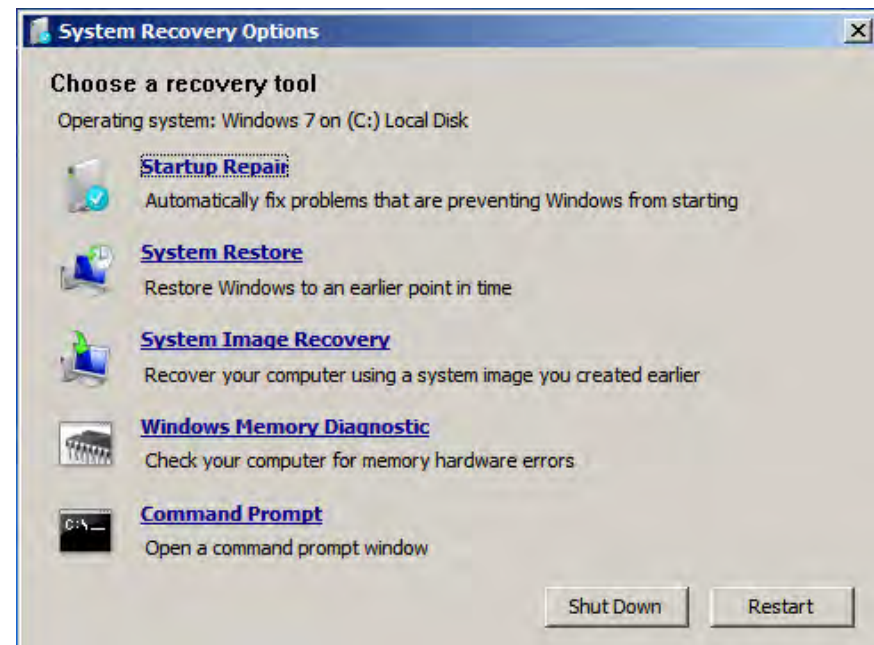
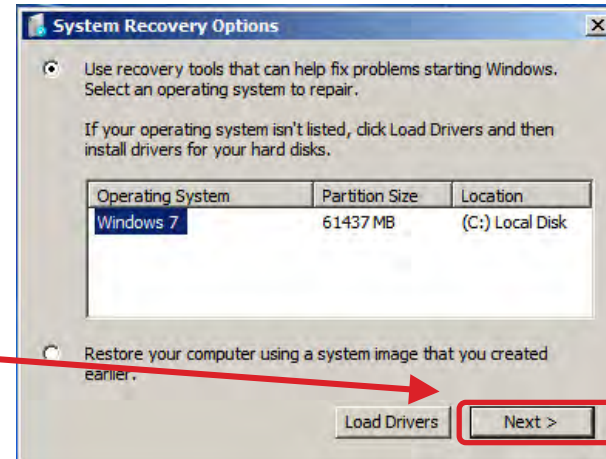

# System Recovery Options Menu



# Windows System Recovery Options Tools

System recovery tool	Description
Startup Repair	Locate and replace missing or damaged system files (with originals from installation disk)
System Restore	Restore system to an earlier point in time from data saved in a System Restore Point
System Image Recovery	Restore hard disk from previously created system image file
Windows Memory Diagnostic	Performs automated memory tests on RAM
Command Prompt	Opens Command Prompt window with full set of commands available



- **Managing Windows**
- **Optimizing Windows**
- **Troubleshooting Windows Startup Problems**
- **Troubleshooting Windows Hardware Problems**



# Troubleshooting Windows Hardware Problems

- **Windows Device Manager is a fundamental tool for troubleshooting hardware problems in windows**
  - Hardware device monitoring/configuration utility
    - Available in all versions of Windows
- **Starting Windows Device Manager**
  - In Search box, type Device Manager
  - Or click Start, right-click Computer, select Properties, then click the Device Manager link

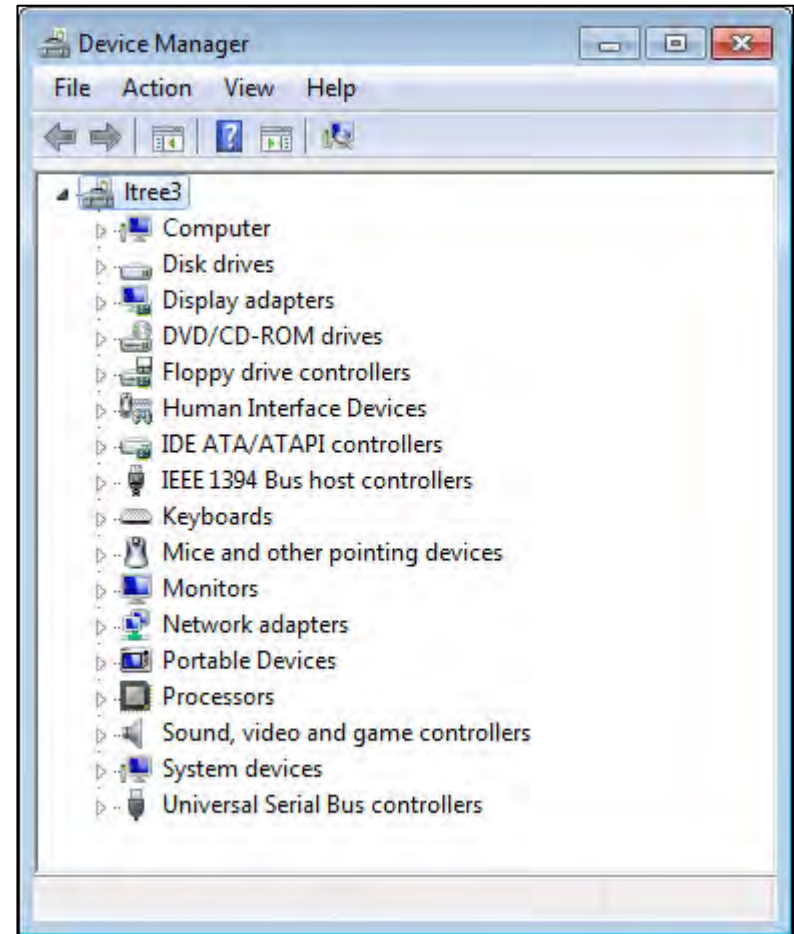

# Troubleshooting Windows Hardware Problems

## ➤ Interpreting Device Manager display

- Device Manager initially displays hardware devices grouped by device type
  - Double-click any device to display its properties
- A down arrow (Windows 7) through a device icon means it has been disabled
- A yellow exclamation mark next to a device indicates a possible problem

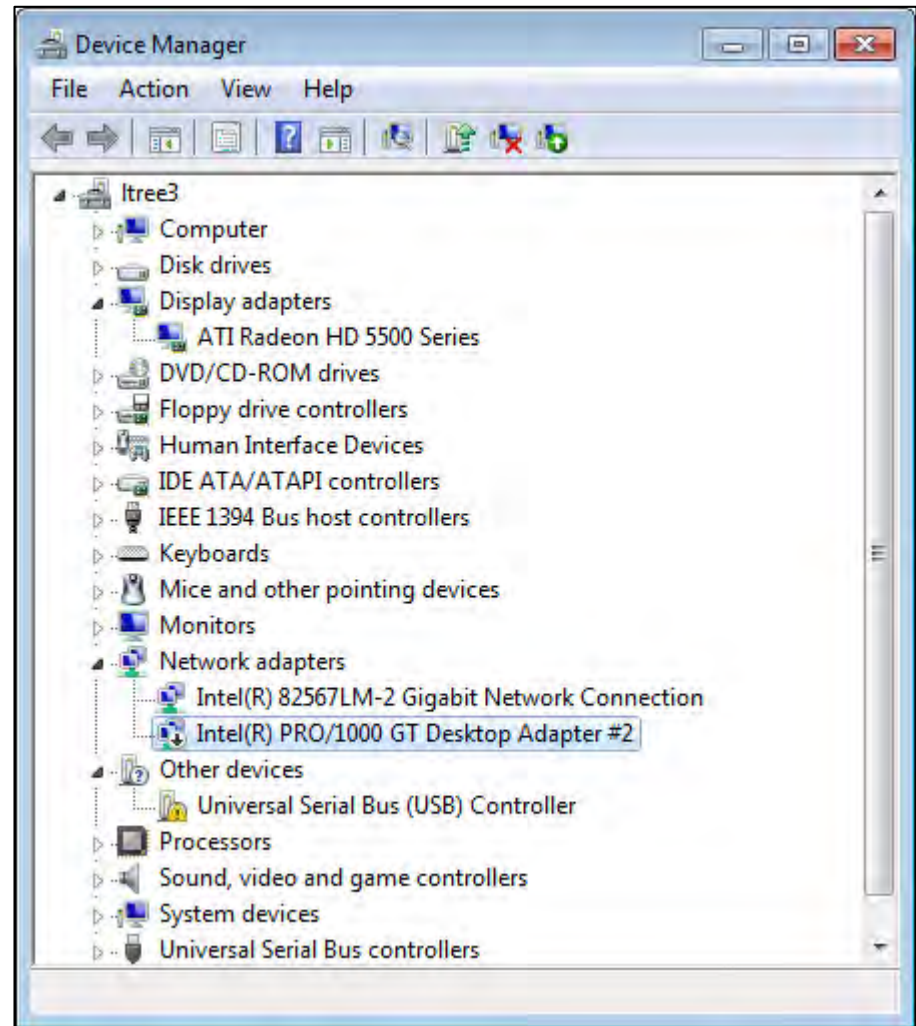

# Troubleshooting Windows Hardware Problems

- **Displaying individual device properties**
  - Double-click any device to display its status
  - Click the Driver tab to display resources allocated to device
    - Example: Network Adapter
- **Device status field indicates if device is working properly or not**

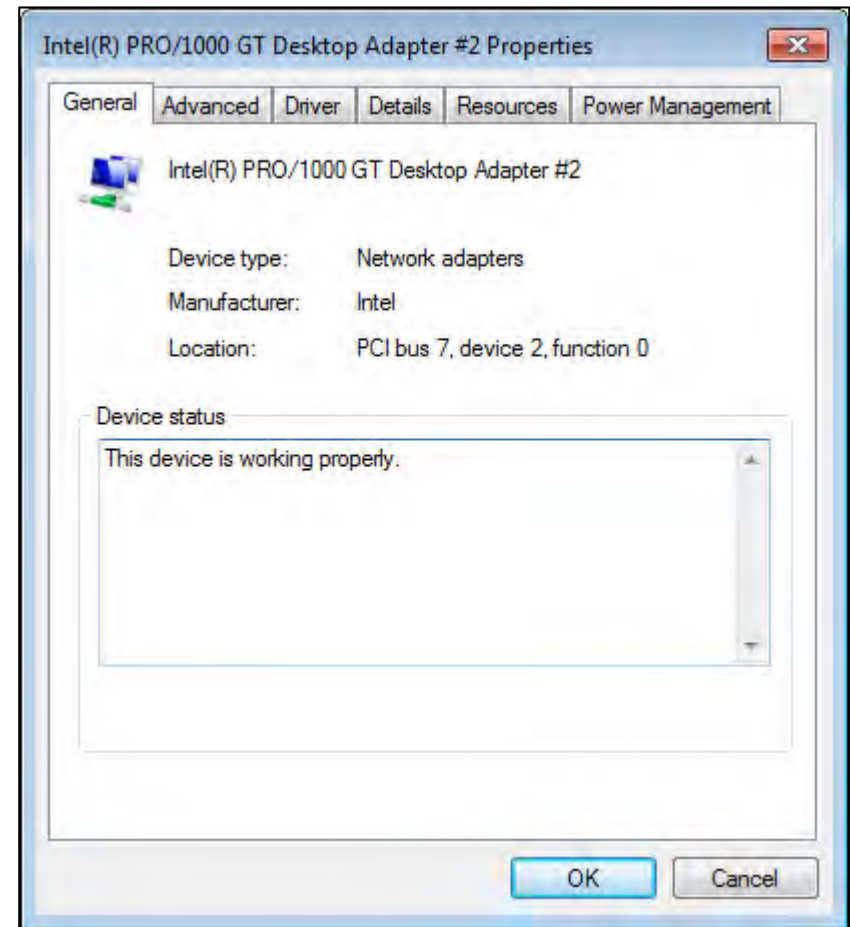

# Troubleshooting Windows Hardware Problems

## ➤ Click the Driver tab to display device driver details

- Driver provider
- Driver date
- Driver version
- Digital Signer
  - Digital certificate from Microsoft indicates approved driver

## ➤ Managing drivers

- Click Update Driver to install new driver
- Click Uninstall to remove driver

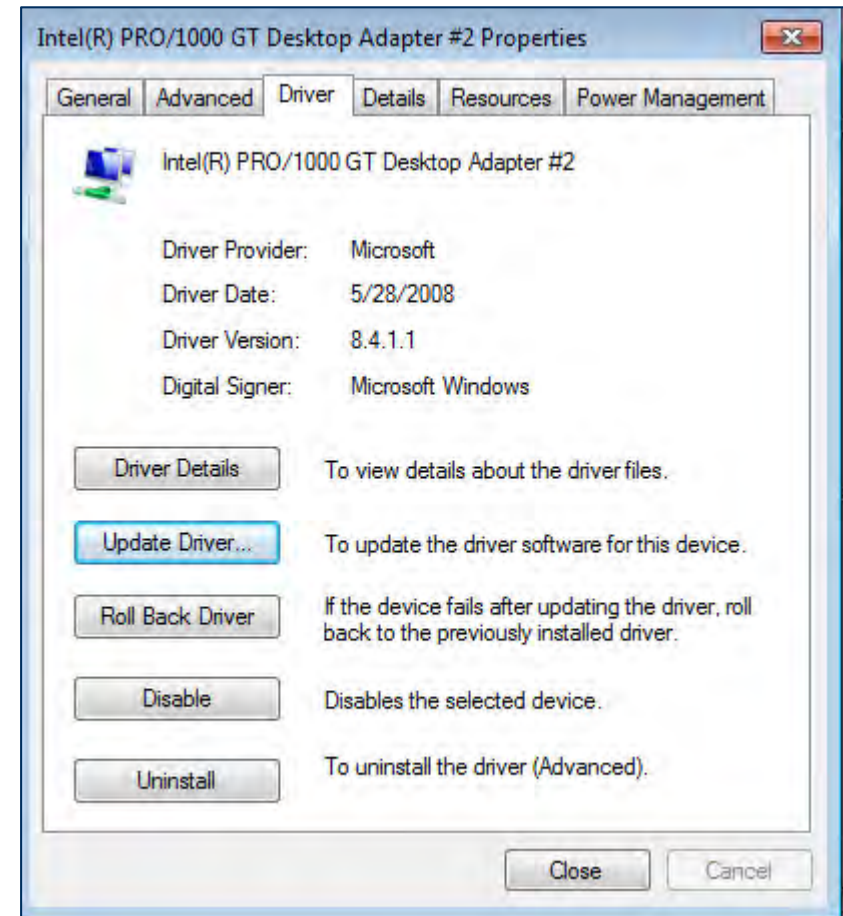



# Driver Rollback

## ➤ What is Driver Rollback?

- Allows user to “roll back” driver to a previous state
  - Useful if a newly upgraded driver causes problems
- Invoked by the Roll Back Driver button in the Drivers dialog

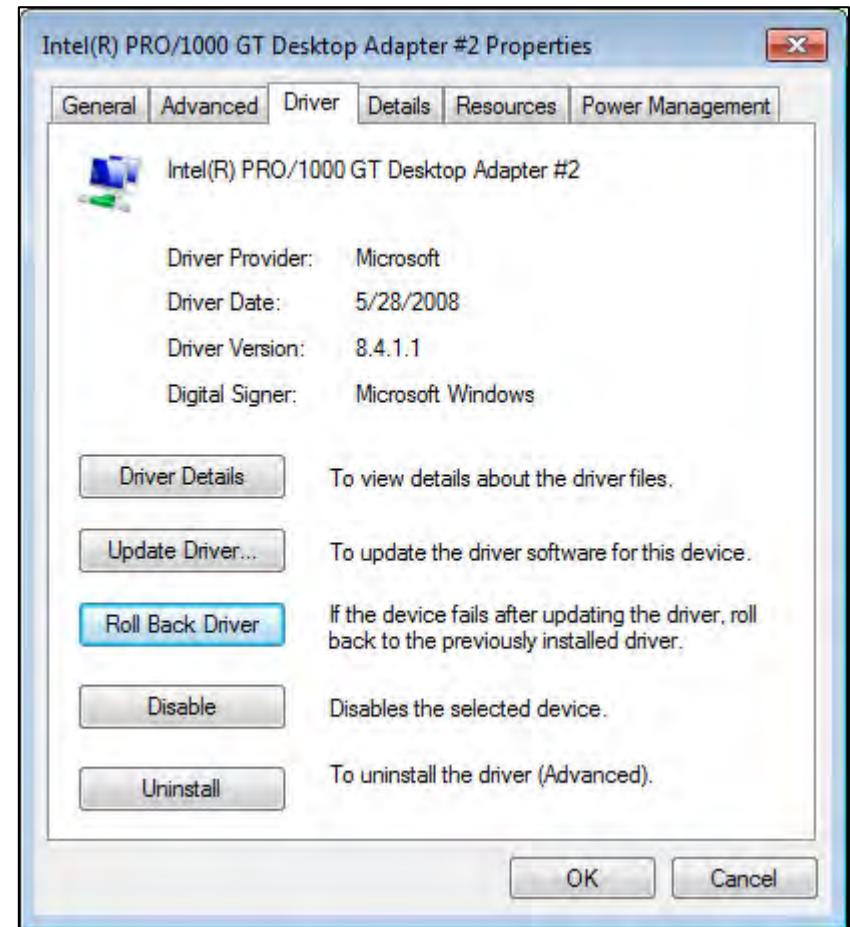

# Troubleshooting Catastrophic Windows Problems

## ➤ What is a Blue Screen Of Death (BSOD)?

- Windows Stop error (blue screen containing error codes)
  - Critical system error that causes operating system to shut down

## ➤ Common causes of BSOD

- Device driver errors or misconfigured hardware
- Memory faults

## ➤ Troubleshooting tips

- Record error codes listed on screen
- Look up in Microsoft Knowledge Base
  - <http://technet.microsoft.com/en-us/ms772425.aspx>

## ➤ Reboot

- Problem may be a one-time occurrence
- If not, boot into Safe mode using <F8>
  - Try “Last Known Good Configuration”



# Troubleshooting Windows General Protection Faults (GPFs)

## ➤ What is a Windows General Protection Fault (GPF)?

- Windows error message indicating a memory access violation
  - Example: Program attempts to use memory space allocated to another program

## ➤ Windows GPF error message

- Example: “Microsoft Internet Explorer has encountered a problem and needs to close.”



## ➤ Common causes of General Protection Faults

- Application program errors
- Memory faults

## ➤ Troubleshooting tips

- Reboot, then try to determine which application program may be causing the GPF
- Check application manufacturer's site for possible patch to correct problem



# Review Questions

- 1. Which Windows utility can show detailed information about a system error that has occurred in the recent past?**
  - A. Task Manager
  - B. System Performance Monitor
  - C. Registry Editor
  - D. Event Viewer
  
- 2. Jim has a program that has locked up and does not respond to any commands to close the application. Which is the best way to terminate the failed application?**
  - A. Right-click the application window and select End Task
  - B. Using Task Manager, click the Applications tab, select application, and then click the End Task button
  - C. Windows must be restarted
  - D. Start Event Viewer, then click any Warning events



# Review Questions

- 3. The Windows 7 Recovery Options tools are available from the (select two):**
- A. Windows 7 installation disk
  - B. Windows 7 keyboard
  - C. Windows 7 Advanced Boot Options menu
  - D. There are no Windows 7 Recovery Options tools
- 4. The preferred way to stop unwanted programs from launching on startup is to use the \_\_\_\_\_ utility.**
- A. REGEDIT.EXE
  - B. Task Manager
  - C. MSCONFIG.EXE
  - D. Event Viewer



# Review Questions

- 5. Susan says her computer started exhibiting major problems after she installed a new application yesterday. What should you do?**
- A. Use `REGEDIT` to examine the registry entries associated with the new program
  - B. Use Task Manager to end the new program
  - C. Use `chkdsk /F` to fix any lost cluster chains on the computer's hard drive
  - D. Use Windows System Restore to restore her computer to its state before the new application was installed
- 6. How is Windows Advanced Options menu for startup invoked?**
- A. Press `<Ctrl><Alt><Del>` as the system boots
  - B. Press `<F8>` when the Starting Windows message is displayed
  - C. Wait until the Windows desktop is displayed, then use Start | Advanced Options
  - D. Press the `<Esc>` key as the system boots



# Chapter Summary

In this chapter, you have learned how to

- Describe strategies and tools for managing Windows (Windows BACKUP, Event Viewer, Task Manager, Windows disk management tools)
- Optimize Windows hard disk, virtual memory, and services
- Describe tools and techniques for troubleshooting Windows startup problems
- Troubleshoot Windows hardware and driver problems with Device Manager



# Chapter 17

# Introduction to Networking

Customer  
Management  
Standard  
Development  
Consistency  
Business  
Optimal



# Chapter Objectives

---

**In this chapter, you will learn how to**

- **Describe the basic types of network configurations and topologies**
- **Identify the common types of network cables**
- **Describe two types of network protocols and their functions**
- **Install and configure a TCP/IP network client**



## ➤ **Network Terms**

- **Network Cabling**
- **Network Protocols**
- **Wireless Networking**
- **Configuring Windows Networking**
- **Optional Hands-On Exercise 17.1**



# Fundamental Terms

## ➤ Network

- Two or more computers linked together for communication and data sharing
  - Note: Two computers can be connected using a null-modem serial cable, or an Ethernet crossover cable

## ➤ Bandwidth

- Overall data throughput capability (in bps)
- Example: Cat 7 cable can support a data rate of up to 10 Gbps

## ➤ Latency

- Delays incurred during processing of network data
- Example: Latency of a satellite Internet connection may be as high as 500 ms

## ➤ Full-duplex vs. half-duplex (data transmission mode)

- Half-duplex—only one side may transmit at a time
- Full-duplex—both sides may transmit at the same time



# Fundamental Terms

## ➤ **Local area network (LAN)**

- Network covering a limited area (usually one site or facility)
- Connection media includes copper or fiber-optic network cabling

## ➤ **Wide Area Network (WAN)**

- Network covering a large geographical area
- Connection media includes telephone, T1, ISDN, cable modem lines, etc.

## ➤ **Metropolitan Area Network (MAN)**

- A network covering a large area (campus or city), using radio as the communication method (e.g., WiMAX)

## ➤ **Personal Area Network (PAN)**

- Localized network for communication between computer-based devices (e.g., Bluetooth)

ISDN = integrated services digital network

WiMAX = Worldwide Interoperability for Microwave Access



# Network Connection Devices

## ➤ Hub

- Forwards bits received on one port to all other ports on a device

## ➤ Switch

- Reads frame headers, and forwards frames to appropriate port

## ➤ Bridge

- Connects two networks using same protocol (e.g., Ethernet)

## ➤ Router

- Routes packets between multiple networks

## ➤ Modem

- Connects network to broadband system by modulating digital data to higher frequencies (e.g., cable modem)

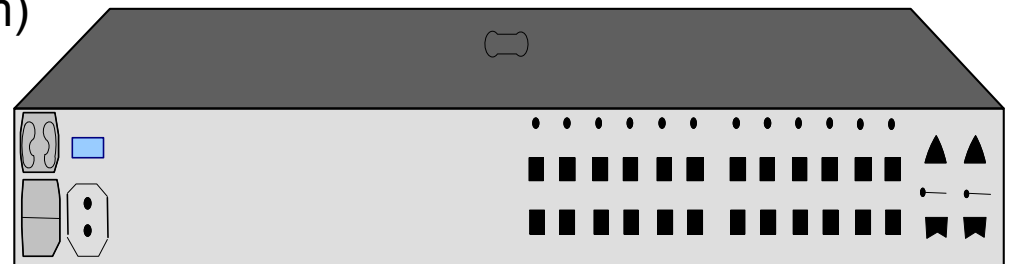

# Network Attached Devices

## ➤ Network Attached Storage (NAS)

- Data storage device that contains network interface

## ➤ **Firewall**

- Hardware (or software) provides protection by controlling incoming and outgoing network traffic

## ➤ **VoIP phones**

- Telephones that use Voice over Internet Protocol (VoIP) protocol

## ➤ **Internet appliance**

- Consumer devices that have a network interface for connection to the Internet (e.g., televisions, game consoles, refrigerators)



# Power over Ethernet (PoE) and Ethernet Over Power Lines

## ➤ Power over Ethernet (PoE)

- Standard for supplying power over Ethernet cables
  - To supply networked devices like VoIP phones
- Power provided by
  - Network switch that supports PoE or
  - PoE injector
    - Powered device plugs into switch port, output RJ-45 connector supplies Power over Ethernet

## ➤ Ethernet over power lines

- Special devices transmit network signals over AC power lines



# Virtual Private Network (VPN)

## ➤ Virtual Private Network (VPN)

- Network that uses public Internet to provide secure communication links between clients and hosts
- VPN software encrypts/decrypts data on sending and receiving end

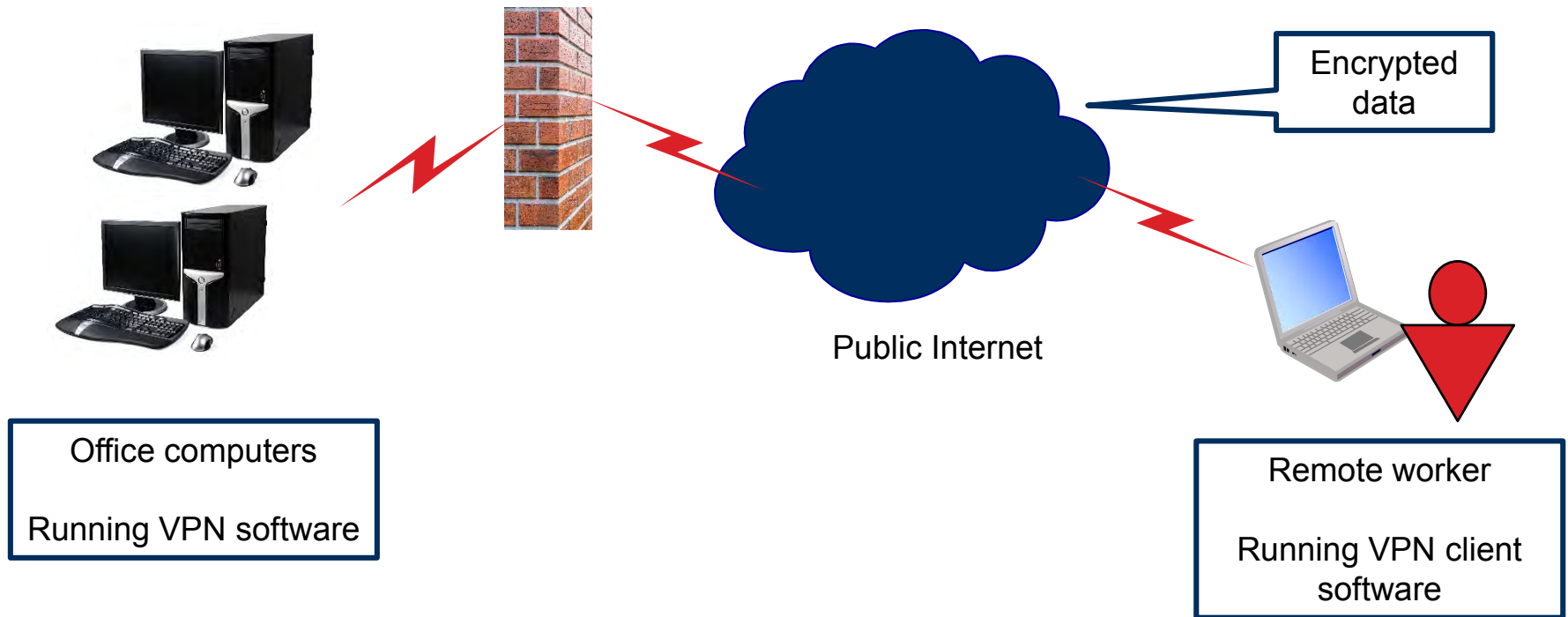



- **Network Terms**
- **Network Cabling**
- **Network Protocols**
- **Wireless Networking**
- **Configuring Windows Networking**
- **Optional Hands-On Exercise 17.1**



# Network Cabling

- **The type of network cable affects**
  - Maximum length of cable segments
  - Data transmission speed
  
- **Types of network cable**
  - Plenum vs. PVC
  - Twisted pair
  - Coaxial
  - Fiber-optic



# Network Cable Types: Plenum vs. PVC

## ➤ What is plenum cable?

- Cable approved for use in plenum spaces (air-conditioning returns) in buildings
  - Plastic jacket is fire-retardant
  - Does not emit toxic fumes when exposed to high heat
- More expensive than standard network cable

## ➤ PolyVinyl Chloride (PVC) cable

- Plastic jacket used on standard network cable
- Most common type of twisted-pair cable



# Network Cable Types: Twisted Pair

## ➤ Twisted pair

- Cable consists of pairs of wire, which are twisted together
  - Twist provides noise immunity from interfering signals

## ➤ Unshielded Twisted Pair (UTP)

- Twisted-wire pairs are contained in a plastic sheath (looks like a telephone cable)
- Most common type of twisted-pair cable



## ➤ Shielded Twisted Pair (STP)

- Twisted wire pairs are wrapped in metal foil for increased shielding



# Twisted Pair Network Cable Connector (RJ-45)

## ➤ RJ-45 connector

- Standard connector for twisted pair network cable
- Uses four pairs (eight wires)

## ➤ RJ-11 connector

- Standard connector for telephone cable
- Uses two pairs (four wires)

## ➤ Connector wiring

- T568A and T568B
  - Difference: Pin positions of Orange/Orange-white and Green/Green-white pairs are swapped
- T568B is more commonly used

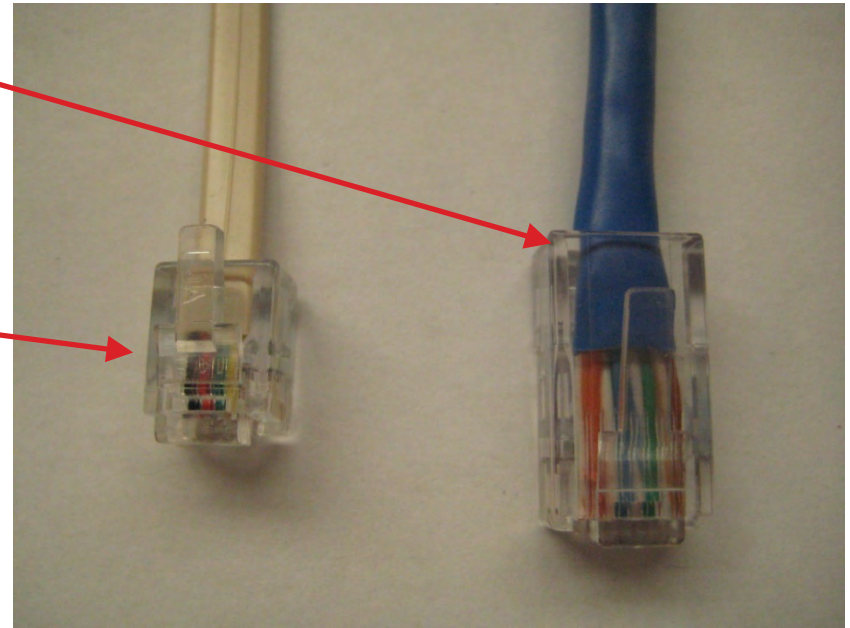

# EIA T568A and T568B

	T568A	T568B
<b>Pin 1</b>	W/Green	W/Orange
<b>Pin 2</b>	Green	Orange
<b>Pin 3</b>	W/Orange	W/Green
<b>Pin 4</b>	Blue	Blue
<b>Pin 5</b>	W/Blue	W/Blue
<b>Pin 6</b>	Orange	Green
<b>Pin 7</b>	W/Brown	W/Brown
<b>Pin 8</b>	Brown	Brown

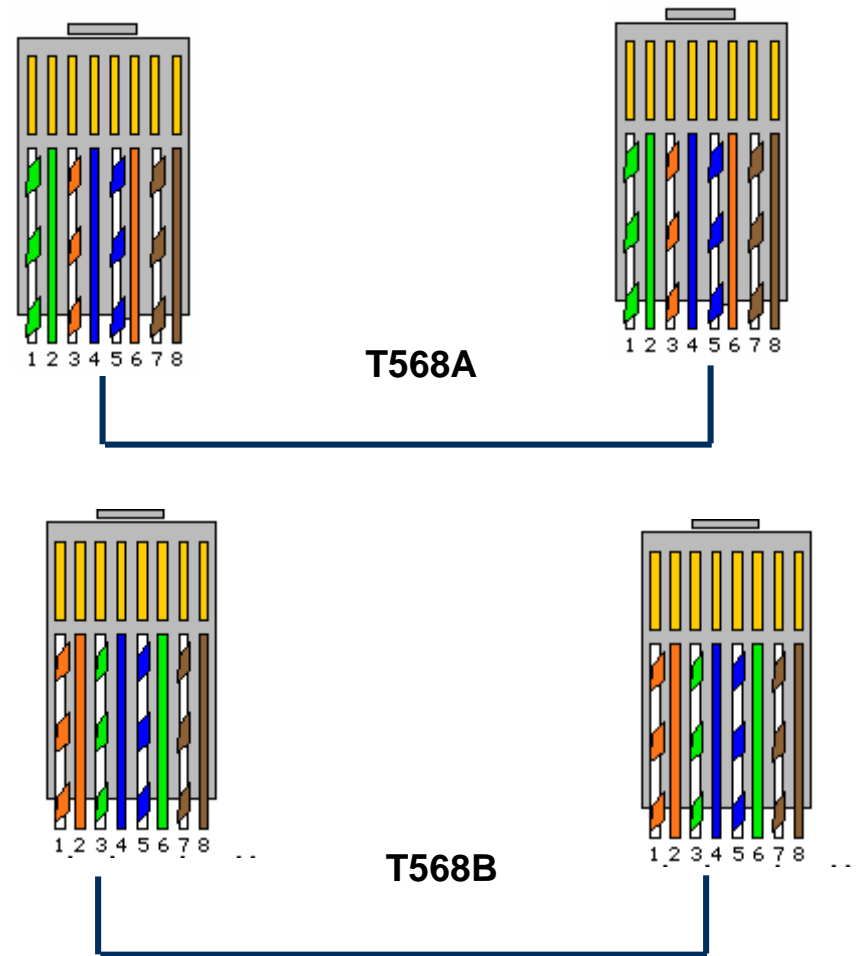
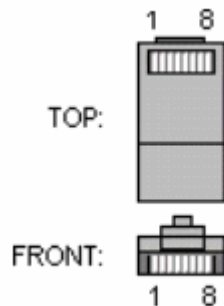

# Network Cable Types: Coaxial

## ➤ Coaxial cable

- Consists of an insulated center conductor wire wrapped in a braided metal shield
- Braided shield wire acts as second conductor

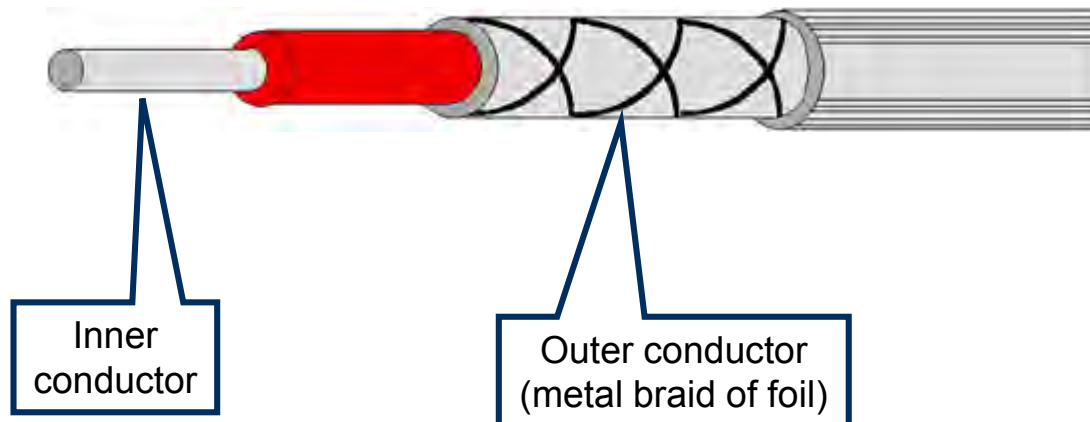

# Network Cable Types: Coaxial

## ➤ Coaxial cable types

- Note: RG-58 can support long segment lengths (up to 600 ft/185 m)

Coax type	Impedance	Size	Use
RG-6	75 ohm	Thick	Cable TV/satellite receiver systems
RG-59	75 ohm	Thin	Cable TV/satellite receiver systems





# Network Cable Types: Fiber-Optic

## ➤ Fiber-optic cable

- Consists of light-conducting glass or plastic fibers wrapped in a protective plastic jacket
- Supports high data rates and is not susceptible to electromagnetic interference (EMI)

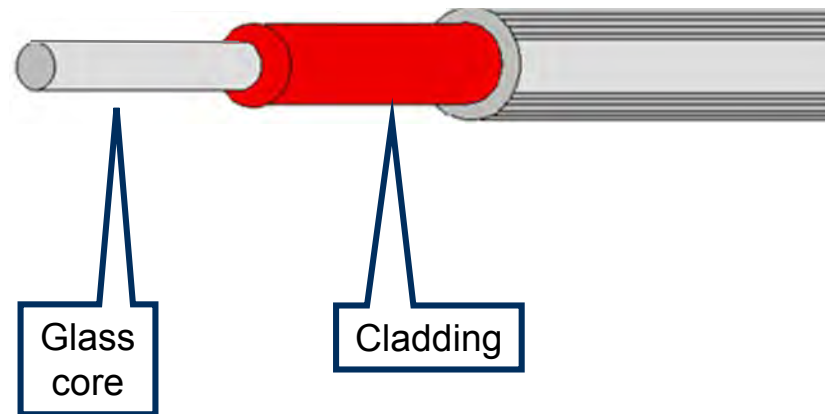

# Network Cable Types: Fiber-Optic

## ➤ Fiber-optic cable types

- Multimode
  - Uses large-diameter core, has multiple pathways for several different light wavelengths
  - Used for general fiber applications (LANs)
  - Usually orange cable
- Single-mode
  - Uses small diameter core, carries one light wavelength
  - Used for long-haul networks (up to 24 miles)
  - Usually yellow cable

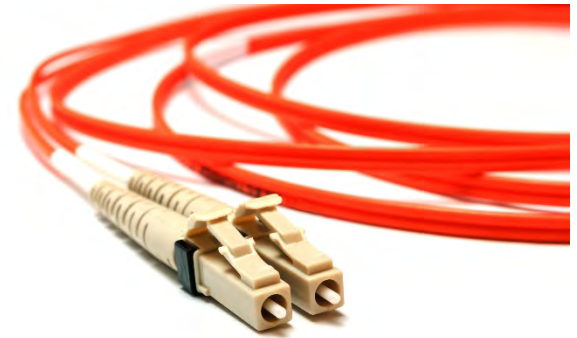

LC

## ➤ Common fiber-optic connectors

- ST (Straight Tip)
- SC (Subscriber Connector)
- LC (Lucent Connector)



ST



SC



# Interpreting Network Cable Nomenclature

## ➤ Nomenclature for network cables consists of three fields

Field	Description
1	Maximum transmission speed (in megabits per second)
2	Bandwidth (base or broad)*
3 (letter)	Type of cable (T = twisted pair, F = fiber-optic)
3 (number)	Approximate maximum length of cable (in hundreds of meters)

## ➤ What are the specifications for 100BaseT network cable?

- Maximum transmission speed: \_\_\_\_\_
- Bandwidth: \_\_\_\_\_
- Cable type: \_\_\_\_\_

\*Note: Broadband transmission superimposes digital information on a carrier signal (like a modem). Baseband transmission sends the digital information directly on the transmission medium.



# Common Ethernet Cable Types

Name	Cable type	Max. length	Max. speed	UTP Category	Comments
10Base2	Thin (.25") coaxial	185 m	10 Mbps		"Thinnet" cable used in older networks
10BaseT	Twisted pair	100 m	10 Mbps	Cat-3	Earlier version of UTP cable
100BaseT	Twisted pair	100 m	100 Mbps	Cat-5	Commonly used UTP cable
1000BaseT	Twisted pair	100 m	1000 Mbps	Cat-5e	Supports Gigabit Ethernet
10GBaseT	Twisted pair	55 m	10 Gbps	Cat 6	Supports 10 Gigabit Ethernet
10GBaseT	Twisted pair (shielded pairs)	100 m	10 Gbps	Cat 7	Supports 10 Gigabit Ethernet over 100m
1000BaseFX/LX	Fiber-optic	0.25 to 20 miles	1000 Mbps		Often used to connect networks between buildings or sites

Note: 1000BaseLX is a long-wave fiber-optic cable that supports Gigabit Ethernet





# Cable Splitters

- **Cable splitters split network signal into two paths**
  - Used for both Ethernet and coax cables
  - *Split signals have less signal strength than original signal*
    - Generally OK, as long as there aren't multiple splitters in a row
- **Coax cable splitter**
  - Input from main cable source
  - Output
    - Cable modem
    - Television





# Network Cabling Tools

Tool		Description
Cable tester	 A blue handheld device with a green LCD screen and several buttons. The text 'FLUKE networks MICROSCANNER PRO' is printed on the front.	Test instrument used to verify connectivity of network cables
Loopback plug		Test plug connects transmit and receive wires in network cable
Punch down tool	 A black and yellow tool with a pointed tip and a handle.	Tool used to insert wires into punch down blocks and network patch panels



# Network Cabling Tools

Tool		Description
Toner and probe		Pair of electronic test instruments used to trace and locate cables on networks; toner injects a signal on one end of cable, probe receives signal on other end of cable
Wire strippers		Tool strips insulation from wires
Crimper		Tool that crimps wires into RJ-45 connectors
Wireless locator		Software tool that locates and provides information about nearby wireless networks



- **Network Terms**
- **Network Cabling**
- **Network Protocols**
- **Wireless Networking**
- **Configuring Windows Networking**
- **Optional Hands-On Exercise 17.1**





# Network Protocols: TCP/IP

## ➤ Transmission Control Protocol/ Internet Protocol (TCP/IP)

- (Open systems) standard network protocol developed by the U.S. Department of Defense
- Widely used today because it is the standard protocol used on the Internet

## ➤ Internet Protocol (IP) address versions

- IPv4
  - Most commonly used IP address
  - IPv4 addresses are 32 bits long
- IPv6
  - New IP addressing format (supported in Windows Vista, Windows 7)
  - IPv6 addresses are 128 bits long
- In this section, we will cover IPv4 first, then IPv6



# IP (Internet Protocol) Addressing: IPv4

- **IPv4 addresses are 32 bits long**
  - Example: 00001010 00000001 00000001 00000001
- **Usually expressed in dotted decimal notation**
  - Organized as 4 octets (8-bit groups described in decimal format), separated by dots
  - Example of an IP address: 10 . 1 . 1 . 1



# IP (Internet Protocol) Addressing: IPv4

➤ **IPv4 addresses are divided into two sections: network ID and host ID**

- Network section defines the number of networks
- Host section defines the number of individual computers (hosts)



➤ **To accommodate different network sizes, IPv4 addresses are defined in classes**

- Class A networks use the first octet of the address for the network ID
- Class B networks use the first two octets of the address for the network ID
- Class C networks use the first three octets of the address for the network ID



# Subnet Masks

## ➤ What is a subnet mask?

- 32-bit value with “1s” used to logically “mask” off the network ID portion of an IP address from the host ID portion
- Used to subdivide the host ID portion of an IP address
  - To isolate segments of a network from one another

## ➤ Class A, B, and C network default subnet masks:

Class	Default subnet mask
A	255.0.0.0
B	255.255.0.0
C	255.255.255.0





# Private IPv4 Address Classes

## ➤ IP address blocks reserved for use on local networks (private intranets)

Class	Lower limit	Upper limit
A	10.0.0.0	10.255.255.255
B	172.16.0.0	172.31.255.255
C	192.168.0.0	192.168.255.255

## ➤ Automatic Private IP Addressing (APIPA)

- Feature that allows systems to automatically self-configure IP address when a DHCP server is not available
  - APIPA address range: 169.254.0.1 to 169.254.255.254
- Note: If a computer is using this IP address, DHCP server may be down
- Note: The IPv6 equivalent address starts with FE80:...

DHCP = Dynamic Host Configuration Protocol



# Classless Inter-Domain Routing (CIDR) Addressing

- **Developed to slow the exhaustion of IPV4 addresses**
  - Variable length subnet mask is used to define network part of IP address
- **CIDR address format**
  - IP address, /, number of bits in subnet mask
    - Starts from beginning of IP address
- **Example: 192.168.1.1/24**
  - /24 = 24-bit subnet mask, starting from beginning of address
    - First three groups of 8 bits
  - Network part of IP address = 192.168.1
  - Note that because we are using a 24-bit subnet mask, the result is the same as the Class C subnet mask (first 24 bits) we saw in the earlier example



# Classless Inter-Domain Routing (CIDR) Addressing

Original IP address

192

168

1

1



+ 24-bit subnet mask

255

255

255

0



= Preserved network ID portion of address

192

168

1

0





# IPv4 Loopback Address

- **127.0.0.1 is reserved for use as an IPv4 loopback address**
  - Used to test functionality of network card
  - Acts like a loopback plug on a physical I/O port
    - Note: All addresses from 127.0.0.0 to 127.255.255.254 act as a loopback address
- **Used with Ping utility to send a test packet**
  - Successful receipt confirms that network card is functioning properly

```
C:\Administrator: C:\Windows\system32\cmd.exe
Microsoft Windows [Version 6.0.6000]
Copyright (c) 2006 Microsoft Corporation. All rights reserved.

C:\Users\mshinn>ping 127.0.0.1

Pinging 127.0.0.1 with 32 bytes of data:

Reply from 127.0.0.1: bytes=32 time<1ms TTL=128
Reply from 127.0.0.1: bytes=32 time<1ms TTL=128
Reply from 127.0.0.1: bytes=32 time<1ms TTL=128
Reply from 127.0.0.1: bytes=32 time<1ms TTL=128

Ping statistics for 127.0.0.1:
    Packets: Sent = 4, Received = 4, Lost = 0 (0% loss),
    Approximate round trip times in milli-seconds:
        Minimum = 0ms, Maximum = 0ms, Average = 0ms
```



# Protecting Private Internal Networks

## ➤ What is Network Address Translation (NAT)?

- Method of using a router that acts as a translating agent between internal network and public Internet

## ➤ Benefits of using NAT

- Conserves public Internet addresses by allowing one IP address to represent an organization's entire computer network
- Increases security by preventing direct access from a computer on the public Internet to a computer on the internal network

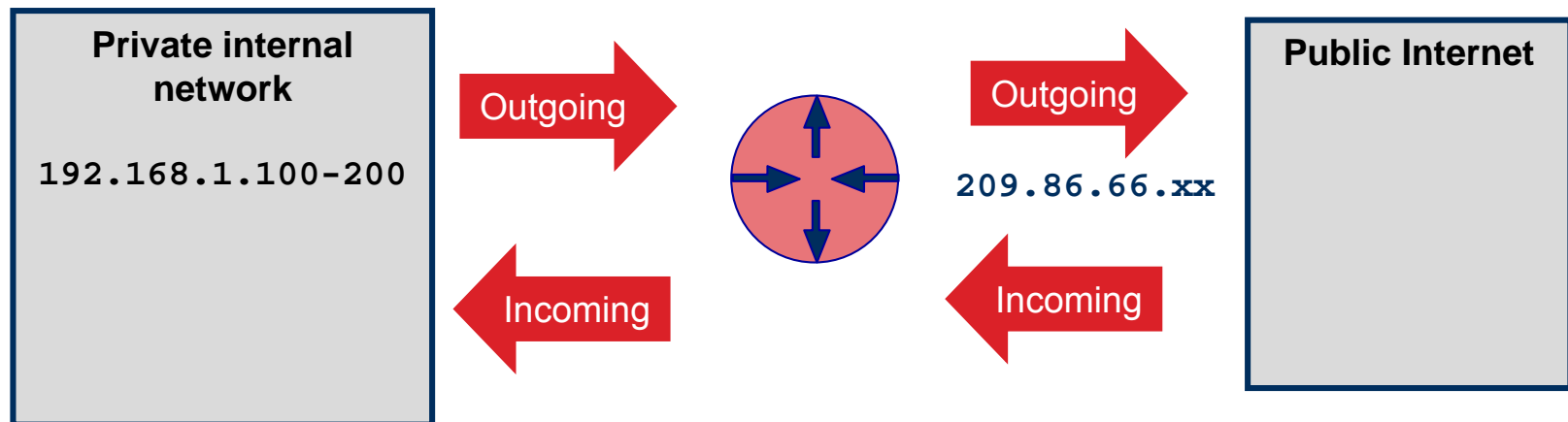

# IP (Internet Protocol) Addressing: IPv6

## ➤ What is IPv6?

- Next generation of IP addressing (128 bits)
- Larger address size solves problem of IPv4 address exhaustion
- IPv6 provides  $2^{128} =$  “Approximately  $5^{28}$  addresses for each of the 6.5 billion people alive today”
  - Source: <http://en.wikipedia.org/wiki/IPv6>

## ➤ IPv6 addresses are 128 bits long (8 groups of 16 bits)



## ➤ Each group of 16 bits is expressed as four hexadecimal digits separated by colons

- Hexadecimal is 16-digit number system
  - Each hex digit represents 4 bits
- Example (convert one 16 bit group to hex equivalent):
  - 1111 1111 1111 1111 = Hex F F F F



# Default Gateway

- **The default gateway is the address of the device that provides connection to the Internet**
  - In enterprises, this is the address of the computer or device that routes traffic from the internal network to the Internet
  - In small offices and homes, this might be the address of a DSL router
- **Summary of IP configuration required to connect to the Internet**
  - Example (workstation connected to DSL router)
    - IP address: 192.168.1.121  
Address provided by DHCP from DSL router
    - Subnet mask 255.255.255.0
    - Default gateway: 192.168.1.1  
Address of DSL router

DSL = digital subscriber line



# Static IP Addresses vs. DHCP

➤ **The IP address for a network adapter is typically assigned in one of two ways**

- Static IP address
  - Fixed, known IP address assigned by the user
- Dynamic Host Configuration Protocol (DHCP)
  - A DHCP server dynamically assigns an IP address to network clients
  - Configured using “Obtain an IP address automatically” in the Internet Protocol (TCP/IP) Properties dialog

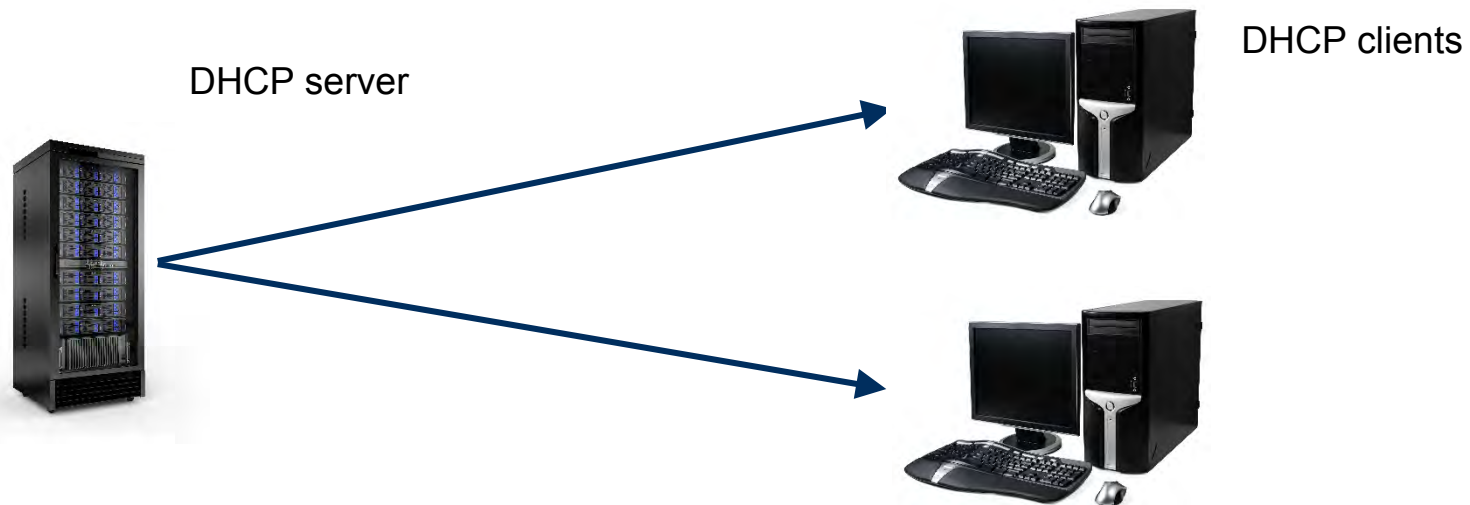

# Configuring a Network Adapter for DHCP

## ➤ Selecting Network Device to configure

1. In the lower right part of the Windows taskbar, right-click the network icon, then select **Open Network and Sharing Center**
  - The Network and Sharing Center screen will be displayed

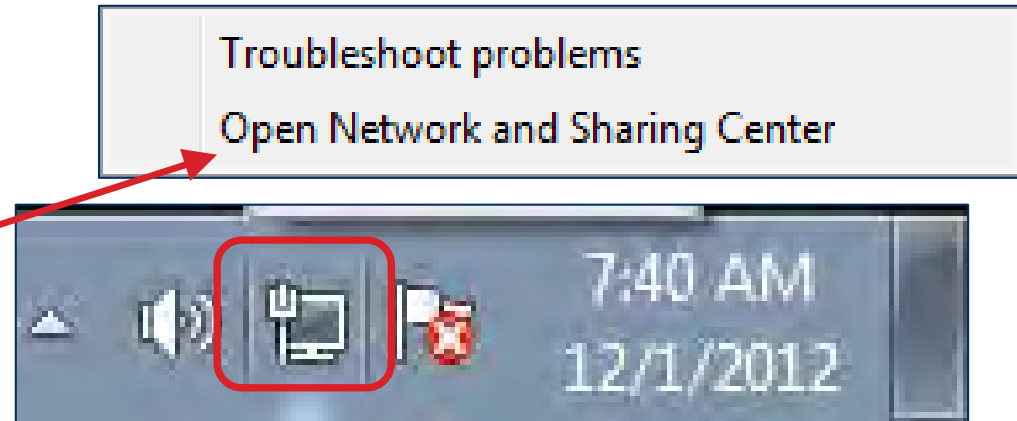

# Configuring a Network Adapter for DHCP

2. In the left pane of the Network and Sharing Center screen, click “Change adapter settings”
  - o The Network Connections screen will be displayed

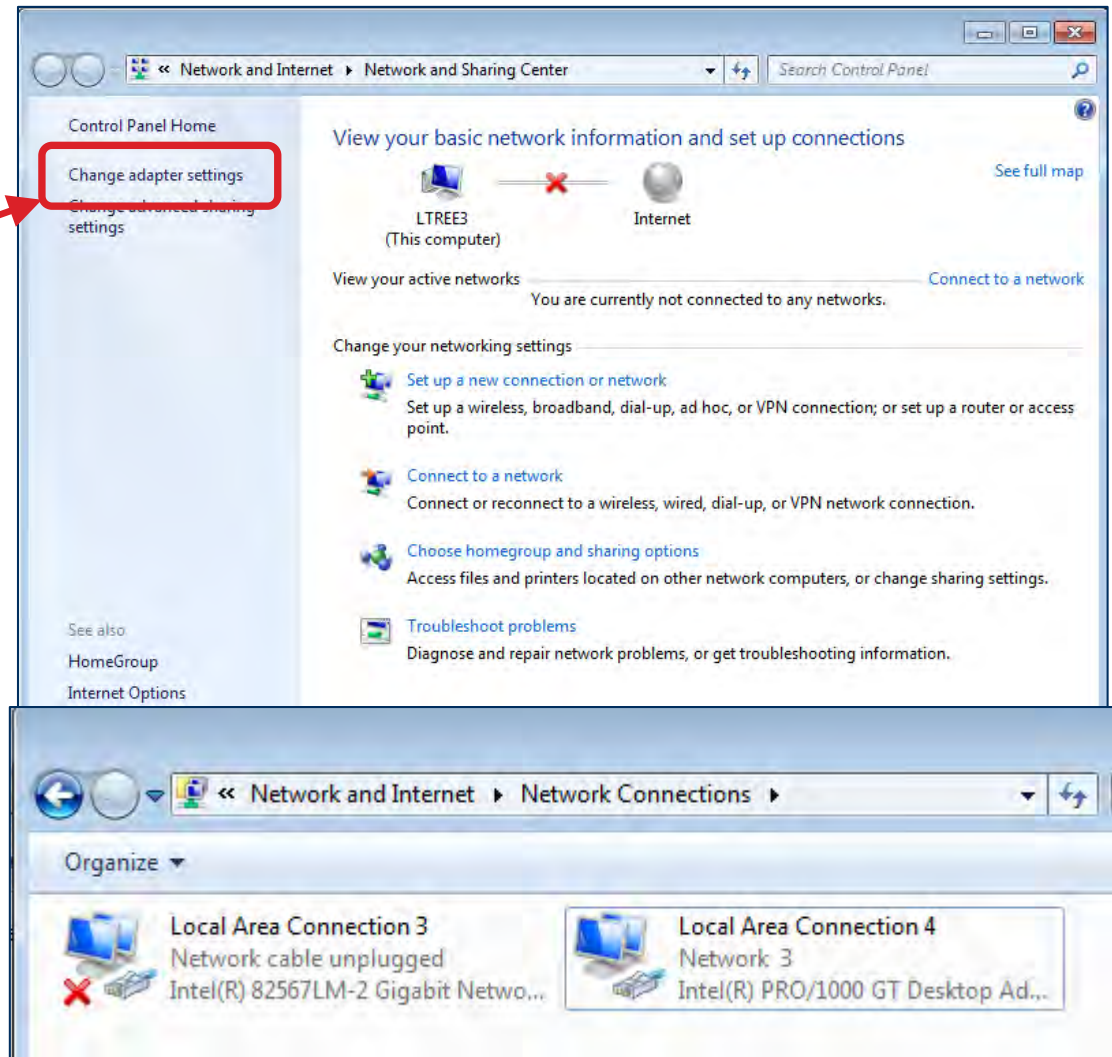

# Configuring a Network Adapter for DHCP

3. In the Network Connections Screen, right-click the desired network adapter, then select Properties
  - The Properties window for the network adapter will be displayed
4. Right-click Internet Protocol Version 4 (TCP/IPv4), then select Properties
  - The Internet Protocol Version 4 Properties dialog will be displayed

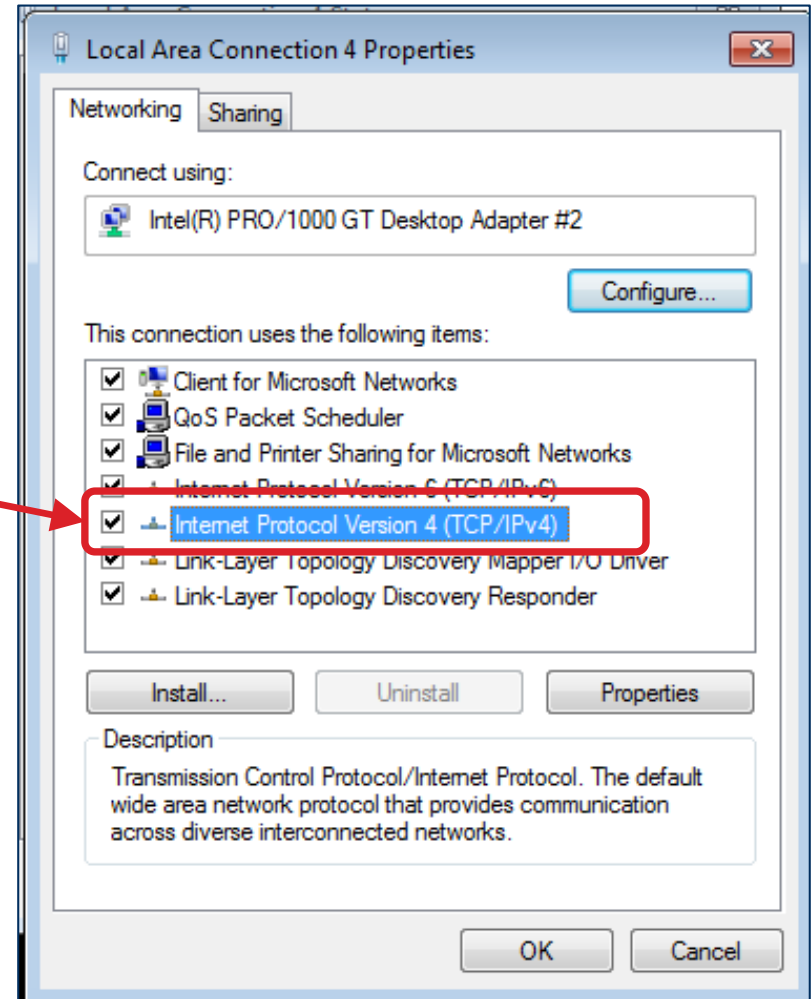



# Configuring a Network Adapter for DHCP

5. In the General tab, the option “Obtain an IP address automatically” should be selected
  - This is the default setting (for DHCP)

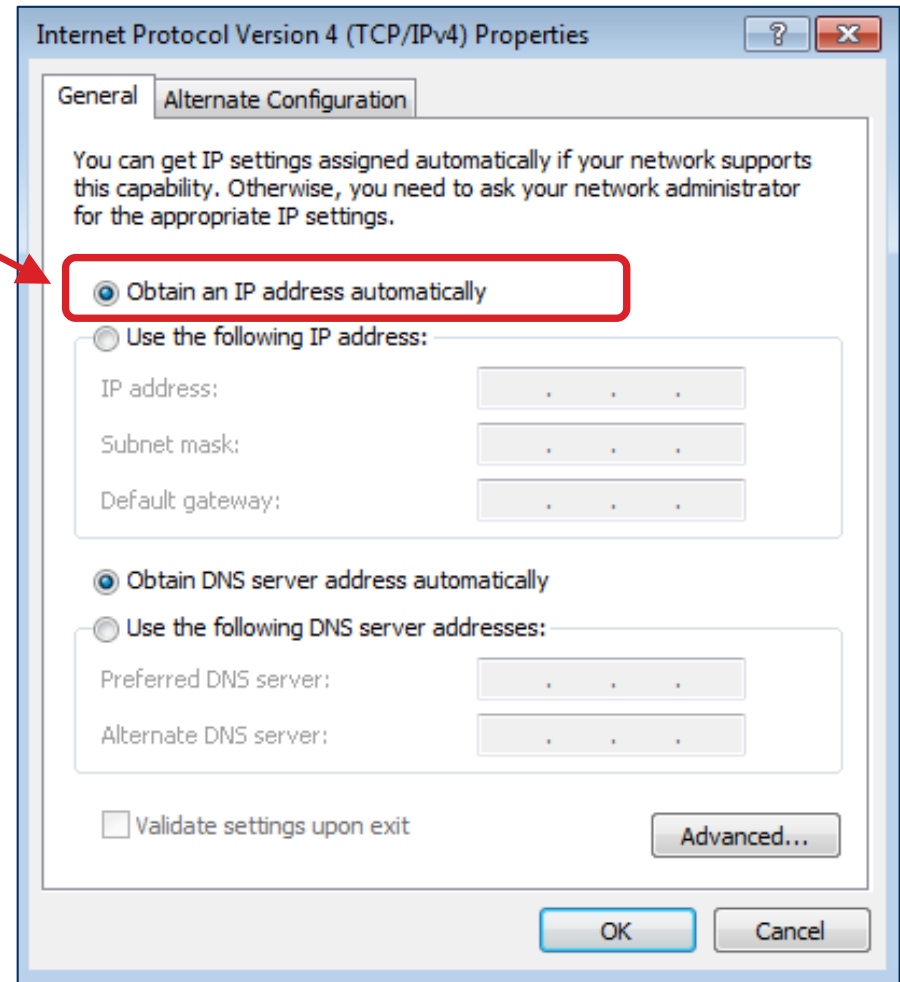

# Configuring a Network Adapter for an Alternate Configuration

## Static IP address

- In some cases, a user may need an alternate configuration for his or her network card
  - Example: John uses DHCP at his office network, but uses a static IP address on his home network
- **Configuring a network adapter for an alternate configuration (static IP address)**
  1. Use the same steps used to configure a network adapter for DHCP, but on the Internet Protocol Version 4 (TCP/IP) Properties dialog, click the Alternate Configuration tab

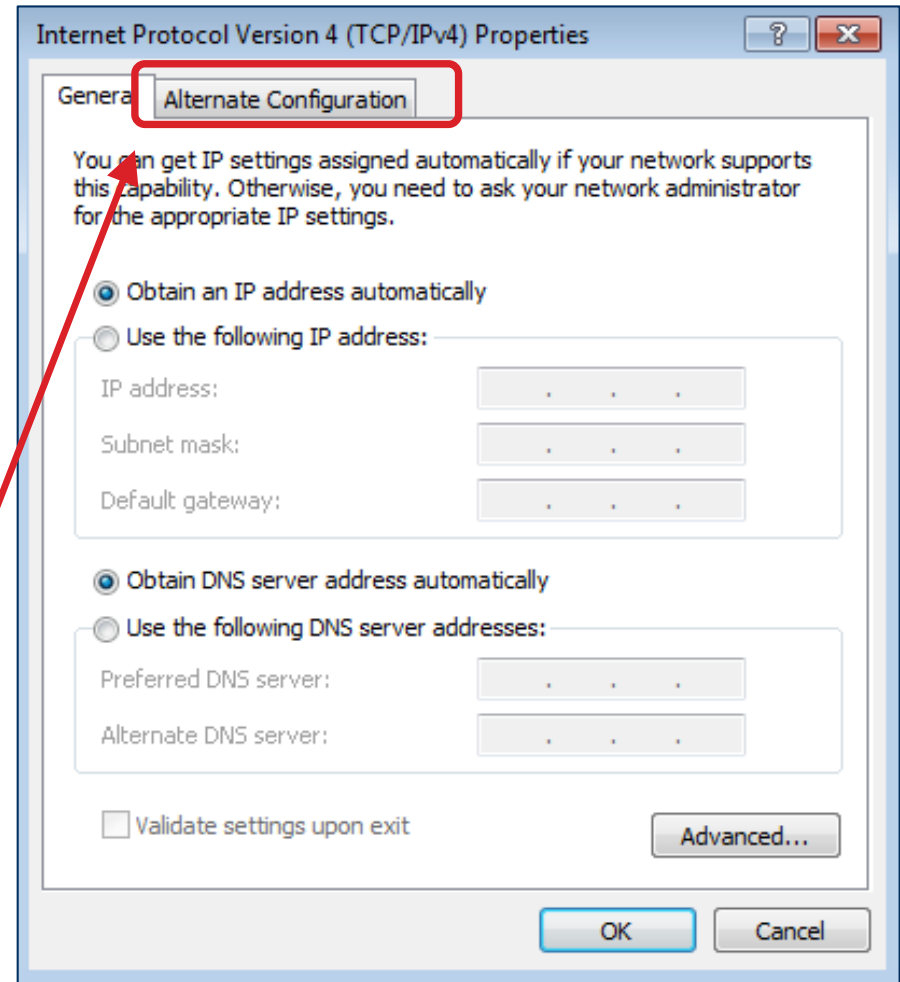

# Configuring a Network Adapter for an Alternate Configuration

2. In the Alternate Configuration tab dialog, select the “User configured” option, then type in the following information:

– Example:

– IP address: 10.0.0.5

– Subnet mask:  
255.255.255.0

– Default gateway:  
10.0.0.1

– Preferred DNS server:  
10.0.0.1

– Note: The same address is often used for the router (default gateway), and the preferred DNS server

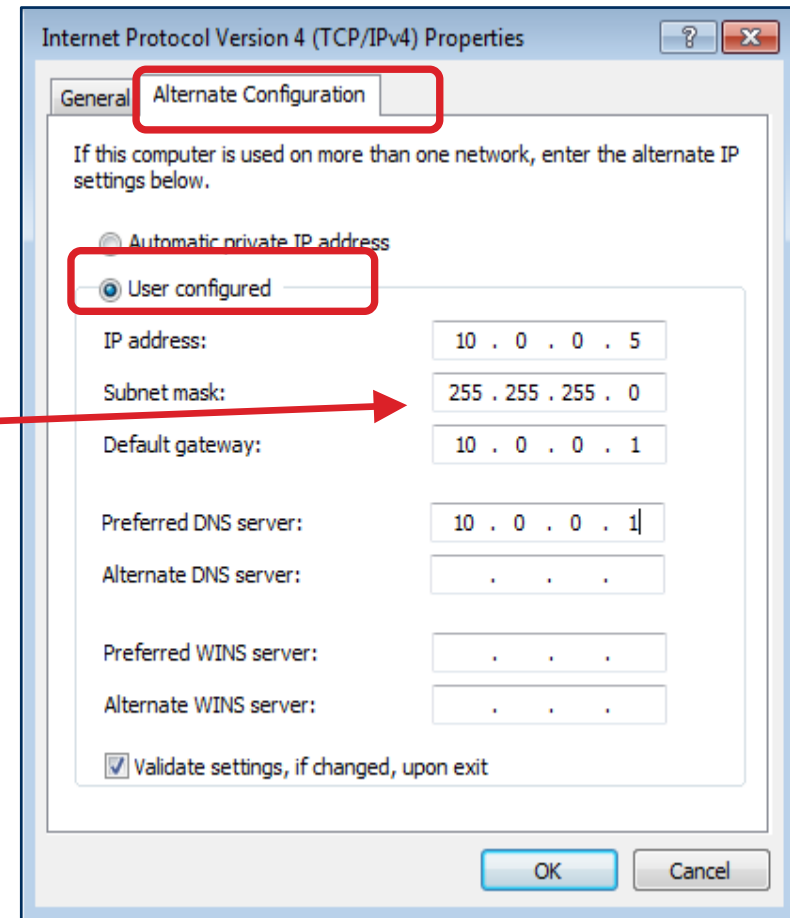

- **Network Terms**
- **Network Cabling**
- **Network Protocols**
- **Wireless Networking**
  - **Configuring Network Networking**
  - **Optional Hands-On Exercise 17.1**



# Wireless Protocols

## ➤ Wireless (Infrastructure mode)

- Computers connect to an Access Point (AP) that is connected to the Internet
  - Wireless service is also available from phone companies (wireless voice/data providers)
- Note: Wireless Ad Hoc mode allows wireless computers to communicate without using an access point

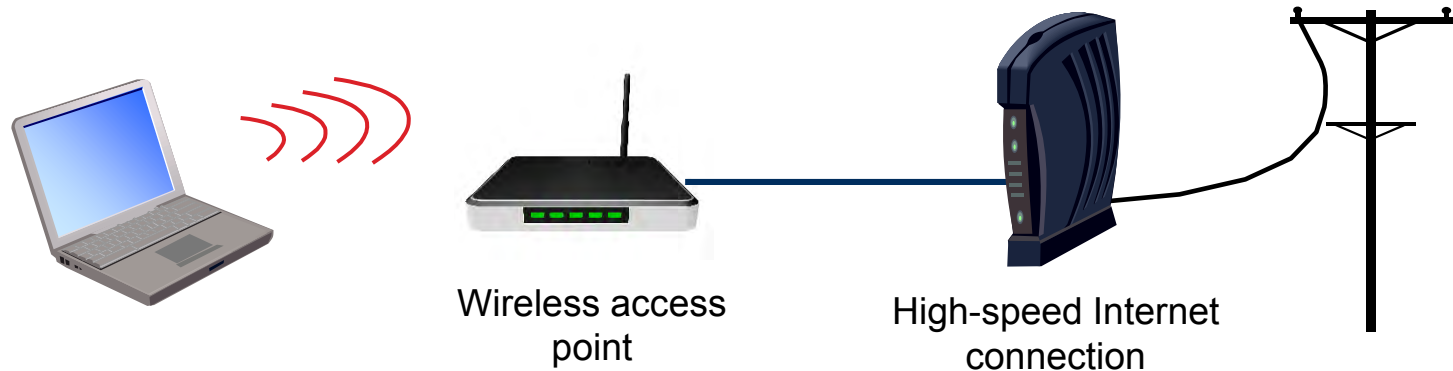

# Wireless Protocols

## ➤ Bluetooth

- Designed for short-range wireless communication with personal devices
  - Wireless headsets, mouse devices, keyboards, PDAs

## ➤ Cellular

- Provides connection to Internet using a cellular phone network
  - Mobile phones, laptops with cellular adapters



# Wireless Protocols

## ➤ IR (Infrared)

- Designed for short-range wireless communication with personal devices
  - Line-of-sight communication only

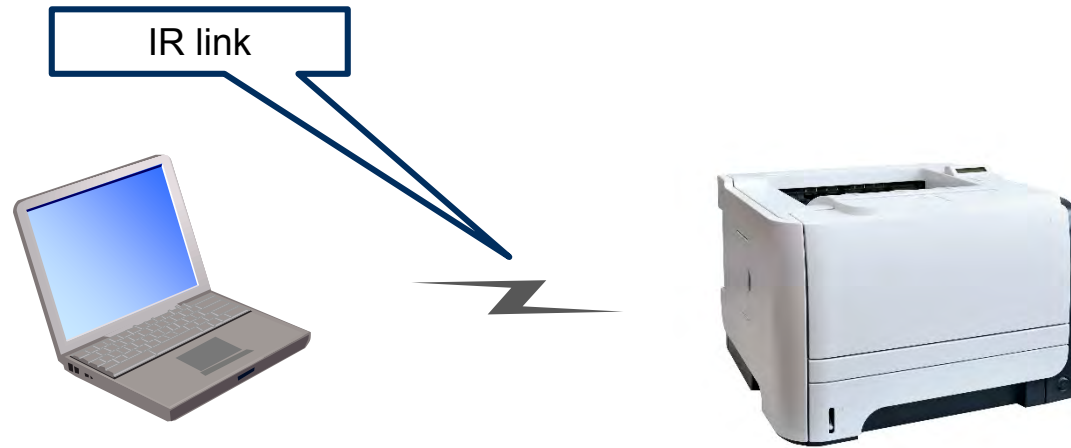

# Wireless Standards: IEEE 802.11

- **Set of engineering standards for wireless networking**
  - Uses RF (Radio Frequency)

Standard	Max. Speed	Frequency	Max. Range	Compatibility	Comments
802.11a	54 Mbps	5 GHz	150 ft	802.11a	Wi-Fi
802.11b	11 Mbps	2.4 GHz	300 ft	802.11b	Wi-Fi
802.11g	54 Mbps	2.4 GHz	300 ft	802.11g, 802.11b	Wi-Fi
802.11n	Up to 600 Mbps	2.4/5 GHz	300+ ft	802.11a, 802.11b, 802.11g	Wi-Fi
802.11ac	Up to 1 Gbps	5 Ghz	115 ft	802.11n	Wi-Fi





# Wireless Configuration Terms

## ➤ Service Set Identifier (SSID)

- Wireless network name
  - Example: JohnDoe
- Alphanumeric string (1-32 characters)
- Wireless access point broadcasts to announce presence

## ➤ Internet access protocol

- DSL modems
  - Point-to-Point Protocol over Ethernet (PPPoE)
  - Point-to-Point Protocol over ATM (PPPoA)
- Cable modems
  - Dynamic Host Configuration Protocol (DHCP)

ATM = asynchronous transfer mode



# Wireless Configuration Terms

## ➤ Encryption types

- Wired Equivalent Privacy (WEP)
  - Uses 64- or 128-bit shared key
  - Has been shown to be vulnerable to attack
- Wi-Fi Protected Access (WPA)
  - Uses 8-to-63-character shared passphrase
  - Uses Temporal Key Integrity Protocol (TKIP) to address security problems in WEP
- WPA2
  - Uses Advanced Encryption Standard (AES) to provide even stronger encryption



# Installing and Configuring a SOHO Wireless Access Point

## ➤ Example: Linksys WRT54G wireless router

1. Connect the WAP to
  - Client computer
  - DSL or cable modem (connected to Internet)

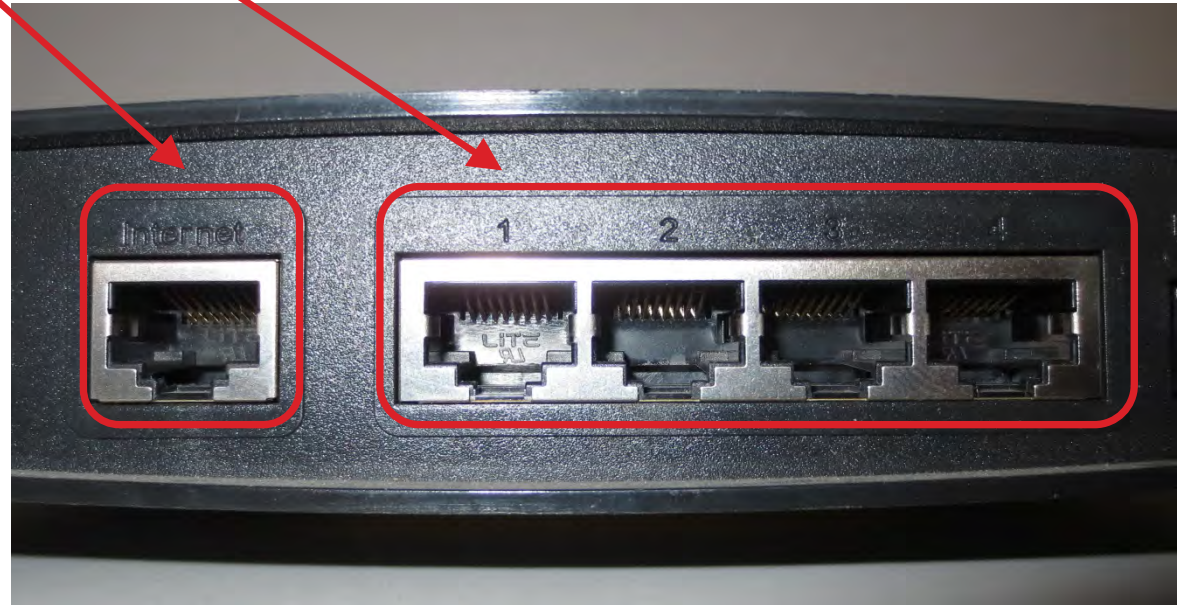

SOHO = small office/home office  
WAP = wireless access point



# Installing and Configuring a SOHO Wireless Access Point

2. Insert the installation CD and run the Setup Wizard
3. Or use web browser to manually configure router
  - Type in IP address of router
  - Example (Linksys router): 192.168.1.1
  - Router configuration menu will be displayed

**LINKSYS** by Cisco

Wireless-G Broad

**Setup**

Setup | Wireless | Security | Access Restrictions | Applications & Gaming

Basic Setup | DHCP | MAC Address Clone | Ac

**Internet Setup**

Internet Connection Type

Automatic Configuration - DHCP

Optional Settings (required by some ISPs)

Router Name: WRT54G

Host Name:

Domain Name:

MTU: Auto

Size: 1500

**Network Setup**

Router IP

Network Address Server Settings (DHCP)

Local IP Address: 192 . 168 . 1 . 1

Subnet Mask: 255 . 255 . 255 . 0

DHCP Server:  Enable  Disable

Starting IP Address: 192.168.1.100

Maximum Number of DHCP Users: 50

Client Lease Time: 0 minutes (0 means one day)



# Installing and Configuring a SOHO Wireless Access Point

4. Select Internet connection type (specified by Internet service provider)
  - Example: Cable providers often use Automatic Configuration—DHCP
5. Select (or enable) Wireless
  - Wireless configuration menu will be displayed

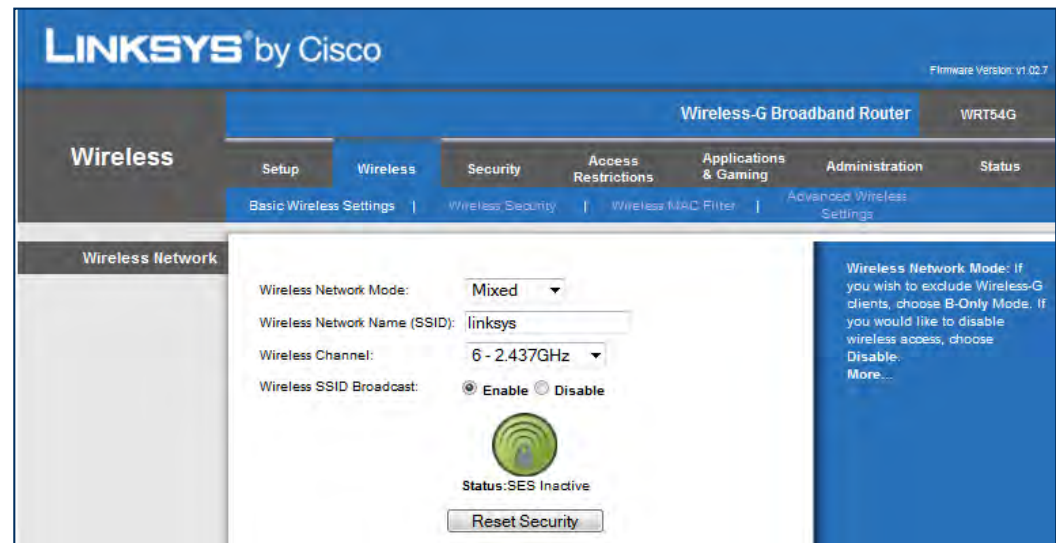
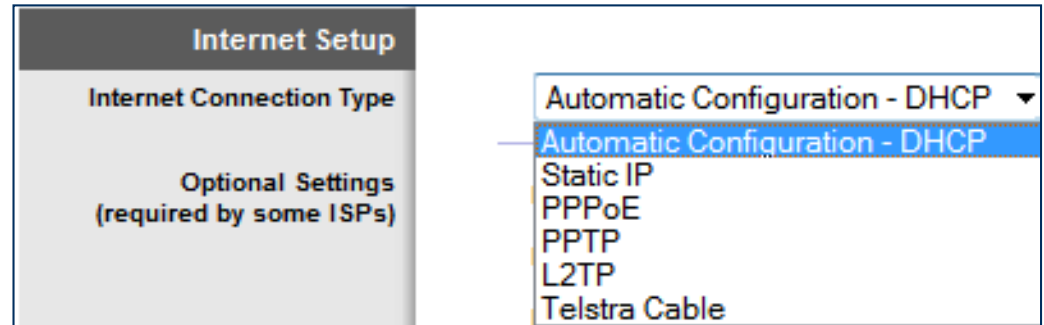

# Installing and Configuring a SOHO Wireless Access Point

6. Enter name (SSID) for wireless network
  - Example: JohnDoe
7. Select a wireless channel (from 1 to 11)
  - Default channel is 6
  - Using different channel may help avoid interference from other nearby wireless routers
8. Enable or Disable SSID broadcast
  - Disabling SSID broadcast is more secure

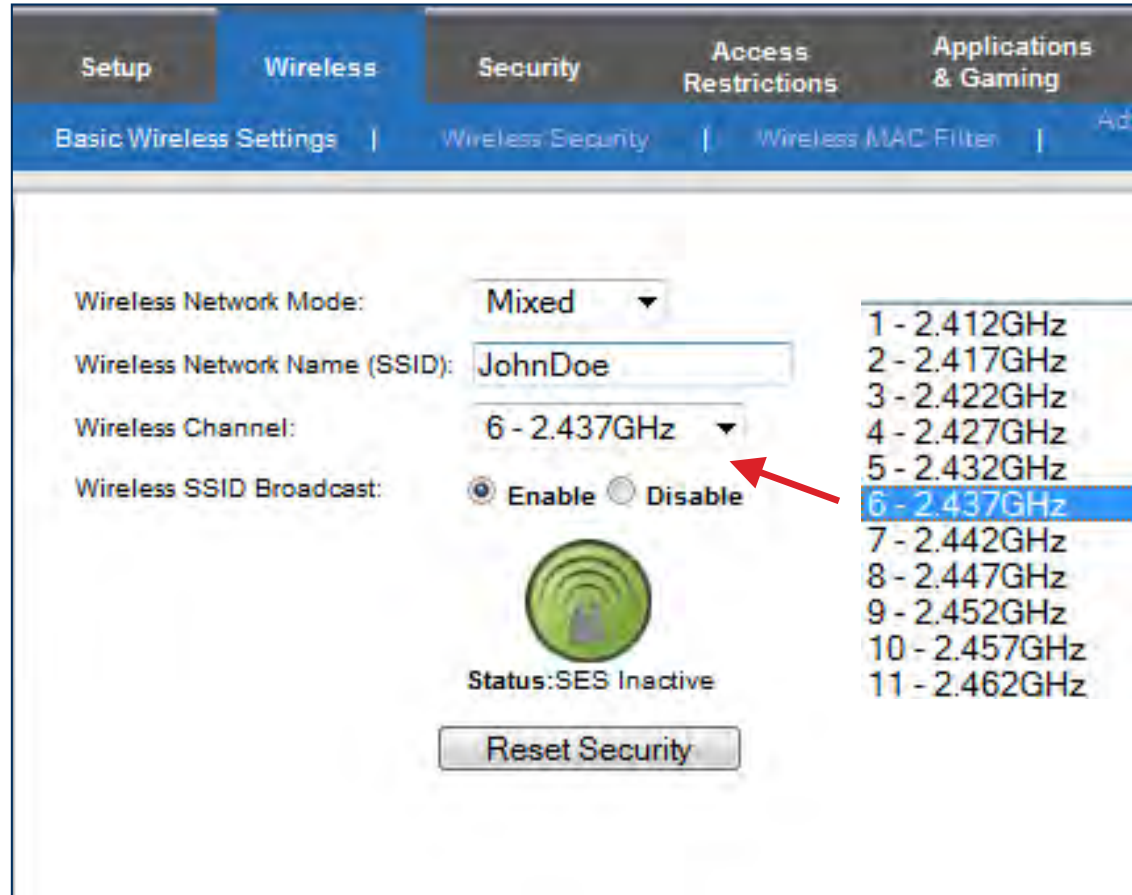

# Installing and Configuring a Wireless Access Point

## Additional settings

### ➤ DHCP (On/Off)

- Dynamic Host Configuration Protocol (normally set to On)
- Allows Wireless Access Point to pass out IP addresses to client computers that connect to it

### ➤ Firewall

- Provides protection by controlling access to ports for incoming and outgoing network traffic

### ➤ DMZ (demilitarized zone)

- Intermediate network area between the Internet and internal private network
- WAP allows a single computer to be set outside the router firewall
  - For applications that cannot run behind firewall



# Installing and Configuring a Wireless Access Point

## ➤ **WPS (Wi-Fi Protected Setup)**

- New standardized setup program automatically configures SSID and WPA2 key
- Note: All devices that connect must support WPS

## ➤ **Basic QoS (Quality of Service)**

- Advanced feature allows networks to control resources to provide better service
  - Reserved bandwidth
  - Network analysis management tools





# Wireless Security

- **Configuring security measures for a wireless system is extremely important**
  - Prevents unauthorized access to sensitive data
  - Prevents malicious intrusions into system
- **What is “wardriving”?**
  - Practice of searching for unsecured wireless networks
    - Hackers use sniffer programs to determine status of wireless networks



# Wireless Security

- To simplify initial connections, wireless access points are configured without any security measures
- Basic wireless security measures
  - Change default administrator name and password
  - Define a new SSID
  - Disable SSID broadcast
- Additional wireless security measures
  - Enable MAC filtering
    - Unique number assigned to all network interface cards

MAC = Media Access Control

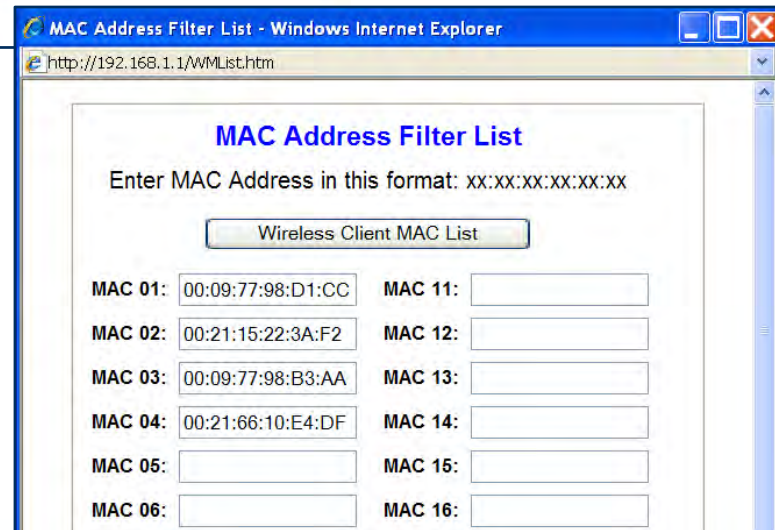

# Configuring Wireless Client Security (Initial Installation)

## ➤ Run the Wireless Network Setup Wizard

1. In My Network Places, double-click Wireless Network Setup Wizard
2. Click Next, then select “Set up a new wireless network”
3. Enter a network name (SSID)
4. Assign a network key
5. Select “Use WPA encryption”
6. Complete the wireless network setup

## ➤ Choose strongest encryption type supported by wireless client and access point

- Windows XP supports WPA and WPA 2 (strongest)

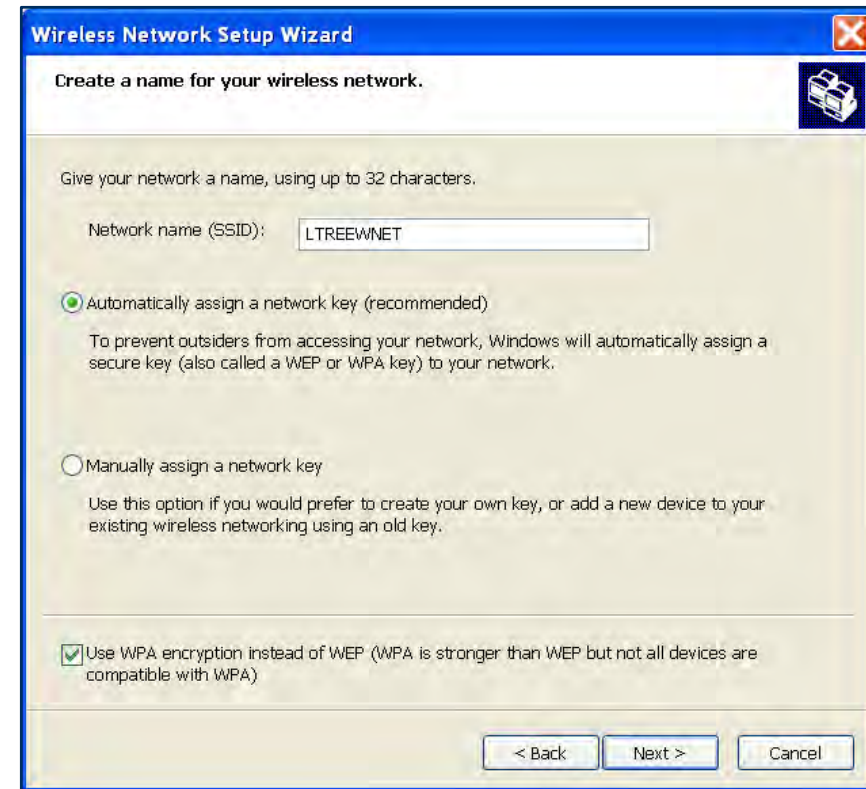

The screenshot shows the 'Wireless Network Setup Wizard' window. The title bar reads 'Wireless Network Setup Wizard'. The main heading is 'Create a name for your wireless network.' Below this, it says 'Give your network: a name, using up to 32 characters.' There is a text input field for 'Network name (SSID)' containing the text 'LTREEWNET'. Below the input field, there are two radio button options: 'Automatically assign a network key (recommended)' which is selected, and 'Manually assign a network key'. Below the 'Manually assign a network key' option, there is a paragraph of text: 'Use this option if you would prefer to create your own key, or add a new device to your existing wireless networking using an old key.' At the bottom of the window, there are three buttons: '< Back', 'Next >', and 'Cancel'. At the very bottom of the window, there is a checked checkbox with the text 'Use WPA encryption instead of WEP (WPA is stronger than WEP but not all devices are compatible with WPA)'.



# Configuring the Client

## ➤ Configure client wireless adapter

1. In Windows, navigate to Network Connections window
2. Right-click Wireless Network Connection, then select Properties
  - The Wireless Network Connection Properties window will be displayed
3. Click Properties to configure SSID and Encryption protocol

Note: For security purposes, all unused wireless adapters on computers should be disabled

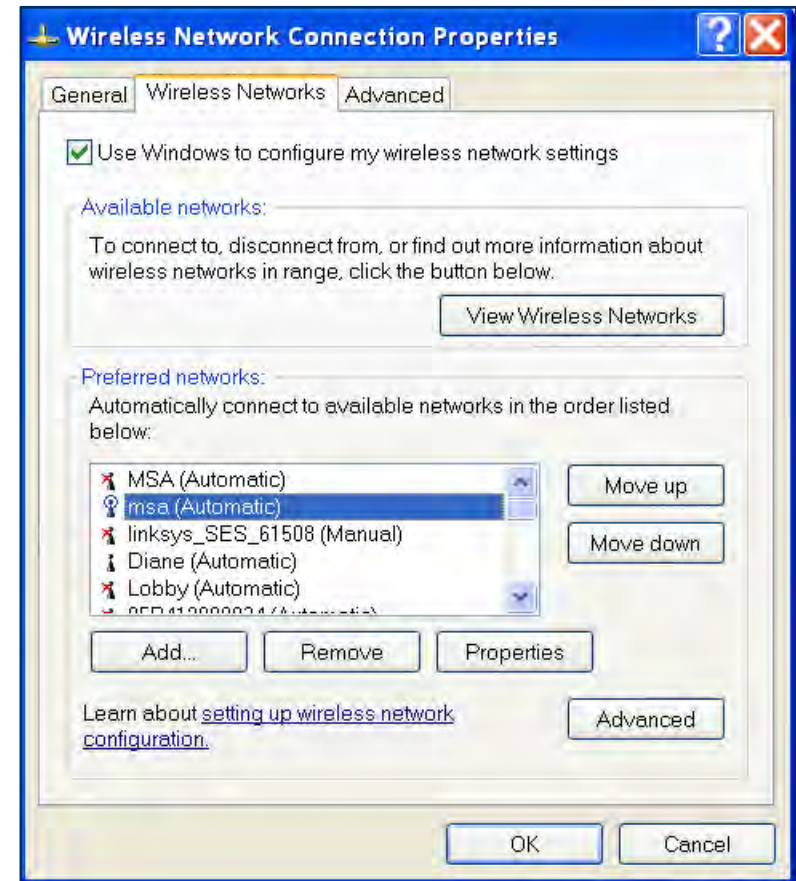

- **Network Terms**
- **Network Cabling**
- **Network Protocols**
- **Wireless Networking**
- **Configuring Windows Networking**
- **Optional Hands-On Exercise 17.1**



# Configuring Windows Networking on a Client/Desktop

## Home setup

### ➤ Small Office/Home Office (SOHO)

- Use Control Panel | Network and Sharing Center
- Select “Choose homegroup and sharing options”

### ➤ A homegroup provides a simple way to share files and printers with other computers on the same network

- Provides file/print sharing

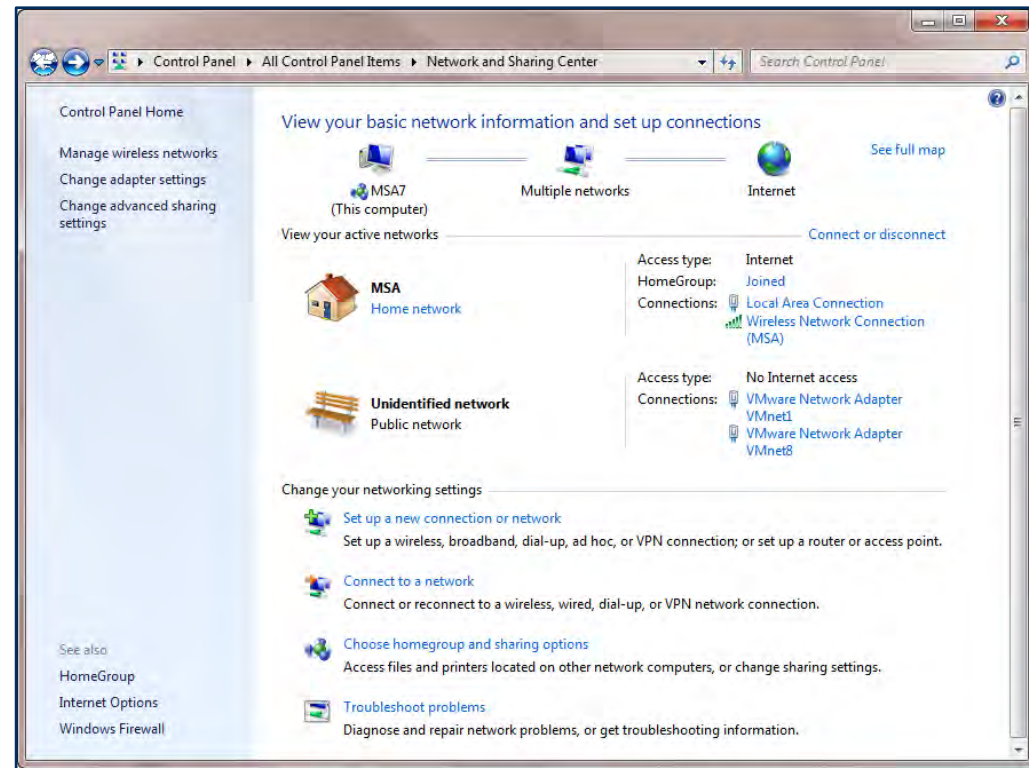

# Configuring Windows Networking: Homegroup

## ➤ Homegroup dialog

- Specify files/printers to share

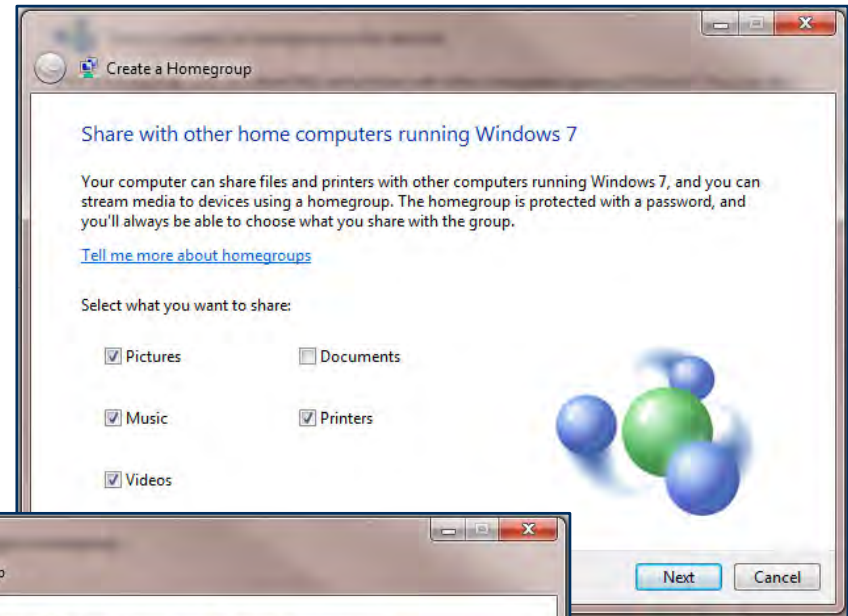

- System will generate a Homegroup password
  - Write down for later use

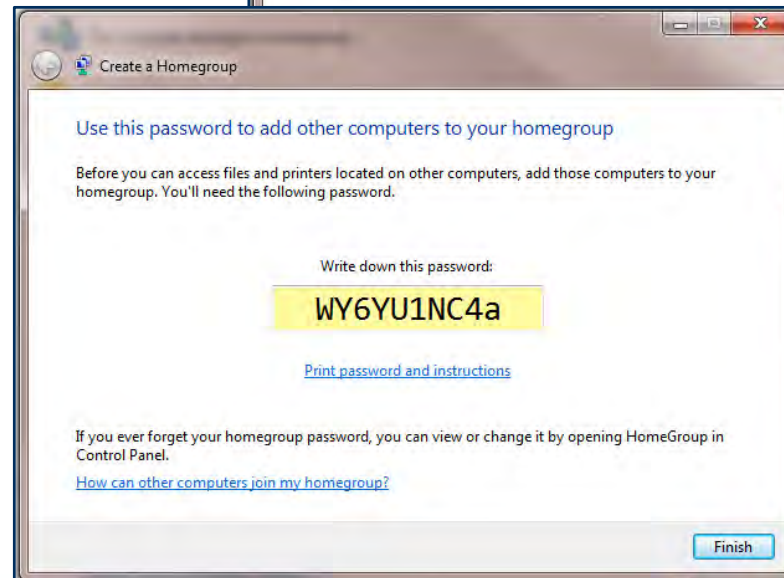

# Configuring Windows Networking on a Client/Desktop

## Work setup

### ➤ Join a domain

- Use Control Panel | System and Maintenance | System
- Under Computer Name, Domain and Workgroup Settings, click “Change settings”
- Click Computer Name tab, then click **Change**
- Select Domain, then type in Domain name
  - You will be prompted for user name and password

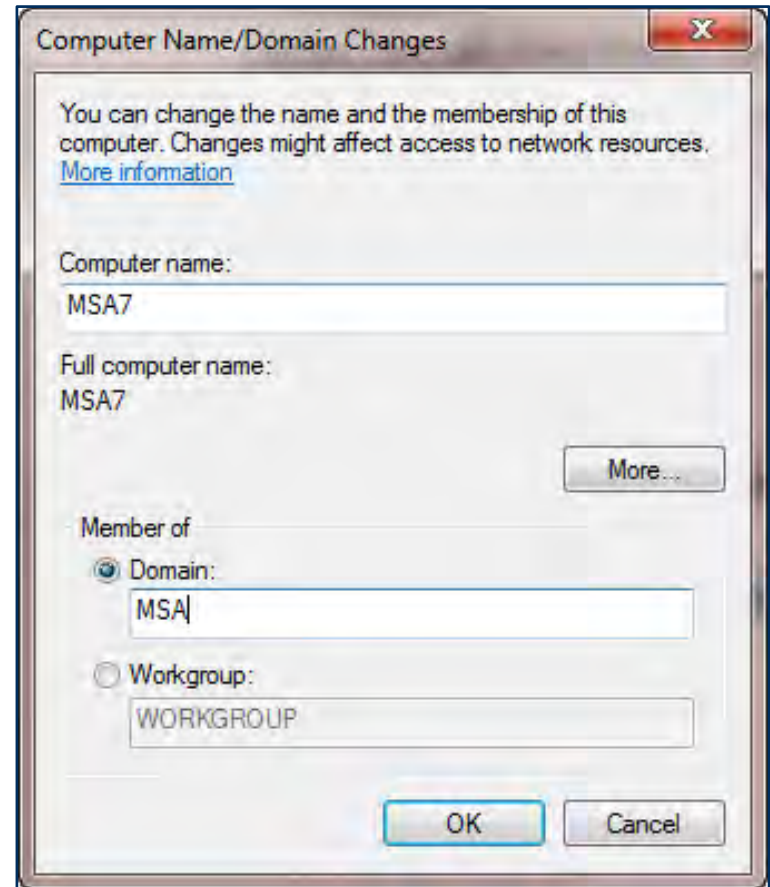



# Network Shares

## ➤ Network shares

- Shares a file or folder out to the network
- In Windows Explorer, right-click folder, then select Properties
- In Properties dialog, click Share button, then use File Sharing dialog to specify users and permissions
  - Note: Advanced Sharing button provides more advanced options

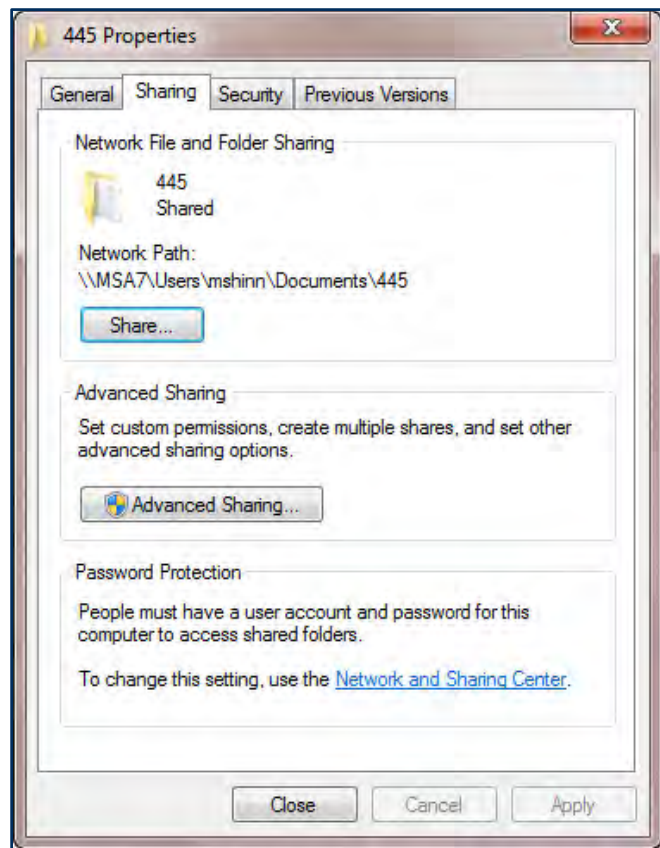
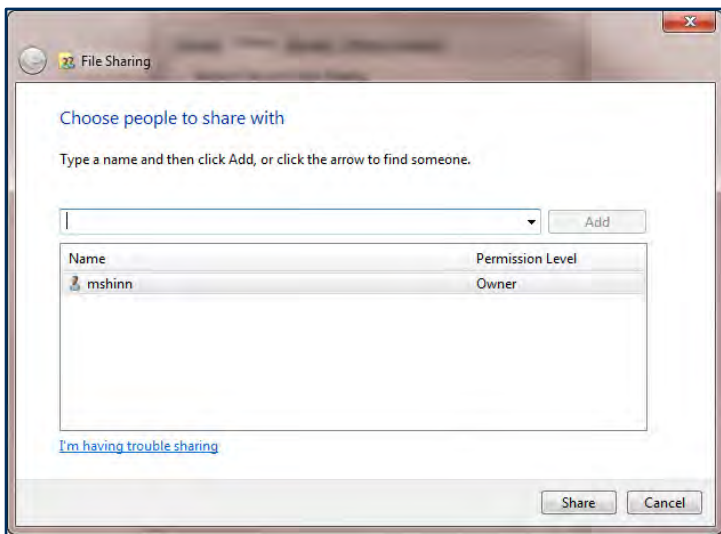

# Mapping Drives

## ➤ Mapping drives

- Maps a network drive to a drive letter for easier access
- Example: \\MSA2\C\445CourseFiles could be mapped as X:

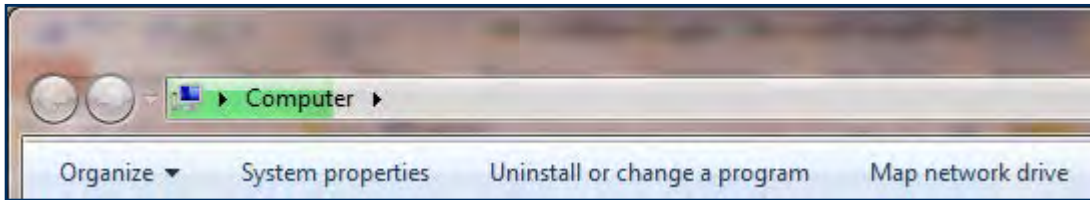

## ➤ Creating a mapped drive

- Click Start | Computer
- From top menu bar, select Map Network Drive
  - Use Map Network Drive to specify network drive and drive letter

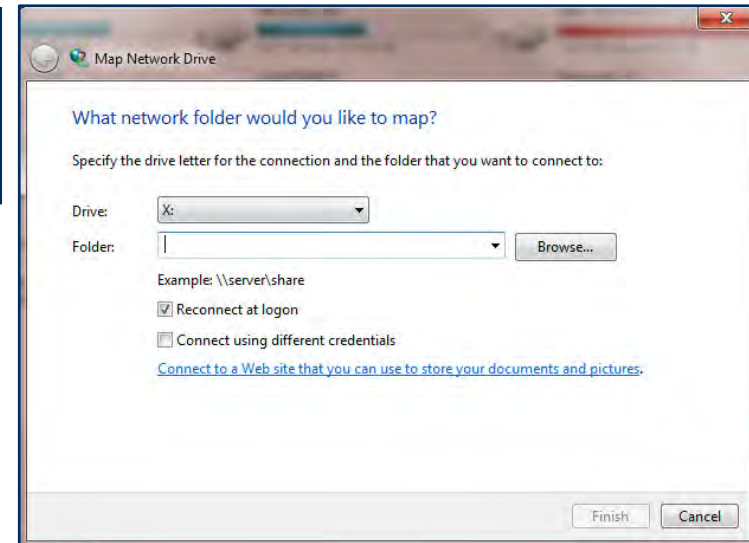

# Establishing Networking Connections

## ➤ Use Control Panel | Network and Sharing Center

- Click “Connect to a network”

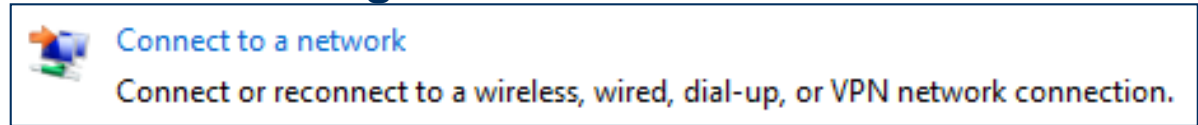

## ➤ Use network connection dialog to connect to network types listed below:

- VPN (Virtual Private Network)
- Dialups
- Wireless
- Wired
- WWAN (Cellular)



# Proxy Settings

## ➤ What is a proxy server?

- Server that acts as an intermediary between internal computers on a network and the Internet

## ➤ Configuring proxy settings

- Use Control Panel | Internet Options
- In Internet Options dialog, click Connections tab, then click LAN button
- Select checkbox for “Use a proxy server for your LAN”
- Enter address and port for proxy server

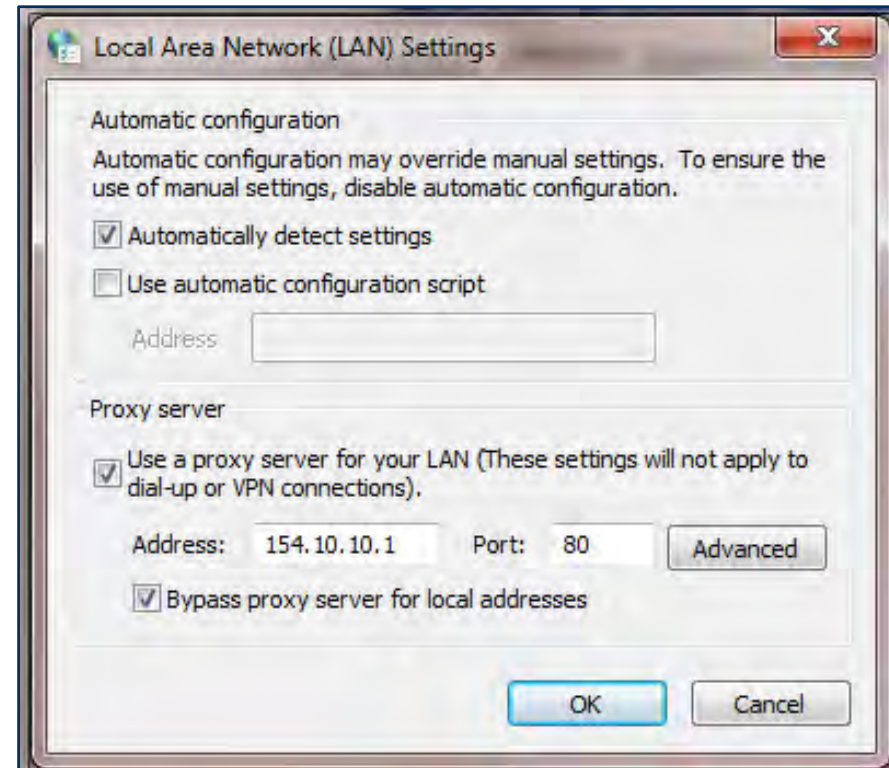

# Windows Network Location Type

## ➤ Windows features network templates for location type

- From Network and Sharing Center, click network type (Home, Work, Public) under network name

## ➤ Home network

- Network discovery turned on
- Allows use of Homegroup to share files and printers

## ➤ Work network

- Network discovery turned on
- Homegroups not allowed, user must have account on shared computers

## ➤ Public network

- Network discovery turned off
- Homegroups not allowed

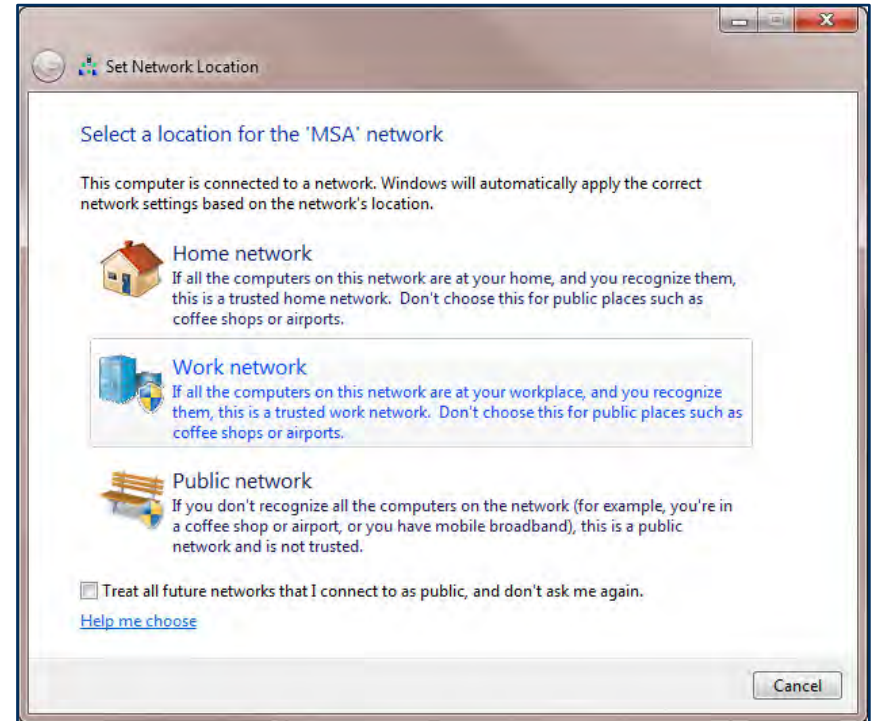

# Configuring an Alternative IP Address in Windows

## ➤ Select network device

- Use Control Panel | Network and Sharing Center | Change Adapter Settings
- Right-click network device, then select Properties
- Select Internet Protocol Version 4 (TCP/IPV4), then click Properties button
- In Internet Protocol Version 4 Properties dialog, click Alternate Configuration tab, then click User Configured
  - Set alternative IP address, subnet mask, DNS server

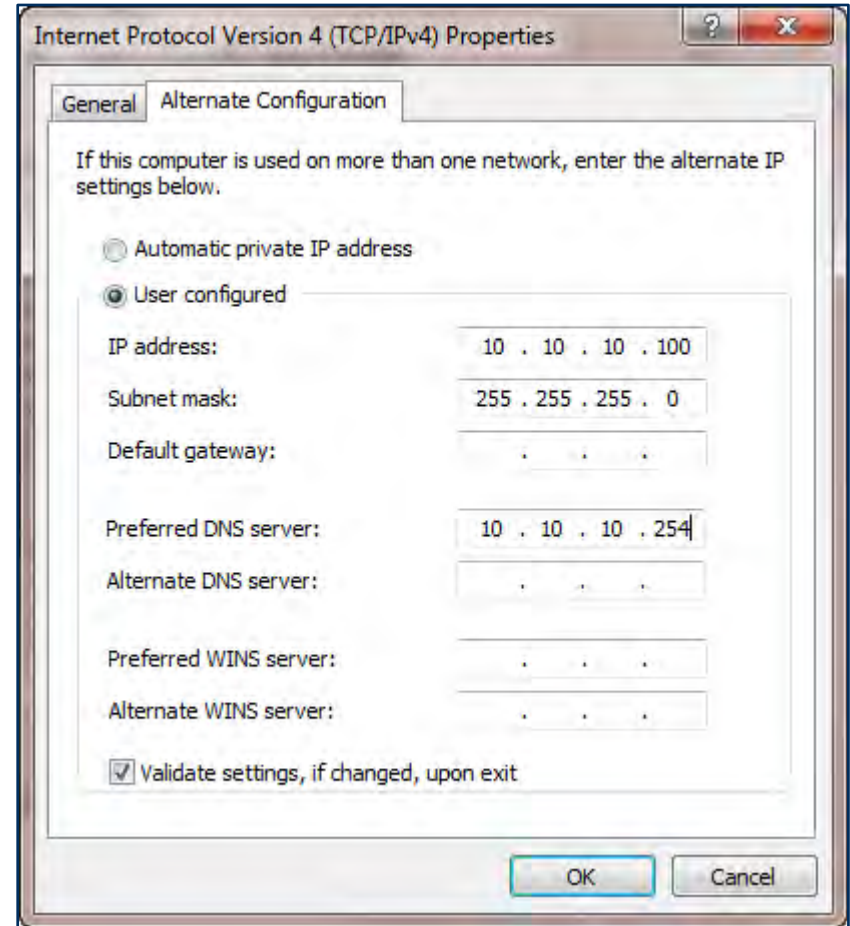

# Configuring Network Card Properties

## ➤ Select network device

- Use Control Panel | Device Manager
- Expand Network Adapters section, then right-click Ethernet Network card and select Properties
- In Properties dialog, click Advanced tab
- Select item to configure
  - Example: Speed and Duplex

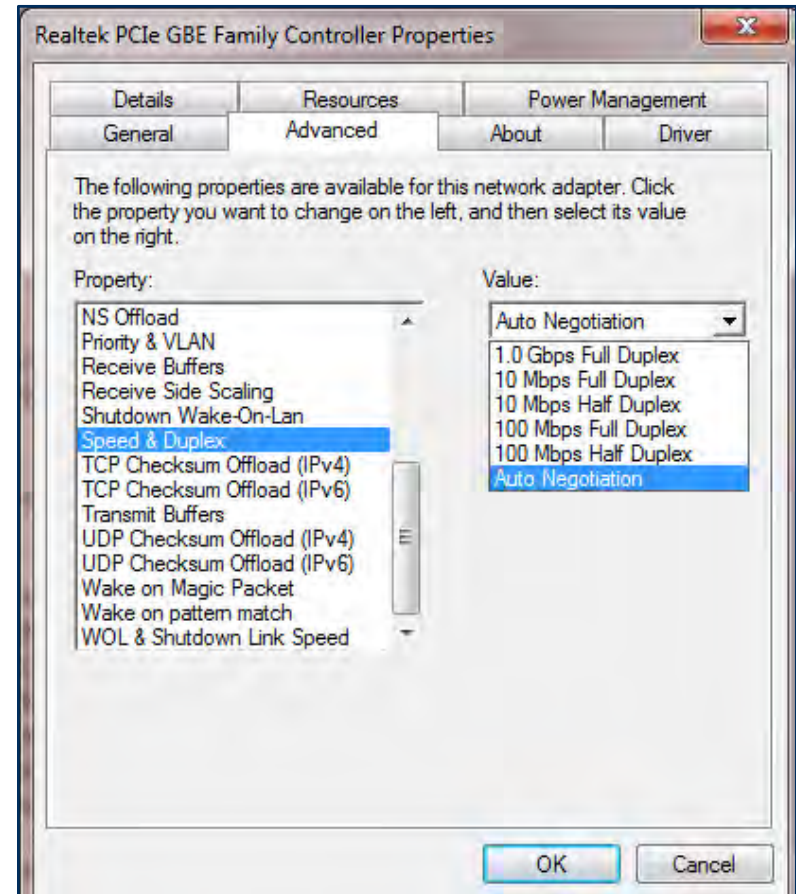

# Configuring Network Card Properties

## ➤ **Half-duplex/Full-duplex/Auto for Ethernet network cards**

- Half-duplex (can only transmit or receive at one time)
- Full-duplex (can simultaneously transmit and receive)
- Auto-negotiation allows two network interface card to select duplex/speed settings

## ➤ **Speed**

- Data transmission speed (100Mbps/1000Mbps, etc.)

## ➤ **Wake-on-LAN**

- Allows computer to be started by a network message

## ➤ **PoE (Power over Ethernet)**

- Allows transmission of electrical power (PoE+ provides up to 25W DC) over Ethernet cables

## ➤ **QoS (Quality of Service)**

- Allows network card to prioritize Ethernet Packets based on source for time-sensitive applications (VoIP, etc.)





# Network Sharing

- **A network share allows system resources to be shared over a network**
- **Creating a network share in Windows XP**
  1. Turn off Simple File Sharing
    - In Windows Explorer, use Tools | Folder Options, click View tab, then clear checkbox “Use Simple File sharing”
  2. Right-click folder to be shared, then select “Sharing and Security”
    - The folder properties dialog will be displayed
  3. Select “Share this folder”
    - The folder name will be assigned as the share name
- **Network share limits**
  - Windows XP limits network shares to 10 users

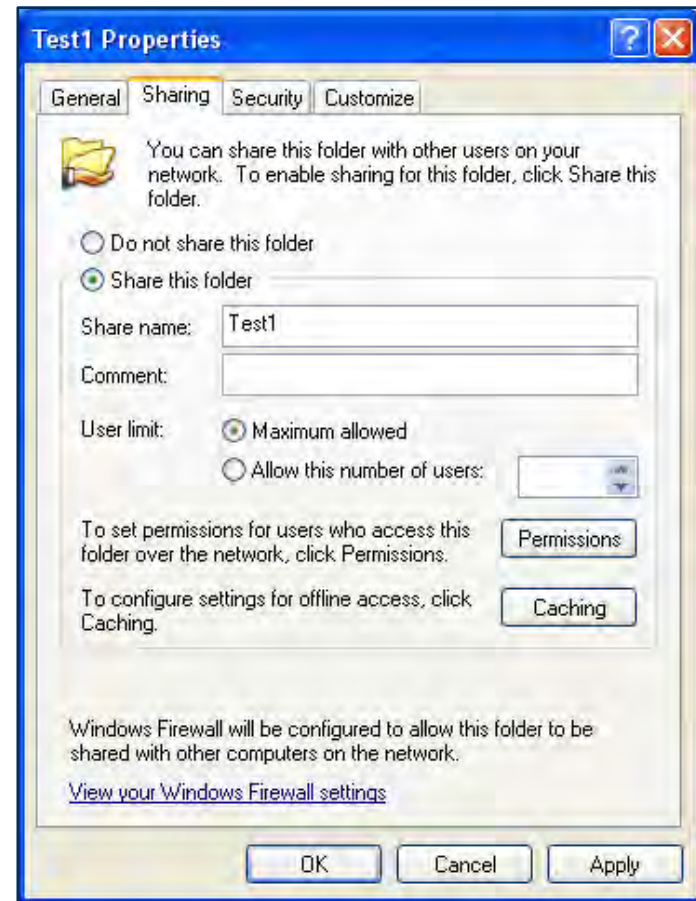

# Setting Share Permissions

- **Permissions allow control over**
  - Who may access the share
  - What actions they may perform
- **Setting share permissions**
  1. Click the Permissions button
    - The Permissions for (folder name) will be displayed
    - The list of groups or users that have access to this share will be displayed
  2. Select a group or user
    - Assign appropriate permissions

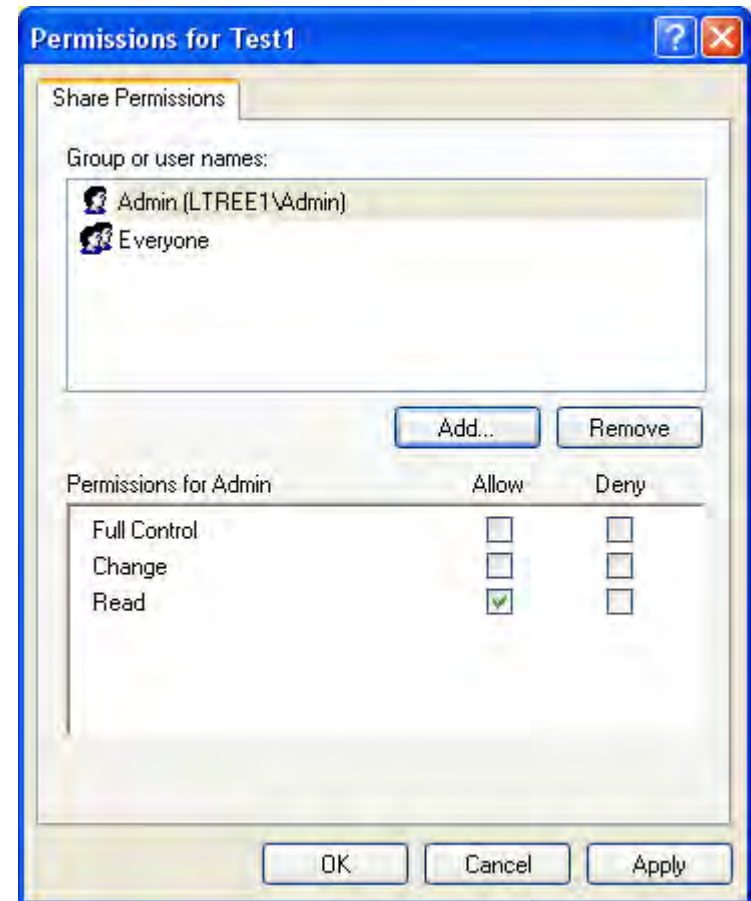

# Sharing Printers in Windows

## ➤ For installed printers

1. Use Start | Printers and Faxes, then right-click printer
2. Select sharing, then click radio button **“Share this printer”**

## ➤ To connect to a network printer

1. Use Start | Printers and Faxes, then click Add Printer
2. In the Add Printer Wizard, click Next
3. The Add Printer Wizard will ask you to specify Local printer or Network printer
4. Select Network printer
  - Enter Uniform Naming Convention (UNC) path to printer

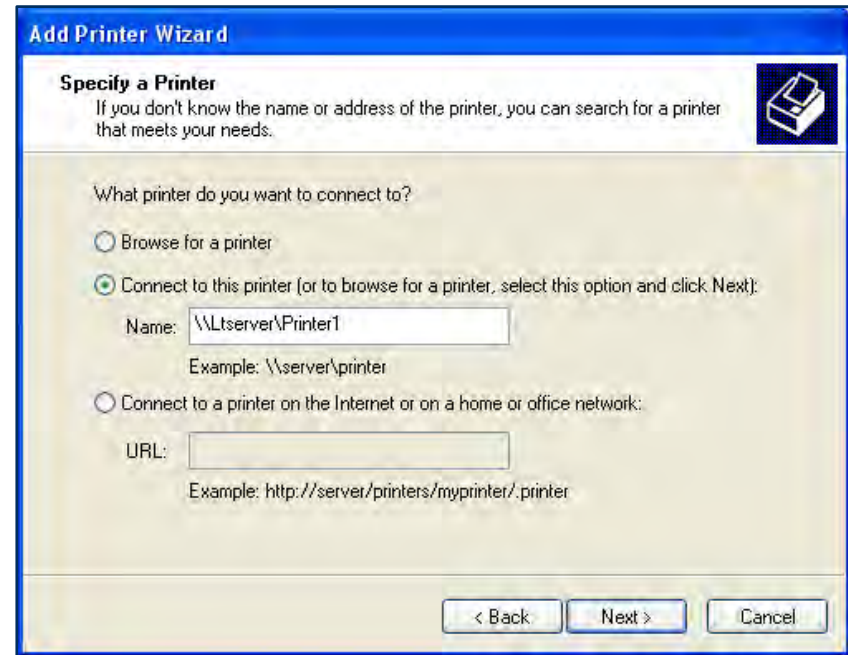

# Sharing Printers in Windows

## ➤ Uniform naming convention (UNC)

- Standard format used to specify path to network resources

## ➤ `\\HostName\ShareName`

- `HostName` = name of computer
- `ShareName` = name of network resource

## ➤ Example

`\\LTserver\Printer1`



# Troubleshooting Wired and Wireless Networks

- For these common symptoms, choose the number of the most likely cause:

Symptom	Cause	Networking fault
No connectivity		1. DHCP server down 2. Network cable damaged or not connected 3. Internet service is down or router hardware problem
Local connectivity only		
Limited connectivity (computers are using APIPA address)		



- **Network Terms**
- **Network Cabling**
- **Network Protocols**
- **Wireless Networking**
- **Configuring Windows Networking**
- **Optional Hands-On  
Exercise 17.1**



*In your Exercise Manual, please refer to  
Optional Hands-On Exercise 17.1:  
Installing and Configuring a TCP/IP Network*



# Review Questions

- 1. Which type of network cable uses twisted-pair wiring and can handle up to a 1-Gbps transmission rate?**
  - A. 10Base2
  - B. 10BaseT
  - C. 1000BaseT
  - D. 100BaseF
  
- 2. Which type of fiber-optic cable is typically used for LANs?**
  - A. Single-mode
  - B. Multimode
  - C. Network-mode
  - D. Reflective-mode





# Review Questions

3. A class C IP address uses the first \_\_\_\_\_ octet(s) of the address for the network ID, and would use a subnet mask \_\_\_\_\_.
- A. one; 255 . 255 . 255 . 0
  - B. two; 255 . 255 . 255 . 0
  - C. three; 255 . 255 . 255 . 0
  - D. four; 255 . 255 . 255 . 0
4. Which is a primary advantage of IPv6 over IPv4?
- A. Its 32-bit address size overcomes the address exhaustion problems of IPv4
  - B. Its 640-bit address size overcomes the address exhaustion problems of IPv4
  - C. Its 128-bit address size overcomes the address exhaustion problems of IPv4
  - D. There is no major advantage



# Review Questions

**5. Which wireless standard supports speeds up to 1 Gbps?**

- A. 802.11a
- B. 802.11b
- C. 802.11g
- D. 802.11ac

**6. Which wireless encryption standard provides the strongest protection?**

- A. WEP
- B. WPA
- C. WPA2
- D. PGA



# Chapter Summary

---

**In this chapter, you have learned how to**

- **Describe the basic types of network configurations and topologies**
- **Identify the common types of network cables**
- **Describe two types of network protocols and their functions**
- **Install and configure a TCP/IP network client**





# Chapter 18

# Internet Technologies

Customer  
Management  
Standard  
Development  
Consistency  
Business  
Optimal

# Chapter Objectives

In this chapter, you will learn how to

- Describe the fundamental structure of the Internet
- List the basic characteristics of at least seven major Internet connection technologies
- Identify the names and uses of Internet-related protocols and services, including TCP/IP, DNS, HTML, HTTP, HTTPS, SSL, SMTP, IMAP, FTP, and TELNET
- Describe the use of network troubleshooting command-line tools (IPCONFIG.EXE, PING.EXE, TRACERT.EXE, NSLOOKUP.EXE)



- **Internet Structure and Connection Technologies**
  - **Internet Protocols and Services**
  - **TCP/IP/Internet Troubleshooting Tools**



# What Is the Internet?

## ➤ Worldwide “Network of Networks”

- Originated as Advanced Research Projects Agency NETwork (ARPANET) in late 1960s
- 1972: 23 “host sites” are connected to ARPANET
- 1974: Researchers Bob Kahn and Vint Cerf propose “network of networks” using TCP/IP protocol

## ➤ The Internet has grown exponentially

- 1996: 50 million nodes
- 1997: 80 million nodes
- 2000: 200 million + nodes
- 2004: “There will exist roughly 5,000 IP addresses for every square micrometer of the Earth’s surface”
  - Simon Farfinkel, *Technology Review*



# Internet Structure Overview

- **Local computers (nodes) can use existing network infrastructures to connect to Internet Service Providers (ISPs)**
  - Telephone network
  - Cable TV network
- **Internet service provider common services**
  - IP address
    - Usually dynamic, but static IPs may be ordered
  - E-mail service
  - Name resolution through Domain Name Systems (DNS)





# Internet Structure Overview

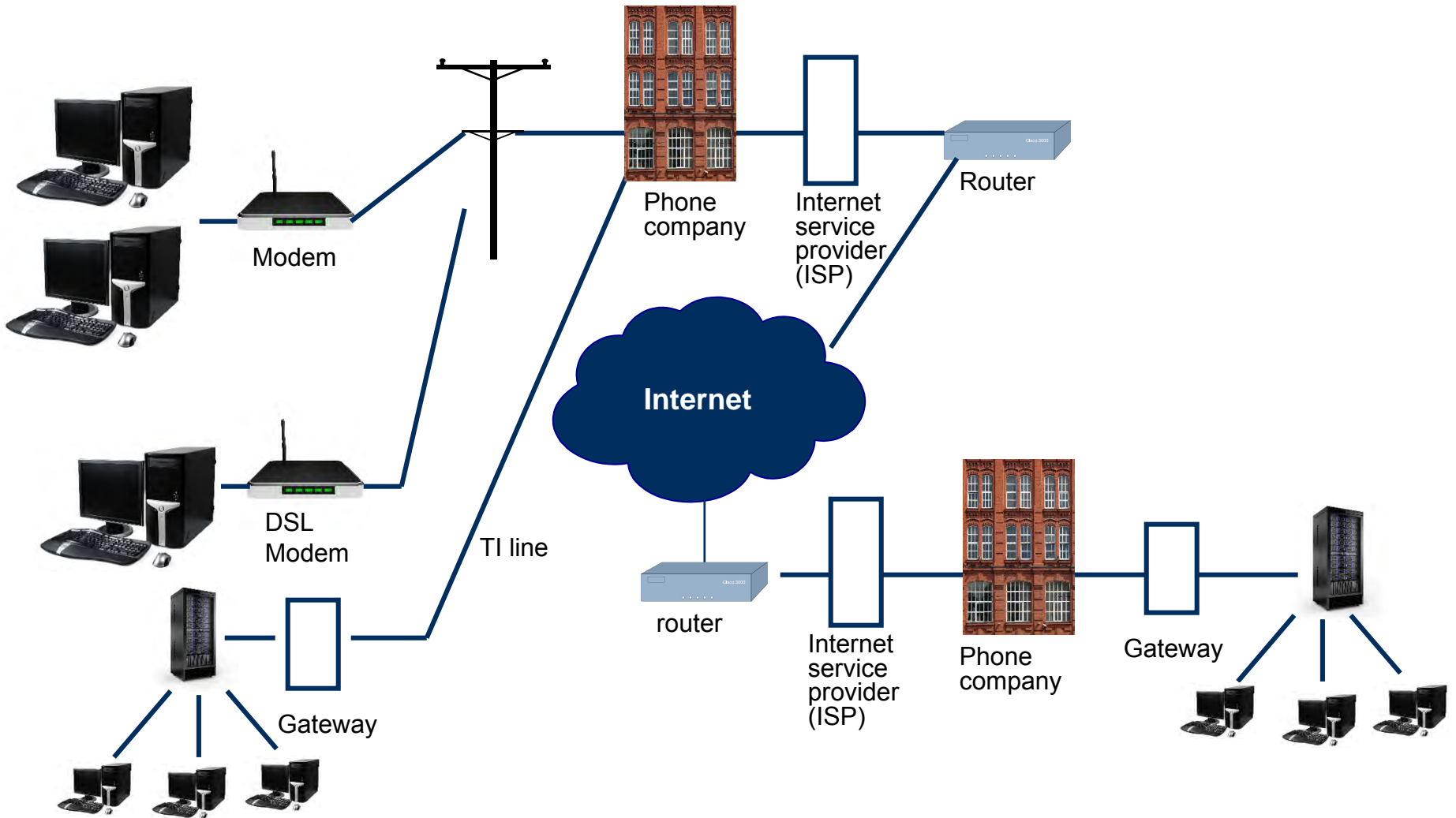

# Internet Connection Technologies

- **The following seven technologies can be used to connect a computer to the Internet**
  - Dial-up
  - ISDN
  - DSL
  - Cable
  - LAN
  - Satellite
  - Wireless



# Dial-Up and ISDN

## ➤ Dial-up

- Computer connects to an analog phone line using a modem (modulator-demodulator)
  - The modem converts digital data to analog sound waves
  - Modems may be external or contained on an internal plug-in card
- Dial-up speeds: up to 56.6 Kbps

## ➤ ISDN (integrated services digital network)

- Older digital service introduced by phone companies to handle both digital and voice information
- Computer connects to a dedicated digital connection using a Terminal Adapter (TA) that looks similar to a modem
- ISDN speeds: 64 Kbps (single-channel) to 128 Kbps (dual-channel)



# Dial-Up and ISDN

## Dial-up

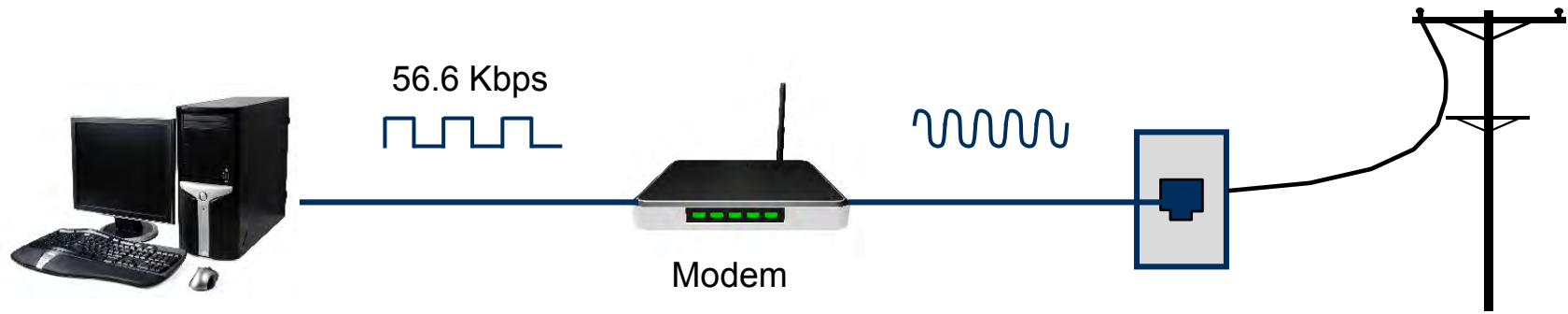

## ISDN

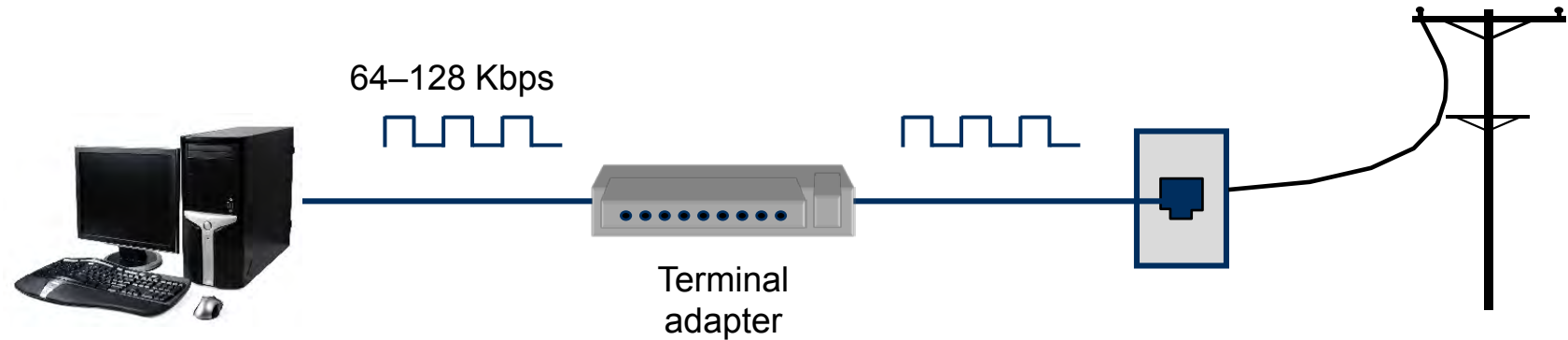

# Digital Subscriber Line (DSL)

## ➤ DSL

- Computer connects to an analog phone line using a DSL modem
  - Permits standard phone line to carry high-speed digital data
    - Note: Maximum distance between DSL installation and phone company central office must be less than 20,000 ft
  - A low-pass filter allows the phone line to carry standard voice signals in addition to digital data
  - Note: Low-pass filters should never be installed between DSL modem and telephone jack, as it will prevent the digital signals from reaching the DSL modem

## ➤ DSL speeds:

- Upload: up to 384 Kbps
- Download: up to 6 Mbps
  - Also referred to as Asymmetric DSL (ADSL) due to difference in upload/download speeds



# Digital Subscriber Line (DSL)

## ➤ DSL types

- Asymmetric DSL (ADSL)
  - Upload/download speeds are different
- Very high bit rate DSL (VDSL)
  - High-speed ADSL type (fastest upload speed)
- Symmetric DSL
  - Upload/download speeds are the same
- High Data Rate DSL (HDSL)
  - High-speed symmetric DSL type
  - Carries data only (no analog voice signals)

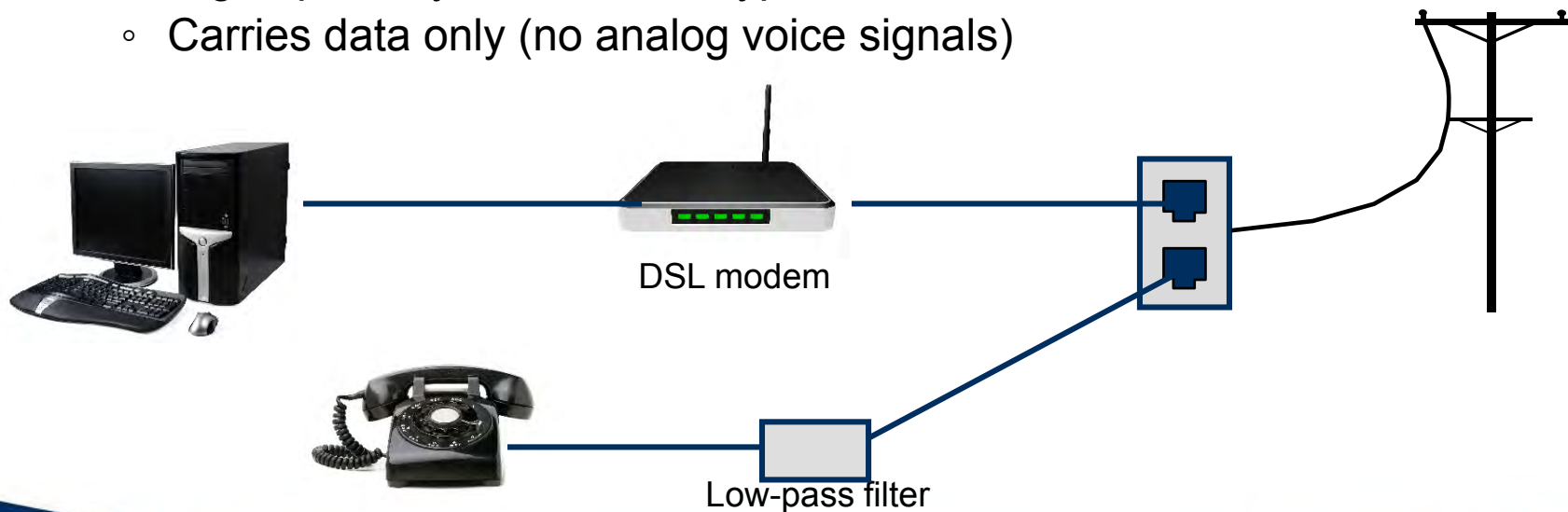

# Cable and Fiber

## ➤ Cable (CATV)

- Computer connects to a coaxial cable TV line using a cable modem
- Cable speeds: Up to 400–600 Kbps upload, up to 6 Mbps download
  - Potential drawback: All users on a single cable line share bandwidth (more users = slower speed)

## ➤ Fiber

- Fiber-optic speeds: Up to 16 Mbps upload, up to 50 Mbps download

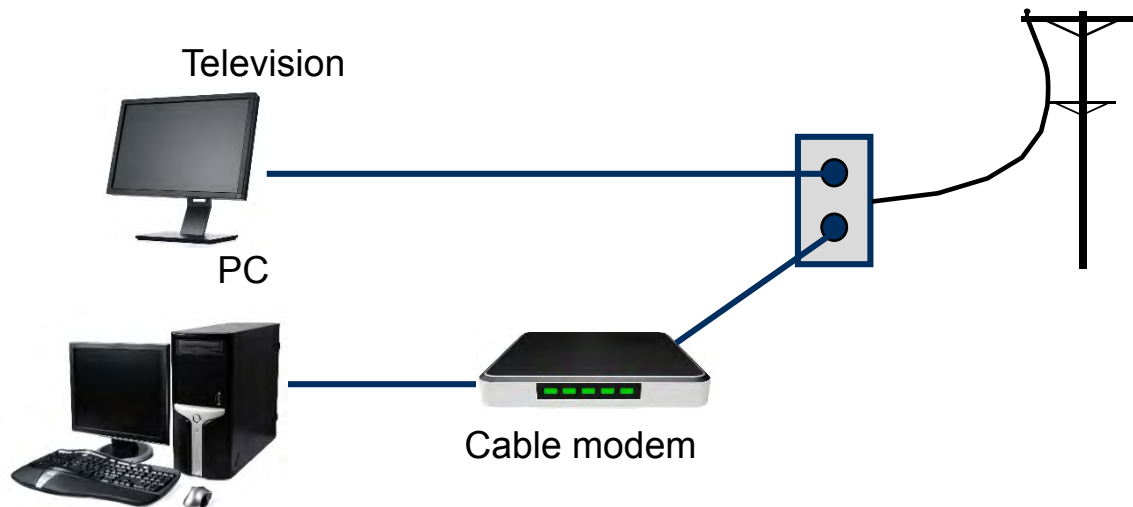

# Satellite

## ➤ Satellite

- Computer connects to a satellite receiver that uses a satellite dish to beam data to and from a satellite
- Satellite speeds: Up to 56-192 Kbps upload, up to 1.5 Mbps download
  - On many systems, there is no direct uplink capability—requests go through modem over phone line to satellite network control center
  - Potential drawback: Significant (up to 50 ms) latency between sending and receiving data

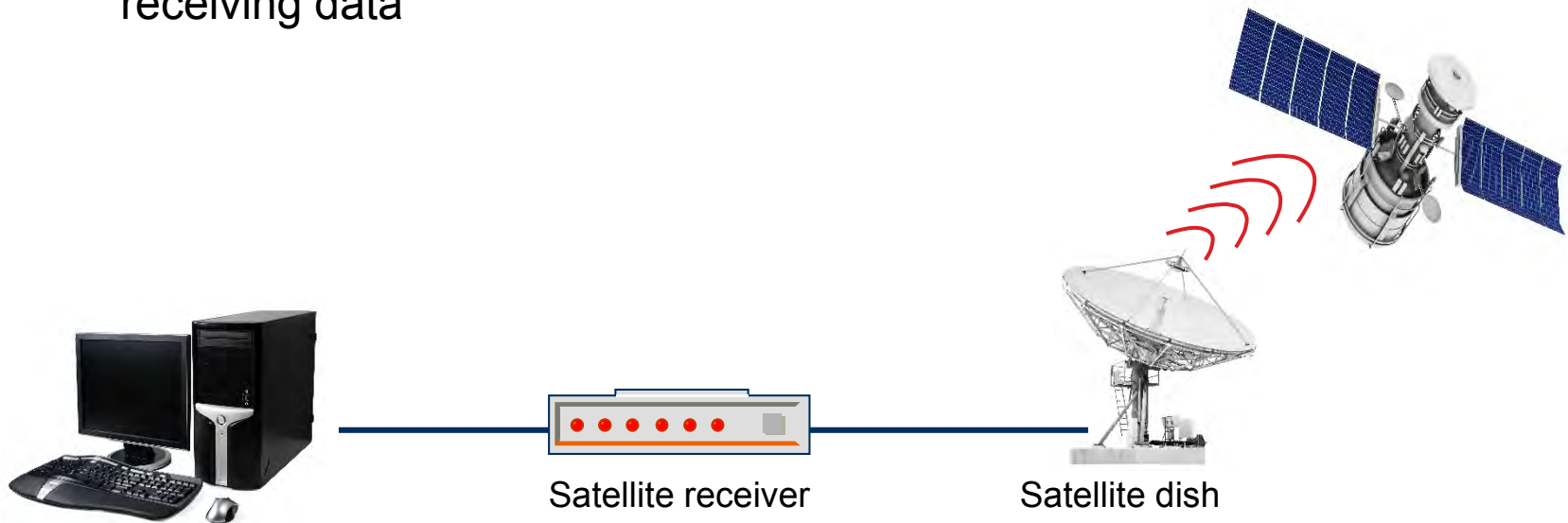



## ➤ Line-of-sight wireless Internet service

- Internet service provider provides line-of-sight wireless connection to subscriber module at recipient's site
  - Uses broadcast towers and special antenna at recipient's site
- Download speeds: Up to 8 Mbps

## ➤ Cellular (mobile hotspot)

- Freestanding mobile wireless hotspot
- Speeds: up to .8 Mbps upload, up to 3 Mbps download

## ➤ WiMAX

- Provides wireless Internet signal over large areas (up to 30 miles)
- Uses broadcast towers, can be received on any Wi-Fi device
- Speeds (WiMAX re. 1.5): up to 83 Mbps upload, 46 Mbps download



- **Internet Structure and Connection Technologies**
- **Internet Protocols and Services**
- **TCP/IP/Internet Troubleshooting Tools**



# Internet Protocol Suite

- **The Internet protocol suite includes a variety of protocols that operate at different levels to provide the services of the Internet**
  - We will provide a brief description of the common Internet protocols that operate at the application layer and that you are expected to be familiar with on the A+ exam
- **Simplified diagram of common protocols/services included in Internet protocol suite:**

Layer	Services/Protocols
Application	DNS, FTP, HTTP, HTTPS, IMAP, POP3, SMTP, TELNET
Transport	TCP, UDP
Internet	IP
Network Access	Ethernet, Wi-Fi, Token ring



# Internet Protocols (TCP vs. UDP)

Two common internet transport protocols are TCP and UDP

## ➤ Transmission Control Protocol (TCP)

- Reliable
  - Connection-oriented, uses acknowledgments to indicate accurate receipt of information
- Used when accuracy of data transmission is important
  - Example: file transfers over FTP

## ➤ User Datagram Protocol (UDP)

- Not guaranteed
  - Connectionless, does not use acknowledgments to indicate receipt of information
- Used when accuracy of data transmission is not as important as speed
  - Examples: streaming video, audio over the Internet



# Internet Domain Names

## ➤ What is an Internet domain name?

- A name that identifies an organization's unique name on the Internet
- Allows user-friendly name descriptors in place of numerical addresses
- Example: earthlink.net = 207.217.125.95
  - From [whois.domaintools.com](http://whois.domaintools.com) lookup

## ➤ What is a Fully Qualified Domain Name (FQDN)?

- Internet domain name consisting of a host (local computer), domain name, and top-level domain name (.com, .net, .gov, etc.)
- Example:  
`www.earthlink.net = host.domain.top-level domain name`



# Domain Name Systems (DNS)

## ➤ What is a DNS server?

- Server that translates a domain name into an IP address
- Implemented as a hierarchy of domain name servers
  - If current DNS cannot resolve domain name, it will ask another DNS in the hierarchy until address is resolved
- Replaces HOSTS file on local computer
  - File containing table of domain name to IP address mappings

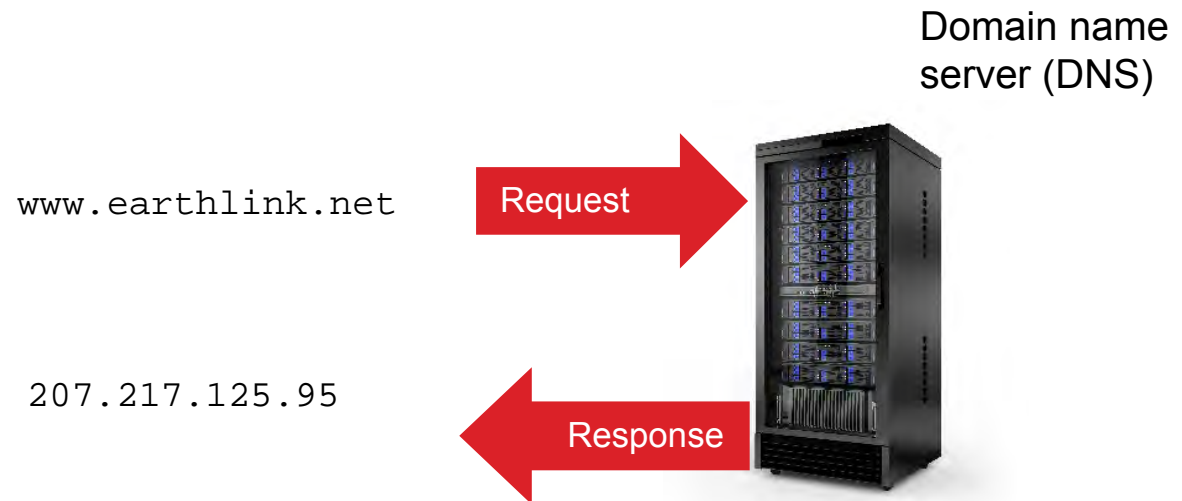

# Hypertext Transfer Protocol (HTTP)

## ➤ Hypertext Transfer Protocol

- Protocol used to transfer information on the World Wide Web
- Web pages are interconnected by hypertext links

## ➤ History of the web

- 1969: Ted Nelson invents the term “hypertext” to describe documents connected by links
- 1989: Tim Berners-Lee of CERN (European Laboratory for Particle Physics) creates first web browser, which launches World Wide Web



# Hyperlinks in Action

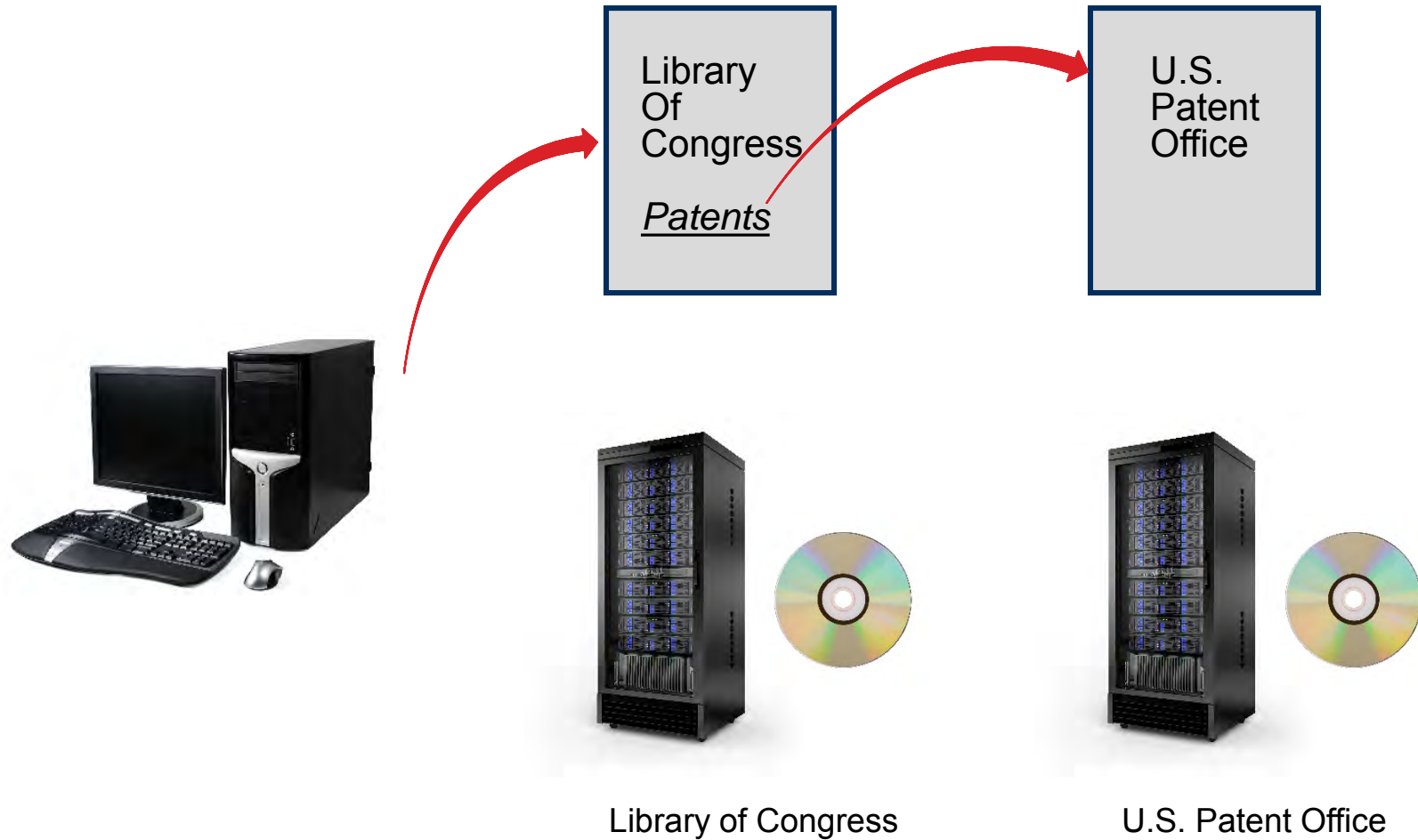



# Secure Shell (SSH)

- **Protocol allows data to be exchanged using a secure channel between computers**
  - Originally designed as a secure replacement for TELNET
  - Uses Public Key cryptography
  
- **LDAP (Lightweight Directory Access Protocol)**
  - Protocol for accessing and maintaining directory information



# Secure Socket Layer (SSL)/HTTPS

## ➤ Secure Socket Layer

- Protocol used to implement secure transactions between web servers and browsers
- A third-party Certificate Authority is used to authenticate one or both of the parties in the transaction
- Information sent or received is encrypted/decrypted using public/private key cryptography

## ➤ Websites using SSL will have an address beginning with `https://`

- Browser will show a lock symbol to indicate secure transaction

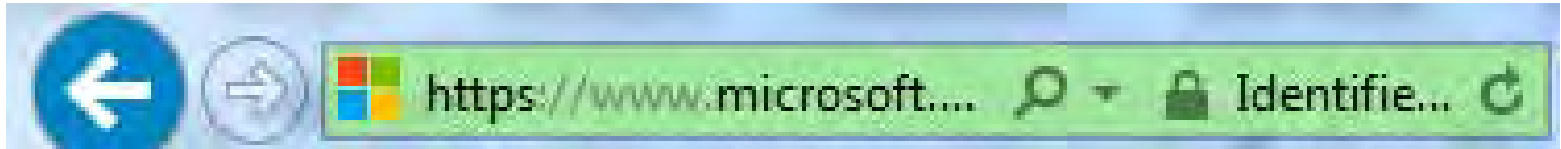

HTTPS = Hypertext Transfer Protocol Secure



# File Transfer Protocol (FTP)

## ➤ File Transfer Protocol

- Used to upload or download files from another computer on the Internet

## ➤ Downloading a file using FTP

1. Start FTP application program (or use web browser)
2. Specify address of target computer
  - Example: `ftp://ftp.FTPplanet.com`
3. Provide user name and password
4. Select file to download

## ➤ FTP anonymous authentication

- Many public FTP sites allow anonymous authentication (does not require the user to supply authentication information)
  - Example: automatic downloading of programs
- Anonymous FTP sites require a user name of `anonymous`, with the user's e-mail address as the password



# Internet E-Mail Protocols: SMTP, POP3, IMAP

## ➤ Simple Mail Transfer Protocol (SMTP)

- Protocol commonly used to send and receive e-mail messages over the Internet
- Due to limitations in ability to queue e-mail messages, it is usually used with other e-mail protocols (POP3 or IMAP) that allow user to store and retrieve messages from an e-mail server
  - That is e-mail usually sent with SMTP, retrieved with POP3 or IMAP

## ➤ Post Office Protocol (POP3)

- Client-server protocol used to retrieve messages from an e-mail server
- Normally deletes e-mail from server upon download

## ➤ Internet Message Access Protocol (IMAP)

- Protocol used to retrieve messages from an e-mail server
- Provides more user control than POP3

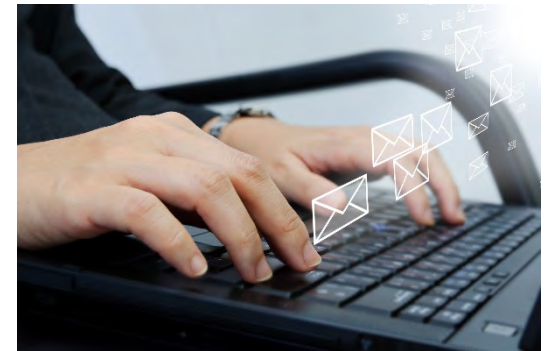

## ➤ Terminal emulation program for networks

- Command-line application allows a local computer to act as a terminal to a remote server
- Allows user to enter (text-only) commands to control remote system (web servers, etc.)
- Example: `telnet://server.address:port-number`
  - The default port number for TELNET is port 23

## ➤ Caution: Because it can remotely control a system over the Internet, TELNET can pose a security risk

- User authentication should be strictly controlled



TELNET = Terminal Emulation Over Networks

# Internet Service Port Numbers

- **Certain Internet port numbers have been reserved for use by specific services**

Service	Port number
FTP	20 (data), 21 (control)
SSH	22
Telnet	23
SMTP	25
DNS	53
HTTP	80
POP3	110
IMAP	143
HTTPS	443
RDP	3389
SMB	137-139 and 145
AFP	548 or 427

RDP = Remote Desktop Protocol

SMB = Server Message Block

AFP = Apple Filing Protocol



- **Internet Structure and Connection Technologies**
- **Internet Protocols and Services**
- **TCP/IP/Internet Troubleshooting Tools**



# TCP/IP Troubleshooting Tools: IPCONFIG.EXE

## ➤ ipconfig (Windows NT, 2000, XP)

- Command-line utility that displays the system TCP/IP configuration
  - Use Start | Run | Command, then type `ipconfig` in the DOS window that is displayed
- Software switches determine the amount of information displayed
  - Example: `ipconfig /all` (displays all TCP/IP configuration settings)

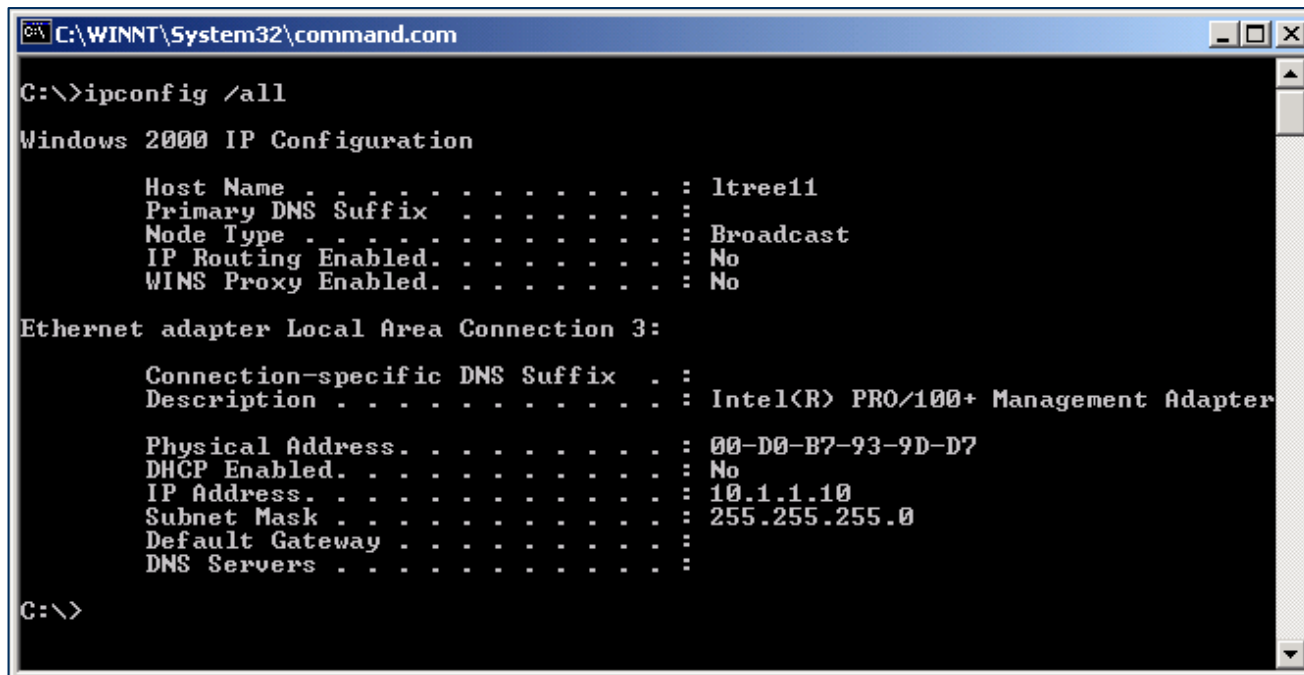

```
C:\WINNT\System32\command.com
C:\>ipconfig /all
Windows 2000 IP Configuration

    Host Name . . . . . : ltree11
    Primary DNS Suffix . . . . . :
    Node Type . . . . . : Broadcast
    IP Routing Enabled. . . . . : No
    WINS Proxy Enabled. . . . . : No

Ethernet adapter Local Area Connection 3:

    Connection-specific DNS Suffix  . :
    Description . . . . . : Intel(R) PRO/100+ Management Adapter

    Physical Address. . . . . : 00-D0-B7-93-9D-D7
    DHCP Enabled. . . . . : No
    IP Address. . . . . : 10.1.1.10
    Subnet Mask . . . . . : 255.255.255.0
    Default Gateway . . . . . :
    DNS Servers . . . . . :
```





## ➤ Troubleshooting DHCP problems with ipconfig

- Use `ipconfig /release` to release currently assigned dynamic IP address
- Use `ipconfig /renew` to obtain a dynamic IP address from DHCP server

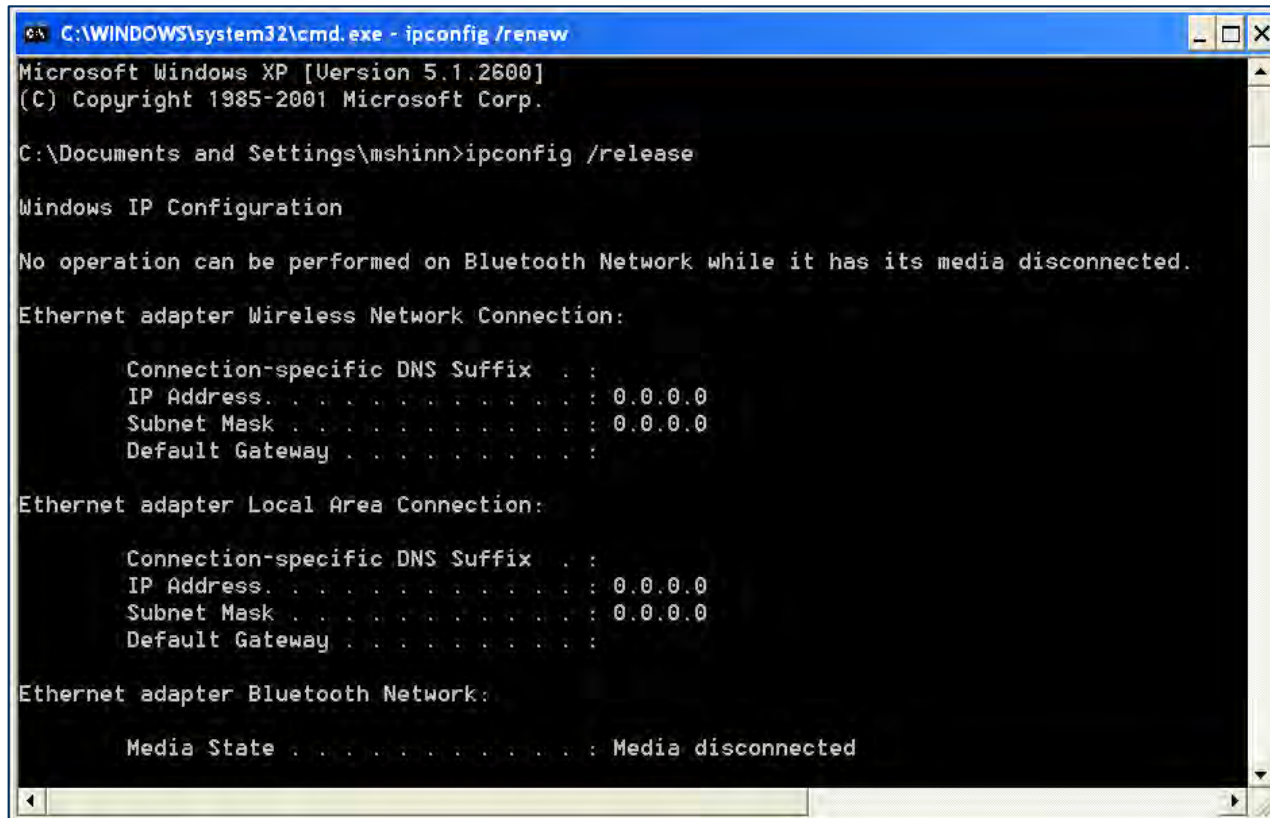

```
C:\WINDOWS\system32\cmd.exe - ipconfig /renew
Microsoft Windows XP [Version 5.1.2600]
(C) Copyright 1985-2001 Microsoft Corp.

C:\Documents and Settings\mshinn>ipconfig /release

Windows IP Configuration

No operation can be performed on Bluetooth Network while it has its media disconnected.

Ethernet adapter Wireless Network Connection:

    Connection-specific DNS Suffix  . : 
    IP Address. . . . . : 0.0.0.0
    Subnet Mask . . . . . : 0.0.0.0
    Default Gateway . . . . . : 

Ethernet adapter Local Area Connection:

    Connection-specific DNS Suffix  . : 
    IP Address. . . . . : 0.0.0.0
    Subnet Mask . . . . . : 0.0.0.0
    Default Gateway . . . . . : 

Ethernet adapter Bluetooth Network:

    Media State . . . . . : Media disconnected
```



# TCP/IP Troubleshooting Tools: PING.EXE

## ➤ Ping (packet Internet groper)

- Command-line utility that tests whether a specific IP address is accessible
  - Sends test packet, then waits for reply
  - Use Start | Run | Command, then type ping ip address

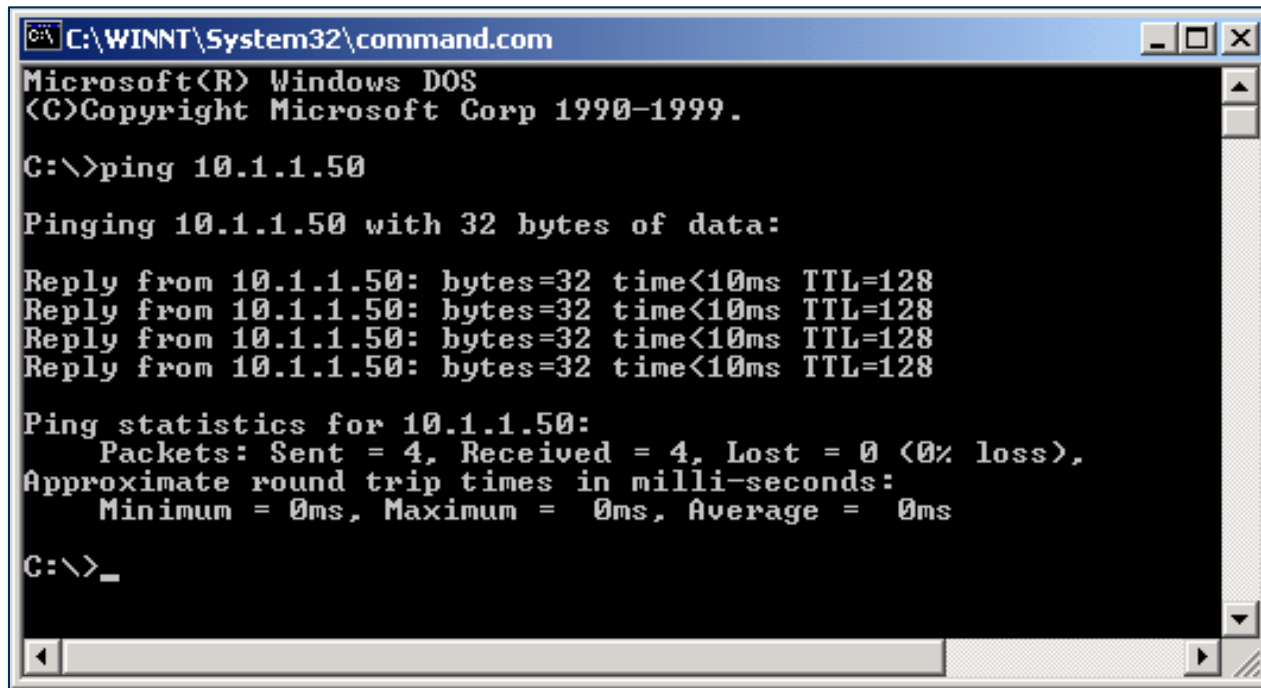

```
C:\WINNT\System32\command.com
Microsoft(R) Windows DOS
(C)Copyright Microsoft Corp 1990-1999.

C:\>ping 10.1.1.50

Pinging 10.1.1.50 with 32 bytes of data:

Reply from 10.1.1.50: bytes=32 time<10ms TTL=128
Reply from 10.1.1.50: bytes=32 time<10ms TTL=128
Reply from 10.1.1.50: bytes=32 time<10ms TTL=128
Reply from 10.1.1.50: bytes=32 time<10ms TTL=128

Ping statistics for 10.1.1.50:
    Packets: Sent = 4, Received = 4, Lost = 0 (0% loss),
    Approximate round trip times in milli-seconds:
        Minimum = 0ms, Maximum = 0ms, Average = 0ms

C:\>_
```



# PING . EXE Switches

➤ The PING utility's action can be modified with switches

PING + Switch	Action	Example	Purpose
ping -t	Pings host continuously	ping -t 192.168.1.1	Monitor a connection over time (press <CTRL><C> to end)
ping -n	Ping host n times	ping -n 30 192.168.1.1	Run as a baseline tool each day
ping -l	Ping host with specified number of bytes per packet	ping -l 512 192.161.1.1	Test result of larger packet sizes (default is 32 bytes)
ping -a	Ping host and display hostname	ping -a 192.168.1.1	Show hostname in result
ping -4 or -6	Ping host using IPV4 or IPV6	ping -6 192.168.1.1	Force use of IPV4 or IPV6



# TCP/IP Troubleshooting Tools: PING.EXE

## ➤ ping

- Command-line utility that tests whether a specific IP address is accessible
  - Sends test packet, then waits for reply
  - Use Start | Run | Command, then type `ping ip address`

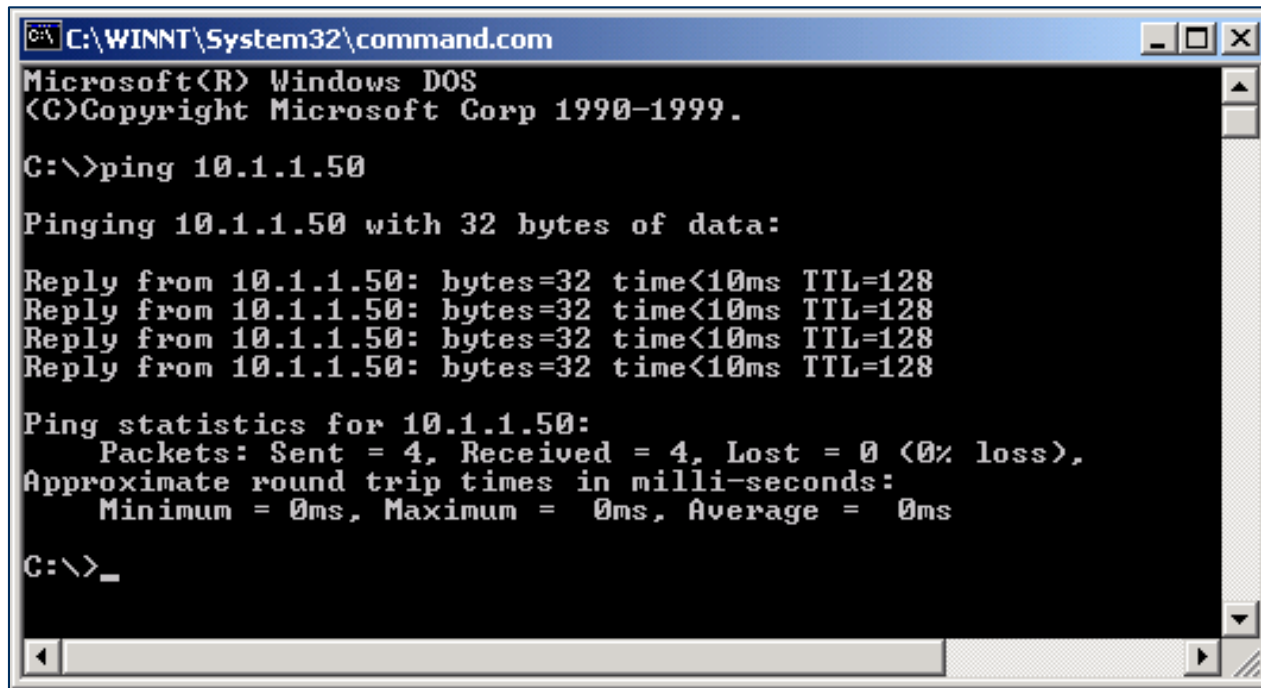

```
C:\WINNT\System32\command.com
Microsoft(R) Windows DOS
(C)Copyright Microsoft Corp 1990-1999.

C:\>ping 10.1.1.50

Pinging 10.1.1.50 with 32 bytes of data:

Reply from 10.1.1.50: bytes=32 time<10ms TTL=128
Reply from 10.1.1.50: bytes=32 time<10ms TTL=128
Reply from 10.1.1.50: bytes=32 time<10ms TTL=128
Reply from 10.1.1.50: bytes=32 time<10ms TTL=128

Ping statistics for 10.1.1.50:
    Packets: Sent = 4, Received = 4, Lost = 0 (0% loss),
    Approximate round trip times in milli-seconds:
        Minimum = 0ms, Maximum = 0ms, Average = 0ms

C:\>_
```

ping = packet Internet proper



# TCP/IP Troubleshooting Tools: TRACERT . EXE

## ➤ TRACERT . EXE (Trace Route)

- Command-line utility that traces routing of a packet from your computer to a destination computer over the Internet
  - Displays intermediate “hops” between routers on the Internet

```
C:\>tracert www.ucla.edu

Tracing route to www.ucla.edu [169.232.33.135]
over a maximum of 30 hops:

  1  31 ms  28 ms  28 ms  172.31.255.247
  2  26 ms  23 ms  26 ms  192.168.28.49
  3  27 ms  25 ms  26 ms  66.238.50.149.ptr.us.xo.net [66.238.50.149]
  4  27 ms  24 ms  26 ms  p3-0-0.mar1.la-ca.us.xo.net [207.88.81.165]
  5  26 ms  26 ms  25 ms  p5-0-0.rar1.la-ca.us.xo.net [65.106.5.5]
  6  27 ms  26 ms  26 ms  71.5.170.30.ptr.us.xo.net [71.5.170.30]
  7  34 ms  35 ms  34 ms  lax-px1--xo-ge.cenic.net [198.32.251.73]
  8  35 ms  35 ms  35 ms  calren3-cust.lsanca01.transitrail.net [137.164.131.242]
  9  37 ms  35 ms  36 ms  ucla-ge-lax-dc1.cenic.net [137.164.24.18]
 10 36 ms  35 ms  34 ms  border-2--core-1-ge.backbone.ucla.net [169.232.4.104]
 11 36 ms  44 ms  35 ms  core-1--csb1-1-ge.backbone.ucla.net [169.232.8.3]
 12 35 ms  36 ms  34 ms  www.ucla.edu [169.232.33.135]

Trace complete.
```



# TCP/IP Troubleshooting Tools: NSLOOKUP . EXE

## ➤ NSLOOKUP . EXE (Name Space Lookup)

- Command-line utility that queries domain name server to look up IP address for a specified computer

- Example: `nslookup microsoft.com` produced the IP addresses

207.46.197.32 and  
207.46.232.182

- Entered IP address in browser, went to `www.microsoft.com`

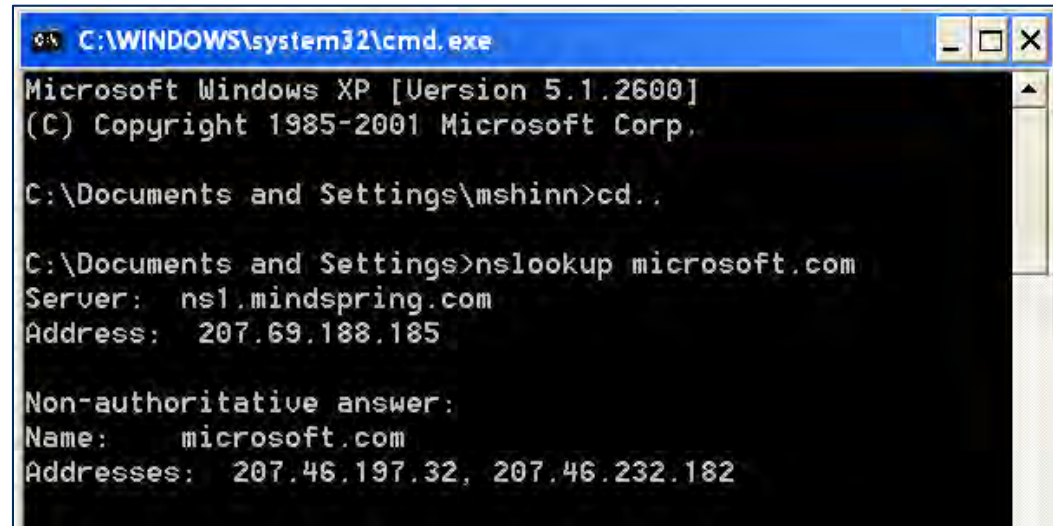

```
C:\WINDOWS\system32\cmd.exe
Microsoft Windows XP [Version 5.1.2600]
(C) Copyright 1985-2001 Microsoft Corp.

C:\Documents and Settings\mshinn>cd .

C:\Documents and Settings>nslookup microsoft.com
Server:  ns1.mindspring.com
Address:  207.69.188.185

Non-authoritative answer:
Name:     microsoft.com
Addresses: 207.46.197.32, 207.46.232.182
```



# TCP/IP Troubleshooting Tools: NETSTAT . EXE

## ➤ NETSTAT . EXE (Network Statistics)

- Displays sessions and connections to remote computers
- Switches:
  - -a Display all active connections
  - -o Display active TCP connections and process ID

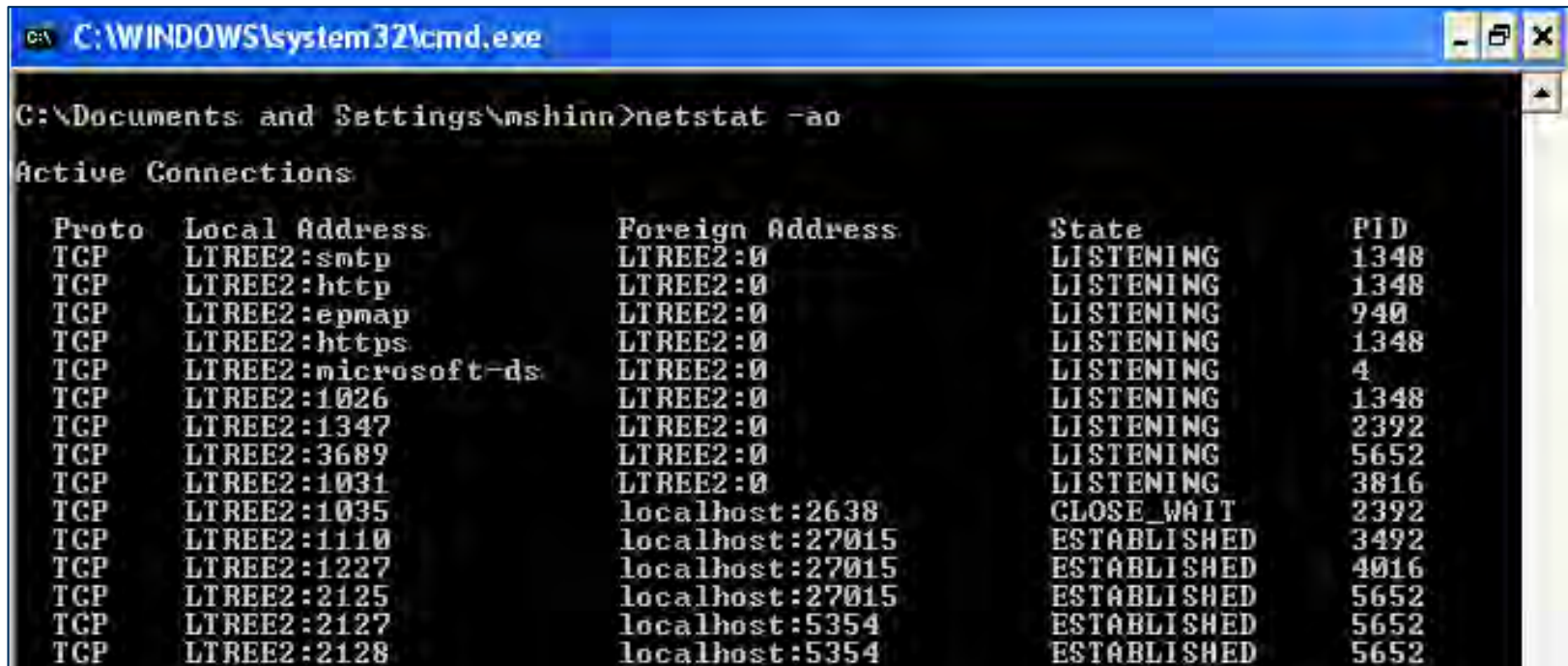

```
C:\WINDOWS\system32\cmd.exe
C:\Documents and Settings\mshinn>netstat -ao

Active Connections

Proto Local Address           Foreign Address         State                   PID
TCP   LTREE2:smtp             LTREE2:0               LISTENING               1348
TCP   LTREE2:http             LTREE2:0               LISTENING               1348
TCP   LTREE2:epmap            LTREE2:0               LISTENING               940
TCP   LTREE2:https            LTREE2:0               LISTENING               1348
TCP   LTREE2:microsoft-ds    LTREE2:0               LISTENING               4
TCP   LTREE2:1026             LTREE2:0               LISTENING               1348
TCP   LTREE2:1347             LTREE2:0               LISTENING               2392
TCP   LTREE2:3689             LTREE2:0               LISTENING               5652
TCP   LTREE2:1031             LTREE2:0               LISTENING               3816
TCP   LTREE2:1035             localhost:2638          CLOSE_WAIT              2392
TCP   LTREE2:1110             localhost:27015         ESTABLISHED              3492
TCP   LTREE2:1227             localhost:27015         ESTABLISHED              4016
TCP   LTREE2:2125             localhost:27015         ESTABLISHED              5652
TCP   LTREE2:2127             localhost:5354          ESTABLISHED              5652
TCP   LTREE2:2128             localhost:5354          ESTABLISHED              5652
```



# TCP/IP Troubleshooting Tools: NET and NBTSTAT

## ➤ NET . EXE (Network management commands)

- Set of commands for network management
- Type NET /? to display list of commands

## ➤ NET Use command is used to connect to shared folders on remote computers

- Net use x:  
\\computername\sharename
  - Maps shared folder to drive letter

## ➤ NBTSTAT

- Diagnostic tool for NetBIOS over TCP/IP
- Used to troubleshoot NetBIOS name resolution problems

```
Administrator: C:\Windows\system32\cmd.exe
C:\Users\mshinn>net use g: \\ltree2\445
The command completed successfully.

C:\Users\mshinn>dir g:
Volume in drive G has no label.
Volume Serial Number is F49F-E5D6

Directory of G:\

12/12/2009  10:41 AM    <DIR>          .
12/12/2009  10:41 AM    <DIR>          ..
06/25/2008  12:42 PM             1,526,077  445-Ch00.pptx
06/25/2008  02:49 PM             958,212  445-Ch01.pptx
06/25/2008  02:50 PM             801,854  445-Ch02.pptx
06/25/2008  02:51 PM             2,743,702  445-Ch03.pptx
              4 File(s)              6,029,845 bytes
              2 Dir(s)      5,172,060,160 bytes free
```





# Review Questions

1. **Internet access via satellite often suffers from latency (up to 50 ms) because:**
  - A. There is sunlight interference
  - B. Uplink requests are usually routed through a phone line to the satellite control center
  - C. There is electrical interference
  - D. There is ISDN interference
  
2. **In a DSL installation, a low-pass filter should be installed between the telephone jack and the:**
  - A. DSL modem
  - B. Computer
  - C. Telephone
  - D. A low-pass filter should never be installed



# Review Questions

- 3. A website URL begins with `https://`. What does this indicate?**
  - A. It is using SSL, making it safe for financial transactions
  - B. It is using SMTP, making it safe for financial transactions
  - C. It is using high-speed HTTP
  - D. It is an e-mail server
  
- 4. Which Internet service that translates a domain name into an IP address?**
  - A. FTP
  - B. SSL
  - C. DNS
  - D. TELNET
  
- 5. Janet is troubleshooting a problem with a PC that is connected to a DHCP server. Which commands can be used to force the DHCP server to drop and reacquire an IP address to this PC? (Select two.)**
  - A. PING
  - B. `IPCONFIG /RELEASE`
  - C. `IPCONFIG /IPASSIGN`
  - D. `IPCONFIG /RENEW`



# Chapter Summary

In this chapter, you have learned how to

- Describe the fundamental structure of the Internet
- List the basic characteristics of at least seven major Internet connection technologies
- Identify the names and uses of Internet-related protocols and services, including TCP/IP, DNS, HTML, HTTP, HTTPS, SSL, SMTP, IMAP, FTP, and TELNET
- Describe the use of network troubleshooting command-line tools (IPCONFIG.EXE, PING.EXE, TRACERT.EXE, NSLOOKUP.EXE)





# Chapter 19

# Computer Security

Customer  
Management  
Standard  
Development  
Consistency  
Business  
Optimal

# Chapter Objectives

---

**In this chapter, you will learn how to**

- **Identify common security threats and vulnerabilities**
- **Describe computer security best practices and threat prevention strategies**
- **Explain how user accounts and security policies are used to implement security in a Windows system**
- **Explain the basic purpose and function of Windows firewalls**



## ➤ **Malware Threats and Remedies**

- **Social Engineering**
- **Computer Security Best Practices**
- **User Access Control and Group Policies**
- **Firewalls**



# Malware Overview

## ➤ Malware

- “Short for *malicious software*, software designed specifically to damage or disrupt a system, such as a virus or a Trojan horse”
  - [www.webopedia.com](http://www.webopedia.com)
- “Programs designed to infiltrate or damage a computer without the user’s informed consent”
  - [www.wikipedia.org](http://www.wikipedia.org)

## ➤ Types of malware

- Viruses
- Trojan horses
- Worms
- Macro viruses
- Script-based viruses
- Spam
- Spyware, adware, grayware



# What Is a Computer Virus?

- **Malicious code that is written to replicate and propagate itself**
- **A computer virus is an executable fragment of code**
  - To infect your system, the virus code must be executed
  - Computer viruses can be categorized by the type of file they attack
- **File infectors**
  - Viruses that attach themselves to (or replace) executable program files
    - .EXE, .COM, .BAT, .DRV, etc.
  - Macro viruses attach infected code (in the form of executable macros) to application data files
    - .DOC, .XLS, etc.
- **Boot sector infectors**
  - Viruses that infect the boot sector of disks or bootable USB flash drives
- **Polymorphic viruses**
  - Viruses that alter their code on each execution to avoid detection





# Computer Virus Pathology

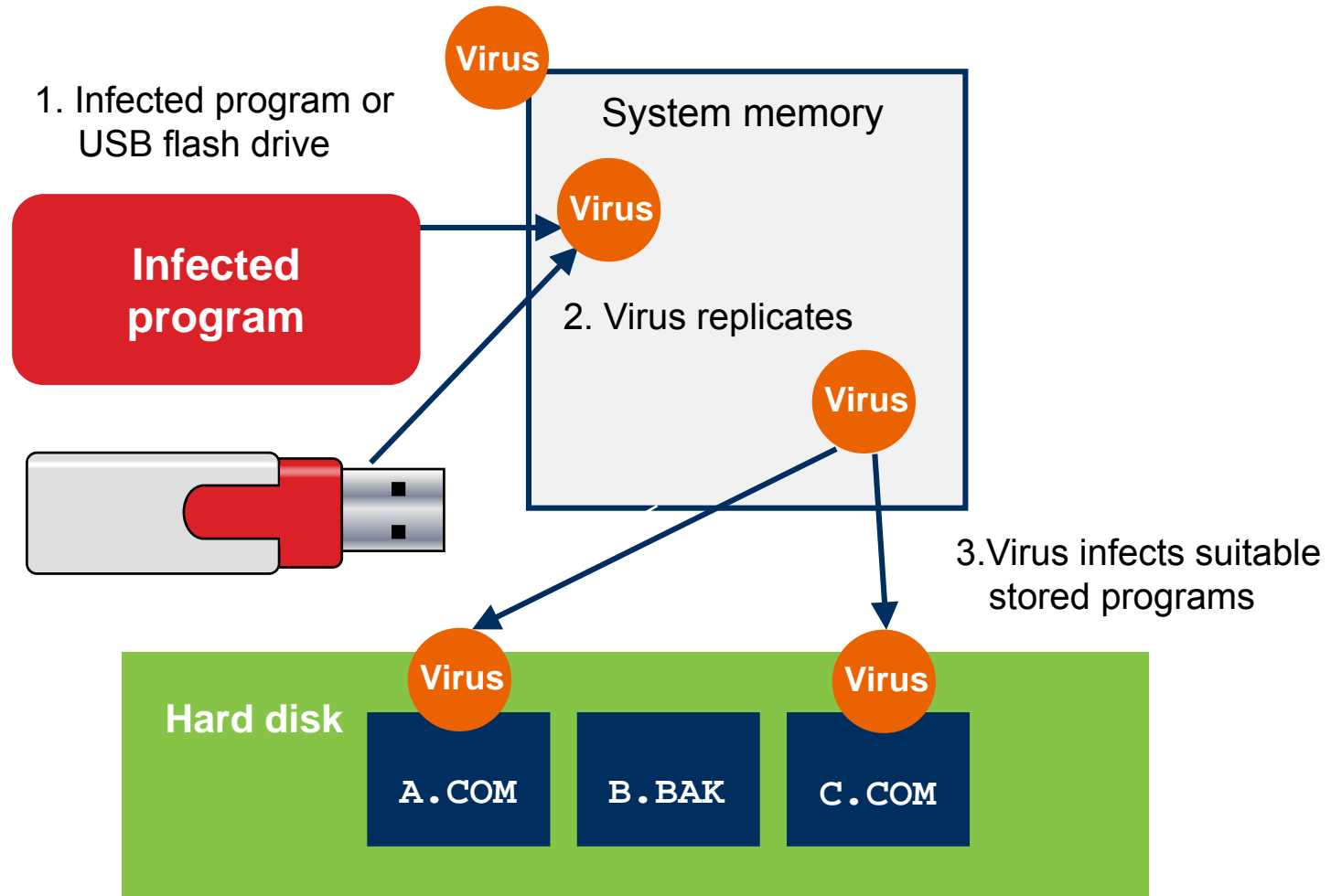

# Related Infectious Programs

## ➤ Worm

- A self-contained program that is able to spread copies of itself to other systems
- Usually propagates via network connections or e-mail attachments

## ➤ Trojan horse (Trojans)

- A destructive program disguised as an innocent one
  - Free games or utilities
- Once loaded into system memory, the destructive core of the program is activated
- Often used to provide backdoor access to infected systems



# Using an Antivirus Program

## ➤ Antivirus program features

- Use signature library to identify viruses
- Automatically quarantine detected viruses
  - Move to a protected location
- Remediate (clean) infected systems

## ➤ Updating antivirus programs

- Signature library and antivirus “engine” (scanner program) should be scheduled for automatic updating

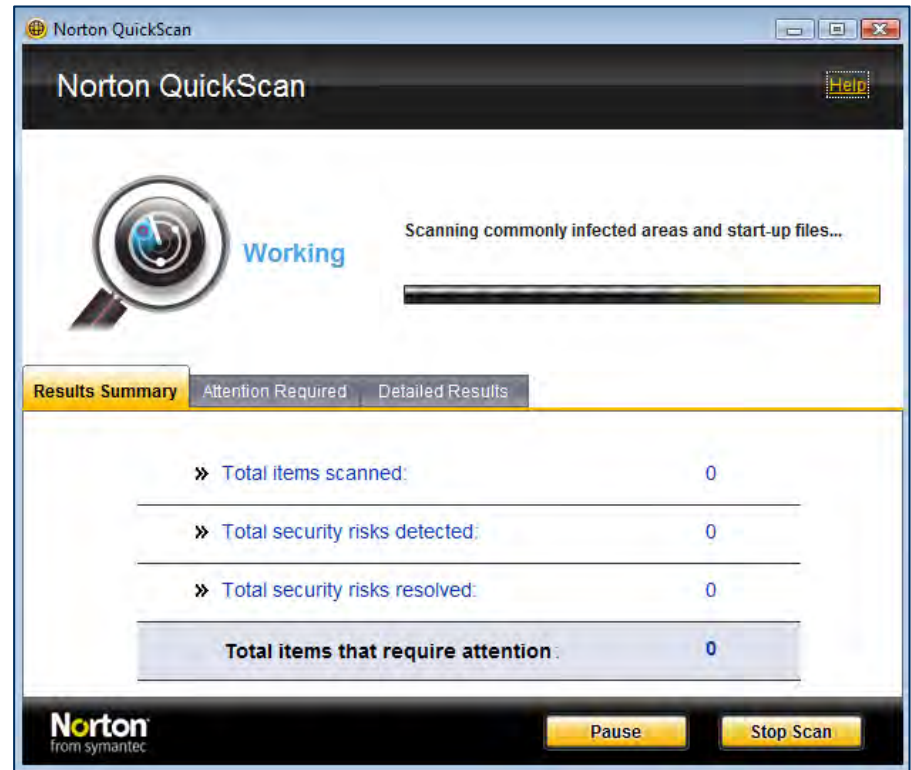

# Spyware Overview

## ➤ What is the purpose of spyware?

- To monitor and collect information about a user's activity on a computer
  - Websites visited
  - Items purchased at a website

## ➤ Dangers posed by spyware programs

- Spam (unsolicited advertisements and emails)
- System performance degradation
- Configuration changes to applications

## ➤ Sources of spyware

- Website links
- E-mail attachments or embedded links

## ➤ Preventing spyware

- Use anti-spyware programs (Windows Defender, Malwarebytes)
- Configure web browser security settings
  - Website checking
  - Anti-phishing



## ➤ Non-compliant systems

- Computer systems that do not have company/government required security measures are common targets for malware
  - Encrypted data
  - Up-to-date security patches
  - User authentication and access controls

## ➤ Rootkits

- Malicious code that infiltrates operating system kernel
  - Masquerades as a device driver (which traditionally requires access to the operating system trusted areas)
- Able to “cloak” itself from the file system, rendering it invisible to antivirus programs



# Troubleshooting Security Issues: Incident Response

## Incident response procedure:

### 1. Identify what has happened

- Use anti-malware tools to identify problems and security violations

### 2. Document activity

- Record all steps taken and discoveries made
- Create forensic images of data storage devices

### 3. Maintain chain of custody

- Record who has possession of all seized computer evidence



# Troubleshooting Security Issues: Fighting Malware

## ➤ Common symptoms of malware

- Pop-ups
- Browser redirection
- Security alerts
- Slow performance
- Internet connectivity issues
- PC/OS lock-up
- OS updates failures
- Rogue antivirus programs
- Spam
- Renamed system files
- Files disappearing
- File permission changes
- Hijacked e-mail
- “Access denied” messages
- Invalid certificate messages

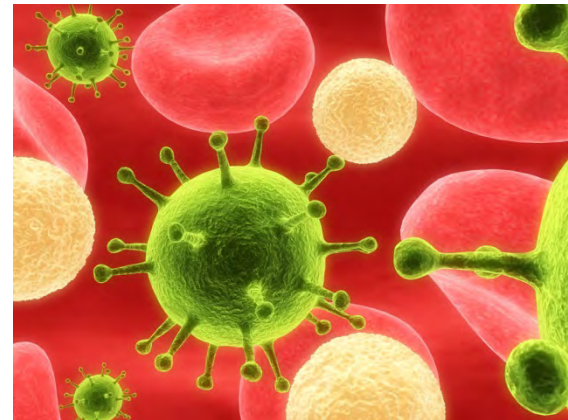

# Detecting Spyware Infestations

- **Use Task Manager to examine running processes**
  1. Press <Ctrl><Alt><Del> to display Windows Task Manager
  2. Click the Processes tab to display running processes
  3. Examine unfamiliar or suspicious process names
    - Google them to obtain information

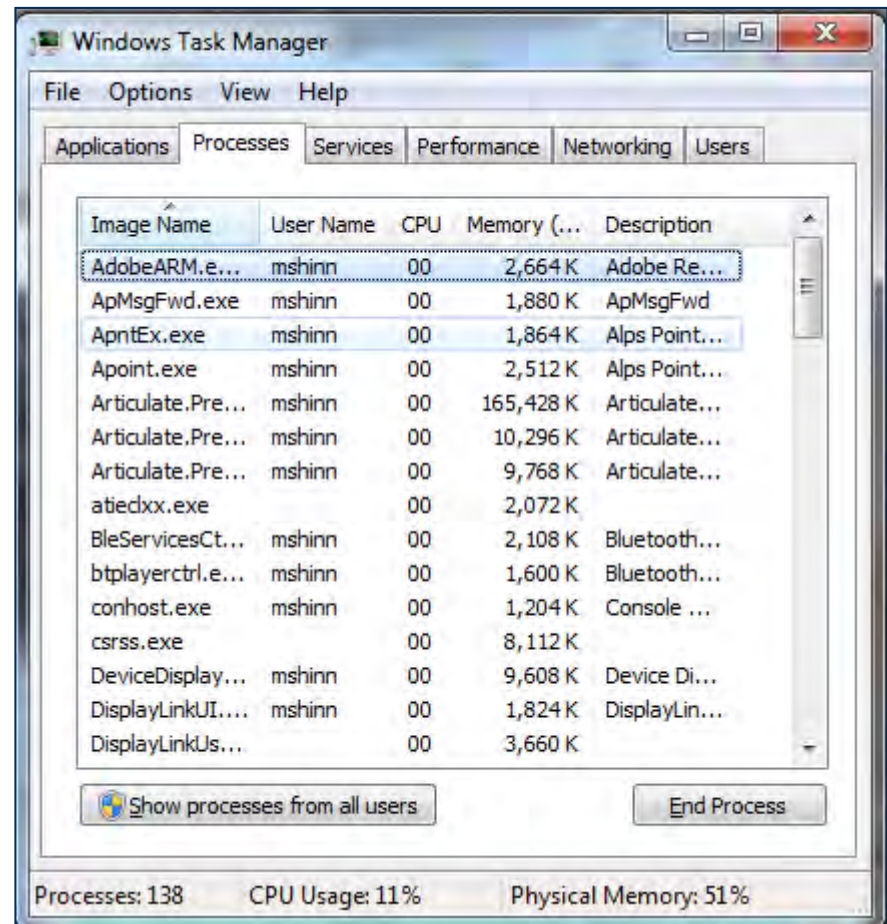



# Scanning for Spyware

## ➤ Scan for spyware with an anti-spyware program

- Ad-Aware by Lavasoft, Defender by Microsoft, MalwareBytes, etc.
- Scan with at least two anti-spyware programs
  - Some spyware may be missed by certain anti-spyware programs

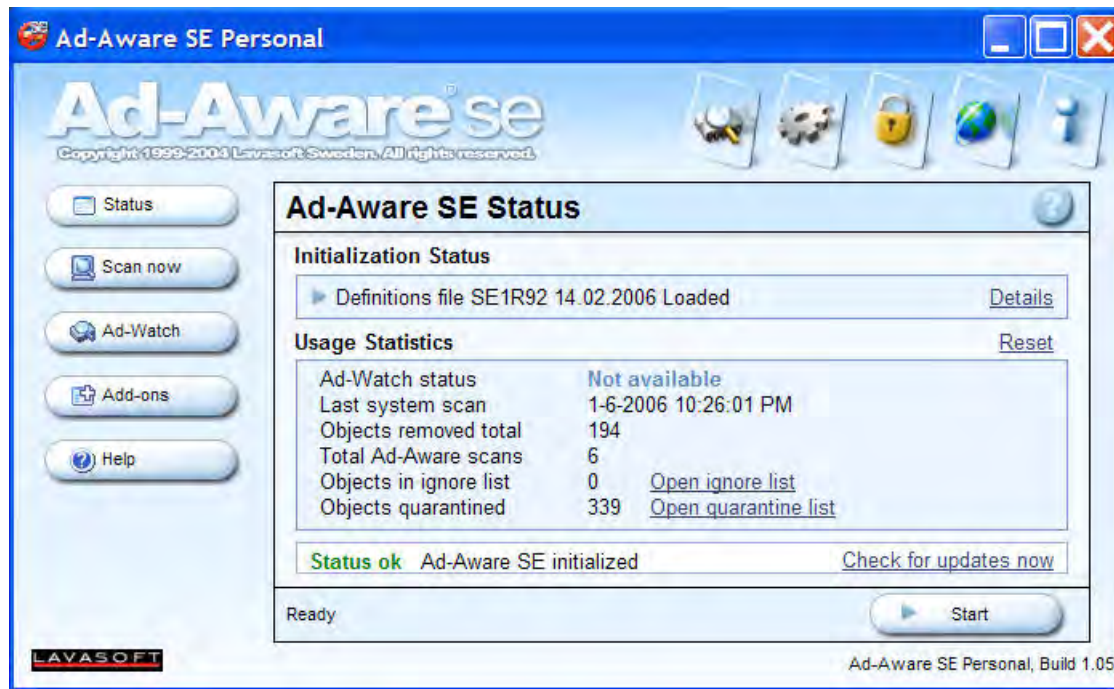

# Fighting Spyware: Example

➤ After downloading a free YouTube-to-.mp3 converter, Jane's Internet browser (IE9) now keeps going to a site named `roguenet.com`

- What steps can she take to correct the problem?

## 1. In IE9, select Tools | Internet Options

- a. Check the home page
  - Browser hijackers often change the home page to point to their website
- b. Change the home page to point to the page you normally use

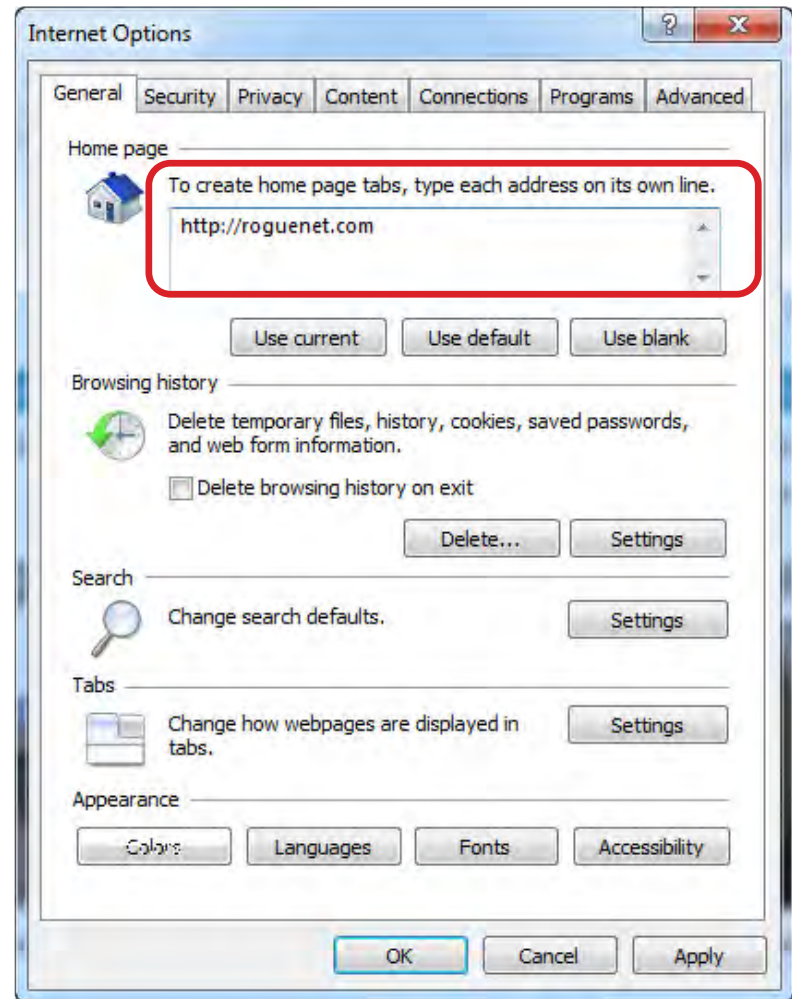

# Fighting Spyware: Example

## 2. Reset Internet Explorer to default options

- Select Tools | Internet Options, then click Advanced tab
- In Advanced dialog, click Reset button
- Click OK to apply changes

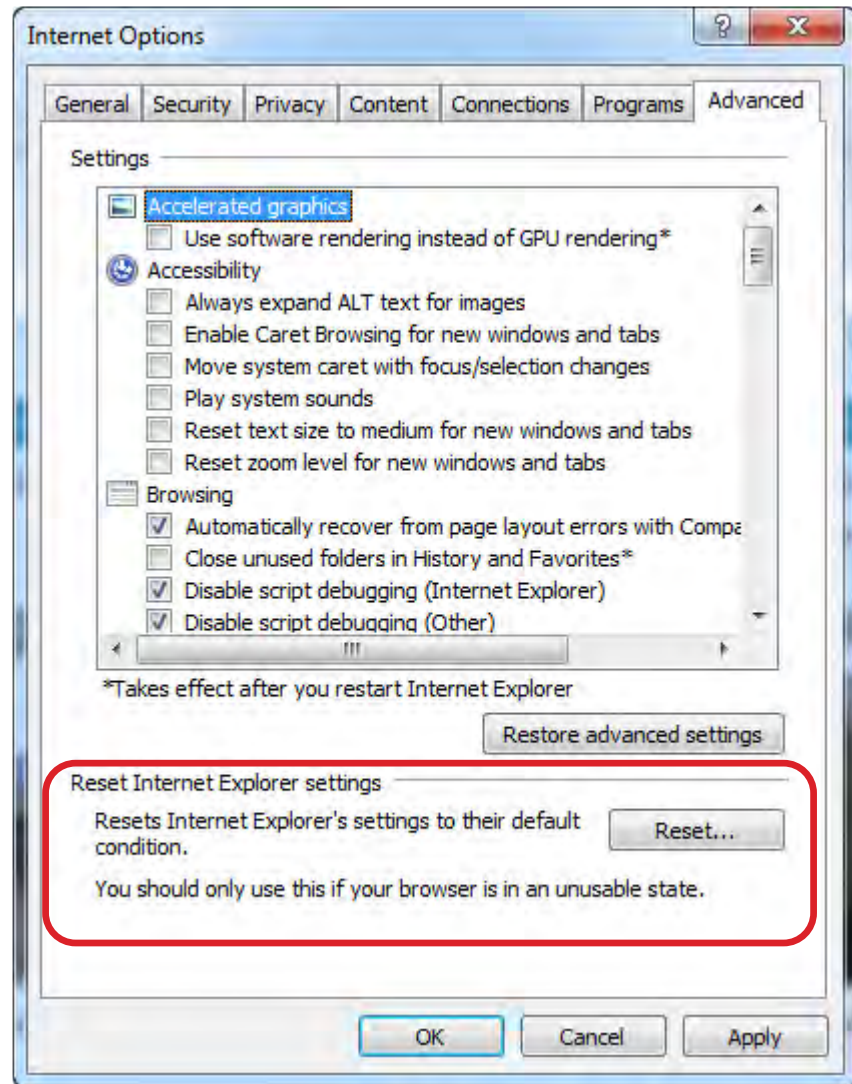

# Best Practices for Malware Removal

## 1. Identify malware symptoms

- Slow system performance
- Suspicious processes
- Altered program behavior

## 2. Quarantine infected system

- Disconnect computer from network

## 3. Disable system restore

- Removes all restore points (that may contain copies of infected files)



# Best Practices for Malware Removal

## 4. Remediate infected systems

- Update antivirus software
- Scan and remove malware
  - Use Safe mode
    - Or boot from Windows pre-installation environment
  - Run antivirus/antimalware scanning and removal tools

## 5. Schedule scans and run updates

- Set for daily updates

## 6. Enable system restore

- Create restore point

## 7. Educate end user

- Explain antivirus protection measures
- Explain safe Internet use practices



- **Malware Threats and Remedies**
- **Social Engineering**
- **Computer Security Best Practices**
- **User Access Control and Group Policies**
- **Firewalls**



# Computer Security Threats

## ➤ Phishing

- Attempts to gain user information by masquerading as legitimate electronic communication
  - E-mails appearing to be from banks, financial institutions, security firms, etc.
  - Trick users into supplying account information, which is then used or sold by hackers
  - “Spear phishing” targets specific individuals in a company
    - Finance, IT, etc.

## ➤ Spoofing

- Falsifying header information in electronic message packets
  - Disguises identity of sender



# Computer Security Threats

## ➤ **Zombie/botnets**

- Hidden malware distributed to many computers
  - Sleeps until it receives activation message
- Often used to implement DDOS (Distributed Denial of Service) attacks
  - Floods servers of targeted companies with messages, causing them to crash

## ➤ **Ransomware**

- Hackers threaten companies with DDOS attacks unless paid
- Hackers plant malware that encrypts content of targeted user's hard drive
  - Users must pay ransom fee to unencrypt their data





# Social Engineering

## ➤ What is social engineering?

- “A non-technical kind of intrusion that ... involves tricking other people to break normal security precautions”\*

## ➤ Example:

- Hacker Steve calls StockInvestInc and asks for the Operations Department
- Ron, a worker in the department, answers the phone
- Hacker Steve: “Hi, this is Dave from the IS department—we’re troubleshooting some access problems with the server from your department and need to run a test. Can you give me your password, so I can see if I can access the server from your area?”
- Ron: “Sure, it’s Ron123xyz#. By the way, don’t you need my user name too?”
- Hacker Steve: “Right—what is it again?”

\*Source: [www.SearchSecurity.com](http://www.SearchSecurity.com)



# Social Engineering

## ➤ Defending against social engineering attacks

- Rule #1: “Trust no one!”\*
- Educate employees about social engineering attacks
  - Have a policy of what they should do if they receive a suspicious call or request for information



\* Source: Kevin Mitnick and William L. Simon: *The Art of Deception*



- **Malware Threats and Remedies**
- **Social Engineering**
- **Computer Security Best Practices**
  - **User Access Control and Group Policies**
  - **Firewalls**



# Physical Security

- **The first wall of defense in computer security is to control physical access**
  
- **Main building**
  - Lock doors
  - Mantrap
    - Double-door secure entry passageway
  - Security desk
    - Require ID badges
    - Be alert to “tailgating” (unauthorized persons entering with a group)
  - Card/keypad access to building
    - Smart card or RFID
  
- **Securing physical documents**
  - Use locking file cabinets, drawers



RFID = Radio Frequency Identification



# Security Best Practices: Encryption

- **Encryption is the conversion of data or information into code**
  - Performed by an encryption algorithm using a digital key
  - Difficulty of breaking key is proportional to bit length of key

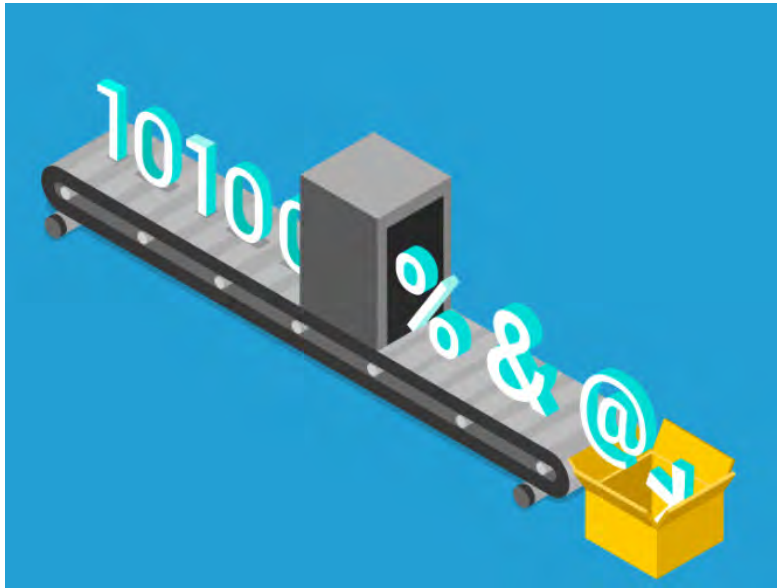

# Security Best Practices

## ➤ Service packs/patches

- Patches are quick fixes to security problems, or program bugs
- Service packs include a comprehensive set of patches in a single software update package
- Use Microsoft Update to automatically download and install patches

## ➤ Users should be trained in basic security measures

- Avoiding “social engineering” traps
- Avoiding “shoulder surfing” (hackers glancing over shoulders to see passwords being typed in)
- Safe Internet practices

## ➤ Password management

- Strong passwords should be used (upper- and lowercase characters; numbers; other characters)
- Passwords should be memorized by users
  - Or, password management devices should be used



# Security Best Practices

## ➤ **Disabling ports**

- Disable USB ports to prevent data loss and introduction of malware

## ➤ **VPN (Virtual Private Network)**

- When working outside of organization premises, employees should use VPN connections
- Encrypts data sent over public Internet

## ➤ **ACL (Access Control List)**

- List of permissions control access to system objects
  - Computers, files, network shares, etc.

## ➤ **DLP (Data Loss Prevention)**

- Policies + network monitoring programs to prevent loss of sensitive data from organizations



# Data Destruction and Disposal Methods

## ➤ **Hard drive physical destruction**

- Physically destroying hard drive through drilling, shredding, incineration, etc.
- Used for top-secret data
- Media destruction companies will provide certificate of destruction

## ➤ **Hard drive electromagnetic destruction**

- Degaussing tools use strong magnetic field to destroy data on drive platters

## ➤ **Recycling/repurposing best practices**

- Hard drives that are donated should always have data wiped

## ➤ **Hard drive sanitization**

- Low-level format will delete data left by standard formatting
- Run software program that performs multiple overwrites of hard drive
  - Drive wipe
- United States Department of Defense Standard 5220.22-M





# Authentication Technologies

## ➤ What is authentication?

- Method to prove that users are who they say they are
- Identification/authentication

## ➤ Authentication factors

- What you know—password, PIN
- What you have—smart card
- What is unique to you—fingerprint; retinal pattern

## ➤ Single Sign-On (SSO)

- User enters one username and password to access multiple systems
- Authentication server validates user credentials

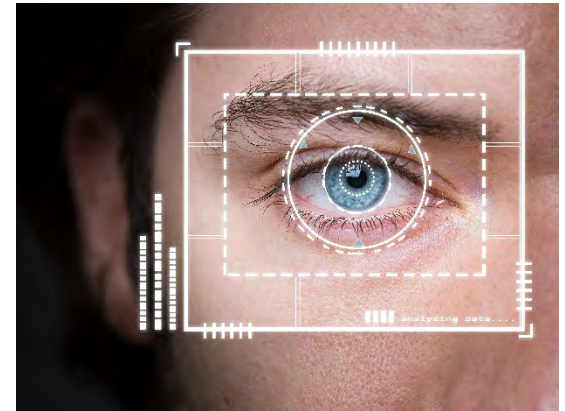

# Authentication Technologies: Multifactor Authentication

## ➤ Multifactor authentication

- System that requires two or more independent credentials to authenticate user

## ➤ Smart cards

- Contain embedded computer and identification information

## ➤ Key fobs

- Display randomly generated code
  - RSA token
- Combined with user PIN to authenticate

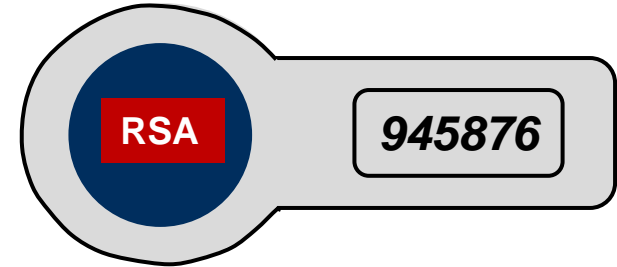

## ➤ Radio-Frequency IDentification (RFID) badge

## ➤ Biometrics

- Fingerprint readers
- Retinal scanners

RSA = Rivest, Shamir, and Adleman



# Password Best Practices

## ➤ Password management

- Strong passwords should be required
- Passwords should be memorized
  - Or password management devices should be used
- Should contain at least one
  - Uppercase letter
  - Number

## ➤ Password complexity guidelines

- Should be at least eight characters long
- Should contain at least one
  - Uppercase letter
  - Number
  - Special character
- Example: miLe\$08xz

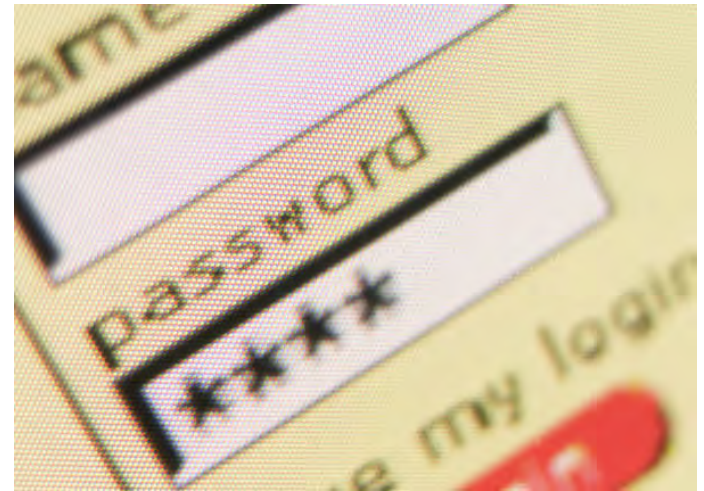

# BIOS Security

## ➤ Set BIOS/UEFI password

- Controls access to BIOS/UEFI setup program

## ➤ Set Drive Lock password\*

- Password controls use of hard drive

## ➤ Enable chassis Intrusion detection\*

- Displays warning message if chassis intrusion detection switch is tripped

## ➤ Trusted Platform Module (TPM)\*

- Chip that can create and store cryptographic keys
- Can be used with Windows Vista BitLocker to encrypt entire hard drive contents

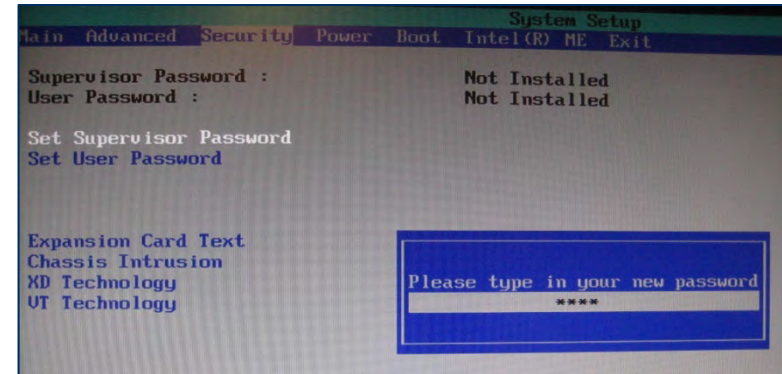

\*Not available in all BIOS setup programs



- **Malware Threats and Remedies**
- **Social Engineering**
- **Computer Security Best Practices**
- **User Access Control and Group Policies**
- **Firewalls**



# Data Access and User Accounts

- **Windows uses Access-Control Lists (ACLs) to control access to data**
  - Specifies access rights that each user has to a particular system object
    - For example, a folder or individual file
- **Windows User Accounts**
  - Define the actions a user can perform
  - Users can be assigned to be members of groups with predefined privileges using the Local Users and Groups snap-in to the Windows Management Console
- **User authentication**
  - Requires user name and password
  - Single sign-on can be configured for Enterprise systems
    - Allows users access to multiple systems with one authentication
    - Requires use of server-based user account management
- **Principle of least privilege**
  - Each user should have only the access privileges necessary to do their job



# Common User Account Groups

## ➤ Administrators

- Allowed to make systemwide changes to the computer (full access)
  - Create and delete user accounts, passwords
  - Install software, hardware

## ➤ Power Users

- Intermediate user level—allowed to install programs
- Supported in Windows XP only
  - Legacy support in Windows 7 (but privileges reduced to Standard User)

## ➤ Users (Standard Users)

- Prohibited from changing most computer settings
  - Cannot change their account type, but can change picture, or password
  - Cannot install software or hardware

## ➤ Guests

- Intended for users without an account on system
  - Allowed access to programs that have already been installed
  - Disabled by default



# Data Access and User Accounts

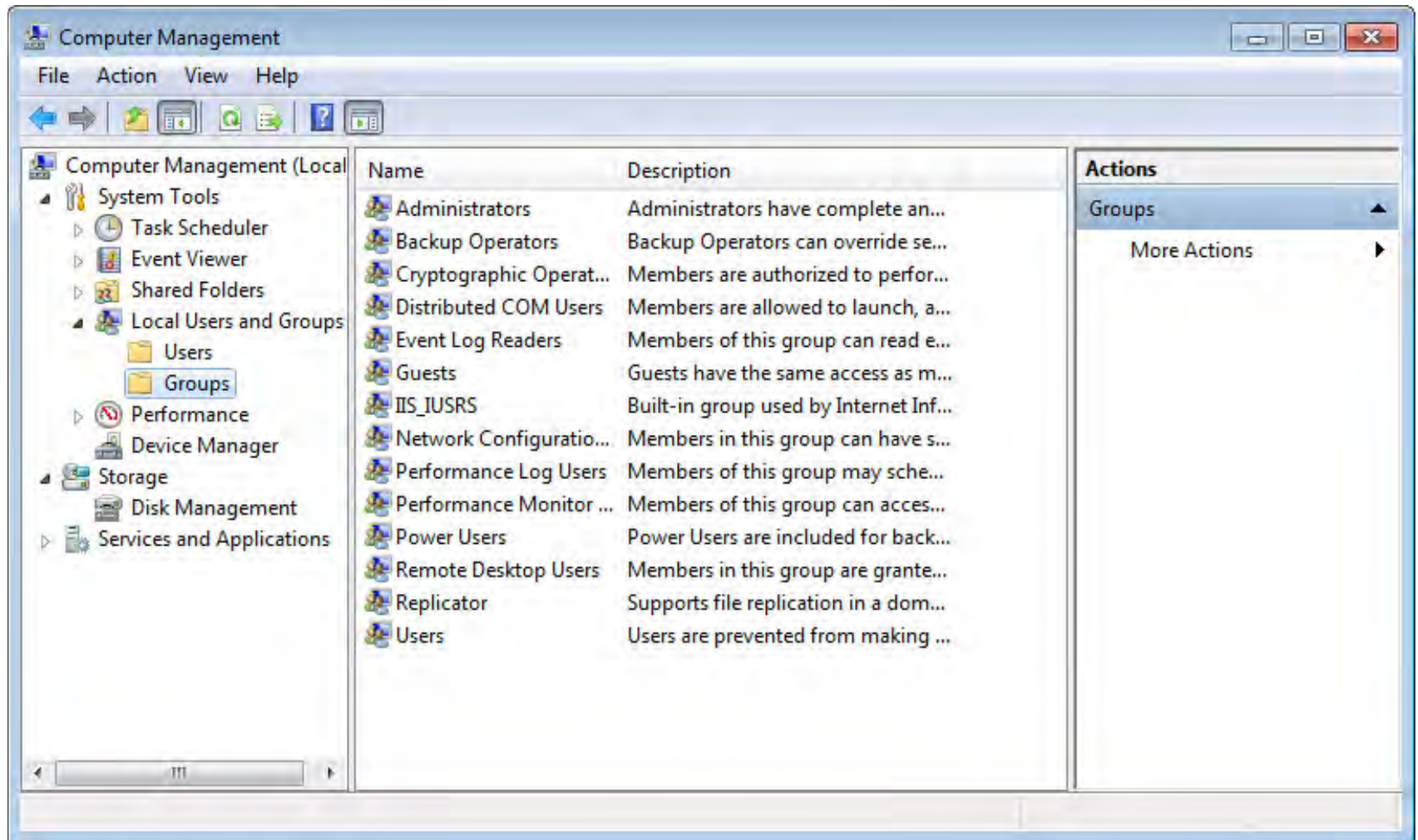



# Managing Groups: Group Policies

## ➤ What is a Group Policy?

- Centralized point of administration for managing user account and computer security policies
- Click Start, then type `gpedit.msc` into Search box to open Group Policy Editor

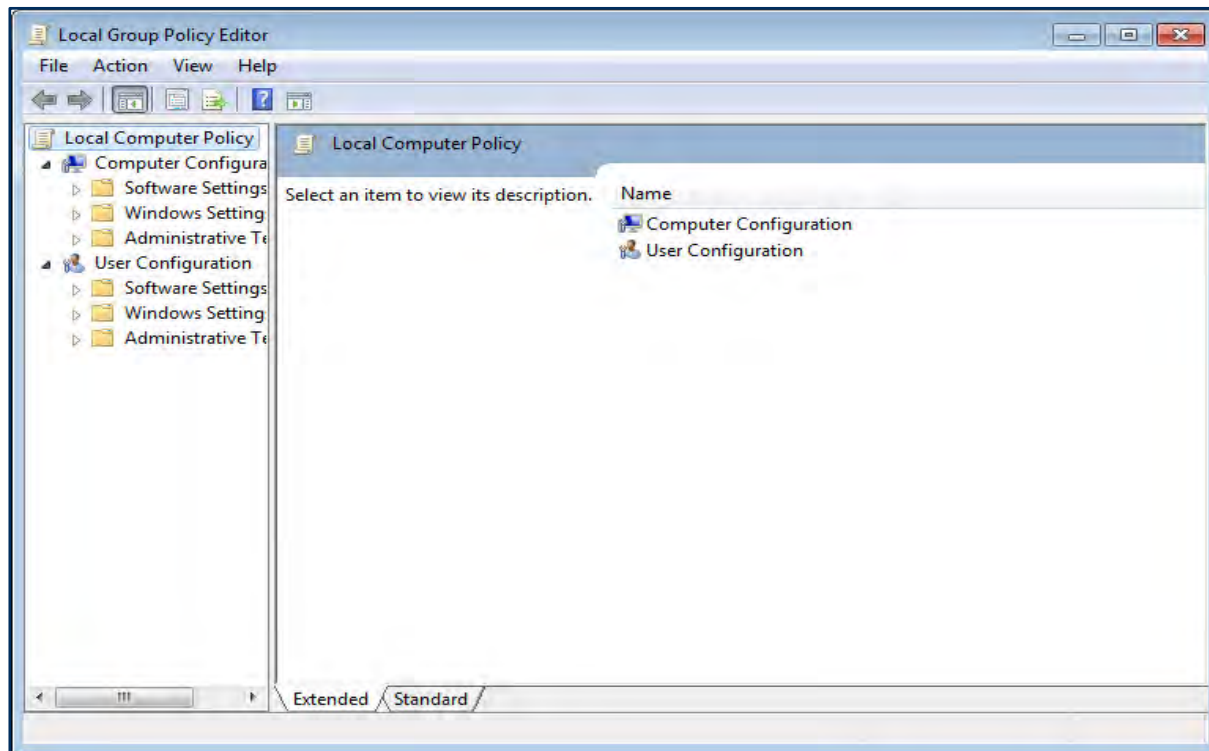

# Group Policies: User Account Policies

## ➤ Group Policy Editor allows management of user account policies

- Local security policy
- Password policies
  - Minimum password length, age
  - Password complexity
- Account lockout policies
  - Lockout threshold
  - Lockout duration

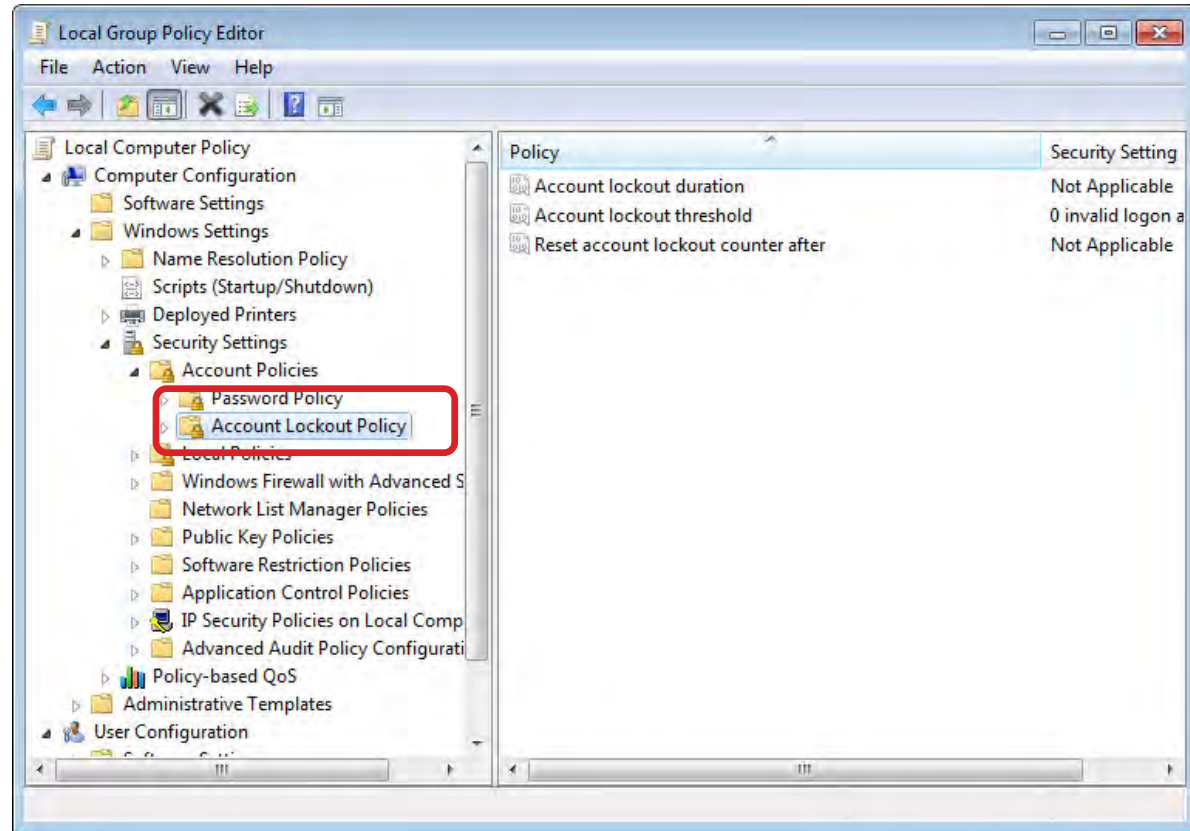

# Group Policies: User Windows Settings

## ➤ Group Policy Editor allows management of user Windows settings

- Administrative templates contain collections of configurable items
- Example: Desktop Settings

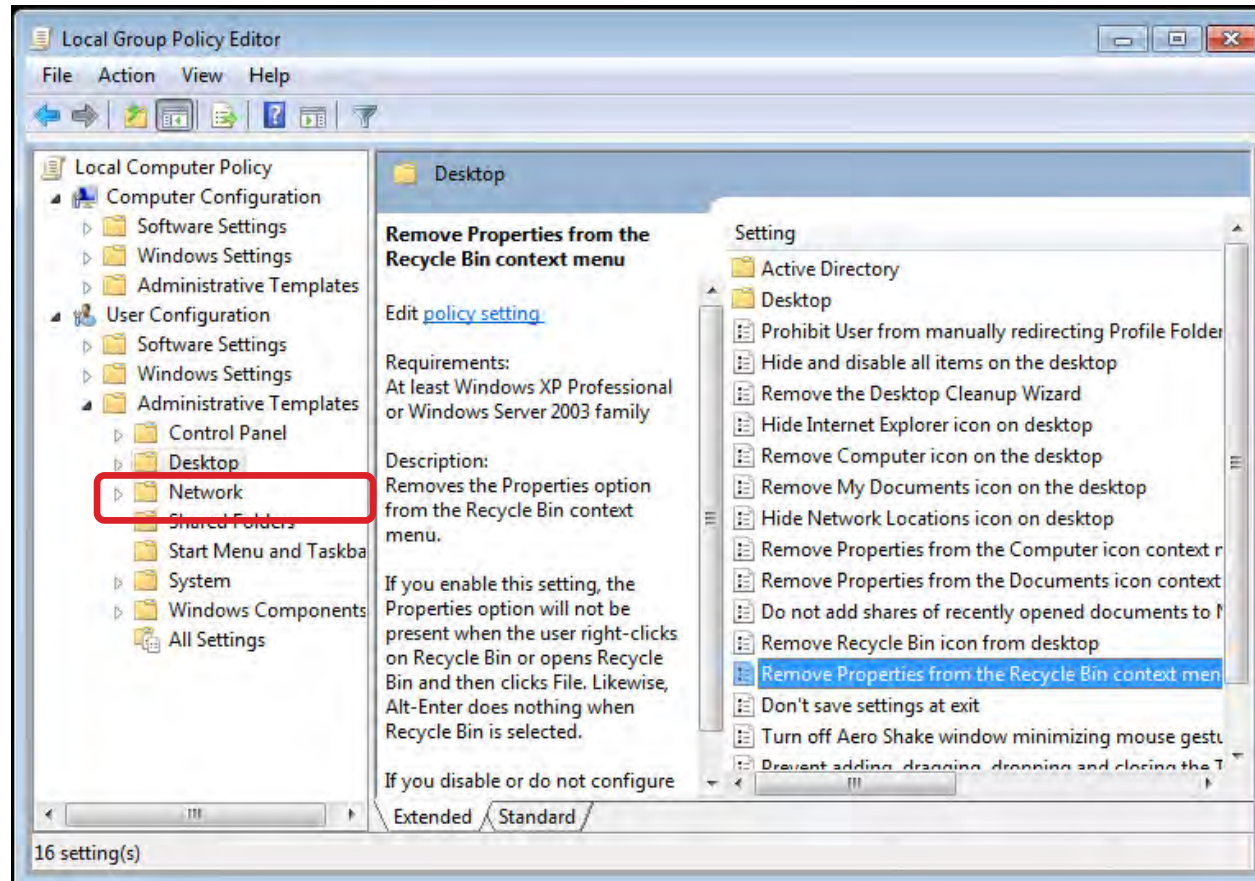

# Group Policies: Enabling Audit Logging

- **Group Policy Editor can be used to enable audit logging of security-related events**
  - Audit logon events, for example
  - Use Local Computer Policy | Computer Configuration | Windows Settings | Security Settings | Audit Policy

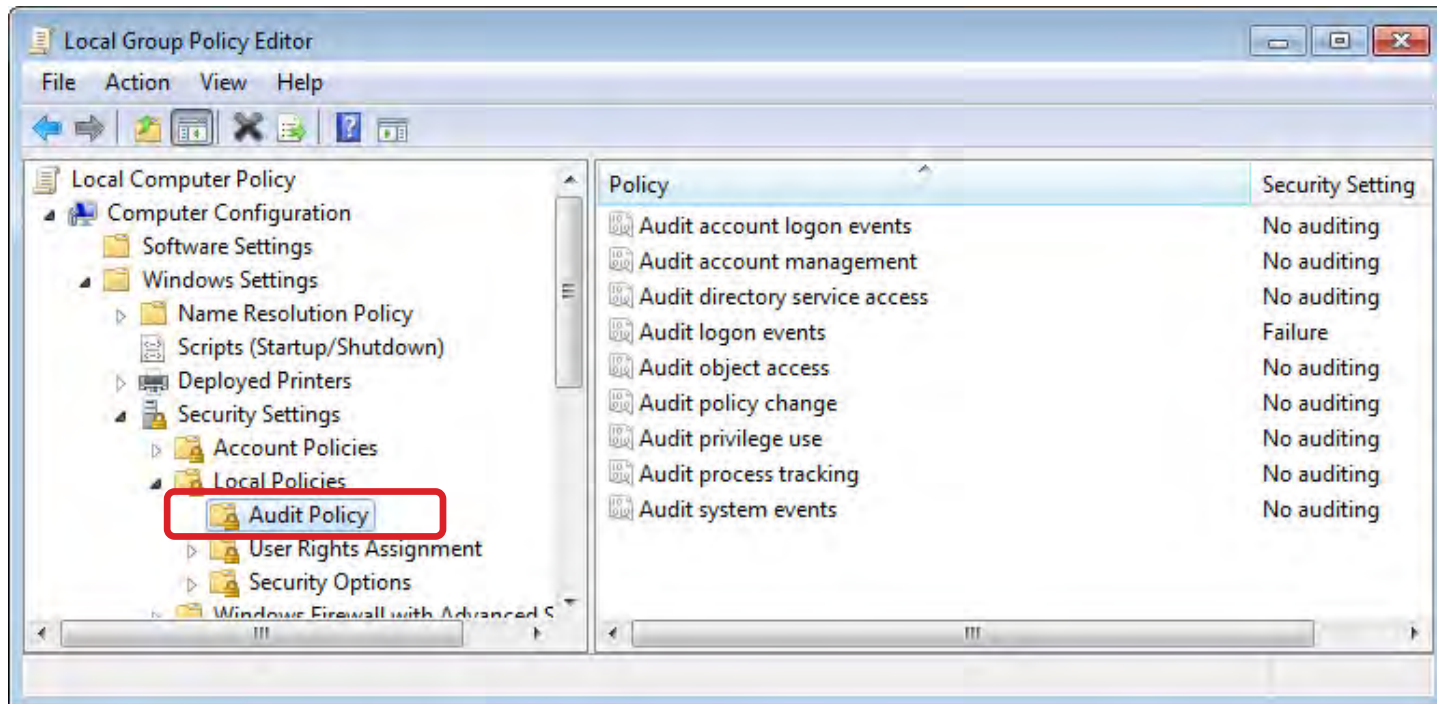

# Windows User Account Control (UAC)

- **Security measure designed to control user privilege mode**
  - Users normally run in Standard user mode
  - Elevation to Administrator mode must be explicitly requested
    - Prevents malware from performing operations in Administrator mode
- **Tasks that require administrator privileges trigger a UAC prompt**
  - Changing System Protection settings
  - Installing an application or driver
  - Running an application as Administrator

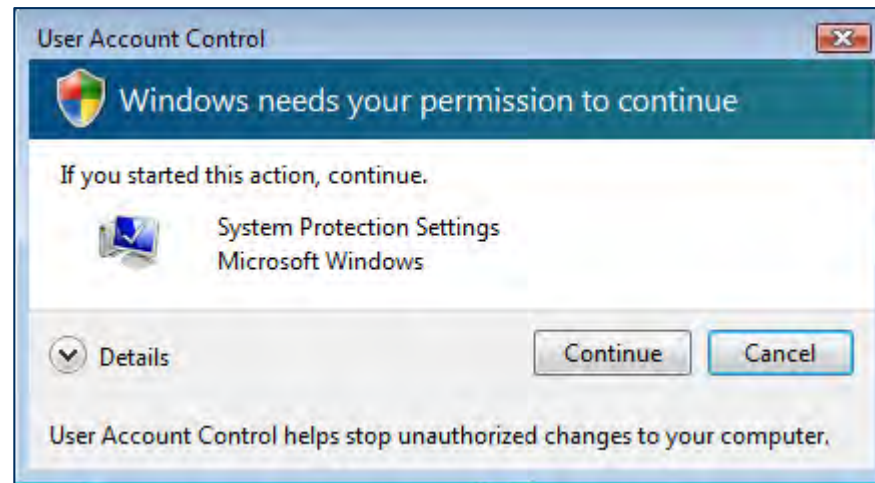

# Vista User Account Control (UAC)

## ➤ Turning User Account Control on or off

- Click Start | Control Panel
- Then select Users | Turn User Account Control (UAC) on or off

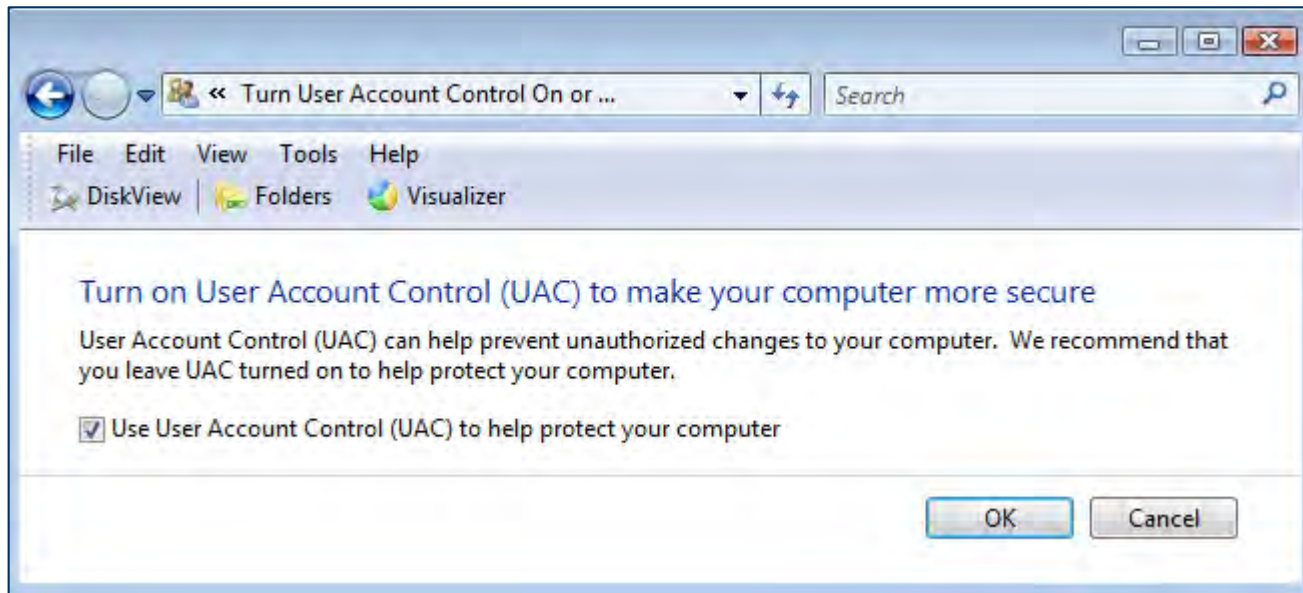

- **Malware Threats and Remedies**
- **Social Engineering**
- **Computer Security Best Practices**
- **User Access Control and Group Policies**

➤ **Firewalls**



# Firewalls

## ➤ What is a firewall?

- System that limits access between two or more networks
- Provides a barrier between your network and the Internet

## ➤ Firewall types

- Hardware (built into routers, wireless access points)
- Software (Windows Firewall, third-party programs)

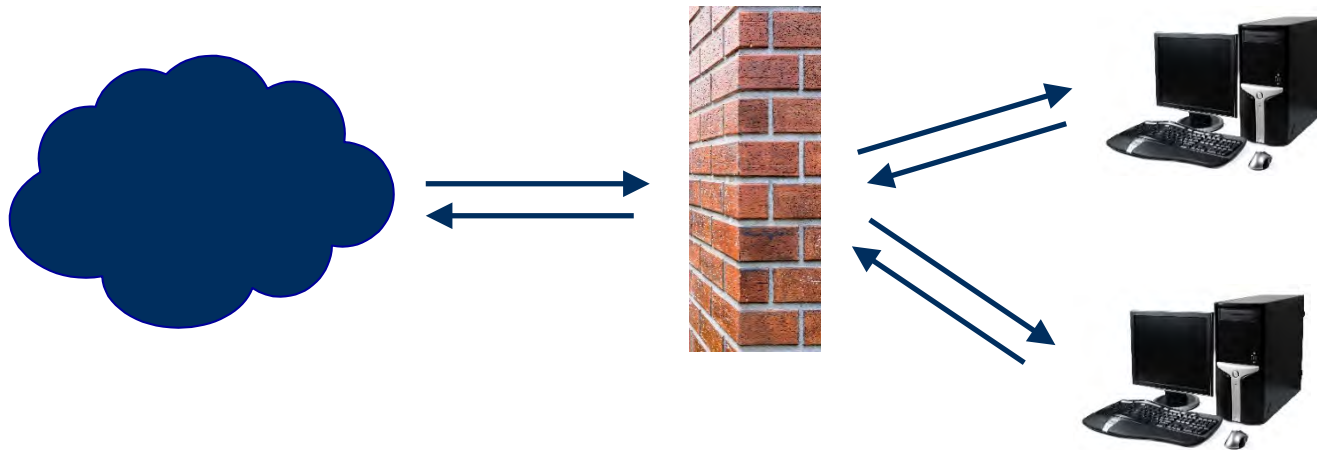



# Firewall Functions

- **Firewalls may perform one or more of the following functions**
- **Packet filter**
  - Examines header information of packets
  - Passes or blocks traffic based on IP addresses and/or other information (port number)
- **Proxy server**
  - Information from the Internet is retrieved by firewall, then sent to requesting client in the network
- **Stateful Packet Inspection (SPI)**
  - Maintains tables that track status of all connections passing through firewall
  - Firewall is programmed to distinguish legitimate packets for specific kinds of connections



# Windows Firewall

## ➤ Enabling/disabling Windows Firewall

- Select Control Panel | Windows Firewall
  - Click “Turn Windows Firewall on or off”

## ➤ Windows Firewall configuration

- Use Windows Firewall dialog for basic configuration
- Click “Advanced settings” to set
  - Inbound, outbound rules
  - Firewall monitoring

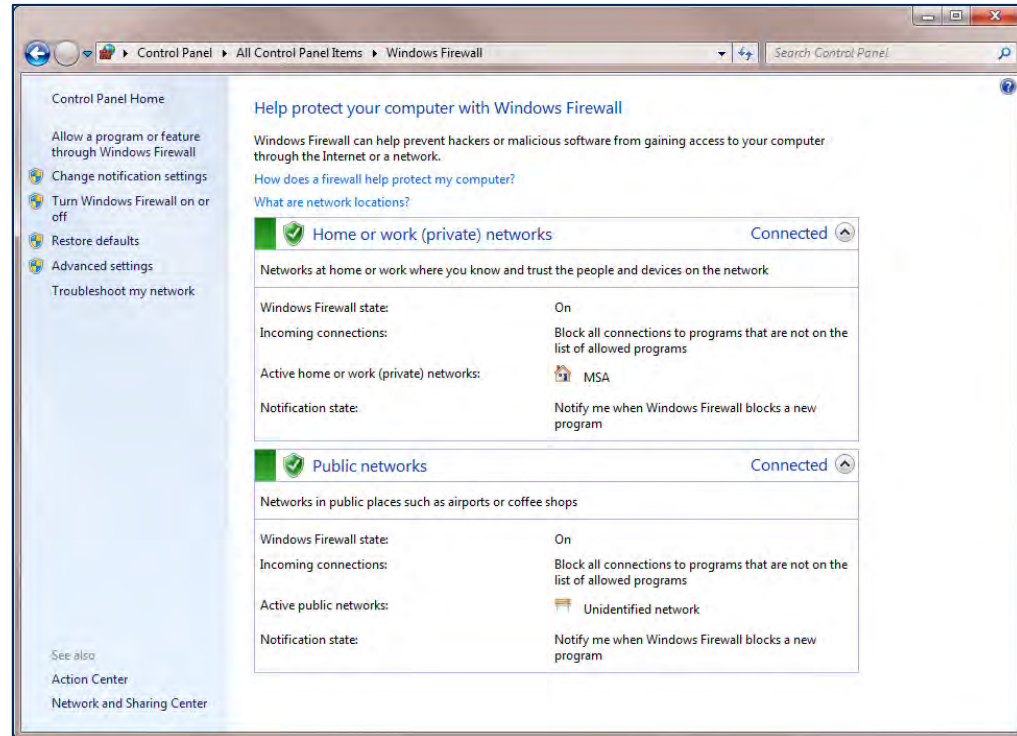

# Windows Firewall

## ➤ Exceptions

- In Windows Firewall dialog, click “Allow a program or feature through Windows Firewall”
- Select programs to allow through firewall

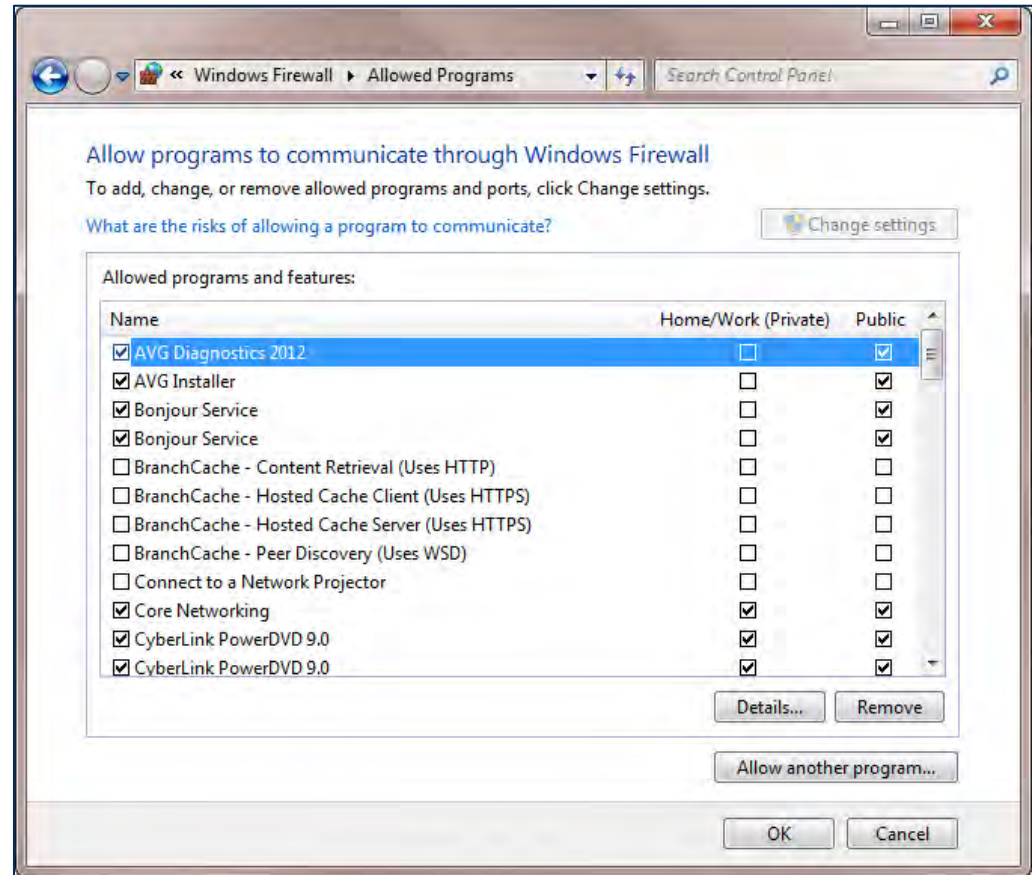

# Windows Security Tools

## ➤ Windows Security Center (Windows Vista)

- Provides status, control of Windows security tools
  - Windows Firewall
  - Windows Defender

## ➤ Windows Action Center (Windows 7)

- Provides status, control of Windows security tools
  - Windows Firewall
  - Windows Defender

## ➤ Windows Defender

- Microsoft free tool for preventing, scanning, and quarantining spyware

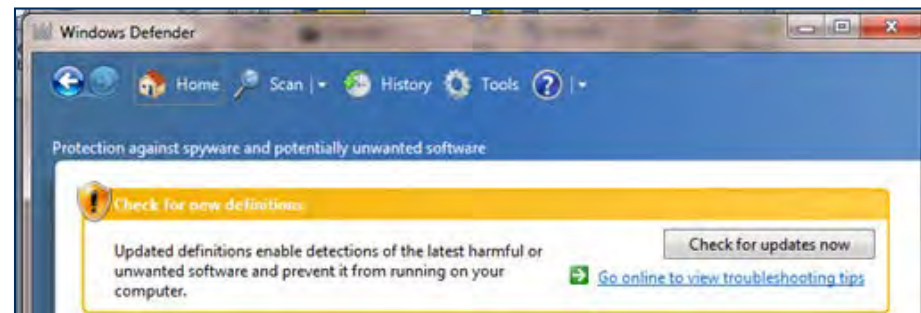
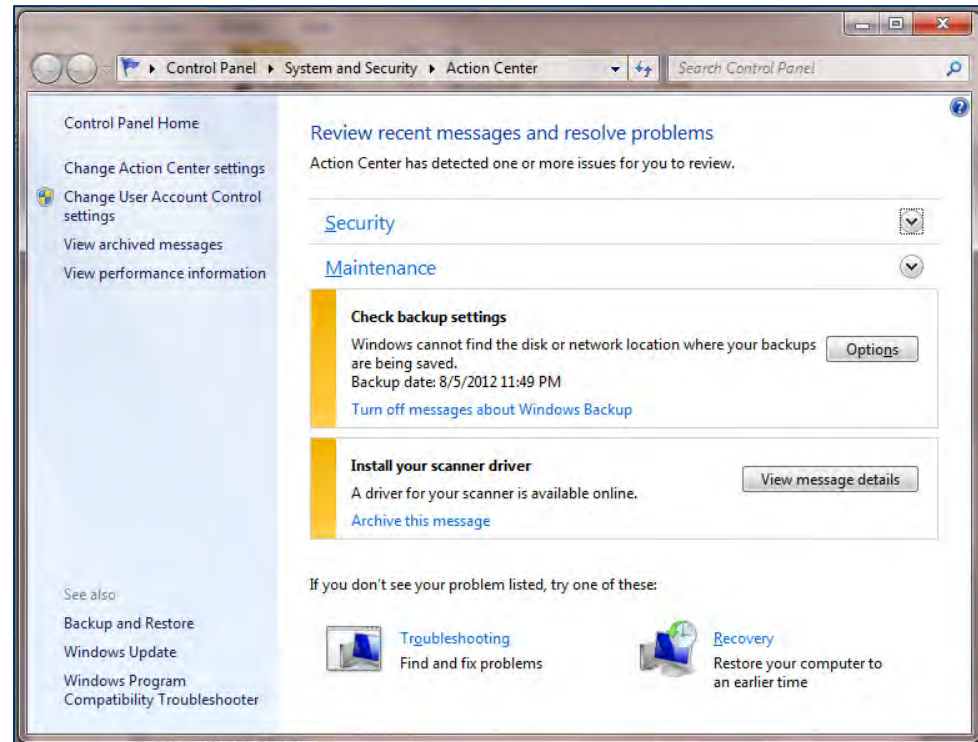

# Best Practices to Secure a Workstation

- **Requiring and setting strong passwords**
- **Restricting user permissions**
- **Changing default user names**
  - Example: `Admin` (default user name on many wireless routers)
- **Disabling guest account**
  - For older operating systems that did not disable by default
- **Screensaver required password**
  - Creating a screensaver password locks the computer while the screensaver is on
    - Screensaver password is the same password used to log on to Windows
- **Disabling autorun**
  - Disable autorun on removable media devices
  - Prevents malicious programs from automatically running when disk or device is inserted in computer



# Review Questions

- 1. While trying to remove malware from a client's computer, John has discovered that the malware program seems to spawn copies of itself with different names. What is this type of malware called?**
  - A. Worm
  - B. Time bomb
  - C. Polymorphic virus
  - D. Spyware
  
- 2. One virus detection method used by antivirus programs is to:**
  - A. Query the user for suspicious program activity
  - B. Scan for known virus signatures
  - C. Modify the file extensions of all executable files
  - D. Search the Internet for new virus types



# Review Questions

- 3. What the best way to protect confidential information on laptops and mobile devices?**
  - A. Enable geotracking
  - B. Require strong passwords
  - C. Encrypt the main storage disk or memory device
  - D. Have a scheduled backup procedure
  
- 4. Which Windows utility is used for central administration of user account and computer security policies?**
  - A. Group Policy Editor
  - B. Registry editor
  - C. Control Panel
  - D. Command line



# Review Questions

5. In computer incident response, keeping a record of who has possession of seized computer evidence is called:
- A. Computer identification
  - B. Chain of custody
  - C. Avoiding “social engineering” attacks
  - D. User login





# Chapter Summary

---

**In this chapter, you have learned how to**

- **Identify common security threats and vulnerabilities**
- **Describe computer security best practices and threat prevention strategies**
- **Explain how user accounts and security policies are used to implement security in a Windows system**
- **Explain the basic purpose and function of Windows firewalls**



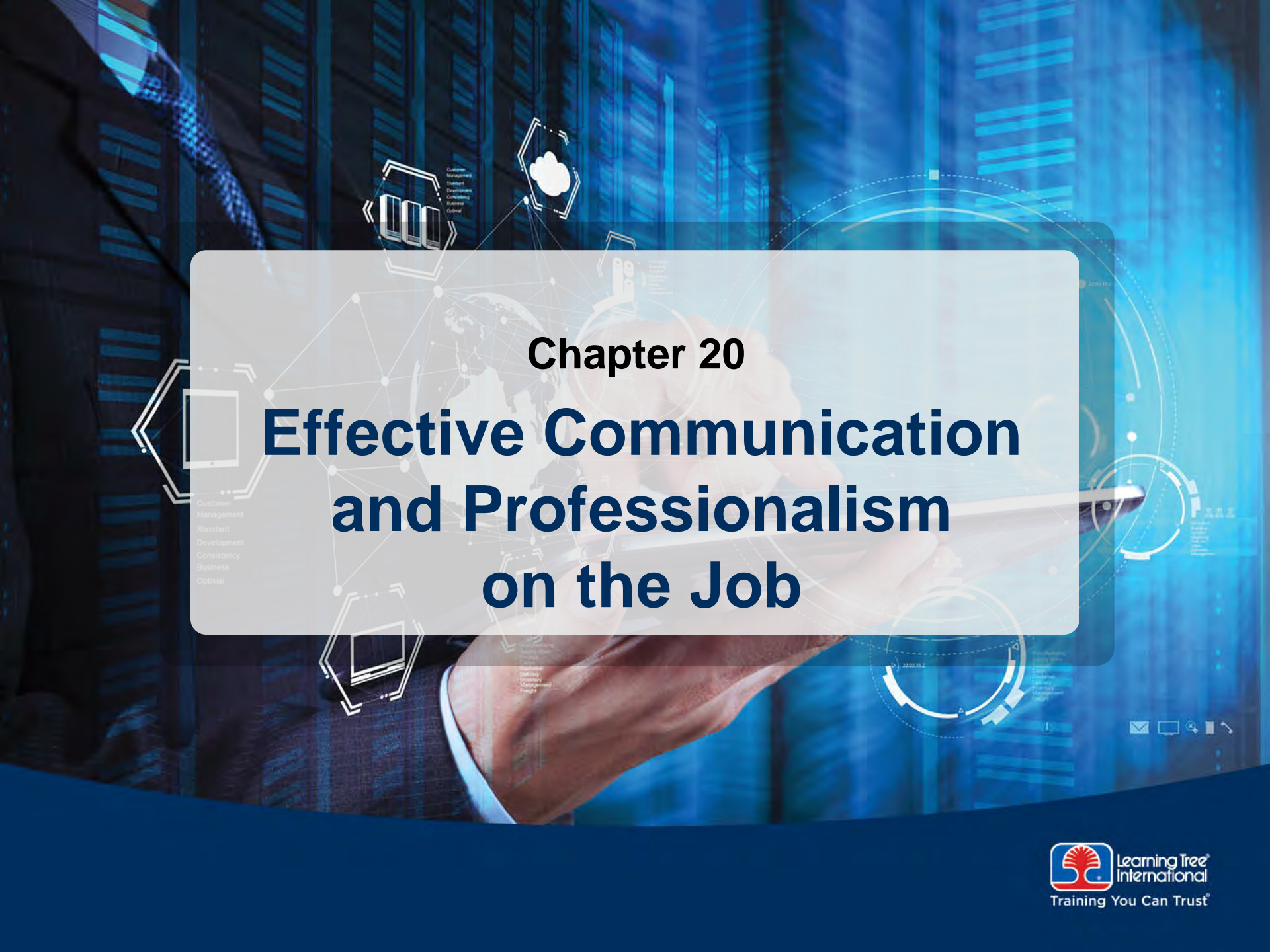

# Chapter 20

## Effective Communication and Professionalism on the Job

Customer  
Management  
Standard  
Development  
Consistency  
Business  
Optimal

# Chapter Objectives

---

**In this chapter, you will learn how to**

- **Describe the use of effective communication skills when dealing with customers**
- **Demonstrate professional behavior on the job, including respect for customers and their property**



## ➤ **Overview**

- **Effective Communication Skills**
- **Professional Behavior**



# Overview

- **In addition to excellent technical knowledge, providing superior computer support service requires**
  - Effective communication skills
  - Professional attitude and conduct



- **Overview**
- **Effective Communication Skills**
- **Professional Behavior**



# Effective Communication Skills

- **Effective communication skills are used to**
  - Elicit information and clues about a problem from a customer
  - Clarify what you'll be doing to resolve the problem
  - Answer customer questions
  - Train the customer in use of any installed devices



# Effective Communication Skills

- **Use the list of effective communication principles below to help answer the questions in this section**
  
- **Effective communication skills principles**
  - Use clear, concise, and direct statements
  - Allow the customer to complete statements—avoid interrupting
  - Actively listen—take notes
  - Use proper language—avoid jargon, acronyms, and slang
  - Be culturally sensitive
    - Use appropriate professional titles
  
- **Helpful communication techniques**
  - Ask neutral questions (“Has anything changed since the last time the computer worked normally?”)
  - Listen to the customer, and guide the conversation with relevant questions based on the information you hear





# Effective Communication Skills Questions

- 1. Jim, a customer, is describing a recurring problem with an Internet connection. You've run across a similar problem on another call recently, and you think you may know what's causing the problem. You should:**
  - A. Tell Jim you think you know what's causing the problem
  - B. Wait for Jim to finish his description of the problem, then ask a few clarifying questions
  - C. Tell Jim to call his Internet service provider for help
  - D. Start testing the Internet connection on Jim's computer
  
- 2. A customer calls you reporting a problem with her computer. She says there is no display, but that the orange light on the display monitor is on. You should ask the customer:**
  - A. To check the DVI connector on the rear of the PC
  - B. If she has recently installed a PCIe video card
  - C. To check whether the cable from the monitor is plugged into a connector on the back of the PC
  - D. To check the VGA connector on the rear of the PC



# Effective Communication Skills Questions

- 3. You have just finished installing a new inkjet printer for a customer. Before leaving, you should:**
- A. Tell him to try it out and give you a call if there are any problems
  - B. Take a few minutes to show him how to use the basic functions of the new printer
  - C. Ask him if any other departments could also use a new printer
  - D. Mention that he can purchase cheaper ink cartridge refills from third-party vendors
- 4. A employee is reporting that she has plugged her laptop into a network switch in the conference room, but she cannot connect to the Internet. Which would be a good question to ask first?**
- A. Is her laptop turned on?
  - B. Which Internet site is she trying to find?
  - C. Does she see any lights on the network switch, and if not, is the AC cord to the switch plugged in?
  - D. What firewall program is she using?



- **Overview**
- **Effective Communication Skills**
- **Professional Behavior**



# Professional Behavior

- **Use the list of professional behavior principles below to help answer the questions in this section**
- **Professional behavior principles**
  - Maintain a positive attitude and tone of voice
  - Be on time
    - If late, contact the customer
  - Avoid distractions
    - Do not take personal calls on the job
    - Avoid texting/social media sites
    - Focus on the customer
      - Do not talk to coworkers while interacting with customers
  - Avoid personal interruptions
  - Avoid being judgmental and/or insulting or calling the customer names
  - Respect customers' personal property: telephone, computer, printers, etc.



## ➤ Helpful hints

- Act with integrity
  - Take responsibility for any damage you may cause to customer systems or properties
  - Do not disclose experiences via social media sites
- Respect customer privacy, but report any illegal software or pornography to your supervisor
- Contact your management if a customer request falls outside the scope of your responsibilities, or if you are unsure of what to do

## ➤ Dealing with difficult customers or situations

- Avoid arguing with customers and/or being defensive
- Do not minimize customer's problems
- Display empathy; avoid being judgmental



# Professional Behavior

- **Set and meet expectations/timeline and communicate status with customer**
  - If applicable, offer other repair/replacement options
  - Provide proper documentation on services provided
  - Follow up with customer/user at a later date to verify satisfaction
  
- **Deal appropriately with customer's confidential materials**
  - Paper documents located on desktop or printer
  - Files/documents on computer



# Professional Behavior

## ➤ **Dealing with prohibited content/activity**

- Violations of company policy
- Pornography, improper materials

## ➤ **First response**

- Identify materials, document steps
- Report through proper channels (company management, incident response team)
- Preserve state of data/device
  - For evidence purposes

## ➤ **Documentation**

- Document all steps taken

## ➤ **Chain of custody**

- Isolate evidence for further investigation by law enforcement or incident response team
- Document chain of custody
  - Allows tracking of evidence/documenting process



## ➤ **Setting and meeting expectations**

- Communicate status/timeline with customer
- Provide proper documentation on services provided
- Follow up with customer at a later date to verify satisfaction

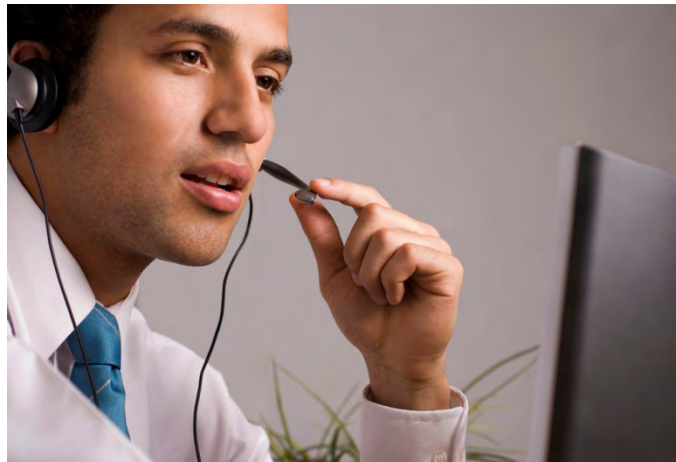



# Professional Behavior Questions

- 1. You've just finished a printer repair at a customer site and want to print a test page, but the printer is out of paper and the user has gone to a meeting. You should:**
  - A. Search nearby cabinets for paper
  - B. Ask the department manager for some paper to test the printer
  - C. Write a note by the printer asking the user to print a test page to verify the repair
  - D. Call the receptionist and ask him to call the user in her meeting
- 2. While working on a PC at a customer's desk, her phone rings. What should you do?**
  - A. Answer the phone and offer to take a message
  - B. Let the phone ring, and let the caller leave a message on the customer's voicemail system
  - C. Only answer the phone if it rings more than once
  - D. Ask the employee in the next cubicle if he can come over to answer the phone



# Professional Behavior Questions

- 3. An angry customer has called you on the help desk complaining that he has called several times and is not getting any help solving his problem. Which is the best way to respond?**
- A. “I’m sorry—I understand your frustration, and will do my best to help you.”
  - B. “Sir, please take a minute to calm down first, then we can talk.”
  - C. “Sorry, but I wasn’t on the previous calls, so don’t take it out on me...”
  - D. “So, exactly what is your problem?”
- 4. While working on an employee’s PC, you run across what appears to be illegal pornography. Which is the best course of action to take?**
- A. Don’t mention it to his supervisor, but discreetly let him know that he should delete it
  - B. Ignore it; it has nothing to do with fixing the PC problem
  - C. Inform your supervisor so that she can deal with it according to company policy
  - D. Delete the offending files



# Chapter Summary

---

**In this chapter, you have learned how to**

- **Describe the use of effective communication skills when dealing with customers**
- **Demonstrate professional behavior on the job, including respect for customers and their property**



# Chapter 21

## Course Summary

Customer  
Management  
Standard  
Development  
Consistency  
Business  
Optimal

# Course Summary

The main objective of this course is to

- Prepare you to pass the CompTIA A+ 220-901 and 220-902 exams

To accomplish this goal, you have learned how to

- Safely disassemble and reassemble a complete PC system
- Install and configure common PC motherboards and adapter cards
- Use an organized strategy to identify and troubleshoot common PC problems
- Select and install the correct type of RAM memory needed to upgrade a PC system
- Install and configure data storage systems, including hard disks, solid state drives (SSD), CD, and DVD-ROM drives
- Identify fundamental components of laptops and mobile devices and describe how to troubleshoot common problems



# Course Summary

- **Identify basic components of printer/scanner technologies and describe configuration/troubleshooting procedures**
- **Explain the fundamentals of using Windows, Mac OS, and Linux operating systems**
- **Describe procedures for installing and upgrading operating systems**
- **Explain methods for managing, optimizing, and troubleshooting Windows**
- **Identify and explain basic principles of computer networking**
- **List fundamental protocols and technologies of the Internet**
- **Describe fundamental principles of computer security**
- **Describe the use of effective communication skills and professional behavior on the job**



---

**Appendix A**  
**CompTIA 2015 A+ Exam Objectives**









# CompTIA A+ Certification Exam Objectives

## Exam Number: 220-901

### Introduction

In order to receive CompTIA A+ certification a candidate must pass two exams. The first exam is CompTIA A+ 220-901 Certification Exam. The CompTIA A+ 220-901 examination measures necessary competencies for an entry-level IT professional with the equivalent knowledge of at least 12 months of hands-on experience in the lab or field.

Successful candidates will have the knowledge required to:

- Assemble components based on customer requirements
- Install, configure and maintain devices, PCs and software for end users
- Understand the basics of networking and security/forensics
- Properly and safely diagnose, resolve and document common hardware and software issues
- Apply troubleshooting skills
- Provide appropriate customer support
- Understand the basics of virtualization, desktop imaging, and deployment

CompTIA A+ is accredited by ANSI to show compliance with the ISO 17024 Standard and, as such, undergoes regular reviews and updates to the exam objectives. The following CompTIA A+ 220-901 exam objectives result from subject matter expert workshops and industry-wide survey results regarding the skills and knowledge required of an entry-level IT professional. The percentages in this document represent the relative importance of the subject areas (domains) in the associated body of knowledge, and together establish the foundation of an entry-level IT professional.

This examination blueprint includes domain weighting, test objectives, and example content. Example topics and concepts are included to clarify the test objectives and should not be construed as a comprehensive listing of all the content of this examination.

Candidates are encouraged to use this document to guide their studies. The table below lists the domains measured by this examination and the extent to which they are represented. The CompTIA A+ 220-901 exam is based on these objectives.

Domain	Percentage of Examination
1.0 Hardware	34%
2.0 Networking	21%
3.0 Mobile Devices	17%
4.0 Hardware & Network Troubleshooting	28%
<b>Total</b>	100%

## CompTIA Authorized Materials Use Policy

CompTIA Certifications, LLC is not affiliated with and does not authorize, endorse or condone utilizing any content provided by unauthorized third-party training sites, aka 'brain dumps'. Individuals who utilize such materials in preparation for any CompTIA examination will have their certifications revoked and be suspended from future testing in accordance with the CompTIA Candidate Agreement. In an effort to more clearly communicate CompTIA's exam policies on use of unauthorized study materials, CompTIA directs all certification candidates to the CompTIA Certification Exam Policies webpage:

<http://certification.comptia.org/Training/testingcenters/policies.aspx>

Please review all CompTIA policies before beginning the study process for any CompTIA exam.

Candidates will be required to

abide by the CompTIA Candidate Agreement

(<http://certification.comptia.org/Training/testingcenters/policies/agreement.aspx>) at the time of exam delivery.

If a candidate has a question as to whether study materials are considered unauthorized (aka brain dumps), he/she should perform a search using CertGuard's engine, found here:

<http://www.certguard.com/search.asp>

Or verify against this list:

<http://certification.comptia.org/Training/testingcenters/policies/unauthorized.aspx>

**\*\*Note:** The lists of examples provided in bulleted format below each objective are not exhaustive lists. Other examples of technologies, processes or tasks pertaining to each objective may also be included on the exam although not listed or covered in this objectives document.

*CompTIA is constantly reviewing the content of our exams and updating test questions to be sure our exams are current and the security of the questions is protected. When necessary, we will publish updated exams based on existing exam objectives. Please know that all related exam preparation materials will still be valid.*

## 1.0 Hardware

### 1.1 Given a scenario, configure settings and use BIOS/UEFI tools on a PC.

- Firmware upgrades – flash BIOS
- BIOS component information
  - RAM
  - Hard drive
  - Optical drive
  - CPU
- BIOS configurations
  - Boot sequence
  - Enabling and disabling devices
  - Date/time
  - Clock speeds
  - Virtualization support
  - BIOS security (passwords, drive encryption: TPM, lo-jack, secure boot)
- Built-in diagnostics
- Monitoring
  - Temperature monitoring
  - Fan speeds
  - Intrusion detection/notification
  - Voltage
  - Clock
  - Bus speed

### 1.2 Explain the importance of motherboard components, their purpose, and properties.

- Sizes
  - ATX
  - Micro-ATX
  - Mini-ITX
  - ITX
- Expansion slots
  - PCI
  - PCI-X
  - PCIe
  - miniPCI
- RAM slots
- CPU sockets
- Chipsets
  - North Bridge
  - South Bridge
- CMOS battery
- Power connections and types
- Fan connectors
- Front/Top panel connectors
  - USB
  - Audio
  - Power button
  - Power light

- Drive activity lights
  - Reset button
- Bus speeds

### **1.3 Compare and contrast various RAM types and their features.**

- Types
  - DDR
  - DDR2
  - DDR3
  - SODIMM
  - DIMM
  - Parity vs. non-parity
  - ECC vs. non-ECC
  - RAM configurations
    - Single channel vs. dual channel vs. triple channel
  - Single sided vs. double sided
  - Buffered vs. unbuffered
- RAM compatibility

### **1.4 Install and configure PC expansion cards.**

- Sound cards
- Video cards
- Network cards
- USB cards
- Firewire cards
- Thunderbolt cards
- Storage cards
- Modem cards
- Wireless/cellular cards
- TV tuner cards
- Video capture cards
- Riser cards

### **1.5 Install and configure storage devices and use appropriate media.**

- Optical drives
  - CD-ROM / CD-RW
  - DVD-ROM / DVD-RW / DVD-RW DL
  - Blu-Ray
  - BD-R
  - BD-RE
- Magnetic hard disk drives
  - 5400 rpm
  - 7200 rpm
  - 10,000 rpm
- Hot swappable drives
- Solid state/flash drives
  - Compact flash
  - SD
  - Micro-SD
  - Mini-SD
  - xD
  - SSD
  - Hybrid

- eMMC
- RAID types
  - 0
  - 1
  - 5
  - 10
- Tape drive
- Media capacity
  - CD
  - CD-RW
  - DVD-RW
  - DVD
  - Blu-Ray
  - Tape
  - DVD DL

### 1.6 Install various types of CPUs and apply the appropriate cooling methods.

- Socket types
  - Intel: 775, 1155, 1156, 1366, 1150, 2011
  - AMD: AM3, AM3+, FM1, FM2, FM2+
- Characteristics
  - Speeds
  - Cores
  - Cache size/type
  - Hyperthreading
  - Virtualization support
  - Architecture (32-bit vs. 64-bit)
  - Integrated GPU
  - Disable execute bit
- Cooling
  - Heat sink
  - Fans
  - Thermal paste
  - Liquid-based
  - Fanless/passive

### 1.7 Compare and contrast various PC connection interfaces, their characteristics and purpose.

- Physical connections
  - USB 1.1 vs. 2.0 vs. 3.0
    - Connector types: A, B, mini, micro
  - Firewire 400 vs. Firewire 800
  - SATA1 vs. SATA2 vs. SATA3, eSATA
  - Other connector types
    - VGA
    - HDMI
    - DVI
    - Audio
      - Analog
      - Digital (Optical connector)
    - RJ-45
    - RJ-11
    - Thunderbolt
- Wireless connections
  - Bluetooth

- RF
- IR
- NFC
- Characteristics
  - Analog
  - Digital
  - Distance limitations
  - Data transfer speeds
  - Quality
  - DRM
  - Frequencies

**1.8 Install a power supply based on given specifications.**

- Connector types and their voltages
  - SATA
  - Molex
  - 4/8-pin 12v
  - PCIe 6/8-pin
  - 20-pin
  - 24-pin
- Specifications
  - Wattage
  - Dual rail
  - Size
  - Number of connectors
  - ATX
  - Micro-ATX
  - Dual voltage options

**1.9 Given a scenario, select the appropriate components for a custom PC configuration, to meet customer specifications or needs.**

- Graphic / CAD / CAM design workstation
  - Multicore processor
  - High-end video
  - Maximum RAM
- Audio/Video editing workstation
  - Specialized audio and video card
  - Large fast hard drive
  - Dual monitors
- Virtualization workstation
  - Maximum RAM and CPU cores
- Gaming PC
  - Multicore processor
  - High-end video/specialized GPU
  - High definition sound card
  - High-end cooling
- Home Theater PC
  - Surround sound audio
  - HDMI output
  - HTPC compact form factor
  - TV tuner
- Standard thick client
  - Desktop applications
  - Meets recommended requirements for selected OS
- Thin client

- Basic applications
- Meets minimum requirements for selected OS
- Network connectivity
- Home Server PC
  - Media streaming
  - File sharing
  - Print sharing
  - Gigabit NIC
  - RAID array

#### **1.10 Compare and contrast types of display devices and their features.**

- Types
  - LCD
    - TN vs. IPS
    - Flourescent vs. LED backlighting
  - Plasma
  - Projector
  - OLED
- Refresh / frame rates
- Resolution
- Native resolution
- Brightness/lumens
- Analog vs. digital
- Privacy/antiglare filters
- Multiple displays
- Aspect ratios
  - 16:9
  - 16:10
  - 4:3

#### **1.11 Identify common PC connector types and associated cables.**

- Display connector types
  - DVI-D
  - DVI-I
  - DVI-A
  - DisplayPort
  - RCA
  - HD15 (i.e. DE15 or DB15)
  - BNC
  - miniHDMI
  - miniDin-6
- Display cable types
  - HDMI
  - DVI
  - VGA
  - Component
  - Composite
  - Coaxial
- Device cables and connectors
  - SATA
  - eSATA
  - USB
  - Firewire (IEEE1394)
  - PS/2

- Audio
- Adapters and converters
  - DVI to HDMI
  - USB A to USB B
  - USB to Ethernet
  - DVI to VGA
  - Thunderbolt to DVI
  - PS/2 to USB
  - HDMI to VGA

### 1.12 Install and configure common peripheral devices.

- Input devices
  - Mouse
  - Keyboard
  - Scanner
  - Barcode reader
  - Biometric devices
  - Game pads
  - Joysticks
  - Digitizer
  - Motion sensor
  - Touch pads
  - Smart card readers
  - Digital cameras
  - Microphone
  - Webcam
  - Camcorder
- Output devices
  - Printers
  - Speakers
  - Display devices
- Input & Output devices
  - Touch screen
  - KVM
  - Smart TV
  - Set-Top Box
  - MIDI enabled devices

### 1.13 Install SOHO multifunction device / printers and configure appropriate settings.

- Use appropriate drivers for a given operating system
  - Configuration settings
    - Duplex
    - Collate
    - Orientation
    - Quality
- Device sharing
  - Wired
    - USB
    - Serial
    - Ethernet
  - Wireless
    - Bluetooth
    - 802.11(a,b,g,n,ac)
    - Infrastructure vs. adhoc
  - Integrated print server (hardware)



- Cloud printing/remote printing
- Public/shared devices
  - Sharing local/networked device via Operating System settings
    - TCP/Bonjour/AirPrint
  - Data privacy
    - User authentication on the device
    - Hard drive caching

**1.14 Compare and contrast differences between the various print technologies and the associated imaging process.**

- Laser
  - Imaging drum, fuser assembly, transfer belt, transfer roller, pickup rollers, separate pads, duplexing assembly
  - Imaging process: processing, charging, exposing, developing, transferring, fusing and cleaning
- Inkjet
  - Ink cartridge, print head, roller, feeder, duplexing assembly, carriage and belt
  - Calibration
- Thermal
  - Feed assembly, heating element
  - Special thermal paper
- Impact
  - Print head, ribbon, tractor feed
  - Impact paper
- Virtual
  - Print to file
  - Print to PDF
  - Print to XPS
  - Print to image

**1.15 Given a scenario, perform appropriate printer maintenance.**

- Laser
  - Replacing toner, applying maintenance kit, calibration, cleaning
- Thermal
  - Replace paper, clean heating element, remove debris
- Impact
  - Replace ribbon, replace print head, replace paper
- Inkjet
  - Clean heads, replace cartridges, calibration, clear jams

## **2.0 Networking**

**2.1 Identify the various types of network cables and connectors.**

- Fiber
  - Connectors: SC, ST and LC
- Twisted Pair
  - Connectors: RJ-11, RJ-45
  - Wiring standards: T568A, T568B
- Coaxial
  - Connectors: BNC, F-connector

**2.2 Compare and contrast the characteristics of connectors and cabling.**

- Fiber
  - Types (single-mode vs. multi-mode)

- Speed and transmission limitations
- Twisted pair
  - Types: STP, UTP, CAT3, CAT5, CAT5e, CAT6, CAT6e, CAT7, plenum, PVC
  - Speed and transmission limitations
  - Splitters and effects on signal quality
- Coaxial
  - Types: RG-6, RG-59
  - Speed and transmission limitations
  - Splitters and effects on signal quality

### **2.3 Explain the properties and characteristics of TCP/IP.**

- IPv4 vs. IPv6
- Public vs. private vs. APIPA/link local
- Static vs. dynamic
- Client-side DNS settings
- Client-side DHCP
- Subnet mask vs. CIDR
- Gateway

### **2.4 Explain common TCP and UDP ports, protocols, and their purpose.**

- Ports
  - 21 – FTP
  - 22 – SSH
  - 23 – TELNET
  - 25 – SMTP
  - 53 – DNS
  - 80 – HTTP
  - 110 – POP3
  - 143 – IMAP
  - 443 – HTTPS
  - 3389 – RDP
  - 137-139, 445 - SMB
  - 548 or 427 - AFP
- Protocols
  - DHCP
  - DNS
  - LDAP
  - SNMP
  - SMB
  - CIFS
  - SSH
  - AFP
- TCP vs. UDP

### **2.5 Compare and contrast various WiFi networking standards and encryption types.**

- Standards
  - 802.11 a/b/g/n/ac
  - Speeds, distances and frequencies
- Encryption types
  - WEP, WPA, WPA2, TKIP, AES

### **2.6 Given a scenario, install and configure SOHO wireless/wired router and apply appropriate settings.**

- Channels

- Port forwarding, port triggering
- DHCP (on/off)
- DMZ
- NAT / DNAT
- Basic QoS
- Firmware
- UPnP

### **2.7 Compare and contrast Internet connection types, network types, and their features.**

- Internet Connection Types
  - Cable
  - DSL
  - Dial-up
  - Fiber
  - Satellite
  - ISDN
  - Cellular
    - Tethering
    - Mobile hotspot
  - Line of sight wireless internet service
- Network Types
  - LAN
  - WAN
  - PAN
  - MAN

### **2.8 Compare and contrast network architecture devices, their functions, and features.**

- Hub
- Switch
- Router
- Access point
- Bridge
- Modem
- Firewall
- Patch panel
- Repeaters/extenders
- Ethernet over Power
- Power over Ethernet injector

### **2.9 Given a scenario, use appropriate networking tools.**

- Crimper
- Cable stripper
- Multimeter
- Tone generator & probe
- Cable tester
- Loopback plug
- Punchdown tool
- WiFi analyzer

## **3.0 Mobile Devices**

### **3.1 Install and configure laptop hardware and components.**

- Expansion options

- Express card /34
- Express card /54
- SODIMM
- Flash
- Ports/Adapters
  - Thunderbolt
  - DisplayPort
  - USB to RJ-45 dongle
  - USB to WiFi dongle
  - USB to Bluetooth
  - USB Optical Drive
- Hardware/device replacement
  - Keyboard
  - Hard Drive
    - SSD vs. Hybrid vs. Magnetic disk
    - 1.8in vs. 2.5in
  - Memory
  - Smart card reader
  - Optical drive
  - Wireless card
  - Mini-PCIe
  - Screen
  - DC jack
  - Battery
  - Touchpad
  - Plastics/frames
  - Speaker
  - System board
  - CPU

### 3.2 Explain the function of components within the display of a laptop.

- Types
  - LCD
    - TTL vs. IPS
    - Fluorescent vs. LED backlighting
  - OLED
- Wi-Fi antenna connector/placement
- Webcam
- Microphone
- Inverter
- Digitizer

### 3.3 Given a scenario, use appropriate laptop features.

- Special function keys
  - Dual displays
  - Wireless (on/off)
  - Cellular (on/off)
  - Volume settings
  - Screen brightness
  - Bluetooth (on/off)
  - Keyboard backlight
  - Touch pad (on/off)
  - Screen orientation
  - Media options (fast forward/rewind)
  - GPS (on/off)

- Airplane mode
- Docking station
- Physical laptop lock and cable lock
- Rotating / removable screens

### **3.4 Explain the characteristics of various types of other mobile devices.**

- Tablets
- Smart phones
- Wearable technology devices
  - Smart watches
  - Fitness monitors
  - Glasses and headsets
- Phablets
- e-Readers
- Smart camera
- GPS

### **3.5 Compare and contrast accessories & ports of other mobile devices.**

- Connection types
  - NFC
  - Proprietary vendor specific ports (communication/power)
  - microUSB/miniUSB
  - Lightning
  - Bluetooth
  - IR
  - Hotspot / tethering
- Accessories
  - Headsets
  - Speakers
  - Game pads
  - Docking stations
  - Extra battery packs/battery chargers
  - Protective covers / water proofing
  - Credit card readers
  - Memory/MicroSD

## **4.0 Hardware and Network Troubleshooting**

### **4.1 Given a scenario, troubleshoot common problems related to motherboards, RAM, CPU and power with appropriate tools.**

- Common symptoms
  - Unexpected shutdowns
  - System lockups
  - POST code beeps
  - Blank screen on bootup
  - BIOS time and settings resets
  - Attempts to boot to incorrect device
  - Continuous reboots
  - No power
  - Overheating
  - Loud noise
  - Intermittent device failure
  - Fans spin – no power to other devices
  - Indicator lights

- Smoke
- Burning smell
- Proprietary crash screens (BSOD/pin wheel)
- Distended capacitors
- Tools
  - Multimeter
  - Power supply tester
  - Loopback plugs
  - POST card / USB

**4.2 Given a scenario, troubleshoot hard drives and RAID arrays with appropriate tools.**

- Common symptoms
  - Read/write failure
  - Slow performance
  - Loud clicking noise
  - Failure to boot
  - Drive not recognized
  - OS not found
  - RAID not found
  - RAID stops working
  - Proprietary crash screens (BSOD/pin wheel)
  - S.M.A.R.T. errors
- Tools
  - Screwdriver
  - External enclosures
  - CHKDSK
  - FORMAT
  - File recovery software
  - Bootrec
  - Diskpart
  - Defragmentation tool

**4.3 Given a scenario, troubleshoot common video, projector and display issues.**

- Common symptoms
  - VGA mode
  - No image on screen
  - Overheat shutdown
  - Dead pixels
  - Artifacts
  - Color patterns incorrect
  - Dim image
  - Flickering image
  - Distorted image
  - Distorted geometry
  - Burn-in
  - Oversized images and icons

**4.4 Given a scenario, troubleshoot wired and wireless networks with appropriate tools.**

- Common symptoms
  - No connectivity
  - APIPA/link local address
  - Limited connectivity
  - Local connectivity
  - Intermittent connectivity
  - IP conflict

- Slow transfer speeds
- Low RF signal
- SSID not found
- Hardware tools
  - Cable tester
  - Loopback plug
  - Punch down tools
  - Tone generator and probe
  - Wire strippers
  - Crimper
  - Wireless locator
- Command line tools
  - PING
  - IPCONFIG/IFCONFIG
  - TRACERT
  - NETSTAT
  - NBTSTAT
  - NET
  - NETDOM
  - NSLOOKUP

**4.5 Given a scenario, troubleshoot and repair common mobile device issues while adhering to the appropriate procedures.**

- Common symptoms
  - No display
  - Dim display
  - Flickering display
  - Sticking keys
  - Intermittent wireless
  - Battery not charging
  - Ghost cursor/pointer drift
  - No power
  - Num lock indicator lights
  - No wireless connectivity
  - No Bluetooth connectivity
  - Cannot display to external monitor
  - Touchscreen non-responsive
  - Apps not loading
  - Slow performance
  - Unable to decrypt email
  - Extremely short battery life
  - Overheating
  - Frozen system
  - No sound from speakers
  - GPS not functioning
  - Swollen battery
- Disassembling processes for proper re-assembly
  - Document and label cable and screw locations
  - Organize parts
  - Refer to manufacturer resources
  - Use appropriate hand tools

**4.6 Given a scenario, troubleshoot printers with appropriate tools.**

- Common symptoms
  - Streaks

- Faded prints
- Ghost images
- Toner not fused to the paper
- Creased paper
- Paper not feeding
- Paper jam
- No connectivity
- Garbled characters on paper
- Vertical lines on page
- Backed up print queue
- Low memory errors
- Access denied
- Printer will not print
- Color prints in wrong print color
- Unable to install printer
- Error codes
- Printing blank pages
- No image on printer display
- Tools
  - Maintenance kit
  - Toner vacuum
  - Compressed air
  - Printer spooler

## CompTIA A+ Acronyms

### Introduction

The following is a list of acronyms which appear on the CompTIA A+ exams. Candidates are encouraged to review the complete list and attain a working knowledge of all listed acronyms as a part of a comprehensive exam preparation program.

<b>Acronym</b>	<b>Definition</b>
AC	alternating current
ACL	access control list
ACPI	advanced configuration power interface
ACT	activity
ADSL	asymmetrical digital subscriber line
AGP	accelerated graphics port
AHCI	Advanced host controller interface
AP	Access point
APIPA	automatic private internet protocol addressing
APM	advanced power management
ARP	address resolution protocol
ASR	automated system recovery
ATA	advanced technology attachment



ATAPI	advanced technology attachment packet interface
ATM	asynchronous transfer mode
ATX	advanced technology extended
AUP	Acceptable Use Policy
A/V	Audio Video
BIOS	basic input/output system
BNC	Bayonet-Neill-Concelman or British Naval Connector
BTX	balanced technology extended
CAPTCHA	Completely Automated Public Turing Test To Tell Computers and Humans Apart
CCFL	Cold Cathode Fluorescent Lamp
CD	compact disc
CD-ROM	compact disc-read-only memory
CD-RW	compact disc-rewritable
CDFS	compact disc file system
CFS	Central File System, Common File System, Command File System
CIFS	Common Internet File System
CMOS	complementary metal-oxide semiconductor
CNR	Communications and Networking Riser
COMx	communication port (x=port number)
CPU	central processing unit
CRT	cathode-ray tube
DAC	discretionary access control
DB-25	serial communications D-shell connector, 25 pins
DB-9	9 pin D shell connector
DC	direct current
DDOS	distributed denial of service
DDR	double data-rate
DDR RAM	double data-rate random access memory
DDR SDRAM	double data-rate synchronous dynamic random access memory
DFS	distributed file system
DHCP	dynamic host configuration protocol
DIMM	dual inline memory module
DIN	Deutsche Industrie Norm
DLT	digital linear tape
DLP	digital light processing
DMA	direct memory access
DMZ	demilitarized zone
DNS	domain name service or domain name server
DOS	denial of service
DRAM	dynamic random access memory
DRM	Digital Rights Management
DSL	digital subscriber line
DVD	digital video disc or digital versatile disc

DVD-RAM	digital video disc-random access memory
DVD-ROM	digital video disc-read only memory
DVD-R	digital video disc-recordable
DVD-RW	digital video disc-rewritable
DVI	digital visual interface
ECC	error correcting code/error checking and correction
ECP	extended capabilities port
EEPROM	electrically erasable programmable read-only memory
EFS	encrypting file system
EIDE	enhanced integrated drive electronics
EMI	electromagnetic interference
EMP	electromagnetic pulse
EPROM	erasable programmable read-only memory
EPP	enhanced parallel port
ERD	emergency repair disk
ESD	electrostatic discharge
EULA	End User License Agreement
EVGA	extended video graphics adapter/array
EVDO	evolution data optimized or evolution data only
FAT	file allocation table
FAT12	12-bit file allocation table
FAT16	16-bit file allocation table
FAT32	32-bit file allocation table
FDD	floppy disk drive
Fn	Function (referring to the function key on a laptop)
FPM	fast page-mode
FRU	field replaceable unit
FSB	Front Side Bus
FTP	file transfer protocol
FQDN	fully qualified domain name
Gb	gigabit
GB	gigabyte
GDI	graphics device interface
GHz	gigahertz
GUI	graphical user interface
GPS	global positioning system
GSM	global system for mobile communications
HAL	hardware abstraction layer
HAV	Hardware Assisted Virtualization
HCL	hardware compatibility list
HDD	hard disk drive
HDMI	high definition media interface
HPFS	high performance file system
HTML	hypertext markup language

HTPC	home theater PC
HTTP	hypertext transfer protocol
HTTPS	hypertext transfer protocol over secure sockets layer
I/O	input/output
ICMP	internet control message protocol
ICR	intelligent character recognition
IDE	integrated drive electronics
IDS	Intrusion Detection System
IEEE	Institute of Electrical and Electronics Engineers
IIS	Internet Information Services
IMAP	internet mail access protocol
IMEI	International Mobile Equipment Identity
IMSI	International Mobile Subscriber Identity
IP	internet protocol
IPCONFIG	internet protocol configuration
IPP	internet printing protocol
IPS	In-plane Switching
IPSEC	Internet Protocol Security
IR	Infrared
IrDA	Infrared Data Association
IRP	Incident Response Plan
IRQ	Interrupt Request
ISDN	Integrated Services Digital Network
ISO	International Organization for Standardization/Industry Standards Organization
ISP	Internet Service Provider
JBOD	Just a Bunch of Disks
Kb	Kilobit
KB	Kilobyte or Knowledge Base
LAN	Local Area Network
LBA	Logical Block Addressing
LC	Lucent Connector
LCD	liquid Crystal Display
LDAP	lightweight directory access protocol
LED	light emitting diode
Li-on	lithium-ion
LPD/LPR	line printer daemon / line printer remote
LPT	line printer terminal
LVD	low voltage differential
MAC	media access control / mandatory access control
MAPI	messaging application programming interface
MAU	media access unit, media attachment unit
Mb	megabit
MB	megabyte
MBR	master boot record

MBSA	Microsoft Baseline Security Analyzer
MFD	multi-function device
MFP	multi-function product
MHz	megahertz
MicroDIMM	micro dual inline memory module
MIDI	musical instrument digital interface
MIME	multipurpose internet mail extension
MIMO	Multiple Input Multiple Output
MMC	Microsoft management console
MP3	Moving Picture Experts Group Layer 3 Audio
MP4	Moving Picture Experts Group Layer 4
MPEG	Moving Picture Experts Group
MSCONFIG	Microsoft configuration
MSDS	material safety data sheet
MUI	multilingual user interface
NAC	network access control
NAS	network-attached storage
NAT	network address translation
NetBIOS	networked basic input/output system
NetBEUI	networked basic input/output system extended user interface
NFS	network file system
NIC	network interface card
NiCd	nickel cadmium
NiMH	nickel metal hydride
NLX	new low-profile extended
NNTP	network news transfer protocol
NTFS	new technology file system
NTLDR	new technology loader
NTP	Network Time Protocol
OCR	optical character recognition
OEM	original equipment manufacturer
OLED	Organic Light Emitting Diode
OS	operating system
PAN	personal area network
PATA	parallel advanced technology attachment
PC	personal computer
PCI	peripheral component interconnect
PCIe	peripheral component interconnect express
PCIX	peripheral component interconnect extended
PCL	printer control language
PCMCIA	Personal Computer Memory Card International Association
PE	Preinstallation Environment
PGA	pin grid array
PGA2	pin grid array 2

PII	Personally Identifiable Information
PIN	personal identification number
PKI	public key infrastructure
PnP	plug and play
POP3	post office protocol 3
PoS	Point of Sale
POST	power-on self test
POTS	plain old telephone service
PPP	point-to-point protocol
PPTP	point-to-point tunneling protocol
PRI	primary rate interface
PROM	programmable read-only memory
PS/2	personal system/2 connector
PSTN	public switched telephone network
PSU	power supply unit
PVC	permanent virtual circuit
PXE	preboot execution environment
QoS	quality of service
RAID	redundant array of independent (or inexpensive) discs
RAM	random access memory
RAS	remote access service
RDP	Remote Desktop Protocol
RF	radio frequency
RFI	radio frequency interference
RGB	red green blue
RIP	routing information protocol
RIS	remote installation service
RISC	reduced instruction set computer
RJ-11	registered jack function 11
RJ-45	registered jack function 45
RMA	returned materials authorization
ROM	read only memory
RTC	real-time clock
SAN	storage area network
SAS	Serial Attached SCSI
SATA	serial advanced technology attachment
SC	subscription channel
SCP	secure copy protection
SCSI	small computer system interface
SCSI ID	small computer system interface identifier
SD card	secure digital card
SDRAM	synchronous dynamic random access memory
SEC	single edge connector
SFC	system file checker

SFF	Small Form Factor
SLI	scalable link interface or system level integration or scanline interleave mode
S.M.A.R.T.	self-monitoring, analysis, and reporting technology
SMB	server message block or small to midsize business
SMTP	simple mail transfer protocol
SNMP	simple network management protocol
SoDIMM	small outline dual inline memory module
SOHO	small office/home office
SP	service pack
SPDIF	Sony-Philips digital interface format
SPGA	staggered pin grid array
SRAM	static random access memory
SSH	secure shell
SSID	service set identifier
SSL	secure sockets layer
ST	straight tip
STP	shielded twisted pair
SXGA	super extended graphics array
TB	terabyte
TCP	transmission control protocol
TCP/IP	transmission control protocol/internet protocol
TDR	time domain reflectometer
TFTP	trivial file transfer protocol
TKIP	Temporal Key Integrity Protocol
TPM	trusted platform module
UAC	user account control
UDF	user defined functions or universal disk format or universal data format
UDP	user datagram protocol
UEFI	Unified Extensible Firmware Interface
UNC	universal naming convention
UPS	uninterruptible power supply
URL	uniform resource locator
USB	universal serial bus
USMT	user state migration tool
UTP	unshielded twisted pair
UXGA	ultra extended graphics array
VESA	Video Electronics Standards Association
VFAT	virtual file allocation table
VGA	video graphics array
VM	Virtual Machine
VoIP	voice over internet protocol
VPN	virtual private network
VRAM	video random access memory
WAN	wide area network

WAP	wireless access protocol/wireless access point
WEP	wired equivalent privacy
WIFI	wireless fidelity
WINS	windows internet name service
WLAN	wireless local area network
WPA	wireless protected access
WPS	WiFi Protected Setup
WUXGA	wide ultra extended graphics array
XGA	extended graphics array
ZIF	zero-insertion-force
ZIP	zigzag inline package

### **A+ Proposed Hardware and Software List**

\*\* CompTIA has included this sample list of hardware and software to assist candidates as they prepare for the A+ exam. This list may also be helpful for training companies who wish to create a lab component to their training offering. The bulleted lists below each topic are a sample list and not exhaustive.

#### Equipment

- Apple tablet / Smart phone
- Android tablet / Smart phone
- Windows tablet / Smart phone
- Windows Laptop / Mac Laptop / Linux Laptop
- Windows Desktop / Mac Desktop / Linux Desktop
- Monitors
- Projectors
- SOHO Router/switch
- Access point
- VoIP phone
- Printer
  - Laser / Inkjet
  - Wireless
- Surge suppressor
- UPS

#### Spare parts/hardware

- Motherboards
- RAM
- Hard drives

- Power supplies
- Video cards
- Sounds cards
- Network cards
- Wireless NICs
- Fans/cooling devices/heat sink
- CPUs
- Assorted connectors/cables
  - USB
  - HDMI
  - etc
- Adapters
- Network cables
- Unterminated network cable / connectors
- AC adapters
- Optical drives
- Screws/stand-offs
- Cases
- Maintenance kit
- Mice/keyboards

### Tools

- Screw drivers
- Multimeter
- Wire cutters
- Punchdown tool
- Crimper
- Power supply tester
- Cable stripper
- POST cards
- Standard technician toolkit
- ESD strap
- Thermal paste
- Cable tester
- WiFi analyzer
- SATA to USB connectors

### Software

- Operating system disks
- Antivirus software



- Virtualization software
- Antimalware
- Driver software



# CompTIA A+ Certification Exam Objectives

## Exam Number: 220-902

### Introduction

In order to receive CompTIA A+ certification a candidate must pass two exams. The first exam is the CompTIA A+ 220-902 Certification Exam. The CompTIA A+ 220-902 Certification Exam is the second exam required in order for CompTIA A+ certification candidates to complete their certification.

The CompTIA A+ 220-902 examination measures necessary competencies for an entry-level IT professional with the equivalent knowledge of at least 12 months of hands-on experience in the lab or field.

Successful candidates will have the knowledge required to:

- Assemble components based on customer requirements
- Install, configure and maintain devices, PCs and software for end users
- Understand the basics of networking and security/forensics
- Properly and safely diagnose, resolve and document common hardware and software issues
- Apply troubleshooting skills
- Provide appropriate customer support
- Understand the basics of virtualization, desktop imaging, and deployment.

CompTIA A+ is accredited by ANSI to show compliance with the ISO 17024 Standard and, as such, undergoes regular reviews and updates to the exam objectives. The following CompTIA A+ 220-902 certification exam objectives result from subject matter expert workshops and industry-wide survey results regarding the skills and knowledge required of an entry-level IT professional. The percentages in this document represent the relative importance of the subject areas (domains) in the associated body of knowledge, and together establish the foundation of an entry-level IT professional.

This examination blueprint includes domain weighting, test objectives, and example content. Example topics and concepts are included to clarify the test objectives and should not be construed as a comprehensive listing of all the content of this examination.

Candidates are encouraged to use this document to guide their studies. The table below lists the domains measured by this examination and the extent to which they are represented. The CompTIA A+ 220-902 certification exam is based on these objectives.

Domain	Percentage of Examination
1.0 Windows Operating Systems	29%
2.0 Other Operating Systems & Technologies	12%
3.0 Security	22%
4.0 Software Troubleshooting	24%
5.0 Operational Procedures	13%
<b>Total</b>	100%

## CompTIA Authorized Materials Use Policy

CompTIA Certifications, LLC is not affiliated with and does not authorize, endorse or condone utilizing any content provided by unauthorized third-party training sites, aka 'brain dumps'. Individuals who utilize such materials in preparation for any CompTIA examination will have their certifications revoked and be suspended from future testing in accordance with the CompTIA Candidate Agreement. In an effort to more clearly communicate CompTIA's exam policies on use of unauthorized study materials, CompTIA directs all certification candidates to the CompTIA Certification Exam Policies webpage:

<http://certification.comptia.org/Training/testingcenters/policies.aspx>

Please review all CompTIA policies before beginning the study process for any CompTIA exam. Candidates will be required to abide by the CompTIA Candidate Agreement (<http://certification.comptia.org/Training/testingcenters/policies/agreement.aspx>) at the time of exam delivery.

If a candidate has a question as to whether study materials are considered unauthorized (aka brain dumps), he/she should perform a search using CertGuard's engine, found here: <http://www.certguard.com/search.asp>

Or verify against this list:

<http://certification.comptia.org/Training/testingcenters/policies/unauthorized.aspx>

**\*\*Note:** The lists of examples provided in bulleted format below each objective are not exhaustive lists. Other examples of technologies, processes or tasks pertaining to each objective may also be included on the exam although not listed or covered in this objectives document.

*CompTIA is constantly reviewing the content of our exams and updating test questions to be sure our exams are current and the security of the questions is protected. When necessary, we will publish updated exams based on existing exam objectives. Please know that all related exam preparation materials will still be valid.*

## 1.0 Windows Operating Systems

### 1.1 Compare and contrast various features and requirements of Microsoft Operating Systems (Windows Vista, Windows 7, Windows 8, Windows 8.1).

- Features:
  - 32-bit vs. 64-bit
  - Aero, gadgets, user account control, bit-locker, shadow copy, system restore, ready boost, sidebar, compatibility mode, virtual XP mode, easy transfer, administrative tools, defender, Windows firewall, security center, event viewer, file structure and paths, category view vs. classic view.
  - Side by side apps, Metro UI, Pinning, One Drive, Windows store, Multimonitor task bars, Charms, Start Screen, Power Shell, Live sign in, Action Center.
- Upgrade paths – differences between in place upgrades, compatibility tools, Windows upgrade OS advisor

### 1.2 Given a scenario, install Windows PC operating systems using appropriate methods.

- Boot methods
  - USB
  - CD-ROM
  - DVD
  - PXE
  - Solid state/flash drives
  - Netboot
  - External/hot swappable drive
  - Internal hard drive (partition)
- Type of installations
  - Unattended installation
  - Upgrade
  - Clean install
  - Repair installation
  - Multiboot
  - Remote network installation
  - Image deployment
  - Recovery partition
  - Refresh/restore
- Partitioning
  - Dynamic
  - Basic
  - Primary
  - Extended
  - Logical
  - GPT
- File system types/formatting
  - ExFAT
  - FAT32
  - NTFS

- CDFS
- NFS
- ext3, ext4
- Quick format vs. full format
- Load alternate third party drivers when necessary
- Workgroup vs. Domain setup
- Time/date/region/language settings
- Driver installation, software and windows updates
- Factory recovery partition
- Properly formatted boot drive with the correct partitions/format

**1.3 Given a scenario, apply appropriate Microsoft command line tools.**

- TASKKILL
- BOOTREC
- SHUTDOWN
- TASKLIST
- MD
- RD
- CD
- DEL
- FORMAT
- COPY
- XCOPY
- ROBOCOPY
- DISKPART
- SFC
- CHKDSK
- GPUPDATE
- GPRESULT
- DIR
- EXIT
- HELP
- EXPAND
- [command name] /?
- Commands available with standard privileges vs. administrative privileges.

**1.4 Given a scenario, use appropriate Microsoft operating system features and tools.**

- Administrative
  - Computer management
  - Device manager
  - Local Users and Groups
  - Local security policy
  - Performance monitor
  - Services
  - System configuration
  - Task scheduler
  - Component services
  - Data sources
  - Print management
  - Windows memory diagnostics
  - Windows firewall

- Advanced security
- MSCONFIG
  - General
  - Boot
  - Services
  - Startup
  - Tools
- Task Manager
  - Applications
  - Processes
  - Performance
  - Networking
  - Users
- Disk management
  - Drive status
  - Mounting
  - Initializing
  - Extending partitions
  - Splitting partitions
  - Shrink partitions
  - Assigning/changing drive letters
  - Adding drives
  - Adding arrays
  - Storage spaces
- Other
  - User State Migration tool (USMT)
  - Windows Easy Transfer
  - Windows Upgrade Advisor
- System utilities
  - REGEDIT
  - COMMAND
  - SERVICES.MSC
  - MMC
  - MSTSC
  - NOTEPAD
  - EXPLORER
  - MSINFO32
  - DXDIAG
  - DEFRAG
  - System restore
  - Windows Update

**1.5 Given a scenario, use Windows Control Panel utilities.**

- Internet options
  - Connections
  - Security
  - General
  - Privacy
  - Programs
  - Advanced
- Display/Display Settings
  - Resolution
  - Color depth

- Refresh rate
- User accounts
- Folder options
  - View hidden files
  - Hide extensions
  - General options
  - View options
- System
  - Performance (virtual memory)
  - Remote settings
  - System protection
- Windows firewall
- Power options
  - Hibernate
  - Power plans
  - Sleep/suspend
  - Standby
- Programs and features
- HomeGroup
- Devices and Printers
- Sound
- Troubleshooting
- Network and Sharing Center
- Device Manager

**1.6 Given a scenario, install and configure Windows networking on a client/desktop.**

- HomeGroup vs. WorkGroup
- Domain setup
- Network shares/administrative shares/mapping drives
- Printer sharing vs. network printer mapping
- Establish networking connections
  - VPN
  - Dialups
  - Wireless
  - Wired
  - WWAN (Cellular)
- Proxy settings
- Remote Desktop Connection
- Remote Assistance
- Home vs. Work vs. Public network settings
- Firewall settings
  - Exceptions
  - Configuration
  - Enabling/disabling Windows firewall
- Configuring an alternative IP address in Windows
  - IP addressing
  - Subnet mask
  - DNS
  - Gateway
- Network card properties
  - Half duplex/full duplex/auto
  - Speed

- Wake-on-LAN
- QoS
- BIOS (on-board NIC)

**1.7 Perform common preventive maintenance procedures using the appropriate Windows OS tools.**

- Best practices
  - Scheduled backups
  - Scheduled disk maintenance
  - Windows updates
  - Patch management
  - Driver/firmware updates
  - Antivirus/ Antimalware updates
- Tools
  - Backup
  - System restore
  - Recovery image
  - Disk maintenance utilities

## **2.0 Other Operating Systems and Technologies**

**2.1 Identify common features and functionality of the Mac OS and Linux operating systems.**

- Best practices
  - Scheduled backups
  - Scheduled disk maintenance
  - System updates/App store
  - Patch management
  - Driver/firmware updates
  - Antivirus/ Antimalware updates
- Tools
  - Backup/Time Machine
  - Restore/snapshot
  - Image recovery
  - Disk maintenance utilities
  - Shell/Terminal
  - Screen sharing
  - Force Quit
- Features
  - Multiple desktops/Mission Control
  - Key Chain
  - Spot Light
  - iCloud
  - Gestures
  - Finder
  - Remote Disc
  - Dock
  - Boot Camp
- Basic Linux commands
  - ls
  - grep
  - cd



- shutdown
- pwd vs. passwd
- mv
- cp
- rm
- chmod
- cd
- chown
- iwconfig/ifconfig
- ps
- q
- su/sudo
- apt-get
- vi
- dd

**2.2 Given a scenario, setup and use client-side virtualization.**

- Purpose of virtual machines
- Resource requirements
- Emulator requirements
- Security requirements
- Network requirements
- Hypervisor

**2.3 Identify basic cloud concepts.**

- SaaS
- IaaS
- PaaS
- Public vs. Private vs. Hybrid vs. Community
- Rapid Elasticity
- On-demand
- Resource pooling
- Measured service

**2.4 Summarize the properties and purpose of services provided by networked hosts.**

- Server roles
  - Web server
  - File server
  - Print server
  - DHCP server
  - DNS server
  - Proxy server
  - Mail server
  - Authentication server
- Internet appliance
  - UTM
  - IDS
  - IPS
- Legacy / embedded systems

**2.5 Identify basic features of mobile operating systems.**

- Android vs. iOS vs. Windows

- Open source vs. closed source/vendor specific
- App source (play store, app store and store)
- Screen orientation (accelerometer/gyroscope)
- Screen calibration
- GPS and geotracking
- WiFi calling
- Launcher/GUI
- Virtual assistant
- SDK/APK
- Emergency notification
- Mobile payment service

## **2.6 Install and configure basic mobile device network connectivity and email.**

- Wireless / cellular data network (enable/disable)
  - Hotspot
  - Tethering
  - Airplane mode
- Bluetooth
  - Enable Bluetooth
  - Enable pairing
  - Find device for pairing
  - Enter appropriate pin code
  - Test connectivity
- Corporate and ISP email configuration
  - POP3
  - IMAP
  - Port and SSL settings
  - Exchange, S/MIME
- Integrated commercial provider email configuration
  - Google/Inbox
  - Yahoo
  - Outlook.com
  - iCloud
- PRI updates/PRL updates/Baseband updates
- Radio firmware
- IMEI vs. IMSI
- VPN

## **2.7 Summarize methods and data related to mobile device synchronization.**

- Types of data to synchronize
  - Contacts
  - Programs
  - Email
  - Pictures
  - Music
  - Videos
  - Calendar
  - Bookmarks
  - Documents
  - Location data
  - Social media data
  - eBooks

- Synchronization methods
  - Synchronize to the Cloud
  - Synchronize to the Desktop
- Mutual authentication for multiple services (SSO)
- Software requirements to install the application on the PC
- Connection types to enable synchronization

## 3.0 Security

### 3.1 Identify common security threats and vulnerabilities.

- Malware
  - Spyware
  - Viruses
  - Worms
  - Trojans
  - Rootkits
  - Ransomware
- Phishing
- Spear phishing
- Spoofing
- Social engineering
- Shoulder surfing
- Zero day attack
- Zombie/botnet
- Brute forcing
- Dictionary attacks
- Non-compliant systems
- Violations of security best practices
- Tailgating
- Man-in-the-middle

### 3.2 Compare and contrast common prevention methods.

- Physical security
  - Lock doors
  - Mantrap
  - Cable locks
  - Securing physical documents/passwords/shredding
  - Biometrics
  - ID badges
  - Key fobs
  - RFID badge
  - Smart card
  - Tokens
  - Privacy filters
  - Entry control roster
- Digital security
  - Antivirus/Antimalware
  - Firewalls
  - User authentication/strong passwords
  - Multifactor authentication

- Directory permissions
- VPN
- DLP
- Disabling ports
- Access control lists
- Smart card
- Email filtering
- Trusted/untrusted software sources
- User education/AUP
- Principle of least privilege

### **3.3 Compare and contrast differences of basic Windows OS security settings.**

- User and groups
  - Administrator
  - Power user
  - Guest
  - Standard user
- NTFS vs. Share permissions
  - Allow vs. deny
  - Moving vs. copying folders and files
  - File attributes
- Shared files and folders
  - Administrative shares vs. local shares
  - Permission propagation
  - Inheritance
- System files and folders
- User authentication
  - Single sign-on
- Run as administrator vs. standard user
- Bitlocker
- Bitlocker-To-Go
- EFS

### **3.4 Given a scenario, deploy and enforce security best practices to secure a workstation.**

- Password best practices
  - Setting strong passwords
  - Password expiration
  - Changing default user names/passwords
  - Screensaver required password
  - BIOS/UEFI passwords
  - Requiring passwords
- Account management
  - Restricting user permissions
  - Login time restrictions
  - Disabling guest account
  - Failed attempts lockout
  - Timeout/screen lock
- Disable autorun
- Data encryption
- Patch/update management

### **3.5 Compare and contrast various methods for securing mobile devices.**

- Screen locks
  - Fingerprint lock
  - Face lock
  - Swipe lock
  - Passcode lock
- Remote wipes
- Locator applications
- Remote backup applications
- Failed login attempts restrictions
- Antivirus/Antimalware
- Patching/OS updates
- Biometric authentication
- Full device encryption
- Multifactor authentication
- Authenticator applications
- Trusted sources vs. untrusted sources
- Firewalls
- Policies and procedures
  - BYOD vs. corporate owned
  - Profile security requirements

**3.6 Given a scenario, use appropriate data destruction and disposal methods.**

- Physical destruction
  - Shredder
  - Drill / Hammer
  - Electromagnetic (Degaussing)
  - Incineration
  - Certificate of destruction
- Recycling or repurposing best practices
  - Low level format vs. standard format
  - Overwrite
  - Drive wipe

**3.7 Given a scenario, secure SOHO wireless and wired networks.**

- Wireless specific
  - Changing default SSID
  - Setting encryption
  - Disabling SSID broadcast
  - Antenna and access point placement
  - Radio power levels
  - WPS
- Change default user-names and passwords
- Enable MAC filtering
- Assign static IP addresses
- Firewall settings
- Port forwarding/mapping
- Disabling ports
- Content filtering / parental controls
- Update firmware
- Physical security

## 4.0 Software Troubleshooting

### 4.1 Given a scenario, troubleshoot PC operating system problems with appropriate tools.

- Common symptoms
  - Proprietary crash screens (BSOD/pin wheel)
  - Failure to boot
  - Improper shutdown
  - Spontaneous shutdown/restart
  - Device fails to start/detected
  - Missing dll message
  - Services fails to start
  - Compatibility error
  - Slow system performance
  - Boots to safe mode
  - File fails to open
  - Missing NTLDR
  - Missing Boot Configuration Data
  - Missing operating system
  - Missing Graphical Interface
  - Missing GRUB/LILO
  - Kernel panic
  - Graphical Interface fails to load
  - Multiple monitor misalignment/orientation
- Tools
  - BIOS/UEFI
  - SFC
  - Logs
  - System Recovery Options
  - Repair disks
  - Pre-installation environments
  - MSCONFIG
  - DEFRAG
  - REGSRV32
  - REGEDIT
  - Event viewer
  - Safe mode
  - Command prompt
  - Uninstall/reinstall/repair

### 4.2 Given a scenario, troubleshoot common PC security issues with appropriate tools and best practices.

- Common symptoms
  - Pop-ups
  - Browser redirection
  - Security alerts
  - Slow performance
  - Internet connectivity issues
  - PC/OS lock up
  - Application crash
  - OS updates failures
  - Rogue antivirus
  - Spam

- Renamed system files
- Files disappearing
- File permission changes
- Hijacked email
  - Responses from users regarding email
  - Automated replies from unknown sent email
- Access denied
- Invalid certificate (trusted root CA)
- Tools
  - Antivirus software
  - Antimalware software
  - Recovery console
  - Terminal
  - System restore/Snapshot
  - Pre-installation environments
  - Event viewer
  - Refresh/restore
  - MSCONFIG/Safe boot
- Best practice procedure for malware removal
  1. Identify malware symptoms
  2. Quarantine infected system
  3. Disable system restore (in Windows)
  4. Remediate infected systems
    - a. Update antimalware software
    - b. Scan and removal techniques (safe mode, pre-installation environment)
  5. Schedule scans and run updates
  6. Enable system restore and create restore point (in Windows)
  7. Educate end user

**4.3 Given a scenario, troubleshoot common mobile OS and application issues with appropriate tools.**

- Common symptoms
  - Dim display
  - Intermittent wireless
  - No wireless connectivity
  - No bluetooth connectivity
  - Cannot broadcast to external monitor
  - Touchscreen non-responsive
  - Apps not loading
  - Slow performance
  - Unable to decrypt email
  - Extremely short battery life
  - Overheating
  - Frozen system
  - No sound from speakers
  - Inaccurate touch screen response
  - System lockout
- Tools
  - Hard reset
  - Soft reset
  - Close running applications
  - Reset to factory default
  - Adjust configurations/settings

- Uninstall/reinstall apps
- Force stop

**4.4 Given a scenario, troubleshoot common mobile OS and application security issues with appropriate tools.**

- Common symptoms
  - Signal drop/weak signal
  - Power drain
  - Slow data speeds
  - Unintended WiFi connection
  - Unintended Bluetooth pairing
  - Leaked personal files/data
  - Data transmission overlimit
  - Unauthorized account access
  - Unauthorized root access
  - Unauthorized location tracking
  - Unauthorized camera/microphone activation
  - High resource utilization
- Tools
  - Antimalware
  - App scanner
  - Factory reset/Clean install
  - Uninstall/reinstall apps
  - WiFi analyzer
  - Force stop
  - Cell tower analyzer
  - Backup/restore
    - iTunes/iCloud/Apple Configurator
    - Google sync
    - One Drive

## 5.0 Operational Procedures

**5.1 Given a scenario, use appropriate safety procedures.**

- Equipment grounding
- Proper component handling and storage
  - Antistatic bags
  - ESD straps
  - ESD mats
  - Self-grounding
- Toxic waste handling
  - Batteries
  - Toner
  - CRT
- Personal safety
  - Disconnect power before repairing PC
  - Remove jewelry
  - Lifting techniques
  - Weight limitations
  - Electrical fire safety
  - Cable management
  - Safety goggles



- Air filter mask
- Compliance with local government regulations

**5.2 Given a scenario with potential environmental impacts, apply the appropriate controls.**

- MSDS documentation for handling and disposal
- Temperature, humidity level awareness and proper ventilation
- Power surges, brownouts, blackouts
  - Battery backup
  - Surge suppressor
- Protection from airborne particles
  - Enclosures
  - Air filters/Mask
- Dust and debris
  - Compressed air
  - Vacuums
- Compliance to local government regulations

**5.3 Summarize the process of addressing prohibited content/activity, and explain privacy, licensing, and policy concepts.**

- Incident Response
  - First response
    - Identify
    - Report through proper channels
    - Data/device preservation
  - Use of documentation/documentation changes
  - Chain of custody
    - Tracking of evidence/documenting process
- Licensing / DRM / EULA
  - Open source vs. commercial license
  - Personal license vs. enterprise licenses
- Personally Identifiable Information
- Follow corporate end-user policies and security best practices

**5.4 Demonstrate proper communication techniques and professionalism.**

- Use proper language – avoid jargon, acronyms, slang when applicable
- Maintain a positive attitude / Project confidence
- Actively listen (taking notes) and avoid interrupting the customer
- Be culturally sensitive
  - Use appropriate professional titles, when applicable
- Be on time (if late contact the customer)
- Avoid distractions
  - Personal calls
  - Texting / Social media sites
  - Talking to co-workers while interacting with customers
  - Personal interruptions
- Dealing with difficult customer or situation
  - Do not argue with customers and/or be defensive
  - Avoid dismissing customer problems
  - Avoid being judgmental
  - Clarify customer statements (ask open ended questions to narrow the scope of the problem, restate the issue or question to verify understanding)
  - Do not disclose experiences via social media outlets

- Set and meet expectations/timeline and communicate status with the customer
  - Offer different repair/replacement options if applicable
  - Provide proper documentation on the services provided
  - Follow up with customer/user at a later date to verify satisfaction
- Deal appropriately with customers confidential and private materials
  - Located on a computer, desktop, printer, etc

**5.5 Given a scenario, explain the troubleshooting theory.**

- Always consider corporate policies, procedures and impacts before implementing changes.
  1. Identify the problem
    - Question the user and identify user changes to computer and perform backups before making changes
  2. Establish a theory of probable cause (question the obvious)
    - If necessary, conduct external or internal research based on symptoms
  3. Test the theory to determine cause
    - Once theory is confirmed determine next steps to resolve problem
    - If theory is not confirmed re-establish new theory or escalate
  4. Establish a plan of action to resolve the problem and implement the solution
  5. Verify full system functionality and if applicable implement preventive measures
  6. Document findings, actions and outcomes

# CompTIA A+ Acronyms

## Introduction

The following is a list of acronyms which appear on the CompTIA A+ exams. Candidates are encouraged to review the complete list and attain a working knowledge of all listed acronyms as a part of a comprehensive exam preparation program.

<b>Acronym</b>	<b>Definition</b>
AC	alternating current
ACL	access control list
ACPI	advanced configuration power interface
ACT	activity
ADSL	asymmetrical digital subscriber line
AGP	accelerated graphics port
AHCI	Advanced host controller interface
AP	Access point
APIPA	automatic private internet protocol addressing
APM	advanced power management
ARP	address resolution protocol
ASR	automated system recovery
ATA	advanced technology attachment
ATAPI	advanced technology attachment packet interface
ATM	asynchronous transfer mode
ATX	advanced technology extended
AUP	Acceptable Use Policy
A/V	Audio Video
BIOS	basic input/output system
BNC	Bayonet-Neill-Concelman or British Naval Connector
BTX	balanced technology extended
CAPTCHA	Completely Automated Public Turing Test To Tell Computers and Humans Apart
CCFL	Cold Cathode Fluorescent Lamp
CD	compact disc
CD-ROM	compact disc-read-only memory
CD-RW	compact disc-rewritable
CDFS	compact disc file system
CFS	Central File System, Common File System, Command File System
CIFS	Common Internet File System

CMOS	complementary metal-oxide semiconductor
CNR	Communications and Networking Riser
COMx	communication port (x=port number)
CPU	central processing unit
CRT	cathode-ray tube
DAC	discretionary access control
DB-25	serial communications D-shell connector, 25 pins
DB-9	9 pin D shell connector
DC	direct current
DDOS	distributed denial of service
DDR	double data-rate
DDR RAM	double data-rate random access memory
DDR SDRAM	double data-rate synchronous dynamic random access memory
DFS	distributed file system
DHCP	dynamic host configuration protocol
DIMM	dual inline memory module
DIN	Deutsche Industrie Norm
DLT	digital linear tape
DLP	digital light processing
DMA	direct memory access
DMZ	demilitarized zone
DNS	domain name service or domain name server
DOS	denial of service
DRAM	dynamic random access memory
DSL	digital subscriber line
DVD	digital video disc or digital versatile disc
DVD-RAM	digital video disc-random access memory
DVD-ROM	digital video disc-read only memory
DVD-R	digital video disc-recordable
DVD-RW	digital video disc-rewritable
DVI	digital visual interface
ECC	error correcting code/error checking and correction
ECP	extended capabilities port
EEPROM	electrically erasable programmable read-only memory
EFS	encrypting file system
EIDE	enhanced integrated drive electronics
EMI	electromagnetic interference
EMP	electromagnetic pulse
EPROM	erasable programmable read-only memory
EPP	enhanced parallel port
ERD	emergency repair disk
ESD	electrostatic discharge

EVGA	extended video graphics adapter/array
EVDO	evolution data optimized or evolution data only
FAT	file allocation table
FAT12	12-bit file allocation table
FAT16	16-bit file allocation table
FAT32	32-bit file allocation table
FDD	floppy disk drive
Fn	Function (referring to the function key on a laptop)
FPM	fast page-mode
FRU	field replaceable unit
FSB	Front Side Bus
FTP	file transfer protocol
FQDN	fully qualified domain name
Gb	gigabit
GB	gigabyte
GDI	graphics device interface
GHz	gigahertz
GUI	graphical user interface
GPS	global positioning system
GSM	global system for mobile communications
HAL	hardware abstraction layer
HAV	Hardware Assisted Virtualization
HCL	hardware compatibility list
HDD	hard disk drive
HDMI	high definition media interface
HPFS	high performance file system
HTML	hypertext markup language
HTPC	home theater PC
HTTP	hypertext transfer protocol
HTTPS	hypertext transfer protocol over secure sockets layer
I/O	input/output
ICMP	internet control message protocol
ICR	intelligent character recognition
IDE	integrated drive electronics
IDS	Intrusion Detection System
IEEE	Institute of Electrical and Electronics Engineers
IIS	Internet Information Services
IMAP	internet mail access protocol
IP	internet protocol
IPCONFIG	internet protocol configuration
IPP	internet printing protocol
IPSEC	internet protocol security
IR	infrared

IrDA	Infrared Data Association
IRQ	interrupt request
ISDN	integrated services digital network
ISO	International Organization for Standardization/Industry Standards Organization
ISP	internet service provider
JBOD	just a bunch of disks
Kb	kilobit
KB	Kilobyte or knowledge base
LAN	local area network
LBA	logical block addressing
LC	Lucent connector
LCD	liquid crystal display
LDAP	lightweight directory access protocol
LED	light emitting diode
Li-on	lithium-ion
LPD/LPR	line printer daemon / line printer remote
LPT	line printer terminal
LVD	low voltage differential
MAC	media access control / mandatory access control
MAPI	messaging application programming interface
MAU	media access unit, media attachment unit
Mb	megabit
MB	megabyte
MBR	master boot record
MBSA	Microsoft Baseline Security Analyzer
MFD	multi-function device
MFP	multi-function product
MHz	megahertz
MicroDIMM	micro dual inline memory module
MIDI	musical instrument digital interface
MIME	multipurpose internet mail extension
MIMO	Multiple Input Multiple Output
MMC	Microsoft management console
MP3	Moving Picture Experts Group Layer 3 Audio
MP4	Moving Picture Experts Group Layer 4
MPEG	Moving Picture Experts Group
MSCONFIG	Microsoft configuration
MSDS	material safety data sheet
MUI	multilingual user interface
NAC	network access control
NAS	network-attached storage
NAT	network address translation

NetBIOS	networked basic input/output system
NetBEUI	networked basic input/output system extended user interface
NFS	network file system
NIC	network interface card
NiCd	nickel cadmium
NiMH	nickel metal hydride
NLX	new low-profile extended
NNTP	network news transfer protocol
NTFS	new technology file system
NTLDR	new technology loader
NTP	Network Time Protocol
OCR	optical character recognition
OEM	original equipment manufacturer
OLED	Organic Light Emitting Diode
OS	operating system
PAN	personal area network
PATA	parallel advanced technology attachment
PC	personal computer
PCI	peripheral component interconnect
PCIe	peripheral component interconnect express
PCIX	peripheral component interconnect extended
PCL	printer control language
PCMCIA	Personal Computer Memory Card International Association
PGA	pin grid array
PGA2	pin grid array 2
PII	Personally Identifiable Information
PIN	personal identification number
PKI	public key infrastructure
PnP	plug and play
POP3	post office protocol 3
PoS	Point of Sale
POST	power-on self test
POTS	plain old telephone service
PPP	point-to-point protocol
PPTP	point-to-point tunneling protocol
PRI	primary rate interface
PROM	programmable read-only memory
PS/2	personal system/2 connector
PSTN	public switched telephone network
PSU	power supply unit
PVC	permanent virtual circuit
PXE	preboot execution environment
QoS	quality of service

RAID	redundant array of independent (or inexpensive) discs
RAM	random access memory
RAS	remote access service
RDP	Remote Desktop Protocol
RF	radio frequency
RFI	radio frequency interference
RGB	red green blue
RIP	routing information protocol
RIS	remote installation service
RISC	reduced instruction set computer
RJ-11	registered jack function 11
RJ-45	registered jack function 45
RMA	returned materials authorization
ROM	read only memory
RTC	real-time clock
SAN	storage area network
SAS	Serial Attached SCSI
SATA	serial advanced technology attachment
SC	subscription channel
SCP	secure copy protection
SCSI	small computer system interface
SCSI ID	small computer system interface identifier
SD card	secure digital card
SDRAM	synchronous dynamic random access memory
SEC	single edge connector
SFC	system file checker
SFF	Small Form Factor
SLI	scalable link interface or system level integration or scanline interleave mode
S.M.A.R.T.	self-monitoring, analysis, and reporting technology
SMB	server message block or small to midsize business
SMTP	simple mail transfer protocol
SNMP	simple network management protocol
SoDIMM	small outline dual inline memory module
SOHO	small office/home office
SP	service pack
SPDIF	Sony-Philips digital interface format
SPGA	staggered pin grid array
SRAM	static random access memory
SSH	secure shell
SSID	service set identifier
SSL	secure sockets layer
ST	straight tip
STP	shielded twisted pair



SXGA	super extended graphics array
TB	terabyte
TCP	transmission control protocol
TCP/IP	transmission control protocol/internet protocol
TDR	time domain reflectometer
TFTP	trivial file transfer protocol
TKIP	Temporal Key Integrity Protocol
TPM	trusted platform module
UAC	user account control
UDF	user defined functions or universal disk format or universal data format
UDP	user datagram protocol
UEFI	Unified Extensible Firmware Interface
UNC	universal naming convention
UPS	uninterruptible power supply
URL	uniform resource locator
USB	universal serial bus
USMT	user state migration tool
UTP	unshielded twisted pair
UXGA	ultra extended graphics array
VESA	Video Electronics Standards Association
VFAT	virtual file allocation table
VGA	video graphics array
VM	Virtual Machine
VoIP	voice over internet protocol
VPN	virtual private network
VRAM	video random access memory
WAN	wide area network
WAP	wireless access protocol/wireless access point
WEP	wired equivalent privacy
WIFI	wireless fidelity
WINS	windows internet name service
WLAN	wireless local area network
WPA	wireless protected access
WPS	WiFi Protected Setup
WUXGA	wide ultra extended graphics array
XGA	extended graphics array
ZIF	zero-insertion-force
ZIP	zigzag inline package

## **A+ Proposed Hardware and Software List**

\*\* CompTIA has included this sample list of hardware and software to assist candidates as they prepare for the A+ exam. This list may also be helpful for training companies who wish to create a lab component to their training offering. The bulleted lists below each topic are a sample list and not exhaustive.

### **Equipment**

- Apple tablet / Smart phone
- Android tablet / Smart phone
- Windows tablet / Smart phone
- Windows Laptop / Mac Laptop / Linux Laptop
- Windows Desktop / Mac Desktop / Linux Desktop
- Monitors
- Projectors
- SOHO Router/switch
- Access point
- VoIP phone
- Printer
  - Laser / Inkjet
  - Wireless
- Surge suppressor
- UPS

### **Spare parts/hardware**

- Motherboards
- RAM
- Hard drives
- Power supplies
- Video cards
- Sounds cards
- Network cards
- Wireless NICs
- Fans/cooling devices/heat sink

- CPUs
- Assorted connectors/cables
  - USB
  - HDMI
  - etc
- Adapters
- Network cables
- Unterminated network cable / connectors
- AC adapters
- Optical drives
- Screws/stand-offs
- Cases
- Maintenance kit
- Mice/keyboards

### Tools

- Screw drivers
- Multimeter
- Wire cutters
- Punchdown tool
- Crimper
- Power supply tester
- Cable stripper
- POST cards
- Standard technician toolkit
- ESD strap
- Thermal paste
- Cable tester
- WiFi analyzer
- SATA to USB connectors

### Software

- Operating system disks
- Antivirus software
- Virtualization software
- Antimalware
- Driver software

---

**Appendix B**  
**Chapter Review Answers**





### Chapter 3

1. A. During the initialization phase of the PC boot process
2. C. Virtualization program
3. B. Failing CMOS backup battery
4. C. PCIe 16X

### Chapter 4

1. B. L2
2. B. Virtualization
3. D. A set of high-integration components that contain key motherboard support devices
4. C. South bridge

### Chapter 5

1. C. Watts
2. A. That the AC power cable is plugged into the power supply
3. D. +5 V, +12 V
4. C. Remove the new adapter card and check the power supply status after powering up again

### Chapter 6

1. B. Install two expansion slot covers
2. B. ESD is normal and shouldn't be worried about
3. A. Interview the user to identify the problem
4. C. Loose internal cable or adapter card
5. D. Document all troubleshooting steps and results



**Chapter 7**

1. C. Resolution
2. B. DVI-I
3. B. Right-click the desktop and select Screen resolution
4. C. That the display monitor cable is plugged into the display adapter connector on the PC
5. B. A problem with Windows display driver

**Chapter 8**

1. C. Parallel
2. B. USB
3. C. 480 Mbps
4. D. PC
5. 1-B, 2-C, 3-D, 4-A

**Chapter 9**

1. B. Parity
2. B. Dual-channel
3. C. The memory will default to working in single-channel mode
4. D. 400 MHz
5. C. DDR2-SDRAM DIMM



**Chapter 10**  
**Troubleshooting Hard Drives and RAID Arrays**

Symptom	Cause	Cause choices
OS (operating system) not found	1	1. Damaged Windows BCD (Boot Configuration Data) file
RAID not found	3	2. Defective or incorrectly configured RAID controller
RAID stops working	2	3. Defective drive in (non-RAID 5) drive array

1. B. Cylinder
2. C. 1 meter
3. A. Low-level formatting
4. C. 4
5. D. RAID 5; 3

**Chapter 11**

1. B. Laptop uses shared video memory
2. C. Defective inverter
3. D. Tethered
4. C. Hibernate
5. B. Passcode locks, C. Remote wipes
6. B. Settings | Wi-Fi





**Chapter 12**

1. A. Impact (dot-matrix)
2. C. Toning
3. A. Primary
4. A. 2 meters (6 ft), 1 meter (3 ft)
5. B. Services, Print Spooler

**Chapter 13**

**Troubleshooting Operating System Problems 1**

Symptom	Cause	Operating system faults
BSOD (Blue Screen Of Death)	2	1. RAID controller driver problem (requires firmware update)
Failure to boot	5	2. Hardware or driver problem
“Improper shutdown” message	3	3. System was not gracefully shut down (Windows Start   Shutdown)
RAID not detected during installation	1	4. Unwanted registry entry is calling .dll routine
“Missing .dll” message	4	5. Missing or damaged boot files



## Troubleshooting Operating System Problems 2

Symptom	Cause	Operating system faults
Missing graphical interface	1	1. Registry entry to load <code>Explorer.exe</code> has been altered or damaged
File fails to open (example, <code>.xlsx</code> file)	4	2. Damaged or defective hard drive 3. Nonbootable disk left in boot drive (DVD drive)
Missing NTLDR	3	4. Attempt to open newer version of file (Excel 2007/2010) with older version of program
Missing operating system	2	

1. D. <Alt><Tab>
2. B., C. `Bootmgr`, `BCD`
3. C. Right-clicking the file, then selecting Properties
4. C. `PAGEFILE.SYS`
5. B. `HKEY_CLASSES_ROOT`

## Chapter 14

1. D. Disk Utility
2. B. `rsync`
3. C. Use: Applications | Utilities | Terminal
4. C. Spotlight
5. B. Private



### Chapter 15

1. D. A partitioned, formatted hard disk
2. D. Windows 8/8.1 (64-bit)
3. B. Press <F6> when prompted during the text phase of the installation process, then supply drivers
4. C. The operating system will work, but with reduced functionality and will not install Windows updates
5. C. Windows 7 Professional, D. Windows 7 Ultimate

### Chapter 16

1. D. Event Viewer
2. B. Using Task Manager, click the Applications tab, select application, and then click the **End Task** button
3. A. Windows 7 installation disk, C. Windows 7 Advanced Boot Options menu
4. C. MSCONFIG.EXE
5. D. Use Windows System Restore to restore her computer to its state before the new application was installed
6. B. Press <F8> when the Starting Windows message is displayed



**Chapter 17**

No connectivity	2	1. DHCP server down 2. Network cable damaged or not connected 3. Internet service is down or router hardware problem
Local connectivity only	3	
Limited connectivity (computers are using APIPA address)	1	

1. C. 1000BaseT
2. B. Multimode
3. C. 3; 255.255.255.0
4. C. Its 128-bit address size overcomes the address exhaustion problems of IPv4
5. D. 802.11ac
6. C. WPA2

**Chapter 18**

1. B. Uplink requests are usually routed through a phone line to the satellite control center
2. C. Telephone
3. A. It is using SSL, making it safe for financial transactions
4. C. DNS
5. B. IPCONFIG /RELEASE, D. IPCONFIG /RENEW



**Chapter 19**

1. C. Polymorphic virus
2. B. Scan for known virus signatures
3. C. Encrypt the main storage disk or memory device
4. A. Group Policy Editor
5. B. Chain of custody

