



P-04B

INSTRUCTION MANUAL '10.5

docomo **PRIME** series

DOCOMO W-CDMA・GSM/GPRS System

Thank you for selecting the “docomo PRIME series P-04B”.

Read this manual before use to correctly operate your P-04B.

About operation explanation of P-04B

The operating procedures for the P-04B are also published in electronic form as in “**使いかたナビ (Guide)**” that is installed onto your FOMA terminal, and “**Instruction Manual (Detailed Version)**” as a PDF. (In Japanese only)

◆“Instruction Manual” (this volume)◆

Description of displayed content and operating procedures for basic functions

◆“使いかたナビ (Guide)” (installed onto your FOMA terminal)◆

Description of the outline of frequently used functions and of operations

From the P-04B  LifeKit  **使いかたナビ (Guide)**

※ This function is available in Japanese mode only.

◆“Instruction Manual (Detailed Version)” (PDF)◆

Use your personal computer to visit the following, and download detailed information about all the functions and their operating procedures. (In Japanese only)
<http://www.nttdocomo.co.jp/support/trouble/manual/download/index.html>

※ Note that the URL and published contents may be modified without notice.

Basic Package

- P-04B Handset
(With Warranty and Back Cover P42)



- Battery Pack P20



- Instruction Manual



- P-04B CD-ROM



- See page 89 for optional items that support this FOMA terminal.

For Using This Manual

- Note that “P-04B” is referred to as “FOMA terminal” in this manual.
- Most operating procedures and displays in this manual are described with the default settings of the “WHITE” handset. Further, displays and illustrations described in this manual are for reference. The actual ones might differ.
- Most operating procedures and displays in this manual are described when the FOMA terminal is in Normal Style.



Contents

| | | |
|---|---|--|
| | FOMA Terminal.....2 | Styles.....6 |
| | What You can Do with P-04B.....3 | Precautions.....7 |
| | Part Names and Functions.....4 | Handling Precautions15 |
| Before Using18 | Character Entry28 | Lock/Security35 |
| Charging, Power ON/OFF, etc. | | Various Security Codes, Various Lock Functions, Reset to Default, etc. |
| Screen Explanation22 | Sound/Screen Setting30 | |
| Viewing Display/Icon, etc. | Select Ring Tone, Changing Displays, etc. | |
| Call Telephone40 | Mail48 | Phonebook53 |
| Making a Call/Videophone Call, Receiving a Call/Videophone Call, Network Services, WORLD WING, etc. | Send i-mode Mail, Deco-mail, Decome-Anime, Receive i-mode Mail, Area Mail, etc. | Store Phonebook, Edit Phonebook, Delete Phonebook |
| i-mode/Full Browser55 | i-Channel58 | Map/GPS58 |
| Access Sites, Full Browser, Viewing and Operating Sites, Add Bookmark, Screen Memo, etc. | | |
| Camera60 | Music67 | i-appli/i-Widget69 |
| Shoot Still Images/Moving Pictures, etc. | Music&Video Channel, Music Player, etc. | Starting i-appli, etc. |
| 1Seg63 | | i-motion/Movie71 |
| Watch 1Seg, etc. | | Play i-motion/Movie, etc. |
| Osaifu-Keitai72 | Convenient Tools74 | Data Management77 |
| Osaifu-Keitai/ToruCa | Schedule, Alarm, Bar Code Reader, Bluetooth | microSD Card, Infrared Communication, iC Communication, PC Connection |
| i-concier73 | | |
| Displaying i-concier Screen, etc. | | |
| Support82 | Appendix90 | Index103 |
| Troubleshooting, Warranty and After-sales Service, i-mode Fault Diagnosis Site, Updating Software, etc. | Function List, Main Specifications, SAR, Export Administration Regulations, Intellectual Property Right | |

Introduction

▶ P.1 ~

Basic Operation

▶ P.18 ~

Connect

▶ P.40 ~

Search

▶ P.55 ~

Enjoy

▶ P.60 ~

More Convenient

▶ P.72 ~

Others

▶ P.82 ~

FOMA Terminal

- Because the FOMA terminal uses a radio wave, you cannot use it in places where the radio wave do not reach, where it is weak even outdoors, or where are out-of-service area, such as inside tunnels, basements, or buildings. You might not be able to operate the FOMA terminal even when you are in a place with a fine view such as in a high-rise building or apartment. Note that you may experience interruption of calls even if the three antennas respond to a strong radio wave, and you remain without moving to use the FOMA terminal.
- Use the FOMA terminal carefully to avoid disturbing other people when in public, or in crowded or quiet places.
- Since the FOMA terminal uses radio waves as the medium of telecommunication, calls may be tapped by a third party. However, the W-CDMA-GSM/GPRS system automatically supports tapping prevention, so your conversation will be incomprehensible to the third party, because it is recognized as mere noise.
- The FOMA terminals change your voice into digital signals and send them to the other party. In places where the radio waves are weak, the digital signals may not be converted correctly, and in such a case, the voice may sound different from the actual original one.
- The user hereby agrees that the user shall be solely responsible for the result of the use of SSL/TLS. Neither DOCOMO nor the certifiers as listed herein make any representation and warranty as for the security in the use of SSL/TLS. In the event that the user shall sustain damage or loss due to the use of SSL/TLS, neither DOCOMO nor the certifiers shall be responsible for any such damage or loss.

Certifiers: VeriSign Japan K.K., Cybertrust Japan Co., Ltd., GlobalSign K.K., RSA Security Japan Ltd.,
SECOM Trust Systems Co., Ltd., Comodo CA Ltd., and Entrust, Inc.

- This FOMA terminal supports FOMA Plus-Area and FOMA High-Speed Area.
- The FOMA terminal can be used only via the FOMA network provided by DOCOMO and in DOCOMO's roaming area.
- You are advised that you make separate notes of information (such as Phonebook entries, schedule events, text memos, record messages, voice memos, movie memos) stored in the FOMA terminal and keep them in a safe place. Note that we cannot be held responsible for the unlikely event of loss of the stored content due to a malfunction, repair, change of your model, or other mishandling of the FOMA terminal.
- You are advised to save your important data on the microSD card. If you have a personal computer, you can transfer and save data such as Phonebook entries, mail messages, schedule events, and others on the personal computer by using DOCOMO keitai datalink.



What You can Do with P-04B

使いかたナビ (Guide)

You can check “使いかたナビ (Guide)” onscreen for how to operate a function you want.

Even when you do not have the printed “Instruction Manual” at hand, you can easily operate your FOMA terminal by referring to it.

 ▶ LifeKit ▶ 使いかたナビ (Guide)

※ This function is available in Japanese mode only.

International Roaming ▶ P.47

You can use the FOMA terminal overseas the same way as you use it in Japan, including phone number and mail address. (3G/ GSM areas are supported.)



eco Mode ▶ P.35

You can easily switch to the eco Mode to minimize battery consumption by a simple key operation.

Camera ▶ P.60

Using the high-image-quality camera with its 13,200,000 pixels, you can shoot the scenes you want to straight away since it takes so little time for auto focusing and shooting to be ready from startup.

Dot Illum. ▶ P.23

Animations are displayed in dot illum., and they advise you of incoming calls, dates, remaining battery charge level and so on.

○○ Railway
Suspension of the
service now...



i-concier ▶ P.73

i-concier is a service that enables you to receive useful information from a character (Machi-chara image) on the Stand-by display and download schedule event (i-schedule) files for your convenience.

※ i-concier is available in Japanese only.

Part Names and Functions

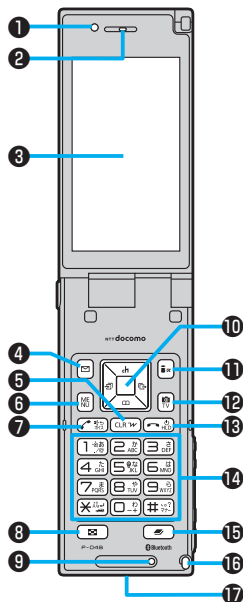

1 Light sensor

For sensing brightness (Do not cover it with your hands or do not put a sticker on it. Doing so might disable you to detect the brightness.)

2 Earpiece

For listening to the other party's voice

3 Display

4 Mail key

For showing the Mail Menu

5 CLR Clear key/i-Widget key

6 MENU Menu key

For showing the Main Menu

7 Start key/Hands-free switch key

8 Picture album key

For activating Picture Album

9 Microphone

For speaking to the other party

10 Command navigation key

For operating functions and menus

11 i-mode key/i-appli key

12 Camera key/1Seg key

13 Power/End key

For turning on/off the power or ending a call

14 Numeric keys

For entering phone numbers and text

15 Multi key

For showing the Task menu

16 Hook for Horizontal Open Style

17 Connector terminal

Integrated terminal for connecting earphone or for charging, etc.

For using earphone

Connect an optional connector-terminal-compatible earphone. When using a connector-terminal-non-compatible earphone, use an optional plug adapter for connection.

Flat plug connector of the Flat-plug Earphone/Microphone with Switch

Earphone terminal (Flat-plug)

Plug for the handset side

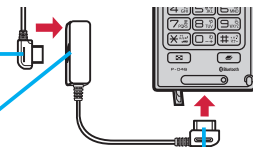

Example for connecting the Flat-plug Earphone/Microphone with Switch (option)

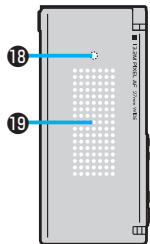

18 Call/Charging indicator

Lights while you are receiving a call or message, talking, or charging.

19 Dot illum.

Animation appears here while you are receiving a call or message.

20 Infrared data port

For using infrared communication and the infrared remote control

21 Camera

For shooting portraits and/or landscapes

22  mark

An IC card is installed. Use it for Osaifu-Keitai or iC communications.

23 Back cover

Remove this when attaching/removing the battery pack, UIM, and microSD card.

24 FOMA antenna/1 Seg antenna

The antenna is embedded in the handset. Do not cover the antenna with your hand for better communication/reception.

25 Strap hole

26 Flash/Photo light

27 Speaker

28 Charging terminal

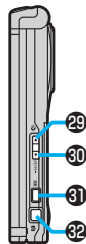
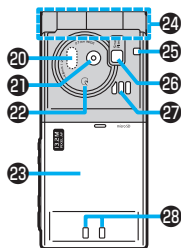

29  Side ▲ key

For turning up the earpiece volume during a call

30  Side ▼ key

For turning down the earpiece volume during a call

31  Recording key

For shooting a subject by the camera

32  Shutter key

For shooting a subject by the camera

33 One-push open button

For opening the FOMA terminal (Be careful not to drop the FOMA terminal by the rebound when opened.)

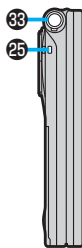

Styles

The P-04B comes with two styles.

■ Normal Style

You can open the FOMA terminal easily by one-push key operation. (One-push Open)

- You can open it also manually without using the button.
- You need to close the FOMA terminal manually. If it does not close, open it fully and then close it.

One-push open button

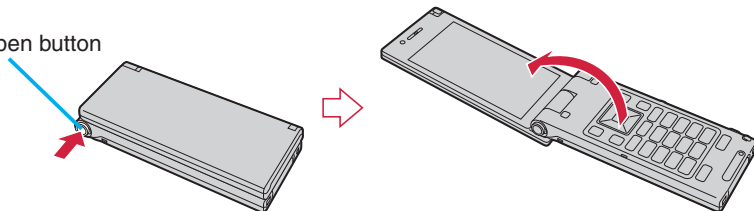

■ Horizontal Open Style

Open the display unit while you are softly depressing part A. Now you can watch 1Seg broadcast programs or messages in Horizontal Open Style.

- When you open the display unit, ensure that the hook is correctly engaged. If the hook is not correctly engaged, re-open the FOMA terminal after closing it once.

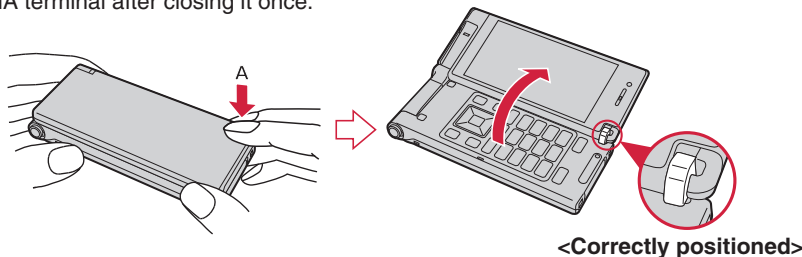

Precautions



ALWAYS FOLLOW THESE DIRECTIONS

■ Before using the FOMA terminal, read these safety precautions carefully so that you can use it correctly.







After reading the precautions, keep them in a safe place.

■ Be sure to observe these safety precautions because they are designed to protect you or those around you from causing injury and to avoid unnecessary damage to the property.

■ The symbols below indicate the levels of danger or damage that can be caused if the particular precautions are not observed.

| | | |
|---|----------------|--|
|  | Danger | This symbol indicates that incorrect handling will almost certainly cause death or serious injury. |
|  | Warning | This symbol indicates that incorrect handling poses a risk of causing death or serious injury. |
|  | Caution | This symbol indicates that incorrect handling poses a risk of causing injury or damage to the product or property. |

■ The following symbols show specific directions:

| | |
|---|--|
|  | Denotes things not to do. (Prohibition) |
| Don't | |
|  | Denotes the units not to disassemble. |
| Do not disassemble | |
|  | Denotes wet hands not to touch with. |
| Not wet hands | |
|  | Denotes the places where not to use, and caution not to wet it. |
| Avoid Water | |
|  | Denotes mandatory instructions (matters that must be complied with). |
| Do | |
|  | Denotes the symbol to pull the power plug out of an outlet. |
| Pull the power plug out | |

■ "Precautions" are divided into the following six sections:

| | |
|--|-----|
| General precautions for FOMA terminal, batteries, adapters, and UIM..... | P8 |
| Precautions for FOMA terminal | P9 |
| Precautions for batteries | P11 |
| Precautions for adapters | P12 |
| Precautions for UIM..... | P13 |
| Notes on using near electronic medical equipment..... | P13 |

General precautions for FOMA terminal, batteries, adapters, and UIM



Danger



Don't

Do not use, store, or leave the mobile phone or its accessories in places with a high temperature (such as near fire, near heating appliances, inside a kotatsu or near other furniture with heating elements, in places exposed to direct sunlight, or in cars heated by the sun).
Fire, burns, or injury may result.



Don't

Do not place the FOMA terminal or its accessories inside cooking appliances such as microwave ovens or high-pressure containers.
Fire, burns, injury or electric shock may result.



Do not disassemble

Do not attempt to disassemble or remodel the FOMA terminal or its accessories.
Fire, burns, injury or electric shock may result.



Avoid Water

Do not allow the FOMA terminal or its accessories to get wet either from water, drinking water or pet urine.
Fire, burns, injury or electric shock may result.



Do

With your FOMA terminal, use the batteries and adapters specified by NTT DOCOMO, INC.
Fire, burns, injury or electric shock may result.



Warning



Don't

Do not throw the FOMA terminal or accessories, or subject them to severe shocks.
Fire, burns, injury or electric shock may result.



Don't

Do not allow electrically conductive foreign objects (such as metal pieces or pencil leads) to come into contact with the FOMA terminal's charging terminal or connector terminal. Do not allow such objects to gain entry into the FOMA terminal.
Fire, burns, injury or electric shock may result.



Don't

Do not cover or wrap the FOMA terminal or its accessories with a cushion or other such objects while it is being used or recharged.
Fire or burns may result.



Do

Before entering a gas station or other places where flammable gases are in the atmosphere, be absolutely sure to turn off the FOMA terminal and, if it is being charged, stop the charging operation.

Otherwise, the flammable gases may ignite.
Use the Osaifu-Keitai with the FOMA terminal turned off when you are near a gas station. (When IC Card Lock is set, release the lock, and then turn off the power.)



Do

If odor, overheat, discoloration, or deformation is detected during use, battery charge, or storage, immediately observe the following:

- Pull the power plug out of the outlet or cigarette lighter socket.
- Turn off the power to the FOMA terminal.
- Remove the battery pack from the FOMA terminal.

Fire, burns, injury or electric shock may result.



Caution



Don't

Do not place the FOMA terminal or accessories on unstable locations such as wobbly tables or slanted locations.
They may fall off and cause injury.



Do not store in humid or dusty places, or in high temperature environments.

Don't

Fire, burns or electric shock may result.



Do

If the FOMA terminal and its accessories are going to be used by a child, the supervising adult should explain how to operate them correctly. During use, the supervising adult should also check that they are being used as instructed.

Otherwise, injury may result.



Do

Keep out of the reach of babies and infants.

Accidental swallowing or injury may result.



Do

Be especially careful when you use the FOMA terminal for a long time with the adapter connected.

If you use the i-appli programs, talk on the videophone, watch 1Seg programs and so on for a prolonged period of time while charging, the temperature of the FOMA terminal, battery pack or adapter may rise.

If you remain in direct contact with high-temperature parts, redness, itching, a rash or low-temperature skin burns may result depending on the state of your health or physical constitution.

Precautions for FOMA terminal



Warning



Don't

Do not directly point the infrared data port at someone's eyes during transmission.

Doing so may harm the person's eyes.



Don't

While using infrared communication, do not point the FOMA terminal's infrared data port at a home electrical appliance which is equipped with an infrared device.

The infrared device may malfunction, possible causing an accident.



Don't

Do not shine the flash/photo light close to eyes.

Doing so can damage eyesight. Also, accidents such as injury might occur if someone is startled or dazzled by the light.



Don't

Do not allow liquids such as water, or foreign materials such as metal pieces or flammable materials to get into the UIM or microSD card slot of the FOMA terminal.

Fire, burns, injury or electric shock may result.



Don't

Do not turn on the flash/photo light to drivers of cars, and others.

It disturbs driving, and accidents may result.



Do

Turn off the FOMA terminal in places where use is prohibited such as in airplanes and hospitals.

Otherwise, the electronic devices and electronic medical equipment in those places may be adversely affected. If the Auto Power ON function is set, deactivate the setting, then turn the power off.

For use inside medical facilities, make sure that you comply with their regulations.

Engaging in any prohibited acts such as using the FOMA terminal in an airplane is punishable by law.



Do

When talking in Hands-free mode or when a ring tone is sounding, be absolutely sure to keep the FOMA terminal away from your ear.

Further, when you play games or play back music with the earphone/microphone connected, adjust the sound volume to moderate volume.

The excessive sound volume impairs your hearing.

Further, accidents may result due to the hardness of hearing of surrounding sound.



Do

For those with weak heart conditions, the vibrator and ring volume must be adjusted carefully.

Otherwise, the functions may adversely affect your heart.



Do

If you are using an electronic medical device or other type of device, check with its manufacturer or vendor as to whether it will be affected by the signals from the FOMA terminal.

The FOMA terminal may adversely affect the device.



Do

Turn off the FOMA terminal when near electronic devices using high-precision control or weak signals.

The FOMA terminal may cause the electronic devices to malfunction and have other adverse effects.

※Electronic devices that may be affected:

Hearing aids, implanted cardiac pacemakers, implanted defibrillators, other electronic medical equipment, fire alarms, automatic doors and other automatically controlled devices.

If you use an implanted cardiac pacemaker, implanted defibrillator or any other electronic medical equipment, consult the manufacturer or retailer of the device for advice regarding possible effects from the radio waves.



Do

If the display part or camera lens is broken, be careful about broken glasses or the exposed interior of the FOMA terminal.

Plastic panels are used for the surfaces of the display area and camera lens, making it hard for their glass to break into pieces. However, if you touch the damaged or exposed parts by mistake, you may injure yourself.



Caution



Don't

Do not swing the FOMA terminal about by its strap or other parts.

You may hit yourself or others, possibly causing injury or other accidents.



Don't

Do not use the FOMA terminal if it has been damaged.

Fire, burns, injury or electric shock may result.



Don't

If the FOMA terminal's display has been damaged and its liquid crystal has leaked out, keep your face, hands and skin clear from it.

Otherwise, the loss of eyesight or injury to your skin may result. If the crystal liquid gets into the eyes or mouth, immediately rinse it out with clean water and then seek medical attention. When it adheres to your skin or clothes, immediately wipe it away with alcohol etc., and then rinse it out with water and soap.



Don't

Do not open the FOMA terminal by pressing the one-push open button near persons around you or your face.

The FOMA terminal may hit you or persons around you, causing accidents and injuries.



Don't

Do not use the FOMA terminal with the hook for Horizontal Open Style protruded.

Otherwise, injury may result.



Do

Before using the FOMA terminal inside a car, check with its manufacturer or dealer whether the signals from the FOMA terminal will have any adverse effects.

In some vehicle models, the signals may adversely affect the electronic devices inside the vehicle. Such cases are rare. However, if this happens, stop using the FOMA terminal immediately.



Do

Itching, rash or eczema may be caused depending on your physical conditions or predisposition. If an abnormality occurs, stop using the FOMA terminal immediately, and then seek medical attention.

See "List of materials used" on page 14.



Do

Be careful not to get your finger or a strap caught in the parts when you close or open the FOMA terminal.

Otherwise, injury or other accidents may result.



Do

View the display in a sufficiently light place keeping a certain distance from your eyes.

Otherwise, your eyesight may become impaired.

Precautions for batteries

- Check the description on the label of the battery pack for the type of battery.

| Description | Type |
|-------------|---------------------|
| Li-ion 00 | Lithium-ion battery |



Danger



Don't

Do not let any metal object such as a wire come in contact with the battery terminals. Also do not carry or store the battery together with any metal objects like a necklace.

Otherwise, the battery pack may ignite, burst or overheat and its electrolyte may leak.



Don't

When installing the battery in the FOMA terminal, check that it is facing the right way, and if the battery cannot be installed easily, do not force it into place.

Otherwise, the battery pack may ignite, burst or overheat and its electrolyte may leak.



Don't

Do not throw the battery into fire.

Otherwise, the battery pack may ignite, burst or overheat and its electrolyte may leak.



Don't

Do not pierce it with nails, hit it with a hammer, or step on it.

Otherwise, the battery pack may ignite, burst or overheat and its electrolyte may leak.



Do

If the battery fluid gets into your eyes, do not rub them. Flush your eyes with clean water and seek medical attention immediately.

Otherwise, the loss of eyesight may result.



Warning



Don't

Never use the FOMA terminal if it has damages such as deformities or scratches as a result of dropping it.

Otherwise, the battery pack may ignite, burst or overheat and its electrolyte may leak.



Do

Immediately stop using the FOMA terminal and keep it away from fire if the battery leaks or emits an odor.

The leaked battery fluid may ignite, causing fire or burst.



Do

Be careful that your pets do not bite into the battery pack.

Otherwise, the battery pack may ignite, burst or overheat and its electrolyte may leak.



Caution



Don't

Do not dispose of the exhausted battery with other waste.

The battery may catch fire or damage the environment. After insulating the battery terminals with tape, take the unneeded battery to a handling counter such as a docomo Shop or dispose of it in accordance with local waste disposal regulations.



Don't

Do not use or attempt to charge a wet battery.

Otherwise, the battery pack may ignite, burst or overheat and its electrolyte may leak.



Do

If the electrolyte fluid inside the battery has leaked out, do not allow it to come into contact with the skin on your face, hands or any other part of your body.

Contact may result in loss of sight or skin problems.

If you get the fluid in your eyes or mouth, or on skin or clothing, immediately wash the affected areas with clean water.

If you get it in your eyes or mouth, immediately seek medical attention after rinsing.

Precautions for adapters



Warning



Do not use the adapter if its cord has been damaged.
Fire, burns or electric shock may result.

Don't



Do not use the AC adapter and desktop holder in steamy places such as a bathroom.
Fire, burns or electric shock may result.

Don't



The DC adapter is for use only in a negative (-) grounded vehicle. Do not use it in a positive (+) grounded vehicle.
Fire, burns or electric shock may result.

Don't



If a thunderstorm is nearby, do not touch the adapter.
Otherwise, you may receive an electric shock.

Don't



Never short-circuit the charging terminal when the adapter is plugged into the power outlet or cigarette lighter socket. Also, never touch the charging terminal with fingers or other bare skin.
Fire, burns or electric shock may result.

Don't



Don't

Do not place heavy objects on the adapter cord.
Fire, burns or electric shock may result.



Don't

When plugging the AC adapter into the power outlet, or when unplugging it from the outlet, do not allow metal straps or other metal objects to come in contact with it.
Fire, burns or electric shock may result.



Not wet hands

Do not touch the adapter cord or power outlet with wet hands.
Fire, burns or electric shock may result.



Do

Use the adapter at the specified V AC.
When charging the FOMA terminal overseas, use the AC adapter available for use overseas to charge the FOMA terminal.

Supplying the wrong voltage to the AC adapter may result in a fire, burns or electric shocks.

AC adapter: 100 V AC

DC adapter: 12/24 V DC

[For negative (-) grounded vehicles only]

AC adapter available for use overseas:

100 V to 240 V AC

[Connect only to household AC outlet]



Do

If a fuse of the DC adapter has blown, replace it with a specified fuse.

Fire, burns or electric shock may result.
For the specified fuse, refer to each instruction manual.



Do

Keep the power plugs dust-free.

Fire, burns or electric shock may result.



Do

When plugging the AC adapter into the power outlet, plug it in securely.

Fire, burns or electric shock may result.



Do

When unplugging the adapter from the power outlet or cigarette lighter socket, do not yank the adapter cord, but take hold of the power plug to unplug it.

Fire, burns or electric shock may result.



Pull the power plug out

When you do not intend to use the adapter for a long period of time, disconnect the power plug from the power outlet or cigarette lighter socket.

Fire, burns or electric shock may result.



Pull the power plug out

If liquids such as water get in the adapter, unplug the power cord immediately from the outlet or cigarette lighter socket.

Fire, burns or electric shock may result.



Pull the power plug out

Before cleaning, pull the power plug out of the outlet or cigarette lighter socket.

Fire, burns or electric shock may result.

Precautions for UIM



Caution



Do

Be careful not to touch the cut surface of the UIM when removing it.

Otherwise, injury may result.

Notes on using near electronic medical equipment

■ The description below meets “Guidelines on the Use of Radio-communication Equipment such as Cellular Telephones – Safeguards for Electronic Medical Equipment” by the Electromagnetic Compatibility Conference Japan.



Warning



Do

Comply with the following in hospitals or health care facilities:

- Do not carry the FOMA terminal into operating rooms, intensive care units (ICU) or coronary care units (CCU).
- Turn off the FOMA terminal in hospital wards.
- If there is any electronic medical equipment near you, turn off the FOMA terminal even when in a location such as a lobby.
- Comply with any regulations of hospital and health care facilities instructing you not to use or carry in a mobile phone.
- If the Auto Power ON function is set, deactivate the setting, then turn the power off.



Do

Turn off the FOMA terminal in trains during the rush hour or other crowded areas as there may be someone near you with an implanted cardiac pacemaker or implanted defibrillator.

The FOMA terminal's signals may adversely affect the operation of implanted cardiac pacemakers and implanted defibrillators.



Do

If you use an implanted cardiac pacemaker or implanted defibrillator, use the mobile phone 22 cm or more away from an implanted cardiac pacemaker or implanted defibrillator.

The FOMA terminal's signals may adversely affect the operation of implanted cardiac pacemakers and implanted defibrillators.



Do

Patients using electronic medical equipment other than implanted cardiac pacemakers or implanted defibrillators (outside medical establishments for treatment at home, etc.) should check the influence of radio waves upon the equipment by consulting its manufacturer.

The FOMA terminal's signals may adversely affect the operation of electronic medical equipment.

■List of materials used

| Where it is used | | Material/Finishing |
|--|--|--|
| Outer casing | Display surface | Polycarbonate + glass fiber/UV coating |
| | Dot illum. surface | Polycarbonate/UV coating |
| | Operation key surface, Battery surface, Back cover | ABS resin/UV coating |
| | Connector terminal | Stainless steel/nickel plating + tin plating |
| Connector terminal cover | | Polycarbonate + elastomer resin/ UV coating |
| Camera panel | | Polycarbonate/ tin vapor deposition + UV coating |
| Camera ring area | | Acrylic urethane |
| Camera lens area | | Acrylic resin/surface hard coating |
| Command navigation key | | Polycarbonate/UV coating |
| Metal part of the command navigation key | | Polycarbonate/ aluminum vapor deposition + UV coating |
| Side ▲ key, Side ▼ key | | ABS resin/UV coating |
| Shutter key | | Polycarbonate/ aluminum vapor deposition + UV coating |
| Charging terminal | | Phosphor bronze/ nickel plating + gold plating |
| Operation key surface | Key area | Polycarbonate |
| | Sheet area | PET resin |
| | Open/close stopper | Acrylic urethane |
| | Hinge side cap | |
| Display panel | | Acrylic resin/surface hard coating |
| Display surface horizontal open stopper | | Acrylic urethane |
| Display surface horizontal open hinge guide area | | Elastomer resin |
| Battery compartment surface | | Polycarbonate |
| Battery terminal | Resin part | PPS resin |
| | Terminal area | Beryllium copper/ nickel plating + gold plating |

| Where it is used | | Material/Finishing |
|--|---------------|---|
| Battery pack | Resin area | Polycarbonate |
| | Label | PET resin |
| | Terminal area | Glass epoxy substrate/ nickel plating + gold plating |
| Screw (Battery compartment) | | Steel/nickel plating |
| Hinge area | | Polyamide + glass fiber/UV coating |
| Hinge area (center) | | ABS resin/UV coating |
| Hinge area (horizontal open side) | | PET resin |
| Flash/Photo light area | | Polycarbonate |
| Hinge area for Horizontal Open Style | | ABS resin/UV coating |
| Metal part of hinge area for Horizontal Open Style | | Polycarbonate/ tin vapor deposition + UV coating |
| Hook for Horizontal Open Style | | Stainless steel/ nickel plating + chrome plating |
| Upper area of roller for Horizontal Open Style | | Polycarbonate + ABS resin/UV coating |
| Roller area for Horizontal Open Style | | |
| Recording key | | Polycarbonate/UV coating |
| One-push open button | | Polycarbonate |
| Metal part of the one-push open button | | Aluminum/alumite treatment |
| microSD card slot (Battery compartment) | Resin part | LCP resin |
| | Metal part | Stainless steel/nickel plating |

Handling Precautions

General notes

Do not wet the equipment.

The FOMA terminal, battery, adapter, and UIM are not waterproofed. Do not use them in environments, which are high in humidity such as in bathrooms, and do not allow them to get wet from rain. Furthermore, if carrying them against your body, they become moist due to perspiration and the internal parts may become corroded, causing malfunction. If the parts are found to have been damaged due to exposure to the liquids, any repairs will not be covered by warranty, or repairs may not be possible. This may be repaired at a cost if repairs are possible.

Use a dry soft cloth such as the one for cleaning glasses to clean the equipment.

- The display may be scratched if it is rubbed hard with a dry cloth.
- Stains may result from droplets of water or dirt if they are left on the display.
- Do not use alcohol, thinner, benzene, detergent or other solvents for cleaning, otherwise the printing may be removed or discoloration may result.

Occasionally clean the terminals of the equipment using a dry cotton swab, etc.

The soiled terminals deteriorate the connection and might cause power discontinuity or incomplete charging. Wipe the terminals with a cotton swab, etc.

Take care not to damage the terminals when cleaning them.

Do not place the FOMA terminal near an air conditioner outlets.

Condensation may form due to rapid changes in temperature, and this may corrode internal parts and cause malfunction.

Do not apply excessive force onto the FOMA terminal and battery pack.

If you put the FOMA terminal in a bag along with many other articles or sit with the FOMA terminal in a clothes pocket, the display, internal circuitry and the battery pack could be damaged or malfunction. Also, if an external device is left connected to the connector terminal (earphone/microphone terminal), the connector could be damaged, or malfunction.

Carefully read each instruction manual attached to the FOMA terminal, adapter, or desktop holder.

Do not rub or scratch the display part with metals.

Doing so might cause damage to the part, resulting in trouble or malfunction.

Notes on handling the FOMA terminal

Avoid using in extremely high or low temperatures.

The FOMA terminal should be used within a temperature range of 5°C to 35°C and a humidity range of 45% to 85%.

If the FOMA terminal is operated near a landline phone, television set, radio or other devices in use, it may adversely affect the devices. Operate the FOMA terminal as far away from these devices as possible.

It is recommended that you make separate notes of the information stored in the FOMA terminal and keep such notes in a safe place.

We take no responsibility for any loss of the stored data items.

Do not drop the FOMA terminal or subject it to strong impacts.

Malfunction or damage may result.

Do not insert an external device to the connector terminal (earphone/microphone terminal) at a slant when connecting, and do not pull it out when it is inserted.

Malfunction or damage may result.

Make sure that nothing, such as a strap, gets caught between the parts of the FOMA terminal when you close it.

Otherwise, malfunction or damage may result.

The FOMA terminal becomes warm during use or charging but this is not an abnormality. Use the FOMA terminal as it is.

Do not leave the camera in places exposed to direct sunlight.

Pixels may be discolored or burns may result.

When using the FOMA terminal, ensure that you shut the lid for the connector terminal.

Dust or water might enter into the FOMA terminal, causing malfunction.

Do not use the FOMA terminal with the back cover left removed.

The battery pack might come out, or malfunction or damage may result.

Do not apply an excessively thick sticker onto the surfaces of the display, keys, or buttons.

Otherwise, malfunctioning, damage or problems with operation may result.

While you are using the microSD card, never take it off or turn off the power to the FOMA terminal.

Data may be erased or malfunction may result.

- **Do not place magnetic cards or similar objects near the FOMA terminal or between phone parts.**

Magnetic data on cash cards, credit cards, telephone cards and floppy disks, etc. may be deleted.

- **Do not bring magnetic substances close to your FOMA terminal.**

Problems with operation may result if items with strong magnetic fields are brought close to the FOMA terminal.

Notes on handling batteries

- **Batteries have a limited life.**

Though it varies depending on the usage state, you are advised to replace the battery if its usable time is extremely short even when you fully charge it. Make sure that you buy the specified battery.

- **Charge the battery in a place with an appropriate ambient temperature of 5°C to 35°C.**

- **The usable time of the battery differs depending on the usage environment or its remaining life.**

- **Depending on how the battery pack is used, it might swell as its operating life becomes short, but this is not a problem.**

- **Note the following points when you store a battery pack over a long period:**

- Storage in a fully charged state (the state immediately after charging is completed)
- Storage with no battery power left (the state you cannot turn on the power of the handset due to battery drain)

These may lower the battery pack's performance and shorten its operating life.

You are advised to store the battery pack in the state of two or three bars of battery icon indication as a guide for when you store it for a long period.

Notes on handling adapters

- **Charge the battery in a place with an appropriate ambient temperature of 5°C to 35°C.**

- **Charge the battery where:**

- There is very little humidity, vibration, and dust.
- There are no land-line phones, television sets or radios nearby.

- **While you are charging, the adapter may become warm. This is not a malfunction, so you can keep on using.**

- **Do not use the DC adapter for charging the battery when the car engine is not running.**
The car battery could go flat.

- **When using the power outlet having the disengaging prevention mechanism, observe the instructions given in that instruction manual.**

- **Do not give a strong shock. Also, do not deform the charging terminal.**
Malfunction may result.

Notes on handling the UIM

- **Do not apply more force than is necessary when installing or removing the UIM.**

- **The warranty does not cover damage caused by inserting the UIM into some other types of IC card reader/writer.**

- **Always keep the IC portion clean.**

- **Use a dry soft cloth such as the one for cleaning glasses to clean the equipment.**

- **It is recommended that you make separate notes of the information stored on the UIM and keep such notes in a safe place.**

We take no responsibility for any loss of the stored data items.

- **For the environmental protection, bring any unneeded UIMs to a handling counter such as a docomo Shop.**

- **Do not damage, carelessly touch, or short-circuit the IC.**

Data might be lost or malfunction may result.

- **Do not drop the UIM or subject it to strong impacts.**

Malfunction may result.

- **Do not bend the UIM or place something heavy on it.**

Malfunction may result.

- **Into the FOMA terminal, do not insert the UIM with a label or sticker pasted.**

Malfunction may result.

Notes on using Bluetooth function

■ As the security for communication using the Bluetooth function, the FOMA terminal supports the security function that meets the Bluetooth Specification. However, the security may not be sufficient depending on the configuration. Take care of the security for communication using the Bluetooth function.

■ Note that even if any leak of data or information occurs while making connection using the Bluetooth function, we take no responsibility.

■ With the FOMA terminal, you can use the following: Headset, Hands-Free, Audio, Dial-up Communication, Object Push, and Serial Port. With Audio, you might be able to use Audio Video Remote Control. (Only with the compatible Bluetooth devices)

■ Radio frequencies

The radio frequencies the Bluetooth function of the FOMA terminal uses are as follows:

2.4 FH 1

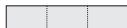

- 2.4 : Indicates radio facilities that use 2400 MHz frequencies.
- FH : Indicates the modulation system is the FH-SS system.
- 1 : Indicates that a supposed coverage distance is 10 meters or less.
-  : Indicates that all radio frequencies 2400 MHz through 2483.5 MHz are used, and that the frequencies for mobile object identifiers shall not be avoided.

■ Cautions on Using Bluetooth Devices
Bluetooth operates at radio frequencies assigned to the in-house radio stations for mobile object identifiers that have to be licensed and are used in production lines of a factory, specific unlicensed low power radio stations, and amateur radio stations (hereafter, referred to “another radio station”) in addition to scientific, medical, industrial devices, or home electric appliances such as microwave ovens.

1. Before using this product, make sure that “another radio station” is not operating nearby.
2. If radio interference between this product and “another radio station” occurs, move immediately to another place or turn off power to avoid interference.
3. For further details, contact “docomo Information Center” on the back page of this manual.

Notes on handling the FeliCa reader/writer

■ The FeliCa reader/writer function on the FOMA terminal uses very weak radio waves which do not require to be licensed as radio stations.

■ The FeliCa reader/writer is operated on the 13.56 MHz frequencies. When you use another reader/writer nearby, take enough distance between your FOMA terminal and the reader/writer. Further, ensure that there are no radio stations that use the same frequencies.

Caution

■ Do not use the modified FOMA terminal. Using a modified FOMA terminal infringes the Radio Law.

The FOMA terminals are granted technical regulations conformity certification as the specified radio equipment under the Radio Law and bear a “technical conformity mark  on the nameplate as evidence of conformity. Unscrewing the FOMA terminal and modifying internal components void the technical regulations conformity certification. Do not use the FOMA terminal in this state, which infringes the Radio Law.

■ Be especially careful not to operate the FOMA terminal while driving.

You will be imposed punishment if you use the mobile phone in your hand while driving. If you answer a call out of necessity, tell the caller with Hands-free that you will call him/her back, park your car to somewhere safe, and then dial.

■ Use the Bluetooth functions in Japan only. The Bluetooth functions on the FOMA terminal have been authorized in compliance with the radio transmission standards in Japan.

You might be imposed punishment if you use them overseas.

■ Use the FeliCa reader/writer functions in Japan only.

The FeliCa reader/writer functions on the FOMA terminal have been authorized in compliance with the radio transmission standards in Japan. You might be imposed punishment if you use them overseas.

Before Using

Attaching UIM (FOMA Card)/Battery Pack

1 Remove the back cover.

While pressing the “” part of the back cover in direction A, slide the back cover (2 mm or more) in direction B to unlock and remove it.

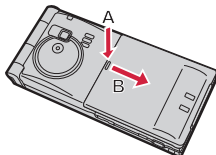

2 Insert the UIM.

With the golden IC surface downward, push the UIM slowly to the end while pressing surface.

- Take care not to damage the IC portion.

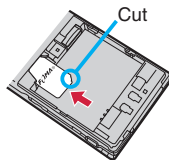

When you remove the UIM

Pull it out slowly while sliding.

About UIM

The UIM is an IC card that holds your information such as phone numbers. You cannot use the FOMA terminal for communications such as voice/videophone calls, i-mode, or sending/receiving mail, unless the UIM is inserted.



3 Attach the battery pack.

With the arrow mark facing up, fit the tab side of the battery pack to the FOMA terminal securely, and then push the battery pack in direction B while pressing it against direction A.

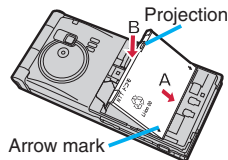

When you remove the battery pack

Engage your nail on the projection of the battery pack, and lift it up.

4 Attach the back cover.

With the back cover stayed open about 2 mm, match it to the groove on the FOMA terminal. Then while pushing the back cover as a whole downward, slide it in the direction of the arrow, and then install.

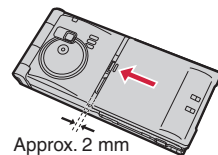

- Confirm there is no gap between the back cover and the FOMA terminal.

- Ensure that you turn off, close, and take hold of the FOMA terminal when you install or remove the UIM.
- You cannot use the UIM (blue) on your FOMA terminal. If you have that blue one, have it replaced at a docomo Shop.

Charging

Charging Using the Desktop Holder

- 1 Plug the connector of the AC Adapter (option) horizontally with its engraved side facing down into the connector terminal of the Desktop Holder (option).

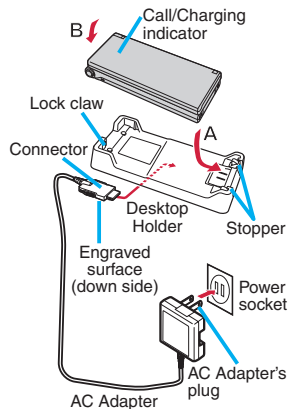

- 2 Pull out the AC Adapter's plug, and plug it into a household power socket of 100 V AC.
- 3 Put the bottom of the FOMA terminal into the stopper of the desktop holder (A) to fit the head to the lock claw, and then depress the FOMA terminal until it clicks (B).
 - Be sure to charge the FOMA terminal with the FOMA terminal closed.
 - Be careful that a commercial strap is not caught between the FOMA terminal and desktop holder.

- 4 When charging is completed, hold the desktop holder with fingers and lift up the head of FOMA terminal to remove.

Charging Only with the AC Adapter

- 1 Pull out the cover of the connector terminal in direction A, and turn it in direction B.
- 2 Insert the connector with the engraved surface facing up until it clicks.

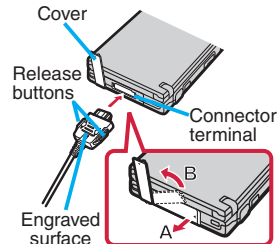

- For detaching, pull out the connector horizontally while pressing the release buttons. Malfunction could result if you try to pull it forcibly.
- When charging starts, the Call/Charging indicator lights in red. When charging is completed, it turns off.

Turning Power ON

1



Press and hold  for at least one second.

After the Wake-up display is displayed, the Stand-by display appears.

To turn power off

Press and hold  for at least two seconds.

The Initial Setting display appears when any of items through step 1 to step 5 at right have not been initialized. In that case, follow onscreen instructions.



Configuring Initial Setting

The Initial Setting display appears when you turn on the power for the first time.

1

Set the date and time.

You can set the date and time. You can also correct the date and time automatically.

2

Set your Terminal Security Code.

You can set your Terminal Security Code required for setting functions.

- "0000" is set at purchase.

3

Set Keypad Sound.

You can select whether to let a keypad sound play.

4

Set Location Request Set.

You can select whether to notify your current location for when a GPS location provision request arrives.

5

Set the size of fonts.

You can set the size of fonts on the display at a time.

Checking Your Own Phone Number



- 1 **MENU** from the Stand-by display ▶ Phonebook
▶ Own number

You can press  to switch the tabs.

- From the display on the right, press  (**Edit**) to store your name, mail address, etc.
- Refer to “Mobile Phone User’s Guide [i-mode] FOMA version” for how to check or change your mail address.



Own number

You can check your own phone number also by pressing   from the Stand-by display.



Switching to English Display

- 1 **MENU** from the Stand-by display
 - ▶ 設定／サービス (Set./Service)
 - ▶ ディスプレイ (Display)
 - ▶ バイリンガル (Select language)
- 2 Select “English (英語)”.

- When you install the UIM onto the FOMA terminal, the “バイリンガル (Select language)” setting is saved on the UIM.

Screen Explanation

Viewing Display/Icon

Battery level (estimate)



- When  is shown, charge the battery.
- Depending on the usage state, the battery level indication might significantly vary.

Radio waves reception level (estimate)

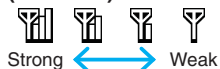

 You are out of the FOMA service area or radio waves do not reach.

 In eco Mode





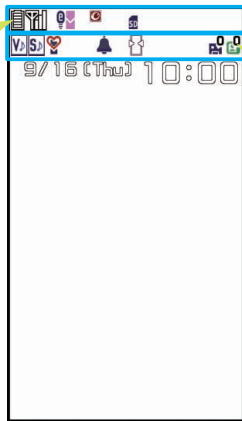

 Unread i-mode mail or SMS messages exist.

 New i-concier information exists.

 A microSD card is inserted.



Status icon

-  Vibrator is set.
-  Ring Volume is set to “Silent”.
-  In Manner Mode
-  An alarm is set.
-  View Blind is set.
-  The number of record messages
-  The number of videophone record messages

Here are given descriptions of the main icons. For descriptions of other icons appearing in the display, you can get them following the procedures as shown below:

-  from the Stand-by display ▶ LifeKit
- ▶ 使いかたナビ (Guide) ▶ 表示アイコン説明 (Icons)
- ※ This function is available in Japanese mode only.



Notification icon

New i-mode mail or SMS

Missed call

Record message

Videophone record message

Desktop icon

使いかたナビ (Guide)

i-concier

Dictionary

P-SQUARE (Maker site)

- “P-SQUARE” is available in Japanese only.

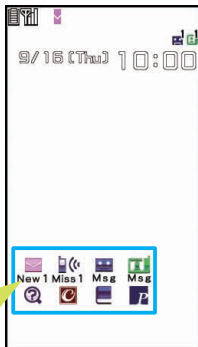

Dot Illum.

Information and animation are displayed on the dot illum. just as shown in the examples below.



While a call is being received



When mail messages have been received successfully

- Information and animation are displayed also in the following case:
 - When you close the FOMA terminal
 - Time signal (0 minutes every hour)
 - When charging starts
 - While a mail message is being received or when the receiving is unsuccessfully completed
 - When you start playback or operate the MUSIC Player
- The dot illum. is displayed while the FOMA terminal is closed. However, when you shoot with camera, it is displayed while the FOMA terminal is open.
- The displayed information and animation vary depending on the settings.



If you press  while the FOMA terminal is closed

The “time”, “date” and “remaining battery charge level/signal status” are displayed. Each time  is pressed, the display changes.

When a missed call or unread mail is found, the missed call or unread mail animation is displayed first.

Proceed to respective functions from icons

You can proceed to respective functions from “Status icon”, “Notification icon”, and “Desktop icon”.

1.  from the Stand-by display
 - ▶ Use  to highlight an icon ▶  (Select)

Navigation Displays and Key Operations

Key Operations in Normal Style

Key operations you can do while you are operating a function are shown at the bottom of the display.

(Navigation displays)

Key assignments and basic navigation displays

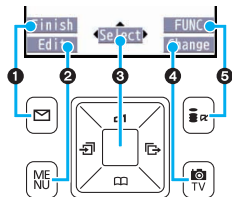

| | | |
|---|---|---------------|
| 1 | Operations you can perform with the key. | Finish |
| 2 | Operations you can perform with the key. | Edit Store |
| 3 | Operations you can perform with the key. | Select Set |
| 4 | Directions in which you can scroll and select items with the key. | |
| 5 | Operations you can perform with the key. | Change Detail |
| 5 | Operations you can perform with the key. | FUNC Set |

Navigation Displays while Dialing

Enter numeric strings in the Stand-by display. Then key operations for the function that you can use according to the number of digits appear in the display. You can now get the target function by one touch.

You can start up the functions like Calculator, Schedule, Alarm etc.

<Example> Enter 0916 to display Schedule.

1. Press from the Stand-by display.
2. Press .



Navigation displays

Command navigation key



- Moves the cursor or highlighted display up. (Hold down to scroll continuously.)
- Scrolls the page up.



- Moves the cursor to the right.
- Scrolls forward page by page. (Hold down to scroll continuously.)



- Fixes the operation.

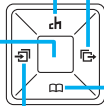

- Moves the cursor or highlighted display down. (Hold down to scroll continuously.)
- Scrolls the page down.

Key Operations in Horizontal Open Style

Key operations you can do are shown the same way as in Normal Style at the bottom of the display.

- While the vertical display is shown, you can operate the same way as in Normal Style even in Horizontal Open Style.
- Even when you have operated on the horizontal display, the display might switch to the vertical display depending on the function.

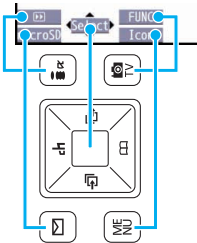

Difference in key operations

Key assignments differ between Normal Style and Horizontal Open Style. Follow and operate respective Navigation displays.

<Example: Displaying the Function Menu on the Inbox Folder list>

In Normal Style

Press .

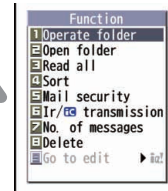
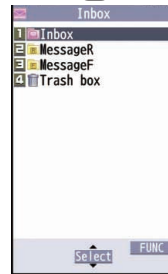

In Horizontal Open Style

Press .

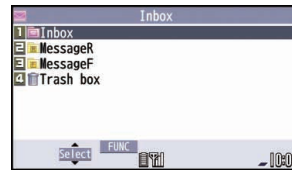

Menu Operation

Main Menu

Press **MENU** from the Stand-by display to show Main Menu.

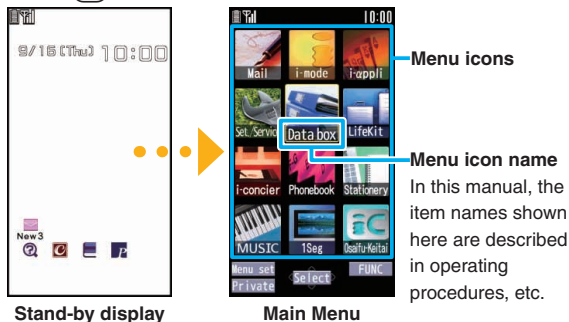

Use **Select** to highlight a menu icon and press **Select**. Functions categorized by every menu item are displayed. Repeat selecting items to call up the target function.

- You can press **CLR** to return to the previous display. When you press **Call** from any display, the Stand-by display returns.
- You can display some functions by pressing **MENU** + menu number from the Stand-by display.
- See “Function List” for the menu items and menu numbers of each function. (See page 90)
- In this volume, the descriptions of operating procedures are given primarily starting with the Stand-by display.

Horizontal Open Menu

Press **MENU** from the horizontal Stand-by display to open Horizontal Open Menu that enables you to quickly access the functions that are available to the horizontal display.

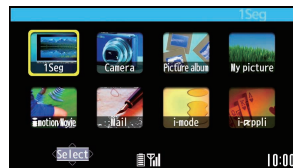

- Some operating procedures and menus shown on the Horizontal Open Menu differ from those on the display in Normal Style as described in this manual.

Simple Menu

Simple Menu is a menu focusing on only basic functions for easy operation. By setting “Menu icon setting” to “Simple menu”, you can show the Simple Menu by pressing **MENU** from the Stand-by display.

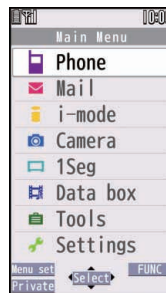

- Some operating procedures or items which appear on the display in Simple Menu differ from the ones described in this manual.

Function menu

When “ FUNC ” is displayed at the lower right of the display, you can use functions such as Store, Edit, and Delete by pressing .

<Example> Display the Function menu of a Phonebook entry

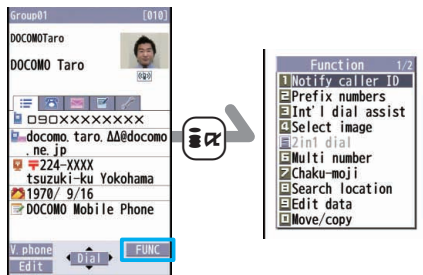







- When a function can be operated also by a key, the numeric key number or other marks may appear on the right of the function name.



Functions Start to Work by Simple Operation

Depending on the function, you can start it either by selecting a menu item or by key operation from the Stand-by display.

The following are the functions you can start by pressing keys for at least one second.

| Key | Performance |
|---|---|
|  | Switches Key Lock on/off. |
|  | Shows the Registration display for Phonebook entries. |
|  | Executes Check New Messages. |
|  | Shows the Software list. |
| MENU | Sets/Releases IC Card Lock. |
|  | Starts 1Seg. |
| 5 | Sets/Releases eco Mode. |
| 6 | Sets/Releases Personal Data Lock. |
| 8 | Switches View Blind on/off. |
| * (Star) | Activates/Deactivates Public mode (Drive mode). |
| # (Hash) | Activates/Deactivates Manner Mode. |
|  | Activates MUSIC Player. |
|  | Activates the camera in Digicam Mode. |

Operations while the FOMA terminal is closed

| Key | Performance |
|---|------------------------------------|
|  | Activates/Deactivates Manner Mode. |
|  | Activates MUSIC Player. |

Character Entry

You can enter characters on the Registration display for Phonebook entries or the Composition display for mail messages, etc.

1 Switch between input modes.

Each time you press  (**Mode**), input modes are switched.

- abc: Alphabet input mode
- ↓
- 123: Numeral input mode
- ↓
- 漢: Kanji/Hiragana input mode
- ↓
- か: Katakana input mode



2 Enter characters.

By repeatedly pressing a numeric key, you can enter other characters assigned to the key.

<Example> When you press 

Kanji/Hiragana input mode

「か→き→く→け→こ」

Katakana input mode

「カ→キ→ク→ケ→コ→2」

Alphabet input mode

「a→b→c→A→B→C→2」





Numeral input mode

「2」

3



Convert/fix characters.

1. Press  to specify the area to be converted.
2. Press  to move the cursor onto the candidate list.
3. Press  to select a conversion candidate.
4. Press  to fix the character.

Other key operations

 (**Pic**): Enter pictograms.

 (**Smiley**): Enter smileys.

 (for at least one second): Enter symbols.

: Enter a line feed.

(You can switch between uppercase and lowercase or enter “ ` ” and “ ° ” by pressing this key after you enter a character.)

 (for at least one second): Undo the fixed/erased characters.

: Clear text.

<Example> Entering “ただの菓子” in a text memo.

- 1  from the Stand-by display ▶ Stationery
▶ Text memo
▶ Select <Not recorded>.



- 2 Enter hiragana characters in Kanji/Hiragana input mode.

た → Press  once and  once.

だ → Press  once and  once.

の → Press  five times.

か → Press  once.

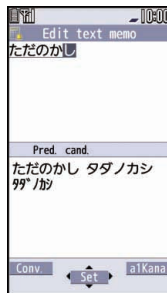

し → Press  twice.

- When a character on the same key comes after a character such as “あ” and “い”, press  to move the cursor, and enter the next character.

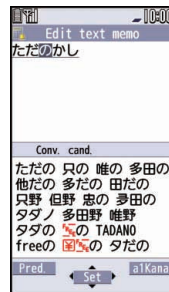

- 3 Use  to move the cursor onto “の”.



- 4 Use  to move the cursor onto the candidate list ▶ Use  to highlight “ただの” and press  (Select).

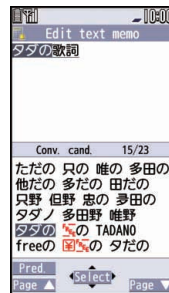



- 5 Use  to move the cursor onto the candidate list ▶ Use  to highlight “菓子” and press  (Select).

Sound/Screen Setting



Changing Ring Tone

<Example> Changing the ring tone for incoming voice calls

- 1  from the Stand-by display
▶ Set./Service ▶ Sound
▶ Select ring tone
- 2 Select “Phone”.
 - Press  () to check the content actually played back or displayed.
 - To set a ring tone for mail messages, videophone calls, and so on, select the corresponding item.
- 3 Select “Select ring tone”.
- 4 Select a type of ring tone.
- 5 Select a folder ▶ Select a ring tone.

Adjusting Ring Volume

<Example> Adjusting the ring volume for incoming voice calls

- 1  from the Stand-by display
▶ Set./Service ▶ Sound ▶ Ring volume
- 2 Select “Phone”.
 - To adjust ring volume for mail messages, videophone calls, and so on, select the corresponding item.
- 3 Use  to adjust the volume.

Setting Vibrator

You can set the vibrator to notify you of incoming calls.
<Example> Setting the vibrator for incoming voice calls

- 1  from the Stand-by display
▶ Set./Service ▶ Incoming call
▶ Vibrator
- 2 Select “Phone”.
 - To set a vibrator for mail messages, videophone calls, and so on, select the corresponding item.
- 3 Select a pattern.

Using Manner Mode

Just by pressing a key, you can make a tone from the FOMA terminal such as a ring tone, keypad sound, and alarm sound silence. When you start Manner Mode, not a sound but the vibrator works to notify you of incoming calls or messages.

1



Press and hold **#** for at least one second from the Stand-by display.



“♥” appears on the Stand-by display.

To release

Perform the same operation.

Using Original

You can use “Original” to tailor your FOMA terminal to how it works while Manner Mode is ON.

1. **MENU** from the Stand-by display ▶ Set./Service ▶ Incoming call ▶ Manner mode set ▶ Original
2. Set each item.
3. Press **Finish**.

- Even in Manner Mode, the shutter tone, and focus lock tone from the camera, and the start and end tones of the voice recorder play.

Setting Keypad Sound OFF

You can silence a Keypad sound for when you press a key.

1. **MENU** from the Stand-by display
▶ Set./Service ▶ Sound ▶ Keypad sound
2. Select “OFF”.

Changing Display Settings

Setting Stand-by display

1. **MENU** from the Stand-by display
▶ Set./Service ▶ Display
▶ Display setting
2. Select “Stand-by display”.
 - To set a display for making/receiving calls, or to show a battery icon, select the menu that corresponds to that item.
3. Select a type of image.
4. Select a folder ▶ Select an image.

Changing the Display Brightness

You can set Backlight to OFF. Then the display dims, and the keys turn off. You can also set the time that elapses before Power Saver Mode activates.

- 1  from the Stand-by display
▶ Set./Service ▶ Display ▶ Backlight
- 2 Select “Lighting” ▶ Select “OFF”.
- 3 Enter a time [time to saver (in seconds)].

Power Saver Mode

Power Saver Mode activates when the time set for “time to saver” has elapsed without any operations on the FOMA terminal. The display turns off to reduce battery consumption.

Making Display Hard to Be Seen by the People Around

You can set “View blind” to make it harder for the people around you to see the display from oblique angles.

- 1 Press and hold  for at least one second from the Stand-by display.





 appears on the Stand-by display.

To release

Perform the same operation.

Selecting a Pattern of the Main Menu Display

- 1  from the Stand-by display
▶  (Menu set)
- 2 Select a pattern.



Changing Font Size

You can change font sizes at a time.

- 1  from the Stand-by display
▶ Set./Service ▶ Display
▶ Font size setting
- 2 Select “Set at one time”.
 - You can also specify a font size for each function such as “Mail” or “Phonebook”.
- 3 Select a font size.



Changing Machi-chara Setting

You can change the Machi-chara image which appears to tell you missed calls, new mail messages, new i-concier information and others.



- 1  from the Stand-by display
▶ Set./Service ▶ Display ▶ Machi-chara
▶ Set to Machi-chara
- 2 Highlight a Machi-chara image and press  ().

Using Kisekae Tool

You can set the ring tone, Stand-by display, menu icons and others at a time.

- 1  from the Stand-by display
▶ Set./Service ▶ Kisekae
- 2 Highlight a Kisekae Tool file and press  ().
- 3 Select “YES”.
 - Some menu configurations change according to the usage frequency depending on the type of the menu.

Reset Menu Icons to Default

1.  from the Stand-by display ▶  ()
▶ Reset
2. Enter your Terminal Security Code
▶ Select “Reset menu screen” ▶ Select “YES”.

Changing Illumination

You can set the pattern of the illuminations such as for incoming calls and talking at a time.

1  from the Stand-by display
▶ **Set./Service** ▶ **Illumination**

2 **Select “All illum. setting”.**

- To set each illumination separately, select a type of illumination.

3 **Select a pattern.**

The indicator lights in the set illuminate in the set pattern when a mail message comes in or in other operations.

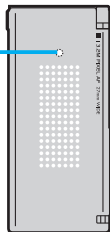

Checking Missed Calls and New Mail by Tone and Call/Charging Indicator

With the FOMA terminal closed, you can check for missed calls, new mail and others.

1  while the FOMA terminal is closed.



You can be notified by the electronic sound and lighting of the Call/Charging indicator.

Double-beep tone:

You have a missed call or new mail.

Triple-beep tone:

You have no missed calls or new mail.

- When “Info notice setting” is set to “ボイス (voice)” on the Japanese display, a voice message announces that you have a missed call or new mail.

Switching to the eco Mode

With a single key, you can set the eco Mode that reduces battery consumption.

1



Press and hold **5** for at least one second from the Stand-by display.



“” appears on the Stand-by display.

To release

Perform the same operation.

eco Mode Setting

You can set the items for reducing battery consumption for when the eco Mode activates.

1. **MENU** from the Stand-by display ▶ Set./Service
▶ Other settings ▶ Battery/eco mode set.
▶ eco mode setting
2. Put a check mark for items to be set.
3. Press **Finish**.

Lock/Security

Various Security Codes

■ Caution on security codes

- You should avoid using the numbers for security codes such as denoting your birth date, part of your phone number, local address number, room number, “1111” or “1234” that is easily decoded by a third party. Also make sure that you take a note of the security codes you have selected just in case you forget them.
- Take care not to let others know your security codes. Even if your security codes are known and used by a third party, we at DOCOMO take no responsibility in any event for the resultant loss.
- If you do not remember your respective security codes, you need to bring an identification card such as your driver’s license, the FOMA terminal and UIM to the handling counter of a docomo Shop.
For details contact “docomo Information Center” on the back page of this manual.
- The PUK (PIN unblock code) is described on the application form (your copy) that is handed over to you at a docomo Shop at the time of contract. If your contract has been made at a shop other than a docomo Shop, take with you something to prove yourself, like the driver license, and the UIM to the handling counter of a docomo Shop, or consult “docomo Information Center” on the back page of this manual.



Terminal Security Code “0000” at purchase

This is a four- to eight-digit number for deleting all files or changing settings. When the display for entering the Terminal Security Code appears, enter your four- to eight-digit code and press  (Set).

To change

-  from the Stand-by display ▶ Set./Service
▶ Lock/Security ▶ Change security code.

Network Security Code Determining at the time of contract

This is a four-digit number required for your identification when you place an order for at a docomo Shop, docomo Information Center, or “お客様サポート (User support)” site, or when you use respective network services.

- “お客様サポート (User support)” is available in Japanese only.

To change

From i-mode, you can change your Network Security Code by selecting “ Menu” → “お客様サポート (User support)” → “各種設定(確認・変更・利用) [Respective settings (Confirmation/Change/Use)]” → “ネットワーク暗証番号変更 (Change Network Security Code)”.

i-mode Password “0000” at the time of your contract

This is a four-digit number required for registering/deleting My Menu, applying for/canceling Message Services or i-mode pay services, etc.

To change

From i-mode, you can change your i-mode password by selecting “ Menu” → “English” → “Options” → “Change i-mode Password”.

PIN1 Code/PIN2 Code “0000” at the time of your contract

The PIN1 code is a four- to eight-digit number for checking the user each time the UIM is inserted into the FOMA terminal or each time the FOMA terminal is turned on, to prevent the unauthorized use by a third party.

The PIN2 code is a four- to eight-digit number for executing Reset Total Cost, using the user certificate or applying for the issue of it.

When the PIN1 Code/PIN2 Code Entry display appears, enter your four- to eight-digit PIN1 code/PIN2 code and press  (Set).

- If you enter a wrong PIN1 code/PIN2 code three times in succession, it is locked and the FOMA terminal cannot be used.

To change

-  from the Stand-by display ▶ Set./Service
▶ Lock/Security ▶ UIM setting
 - Enter your Terminal Security Code
▶ Select “Change PIN1 code” or “Change PIN2 code”.
- You need to have set “PIN1 code entry set” to “ON” to change the PIN1 code.

■ PUK (PIN Unblock Code)

The PUK (PIN unblock code) is the eight-digit number for releasing the PIN1 code and PIN2 code locks.

You cannot change this code by yourself.

- If you enter a wrong PUK (PIN unblock code) 10 times in succession, the UIM is locked. In that case contact one of docomo Shops.



■ PIN1 Code Entry Set





You can set the FOMA terminal not to work unless you enter your PIN1 code when turning the power on.

1.  from the Stand-by display
▶ Set./Service ▶ Lock/Security
▶ UIM setting
2. Enter your Terminal Security Code
▶ Select “PIN1 code entry set”.
3. Select “ON” ▶ Enter the PIN1 code.
To release
Select “OFF”.

Various Lock Functions

A variety of lock functions is installed on your FOMA terminal such as preventing a third party from illegally using it, or protecting your private information in it.

| | |
|--------------|--|
| Lock All | <p>You can set your FOMA terminal not to be used by a third party. You can do no operations other than answering calls and turning on/off the power.</p> <ol style="list-style-type: none"> 1.  from the Stand-by display ▶ Set./Service ▶ Lock/Security ▶ Lock all ▶ Enter your Terminal Security Code. • To cancel, enter your Terminal Security Code from the Stand-by display. |
| IC Card Lock | <p>You can lock the IC card function. You cannot use the Osaifu-Keitai, ToruCa download, iC Communication, etc.</p> <ol style="list-style-type: none"> 1. Press and hold  for at least one second from the Stand-by display. • To cancel, perform the same operation and enter your Terminal Security Code. |

| | |
|---------------------------|---|
| Omakase Lock | <p>When you have lost your FOMA terminal or in other cases, you can lock your personal data (such as Phonebook entries) and the IC Card function of Osaifu-Keitai by contacting DOCOMO.</p> <ul style="list-style-type: none"> For details on Omakase Lock, refer to "Mobile Phone User's Guide [i-mode] FOMA version". <p>■Setting/Releasing Omakase Lock</p> <p> 0120-524-360 (In Japanese only) Business hours: 24 hours (open all year round)</p> <ul style="list-style-type: none"> ※ Available from mobile phones and PHSS (including non-DOCOMO phones). ※ Unavailable from some IP phones. You can set/release also from the My docomo site via your personal computer or other devices. (In Japanese only) |
| Personal Data Lock | <p>You can lock functions which use personal information such as Phonebook entries or schedule events.</p> <ol style="list-style-type: none"> Press and hold  for at least one second from the Stand-by display. <ul style="list-style-type: none"> To cancel, perform the same operation and enter your Terminal Security Code. |
| Key Lock | <p>The keys except  are disabled.</p> <ol style="list-style-type: none"> Press and hold  for at least one second from the Stand-by display. <ul style="list-style-type: none"> To release, perform the same operation. Even during Key Lock, you can answer incoming calls by pressing . |

Restricting Incoming Calls

Rejecting Calls from No Caller ID

You can set whether to receive (accept) or not to receive (reject) a voice call and videophone call according to the reason for no caller ID. There are three reasons; "Unavailable", "PublicPhone", and "User unset".

-  from the Stand-by display
 - ▶ Set./Service ▶ Lock/Security
 - ▶ Call setting w/o ID
- Enter your Terminal Security Code
 - ▶ Select a reason for no caller ID.
- Select "Accept" or "Reject".
 - If you select "Accept", you can set a ring tone for incoming calls without caller IDs.

Rejecting Calls from Parties which are not Stored in Phonebooks

-  from the Stand-by display
 - ▶ Set./Service ▶ Lock/Security
 - ▶ Reject unknown
- Enter your Terminal Security Code
 - ▶ Select "Accept" or "Reject".

Reset to Default

Resetting the Function Settings

You can reset the items on “Function List”, which are indicated by . (See page 90)

- The items indicated by  might include the functions which do not return to their default settings or state.

- 1  from the Stand-by display
 - ▶ Set./Service ▶ Other settings
 - ▶ Reset settings
- 2 Enter your Terminal Security Code
 - ▶ Select “YES”.

Deleting All the Saved Data

You can delete all stored files at a time, then all the settings of functions return to their defaults.

- 1  from the Stand-by display
 - ▶ Set./Service ▶ Other settings
 - ▶ Initialize
- 2 Enter your Terminal Security Code
 - ▶ Select “YES”.
- 3 Select “YES”.

Resetting Data by Remote Control

If you contract with the service of this function (Business mopera Anshin Manager), you can initialize data on your FOMA terminal (memory within the handset/microSD card/UIM) by your (administrator’s) offer.

Inquiries

DOCOMO-enterprise-oriented website
docomo Business Online



From personal computers

<http://www.docomo.biz/> (in Japanese only)

※ You may not be able to access due to system maintenance, etc.

When Remote Reset starts

The display appears telling that operation is disabled and the initialization starts.





- When Remote Reset starts, all key operations except those for answering a voice call and holding answer (On Hold) are locked.
When the initialization starts, you are disabled to use all functions.
- When Remote Reset starts while a call is coming in or you are talking, all the key operations except those by  and  are locked. When the initialization starts, the incoming call and your talk are disconnected automatically.

- The microSD card might not be initialized when the FOMA terminal is connected to a personal computer.

Call Telephone

Making a Call/Videophone Call

Enter a Phone Number to Make a Call

- 1 From the Stand-by display, enter a phone number starting with a city code.
- 2 Press  to make a call.
 - To make a videophone call, press  (V. phone) instead of .
- 3 Press  to end the call.

- This FOMA terminal has no inward-facing camera. Therefore, the image sent to the other party is a Chara-den image, still image, or image being shot by the outward-facing camera.

You can put a call on hold by pressing  (Hold) during a call.

You can release holding by pressing  (Answer).









Making a Call from Phonebooks

<Example> Search a Phonebook entry by the name stored in Phonebook





- 1 Press  from the Stand-by display.
- 2 Select “Name?”.

From the second search, the search-method-selection display does not appear. To show it again, press .

 - You can use another search method such as “Phone number?”, “Mail address?”, and others.
- 3 Enter a part of the name 
 - If you enter nothing and press ; then you can display all Phonebook entries.
- 4 Select a Phonebook entry.

When an entry contains multiple phone numbers, press  to select a desired phone number.
- 5 Press  to make a call.
 - To make a videophone call, press  (V. phone) instead of .

Using Redial/Received Calls to Make a Call

- 1 Press  (Redial) or  (Received Calls) from the Stand-by display.
- 2 Select a call record.
- 3 Press  to make a call.
 - To make a videophone call, press  (V. phone) instead of .

Notifying the Other Party of Your Phone Number



- 1  from the Stand-by display
 - ▶ Set./Service ▶ NW services
 - ▶ Caller ID notification
- 2 Select “Activate/Deactivate”.
- 3 Select “Activate”.

- If you hear the guidance requesting your caller ID, either set the Caller ID notification or add “186” first and then try calling again.

Make an International Call

You can use WORLD CALL to make an international call from Japan.

- Contact “docomo Information Center” on the back page of this manual for inquiries about WORLD CALL.
- When using international carriers other than DOCOMO, contact them.

- 1  (for at least one second) from the Stand-by display ▶ Enter numbers in order of country/area code → area code (city code) → destination phone number.
 - When the area code (city code) begins with “0”, enter it except for the “0”. However, include “0” when making a call to some countries or regions such as Italy.
- 2 Press .
 - Press  (V. phone) to make a videophone call.
- 3 Select “Dial”.

- DOCOMO videophones conform to “3G-324M standardized by the international standard 3GPP”. You cannot connect to the videophone that uses a different format.

Receiving a Call/Videophone Call

1 A call comes in.

The ring tone sounds and the Call/Charging indicator lights.

2 Press to answer the call.

When a videophone call comes in

You can receive the videophone call the same way as with a voice call.

The substitute image is sent to the other party.

3 Press to end the call.

Adjusting Earpiece Volume

1 Press or during a call.

2 Press / to adjust the earpiece volume.

When You cannot Answer a Call

■ Activate Record Message

By activating Record Message, you can record a caller's voice/video message when you cannot answer the call.

- When a call comes in, an answer message is played back after the ring time elapses. Then, the caller's business is recorded with audio or video.

1 from the Stand-by display ▶ LifeKit





▶ Rec.msg/voice memo

▶ Record message setting

2 Select "ON".

3 Select an answer message

▶ Enter a ring time (seconds).

When a voice or video message is recorded as Record Message, the notification icon like " Msg" or " Msg" appears in the Stand-by display. Select " Msg" or " Msg" icon to play either the voice or video message.



Using Public Mode (Drive Mode)

Once you activate Public mode (Drive mode), the guidance is played back telling that you cannot answer the call as you are currently driving or in a place where you should refrain from speaking on the phone. Then the call is disconnected.

1



Press and hold  for at least one second, from the Stand-by display.

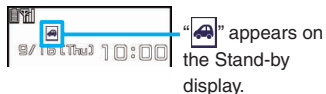

To deactivate

Perform the same operation.



When a call comes in during Public mode (Drive mode), the ring tone does not sound and the record is stored in "Received calls". The alarm does not sound even when the specified alarm time comes.

Using Public Mode (Power Off)

Once you activate Public mode (Power off), the guidance is played back for an incoming call while the power is off, telling that you cannot answer the call as you are currently in a place where the power should be turned off (hospital, airplane, around priority seat in a train, etc.). Then the call is disconnected.

1

Enter  from the Stand-by display.

2

Press .

To deactivate

1. Enter  from the Stand-by display.
2. Press .

Using Various Network Services

■ Network services available

The following are the DOCOMO network services available to the FOMA terminal.

- The network services are not available when you are out of the service area or out of reach of radio waves.
- For details, refer to “Mobile Phone User’s Guide [Network Services]”.
- For subscriptions and inquiries, contact “docomo Information Center” on the back page of this manual.

| Service | Application | Monthly fee |
|-----------------------------------|--------------|-------------|
| Voice Mail Service | Required | Charged |
| Call Waiting Service | Required | Charged |
| Call Forwarding Service | Required | Free |
| Nuisance Call Blocking Service | Not required | Free |
| Caller ID Notification Service | Not required | Free |
| Caller ID Display Request Service | Not required | Free |
| Dual Network Service | Required | Charged |

| Service | Application | Monthly fee |
|--------------------------|--------------|-------------|
| English Guidance | Not required | Free |
| Multi Number | Required | Charged |
| 2in1 | Required | Charged |
| Public mode (Drive mode) | Not required | Free |
| Public mode (Power off) | Not required | Free |
| OFFICEED | Required | Charged |
| Melody Call | Required | Charged |

- “OFFICEED” is a pay service that is available on a subscription basis.

For details, refer to the DOCOMO-enterprise-oriented website (in Japanese only).

<http://www.docomo.biz/html/service/officed/>

- “Deactivate” does not mean that the contract for Voice Mail Service, Call Forwarding Service or other services is canceled.
- When new network services are provided by DOCOMO, you can add them as menus.
- The way the outline of respective networks is described in this volume is by the menus on the FOMA terminal.



Using Voice Mail Service

- 1  from the Stand-by display
 - ▶ Set./Service ▶ NW services
 - ▶ Voice mail

Activate the service

1. Select "Activate" ▶ Select "YES".
 - You can also specify a ring time.

To play back the message

1. Select "Play messages" ▶ Select "Play (voice call)" or "Play (videophone)" ▶ Select "YES".
2. Operate following the voice guidance.



Using Call Waiting Service

- 1  from the Stand-by display
 - ▶ Set./Service ▶ NW services
 - ▶ Call waiting

Activate the service

1. Select "Activate" ▶ Select "YES".

Answer an Incoming Call during a Call

Press . Each time you press , you can switch the parties you can talk with.

Using Call Forwarding Service

- 1  from the Stand-by display
 - ▶ Set./Service ▶ NW services
 - ▶ Call forwarding

Activate the service

1. Select "Activate" ▶ Select "Activate"
 - ▶ Select "YES".
 - You can set the phone number of forwarding destination or ring time as well.

Services Available for FOMA Terminal

| Available services | Phone number |
|---|---|
| Directory assistance service (Charges apply: guidance fee + call fee) ※Listed phone numbers only are supported. | (No prefix) 104 |
| Telegrams (Telegram charges apply) | (No prefix) 115 |
| Time check (Charges apply) | (No prefix) 117 |
| Weather forecast (Charges apply) | City code of the desired area + 177 |

| Available services | Phone number |
|---|-----------------|
| Emergency calls to police | (No prefix) 110 |
| Emergency calls to fire station and ambulance | (No prefix) 119 |
| Emergency calls for accidents at sea | (No prefix) 118 |
| Disaster messaging service (Charges apply) | (No prefix) 171 |
| Collect calls (Charges apply: guidance fee + call fee) | (No prefix) 106 |

- If you use “Call Forwarding Service” for the land-line phone and specify a mobile phone as the forwarding destination, callers may hear ringback tone even when the mobile phone is busy, out of the service area, during Self Mode, or the power is turned off depending on the settings of the land-line phone/mobile phone.
- This FOMA terminal supports “Emergency Location Report”. When you make an emergency call such as at 110/119/118, information about the place where you are dialing from (location information) is automatically notified to emergency-response agencies such as police stations. It might happen that your correct location is not detected by emergency-response agencies depending on the location you dial from or radio wave conditions. When your location information is notified, the name of emergency-response agency is displayed on the Stand-by display. When you do not notify your phone number such as by adding “184” by every call, your location information and phone number are not notified. However, when an emergency-response agency has judged that the location information and phone number should be detected because of emergency priority such as for protection of human life, they might be notified regardless of your setting. Areas and timing “Emergency Location Report” introduced vary depending on the preparation of respective emergency-response agencies.
- When you make a call at 110/119/118 from the FOMA terminal, tell an operator that you are calling from a mobile phone and let them know your phone number, and then clearly tell where you are currently around, so that police/fire station can make a confirmation call to your mobile phone. Further, remain without moving while talking to prevent the call from being disconnected. Do not turn off the power immediately after the call, and make sure to place your phone standby for at least 10 minutes.
- You might not be connected to regional police/fire station depending on the area where you are calling from. If this happens, use public phones nearby or land-line phones.

Using Overseas

International Roaming (WORLD WING) is a service that allows you to use the FOMA terminal with the phone number and mail address you use in Japan, in a service area of the overseas carrier partnered with DOCOMO. It enables you to continue using the voice call, SMS and i-mode mail settings without having to make any changes.

- Concerning the areas where the service is supported
This FOMA terminal is available within the service area of 3G network and GSM/GPRS network, and in the countries/regions supporting 3G 850MHz. Check the areas where you can use the service.
- Refer to the following before you use this FOMA terminal overseas:
 - “海外ご利用ガイド (Guide for Overseas Use)” pre-installed in “My documents” in Data Box
 - “Mobile Phone User’s Guide [International Services]”
 - DOCOMO International Services website
 - ※“海外ご利用ガイド (Guide for Overseas Use)” is available in Japanese only.
- For the country/area codes, international call access codes, and international prefix numbers for the universal number, refer to “Mobile Phone User’s Guide [International Services]” or the DOCOMO International Services website.
- A fee charged for overseas use (call fee, packet communication fee) differs from that of in Japan.



Available Services Overseas

| Communication Service | 3G | GSM | GPRS |
|---|----|-----|------|
| Voice call※1 | ○ | ○ | ○ |
| Videophone call※1 | ○ | — | — |
| SMS※2 | ○ | ○ | ○ |
| i-mode※3 | ○ | — | ○ |
| i-mode mail | ○ | — | ○ |
| i-Channel※3※4 | ○ | — | ○ |
| i-concier※5 | ○ | — | ○ |
| i-Widget※6 | ○ | — | ○ |
| Packet communication by connecting with a personal computer | ○ | — | ○ |

○: Available —: Not available

- ※1 When using 2in1, you cannot make calls using your B number. When using multiple numbers, you cannot make calls using an additional number.
 - ※2 If the destination is a FOMA terminal, enter the other party’s phone number as you do in Japan.
 - ※3 You need to establish i-mode International Settings.
 - ※4 You need to establish i-Channel International Settings. You are charged a packet communication fee for automatically updating the basic channel information as well (which, in Japan, is included in the i-Channel fee).
 - ※5 You need to establish i-concier International Settings. You are charged a packet communication fee for each information you receive.
 - ※6 You need to establish i-Widget roaming settings. When you show an i-Widget display, multiple Widget Appli programs might start. In that case, you are charged a packet communication fee for each communication.
- The GPS function is not available overseas.
 - Some services are not available depending on the overseas carrier or network. For connectable countries, regions, and overseas carriers, refer to “Mobile Phone User’s Guide [International Services]” or the DOCOMO International Services website.

Make a Call to Outside the Country You Stay at

- 1  (for at least one second) from the Stand-by display ▶ Enter numbers in order of country/area code → area code (city code) → destination phone number.

- Enter “81” as a country/area code when you make an international call to Japan.
- When the area code (city code) begins with “0”, enter it except for the “0”. However, include “0” when making a call to some countries or regions such as Italy.

- 2 Press  to make a call.

- Press  (V. phone) to make a videophone call.

Making a Call to a Person in the Country You Stay at

- 1 From the Stand-by display enter a phone number.

- 2 Press  to make a call.

- Press  (V. phone) to make a videophone call.

Make a Call to a Person who is Staying Overseas and Using WORLD WING

When you make a call to a person who is also internationally roaming, make the call the same way as to make international calls to Japan even if he/she is in the country you stay at.

Mail

Sending i-mode Mail

Once you subscribe to i-mode, you can exchange e-mail messages over the Internet. You can attach less than 2 Mbytes of up to 10 files (photos, moving pictures, etc.) with body text added. For details on i-mode mail, refer to “Mobile Phone User’s Guide [i-mode] FOMA version”.

- 1  from the Stand-by display



- 2 Enter each item.

Enter a destination
(mail address).

Enter a subject.

Select a file such
as an image.

Enter text.



- 3 Press  (Send).

- 4 Select “OK”.

Sending Deco-mail

You can change the color or size of characters or background color, or insert images or Deco-mail pictograms.

1 from the Stand-by display

▶  (New)

- You can also select “Template” to create Deco-mail.

2 Enter an address and subject.

3 Select the text field

▶  (FUNC)

▶ Decorate mail

▶ Select one of decorations ▶ Enter text

▶  (Set)

Decorations

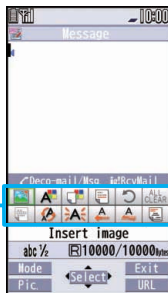

4 Press (Send).

5 Select “OK”.

Sending Decome-Anime

You can create impressive messages by inserting text or images into a Flash file.

1 from the Stand-by display ▶ Create new Decome-Anime

2 Enter an address and subject.

3 Select the text field ▶ Select “Phone” ▶ Highlight a template and press

 (NewMail).

4 Edit characters and images

▶  (Finish)

5 Press (Send).

6 Select “OK”.

Displaying Received i-mode Mail

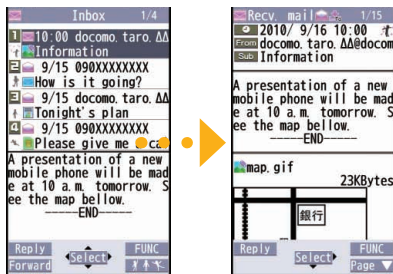

- 1 Press  from the Stand-by display ▶ Inbox
- 2 Select a folder.
- 3 Select an i-mode mail message.





When you receive an i-mode mail message,  appears on the Stand-by display.



Replying to i-mode Mail

- 1 Press  (**Reply**) while an i-mode mail is displayed.
- 2 Enter each item.
- 3 Press  (**Send**).
- 4 Select "OK".

Forward to i-mode Mail

1.  (**FUNC**) while an i-mode mail is displayed
▶ Reply/forward ▶ Forward
2. Enter each item.
3. Press  (**Send**).
4. Select "OK".

Checking New i-mode Mail

You can check the i-mode Center for a new mail message or Message R/F.

1



Press and hold  for at least one second from the Stand-by display.

When you receive an i-mode mail message or Message R/F, the following display appears.



Number of messages
Select an item to show the display for selecting a message.

Sorting i-mode Mail

You can use “Auto-sort” to sort received/sent i-mode mail messages into a folder such as “Business” or “Friend” which has been created in advance.

<Example> Sorting mail messages, which come from the address stored in the Phonebook, into a folder

- 1 Highlight a folder from Inbox Folder list and press  (FUNC) ▶ Sort
▶ Auto-sort
- 2 Select “Address sort”.
- 3 Select “Look-up address”
▶ Select “Phonebook”.
- 4 Look up for Phonebook entries and select a target i-mode mail address.

Early Warning “Area Mail”

Receiving Area Mail

You can receive information such as about earthquake alerts that are issued from the Japan Meteorological Agency as an Area Mail message.

When an Area Mail message arrives, “” lights and the buzzer for Area Mail sounds.

The received content of some messages is automatically displayed. To erase the displayed content, press .

- You can receive Area Mail messages even when you are not contracted to use i-mode.



Setting Area Mail

1 from the Stand-by display

▶ Area Mail settings

2 Select an item to be set

▶ Set each setting.

- You can also check “Check ring tone” for how your FOMA terminal works when you receive an Area Mail message.

Using SMS



You can send text messages to the mobile phone number at the other end.

Sending SMS

1 from the Stand-by display

▶ Compose SMS

2 Enter each item.

Enter a phone number. 
Enter text. 

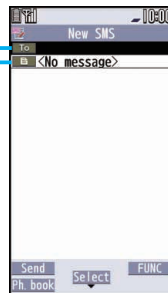

3 Press ().

4 Select “OK”.

Displaying Received SMS Message

- 1  from the Stand-by display ▶ Inbox
- 2 Select a folder.
- 3 Select an SMS message.

When you receive an SMS message,  appears on the Stand-by display.



Phonebook

Storing Phonebook Entries

Storing New Phone Numbers/Mail Addresses

- 1 Press and hold  for at least one second from the Stand-by display.

- 2 Select “Phone”.

The display for entering a name appears. Enter a name and proceed.

When storing entries onto the Phonebook on the UIM

Select “UIM”.

- 3 Enter each item.

Enter a name.

Enter a reading.



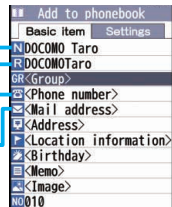

Enter a phone number.

Enter a mail address.



- 4 Press  (Finish).



Storing Phonebook Entries from Redial/Received Call Records

- 1 Press  (Redial) or  (Received Calls) from the Stand-by display.
- 2 Highlight a call record and press  (FUNC)
 - ▶ Select “Add to phonebook”.
- 3 Select “Phone” ▶ Select “New”.
- 4 Enter each item.
- 5 Press  (Finish).



Register a birthday to the Phonebook to have it shown on Schedule.



Editing Phonebook Entries

- 1  from the Stand-by display
 - ▶ Search and select a Phonebook entry.
- 2  (Edit)
 - ▶ Select an item to be edited
 - ▶ Edit the contents.
- 3 Press  (Finish).
- 4 Select “YES”.

Deleting Phonebook Entries

- 1  from the Stand-by display
 - ▶ Search and select a Phonebook entry.
- 2  (FUNC) ▶ Select “Delete data”.
- 3 Select “This phonebook”.
- 4 Select “YES”.

i-mode/Full Browser

Displaying i-mode Sites



i-mode is a service that enables you, by using the display of the FOMA terminal supporting i-mode (i-mode phone), to use online services such as site access, Internet access, and i-mode mail.

- i-mode is a pay service that is available on a subscription basis.
- For details on i-mode, refer to “Mobile Phone User’s Guide [i-mode] FOMA version”.
- You can display SSL/TLS*-compatible pages via i-mode and Full Browser.

*SSL/TLS are the safer data communication systems using authentication/encryption technology to protect your privacy.

1 Press from the Stand-by display.

You can access the  Menu. Repeat selecting items (links) to display the desired site.

- While you are online, “” blinks.
-  Menu is available in English. Select “English” from the display on the right.



■ Before using i-mode

- Content of sites or websites is in general protected by copyrights law. You can use data such as text and images for your entertainment, which you download to your i-mode phone, but you cannot use them, part or whole of it as is, or modify them for the purpose of sale or redistribution, without approval from copyright holders.
- If you replace the UIM with another one or turn on the power with the UIM not inserted, you cannot display/play back files, such as still images/moving pictures/melodies you download from sites, attached files (still images/moving pictures/melodies and other files) sent/received by mail, screen memos, and Messages R/F depending on the model.
- When the file has been set for the Stand-by display or for specified ring tone, of which display or playback is restricted by the UIM, the settings return to default if you replace it with new one or turn the power on with the UIM not inserted.

Displaying Websites Designed for PC

You can browse Internet websites designed for PCs using the Full Browser function.

- Note that you are charged a high communication fee for the massive data communication such as browsing Internet websites having many images or downloading data. For details on the packet communication fee, refer to “Mobile Phone User’s Guide [i-mode] FOMA version”.
- You can browse Internet websites composed of frames. You can select a frame to display it as well.

1 from the Stand-by display ▶ i-mode ▶ Full Browser Home

- By default, a confirmation display appears asking whether you want to use Full Browser.

• You might not correctly display some Internet websites.

Switching Browsers



You can switch to Full Browser to show the Internet websites incorrectly displayed by i-mode.

- The billing system differs between i-mode and Full Browser. With the latter, as packet communications fee will be a large sum, you are advised to use i-mode packet flat-rate service.

1 () while the website is displayed by i-mode ▶ Full Browser ▶ Switch to FB

2 Select “YES”.

To switch from Full Browser to i-mode

1.  () while the website is displayed by Full Browser ▶ i-mode Browser
▶ i-modeBRWSR Switch

Viewing and Operating Sites

Operations on site viewing display

Scroll display/Move highlighted/

Move the pointer: 

Select an item (link):  (Select)

Return to previous page:  (Back)

Forward to next page:  (Next)

Mute/Release mute:

 (for at least one second)

 appears while
accessing by Full Browser.

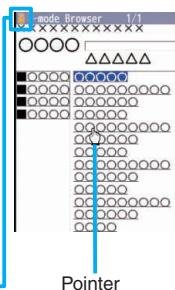

Storing Frequently Accessed Sites

Bookmark websites or i-mode sites you frequently visit to get easy access to them.

1.  (FUNC) while the site is displayed
▶ Bookmark ▶ Add bookmark

2. Select "YES" ▶ Select a destination folder.

To access a site stored in Bookmark

1.  from the Stand-by display ▶ i-mode ▶ Bookmark
2. Select a folder ▶ Select a bookmark.

Saving Site Content

If you save the page once you visited as a screen memo, you can easily refer to it without connecting to i-mode.

1.  (FUNC) while the site is displayed
▶ Screen memo ▶ Save screen memo

2. Select "Phone" ▶ Select "YES"
▶ Select a destination folder.

To display a saved screen memo

1.  from the Stand-by display ▶ i-mode
▶ Screen memo
2. Select "i-mode Browser" or "Full Browser".
3. Select a folder ▶ Select a screen memo.

- Depending on the site, for instance, when saving of screen memos is disabled at the site, you may not be able to save screen memos properly.

i-Channel

This service distributes information such as news and weather forecast to i-Channel mobile phones. The automatically received latest information flows on the Stand-by display by tickers. You can read it on the i-Channel list by pressing the i-Channel key.

Further, two types of channels, “Basic channel” provided by DOCOMO and “Favorite channel” provided by IPs (Information Providers) are available. You are not charged a packet communication fee for auto-updates of “Basic channel” information.

You are charged a packet communication fee for auto-updates of “Favorite channel” information that will be available by registering your favorite channels. Note that you are charged separately a packet communication fee for browsing detailed information for both “Basic channel” and “Favorite channel”.

When you use the international roaming service, you are charged a packet communication fee for both auto-update and browsing detailed information.

- i-Channel is a pay service which is available on a subscription basis (You need to subscribe to i-mode to apply for i-Channel).
- For details on i-Channel, refer to “Mobile Phone User’s Guide [i-mode] FOMA version”.
- The i-Channel service is provided in Japanese only.



Accessing i-Channel

- 1 Press  from the Stand-by display.

Select each channel to browse its detailed information.

Map/GPS

- GPS is operated by the United States Department of Defense, so the GPS radio wave conditions might be controlled (accuracy deterioration, radio wave supply suspension, etc.) depending on the defense strategy of the United States Department of Defense.
- Note that we do not take any responsibility for a loss such as pure economic loss resulting from the facts that you have missed the chance to check the positioned (communication) results, which have been caused by external factors such as malfunctions, erroneous operations, troubles, or power failure (including battery shortage) on the FOMA terminal.
- You cannot use the FOMA terminal as a navigating system for aircraft, vehicles, and people. Therefore, note that we are not held responsible for any damage resulting from the use of the location information for navigation.
- You cannot use GPS as a high-accuracy positioning device. Note that we do not take any responsibility for the damage caused by an error in the location information.
- You cannot use the GPS function when the FOMA terminal is out of the service area (or overseas).



■ Checking Your Location

You can pinpoint your current location by positioning, and display the location information. You can also display a map using the location information and send this information by i-mode mail.

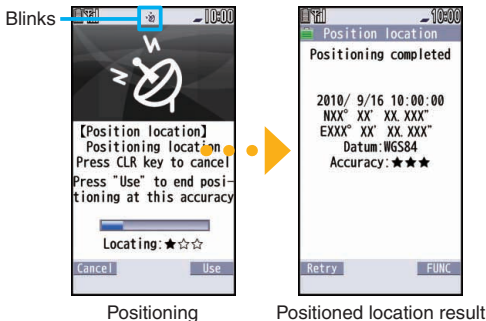

- You are not charged a packet communication fee for checking your current location. However, a separate packet communication fee are charged in cases where, for instance, a map has been displayed from the location information.

1 from the Stand-by display ▶ LifeKit ▶ Map/GPS ▶ Position location



The current location is positioned and displayed by the latitude and longitude.

To display the map of the current location

1.  () from the Position Location Result display ▶ Read map
- GPS compatible i-αppli starts and shows the map.

■ Reading Map

You can start GPS compatible i-αppli, and you can read a map of current or specified location.

- At purchase, “地図アプリ (Map Application)” is set.

1 from the Stand-by display ▶ LifeKit ▶ Map/GPS ▶ Map

To change GPS compatible i-αppli to be started

1.  from the Stand-by display ▶ LifeKit
▶ Map/GPS ▶ GPS settings
2. Map setting ▶ Select map
3. Select an i-αppli program ▶ Select “OK”.

When you use a GPS compatible i-αppli, the location information is sent to the information provider of the i-αppli program you use.



Camera

Viewing and Operating Finder Display

Menu

You can check the settings.

Select photo mode

iA: intelligent Auto

Image size setting

1080 x 1920: 2M Wide (1080x1920)

Image quality setting

S: Super fine

Flash setting

Auto

Store in

Phone (Camera)

Auto review

2 seconds

Key guidance

The key operation guide is displayed.

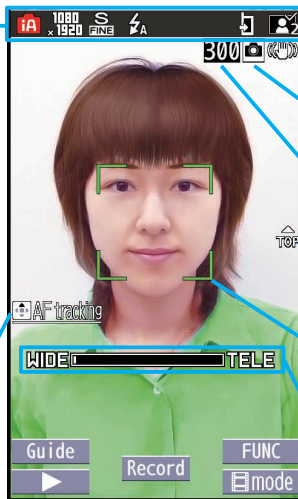

Image stabilizer

Auto

Continuous setting

1 image

Number of recordable image

Shows the number of remaining recordable still images.

Top icon

Shows the vertical direction for shooting.

Focus frame

When a subject is focused on, the frame becomes green.

Zoom bar

The zooming status is displayed.

For Digicam mode

Operations for shooting

Shutter/Save: , or

Zoom: (TELE) / (WIDE)

Focus function: , or (halfway)

Change camera-mode:



Flash setting/Photo light set.:

- Do not leave the FOMA terminal with the lens pointing to direct sunlight. Pixels may be discolored or burns may result.
- When the battery level is low, you may not be able to save still images/moving pictures you shoot.

Shooting Still Images/Moving Pictures

Shooting Still Images (Digicam Mode)



You can shoot still images within the sizes from Square (small) (480 x 480) to 13M (3120 x 4160).

- 1 Press  from the Stand-by display.
- 2 Press  (Record).





The still image is automatically saved to the set storage location.

Shooting Still Images (Photo Mode)

You can shoot still images within the sizes from Sub-QCIF (96 x 128) to 3M (1536 x 2048).

1.  from the Stand-by display ▶  (FUNC)
▶ Camera-mode ▶ Photo mode
2. Press  (Record).



Shooting Moving Pictures

- 1  from the Stand-by display
▶  (mode)
- 2 Start recording by pressing  (Record) ▶ End the recording by pressing  (Stop).
- 3 Press  (Save).

Viewing Still Images/Moving Pictures after Shooting

The still image you shot is saved to “My picture” in Data Box. The shot moving picture is saved to “motion/Movie” in Data Box.

The still image/moving picture can be set for the Stand-by display or other displays.

- 1  from the Stand-by display
▶ Data box
▶ My picture or  motion/Movie
- 2 Select the “Camera”
▶ Select still image or a moving picture.

Picture Album

You can detect a person's face on the still image you have shot and expand it, or add corrective effects to the detected face. You can also play expressive slide shows with the effect function.

1.  from the Stand-by display ▶ Select still image.
 - You can display the still images in Picture Album also by pressing  (▶) from the Finder display in the Digicam Mode or Photo Mode.

Shooting Still Images Using Various Methods

Shooting Still Images Using Omakase Choice



You can shoot 8 still images in succession. The FOMA terminal automatically displays the successfully-shot still images judging from the focus and composition.

1 Press  (FUNC) from the Finder display for Digicam Mode ▶ Cont. set.

▶ Omakase choice

2 Press  (Record).

3 The Post View display appears with the first successfully-shot still image selected.

- “” is added to three superior images.
- You can check out other still images by pressing .

4 Press  (Save).

- You can save all the shot images by pressing  (STO all).

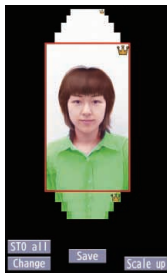

Shooting Still Images Using Auto Shutter

The camera automatically shoots identifying the number of faces and the distance between faces by face recognition.

<Example> Using “Group shutter” to shoot a group of three persons

1 Press  (FUNC) from the Finder display for Digicam Mode ▶ Auto shutter

2 Select “Group shutter”.

3 Select “Three”.

When the faces of three persons are recognized, the self timer works, and three seconds later an image of the group is shot.

The still image is automatically saved to the set storage location.

Using 1Seg

■ Using 1Seg

1Seg is a service provided by television entrepreneurs (broadcasting stations). You are not charged a communication fee for receiving video and audio. For about fee charged by NHK, contact NHK.

※ You are charged a packet communication fee for browsing “Data broadcasting site” and “i-mode site”. You might be charged an information fee for using some sites (i-mode pay sites).

※ For details on the 1Seg service, browse the following websites:

The Association for Promotion of Digital Broadcasting

From personal computer: <http://www.dpa.or.jp/english/>

From i-mode: <http://www.dpa.or.jp/1seg/k/> (In Japanese only)

※ 1Seg is not available overseas.

■ Radio waves

1Seg is one of the broadcasting services receiving radio waves (broadcasting waves) different from that used for the FOMA services.

You might not be able to correctly receive 1Seg broadcast in places as follows:

- Places far away from radio towers that transmit broadcasting waves
- Mountain-ringed regions or behind buildings
- In tunnels, underground, or recesses of buildings

※ The reception conditions might be improved by moving your FOMA terminal away from or close to you, or by moving yourself to another place.

■ Battery level

If you try to start 1Seg when the battery is low, the battery alert tone sounds, and a confirmation display appears asking whether to start it. In addition, when the battery level becomes low while you are watching or recording a 1Seg program, the battery alert tone sounds.

- When you do nothing on the confirmation display for about one minute, 1Seg automatically terminates.

■ Messages on the display when you use 1Seg for the first time

When you use 1Seg for the first time after purchase, the Exemption Clause Confirmation display appears.

If you select “NO” on a confirmation display which appears after pressing  (OK), the same confirmation display does not appear afterward.



Setting Channels

When you activate 1Seg for the first time or change the area you are in, you need to operate “Channel setting”. Select “Auto channel setting” to enable you to search automatically for broadcast stations you can watch.

- You need to set this function when you are in the terrestrial digital TV broadcasting service area.

1  from the Stand-by display ▶ 1Seg
▶ Channel setting
▶ Auto channel setting

2 Select “YES”.

3 Select “YES” ▶ Enter a title.

To execute Channel Setting by selecting an area

1.  from the Stand-by display ▶ 1Seg
▶ Channel setting ▶ Select area
2. Select an area ▶ Select a prefecture.
3. Select “YES”.

Watching 1Seg

1



Press and hold  for at least one second from the Stand-by display.

1Seg starts and the viewer display appears.

When you switch to Horizontal Open Style, you can watch a 1Seg program on the horizontal display.



Viewing and Operating Viewer Display

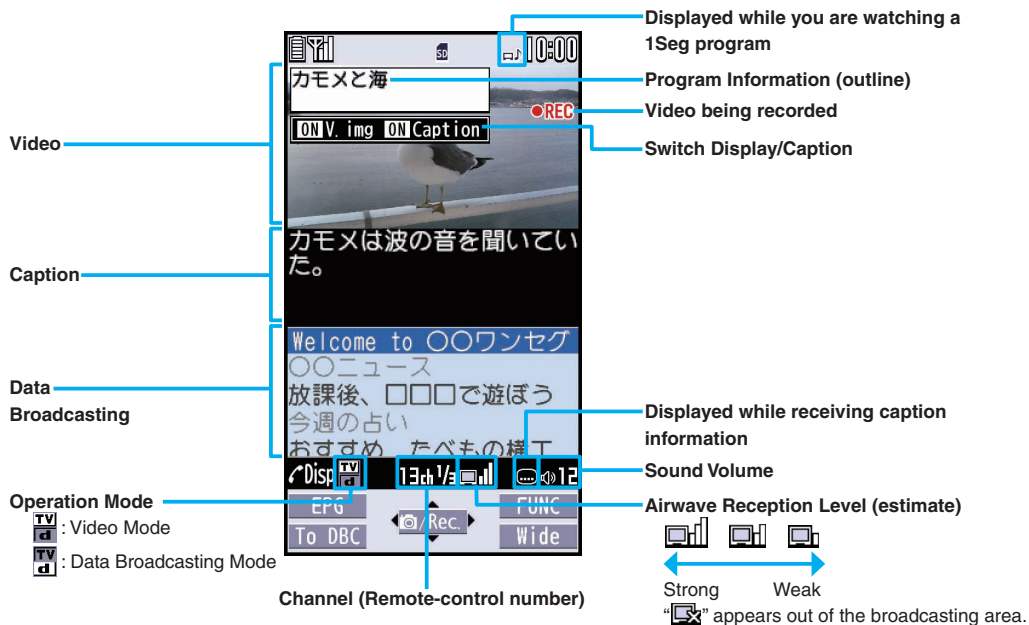

The operation on the viewer display

Channel selection: or (for at least one second)

Sound volume adjustment: or

Video recording: () (for at least one second) or (for at least one second)

- The recorded video is saved on the microSD card.

Switch TV/data BC:

Switch display directions:

Setting Timer for Watching or Recording 1Seg Programs

Set the date and time, a channel, and program name, and enter them to the TV Timer List or Timer Recording List. When the set time arrives, watching or recording starts.

1  from the Stand-by display ▶ 1Seg

2 Select “TV timer list” or “Timer recording list”.

3 Press  ().

4 Enter each item.

5 Press  ().

Playing Recorded Video

1  from the Stand-by display
▶ Data box ▶ 1Seg

2 Select “Video” ▶ Select a file.

While playing the video, press  to switch to horizontal display to make images appear enlarged.



Music&Video Channel

Music&Video Channel is a service which automatically delivers up to about one-hour programs at night just by selecting your favorite music programs in advance. Further, you can enjoy high-quality video program of up to about 30 minutes. Programs are updated periodically and you can enjoy the delivered programs at any time such as on commuting.

■ Before using Music&Video Channel

- Music&Video Channel is a pay service that is available on a subscription basis. (To apply for Music&Video Channel, you need to subscribe to i-mode and i-mode packet flat-rate service.)
- In addition to the service fee for using Music&Video Channel, you might be charged separately an information fee depending on the program.
- If you insert the UIM to the Music&Video Channel incompatible FOMA terminal after you subscribe to Music&Video Channel, you cannot use Music&Video Channel Service. Note that the service fee applies unless you cancel the Music&Video Channel subscription.
- You cannot set or download programs during international roaming.* Take procedures to halt the distribution of programs before going abroad. Then, after homecoming, resume the reception of distribution.
*When you try to set or download programs during international roaming, note that you are charged a packet communication fee for i-mode communication.
- For the details on Music&Video Channel, refer to "Mobile Phone User's Guide [i-mode] FOMA version".
- The Music&Video Channel service is provided in Japanese only.

Setting Programs

- 1  from the Stand-by display ► MUSIC
► Music&Video Channel ► Set program
- 2 Follow the instructions on the display to set a program.
The program automatically downloads at night.

Playing Program



- 1  from the Stand-by display ► MUSIC
► Music&Video Channel
- 2 Select a program.

Operation while playing back a Music&Video Channel program

Halt:  

Pause:  

Sound volume adjustment:

 or 

Search (fast forward):

Press and hold 

Search (fast rewind): Press and hold 



Downloading Chaku-uta Full® Music Files

You can download Chaku-uta Full® music files from sites.

- 1 Select a Chaku-uta Full® music file at a downloadable site.
- 2 Select “Save” ▶ Select “YES”.
- 3 Select a destination folder.

- “Chaku-uta Full” is a registered trademark of Sony Music Entertainment Inc.

■ Handling music files

You can use music files saved on the microSD card for personal use only. Before using, give enough consideration not to infringe on the third party’s intellectual property rights or other rights such as copyright.













Playing Music Files

MUSIC Player enables you to play Chaku-uta Full® music files you have downloaded from sites, or to play Windows Media® Audio (WMA) files you saved on the microSD card using your personal computer.

- 1  from the Stand-by display ▶ MUSIC ▶ MUSIC Player
- 2 Select “All tracks” ▶ Select a music file.



Operations of MUSIC Player display

- Halt:  () Pause:  ()
- Search (fast forward): Press and hold 
- Search (fast rewind): Press and hold 
- Sound volume adjustment:  or 
- Replay next file:  or  (for at least one second)
- Replay previous file or go back to the beginning of the file:  or  (for at least one second)

i-αppli/i-Widget

“i-αppli” is a software program for i-mode mobile phones. By downloading various software programs from the i-mode site, you can use your FOMA terminal more conveniently. You can automatically update the stock price information or weather information, and enjoy games without accessing network.

Your press of the single i-Widget key (CLR) enables you to access the frequently used content such as calculator, clock, and stock price information (Widget Appli).

You can add Widget Appli programs by downloading from sites provided by IPs (Information Providers).

- You are charged separately a packet communication fee for downloading i-αppli programs or Widget Appli programs.
- A multiple number of Widget Appli programs may start communicating when you open the i-Widget display. In that case, you are charged separately a packet communication fee.
- For details on i-αppli/i-Widget, refer to “Mobile Phone User’s Guide [i-mode] FOMA version”.



Starting i-αppli

- 1 Press and hold (CLR) for at least one second from the Stand-by display.
- 2 Select a software program.



Using i-Widget

- 1 Press (CLR) from the Stand-by display. i-Widget that can simultaneously start multiple Widget Appli programs opens.
- 2 Select a Widget Appli program.

You can operate Widget Appli program separately.

Widget Appli

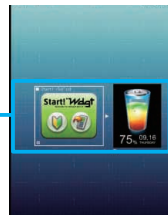

Downloading i-αppli from Sites

- 1 Select a software program from downloadable site.
- 2 Select “OK” when downloading ends.
- 3 Select “YES”.

- You can delete the pre-installed i-αppli programs except for the “ケータイTOOL<辞書> (KEITAI TOOL Dictionary)”. You can re-download deleted programs from the “P-SQUARE” site.

You can download not only i-αppli programs but also the pre-installed Chara-den images, Machi-chara images, Kisekae Tool files, templates, dictionaries, and Deco-mail pictograms from the “P-SQUARE” site (in Japanese only).



QR code for
accessing the site

☰ Menu→メニューリスト (Menu List)→ケータイ電話メーカー (Mobile Phone Maker)→P-SQUARE

- Deadlines for re-download services
 - ・“モバイルGoogleマップ (Google Map for Mobile)”: the end of May, 2013
 - ・“リバーシ (REVERSI)”: the end of March, 2014
 - ・“ハイパー四川省 (Hyper Sichuan)”: the end of March, 2014
- The services such as re-downloading might be halted or closed without notice even in the service period.

i-motion/Movie

i-motion is a file consisting from video, audio, and music which you can download to your FOMA terminal from i-motion sites that support i-motion. You can also set it for a ring tone.

Also, by using high speed communication, you can play back smooth and high-quality movie files provided by portal sites, movie specialty sites and other sites on the Internet.



- When downloading or streaming an i-motion/movie file, you might receive a bulky file. When data size required for sending or receiving is bulky, packet communications fees will be a large sum. You are advised to use i-mode packet flat-rate service.
- Two types of i-motion/movie files, streaming type and normal/download type are available.

| Categories | Description |
|--|--|
| Streaming type (cannot be saved) | Plays data while receiving. |
| Normal/Download type (can be saved) | When download is completed, the Download Completion display appears. You can then play or save data. |

Downloading i-motion/Movie

- 1 Select an i-motion/movie file from an i-motion/movie downloadable site.
- 2 Select “Save” ► Select “YES”.
- 3 Select a destination folder.

Playing i-motion/Movie

- 1  from the Stand-by display
► Data box ► 
- 2 Select a folder
► Select an i-motion file or a movie file.

Osaifu-Keitai

Osaifu-Keitai/ToruCa

Osaifu-Keitai is equipped with the IC card so that you can make payments, use coupons, enjoy stamp rallies and so on by placing the FOMA terminal over the scanning device in the stores or other locations. Furthermore, by placing the FOMA terminal over a scanning device, you can access sites and web pages, obtain the latest coupons by communication, and check the deposits of electronic money and the status of its use. Security of the card is well established so that you can use it carefree.

ToruCa is an electronic card that you can receive with Osaifu-Keitai for use as fliers, restaurant cards, and coupon tickets. You can download ToruCa files from scanning devices, sites, or data broadcasting, and can easily exchange them using mail, infrared communication, iC communication, or a microSD card. The downloaded ToruCa files are saved to “ToruCa” on “Osaifu-Keitai”. For details on Osaifu-Keitai and ToruCa, refer to “Mobile Phone User’s Guide [i-mode] FOMA version”.

- Data on the IC card (including electronic money, reward points, etc.) might be lost or deformed owing to the malfunction of the FOMA terminal. (You cannot deposit your FOMA terminal at our hand for repair, remaining data files on it. You are asked, as a rule, to delete them by yourself.) As to the support such as reissue, restoration, temporal storage, and transfer of data, consult the provider of your Osaifu-Keitai compatible service, except for the transfer by the iC transfer service. For your important data, be sure to use the service with backup support.
- In any case including malfunction or model change, we cannot be held responsible for the loss or deformation of data on the IC card or other losses caused regarding Osaifu-Keitai compatible services.
- When your FOMA terminal is stolen or lost, immediately inquire of the provider of your Osaifu-Keitai compatible service about the countermeasures.
- Even when the power is turned off or the battery runs out, the “Osaifu-Keitai” function is available by holding the  mark over the scanning device. The function may not be available, however, if you do not use the battery pack for a long time or leave the battery uncharged after the battery alert activates.



1 Place the mark of the FOMA terminal over a scanning device to use the target service.

The Call/Charging indicator lights when you bring your FOMA terminal close to the scanning device and communication becomes ready.

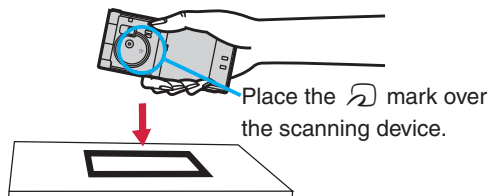

i-concier

“i-concier” works to serve you with a pleasant life just like a clerk or concierge does. The service holds your data (area information about your neighborhood, Schedule, ToruCa, Phonebook, etc.) and sends you information, with good timing, about a variety of things according to your living area, your current location, or your preference or interest. This service automatically updates schedule events or ToruCa files to the latest ones, and automatically adds useful information such as about the opening period of various shops to your Phonebook. It also allows you to share the schedules or images held by the DOCOMO’s Data Storage Center with friends, family members or other groups. It also enables you to easily print out the images held. i-concier information is notified by a Machi-chara image (cartoon character that appears on the Stand-by display).

- For details on i-concier, refer to “Mobile Phone User’s Guide [i-mode] FOMA version”.
- i-concier is a pay service which is available on a subscription basis (You need to subscribe to i-mode to apply for i-concier).
- If you have not subscribed to Data Security Service but will newly subscribe to i-concier, you are to subscribe to Data Security Service as well as i-concier.
- Depending on the content (information, i-schedule, and others), you might be charged separately an information fee other than the i-concier monthly fee.
- You are charged a packet communication fee separately for receiving information except some.
- You are charged separately a packet communication fee for using detailed information.
- You are charged separately a packet communication fee for auto-updates of i-schedule, ToruCa, and Phonebook.
- i-concier is available in Japanese only.

Receiving Information

- 1 When information arrives,  blinks and the content is displayed on the Stand-by display.

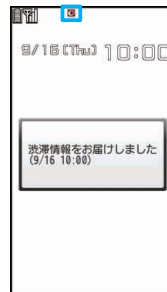

- 2 Select a message.

Displaying i-concier Screen

- 1  from the Stand-by display
▶ i-concier
- 2 Select a piece of information.

Convenient Tools

Using Schedule

- 1  from the Stand-by display ▶ Stationery ▶ Schedule

Select a date to show a schedule event of the selected date. Select the schedule event to confirm its details.



- 2  (**FUNC**) ▶ Select “New”.

You can store a new schedule event.

- 3 Enter each item.

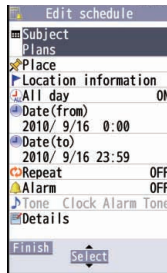

- 4 Press  (**Finish**).

Using Alarm

- 1  from the Stand-by display
▶ Stationery ▶ Alarm

- 2 Highlight an alarm and press



- 3 Enter each item.

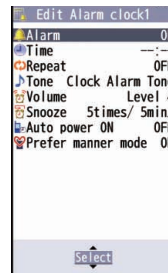

- 4 Press  (**Finish**).

- The alarm does not sound in Public mode (Drive mode), Lock All, Personal Data Lock, or Omakase Lock.

Using Bar Code Reader

You can use the camera to scan QR codes and others, and store them as files.

From the scanned data, you can make calls, compose i-mode mail messages, access Internet websites, and so on.

■ When scanning with Bar Code Reader

- Scan the code as large as possible within the guide frame.
- Autofocus works when you scan the code about 10 cm or more away from it.

When you scan the code in the out-of-focus state, the recognition rate lowers.

- Scan so that the camera is in parallel with the code.



■ QR code

QR code is one of the 2-dimensional codes that denotes data in the vertical and horizontal directions.

- “株式会社NTTドコモ (NTT DOCOMO, INC.)” is displayed when you scan the QR code with the FOMA terminal.





■ Scan a Code

<Example> Access P-SQUARE by using QR code on the right



QR code for accessing the site

- 1  from the Stand-by display ▶ LifeKit
▶ Bar code reader
- 2 Select “Scan code”.
- 3 Fit a code to the guide frame and press .
- The subject is focused on by autofocus function.
- 4 Press  (Start) to scan the code.
A URL is displayed as a scanned result.
- 5 Select the URL
▶ Select “i-mode Browser”
▶ Select “YES”.

Bluetooth Function

You can connect your FOMA terminal to a Bluetooth device such as Wireless Earphone Set 02 (option), and can talk on the phone or play music files.

■ Register a Bluetooth Device to the FOMA Terminal

You can search and register a Bluetooth device to the FOMA terminal. You need to place the Bluetooth device to be registered standby for registration beforehand.

<Example> Register Wireless Earphone Set 02 and connect using the Hands-free service

- 1  from the Stand-by display ▶ LifeKit
▶ Bluetooth ▶ Register New Devices
- 2 Select “OK”.
- 3 Select Wireless Earphone Set 02
▶ Select “YES”.
 - When you register a Bluetooth device other than Wireless Earphone Set 02, you need to enter “Bluetooth passkey”.
- 4 Select “Hands-free”.
Select “Headset” or “Hands-free” for talking, and select “Audio streaming” for playing music.

■ Connect the Bluetooth Device

- 1  from the Stand-by display ▶ LifeKit
▶ Bluetooth ▶ Device list
- 2 Select a Bluetooth device
▶ Select a service to connect to.

While the Bluetooth device is connected, “” blinks.



Data Management

Using microSD Card

If you do not have a microSD card, you need to purchase it.

- P-04B supports a commercial microSD card of up to 2 Gbytes and microSDHC card of up to 16 Gbytes (As of April 2010).

For the latest operation check information such as the memory capacity and manufacturers of microSD cards, access the following sites (in Japanese only). Note that the microSD cards other than published in the sites might not correctly work.

- From i-mode to P-SQUARE (As of April 2010)

☰ Menu →メニューリスト (Menu List)
→ケータイ電話メーカー (Mobile Phone Maker) → P-SQUARE

- From personal computers
<http://panasonic.jp/mobile/>

Note that the published information is the result obtained from the operation check, which does not necessarily guarantee all performances of those microSD cards.

- Make sure that you turn off the power, and then insert/remove the microSD card.



QR code for accessing the site



Inserting/Removing microSD Card

- 1 With the metal terminal surface facing downward, make sure that the cut edge is positioned at right and then insert.

- Push it until it clicks.

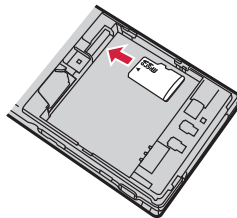

When you remove the microSD card

Push the microSD card until it stops and remove it.

- Note that the microSD card may pop out when you insert or remove it.

The inserting slot of the microSD card is in the inside of the back cover. To insert, first remove the back cover and battery pack.



Icons on the Display



: A microSD card is inserted.

: Data is being read/written.

(Do not remove the microSD card nor turn off the FOMA terminal.)

: The microSD card is write-protected.



: The microSD card cannot be used.

(Insert the microSD card again. If “” is still displayed, execute “Check microSD” or “microSD format”.)

Formatting microSD Card

When you use the microSD card for the first time, you need to format (initialize) it.

- Be sure to use P-04B for formatting. The microSD card formatted using other devices such as personal computers may not work properly.
- Note that formatting deletes all content on the microSD card.

-  from the Stand-by display ▶ LifeKit
 ▶ microSD ▶ Refer microSD data
 ▶  () ▶ microSD format
- Enter your Terminal Security Code
 ▶ Select “YES”.

Copying Data to the microSD Card

<Example> Copying a still image

- 1  from the Stand-by display
 - ▶ Data box ▶ My picture
 - ▶ Select a folder.
- 2 Highlight a still image to be copied and press  ()
 - ▶ Select “Copy to microSD”
 - ▶ Select “Copy this”.



Copying Data to the FOMA Terminal

<Example> Copying a still image

- 1  from the Stand-by display
 - ▶ Data box ▶ My picture ▶  (microSD)
 - ▶ Select a folder.
- 2 Highlight a still image to be copied and press  ()
 - ▶ Select “Copy to phone”
 - ▶ Select “Copy this”.



Displaying Data Stored on the microSD Card

<Example> Displaying still image

- 1  from the Stand-by display
 - ▶ Data box ▶ My picture ▶  (microSD)
- 2 Select a folder ▶ Select an image.

Check Capacity of microSD Card

You can check the used and unused memory space (estimate) on the microSD card.

1.  from the Stand-by display ▶ LifeKit ▶ microSD
 - ▶ Refer microSD data
2.  () ▶ Select “microSD info”.

Back up Data to the microSD Card

You can back up Phonebook entries, schedule events, ToDo items, messages, text memos, and bookmarks, and the settings on and information about your FOMA terminal collectively onto the microSD card. When restoring the backup data onto your FOMA terminal, they are collectively restored.

- Backing up data from the FOMA terminal onto the microSD card is collectively applied to all data, so data not created in the FOMA terminal is also backed up on the microSD card. When you restore such data onto your FOMA terminal, either data that was vacant on the microSD memory card at the time of backup write over data in the FOMA terminal or even data created later in the FOMA terminal is written over.

1.  from the Stand-by display ▶ LifeKit
▶ microSD ▶ Backup/Restore
▶ Backup to microSD

2. Enter your Terminal Security Code
▶ Select "YES".

To restore backup data to FOMA terminal

1.  from the Stand-by display ▶ LifeKit ▶ microSD
▶ Backup/Restore ▶ Restore to phone
2. Enter your Terminal Security Code ▶ Select "YES".

Sending/Receiving Data by Infrared Communication/iC Communication

You can send or receive data such as Phonebook entries to or from a device supporting the infrared communication function or iC communication function.

- You cannot exchange data depending on the other party's device or FOMA terminal.

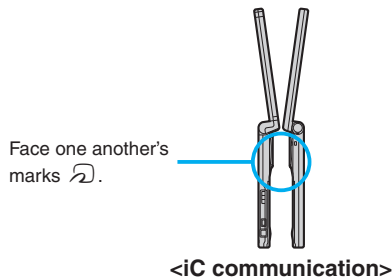
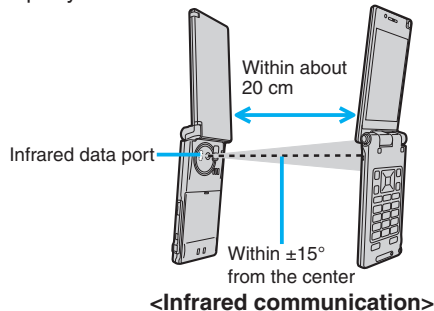

Sending Data

- For infrared communications, set the receiving end terminal first, and then start sending data within 30 seconds.

1 Function menu of the data to be sent

▶ Select “Send Ir data” or “iC transmission”.

- Procedure for sending data might differ depending on the data.

2 Select “YES”.

Receiving Data by Infrared Communication

1 from the Stand-by display ▶ LifeKit

▶ Receive Ir data ▶ Receive

2 Select “YES”.

Receiving Data by iC Communication

1 Face the mark of the receiving end terminal which shows the Stand-by display, to the mark of the sending end terminal.

2 Select “YES”.

Connecting to Personal Computer

You can connect the FOMA terminal to a personal computer to exchange WMA files, images or other files stored on microSD card.

You can also access the Internet to perform data communication.

- You need the FOMA USB Cable with Charge Function 01/02 (option) or FOMA USB Cable (option).
- To perform data communication, you need to install the “FOMA communication configuration file” (driver) on the CD-ROM provided.

For details, refer to the “Manual for PC Connection” on the CD-ROM provided.

Support

Troubleshooting

- **First of all, check to see if you need to update the software program and then update it if necessary. See page 86 for how to update software programs.**
- **When symptom persists even after you check the countermeasures for the problem you suffer, contact the “Repairs” counter listed on the back page of this manual or a repair counter specified by DOCOMO.**
The “Repairs” counter is available in Japanese only.

Power source

The FOMA terminal does not turn on.

- … Make sure the battery pack is attached to the FOMA terminal correctly. (See page 18)
- … Make sure the battery is fully charged. (See page 19)

Charging

Cannot charge.

(The Charging indicator does not light, or it flickers.)

- … Make sure the battery pack is attached to the FOMA terminal correctly. (See page 18)
- … Make sure the power plug of the adapter is securely inserted into the outlet or cigarette lighter socket.
- … Make sure the adapter and the FOMA terminal are connected correctly. (See page 19)
- … When you use an AC adapter (option), make sure its connector is firmly connected to the FOMA terminal or the desktop holder (option). (See page 19)
- … When you use the desktop holder, make sure the connector terminal of the FOMA terminal is not stained. If it is stained, wipe the terminal part with a dry cotton swab, etc.
- … If you talk on the phone, have communications, or operate other functions for a long time during battery charge, the temperature of the FOMA terminal may rise to flicker the Call/Charging indicator. In that case, charge the battery after the FOMA terminal cools down. (See page 19)

Operation of terminal

While you operate the FOMA terminal or charge the battery, they get hot.

- … While operating or charging, or when you operate i-appli programs, talk on the videophone, or watch 1Seg programs for a long time during battery charge, the FOMA terminal, battery pack, or adapter may become warm, but this is not a safety hazard, so you can continue to use them.

The usable time of the battery is short.

- … Make sure not to leave the FOMA terminal out-of-service-area for a long time. If your FOMA terminal is left out-of-service area, it searches for radio waves to establish communications, consuming more power.
- … The usable time of the battery pack varies depending on the usage environment or its remaining life.
- … Battery packs are consumables. The usable time slightly shortens each time you charge the battery. If the usable time becomes extremely short as compared with the default state even if fully charged, purchase the specified battery pack.

The power of the FOMA terminal shuts down and restarts.

- … If the terminal of the battery pack is stained, the connection might deteriorate to shut down the power. Wipe the battery terminal with a dry cotton swab, etc.

Pressing keys is disabled.

- … Make sure Lock All is deactivated. (See page 37)
- … Make sure Key Lock is deactivated. (See page 38)
- … Make sure Side Keys Guard is set to “OFF”.

The UIM is not recognized.

- … Make sure you insert the UIM in the correct direction. (See page 18)

Call

Cannot make a call by pressing numeric keys.

- … Make sure Keypad Dial Lock is deactivated.
- … Make sure Restrict Dialing is deactivated.
- … Make sure Lock All is deactivated. (See page 37)
- … Make sure Self Mode is deactivated.

Cannot talk.

(“”) **does not disappear even if you move to another place. You cannot make or receive a call, though the radio wave conditions are not bad.)**

- … Turn off and on the FOMA terminal, or remove and attach/insert the battery pack or UIM. (See page 18, page 20)
- … Depending on the radio wave property, you may not be able to make or receive a call even if the FOMA terminal is “within service area” or “” is displayed for a radio wave condition. Move to another place and redial.
- … Make sure the call restrictions such as Call Rejection, Call Acceptance, etc. are deactivated.
- … Depending on the radio wave congestion state, calls and mail messages may be congested and hard to be connected in crowded places. In that case, the message “Please wait” or “Please wait for a while” is displayed and a busy tone sounds. Move to another place or wait for a while, and then redial.

Osaifu-Keitai

Cannot use Osaifu-Keitai function.

- … If you remove the battery pack or activate Omakase Lock, the IC card function becomes unavailable regardless of the setting of IC Card Lock. (See page 18, page 37)
- … Make sure IC Card Lock is deactivated. (See page 37)
- … Make sure you place the  mark on the FOMA terminal over the scanning device. (See page 72)

Warranty and After-sales Service

Warranty

- Make sure that you have received a warranty card provided at purchase. After checking the contents of the warranty card as well as “Shop name and date of purchase”, keep the warranty card in a safe place. If you notice that necessary items of the warranty card are not filled in, immediately contact the shop where you purchased the FOMA terminal from. The term of the warranty is one year from the date of purchase.
- All or part of this product including the accessories may be modified for improvement without notice.

After-sales Services

○When there is a problem with the FOMA terminal

Before asking repairs, check “Troubleshooting” in this manual or in “使いかたナビ (Guide)” mounted on the FOMA terminal. (“使いかたナビ (Guide)” is available in Japanese mode only.) If the problem remains unsolved, contact the “Repairs” counter listed on the back page of this manual for malfunction and consult them.

The “Repairs” counter is available in Japanese only.

○When repairs are necessitated as a result of consultation:

Bring your FOMA terminal to a repair counter specified by DOCOMO. Note that your FOMA terminal is accepted for repair during the repair counter’s business hours. Further, note that you may need to wait for fixing depending on the malfunction state.

■In warranty period

- Your FOMA terminal is repaired charge free in accordance with the terms of warranty.
- Make sure that you bring the warranty card to the counter for repair. If you do not show the warranty card, or when troubles or malfunctions are regarded to be caused by your mishandling (the damages of liquid crystal display, connector, etc.), the repair cost is charged even within the warranty period.

- The cost for troubles caused by the use of devices and consumables other than those specified by DOCOMO is charged even within the warranty period.

■Repairs may not be carried out in the following cases:

- When exposure to water is found at our repair counter (Example: When the moisture detection sticker has reacted)
- When, as a result of inspection at our repair center, corrosion is found due to exposure to water, dew condensation, or sweat, or when damage or deformation is found in the circuit board [Repairs might not be carried out when damage to the connector terminal (earphone/microphone terminal) or LCD, or cracks in the body are found.]
- ※Even if repair is feasible, the repair cost is charged when the trouble you suffer matches one of the symptoms listed above, which is not supported by the warranty.

■After the warranty period

We will repair your FOMA terminal on request (charges will apply).

■Spare parts availability period

The minimum storage period of the performance spare parts (parts required for maintaining performance) for the FOMA terminal is basically six years after the closure of its production. Note, however, that your FOMA terminal might not be repaired depending on the troubled portions because of the shortage of spare parts.

○Other points to note

- Make sure not to modify the FOMA terminal or its accessories.
 - We might reject to repair depending on the degrees of your modification. The following might be regarded as modifications:
 - To put stickers, etc. onto the liquid crystal display or keys
 - To decorate the FOMA terminal using adhesives
 - To replace the coverings etc. with those of other than DOCOMO genuine products
 - Repairs of troubles or malfunctions resulting from the modifications are charged even within the warranty period.
- Do not peel the nameplate off the FOMA terminal.

Note that when we cannot ensure the contents described on the nameplate and therefore cannot verify the product conformity to the technical standard, it might happen that we at DOCOMO reject to repair the malfunction.

- The information such as about function settings and Total Calls Duration, etc. might be reset depending on the troubles or repairs, or the way you handle the FOMA terminal. Set the settings again.
- The parts generating magnetism are used in the following portions of the FOMA terminal. Note that if you place a magnetism-sensitive object such as a cash card near the FOMA terminal, the card might become unusable.
Portions: speaker, earpiece
- If the FOMA terminal gets wet or becomes moist, immediately turn off the power and remove the battery pack; then visit a repair counter. The FOMA terminal may not be repaired depending on the condition.

i-mode Fault Diagnosis Site

You can check on your FOMA terminal whether sending/receiving mail messages, downloading images/melodies, and others are normally working. When you think your FOMA terminal is in trouble as a result of your check, contact the “Repairs” counter listed on the back page of this manual.

The “Repairs” counter is available in Japanese only.

- To connect to “i モード故障診断サイト (i-mode Fault Diagnosis Site)” [in Japanese only]

i-mode site: ☰ Menu→お知らせ (News)

→ サービス・機能 (Services & Functions)

→ i モード (i-mode)

→ i モード故障診断 (i-mode Fault Diagnosis)



QR code for
accessing the site

- A packet communication fee for connecting to the i-mode Fault Diagnosis Site is free. (When you access it from overseas, you are charged a fee.)

Updating Software

This function is for updating software programs in the FOMA terminal by using packet communication if necessary.

※A packet communication fee for updating software programs is free.

The DOCOMO website and “お客様サポート (User support)” in Japanese  Menu lets you know information about updating software programs. There are three methods for updating software programs; “Auto-update”, “Update Now” and “Reserve Update”.

- You can update software programs, with data retained, such as Phonebook entries, images shot by the camera, or downloaded data in the FOMA terminal; however note that data may not be protected depending on the conditions (such as malfunction, damage, or drench) your FOMA terminal is placed in. You are advised to back up important data. Note that data such as downloaded ones might not be backed up.

■ Before using Software Update

- Do not remove the battery pack while updating software programs. You may fail to update.
- Fully charge the battery before updating software programs.
- It may take time to update (download or rewrite) software programs.
- You cannot make/receive calls, use communication functions, and other functions while updating software programs. (You can receive voice calls during download.)
- You are advised to update software programs when radio wave is strong enough with the three antennas displayed and while you are not moving. If radio wave conditions get worse while downloading software programs, or download is suspended, move to a place with better radio wave conditions and try again to update software programs.
- When updating software programs, the proprietary information about your FOMA terminal (model name or serial number, etc.) is automatically sent to the server (DOCOMO-managed server for Software Update). We at DOCOMO never use the sent information for purposes other than to update software programs.
- If you fail to update software programs, “Rewrite failed” is displayed and you cannot do all operations. In that case, you are kindly requested to come to a repair counter specified by DOCOMO.
- You cannot use Software Update overseas.



Start Software Update from Icon

- 1 Select “Update notification icon” on the Stand-by display.

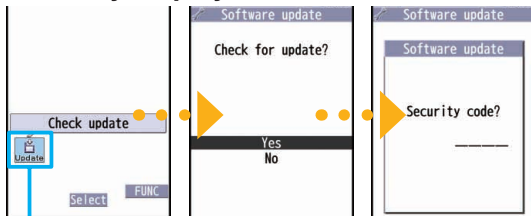

Update notification icon

Check whether you need to update software programs.

- 2 When update is necessary, “Update is needed” is displayed. And you can select either “Now update” or “Reserve”.

- When you select “Now update”, update immediately starts.
- When rewriting is completed, your FOMA terminal automatically restarts and the Update Completion Confirmation display appears.
- When you select “Reserve”, you can select the date and time you want.

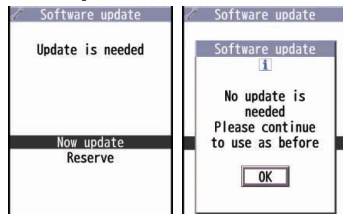

Start Software Update from Menu

- 1  from the Stand-by display
 - ▶ Set./Service ▶ Other settings
 - ▶ Software update
- 2 Enter your Terminal Security Code
 - ▶ Select “Update”.

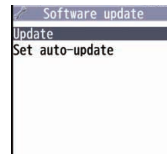

- 3 Go to step 2 of “Start Software Update from Icon” on page 87.

Check Harmful Data

About scanning function

You can detect data or application programs, which might cause troubles, from among those downloaded to your FOMA terminal, and then can delete the data or stop starting the application programs.

- This scan function provides a certain protective measure to filter out data that might cause troubles with your FOMA terminal at the time when you browse websites or receive messages. Note that when the virus pattern data supporting respective troubles is not yet downloaded to your FOMA terminal, or when no virus pattern data supporting them is found, this function is disabled to prevent troubles from occurring.
- The virus pattern data installed on the FOMA terminal differs in content by every model. Note that we at DOCOMO might stop to distribute the virus pattern data for models on market for last three years since their release.

Update pattern data

■ First of all, update the pattern data to make it the latest.

(MENU) from the Stand-by display ▶ Set./Service ▶ Lock/Security ▶ Scanning function ▶ Update ▶ YES ▶ YES ▶ OK

About displays for scanning results

■ About the display for scanned problem elements

```
Following problems were detected
Other XXXX
XXXXXXXXXX
XXXXXXXXXX
XXXXXXXXXX
XXXXXXXXXX
XXXXXXXXXX
XXXXXXXXXX
```

A warning display appears when problematic data is found. Select “Detail” from the warning display to show the name of the problem element.

- When six or more problem elements are found, the sixth and later problem element names are omitted.
- “Detail” might not appear depending on the detected problem element.

■ The displays for scanning result

| Alert level 0 | Alert level 1 | Alert level 2 | Alert level 3 | Alert level 4 |
|--|--|--|--|--|
| <p>Operation may not run properly</p> <p>OK Detail</p> | <p>Operation may not run properly Cancel operation?</p> <p>YES NO Detail</p> | <p>Operation may not run properly Canceling operation</p> <p>OK Detail</p> | <p>Operation may not run properly Delete data?</p> <p>YES NO Detail</p> | <p>Operation may not run properly Deleting data</p> <p>OK Detail</p> |
| OK Continues the operation. | YES ... Stops and ends the operation. NO Continues the operation. | OK Stops and ends the operation. | YES ... Deletes the data and ends the operation. NO Stops and ends the operation. | OK Deletes the data and ends the operation. |

- The alert displays for displaying i-mode mail messages or SMS messages may differ from those at left.

Introduction of Options and Related Devices

Combining various options with the FOMA terminal, you can realize more versatile use from personal purpose to business purposes. Some products may not be dealt in depending on the area. For details, consult a handling counter such as a docomo Shop. For details on options, refer to the user's manuals of respective options and related devices.

- Battery Pack P20
- Back Cover P42
- FOMA AC Adapter 01/02^{※1}
- FOMA AC Adapter 01 for Global use^{※1}
- FOMA DC Adapter 01/02
- FOMA Portable Charging Adapter 01
- FOMA Dry Battery Adapter 01
- Desktop Holder P39
- FOMA USB Cable with Charge Function 01/02^{※2}
- FOMA USB Cable^{※2}
- FOMA Indoor Booster Antenna^{※3}
- FOMA Indoor Booster Antenna (Stand Type)^{※3}
- Carry Case L 01
- In-Car Holder 01
- Flat-plug AV Output Cable P01^{※4}
- Earphone/Microphone 01
- Stereo Earphone Set 01
- Earphone/Microphone with Switch P001/P002^{※5}
- Flat-plug Earphone/Microphone with Switch P01/P02^{※4}
- Flat-plug Stereo Earphone Set P01^{※4}
- Earphone Plug Adapter P001^{※4}
- Earphone Plug Adapter for External connector terminal 01
- Earphone Plug Adapter 01
- Flat-plug Connector/Stereo Mini-jack Conversion Adapter P01^{※4}
- Bluetooth Headset F01^{※6}
- AC Adapter for Bluetooth Headset F01
- Wireless Earphone Set P01/02
- Bone conduction microphone/receiver 01^{※4/02}
- In-Car Hands-Free Kit 01^{※7}
- FOMA In-Car Hands-Free Cable 01

※1 See page 19 for charging batteries using AC adapter.

※2 If you use a USB hub, outer devices may not work correctly.

※3 Use it in Japan only.

※4 Earphone Plug Adapter for External connector terminal 01 is required.

※5 Earphone Plug Adapter P001 and Earphone Plug Adapter for External connector terminal 01 are required.

※6 AC Adapter for Bluetooth Headset F01 is required.

※7 To charge the P-04B, FOMA In-Car Hands-Free Cable 01 is required.

Appendix

Function List

Execute “Resetting the Function Settings” on page 39 for the items indicated by , to return to the respective defaults.

| | | | |
|------------------------|-------------------------|-------------------|--|
| Mail | Inbox | | |
| | Outbox | | |
| | Draft | | |
| | Compose message | | |
| | Create new Decome-Anime | | |
| | Template | Deco-mail | |
| | | Decome-Anime | |
| | Check new messages | | |
| | Compose SMS | | |
| | Check new SMS | | |
| | Receive option | | |
| | Mail settings | Scroll | |
| | | Font size setting | |
| | | Mail list display | |
| | | Message display | |
| Mail security | | | |
| Secret mail display | | | |
| Auto color label | | | |
| Pred. conv. at reply | | | |
| Header/signature | | | |
| Set check new messages | | | |
| Auto-display | | | |
| Receiving display | | | |
| Receive option setting | | | |

| | | |
|-------------|---------------------------|------------------------|
| Mail | Mail settings | Attachment preference |
| | | Auto-start attachment |
| | | Address/Spam Mail set. |
| | | Feel * Mail |
| | | Auto save setting |
| | | Text predict |
| | SMS settings | Check settings |
| | | SMS report request |
| | | SMS validity period |
| | | SMS input character |
| | Area Mail settings | SMS center setting |
| | | Receive setting |
| | | Beep time |
| | | Manner/Public mode set |
| | | Check ring tone |
| Other menu | | |

| | | | |
|---------------------|---|-----------------------|--|
| i-mode | Menu  Search | | |
| | Bookmark | | |
| | Screen memo | i-mode Browser | |
| | | Full Browser | |
| | Last URL | | |
| | Enter URL | | |
| | i-Channel | Channel list | |
| | | Ticker ON/OFF | |
| | | Ticker font size set. | |
| | | Ticker color set. | |
| Ticker scroll speed | | | |
| Reset i-Channel | | | |
| Post blog | | | |

| | | |
|-------------------|-----------------|----------------------|
| i-mode | i-mode settings | i-mode Browser set. |
| | | Full Browser set. |
| | | Common settings |
| | | Check settings |
| | | Reset i-mode setting |
| Full Browser Home | | |

| | | |
|----------------|-----------------------|------------------------|
| i-αppli | Software list (phone) | |
| | αppli (microSD) | Software list |
| | | αppli data |
| | αppli call logs | |
| | αppli info | End stand-by info |
| | | End Widget appli inf |
| | | Security error history |
| | | Auto start info |
| | | Trace info |
| | αppli settings | Auto start setting |
| | | Disp. software info |
| | | i-Widget roaming set. |
| | | i-Widget sound effect |
| | | αppli call settings |
| | | αppli volume |
| Preferred tone | | |
| αBacklight | | |
| αPower saver | | |
| αVibrator | | |
| Check settings | | |
| About αppli | | |

| | | | |
|--------------|---------------------------------|---------------------------------|--------------------|
| Set./Service | Sound | Select ring tone (MENU 13) | |
| | | Ring volume (MENU 50) | |
| | | Keypad sound (MENU 30) | |
| | | Melody effect (MENU 64) | |
| | | Headset usage setting (MENU 51) | |
| | | Mail/Msg. ring time (MENU 68) | |
| | | Charge sound | |
| | | Display setting (MENU 56) | |
| | | Backlight (MENU 70) | |
| | | View blind | |
| | Display | Color theme setting (MENU 86) | |
| | | Machi-chara | |
| | | Menu icon setting (MENU 57) | |
| | | Horizontal open menu | |
| | | Private menu setting (MENU 52) | |
| | | Desktop icon (MENU 63) | |
| | | Font (MENU 66) | |
| | | Font size setting | |
| | | Select language (MENU 15) | |
| | | Recv. mail/call at open | |
| | | Image quality | |
| | | LCD AI | |
| | | Icons (MENU 36) | |
| | | Illumination | Dot illum. |
| | | | All illum. setting |
| | Incoming illumination (MENU 89) | | |
| | Illumination in talk | | |
| | Missed/unread illum. | | |
| | Music&Video Ch illum. | | |
| | Illum. when closed | | |
| | Hourly illumination | | |

| | | |
|---------------|---------------------------|----------------------------------|
| Set./Service | Illumination | MUSIC illumination |
| | | Bluetooth illumination |
| | | IC card illumination |
| | | Check settings |
| | Kisekae | |
| | i-concier | Information disp. set. |
| | Lock/Security | Self mode |
| | | Lock all |
| | | Personal data lock |
| | | IC card lock |
| | | Secret mode (MENU 40) |
| | | Secret data only (MENU 41) |
| | | Secret recv. call |
| | | Keypad dial lock |
| | | Reject unknown |
| | | Call setting w/o ID (MENU 10) |
| | | Change security code (MENU 29) |
| | | UIM setting |
| | | Scanning function |
| | Lock setting | |
| | Call time/cost | Call data (MENU 61) |
| | | Reset total cost&dura. (MENU 60) |
| | | Notice call cost |
| | | CLR max cost icon |
| | Clock | Set time (MENU 31) |
| | | World time watch |
| | | Summer time |
| | | Auto power ON/OFF |
| | | Alarm setting |
| Incoming call | Vibrator (MENU 54) | |
| | Manner mode set (MENU 20) | |

| | | |
|---------------------|-----------------|----------------------------------|
| Set./Service | Incoming call | Answer setting (MENU 58) |
| | | Setting when opened |
| | | Record display set |
| | | Disp. PH-book image |
| | | Set call/receive No. |
| | | Ring time (MENU 90) |
| | | Info notice setting (MENU 65) |
| | | V.phone while packet |
| | | Auto call/answer set. |
| | | Melody Call setting |
| | Talk | Volume |
| | | Setting when closed (MENU 18) |
| | | Hold tone setting |
| | | Shikkari Talk |
| | | Noise reduction (MENU 76) |
| | | Quality alarm (MENU 75) |
| | | Reconnect signal (MENU 77) |
| | Videophone | Visual preference |
| | | Select image |
| | | Hands-free w/ V.phone |
| | | Voice call auto redial |
| | Network setting | Notify switchable mode |
| | | Reject videophone |
| | | Prefix setting |
| | NW services | Femtocell setting |
| | | Caller ID notification (MENU 17) |
| | | Voice mail |
| | | Call waiting |
| | | Call forwarding |
| Nuis. call blocking | | |
| Caller ID request | | |

| | | |
|--------------------------|----------------|---|
| Set./Service | NW services | 2in1 setting |
| | | Multi number |
| | | Arrival call act |
| | | Set in-call arrival act |
| | | Remote access |
| | | Dual network |
| | | English guidance |
| | | Overseas NW search |
| | | Overseas setting |
| | | Overseas service |
| | | Additional service |
| | | Contact DOCOMO |
| | | OFFICEED |
| | | Chaku-moji |
| | Other settings | Work with style |
| | | Side keys guard |
| | | 録画 long press set. |
| | |  long press set. |
| | | Character input method (MENU)35) |
| | | Battery/eco mode set. |
| Pause dial (MENU)84) | | |
| Sub-address setting | | |
| Headset mic. setting | | |
| Voice settings | | |
| USB mode setting | | |
| Check settings | | |
| Reset settings (MENU)23) | | |
| Initialize | | |
| Software update | | |

| | | |
|----------|--|-----------------|
| Data box | My picture (MENU)46) | |
| | MUSIC | |
| | Music&Video Channel | |
| |  motion/Movie | |
| | Melody (MENU)16) | |
| | My documents | |
| | Kisekai Tool | |
| | Machi-chara | |
| | Chara-den | |
| | 1Seg | Image |
| | | Video |
| | | Position memory |
| | Document viewer | |
| | Font | |
| | SD other files | |

| | | |
|---------|---------------------------|--------------------|
| LifeKit | Bar code reader | Scan code |
| | | Saved data |
| | Receive Ir data (MENU)79) | Receive |
| | | Receive all |
| | microSD | Refer microSD data |
| | | Backup/Restore |
| | Camera | Digicam mode |
| | | Photo mode |
| | | Movie mode |
| | | View photos |
| | | View movies |

| | | |
|---------|-----------------------------|--|
| LifeKit | Bluetooth | Device list |
| | | Register New Devices |
| | | Activate Bluetooth/Bluetooth power OFF |
| | | Accept registered |
| | | Accept dialup devices |
| | | Bluetooth settings |
| | Map/GPS | Map |
| | | imadoco search |
| | | imadoco kantan search |
| | | i-area |
| | | Map/GPS appli |
| | | Position location |
| | | Notify of location |
| | | Location history |
| | | GPS settings |
| | Rec. msg/voice memo (MEM55) | Play/Erase msg. |
| | | Play/Erase VP msg. |
| | | Record message setting |
| | | Voice memo |
| | | Voice announce |
| | Voice recorder | |
| | Data Security Service | Check/How to update |
| | | Exchanging history |
| | | PB image sending |
| | | Backup PB etc./update |
| | | Backup set./update |
| | Guide | Backup images |

i-concier

| | | |
|----------------------------|----------------------------|--------------------------------|
| Phonebook | Add to phonebook | Phone UIM |
| | Search phonebook | Reading? |
| | | Group? |
| | | Memory No.? |
| | | Name? |
| | | Phone number? |
| | | Mail address? |
| | UIM operation | 2-touch dial? |
| | | Copy Delete |
| | Dialed/recv. calls (MEM24) | Dialed calls Received calls |
| | Own number (MEM0) | |
| | Group setting | |
| | Restrictions | Restrict dialing |
| | | Call rejection |
| | | Call acceptance |
| | | Call forwarding |
| | | Voice mail |
| Phonebook settings (MEM26) | Font size setting | |
| | Voice dial setting | |
| | Mail group | |
| | Forwarding image | |
| No. of phonebook | | |

| | | |
|------------|-------------------------------|----------------|
| Stationery | Alarm (MENU 44) | |
| | Schedule (MENU 45) | |
| | ToDo (MENU 95) | |
| | Text memo (MENU 42) | |
| | Calculator (MENU 85) | |
| | Dictionary | |
| | Phrase/own dict. (MENU 38) | Common phrases |
| | | Own dictionary |
| | Download dictionary | |
| | Create learned wd list | |

| | |
|-------|---------------------|
| MUSIC | MUSIC Player |
| | Music&Video Channel |

| | | |
|------|----------------------|----------------------|
| 1Seg | Activate 1Seg | |
| | Program guide | |
| | TV timer list | |
| | Timer recording list | |
| | Recording result | |
| | TVlink | |
| | Channel list | |
| | Channel setting | Select area |
| | | Auto channel setting |
| | | Display/operation |
| | | Video |
| | | Display light |
| | | Sound effect |
| | | Recording |
| | Data broadcasting | |
| | 1Seg eco mode | |

| | | |
|------|---------------|-----------------------|
| 1Seg | User settings | Reset channel setting |
| | | Reset storage area |
| | | Reset TV settings |
| | | Check TV settings |

| | | |
|------------------|-------------------|----------------------|
| Osafu-Keitai | IC card content | |
| | DCMX | |
| | ToruCa | |
| | IC card lock set. | IC card lock |
| | | IC lock (power-off) |
| | Settings | ToruCa from IC card |
| | | Auto reading ToruCa |
| | | Recv. ToruCa display |
| | | ToruCa from 1Seg |
| | | Check same ToruCa |
| Check IC owner | | |
| Change IC owner | | |
| Search by i-mode | | |

| | |
|--------|--------------------------|
| Others | Redial |
| | Public mode (Drive mode) |
| | Manner mode |
| | eco mode |
| | Videophone |
| | Character input |

Main Specifications

■ Handset

| | | | |
|--|------------------|---|---|
| Model | | P-04B | |
| Dimensions (when closed) | | Height: Approx. 111 mm Width: Approx. 50 mm Depth: Approx. 17.1 mm (at thickest point: Approx. 20 mm) | |
| Weight (with the battery pack attached) | | Approx. 131 g | |
| Continuous standby time | FOMA/3G | 3G/GSM setting [3G] | In motion: Approx. 350 hours |
| | | 3G/GSM setting [Auto] | Standstill: Approx. 540 hours In motion: Approx. 340 hours |
| | GSM | 3G/GSM setting [Auto] | Standstill: Approx. 240 hours |
| Continuous talk time | FOMA/3G | | Voice call : Approx. 190 minutes Videophone call : Approx. 130 minutes |
| | GSM | | Voice call: Approx. 230 minutes |
| 1Seg watching time | | Approx. 220 minutes (when Mobile W-Speed is OFF: Approx. 280 minutes) (in 1Seg eco Mode: Approx. 310 minutes) | |
| Charging time | | AC adapter: Approx. 120 minutes DC adapter: Approx. 120 minutes | |
| LCD | Type | TFT 262,144 colors | |
| | Size | Approx. 3.3 inches | |
| | Number of pixels | 409,920 pixels (480 dots x 854 dots) | |
| Image pickup device | Type | CMOS | |
| | Size | 1/2.4 inches | |

| | | |
|-----------------|--|---|
| Camera | Number of effective pixels | Approx. 13,200,000 pixels |
| | Number of recording pixels (maximum) | Approx. 13,000,000 pixels |
| Recording | Number of recordable still images*1 | Approx. 2,400 max. (default) |
| | Number of still images for continuous shooting | For Digicam Mode in Continuous setting 3M: 8 2M Wide: 8 2M: 8 Stand-by: 8 For Continuous Mode VGA: 4 QVGA: 5 to 10 QCIF: 5 to 20 Sub-QCIF: 5 to 20 |
| Music playback | Continuous playback time**2 | SD-Audio file (supports Play Background): Approx. 6,500 minutes**3 Chaku-uta Full® music file (supports Play Background): Approx. 6,000 minutes**3 i-motion file (including Chaku-uta® music file): Approx. 1,260 minutes**3 WMA file (supports Play Background): Approx. 4,600 minutes Music&Video Channel program (supports Play Background) Sound : Approx. 6,000 minutes Moving picture : Approx. 290 minutes |
| Memory capacity | Chaku-uta® | Approx. 204 Mbytes (default)**4 |
| | Chaku-uta Full® | |

*Chaku-uta™ is a registered trademark of Sony Music Entertainment Inc.

**1: Image size: QVGA (320 x 240), Image quality: Normal, File size: 25 Kbytes

**2: The continuous playback time is the estimated duration that you can play back using the Stereo Earphone Set 01 (option) with the FOMA terminal closed.

**3: File format: AAC

**4: Shares with still images, i-motion files, melodies, PDF files, Music&Video Channel programs, Kisekai Tool files, Machi-chara images, font files, ToruCa files, and i-αpli programs.

■ Battery pack

| | |
|-----------------|------------------------------|
| Name of product | Battery Pack P20 |
| Battery type | Li-ion (lithium ion) battery |
| Voltage | 3.7 V |
| Capacity | 800 mAh |

■ Specifications of shooting

<Still image>

| | |
|--|-------------------------|
| File format (Extension) | JPEG (jpg) |
| The number of files that can be saved to P-04B | Approx. 2,400 max. ※1※2 |
| The number of files that can be saved to the microSD card (2 Gbytes) | Approx. 61,466 max. ※2 |

<Movie>

| | |
|--|-------------------------------|
| File format (Extension) | MP4, ASF (3gp, asf) |
| Recordable time to P-04B | Approx. 497 seconds max. ※1※3 |
| Recordable time to the microSD card (2 Gbytes) | Approx. 180 minutes max. ※4 |

<Zoom (Digital)>

| | | |
|---------|----------------------------|--------------------|
| Digicam | Level of zoom | 21 levels |
| | The maximum magnifications | Approx. 6.0 times |
| Photo | Level of zoom | 21 levels |
| | The maximum magnifications | Approx. 16.2 times |
| Movie | Level of zoom | 21 levels |
| | The maximum magnifications | Approx. 5.8 times |

※1 Default setting

※2 The number of files that can be saved under the conditions of "Image size: QVGA (320 x 240), Image quality: Normal, File size: 25 Kbytes".

※3 Maximum recording duration per shot that can be saved to the main unit under the conditions of "Image size: Sub-QCIF (128 x 96), File size setting: Mail restriction (L), Image quality: Normal, Movie type set: Normal".

※4 Maximum recording duration per shot that can be saved to the microSD card (2 Gbytes) under the conditions of "Image size: Sub-QCIF (128 x 96), File size setting: Long time, Image quality: Normal, Movie type set: Normal".

■ Recordable time of 1Seg

| | |
|---|-----------------------|
| Maximum (total) recordable time to the microSDHC card (16 Gbytes) | Approx. 5,120 minutes |
|---|-----------------------|

- The maximum recordable time is the estimate for 224 kbps of video, 48 kbps of audio, and 52 kbps of data (including captions). The recordable time varies depending on the broadcasting station or program.
- The maximum file size for continuous recording is up to 2 Gbytes under SD-VIDEO specifications.

■ Number of savable/registerable items in FOMA Terminal

| Function | | Number of savable/registerable items |
|---------------------|--------------------|--------------------------------------|
| Phonebook | | 1,000 |
| Schedule | | 2,500 |
| Mail | Received mail | 2,500 max. ※1※2 |
| | Sent mail | 1,000 max. ※2 |
| Still image | | 3,500 max. ※2 |
| i-motion file | | 3,500 max. ※2 |
| Music&Video Channel | Downloaded program | 2 |
| | Saved program | 10 max. ※2 |
| Kisekae-Tool | | 3,500 max. ※2 |
| i-appli | | 100 max. ※2 |

※1 Includes pre-installed data.

※2 The number of savable/registerable items may decrease depending on the data volume.

Specific Absorption Rate (SAR) of Mobile Phone

SAR Certification Information

This model phone P-04B meets the MIC's* technical regulation for exposure to radio waves.

The technical regulation established permitted levels of radio frequency energy, based on standards that were developed by independent scientific organizations through periodic and thorough evaluation of scientific studies. The regulation employs a unit of measurement known as the Specific Absorption Rate, or SAR. The SAR limit is 2 watts/kilogram (W/kg)** averaged over ten grams of tissue. The limit includes a substantial safety margin designed to assure the safety of all persons, regardless of age and health. The value of the limit is equal to the international guidelines recommended by ICNIRP***.

All phone models should be confirmed to comply with the regulation, before they are available for sale to the public. The highest SAR value for this model phone is 0.940 W/kg.

It was taken by the Telecom Engineering Center (TELEC), a Registered Certification Agency on the Radio Law. The test for SAR was conducted in accordance with the MIC testing procedure using standard operating positions with the phone transmitting at its highest permitted power level in all tested frequency bands. While there may be differences between the SAR levels of various phones and at various positions, they all meet the MIC's technical regulation. Although the SAR is determined at the highest certified power level, the actual SAR of the phone during operation can be well below the maximum value.

For further information about SAR, please see the websites as shown on the right:

| | |
|--|---|
| World Health Organization (WHO): | http://www.who.int/peh-emf/en/ |
| ICNIRP: | http://www.icnirp.de/ |
| MIC: | http://www.tele.soumu.go.jp/e/sys/ele/index.htm |
| TELEC: | http://www.telec.or.jp/ENG/Index_e.htm |
| NTT DOCOMO: | http://www.nttdocomo.co.jp/english/product/sar/ |
| Panasonic Mobile Communications Co., Ltd.: | http://panasonic.jp/mobile/ (In Japanese only) |

* Ministry of Internal Affairs and Communications

** The technical regulation is provided in Article 14-2 of the Ministry Ordinance Regulating Radio Equipment.

*** International Commission on Non-ionizing Radiation Protection

European RF Exposure Information

This mobile phone complies with the EU requirements for exposure to radio waves.

Your mobile phone is a radio transceiver, designed and manufactured not to exceed the SAR* limits for exposure to radio-frequency (RF) energy, which SAR* value, when tested for compliance against the standard was 0.639 W/kg. While there may be differences between the SAR* levels of various phones and at various positions, they all meet*** the EU requirements for RF exposure.**

* The exposure standard for mobile phones employs a unit of measurement known as the Specific Absorption Rate, or SAR.

** The SAR limit for mobile phones used by the public is 2.0 watts/kilogram (W/kg) averaged over ten grams of tissue, recommended by The Council of the European Union. The limit incorporates a substantial margin of safety to give additional protection for the public and to account for any variations in measurements.

*** Tests for SAR have been conducted using standard operating positions with the phone transmitting at its highest certified power level in all tested frequency bands. Although the SAR is determined at the highest certified power level, the actual SAR level of the phone while operating can be well below the maximum value. This is because the phone is designed to operate at multiple power levels so as to use only the power required to reach the network. In general, the closer you are to a base station antenna, the lower the power output.

Declaration of Conformity

CE 0168

The product "P-04B" is declared to conform with the essential requirements of European Union Directive 1999/5/EC Radio and Telecommunications Terminal Equipment Directive 3.1(a), 3.1(b) and 3.2. The Declaration of Conformity can be found on <http://panasonic.net/pmc/support/index.html>.

※The European RTTE approval of this product is limited to the use of the P-04B handset, Battery Pack and FOMA AC Adapter for Global use (100 to 240 V AC) only. Other accessories are not part of the approval.

FCC Notice

- This device complies with part 15 of the FCC Rules. Operation is subject to the following two conditions:
 - (1) This device may not cause harmful interference, and
 - (2) This device must accept any interference received, including interference that may cause undesired operation.
- Changes or modifications not expressly approved by the manufacturer responsible for compliance could void the user's authority to operate the equipment.

FCC RF Exposure Information

This model phone meets the U.S. government's requirements for exposure to radio waves.

Your wireless phone contains a radio transmitter and receiver. Your phone is designed and manufactured not to exceed the emission limits for exposure to radio frequency (RF) energy set by the Federal Communications Commission of the U.S. Government. These limits are part of comprehensive guidelines and establish permitted levels of RF energy for the general population. The guidelines are based on standards that were developed by independent scientific organizations through periodic and thorough evaluation of scientific studies.

The exposure standard for wireless mobile phones employs a unit of measurement known as the Specific Absorption Rate (SAR). The SAR limit set by the FCC is 1.6 W/kg.* Tests for SAR are conducted using standard operating positions accepted by the FCC with the phone transmitting at its highest certified power level in all tested frequency bands. Although the SAR is determined at the highest certified power level, the actual SAR level of the phone while operating can be well below the maximum value. This is because the phone is designed to operate at multiple power levels so as to use only the power required to reach the network. In general, the closer you are to a wireless base station antenna, the lower the output.

Before a phone model is available for sale to the public, it must be tested and certified to the FCC that it does not exceed the limit established by the U.S. government-adopted requirement for safe exposure. The tests are performed in various positions and locations (for example, at the ear and worn on the body) as required by FCC for each model. The highest SAR value for this model phone as reported to the FCC when tested for use at the ear is 0.746 W/kg, and when worn on the body in a holster or carry case, is 0.328 W/kg. (Body-worn measurements differ among phone models, depending upon available accessories and FCC requirements). While there may be differences between the SAR levels of various phones and at various positions, they all meet the U.S. government requirement.

The FCC has granted an Equipment Authorization for this model phone with all reported SAR levels evaluated as in compliance with the FCC RF exposure guidelines. SAR information on this model phone is on file with the FCC and can be found under the Display Grant section at <http://www.fcc.gov/oet/ea/fccid/> after search on FCC ID UCE210027A.

For body worn operation, this phone has been tested and meets the FCC RF exposure guidelines when used with an accessory designated for this product or when used with an accessory that contains no metal and that positions the handset a minimum of 1.5 cm from the body.

* In the United States, the SAR limit for wireless mobile phones used by the public is 1.6 watts/kg (W/kg) averaged over one gram of tissue. SAR values may vary depending upon national reporting requirements and the network band.

Important Safety Information

AIRCRAFT

Switch off your wireless device when boarding an aircraft or whenever you are instructed to do so by airline staff. If your device offers a 'flight mode' or similar feature consult airline staff as to whether it can be used on board.

DRIVING

Full attention should be given to driving at all times and local laws and regulations restricting the use of wireless devices while driving must be observed.

HOSPITALS

Mobile phones should be switched off wherever you are requested to do so in hospitals, clinics or health care facilities. These requests are designed to prevent possible interference with sensitive medical equipment.

PETROL STATIONS

Obey all posted signs with respect to the use of wireless devices or other radio equipment in locations with flammable material and chemicals. Switch off your wireless device whenever you are instructed to do so by authorized staff.

INTERFERENCE

Care must be taken when using the phone in close proximity to personal medical devices, such as pacemakers and hearing aids.

Pacemakers

Pacemaker manufacturers recommend that a minimum separation of 15 cm be maintained between a mobile phone and a pacemaker to avoid potential interference with the pacemaker. To achieve this use the phone on the opposite ear to your pacemaker and do not carry it in a breast pocket.

Hearing Aids

Some digital wireless phones may interfere with some hearing aids. In the event of such interference, you may want to consult your hearing aid manufacturer to discuss alternatives.

For other Medical Devices:

Please consult your physician and the device manufacturer to determine if operation of your phone may interfere with the operation of your medical device.

Export Administration Regulations

This product and its accessories might be covered by the Japan Export Administration Regulations ("Foreign Exchange and Foreign Trade Law" and its related laws). To export this product and its accessories, take the required measures on your responsibility and at your expenses. For details on the procedures, contact the Ministry of Economy, Trade and Industry.

Intellectual Property Right

Copyrights and Portrait Rights

You have no right to copy, modify, or distribute the contents such as text, images, music, or software programs downloaded from websites on the Internet, or images shot by the cameras of this product without permission from the copyright holder except for when the copy or quote is for personal use that is allowed by the copyright law.

Note that it may be prohibited to shoot or record live performances or exhibitions even for personal use. Make sure that you refrain from shooting portraits of other persons and distributing such portraits over the Internet without consent, as this violates portrait rights.

Trademarks

- "FOMA", "i-mode", "i-appli", "i-motion", "Deco-mail", "Chara-den", "ToruCa", "mopera", "WORLD CALL", "DCMX", "i-area", "WORLD WING", "OFFICEED", "2in1", "docomo PRIME series", and the logos of "FOMA", "i-mode", "i-appli", "iC", and "Music&Video Channel" are trademarks or registered trademarks of NTT DOCOMO, INC.
- "Catch Phone (Call waiting service)" is a registered trademark of Nippon Telegraph and Telephone Corporation.
- Free Dial logo mark is a registered trademark of NTT Communications Corporation.
- McAfee® is registered trademarks or trademarks of McAfee, Inc. and/or its affiliates in the US and/or other countries.
- G-GUIDE, G-GUIDE MOBILE and their logos are registered trademarks in Japan of U.S. Gemstar-TV Guide International, Inc. and/or its affiliates. 
- QuickTime is a registered trademark of Apple Inc., in the US and other countries.
- NAVIDIAL and NAVIDIAL logo mark are trademarks of NTT Communications Corporation.
- Microsoft®, Windows®, and Windows Vista® are trademarks or registered trademarks of Microsoft Corporation in the United States and other countries.
- Windows Media® is either a registered trademark or trademark of Microsoft Corporation in the United States and/or other countries.

- Powered by JBlend™ Copyright 2002-2009 Aplix Corporation. All rights reserved.

JBlend and JBlend-related trademarks are trademarks or registered trademarks of Aplix Corporation in Japan and other countries.

-  is a registered trademark of FeliCa Networks, Inc.
- microSDHC logo is a trademark of SD-3C, LLC.



- "Multitask" is a registered trademark of NEC Corporation.
- QR code is a registered trademark of Denso Wave Inc.
- "VIERA®" and "One-push Open™" are trademarks or registered trademarks of Panasonic Corporation.
- Google and Google Map for Mobile are trademarks of Google Inc.
- Java and all Java based trademarks and logos are trademarks or registered trademarks of Sun Microsystems, Inc. in the U.S. and other countries.
- Powered by Mascot Capsule®/Micro3D Edition™ Mascot Capsule® is a trademark of HI CORPORATION.
- Other company names and product names described in the text are trademarks or registered trademarks of those companies.

Others

- This product contains NetFront Browser, NetFront Document Viewer and NetFront Sync Client of ACCESS CO., LTD. ACCESS, the ACCESS logo, and NetFront are registered trademarks or trademarks of ACCESS CO., LTD. in the United States, Japan and/or other countries. Copyright © 2010 ACCESS CO., LTD. All rights reserved.
- This software is based in part on the work of the Independent JPEG Group.
- IrFront is a trademark or registered trademark of ACCESS CO., LTD. in Japan and other countries. The IrDA Feature Trademark is owned by the Infrared Data Association and used under license therefrom.



- Contains Adobe® Flash® Lite® and Adobe Reader® Mobile technology by Adobe Systems Incorporated. Adobe Flash Lite Copyright © 2003-2010 Adobe Systems Incorporated. All rights reserved. Adobe Reader Mobile Copyright © 1993-2010 Adobe Systems Incorporated. All rights reserved. Adobe, Adobe Reader, Flash, and Flash Lite are either registered trademarks or trademarks of Adobe Systems Incorporated in the United States and/or other countries.
- FeliCa is a contactless IC card technology developed by Sony Corporation.
- FeliCa is a registered trademark of Sony Corporation.
- "CROSS YOU" is a trademark of Sony Corporation.
- This product contains software licensed complying with GNU General Public License (GPL), GNU Lesser General Public License (LGPL), etc. For more details, see "readme.txt" in the "GPL・LGPL等について" folder on the bundled CD-ROM. ("readme.txt" is only available in Japanese version.)
- iWnn of OMRON SOFTWARE Co., Ltd. is used for conversion methods for Japanese language. iWnn © OMRON SOFTWARE Co., Ltd. 2008-2010 All Rights Reserved.
- "Text Profiler" is trademark of OMRON Corporation.
- The Bluetooth® word mark and logos are owned by Bluetooth SIG, Inc. and any use of such marks by NTT DOCOMO, INC. is under license. Other trademarks and trade names are those of their respective owners.
- This product is loaded with Bluetooth™ Stack for Embedded Systems Spec 2.0 by Toshiba Corp.
- MPEG Layer-3 audio coding technology licensed from Fraunhofer IIS and Thomson.
- This product is licensed under the MPEG-4 patent portfolio license, AVC patent portfolio license and VC-1 patent portfolio license for the personal and non-commercial use of a consumer to
 - encode video in compliance with the MPEG-4 Visual Standard, AVC Standard and VC-1 Standard ("MPEG-4/AVC/VC-1 Video") and/or
 - decode MPEG-4/AVC/VC-1 Video that was encoded by a consumer engaged in a personal and non-commercial activity and/or was obtained from a licensed video provider licensed to provide MPEG-4/AVC/VC-1 Video.
 No license is granted or implied for any other use. Additional information may be obtained from MPEG LA, L.L.C. See <http://www.mpegla.com>.
- Copyright 2001 Seiko Epson Corporation. All Rights Reserved. PRINT Image Matching is a trademark of Seiko Epson Corporation. The PRINT Image Matching logo is a trademark of Seiko Epson Corporation.
- This product is manufactured or sold under license from InterDigital Technology Corporation.



- The abbreviations used for respective operating systems (Japanese version) in this manual are as shown below: Windows 7 is the abbreviation of Microsoft® Windows® 7 (Starter, Home Basic, Home Premium, Professional, Enterprise, and Ultimate). Windows Vista is the abbreviation of Windows Vista® (Home Basic, Home Premium, Business, Enterprise, and Ultimate). Windows XP is the abbreviation of Microsoft® Windows® XP Professional operating system or Microsoft® Windows® XP Home Edition operating system.
- This product is protected by certain intellectual property rights of Microsoft Corporation and third parties. Use or distribution of such technology outside of this product is prohibited without a license from Microsoft or an authorized Microsoft subsidiary and third parties.
- This product is protected by certain intellectual property rights of Microsoft Corporation. Use or distribution of such technology outside of this product is prohibited without a license from Microsoft or an authorized Microsoft subsidiary.
- Content providers are using the digital rights management technology for Windows Media contained in this device ("WM-DRM") to protect the integrity of their content ("Secure Content") so that their intellectual property, including copyright, in such content is not misappropriated. This device uses WM-DRM Software to play Secure Content ("WM-DRM Software"). If the security of the WM-DRM Software in this device has been compromised, owners of Secure Content ("Secure Content Owners") may request that Microsoft revoke the WM-DRM Software's right to acquire new licenses to copy, display and/or play Secure Content. Revocation does not alter the WM-DRM Software's ability to play unprotected content. A list of Revoked WM-DRM Software is sent to your device whenever you download a license for Secure Content from the Internet or from a PC. Microsoft may, in conjunction with such license, also download revocation lists onto your device on behalf of Secure Content Owners.
- "ケータイTOOL<辞書> (KEITAI TOOL <Dictionary>)" pre-installed in this product uses "English-Japanese/Japanese-English/Japanese dictionaries of Gakken Co., LTD."



Index

A

| | |
|---------------------------|----|
| AC adapter | 19 |
| After-sales services..... | 84 |
| Alarm | 74 |
| Antenna | 5 |
| Area mail | 52 |
| Auto shutter | 62 |
| Auto-sort | 51 |

B

| | |
|--------------------------|----|
| Back cover | 5 |
| Backlight | 32 |
| Bar code reader | 75 |
| Battery level | 22 |
| Battery pack | |
| Attaching/removing | 18 |
| Charging | 19 |
| Bluetooth function..... | 76 |
| Bookmark..... | 57 |

C

| | |
|-------------------------------|----|
| Calendar | 74 |
| Call/charging indicator..... | 5 |
| Caller ID notification..... | 41 |
| Call forwarding service | 45 |
| Call setting without ID..... | 38 |
| Call waiting service | 45 |

| | |
|---|-------|
| Camera | 5, 60 |
| Shooting still images/moving pictures | 61 |
| Viewing still images/moving pictures after shooting..... | 61 |
| Channel setting..... | 64 |
| Character entry | 28 |
| Line feed | 28 |
| Pictograms | 28 |
| Smiley | 28 |
| Symbols | 28 |

| | |
|------------------------------|-----|
| Charging..... | 19 |
| Charging terminal..... | 5 |
| Check new messages | 51 |
| Command navigation key | 25 |
| Connector terminal..... | 4 |
| Copyrights..... | 101 |

D

| | |
|-----------------------|-------|
| Deco-mail | 49 |
| Decome-Anime | 49 |
| Desktop holder | 19 |
| Desktop icon..... | 23 |
| Digicam mode | 61 |
| Display | 4, 22 |
| Display setting | 31 |
| Dot illum. | 5, 23 |

E

| | |
|--|-----|
| Early warning "Area Mail"..... | 52 |
| Earphone | 4 |
| Earpiece..... | 4 |
| Earpiece volume | 42 |
| eco mode..... | 35 |
| English display | 21 |
| Export administration regulations | 100 |

F

| | |
|-------------------------|-----------|
| FeliCa..... | 5, 72, 80 |
| Osaifu-Keitai | 72 |
| Finder display | 60 |
| Flash | 5 |
| FOMA antenna | 5 |
| FOMA card | 18 |
| Font size setting | 33 |
| Full browser | 56 |
| Function list | 90 |
| Function menu..... | 27 |

G

| | |
|------------------------------|----|
| GPS | 58 |
| GPS compatible i-appli | 59 |

| | |
|-------------------------------------|--------|
| H | |
| Holding | 40 |
| Hook for horizontal open style..... | 4 |
| Horizontal open menu..... | 26 |
| Horizontal open style | 6 |
| I | |
| i-αppli..... | 69 |
| IC card lock | 37 |
| iC communication | 80 |
| i-Channel | 58 |
| i-concier..... | 73 |
| Illumination | 34 |
| i-mode..... | 55 |
| i-mode fault diagnosis site | 85 |
| i-mode mail..... | 48 |
| Compose..... | 48 |
| Forward..... | 50 |
| Receive | 50 |
| Reply..... | 50 |
| Send..... | 48 |
| i-mode password | 36 |
| i-motion | 71 |
| i-motion player..... | 61, 71 |
| Info notice setting..... | 34 |
| Infrared communication..... | 80 |
| Infrared data port..... | 5, 80 |
| Initialize | 39 |
| Initial setting | 20 |
| Intellectual property right | 101 |

| | |
|----------------------------|----|
| International calls..... | 41 |
| International roaming..... | 47 |
| i-Widget | 69 |

K

| | |
|--------------------|----|
| Key lock..... | 38 |
| Keypad sound..... | 31 |
| Kisekae tool | 33 |

L

| | |
|--------------------|----|
| Light sensor | 4 |
| Lock all | 37 |

M

| | |
|-------------------------------|----|
| Machi-chara..... | 33 |
| Mail..... | 48 |
| Main menu..... | 26 |
| Main specifications | 96 |
| Making a call | 40 |
| Making a videophone call..... | 40 |
| Manner mode | 31 |
| Map | 58 |
| Map application | 59 |
| Menu icon..... | 26 |
| Menu icon setting..... | 32 |
| Microphone | 4 |
| microSD card | 77 |
| Back up/restore..... | 80 |
| Copy..... | 79 |
| Format..... | 78 |

| | |
|----------------------------|----|
| Inserting/removing | 77 |
| Movie | 71 |
| Movie mode..... | 61 |
| Movie player | 71 |
| MUSIC player | 68 |
| MUSIC player display | 68 |
| Music&Video channel | 67 |

N

| | |
|-----------------------------|----|
| Navigation displays..... | 24 |
| Network security code | 36 |
| Network services | 44 |
| Normal style..... | 6 |
| Notification icon | 23 |
| Numeric keys | 4 |

O

| | |
|------------------------------------|------|
| Omakase choice | 62 |
| Omakase lock | 38 |
| One-push open | 6 |
| One-push open button | 5, 6 |
| Options..... | 89 |
| Original..... | 31 |
| Osaifu-Keitai | 72 |
| Out-of-service-area indication.... | 22 |
| Overseas use | 47 |
| Own number..... | 21 |

P

| | |
|-------------------------------|---|
| Part names and functions..... | 4 |
|-------------------------------|---|

| | |
|--------------------------------|-----|
| PC connection | 81 |
| Personal data lock | 38 |
| Phonebook | |
| Add to phonebook | 53 |
| Delete data | 54 |
| Edit phonebook | 54 |
| Search phonebook | 40 |
| Photo light | 5 |
| Photo mode | 61 |
| Picture album | 61 |
| Picture viewer | 61 |
| PIN1 code | 36 |
| PIN1 code entry set | 37 |
| PIN2 code | 36 |
| Portrait rights | 101 |
| Position location | 59 |
| Power on/off | 20 |
| Power saver mode | 32 |
| Public mode (Drive mode) | 43 |
| Public mode (Power off) | 43 |
| PUK (PIN unblock code) | 37 |

Q

| | |
|---------------|----|
| QR code | 75 |
|---------------|----|

R

| | |
|-----------------------------------|----|
| Radio waves reception level | 22 |
| Received calls | 41 |
| Receiving a call | 42 |
| Receiving a videophone call | 42 |

| | |
|----------------------|----|
| Record message | 42 |
| Redial | 41 |
| Reject unknown | 38 |
| Remote reset | 39 |
| Reset settings | 39 |
| Ring volume | 30 |

S

| | |
|---|----|
| SAR | 98 |
| Scanning function | 88 |
| Schedule | 74 |
| Screen memo | 57 |
| Security codes | 35 |
| Security scan function (Scanning function) | 88 |
| Select language | 21 |
| Select ring tone | 30 |
| Services available for FOMA terminal | 46 |
| Simple menu | 26 |
| Site access | 55 |
| SMS | 52 |
| Software update | 86 |
| Speaker | 5 |
| Specific absorption rate | 98 |
| Stand-by display | 26 |
| Status icon | 22 |
| Strap hole | 5 |
| Styles | 6 |

T

| | |
|------------------------------|-----|
| Terminal security code | 36 |
| Timer recording | 66 |
| ToruCa | 72 |
| Trademarks | 101 |
| Troubleshooting | 82 |
| TV timer | 66 |

U

| | |
|-----------------------------|----|
| UIM | 18 |
| Update (Pattern data) | 88 |

V

| | |
|--------------------------|----|
| Vibrator | 30 |
| Video | 66 |
| Video recording | 65 |
| View blind | 32 |
| Viewer display | 65 |
| Voice mail service | 45 |

W

| | |
|------------------|----|
| Warranty | 84 |
| WORLD CALL | 41 |
| WORLD WING | 47 |

Numerics

| | |
|--------------------|----|
| 1Seg | 63 |
| 1Seg antenna | 5 |

Access the following for checking or changing the contents of your contract, or for applying to respective services, and asking for related documents:

From i-mode

i Menu ▶ お客様サポート (User support) ▶ お申込・お手続き (Applications/Procedures)

▶ 各種お申込・お手続き (Respective applications/procedures)

Packet communication charges free

From PC

My docomo (<http://www.mydocomo.com/>) ▶ 各種お申込・お手続き (Respective applications/procedures)

- “お客様サポート (User support)” and My docomo are available in Japanese only.
- You will need your “network ID” for the access from i-mode.
- No packet communication charges are incurred for the access from i-mode. Accessing from overseas will incur charges.
- You will need your “docomo ID/password” for the access from a PC.

- If you do not have or you have forgotten your “network ID” or “docomo ID/password”, contact the docomo Information Center listed on the back page of this manual.
- You may not be able to access the site depending on the details of your subscription.
- You may not be able to access the site due to system maintenance, etc.



Using mobile phone with your manners!

When using your mobile phone in a public place, don't forget to show common courtesy and consideration for others around you.

In the following cases, be certain to turn off the power.

■ **Where use is prohibited**

- Be sure to turn off the power to your FOMA terminal in airplanes, in hospitals and around priority seat in a train, etc.

In the following cases, be certain to set Public mode.

■ **While driving**

- Using the mobile phone in your hand while driving is subject to punishment.

■ **When in theaters, movie theaters, museums, and similar venues**

Respect the privacy.



Please be considerate of the privacy of individuals around you when shooting and sending photos using camera-equipped mobile phones.



An Environment Protection Program by DOCOMO

Simplified Version of the Manual

We, the publisher, have edited the Japanese Instruction Manual so that the descriptions of basic operational procedures for respective functions are simplified, and as a result, have succeeded to reduce the number of sheets of paper used. You can refer to “使いかたナビ (Guide)” (in Japanese only) that comes with the FOMA terminal, and the DOCOMO website for functions frequently used, and more detailed descriptions.

Collection and Recycling of Mobile Phones



モバイル・リサイクル・ネットワーク
携帯電話・PHSのリサイクルにご協力。

To carry out the protection of environment and the reuse of precious resources, we at mobile phone and PHS carriers collect your disused mobile phones, batteries, or chargers for recycling to a shop having the mark at left, regardless of brand names or makers. Kindly take your disused ones to a docomo Shop nearby.

General Inquiries

<docomo Information Center>

(Business hours: 9:00 a.m. to 9:00 p.m.)

 **0120-005-250 (toll free)**

- * Service available in English, Portuguese, Chinese, Spanish, and Korean.
- * Available from mobile phones and PHSs (including non-DOCOMO phones).
- * Unavailable from part of IP phones.

(Business hours: 9:00 a.m. to 8:00 p.m. (open all year round))

■ **From DOCOMO mobile phones**
(In Japanese only)

■ **From land-line phones**
(In Japanese only)

 **(No prefix) 151 (toll free)**

* Unavailable from land-line phones, etc.

 **0120-800-000 (toll free)**

- * Available from mobile phones and PHSs (including non-DOCOMO phones).
- * Unavailable from part of IP phones.

● Please confirm the phone number before you dial.

● For Applications or Repairs and After-Sales Service, please contact the above-mentioned information center or the docomo Shop etc. near you on the NTT DOCOMO website or the i-mode site.

NTT DOCOMO website <http://www.nttdocomo.co.jp/english/>

i-mode site | Menu ▶ お客様サポート (User support) ▶ ドコモショップ (docomo Shop) (In Japanese only)

Loss or theft of FOMA terminal or payment of cumulative cost overseas

<docomo Information Center>

(available 24 hours a day)

■ **From DOCOMO mobile phones**

International call access code for the country you stay at

-81-3-6832-6600* (toll free)

- * You are charged a call fee to Japan when calling from a land-line phone, etc.
- ※ If you use P-04B, you should dial the number +81-3-6832-6600 (to enter "+", press and hold the "0" key for at least one second).

■ **From land-line phones <Universal number>**

Universal number international prefix

-8000120-0151*

- * You might be charged a domestic call fee according to the call rate for the country you stay at.
- ※ For international call access codes for major countries and universal number international prefix, refer to the DOCOMO International Services website.

● **If you lose your FOMA terminal or have it stolen, immediately take the steps necessary for suspending the use of the FOMA terminal.**

● **If the FOMA terminal you purchased is damaged, bring your FOMA terminal to a repair counter specified by DOCOMO after returning to Japan.**

Repairs

(Business hours: 24 hours (open all year round))

■ **From DOCOMO mobile phones**
(In Japanese only)

■ **From land-line phones**
(In Japanese only)

 **(No prefix) 113 (toll free)**

* Unavailable from land-line phones, etc.

 **0120-800-000 (toll free)**

- * Available from mobile phones and PHSs (including non-DOCOMO phones).
- * Unavailable from part of IP phones.

Failures encountered overseas

<Network Support and Operation Center>

(available 24 hours a day)

■ **From DOCOMO mobile phones**

International call access code for the country you stay at

-81-3-6718-1414* (toll free)

- * You are charged a call fee to Japan when calling from a land-line phone, etc.
- ※ If you use P-04B, you should dial the number +81-3-6718-1414 (to enter "+", press and hold the "0" key for at least one second).

■ **From land-line phones <Universal number>**

Universal number international prefix

-8005931-8600*

- * You might be charged a domestic call fee according to the call rate for the country you stay at.
- ※ For international call access codes for major countries and universal number international prefix, refer to the DOCOMO International Services website.



Don't forget your mobile phone ... or your manners!
When using your mobile phone in a public place, don't forget to show common courtesy and consideration for others around you.



Li-ion 00

To prevent damage to the environment, bring used battery packs to a docomo service counter, a docomo agent or a recycle center.

May '10 (Edition 1.1)

3TR100265AAA

F0410-1

P-04B

Manual for PC Connection

| | |
|---|----|
| Data Communication Available from FOMA Terminal | 1 |
| Before Using Data Communication | 2 |
| Setup Flow for Data Transfer (OBEX™ Communication) | 5 |
| Setup Flow for Data Communication | 5 |
| Installing FOMA Communication Configuration File (Driver) | 7 |
| Preparing Bluetooth Communication | 11 |
| «Dial-up Communication Service» | |
| DOCOMO Connection Manager | 13 |
| Before Installing DOCOMO Connection Manager | 14 |
| Installing DOCOMO Connection Manager | 15 |
| Starting DOCOMO Connection Manager | 18 |
| Setting Dial-up Network | 19 |
| Making Dial-up Connection | 33 |
| AT Command | 37 |
| AT Command List | 38 |

About Manual for PC Connection

This manual gives you the explanations of details required for having data communication with your P-04B, and installing “FOMA communication configuration file”/“DOCOMO Connection Manager” within the CD-ROM on your personal computer assuming that you are using the one that comes with Windows 7.
Some procedures and displays may differ depending on your operating environment.

Data Communication Available from FOMA Terminal

The data communication services you can use by connecting the FOMA terminal to a personal computer are classified as data transfer (OBEX™ communication), packet communication, and 64K data communication. The FOMA terminal is equipped with the adapter function for packet communication.

- To perform the packet communication overseas, perform it via the IP connection. (You cannot perform the packet communication via the PPP connection.)
- 64K data communication is not available overseas.

Data Transfer (OBEX™ Communication)

You can exchange data files such as images, music files, Phonebook entries and mail messages with another FOMA terminal or a personal computer.

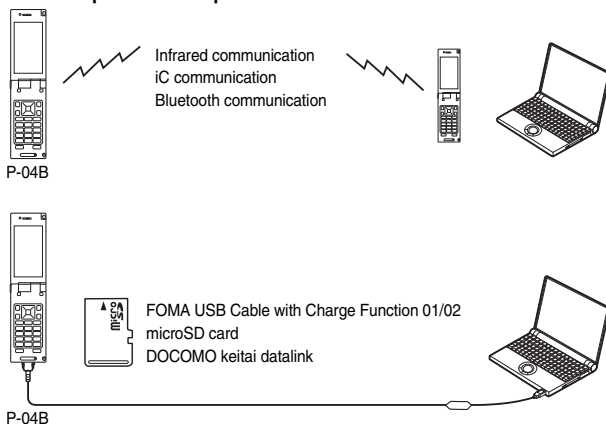

Packet Communication

This communication system requires a communication fee according to the amount of data you sent and received. (Best effort system with 7.2 Mbps of maximum download speed and 2.0 Mbps of maximum upload speed)[※] It uses an access point which supports FOMA packet communication such as DOCOMO Internet access service “mopera U”.

Packet communication is available by configuring settings after connecting the FOMA terminal to a personal computer via the FOMA USB Cable with Charge Function 01/02 (option) or Bluetooth communication, and is suitable for using applications which require the high-speed communication.

To carry out the settings and connection, see page 5 and after.

[※] The maximum speed is based on the technical specification. The actual communication speed varies depending on the network congestion state and the communication environment. The communication speed might be lowered when you connect the FOMA terminal to an access point which does not support HIGH-SPEED or the terminal is outside the FOMA High-Speed Area, or when you use the device which does not support High-Speed such as DOCOMO’s PDA “sigmarion III”.

- The packet communication is charged according to the amount of data you sent and received. Note that you are charged a high communication fee for the massive data communication such as browsing Internet websites having many images or downloading data files.

64K Data Communication

This communication system requires a communication fee according to the duration of connection. By connecting the FOMA terminal to a personal computer via the FOMA USB Cable with Charge Function 01/02 (option) or Bluetooth communication, you can execute communication.

To use this service, connect to an access point which supports FOMA 64K data communication such as DOCOMO Internet access service “mopera U”, or an ISDN-synchronous 64K access point. To carry out the settings and connection, see page 5 and after.

- The 64K data communication is charged according to the duration of connection. Note that a communication fee becomes expensive if you use this service for a long time.

Information

- The FOMA terminal does not support Remote Wakeup.
- The FOMA terminal does not support the FAX communication.
- You can perform data communications by connecting the FOMA terminal with DOCOMO's PDA "sigmarion III".

Before Using Data Communication

Charge of Internet service provider

To use the Internet, you need to pay the charge for the Internet service provider you use. Besides the FOMA service fee, you need to directly pay this charge to the Internet service provider. For details on the charge, contact the Internet service provider you use.

You can use the DOCOMO Internet access service, "mopera U". To use "mopera U", subscription (charged) is required.

Setting access point (Internet service provider, etc.)

The access points for the packet communication and 64K data communication differ. To use the packet communication, connect to an access point which supports packet communication. To use the 64K data communication, connect to an access point which supports FOMA 64K data communication or ISDN-synchronous 64K.

- You cannot connect to the DoPa access point.
- For the service contents and connection method of "mopera", refer to the "mopera" website (in Japanese only):
<http://www.mopera.net/mopera/index.html>

About user authentication for accessing network

User authentication (ID and password) may be required at connection to some access points. In that case, enter your ID and password on the communication software (dial-up network). ID and password are specified by the Internet service provider or network administrator of the access point. For details, contact the provider or network administrator.

About access authentication for using browser

To use the FirstPass supporting site from a browser on your personal computer, you need to have FirstPass (user certificate) for access to authentication. Download the FirstPass PC software from the DOCOMO website, and then install it and establish the settings on your personal computer.

For details, refer to the DOCOMO website.

Conditions of packet communication and 64K data communication

To carry out the communication using the FOMA terminal in Japan, the following conditions are required:

- The personal computer to be used can use the FOMA USB Cable with Charge Function 01/02 (option).
- When connecting using Bluetooth communication, the personal computer should support Dial-up Networking Profile of Bluetooth Specification Ver. 1.1, Ver. 1.2 or Ver. 2.0+EDR.
- The PDA to be used should support FOMA packet communication and 64K data communication.
- Within the FOMA service area
- For packet communication, the access point should support packet communication of the FOMA.
- For 64K data communication, the access point should support the FOMA 64K data communication or ISDN-synchronous 64K.

Even when these conditions are satisfied, if the base station is congested or the radio wave conditions are bad, you may not carry out the communication.

Operating Environment

For the data communication, the following operating environment is required for your personal computer:

| Item | Description |
|----------------------|--|
| PC main unit | PC/AT compatible model When using the FOMA USB Cable with Charge Function 01/02 (option): USB port (Universal Serial Bus Specification Rev1.1/2.0 compliant) When using Bluetooth communication: Bluetooth Specification Ver. 1.1, Ver. 1.2 or Ver. 2.0+EDR compliant (Dial-up Networking Profile) Display resolution 800 x 600 dots, high color 16 bits or more recommended. |
| OS | Windows 7, Windows Vista, Windows XP (Japanese version in each) |
| Memory requirements | Windows 7 32 bit version: 1 Gbyte or more Windows 7 64 bit version: 2 Gbytes or more Windows Vista: 512 Mbytes or more Windows XP: 128 Mbytes or more (Japanese version in each) |
| Hard disk space size | Unused memory space of 5 Mbytes or more ●Unused memory space of 10 Mbytes or more for “DOCOMO Connection Manager” |

- For the latest information about the operating environment, refer to the DOCOMO website.
- The operation on the upgraded OS is not guaranteed.
- The memory requirements and hard disk space size may vary depending on the system environment.
- The recommended environment that the Menu operates is Microsoft® Internet Explorer 7.0 or later.※ When the Menu does not appear after you set the CD-ROM, operate as follows:
<For Windows 7 or Windows Vista>
Refer to the CD-ROM from “コンピュータ (Computer)”, then double-click “index.html”.
<For Windows XP>
Refer to the CD-ROM from “マイコンピュータ (My computer)”, then double-click “index.html”.
※For Windows XP, the recommended environment is Microsoft® Internet Explorer 6.0 or later.

■When you set the CD-ROM on your personal computer

An alert message might appear on the display. This alert message appears depending on the security settings of Internet Explorer, but you can proceed without problems.

Click “はい (Yes)”.

Necessary Devices

The following hardware and software are required besides the FOMA terminal and personal computer:

- FOMA USB Cable with Charge Function 01/02 (option) or FOMA USB Cable (option)※
- Provided “P-04B CD-ROM”

※For USB connection

Information

- Use a dedicated FOMA USB Cable with Charge Function 01/02 or FOMA USB Cable. The USB cable for personal computers cannot be used because the shape of the connector differs.
- If you use a USB hub, the devices may not work correctly.

Connect FOMA Terminal to Other Devices

The following three ways are available for connecting the FOMA terminal to another device:

Use FOMA USB Cable with Charge Function 01/02

Connect the FOMA terminal to a personal computer provided with the USB port using the FOMA USB Cable with Charge Function 01/02 (option). (See page 6)

This way of connection applies to all communication systems such as packet communication, 64K data communication, and data transfer.

- Set "USB mode setting" to "Communication mode" for data communication.
Operate **[MENU]** ▶ **Set./Service** ▶ **Other settings** ▶ **USB mode setting** ▶ **Communication mode**".
- You need to install the FOMA communication configuration file (driver) before use.

Use Bluetooth Communication

Connect a Bluetooth communication compatible personal computer wirelessly to the FOMA terminal. (See page 11)

This way of connection applies to packet communication and 64K data communication.

- When you perform data communication by using Bluetooth function, the high speed communication is applied to the FOMA terminal. However, you may not be able to communicate at the maximum speed, because of the limit of communication speed of Bluetooth function.
- Use a Bluetooth linked standard modem or a Bluetooth modem provided by the Bluetooth device maker. Contact the maker of your personal computer or Bluetooth device maker for how to install and to set up.

Use Infrared Communication

By using infrared rays, you can send/receive data between your FOMA terminal and another FOMA terminal, mobile phone, or personal computer provided with the infrared communication function.

This applies to data transfer only.

Setup Flow for Data Transfer (OBEX™ Communication)

When you use the FOMA USB Cable with Charge Function 01/02 (option), install the FOMA communication configuration file.

Download or install the "FOMA communication configuration file" (driver). (See page 7)

- Install the FOMA communication configuration file from the provided CD-ROM, or download it from the DOCOMO website and install.

Data transfer

Setup Flow for Data Communication

The following outline shows a setup flow for packet communication or 64K data communication.

For USB connection

Connect a personal computer to the FOMA terminal using the FOMA USB Cable with Charge Function 01/02 (option).

For Bluetooth connection

Connect a personal computer wirelessly to the FOMA terminal using Bluetooth communication. (P.11)

Download or install the "FOMA communication configuration file" (driver). (P.7)

- Install the FOMA communication configuration file from the provided CD-ROM, or download it from the DOCOMO website and install.

Check the setting after installation. (P.8)

Check the modem. (P.12)

Install "DOCOMO Connection Manager". (P.14)

Carry out the setting manually without using "DOCOMO Connection Manager". (P.19, P.36)

Connect. (P.18, P.33)

■ Provided "P-04B CD-ROM"

When performing packet communication by connecting the FOMA terminal to your personal computer via the FOMA USB Cable with Charge Function 01/02, install the "FOMA communication configuration file" (driver) from the provided "P-04B CD-ROM" onto the personal computer. You are advised to install "DOCOMO Connection Manager" which enables you to easily set up the APN or dial-up for communication.

Connecting PC and the FOMA Terminal

The following steps explain how to connect the FOMA USB Cable with Charge Function 01/02 (option).

- 1 Check the direction of the connector terminal of the FOMA terminal, then straight insert the external connector of the FOMA USB Cable with Charge Function 01/02 until it clicks.**

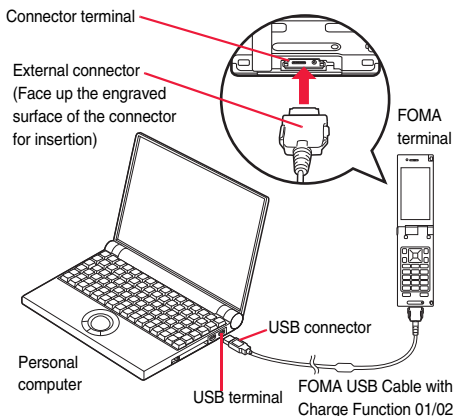

- 2 Connect the USB connector of the FOMA USB Cable with Charge Function 01/02 to the USB terminal of the personal computer.**

Information

- Do not forcibly insert the FOMA USB Cable with Charge Function 01/02. Malfunction may result. Insert each connector in the correct direction at the correct angle; otherwise, you will fail connection. When the direction and angle are correct, you can insert a connector smoothly without the strong force. If you fail to insert a connector, check its shape and direction once more without inserting a connector forcibly.
- Use a dedicated FOMA USB Cable with Charge Function 01/02. (The USB cable for personal computers cannot be used because the shape of the connector differs.)
- Symbol "Ⓜ" appears on the FOMA terminal when the FOMA terminal recognizes the connection with the personal computer after you install the FOMA communication configuration file (driver) for packet communication or 64K data communication. Before you install the FOMA communication configuration file (driver), the FOMA terminal does not recognize the connection with the personal computer, and symbol "Ⓜ" does not appear.

Removing

- 1. While holding down the release buttons of the external connector of the FOMA USB Cable with Charge Function 01/02, straight pull out the connector.**
- 2. Pull out the FOMA USB Cable with Charge Function 01/02 from the USB terminal of the personal computer.**

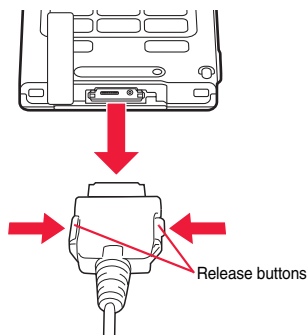

Information

- Do not disconnect the FOMA USB Cable with Charge Function 01/02 forcibly. Malfunction may result.
- Do not disconnect the FOMA USB Cable with Charge Function 01/02 during data communication. Erroneous operation or malfunction of the personal computer or FOMA terminal, or loss of data could result.
- Do not connect/disconnect the FOMA USB Cable with Charge Function 01/02 in succession. Once you connect the cable, wait for a while, then disconnect it and vice versa.

Installing FOMA Communication Configuration File (Driver)

Installing the FOMA communication configuration file (driver) is required when you connect the FOMA terminal to your personal computer via the FOMA USB Cable with Charge Function 01/02 (option) for the first time.

- When connecting wirelessly using Bluetooth communication, you do not need to install the FOMA communication configuration file (driver).
- Operate as the user who has the PC administrator right.
- End all the programs resident on your personal computer before installing the FOMA communication configuration file (driver).

1 Start Windows, then set the provided “P-04B CD-ROM” into the personal computer.

2 Click “データリンクソフト・各種設定ソフト (Data link software/Setup software)”.

- If this display appears during installation of the “FOMA communication configuration file” (driver), close the display.



3 Click “インストール (Install)” under “FOMA通信設定ファイル (USBドライバ) [FOMA communication configuration file (USB driver)]”.

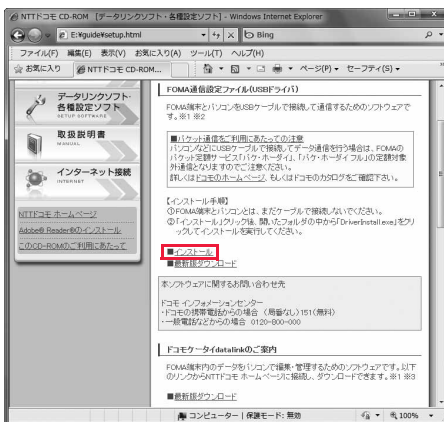

4 Double click “DriverInstall.exe” in opened folder, and click “はい (Yes)”.

- For Windows Vista, click “続行 (Continue)” instead of “はい (Yes)”.
- For Windows XP, the user account control display does not appear.

5 Click “OK”.

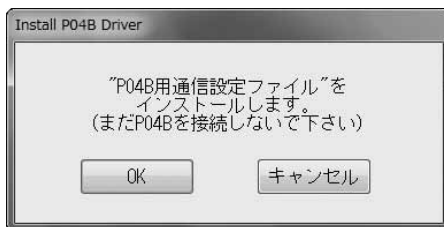

6 Turn on the FOMA terminal’s power, then connect the FOMA terminal to the personal computer using the FOMA USB Cable with Charge Function 01/02. (See page 6)

Installation starts.

7 Click “OK”.

After the installation of all the “FOMA communication configuration files” (driver) is completed, a pop-up message “デバイスを使用する準備ができました。デバイス ドライバソフトウェアが正しくインストールされました。(The system is ready to use the device. The device driver software was installed correctly.)” appears for a few seconds from the indicator on the task bar.

Confirm Installed FOMA Communication Configuration File (Driver)

Confirm that the “FOMA communication configuration file” (driver) is installed correctly.

For Windows 7

1 “ [スタート (Start)]”

▶ Open “デバイスとプリンター (Devices and printers)”.

2 Open “docomo PRIME series P-04B”

▶ Click the “ハードウェア (Hardware)” tab.

3 Confirm the installed driver names.

Confirm that all driver names are displayed.

- The COM port number varies depending on the personal computer you use.

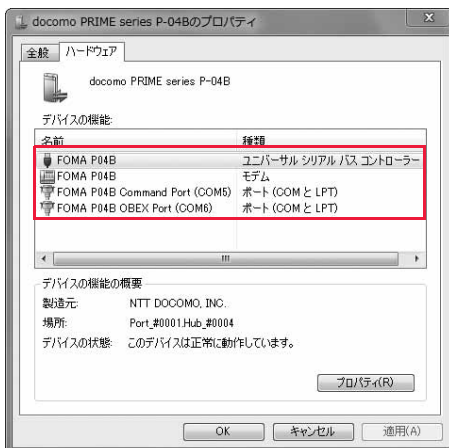

For Windows Vista, Windows XP

- 1 “ [スタート (Start)]” ▶ Open “コントロールパネル (Control panel)”
▶ Open “システムとメンテナンス (System and maintenance)”.

<For Windows XP>

“スタート (Start)” → Open “コントロールパネル (Control panel)”

→ “パフォーマンスとメンテナンス (Performance and maintenance)” → Open “システム (System)”.

- 2 Open “ハードウェアとデバイスを表示 (Show hardwares and devices)”
▶ Click “続行 (Continue)”.

<For Windows XP>

Click the “ハードウェア (Hardware)” tab → Click “デバイスマネージャ (Device manager)”.

- 3 Click each device, then confirm the installed FOMA communication configuration file (driver) names.

Confirm that all FOMA communication configuration file (driver) names are displayed under “ポート (COMとLPT) [Port (COM/LPT)]”, “モデム (Modem)”, and “ユニバーサル シリアル バス コントローラ (Universal serial bus controller)”.

- The COM port number varies depending on your personal computer.

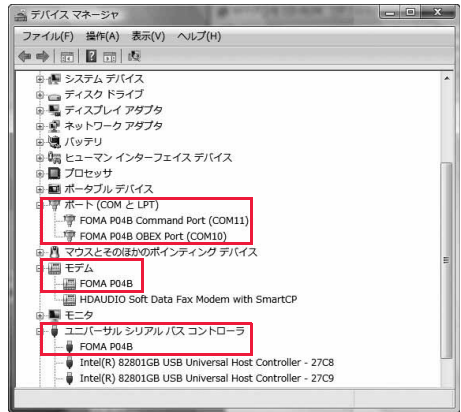

The following drivers are installed by installation of the “FOMA communication configuration file” (driver):

| Device name | FOMA communication configuration file (driver) name |
|--|---|
| ポート (COMとLPT) [Port (COM/LPT)] | <ul style="list-style-type: none"> ・ FOMA P04B Command Port ・ FOMA P04B OBEX Port |
| モデム (Modem) | <ul style="list-style-type: none"> ・ FOMA P04B |
| <For Windows 7, Windows Vista> ユニバーサル シリアル バス コントローラ (Universal serial bus controller) <For Windows XP> USB (Universal Serial Bus) コントローラ [USB (Universal Serial Bus) controller] | <ul style="list-style-type: none"> ・ FOMA P04B |

Uninstall FOMA Communication Configuration File (Driver)

When uninstalling the “FOMA communication configuration file” (driver) is necessary (such as when upgrading the version), perform the operation below.

● Operate as the user who has the PC administrator right.

1 If the FOMA terminal is connected to a personal computer via the FOMA USB Cable with Charge Function 01/02 (option), disconnect the FOMA USB Cable with Charge Function 01/02.

2 “ [スタート (Start)]”▶ Open “コントロールパネル (Control panel)”
▶ Open “プログラムのアンインストール (Uninstall programs)”.

<For Windows Vista>

“ [スタート (Start)]”→Open “コントロールパネル (Control panel)”→Open “プログラムと機能 (Programs and functions)”.

<For Windows XP>

“スタート (Start)”→Open “コントロールパネル (Control panel)”→Open “プログラムの追加と削除 (Add and delete programs)”.

3 Select “FOMA P04B USB” and click “アンインストールと変更 (Uninstall and change)”.

<For Windows Vista>

When the user account control display appears after step 3, click “続行 (Continue)”.

<For Windows XP>

Select “FOMA P04B USB” and click “変更と削除 (Change and delete)”.

4 Click “OK”.

5 Click “はい (Yes)” to restart Windows.

The uninstallation is then completed.

● If you click “いいえ (No)”, restart Windows manually.

Information

● If you remove the FOMA USB Cable with Charge Function 01/02 from the personal computer or click the “キャンセル (Cancel)” button to stop installation while installing the “FOMA communication configuration file” (driver), the “FOMA communication configuration file” (driver) may not be installed correctly. In that case, execute “P04B_un.exe”※ on “P-04B CD-ROM” to delete the “FOMA communication configuration file” (driver), and then install the files again.

※ Execute “P04B_un.exe” in the following folders:

Windows 7 32 bit version: “P04B_USB_Driver” → “Win7_32”

Windows 7 64 bit version: “P04B_USB_Driver” → “Win7_64”

Windows Vista 32 bit version: “P04B_USB_Driver” → “WinVista32”

Windows Vista 64 bit version: “P04B_USB_Driver” → “WinVista64”

Windows XP: “P04B_USB_Driver” → “Win_XP”



Preparing Bluetooth Communication

You can make data communication by connecting a Bluetooth communication compatible personal computer wirelessly to your FOMA terminal.

Connect to Personal Computer for the First Time

To connect a personal computer to the FOMA terminal for the first time, register the personal computer to the FOMA terminal.

1 ► LifeKit ► Bluetooth ► Accept dialup devices

- To cancel, press  (Quit) in standby. When no connection is made for five minutes in standby, the connection is automatically released.
- During standby, “ (blue)” lights.

2 Search and register the Bluetooth device from the personal computer.

- Register the device from the personal computer while the FOMA terminal is in standby.
- Refer to the operating manual of your personal computer for the details of how to operate it. (Depending on your personal computer, “探索 (search)” or “サーチ (search)” is used instead of “検索 (search)”, and “ペアリング (pairing)” is used instead of “機器登録 (register devices)”.

3 When the display for connection request appears, select “YES”.

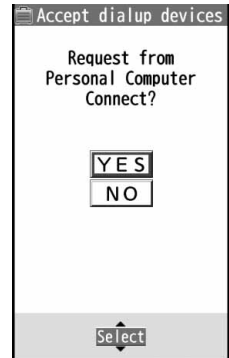

4 Select the text box for a Bluetooth pass key ► Enter the Bluetooth pass key ► Set

- You can enter 1 through 16 half-pitch alphanumeric characters for the Bluetooth pass key.
- Enter the same Bluetooth pass key for both the FOMA terminal and personal computer.

5 The personal computer is registered and a wireless connection starts.

When the connection is completed, “ (blue)” blinks.

Information

- You cannot place the devices using the Headset service or Hands-free service in the state of “Accept registered” while the FOMA terminal is in the state of “Accept dialup devices”.
- When the personal computer found multiple devices for registering the FOMA terminal on the personal computer, identify the FOMA terminal by the device name. When the personal computer found multiple devices having the same device names, identify the FOMA terminal by the device address.
- In the state of “Accept dialup devices”, searches are made from all the Bluetooth devices around, however, you cannot connect to any service other than the Dial-up Communication service.

■ To connect to the registered personal computer

When you connect to the FOMA terminal from a registered personal computer, place “Dial-up” in the state of “Accept registered”. Then you can make a connection from the personal computer to the FOMA terminal by operating from the personal computer. You can connect even in the state of “Accept dialup devices”.

Confirm the Modem

Before setting communication, confirm the name and COM port number of the modem used for connecting the dial-up service.

For Windows 7

- 1 “ [スタート (Start)]”
▶ Open “デバイスとプリンター (Devices and printers)”.
- 2 Open “docomo PRIME series P-04B”
▶ Click the “ハードウェア (Hardware)” tab.
- 3 Confirm the modem name or COM port number.

For Windows Vista, Windows XP

- 1 “ [スタート (Start)]” ▶ Open “コントロールパネル (Control panel)”
▶ Open “システムとメンテナンス (System and maintenance)”.
<For Windows XP>
“スタート (Start)” → Open “コントロールパネル (Control panel)”
→ “パフォーマンスとメンテナンス (Performance and maintenance)” → Open “システム (System)”.
- 2 Open “ハードウェアとデバイスを表示 (Show hardwares and devices)”
▶ Click “続行 (Continue)”.
<For Windows XP>
Click the “ハードウェア (Hardware)” tab → Click “デバイスマネージャ (Device manager)”.
- 3 Click each device, then confirm the modem name or COM port number.
The modem name or COM port number is displayed under “ポート (COMとLPT) [Port (COM/LPT)]” and “モデム (Modem)”.

Have Dial-up Communication Service Closed

You can close the Dial-up Communication service that is connected.

- 1  ▶ LifeKit ▶ Bluetooth ▶ Device list
- 2 Select the Bluetooth device that is connected.
- 3 Dial-up ▶ YES
The Dial-up Communication service is closed.

DOCOMO Connection Manager

“DOCOMO Connection Manager” is a convenient software program to perform flat-rate data communication and volume charging data communication. It enables you to sign up for “mopera U” and easily make PC settings according to your contract situation.

It also enables you to check the estimate data traffic and usage amount with the charge counter function.

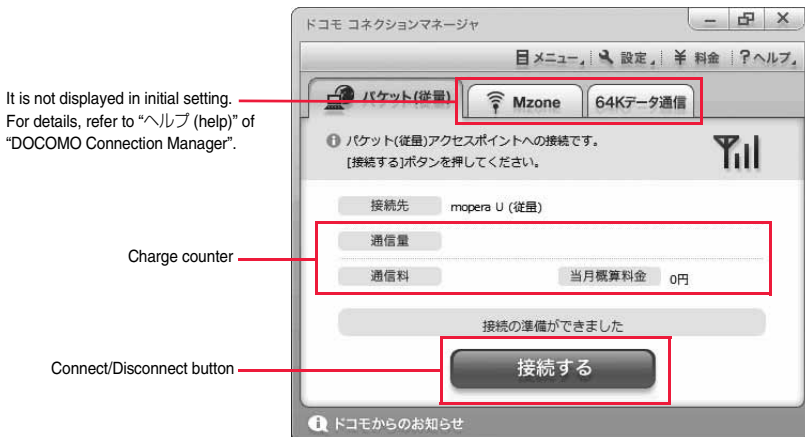

This manual explains how to install “DOCOMO Connection Manager”.

To access the Internet by using a terminal, you need to contract with a Internet service provider (such as “mopera U”) which supports the service and data communication.

For details, refer to the DOCOMO website.

■When Using Volume Charging Data Communication (including i-mode packet flat-rate service, etc.)

Note that a communication fee might become expensive when you transfer a large amount of data such as by browsing websites having many images, or by downloading data (such as application, music/movie data, updating of OS/Anti-virus software).

When you perform data communication by connecting this FOMA terminal to your personal computer via the USB cable, note that the communication is not covered by the flat-rate service of “Pake-hodai” and “Pake-hodai full”.

■When Using Flat-Rate Data Plan

To use the flat-rate data plan, you need to apply for a billing plan which supports flat-rate data communication and sign a contract with the Internet service provider. For details, refer to the DOCOMO website.

■When Using “mopera”

For details on method of connection and setting, refer to the “mopera” website (in Japanese only):

<http://www.mopera.net/mopera/support/index.html>

Before Installing DOCOMO Connection Manager

Installation Flow

STEP

1 Prepare the FOMA terminal and the FOMA USB Cable with Charge Function 01/02 (option) or the FOMA USB Cable (option).

STEP

2 Check the service contents and the contract contents with Internet service provider.

STEP

3 When a connection software program other than “DOCOMO Connection Manager” is installed, set it not to start automatically.

• See page 14 for using communication software other than “DOCOMO Connection Manager”.

■About Internet Explorer Settings

Before using this software program, make the setting on the “接続 (Connection)” tab of “インターネットオプション (Internet option)” of Internet Explorer to “ダイヤルしない (Not to dial)”.

1. Start Internet Explorer, and select “ツール (Tool)”
→ “インターネットオプション (Internet option)”.
2. Select the “接続 (Connection)” tab and select “ダイヤルしない (Not to dial)”.
3. Click “OK”.



Information

<Use of connection software other than “DOCOMO Connection Manager”>

• You do not simultaneously need following software programs as this software program includes the functions equivalent to them.

Uninstall or set them not to start depending on your needs.

- ・mopera Uかんたんスタート (mopera U start up tool)
- ・Uかんたん接続設定ソフト (mopera U connection & setting tool)
- ・FOMA PC設定ソフト (FOMA PC configuration software)
- ・FOMA/バイトカウンタ (FOMA byte counter)

When you use Mzone (public wireless LAN connection) with this software program, uninstall the following public wireless LAN connection software programs.

You cannot use Mzone when they are simultaneously installed:

- ・U公衆無線LANユーティリティソフト (U public wireless LAN utility software)
- ・ドコモ公衆無線LANユーティリティソフト (DOCOMO public wireless LAN utility software)
- ・ドコモ公衆無線LANユーティリティプログラム (DOCOMO public wireless LAN utility program)

Installing DOCOMO Connection Manager

To connect the FOMA terminal to a personal computer and perform the packet communication or 64K data communication, you need to configure various settings related to the communication.

Using “DOCOMO Connection Manager”, you can easily set up dial-up, communication setup optimization, and access point name (APN).

- Operate as the user who has the PC administrator right.
- End all the running application programs.

End the programs resident on Windows including anti-virus software.

(Example) Right click the icon appears on the task tray, and select “閉じる (Close)” or “終了 (Exit)”

1 Set the provided “P-04B CD-ROM” into your personal computer.

2 Click “インターネット接続 (Internet connection)”.

- If this display appears during installation of “DOCOMO Connection Manager”, close the display.



3 Click “インストール (Install)” of 操作③ (Operation ③) in “本CD-ROMからのFOMAデータ通信の設定方法 (How to set data communication of FOMA with this CD-ROM)”

- ▶ Click “実行 (Run)”
- ▶ Click “はい (Yes)”.

- For Windows Vista, you click “続行 (Continue)” instead of “はい (Yes)”.
- For Windows XP, the user account control display does not appear.

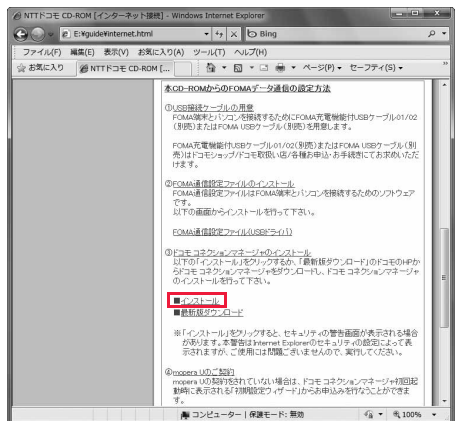

When MSXML6 and Wireless LAN API are not installed on the Windows XP environment, you need to install them before installing “DOCOMO Connection Manager”. When a confirmation display appears, click “Install” and install MSXML6/Wireless LAN API. When you restart Windows after installation of MSXML6/Wireless LAN API is completed, installation of “DOCOMO Connection Manager” automatically starts.

4 Click “次へ (Next)”.

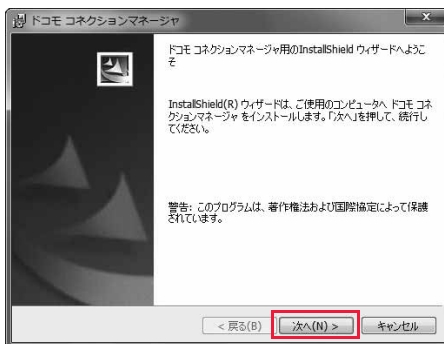

5 Confirm the display precautions and click “次へ (Next)”.

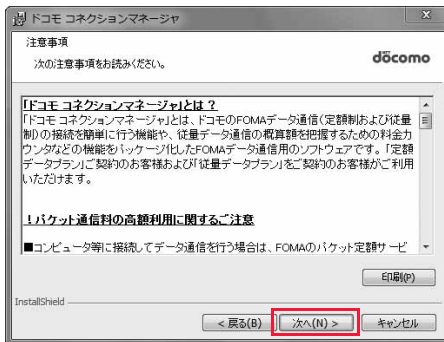

6 Confirm the licensing contract contents. If you agree with the contents, select “使用許諾契約の条項に同意します (Agree with the licensing contract contents)” and click “次へ (Next)”.

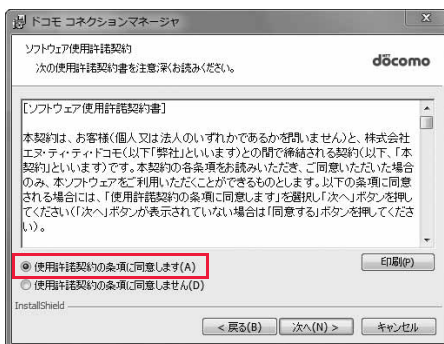

7 Confirm the installation destination folder, then click “次へ (Next)”.

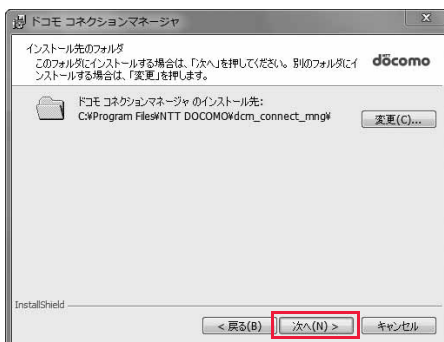

8 Click “インストール (Install)”.

Installation starts.

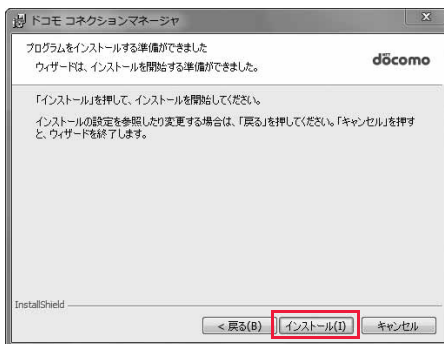

9 Click “完了 (Finish)”.

Installation is completed.



Starting DOCOMO Connection Manager

- 1 “ [スタート (Start)]” ▶ “すべてのプログラム (All programs)”
 - ▶ “NTT DOCOMO”
 - ▶ “ドコモ コネクションマネージャ (DOCOMO Connection Manager)”
 - ▶ “ドコモ コネクションマネージャ (DOCOMO Connection Manager)”

“DOCOMO Connection Manager” starts.

2 When this is the first start-up, the setting wizard appears automatically.

Hereafter, proceed operation/settings following the instruction of software to complete the preparation to access the Internet.

For details, refer to “ドコモ コネクションマネージャ操作マニュアル.pdf (DOCOMO Connection Manager operation manual by PDF format)”.

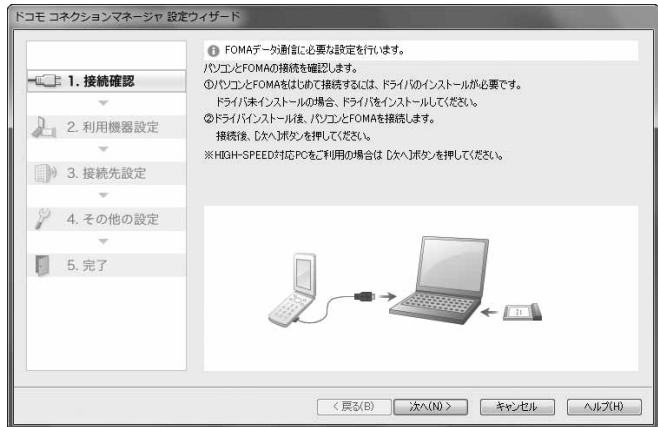

■When you disconnect the communication line

You cannot disconnect the communication line only by exiting a browser software or e-mail software.

When you do not use the communication line, be sure to click “切断する (Disconnect)” to disconnect the communication line.

When you have set the auto-update for OS and others, note that you may be charged a high packet communication fee for when they are automatically updated.

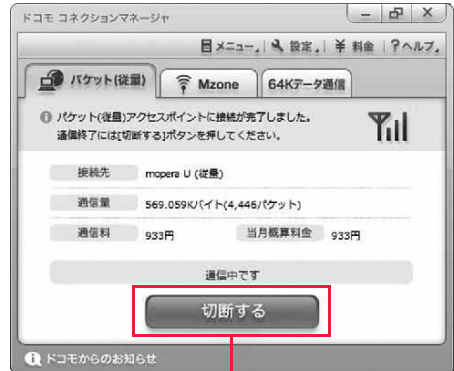

Connect/Disconnect button

Setting Dial-up Network

Set Packet Communication

This section explains how to set up a connection for packet communication without using “DOCOMO Connection Manager”.

The packet communication uses AT commands to carry out the settings from a personal computer. To specify settings, communication software to enter AT command is required. “Hyper Terminal”, which is attached to Windows as the standard software, is used here for explanation.

When using DOCOMO Internet access service “mopera U” or “mopera”, you do not need to set an access point name (APN) (see page 22).

You can set “caller ID notified/not notified” (see page 25) as required. (You need to set “caller ID notified” when using “mopera U” or “mopera”.)

•Windows 7 and Windows Vista do not support “Hyper Terminal”. For these operating systems, use a software program which supports Windows 7 or Windows Vista for setting up the connection. (Follow the settings of the software program used.)

<Packet communication setting flow using AT commands>

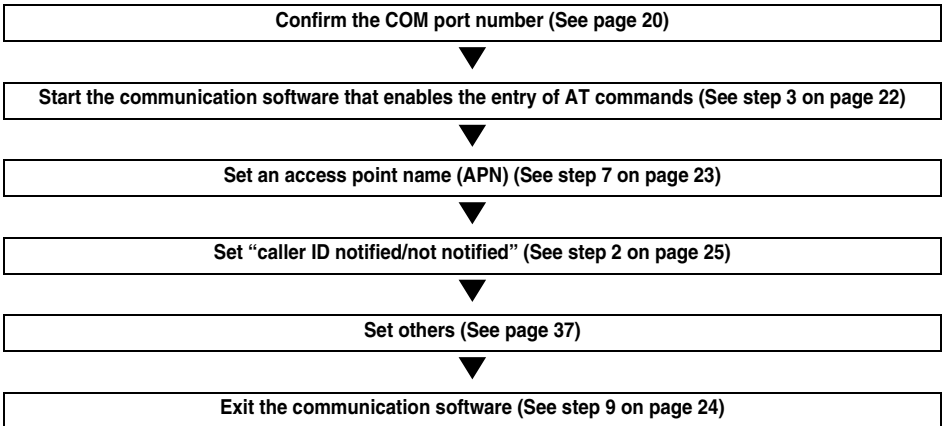

■AT commands

- The AT commands are used to control a modem. The FOMA terminal, which conforms to the AT commands, supports some extended commands and unique AT commands.
- By entering AT commands, you can carry out detailed setting for packet communication and FOMA terminal, and confirm (display) the setting contents.
- If the entered AT command is not displayed, enter “ATE1 ”.

Confirm COM Port Number

To manually carry out the communication setting, you need to specify a COM port number, which is assigned to “FOMA P04B” (modem) embedded after you install the “FOMA communication configuration file” (driver). The confirmation method varies depending on the operating system of your personal computer.

- When using DOCOMO Internet access service “mopera U” or “mopera”, you do not need to set an access point name (APN); therefore, you do not need to confirm the modem.

For Windows 7

1 “ [スタート (Start)]” ▶ Open “コントロールパネル (Control panel)”.

- The “表示方法 (Display method)” changes to “大きいアイコン (Large icon)” or “小さいアイコン (Small icon)” for “カテゴリ (Category)”.

2 Open “電話とモデム (Phone and modem)”.

3 If the “所在地情報 (Address information)” display appears, enter “市外局番/エリアコード (City code/Area code)”, then click “OK”.

4 Open the “モデム (Modem)” tab, confirm the COM port number in the “接続先 (Access point)” field of “FOMA P04B”, then click “OK”.

- When connecting wirelessly using Bluetooth communication, confirm the COM port number of the in-use Bluetooth linked standard modem or Bluetooth modem provided by a Bluetooth device maker in the “接続先 (Access point)” field.
- The COM port number you confirmed is used to set an access point name (APN) (see page 22).
- The contents on the property display and COM port number vary depending on your personal computer.



For Windows Vista

1 “ [スタート (Start)]” ▶ Open “コントロールパネル (Control panel)”.

2 From “ハードウェアとサウンド (Hardware and sound)” in “コントロールパネル (Control panel)”, open “電話とモデムのオプション (Phone and modem options)”.

3 If the “所在地情報 (Address information)” display appears, enter “市外局番/エリアコード (City code/Area code)”, then click “OK”.

4 Open the “モデム (Modem)” tab, confirm the COM port number in the “接続先 (Access point)” field of “FOMA P04B”, then click “OK”.

- When connecting wirelessly using Bluetooth communication, confirm the COM port number of the in-use Bluetooth linked standard modem or Bluetooth modem provided by a Bluetooth device maker in the “接続先 (Access point)” field.
- The COM port number you confirmed is used to set an access point name (APN) (see page 22).
- The contents on the property display and COM port number vary depending on your personal computer.



For Windows XP

1 “スタート (Start)” ▶ Open “コントロールパネル (Control panel)”.

2 From “プリンタとその他のハードウェア (Printer and the other hardware)” in “コントロールパネル (Control panel)”, open “電話とモデムのオプション (Phone and modem options)”.

3 If the “所在地情報 (Address information)” display appears, enter “市外局番/エリアコード (City code/Area code)”, then click “OK”.

4 Open the “モデム (Modem)” tab, confirm the COM port number in the “接続先 (Access point)” field of “FOMA P04B”, then click “OK”.

- When connecting wirelessly using Bluetooth communication, confirm the COM port number of the in-use Bluetooth linked standard modem or Bluetooth modem provided by a Bluetooth device maker in the “接続先 (Access point)” field.
- The COM port number you confirmed is used to set an access point name (APN) (see page 22).
- The contents on the property display and COM port number vary depending on your personal computer.



Set an Access Point Name (APN)

This section explains how to set an access point name (APN) for packet communication. You can register up to 10 access point names (APNs), which are managed with cid1 to cid10 (see page 24).

When using “mopera U” or “mopera”, you do not need to set the access point name (APN).

The explained here is an example when you use “XXX.abc” as the access point name (APN) and use the FOMA USB Cable with Charge Function 01/02 (option). For the actual access point name (APN), contact your Internet service provider or network administrator.

The setting here will be the access point number for dial-up network setting (see page 28).

For Windows XP

- 1** Connect the FOMA USB Cable with Charge Function 01/02 to the FOMA terminal.
- 2** Turn the power to the FOMA terminal on, then connect the FOMA USB Cable with Charge Function 01/02 connected to the FOMA terminal to the personal computer.

- 3** Start Hyper Terminal.

“スタート (Start)”→“すべてのプログラム (All programs)”→“アクセサリ (Accessories)”→“通信 (Communications)”→Open “ハイパーターミナル (Hyper Terminal)”.

After starting Hyper Terminal, when the message “『既定のTelnet』プログラムにしますか? (Select the specified Telnet program?)” is displayed, set as desired. Contact the maker of your personal computer and Microsoft Corporation for the setting contents.

- 4** Enter any name in the “名前 (Name)” field, then click “OK”.

Here, “Sample” is entered as an example.



5 Select a connection method.

<When you can select the COM port number of "FOMA P04B">

Select the COM port number with which you install the "FOMA P04B" in the "接続方法 (Connection method)" field, then click "OK".

Then, go to step 6.

- Here, "COM3" is selected as an example. See page 20 for the COM port number of "FOMA P04B" you should actually select in the "接続方法 (Connection method)" field.

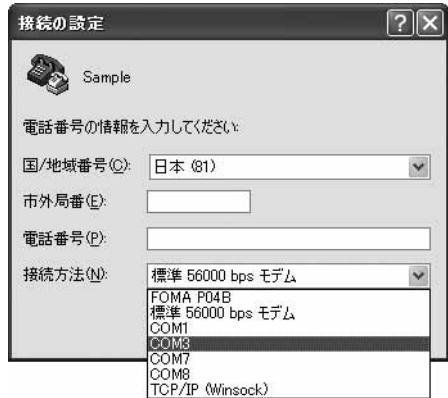

<When you cannot select the COM port number of "FOMA P04B">

Click "キャンセル (Cancel)" to close the "接続の設定 (Set a connection)" display, then perform the following operations:

- (1) "ファイル (File)" menu → Select "プロパティ (Properties)".
- (2) Select "FOMA P04B" in the "接続方法 (Connection method)" field of the "接続の設定 (Set a connection)" tab on the "Sampleのプロパティ (Sample properties)" display.
- (3) Uncheck "国/地域番号と市外局番を使う (Use country/region code and city code)".
- (4) Click "OK".

Then, go to step 7.



6 The properties of the COM port number appear on the display, then click "OK".

- This display appears when you select a COM port number in step 5.

7 Set an access point name (APN).

Enter an access point name (APN) in the following format:

AT+CGDCONT = cid, "PDP_type", "APN"

cid: Enter any number from 5 through 10.

※ If you have already specified cid, be careful that its contents are overwritten by the access point name you enter here.

"PDP_type": Enter "PPP" or "IP".

"APN": Enclose an access point name (APN) in double quotation marks ("").

(Example: When specifying APN "XXX.abc" in cid5)

AT+CGDCONT=5,"PPP","XXX.abc"

Enter this character string, then press [Enter]. If "OK" appears, the APN setting is completed.

- To confirm the current APN setting, enter "AT+CGDCONT?" [Enter]. The set APNs are listed on the display.



8 Confirm that “OK” appears on the display.



9 “ファイル (File)” menu ▶ Select “ハイパーターミナルの終了 (Exit Hyper Terminal)” to exit Hyper Terminal.

- If the message “現在、接続されています。切断してもよろしいですか? (Currently connected. Do you want to disconnect this line?)” appears, select “はい (Yes)”.
- The message “セッションXXXを保存しますか? (Do you want to save session XXX?)” then appears. You do not need to especially save that session.

Information

- The access point name (APN) is information to be registered in the FOMA terminal, so if you connect another FOMA terminal, you need to register the access point name (APN) again.
- To continue using the access point name (APN) of the personal computer, register the same access point name (APN) for the same cid number in the FOMA terminal.
- If the entered AT command is not displayed, enter “ATE1 ”.

■cid (Registration number)

The FOMA terminal has registration numbers cid1 through cid10. cid1 contains “mopera.ne.jp”, cid2 and cid3 contain “mopera.net”, and cid4 contains “mpr.ex-pkt.net” as the default access point names (APN). To connect to a provider other than “mopera U” or “mopera”, the access point name (APN) must be set to the number from cid5 to cid10 specified by the provider or network administrator.

Default cid contents

| Registration No. (cid) | Access point name (APN) |
|------------------------|-------------------------|
| 1 | mopera.ne.jp (PPP) |
| 2 | mopera.net (PPP) |
| 3 | mopera.net (IP) |
| 4 | mpr.ex-pkt.net (PPP) |
| 5 to 10 | Not set |

■“Phone number” for connecting to an access point name (APN) you register in cid

“*99**<cid No.>#”

(Example) When connecting to the access point name (APN) you register in cid5, enter the following:

*99**5#

■Resetting/Confirming the access point name (APN) settings

You can use AT commands to reset/confirm the access point name (APN) settings.

Resetting access point name (APN)

The access point name (APN) for cid1 returns to “mopera.ne.jp” (default), the names for cid2 and cid3 return to “mopera.net” (default), and the name for cid4 returns to “mpr.ex-pkt.net” (default). The settings for cid5 through cid10 will be reset to the unregistered status if you proceed with resetting.

(Entry method)

AT+CGDCONT= (When resetting all the cid contents)

AT+CGDCONT=<cid> (When resetting only a specific cid)

Confirming access point name (APN)

The currently specified access point name appears on the display.

(Entry method)

AT+CGDCONT?

Set Caller ID Notified/Not Notified

For packet communication, you can specify whether to notify your caller ID (caller ID notified/not notified). The caller ID is your important information; so, take a great care to notify your caller ID. You can use AT commands (*DGPIR command) to specify “caller ID notified/not notified” before dial-up connection.

1 Start the communication software such as “Hyper Terminal”.

- See page 22 for details on how to operate “Hyper Terminal”.

2 Use the *DGPIR command (see page 39) to specify “caller ID notified/not notified”.

- To automatically add “184 (not notify)” for outgoing or incoming call, enter the following:
AT*DGPIR=1
- To automatically add “186 (notify)” for outgoing or incoming call, enter the following:
AT*DGPIR=2



3 Confirm that “OK” appears on the display.



Information

- When using DOCOMO Internet access service “mopera U” or “mopera”, you need to set your caller ID to be “notified”.
- If the entered AT command is not displayed, enter “ATE1 ”.

■ Specifying “caller ID notified/not notified” in dial-up network

Also by dial-up network setting (see page 28), you can add “186 (notify)” or “184 (not notify)” to each access point number.

When you specify “186 (notify)” or “184 (not notify)” using both the *DGPIR command and dial-up network setting, the caller ID is set as follows:

| Dial-up network setting (cid = 3) | Caller ID notification setting by *DGPIR command | Notify/Not notify caller ID |
|-----------------------------------|--|---|
| *99***3# | Not set | Notify |
| | Not notify | Not notify |
| | Notify | Notify |
| 184*99***3# | Not set | Not notify |
| | Not notify | ("184" specified in the dial-up network has a priority) |
| | Notify | |
| 186*99***3# | Not set | Notify |
| | Not notify | ("186" specified in the dial-up network has a priority) |
| | Notify | |

- To connect to “mopera U” or “mopera”, you need to notify your caller ID.

Set Dial-up Network for Windows 7

1

- “ [スタート (Start)]”
- ▶ Open “コントロールパネル (Control panel)”
- ▶ “インターネットへの接続 (Connection to Internet)”
- ▶ Click “ダイヤルアップ接続 (Dial-up connection)”.

•After the access point has been set, the confirmation display appears asking whether the existing connection is to be used. In response, check “いいえ、新しい接続を作成します (No, I will create a new connection)”, then click “次へ (Next)”.

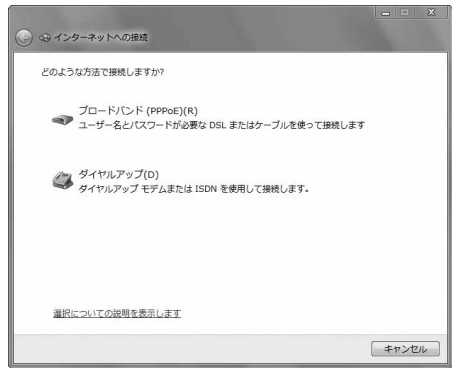

2

If the display for selecting a modem appears, click “FOMA P04B”.

- When connecting wirelessly using Bluetooth communication, put a check mark for only the in-use Bluetooth linked standard modem or Bluetooth modem provided by a Bluetooth device maker.
- The display for selecting a modem appears only when you have registered two or more modems.

3

Enter any name in the “接続名 (Connection name)” field.

- Here, “SAMPLE” is entered as an example.

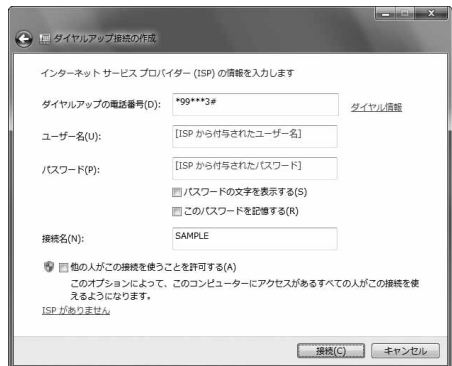

4

Enter an access point number in the “ダイヤルアップの電話番号 (Phone number for dial-up)” field.

- When connecting to “mopera U”, enter “*99***3#” as the access point number.
See page 24 for access point numbers other than “mopera U”.

5

Enter the user name and password supplied from your Internet service provider or network administrator in the “ユーザー名 (User name)” and “パスワード (Password)” fields. Then click “接続 (Connect)”

- ▶ Click “スキップ (Skip)”.

- When connecting to “mopera U” or “mopera”, you can leave the user name and password fields blank.
- Only confirm the setting contents without connecting here.

6

Click “閉じる (Close)”.

7

- “ [スタート (Start)]”▶ Open “コントロールパネル (Control panel)”
- ▶ “ネットワークの状態とタスクの表示 (View network status and tasks)”
- ▶ Click “アダプターの設定の変更 (Change the adapter settings)”.

8 Highlight the access point which is finished with setting, and select “プロパティ (Property)” after the right click

▶ Click the “全般 (General)” tab to confirm the setting contents.

When two or more modems are connected to your personal computer, confirm that “モデム (Modem) - FOMA P04B” or “モデム (Modem) - the name of the in-use Bluetooth linked standard modem or Bluetooth modem provided by a Bluetooth device maker” is checked in the “接続の方法 (Connection method)” field. If it is not checked, check it. If two or more modems are checked, click the  button to position the priority level of “モデム (Modem) - FOMA P04B” or “モデム (Modem) - the name of the in-use Bluetooth linked standard modem or Bluetooth modem provided by a Bluetooth device maker” to the top or uncheck modems other than “モデム (Modem) - FOMA P04B” or “モデム (Modem) - the name of the in-use Bluetooth linked standard modem or Bluetooth modem provided by a Bluetooth device maker”.

When “ダイヤル情報を使う (Use dial information)” is checked, uncheck it.

•The COM port number allocated to “FOMA P04B” or “the in-use Bluetooth linked standard modem or Bluetooth modem provided by a Bluetooth device maker” varies depending on your personal computer.

•When connecting to “mopera U”, enter “*99**3#” as the access point number.

See page 24 for access point numbers other than “mopera U”.



9 Click the “ネットワーク (Network)” tab, then carry out respective settings.

In the “この接続は次の項目を使用します (Use the following items for this connection)” field, select “インターネットプロトコルバージョン4 (TCP/IPv4) [Internet protocol version 4 (TCP/IPv4)]”.

Contact your ISP (Internet service provider) or network administrator for how to set up TCP/IP to connect to a general ISP and so on.

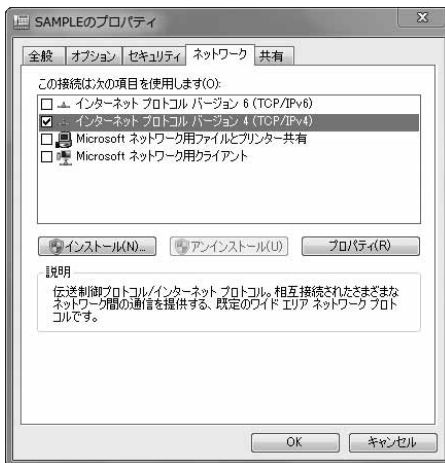

10 Click the “オプション (Option)” tab, then click “PPP設定 (PPP settings)”.

11 Uncheck all the items, then click “OK”.



12 Return to the display in step 9, then click “OK”.

Set Dial-up Network for Windows Vista

1 “ [スタート (Start)]” ▶ “接続先 (Access point)” ▶ Click “接続またはネットワークをセットアップします (Setup the connection or network)”.

2 Select “ダイヤルアップ接続をセットアップします (Setup the dial-up connection)”, then click “次へ (Next)”.



3 If the display for selecting a modem appears, click “FOMA P04B”.

- When connecting wirelessly using Bluetooth communication, put a check mark for only the in-use Bluetooth linked standard modem or Bluetooth modem provided by a Bluetooth device maker.
- The display for selecting a modem appears only when you have registered two or more modems.

4 Enter any name in the “接続名 (Connection name)” field.

- Here, “SAMPLE” is entered as an example.

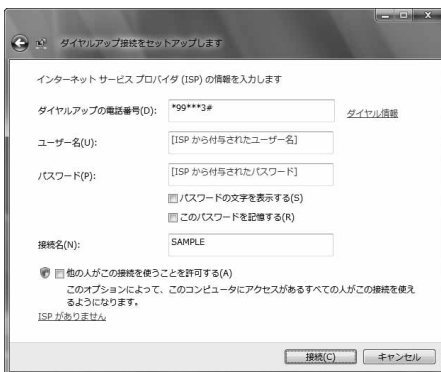

5 Enter an access point number in the “ダイヤルアップの電話番号 (Phone number for dial-up)” field.

- When connecting to “mopera U”, enter “*99***3#” as the access point number.
See page 24 for access point numbers other than “mopera U”.

6 Enter the user name and password supplied from your Internet service provider or network administrator in the “ユーザー名 (User name)” and “パスワード (Password)” fields. Then click “接続 (Connect)”

▶ Click “スキップ (Skip)”.

- When connecting to “mopera U” or “mopera”, you can leave the user name and password fields blank.
- Only confirm the setting contents without connecting here.

7 Click “接続をセットアップします (Setup the connection)”

▶ Click “閉じる (Close)”.

8 “ [スタート (Start)]” ▶ “接続先 (Access point)”

▶ Highlight the access point which is finished with connection, and select “プロパティ (Property)” after the right click.

9 Click the “全般 (General)” tab to confirm the setting contents.

When two or more modems are connected to your personal computer, confirm that “モデム (Modem) - FOMA P04B” or “モデム (Modem) - the name of the in-use Bluetooth linked standard modem or Bluetooth modem provided by a Bluetooth device maker” is checked in the “接続の方法 (Connection method)” field. If it is not checked, check it. If two or more modems are checked, click the  button to position the priority level of “モデム (Modem) - FOMA P04B” or “モデム (Modem) - the name of the in-use Bluetooth linked standard modem or Bluetooth modem provided by a Bluetooth device maker” to the top or uncheck modems other than “モデム (Modem) - FOMA P04B” or “モデム (Modem) - the name of the in-use Bluetooth linked standard modem or Bluetooth modem provided by a Bluetooth device maker”.

When “ダイヤル情報を使う (Use dial information)” is checked, uncheck it.

- The COM port number allocated to “FOMA P04B” or “the in-use Bluetooth linked standard modem or Bluetooth modem provided by a Bluetooth device maker” varies depending on your personal computer.
- When connecting to “mopera U”, enter “*99***3#” as the access point number.
See page 24 for access point numbers other than “mopera U”.

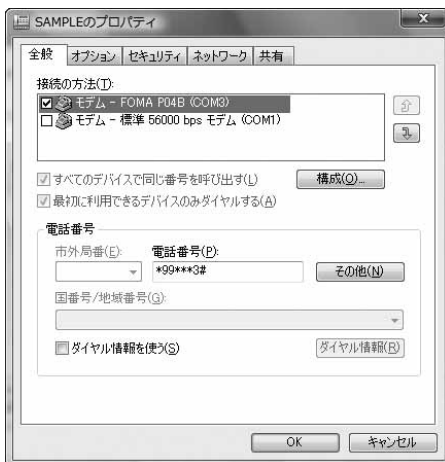

10 Click the “ネットワーク (Network)” tab, then carry out respective settings.

In the “この接続は次の項目を使用します (Use the following items for this connection)” field, select “インターネットプロトコルバージョン4 (TCP/IPv4) [Internet protocol version 4 (TCP/IPv4)]”.

You can set the “QoS パケットスケジューラ (QoS packet scheduler)” if necessary.

Contact your ISP (Internet service provider) or network administrator for how to set up TCP/IP to connect to a general ISP and so on.



11 Click the “オプション (Option)” tab, then click “PPP設定 (PPP settings)”.

12 Uncheck all the items, then click “OK”.

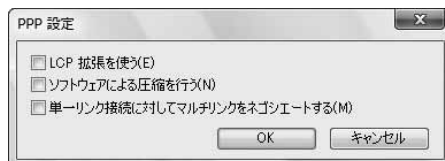

13 Return to the display in step 10, then click “OK”.

Set Dial-up Network for Windows XP

- 1 “スタート (Start)” ▶ “すべてのプログラム (All programs)”
▶ “アクセサリ (Accessories)” ▶ “通信 (Communications)”
▶ Open “新しい接続ウィザード (New connection wizard)”.

- 2 When the “新しい接続ウィザード (New connection wizard)” display appears, click “次へ (Next)”.

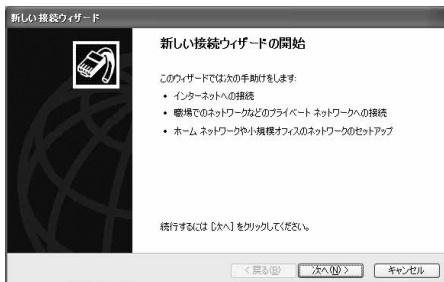

- 3 Select “インターネットに接続する (Connect to the Internet)”, then click “次へ (Next)”.
- 4 Select “接続を手動でセットアップする (Manually set up the connection)”, then click “次へ (Next)”.
- 5 Select “ダイヤルアップモデムを使用して接続する (Use a dial-up modem for connection)”, then click “次へ (Next)”.
- 6 If the “デバイスの選択 (Select a device)” display appears, check “FOMA P04B” only, then click “次へ (Next)”.

- When connecting wirelessly using Bluetooth communication, put a check mark for only the in-use Bluetooth linked standard modem or Bluetooth modem provided by a Bluetooth device maker.
- The “デバイスの選択 (Select a device)” display appears only when you have registered two or more modems.

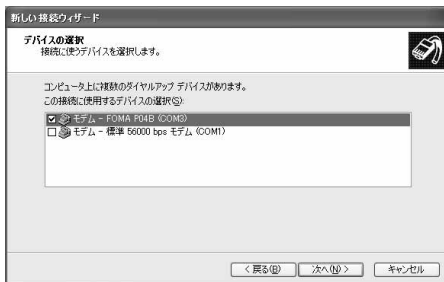

- 7 Enter any name in the “ISP 名 (ISP name)” field, then click “次へ (Next)”.

- Here, “SAMPLE” is entered as an example.

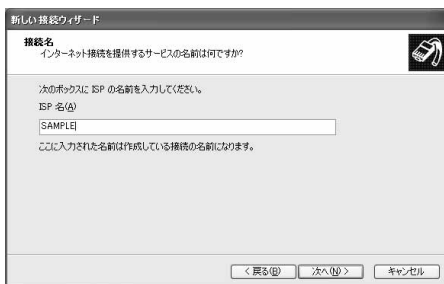

8 Enter an access point number in the “電話番号 (Phone number)” field, then click “次へ (Next)”.

- When connecting to “mopera U”, enter “*99**3#” as the access point number.
See page 24 for access point numbers other than “mopera U”.



9 Enter the user name and password supplied from your Internet service provider or network administrator in the “ユーザー名 (User name)”, “パスワード (Password)” and “パスワードの確認入力 (Confirm the password)” fields. Then click “次へ (Next)”.

- When connecting to “mopera U” or “mopera”, you can leave the user name and password fields blank.

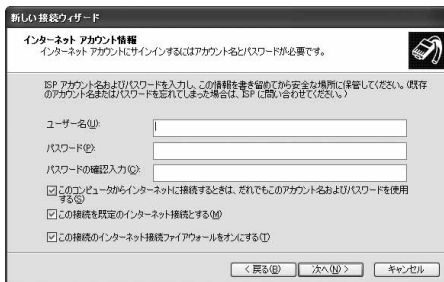

10 Click “完了 (Complete)”.

11 スタート (Start)” ▶ “すべてのプログラム (All programs)” ▶ “アクセサリ (Accessories)” ▶ “通信 (Communications)” ▶ Open “ネットワーク接続 (Connect to network)”.

12 Select the dial-up icon, then select “ネットワークタスク (Network task)”

- ▶ “この接続の設定を変更する (Modify this connection setting)”.

Here, click the icon of the name you entered in step 7.



13 Click the “全般 (General)” tab to confirm the setting contents.

When two or more modems are connected to your personal computer, confirm that “モデム (Modem) - FOMA P04B” or “モデム (Modem) - the name of the in-use Bluetooth linked standard modem or Bluetooth modem provided by a Bluetooth device maker” is checked in the “接続方法 (Connection method)” field. If it is not checked, check it. If two or more modems are checked, click the  button to position the priority level of

“モデム (Modem) - FOMA P04B” or “モデム (Modem) - the name of the in-use Bluetooth linked standard modem or Bluetooth modem provided by a Bluetooth device maker” to the top or uncheck modems other than “モデム (Modem) - FOMA P04B” or “モデム (Modem) - the name of the in-use Bluetooth linked standard modem or Bluetooth modem provided by a Bluetooth device maker”.

When “ダイヤル情報を使う (Use dial information)” is checked, uncheck it.

- The COM port number allocated to “FOMA P04B” or “the in-use Bluetooth linked standard modem or Bluetooth modem provided by a Bluetooth device maker” varies depending on your personal computer.
- When connecting to “mopera U”, enter “*99**3#” as the access point number.

See page 24 for access point numbers other than “mopera U”.



14 Click the “ネットワーク (Network)” tab, then carry out respective settings.

In the “呼び出すダイヤルアップサーバーの種類 (Type of calling dial-up server)” field, select “PPP: Windows 95/98/NT4/2000, Internet”.

In the “この接続は次の項目を使用します (Use the following items for this connection)” field, select “インターネットプロトコル (TCP/IP) [Internet protocol (TCP/IP)]”.

You cannot modify the setting of the “QoS パケットスケジューラ (QoS packet scheduler)” field; so use the default setting as it is. Next, click “設定 (Setting)”.

Contact your ISP (Internet service provider) or network administrator for how to set up TCP/IP to connect to a general ISP and so on.



15 Uncheck all the items, then click “OK”.

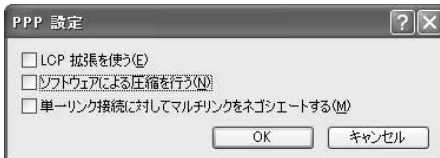

16 Return to the display in step 14, then click “OK”.

Making Dial-up Connection

Making Dial-up Connection for Windows 7

Perform the operation on page 6 to connect the FOMA terminal to your personal computer.

1 “ [スタート (Start)]”▶ Open “コントロールパネル (Control panel)”
▶ Click “インターネットへの接続 (Connection to Internet)”.

2 Check “はい、既存の接続を選びます (Yes, I choose the existing connection)”, then select the access point, and click “次へ (Next)”.



3 Confirm the contents and click “ダイヤル (Dial)”.

•When connecting to “mopera U” or “mopera”, you can leave the user name and password fields blank.

4 The display appears to indicate the connecting state.

In this period, the system performs logon processing to confirm the user name and password.



5 After the connection is completed, click “閉じる (Close)”.

•You can start the browser software to browse websites, use e-mail and so on.



Making Dial-up Connection for Windows Vista

Perform the operation on page 6 to connect the FOMA terminal to your personal computer.

1 “ [スタート (Start)]” ▶ Open “接続先 (Access point)”.

2 Select access point and click “接続 (Connect)”.



3 Confirm the contents and click “ダイヤル (Dial)”.

•When connecting to “mopera U” or “mopera”, you can leave the user name and password fields blank.

4 The display appears to indicate the connecting state.

In this period, the system performs logon processing to confirm the user name and password.

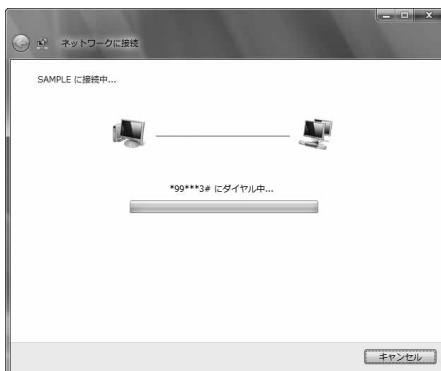

5 After the connection is completed, click “閉じる (Close)”.

•You can start the browser software to browse websites, use e-mail and so on.

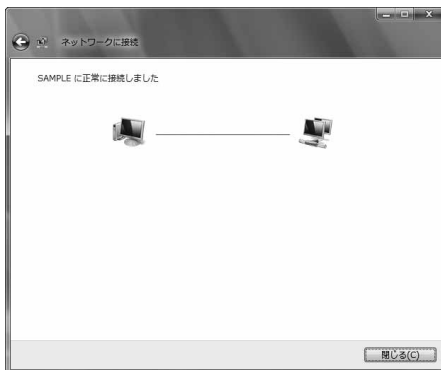

Making Dial-up Connection for Windows XP

Perform the operation on page 6 to connect the FOMA terminal to your personal computer.

- 1 “スタート (Start)” ▶ “すべてのプログラム (All programs)”
▶ “アクセサリ (Accessories)” ▶ “通信 (Communications)”
▶ Open “ネットワーク接続 (Network connection)”.

- 2 Open the access point to be used.

Select the access point icon of the ISP name (see page 30) you specified in “Set Dial-up Network”, then “ネットワークタスク (Network task)”→“この接続を開始する (Start this connection)”.

Otherwise, double-click the access point icon.



- 3 Confirm the contents and click “ダイヤル (Dial)”.

•When connecting to “mopera U” or “mopera”, you can leave the user name and password fields blank.

- 4 The display appears to indicate the connecting state.

In this period, the system performs logon processing to confirm the user name and password.



- 5 The connection is completed.

After the connection is completed, the message appears from the indicator on the task bar for a few seconds.

•You can start the browser software to browse websites, use e-mail and so on.

•If this message does not appear, confirm the setting of the access point again.



Information

- For dial-up connection, use the FOMA terminal with the dial-up setting completed. To connect another FOMA terminal, you may need to reinstall the FOMA communication configuration file (driver).
- The power consumption of the FOMA terminal increases during communication.
- During packet communication, the communication state appears on the FOMA terminal.

| | |
|--|--------------------------------------|
| “→” (Communicating, data sending) | “←” (Communicating, data receiving) |
| “ ” (Communicating, no data sending/receiving) | “ ” (Outgoing or being disconnected) |
| “↑” (Incoming or being disconnected) | |
- During 64K data communication, “↑” appears on the FOMA terminal.

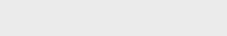

Disconnecting Communication Line

- 1 Click the dial-up icon on the task tray.



- 2 Select the access point with which the connection is to be terminated, and click “切断 (Disconnect)”.

<For Windows Vista>

Select “接続または切断 (Connect or disconnect)” and click “切断 (Disconnect)”, then click “閉じる (Close)”.

<For Windows XP>

Click “切断 (Disconnect)”.

Information

- The communication line may not be disconnected just by exiting the browser software. To surely disconnect the communication line, perform this operation.
- The baud rate displayed on your personal computer may be different from the actual one.

When you cannot connect to network

If you cannot connect to network (if you fail a dial-up connection), confirm the following items:

| If this error occurs | Confirm those: |
|---|---|
| Your personal computer cannot recognize "P-04B" | <ul style="list-style-type: none">· Confirm whether your personal computer satisfies the operating environment (see page 3).· Confirm whether "FOMA communication configuration file" (driver) is installed in your personal computer.· Confirm whether the FOMA terminal is connected to your personal computer and powered on.· Confirm whether the FOMA USB Cable with Charge Function 01/02 (option) is securely connected.· Confirm whether the Bluetooth device is connected using the Dial-up service. |
| You cannot connect to the access point | <ul style="list-style-type: none">· Confirm whether the ID (user name) and password are correct.· When you need to notify your caller ID such as when using "mopera U" or "mopera", make sure "184" is not prefixed to the phone number.· Confirm that "フロー制御を使う (Use the flow control)" is checked in the modem properties.· If you cannot connect to the access point even after confirming above, contact your Internet service provider or network administrator for the setting method, and so on. |

Set 64K Data Communication

This section explains how to set up a connection for the 64K data communication without using "DOCOMO Connection Manager".

Setting dial-up connection and TCP/IP

The setting of dial-up connection and TCP/IP for the 64K data communication is the same as for the packet communication (see page 19).

Take care of the following points:

- In the 64K data communication, you do not need to set an access point name (APN). For the access point of the dial-up connection, enter the phone number of the access point specified by your Internet service provider or network administrator. (To connect to "mopera U", enter "*8701" in the phone number field, and to connect to "mopera", enter "*9601".)
- Set "caller ID notified/not notified" and "others" as required.
(When connecting to "mopera U" or "mopera", you need to notify your caller ID.)
- Contact your Internet service provider or network administrator for details on the setting contents.

Connecting and Disconnecting

You can operate in the same way as for the packet communication. Perform the operations on page 18, page 33 or page 35.

AT Command

AT commands are used to specify and modify the functions of the FOMA terminal through the personal computer.

※The following abbreviations are used in the AT command list:

[AT]: Commands which are available at the FOMA P04B Command Port.

[M]: Commands which are available in the FOMA P04B (modem).

[&F]: Commands whose settings are initialized by the AT&F command.

[&W]: Commands whose settings are saved by the AT&W command. The set value can be recalled by the ATZ command.

Information

- When you make a call from an external device or make an AT command call, the call is made from Number A in A Mode or Dual Mode of 2in1, and the call is made from Number B in B Mode of 2in1.

Entry Format of AT Command

To enter an AT command, use the terminal mode display of the communication software. Be sure to enter half-pitch alphanumeric characters.

- Entry example

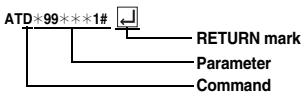

- You need to enter an AT command on one line, including a parameter (digits and symbols) which follows the command.

Information

- The terminal mode enables you to operate a personal computer as one communication terminal. Using this mode, you can send characters you have entered from the keyboard to a line connected to the communication port.

Switch between Online Data Mode and Online Command Mode

There are following two methods of switching the FOMA terminal between the online data mode and online command mode:

· Enter the “+++” command or enter the code specified in the “S2” register.

· Set the ER signal of the RS-232C※ off when “AT&D1” is set.

•To switch the online command mode to the online data mode, enter “ATO”.

※The RS-232C signal line, which is emulated via the USB interface, is controlled by a communication application.

■Saving the setting contents

Please be careful that the setting contents with AT commands are initialized when the FOMA terminal is turned off and on or the external device is removed, except for the access point name (APN) setting with the AT+CGDCONT command, QoS setting with the AT+CGEQMIN or AT+CGEQREQ command, incoming call acceptance/rejection setting with the AT*DGAPL, AT*DGARL, or AT*DGANSM command, phone number notification/no notification setting (for packet communication) with the AT*DGPIR command and caller ID notification restriction setting with the AT+CLIR command. For commands with [&W], you can enter “AT&W” (after setting) to save the setting contents and other set values with [&W] at the same time. If necessary, you can restore these set values by entering in “ATZ” even after the power is turned off and on.

AT Command List

| AT command | Outline | Parameter/Explanation | Command execution example |
|------------------------------|---|--|---|
| A/ [M] | Re-executes the last executed command. No carriage return is required. | - | A/ OK |
| AT%V [M] | Displays the version of the FOMA terminal. | - | AT%V Ver1.00 OK |
| AT&Cn [M] [&F]&W] | Selects the operating conditions of the circuit CD signal sent to the DTE. | n=0: CD is always ON. n=1: CD varies according to the carrier of the other party's modem. (default) | AT&C1 OK |
| AT&Dn [M] [&F]&W] | Selects an operation to be performed when the circuit ER signal received from the DTE transits from ON to OFF. | n=0: Ignores the ER status. (Always assumed to be ON.) n=1: Sets the online command state when the ER changes from ON to OFF. n=2: Sets the offline command state when the ER changes from ON to OFF. (default) | AT&D1 OK |
| AT&En [M] [&F]&W] | Selects the speed display specification for connection. | n=0: Displays communication speed between radio wave blocks. n=1: Displays DTE serial communication speed. (default) | AT&E0 OK |
| AT&Fn [AT][M] | Returns all registers to the default. Performs line disconnection processing if you enter this command during communication. | Only n=0 is specifiable. (Can be omitted) | - |
| AT&Sn [M] [&F]&W] | Specifies the control of the data set ready signal to be output to the DTE. | n=0: DR is always ON. (default) n=1: DR is set to ON at connection of the line (at establishment of a communication call). | AT&S0 OK |
| AT&Wn [M] | Stores the current set values. | Only n=0 is specifiable. (Can be omitted) | - |
| AT* DANTE [AT][M] | Shows the number of antenna bars. (0 to 3) | 0: Antenna shows the out of the service area 1: Zero antenna bars or a single antenna bar 2: Two antenna bars 3: Three antenna bars | AT* DANTE * DANTE:3 OK AT* DANTE=? * DANTE:(0-3) OK |
| AT* DGANSM=n [M] | Sets the reject/accept setting mode for the packet incoming call. The setting with this command is valid for incoming calls in packet communication after you enter the setting command. | n=0: Invalidates the incoming call reject/accept setting. (default) n=1: Validates the incoming call reject setting (AT* DGARL). n=2: Validates the incoming call accept setting (AT* DGAPL). AT* DGANSM?: Displays the current setting. | AT* DGANSM=0 OK AT* DGANSM? * DGANSM:0 OK |
| AT* DGAPL=n [,cid] [M] | Sets the APN of which packet incoming call is to be accepted. To specify the APN, use the <cid> parameter defined in AT+CGDCONT. | n=0: Adds the APN defined by <cid> to the incoming call accept list. n=1: Deletes the APN defined by <cid> from the incoming call accept list. Applied to all the cid contents if <cid> is omitted. AT* DGAPL?: Displays the incoming call accept list. | AT* DGAPL=0,1 OK AT* DGAPL? * DGAPL:1 OK AT* DGAPL=1 OK AT* DGAPL? OK |
| AT* DGARL=n [,cid] [M] | Sets the APN of which packet incoming call is to be rejected. To specify the APN, use the <cid> parameter defined in +CGDCONT. | n=0: Adds the APN defined by <cid> to the incoming call reject list. n=1: Deletes the APN defined by <cid> from the incoming call reject list. Applied to all the cid contents if <cid> is omitted. AT* DGARL?: Displays the incoming call reject list. | AT* DGARL=0,1 OK AT* DGARL? * DGARL:1 OK AT* DGARL=1 OK AT* DGARL? OK |

| AT command | Outline | Parameter/Explanation | Command execution example |
|--------------------------------------|---|---|--|
| AT+DGPIR=n [M] | This command is valid at dialing/receiving calls. In the dial-up network setting, you can add "186" (notify) or "184" (not notify) to the phone number of the access point. (See page 25) | n=0: Uses the APN as it is. (default) n=1: Adds "184" to the APN. (always not notify) n=2: Adds "186" to the APN. (always notify) AT+DGPIR?: Displays the current setting. | AT+DGPIR=0 OK AT+DGPIR? +DGPIR:0 OK |
| AT+DRPW [AT][M] | Displays the output power index for receiving. (0: minimum value to 75: maximum value) | — | AT+DRPW +DRPW:0 OK |
| +++ [M] | Changes to the online command state without disconnecting the line when the escape sequence is executed in the online mode. | — | — |
| AT+CAOC [M] | Displays the charging information for now or latest call. | Result: +CAOC:"n" n: Displays the charging information in a hexadecimal number. | AT+CAOC +CAOC:"00001E" OK |
| AT+CBC [M] | Displays the battery level. | Result: +CBC:n,m n=0: FOMA terminal is powered by the battery. n=1: During charging n=2: The battery is not connected. n=3: Power-supply error m=0~100: Battery level | AT+CBC +CBC:0,80 OK |
| AT+CBST=n,1,0 [M] [&W][&F] | Sets the bearer service to be used. | n=116: 64000 bps (bit transparent) (default) n=134: 64000 bps (multimedia) | AT+CBST=116,1,0 OK AT+CBST? +CBST:116,1,0 OK |
| AT+CDIP=n [M][AT] [&F][&W] | Sets whether to display "Received sub-address" on your personal computer when you receive a call. | n=0: Does not display "Received sub-address" when you receive a call. (default) n=1: Displays "Received sub-address" when you receive a call. Result: +CDIP:<n>,<m> m=0: Not signed up for Multi Number m=1: Signed up for Multi Number m=2: Unknown | AT+CDIP=0 OK AT+CDIP? +CDIP:0,1 OK |
| AT+CEER [AT][M] | Displays the reason why the preceding call was disconnected. | <report> Disconnection reason list (See page 46) | AT+CEER +CEER:36 OK |
| AT+CGDCONT [M] | Sets the access point name (APN) for when dialing for packet communication. | See page 44. | See page 44. |
| AT+CGEQMIN [M] | Registers the reference value to judge whether the system permits QoS (Quality of service) reported from the network at establishment of the packet communication. | AT+CGEQMIN=[parameter] See page 45. AT+CGEQMIN=? Lists the settable values. AT+CGEQMIN? Displays the current setting. | See page 45. |
| AT+CGEQREQ [M] | Sets QoS (Quality of service) to be requested to the network at dialing of the packet communication. | AT+CGEQREQ=[parameter] See page 45. AT+CGEQREQ=? Lists the settable values. AT+CGEQREQ? Displays the current setting. | See page 45. |
| AT+CGMR [M] | Displays the version of the FOMA terminal. | — | AT+CGMR 1234512345123456 OK |

| AT command | Outline | Parameter/Explanation | Command execution example |
|------------------------------------|--|---|---|
| AT+CGREG=n [M] [&F]&W | Sets whether the network registration state is notified. Displays whether you are inside or outside the service area according to the returned notification. | n=0: Not notified. (default) n=1: Notified at switching between the inside and outside of the service area. (Inquiry) AT+CGREG? +CGREG: <n>,<stat> n: Set value stat: 0: Outside packet area 1: Inside packet area 4: Unknown 5: Inside packet area (during roaming) | AT+CGREG=1 OK (set to "Notified") AT+CGREG? +CGREG:1,0 OK (means the outside of the service area) (when moved from the outside to the inside of the service area) +CGREG: 1 |
| AT+CGSN [M] | Displays the serial number of the FOMA terminal. | — | AT+CGSN 123456789012345 OK |
| AT+CLIP=n [AT][M] [&F]&W | Enables to display the other party's caller ID on the personal computer at reception of 64K data communication or videophone calls. | n=0: Does not notify. (default) n=1: Notifies. Result: +CLIP: <n>,<m> m=0: NW setting not to notify caller ID at calling m=1: NW setting to notify caller ID at calling m=2: Unknown | AT+CLIP=0 OK AT+CLIP? +CLIP:0,1 OK |
| AT+CLIR=n [M] | Sets whether to notify your phone number to do 64K data communication or to make videophone calls. | n=0: Notifies (does not notify) caller ID according to CLIR service. n=1: Does not notify the other party of your caller ID. n=2: Notifies the other party of your caller ID. (default) Result: +CLIR: <n>,<m> m=0: CLIR is not launched. (always notify) m=1: CLIR is launched. (always not notify) m=2: Unknown m=3: CLIR temporary mode (not notify, default) m=4: CLIR temporary mode (notify, default) | AT+CLIR=0 OK AT+CLIR? +CLIR:0,1 OK AT+CLIR=? +CLIR:(0-2) OK |
| AT+CMEE=n [M] [&F]&W | Sets how the FOMA terminal shows an error report. | n=0: Uses the ordinary ERROR result. (default) n=1: +CME ERROR: Uses the <err> result code. <err> indicates a numeric value. n=2: +CME ERROR: Uses the <err> result code. <err> indicates characters. AT+CMEE?: Displays the current setting. Command execution examples on the right are for when the FOMA terminal or connection has abnormality. Below listed are the +CME ERROR result codes. 1: no connection to phone 10: SIM not inserted 15: SIM wrong 16: incorrect password 100: unknown | AT+CMEE=0 OK AT+CNUM ERROR AT+CMEE=1 OK AT+CNUM +CME ERROR: 10 AT+CMEE=2 OK AT+CNUM +CME ERROR: SIM not inserted |
| AT+CNUM [AT][M] | Displays the own phone number of the FOMA terminal. | number: Phone number (In B Mode of 2in1, Number B is displayed.) type: 129 or 145 129: Does not include the IDD prefix code (+). 145: Includes the IDD prefix code (+). Result: +CNUM:,<number>,<type> | AT+CNUM +CNUM:,"+8190123 45678",145 OK |

| AT command | Outline | Parameter/Explanation | Command execution example |
|-------------------------------------|--|--|---|
| AT+COPS=n,2,m [M] | Selects the carrier to be connected. | n=0: Automatic (searches the network and switches the network operator automatically) (default) n=1: Manual (connects to the network operator specified in "m") n=2: Disconnects the connection to the network operator n=3: Mapping is not performed. n=4: Manual/Automatic (if the connection to the network operator specified in "m" fails, works as automatic mode.) m: Country code (MCC) and operator code (MNC) are displayed in a hexadecimal number. The format is as follows: Digit 1 of MCC octet 1 bits 1 to 4. Digit 2 of MCC octet 1 bits 5 to 8. Digit 3 of MCC octet 2 bits 1 to 4. Digit 3 of MNC octet 2 bits 5 to 8. Digit 2 of MNC octet 3 bits 5 to 8. Digit 1 of MNC octet 3 bits 1 to 4. | AT+COPS=1,2,'44F001' OK |
| AT+CPAS [M] | Displays whether to send the control signals to the FOMA terminal. | Result: +CPAS:n n=0: Can send/receive control signals to/from the FOMA terminal. n=1: Cannot send/receive control signals to/from the FOMA terminal. n=2: Unknown (control signal sending/receiving is not assured), n=3: Can send/receive control signals to/from the FOMA terminal, and currently receiving. n=4: Can send/receive control signals to/from the FOMA terminal, and currently communicating. | AT+CPAS +CPAS:0 OK |
| AT+CPIN=n,m [M][AT] | Enters the UIM password (PIN1 or PIN2). | When the UIM is in a state waiting for the entry of PIN1 or PIN2 code n: PIN1/PIN2 When the UIM is in a state waiting for the entry of PUK due to failure in unblocking PIN1 or PIN2 code n: PUK m: New PIN1 or PIN2 AT+CPIN?: Displays the state of code entry requested about current SIM. Result: +CPIN: <state> <state>=READY: Code entry not requested <state>=SIM PIN: PIN1 code entry waited <state>=SIM PIN2: PIN2 code entry waited <state>=SIM PUK: PUK entry waited due to failure in unblocking PIN1 code <state>=SIM PUK2: PUK entry waited due to failure in unblocking PIN2 code | AT+CPIN="1234" OK AT+CPIN="12345678", "1234" OK AT+CPIN? +CPIN:SIM PIN OK |
| AT+CR=n [M] [&F][&W] | Displays the bearer service type before the CONNECT result code appears at connection of the line. | n=0: Does not display. (default) n=1: Displays. <serv>: Displays only "GPRS" that means packet communication. (Displays "SYNC" or "AV64K", depending on the line type.) AT+CR?: Displays the current set value. | AT+CR=1 OK ATD*99**1# +CR: GPRS CONNECT |
| AT+CRC=n [AT][M] [&F][&W] | Sets whether the extended result code is used at reception. | n=0: Does not use +CRING. (default) n=1: Uses +CRING.<type>. AT+CRC?: Displays the current setting. The +CRING format is as follows: +CRING: <type> During PPP packet ringing +CRING: GPRS "PPP",,<APN> | AT+CRC=0 OK AT+CRC? +CRC: 0 OK |

| AT command | Outline | Parameter/Explanation | Command execution example |
|--|---|--|--|
| AT+CREG=n [AT][M] [&F][&W] | Sets whether the result is displayed about the inside and outside of the service area. | n=0: Not notified. (default) n=1: Notified at switching between the inside and outside of the service area. (Inquiry) AT+CREG? +CREG: <n>,<stat> n: Set value stat: 0: Outside voice call area 1: Inside voice call area 4: Unknown 5: Inside voice call area (during roaming) | AT+CREG=1 OK (set to "Notified") AT+CREG? +CREG: 1,0 OK (means the outside of the service area) (when moved from the outside to the inside of the service area) +CREG: 1 |
| AT+CUSD=n,"<str>",0 [M] [&F][&W] | Sets or checks the additional service for network. | n=0: Does not display mid result. (default) n=1: Displays mid result. <str>: Service code Mid result: m,"<str>",0 m=0: Shows the setting is completed. m=1: Shows the network requires the information. | AT+CUSD=0, OK AT+CUSD=1,"*148*1*0000#",0 +CUSD:0,"148*7#",0 OK |
| AT+FCLASS=n [M] [&F][&W] | Sets communication class in the FOMA terminal. | n=0: Data communication (default) | AT+FCLASS=0 OK |
| AT+GCAP [M] | Displays the AT command supported by FOMA terminal. | Result +GCAP: n n=+CGSM: Some or all GSM commands are supported. n=+FCLASS: +FCLASS command is supported. n=+W: +W command is supported. | AT+GCAP +GCAP:+CGSM,+FCLASS,+W OK |
| AT+GMI [M] | Displays the manufacturer name (Panasonic). | — | AT+GMI Panasonic OK |
| AT+GMM [M] | Displays the product name (FOMA P-04B) of the FOMA terminal. | — | AT+GMM FOMA P04B OK |
| AT+GMR [M] | Displays the version of the FOMA terminal. | — | AT+GMR Ver1.00 OK |
| AT+IFC=n,m [M] [&F][&W] | Selects the flow control method. | n: DCE by DTE m: DTE by DCE 0: No flow control 1: XON/XOFF flow control 2: RS/CS (RTS/CTS) flow control Default: n, m = 2,2 AT+IFC?: Inquires the set value. | AT+IFC=2,2 OK |
| AT+WS46=n [M] | Selects the wireless communication network of the FOMA terminal. | Returns "ERROR" for the mode setting because the wireless communication network is not selected on the FOMA terminal by this command. n=12: GSM/GPRS n=22: W-CDMA (Wideband CDMA) n=25: Automatic | AT+WS46=22 ERROR AT+WS46? 25 OK |
| ATA [AT][M] | Performs the receiving process in the mode when the FOMA terminal received the incoming call. | — | RING ATA CONNECT |
| ATD [AT][M] | Performs the automatic outgoing process to the FOMA terminal according to the contents specified in the parameter and dial parameter. | <cid>: 1 to 10. Displays the APN defined by +CGDCONT. When calling cid1, you can omit the phone number like "ATD:*99*.*#." | ATD:*99*.*#1# CONNECT |
| ATEn [AT][M] [&F][&W] | Sets whether echo-back is issued to the DTE in the command mode. | n=0: Issues no echo-back. n=1: Issues echo-back. (default) | ATE1 OK |
| ATHn [AT][M] | Places the FOMA terminal into the on-hook state. | n=0: Disconnects the line. (can be omitted) | (During packet communication) +++ ATH NO CARRIER |

| AT command | Outline | Parameter/Explanation | Command execution example |
|------------------------------|--|---|--|
| ATIn [AT][M] | Displays the ID code. | n=0: Displays "NTT DoCoMo". n=1: Displays the product name. (same as +GMM) n=2: Displays the version of the FOMA terminal. (same as +GMR) n=3: Displays ACMP information element. n=4: Displays the details of the function available for communication on the FOMA terminal. | ATI0 NTT DoCoMo OK ATI1 FOMA P04B OK |
| ATOn [M] | Returns from the online command mode to the online data mode during communication. | n=0: Returns from the online command mode to the online data mode. (can be omitted) | ATO CONNECT |
| ATQn [M] [&F]&W] | Sets whether the result code is to be displayed for the DTE. | n=0: Displays the result code. (default) n=1: Does not display the result code. | ATQ0 OK ATQ1 ("OK" is not returned at this time.) |
| ATS0=n [M] [&F]&W] | Sets the number of rings required until the FOMA terminal automatically receives an incoming call. | n=0: Does not automatically receive an incoming call. (default) n=1 to 255: Automatically receives an incoming call with the specified number of rings. (when $n \geq 10$, does not automatically receive a packet (PPP) incoming call, then the line is disconnected after about 30 seconds.) ATS0?: Inquires the set value. | ATS0=0 OK ATS0? 000 OK |
| ATS2=n [M] [&F] | Sets the escape character. | n=43: Default n=127: Makes escape processing invalid. ATS2?: Inquires the set value. | ATS2=43 OK ATS2? 043 OK |
| ATS3=n [M] [&F] | Sets the carriage return (CR) character. | n=13: Default (n=13 only specifiable) ATS3?: Inquires the set value. | ATS3=13 OK ATS3? 013 OK |
| ATS4=n [M] [&F] | Sets the line feed (LF) character. | n=10: Default (n=10 only specifiable) ATS4?: Inquires the set value. | ATS4=10 OK ATS4? 010 OK |
| ATS5=n [M] [&F] | Sets the back space (BS) character. | n=8: Default (n=8 only specifiable) ATS5?: Inquires the set value. | ATS5=8 OK ATS5? 008 OK |
| ATS30=n [M][&F] | Sets the inactive timer (minute). When no user data is sent or received, the connection is cut after the set time has elapsed. This command is for only 64K data communication. When 0 is set, the inactive timer turns OFF. | n=0 to 255 (default=0) (unit: minute) | ATS30=0 OK |
| ATS103=n [M][&F] | Selects characters to pause for incoming sub-address. | n=0: *(asterisk) n=1: / (slash) (default) n=2: ¥ or back slash | ATS103=0 OK |
| ATS104=n [M][&F] | Selects characters to pause for outgoing sub-address. | n=0: # (sharp) n=1: % (percentage) (default) n=2: & (and) | ATS104=0 OK |
| ATVn [M] [&F]&W] | Sets all the result codes in the numeric or alphabetical notation. | n=0: Returns the result code in a numeric value. n=1: Returns the result code in alphabetical characters. (default) | ATV1 OK |
| ATXn [M] [&F]&W] | Sets whether to display the speed in the CONNECT display at connection. Detects busy tone and dial tone. | n=0: Dial tone not detected; busy tone not detected; speed not displayed. n=1: Dial tone not detected; busy tone not detected; speed displayed. n=2: Dial tone detected; busy tone not detected; speed displayed. n=3: Dial tone not detected; busy tone detected; speed displayed. n=4: Dial tone detected; busy tone detected; speed displayed. (default) | ATX1 OK |

| AT command | Outline | Parameter/Explanation | Command execution example |
|-------------------------|--|--|---|
| ATZn [M] | Resets the setting to the contents of the nonvolatile memory. If this command is entered during communication, the line is disconnected. | Only n=0 is specifiable. (Can be omitted) | (In online) ATZ NO CARRIER (In offline) ATZ OK |
| AT+Sn [M] | Displays the contents of the each command and S register currently set. | Only n=0 is specifiable. (Can be omitted) | AT+Sn E1 Q0 V1 X4 &C1 &D2 &S0 &E1 ¶V0 S000=000 S002=043 S003=013 S004=010 S005=008 S006=005 S007=060 S008=003 S010=001 S030=000 S103=000 S104=000 OK |
| AT+Vn [M] [&F]&W] | Selects the response code specifications at connection. | n=0: Does not use the extended result code. (default) n=1: Uses the extended result code. | AT+Vn OK |

※The following commands do not result in an error even if specified; however, they do not function as commands.

- AT (AT only entered.)
- ATP (Pulse setting)
- ATS8 (Setting the pause time by comma dialing)
- ATT (Tone setting)
- ATS6 (Setting the pause time taken for dialing)
- ATS10 (Setting the automatic disconnection delay time)

Supplementary Explanation of AT Commands

- Command name: +CGDCONT=[parameter] [M]
 - Outline

This command sets an access point name (APN) for when dialing for packet communication.
 - Format

+CGDCONT=[<cid>[,"<PDP_type>"],"<APN>"]]
 - Explanation of parameters

You set an access point name (APN) for when dialing for packet communication. See the example below for command instructions.

<cid>※: 1 to 10
<PDP_type>: PPP or IP
<APN>※: Arbitrary

※The <cid> numbers are used to manage access point name (APN) for packet communication, and they are registered in the FOMA terminal. Although it is possible to register numbers cid1 to cid10 in the FOMA terminal, "mopera.ne.jp" (PPP) was already registered for <cid>=1, "mopera.net" (PPP) for <cid>=2, "mopera.net" (IP) for <cid>=3 and "mpr.ex-pkt.net" (PPP) for <cid>=4 prior to purchase. Use numbers 5 to 10 to register other access point names.

<APN> indicates any character string for each access point name.
 - Operation at omission of parameters

+CGDCONT= : Sets all the <cid> contents to the default.
+CGDCONT=<cid> : Sets the specified <cid> to the default.
+CGDCONT=? : Lists the specifiable values.
+CGDCONT? : Displays the current setting.
 - Command execution example

AT+CGDCONT=5,"PPP","abc"
OK

※The command used to register an APN name, abc (cid=5)
※This command, which is a setting command, is not stored in the nonvolatile memory written by [&W], and is not reset by [&F] and [Z], either.

- **Command name:** +CGEQMIN=[parameter] [M]
 - **Outline**

This command registers the reference value to judge whether the system permits QoS (Quality of service) reported from the network at establishment of the packet communication.

You can specify four setting patterns described in the command execution example below.
 - **Format**

+CGEQMIN=[<cid>[,<Maximum bitrate UL>[,<Maximum bitrate DL>]]]
 - **Explanation of parameters**

<cid>※ : 1 to 10

<Maximum bitrate UL>※ : None (default) to 2048

<Maximum bitrate DL>※ : None (default) to 7232

※ <cid> is a number used to manage an access point name (APN) for packet communication, which is registered in the FOMA terminal.

<Maximum bitrate UL> and <Maximum bitrate DL> are used to specify the maximum baud rates (kbps) for upload and download between the FOMA terminal and base station. "None" (default) accepts all baud rates, however, you may not be able to establish packet communication if you specify 2048 and 7232 because the baud rate less than these values are not accepted.
 - **Operation at omission of parameters**

+CGEQMIN= : Sets all the <cid> contents to the default.

+CGEQMIN=<cid> : Sets the specified <cid> to the default.
 - **Command execution example**

You can specify only the following four setting patterns:
(The setting in (1) is defined in each cid as the default.)

(1) Command that accepts all the baud rates for both upload and download (cid=2)

```
AT+CGEQMIN=2
OK
```

(2) Command that accepts 2048 kbps for upload and 7232 kbps for download (cid=3)

```
AT+CGEQMIN=3,,2048,7232
OK
```

(3) Command that accepts 2048 kbps for upload and all baud rates for download (cid=4)

```
AT+CGEQMIN=4,,2048
OK
```

(4) Command that accepts all baud rates for upload and 7232 kbps for download (cid=5)

```
AT+CGEQMIN=5,,,7232
OK
```

※ This command, which is a setting command, is not stored in the nonvolatile memory written by [∧W], and is not reset by [∧F] and [Z], either.
- **Command name:** +CGEQREQ=[parameter] [M]
 - **Outline**

This command sets QoS (Quality of service) to be requested to the network at dialing of the packet communication.

You can specify only one setting pattern described in the command execution example below, which is set as the default.
 - **Format**

+CGEQREQ=[<cid>]
 - **Explanation of parameter**

<cid>※: 1 to 10

※ <cid> is a number used to manage an access point name (APN) for packet communication, which is registered in the FOMA terminal.
 - **Operation at omission of parameter**

+CGEQREQ= : Sets all the <cid> contents to the default.

+CGEQREQ=<cid> : Sets the specified <cid> to the default.
 - **Command execution example**

You can specify only the following one pattern:
(This setting is defined in each cid as the default.)

(1) Command that requests a connection at arbitrary speed NW sets (cid=3)

```
AT+CGEQREQ=3
OK
```

※ This command, which is a setting command, is not stored in the nonvolatile memory written by [∧W], and is not reset by [∧F] and [Z], either.
- **Command name:** +CLIP
 - **Outline**

The result for "AT+CLIP=1" is displayed in the following format:

+CLIP: <number> <type>
 - **Command execution example**

```
AT+CLIP=1
OK
RING
+CLIP: "09012345678",49
```

Disconnection Reason List

■ 64K Data Communication

| Value | Reason |
|-------|--|
| 1 | The specified number does not exist. |
| 16 | The line was normally disconnected. |
| 17 | Cannot communicate because the other party is communicating. |
| 18 | Dialed but no response has come in within the specified duration. |
| 19 | Cannot communicate because the other party is dialing. |
| 21 | The other party rejected to receive the call. |
| 63 | The network service and options are not valid. |
| 65 | The specified transmission performance is not provided. |
| 88 | Dialed to or received the call from the phone with different properties. |

■ Packet Communication

| Value | Reason |
|-------|--|
| 27 | No APN was found; or an invalid APN was specified. |
| 30 | The line was disconnected from the network. |
| 33 | You have not applied for the service option you requested. |
| 36 | The line was normally disconnected. |

Result Codes

■ Result Code List

| Numeric notation | Character notation | Meaning |
|------------------|--------------------|---|
| 0 | OK | Processing has been executed normally. |
| 1 | CONNECT | The line has been connected to the other party. |
| 2 | RING | An incoming call has arrived. |
| 3 | NO CARRIER | The line has been disconnected. |
| 4 | ERROR | The system can receive no command. |
| 6 | NO DIALTONE | The system can detect no dial tone. |
| 7 | BUSY | The system is detecting the busy tone. |
| 8 | NO ANSWER | The connection completed; timeout |
| 100 | RESTRICTION | The network is restricted. |
| 101 | DELAYED | Within restricted redialing time |

■ Extended Result Code List

For &E0

Connection speed between the FOMA terminal and the base station is displayed.

| Numeric notation | Character notation | Connection speed |
|------------------|--------------------|------------------|
| 121 | CONNECT 32000 | 32,000bps |
| 122 | CONNECT 64000 | 64,000bps |
| 125 | CONNECT 384000 | 384,000bps |
| 133 | CONNECT 3648000 | 3,648,000bps |
| 135 | CONNECT 7232000 | 7,232,000bps |

| Numeric notation | Character notation | Connection speed |
|------------------|--------------------|------------------|
| 5 | CONNECT 1200 | 1,200bps |
| 10 | CONNECT 2400 | 2,400bps |
| 11 | CONNECT 4800 | 4,800bps |
| 13 | CONNECT 7200 | 7,200bps |
| 12 | CONNECT 9600 | 9,600bps |
| 15 | CONNECT 14400 | 14,400bps |
| 16 | CONNECT 19200 | 19,200bps |
| 17 | CONNECT 38400 | 38,400bps |
| 18 | CONNECT 57600 | 57,600bps |
| 19 | CONNECT 115200 | 115,200bps |
| 20 | CONNECT 230400 | 230,400bps |
| 21 | CONNECT 460800 | 460,800bps |

Information

- Result codes are displayed in the character notation (default) when the ATVn command (see page 43) is set to n=1 and displayed in the numeric notation when it is set to n=0.
- The baud rate is displayed to keep the compatibility with a conventional modem connected via RS-232C. However, the FOMA terminal and personal computer are connected via the FOMA USB Cable with Charge Function 01/02 (option) or Bluetooth communication; so, the baud rate is different from the actual connection speed.
- "RESTRICTION" (numeric notation: 100) means that the communication network is congested. If this result code appears, wait for a while, then connect the line again.

Communication Protocol Result Code List

| Numeric notation | Character notation | Meaning |
|------------------|--------------------|-------------------------------------|
| 1 | PPPOverUD | Connected by 64K data communication |
| 3 | AV64K | Connected by 64K videophone |
| 5 | PACKET | Connected by packet communication |

Result Code Display Examples

- When ATX0 is set:

CONNECT only appears at completion of the connection, regardless of the contents specified in the AT#V command (see page 44).

Example in character notation: ATD*99**1#
CONNECT

Example in numeric notation: ATD*99**1#
1

- When ATX1 is set*1:

· If ATX1 and AT#V0 are set (default):

A result code appears in the following format at completion of the connection: CONNECT<baud rate between the FOMA terminal and PC>

Example in character notation: ATD*99**1#
CONNECT 460800

Example in numeric notation: ATD*99**1#
1 21

· If ATX1 and AT#V1 are set*1:

A result code appears in the following format at completion of the connection:

CONNECT<baud rate between the FOMA terminal and PC>PACKET<access point name (APN)><maximum baud rate for upload (the FOMA terminal → wireless base station)><maximum baud rate for download (the FOMA terminal ← wireless base station)>*2

Example in character notation: ATD*99**1#
CONNECT 460800 PACKET
mopera.ne.jp /5440/7232

Example in numeric notation: ATD*99**1#
1215

*1 If you specify ATX1 and AT#V1 at the same time, you may not be able to correctly carry out the dial-up connection.

You are advised to use only AT#V0.

*2 The displayed maximum band rate is the one reported from the wireless base station and does not guarantee the actual communication speed.

P-04B

Kuten Code List

