



Addresses

Headquarters

Triax-Hirschmann Multimedia GmbH
Karl-Benz-Str. 10
D-72124 Pliezhausen
Phone: +49 (0)7127-14-0
Fax: +49 (0)7127-14-1697
E-mail: info@triax-hirschmann.com
Web:: www.triax-hirschmann.com

Service-Center

Triax-Hirschmann Multimedia GmbH
Service-Center
Karl-Benz-Str. 10
D-72124 Pliezhausen

Hotline

Phone: 0180 3232 341
E-mail: info@triax-hirschmann.de

Companies abroad

Austria

Triax-Hirschmann Austria GmbH
Oberer Paspelsweg 6-8
A-6830 Rankweil-Brederis
Phone: +43 5522 307-0
Fax: +43 5522 307-394
E-mail: rankweil@hirschmann-austria.at
Web:: www.triax-hirschmann.at

Spain

Hirschmann Multimedia España S.A.
N.I.F B 28257848
C/ Ingeniero Torres Quevodo, No 20
Poligono Fin de Semana
E-28042 Madrid
Phone: +34 91 74 828 36
Fax: +34 91 32 961 47
E-mail: hms@triax-hirschmann.es
Web:: www.hirschmann-multimedia.es

Hungary

Hirschmann Multimédia Electronics Kft.
Rokolya u. 1-13
H-1131 Budapest
Phone: +36 1 349 7575
Fax: +36 1 3298453
E-mail: info@hirschmann-multimedia.hu
Web:: www.hirschmann-multimedia.hu

Satellite components		Terrestrial antennas		Receivers		Mechanical Accessories	
Parabolic reflectors	8	Introduction	18	Digital receivers (DVB-S)	28	Introduction	34
Feedmounts	8	FM antennas	19	Digital receivers (DVB-T)	32	Mounts, masts	35
Universal reception - systems (LNBS)	13	Band antennas for VHF band I and III	20			Wall mounts	35
Digital single cable systems	16	Channel antennas for VHF band III (incl. DVB-T antennas)	21			Antenna masts	38
		Band antennas for UHF band IV and V (incl. DVB-T antennas)	22			Roof joist supports	38
		Multi-band antennas for VHF band III and UHF IV/V (incl. DVB-T antennas)	25			Telescopic masts	39
		Channel group antennas for UHF band IV/V	25			Mast roof entry plates, Sealing collars	
		Indoor antennas (incl. DVB-T antennas)	25			Fixing clamps	40
						Mast base brackets	41
						Mast accessory sets	
						Earthing strap,	41
						Earth bar	
						Support for antennas	42

Table of contents

Amplifier		Multiswitches		Signal processing	
Overview - amplifiers	44	Overview - multiswitches	62	Headend overview	84
CATV amplifiers		ECO single multiswitch for		CDH 1000 Compact Digital Headend	85
- House connection amplifiers	46	5, 9 and 17 cable systems	64	CSE 2000 Generation 2 headend	
- Line-/distribution amplifiers	51	Single switches and cascading		system	90
- Accessories	56	switches for 5 cable systems	70	CSE 6000 semi-professional	
Super broadband amplifiers		Single switches and cascading		headend	100
- Amplifiers for terrestrial and		switches for 9 cable systems	74		
SAT signals	58	Single switches and cascading			
Multi-band amplifiers	59	switches for 17 cable systems	79		
Terrestrial multi-band amplifiers	60	Switching relays	82		

Tap-offs, distribution boxes, couplers
Antenna outlet sockets
Connectors, cables, level meters

Introduction	102	Introduction	114	Overview	128
Overview - tap-offs/distribution boxes	103	Product line overview	115	IEC connectors	129
Tap-offs/distribution boxes for CATV with F-sockets	104	Technical data		F-connectors	130
Tap-offs/distribution boxes for SAT with F-socket	107	- General technical data	116	F-transition and bridging connectors	132
Second unit distribution boxes	109	- Universal Boxes	118	Earth block	132
Tap-offs/distribution boxes with screw clamps in semi-circular housing	110	- SAT special boxes	120	Level adjuster	133
Antenna couplers, remote feed coupler	111	- CATV special boxes	122	Fixed attenuators	133
		Accessories	126	Terminating resistors	133
		- Terminating resistors	126	Coaxial cable	134
		- On-wall frames, covers	126	Measuring devices	137
		Receiver connecting cable	126		

Table of contents

catTV		CATV components		Technical appendix	
Introduction	142	Overview	146	Basic technical requirements, Class A	148
catTV panel	144			Planning and installation instructions	150
catTV balun	144			Television standards	152
				Frequency ranges and channel allocation	153
				Technical specification Standards and directives	156
				Liability	156
				Content from A to Z	157

▶ **Satellite components**

Page 7 - Page 16

Parabolic reflectors

Feedmount

Universal reception systems (LNBs)

Digital single cable systems



Satellite components

Offset parabolic reflectors 88 and 110 cm Ø

Reflector colours

- Light grey (RAL 7035)
- Slate grey (RAL 7011)
- Brick red (RAL 8012)

Offset parabolic reflectors

HiQ line

- HiQ - the new premium class from Hirschmann for parabolic reflectors and LNBs offers sophisticated design with maximum functionality for single-subscriber and multiple-subscriber systems. With ideal reception characteristics and highest quality in the selection, processing, and finishing of materials used, the HiQ satellite antennas enable reception at the highest level.

- With 1.6 mm thick aluminium reflector and single-piece construction of feed arm and LNB mounting HiQ offers maximum stability even under extreme weather conditions. Reliable, stable, and with future-oriented technology.

- Simple and fast installation thanks to pre-assembly

- Integrated cable routing with metal clips

- Trouble-free and precise alignment without additional tools and adjustment scales

- All installation parts are protected against corrosion



Type		FESAT 88 HiQ	FESAT 110 HiQ
Order number	Light grey	940 156-001	940 157-001
	Slate grey	940 156-011	940 157-011
	Brick red	940 156-023	940 157-023

Reflector Ø	mm	880	1100
Frequency range	GHz	10.7-12.75	10.7-12.75
Gain at 10.95 GHz	dBi	38.8	40.2
Half-value aperture		2.0°	1.8°
Offset angle		21°	26°
G/T	dB/K	19.2	20.6
Mount for mast Ø	mm	32-90	32-90
Adjustment range - elevation		5-50°	5-50°
Wind load	N	627 ¹⁾	849 ¹⁾
Reflector width/ height	mm	850 x 950	1000 x 1050
Weight	kg	9.46	11.07
Packaging dimensions			
Reflector/mast mounting	mm	1045 x 950 x 275	1100 x 1190 x 285
Scope of delivery			
		- Reflector	- Reflector
		- Mast mounting	- Mast mounting
		- LNB mounting	- LNB mounting
Can be combined with			
		- All reception systems CS ...	- All reception systems CS ...
		- Multifeed extension DFH 1	- Multifeed extension DFH 1

¹⁾ Wind load calculated in accordance with EN 50083 Part 1 with q = 800 N/m² (installation height to 20 m)

Multifeed set DFH 1

- Enables reception of two satellite positions in the range from 4 ... 10° (FESAT 110 HiQ) and in the range of 5 ... 12° (FESAT 88 HiQ)

- Set consists of 2x multifeed extension and additional LNB mounting

Type	DFH 1
------	-------

Order number 750 061



Material	Aluminium
Weight	g 40
Packaging	Polythene bag

Offset parabolic reflectors

150 cm Ø

Type	FESAT 150	FESAT 120 K
------	-----------	-------------

Order number without mount	Light grey	913 054-001	913 968-001
Order number with mount	Light grey	913 053-001	



Reflector Ø	mm	1500	1200
Frequency range	GHz	10.7 to -12.75	10.7 to -12.75
Gain at 10.95 GHz	dBi	43.0	41.5
Half value aperture at	3 dB	1.1°	1.37°
Offset angle		21.3°	21.3°
Noise temp. at 30° elevation	K	33	36
G/T	dB/K	20.6	25.9
Mount for mast Ø	mm	50-89	60-89
Adjusting range elevation/azimuth		20°-90° / 0°-360°	5°-45°
Wind load	N	2305 ¹⁾	1270 ¹⁾
Reflector width/ height	mm	1550 x 1660	1245 x 1335
Weight	kg	26.0 with mount	21.0 with mount
Packing dimensions	Antenna mm	1730 x 1660 x 180	1410 x 1320 x 90
	El/Az mount	500 x 500 x 250	
Scope of delivery		- Reflector - Feed arm - El/Az mast mount	- Reflector - Feed arm - El/Az mast mount
Can be combined with		- All reception systems CS.. - Double feed mounting DFH 1502 - Triple feed mounting TFH 1503 - Mount: CSG 2401 A	

¹⁾ Wind load in accordance with EN 50083 Part 1 calculated with $q = 800 \text{ N/m}^2$ and $c = 1.2$

Feedmount

Type	DFH 850	CAS 5585 E	CAS 4000 N
------	---------	------------	------------

Order number	913 988-001	913 838-002	961 101-001
--------------	-------------	-------------	-------------



Material		Aluminium	Aluminium	Die-cast aluminium
Weight	g	40	40	160
Packaging		Polythene bag	Polythene bag	Cardboard box

Offset parabolic reflector FESAT 150

- For fixed alignment to one satellite in the frequency range 10-13 GHz
- Aluminium reflector
- Adjustment scale for elevation
- Stable mount
- Parts protected against corrosion
- Cable routing in feed arm and bracket
- Feed arm of galvanised steel, powder-coated in reflector colour, with additional aluminum side braces
- El/Az mounting of galvanised steel, powder coated in reflector colour
- Feedmount to accommodate reception systems of 23 and 40 mm Ø, e.g. CS...

Accessories

- Double feed mounting DFH 1502
Order no. 940,056-001
- Triple feed mounting TFH 1503
Order no. 940,057-001
- Mount CSG 2401 A
Order no. 813,627-101
- El/Az mounting CEM 150 (reflectors without mounting)
Order no. 940,055-001

Double feed mounting DFH 850

- For attachment of a second reception system (e.g. CS) for existing systems, e.g. Fesat 850
- For simultaneous reception of satellites at a distance of around 6° e.g. ASTRA 19.2° east and Eutelsat 13° east

System feedmount CAS 5585 E

- For upgrading existing systems, e.g. Fesat 850, to LNB with 40 mm feed mounting (e.g. CS...)

System mounting CAS 4000 N

- For upgrading existing systems, e.g. FESAT...K, to LNB with 40 mm feed mounting.

Satellite components

Offset parabolic reflectors 65, 75, and 85 cm Ø

Reflector colours

- Light grey (RAL 7035)
- Slate grey (RAL 7011)
- Brick red (RAL 8012)

Type		Hit FESAT 65	Hit FESAT 75	Hit FESAT 85
Order number	Light grey	965 038-001	965 039-001	965 040-001
	Slate grey	965 038-011	965 039-011	965 040-011
	Brick red	965 038-023	965 039-023	965 040-023



The solution for single-subscriber or multi-subscriber systems with future-safe technology, top quality and an attractive price/performance ratio.

- For fixed alignment to one satellite in the frequency range 10.7-12.75 GHz
- Aluminium feed mounting for all CS series reception systems
- Feedmount 23-40 mm
- Aluminium reflector
- Adjustment scale for elevation
- Stable mount
- Parts protected against corrosion
- Cable routing in feed arm and bracket
- Feed arm pre-assembled, can fold out
- Reverse and mast mounting pre-assembled, folded together – for simple installation, no single parts



Reflector Ø	mm	650	750	850
Frequency range	GHz	10.7-12.75	10.7-12.75	10,7-12,75
Gain at 10.95 GHz	dBi	min. 36.0	min. 37.3	min. 38.3
Half-value aperture		2.85°	2.4°	2.1°
Offset angle		21.3°	21°	21.1°
Noise temp. at 30° elevation	K	46	42	40
G/T	dB/K	19.4	21.1	22.3
Mount for mast Ø	mm	40-89	40-89	40-89
Adjustment range - elevation		15°-45°	15°-45°	15°-45°
Wind load	N	375 ¹⁾	480 ¹⁾	600 ¹⁾
Reflector width/ height	mm	670 x 715	750 x 800	855 x 905
Weight	kg	6	6,5	9
Packaging dimensions	mm	800 x 950 x 220	800 x 950 x 220	900 x 950 x 240
Scope of delivery		Reflector with reverse/feed arm and aluminium feedmount FH 40 - El/Az mast mount		
Can be combined with		- Reception systems CS300S / CS320T / CS400QT and CS404QS / CS4080S /CS504QST - Wall mounts, and mount see chapter "Mechanical accessories"		

¹⁾ Wind load calculated in accordance with EN 50083 Part 1 with q = 800 N/m² (installation height to 20 m)



Type	NTS - 1 set	MFU - 1 set	MFS - 3/4 alu.	FH - 23 alu.	FH - 40 alu.
Order number	940 304-001	940 305-001	940 306-001	940 307-001	940 308-001
Material	Multifeed upgrade -Set consisting of interface piece, Die-cast alu. Feedmount 40 mm and allen wrench in polythene bag e.g. for existing Hit FESAT systems	Alu. multifeed extension (short, 17 cm) and Alu. LNB mount 40 mm Feedmount	Alu. multifeed extension (long; 38 cm)	Diecast alu. Feedmount with 23 mm feed-mount	Diecast alu.- Feedmount with 40 mm Feed-mount

Offset parabolic reflectors

65, 80, and 90 cm Ø

Type	ECO FESAT 65 S	ECO FESAT 80 S	ECO FESAT 90 S
Order number	Light grey 940 192-001 anthrazit 940 192-011 Brick red 940 192-023	940 193-001 940 193-011 940 193-023	940 194-001 940 194-011 940 194-023

Reflector colours

-  Light grey (RAL 7035)
-  Anthracite (RAL 7016)
-  Brick red (RAL 8012)

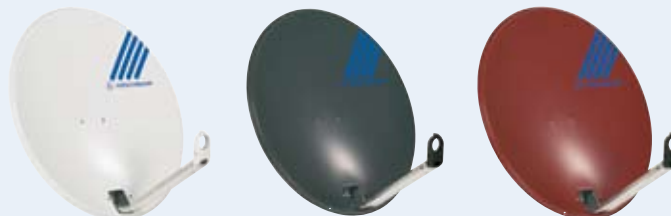

In addition to proven reception characteristics the "ECO FESAT" series offset parabolic antennas also offer a good price/performance ratio. The new design with an improved elevation mounting facilitates adjustment; simply fold out the pre-assembled feed arm and click in the LNC mounting and LNC.

- User-friendly, fast installation
- Steel reflector
- Includes pre-assembled feed arm and LNC mounting
- Aluminium feed arm and El/Az mounting
- Pre-assembled elevation mounting with adjustment scale
- Stable mast mounting with one or two U-brackets
- Double and multifeed mountings available as accessories
- 5-year function guarantee

Reflector Ø	mm	650	800	900
Frequency range	GHz	10.7-12.75	10.7-12.75	10.7-12.75
Gain at 11.3 GHz	dBi	35.8	37.1	38.8
Half-value aperture		3.1	2.6	2.0
Offset angle		26°	26°	26°
G/T	dB/K	16.0	17.3	19.2
Mount for mast Ø	mm	32-60	32-60	32-60
Adjustment range - elevation	°	10-50	10-60	10-60
Wind load	N	299 ¹⁾	412 ¹⁾	609 ¹⁾
Reflector width/height	mm	600 x 660	700 x 780	850 x 950
Weight	kg	4.5	5.2	7.5
Packaging dimensions				
width/height/depth	mm	658 x 653 x 115	778 x 773 x 126	942 x 937 x 150
Scope of delivery		- Reflector - Feed arm with adapter plate for accommodating 1 or 2 LNB's		
Can be combined with		- All reception systems CS ... - - Wall mounts, and mount see chapter "Mechanical accessories"		

¹⁾ Wind load calculated in accordance with EN 50083 Part 1 with $q = 800 \text{ N/m}^2$ (installation height to 20 m)

Type	ECO FESAT 65 S-5	ECO FESAT 80 S-5	ECO FESAT 90 S-3
Mini bulk, content	5	5	3
Order number			
Light grey	940 195-001	940 196-001	940 197-001
Anthracite	940 195-011	940 196-011	940 197-011
Brick red	940 195-023	940 196-023	940 197-023

- Various multifeed solutions are available as accessories for the ECO FESAT series that can be used to extend your satellite systems.

Type	ECO DFH-2	ECO DFH-2 Flex	ECO VFH-4
	Double feed mount 6°	Double feed mount Flexi, 6-10°	Quad feedmount 3-20° order number
Grey	940 203-001	-	-
Black	940 203-002	940 204-001	940 206-001



Material	Plastic	Plastic	Plastic
Packaging	Polythene bag	Polythene bag	Polythene bag

Application examples

Typical system examples for single, twin, quatro and quatro switch LNBs

Additional examples are provided in the brochure "System examples CATV - SAT - terrestrial communication" or on the internet at www.com.com.
www.com.com

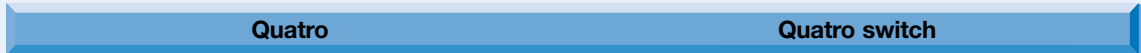
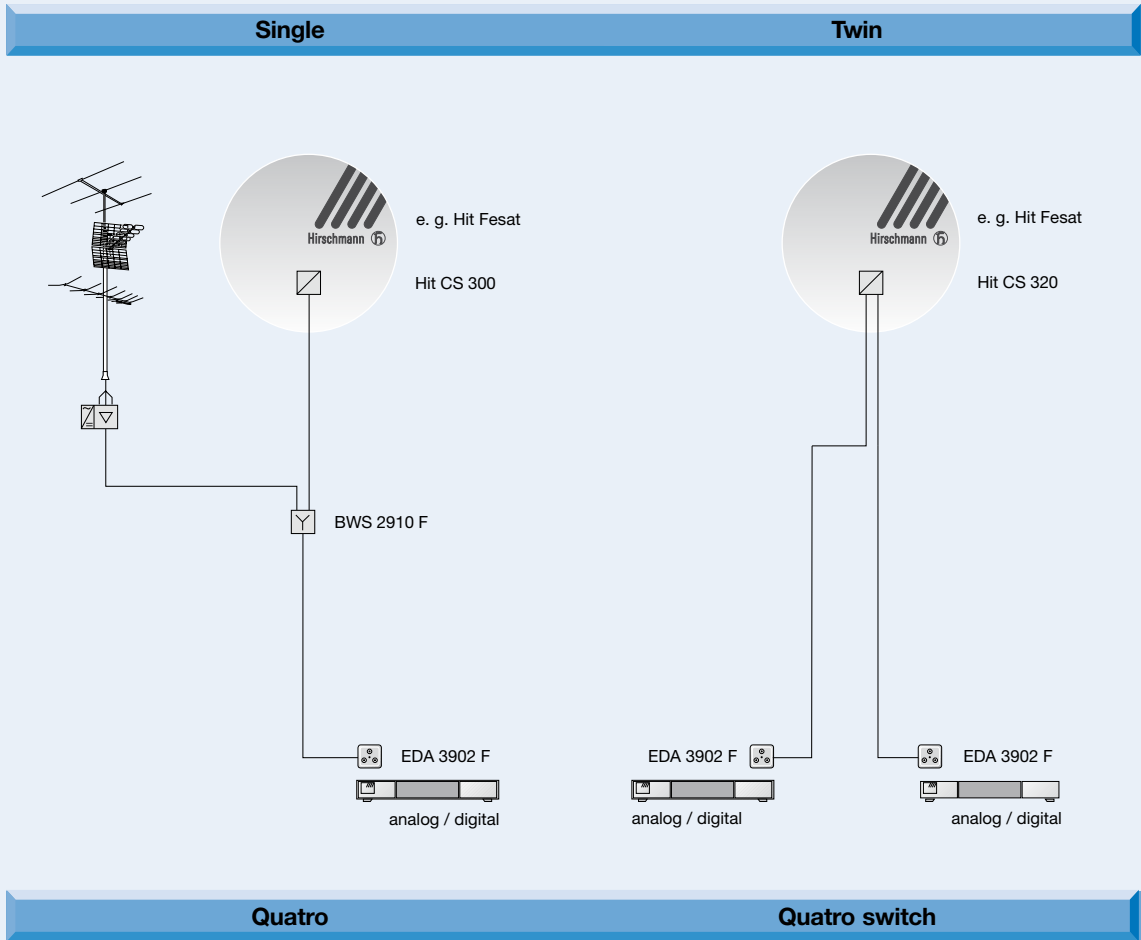

HiQ universal reception systems

Type	CS 22 HiQ	CS 40 HiQ	CS 44 HiQ
Order number	940 135-001	940 136-001	940 134-001
			

Frequency range				
Input				
lower band	GHz	10.7-11.7	10.7-11.7	10.7-11.7
upper band	GHz	11.7-12.75	11.7-12.75	11.7-12.75
Output				
lower band	MHz	975	975	975
upper band	MHz	1060	1060	1060
Oscillator frequency	GHz	9.75 (lower band)	9.75 (lower band)	9.75 (lower band)
	GHz	10.6 (upper band)	10.6 (upper band)	10.6 (upper band)
Noise factor typ.	dB	0.2	0.2	0.2
Gain	dB	55	50	55
Polarisation		linear, 2 outputs independent vertical or horizontal switchable	linear, 4 outputs, 2 horiz. + low/high, 2 vert. + low/high,	linear, 4 outputs independent, vert./horiz. + low/high switchable
Polarisation decoupling	dB	25	25	20
Switch voltage for				
vertical plane	V	14	-	14
horizontal plane	V	18	-	18
Switch signal for				
lower band	kHz	0	0	0
upper band	kHz	22	-	22
Remote feed voltage	V	-	12 ... 18	12 ... 18
Current consumption	mA	max. 350	200	300
Connections Ohm		F-socket, 75	2xF-socket, 75	2xF-socket,75
Feed receptacle	mm	40	40	40
Ambient temperature	°C	-25 to +50	-40 to +60	-25 to +50
Weight net/gross	g	470/550	470/550	470/550
Packaging dimensions W x H x D	mm	160 x 140 x 85	160 x 140 x 85	160 x 140 x 85

The HiQ reception systems are particularly good matches

- For parabolic reflectors
FESAT 88 HiQ and FESAT 110 HiQ
- Ideal for multiswitches, headends and master antenna television systems

CS 22 HiQ

11/12 GHz, dual/twin

2 outputs horizontal/vertical

- For antenna systems with up to 2 subscribers
- Switch-over of polarisation levels independently of each other with 13/18 V from the receiver
- Switch-over of frequency ranges independently of each other with 0/22 kHz from the receiver

CS 40 HiQ

11/12 GHz, Quatro - 4 outputs

- For star distribution or storey distribution in conjunction with Multiswitches (single or cascade)
- For channel processing
- Remote feed possible with 12 to 18 V on each output
- Multiswitch with standard feed can be used with no problems

CS 44 HiQ

11/12 GHz Quatro switch

4 outputs horizontal/vertical

- For antenna systems with up to 4 subscribers
- Switchover via integrated multiswitch
- All participants can receive analog and digital signals independently of each other
- Can be extended to multi-subscriber systems via multiswitch with 22 kHz switch signal

Characteristics:

- Very low noise factor of 0.2 dB
- Constant amplification of 50 or 55 dB
- Weather-resistant housing
- Single function test with measurement log

Accessories:

- 2x multifeed extension with LNB mounting (DFH 1), see page 8

Universal reception systems

- For all offset parabolic antennas standard feedmounts Ø 40 mm
- For reception of all standard satellites like ASTRA, Eutelsat, and Türksat, digital and analog
- In completely encapsulated, weatherresistant diecast alu. housing
- Additional protection is offered by plastic outer housing with interior slider
- Low power consumption
- Satisfies EN 50083-1 and EN 50083-2
- **CE**

CS 300 S

11/12 GHz, Single

1 output horizontal/vertical

- For single antenna systems
- Switch-over of polarisation levels 13/18 V from the receiver
- Switch-over of frequency levels 0/22 kHz from the receiver

CS 320 T

11/12 GHz, dual/twin

2 outputs horizontal/vertical

- For antenna systems with up to 2 subscribers
- Switch-over of polarisation levels independently of each other with 13/18 V from the receiver
- Switch-over of frequency ranges independently of each other with 0/22 kHz from the receiver

CS 400 QT

11/12 GHz, Quatro

4 outputs

- For star distribution or storey distribution in conjunction with multiswitches (single or cascade)
- For channel processing
- Remote feed possible with 12 to 18 V on each output
- Multiswitcher with standard feed easy to use

Type	CS 300 S	CS 320 T	CS 400 QT
Order number	940 251-001	940 252-001	940 253-001



Frequency range					
Input	lower band	GHz	10.7-11.7	10.7-11.7	10.7-11.7
	upper band	GHz	11.7-12.75	11.7-12.75	11.7-12.75
Output	lower band	MHz	950-1950	950-1950	950-1950
	upper band	MHz	1100-2150	1100-2150	1100-2150
Oscillator frequency		GHz	9.75 (lower band)	9.75 (lower band)	9.75 (lower band)
		GHz	10.6 (upper band)	10.6 (upper band)	10.6 (upper band)
Noise factor typ.		dB	0.3	0.3	0.3
Gain		dB	56	56	56
Polarisation			linear, vertical or horizontal switchable	linear, 2 outputs independent, vertical	linear, 4 outputs 2 horiz. + low/high, or horizontal 2 vert. + low/high switchable
Polarisation decoupling		dB	25	25	25
Switch voltage for					
	vertical plane	V	10.5...14.5	10.5...14.5	-
	horizontal plane	V	15.5...21	15.5...21	-
Switch signal for					
	lower band	kHz	0	0	0
	upper band	kHz	22	22	-
Remote feed voltage		V	-	-	12...18
Current consumption		mA	110	140	160
Connections		Ohm	4xF-socket, 75	8xF-socket, 75	4xF-socket, 75
Feed receptacle		mm	40	40	40
Ambient temperature		°C	-40 to +60	-40 to +60	-40 to +60
Weight		g	130	130	130
Packaging dimensions W x H x D		mm	165 x 117 x 77	165 x 117 x 77	165 x 117 x 77

Type	CS 404 QS	CS 408 OS	CS 504 QST
------	-----------	-----------	------------

Order number	940 254-001	940 255-001	940 256-001
--------------	-------------	-------------	-------------



Frequency range					
Input	lower band	GHz	10.7-11.7	10.7-11.7	10.7-11.7
	upper band	GHz	11.7-12.75	11.7-12.75	11.7-12.75
Output	lower band	MHz	950-1950	950-1950	950-1950
	upper band	MHz	1100-2150	1100-2150	1100-2150
Oscillator frequency		GHz	9.75 (lower band)	9.75 (lower band)	9.75 (lower band)
		GHz	10.6 (upper band)	10.6 (upper band)	10.6 (upper band)
Noise factor typ.		dB	0.3	0.3	0.3
Gain		dB	56	56	56
Polarisation			linear, 4 outputs; independent vert./horiz.+low/high switchable	linear, 8 outputs; independent vert./horiz.+low/high switchable	linear, 4 outputs; independent vert./horiz.+low/high switchable
Polarisation decoupling		dB	25	25	25
Switch voltage for	vertical plane	V	10.5 ... 14.5	10.5 ... 14.5	10.5 ... 14.5
	horizontal plane	V	15.5 ... 21	15.5 ... 21	15.5 ... 21
Switch signal for	lower band	kHz	0	0	0
	upper band	kHz	22	22	22
Remote feed voltage		V	12...18	12...18	12...18
Current consumption		mA	140	140	140
Connections 8xF-sockets,75		Ohm		8xF-socket, 75	8xF-socket, 75
Feed receptacle mm			40	40	40
Ambient temperature		°C	-40 to +60	-40 to +60	-40 to +60
Weight		g	130	130	130
Packaging dimensions W x H x D		mm	165 x 117 x 77	165 x 117 x 77	165 x 117 x 77

**CS 404 QS 11/12 GHz,
Quatro switch - 4 outputs**

- For antenna systems with up to 4 subscribers
- Switchover via integrated multiswitch
- All participants can receive analog and digital signals independently of each other
- Can be extended to multi-subscriber systems via multiswitch with 22 kHz switch signal

**CS 408 OS 11/12 GHz
Octo switch - 8 outputs**

- For antenna systems with up to 8 subscribers
- Switchover via integrated multiswitch
- All participants can receive analog and digital signals independently of each other

**CS 504 QST 11/12 GHz
Quatro switch with terrestrial input
(47-862 MHz) - 4 outputs**

- For antenna systems with up to 4 subscribers
- Switchover via integrated multiswitch
- All subscribers can receive analog and digital as well as terrestrial signals independently of each other
- Attenuation on the terrestrial output: -16 dB at 47...862 MHz

Digital single cable systems

The digital single cable systems CEF 211 D and CEF 311 Digital are ideal for cost-effective and simple upgrading of analog systems for digital SAT reception. They can be used in all distribution networks and are particularly well suited for upgrading existing tree structure systems.

- For reception of
 - All horizontal polarised, freely receivable German-language radio and television stations in MPEG2 processes from Astra
 - Numerous freely receivable foreign digital radio and television stations
 - PREMIERE (with appropriate CAM module or released Smart card)
 - Infeed of terrestrial signals possible
 - Each digital SAT receiver can be activated
 - Thanks to the integrated 22 kHz generator all Hirschmann series CS LNCs can be activated
- Features CEF 211 D
 - Hirschmann receivers are pre-programmed for CEF 211 D
 - via the option IF/IF-conversion 2 additional transponders can be loaded additional to the channels of the channels list
- Features CEF 311 Digital
 - 2 supplied plug-in modules enable reception of additional channels (Arena or Viva)
 - 20 dB amplification in the SAT range
 - Economical operation through switch-mode power supply and DC/DC - converters
 - Hirschmann receivers are even prepared for CEF 311 Digital

Type	CEF 211 D	CEF 311 digital
------	-----------	-----------------

Order number	940 007-002	940 302-001
--------------	-------------	-------------



Input				
terrestrial/ SAT	MHz	47-862		47-862
output terrestrial		47-862		47-862
SAT 1 (horiz.)		950-1600		1100-2150
SAT 2 (vert.)		1800-2150		
SAT 2 (plug-in modules)				960 (Transponders 104 + 78) 1055 (Transponders 104 + 102)
Input "Option"		MHz	950...1050	960...1055
Gain				
SAT-IF	dB	15		20
terrestrial	dB	3		2
Input "option"	dB	15		
Max. output level	dBµV	104		110
Power supply		190...250 VAC (50 Hz, 23 VA)		190...240 VAC (50 Hz, 23 VA)
DC	mA	900 max		850 max
Integrated				
		power supply for LNB 13 and 18 V with 22 kHz signal amplifier,		power supply for LNB 13 and 18 V with 22 kHz signal amplifier, compensated for tilted position

System examples

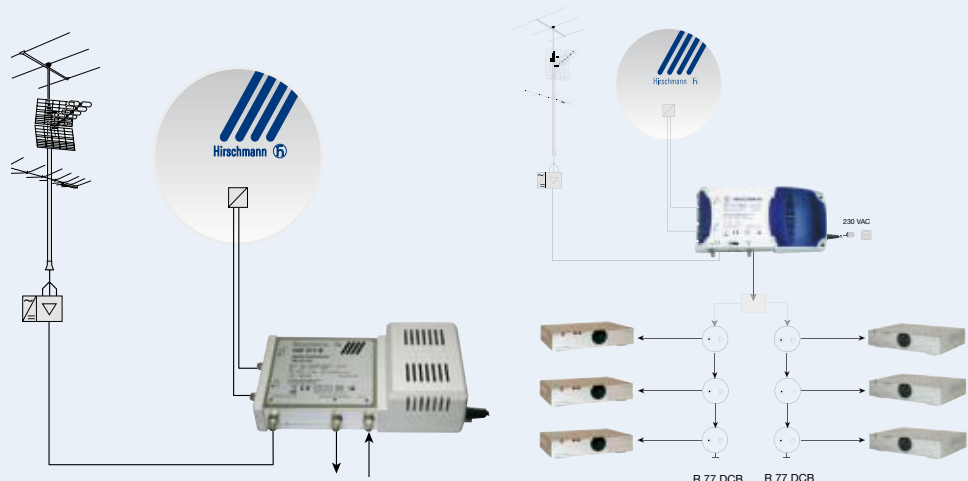

▶ Terrestrial antennas

Page 17– Page 26

FM antennas

Band antennas for television VHF I and III

Channel antennas for television band III (incl. DVB-T antennas)

Band antennas for television UHF IV and V (incl. DVB-T antennas)

Multi-band antennas for television VHF III and UHF band IV and V (incl. DVB-T antennas)

Multi-band antennas for television UHF IV and V

Indoor antennas (incl. DVB-T antennas)

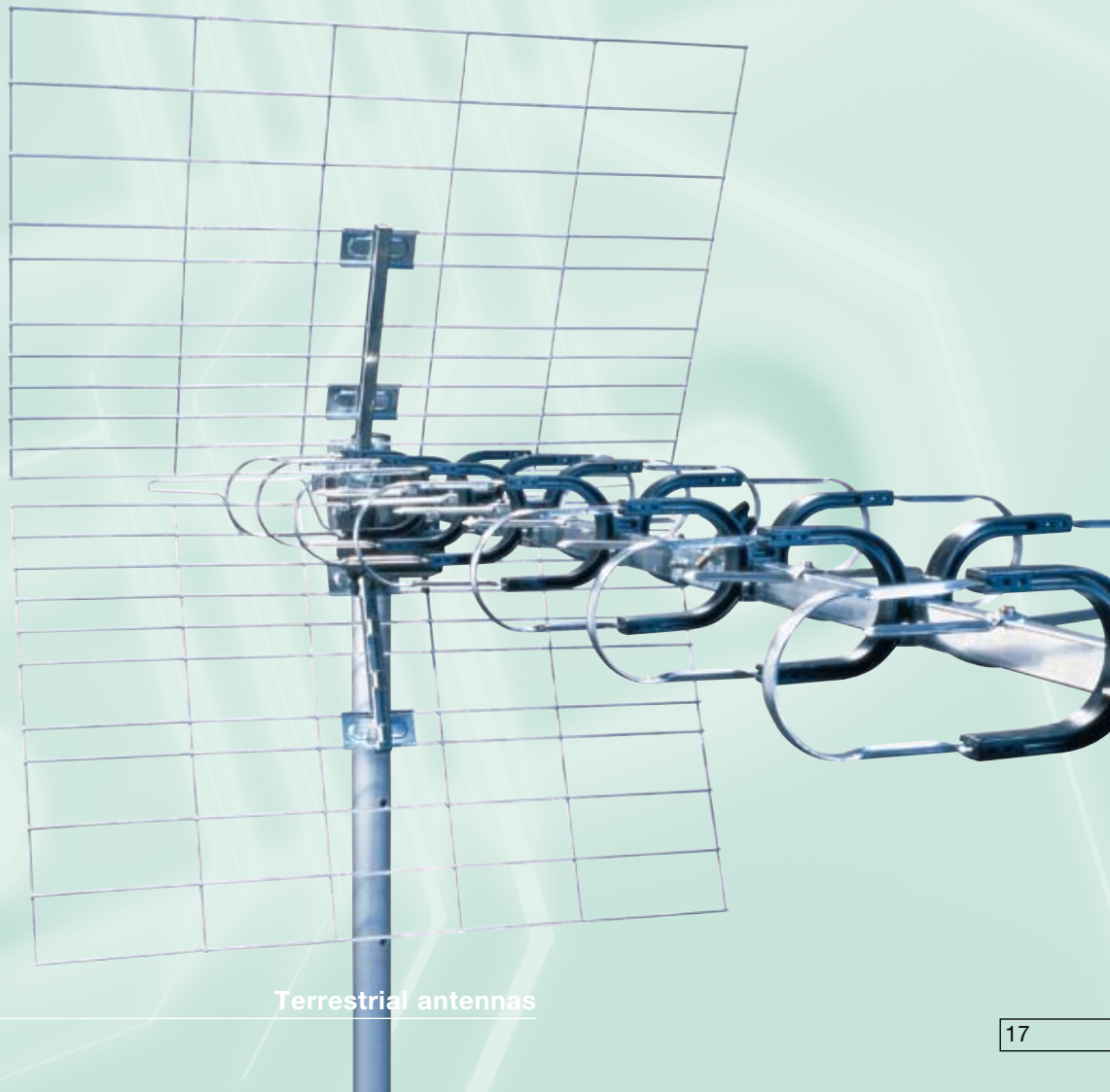

Introduction

FM antennas

Stereo signals can be received using any Hirschmann VHF antenna. However since higher signal levels and greater freedom from reflection are required for clear stereo reception than are required for mono reception, a directional antenna is usually necessary.

Television antennas for DVB-T

DVB-T reception is possible with any Hirschmann antenna that is suitable for the respective frequency range and polarisation. In the catalog all antennas suitable for the reception of DVB-T signals in VHF III and UHF IV/V bands are marked with the DVB logo.

Omnidirectional reception

The omnidirectional antenna has approximately the same sensitivity for all directions and can only be recommended for well-supplied radio reception areas.

Directional reception

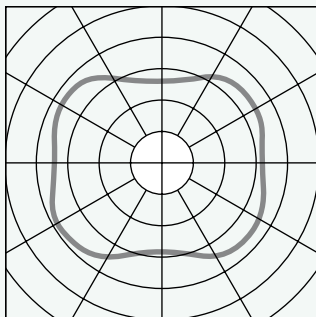

The directional antenna receives signals from one main direction better than does an omnidirectional antenna, but has poorer reception of signals from other directions. A directional antenna is absolutely necessary for areas where signals are weak, or in areas where a particular weak station is to be received.

Radiation pattern - the most important terms

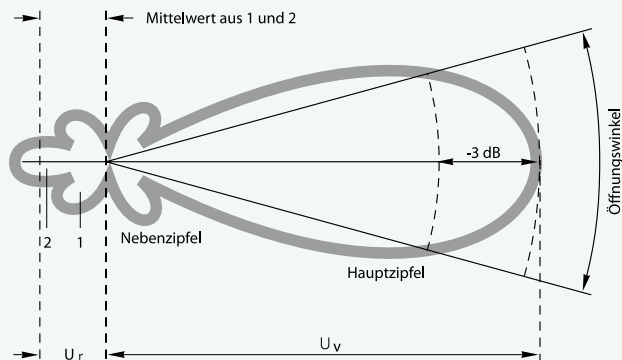
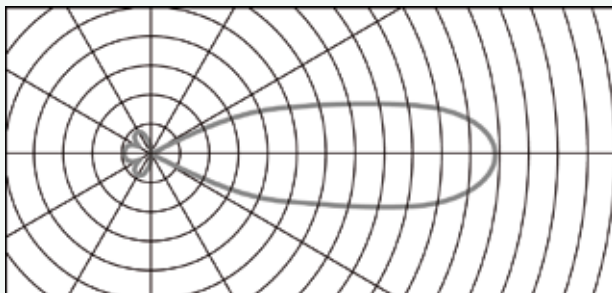

Gain

The ratio of an antenna's receiving power in its main receiving direction to the receiving power of an $\lambda/2$ dipole at the same installation site (logarithmic measure expressed in dB)

Angle of acceptance

Angular aperture of the major lobe between the points where the gain is lower by 3 dB than its maximum value

Major lobe

Section of the radiation pattern in the direction of maximum gain

Side lobe

Lateral and rearward lobe-shaped sections of the radiation pattern that have a lower gain than in the main receiving direction

Front-to-back ratio*

Ratio of the voltage U_v in the main receiving direction to an average value U_r generated on the basis of the voltages of the side lobe 2 in the back direction (180°), and of the larger side lobe 1 in the rear sector (90° - 270°) of the directional diagram (logarithmic measure expressed in dB)

* According to a definition of the Technical commission of the "Receiving Antennas" association in ZVEI



Antennas are suitable for reception of digital - terrestrial signals (DVB-T)

FM antennas

Antennas for VHF

Type	U1	U3	U4
------	----	----	----

Order number	910 980-601	912 515-601	910 664-601
--------------	-------------	-------------	-------------

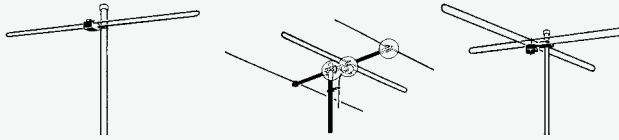

Gain	dB	0	5	-3
Front-to-back ratio	dB		14	
Angle of acceptance				
horizontal		78°	67°	360°
vertical		-	115°	-
Dipole length	m	1.5	1.1	1.5
Wind load	N	27	51	49
Mast Ø	mm	max. 54	max. 60	max. 60
Weight	kg	0.7	1.2	0.8
Individual packing-dimensions	cm	149 x 12.5 x 11	149 x 12.5 x 11	152 x 14 x 12

- Frequency range 87.5 - 108 MHz
- Coaxial connection or symmetrical with screw clamp
- Elements pre-assembled

Type	FM 30	FM 50
------	-------	-------

Order number	910 906-601	910 907-601
--------------	-------------	-------------

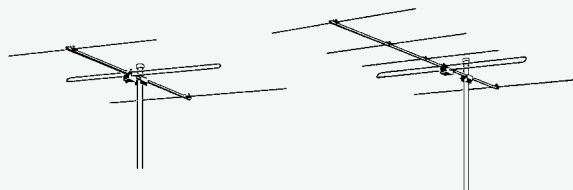

Gain	dB	5	6.5-7
Front-to-back ratio	dB	14	15
Angle of acceptance			
horizontal		70°	66°
Length	m	1.16	1.76
Wind load	N	58	87
Mast Ø	mm	max. 60	max. 60
Weight	kg	0.92	1.35
Individual packing-dimensions	cm	153 x 26 x 22	151 x 29 x 24

- Frequency range 87.5 - 108 MHz
- Coaxial or symmetrical connection with screw clamp
- Swiveling mast mount
- Elements pre-assembled
- Suitable for masts to 60 mm in ø

FM antennas

Antenna head for AM and FM

Type	GEMA 4 KR
------	-----------

Order number

910 802-601

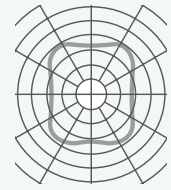
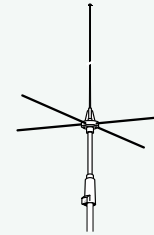

Alignment characteristics

- Frequency range: LMK 0.15 - 26.1 MHz, FM 87.5 - 108 MHz
- Mount at the end of masts
- LMK reception with fibreglass rod
- Coaxial connection
- Protected from surge voltages and static charging in accordance with EN 50083-1

LMK reception with		fibreglass rod 1.2 m
Gain for AM	dB	6 ¹⁾
Directional characteristics for FM reception		Crossed dipole
Gain for FM	dB	-3
Front-to-back-ratio	dB	-
Angle of acceptance horizontal		360°
Length	m	1.5 (dipole)
Wind load	N	71
Mast Ø	mm	36-54
Weight	kg	2.0
Individual packing dimensions	cm	120 x 13 x 13

¹⁾ With reference to FM antenna complying with DIN 57 855 Part 2/VDE 0855 Part 2, 4.1.1.with 2 measuring frequency 1 MHz

Band antennas for VHF I

Type	FESA 2 RA/K2-4
------	----------------

Order number

912 650-601

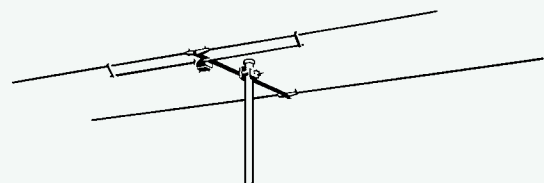

- For channels 2-4
- Coaxial connection with screw clamp
- Swiveling mast mount

Channels		2-4	
Gain	dB	3	
Front-to-back-ratio	dB	9	
Angle of acceptance horizontal		75°	
Length	m	1,09	
Wind load	horizontal	N	82
	vertical	N	104
Mast Ø	mm	max. 60	
Weight	kg	1.6	
Individual packing dimensions	cm	186 x 18.5 x 12.5	

Band antennas for B III

Type	FESA 4 BV ¹⁾	FESA 6 BV ¹⁾	FESA 10 BV ¹⁾	FESA 13 BV ¹⁾
Order number	910 890-601	910 896-601	910 897-601	910 893-601

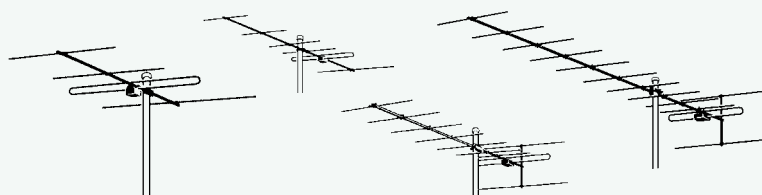

Channels		5-12	5-12	5-12	5-12
Gain	dB	5.5	7-8	7.5-10	9-11
Front-to-back ratio	dB	14	16	20	23
Angle of acceptance horizontal		60°	55°	50°	45°
vertical		95°	75°	63°	60°
Length	m	0.53	1.02	1.68	2.51
Wind load horiz.	N	32	44	55	89
vertical	N	36	56	74	112
Mast Ø	mm	max. 54	max. 54	max. 60	max. 60
Mast mount		Fixed	Fixed	Swiveling	Swiveling
Weight	kg	0.6	0.6	1.1	1.5
Individual packing-dimensions	cm	18 x 97	18 x 129	28 x 106	28 x 141

- For channels 5-12
- Can be mounted horizontally or vertically
Vertical mounting only on TRAG 53 support (see the section on Mechanical accessories)
- Coaxial connection or symmetrical with screw clamp
- Suitable for DVB-T (B III)

¹⁾ In consumer polythene bag

Channel antennas for VHF III, Super-Magneta

Gain class 9 dB

Type	FESA 309 AN K ..								
Order number	910 838-...								
Order no. index	-605	-606	-607	-608	-609	-610	-611	-612	

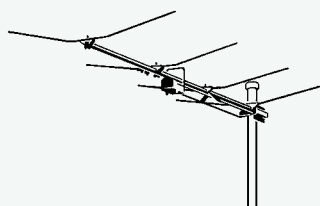

Channel		5	6	7	8	9	10	11	12
Gain	dB	9	9	9	9	9	9	9	9
Front-to-back ratio	dB	23	23	23	23	23	23	23	23
Angle of acceptance horizontal		52°	52°	52°	52°	52°	52°	52°	52°
vertical		66°	66°	66°	66°	66°	66°	66°	66°
Length	m	1.53	1.48	1.44	1.39	1.35	1.29	1.23	1.24
Wind load horiz.	N	32	31	30	29	29	28	27	27
vertical	N	54	52	50	49	47	46	44	44
Weight	kg	1.34	1.34	1.34	1.30	1.30	1.30	1.30	1.30
Individual packing-dimensions	cm	112 x 15 x 11,5			104 x 15 x 11,5				

- Coaxial connection or symmetrical with screw clamps
- Swivel mast mounting for masts up to 60 mm in Ø
- Completely pre-assembled
- Can be mounted horizontally or vertically
- Extremely high front-to-back ratio
- Extremely low wind load
- Suitable for DVB-T (B III)

Band antennas for UHF IV/V, Super-Spectral

Gain class 15 dB

Type FESA 813 N 69

Order number 910 860-601

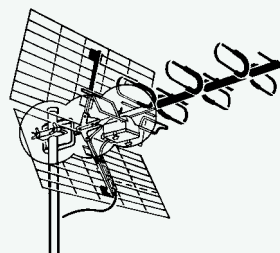

- Coaxial connection or symmetrical with screw clamps
- Swivel mast mounting for masts up to 60 mm in Ø
- Can be mounted horizontally or vertically
- Extremely high front-to-back ratio
- High side lobe attenuation
- Completely pre-assembled
- Surface wave trap
- Suitable for DVB-T (B IV/V)

For channels		21-69						
Channels		21-25	26-30	31-36	37-42	43-49	50-55	56-69
Gain	dB	9	9.5	10	11	12	13	13
Front-to-back-ratio	dB	23	26	30	30	29	28	23
Angle of acceptance	horiz.	55°	53°	49°	45°	42°	39°	33°
	vertical	71°	68°	66°	60°	54°	49°	43°
Length	m	0,70						
Wind load	horiz.	59						
	vertical	76						
Weight	kg	2.0						
Individual packing dimensions	cm	58 x 39 x 10.5						

Type FESA 815 N 37 FESA 815 N 48

Order number 910 862-601 910 863-601

For channels		21-37		21-48					
Channels		21-24	25-30	31-37	21-23	24-28	29-34	35-41	42-48
Gain	dB	12,5	13,5	15	11,5	12	13	14	15
Front-to-back-ratio	dB	30	30	30	28	30	28	30	26
Angle of acceptance	horiz.	42°	37°	31°	44°	41°	37°	32°	27°
	vertical	50°	43°	34°	52°	48°	42°	36°	29°
Length	m	1.45		1.38					
Wind load	horiz.	89		87					
	vertical	124		120					
Weight	kg	2.8		2.7					
Individual packing dimensions	cm	78 x 49.5 x 10		71 x 50 x 10					

Type FESA 815 N 69

Order number 910 865-601

For channels		21-69								
Channels		21-25	26-30	31-36	37-42	43-49	50-55	56-62	63-69	
Gain	dB	9	9,5	10	10,5	11	12	13,5	15	
Front-to-back-ratio	dB	22	23	25	28	28	25	24	22	
Angle of acceptance	horiz.	50°	46°	42°	40°	38°	35°	31°	27°	
	vertical	60°	55°	50°	47°	43°	39°	35°	30°	
Length	m	1.22								
Wind load	horiz.	83								
	vertical	110								
Weight	kg	2.6								
Individual packing dimensions	cm	71 x 50 x 10								

Gain class 17 dB

Type FESA 817 N 37

Order number 910 866-601

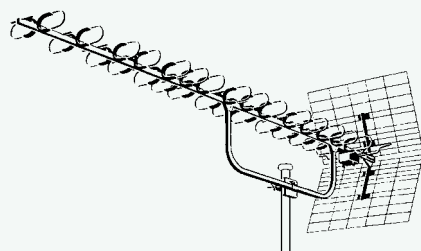

For channels	21-37				
Channels	21-23	24-26	27-30	31-37	
Gain	dB	14.5	15	16	17
Front-to-back-ratio	dB	30	30	30	28
Angle of acceptance	horiz.	33°	30°	28°	23°
	vertical	37°	35°	32°	26°
Length	m	2.72			
Wind load	horiz.	N	136		
	vertical	N	217		
Weight	kg	3.8			
Individual packing dimensions	cm	104.5 x 61 x 10			

- Coaxial connection or symmetrical with screw clamps
- Swivel mast mounting for masts with 60 mm Ø
- Can be mounted horizontally or vertically
- For horizontal reception mounting on the mast tip or on a boom (TRAG 53, see chapter Mechanical accessories) is recommended
- Can be mounted horizontally or vertically
- Extremely high front-to-back ratio
- High side lobe attenuation
- Completely pre-assembled
- Surface wave trap
- Suitable for DVB-T (B IV/V)

Type FESA 817 N 48

Order number 910 867-601

For channels	21-48					
Channels	21-24	25-29	30-34	35-40	41-48	
Gain	dB	13	14	15	16	17
Front-to-back-ratio	dB	30	27	30	29	29
Angle of acceptance	horiz.	34°	33°	30°	25°	21°
	vertical	37°	36°	33°	30°	24°
Length	m	2.54				
Wind load	horiz.	N	132			
	vertical	N	203			
Weight	kg	3.8				
Individual packing dimensions	cm	100 x 58.5 x 11				

Type FESA 817 N 69

Order number 910 869-601

For channels	21-69							
Channels	21-26	27-33	34-40	41-48	49-55	56-62	63-69	
Gain	dB	10.5	12	13	14	15	16	17
Front-to-back-ratio	dB	24	28	30	30	28	27	26
Angle of acceptance	horizontal	43°	39°	35°	31°	27°	24°	21°
	vertical	51°	45°	40°	35°	31°	28°	26°
Length	m	2.08						
Wind load	horiz.	N	124					
	vertical	N	183					
Weight	kg	3.4						
Individual packing dimensions	cm	115 x 39 x 11						

Band antennas for UHF IV/V



- For channels 21-60
- Can be installed horizontally or vertically
- Coaxial connection or symmetrical with screw clamps
- Suitable for DVB-T (B IV/V)

Type	FESA 7 BO 60 ¹⁾	FESA 12 BO 60 ¹⁾
Order number	910 977-601	910 978-601

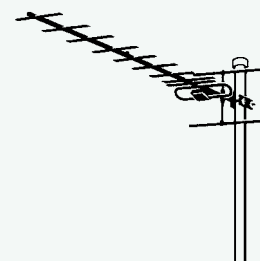

Channels		21-60	21-60
Gain	dB	5-9.5	6-12
Front-to-back-ratio	dB	12-18	17-23
Angle of acceptance horizontal		67°-49°	64°-38°
	vertical	90°-63°	92°-49°
Length	m	0.64	1.07
Wind load	horizontal	N	20
	vertical	N	36
Mast Ø	mm	max. 54	max. 54
Mast mount		Fixed	Fixed
Weight	kg	0.3	0.5
Individual packing dimensions	cm	16 x 76	16 x 71

¹⁾ in consumer polythene bag



- For channels 21-60 or 21-68
- Can be installed horizontally or vertically
- Coaxial connection or symmetrical with screw clamps
- Suitable for DVB-T (B IV/V)

Type	FESA 805	FESA 243
------	----------	----------

Order number	910 486-601	910 840-601
--------------	-------------	-------------

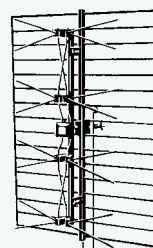

Channels		21-68	21-60
Gain	dB	10-13	7-13
Front-to-back-ratio	dB	20-23	21-26
Angle of acceptance horizontal		50°-37°	52°-29°
	vertical	40°-28°	65°-37°
Length	m	0.62 x 0.80 Alu. shielding	1.25
Wind load	horizontal	N	95
	vertical	N	87
Mast Ø	mm	max. 54	max. 54
Mast mount		Fixed	Swiveling
Weight	kg	2.1	1.9
Individual packing dimensions	cm	82 x 58 x 11	66 x 45 x 10

Multi-band antennas for VHF III and VHF IV/V

Type	FESA 218 LDK	FESA 215 L 665
Order number	910 501-602	971 116-602

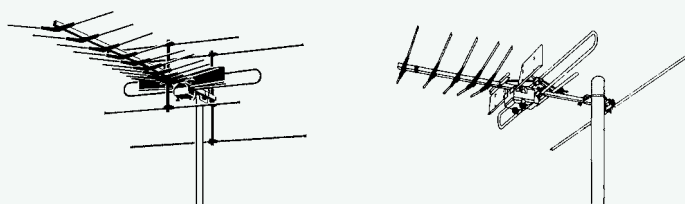

Reception ranges		B III	BIV/V	B III	BIV/V
Channels		5-12	21-69	5-12	21-65
Gain	dB	max. 7.5	6-14	2-3	7-11
Front-to-back-ratio	dB	15-20	17-28	15	20
Angle of acceptance horiz.			70°	53°-31°	70° 46°
Length	m	1,28		0,7	
Wind load horiz./vert.	N	104/86.8		42/55.8	
Weight	kg	2.1		1.2	
Packing dimensions	cm	72.5 x 44 x 18.5		72 x 49 x 11	



- Can be mounted vertically and horizontally
- Connection coaxial or symmetrical with screw clamps
- Swivel mast mounting for masts up to 60 mm in Ø
- Suitable for DVB-T (B III, B IV/V)
- FESA 218 LDK: for reception to channel 69

Indoor antenna for VHF III and UHF IV/V

Type	ZIFA 796 LP-V
Order number	910 887-602

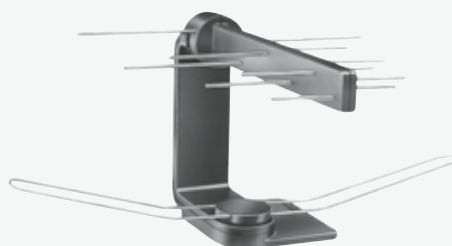

Reception range		B III	B IV/V
Gain	dB	max. 17 ¹⁾	max. 20 ¹⁾
Noise factor	dB	2,5	3
Front-to-back-ratio	dB	-	15-22
Operating voltage		230 V ~ +6%, -10%/50-60 Hz	
Power consumption	W	1.5	
Line connection	m	Cable approx. 1.5 m (with Euro-plug)	
Antenna connection cable plug connector	m	1.5 connector in acc. w. IEC 169-2 (DIN 45 325)	
Individual packing dimensions	cm	36 x 35 x 7.7	

¹⁾ Antenna gain including amplification.



- For channels 5-12 or 21-69
- Logarithmic/periodic antenna for bands IV/V, shortened dipole for band III
- High receiver power
- UHF antenna can be rotated for alignment to horizontally or vertically polarised channels
- VHF dipole can be swiveled opposite to UHF antenna
- Good directivity to eliminate reflections (ghosting)
- Brown plastic base and support
- High-gloss nickel-plated components
- Suitable for DVB-T (B III, B IV/V)
- CE



LapTV is a mobile DVB-T reception set for PC/notebook, combining an active DVB-T

indoor antenna with a TV tuner - wherever you are you can receive all DVB-T programs in excellent quality and using the software supplied, you can turn your notebook into a TV set with a digital video recorder.

- Frequency range: VHF and UHF
- Active indoor antenna with 15 dB gain
- Integrated GSM rejection filter
- MPEG2 format
- Remote control with all common TV/ receiver functions
- Time-shift function
- Direct burning to DVD (on-the-fly)
- Child protection, electronic program guide, teletext
- Additional high performance media management system

DVB-T flat-panel antenna for PC/notebook

Type	LapTV
------	-------

Order number 940 142-001



		VHF	UHF
Frequency range	MHz	174-230	470-862
Gain	dB	15	15
Gain (relative to $\lambda/2$ dipole)	dB	10	15
Max. output level	dB μ V	96	96
Return loss	dB	8	8
Operating voltage		+5 V DC/30 mA via USB port Notebook/PC	
Output impedance	Ohm	75	
Dimensions W x H x D	mm	150 x 56 x 21, folded up	
Accessories:		Installation CD, remote control, adapter for roof antenna, notebook holder clip	

Indoor antenna for DVB-T

Type	ZIFA D-15 V
------	-------------

Order number 940 169-001



		174...230	470...862
Frequency range	MHz	174...230	470...862
Polarisation at upright standing antenna		Vertical for best utilization of omnidirectional characteristics	
Gain based on $\lambda/2$ dipole	dB	8	12
Return loss	dB	8	8
Noise factor	dB	3.4	3.6
Output level IMA 3 at 60 dB IMA (in acc. w. EN 50083-5)	dB μ V	94	96
Operating voltage from receiver		+5 VDC / 30 mA max	
Ambient temperature	°C	+5...+40	
Weight	g	120	
Connecting cable		DVB-T coaxial, 2.5 m	
Plug connection antenna subscriber.		IEC plug 45325	
Packing dimensions	mm	300 x 150 x 32	



- Reception ranges:
VHF: 174...230 MHz
UHF: 470...0.862 MHz
- Excellent omnidirectional characteristics, no special alignment required
- Reception of vertical and horizontal polarisation in enclosed areas
- Active version with additional filter to suppress interference e.g. from GSM/ DECT telephones
- Extremely low noise factor
- Up-to-date, space-saving design in black plastic housing, with plug-in stand

► Receivers

Page 27 - Page 32

DVB-S receivers
DVB-T receivers



Digital receivers for DVB-S

Type	CSR 100 CI / CSR 100 CC
------	-------------------------

Order number 940 246-001 / 940 247-001



High quality with a slimline look!

The DVB-S receivers CSR 100 CI and CSR 100 CC are suitable for reception of all free-to-air digital television and radio stations. Both receivers have a CI interface and thus with the appropriate CA module and released smart card they are also ready for encrypted stations. In addition the CSR 100 CC has an integrated CA module for receiving Cryptoworks encrypted programs (Arena/Bundesliga, ORF). Released smart card required.

Main features:

- CSR 100 CC - suitable for Arena/Bundesliga
- 16-character LCD display for plain text display of station name and information
- YUV output for flat screen televisions and projectors
- Digital audio output (coax) for CD quality listening enjoyment
- S-VHS connection for excellent picture quality
- Mechanical power switch on the front side (all off)
- Automatic software checks via satellite
- Support of single cable LNBs (SatCR technology)

Additional equipment features:

- 4000 station presets (3000 TV + 1000 radio)
- Stations from Astra, Hotbird and Türksat are pre-programmed
- 14 menu languages available
- Fast and interruption-free changing from one channel to another
- 5 personal favourite lists
- EPG - electronic program guide, timer, PIG (Picture in Graphics)
- Child protection and block function for specific channels
- OTA (software download via satellite)
- RS 232C port for data transmission of software and station lists
 - from PC to receiver
 - from receiver to receiver (Master to Slave)
- 800 pages of teletext memory
- 7-event timer
- Accessories: Remote control, batteries, Scart cable, operating instructions
- Colour: silver

General data	
System	Corresponds to the DVB standard
Dimensions W x H x D	320 x 45 x 200 mm
Weight	2.3 kg
Ambient temperature	0...40 °C
LNB/tuner input	
Input frequency	950...2150 MHz
Input level range	44..0.84 dBµV
Input impedance	75 Ohm
LNB supply current	13/18 + 14/19 VDC, max. 400 mA, short-circuit proof
LNB control signal	22 kHz (0/12 V)
DiSEqC control	Version 1.2
Demodulator	
Demodulation capacity	QPSK
Spectral inversion	Automatic conversion
Symbol rate	2...45 MS/s, SCPC and MCPC capable for C/KU band
Viterbi decoding rate	1/2, 2/3, 3/4, 5/6, 7/8, Auto
System resources	
Processor	32 bit (60 MHz)
DRAM	8 Mbyte
FLASH	2 Mbyte
Video decoder	
MPEG 2	Main Profile @ Main Level
Transmission speed	15 Mbit/s max
Video format	NTSC, PAL, Multi
Screen format	4:3, 16:9
Teletext	
Corresponds to the DVB standard	Receivers / TV
Audio parameters	
Operating mode	mono, dual mono, stereo, opt. Controllable output 32, 44.1 and 48SFib
Hard drive	
HDD	-
CI interfaces	
	1 x PCMCIA slot for CAM
Power supply	
Operating voltage	90...250 VAC
Power consumption	16 W
Connections	
SAT input = LNB INPUT	F socket (in acc. w. IEC 169-24)
SAT-IF loop through	
Output = LOOP OUT	F socket (in acc. w. IEC 169-24)
TV	SCART (RGB, CVBS, YUV, audio)
VCR	SCART (CVBS, YUV, audio)
YUV (components video) 3 x RCA Cinch	
Audio L/R, digital audio	3 x RCA Cinch
Data interface	Sub-D, 9-pole, data rate 115 Kb/s
S-VHS, Video	Mini-DIN connector (Hosiden socket)
power switch front side (all off)	0 / 1

Digital receivers for DVB-S

Type	CSR 61 CC	CSR 60 II CI
------	-----------	--------------

Order number	940 244-001	940 008-004
--------------	-------------	-------------



The DVB-S receivers CSR 60 II CI and CSR 61 CC are suitable for reception of all free-to-air and encrypted digital television and radio stations.

The CSR 60 II CI has 2 CI interfaces for this. The CSR 61 CC has 1 CI interface and an integrated CA system for encryption of Cryptoworks coded programs (Arena/Bundesliga, ORF). A released smart card is necessary for this.

Main features CSR 60 II CI:

- 2 CI interfaces
- RF modulator for TV sets without Scart socket
- Digital audio output
- Colour: Anthracite

Main features - CSR 61 CC:

- Suitable for Arena (Bundesliga)
- Integrated CA system (Cryptoworks) for receiving coded stations
- 2 digital audio outputs
- S-VHS connection for excellent image quality
- RF modulator for TV sets without Scart socket
- Colour: silver

Additional equipment features:

- 4000 station presets (3000 TV + 1000 radio)
- Stations from Astra, Hotbird and Türksat are pre-programmed
- 14 menu languages are available
- Up to 5 personal favourite lists
- EPG - electronic program guide with direct program selection
- PIG (Picture in Graphics)
- 800 pages of teletext memory
- Child protection and block function for specific channels
- 7 timer dates can be set separately
- OTA (software download via satellite)
- RS 232C port for data transmission of software and station lists - from PC to receiver - from receiver to receiver (Master to Slave)
- Digital audio output (S/PDIF), adjustable
- Accessories: Remote control, batteries, Scart cable, operating instructions
- Power switch for energy savings

General data		
System	Corresponds to the DVB standard	Corresponds to the DVB standard
Dimensions W x H x D	315 x 60 x 210 mm	270 x 60 x 205 mm
Weight	1.8 kg	2.2 kg
Ambient temperature	0...40 °C	0...40 °C
LNB/tuner input		
Input frequency	950...2150 MHz	950...2150 MHz
Input level range	44..0.84 dBµV	44...84 dBµV
Input impedance	75 Ohm	75 Ohm
LNB supply current	13/18 + 14/19 VDC, max. 400 mA, short-circuit proof	13/18 + 14/19 VDC, max. 400 mA, short-circuit proof
LNB control signal	22 kHz (0/12 V)	22 kHz
DiSeqC control	Version 1.2 (USALS)	Version 1.2 compatible
Demodulator		
Demodulation capacity	QPSK	QPSK
Spectral inversion	Automatic conversion	Automatic conversion
Symbol rate	2...45 MS/s, SCPC- and MCPC capable for C/KU band	2-45 MSps, SCPC and MCPC capable for C/KU band
Viterbi decoding rate	1/2, 2/3, 3/4, 5/6, 7/8, Auto	1/2, 2/3, 3/4, 5/6, 7/8, Auto
System resources		
Processor	32 bit (60 MHz)	32 bit (60 MHz)
DRAM	8 Mbyte	8 Mbyte
FLASH	2 Mbyte	2 Mbyte
Video decoder		
MPEG 2	Main Profile @ Main Level	Main Profile @ Main Level
Transmission speed	15 Mbit/s max	to 15 Mbit/s
Video format	NTSC, PAL, Multi	PAL, Multi, NTSC
Screen format	4:3, 16:9	4:3; 16:9
Teletext		
Corresponds to the DVB standard	Receivers / TV	Receivers / TV
Audio parameters		
Operating mode	mono, dual mono, stereo	mono, dual mono, stereo, opt. Controllable output
Bit rate	32, 44.1 and 48 kHz	32, 44.1 und 48 kHz
Power supply		
Operating voltage	90...250 VAC	90...250 VAC (50/60 Hz)
Power consumption	17 W max	30 W
CI interfaces	1 x PCMCIA slot for CAM	2 x PCMCIA slot for CAM
Connections		
SAT input = LNB INPUT	F socket (in acc. w. IEC 169-24)	F socket (in acc. w. IEC 169-24)
SAT-ZF-Loop through-Output = LOOP OUT	F socket (in acc. w. IEC 169-24)	F socket (in acc. w. IEC 169-24)
TV	SCART (RGB, CVBS, audio)	SCART (RGB, CVBS, YUV, Audio)
VCR	SCART (CVBS, audio)	SCART (CVBS, Y/C, Audio)
Audio L/R, Digital Audio	3 x RCA Cinch	3 x RCA Cinch
Data interface	Sub-D, 9-pole, data rate 115 Kb/	Sub-D, 9-pole, data rate 115 Kb/s
S-VHS, Video	Mini-DIN connector (Hosiden socket)	IEC male
Digital audio output (S/PDIF)	electric (coaxial)	optical
Power switch front side (all off)	0 / 1	0 / 1

Digital receivers for DVB-S

Type	CSR 50 II
------	-----------

Order number 940 173-001



The DVB-S receiver CSR 50 II is suitable for reception of all non-encrypted digital television and radio programs. CD quality thanks to digital audio outputs (optical + electrical). S-VHS connection for excellent image quality.

Main features:

- Automatic software checks via satellite - this means you will be notified when new software is available for download
- Support of single cable LNBs (SatCR technology)
- Reduced power consumption in standby mode of only 4 W
- Now with additional 2nd remote control for simple operation (7 buttons)

Additional equipment features:

- 4000 station presets (3000 TV + 1000 radio)
- Stations from Astra, Hotbird and Türksat are pre-programmed
- 14 menu languages available
- Fast and interruption-free changing from one channel to another
- Up to 5 personal favourite lists
- Electronic program guide EPG, timer, PIG (Picture in Graphics), 800 pages of teletext memory
- Child protection and block function for specific channels
- OTA (software download via satellite)
- RS 232C port for data transmission of software and station lists
 - from PC to receiver
 - from receiver to receiver (Master to Slave)
- Separate power switch for energy savings
- Accessories: Remote control, batteries, Scart cable, operating instructions
- Colour: Anthracite

General data	
System	Corresponds to the DVB standard
Dimensions W x H x D	270 x 60 x 195 mm
Weight	1.8 kg
Ambient temperature	0...40 °C
LNB/tuner input	
Input frequency	950...2150 MHz
Input level range	44...84 dBµV
Input impedance	75 Ohm
LNB supply current	13/18 + 14/19 VDC, max. 400 mA, short-circuit proof
LNB control signal	22 kHz
DiSEqC control	Version 1.2
Demodulator	
Demodulation capacity	QPSK
Spectral inversion	Automatic conversion
Symbol rate	2-45 MSps, SCPC and MCPC capable for C/KU band
Viterbi decoding rate	1/2, 2/3, 3/4, 5/6, 7/8, Auto
System resources	
Processor	32 bit (60 MHz)
DRAM	8 Mbyte
FLASH	2 Mbyte
Video decoder	
MPEG 2	Main Profile @ Main Level
Transmission speed	to 15 Mbit/s
Video format	PAL, Multi, NTSC
Screen format	4:3; 16:9
Teletext	
Corresponds to the DVB standard	Receiver and TV
Audio parameters	
Operating mode	mono, dual mono, stereo, opt. Controllable output
Bit rate	32, 44.1 and 48 kHz
Power supply	
Operating voltage	90...250 VAC (50/60 Hz)
Power consumption	30 W, standby 4 W
CI interfaces	-
Connections	
SAT input = LNB INPUT	F socket (in acc. w. IEC 169-24)
SAT-ZF-Loop through-Output = LOOP OUT	F socket (in acc. w. IEC 169-24)
TV	SCART (RGB, CVBS, YUV, Audio)
VCR	SCART (CVBS, YUV, Audio)
Audio L/R, Digital Audio	3 x RCA Cinch
Data interface	Sub-D, 9-pole, data rate 115 Kb/s
S-VHS, Video	Mini-DIN connector (Hosiden socket)
Digital audio output (S/PDIF)	optical
Power switch front side (all off)	0 / 1

Digital receivers for DVB-S

Type	CSR 10 FTA	CSR 10 CW
------	------------	-----------

Order number	940 249-001	940 248-001
--------------	-------------	-------------



General data		
System	Corresponds to the DVB standard	Corresponds to the DVB standard
Dimensions W x H x D	215 x 45 x 155 mm	215 x 45 x 155 mm
Weight	1.9 kg	1.9 kg
Ambient temperature	0...40 °C	0...40 °C
LNB/tuner input		
Input frequency	950...2150 MHz	950...2150 MHz
Input level range	44...84 dBµV	44...84 dBµV
Input impedance	75 Ohm	75 Ohm
LNB supply current	13/18 + 14/19 VDC, max 400 mA, short-circuit proof	13/18 + 14/19 VDC, max 400 mA, short-circuit proof
LNB control signal	22 kHz (0/12V)	22 kHz (0/12 V)
DiSEqC control	Version 1.2 (USALS)	Version 1.2 (USALS)
Demodulator		
Front end module	QPSK	QPSK
Spectral inversion	Automatic conversion	Automatic conversion
Symbol rate	2...45 MSps, SCPC and MCPC capable for C/KU band	2-45 MS/s, SCPC and MCPC capable for C/KU band
Viterbi decoding rate	1/2, 2/3, 3/4, 5/6, 7/8, Auto	1/2, 2/3, 3/4, 5/6, 7/8, Auto
System resources		
Processor	32 bit (60 MHz)	32 bit (60 MHz)
DRAM	8 Mbyte	8 Mbyte
FLASH	2 Mbyte	2 Mbyte
Video decoder		
MPEG 2	Main Profile @ Main Level	Main Profile @ Main Level
Transmission speed	15 Mbit/s max	15 Mbit/s max
Video format	NTSC, PAL, SECAM	NTSC, PAL, SECAM
Screen format	4:3, 16:9	4:3, 16:9
Teletext		
Corresponds to the DVB standard	Receiver and TV	Receiver and TV
Audio parameters		
Operating mode	mono, dual mono, stereo	mono, dual mono, stereo,
Bit rate	32, 44.1, 48 kHz	32, 44.1, 48 kHz
Power supply		
Operating voltage	90...250 VAC (50/60 Hz)	90...250 V AC (50/60 Hz)
Power consumption	16 W, standby 7W	16 W, standby 7W
Power switch	yes	yes
Connections		
SAT input	1xF socket (in acc. w. IEC 169-24)	1xF socket (in acc. w. IEC 169-24)
SAT-IF loop through output	1xF socket (in acc. w. IEC 169-24)	1xF socket (in acc. w. IEC 169-24)
TV	SCART (RGB, CVBS, Y/C, audio)	SCART (RGB, CVBS, Y/C, audio)
VCR	SCART (CVBS, Y/C, audio)	Scart (CVBS, Y/C, audio)
Audio L/R	2 x RCA Cinch	2 x RCA Cinch
Digital audio output	1 x RCA Cinch	1 x RCA Cinch

With the ultra compact DVB-S Slimline receivers CSR 10 FTA and CSR 10 CW you receive all free-to-air digital television and radio channels. In addition, the CSR 10 CW has an integrated CA module for receiving Cryptoworks encrypted programs (Arena/Bundesliga, ORF); released smart card required.

Main feature CSR 10 CW:

- Suitable for receiving Arena/ Bundesliga

Additional equipment features:

- Automatic software update - this means you will be notified when new software is available for download
- Support of single cable LNBs (SatCR technology)
- 800 pages of teletext memory
- 4000 station presets (3000 TV + 1000 radio)
- Stations from Astra, Hotbird and Türksat are pre-programmed
- 14 menu languages available
- Fast and interruption-free changing from one channel to another
- Up to 5 personal favourite lists
- EPG - electronic program guide, timer, PIG (Picture in Graphics), integrated teletext decoder
- Child protection and block function for specific channels
- SW update via OTA and Scart
- 7-event timer
- Separate power supply for energy savings
- Accessories: Remote control, batteries, Scart cable, operating instructions
- Colour: silver

Digital receivers for DVB-T

Type	CTR - X 01
-------------	-------------------

Order number 940 292-001



The DVB-T receiver CTR - X 01 is suitable for the reception of all terrestrial broadcast digital television stations, depending on the region also radio stations.

Main features:

- Swap function (change to previously viewed station via recall button)
- 1.000 station presets
- 12 menu languages
- 1 personal favourite list and 8 adjustable station groups
- Electronic program guide EPG, timer, integrated teletext decoder, child protection.
- Extremely low power consumption of only 2 W in standby mode
- RS 232C port for data transmission of software and station lists
- ROHS conformant
- Power switch
- Accessories: Remote control, batteries, operating manual
- Colour: silver

General data	
System	Corresponds to the DVB standard
Dimensions W x H x D	290 x 40,5 x 190 mm
Weight	1.15 kg
Ambient temperature	+5...+40 °C
Accessories	Remote control, batteries, without scart cable
Tuner input	
Input frequency	VHF: 174..230 MHz UHF: 470...862 MHz
Bandwidth	6 / 7 / 8 MHz
Input level range	31...89 dBµV
Input impedance	75 Ohm
Demodulator	
COFDM spectrum	2k, 8 k carrier
FEC mode	Rate 1/4, 1/8, 1
System resources	
Processor	32 bit (60 MHz)
DRAM	8 Mbyte
FLASH	2 Mbyte
Video decoder	
MPEG 2	Main Profile @ Main Level
Transmission speed	15 Mbit/s max
Video format	NTSC, PAL, Auto
Screen format	4:3, 4:3 Letterbox, 16:9
MPEG audio	
MPEG 2, MPEG 1, layer 1&2	mono, dual mono, stereo
Bit rate	32, 44.1 and 48 KHz
Teletext	STB standard
Software update	via RS 232C interface
Power supply	
Operating voltage	100...240 VAC (50/60 Hz)
Power consumption	10 W max
Remote feed voltage	5 V, 30 mA max
	For active antennas, switchable on the RF input
Connections	
Digital tuner input (antenna in)	IEC socket (in acc. w. IEC 169-24)
Rf loop-through output (Loop out)	IEC connector (in acc. w. IEC 169-24)
TV	SCART (RGB, CVBS, YUV, audio)
VCR	SCART (CVBS, Y/C, audio)
Dig. audio output	SPDIF, optical
Audio L/R, Digital Audio	3 x RCA Cinch
Data interface	Sub-D, 9-pole, data rate 115 Kb/s
Power switch front side (all off)	0 / 1

▶ Mechanical Accessories

Page 33 – Page 42

Mount, masts
Wall mounts
Antenna masts
Rafter mounts
Plug-in masts
Mast roof entry plates
Sealing collars
Clamps
Mast base bracket
Mast accessory sets
Earth strap, earth bar
Support for antennas



Introduction

Mast calculation

The conditions detailed in EN 50083-1 must be observed when mounting antennas on a mast.

The sum of the moments resulting from the intrinsic moment of the mast and the bending moments caused by the mounted antennas must not exceed the maximum permitted bending moments of the mast itself. The bending moment caused by an antenna is calculated with the following formula:

$$\text{Wind load (N)} \times \text{distance (m)} = \text{bending moment (Nm)}$$

The distance and bending moment refer to the top clamping point. Bending moments in excess of 1650 Nm require proof of structural stability

Wind load	x	distance	=	bending moment
¹⁾ 49 N	x	3.6 m	=	176.4 Nm
²⁾ 32 N	x	2.8 m	=	89.6 Nm
³⁾ 83 N	x	2.0 m	=	166.0 Nm
600 N	x	1 m	=	600.0 Nm
Total bending moment of the antennas				1032 Nm

The total bending moment for the antenna at 1032 Nm is less than the usable bending moment for the antenna to be mounted of 1041 Nm. Therefore the intended configuration is permitted!

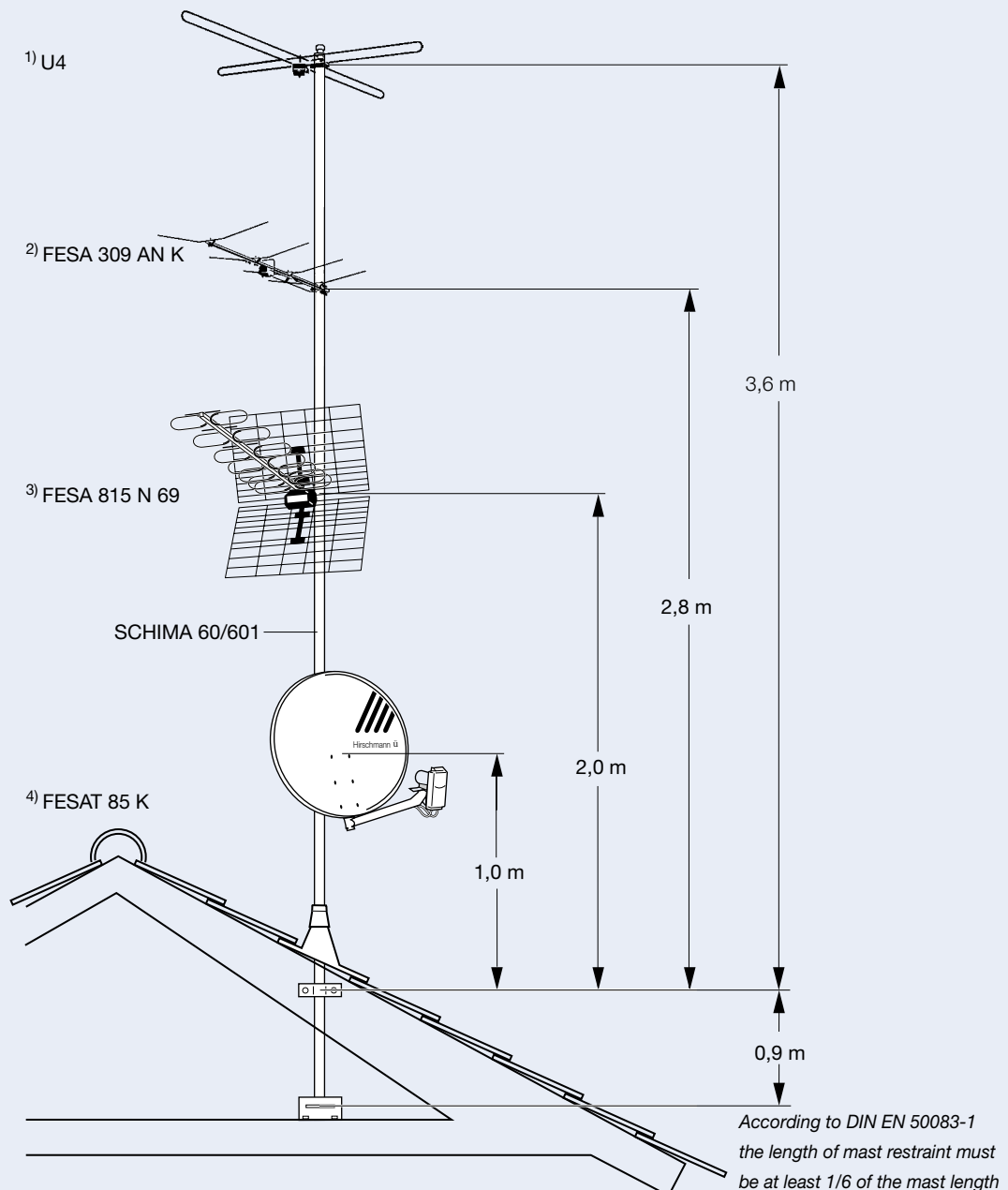

Mount for satellite antennas

Type	STG 60
------	---------------

Order number 981 000-073

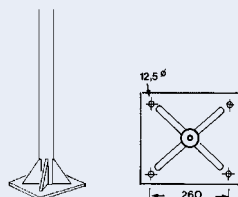

- Strong design
- Thick-walled pipe
- Hot-dip galvanised

Substructure		Mounting plate
Length	m	1.2
Diameter Ø	mm	60
Wall thickness	mm	3.6
Weight	kg	12.7
Use for antennas with Ø		m
		1.20

Masts

Type	MAR 60/200	MAR 60/300	MAR 89/300	MAR 48/200	MAR 48/300
------	-------------------	-------------------	-------------------	-------------------	-------------------

Order number 981 000-055 981 000-056 981 000-057 981 000-054 981 000-053



		981 000-055	981 000-056	981 000-057	981 000-054	981 000-053
Length	m	2.0	3.0	3.0	2.0	3.0
Diameter Ø	mm	60	60	89	48	48
Wall thickness	mm	3.4	3.4	3.4	2	2
Weight	kg	10	15	16	4.5	6.75
Use for antennas with Ø m		0.9	0.9	1.2/1.5/1.8	0.9 max	0.9 max
Max. permissible bending moment	Nm	1650	1650	3848	1180	1180
		(2035)	(2035)			

- For mounting satellite antennas on walls, roof beams etc.
 - Hot-dip galvanised
- ¹⁾ Note the restriction specified in EN 50083-1: 1650 Nm
For the value in parentheses sufficient static strength of the building must be verified

Wall mount

Type	MH 50
------	--------------

Order number 601 140-100

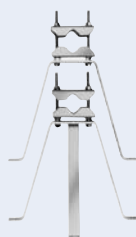

For mast Ø	mm	27-60
Distance from wall	mm	225
Weight	kg	2.45

- For fastening antenna to outside walls
- Only use masonry screws for wall fastening, do not use plastic plugs

Wall mounts

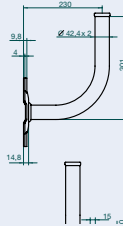
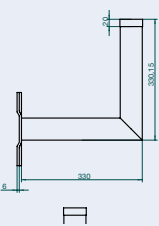
Type	MHR 42	MHR 60	
Order number	981 000-059	981 000-062	
			
Diameter	mm	42.4	60
Pipe thickness	mm	2.3	3.65
Distance from wall	mm	163	223
Bore diameter	mm	10	12
Weight	kg	2	5.4
Special property		for small parabolic antenna	
Use for		Hit FESAT 65/75	Hit FESAT 75/85

- For fastening parabolic antennas to outside walls
- Hot-dip galvanised
- Sealed with plastic plugs

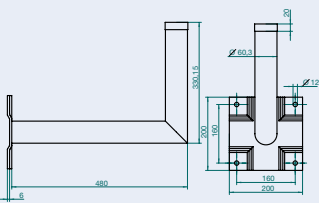
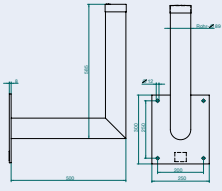
Type	MHR 61	MHR 89	
Order number	981 000-063	981 000-064	
			
Diameter	mm	60	89
Pipe thickness	mm	3.65	3.2
Distance from wall	mm	428	413
Bore diameter	mm	12	14
Weight	kg	6.3	12.7
Special property		Greater distance to wall for 90° installation, thus 180° swivel angle of the antenna	
Use for		ECO FESAT 80 S, Hit FESAT 65/75, FESAT 95 K, FESAT 120 K, ECO FESAT 65 S, FESAT 88 HiQ, FESAT 88 HiQ	

- For fastening parabolic antennas to outside walls
- Hot-dip galvanised
- Sealed with plastic plugs
- MHR 61 at greater distance to wall

Wall mounts

Type	WH 30	WH 40	WH 50
Order number	965 014-102	965 015-102	965 016-102

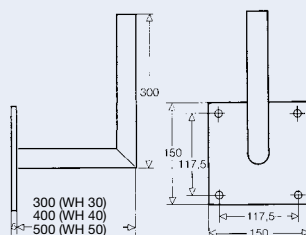

Diameter	mm	50	50	50
Pipe thickness	mm	3	3	3
Distance from wall	mm	300	400	500
Drill hole diameter	mm	11	11	11
Weight	kg	1.1	1.4	1.5
Use for		Hit FESAT 65, Hit FESAT 75, Hit FESAT 85, ECO FESAT 65 S	Hit FESAT 65, Hit FESAT 75, Hit FESAT 85, ECO FESAT 65 S,	Hit FESAT 65, Hit FESAT 75, Hit FESAT 85, FESAT 88 HiQ, ECO FESAT 80 S, ECO FESAT 65 S, FESAT 88 HiQ ECO FESAT 80 S, ECO FESAT 90 S

- For fastening parabolic antennas to outside walls
- Aluminium
- High stability thanks to special alu. profile
- Sealed with plastic plugs

Roof support system antenna masts

Type	UDR 1*	UDR 3*
Order number	981 000-018	981 000-019



Length	m	1	1
Attachment method		With screw pressed in	With screws or nails
Mast diameter	mm	21	34
Pipe thickness	mm	2	2

- For fastening terrestrial antennas on the roof support system

* Only in Austria, can also be delivered in other countries on request.

Plug-in antenna masts

Type	STEMA 42/200	STEMA 50/200	STEMA 50/300
------	--------------	--------------	--------------

Order number 811 077-102 813 775-102 813 775-103



- Can be plugged into same outer diameter
- Different lengths for economical combination
- Safeguards against twisting
- High-quality steel
- STEMA 42/... hot-dipped galvanised in Sendzimier method,
STEMA 50/..., hot-dipped galvanised

Length	m	2,0	2,0	3,0
Diameter Ø	mm	42	50	50
Wall thickness	mm	2	2	2
Weight	kg	3.92	4.74	7.12
Load carrying capacity of the antenna masts				
Total length	L_g m	2.00	2.00	3.00
Clamped length $L_c=1/6 L_g$	L_c m	0.33	0.33	0.50
Max. perm. bend. moment	M_g Nm	730	1040	1040
Antennas up to 20 m above ground				
Usable bending moment	M_n Nm	673	975	896
Intrinsic moment of mast	M_s Nm	57	64	144
Antenna over 20 m above ground				
Usable bending moment	M_n Nm	652	952	842
Intrinsic moment of mast	M_s Nm	78	88	198

Rafter mounts

Type	DSH 48/90	DSH 48/130
------	-----------	------------

Order number 940 138-001 940 139-001



DSH 48/90

- For roof installation of a parabolic antenna

DSH 48/130

- For roof installation of a parabolic antenna and additional FM antenna



Length	cm	90	130
Diameter	mm	48	48
Distance between rafters	cm	50-90	50-90
Slope	°	0-90	0-90
Frame size of the rafters	cm	58-98x14.8x4	58-98x14.8x4
Weight	kg	5.4	6.5
Material		Hot-dip galvanised steel	Hot-dip galvanised steel

Plug-in masts

Type	SCHIMA 48/500	SCHIMA 60/601
------	---------------	---------------

Order number	910 820-101	910 818-101
--------------	-------------	-------------

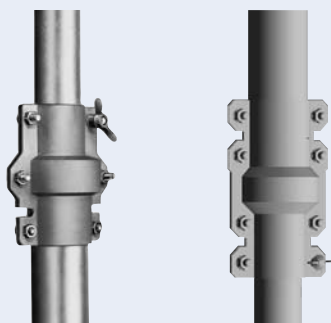

Total length	m	4.8	5.8
Diameter \varnothing /wall thickness,	inner pipe	mm	40/2.0
	outer pipe	mm	48/2.0
Number of cable inlets	4	5	
Weight	kg	11.3	18.4
Length as delivered	mm	2.6	3.1
Load carrying capacity of telescopic masts			
Total length	L_g m	4.8	5.8
Clamped length $L_e=1/6 L_g$	L_e m	0.80	0.95
Max. perm. bend. moment	outer pipe	M_g Nm	1055
			1650 (2058) ¹⁾
Antennas up to 20 m above ground			
Usable bending moment	M_n Nm	723	1041 (1449) ¹⁾
Intrinsic moment of mast	M_s Nm	332	609
Antenna over 20 m above ground			
Usable bending moment	M_n Nm	599	813 (1221) ¹⁾
Intrinsic moment of mast	M_s Nm	456	837

- Two-part
- Stop prevents the inner pipe from being pulled out
- Quick inner pipe fastening with wing nut
- Rubber sleeves included in the scope of delivery
- Hot-dipped galvanised with the Sendzimir method (SCHIMA 60/601 is only hot-dip galvanised)
- In accordance with EN 50083-1

¹⁾ The value in parentheses should only be used if adequate strength of the building component which bears the antenna has been verified mathematically.

Explanation:

This means for a minimum clamping length of 1/6 of the total pipe length:

M_n = Maximum bending moment on the upper clamping point, can be used for the antennas that will be installed.

M_s = intrinsic moment of the mast at the upper clamping point.

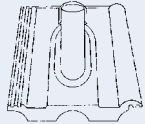
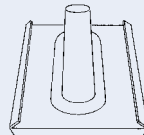
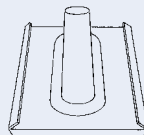

M_g = Maximum permissible bending moment of the mast.

Mast roof entry plates

Type	DAB 50-6	DAB 52-3 N	DAB 52-3 A	
Order number	601 113-100	601 131-101	940 224 001 (bare) 940 224 011 (graphite) 940 224 023 (brick-red)	
				
Diameter Ø	mm	60	t60	60
Material		Weather resistant black Plastic	Prop made of zinc sheet metal Plate made of leed sheet	Prop and plate made of Zink
Suitable for		"Frankfurter style" pan tile	universal	Universal
Dimensions	mm	410 x 330 2 mm thick	400 x 300 Prop 0.6 mm thick, Plate 0.8 mm thick	400 x 300 0.65 mm thick



- Roof covers for pitched roof 5° to 50°
- Please order additional seal collar

Sealing collars

Type	DAB 60-1	DAB 50-2	DAB 42-2	
Order number	910 822-101	601 026-101	601 025-101	
				
Diameter Ø	mm	32-60	48-57	40-48
For masts		STEMA 42/..., STEMA 50/..., SCHIMA 48/500, SCHIMA 60/601 DSH 48/.. MAR 48/.. MAR 60/..	STEMA 50/..., SCHIMA 48/500 MAR 48/.. MAR 60/.. DSH 48/..	STEMA 42/..., SCHIMA 48/500

- For rain-tight covering of mast roof entry plates
- Weather-resistant
- DAB 60-1: Self-sealing with additional clamp band

Clamps

Type	BEG 60 U	BEG 50 U	BEG 42 U	
Order number	810 910-100	810 909-100	810 971-100	
				
Diameter Ø	mm	60	48-50	42
For masts		SCHIMA 60/601	STEMA 50/..., SCHIMA 48/500	STEMA 42/...,

- For fastening antenna masts to straight and diagonal beams using two hex wood screws

Mast base bracket, mast cap

Type	MF 64	MAKA 15
Order number	940 162-001	910 231-100
		
Diameter Ø	mm 30-60	32-60
Material		Black plastic

MF 64

- For fastening antenna masts to almost horizontal roofs with 2 hex wood screws 8 x 45
- With integrated claw

MAKA 15

- End piece for antenna mast

Earth strap

Type	ERB 50
Order number	910 397-000
	
Diameter Ø	mm max. 60
Diameter Ø	mm -

- For equipotential bonding and for earthing in accordance with VDE 0855, Part 1

Mast accessory sets / rafter accessory set

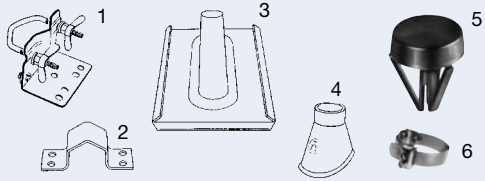
Type	MZ 60	MZ 50	MZ 89	DZ 48
Order number	910 852-102	910 851-102	913 689-102	940 207-001
				
For diameter Ø	mm 60	48 - 50	89	48 - 50
Mast base (1)	MF 64	MF 64	MAFU 89	-
Fixing clamp (2)	BEG 60 U	BEG 50 U	S 90	-
Mast roof entry plate (3)	DAB 52-3 N	DAB 52-3 N	BBZ 90	DAB52-3 N
Sealing collars/ Dichtband (4)	DAB 60-1	DAB 50-2	MAB 60; 2 St.	DAB 50-2
Mastcap/ pipe cover (5)	MAKA 15	MAKA 15	KK 90	-
Earth strap (6)	-	-	EB 1	-

- For fastening antenna masts (MZ....) or rafters (DZ....) and passing through the roof

Earth bar

- For clamping 10 HF cable screens and one earth wire
- Parts made of steel, surfaces are galvanised
- Specified application
- see EN 50083-1



Type	ES 6	
Order number	942 234-101	
HF cable diameter	mm	3-8
Earthing diameter Ø	mm	min. 2

Support for antenna, window support

TRAG 53

- For mounting one VHF III eller UHF IV/V antenna
- Made of steel, galvanised (sendzimier)

FETRA 2

- Light metal, for antennas with smaller dimensions 40 cm from mast
- Easy installation as the support can be fastened to the antenna on the previously mounted holding bracket.
- With drip protection ring

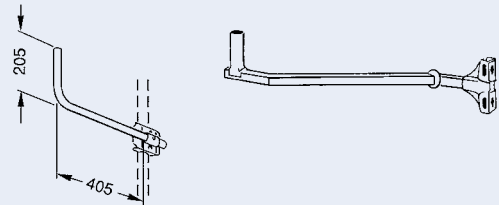

Type	TRAG 53		FETRA 2	
Order number	912 027-100		910 982-501	
Distance to antenna			40 cm from mast	
Diameter Ø	mm	max. 60	-	
Support pipe	mm	Ø 30 x 1.5	-	
Wind load	N	18	-	
Projection	cm	-	67	

Overview - CATV amplifiers

	Apartment amplifier		House connection amplifiers					
Product family	eco-power		eco-power +			eco-power +		
Use	Flats, detached and Semi-detached homes		Smaller building distribution systems					
With multimedia capability (return channel)	•		•			•		
Types	GHV 24 E	GHV 20 M	GHV 20 E	GHV 820 A	GHV 820 C	GHV 30 E	GHV 833	
Mains supply 230V								
Remote feeding								
HF - connections	F	F	F	F	F	F	F	
Level attenuator	• Pot.	• Pot.	• Pot.	• Pot.	• JME	• Pot.	• Pot.	
Line equaliser				• Pot.	• JME	•	• Pot.	
Interstage preemphasis								
Return path options	-	p	-	p, a	p, a	-	p	
ROB ¹⁾	-	-	-	•	•	-	-	
VHF/RF switch over	-	-	-	-	•	-	-	
Return path modules	-	-	-	-	-	-	-	
5 - 30 MHz	-	-	-	-	-	-	•	
5 -65 MHz	-	•	-	•	•	-	-	
Output level (forward)								
IMA3 > 60 dB (EN 50083-5) dBµV	103	103	113	113	113	115	115	
CSO > 60 dB (CENELEC 42Ch) dBµV	91	87	97	97	99	101	103	
CTB > 60 dB (CENELEC 42Ch) dBµV	91	90	100	100	101	101	103	
Basic gain	dB							
	17/18	10/12	21	21	21	29	29	

1) ROB: Return channel on board with VHF switchover

2) Can be switched from 862 MHz to 606 MHz

3) Interstage Slope 7 dB

4) Regulated output level range

5) 5/8" connection on request

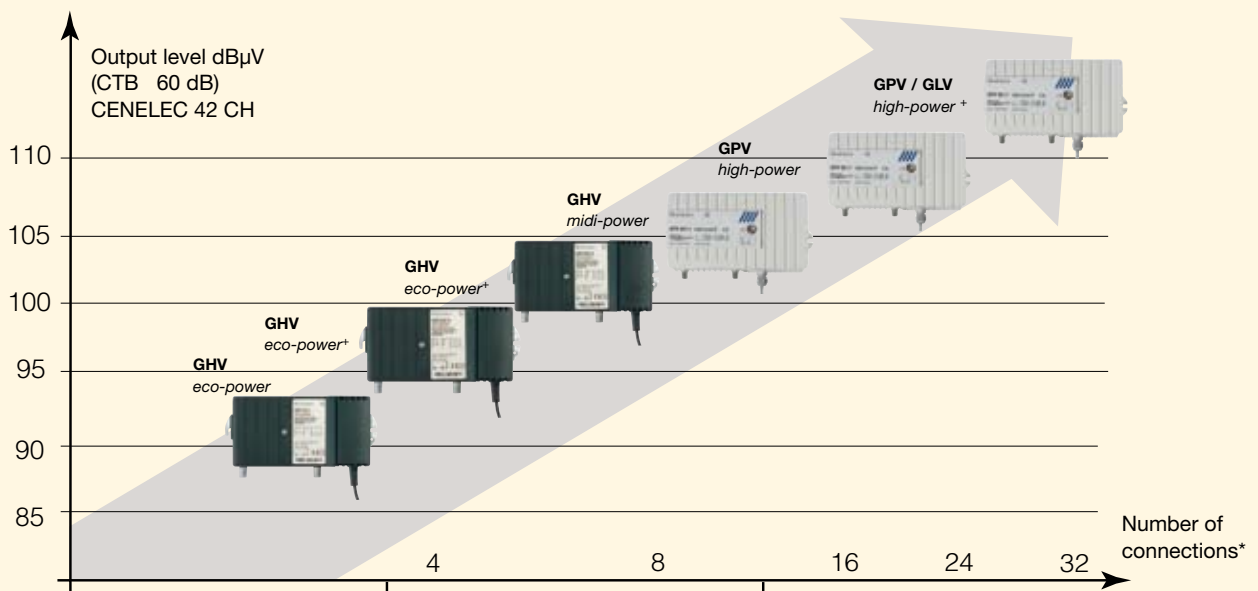

Line / distribution / control amplifiers

		medi-power	high-power		high-power +	
		Medium-sized building	Large house installations		CATV distribution distribution	Line amplifier installations
GHV 830 A	GHV 830 C	GHV 834 C	GPV 845 E	GPV 845 C 845 CF	GPV 851 I 851 F	GPV 865 F 865 F AGC
F	F	F	F	F 5/8" ⁵⁾	F	PG11 PG11
• Pot. • Pot.	JME JME •	JME JME •	• Pot. • Pot. •	JME JME •	• Pot. • Pot. ²⁾ •	• Pot. • Pot. ²⁾ •
p, a • - - •	p, a • • - - •	p, a • • - - •	- - - - -	p, a • • • • •	p, a m • • • •	p, a m • • • •
115	115	118	123	123	124	124 (124)
101	103	106 ³⁾	111 ³⁾	111 ³⁾	114 ³⁾	114 ³⁾
101	102	105 ³⁾	110 ³⁾	110 ³⁾	114 ³⁾	(95 - 105) ⁴⁾
30	30	34	36/30	36/30	36/29	36/29 28

Pot. = potentiometer
 JME = Jumper Matrix Elemente
 p = passive return channel
 a = active return channel
 m = return path via plug-in modules

Application example

- A : Home connection point
- B : House connection amplifiers
GHV... / GPV...
- C : Tap-off AFC 1861
- D : Antenna outlet socket EDU 04 F
- E : Line amplifier GLV 865 F
- F : Tap-off

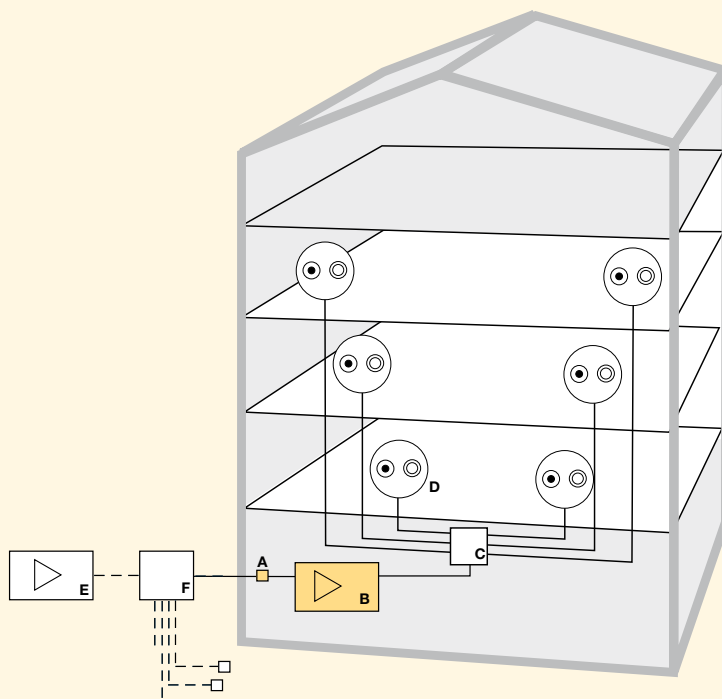

House connection amplifier reco-power

Small but powerful

The house connection amplifiers are optimal CATV amplifiers for smaller building units without return channel utilisation.

GHV 20 E and GHV 30 E.

These inexpensive amplifiers are suitable for digital TV and ideal for use in (MATV and SMATV) systems.

- Very efficient with extremely low power consumption
- Compact integrated transformer power supply unit with permanent screw-on housing
 - Shock protection even when the amplifier is opened
- Control elements:
 - Removable cover main screw allows easy configuration
 - Not accessible when closed thus protected from tampering
- The die-cast basic housing reduces component temperature to increase service life and reliability.
- Satisfies the standards
 - EN 60065
 - EN 50083-1
 - EN 50083-2, Class A
 - EN 50083-3, quality class 2

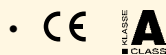

GHV 24 E

CATV indoor distribution amplifier with integrated 4-way tap-off

The GHV 24 E apartment amplifier has 4 outputs for direct, point-to-point distribution of analog and digital signals.

The ideal distributor amplifier without return channel utilisation for

- Apartments
- Family homes and semi-detached homes
- Small apartment blocks
- Single floors in large apartment blocks

Special features:

- Amplification adjustable from 0 to 18 dB
- Outputs decouples using directional coupler
- TV band I compatible
- 1 GHz amplifier technology
- High level output at low power consumption
- High-quality die-cast housing with integrated power supply unit
- Compatible with standards
 - EN 60065, EN 50083-1,
 - EN 50083-2, Class A
 - EN 50083-3, quality class 2,



Advantages offered by the compact solution:

No external tap-offs, or distributors, therefore:

- Easier and visually appealing installation in residential buildings
- Increased reliability
- Cost advantages

Type	GHV 20 E	GHV 30 E	GHV 24 E
------	----------	----------	----------

Order number	940 023-001	940 024-001	941 081-001
--------------	-------------	-------------	-------------



Frequency range				
Return/forward MHz	-- / 40...862	-- / 40...862	-- / 40...862	
	(1000)	(1000)	(1000)	
Gain				
@ 862 MHz	dB	21	29	
@ 862 MHz output 1	dB			16
@ 862 MHz output 2, 3, 4	dB			17
Level attenuator	dB	0...20	0...20	0...20
Linearity amplitude frequency response				
40...862 (1000) Mhz	dB	1.5 (3)	1.5 (3)	1.5
Fixed slope	dB	+1	+1	+1
Noise factor	dB	4.5	4.5	4.5
Return loss				
40 MHz, -1.5 dB/octave	dB	>14	>14	>14
Output level, IMA = 60 dB				
IMA 2 in acc. with EN 50083-3	dBµV	100	105	92
IMA 3 in acc. with EN 50083-5	dBµV	113	115	103
CSO Cenelec 42 chan. 862 MHz	dBµV	97	101	91
CTB Cenelec 42 chan. 862 MHz	dBµV	100	101	91
HF connectors (75 Ω)				
Input		F-socket	F-socket	F-socket
Output		F-socket	F-socket	F-socket
Decoupling of outputs	dB			30
Operating conditions				
Maximum output level (EMC)	dBµV	105	105	105
Dimensions W x H x D	mm	150 x 80 x 50	150 x 80 x 50	150 x 80 x 50
Operating voltage	V	230 10%	230 10%	230 10% Power
Power consumption	W	3	5	5
Operating temperature range	°C	-25 ... +55	-25 ... +55	-25 ... +55
Protection class	II		II	II
Protection class (IP)		IP 20	IP 20	IP 20
Weight	kg	0.64	0.64	0.64
RoHS 2002/95/EC conformant		yes	yes	yes

House connection amplifier *eco-power*

Type
GHV 20 M

Order number

940 030-061

**Four decoupled
Outputs**



		Forward	reverse
Frequency range	MHz	85...862	5...65
Gain			
@ 862 (65) MHz output 1 (data)	dB	12	-1.0
@ 862 MHz output 2, 3, 4	dB	10,5	
Level attenuator	dB	0...20	
Linearity amplitude frequency response	dB	1.5	
Noise factor	dB	4.5	
Return loss			
@ 40 Mhz, -1.5 dB/octave	dB	>14	
Output level, IMA = 60 dB			
IMA 2 in acc. with EN 50083-3	dB μ V	90	
IMA 3 in acc. with EN 50083-5	dB μ V	103	
CSO Cenelec 42 chan. 862 MHz	dB μ V	87	
CTB Cenelec 42 chan. 862 MHz	dB μ V	90	
HF connectors (75 Ω)			
Input		F-socket	
Output		F-socket	
Operating conditions			
Maximum output level (EMC)	dB μ V	105	
Dimensions W x H x D	mm	150 x 80 x 50	
Operating voltage	V	230	
Power consumption	W	3	
Operating temperature range	$^{\circ}$ C	-25 ... +55	
Protection class		II	
Protection class (IP)		IP 20	
Weight	kg	0.65	
RoHS 2002/95/EC conformant		yes	

GHV 20 M
CATV in-premises amplifier with integrated 4-way tap-off

The GHV 24 E apartment amplifier has 4 outputs for direct, point-to-point distribution of analog and digital signals.

The ideal distribution amplifier with return channel applications

- Apartments
- Family homes

Special features:

- Return channel capable data output 1 5...65 MHz
- Outputs decoupled via directional couplers
- High-quality die-cast housing with integrated power supply unit
- Compatible with standards EN 60065, EN 50083-1, EN 50083-2, Class A EN 50083-3, quality class 2,



Advantages offered by the compact solution:

No external tap-offs, or splitters, therefore:

- Easier and visually appealing installation in residential buildings
- High decoupling between data return channel and other connections suppresses interference
- Increased reliability
- Cost advantages

House connection amplifier *reco-power* with return channel (passive/active)

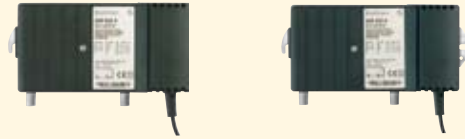
Type	GHV 820 A	GHV 830 A
Order number	940 020-065	940 022-065



GHV 820 A/GHV 830A

The optimal solution for preparing house distribution networks for expansion. The multimedia enabled amplifiers are suitable for digital TV and interactive services, and ideal for implementation in smaller building units and CATV domestic networks.

"All on board".

- Forward channel for TV band 1 or return channel are alternatively available through configuration of the diplex filters
- **Integrated return channel amplifier can be connected via jumper**
- **Return channel optionally active/passive/blocked.**
- Compatible with standards EN 60065, EN 50083-1, EN 50083-2, Class A EN 50083-3, quality class 2



Frequency range MHz			
Setting: VHF I "on", RC "off"		-/40...862	-/40...862
Setting: VHF I "off", RC "on"		5...65 /85...862	5...65 /85...862
Gain forward			
@ 862 Mhz	dB	21	30
Level attenuator	dB	0...20	0...20
Line equaliser	dB	0..18	0...18
Amplification backward			
@ 60 MHz via output 1	dB	-1,5/20	-1,5/24
Level attenuator (input RC)	dB	0...20	0...20
Attenuation Jumper (output RC)	dB	0/10	0/10
Linearity amplitude frequency response			
40...862 (1000) MHz	dB	1.5	1.5
Noise factor			
forward (VHF I "on")	dB	5.5	5.5
Return loss			
@ 40 Mhz, -1.5 dB/octave	dB	>14	>14
Output level forward			
IMA/IMA >60 dB	dB μ V	100/113	105/115
CSO/CTB >60 dB, 42 ch,	dB μ V	97/100	101/101
HF connectors (75 Ω)			
Input		F-socket	F-socket
Output		F-socket	F-socket
Operating conditions			
Maximum output level (EMC)	dB μ V	105	105
Dimensions W x H x D	mm	150 x 80 x 50	150 x 80 x 50
Operating voltage	V	230 10%	230 10%
Power consumption	W	4.5	6
Operating temperature range	$^{\circ}$ C	-25 ... +55	-25 ... +55
Protection class		II	II
Protection class (IP)		IP 20	IP 20
Weight	kg	0.64	0.64
RoHS 2002/95/EC conformant		yes	yes

House connection amplifier/reco-power with return channel (passive/active)

Type	GHV 820 C	GHV 830 C
Order number	940 020-062	940 022-062



Frequency range			
Setting: VHF I "on", RC "off"	MHz	-/40...862	-/40...862
Setting: VHF I "off", RC "on"	MHz	5...65 /85...862	5...65 /85...862
Gain forward			
@ 862 MHz	dB	21	30
Attenuator (2 dB increments) input	dB	0...16	0...16
Line equalisation (2.5 dB increments)	dB	0...16	0...16
Gain return path			
@ 60 MHz on output 1	dB	-1.5/20	-1.5/25
Attenuator increments input	dB	0/3/6/9/50	0/3/6/9/50
Attenuator increments output	dB	0/10	0/10
Linearity amplitude frequency response			
40...862 (1000) MHz	dB	1.5	1.5
Fix slope	dB	+1	+1
Linearity amplitude frequency response			
5...60 MHz	dB	1.5	1.5
Noise factor			
forward (VHF I "on")	dB	5	5
return path (VHF I "off")	dB	6	6
Return loss			
@ 40 Mhz, -1.5 dB/octave	dB	>14	>14
Output level forward			
IMA2 >60 dB	dB μ V	100	105
IMA3 >60dB	dB μ V	113	115
CSO >60 dB, 42 ch, Slope 0/7	dB μ V	97/99	101/103
CTB >60 dB, 42 ch, Slope 0/7	dB μ V	100/101	100/102
HF connectors (75 W)			
Input		F-socket	F-socket
Output		F-socket	F-socket
Operating conditions			
Maximum output level (EMC)	dB μ V	110	110
Dimensions W x H x D	mm	150 x 80 x 50	150 x 80 x 50
Operating voltage	V	230 10%	230 10%
Power consumption	W	5	6
Operating temperature range	°C	-25 ... +55	-25 ... +55
Protection class		II	II
Protection class (IP)		IP 20	IP 20
Weight	kg	0.64	0.64
RoHS 2002/95/EC conformant		yes	yes

GHV 820 C/GHV 830 C

GHV 820 C and GHV 830 C are multimedia-enabled house connection amplifiers for smaller to medium-sized building units. All important function units such as forward amplifier, diplex filters, return channel amplifier and the associated actuators are completely implemented on the PCB.

Easy migration of the return channel "TV band I" or "return channel 65 MHz" can be selected, return channel switchable: "active or "passive". Adjustment of the return channel amplification by means of adjustable attenuators on the input and output

Structure

- Increased long-term stability thanks to discrete, switchable attenuators and equalisers (i.e. potentiometers are not used)
- Compact integrated transformer power supply with permanent screw-on plastic hood as shock protection
- Maximum output level 110 dB μ V
- Compatible with standards EN 60065, EN 50083-1, EN 50083-2, Class A, EN 50083-3, quality class 2,



House connection amplifier *midi-power* with return channel (passive/active)

Type	GHV 834 C
Order number	940 030-062



GHV 834 C

GHV 834 C is a multimedia-enabled house distribution amplifier for medium-sized building units. All important function units such as forward amplifier, diplex filters, return channel amplifier and the associated actuators are completely implemented on the PCB. Easy migration of the return channel "TV band I" or "return channel 65 MHz" can be selected, return channel switchable: "active or "passive" adjustment of the return channel amplification by means of adjustable attenuators on the input and output

Structure

- Increased long-term stability thanks to discrete, switchable attenuators and equalisers (i.e. potentiometers are not used)
- Compact integrated transformer power supply with permanent screw-on plastic hood as shock protection
- Maximum output level 110 dB μ V
- Compatible with standards EN 60065, EN 50083-1, EN 50083-2, Class A EN 50083-3, quality class 2,



Frequency range		
Setting: VHF I "on", RC "off"	MHz	-/40...862
Setting: VHF I "off", RC "on"	MHz	5...65 / 87...862
Gain forward		
@ 862 MHz	dB	34
Attenuator input (2 dB increments)	dB	0...16
Line equaliser (2.5 dB increments)	dB	0...16
Interstage pre-equalisation	dB	0/7
Gain return path		
@ 60 MHz on output 1	dB	-1.5/26
Attenuator increments input	dB	0/3/6/9/50
Attenuator increments output	dB	0/10
Linearity amplitude frequency response		
47...862 MHz	dB	1.5
Fix slope	dB	+2
Noise factor	dB	6
Return loss		
@ 40 MHz, -1.5 dB/octave	dB	>14
Output level, IMA = 60 dB		
IMA 2 in acc. with EN 50083-3	dB μ V	112
IMA 3 in acc. with EN 50083-5	dB μ V	118
CSO (42 chan. 862 MHz) Slope 0/7	dB μ V	104 / 106
CTB (42 chan. 862 MHz) Slope 0/7	dB μ V	103 / 105
HF connectors (75 Ω)		
Input		F-socket
Output		F-socket
Operating conditions		
Maximum output level (EMC)	dB μ V	110
Dimensions W x H x D	mm	150 x 80 x 50
Operating voltage	V	230 +6 / -10%
Power consumption	W	7.5
Operating temperature range	$^{\circ}$ C	-25 ... +55
Protection class		II
Protection class (IP)		IP 20
Weight	kg	0.68
RoHS 2002/95/EC conformant		yes

Line / distribution amplifiers *high-power*

Type	GPV 845 C	GPV 845 CF
Order number	940 153-061	940 154-061

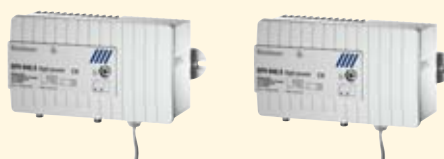

Frequency range MHz			
Setting: VHF I "on", RC "off"		-/40...862	-/40...862
Setting: VHF I "off", RC "on"		5...65 /85...862	5...65 /85...862
Gain forward			
@ 862 Mhz	dB	36	36
Attenuator (2 dB increments) input	dB	0...16	0...16
Equaliser (2 dB increments) input (jumper)	dB	0...16	0...16
Interstage / equalisation (jumper)	dB	0/6	0/6
Interstage / equalisation (jumper)	dB	0/7	0/7
Gain return path			
@ 60 MHz	dB	-1.5/26	-1.5/26
Attenuation on the input	dB	0/2/4/6/50	0/2/4/6/50
Attenuation on the output	dB	0/3/6/9	0/3/6/9
Linearity amplitude frequency response			
40...862 (1000) Mhz	dB	1.5	1.5
Fix slope	dB	+1	+1
Linearity amplitude frequency response			
5...60 MHz	dB	1.5	1.5
Noise factor			
forward (VHF I "on")	dB	5.5	5.5
Return channel (VHF I "off")	dB	6	6
Return loss			
@ 40 Mhz, -1.5 dB/octave	dB	>14	>14
Output level forward			
IMA2 >60 dB	dB μ V	114	114
IMA3 >60 dB	dB μ V	123	123
CSO >60 dB, 42 ch, Slope 0/7	dB μ V	109/111	109/111
CTB >60 dB, 42 ch, Slope 0/7	dB μ V	108/110	108/110
HF connectors (75 Ω)			
Input		F sockets	F sockets
Output		F sockets	F sockets
Operating conditions			
Maximum output level (EMC)	dB μ V	113	113
Dimensions WxHxD	mm	150x80x50	150x80x50
Operating voltage	V	180...253	25...65
Power consumption			
Operating temperature range	$^{\circ}$ C	-25 ... +55	-25 ... +55
Protection class		II	II
Protection class (IP)		IP 65	IP 65
Weight	kg	2	0.64
RoHS 2002/95/EC conformant		yes	yes

GPV 845 C / CF

GPV 845 C (CF) is a multimedia-enabled house connection amplifier for medium-sized to larger building units. It is used to compensate the cable and distribution attenuation in the CATV domestic network. "All on board" - all important functional units such as forward amplifier, diplex filters, return channel amplifier and the associated actuators are completely implemented on the PCB. The amplifier is configured for the specific case via jumpers in the device and settings can be made during installation as well as operation.

- Easy migration of the return channel without additional modules. Either "TV band I" or "Return channel 65 MHz" ¹⁾ can be selected. Adjustable return channel: "active" / "passive" / "off". Optimal adjustment of the return channel amplification (C/N) by means of adjustable at the input and output.
- Increased long-term stability due to discrete, switchable attenuators and equalisers, i.e. neither potentiometers nor a large number of plug-in pads are necessary
- High output level with extremely low power consumption thanks to MMIC GaAs push/pull output stage and switched-mode, high-efficiency power supply
- Long service life through low temperature development (low power consumption and diecast housing with cooling fins and extensive protection against ESD and surge voltage)
- Power supply GPV 845 C
Local supply from 230 V
- domestic network
GPV 845 CF remote feeding via coaxial HF input
- Compatible with standards
EN 60065, EN 50083-1,
EN 50083-2, Class A
EN 50083-3, quality class 2,



Line / distribution amplifiers *high-power*

Type **GPV 845 E**

Order number 940 153-001



GPV 845 E

GPV 845 E is a variant of the high-power GPV 845 house connection amplifier family, especially equipped for MATV installations with local SMATV headends that do not provide any interactive services via this network.

Features:

- Only the forward path - including VHF band I is implemented
- Level adjuster and line equaliser with potentiometers.
- High output level at extremely low power consumption through MMIC GaAs push/pull output stage and switched-mode, high-efficiency

Power supply:

- Local supply from 230 V domestic network
- Compatible with standards EN 60065, EN 50083-1, EN 50083-2, Class A, EN 50083-3, quality class 2,

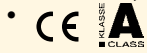

Frequency range MHz	40...862	
Gain forward		
@ 862 Mhz	dB	36
Attenuator / input	dB	0...20
Line equaliser / input	dB	0...17
Interstage attenuation	dB	0/6
Interstage pre-equalisation	dB	0/7
Linearity amplitude frequency response		
40...862 (1000) Mhz	dB	1.5
Fix slope	dB	+1
Noise factor	dB	5
Return loss		
@ 40 Mhz, -1.5 dB/octave	dB	>14
Output level, IMA = 60 dB		
IMA 2 in acc. with EN 50083-3	dBµV	114
IMA 3 in acc. with EN 50083-5	dBµV	123
CSO (42 chan. 862 MHz) Slope 0/7	dBµV	109 / 111
CTB (42 chan. 862 MHz) Slope 0/7	dBµV	108 / 110
HF connectors (75 Ω)		
Input	F-socket	
Output	F-socket	
Test point output (bi-directional)	F-socket, -20 dB	
Operating conditions		
Maximum output level (EMC)	dBµV	105
Dimensions W x H x D	mm	150 x 80 x 50
Operating voltage	V	180...253
Power consumption	W	6.4
Operating temperature range	°C	-25 ... +55
Protection class	II	
Protection class (IP)	IP 65	
Weight	kg	2.0
RoHS 2002/95/EC conformant	yes	

House connection amplifier high-power +
GPV 851 I
GPV 851 F

Order number

944 770-013

944 777-001



Frequency range	MHz	
Device without return channel modules	47 ... 862	47 ... 862
Gain		
@ 862 Mhz	dB	36
Level attenuator	dB	0 ... 20
Interstage slope	dB	0/7
Linearity amplitude frequency response		
47...862	MHz	1.5
Lineequaliser	dB	0 ... 18
Equalisation / switchable	MHz	862 / 606
Interstage / pre-equalisation	dB	0/7
Noise factor		
Noise factor	dB	7
Return loss		
@ 40 Mhz, -1.5 dB/octave	dB	>14
Output level forward		
IMR2/IMR3 >60 dB	dB μ V	117 / 124 dB μ V
CSO/CTB >60 dB, 42 ch,	dB μ V	113 / 112 dB μ V
Pre-equalisation 7 dB	dB μ V	114 / 114 dB μ V
HF connectors (75 Ω)		
Input		F-socket
Output		F-socket
Test point input: bi-directional	dB	-30 dB
Test point output: bi-directional	dB	-30 dB
Operating conditions		
Maximum output level (EMC)	dB μ V	113 dB μ V
Dimensions W x H x D	mm	190 x 110 x 85
Operating voltage	V	195 ... 244 V
Power consumption	W	13
Operating temperature range	°C	-40°... +55°C
Protection class		II
Protection class	(IP)	65
Weight	kg	2.0
Standards		EN 50083-3, Class 2
Product standard		EN 50083-1; EN 60065
Safety standards		EN 50083-2
EMC		yes
RoHS 2002/95/EC conformant		

GPV 851 I / GPV 851 F

- Implementation in local CATV distribution networks to 862 MHz
- Power doubler output stage
- HF connectors with F sockets (female)
- Die-cast housing, protection class IP 54 (when using the appropriate F connectors), for installation inside and outside of buildings
- Local supply or remote feed
- Two basic amplifications selected using internal jumpers (Interstage)
- Equalisation with internal jumpers can be switched from 606 MHz or 862 MHz
- Level adjuster on the input
- Equalisation frequency-dependent line attenuator on the input
- Return channel
(in conjunction with plug-in modules)
 - passive with diplex module
 - active with return channel module
- With diplex modules individual configurable return channel and Forward channel 5-30 MHz 47-862 MHz, 5-65 MHz, 85-862 MHz
- Return channel modules, with adjusters for level and frequency-dependent line attenuation
- Screw clamp for equipotential bonding outside on the housing
- Satisfies EN 50083-1, 2 return loss in accordance with EN 50083-3 quality class 2

Note

- Diplex and return channel modules are listed after the line/distribution amplifiers
- Remote feed version GPV 851 F
- Selectable remote feed route:
 - via input
 - via output
 - feed through

Line/distribution amplifier

Type	GLV 865	GLV 865 F
Order number	944 409-002	944 410-002
		
Frequency range	MHz	
Basic device without return channel modules	47 ... 862	47 ... 862
Gain		
@ 862 Mhz	dB 36	36
Level attenuator	dB 0 ... 20	0 ... 20
Interstage attenuation	dB 0/7	0/7
Linearity amplitude frequency response		
47...862	MHz 1.5	1.5
Line equaliser	dB 0 ... 18	0 ... 18
Equalisation / switchable	MHz 862 / 606	862 / 606
Interstage / pre-equalisation	dB 0/7	0/7
Noise factor		
Noise factor	dB 7	7
Return loss		
@ 40 Mhz, -1.5 dB/octave	dB >14	>14
Output level forward		
IMR2/IMR3 >60 dB	dBµV 117 / 124	117 / 124
CSO/CTB >60 dB, 42 ch,	dBµV 113 / 112	113 / 112
Pre-equalisation 7 dB	dBµV 114 / 114	114 / 114
HF connectors (75 Ω)		
Input	PG 11	PG 11
Output	PG 11	PG 11
Test point input:	bi-directional - 20 dB	- 20 dB
Test point output:	bi-directional - 20 dB	- 20 dB
Operating conditions		
Maximum output level (EMC)	dBµV 113	113
Dimensions W x H x D	mm 190 x 110 x 85	190 x 110 x 85
Operating voltage	V 195 ... 244	32 ... 65
Power consumption	W 13	14
Operating temperature range	°C -40°... +55°C	-40°... +55°C
Protection class	II	II
Protection class (IP)	65	65
Weight	kg 2.0	2.0
Standards	EN 50083-3, Class 2	EN 50083-3, Class 2
Product standard	EN 50083-1; EN 60065	EN 50083-1; EN 60065
Safety standards	EN 50083-2	EN 50083-2
EMC		
RoHS 2002/95/EC conformant	yes	yes

GLV 865/865 F

- Implementation in CATV distribution networks to 862 MHz
- Power doubler output stage
- HF connectors for PG 11
- Screw-fastening
- Diecast housing, protection class IP 65 for installation inside and outside of buildings
- Cascading up to 5 devices
- Local supply or remote feed
- Two basic amplifications selectable with internal jumpers (Interstage)
- Equalisation with internal jumpers can be switched from 606 MHz or 862 MHz
- Return channel (in conjunction with plug-in modules)
 - passive with diplex module
 - active with return channel module
- With diplex modules individual configurable return channel and Forward channel 5-30 MHz 47-862 MHz 5-65 MHz 85-862 MHz
- Return channel modules, with adjusters for level and frequency-dependent line attenuation
- GLV...F: remote feed via input, output or loop-through of the remove feed voltage can be selected by plugging fuses into different sockets
- Additional internal terminals for direct feed voltage connection
- Internal F test sockets on input and output for forward channel and return channel measurements
- Input and output are surge protected
- Screw clamp for equipotential bonding on the exterior of the housing
- Satisfies EN 50083-1, -2, 50083-3 Class 2

Note

- Diplex and return channel modules are listed after the line/distribution amplifiers
- Compatible with standards EN 60065, EN 50083-1, EN 50083-2, Class A EN 50083-3, quality class 2,

Line / distribution amplifiers with automatic level control

Type	GLV 865 AGC		GLV 865 F AGC	
Order number	944 786-002		944 799-002	
				
Frequency range ¹⁾	MHz	47 ... 862	47 ... 862	
Basic gain	dB	28	28	
Noise factor	dB	7	7	
Output level in accordance with DIN EN 50083				
at 60 dB IMA second order	dB μ V	117	117	
at 60 dB IMA third order	dB μ V	124	124	
Cenelec ²⁾ CSO at 100 dB μ V	dB	69	69	
CTB at 100 dB μ V	dB	78	78	
Total level analysis	MHz	47 ... 320	47 ... 320	
Setting range	dB μ V	95 - 105	95 - 105	
Delivery condition	dB μ V	100	100	
Control stroke	dB	\pm 5		
Return loss on				
input and output	dB	18	18	
Impedance	Ω	75	75	
Adjustable line equaliser	dB	0...18	0...18	
Level adjuster	dB	0...18	0...18	
Test sockets internal F				
on the input bi-directional	dB	-20	-20	
on the output directional	dB	-20	-20	
Operating voltage	V \sim	230	32 - 65	
Power consumption	W	14	14 (at 40 V)	
Max. admissible current of the remote feed	A	-	3.5	
Ambient temperature range				
in accordance with EN 60065	$^{\circ}$ C	-20 ... +55	-20 ... +55	
Functional in the temperature range	$^{\circ}$ C	-40 ... +60	-40 ... +60	
Housing				
Weight	kg	approx. 2.0	approx. 2.0	
Dimensions W x H x D	mm	190 x 110 x 80	190 x 110 x 80	
HF connectors 75 W		PG11 thread	PG11 thread	

¹⁾ Basic device without diplex module and without active return channel module

²⁾ 42 channels

Description

- Line and distribution amplifiers for implementation in CATV / installations
- Local feed (GLV 865 AGC) or remote feed GLV 865 F AGC:
- Frequency range 862 MHz
- AGC - automatic level control for compensating attenuation fluctuations in the cable network; total load control 47-320 MHz
- Power doubler GaAs hybrid
- Cascading up to 5 devices
- With diplex modules individually configurable
- Return channel optionally active with adjuster for level and frequency-dependent line attenuation
- Level adjuster
- Operating display LED, internal
- Equalisation of frequency-dependent, line attenuation, adjustable
- GLV 865 F AGC: Remote feed via input, output or loop-through of the remote feed voltage
- Internal F test sockets on the input and output
- HF connections for PG 11 screw-fastening, adapters are available to F 5/8", IEC M14 and 3.5/12
- Diecast zinc housing, protection class IP 65 with screw terminal for equipotential bonding
- Satisfies EN 50083-3, quality class 2,

Note

- Diplex and return channel modules are listed after the line/distribution amplifiers
- Compatible with standards EN 60065, EN 50083-1, EN 50083-2, Class A EN 50083-3, quality class 2,

Modules for house connection amplifiers GPV... and line/distribution amplifiers GLV

Diplex modules for house connection amplifiers GPV...

and line/distribution amplifiers GLV ...

- Diplex modules passively distribute the frequency range in return channel and forward channel

Additional versions are available on request!

Diplex modules		GRM 3047 P	GRM 6585 P
Order number		944 412-001	944 416-001
Frequency range			
Return channel	MHz	5-30	5-65
Forward channel	MHz	47- 862	85-862
Throughpass attenuation			
Return channel	dB	1	1
Forward channel	dB	1	1
Return loss	dB	20	20
Decoupling between			
Forward channel / return channel	dB	63	63
Environmental temperature range	°C	-20 to +80	

Return channel amplifier modules for house connection amplifiers GPV ...

and Line/distribution amplifiers GLV ...

- Equaliser and level adjuster on the module input
- Use for high input level of the return channels

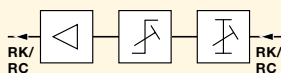

Additional versions are available on request!

Return channel modules		GRM 3005 G	GRM 6505 G
Order number		944 411-001	944 419-001
Frequency range	MHz	5-30	5-65
Gain	dB	20	20
Frequency response	dB	1	1
Noise factor	dB	7	7
Output level			
IMA2 P 60 dB (EN 50083-3)	dB μ V	110	110
IMA3 P 60 dB (EN 50083-5)	dB μ V	118	118
Return loss on			
input and output	dB	20	20
Adjustable line equaliser	dB	0-10	0-10
Level adjuster	dB	0-10	0-10
Current consumption of the internal operating voltage 24 V	mA	approx. 60	approx. 60
Environmental temperature range	°C	-20 to +80	-20 to +80

Return channel amplifier modules for house connection amplifiers GPV ... and Line/distribution amplifiers GLV ...

- Equaliser and level adjuster on the module - output
- Better signal/noise ratio for RC input level below 90 dB

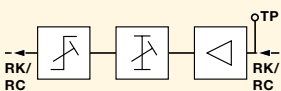

Additional versions are available on request!

Return channel modules		GRM 2030 G	GRM 2065 G
Order number		944 414-002	944 420-002
Frequency range	MHz	5-30	5-65
Gain	dB	20	20
Frequency response	dB	1	1
Noise factor	dB	5	5
Output level			
IMA2 P 60 dB (EN 50083-3)	dB μ V	108	105
IMA3 P 60 dB (EN 50083-5)	dB μ V	116	116
Return loss on			
input and output	dB	20	20
Adjustable line equaliser	dB	0-10	0-10
Level adjuster	dB	0-10	0-10
Test socket return channel input	dB	-20	
Current consumption of the internal operating voltage 24 V	mA	approx. 60	approx. 60
Environmental temperature range	°C	-20 to +80	-20 to +80

Remote feed power supply

Type	SWF 6530
------	-----------------

Order number 947 592-001



Operating voltage	230 or 240 V~ (switchable) 50-60 Hz
Output voltage / Output current, max.	42/ 50/ 58/ 65 V~ (switchable) 4.75/ 4.0/ 3.45/ 3.05 A
Power consumption, max.	200 VA
Operating conditions	
Ambient temperature	-20°... +50°C
Weight	5.33 kg
Dimensions W x H x D	170 x 188 x 85 mm

Line equaliser LES ...

Type	LES 450	LES 600	LES 860
------	---------	---------	---------

Order number 947 558-001 947 559-001 947 560-001

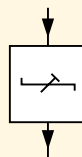

Frequency range	47-450 MHz	47-606 MHz	47-862 MHz
Adjustable equalisation	18 dB	18 dB	18 dB
Basic attenuation (frequency-dependent)	1 dB	1 dB	1 dB
Operating conditions			
Dimensions W x H x D	48 x 44 x 24 mm	48 x 44 x 24 mm	48 x 44 x 24 mm

Accessories

Type	LES 2020 F
------	-------------------

Order number 947 589-001



Frequency range	40 MHz	940 MHz	2150 MHz
Throughpass attenuation	21 dB	12 dB	2 dB
Max. remote feed current	1 A / 24 V DC		

SWF 6530

- For supply of remote feed amplifiers in distribution networks, such as the
 - GPV series
 - GLV series
- 4 selectable output voltages
- Output: IEC screwed connection M 14/1 (connector with cable in scope of delivery)
- Control output: 4 mm round socket
- Short-circuit proof through electronic output fuse
- Interior mounting on the wall
- Power cord approx. 1.5 m with Shock-proof plug
- Protection class 1, protection class IP 65
- Satisfies EN 60 065, EN 50083-1,-2
- 4 selectable output voltages
- Output: IEC screw connection M 14/1 (connector with cable in scope of delivery)
- Control output: 4 mm round socket
- Short-circuit proof through electronic output fuse
- Interior mounting on the wall
- Power cord approx. 1.5 m with Shock-proof plug
- Protection class 1, protection class IP 65
- Satisfies EN 60 065, EN 50083-1,-2



Accessories

- Remote feed coupler CA 1065-14 for 5/8" cable connector (to 1 GHz)
Order number 980 000-377
- Fitting 5/8 M-AC
Order number 980 000-391

Accessory for eco-power series Line equaliser LES ...

- For compensating frequency-dependent cable attenuation
- Slope adjustable in the respective frequency range
- HF connections with F connectors and F-socket
- Can be screw-fastened to the house connection amplifiers GHV 20 E and GHV 30 E
- Metal housing
- Satisfies EN 50083-1, 2



Line equaliser 40-2150 MHz

- For compensating frequency-dependent cable attenuation
- Use for example with amplifiers CVE ...
- With DC passthrough
- Adapter F-IEC (SBFC 01, see section Connectors), please order separately
- HF connectors: F sockets
- Satisfies EN 50083-2

Terrestrial and SAT amplifier

Type	CNV 11 F	CNV 235 E
------	----------	-----------

Order number	947 764-001	947 643-002
--------------	-------------	-------------



CNV 11 F

- Remote feed
- Post-amplifier terrestrial and SAT signals
- Remote feed of LNB's via the HF cable
- For single antenna systems with longer cable sections
- One input, one output
- Operating voltage of the LNBs and of the post-amplifier is provided by the receiver or by the multiswitch
- Line equaliser LES 2020 F for compensating the frequency-dependent cable attenuation in the distribution network at the end of this section
- Satisfies EN 50083-2

CNV 235 E

- Post-amplifier for compensating the attenuation losses in the distribution network
- Selective signal amplification of the terrestrial and two SAT signals
- Level adjuster -20 dB for each band
- Line equalisers for each range.
- Power supply via the DC input with provided power pack
- Satisfies EN 50083-1, 2

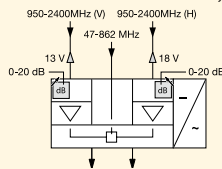

47-862 MHz		
Gain	12 dB	29 dB
Level attenuator	5 dB	0...20 dB
Line equaliser		0...20 dB
Isolation IN / IN		60-55 dB
Isolation OUT / OUT		20-18dB
Output level	95 ¹ / 113 ² dBμV	108 ¹ / 118 ² dBμV
Noise factor	5 dB	5 dB
Return loss on		12 dB
Return loss off		12 dB
950-2150 MHz		
Gain	13-21 dB	36 dB
Level attenuator		0...20 dB
Line equaliser		0...20 dB
Isolation SAT in/in		60 dB
Isolation SAT out/out		55 dB
Isolation SAT on/out		60 dB
Output level	103 ³ / 115 ⁴ dBμV	110 ³ / 121 ⁴ dBμV
Noise factor	6 dB	8 dB
Return loss in		10 dB
Return loss out		10 dB
2150-2400 MHz		
Gain	20 dB	27 dB
Isolation SAT in/in		55 dB
Isolation SAT out/out		55 dB
Isolation SAT on/out		55 dB
Output level	103 ³ / 113 ⁴ dBμV	107 ³ / 118 ⁴ dBμV
Noise factor	6 dB	
Return loss in		8 dB
Return loss out		8 dB
Operating conditions		
Remote feed voltage, current	max 450 mA	
Operating voltage	13-18V	
Current consumption	35 mA	
Power consumption	approx. 0.6 W	
Weight	0.6 kg	1.5 kg
Dimensions	80 x 44 x 25 mm	285 x 115 x 70 mm
Operating voltage		230V~/50-60Hz
Operating temperature	-20°C to +60°C	

¹⁾ in accordance with EN 50083, Part 5 for interference products, second order at 60 dB IMA

²⁾ in accordance with EN 50083, Part 5 for interference products third order at 60 dB IMA

³⁾ in accordance with EN 50083, Part 5 for interference products, second order at 35 dB IMA

⁴⁾ in accordance with EN 50083, Part 5 for interference products third order at 35 dB IMA

All values with level adjuster on 0 dB and linear frequency response (equalisation 0 dB)

Multi-band amplifiers

Type		HMB 6	HMB 10A	HMB 10B	HMB 10S
Order number		940 310-001	940 311-001	940 312-001	940 313-001
					
Number of inputs	St.	5	5	6	8
Number of outputs	St.	1	1	1	2
Number of channel filters	St.	6	6	10	10
Test socket	St.	no	1 (- 20 dB)	1 (- 20 dB)	1 (- 20 dB)
Gain					
Input BI/FM	dB	24	48	48	45
Input BIII/DAB	dB	35	48	48	45
Input HF and UHF (aux)	dB		39	39	35
Input UHF 1	dB	48	55	55	50
Input UHF 2	dB	42	55	55	50
Input UHF 3	dB	30		55	50
Input SAT 1	dB				36-49 slope
Input SAT 2	dB				36-49 slope
Attenuation	dB	0-20	0-20	0-20	0-20
Selectivity	dB / MHz		16/16	16/16	16/16, 40@862
Noise figure					
VHF	dB	9.0/3.0	5.0	5.0	5.0
DVB-T VHF	dB		5.0	5.0	5.0
VHF and UHF (aux)	dB		6.0	6.0	6.0
UHF	dB	3.0/5.0/5.0	9.0	9.0	9.0
SAT	dB				6.0
Output level (IMA3 / -60 dB/third order)					
BI	dB μ V	103	124	124	118
BIII	dB μ V	108	124	124	118
VHF/UHF (aux)	dB μ V		124	124	118
UHF	dB μ V	112/115/112	124	124	118
SAT (-35 dB)	dB μ V				118
General data					
DC (pre-amplifier)	V/mA	12/50	12 or 24/60	12 or 24/60	12 or 24/60
LNB supply	V/mA kHz			0-22	0/13/17/300
Power supply	VAC/Hz	230/50	230/50	230/50	230/50
Connections		F sockets	F sockets	F sockets	F sockets
Impedance	Ohm	75	75	75	75

The programmable multi-band amplifier HMB 10 is ideally suited for implementation in a network where many different signals must be amplified and distributed.

With just one device digital and analog signals from up to 8 differently aligned terrestrial TV and FM antennas or SAT antennas can be actively interconnected.

Additional equipment features:

- Very flexible thanks to 10 highly selective and adjustable filters in the VHF range
- In the amplifier, integrated easy programming. Channels are programmed directly via the keypad and are shown in the numeric display
- All settings can be transferred to other amplifiers. The programmed data can be copied to off-the-shelf MMC/SD memory cards and imported into other amplifiers.
- Up to 8 inputs, depending on type: FM, BIII, VHF/UHF aux, 3 UHF inputs, 2 SAT inputs
- Signal level

Amplifier

Terrestrial multi-purpose amplifier 0.15-862 MHz

GNS 320 A

- For small to medium-sized MATV installations

GNS 440 A, GNS 445 A

- For medium-sized master antenna installations

GNS 440 A

- Level adjuster 20 dB on each input except LMK

GNS 445 A

- Level adjuster 20 dB on all inputs
- External terminal + 24 V for remote feed-stepped pre-switching devices (max. 60 mA)

Common features

- For amplifying signals received from terrestrial sources
- Implementation in receiving stations
- HF connectors: Coaxial sockets in accordance with IEC 60169-2
- Operating voltage 230 V~/50-60 Hz
- Metal/plastic housing
- Ambient temperature -20 °C to +50 °C
- Satisfies EN 50083-1, 2



A new generation will be available in the second half of 2007:

- GNS 20 (GNS 320A)
Order number 940,320-001
- GNS 30 (GNS 440A, GNS 445A)
Order number 940,321-001
- GNS 35 (new)
Order number 940 322-001

Type

GNS 320 A

Order number

944 652-001

Power consumption

4 W

Dimensions

200 x 105 x 63 mm

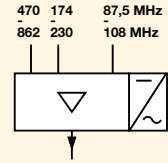

		LMK	FM	BI	BIII	BIV/V
Frequency range	MHz	0.15-10	87.5-108	47-68	174-230	470-862
Gain	dB	-	20	-	20	20
Output level	dB μ V	-	109 ¹⁾	-	109 ¹⁾	109 ¹⁾
	dB μ V	-	109 ²⁾	-	-	-
Noise factor	dB	-	7	-	7	7

Type

GNS 440 A

Order number

944 655-001

Power consumption

4 W

Dimensions

200 x 105 x 63 mm

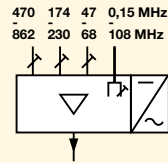

		LMK	FM	BI	BIII	BIV/V
Frequency range	MHz	0.15-10	87.5-108	47-68	174-230	470-862
Gain	dB	-1.5	27 \nearrow	27 \nearrow	27 \nearrow	27 \nearrow
Output level	dB μ V	-	109 ¹⁾	109 ¹⁾	109 ¹⁾	109 ¹⁾
	dB μ V	-	109 ²⁾	-	-	-
Noise factor	dB	-	7	7	7	7,5

Type

GNS 445 A

Order number

944 652-001

Power consumption

min. 6.5 W/max. 8.5 W

Dimensions

200 x 105 x 63 mm

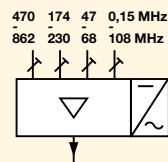

		LMK	FM	BI	BIII	BIV/V
Frequency range	MHz	0.15-10	87.5-108	47-68	174-230	470-862
Gain	dB	26 \nearrow	27 \nearrow	27 \nearrow	27 \nearrow	27 \nearrow
Output level	dB μ V	113 ³⁾	109 ¹⁾	109 ¹⁾	109 ¹⁾	109 ¹⁾
	dB μ V	-	109 ²⁾	-	-	-
Noise factor	dB	-	7	7	7	7.5

¹⁾ In accordance with EN 50083-5, 66 dB IMA if configured with 2 channels (interference products third order)

²⁾ In accordance with EN 50083-5, 60 dB (interference products second order)

³⁾ For 66 dB harmonic distortion attenuation (ak2 and ak3) at f = 260 kHz

All values with level adjuster T on 0 dB

Overview

Single switch



	1 satellite	2 satellites	4 satellites
	e.g. Astra	e.g. Astra + Eutelsat	e.g. Astra I + Astra II + Eutelsat + Türksat
4 subscribers	CKR 5041, ECO CKR 504	CKR 9400 ND , ECO CKR 904	
6 subscribers	CKR 5061, ECO CKR 506	CKR 9600 ND , ECO CKR 906	CKR 1706, ECO CKR 1706
8 subscribers	CKR 5081, ECO CKR 508	CKR 9800 ND , ECO CKR 908	CKR 1708, ECO CKR 1708
12 subscribers	CKR 5121, ECO CKR 512	CKR 9120 ND , ECO CKR 912	CKR 1712, ECO CKR 1712
16 subscribers	CKR 5161, ECO CKR 516	CKR 9160 ND , ECO CKR 916	CKR 1716, ECO CKR 1716
24 subscribers	CKR 5241	CKR 9240 ND	CKR 1724
32 subscribers	CKR 5321	CKR 9320 ND	CKR 1732

Launch amplifier



	1 satellite	2 satellites	4 satellites
	e.g. Astra	e.g. Astra + Eutelsat	e.g. Astra I + Astra II + Eutelsat + Türksat
	CVE 5510 R	CVE 9409 ND	CVE 1708
	CVE 5520 R		CVE 1712
	ECO CVE 55		CVE 1716

Cascade switches



	1 satellite	2 satellites	4 satellites
	e.g. Astra	e.g. Astra + Eutelsat	e.g. Astra I + Astra II + Eutelsat + Türksat
4 subscribers	CMK 5405 R	CMK 9409 ND	CMK 1704
6 subscribers			CMK 1706
8 subscribers	CMK 5805 R	CMK 9809 ND	CMK 1708
12 subscribers			CMK 1712
16 subscribers			CMK 1716

Post amplifier

	1 satellite	2 satellites	4 satellites
	e.g. Astra	e.g. Astra + Eutelsat	e.g. Astra I + Astra II + Eutelsat + Türksat
	CNV 5510 R	CNV 9009 ND	CNV 1720
	CNV 5520 R		

Five cable system (with terr. input) for 4 and 6 subscribers

Attractively priced ECO single multiswitch

- With five inputs for distributing analog and digital signals
- Separate input for terrestrial signals with permanent routing to all subscribers (terrestrial passive)
- Switchable by each subscriber via 13/18 V (vertical/horizontal) and 0/22 kHz (low band/high/band)
- LNB power supply via built-in power pack
- HF connectors: F sockets
- Metal housing with plastic brackets for mounting indoors
- Satisfies EN 50083-1, 2

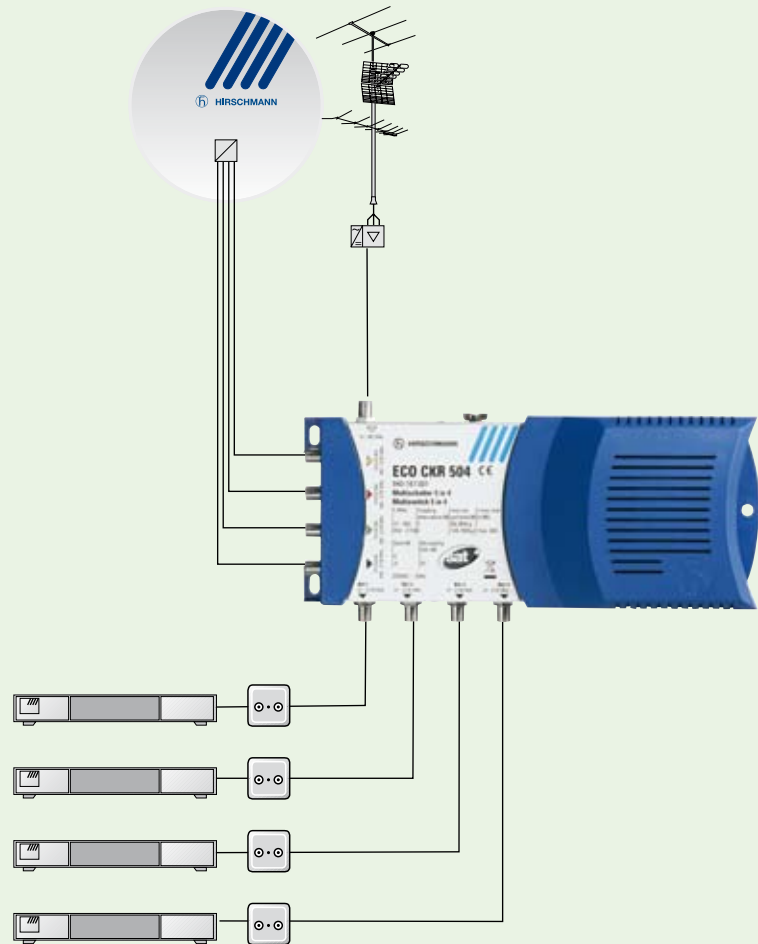

Type		ECO CKR 504	ECO CKR 506	ECO CKR 508	ECO CKR 512
Order number		940 187-001	940 188-001	940 189-001	940 190-001
Applications	Device type	Single switch	Single switch	Single switch	Single switch
	Inputs	5	5	5	5
	Outputs (subscribers)	4	6	8	12
Frequency range	terrestrial	47 – 862 MHz	47 – 862 MHz	47 – 862 MHz	47 – 862 MHz
	SAT	950 – 2150 MHz	950 – 2150 MHz	950 – 2150 MHz	950 – 2150 MHz
Tap off	terrestrial	2 dB	2 dB	2 dB	2 dB
	SAT	2 dB	2 dB	2 dB	2 dB
Isolation	terrestrial				
	H/V SAT	25 dB	25 dB	25 dB	25 dB
Isolation subscriber/subscriber	terrestrial	30 dB	28 dB	28 dB	28 dB
	SAT	30 dB	35 dB	35 dB	35 dB
Output level	terrestrial ¹⁾ (IMA 3)	88 dB μ V	85 dB μ V	85 dB μ V	85 dB μ V
	SAT ²⁾ (IMA 3)	100 dB μ V	100 dB μ V	100 dB μ V	100 dB μ V
Switching	vertical/horizontal	13/18 V	13/18 V	13/18 V	13/18 V
	low/high band 0/22 kHz	0/22 kHz	0/22 kHz	0/22 kHz	0/22 kHz
LNB	remote feeding	max 600 mA	max 600 mA	max 600 mA	max 600 mA
	Power connection		230 V~ /50 Hz	230 V~ /50 Hz	230 V~ /50 Hz
Dimensions	W x H x D mm	249 x 71 x 103	359 x 71 x 103	359 x 71 x 103	459 x 71 x 103
Weight	g	1100	1200	1200	1400

¹⁾ in accordance with EN 50083, Part 5 for interference products, third order at 60 dB IMA

²⁾ in accordance with EN 50083, Part 5 for interference products third order at 35 dB IMA

Five cable system (with terr. input) for 8, 12, and 16 subscribers

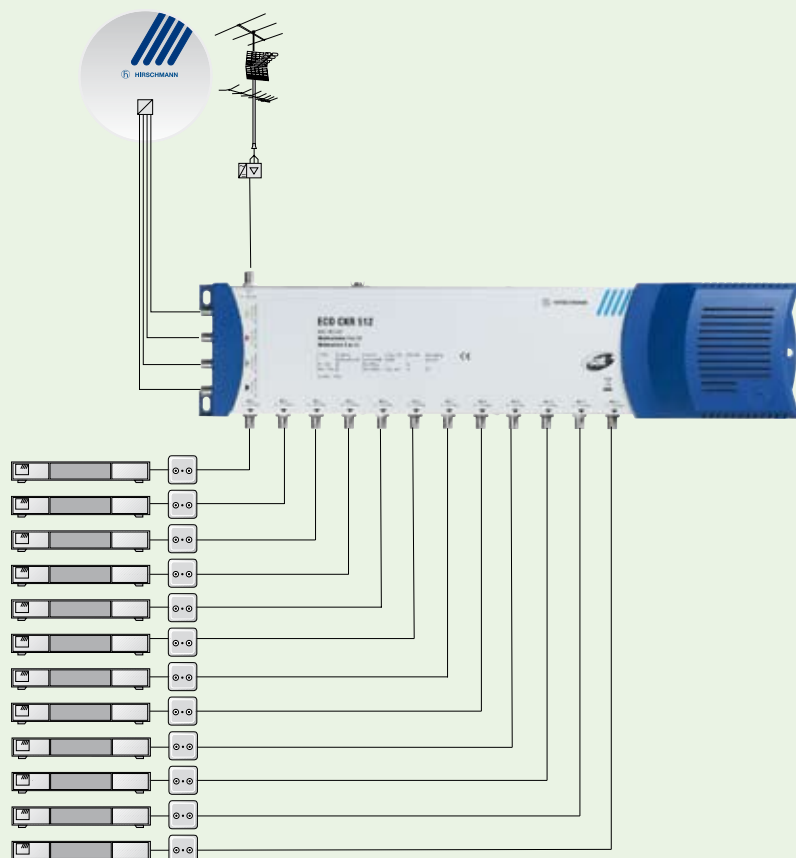

- The ECO CNV 55 SAT IF amplifier and the ECO CVE 55 SAT IF tap-off can be used to quickly and easily create cascades for larger networks
- The tap-off has DC throughpasses (IN/OUT) in the SAT range
- The variable attenuators on the ECO CNV 55 allow 0-15 dB adjustment of the SAT signal and 0-17 dB in the terrestrial range. The SAT-IF amplifier has a slope of 5 dB (fixed) in the SAT range and 7-12 dB in the terrestrial range.

Type		ECO CKR 516	ECO CNV 55	ECO CVE 55
Order number		940 191-001	940 202-001	940 201-001
Applications	Device type	Single switch	Amplifier	Tap-offs
	Inputs	5	5	5
	Outputs (subscribers)	16	5	5 (+5 tap-offs)
Frequency range	terrestrial	47 – 862 MHz	47 – 862 MHz	47 – 862 MHz
	SAT	950 – 2400 MHz	950 – 2400 MHz	950 – 2400 MHz
Connection loss	terrestrial	2 dB		
	SAT	2 dB		
Isolation	terrestrial			
	SAT	25 dB		
Isolation subscriber/subscriber	terrestrial	28 dB		
	SAT	35 dB		
Output level	terrestrial ¹⁾ (IMA 3)	85 dB μ V		
	SAT ²⁾ (IMA 3)	100 dB μ V		
Switching	vertical/horizontal	13/18 V		
	low/high band	0/22 kHz		
LNB	remote feeding	max 600 mA	Ext. Power supply	
	Power connection	230 V~/50 Hz	230 VAC/50 Hz CST 18-800 (940 220-001)	
Throughpass attenuation				terr. 2.5 dB SAT 1.2 dB
Tap-off attenuation				terr. 12.5 dB SAT 12.5 dB
Gain (with level adjuster)			terr.17 dB SAT 20...25 dB	
Dimensions	W x H x D mm	559 x 71 x 103	196 x 105 x 43	119 x 145 x 42
Weight	g	1600		

¹⁾ in accordance with EN 50083, Part 5 for interference products, third order at 60 dB IMA

²⁾ in accordance with EN 50083, Part 5 for interference products third order at 35 dB IMA

9x single multiswitch for multi-satellite reception

ECO multiswitch: The ideal solution for routing digital and analog signals from two satellites (e.g. Astra and Eutelsat) to 4 to 16 subscribers. The 9 cable system with DiSEqC switching enables changing between 8 SAT levels per receiver. A separate input allows feed of additional terrestrial signals.

Common features:

- 8 SAT-IF inputs and an additional terrestrial input
- Reception of two satellite positions (e.g. Astra - Eutelsat)
- Low attenuation in the terrestrial range
- Gain in the SAT ranges (2 dB - 0 dB)
- DiSEqC 2.0 compatible
- All multiswitches have an integrated power unit



Type		ECO CKR 904	ECO CKR 906	ECO CKR 908
Order number		940 225-001	940 226-001	940 227-001
Applications	Device type	Single switch	Single switch	Single switch
	Inputs	9	9	9
	Outputs (subscribers)	4	6	8
Frequency range	terrestrial	47 – 862 MHz	47 – 862 MHz	47 – 862 MHz
	SAT	950 – 2150 MHz	950 – 2150 MHz	950 – 2150 MHz
Gain	terrestrial	-2 dB	-2 dB	-2 dB
	SAT	2 dB	2 dB	2 dB
Isolation	terrestrial	30 dB	30 dB	30 dB
	SAT/terrestr.	28 dB	28 dB	28 dB
Isolation	terrestrial	30 dB	30 dB	30 dB
	SAT/SAT	28 dB	28 dB	28 dB
Isolation	terrestrial	30 dB	30 dB	30 dB
	subscriber/subscriber	SAT	28 dB	28 dB 28 dB
Output level	SAT ¹⁾	100 dBµV	100 dBµV	100 dBµV
Switching	vertical/horizontal	14/18 V	14/18 V	14/18 V
	low/high band	0/22 kHz	0/22 kHz	0/22 kHz
LNB	remote feeding	max 800 mA	max 800 mA	max 800 mA
	Power connection	230 V~/50 Hz	230 V~/50 Hz	230 V~/50 Hz
Dimensions	W x H x D mm	360 x 103 x 71	360 x 103 x 71	360 x 103 x 71
Weight	g	1600	1600	1600
		DiSEqC 2.0	DiSEqC 2.0	DiSEqC 2.0

¹⁾ in accordance with EN 50083, Part 5 for interference products, third order at 35 dB IMA

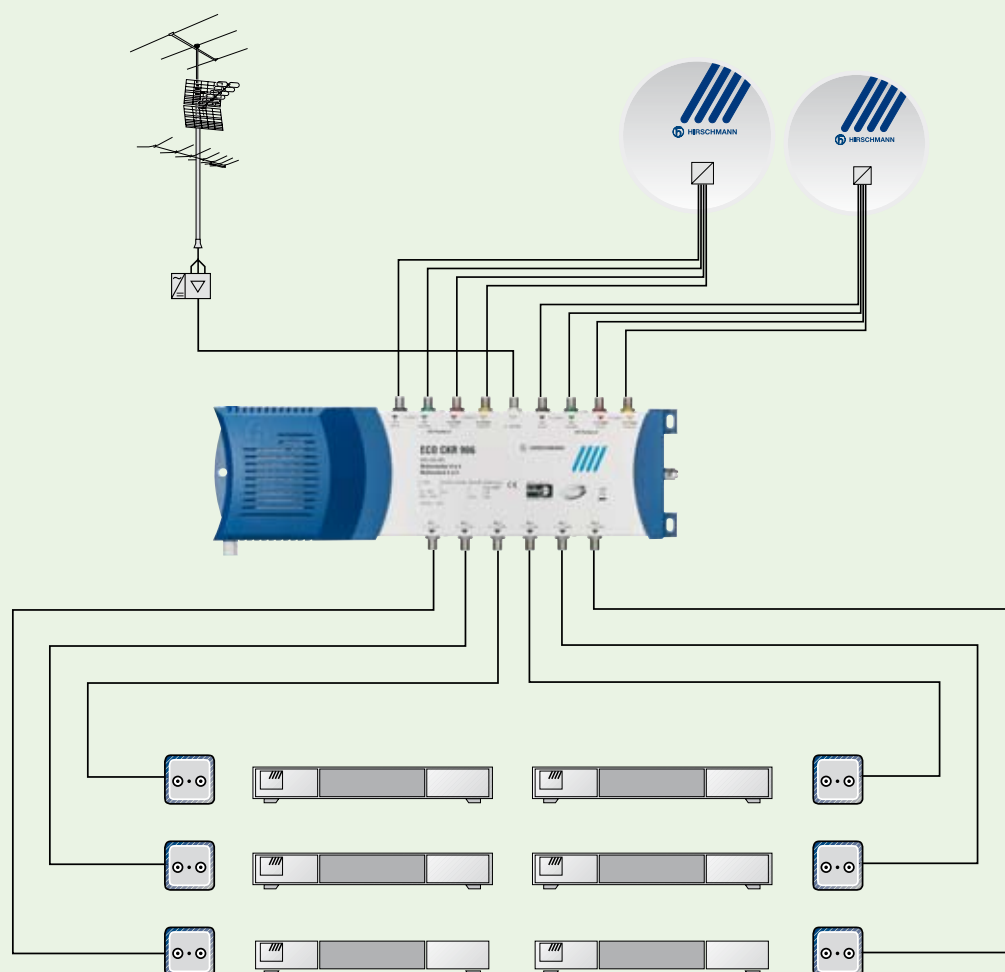

Type		ECO CKR 912	ECO CKR 916
Order number		940 228-001	940 229-001
Applications	Device type	Single switch	Single switch
	Inputs	9	9
	Outputs (subscribers)	12	16
Frequency range	terrestrial	47 – 862 MHz	47 – 862 MHz
	SAT	950 – 2150 MHz	950 – 2150 MHz
Tap out	terrestrial	4 dB	2 dB
	SAT	0 dB	0 dB
Isolation	terrestrial	30 dB	30 dB
	SAT/terrestr.	25 dB	25 dB
Isolation	terrestrial	30 dB	30 dB
	SAT/SAT	25 dB	25 dB
Isolation	terrestrial	30 dB	30 dB
	subscriber/subscriber	SAT	25 dB 25 dB
Output level	SAT ¹⁾	100 dB μ V	100 dB μ V
Switching	vertical/horizontal	14/18 V	14/18 V
	low/high band	0/22 kHz	0/22 kHz
LNB	remote feeding	max 800 mA	max 800 mA
	Power connection	230 V~/50 Hz	230 V~/50 Hz
Dimensions	W x H x D mm	460 x 103 x 71	560 x 103 x 71
Weight	g	1750	2000
		DiSEqC 2.0	DiSEqC 2.0

¹⁾ in accordance with EN 50083, Part 5 for interference products, third order at 35 dB IMA

17x single multiswitch for multi-satellite reception

The new ECO series from Hirschmann - 17x single multiswitch for multi-satellite reception

The ideal solution for routing digital and analog signals from multiple satellites to 8 to 16 subscribers. The 17 cable system with DiSEqC switching enables changing between 16 SAT levels per receiver. A separate input allows feed of additional terrestrial signals.

- 16 SAT-IF inputs and an additional terrestrial input
- Reception of four satellite positions
- DiSEqC 2.0 compatible
- Power In for supply voltage to switches and also connected LNB if necessary
- The Power Link connection is a pure throughpass
- Gain in SAT ranges (2 dB - 0 dB)
- Return channel capable
- The external power unit ECO 17 PSU
Order number 940 265 - 001
(not included in scope of delivery)



Type		ECO CKR 1706	ECO CKR 1708
Order number		940 230-001	940 231-001
Applications	Device type	Single multiswitch	Single multiswitch
	Inputs	17	17
	Outputs (subscribers)	6	8
Frequency range	terrestrial	5 – 862 MHz	5 – 862 MHz
	SAT	950 – 2400 MHz	950 – 2400 MHz
Tap off	terrestrial	-21 dB	-22 dB
	SAT	-2 dB	0 dB
Isolation	terrestrial	30 dB	30 dB
	SAT/terrestrial	28 dB	28 dB
Isolation	terrestrial	30 dB	30 dB
	SAT/SAT	28 dB	28 dB
Isolation	terrestrial	30 dB	30 dB
	Subscriber/subscriber SAT	28 dB	28 dB
Level adjuster	terrestrial		
	SAT	0..6 dB	0...6 dB
Switching	vertical / horizontal	13 / 18 V	13 / 18 V
	low / high band	0 / 22 kHz	0 / 22 kHz
LNB	remote feeding	60 mA	60 mA
	Power connection	15 VDC	15 VDC
Dimensions	W x H x D mm	355 x 125 x 55	355 x 125 x 55
Weight	g	900	950

17x single multiswitch for multi-satellite reception

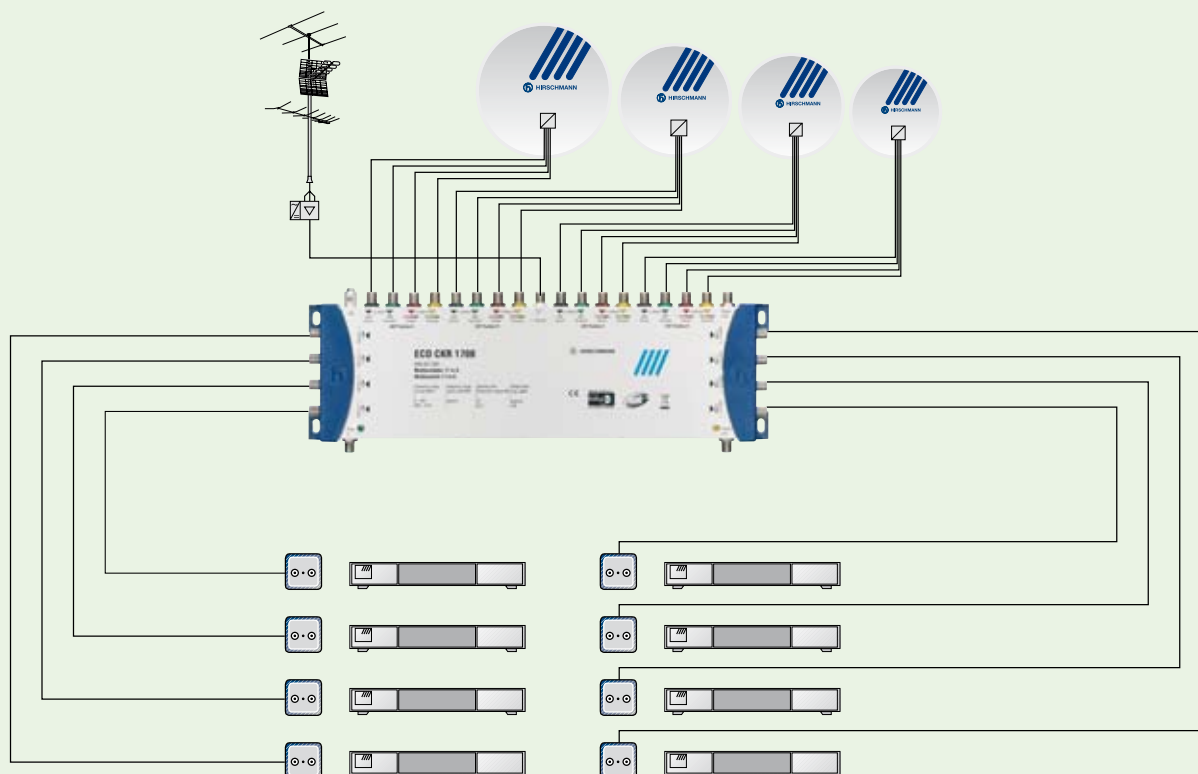

Type		ECO CKR 1712	ECO CKR 1716
Order number		940 232-001	940 233-001
Applications	Device type	Single multiswitch	Single multiswitch
	Inputs	17	17
	Outputs (subscribers)	12	16
Frequency range	terrestrial	5 – 862 MHz	5 – 862 MHz
	SAT	950 – 2400 MHz	950 – 2400 MHz
Tap off	terrestrial	-24 dB	-24 dB
	SAT	-2 dB	-0 dB
Isolation	terrestrial	30 dB	30 dB
	SAT/terrestrial	28 dB	28 dB
Isolation	terrestrial	30 dB	30 dB
	SAT/SAT	28 dB	28 dB
Isolation	terrestrial	30 dB	30 dB
	subscriber/subscriber	SAT	28 dB 28 dB
Level adjuster	terrestrial		
	SAT	0..0.6 dB	0..0.6 dB
Switching	vertical / horizontal	13 / 18 V	13 / 18 V
	low / high band	0 / 22 kHz	0 / 22 kHz
LNB	remote feeding	60 mA	60 mA
	Power connection	15 VDC	15 VDC
Dimensions	W x H x D mm	355 x 125 x 55	355 x 125 x 55
Weight	g	1400	1450

Five cable system (with terr. input) for 4, 6, and 8 subscribers

High-quality standard multiswitch

- With integrated 22-kHz generator
- Use as single device 5 inputs, for analog and digital signals
- For selecting one of four satellite levels independently of the connected receiver, e.g. H/low band or H/high band or V/low band or V/high band
- Select by receiver switch command with 13/18 V and 0/22 kHz via HF cable

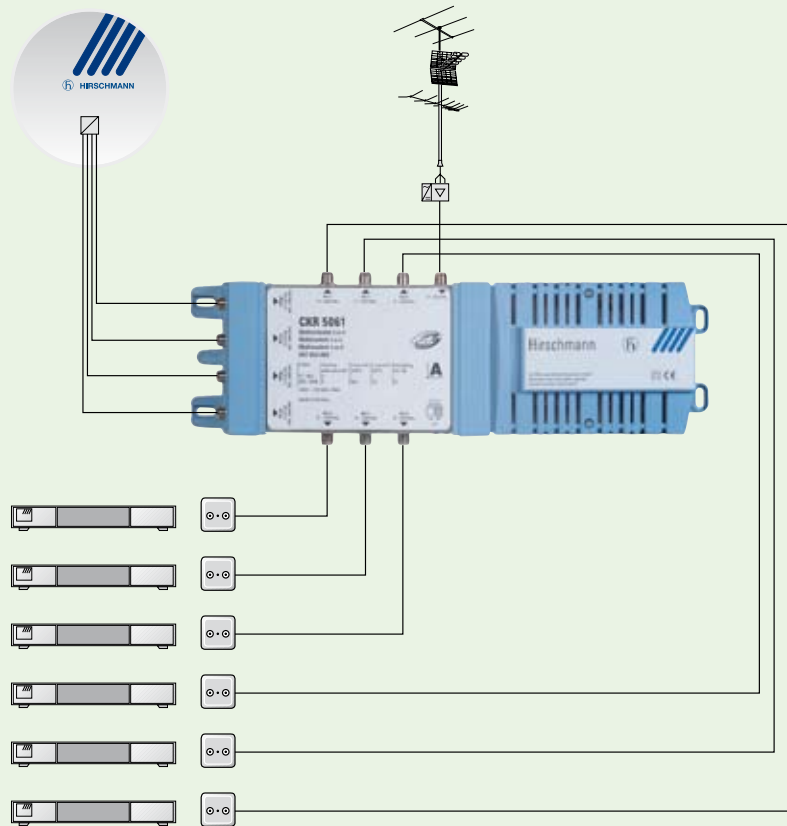

Type		CKR 5041	CKR 5061	CKR 5081
Order number		947 640-004	947 652-004	947 637-004
Applications	Device type	Single switch	Single switch	Single switch
	Inputs	5	5	5
	Outputs (subscribers)	4	6	8
Frequency range	terrestrial	47 – 862 MHz	47 – 862 MHz	47 – 862 MHz
	SAT	950 – 2400 MHz	950 – 2400 MHz	950 – 2400 MHz
Tap off	terrestrial	0 dB	0 dB	0 dB
	SAT	0 dB	0 dB	0 dB
Isolation	terrestrial			
	H/V SAT	25 dB	25 dB	25 dB
Isolation subscriber/subscriber	terrestrial	18 dB	22 dB	22 dB
	SAT		35 dB	35 dB 35 dB
Output level	terrestrial ¹⁾	92 dB μ V	90 dB μ V	90 dB μ V
	SAT ²⁾	90 dB μ V	90 dB μ V	90 dB μ V
Switching	vertical/horizontal	13/18 V	13/18 V	13/18 V
	low/high band	0/22 kHz	0/22 kHz	0/22 kHz
LNB	remote feeding	max 500 mA	max 500 mA	max 500 mA
	Power connection	230 V~ /50-60 Hz	230 V~ /50-60 Hz	230 V~ /50-60 Hz
Dimensions	W X H x D mm	300 x 80 x 115	350 x 80 x 115	350 x 80 x 115
Weight	g	1400	1480	1500

¹⁾ in accordance with EN 50083, Part 5 for interference products, third order at 60 dB IMA

²⁾ in accordance with EN 50083, Part 5 for interference products third order at 35 dB IMA

Five cable system (with terr. input) for 12 to 32 subscribers

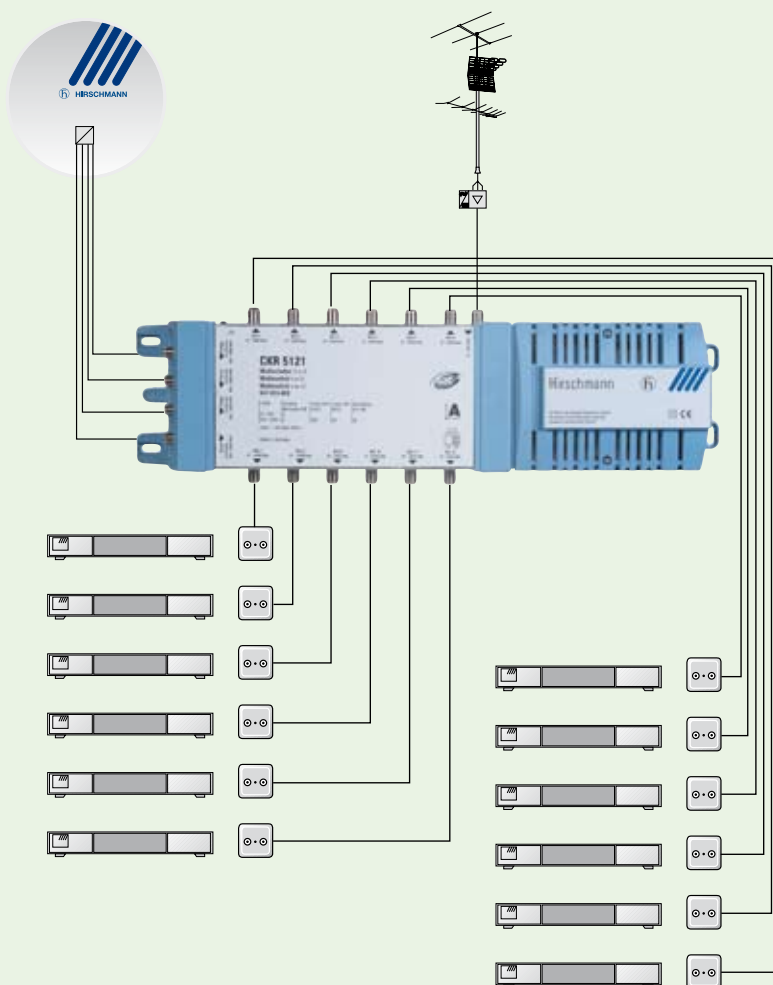

- Separate input for feeding terrestrial signals and permanent routing to all subscribers
- Active in SAT range for reducing distribution attenuation
- Local supply
- LNB power sourced from multiswitch
- Metal housing with plastic side brackets for mounting indoors
- HF connectors with F sockets
- Satisfies EN 50083-1, 2
- For maximum reliability in digital technology, all multiswitches in the five cable system are equipped with high-tech components
- CE



Type		CKR 5121	CKR 5161	CKR 5241	CKR 5321
Order number		947 653-004	947 654-004	940 159-001	940 160-001
Applications	Device type	Single switch	Single switch	Single switch	Single switch
	Inputs	5	5	5	5
	Outputs (subscribers)	12	16	24	32
Frequency range	terrestrial	47 – 862 MHz	47 – 862 MHz	5 – 862 MHz	5 – 862 MHz
	SAT	950 – 2400 MHz	950 – 2400 MHz	950 – 2400 MHz	950 – 2400 MHz
Tap off	terrestrial	0 dB	0 dB	1 dB	1 dB
	SAT	0 dB	0 dB	0 dB	0 dB
Isolation	terrestrial				
	SAT	25 dB	25 dB	> 25 dB	>25 dB
Isolation subscriber/subscriber	terrestrial	25 dB	25 dB	> 25 dB	>25 dB
	SAT	35 dB	35 dB	> 35 dB	>35 dB
Output level	terrestrial ¹⁾	90 dB μ V	90 dB μ V	85 dB μ V	85 dB μ V
	SAT ²⁾	90 dB μ V	90 dB μ V	90 dB μ V	90 dB μ V
Switching	vertical/horizontal	13/18 V	13/18 V	13/18 V	13/18 V
	low/high band	0/22 kHz	0/22 kHz	0/22 kHz	0/22 kHz
LNB	Remote feeding	max 500 mA	max 500 mA	max 500 mA	max 500 mA
	Power connection	230 V~/50-60 Hz	230 V~/50-60 Hz	230 V~/50-60 Hz	230 V~/50-60 Hz
Dimensions	W x H x D mm	400 x 80 x 115	468 x 80 x 115	450 x 80 x 125	450 x 80 x 125
Weight	g	1580	1600	1600	1600

¹⁾ in accordance with EN 50083, Part 5 for interference products, third order at 60 dB IMA

²⁾ in accordance with EN 50083, Part 5 for interference products third order at 35 dB IMA

Five-cable system. cascadable, launch amplifiers and post amplifiers

Common features:

- For reception of analog and digital signals
- Powered by the built-in power supply unit
- All connections of the CVE 5510 R or CVE 5520 R are voltage-free
- Metal housing with plastic side brackets for mounting indoors
- Suitable for CATV
- Suitable for return channel, passive
- Inputs and outputs: F sockets
- Satisfies EN 50 083-1, 2

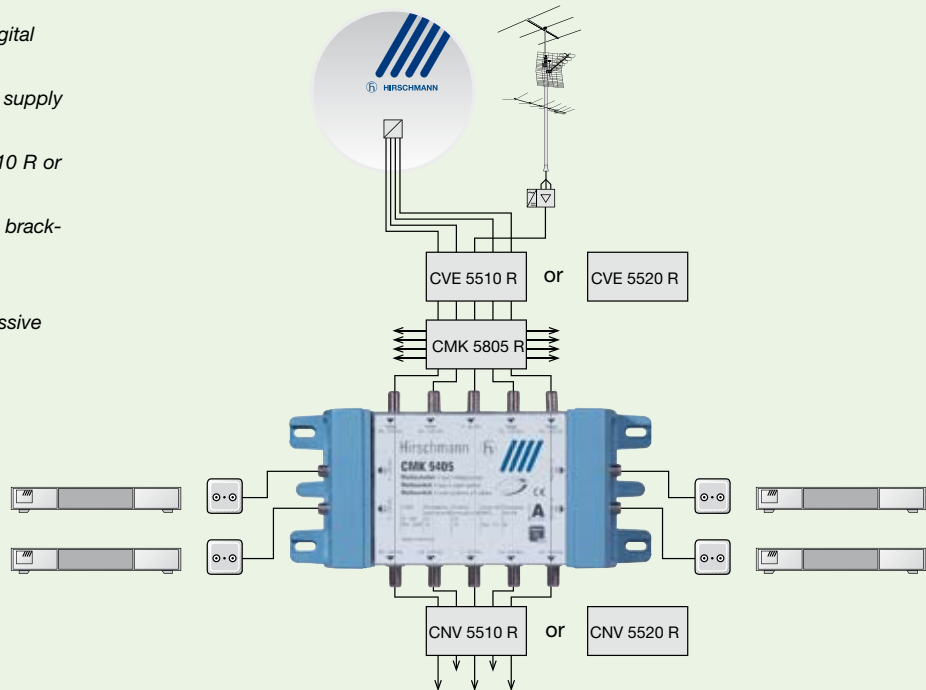

Type		CVE 5510 R	CVE 5520 R	CNV 5510 R	CNV 5520 R
Order number		947 635-003	947 620-003	947 636-003	947 634-003
Applications	Device type	Infeed ampl.	Infeed ampl.	Post amplifier	Post amplifier
	Inputs	5	5	5	5
	Loop-through outputs	5	5	5	5
Frequency range	terrestrial	5 – 862 MHz	5 – 862 MHz	5 – 862 MHz	5 – 862 MHz
	SAT	950 – 2400 MHz	950 – 2400 MHz	950 – 2400 MHz	950 – 2400 MHz
Isolation	terrestrial	40 dB	40 dB	40 dB	40 dB
	SAT/terrestr.	40 dB	30 dB	40 dB	30 dB
Isolation	terrestrial	40 dB	45 dB	40 dB	45 dB
	SAT/SAT	40 dB	35 dB	40 dB	35 dB
Gain	terrestrial	10 – 11 dB	19 – 23 dB	10 – 11 dB	19 – 23 dB
	SAT	7 – 12 dB	22 – 26 dB	7 – 12 dB	22 – 26 dB
Level adjuster	terrestrial		0 ... 20 dB	0 ... 20 dB	0 ... 20 dB
	SAT		0 ... 20 dB		0 ... 20 dB
Output level	terrestrial ¹⁾	114 dB μ V	114 dB μ V	114 dB μ V	114 dB μ V
	SAT ²⁾	107 dB μ V	114 dB μ V	107 dB μ V	114 dB μ V
	terrestrial ³⁾	103 dB μ V	102 dB μ V	103 dB μ V	102 dB μ V
	SAT ⁴⁾	94 dB μ V	102 dB μ V	94 dB μ V	102 dB μ V
LNB	remote feeding	max 700 mA	max 500 mA		
	Power connection	230 V~/50-60 Hz	230 V~/50-60 Hz	230 V~/50-60 Hz	230 V~/50-60 Hz
Dimensions	W x H x D mm	348 x 83 x 115	348 x 83 x 115	348 x 83 x 115	348 x 83 x 115
Weight	g	1500	1600	1500	1600
		With level adjuster	With level adjuster	With level adjuster ^{2) 3)}	

¹⁾ in accordance with EN 50083, Part 5 for interference products third order at 60 dB IMA

²⁾ in accordance with EN 50083, Part 5 for interference products third order at 35 dB IMA

³⁾ in accordance with EN 50083, Part 5 for interference products, second order at 60 dB IMA

⁴⁾ in accordance with EN 50083, Part 5 for interference products third order at 35 dB IMA

Five cable system, cascading for 4 or 8 subscribers per device

Launch amplifier

- Use as headend of the multiswitch five cable system
- Separate input for feeding terrestrial signals and separate routing
- Remote feed voltage to the LNB
- Cascadable with multiswitches CMK 5405 R or CMK 5805 R and the post amplifiers CNV 5510 R or CNV 5520 R
- Level adjuster for all inputs with CVE 5520 R

Post amplifier

- For post amplification of 4 SAT IF signals and terrestrial signals
- SAT IF signals and terrestrial signals are amplified and routed separately
- Cascadable with launch amplifiers CVE 5510 R or CVE 5520 R and multiswitches CMK 5405 R or CMK 5805 R
- Level adjuster for all inputs with CNV 5520 R

Multiswitches

- For distribution of 4 SAT-IF signals and terrestrial signals to 4 or 8 subscribers in conjunction with launch amplifiers CVE 5510 R or CVE 5520 R
- Cascadable with multiswitches CMK 5405 R or CMK 5805 R and the post amplifiers CNV 5510 R or CNV 5520 R
- Power is supplied to the CMK via remote feed or via the connected receivers
- Each user output can switch to one of the four SAT inputs using the switch command 13/18 V and 0/22 kHz
- The terrestrial signals are present even when the receiver is switched off
- All connectors of the CVE 5510 R or CVE 5520 R launch amplifier carry no voltage
- For maximum reliability in digital technology, all multiswitches in the five cable system are equipped with the ASIC high-tech component



Type		CMK 5405 R	CMK 5805 R
Order number		947 619-003	947 641-003
Applications	Device type	Cascade switches	Cascade switches
	Inputs	5	5
	Outputs (subscribers)	4	8
	Loop-through outputs	5	5
Frequency range	terrestrial	5 – 862 MHz	5 – 862 MHz
	SAT	950 – 2400 MHz	950 – 2400 MHz
Through pass loss	terrestrial	2.5 dB	3 dB
	SAT	1.5 dB	1.5 dB
Tap off	terrestrial	16 dB	21 dB
	SAT	15 dB	15 dB
Isolation	SAT/terrestrial	40 – 36 dB	40 – 36 dB
Isolation	SAT/SAT	25 dB	25 dB
Isolation subscriber/subscriber	terrestrial	20 dB	20 dB
	SAT		30 dB 30 dB
Output level	terrestrial ¹⁾	passive	passive
	SAT ²⁾	90 dB μ V	90 dB μ V
Switching	vertical/horizontal	13/18 V	13/18 V
	low/high band 0/22 kHz	0/22 kHz	
Dimensions	W x H x D mm	235 x 70 x 115	235 x 70 x 115
Weight	g	600	800

¹⁾ in accordance with EN 50083, Part 5 for interference products, third order at 60 dB IMA

²⁾ in accordance with EN 50083, Part 5 for interference products third order at 35 dB IMA

Nine cable system/DiSEqC (with terr. input) for 4, 6 and 8 subscribers

- Use as single device 9 inputs, for analog and digital signals
- For selection of one of eight SAT levels, for example from two different satellites independently from each connected receiver. Selectable from both satellites are:
H/low band, H/high band,
V/low band or V/high band
- Selection is made from the receiver via the HF cable with
- switch command 13/18V, 0/22 kHz and DiSEqC signal
- Fully DiSEqC enabled (DiSEqC 2.0).
This means that the switching relay e.g.
- sends a confirmation of the selection process to the receiver
- Receiver queries regarding relay setting are answered

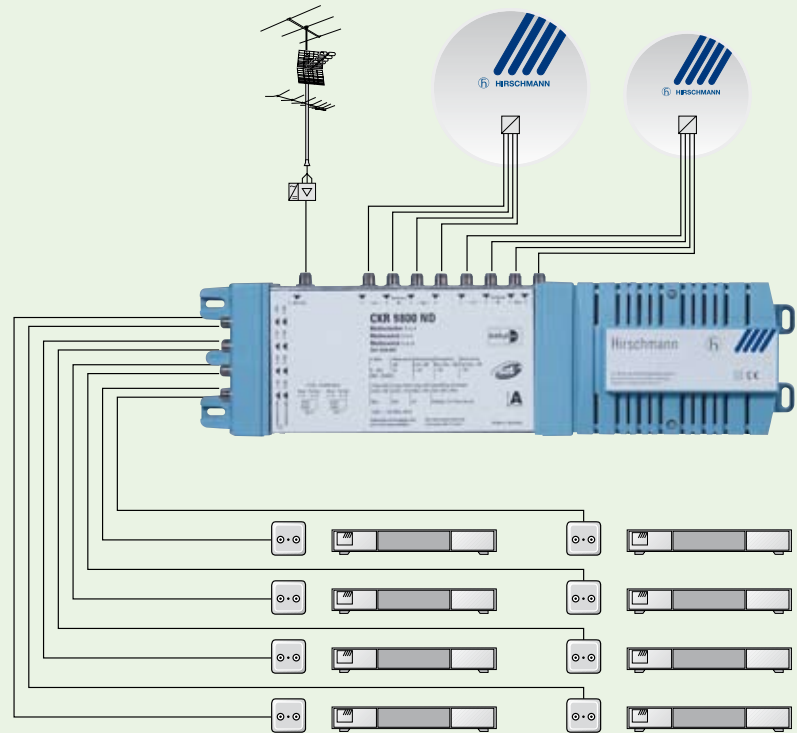



Type		CKR 9400 ND	CKR 9600 ND	CKR 9800 ND
Order number		947 648-003	947 649-003	947 650-003
Applications	Device type	Single switch	Single switch	Single switch
	Inputs	9	9	9
	Outputs (subscribers)	4	6	8
Frequency range	terrestrial	5 – 862 MHz	5 – 862 MHz	5 – 862 MHz
	SAT	950 – 2400 MHz	950 – 2400 MHz	950 – 2400 MHz
Tap off	terrestrial	16 dB	18 dB	18 dB
	SAT	6 dB	6 dB	6 dB
Isolation	terrestrial	≥ 40 dB	≥ 40 dB	≥ 40 dB
	SAT/terrestr.	≥ 40 dB	≥ 40 dB	≥ 40 dB
Isolation	terrestrial	≥ 40 dB	≥ 40 dB	≥ 40 dB
	SAT/SAT	≥ 40 dB	≥ 40 dB	≥ 40 dB
Isolation	terrestrial	≥ 25 dB	≥ 25 dB	≥ 25 dB
	subscriber/subscriber	≥ 25 dB	≥ 25 dB	≥ 25 dB
Output level	SAT ¹⁾	102 dBμV	102 dBμV	102 dBμV
Switching	vertical / horizontal	13/18 V	13/18 V	13/18 V
	low/high band	0/22 kHz	0/22 kHz	0/22 kHz
LNB	remote feeding	max 1200 mA	max 1200 mA	max 1200 mA
	Power connection	230 V~/50-60 Hz	230 V~/50-60 Hz	230 V~/50-60 Hz
Dimensions	W x H x D mm	400 x 80 x 115	400 x 80 x 115	400 x 80 x 115
Weight	g	1700	1700	1700
		DiSEqC 2.0	DiSEqC 2.0	DiSEqC 2.0

¹⁾ in accordance with EN 50083, Part 5 for interference products, third order at 35 dB IMA

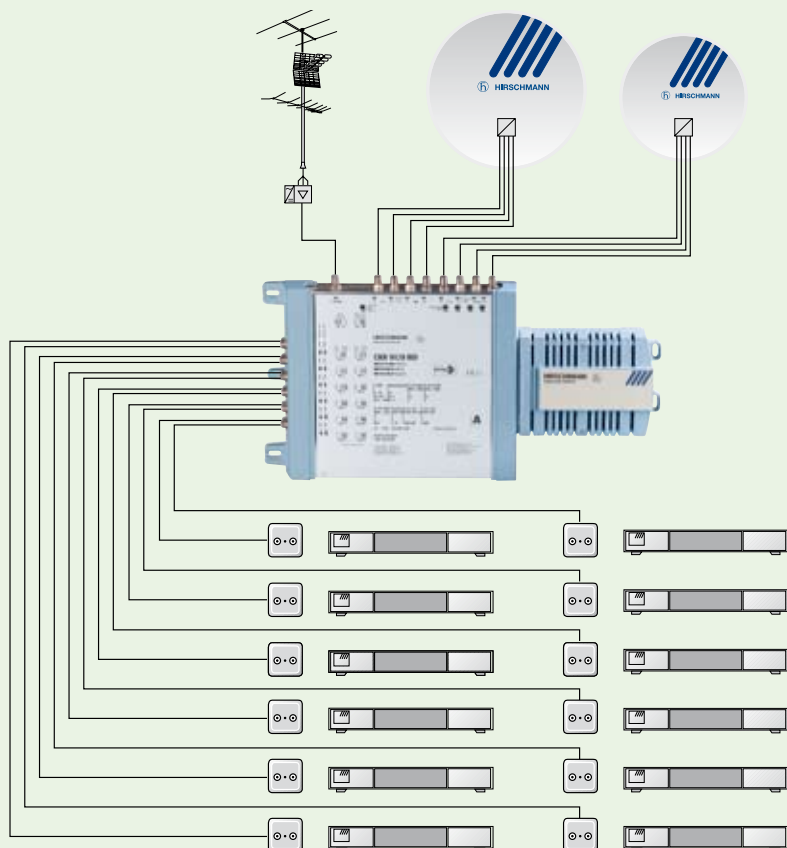
Nine cable system/DiSEqC (with terr. input) for 12 to 32 subscribers



- Separate input for feeding terrestrial signals and permanent routing to all subscribers
- Distribution to 12- 32 subscribers
- Switch signal 22 kHz for universal LNB
- Level adjuster 10 dB for each input
- Local supply
- LNB supply from multiswitch
- Metal housing with plastic side brackets for mounting indoors
- HF connectors with F sockets
- Temperature range -20 to +60 ° C
- Satisfies EN 50083-1, 2
-  

Type			CKR 9120 ND	CKR 9160 ND	CKR 9240	CKR 9320
Order number			947 685-003	947 686-003	940 167-001	940 168-001
Applications	Device type		Single switch	Single switch	Single switch	Single switch
	Inputs		9	9	9	9
	Outputs (subscribers)		12	16	24	32
Frequency range	terrestrial		47 – 862 MHz	47 – 862 MHz	5 – 862 MHz	5 – 862 MHz
	SAT		950 – 2400 MHz	950 – 2400 MHz	5 – 2400 MHz	5 – 2400 MHz
Tap off	terrestrial		8 dB	10 dB	>25	>25
	SAT		8 dB	8 dB	>25	>25
Isolation	terrestrial		≥ 40 dB	≥ 40 dB	>25	>25
	SAT/terr.	SAT	≥ 40 dB	≥ 40 dB	>25	>25
Isolation	terrestrial		≥ 40 dB	≥ 40 dB	>25	>25
	SAT/SAT	SAT	≥ 40 dB	≥ 40 dB	>25	>25
Isolation	terrestrial		≥ 25 dB	≥ 25 dB	>40	>40
	subscriber/subscriber	SAT	≥	≥ 25 dB	25 dB	>40 >40
Level adjuster	terrestrial		0 ... 20 dB	0 ... 20 dB		
	SAT		0 ... 10 dB	0 ... 10 dB		
Output level	SAT ²⁾		102 dBμV	102 dBμV	102 dBμV	102 dBμV
Output level	terrestrial ¹⁾		79 dBμV	79 dBμV	73/85 dBμV	72/84 dBμV
Switching	vertical/horizontal		13/18 V	13/18 V	13/18 V	13/18 V
	low/high band	0/22 kHz	0/22 kHz	0/22 kHz	0/22 kHz	0/22 kHz
LNB	remote feeding		max 1200 mA	max 1200 mA	max.600 mA	max 600 mA
Power connection			230 V~/50-60 Hz	230 V~/50-60 Hz	265 V~/47-63 Hz	265 V~/47-63Hz
Dimensions	W x H x D	mm	400 x 80 x 205	400 x 80 x 205	400 x 350 x 80	400 x 350 x 80
Weight		g	1650	1680	1650	1760
			DiSEqC 2.0	DiSEqC 2.0	DiSEqC 2.0	DiSEqC 2.0

¹⁾ in accordance with EN 50083, Part 5 for interference products, second order at 60 dB IMA

²⁾ in accordance with EN 50083, Part 5 for interference products third order at 35 dB IMA

Nine cable system with DiSEqC, cascadable, infeed and post amplifier

Common features

- For multi dwelling distribution in installations for analog and digital signals
- For selection of one of eight SAT levels, for example from two different satellites independently from each connected receiver. H/V low band and H/V high band
- Selection is made from the receiver via the HF cable with - switch command 13/18V, 0/22 kHz and - DiSEqC signal
- Fully DiSEqC enabled (DiSEqC 2.0). This means that the switching relay e.g.
 - sends a confirmation of the selection process to the receiver
 - Receiver queries regarding relay setting are answered
- Terrestrial signals are permanently routed to all receivers via separate trunk line even of receivers are switched off.

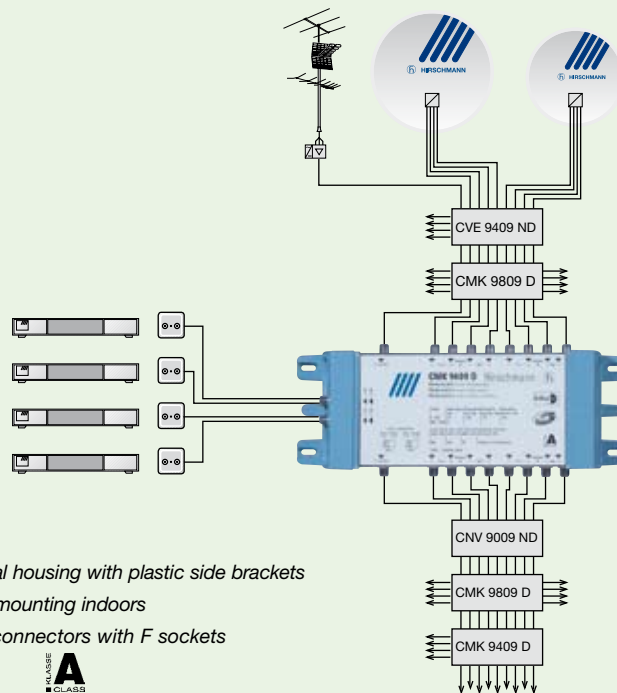

- Metal housing with plastic side brackets for mounting indoors
- HF connectors with F sockets
- CE

Type		CVE 9409 ND	CNV 9009 ND
Order number		940 003-002	940 004-002
Applications	Device type	Infeed amplifier	Post amplifier
	Inputs	9	9
	Outputs (subscribers)	4	
	Loop-through outputs	9	9
Frequency range	terrestrial	5 – 862 MHz	47 – 862 MHz
	SAT	950 – 2300 MHz	950 – 2300 MHz
Throughpass loss	terrestrial	4 dB	-
	SAT	1 – 3 dB	-
Tap off	terrestrial	21 dB	-
	SAT	6 dB	-
Isolation SAT/terrestr.	terrestrial	≧ 40 dB	≧ 35 dB
	SAT	≧ 40 dB	≧ 35 dB
Isolation SAT/SAT	terrestrial	≧ 40 dB	≧ 35 dB
	SAT	≧ 40 dB	≧ 35 dB
Isolation subscriber/subscriber	terrestrial	≧ 25 dB	-
	SAT	≧ 30 dB	-
Gain	terrestrial	-	12 – 15 dB
	SAT	-	16 – 19 dB
Output level	terrestrial ¹⁾	-	110 dBμV
	SAT ²⁾	95 dBμV	108 dBμV
Switching	vertical/horizontal	13/18 V	-
	low/high band	0/22 kHz	-
LNB	remote feeding	max 1200 mA	-
	Power connection	230 V~/50-60 Hz	230 V~/50-60 Hz
Dimensions	W x H x D	mm	330 x 65 x 115
Weight		g	1740
DiSEqC 2.0, suitable for return channel			

Nine cable system, cascading for 4 or 8 subscribers per device

Launch amplifier

- Use as headend of the multiswitch nine cable system
- Separate input for feeding terrestrial signals and separate routing
- Local supply
- Terminating resistors for termination of the cascade are included with infeed multiswitch CVE 9409 ND
- LNB's supplied with power from the multiswitch
- Integrated multiswitch for 4 subscribers
- Satisfies EN 50083-1, -2

Post amplifier

- For compensating attenuation losses in the cascade:
Amplifies SAT and terrestrial signals, analog and digital
- Cascadable with multiswitch CMK 949 D
- Terrestrial signals are routed via a separate trunk line
- An CNV 9009 ND post amplifier must be provided after every second CMK 9409 D
- Terminating resistors for termination of the cascade are included with launch amplifier CVE 9409 ND
- Local supply
- Satisfies EN 50083-1, 2

Multiswitches

- Cascadable through further routing of the trunk lines
- Remote feed from the connected receivers, additional power supply not required
- An CNV 9009 ND post amplifier must be provided after every second CMK 9409 D
- Satisfies EN 50083-2

Type		CMK 9409 D	CMK 9809 D
Order number		940 005-002	940 006-002
Applications	Device type	Cascade switches	Cascade switches
	Inputs	9	9
	Outputs (subscribers)	4	8
	Loop-through outputs	9	9
Frequency range	terrestrial	5 – 862 MHz	5 – 862 MHz
	SAT	950 – 2300 MHz	950 – 2300 MHz
Throughpass loss	terrestrial	4 dB	4 dB
	SAT	1 – 3 dB	1 – 3 dB
Tap off	terrestrial	21 dB	22 dB
	SAT	6 dB	6 dB
Isolation SAT/terr.	terrestrial	≥40 dB	≥40 dB
	SAT	≥40 dB	≥40 dB
Isolation SAT/SAT	terrestrial	≥40 dB	≥40 dB
	SAT	≥40 dB	≥40 dB
Isolation subscriber/subscriber	terrestrial	≥25 dB	≥25 dB
	SAT	≥ 30 dB	≥30 dB
Output level	SAT ²⁾ 95 dB μ V	95 dB μ V	
Switching	vertical/horizontal	13/18 V	13/18 V
	low/high band 0/22 kHz	0/22 kHz	
Dimensions	W x H x D mm	355 x 65 x 115	355 x 65 x 115
Weight	g	780	820
		DiSEqC 2.0	DiSEqC 2.0
		Suitable for return channel	Suitable for return channel

¹⁾ in accordance with EN 50083, Part 5 for interference products third order at 60 dB IMA

²⁾ in accordance with EN 50083, Part 5 for interference products third order at 35 dB IMA

17 cable multiswitch system for unrestricted channel variety

Programming aid

The 17 cable multiswitches are equipped with a programming aid. After the programming setting on the receiver the associated SAT input on the multiswitch is displayed.

Installation aid

The cascade multiswitches have a patented installation aid for correct allocation of the trunk cable. This feature identifies the trunk cables electronically during installation and displays the input number on the LED display (see example on this page).

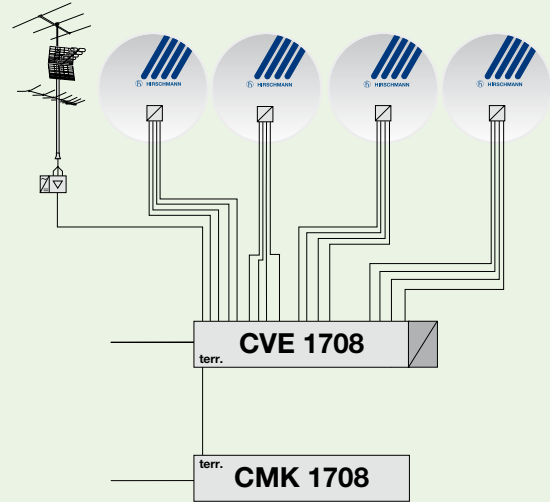

Eingang/Input



The terr. input must be connected first.
If the cable is correct, the LED display shows "0".

aus/off

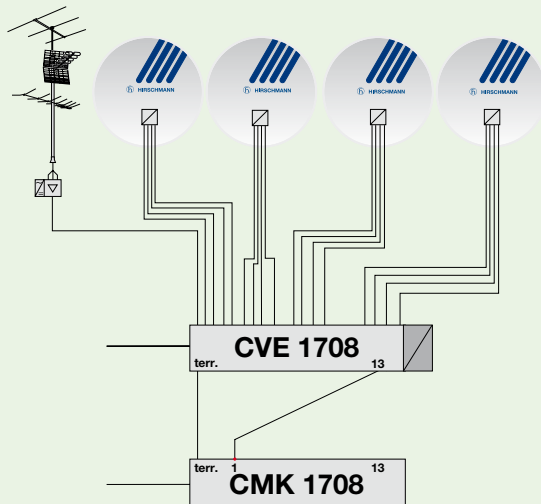

Eingang/Input



The patented installation aid electronically identifies the trunk cable on input 1

aus/off

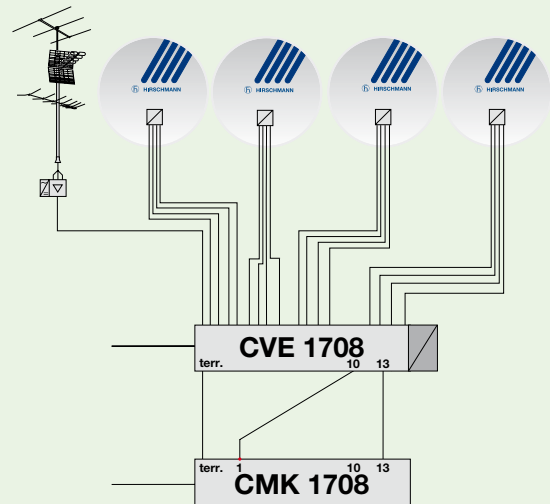
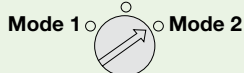

Eingang/Input



aus/off



17x single multiswitch system for up to 32 subscribers

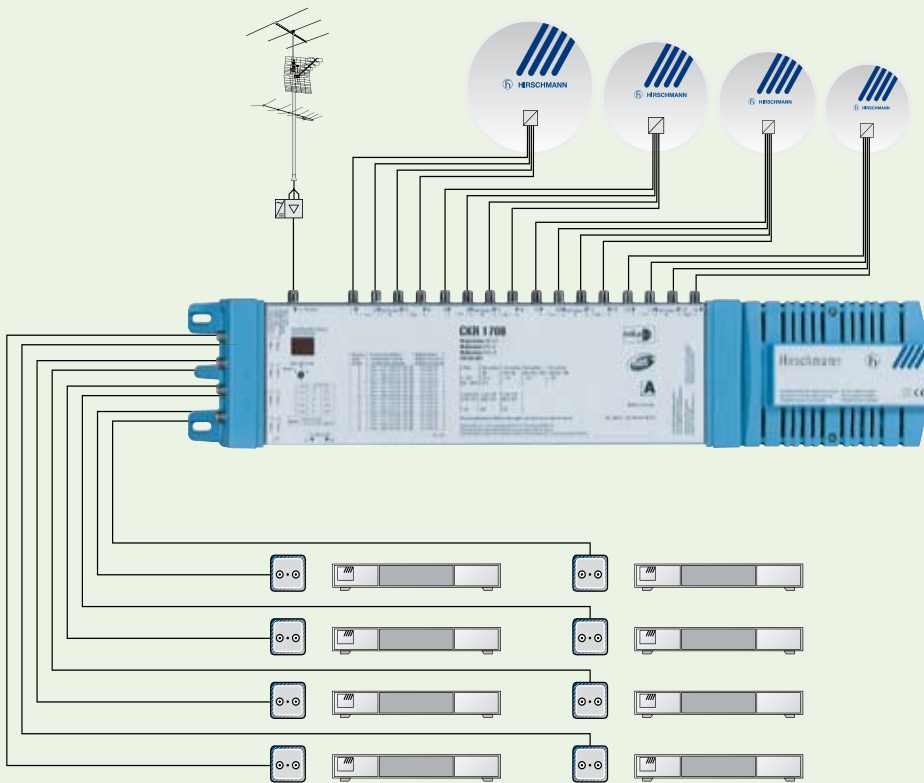

Single multiswitch

- Green function-LED in the power-supply unit shows operating status and serves as an installation aid
- Programming aid: According to the programming setting on the receiver the associated SAT input on the multiswitch is displayed
- All voltages on the outputs are short-circuit proof.
- 22 KHz generator for operation on universal switch LNBS
- Distribution of the terrestrial band (5 – 862 MHz) is broadband passive
- For reception of analog and digital signals
- Metal housing with plastic brackets for mounting indoors
- Suitable for return channel
- Inputs and outputs: F sockets
- Satisfies EN 50 083-1, 2
- CE

Type		CKR 1708	CKR 1712	CKR 1716	CKR 1724	CKR1732
Order number		940 034-002	940 035-002	940 036-002	940 164-001	940 165-001
Applications	Device type	Single multiswitch	Single multiswitch	Single multiswitch	Single multiswitch	Single multiswitch
	Inputs	17	17	17	17	17
	Outputs (subscribers)	8	12	16	24	32
Frequency range	terrestrial	5/80-862 MHz	5/80-862 MHz	5/80-862 MHz	5/80-862 MHz	5/80-862 MHz
	SAT	950 – 2400 MHz	950 – 2400 MHz	950 – 2400 MHz	950 – 2400 MHz	950 – 2400 MHz
Tap off	terrestrial	0 dB	0 dB	0 dB	0 dB	0 dB
	SAT	0 dB	0 dB	0 dB	0 dB	0 dB
Isolation	terrestrial	≥ 40 dB	≥ 40 dB	≥ 40 dB	≥ 40	≥ 40
	SAT/terrestrial	≥ 40 dB	≥ 40 dB	≥ 40 dB	≥ 40	≥ 40
Isolation	terrestrial	≥ 40 dB	≥ 40 dB	≥ 40 dB	≥ 40	≥ 40
	SAT/SAT	≥ 40 dB	≥ 40 dB	≥ 40 dB	≥ 40	≥ 40
Isolation	terrestrial	≥ 25 dB	≥ 25 dB	≥ 25 dB	≥ 25	≥ 25
	subscriber/subscriber SAT	≥ 25 dB	≥ 25 dB	≥ 25 dB	≥ 25	≥ 25
Level adjuster	terrestrial	-	-20 dB	-20 dB	-20 dB	-20 dB
	SAT	-	-6 dB	-6 dB	-6 dB	-6 dB
Switching	vertical / horizontal	13 / 18 V	13 / 18 V	13 / 18 V	13 / 18 V	13 / 18 V
	low / high band	0 / 22 kHz	0 / 22 kHz	0 / 22 kHz	0 / 22 kHz	0 / 22 kHz
LNB	remote feeding	600...1300 mA	600...1300 mA	600...1300 mA	max 600 mA	max 600 mA
	Power connection	94...265 V~	94...265 V~	94...265 V~	94...265 V~	94...265 V~
Dimensions	W x H x D mm	355 x 125 x 55	355 x 125 x 55	355 x 125 x 55	355 x 125 x 55	355 x 125 x 55
Weight	g	950	1400	1450	1450	1450

Multiswitches

Cascadable 17 cable multiswitch system for unrestricted channel variety

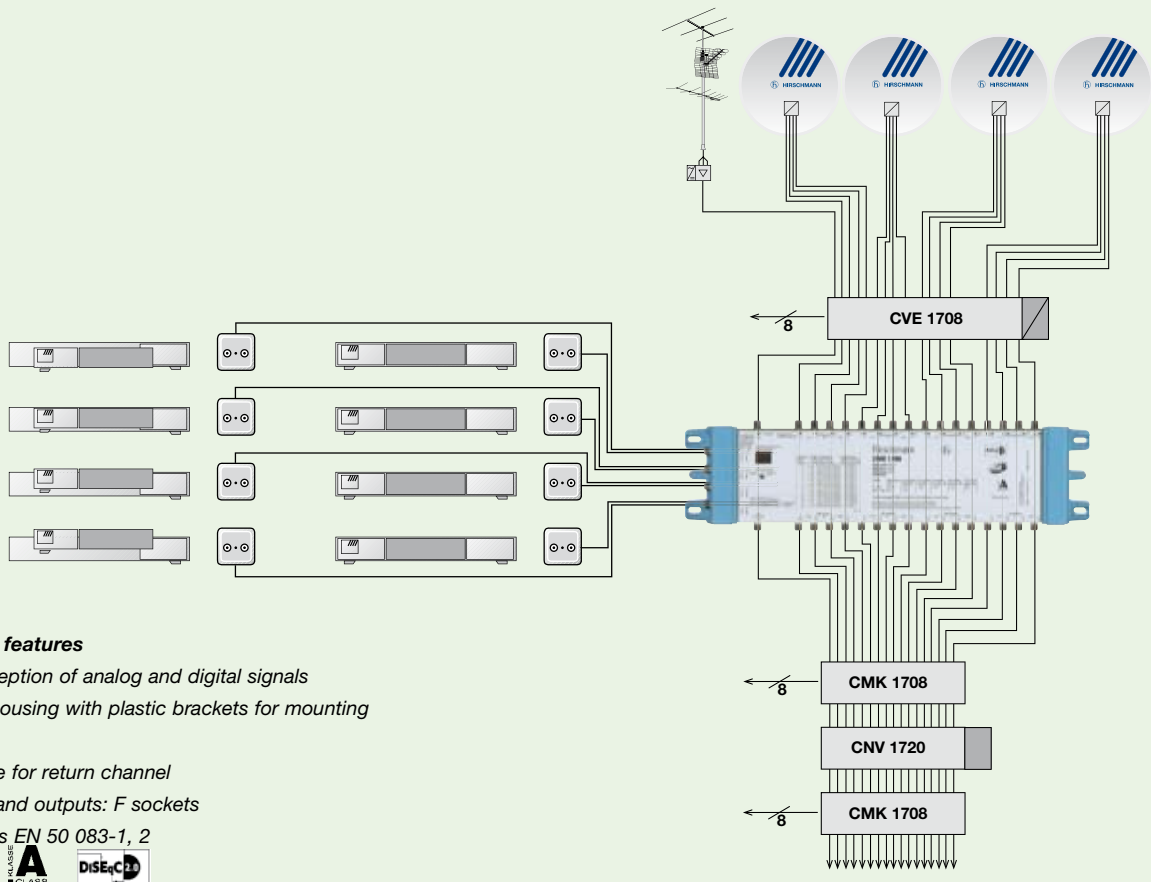

Common features

- For reception of analog and digital signals
- Metal housing with plastic brackets for mounting indoors
- Suitable for return channel
- Inputs and outputs: F sockets
- Satisfies EN 50 083-1, 2



Type		CVE 1708	CVE 1712	CVE 1716
Order number		940 037-002	940 038-002	940 039-002
Applications	Device type	Launch amplifier	Launch amplifier	Launch amplifier
Loop-through outputs	Inputs	17	17	17
	Outputs (subscribers)	8	12	16
	Loop-through outputs	17	17	17
Frequency range	terrestrial	5 – 862 MHz	5 – 862 MHz	5 – 862 MHz
	SAT	950 – 2400 MHz	950 – 2400 MHz	950 – 2400 MHz
Throughpass loss	terrestrial	6 dB	6 dB	6 dB
	SAT	3 dB	4 dB	4 dB
Tap off	terrestrial	25 dB	27 dB	28 dB
	SAT	0 dB	0 dB	0 dB
Isolation SAT/terrestrial	terrestrial	≧ 40 dB	≧ 40 dB	≧ 40 dB
	SAT	≧ 40 dB	≧ 40 dB	≧ 40 dB
Isolation SAT/SAT	terrestrial	≧ 40 dB	≧ 40 dB	≧ 40 dB
	SAT	≧ 40 dB	≧ 40 dB	≧ 40 dB
Isolation subscriber/subscriber	terrestrial	≧ 25 dB	≧ 25 dB	≧ 25 dB
	SAT	≧ 25 dB	≧ 25 dB	≧ 25 dB
Level adjuster	terrestrial			
	SAT	0 ... 6 dB	0 ... 6 dB	0 ... 6 dB
Gain	terrestrial			
	SAT			
Switching	vertical / horizontal low / high band			
LNB	remote feeding	600...1300 mA	600...1300 mA	600...1300 mA
	Power connection (50/60 Hz)	94...265V~	94...265V~	94...265V~
Dimensions	W x H x D mm	355 x 125 x 55	355 x 125 x 55	355 x 125 x 55
Weight	g	950	1400	1450

Cascade headend

- Green function-LED in the power-supply unit shows operating status and serves as an installation aid
- Patented installation and: Correct allocation of the trunk cable shown by LED display
- Programming aid: According to the programming setting on the receiver the associated SAT input on the multiswitch is displayed
- All voltages on the outputs are short-circuit proof.
- 22 KHz generator for operation on universal switch LNBS
- Level adjusters for SAT IF inputs (covered by sticker on housing)
- Distribution of the terrestrial band (5 – 862 MHz) is broadband passive
- Trunk passages for SAT-IF and terrestrial band are passive
- SAT-IF paths to the subscriber are active and is DC supplied by the receiver

Cascade multiswitch

- Patented installation and: Correct allocation of the trunk cable shown by LED display
- Programming aid: According to the programming setting on the receiver the associated SAT input on the multiswitch is displayed
- Distribution of the terrestrial band (5 – 862 MHz) is broadband passive
- Trunk passages for SAT-IF and terrestrial band are passive
- SAT-IF paths to the subscriber are active and is DC supplied by the receiver

Cascade amplifiers

- Green function-LED in the power-supply unit shows operating status
- 16 SAT IF amplifiers with level adjusters and permanent equalisation
- 1 forward amplifier with attenuator and equaliser for the terr. Band (47/80 -862 MHz)
- 1 return channel amplifier with attenuator and switchable return channel filter (5 – 30/65 MHz)
- DC bypass for all paths to support the installation aid
- The device can be used as pre-amplifier and post amplifier

CMK 1704	CMK 1706	CMK 1708	CMK 1712	CMK 1716	CNV 1720
940 040-001	940 041-001	940 042-001	940 043-002	940 044-002	940 045-001
Cascade multiswitches	Cascade multiswitch	Cascade multiswitch	Cascade multiswitch	Cascade multiswitch	Cascade amplifier
17	17	17	17	17	17
4	6	8	12	16	
17	17	17	17	17	
5 – 862 MHz	5 – 862 MHz	5 – 862 MHz	5 – 862 MHz	5 – 862 MHz	5 – 862 MHz
950 – 2400 MHz	950 – 2400 MHz	950 – 2400 MHz	950 – 2400 MHz	950 – 2400 MHz	950 – 2400 MHz
6 dB	6 dB	6 dB	6 dB	6 dB	
3 dB	3 dB	3 dB	4 dB	4 dB	
22 dB	23 dB	25 dB	27 dB	28 dB	
0 dB	0 dB	0 dB	0 dB	0 dB	
≥ 40 dB	≥ 40 dB	≥ 40 dB	≥ 40 dB	≥ 40 dB	
≥ 40 dB	≥ 40 dB	≥ 40 dB	≥ 40 dB	≥ 40 dB	
≥ 40 dB	≥ 40 dB	≥ 40 dB	≥ 40 dB	≥ 40 dB	
≥ 40 dB	≥ 40 dB	≥ 40 dB	≥ 40 dB	≥ 40 dB	
≥ 25 dB	≥ 25 dB	≥ 25 dB	≥ 25 dB	≥ 25 dB	
≥ 25 dB	≥ 25 dB	≥ 25 dB	≥ 25 dB	≥ 25 dB	
					0 ... 20 dB
					0 ... 20 dB
					19 ... 22 dB
					16 ... 22 dB
13 / 18 V	13 / 18 V	13 / 18 V	13 / 18 V	13 / 18 V	
0 / 22 kHz	0 / 22 kHz	0 / 22 kHz	0 / 22 kHz	0 / 22 kHz	
					94 ... 265 V
355 x 125 x 55	355 x 125 x 55	355 x 125 x 55	355 x 125 x 55	355 x 125 x 55	355 x 125 x 55
1450	1450	1450	1450	1450	1450

DiSEqC switches

Type	CKR 22 DD
Order number	981 000-487



DiSEqC switch CKR 22 DD for

- Use as single device for analog and digital signals
- For selecting one of two satellite positions
- Pre-switch device on the input of the satellite receiver or at the beginning of the branch
- Remote feed via the HF cable
- Internal routing of the remote feed voltage 13/18 V and the 22 kHz switch signal (only practical in tone burst mode) to the LNBS
- Metal housing with plastic brackets for installation indoors
- HF connectors: F sockets
- Satisfies EN 50083-1, 2
- CE

Frequency range	MHz	5 – 2150	2150 – 2400
Throughpass attenuation	dB	< 1.5	< 2.5
Isolation			
47-862 MHz	dB	> 25	> 20
950-2300 MHz	dB	> 25	> 20
Operating voltage	V	18	
Current consumption at 18V	mA	40	
Remote feed current, max. on input/output	mA	300	
Ambient temperature	°C	-30 to +60	
Weight	g	55	
Dimensions W x H x D	mm	55 x 50 x 24	

▶ Signal processing

Page 83 – Page100

CDH 1000 - Compact Digital Headend
CSE 2000 Generation 2 - headend system
CSE 6000 - Semi-professional headend



Signal processing

Headend overview

Three different headend concepts to meet virtually any requirement - the overview shows typical applications:

CDH 1000



Applications:

For up to approximately
200 subscribers
24 channels

- Small hotels
- Guest houses
- Care centres
- Blocks of flats
- Terraced houses

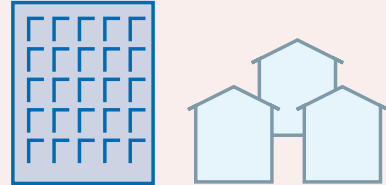

CSE 2000 Generation 2



For up to approximately
2,000 subscribers
80 channels

- Hotels
- Large blocks of flats
- Small residential areas
- CATV islands
- Additional channels

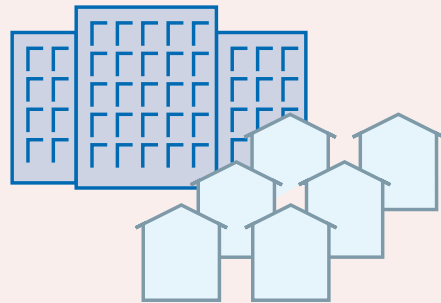

CSE 6000



For up to approximately
20,000 subscribers
80 channels

- Medium-sized CATV installations
- Districts
- Smaller towns

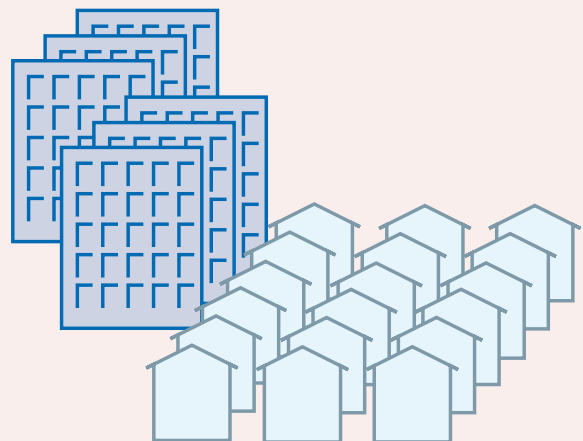

CDH Compact Digital Headend



CDH 1000 is a new generation compact headend and is used to process digital TV and radio programs in accordance with the DVB-S and DVB-T standards

The system features a compact design with up to 8 processing units per basic unit and very flexible configuration options. The channels can be transmitted over any existing building distribution network. The subscribers do not require digital receivers; all existing televisions can continue to be used without conversion.

- For use in new and existing master installations for 20 to 200 connections.
- Flexible configuration options - available as fully equipped unit or as individual components (basic unit, receiver modules and output modules can be configured as required)
- Master - slave:
An efficient variant of the configuration options is the use of a receiver module as a "master" with looping through of the MPEG data stream to 7 slave modules CDF 1000 M.
- Additional features:
 - Simple programming of the individual modules using remote control and on-screen display
 - Stations that can be received: Free-to-air (FTA) and encrypted with CA module
 - Automatic 16:9 switchover

Typical installation example

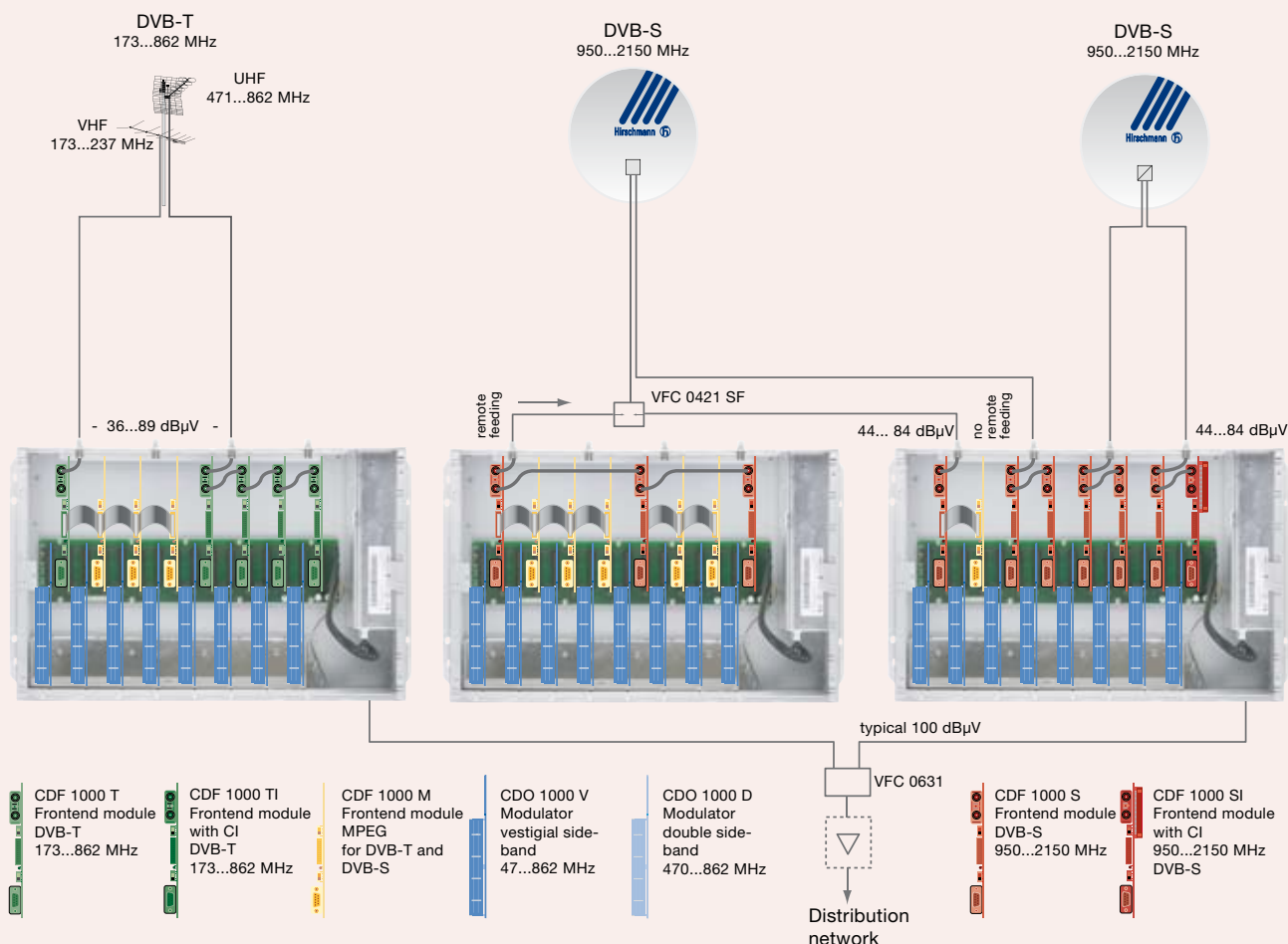

CDH Compact Digital Headend

Type	CDH 1000
-------------	-----------------

Order number 940 059-001



CDH 1000

- Basic device with power supply for accomodating up to 8 input modules and 8 modulator modules
- Per channel duct any combination of input modules and modulators is possible
- Stable, shielded metal housing
- Contains an active output combiner
- HF connectors with F sockets
- 19" or wall mount installation

Basic device		
Number of modules		max. 8
Electrical connection values		
Operating voltage		180-265 V, 47-63 Hz
Power consumption		
- configured with 4/6/8 module pairs VSB	W	60/85/110
- configured with 4/6/8 module pairs DSB	W	48/66/85
Remote feed voltage	V DC	14/18 V, switchable on the receiver module
Remote feed current	mA	400 per input module, max. 1.0 A
Control LNC (via input modules)	kHz	0/22
Output amplifier	MHz	47-862
Gain	dB	20
Output level total		
CSO, CTB 60 dB IMA	dB μ V	104
Level adjuster (total)	dB	10
Operating data		
Ambient temperature	°C	0-50
Type of installation		19", wall
Connections		F sockets
Dimensions W x H x D	mm	443 x 284 x 211
Weight	kg	6.7 unequipped, 10.5 fully equipped

CDH Compact Digital Headend

Type	CDH 1802 S	CDH 1802 SI
------	------------	-------------

Order number	940 064-001	940 063-001
--------------	-------------	-------------



Input frequency	MHz	950-2150	950-2150
Modulation type		QPSK	QPSK
Channels		8	8
Common Interface (CI)		-	8
Output frequency	MHz	470-862	470-862
Adjacent channel suitable		-	-
Modules			
CDF 1000 S		8	-
CDF 1000 SI		-	8
CDO 1000 D		8	8

CDH 1802 S

- 8 channels SAT FTA
- Non-adjacent channel/UHF

CDH 1802 SI

- 8 channels SAT CI
- Non-adjacent channel/UHF

Type	CDH 1801 S	CDH 1801 SI
------	------------	-------------

Order number	940 015-001	940 065-001
--------------	-------------	-------------



Input frequency	MHz	950-2150	950-2150
Modulation type		QPSK	QPSK
Channels		8	8
Common Interface (CI)		-	8
Output frequency	MHz	47-862	47-862
Adjacent channel suitable		yes	yes
Modules			
CDF 1000 S		8	-
CDF 1000 SI		-	8
CDO 1000 V		8	8

CDH 1801 S

- 8 channels SAT FTA
- Adjacent channel

CDH 1801 SI

- 8 channels SAT CI
- Adjacent channel

CDH Compact Digital Headend

Type	CDH 1402 S	CDH 1132 S
Order number	940 088-001	940 089-001



CDH 1402 SI

- 4 channels SAT FTA
- Non-adjacent channel/UHF

CDH 1132 S

- 4 channels SAT FTA
- 3 slave modules
- Non-adjacent channel/UHF

Input frequency	MHz	950-2150	950-2150
Modulation type		QPSK	QPSK
Channels		4	4
		-	1 master
		-	3 slave
Common Interface (CI)		-	-
Output frequency	MHz	470-862	470-862
Adjacent channel suitable		-	-
Modules			
CDF 1000 S		4	1
CDF 1000 M		-	3
CDO 1000 V		-	-
CDO 1000 D		4	4

Type	CDH 1261 T	CDH 1301 T
Order number	940 151-001	940 291-001



CDH 1261 T

- 8 channels terr FTA
- 6 slave modules
- 2 maske modules
- Adjacent channel

CDH 1301 T

- 3 channels terr FTA
- 3 maske modules
- Adjacent channel

Input frequency	MHz	174-862	174-862
Modulation type		COFDM	COFDM
Channels		8	3
Output frequency	MHz	47-862	47-862
Adjacent channel suitable		yes	yes
Modules			
CDF 1000 T		2	3
CDF 1000 M		6	-
CDO 1000 V		8	3
CDO 1000 D		-	-

CDH Compact Digital Headend

Type	CDF 1000 S	CDF 1000 T	CDF 1000 M
Order number	940 060-001	940 074-001	940 069-001

Type	CDF 1000 SI	CDF 1000 TI
Order number	940 061-001	940 075-001



CDF 1000 S

Input module for SAT digital

CDF 1000 SI

CI input module for SAT digital

CDF 1000 T

Input module for terrestrial digital (DVB-T)

CDF 1000 TI

Input module CI for terrestrial digital (DVB-T)

CDF 1000 M

Input module with MPEG input. MPEG signal can be fed in from DVB-S or DVB-T module

- For processing digital signals into analog audio/video signals (internal)
- Receiver modules can be installed in any mix
- FTA and CI variants
- The CDF 1000 M MPEG input module can be used as a slave for all other input modules
- HF connectors with F sockets
- TV and radio mode with automatic station display

Technical data				
Input frequency	MHz	950-2150	174-231 + 470-862	MPEG data current
AFC	MHz	± 4	± 4	
Input level	dBµV	44-84	36-89	
Modulation type		QPSK		
Symbol rate	MSps	2-45		
COFDM spectrum			2k, 8k with QPSK/ 16 QAM/64 QAM	
Viterbi code rate		1/2, 2/3, 3/4, 5/6, 7/8	1/2, 2/3, 3/4, 5/6, 7/8	
Power consumption	W	6 (CI 7)	6 (CI 7)	4

Type	CDO 1000 D	CDO 1000 V
Order number	940 062-001	940 066-001



CDO 1000 D

Double sideband modulator, DSB, non-adjacent channel suitable

CDO 1000 V

Vestigial sideband modulator, VSB, adjacent channel suitable

- Modulators audio / video (internal) in multi-standard TV signals
- Modulators can be installed in any mix
- Audio processing in mono/stereo or 2-channel audio
- HF connectors with F sockets

Technical data			
Output level		90 dBµV	90 dBµV
Audio modes - standard B/G		mono / stereo / dual channel	mono / stereo / dual channel
Output frequency range		470-862 MHz (K21-K69)	47-862 MHz (K02-K69)
Power consumption		3.3 W	5.2 W
Attenuators		0..0.10 dB	0...20 dB
TV standard		G, K, I,	B/G, D/K, I, L
S/N video, weighted		56 dB	56 dB

CSE 2000 Generation 2 - the new headend generation from Hirschmann

With the CSE 2000 Generation 2 Hirschmann offers a flexible, modular system in which analog and digital processing units ideally complement each other. CSE 2000 Generation 2 is the headend system that satisfies all current requirements and leaves all possibilities open for the future.

- The adjacent channel suitable head-end system is used for receiving and processing analog and digital TV and radio stations; terrestrial or via satellite.
- The system consists of the basic device with slots for 8 modules. A programmable input distribution panel is integrated; this panel has six inputs and 16 freely programmable outputs to the SAT modules.
- An integrated, ergonomic control unit permits common or individual programming of all modules.
- Multi-standard modules for international TV standards
- Additional audio/video modulators for injecting external signals
- Twin modules permit space-saving installations
- Neighbouring channel operation is possible without system limitation
- Can be programmed remotely
- The integrated output amplifier is also designed for larger networks
- Installation in 19" rack or wall mounting possible

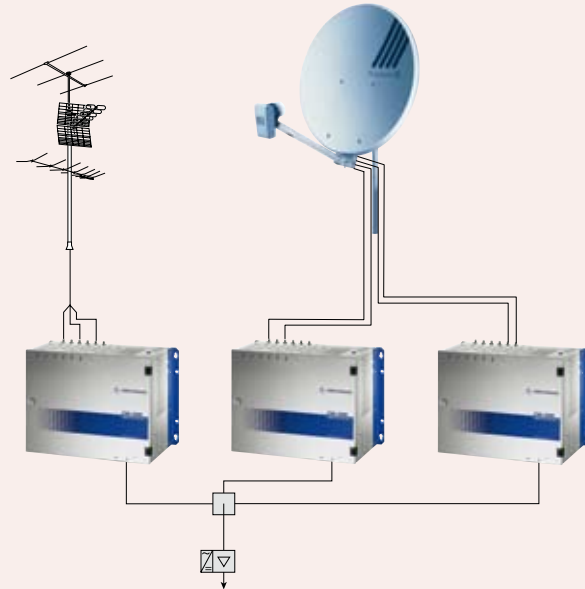

CSE 2000 Generation 2

CSE 2000 Generation 2 offers the right module for every application

	Twin module		Input						Output			
	single module		SAT analogue	SAT digital	terrestrial analogue	terrestrial digital	FM	A/V	PAL/SECAM	QAM	FM	A/V
Base unit CSE 2000 Generation 2												
Base unit CSE 2000 M Generation 2												
SAT digital / PAL CHD 2022 S												
SAT digital / PAL CHD 2022 SI												
SAT digital / PAL CHD 2022 MI												
SAT analog / PAL CHS 2000 M												
SAT analog / PAL CHS 2000 S												
SAT analog / PAL CHS 2001 S												
SAT analog / PAL CHS 2001 M												
Terr. analog / PAL CHT 2000 T												
Terr. analog / PAL CHT 2000 M												
Terr. analog / PAL CHT 2000 B												
Terr. analog / PAL CHT 2001 T												
Terr. analog / PAL CHT 2001 M												
Terr. digital / PAL CHC 2022 S												
Terr. digital / PAL CHC 2022 SI												
Terr. digital / PAL CHC 2022 MI												
Terr. digital / PAL CDT 2000 S												
Terr. digital / PAL CDT 2000 SI												
Terr. digital / PAL CDT 2000 M												
Terr. digital / PAL CDT 2000 MI												
Modulator (PAL) CHM 2000 S												
Modulator (PAL) CHM 2000 M												
Modulator (PAL) CHM 2001 S												
Modulator (PAL) CHM 2001 M												
SAT digital / QAM CHD 2022 Q												
SAT digital / QAM CHD 2022 QN												
Terr. digital / QAM CHC 2022 QN												
Amplifier SAT/terr. / FM CHV 2000 U												
FM module ADR (SAT/terr) / FM CHA 2000 A												
FM module SAT/terr. / FM CHA 2000 U												
FM module SAT dig. / FM CHD 2022 U												



CSE 2000 Generation 2

Type	CSE 2000 Generation 2	CSE 2000 M Generation 2
Order number	940 137-101	940 146-101

Basic device with power supply for accommodating up to 8 twin or single modules

- Stable, shielded metal housing (can be locked)
- Integrated ergonomic control unit with PC and remote control interface
- Includes intelligent input distribution panel with programmable SAT IF changeover switches
- Includes high-quality output amplifier
- All HF connectors are F sockets

CSE 2000 Generation 2

Basic device complete

CSE 2000 M Generation 2

Basic device without input distribution



Technical data		
Channels	max. 16 (8 twin modules)	max. 16 (8 twin modules)
Operating voltage	200 - 250 V~, 50 - 60 Hz	200 - 250 V~, 50 - 60 Hz
Attenuation loop-through input	4 dB	4 dB
Loop-through input	F sockets	F sockets
Power consumption	Max. 160 W	Max. 160 W
Serial interface	RS 232 / RJ 45 (RS 485)	RS 232 / RJ 45 (RS 485)
Ambient temperature C	0 to 50 °C	0 to 50 °C
Dimensions WxHxD	484x358x221 mm	484x358x221 mm
Input distribution panel		
Inputs	6	
Input frequency	950-2400 MHz	
Input level	60-85 dBμV	
Module connections	16 (2 per module slot)	
Inputs 5-6 distributable	to modules 7, 8	
Inputs 1-4 distributable	to modules 1-8	
Remote feed (inputs 1, 3, 5, 6)	4x500 mA	
Remote feed current	max. 1 A (total)	
Output amplifier		
Output level analog (16 channels)	108 dBμV	108 dBμV
Gain	28 dB	28 dB
Output level digital (16 channels)	104 dBμV	104 dBμV
Frequency range	47-862 MHz	47-862 MHz
Attenuators	0...20 dB	0...20 dB

CSE 2000 Generation 2

Twin modules SAT-TV analogue in accordance with PAL/SECAM

Type	CHS 2000 S	CHS 2000 M
Order number	960 899-101	960 898-101



- For processing analog SAT IF signals into analog output signals
- Output signal adjacent channel suitable (VSB)
- Twin modules with 2 adjacent output channels
- Integrated baseband interface in conjunction with CHE 2000 D
- All HF connectors are F sockets

Technical data		
Implemented channels	2 (twin)	2 (twin)
Input frequency range	950-2150 MHz	950-2150 MHz
AFC	± 8 MHz	± 8 MHz
Input level	47 - 70 dBµV	47 - 70 dBµV
Output level	90 dBµV	90 dBµV
Video hub is adjustable	16 / 22.5 MHz	16 / 22.5 MHz
Video polarity	neg. / pos.	neg. / pos.
Audio frequency	5.5-9.5 MHz	5.5-9.5 MHz
Output frequency range	110-862 MHz	110-862 MHz
Attenuators	0...20 dB	0...20 dB
TV standard	B / G (stereo)	PAL D/K , I; SECAM L
Power consumption	11.7 W	10.6 W

CHS 2000 S

Twin module with stereo modulator (B/G)

CHS 2000 M

Twin module with multi-standard modulator

Type	CHE 2000 D
Order number	960 901-101



Interface CHE 2000 D

- For analog modules
- For connection of decoders/descramblers for signal encryption
- For feeding video and audio signals into the system
- Forced switchover via 12 V switch voltage possible
- One 15-pole submin D socket per channel with inputs and outputs for video and audio signals

Function with module type	analog
Interface for allowing modules	CHA 2000 A CHS 2000 S CHS 2000 M

CSE 2000 Generation 2

Twin modules SAT-TV digital in accordance with PAL/SECAM

Type	CHD 2022 S1	CHD 2022 S11	CHD 2022 MI1
Order number	940 141-102	940 144-102	940 145-102



- For processing digital SAT IF signals into analog output signals
- Output signal adjacent channel suitable (VSB)
- Twin modules with 2 adjacent output channels
- Output signals in VHF I only for single channel mode
- CI variant for 1 CA module encryption of 2 channels from one datastream possible
- All HF connectors are F sockets
- CE



CHD 2022 S1

Twin module with stereo modulator (B/G)

CHD 2022 S11

Twin module CI with stereo modulator (B/G)

CHD 2022 MI1

Twin module CI with multi-standard modulator

Technical data	CHD 2022 S1	CHD 2022 S11	CHD 2022 MI1
Implemented channels	2 (twin)	2 (twin)	2 (twin)
Input frequency range	950-2150 MHz	950-2150 MHz	950-2150 MHz
AFC	± 4 MHz	± 4 MHz	± 4 MHz
Input level	47 - 70 dBμV	47 - 70 dBμV	47 - 70 dBμV
Modulation type	QPSK	QPSK	QPSK
Symbol rate	2-35 MS/s	2-35 MS/s	2-35 MS/s
Output level	90 dBμV	90 dBμV	90 dBμV
Output frequency range	(47) 110 - 862 MHz	(47) 110 - 862 MHz	(45) 110 - 862 MHz
Attenuators	0...20 dB	0...20 dB	0...20 dB
TV standard	B / G (stereo)	B / G (stereo)	PAL D/K , I, SECAM L
Power consumption	12 W	13 W	13 W

CSE 2000 Generation 2

Twin modules SAT TV digital in acc. QAM DVB-S -> DVB-C

Type	CHD 2022 QN	CHD 2022 Q
------	-------------	------------

Order number	940 012-101	940 166-101
--------------	-------------	-------------



- For processing analog SAT IF signals into analog output signals
- Output signal adjacent channel suitable
- Twin modules with 2 adjacent output channels
- All HF connectors are F sockets

Technical data		
Implemented channels	2 (twin)	2 (twin)
Input frequency range	950-2150 MHz	950-2150 MHz
AFC	± 4 MHz	± 4 MHz
Input level	47 - 70 dBμV	47 - 70 dBμV
Modulation type	QPSK	QPSK
Symbol rate	2-35 MS/s	2-35 MS/s
Output frequency range	110-862 MHz	110-862 MHz
Modulation type	16-256 QAM	16-256 QAM
Symbol rates	7,0 MS/s max.	7,0 MS/s max.
Output level	90 dBμV	90 dBμV
Attenuators	0...20 dB	0...20 dB
Power consumption	11 W	11 W

CHD 2022 QN

Twin module with QAM modulator

- Datastream processing (NIT) and stuffing possible

CDH 2022 Q

Twin module with QAM modulator

Twin modules SAT TV digital in acc. QAM DVB-S /S2 in accordance with DVB-C

Type	CHE 2022 QN
------	-------------

Order number	940 223-101
--------------	-------------



CHE 2022 QN

For converting QPSK and 8PSK modulated SAT IF signals into QAM modulated channels S02...K60

- Datastream processing (NIT) and stuffing possible
- Particularly suited for HDTV

Technical data	
Implemented channels	2 (twin)
Input frequency range	950-2150 MHz
AFC	± 4 MHz
Input level	47-70 dBμV
Modulation type	QPSK/8PSK
Symbol rate	1-45 MS/s (DVB-S) 10-31 (DVB-S2 QPSK) 10-30 (DVB-S2 8PSK)
Output frequency range	110-862 MHz
Modulation type	16-256 QAM
Symbol rates	7,0 MS/s max
Output level	90 dBμV
Attenuators	0...20 dB
Power consumption	11 W

CSE 2000 Generation 2

Modules terrestrial TV analog

Type	CHT 2000 T	CHT 2000 M	CHT 2000 B
Order number	960 903-101	960 973-101	960 911-101

- For converting analog terrestrial signals into analog output signals
- Twin module and single module
- Output signal adjacent channel suitable (VSB)
- Twin modules with 2 adjacent output channels
- Automatic amplifier control (AGC)
- HF connectors with F sockets



CHT 2000 T

Twin module with stereo modulator (B/G)

CHT 2000 M

Twin module with multi-standard modulator

CHT 2000 B

Signal module with multi-standard modulator for VHF I and III

Technical data	CHT 2000 T	CHT 2000 M	CHT 2000 B
Implemented channels	2 (twin)	2 (twin)	1 (single)
Input frequency range	47-862 MHz	45-862 MHz	45-862 MHz
Input level	70 - 85 dB μ V	70-85 dB μ V	70-85 MHz
Output level	90 dB μ V	90 dB μ V	90 dB μ V
Output frequency range	110-862 MHz	110-862 MHz	45-470 MHz
Attenuators	0...20 dB	0...20 dB	0...20 dB
TV standard	B/G stereo	D/K , I, L	D/K, I, L (B/G stereo)
Power consumption	7.2 W	7.2 W	3.8 W

Type

CHT 2001 M

Order number 961 105-101

CHT 2001 M

Single module with multi-standard modulator

Technical data	CHT 2001 M
Implemented channels	1 (single)
Input frequency range	45-862 MHz
Input level	79-85 dB μ V
Output level	90 dB μ V
Output frequency range	110-862 MHz
Attenuators	0...20 dB
TV standard	D/K , I, L
Power consumption	3.8 W

CSE 2000 Generation 2

Modules terrestrial TV digital in accordance with PAL

Type	CHC 2022 S1	CHC 2022 SI1	CHC 2022 MI1
Order number	940 147-102	940 148-102	940 149-102



DVB-T

- Twin modules
- For processing digital terrestrial TV signals into analog output signals
- Output signal adjacent channel suitable
- Output signal in VHF I only for single channel mode

CI variant for CA module:

- Encryption of 2 channels from one datastream possible
- All HF connectors are F sockets

Technical data			
Implemented channels	2 (twin)	2 (twin)	2 (twin)
Input frequency range	174-230 MHz 470-862 MHz	174-230 MHz 470-862 MHz	174-230 MHz 470-862 MHz
AFC	+/- 4 MHz	+/- 4 MHz	+/- 4 MHz
Input level	30 - 80 dB μ V	30 - 80 dB μ V	30 - 80 dB μ V
Modulation type	COFDM 2k, 8k	COFDM 2k, 8k	COFDM 2k, 8k
Symbol rate	2 - 35 MS/s	2 - 35 MS/s	2 - 35 MS/s
Output frequency range	(47) 110 - 862 MHz	(47) 110 - 862 MHz	(47) 110 - 862 MHz
Output level	90 dB μ V	90 dB μ V	90 dB μ V
Attenuators	0...20 dB	0...20 dB	0...20 dB
TV standard	B/G stereo	B/G stereo	PAL D / K.I: SECAM L
Power consumption	12 W	13 W	13 W

Modules terrestrial TV digital in accordance with QAM

Type	CHC 2022 QN
Order number	940 150-101



DVB-T

Technical data	
Implemented channels	2 (twin)
Input frequency range	174-230 MHz 470-862 MHz
AFC	\pm 4 MHz
Input level	30 - 80 dB μ V
Modulation type	COFDM 2k, 8k
Symbol rate	2 - 35 MS/s
Output frequency range	110-862 MHz
Modulation type	16 - 256 QAM
Output level	90 dB μ V
Attenuators	0...20 dB
Power consumption	12 W

CHC 2022 S1

Twin module with stereo modulator (B/G)

CHC 2022 SI1

Twin module with stereo modulator (B/G)

CHC 2022 MI1

Twin module CI with multi-standard modulator

CHC 2022 QN

Twin module with QAM modulator
Datastream processing (NIT) and stuffing possible

CSE 2000 Generation 2

Module audio/video modulator

Type	CHM 2000 S	CHM 2000 M	CHM 2001 M
------	------------	------------	------------

Order number	960 912-101	960 913-101	961 109-101
--------------	-------------	-------------	-------------

- For processing analog audio / video signals into analog output signals
- Twin single modules
- Output signal adjacent channel suitable (VSB)
- Twin modules with 2 adjacent output channels
- Integrated baseband interface CHE 2000 D included in scope of delivery
- All HF connectors are F sockets



CHM 2000 S stereo modulator B/G

Twin module multi-standard modulator

CHM 2000 M

Twin module multi-standard modulator

CHM 2001 M multi-standard modulator

Single module

Technical data			
Implemented channels	2 (twin)	2 (twin)	1 (single)
Video bandwidth	20 Hz - 5 MHz	20 Hz - 5 MHz	20 Hz - 5 MHz
Video input level	1 Vss	1 Vss	1 Vss
Audio signal	Stereo, 2 tone, mono	Mono	Mono
Audio input level	500, Ri = 10 kOhm mV	500, Ri = 10 kOhm mV	500, Ri = 10 kOhm mV
Audio bandwidth	40 Hz - 15 kHz	40 Hz - 15 kHz	40 Hz - 15 kHz
Output frequency range	110-862 MHz	110-862 MHz	110-862 MHz
Output level	90 dBμV	90 dBμV	90 dBμV
Attenuators	0...20 dB	0...20 dB	0...20 dB
TV standard	B / G (stereo)	D/K , I, L	D/K , I, L
Power consumption	7.3 W	6.3 W	5.8 W

CSE 2000 Generation 2

FM modules

Type	CHA 2000 A	CHA 2000 U	CHV 2000 U	CHD 2022 U
Order number	960 905-101	960 906-101	960 904-101	940 161-101



- For processing analog or digital signals into FM
- Twin modules

Technical data	CHA 2000 A	CHA 2000 U	CHV 2000 U	CHD 2022 U
Implemented channels	2 (twin)	2 (twin)	-	2 (twin)
Input frequency range	950-2150 MHz	87.5-108 MHz	87.5-108 MHz	950-2150 MHz
AFC				± 4 MHz
Input level	47 - 70 dBμV	53 - 99 dBμV		47 - 70 dBμV
Modulation type				QPSK
Symbol rate				2-35 MS/s
Analog subcarriers	6-9 MHz			
ADR subcarriers	0.18-9 MHz			
Gain			34 dB	
Noise factor			3 dB	
Reduction per rejection			14 dB	
Output frequency range	87.5-108 MHz	87.5-108 MHz	87.5-108 MHz	87.5-108 MHz
Output level	91 dBμV	91 dBμV	91 dBμV	91 dBμV
Attenuators	0...20 dB	0...20 dB		0...20 dB
Power consumption	8 W	1.9 W	1,5 W	10 W

CHA 2000 A

Twin module SAT - analog FM modulator

- Processes analog and digital subcarriers (ADR)
- Generates RDS signal
- Feed of external audio signals possible with CHE 2000 D

CHA 2000 U

Twin module FM converter

- Same channel operation possible
- Automatic gain control (AGC)

CHV 2000 U

Single module FM amplifier

- Six adjustable rejection filters
- Two rejection filters can be set to increase the attenuation of the same frequency

CHD 2022 U

Twin module SAT digital FM modulator

Remote programming

Type	CHZ 2020 R
------	------------

Order number 940 301-001

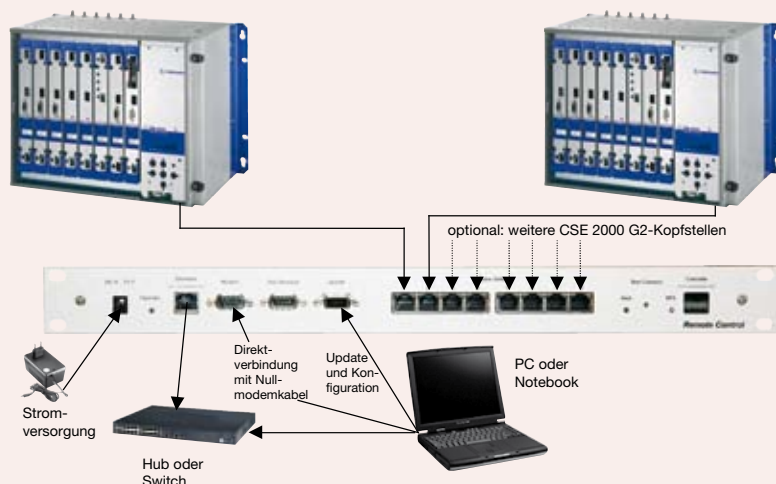

- Up to 8 basic devices can be programmed remotely via 1 CHZ 2020 R
- 19" 1 U
- Remote control software included in the scope of delivery

CSE 6000 - the semi-professional headend

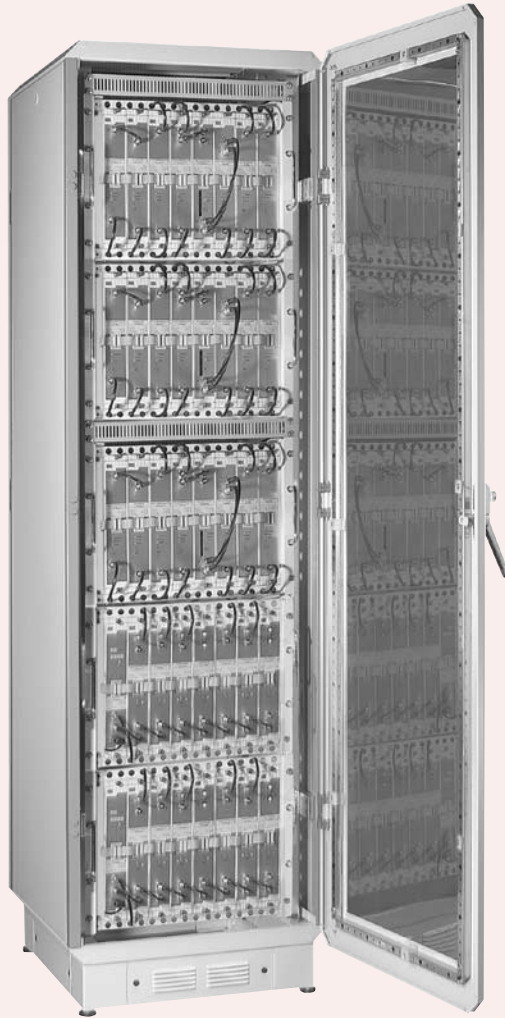

The CSE 6000 headend

is widely used in medium-sized cable networks with the functionalities:

- Adjacent channel suitability for modern CATV systems with a high number of channels
- Very user friendly due to standardised interfaces (all inputs and outputs in F-system, RJ 45 as remote control interface)
- Straightforward and quick installation, as well as commissioning (programming of all modules using a central RJ 45 interface)
- High performance (output level, S/N, etc.)
- Optimal heat dissipation guarantees reliable operation
- All input and output interfaces are as standard 75 Ω impedance
- For TV standards B/G, D/K
- RF output frequency range to 862 MHz
- One 19" / 8 U frame can be fitted with up to 16 channel processing cassettes
- 40 analog SAT channels can be processed per 19" cabinet
- Software configuration of maximum 240 components possible

The CSE 6000 headend station system provides the complete range of components for analog and digital processing. The system is characterised by its modular design, flexible configuration features, the open interface concept and the use of a headend station management system. In this way the CSE 6000 can not only be set up as a complete system, but can also be integrated in existing headend stations.

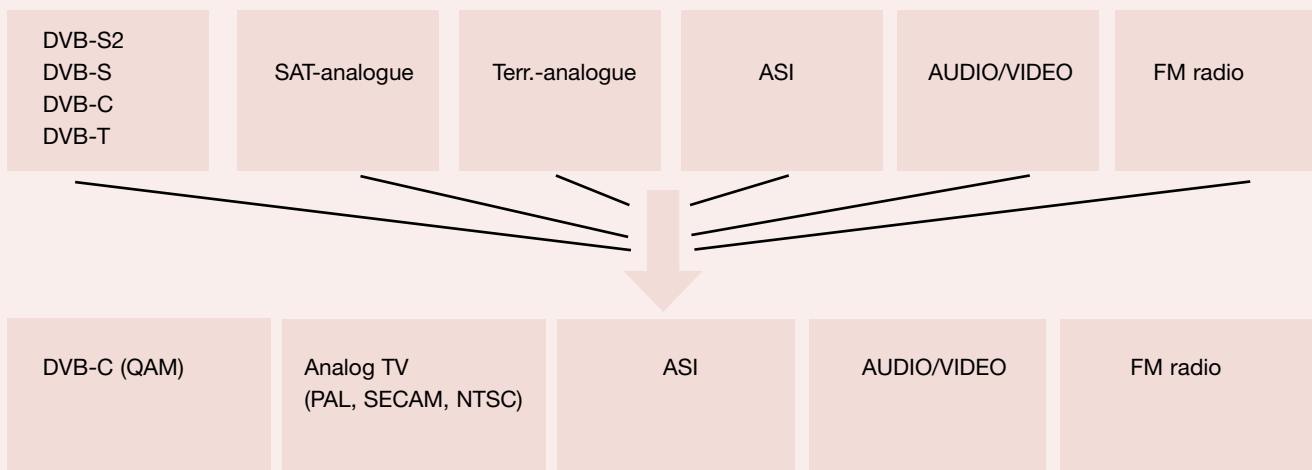

Please request the specific brochure for the complete headend system including technical parameters

▶ Taps, splitters, combiners and inserters

Page 101 – Page 112

Tap-offs/splitters for CATV with F-sockets

Tap-offs/splitters for SAT with F sockets

Tap-offs/splitters with screw terminals in semi-circular housing

Second unit Splitters

Combiners, remote supply voltage inserters



Introduction

Tap-offs

For the connection of one or more tap-off cables to a continuous (trunk) cable.

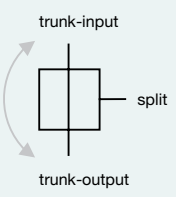

Throughpass attenuation
Attenuation between trunk input and trunk output

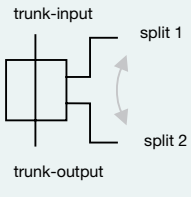

Coupling attenuation
Attenuation between the tap-offs (for multiple tap-offs)

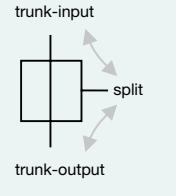

Tap-off attenuation
Attenuation between trunk input and the tap-off (for tap-offs without directional coupler, even between trunk output and the tap-off)

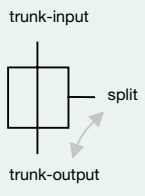

Directional attenuation
Attenuation between the trunk output and tap-off (for tap-offs with directional couplers)

Splitters

For distributing the energy of an incoming main trunk line into two or more trunk lines

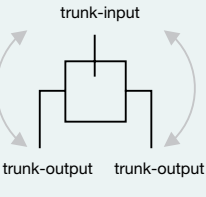

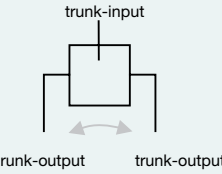

Distribution attenuation
Attenuation between trunk input and trunk outputs



Coupling attenuation
Attenuation between the outputs

Overview

Main application			
Single/MATV with SAT	•		•
CATV indoor distribution	•	•	
Frequency range			
Terr., CATV (5-862 MHz)	•	•	
Terr. + SAT (5-2400 MHz)	•		•
Suitable for return channel	•	•	•
Connections			
Screw terminals	•		
F sockets		•	•
Installation			
Surface mounting	•	•	•
Flush mounting	•		
Remote feed possible	•		•
Tap-offs 1x			
	ARS 101	AFC 0811 AFC 1211 AFC 1611 AFC 2011	AFC 1011 S AFC 1511 S AFC 2011 S AFC 2511 S
2x	ARS 102	AFC 0921 AFC 1221 AFC 1621 AFC 2021	AFC 1021 S AFC 1521 S AFC 2021 S AFC 2521 S
4x		AFC 1441 AFC 1641	AFC 1041 S AFC 1541 S AFC 2041 S AFC 2541 S
6x		AFC 1861	
8x		AFC 2081	
Splitters 2x			
	VEDO 042	VFC 0421	VFC 0421 SF
3x	VEDO 063 F	VFC 0631	VFC 0631 SF
4x		VFC 0741	VFC 0741 SF
6x		VFC 1061	VFC 1061 SF
8x		VFC 1281	VFC 1281 SF
12x		VFC 1219	

Tap-offs with F sockets, frequency range to 1000 MHz

1x

Type	AFC 0811	AFC 1211	AFC 1611	AFC 2011
Order number	947 359-101	947 360-101	947 361-101	947 362-101



1x tap-off

- Die-cast housing
- CATV indoor distribution
- Surface mounting
- For F connections with Inner conductor Ø: min. 0.5 mm max. 1.2 mm
- Suitable for return channel
- Inner conductor isolated capacitively
- Satisfies EN 50083-2



		Frequency range MHz				
Throughpass	dB	5-40	1.5	0.9	0.7	0.7
loss		40-1000	1.5-2.0	0.9-1.4	0.7-1.0	0.7-0.9
Tap-off	dB	5-40	8.5	12	16	20
loss		40-1000	8.5	12	16	20
Directional	dB	5-40	30	24	36	38
loss		40-1000	30 ¹⁾	32 ¹⁾	36	40 ¹⁾
Dimensions L x W x H mm			24x50x51	24x50x51	24x50x51	24x50x51

¹⁾ From 40 MHz reduced by 1.5 dB per octave

2x

Type	AFC 0921	AFC 1221	AFC 1621	AFC 2021
Order number	947 363-101	947 364-101	947 365-101	947 366-101



2x tap-off

- Die-cast housing
- CATV indoor distribution
- Surface mounting
- For F connections with Inner conductor Ø: min. 0.5 mm max. 1.2 mm
- Suitable for return channel
- Inner conductor isolated capacitively
- Satisfies EN 50083-2

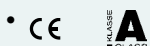

		Frequency range MHz				
Throughpass	dB	5-40	3.0	1.6	1.3	1.2
loss		40-1000	3.4-4.3	1.6-2.1	1.3-1.5	1.3-1.5
Tap-off	dB	5-40	8.5	13	16.5	20
loss		40-1000	8.5	13	16.5	20
Coupling	dB	5-40	30	40	46	50
loss		40-1000	28-30	40-32	46-36	50-36
Directional	dB	5-40	25	28	34	36
loss		40-1000	28 ¹⁾	30 ¹⁾	34 ¹⁾	36 ¹⁾
Dimensions L x W x H mm			24x72x51	24x72x51	24x72x51	24x72x51

¹⁾ From 40 MHz reduced by 1.5 dB per octave

Tap-offs with F sockets, frequency range to 1000 MHz

	4x	6x	8x	12x	
Type	AFC 1441	AFC 1641	AFC 1861	AFC 2081	VFC 1219
Order number	940 294-001	947 367-101	947 368-101	947 369-101	947 585-001

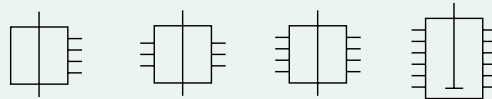

Fig.: AFC 1641

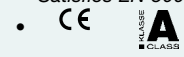

Fig.: VFC 1219

		Frequency range MHz	4x	6x	8x	12x	
Throughpass loss	dB	5-40	3.6	4.5	6	9	-
		40-1000	3.6	3.8-4.0	6	8	-
Tap-off attenuation 1	dB	5-40	14	12.5	12.5	12.5	11.5
		40-1000	14	12.5	12.5	12.5	11.5
Tap-off attenuation 2	dB	5-40	14	13.5	13.5	13.5	13
		40-1000	14	13.5	13.5	13.5	13
Tap-off attenuation 3	dB	5-40	14	14.5	14.5	14.5	15
		40-1000	14	14.5	14.5	14.5	15-16
Tap-off attenuation 4	dB	5-40	14	15	15.5	15 15	
		40-1000	14	15	15.5	15 15-16	
Tap-off attenuation 5	dB	5-40	-	16.5	16	16.3	
		40-1000	-	16.5	16	17	
Tap-off attenuation 6	dB	5-40	-	17.5	17	16.3	
		40-1000	-	17.5	17	17	
Tap-off attenuation 7	dB	5-40	-	-	18	17.5	
		40-1000	-	-	18	18	
Tap-off attenuation 8	dB	5-40	-	-	19	17.5	
		40-1000	-	-	19	18	
Tap-off attenuation 9+10	dB	5-40	-	-	-	18	
		40-1000	-	-	-	18	
Tap-off attenuation 11+12	dB	5-40	-	-	-	19	
		40-1000	-	-	-	19	
Coupling loss	dB	5-40	36	38	40	36 36	
		40-1000	40-32	40-34	40-36	40-36	36-34
Directional loss	dB	5-40	26 min	26 min	26 min	26 min	-
		40-1000	30-26	30-25	30-24	30-24	-
Dimensions L x W x H mm			91x61x40	91x60x40	135x60x40	135x60x40	179x52x40



- 4x, 6x, 8x, 12x tap-off**
- Die-cast housing
 - CATV indoor distribution
 - Surface mounting
 - For F connections with Inner conductor Ø: min. 0.5 mm max. 1.2 mm
 - Suitable for return channel
 - Inner conductor isolated capacitively
 - Satisfies EN 50083-2



Splitters with F sockets, frequency range to 1000 MHz

	2x	3x	4x
Type	VFC 0421	VFC 0631	VFC 0741
Order number	947 355-101	947 356-101	947 357-101





Fig.: VFC 0421

2x, 3x, 4x splitters

- Die-cast housing
- CATV indoor distribution
- For F connections with Inner conductor Ø: min. 0.5 mm max. 1.2 mm
- Suitable for return channel
- Inner conductor isolated capacitively
- Surface mounting
- Satisfies EN 50083-2



		Frequency range MHz			
Distribution	dB	5-40	3.5	5.5	7.2
attenuation 1		40-1000	3.9-4.4	5.8-6.8	7.5-8.2
Distribution	dB	5-40	3.5	5.5	7.2
attenuation 2		40-1000	3.9-4.4	5.8-6.8	7.5-8.2
Distribution	dB	5-40	-	5.5	7.2
attenuation 3		40-1000	-	5.8-6.8	7.5-8.2
Distribution	dB	5-40	-	-	7.2
attenuation 4		40-1000	-	-	7.5-8.2
Coupling	dB	5-40	24	20	22
loss		40-1000	25-20	25-22	24-20
Dimensions L x W x H mm			50 x 51 x 24	72 x 51 x 24	72 x 51 x 24

	6x	8x
Type	VFC 1061	VFC 1281
Order number	981 000-108	981 000-109





Fig.: VFC 1281

6x, 8x Splitters





- Die-cast housing
- CATV indoor distribution
- For F connections with Inner conductor Ø: min. 0.5 mm max. 1.2 mm
- Test output – 20 dB
- Suitable for return channel
- Inner conductor isolated capacitively
- Surface mounting
- Satisfies EN 50083-2





		Frequency range MHz		
Distribution	dB	5-40	10.7	12.3
attenuation 1+2		40-1000	10.7-12.0	12.3-13.2
Distribution	dB	5-40	10.7	12.3
attenuation 3+4		40-1000	10.7-12.0	12.3-13.2
Distribution	dB	5-40	10.7	12.3
attenuation 5+6		40-1000	10.7-12.0	12.3-13.2
Distribution	dB	5-40	-	12.3
attenuation 7+8		40-1000	-	12.3-13.2
Coupling	dB	5-40	12	14
loss		40-1000	20	20
Dimensions L x W x H mm			135 x 60 x 41	135 x 60 x 41

Tap-offs with F sockets, frequency range to 2400 MHz







1x

Type		AFC 1011 S	AFC 1511 S	AFC 2011 S	AFC 2511 S
Order number		947 564-002	947 565-002	947 658-002	947 659-002 SF1b
					
					
	Frequency range MHz				
Throughpass loss	dB	5-40	2	1.5	1.5
		40-1000	2.5	1.5	1.5
		1000-2400	3.2	2.2	2.2
Tap-off loss	dB	5-40	11	15	20
		40-1000	10	15	20
		1000-2400	10	15	20
Directional loss	dB	5-40	26	30	35
		40-1000	22	25	30
		1000-2400	20-18	22-20	25
Dimensions L x W x H	mm	53 x 53 x 16	53 x 53 x 16	53 x 53 x 16	53 x 53 x 16

1x tap-off



- With the included spacer two tap-offs can be mounted on top of each other
- For SAT IF distribution in buildings
- Remote feed via trunk max. 1 A/24 V DC
- Die-cast housing
- Satisfies EN 50083-2
-  

2x

Type		AFC 1021 S	AFC 1521 S	AFC 2021 S	AFC 2521 S
Order number		947 566-002	947 567-002	947 622-002	947 660-002
					
					
	Frequency range MHz				
Throughpass loss	dB	5-40	4.5	3	2
		40-1000	3.5	3	2
		1000-2400	4.5	4	3
Tap-off loss	dB	5-40	11	15	20
		40-1000	11	15	20
		1000-2400	11	15	20
Coupling loss	dB	5-40	35	40	45
		40-1000	25	35	35
		1000-2400	25-20	30-25	30
Directional loss	dB	5-40	18	23	25
		40-1000	18	20	22
		1000-2400	17	20	22
Dimensions L x W x H	mm	75 x 53 x 16	75 x 53 x 16	75 x 53 x 16	75 x 53 x 16

Installation example



2x tap-off

- With the included spacer two tap-offs can be mounted on top of each other
- For SAT IF distribution in buildings
- Remote feed via trunk max. 1 A/24 V DC
- Die-cast housing
- Satisfies EN 50083-2
-  

Tap-offs, splitters, combiners and inserters

Tap-offs with F sockets, frequency range to 2400 MHz

4x

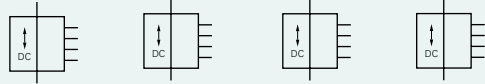

Type	AFC 1041 S	AFC 1541 S	AFC 2041 S	AFC 2541 S		
Order number	947 602-002	947 603-002	947 604-002	947 661-002		
		 		<p>Installation example</p> 		
		Frequency range MHz				
Throughpass	dB	5-40	5	3	1.5	1.5
loss		40-1000	5	3.5	2	1.5
		1000-2400	6	5	3	2.5
Tap-off	dB	5-40	10.5	15	20	25
loss		40-1000	11.5	15	20	25
		1000-2400	13	15.5	20.5	25.5
Coupling	dB	5-40	18	20	20	20
loss		40-1000	20	22	22	22
		1000-2400	18	20	20	20
Directional	dB	5-40	20	30	40	45
loss		40-1000	23	23	25	30
		1000-2400	20-18	20	20	25
Dimensions L x W x H	mm		75 x 62 x 16	75 x 62 x 16	75 x 62 x 16	75 x 62 x 16

4x tap-off

- With the included spacer two tap-offs can be mounted on top of each other
- For SAT IF distribution in buildings
- Remote feed via input, max. 1 A/24 V DC
- Die-cast housing
- Satisfies EN 50083-2

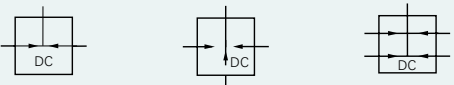

Splitters with F sockets, frequency range to 2400 MHz

Type	2x	3x	4x		
Type	VFC 0421 SF	VFC 0631 SF	VFC 0741 SF		
Order number	947 568-002	947 569-002	947 570-002		
		 			
		<p>Installation example</p> 			
		Frequency range MHz			
Distribution	dB	5-40	4.5	7.5	8.5
loss		40-1000	5	8	9
		1000-2400	6.2	10.5	11
Coupling	dB	5-40	18	20	22
loss		40-1000	20	20	20
		1000-2400	20	20	20
Dimensions L x W x H	mm		53 x 53 x 16	53 x 53 x 16	53 x 53 x 16

2x, 3x, 4x Splitters

- With the included spacer two splitters can be mounted on top of each other
- For SAT IF distribution in buildings
- Diecast housing
- Surface mounting
- For F connections with Inner conductor Ø: min. 0.5 mm max. 1.2 mm
- Remote feed possible via all outlets
- max. 1 A/24 V DC
- Satisfies EN 50083-1, -2

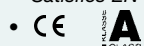

Splitters with F sockets, frequency range to 2400 MHz

		6x		8x	
Type		VFC 1061 SF		VFC 1281 SF	
Order number		947 741-002		947 742-002	
		Frequency range MHz			
Distribution loss	dB	5-40	11.5	12	
		40-1000	13	14	
		1000-2400	16.5	16	
Coupling loss	dB	5-40	22	22	
		40-1000	21	21	
		1000-2400	20	20	
Dimensions L x W x H		mm	118 x 57 x 17	118 x 57 x 17	

6x, 8x Splitters

- With the included spacer two splitters can be mounted on top of each other
- For SAT IF distribution in buildings
- Diecast housing
- Surface mounting
- For F connections with Inner conductor Ø: min. 0.5 mm max. 1.2 mm
- Remote feed possible via all outlets
- Max. 1 A/24 V DC
- Satisfies EN 50083-1, -2



Second unit splitters, passive, active

Type		ZGV 77		ZVA 134	
Order number		947 502-001		944 440-002	
		Frequency range MHz			
Distribution loss	dB	0.15-862	3.5	-	
		950-2150	5	-	
Coupling loss	dB	0.15-862	18	-	
		950-2150	15	-	
Gain per output	dB	47-862	-	6	
Max. perm. output level	dbµV	47-862	-	100 ¹⁾ , 80 ²⁾	
Coupling attenuation	dB	47-862	-	16	
Noise factor	dB	47-862	-	6	
Operating voltage			-	230 V~50-60Hz	
Ambient temperature C			-20 to +50		

- For connecting two televisions to an antenna socket
- Can be plugged into the TV output of antenna sockets meeting EN 60169-2
- **ZVA 134:** With built-in amplifier. Separate plug-type power supply unit, cable approx. 1.5 m
- Satisfies EN 50083-1, 2

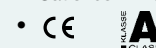

¹⁾ For 60 dB IMA third order (interference product) in accordance with EN 50083-5 and assignment with 2 channels.
When assigned with more than 2 channels, the output level must be reduced as usual.

²⁾ For 60 dB IMA second order (interference products) in accordance with 50083-5.
The maximum operating level is the lower value from ¹⁾ and ²⁾!



Tap-offs with screw terminals in semi-circular housing

Type	1x	2x
	ARS 101	ARS 102
Order number	945 020-001	945 021-001



1x, 2x tap-offs

- Die-cast housing with integrated hinged clamps
- Lockable hinge clamps
- Universal implementation for all indoor distributions
- Surface mounting or flush in Ø70 mm mounting box (with mini or midi cables, also in 55 mm, \triangle 58 mm Ø, flush mounting box), screw for surface mounting in scope of delivery
- Suitable for return channel
- For cables with
Inner conductor Ø: 0.4 -1.4 mm
Outer conductor Ø: 2.7 -5.7 mm
- Remote feed via trunk input/output, max. 500 mA/24 V DC
- Satisfies EN 50083-2
- CE

		Frequency range MHz		
Throughpass loss	dB	4-30	1.4	2.8
		47-862	1.2-1.4	2.4-2.6
		950-2400	2.0-2.4	4.0-4.8
Tap-off attenuation 1	dB	4-30	10-10.5	11.5
		47-862	10	10
		950-2400	10	10.5
Tap-off attenuation 2	dB	4-30	-	12.5
		47-862	-	11.5
		950-2400	-	12.5
Coupling loss	dB	4-30	-	32
		47-862	-	42-44
		950-2400	-	28-30
Directional loss	dB	4-30	22	22
		47-862	34-32	34-32
		950-2400	20-18	20-18
Dimensions Ø mm			53.5 (26 high)	53.5 (26 high)



Splitters with screw terminals in semi-circular housing

Type	2x	3x
	VEDO 042	VEDO 063 F
Order number	945 022-001	945 023-001



2x, 3x Splitters

- Die-cast housing with integrated hinged clamps
- Lockable hinge clamps
- Universal implementation for all indoor distributions
- Surface mounting or flush in Ø70 mm mounting box (with mini or midi cables, also in 55 mm, \triangle 58 mm Ø, flush mounting box), screw for surface mounting in scope of delivery
- Suitable for return channel
- For cables with
Inner conductor Ø: 0.4 -1.4 mm
Outer conductor Ø: 2.7 -5.7 mm
- VEDO 042: Remote DC-feed via trunk input and outputs, max. 500 mA/24 V DC
- VEDO 063 F: Remote DC-feed via trunk input/output, max. 500 mA/24 V DC
- Satisfies EN 50083-2
- CE

		Frequency range MHz		
Distribution loss	dB	4-30	5	7
		47-862	3.8-4.2	7.0-7.7
		950-2400	4.8-5.8	8.5-9.5
Coupling loss	dB	4-30	20	22
		47-862	24-20	22-18
		950-2400	20-18	18
Dimensions Ø mm			53.5 (26 high)	53.5 (26 high)

Combiners for indoor mounting

Range coupler for 0,15-446 MHz and 470-862 MHz

Type	BWS 202
-------------	----------------

Order number 947 338-001

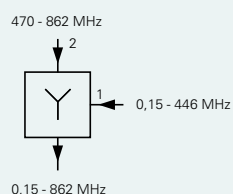

Frequency range		
Input 1/2	MHz	0.15-446/470-862
Throughpass att.	dB	0.5/0.5
Rej. atten.	dB	24
Dimensions	mm	70 x 90 x 35

- For combining or separating two frequency ranges
- HF connections with coaxial sockets and connectors in accordance with EC 60169-2
- Bracket for wall mounting supplied
- Satisfies EN 50083-2
-

Range coupler for 47-446 MHz and 950-862 MHz

Type	BWS 2910 F
-------------	-------------------

Order number 981 000-041



Frequency range		
Input 1 SAT / 2 terr.	MHz	950-2050/47-862
Throughpass attenuation		
Input SAT/terr.	dB	1.5/1.0
Remote feed		Input 1
Remote feed current		max. 1 A
Dimensions	mm	67 x 71 x 24

- For combining or separating terrestrial signals and satellite IF signals
- All connections are designed as F sockets
- Satisfies EN 50083-2
-

Type	BWS 3910 F
-------------	-------------------

Order number 981 000-042



Frequency range		
1 input terr.	MHz	47-862
2 inputs SAT	MHz	950-2200
Throughpass attenuation terr.	dB	4.5
Throughpass attenuation SAT	dB	2
Remote feed		2 SAT inputs
Remote feed current		per branch max. 1
Dimensions	mm	100 x 95 x 32

- For combining terrestrial signals and satellite IF signals together for 2 subscribers
- All connections are designed as F sockets
- Satisfies EN 50083-2



Type **BWS 4910 F**

Order number 981 000-552



- For combining terrestrial signals and satellite IF signals together for 4 subscribers
- For use with Hit CS 404 Quatro switch LNB
- All connections are designed as F sockets
- To ensure active terrestrial operation even when the receiver is switched off, a standard power supply unit with a 3.5 mm jack plug needs to be connected. In passive mode, terrestrial transfer is possible without a power supply unit
- Satisfies EN 50083-2

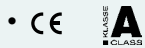

Frequency range			
1 input terr.	MHz	47-862	
4 inputs SAT	MHz	950-2200	
4 outputs	MHz	47-2200	
Throughpass attenuation terr.	dB	12-14 (passive), 4-6 (active)	
Throughpass attenuation SAT	dB	4-6	
Remote feed		4 SAT inputs	
Remote feed current		Per branch 500mA	
DC for active operation		12-18 V/100 mA (jack plug 3.5 mm)	
Current consumption terr. active		approx. 40 mA	
Dimensions	mm	120 x 85 x 40	

DC inserter

Type **FW 2**

Order number 947 442-001



- For combining or separating HF and remote feed voltage
- Suitable for return channel
- Can be plugged into all device inputs HF sockets in accordance with IEC 60169-2
- Routing of the operating voltage with power supply that must be connected to unit
- Satisfies EN 50083-2



Frequency range	MHz	5-2050	
Maximum load		60 V/540 mA	
Throughpass attenuation	dB	0.8-2.0	
Dimensions	mm	36 x 35 x 22	

▶ Antenna outlet sockets

Page 113 – Page 126

Introduction

Product line overview

Technical data

- General technical information
- Universal sockets
- SAT special boxes
- CATV special boxes

Accessories

- Terminating resistors
- Wall frames, covers

Receiver connecting cable

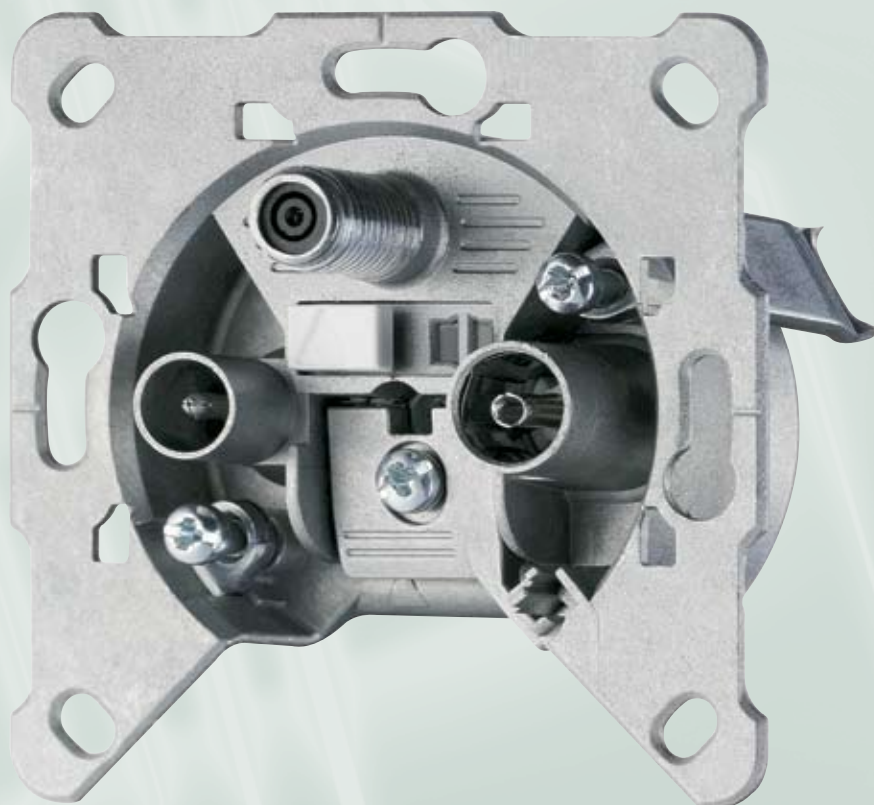

Introduction

Attenuation

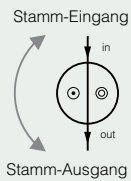

Throughpass attenuation
Attenuation between trunk input and trunk output

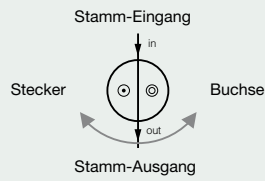

Isolation internal
Attenuation between the outlets relative to each other

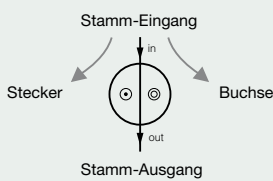

Connection attenuation
Attenuation between trunk input and the outlets

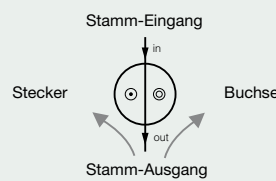

Isolation
Attenuation between the trunk output and the outlets

Outlet versions

Individual outlets

Individual outlets are used to end cables coming from the tap-off (multi-tap), multiswitch or SAT LNB (star structure).

Throughpass outlets

Throughpass outlets can also be cascaded (tree structure). The last outlet on a trunk or stub cable must be fitted with a terminator resistor (see accessories).

Network structures

Floor star with individual sockets

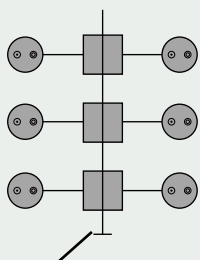

Floor tap-offs

Star network with individual sockets

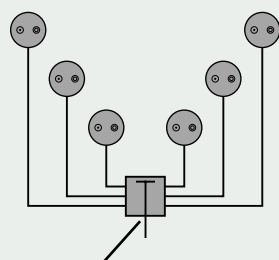

Tap-offs or multiswitch

Tree network with throughpass sockets

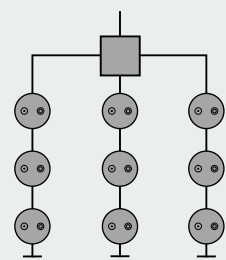

Switching technology

The *filter principle*, used in most SAT and CATV sockets offers the lowest distribution attenuation as well as additional selective isolation. However, non-usable transition ranges between the frequency bands occur. *Broadband distribution boxes or directional couplers* on the other hand transmit the frequency ranges seamlessly.

This requires connection attenuation that is approximately 3 dB higher for individual outlets. One example in this regard is offered by the super broadband sockets. In order to use the advantages of both principles, both technologies are combined in the SAT/CATV combination sockets and in the modem sockets.

Overview

Universal	Use		
Super broadband socket EDU 04 F GEDU 10/15/20		Universal implementation for SAT and CATV	RK FM VHF/UHF SAT TV RADIO
SAT/CATV combination socket EDA 302 F GDA 313 F		Broadband filter socket for SAT and BK	RK FM VHF/UHF SAT TV RADIO SAT
SAT filter socket EDS 01 F GDS 08 F GDS 11 F		Optimal for SAT and DVB-T	RK FM VHF/UHF SAT TV SAT
SAT filter socket FS 302 F		Selectively decoupled for SAT, terr. TV and FM	RK FM VHF/UHF SAT TV RADIO SAT
TWIN-SAT socket EDS 322 F		Double SAT socket for two SAT receivers and DVB-T reception	RK FM VHF/UHF SAT TV SAT 1 SAT 2
CATV modem socket EDM 304 GDM 310 GDM 315		Standard for inactive CATV networks, selective, High-decoupled RC, Lowest attenuation	RK FM VHF/UHF SAT TV RADIO DATA
EDM 306 GDM 312		Broadband filter socket for interactive CATV networks S2/S3 assignment, FM block for interference suppression on TV	RK FM VHF/UHF SAT TV RADIO SAT/DATA
CATV modem socket EDM 02 GDM 06		Modem broadband for interactive CATV networks, two equal, strong decoupled broadband outlets	RK FM VHF/UHF SAT TV RADIO
CATV filter socket EDC01NL		CATV filter with galvanic isolation of the inner conductor from the outer conductor	RK FM VHF/UHF SAT TV RADIO
CATV filter socket FS 01 FS 07 FS 12		For terrestrial and MATV distribution Low attenuation, selective for TV (without S2/S3 operation!) and FM	RK FM VHF/UHF SAT TV RADIO

Connector types

- IEC-connector „TV“
- IEC-connector „RF“
- F-connector „SAT“/„DATA“

Antenna outlet sockets

General technical characteristics

Operating conditions

Temperature range	-25 ... + 55 C	ETSI 300 019-1-3 Class 3.3 Fixed, protected against water
Reliability (MTBF)	> 1.6 mio. hours	Belcore @ 25 °C
Standards	EN 50083-2 (Class A) EN 50083-4 (measuring methods) RoHS 2002/95/EC	

Electrical connection values

Connection impedance	75 Ohm	All HF - connections
DC load	max. 24V / 0.5 A / 22 kHz	Only via SAT connections
Shielding attenuation	Class A	EN 50 083-2
	> 85 dB	30...300 MHz
	> 80 dB	300...470 MHz
	> 75 dB	470...1,000 MHz
	> 55 dB	1,000...2,400 MHz

Mechanical design

Socket body	Torsion-free die-cast zinc	
Weight	approx. 90 g	
Outlet "TV"	IEC plug (male)	IEC 60 169-2
Outlet "RADIO"	IEC socket (female)	IEC 60 169-2
Outlet "SAT" / "DATA"	F-socket (female)	IEC 60 169-24

Shipping formats antenna outlet sockets:

- 10 sockets in compartment bulk pack 229 x 142 x 75 mm
- 100 sockets (10 packs) in box 385 x 285 x 230 mm
- 3,000 sockets per Euro pallet, transparent blister pack for one socket with cover plate AD 23 on request

Install dimensions

Socket body

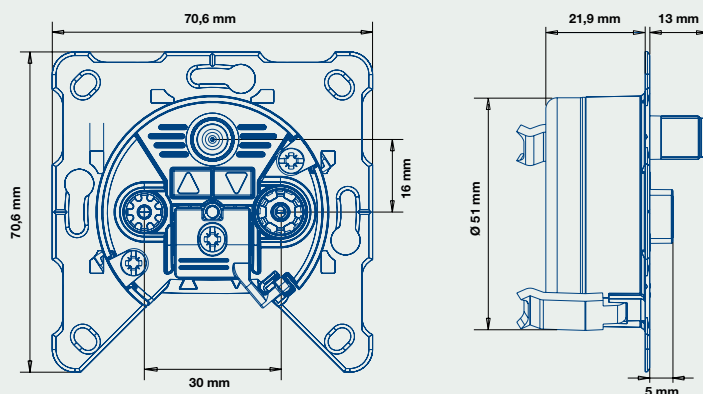

Recommended cable dimensions

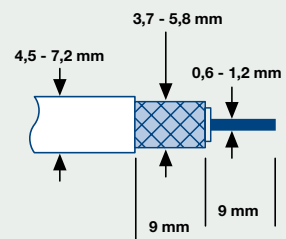

General technical characteristics

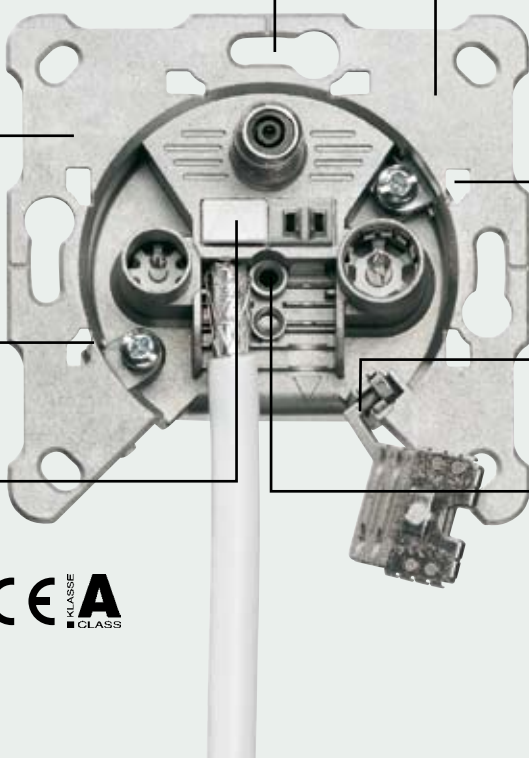

- **Third keyhole** – Better fixing in partition wall flush-mount sockets
- **New support ring geometry** – universal for major switch product lines. For easy alignment and improved form fit.
- **Reduced in depth and diameter** – easier insertion in flush-mount socket.
- **Plug-in clamp technology** – Faster install. Securely fixed in place. Removed at the touch of button.
- **Fracture edges on frame corners** – well-equipped for round switch product lines.
- **New generation claw fixation and fitting claw shape** – trouble-free install and removal in flush-mount outlets, also with battery-powered screwdriver (PZ 1 screw)
- **Locking hinged clamp** – convenient in any install position
- **Inner conductor clamp in centre of outlet** – facilitates connection of short cable ends when replacing the socket.

CE KLASSE CLASS **A**

Installation in detail

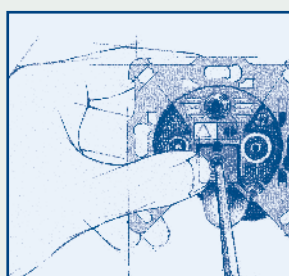

Open.
Easily opened. Use screwdriver to lever out hinged clamp on the cutout. Tip the hinged clamp in the fixing device for any install position.

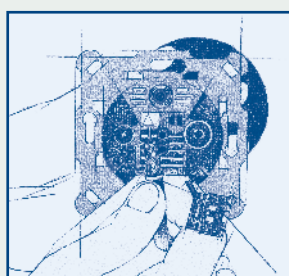

Insert.
The new technology for inner conductor contacting. Simply insert stripped coaxial cable into the spring contact until the stop - securely clamps. To remove press the button and pull out the cable.

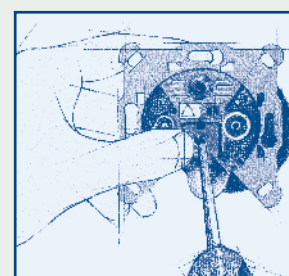

Closed.
Close hinged clamp and screw fasten. Insert socket, align using the straight edges and anchor by tightening the claw screws. PZ 1 screws for battery powered screw driver.

Antenna outlet sockets

Universal antenna outlet sockets

Super broadband sockets:

- 2-hole universal socket with pass-through frequency ranges for TV/RADIO und SAT, thus flexible and future proof
- Suitable for CATV and SAT IF domestic distribution installations
- 2 equal outlets for various end devices
- Suitable for return channel
- Remote DC-feed via TV outlet (only EDU 04 F)
- **EDU 04 F:** Individual socket for decoupled stub cables from the floor tap-off or multiswitch or LNC
- **GEDU 10/15/20:** Throughpass socket for tree structures

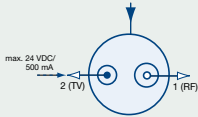
Type	EDU 04 F	Individual socket
Order number	940 105-001	
		
	Frequencyrange MHz	5 47 87,5 108 470 862 950 2150 2500 RK VHF I FM VHF III/ UHF SAT
	Connection attenuation	
	1 (RADIO), socket dB	4,0 4,7 5,5
	2 (TV), plug dB	4,0 4,7 5,5
	Decoupling	
	TV-RADIO dB	14 20
	Remote feed voltage/current	max. 24 V/ 500 mA via TV

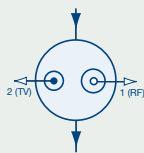
Type	GEDU 10	Throughpass socket
Order number	940 106-001	
		
	Frequencyrange MHz	5 47 87,5 108 470 862 950 2150 2500 RK VHF I FM VHF III/ UHF SAT
	Throughpass attenuation	
	dB	2,8 2,2 10,0 2,4 3,2 4,2
	Connection attenuation	
	1 (RADIO), socket dB	11,5 10,0 10 11,5
	2 (TV), plug dB	11,5 10,0 10 11,5
	Decoupling	
	OUT-TV/RADIO dB	35 36 30 22 20
	TV-RADIO dB	40 40 30 30 26

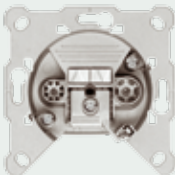
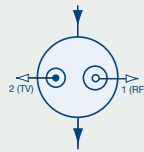
Type	GEDU 15	Throughpass socket
Order number	940 107-001	
		
	Frequenzbereich MHz	5 47 87,5 108 470 862 950 2150 2500 RK VHF I FM VHF III/ UHF SAT
	Throughpass attenuation	
	dB	1,0 1,6 2,4
	Connection attenuation	
	1 (RADIO), socket dB	14,5 14,5
	2 (TV), plug dB	14,5 14,5
	Decoupling	
	OUT-TV/RADIO dB	30 36 30 26
	TV-RADIO dB	18 24 24

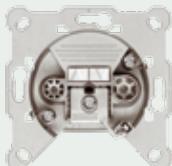
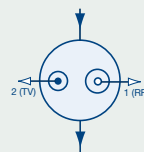
Type	GEDU 20	Throughpass socket
Order number	940 108-001	
		
	Frequencyrange MHz	5 47 87,5 108 470 862 950 2150 2500 RK VHF I FM VHF III/ UHF SAT
	Throughpass attenuation	
	dB	0,8 1,4 1,8
	Connection attenuation	
	1 (RADIO), socket dB	20,0 20,0
	2 (TV), plug dB	20,0 20,0
	Decoupling	
	OUT-TV/RADIO dB	40 44 40 30
	TV-RADIO dB	18 24 22 20

Universal antenna outlet sockets

SAT/CATV combination sockets:

- 3-hole all-round antenna socket with interconnected frequency bands, thus flexible and future proof
- Suitable for SAT IF and CATV domestic distribution installations
- Seamless CATV and SAT ranges and low distribution attenuation thanks to combined filter-tap structure
- Suitable for return channel
- Remote DC-feed via SAT outlet
- **EDA 302 F:** Individual socket for stub lines from multiswitch, LNC or floor tap-off
- **GDA 313 F:** Throughpass socket for SAT individual cable solutions/tree structures
- **Attention:** For DC on the trunk cable (13/18V) use terminating resistor with DC isolation R77 DCB

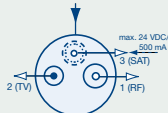
Type	EDA 302 F	Individual socket																								
Order number	940 109-001																									
																										
		<table border="1"> <thead> <tr> <th>Frequencyrange MHz</th> <th>5</th> <th>47</th> <th>87,5</th> <th>108</th> <th>118</th> <th>139</th> <th>470</th> <th>862</th> <th>950</th> <th>2150</th> <th>2500</th> </tr> <tr> <th></th> <th>RK</th> <th>VHF I</th> <th>FM</th> <th></th> <th></th> <th></th> <th>VHF III/</th> <th>UHF</th> <th></th> <th>SAT</th> <th></th> </tr> </thead> </table>	Frequencyrange MHz	5	47	87,5	108	118	139	470	862	950	2150	2500		RK	VHF I	FM				VHF III/	UHF		SAT	
Frequencyrange MHz	5	47	87,5	108	118	139	470	862	950	2150	2500															
	RK	VHF I	FM				VHF III/	UHF		SAT																
		Connection attenuation 1 (RADIO), socket dB: 6,5 20 3 (SAT), F socket dB: 40,0 15 2 (TV), plug dB: 2,5	<table border="1"> <tr><td>30</td><td>25</td></tr> <tr><td>2</td><td>3</td></tr> <tr><td>20</td><td>15</td></tr> </table>	30	25	2	3	20	15																	
30	25																									
2	3																									
20	15																									
		Decoupling RADIO-SAT dB: 40 35 TV-SAT dB: 35 30 20 TV-RADIO dB: 15 20	<table border="1"> <tr><td>30</td><td>25</td></tr> <tr><td>20</td><td>15</td></tr> <tr><td>20</td><td>15</td></tr> </table>	30	25	20	15	20	15																	
30	25																									
20	15																									
20	15																									
		Remote feed voltage/current max. 24 V/ 500 mA via SAT																								

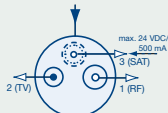
Type	GDA 313 F	Throughpass socket																								
Order number	940 110-001																									
																										
		<table border="1"> <thead> <tr> <th>Frequencyrange MHz</th> <th>5</th> <th>47</th> <th>87,5</th> <th>108</th> <th>118</th> <th>139</th> <th>470</th> <th>862</th> <th>950</th> <th>2150</th> <th>2500</th> </tr> <tr> <th></th> <th>RK</th> <th>VHF I</th> <th>FM</th> <th></th> <th></th> <th></th> <th>VHF III/</th> <th>UHF</th> <th></th> <th>SAT</th> <th></th> </tr> </thead> </table>	Frequencyrange MHz	5	47	87,5	108	118	139	470	862	950	2150	2500		RK	VHF I	FM				VHF III/	UHF		SAT	
Frequencyrange MHz	5	47	87,5	108	118	139	470	862	950	2150	2500															
	RK	VHF I	FM				VHF III/	UHF		SAT																
		Throughpass attenuation dB: 1,0 1,4 1,8 2,8																								
		Connection attenuation 1 (RADIO), socket dB: 16,5 17,0 26 3 (SAT), F socket dB: 55 50,0 35 2 (TV), plug dB: 12,5	<table border="1"> <tr><td>24</td><td>20</td></tr> <tr><td>12</td><td>13,5</td></tr> <tr><td>24</td><td>18</td></tr> </table>	24	20	12	13,5	24	18																	
24	20																									
12	13,5																									
24	18																									
		Decoupling OUT-TV/FM/SAT dB: 25 35 28 RADIO-SAT dB: 40 35 TV-SAT dB: 35 30 20 TV-RADIO dB: 15 20 25	<table border="1"> <tr><td>18</td><td>15</td></tr> <tr><td>30</td><td>25</td></tr> <tr><td>20</td><td>15</td></tr> <tr><td>20</td><td>18</td></tr> </table>	18	15	30	25	20	15	20	18															
18	15																									
30	25																									
20	15																									
20	18																									
		Remote feed voltage/current max. 24 V/ 500 mA via SAT																								

Antenna outlet sockets

SAT special antenna outlet sockets

SAT filter sockets:

- 2-hole SAT antenna outlet socket suitable for use in multiswitch installations, single cable solutions and individual SAT installations
- Extremely low distribution attenuation thanks to selective splitting of the frequency bands via filters
- Outlets for SAT (F socket) and TV/RADIO (IEC plug)
- Remote feed and Diseqc enabled SAT IF outlet as direct F termination for SAT receiver

- **EDS 01:** Individual socket for decoupled stub lines from the multiswitch, LNC or floor tap-off
- **GDS 08 F/GDS 11 F:** Throughpass socket for SAT individual cable solutions and SAT sub-distribution boxes
- **Attention:** For DC on the trunk cable (13/18V) use terminating resistor with DC isolation R77 DCB

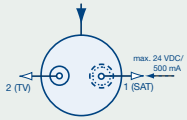
Type	EDS 01 F	Individual socket					
Order number	940 111-001	Frequency range MHz 5 RK VHF I FM 790 VHF III/ UHF 862 950 SAT 2150 2400					
		Connection attenuation					
		1 (SAT), socket dB	30,0	25	1,2		
		2 (TV), plug dB	1,0	1,2	25	20	
		Decoupling TV-SAT dB	30,0	25	20	15	
		Remote feed voltage/current	max. 24 V/ 500 mA via SAT				

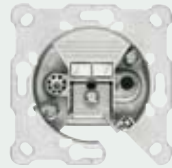
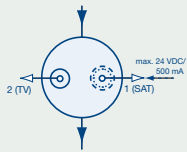
Type	GDS 08 F	Throughpass socket					
Order number	940 112-001	Frequency range MHz 5 RK VHF I FM 790 VHF III/ UHF 862 950 SAT 2150 2400					
		Throughpass attenuation dB	2,4	2	3,2	4,2	
		Connection attenuation					
		1 (SAT), socket dB	33,0		8	9	
		2 (TV), plug dB	8,0	9	25	20	
		Decoupling					
		OUT-TV dB	30,0		25	20	
		OUT-SAT dB	35,0	30	30	15	
		SAT-TV dB	30,0	25	20		
		Remote feed voltage/current	max. 24 V/ 500 mA via SAT				

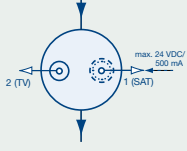
Type	GDS 11 F	Throughpass socket					
Order number	940 113-001	Frequency range MHz 5 RK VHF I FM 470 VHF III/ 790 UHF 862 950 SAT 2150 2400					
		Throughpass attenuation dB	1,0	1,2	1,6	2,4	
		Connection attenuation					
		1 (SAT), socket dB	35,0		11,5	12	
		2 (TV), plug dB	11,0	11,5	25	20	
		Decoupling					
		OUT-TV dB	30,0		25	20	
		OUT-SAT dB	35,0	30	20	15	
		SAT-TV dB	30,0	25	20		
		Remote feed voltage/current	max. 24 V/ 500 mA via SAT				

SAT special antenna outlet sockets

SAT filter sockets:

- 3-hole SAT antenna outlet socket, especially suitable for implementation in multiswitch installations and individual SAT installations
- 3 connection possibilities: SAT receiver via the F socket, terr. end devices via IEC connectors, FM radio via IEC socket.
- Extremely low tap-out attenuation due to selective splitting of the frequency bands via filters
- Remote DC-feed via SAT outlet
- Individual socket for stub lines from SAT multiswitch

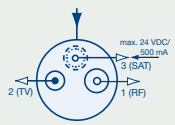
Type	FS 302 F	Throughpass socket																														
Order number	940 117-001																															
																																
																																
		<table border="1"> <thead> <tr> <th>Frequencyrange Mhz</th> <th>5</th> <th>75 88</th> <th>108 . 118</th> <th>470</th> <th>790</th> <th>862</th> <th>950</th> <th>2150</th> <th>2500</th> </tr> <tr> <td></td> <td>RK</td> <td>VHF I FM</td> <td></td> <td>VHF III/</td> <td>UHF</td> <td></td> <td colspan="3">SAT</td> </tr> </thead> </table>	Frequencyrange Mhz	5	75 88	108 . 118	470	790	862	950	2150	2500		RK	VHF I FM		VHF III/	UHF		SAT												
Frequencyrange Mhz	5	75 88	108 . 118	470	790	862	950	2150	2500																							
	RK	VHF I FM		VHF III/	UHF		SAT																									
		<p>Connection attenuation</p> <table border="1"> <tr> <td>1 (TV), socket dB</td> <td>28</td> <td>1,5</td> <td></td> <td>24</td> <td></td> <td></td> <td></td> <td></td> <td></td> </tr> <tr> <td>2 (SAT), socket dB</td> <td>35</td> <td>35</td> <td></td> <td>25</td> <td></td> <td></td> <td>2,0</td> <td>3,0</td> <td></td> </tr> <tr> <td>3 (TV), plug dB</td> <td>1,5</td> <td>10</td> <td></td> <td>1,5</td> <td></td> <td></td> <td></td> <td></td> <td></td> </tr> </table>	1 (TV), socket dB	28	1,5		24						2 (SAT), socket dB	35	35		25			2,0	3,0		3 (TV), plug dB	1,5	10		1,5					
1 (TV), socket dB	28	1,5		24																												
2 (SAT), socket dB	35	35		25			2,0	3,0																								
3 (TV), plug dB	1,5	10		1,5																												
		<p>Decoupling</p> <table border="1"> <tr> <td>RADIO-SAT dB</td> <td>35</td> <td>35</td> <td></td> <td>30</td> <td></td> <td></td> <td></td> <td>20</td> <td></td> </tr> <tr> <td>TV-SAT dB</td> <td>40</td> <td>35</td> <td></td> <td>20</td> <td></td> <td></td> <td></td> <td>20</td> <td></td> </tr> <tr> <td>TV-RADIO dB</td> <td>25</td> <td>20</td> <td></td> <td>20</td> <td></td> <td></td> <td></td> <td></td> <td></td> </tr> </table>	RADIO-SAT dB	35	35		30				20		TV-SAT dB	40	35		20				20		TV-RADIO dB	25	20		20					
RADIO-SAT dB	35	35		30				20																								
TV-SAT dB	40	35		20				20																								
TV-RADIO dB	25	20		20																												
		<p>Remote feed voltage/current</p> <p>max. 24 V/ 500 mA via SAT</p>																														

TWIN-SAT socket:

- 3-hole SAT antenna outlet socket, especially suitable for implementation in multiswitch installations and individual SAT installations
- For concurrent independent operation of two SAT receiver (e.g. twin SAT with hard drive memory)
- Extremely low distribution box attenuation due to selective splitting of the frequency bands via filters
- 2 separate remote feed SAT outlets (2 x F sockets), 1 TV/RADIO outlet (IEC connector)
- Individual socket for two separate stub lines from SAT multiswitch or LNB

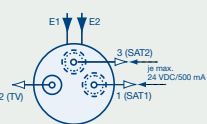
Type	EDS 322 F	Individual socket																																																		
Order number	940 114-001																																																			
																																																				
																																																				
		<table border="1"> <thead> <tr> <th>Frequencyrange Mhz</th> <th>5</th> <th>75 88</th> <th>108 . 118</th> <th>470</th> <th>790</th> <th>862</th> <th>950</th> <th>2150</th> <th>2500</th> </tr> <tr> <td></td> <td>RK</td> <td>VHF I FM</td> <td></td> <td>VHF III/</td> <td>UHF</td> <td></td> <td colspan="3">SAT</td> </tr> </thead> </table>	Frequencyrange Mhz	5	75 88	108 . 118	470	790	862	950	2150	2500		RK	VHF I FM		VHF III/	UHF		SAT																																
Frequencyrange Mhz	5	75 88	108 . 118	470	790	862	950	2150	2500																																											
	RK	VHF I FM		VHF III/	UHF		SAT																																													
		<p>Connection attenuation</p> <table border="1"> <tr> <td>1 (SAT1), socket dB</td> <td></td> <td></td> <td></td> <td>30</td> <td></td> <td>25</td> <td></td> <td></td> <td>1,2</td> </tr> <tr> <td>2 (SAT2), socket dB</td> <td></td> <td></td> <td></td> <td></td> <td></td> <td></td> <td></td> <td></td> <td>1,2</td> </tr> <tr> <td>3 (TV), plug dB</td> <td></td> <td></td> <td></td> <td>1,0</td> <td></td> <td>1,2</td> <td></td> <td>20</td> <td>15</td> </tr> </table>	1 (SAT1), socket dB				30		25			1,2	2 (SAT2), socket dB									1,2	3 (TV), plug dB				1,0		1,2		20	15																				
1 (SAT1), socket dB				30		25			1,2																																											
2 (SAT2), socket dB									1,2																																											
3 (TV), plug dB				1,0		1,2		20	15																																											
		<p>Decoupling</p> <table border="1"> <tr> <td>TV-SAT1 dB</td> <td></td> <td></td> <td></td> <td>30</td> <td></td> <td>25</td> <td></td> <td>20</td> <td>15</td> </tr> <tr> <td>TV-SAT2 dB</td> <td></td> <td></td> <td></td> <td>45</td> <td></td> <td>40</td> <td></td> <td>30</td> <td>25</td> </tr> <tr> <td>IN1-IN2 dB</td> <td></td> <td></td> <td></td> <td>40</td> <td></td> <td>35</td> <td></td> <td>25</td> <td>20</td> </tr> <tr> <td>SAT1-SAT2 dB</td> <td></td> <td></td> <td></td> <td>40</td> <td></td> <td>35</td> <td></td> <td>25</td> <td>20</td> </tr> <tr> <td>IN2-SAT1/ IN1-SAT2 dB</td> <td></td> <td></td> <td></td> <td>40</td> <td></td> <td>35</td> <td></td> <td>25</td> <td>20</td> </tr> </table>	TV-SAT1 dB				30		25		20	15	TV-SAT2 dB				45		40		30	25	IN1-IN2 dB				40		35		25	20	SAT1-SAT2 dB				40		35		25	20	IN2-SAT1/ IN1-SAT2 dB				40		35		25	20
TV-SAT1 dB				30		25		20	15																																											
TV-SAT2 dB				45		40		30	25																																											
IN1-IN2 dB				40		35		25	20																																											
SAT1-SAT2 dB				40		35		25	20																																											
IN2-SAT1/ IN1-SAT2 dB				40		35		25	20																																											
		<p>Remote feed voltage/current</p> <p>max. 24 V/ 500 mA via SAT</p>																																																		

Antenna outlet sockets

CATV special antenna outlet sockets

CATV-modem outlet sockets:

- 3-hole antenna socket for use in interactive CATV networks with cable modem operation
- Combined tap-out filter socket with broadband "Data" outlet (F socket) and selective decoupled TV and RADIO outlets
- High isolation of the return channel, thus suppression of interference when operating the cable modem

- **EDM 304:**
Individual socket for decoupled stub cables
- **GDM 310/315:**
Throughpass socket for decoupled stub cables

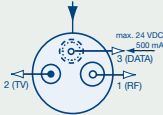
Type	EDM 304	Individual socket																																																																						
Order number	940 097-001																																																																							
																																																																								
	<p>Connection attenuation</p> <p>1 (RADIO), socket dB</p> <p>2 (DATA), socket dB</p> <p>3 (TV), socket dB</p> <p>Decoupling</p> <p>TV-RADIO dB</p> <p>DATA-TV/RADIO dB</p>	<p>Frequenzbereich MHz</p> <table border="1"> <thead> <tr> <th>5</th> <th>30</th> <th>65</th> <th>87,5</th> <th>108</th> <th>109</th> <th>118</th> <th>470</th> <th>862</th> <th>1000</th> </tr> <tr> <th>RK</th> <th>VHF I</th> <th></th> <th></th> <th>FM</th> <th></th> <th></th> <th>VHF III/</th> <th>UHF</th> <th></th> </tr> </thead> <tbody> <tr> <td>70</td> <td>56</td> <td colspan="2">6</td> <td colspan="2"></td> <td colspan="2">24</td> <td colspan="2"></td> </tr> <tr> <td colspan="2">3,5</td> <td colspan="2"></td> <td>14</td> <td>6</td> <td>4</td> <td colspan="2">3,7</td> <td>4</td> </tr> <tr> <td>75</td> <td>56</td> <td colspan="2"></td> <td colspan="2"></td> <td colspan="2"></td> <td colspan="2">4,5</td> </tr> <tr> <td>68</td> <td>44</td> <td colspan="2"></td> <td>10</td> <td colspan="2"></td> <td>24</td> <td colspan="2">20</td> </tr> <tr> <td>85</td> <td>75</td> <td colspan="2"></td> <td colspan="2"></td> <td colspan="2">30</td> <td colspan="2">25</td> </tr> </tbody> </table>	5	30	65	87,5	108	109	118	470	862	1000	RK	VHF I			FM			VHF III/	UHF		70	56	6				24				3,5				14	6	4	3,7		4	75	56							4,5		68	44			10			24	20		85	75					30		25	
5	30	65	87,5	108	109	118	470	862	1000																																																															
RK	VHF I			FM			VHF III/	UHF																																																																
70	56	6				24																																																																		
3,5				14	6	4	3,7		4																																																															
75	56							4,5																																																																
68	44			10			24	20																																																																
85	75					30		25																																																																

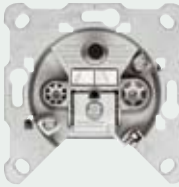
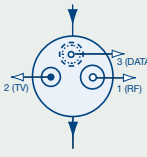
Type	GDM 310	Throughpass socket																																																																																																				
Order number	940 098-001																																																																																																					
																																																																																																						
	<p>Throughpass attenuation</p> <p>dB</p> <p>Connection attenuation</p> <p>1 (RADIO), socket dB</p> <p>2 (DATA), socket dB</p> <p>3 (TV), socket dB</p> <p>Decoupling</p> <p>OUT-TV/RADIO dB</p> <p>OUT-DATA dB</p> <p>TV-RADIO dB</p> <p>DATA-TV/RADIO dB</p>	<p>Frequenzbereich MHz</p> <table border="1"> <thead> <tr> <th>5</th> <th>30</th> <th>65</th> <th>87,5</th> <th>108</th> <th>109</th> <th>118</th> <th>470</th> <th>862</th> <th>1000</th> </tr> <tr> <th>RK</th> <th>VHF I</th> <th></th> <th></th> <th>FM</th> <th></th> <th></th> <th>VHF III/</th> <th>UHF</th> <th></th> </tr> </thead> <tbody> <tr> <td>3,4</td> <td colspan="2">2,4</td> <td colspan="2"></td> <td colspan="2"></td> <td colspan="2">2,6</td> <td></td> </tr> <tr> <td>80</td> <td>64</td> <td colspan="2">14,0</td> <td colspan="2"></td> <td colspan="2">30,0</td> <td colspan="2">35</td> </tr> <tr> <td colspan="2">10,0</td> <td colspan="2"></td> <td colspan="2"></td> <td colspan="2"></td> <td colspan="2">11</td> </tr> <tr> <td>80</td> <td>68</td> <td colspan="2">20,0</td> <td colspan="2">13,0</td> <td colspan="2">11</td> <td colspan="2"></td> </tr> <tr> <td>86</td> <td>64</td> <td colspan="2">34</td> <td colspan="2"></td> <td colspan="2"></td> <td colspan="2">30</td> </tr> <tr> <td>30</td> <td>34</td> <td colspan="2">38</td> <td colspan="2"></td> <td colspan="2">34</td> <td colspan="2">30</td> </tr> <tr> <td>56</td> <td>44</td> <td colspan="2">10</td> <td colspan="2"></td> <td colspan="2">30</td> <td colspan="2"></td> </tr> <tr> <td>88</td> <td>68</td> <td colspan="2">40</td> <td colspan="2"></td> <td colspan="2">36</td> <td colspan="2"></td> </tr> </tbody> </table>	5	30	65	87,5	108	109	118	470	862	1000	RK	VHF I			FM			VHF III/	UHF		3,4	2,4						2,6			80	64	14,0				30,0		35		10,0								11		80	68	20,0		13,0		11				86	64	34						30		30	34	38				34		30		56	44	10				30				88	68	40				36			
5	30	65	87,5	108	109	118	470	862	1000																																																																																													
RK	VHF I			FM			VHF III/	UHF																																																																																														
3,4	2,4						2,6																																																																																															
80	64	14,0				30,0		35																																																																																														
10,0								11																																																																																														
80	68	20,0		13,0		11																																																																																																
86	64	34						30																																																																																														
30	34	38				34		30																																																																																														
56	44	10				30																																																																																																
88	68	40				36																																																																																																

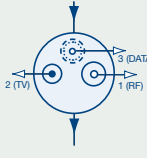
Type	GDM 315	Throughpass socket																																																																																																				
Order number	940 099-001																																																																																																					
																																																																																																						
	<p>Throughpass attenuation</p> <p>dB</p> <p>Connection attenuation</p> <p>1 (RADIO), socket dB</p> <p>2 (DATA), socket dB</p> <p>3 (TV), socket dB</p> <p>Decoupling</p> <p>OUT-TV/RADIO dB</p> <p>OUT-DATA dB</p> <p>TV-RADIO dB</p> <p>DATA-TV/RADIO dB</p>	<p>Frequenzbereich MHz</p> <table border="1"> <thead> <tr> <th>5</th> <th>30</th> <th>65</th> <th>87,5</th> <th>108</th> <th>109</th> <th>118</th> <th>470</th> <th>862</th> <th>1000</th> </tr> <tr> <th>RK</th> <th>VHF I</th> <th></th> <th></th> <th>FM</th> <th></th> <th></th> <th>VHF III/</th> <th>UHF</th> <th></th> </tr> </thead> <tbody> <tr> <td>2,6</td> <td colspan="2">1,6</td> <td colspan="2"></td> <td colspan="2"></td> <td colspan="2">1,8</td> <td></td> </tr> <tr> <td>84</td> <td>70</td> <td colspan="2">18,0</td> <td colspan="2"></td> <td colspan="2">35,0</td> <td colspan="2">30</td> </tr> <tr> <td colspan="2">15,0</td> <td colspan="2"></td> <td colspan="2"></td> <td colspan="2"></td> <td colspan="2">15</td> </tr> <tr> <td>84</td> <td>70</td> <td colspan="2">22,0</td> <td colspan="2">17,0</td> <td colspan="2">15</td> <td colspan="2"></td> </tr> <tr> <td>86</td> <td>64</td> <td colspan="2">34</td> <td colspan="2"></td> <td colspan="2"></td> <td colspan="2">30</td> </tr> <tr> <td colspan="2">35</td> <td colspan="2"></td> <td colspan="2"></td> <td colspan="2"></td> <td colspan="2">30</td> </tr> <tr> <td>56</td> <td>44</td> <td colspan="2">10</td> <td colspan="2"></td> <td colspan="2">30</td> <td colspan="2"></td> </tr> <tr> <td>88</td> <td>68</td> <td colspan="2">40</td> <td colspan="2"></td> <td colspan="2">38</td> <td colspan="2">30</td> </tr> </tbody> </table>	5	30	65	87,5	108	109	118	470	862	1000	RK	VHF I			FM			VHF III/	UHF		2,6	1,6						1,8			84	70	18,0				35,0		30		15,0								15		84	70	22,0		17,0		15				86	64	34						30		35								30		56	44	10				30				88	68	40				38		30	
5	30	65	87,5	108	109	118	470	862	1000																																																																																													
RK	VHF I			FM			VHF III/	UHF																																																																																														
2,6	1,6						1,8																																																																																															
84	70	18,0				35,0		30																																																																																														
15,0								15																																																																																														
84	70	22,0		17,0		15																																																																																																
86	64	34						30																																																																																														
35								30																																																																																														
56	44	10				30																																																																																																
88	68	40				38		30																																																																																														

CATV special antenna outlet sockets

CATV-modem outlet sockets:

- Broadband 3-hole antenna socket for use in interactive CATV networks with S2, S3 QAM from 109 MHz and cable modem operation
- For concurrent connection of three CATV end devices, e.g. TV, RADIO and QAM Set Top Box/cable modem
- High internal isolation between TV and modem outlet avoids interference of TV reception at modem reception
- FM rejection filter on the TV outlet suppresses interference through FM carriers
- **EDM 306:**
Individual socket for decoupled stub cables
- **GDM 312:**
Throughpass socket for decoupled stub cables

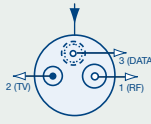
Type	EDM 306	Individual socket																																																
Order number	940 266-001																																																	
																																																		
		<table border="1"> <thead> <tr> <th>Frequencyrange MHz</th> <th>5</th> <th>30</th> <th>65</th> <th>80</th> <th>100</th> <th>90</th> <th>118</th> <th>470</th> <th>862</th> <th>1000</th> </tr> <tr> <th></th> <th>RK</th> <th>VHF I</th> <th></th> <th></th> <th>FM</th> <th></th> <th></th> <th>VHF III</th> <th>UHF</th> <th></th> </tr> </thead> </table>	Frequencyrange MHz	5	30	65	80	100	90	118	470	862	1000		RK	VHF I			FM			VHF III	UHF																											
Frequencyrange MHz	5	30	65	80	100	90	118	470	862	1000																																								
	RK	VHF I			FM			VHF III	UHF																																									
		<table border="1"> <thead> <tr> <th>Connection attenuation</th> <th colspan="11"></th> </tr> </thead> <tbody> <tr> <td>1 (RADIO), socket dB</td> <td>70</td> <td>56</td> <td></td> <td></td> <td></td> <td>7</td> <td></td> <td>6,5</td> <td></td> <td>7</td> <td></td> </tr> <tr> <td>2 (DATA), socket dB</td> <td colspan="11">7,0</td> </tr> <tr> <td>3 (TV), plug dB</td> <td>75</td> <td>56</td> <td>30,0</td> <td></td> <td></td> <td>7</td> <td></td> <td>6,5</td> <td></td> <td>7</td> <td></td> </tr> </tbody> </table>	Connection attenuation												1 (RADIO), socket dB	70	56				7		6,5		7		2 (DATA), socket dB	7,0											3 (TV), plug dB	75	56	30,0			7		6,5		7	
Connection attenuation																																																		
1 (RADIO), socket dB	70	56				7		6,5		7																																								
2 (DATA), socket dB	7,0																																																	
3 (TV), plug dB	75	56	30,0			7		6,5		7																																								
		<table border="1"> <thead> <tr> <th>Decoupling</th> <th colspan="11"></th> </tr> </thead> <tbody> <tr> <td>TV-RADIO dB</td> <td colspan="2"></td> <td colspan="3">20</td> <td colspan="2"></td> <td colspan="2">24</td> <td colspan="2">20</td> </tr> <tr> <td>DATA-TV/RADIO dB</td> <td>85</td> <td>75</td> <td colspan="8"></td> <td colspan="2">40</td> </tr> </tbody> </table>	Decoupling												TV-RADIO dB			20					24		20		DATA-TV/RADIO dB	85	75									40												
Decoupling																																																		
TV-RADIO dB			20					24		20																																								
DATA-TV/RADIO dB	85	75									40																																							

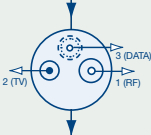
Type	GDM 312	Throughpass socket																																																													
Order number	940 267-001																																																														
																																																															
		<table border="1"> <thead> <tr> <th>Frequencyrange MHz</th> <th>5</th> <th>30</th> <th>65</th> <th>80</th> <th>100</th> <th>90</th> <th>118</th> <th>470</th> <th>862</th> <th>1000</th> </tr> <tr> <th></th> <th>RK</th> <th>VHF I</th> <th></th> <th></th> <th>FM</th> <th></th> <th></th> <th>VHF III</th> <th>UHF</th> <th></th> </tr> </thead> </table>	Frequencyrange MHz	5	30	65	80	100	90	118	470	862	1000		RK	VHF I			FM			VHF III	UHF																																								
Frequencyrange MHz	5	30	65	80	100	90	118	470	862	1000																																																					
	RK	VHF I			FM			VHF III	UHF																																																						
		<table border="1"> <thead> <tr> <th>Throughpass attenuation</th> <th colspan="11"></th> </tr> </thead> <tbody> <tr> <td>dB</td> <td>3,0</td> <td></td> <td colspan="5">2,8</td> <td></td> <td></td> <td colspan="2">3,0</td> </tr> </tbody> </table>	Throughpass attenuation												dB	3,0		2,8							3,0																																						
Throughpass attenuation																																																															
dB	3,0		2,8							3,0																																																					
		<table border="1"> <thead> <tr> <th>Connection attenuation</th> <th colspan="11"></th> </tr> </thead> <tbody> <tr> <td>1 (RADIO), socket dB</td> <td>80</td> <td>64</td> <td></td> <td></td> <td></td> <td>12,0</td> <td></td> <td>12,5</td> <td></td> <td>13,0</td> <td></td> </tr> <tr> <td>2 (DATA), socket dB</td> <td colspan="11">12,0</td> </tr> <tr> <td>3 (TV), plug dB</td> <td>80</td> <td>64</td> <td>30,0</td> <td></td> <td></td> <td>12,0</td> <td></td> <td>12,5</td> <td></td> <td>13,0</td> <td></td> </tr> </tbody> </table>	Connection attenuation												1 (RADIO), socket dB	80	64				12,0		12,5		13,0		2 (DATA), socket dB	12,0											3 (TV), plug dB	80	64	30,0			12,0		12,5		13,0														
Connection attenuation																																																															
1 (RADIO), socket dB	80	64				12,0		12,5		13,0																																																					
2 (DATA), socket dB	12,0																																																														
3 (TV), plug dB	80	64	30,0			12,0		12,5		13,0																																																					
		<table border="1"> <thead> <tr> <th>Decoupling</th> <th colspan="11"></th> </tr> </thead> <tbody> <tr> <td>OUT-TV/RADIO dB</td> <td>86</td> <td>64</td> <td colspan="4"></td> <td>36,0</td> <td></td> <td>32,0</td> <td colspan="2">30,0</td> </tr> <tr> <td>OUT-DATA dB</td> <td>30</td> <td></td> <td colspan="5">36</td> <td></td> <td></td> <td>32</td> <td>30</td> </tr> <tr> <td>TV-RADIO dB</td> <td colspan="2"></td> <td colspan="3">20</td> <td colspan="2"></td> <td colspan="2">24</td> <td colspan="2">20</td> </tr> <tr> <td>DATA-TV/RADIO dB</td> <td>90</td> <td>80</td> <td colspan="8"></td> <td colspan="2">40</td> </tr> </tbody> </table>	Decoupling												OUT-TV/RADIO dB	86	64					36,0		32,0	30,0		OUT-DATA dB	30		36							32	30	TV-RADIO dB			20					24		20		DATA-TV/RADIO dB	90	80									40	
Decoupling																																																															
OUT-TV/RADIO dB	86	64					36,0		32,0	30,0																																																					
OUT-DATA dB	30		36							32	30																																																				
TV-RADIO dB			20					24		20																																																					
DATA-TV/RADIO dB	90	80									40																																																				

CATV modem sockets:

- Broadband 2-hole antenna socket for use in CATV networks
- For concurrent connection of two CATV end devices, e.g. TV, and RADIO/QAM Set Top Box/cable modem
- High directional attenuation and high internal isolation, thus also suitable for cable modem operation
- **EDM 02:** Individual socket for decoupled stub lines
- **GDM 06:** Throughpass socket for decoupled stub lines

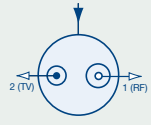
Type	EDM 02	Individual socket																																	
Order number	940 268-002																																		
																																			
		<table border="1"> <thead> <tr> <th>Frequencyrange MHz</th> <th>4</th> <th>30</th> <th>68</th> <th>87,5</th> <th>160</th> <th>174</th> <th>470</th> <th>862</th> <th>1000</th> </tr> <tr> <th></th> <th>RK</th> <th>VHF I</th> <th></th> <th></th> <th>FM</th> <th></th> <th>VHF III</th> <th>UHF</th> <th></th> </tr> </thead> </table>	Frequencyrange MHz	4	30	68	87,5	160	174	470	862	1000		RK	VHF I			FM		VHF III	UHF														
Frequencyrange MHz	4	30	68	87,5	160	174	470	862	1000																										
	RK	VHF I			FM		VHF III	UHF																											
		<table border="1"> <thead> <tr> <th>Connection attenuation</th> <th colspan="10"></th> </tr> </thead> <tbody> <tr> <td>1 (DATA), socket dB</td> <td>6,5</td> <td></td> <td></td> <td>6,3</td> <td></td> <td>6,5</td> <td></td> <td>6,6</td> <td colspan="2">6,8</td> </tr> <tr> <td>2 (TV), plug dB</td> <td>2,2</td> <td>1,8</td> <td></td> <td></td> <td>2</td> <td></td> <td></td> <td>2,5</td> <td colspan="2">2,7</td> </tr> </tbody> </table>	Connection attenuation											1 (DATA), socket dB	6,5			6,3		6,5		6,6	6,8		2 (TV), plug dB	2,2	1,8			2			2,5	2,7	
Connection attenuation																																			
1 (DATA), socket dB	6,5			6,3		6,5		6,6	6,8																										
2 (TV), plug dB	2,2	1,8			2			2,5	2,7																										
		<table border="1"> <thead> <tr> <th>Decoupling</th> <th colspan="10"></th> </tr> </thead> <tbody> <tr> <td>TV-RADIO dB</td> <td colspan="5"></td> <td colspan="2">34</td> <td colspan="2">30</td> <td>28</td> </tr> </tbody> </table>	Decoupling											TV-RADIO dB						34		30		28											
Decoupling																																			
TV-RADIO dB						34		30		28																									

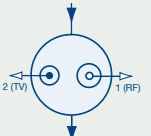
Type	GDM 06	Throughpass socket																																													
Order number	940 269-002																																														
																																															
		<table border="1"> <thead> <tr> <th>Frequencyrange MHz</th> <th>4</th> <th>30</th> <th>68</th> <th>87,5</th> <th>160</th> <th>174</th> <th>470</th> <th>862</th> <th>1000</th> </tr> <tr> <th></th> <th>RK</th> <th>VHF I</th> <th></th> <th></th> <th>FM</th> <th></th> <th>VHF III</th> <th>UHF</th> <th></th> </tr> </thead> </table>	Frequencyrange MHz	4	30	68	87,5	160	174	470	862	1000		RK	VHF I			FM		VHF III	UHF																										
Frequencyrange MHz	4	30	68	87,5	160	174	470	862	1000																																						
	RK	VHF I			FM		VHF III	UHF																																							
		<table border="1"> <thead> <tr> <th>Throughpass attenuation</th> <th colspan="10"></th> </tr> </thead> <tbody> <tr> <td>dB</td> <td colspan="2"></td> <td colspan="3">3,0</td> <td colspan="2">3,2</td> <td colspan="2">3,4</td> <td colspan="2">3,6</td> </tr> </tbody> </table>	Throughpass attenuation											dB			3,0			3,2		3,4		3,6																							
Throughpass attenuation																																															
dB			3,0			3,2		3,4		3,6																																					
		<table border="1"> <thead> <tr> <th>Connection attenuation</th> <th colspan="10"></th> </tr> </thead> <tbody> <tr> <td>1 (RADIO), socket dB</td> <td colspan="10">11,3</td> </tr> <tr> <td>3 (TV), plug dB</td> <td>6,5</td> <td></td> <td>6,3</td> <td></td> <td>6,5</td> <td></td> <td>6,6</td> <td colspan="3">6,8</td> </tr> </tbody> </table>	Connection attenuation											1 (RADIO), socket dB	11,3										3 (TV), plug dB	6,5		6,3		6,5		6,6	6,8														
Connection attenuation																																															
1 (RADIO), socket dB	11,3																																														
3 (TV), plug dB	6,5		6,3		6,5		6,6	6,8																																							
		<table border="1"> <thead> <tr> <th>Decoupling</th> <th colspan="10"></th> </tr> </thead> <tbody> <tr> <td>OUT-TV dB</td> <td>26</td> <td colspan="4"></td> <td colspan="2">32,0</td> <td colspan="2">30,0</td> <td colspan="2">28,0</td> </tr> <tr> <td>OUT-RADIO dB</td> <td>30</td> <td></td> <td>34</td> <td></td> <td>36,0</td> <td>34,0</td> <td></td> <td>30,0</td> <td colspan="2">28,0</td> </tr> <tr> <td>TV-RADIO dB</td> <td>40</td> <td></td> <td>44</td> <td></td> <td>46,0</td> <td>44,0</td> <td></td> <td>40,0</td> <td colspan="2">38,0</td> </tr> </tbody> </table>	Decoupling											OUT-TV dB	26					32,0		30,0		28,0		OUT-RADIO dB	30		34		36,0	34,0		30,0	28,0		TV-RADIO dB	40		44		46,0	44,0		40,0	38,0	
Decoupling																																															
OUT-TV dB	26					32,0		30,0		28,0																																					
OUT-RADIO dB	30		34		36,0	34,0		30,0	28,0																																						
TV-RADIO dB	40		44		46,0	44,0		40,0	38,0																																						





Antenna outlet sockets

CATV special antenna outlet sockets

CATV filter sockets:

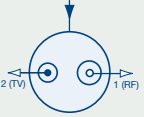
- Selective 2-hole filter antenna sockets, especially suitable for use in MATV installations or terrestrial individual installations

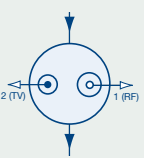
- **FS 01:** Individual socket for tap-out stub cables from the tap-off or for direct connection to single installation
- **FS 07/12:** Throughpass socket for tap-out stub cables from the tap-off or for direct connection to single installation

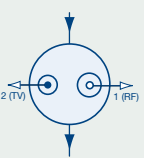
Type	FS 01	Individual socket																				
Order number	940 115-001	Frequencyrange MHz 5 40 68 87,5 108 118 125 470 862 1000 RKVHF I FM VHF III/ UHF																				
		Connection attenuation 1 (RADIO), socket dB 30 2 (TV), plug dB 0,8 Decoupling TV-RADIO dB 10																				
		<table border="1"> <tr> <td>20</td> <td>26</td> </tr> <tr> <td>1</td> <td>0,5</td> </tr> <tr> <td>1</td> <td>1</td> </tr> </table>	20	26	1	0,5	1	1														
20	26																					
1	0,5																					
1	1																					
Type	FS 07	Throughpass socket																				
Order number	940 158-001	Frequencyrange MHz 5 40 68 87,5 108 118 125 470 862 1000 RKVHF I FM VHF III/ UHF																				
		Throughpass attenuation dB 2 Connection attenuation 1 (RADIO), socket dB 30 2 (TV), plug dB 8 Decoupling OUT-TV dB 25 OUT-RADIO dB 25 TV-RADIO dB 10																				
		<table border="1"> <tr> <td colspan="2">2,2</td> <td colspan="2">2,4</td> </tr> <tr> <td>9,0</td> <td>18,0</td> <td colspan="2">8</td> </tr> <tr> <td colspan="2">bei 40 MHz min 30</td> <td colspan="2">bei 40 MHz min 30</td> </tr> <tr> <td colspan="2">min 10</td> <td colspan="2">min 10</td> </tr> </table>	2,2		2,4		9,0	18,0	8		bei 40 MHz min 30		bei 40 MHz min 30		min 10		min 10					
2,2		2,4																				
9,0	18,0	8																				
bei 40 MHz min 30		bei 40 MHz min 30																				
min 10		min 10																				
Type	FS 12	Throughpass socket																				
Order number	940 116-001	Frequencyrange MHz 5 40 68 87,5 108 118 125 470 862 1000 RK VHF I FM VHF III/ UHF																				
		Throughpass attenuation dB 1,0 Connection attenuation 1 (RADIO), socket dB 40 2 (TV), plug dB 11 Decoupling OUT-TV dB 25 OUT-RADIO dB 25 TV-RADIO dB 10																				
		<table border="1"> <tr> <td colspan="4">1,0</td> </tr> <tr> <td>12,0</td> <td>24,0</td> <td>12,0</td> <td>11</td> </tr> <tr> <td colspan="4">bei 40 MHz min 30</td> </tr> <tr> <td colspan="4">bei 40 MHz min 30</td> </tr> <tr> <td colspan="2">min 10</td> <td colspan="2">min 10</td> </tr> </table>	1,0				12,0	24,0	12,0	11	bei 40 MHz min 30				bei 40 MHz min 30				min 10		min 10	
1,0																						
12,0	24,0	12,0	11																			
bei 40 MHz min 30																						
bei 40 MHz min 30																						
min 10		min 10																				

CATV special antenna outlet sockets

CATV filter socket:

- Selective 2-hole special antenna socket, preferred implementation in CATV networks in Holland and Belgium
- Galvanic isolation of the outlet inner conductor to 2 kV
- Individual socket for decoupled stub lines

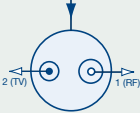
Type	EDC 01 NL	Individual socket									
Order number	940 104-001	Frequencyrange	MHz	5	75	87,5	108	118	125	470	862
				RK	VHF I	FM				VHF III/ UHF	
 		Connection attenuation									
		1 (RADIO), socket	dB	30...12	1,8		12..14	14..26	26		
		2 (TV), plug	dB	1,8	12		1,8	0,8			
		Decoupling									
	TV-RADIO	dB	30...12	12		12..14	14..26	26			

Antenna outlet sockets

Accessories

Terminating resistor R 77:

- 75 Ohm for low reflection termination of the last throughpass socket such as GDM, GEDU, FS 07, FS 12
- Frequency range 0...2,400 MHz

Terminating resistor R 77 DCB:

- 75 Ohm with capacitive isolation for low reflection termination of the last throughpass socket such as GDA, GDS with DC operation
- Frequency range 10...2,400 MHz

Type	R 77	R 77 DCB
------	------	----------

Order number

947 508-002

940 152-001



Surface-mount frame AR 20:

- For surface mount installation of all Hirschmann antenna outlet sockets
- Associated cover for AR 20: AD 23

Cover plate AD 23:

- For Hirschmann antenna outlet sockets with 2 or 3 outlets

Type	AR 20	AD 23
------	-------	-------

Order number

ivory
white

910 382-002
910 382-005

940 222-021
940 222-001



Dimensions

81 x 81 mm

81 x 81 mm

Receiver connecting cable

Type	FEKAB 1.5 m	SATKAB 1.5 m
------	-------------	--------------

Order number

947 679-151

947 665-151

Type	FEKAB 3 m	SATKAB 3 m
------	-----------	------------

Order number

947 680-151

947 666-151



Fig. FEKAB

Type	IEC plug	F/F fast plug
Frequency range	0.15-2400 MHz	0.15-2400 MHz
Connection	IEC connection	F/F connection

FEKAB:

- For connecting a radio receiver, TV and radio receiver or satellite receiver to an antenna outlet socket in accordance with IEC 60169-2
- Completely assembled with coaxial angled plug and coaxial angled coupling in accordance with IEC 60169-2

SATKAB:

- For connecting a satellite receiver to an antenna outlet socket with F socket
- Completely assembled with 2 angled plug connectors

Common features:

- Cable and plug connector white
- Packed in polythene bag
- Packing unit 10 pc.
- Shielding rate ≥ 90 dB
- 

► Coax connectors, cables, level meters

Page 127 – Page 144

IEC connectors

F-connectors

F-transition and bridging connectors

Earth block

Attenuators

Fixed attenuators

Terminating resistors

Coaxial cable

Level meters

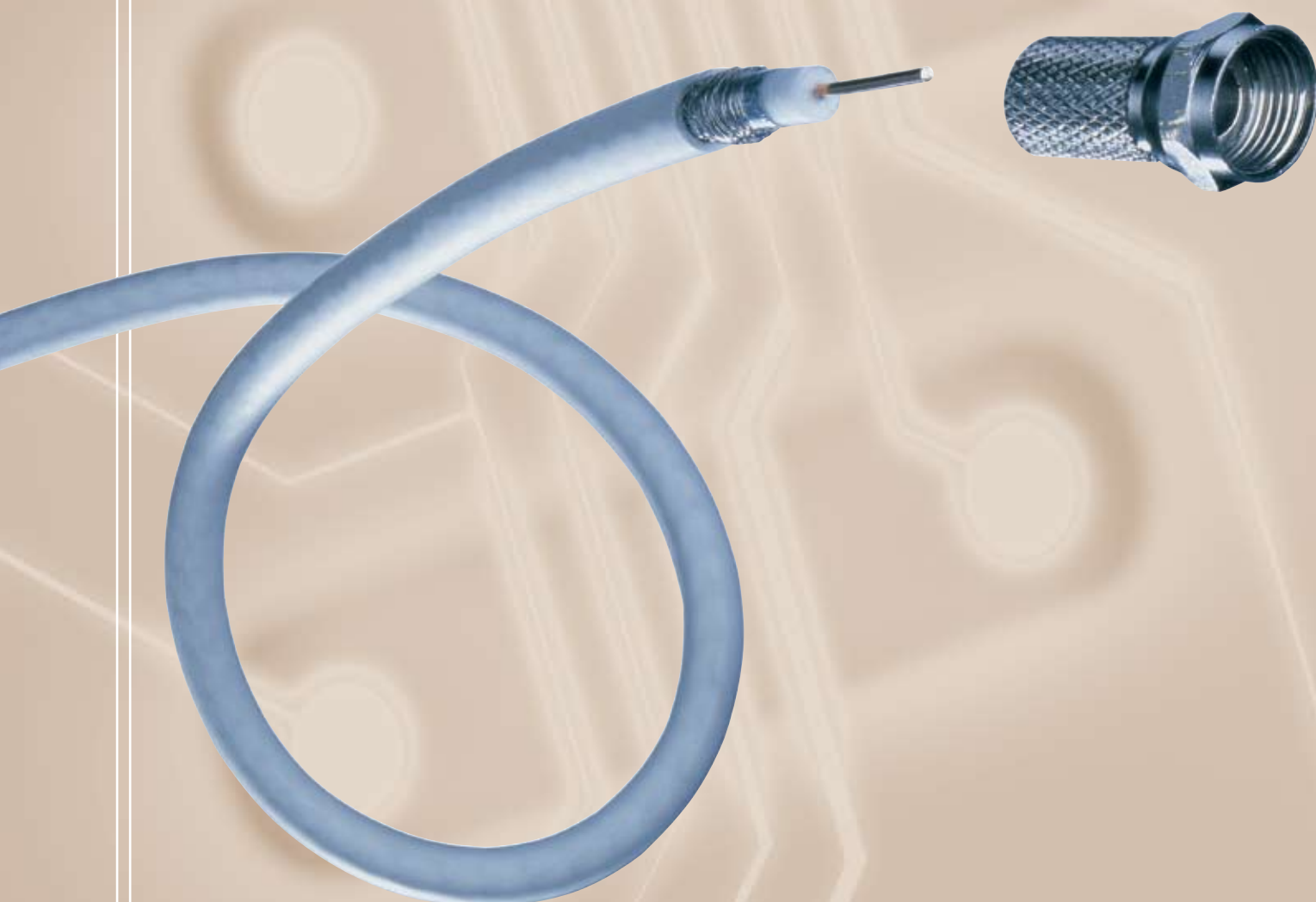

Overview

HF cable with matching plug connectors

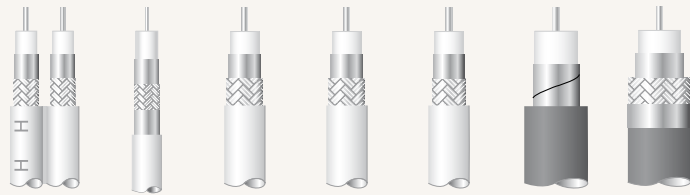

Connector KOKA ... 780 7539 90 100 120 741 7OK/7MK

Screw on plug								
SFC 052		•	•					
SFC 070				•	•	•		
Crimp connector								
CFS 56 JUV				•	•	•		
SFC 273							•	
CFS 11								•
Compression plug								
Ex 11								•
Ex 651				•	•	•		

IEC connectors

Connector								
KOS 1 Z				•	•	•		
KOS 3 N				•	•	•		
KOSWI 3				•	•	•		
Couplings								
KOK 1 Z				•	•	•		
KOK 3 N				•	•	•		
KOKWI 3				•	•	•		

Cable plugs and angled plugs in accordance with IEC 60169-2

Type		KOS 1 Z	KOK 1 Z
Order number		947 537-100	947 541-100
			
Version		IEC male	IEC female
For cable with	Inner conductor Ø mm	0.6-1.13	0.6-1.13
	Outer conductor Ø mm	max. 5.2	max. 5.2
	Sheath Ø mm	max. 7.2	max. 7.2
Cable type		KOKA 90, 100, 120	KOKA 90, 100, 120

- Screwless connection for inner conductors, tool-free
- With strain relief
- Frequency range 0-2400 MHz
- Shielding rate
to 470 MHz ≥ 75 dB
470-862 MHz ≥ 70 dB
950-1750 MHz ≥ 60 dB
1750-2400 MHz ≥ 55 dB
- Packing unit:
50 pc. individual packed
- Colour: white

Type		KOS 3 N	KOK 3 N
Order number		947 539-100	947 546-100
			
Version		IEC male	IEC female
For cable with	Inner conductor Ø mm	0.6-1.13	0.6-1.13
	Outer conductor Ø mm	max. 5.2	max. 5.2
	Sheath Ø mm	max. 7.8	max. 7.8
Cable type		KOKA 90, 100, 120	KOKA 90, 100, 120

- Screw connection for inner conductor
- With strain relief
- Frequency range 0-2400 MHz
- Shielding rate
to 862 MHz ≥ 75 dB
950-1750 MHz ≥ 65 dB
1750-2400 MHz ≥ 60 dB
- Colour: white

Type		KOSWI 3	KOKWI 3
Order number		947 544-100	947 548-100
			
Version		Angled IEC male	Angled IEC female
For cable with	Inner conductor Ø mm	max. 1.13	max. 1.13
	Outer conductor Ø mm	max. 5.6	max. 5.6
	Sheath Ø mm	4.5-7.2	4.5-7.2
Cable type		KOKA 90, 100, 120	KOKA 90, 100, 120

- Screw connection for inner conductor
- With strain relief
- Frequency range 0-2400 MHz
- Packing unit:
50 pc. individual packed
- Colour: white



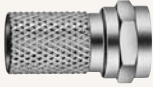

Coaxial F-connectors

Screw on plugs

Type	SFC 052	SFC 070
Order number	947 389-001	947 388-002
		
For cable with outer diameter Ø mm	approx. 5.2	approx. 7.0
Cable type	KOKA 780 TWIN-SAT	KOKA 90, 100, 120

- Frequency range 0-2400 MHz
- Shielding rate > 90 dB

Crimp connector

Type	SFC 273	CFS 11
Order number	947 391-001	980 000-120
		
For cable braid Ø mm	approx. 7.3	8.0
Cable type	KOKA 741	KOKA 70K/7 MK
a=dimension for crimp pliers 	0.475"	0.475"/0.096"

- Frequency range 0-2400 MHz
- Shielding rate > 90 dB

Crimp connector

Type	CFS 56 JUV
-------------	-------------------

Order number 940 017-001



For cable with dielectric	mm	approx. 4.8
Cable type		KOKA 90, 100, 120
a=dimension for crimp pliers		0.360"

- Frequency range 0-2400 MHz
- Shielding rate > 90 dB
- Protection class, IP 67
- Installation with crimp pliers

Compression plug

Type	EX 651
-------------	---------------

Order number 940 016-001



For cable with dielectric	mm	approx. 4.8
Cable type		KOKA 90, 100, 120
Compression pliers		EX 59/6 CAT EX 59/6 CAT
		Order no. 981 000-752 Order no. 981 000-752

- Frequency range 0-2400 MHz
- Shielding rate > 90 dB
- Protection class, IP 67
- Installation with compression tool

Compression plug

Type	EX 11
-------------	--------------

Order number 981 000-734



For cable with dielectric	mm	approx. 8.0
Cable type		KOKA 7 OK/7 MK

- Frequency range 0-2400 MHz
- Shielding rate > 90 dB
- Protection class, IP 67
- Installation with compression tool

Adapter plugs

Type	SBFC 01	SBFC 02	WFC 01
Order number	947 395-001	947 415-001	947 372-001
Transition	IEC socket/ F-connectors	IEC connector/ F-socket	F-socket F-connectors

- Frequency range 0-2400 MHz



Cable connectors

Type	KVFC 01	KVFC 02
Order number	947 374-001	947 387-001
Connection	F-socket/ F-socket	F-connector/ F-connectors

- For connecting two HF cables with F-connector or F-socket
- Frequency range 0-2400 MHz
- Shielding rate > 90 dB

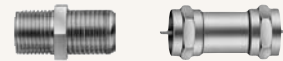

Quick F-connectors

Type	KVFC 03
Order number	947 591-001

- For connecting two F-sockets
- Use for example with cascading multi-switches
- Frequency range 0-2400 MHz



Earthing and F-connection block

Type	GBD-1
Order number	980 000-160

- Connecting any coax cable with F-connectors
- Easy to earth
- Frequency range 0-2400 MHz
- Shielding rate > 90 dB
- Additional earth blocks and angles are provided in Hirschmann's current price list



Adjustable attenuators

Type	VDF 18 F	VDF 757 F
Order number	947 590-001	947 504-001

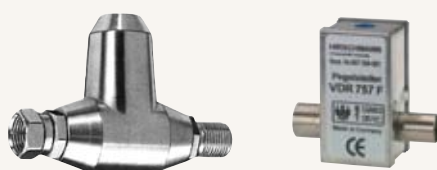

Frequency range	MHz	47-2150	40-2150
Setting range attenuator	dB	18	20
Max. remote feed current		1 A / 24 V DC	1 A / 24 V DC
Connections		F-socket, F-plug	IEC
Dimensions	mm	58 x 38 x 20	44 x 47 x 24

- For reducing excessive input levels
- Remote feed voltage is forwarded
- Satisfies EN 50083-2
- 

Fixed attenuators

Type	FDFC 6	FDFC 10
Order number	947 445-006	947 445-010



Frequency range	MHz	0.15-862	0.15-862
Attenuation	dB	6	10

- For reducing excessive input levels, particularly for adjusting control amplifiers and converters (10 dB value)
- Adapter plug with fixed attenuation values
- Shielding rate to 470 MHz \geq 75 dB
470-862 MHz \geq 65 dB

Terminating resistor

Type	RFC 75	RFC 75 DCB
Order number	947 373-001	940 163-001



Frequency range MHz		0-2.400	10-2.400
DC-path Ohm	75	electrically isolated	

- For sealing open outputs with F-connections
- Packing units
Single pack 10 pc.
Bulk pack 100 pc.
- Terminating resistor (R77) for use with antenna outlet sockets see page 126



Coaxial cable

Type		KOKA 7539	KOKA 743
Order number	200 m drum	128 111-002	-
	500 m drum	-	198 743-500



Koka 7539

- Coaxial cable 75 Ohm in accordance with EN 50117
- Triple shielded
- Mini cable for space saving installation
- Marked by the meter





Koka 7543

- Coaxial cable 75 Ohm in accordance with EN 50117
- Underground cable
- Copper pipe welded

Features			Triple shielded	copper pipe welded
			Extremely high	strong protective sheath
			Shielding rate	For underground installations
			Cell-PE	
Diameter/material				
Innner conductor	mm	0.61/Cu	3.3/Cu	
Insulation	mm	2.72 Cell-PE	13.4 Cell-PE	
Outer conductor	mm	3.7/Al/PET/Al foil	17.0 Outer sheath	
		Braid Al (60%) Al/PET/Al foil	copper pipe welded	
Sheath	mm	4.5/PVC white	polyethylene, black	
Bending radius, min. one-time	cm	4.5	20	
DC resistance	Ohm	8.2 ¹⁾	0.45 ¹⁾	
Propagation velocity		0.82	0.88	
Return loss	5-30 MHz	dB	≥ 20	
	30-470 MHz	dB	≥ 20	
	470-862 MHz	dB	≥ 20	
	862-2150 MHz	dB	-	
Shielding rate	30-470 MHz	dB	≥ 90	≥ 75
	470-1000 MHz	dB	≥ 90	≥ 70
	1000-2150 MHz	dB	≥ 90	-
Attenuation (100 m/20 °C)				
5 MHz	dB	2.82	1 MHz	0.15 dB
50 MHz	dB	7.78	47 MHz	1.3 dB
100 MHz	dB	10.59	68 MHz	1.6 dB
200 MHz	dB	14.63	100 MHz	1.9 dB
400 MHz	dB	20.77	174 MHz	2.7 dB
800 MHz	dB	29.93	230 MHz	3.0 dB
1000 MHz	dB	33.67	300 MHz	3.3 dB
1600 MHz	dB	42.61	470 MHz	4.2 dB
2150 MHz	dB	44.36	500 MHz	4.4 dB
2400 MHz	dB	52.18	600 MHz	4.9 dB
Fire loss	MJ/m	0.183	-	-
Operating temperature	°C	-25 to +70	-	-

¹⁾ DC resistance of the loop of inner conductor and outer conductor at 100 m cable and +20 °C

Coaxial cable

Type	KOKA 90	KOKA 100	KOKA 120
Preferred use	SMATV installation	SMATV installation	SMATV installation
Order number	SAT IF	SAT-IF, CATV multimedia	SAT-IF, CATV multimedia
100 m reel	-	940 270-100	940 272-100
100 m coil, white	940 271-110	-110	-110
250 m coil, black	-	-210	-
500 m drum, white	940 271-500	-500	-500
100 m coil, (PE) black	-	-113	-
100 m coil FRNC	-	-115	-
100 m coil FRNC	-	-	-115
500 m drum FRNC	-	-	-515
			
Features	Cell PE cable Double shielded High shielding rate	Cell PE cable Double shielded Extremely high shielding rate Extremely low attenuation	Cell PE cable Triple shielded Extremely high shielding rate Extremely low attenuation
Mechanical characteristics			
Inner conductor	1.02 mm, steel Cu	1.13 mm, bare Cu	1.13 mm, bare Cu
Dielectric Ø	4.8 mm PE foamed	4.8 mm Foamed skin PE/ skin blue	4.8 mm Foamed skin PE/ white
Outer conductor Ø	5,4 mm	5,4 mm	5,4 mm
1. Foil	Al/ PET/ Al	Al/ PET/ Copolymer bonded	Al/ PET/ Copolymer bonded
Braid	CuSu	CuSu	CuSu
2. Foil	PET transparent	PET transparent	Al/PET bonded
Sheath Ø	6.8 mm	6.8 mm	6.8 mm
Sheath material	PVC white	PVC white/ PE black/ FRNC grey	PVC white/ PE black/ FRNC grey
Electrical characteristics			
DC resistance*	5.5 Ω/100 m	2.9 Ω/100 m	3.2 Ω/100 m
Propagation velocity	0.81	0.84	0.84
Return loss			
5-470 MHz	25 dB	35 dB	35 dB
470-862 MHz	23 dB	28 dB	28 dB
862-2150 MHz	28 dB	24 dB	24 dB
Coupling resistance (5...30 MHz)	8 m Ωm	3 m Ωm	3 m Ωm
Shielding rate			
30-100 MHz	90 dB	95 dB	110 dB
100-1000 MHz	90 - 100 dB	100 - 110 dB	120 dB
1000-2150 MHz	90 dB	100 dB	110 dB
Attenuation (100 m/20 °C)			
5 MHz	1.90	1.4	1.4
50 MHz	4.68	4.0	4.0
100 MHz	6.30	5.7	5.7
200 MHz	8.70	8.1	8.1
400 MHz	12.31	11.7	11.7
800 MHz	18.75	16.8	16.8
1000 MHz	21.20	19.0	19.0
1600 MHz	27.40	24.5	24.6
2150 MHz	32.70	29.0	29.0
Operating conditions			
Fire loss	0.77 MJ/m (PVC)	0.77 MJ/m (PVC)	0.77 MJ/m (PVC)
Operating temperature	-40°... +70°C	-40°... +70°C	-40°... +70°C
Install temperature	-5°... +50°C	-5°... +50°C	-25°... +50°C
Bending radius, min. one-time	35 mm	35 mm	35 mm
Reference standards			
Product standard	EN 50117-4 Class B ROHS conformant	EN 50117-4 Class A ROHS conformant	EN 50117-4 Class A ROHS conformant

Koka 90 - The inexpensive alternative for cabling MATV installations and SAT - IF building distribution systems.

- Good shielding characteristics throughout the entire terrestrial and SAT-IF range
- Extensively protected against corrosion thanks to copper braid (Cu Sn) and copper sheathed steel inner conductor
- Good installation characteristics
- RoHS conformant

Koka 100 - The blue universal cable is ideal for television distribution systems in the building - uniformly predestined for SAT-IF, terrestrial and return channel enabled CATV installations.

- Low attenuation through 1.13 mm inner conductor and phys. foamed PE as dielectric
- Excellent shielding characteristics over the entire frequency range
- Durable and reliable
- Copper insert for inner conductor and braid (tinned)
- 3 layer dielectric, bonded special Al foil
- Excellent stripping and installation characteristics
- Special versions KOKA 100 PE and KOKA 100 FRNC
- RoHS conformant
- Satisfies new Class A in acc. with EN 50117-4
- Black variant (UV-resistant) or outside installation

Koka 120 - The triple shielding is recommended for television distribution installations in the building with increased shielding requirements and particularly for multimedia enabled CATV networks in critical EMC environments

- Extremely good shielding characteristics over the entire CATV range to 1000 MHz
- Low attenuation through 1.13 mm inner conductor and phys. foamed PE as dielectric
- Durable and reliable - Copper insert for inner conductor and braid (tinned)
- 3 layer dielectric, bonded special Al foil
- Excellent stripping and installation characteristics
- Special version - KOKA 120 FRNC
- RoHS conformant
- Satisfies new Class A in acc. with EN 50117-4

* Loop inner conductor + outer conductor

Coaxial cable

Type		KOKA 780 TWIN-SAT	KOKA 741	KOKA 7 OK/MK
Order number	100 m reel	198 780-100	-	-
	305 m drum	-	-	980 000-395 (OK) 980 000-393 (MK)
	500 m drum	-	198 741-500	

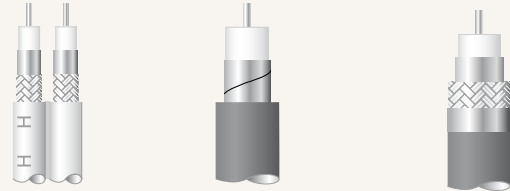

- Coaxial cable 75 Ω in accordance with EN 50117
- **A** For KOKA 7 OK/MK

KOKA 7 MK equivalent to KOKA 7 OK
Outer conductor foil bonded for underground installation

Features		Double Cell-PE cable	Robust full-E Cable, attenuation halogen-free	Triple shielded Cell-E-cable Very low attenuation halogen-free
Preferred use		1. Sat-IF for all two and four cable solutions	CATV networks Trunk line	Trunk line for Sat-IF and CATV Building distribution systems, MK for underground cable
Marked by the meter		yes	-	-
Diameter/material				
Innner conductor	mm	0.8/Cu	1.1/Cu	1.63/coppered steel
Insulation	mm	3.5 Cell-PE	7.2/PE	7.11 Cell-PE
Outer conductor	mm	4.2/Al/PET/Al foil + Cu braid (tinned)	7.7/Cu strip overlapping	7.29/Al/PET/Al foil + Al braid (60%) + Al/PET/Al foil
Sheath	mm	5.4x11,5/PVC white	10.4/PE black	10,3/PE black
Bending radius, min. one-time	cm	3.5	10	10
DC path	Ohm	7.0 ¹⁾	2.4 ¹⁾	6.8 ¹⁾
Propagation velocity		0.85	0.66	0.85
Return loss	5-30 MHz	dB ≥ 20	dB ≥ 24	dB ≥ 23
	30-470 MHz	dB ≥ 20	dB ≥ 26	dB ≥ 23
	470-862 MHz	dB ≥ 20	dB ≥ 23	dB ≥ 20
	862-2150 MHz	dB ≥ 15	-	dB ≥ 20
Shielding rate	30-470 MHz	dB ≥ 75	dB ≥ 75	dB ≥ 90
	470-1000 MHz	dB ≥ 75	dB ≥ 75	dB ≥ 90
	1000-2150 MHz	dB ≥ 65	-	dB ≥ 90
Attenuation (100 m/20 °C)				
	5 MHz	dB -	dB -	dB 1.25
	50 MHz	dB 5.6	dB 3.4	dB 2.7
	100 MHz	dB 8.1	dB 5.3	dB 3.8
	200 MHz	dB 11.7	dB 7.7	dB 5.6
	400 MHz	dB 16.9	dB 11.5	dB 8.53
	800 MHz	dB 24.8	dB 17.0	dB 12.0
	1000 MHz	dB 27.7	-	dB 14.27
	1600 MHz	dB 29.4	-	dB 18.1
	2150 MHz	dB 42.3	-	dB 21.6
	2400 MHz	dB 45.9	-	dB 23.2
Fire loss	MJ/m	0,8	-	-
Ambient temperature	°C	-25 to +70	-25 to +70	-25 to +70

¹⁾ DC current resistance of the loop of inner conductor and outer conductor at 100 m cable and + 20 °C

Level meter DVB-S, DVB-C, DVB-T, return channel and analog

Type	UPM 3300
-------------	-----------------

Order number 948 404-001



Frequency range	MHz	5-2150
Measuring range		
UKW / TV	dBµV	20-120
SAT	dBµV	30-120
Return channel	dBµV	25-120
Metering precision	dB	+/- 1.5 (20°C) +/- 2.0 (0-40°C)
TV standards		Standards B/G, I, L, M/N, D/K
TV image display		5.5" TFT screen
DVB measurements		Level measurement for QPSK and QAM BER for QPSK & 16/32/64/128/256 QAM MER for 16/32/64/128 Configuration diagram MPEG-2 decoder* SI evaluation/NIT* COFDM front end for DVB-T* S/N with Scope/Brumm*
CI interfaces		2 x CI for CAM modules with smart card*
Audio playback		Integrated speaker Stereo jack for headphones Acoustic level tendency indicator SAT subcarrier freely selectable
Audio measuring		Separate measuring TT1 and TT2 NICAM sound carrier measurement* ADR sound carrier measurement optional*
SAT sound IF frequency	MHz	5.00-9.75 adjustable in 10 kHz increments
Spectrum analyzer		Digital analyzer with switchable measuring bandwidths for broadband and narrowband display in all ranges
Printer		23-character thermal printer for printing out measured values and spectrum as well as for automatic level monitoring*
Memory functions		200 tuner memory 20,000 measured values can be stored
Remote feed voltage/ LNB supply		SAT: Feed voltage 10-20V in 0.1V increments DiSEqC 1.0 and 2.0, 22kHz switching, Measurement of LNB current consumption 5-500mA TV/DVB-T: Remote feed 5V/18V Measurement of current consumption 5-500mA
HF input		IEC socket/75 Ohm (DIN 45 325)
Power supply		100-250V mains operated, 12V intern/extern rechargeable battery pack 12V/4.5 Ah (NiMH)
Weight	kg	6.6 with battery pack
Dimensions W x H x D	mm	365 x 150 x 285
Protection class		II in accordance with VDE 0411

* Not included in scope of delivery. option

Level measuring device for analog and digital TV with printer and real time clock

- Colour TFT screen 5.5"
- 24-character thermal printer
- Level monitoring program
- Frequency range 5-2150 MHz
- Video text can be called for each station
- With bit error rate (BER) before and after Viterbi for QPSK and QAM, configuration diagram, modulation error rate (MER) and S/N
- RDS display for UKW
- DiSEqC 1.0 / 1.2 / 2.0
- Graphic colour LC display
- 200 station pre-sets, freely programmable with memory save function
- Terrestrial remote supply for feeding amplifiers
- Screen display of the configuration diagram for QAM and QPSK
- Acoustic signal for antenna alignment
- Water-resistant, dirt-resistant keypad
- RS 232 interface
- SCART connection (video input and output)
- 12 V connection socket internal/external
- Connection for stereo headphones
- Factory installed
Rechargeable battery pack 12V/4,5 Ah (NiMH)
- Scope of delivery Measuring cable IEC-IEC, power cord, operating manual
- Weight 6.6 kg with rechargeable battery pack

Options/accessories

- DVB-S2 front end for measuring HDTV signals for SAT
- MPEG2 decoder with NIT evaluation
- 2xCI (Common Interface) for all major CA modules
- COFDM front end for DVB-T measurements
- S/N measuring module with SCOPE/BRUMM for analog TV
- ADR decoder or NICAM decoder
- Leather case
- Logging software

Type	UPM 3300 SET
-------------	---------------------

Order number 940 130-001

Incl. MPEG2 decoder, DVB-T front end
Leather case

Level meter DVB-S, DVB-C, DVB-T, return channel and analog

Level measuring device for analog and digital TV

- TV screen s/w 5.5"
- Frequency range 5-2150 MHz
- Video text can be called for each station
- With bit error rate (BER) before and after Viterbi for QPSK and QAM, configuration diagram, modulation error rate (MER) and S/N
- RDS display for UKW
- DiSEqC 1.0 / 1.2 / 2.0
- Graphic colour LC display
- 200 station pre-sets, freely programmable with memory save function
- Terrestrial remote supply for feeding amplifiers
- Screen display of the configuration diagram for QAM and QPSK
- Acoustic signal for antenna alignment
- Water-resistant, dirt-resistant keypad
- RS 232 interface
- SCART connection (video input and output)
- 12 V connection socket
- Connection for stereo headphones
- Factory installed
Rechargeable battery pack 12V/4,5 Ah (NiMH)
- Scope of delivery Measuring cable IEC-IEC, power cord, operating manual
- Weight 6,9 kg with rechargeable battery pack

Options/accessories

- DVB-S2 front end for measuring HDTV signals for SAT
- MPEG2 decoder with SI/NIT evaluation
- 2xCI (Common Interface) for all major CA modules
- COFDM front end for DVB-T measurements
- S/N measuring module with SCOPE/BRUMM for analog TV
- ADR decoder or NICAM decoder
- Printer
- Leather case
- Logging software

Incl. MPEG2 decoder, DVB-T front end
Leather case

Type UPM 3100

Order number 948 407-001



Frequency range	MHz	5-2150
Measuring range		
UKW / TV	dBµV	20-120
SAT	dBµV	30-120
Return channel	dBµV	25-120
Metering precision	dB	+/- 1.5 (20°C) +/- 2.0 (0-40°C)
Colour TV standards		PAL/SECAM/NTSC
TV standards		Standards B/G, I, L, M/N, D/K
TV image display		5.5" b/w screen
DVB measurements		Level measurement for QPSK and QAM BER for QPSK & 16/32/64/128/256 QAM S/N for QPSK configuration diagram in real time MPEG-2 decoder with SI evaluation/NIT* COFDM front end for DVB-T measurements level, BER, S/N, configuration diagram*
CI interfaces		2 x CI for CAM modules with smart card*
Audio playback		Integrated speaker, stereo jack for headphones Acoustic level tendency indicator SAT subcarrier freely selectable
Audio measuring		Separate measuring TT1 and TT2 NICAM sound carrier measurement ADR sound carrier measurement optional*
SAT sound IF frequency	MHz	5.00-9.75 adjustable in 10 kHz increments
Spectrum analyzer		Digital analyzer with switchable measuring bandwidths for broadband and narrowband display in all ranges
Printer		24-character thermal printer for printing out measured values and spectrum as well as for automatic level monitoring*
Memory functions		200 tuner memory 20,000 measured values can be stored
Remote feed voltage/		SAT: Feed voltage 10-20V in 0.1V increments
LNB supply		DiSEqC 1.0 and 2.0, 22kHz switching, Measurement of LNB current consumption 5-500mA TV/DVB-T: Remote feed 5V/18V Measurement of current consumption 5-500mA
HF input		IEC socket/75 Ohm (DIN 45 325)
Power supply		100-250V mains operated, 12V intern/extern rechargeable battery pack 12V/4.5 Ah (NiMH)
Weight	kg	6.9 with battery pack
Dimensions W x H x D	mm	365 x 150 x 285
Protection class		II in accordance with VDE 0411

* Not included in scope of delivery, option

Type UPM 3100 SET

Order number 940 131-001

Level meter DVB-S, DVB-C, DVB-T, return channel and analog

Type	UPM 2100
-------------	-----------------

Order number 940 303-001**



Frequency range	MHz	5-2150
Measuring range		
UKW / TV	dBµV	25-110
SAT	dBµV	30-110
Return channel	dBµV	25-110
Metering precision	dB	+/- 1.5 (20°C) +/- 2.5 (0-40°C)
TV image display		4" TFT colour display
DVB measurements		Level measurement for QPSK, QAM and COFDM, BER for QPSK, 16-256 QAM and COFDM S/N and MER, MPEG-2 decoder SI evaluation/NIT
CI interfaces		1 x CI bay for CAM module with smart card
Audio playback		Integrated speaker Acoustic level tendency indicator
SAT sound IF frequency	MHz	5.00-9.00 adjustable in 10 kHz increments
Spectrum analyzer		Digital analyzer for all ranges, narrow band and broadband
Memory functions		99 tuner memory
Remote feed voltage/ LNB supply		Feed voltage 5/18V (TV analog and DVB-T) Current measurement 5-100 mA Feed voltage 14/18V, (SAT) 22kHz switching DiSEqC 1.0, V1.1, V1.2, V2.0, V2.2 Measurement of LNB current consumption 5-500mA
HF input		IEC socket/75 Ohm (DIN 45 325)
Power supply		100-250V on-grid operation 50-60Hz, 12V external, Rechargeable battery pack 12V/4.5 Ah (NiMH)
Weight	kg	3.5 with battery pack
Dimensions W x H x D	mm	252 x 135 x 272
Protection class		II in accordance with VDE 0411

* Illustration similar

** Available 2nd quarter 2007

Level meter for analog and digital DVB

- Frequency range 5-2150 MHz
- DiSEqC 1.0 / 1.1 / 1.2 / 2.0 / 2.2
- Operation via membrane keypad and rotary pulse encoder
- Integrated battery pack 12V/4.5 Ah (NiMH)
- Integrated speaker
- Analyzer function for all ranges
- MPEG2 decoder with SI/NIT evaluation
- 1xCI (Common Interface) for all major CA modules
- Audio and video output
- 99 station memory
- Canvas bag with carrying strap
- With power cord, measuring cable IEC-IEC, operating manual

Level meter DVB-S

Type	SPM 1
-------------	--------------

Order number 940 140-001



The cost-efficient entry model

- Automatic satellite selection
- Preprogrammed for 20 different orbit positions
- Total of 62 station presets, can be reprogrammed via PC at any time (Option RS 232 adapter)
- Concurrent display of level and signal quality
- With audio signal for good signal quality
- DiSEqC 1.0
- DVB standard DVB/DSS
- High-resolution display
- Up to 5 hours of off-grid operation
- With robust protective case

Frequency range	MHz	950-2150
Measuring range SAT	dB μ V	34-90
DVB measurements		Level metering QPSK Bar graph
Audio playback		Acoustic level tendency indicator
Memory functions		62 station memory
Remote feed voltage/		Feed voltage 13/18 V
LNB supply		DiSEqC 1.0 22kHz switching
HF input		F-connector/75 Ohm
Power supply		Power supply 230 V/12/17V external Rechargeable battery NI-MH, 9.6V/2.2A
Weight	kg	approx. 1.5
Dimensions W x H x D	mm	120 x 60 x 235

► catTV

Page 141 – Page 144

catTV panel

catTV balun



TV over symmetric data cable

Multimedia networks via application-neutral cabling using catTV:

catTV technology from Hirschmann was developed to enable transmission of radio, television, and value-added services via the data network that formerly was used only for telephone and Internet. Thus additional coax cabling can be dispensed with for television reception. Television reception can then be implemented at any point of the data network.

- Multimedia application (radio, TV) directly via the existing 100 Ohm application-neutral building cabling = "structured cabling" (symmetric cabling in accordance with category 6/7)
- With the double-active catTV systems (distribution panel and Balun) link attenuation of up to 50 dB can be compensated.
This also means that the maximum structured cabling length of (90 m) can be bridged.

- The service can be fed individually to each subscriber via star-shaped "structured cabling"
- Cost-effective extensions and supplemental integration of additional subscribers are possible without installation expenses - additional calibration is not required
- Installation of an additional coax network is not required for the TV multimedia application
- All TV channels offered from 45 (85) to 862 MHz can be transmitted
- Return channel enabled, optionally available with active or passive return channel (5-30 MHz or 5-65 MHz)
- Plug and play system. Adjustment of attenuation and slope to the existing cable length merely requires a changeover switch (in 3 steps) on the balun

catTV panel

Active distribution panel for distributing CATV signals over application-neutral building cabling.

The catTV panel converts the CATV signal (coaxial/75 Ohm) into a symmetric signal (sym./100 Ohm) in order to feed it to the subscriber line via the building cabling patch panel.

catTV balun

The catTV balun is connected to the RJ45 subscriber socket via a patch cable.

The balun (balanced - unbalanced) converts the symmetric signal from the catTV panel via application-neutral cabling into a coaxial signal (75 Ohm) that can be processed for the end devices (e.g. TV set and radio).

catTV for use in/on

- Office and industrial buildings
- Clinics and hospitals
- Rehabilitation centres
- Banks, savings institutions
- Stock exchange workstations
- Brokerage firms
- Insurance buildings
- Airports
- TV stations and television studios
- Municipality buildings
- Hotels, vacation resorts
- Housing estates
- Athletic arenas
- Correspondent workstations

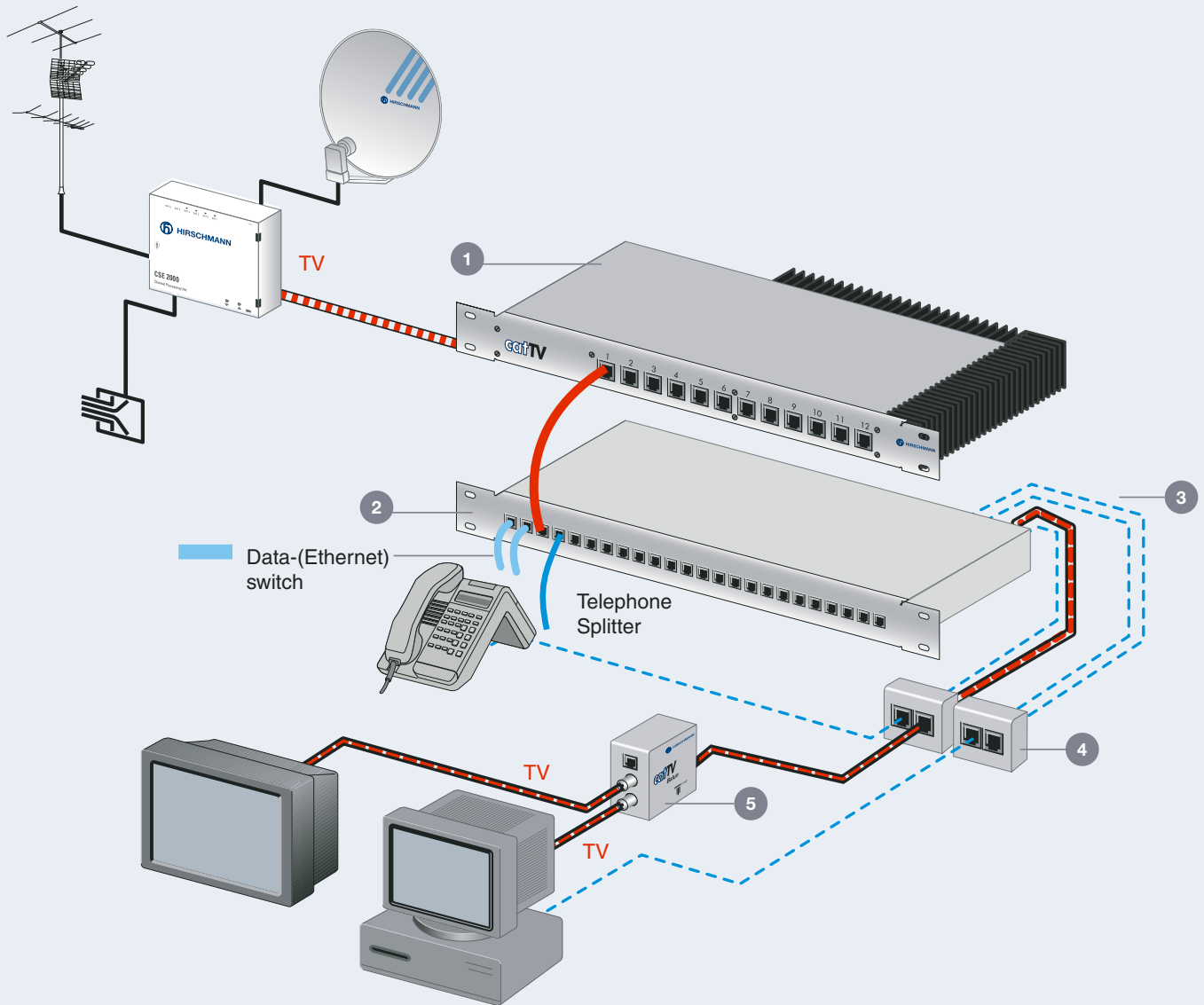

- 1 catTV panel
- 2 Standard patch panel
- 3 Symmetric cabling (cat. 6/7)
- 4 RJ45 double socket
- 5 catTV balun

catTV panel

- Infeed of HF signals
- Attenuator + equaliser on the input
- Input measuring socket
- Amplification through GaAs- hybrids
- Conversion of 75 Ω (coaxial) to 100 Ω (symmetric), RJ 45
- Paired cable configuration (HF 1,2; remote feed/RC 7, 8)
- TV signals are only actively switched when balun is connected
- Standard RC module active and passive can be retrofitted (see p. 60)
- Static switch-off of individual ports is possible
- External power supply

1) Normal mode. Maximum bridgeable cable attenuation 40 dB. Externally connected passive network components must have minimum shielding of 75 dB.

2) Special mode. Maximum bridgeable cable attenuation 50 dB. Externally connected passive network components must have minimum shielding of 85 dB.

catTV panel

Type		NPN 3412	
Order number		947 745-001	
			
Input frequency	MHz	45-862, optional return channel	
Input level	dBμV	60-83	
Level adjuster	dB	0-20	
Equaliser	dB	0-18	
Noise factor	dB	7	
Gain	dB	34	
Pre-equalisation	dB	15	
operating level ¹⁾			
42 channels	dBμV	94 ¹⁾	104 ²⁾ (at 60 dB CS0/CTB)
Test jack	dBμV	70 ¹⁾	80 ²⁾
Input, test jack		F-socket	
Outputs		RJ 45 socket, 6-pole, 100 Ω	
Control		Sub-D socket, 15-pole	
Power supply		28 V DC ±5%; max. 1.9 A	
Current consumption		930 mA, without balun	
Power supply		External, protection class 2, short-circuit proof	
Ambient temperature		0 -50 °C	
Dimensions	mm	483 x 42 x 180 (19", 1 U)	
Weight	kg	2.8	

catTV balun

- Signal infeed via RJ 45
- Back conversion of 100 Ω into 75 Ω
- Amplification of the HF signal
- Allocation of the signals to the outputs
- 3 variants without RK, RK 5-30 MHz, RK 5-65 MHz
- Slope and attenuation of max. 50 dB are compensated Plug and play 3 switch settings for easy adjustment to different cable lengths

catTV balun

Type		NBL 0200	NBL 0230	NBL 0265
Order number		947 747-001	947 749-001	947 748-001
				
Input frequency	MHz	45-862	45-862	45-862
Return channel	MHz		5-30	5-65
Input level	dBμV	54-90	54-90	54-90
Gain dB	6/-7/-20	6/-7/-20	6/-7/-20	6/-7/-20
Pre-equalisation	dB	18/10/0	18/10/0	18/10/0
Output level	dBμV	60-77	60-77	60-77
Input		RJ 45 socket, 8-pole, 100 W symmetric		
Outputs	TV	Plug, IEC, 75 W		
	RADIO	Socket, IEC, 75 W	-	-
	DATA	-	Socket, F, 75 W	Socket, F, 75 W
	Phone	RJ 45 socket, 8-pole, 100 W, symmetric		
Power supply		10 V	10 V	10 V
Current consumption		70 mA	70 mA	70 mA
Ambient temperature		0-50 °C	0-50 °C	0-50 °C
Dimensions	mm	81 x 35 x 59	81 x 35 x 59	81 x 35 x 50
Weight	g	112	112	112

► Products for CATV and access networks

Page 145 – Page 146

Satellite receiving antenna and accessories

Terrestrial antennas and mechanical accessories

Coaxial cable and fittings

Passive distribution material

CATV amplifiers

Optical devices and systems

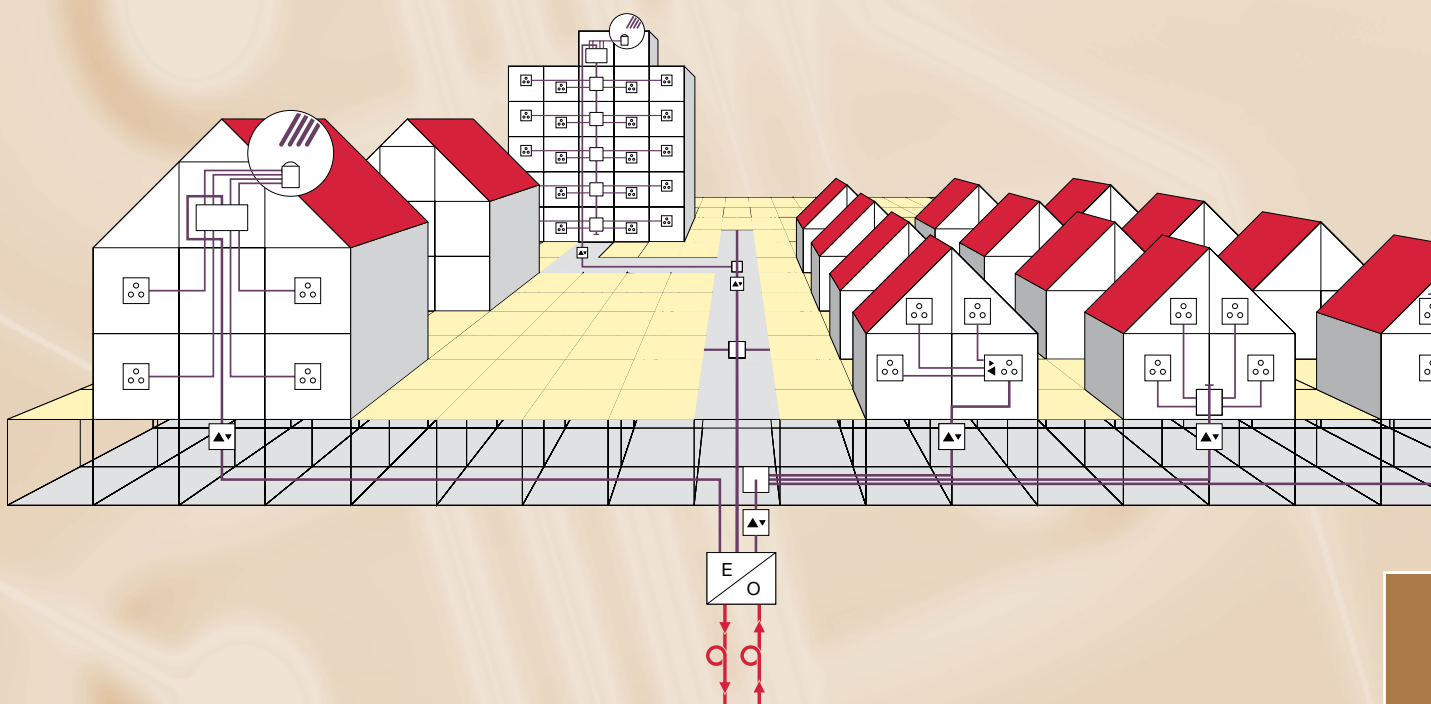

The products listed in this catalog have their primary applications in the headend area (signal reception and processing), and the area of in-house networks for transmission of television signals, radio signals and interactive services.

In addition Hirschmann offers an extensive product line of active and passive devices and system components that are suitable for implementation of CATV and access networks for the subscriber area. In addition to optical system components, these products include line and distribution amplifiers with high

gain and/or high output levels, remote feed tap-offs and distribution boxes, low-attenuation coaxial cable with fittings, even terrestrial antennas and exterior satellite units (antennas, LNBS) for applications with more rigorous mechanical and/or electrical requirements.

The Hirschmann partners in your area or our planning office in Stolberg, headed by Mr. Gerhard Müller, offer planning services for concrete CATV projects, email: triax-hirschmann@ib-gm.de

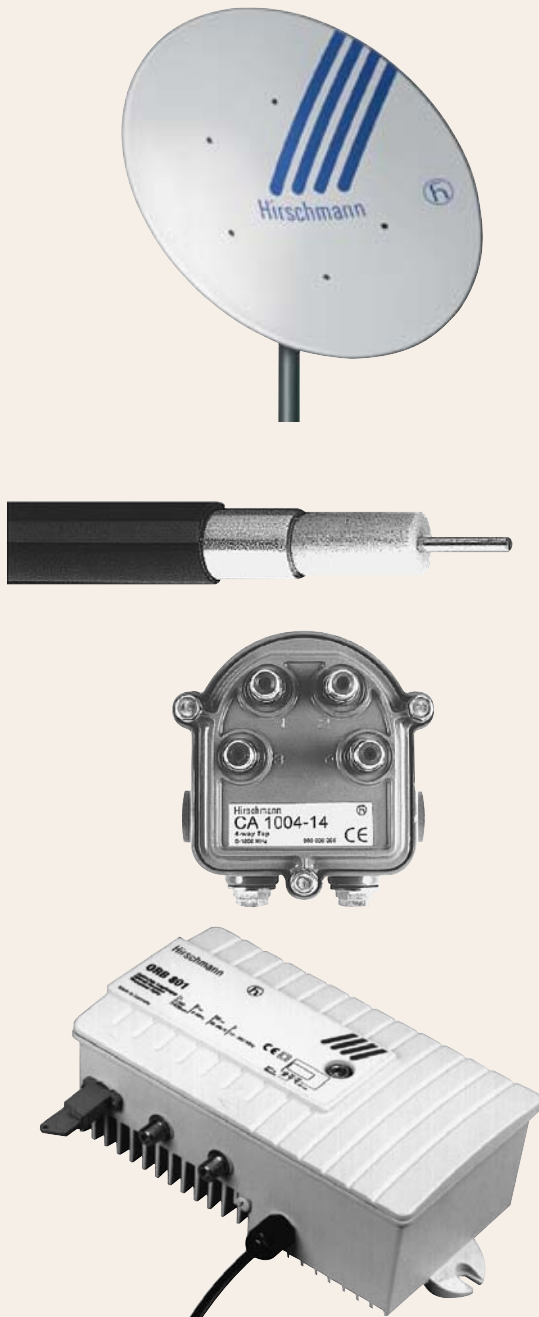

Satellite receiving antenna and accessories

- Antennas (1.5 m/1.8 m/2.4 m)
- Mounts
- Feed systems
- LNB for Ku- and CA-band

Terrestrial antennas and mechanical accessories

- VHF band I
- VHF band II
- VHF band III
- UHF band IV/V

Coaxial cable and fittings

- Underground cable
- Coaxial cable with cavity insulation
- Coaxial cable for special applications
- Connectors and fittings for different cable
- Transitions to FL, PG 11, 5/8" connections

Passive distribution material

- Tap-offs
- Distribution boxes
- Remote feed couplers

CATV amplifiers

- Line amplifiers
- Distributor amplifiers
- Supplemental modules for configuration

Optical devices and systems

- Optical transmitters
- Optical receivers
- Return channel transmitters and receivers

► Technical appendix

Page 147 – Page 160

Basic technical requirements, Class A

Planning and installation instructions

Television standards

Frequency ranges and channel classification

Technical specifications and directives

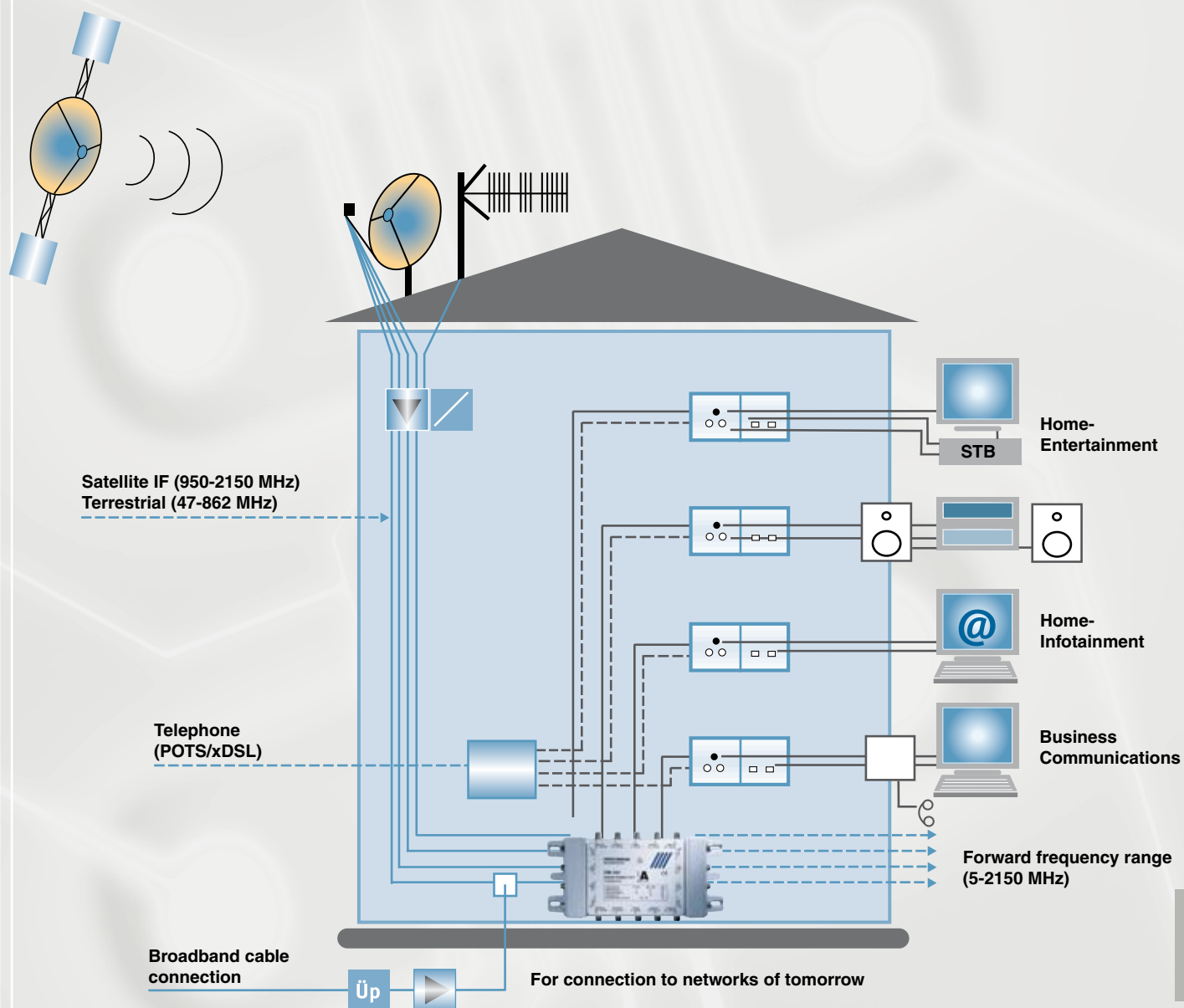

1. Basic technical requirements

1.1. Normative basis

All devices and components in this catalogue, unless indicated otherwise, satisfy the European standards for "Cable networks for television signals, audio signals, and interactive services" established by the standards organization CENELEC, and which have been taken over in national versions (editions).

- EN 50083-1 Safety requirements
- EN 50083-2 Electromagnetic compatibility (EMC) of devices

In addition the CENELEC committee, TC 209, adopted European device and system standards for "Cable networks for television signals, audio signals, and interactive services":

- EN 50083-3 Active broadband devices for coaxial cable networks
- EN 50083-4 Passive broadband devices for coaxial cable networks
- EN 50083-5 Devices for headends
- EN 50083-6 Optical devices
- EN 50083-7 System requirements
- EN 50083-8 Electromagnetic compatibility of cable networks
- EN 50083-9 Interfaces for CATV/SMATV headends and comparable professional devices for DVB/MPEG-2 transport streams
- EN 50083-10 Return system requirements

The system and device requirements are matched in such a manner that minimum requirements for signal quality are achieved on the subscriber socket. In this regard requirements that arise from analog, as well as digital signal transmissions, are taken into consideration. With the EN 50083 series of standards the network operator, network planner and installer has concrete guidelines available to him for network design and selection of suitable network components. Hirschmann network components are developed and tested in accordance with these standards.

1.2 The Electrical and Electronic Equipment Act

Based on the current interpretation of the underlying European WEEE directive concerning disposal of old electrical equipment, there are very few products in this catalog that are affected by the Electrical and Electronic Equipment Act.

In other words, only these few products (receivers and DVB-T indoor antennas) are subject to the restriction on the use of hazardous substances set forth in the RoHS directive.

Nevertheless Hirschmann has decided to provide all electronic products in this catalogue RoHS-conformant in the interest of protecting the environment.

1.3 Identification of components for TV cable networks

With the CE mark Hirschmann confirms that its products are in conformance with the respective applicable EU



directives (currently the EMC and low-voltage directives), as well as with standards EN 50083-1, EN 50083-2 and EN 60065.

The standards EN 55013, EN 55020 and EN 61000 apply for receivers.

The CE mark is affixed to the product, to the packaging, and/or in the operating manual.

To avoid interference between TV cable networks and wireless services, use of devices with sufficient shielding ratings is required. Due to the different conditions in European countries, in the European standard EN 50083-2 shielding ratings are specified in two classes, the premium class A, and class B with reduced shielding rating values.



For example, the high wireless density that exists in Germany makes use of class A devices required, to avoid mutual influences, particularly for safety-relevant wireless services such as aeronautical wireless service. Since external differentiation of devices is not possible for the trade and installers, Hirschmann and the other companies in the "Satellite and Cable" association in the German Electrical and Electronic Manufacturers' Association (ZVEI), identify the products with the registered mark shown here. This clearly indicates the higher quality of the devices. (See also 3.3 Shielding rating)

To comply with the legal EMC requirements for TV and cable networks Hirschmann expressly recommends the use of class A devices, including the connecting cable that is so marked for end devices.

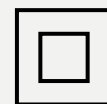

Protection class 2 in accordance with EN 60065 for components with 230 V ~ mains supply.



The symbol of a crossed-out waste bin affixed to products indicates that old equipment should not be disposed of via household waste, but rather such products should be disposed of via the country-specific collection systems for environmentally responsible recycling. This mark does not provide any information relative to the take-back path that is derived from the user groups (BtoB or BtoC).

2. Technical data in the catalogue

2.1. Wave resistance (impedance)

All technical data specified in the catalogue refer to an impedance of the HF connections of 75 Ohm - unless expressly stated otherwise.

2.2. Ambient temperature

All passive devices in the catalog can be used in an ambient temperature range of $-20\text{ }^{\circ}\text{C}$ to $+60\text{ }^{\circ}\text{C}$. Mains-operated devices satisfy the standard EN 6005 in the temperature range of $-20\text{ }^{\circ}\text{C}$ to $+50\text{ }^{\circ}\text{C}$.

However the functional capability of these devices also remains fully intact in the temperature range of $-20\text{ }^{\circ}\text{C}$ to $+60\text{ }^{\circ}\text{C}$. Operating temperature ranges that deviate from the above are specified for the individual devices.

2.3. Mains supply

All mains-operated devices in the catalogue correspond at least to the requirements of standard IEC 60038, with a nominal voltage of 230 V~ $+6\%$ / -10% .

2.4. Wind load

The safety provisions of EN 50083-1 distinguish between two heights for the antenna location above the surface of the terrain (up to 20 m and more) with the dynamic pressure values $q = 800\text{ N/m}^2$, or $q = 1100\text{ N/m}^2$. Wind load values (horizontal and vertical) specified in this catalog for specific antennas are determined with a dynamic pressure of $q = 800\text{ N/m}^2$. If the value for $q = 110\text{ Nm}^2$ is required for the calculation, then the wind load values must be multiplied by the factor 1.37.

2.5. Max. output level for active electronic devices

The max. output level is specified in accordance with EN 50083-3 "Active broadband devices for coaxial cable networks for an inter module - release status

- IMA = 60 dB for amplifiers for AM, QAM and FM signals (in MATV, SMATV, and CATV systems)
- FM exclusively (Sat IF transmission)

Thanks to the Europe wide adoption of this measuring process this important parameter is transparent and comparable. Given this information the network planner and the installer are able to specify the optimum amplifier control (output level) for the required minimum

interference differences and the channel allocation (see the Planning instructions).

This process offers advantages, particularly for planning new networks with minimum amplifier expense (cost advantage) or for situations where higher-level guidelines exist for certain network sections.

You will find the following information in the catalogue:

- Max. output level for IMA2, IMA3 = 60 dB (Two or three station mode)
- Max. output level for CSO, CTB = 60 dB (multi-channel assignment with 42 analog TV-channels in the CENELEC raster)

These maximum levels must be converted for assignment with other channel loads or intermodulation distances according to the instructions in 3.1.

- Max. (permissible) operating level (EMC)

The EMC-limited maximum operating level should not be exceeded in any operating state. This limit value ensures that the electromagnetic radiation emitted by the device does not exceed the legal specification.

3. Planning and installation instructions

3.1. Max. output level for house connection amplifiers, multi-purpose amplifiers, and return channel amplifiers

We always recommend performing these level calculations on the PC with the Hirschmann-Turbo planner III (order no. 499 999-003). The following information is offered as an additional aid for special planning problems, and for an understanding of the underlying relationships.

The permissible output level depends on

- The required interference distance CTB, CSO
- The number of TV channels that will be transmitted
- The frequency distribution of the channels

The FM signals of the FM band can be counted as one TV channel if their level is 6-8 dB below the level of the TV channels. The first selection criterion is the number of TV channels that will be transmitted.

3.1.1 Number of TV channels max. 10 (MATV installations)

- Determine the permissible output level from the technical data; for IMA2 (60 dB interference products, second order, in accordance with EN 50083-5), for IMA3 (60 dB interference products, third order in accordance with EN 50083-5)
- Reduce the IMA3-value according to the number of channels

Number of the configured channels	Correction of the Catalogue value in dB
2	0
3	- 2
4	- 3
5	- 4
6	- 5
7	- 5.5
8	- 6
10	- 7

Table 1:
Level reduction for multi-channel allocation

The lower of the two output levels (based on IMA2, IMA3) is the max. output level (dB(μV)) for a signal to noise ratio IMA=60 dB.

3.1.2 More than 10 TV channels (CATV, SMATV)

For optimum control of the amplifiers with multi-channel allocation the max. output levels that are specially indicated for this at a CSO and CTB distance of 60 dB and an approximate comparable spacing must be used.

3.1.3 Approximate calculations for the max. output level:

a) Conversion to CSO / CTB distances that deviate from the catalogue value of 60 dB

$$n_2 = n_1(\text{CSO}) + (\text{CSOA}_1 - \text{CSOA}_2)$$

i.e. for a CSO distance that is higher by Δ the amplifier must be modulated lower by the value of Δ.

$$n_2 = n_1(\text{CTB}) + (\text{CTBA}_1 - \text{CTBA}_2) / 2$$

i.e. for a CTB distance that is higher by Δ the amplifier must be modulated lower by Δ a / 2."

b) Conversion to channel loads that deviate from the catalogue value of 42 channels (CENELEC spacing).

The CENELEC spacing is a critical system load relative to occurrence of non-linear distortion (CTB, CSO). Thus the catalogue value for the max. output level can be applied at slight deviation to the real channel allocation.

For significantly deviating channel load in the first approximation you can calculate as follows:

- For allocation with doubled number of analog TV channels (42 to 80) reduce the max. output level by approx. 3 dB.
- For allocation with only half the number of channels (42 to 20) of the frequency transmitter the output level can be increased by 3 dB.
- For a full allocation with analog and digital (QAM 64) channels like ANGA/Zvei spacing (see table) the catalogue values of 42 channels offer a good orientation for the max. output level in accordance with CENELEC.

c) Maximum output level for frequency-coded preemphasis

The frequency-coded preemphasis by for example 7 dB makes it possible to modulate the amplifier higher by approx. 2 dB. This value can also be considered as modulation reserve In this regard however note that the signal to noise ratio at low frequencies is worsened by this equalisation attenuation.

Thus for extreme implementation cases optimisation by a planning specialist is required.

d) Max. output level for cascading of amplifiers

For cascades at the same signal to noise ratio output level must be reduced by 3 dB with each doubling of the number of cascading amplifiers.

3.2. Radiation and maximum operating level

The radiation of an antenna system in accordance with EN 50083-2 should be a maximum of:

- 20 dB(pW) = 39 dB(μV) at 75 Ohm in the frequency range of 30-950 MHz
- 43 dB(pW) = 62 dB(μV) at 75 Ohm in the frequency range of 950-2500 MHz

Thus the maximum operating level is derived together with the shielding rating SR specified for the devices, as follows:

Maximum operating level =

- SM + 39 dB(μV) (in the frequency range 30-950 MHz)
- SM + 62 dB(μV) (in the frequency range 950-2500 MHz)
- For active devices the max. operating level (EMC) shown on the device or in the operating manual should not be exceeded.

3.3. Shielding rating

Passive Hirschmann components in this catalogue satisfy at least the shielding rating values required for class B in accordance with EN 50083-2.

- 5-470 MHz 75 dB min
- 470-950 MHz 65 dB min
- 950-3000 MHz 50 dB min

Class A passive devices satisfy the more rigorous requirements in accordance with EN 50083-2

- 5-300 MHz 85 dB min
- 300-470 MHz 80 dB min
- 470-950 MHz 75 dB min
- 950-3000 MHz 55 dB min



For active devices the class A mark likewise documents compliance with EN 50083-2.

Coaxial cable EN 50117

Coupling resistance

- 5-30 MHz Class A $\leq 5\text{m } \Omega/\text{m}$
- Class B $\leq 15\text{m } \Omega/\text{m}$

Shielding attenuation

- 30-1000 MHz Class A 85 dB
- Class B 75 dB
- 1000-2000 MHz Class A 75 dB
- Class B 65 dB
- 2000-3000 MHz Class A 65 dB
- Class B 55 dB

3.4. Signal/noise ratio, noise factor

The **signal/noise ratio** is the ratio of wanted signal to noise output expressed in decibels. The **noise factor** indicates the amount by which the signal-to-noise ratio is lower on the output, than the signal-to-noise level is on the output of an active component (e.g. amplifier).

The **thermal noise level** on an 75 Ohm resistor is approx. 2 dB(μV)

- At a bandwidth of 5 MHz (television channel) and at a temperature of 293 K

For the picture quality of a television receiver the signal-to-noise level of the applied signal is also a crucial factor (see below). The signal-to-noise ratio on the output of an individual amplifier can (with an ideal, i.e. noise-free, input signal) can be determined as follows:

Operating level on the output

- Gain
- Noise factor
- Noise level

Example:

Amplifier with operating level on the output 94 dB(μV), gain 21 dB and noise factor 7 dB. The signal-to-noise ratio on the output of an individual amplifier is in this case:

$$\begin{array}{r} 94 \text{ dB}\mu\text{V} \\ - 21 \text{ dB} \\ - 7 \text{ dB} \\ \hline - 2 \text{ dB}\mu\text{V} \\ \hline 64 \text{ dB} \end{array}$$

3.5. Signal-to-noise ratio, signal noise, image quality

Signal-to-noise ratio	Noise	Picture quality
$\leq 46 \text{ dB}$	invisible	very good
37 dB	visible, but not interfering	good
30 dB	clearly visible, interfering	unsatisfactory
$\leq 26 \text{ dB}$	dominant compared to required signal	unusable

4. Earthing and equipotential bonding lines

In accordance with EN 50083-1 the following earthing and equipotential bonding compensating lines are prescribed for antennal systems:

Earthing lines:

Material	Cross section	Ø	Condition	Example
Copper	16 mm ²	P 4.6 mm	bare or insulated	H 07 V-U, H 07 V-R (NYA), NYY, NYM
Aluminium	P 25 mm ²	P 5.7 mm	bare (only indoors) or insulated	NAYY
Aluminium	P 50 mm ²	P 8,0 mm	(ductile) alloy	–
Steel wire	–	8.0 mm	galvanised	–
Steel strip	2.5 x 20 mm	–	galvanised	–

Condition of the lines: Single solid cored

Equipotential bonding lines:

Material	Cross section	Ø	Condition	Example
Copper	4 mm ²	2.3 mm	bare or insulated	H 07 V-U (NYA)

5. Television standards

Standard	Line count	Channel width (MHz)	Video bandwidth (MHz)	Video/audio separation (MHz)	Vestigial sideband (MHz)	Video modulation	Audio modulation
B (CCIR)	625	7	5	+5.5, (+5.742) ¹⁾	0.75	negative	FM, FM ¹⁾
D (OIRT)	625	8	6	+6.5	0,75	negative	FM
G (CCIR)	625	8	5	+5.5, (+5.742) ¹⁾	0.75	negative	FM, FM ¹⁾
H (B)	625	8	5	+5.5	1.25	negative	FM
I (GB)	625	8	5.5	+6	1.25	negative	FM
K (OIRT)	625	8	6	+6.5	0.75	negative	FM
K1(F)	625	8	6	+6.5	1.25	negative	FM
L (F)	625	8	6	+6.5	1.25	positive	AM
M (FCC)	525	6	4.2	+4.5	0.75	negative	FM
N (South America)	625	6	4.2	+4.5	0.75	negative	FM

¹⁾ Second audio carrier for dual or stereo mode

6. Frequency ranges and channel allocation

Channel limits	Channel carrier (MHz)	Video carrier (MHz)	Colour carrier (MHz)	1.Audio carrier ¹⁾ (MHz)		
Standard B, Europe						
B I	2	47-54	48.25	52.68	53.75	
	3	54-61	55.25	59.68	60.75	
	4	61-68	62.25	66.68	67.75	
USB Low Special Channel range	S 2	111-118	112.25	116.68	117.75	
	S 3	118-125	119.25	123.68	124.75	
	S 4	125-132	126.25	130.68	131.75	
	S 5	132-139	133.25	137.68	138.75	
	S 6	139-146	140.25	144.68	145.75	
	S 7	146-153	147.25	151.68	152.75	
	S 8	153-160	154.25	158.68	159.75	
	S 9	160-167	161.25	165.68	166.75	
	S 10	167-174	168.25	172.68	173.75	
	B III	5	174-181	175.25	179.68	180.75
6		181-188	182.25	186.68	187.75	
7		188-195	189.25	193.68	194.75	
8		195-202	196.25	200.68	201.75	
9		202-209	203.25	207.68	208.75	
10		209-216	210.25	214.68	215.75	
11		216-223	217.25	221.68	222.75	
12		223-230	224.25	228.68	229.75	
OSB High Special Channel range		S 11	230-237	231.25	235.68	236.75
		S 12	237-244	238.25	242.68	243.75
		S 13	244-251	245.25	249.68	250.75
		S 14	251-258	252.25	256.68	257.75
	S 15	258-265	259.25	263.68	264.75	
	S 16	265-272	266.25	270.68	271.75	
	S 17	272-279	273.25	277.68	278.75	
	S 18	279-286	280.25	284.68	285.75	
	S 19	286-293	287.25	291.68	292.75	
	S 20	293-300	294.25	298.68	299.75	
	ESB 8 MHz- Spacing Ext ended Special Channel range	S 21	302-310	303.25	307.68	308.75
S 22		310-318	311.25	315.68	316.75	
S 23		318-326	319.25	323.68	324.75	
S 24		326-334	327.25	331.68	332.75	
S 25		334-342	335.25	339.68	340.75	
S 26		342-350	343.25	347.68	348.75	
S 27		350-358	351.25	355.68	356.75	
S 28		358-366	359.25	363.68	364.75	
S 29		366-374	367.25	371.68	372.75	
S 30		374-382	375.25	379.68	380.75	
S 31		382-390	383.25	387.68	388.75	
S 32		390-398	391.25	395.68	396.75	
S 33		398-406	399.25	403.68	404.75	
S 34		406-414	407.25	411.68	412.75	
S 35		414-422	415.25	419.68	420.75	
S 36		422-430	423.25	427.68	428.75	
S 37		430-438	431.25	435.68	436.75	
S 38		438-446	439.25	443.68	444.75	

Standard G, H, I, K, L					
B IV/V	21	470-478	471.25	475.68	476.75
	22	478-486	479.25	483.68	484.5
	23	486-494	487.25	491.68	492.75
	24	494-502	495.25	499.68	500.75
	25	502-510	503.25	507.68	508.75
	26	510-518	511.25	515.68	516.75
	27	518-526	519.25	523.68	524.75
	28	526-534	527.25	531.68	532.75
	29	534-542	535.25	539.68	540.75
	30	542-550	543.25	547.68	548.75
	31	550-558	551.25	555.68	556.75
	32	558-566	559.25	563.68	564.75
	33	566-574	567.25	571.68	572.75
	34	574-582	575.25	579.68	580.75
	35	582-590	583.25	587.68	588.75
	36	590-598	591.25	595.68	596.75
	37	598-606	599.25	603.68	604.75
	38	606-614	607.25	611.68	612.75
	39	614-622	615.25	619.68	620.75
	40	622-630	623.25	627.68	628.75
	41	630-638	631.25	635.68	636.75
	42	638-646	639.25	643.68	644.75
	43	646-654	647.25	651.68	652.75
	44	654-662	655.25	659.68	660.75
	45	662-670	663.25	667.68	668.75
	46	670-678	671.25	675.68	676.75
	47	678-686	679.25	683.68	684.75
	48	686-694	687.25	691.68	692.75
	49	694-702	695.25	699.68	700.75
	50	702-710	703.25	707.68	708.75
	51	710-718	711.25	715.68	716.75
	52	718-726	719.25	723.68	724.75
	53	726-734	727.25	731.68	732.75
	54	734-742	735.25	739.68	740.75
	55	742-750	743.25	747.68	748.75
	56	750-758	751.25	755.68	756.75
	57	758-766	759.25	763.68	764.75
	58	766-774	767.25	771.68	772.75
	59	774-782	775.25	779.68	780.75
	60	782-790	783.25	787.68	788.75
	61	790-798	791.25	795.68	796.75
	62	798-806	799.25	803.68	804.75
	63	806-814	807.25	811.68	812.75
	64	814-822	815.25	819.68	820.75
	65	822-830	823.25	827.68	828.75
	66	830-838	831.25	835.68	836.75
	67	838-846	839.25	843.68	844.75
	68	846-854	847.25	851.68	852.75
	69	854-862	855.25	859.68	860.75

¹⁾ Addition of 0.242 MHz provides 2nd audio carrier

Satellite intermediate frequency

1. Sat IF: 950-2150 MHz (2400 MHz¹⁾)

¹⁾Hirschmann recommendation

Radio signals

LW	150-285 kHz	SW	3.95-26.1 MHz
MW	520-1605 kHz	UKW (BII)	87.5-108 MHz

Channel		Channel limits (MHz)	Video carrier (MHz)	1.Audio carrier (MHz)
Standard B, Italy				
B I	A	52.5-59.5	53.75	59.25
	B	61-68	62.25	67.75
B II	C	81-88	82.25	87.75
B III	D	174-181	175.25	180.75
	E	182.5- 189.5	183.75	189.25
	F	191-198	192.25	197.75
	G	200-207	201.25	206.75
	H	209-216	210.25	215.75
	H 1	216-223	217.25	222.75
	H 2	223-230	224.25	229.75

Channel		Channel limits (MHz)	Video carrier (MHz)	1.Audio carrier (MHz)
Standard D, OIRT				
B I	R I	48.5-56.5	49.75	56.25
	R II	58-66	59.25	65.75
	R III	76-84	77.25	83.75
(B II)	R IV	84-92	85.25	91.75
	R V	92-100	93.25	99.75
Special channels	s1	110-118	111.25	117.75
	s2	118-126	119.25	125.75
	s3	126-134	127.25	133.75
	s4	134-142	135.25	141.75
	s5	142-150	143.25	149.75
	s6	150-158	151.25	157.75
	s7	158-166	159.25	165.75
	s8	166-174	167.25	173.75
(B III)	R VI	174-182	175.25	181.75
	R VII	182-190	183.25	189.75
	R VIII	190-198	191.25	197.75
	R IX	198-206	199.25	205.75
	R X	206-214	207.25	213.75
	R XI	214-222	215.25	221.75
	R XII	222-230	223.25	229.75
Special channels	s9	230-238	231.25	237.75
	s10	238-246	239.25	245.75
	s11	246-254	247.25	253.75
	s12	254-262	255.25	261.75
	s13	262-270	263.25	269.75
	s14	270-278	271.25	277.75
	s15	278-286	279.25	285.75
	s16	286-294	287.25	293.75
	s17	294-302	295.25	301.75
	s18	302-310	303.25	309.75
	s19	310-318	311.25	317.75
	s20	318-326	319.25	325.75
	s21	326-334	327.25	333.75
	s22	334-342	335.25	341.75
	s23	342-350	343.25	349.75

	s38	462-470	463.25	469.75

Channel		Channel limits (MHz)	Video carrier (MHz)	1.Audio carrier (MHz)
Standard D, China				
B I	1	48,5-56,5	49,75	56,25
	2	56,5-64,5	57,75	64,25
	3	64,5-72,5	65,75	72,25
	4	76,0-84,0	77,25	83,75
	5	84,0-92,0	85,25	91,75
B III	6	167-175	168,25	174,75
	7	175-183	176,25	182,75
	8	183-191	184,25	190,75
	9	191-199	192,25	198,75
	10	199-207	200,25	206,75
	11	207-215	208,25	214,75
	12	215-223	216,25	222,75

Channel		Channel limits (MHz)	Video carrier (MHz)	1.Audio carrier (MHz)
Standard I, Ireland				
B I	I A	44,5-52,5	45,75	51,75
	I B	52,5-60,5	53,75	59,75
	I C	60,5-68, 5	61,75	67,75
B III	I D	174-182	175,25	181,25
	I E	182-190	183,25	189,25
	I F	190-198	191,25	197,25
	I G	198-206	199,25	205,25
	I H	206-214	207,25	213,25
	I J	214-222	215,25	221,25

Channel		Channel limits (MHz)	Video carrier (MHz)	1.Audio carrier (MHz)
Standard L, France				
B I	A	41,00-49,00	47,75	41,25
	B	49,00-57,00	55,75	49,25
	C	57,00-65,00	63,75	57,25
	C 1	53,75-61,75	60,50	54,00
B III	5	174,75-182,75	176,00	182,50
	6	182,75-190,75	184,00	190,50
	7	190,75-198,75	192,00	198,50
	8	198,75-206,75	200,00	206,50
	9	206,75-214,75	208,00	214,50
	10	214,75-222,75	216,00	222,50

Channel		Channel limits (MHz)	Video carrier (MHz)	1.Audio carrier (MHz)
Standard K1, (France)				
B III	4	174-182	175,25	181,75
	5	182-190	183,25	189,75
	6	190-198	191,25	197,75
	7	198-206	199,25	205,75
	8	206-214	207,25	213,75
	9	214-222	215,25	221,75

7. Channel spacing

Channel	Video carrier MHz	BB raster 47PAL+ 46QUAM	CENELEC 29 TV	CENELEC 42 TV	Channel	Video carrier MHz	BB raster 47PAL+ 46QUAM	CENELEC 29 TV	CENELEC 42 TV
K 2	48.25	•	•	•	K 21	471.25	•		
K 3	55.25	•			K 22	479.25	•	•	•
K 4	62.25	•			K 23	487.25	•		
Pilot	80.15				K 24	495.25	•	•	•
S 2	112.25	•			K 25	503.25	•		
S 3	119.25	•	•	•	K 26	511.25	•	•	•
S 4	126.25	•			K 27	519.25	•		
S 5	133.25	•			K 28	527.25	•	•	•
S 6	140.25	•			K 29	535.25	•		
S 7	147.25	•			K 30	543.25	•	•	•
S 8	154.25	•			K 31	551.25	•		
S 9	161.25	•			K 32	559.25	•		
S 10	168.25	•			K 33	567.25	•	•	•
K 5	175.25	•	•	•	K 35	583.25		•	•
K 6	182.25	•			K 37	599.25		•	•
K 7	189.25	•			K 39	607.25	•		
D 8	191.25		•	•	K 39	615.25	•		
K 8	196.25	•			K 40	623.25	•		
K 9	203.25	•			K 41	631.25	•		
D 10	207.25		•	•	K 42	639.25	•		
K 10	210.25	•			K 43	647.25	•		
K 11	217.25	•			K 44	655.25	•		
D 12	223.25		•	•	K 45	663.25	x		•
K12	224.25	•			K 46	671.25	x		
S 11	231.25	•	•	•	K 47	679.25	x		•
S 12	238.25	•			K 48	687.25	x		
S 13	245.25	•			K 49	695.25	x		•
S 11 ^o	247.25		•	•	K 50	703.25	x		
S 14	252.25	•			K 51	711.25	x		•
S 15	259.25	•			K 52	719.25	x		
S 13 ^o	263.25		•	•	K 53	727.25	x		•
S 16	266.25	•			K 54	735.25	x		
S 17	273.25	•			K 55	743.25	x		•
S 18	280.25	•			K 56	751.25	x		
S 19	287.25	•	•	•	K 57	759.25	x		•
S 20	294.25	•			K 58	767.25	x		
S 21	303.25	•			K 59	775.25	x		•
S 22	311.25	•	•	•	K 60	783.25	x		
S 23	319.25	•			K 61	791.25	x		•
S 24	327.25	•	•	•	K 62	799.25	x		
S 25	335.25	x			K 63	807.25	x		•
S 26	343.25	x	•	•	K 64	815.25	x		
S 27	351.25	x			K 65	823.25	x		•
S 28	359.25	x	•	•	K 66	831.25	x		
S 29	367.25	x			K 67	839.25	x		•
S 30	375.25	x	•	•	K 68	847.25	x		
S 31	383.25	x			K 69	855.25	x		•
S 32	391.25	x	•	•					
S 34	407.25	x	•	•					
S 35	415.25	x							
S 36	423.25	x	•	•					
S 37	431.25	x							
S 38	439.25	x	•	•					
S 39	447.25		•	•					
S 40	455.25		•	•					
S 41	463.25		•	•					

• PAL channel
x QAM channel

8. Channel allocation CCIR

Standard B

Ranges BI, USB, BIII und OSB

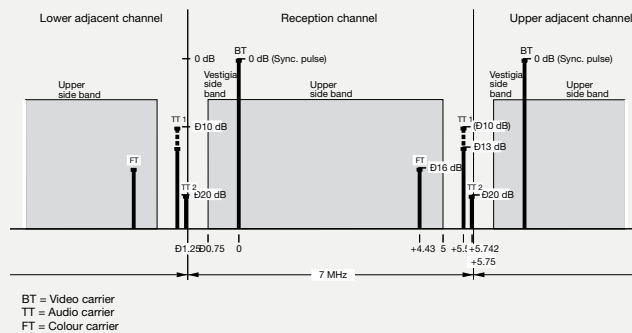

Standard G

Ranges ESB and B IV/V

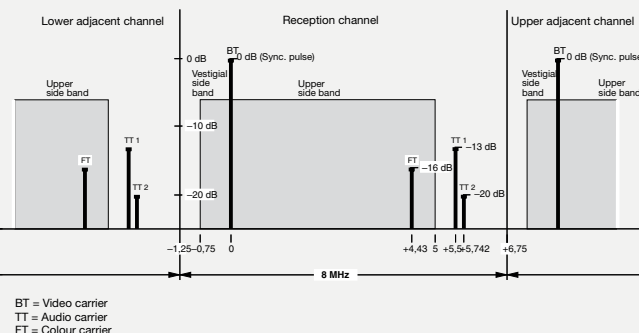

9. Technical specification, standards and directives

Configuring and setting up an antenna or CATV system requires knowledge of the components and how they work together, as well as knowledge of the applicable directives, standards, and regulations.

These can be obtained at the following addresses:

VDE documents

VDE Verlag GmbH • Bismarckstrasse 33 • 10625 Berlin

DIN EN and DIN standard sheets

Beuth-Verlag GmbH • Burggrafenstrasse 6 • 10787 Berlin

RGA guidelines

VISTAS-Verlag GmbH • Bismarckstrasse 84 • 10627 Berlin

Technische Richtlinien Fachverband Satellit und Kabel des ZVEI • Stresemannallee 19 • 60596 Frankfurt am Main

10. Liability

This catalog has been created by Triax-Hirschmann Multimedia GmbH to the best of our knowledge. All technical information has been carefully collected and checked. The information corresponds to the current status of the applicable directives, standards, and measuring methods at the time this catalogue went to print.

Our oral and written technical application advice is provided to support your own work. Our advice is provided as a non-binding reference - also relative to possible property rights of third parties - and does not release you from the responsibility of making your own product tests to determine product suitability for the intended processes and purposes. Any liability and warranty claims are excluded in the case of misuse.

The typical values are documented for the individual products for proper dimensioning and planning of installations and systems, unless expressly stated otherwise,

in practice these typical values can fluctuate below or above the min./max. values) within the reasonable (standard for the industry) tolerance range. Product descriptions do not contain any statements concerning liability for possible damage. Nevertheless should liability become an issue, then such liability for all damage shall be limited to the value of the delivered and implemented goods. Our terms and conditions apply

The content published in this catalogue is protected. Reprints, duplications, or other types of use (incl. electronic use) of this catalogue - even of excerpts - are not permitted without Hirschmann's prior written consent. The illustrations are not-binding.

The preceding version of this catalogue loses its validity

Content from A to Z

A		CDH 1261 T	88	CKR 5321	71
AD 23	126	CDH 1301 T	88	CKR 9120 ND	75
AFC 0811	104	CDH 1402 S	88	CKR 9160 ND	75
AFC 0921	104	CDH 1801 S	87	CKR 9240	75
AFC 1011 S	107	CDH 1801 SI	87	CKR 9320	75
AFC 1021 S	107	CDH 1802 S	87	CKR 9400 ND	74
AFC 1041 S	108	CDH 1802 SI	87	CKR 9600 ND	74
AFC 1211	104	CDO 1000 D	89	CKR 9800 ND	74
AFC 1221	104	CDO 1000 V	89	CMK 1704	81
AFC 1441	105	CEF 211 D	16	CMK 1706	81
AFC 1511 S	107	CEF 311 D	16	CMK 1708	81
AFC 1521 S	107	CFS 11	130	CMK 1712	81
AFC 1541 S	108	CFS 56 JUV	131	CMK 1716	81
AFC 1611	104	CHA 2000 A	99	CMK 5405 R	73
AFC 1621	104	CHA 2000 U	99	CMK 5805 R	73
AFC 1641	105	CHC 2022 MI1	97	CMK 9409 D	77
AFC 1861	105	CHC 2022 QN	97	CMK 9809 D	77
AFC 2011	104	CHC 2022 S1	97	CNV 11 F	58
AFC 2011 S	107	CHC 2022 SI1	97	CNV 1720	81
AFC 2021	104	CHD 2022 MI1	94	CNV 235 E	58
AFC 2021 S	107	CHD 2022 Q	95	CNV 5510 R	72
AFC 2041 S	108	CHD 2022 QN	95	CNV 5520 R	72
AFC 2081	105	CHD 2022 S1	94	CNV 9009 ND	76
AFC 2511 S	107	CHD 2022 SI1	94	CS 22 HiQ	13
AFC 2521 S	107	CHD 2022 U	99	CS 300 S	14
AFC 2541 S	108	CHE 2000 D	93	CS 320 T	14
AR 20	126	CHE 2022 QN	95	CS 40 HiQ	13
ARS 101	110	CHM 2000 M	98	CS 400 QT	14
ARS 102	110	CHM 2000 S	98	CS 404 QS	15
		CHM 2001 M	98	CS 408 OS	15
		CHS 2000 M	93	CS 44 HiQ	13
B		CHS 2000 S	93	CS 504 QST	15
BEG 42 U	40	CHT 2000 B	96	CSE 2000 Generation 2	90
BEG 50 U	40	CHT 2000 M	96	CSE 2000 M Generation 2	92
BEG 60 U	40	CHT 2000 T	96	CSE 6000	100
BWS 202	111	CHT 2001 M	96	CSR 10 CW	31
BWS 2910 F	111	CHV 2000 U	99	CSR 10 FTA	31
BWS 3910 F	111	CHZ 2020 R	99	CSR 100 CC	28
BWS 4910 F	112	CKR 1708	79	CSR 100 CI	28
		CKR 1712	79	CSR 50 II	30
C		CKR 1716	79	CSR 60 II CI	29
CAS 4000 N	9	CKR 1724	79	CSR 61 CC	29
CAS 5585 E	9	CKR 1732	79	CTR - X 01	32
CDF 1000 M	89	CKR 22 DD	82	CVE 1708	80
CDF 1000 S	89	CKR 5041	70	CVE 1712	80
CDF 1000 SI	89	CKR 5061	70	CVE 1716	80
CDF 1000 T	89	CKR 5081	70	CVE 5510 R	72
CDF 1000 TI	89	CKR 5121	71	CVE 5520 R	72
CDH 1000	85	CKR 5161	71	CVE 9409 ND	76
CDH 1132 S	88	CKR 5241	71		

Content from A to Z

D

DAB 42-2	40
DAB 50-2	40
DAB 50-6	40
DAB 52-3 A	40
DAB 52-3 N	40
DAB 60-1	40
DFH 1	8
DFH 850	9
DSH 48/130	38
DSH 48/90	38
DZ 48	41

E

ECO 17 PSU	68
ECO CKR 1706	68
ECO CKR 1708	68
ECO CKR 1712	69
ECO CKR 1716	69
ECO CKR 504	64
ECO CKR 506	64
ECO CKR 508	64
ECO CKR 512	64
ECO CKR 516	65
ECO CKR 904	66
ECO CKR 906	66
ECO CKR 908	66
ECO CKR 912	67
ECO CKR 916	67
ECO CNV 55	65
ECO CVE 55	65
ECO DFH 2	11
ECO DFH 2 Flex	11
ECO FESAT 65 S	11
ECO FESAT 65 S-5	11
ECO FESAT 80 S	11
ECO FESAT 80 S-5	11
ECO FESAT 90 S	11
ECO FESAT 90 S-3	11
ECO VFH 4	11
EDA 302 F	119
EDC 01 NL	125
EDM 02	123
EDM 304	122
EDM 306	123
EDS 01 F	120
EDS 322 F	121
EDU 04 F	118
ERB 50	41
ES 6	42
EX 11	131
EX 651	131

F

FDFC 10	133
FDFC 6	133
FEKAB 1,5 m	126
FEKAB 3 m	126
FESA 10 BV	21
FESA 12 BO 60	24
FESA 13 BV	21
FESA 2 RA/K2-4	20
FESA 215 L 665	25
FESA 218 LDK	25
FESA 243	24
FESA 309 AN K...	21
FESA 4 BV	21
FESA 6 BV	21
FESA 7 BO 60	24
FESA 805	24
FESA 813 N 69	22
FESA 815 N 37	22
FESA 815 N 48	22
FESA 815 N 69	22
FESA 817 N 37	23
FESA 817 N 48	23
FESA 817 N 69	23
FESAT 88 HiQ	8
FESAT 110 HiQ	8
FESAT 150	9
FETRA 2	42
FH - 23 alu.	10
FH -40 alu.	10
FM 30	19
FM 50	19
FS 01	124
FS 07	124
FS 12	124
FS 302 F	121
FW 2	112

G

GBD-1	132
GDA 313 F	119
GDM 06	123
GDM 310	122
GDM 312	123
GDM 315	122
GDS 08 F	120
GDS 11 F	120
GEDU 10	118
GEDU 15	118
GEDU 20	118

GEMA 4 KR	20
GHV 20 E	46
GHV 20 M	47
GHV 24 E	46
GHV 30 E	46
GHV 820 A	48
GHV 820 C	49
GHV 830 A	48
GHV 830 C	49
GHV 834 C	50
GLV 865	54
GLV 865 AGC	55
GLV 865 F	54
GLV 865 F AGC	55
GNS 320 A	60
GNS 440 A	60
GNS 445 A	60
GPV 845 C	51
GPV 845 CF	51
GPV 845 E	52
GPV 851 F	53
GPV 851 I	53
GRM 2030 G	56
GRM 2065 G	56
GRM 3005 G	56
GRM 3047 P	56
GRM 6505 G	56
GRM 6585 P	56

H

Hit FESAT 65	10
Hit FESAT 75	10
Hit FESAT 85	10
HMB 6	59
HMB 10 A	59
HMB 10 B	59
HMB 10 S	59

K

KOK 1 Z	129
KOK 3 N	129
KOKA 100	135
KOKA 120	135
KOKA 7 OK/MK	136
KOKA 741	136
KOKA 743	134
KOKA 7539	134
KOKA 780 TWIN-SAT	136

Content from A to Z

KOKA 90	135	S		W	
KOKWI 3	129	SATKAB 1.5 m	126	WFC 01	132
KOS 1 Z	129	SATKAB 3 m	126	WH 30	37
KOS 3 N	129	SBFC 01	132	WH 40	37
KOSWI 3	129	SBFC 02	132	WH 50	37
KVFC 01	132	SCHIMA 48/500	39		
KVFC 02	132	SCHIMA 60/601	39	Z	
KVFC 03	132	SFC 052	130	ZGV 77	109
		SFC 070	130	ZIFA 796 LP-V	25
L		SFC 273	130	ZIFA D-15 V	26
LapTV	26	SPM 1	140	ZVA 134	109
LES 2020 F	57	STEMA 42/200	38		
LES 450	57	STEMA 50/200	38		
LES 600	57	STEMA 50/300	38		
LES 860	57	STG 60	35		
		SWF 6530	57		
M		T			
MAKA 15	41	TRAG 53	42		
MAR 48/200	35				
MAR 48/300	35	U			
MAR 60/200	35	U1	19		
MAR 60/300	35	U3	19		
MAR 89/300	35	U4	19		
MF 64	41	UDR 1	37		
MFS - 3/4 alu.	10	UDR 3	37		
MFU - 1 set	10	UPM 2100	139		
MH 50	35	UPM 3100	138		
MHR 42	36	UPM 3100 SET	138		
MHR 60	36	UPM 3300	137		
MHR 61	36	UPM 3300 SET	137		
MHR 89	36				
MZ 50	41	V			
MZ 60	41	VDF 18 F	133		
MZ 89	41	VDR 757 F	133		
		VEDO 042	110		
N		VEDO 063 F	110		
NBL 0200	144	VFC 0421	106		
NBL 0230	144	VFC 0421 SF	108		
NBL 0265	144	VFC 0631	106		
NPN 3412	144	VFC 0631 SF	108		
NTS - set	10	VFC 0741	106		
		VFC 0741 SF	108		
R		VFC 1061	106		
R 77	126	VFC 1061 SF	109		
R 77 DCB	126	VFC 1219	105		
RFC 75	133	VFC 1281	106		
RFC 75 DCB	133	VFC 1281 SF	109		

Notes

Notes

Addresses

Headquarters

Triax-Hirschmann Multimedia GmbH
Karl-Benz-Str. 10
D-72124 Pliezhausen

Phone: +49 (0)7127-14-0
Fax: +49 (0)7127-14-1697
E-mail: info@triax-hirschmann.com
Web:: www.triax-hirschmann.com

Service-Center

Triax-Hirschmann Multimedia GmbH
Service-Center
Karl-Benz-Str. 10
D-72124 Pliezhausen

Hotline

Phone: 0180 3232 341
E-mail: info@triax-hirschmann.de

Companies abroad

Austria

Triax-Hirschmann Austria GmbH
Oberer Paspelsweg 6-8
A-6830 Rankweil-Brederis
Phone: +43 5522 307-0
Fax: +43 5522 307-394
E-mail: rankweil@hirschmann-austria.at
Web:: www.triax-hirschmann.at

Spain

Hirschmann Multimedia España S.A.
N.I.F B 28257848
C/ Ingeniero Torres Quevodo, No 20
Poligono Fin de Semana
E-28042 Madrid
Phone: +34 91 74 828 36
Fax: +34 91 32 961 47
E-mail: hms@triax-hirschmann.es
Web:: www.hirschmann-multimedia.es

Hungary

Hirschmann Multimédia Electronics Kft.
Rokolya u. 1-13
H-1131 Budapest
Phone: +36 1 349 7575
Fax: +36 1 3298453
E-mail: info@hirschmann-multimedia.hu
Web:: www.hirschmann-multimedia.hu

