



[www.connection.eu](http://www.connection.eu)

**CONNECTION**

# PRODUCT INFORMATION

2017



# PHILOSOPHY

The car Audio world is in constant evolution and many things have changed in the last ten years. The installation space available has reduced considerably and the challenge for the OEM integration has become more difficult than ever. For this reason the **Connection line has been renewed to offer intelligent solutions for professionals** further improving its distinctive high quality standard.

**The R&D team has concentrated specifically on the installation friendliness:** the engineers have created innovative solutions to provide the ability to use the Connection products in any space condition, aiming at developing any kind of project under the best possible conditions.

**Thanks to this evolution Connection is ready to face the future playing a leading role,** with a product range providing the best solution to any of the needs of car audio professionals.

0.5mt

CONNECTION

Three performance / price levels to satisfy the needs of any reference audiophile, sound contest participant or enthusiast.



REFERENCE INSTALLATION ACCESSORIES  
FOR NO-COMPROMISE AUDIOPHILES



COMPETITION INSTALLATION ACCESSORIES  
FOR SERIOUS ENTHUSIASTS



PROFESSIONAL INSTALLATION ACCESSORIES  
FOR EXCEPTIONAL VALUE

## INDEX

Philosophy	2-3
Technologies	4-7
Power Cables	8-9
Speaker Cables	10-13
Audio Interconnects	14-17
Interfaces	18
Fuse holders	19-20
Fuse & Ground Distributors	21-22
Battery Clamps	23-24
Fuses	24
Terminals & Main crimps	25
Superfarad Capacitors	26
Amplifier & Power kits	27
Technical Notes	28-29
General information	30

When unparalleled quality and uncompromising reliability are not choices, they are requirements.

**CONNECTION... THE TRANSFER SYSTEM**

# FLEXIBILITY & INSULATION MATERIAL

## INFINITE FLEXIBILITY

The extremely high 250% deformation limit, in compliance with ISO R527 standards, establishes a new benchmark in the fight against space limitation and tortuous cable routes found in today's car audio installations.

## X<sup>N</sup> FLEXIBILITY™

Because of the tight confines of today's vehicles, flexibility of cables is very important to the ease of installation. Connection cables adopt three technologies, each with a different grade of flexibility. The number of "N" value indicates a higher degree of flexibility, for effortless installations.



- X<sup>3</sup>FLEXIBILITY™ for "Reference" grade installations;
- X<sup>2</sup>FLEXIBILITY™ for "Competition" grade installations;
- X<sup>1</sup>FLEXIBILITY™ for "Exceptional" grade installations;

Under this "soft" feeling flows a tremendous amount of current letting you experience the full dynamic capabilities of your system. The Soft Touch jacket is created from a special polymer, properly selected to improve the actual X<sup>3</sup> FLEXIBILITY™ without renouncing to comply with RoSH II, REACH and many other safety standards and protecting the cable winding against abrasions and the corrosive nature of chemical solvents.

After the introduction of the special Audison jacket with Translucent effect, which has marked the history of the car audio industry, the Audison staff introduced the new Matt Solid jacket with soft touch feeling, to enhance the cosmetics of your installation and launch a new communication image of the Connection brand.

# SOFT TOUCH™





# WINDING

Thanks to the continuous and in-depth research into the cable winding technologies, materials and their direct effect on the transfer of audio signals, Connection produces power, speaker and interconnect cables that will satisfy the most demanding audiophile.



# WINDING GEOMETRIES



## SMT™

Strand Multiple Twisted geometry provides 30% higher wire content than any other competitor's. This technique, combined with a superlative selection of conductor materials compliant with ASTM safety standards, ensures instantaneous high current transfer, minimizing eddy current power losses.



## TMT™

Textile Multiple Twisted Configuration consists of eight linear strands wound in a textile configuration. It brings to life a huge sound stage, pinpoint imaging and faithful reproduction of every sound nuance.

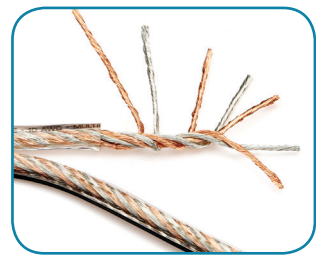

## MTW™

Multiple Twisted Winding is a high strand count twisted construction for detailed musicality and low-loss audio signal transfer.



# MAINPOWER

MAINPOWER CABLES FOR EXTREME CURRENT TRANSFER



MP 1/0 BL.2

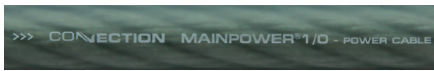

MP 1/0 G.2

- SOFT TOUCH™ jacket to enhance the feel and flexibility.
- BLUE & GREY translucent matt finish jacket for unparalleled cosmetics.
- RESISTANT JACKET against abrasion, heat and chemicals.
- 6+1 STRAND MULTIPLE TWIST TECHNOLOGY, for extreme current transfer and to minimize eddy current power losses.
- X<sup>3</sup> FLEXIBILITY for "REFERENCE" installations.

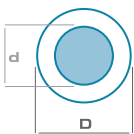

Soft  
Touch

ITEM	DESCRIPTION
MP 1/0 BL.2	1/0 AWG (53,2 mm <sup>2</sup> ), Blue, d 12.2 mm, D 16.5 mm.
MP 1/0 G.2	1/0 AWG (53,2 mm <sup>2</sup> ), Grey, d 12.2 mm, D 16.5 mm.
MP 4 BL.2	4 AWG (21,05 mm <sup>2</sup> ), Blue, d 7.7 mm, D 11.2 mm.
MP 4 G.2	4 AWG (21,05 mm <sup>2</sup> ), Grey, d 7.7 mm, D 11.2 mm.







# POWER FLOW

POWER FLOW CABLES FOR HIGH EFFICIENCY CURRENT TRANSFER



PF 4 OR.2



PF 4 BK.2

- SOFT TOUCH™ jacket to enhance the feel and flexibility.
- ORANGE & BLACK matt solid finish jacket for enhanced cosmetics.
- RESISTANT JACKET against abrasion, heat and chemicals.
- SEVEN STRAND MULTIPLE TWIST construction, for high efficiency current transfer and to reduce voltage losses.
- X<sup>2</sup> FLEXIBILITY for "COMPETITION" installations.

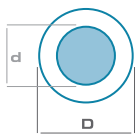

ITEM	DESCRIPTION
PF 1/0 OR.2	1/0 AWG (46,13 mm <sup>2</sup> ), Orange, d 11.4 mm, D 15.5 mm.
PF 2 OR.2	2 AWG (27,43 mm <sup>2</sup> ), Orange, d 8.9 mm, D 13 mm
PF 2 BK.2	2 AWG (27,43 mm <sup>2</sup> ), Black, d 8.9 mm, D 13 mm
PF 4 OR.2	4 AWG (18,70 mm <sup>2</sup> ), Orange, d 7.2 mm, D 10.5 mm.
PF 4 BK.2	4 AWG (18,70 mm <sup>2</sup> ), Black, d 7.2 mm, D 10.5 mm.
PF 8 OR.2	8 AWG (6,94 mm <sup>2</sup> ), Orange, d 3.9 mm, D 7.5 mm.
PF 8 BK.2	8 AWG (6,94 mm <sup>2</sup> ), Black, d 3.9 mm, D 7.5 mm.
PF 10 OR.2	10 AWG (4,27 mm <sup>2</sup> ), Orange, d 3.0 mm, D 6 mm.
PF 10 BK.2	10 AWG (4,27 mm <sup>2</sup> ), Black, d 3.0 mm, D 6 mm.

## POWER FLOW SERVICE, ALL-IN-ONE CABLE FOR SMART INSTALLATIONS

- 3 PARALLEL WIRES: 2 X 18AWG power and ground conductors, 1 X 20 AWG service wire.
- ALL-IN-ONE wire bundle for easy, time saving installations.
- SOFT TOUCH™ jacket to enhance the feel and flexibility.
- ORANGE & BLACK matt solid finish jacket for enhanced cosmetics.
- RESISTANT JACKET against abrasion, heat and chemicals.
- CONVENIENT for powering processors and accessories.

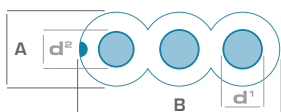

ITEM	DESCRIPTION
PF PGI.2	18/20 AWG (0,81 mm <sup>2</sup> /0,63 mm <sup>2</sup> ), Orange, Black & Orange-Black, d <sup>1</sup> 1.18 mm & d <sup>2</sup> 0.93 mm, A 3.1mm, B 9.3 mm



# S

## "SONUS" SERIES REFERENCE, AUDIOPHILE SPEAKER CABLES



S 212.2



S 214.2

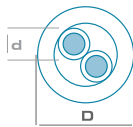

- SOFT TOUCH™ jacket to enhance the feel and flexibility.
- TRASPARENT translucent matt finish jacket for enhanced cosmetics.
- RESISTANT JACKET against abrasion, heat and chemicals.
- TMTC™ TEXTILE MULTIPLE TWISTED CONFIGURATION, 8 linear bundles wound in a textile configuration to a wide open soundstage, pinpoint imaging and faithful reproduction of every nuance.
- PRECIOUS METAL treated wire.
- X<sup>3</sup> FLEXIBILITY for "REFERENCE" installations.

ITEM	DESCRIPTION
S 212.2	12 AWG (2,69 mm <sup>2</sup> ), Traslucent, d 4.1 mm, D 10 mm.
S 214.2	1/0 AWG (1,75 mm <sup>2</sup> ), Traslucent, d 3.6 mm, D 8.8 mm.

## "Y-BOOT" TRANSLUCENT BLUE TERMINATION

- For clean installations.

ITEM	DESCRIPTION
SYB 212	Y-BOOT D 11.5 mm, d 4.5 mm for S 212.2 cable
SYB 214	Y-BOOT D 9 mm, d 3.2 mm for S 214.2 cable

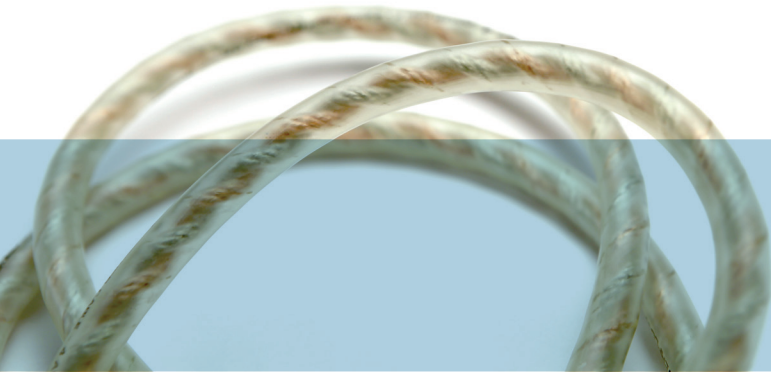
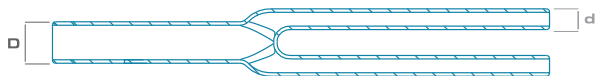



# SL

## "SILVER" SERIES HIGH RESOLUTION, COMPETITION SPEAKER CABLES

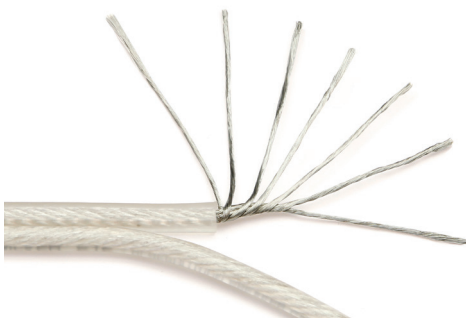

- SOFT TOUCH™ jacket to enhance the feel and flexibility.
- SILVER translucent matt finish.
- RESISTANT JACKET against abrasion, heat and chemicals.
- SQUARE+ROUND outer jacket shape to improve the wire polarity identification.
- MULTIPLE TWISTED WINDING CONFIGURATION, 7 bundles construction for detailed musicality and high power transfer.
- X<sup>2</sup> FLEXIBILITY for "COMPETITION" installations.



SL 212.2



SL 214.2



SL 216.2

ITEM	DESCRIPTION
SL 212.2	12 AWG (2,69 mm <sup>2</sup> ), Silver, d 2.4 mm, A 4.7 mm, B 9.4 mm.
SL 214.2	14 AWG (1,74 mm <sup>2</sup> ), Silver, d 1.9 mm, A 3.9 mm, B 7.8 mm.
SL 216.2	16 AWG (1,26 mm <sup>2</sup> ), Silver, d 1.6 mm, A 3.3 mm, B 6.6 mm.





# FT

## “FIRST” SERIES HIGH FLEXIBILITY, PROFESSIONAL SPEAKER CABLES



- CLEAR, HIGHLY TRANSPARENT jacket with BLACK STRIP to enhance look and improve the wire polarity identification.
- ZERO GRIP JACKET for easy installation.
- MULTIPLE TWISTED WINDING CONFIGURATION for enhanced music reproduction.
- X<sup>2</sup> FLEXIBLE for “EXCEPTIONAL VALUE” installations.



FT 210.2



FT 212.2



FT 214.2



FT 216.2

ITEM	DESCRIPTION
FT 210.2	10 AWG (4,27 mm <sup>2</sup> ), Transparent, d 3.5 mm, A 5.0 mm, B 10 mm.
FT 212.2	12 AWG (2,67 mm <sup>2</sup> ), Transparent, d 2.2 mm, A 4.5 mm, B 9 mm.
FT 214.2	14 AWG (1,78 mm <sup>2</sup> ), Transparent, d 1.8 mm, A 3.6 mm, B 7.4 mm.
FT 216.2	16 AWG (1,24 mm <sup>2</sup> ), Transparent, d 1.6 mm, A 3.5 mm, B 7.2 mm.

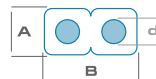



# B

## "BASIC2" SERIES COMPACT, VALUE SPEAKER CABLES



CONNECTION B 216.2

CONNECTION B 218.2

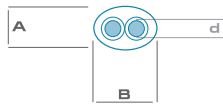

- BLUE jacket to enhance look.
- LOW GRIP JACKET for easy installation.
- MULTIPLE WIRE WINDING CONFIGURATION for improved music reproduction.
- X<sup>1</sup> FLEXIBLE for "STANDARD" installations.
- DOUBLE JACKET for protection against accidental cuts causing short circuits.

ITEM	DESCRIPTION
B 216.2	16 AWG (1,23 mm <sup>2</sup> ), Transparent & Transparent-Blue, d 1.8 mm, A 3.5 mm, B 7.2 mm.
B 218.2	18 AWG (0,81 mm <sup>2</sup> ), Transparent & Transparent-Blue, d 1 mm, A 3 mm, B 6 mm.

>>> CONNECTION B 416.2

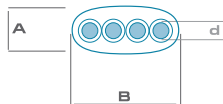

ITEM	DESCRIPTION
B 416.2	16 AWG (1,23 mm <sup>2</sup> ), Transparent, Transparent-Blue, Transparent-Red, Transparent-Black, d 1.8 mm, A 3.5 mm, B 14,8 mm.



- OEM INTEGRATION SPEAKER CABLE for advanced OEM audio upgrading.
- 8+1 WIRES TWISTED-PAIRS dedicated to SPEAKERS and SERVICE signals with ISO standard colours, double-twisted in a compact ALL-IN-ONE wire bundle for extremely high noise rejection and easy, time saving installation.

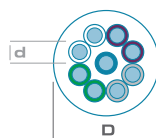

ITEM	DESCRIPTION
B 918.2	18 AWG (0,81 mm <sup>2</sup> ), White & White-Black, Grey & Grey-Black, Purple & Purple-Black, Green & Green-Black, Blue, d 2 mm, D 12 mm



# ST 2

"ST" SERIES HIGH RESOLUTION  
AUDIOPHILE SIGNAL CABLES



- DURA-TEX™ outer jacket for protection and to enhance the feel and flexibility.
- SOFT TOUCH™ outer jacket for an extremely flexible cable.
- 110% TWISTED MYLAR AND DOUBLE ALUMINIUM shield rejects RFI and EMI.
- DDW™ (Double Drain Wire) system for "noise-free" transmission.
- WTP™ (Winding Twisted Pair) balanced conductors reject low frequency electro-magnetic fields.
- OVER 115 dB noise rejection.
- PLATINUM SATIN machined ABS™ style connector for a strong, long lasting connection.
- TUG-PROOF sealed internal connection for maximum reliability.
- DIE-CAST Y BLOCK for full protection of the conductors in critical split point.
- "REFERENCE GRADE" performance.



ITEM	DESCRIPTION
ST2 050	Two channel, Reference Grade Interconnection, 0,5 m/1.6 ft.
ST2 100	Two channel, Reference Grade Interconnection, 1 m/3.3 ft.
ST2 250	Two channel, Reference Grade Interconnection, 2,5 m/8.2 ft.
ST2 450	Two channel, Reference Grade Interconnection, 4,5 m/14.8 ft.
ST2 550	Two channel, Reference Grade Interconnection, 5,5 m/18 ft.

# ST Y ADAPTER



ITEM	DESCRIPTION
STM 030	Reference Grade Y-Adaptor, 1 female 2 male, 0,3 m/1 ft.
STF 030	Reference Grade Y-Adaptor, 1 male 2 female, 0,3 m/1 ft.



# BT 2

"BT" SERIES HIGH EFFICIENCY SIGNAL CABLES

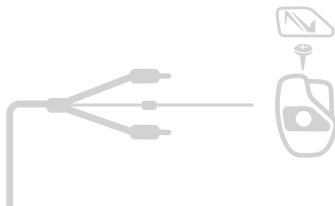

- 2-4-6 CHANNELS available.
- SOFT TOUCH™, matt black jacket makes for an extremely flexible cable.
- POLYAMIDE POLYMER inner jacket protects inner conductors.
- 110% TWISTED MYLAR AND DOUBLE ALUMINIUM shield rejects RFI and EMI.
- WTP™ (Winding Twisted Pair) balanced conductors reject low frequency electro-magnetic fields.
- CDAS™ (Cascaded Dual Aluminium Shield) to eliminate radiated interference and ensure "noise-free" signal transfer.
- OVER 100 dB noise rejection.
- PLATINUM SATIN ABS™ style machined metal contacts.
- EXTENDED REMOTE TURN ON WIRE, built-in remote conductor for ease of installation.
- TUG-PROOF sealed internal connection for maximum reliability.
- MOLDED Y BLOCK for protection of the conductors in critical split point.
- "COMPETITION GRADE" performance.

ITEM	DESCRIPTION
BT2 050	Two channel, Competition Grade Interconnection, 0,5 m/1.6 ft.
BT2 100	Two channel, Competition Grade Interconnection, 1 m/3.3 ft.
BT2 250	Two channel, Competition Grade Interconnection, 2,5 m/8.2 ft.
BT2 450	Two channel, Competition Grade Interconnection, 4,5 m/14.8 ft.
BT2 550	Two channel, Competition Grade Interconnection, 5,5 m/18 ft.

# BT 4



ITEM	DESCRIPTION
BT4 250	Four channel, Competition Grade Interconnection, 2,5 m/8.2 ft.
BT4 550	Four channel, Competition Grade Interconnection, 5,5 m/18 ft.

# BT 6



ITEM	DESCRIPTION
BT6 250	Six channel, Competition Grade Interconnection, 2,5 m/8.2 ft.
BT6 550	Six channel, Competition Grade Interconnection, 5,5 m/18 ft.

# BT Y ADAPTER



BTM 030

ITEM	DESCRIPTION
BTM 030	Competition Grade Y-Adaptor, 1 female 2 male, 0,3 m/1 ft.
BTF 030	Competition Grade Y-Adaptor, 1 male 2 female, 0,3 m/1 ft.



# FT 2

## "FT" SERIES HIGH VALUE SIGNAL CABLES



- HIGHLY TRANSPARENT clear outer jacket for enhanced cosmetics.
- BALANCED twisted pair, silver finished conductors ensure noise rejection.
- NICKEL PLATED connectors with split tip for improved performance and reliability.
- RIGHT ANGLE CONNECTOR on one end to aid in tough installations.
- TUG-PROOF sealed internal connection for maximum reliability.
- MOLDED Y BLOCK for protection of the conductors in critical split point.
- "PROFESSIONAL GRADE" performance.



ITEM	DESCRIPTION
FT2 100	Two channel, Professional Grade Interconnection, 1 m/3.3 ft.
FT2 250	Two channel, Professional Grade Interconnection, 2.5 m/8.2 ft.
FT2 450	Two channel, Professional Grade Interconnection, 4.5 m/14.8 ft.
FT2 550	Two channel, Professional Grade Interconnection, 5.5 m/18 ft.

# FT Y ADAPTER



FTM 030



ITEM	DESCRIPTION
FTM 030	Professional Grade Y-Adaptor, 1 female 2 male, 0,3 m/1 ft.
FTF 030	Professional Grade Y-Adaptor, 1 male 2 female, 0,3 m/1 ft.





# FS 2

"FS" SERIES VALUE SIGNAL CABLES



- SOFT TOUCH™ translucent, matt blue jacket for an extremely flexible cable.
- UCSTM LOW NOISE SHIELD for improved noise rejection.
- NICKEL PLATED connectors with split tip for enhanced performance and reliability.
- TUG-PROOF sealed internal connection for maximum reliability.
- EXTENDED REMOTE TURN ON WIRE to "power up" connected components.
- MOLDED Y BLOCK for protection of the conductors in critical split point.
- "VALUE GRADE" performance.

ITEM	DESCRIPTION
FS2 100	Two channel, High Value Interconnection, 1 m/3.3 ft.
FS2 250	Two channel, High Value Interconnection, 2.5 m/8.2 ft.
FS2 450	Two channel, High Value Interconnection, 4,5 m/14.8 ft.
FS2 550	Two channel, High Value Interconnection, 5,5 m/18 ft.



# FS Y ADAPTER



ITEM	DESCRIPTION
FSM 030	High Value Y-Adaptor, 1 female 2 male, 0,3 m/1 ft.
FSF 030	High Value Y-Adaptor, 1 male 2 female, 0,3 m/1 ft.

# FS

"FS" SERIES, AUDIO SIGNAL CABLES

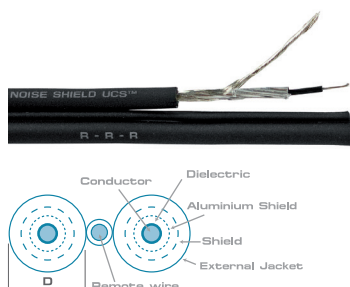

- The SOFT TOUCH™ jacket makes the cable soft to touch and improves its flexibility.
- UCSTM™, low noise shielding to increase immunity to interference.
- Built-in remote conductor for ease of installation.
- High quality/price ratio, "PROFESSIONAL GRADE" performance.

ITEM	DESCRIPTION
FS 20	Double Shield Signal Cable, D 4 mm.



# BCP 100

PIN RCA CONNECTOR FOR "COMPETITION" INSTALLATIONS



- Machined connector with chrome satin finish and ABS™ design.
- SMB™ (Solid Machined Brass) construction for efficient signal transfer.
- Platinum satin finish contacts.
- High Dielectricity Insulation.

ITEM	DESCRIPTION
BCP 100	Professional RCA connectors Platinum Plated, 2 pcs RED & 2 pcs WHITE



# SLI

## SPEAKER LEVEL TO RCA LINE OUTPUT CONVERTER 4:1 STEPDOWN RATIO



- Level conversion operated by Audiophile Grade isolation transformers.
- ART™ Automatic Remote Turn-on.
- High noise rejection.
- Chrome-plated RCA's.
- Durable die-cast aluminium chassis.
- Protective translucent black polycarbonate cover.

ITEM	DESCRIPTION
SLI 2	SLI 2 - Speaker Level Interface 4:1 Stepdown 2ch.



ITEM	DESCRIPTION
SLI 4	SLI 4 - Speaker Level Interface 4:1 Stepdown 4ch.





# SFH

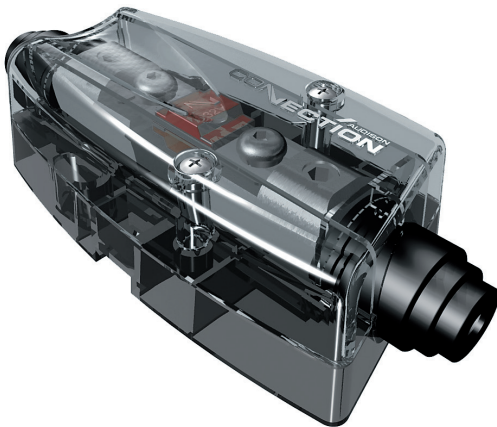

- COMPLETELY WATERPROOF POLYCARBONATE CRYSTALS casing.
- 4 AWG thru 1/0 AWG inputs for any current demand.
- SMB™ (Solid Machined Brass) construction for improved current transfer.
- PLATINUM SATIN finish for unparalleled cosmetic appeal.
- KNURLED SCREWS for best contact with the cable strands.
- AFS FUSE 15A to 300 A available.

ITEM	DESCRIPTION
SFH 11WP	AFS Waterproof Fuse Holder, 1/0 AWG, 4 AWG adaptor, single position.



# BFH



- POLYCARBONATE CRYSTALS casing, strong and scratch resistant.
- 4 AWG thru 1/0 AWG inputs for any current demand.
- SMB™ (Solid Machined Brass) construction for improved current transfer.
- PLATINUM SATIN finish for enhanced cosmetics.
- KNURLED SCREWS for low-loss contact with the cable strands.
- RECESSED inset cable collar for protection against "stray" wire strands.
- AFS FUSE 15A to 300 A available.
- Blue Digital Volt Meter included with the BFH 11DGT version.

ITEM	DESCRIPTION
BFH 11	AFS Fuse Holder, 1/0 AWG, 4 AWG adaptor, single position.



MODULAR  
FUSE  
SYSTEM



BFH



- PROPRIETARY MODULAR fuse and ground distribution system.
- "ADD-ON" distribution capability growing with your system upgrades.
- EXTENSION LINKS provided with each BFH 14, BDB 24 and BDB 44.
- POLYCARBONATE casing, strong and scratch resistant.
- 4 AWG input and output on both AFS fused and ground modules.
- SMB™ (Solid Machined Brass) construction for improved current transfer.
- PLATINUM SATIN finish for enhanced cosmetics.
- KNURLED SCREWS for low-loss contact with the cable strands.
- RECESSED inset cable collar for protection against "stray" wire strands.

ITEM	DESCRIPTION
BFH 14	AFS Modular Fuse Holder, 4 AWG input, 4 AWG output, single position, link included.



FUSES  
FUSE HOLDERS



FFH



- POLYCARBONATE casing, strong and scratch resistant.
- 4 AWG inputs for high current demand.
- SMB™ (Solid Machined Brass) construction for improved current transfer.
- NICKEL SATIN finish for enhanced cosmetics.
- AFS FUSE 15 A to 300 A available.

ITEM	DESCRIPTION
FFH 14	AFS Fuse Holder, 4 AWG, single position.

FUSED DISTRIBUTIONS



BFD



- POLYCARBONATE CRYSTALS casing, strong and scratch resistant.
- 4 AWG to 1/0 AWG inputs for any current demand.
- SMB™ (Solid Machined Brass) construction for improved current transfer.
- PLATINUM SATIN finish for enhanced cosmetics.
- KNURLED SCREWS for low-loss contact with the cable strands.
- RECESSED inset cable collar for protection against "stray" wire strands.
- TWO AND FOUR POSITION AFS 15 A to 300 A fused outputs available.
- Blue Digital Volt Meter included with the BFD 31DGT version.

ITEM	DESCRIPTION
BFD 21	AFS Fused Distribution, 1/0 & 4 AWG input, two for 4 AWG output, 2 positions, 8 AWG adapter.
BFD 41	AFS Fused Distribution, 1/0 & two for 4 AWG input, one for 2 AWG & three for 4 AWG output, 4 positions, 8 AWG adapter.



DISTRIBUTION SYSTEMS



BDB



- POLYCARBONATE casing, strong and scratch resistant.
- 8 AWG to 1/0AWG inputs for any current demand.
- SMB™ (Solid Machined Brass) construction for improved current transfer.
- PLATINUM SATIN finish for enhanced cosmetics.
- KNURLED SCREWS for low-loss contact with the cable strands.
- RECESSED inset cable collar for protection against "stray" wire strands.
- TWO CONVENIENT SIZES: 5 position and 11 position.

ITEM	DESCRIPTION
BDB 51	Distribution System, one for 1/0 AWG, one for 2 AWG, three for 4 AWG, 4 positions, 8 AWG adapter.





# SFD

- UNIQUE ONE PIECE fuse and ground system for clean, reliable installations.
- POLYCARBONATE casing, strong and scratch resistant.
- 1/0 AWG on both fused and ground input, 1/0 AWG pass through on fused block.
- SMB™ (Solid Machined Brass) construction for improved current transfer.
- PLATINUM SATIN finish for unparalleled cosmetic appeal.
- KNURLED SCREWS for low-loss contact with the cable strands.
- RECESSED inset cable collar for protection against "stray" wire strands.
- MOLDED CABLE REST keeps wires safe and nicely laid out.
- 1 – 2 AWG and 3 – 4 AWG on both AFS fused and ground outputs.

ITEM	DESCRIPTION
SFD 41C	AFS COMBO SYSTEM. Fused distribution: 1/0 AWG input, one for 2 AWG & three for 4 AWG output, 4 positions, 8 AWG adapter included. Distribution system: one for 1/0 AWG, one for 2 AWG, three for 4 AWG, 5 positions, 8 AWG adapter included.





# SBC



- POLYCARBONATE CRYSTALS casing, strong and scratch resistant.
- SEPARATE POSITIVE AND NEGATIVE post designs for better fit.
- WRAP AROUND "clamp" design for a tight, reliable connection.
- SMB™ (Solid Machined Brass) construction for improved current transfer.
- PLATINUM SATIN finish for unparalleled cosmetic appeal.
- KNURLED SCREWS for low-loss contact with the cable strands.
- RECESSED inset cable collar for protection against "stray" wire strands.

ITEM	DESCRIPTION
SBC 41P	Positive Post Battery Clamp, 1/0 AWG, 4 AWG & two 8 AWG outputs.
SBC 41N	Negative Post Battery Clamp, 1/0 AWG, 4 AWG & two 8 AWG outputs.



# BBC



- UNIQUE AFS FUSED POSITIVE post battery clamp, 15 A to 300 A available.
- POLYCARBONATE CRYSTALS casing, strong and scratch resistant.
- WRAP AROUND "clamp" design for a tight, reliable connection.
- SMB™ (Solid Machined Brass) construction for improved current transfer.
- PLATINUM SATIN finish for enhanced cosmetics.
- KNURLED SCREWS for low-loss contact with the cable strands.
- RECESSED inset cable collar for protection against "stray" wire strands.

ITEM	DESCRIPTION
BBC 41PF	Positive Post Battery Clamp, 1/0 AWG FUSED OUTPUT, one 4 AWG & two 8 AWG non-fused output, integrated SFA fuse (80 A included).





# FBC



- POLYCARBONATE casing, strong and scratch resistant.
- SEPARATE POSITIVE AND NEGATIVE post designs for better fit.
- WRAP AROUND "clamp" design for a tight, reliable connection.
- RING TERMINAL connection and 2 – 8 AWG outputs for flexible system design.
- SMB™ (Solid Machined Brass) construction for improved current transfer.
- NICKEL SATIN finish for enhanced cosmetics.

ITEM	DESCRIPTION
FBC 28P	Positive Post Battery Clamp, screw for terminal ring and two 8 AWG outputs.
FBC 28N	Negative Post Battery Clamp, screw for terminal ring and two 8 AWG outputs.



# SFA

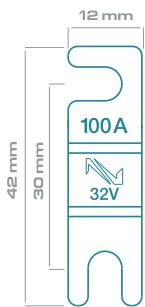
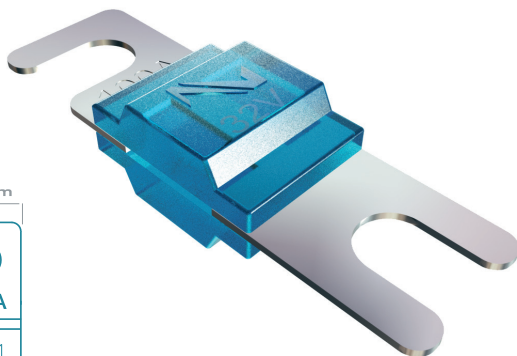

- PLATINUM SATIN AFS fuse compatible with all Connection fuse systems.
- CONVENIENT transparent casing for easy condition verification.
- CONNECTION monogram molded into casing for enhanced cosmetics.
- 15 A to 300 A values available.

ITEM	DESCRIPTION
SFA 015	15 A, ASF Fuse, light blue, 2 pcs.
SFA 020	20 A, ASF Fuse, light pink, 2 pcs.
SFA 030	30 A, ASF Fuse, green, 2 pcs.
SFA 040	40 A, ASF Fuse, orange, 2 pcs.
SFA 060	60 A, ASF Fuse, blue, 2 pcs.
SFA 080	80 A, ASF Fuse, transparent, 2 pcs.
SFA 100	100 A, ASF Fuse, yellow, 2 pcs.
SFA 150	150 A, ASF Fuse, dark yellow, 2 pcs.
SFA 300	300 A, ASF Fuse, black, 2 pcs.





# SGT

## GROUND TERMINALS

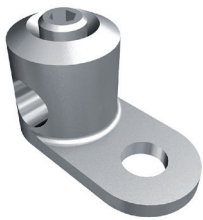

- LARGE FOOTPRINT for better ground on high power systems.
- 1/0 AWG input for high current systems.
- SMB™ (Solid Machined Brass) construction for improved current transfer.
- PLATINUM SATIN finish with Connection monogram.

ITEM	DESCRIPTION
SGT 11	Reference Ground Terminal, for 1/0 AWG.



# SMC

## MAIN CRIMPS



- 1/0, 2, 4, 8 and 10 AWG sizes available.
- PROVIDES unparalleled contact between cable and chosen connector.
- MORE contact area = MORE current transfer = MORE POWER.
- PREVENTS "stray" wire strands shorting out for safety and reliability.
- SILVER FINISHED copper construction.

ITEM	DESCRIPTION
SMC 1/0	Main Crimp, 1/0 AWG, d 10,5 mm.
SMC 02	Main Crimp, 2 AWG, d 8,5 mm.
SMC 04	Main Crimp, 4 AWG, d 7,5 mm.
SMC 08	Main Crimp, 8 AWG, d 4,5 mm.
SMC 10	Main Crimp, 10 AWG, d 3,5 mm.



# FRT

## RING TERMINALS



- CRIMP OR SOLDER TYPE ring terminal.
- 2, 4, 8 and 10 AWG input sizes available.
- BLUE & SILVER connector jackets for safety and cosmetic appeal included.

ITEM	DESCRIPTION
FRT 2	Crimp style ring terminal 2 AWG.
FRT 4	Crimp style ring terminal 4 AWG.
FRT 8	Crimp style ring terminal 8 AWG.
FRT 10	Crimp style ring terminal 10 AWG.



# SSF



- 20 VOLT DESIGN for high current capability.
- LOW ESR for improved current transfer >1,5 mΩ.
- WIDE TEMPERATURE RANGE for constant performance.
- ANTI-VIBRATION DESIGN for improved reliability.
- ELECTROLYTE RESERVE for long lasting capability.
- TOLERANCE ±2%.
- Digital voltmeter included.

ITEM	DESCRIPTION
SSF 2.5 DGT	2,5 Farad Capacitor with digital voltmeter.



# FSF



- 20 VOLT DESIGN for high current capability.
- X<sup>2</sup> – LOW ESR for improved current transfer < 1,5 mΩ.
- WIDE TEMPERATURE RANGE for constant performance.
- ANTI VIBRATION DESIGN for improved reliability.
- ELECTROLYTE reserve for long lasting capability.
- Tolerance ± 20%.
- Blue Digital Volt Meter included with the FSF10 DGT model.

ITEM	DESCRIPTION
FSF 1.0 DGT	1,0 Farad Capacitor with digital voltmeter.



# FSK

INSTALLATION KIT FOR THE COMPLETE CONNECTION OF A SINGLE AMPLIFIER UP TO 700W

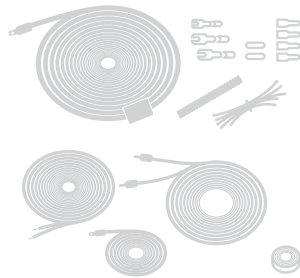

- 5,2 m / 17 ft, translucent red Power flow provided with assembled ATO fuse holder (fuse included).
- 1 m / 3,3 ft, translucent black Power Flow ground cable.
- 5,2 m / 17 ft, of 18 AWG blue remote turn-on cable.
- 10 m / 33 ft, speaker cable.
- 4,5 m / 14.8 ft, FS2 450 audio interconnect.
- 1,5 m / .5 ft split loom.
- All required ring and fork terminals included.
- Cable ties, split loom and snap grommet included.



ITEM	DESCRIPTION
FSK 175	AMPLIFIER KIT 175W, 10 AWG power & ground cable, 40 A fuse.
FSK 350	AMPLIFIER KIT 350W, 8 AWG power & ground cable, 60 A fuse.
FSK 700	AMPLIFIER KIT 700W, 4 AWG power & ground cable, 80 A fuse.



# FPK

INSTALLATION KIT FOR THE POWER CONNECTION OF A SINGLE AMPLIFIER UP TO 700W

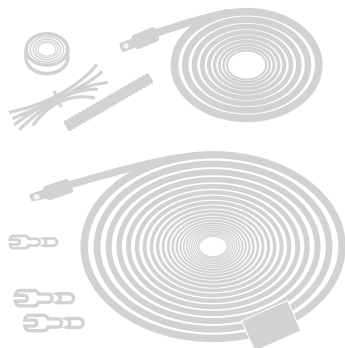

- 5,2 m/17 ft. translucent red Power Flow cable.
- ATO fuse holder with fuse included.
- 1 m/3.3 ft. translucent black Power Flow ground cable.
- 5,2 m/17 ft. of 18 AWG blue remote turn-on cable.
- 1,5 m/5 ft. split loom.
- All required ring and fork terminals included.
- Cable ties, split loom and snap grommet included.

ITEM	DESCRIPTION
FPK 350	POWER KIT 350W, 8 AWG power & ground cable, 60 A fuse.
FPK 700	POWER KIT 700W, 4 AWG power & ground cable, 80 A fuse.

## TECHNICAL NOTES

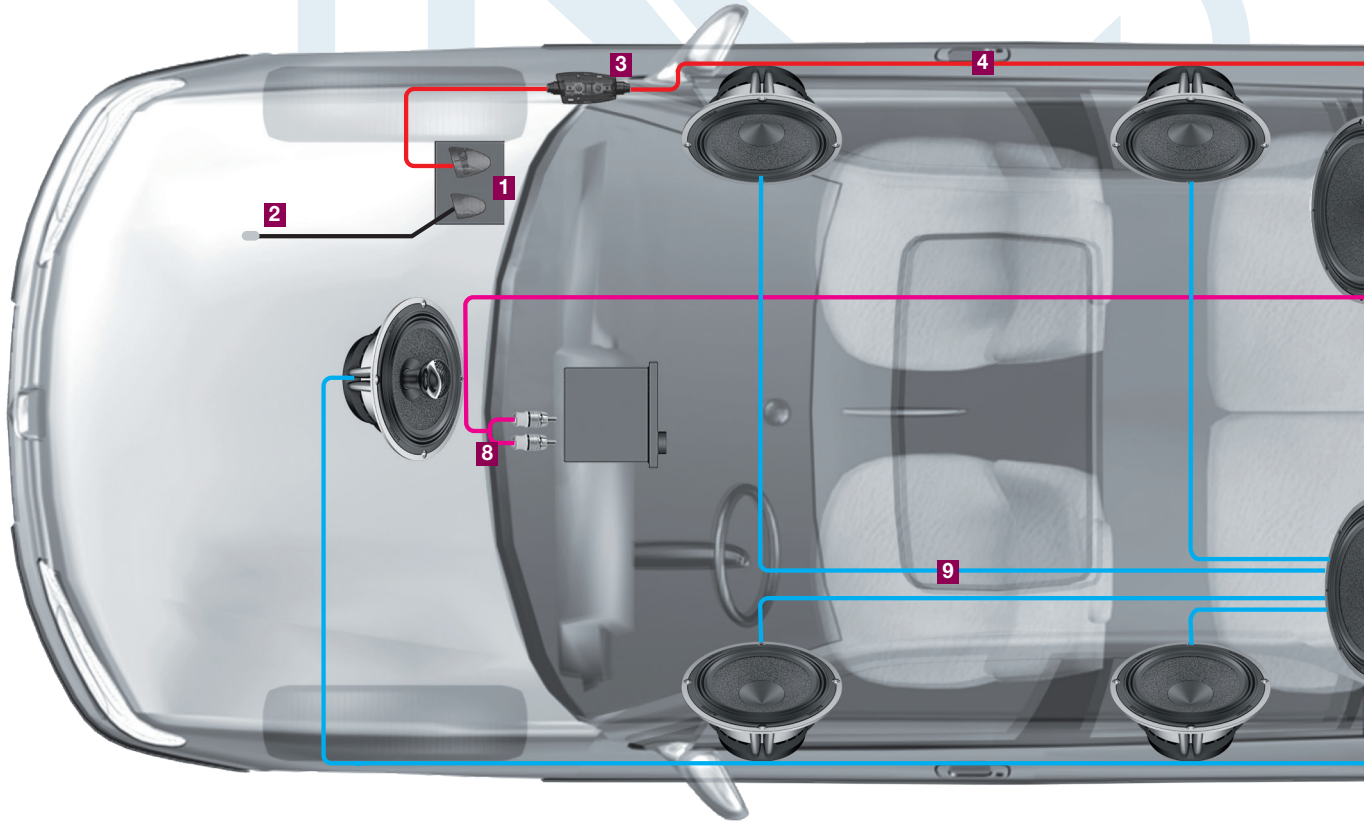

### SUGGESTED UPGRADES FOR BETTER PERFORMANCE

- 1 BATTERY CLAMPS** ensure high current transfer without the power robbing consequences of a high resistance connection.
- 2 GROUND TERMINALS** minimize resistance and the consequent power losses associated with poor system grounding.
- 3 FUSE HOLDERS** are the first element to protect your vehicle and yourself from dangerous short circuits. The high temperature case and waterproof construction ensure reliability in any environmental condition.
- 4 POWER & GROUND CABLES** are of fundamental importance to obtain reference performance from your car audio/video system. Mainpower and power flow cables special structure minimizes eddy current power losses and ensures high instantaneous current transfer, enabling you to experience the full dynamics of your music.
- 5 FUSED DISTRIBUTION SYSTEMS** available in two or four position outputs, or in a modular version. AFS fuses are used to protect even the most complicated car audio/video system. The wide range of AFS values allows you to choose the right fuse for each component in your system.
- 6 GROUND DISTRIBUTION SYSTEMS** are as important to your system's overall performance as the power distribution. Solid, low resistance ground points prevent harmful voltage differences between components and improve high-level current transfer without power loss.
- 7 SUPERFARAD™ capacitors** act as a "current reserve" storing DC energy for when your amplifiers will need it most.
- 8 AUDIO INTERCONNECTS** are the first components in your system where audio signals pass through. For faithful reproduction, they must transfer these signals from the head unit to the amplifiers without modifying the sound, while, at the same time, rejecting the tremendous amount of noise radiated by on-board computer-controlled devices.
- 9 SPEAKER CABLES** provide that last step for in-car faithful reproduction. They ensure the transfer of music to your speakers without signal coloration or degradation.

## POWER & GROUND CABLE CALCULATION TABLE

How to choose the proper Power & Ground cable size for your system

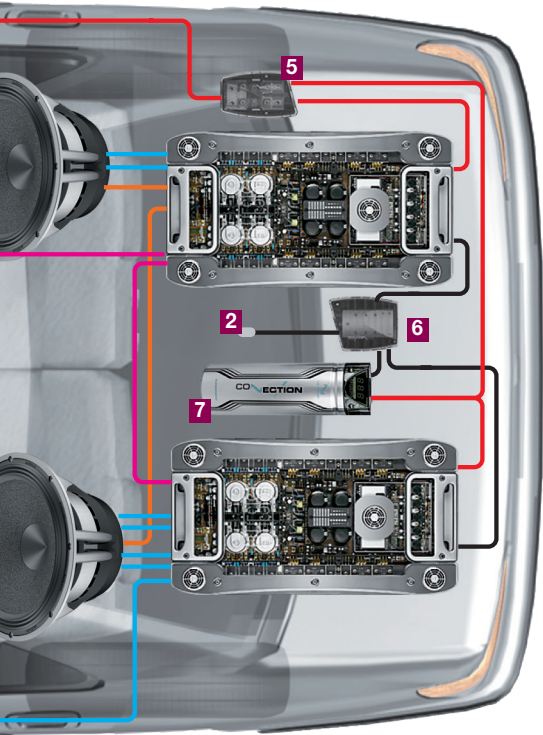

- Power Cable
- Ground Cable
- Speaker Cable
- Subwoofer Cable
- Audio Interconnect

Power & Ground cable calculation table		Cable Size	
Minimum gauge size recommended for MAINPOWER & POWER FLOW cables. MAINPOWER cables ensure higher instantaneous current transfer.		A.W.G.	mm <sup>2</sup>
240-350		1/0	53,5
180-240		2	33,6
150-180		4	21,2
120-150		8	8,4
100-120		10	5,3
80-100		12	3,3
60-80		14	2,1
40-60		16	1,3
20-40		18	0,8
8-20			
0-8			
ft	0-3,3   3,3-6,6   6,6-9,9   9,9-13,2   13,2-16,5   16,5-19,8   19,8-23,1   23,1-26,4		
m	0-1   1-2   2-3   3-4   4-5   5-6   6-7   7-8		

\*Current Draw I (A)

Cable Length (m/ft)

\*How to calculate current draw of your system

$$I = \frac{TP \times 2}{V_{batt}}$$

**I** = Current draw of your system in ampere;  
**TP** = Total power (RMS) of all channels of all amplifiers in your system;  
**V<sub>batt</sub>** = Usually value is 12 V, the nominal automotive electrical system voltage.

Example:

- Your total system power (RMS) of all channels in all amplifiers is a combined 650 W.
- Your amplifiers average 50% efficiency, as most amplifiers today.
- Your electrical system is 12 Volt.

$$I = \frac{650 \times 2}{12} = 108,3 \text{ A Current Draw}$$

On the table above, find the corresponding current draw on the left hand side of the chart. Then on the bottom of the chart find how long the cable run will be. Where these two points intersect in the table is the Connection minimum recommended gauge size to use for the reliable performance of your system.

# GENERAL INFORMATION

PRODUCT IDENTIFICATION

## Product model legenda

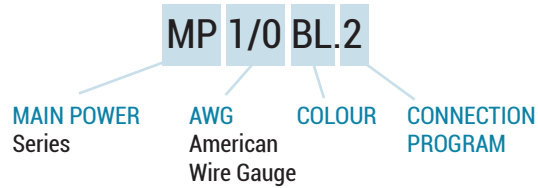

## WARRANTY

All the products in this catalogue are guaranteed according to the terms of law. Potentially defective products must be returned to an authorized Connection dealer for repair or replacement. Product's damages due to misuse are not covered by this warranty.





**CONNECTION**

**CONNECTION PART OF ELETTROMEDIA**

62018 Potenza Picena (MC) Italy - T +39 0733 870 870 - F +39 0733 870 880 - [www.elettromedia.it](http://www.elettromedia.it)