

Ontario Traffic Manual Book 12 – Traffic Signals

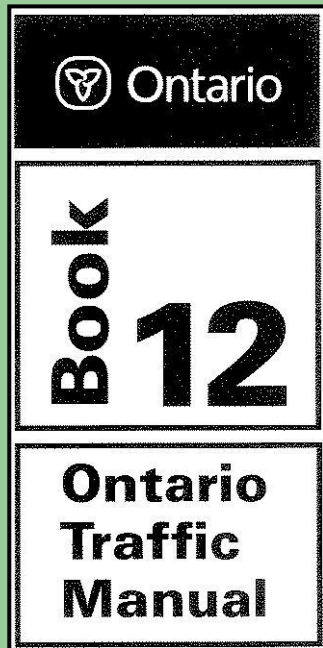

Training Material
Section 1
General Information

Traffic Signals:

- Warn of intersecting roadways
- Convey control messages
- Alternate right-of-way among road users
- Promote observance with the law

Consistency in Traffic Signal Designs:

- Promotes legibility
- Assists with comprehension
- Minimizes distractions and interference

OTM Book 12:

- Provides elementary instructions
- Acts as a reference for experienced persons
- Provides recommended best practices

Sections of Book 12

- Section 1 – General Information
- Section 2 – Legal Requirements
- Section 3 – Operational Practice
- Section 4 – Planning and Justification
- Section 5 – Design Practice
- Section 6 – Miscellaneous

Use of Terms (1)

- Legal Requirements
 - Established under the Highway Traffic Act and Regulations
 - Use “must”
- Interpretation
 - Not precise wording but interpretations of the HTA and its regulations
 - Use “must” or “shall”

Use of Terms (2)

- Recommended Practice
 - Manner in which the legal requirements are applied
 - Use “should”
- Guideline
 - Method of practical application
 - Use “may”

Unjustified Traffic Control Signals:

- May increase overall delay
- Contribute to disobedience
- Increase noise and fuel consumption
- Do not necessarily improve safety
- Do not work well to calm traffic

Driver's Needs & Limitations

- Drivers will find information if it is where they expect it to be
- Standardization is critical for drivers to find the traffic control devices
- Standards should promote uniformity in application and design

Continuity of Operations

- Once activated, signals should operate continuously

Ontario Traffic Manual Book 12 – Traffic Signals

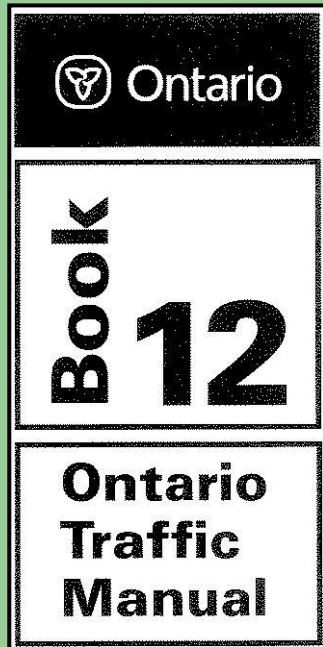

Training Material
Section 2
Legal Requirements

Highway Traffic Act:

- Section 144 (31) – Approvals of Signal Designs
- Section 144(19.1) – Bus Priority Signal Indications
- Section 146 – Portable Lane Control Signals
- Regulation 626 – Traffic Signal Heads
- Regulation 606 - Portable Lane Control Signal Systems
- Unregulated – Bicycle Signals

HTA Statute 144 (31) – Approvals of Signal Designs

- Road Authorities are responsible to designate a person to approval traffic signals
- Signals shall not be installed until approved
- Ministry shall approve signals on connecting links

Designated Persons

- Competent and qualified
- May designate through Council resolutions
- Recommended both the designer and the person designated to authorize
- Drawings are recommended (representing head placements and aiming requirements)
- Expertise may be acquired externally

White Vertical Bar Indication

- Transit signals apply to the lane(s) occupied by transit vehicles.
- An education program for transit drivers (as well as the public) is strongly recommended
- The total number of indications per head, including the transit section, should not exceed five.

Flashing Green

- Circular flashing green provides advanced phase in a single direction only
- Flashing arrows are recognized in the HTA as substitutes for the flashing green (subject to individual legal interpretations)
- **SUNSET CLAUSE** – January 1, 2010 – Flashing green no longer permitted

Minimum Signal Head Requirements

- Every traffic control signal head must have a circular red and amber indication
- Every traffic control signal head must have a green indication composed of:
 - A circular indication
 - An arrow

Figure 2 – Traffic Control Signal Heads

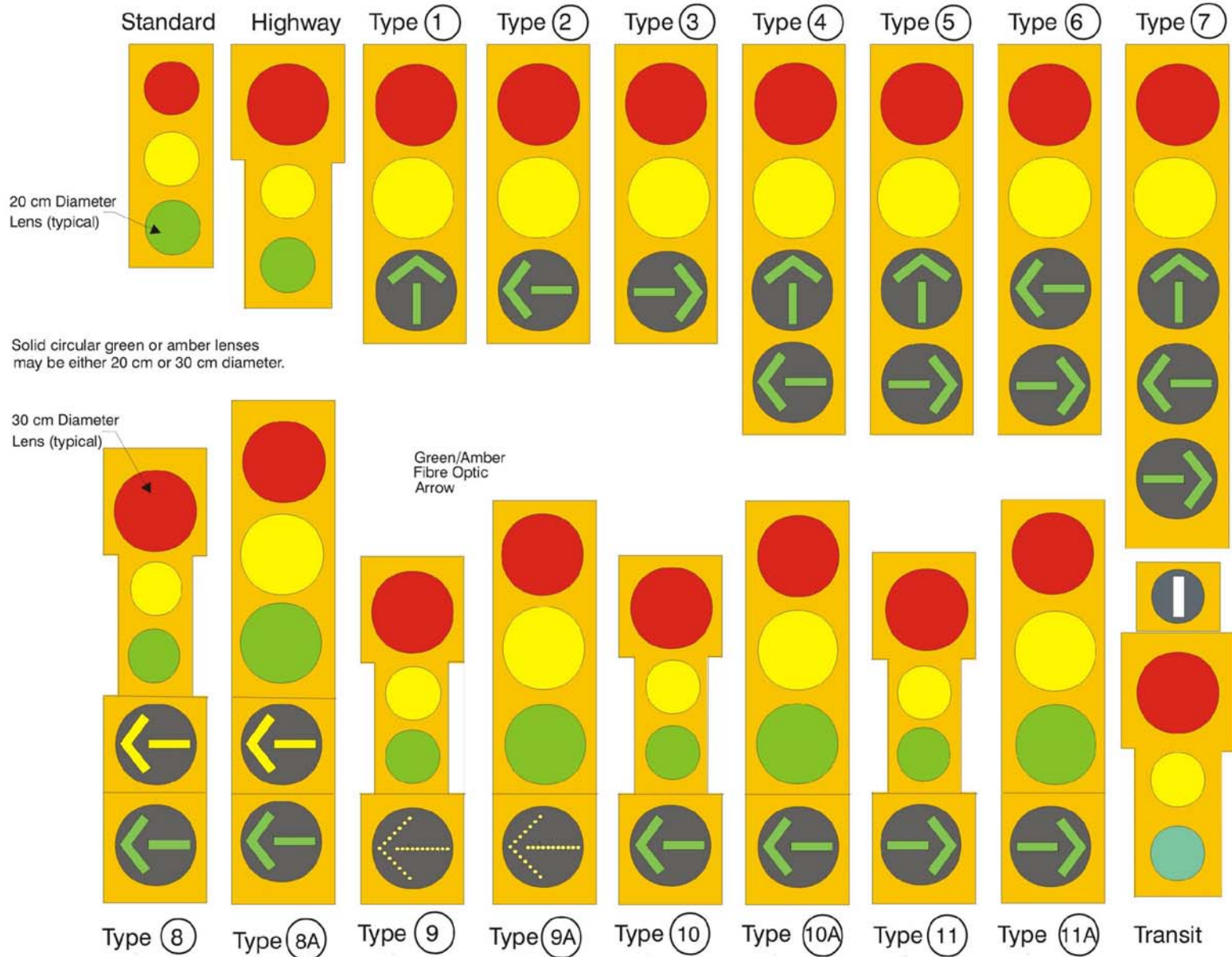

Requirement for Two Signal Heads

- Every approach requires two signal heads (including a private driveway that fronts onto an intersection)
- At least one signal head must be mounted on the far right side
- All approaches at an intersection must be signalized except for Intersection Pedestrian Signals

Intersection Pedestrian Signals

- Roadway being signalized must have two signal heads facing approaching traffic in each direction
- Other roadway is controlled with stop signs
- Intended for use as an alternative to Pedestrian Crossovers
- Conventional pedestrian heads are required

Height of Signal Heads

- Minimum of 5.0 m when over traffic lanes
- 5.8 m recommended for span wire installations
- Secondary heads (not over traffic lanes) may be mounted between 2.75 m and 5.0 m
- Intermediate mounting heights for secondary heads should be used to optimize visibility

Don't Walk Signals

- Minimum 30 x 30 cm heads should be used
- Shape must conform to HTA Reg. 626 to satisfaction of road authority
- Minimum mounting height 2.75 m
- Do not mount over travelled portions of the roadway

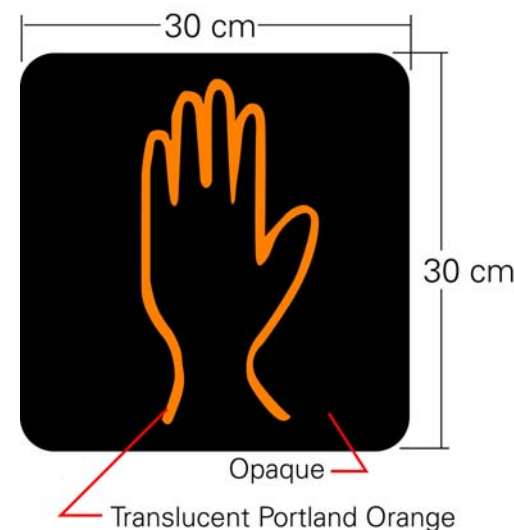

Walk Signals

- Same size and mounting as don't walk
- Must not be displayed at the same time as the flashing don't walk indication
- Shape must conform to HTA Reg. 626 to satisfaction of road authority

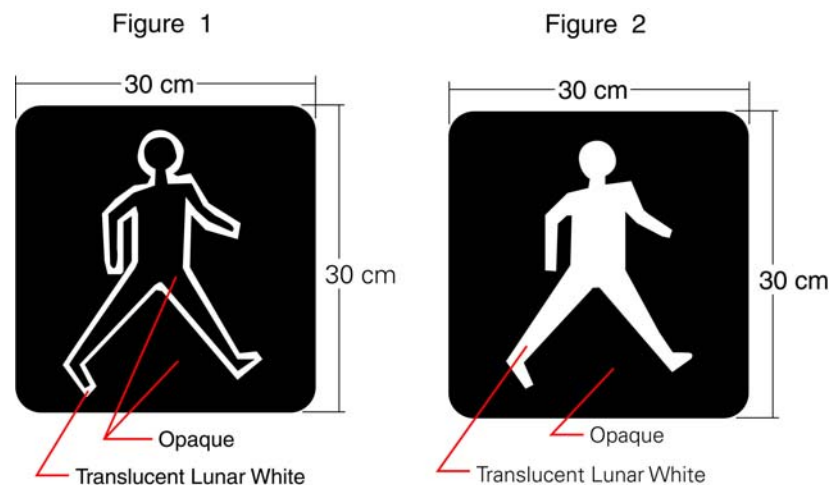

Orientation of Pedestrian Indications

- One of three orientations allows:
 - Both displays shown in the same lens
 - Hand symbol to the left of the walk symbol
 - Hand symbol above the walk symbol

Signals Not At Intersections

- Midblock signals
- Private driveways
- Special applications:
 - Moveable bridge spans
 - Rail or transit crossings
 - Tunnels
- Ramp metering signals

Amber Left Turn Arrows

- Simultaneous protected permissive left turns may not terminate at the same time
- Amber arrows must follow green arrows for protected permissive indications
- The left turn amber arrow may be:
 - In the same section as the green arrow, or
 - In a separate section mounted directly above the green arrow

Portable Lane Control Systems

- Intended for mobile operations and “very short” or “short” duration work
- Two signal heads are recommended
- If used unattended or for “long” duration work, legal approval (with two signal heads) is required

Bicycle Signals

- Currently unregulated
- Municipalities may apply for a regulation granting permission for the pilot under the “New Technology Trial” legislation
- Refer to TAC – Traffic Signal Guidelines for Bicycles

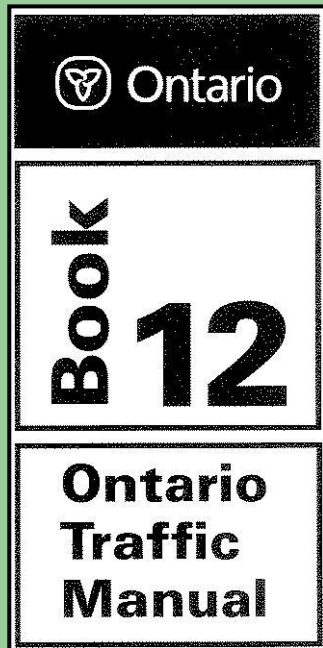

FIGURE 3.1

Quebec Bicycle Signal Head

Source: Gouvernement du Québec; Ministère des Transports

Ontario Traffic Manual Book 12 – Traffic Signals



Training Material
Section 3
Operational Practice

Operational Practice:

- Overview of traffic signal operations
- Requires understanding of traffic flow theories
- Standardization of traffic control signal operation is important from the viewpoint of motorists expectations and safety

Controller Operation

- Focus on solid state controller (Type 170 & Nema)
- Detailed information on controllers may be found in the publications of the major controller manufacturers

Determination of Intersection Operation

- The selection of the type of control
- The objective of the traffic control is to optimize traffic flow and provide measure of quality of service to road users
- Recommended four-step process

Selection of Mode of Control

- Guideline for selecting control mode - pre-timed or fixed mode, actuated mode and semi-actuated mode
- Other considerations:
 - Long distance and double long distance detection
 - System operations and coordination

Phase Determination Principles

- The number and type of phases required will be largely dependent on the volumes and intersection geometrics
- Least number of phases should always be used to reduce lost time in phase determination

Phase Numbering Convention

- Standard Movements
 - traffic movements identified by number according to the type of controller

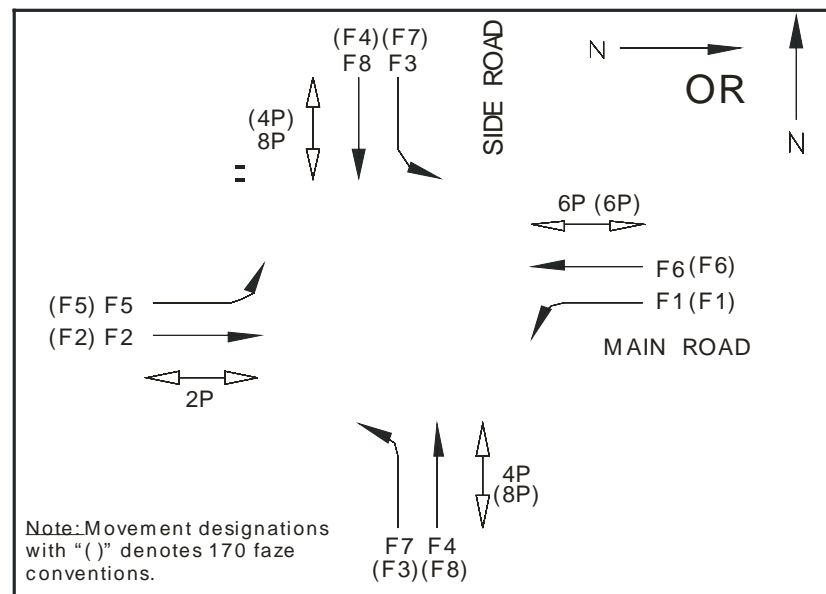

Phase Intervals

- Each phase is broken down into sequence of intervals or indications
 - Two phase operations
 - Three phase operations
 - Multi phase operations

Phase Diagrams

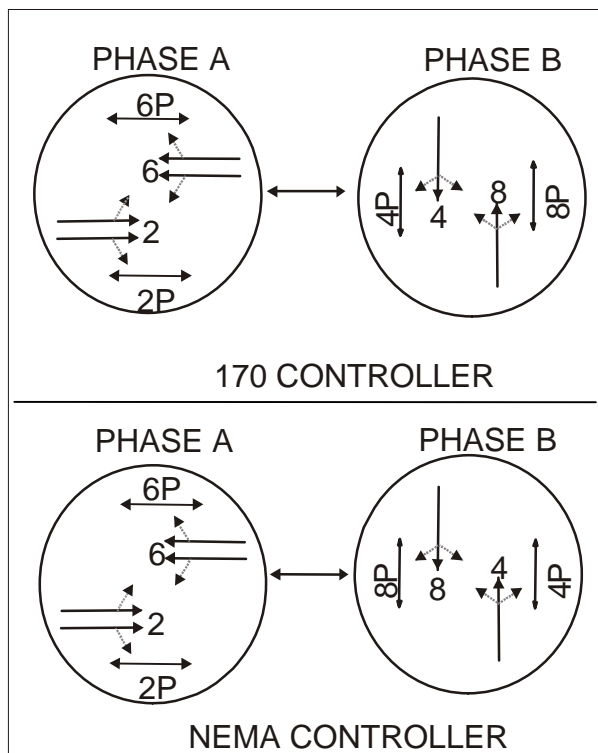

2-Phase Diagram

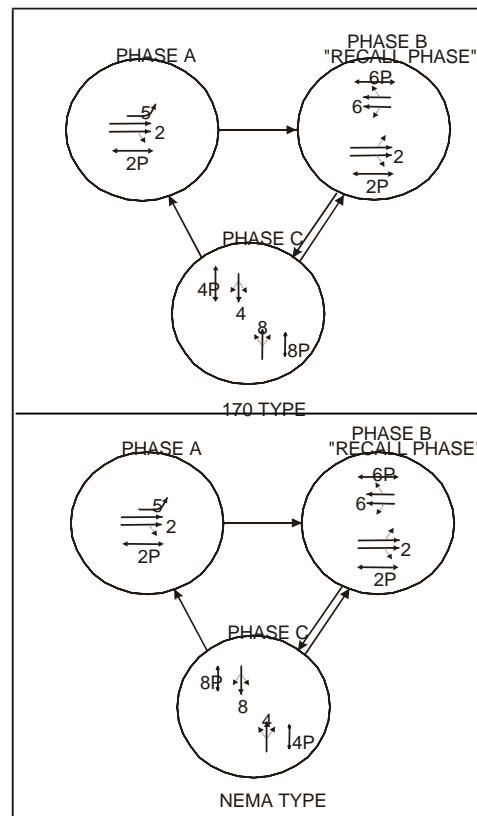

3-Phase Diagram

Pedestrian Phases

- Guideline for pedestrian phases
- Pedestrian Phase - pedestrian signal indications should follow the sequence:
 - Walking Pedestrian (“Walk”)
 - Flashing Hand (“Flashing Don’t Walk”, FDW)
 - Steady Hand Outline (“Don’t Walk”)
- Exclusive Pedestrian Phase may be used

Pedestrian Signal Operation

- Guideline for pedestrian signal operation
 - Pedestrian right-of-way
 - Clearance interval for pedestrians should terminate at onset of the accompanying vehicular amber
 - In practice, the clearance interval is allowed to continue until the beginning of the all-red

Left Turn Phase Justification

- Left turn phase justification
 - Left-turning movements are affected by turning volume, lane configurations, pedestrian movements, opposing traffic flow, the width of the intersection and the phasing of the traffic control signals.
 - The need for left-turn phases may be approximated using a simplified method by calculating the delay using the traffic volume (for preliminary assessment)

Left Turn Phase Justification (Cont.)

- Left turn phase justification – method of analysis:
 - Capacity Analysis Method (TCSTCA) - useful for planning of new signals; TCSTCA provides nomographs to assist with the analysis
 - Left-turn Delay Method (former Metro Transportation)

Type of Left-turn Phase

- Determination of the Type of left-turn phase
- Types of left-turn phasing includes:
 - Advanced green, single direction
 - Protected/Permissive Simultaneous Left Turns
 - Fully Protected Simultaneous Left Turn
 - Permissive/Protected Lagging Left Turn – Single Direction
 - Separate Protected Left-Turn Operation (Separate Phasing)
 - Lagging Fully Protected Simultaneous Left Turn

Type of Left-turn Phase (Cont.)

PROTECTED/PERMISSIVE LEADING LEFT-TURN PHASING

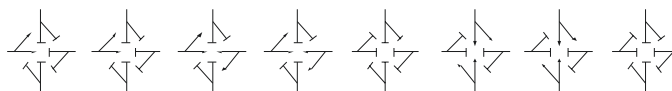

INTERVAL →										
INTERVAL										

SIGNAL HEAD PLACEMENT
 The minimum requirement is one primary and one secondary signal head for each approach. Auxiliary signal heads may be used as necessary.

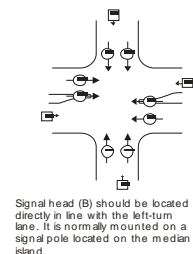

Signal head (B) should be located directly in line with the left-turn lane. It is normally mounted on a signal pole located on the median island.

NOTE: Signal head (B) can be a five-section signal head with separate amber and green arrow lenses as illustrated, or a four-section signal head with a single fibre optic green/amber arrow lens.

OPERATION:
 The phasing sequence has a protected left turn on approach (1) during which all traffic on approach (1) may exclusively enter the intersection (Interval I). The protected left-turn phase is cleared through the use of an amber arrow indication (Interval II). Traffic on approaches (1) and (2) are permitted to enter the intersection (Interval III) during which time left turns on approaches (1) and (2) are permitted. Traffic on approaches (1) and (2) are cleared with an amber ball indication (Interval IV) and an all-red indication (Interval V). The standard phasing is used for approaches (3) and (4) (Intervals VI to VIII).

If no median island is present, this can be accomplished by using an extended mast arm, span wire, or a signal bridge that also holds the primary signal head (A) for the through/right-turn movements.

Timing

- Traffic demand analysis will determine the optimum interval timing to best balance safety and traffic flow efficiency.
- Guidelines include Ministry's "Traffic Control Signal Timing and Capacity Analysis at Signalized Intersections" and "ITE Canada's Canadian Capacity Guide for Signalized Intersections"
- The reference documents use the theory of intersection and lane flow ratios to determine minimum and optimum cycle times, capacity, delay and lost time per cycle.

Timing - Minimum Interval Timing

- Minimum interval timing is required

Interval	Desirable Minimum (seconds)	Acceptable Minimum (seconds)
Circular green for roads posted at less than 80 km/h	10.0	7.0
Circular green for roads posted at 80 km/h or more	20.0 (Main Road) 10.0 (Side Road)	15.0 (Main Road) 7.0 (Side Road)
Advanced Green	7.0	5.0
Flashing advanced green clearance	2.0	1.5
Circular amber	3.0	3.0
Amber arrow	3.0	2.0*
All red	1.0	1.0
Transit priority	5.0	3.0
Pedestrian walk	7.0	5.0
Pedestrian clearance	5.0	3.0

Timing - Clearance Interval

- Calculation of clearance interval (amber interval clearance and all-red interval clearance) is based on approach operating speed, the motorist's perception and reaction times, the crossing width and the average deceleration rate of the vehicles

$$\text{clearance} = \text{Amber} + \text{All-Red}$$

Amber indicates to the driver that the right-of-way is about to be changed and therefore must provide sufficient time for the approaching motorist to travel the Stopping Sight Distance

The all-red interval represents the time required to provide a safe passage across the intersection for vehicles entering the intersection at or near the end of the amber interval

Timing - Clearance Interval (Cont.)

- Clearance for left-turn signals for:
 - Left-turn green
 - Fully protected left turns

Level of Service (LOS)

- Level of service may be determined based on delay

Level of service	Stopped delay per vehicle (seconds)
A	5.0
B	> 5.0 and < = 15.0
C	> 15.0 and < = 25.0
D	> 25.0 and < = 40.0
E	> 40.00 and < = 60.0
F	> 60.0

Level of Service (LOS)

- Level of service may be based probability of clearing the intervals

Level of service	Probability of arrival vehicles clearing
A	95%
B	90%
C	75%
D	60%
E	50%

Determination of Green Interval Timing

- Determination of Green Interval Timing
 - Ministry of Transportation Methodology
 - Canadian Capacity Guide Methodology
 - Highway Capacity Manual Methodology
- Calculation of Green Extension Time
- Determination of Delays on Actuation

Calculation of Pedestrian Timing

- Pedestrian timings must be generous enough to ensure that pedestrians are given enough time to cross safely and comfortably, yet not over-generous such that service to vehicular traffic is unduly compromised
- Walking speed normally varies between 1.0 m/s and 1.25 m/s, 1.2 m/s is usually assumed for initial calculations
- CCG Method

Determination of Cycle Length

- Cycle Length
 - Guideline for cycle length selection
 - Worked examples may be found in the TCSTCA and the CCG

Signal Spacing

- Where a new “interstitial” intersection is planned, the distance between signalized intersections should be reviewed
 - Consideration for coordination
 - Minimum distance between intersections
 - Progression efficiency

Flashing Operations

- Advanced flashing green
 - Sunset clause January 1, 2010
 - Flashing advanced green arrow should be used at discretion of road authorities
- Standardized flashing operations
 - Start-up flash
 - Emergency flash
 - Timed flash

Pre-emption and Priority

- Overview application of:
 - Railway crossing
 - Emergency vehicles
 - Transit priority

Operation Of Miscellaneous Signals

- Pedestrian signals (Intersection Pedestrian Signals, IPS and Midblock Pedestrian Signals, MPS)
- Transit priority signals
- Movable span bridge traffic control signals
- Lane Direction Signals

Operation Of Miscellaneous Signals (Cont.)

- Remote control devices
- Portable lane control signal systems
- Portable temporary traffic signals
- Temporary traffic signals
- Accessible pedestrian indications
- Countdown pedestrian signals

Operation Of Miscellaneous Signals (Cont.)

- Tunnel signals
- Ramp metering signals
- Optically programmable traffic signals
- Bicycle signal indications

Flashing Beacon Signals

- Hazard identification beacon
- Beacons in advance of signalized intersection
- Intersection control beacons
 - 1-way or 2-way overhead red flashing beacons
 - 3-way and 4-way overhead red flashing beacons
 - 3-way and 4-way overhead red/amber flashing beacons
 - Red beacon for stop sign reinforcement

Flashing Beacon Signals (Cont.)

- Continuous advance warning beacons for traffic signals
- Active advance warning beacons for traffic signals

Systems

- Traffic signal control systems can be used to operate, monitor and control traffic signal controllers located at each intersection. Traffic signal control systems can be very cost effective if frequent adjustments to the timing or more dynamic forms of control are required or frequent retrieval of the traffic data is necessary.

Maintenance

- The required maintenance of traffic control signals is provided in the Municipal Act, Regulation 239/02 as amended. This Regulation is entitled “Minimum Maintenance Standards for Municipal Highways”.
- Suggested maintenance standard

Ontario Traffic Manual Book 12 – Traffic Signals

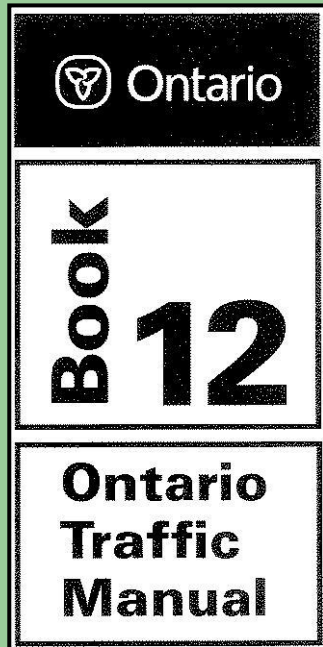

Training Material

Section 4

Planning and Justification

Traffic Signals:

- Warn of intersecting roadways
- Convey control messages
- Alternate right-of-way among road users
- Promote observance with the law

General

Section 4 of OTM Book 12 is intended to:

- Discuss the Planning and Justification for Traffic Signal Installation
- Provide Justifications (Seven in Total) for Traffic Signal Installation

Information Requirements

Basic Input Data

- Analysis of Signal Justification requires:
 - Intersection Configuration
 - Traffic Volumes
 - Pedestrian Volumes
 - Roadway Speed
 - Area Population
 - Collision Data
 - Pedestrian Delay
 - Pedestrian Crossing Opportunities

Information Requirements

Flow Conditions

- Justification developed for two types of Flow Conditions:
 - Restricted Flow – Roads with Operating or Posted Speeds < 70 km/h (normally in urban areas)
 - Free Flow - Roads with Operating or Posted Speeds ≥ 70 km/h (normally in rural areas or controlled access in urban areas)

Information Requirements

Intersection/Roadway Configuration

- Characteristics which affects Volume Justification values:
 - Main Street Approach
 - Median Islands
 - Roadway Type

Information Requirements

Traffic Volume Data

- Include:
 - Main Road (greatest hourly traffic volume)
 - Representative Average Day Volume
 - Vehicle Counts
 - Bicycles
 - Heavy Vehicle Movements

Information Requirements

Pedestrian Volume Data

- Adjusted Pedestrian Volume used in Justification based on:
 - Unassisted (adults and adolescents aged ≥ 12 years)
 - Assisted (children under 12, senior citizens, disabled pedestrians, etc.)
- Adjusted Volume = Unassisted Pedestrian Volume + 2 x Assisted Pedestrian Volume

Information Requirements

Collision Data

- Reportable Collisions – personal injury or property damage collisions that appeared to require police reports

Information Requirements

Supplementary Input Data

- Additional data which provide better understanding of Intersection Operation:
 - Vehicle Delay
 - Gaps
 - Site Conditions

Principles of Justification

- Signal Installations usually Initiated by Complaints or Analysis of Delay, Safety, etc.
- Technical Framework needed to Justify Signals
- At least One of Seven Justifications must be Satisfied

Justification 1

Minimum Vehicle Volume

- Considers Cumulative Delay produced by Large Volume of Intersecting Traffic
- Compares:
 - Lowest Total Intersection Volume – 1A
 - Lowest Volume on Minor Road – 1B
- Both 1A and 1B must be 100% satisfied

Justification 2

Delay to Cross Traffic

- Applied where Heavy Main Road Volume results in Excessive Minor Road Delay or Hazardous Crossing Conditions
- Compares:
 - Major Road Volume – 2A
 - Minor Road Movements Crossing Intersection – 2B
- Both 2A and 2B must be 100% satisfied

Justification 3

Volume/Delay Combination

- Used occasionally where Justifications 1 or 2 are:
 - $80\% \leq \text{Satisfied} < 100\%$
- Applied only after other Remedial Measures failed to solve Operational Issues

Justification 4

Minimum Four-Hour Vehicle Volume

- Intended for Intersections with Excessive Peak Hour Delays (4 hrs < Delay < 8 hrs)
- Not to be Applied in Combination with other Justifications!

Justification 5

Collision Experience

- Signals may be considered at Intersections with Unusually High Collision History (Average of 5 or more Collisions susceptible to correction per 12 month period)
- Less restrictive Remedies and Enforcement failed to reduce Collisions

Justification 6

Pedestrian Volume Delay

- Applicable where Pedestrians experience Excessive Delays or Hazard due to heavy Traffic Volumes
- Also applicable for high Pedestrian Crossing Volumes
- Justification may occur at Unsignalized Intersection or Mid-Block

Justification 7

Projected Volumes

- Peak Hour Volumes (Future Development)
Converted to Average Hourly Volumes (AHV)
- AHV applied to Justifications 1 and 2
- Existing Signals - Satisfy 1 and 2 by 120%
- New Signals - Satisfy 1 and 2 by 150%

Signal Installation Prioritization

- Network-wide Framework for addressing Funding Limitations or other Constraints
- Signals Rank in terms of Benefit/Cost Ratios
- Movement of People and Safety are Primary Considerations
- Signals with Highest Overall Benefits are given Priority

Removal of Existing Signals

- ALWAYS consult with affected Community
- Inform Public of Removal Study using Signs
- Analyze Signal using Justifications 1 to 6 as for New Signal
 - Signal Fails 1 to 6 - Consider Removal
 - Only 6 Satisfied – Ensure Appropriate Pedestrian Crossing Protection is Used

Appendix A

Collision Experience/Safety Change Estimation

- Analysis and Evaluation Tool for Estimating Likely Safety Impact following Signal Installation
- Process improves on Justification 5 – “Collision Experience”
- Uses Empirical Bayes (EB) Statistical Analysis Method combined with Expected Collision Performance

Ontario Traffic Manual Book 12 – Traffic Signals

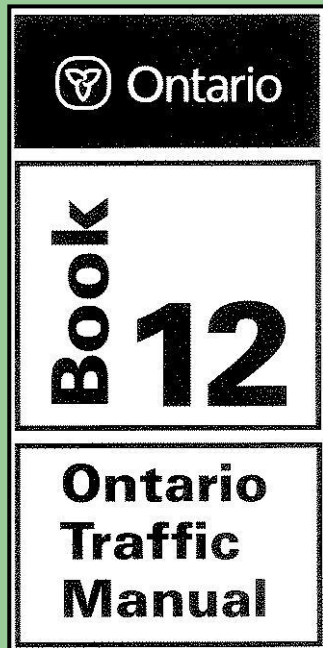

Training Material
Section 5
Design Practice

Traffic Signals:

- Warn of intersecting roadways
- Convey control messages
- Alternate right-of-way among road users
- Promote observance with the law

General

Section 5 of OTM Book 12 is intended to:

- Provide General Design Interpretation
- Provide Recommended Practices
- Provide Guidance for the Design of Traffic Signals

Practical Requirements

Responsibility of Designer:

- Free of Utility Interference
- Meets Signal Head Visibility Requirements
- Compatible with the Roadway, Pavement Structure and Roadside Works
- Uses Standardized Equipment
- Is readily Expandable to additional Phases or Movements

Safety Considerations

Detailed Design should include the following safety factors:

- Adequate Pole Offset
- Pole types that meet Requirements
- Adequate Vertical Clearance
- Proper Electrical Fusing, Connection and Grounding

Future Considerations

Anticipated Traffic Demand

- Prepare Needs Report or Justification Report for Current Traffic Volume and 5 Year Horizon.
- Incorporate Future Needs into Current Design
- Provide Underground Provisions at New Intersections for Future Needs

Signal Visibility

General

- Signal Visibility is Critical in Ensuring Drivers Receive Timely Information about the Need to Slow or Stop

Signal Visibility

Non-Geometric Considerations

- Lamp Ratings, Lumen Output & Age
- Reflectors and Refractors
- Dirt Accumulation
- 'Sun Phantoms' Appears ON when Not
- Type of Optical System
- Size of Lenses

Signal Visibility

Signal Head Locations

Signal Head Conspicuity is affected by the following:

- Horizontal and Vertical Curve Alignment
- Visual Obstructions or Distractions
- Contrasting Signal Heads and Backboards
- Ensure Standardized Placement

Signal Visibility

Lateral Signal Head Locations

With Median Island Secondary Head

- Pavement Edge (0.5m over receiving lane preferred)

Without Median Island Secondary Head

- $\frac{1}{2}$ to $\frac{3}{4}$ point of Receiving Curb Lane

Signal Visibility

Signal Visibility Distance

85 th Percentile Speed (km/h)	Minimum Distance from Which Signal Must be Clearly Visible (m)
40	65
50	85
60	110
70	135
80	165
90	200
100	230

Signal Visibility

Mounting Height

Legally Set Under Highway Traffic Act – Section 2

- Minimum Mounting Height 2.75m for Secondary Head (Posted Speed less than 80 km/h)
- Primary Mounting Height 5.0m
- Primary and Secondary Mounting Height 5.0m (Posted Speed equal or greater than 80 km/h)

Signal Visibility

Obstruction by Other Signals

- Ensure that Near Side Secondary Head is not Blocking the front of the Far Side Primary Head
- One Signal Head must be Visible to Approaching Motorist at all Times (Based on Minimum Sight Distance)

Signal Visibility

Backboards

- Recommended for all Primary Heads
- Preferred for all Heads
- Typical Use:
 - Posted Speed greater than 60km/h
 - Use Backboard for Primary and Secondary Heads
 - Posted Speed less than 60km/h
 - Use Backboard for Primary Head (Secondary Head Optional)

Signal Visibility

Auxiliary Signal Heads and Beacons

Used to Warn in Advance of Obstructed Signal

- Auxiliary Signal Heads must Display the same Indications and have the same Timing as the Primary and/or Secondary Heads
- Auxiliary Signal Heads or 'Signals Ahead' Flasher Signs must meet the Minimum Signal Visibility Distance

Signal Visibility

L.E.D. Signal Heads

ITE Published Specifications for 300mm and 200mm
Traffic Signals

- Modules must fit into Existing Traffic Signal Housing built to the VTCSH Standard
- Modules must Connect Directly to Existing Electrical Wiring System
- Module must Replace Existing Optical Components

Signal Visibility

Optically Programmable Signal Heads

Precise Lane Control by means of Projecting an Indication that is Visible only within the Boundaries of a Specific Area

- Used for Closely Spaced, Offset or Skewed Intersections

Pole and Signal Head Locations

Primary Signal Head Locations

In Addition to Lateral Placement

- Minimum Longitudinal Distance from the Approach Stop Line - 12m (15m preferred)
- Maximum Longitudinal Distance from the Approach Stop Line - 55m

Pole and Signal Head Locations

Secondary Signal Head and Pole Locations

- Minimum Lateral Distance from Primary Head - 5m (15m desirable) without Medians
- Maximum Longitudinal Distance either way from Primary Pole - 10m without Medians
- Ensure same elevation level to Primary Head from motorist's perspective at Median Islands

Pedestrian Signal Heads

Pedestrian Indications

- Must consist of:
 - “lunar white” Walking Pedestrian Symbol (outline or solid)
 - “translucent orange” Hand Outline Symbol
- Illuminated Symbols must be Visible from 30m under Normal Conditions
- Use Flashing Hand Outline to warn Walking Time is ending

Pedestrian Signal Heads

Pedestrian Signal Head Installation

- Mandatory where Independent Control of Pedestrian Phases is desired and to eliminate Pedestrian confusion
- Usually desirable on all Crosswalks at an Intersection for uniformity

Pedestrian Signal Heads

Pedestrian Pushbuttons

- Required at Pedestrian Actuated Traffic Signals
- Installed at Minimum Height 1.1m on “through sidewalk” side of Pole
- In line with Crosswalk and within 3.0m of Crosswalk Edge

Pedestrian Signal Heads

Mounting Height and Location

- Minimum Height of 2.5m from finished Grade of Pavement Edge to bottom of Signal Housing
- If practical, mount directly behind Sidewalk facing Crosswalk
- May mount within 3.0m from Sidewalk Edge facing Crosswalk and laterally within 1.5m

Pedestrian Signal Heads

Accessible Pedestrian Signals

- Designed to assist Visually Impaired Pedestrians
- Communicate Pedestrian Timing information through Audible Tones, Verbal Messages, and/or Vibrating Surfaces
- Must be used in Combination with Pedestrian Signal Timing

Pedestrian Signal Heads

Pedestrian Countdown Displays

- Provide Visual descending Numerical Countdowns indicating number of Remaining Seconds available for Crossing
- Optional Device for installation on Pedestrian Signal Heads

Miscellaneous Traffic Control

The following is a list of Traffic Control Devices or Methods identified and explained in detail within Chapter 5 of OTM Book 12

- Intersection Pedestrian Signals
- Mid-Block Pedestrian Signals
- Lane Directional Signals
- Ramp Metering Signals
- Signals Near Railway Crossings
- Transit Priority Signals
- Movable Span Bridge Signals
- Temporary Traffic Control and Portable Lane Control Signals
- Tunnel Signals
- Bicycle Control Signals

Detection

- Vehicle Detection at Actuated Traffic Signals is Commonly used to indicate need for Call or Extension of Green Time
- Also used to indicate Vehicles Waiting for Signal Indications to change
- Various Vehicle Detectors are Available
- Pedestrians, Emergency and Transit Vehicles Detectors are also Available

Layout Design

- Safety Considerations should be closely followed when laying out Primary and Secondary Pole Locations
- Inappropriate Crosswalks or Sidewalks Design can significantly hinder Traffic Signals Design

Utilities

- Designer must capture Temporary and Final Utilities Locations during Construction with special emphasis on Overhead High Voltage Lines
- Note that Underground Utility Plans are not reliable – Spot Excavations may be needed
- Co-operation and Compromise between Utilities and Road Authority is Vital

Layout Practice

The following is a list of Traffic Signal Guidelines or Practices identified and explained in detail within Chapter 5 of OTM Book 12

- “T” Intersection Approach
- Approach Without Median Island
- Approach With Median Island
- Approach With Wide Median
- Approach with Double Lane LTL
- Ramp Terminal Opposite Free-Flow Ramp
- Short Offset Intersections
- Long Offset Intersections
- Pedestrian Signal Poles

Controller Locations

- Consider Safety, Maintenance Access, Visibility of approaching Traffic, Service Supply, grounding and Electromagnetic Interference during Location Design
- Detailed Location Design is covered in MTO Electrical Design Manual

Ontario Traffic Manual Book 12 – Traffic Signals

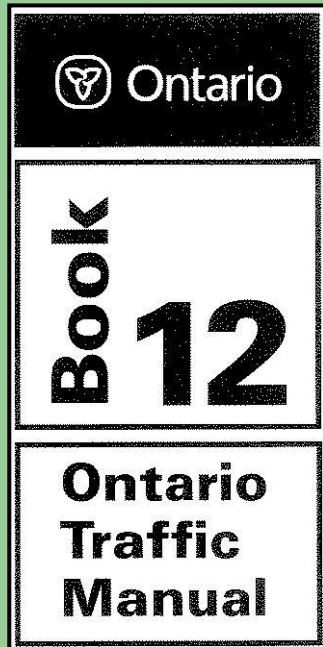

Training Material
Section 6
Miscellaneous

Standard Equipment

- Consideration for uses of standard equipment:
 - Compatibility with existing field equipment
 - Some municipalities make allowances for special equipment e.g. beautification schemes
 - Best practice is to make signals as close to standard as is practical

Other Consideration

- Electrical Considerations
 - Traffic control signal design has traditionally been managed and approved by traffic engineers
 - Traffic signal installations in Ontario are subject to inspections from the Electrical Safety Authority (ESA)
 - Recommended practices
- Aesthetic Considerations

Lamps, Lenses & Visors

- Compliance with ITE specifications
- Lamps - compliance with ITE specification for luminous output and for ruggedness and relative longevity
- Lenses - standard prismatic plastic refractors meeting the requirements in the ITE Specification *Vehicle Traffic Control Signal Heads* contained in ITE Publication No. ST-017. Optically programmable lenses and LED excepted
- Visors must be used on all signal display assemblies

Uninterruptible Power Supplies

- Uninterruptible Power Supplies (UPS) is a backup system that allow the signals to continue to operate for a short while after a power interruption
- UPS protect the control equipment from variations or surges in the supply voltage
- Criteria to consider when establishing priority locations for UPS control

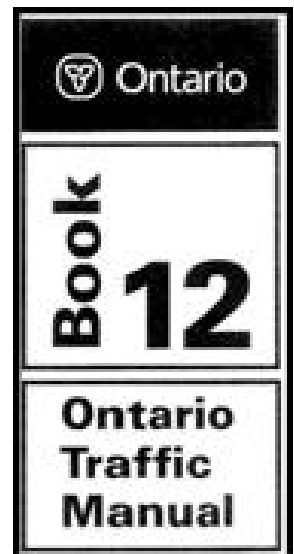

Ontario Traffic Manual Traffic Signals

Training Notes

Training Material – Section 1 – General Information

This training material has been developed to summarize the information provided in Book 12 of the Ontario Traffic Manual Series. It is provided as both slides and text. The slides are intended to summarize in point form the important aspects of the material from Book 12 and will include graphics, figures, photos or charts to enhance the trainees understanding of the points. The text is intended to provide a more detailed explanation to the points. However, the training material is by necessity presented at a cursory level. For additional details, the trainee is referred to the actual manual.

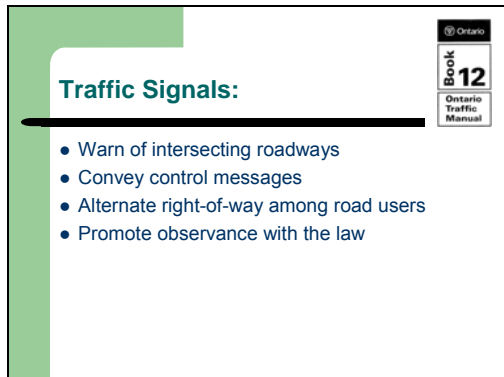

Traffic Signals:

- Warn of intersecting roadways
- Convey control messages
- Alternate right-of-way among road users
- Promote observance with the law

Ontario
Book 12
Ontario Traffic Manual

Traffic control signals intend to convey control messages to the road user. The objective of these messages is to advise motorists of traffic regulations in order to enable observance of the law, warn of intersecting roadways or road hazards, and provide the information necessary for the driver to safely navigate through the intersection.

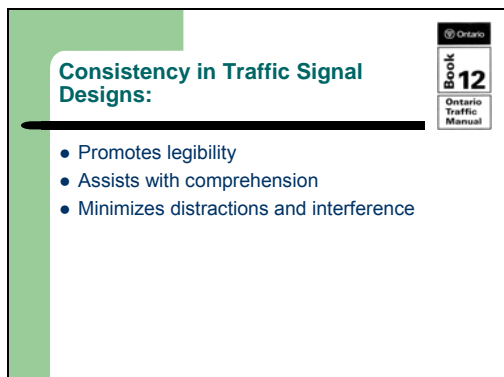

Consistency in Traffic Signal Designs:

- Promotes legibility
- Assists with comprehension
- Minimizes distractions and interference

Ontario
Book 12
Ontario Traffic Manual

If traffic control signals are not properly designed, installed and operated, they can interfere and distract from each other, become visually ineffective and lose their effectiveness through excessive use. Therefore, simplicity in design, care in placement and a high standard of maintenance are essential. An effective traffic control signal will attract attention, be legible and comprehensible and be appropriate to the road user's needs.

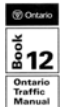

OTM Book 12:

- Provides elementary instructions
- Acts as a reference for experienced persons
- Provides recommended best practices

Book 12 of the Ontario Traffic Manual (OTM) is a user manual intended to provide some elementary instructions to beginners and to provide a reference to experienced persons for the design and operation of traffic signals. The intent is to provide a recommended best practice guide.



Sections of Book 12

- Section 1 – General Information
- Section 2 – Legal Requirements
- Section 3 – Operational Practice
- Section 4 – Planning and Justification
- Section 5 – Design Practice
- Section 6 – Miscellaneous

The Manual is organized in the order shown:



Use of Terms (1)

- Legal Requirements
 - Established under the Highway Traffic Act and Regulations
 - Use “must”
- Interpretation
 - Not precise wording but interpretations of the HTA and its regulations
 - Use “must” or “shall”

”**Legal Requirement(s)**”, “**Legally Required**”, “**Legal**” and equivalent terms mean that the requirement is the law of Ontario as established under the Highway Traffic Act 7 (HTA) and its Regulations. The requirement is typically described by the use of “shall” or “must”. “**Must**” indicates that the requirements of the design or application of the device as described in this manual are mandatory.

”**Interpretation**” means the interpretations and emphasis of the legal requirements. The interpretations are not necessarily precise wording interpretations of the HTA7 and Regulations. The interpretations are given in lay language and may include some jargons of the industry. The requirement is typically described by the use of “shall”. “**Shall**” means the same as “must”.



Use of Terms (2)

- Recommended Practice
 - Manner in which the legal requirements are applied
 - Use "should"
- Guideline
 - Method of practical application
 - Use "may"

“**Recommended Practice**” suggests a consistent manner in which the legal requirements and interpretations are applied using the typical procedures and equipments in use in Ontario. The recommended practices are not necessarily the only practices available based on the interpretation of the legal requirements or the selection of equipment or methods of operation. The recommendation is typically described by the use of “should”. “**Should**” indicates that the action is advised; recommended but not mandatory.

”**Guideline**” suggests a method of practical application of the legal requirements and interpretations using the typical procedures and equipments and methods of operation in use in Ontario. The guidelines are meant to provide guidance to those in the traffic signal industry who may be unsure of the methods of application. A guideline has no legal connotation and several alternate methods of achieving the same result may be available. A guideline is typically described by the use of “may”. “**May**” indicates a permissive condition. No requirement for design or application is intended.

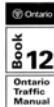

Unjustified Traffic Control Signals:

- May increase overall delay
- Contribute to disobedience
- Increase noise and fuel consumption
- Do not necessarily improve safety
- Do not work well to calm traffic

Unjustified traffic control signals can lead to excessive delay, increased use of fuel, increased air pollution, increased noise, motorist frustration, greater disobedience of the signals and to the use of alternate routes in attempting to avoid these types of signals. Unjustified traffic control signals may alter the type of collisions and in some cases increase the collision frequency, particularly rear-end collisions, as opposed to right-angle collisions prevalent at intersections controlled by stop signs. Therefore, installation of traffic control signals does not necessarily guarantee a reduction in collision frequency however some signals can be justified on a safety basis only.

A traffic control signal is a control device rather than a safety device. Traffic control signals should not be used for traffic calming schemes, for limiting traffic volumes on specific routes, for speed control devices, for demand control devices or for the discouragement of motorists and pedestrians for use of a specific route.

 **Book 12**
Ontario Traffic Manual

Driver's Needs & Limitations

- Drivers will find information if it is where they expect it to be
- Standardization is critical for drivers to find the traffic control devices
- Standards should promote uniformity in application and design

During the design of traffic control signals, consideration must be given to how drivers search the roadway, how driving demands affect what drivers notice, and drivers' tendency to inattention in familiar or monotonous environments.

Where drivers look is mainly determined by the demands of the driving task. For this reason standardization in location and design of traffic control devices is critical in assisting the driver to know where to direct his attention and when. The standards selected for the design and operations of traffic control signals need to continually promote effective communication to drivers.

 **Book 12**
Ontario Traffic Manual

Continuity of Operations

- Once activated, signals should operate continuously

Unless absent of power, or unusual or emergency conditions prevail at the intersection, a set of traffic signals should always operate with some active indications displayed to the road users. If activities are planned that involve the deactivation of the signal indications, control should be provided by a police officer.

When the traffic signal is to be taken out of service for an extended period of time, the signal heads should be either removed or the signal indications covered in such a manner that they are no longer visible to motorists and/or pedestrians.

Training Material – Section 2 – Legal Requirements

This training material has been developed to summarize the information provided in Book 12 of the Ontario Traffic Manual Series. It is provided as both slides and text. The slides are intended to summarize in point form the important aspects of the material from Book 12 and will include graphics, figures, photos or charts to enhance the trainees understanding of the points. The text is intended to provide a more detailed explanation to the points. However, the training material is by necessity presented at a cursory level. For additional details, the trainee is referred to the actual manual.

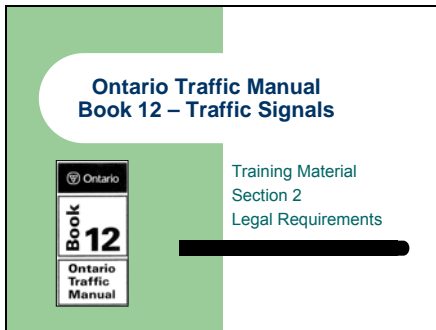

Section 2 provides an interpretation of various Sections and Regulations of the Highway Traffic Act (HTA) associated with traffic control signal systems and traffic control signals.

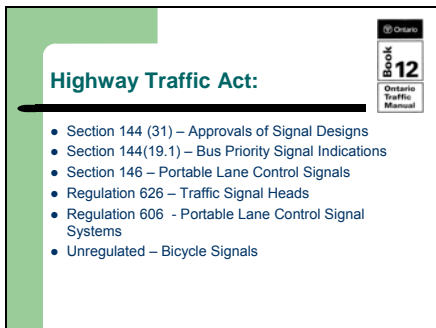

The Sections of the HTA covered in Section 2 include:
Section 144 (31) – Approvals of Signal Designs
Section 144(19.1) – Bus Priority Signal Indications
Section 146 – Portable Lane Control Signals
Regulation 626 – Traffic Signal Heads
Regulation 606 - Portable Lane Control Signal Systems
Unregulated – Bicycle Signals

HTA Statute 144 (31) – Approvals of Signal Designs

- Road Authorities are responsible to designate a person to approval traffic signals
- Signals shall not be installed until approved
- Ministry shall approve signals on connecting links

Book 12
Ontario Traffic Manual

- i All Road Authorities in Ontario are responsible for designating a person to approve traffic signal designs and installations on their own roadways;
- ii The Ministry of Transportation must approve traffic signal designs and installations for connecting links; and
- iii For highways and ramp terminal intersections under Ministry jurisdiction but where the Ministry has entered into maintenance and operations agreements with Municipalities, the particular Municipality is responsible for preparing the legal drawing (PHM-125 format) and submitting it to the Ministry for approval.

Designated Persons

- Competent and qualified
- May designate through Council resolutions
- Recommended both the designer and the person designated to authorize
- Drawings are recommended (representing head placements and aiming requirements)
- Expertise may be acquired externally

Book 12
Ontario Traffic Manual

It is a recommended practice that all road authorities should ensure that competent, qualified persons review the design for the traffic control signal system to ensure the design complies with applicable standards and guidelines, thereby optimizing the safety and operation of the signal and assisting in the protection of the road authority should a traffic collision or other mishap occur. In many cases, Municipalities have formally designated the positions responsible for the approval through Council resolutions (although this is not specifically required by law). It is recommended practice that the responsibility for approval should be granted to two people, both the designer and another person designated to authorize the signal design. It is also recommended that the signal design be represented as a drawing as this is the best way to represent head placements and aiming requirements that are consistent with HTA Regulation 626, this manual and the road authority's internal standards.

Where smaller Municipalities are undertaking traffic signal installations or modifications and do not have a person experienced with the work, it is strongly suggested that the Municipalities engage competent, qualified persons with experience and training who can design, and/or certify the design, prior to approval by the designated persons of the Municipalities. These persons do not have to be an internal staff member.

White Vertical Bar Indication

- Transit signals apply to the lane(s) occupied by transit vehicles.
- An education program for transit drivers (as well as the public) is strongly recommended
- The total number of indications per head, including the transit section, should not exceed five.

Book 12
Ontario Traffic Manual

Transit signals apply to the lane(s) occupied by the transit vehicles. It is strongly recommended that all transit operators be educated on the safe operation of transit signals when first introduced on a jurisdictions' roadways.

Transit signals must also conform to the standards set out in HTA Regulation 626. Where a white vertical bar transit priority section is used, the total number of indications, including the transit section, should not exceed five

Flashing Green

- Circular flashing green provides advanced phase in a single direction only
- Flashing arrows are recognized in the HTA as substitutes for the flashing green (subject to individual legal interpretations)
- SUNSET CLAUSE – January 1, 2010 – Flashing green no longer permitted

Book 12
Ontario Traffic Manual

The circular flashing green indication has been used to provide a separate advanced left turn phase to represent the protected portion of a protected/permissive phase in a single direction only. The protected portion of the protected/permissive left turn phase may also be provided using a solid or flashing arrow in conjunction with a green ball.

Ontario is one of only a few users of the circular flashing advanced green in North America and its' use may cause some confusion for unfamiliar motorists. Consequently, it is recommended that after January 1, 2010 the use of the circular flashing advanced green should no longer be permitted in Ontario. During the phase out period, it is strongly recommended that a flashing green arrow not be used in the proximity of intersections with circular flashing advanced greens since drivers may be confused by the different methods.

Road Authorities are encouraged to seek their own legal interpretation of the Highway Traffic Act prior to adopting the use of flashing arrows.

Minimum Signal Head Requirements

- Every traffic control signal head must have a circular red and amber indication
- Every traffic control signal head must have a green indication composed of:
 - A circular indication
 - An arrow

Every traffic control signal must have a mandatory circular red and circular amber indication and a mandatory green indication. The green indication may be composed of a single circular green or a maximum of three green arrows, indicating only right, left and through traffic movements. Every circular green indication must have an circular amber indication to indicate that the green interval has ended;

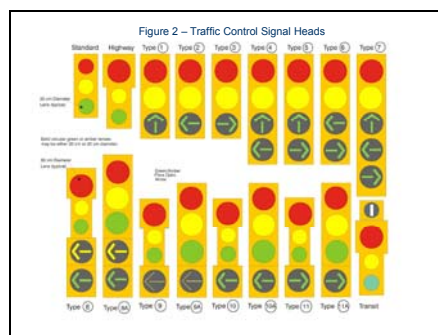

Figure 2 – Traffic Control Signal Heads

For reasons of simplicity and physical constraints and to increase their effectiveness, it is a recommended practice that no more than five indications should be combined in one signal head. The standard indications shown in Figure 2 are the only configurations that should be allowed to be installed in the majority of circumstances so that the burden of interpretation is not on the motorist.

Lens sizes may be either 20 cm or 30 cm for solid green and amber circular displays in any of the signal heads given in Figure 2. All arrow lenses and all circular red lenses, except the red lens for the "standard" signal head, should be 30 cm diameter.

Requirement for Two Signal Heads

- Every approach requires two signal heads (including a private driveway that fronts onto an intersection)
- At least one signal head must be mounted on the far right side
- All approaches at an intersection must be signalized except for Intersection Pedestrian Signals

The signal head on the far right side is designated as the "primary" signal head. The signal head on the left of the primary head is designated as the "secondary" signal head. A signal head installed in addition to the primary and secondary signal heads is for the purposes of aiding in signal visibility and is termed an "auxiliary" signal head.

Auxiliary signal heads shall display the same indications, at the same times, as the primary and secondary heads. If signal head indications are timed differently, they must be on a separate phase from the primary and secondary heads.

Two separate signal heads shall be provided for any fully protected phase, (such as a left turn operation facing type 2 signal heads), a bicycle phase, or a phase that

represents the only opportunity for traffic to be served during a cycle. In the case of the fully protected left turn operation, the type 2 head on the traffic island is the primary signal and the type 2 signal head on the far left side of the intersection fulfills the need for the secondary signal head.

A protected/permissive left turn operation facing type 8, 8A, 9, 9A, 10 or 10A signal heads mounted in the median traffic island must not utilize four signal heads on the same side of the intersection to ensure the orientation of the heads is distinct from a fully protected type of left operation.

Intersection Pedestrian Signals

- Roadway being signalized must have two signal heads facing approaching traffic in each direction
- Other roadway is controlled with stop signs
- Intended for use as an alternative to Pedestrian Crossovers
- Conventional pedestrian heads are required

For the roadway being signalized, two signal heads must face approaching traffic in each direction. The signal heads shall be conventional "standard" or "highway" signal heads as no turns are to be signalized, although a Transit Priority signal head may be used for turning buses. The other roadway is always controlled with stop sign(s).

IPS applications are intended for use as an alternative to Pedestrian Crossovers (PXOs). At this time, it is recommended that the IPS should be restricted to a single crosswalk at any intersection. The opposite side of the intersection requires a pedestrian crossing prohibition sign.

Conventional pedestrian heads are required to cross the main roadway as there are no other signal indications facing either direction along the crosswalk.

Height of Signal Heads

- Minimum of 5.0 m when over traffic lanes
- 5.8 m recommended for span wire installations
- Secondary heads (not over traffic lanes) may be mounted between 2.75 m and 5.0 m
- Intermediate mounting heights for secondary heads should be used to optimize visibility

The recommended practice for mounting of any signal heads over traffic lanes is 5.0 m height, with 5.8 m recommended for span-wire mounted signal heads. It has been found by experience that signal heads mounted at the 4.5 m minimum height sometimes interfere with over height trucks, loose truck tarpaulins or similar objects and are then damaged. Further, span-wire mounted signals with 8-pole rather than 4-pole configurations may be considered so that the entire assembly is not damaged in the event of a vehicle colliding with a pole.

Secondary heads, where mounted on the far left and not

over traffic lanes, may be mounted at a minimum height of 2.75 m or higher and desirably at a height of 5.0 m so that they may be seen over the tops of vehicles from a distance. Intermediate mounting heights between 2.75 m and 5.0 m are useful to improve visibility in congested urban areas where it may be difficult to otherwise keep the secondary heads from being masked by the opposing primary heads. For roads of 80 km/h and over posted speed, all secondary heads should be mounted at least at the 5.0 m clearance height.

Don't Walk Signals

- Minimum 30 x 30 cm heads should be used
- Shape must conform to HTA Reg. 626 to satisfaction of road authority
- Minimum mounting height 2.75 m
- Do not mount over travelled portions of the roadway



Ontario
Book 12
Ontario Traffic Manual

Minimum 30 x 30 cm pedestrian control heads should be used. Light sources for pedestrian control indications must meet the colour requirements of ITE Publication ST-217. The shape of the orange hand shall conform with the figures provided in the HTA Regulation 626 Sub-section 1 to the satisfaction of the road authority.

The pedestrian control signal shall be mounted at a minimum height of 2.75 m or higher from finished grade to the bottom of the housing (clearance distance) if in a single housing or a minimum height of 2.75m from finished grade to the bottom of the “walk” section of the head where used independently or as part of a two-section “pedestrian head”. Pedestrian control indications shall be mounted so as to be visible along the crosswalk from the opposite side of the roadway at an intersection and shall not be mounted over the travelled portions of roads

Walk Signals

- Same size and mounting as don't walk
- Must not be displayed at the same time as the flashing don't walk indication
- Shape must conform to HTA Reg. 626 to satisfaction of road authority

Figure 1
300 mm
300 mm
White Symbol on Black Background

Figure 2
300 mm
300 mm
Black Symbol on White Background

The walking pedestrian symbol must not be displayed at any time during which the orange hand (“Don’t Walk”) or flashing orange hand (Pedestrian Clearance Interval) is displayed. The shape of the walking pedestrian symbol shall conform with the figures provided in the HTA Regulation 626 Sub-section 1 to the satisfaction of the road authority. Light sources for pedestrian control indications must meet the colour requirements of ITE Publication ST-217.

Orientation of Pedestrian Indications

- One of three orientations allows:
 - Both displays shown in the same lens
 - Hand symbol to the left of the walk symbol
 - Hand symbol above the walk symbol

Both the don't walk and the walk displays may be integrated into a single lens with the “hand” symbol superimposed on the “walking pedestrian” symbol or, both displays may be integrated in a single lens with the “hand” symbol to the left of the “walking pedestrian” symbol or the “walking pedestrian” symbol may be in a separate section mounted below the hand.

Signals Not At Intersections

- Midblock signals
- Private driveways
- Special applications:
 - Moveable bridge spans
 - Rail or transit crossings
 - Tunnels
- Ramp metering signals

The installation of traffic signals at locations other than intersections shall give an outward appearance to approaching motorists that is consistent with the appearance of a normally signalized intersection. All primary, secondary and auxiliary signal heads should obey the legal requirements as if an intersection where present in front of the activity that is taking place.

Amber Left Turn Arrows

- Simultaneous protected permissive left turns may not terminate at the same time
- Amber arrows must follow green arrows for protected permissive indications
- The left turn amber arrow may be:
 - In the same section as the green arrow, or
 - In a separate section mounted directly above the green arrow

Book 12
Ontario Traffic Manual

A simultaneous protected and permissive left turn operation includes opposing left turn movements which overlap but do not necessarily terminate at the same time. Where both a circular green and a left green arrow indication are used to allow simultaneous protected/permissive movements during a left turn, an amber arrow must follow a green arrow to conclude the protected left turn portion of the phase. The left turn amber arrow may be included with the green arrow in a single unit which changes from green to amber, or a separate amber arrow section may be mounted directly above the left green arrow section.

Portable Lane Control Systems

- Intended for mobile operations and "very short" or "short" duration work
- Two signal heads are recommended
- If used unattended or for "long" duration work, legal approval (with two signal heads) is required

Book 12
Ontario Traffic Manual



Portable lane control signals are intended for use on work sites for mobile operations, Very Short Duration or Short Duration Work as Defined in OTM Book 7, Temporary Conditions and should be operated during daylight hours where the signal is attended during use.

Two signal heads are recommended in a portable lane control situation and the second signal head be located in the standard secondary head location.

In the event that a portable lane control signal has to be left unattended or for Long term duration work as defined in OTM Book 7, Temporary Conditions, the signals should meet the requirements for temporary signals and a legal drawing should be prepared and approved, in conformance with Regulation 626 including the use of at least two signal heads for each approach.

Bicycle Signals

- Currently unregulated
- Municipalities may apply for a regulation granting permission for the pilot under the "New Technology Trial" legislation
- Refer to TAC – Traffic Signal Guidelines for Bicycles



© 2010 MTO
Ontario Traffic Manual
Book 12
Chapter 12.01
Traffic Signal Manual
Section 12.01.01
Bicycle Signals

There are currently no legal regulations or statutes for bicycle signals in the Province of Ontario. In the meantime, Municipalities, considering a pilot project to implement and study new signal displays not covered under the HTA may apply for a regulation granting permission for the pilot project for a period up to 12 years.

Although bicycle signals do not currently have any formal regulations in Ontario, they have been adopted in other parts of Canada. At the time Book 12 was updated, the Transportation Association of Canada is formulating guidelines for use and recommending the specifications for the symbol.

Training Material – Section 3 – Operational Practice

This training material has been developed to summarize the information provided in Book 12 of the Ontario Traffic Manual Series. It is provided as both slides and text. The slides are intended to summarize in point form the important aspects of the material from Book 12 and will include graphics, figures, photos or charts to enhance the trainees understanding of the points. The text is intended to provide a more detailed explanation to the points. However, the training material is by necessity presented at a cursory level. For additional details, the trainee is referred to the actual manual.

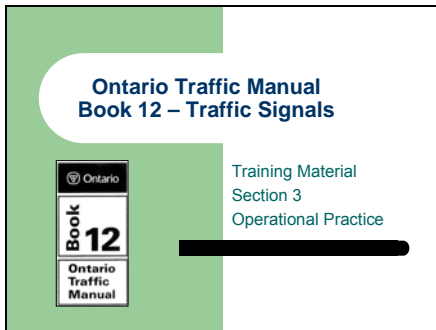

This training material has been developed to summarize the information provided in Book 12 of the Ontario Traffic Manual Series. It is provided as both slides and text. The slides are intended to summarize in point form the important aspects of the material from Book 12 and will include graphics, figures, photos or charts to enhance the trainees understanding of the points. The text is intended to provide a more detailed explanation to the points. However, the training material is by necessity presented at a cursory level. For additional details, the trainee is referred to the actual manual.

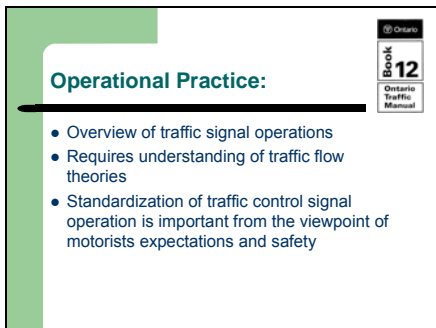

This part of the manual gives an overview of traffic signal operational practice.

Operational analysis requires an understanding of the theories of traffic flow and experience in its application to traffic control signals. References may be found in TRB's "Highway Capacity Manual" (HCM), in ITE's "Canadian Capacity Guide for Signalized Intersections" (CCG) and in the Ministry's "Traffic Control Signal Timing and Capacity Analysis at Signalized Intersections" (TCSTCA).

Standardization of many of the aspects of traffic control signal operations throughout Ontario is important from the viewpoint of motorists' expectations and safety. Items requiring standardization provincially and locally are:

the operational design of phasing requirements and phase and interval timing;
timing of clearance intervals; and
determination of phase omissions or additions by time-of-day.

Controller Operation

- Focus on solid state controller (Type 170 & Nema)
- Detailed information on controllers may be found in the publications of the major controller manufacturers

Book 12
Ontario Traffic Manual

The focus of the manual is on solid state controllers including the Type 170 controller and the NEMA Standard controller. Although other types of solid state and electro-mechanical controllers are still used by municipalities, they are not discussed in this manual. It is at the discretion of the roadway authority to select the type and brand of traffic signal controllers.

Detailed information on controllers may be found in the publications of the major controller manufacturers as stated in the manual:

Ontario Traffic Signal Control Equipment Specifications, MTO – Type 170

Traffic Control Systems, NEMA Standards Publications No. TS 1

Traffic Control Assemblies, NEMA Standards Publications No. TS 2

Determination of Intersection Operation

- The selection of the type of control
- The objective of the traffic control is to optimize traffic flow and provide measure of quality of service to road users
- Recommended four-step process

Book 12
Ontario Traffic Manual

The manual provides guideline in the selection of the type of control.

The stated objective of the traffic control is to optimize traffic flow and provide measure of quality of service to road users

To achieve these objectives the ITE's "Canadian Capacity Guide for Signalized Intersections¹" (CCG) recommends a four-step process which is paraphrased: 1) Definition of objectives, 2) Analysis, 3) Planning and Design, 4) Evaluation

Selection of Mode of Control

- Guideline for selecting control mode - pre-timed or fixed mode, actuated mode and semi-actuated mode
- Other considerations:
 - Long distance and double long distance detection
 - System operations and coordination

Book 12
Ontario Traffic Manual

The manual prescribes guideline for the selection of Mode of Control. The control modes may be used either for isolated intersections (operating independently) or within an interconnected system or a central system.

The manual also provides guideline for:

Long distance detection - used to provide an extra level of safety for motorists at high speed signalized intersections by providing dilemma zone protection. Double Long Distance Detection can be used where high speed vehicles (above the operating speed of the roadway) are creating a safety concern.

System operation - a system can vary from two or more

interconnected controllers to large centralized computers controlling thousands of intersection controllers. Coordination – which may be considered advantageous where intersections are spaced less than 1.0 km apart with posted speeds less than 80 km/h or are spaced less than 1.5 km apart for posted speeds of 80 km/h and over.



Phase Determination Principles

- The number and type of phases required will be largely dependent on the volumes and intersection geometrics
- Least number of phases should always be used to reduce lost time in phase determination

Principles for phase determination in the manual: The number of phases required for efficient operation depends on; the physical characteristics of the intersection, collision trends and patterns, and the through and turning movements taking place.

The least number of practical phases should always be used to reduce the “lost time” due to clearance intervals between phases.



Phase Numbering Convention

- Standard Movements
 - traffic movements identified by number according to the type of controller

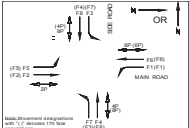

Note: Movement designations with 'P' designate the 'pedestrian' movements.

In the manual, it is recommended that the standard traffic movements be identified by number according to the type of controller. The type 170 controller and the NEMA type controller use similar numerical methods to identify phases. However, by convention, the side street phase numbers used by 170 and NEMA controllers are reversed.

The NEMA convention for traffic movements is shown in Figure 4. The “F” designates a “faze” (movement) number and “P” designates a pedestrian movement number.

Phase Intervals

- Each phase is broken down into sequence of intervals or indications
 - Two phase operations
 - Three phase operations
 - Multi phase operations

A phase can be broken down into a sequence of intervals. An interval may be defined as a period of time during which the signal indications do not change. An interval may include a green ball and green arrow for example, or a solid amber ball indication. The traditional normal sequence of indications is indicated in a phase “diagram”.

Various phasing operations are described in the manual:
 Two phase operation
 Three phase operation
 Multi phase operation

Phase Diagrams

The diagrams illustrate various phasing operations. The 2-Phase Diagram shows two phases (A and B) for both ITS and NEMA controllers. The 3-Phase Diagram shows three phases (A, B, and C) for both controllers. Each diagram includes symbols for green ball, green arrow, and solid amber ball.

The manual strongly recommends that phase sequence diagrams be on or attached to the approved signal plan to ensure the phasing matches the signal layout shown. **All phase sequence diagrams are specific to the intersection and must be individually devised.**

Pedestrian Phases

- Guideline for pedestrian phases
- Pedestrian Phase - pedestrian signal indications should follow the sequence:
 - Walking Pedestrian (“Walk”)
 - Flashing Hand (“Flashing Don’t Walk”, FDW)
 - Steady Hand Outline (“Don’t Walk”)
- Exclusive Pedestrian Phase may be used

Manual provides guideline for pedestrian phase design:

Pedestrian signal should follow the sequence: walking pedestrian, flashing hand, steady hand outline.

Exclusive pedestrian phases are normally required only where the volumes of crossing pedestrians are extremely high and safety is impaired by the use of normal pedestrian display intervals parallel to the (vehicle) signal head.

Pedestrian Signal Operation

Book 12
Ontario Traffic Manual

- Guideline for pedestrian signal operation
 - Pedestrian right-of-way
 - Clearance interval for pedestrians should terminate at onset of the accompanying vehicular amber
 - In practice, the clearance interval is allowed to continue until the beginning of the all-red

Pedestrians facing the Walking Pedestrian indication may enter the crosswalk and proceed in the direction of the Walk display.

For the pedestrian interval clearance, the Hand Outline should be a flashing indication. The clearance interval should terminate (and change to the steady Hand display) at the onset of the accompanying vehicular amber but in practice is allowed to continue until the beginning of the all-red.

Left Turn Phase Justification

Book 12
Ontario Traffic Manual

- Left turn phase justification
 - Left-turning movements are affected by turning volume, lane configurations, pedestrian movements, opposing traffic flow, the width of the intersection and the phasing of the traffic control signals.
 - The need for left-turn phases may be approximated using a simplified method by calculating the delay using the traffic volume (for preliminary assessment)

Except for the case of a protected left-turn phase, left-turning vehicles will take more time to clear the intersection than the straight through vehicles because of the opposing traffic. The left-turning vehicles may also block through vehicles unless a separate left-turn lane is provided with adequate storage.

A simplified method using traffic volumes to estimate delays may be used to initially analyze the need for left-turn phases at planned or existing signalized intersections.

Left Turn Phase Justification (Cont.)

Book 12
Ontario Traffic Manual

- Left turn phase justification – method of analysis:
 - Capacity Analysis Method (TCSTCA) - useful for planning of new signals; TCSTCA provides nomographs to assist with the analysis
 - Left-turn Delay Method (former Metro Transportation)

There are several methods used in Ontario to determine justification for separate left-turn phases. Two of these approaches are discussed as follows

Type of Left-turn Phase

- Determination of the Type of left-turn phase
- Types of left-turn phasing includes:
 - Advanced green, single direction
 - Protected/Permissive Simultaneous Left Turns
 - Fully Protected Simultaneous Left Turn
 - Permissive/Protected Lagging Left Turn – Single Direction
 - Separate Protected Left-Turn Operation (Separate Phasing)
 - Lagging Fully Protected Simultaneous Left Turn

Once it has been determined that a left-turn phase is required, it is necessary to assess the type of operational characteristics that are required. These range from the relatively simple and common protected/permissive advanced green on one approach only (using type 8, 8A, 9 or 9A signal heads), to the complex multiple phase operation with left-turn phases in all directions. They are documented in the manual.

Type of Left-turn Phase (Cont.)

Example of Left-turn phasing diagram

Timing

- Traffic demand analysis will determine the optimum interval timing to best balance safety and traffic flow efficiency.
- Guidelines include Ministry's "Traffic Control Signal Timing and Capacity Analysis at Signalized Intersections" and "ITE Canada's Canadian Capacity Guide for Signalized Intersections"
- The reference documents use the theory of intersection and lane flow ratios to determine minimum and optimum cycle times, capacity, delay and lost time per cycle.

In order to estimate the timing required for intervals and phases, it is necessary to have on hand reasonably up-to-date or predicted traffic volumes per movement. Prior to deriving the traffic control signal timing, vehicle and pedestrian traffic flow and equivalent volumes must be analyzed. Traffic demand analysis will determine the optimum interval timing to best balance safety and traffic flow efficiency.

Guidelines are primarily found in the Ministry's "Traffic Control Signal Timing and Capacity Analysis at Signalized Intersections" and ITE Canada's "Canadian Capacity Guide for Signalized Intersections".

The reference documents use the theory of intersection and lane flow ratios to determine minimum and optimum cycle times, capacity, delay and lost time per cycle.

Timing - Minimum Interval Timing

• Minimum interval timing is required

Interval	Desirable Minimum (seconds)	Acceptable Minimum (seconds)
Circle green for roads posted at less than 50 km/h	15.0	7.0
Circle green for roads posted at 50 km/h or more	20.0 (Main Road) 15.0 (Side Road)	10.0 (Main Road) 7.0 (Side Road)
Advanced Green	7.0	5.0
Flashing advanced green clearance	2.0	1.5
Circle amber	3.0	3.0
Amber arrow	3.0	2.0*
All red	1.0	1.0
Travel priority	5.0	3.0
Pushbutton walk	7.0	3.0
Redesign clearance	5.0	3.0

Motorists do not expect an immediate termination of a signal display that has just started.

The required clearance time for any through movement phase is related to the approach operating speed, the motorists' perception and reaction times, the crossing width of the intersection and the average deceleration rate of the vehicles. Amber times are set so that motorists can reach the intersection if the motorist is unable to stop when at the decision point for stopping or proceeding. The all red times are set so that vehicles just crossing the stop line have sufficient time to clear the intersection. It is generally accepted that the posted speed is used to ensure safe clearance times.

Timing - Clearance Interval

• Calculation of clearance interval (amber interval clearance and all-red interval clearance) is based on approach operating speed, the motorist's perception and reaction times, the crossing width and the average deceleration rate of the vehicles

clearance = Amber + All-Red

Amber indicates to the driver that the right-of-way is about to be changed and therefore must provide sufficient time for the approaching motorist to travel the Stopping Sight Distance

The all-red interval represents the time required to provide a safe passage across the intersection for vehicles entering the intersection at or near the end of the amber interval

The required clearance time for any through movement phase is related to the approach operating speed, the motorists' perception and reaction times, the crossing width of the intersection and the average deceleration rate of the vehicles. Amber times are set so that motorists can reach the intersection if the motorist is unable to stop when at the decision point for stopping or proceeding. The all red times are set so that vehicles just crossing the stop line have sufficient time to clear the intersection. It is generally accepted that the posted speed is used to ensure safe clearance times.

Timing - Clearance Interval (Cont.)

• Clearance for left-turn signals for:

- Left-turn green
- Fully protected left turns

A minimum clearance time of 1.5 to 3.0 seconds must follow the left-turn green (green arrow, or fast flash green ball) before the opposing traffic is released. An all red of 1.0 to 1.5 seconds may be used after the amber arrow if additional clearance is required.

Where the fully protected mode of operation in a left-turn lane is used, a nominal amber clearance time of 3.0 seconds should be used followed by a 1.5 second to 2.0 second all-red to complete the clearance of any left turning vehicles left trapped in the intersection 25.

Level of Service (LOS)

- Level of service may be determined based on delay

Level of service	Stopped delay per vehicle (seconds)
A	≤ 5.0
B	> 5.0 and ≤ 15.0
C	> 15.0 and ≤ 25.0
D	> 25.0 and ≤ 40.0
E	> 40.0 and ≤ 60.0
F	> 60.0

Various methods may be used to define the Level of Service (LOS) at an intersection.

The Level of Service for signalized intersections may be defined in terms of delay, which is a measure of driver discomfort and frustration, fuel consumption, and lost travel time as given in the HCM

Level of Service (LOS)

- Level of service may be based probability of clearing the intervals

Level of service	Probability of arrival vehicles clearing
A	95%
B	90%
C	75%
D	60%
E	50%

LOS may be based on a probability that all vehicles arriving in the critical lane will clear the intersection in one cycle (one green interval). This method is based on average lane arrivals per cycle per critical lane (note the actual arrival patterns could be different).

Determination of Green Interval Timing

- Determination of Green Interval Timing
 - Ministry of Transportation Methodology
 - Canadian Capacity Guide Methodology
 - Highway Capacity Manual Methodology
- Calculation of Green Extension Time
- Determination of Delays on Actuation

The analysis of the traffic flow to determine green interval times may be accomplished by several methods as prescribed in the manual.

The MTO methodology for calculating green times employs the Poisson random probability function. The degree of probability of the vehicles clearing the intersection determines the level of service.

The Canadian Capacity Guide for Signalized Intersections, 2nd Edition, (CCG) gives a theoretical method for determining capacity based on saturation flow. This method generally employs the use of arrival flows to represent travel demand for the analysis, design or evaluation at the intersection.

The Highway Capacity Manual (HCM) method uses volume to capacity ratios and average delays to measure intersection performance. Capacities are determined by multiplying “Saturation Flows” by the proportion of time the movements have green during the design hour.

Also includes guidelines for
 Calculation of Green Extension Time
 Determination of Delays on Actuation

Book 12
Ontario
Traffic
Manual

Calculation of Pedestrian Timing

- Pedestrian timings must be generous enough to ensure that pedestrians are given enough time to cross safely and comfortably, yet not over-generous such that service to vehicular traffic is unduly compromised
- Walking speed normally varies between 1.0 m/s and 1.25 m/s, 1.2 m/s is usually assumed for initial calculations
- CCG Method

Where pedestrians are present at signalized intersections, the minimum safe crossing needs should be accommodated in the times provided for the pedestrian interval (walk) and pedestrian clearance interval (flashing don't walk and solid don't walk). Pedestrian timings must be generous enough to ensure that pedestrians are given enough time to cross safely and comfortably, yet not over-generous such that service to vehicular traffic is unduly compromised.

The walking speed of pedestrians (W_s) normally varies between 1.0 m/s and 1.25 m/s. A normal walking speed of 1.2 m/s is usually assumed for initial calculations although the time of 1.0 m/s may be used at crossings frequented by young children, seniors and special needs persons.

This prescribed method is the Canadian Capacity Guide. For crosswalks without an island refuge (islands less than 1.5 m width), the pedestrian walk interval should allow time for the pedestrians to notice the change of the signal indication, and initiate the crossing.

Book 12
Ontario
Traffic
Manual

Determination of Cycle Length

- Cycle Length
 - Guideline for cycle length selection
 - Worked examples may be found in the TCSTCA and the CCG

The calculation and selection of cycle lengths requires an estimation of the "lost capacity" per phase due to start-up headways and the effects of cycle length on vehicle delay. It also requires good judgement on the part of the traffic engineer/analyst.

Many worked examples of cycle composition may be found in the TCSTCA and the CCG

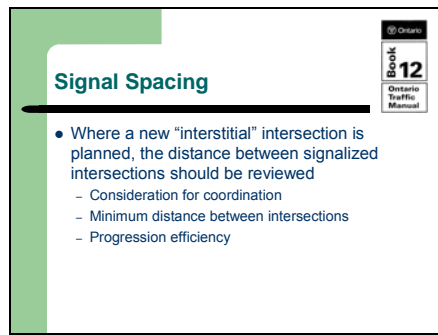

Where a new "interstitial" intersection is planned, the distance between signalized intersections should be reviewed with consideration to:

A coordinated system for local or central operation system

Minimum distance for different posted speed

Progression efficiency

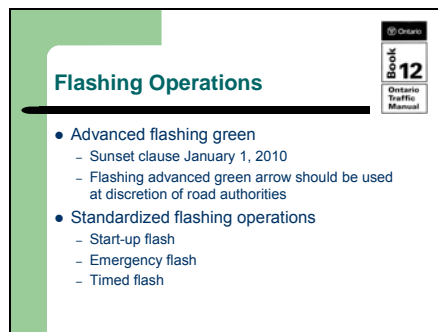

The circular flashing green indication has been used in Ontario to provide a separate advanced left turn phase for a single approach at the intersection when protected/permissive green is necessary in a single direction only. Ontario is one of only a few users of the circular flashing advanced green in North America and its use may cause some confusion for out-of-province motorists. Consequently the use of the circular flashing advanced green should no longer be permitted in Ontario after **January 1, 2010**. During the phase out period, it is strongly recommended that a flashing green arrow not be used in the proximity of intersections with circular flashing advanced greens since drivers may be confused by the different methods.

The national standards, as given in the TAC MUTCD12, use flashing arrow signals only and do not recognize steady arrow or flashing circular displays. The use of the arrow flashing advanced green is at the discretion of the road authority. It is recommended that, if the flashing advanced green arrow is used, that it only be used in an area which does not have any circular flashing advance greens.

Traffic control signals (which do not use left-turn arrow heads, excluding types 8, 8A, 9 and 9A in Figure 1, Section 2), may be switched from their normal phase indication to flashing operation. Three modes of flashing operation are normally used:

start-up flash

emergency flash

timed flash

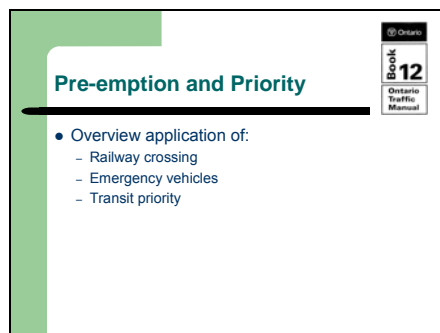

All modern controllers offer both pre-emption and priority operations in addition to signal plans. Pre-emption involves an interruption in the timing or phasing operations of the traffic signal. Priority operations allow for phasing and timing changes (generally within the active cycle time) that do not require the controller to interrupt the operations of the timing plan.

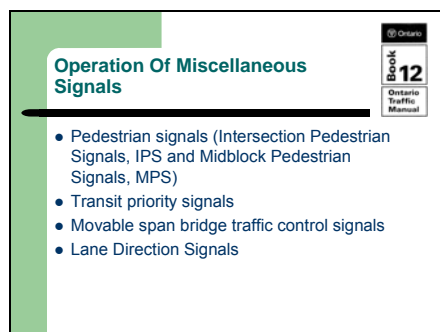

Traffic control signal systems which are intended to serve only pedestrian traffic may be installed at desirable pedestrian crossing locations. The locations may be at intersections (Intersection Pedestrian Signals or IPS) or between intersections (Midblock Pedestrian Signals or MPS). Both types require that main road traffic be fully signalized.

A transit priority signal display may be used to assign right-of-way to public transit vehicles over all other vehicular and pedestrian traffic movements within a signalized intersection.

When a roadway crosses a drawbridge, swing bridge or lift bridge, normal traffic signal heads should be considered in conjunction with control gates or other forms of physical protection. The traffic signals and protection system are to be interconnected with the bridge mechanism in such a way that the signal indications will change to amber at least 15 seconds before the gates are closed and will not show green at any time the bridge is not traversable.

Lane direction signals are used to legally indicate the direction of traffic flow on reversible direction lanes. The downward green arrow indicates right-of-way in the lane for through traffic approaching the display. A red "X" indicates that approaching traffic must not travel in the lane.

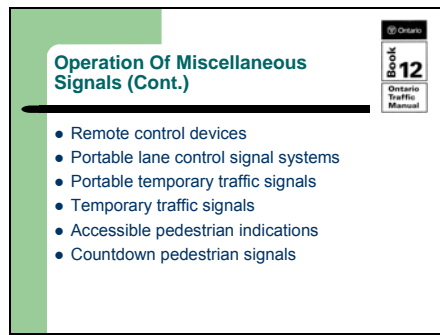

A remote control device is intended to augment a traffic control person and is used to separate two way traffic operations through a single lane. One remote control device is placed at each end of the lane closure displaying a red or amber lens, generally in conjunction with a control arm. A remote control device is **not** considered a traffic control signal according to the HTA allowing each road authority to establish their own policies to govern the use within construction zones.

Portable lane control signal systems - these signals are sometimes used to reduce traffic flow to a single lane in alternate directions at very local work areas requiring lane closures.

Portable Temporary Traffic Signals consist of standard traffic signal heads mounted on movable trailers. The trailers are typically positioned at intersections to emulate traffic control signals or can be used as portable lane control signals for short or very short duration work.

Temporary traffic signals typically consist of traffic signal heads positioned on span wires or temporary poles. Temporary signals are intended to be used as an alternative to permanent traffic signals for limited periods prior to or during re-construction of roadways.

Signalized intersections which are used by the visually impaired may be equipped with auxiliary audible or tactile devices to provide additional information about the status of the intersection or of the traffic signals, thereby aiding the crossing movement. The use of these devices at traffic signals may be best determined by a recognized agency or body trained in the needs of the visually impaired, such as the Canadian National Institute of the Blind.

Pedestrian countdown signals supplement the regular walk and flashing don't walk symbols with a numeric countdown of the number of seconds left in the interval(s).

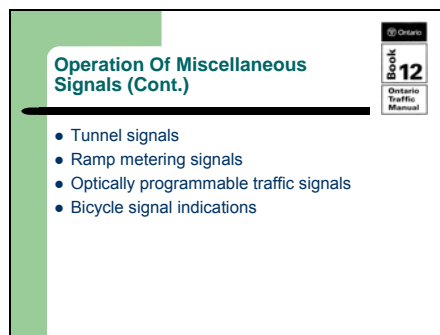

“Tunnel Signals” may consist of signals at the ends of a tunnel which are used to prohibit the entrance of traffic or lane control signals within the tunnel, and on the tunnel approaches.

Ramp metering signals are used on freeway or expressway entrance ramps to control the rate of traffic flow onto the highway. The operation of the metering signals is normally carried out only during rush hours and in a preferred direction (normally toward the CBD in morning and outbound from it in the evening).

Optically Programmable Signal indications can be used to limit the visibility of signal indications to specific areas. These types of indications are generally used to avoid conflicting or confusing indications to drivers approaching in adjacent lanes or where signals are very closely spaced. Example applications may include left turn indications on high speed roadways with centre medians or unusual geometric intersection configurations.

Bicycles are defined as vehicles in the Highway Traffic Act and therefore are governed by the rules of the road as defined in the act. Under the vast majority of circumstances, standard vehicle displays are adequate to control bicycle movements through intersections. The use of bicycle signals should, therefore, be limited to special circumstances and not randomly or universally applied to all signalized intersections

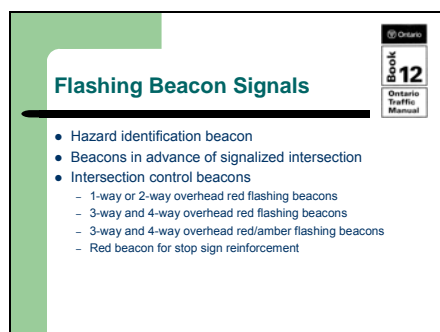

Flashing beacons may be used at locations where full traffic control signals are not justified but where, due to lack of visibility or other hazards, regulatory or cautionary signs alone are not sufficient.

Hazard beacons include those used for reinforcement of signs for obstructions in or immediately adjacent to the roadway or as a supplement to advance warning and regulatory signs such as KEEP RIGHT, STOP or SIGNALS AHEAD. They are also used as visual warning on pedestrian crossovers.

An intersection control beacon consists of either 20 cm or 30 cm diameter lenses with continuously flashing red or amber indications. Applications include overhead beacons mounted on suspension wire at the centre of an intersection and visual assistance where stop signs are

not conspicuous.

Flashing beacons may be used when two major high speed roads intersect in a rural area or when collision history suggests additional treatments are required.

1-Way or 2-Way Overhead Red Flashing Beacons
3-Way and 4-Way Overhead Red Flashing Beacons
3-Way and 4-Way Overhead Red/Amber Flashing Beacons
Red beacon for stop sign reinforcement

Flashing Beacon Signals (Cont.)

- Continuous advance warning beacons for traffic signals
- Active advance warning beacons for traffic signals

Book 12
Ontario Traffic Manual

These types of single 20 cm diameter beacons are used as reinforcement to the “Traffic Signals Ahead” symbolized warning signs where visibility of intersections with traffic control signals is restricted, where signal observance is found to be substandard or where signals may not be expected by motorists such as on remote highways.

The beacons are interconnected to the traffic control signal and are activated at the beginning of the corresponding amber signal display. The beacons continue to flash until the approach receives the next green signal indication. The beacons should also flash when the traffic control signal goes into flash operation.

Systems

- Traffic signal control systems can be used to operate, monitor and control traffic signal controllers located at each intersection. Traffic signal control systems can be very cost effective if frequent adjustments to the timing or more dynamic forms of control are required or frequent retrieval of the traffic data is necessary.

Book 12
Ontario Traffic Manual



Traffic Control Signals require regular maintenance in order to ensure that they are functioning properly, to maximize safety to the public and to proactively avoid potential operational problems.

Training Material – Section 4 – Planning and Justification

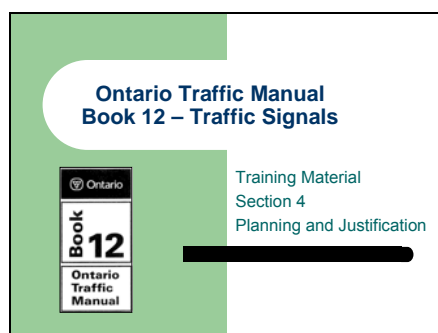

This training material has been developed to summarize the information provided in Book 12 of the Ontario Traffic Manual Series. It is provided as both slides and text. The slides are intended to summarize in point form the important aspects of the material from Book 12 and will included graphics, figures, photos or charts to enhance the trainees understanding of the points. The text is intended to provide a more detailed explanation to the points. However, the training material is by necessity presented at a cursory level. For additional details, the trainee is referred to the actual manual.

Traffic Signals:

- Warn of intersecting roadways
- Convey control messages
- Alternate right-of-way among road users
- Promote observance with the law

Book 12
Ontario Traffic Manual

Traffic control signals intend to convey control messages to the road user. The objective of these messages is to advise motorists of traffic regulations in order to enable observance of the law, warn of intersecting roadways or road hazards, and provide the information necessary for the driver to safely navigate through the intersection.

General

Section 4 of OTM Book 12 is intended to:

- Discuss the Planning and Justification for Traffic Signal Installation
- Provide Justifications (Seven in Total) for Traffic Signal Installation

Book 12
Ontario Traffic Manual

Information Requirements

Basic Input Data

- Analysis of Signal Justification requires:
 - > Intersection Configuration
 - > Traffic Volumes
 - > Pedestrian Volumes
 - > Roadway Speed
 - > Area Population
 - > Collision Data
 - > Pedestrian Delay
 - > Pedestrian Crossing Opportunities

Book 12
Ontario Traffic Manual

Information Requirements



Flow Conditions

- Justification developed for two types of Flow Conditions:
 - > Restricted Flow – Roads with Operating or Posted Speeds < 70 km/h (normally in urban areas)
 - > Free Flow - Roads with Operating or Posted Speeds \geq 70 km/h (normally in rural areas or controlled access in urban areas)

Information Requirements

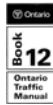

Intersection/Roadway Configuration

- Characteristics which affects Volume Justification values:
 - > Main Street Approach
 - > Median Islands
 - > Roadway Type

Information Requirements

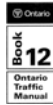

Traffic Volume Data

- Include:
 - > Main Road (greatest hourly traffic volume)
 - > Representative Average Day Volume
 - > Vehicle Counts
 - > Bicycles
 - > Heavy Vehicle Movements

Information Requirements



Pedestrian Volume Data

- Adjusted Pedestrian Volume used in Justification based on:
 - > Unassisted (adults and adolescents aged ≥ 12 years)
 - > Assisted (children under 12, senior citizens, disabled pedestrians, etc.)
- Adjusted Volume = Unassisted Pedestrian Volume + 2 x Assisted Pedestrian Volume

Information Requirements

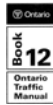

Collision Data

- Reportable Collisions – personal injury or property damage collisions that appeared to require police reports

Information Requirements

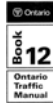

Supplementary Input Data

- Additional data which provide better understanding of Intersection Operation:
 - > Vehicle Delay
 - > Gaps
 - > Site Conditions

Principles of Justification

- Signal Installations usually Initiated by Complaints or Analysis of Delay, Safety, etc.
- Technical Framework needed to Justify Signals
- At least One of Seven Justifications must be Satisfied

Justification 1

Minimum Vehicle Volume

- Considers Cumulative Delay produced by Large Volume of Intersecting Traffic
- Compares:
 - > Lowest Total Intersection Volume – 1A
 - > Lowest Volume on Minor Road – 1B
- Both 1A and 1B must be 100% satisfied

Justification 2

Delay to Cross Traffic

- Applied where Heavy Main Road Volume results in Excessive Minor Road Delay or Hazardous Crossing Conditions
- Compares:
 - > Major Road Volume – 2A
 - > Minor Road Movements Crossing Intersection – 2B
- Both 2A and 2B must be 100% satisfied

Justification 3



Volume/Delay Combination

- Used occasionally where Justifications 1 or 2 are:
 - > $80\% \leq \text{Satisfied} < 100\%$
- Applied only after other Remedial Measures failed to solve Operational Issues

Justification 4

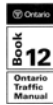

Minimum Four-Hour Vehicle Volume

- Intended for Intersections with Excessive Peak Hour Delays ($4 \text{ hrs} < \text{Delay} < 8 \text{ hrs}$)
- Not to be Applied in Combination with other Justifications!

Justification 5

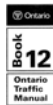

Collision Experience

- Signals may be considered at Intersections with Unusually High Collision History (Average of 5 or more Collisions susceptible to correction per 12 month period)
- Less restrictive Remedies and Enforcement failed to reduce Collisions

Justification 6



Pedestrian Volume Delay

- Applicable where Pedestrians experience Excessive Delays or Hazard due to heavy Traffic Volumes
- Also applicable for high Pedestrian Crossing Volumes
- Justification may occur at Unsignalized Intersection or Mid-Block

Justification 7

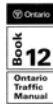

Projected Volumes

- Peak Hour Volumes (Future Development) Converted to Average Hourly Volumes (AHV)
- AHV applied to Justifications 1 and 2
- Existing Signals - Satisfy 1 and 2 by 120%
- New Signals - Satisfy 1 and 2 by 150%

Signal Installation Prioritization

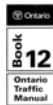

- Network-wide Framework for addressing Funding Limitations or other Constraints
- Signals Rank in terms of Benefit/Cost Ratios
- Movement of People and Safety are Primary Considerations
- Signals with Highest Overall Benefits are given Priority

Removal of Existing Signals



- ALWAYS consult with affected Community
- Inform Public of Removal Study using Signs
- Analyze Signal using Justifications 1 to 6 as for New Signal
 - Signal Fails 1 to 6 - Consider Removal
 - Only 6 Satisfied – Ensure Appropriate Pedestrian Crossing Protection is Used

Appendix A

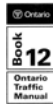

Collision Experience/Safety Change Estimation

- Analysis and Evaluation Tool for Estimating Likely Safety Impact following Signal Installation
- Process improves on Justification 5 – “Collision Experience”
- Uses Empirical Bayes (EB) Statistical Analysis Method combined with Expected Collision Performance

Training Material – Section 5 – Design Practice

This training material has been developed to summarize the information provided in Book 12 of the Ontario Traffic Manual Series. It is provided as both slides and text. The slides are intended to summarize in point form the important aspects of the material from Book 12 and will include graphics, figures, photos or charts to enhance the trainees understanding of the points. The text is intended to provide a more detailed explanation to the points. However, the training material is by necessity presented at a cursory level. For additional details, the trainee is referred to the actual manual.

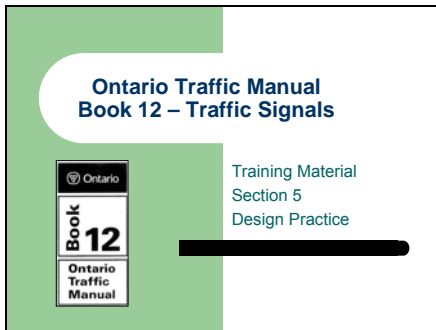

This training material has been developed to summarize the information provided in Book 12 of the Ontario Traffic Manual Series. It is provided as both slides and text. The slides are intended to summarize in point form the important aspects of the material from Book 12 and will include graphics, figures, photos or charts to enhance the trainees understanding of the points. The text is intended to provide a more detailed explanation to the points. However, the training material is by necessity presented at a cursory level. For additional details, the trainee is referred to the actual manual.

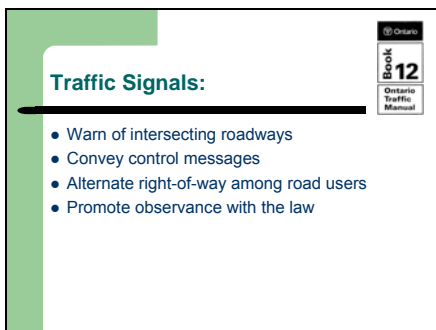

Traffic control signals intend to convey control messages to the road user. The objective of these messages is to advise motorists of traffic regulations in order to enable observance of the law, warn of intersecting roadways or road hazards, and provide the information necessary for the driver to safely navigate through the intersection.

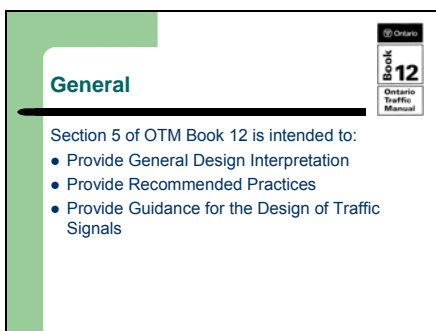

Although design practices and guidelines are recommended in this manual the advice of experienced people should be acquired for intersections with challenging configurations. Also, each road authority may have its own specific design requirements. Designers should refer to the authority's documents for design as this section of the manual provides only general design requirements.

Practical Requirements

Responsibility of Designer:

- Free of Utility Interference
- Meets Signal Head Visibility Requirements
- Compatible with the Roadway, Pavement Structure and Roadside Works
- Uses Standardized Equipment
- Is readily Expandable to additional Phases or Movements

Book 12
Ontario Traffic Manual

A designer has to produce a safe, effective and efficient signal design that is acceptable to the road authority, provides acceptable levels of service and delay to motorist, meets recognized standards and is practical in the listed points. Compromise is necessary where limitations are imposed by boulevard conditions, sidewalk location, and utility locations.

Safety Considerations

Detailed Design should include the following safety factors:

- Adequate Pole Offset
- Pole types that meet Requirements
- Adequate Vertical Clearance
- Proper Electrical Fusing, Connection and Grounding

Book 12
Ontario Traffic Manual

The detailed requirements for the listed points may be found in the Ministry's Electrical Engineering Manual 2,3 series, municipal practice manuals and in other referenced documents. Many other aspects of signal design, such as phasing, signal head visibility, and synchronization, affect safety with respect to accident risk. These factors are discussed in the relevant sections.

Future Considerations

Anticipated Traffic Demand

- Prepare Needs Report or Justification Report for Current Traffic Volume and 5 Year Horizon.
- Incorporate Future Needs into Current Design
- Provide Underground Provisions at New Intersections for Future Needs

Book 12
Ontario Traffic Manual

Effective management anticipates the future traffic demands on intersections and designers could use this information to:

Incorporate any desired features, if confirmed within five years, for an intersection.

If adequate funding is not available, the designer could locate items such as electrical chambers and ducts in the locations required for future reconstruction.

Signal Visibility

General

- Signal Visibility is Critical in Ensuring Drivers Receive Timely Information about the Need to Slow or Stop

Book 12
Ontario Traffic Manual

This component of signal design is absolutely vital! Refer to manual for details since without visibility the signal will be useless.

Signal Visibility

Book 12
Ontario Traffic Manual

Non-Geometric Considerations

- Lamp Ratings, Lumen Output & Age
- Reflectors and Refractors
- Dirt Accumulation
- 'Sun Phantoms' Appears ON when Not
- Type of Optical System
- Size of Lenses

Signal visibility is affected by both geometric and non-geometric factors. The listed points and some non-geometric factors that impact on signal visibility.

Signal Visibility

Book 12
Ontario Traffic Manual

Signal Head Locations

Signal Head Conspicuity is affected by the following:

- Horizontal and Vertical Curve Alignment
- Visual Obstructions or Distractions
- Contrasting Signal Heads and Backboards
- Ensure Standardized Placement

The effectiveness of any traffic control signal installation will largely depend on the ease with which the signal heads can be seen and recognized. Signal indications should be easily noticeable. A minimum of two signal heads must face each approach of the intersection, including public-use driveways within the intersection. At least one, and preferably both signal heads should be located within the motorists' cone of vision, extending 40° horizontally and 15° vertically from the eyes when facing straight ahead.

Where horizontal or vertical geometry prohibits visibility of at least one signal head within the cone of vision from the desired visibility distance, the use of an auxiliary signal head and possibly a continuous or activated flasher / "signals ahead" sign may be required.

Signal Visibility

Book 12
Ontario Traffic Manual

Lateral Signal Head Locations

With Median Island Secondary Head

- Pavement Edge (0.5m over receiving lane preferred)

Without Median Island Secondary Head

- ½ to ¾ point of Receiving Curb Lane

The primary signal head must be located on the far right side of the intersection. At intersections with a signal head on a median island, the primary signal head should be located laterally at least at the edge of pavement (0.5 m over the receiving lane is preferred). Where median islands do not exist, the primary signal heads should be located at the ½ to ¾ point of the receiving curb lane and at a minimum of 1.2 m. The signal head should be aimed so that it is centered on the approach.

The secondary signal head must be located on the left of approaching through lanes. They may be placed on the median or, where there is no median, on the far left side of the intersection at least at the edge of pavement.

Signal Visibility

Book 12
Ontario Traffic Manual

Signal Visibility Distance

85 th Percentile Speed (km/h)	Minimum Distance from Which Signal Must be Clearly Visible (m)
40	65
50	85
60	110
70	135
80	165
90	200
100	230

The minimum sight distance, for a given 85th percentile speed, from which a signal must be clearly visible is provided in this table which is included in Chapter 5 of OTM Book 12.

Signal Visibility

Book 12
Ontario Traffic Manual

Mounting Height

Legally Set Under Highway Traffic Act – Section 2

- Minimum Mounting Height 2.75m for Secondary Head (Posted Speed less than 80 km/h)
- Primary Mounting Height 5.0m
- Primary and Secondary Mounting Height 5.0m (Posted Speed equal or greater than 80 km/h)

Signal head mounting heights are legally set under the Highway Traffic Act and are covered in Section 2, Legal Requirements.

Secondary heads mounted on the far left and not over traffic lanes may be mounted at a minimum height of 2.75 m for roadways posted at less than 80 km/h. Secondary heads for roadways posted at 80 km/h or more are preferred to be at the same height as the primary head for long range visibility. Where a secondary head is installed in a median island and where the left-turn lane is often blocked by large vehicles, auxiliary heads may be used on the far left of the intersection to allow better visibility. Auxiliary heads may be mounted at a minimum height of 2.75 m or as high as necessary to obtain good visibility. The desirable height in most cases is still 5.0 m. For King's Highways and other roads posted at 80 km/h and over, all signal heads should be mounted at a 5.0 m clearance height.

Signal Visibility

Book 12
Ontario Traffic Manual

Obstruction by Other Signals

- Ensure that Near Side Secondary Head is not Blocking the front of the Far Side Primary Head
- One Signal Head must be Visible to Approaching Motorist at all Times (Based on Minimum Sight Distance)

If positioned incorrectly, the secondary signal head could possibly act as a sight line obstruction. The design must be checked to ensure that the near side secondary head is not blocking the front of the far side primary head and that at least one signal head is visible to the motorist at all times for at least the minimum sight distance given in the OTM (Chapter 5 of Book 12). A field check of these requirements is required during installation.

Signal Visibility

Book 12
Ontario Traffic Manual

Backboards

- Recommended for all Primary Heads
- Preferred for all Heads
- Typical Use:
 - Posted Speed greater than 60km/h
 - Use Backboard for Primary and Secondary Heads
 - Posted Speed less than 60km/h
 - Use Backboard for Primary Head (Secondary Head Optional)

Backboards improve the conspicuity of the traffic signal head and the signal display. Backboards are recommended for all primary heads and are preferred on all heads. The OTM (Chapter 5 of Book 12) provides typical uses for signal heads and backboards. Backboard faces must be traffic yellow in colour under most conditions. Specific conditions may exist where current policies dictate or the visibility and conspicuity of the backboard faces may be enhanced by use of a dark colour such as dark green or black.

Signal Visibility

Book 12
Ontario Traffic Manual

Auxiliary Signal Heads and Beacons

Used to Warn in Advance of Obstructed Signal

- Auxiliary Signal Heads must Display the same Indications and have the same Timing as the Primary and/or Secondary Heads
- Auxiliary Signal Heads or 'Signals Ahead' Flasher Signs must meet the Minimum Signal Visibility Distance

Signal heads may be obstructed by various objects. Thus, auxiliary signal heads are installed to augment the primary signal head and therefore **auxiliary signal heads must display the same indications and have the same timing as the primary and/or secondary heads**. Auxiliary heads or active or continuous "signals ahead" flasher signs should be used whenever the traffic signal visibility distance recommended in the OTM cannot be obtained. The location of the auxiliary heads themselves must comply with the visibility distance recommended in the OTM (Chapter 5 of Book 12) or the "signals ahead" flasher signs must be used. The designer must check each design carefully, recognize sight line limitations, and eliminate obstructions or optimize the design to provide drivers with the best possible visibility.

Signal Visibility

Book 12
Ontario Traffic Manual

L.E.D. Signal Heads

ITE Published Specifications for 300mm and 200mm Traffic Signals

- Modules must fit into Existing Traffic Signal Housing built to the VTCSH Standard
- Modules must Connect Directly to Existing Electrical Wiring System
- Module must Replace Existing Optical Components

The Institute of Transportation Engineers (ITE) has published specifications to provide the minimum performance requirements for light emitting diode (LED) 200mm and 300mm traffic signals. A summary of the physical, mechanical, photometric, and electrical requirements is provided in Chapter 5 of OTM Book 12.

Signal Visibility

Book 12
Ontario Traffic Manual

Optically Programmable Signal Heads
Precise Lane Control by means of Projecting an Indication that is Visible only within the Boundaries of a Specific Area

- Used for Closely Spaced, Offset or Skewed Intersections

Optically Programmable Signal indications can be used as a means for precise lane control by projecting an indication that is visible only within the boundaries of a specific area. Closely spaced, offset or skewed intersections may require optically programmable signal heads. Note that it is recommended practice to install optically programmed heads where signals need to be visible only within the boundaries of a specific area to reduce motorist confusion. This concept is explained with diagrams in the OTM (Chapter 5 of Book 12).

Pole and Signal Head Locations

Book 12
Ontario Traffic Manual

Primary Signal Head Locations
In Addition to Lateral Placement

- Minimum Longitudinal Distance from the Approach Stop Line - 12m (15m preferred)
- Maximum Longitudinal Distance from the Approach Stop Line - 55m

In addition to the guidelines for lateral placement provided in a previous section of the OTM (Section 5.5 – Signal Visibility), the primary heads should be located at a minimum longitudinal distance from the approach stop line of 12 m (with 15 m preferred) to a maximum of 55 m. The 15 m distance corresponds to the cut-off for visibility through a normal windshield to a signal head mounted at a 5.0 m height. Detailed guidelines for the location of primary signal heads at intersections with or without medians are given in the OTM (Chapter 5 of Book 12).

Pole and Signal Head Locations

Book 12
Ontario Traffic Manual

Secondary Signal Head and Pole Locations

- Minimum Lateral Distance from Primary Head - 5m (15m desirable) without Medians
- Maximum Longitudinal Distance either way from Primary Pole - 10m without Medians
- Ensure same elevation level to Primary Head from motorist's perspective at Median Islands

At intersections with median islands, secondary signal heads should be located at:
A minimum lateral distance of 5.0 m and a maximum (desirable) lateral distance of 15.0 m is required between the primary and secondary heads under normal conditions (22 m absolute maximum distance).
A maximum longitudinal distance of 10 m either way from the primary pole location, as measured along the centreline of the roadway, should be maintained where possible.
Secondary heads with left turn arrows should be located as near to the approach as practical.
Where medians are present with two or more receiving lanes, primary and secondary signal heads should not be too close together laterally nor too far apart longitudinally such that one head appears to be much higher than the other from the approaching motorist's perspective.

Pedestrian Signal Heads

Book 12
Ontario Traffic Manual

Pedestrian Indications

- Must consist of:
 - “lunar white” Walking Pedestrian Symbol (outline or solid)
 - “translucent orange” Hand Outline Symbol
- Illuminated Symbols must be Visible from 30m under Normal Conditions
- Use Flashing Hand Outline to warn Walking Time is ending

Pedestrian indications must consist of two symbols, the “lunar white” Walking Pedestrian (outline or solid) and the “translucent orange” Hand Outline. Note that the Ontario and Canadian standards are different from that of ITE Publication ST-217. The symbols may be contained in a single minimum 30 x 30 cm (lens) housing or have separate housing.

When illuminated, the pedestrian signals must be recognizable from a distance of 30 m under normal conditions of visibility. The flashing Hand Outline should be used in all traffic control signals as a clearance interval and a warning to pedestrians that the walking time is terminating.

Pedestrian Signal Heads

Book 12
Ontario Traffic Manual

Pedestrian Signal Head Installation

- Mandatory where Independent Control of Pedestrian Phases is desired and to eliminate Pedestrian confusion
- Usually desirable on all Crosswalks at an Intersection for uniformity

It is recommended practice to install pedestrian traffic control signals in most cases. Pedestrian traffic control signals are mandatory where it is necessary to control the sequence or length of pedestrian phases independent of vehicular phases or where it is necessary to eliminate pedestrian confusion at approaches containing traffic control signal heads with arrows. Where one or more of the pedestrian crosswalks at an intersection justify pedestrian signals, it is usually desirable for uniformity and good observance to place pedestrian signals on all crosswalks.

A pedestrian must be able to walk to any corner of an intersection. Any restrictions to this rule must be supported by proper signing as shown elsewhere in Chapter 5 of OTM Book 12. Installation guidelines for pedestrian signal heads are given in the OTM (Chapter 5 of Book 12).

Pedestrian Signal Heads

Book 12
Ontario Traffic Manual

Pedestrian Pushbuttons

- Required at Pedestrian Actuated Traffic Signals
- Installed at Minimum Height 1.1m on “through sidewalk” side of Pole
- In line with Crosswalk and within 3.0m of Crosswalk Edge

Pedestrian pushbuttons are required at pedestrian actuated traffic signals. Pedestrian pushbuttons should be located on the “through sidewalk” side of the pole at a minimum height of 1.1 m and in line with the crosswalk and not perpendicular to the crosswalk; location should be within 3.0 m of the edge of the crosswalk. It is also desirable that a “push button for walk signal” or equivalent sign be installed at each pushbutton.

Pedestrian Signal Heads

Book 12
Ontario Traffic Manual

Mounting Height and Location

- Minimum Height of 2.5m from finished Grade of Pavement Edge to bottom of Signal Housing
- If practical, mount directly behind Sidewalk facing Crosswalk
- May mount within 3.0m from Sidewalk Edge facing Crosswalk and laterally within 1.5m

Pedestrian heads must be mounted at a minimum of 2.5 m as measured from finished grade at the edge of pavement to the bottom of the signal housing. This dimension should be used unless unusual circumstances require a greater height but pedestrian heads must not be mounted at the height of vehicle heads.

If practical, pedestrian heads should be mounted directly behind the sidewalk facing along the crosswalk. Where necessary, the heads may be mounted within 3.0 m of the edge of the sidewalk in the crosswalk-facing direction and within 1.5 m of the edge of the crosswalk laterally. A check should be made that the pedestrian heads will not be hidden from pedestrians on the other side of the roadway by vehicles stopped at the stop line.

Pedestrian Signal Heads

Book 12
Ontario Traffic Manual

Accessible Pedestrian Signals

- Designed to assist Visually Impaired Pedestrians
- Communicate Pedestrian Timing information through Audible Tones, Verbal Messages, and/or Vibrating Surfaces
- Must be used in Combination with Pedestrian Signal Timing

Audible or Accessible Pedestrian Signals (APS) are designed to assist visually impaired pedestrians by providing information that they can interpret to understand when they may cross. APS devices communicate information about pedestrian timing in non-visual format such as audible tones, verbal messages, and/or vibrating surfaces coinciding with the beginning of the WALK interval.

Accessible pedestrian signals must be used in combination with pedestrian signal timing. The information provided by an accessible pedestrian signal must clearly indicate which pedestrian crossing is served by each device. Locations that may need APS are covered in the OTM (Chapter 5 of Book 12).

Pedestrian Signal Heads

Book 12
Ontario Traffic Manual

Pedestrian Countdown Displays

- Provide Visual descending Numerical Countdowns indicating number of Remaining Seconds available for Crossing
- Optional Device for installation on Pedestrian Signal Heads

The Pedestrian Countdown Display may be added to a pedestrian signal head to show a descending numerical countdown that indicates to pedestrians the number of remaining seconds available for crossing. The proposed guidelines in the OTM (Chapter 5 of Book 12) allow for the optional use of Pedestrian Countdown Timers at the discretion of signal operating agencies.

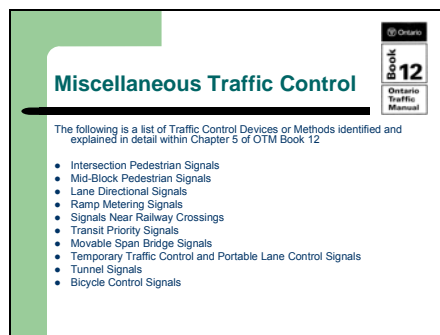

For details on points listed see Chapter 5 of OTM Book 12.

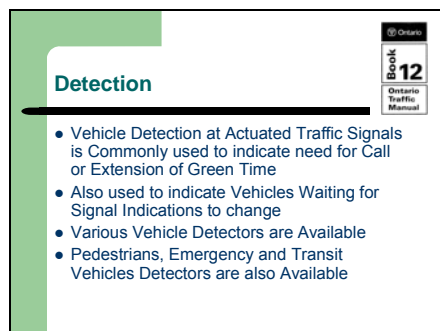

Vehicle detection is achieved through the use of vehicle detectors. A Vehicle Detector is a device for indicating the presence or passage of a vehicle in a designated area of a roadway. Passage detection is the sensing of a road user in motion within the detection zone while presence detection is the sensing of a road user in the detection zone, whether stopped or moving.

Vehicle Detectors are commonly installed at actuated traffic signals, urban and highway permanent vehicle counting stations, and parking lots/garages. In actuated traffic signals, vehicle detection devices are used to indicate the need for a call or extension of green time by passage of vehicles over a specific point on the roadway. Vehicle detection devices are also used to indicate that vehicles are present and waiting for signal indications to change and to indicate that vehicles are in line behind other vehicles waiting for signal indications to change (left turn “setback” loops).

Details on different types of detectors and guidelines on their use are provided in Chapter 5 of OTM Book 12.

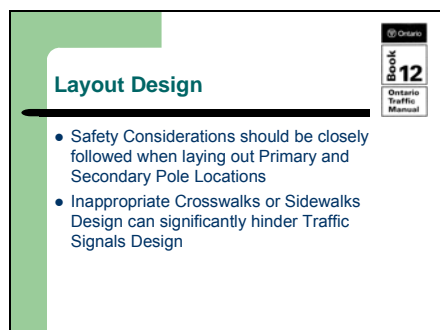

The general safety considerations given in Chapter 5 of OTM Book 12 should be closely followed when laying out primary and secondary head and pole locations. Chapter 5 also provides an overview of the design procedures required to produce the signal and crosswalk/sidewalk designs related to the overall traffic signal design. The design procedures provided should be treated as the first step in a detailed design.

Utilities

- Designer must capture Temporary and Final Utilities Locations during Construction with special emphasis on Overhead High Voltage Lines
- Note that Underground Utility Plans are not reliable – Spot Excavations may be needed
- Co-operation and Compromise between Utilities and Road Authority is Vital

Book 12
Ontario Traffic Manual

The designer must capture the temporary and final location of utilities that will be on site during the traffic signal construction. The final locations may include existing utility locations (where relocations are not required for roadway purposes), relocated utilities or combinations of both (as is normally the case if roadway construction is involved). The designer should not assume that utilities marked up from a field visit to the site are to remain in place throughout construction. Note that most intersection reconstruction projects widen the pavement and hence most pole lines require relocation and will not be in the same location at the time of construction.

Guidelines for dealing with utilities locations are provided in Chapter 5 of OTM Book 12.

Layout Practice

The following is a list of Traffic Signal Guidelines or Practices identified and explained in detail within Chapter 5 of OTM Book 12

- "T" Intersection Approach
- Approach Without Median Island
- Approach With Median Island
- Approach With Wide Median
- Approach with Double Lane LTL
- Ramp Terminal Opposite Free-Flow Ramp
- Short Offset Intersections
- Long Offset Intersections
- Pedestrian Signal Poles

Book 12
Ontario Traffic Manual

For details on points listed see Chapter 5 of OTM Book 12.

Controller Locations

- Consider Safety, Maintenance Access, Visibility of approaching Traffic, Service Supply, grounding and Electromagnetic Interference during Location Design
- Detailed Location Design is covered in MTO Electrical Design Manual

Book 12
Ontario Traffic Manual

The location of the traffic signal controllers may require grading, re-routing of ditches, etc. Coordination with the road designer is required. Locations for controller cabinets must be designed with due consideration to safety, maintenance access, visibility of approaching traffic, service supply, grounding and electromagnetic interference. General guidelines for locating traffic signal controllers are provided in Chapter 5 of OTM Book 12. For detailed information on controller location design, refer to the Ministry's Electrical Design Manual.

Training Material – Section 6 – Miscellaneous

This training material has been developed to summarize the information provided in Book 12 of the Ontario Traffic Manual Series. It is provided as both slides and text. The slides are intended to summarize in point form the important aspects of the material from Book 12 and will include graphics, figures, photos or charts to enhance the trainees understanding of the points. The text is intended to provide a more detailed explanation to the points. However, the training material is by necessity presented at a cursory level. For additional details, the trainee is referred to the actual manual.

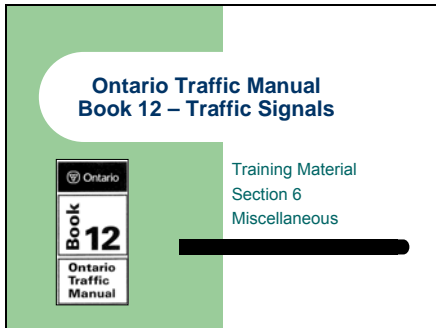

This training material has been developed to summarize the information provided in Book 12 of the Ontario Traffic Manual Series. It is provided as both slides and text. The slides are intended to summarize in point form the important aspects of the material from Book 12 and will include graphics, figures, photos or charts to enhance the trainees understanding of the points. The text is intended to provide a more detailed explanation to the points. However, the training material is by necessity presented at a cursory level. For additional details, the trainee is referred to the actual manual.

This part of the manual contains information on various miscellaneous aspects of traffic signal design and operation as well as some hardware information.

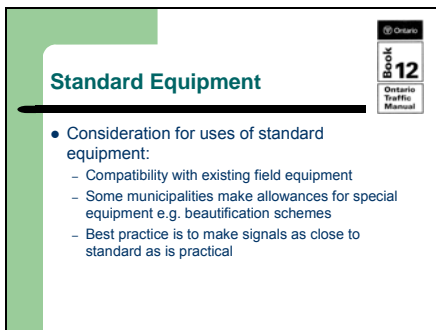

The selection of standard equipment as stock items should consider the compatibility with existing field equipment

The design of signals is not an architectural competition although some municipalities make allowances for special equipment for downtown beautification schemes, prestige routes, etc.

The best practice is to make each set of signals as close to standard as is practical since anything out of the ordinary may cause unfamiliarity for motorists and therefore may affect safety.

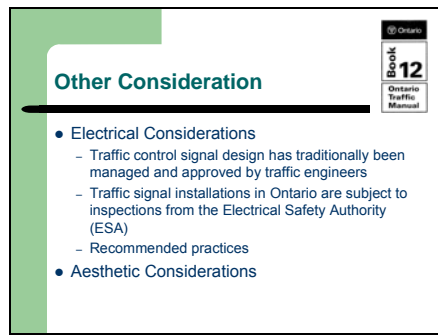

Electrical Considerations:

Traffic control signal design has traditionally been managed or approved by traffic engineers since the signals are a tool of traffic management and regulation. Traffic signal installations in Ontario are subject to inspections from the Electrical Safety Authority (ESA). Recommended practices for electrical design of traffic control signals – role of consultants, contractors, municipalities.

Since standard equipment is used in most installations, the treatment of aesthetic values consists mainly in avoidance of signal elements that are not considered to be very pleasing. Some examples are listed in the manual.

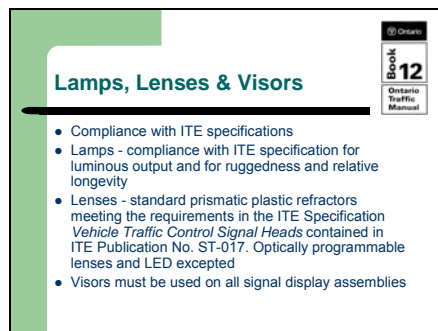

Copies of these specifications and more information can be obtained or purchased at www.ite.org.

The lamps used for traffic signal indications should be chosen for compliance with ITE specifications for luminous output and for ruggedness and relative longevity.

Predominantly, lenses for incandescent displays should be standard prismatic plastic refractors meeting the chromaticity requirements of ITE Specification *Vehicle Traffic Control Signal Heads* contained in ITE Publication No. ST-017. Exceptions to the standard lenses include optically programmable lenses, fibre optic lenses and light emitting diode lenses.

Visors must be used on all signal display assemblies to minimize the return of outside light through the lenses, which can cause the optical assemblies to appear illuminated.

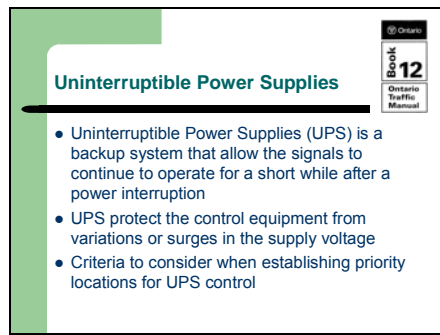

The image shows a page from a manual with a green header bar. The title 'Uninterruptible Power Supplies' is in bold. A small box in the top right corner contains the text 'Book 12 Ontario Traffic Manual'. Below the title is a list of three bullet points.

Uninterruptible Power Supplies

Book 12
Ontario Traffic Manual

- Uninterruptible Power Supplies (UPS) is a backup system that allow the signals to continue to operate for a short while after a power interruption
- UPS protect the control equipment from variations or surges in the supply voltage
- Criteria to consider when establishing priority locations for UPS control

Uninterruptible Power Supplies (UPS) is a backup system that allow the signals to continue to operate for a short while after a power interruption

Most UPS's filter the incoming power and therefore also protect the control equipment from variations or surges in the supply voltage

Those road authorities that are implementing UPS backup systems generally can do so only at a limited number of intersections at a time. As a result, the process of identifying selected sites requires some form of prioritization.