

DIA-COMPE

2023-2024



www.diacompe.com.tw



P4 . . .  **ENE CICLO**
P12 . . . *Gran Compe*[®]
P16 . . . **DIA-COMPE**[®]

FLAT-1 FRAME SET



Rear Chain Stay Bridge

ENE CICLO FLAT-1	
Material	4130 Cr-mo
Head Set	Non-Thread
Seat Clamp	Gran Compe
C-T	460mm
HeadAngle	74°
Top Tube	529mm
R.C	380mm
F.C	572mm

Color : Pink,White,Black



Uni Crown Straight Fork



Stay

ENE CICLO CHAIN WHEEL TRIPLE

- Cold Forged aluminum crank arm.
- Polished Silver finish.
- Chainring: 46T/38T/30T.
- Length: 165mm/170mm.
- PCD: 96mm.
- Square Taper BB.
- Weight : 700g wo/BB

ENE CICLO CHAIN WHEEL DOUBLE

- Cold Forged aluminum crank arm
- Polished Silver Finish
- Chainring : 48T/36T,46T/34T
- Length : 165mm/170mm
- PCD : 96mm
- Square Taper BB(68x116)
- Weight : 688g wo/BB

ENE CICLO CHAIN RING

- 30T,34T,36T,38T,46T,48T

ITA

JIS
ENE BOTTOM BRACKET

- JIS BC1.37x24T (68mm) 116mm, Double Crank, weight: 270g
- ITA BC M36x24T (70mm) 116mm, Double Crank, weight: 260g
- JIS BC1.37x24T (68mm) 122mm, Triple Crank, weight: 280g
- JIS BC1.37x24T (68mm) 103mm, Single Crank, weight: 256g
- JIS Taper

**ENE FENDER F-1**

- Aluminum
- High polished
- Width : 36mm Depth : 20mm
- Length : F 735mm / R 1140mm
- For 700X23C~700X28C Tire

**ENE FENDER F-1 BLACK**

- Aluminum
- Black anodized
- Width : 36mm Depth : 20mm
- Length: F 735mm / R 1140mm
- For 700x23C~700x28C Tire

**ENE FENDER F-2**

- Aluminum
- High polished
- Width : 36mm Depth : 20mm
- Length : F 735mm / R 1140mm
- For 700X23C~700X28C Tire

**ENE FENDER F-2 BLACK**

- Aluminum
- Black anodized
- Width : 36mm Depth : 20mm
- Length: F 735mm / R 1140mm
- For 700x23C~700x28C Tire

ENE FENDER F-35

- Aluminum
- High polished
- Width : 41mm Depth : 11mm
- Length : F 735mm / R 1140mm
- For 700X25C~700X35C Tire

ENE FENDER F-3 COPPER

- Aluminum
- Copper anodized
- Width : 47mm Depth : 20mm
- Length : F 735mm / R 1140mm
- For 650X35C~650X38C Tire

ENE CICLO FENDER STAY ADAPTER

- Stainless Steel(SUS304) made stay adapter
- Especially designed for frames without end tabs
- ID 6mm

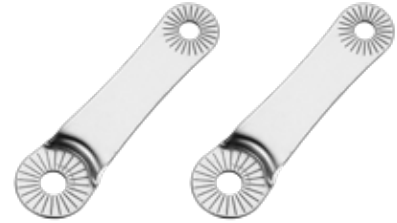
ENE FENDER F-3

- Aluminum
- High polished
- Width : 47mm Depth : 20mm
- Length : F 735mm / R 1140mm
- For 650X35C~650X38C Tire

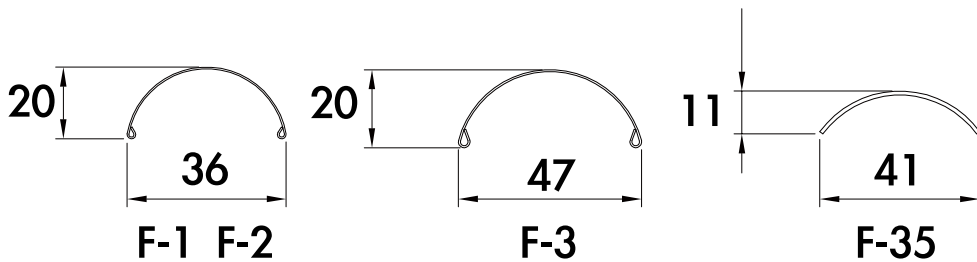



ENE 11S THUMB SHIFTER

- Clamp : Aluminum CNC, Silver anodized
Φ26.0mm standard diameter
Φ23.8mm or Φ22.2mm with shims
- 11speed compatible
- Weight : 140g/pair

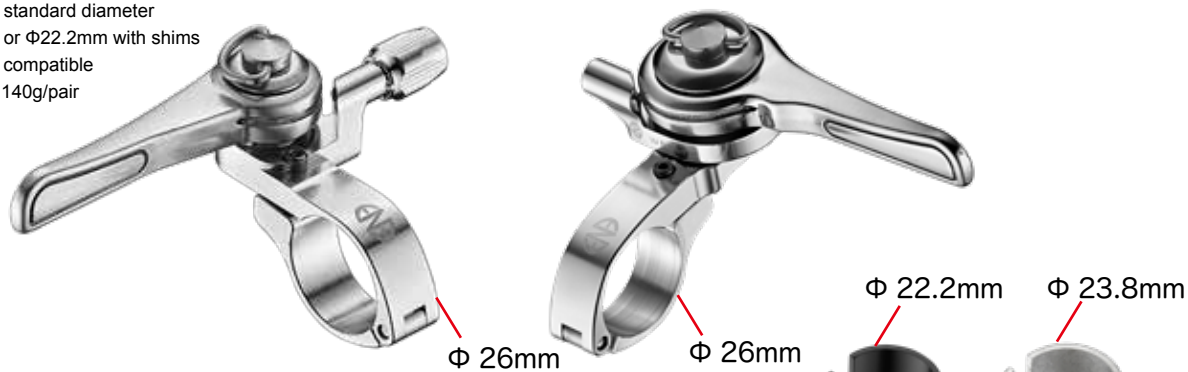

ENE THUMB SHIFTER

- Clamp : Aluminum CNC, Silver or Black anodized.
Φ26.0mm standard diameter
Φ23.8mm or Φ22.2mm with shims
- Weight : 116g/pair complete
- 8, 9, 10 Speed Compatible
- Cable Adjuster

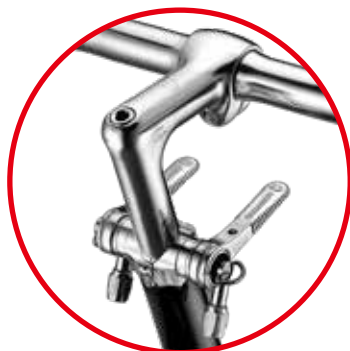

ENE STEM MOUNT SHIFTER

- Shifter on stem column
- Clamp : Φ22.2mm, Aluminum CNC, silver anodized
- 8,9,10 speed compatible
- weight : 110g/pc

ENE DOWN TUBE SHIFTER

- ENE Shifter with Clamp Ø 28.6mm
- Down tube use
- 8,9,10 Speed compatible
- Silver anodized clamp
- Weight : 94g/pc

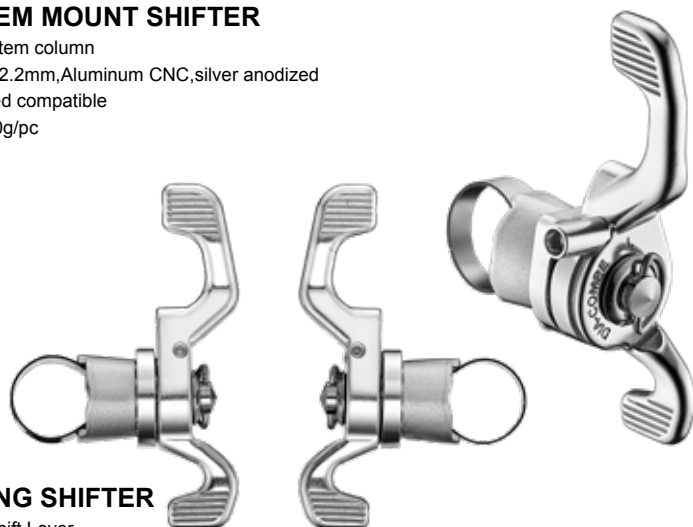

ENE WING SHIFTER

- Drop Bar Shift Lever
- Clamp Φ22.2mm-24mm
- Multi speed function up to 11S
- Shimano/Compagnolo compatible
- Silver finish
- Weight : 164g/pair

ENE BAR TAPE CLAMP

- Aluminum CNC Clamp
- Silver or Black anodized
- ID:22-24mm
- Weight : 32g/pair



ENE 11S SHIFTER

- 11 speed compatible
- Down Tube use
- Weight : 100g/pair



ENE W-SHIFT LEVER

- 8, 9, 10 Speed Compatible
- Down Tube use
- Weight : 64g/pair



"SILVER" W-SHIFT LEVER

- 8, 9, 10 Speed Compatible
- Down Tube use
- weight : 64g/pair



ENE BAR END CONTROL

- Power Ratchet Shifting Lever
- Silver clear finish
- Weight : 162g/pair



BAR END CONTROL "SILVER"

- Power Ratchet Shifting Lever
- Silver clear finish
- Bar end control shifting lever use
- weight : 162g/pair

ENE STEM

- Aluminum Cold Forged
- Angle 70°
- Bar bore Ø25.4mm or Ø26mm
- Post Length 130mm : Extension 60L(Silver only) or 80L or 100L
- Post Length 180mm(Silver only): Extension 80L or 100L
- Color : Buffed Anodized (Silver, Black, Gold, or Blue)
- Weight : 268g(Ø25.4/80L/Post Length 130mm)
290g(Ø25.4/100L/Post Length 130mm)



ENE STEM HOLE-IN

- CNC hole for light Weight
- Aluminum Forged
- Angle 70°
- Bar bore Ø25.4mm or Ø26mm x 80L or 100L
- Post Length 130mm
- Color : Buffed Anodized (Silver or Black)
- Weight : 248g(Ø25.4/80L/Post Length 130mm)
270g(Ø25.4/100L/Post Length 130mm)



ENE TOURING DISC HUB

- Hub Shell : A6061 Aluminum
- Bearing : Sealed bearing
- Front : 32H. O.L.D 100mm, Silver anodized
- Rear : 32H. O.L.D 135mm, Silver anodized
- SHIMANO 11 Speed cassette compatible
- Weight : 177g(Front) 408g(Rear)

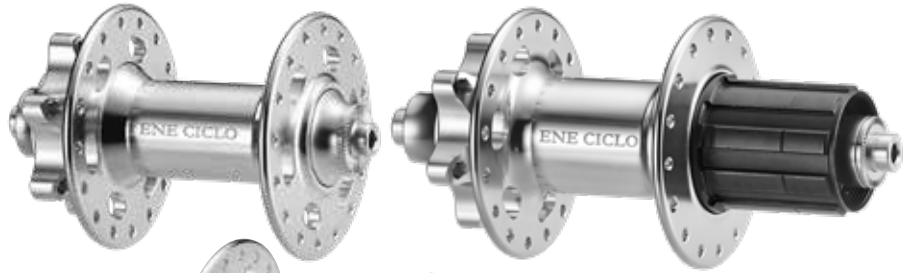

"NEW"S-type

C-type

ENE TOURING HUB(CASSETTE)

- Hub Shell : A6061 Aluminum
- Bearing : Sealed bearing
- Front : 32H or 36H, O.L.D 100mm, Silver anodized with QR
- Rear : 32H or 36H, O.L.D 130mm, Silver anodized with QR
- Cassette : "NEW"S-type/11speed,C-type/11speed
- S Cassette body : Aluminum
- C Cassette body : Aluminum
- S-type for Shimano Cassette free
- C-type for Campagnolo Cassette free
- Weight : 266g(Front) 382g(Rear/S-type) 372g(Rear/C-type)

ENE TOURING HUB(BOSS FREE)

- Hub Shell : A6061 Aluminum
- Bearing : Sealed bearing
- Front : 32H or 36H, O.L.D 100mm, Silver anodized with QR
- Rear : 32H or 36H, O.L.D 126mm or 130mm, Silver anodized with QR
- Boss Free : 6S or 7S
- Weight : 270g(Front) 320g(Rear)

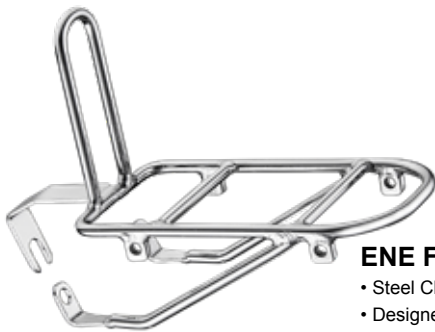

ENE FRONT CARRIER

- Steel CP
- Designed only for GC610,GC700 & DC750 Brakes
- Light weight bag carrier
- Carrier only (without brake)
- 4 Light brackets



ENE BOTTLE CAGE(R1)

- Stainless steel Ø 4 pipe
- Weight : 46g
- High polished finish



ENE CLASSIC RACING BAR

- Classic Road Bike use.
- Size : Ø26mmX360mm,380mm,400mm or 420mm
- Drop : 125mm(360mm,380mm)
145mm(400mm,420mm)
- Aluminum.
- Color : Silver anodized.
- Weight : 280g(Ø26mmX400mm)



ENE TOURING BAR

- Touring Bike use.
- Special designed for DC139 Lever and DC138 Hand Rest.
- Size : Ø26mmX390mm or 410mm
- Aluminum.
- Color : Silver anodized.
- Weight : 288g(Ø26mmX390mm) 294g(Ø26mmX410mm)



ENE CHAIN COVER

- Aluminum
- For Crank 44T-48T
- clamp : 28.6mm
- weight : 78g



ENE TOURING SADDLE

- Touring Bike use
- Width:170mm
- Length:285mm
- Material:Australia cowhide
- Color:Brown,Light Brown,Black
- Weight:588g

Light Brown



Black



Brown



ENE SEAT POST

- Aluminum 6061 T6
- Ø27.2mmX250mm
- Color : Silver anodized
- Weight : 240g

ENE FRONT BAG

- Special designed for ENE Front Carrier
- Size : 120x160x115mm
- Material : canvas
- Volume : 1.7L
- Weight : 138g



ENE CICLO PASSAGE TIRE

- 700x32C
- Open Tubular Tire
- Wire bead
- Top Dark Brown with natural rubber color on side walls
- Weight:350g



ENE CICLO TOURER TIRE

- 700 x 28C
- Open Tubular Tire
- Wire bead
- Top Light Brown with side Natural Material color
- New modified tread design reduces rolling resistance and increases its mud shedding ability
- Weight:370g



ENE CICLO TIRE

- 700X28C
- Open Tubular Tire
- Wire bead
- Top Brown with side Beige color
- Weight : 460g



GRAN COMPE CR-X TIRE

- 700 x 32C
- Open Tubular Tire
- Aramid Bead
- Top Black with side Blue color
- Weight : 296g (Ava)



TRACK

GRAN COMPE PRO

- KEIRIN Race
- NJS approved
- Angular contact Ball Bearing
- Front : 36H Rear : 36H Fixed/Fixed
- O.L.D : 100mm(Front) 120mm(Rear)
- Cold forged aluminum hub body
- Color : silver anodized
- Weight : 270g(Front) 310g(Rear)

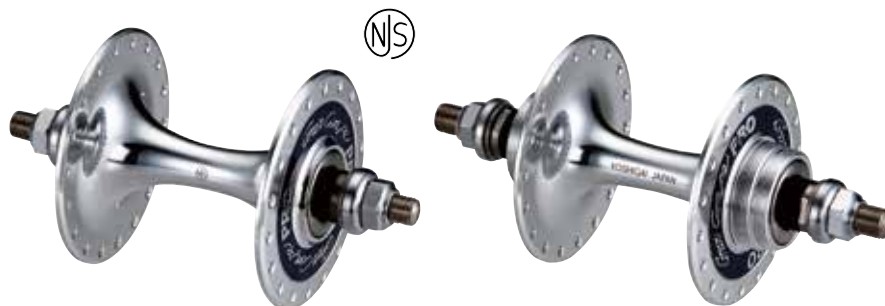
**GRAN COMPE- II HUB**

- Single Speed use
- Cold forged aluminum hub body
- Sealed bearing
- Front : 32H or 36H
- Rear : Fixed/Fixed 32H or 36H
Fixed/Free 32H or 36H
- O.L.D : 100mm (Front) 120mm (Rear)
- Color : Silver, Black
- 280g (Front) 335g (Rear)

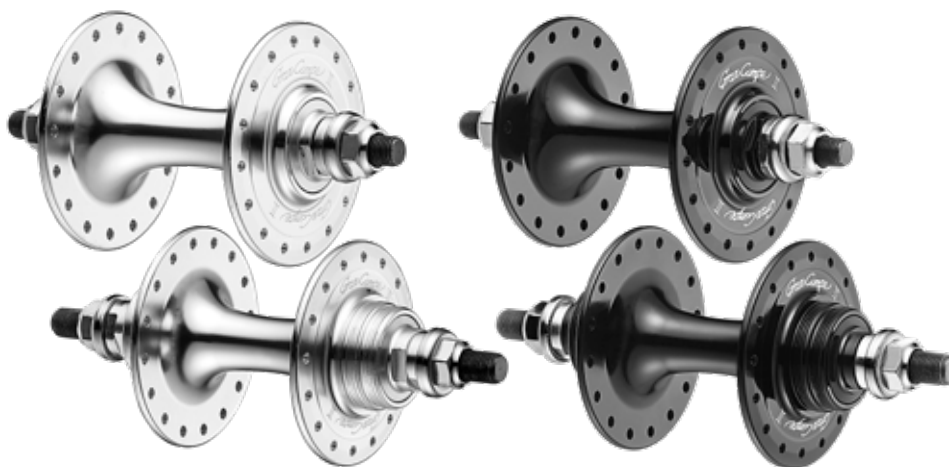
**GRAN COMPE SF HUB**

- Single Speed Bike use
- Cold forged aluminum hub body
- Sealed bearing
- Front : 20H 24H or 32H
- Rear : Fixed/Fixed 24H or 32H
- O.L.D : 100mm(Front) 120mm(Rear)
- Color : Silver, Black
- 176g (Front) 224g(Rear)

**GC- II HUB/ GC HUB QR KIT**

- Front : 100mm
- Rear : 120mm
- ※ The QR KIT for GC-II Hub is not compatible with GC Hub



TRACK

GRAN COMPE II WHEEL

- Gran Compe Wheel Assembled.
- DIA-COMPE Original Rim
- 32H/2.0mm Spoke
- O.L.D : 100mm (Front)/120mm (Rear)
- Color : Anodized Black or Silver
- Weight : 1100g (Front)/1150g (Rear)



GRAN COMPE CHAINWHEEL

- PCD 130mm 46T
- Color : Silver or Blue anodized
- Weight : 100g

COG

- 15T, 16T, 17T, 18T
- Steel (Black, Silver, White, Blue, Red, Pink, Green, Gold)

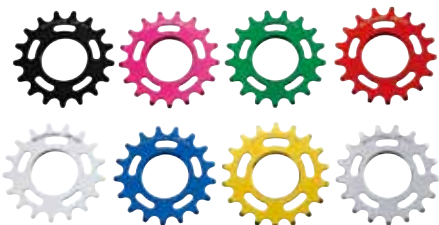

LOCK RING

- CrMo steel CNC (Black, Silver, White, Red, Blue, Pink, Green, Gold)



TORX BOLT & NUT

- Aluminum
- Torx (T30) bolt
- Single Speed bike use
- Color : Black, Red, Gold or Blue anodized



GRAN COMPE SADDLE BAG

- Leather
- Color : Brown, White, Red
- Weight : 250g



GRAN COMPE SADDLE

- ① GCLS-04 : Leather, Pink
- ② GCLS-05 : Leather, Red
- Weight : 560g

TRACK



GRAN COMPE SHOT LEVER

- Drop Bar use
- Hinged clamp diameter : 25.4mm (22.2mm with reducers)
- One clamp with two side Lever Handle for one Cable.
- Assembly with flexie adjustable lead pipe
- Weight : 110g
- Color : Silver, Black, Gold, Green, Red, Pink or Blue anodized



CASING CLIPS

- Stainless steel
- Single Speed Bike Use.
- Item&Size : 1501 (25.4mm)
1501M-1 (28.6mm)
1501M-2 (31.8mm)
- Color : Black, Silver, White, Blue, Red, Pink, Orange, Gold or Purple



GRAN COMPE SEAT POST

- 6061 aluminum.
- Ray Back Type Seat Post
- Length 250mm. OD 27.2mm
- Color : Silver anodized, Black anodized
- Weight : 240g

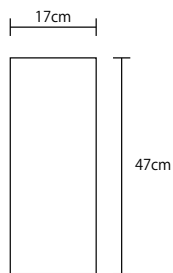

FRAME PAD (BLACK)

FRAME PAD (WHITE)

TRACK BRAKE & PARTS



TRACK BRAKE SET FOR FRONT

- On road assist brake set for Track race bikes with front brake, adapter, lever and cable
- Oval, circle or aerofork clamp



For aerofork

TRACK BRAKE CLAMP

- Oval, circle or aerofork
- Suggest not use on carbon or Aluminum fork



Oval



Circle



Aerofork



TRACK BRAKE SET FOR REAR

- On road assist brake set for track race bikes
- With rear brake, adapter, lever, cable and assembly kits



HEADSET

CLASSIC 1"

- 1" ITA(Ø26.4mm X Ø30.2mm)
- Material : Steel Cup, Cone and Race
- Especially designed for Track bike
- Color : Black, Silver, Gold, Blue or Red ED
- Weight : 110g



IB

- Sealed bearing (41mm or 41.8mm)
- Integrated Headset
- Size : 1-1/8"
- Color : Anodized Black, Powder white
- Weight : 90g



ENE CICLO CLA1"

- A6061 aluminum Cups
- 1" ITA(Ø26.4mm X Ø30.2mm)
- Threaded steerer tube
- Cartridge bearing
- Silver anodized
- Weight:95g



IB-2

- Sealed bearing (41mm or 41.8mm)
- Integrated Headset
- Size : 1-1/8"
- Color : Anodized Black
- Weight : 88g(Φ41),96g(Φ41.8)



CB-2

- Aluminum Headset
- Cartridge bearing
- Size : 1-1/8"
- Color : Silver, Black, Pewter, Red, or Green anodized, White
- Weight : 110g



HEADSET

D-1 D-1FS

- Material : Steel Cup, Cone and race
- Special : "Heavy duty" lower cup design (D-Cup)
- Especially designed for BMX, Freestyle, Jumping and ATB bikes.
- Optional parts : Adjusting plug set with STD bolt (D-1) or Hollow bolt (D-1 FS).
- Size : 1-1/8"
- Color : Black, Red or Blue ED
- Weight : 180g(D-1)/194g(D-1FS)



D-1FS

D-1

RB-1

- Aluminum Headset
- Ball retainers bearing
- Size : 1-1/8"
- Color : Silver or Black anodized
- Weight : 100g



NB-1

- 1" ITA(Ø26.4mm X Ø30.2mm)
- Aluminum Headset
- Cartridge bearing
- Color : Silver or Black anodized
- Weight : 100g

PFITZINGER(Semi Integrated)

- For tapered 50mm/61mm OD headtube
- For tapered fork steerer 1.5" to 1-1/8"
- Cup(Upper&Lower):Alloy CNC
- Weight : 190g



PFITZINGER(std)

- For tapered 50mm/57mm OD headtube
- For tapered fork steerer 1.5" to 1-1/8"
- Forged alloy deeper cup and lower cup
- Sealed Bearings
- Weight : 190g



STAR NUT

- Steel
- 1", 1-1/8", 1-1/4"



PRESSURE PLUG

- Size : 1-1/8"
- Top cap : Black or Silver

SBN

- 1-1/8"
- Steel bearing cup
- Basic adjusting clamp
- Non threaded steerer cup
- Color : Black
- Weight : 160g



ROAD/RACING

BRS101N

- Dual-Pivot design
- Forged aluminum arms
- BRS index quick release
(Color : Anodized : Silver or Black)
- 101-pad
- Dimension : 45-57mm
- 188g/Wheel

**BRS101**

- Dual-Pivot design
- Forged aluminum arms
- BRS index quick release
(Color : Anodized : Gold)
- 101-pad
- Dimension : 45-57mm
- 188g/Wheel

**BRS101 CARTRIDGE**

- BRS101 with ARC-PAD
- BRS index quick release
- Color : powder white
- 190g/wheel

**BRS100 CARTRIDGE**

- BRS100 with ARC-PAD
- BRS index quick release
- Color : Powder White
- 180g/wheel

**BRS100**

- Dual-Pivot Design
- Forged aluminum arms
- Quick release
- Color : Anodized(Silver, Black, Pink, Green, Blue or Red)
- 101-pad
- Dimension : 39-49mm
- 178g/Wheel



ROAD/RACING



505Q

- Cold forged aluminum arms
- Color : Anodized
- Twist quick release
- OPC-30 PAD
- Dimension : 45-57mm
- 146g/wheel

287V

- Designed for V-Brakes
- Diecast aluminum bracket
- Aluminum plate lever handle (Silver anodized)
- Anatomically designed rubber hood (Bracket)
- BRS return spring
- Cable travel 20mm
- 270g/pair

EVO-V

- Designed for V-Brakes
- Forged aluminum lever in buffed silver or black anodized finish
- 2mm Allen-key reach adjustment system
- BRS return spring mechanism
- Brown and Black rubber hoods are available
- 308g/pair



287V COVER

- 287V, EVO-V and EVO use
- Color : Black, Brown



BL100 WHITE

- Resin bracket.
- Aluminum plate lever handle (white painting)
- Return spring
- 220g/pair



ROAD/RACING

DC165EX

- For Dropbar with extension lever.
- Designed for Side-pull, Cantilever & Center-pull brakes use
- A6061 forged aluminum extension lever handle
- Silver finish
- Rubber hoods: Black, Brown
- 280g/pair

**144.7**

- DC165 Lever use
- Color : Brown, Black, Amber

**BL07**

- Diecast aluminum Bracket
- Aluminum plate lever handle (Silver anodized)
- Brown, Black and White rubber hoods are available.
- BRS return spring
- 244g/pair

**GC07H**

- BL07 with CNC Hole Lever handle (Buffed silver anodized)
- Brown, Black and White rubber hoods are available.
- With stainless clamp
- 248g/pair

**BL07 COVER**

- GC07H and BL07 use
- Color: White, Black, Brown

**HR07**

- HAND REST for Tandem bike
- Diecast aluminum bracket
- Resin lever (black)
- Anatomically designed bracket cover
- 204g/pair



TOURING

GC202H

- GC202 with CNC Hole Lever handle
- 216g/pair



GC202

- For Touring Bike (For Side-pull & Canti Brakes)
- Diecast aluminum bracket.
- Aluminum plate lever handle (Buffed Silver anodized)
- Brown, Black and White rubber hoods are available.
- With cable adjuster
- Without quick release
- 220g/pair



GC202Q

- Aluminum high polished lever in silver anodized with cast bracket and cable adjuster.
- Brown, Black and White rubber hoods are available.
- With quick release
- 240g/pair



DC204QC COVER

- GC202H, GC202, GC202Q and DC204QC use
- Color : White, Black, Brown, Amber



DC204QC

- For Touring Bike (For Side-pull & Canti Brakes)
- Diecast aluminum bracket.
- Aluminum plate lever handle. (Silver anodized)
- Brown, Black and White rubber hoods are available.
- With quick release
- 200g/pair



CABLE ADJUST BOLT

- GC202H, GC202, GC202Q, DC204QC and DC165EX use



TOURING

**GC450**

- A6066 forged aluminum body
- Buffed and Silver anodized
- GC450 PAD
- 1245 pulley guide cable bridge
- 1273-100 Straddle Cable
- Dimension:40-52mm
- 180g/wheel

**DC610-N**

- Cold forged Aluminum arms
- 101-Pad
- Dimension 47-61mm
- Silver anodized
- 190g/wheel
- 1242 Straddle Cable Guide
- 1270-110 Straddle Cable

**GC610**

- Aluminum CNC Machined arms
- 101-Pad
- Dimension 47-61mm
- Silver anodized
- 186g/wheel
- 1242 Straddle Cable Guide
- 1270-110 Straddle Cable

**GC700**

- Aluminum CNC Machined arms
- OPC-12 Black Pad
- Dimension 53-70mm
- Silver anodized
- 230g/wheel
- 1242 Straddle Cable Guide
- 1270-110 Straddle Cable

**DC750**

- Cold forged aluminum arms (Silver anodized)
- Designed for Comfort bike
- OPC-30 PAD
- dimension 60-78mm
- 190g/wheel
- 1242 Straddle Cable Guide
- 1270-110 Straddle Cable

**BRS202N**

- Dual-Pivot Design
- Forged aluminum arms
- BRS index quick release
- 101-PAD
- Dimension : 57-75mm
- Color : Silver or Black anodized
- 200g/Wheel

**MX806**

- Forged aluminum arms (Silver anodized)
- Power reinforcement with dual-pivot device.
- Dimension 57-75mm
- 210g/wheel

CENTER PULL PIVOT

- Material : steel
- Brazed on pivot for GC610, GC700 and DC750 center pull brakes.

**GC450 CENTER PULL CALIPER ASSEMBLY KITS**

- Spring and aluminum plate
- For assembly of GC450 caliper with Front fork or Back fork

CENTER PULL CALIPER ASSEMBLY KITS

- Spring and aluminum plate
- For assembly of caliper (GC610,GC700,DC610-N & DC750) with Front fork or Back fork

**GC450 CENTER PULL PIVOT**

- Material : steel
- Brazed on pivot for GC450 center pull caliper brakes

TOURING



DC179

- Aluminum Lever Handle(anodized)
- Aluminum Bracket(Painting)
- Same Bracket for Right & Left side
- Stainless clamp $\Phi 22.2\sim 23.8$ mm
- Reach adjustment washer
- Guidonnet Lever
- 150g/pair



DC175

- Aluminum Lever Handle(anodized)
- Aluminum Bracket(Painting)
- Same Bracket for Right & Left side
- Stainless clamp $\Phi 22.2\sim 23.8$ mm
- Reach adjustment washer
- 140g/pair



DC139

- Aluminum Lever Handle and Bracket
(Silver, Black, Gold or Copper anodized)
- Stainless clamp $\Phi 23.8$ mm
- Guidonnet lever
- 128g/pair



DC135

- Aluminum Lever Handle and Bracket
(Silver, Black, Gold or Copper anodized)
- Stainless clamp $\Phi 22.2$ mm
- 120g/pair



DC138

- Hand rest
- Clamp $\Phi 23.8$ mm
- Color : Brown or Black
- 110g/pair



DC139 & DC138 & ENE TOURING BAR

128S-II

- Aluminum bracket
(Silver finish/Black anodized)
- Cold forged aluminum lever handle
(Silver finish/Black anodized)
- Thumb-lock stopper
- 120g/pair



DC131

- Aluminum bracket
(Silver finish/Black anodized)
- Cold forged aluminum lever handle
(Silver finish/Black anodized)
- 100g/pair



CITY

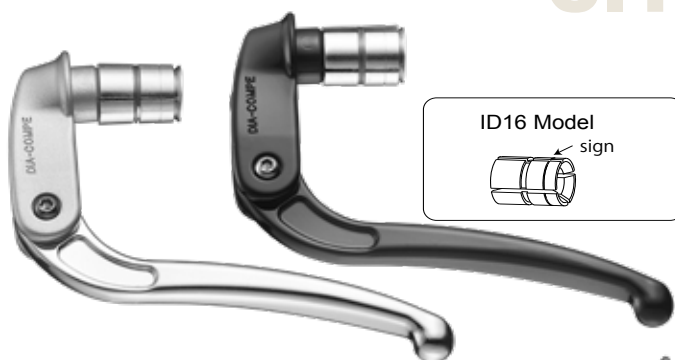

ID16 Model
sign



DC189

- Cold forged aluminum Lever handle (Silver or black anodized)
- Diecast aluminum Bracket (Silver painting or black ED)
- Handle bar trailing cable mount system
- 2mm Allen-key reach adjustment system
- Handle Bar Diameter over ID19mm
- Weight: 200g/pair

DC189 ID16

- Cold forged aluminum Lever handle (Silver or black anodized)
- Diecast aluminum Bracket (Silver painting or black ED)
- Handle bar trailing cable mount system
- 2mm Allen-key reach adjustment system
- Handle Bar Diameter ID16.5-19mm
- Weight: 192g/pair



For Handle Bar
ID20mm



For Handle Bar
ID18mm

DL800

- Cold forged aluminum arms (Silver or Black anodized)
- Op-33 Gray pad
- Dimension 61-79mm
- 188g/wheel

DC188

- Cold forged aluminum lever handle (Silver finish / Black anodized)
- Cable system Build in type/Handle bar
- Handle Bar Diameter ID20mm or ID18mm
- Bracket : Brown, Black
- Weight 140g/pair

DC188 ID16

- Cold forged aluminum lever handle (Silver finish / Black anodized)
- Cable system Build in type/Handle bar
- Handle Bar Diameter ID16mm
- Bracket : Brown
- Weight 140g/pair

DC188 GRIP

- Color : Brown, Black
- Compatible with DC189 & DC188 Lever



TOURING

DC808

- Cold forged aluminum arms
- Better stopping power with long caliper arms
- Designed for comfort bike & electrical assist bikes
- Diameter 61-79mm
- OPC-30 pads
- Silver finished
- 190g/wheel



CLASSIC DC730

- Cold forged aluminum arms
- Silver Anodized
- Dimension : 53mm-71mm
- MX1000N-PAD
- 164g/wheel



CLASSIC DC810

- Cold forged aluminum arms
- Silver Anodized
- Dimension : 61mm-79mm
- MX1000N-PAD
- 168g/wheel



MLB-50

- Multi Condition metal link brake system.
- Passed BAA (Bicycle Association Approved)
- Non asbest
- Weight 512g

BMX/FREE STYLE



BOX-U

- Aluminum full CNC
- Dual Spring tension adjustment (Super Low Profile green tension adjuster)
- Stainless steel spring & Ultra small cable anchor unit
- Hombre-pads green
- 160g/Wheel
- BOX-U Straight : Straight type
- BOX-U Angle : Angle type (15 degrees)
- Color : Anodized; Powder white
- Weight : 190g/wheel



BOX-U ANGLE

- Angle type (15 degree) of BOX-U



AD MIL

- Cold forged aluminum arms (anodized)
- Rear wheel use
- dual spring tension adjustment (Super low profile green tension adjuster)
- Stainless steel spring & ultra small cable anchor unit
- Green pads
- 200g/wheel



AD990

- Cold forged aluminum arms (Silver finish/Black anodized)
- Dual spring tension adjustment
- Black pad
- 280g/Wheel



AD990TW

- Dual cable pull version of AD990

FS990HB

- Cold forged aluminum arms (Silver finish/Black anodized)
- Dual spring tension adjustment
- Black pad
- Reverse pull for left crank side
- 290g/Wheel



AD997TW "MAGIC"

- Melt forged aluminum arms (Black ED/Powder white)
- Dual Cable Pull for rear wheel w/anchor bolts
- Dual spring tension adjustment
- V-type brake shoe can accommodate rim width of 22-32mm
- Hombre pads
- 215g/wheel

BMX/FREE STYLE

FS996 "HOMBRE"

- Cold forged aluminum arms
- Freestyle use
- Dual Spring tension adjustment
- W/anchor bolt parts
- V-type Brake shoe can accommodate rim width between 22-32mm
- Hombre-Pads
- Color , Silver finish, Anodized; powder white or pink
- 208g/wheel

**AD996 "HOMBRE"**

- Cold forged aluminum arms
- Dual Spring tension adjustment
- W/Anchor bolt parts
- Available double cable control (add anchor bolt assy)
- V-type brake shoe can accommodate rim width between 22-32mm
- Hombre-pads
- Color , Silver finish, Anodized; powder white or pink
- 216g/wheel

**AD996TW ANGLE "HOMBRE"**

- Angle type (15 degree) of AD996TW "HOMBRE"

**AD996 "FIESTA" & FS996 "FIESTA"**

- Cold forged aluminum arms
- Dual Spring tension adjustment (Super low Profile green Tension Adjuster)
- Stainless steel Spring & Ultra small cable anchor unit.
- Hombre-pads green
- V-type brake shoe can accommodate rim width between 22-32mm
- Color, Silver finish, Anodized; powder white or pink
- 216g/wheel (AD996 "FIESTA")
- 208g/Wheel (FS996 "FIESTA")

**AD996TW "HOMBRE"**

- Dual cable pull version of AD996

**884Q**

- Quick release
- Cold forged aluminum arms (Silver finish/ anodized)
- Dimension 68-86 mm • OPC30/31 pads
- 210g/Wheel

**884L**

- Cold forged aluminum arms (Silver finish/ anodized)
- Dimension 68-86 mm • OPC30/31 pads
- Reverse pull
- 200g/Wheel

**884QL**

- Cold forged aluminum arms (Silver finish/ anodized)
- Dimension 68-86 mm
- OPC30/31 Pads
- Quick release, reverse pull
- 210g/Wheel

**884**

- Cold forged aluminum arms (Silver finish/ anodized)
- Dimension 68-86 mm • OPC30/31 pads
- 200g/wheel

**883QL**

- Cold forged aluminum arms (Silver finish/ anodized)
- Dimension 68-86 mm • OPC30/31 Pads
- Quick release, reverse pull
- 210g/Wheel

**883Q**

- Cold forged aluminum arms (Silver finish/ anodized)
- Dimension 68-86 mm • OPC30/31 pads
- Quick release
- 210g/Wheel

BMX/FREE STYLE

TECH99DS "GOLD FINGER"

- Forged aluminum bracket (Anodized)
- Forged aluminum Lever handle (Anodized)
- Double bent lever handle for Dirt jump
- Hinged clamp
- Clamp 25.4mm standard or w/sleeve for 22.2mm handle bar.
- Usable on curve position (Short handle bar)
- Freestyle use.
- 240g/pair



TECH99D "DIRT HARRY"

- Forged aluminum bracket (Anodized)
- Forged aluminum lever handle (Anodized)
- Double bent lever handle for Dirt Jump
- Hinged clamp
- Clamp 25.4mm standard or w/sleeve for 22.2mm handle bar
- Usable on curve position (Short handle bar)
- Freestyle use.
- 248g/pair



GOLD FINGER 318

- Forged aluminum bracket (Anodized)
- Forged aluminum Lever handle (Anodized)
- Double bent lever handle for Dirt jump
- Hinged clamp
- Clamp 31.8 mm
- Usable on curve position (Short handle bar)
- Freestyle use.
- 260g/pair



DIRT HARRY 318

- Forged aluminum bracket (Anodized)
- Forged aluminum Lever handle (Anodized)
- Double bent lever handle for Dirt jump
- Hinged clamp
- Clamp 31.8 mm
- Usable on curve position (Short handle bar)
- Freestyle use.
- 268g/pair



TECH99DS-H "GOLD FINGER"

- GOLD FINGER with CNC Hole Lever handle
- 238g/pair



MX-2 BL200

- Designed for V-Brakes and caliper brakes
- Aluminum diecast bracket. (Powder black, red or white)
- Cold forged aluminum handle (Silver finish/Black anodized)
- 2mm reach adjustable leverage
- Cable travel : 23.8mm (V type brake)
15.0mm (For caliper brake)
- "V" Position for V type brake
- "N" Position for caliper brake
- 168g/pair



BMX/FREE STYLE



MX 1000

- Color : Anodized, Powder white
- Adjust/Quick Release
- Dimension 73-92 mm
- Cold forged aluminum arms
- MX1000N-PAD
- 210g/wheel



MX 890

- Color : Anodized, Powder white
- Dimension 68-86 mm
- Cold forged aluminum arms
- MX1000N-PAD
- 160g/wheel



MX1500N

- Hinged seat post clamp
- Diameter 25.4 mm or 28.6mm
- Anodized (Silver,Black,Gold, Red, Blue), Powder white.
- Weight : 58 g

MX1500

- Two Bolts Seat Post Clamp.
- Diameter 25.4mm.
- Anodized (Silver,Black,Gold, Red, Blue), Powder white.
- Weight: 60g.



132MT45

- Aluminum bracket (Silver finish, anodized, powder white)
- Cold forged aluminum Lever handle bend 45 degrees (Anodized, powder white)
- Clamp 22.2mm (Silver finish, anodized, powder white)
- 100g/pair



BMX/FREE STYLE



MX123/TECH-4

- Aluminum bracket(Anodized,Powder white)
- Cold forged aluminum lever handle(Anodized,Powder white)
- Clamp 22.2mm or 23.8mm
- 80g/pair



MX121/TECH-3

- Aluminum Bracket (Anodized, Powder white)
- Cold forged aluminum lever handle (Anodized, Powder white)
- Clamp 22.2 mm or 23.8 mm
- 100g/pair



MX 122

- Aluminum Bracket (Silver finish, Anodized, Powder white)
- Cold forged Aluminum lever Handle (Silver finish, Anodized, Powder white)
- Clamp 22.2 mm or 23.8 mm (Silver finish, Anodized, Powder white)
- Clamp 26 mm (Silver finish or Black anodized only)
- 88g/pair



MX120

- Aluminum bracket(Anodized,Powder white)
- Cold forged aluminum lever handle(Anodized,Powder white)
- Clamp 22.2mm or 23.8mm
- 112g/pair



- TECH5**
- Diecast aluminum bracket (Black finish, Powder White)
 - Cold forged aluminum lever handle (Silver finish, Anodized, Powder white)
 - Freestyle use
 - 98g/pc



- 183S-II**
- TECH5 with thumb-Lock stopper
 - 102g/pc



- 282W**
- Tech77W with 15mm Longer Lever handle
 - 138 g/pc



- 282SW**
- Double cable pull of 282S
 - Weight: 142g/pc



- TECH-77W**
- Double cable pull
 - Diecast aluminum bracket(Black finish)
 - Cold forged aluminum lever handle (Silver finish)
 - Hinged clamp
 - 136 g/pc



- 282**
- 15mm Longer handle compared with Tech77
 - Weight: 228g/pair

- 182S-2**
- Tech77 with thumb-lock stopper



- 282S**
- 15mm Longer handle compared with Tech77
 - 240g/pair



- 182S-2W**
- TECH77W with thumb-Lock stopper
 - 146g/pc

- TECH99**
- Design for freestyle
 - Forged aluminum bracket (Anodized)
 - Forged aluminum lever handle (Anodized)
 - Hinged clamp
 - Clamp 25.4mm standard or w/sleeve for 22.2mm handle bar
 - Freestyle use
 - 248g/pair



BMX/FREE STYLE

MX-2 BA733

- V type brake
- Cold forged aluminum arms (Silver or Black anodized/ Powder red)
- ⊕ Dual spring tension adjustment
- Linear springs
- S-pads
- 186g/Wheel



MX110N

- Diecast aluminum bracket (Black ED)
- Cold forged aluminum lever handle (Black ED)
- Two finger designed
- 160g/Pair



TECH-77

- Diecast aluminum bracket (Black finish, Powder White)
- Cold forged aluminum lever handle (Silver finish, Anodized, Powder white)
- Hinged clamp
- Freestyle use
- 228g/pair



MX-99

- Diecast aluminum bracket (Black finish)
- Forged aluminum lever handle (Silver anodized/ Black finish)
- 2mm reach adjuster
- BRS return spring
- 176g/Pair



TECH-77 DJ

- Diecast aluminum bracket (Black finish)
- Cold forged aluminum lever handle (Silver finish)
- Double bent lever handle for dirt jump & Freestyle
- Hinged Clamp
- 214g/pair



DISC BRAKE ACCESSORIES

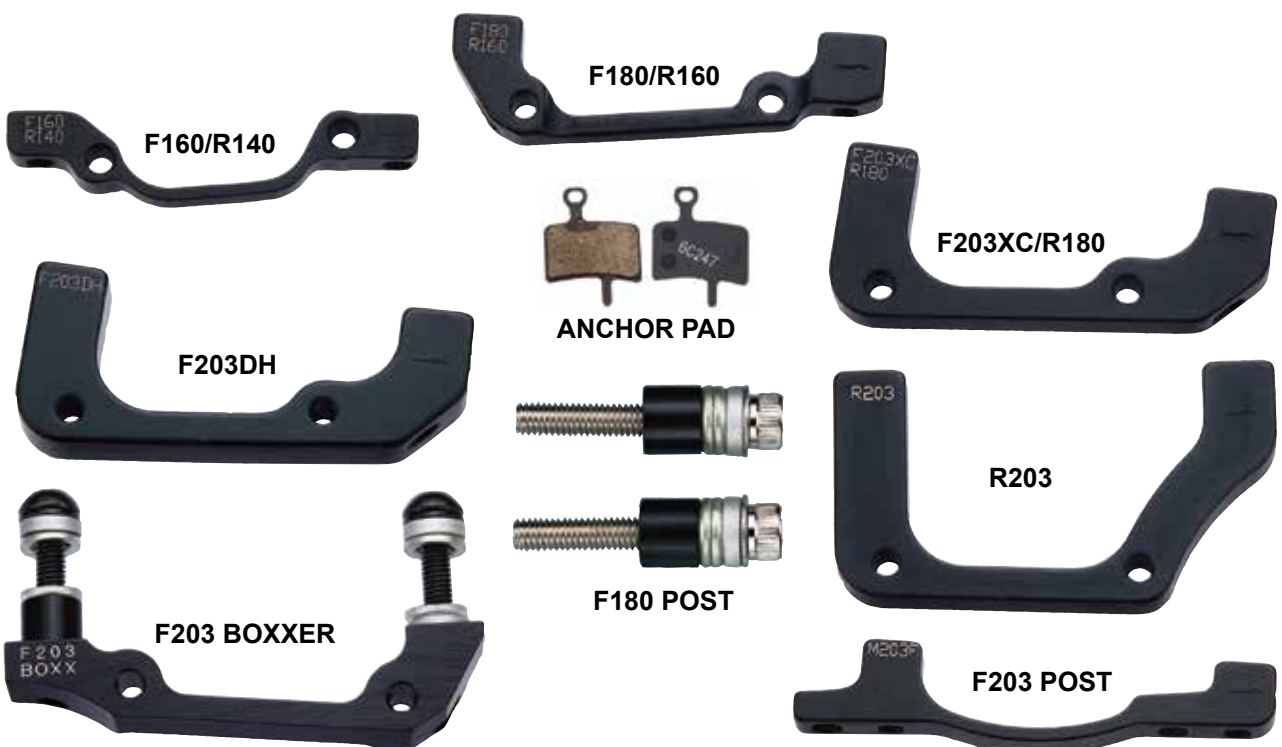

F160/R140

F180/R160

F203XC/R180

F203DH

ANCHOR PAD

R203

F203 BOXXER

F180 POST

F203 POST

DIA-COMPE®

DC980EX

- Forged aluminum arms
- Silver or Black anodized
- Dual spring tension adjustment
- 980EX-pad
- 1274-380 Straddle cable
- 1242 Straddle Cable Guide
- Weight: 165g/wheel



DC980

- Forged aluminum arms
- Silver or Black anodized
- Dual spring tension adjustment
- 980-pad
- 1274-380 Straddle Cable
- 1242 Straddle Cable Guide
- Weight: 140g/wheel



GC 999

- Forged aluminum Arms (Silver anodized)
- Adjustable for Rim, Brake pad, Spring & Straddle wire
- OPC-12L Brown pad
- 1275-500 Straddle Cable
- 1242 Straddle Cable Guide
- weight : 167g/wheel



CR-X

- Forged aluminum Arms (Black anodized)
- Adjustable for Rim, Brake pad, Spring & Staddle Wire
- CR-X black cartridge pad
- 1275-500 Straddle Cable
- 2001BL Straddle Cable Guide
- Weight : 149g/wheel



SS6

- High power out put design
- Diecast aluminum bracket (Black or Silver finish)
- Cold forged aluminum lever handle (Silver finish, Black anodized)
- 2mm reach adjuster
- BRS return spring
- 160g/Pair



VC733

- Long arm canti brake
- Cold forged aluminum arms (Silver anodized)
- ⊕ Dual spring tension adjustment
- Linear springs
- S-pads
- 186g/Wheel



DP7PLUS

- 2-Position V type brake leverage adjustment
- Diecast aluminum bracket (Black finish)
- Cold forged aluminum lever handle (Silver finish)
- 2mm reach Adjuster
- BRS return spring
- 180g/Pair



DC988

- Cold forged aluminum arms. (Silver anodized)
- Dual spring tension adjustment
- OPC-12L Brown Pad
- 1276-300 EZR Straddle Cable
- 1242 Straddle Cable Guide
- Weight : 198g/wheel



ACCESSORIES

FLEXIE

- Extra flexible casing with cable adjuster
- Additional length to the cable : 125mm
- Stainless steel casing & aluminum adjuster
- Color : Silver, Black, Gold, Green, Red, Blue

FLEXIE-V

- Extra flexible lead pipe with cable adjuster
- Additional length to the cable : 125mm
- Stainless steel casing & aluminum adjuster
- Color : Silver, Black, Gold, Green, Red, Blue
- For long arm Canti Brake use

SHORT FLEXIE

- Extra flexible casing with cable adjuster
- Additional length to the cable : 95mm
- Stainless steel casing & aluminum adjuster
- Color : Silver



SHORT FLEXIE



BOOT



DOWN TUBE CABLE HOUSING STOPS

- Braze-on down tube adjuster for shifter
- Include barrel adjuster and mounting bolts



1260ES

- 6mm ID hole
- 30mm opening
- 36mm pitch



1260ES-40

- 6mm ID hole
- 40mm opening
- 38mm pitch

LEAD PIPES

- Stainless steel
- 90° 105° 135°



LEAD PIPE FOR SKID CONTROL

- 135°



OPEN LEAD PIPE

- 135°



ACCESSORIES

2001

- Aluminum body
- Free positioning
- Color : Silver

2001G

- Aluminum body
- Free positioning
- Color : Green anodized

2001BL

- Aluminum body
- Free positioning
- Color : Black anodized

1242

- Aluminum body
- Color : Silver

1242G

- Aluminum body.
- Color : Green anodized

1245

- GC450 use
- Aluminum body
- Buffed and Silver or Black anodized
- Cable bridge with pulley guide

1701

- 1"
- Aluminum
- Color : Anodized Silver, Black, Gold, Red, Pink, Blue, Green, Purple, Gray

1252

- 1"
- Steel. CP
- Without QR

1254

- 1"
- Steel. CP
- With QR

1255

- 1"
- Steel. CP
- Without QR

1266

- 8mm ID hole
- 30mm pitch
- Width:2mm
- With cap or adjust bolt

1267-2

- Cold forged aluminum with cable angle adjuster and ferrule
- 8mm ID hole
- 25mm pitch

RECESSED BRAKE NUT

- $\Phi 10 \times L10$
- $\Phi 10 \times L12$
- $\Phi 10 \times L20$
- $\Phi 10 \times L32$

1268-2

- 6mm ID hole
- 20mm pitch

1268-3

- 8mm ID hole
- 20mm pitch

65AL

- Aluminum
- M6
- Silver or Black

1707

- cable hanger for AHEADSET fork
- 1 1/8"
- Cable drop : 34mm
- Cold forged aluminum
- Color : Silver or Black anodized
- with short flexie 95mm

1707-1

- cable hanger for AHEADSET fork
- 1"
- Cable drop : 34mm
- Cold forged aluminum
- Color : Silver or Black anodized
- with short flexie 95mm





980EX-PAD

- DC980EX brake use
- Adjustable cartridge type pad
- Black anodized holder / Black pad



980-PAD

- DC980 brake use
- New compound with adjustable hardware
- Color:Black

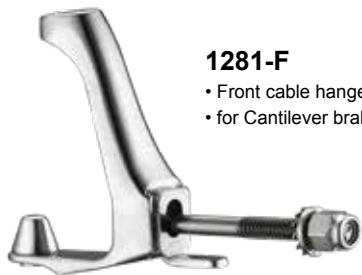

1281-F

- Front cable hanger
- for Cantilever brake

94A

- Material : A 6061
- Color : Silver, Black, Red, Blue, Gold, Green and Purple
- For DC131, DC133, DC135, DC139, MX121, MX122 and 128S-II



CARBON SPACER

- Size : 1", 1-1/8", 1.5", Thickness : 3, 5, 10, 15, 20mm

99A

- Material : A 6061 CNC
- Color : Silver, Black, Red, Blue, Gold, Green and Purple



CARBON PROTECTOR

- Carbon Chain Guard, carbon frame protector.



ALUMINUM SPACER

- Size : 1", 1-1/8", Thickness : 2, 5, 10, 15, 20mm
- Color : Silver, Black, Red, Green, Gold, Blue, Pink, Purple or Pewter anodized, Powder white



BAR TAPE

- Material : Pet
- Color : Beige, Brown, Green, Blue
- Length : 2M



ACCESSORIES

GC76AL PAD

- For GC700,GC610,DC750 &Old type Caliper
- Aluminum pad holder & Silver anodized
- Black or Brown color pad
- M6SUS nut & washer
- Only 0° tapered angle

**GC450 PAD**

- Cartridge type pad for GC450 brake
- Φ7mmx22mm length post mount
- Silver anodized holder/Black pad

MX1000N-PAD

- Pad Length 40mm
- Color : Brown, Black, White
- MX1000, MX890, CLASSIC DC730 or CLASSIC DC810 brake use

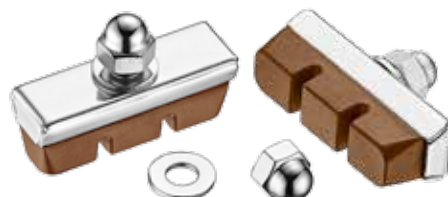
**ARC-PAD**

- Adjustable cartridge type pad for Racing brakes
- Silver anodized holder/Black pad

**CR-X-PAD**

- Cartridge type pad for CR-X Canti brake use
- Black holder/Black pad

**RC-PAD**

- Cartridge type pad for Racing brakes
- Silver anodized holder/Black pad

**CTM-PAD**

- Cartridge type pad for LACB with adjustable hardware
- 2 color pad

**CTR-PAD**

- Cartridge type pad for Racing brakes
- 3 color Pad

**CT-PAD**

- Cartridge type pad for L.C.A.B. with adjustable hardware
- For ceramic coating rim
- Satin anodized holder / Black pad

ACCESSORIES



FIESTA PACK

- Green Hombre-pads
- Low-profile aluminum spring tension adjuster.
- Stainless steel spring
- Aluminum end cap and wire stopper.

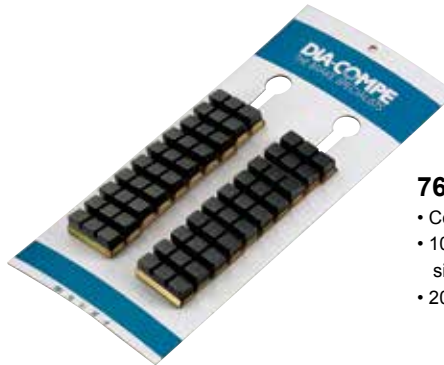

76BK-S

- Color : Black
- 10 degree brake pad for side pull brakes
- 20 pcs/sheet

S-PAD

- Color : Black with toe-in dots
- New compound for LACB with adjustable hardware



HOMBRE-PAD

- Color : Black, Green or White
- Designed for freestyle bike
- New Compound with adjustable hardware



101-PAD

- Color : Black
- New compound for Racing brakes with adjustable hardwares



DEKKA-PAD

- Color : Black or Green
- Especially designed for Freestyle & BMX high wall rims
- 18mm high & special compound
- Theaded post & Canti brake post



OPC-30

- Color : Black, White
- 0° tapered angle for side pull brakes



F-1 PAD

- Color : Black
- 0° or 10° tapered angle for side pull brakes
- New compound
- Long type pad



OPC-12L PAD

- Color : Brown,Black



OPC-33

- Color : Gray
- 0° tapered angle for side-pull brakes
- Passed BAA (Bicycle Association Approved)



OPC-34

- Color : Gray
- 10° tapered angle for side-pull brakes
- Passed BAA (Bicycle Association Approved)



OPC-12 BLACK PAD

- GC700,AD990 brake use
- Color : Black



ACCESSORIES



1274-380
• 380mm Straddle cable



1276-300EZR
• 300mm Straddle cable w/easy release



1273-100
• For GC450
• ø1.2 x 100mm



GC60.4
• t 2.5mm



1270-110
• For GC610,DC610-N,GC700 & DC750 center pull brake
• Length :110mm



1275-500
• For CRX & GC999 canti brake use
• Length 500mm

1270-290
• For GC610,DC610-N,GC700 & DC750 center pull brake
• Length :290mm



100.2/G
• Aluminum end cap with green color



100.2-RP
• Aluminum cable end cap for ø1.6mm
• 700Pcs/bottle



COLOR CHIPS
• Aluminum cable end cap for ø1.8mm
• 500 pcs (Black, Silver, Gold, Green, Purple each 100pcs)/bottle



100.2M-RP
• Aluminum cable end cap for ø1.8mm
• 500 pcs/bottle

Description	REACH							SUITABLE RIM WIDTH		
	30	40	50	60	70	80	90	20	25	30
BRS100		39-49						●		
GC450		40-52							●	
505Q BRS101/101N			45-57					●		
GC610 DC610-N			47-61					●		
GC700				53-70				●		
DC730				53-71					●	●
BRS202N				57-75					●	●
MX806				57-75					●	●
DC750				60-78				●		
DL800 DC810 DC808				61-79					●	●
883 884 890						68-86				●
MX 1000						73-92				●



DIA-COMPE TAIWAN CO., LTD.

No.62, 35th RD, Taichung Industrial Park. Taichung, Taiwan R.O.C
TEL:886-4-2359-1117 FAX:886-4-2359-3188
E-mail:diatech@ms15.hinet.net
www.diacompe.com.tw

DIA-COMPE GROUPS

- YOSHIGAI CORPORATION
OSAKA, JAPAN www.diacompe.co.jp
- KUNSHAN DIA-COMPE CO., LTD.
JIANG-SU, CHINA www.diacompe.com.cn