

EPCAMR

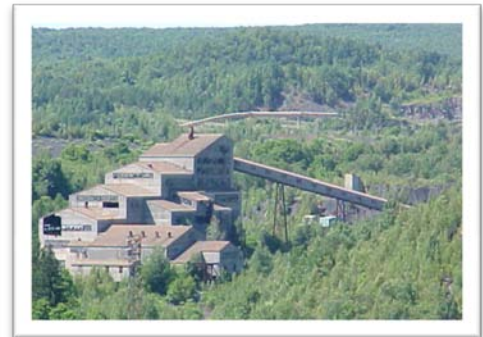

Mine Water Resources of the Anthracite Coal Fields of Eastern Pennsylvania

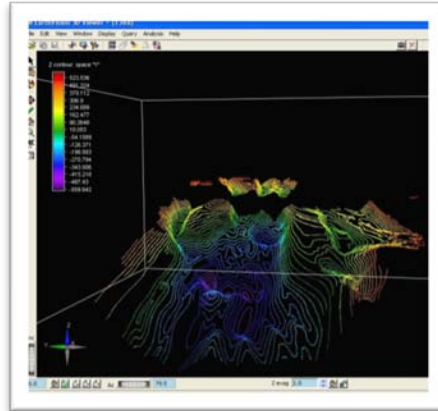

In partnership with the following major contributors and Technical Committee Organizations represented:

The United States Geological Survey, PA Water Science Center

Roger J. Hornberger, P.G., LLC (posthumously)

Susquehanna River Basin Commission

Dauphin County Conservation District

Ian C. Palmer-Researcher

**PA Department of Environmental Protection-- Bureau of Abandoned Mine Reclamation,
Bureau of Deep Mine Safety, & Pottsville District Mining Office**

MINE WATER RESOURCES OF THE ANTHRACITE REGION OF PENNSYLVANIA

Foreword: Dedication to Roger J. Hornberger, P.G. (Robert E. Hughes)

PART 1. Mine Water of the Anthracite Region

Chapter 1. Introduction to the Anthracite Coal Region

(Robert E. Hughes, Michael A. Hewitt, and Roger J. Hornberger, P.G.)

Chapter 2. Geology of the Anthracite Coal Region

(Robert E. Hughes, Roger J. Hornberger, P.G., Caroline M. Loop, Keith B.C. Brady, P.G., Nathan A. Houtz, P.G.)

Chapter 3. Colliery Development in the Anthracite Coal Fields

(Robert E. Hughes, Roger J. Hornberger, P.G., David L. Williams, Daniel J. Koury and Keith A. Laslow, P.G.)

Chapter 4. A Geospatial Approach to Mapping the Anthracite Coal Fields

(Michael A. Hewitt, Robert E. Hughes & Maynard L. (Mike) Dunn, Jr., P.G.)

Chapter 5. The Development and Demise of Major Mining in the Northern Anthracite Coal Field

(Robert E. Hughes, Roger J. Hornberger, P.G., and Michael A. Hewitt)

Chapter 6. The Development of Mining and Mine Drainage Tunnels of the Eastern Middle Anthracite Coal Field

(Robert E. Hughes, Michael A. Hewitt, Jerrald Hollowell. P.G., Keith A. Laslow, P.G., and Roger J. Hornberger, P.G.)

Chapter 7. Environmental Resource Economics of Mine Water

(Robert E. Hughes, Keith A. Laslow, and Roger J. Hornberger, P.G.)

PART 2. The Western Middle Anthracite Coal Field

Chapter 1. The Development of Mining, Mine Drainage, Tunnels, & Multi-Colliery Hydrologic Units of the Western Middle Anthracite Coal Field

(Robert E. Hughes, Roger J. Hornberger, P.G., Michael A. Hewitt, and Jim Andrews, P.G.)

Chapter 2. Mine Drainage Discharges and Boreholes of the Western Middle Anthracite Coal Field

(Robert E. Hughes, Roger J. Hornberger, P.G., Mike A. Hewitt, Ian C. Palmer, Jim Andrews, P.G., Daniel J. Koury, and Todd Wood, P.E.)

Chapter 3. Volume 1- Mine Pool Hydrology in the Eastern Half of the Western Middle Anthracite Coal Field (Schuylkill County): Colliery, Basin(s), Pool(s), Borehole(s), Barrier(s), Discharge(s), Water-filled Pit(s)
(Michael A. Hewitt, Robert E. Hughes, Jim Andrews, P.G., Roger J. Hornberger, P.G.)

PART 3. Water Budgets & Groundwater Volumes for Abandoned Underground Mines in the Western Middle Anthracite Coalfield, Schuylkill, Columbia, & Northumberland Counties, PA—Preliminary Estimates with Identification of Data Needs

(Daniel J. Goode, Charles A. Cravotta III, Roger J. Hornberger, P.G., Michael A. Hewitt, Robert E. Hughes, Daniel J. Koury, and Lee W. Eicholtz)

PART 4. The Southern Anthracite Coal Field

Chapter 1. The Development of Mining, Mine Drainage, Tunnels, Shafts, & Multi-Colliery Hydrologic Units of the Southern Anthracite Coal Field

(Robert E. Hughes, Roger J. Hornberger, P.G., Michael A. Hewitt, and Jim Andrews, P.G.,)

Chapter 2. Mine Drainage Discharges and Shafts of the Southern Anthracite Coal Field

(Robert E. Hughes, Roger J. Hornberger, P.G., Mike A. Hewitt, Ian C. Palmer, Jim Andrews, P.G., Daniel J. Koury, and Todd Wood, P.E.)

Chapter 3. Volume 2- Mine Pool Hydrology in the Southern Anthracite Coal Field (Schuylkill and Dauphin County): Colliery, Basin(s), Pool(s), Borehole(s), Barrier(s), Discharge(s), Water-filled Pit(s)

(Michael A. Hewitt, Robert E. Hughes, Jim Andrews, P.G., and Roger J. Hornberger, P.G.)

Conclusions

Appendix A. Figures, Plates, Tables, Graphs, and Maps

(Robert E. Hughes, Michael A. Hewitt, and Roger J. Hornberger, P.G.)

Appendix B. Notes of Mine Map Evaluation

(Roger J. Hornberger, P.G.)

Appendix C. EPCAMR Mine Drainage Water Quality Samples Inventory Database

(Michael A. Hewitt, Robert E. Hughes, & Ian C. Palmer)

Appendix D. Core Log of Southern Anthracite Coal Stratigraphy

(William Bragonier and Roger J. Hornberger, P.G.)

Appendix E. Western Middle Anthracite Coal Field Borehole Data Charts (1982-2003)

(Mike A. Hewitt, Robert E. Hughes, & PA DEP Bureau of Abandoned Mine Reclamation)

Appendix F. Southern Anthracite Coal Field Shaft Data Charts (1975-1982)

(Mike A. Hewitt, Robert E. Hughes, & PA DEP Bureau of Abandoned Mine Reclamation)

Foreword: Dedication to Roger James Hornberger

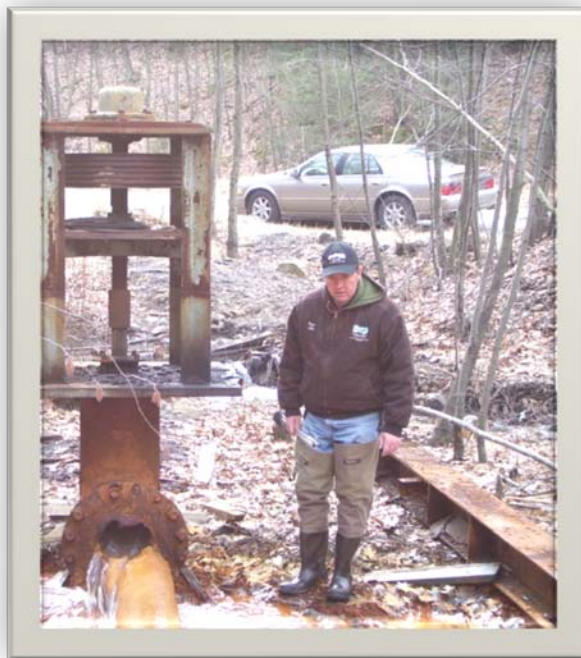

EPCAMR would like to dedicate this series of Reports on the subject of Mine Water Resources in the Anthracite Region of Pennsylvania to Roger J. Hornberger, P.G., who passed away on March 19, 2010 at his home. He was a son of the late James W. and Olive R. Ryland Hornberger. Roger was born on December 9, 1950 in Pottsville, PA and lived at home in Schuylkill Haven. He was a graduate of Schuylkill Haven High School Class of 1968. He was a member of Jerusalem Lutheran Church, Schuylkill Haven, Schuylkill Country Club for many years, Tremont Clubsters and the Schuylkill Haven Golf League. Roger was a member of the Army National Guard for 22 years in Schuylkill County with the Red Horse Division. Surviving are his aunt, Grace Koble, Schuylkill Haven; his uncle, Calvin Hornberger, Cressona; and many cousins.

Roger was the epitome of an honorable gentleman who served his nation and this Commonwealth with dignity, a passion for the environment, and honor. He always had a smile on his face, was very soft spoken, yet spoke with zeal and confidence about PA's environment, particularly related to mining, and went about performing his duties with dedication and in the greatest level of detail. Personally, Roger had been a mentor for me ever since I was an intern with the PA Department of Environmental Protection in the early

90s, through the time that I had become the Executive Director of the Eastern PA Coalition for Abandoned Mine Reclamation (EPCAMR), nearly fifteen years ago. He was the one man that took the time to teach myself, and my co-worker, Michael A. Hewitt, as much information that he could about mine water resources in Pennsylvania throughout our young careers until his passing.

Mike and I have enjoyed many lunches with Roger and Dan Koury, yet another disciple of Roger's from the Pottsville District Mining Office, reviews of underground mine maps, meetings with our technical team partners, teaching sessions where we just absorbed every word that came out of his mouth whether it was on a mining tour, at a Conference presentation, or in each other's Office reviewing and having very complicated discussions on the hydrogeological complexities of Anthracite mining geology and the recent advent of EPCAMR's use of 3-dimensional mapping technologies to once again daylight the underground mining resources for the public to gain an even better understanding of just what lies beneath our feet. I would call him a genius and someone who, we had the privilege of knowing personally, as a friend and a colleague that allowed us to absorb his institutional knowledge of mining and become very knowledgeable on the subject matter ourselves. Roger did pioneering research into the impacts of abandoned mine drainage on aquatic life and water uses and helped develop groundbreaking policies and technologies to remediate mine drainage and abandoned mines that EPCAMR is just one of many organizations that are following in his footsteps.

Roger was the original visionary for the development of this project in partnership with EPCAMR, USGS, the PA DEP, PA DEP BAMR, SRBC, collaborating County Conservation Districts, PA DEP Deep Mine Safety, and other colleagues throughout the Anthracite Region. Roger's extensive knowledge of PA's geology, mining history, water quality and geo-chemistry, had by far, made him one of our greatest experts in the field of abandoned mine reclamation, mine drainage abatement, mine drainage remediation, remining, predicting AMD, coal ash reclamation, underground mining, and most importantly, the topic of underground mine pools. EPCAMR would be remiss if we did not highlight some of Roger's greatest accomplishments to contributing as a public servant within the Commonwealth of Pennsylvania and as a pioneer in the field of mine water resources.

Roger's professional experience first began when he received his Bachelor's of Science in Landscape Architecture in 1972. He was a Research Assistant, with the Institute for Research on Land and Water Resources at The Pennsylvania State University from September 1974 to August of 1975, where he began early on to compile data on social, economical, and environmental effects of highway construction for use in

Environmental Impact Assessments (EIAs) on a multi-disciplinary research team that provided him with the qualities and level of detail that he carried with him for the remainder of his professional career.

Roger then became a Project Assistant, in the Department of Landscape Architecture at The Pennsylvania State University from 1973-1976. At this time during his early career, he continued on as a Research Assistant on various projects involving landscape architectural, geological, and ecological aspects of highway construction, surface mining, and other land use developments.

Roger then went back to the Institute for Research on Land and Water Resources at The Pennsylvania State University, once again as a Research Assistant from July 1976 to November 1978 working on a project funded by the U.S. Department of the Interior to evaluate stratigraphic and hydrogeologic aspects of variations in abandoned mine drainage (AMD) pollution associated with bituminous coal mines in western Pennsylvania. From November 1978 to May 1979, Roger went on to become a Geologist Trainee, with the Pennsylvania Department of Environmental Resources, in the Bureau of Water Quality Management where he was employed as a Geologist on a team project funded by the U.S. Environmental Protection Agency to (1), compile an inventory of all surface water impoundments associated with industry, mining, oil and gas development, agriculture, municipal developments, or other land uses in Pennsylvania, and (2), perform an assessment of ground-water pollution potential of selected impoundments.

As he climbed up the ladder with his early successes with the Pennsylvania Department of Environmental Resources, he went on to become a Hydrogeologist for the Department within the Bureau of Mining & Reclamation first becoming a Hydrogeologist 1 from May 1979 to June 1983. He then went on to obtain his Master's of Science in Geology in 1985 from The Pennsylvania State University and eventually ended up as a Hydrogeologist 3 from June 1983 to 1986 with the Pennsylvania Department of Environmental Resources, Bureau of Mining and Reclamation. His duties included:

- Developing and determining methodology for the analysis of overburden, coal, and associated materials in conjunction with the evaluation of potential environmental impact of surface mining upon high quality watersheds and other environmentally sensitive areas;
- Preparing research proposals and conducting research activities necessary for the calibration and analysis of an array of overburden analysis techniques with a wide range of available overburden strata in Pennsylvania, correlating overburden analysis techniques with mine drainage quality and determining the most efficient predictors of mine drainage quality;
- Coordinating scientific and technical developments of a policy and computer program components for remining or re-affecting areas where abandoned surface and underground mines were causing surface-water and ground-water pollution;

- Reviewing permit data in order to evaluate potential environmental impact and conduct hydrogeologic investigations of surface mine sites and surrounding areas concerning overburden analyses, mine drainage chemistry, complaints of water-supply degradation, and other problems associated with stratigraphy, hydrogeology, and geochemistry of surface mining regions within Pennsylvania;
- Providing testimony as an expert witness on overburden analysis, acid mine drainage problems, other aspects of stratigraphy and hydrogeology pertaining to surface mines, as related to litigation arising from appeals from the denial or issuance of mine drainage permit and appeals from Departmental Orders to treat or abate AMD problems; and
- Coordinating and conducting special investigations of an interdisciplinary or interbureau nature involving complex hydrogeological problems including: environmental effects of illegal hazardous waste dumping in abandoned flooded underground mines; interrelationships between siting of proposed hazardous waste disposal facilities and hydrogeologic setting of associated active or abandoned, surface or underground mines; and interactions among high-volume ground-water pumping activities of quarries, public water supply wells and ground-water pollution cleanup activities at a Superfund site in an urbanizing carbonate basin

In March 1986 to January 1987, Roger became a Hydrogeologist Supervisor & Chief for the Surface Mining Permits Section, Division of Permits, Bureau of Mining & Reclamation, Pennsylvania Department of Environmental Resources. From 1987 to 1989 Roger became the Hydrogeologist Manager & Acting District Mining Manager, for the Pottsville District Mining Office, Bureau of Mining & Reclamation, Pennsylvania Department of Environmental Resources, and began his concentration on the Anthracite Coal Region of PA. From 1989 to July 2006, Roger had been promoted within the Department to the District Mining Manager, of the Pottsville District Mining Office. His main responsibilities were for the permitting, inspection, compliance monitoring and enforcement activities of Anthracite coal mines and industrial mineral quarries in 32 counties.

Upon his retirement, in 2006, after spending 19 years with the PA DEP, Roger kept very busy on special projects and investigations, litigation cases for the Department and in the private sector as an independent consultant, which he was, while working with EPCAMR on this project. He was the author of publications on coal mine drainage prediction and prevention and was the Interstate Mining Compact Commission's representative on the Operations Committee of the Acid Drainage Technology Initiative. He will always be recognized as a national and international expert on mine remediation, including both active and passive treatment systems, and in preventing mine drainage problems from modern surface and deep mines.

Thank you so much for your words of wisdom and intellectual conversations, your companionship and friendship, your caring words, and your overall willingness to share your brilliant thoughts that led Mike and I, and many others to make the best professional judgments and conclusions possible about the newest developments in our collective concepts of the multi-colliery hydrologic units that either connect or disconnect the underground Anthracite mine pool complexes throughout the Coal Fields. We can only hope that you would give us your blessing from the heavens above that we are heading down the right paths to revealing the potential re-use of the mine water resources for the greater common good across Pennsylvania.

Forever in our thoughts and prayers,

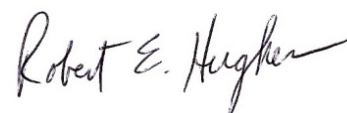
A handwritten signature in black ink that reads "Robert E. Hughes". The signature is written in a cursive style with a long, sweeping underline.

Robert E. Hughes, EPCAMR Executive Director

All publication rights and copyrights, in the documentation produced by EPCAMR in connection with the work provided for under the Grant Agreement, shall rest with the Commonwealth. EPCAMR shall not publish any of the results of the work without the written permission of the Department of the Environmental Protection. EPCAMR shall not publish or otherwise disclose, except to the Commonwealth and except matters of public record, any information or data obtained hereunder from private individuals, organizations, or public agencies, in a publication whereby the information or data furnished by or about any particular person or establishment can be identified, except with the consent of such person or establishment. This project was financed in part by a Growing Greener Grant provided by the Pennsylvania Department of Environmental Protection. The views expressed herein are those of the authors and do not necessarily reflect the views of the Department of Environmental Protection.

Mine Water Resources of the Anthracite Coal Fields of Eastern Pennsylvania

Part 1. Anthracite Mine Water

Chapter 1 Introduction to the Anthracite Coal Region

By Robert E. Hughes¹ and Roger J. Hornberger, P.G.²

The Anthracite Coal Region of eastern Pennsylvania occupies portions of **7** counties as shown on (see **Figure 1. The Anthracite Coal Fields** and further discussion on the **3** orogenic episodes and the physiographic provinces are in Chapter 2). The Anthracite Coal Fields extend 50 miles east to west and 100 miles north to south covering around 484 square miles. Current estimates show **4** to **6** billion tons of reserves of Anthracite left in the region (Council, 2011). Anthracite is a naturally high carbon, clean burning solid fuel with a typical sulfur content of less than 0.7% and volatile matter of just 4% to 6%. In fact, Anthracite is the cleanest burning solid fuel on the commercial market today. Coal companies have mined and prepared Anthracite coal for more than 150 years. It has lower sulfur content than some heavy fuel oils. Its uses range from residential, commercial, industrial, carbon, and water filtration media. Anthracite's heat value is measured in British Thermal Units (BTUs) like all other sources of energy. There are about 25 million BTUs per ton of Anthracite. This is the equivalent of 180 gallons of home heating oil and 260 therms of natural gas. Current estimates show between 300 to 500 years of Anthracite reserves remain in the ground today (Council, 2011). Anthracite coal is generically called "hard coal" mineral (see **Figure 1. Anthracite Coal**) because it is of higher rank on the carbon scale (i.e. harder) than the coal beds of the Bituminous Coal Region of western Pennsylvania, its high luster, high carbon content, typically between 92-98% , and relatively few impurities (Stefanenko, 1983).

Figure 1.1 Anthracite Coal (Courtesy of the PA Anthracite Council)



¹ Executive Director-Eastern Pennsylvania Coalition for Abandoned Mine Reclamation, Robert E. Hughes

² Professional Geologist, Roger J. Hornberger, LLC

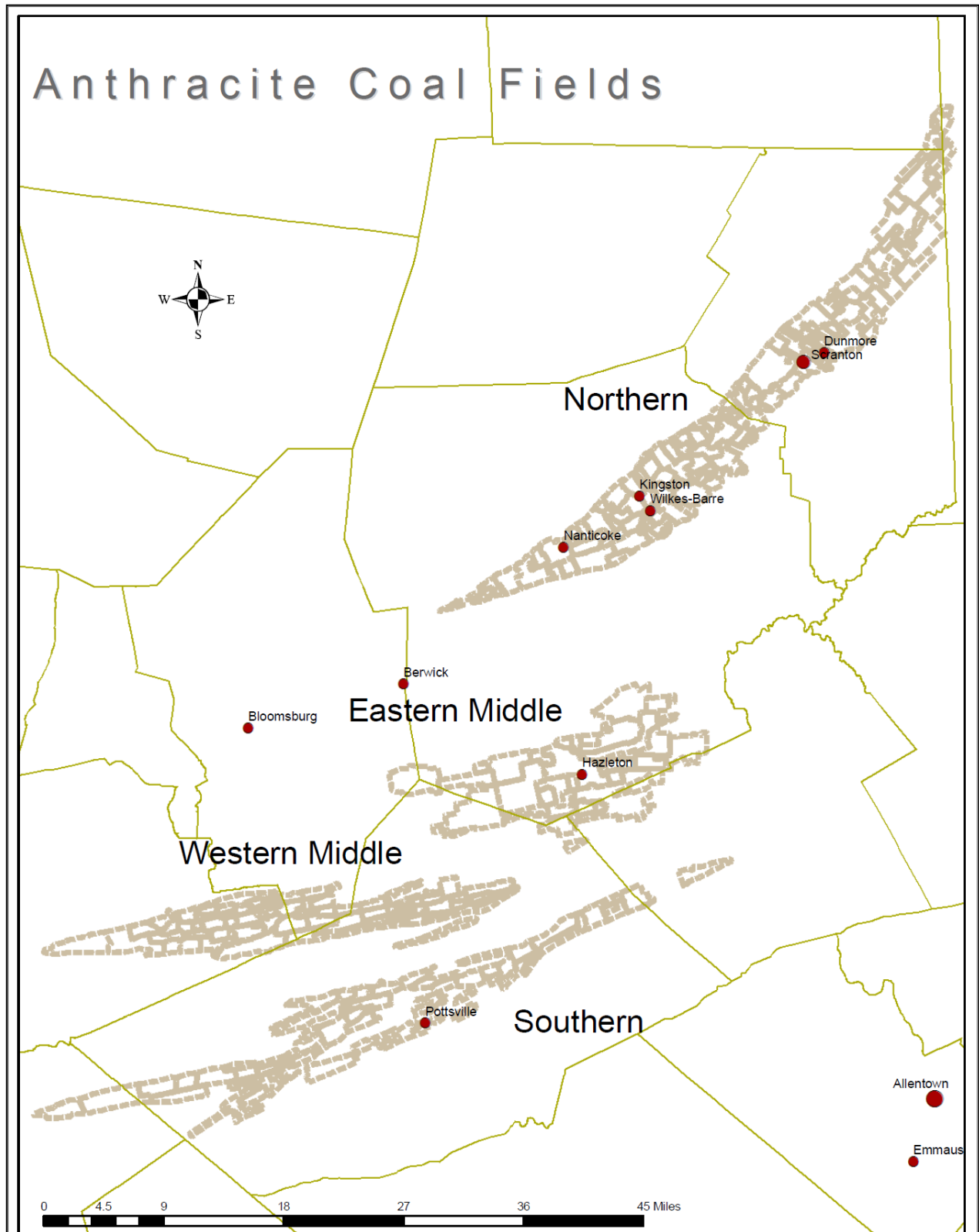

Figure 1. Anthracite Coal Fields (Hughes, 2011)

The birth of Anthracite and bituminous coals of PA are time equivalent (about 250-400 million years before present), but the Anthracite coals are higher rank due to being subjected to higher temperature and pressure (i.e. metamorphism) during the mountain building episodes of the Ridge and Valley Physiographic Province. The geologic structure of the 4 eastern Anthracite fields consists of one or more deep, steep-sided synclinal basins. Coal veins exhibiting dip in excess of 60 degrees have been measured in some of the Anthracite Coal Fields while others have been completely overturned and fold back on themselves. This is in contrast to the relatively flat-lying bituminous coals of the Allegheny Plateau Physiographic Province of western PA and Deep Valleys and Glaciated High and Low Plateau Sections of the northern tier of PA (**Figure 1.2 Physiographic Provinces of PA**). Material deposition of pre-historic swamps, flora, fauna, and peat beds were deposited that eventually transformed to Anthracite coal. This occurred during the Carboniferous Geologic Period. At that time, most of PA was a flat, hot, moist plain covered with steaming swamps thick with tall trees and wide spreading ferns. The Anthracite Coal Region is located in the Anthracite Valley Section, portions of the Susquehanna Lowland Section, Anthracite Upland Section, and portions of the Blue Mountain Section, of the Ridge and Valley Physiographic Province.



Figure 1.2 Physiographic Provinces of PA (DCNR, 2011)

There are four main Coal Fields of the Anthracite Region as shown on **Figure 2.1. Distributions of PA Coals**

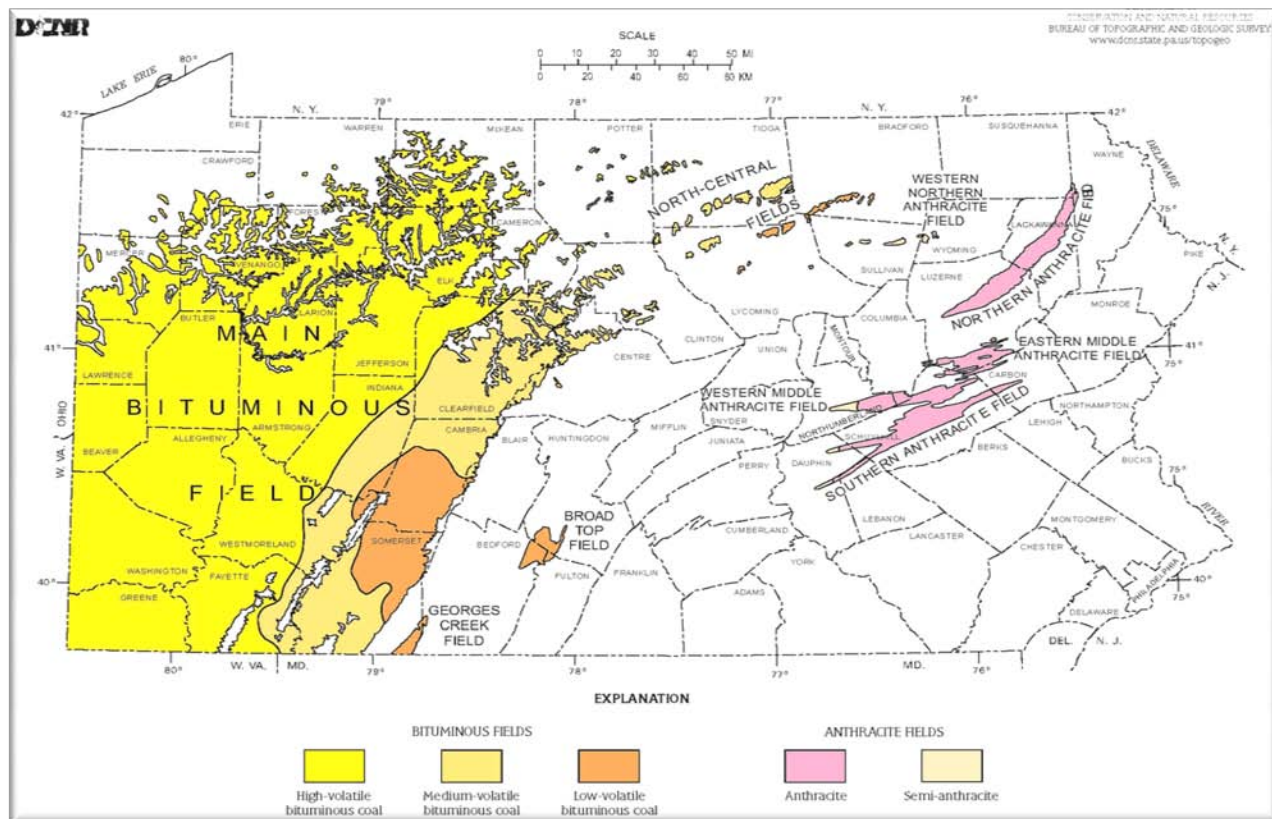

Figure 2.1 Distributions of PA Coals (DCNR, 2011)

However, there is the Western Northern Coal Field that extends across Sullivan County into Wyoming County in several smaller discontinuous pockets of semi-anthracite. The Northern Coal Field extends from Mocanaqua, Luzerne County, on the western end of the field northeastward to Forest City, Susquehanna County, on the eastern end. The Northern Field is divided into two major “canoe-shaped” basins, the Lackawanna Basin in the northeastern half, and the Wyoming Basin in the southwestern half. The hydrogeology of the Lackawanna Basin is described in (Hollowell, 1975) and the hydrogeology and movement of subsurface water through rocks and the effect of moving water on rocks, including their erosion of the Wyoming Basin is described in (Hollowell, 1974). These two Water Resources Reports of the Pennsylvania Geologic Survey, prepared in cooperation with the then PA Department of Environmental Resources and the Branch of Environmental Affairs-Wilkes-Barre Field Office, United States Bureau of Mines provide much valuable information on the mine water resources of the Northern Field.

The Eastern Middle Coal Field is the smallest of the four coal fields and is comprised of parallel discontinuous coal basins, most of which lie above the regional drainage system. The Hazleton Basin and the Jeansville Basin are the largest of **11** geobasins surrounding an approximate 8-mile radius around the City of Hazleton, Luzerne County and extend to the Stockton Basins. The hydrology of the major mine drainages discharges and surface overflows of abandoned mines of the Eastern Middle Coal Field is described in (Hollowell, 1999). A description of the inundation of the Anthracite reserves for the Eastern Middle Coal Field is described in a Bureau of Mines Bulletin 491 (Ash, et al., 1950a). Bedrock and glacial geology of the Eastern Middle Anthracite Coal Field can be found in the 53rd Annual Field Conference of PA Geologists (LaRegina, 1988).

The Western Middle Coal Field extends from the town of Trevorton, Northumberland County, on the western end of the field northeastward to the town of Delano, Schuylkill County, on the eastern end. See **Figure 1.1**. The hydrology of the Western Middle Coal Field is described in (Reed, et al., 1987) and two more recent reports dealing with the Mahanoy and Shamokin Creek basins (Cravotta, 2004) (Cravotta, et al., 2004). The westernmost tip of the coal field is comprised of semi-anthracite. Topographic ridges surround the Western Middle Coal Field and they impede the erosion of the coal measures that lie within. On the western end of the field, the Big Mountain and Little Mountain lie to the north. The Mahanoy Mountain and the Line Mountain lie to the south. Moving eastward, the Broad Mountain becomes the southern boundary. The Western Middle Coal Field is structurally very complex, but it may be simplified as shown on **Figure 2.2**. Accordingly, there are two major synclinoria separated by an anticlinorium. These structural features are the Northumberland Synclinorium, the Shade Mountain-Selinsgrove Anticlinorium, and the Western Middle Field Synclinorium.

Much has been written on the stratigraphy and lithology of the Western Middle Coal Field and the Anthracite Region as a whole. Two of the most comprehensive descriptions are found in (Edmunds, et al., 1999) and (Wood, et al., 1986). Both authors in each of their respective reports present this information graphically. The Pottsville Formation has been subdivided into the Tumbling Run Member, the Schuylkill Member, and the Sharp Mountain Member in the Western Middle and Southern Coal Fields.

The Southern Coal Field is the largest field and it extends from just northwest of the Borough of Lykens, Dauphin County, on the western end of the field, with a prong diving down towards the Borough of Dauphin, Dauphin County, northeastward to the Borough of Nesquehoning, Carbon County, on the eastern end. Little has been written about the hydrogeology or hydrology of the Southern Anthracite Coal Field, although much information on the geologic structure and stratigraphy is contained in (Wood, et al., 1956)

(Wood, et al., 1963) (Wood, et al., 1969) (Wood, et al., 1970) and (Wood, et al., 1986). By 1850, numerous collieries (i.e. large underground mines and associated surface coal mine structures) had been developed, some having vertical shafts with depths of more than 1,000 feet. The westernmost tips of the coal field are also semi-anthracite.

Anthracite coal was discovered in eastern Pennsylvania in about 1750, according to (Miller, et al., 1985), who describe the Anthracite pioneers in their excellent book on the Anthracite Region. They report that blacksmith brothers Obediah and Daniel Gore used Anthracite successfully in their workplace in 1769. Necho Allen is credited with discovering Anthracite coal in the Southern Coal Field near the City of Pottsville, Schuylkill County, in 1790. They also describe how Colonel Jacob Weiss, Michael Hillegas, Charles Cist, and John Nicholson, formed the Lehigh Coal Mine Company in February 1792 to begin to capitalize on their findings. The greatest book that provides a detailed chronology of the development of the Anthracite Region from that point from the coal town and sociological perspective can be found in (Wallace, 1981).

Most of the Anthracite coal was deep mined up through the 1930's, however, some surface mines existed and their coal production increased following World War II. Anthracite production peaked at just over one hundred million tons in 1917 (100,445,299 tons) and most of this was obtained by underground mining. Surface mining is divided into open pits and coal refuse banks (i.e., refuse waste rock deposits from the collieries). Surface mine production did not exceed deep mine production until about 1960. Refuse bank production increased sharply in the 1980's with the advent of cogeneration plants (i.e. fluidized bed combustors). Since 1985, refuse bank production and reclamation by cogeneration plants and affiliated mining companies has accounted for a significant amount of the total annual production and use. See ARIPPA's website for the history and the legacy of past mining on the PA landscape at (ARIPPA, 2011)

The Pennsylvania Department of Environmental Protection's (PA DEP) Bureau of Mine Safety and its predecessor, the Department of Mines and Mineral Industries (DMMI), has maintained coal production statistics since 1870, when the total yearly production was 14,172,004 tons. The DMMI started reporting Anthracite coal production from refuse banks in 1894 and Anthracite coal production from strip mining in 1932. Prior to 1932, almost all of the Anthracite coal production was from underground mines.

Table 1. 2009 Anthracite State-wide Production Summary (DEP, 2009)

	2009	2008	Change	% Change
<i>Underground Mines</i>				
Production (tons)	171,720	235,899	-64,179	-27%
<i>Production (cubic yards)*</i>	<i>135,319</i>	<i>185,894</i>		
Employees	91	110	-19	-17%
Hours Worked	158,235	201,432	-43,197	-21%
Mines Reporting Production	11	12	-1	-8%
Companies Reporting Production	11	12	-1	-8%
<i>Surface Mines</i>				
Production (tons)	2,771,298	2,316,715	454,583	20%
<i>Production (cubic yards)*</i>	<i>2,183,844</i>	<i>1,825,623</i>		
Employees	393	368	25	7%
Hours Worked	766,422	640,940	125,482	20%
Mines Reporting Production	61	58	3	5%
Companies Reporting Production	37	47	-10	-21%
<i>Coal Refuse Sites</i>				
Production (tons)	3,876,312	5,444,504	-1,568,192	-29%
<i>Production (cubic yards)*</i>	<i>3,054,619</i>	<i>4,290,389</i>		
Employees	243	323	-80	-25%
Hours Worked	440,894	516,722	-75,828	-15%
Sites Reporting Production	54	54	0	0%
Companies Reporting Production	40	42	-2	-5%
<i>Total Anthracite Production</i>				
Production (tons)	6,819,330	7,997,118	-1,177,788	-15%
<i>Production (cubic yards)*</i>	<i>5,373,783</i>	<i>6,301,905</i>		
Employees	727	801	-74	-9%
Hours Worked	1,365,551	1,359,094	6,457	0%
Sites Reporting Production	126	124	2	2%
Companies Reporting Production	79	80	-1	-1%

The Energy Information Administration (EIA) estimates the demonstrated US coal reserve base at **496** billion tons distributed geographically among 31 states; with **27** billion tons in Pennsylvania. Pennsylvania is the fourth leading coal producing state, mining 68 million tons (Energy Information Administration, 2008). Almost **80** percent of this output came from **39** underground mines and the remainder from **377** surface mining and reprocessing sites. In addition, the Pennsylvania mining industry constitutes a major source of employment and tax revenue. In 2009, it created 49,100 direct and indirect jobs with a total payroll in excess

of \$2.2 billion. Taxes on these wages netted over \$700 million to the coffers of federal, state and local governments. Current estimates show **4 to 6** billion tons of reserves of Anthracite left in the region. Northeastern PA holds **75%** of the world's and **95%** of the northern hemisphere's Anthracite reserves.

Two major events, the Knox Mine Disaster, on January 22, 1959, in the Northern Field's Jenkins Township, near Port Griffith, Luzerne County, and the changes in Pennsylvania Clean Streams Law in 1965, spelled the end of almost all of the major collieries and the decline in Anthracite production as a major industry in Northeastern Pennsylvania. The Knox Mine disaster is described in detail in **Chapter 5** and in (Wolensky, 1999). Essentially, a breach in the mine opened up (see **Figure 1.3 Knox Mine Disaster breakthrough at the River Slope Mine beneath the Susquehanna River**). The text on the State Historical Marker at the site succinctly describes the event can be found on **Figure 1.4 Knox Mine Disaster PA Historical Museum Commission Marker Inscription**. The overlying Susquehanna River flooded that mine and many adjacent mines in the Lackawanna and Wyoming Basins (see **Figure 1.5 Location of Large Capacity Pumps, Openings Where the Men Escaped, and Approximate Shore Line of Pool following River Break In**), and most of these mines never recovered to continue pumping and mining.

The Susquehanna River broke throughout the thin rock roof of the River Slope Mine, Knox Coal Company. The hole was an estimated 150 feet in diameter, funneling in **10** billion gallons of water through the mine and other mine pools in the vicinity. One of the railroad tracks above were cut and bent towards the river. Over 50 Coal Hopper cars were pushed into the breach by a diesel locomotive. Over 400 mine cars were dumped over the bank into the hole but the water just kept rushing right in. Thousands of bales of hay and hundreds of railroad ties were also added. Culm, dirt, and rock barely stopped the river. Finally, the river was diverted around Wintermoot Island by building dams at both ends. Once they pumped the water out between the dams, the size of the hole was evident. Tons of clay and rock were poured into the hole and a concrete cap was placed on top of the opening. They then pumped much of the water out of the mine to look for the **12** missing miners. No bodies were ever recovered.

Pictures on the front page of the New York Times and in (Wolensky, 1999) show a giant vortex in the Susquehanna River where the river invaded the underlying Knox Mine and numerous adjacent mines. The volume of infiltrating water was so great that many mines could not pump a sufficient amount to remain dewatered, and consequently these mines became flooded and ceased working, never to reopen again. Wolensky et al. (Wolensky, 1999) include a photo showing where "Lehigh Valley Railroad tracks were cut and extended toward the river so that gondolas could be pushed into the whirlpool" (p.47) and they state that

“In a scene that persists as one of the most powerful visual legacies of the disaster, trainmen thrust one gondola after another into the massive hole using a yard locomotive” (p.46).



Figure 1.3 Knox Mine Disaster breakthrough at the River Slope Mine beneath the Susquehanna River (Wyoming Valley Geological Society photo)

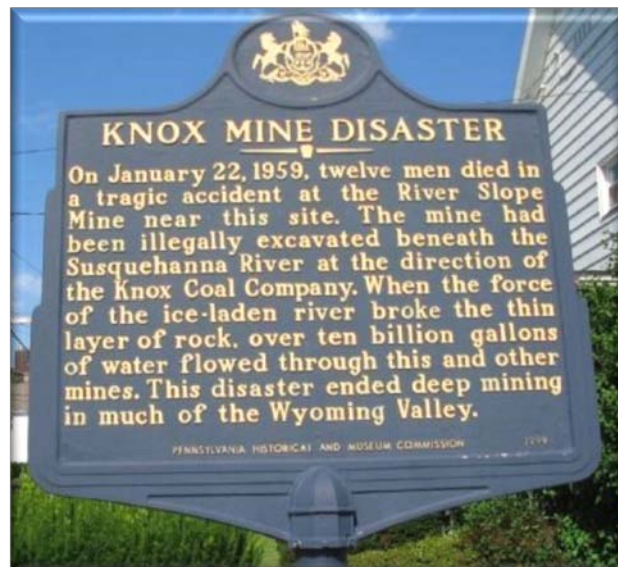

Figure 1.4 Knox Mine Disaster PA Historical Museum Commission Marker Inscription (courtesy of photo taken by Craig Swain, July 25, 2008)

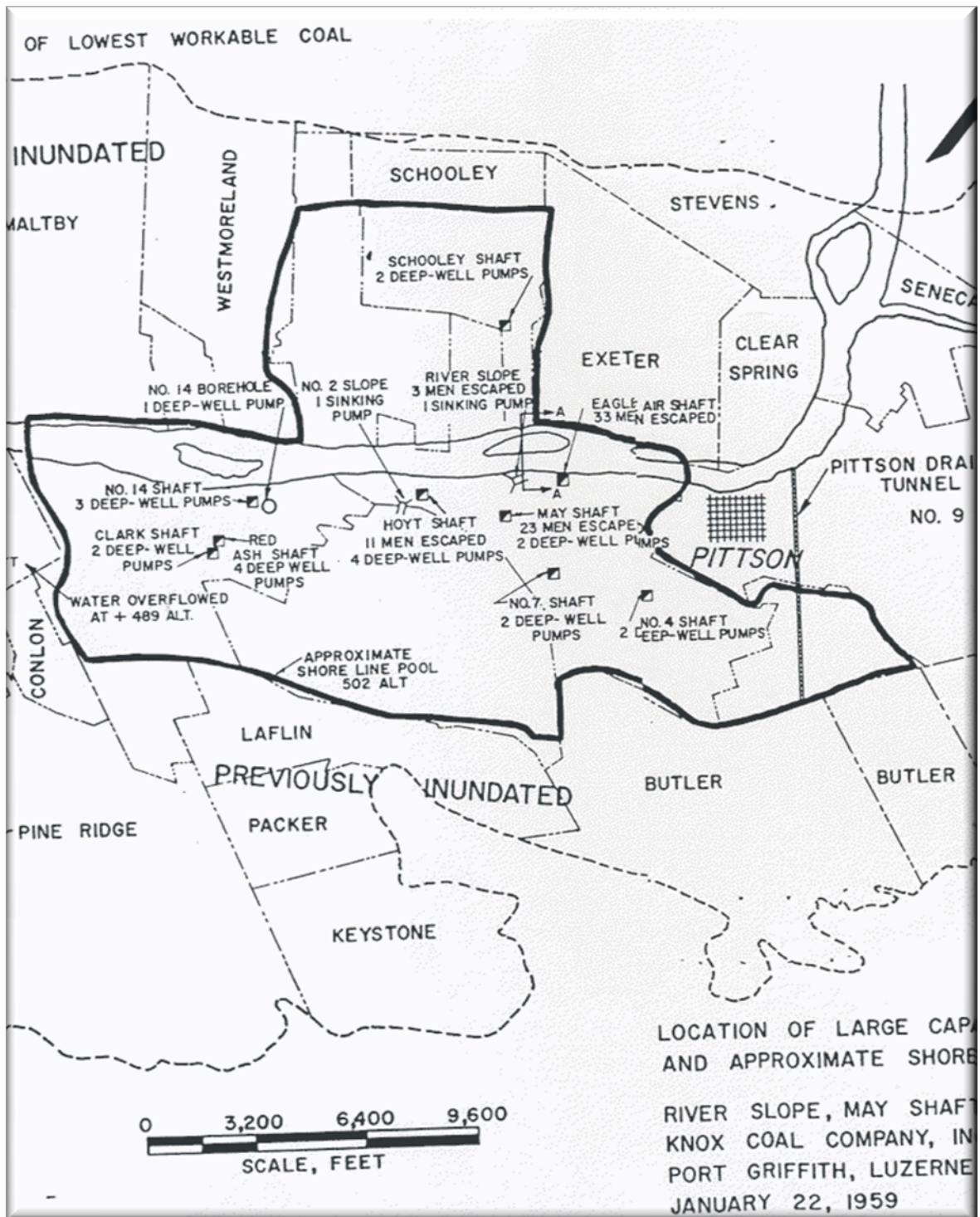

Figure 1.5 Location of Large Capacity Pumps, Openings Where the Men Escaped, and Approximate Shore Line of Pool following River Break In (MHSA, 1959)

The Pennsylvania Clean Streams Law was enacted in 1937; however, mine drainage was exempted until amendments to the law were made in 1965, requiring treatment of mine drainage. In 1966, mining companies throughout the State had to make a decision on whether they would construct and operate mine drainage treatment facilities, or simply stop pumping and go out of business. Virtually all of the major Anthracite deep mine companies ultimately ceased pumping and allowed their mines to fill up with inflowing ground water.

The water levels of these developing mine pools eventually stabilized when spill-over points were reached at the lowest topographic elevation of a sizeable orifice of the abandoned underground mine. In many cases, the spillover opening was the main tunnel, slope, or drift entry to the mine; in other cases the lowest opening was an airshaft, borehole, or some other underground mine feature. Consequently, about 100 large abandoned mine discharges appeared in the four coal fields of the Anthracite Region (Growitz, 1985), (Wood, 1996). These major discharges and thousands of more minor seeps persist to the present day throughout the Anthracite Region.

The mine drainage discharges of the Anthracite Region generally have lower concentration of acidity, sulfates and metals than the discharges of the Bituminous Coal Region of western Pennsylvania. This is principally due to variations in paleo-environment, in that the coals and overburden strata of the Anthracite Region generally have low total sulfur contents due to deposition in a freshwater paleoenvironment.

The abandoned deep mine discharges have polluted many of the streams and rivers of the Anthracite Region with (relatively high) concentrations of acidity, iron, manganese, aluminum, sulfate, and other constituents. The streambeds of these water courses are typically covered with “yellow boy” (i.e., iron hydroxide) and the waters are frequently devoid of fish and benthic aquatic life and macro invertebrates. However, many of these streams and rivers of the Region were already essentially dead from many years of receiving untreated discharges when the active underground mines were pumping the mine water prior to 1966.

There are billions and billions of gallons of mine water in the flooded abandoned underground mines in mine pools that are very hydrogeologically complex and in surface mine water filled pits and lakes. For example, (Ash, et al., 1953) stated: “In the Western Middle Field are **58** underground water pools containing **38** billion gallons of water.” The **81** barrier pillars investigated in the Western Middle Field have a total length of **67** miles. These calculations were made at a time in the 1950’s when many of the collieries were still mining and actively pumping water, so the present day total for the Western Middle Coal Field is much greater. It has been estimated that from 1944-1948 alone, **30%** of the water pumped to the surface was from

abandoned mines. These are figures and revised estimates that this report is trying to update given, all of the new underground and groundwater modeling applications, 3-D modeling, structural geology modeling, and geographic information system (GIS) available to our partners. The volumes of coal reserves that remain inundated in the Anthracite Coal Fields due to the mine pool extents and depths are impressive and vast, but also are reserves that could potentially be a boost to the economy of our Nation, if gravity drainage tunnel systems could lower the altitudes where mining could be conducted in the future thereby eliminating many of the mine drainage discharges that currently discharge on the surface and find their ways into our local waterways.

The mine pools of the Anthracite Region are typically stratified similar to natural lakes. This stratification is discussed in (Barnes, et al., 1964), (Ladwig, et al., 1988), and (Brady, et al., 1998). Typically, the layers of water in the mine pools are referred to as “top water” and “bottom water”. The top water is caused by shallow groundwater recharge and discharge cycles, plus surface water entering the mine pool through subsidence features, fractures, faults, and other geologic features with openings to the mine pool. The bottom water is in a deep zone that is usually not well circulated. The bottom water typically has sulfate concentrations of several hundred milligrams per liter and relatively high concentrations of acidity and metals. The top water typically has sulfates less than 100 mg/l and frequently meets the National Pollution Discharge Elimination System (NPDES) effluent limits for metals without treatment.

There is a very large amount of relevant data residing in three Pennsylvania Department of Environmental Protection (PA DEP) Bureaus. The Bureau of Mine Safety has more than 5,000 maps and associated drawings (e.g. cross-sections) of the abandoned underground mines (some of the maps are pre 1900) in the Mine Maps Repository at the Pottsville District Mining Office. The PA DEP’s Bureau of District Mining Operations issues and maintains permit files of all the surface and underground mines in the Anthracite Region at the Pottsville District Mining Office. These files contain thousands of water samples, more than **6,500** for the Western Middle Fields alone. The PA DEP’s Bureau of Abandoned Reclamation, Wilkes-Barre Office, has maintained a sporadic program of measuring mine pool water levels for nearly 20 years. They conducted monthly measurements during the study period, at **30** boreholes throughout the Western Middle Coal Field and **15** shaft locations for a portion of the Southern Coal Field.

The EPCAMR Staff have found that several of these boreholes have been paved over with macadam by local municipal street and road departments. Others have been packed down under several inches of dirt alongside drainage courses next to roads as a result of redevelopment, land reclamation, or construction projects that often make them inaccessible for additional sampling. EPCAMR believes that there is a need for

an educational awareness campaign directed towards municipal officials to keep them apprised of the importance of not covering these Commonwealth-owned monitoring stations. The accessibility to them to EPCAMR and State abandoned mine reclamation staff are not only important to this project, but to the local communities as well for their value in determining the fluctuating rise and fall in the depth of the underground mine pool water elevations, warnings related to flooding possibilities, and for future redevelopment use of the mine pool water as a commodity as opposed to a dormant underground flowing pollutant pool.

The mine pools may be viewed as both a curse and a blessing in disguise. Extensive groundwater pollution and thousands of miles of streams degraded by abandoned mine drainage are the curse of more than 200 years of mining Anthracite coal. The blessing in disguise is the potential availability of billions of gallons of water in the mine pools and high volume abandoned mine drainage discharges as a resource for present and future uses, as well as the potential market for the metal precipitates for resource recovery, such as iron oxide and aluminum oxide that coat the bottoms of PA's streams and rivers. An example of mine pool use is cooling water for electrical power generation plants. Several of the cogeneration plants in the Anthracite Region pump and treat water from the underlying mine pools for cooling water.

In addition, the Exelon nuclear power plant, near Pottstown, PA uses water pumped from the Wadesville mine pool, in Schuylkill County, just outside of the City of Pottsville, to augment low flow conditions in the Schuylkill River, many miles downstream where the cooling water is extracted from the river (Veil, et al., September 2003), (Normandeau Associates Inc. and URS, April 2004), (Normandeau Associates Inc. and URS, January 2006). Fortunately, the Wadesville mine pool water is net alkaline and it meets the NPDES effluent limits without treatment. EPCAMR is working towards becoming one of the leading community environmental groups who are on the cutting edge of finding other innovative uses of the mine pool water for the future.

This is the first in a series of four reports on mine pools of the Anthracite Region. A comprehensive updated inventory of mine pools or mine pool complexes currently does not exist for Pennsylvania. This report contains some general information applicable to all four Anthracite Coal Fields, and some specific information for these fields, as well. The succeeding reports will deal with the Western Middle Coal Field and the Southern Coal Field. This report focuses on some aspects of the Northern and Eastern Middle Coal Field that have been the subject of other reports. It also references some of the out of print, obscure, hard to find, and otherwise, unavailable reports and studies on the Anthracite Coal Fields. It is not our intent to go into great detail about every single abandoned mine drainage discharge or large flowing discharges throughout the entire Anthracite Coal Region in this series of reports because of our focus on the elevations of the mine pools

and the flow patterns and hydrogeological connections from one multi-colliery hydrologic unit to other and the desire by all partners involved to gain a better understanding of the underground mine pool complexes of the Region.

Chapter 2. Geology of the Anthracite Coal Region

Robert E. Hughes¹, Roger J. Hornberger, P.G.², Caroline M. Loop³, Keith B. C. Brady⁴, Nathan A. Houtz⁵

2.1 PHYSIOGRAPHY AND TOPOGRAPHY

Pennsylvania's Anthracite Region is located in the Valley and Ridge Province of the Appalachian Mountains as shown on **Figure 2.1**. The Valley and Ridge Province and other provinces and sections of the Appalachian Highlands were described in (Fenneman, 1938) and delineated on a U.S. Geological Survey Map by (Fenneman, 1946). The province extends for a distance of 1200 miles from the St. Lawrence Lowland to Alabama, according to (Thornbury, 1965) who calls it the Ridge and Valley Province. This province is generally divided into three sections: a northern section also known as the Hudson-Champlain section; a middle section reaching from the Delaware River to the New River in southern Virginia; and a southern section from southern Virginia to the end of the highlands in Alabama. The width of the Valley and Ridge Province ranges from about 20 miles in New York near the Hudson River to about 80 miles wide in central Pennsylvania between Williamsport and Harrisburg, according to (Hunt, 1974) and (Thornbury, 1965).

¹ Executive Director-Eastern Pennsylvania Coalition for Abandoned Mine Reclamation, Robert E. Hughes

² Professional Geologist, Roger J. Hornberger, LLC

³ Ph. D. graduate student-The Pennsylvania State University, Caroline M. Loop

⁴ Professional Geologist, PA Department of Environmental Protection's Pottsville District Mining Office, Keith B.C. Brady

⁵ Professional Geologist, PA Department of Environmental Protection's Pottsville District Mining Office, Nathan A. Houtz

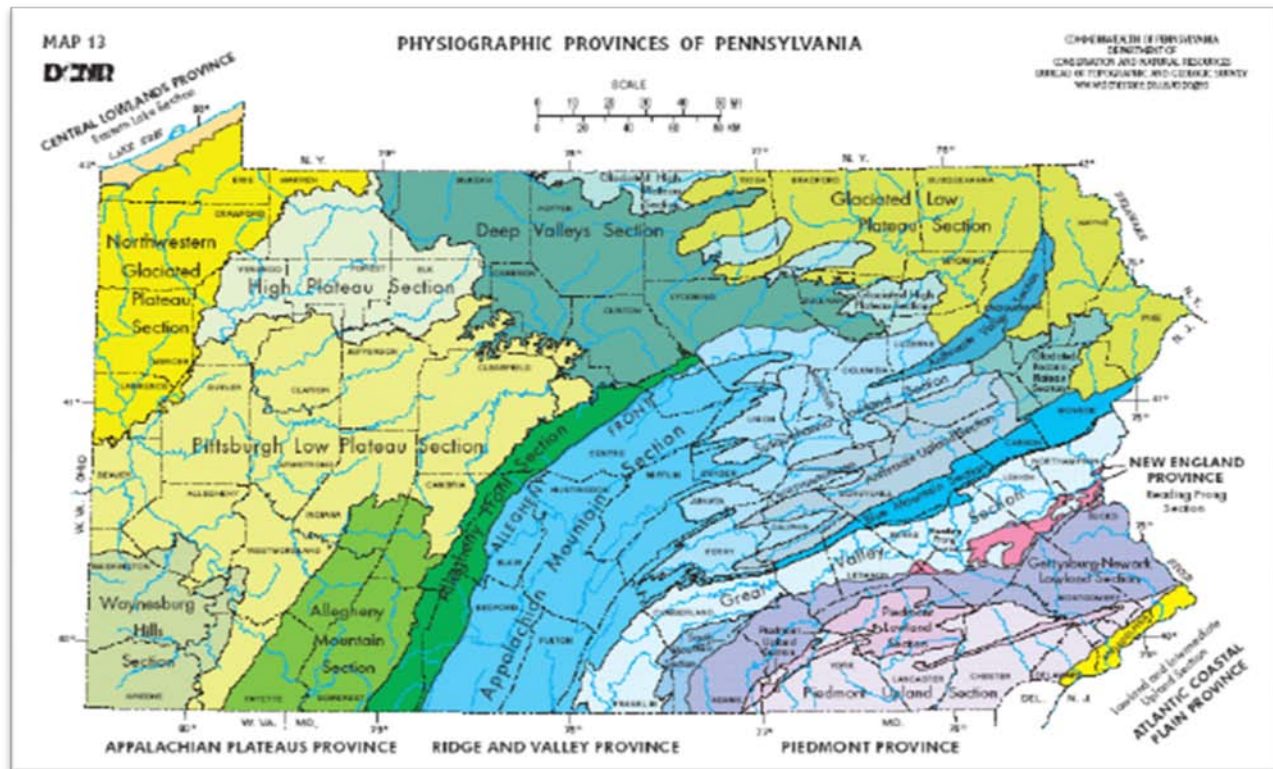

Figure 2.1 Map of Physiographic Provinces of PA (DCNR, 2011)

In a classic work on the evolution of North America, (King, 1977) divides the Appalachian Mountains into two parts, referred to as the “sedimentary Appalachians” including the Valley and Ridge Province and the “crystalline Appalachians” in the New England Upland and Piedmont Plateau. (King, 1977)(p. 45) states: “In the humid climate of the eastern states, the limestones and dolomites are more susceptible to erosion than are the sandstones and shales; wherever deformation has raised them to view they are worn down to low ground, whereas the adjacent sandstones and shales project in ridges. Characteristic topography of the sedimentary Appalachians is thus a succession of parallel valleys and ridges which form the Valley and Ridge province”. This pattern of alternating ridges and valleys, with many cross-cutting water gaps and wind gaps in the ridges is very distinctive on the USGS digital shaded relief map of landforms of the conterminous United States by (Thelin, 1991). Additional description of the Appalachian Mountain Section of the Ridge and Valley Province, including the topographic features of the Anthracite Regions is included in (Way, 1999).

The Anthracite Coal Region consists of **4** major coal fields: the Northern, Eastern Middle, Western Middle, and Southern Anthracite Fields as shown on **Figure 1**. The Anthracite coal fields contain approximately 95% of the remaining identified Anthracite and semi Anthracite resources in the United States (Averitt, 1975). The Anthracite Coal fields are of Pennsylvanian age and are time equivalent to the Bituminous

fields of western Pennsylvania. The time equivalence and other stratigraphic relationships between the Anthracite and Bituminous Coal Regions of Pennsylvania will be discussed in the stratigraphy section of this chapter. The principal difference between the Anthracite and bituminous regions is the geologic structure, with the Anthracite coals located within the extensively folded and faulted terrain of the Valley and Ridge Province and the Bituminous coals located on the adjacent Allegheny Plateau Province shown on **Figure 2.1**, which was considerably less affected, tectonically.

The four Anthracite fields are preserved in synclinal basins that are essentially surrounded and “defended” by sandstone ridges. These ridges are more resistant to erosion than the shales and coals of the Pottsville and Llewellyn Formations. The slope forms of the ridges are typically mature (i.e., convex-concave), but some free faces occur, such as the Harveys Creek water gap in the Northern Anthracite Coal Field. Descriptions of Appalachian slope form development are contained in (Hack, 1960), (Hack, 1979). Additional information on weathering in the Ridge and Valley is found in (Thornbury, 1965), (Thornbury, 1969), (Clark, 1988), and (Sevon, 2000a) (Sevon, 2000b).

2.2 GEOLOGIC STRUCTURE

The structural geology of the four Anthracite coal fields within the folded and faulted Valley and Ridge Province is much more complex than the relatively flat-laying strata of most of the bituminous coal fields within the Allegheny Plateau of western Pennsylvania, shown on **Figures 1** and **Figure 2.1**.

Intense orogenic activity in the Ridge and Valley Province occurring during the Permian Period resulted in: (a) substantial increase in rank of the Anthracite coals due to metamorphism as compared to time-equivalent coal beds in the Appalachian Plateau Province of the bituminous region, and (b) the preservation of the Anthracite coal fields within synclinal basins which are essentially surrounded by sandstone/conglomerate ridges that are more resistant to erosion than the coal and associated finer-grained sedimentary rocks. Though there were three major orogenies responsible for the formation of the Appalachian Mountains, only the final one, the Alleghenian Orogeny, had any effect on the coal-bearing rocks of the Ridge and Valley Province in Pennsylvania.

According to (Rodgers, 1970)(Chapter 11), who summarized the tectonics of the Appalachian Mountains, there were three major orogenic movements which resulted in the development of the Valley and Ridge Province of the Appalachian Mountains in Pennsylvania, including the Anthracite Region. First was the Taconic Orogeny occurring from approximately 450 through 500 million years ago, second was the Acadian Orogeny occurring during the Devonian Period from approximately 360 through 400 million years ago, and third was the Allegheny Orogeny occurring from approximately 230 through 260 million years ago.

The Allegheny Orogeny was the most significant mountain-building development in the present geologic structure of the Valley and Ridge Province of central and eastern Pennsylvania (including the Anthracite coal region). The coal beds were deposited during the Pennsylvanian Period approximately 275 million years ago. At the type section of the Pottsville Group strata located on Sharp Mountain at Pottsville, Pennsylvania, the Mammoth coal seam and associated strata have been uplifted from a horizontal, to a nearly vertical structural orientation.

Orogenic deformation preceding Pennsylvanian sedimentation did not structurally affect Pennsylvanian rocks. As the Allegheny Orogeny postdated the deposition of these coal seams, it is responsible for most of the structural deformation.

A comprehensive description of the geologic history of the north-central Appalachians, is contained in Faill (Faill, 1997a), (Faill, 1997b), (Faill, 1998a), (Faill, 1998b). The most recent orogenic episode, the Alleghenian, commenced in the Early Permian (Faill, 1997b). Faill (1997a, p. 552) states that "late in the

Allegheny Orogeny, rock thrust northward over the Carboniferous rocks in the Anthracite Region of northeastern Pennsylvania and caused anthracitization of the underlying coals.”

Following these significant orogenic episodes during Paleozoic times, the Appalachian Mountains continue to mature. Concerning the post-Paleozoic history, (Rodgers, 1970)(p. 218) states: “Our next glimpse of the Appalachians is in the Late Triassic; they were now a chain of mountains, though not necessarily lofty ones, and the core areas were already deeply eroded.... Only in the Cretaceous or the Late Jurassic did the sea once more enter the region, and then only to wash the southeastern and southern margins of the Appalachian chain, which repeated arch-like uplifts kept high and subject to erosion During this period the mountains approached the forms we see today.”

For the past approximately 65 through 100 million years, Sharp Mountain in Schuylkill County, Pennsylvania and other Appalachian ridges have been undergoing further weathering and erosion to produce the mature slope forms seen today. During these millions of years of weathering, the rough edges of the tops of these mountains were worn down and colluvium developed as a veneer over the bedrock on the middle to lower slopes of the ridges.

A concise description of the structural geology of the Ridge and Valley Province in Pennsylvania is provided by (Faill, 1999), including a tectonic map of the province, a cross-section of the Minersville Synclinorium, and other relevant information about the Anthracite Region. Wood and his associates (Wood, et al., 1968), for example, the Minersville Quadrangle, have geologically mapped much of the Southern and Western Middle Coal Fields. The maps depict the synclinoria and other complex geologic structures. The geologic structure and stratigraphy of the Southern Anthracite Coal Field are described in (Wood, et al., 1969) and the depositional and structural history of the entire Anthracite Region is presented in (Wood, et al., 1986). The complexity of the geologic structure, particularly the nearly vertical beds of rocks in many areas of the Anthracite Coal Fields, has impeded the acquisition of stratigraphic data from routine exploration drilling.

According to (Wood, et al., 1986): “Each coal field of the Anthracite Region is a complexly folded and faulted synclinorium, with structural trends between N55°E and N85°E.... The Southern field is the most highly deformed, with several highly faulted, closely spaced synclinal basins. Deformation is most complex toward the southeast, where it is characterized by hundreds of thrust, reverse, tear and bedding plane faults and tightly compressed, commonly overturned folds.”(p. 45). The principal structural features of these four Anthracite coal fields are shown on **Figure 2.2**, from (Wood, et al., 1986)(p. 44) and (Wood, et al., 1970)(p.150).

The tremendous structural complexity of the Southern Coal Field is described in greater detail in (Wood, et al., 1969), including descriptions of the three principal structural elements, the Minersville Synclinorium, the New Bloomfield Anticlinorium and the Broad Mountain Anticlinorium, plus detailed descriptions of individual anticlines, synclines and fault complexes within these three major structural features. The geological map of the Pottsville Quadrangle by (Wood, 1972) includes several cross-sections of the Minersville Synclinorium, one of which is shown in **Figure 2.3**. This cross-section shows the Llewellyn Syncline, the Donaldson Syncline, and numerous other structural features of the synclinorium. Of the many hundreds of anticlines, associated synclines and significant faults present in the area, (Wood, et al., 1969)(p.87) examples include: the Donaldson Syncline, with an amplitude of 4,000 to 7,800 feet in the Tower City, Donaldson and Tremont area (Wood, et al., 1969)(p. 91), and the Mine Hill Fault complex (in the area of the Lytle, Oak Hill and Wadesville Collieries) which has, in places, a klippe composed of beds of the Schuylkill Member overlying the Upper Mine Hill Fault and upright beds of the Llewellyn Formation (p. 102).

The report by (Wood, et al., 1969) is the definitive report on the structure and stratigraphy of the Southern Coal Field. As companions to the authentic report, Wood and his associates prepared a series of detailed geologic maps and cross-sections on portions of the Southern Coal Field (Wood, et al., 1968), (Wood, 1972), (Wood, 1972a), (Wood, 1974), and (Wood, 1974a). An example of the complexity and diversity of structural elements and features is from (Wood, et al., 1968), Cross Section D-D', which shows the following from north to south:

Frackville Fault, South Frackville Fault, New Boston Syncline, Broad Mountain Fault, Eisenhoth Run Anticline, Dyer Run Fault, Jugular Fault, Jugular Syncline, Heckscherville Syncline, Peaked Mountain Anticline, Rohersville Syncline, Mine Hill Anticline, Mine Hill Fault, Dam Syncline, Crystal Run Anticline, Forestville Syncline, Swatara Anticline, New Mines Anticline, Phoenix Park Syncline, Phoenix Park Anticline, Donaldson Syncline, Branchdale Anticline, Newtown Fault, Llewellyn Syncline, East Georges Head Anticline, Red Mountain Fault, Silverton Fault, South Branch Silverton Fault, Blackwood Fault, and the Dauphin Syncline.

The following maps and cross-sections can be found in the back of the report along with the **Appendix A. Figures, Plates, Tables, Graphs, and Maps** in the Large Maps and Plates Pocket Folder and further use of them will be made in **Chapter 2, Part 2** of this report.

Map I-528, Miscellaneous Geological Investigations (4 sheets of maps and 2 sheets of cross-sections) by: (Wood, 1968a) titled ***Geologic Maps of Anthracite-Bearing Rocks in the West-Central Part of the Southern Anthracite Field, Pennsylvania, Eastern Area (portions of the Minersville, Tremont, Pine Grove, and Swatara Hill Quadrangles)***

Map I-529 Miscellaneous Geological Investigations by: (Wood, 1968b) titled ***Geologic Maps of Anthracite-Bearing Rocks in the West-Central Part of the Southern Anthracite Field, Pennsylvania, Western Area (Tower City and Valley View Quadrangles)***

Map I-681 Miscellaneous Geological Investigations (1 page map and 1 page of cross-sections) by: (Wood, 1972) titled ***Geologic Maps of Anthracite-Bearing Rocks in the West-Central Part of the Southern Anthracite Field, Pennsylvania, Western Area (Pottsville Quadrangle)***

Map I-809 Miscellaneous Geological Investigations (1 page map and 1 page of cross-sections) by: (Wood, 1974a) titled ***Geologic Maps of Anthracite-Bearing Rocks in the West-Central Part of the Southern Anthracite Field, Pennsylvania, Western Area (Tamaqua Quadrangle)***

Map I-737 Miscellaneous Geological Investigations (1 page map) by: (Wood, 1974) titled ***Geologic Maps of Anthracite-Bearing Rocks in the West-Central Part of the Southern Anthracite Field, Pennsylvania, Western Area (Southern Half of Delano Quadrangle)***

Map I-689 Miscellaneous Geological Investigations by: (Wood, 1972a) titled ***Geologic Maps of Anthracite-Bearing Rocks in the West-Central Part of the Southern Anthracite Field, Pennsylvania, Western Area (Northern Half of Orwigsburg Quadrangle)***

The Western Middle Coal Field is not as structurally complex as the Southern Coal Field, but it exhibits great complexity” ...whereas the Western Middle Coal Field is made up of two large thrust-faulted adjacent synclines, a greatly deformed, intervening major anticline, and many lesser anticlines and synclines” (Wood, et al., 1986)(p.45). A series of USGS maps and cross-sections provide additional detail of portions of the Western Middle Coal Field, including the work by (Maxwell, 1955), (Kehn, 1955) (Danilchik, et al., 1962), (Arndt, et al., 1963a), (Arndt, et al., 1963b), (Arndt, 1971a) (Arndt, 1971b), (Arndt, et al., 1973)and (Wood, 1974).

(Wood, et al., 1986)

Figure 2.3(a) Cross-section of the Geologic Structure of the Allegheny Plateau (King, 1977)

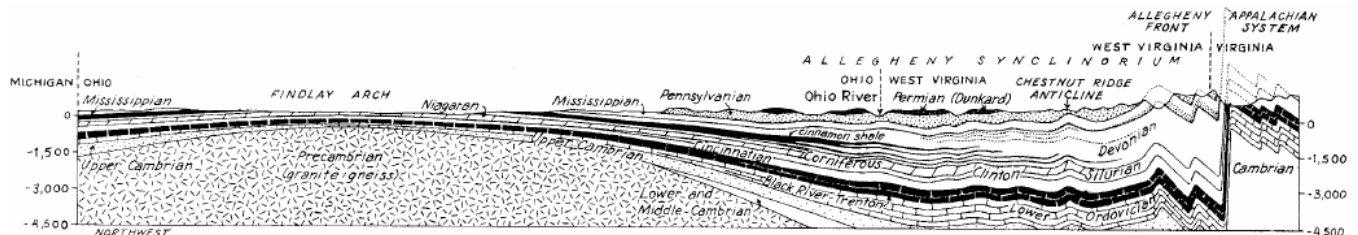
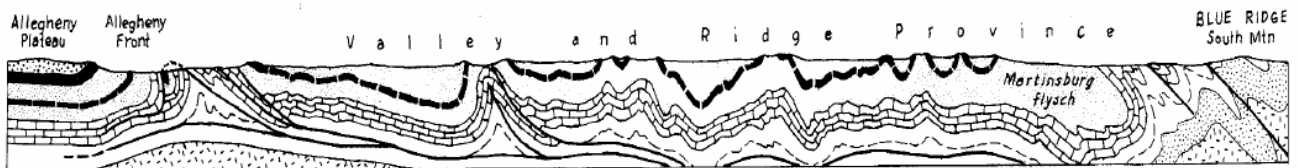

Figure 2.3(b) Cross-section of the Geologic Structure of the Ridge and Valley Province (King, 1977)



The structural and topographic transition between the Allegheny Plateau and the Valley and Ridge Province to the east is the Allegheny Front, which is shown on the eastern side of **Figure 2.3(a)** and the western side of **Figure 2.3(b)**, and is described by (King, 1977) as follows: “On the southeast the Allegheny Plateau breaks off along the Allegheny Front **Figure 2.3(b)**, an imposing escarpment that overlooks the more varied, linear ridges and valleys of the true Appalachians. The front marks an abrupt change in style of deformation; the strata now turn up abruptly, and beyond they are heavily folded and faulted; we pass here from the foreland into the main deformed belt.” (p. 45).

2.3 STRATIGRAPHY

Far more is known about the stratigraphy of the Bituminous Coal Region of western Pennsylvania than the Anthracite Coal Region. This is for several reasons, including the abundance of drill hole data, the availability of paleontological information, and the fact that it is less difficult to correlate strata between drill holes and other exposures in the relatively flat-lying strata of the Allegheny Plateau than in the structurally

complex Anthracite coal region. The stratigraphy of the Anthracite Region of eastern Pennsylvania has not been studied as extensively as that of Pennsylvania's bituminous coal region. Geologic and mining engineering work done in the Anthracite Region over the past 150 years documents some significant stratigraphic differences between the Anthracite and Bituminous Coal Regions. The complexity of the geologic structure, resulting in nearly vertical beds of coal and other rocks in some areas of the Anthracite fields, has impeded the acquisition of stratigraphic data from routine exploration drilling. Detailed mine maps of the abandoned underground mines and cross-sections through vertical shafts and nearly horizontal tunnels have added to the understanding of the structure and stratigraphy of the Anthracite coal fields, however most stratigraphic efforts have been directed toward coal seam delineation.

EPCAMR has undertaken the challenge of digitizing and geo-referencing hundreds of these mine maps in the Anthracite Region over the last 5 years to create the most comprehensive digital collection of underground mining maps, complete with cross-sections, and 3-dimensional structural contour models of some of the major marker Anthracite coal beds including the Mammoth Vein and the Buck Mountain Vein. With the completion of this report, EPCAMR will have completed the majority of the mapping for the Western Middle Anthracite Coal Fields underground mine pools, major coal seams that were extracted, locations of boreholes, current mine pool surface elevations, a portion of the Southern Anthracite Coal Fields, and an even greater understanding of the multi-colliery hydrogeologic units of underground mine pool water that flow beneath the coal fields.

2.3.6 Pottsville Group-Anthracite

The coal-bearing rocks in Pennsylvania are from the Pennsylvanian and Permian Periods of geologic time. The strata in the Anthracite Region are divided, from oldest to youngest, into the Pottsville and Llewellyn Formations. Pennsylvanian age rocks contain all the coal seams of the Anthracite Region of Pennsylvania, and have been divided into two major formations, the Pottsville and the Llewellyn. Generalized columnar sections of the Pottsville and Llewellyn Formations are shown on **Figure 2.4**.

The Pottsville Formation ranges in thickness from a maximum of approximately **1600** ft (490 m) in the Southern Coal Field to less than **100** ft (30 m) in the Northern Coal Field. The Pottsville Formation is subdivided into three members, from oldest to youngest; they are the Tumbling Run Member, the Schuylkill Member and the Sharp Mountain Member. The Tumbling Run and Schuylkill Members of the Formation are not present in the Northern Anthracite Coal Field (Wood, et al., 1969) (Wood, et al., 1986) (Edmunds, et al., 1979), (Edmunds, et al., 1999), (Meckel, 1967), and (Meckel, 1970).

The Pottsville Formation contains up to **14** coal beds in some areas, but most are relatively discontinuous and only a few persist outside of the Southern Coal Field (Edmunds, et al., 1999). **Figure 2.4** shows the mineable coals of the Pottsville Formation. The Lykens Valley Coal Numbers 4 through 7 are within the Tumbling Run Member; the Lykens Valley Coal Numbers 1 through 3 are within the Schuylkill Member; and the Scotty Steel and Little Buck Mountain Coals are within the Sharp Mountain Member of the Pottsville Formation (**Figure 2.4**).

The base of the Buck Mountain Coal is considered the top of the Pottsville Formation in the Anthracite Coal Fields of eastern Pennsylvania. The Buck Mountain Coal is tentatively correlated with the lower Kittanning Coal within the lower Allegheny Group in western Pennsylvania, and since the upper boundary of the Pottsville Formation in western Pennsylvania is defined as the base of the Brookville Coal, positioned below the Lower Kittanning Coal, the Pottsville of eastern Pennsylvania and the Pottsville of the western Pennsylvania main bituminous field are not precisely equivalent (Edmunds, et al., 1999). The type section of the Pottsville Formation (located near Pottsville) is described by (White, 1900) and more recently by (Wood, et al., 1956) and (Levine, 1987).

The Pottsville Formation in eastern Pennsylvania is entirely of a non-marine depositional environment (Edmunds, et al., 1999). As in western Pennsylvania, the dominant lithology of the Pottsville Group is sandstone and conglomerate; but the Pottsville Formation of the Anthracite Region contains significantly more pebble conglomerates derived from an orogenic source area relatively close to the southeast (Edmunds, et al., 1999), (Meckel, 1967), (Meckel, 1970), and (Faill, 1997a), (Faill, 1997b). The Tumbling Run Member is composed of approximately 55% conglomerate and conglomeratic sandstone, about 30% fine- to coarse-grained sandstone, and about 15% shale and siltstone. Conglomerate and conglomeratic sandstone comprise about 50% of the Schuylkill Member, and the sandstone in the member ranges from very fine to very coarse, constituting approximately 30% of the member. The Sharp Mountain Member in most of the Southern Anthracite Field is composed of about 45% conglomerate, 25% conglomeratic sandstone, 15% sandstone, 5% siltstone, 9.5% shale, and 0.5% Anthracite (Wood, et al., 1969), (Wood, et al., 1986). The carbonate content of the rocks has not been determined, except for a few localities.

Figure 2.4 Generalized Columnar Sections Showing Names, Average Thickness of Coals (in ft), and Intervals between Coal Beds in the PA Anthracite Coal Fields

Figure is primarily from (Wood, et al., 1986). Data from (Edmunds, et al., 1999), (Inners, 1997) have supplemented information on calcareous zones in the Northern Anthracite Coal Field

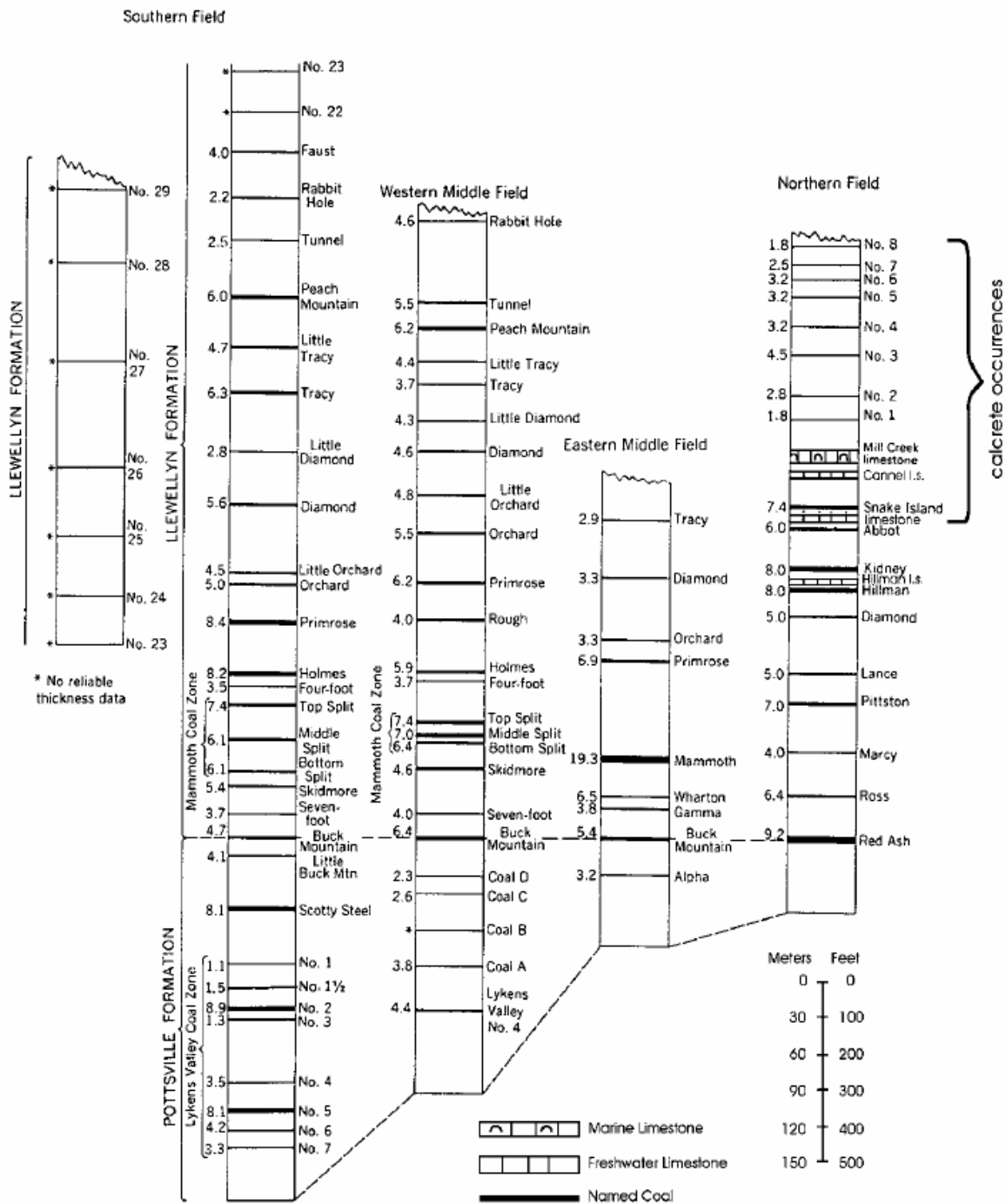

2.3.7 Llewellyn Formation- Anthracite

The Llewellyn Formation is as much as **3500** feet thick. The maximum known thickness of the Pennsylvanian in Pennsylvania is approximately **4400** ft near the town of Llewellyn in Schuylkill County (Edmunds, et al., 1999). The Llewellyn Formation contains up to **40** mineable coals (Edmunds, et al., 1999) most of which are shown on **Figure 2.4**. The thickest and most persistent coals occur in the lower part of the Llewellyn Formation, particularly the Mammoth Coal zone. The Mammoth Coal zone typically contains **20** ft. of coal, and thicknesses of **40** ft to **60** ft. are not unusual. A local thickness of greater than **125** ft. has been reported in the Western Middle Coal Field. This was attributed to structural thickening in the trough of the syncline. The nomenclature and stratigraphy of the coal bearing rocks of the Llewellyn Formation in the Northern Anthracite Coal Field are different than in the Southern and Middle Coal Fields (**Figure 2.4**).

The dominant lithology of the Llewellyn Formation is sandstone, including conglomerate units, as in the Pottsville Formation. According to (Edmunds, et al., 1999)(p.159): “Lithologically, the Llewellyn is a complex, heterogeneous sequence of subgraywacke clastics, ranging from conglomerate to clay shale and containing numerous coal beds. Conglomerates and sandstones dominate”. The Llewellyn Formation in the Southern and Middle Coal Fields is believed to be entirely terrestrial in depositional environment (i.e., lacking any marine beds).

The Llewellyn Formation in the Northern Field, however, contains one known marine bed, the Mill Creek Limestone (**Figure 2.4**). (White, 1903) suggested that the Mill Creek was correlative with the Ames Limestone in the Conemaugh Group of western Pennsylvania. This belief is generally held to the present. The Mill Creek Limestone is a one- to three-ft, richly fossiliferous marine limestone (Chow, 1951). The Llewellyn Formation contains several non-marine limestones in the Northern Field in a 330 ft thick zone directly below the Mill Creek Limestone, including the Cannal and Hillman Limestones (Chow, 1951),(Edmunds, et al., 1999). Additionally, (Inners, 1997) have identified calcareous paleosols (“calcrete”) in the uppermost Llewellyn Formation in the Northern Coal Field. They have tentatively correlated this portion of the stratigraphy with the Conemaugh of western Pennsylvania. These two zones combined potentially provide an appreciable amount of calcareous material in the top approximately 850 feet of the Llewellyn Formation of the Northern Anthracite Coal Field.

Deep drill holes of the stratigraphic sequence of the Pottsville and Llewellyn Formations in the Anthracite Region are rarely included in the permit files for Anthracite coal mine permits. However, EPCAMR, the PA DEP, and the PA Geologic Survey cooperated with Reading Anthracite Company (a landowner with major land holdings in the Southern Anthracite Coal Field) to obtain a significant core and several deep air-

rotary drill holes in the Southern Field (at Reading’s Wadesville Mine). A graphic drill log for 500 feet of the Llewellyn Formation above the Mammoth Coal is shown in **Figure 2.6**, for one of the air-rotary drill holes at Wadesville.

Figure 2.6 Stratigraphic Intervals from the Mammoth Coal Zone up to the Primrose Coal Bed at the Wadesville Site (Anthracite, 2003)

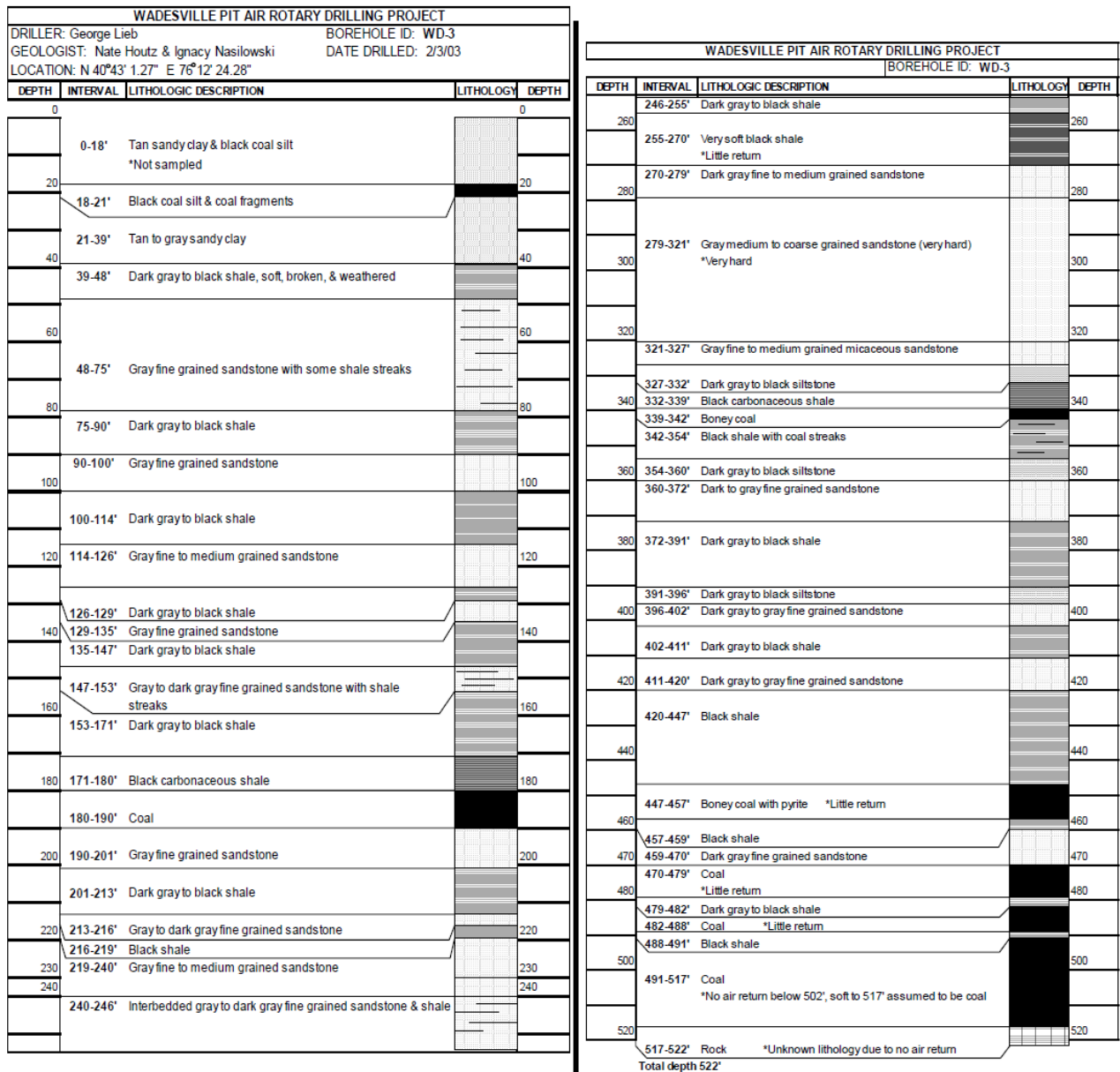

The identification and mapping of limestone and other calcareous rocks in the Southern and Eastern Middle Anthracite Coal Fields have not been reported in the literature; however, some large mine pool discharges such as the Wadesville Colliery, have alkalinity of several hundred milligrams per liter, which must be attributed to some carbonate minerals in the overburden. Discharges in the Eastern Middle Anthracite Coal Field have little if any alkalinity. This strongly suggests a lack of calcareous rock in this Coal Field. (Kochanov, 1997) has found calcareous sandstones in the lower part of the Llewellyn in the Northern Anthracite Coal Field. EPCAMR believes that further study of carbonate minerals and identification of calcareous lithologic units in the Southern and Eastern Middle Anthracite Coal Fields is needed.

2.3.8 Stratigraphic Observations and Inferences in the Anthracite Coal Fields

Bedrock formations exposed near the Eastern Middle Coal Field are the products of weathering to the southeast. A poorly understood tectonic event in the early Carboniferous produced uplift to the southeast that was the primary source of clastic material to the basin. It is speculated that the cause of this possible orogeny may have resulted from strike slip movement generated by the approaching African plate (Faill, 1997a), (Faill, 1997b). While these highlands were eroding, the Mauch Chunk Formation and the overlying Pottsville Formation were deposited. The Mauch Chunk consists of predominantly fining upward alluvial cycles of interbedded sandstones, siltstones, mudstones, and conglomerates (Inners, 1988), and can be recognized in the field by its characteristic reddish purple color. The contact between the Mauch Chunk Formation and the Pottsville Formation represents a transition from the warm, seasonally dry climate present at the time of Mauch Chunk red bed deposition to the much wetter climate in which the Pottsville coal forming peat swamps flourished (Edmunds, et al., 1999). Sedimentary structures, thickness patterns, and a southeastward increase in grain size indicate that the Pottsville Formation was also derived from a southeastern source (Wood, et al., 1986).

Figure 2.7 shows a schematic of the Spring Mountain cut along I-81, approximately 4 miles south of Hazleton. The outcrop exposes the contact between the Mauch Chunk and the Pottsville Formation as part of a large syncline (Bolles, 1976). Superimposed on the syncline in **Figure 2.7** is a large fault, which occurred during the rock's burial during the Permian. The resistant Pottsville Formation forms many of the high ridges around each field, and the overlying less resistant Llewellyn Formation occupies the valley floors within each field (Eggleston, et al., 1999) (Van Diver, 1990).

Figure 2.7 A Schematic of the Outcrop at Mile Marker 138 along Interstate 81, near McAdoo, PA, Showing the Contact between the Mauch Chunk and Pottsville Formations modified from (Bolles, 1976) (Eggleston, et al., 1999) (Van Diver, 1990)

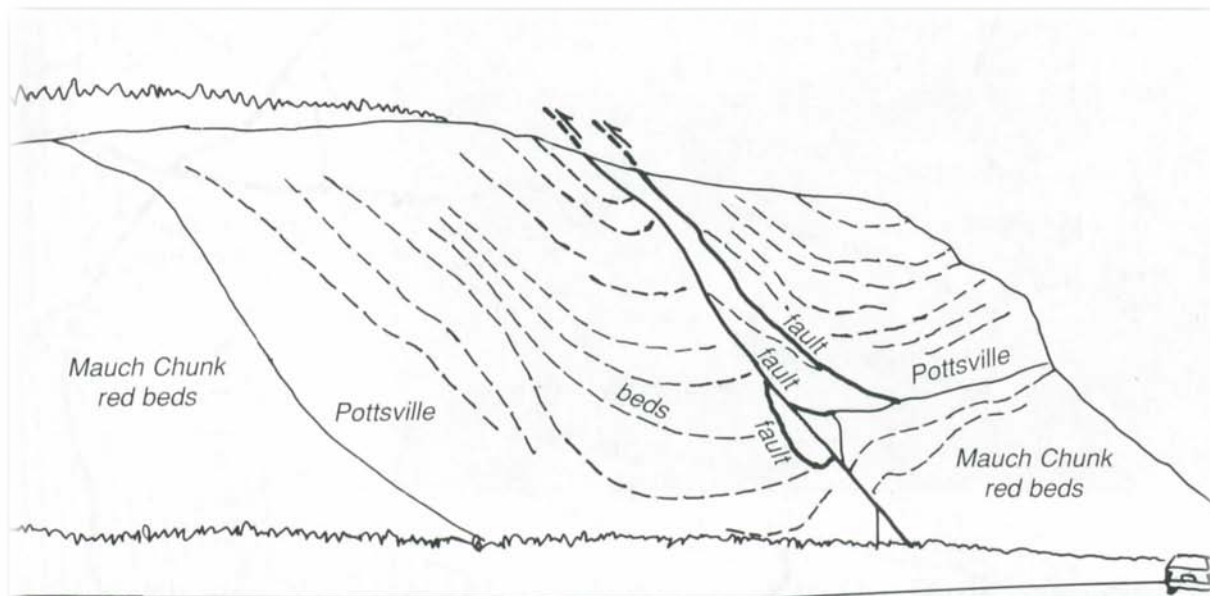

The enormous Spring Mountain cut at mile 138 of I-81 exposes a faulted syncline in Pennsylvanian Pottsville sandstones and conglomerates, above Mississippian Mauch Chunk redbeds.

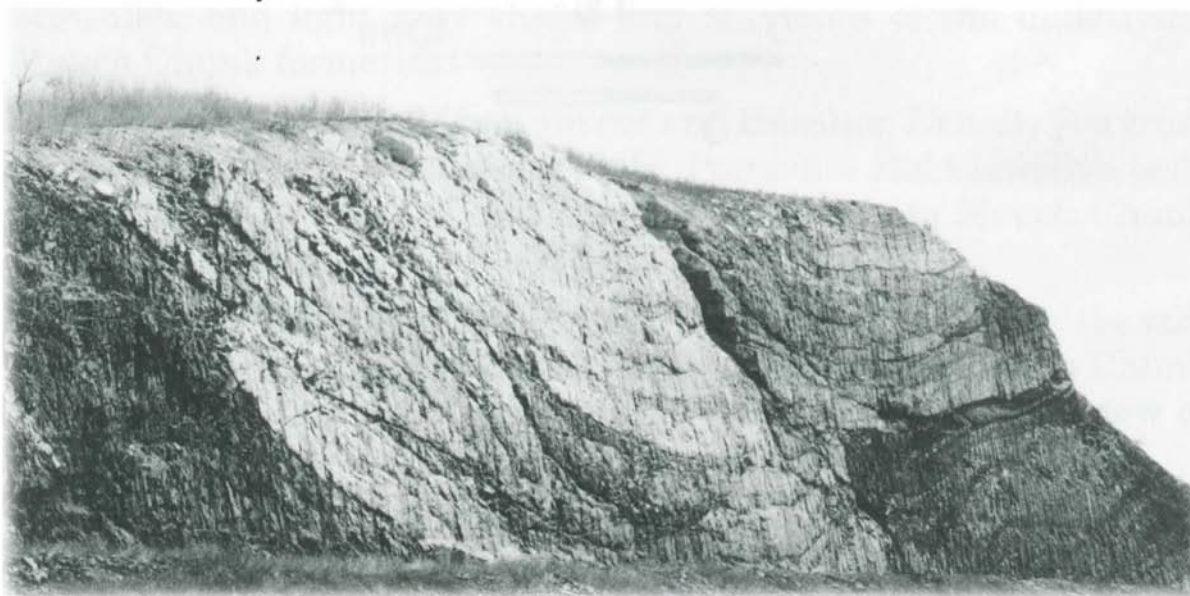

2.4 Regional Hydrogeology of the Anthracite Coal Region

The hydrogeology of the Anthracite and Bituminous Coal Regions of Pennsylvania is the product of the topography, geologic structure and stratigraphy of these regions. Whereas the Bituminous Region has a more conventional integration of these geologic factors, the hydrogeology of the Anthracite Region is largely controlled by the hydrology of the mine pools related to large abandoned underground mine complexes, or collieries as they are called in the region. However, in considering the integration of these geologic factors, the hydrogeology of the Anthracite Region is much simpler in some respects, while being more complex than the bituminous regions hydrogeology in other respects. Part of the simplicity is that a large portion of the groundwater in the four Anthracite coal fields is accounted for by about **100** large mine pool discharges, in comparison to the many thousands of mine drainage discharges and AMD seeps in the Bituminous coal fields of Pennsylvania. In addition, much is known about the areal extent, depth and other aspects of the geometry and hydrology of the Anthracite mine pools along with their interconnections from the detailed mine maps that are available for most of the abandoned deep underground mines.

The complexity of the Anthracite Region hydrogeology is largely a result of the complexity of the geologic structure and how that complex structure is translated into an elaborate system of mine development patterns, including numerous overlapping gangways, chutes or breasts, and slopes, that are interconnected by nearly horizontal rock tunnels and vertical shafts. The configuration of anticlinal and synclinal folds and the presence of significant faults can often be interpreted from the mine development patterns on the colliery maps. The gangways are frequently significant components of groundwater flow patterns, analogous to the conduit and sinkhole systems in karst hydrology, because the gangways are long voids developed parallel to the strike of the beds, that are often connected vertically to the land surface by cropfalls (mine subsidence features), which resemble sinkholes and promote infiltration of surface water into the groundwater flow system.

Adding to the complexity of the Anthracite Region hydrogeology in some areas is the presence of local-scale shallow groundwater flow systems, that may be somewhat independent of, or interconnected with, the more regional-scale underlying mine pool flow systems. Examples of these shallow groundwater flow systems are found along ridges in the Southern Anthracite Coal Field near Tamaqua, where abandoned, relatively small pits on the flanks of the ridges, and the sandstone ridge tops themselves, serve as groundwater recharge areas, and the discharge areas are through the colluvium or underlying bedrock into the underlying mine pool system in the valley bottom.

Strong control on the patterns of groundwater flow also may be exerted by the orientations and the frequency of joints, zones of fracture concentration (revealed by fracture traces), and other linear structural features which introduce a secondary porosity and permeability to the bedrock. (Lattman, 1964), (Brown, 1971), (Parizek, 1971), (Parizek, et al., 1971), (Parizek, 1972), (Lovell, 1974), (Parizek, 1976), (Parizek, 1979), (Cline, 1968) and others, have shown the dramatic influence of these linear features on groundwater flow. (Siddiqui, 1971a), (Siddiqui, 1971b) and others have documented the relationship of fracture-trace intersections and/or lineament intersections to high productivity of water supply wells.

The configurations of the mine pools and associated barrier pillars for most of the Anthracite Region were documented in a series of reports by S.H. Ash and associates at the U.S. Bureau of Mines (Ash, et al., 1947), (Ash, 1949), (Ash, et al., 1950), (Ash, et al., 1950a), (Ash, 1950b), (Ash, 1951), (Ash, 1952), (Ash, 1952a), (Ash, et al., 1953), (Ash, 1953a), (Ash, et al., 1953), (Ash, 1954b), (Ash, 1954c), (Ash, et al., 1954d), and (Ash, et al., 1956). These reports contain delineations of the shorelines of the mine pools, locations of documented breaches in the barrier pillars, and estimations of the volume of water impounded in specific mine pools. Two USGS reports contain data for most of the large Anthracite mine pool discharges from 1975 (Growitz, 1985) and 1991 (Wood, 1996) that allow comparison of water quality changes through time.

The work of J.R. Hollowell of the Susquehanna River Basin Commission (SRBC) and associates provided significant hydrogeological information on the Northern and Eastern Middle Anthracite Coal Fields. (Hollowell, 1974) described the mine-water hydrology for the Wyoming Basin of the Northern Anthracite Field, and (Hollowell, 1975) contains a similar description of the mine-water hydrology of the Lackawanna Basin of the Northern Anthracite Field. **Figure 2.41** from (Hollowell, 1971) (Hollowell, 1971) (Hollowell, 1971) is a map of the collieries of the Wyoming Basin, and **Figure 2.42** from the same publication is a companion schematic plumbing diagram of mine water flow through these abandoned underground mines of the Wyoming Basin. (Hollowell, 1975) contains a large water-table contour map (**Plate 2**) showing the collieries of the Lackawanna Basin and the associated mine pool shoreline, plus the mine pool elevations in key shafts and the associated potentiometric surface contours.

Figure 2.41 Map of Collieries in Wyoming Basin of the Northern Coal Field

(Hollowell, 1971)

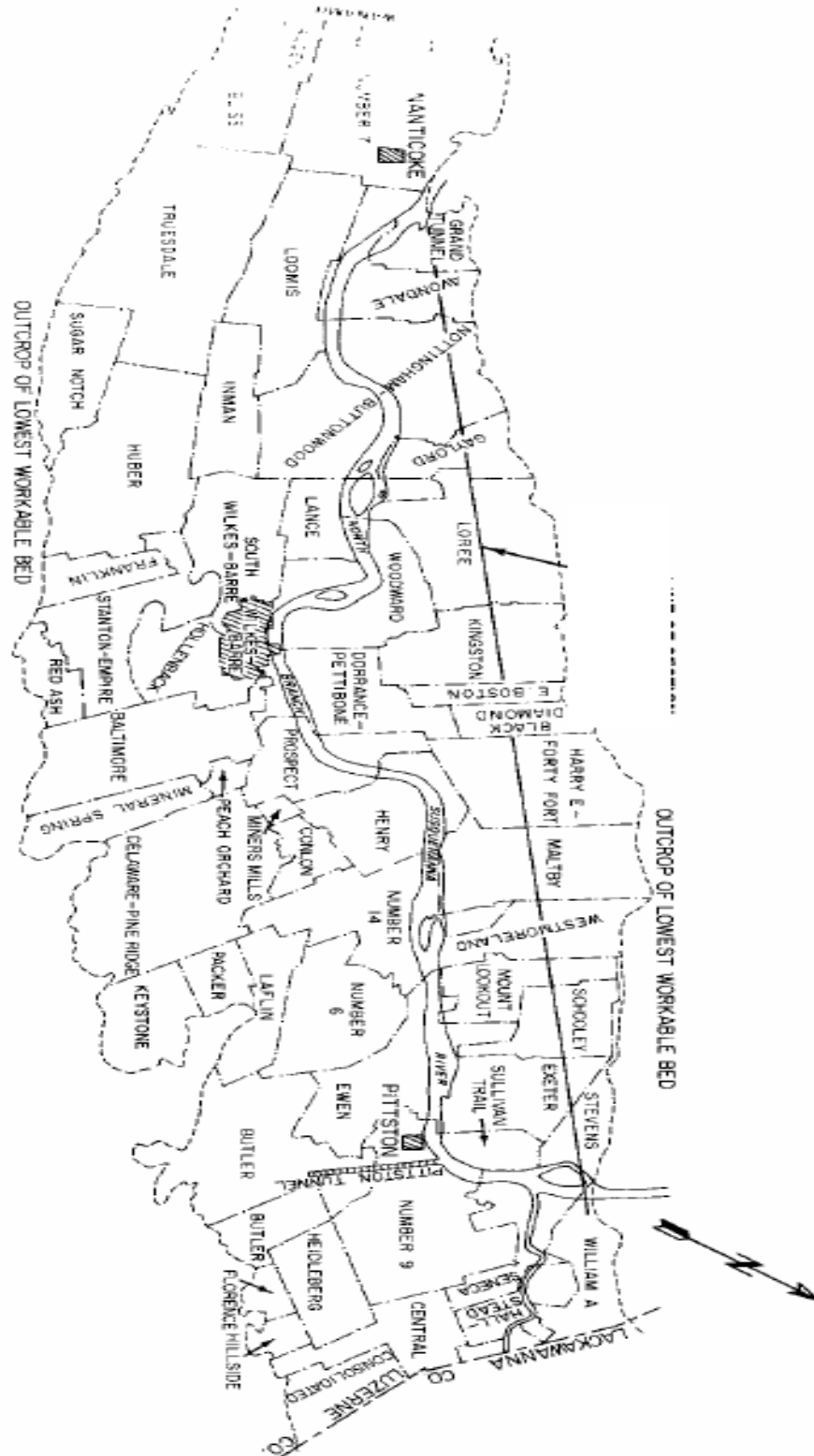
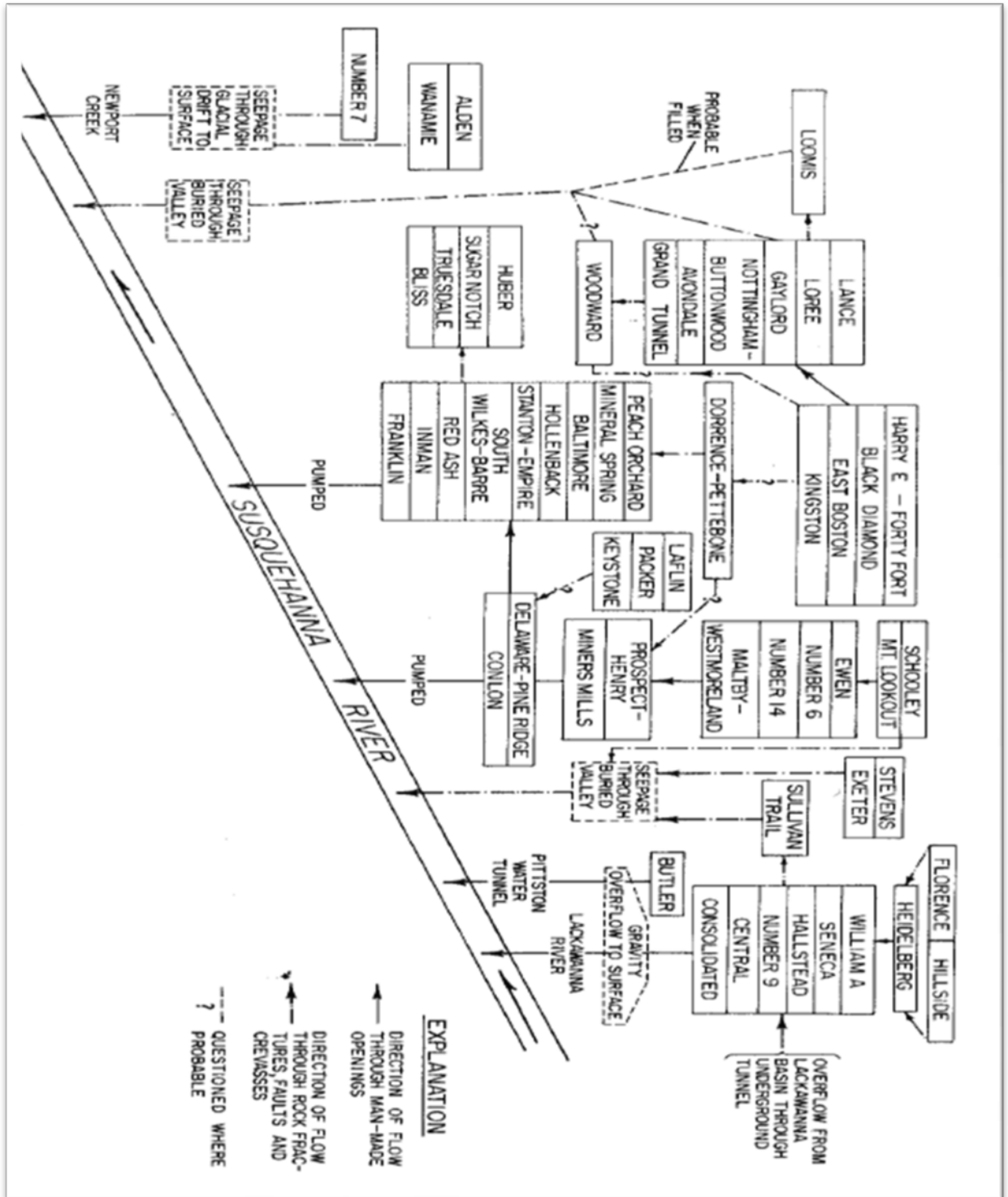

Figure 2.42 Schematic Diagram of Water Flow through the Mines (e.g. Barrier pillar breaches) in the Wyoming Basin (Hollowell, 1971)



(Hollowell, 1999) describes the mine drainage outfalls of the Eastern Middle Anthracite Field, and delineates the individual coal basins, the locations of the outfalls and the extent of the Jeddo drainage tunnel system, as shown on **Figure 2.43**. According to (Hollowell, 1999) (p. 1), there are **13** functional mine drainage tunnels in the Eastern Middle Anthracite Field that were specifically driven to dewater the mine workings. This drainage system was most successful in the Eastern Middle Anthracite Coal Field because of the comparable elevation of the drainage tunnel discharge to the receiving streams. The Jeddo Tunnel is by far the most extensive of these. The other discharges each yield a comparatively minor amount of water.

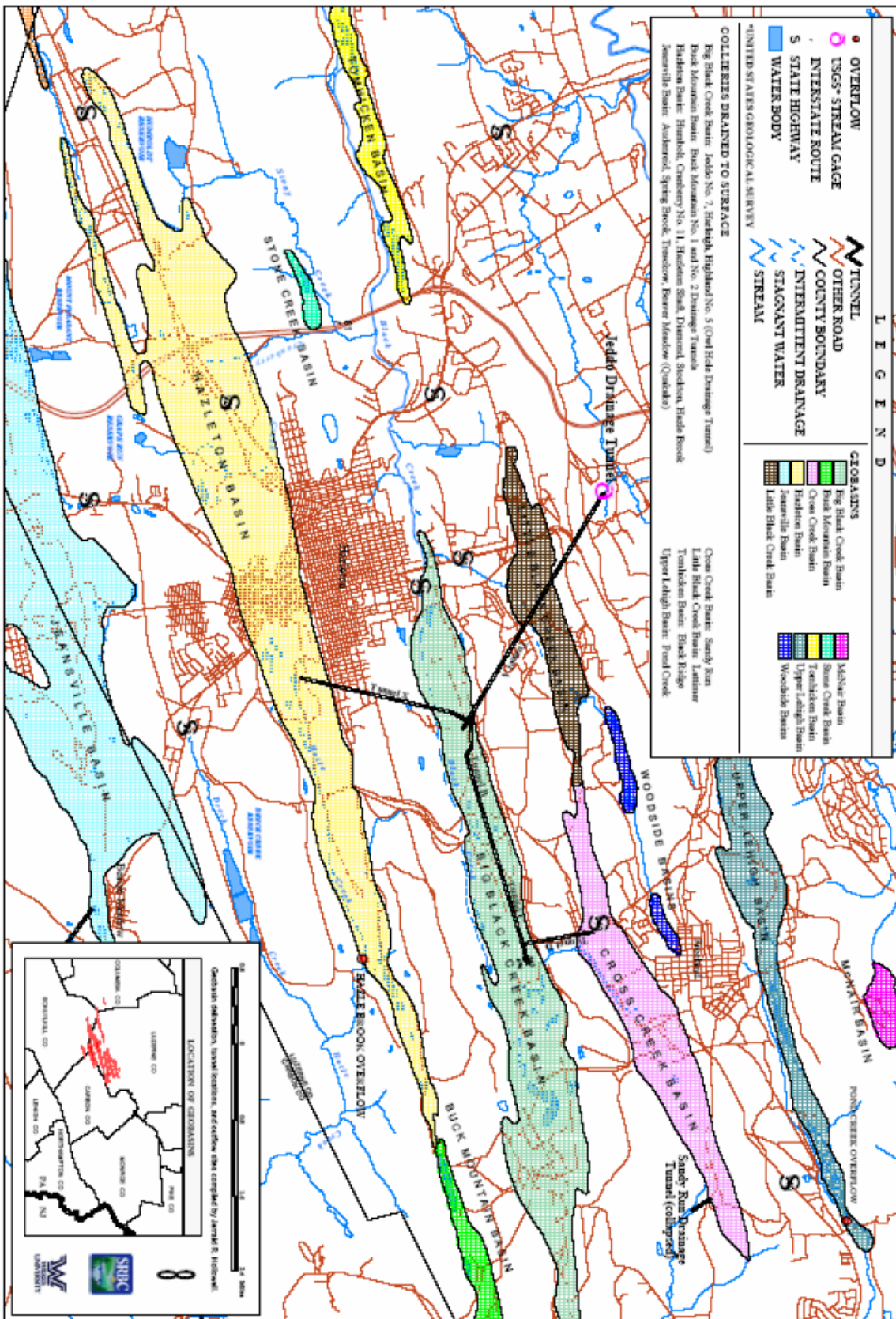

Figure 2.43 Jeddo Tunnel Drainage System (Hollowell, 1999)

The report by Hollowell (Hollowell, 1999) includes plots of the flow and pollution load (i.e. acidity, sulfate, iron, manganese, aluminum, magnesium, zinc) of the 16 major mine drainages of the Eastern Middle Coal Field for 3 water years. In a companion report by the SRBC, Ballaron (Ballaron, 1999) describes a hydrologic budget for the Jeddo Tunnel Basin that was done in cooperation with USGS, DEP and the Little Nescopeck Watershed Association.

Few detailed hydrogeologic studies have been completed for the Southern Field and the Western Middle Field, except for some unpublished hydrogeologic reports in DEP files, and some thesis publications including the groundwater modeling study by (Bair, 1981) of an area near Tamaqua in the Southern Field. However, a number of significant geochemical and hydrologic studies have been completed by C.A. Cravotta and associates at USGS for the Swatara Creek Watershed and other selected watersheds in the Southern Field and Western Middle Fields including (Cravotta, 2000), (Cravotta, 2002), (Cravotta, 2003), and (Cravotta, et al., 2004)

2.4.3 Jeddo Tunnel Discharge

Much has been written about the Jeddo Tunnel, in terms of an extraordinary engineering feat, the eventual success of dewatering the coal basins (Ash, et al., 1950a) and more recently, its environmental impact. The Jeddo Tunnel mine discharge near Hazleton, Pennsylvania is the largest abandoned underground mine discharge in the Eastern Middle Field of the Anthracite Region, and is among the largest mine drainage discharges in Pennsylvania. The Jeddo Tunnel has a total drainage area of 32.24 square miles, and its underground drainage system collects and discharges more than half of the precipitation received in the drainage area (Ballaron, 1999).

The flow of this discharge was monitored with a continuous recorder from December 1973 through September 1979 by the USGS in cooperation with Pennsylvania Department of Environmental Resources. The results of that monitoring for the water year from October 1, 1974 through September 30, 1975 are shown in **Figure 2.44** (Growitz, 1985). During that year, the discharge ranged from 36 to 230 cfs (16,157 to 103,224 gpm).

Figure 2.44. Water Discharge from the Jeddo Tunnel in Hazleton, and Wapwallopen Creek near Wapwallopen, PA, October 1, 1974 to September 30, 1975 (Growitz, 1985)

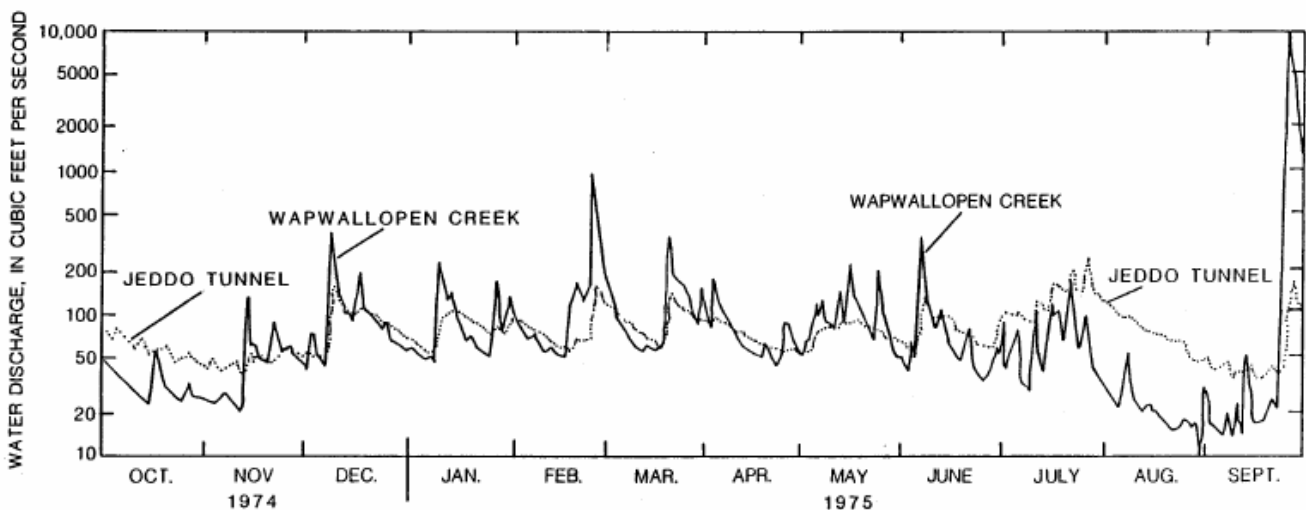

The Wapwallopen Creek, ten miles north of the Jeddo Tunnel drains an area of **43.8** square miles and has a measured mean discharge of 78 cfs (35,008 gpm) (Growitz, 1985). The Jeddo Tunnel discharge flows are compared to the stream-flow of Wapwallopen Creek (approximately 10 miles north of the Jeddo Tunnel) on **Figure 2.44**. (Growitz, 1985) found that the response of the Jeddo Tunnel discharge to precipitation events is considerably less than that of the Wapwallopen Creek, and that during large storm events, the Jeddo Tunnel data peaked later than the stream discharge.

The continuous flow recording station at the mouth of the Jeddo Tunnel was reconstructed and operated by USGS from October 1995 through September 1998 in cooperation with PA DEP, the Susquehanna River Basin Commission, US EPA and other project cooperators. **Figure 2.45(a)** (Balleron, et al., 1999) shows variations in the flow of this discharge during this period. The average annual discharge flow was 79.4 cfs (35,635 gpm) and the range of recorded flow measurements was between 20 cfs (8,976 gpm) in October 1995 and 482 cfs (216,322 gpm) in November 1996, following 3.89 inches of rainfall (Balleron, 1999). In comparison, **Figure 2.45(b)** shows a graph of precipitation data from Hazleton Pennsylvania for the period from October 1995 through September 1998. This graph was plotted from data contained in (Balleron, 1999). Additional information on the Jeddo Tunnel discharge is contained in (Fox, et al., 2001).

Figure 2.45(a) Discharge from the Jeddo Tunnel-Water Years 1996-1998

(Balleron, 1999)

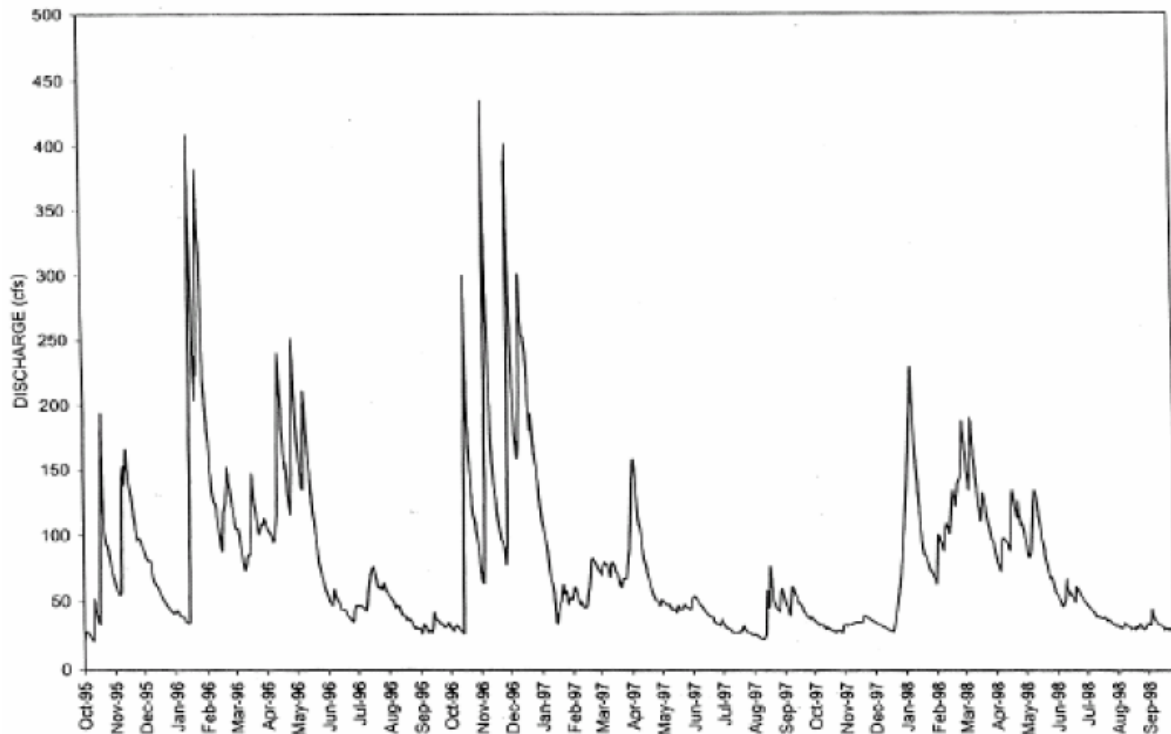

Figure 2.45(b) Precipitation Data from the Hazleton Area 1996-1998

(Fox, et al., 2001)

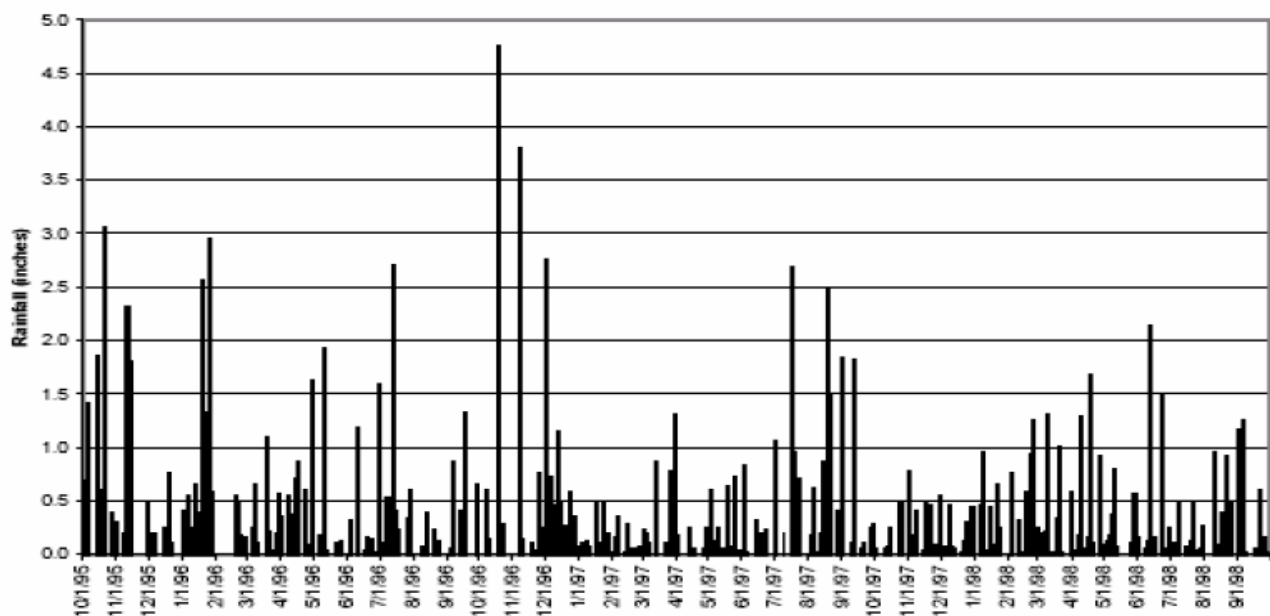
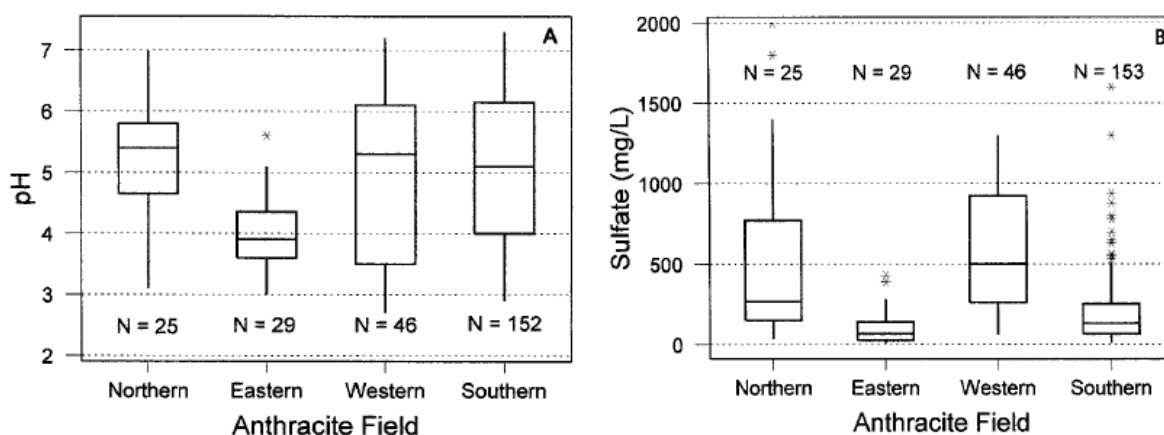

Figure 2.45(a) depicts variations in the pH of mine discharges for the four Anthracite fields. The Eastern Middle Field has the lowest median pH and the least variability in pH, consistent with an absence of carbonate strata. **Figure 2.45(b)** shows that the Eastern Middle Field discharges also have the lowest sulfate concentrations and the least variability in concentration. The other fields show a wider range in pH and sulfate, although the Southern Field typically has lower sulfate than the Northern and Western Middle Fields.

Figure 2.45(a) and (b). Box Plots Showing Differences in pH and Sulfates from the Four Anthracite Fields in Eastern PA (Brady, et al., 1998)



2.5 Anthracite Mining

The Anthracite Region has been mined commercially from the late 1700s until the present. Anthracite mining peaked in 1917 (**Fig. 2.5**), and has declined significantly since then due to: 1) competition from cheaper and cleaner fuels; 2) labor disputes that disrupted supplies at critical times; 3) labor intensive mining methods; 4) depletion of more accessible coal beds; and 5) liability for water treatment and environmental concerns.

Figure 2.5 Anthracite Production, 1890-1995 (Eggleston, et al., 1999)

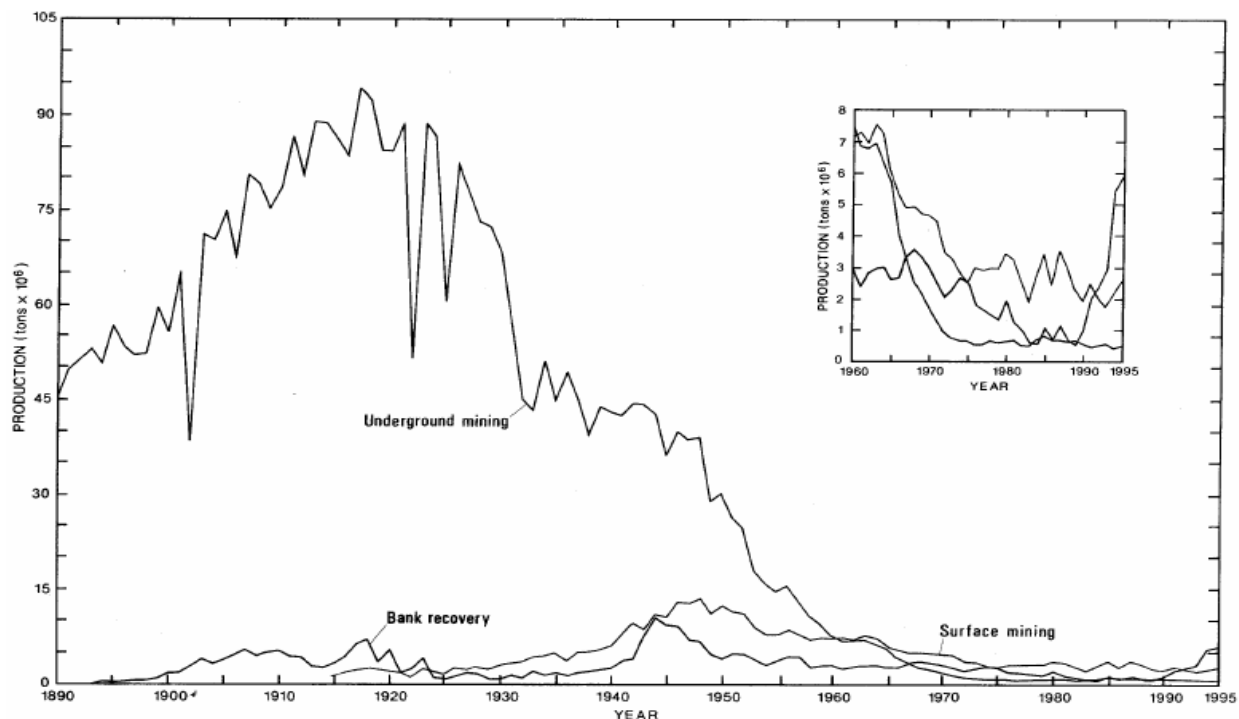

Anthracite production in 2001 was reported as 2,979,287 tons. Of this total amount, underground mining, once the dominant method for extraction, accounted for 154,111 tons, only 5 percent of Pennsylvania's total Anthracite production, and surface mines produced 725,452 tons (Dodge, 2003).

(Eggleston, et al., 1999) describe the process of underground mining Anthracite coal in the following steps: 1) miners enter by a tunnel, slope, or shaft; 2) two horizontal headings are driven parallel to the strike of the coal bed from the shaft; 3) the upper heading, called the monkey, provides access to drill and blast upwards in the coal bed dip for distances of 200 to 300 feet (breast development); 4) coal then falls by gravity into coal cars in the lower heading, called the gangway, and 5) coal is hauled out through the gangway (**Figure 2.51**). The breast-and-pillar method just described is very labor intensive.

Figure 2.51 Typical Anthracite Underground Mining Practices modified from (Eggleston, et al., 1999)

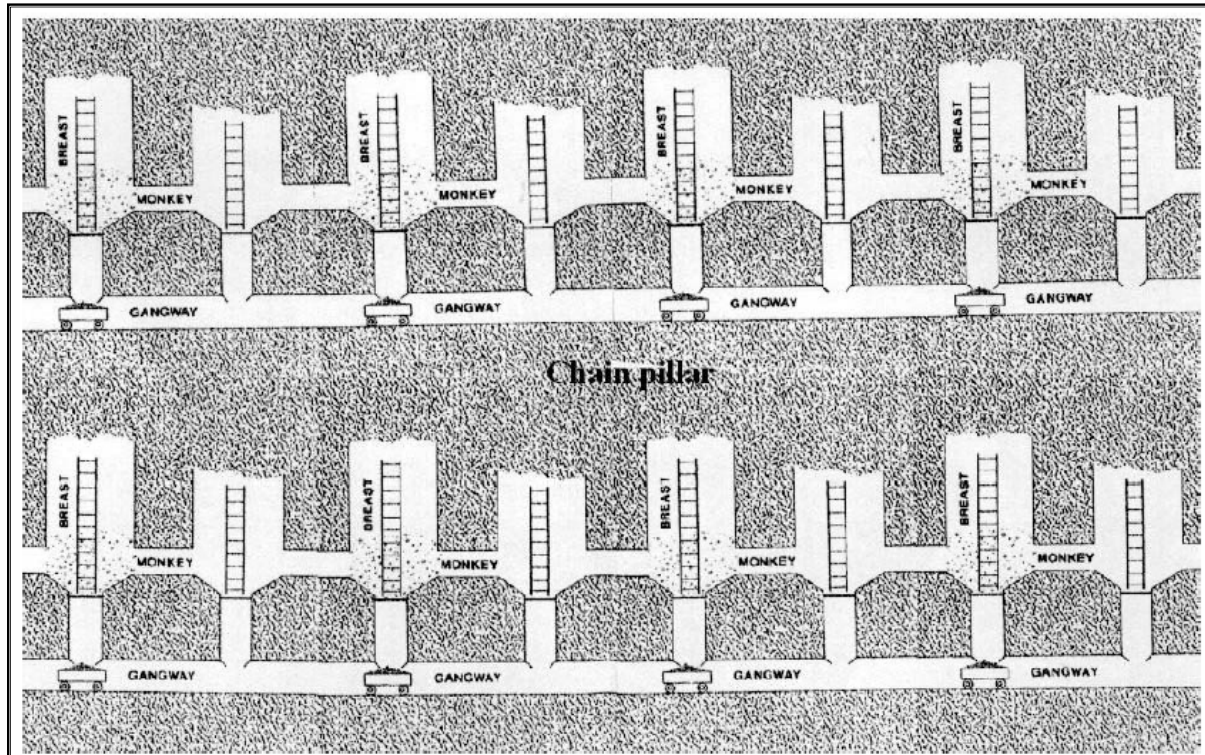

Neither surface mining nor bank recovery has surpassed the quantity of coal historically extracted by underground mining in the Anthracite Region of Pennsylvania. Surface mining dominated Anthracite production in Pennsylvania between 1961 and 1991 (Eggleston, et al., 1999). Bank recovery of coal silt and waste Anthracite (culm) currently accounts for the largest percentage of Anthracite production, 10,661,043 tons of coal extracted in 2001 (Dodge, 2003). Small (18 to 108 MW) co-generation plants have been constructed throughout the Anthracite Region in order to make use of this formerly discarded material. The culm-burning plants have provided a number of benefits to the region, including: 1) a reduction in AMD production from the culm, 2) reclamation of land, 3) a regional increase in jobs, and 4) an increase in the attractiveness of the landscape. Because many of these waste piles were created prior to SMCRA (1977), little money has been available to remove them.

The Anthracite Coal Fields have the most significant abandoned mine land reclamation problems due to the complexity of the geologic structure, the thickness of these coals, and the hydrology of the mine pool systems.

Chapter 3. Colliery Development in the Anthracite Coal Fields

By Robert E. Hughes³, Roger J. Hornberger, P.G.⁴, David L. Williams⁵, Daniel J. Koury⁶, & Keith A. Laslow⁷

The development of large underground mines or collieries in the four Anthracite Coal Fields flourished from the early 1800's through the mid-1900's as described in **Part 1. Chapter 1**. The development of new mining features of each colliery and the cessation of mining activities in the portions of the colliery were chronicled in detailed mine maps of the collieries by the parent coal companies and those with real estate interests. It is not known exactly when the requirement to delineate and maintain mine maps was initiated. The first comprehensive Act found was the Act of March 3, 1870 (Public Law 3), entitled, "An Act providing for the health and safety of persons employed in coal mines," however, most of the mine maps in the archives of the PA Department of Environmental Protection's Bureau of Mine Safety were originally delineated in the period from 1880 to 1925. The current applicable provision of Act 346, of November 10, 1965 is Section 301 (Assembly, 1965), which states:

"The Operator or Superintendent of every coal mine or colliery shall make, or cause to be made, an accurate map or plan of the workings or excavations of such coal mine or colliery, on a scale of one hundred feet to the inch, which map or plan shall exhibit the workings or excavations in each and every seam of coal and the tunnels and passages connecting with such workings or excavations. It shall state in degrees the general inclination of the strata with any material deflection therein in said workings or excavations, the seam thickness and shall also state the tidal elevations of the bottom of each and every shaft, slope, tunnel, and gangway, and of any other point in the mine or on the surface where such elevation shall be deemed necessary by the Inspector. The map or plan shall show the number of the last survey station and date of each survey on the gangways or the most advanced workings and the location and identity of each working face advanced and the location of each area of pillar removed since the last inspection."

3 Executive Director-Eastern Pennsylvania Coalition for Abandoned Mine Reclamation, Robert E. Hughes

4 Professional Geologist-Roger J. Hornberger, LLC

5 Anthracite Deep Mine Inspector Supervisor-Pennsylvania Department of Environmental Protection's Bureau of District Mining Operations-Pottsville Office, David L. Williams

6 Mining Inspector- Pennsylvania Department of Environmental Protection's Bureau of District Mining Operations-Pottsville Office, Daniel J. Koury

7 Professional Geologist Manager-Pennsylvania Department of Environmental Protection's Bureau of District Mining Operations-Pottsville Office, Keith A. Laslow

The mine maps were updated regularly and were equally important to the mine operator and the State Inspector. The Inspector would use the maps to ensure that the integrity of the barrier pillars between adjacent collieries were maintained for safety purposes, and to check on elevations of key features throughout the mine. The mine operator used the mine maps to keep track of production of coal and new developments within the mine, as well as pillars removed during retreat mining. The initial development of new gangways, chutes, and breasts within the mine was referred to as “first mining”; “second mining” involved shaving breast pillars and other features to extract even more coal; and “third, fourth, and even fifth mining” referred to removing or “robbing” the pillars (including the chain pillars) in retreat mining of portions of the colliery that would not be revisited again.

The mine maps were precisely drawn on treated linen with a variety of colored inks. The draftsmen of a large mining company would use the same color code for all of the mine maps. For example, the Philadelphia and Reading Coal and Iron Company used French Blue for workings on the Top-Split Mammoth Vein, Indian Red for the Middle Split and Dark Green for the Buck Mountain Vein. This standard practice allowed mine workings of numerous veins of coal to be portrayed on the same map, referred to as an “all seams map”. The maps were drawn with the orientation of North generally toward the top of the map. EPCAMR, is diligently working to digitize any all colors available on the “all seams maps” that are recognized by our computer software to create the 3-dimensional coal seams, based on color and contour elevations so that an individual does not have to peel through several linens anymore and can now just turn on the digital geographically referenced coal seam data layers with the click of a button.

The abandoned deep mine maps are currently used as a reference in the preparation of new surface mining and deep mining permits, and for a variety of other purposes, including the rescue of trapped miners in case of emergencies, similar to the Que Creek Mining Disaster in Western PA. The purpose of this Chapter is to provide a guide to the interpretation of mapped features on the mine maps for future professionals in this field of interest, because the number of mining engineers, surveyors, and geologists with a working knowledge of this institutional memory of what is contained on these mine maps is dwindling and has become a lost art. EPCAMR intends for this Chapter to be a learning tool for those who want an increased knowledge base on how to interpret Anthracite underground mine maps.

Mine map repositories for these Anthracite deep mine maps do exist in the Pottsville District Mining Office of the PA DEP Bureau of Mine Safety, the Wilkes-Barre Office of the PA DEP Bureau of Abandoned Mine Reclamation, the Federal US Department of the Interior’s Wilkes-Barre Regional Office of Surface Mining

Reclamation and Enforcement, plus the archives of several large Anthracite coal companies. Not all Anthracite coal companies are as forthcoming with their maps for archival purposes because they may feel that it could put them at a competitive disadvantage, if other coal companies or industries knew too much about their land holdings, be it on the surface, or underground. EPCAMR respects their perspective and reasoning. These maps are a valuable resource that must be preserved and archived for the future and EPCAMR and the PA DEP, along with other contracted higher learning institutions like Carnegie-Mellon University in Pittsburgh and Indiana University of Pennsylvania in Indiana are just some of the organizations that are building up this repository into a digital geographic format.

Preserving Mine Maps for Future Generations

The Office of Surface Mining Reclamation and Enforcement (OSM) maintains two mine map repositories, one in Green Tree, located in western Pennsylvania, just outside of Pittsburgh, which collects and maintains mine map information and images for all types of mining for the entire country, and one in Wilkes-Barre, Pennsylvania, which maintains maps specific to the coal fields in the Anthracite Coal Region of northeastern Pennsylvania. The National Mine Map Repository (NMMR, 2011) is part of the Technology Services Branch of the Technical Support Division in the Appalachian Regional Office of OSM. Some of the customers of the NMMR include; government entities, realtors, land developers, mining companies and homeowners. Many of the maps in the repository are currently available in digital format and the repository is in the process of scanning all the maps in the collection. The National Repository is always looking for additional mine maps. The website is (<http://mmr.osmre.gov/>, 2011). The National Mine Map Repository has recently added the capability for the public to search the index of all mine maps in the collection on their website. This new search capability will permit the public and other customers to directly identify mine maps in the collection.

Since most of these maps were delineated at a scale of 1-inch equals 100 feet, many of the maps are quite large. For example, the original linen map of the Mid Valley No. 1 and No. 2 collieries measures 4 feet, 5 inches wide by 21 feet, 11.8 inches long. In the aftermath of the Que Creek Mine Disaster in Western Pennsylvania in 2002, major efforts have been made by the PA DEP Bureau of Mine Safety to scan all available maps so that an electronically retrievable database exists for current and future users of the mine maps. Most of the figures in this Chapter are scanned images of portions of the relevant mine maps and cross-sections that will be referenced.

Points of Entry

There are four ways to enter or exit an Anthracite underground mine: a slope, a drift, a shaft, and a tunnel. It is not unusual for an Anthracite deep mine to have more than one of these types of entries. A slope starts at the up dip outcrop of a seam of coal and is dug downdip in the coal to the level of the first lift gangway (i.e., 200 to 300 feet). The chutes are usually numbered and coal production quantities are written at the top on the maps. Presuming that the coal is dipping to the south, the east, and the west gangways are driven at a slight incline to facilitate drainage back to the slope sump (e.g. 1 to 2%). When mining is substantially completed on this “first lift”, the slope is driven downdip another 200 to 300 feet and a new sump is established for the pumping of water to the surface from the second lift, and the process is repeated for each successive lift. Slopes have been the most common entry from 1950 to the present, although they were also used heavily in the 1800’s and early 1900’s. The pumping of the water at the time of the early underground mining was to allow the men to work “in the dry” while extracting the coal from the various lifts.

A drift entry is essentially a gangway driven in coal from a fortuitous outcrop of the coal, such as would occur in the water gap of a ridge. A shaft is started in rock and dug vertically like an elevator shaft; The shaft intercepts numerous veins of coal as it is typically driven to the bottom of the mine; A tunnel is started in rock, essentially, perpendicular to the strike of the coal seams, and is driven almost horizontally (e.g., 0.5% to 1% slope toward the surface for positive drainage); The tunnel intercepts numerous seams of coal and typically terminates at the center of the colliery. The shaft and tunnel were the most common entries from 1850 to 1950. **Figure 3.1** shows a small portion of the mine map for the Tunnel Ridge/Elmwood Colliery. The Elmwood slope is near to the center of the figure and its top entry elevation is marked as 1207.2 feet. A short distance to the right of the slope entry is the surface entry of a drift with an entry elevation of 1210.0 feet and the drift gangway is labeled.

A typical four-compartment shaft is shown in **Figure 3.2**. The number of solid triangles in the box indicates how many compartments the shaft has. This shaft is from the Gilberton Colliery. Frequently, there are two shafts for one colliery as shown on **Figure 3.3a** from the Kohinoor Colliery and **Figure 3.3b** from the Shenandoah Colliery. The Sayre Colliery shaft shown in **Figure 3.4** is a somewhat unusual 6-compartment shaft. **Figure 3.5** is a cross-section of the Valley View Tunnel. The synclinal structure of the bedrock is evident on the drawing. The mine drainage emanating from the mouth of the Valley View Tunnel flows to the Rausch Creek Abandoned Mine Drainage (AMD) Treatment Plant operated by the PA DEP Bureau of Abandoned Mine Reclamation. A photo of the R S & W drift entry near Pottsville, PA is shown in **Figure 3.6**.

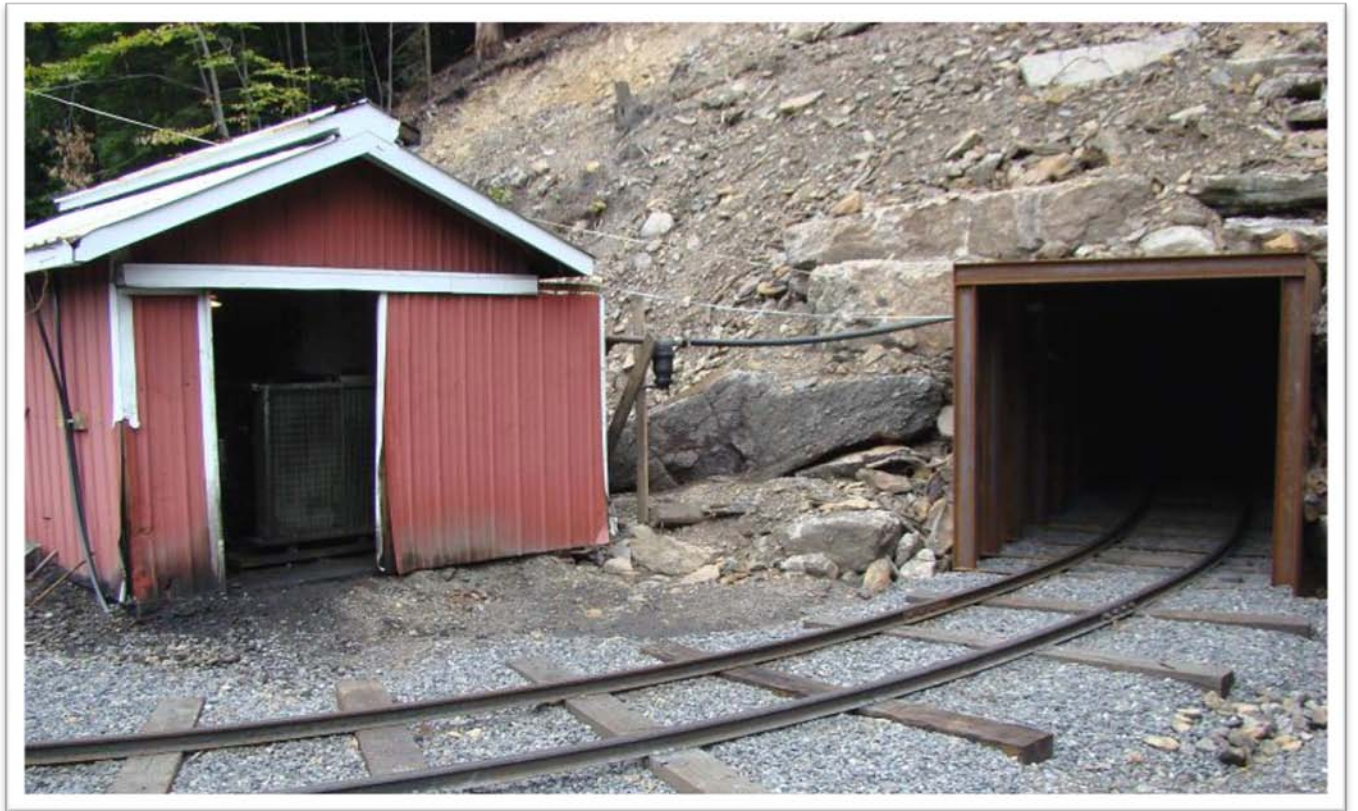

Figure 3.6 Photo of the R S & W Drift Entry, near Pottsville, PA (Hughes, 2011)

Underground Mine Development

Figure 3.1 is only a small portion of the **Tunnel Ridge/Elmwood Colliery on the Bottom Split Mammoth Vein**, but it shows a lot about underground mine development. There are two airways, a water hole, and a fanway running parallel to the main slope, labeled Elmwood Slope. The first lift gangway is labeled on the left side of the drawing and the second lift gangway and third lift gangway are labeled below the first lift. In the big picture of **Figure 3.1**, all of the underground workings above the Primrose Stripping note on the drawing are “South dip” workings, and all the workings below the Primrose label are “North dip” workings. The geologic structure of this colliery is a synclinal basin, so the rocks in the lower part of the drawing are literally dipping to the North, hence the name “North dip”. In the fine print, there are arrows showing the direction and degree of the dip of the beds. Looking at the northern portion of this drawing, the “South dip”, there are numbered “chutes” or “breasts” extending updip from the first lift and second lift gangways. The area of solid coal between the top of these breasts on the second lift and the bottom of the first lift gangway is called the “chain pillar”; its use is to support the first lift gangway during the first mining of the colliery. The coal that was mined up in the breasts was drilled and blasted, and then it tumbled down by gravity to the bottom of the chute. From that point, the coal was loaded into mine cars on rails in the gangway, and hauled to the slope to a transfer point and then transported to the surface. The gangways were the main arteries for men, boys, and equipment within the mine complexes.

The numbers at the top of some of the breasts indicate the distance from the floor of the gangway in yards, as measured by the mine foreman for recording production of coal. In the cross-section of **Figure 3.7**, a portion of the mine workings near the Kaiers borehole is shown. The borehole was 1985 feet deep (i.e., top elevation- +1224.0 feet; bottom elevation- -761.0 feet) and was completed on December 16, 1896. To the right of the borehole, in the center of the drawing is shown the “Elmwood 1st Lift East Gangway” at elevation 1048.0 feet and the Elmwood 2nd lift East Gangway at 849.5 feet on the Bottom Split Mammoth Vein. These two lifts were almost exactly 200 vertical feet apart in the downdip direction. This cross-section documents the interconnection of numerous collieries in the Mahanoy Basins, including Tunnel Ridge, Elmwood, Mahanoy City, and North Mahanoy.

The chutes and breasts in the upper right and lower left on **Figure 3.1** are cross-hatched, indicating that they were “third mined” (i.e., robbed or removed). The chutes and breasts in the center of **Figure 3.1** are not cross-hatched because the pillars in this area of the mine were left intact in a “reservation pillar” to maintain the stability and integrity of the main slope, airway, and surface structures. **Figure 3.8** is from the Glen Burn Colliery near Shamokin, and it shows gangways on two lifts, with chutes, breasts, and cross-hatched

pillars, with the label “chain pillar” separating the two gangways. The horizontal connections between chutes were known as the “monkey headings”.

The gangways and chutes in the Anthracite deep mines were driven in the coal that was mined to whatever limits were safe and technologically feasible, and consistent with lease or property lines where barrier pillars were agreed upon. Within the typical colliery, numerous tunnels were usually driven in rock. **Figure 3.9a** is a portion of an excellent drawing of the Saint Nicholas and Suffolk Collieries. In the lower center portion of that Figure are two parallel features that have horizontal cross-hatching; That pattern is most typically used for rock tunnels. The tunnel on the right connects the lowest (i.e, third lift) north dip gangway with the south dip workings shown in the top half of **Figure 3.9a**. The south dip workings of this colliery show a main slope and parallel airway to the right of the Saint Nicholas and Suffolk breaker. The slope and airway are shown in a different color than most of the surrounding workings because the slope was driven in a different coal bed. There is a drift entry located between the breaker and the top of the slope.

The chutes and breasts in the left center portion of **Figure 3.9a** have short dashed lines parallel to the long dimension of the breast; That pattern indicates that the chutes and breasts were “slushed” with waste rock. These chutes and breasts area labeled either “slate” or the number of mine cars of rock used to fill them. This practice of filling mine-out chutes and breasts with coal refuse was done to provide stability for surface features like the railroad, where subsidence was a deep concern. This method does not mean that the material was impervious, in fact, just the opposite. The filling of the chutes with the waste rock allowed for creation of an underground porous, loosely consolidated fill between lifts that could and did serve as conduits for groundwater and the formation of additional underground AMD.

Figure 3.9b shows the eastern portion of the Saint Nicholas Colliery in the Buck Mountain coal bed (Dark Green) with the Bottom Split of the Mammoth coal bed in Carmine Red color overlaying the Buck Mountain workings. The barrier pillar at the right edge of the Figure was partially penetrated by a gangway showing a stop date of July 7, 1900. The V-shaped pattern in this gangway symbolizes that the thickness of the bed of coal was “thinning” or “pinching out”.

Tunnels were driven in rock to serve a number of purposes within the colliery complex. A primary reason for the rock tunnels was to interconnect numerous beds of coal as seen on **Figure 3.10** from the William Penn Colliery. On this cross-section Figure, a rock tunnel is shown connecting coal beds in the third slope level, and another rock tunnel serves the same purpose on the fourth slope level. The overall rock structure in this portion of the colliery is a syncline as seen on the left side of the Figure. A fault or recumbent fold is also seen in the rock structure of the Holmes coal bed. **Figure 3.11** shows six nearly horizontal tunnels

interconnecting four coal beds. This cross-section also shows smaller “rock holes” that provide additional connections of the tunnels and the coal beds. This cross-section is also significant in showing that the Weston Colliery was down 11 levels on the Buck Mountain bed and 13 levels on the Seven-Foot bed. Mining was occurring at a significant depth in the Western Middle Coal Fields at that time.

Rock tunnels could also be used to connect adjacent collieries as seen in **Figure 3.12**, where the No. 6 Tunnel connects the West Shenandoah Colliery to the Kohinoor Colliery. **Figure 3.12** is from the same mine map on the Little Buck vein as **Figure 3.3a** in the Kohinoor Colliery.

Yet another purpose of the rock tunnels and probably the most prolific cause of flooded underground mine workings and some of the largest volume AMD discharges throughout the Anthracite Coal Region was their ability to provide drainage control of underground mine water for the mine operators to the surface.

Figure 13 is a small portion of the Germantown or Locust Run Colliery, with a long tunnel running diagonally across the south dip workings. This rock tunnel is the Centralia drainage tunnel from the Centralia Colliery located to the north. The Centralia Tunnel is a major mine drainage pollution source in the Western Middle Coal Field, and the tunnel freely drains the anticlinal structure of the Centralia Colliery, eliminating the ground water mound usually under an anticline, and allowing the Centralia Mine Fire to keep spreading. In the center of **Figure 13**, is a three-pronged connection of the Germantown workings to the Centralia Tunnel. Some mining engineers have advocated plugging the outlet to the tunnel in hopes that the backup of mine water would serve to extinguish the Centralia Mine Fire, but this connection to the Germantown workings shows that the Centralia workings are not likely to flood if there is a down gradient connection to another abandoned underground mine.

There are two major drainage tunnels to dewater the Locust Gap Colliery located further to the west. These tunnels are the Helfenstein and Doutyville Tunnels, which are also major mine drainage discharges to the Mahanoy Creek Watershed. The mine drainage tunnels of the Anthracite Region were constructed prior to the enactment of the Pennsylvania Clean Streams Law in 1937. That law made the gravity drainage of mine water discharges from underground mines illegal, but these tunnels were all constructed during the time that is commonly known as “Pre-Act”. A drainage tunnel was an effective mining engineering solution to accumulations of mine water within the deep mines, because pumping costs were eliminated or reduced by these gravity drainage discharges. **Figure 3.13** also shows chutes, breasts, and gangways drawn with dashed lines. This signifies that these deep mine features exist but were not surveyed underground, or were traced off another mine map.

Getting the Coal Out of the Mine

A number of mine map features represent pathways of getting the coal out of the mine, which was a principal goal in mine design and operation. A counter chute is shown in **Figure 3.14a** from the East Bear Ridge Colliery. This chute is directly across from a rock tunnel that was probably used to get the coal out of this level of the underground mine. **Figure 3.14b** shows a counter gangway that would have been used to transport the coal from the upper chutes and breasts on this figure westward within the Richards Colliery. This figure documents a connection of the Richards Colliery with the Hickory Swamp Colliery to the east as shown by the label below the gangway in the No. 8 vein. The coal in this area is rather steeply dipping as indicated by the 62 degree dip arrow in the upper right portion of the Figure and the 67 degree dip arrow in the lower left.

Figure 3.15 shows a portion of the Raven Run Colliery, where “slants” have been developed, instead of the typical chutes and breasts. These slants were mostly used in steeply dipping coal. Another example of the slants is shown in **Figure 3.16a** from the William Penn Colliery. This portion of the colliery also has numerous rock tunnels, and a barrier pillar at the right edge of the Figure. The small tunnel features shown on **Figure 3.16b** from the William Penn Colliery are “rock holes”, which are short inclined tunnels up to the overlying coal seam to obtain additional coal without developing another set of gangways and breasts.

Figure 3.17a from the Lawrence Colliery shows similar inclined rock holes driven to the gangway above. The numbers above the rock holes (e.g., 15 ½, 20 ½) are halfway between the numbered breasts as shown by numbered chutes (15 and 20) to the lower right of the ½ numbers. These features are all on the north dip side of the colliery. **Figure 3.17b** also from the Lawrence Colliery depicts rock holes to the vein above the south dip side of the colliery.

Numbered rock holes inclined to a rock gangway above, plus ventilation features, are shown in **Figure 3.18** from the Hammond Colliery. These features driven in rock rather than coal are connected to a rock tunnel used to remove the coal from the working faces. **Figure 3.19** from the Locust Gap Colliery shows three levels of mining on the Top Split of the Mammoth coal. The upper level shows normal gangway development. The second level gangway has a curved rock tunnel connected to the Middle Split. The third level shows rock holes and chutes originating on the Middle Split of the Mammoth coal driven up the Top Split of the Mammoth coal.

The mine features shown on **Figures 3.15** through **Figure 3.19** are variations on the principal method of getting the coal from the working face to the outside of the mine. In that principal pathway, the coal blasted in the breasts is allowed to fall by gravity to collect in the chute, where it is loaded into mine cars,

which transport the coal through the gangway to a hoisting slope or some other major form of egress, such as a shaft, tunnel, or drift.

Barrier Pillars and Other Types of Reservation and Basin Pillars

Barrier Pillars were major mining control features in virtually all of the large collieries. These barriers were designed and maintained to provide a separation between adjacent collieries. The barriers were needed to keep the pumping of mine water from each mine separate, and for safety reasons, if one mine ceased operations and pumping responsibilities-it would not flood the adjacent active mines. Barrier pillars were typically about 300 feet wide and they were usually oriented perpendicular to the strike of the coal bed and the gangways. **Figure 3.20a** shows a barrier pillar in the Kohinoor Colliery, and **Figure 3.20b** shows a more complex barrier pillar configuration in the Primrose Colliery. Occasionally, longitudinal barrier pillars were maintained along strike in the base of synclines as shown on **Figure 3.20c** from the Hammond and Packer V Collieries. The barrier pillars were supposed to be carefully surveyed, delineated, and deeded as no mining zones for safety and operational reasons including ventilation and mine water control. Minimum thickness of the barrier pillar was governed by State law which required 0.01 times the depth below the water table, times the thickness of the coal seam, plus five times the thickness of the coal seam.

The miners were supposed to stop mining development of gangways and breasts at the edge of the barrier pillar as shown on **Figure 3.21**. The upper gangway in that Figure shows a “stopped” date of March 1, 1916 and the gangway below shows a stop date of May 15, 1913. Unfortunately, the barrier pillars were penetrated in numerous mines, especially if the same mining company owned the adjacent mine. Sometimes the barrier pillar was punctured by the main line mining companies as shown in **Figure 3.20a**, where the Keehley Run Colliery (shown in cross-hatch, robbed) at the top of the Figure fully penetrated the barrier pillar in two locations in 1943 and 1945. More frequently, bootleg miners, as shown in **Figure 3.22** from the William Penn Colliery robbed the barrier pillars.

Reservation pillars were delineated and maintained in most well run mines. **Figure 3.23** from the Henry Clay-Sterling Colliery shows a 1000 foot square “Reservation Pillar” to protect the 3-compartment hoisting shaft and numerous key surface features including the breaker and pump house. Within this reservation pillar, “first mining” development occurred but no pillars were robbed. In the upper right zone and lower right portion of the Figure, the pillars are cross-hatched (indicating the robbing of the pillars) outside of the 1000 foot reservation pillar. On **Figure 3.3a**, from the Kohinoor Colliery, two circles are delineated around the two shafts as reservation pillars. **Figure 3.24** from the Indian Ridge Colliery shows a

large circulation reservation pillar surrounding the 3-compartment Indian Ridge shafts. There is additional information displayed in the notes and symbols of this mine map. The pillars at the top, left, and right of the figure have been robbed as shown by the cross-hatched pattern. The many fine dashed lines in the breasts indicate that these breasts were filled with refuse (see notes with dates filled) to add support. This practice of “slushing” the breasts was done where mine subsidence was a concern. Notice that the breasts and former pillar sites have all been filled with refuse for support and are dated.

Reading the Geology from Mine Development Patterns

The geologic structure of the four Anthracite Coal Fields is very complex as described in **Part 1. Chapter 2** of this report, (Wood, et al., 1986), and numerous other references. The miners who developed the major collieries in the 1800's and 1900's were not geologists, but their mine development patterns were closely related to the geologic features encountered underground. For example, if the miners encountered a major thrust fault when advancing a gangway and the coal "pinched out, the gangway development would cease until a workable coal vein could be located. The typical development of north dip and south dip breasts and gangways on synclines and anticlines was described in an earlier section of this Chapter. Some more dramatic and more subtle features are described herein.

Figure 3.25 is a classic example of a plunging synclinal basin from the Richards Colliery. In this example, the gangways curve and the breasts and chutes radiate to form the spoon-like shape of the syncline plunging toward the left side of the figure. A similar pattern of curving gangways in a plunging syncline is shown in **Figure 3.25b** from the Pennsylvania Colliery. In this figure, there is a "basin slope" plunging from elevation 1224.57 feet on the right side of the figure down to 1077.20 feet elevation at the left side of the figure. There are also two backswitch features in this figure, which were used to create a new floor elevation to help use gravity to haul coal from one transfer point to another.

Figure 3.26 shows a gently dipping bed of coal located north of the barrier pillar in the Scott Colliery. This pillar is a longitudinal barrier pillar. The coal bed is shown dipping 12 degrees to the southeast and then 10 degrees to the northeast, a small distance north of the barrier pillar. The dips are 2 degrees to the north and 12 degrees north on the right central portion of the figure. The seemingly random pattern of gangways and breasts is due to the many gentle rolls in this nearly flat coal bed, which is unusual for the Anthracite Region. The companion **Figure 3.26b** shows a different configuration of the barrier pillar from the Scott Colliery, adjacent to the Pennsylvania Colliery. The coal bed dips 5 degrees north and 11 degrees north to the east of the barrier pillar, and 8 degrees north and 6 six degrees south to the west of the barrier pillar.

Chapter 4. A Geospatial Approach to Mapping the Anthracite Coal Fields

By Michael A. Hewitt⁴, Robert E. Hughes⁵ and Maynard L. (Mike) Dunn, Jr.⁶, P.G.

Existing Datasets

EPCAMR researched and data mined several datasets received by project partners through the data gathering and compilation process. In general, there was an abundance of geographic information systems (GIS) data related to the surface mine features, but not too much readily available when it came to underground mine feature layers.

Abandoned Mine Land Inventory System Layers

Vector layers dealing with aboveground abandoned mine features exist as a database are created and maintained by the Pennsylvania Department of Environmental Protection Bureau of Abandoned Mine Reclamation (PA DEP BAMR) known as the Abandoned Mine Land Inventory System (AMLIS). This three part inventory identifies point features, polygon features, and a third layer called the Problem Area which ties the points and polygon features together into one loosely defined abandoned mine area. The point layer represents the location of mine features such as shafts, slopes, and abandoned buildings. The polygon layer represents the area covered by features such as water filled strip pits and subsidence prone areas.

Abandoned Mine Discharges (AMD) Layer

This layer shows where abandoned mine discharges (AMD) emanate from the ground or create a large enough flow to be sampled. The original source of the data is from a USGS Water Resources Investigation Report 83-4274 (Growitz, 1985) and updated in a USGS Water Resources Investigation Report 95-4243 (Wood, 1996). This layer was developed to showcase these USGS collections of locations and water quality of the Anthracite discharges. Chemical and physical attributes were sampled several times from early 1960s to the late 1990s. Data represented within the attribute table is from the year 1975 when the most complete information is available, or averaged and interpolated when no data was present. With field verification, EPCAMR has found that many of the discharge points are within acceptable deviation from their actual

⁴ Program Manager-Eastern Pennsylvania Coalition for Abandoned Mine Reclamation, Michael A. Hewitt

⁵ Executive Director-Eastern PA Coalition for Abandoned Mine Reclamation, Robert E. Hughes

⁶ Professional Geologist-Office of Surface Mining, Reclamation, & Enforcement-Pittsburgh Regional Field Office- Maynard L. (Mike) Dunn, Jr.

location. However, some are as far off as a quarter mile, but discharge locations can change over time with changes in underground hydrology or reclamation of the land. The layer was updated by EPCAMR (2004-2005) to include additional sites identified in watershed assessment reports, rivers conservation plans, watershed implementation plans, and watershed restoration action strategies, completed by community watershed groups, Conservation Districts, EPCAMR, and other organizations throughout the Anthracite Region. EPCAMR Staff and the USGS Staff verified the location of data points based on their monitoring point database and made changes when it was deemed appropriate during field reconnaissance trips into the field to collect samples or locate the AMD discharge points.

Borehole Data Layer

The Western Middle and Southern Anthracite Coal Field borehole data was received from PA DEP BAMR's Wilkes-Barre Office. The Western Middle Anthracite Coal Field information came with a geographic reference (Latitude and Longitude) while the Southern Anthracite Coal Field data did not. EPCAMR Staff extracted data and compared borehole locations in the **U.S. Geological Survey Water Resources Investigation Report 85-4038** (Reed, et al., 1987). USGS Staff verified both sets of borehole data based on their monitoring point database. This allowed them to assign locations to the shafts in the Southern Anthracite Coal Fields.

Colliery Boundary Layers

PA DEP Pottsville District Mining Office (DMO) supplied three colliery boundary layers to EPCAMR. One layer consisted of all the known collieries in the Anthracite Region, while the other two contained only collieries in the Western Middle and Southern Anthracite Coal Fields, respectively. There were several inconsistencies when the layers were compared in relation to the boundaries and the names of the collieries. These inconsistencies can probably be explained because they were boundaries that were delineated at the time when the Federal Office of Surface Mining began to collect them from the mine operators.

Raster Maps

Several paper maps, blue prints, linens, and older historical mine maps were scanned into digital format to portray underground mining features. Examples of the maps came from the Operation Scarlift Reports, Bureau of Mines Reports, USGS Reports including the Coal Series Investigations (Western Middle Anthracite Coal Field) and Miscellaneous Investigations (Southern Anthracite Coal Field), OSM Folios, 2nd U. S. Geologic Surveys and Surface Mine Permit Maps.

These scanned raster maps were cumbersome to use in a mapping setting because of their limited display properties and absence of a database table to store information about individual attributes. EPCAMR Staff georeferenced the raster maps by locating points within the maps that stood out as physical locations that tended not to move and could be found common to other map layers by providing them with a longitude and latitude and began extracting individual sets of information from them. The process of transforming the raster information into vector data is called digitizing. Useful information contained in the tables and text of the reports was then added to the table of the individual vector layers.

GIS Layers Created for this Report

In summary, this collection is a representation of underground abandoned mine features and is to be used in conjunction with PA DEP BAMR's AMLIS Database, a collection of surface abandoned mine features. It is generally difficult to picture these features under the ground, but thinking of them as surface water features, the layers are Watersheds & Lakes, Dams, Outlets, Streams & Currents, respectively. The files are in the Universal Transverse Mercator Zone 18 North (UTM) projection with a horizontal datum of North American Datum 1927 (NAD 27) and a vertical datum of National Geographic Vertical Datum 1929 (NGVD 1929).

There are **163** mine pools and hydrogeologic basins digitized in the Western Middle and Southern Anthracite Coal Fields in the layer. **112** of these are separate pools of ground water that still exist in abandoned mine workings; most of these pools were drawn directly from the Bureau of Mines Reports. The other **51** are areas that drain directly to a mine pool or an aboveground outlet (i.e., . drainage tunnel, shaft, airway, or borehole). Some drainage areas and mine pools can have one or many associated aboveground outlets. For example, the Packer #5 discharge is the main drain for several mines in the Upper Mahanoy Creek Watershed, but there are several other seeps and outlets in different locations but have similar elevations where water from the mine pool leaks out, especially during seasonal and high flow events. EPCAMR has referred to the underground connected drainage basins as multi-colliery hydrogeologic units in this report.

Geobasins / Drainage Areas

This layer showcases the extent of mine pool complexes as shown on a collection of maps. Care was taken to draw the most recent extents of the underground mines, from Surface Mine Permit files, Operation

Scarlift Reports (1970s) or OSM Mine Map Folios (in some areas where great detail was needed to research a connection). There was also a determination made if the area was an actual pool of mine water or a drainage basin. Pools of mine water were then separated into another layer.

Ash Mine Pool Layers

This layer contains actual pools of water that existed in mine workings from Bureau of Mines Reports, aka the “Ash Reports” (Ash, et al., 1947), (Ash, 1949), (Ash, et al., 1950), (Ash, et al., 1950a), (Ash, 1950b), (Ash, 1951), (Ash, 1952), (Ash, 1952a), (Ash, et al., 1953), (Ash, 1953a), (Ash, et al., 1953), (Ash, 1954b), (Ash, 1954c), (Ash, et al., 1954d), and (Ash, et al., 1956). These reports contain delineations of the shorelines of the mine pools, locations of documented breaches in the barrier pillars, and estimations of the volume of water impounded in specific mine pools, where available. EPCAMR created a reference attribute that was recorded for each feature. Many of the water levels and flooded volumes were taken to compare to their estimated volumes based on a borehole or discharge elevation and status of the mines when the data was estimated (ex. Were the mines being actively pumped?). Much of the documentation in the Ash Reports does refer to active pumping in many locations throughout the Coal Fields and the actual locations of where the mine water was drawn down to specifically to keep the elevations of the mine pools low enough for the coal companies to access and mine out the deeper layers of Anthracite coal.

Calculation of Volume of Impounded Water from Ash Reports

EPCAMR gathered most of its information on the underground mine pools by studying the same geological maps and cross sections, mine maps, cross sections showing mine workings, and other information obtained from mining company maps and permit files as Ash did. Each of the underground mine pools were studied independently of one another before determinations could begin to be made about their interconnections as possible multi-colliery hydrologic units. To determine the extent of a water pool, the altitude of the surface of the water in an accessible mine opening was ascertained. The extent of the inundated mine workings in each bed was then determined and outlined in GIS. Some water pools studied were found to extend into 17 or 18 beds of coal and into 2 or 3 separate basins. The longitudinal extent of the water pools in each bed was measured from the plan maps. The transverse extent of the pools due to the steep dips and overturned nature of many of the anthracite beds were measured from the cross-sections that were reviewed and geo-referenced. The thickness of each of the beds was ascertained from the maps, the borehole records, and other mining records.

Other information on the water pools, such as the altitude of the surface overflow points, the altitude of the lowest mine workings, and the altitude of the bottom of the basins of the beds, were obtained from mine maps and cross sections.

To determine the volume of water contained in the mine pools in the workings, (Ash, 1949) used a factor of **40%** of the total area mined which is somewhat equivalent to porosity. Mine records show that recovery (in percentage), or the anthracite actually produced from mining operations, varies in each mine and often in the same bed in different parts of the same mine. Where mines have been flooded to extinguish mine fires or abandoned mines have been dewatered, the mining records show that the volume of water contained in the mine workings was 40% of the total original volume of the mine workings that had been flooded, whether the area had been first mined, robbed, or backfilled by hand-pack or hydraulic methods. The **40%** figure is a conservative estimate, errs on the safe side, and was employed to determine the quantity of water impounded in all underground water pools in all fields during Ash's investigations.

Realizing that many mine pools were being actively pumped down by other active coal mining companies, the volumes projected by Ash can be expected to be even lower than what they would have been if pumping of the operations ceased to exist and the annual rainfall factor for those years in which the investigations were completed would have to be considered. EPCAMR has revised those boundaries and extents of the mine pools in the present day, capturing the new extents of the mine pool boundaries and elevations since mining has relatively ceased to occur in many of these deeper underground mines and because the borehole elevations today are showing dramatic increases in the elevation of the mine pool water and the beach areas that along the mined out coal measures marker beds and bottom rock.

Because of the irregular shape of an underground mine pool, an adaptation of the average end-area method was employed to determine the volume of the water in each bed in a mine by Ash. The formula used is as follows:

Q = L x W x T x 7.5 x .40, where Q=quantity (gal), L=length (longitudinal distance, in ft.), W=average width of pool between cross-sections, in ft.), T=thickness of bed, in ft.), 7.5=number of gallons to a cubic foot, and .40=percentage factor (area of mine flooded)

In 1948, it was estimated that **2.3** billion gallons of water contained in **141** surface water pools were in abandoned stripping excavations (Ash, 1949).

Mine Pools based on Borehole Water Elevations (Western Middle Anthracite Coal Fields only)

Mine pool layers based on DEP BAMR borehole water level elevations and the C-series Buck Mountain (and Mammoth in some areas) contours in the Western Middle Anthracite Coal Field. Where borehole elevations were not available, discharge elevations were used. Out of all **71** collieries, only **11** did not contain enough information to draw mine pools (*Lavelle, Helfenstein, Raven Run, Morris Ridge, Sayre, Big Mtn., Stirling, Maysville, Buck Ridge, Royal Oak, and Neilson*). Either there was no discharge/borehole information or mines in the colliery did not penetrate the Buck Mountain coal seam. **12** mine pools were delineated in areas where mines were shown as being pumped in Ash Maps, previously “blank” areas (*Alaska, Reliance, Sioux, Potts, Locust Run, Miriam, Continental, Hammond, Packer #5, West Shenandoah, and Maple Hill*).

Barrier Pillar Layer

This layer shows the barrier pillar Roman Numeral number or name and our collective best professional geologic judgment of the pillar’s integrity made by EPCAMR Staff and our researchers. Several pillars are still solid and intact, holding back water, but some are breached or partially breached, either intentionally or weakened over time, becoming semi-permeable. Other barrier pillars are submerged based on current mine water elevations and therefore rendered ineffective. Additionally, charts in the **Bureau of Mines Bulletin 521** (Ash, et al., 1953) and **Bureau of Bulletin 526** (Ash, 1953b) were used to add effective altitude numbers to the layer and aided in the integrity judgment that was made by the EPCAMR Staff and our researchers. Locations were also verified with the Surface Mine Permit maps and the **Coal Investigation Series** or **2nd Geologic Survey** in their respective Coal Fields. There are **118** separate barrier pillars identified for the Western Middle and Southern Anthracite Coal Fields.

Drainage Tunnel Layer

This layer shows the drainage tunnel name, the recorded length, portal elevation, inside elevation, history of the tunnel where available, the mine it drains and reference information. These tunnels were found in Bureau of Mines Reports, Operation Scarlift Reports and Surface Mine Permit files. Locations were also verified with the Coal Investigation Series or 2nd Geologic Survey in their respective Coal Fields. Future development of this layer may include separating the features by type (i.e., rock driven tunnel, borehole, shaft, airway, etc). There are **43** separate drains identified for the Western Middle and Southern Anthracite Coal Fields.

Mine Water Flow Direction Layer

This layer shows the direction of flowing mine water in mine pools. In the Southern Anthracite Coal Field most of these lines were initially taken from the “Ash Reports” (except for the Panther Valley Area at the extreme northern tip). The Ash Reports show a general flow direction (usually toward the discharge), while the Panther Valley Report, produced by James Gage (Gage, 1966), shows actual mine water flow paths as recorded based on mine pool hydrogeology. Best professional judgment was again made by EPCAMR Staff and researchers on the direction of flow in this layer based on discharge location (if it had migrated at the surface after the most recent report), status of the mines when the flow lines were drawn (ex. Were the mines being actively pumped?) and current average borehole water elevation levels. These adjustments were made to more accurately reflect the current flow direction of water in the underground mines. Locations were also verified with the Surface Mine Permit maps where available. There are **300** separate mine flow direction lines identified in the Western Middle and Southern Anthracite Coal Fields. Collapses in the mine could cause blockages and re direction of mine pool water. An evaluation of existing known and suspected subsidence prone areas have been evaluated by EPCAMR during the process of updating the Ash mine pools information (Ash, 1949).

Infiltration Point Layer

This layer shows where surface water enters a mine pool identified by either field investigation tours or Operation Scarlift reports. This layer is mainly propagated with points in the Northern and Eastern Middle Anthracite Coal Fields using Operation Scarlift Reports and SRBC’s Report on the Jeddo Mine Basin (Balleron, et al., 1999). Also, after a field tour of the Heckscherville Valley, Schuylkill County, with Paul Lohin, Schuylkill Headwaters Association community volunteer and EPCAMR Board of Trustee (Lohin, 2009), and follow up with Operation Scarlift Reports, EPCAMR staff were able to add an additional **27** infiltration points to the layer for the Southern Anthracite Coal Field. This layer records a name/description, estimated flow loss in gallons per minute (where available), the related Abandoned Mine Land Inventory System (AMLIS) Problem Area, the type (ex. stream flow loss, surface water loss, stream blockage or reclaimed) and reference information. This layer is an attempt to connect surface water loss to AMD discharge gains, or losses as infiltration points are reclaimed.

Multi-Colliery Hydrologic Unit Layer

After review of mine maps and comparison of the **3** colliery boundary layers, EPCAMR and PA DEP DMO Staff estimated the boundary of individual collieries, then combined collieries with common drainage into multi-colliery hydrologic units. EPCAMR Staff then created a hybrid layer, which is believed to be the best representation of actual conditions under ground for the Western Middle Anthracite Coal Fields and partially for the Southern Anthracite Coal Fields, due to the lack of data available. There are **69** collieries in the Western Middle Anthracite Coal Field and **60** in the Southern Anthracite Coal Field. When combined into common drainage, there are **19** multi-colliery hydrologic units in the Western Middle Anthracite Coal Field and **20** in the Southern Anthracite Coal Field.

Structure Contours (Western Middle Anthracite Coal Fields only)

The geologic extend of the structure contours layer is exclusively for the Western Middle Anthracite Coal Field, taken from the Coal Series “C-series” Investigations. EPCAMR used these scanned raster maps to create structural contours of the Buck Mountain vein of coal (the lowest minable seam of coal) in most areas and the Mammoth vein of coal in a few areas in the Southern Middle section. Lines were auto-vectorized in raster to vector (R2V) Software, exported to EarthVision, and finally to ArcView ArcGIS. EPCAMR is producing 3-Dimensional (3-D) images and models from this dataset since the information contained not only x and y values, but also z values representing the altitude above mean sea level. This is the first time that the underground mine workings, mine pool complexes, and multi-colliery hydrologic units have been portrayed in this innovative fashion for the Anthracite Coal Region.

EPCAMR used these maps to match up structural elements of the underground mine complex, barrier pillars, faults and drainage tunnels, in (Ash, 1948), (Ash, et al., 1950a) (Ash, et al., 1950a) (Ash, et al., 1950a), (Ash, et al., 1953), (Ash, 1949). These maps also showed extent of mining in the lowest mineable bed. Solid structural contour lines represented areas that were mined and dotted structural contour lines represented unmined areas, however, EPCAMR believes that these areas have most likely have been mined out or have seen mining expanded into these areas since the reports were done in the mid 1950s.

Faults and Anticline Layer

EPCAMR Staff digitized from the **2nd U.S. Geologic Survey** the fault and Anticline layer to show anticline peaks which would most likely serve as geologic barriers within mines, shedding water to either side

and synclinal bowls where water has the potential to be sitting similar to the bottom of a bathtub. Geographic extent of the layer was also delineated in the Southern Anthracite Coal Field. The faults and anticlines of the Western Middle Anthracite Coal Field were delineated from the **“C-Series” Maps** as well as their geographic extent.

Old Workings Layer (Southern Anthracite Coal Fields only)

EPCAMR Staff digitized from the **2nd U.S. Geologic Survey** this layer to show old mine workings that had been established before the creation of the map. Most of the survey was completed before 1900, saving a snapshot of mining in the Southern Anthracite Coal Field. Some structural elements within the mines such as tunnels and barrier pillars already existed at this time. This layer also helped explain the existence of suspected mine discharges in this Coal Field where colliery boundaries did not exist on maps or GIS layers. This layer can be substituted for the geobasins layer for the Southern Anthracite Coal Field to show the extent of underground mining around the turn of the century.

EPCAMR’s Use of EarthVision Software for 3D Modeling of the Underground Mine Pool Complexes

During the week of the 14-16th of September, 2010, EPCAMR’s very own Executive Director and Program Manger who are highly skilled Geographic Information Systems analysts and self-taught computer modelers of Dynamic Graphics, Incorporated’s EarthVision 8 2D and 3D premiere modeling software, became the first two non-profit community members across the country to complete, assist with teaching, and receiving certification from the Office of Surface Mining and Reclamation and Enforcement (OSMRE) Technical Innovation & Professional Services (TIPS) Training Class, held in Pittsburgh, PA, instructed by Mr. Mike Dunn, Professional Geologist, with the Office of Surface Mining. EarthVision 8 is a true 2D and 3D modeling application that, in its various incarnations, has been a part of OSMRE’s TIPS core software packages for Federal and State regulators for many years. There are tools that allow for header building, importing/exporting well known computer animated design data (CADD), geographic information system (GIS), and other formats, and editing and other utilities. Additional modules exist for more complex tasks like building 2D or 3D grids and models, analyzing and extracting model information, performing sophisticated volume calculations, and more.

While the training course was an introduction to EarthVision 8, even the instructor, Mr. Dunn acknowledged that the work and progress that the EPCAMR Staff have completed and modeled for the

Anthracite Region of Northeastern PA's underground mines and abandoned mine pool complexes is clearly advanced. EPCAMR's utilization of the many tools in EarthVision 8, that they had to learn on their own over the last two years since receiving the donated software license from the OSMRE due to their selection and membership on the National TIPS Team and the National Geospatial Data Standards Development Team for Coal Mining has allowed them to further understand the complex nature of the geology and hydrogeology of the Anthracite Region of Northeastern PA, compared to the typical layer-cake geology of the Bituminous Coal Regions across the rest of the Country.

The 3-day course and class consisted of lectures, demonstrations, and hands-on exercises. The training was built around a dataset from an abandoned mine land and abandoned mine drainage impacted site in the headwaters of Dents Run, Elk County, the PA Wilds area. The data sets reviewed and utilized were typical of that required by most Regulatory Programs and State Environmental Protection Agencies. The course materials were developed for the OSMRE by Mr. Robert McFaul of Dynamic Graphics, Inc. using data provided to Mr. Dunn by Mr. Rich Beam of the PA Department of Environmental Protection.

The data were also familiar to the EPCAMR Staff and therefore was ideal to introduce the EarthVision 8 modeling of stratigraphy, structure, overburden analyses, water quality, aerial photography, and 2D, as well as 3D imagery. EPCAMR Staff achieved the goal of successfully building and viewing a 3D model of the Dent's Run AML Site using the EarthVision 8 software.

EPCAMR Staff were also able to build the 3D model in such a way that they created properties that enabled them to calculate volumetrics in the underground mine as it related to determining whether or not a regulatory agency should be hypothetically approved or denied a mining permit. The aim of the modeling was to build structure and property models, and then calculates volumes based on the Net Neutralization Potential (NNP) property throughout the zones of the underground mine to determine the balance of acid versus neutralizing volumes of rock, typically found in limestone formations. Another method commonly used by States to determine this is called Acid Base Accounting (ABA) or Overburden Analyses (OA).

The EPCAMR Staff were able to attend the class with nearly a dozen other Federal and State employees from across the United States and receive the actual training 24 Professional Development Hours of class thanks to the funding, technical assistance, and training provided to both Mike and Robert through TIPS.

EPCAMR is one of the only non-profit organizations, nationally, to have entered into a Memorandum of Agreement with the OSMRE, under the US Department of the Interior, for more than a decade, and have been contributing technical assistance to community groups across PA and throughout Northern Appalachia,

through the Appalachian Coal Country Watershed Team working on poverty and environmental issues related to watersheds impacted by abandoned mine drainage and abandoned mine lands. It was a very unique opportunity and cutting edge training course that EPCAMR Staff had gone through. Mind boggling at times, however, the EPCAMR Staff have been working on the forefront of mapping the underground mine pool complexes for the Anthracite Region for the last five years and have completed some innovative work in the Western and Southern Anthracite Coal Fields utilizing the EarthVision 8 software provided to us by OSM, before they even had an official training on the use of the software. EPCAMR needed this software to get as far as they have and would like to continue mapping the remaining two Coal Fields in the Eastern Middle Anthracite and Northern Anthracite Regions. EPCAMR Staff have learned even more intricacies in the software updates since the training that now allow them to more efficiently continue their work, as long as the future funding for our efforts continue to be supported by the State of PA, the PA Department of Environmental Protection, Bureau of District Mining Operations, and the Bureau of Abandoned Mine Reclamation.”

Mike A. Hewitt is definitely the day to day user of the software tool. EPCAMR is referenced in the training manual, that the EarthVision 8 does not accurately calculate True Stratigraphic Thickness (TST) in synclinal folds more acute than about 45 degrees. EPCAMR knew this already, all too well that in the Anthracite Region, they had already begun mapping synclinal and anticlinal folds that were not only in excess of 45 degrees, but were actually overturned beds, nearly vertical cropfalls, and numerous other angles because of the nature of the Anthracite geology. EPCAMR Staff continue to work with Mr. Dunn and Skip Pack from Dynamic Graphics, Inc. to work on the further development of scripts for these extreme cases within the software, but all too common cases for the Anthracite Region.

Chapter 5. The Development and Demise of Major Mining in the Northern Anthracite Coal Field

By Robert E. Hughes⁵, Roger J. Hornberger, P.G.⁶, and Michael A. Hewitt⁷

The Northern Anthracite Coal Field consists of the Lackawanna Basin and the Wyoming Basin. The City of Scranton is near to the center of the Lackawanna Basin and the City of Wilkes-Barre is near to the center of the Wyoming Basin. The Lackawanna Basin extends from a point near Old Forge and Moosic northeastward to Forest City, the tip of the Northern Anthracite Coal Field.

The Lackawanna Basin is a canoe-shaped geologic structure in that the coals and other beds of rock are essentially flat-lying in the center of the valley and the dips become considerably steeper on the flanks of the sandstone ridges that surround the basin. According to (Hollowell, 1975), the principal structural feature of Lackawanna County is the Wyoming-Lackawanna Syncline. “ It enters the northeast corner of the County as a shallow trough and gradually deepens and broadens southwestward, toward the Wyoming Valley, Luzerne County...The rim rocks bordering the Lackawanna Valley (Pottsville and older) suggest a simple synclinal structure, however, the Llewellyn Formation is folded into a series of small anticlines and synclines.” (p. 14).

The Lackawanna Basin and the Wyoming Basin structures are separated by the Moosic Anticline, which is a bedrock structural high located near the Luzerne, Lackawanna County municipal boundary and the confluence of the Lackawanna and Susquehanna Rivers. More information can be found on the Lackawanna Basin as described in the Lackawanna River Corridor Associations’ Rivers Conservation Plan (McGurl, et al., 2001) The Wyoming Basin extends from the Moosic Anticline southwestward to the Borough of Shickshinny, the southernmost tip of the Northern Anthracite Coal Field, and is structurally more complex than the Lackawanna Basin.

According to (Hollowell, 1971) (Hollowell, 1971) (Hollowell, 1971)

“The rocks bordering the Wyoming Valley suggest a simple synclinal structure. However, the area is structurally anomalous to the Appalachians, and the rocks within the valley are complexly folded and faulted, containing many sub-parallel anticlines, synclines, and related faults. These features are discontinuous, and are seldom over a few miles in

⁵ Executive Director-Eastern Pennsylvania Coalition for Abandoned Mine Reclamation, Robert E. Hughes

⁶ Professional Geologist, Roger J. Hornberger, LLC

⁷ Program Manager-Eastern Pennsylvania Coalition for Abandoned Mine Reclamation, Michael A. Hewitt

length. The deepest part of the synclinorium is about 1 mile east of the City of Nanticoke (p. 12). Additional information on the geologic structure of the area is found in (Darton, 1940). As with the other Anthracite Coal Fields, the complexity of the geology leads to the complexity of the underground mining patterns. The structure of the Wyoming Basin is complex and the coal was mined to great depth. For example, the Auchincloss No. 1 shaft near the City of Nanticoke had a bottom elevation of -975.9 feet, as shown on **Figure 5.1**. The land surface in that area is about 300 feet above seal level, thus the shaft was approximately 1200 feet deep. Nearby, in the Truesdale-Bliss Colliery, the Askam shaft had a surface elevation of +641 feet and a bottom elevation of -1492 feet, for a total depth of 2,133 feet, according to (Ladwig, et al., 1988).”

Mine Pools and Mine Water Flow Paths

Excellent information on the mine pools of the Northern Anthracite Coal Field is contained in two PA Geologic Survey Reports by (Hollowell, 1971) (Hollowell, 1971) (Hollowell, 1971) and (Hollowell, 1975). Prior to these two publications, a great deal of information was contained in the series of US Bureau of Mines publications by (Ash, et al., 1947), (Ash, 1948) (Ash, 1949), (Ash, et al., 1950a), (Ash, 1950b), (Ash, 1950c), (Ash, 1952a), (Ash, et al., 1953), (Ash, 1954a), (Ash, 1954b) and (Ash, et al., 1956). In addition, stratification of the minepools was investigated in a US Bureau of Mines Report by (Ladwig, et al., 1988). Finally, information on the mine pool discharges is found in two US Geological Survey reports by (Growitz, 1985) and (Wood, 1996).

The presence of multi-colliery hydrologic units is evident in the Northern Anthracite Coal Field because there are many more collieries than the number of sizable mine discharges. A 1905 map in the archives of the PA DEP Bureau of Deep Mine Safety (PA DEP DMS) shows **189** collieries at that time, and a more recent inventory by the PA DEP Bureau of Abandoned Mine Reclamation (PA DEP BAMR) in 2009 lists **121** abandoned collieries. The report by (Wood, 1996) lists **16** mine discharges with flows greater than 1 cfs. Table 5.1 in the (Wood, 1996) report contain flows measured by Wood in the low-flow period of October and November of 1991 and flows of the same mine discharges measured by (Growitz, 1985) during the high-flow period of April 1975. When making the determination of flows greater than 1 cfs, the April 1975 discharge measurements were used. Of the **16** major discharges listed in (Wood, 1996), **8** are in the Lackawanna Basin and **8** are in the Wyoming Basin.

Figure 5.2 is a map of the Lackawanna Basin showing the colliery boundaries, locations of major discharges, locations of boreholes, and water table contours. This map was adapted from the water table contour map (**Plate 2**) of (Hollowell, 1975) and a base map used by the PA DEP BAMR. PA DEP BAMR has tried to maintain **55** boreholes in the Northern Anthracite Coal Field that are used to monitor mine pool elevations; Of these, **27** boreholes are in the Lackawanna Basin and **28** are in the Wyoming Basin. **Figure 5.3** shows two typical borehole plate covers fabricated by the Neenah Foundry, in Wisconsin, Illinois (Foundry, 2011).

EPCAMR, Susquehanna River Basin Commission (SRBC), Lackawanna River Corridor Association (LRCA), PA DEP Bureau of Water Quality Management-Section 319 Program, and the PA DEP Bureau of Abandoned Mine Reclamation (PA DEP BAMR) in the Fall of 2010 started a long-term monthly water monitoring program of dozens of abandoned mine drainage discharges and borehole elevation monitoring throughout the Wyoming and Lackawanna Valley at **37** locations within our region. **14** of the boreholes are in the Lackawanna Valley and **23** are in the Wyoming Valley.

For the last 6 months, EPCAMR has been monitoring the elevations of water levels in the boreholes around both of the Valleys that have seen dramatic fluctuations in their levels on a monthly basis over time. EPCAMR has compiled the historical water levels from these boreholes from the PA DEP BAMR and have graphed the data to show temporal changes in the underground mine pool levels. EPCAMR has also compiled historic and available water quality data from the SRBC, LRCA, and the PA DEP to monitor the flows of the abandoned mine discharges and the chemical loadings to the rivers and streams. EPCAMR has the ability to graph this data to show the changes in the elevations of the mine pool complexes to make a scientific-based inference on the differences, separation, or combination of the mine pools that we have termed multi-colliery hydrogeologic units.



Figure 5.3 Two Typical Borehole Plate Covers commonly found in the middle of Municipal Streets and State Highways throughout the Coal Fields (Photos taken by Robert E. Hughes, EPCAMR, 2011)

EPCAMR has also digitized historic mine pool reports from Stephen H. Ash and others from the Federal Bureau of Mines (1949-1953) by (Ash, et al., 1947), (Ash, 1948) (Ash, 1949), (Ash, et al., 1950a), (Ash, 1950b), (Ash, 1950c), (Ash, 1952a), (Ash, et al., 1953), (Ash, 1954a), (Ash, 1954b) and (Ash, et al., 1956) that helped us show the levels of the mine pools and the estimated volumes of water that was pumped down by the Anthracite Mining industry prior to its collapse around the 1970s. Currently, EPCAMR is in the process of developing an Anthracite AMD Remediation Strategy in partnership with the SRBC and other regional partners to prioritize and determine which abandoned mine discharges could potentially be treated, eliminated by mine pool elevation manipulation for storage, utilized for low flow augmentation water, and/or the combination of discharges for treatment.

EPCAMR has also digitized underground Anthracite abandoned mine barrier pillars for the Wyoming Valley and is working on digitizing the barrier pillars for the Lackawanna Valley. Archived Federal Office of Surface Mining Folio Maps has been used to accurately develop these data layers. From the collection and

detailed research of this data, EPCAMR is making determinations on the integrity of the barrier pillars to analyze if solid, breached, partially breached, submerged, or entirely removed by the coal companies as they retreated from the mines as they began to develop other sections. The Office of Surface Mining, Wilkes-Barre Regional Office will be closing in September 2011 after 34 years. When it leaves town, so will the collection of mine maps that guide engineers, land developers, and even homeowner's debating whether or not to buy mine subsidence insurance. The Mine Map collection will be moved to Pittsburgh, PA, where technicians can continue to scan the maps and perhaps, make them available online or on DVD to the public.

There are **5** boreholes in the Wyoming Valley and **9** in the Lackawanna Valley that have been paved over by municipal road departments. EPCAMR has geographical positions of these boreholes that are very accurate and are working to reach out to each of those municipalities where the boreholes are located. The Commonwealth of PA between the late 1970's drilled most of the boreholes and early 1980's to monitor the underground mine pools when funding was available. EPCAMR is trying to secure additional funding for the installation, repair, and day lighting of these boreholes throughout the Wyoming and Lackawanna Valley to obtain additional crucial data to help us make better determinations on the flows, height of the water elevations, and future advanced warning development for flooding potential throughout our communities. Most municipalities are not aware of these boreholes, what they look like, who owns them, and what their value is. EPCAMR would like to change that through our awareness campaign. If continued road milling and paving projects continue throughout the area, there is the potential for these boreholes to get paved over and we would like to prevent that and take a proactive approach to making the municipalities and road departments aware of their locations.

EPCAMR does not have the funding or equipment to reach the depths of the boreholes with water quality/elevation monitoring devices such as data loggers and/or pressure transducer that can monitor continuously over long periods. EPCAMR will make the data publicly available upon completion of our work.

EPCAMR is recommending that an Anthracite Region Borehole Monitoring Awareness Education Program be instituted to inform the municipalities and agencies of the importance of keeping these monitoring locations accessible to the PA DEP BAMR and EPCAMR. EPCAMR will more than likely pursue some funding to implement this education program in the near future.

Concerning the mine pools and major mine drainage discharges of the Lackawanna Basin, (Hollowell, 1975) stated:

“The mine pools formed by rock structure, unmined coal, collapsed roof rock, and barrier pillars are shown in **Plate 2**. Water filling the mine voids form a shoreline that is dictated by the structural limits of the bottom rock of the mined-out bed. This shoreline represents a contour on the inclined bottom rock of the mine and moves outward or inward with the rise or fall of the water surface. Most of those pools northeast of Archbald Borough are confined by the individual basin structures, each having a mine discharge overflow. South of Archbald Borough, the mines form one large underground pool (Scranton Pool) terminated at the downstream end by the Moosic Anticline. The pool has a stair step profile from a high near Olyphant Borough to a low near Old Forge Borough (See Section on **Plate 2**). The Scranton Pool overflows underground into the Old Forge mine pool, which overflows into the Central and Seneca Mine Pools. The Seneca Mine Pool overflows to the Lackawanna River through a backfilled stripping area (most of the discharge is concentrated at one point) just downstream from Duryea Borough in Luzerne County. The Commonwealth of PA in September 1962, to permit gravity discharge from the pool into the Lackawanna River, drilled a 42” borehole into the Old Forge Mine, more commonly known as the Old Forge AMD Borehole. This prevented the flooding of basements in Old Forge Borough.”

The stair step profile described by (Hollowell, 1975) for the Scranton Mine Pool is at an elevation of 707 feet around the Olyphant Shaft, an elevation of 613 feet around the Storrs Shaft, at an elevation of 600 feet around the Pine Brook and Bellvue Shafts, and at an elevation of 580 feet, near the Old Forge AMD Borehole.

The eight major mine discharges of the Lackawanna Basin of the Northern Anthracite Coal Field are shown in **Table 5.1**, with flows measured by Growitz et. al., 1975 (Growitz, 1985). The major discharges from the Scranton Mine Pool are the **Old Forge Borehole**, which was drilled within the streambed of the Lackawanna River and represents 97 cfs in **Table 5.1**, and the **Duryea Outfall** at 34 cfs from the Seneca Mine. The flows by comparison are as follows: The **Vandling Drift** from the Klondike Mine at 4 cfs or 1795 gpm, the **Upper Wilson Creek Drift** from the Coalbrook Mine at 2.6 cfs or 1166 gpm, the **Lower Wilson Creek Shaft** from the Coalbrook Mine at 16 cfs or 7,182, the **Jermyn Slope** from the Jermyn Mine at 39 cfs or 17,506, the **Peckville Shaft** from the Gravity Slope Mine at 23 cfs or 10,324 gpm, the **Jerome Shaft** from the Lackawanna Mine at 2.4 cfs or 1,077 gpm, the **Old Forge Borehole** at 97 cfs or 43,539 gpm, and the **Duryea Outfall** at 34 cfs or 15, 261 gpm . Seasonal variations in the flow at these discharges are important because two of the discharge sites, the Vandling Drift and the Jerome Shaft were not flowing in the October 1991 sampling by (Wood, 1996).

Table 5.1. Flows from 8 Major AMD Discharges for the Lackawanna Valley, 1985 (Growitz, 1985)

Major Discharge Point	Flow in cubic feet per second (cfs)	Flow in gallons per minute (gpm)
Vandling Drift	4	1,795
Upper Wilson Creek Drift	2.6	1,166
Lower Wilson Creek Shaft	16	7,182
Jermyn Slope	39	17,506
Peckville Shaft	23	10,324
Jerome Shaft	24	1,077
Old Forge Borehole	97	43,539
Duryea Outfall	34	15,261

The colliery boundaries of the Wyoming Basin are shown in **Figure 5.1**, which was adapted from a base map used by the PA DEP BAMR. This map shows the locations of the PA DEP BAMR boreholes and the major mine pool discharges. **Table 5.2** shows the **8** major discharges of the Wyoming Basin of the Northern Anthracite Coal Field with flows measured by (Growitz, 1985). The flows by comparison in the Northern Anthracite Coal Field are as follows: The **Butler Mine Tunnel** from the Number 9 Mine at 8.75 cfs or 3,905 gpm, the **Plainsville Borehole** at 9.2 cfs or 4,130 gpm, the **Solomon Creek Boreholes** from the South Wilkes-Barre Mine at 39 cfs or 17, 506 gpm, **Airshaft No. 22** from the Nottingham-Buttonwood Mine at 27 cfs or 12,119 gpm, the **Askam Shaft borehole** from the Truesdale Mine at 11 cs or 4,937 gpm, seepage from the **No. 7 Mine** at 3.5 cfs or 1,571 gpm, the **Susquehanna No. 2 Shaft** from the Number 7 Mine at 8.5 cfs or 3,815 gpm, and the **Mocanaqua Tunnel** from the West End Mine at 5.8 cfs or 2,603 gpm. Seasonal variations in the flow of these discharges are important because two of these significant discharges, the **Plainsville Outlet** and the **Askam Airshaft borehole** were not flowing in the October 1991 sampling by (Wood, 1996), indicating substantial fluctuations in the mine pools. The largest discharges are the three **South Wilkes-Barre boreholes**, both located in Hanover Township, Luzerne County, at 39 cfs, and the Nottingham-Buttonwood **Airshaft No. 22** at 27 cfs.

Table 5.2. Flows from 8 Major AMD Discharges for the Wyoming Valley, 1985 (Growitz, 1985)

Major Discharge Point	Flow in cubic feet per second (cfs)	Flow in gallons per minute (gpm)
Butler Mine Tunnel	8.75	3,905
Plainsville Borehole	9.2	4,130
Solomons Crk. Boreholes	39	17,506
Airshaft No. 22	27	12,119
Askam Shaft Borehole	11	4,937
No. 7 Mine Seep	3.5	1,571
Susquehanna No. 2 Shaft	8.5	3,815
Mocanaqua Tunnel	5.8	2,603

(Hollowell, 1971) (Hollowell, 1971) (Hollowell, 1971) drew a diagrammatic cross-section from the Grand Tunnel Colliery, Plymouth Township on the west side of the Southern Wyoming Valley to the Stevens Colliery, Exeter Borough, on the east side of the Northern Wyoming Valley, that shows a stair step pattern of mine pool elevations descending from northeast to southwest, similar to that of the Scranton Mine Pool.

The concept of the multi-colliery hydrologic units has been discussed in this publication several times and in (Hornberger, 2004). **Figure 2.42** is a schematic “plumbing” diagram from (Hollowell, 1971) (Hollowell, 1971) (Hollowell, 1971), which essentially defines multi-colliery hydrologic units for the Wyoming Basin of the Northern Anthracite Coal Field. This schematic diagram shows all of the collieries draining to seven major discharge locations into the Susquehanna River, two of which are pumped discharges. Since these mines have been abandoned, pumping has ceased and no active mining operations are drawing water from the pools, this schematic diagram would need to be revised to account for flow to the current eight major discharges of the Wyoming Basin.

The mine pool elevation in PA DEP BAMR’s 27 boreholes were compared to the water table maps by (Hollowell, 1975) and in some cases there was very close agreement with the elevations shown by (Hollowell, 1975). In other cases, the borehole elevations were very different from the water table map. PA DEP BAMR elevations were taken with survey grade Geographic Positioning System (GPS) units with a vertical accuracy that would have been a little more precise than the methodologies that were more than likely used by (Hollowell, 1975).

(Hollowell, 1971) (Hollowell, 1971) (Hollowell, 1971) includes a table showing mine pool elevations at 16 locations in the Wyoming Basin, wherein, an average fluctuation of 22 feet was recorded from May 1964 to

December 1967. It is natural to expect annual fluctuations in the borehole elevations because the Tables in (Wood, 1996) show that some major discharges are flowing in the Spring high-flow period, but are not flowing during the Fall low-flow period of the water year. It can be concluded that the surface water infiltration to the abandoned mines have a strong correlation to the temporal flows within the mine pool.

Stratification of the mine pools is discussed in (Barnes, et al., 1964) and (Ladwig, et al., 1988). The Loree No. 2 Shaft, in Larksville Borough, in the Wyoming Basin was found to have three chemically distinct layers of water within the mine with respect to Eh, pH, and other parameters of water chemistry according to (Barnes, et al., 1964). (Stuart, 1961) also found variations of pH with depth in Anthracite mine pools. (Ladwig, et al., 1988) found vertical stratification in five of nine shafts in the Northern Anthracite Coal Field, each characterized by two easily recognizable zones, separated by sharp changes in Eh, Ph, and other water quality parameters. They found the poorest water quality in the deeper flow-restricted zones. Concerning the top-water, (Ladwig, et al., 1988) state” “The results of this study raise the possibility that the relatively good water quality within some of the upper zones may eventually become a usable resource”. Before any resource development is considered, however, careful thought must be given to the effects of groundwater withdrawal on the present geochemical environment and water quality zonation, and the possibilities of induced recharge, subsurface flow diversion, and subsidence. (p.26).

The Demise of Underground Mining

The Knox Mine Disaster occurred on January 22, 1959 in the Wyoming Basin of the Northern Anthracite Coal Field, and it is described in detail in (Wolensky, 1999). The text on the State Historical Marker at the site succinctly describes the event in Chapter 1. (See **Figure 1.4 Knox Mine Disaster PA Historical Museum Commission Marker Inscription**).

Pictures on the front page of the New York Times and in (Wolensky, 1999) show a giant vortex in the Susquehanna River where the River invaded the underlying Knox Mine and numerous adjacent mines. The volume of infiltrating water was so great that many mines could not pump a sufficient amount to remain dewatered, and consequently, these mines became flooded and ceased working, never to reopen again. (Wolensky, 1999) includes a photo showing where “Lehigh Valley Railroad tracks were cut and extended toward the River so that gondolas could be pushed into the whirlpool” (p.47) and they state that “in a scene that persists as one of the most powerful visual legacies of the Disaster, trainmen thrust one gondola after another into the massive hole using a yard locomotive” (p. 46).

The Knox Mine Disaster was discussed in **Part 1. Chapter 1.** of this report and in more detail in (Wolensky, 1999). Essentially, a breach in the mine opened up (see **Figure 1.3 Knox Mine Disaster breakthrough at the River Slope Mine beneath the Susquehanna River**). The text on the State Historical Marker at the site succinctly describes the event can be found on **Figure 1.4 Knox Mine Disaster PA Historical Museum Commission Marker Inscription**. The overlying Susquehanna River flooded that mine and many adjacent mines in the Lackawanna and Wyoming Basins (see **Figure 1.5 Location of Large Capacity Pumps, Openings Where the Men Escaped, and Approximate Shore Line of Pool following River Break In**), and most of these mines never recovered to continue pumping and mining.

The Susquehanna River broke throughout the thin rock roof of the River Slope Mine, Knox Coal Company. The hole was an estimated 150 feet in diameter, funneling in 10 billion gallons of water through the mine and other mine pools in the vicinity. One of the railroad tracks above were cut and bent towards the river. Over 50 Coal Hopper cars were pushed into the breach by a diesel locomotive. Over 400 mine cars were dumped over the bank into the hole but the water just kept rushing right in. Thousands of bales of hay and hundreds of railroad ties were also added. Culm, dirt, and rock barely stopped the river. Finally, the river was diverted around Wintermoot Island by building dams at both ends. Once they pumped the water out between the dams, the size of the hole was evident. Tons of clay and rock were poured into the hole and a concrete cap was placed on top of the opening. They then pumped much of the water out of the mine to look for the 12 missing miners. No bodies were ever recovered.

It was not the sole cause for the demise of deep mining in the Northern Anthracite Coal Field, but it was the main cause by far. The Knox Mine had illegally mined under the Susquehanna River by mining past “stop lines” that had been established for decades to govern mining near the River, and did not providing sufficient roof support to prevent the ice-laden River from inundating the mine. The US Bureau of Mines in the report by (Rachunis, 1959) completed an investigation of the Disaster.

(Ash, 1950b) had prophetically predicted the possibility of the event as follows:

“If an opening should be driven from the mine workings beneath the buried valley into the water-bearing deposits or if, because of subsidence, a cave[-in] should occur and water from the Susquehanna River flow suddenly inot the mine workings, a major catastrophe could result. It is probably that a stream the size of the Susquehanna River would resist all efforts to contain it in time to avert a large loss of life and could result in the loss of a major portion of the Northern Field. “ (p. 2)

The Pennsylvania Legislature established a Joint Committee to investigate the Knox Mine Disaster. Actually, there were four inquiries of the disaster as reported in (Wolensky, 1999), the fourth involving the Federal Bureau of Investigations (FBI), the Internal Revenue Service (IRS), and the Special Group on Organized

Crime (SGOC), within the US Department of Justice. Union officials were found guilty of accepting bribes and were sent to prison.

According to (Wolensky, 1999), (p. 110):

“As serious as it was, the Knox Mine Disaster did not, by itself, bring an end to the Anthracite Mining in the Northern Field. Indeed, by early Summer 1959, the massive pumping campaign paid for by the State Government had lifted more than 11 Billion gallons of mine water from the earth, approximately equal to the amount that had flowed underground following the Knox rupture. Although millions of gallons of mine water continued flowing underground, the relatively low pool levels could have been maintained and numerous mines could have been rehabilitated. But the large capital investments required to restore the mines, coupled with the high costs of pumping, discouraged the large companies after the Government withdrew from pumping in July 1959. Furthermore, by this time, decades of inadequate investments in advance technology for mining and burning coal (home heating had always been Anthracite’s main market) had become readily apparent. On the other hand, the significant technological advances in the oil and natural gas industries meant that Anthracite had become terribly uncompetitive.”

In addition to the factors discussed in (Wolensky, 1999), the Wilkes-Barre and Scranton Metropolitan Areas have seen continually expanding urbanization and suburbanization in the past 50 years. The zone of spreading commercial and residential growth has essentially connected the two Cities and spread to areas beyond. Consequently, there is presently very little Anthracite coal mining in the Northern Anthracite Coal Field. Most active mining related work that continues is through remining, surface mining, refuse pile reprocessing, culm bank removal, silt basin removal, and abandoned mine reclamation projects that have led to a growth in redevelopment opportunities of brownfields in the Northeast. Underground mining or surface mining, looking into the near future, will probably never touch the remaining coal reserves beneath all of this urban and suburban redevelopment. However, the other resource that remains behind that could be a viable water resource, is the billions of gallons of abandoned mine drainage that already flows to the surface and is stored in the underground mine pools that is relatively easily accessible for future water usage and users.

Chapter 6. The Development of Mining & Mine Drainage Tunnels of the Eastern Middle Anthracite Coal Field

By Robert E. Hughes⁸, Jerrold Hollowell, P.G.⁹, Keith A. Laslow¹⁰, and Roger J. Hornberger, P.G.¹¹

The Eastern Middle Anthracite Coal Field is the smallest of the four Anthracite coal fields, but it was extensively deep mined during the 1800's and 1900's. By 1905, there were **58** operating collieries according to a map in the archives of the DEP Bureau of Mine Safety. According to (Hollowell, 1999)

“The Eastern Middle Anthracite Field consists mainly of comparatively small, parallel discontinuous coal basins, most of which lie above the regional drainage system. The geologic structure of the coal field is typical of the geology in the Anthracite region. The major structural fold in the field is the Hazleton basin, whose axis parallels the major regional folds trending SW to NE. The basin becomes broader and shallower in the eastern and western margins.” (p. 1)

Hydrology

The report by (Hollowell, 1999) is one of a series of 4 reports completed by SRBC under an Environmental Protection Agency (EPA)/ PA DEP grant concerning the Little Nescopeck Creek Watershed. The Water Balance for the Jeddo Tunnel Basin study by (Balleron, 1999) is another report of that series. Yet another is the ***Assessment of Conditions Contributing Acid Mine Drainage to the Little Nescopeck Creek Watershed, Luzerne County, PA*** and an ***Abatement Plan to Mitigate Impaired Water Quality in the Watershed*** by (Balleron, Kocher, & Hollowell, 1999). The hydrology of the Eastern Middle Coal Field section (Hollowell, 1999) report is reprinted here with permission from the Susquehanna River Basin Commission:

“The Eastern Middle Anthracite Field has been extensively mined since the early 1800's. The subsurface is a maze of collapsed gangways, tunnels and chambers that interconnect the Buck Mountain, Gamma, Wharton, three splits of the Mammoth Vein, and numerous other beds of lesser thickness and poor quality of coal. The surface also has been extensively disturbed by previously unregulated surface mining operations and is presently

8 Executive Director-Eastern Pennsylvania Coalition for Abandoned Mine Reclamation, Robert E. Hughes

9 Professional Geologist, Susquehanna River Basin Commission, Jerrold Hollowell

10 Professional Geologist Manager-Pennsylvania Department of Environmental Protection's Bureau of District Mining Operations-Pottsville Office, Keith A. Laslow

11 Professional Geologist, Roger J. Hornberger, LLC

scarred with open abandoned pits, spoil piles, and refuse banks. These abandoned deep and surface mining operations have completely destroyed the natural surface and ground water systems within the mining area. The open pits and fractured strata allow all surface water not controlled at the surface to infiltrate into the deep mine workings. The quality of this water has been greatly affected through contact with acid-producing minerals present in the coal and associated rock exposed to infiltrating water.”

The Eastern Middle Coal Field is mostly drained to the surface by the drainage tunnels and a few surface outfalls. **Figure 6.1** is a composite U.S. Geological Survey topographic map of the area showing the location of the outfalls listed in **Table 2**, and the coal basin’s approximate surficial contact with the lowest mined bed. Surface projections of underground mine tunnel systems that drain to the surface are also designated. Included in the Appendix are detailed maps showing principal mine outfalls in the Eastern Middle Anthracite Coal Field and their water quality characteristics.

There are **13** functional mine drainage tunnels in the Eastern Middle Coal Field that were specifically driven to dewater the mine workings as (Growitz, 1985) described in (Hollowell, 1999). This drainage system was most successful here because of the comparable elevation of the drainage tunnel discharge to the receiving streams. Using flows from (Growitz, 1985), the reported mine drainage tunnel flows in **Table 2. Flows of Mine Tunnels in the Eastern Middle Anthracite Fields, April 1975** are as follows:

Table 2. Flows of Mine Tunnels in the Eastern Middle Anthracite Fields, April 1975 (Growitz, 1985)

Mine Tunnel	Flow in cubic feet per second (cfs)	Flow in gallons per minute (gpm)
Gowen Tunnel	6.6	2962.3
Derringer Tunnel	8.8	3949.7
Oneida #1 Tunnel	6.4	2872.5
Oneida #3 Tunnel	9.1	4084.4
Catawissa Tunnel	0.8	359.1
Green Mountain Tunnel	2.1	942.5
Audenreid Tunnel	19.0	8527.8
Jeddo Tunnel	65	29174
Quakake Tunnel	20	8976.6
Hazle Brook Tunnel	1.5	673.2
Buck Mountain #1 Tunnel	1.7	763
Buck Mountain #2 Tunnel	0.1	44.9
Owl Hole Tunnel	4.5	2019.7

The Jeddo Tunnel

The Jeddo Tunnel is the most extensive, constructed gravity drainage system in the Eastern Middle Anthracite Coal Field. The construction of this system prior to 1900 was an engineering feat conducted under the direction of mining engineer and mine owner, John Markle. According to (Novak, 1978):

“He bought out the large interest held in the G.B. Markle and Company by the Asa Packer estate and thus assumed financial as well as administrative control. He gained new leases or made new outright purchases, securing mines at Jeddo, Highland, Ebervale, and Harleigh. When underground floods forced the abandonment of the nearby Harleigh and Ebervale mines in 1886, and all efforts to clear the waters failed, John Markle purchased the properties and designed a system to salvage them. He formed the Jeddo Tunnel Company, invested a million dollars in an improbable engineering feat, and personally supervised the precise surveying required for underground work. Using compressed air drills and powerful explosives, his men labored for 3 years, at constant risk of their lives, once team driving north and the other south in underground darkness. On September 15, 1894, the two teams met and tore out the intervening wall. Their floors did not differ by as much as an inch. Esteem for Markle spread. When later strikes brought flooding to other unworked mines in the area, Markle’s drainage tunnel kept his mines free of water damage. Much has been written about the Jeddo Tunnel, in terms of the extraordinary engineering feat, the eventual success of dewatering approximately 33 square miles of coal basins (Ash, et al., 1950) and more recently, its environmental impact. The other discharges each yield a comparatively minor amount of water.” (p.40)

The Jeddo Tunnel system is shown in **Figure 6.1**. The main tunnel is Tunnel A and it branches out into Tunnel B, Tunnel C, Tunnel D, and Tunnel X. The Jeddo Tunnel system drains mine water from the Little Black Creek Basin, Big Black Creek Basin, Cross Creek Basin, and the Hazleton Basin into the Little Nescopeck Creek as shown on **Figure 6.1**. According to Ash et al. (Ash, et al., 1950), Tunnel A is 15,100 feet long and 8 feet by 10 feet in cross section, Tunnel B is 9,880 feet long, Tunnel C is 4,268 feet long, Tunnel D is 4,038 feet long, and Tunnel X is 9,601 feet long.

The Jeddo Tunnel mine discharge near Hazleton, PA is the largest abandoned underground mine discharge in the Eastern Middle Coal Field of the Anthracite Region, and is among the largest mine drainage discharges in Pennsylvania. The Jeddo Tunnel has a total drainage area of 32.24 square miles and its underground drainage system collects and discharges more than half of the precipitation received in the drainage area (Balleron P. B., 1999). The US Geological Survey in cooperation with the Pennsylvania Department of Environmental Resources (PA DER) monitored the flow of this discharge with a continuous recorder from December 1973 through September 1979.

The results of that monitoring for the water year from October 1, 1974 through September 30, 1975 are shown in **Figure 6.3** (Growitz, 1985). During that year, the discharge ranged from 36 to 230 cfs (16,157 to 101,224 gpm). The Jeddo Tunnel discharge flows are compared to the stream-flow of Wapwallopen Creek (approximately 10 miles north of the Jeddo Tunnel).

The Jeddo Tunnel system drains mine water from the Little Black Creek, Big Black Creek, Cross Creek, and Hazleton Basins. Since the completion of the initial rock tunnels and subsequent connecting tunnels and slopes, the Jeddo Tunnel collects and discharges about half of the precipitation and ground water infiltrating the Eastern Middle Coal Field mines. **Figure 6.2** is a plan map showing the Jeddo Tunnel drainage system and general internal flow directions.

Most of the Eastern Middle Anthracite Coal Field drains westward to the Susquehanna River. The eastern-most basins drain to the Lehigh River. The drainage divide is approximately along a line between Freeland, to the north, and Weatherly, to the south. An expression of this divide on the surface is a broadening of Cross Creek Basin and Big Black Creek Basin and easterly pinching out of the Hazleton and Jeansville Basins.

Infiltration of precipitation, seepage from stream channels, and ground-water discharge are principal sources of water to the drainage tunnels. Both underground and surface mining, with associated subsidence, create surface catchment basins fractured rock strata and artificial ponding that increases the amount of water discharged by the tunnels. Surface runoff will have to be controlled to reduce mine water drainage in the Eastern Middle Anthracite Coal Field. (p. 3)

Mine Pools, Barriers and Tunnels

The Eastern Middle Anthracite Coal Field differs from the other three Anthracite coal fields in respect to the importance of mine pools and barriers pillars, and the prevalence of mine drainage tunnels to control mine water. According to (Ash, et al., 1947), "Most of the basins lie above the natural drainage horizon of the nearby surface areas" and (Ash, et al., 1950a) (p.1) state: "The altitude of the Anthracite measures is higher than that of the surrounding valleys, which has made it possible to remove mine water by conveying it to the surface through tunnels". Most of the mine water in the Eastern Middle Anthracite Coal Field is drained to the surface through tunnels, and most of the mine pools in this field lie below the altitude of the drainage tunnels. According to (Ash, et al., 1947), "The pools are in basins that are not drained by tunnels or because the overflow points of the pools lie below the altitude of the drainage tunnels. The water in some pools in abandoned mines is confined by barrier pillars." (Ash, et al., 1950a) state, "Water impounded in underground

pools in the Eastern Middle Anthracite Field contained in **32** pools. The total volume of water in these pools is **3,744,466,000** gallons.”

Figure 6.2 from (Ash, et al., 1950a) show the location of the mine pools of the Eastern Middle Anthracite Coal Field. From **Figure 6.2** and examination of the mine maps of collieries of the Eastern Middle Anthracite Coal Field, it can be seen that barrier pillars are not as prominent in controlling mine water as in the other three Anthracite coal fields.

Figure 6.3. Water discharge from the Jeddo Tunnel in Hazleton, and Wapwallopen Creek near Wapwallopen, PA, October 1, 1974 to September 30, 1975 (Growitz, 1985)

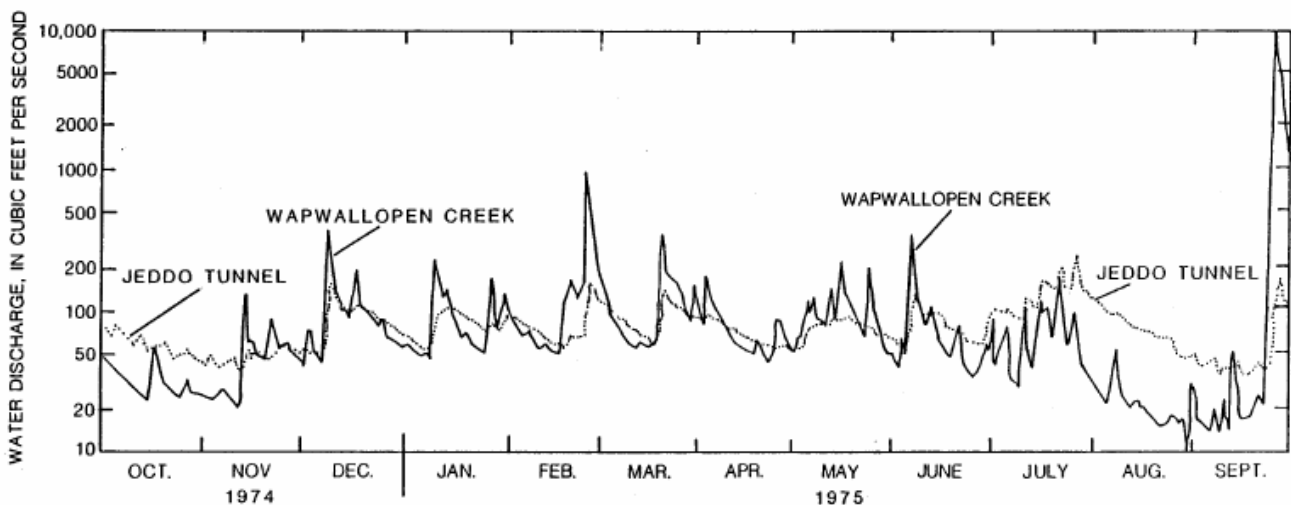

The continuous flow recording station at the mouth of the Jeddo Tunnel was reconstructed and operated by United State Geologic Survey (USGS) from October 1995 through September 1998, in cooperation with the PA DEP, the Susquehanna River Basin Commission, US EPA and other project cooperators. **Figure 6.4** (Balleron, Kocher, & Hollowell, 1999) shows variations in the flow of this discharge during this period. The average annual discharge flow was 79.4 cubic feet per second (cfs) (35,635 gallons per minute (gpm) and the

range of recorded flow measurements as between 20 cfs (8,976 gpm) in October 1995 and 482 cfs (216,322 gpm) in November 1996, following 3.89 inches of rainfall (Balleron, 1999).

Figure 6.5 shows a graph of precipitation data from Hazleton, Pennsylvania for the period from October 1995 through September 1998. This graph was plotted from data contained in (Balleron, 1999).

Figure 6.4 Jeddo Tunnel Flow Data (Balleron, 1999)

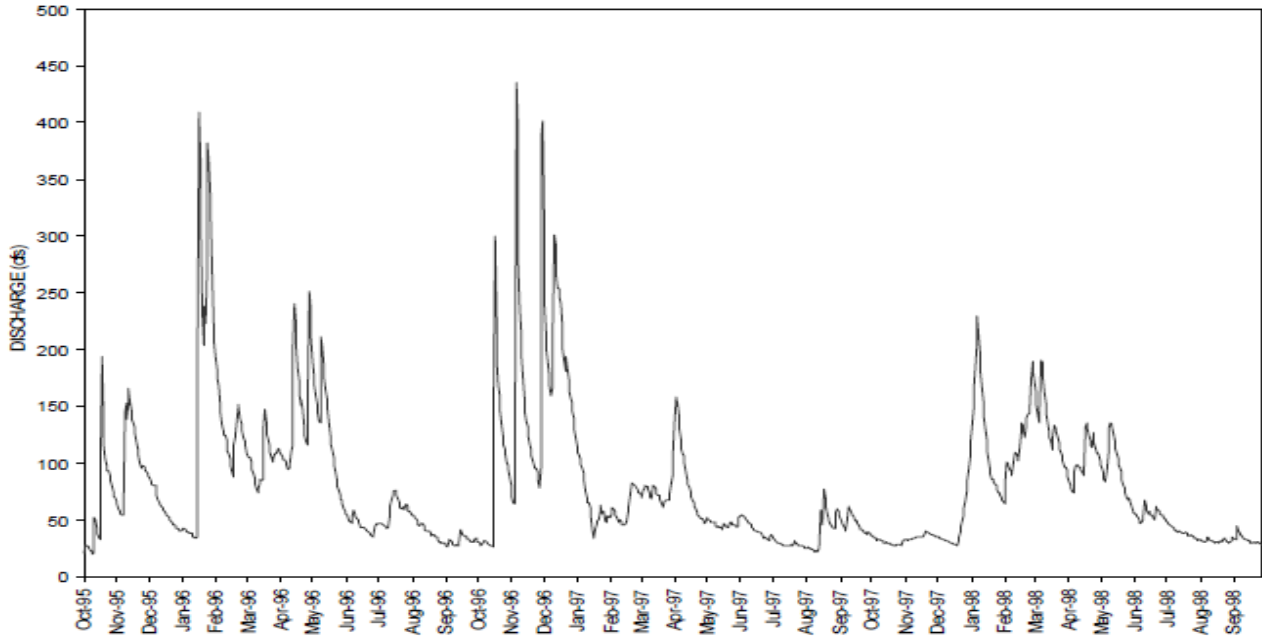
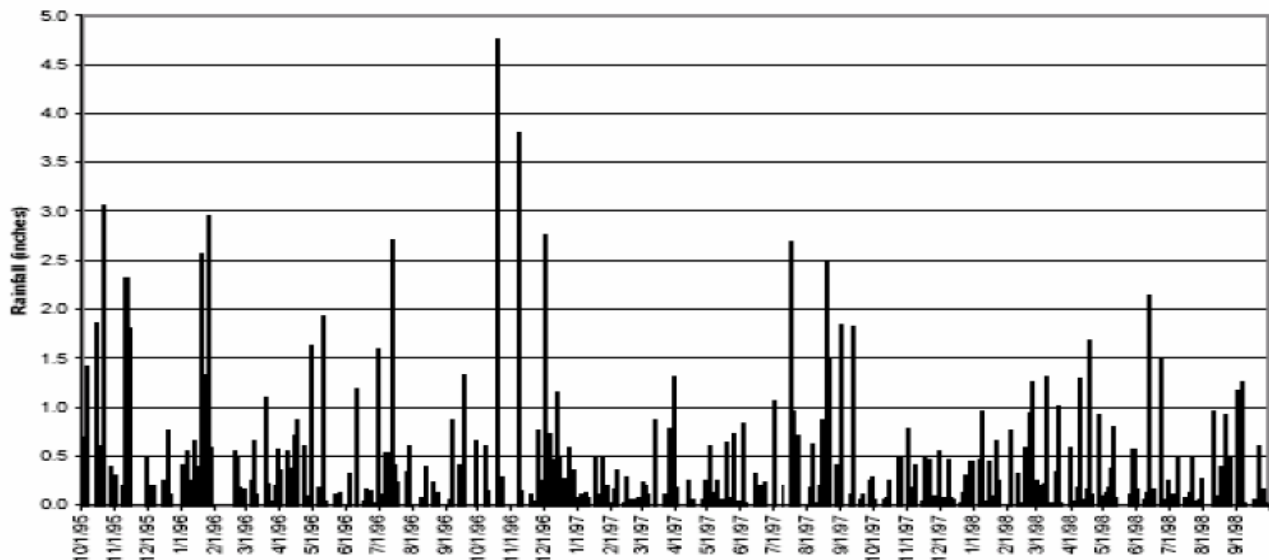

Figure 6.5 Precipitation Data from the Hazleton Area 1996-1998

(Fox, et al., 2001)



The water levels of these developing mine pools eventually stabilized when spillover points were reached at the lowest topographic elevation of a sizable orifice of the abandoned mine. In many cases, the spill-over opening was the main tunnel or slope entry to the mine and in other cases the lowest opening was an air shaft, borehole, or some other minor underground mine feature. Consequently, about 100 large abandoned mine drainage (AMD) discharges appeared in the four coal fields of the Anthracite Region.

Water Quality

No severe acid mine drainage [i.e., $\text{pH} < 3.0$, acidity $> 1,000$ milligrams per Liter (mg/L)] is known to exist in the Eastern Middle Anthracite Coal Field and it appears to lack both calcareous rocks and high-sulfur rocks. There are **15** major mine drainage discharges in the Eastern Middle Anthracite Coal Field, **13** of which are mine drainage tunnels with no significant alkalinity in any of these discharges. As far as is known, there are no limestone beds or other calcareous strata in this field. The alkalinity data tabulated in (Hollowell, 1999) shows that the average alkalinity for all **15** of these discharges is less than 10 mg/L.

Figure 2.45a depicts variations in the pH of mine discharges for the four Anthracite fields. The Eastern Middle Anthracite Coal Field has the lowest median pH and the least variability in pH, consistent with an absence of carbonate strata. The range of pH values is from 3.0 to a little greater than 5.0. **Figure 2.45b** shows that the Eastern Middle Anthracite Coal Field discharges also have the lowest medium sulfate concentrations and the least variability in concentration. The median sulfate concentration is less than 100mg/L.

Chapter 7. Environmental Resource Economics of Mine Water

By Robert E. Hughes⁹ and Jonathan M. Dietz, Ph.D.¹⁰

Potential Untapped Underground Mine Water Resource

This Chapter's intent is to provide some preliminary information about various opportunities to reuse an overabundant and underutilized water source, ground water and mine water accumulated in underground coal mines. As the underground mines closed in the Anthracite coal fields of eastern Pennsylvania, the pumping operations that kept the mines dry were turned off. Over time, when the mines became inactive or shut down completely, natural ground water accumulation in the voids left by the mining operations created large underground pools of untapped mine water.

The water quality varies as the result of the chemistry of the individual coal seam of the mine, the residence time of water in the mine, the interconnection to adjacent mines where barrier pillars were either breached, drilled through, or robbed, and the method of mining employed. Although a mine may be conveniently located, its mine pool water can have very poor water quality (high acidity, low pH, and high total dissolved solids or TDS) than the other local mines. Mine pool water becomes acidic from the reaction of oxygen and water with iron-sulfide-bearing minerals found in the coal, such as pyrite (FeS_2). Near-neutral pH mine pool water results from the buffering of mine pool water with calcareous minerals, such as calcite (CaCO_3). There are many factors that affect the chemistry of mine pool water. (Wood, 1996) suggests that the following factors will affect the pH, acidity, and metals concentrations in the discharged water:

- mineralogy of the coals and overburden;
- quantity of water flowing through the mine;
- residence time, path length and depth of water circulation through the mine;
- availability of oxygen in the mine water;
- mine design (e.g., up-dip versus down-dip);
- active pumping, either within the mine or within the influence of adjacent mines; and
- exposed surface of sulfide minerals.

⁹ Executive Director-Eastern Pennsylvania Coalition for Abandoned Mine Reclamation, Robert E. Hughes

¹⁰ Ph. D.-Environmental Science & Engineering, Dietz Gourley Consulting, LLC, Jonathan M. Dietz

Water levels in the mine would continue to rise until hydraulic equilibrium with the regional water table until a surface elevation across the mine was achieved or the water followed paths to topographically low areas in deeper pools. Fractures caused by roof cave-ins, removed or breached pillar barriers, as well as mine tunnels and abandoned air shafts, allowed water to freely flow within one mine or a series of mines (commonly referred throughout this report as multi-colliery hydrogeologic units or mine pool complexes).

Dozens of underground abandoned mine pools are already actively releasing water to surface water streams. Several noteworthy underground mines in Pennsylvania and West Virginia are nearly filled with contaminated ground water and are expected to begin overflowing into nearby water bodies in the near future if blockages or roof falls and other collapses occur in the mines. EPCAMR and other regional community watershed organizations are concerned that the influx of the mine pool water will damage their streams and potentially affect their potable water supplies in addition to possibly creating reoccurring stream impairments to sections of streams that have already been remediated over the last two decades. While it is true that local and State agencies are working on control strategies, comprehensive AMD remediation plans, and operation, maintenance, and repair or replacement plans, one must recognize that these solutions are not easy, nor are they inexpensive. It is vital for the private sector to invest in potentially reusing this mine water resource for economical redevelopment potential, in partnership with all levels of government and groups like EPCAMR.

The complex nature of these underground mine pools, the fluctuations in the mine pool elevations, the interconnectedness of the mines, and the uncertainty of the potential volumes of water that can be in any one mine pool multi-colliery hydrologic unit can be a daunting environmental challenge for the regulatory agencies and the community organizations and partners, both public and private, who are supportive of utilizing the water as a resource. It could provide a future profit or return on capital investment. It does take a little creativity and out of the box ideas to envision future potential uses of the underground abandoned mine pool complexes, however they are not unrealistic goals or expectations to make.

In 2002, the Pennsylvania Department of Environmental Protection (PADEP) was faced with the reality that as many as **15** major underground mine drainage treatment plants could cease operations unless they were taken over by the Commonwealth. The Secretary of PADEP asked the Mining and Reclamation Advisory Board (MRAB), an advisory body created by statute in 1984, for input and advice on the looming underground mine pool issue. The MRAB responded by forming the Orphan Mine Discharge Task Force. In July 2003, the task force presented to the MRAB 19 resolutions organized into four topics—technology, outreach, financial, and legal and legislative. EPCAMR has been involved as a voting member of the MRAB, appointed by the State

Conservation Commission for over a decade and was involved with developing fact sheets in partnership with the Western Pennsylvania Coalition for Abandoned Mine Reclamation (WPCAMR) and other members of the Technical Committee that formed the Orphan Mine Discharge Task Force on the development of the resolutions.

The technology resolutions called for a Request for Proposal to demonstrate technologies related to mine pools (in-situ and ex-situ treatment of the mine water, reduction of infiltration of surface water, and economical metals recovery), the use of airborne geotechnology to map mine pools, and the development and consolidation of databases of mine pools and discharges. The outreach resolutions invited the PADEP to form partnerships with state and local agencies and industry to market recycling and reuse of mine pool water. The financial resolutions asked PADEP to develop funding partnerships and vehicles to address the long-term treatment of discharges. The legal resolutions covered the use of alternative treatment standards (for example, best professional judgment), Good Samaritan protection, mine discharge effluent trading, and ownership, access, and liability issues. The resolutions were unanimously adopted and presented to the Secretary of PADEP. In April 2004, the task force presented its action plan for addressing the **19** resolutions (OMDTF, 2004) at an MRAB board meeting.

See the link to the resolutions below:

http://www.dep.state.pa.us/dep/subject/advoun/minrec/MRAB_2004/ActionPlanMRABOrphanMineDischargeTaskForceResolutions.doc

One of the projects that have demonstrate the reuse of mine pools to highlight PA DEP's marketing approach in the Anthracite Region will be discussed further here:

- The Wadesville Mine pool in Schuylkill County, Pennsylvania
- The abandoned Shannopin deep mine in Greene County, Pennsylvania is yet another project that has had great success and further information can be found in (Veil, et al., September 2003), (Veil, 2006)

The most innovative resolutions involve the marketing of mine pools to industries and other public and private water users to promote economic development. More than **1.3 trillion** gallons of acid mine water are estimated to be ebbing and flowing in abandoned mines mostly beneath Fayette, Greene, and Washington counties in Pennsylvania and in Monongalia County in West Virginia, alone. In the words of one official, it would take more than **230** years to accomplish a cleanup. As user demands for water from aquifers and streams increase, the promoters of unused underground mine pool water consider it a valuable resource to be utilized. (Veil, 2006)

EPCAMR had requested and received permission from Environmental Science & Engineering-Dietz, Gourley Consulting, LLC to reference another study that was being completed simultaneously with this report, pertaining to AMD in the Shamokin Creek Watershed, with a particular focus on three Chapters that are relevant within this Chapter. EPCAMR was able to provide Dietz our completed evaluation of the mine pools in the Shamokin Creek Watershed with the permission of the PA Department of Environmental Protection prior to the completion of this report to assist him with making decisions in his study of the 4 discharges that were the focus of his report. In order to not duplicate the workload on similar topics, EPCAMR found the **Investigation of AMD Treatment, Water/Solids Reuse and Industrial Development: Feasibility Study for the Scotts Tunnel, Colbert Breach, Excelsior Overflow, and Maysville Borehole Discharges** (Dietz, 2011) to be quite comprehensive and complimentary to what is discussed here.

Chapter 4-Beneficial Use of Treated Water. This chapter focuses on identifying the potential beneficial reuses of the treated AMD that may benefit the local economy as well as provide revenue to offset the AMD treatment costs. The revenue potential is an integral and key aspect of the Feasibility Study and is needed in order to offset the annual costs of treatment, as well as provide economic benefit to the local region.

Chapter 5-By-Product Disposal and Re-use. Sludge production, handling, reuse and/or disposal are integral to the treatment of water and wastewater because the costs associated with the sludge handling represent a significant cost in treatment. AMD Treatment systems are developed and designed with various considerations related to the solids production and handling that include treatment process design, chemicals use, sludge stabilization and dewatering facilities, transportation facilities, and reuse and/or disposal. The goal of the overall treatment system design is to minimize the costs associated with the solids byproduct, or sludge, produced from water and wastewater treatment. This Chapter discusses: 1) the current disposal and reuse practices for water and waste water treatment solids; 2) current practices for handling and disposal of AMD treatment; and 3) current and potential beneficial reuses of AMD treatment solids.

Chapter 6-Treatment of High Flow Acid Mine Drainage Discharges. This Chapter discusses the various options and unique considerations that must be evaluated on high flow acid mine drainage discharges that are typically found in the Anthracite Region of PA.

Dietz's Study goes into even greater detail on the environmental resource economics, AMD treatment design costs, operation & maintenance costs, several pilot-scale AMD treatment system construction projects, and potential re-use for not only the mine water resources, but the iron oxides that are generated in the process of treating the abandoned mine water (Dietz, 2011).

EPCAMR has also combined Dietz's References to our exhaustive bibliography list at the end of the report that are cited in the **Investigation of AMD Treatment, Water/Solids Reuse and Industrial Development: Feasibility Study for the Scotts Tunnel, Colbert Breach, Excelsior Overflow, and Maysville Borehole Discharges** (Dietz, 2011)

Use of Mine Pool Water in Northeastern Pennsylvania

Abandoned mine lands and remnant culm banks, mountains of culm, spoil piles, mine dumps, whatever the colloquial term is for the black banks that encompass many of the small coal mining towns throughout Northeastern PA do have value to some. The culm has a caloric value and is used as a fuel by some small power plants in the region. (Veil, et al., September 2003) described the plants.

Table 1 provides a summary of the characteristics of those six plants. Two of the plants—Panther Creek Generating Station and Schuylkill Energy Resources—use the mine pool water as a back-up to their preferred water supply from a reservoir. During dry periods, the reservoirs cannot supply sufficient water, so the plants use the more expensive mine pool water.

Table 1: Characteristics of Six Plants in Northeastern Pennsylvania Currently Using Mine Pool Water

Company Name	Plant Location	Generating Capacity	Source of Cooling Water	Withdrawal Rate	Distance from Mine Pool to Plant	Length of Time Using Mine Pool Water	Comments	Company Contact
Gilberton Power Company	Frackville, PA	80 MW	Unnamed mine pool	- 833 gpm - 1,500 gpm (pump capacity) - 500 MG/year	- 1.5 miles - change in elevation of 550–600 feet	> 15 years	- need a treatment system (\$0.20/1,000 gal) - pay \$0.20/1,000 gal to SRBC	Jim Weaver 570-874-4456, x421 jimweaver@culm2energy.com
Northeastern Power Company	McAdoo, PA	50 MW	Silverbrook mine basin	100 gpm	3,000 feet	17 years	- main cooling system is an air-cooled condenser - water is used for auxiliary cooling tower, boiler makeup, and other plant purposes - need to treat - need to clean the transfer line because of iron hydroxide precipitation	Jim Wetzel 570-929-3242 jwetzel@nepco2.com
Panther Creek Generating Station	Nesquehoning, PA	83 MW	Lausanne mine tunnel	- 764 gpm - 1.1 MGD	5 to 6 miles	14 years	- they have the ability to use mine pool water but have chosen a less expensive supply from a reservoir - mine pool water is used when reservoir is too low - need to treat - pumping and treatment costs are high	Jim Carroll 570-645-8721 jcarroll@panthercreekenergy.com
Schuylkill Energy Resources, Inc.	Shenandoah, PA	100 MW	Maple Hill mine	- 1,100 gpm maximum when in use - 500 gpm average	¼ mile	20 years	- need to treat - also can use reservoir or can blend the two sources - they prefer to use a reservoir when it is available	Bob Boretzki, 570-462-2822, x25 bobbser@verizon.net
WPS – Westwood Generation Plant	Tremont, PA	31 MW	Used Lyken mine since 1993; previously used two other sources	800 gpm	< 200 feet	18 years	- have a backup well in another mine pool with worse water quality - treatment costs ~\$75,000 to 100,000 per year - pay \$0.14/1,000 gal to SRBC	Jim Shuey 570-695-3175 jshuey@wpsenergy.com
Wheelabrator Frackville Energy Co.	Frackville, PA	42 MW	Morea mine	400–700 gpm	300–600 feet	18 years	- need to treat	Duane Slonaker 570-773-0405 dslonake@wm.com

(Veil, 2006)

Five of the six plants operate on a closed-cycle cooling system and use the mine pool water as makeup water for the cooling system. Some also use the water for boiler feed and other plant operations. The Northeastern Power Company uses an air-cooled condenser (also known as a dry cooling tower) for its main

cooling source but maintains a small auxiliary wet cooling tower. Typically, circulating fluidized-bed boiler technology is used to produce steam for power generation. The rated capacity of the plants ranges from **31 MW to 83 MW**. The volume of mine pool water used for process cooling (cooling towers) and boiler and water make-up range from **100 to 1,100 gpm**.

All of the plants need to treat the mine pool water before using it. The details of their treatment systems are provided in **Table 2**. The mine pool water contains iron and/or other metals. Generally, the pH of the water is raised to form metal hydroxides, which are then settled and/or filtered. Each plant uses similar but slightly different process components. Photos of the various plants can be viewed in the Argonne National Labs Report. (Veil, 2006)

Table 2 – Summary of Processes Used to Treat Mine Pool Water

Company Name	Treatment Processes Used
Gilberton Power Company	- aeration tower - pH adjustment - polymer addition and solids contact tank - filtration - reverse osmosis and ion exchange to make boiler feed water
Northeastern Power Company	- oxygen addition - polymer addition - settling basin - boiler makeup is further treated in a demineralizer
Panther Creek Generating Station	- pH adjustment - polymer addition - coagulation and flocculation - clarification - filtration
Schuylkill Energy Resources, Inc.	- aeration - chlorination - pH control - polymer addition - coagulation - clarification - filtration - filtration, reverse osmosis, and ion exchange to make boiler feed water
WPS – Westwood Generation Plant	- coagulation - tube settlers - filtration
Wheelabrator Frackville Energy Co.	- pH adjustment - chlorination - polymer addition and flocculation - lamellar plate separation - filtration, reverse osmosis, and ion exchange to make boiler feed water

(Veil, 2006)

Use of Mine Pool Water at Exelon’s Limerick Generating Station

Exelon Generation Company LLC (Exelon) operates the Limerick Generating Station, a nuclear power plant, near Limerick in southeastern Pennsylvania, roughly halfway between Philadelphia and Reading. The plant consists of two units, each with a nameplate generating capacity of 1,138 MW (Institute, 1996). The units are cooled by closed-cycle natural-draft cooling towers that combined require an average of 24,300 gpm and a maximum of 29,200 gpm at full power. This flow is equivalent to 17.5 million gallons per day (MGD) average and 21 MGD maximum.

The Limerick plant's primary cooling water intake is from the Schuylkill River. An alternate intake is located in Perkiomen Creek (a tributary that enters the Schuylkill River near Limerick). During parts of the year, the flows in the Schuylkill River and Perkiomen Creek are large enough that the plant can withdraw all of its cooling tower makeup water directly from the river and creek. Until the past few years, during the times of the year when the natural flows were low, Exelon supplemented natural flows by diverting water from the Delaware River into the East Branch of the Perkiomen Creek via the Point Pleasant pumping station and Bradshaw Reservoir. In addition to these water sources, Exelon had a contract with the Borough of Tamaqua Water Authority to release water from the Still Creek Reservoir on an emergency basis to supplement flow to the upper reaches of the Schuylkill River.

Figure 13 shows a map of the Schuylkill River detailing the location of these key features and their proximity to the Southern Anthracite Region Coal Fields.

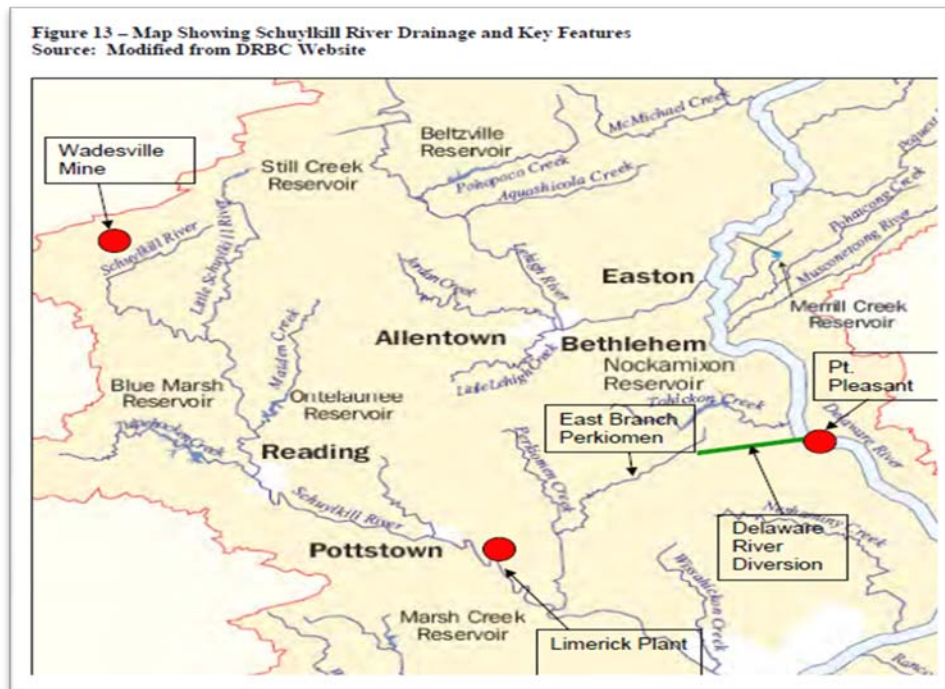

(Veil, 2006)

Exelon's Initial Demonstration Project

The process of diverting water from the Delaware River is costly. During 2002, Exelon evaluated other less costly alternatives for supplementing natural flows. Exelon identified the mine pool at the Wadesville mine located about 70 miles upstream along the Schuylkill River in Schuylkill County in partnership with many of our local partners is Schuylkill County, including the Schuylkill County Conservation District, Schuylkill Headwaters Association, EPCAMR, and Reading Anthracite. The Wadesville mine property is owned by the

Reading Anthracite Company, which pumps water from the mine to allow the extraction of Anthracite that would otherwise be flooded. Two vertical turbine pumps are installed in the mine shaft. They discharge to East Norwegian Creek, a tributary to the Schuylkill River. Unlike many other Anthracite mines in the area, the Wadesville mine pool has near-neutral pH; the water quality is high enough that it can be discharged without treating it first, thereby avoiding treatment costs. Excess water from the mine pool could be discharged into the headwaters of the Schuylkill River and flow downstream to the Limerick cooling water intake. There is a calcareous limestone formation in the local geology that allows for the higher than normal alkalinity that is generated in this area.

Exelon was required to obtain approval from the Delaware River Basin Commission (DRBC) before it could use the Wadesville mine pool water. In June 2003, the DRBC made Revision 11 to Docket D-69-210 CP (Final) to authorize Exelon to conduct a short-term demonstration project of pumping up to 10,000 gpm of Wadesville mine pool water into the headwaters of the Schuylkill River to augment river flow. On July 8, 2003, the Philadelphia Inquirer included an article describing the impending use of mine pool water by the Limerick nuclear power plant in southeastern Pennsylvania.

<http://www.philly.com/mld/philly/news/local/6253550htm?template=contentModules/printstory.jsp>.

As part of the authorization, Exelon needed to conduct studies under an Operating and Monitoring Plan (Normandeau Associates Inc. and URS, April 2004) to ensure that the addition of mine pool water did not cause environmental harm downstream. The plan outlines the responsibilities of Exelon, Reading Anthracite Company, and the DRBC. Exelon must conduct extensive monitoring for chemical, physical, and biological parameters at various locations from the mine pool to Pottstown, Pennsylvania, near Limerick. The level of the mine pool must be measured daily during the mine discharge period to determine drawdown and afterwards to determine the rate of recovery. Exelon must transmit the results of the monitoring data to the DRBC weekly.

Water was pumped from the Wadesville mine pool from July 11 to October 15, 2003. The results of the 2003 monitoring were compiled and reported in (Normandeau Associates Inc. and URS, April 2004). The key findings include:

- The daily water volume discharged from the mine ranged from 2.5 to 11.9 MGD. On most days more than 9 MGD were discharged.
- The water level of the mine pool dropped about 86 feet during pumping, but it recovered quickly after pumping stopped.
- The quality of the water discharged from the mine pool was relatively constant throughout the season.

- Little effect stemming from mixing water from East Norwegian Creek (containing the mine pool water) with Schuylkill River water was observed. However, total dissolved solids, specific conductance, total alkalinity, and pH were higher downstream, and iron levels were lower downstream.
- The biological monitoring showed no significant effects from the mine pool water.
- Discharge of mine pool water did not adversely affect the Pottstown Water Treatment Plant intake.

The demonstration was scheduled to run only during the flow-augmentation months of 2003. However, 2003 was a wetter-than-normal year, and stream flows were unusually high. Consequently, no opportunity arose to conduct environmental monitoring under typical low-flow and high-temperature conditions. Therefore, the DRBC agreed to extend the demonstration project for another year. Flows during the flow-augmentation months of 2004 were also much higher than normal, and therefore, it was not possible to conclusively demonstrate the effects of mine pool water discharge on downstream waters.

Revised Demonstration Project

Under the original Demonstration Project, Exelon needed to begin supplementing cooling water withdrawals when the Schuylkill River water temperature reached 59°F. During 2004, Exelon sought permission from the DRBC to modify and extend the Demonstration Project to show that water withdrawal when the river temperature exceeded 59°F would not cause adverse impacts. In October 2004, the DRBC approved Revision 12 to Docket D-69-210 CP (DRBC, 2004). The document is available (<http://www.state.nj.us/drbc/D1969-210CPfinalRev12-102704.pdf>, 2004). The approval expanded the scope of the Demonstration Project and extended operations through 2007, subject to an option to continue through 2008. Exelon is presently allowed to continue cooling water withdrawal from the Schuylkill River after the temperature reaches or exceeds 59°F, as long as the river flow at Pottstown is higher than 560 cubic feet per second (cfs) for two-unit operation or 530 cfs for one-unit operation.

In addition to continuing and expanding the monitoring program, Revision 12 created a Restoration and Monitoring Fund. Exelon must contribute to this fund based on the quantities of water that are not required to be augmented. The fund will be used to support projects that can improve water quality within the Schuylkill River basin. Exelon has created a Restoration Fund that has been providing grant awards for the last several years to local partners in the Schuylkill Action Network to continue to make improvements to the watershed through the support of the construction and operation and maintenance of AMD treatment systems.

Water was pumped from the Wadesville mine pool on 126 days between May 16 to October 13, 2005. The results of the 2005 monitoring were compiled and reported in (Normandeau Associates Inc. and URS, January 2006). The key findings include:

- The amount of rainfall and the resulting stream flows were considerable lower than in 2003 and 2004.
- The daily water volume was typically in the range of 7 to 8 MGD. The maximum discharge was measured at 14 MGD. The total volume of mine pool water discharged during the year was 852.5 million gallons.
- The water level of the mine pool dropped about 167 feet during pumping. However, one week after pumping stopped, the water level had already risen 14 feet.
- The quality of the water discharged from the mine pool was relatively constant throughout the season and was similar to the previous years.
- As in previous years, little effect from mixing water from East Norwegian Creek (containing the mine pool water) with Schuylkill River water was observed. The biological monitoring showed no significant effects from the mine pool water.
- Discharge of mine pool water did not adversely affect the Pottstown Water Treatment Plant intake or any other water supplies.
- Partial suspension of the 59°F temperature restriction did not cause any negative effect on downstream dissolved oxygen concentrations.
- By using the mine pool water, Exelon was able to reduce the previously required minimum diversion flow from the Delaware River to the East Branch Perkiomen Creek from 27 cfs to 10 cfs. At the time, some concern was voiced that this could cause impacts in that creek. Exelon's monitoring, however, showed that the 10 cfs minimum flow release maintained sufficient stream flow even under the near-drought conditions experienced there during 2005.

Exelon continued to monitor in 2006. According to Exelon's data submitted to the DRBC and posted on the DRBC website (<http://www.state.nj.us/drbc/wadesville.htm>), water was discharged from the Wadesville Mine only seven days during June 2006. Particularly in late June, this region experienced very heavy rainfall that caused serious flooding. One of the two Wadesville Mine pumps is damaged and out of service indefinitely. This means that pumping rate capacities are reduced in half.

During a project update meeting with the DRBC on July 27, 2006, Exelon's consultant reported that he has identified a second mine, the Tracy shaft, near Minersville, PA. This mine, which discharges water near the surface, could provide additional clean mine pool water to the West Branch of the Schuylkill River. Exelon will continue to evaluate the feasibility of using the Tracy shaft water. In light of the evaluations, Exelon may seek a docket revision from the DRBC during the next year to use that source (Veil, 2006). Pictures of

Wadesville, the Pump Shaft, and other photos are also available in the Argonne National Labs Report (Veil, 2006).

Steam Electric and Nuclear Power Facilities

New water demands are on the rise. Water is used in many industrial applications to condense steam or to cool down machinery equipment. Power plants, both electric and nuclear have the potential to withdraw and consume several million gallons per day (MGD) of water from the Susquehanna or Delaware River for makeup water in cooling towers. Because of predicted overall water demands on these rivers, the incremental withdrawal volume is not guaranteed over the long term. However, if these facilities are planning for large, onsite water storage capacities that can be filled during periods of high or medium river flow, offsetting these periods with the reuse of mine water has great potential. At low flow, presumably, the plants would utilize their stored water supplies rather than withdrawing each day from the rivers. As power companies site new steam electric generation units in the mid-Atlantic region, and if other cooling towers were to come online, these industries will face serious concerns of water supply availability similar to those described above.

Underground mine pools in the Anthracite Region may present a solution to water supply shortages that can be expected at some of these locations. From a cooling perspective, the power and steam electric industry operate more efficiently when the influent cooling water temperature is low. Mine pool water is because it has a relatively consistent and low temperature throughout the year. In situations where mine pool water will be used only as a seasonal supply, the time of year when it is most likely to be used is during low flow Summer periods. The cool mine pool water will be an effective cooling medium compared to the warmer surface waters of the rivers or streams that might be used as an alternative.

The use of mine water as makeup water for steam electric power plants with closed-cycle cooling technology (like wet cooling towers), as a closed-cycle cooling underground reservoir (by recirculating the water back to the underground mine where it can be naturally geothermal), and as a source of pass-through cooling water are just three interesting and innovative viable solutions to reusing Pennsylvania's underground mine water complexes. Obviously, location, siting, hauling, and transportation issues are some of the concerns that play into whether or not the use will be a viable solution to the industry. There are also many other technical, legal, and policy questions that remain before the use can be conducted on very large scale projects, although a few have already been undertaken in PA, such as the Barnes & Tucker Project and the Hollywood Plant Project, in Western Pennsylvania.

Use of Mine Pool Water by ARIPPA Co-Generation Facility Plants

At least 6 Co-Generation Power Producing Plants in the Anthracite Region use mine pool water for cooling for over a decade are removing waste culm, reclaiming thousands of acres of abandoned mine lands, and improving the water quality of the streams within the watersheds in which they operate. These Co-Gen Plants rely heavily on the mine pool water to economically meet their water needs at operations. (Veil, et al., September 2003)

This chapter cannot and does not answer all the relevant questions, nor does it give specific examples of the details of many of the projects that are currently using mine pool water, it is merely written to present the present and future use market potential of several industry users. It is meant to be an initial introduction to identify the important issues, concerns, innovative uses, renewable energy alternatives, markets, legal issues, and impediments. There are areas that do require further study, hydrogeological investigations, and applied science, because of the unique complex geology of the Anthracite Region, as opposed to making the same assumptions for areas in Western PA and the Northern Tier's Bituminous Region. There are also areas that information is non-existent or lies in the hands of independent private coal companies that choose not to divulge mining maps and geological investigations, cross sections, water level elevations, and other confidential information that allows them to stay competitive in the tight coal market that exists today.

EPCAMR has attempted to provide as much relevant information that is pertinent while operating under the constraints of a limited budget. EPCAMR hopes that the discussions presented in this chapter will serve as an incentive and natural progression for future detailed investigations on this reuse of mine pool water as viable and economically profitable environmental resource as opposed to being considered an environmental pollutant.

Alternative Renewal Energy Potential with Geothermal Usage of Mine Water, Marywood University, City of Scranton, and Dunmore Borough, Lackawanna County, PA, Northern Anthracite Coal Field

In terms of culture, economics and the environment, the story of Northeast Pennsylvania over the last 50 years has been a struggle to escape the negative legacy of anthracite coal mining. Many people that our residents are owed something for this pillaging of the land and now there's a chance that our abandoned mine lands might be able to provide a payback in a most counterintuitive way - with abundant, inexpensive, clean and easily accessible geothermal energy. The honeycomb of mines beneath Northeastern Pennsylvania is now, in effect, vast underground lakes or mine pools of water separated by coal barrier pillars, if they have not been robbed or mined through.

Marywood University was interested in testing the concept on its campus. With funding from the Ben Franklin Technology Partners Mellow Technical Assistance Program, the Commonwealth Financing Authority, the Pennsylvania Energy Development Authority, and the Pennsylvania Department of Community and Economic Development, the technology was implemented at Marywood's School of Architecture. Earlier in 2009, Marywood engaged Greenman Pedersen, Inc., a Scranton-based engineering and construction services firm, and Infinity Geotech Services to drill bore holes and test mine water samples as part of a Geothermal Energy Feasibility Study. Results of the study helped inform the design of the geothermal system.

Marywood University and Greenman-Pedersen, Inc. revisited abandoned coal mines underneath campus into a source of geothermal energy for the Center for Architectural Studies. A highly efficient and environmentally friendly practice, using mine shafts as a source of geothermal energy can minimize or eliminate the need for fossil-fired heating systems. At the same time, geothermal energy systems help reduce greenhouse gas emissions, make use of local resources, don't pollute the environment, reduce operating costs, and don't require a lot of construction and development.

In June of 2010, Marywood University was awarded \$205,000 in American Recovery and Reinvestment Act (ARRA) Federal funds to demonstrate a geothermal energy pilot project on the grounds of the University that was matched by another \$324,600 locally through a federal stimulus grant from the Pennsylvania Energy Development Authority (PEDA), and the rest was financed through a low-interest state loan.

ARRA awards helped to pave roads, fix bridges, fund clean water projects, strengthen a public education system that continues to produce academic gains for students, and improve our state's

environment and energy efficiency. The idea of using mine water to heat and cool buildings is not a new concept - but this is the first time it has been used successfully on a practical scale in Northeast Pennsylvania. The hope was to use water from underground anthracite coal mines for geothermal applications will allow the entire region to save money, reduce fossil fuels use, and create and retain jobs. Abandoned mine shafts beneath campus, long perceived as an unusable relic of an industrial past, have a new purpose in the quest for alternative energy sources.

Ground-coupled geothermal systems use the constant temperature of the earth's crust to exchange energy for heating and cooling applications. Marywood's project uses flooded underground mine shafts for this purpose. Geothermal systems can either be open or closed loop systems. Open loop systems extract ground water from a well and use that water to meet cooling or heating needs. Closed loop systems include numerous borings or horizontal trenches with long lengths of piping that are completely buried to exchange heat with the earth.

Marywood University uses an open loop geothermal system that utilizes two wells to extract the energy from the earth. The Center for Architectural Studies uses a direct cooling application. The water extracted from the earth is cold enough to cool the space without any compressorized air conditioning equipment, eliminating the need for refrigerant-driven, energy-consuming equipment. The Center uses the cooling capacity in the geothermal system to serve chilled beams in the large, open studio areas. Water (with a temperature of 58°F to 60°F) is circulated through long, ceiling-mounted chilled beams, providing the necessary cooling capacity to meet the space needs. Chilled beams require no electrical energy to operate and are silent; they simply rely on natural convection (the cool air "dropping") from the beams along the ceiling to the occupied areas below. Little is visible above ground, except for two wellheads outside the building. Inside the mechanical room in the building's basement, a series of pipes contain water pumped from the mines below. Water from the mines never touches the water flowing through the cooling system throughout the building. Instead, the mine water goes into an exchanger, where the mine water cools the water inside the building. The used, unaltered mine water then goes back into the mines. The building has a supplemental heat system for extremely cold days, but the constant temperature of the mine water maintains a comfortable indoor climate most of the year.

Marywood's new geothermal system, completed during the summer of 2010, serves a portion of the cooling needs of the Center for Architectural Studies. The system can be expanded and will be utilized in

Phase II of the Center's construction, in an effort to continue the University's commitment to sustainability and environmental stewardship. The system uses water from abandoned coal mines underneath the campus in the vicinity of the Underwood Colliery, to cool the Center for Architectural Studies, which was a converted gymnasium. (University, 2010). Beyond that, Marywood University wants to expand the geothermal system to other buildings on campus. Marywood's example could be the start of a new era of energy. The building has earned a prestigious Green Building Council's Leadership in Energy and Environmental Design (LEED) gold certification for the eco-friendly renovations.

A geothermal heat pump uses up to 50 percent less electricity than conventional heating or cooling systems, according to the U.S. Department of Energy, due in large part to their reliance on the relatively constant temperature of the underground mines. With the School of Architecture's focus on sustainable design, the system also serves as a learning tool for students. The system will also be a way to learn what kind of maintenance is needed in the future related to the piping and possible corrosion buildup from the underground mine water. The pilot was a success. This is not the first time using mine water for geothermal energy has been discussed. In 2007, Lackawanna County created the Authority for Innovative and Renewable Energy (AIRE) and began obtaining rights from three coal companies to access mine water under the majority leadership of County Commissioner A.J. Munchak and Robert C. Cordaro.

Recuperating the Costs

Engineers have already outlined an area in Scranton, which the holes wouldn't go below 150 feet, making construction of a system cost-effective. J.P. Singh said customers could recoup their costs within about four years. The only electricity being used is to run several pumps. Residential system design could run between \$3,000 and \$15,000, said Arthur Hunt, of J and P Engineers. Construction was estimated at about \$2,500 to \$3,000 per 12,000 BTUs. That compares favorably to construction costs for a gas heat and electric air-conditioning system, he said. To combat potential deterioration from the water's pollutants, the pipes in the holes are plastic and the heat exchanger is stainless steel. The contaminants would be filtered out by then, so the rest of the system need not be so resistant. The filter would need cleaning about twice a year, Singh said. Because there is more undermined land in the Wilkes-Barre area, it would work even better there. The idea even poses advantages for property values, he said, because the worth of the energy underneath it could then be included (Times-Leader, 2007)

The efforts quickly ended, as then-county Commissioner Cordaro led the effort to dismantle and defund the energy initiative that he proposed and would have become Chairman. Fees that were eventually supposed to be collected were going to be used for property tax reductions.

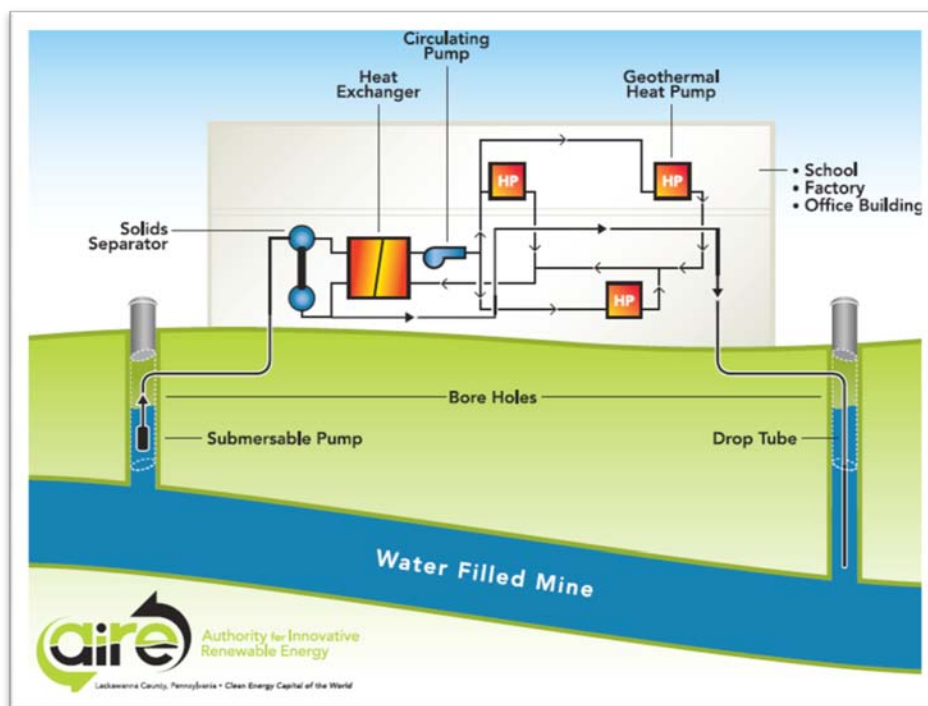

(County, 2007)

Figure 1. Geothermal Mine Pool Heating System General Schematic-AIRE

It is an idea worth revisiting once EPCAMR's mine pool mapping work is completed for the Upper and Lower Lackawanna Valley, which should be completed by 2012. There is the potential to heat and cool an entire downtown area in Scranton, including State Office Buildings, the Steamtown Mall, and the Steamtown National Historic Site, utilizing mine pool water from the general vicinity, once examined closer, let alone the energy cost savings and a way to make the City of Scranton even more energy independent and self-sustaining. It could actually spread to residential homes, local governments, including school districts. Long-term energy savings from the development of systems like Marywood's would cover the development costs and, ultimately, save a great deal of money for taxpayers throughout the entire Northern Anthracite Coal Field and beyond. (Tribune, 2010)

The idea is relatively simple, but it's unique and wouldn't exist without the mining operations. Because the ground is so undermined, the mine pools create vast complexes of heating and cooling. J.B. Singh the president of J and P Engineers., stated back in 2007, "The ground insulates the water, keeping it a consistent 55 degrees, and there is vastly too much water all surrounded by highly heat-conductive rock to affect the temperature, no matter how many people draw on the resource". In fact, the high concentration of people in the (Lackawanna) Valley creates a "fortuitous juxtaposition" because they can all tap in with little impact, making the idea more effective (Times-Leader, 2007).

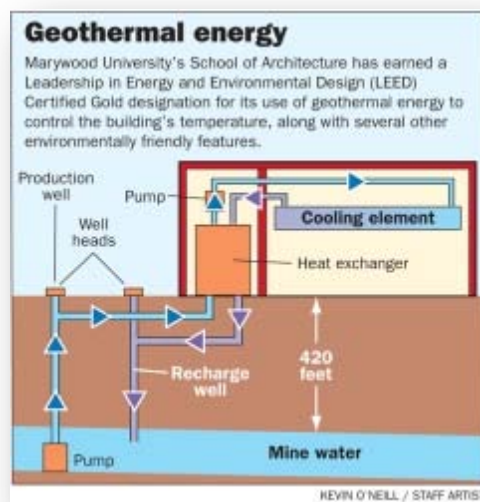

Figure 2. Explaining Marywood's Geothermal Energy Usage by Kevin O'Neill-Staff Artist for The Scranton Times Tribune and **Photo** by Linda Morgan / Staff Photographer-The Scranton Times Tribune A wellhead outside Marywood University's School of Architecture is about all that's visible of the geothermal system (Tribune, 2010)

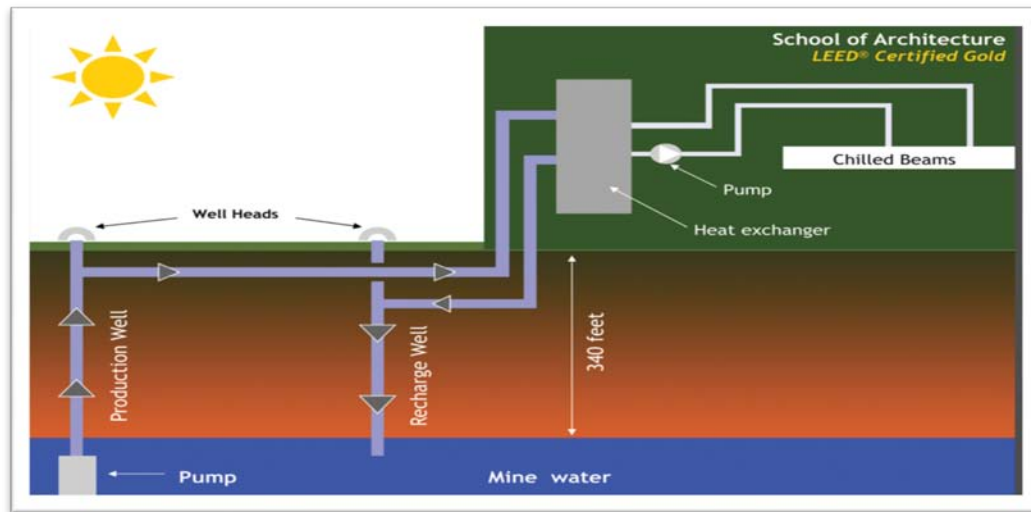

Figure 3. How an Open Geothermal System Works: The production well contains a submersible pump, similar to a traditional potable water well pump, to extract water from the flooded mine and pipe it to the surface. The water is then piped to a heat exchanger to extract heat to the building system. The heat exchanger cools the water circulated in the building system, while at the same time preventing the raw mine water from mixing with the building water circulation system. After passing through the heat exchanger, the mine water is returned to the recharge well, which ends in the same mine shaft as the production well. All water extracted from the production well is returned to the recharge well. (University, 2010)

Private Investment in Partnership with the Ben Franklin Technology Partners in Scranton, PA

Noble Biomaterials, Inc., also conducted a mine pool geothermal feasibility study at the company's location in Scranton. Noble tapped its own funds as well as a cash investment from the Ben Franklin Technology Partners of Northeastern Pennsylvania. In November 2010, the Ben Franklin Technology Partners of Northeastern Pennsylvania invested \$13,650 in Noble Biomaterials, Inc. to conduct a mine pool geothermal feasibility study at the company's facility site in Scranton. Noble, which matched their investment in cash, provided an additional \$24,000 of in-kind investment to work with the Emerging Technologies Application Center at Northampton Community College in Bethlehem to perform this study. This project demonstrated the collaborating of government, higher education, and the private industry to advance the use of natural resources in Northeast Pennsylvania in new and innovative ways. The Ben Franklin Technology Partners of Northeastern Pennsylvania, the Scranton Chamber of Commerce, and Marywood University came together with the goal of validating the concept so it could be applied commercially. The availability of lower-cost energy creates a significant advantage in attracting companies to this region, particularly those whose processes are energy-intensive.

With the BFTP/NEP investment, Noble Biomaterials will apply the information gathered at the Marywood pilot in a study analyzing the commercial feasibility of implementing mine water geothermal

applications at Noble's facility. Geothermal processes will be utilized to control the temperature of water used in production, and to provide environmental humidity and temperature control in critical areas at the Noble plant. The efficient progression of these economic development activities represents great foresight and cooperation throughout the public and private sectors. When the Marywood project was first conceived in 2008, the Ben Franklin Technology Development Authority and the Commonwealth Financing Authority (CFA) had programs in position to support it. This funding allowed work to begin. Further, when funding was needed to commercialize the technology, the Ben Franklin Technology Partners had investment money available through the Alternative Energy Development Program (AEDP), despite BFTP/NEP's recent 42 percent funding cut.

A grant from the AEDP allows Ben Franklin to invest in companies that are exploring alternative energy and energy efficiency. Ben Franklin Technology Partners' investments in Noble Biomaterials and other regional technology companies are critical to Pennsylvania's future. Ben Franklin Technology Partners should be embraced as a key resource to create and retain the highly paid, sustainable jobs that will be critical to our state's economic recovery, redevelopment of our abandoned mines, re-use of our underground mine pool water, and long-term financial stability (Biomaterials, 2010). As utility prices continue to soar, the exploration of alternative, efficient, and less costly ways to meet energy needs will continue to become more urgent for schools, hospitals, nonprofit organizations, businesses, and residents throughout Northeastern PA and across the Commonwealth.

A similar project is being benchmarked to Quadrant Engineering Plastics Products, Inc., a commercial manufacturer in the region, to ensure that the design meets their process application needs. Additional collaborators include the Penn State University Cooperative Extension, Wilkes University, and the Pennsylvania Department of Environmental Protection.

The Geothermal Project at John Wesley AME Zion Church – Pittsburgh, Pennsylvania

Darwin Burtner-Western Pennsylvania Geothermal, Pastor Calvin Cash, and the Pennsylvania Department of Environmental Protection's Holly Cairns, in 2006, presented at EPCAMR's Annual Conference on Abandoned Mine Reclamation about the success that they had with geothermal applications using mine pool water in the Hill District of Pittsburgh, Pennsylvania. Underground Bituminous coal mining in the Hill District began in the early to mid 1800's and was some of the earliest coal mining in Western Pennsylvania. The Pittsburgh Seam is about 8 feet thick, so the mine nearly 8 feet high. It is nearly flat, lying at an approximate elevation of 1055 ft.

The average depth to the coal mine is about 50 feet in the Hill District. As far back as June 21, 2002, DEP's Environmental Clean-Up Program (ECUP) organized a summit with DEP representatives, local advocates and Carnegie Mellon University, where several mining-related sites in the Hill District were toured.



Figure 4. AMD emanating from lamp posts in front of the John Wesley AME Zion Church



Figure 5. The John Wesley AME Zion Church, Hill District, Pittsburgh, PA

In the Fall of 2004, PA Department of Environmental Protection's Bureau of Abandoned Mine Reclamation (PA DEP BAMR) drained the mine pool in excess of 50 million gallons. The mine was flooded such that approximately .12 feet of water was pooled in the hillside behind the Church. The mine pool was reduced through drilling, and then drained away. A permanent drainpipe was installed on the mine floor in order to prevent the water from building up again. There are four monitoring wells behind the Church to monitor water movement through the mine. The mine currently safely drains at a rate of about 75 gallons per minute into the storm-water and sanitary sewer drainage system beneath the street.

In 2007, the Herron Avenue Corridor Coalition applied for an PA DEP Energy Harvest grant for \$80,891 entitled "Beneficial Use of Mine Water for Heating & Cooling." This project had taken an environmental detriment and turned it into beneficial use. The project used the constant temperature of the mine water. Savings of 75-80% in heating and 50% in cooling were estimated. The vault handled a newly constructed building adjacent to the Church at 40,000 sq ft. This project was the 3rd of its kind and 1st in the US.

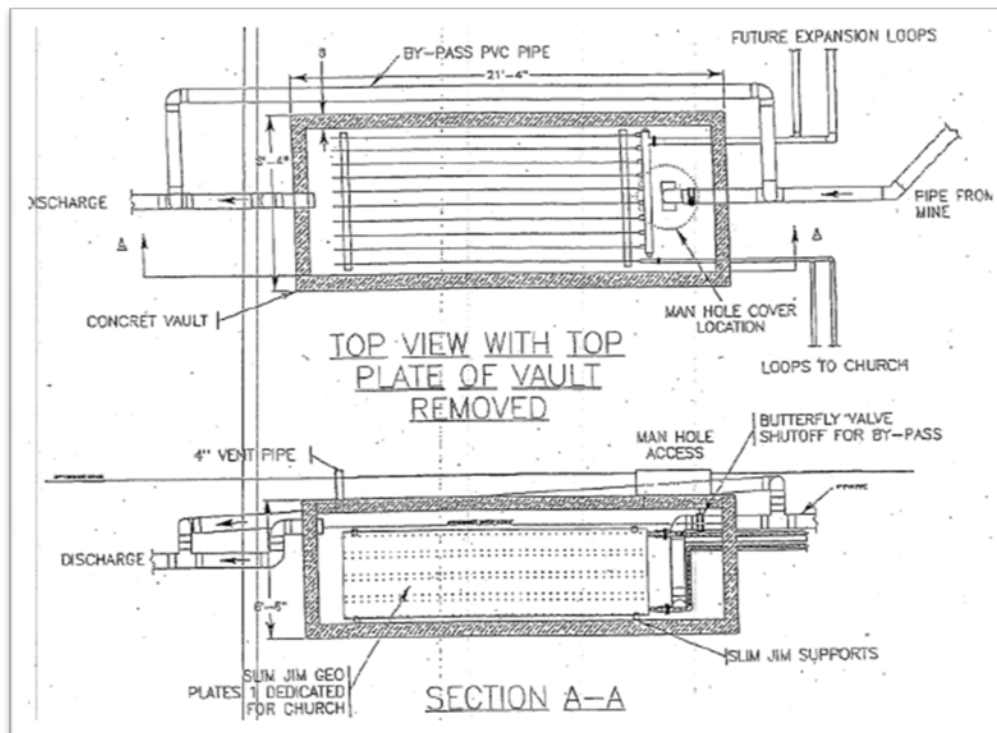

Figure 6. Schematic of the Geothermal Vault utilized at the John Wesley AME Zion Church, Pittsburgh, PA

Volume Estimates of the Mine Pool Water Resource and Distribution

The most comprehensive inventory of mine pools and multi-colliery hydrogeologic units for Northeastern Pennsylvania's Anthracite Coal Fields is being conducted by EPCAMR, SRBC, USGS, LRCA, support from County Conservation Districts, the PA DEP, Federal OSM, and the US EPA, in collaboration with many more partnerships built by EPCAMR over the last fifteen years. In other cases, evaluations of individual mines in the Bituminous Coal Fields of Pennsylvania have occurred, however, EPCAMR has not had a chance to compare and review those investigations and studies to see how they relate to the Anthracite Region's complex mine pools and regional geology. This data, once presented, and layered, possibly through 3-dimensional graphic technology applications being utilized intensively by EPCAMR through the EarthVision8.1 3-D software modeling package and extensions, can not only identify the potential for using mine pool water as cooling water at power plants or steam electric plants, but for other industrial purposes and needs such as the gas and oil industry, the geothermal sector, hydro-electric generation, greenhouse distribution, aquaculture, fish farming, non-potable waste water, the potential for potable water, or some other industrial needs.

The PA DEP had produced an older map dated April 2003 that shows **43** large Anthracite AMD discharges greater than 250 gpm that are on the Priority List for Treatment. EPCAMR has significantly updated that map over the last 8 years. The map shows the geographic distribution of AMD sites that have the potential to be considered as source of cooling water for power plants. The map only represents a small fraction of underground abandoned mines in both the Anthracite and Bituminous Coal Fields. PA DEP estimates that there are between 10,000 and 15,000 abandoned underground mines in Pennsylvania. Records in the form of mine maps and mine permits that are paper copies, sensitive linens, blue prints, mylars, and again, locked in some air tight, temperature controlled facilities for preservation and confidentiality sake.

They do exist for the majority of the abandoned underground mine sites, just not in the form that would allow for increased interpretation, such as a Geographic Information System (GIS), similar to what EPCAMR has created with RAMLIS. EPCAMR continues to seek additional funding for work in this field, where we field we are on the cutting edge of the technology and deep understanding of the interpretation of the mine pool maps, which is a lost art. Given sufficient resources, we could continue to digitize this information and delineate the actual sizes of the mine pool resources across Pennsylvania. Mine pools are still waiting to be found and EPCAMR intends to find them.

To Withdrawal or Not Withdrawal: Ownership of the Mine Pool Water in its Current Condition and Upon Withdrawal

Pennsylvania's groundwater law is based on the "**American Rule**", which stems from the era of the Industrial Revolution and provides that a landowner may withdraw groundwater from beneath the property for "natural and ordinary" usage, whereas extraction for use off-site is "unreasonable" and "unlawful" (Abdallah, 1997). In light of the benefits associated with the withdrawal, treatment, and use of the mine pool water, PA DEP is exploring innovative resolutions to the ownership issues raised when a project operator has not previously purchased the land. Several important questions have been formulated in light of this. Can someone who treats polluted mine water and develops it as a useful public and private water supply rely on the exercise of dominion over the water supply as a conclusive resolution of the ownership issue? How will the "capture rule" and common law, as modified by the Pennsylvania Water Rights Act of 1939 (32 P.S. § 631 et seq.), affect the ability to treat and use the mine pools and discharges? Does it make a legal difference if the industrial use operations occur on-land or off-land? PA DEP tends to request Legal Counsel on ownership of mine water. PA DEP does not regulate the amount of the mine pool water withdrawn. PA DEP allocates only public suppliers of surface waters and regards the mine pools as groundwater. Groundwater includes all water from dug, drilled, bored, jetted, or driven wells and infiltration galleries, as well as springs that emerge at the surface within the confines of a springhouse.

Anthracite Towns on the Economic Rebound

The towns may have shrunk in population growth, but not nearly as fast as employment in mining. For all their troubles an unattractive and unproductive physical environment and a crippled economy - these towns are far healthier than the industry that created them. In one quality, the adamant loyalty of the residents to their towns, the places are much richer than many towns more vigorous than they are. The apparent mismatch of the strength of the community in these towns with the inability of the landscape to support them is a simple result of the history: the stresses of the early mine towns created a community strong enough to resist any threat to itself, change for the worse or change for the better. That past has constrained people's repertoire of responses to the world, limiting them to those that conserve community. The landscape is asymmetrical: the place is now rich with meaning ... identification with the land and reasons to stay here, but impoverished of the means to support that the old way of life.

In order for the anthracite towns to exist, they still must yield both of the two parts that constitute their sense of place: the meaning to the landscape, which establishes the reasons for people to live in these

towns, and the means whereby people are able to go on about the business of living. Economic redevelopment in these anthracite towns once again around the extraction of the mine water for potential reuse can provide an economic upswing to these communities if they position themselves to be able to manage the influx of ripple effect jobs and secondary benefits to the community as long as they are some of the people obtaining the jobs locally. Most people make considerable and continuous economic sacrifices to remain in this region, which is so sparse in means, so reluctant to yield the resources of life. The residents pay a subsidy to the coal field communities by accepting low wages or by traveling beyond the valley for better work and higher paying wages. (Marsh, 1987)

Part 2. The Western Middle Anthracite Coal Field

Chapter 1. The Development of Mining, Mine Drainage, Tunnels, & Multi-Colliery Hydrologic Units of the Western Middle Anthracite Coal Field

By Robert E. Hughes¹⁰, Michael A. Hewitt¹¹, Jim Andrews¹² and Roger J. Hornberger, P.G.¹³

This chapter is intended to be a brief overview of the Western Middle Anthracite Coal Field as Part 2 of this report is devoted entirely to the Western Middle Anthracite Coal Field. It will also provide a brief summary of the facts and characteristics of the mine pools of the Western Middle Anthracite Coal Field. A separate, subsequent, more detailed present day water quality and quantity Scientific Investigations Report on the Western Middle Anthracite Coal Field entitled: **Water Budgets and Groundwater Volumes for Abandoned Underground Mines in the Western Middle Anthracite Coalfield, Schuylkill, Columbia, and Northumberland Counties, Pennsylvania—Preliminary Estimates with Identification of Data Needs** been completed by the US Geological Survey in partnership with EPCAMR, the Dauphin County Conservation District, the PA DEP Bureau of Abandoned Mine Reclamation, and the PA DEP Pottsville District Mining Office and is included as Part 3 of this report (Goode, et al., 2011). The area of the Western Middle Anthracite Coal Field extends from the town of Treverton on the western end to the town of Delano, Schuylkill County, at the eastern end of the field, encompassing 85.8 square miles.

The Western Middle Anthracite Coal Field has been historically, and presently, one of the most productive areas of the Anthracite Region of Pennsylvania. The Western Middle Anthracite Coal Field extends from the town of Treverton on the western end of the coal field to the town of Delano, on the eastern end as shown on **Figure 1**. Within this area, there are many large underground mines, or collieries, which operated from the early 1800's to the middle 1900's. These large deep mines were virtually all abandoned by 1966 and

¹⁰ Executive Director-Eastern Pennsylvania Coalition for Abandoned Mine Reclamation, Robert E. Hughes

¹¹ Program Manager-Eastern Pennsylvania Coalition for Abandoned Mine Reclamation, Michael A. Hewitt

¹² Professional Geologist, PA Department of Environmental Protection's Bureau of District Mining Operations-Pottsville Office, Jim Andrews

¹³ Professional Geologist, Roger J. Hornberger, LLC

allowed to fill with groundwater or mine water. This report will focus on the mine pools and mine drainage discharges of the abandoned collieries of the Western Middle Anthracite Coal Field.

The Pennsylvania Clean Streams Law was enacted in 1937, but mine drainage was exempted until amendments to the law were made in 1965, requiring treatment of mine drainage. In 1966, mining companies had to make a decision on whether they would construct mine drainage treatment facilities or stop pumping and go out of business. Virtually all of the major Anthracite deep mine companies ultimately ceased operations and pumping and allowed their mines to fill up with inflowing groundwater.

The water levels of these developing mine pools eventually stabilized when spillover points were reached at the lowest topographic elevation of a sizable orifice of the abandoned mine. In many cases, the spillover opening was the main tunnel or slope or drift entry to the mine; in other cases, the lowest opening was an air shaft, borehole, or some other minor underground mine feature. Consequently, about 100 large abandoned mine discharges appeared in the four coal fields of the Anthracite Region (Growitz, 1985), (Wood, 1996). Thousands of minor seeps persist to the present day in the Anthracite Coal Region.

There are billions and billions of gallons of mine water in the flooded abandoned underground mines and surface pit lakes of the Western Middle Anthracite Coal Field. The Western Middle Anthracite Coal Field has an interesting industrial history. The recent book by (Hemenway, 2008) is devoted to the collieries and railroads of the Western Middle Coal Field. This book contains a wealth of photographs of the coal breakers and associated structures of many of the collieries of the Western Middle Anthracite Coal Field. The book by (Miller, et al., 1985) not only provides a detailed chronology of the development of the entire Anthracite Region, but it contains valuable information pertinent to the Western Middle Anthracite Coal Field. Although another book was written about the St. Clair area of the Southern Anthracite Coal Field, the exceptional resource by (Wallace, 1981), also contains valuable information on Anthracite Coal Mine Development that is relevant to the Western Middle Anthracite Coal Field.

The US Geological Survey, principally by G.H.Wood and associates, has investigated the geology of the Western Middle Anthracite Coal Field in numerous publications. These publications include at least twelve Coal Investigations Maps and associated cross-sections, all of which have been digitally scanned, geo-referenced, and used by EPCAMR to assist with making the determinations of estimated water volumes in the mine pools of the Western Middle Anthracite Region. These Coal Investigation Maps are as follows: C-3, C-7, C-10, C-12, C-13, C-14, C-19, C-21, C-25, C-46, C-47, and C-48). These very detailed maps and cross-sections are discussed in detail in this report.

Multi-colliery Hydrologic Units of the Western Middle Anthracite Coal Field

An overall goal of this project is to delineate multi-colliery hydrologic units wherever they exist in the four Anthracite Coal Fields. A multi-colliery hydrologic unit is where two or more collieries drain to a common discharge point. There are examples of multi-colliery hydrologic units in all four Anthracite Coal Fields. In the Wyoming Basin of the Northern Anthracite Coal Field, (Hollowell, 1971) (Hollowell, 1971) (Hollowell, 1971) (p.37) developed a schematic “plumbing diagram”, showing that the mine drainage of the **55** collieries in that basin drain to seven major discharges to the Susquehanna River (See **Figure 2.14**). In the Lackawanna portion of the Northern Anthracite Coal Field, Hollowell and Koester ((Hollowell, 1975)(See **Plate 2**) developed a water table contour map showing the water levels in various shafts in the Lackawanna Basin. Numerous collieries surrounding these shafts have the same water levels indicating interconnections between adjacent mines.

Hollowell and Koester (Hollowell, 1975) show a longitudinal section through the Lackawanna Basin that groups the mine pools of the many collieries into six common water levels in a stair-step fashion down valley heading southward. In the Eastern Middle Anthracite Coal Field, the Jeddo Tunnel system forms a multi-colliery hydrologic unit of the numerous collieries connected to the tunnel system. Further information on the Northern Anthracite Coal Fields multi-colliery development and connections are found elsewhere in this report. The entire Western Middle Anthracite Coal Field is within the Susquehanna River drainage basin. The principal streams within this drainage pattern are the Mahanoy Creek, the Shamokin Creek and Zerbe Run as shown on **Figure 2.2**

A detailed study of the Shamokin Creek drainage characteristics was completed by (Cravotta, et al., 2004), and a similar detailed report of the Mahanoy Creek is presented in (Cravotta, 2004). An earlier report on the hydrology of the entire Western Middle Coal Field is contained in (Reed, et al., 1987).

The Western Middle Anthracite Coal Field had a very well developed system of **19** multi-colliery hydrologic units that are abandoned. The exact boundaries of some these hydrologic units were somewhat tentative or unknown, but there is no doubt that the multi-colliery hydrologic units exist. The Western Middle Anthracite Coal Field has **58** underground mine pools and **81** barrier pillars, and the mine pools contain a total of **38** billion gallons of mine water, according to Ash (Ash, et al., 1953). The colliery boundaries are shown on **Figure 2.2** These calculations were made at a time in the 1950’s when many of the collieries were still mining and pumping water, so the present day total for the Western Middle Anthracite Coal Field is predicted to be much greater.

(Ash, et al., 1953) is one report in a series of about fifteen reports on the Anthracite Region by S.H. Ash and associates of the US Bureau of Mines. The report by (Reed, et al., 1987) of the US Geological Survey is devoted to the quality of water in mines in the Western Middle Anthracite Coal Field, and it divides the Western Middle Anthracite Coal Field into five drainage areas. The division of these drainage areas is stated to arbitrary in the report but it was apparently done for logistical reasons of water quality sampling and measuring flows. The five drainage areas are: 1) Mahanoy Creek at Ashland, 2) unnamed tributary to Mahanoy Creek at Locustdale, 3) tunnels near Locust Gap discharging beneath Mahanoy Mountain into Mahanoy Creek, 4) Shamokin Creek at Shamokin, and 5) Zerbe Run, near Trevorton.

The Western Middle Anthracite Coal Field has active underground mines and they are concentrated in the western part of the field. However, there are less than **10** of these mines that are all small active mining operations, except for one active mine near Mount Carmel, Northumberland County, which employs about 35 people.

At the eastern end of the Western Middle Anthracite Coal Field, the Park No. 1, No. 2, No. 3, and No. 4 Collieries, the Primrose Colliery, and the Vulcan Buck Mountain Collieries form a multi-colliery hydrologic unit with the major mine drainage discharges being the Vulcan Buck Mountain mine seepage and borehole discharge. This unit may have some leakage into the Mahanoy City or North Mahanoy Collieries to the west.

Moving westward, the second, third, and fourth, multi-colliery hydrologic units include numerous collieries in the Mahanoy City and Shenandoah Basins. Some major thrust faults in the southern portion of this area are presumed to divide the mine workings and mine water flow paths, so three minor subdivisions have been made on the southern side (Units 2, 3, and 4). The collieries included in this second unit (2) are the Mahanoy City Colliery, North Mahanoy City Colliery, Knickerbocker Colliery, Maple Hill Colliery, Kehley Run Colliery, Indian Ridge, Shenandoah City Collieries, West Shenandoah Colliery, Kohinoor Colliery, William Penn Colliery, Hammond Colliery, and the Packer No. 2, No. 3, No. 4. and No. 5 Collieries. The major discharge point for this multi-colliery hydrologic unit is the Packer No. 5 in the town of Girardville. The next unit (3) begins with the Tunnel Ridge Colliery, Saint Nicholas Colliery, Draper and Gilberton Collieries, East Bear Ridge Colliery, Lawrence Colliery, and Boston Run Colliery. The major discharge for this multi-colliery hydrologic unit is the pumped discharge at the Gilberton Shaft. The West Bear Ridge Colliery and Girard Colliery are by themselves a separate multi-colliery hydrologic unit (4). The major discharge for this multi-colliery hydrologic unit is the Girard discharge flowing into Mahanoy Creek.

The fifth multi-colliery hydrologic unit of the Western Middle Anthracite Coal Field is the Weston Colliery with a discharge at the village of Upper Brownville. The discharge makes its way to a stripping pit that

drains the water back into the Packer No. 5 multi-colliery hydrologic Unit 2. The sixth multi-colliery hydrologic unit includes the Raven Run Colliery. Its discharge is from a shaft. The seventh multi-colliery hydrologic unit consists of the Continental Colliery, Centralia Colliery, and Logan Colliery. The major mine discharge from this unit is the Centralia Tunnel discharge. The eighth multi-colliery hydrologic unit includes the the Bast Colliery, Germantown (Locust Run). There are two major discharge points, the Bast Mine Tunnel, the Oakland Tunnel, and a borehole locally known as the Ashland Fountain. The borehole discharge is in the village of Big Mine Run. The ninth multi-colliery hydrologic unit is the Preston No. 3 Colliery. The discharge from the Preston workings is the Preston #3 Tunnel overflow. The tenth multi-colliery hydrologic unit is the Mid-Valley No. 1, No. 2, No. 3, and No. 4 Collieries. A long rock tunnel connects the No. 1 and No. 2 mines with the No. 3 and No. 4 mines. The major discharge from this unit is a tunnel discharge from the Mid-Valley No. 1 Colliery. The eleventh multi-colliery hydrologic unit includes the Potts Colliery, Bancroft and Tunnel Collieries. There are two major discharge points from the Potts Colliery, the East and West Potts Mine Breaches.

The twelfth multi-colliery hydrologic unit is a large area including the Morris Ridge Colliery, Sayre Colliery, Sioux No. 1 and No. 3 Collieries, Pennsylvania Colliery, Richards Shaft Colliery, Richards Water Level Colliery, Natalie Colliery, Greenough Colliery, Scott Ridge Colliery, and the Scott Colliery. The major mine drainage discharges from these collieries are the Scott overflow primary discharge and the Scott secondary discharge. The thirteenth multi-colliery hydrologic unit contain a small portion of the Merriam Colliery and the Locust Gap Colliery. There are two major tunnel discharges emanating from this colliery, the Doutyville Tunnel and the Helfenstein Tunnel. The fourteenth multi-colliery hydrologic unit includes the Maysville No. 1 and No. 2 Collieries, Buck Ridge No. 1 and No. 2 Collieries, Greenback, Corbin, and Excelsior Collieries, Reliance Colliery, Alaska Colliery and the Enterprise Colliery. There are four major discharges from this hydrologic unit, a tunnel discharge from the Maysville Colliery, and a large surface impoundment discharge from the Excelsior Colliery stripping pit, the Colbert Mine Breach (a misnomer since it is in the Maysville Colliery), and the Corbin water level drift. The fifteenth multi-colliery hydrologic unit includes the Hickory Ridge Colliery, Hickory Swamp Colliery, Colbert Colliery, Luke Fidler Colliery, the Glen Burn Colliery, Neilson Colliery, and Cameron Colliery,. There are two discharges from this hydrologic unit, the Cameron drift and the Cameron airshaft,

The sixteenth multi-colliery hydrologic unit in the Western Middle Anthracite Coal Field is the Big Mountain Colliery, which has a discharge, called the Big Mountain Mine #1 Slope. The seventeenth multi-colliery hydrologic unit includes the Royal Oak Colliery, Henry Clay-Stirling Colliery, Burnside Colliery, and the Bear Valley Colliery. The two major discharge from this hydrologic unit are the Stirling slope discharge, which is the drainage point for approximately 7,000 acres and the Bear Valley Mine North Mountain Tunnel (locally

known as the Carbon Run discharge or Site 42). The eighteenth multi-colliery hydrologic unit is the North Franklin Colliery. The major discharge from this colliery is the North Franklin Tender Slope discharge. The North Franklin Colliery is at the western most end of the Western Middle Anthracite Coal Field. The nineteenth multi-colliery hydrologic unit is in the Morea-New Boston Basin, which is a separate, isolated, narrow basin of the Western Middle Anthracite Coal Field located south of Mahanoy City and Shenandoah as shown in **Figure 2.2**. This hydrologic unit includes the Morea Colliery and the New Boston Colliery. The major discharge from this unit is at the western end of the Morea Colliery, known as the Morea Mine Strip Pool overflow.

The depth of mining of the abandoned underground mines in the Western Middle Anthracite Coal Field varies considerably. For example, the lowest elevation found in the Natalie Colliery is 982.9 feet and the surface elevations are around 1,400 feet. That lowest elevation of depth of underground mine development is – 586.9 feet and the surface elevation for the Luke Fidler Colliery are about 1,100 feet. The Luke Fidler Colliery is in the western portion of the Western Middle Anthracite Coal Field. The Buck Ridge No. 1 Colliery is adjacent to the south side of the Luke Fidler Colliery and it has a similar lowest elevation found of – 549.6 feet below sea level.

Almost the entire Western Middle Anthracite Coal Field has been previously deep mined and surface mined. Therefore, there are a multitude of abandoned mine land features throughout the area. There is one active large open-pit mine, the Continental Mine, in the central portion of the Western Middle Anthracite Coal Field near the Borough of Centralia, Columbia County. There are also numerous small open pits and coal refuse reprocessing operations working throughout the Western Middle Anthracite Coal Field.

Co-Generation Facilities

Fortunately, a non-profit trade association called ARIPPA (ARIPPA, 2011), based in Pennsylvania organized in 1988 with its membership comprised of electric generating plants producing alternative energy and/or steam and businesses associated with the industry. (“Co-Generation” plants produce and sell both alternative energy electricity and steam). Most ARIPPA member plants are currently located in or near the Anthracite or Bituminous coal regions of the United States. Collectively, member plants generate alternative energy electricity using environmentally friendly Circulating Fluidized Bed (CFB) boiler technology to convert waste coal (coal mining refuse) and/or other alternative fuels such as biomass into alternative energy and steam. Accordingly, ARIPPA is organized to:

-
- advance the alternative energy electric power production industry;
 - encourage education about alternative energy electric power production and related industries;
 - promote the environmentally responsible production of electric power;
 - promote the utilization of electricity produced by alternative energy electric power producers;
 - endorse the continuity and growth of the alternative energy power production industry; and
 - assist in meeting this country's energy, industrial, economic, and environmental needs.

More information about the member plants can be found on the ARIPPA website at www.arippa.org.

The refuse reprocessing operations are concentrated in the eastern half of the Western Middle Anthracite Coal Field, and at the center of the field near the Borough of Mount Carmel, Northumberland County. Although large coal refuse banks associated with abandoned underground mines occur at the western end of the field near the census-designated place of Trevorton, Northumberland County. The large refuse reprocessing operations are important to the mining industry and the electrical power industry because they are mining the Western Middle Anthracite Coal Field for the Co-Generation plants in the area. Four of the six operating Co-Gen plants in the Anthracite Region are within the Western Middle Anthracite Coal Field; from west to east they are Mount Laurel, Gilberton Power Company, Wheelabrator Frackville Energy, and Schuylkill Energy Resources.

These cogeneration plants have consumed tens of millions of tons of coal refuse since the mid 1980's, and they consume limestone as part of the combustion fluidized bed (CFB) process, thereby producing an alkaline coal ash. This alkaline waste product is beneficially used to backfill and reclaim abandoned surface mine pits and other abandoned mine features. In addition to the abandoned mine land reclamation benefits, the alkaline character of the coal ash promotes increased alkalinity in groundwater infiltrating to the mine pool flow system.

There are uncalculated coal reserves remaining in these and other collieries of the Western Middle Anthracite Coal Field at deeper depths and near to the surface, above the mine pool level. However, most of the colliery maps show that most of these areas were "third mined" (i.e., the barrier pillars in the breasts were removed).

Part 3 of this report presents a groundwater model of the entire Western Middle Anthracite Coal Field, which was constructed by Dan Goode and Chuck A. Cravotta III of the US Geological Survey using the MODFLOW computer program. **Part 3** is like a report within a report and it was an integral component to this project from the beginning, so it is contained herein.

Chapter 2. Mine Drainage Discharges and Boreholes of the Western Middle Anthracite Coal Field

By Robert E. Hughes¹¹, Michael A. Hewitt¹², Ian C. Palmer¹³, Daniel J. Koury¹⁴, Todd Wood¹⁵, Jim Andrews, P.G.¹⁶, and Roger J. Hornberger, P.G.¹⁷

A very large amount of water quality data from the PA DEP files of three Bureaus was compiled and evaluated for this study as well gathered by one of our team researchers, Ian C. Palmer. The water quality data sits in an extensive database created by EPCAMR that was compiled from essentially all of the permits in the public files of the Bureau of District Mining Operations for active and reclaimed mines in the Western Middle Anthracite Coal Field. This database was constructed primarily to evaluate trends in the discharges from the abandoned underground mines (monitoring points), but it was also compiled for water samples from receiving streams for baseline analyses of water quality in many of the streams impacted by abandoned mine drainage. The project team also evaluated the mine pool water level data from boreholes drilled and are somewhat maintained by the PA DEP Bureau of Abandoned Mine Reclamation. This water level data was used in the construction of the groundwater model, and in evaluating the seasonal variations of the mine pool levels. The data from the mine maps, borehole, water levels, and mine drainage discharges were also evaluated to determine where the multi-colliery hydrologic units exist in the Western Middle Anthracite Coal Fields. The data is compilation of existing data from DEP files and the database is an unofficial representation of the data that has not been thoroughly reviewed for correctness, by DEP, therefore it is the responsibility of

¹¹ Executive Director-Eastern Pennsylvania Coalition for Abandoned Mine Reclamation, Robert E. Hughes

¹² Program Manager-Eastern Pennsylvania Coalition for Abandoned Mine Reclamation, Michael A. Hewitt

¹³ Researcher, Ian C. Palmer

¹⁴ Environmental Program Manager, PA Department of Environmental Protection's Bureau of District Mining Operations-Pottsville Office, Daniel J. Koury

¹⁵ Professional Engineer, PA Department of Environmental Protection's Bureau of Abandoned Mine Reclamation-Wilkes-Barre Office, Todd Wood

¹⁶ Professional Geologist, PA Department of Environmental Protection's Bureau of District Mining Operations-Pottsville Office, Jim Andrews

¹⁷ Professional Geologist, Roger J. Hornberger, LLC

the user to verify the data with the data source. The data can be found in **Appendix B. EPCAMR Mine Drainage Water Quality Samples Inventory Database.**

This was one of the major goals of the project by EPCAMR and our partners. Numerous multi-colliery hydrologic units have been identified. The database covers the Western Middle and Southern Fields, from Trevorton and Lykens in the west to Delano and Nesquehoning in the east. Some permits have only one monitoring point associated with them, while others have up to twenty; some permits have only a handful of data sets, while some have almost three thousand. It involves five counties: Carbon, Columbia, Dauphin, Northumberland, and Schuylkill. (See below for a breakdown.)

Summary of work completed:

Data sets entered: **24,375**

Monitoring points: **578**

It will still be possible to expand this knowledge base by adding future monitoring results (perhaps electronically from eFacts), by adding other known data from other sources (e.g., mine pool water level), and by field truthing data with actual observations.

County	SMPs *	Data available	Completed	Outstanding
Northumberland	42	30	30	0
Columbia	10	10	10	0
Dauphin	4	4	4	0
Schuylkill (Western Middle Field)	47	46	46	0
Schuylkill (Southern Field)	115	111	111	0
Carbon	1	1	1	0
TOTAL	219	202	202	0

(*) These are locations identified as Surface Mining Permit holders on the map at the PA DEP Office of District Mining, in Pottsville, PA, updated from the PA DEP database of active Surface Mining Permits.

Mine Drainage Quality

The description of water sample sites in (Wood, et al., 1986) and (Growitz, 1985) shows that essentially every type of mine drainage discharges occur in the Western Middle Anthracite Coal Field. Examples are the Doutyville Tunnel from the Locust Gap Mine, the Cameron Mine airshaft, the slope at the Henry Clay Stirling Mine, the Corbin Water-level Drift, the Connerton Village boreholes from the Hammond Mine and seepage from the Girard Mine.

A general view of the mine drainage characteristics of the Western Middle Anthracite Coal Field are shown on **Figure 2.6** from (Brady, et al., 1998) [using data from (Growitz, 1985)] where the median, range and quartiles are delineated in box plots of the pH and sulfates of the four Anthracite Coal Fields. These box plots show that the Western Middle Coal Field exhibits the greatest range in pH and the highest median sulfate concentration of 500 mg/L.

Additional information on the geology of the Anthracite Coal Region of PA is contained in two recent comprehensive publications: *The Geology of PA* (Barnes, 2002) and *Coal Mine Drainage Prediction and Pollution Prevention in PA*, (DEP, 1998).

Figure 2.6(a) and (b). Box Plots Showing Differences in pH and Sulfates from the Four Anthracite Fields in Eastern PA (Brady, et al., 1998)

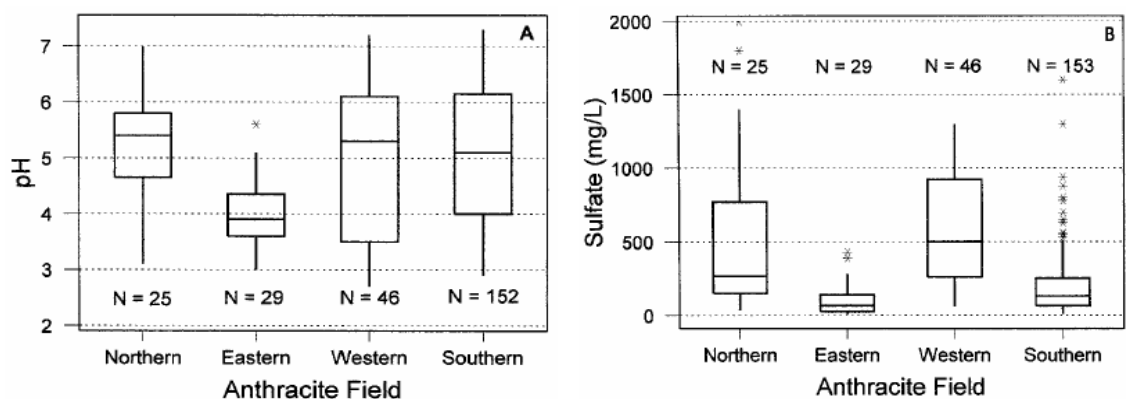

Almost all of the abandoned underground mine maps for the Western Middle Anthracite Coal Field in the archives of the Bureau of Mine Safety were evaluated by Roger J. Hornberger, P.G., Michael A. Hewitt, and Robert E. Hughes and all of the associated cross-sections were also examined before being scanned and digitized. The mine pooling mapping evaluation was conducted to determine the lowest elevation of mining in

each colliery (for use in the groundwater mode), and to record observations of breaches in barrier pillars and other significant abandoned mine features.

Boreholes of the Western Middle Coal Field

The PA DEP BAMR has maintained about **44** boreholes throughout the Western Middle Coal Field. From February 1982 to August 2003, the water level measurements in the boreholes were taken quarterly. After that, the measurements were less frequent. All of the following referenced graphs can be found in the **Table 2.46, Appendix E. Western Middle Coal Fields Borehole Data Charts (1982-2003)**.

The **Mahanoy City borehole (1B)** has an average elevation of 1131.93' and varies by 59'. The highest measurement was May of 1993 at 1166.46' and other high measurements were in April 1983, April and August of 1984, and in April of 1994, as shown in **Graph 2.1**. There was a series of low measurements during 1986 and 1987. The lowest measurements were November 1985, February 1992 being the lowest at 1107.01', and November 1993.

The **Maple Hill borehole (BH2)** is in a pool that is pumped for the Schuylkill Energy Resources Co-Generation Plant so there is less variability. **See Graph 2.2**. The average elevation is 1133.33' and there is 60' of water level fluctuation. The highest month is May 1993 at 1166.86'' and the lowest elevation is February 1986 at about 1107.01'.

The **Buck Mountain Vulcan borehole (BH3)** is located at the eastern end of the Western Middle Coal Field as shown on **Graph 2.3**. The average elevation is 1251.67' and there is 11' of variation. The highest measurements are in April 1994 and February 1996, when the elevation is about 1259.03'. The lowest elevation is in February 1985 with an elevation of 1247.73' and another equally low elevation is in February 1992.

The **Tunnel Ridge borehole (BH4A)** is located near the boundary between Tunnel Ridge and Mahanoy City mines. The average elevation is 1150.64' and there is 58' of variation in water levels. The highest water level is April 1994 at 1177.81'. The lowest elevations are January 1985 at 1120.21' and December 1985 at around the same elevation of 1121', slightly higher, as shown in **Graph 2.4**.

The **St. Nicholas borehole (BH5)** has an average elevation of 1131.67' with 51' difference in elevation. The highest elevations are in February 1993 with an elevation of 1156.48', April 1994, and February 1996 when the water level was about 1156.5'. The lowest elevations were in February 1982, August, and

November 1985, and November 1989. In February 1982, the elevation was 1105.03'; on the other 3 dates, the elevation was 1110'. The pool appears to be rising slightly in **Graph 2.5**.

The **Kohinoor borehole (BH7)** has an average elevation of 1123.23' and exhibits 52' of variation as shown on **Graph 2.6**. The highest elevation was February 1997 at 1149.37'. August 1993 was several feet less than that. The lowest elevations were in February 1982, 1985, and 1992, between 1097.47' and 1108'.

The **Gilberton borehole (BH8)** has an average elevation of 1099.69'. It only varies 25' because it is a pumped discharge. The highest elevation was December 1999 at 1119.48'. The lowest elevation was at 1094.63' in December of 1988. See **Graph 2.7**.

The **West Bear Ridge borehole (BH9A)** has an average elevation of 1068.09' and exhibits a variation of around 46', as shown on **Graph 2.7A**. The highest elevation was at 1092.43' in February of 1994. The lowest elevation was 1044.38' in February of 1992.

The **Girardville borehole or Packer #5 (BH10)** has an average elevation of 956.21', with only 8' of variation. The highest elevations were in August 1989 and February 1990 at 959.84', as shown in **Graph 2.8**. The lowest elevation was February 1992 at about 951.84'.

The **Indian Ridge borehole (BH11A)** has an average elevation of 1120.23' with 52' of variations in water levels. The highest elevation was 1145.49' in February 1997 and May 1993 was a just a few feet lower than that. The lowest elevation was February 1982 at 1093.14'. Other similarly low elevations were November 1985 and February 1992 as shown on **Graph 2.9**.

The **Burnside borehole (12A)** has an average water level of 800.07'. The highest elevation was in February 1984 at 846.04', as plotted on **Graph 2.10**. Other high elevations were in April 1982 and May 1983 at 834'. The latter half of this plot, after February 1991 drops precipitously to lower levels. The lowest level is 779' in November 1994. In the first series, the lowest elevation was 778.59' in December 1994.

The **Greenback borehole (13B)** has an average elevation of 820.34' with 21' of water level fluctuations, as shown on **Graph 2.11**. The highest elevation was 830.73' in April 1994. The lowest elevations were 809.53' and 810' in November 1982, November 1988, February 1989, November 1991, and November 1994.

The **Scott borehole (BH15)** has an average elevation of 999.51' and 22' of water level variations. The highest water level elevations are May 1993, April 1994, and February 1996, when the water level was 1014.93', as seen on **Graph 2.12**. The lowest elevations were August 1991, when the water level was 993.03' and May 1993.

The **Reliance borehole (BH16)** has an average elevation of 998.03' and 40' of variations. The highest elevations were in May 1993, April 1994, and February of 1996, when the water level was 1024.09'. The lowest elevations of water levels were February 1983 at 984.29', November 1988, and November 1993. This borehole fluctuates greatly from high elevations to low elevations as shown on **Graph 2.13**.

The **Sioux-Sayre borehole (BH17)** has an average water level of 1007.62' and it has 42' of water level variations. The highest elevations are April 1983, April 1984, May 1993, and February 1996. The highest of these is 1037.95' in May 1993. There are a series of low elevations in November 1983, November 1984, February 1985, November 1988, and February 1989. All of these low elevations are about 995.45' as shown on **Graph 2.14**.

The **Park No. 1 and No. 2 borehole (BH18B)** has an average water level elevation of 1257.35' and 39' difference in water level variations, as shown on **Graph 2.15**. The highest elevation is 1276.10' in May 1990. Other high elevations are in April 1994 and February 1996. The lowest elevation was February 1985 at 1237'. November 1984 was similarly low, as was February 1992.

The **Knickerbocker borehole (BH21)** has an average water level of 1135.36' with 63' of variation. The highest elevations are April 1983, May 1993, April 1994, and February 1996, which had the highest water level of 1173.57'. The lowest elevations were 1110.12' in February 1982 and November 1985. The second half of the Knickerbocker graph varies more widely than the first as shown on **Graph 2.16**.

The **Germantown borehole (BH24)** has an average water level of 975.73' and it only has 5' of variation as shown on **Graph 2.17**. The **Bast borehole (BH25)** has an average water level of 908.34' and it only varies 4' in the period of water level recordings as shown on **Graph 2.18**. The **Tunnel borehole (BH26A)** only varies by 4' for the period of records on **Graph 2.19**.

The **Potts borehole (BH28)** has an average water level elevation of 1001.79' and there is 47' of variation on **Graph 2.20**. There are numerous periods of dry sample-blocked borehole readings. The highest elevation of a reported water level was 1024.72' in April 1994. The lowest elevation is November 1985 at 977.77'.

The **Richards Shaft borehole (BH30A)** has an average water level of 1174.65' and 117' of variation. The water level varies erratically between 1100' and 1230' in elevation as shown on **Graph 2.21**. The highest elevation is 1224.83' in April 1994. The lowest elevations are in November 1983 and November 1985 at elevation 1108.33' as shown in **Graph 2.21**.

The **Greenough borehole (BH31)** is actually located within the boundaries of the Luke Fidler Mine. The average water level elevation is 1090.34' and there is 50' of variation in water levels as shown on **Graph**

2.22. There is a break in the period of records between August 1988 and August 1991. The highest water levels was 1140.65' in May 1993, and other highs in April 1994 and May 1996. The lowest elevation is 1073.15' in November 1983.

The **Scott Ridge borehole (BH32)** has an average water level of 998.95' with 22' of variations. The highest elevations are May 1983 at 1009', May 1993 at 1014' and February 1996 at 1015.24'. The lowest elevations are 993.44' in November 1984 and August 1985, as shown on **Graph 2.23**.

The **Alaska borehole (BH33)** has an average water elevation of 1004.21' with 38' of variations. The highest elevations are April 1993, April 1994, and February 1996, all near to 1030.01' in elevation. There are numerous low elevation measurements near 991.91' between August 1983 and August 1993, as shown on **Graph 2.24**. There is no information for the **Locust Gap borehole (BH34)** available.

The **Colbert borehole (BH35)** has an average water level of 735.08' with 58' of variations. The highest elevation was 773.80' in February 1996. Other similar highs are in May 1993 and April 1994. The lowest elevation was 715.65' in November 1993. There are numerous low water levels at 719'. This borehole exhibits regular seasonal variation, as shown on **Graph 2.25**.

The **Enterprise borehole (BH36)** has an average water level of 962.93'. The highest elevation was 1010.31' in April 2003. The lowest elevation was 959.01' in June 1985. This borehole varies in pool elevation by about 50', as can be seen in **Figure 2.26**.

The **Maysville borehole (BH37A)** has an average water level of 852.18. The highest elevation was 856.68' in April 1982. The lowest elevations were around 849.38' in March and April of 1985. The **Maysville borehole (BH37A)** exhibits about 7' of variation between 848' and 796', but then it collapsed and became blocked in 1988, as can be seen in **Graph 2.27**.

The **Luke Fidler borehole or (BH38)** has an average elevation of 750.75' for water levels within this borehole. The variations are only 19'. The highest elevation is 757.87' from February 1996. The lowest elevation of a water level is 738.67' from November 1984. Most of the water level variations are within a few feet of the 750' elevation, as shown on **Graph 2.28**.

The **Henry Clay-Sterling borehole (BH40)** varied by 1' or 2' around the 779.50' water level from 1982 through 1986. At that point, all of the water level measurements are the same at 779.61', as shown on **Graph 2.29**. This is indicative of the borehole being influenced by the weir on the major Sterling discharge.

The **Bear Valley borehole (BH42)** was operational until 1983 when it became blocked at the 800' elevation. The average elevation was 784.97'. The highest elevation was 799.84' and the lowest was 757.34'. After that point, no water level data was retrievable from the borehole, as seen on **Graph 2.30**. Blockages

could occur for a variety of reasons, mostly likely rock falls, boulder blockages, heavy siltation, change in direction of the water in the underground mine pools, or any number of diversions that would prevent one from obtaining a reliable data point.

The **North Franklin borehole (BH43)** has an average water level elevation of 1099.9' with 7' of variations between 868' and 887' elevation, as shown on **Graph 2.31**, but the pattern is less variable than for the Lawrence borehole.

The **Lawrence borehole (BH46)** has an average water level of 1199.90' with 25' of variation, as shown on **Graph 2.32**. The highest water level was 1116.71' in April 1994. A similar high was measured in May 1993. The lowest elevation was 1091.70' in February 1992. This borehole exhibits a good pattern of seasonal variation as well.

The **Hammond borehole (BH47A)** was operational until 1987 when the road was resurfaced, covering the borehole. The average elevation was 1099.90'. The highest water level was 1040.08' in May 1983. The lowest elevations are a series of 3 measurements at elevation 1001.48' in 1984 and 1985, as shown on **Graph 2.33**.

The **Richards Water Level colliery borehole (BH48)** has an average of 1197.52' computed from existing data. The difference in water levels has been 42'. PA DEP BAMR was unable to access this well from 1988 to 1991. The highest water level was 1213.24' in February 1984. The lowest water level was 1171.74' in November 1983, as shown on **Graph 2.34**.

The **Natalie borehole (BH49)** has an average water level of 1097.70' exhibiting 59' of variation. The highest water level was 1142.04' in May 1993. This followed one of the lowest elevations in August 1997 at 1083.54', as seen on **Graph 2.35**. Another high elevation was 1140' in April 1994. There are many low elevations near 1092'.

The **Hickory Ridge borehole (BH50)** has an average water elevation of 1054.14' and a variation of 17', as shown on **Graph 2.36**. The highest was 1060.75' in November 1990, and the lowest was 1043.85' in November 1991.

The **Royal Oak borehole (BH52)** shows a trend of gradually increasing water level elevations from 760' to 771.22', as shown on **Graph 2.37**. The average elevation is 764.12' with 24' of variation. The only deviation from the trend is in August 1984, when the water level drops to 747.27'.

The **Nielsen borehole (BH53)** was terminated in 1991 when the road was resurfaced covering the borehole. The average water elevation is 728.91' with 20' of variation. The water levels do not vary more

than 4' above and below elevation 732.37', except for the sharp drop in August 1984 to 712.87', as with the **Royal Oak borehole** above, as seen on **Graph 2.38**.

The **Excelsior borehole (BH55)** has an average elevation of 947.52' and water level variations of 29'. The highest elevation was 969.35' in April of 1994. Another high was 965' in May 1996. There are numerous low elevations at 939.95' as shown on **Graph 2.39**, which should correspond to the impoundment overflow weir location.

The **William Penn borehole (BH57)** has had an average water level of 1031.72' with 37' of variation. In February 1996, the borehole was overflowing at the land surface of 1149.5'. Other similar high water levels were in May 1993 and April 1994 at around 1049.48'. The lowest water level recorded was 1012.48' in February 1992, as shown on **Graph 2.40**.

The **Lawrence borehole (BH58A)** has an average water level elevation of 1096' with 24' of variation, as shown on **Graph 2.41**. The borehole became inaccessible after 1983. The highest elevation was 1114' in March 1983 and the lowest elevation was 1088' in February 1992. The **Old Richards Shaft colliery borehole (BH30A)** has an average water level of 1081.01' and 117' of variation. The highest elevation was 1088.20' in March 1984 and the lowest was 1074.60' in November of 1983, as shown in **Graph 2.42**.

The **E-31-Luke Fidler (See BH #38)** has an average elevation of 736.20', and varies from around 50'. The highest elevation was during the months of April 1994 and 1996 at 768.55'. The lowest elevation was 718.30' in July 1994, as shown in **Graph 2.43**.

The **Pennsylvania Shaft** was operational as a water level measurement point from February 1982 through 1987 when it was backfilled. The average water level elevation was 999.38'. The variation in water levels was 16', as shown on **Graph 2.44**. The highest elevation was 1008.18' and the lowest was 992.08'.

Finally, the **Centralia Water Level monitoring point (N62)** was operational from 1983 to 1993. The average water level elevations during that period of record was 1016.93', as shown on **Graph 2.45**. The variation in water levels was 13'. The highest elevation is a spike in 1984 to about 1024.50'. The lowest elevation was in 1985 and was about 1011.90'.

It's unclear why the PA DEP BAMR didn't communicate to the local road departments of the municipalities in the Western Middle Coal Field the importance of not blocking these boreholes. It is another reason why EPCAMR has initiated its own Borehole Awareness Campaign to prevent this from happening further in other parts of the Coal Region, where the mine pool monitoring is very critical and important to our project and future energy redevelopment projects that might one day use the boreholes as additional monitoring locations.

Table 2.46 in **Appendix E. Western Middle Coal Field Borehole Dataset (1982-2003)** gives the reader a comprehensive look at the Average Mine Pool elevation, Standard Deviation, Maximum elevation, Minimum elevation, and the Number of Samples, of the data sets that were monitored for the period of February 1982 to August 2003.

Chapter 3. Volume 1- Mine Pool Hydrology in the Eastern Half of the Western Middle Anthracite Coal Field (Schuylkill County): Colliery, Basin(s), Pool(s), Borehole(s), Barrier(s), Discharge(s), Water-filled Pit(s)

By Michael A. Hewitt¹¹, Robert E. Hughes¹², Jim Andrews¹³ and Roger J. Hornberger, P.G.¹⁴

The U.S. Bureau of Mines Bulletin 521, titled Barrier Pillars of the Western Middle Field (Ash, et al., 1953) is the definitive guide to the barrier pillars of the Western Middle Anthracite Coal Field. Although it was written more than 50 years ago, most if it is still relevant today. If the barrier pillar was breached then, the breach probably still exists today. Arrows on the maps show the direction and path of flow of water through the mines affected by the barrier pillar system. However, at the time of the writing of Bulletin 521, S. H. Ash and others noted many instances where the active underground mine was pumping to control water in the mine. In those cases, the mine pools shown on the maps would be at a lower elevation and generally less extensive than the post-mining impounded water of the present time. Barrier Pillars were numbered from 1 to 80 in roman numerals, while mine pools were numbered 1 to 58 in Bureau of Mines Bulletin 521 starting at the eastern end of the western middle field.

Four years earlier, Ash and others produced the U.S. Bureau of Mines Technical Paper 727, titled Water Pools in Pennsylvania Anthracite Mines (Ash, et al., 1949), in which mine pools were delineated, elevation levels of the mine pool, the surface, the lowest level and estimated mine pool volumes were noted for all four coal fields. Between these two reports, one can begin to build a baseline for mine pools in the Western Middle Anthracite Coal Field.

The Pennsylvania Department of Environmental Protection's Bureau of Abandoned Mine Reclamation, (BAMR) of the drilled approximately **30** boreholes throughout the Western Middle Anthracite Coal Field, and maintained a program of monthly monitoring of mine pool elevations for approximately the last 20 years. The

¹¹ Program Manager-Eastern Pennsylvania Coalition for Abandoned Mine Reclamation, Michael A. Hewitt

¹² Executive Director-Eastern Pennsylvania Coalition for Abandoned Mine Reclamation, Robert E. Hughes

¹³ Professional Geologist, PA Department of Environmental Protection's Bureau of District Mining Operations-Pottsville Office, Jim Andrews

¹⁴ Professional Geologist, Roger J. Hornberger, LLC

median elevation for the entire period for record has been labeled adjacent to the boreholes plotted on **Plate II**. It is useful to compare these borehole water levels to the mine pool maps found in Bureau of Mines Bulletin 521 and Technical Paper 727.

A team of geologists from the U.S. Geological Survey (USGS), under the direction of Gordon H. Wood Jr., studied the Western Middle Field and produced a series (a.k.a. USGS C-series) of maps across the field showing structure contours of the lowest mineable seam (the Buck Mountain or Mammoth Coal Bed in some areas), the location of the axis of synclines and anticlines, and the location of major faults. Barrier pillars, some drainage tunnels and extent of underground mining on the Buck Mountain Vein are also shown. Barrier pillars were drawn from Bureau of Mines Bulletin 521 maps and overlain on the structural geology map on **Plate I & II**. In most cases, both barrier pillars from the two different sources lined up nicely.

In this chapter we will attempt to explain changes to mine pool levels in the Western Middle Anthracite Coal Field as compared to the U.S. Bureau of Mines (US BOM) Technical Paper 727 (Ash, et al., 1949) and 4 years later in Bulletin 521 in 1953 (Ash, et al., 1953). Certain areas were also checked for accuracy against U.S. Office of Surface Mining (OSM) Mine Map Folios. Two Operation SCARLIFT reports, segregated by watershed: SLR 113 - Shamokin Creek (Gannett Fleming Corddry and Carpenter, 1972) and SLR 197 - Mahanoy Creek (Sanders & Thomas, 1975), also attempted to explain the existence and movement of water in the mine pools in the early to mid 1970's. However, the areas shown in the Shamokin Creek SCARLIFT Report Maps represent the extent of major deep mine workings on any vein, also known as geobasins, and not the actual mine pool wetted perimeters as in the Ash Reports. These geobasins can be considered the maximum possible extent of the mine pools. The Mahanoy Creek SCARLIFT Report does define mine pools based on actual borehole or discharge elevations at the time. EPCAMR calculated the approximate coverage areas for the pools represented in the Bureau of Mines and Mahanoy Creek SCARLIFT maps using ArcGIS to show the growth (or reduction) of the pools over the years (**Table 1. Mine Pools and Multi-Colliery Hydrologic Units**).

Recent borehole data ranging from February 1982 to August 2003 from the PA Department of Environmental Protection (DEP) Bureau of Abandoned Mine Reclamation (BAMR) often shows higher water levels, which were subtracted from the surface elevation of the borehole to find the pool level in feet above mean sea level. In collieries where borehole data was not available, discharge elevations or water filled strip pits that mimic mine pool elevations on the surface were used. These elevation averages were used with the lowest mineable seam structural contour data from the U.S. Geologic Survey (USGS) Coal Investigation Series (C-Series) Maps to interpolate present day average mine pool levels, wetted perimeters and boundaries on the lowest mineable coal seam in the field. Many factors were integrated to account for the actual extent of

mining and complex geological structures, such as faults and anticlines. Although the structural geology of the Western Middle Field is not as extreme as the Southern Field, it is complex enough to create barriers to water flow of varying degrees of permeability, especially in cases where thrust faults stack seams of coal on top or below each other; creating overlap and underlap seams. Pools were drawn to mirror mined out seams on the Buck Mountain Vein as recorded in C-Series maps, mining above this seam could have taken place and can often account for any discrepancies in mine pool coverage area comparisons. In general, one can say that mine pools have been filling since colliery operations closed to an elevation where the pool stabilizes by either discharging directly to the surface or it overcomes a barrier, then discharges to another mine and becomes part of a multi-colliery hydrologic unit. The wetted perimeter and volumes of mine water have increased over time. Detailed individual past and current colliery and mine pool situations are described below.

Pool 1: Park No.1 Pool

The Park No. 1 & 2 collieries were developed in the Delano Basin and is bounded on the south edge by the Delano Anticline and Fault. The altitude of the surface is at 1335' and the altitude of the lowest level is 880' (Ash, et al., 1949). The mine pool was at 1172' (Ash, et al., 1949) and pumped to a level of 990' (Ash, et al., 1953). The pool covered approximately 79.7 acres. At the time of the creation of the US BOM reports, the collieries were being actively underground mined. The operations ceased in 1953 (Reed, et al., 1987). At the time of the Mahanoy Creek SCARLIFT Report, the pool had expanded to 167.5 acres with an elevation 1250' (Sanders & Thomas, 1975). More current data from the Park No. 1 & 2 borehole reports an average pool elevation of 1257' which expands the pool on the Buck Mountain Vein to approximately 278.6 acres (**Plate II and Table 1.**). The altitude of effectiveness of barrier pillar III, on the east side, is reported to be 1169', and acts as a dam for the pool as it spills into the Nickerbocker Pool 3 (Ash, et al., 1953). This colliery is most likely part of the Packer #5 multi colliery hydrologic unit.

Pool 2: North Mahanoy Pool

The North Mahanoy colliery was developed in the Ellangowan Basin and is bounded by the Delano Anticline and Shenandoah Fault on the north and the Shenandoah Fault and an unnamed anticline to the south. The altitude of the surface is at 1305' and the altitude of the lowest level is 528.4' (Ash, et al., 1949). US BOM reports showed portions of this colliery active and the mine pool elevations range between 715' (Ash, et al., 1949) and 700' (Ash, et al., 1953). The altitude of effectiveness of barrier pillar V, on the east side, is reported to be 700'. Water was sent through boreholes in the barrier pillar at an altitude of 532' to Maple Hill

mine to prevent excessive hydrostatic pressure. The pool covered approximately 81.7 acres (Ash, et al., 1953). The operations ceased in 1953 (Reed, et al., 1987). At the time of the Mahanoy Creek SCARLIFT Report, the pool had expanded to 356.5 acres with an elevation 1095' (Sanders & Thomas, 1975). More current data from the Mahanoy City borehole reports an average pool elevation of 1132', which connects it to the Mahanoy City mine pool 10 and expands the pool to approximately 499.8 acres on the Buck Mountain vein for both pools (**Plate II and Table 1.**, see Pool 10 description). The boreholes may still serve as a conduit for water through the pillar, but a majority of the water flows over or around barrier pillar V to the Maple Hill Pool 9. This colliery is most likely part of the Packer #5 multi colliery hydrologic unit.

Pool 3: Nickerbocker Pool

The Nickerbocker Colliery was developed in the Nickerbocker Basin and is bounded by the Delano Anticline and Shenandoah Fault on the south, barrier pillar III to the east and barrier pillar VI on the west side. The altitude of the surface is at 1327' and the altitude of the lowest level is 506' (Ash, et al., 1949). US BOM reports showed portions of this colliery active and the mine pool elevation at 589'. The pool covered approximately 84.9 acres (Ash, et al., 1949) (Ash, et al., 1953). The operations ceased in 1953 (Reed, et al., 1987). At the time of the Mahanoy Creek SCARLIFT Report, the pool had expanded to 260.7 acres with an elevation 1095' (Sanders & Thomas, 1975). More current data from Nickerbocker borehole reports an average pool elevation of 1135' which expands the pool on the Buck Mountain Vein to approximately 161.4 acres (**Plate II and Table 1.**). The altitude of effectiveness of barrier pillar VI is reported to be 881' and acts as a dam for the pool as it spills into the Shenandoah City pool 4; some water also drains through boreholes into the Maple Hill mine (Ash, et al., 1953). This colliery is most likely part of the Packer #5 multi colliery hydrologic unit.

Pool 4: Shenandoah City Pool & Pool 5: Indian Ridge Pool

The Shenandoah City Colliery was developed in the Nickerbocker Basin, is bounded by the Shenandoah Fault to the south, the Shenandoah Anticline to the north and barrier pillar VI to the east. The altitude of the surface is at 1316' and the altitude of the lowest level is 476' (Ash, et al., 1949). The Indian Ridge Colliery was developed in the Shenandoah Basin and is bounded by the Shenandoah Anticline to the south, barrier pillar XII to the north and barrier pillar XI to the west. The altitude of the surface is at 1264' and the altitude of the lowest level is 739' (Ash, et al., 1949). The mine pool elevation for the Indian Ridge pool was at 915', 187.8 acres, and flows over the anticline into the Shenandoah City pool at 881', 185.9 acres (Ash,

et al., 1949) (Ash, et al., 1953). US BOM reports showed both collieries inactive, operations ceased in 1932 (Reed, et al., 1987). At the time of the Mahanoy Creek SCARLIFT Report, the Indian Ridge pool had expanded to 259.0 acres and the Shenandoah City pool had expanded to 289.0 acres, both with an elevation 1095'. The pools are still shown as separated and discharged in different directions. The Indian Ridge pool drained through barrier pillar XIII into the Kehley Run colliery while the Shenandoah City pool is still shown as draining south through the Shenandoah Fault to the Maple Hill colliery (Sanders & Thomas, 1975). More current data from Indian Ridge and Shenandoah – Indian Ridge borehole reports an average pool elevation of 1120' which connects it over the Shenandoah Anticline into the Indian Ridge pool 5 and expands them to 1183.3 acres on the Buck Mountain vein (Kehley Run, Kohinoor and West Shenandoah collieries also included in acreage do to similar borehole elevations and assumed connection). The mine pool flow paths, as determined by the PA Department of Environmental Protection, show the water now flowing through barrier pillar VI to pool 3 to the east (Scheetz, et al., 2004). This is most likely the main conveyance, but is one of the many outlets of this mine complex at current water levels. The altitude of effectiveness of barrier pillar XI, the west boundary, was reported to be 915', which was the maximum altitude of pool 5, but is assumed to be solid above this level. The altitude of effectiveness of barrier pillar XII, the north boundary, is 996' where it is punctured and water flowed from the Kehley Run pools 6 & 6A (Ash, et al., 1953). Now, most likely, the water flows back into the Kehley Run pools and/or flows over the Shenandoah fault, south toward the West Shenandoah pool via the Maple Hill pool as previously reported and represented by the structure contours of the Buck Mountain seam, the Shen City Shaft and No. 6 Slope may also aide in this connection (**Plate III**). This colliery is most likely part of the Packer #5 multi colliery hydrologic unit.

The Shen-Pen water filled strip pit lies above these pools. The 532' deep pit is flooded to 300', but this level has fluctuated in the past. The elevation of the water in the pit is believed to have a direct correlation to the level of water in the mine pool as reported in the PA DEP BAMR Abandoned Mine Land Inventory (AMLIS) database, Problem Area 1010 comments last updated in 1994 (PA DEP, 1982-Present). This water body may also serve as another connection between the pools 5 & 6.

Pools 6 & 6A: Kehley Run Pools

The Kehley Run colliery was developed on the south dip of the Shenandoah Basin and bounded on the south by barrier pillars XII and XIII. It is also possibly bounded on the west by an extension of barrier pillar XIV. The altitude of the surface is at 1379' and the altitude of the lowest level is 831' (Ash, et al., 1949). US BOM reports showed this mine inactive. Pool 6A covered 13.1 acres and drained to the Kohinoor at level 881'. Pool

6 covered 35.5 acres and drained to Indian Ridge at level 996' (Ash, et al., 1949) (Ash, et al., 1953). At the time of the Mahanoy Creek SCARLIFT Report, the Kehley Run pools were connected and expanded to 94.5 acres, both with an elevation 1087' (Sanders & Thomas, 1975). There is no current borehole information for either of the Kehley Run mine pools, however, current average water elevations in each of the formerly receiving mines are above these levels. Indian Ridge across barrier pillar XII is at 1120' and the Kohinoor across barrier pillar XIII is at 1123'. Pools 6 & 6A are assumed to be expanded to at least 1120' and still connected (see acreage associated with Pools 4 & 5 above). Barrier pillar XIV on the west side was robbed and may allow for leakage from the Kehley Run mine to the Weston mine, aka., Packer No. 3 & 4 (**Plate II**). This colliery is most likely part of the Packer #5 multi colliery hydrologic unit.

There was a mine fire in 1957 that burned for approximately 15 years until it was dug up, doused and backfilled¹³. This disturbed area was east of Shenandoah Creek and adjoins the Shen Pen Pit. This backfilling action may have affected drainage in this area, and may have even created a barrier of unknown permeability between pool 6 and 6A.

Pool 7: Kohinoor & West Shenandoah Pools

The Kohinoor Colliery was developed in the Shenandoah basin and is bounded on the south side by the Shenandoah Fault. The altitude of the surface is at 1225' and the altitude of the lowest level is 244' (Ash, et al., 1949). The colliery is bounded to the north by barrier pillar XIII, to the west by barrier pillar XIV and to the east by barrier pillar XI. The Kohinoor pool was maintained at an elevation of 635' and spanned approximately 76.9 acres. The West Shenandoah Colliery was developed in 2 synclinal basins: the Maple Hill to the south (aka. the Turkey Hill Mine) and the William Penn to the north (aka. the Shenandoah Mine) which partially overlaps the Kohinoor colliery. The West Shenandoah pool was also maintained at an elevation of 635' and spanned approximately 68.5 acres on all veins. The pools are geologically separated by the Bear Ridge Anticline, but the Kohinoor No.6 Tunnel is driven through the Shenandoah fault and anticline and the Bear Ridge anticline to connect both collieries at an elevation of 508'. The West Shenandoah pool then drained through boreholes in barrier pillar X at elevation 536' where water was actively pumped to the Maple Hill No. 6 slope pump plant. Barrier pillar XI to the east has an altitude of effectiveness of 915', the level of pool 5. Barrier pillars XV and XIV to the west have an altitude of effectiveness of 635', the level of pool 7 (Ash, et al., 1949) (Ash, et al., 1953). Operations ceased in 1953 (Reed, et al., 1987). At the time of the Mahanoy

¹³ "\$9.7 Million to Douse Coal Fire." *Beaver County (PA) Times*. September 17, 1970. A-2

Creek SCARLIFT Report, the Kohinoor pool had expanded to 228.5 acres and connected to the West Shenandoah which had also expanded to 329.6 acres, both with an elevation 1087'. Drainage patterns were reversed and shown to drain to the Weston (aka, Packer #2-4) through barrier pillar XIV (Sanders & Thomas, 1975).

Current average borehole water elevations in the Kohinoor borehole are at 1123' which expands the pool. The area of the pool on the Buck Mountain Vein including pools 4-7A is approximately 1,183.3 acres on the Buck Mountain vein (**Plate II and Table 1.**, see also explanation associated with Pools 4-6 above). Barrier pillar XIV on the west side was removed at 1044' and may allow for flow to the Weston mine (aka, Packer #2-4) in the Buck Mountain south dip overlap (Ash, et al., 1953) (Sanders & Thomas, 1975). Barrier pillar XV, also to the west, has a known breach at 1224', still 100' above current water levels (Ash, et al., 1953). This pool is most likely part of the Packer #5 multi-colliery hydrologic unit.

Pool 7A: William Penn (et. al)

The William Penn colliery was developed on the north dip of the William Penn Basin and bounded the south by the Bear Ridge anticline. US BOM reports showed this mine inactive. Operations ceased in 1946 (Reed, et al., 1987). Barrier pillar XVII, to the south along the Bear Ridge Anticline, has an effective altitude of 1217'. Barrier pillar XX, to west, has an effective altitude of 1100'. Barrier pillar XV, to the east, has an altitude of effectiveness of 635', the level of pool 7 (Ash, et al., 1949). Barrier pillar XIX, to the north, acts as a dam for Pool 7A where the water level was maintained at 210' by a tunnel at 190' that drains into the Weston Mine (aka, Packer #2-4). The pool covered approximately 30.2 acres. The effective altitude of the "dam" is considered 446' where the barrier pillar is removed in the Bottom Split Mammoth Bed and (Ash, et al., 1953). At the time of the Mahanoy Creek SCARLIFT Report, the William Penn pool had expanded to 234.2 acres on all veins and risen to an elevation of 1025' and changes the drainage patterns through the mines toward, the now inactive, Weston (aka Packer #2-4) and Packer #5 Collieries (Sanders & Thomas, 1975). All of these mines drain to the Packer #5 discharges and are part of the Packer #5 Multi-colliery Hydrologic unit. Current average borehole water elevations in the William Penn borehole are at 1031', which expands the pool to 195.2' on the Buck Mountain Vein.

The Weston Colliery may have been misnamed in the Bureau of Mines and SCARLIFT Reports as the same area is covered by the Packer #2, 3 and 4 collieries as reported by the C-Series maps and another Weston mine exists approximately $\frac{3}{4}$ of a mile to the north in the Locust Mountain basin. The Packer #3 colliery was developed on the south dip underlap of the William Penn basin and bounded to the south by the

Shenandoah fault and to the east by barrier pillar XIV. Flow may be constricted to the west by the Lost Creek fault and an unnamed barrier pillar that exists on the C-Series maps under Lost Creek. The Packer #4 colliery was developed on the south dip overlap and bounded to the south by barrier pillar XIX and XIV to the east. The Packer #2 colliery was developed on the south dip of the William Penn basin and is bounded to the north by the Lost Creek and Shenandoah faults, to the west by barrier pillar XXV, to the south by XIX and to the southeast by XX (Ash, et al., 1949) (Ash, et al., 1953). At the time of the US BOM reports, the Weston (aka. Packer #2) mine was actively pumping water to a surface elevation of 1123'. Operations ceased in 1959 (Reed, et al., 1987). At the time of the Mahanoy Creek SCARLIFT Report, the Weston Mine pool was at an elevation of 1025' covering an approximate 602.1 acres.

Residents of East and West William Penn experienced up-welling of mine water from underground. Several homes have impoundments of shallow, smelly water in their front yards due to deep mines. A sample of one of these showed a pH of 6.3 with 0.5 mg/l of iron. Nearby, a water filled strip pit exists in about the middle of the colliery associated with a 110' highwall. The water depth is estimated to be 50' and varies 20' with rainfall conditions. The water in the pit appears unpolluted and has no visible outflow. The water body is approximately 40 feet wide and 300 feet long. The pit holds approximately 600,000 cu. yds. of water as reported in the PA DEP BAMR Abandoned Mine Land Inventory (AMLIS) database, Problem Area 1007 comments last updated in 1990 (PA DEP, 1982-Present).

The residents of Lost Creek also experienced upwelling of mine water in their basements and near their homes as mines filled up and the mine water began discharging averaging 500 GPM from the pump shaft AMLF #1 and into a priority 2 flooded strip pit AMLF #7. The SCARLIFT Report calls this the Lost Creek discharge (Sanders & Thomas, 1975) it is also known as the West Buck Mountain Mine Overflow. There is a second water filled pit that may be connected to the underground mine pool. This three-sectioned water-filled pit AMLF #2 is located 40' west of Lost Creek Road and detains Lost Creek. The eastern pit has a water body that measures approximately 300' x 75' x unknown depth. There is no dangerous highwall at the eastern pit. The center pit has a hazardous water body that measures 1000' x 200' x unknown depth. It has a dangerous highwall on the north side that measures 200' x 80' and extends down to the water body. To the southwest, there were 2 other discharges closer to the village of Lost Creek with a combined flow of approximately 2000 GPM: Packer #2 Overflow and a seep from the Weston Mines (Sanders & Thomas, 1975). The PA DEP completed the Lost Creek Mine Pool Control Project in 1995. The PA DEP drilled the Lost Creek Boreholes to relieve local residential property flooding as reported in the PA DEP BAMR Abandoned Mine Land Inventory (AMLIS) database, Problem Area 1015 comments last updated in 1996 (PA DEP, 1982-Present).

To the northeast, near Upper Brownville, there is a discharge from the “real” Weston Mine delivered via a rock tunnel through the Locust Mountain Anticline originating in the Locust Mountain Basin to the north. The portal (AMLF #8), known as the Locust Mt. Tunnel is 6 feet high and 15 feet wide and is seeping acid/iron mine drainage at rate of 5,000 gpm. Yellow boy is evident but no water quality data are available. Water flows into a pit (AMLF #3), approximately 500' long, 250' wide and 90' deep, where it enters the ground at the location of a collapsed slope. There were also reports of a deteriorated flume, but polluted water does not leave the problem area as surface flow, though it may enter a subsurface mine pool (Packer #2). Both features are rated priority 2 health and safety hazards as reported in the PA DEP BAMR Abandoned Mine Land Inventory (AMLIS) database, Problem Area 1008 comments last updated in 1989 (PA DEP, 1982-Present).

The Packer #5 colliery was developed on the north dip of the William Penn Basin, over the Bear Ridge anticline to the south dip of the Girardville Basin and bounded the south by the Suffolk Fault. Barrier pillar XXII, to the southeast along the Bear Ridge Anticline, has an effective altitude of 1139'. Barrier pillar XX, to east, has an effective altitude of 1100'. Barrier pillar XXV, to the north, has an effective altitude of 1072' (Ash, et al., 1949) (Ash, et al., 1953). US BOM reports showed these mines active. Operations ceased in 1959 (Reed, et al., 1987). The coal is unmined in all beds to the west along the border with the Preston #3 colliery as shown in C-series maps and verified by OSM Folio Maps. At the time of the Mahanoy Creek SCARLIFT Report, the Packer #5 pool was 519.5 acres on all veins and at an elevation of 961' (Sanders & Thomas, 1975). Current average water levels in the Packer #5 borehole are at 956' which most likely confirms the stability of the mine pool since the SCARLIFT days. A mine pool was drawn on the Buck Mountain Vein, which was estimated to be approximately 161.2 acres.

The east side of Girardville has flooding problems due to several deep mine pool discharges. The Mahanoy Creek SCARLIFT reports 6 discharges, all from underground mines. Two are most likely discharging from the Packer #5 colliery and the other 4 are seeps from the Girard colliery (see pool 19). The pH ranges from 3.7-6.4 and the iron content ranges from 11-30 mg/L. Total flow rate of all 6 discharges is over 10,000 gpm. The largest quantity of mine pool water is discharging from the collapsed boreholes of the Packer #5 mine (AMLF #1-2). This is the Packer #5A overflow. SCARLIFT Report 197 reports a pH of 6.3 with 30 mg/l of iron. The actual entry is closed and the discharge is moved by culvert to Mahanoy Creek. Site visitors found a pH of 6.5 with 40 mg/l iron. Maximum reported flow rate is 12,253 gpm. Once the discharge comes out the end of the culvert (AMLF #9) it is ranked Priority 2 in AMLIS Problem Area 1002. The 6 discharges enter Mahanoy Creek directly. Here they combine with discharges from Shenandoah Creek to cause a flooding

problem in Girardville as reported in the PA DEP BAMR Abandoned Mine Land Inventory (AMLIS) database, Problem Area 4182 comments last updated in 1986. (PA DEP, 1982-Present). **(Plate II)**

The Hammond colliery was developed on the south dip of the William Penn Basin and bounded the north by the Locust Mountain anticline, the Lost Creek Fault and barrier pillar XXVI with an effective altitude of 1394'. Barrier pillar XXV, to the south, has an effective altitude of 1072'. Barrier pillar XXIII, to east, has an effective altitude of 1072'. Barrier pillar XXVIII, to the west, has an effective altitude of 1146' (Ash, et al., 1949) (Ash, et al., 1953). US BOM reports showed these mines active. Operations ceased in 1954 (Reed, et al., 1987). At the time of the Mahanoy Creek SCARLIFT Report, the Hammond pool was 505.6 acres on all veins and at an elevation of 1006' (Sanders & Thomas, 1975). Current average water levels in the Packer #5 borehole are at 1009.25' which most likely confirms the stability of the mine pool since the SCARLIFT days. A mine pool was drawn on the Buck Mountain Vein, which was estimated to be approximately 205.5 acres.

Five discharges emanate from the Hammond colliery as reported by The Mahanoy Creek SCARLIFT Report. The range of reported pH values is 4.1-6.4. Iron concentrations range from 2-46 mg/l. Total combined flow rate of all the discharges is 2700 gpm. One discharge is not polluted according to PA DEP BAMR Reports.

AMLF #4-5 are the Connerton #2 slope and discharge. The SLR 197 reports a pH of 6.4 with 35 mg/l iron. Maximum reported flow rate is 184 gpm. AMLF #6-7 are the Connerton #1 slope and discharge. SLR 197 reports a maximum flow rate of 1665 gpm, but the discharge is not polluted (pH is 6.7 and iron is 1.5 mg/l). AMLF #8: U.S.G.S. reports the Hammond mine seepage to have a pH of 6.3 with 20 mg/l iron. Site visitors found the discharge to have a pH of 6.2 with 30 mg/l iron where it crosses the highway. AMLF #9 is reported by SLR 197 to be the Hammond mine Connerton boreholes. The reported pH is 6.2 with 46 mg/l iron and a maximum flow of 2410 gpm. AMLF #10: SLR 197 calls this the Hammond overflow with a pH of 4.1 and 15 mg/l iron. AMLF #11 is a flooded and swampy area located 1500' northeast of Girardville near the former village of Connerton, Butler Township. The affected area measures 1300' x 350' and is the consequence of acid mine drainage water outflows. The area is adjacent to PA Route 54. A seepage (AMLF #8) originates to the northwest of Route 54 and drains via culverts under the roadway to the affected area. Two (2) additional discharges (AMLF #5 and #7) are known to exist and are also contributing sources of AMD. These two (2) sites are to the southeast of Route 54, and inaccessible due to the field conditions at the time of the investigation; thus, were not exactly located. The impounded water collects in a low lying area, and in the periods of high water, drains to Shenandoah Creek and subsequently contributes to the pollution load of Mahanoy Creek. Because of subsidence and flooding, the majority of residences of Connerton were acquired and demolished by the housing authority. Reoccurring associated problems have plagued the municipal authority and the

department of transportation. A break in the existing water line within the swamp area reportedly cannot be repaired due to existing conditions. A two (2) inch bypassing the break does not provide adequate pressure for fire protections, and has caused the municipal authority to cancel an agreement to provide fire hydrants to the Connerton district. Penn DOT has found it necessary to place under drain tiles in the highway to stabilize the base. Remedial work to correct the flooding and swamp problem will require altering the topography to allow free flow, backfilling the lower terrain, and placement of channels for the mine water discharges as reported in the PA DEP BAMR Abandoned Mine Land Inventory (AMLIS) database, Problem Area 4183 comments last updated in 1989 (PA DEP, 1982-Present).

Approximately ½ mile west a proving hole was tapped through the Barrier pillar XXV from the Packer #5 Kimber Slope into the 3rd level of the Diamond vein into the Hammond colliery. AMLF #2: the Packer #5 Kimber Slope is collapsed to a 1' x 1' opening and discharging mine drainage water (AMLF #3). Water flows from the opening into a rip rapped channel constructed under OSM 54(1379)101.1 (AMLF #1, CS). The opening is located along the west end of north Second Street in Girardville, about 100' north of an occupied residence. AMLF #3 is the mine water outfall of the Packer #5 Kimber Slope (AMLF #2). The water flows through a riprapped channel to north Second Street, then for several hundred feet to the receiving stream, Mahanoy Creek. According to the original report, dated 03/82, site investigators found a discharge of approximately 90 gpm and reported the water quality as having a pH of 6.1 and an iron concentration of 42 mg/l. Yellow boy was evident along the entire channel. A subsequent sample taken on October 22, 1991, showed the following analysis results: pH 6.60, alkalinity 256 mg/l, hardness 581 mg/l, sulfate 528 mg/l, ferrous iron 124,000 ug/l, manganese 4,610 ug/l, aluminum 10,300 mg/l, acidity 0 mg/l as reported in the PA DEP BAMR Abandoned Mine Land Inventory (AMLIS) database, Problem Area 1379 comments last updated in 1994 (PA DEP, 1982-Present). (See also OSM Folio W-7H-XSA).

Pool 8: East Bear Ridge Pool

The East Bear Ridge colliery was developed on the south dip of the Girardville basin and bounded to the north by the Bear Ridge anticline and barrier pillar XVIII with an effective altitude of 1217'. The altitude of the surface is at 1139' and the altitude of the lowest level is 680' (Ash, et al., 1949). Barrier pillar XVI, to east, has an effective altitude of 1139'. Barrier pillar XXII, to the west, has an effective altitude of 1139'. US BOM reports showed this mines inactive and the mine pool levels at 1139' covering approximately 165.5 acres on all veins. Water is drained through a water level tunnel and finds its way through strata to the Lawrence Pool (Ash, et al., 1949) (Ash, et al., 1953). At the time of the Mahanoy Creek SCARLIFT Report, the East Bear Ridge

pool was 173.8 acres on all veins and at an elevation of 1116' (Sanders & Thomas, 1975). No current borehole data is available for this perched mine, but there is no reason to believe that it has changed much since it is a gravity-drained pool. OSM Mine Map Folio W-8C Cross Section 1 shows a Slope Level tunnel at 893' and Water Level Tunnel at 1142' connected by a vertical shaft projected 460' to the west. The water level tunnel empties into the Little Buck Mountain and Buck Mountain Veins in the Lawrence Mine where it becomes part of the Girard multi-colliery hydrologic unit.

Pool 9: Maple Hill Pool

The Maple Hill colliery was developed in the Maple Hill basin, bounded to the south by the Suffolk Fault and Girardville anticline and to the north by the Shenandoah Fault. The altitude of the surface is at 1251' and the altitude of the lowest level is 160.1' (Ash, et al., 1949). Barrier pillar X, to west, has an effective altitude of 639'. Barrier pillar V, to the east, has an effective altitude of 700'. Barrier pillar V, to the east, has an effective altitude of 700'. C-Series maps show an extension of this barrier pillar on the Buck Mountain Vein, but no additional information is available. US BOM reports show this mine as active and the mine pool very low due to 2 pumps. The east side of the mine was pumped to 553' from the Maple Hill No. 1 Shaft, and the west side to 443' from the No. 6 Slope (Ash, et al., 1949). Four years later the US BOM report showed the mine pool was pumped to a level of 293' covering approximately 37.9 acres on all veins (Ash, et al., 1953). Operations ceased in 1954 (Reed, et al., 1987). At the time of the Mahanoy Creek SCARLIFT Report, the Maple Hill pool was 1089.9 acres on all veins and at an elevation of 1095', overtaking barrier pillars changing mine pool flow direction to the west and becoming part of the Packer #5 multi-colliery hydrologic unit (Sanders & Thomas, 1975).

Current average borehole water levels on the Maple Hill borehole are at 1133' which greatly expands the pool in this mine on the Buck Mountain Vein to approximately 1,062.2 acres (see plate and mine pool table?). Currently, the mine pool is pumped on the east side of this pool from the Maple Hill Shaft at a rate of approximately 833 gpm. This mine serves as a connection between almost all of its neighboring mines (see Maple Hill Interconnections Map). Water also flows out of this pool to the north through the Shenandoah fault into the Shenandoah City pool aided by 3" drill holes at 545' and 788' and the Shenandoah City Shaft. The Suffolk fault to the south acts as a barrier to water flow between pools 14 & 9 (See C Series 19 Cross Section C & D). Water levels in these pools are so similar, but it is just a coincidence due to similar geologic structure and a connection cannot be confirmed based on available mine maps along the fault (See OSM Folio W-10A-04 & 08).

Pool 10: Mahanoy City Pool

The Mahanoy City colliery was developed in the Mahanoy City basin, bounded to the south by the Suffolk Fault and to the north by the Shenandoah Fault. The altitude of the surface is at 1337' and the altitude of the lowest level is 472' (Ash, et al., 1949). Barrier pillar II, to the east, has an effective altitude of 1000'. Barrier pillar V, to the east, has an effective altitude of 700'. C-Series maps show an extension of this barrier pillar on the Buck Mountain Vein, but no additional information is available. US BOM reports show this mine as active and the mine pool was pumped to a level of 622' covering approximately 53.3 acres on all veins (Ash, et al., 1949) (Ash, et al., 1953). Operations ceased in 1953 (Reed, et al., 1987). At the time of the Mahanoy Creek SCARLIFT Report, the Mahanoy City pool was 417.0 acres on all veins and at an elevation of 1095', overtaking barrier pillars changing mine pool flow direction to the west and becoming part of the Packer #5 multi-colliery hydrologic unit (Sanders & Thomas, 1975).

More current data from Mahanoy City borehole reports an average pool elevation of 1132' which expands the pool over the Shenandoah Fault to connect with the North Mahanoy pool 2 to the north and expands the pool to approximately 499.8 acres on the Buck Mountain vein for both pools. The pool may also still flow west over the barrier pillar to the Maple Hill Pool (**Plate II**). Mine maps confirm no connections south over the Suffolk Fault to the Tunnel Ridge Mine.

Pool 11: Primrose Pool

The Primrose colliery was developed in the Mahanoy City basin, bounded to the south by the Suffolk Fault and to the north by the Shenandoah Fault, the Delano Fault and an anticline. The altitude of the surface is at 1507' and the altitude of the lowest level is 850' (Ash, et al., 1949). Barrier pillar II, to the west, has an effective altitude of 1000'. US BOM reports show this mine as inactive and the mine pool at 1000' covering approximately 144.6 acres on all veins. This level was maintained by boreholes through barrier pillar II at 911' (Ash, et al., 1949) (Ash, et al., 1953). An OSM Folio Primrose Vein Mine Map for the area shows an elevation of 1023' measured in the Primrose Shaft. A note on the Seven Foot Vein map says the "pumps stopped & valves closed 12M June 25, 1954". At the time of the Mahanoy Creek SCARLIFT Report, the Primrose pool had expanded to 228.5 acres on all veins and at an elevation of 1095' (Sanders & Thomas, 1975). There is no current borehole information for the Primrose Pool and there are no reported surface discharges from this pool. It has been assumed that the boreholes remain open to drain the pool regardless of the notation on the map. If this is true, the pool elevation is at 1132', also the height of the Mahanoy City pool. The area of the

pool on the Buck Mountain Vein is also, then assumed to be approximately 359.9 acres and part of the Packer #5 multi-colliery hydrologic unit (**Plate II and Table 1.**).

Pool 12: Vulcan - Buck Mountain Pool

The Vulcan - Buck Mountain and Park 3 & 4 collieries were developed in the Mahanoy basin, bounded to the north by the Suffolk Fault and the Girardville Anticline. The altitude of the surface is at 1570' and the altitude of the lowest level is 670' (Ash, et al., 1949). US BOM reports show these mines as inactive, operations ceased in 1932 (Reed, et al., 1987). The collieries are separated by a barrier pillar on the Buck Mountain as shown on the C-Series maps. Barrier pillar I, to the west, has an effective altitude of 1290'. The mine pool was at 1250' covering approximately 454.8 acres on all veins. This level was maintained by a surface breach at the same level (Ash, et al., 1949) (Ash, et al., 1953). At the time of the Mahanoy Creek SCARLIFT Report, the Vulcan – Buck Mountain pool was maintained at an elevation of 1245' by the Mahanoy City Boreholes and had expanded to 634.1 acres on all veins (Sanders & Thomas, 1975).

Current average water levels at the Buck Mountain – Vulcan Borehole are 1251' and confirm that the hydraulics of the pool have not changed much since the 1950s. The area on the Buck Mountain Vein is approximately 634.1 acres (see plate and mine pool table?). The pool is most likely isolated and makes up the Vulcan-Buck Mountain multi-colliery hydrologic unit. Currently there is one main discharge from a breach which flows at 8.79 cfs, 2 borehole discharges closer to the barrier pillar at 5.28 cfs (Cravotta, 2005). In the 1970's the Morris Tunnel further east in the Park 3 & 4 section of the pool also flowed at .3 cfs, while the breach flowed at .6 cfs and the boreholes at 9.8 cfs, respectively, with a total of approximately 11 cfs combined (Growitz, et al., 1985). Mine maps also show a water level tunnel driven north through the Suffolk Fault which connects the Vulcan and Park 3 & 4 Mines Buck Mountain Vein at an altitude of 1045' to the Primrose Mine Primrose Vein at an altitude of 1253'. This is a similar level to the Vulcan - Buck Mountain surface outlets; therefore it is most likely not a strong hydrologic connection, but a possible overflow, at elevated water levels.

Three Priority 2 water filled pits 200' south of a railroad bed and 900-1500' northeast of PA Route 54 which are used as swimming holes by local youth. Pit 1 is 400' X 200' X 15' to water of unknown depth. Pit 2 is 250' X 200' X 15' to water of unknown depth. Pit 3 is 450' X 200' X 55-60' to water of unknown depth. The altitude of these pits lie at between 1280' and 1300', they do not discharge and may be connected to the mine pool levels as reported in the PA DEP BAMR Abandoned Mine Land Inventory (AMLIS) database Problem Area 3107 comments, last updated in 1994 (PA DEP, 1982-Present).

Pool 13: Tunnel Ridge Pool

The Tunnel Ridge colliery was developed in the Mahanoy basin, bounded to the north by the Suffolk Fault. The south dip was also known as the Elmwood colliery. The altitude of the surface is at 1292' and the altitude of the lowest level is 368' (Ash, et al., 1949). US BOM reports showed this mine inactive, operations ceased in 1931 (Reed, et al., 1987). Barrier Pillar I to the east is solid with an altitude of effectiveness to 1290' and holds back water from pool 12. Barrier Pillar IV, to the west, on the south dip is effective up to an altitude of 622' acting as a submerged dam between pool 13 and 14. Barrier Pillar VII, to the west, on the north dip is removed in most beds and water can flow from pool 13 to 15. There is a cross-cut tunnel driven in the barrier pillar (on the south dip) from the mined out workings on the north dip at an altitude of 622'. The mine pool elevations for the Tunnel Ridge pool ranged between 970' (Ash, et al., 1949) and 997' controlled by deep well pumps in the St. Nicholas mine (Ash, et al., 1953). The mine pool was at 369.7 acres on all veins. At the time of the Mahanoy Creek SCARLIFT Report, the Tunnel Ridge pool had shrunk to 343.6 acres on all veins at an elevation of 1121' (Sanders & Thomas, 1975). This discrepancy could be due to incorrect line up of the maps during digitization. Most likely it is a mistake in the original mapping when compared to the structural contours.

Current average water levels at the Tunnel Ridge borehole are at 1151' on the south dip (aka. Elmwood) which expands the pool in this mine on the Buck Mountain Vein to approximately 173.5 acres on the south dip and 175.2 acres on the north dip (**Plate II and Table 1.**). South dip and north dip sections are partially connected with cross-cut tunnels. Mine map cross sections show the 3rd level tunnel connects the south and north dip in the Top Split Mammoth Vein at elevation 1030' and the 4th level tunnel connects the Buck Mountain Vein on both sides at elevation 890' on the eastern portion of the mine (see also DMS map 3538). This colliery is most likely part of the Gilberton multi colliery hydrologic unit via St. Nicholas and Boston Run Collieries (see C Series 19 Cross Section A & B). A water level tunnel was drilled to the breaker at 1178' and may discharge at higher levels directly into the Mahanoy Creek. A tunnel was also partially driven from the Mahanoy City Mammoth Bottom Split Vein at an altitude of 723' toward the Tunnel Ridge Buck Mountain Vein, but the progress stopped when a diamond drill hole revealed perpendicular unstable slate along the fault (3287 Kaiers Borehole Cross Section & OSM Folio W-10F-09).

Pool 14: St. Nicholas Pool

The St. Nicholas colliery was developed in the Mahanoy basin, bounded to the north by the Suffolk Fault and the Girardville Anticline. The altitude of the surface is at 1236' and the altitude of the lowest level is

128.3' (Ash, et al., 1949). US BOM reports showed this mine inactive, operations ceased in 1928 (Reed, et al., 1987). Barrier Pillar IV, to the east, is effective up to an altitude of 622' acting as a submerged dam between pool 14 and 13 on the south dip. Barrier Pillar IX, to the west, is effective up to an altitude of 670'. Barrier Pillar VIII, to the south in the center of the mine, is considered effective up to an altitude of 629' where workings in the St. Nicholas mine are connected to the Boston Run mine pool 15 (Ash, et al., 1953). The mine pool elevations ranged between 970' (Ash, et al., 1949) and 997' controlled by deep well pumps on the St. Nicholas Shaft. The mine pool was at 246.1 acres on all veins. At the time of the Mahanoy Creek SCARLIFT Report, the Tunnel Ridge pool had expanded to 281.8 acres on all veins at an elevation of 1121' (Sanders & Thomas, 1975).

The line between pools 14 & 15 is almost indistinguishable and levels are now being controlled by pumps in the Gilberton mine. Current average water levels at the St. Nicholas borehole are at 1132' on the south dip which expands the pool in this mine on the Buck Mountain Vein to approximately 223.1 acres (**Plate II and Table 1.**). This colliery is most likely part of the Gilberton multi colliery hydrologic unit via the Boston Run colliery. The Suffolk fault to the north acts as a barrier to water flow between pools 14 & 9 (See C Series 19 Cross Section C & D). Water levels in these pools are so similar, but it is just a coincidence due to similar geologic structure and a connection cannot be confirmed based on available mine maps along the fault (See OSM Folios W-10A-04 & 08). This colliery is a part of the Gilberton multi-colliery hydrologic unit.

Pool 15: Boston Run Pool

The Boston Run colliery was developed in the north dip of the Mahanoy basin. Barrier Pillar IX, to the west, is effective up to an altitude of 670', where workings in the Boston Run and Gilberton (Draper) mines are interconnected on the north dip. The altitude of the surface is at 1245' and the altitude of the lowest level is -29.1' (Ash, et al., 1949). US BOM reports showed this mine inactive. Barrier Pillar VII, to the east, is removed in most beds and water can flow from pool 13 to 15 on the north dip. Barrier Pillar VIII, to the north toward the center of the mine, is considered effective up to an altitude of 629' where workings in the Boston Run mine are connected to the St. Nicholas mine pool 15. The mine pool elevations for the pool ranged between 970' (Ash, et al., 1949) and 997' controlled by deep well pumps in the St. Nicholas mine (Ash, et al., 1953). The mine pool was at 131.8 acres on all veins. At the time of the Mahanoy Creek SCARLIFT Report, the Tunnel Ridge pool had shrunk to 121.9 acres on all veins at an elevation of 1121' (Sanders & Thomas, 1975). This discrepancy could be due to incorrect line up of the maps during digitization. Most likely it is a mistake in the

original mapping when compared to the structural contours. Also, water was being pumped at St. Nicholas colliery, therefore mine pool flow lines gravitated toward the pump.

There is no current borehole information for the Boston Run Pool, but current average water levels at the St. Nicholas borehole are at 1132' and 1100' at the Gilberton borehole, both on the south dip. It is assumed that the current water levels are somewhere in between because of the interconnectivity of the mines. The lines between pools 14, 15 & 16 are almost indistinguishable and levels are being controlled by pumps in the Gilberton mine. Being conservative, the average water level was assumed 1100', which expands the pool in this mine on the Buck Mountain Vein to approximately 114.6 acres (see plate and mine pool table?). This colliery is most likely part of the Gilberton multi colliery hydrologic unit and mine pool flow lines have reversed.

As reported in the PA DEP BAMR Abandoned Mine Land Inventory (AMLIS) database, there are several surface features that most likely are directly connected to the mine pool. A partially flooded strip pit of undetermined priority exists in the southwest corner of the colliery near the barrier pillar above the mine pool with an estimated volume of 120,000 cu. yds. in the East Gilberton Problem Area (PA 3758 AMLF #6). The comments also note a highwall with a 25' depth to water surface, water depth and pollution load unknown (PA DEP, 1982-Present).

Pool 16: Gilberton Pool

The Gilberton colliery was developed in the south dip of the Mahanoy basin, bounded to the north by the Suffolk Fault and the Girardville Anticline. The Draper colliery was developed in the north dip of the Mahanoy basin (also referred to as Gilberton in some reports and maps). The altitude of the surface is at 1138' and the altitude of the lowest level is -66' (Ash, et al., 1949). US BOM reports showed this mine inactive, operations ceased in 1938 (Reed, et al., 1987). Barrier Pillar IX, to the east, is effective up to an altitude of 670', where workings in the Boston Run and Gilberton (Draper) mines are interconnected on the north dip. Barrier Pillar XVII, to the west, is considered effective to an altitude of 977', the water level of the pool at the time. The barrier pillar is removed at 1183' in the Mammoth vein but solid in the Buck Mountain Vein and may still be effective up to this level. The mine pool elevations for the pool ranged between 975' (Ash, et al., 1949) and 997' controlled by deep well pumps in the St. Nicholas mine (Ash, et al., 1953). The mine pool was at 386.0 acres on all veins. At the time of the Mahanoy Creek SCARLIFT Report, the Tunnel Ridge pool had expanded to 394.8 acres on all veins at an elevation of 1116' (Sanders & Thomas, 1975).

Current average water levels at the Gilberton borehole are at 1100' on the south dip which expands the pool in this mine on the Buck Mountain Vein to approximately 144.8 acres on the south dip and 133.0 acres on the north dip (**Plate II and Table 1.**). 3 cross cut drainage tunnels connect the north dip to the south dip, 2 at approximately 100' in elevation and 1 at approximately 480', as seen in DMS maps 690 and 1512. Gilberton Power currently pumps approximately 1,200 gpm from the mine and PA DEP BAMR pumps 5,140 gpm to the Mahanoy Creek to maintain current water levels near 1100' and to prevent flooding in the town of Gilberton. The Gilberton colliery accepts and discharges water from multiple mines to the east and remains unconnected to mines north of the Suffolk fault (as seen in C Series 21 Cross Section C and OSM Folio W-9E-04-09 & Cross Section 2).

As reported in the PA DEP BAMR Abandoned Mine Land Inventory (AMLIS) database, a Priority 2 partially flooded strip pit exists in the southwest corner of the colliery near the barrier pillar above the pool in the Gilberton Problem Area (PA 1005 AMLF#5) with an estimated volume of 180,000 cu. yds. 3 slurry ponds also hold water in the problem area to the northeast. 2 of the ponds were sampled. One had a pH of 3.6 and 7 mg/l iron and the other had a pH of 3.3 and 14 mg/l iron (PA DEP, 1982-Present).

Pool 17: Lawrence Pool

The Lawrence colliery was developed in the Mahanoy basin, bounded to the north by the Suffolk Fault. The altitude of the surface is at 1160' and the altitude of the lowest level is 147' (Ash, et al., 1949). Barrier Pillar XVII, to the east, is considered effective to an altitude of 977', the water level of the pool at the time. The barrier pillar is removed at 1183' in the Mammoth vein but solid in the Buck Mountain Vein and may still be effective at current water levels. OSM Mine Map Folio W-8D-04 shows the breach. Barrier Pillar XXI, to the west, is effective up to an altitude of 986'. The mine pool elevation was reported as 973' (Ash, et al., 1949) (Ash, et al., 1953). The mine pool was at 265.9 acres on all veins and discharged at an unknown location on the surface. At the time of the Mahanoy Creek SCARLIFT Report, the Tunnel Ridge pool had expanded to 269.8 acres on all veins at an elevation of 1116'. The water in the mine was shown to be drawn toward the Gilberton Pump (Sanders & Thomas, 1975), which is a contradiction to the US BOM report.

Current average water levels at the Lawrence borehole on the south dip are at 1100' and 1095' on the north dip, which expands the pool in this mine on the Buck Mountain Vein by approximately an additional 41 acres on the south dip and 38 acres on the north dip (**Plate II and Table 1.**). OSM Mine Map Folio W-8D Cross Section 1 shows at least 2 cross cut drainage tunnels connect the north dip to the south dip, Basin Tunnel at 640' in elevation and No. 1 Tunnel at approximately 435' on the east side of the colliery. The Mammoth Vein

is also completely mined under the valley connecting one side to the other (as seen in C Series 21 Cross Section D). If Barrier Pillar XVII is still mostly solid below 1183', this colliery is most likely part of the Girard multi colliery hydrologic unit.

As reported in the PA DEP BAMR Abandoned Mine Land Inventory (AMLIS) database Maizeville/Mahanoy Plane Problem Area (PA 1004), there are several surface features that may be directly connected to the mine pool. Site visitors sampled a pipe discharge (AMLF #1) designed to dewater the deep mines during periods of high recharge. The pH was 3.9 with less than 1 mg/l of iron from the estimated 60 gpm flow. A flooded slurry area also exists within the problem area. A sample of the slurry area indicated a pH of 3.2 with 4 mg/l of iron. A priority 2 vertical opening (AMLF #12): the mine opening is funnel shaped with a surface opening of 25' by 35' and an unknown depth. The area around the opening is level with little vegetation. Sewage from the borough of Frackville is channeled into the mine opening at a flow estimated in excess of 100 gpm. The sewage level in the mine opening varies with the flow and at times overflows into a stripping pit (AMLF #5) located southwest of the opening and also flows directly into another strip pit (AMLF #6). These comments were last updated in March 1989 (PA DEP, 1982-Present).

Pool 18: West Bear Ridge Pool

The West Bear Ridge colliery was developed in the Mahanoy basin, bounded to the north by the Suffolk Fault. The altitude of the surface is at 1178' and the altitude of the lowest level is 370' (Ash, et al., 1949). US BOM reports showed this mine inactive, operations ceased in 1938 (Reed, et al., 1987). Barrier Pillar XXI, to the east, is effective up to an altitude of 986'. Barrier Pillar XXIV, to the west, has an unknown altitude of effectiveness. Water from pool 18 is assumed to seep through the barrier to pool 19 at an unknown altitude. The mine pool elevation was reported as 986' (Ash, et al., 1949) (Ash, et al., 1953). The mine pool was at 121.3 acres on all veins. At the time of the Mahanoy Creek SCARLIFT Report, the Tunnel Ridge pool had expanded to 126.7 acres on all veins at an elevation of 1116'. The water in the mine was shown to be drawn toward the Lawrence and to the Gilberton Pump (Sanders & Thomas, 1975), which is a contradiction to the US BOM report.

Current average water levels at the West Bear Ridge borehole are at 1068' on the south dip which expands the pool in this mine on the Buck Mountain Vein by approximately an additional 13 acres on the south dip and 14.7 acres on the north dip (**Plate II and Table 1.**). As seen on OSM Mine Map Folio W-8C and W-8B, at least 1 cross tunnel called Basin Tunnel connects the north dip and the south dip at about 880' on the east side of the colliery. The north dip and south dip are less separated on the west side of the colliery and

interconnected by at least 2 tunnels in the Mammoth Vein. However, OSM Folio W-8B Cross Section A shows a definite disconnect with the mines in the Packer #5 Basin, divided by a fault. This colliery is most likely part of the Girard multi colliery hydrologic unit.

Pool 19: Girard Pool

The Girard colliery was developed in the Mahanoy basin, bounded to the north by the Suffolk Fault and the Girardville anticline. The altitude of the surface is at 1083' and the altitude of the lowest level is 450' (Ash, et al., 1949). US BOM reports showed this mine inactive. Barrier Pillar XXIV, to the east, has an unknown altitude of effectiveness. Water from pool 18 is assumed to seep through the barrier to pool 19 at an unknown altitude. Barrier Pillar XXVII, to the west, is considered effective to an altitude of 986', the water level of the pool at the time. The report does not reference a breach above this level and may still be effective at current water levels. The pool discharges to the surface through the Girard Water Level Tunnel at elevation 986' (Ash, et al., 1949) (Ash, et al., 1953). The mine pool was at 175.5 acres on all veins. At the time of the Mahanoy Creek SCARLIFT Report, the Tunnel Ridge pool had expanded to 183.5 acres on all veins at an elevation of 1008' (Sanders & Thomas, 1975).

Although current average mine pool levels are not available through borehole data. It is believed that the pool is at least above 1005', the elevation of a seep discharging water between 1,800 gpm (Cravotta, 2005) and 3,600 gpm (Growitz, et al., 1985). This elevation expands the pool in this mine on the Buck Mountain Vein by approximately an additional 36.8 acres on the south dip and 19.9 acres on the north dip (**Plate II and Table 1.**). The Girard colliery accepts and discharges water from multiple collieries to the east. OSM Folio W-8A Cross Sections 1 & 2, W-8B Cross Section B and C Series 14 Cross Section B show a definite disconnect with the mines Packer #5 Basins, divided by a fault.

As reported in the PA DEP BAMR Abandoned Mine Land Inventory (AMLIS) database East Girardville Problem Area (PA 1002), the Girard Colliery seepage (AMLF #7) discharges directly into the creek and was given a Priority 2 since it contributes to local flooding on the east side of Girardville. There are two Priority 2 water filled strip pits in the problem area and above the mine pool. Known locally as the "B hole"(AMLF #1), this water filled strip pit is located 300' south of several residences and also the intersection of state highway routes SR4041 and SR4030. The pit measures 1600' x 400-600' wide and contains a water body measuring 1200' x 200-400' wide. A hydrographic survey measured a maximum depth of 80 feet with an average depth of about 40 feet. Analysis of water samples taken on 5/3/95 show the following average results: pH 7.3, total alkalinity 68 mg/l, SO4 total 92.5 mg/l, iron 724 ug/l, ferrous iron 20 ug/l, manganese 1019 ug/l, aluminum

<135 ug/l, total acidity 0 mg/l. It is situated about 75' east of another pit (AMLF #2) known locally as the "A hole". This pit is 600' south of residences in the borough of Girardville. It measures 2500' x 500' x 35-190' deep to the surface of a water body measuring 1700' x 75-300' wide. A hydrographic survey measured a maximum depth of 95 feet, with an average depth of about 50 feet. Analysis of water samples taken on 5/3/95 show the following average results: pH 7.2, total alkalinity 54 mg/l, SO₄ total 88 mg/l, iron 107 ug/l, ferrous iron 10 ug/l, manganese 395.5 ug/l, aluminum <135 ug/l, total acidity 0 mg/l. In 1990, a 26-year old man fell 100 feet off the highwall and died.

Pool 20: Preston #3 Pool

The Preston colliery was developed in the north dip and south dip of the Mahanoy basin and over the Girardville anticline to the north dip of the Girardville basin. The pool is bounded to the north by unmined coal deep in the Girardville basin and south dip of the Mahanoy basin. The altitude of the surface is at 1062' and the altitude of the lowest level is 434' (Ash, et al., 1949). US BOM reports showed this mine inactive. Barrier Pillar XXX to the west has an effective altitude of 872', which was the altitude of pool 21. Barrier Pillar XXVII to the east has an effective altitude of 986', which was the altitude of pool 19. There are no known breaches above the altitude of effectiveness of either of the barrier pillars, therefore both are assumed to be solid to the surface. The pool discharges to the surface through the Preston #3 Water Level Drift at elevation 948' (Ash, et al., 1949) (Ash, et al., 1953). The mine pool was at 117.1 acres on all veins. At the time of the Mahanoy Creek SCARLIFT Report, the Tunnel Ridge pool had expanded to 184.1 acres on all veins at an elevation of 958' (Sanders & Thomas, 1975).

No borehole exists in the basin to represent current water levels, but there is a Preston #3 Tunnel Discharge is at a surface elevation 960', which discharges water between 300 gpm (Cravotta, 2005) and 1050 gpm (Growitz, et al., 1985). Acid water is discharging from the Preston #3 Tunnel at a flow rate of 720 gpm with a pH of 6.5 and 14 mg/l iron. Acid water from the tunnel is channeled into the Preston Avenue storm system and then into Mahanoy Creek 400' away (PA DEP, 1982-Present). The current mine pool elevation is assumed to be 960'. This elevation expands the pool in this mine on the Mammoth Vein by approximately an additional 90.7 acres (**Plate II and Table 1.**). OSM Folio W-7C Cross Section C also indicates a Hunter Water Level Tunnel that is at a surface elevation of 1041'. OSM Folio W-7D Cross Section 1 and C Series 14 Cross Section C shows no fault but segregated workings divided by an anticlinal feature on the east side of the basin. Cross Section 2 shows tunnel connections through the anticlinal feature within the folio boundaries. OSM Folio W-7C Cross Section A, B, C & D and C Series 14 Cross Section D show underground mining in the Preston

separated from the Bast Colliery, to the north, by deep unmined coal diving from ~-650 to -800 feet on the Buck Mountain Vein. The Preston colliery is most likely isolated from other mines and has its own discharges.

As reported in the PA DEP BAMR Abandoned Mine Land Inventory (AMLIS) database East Girardville Southwest Problem Area (PA 2334), a flooded strip pit (AMLF #15) exists in the southwestern portion of the colliery. The pit is flooded and contributes to stream clogging in the problem area and flooding of Preston Avenue (PA DEP, 1982-Present).

Pool 21: Tunnel Pool

The Tunnel colliery was developed in the north dip of the Mahanoy basin. The western half of the mine was also known as the Bancroft colliery. The pool is bounded to the north by unmined coal deep in the Mahanoy basin that dives below -1000' as seen in C Series 13 Cross Section B&C. The altitude of the surface is at 993' and the altitude of the lowest level is 11' (Ash, et al., 1949). US BOM reports showed this mine inactive, operations ceased in 1891 (Reed, et al., 1987). Barrier Pillar XXX to the east has an effective altitude of 872', which was the altitude of the pool at the time. There are no known breaches above the altitude of effectiveness of the barrier pillar, therefore it is assumed to be solid to the surface. Barrier Pillar XXXV to the west has an effective altitude of 874', where there is a connection through the barrier pillar in the Mammoth vein to the Potts colliery. The pool discharges to the surface through a Water Level Tunnel at elevation 872' (Ash, et al., 1949) (Ash, et al., 1953) (also seen on OSM Folio W-7AA-XS2). The mine pool was at 104.6 acres on all veins. At the time of the Mahanoy Creek SCARLIFT Report, the Tunnel Ridge pool had expanded to 211.7 acres on all veins at an elevation of 879' and drained through Ashland #1(East), 2(West) & 3(Orchard Drift) Overflows (Sanders & Thomas, 1975).

Current water levels at the Tunnel borehole are at an average of 886' and only varied by 3' in a 20 year period. Tunnel borehole is drilled into the Little Tracy Vein and no mining void is shown in that vein or connected to that vein in that location (see W-7A). Mining does not exist under the main portion of Ashland and only extends into the upper portions of the Primrose in the Tunnel Colliery and the Little Orchard in the Bancroft section. It is undetermined how much this water level ties to the actual Tunnel mine pool, however at these levels; this elevation expands the pool in this mine on the Mammoth Vein by approximately an additional 3.1 acres. Currently there are 4 locations where water discharges from the Tunnel colliery all at a surface elevation 900'. Starting in the east, the Tunnel Mine seepage to ditch from spoil bank/pond (M22) discharges water at 13 gpm, the Tunnel Mine discharge from spoil bank/pond (M23) discharges water at 13 gpm, the Tunnel Mine drain pool area and storage (M24) discharges water at 58 gpm and Tunnel Mine

Orchard Drift overflow at Ashland sewage (M25) discharges water at 18 gpm (Cravotta, 2005). For comparison, the average discharge from the water level tunnel (M24) in 1975 was 112 gpm (Growitz, et al., 1985). Some influence may be coming from the Potts pool 25 over barrier pillar XXXV. Because of this interconnection it shares a multi colliery hydrologic unit with the Potts colliery.

Pool 22: Bast Pool

The Bast colliery was developed in the south dip of the Girardville and North (Wm. Penn) Basins. The Locust Gap (Germantown) Fault bisects the colliery separating the northern portion from the southern portion, but cross cut tunnels connect drainage across the fault (See C Series 13 Cross Section A). The pool is bounded to the south by unmined coal deep in the Mahanoy basin that dives below -650 to -1000' as seen in OSM Folio W-7C Cross Section A, B, C & D, C 14 XS D and C13 XS A, B&C. The altitude of the surface is at 1154' and the altitude of the lowest level is 16' (Ash, et al., 1949). US BOM reports showed this mine actively pumping even though operations ceased in 1934 (Reed, et al., 1987). Barrier Pillar XXVIII to the east has an effective altitude of 1146' where mine workings are connected on the Mammoth Vein. Barrier Pillar XXXIV to the west has an effective altitude of 780', which was the altitude of the pool at the time. There are no known breaches above the altitude of effectiveness of the barrier pillar, therefore it is assumed to be solid to the surface. Barrier Pillar XXXI to the north has an effective altitude of 885' where it is connected to the Germantown mine by a rock hole in the Mammoth Vein and the barrier pillar is removed above this elevation. The pool was pumped to the surface to an elevation between 757' (Ash, et al., 1949) and 780' (Ash, et al., 1953). The mine pool was at 533.1 acres on all veins. At the time of the Mahanoy Creek SCARLIFT Report, the Tunnel Ridge pool had expanded to 821.1 acres on all veins at an elevation of 901' and drained through Bast (Oakland) Tunnel (38), N. Preston (Preston #1) Tunnel (34) & N. Girardville (Preston #2) Overflow (31) Discharges (Sanders & Thomas, 1975). A discharge of approximately 309 gpm was reported (Growitz, et al., 1985).

Current water levels at the Bast borehole are at an average of 908' and only varied by 4' in a 20 year period. Bast borehole is drilled into the Diamond Vein and no mining void is shown in that vein in that location (See OSM Folio W-7B). It is undetermined how much this water level ties to the actual Bast mine pool, however at these levels; this elevation expands the pool in this mine on the Mammoth Vein to approximately 450.3 acres. Currently water discharges from 3 outlets, which are a little different from those reported in the SCARLIFT Report. The largest discharge is reported to be emanating at approximately 1795 gpm from the Oakland Tunnel (M21 & SCARLIFT 38) at a surface elevation of 900'. Moving east, the second

largest flow is approximately 1000 gpm from the Bast Mine Overflow (M20), locally known as the Ashland Fountain at a surface elevation of 910'. This borehole does not always flow and is noted as a second Bast Borehole #80 in the PA DEP BAMR borehole database. Further east is the smallest average discharge of 300 gpm from the Bast Mine Tunnel (M18 & SCARLIFT 34) at a surface elevation of 930' (Cravotta, 2005). This same discharge was labeled as Preston Water Level Tunnel at 923' on W-7C XSB. The Germantown – Locust Run Colliery is connected to the Bast colliery and these 2 mines make up the Bast multi colliery hydrologic unit.

Pool 23: Germantown (Big Mine Run-Locust Run-Merriam) Pool

The Germantown colliery was developed in the south dip of the North (Wm. Penn - Germantown) Basin. The altitude of the surface is at 1110' and the altitude of the lowest level is 725' (Ash, et al., 1949). US BOM reports showed this mine in active in 1949 and actively pumping in 1953. Operations ceased in 1960 (Reed, et al., 1987). Barrier Pillar XXXI to the south (eastern half known as Locust Run) has an effective altitude of 885' where it is connected to the Bast mine by a rock hole in the Mammoth Vein and the barrier pillar is removed above this elevation. Barrier Pillar XXXVI to the south (western half known as the Merriam) has an effective altitude of 1059'. There is a very small unnamed barrier pillar at the western tip as shown by the C Series 12 map. OSM folio W-600 confirms the barrier pillar and shows a gangway driven through it at 868', making this the effective altitude of the barrier pillar. The pool was at an elevation between 989' (Ash, et al., 1949) and 725' when the mine was pumped dry through a drainage gangway to the surface via the Centralia Tunnel (Ash, et al., 1953). The mine pool was at 78.5 acres on all veins. At the time of the Mahanoy Creek SCARLIFT Report, the Tunnel Ridge pool had expanded to 473.2 acres on all veins at an elevation of 901' and drained through Barrier Pillar XXXI to the Bast Mine (Sanders & Thomas, 1975).

Current water levels at the Germantown borehole are at an average of 976' and only varied by 5' in a 20 year period. Germantown borehole is drilled into the Mammoth Vein and is actually on the other side of the barrier pillar in the Bast Colliery. This borehole may actually still represent the level in the Germantown colliery since the mine pools are interconnected in this vein through a breach in barrier pillar XXXI at 885'. This elevation expands the pool on the Buck Mountain and Mammoth veins by 272.7 acres.

Centralia Tunnel runs through the colliery and is interconnected, but above current water levels. Buck Mountain Vein is above Centralia Tunnel See W-7J XS2 and C13 XSB. It intersects the Buck Mountain vein near the Northumberland/Schuylkill county boundary at an elevation above 1000' then travels through more solid

rock till the Mammoth Vein outcrop where it reaches the surface at 984'. This pool is connected to the Bast colliery MCU.

There is a pinch point as seen in mine maps near the Merriam shaft where gangways connect the drainage at 650' and above, but deeper mining occurred upslope to the west and may hold back water along barrier pillar XXXVI, represented on the surface as 2 water filled strip pits. South of the Merriam Shaft along the barrier pillar lies a water filled strip pit (AMLF #4) that is 1200' x 130' x 50' deep. A highwall on north side located 20' east of west end of pit and is 1100' x 50' high with an 85 degree stable slope with 25% revegetation. The feature is a priority 3 and exists in the Ashland Northwest Problem Area 4036 (which is the same as the Centralia Mine Fire). The second is a partially water filled strip pit (AMLF #17) that measures 1000' x 60' x 60' to the water surface. The impounded water area is in the eastern end and measures 200' x 60' x unknown depth. The access road to this feature takes a sharp turn at the eastern end of this pit, with a dirt mound placed as a deterrent to accessibility. However, the dirt mound is worn down and is used as a motocross jump, and can also be crossed by a four-wheel drive vehicle. The haul road then borders the south side within 5' of the 1000' long dangerous highwall to the western end of the pit. Site visitation is common with dirt bikes, four-wheel drive tracks, beer and soda cans, swimmers and dumpers. The area is heavily used for hunting also. The feature is a priority 2 and exists in the Merriam East Problem Area 3665 (PA DEP, 1982-Present).

Pool 24 & 25: Cambria and Potts Pools

The Potts colliery was developed in the north and south dip of the Mahanoy Basin and the south dip of the North Basin behind the Germantown Fault. The pool is split on the east side by unmined coal deep in the Mahanoy basin that dives below -900' as seen OSM Folio 6C and C13 XS C-E (no connection from north dip to south dip). 6B XS A & B and C12 XS C however, show 3 interconnecting rock tunnels at 252', 508-518' and 806'. The altitude of the surface is at 1,177' and the altitude of the lowest level is 9' (Ash, et al., 1949). US BOM reports showed this mine as active above the third level and actively pumping even though operations ceased in 1934 (Reed, et al., 1987). The pool is bound to the east on the south dip by barrier pillar XXXIV with an effective altitude of 780', which was the altitude of the Bast pool at the time. There are no known breaches above the altitude of effectiveness of the barrier pillar, therefore it is assumed to be solid to the surface. The pool is bound on the north dip to the east by barrier pillar XXXV which has an effective altitude of 874', where there is a connection through the barrier pillar in the Mammoth vein to the Tunnel colliery. The pool is bound to the north by barrier pillar XXXVI, with an effective altitude of 1059'. The pool is bound to

the west by barrier pillars XXXVIII, XL, and XLI with effective altitudes of 1135', 1059', and 1059' respectively. There were 2 pools that existed at the time of the US BOM Reports: Cambria and Potts. The Cambria pool was at an elevation of 1,085' and drained to the Potts pool, which was pumped to the surface to an elevation of 251' (Ash, et al., 1949) (Ash, et al., 1953). The Cambria pool was at 7.2 acres on all veins and the Potts pool was at 6.6 acres on all veins. At the time of the Mahanoy Creek SCARLIFT Report, the Cambria and Potts pools were combined and had expanded to 1111.2 acres on all veins at an elevation of 986'. The pool drained through Big Run #1(48) & Big Run #2 (49) Discharges (Sanders & Thomas, 1975). Big Run #1(48), also known as the Potts Mine West Breach, was reported to flow at 279 gpm. Big Run #2 (49), also known as the Potts Mine East Breach, was reported to flow at 1566 gpm (Growitz, et al., 1985).

Current water levels at the Potts borehole are at an average of 1002' in the Little Diamond Vein on the north dip and varied 13' over the past 20 years. This elevation expands the pool in this mine on the Mammoth Vein to approximately 236 acres on the south dip, 57 acres on the north dip and 130.5 acres behind the fault in the north basin for a total of 423.5 acres. Currently water discharges from 2 outlets, which are the same from those reported in the SCARLIFT Report, but the flows have changed. The largest discharge is reported to be emanating at approximately 1795 gpm from the Potts Mine West breach (M26 & SCARLIFT 48) at a surface elevation of 979'. Moving south, the smaller flow is approximately 130 gpm from the Potts Mine East breach (M27 & SCARLIFT 49), at a surface elevation of 980' (Cravotta, 2005). This pool is connected to the Tunnel pool.

Pool 26: Lavelle Pool

The Lavelle colliery was developed in the south dip of the Mahanoy Basin, but it exists only in the Buck Mountain and Lykens Valley Veins. The altitude of the surface is at 1,135' and the altitude of the lowest level is 849' (Ash, et al., 1949). The pool is bound to the north by barrier pillar XXXIX and to the east with barrier pillar XXXVIII both with an effective altitude of 1135', which was the altitude of the Lavelle pool at the time as it overflowed to the surface through a rock slope (Ash, et al., 1953). The Lavelle pool was at 11.2 acres on all veins. At the time of the Mahanoy Creek SCARLIFT Report, the pool was discharging in the same location, but it was called the Mowry Discharge at an elevation of 1080'. No boundaries were drawn to show the mine pool.

There are no boreholes that exist in the colliery, but the discharge at elevation 1080' remains and is known as the Lavelle Slope with a flow of 103 gpm. C-Series 12 Cross sections B & C do not show the mine, but cross section C shows the barrier pillar and mining in the Lykens Valley Vein. No current pools were drawn

based on this level because contours for the Buck Mountain and Lykens Valley veins are not available in this area. This pool is isolated from other pools and not connected to any multi-colliery hydrologic units.

Pool 27: Helfenstein Pool

Like the Lavelle colliery, the Helfenstein colliery was developed in the south dip of the Mahanoy Basin, but it exists only in the Buck Mountain and Lykens Valley Veins. The altitude of the surface is at 1,173' and the altitude of the lowest level is 996' (Ash, et al., 1949). The pool is bound to the north by the Locust Spring Fault, at an altitude of 1,173 where it is controlled by a water level tunnel to the surface at (Ash, et al., 1953). The Lavelle pool was at 11.2 acres on all veins. At the time of the Mahanoy Creek SCARLIFT Report, the pool was discharging in the same location, but it was called the Mowry Discharge at an elevation of 1080'. No boundaries were drawn to show the mine pool.

This volume explains the Western Middle Coal Field mine pool hydrology in Schuylkill County starting at the eastern tip up to the Schuylkill County border. Due to funding, unforeseen circumstances, and time constraints the explanation of Western Middle Field mine pool hydrology in Northumberland County and portions of Columbia County will be completed in another Volume.

Part 3. Water Budgets and Groundwater Volumes for Abandoned Underground Mines in the Western Middle Anthracite Coalfield, Schuylkill, Columbia, and Northumberland Counties, Pennsylvania— Preliminary Estimates with Identification of Data Needs

By Daniel J. Goode, Charles A. Cravotta III, Roger J. Hornberger, Michael A. Hewitt, Robert E. Hughes, Daniel J. Koury, and Lee W. Eicholtz

This report is included on the CD/DVD and can be found at the online link below.

USGS Website Online Link: <http://pa.water.usgs.gov/projects/groundwater/westernmiddle/>

Part 4. The Southern Anthracite Coal Field

Chapter 1. The Development of Mining, Mine Drainage, Tunnels, Shafts, & Multi-Colliery Hydrologic Units of the Southern Anthracite Coal Field

By Robert E. Hughes¹⁴, Roger J. Hornberger, P.G.¹⁵, Michael A. Hewitt¹⁶, Ian C. Palmer¹⁷, Daniel J. Koury¹⁸, Todd Wood¹⁹, and Jim Andrews, P.G.²⁰

This chapter intends to be a brief overview of the Southern Anthracite Coal Field as Part 4 of this report is devoted entirely to the Southern Anthracite Coal Field, the largest of the four coal fields as shown in **Figure 1.1**. The area of the Southern Anthracite Coal Field extends from a few thousand feet west of Wiconisco Township, Schuylkill County, on the western end, and eastward to a few thousand feet east of the town of Nesquehoning, Carbon County, on the eastern end of the field. The western end is divided into two lobes, commonly called the “fishtails” of the Southern Anthracite Coal Field. The northern and southern boundaries of most of the Coal Field, including the fishtails are usually well defined by mountainous terrain. For example, the northern lobe of the fishtail is defined by the Mahantango Mountain to the north. The southern boundary is defined by Beery Mountain. Another example is the margin of the eastern end of the Southern Coal Field, which is defined by the Nesquehoning Mountain in the north and Pisgah Mountain on the south. The area contained in the Southern Coal Field is 91.3 square miles.

¹⁴ Executive Director-Eastern Pennsylvania Coalition for Abandoned Mine Reclamation, Robert E. Hughes

¹⁵ Professional Geologist, Roger J. Hornberger, LLC

¹⁶ Program Manager-Eastern Pennsylvania Coalition for Abandoned Mine Reclamation, Michael A. Hewitt

¹⁷ Researcher, Ian C. Palmer

¹⁸ Environmental Program Manager, PA Department of Environmental Protection’s Bureau of District Mining Operations-Pottsville Office, Daniel J. Koury

¹⁹ Professional Engineer, PA Department of Environmental Protection’s Bureau of Abandoned Mine Reclamation-Wilkes-Barre Office, Todd Wood

²⁰ Professional Geologist, PA Department of Environmental Protection’s Bureau of District Mining Operations-Pottsville Office, Jim Andrews

The surface drainage basin characteristics of the Southern Field are more varied and complex than the other three coal fields. The area east of the Boroughs of Coaldale, Schuylkill County and Lansford, Carbon County, is within the Lehigh River drainage basin. The central portion of the Southern Anthracite Coal Field around the City of Pottsville, drains the headwaters tributaries of the Schuylkill River, southward as it exits the Southern Anthracite Coal Field towards the Schuylkill River flowing to Philadelphia. The western portion of the southern field drains westward taking in tributaries including the Wiconisco and Swatara Creek that eventually drain to the Susquehanna River. The surface drainage divide is near the village of Branchdale, a census designated place in Schuylkill County, within the boundaries of the Otto Colliery. Therefore, the Southern Anthracite Coal Field has substantial areas within the drainage basin of three major rivers.

Multi-colliery Hydrologic Units of the Southern Anthracite Coal Field

The Southern Anthracite Coal Field has **37** underground mine pools and **35** barrier pillars, and the mine pools contain a total of **37.5** billion gallons of mine water according to (Ash, 1953b). The Southern Anthracite Coal Field has several large multi-colliery units like those of the Western Middle Anthracite Coal Field, but the Southern Coal Field is mostly composed of smaller multi-colliery hydrologic units and individual mines with discharges.

The collieries of the Southern Anthracite Coal Field are shown in **Figure 4.1**. At the eastern end of the Southern Anthracite Coal Field, the Nesquehoning Colliery and the Lansford Colliery are an interconnected multi-colliery hydrologic unit, with the Lausanne Tunnel discharging directly to the Lehigh River. Moving westward, the Coaldale Colliery, Greenwood Colliery, Rahn Colliery, and Tamaqua Colliery form a multi-colliery hydrologic unit. The mine drainage discharge from this unit is adjacent to State Route 309 at the southern end of Tamaqua. West of Tamaqua, a multi-colliery hydrologic unit is formed by the Reevesdale Colliery, Tamaqua Lands Colliery, and the Newkirk Colliery. There are two mine drainage discharges from this unit, the Newkirk Tunnel and the Reevesdale Tunnel. The Newkirk mine workings and the Reevesdale workings are clearly interconnected according to the mine maps. However, the barrier pillar between these workings and the Mary D Colliery to the west, appears to be intact.

Interpretation of the mine maps from the abandoned Silver Creek and Eagle Hill Collieries gives an indication that the workings are interconnected. However, (Ash, 1953b) show the Silver Creek mine pool at an elevation of 814 feet and the Eagle Hill mine pool elevation of 680 feet. This large difference in the mine pool elevations indicates that the barrier pillar between these two collieries is intact. Therefore, they will be

interpreted as separate mine pools, unless additional field validation shows a similarity in the mine pool elevations.

The largest multi-colliery hydrologic unit in the Southern Anthracite Coal Field is the Minersville Synclitorium near the Borough of Minersville in Schuylkill County. This unit includes all of the collieries in the Hecshersville Valley, except the Repplier Colliery. The abandoned underground mines included in this unit are the Buck Run Colliery, Glendower Colliery, Richardson Colliery, Thomaston Colliery, Pine Knot Colliery, the Pine Hill, and the Oak Hill Collieries. The two major mine drainage discharges from this unit are the Pine Knot Tunnel and the Oak Hill boreholes. The Pine Knot Tunnel is the largest mine drainage discharge in the Southern Anthracite Coal Field.

The presence of a multi-colliery hydrologic unit involving the Lythe Colliery is in question. There is no major discharge from the Lythe Colliery, and it was extensively mined to a depth of -450 feet below sea level. (Ash, 1953b) state that there is no barrier pillar between the Lythe and Phoenix Park mines (p. 26), and that the Lythe Colliery pool drains into the Oak Hill pool (p.27). According to (Ash, 1953b), the Lythe mine pool and the Oak Hill mine pool are both at an elevation of 702 feet. They show the Phoenix Park mine pool to be at an elevation of 728 feet and overflowing through a drainage tunnel to the surface. Hence, the Lythe Colliery could be grouped with the Phoenix Park in a multi-colliery hydrologic unit or it may be grouped with the Oak Hill Colliery.

The Middle Creek Colliery and the Colket Colliery can be considered a multi-colliery hydrologic unit, despite the fact that they have separate discharge points and that there is 60 feet elevation difference between their mine pools. According to (Ash, 1953b), the Middle Creek mine pool is at an 885 feet elevation and the Colket mine pool is at a 945 feet elevation. There is no barrier pillar shown between these adjacent mines and the mine workings of the Middle Creek Colliery merge with the Colket Colliery workings.

A multi-colliery hydrologic unit comprising the Lincoln and Kalmia Collieries is the westernmost section of the southern fishtail of the Southern Anthracite Coal Field. The Lincoln Colliery has very extensive workings and the mine has a major mine discharge point at the Rowe Tunnel. Some large scale maps, including (Ash, 1953b), show a barrier pillar (i.e., XXV) between the Lincoln and the Kalmia Collieries. However, the mine maps in the archives of the PA DEP Bureau of Mine Safety show the Lincoln workings interconnected to the Kalmia workings, without any barrier pillar separating the two collieries. According to (Ash, 1953b) “no pool lies in the Kalmia, as its workings are above the drainage level, and the water flows through a tunnel to the surface.”

In the northern fishtail of the Southern Anthracite Coal Field, the Brookside Colliery and the Valley View Colliery form a multi-colliery hydrologic unit. The Brookside Colliery appears to have more extensive workings than the Valley View Colliery. However, the mine drainage from these two collieries is from the Valley View Tunnel, which emanates from the Brookside Colliery workings.

In the extreme western end of the Southern Anthracite Coal Field, the Williamstown Colliery and the Lykens-Short Mountain Colliery make up another multi-colliery hydrologic unit. The Williamstown Colliery contains the deepest mining in the Southern Anthracite Coal Field. The depth of mine development in the Southern Anthracite Coal Field was much greater than the Western Middle Anthracite Coal Field, as determined in this study of both Coal Fields. The greatest depth of mining in the Western Middle Anthracite Coal Field was in the Luke Fidler Colliery where a depth of -586.9 feet was reached.

For example, the deepest elevation found on the mine maps for the Colket Colliery is -945.8 feet, and the surface elevations range from about 1,100 feet to 1,400 feet. The Williamstown – Lykens Colliery to the greatest depth found on all of the mine maps for the Southern Anthracite Coal Field and the Western Middle Anthracite Coal Field. The Williamstown Colliery maps show that the lowest elevation of depth of underground mine development to be -1489.1 feet was reached on June 25, 1930 on the # 10 Level and the surface elevation of the Williamstown Shaft is approximately 1,000 feet. The vein of coal is the Lykens Valley No. 5 or the “Big Vein”, was 7 feet 10 inches thick at that point. The major drainage from the Williamstown Colliery is the Big Lick Tunnel. The Short Mountain or Lykens Colliery is the westernmost colliery in the Southern Anthracite Coal Field.

A more detailed report on the Southern Anthracite Coal Field will follow this report in the near future through a partnership with the Susquehanna River Basin Commission and EPCAMR. Additional funding and time will be necessary to complete the same amount of work and quality of work for the Southern Anthracite Coal Field by EPCAMR that was done in the Western Middle Anthracite Coal Field due to the gap analyses that was completed and the lack of similar available cross-sections, mining maps, historical mining reports, and hydrogeologic investigations in the southernmost Anthracite Coal Field.

The subsurface flow of groundwater and mine drainage is generally consistent with the surface water drainage areas described above. However, notable exceptions do exist. For example, the USGS topographic quadrangle map and field evidence shows Panther Creek in the area between Coaldale and Lansford flowing westward to a confluence with the Little Schuylkill River at Tamaqua. An intact barrier pillar in the underlying abandoned deep mine limits mine water flow to the west. The mine drainage east of the barrier pillar flows eastward to the Lausanne Tunnel, the mouth of which is directly adjacent to the Lehigh River. Therefore, the

surface water flows to one major water body (the Schuylkill River) and the ground-water or mine water flows to another major water body (the Lehigh River) (Gage, 1966). To examine this area on a more detailed scale, however, it may be determined that some portions of Panther Creek are a losing stream, or there may be some infiltration points where surface water enters the groundwater/mine water flow system.

It appears that the Southern Anthracite Coal Field had major colliery development from the early 1800's through the middle 1900's, consistent with the other three Coal Fields.

Chapter 2. Mine Drainage Discharges and Shafts of the Southern Anthracite Coal Field

By Robert E. Hughes¹⁵, Michael A. Hewitt¹¹, Jim Andrews, P.G.,¹² and Roger J. Hornberger, P.G.¹³

Abandoned Mine Drainage (AMD) Water Quality

The Southern Anthracite Coal Field has some mine drainage quality characteristics not found in the other three Anthracite Coal Fields. The Southern Anthracite Coal Field has an array of abandoned mine drainage sample site types that are similar to those of the Western Middle Anthracite Coal Field, as would be expected, and the range of flow characteristics is similar. However, the most acidic and alkaline mine drainage qualities found in PA DEP file of the Anthracite Region are from the Southern Anthracite Coal Field. These differences in drainage quality characteristics are not apparent in comparing the Southern Anthracite Coal Field to the Western Middle Anthracite Coal Field in the box plots in **Figure 2.6(a)(b)**.

The most acidic mine drainage sample found in the PA DEP files was a seep at the active deep mine, Shadle Coal Company in Tremont Township, Schuylkill County. That sample from November 1990 has a pH of 2.4, acidity of 1,540 mg/L, iron of 242 mg/L and aluminum of 0.107 mg/L. A later sample at the Shadle site in June 2001 had a pH of 3.7 and acidity of 542.8 mg/L; but despite the pH increase, iron was 165 mg/L and sulfate of 1,061.1 mg/L. The typical mine drainage sample in PA DEP files is tested for only iron, manganese and aluminum. The large database of abandoned Anthracite and Bituminous mine drainage discharges that was collected, compiled and described by Cravotta (Cravotta, 2008a) (Cravotta, 2008b) quantified 92 parameters, including flow. That database contained 41 mine water samples, of which 10 are from the Southern Anthracite Coal Field, including the Shadle mine site.

The most alkaline coal mine drainage sample in PA DEP files from the Anthracite Region found in the pumped Wadesville Shaft discharge from the Wadesville open pit mine near Saint Clair Borough, Schuylkill

¹⁵ Executive Director-Eastern Pennsylvania Coalition for Abandoned Mine Reclamation, Robert E. Hughes

¹¹ Program Manager-Eastern Pennsylvania Coalition for Abandoned Mine Reclamation, Michael A. Hewitt

¹² Professional Geologist, PA Department of Environmental Protection's Bureau of District Mining Operations-Pottsville Office, Jim Andrews

¹³ Professional Geologist, Roger J. Hornberger, LLC

County. A typical mine water sample from that mine dated August 14, 2003, had a pH of 6.0 and an alkalinity of 338.2 mg/L and sulfate of 717.4 mg/L. These high alkalinity samples appear to be localized to the Saint Clair area, including the Eagle Hill Shaft, which is east of Saint Clair Borough. The high Alkalinity is evidently attributable to thick calcareous sandstone.

The colliery boundaries within the Southern Anthracite Coal Field and the major streams are shown on **Figure 4.1**. All of these collieries are abandoned and some are interconnected multi-colliery hydrogeologic units. There are approximately 10 active underground mines, which are all small operations. They are spread throughout the Southern Anthracite Coal Field, but most of them are concentrated in the area between the Township of Jolliet, Schuylkill County, and Lykens Borough, Dauphin County.

There are many active surface mines in the Southern Anthracite Coal Field, and many abandoned pits, refuse piles and other abandoned mine land features. Almost all of these active surface mines would be considered remining operations. Remining can be an effective tool for abandoned mine drainage (AMD) abatement. This process includes the extraction of remaining coal reserves from previously mined lands. Through remining, these areas are reclaimed to today's standards and polluted discharges can often be eliminated, or at least improved. Financed partially or entirely by coal removal, little or no public funds are required. Remining, through government-financed construction contracts (GFCCs) and surface mining permits have resulted in very significant reclamation of abandoned mine lands in Pennsylvania and have resulted in substantial water quality improvements. The active mining characteristics of the Southern Anthracite Coal Field are not dramatically different from those of the Western Middle Anthracite Coal Field, except the Southern Anthracite Coal Field has two large open pit operations.

One was the Wadesville Mine of Reading Anthracite Company, near Saint Clair Borough. The Wadesville Mine has been in operation since before 1950. Reading Anthracite Company's origins date back to 1871, when its predecessor, the Philadelphia and Reading Coal and Iron Company (P. & R. C. & I.) was chartered. As a large publicly traded concern, P. & R. C. & I. had diverse industrial interests, which revolved primarily around its main business of railroading. P. & R. C. & I. changed its corporate title in 1956 to The Philadelphia & Reading Corporation, of which Reading Anthracite Company was one of its many operating divisions. In 1961, Philadelphia & Reading Corporation divested itself of its Anthracite coal interests, selling the Reading Anthracite company to its present owners, The Rich Family of Companies.

The other was the Lehigh Coal and Navigation Company (LCN) Mine near Tamaqua, Coaldale and Lansford Boroughs. The company was officially formed in 1820 with the merger of "The Lehigh Coal Company" and the "Lehigh Navigation Company" which both operated in the Lehigh Valley, PA from 1818

(Records, 1820-1965). It formerly operated two canals, the Lehigh Canal and the Delaware Division of the Pennsylvania Canal, and owned a railroad, the Lehigh and Susquehanna Railroad. They also built the Mauch Chunk and Summit Hill Switchback Railroad to move coal. It was founded by Josiah White (1780-1850) and Erskine Hazard (1790-1865). Coaldale Borough in the Panther Valley still has a bus stop, which boasts a billboard on one side reading, "Everybody's Goal Is Mine More Coal". BET Associates IV, doing business as Lehigh Natural Resources has taken over the operation at LCN and has acquired the 8,000 acre stripping operations permit. Both of these large open pit mines have permitted reserves that would allow them to continue mining far into the future.

Southern Anthracite Coal Field Shafts

Unlike the Western Middle Anthracite Coal Fields, the Southern Anthracite Coal Fields has more shafts than it does boreholes. There were **15** shafts that had surface and water elevation data associated with each for the Southern Anthracite Coal Field.

The **Nesquehoning No. 3 Shaft** is a 4-compartment shaft in the northeast corner of the underground mine workings. The surface elevation of the shaft is 1038.5'. The maximum water elevation was 602.7' in July 1982. The minimum water elevation was 598.6' in December 1975. The average water elevation in the shaft was 601'. The shaft water elevation range fluctuated by only 4', as shown in **Figure 3.1**. A 2-compartment **No. 2 Shaft** was located 500' to the southwest of the **No. 3 Shaft**. The **No. 2 Shaft** has a surface elevation of 1043' and a bottom elevation of 545.5'. The **No. 1 Shaft** was located 1700' south of the **No. 2 Shaft**, with a top elevation of 1074.86'. This shaft was near the southern end of several significant tunnels.

The **Lansford No. 4 Shaft** was the secondary shaft for that Colliery, with the **No. 6 Shaft** being the main shaft. The **No. 4 Shaft** was 500' southeast of the No. 6 Shaft. The **No. 6 Shaft** was adjacent to the main shaft tunnel. The **No. 4 Shaft** had a surface elevation of 1169'. The maximum water elevation was 623.2' in March 1976. The minimum water elevation was 619.2' in July 1975. The average water elevation in the shaft was 620.48'. The shaft water elevation range fluctuated by only 4', as shown in **Figure 3.2**. The **No. 4 Shaft** was a 5-compartment shaft. The **No. 6 Shaft** has a top elevation of 1165.4' and a bottom elevation of 152'.

The **No. 11 Rahn Shaft** was one of the shafts used in dewatering the large open pit mine on the Lehigh Coal & Navigation (LCN) Company property. The surface elevation of the shaft is at 1056.5' in elevation. The maximum water elevation was 746.4' in July 1982. The minimum water elevation was 613.7' in October 1977.

The average water elevation in the shaft was 680.59'. The shaft water elevation range fluctuated by 132', as shown in **Graph 3.3**. The water level in the shaft was frequently pumped down below the 700' level.

The **No. 12 Greenwood Shaft** was also known on some maps as the **No. 10 Shaft**. It was the main pumping center for the large open pit mine. The surface elevation is 1005' and the water was frequently pumped down to an elevation at or below 500'. The maximum water elevation was 727.4' in August 1975. The minimum water elevation was 505.7' in April 1980. The average water elevation in the shaft was 619.47'. The shaft water elevation range fluctuated by 221', as shown in **Graph 3.4**. This was the location at the main water treatment plant and Dorr thickener when they were pumping and treating the mine water.

The **Tamaqua No. 15 Shaft** was monitored for water levels, but the **No. 14 Shaft**, located 700' south of the **No. 15 Shaft** is the auxiliary treatment system that was used when the open pit mine was pumping and treating the mine water. The surface elevation is 1005.63'. The maximum water elevation was 737.93' in February 1979. The minimum water elevation was 609.33' in October 1977. The average water elevation in the shaft was 678.80'. The shaft water elevation range fluctuated by 129', as shown in **Graph 3.5**.

For the 10 remaining shafts, details of their connections within the mine are incomplete at this time due to the nature of where Roger J. Hornberger had come to a point where he was not able to complete the full review of the remaining maps and EPCAMR was not able to determine where he had left off. We didn't have any map references for the remaining 10 shafts for further review by the EPCAMR Staff. This review can be completed at a later date. What is important is the water monitoring elevation levels which EPCAMR was able to still obtain and create Figures for the remainder of the shafts. Some background information is presented here on those remaining 10 shafts.

The **Silver Creek Shaft** was monitored for water levels. The surface elevation is 949.2'. The maximum water elevation was 826.6' in March 1979. The minimum water elevation was 799.8' in September 1977. The average water elevation in the shaft was 809.23'. The shaft water elevation range fluctuated by only 27', as shown in **Graph 3.6**.

The **Eagle Hill Air Shaft** was monitored for water levels. The surface elevation is 737.4'. The maximum water elevation was 730.8' in January 1978. The minimum water elevation was 726.8' in . The average water elevation in the shaft was 809.23' in January 1981. The shaft water elevation range fluctuated by only 4', as shown in **Graph 3.7**.

The **Replier Shaft** was monitored for water levels. The surface elevation is 1095'. The maximum water elevation was 901.3' in March 1979. The minimum water elevation was 882.4' in July 1982. The

average water elevation in the shaft was 887.79'. The shaft water elevation range fluctuated by only 19', as shown in **Graph 3.8**.

The **Oak Hill Shaft** was monitored for water levels. The surface elevation is 812.9'. The maximum water elevation was 712.3' in March 1979. The minimum water elevation was 697.7' in January 1981. The average water elevation in the shaft was 705.19'. The shaft water elevation range fluctuated by only 14', as shown in **Graph 3.9**.

The **Lytle-Phoenix Park Shaft** was monitored for water levels. The surface elevation is 840.6'. The maximum water elevation was 738.9' in January 1978. The minimum water elevation was 630.1' in July 1975. The average water elevation in the shaft was 712.80'. The shaft water elevation range fluctuated by 109', as shown in **Graph 3.10**.

The **Otto Colliery-Primrose Shaft** was monitored for water levels. The surface elevation is 1005.7'. The maximum water elevation was 886' in March 1979. The minimum water elevation was 874.4' in November 1980. The average water elevation in the shaft was 880.55'. The shaft water elevation range fluctuated by only 12', as shown in **Graph 3.11**.

The **Otto Colliery-Otto Shaft** was monitored for water levels. The surface elevation is 964.1'. The maximum water elevation was 840.3' in November 1979. The minimum water elevation was 818.4' in November 1978. The average water elevation in the shaft was 823.08'. The shaft water elevation range fluctuated by only 22', as shown in **Graph 3.12**.

The **Middle Creek Shaft** was monitored for water levels, but was only monitored for two years in 1975 and 1976. Recent data is not available. The surface elevation is 985.2'. The maximum water elevation was 924.4' in April 1976. The minimum water elevation was 893.3' in September 1976. The average water elevation in the shaft was 909.39'. The shaft water elevation range fluctuated by only 31', as shown in **Graph 3.13**.

The **John Veth Shaft** was monitored for water levels, but has only two data points from August and October of 1975. Recent data is not available. The surface elevation is 872', as shown in **Graph 3.14**. Additional long term monitoring here is still necessary to get a better handle on the flow of the mine water.

The **Sayre Shaft** was monitored for water levels, but has only two data points from February and March of 1978. The surface elevation is 1175.06', as shown in **Graph 3.15**. Additional long term monitoring here is still necessary to get a handle on the flow of the mine water. **Table 3.16** shows a comprehensive summary table of the **Southern Anthracite Coal Field Shaft Water Level Dataset (1975-1982)**, with maximum

water elevations, minimum water elevations, average elevation of the water in the shafts, and the standard deviation of the data points.

Chapter 3. Mine Pool Hydrology in the Southern Anthracite Coal Field (Schuylkill and Dauphin County): Colliery, Basin(s), Pool(s), Borehole(s), Barrier(s), Discharge(s), Water-filled Pit(s)

By Robert E. Hughes¹⁶, Michael A. Hewitt¹¹, Jim Andrews, P.G.,¹² and Roger J. Hornberger, P.G.¹³

Due to funding, unforeseen circumstances, and time constraints the explanation of Southern Anthracite Coal Field mine pool hydrology in Schuylkill and Dauphin Counties will be completed in another Volume.

¹⁶ Executive Director-Eastern Pennsylvania Coalition for Abandoned Mine Reclamation, Robert E. Hughes

¹¹ Program Manager-Eastern Pennsylvania Coalition for Abandoned Mine Reclamation, Michael A. Hewitt

¹² Professional Geologist, PA Department of Environmental Protection's Bureau of District Mining Operations-Pottsville Office, Jim Andrews

¹³ Professional Geologist, Roger J. Hornberger, LLC

Conclusions from Existing Data, Future Data Needs, and Recommendations to Proceed Forward on Mine Water Reuse in the Anthracite Region of PA

By Robert E. Hughes¹ and Michael A. Hewitt¹⁷

Before the mine water resources can be more fully utilized, many questions will need to be answered, and industrial users, regulators, and the public must gain a better understanding of the value and potential impacts of using mine pool water. EPCAMR recommends that some of the areas that require further investigation should include:

- a) better characterization of the locations and volumes of mine pools on a regional level;
- b) better characterization of the variation in water quality parameters at various mine pools on a regional level;
- c) hydrological information relating to recharge rates of the mine pools;
- d) funding of more regional mine pool evaluations for industrial reuse and economic redevelopment within PA;
- e) provide a clearinghouse of reference documents and reports on mine pools, water quality, mining, AMD, water resources, coal mining, research and development, special investigations, and other materials that could be made available online in one location, such as the www.amrclearinghouse.org , www.treatminewater.com , www.epcamr.org site, in addition to the PA DEP website, www.dep.state.pa.us
- f) funding for water quality monitoring equipment and devices that can be fished down existing boreholes to obtain water quality data from various depths from within the mine pool complexes and multi-colliery hydrologic units
- g) the potential for ground surface subsidence as water is drawn down or removed from mine pools;
- h) additional support for private investment opportunities from the private sector in creating partnerships that can capitalize on the reuse of the mine pool water and the mineral extraction of the iron oxides, manganese oxides, and aluminum oxides most commonly found in our AMD Treatment Systems and on our stream beds upon precipitation outside of the mines;

¹ Executive Director-Eastern Pennsylvania Coalition for Abandoned Mine Reclamation, Robert E. Hughes

¹⁷ Program Manager-Eastern Pennsylvania Coalition for Abandoned Mine Reclamation, Michael A. Hewitt

-
- i) additional funding for GIS and 3-D Software packages and extensions that will drive the innovation of the mine mapping technology to the forefront of the mining industry;
 - j) increased partnerships with the mining sector to obtain additional mine pool maps and coal mining maps that are not necessarily proprietary to the company and would benefit the entire community where existing AMD problems within the watersheds exist where they operate;
 - k) provide funding for EPCAMR to train PA DEP District Mining, Professional Geologists, Surface Mine Inspectors, Water Pollution Biologists, GIS Technicians, and Hydrogeologists Staff on the use of Earthvision software;
 - l) the feasibility of using mine pools as heat sinks over several decades;
 - m) fund an re-establish a long term borehole and shaft monitoring program
 - n) develop actual costs associated with treatment, pumping, and piping mine pool water;
 - o) development of clear Federal and State policies on withdrawal of the mine pool water and the determination as to whether or not it is solution mining due to the dissolved mineral rich nature of the water;
 - p) additional boreholes drilled within each of the 4 coalfields to obtain better water elevation data across the mine pools;
 - q) funding for the replacement or daylighting of existing boreholes throughout the Coal Fields to obtain additional water elevation levels on a monthly or more frequent basis;
 - r) create an awareness campaign to alert local municipalities and PA Department of Transportation of the need to not tar patch, coat, seal, blacktop, or cap, boreholes within their road infrastructure system;
 - s) continued entry into the water quality database created by EPCAMR at the District Mining Offices throughout PA to develop a comprehensive digital and electronic copy of water quality data from the Surface Mine Permit files as opposed to continuing to file paper copies within the permit that do not lend themselves to interpretation graphically as they do in a database format that can be used in GIS;
 - t) create a Mine Map Index within the District Mining Offices that is available for public review based on colliery divisions and or mine pool multi-colliery hydrologic units;
 - u) evaluation of mine pool resources in other states for comparison; and
 - v) improve the coordination and sharing of information efforts on the subject of mine pool mapping between State and Federal agencies in collaboration with Colleges, Universities, EPCAMR, Deep Mine Safety, and the National Mine Map Repository so that maps are readily accessible.

Figures, Plates, Tables, Graphs, & Maps

Part 1. Chapter 1.

- Figure 1. Anthracite Coal
- Figure 1.1 The Anthracite Coal Fields
- Figure 1.2 Physiographic Provinces of PA
- Table 1. 2009 Anthracite State-wide Production Summary
- Figure 1.3 Knox Mine Disaster breakthrough at the River Slope Mine beneath the Susquehanna River
- Figure 1.4 Knox Mine Disaster PA Historical Museum Commission Marker Inscription
- Figure 1.5 Location of Large Capacity Pumps, Openings Where the Men Escaped, and Approximate Shore Line of Pool following River Break In

Part 1. Chapter 2.

- Figure 2.1 Distributions of PA Coals
- Figure 2.2 Principal Structural Features of the Anthracite Coal Fields
- Figure 2.3 The Geological Map of the Pottsville Quadrangle including several cross-sections of the Minersville Synclinorium showing the Llewellyn Syncline, the Donaldson Syncline, and numerous other structural features
- Figure 2.3(a) Cross-section of the Geologic Structure of the Allegheny Plateau
- Figure 2.3(b) Cross-section of the Geologic Structure of the Ridge and Valley Province
- Figure 2.4 Generalized Columnar Sections Showing Names, Average Thickness of Coals (in ft), and Intervals between Coal Beds in the PA Anthracite Coal Fields
- Figure 2.41 Map of Collieries in Wyoming Basin of the Northern Coal Field
- Figure 2.42 Schematic Diagram of Water Flow through the Mines (e.g. Barrier pillar breaches) in the Wyoming Basin
- Figure 2.43 Jeddo Tunnel Drainage System
- Figure 2.44 Water Discharge from the Jeddo Tunnel in Hazleton, and Wapwallopen Creek near Wapwallopen, PA, October 1, 1974 to September 30, 1975

Figure 2.45(a) Discharge from the Jeddo Tunnel-Water Years 1996-1998

Figure 2.45(b) Precipitation Data from the Hazleton Area 1996-1998

Part 1. Chapter 2.

Figure 2.5 Anthracite Production, 1890-1995

Figure 2.51 Typical Anthracite Underground Mining Practices

Figure 2.6 Stratigraphic Intervals from the Mammoth Coal Zone up to the Primrose Coal Bed at the Wadesville Site

Figure 2.7 A Schematic of the Outcrop at Mile Marker 138 along Interstate 81, near McAdoo, PA, Showing the Contact between the Mauch Chunk and Pottsville Formations

Map I-528 Miscellaneous Geological Investigations (4 sheets of maps and 2 sheets of cross-sections) by: (Wood, 1968a) titled *Geologic Maps of Anthracite-Bearing Rocks in the West-Central Part of the Southern Anthracite Field, Pennsylvania, Eastern Area (portions of the Minersville, Tremont, Pine Grove, and Swatara Hill Quadrangles)*

Map I-529 Miscellaneous Geological Investigations by: (Wood, 1968b) titled *Geologic Maps of Anthracite-Bearing Rocks in the West-Central Part of the Southern Anthracite Field, Pennsylvania, Western Area (Tower City and Valley View Quadrangles)*

Map I-681 Miscellaneous Geological Investigations (1 page map and 1 page of cross-sections) by: (Wood, 1972) titled *Geologic Maps of Anthracite-Bearing Rocks in the West-Central Part of the Southern Anthracite Field, Pennsylvania, Western Area (Pottsville Quadrangle)*

Map I-809 *Miscellaneous Geological Investigations* (1 page map and 1 page of cross-sections) by: (Wood, 1974a) titled *Geologic Maps of Anthracite-Bearing Rocks in the West-Central Part of the Southern Anthracite Field, Pennsylvania, Western Area (Tamaqua Quadrangle)*

Map I-737 Miscellaneous Geological Investigations (1 page map) by: (Wood, 1974) titled *Geologic Maps of Anthracite-Bearing Rocks in the West-Central Part of the Southern Anthracite Field, Pennsylvania, Western Area (Southern Half of Delano Quadrangle)*

Map I-689 Miscellaneous Geological Investigations by: (Wood, 1972a) titled *Geologic Maps of Anthracite-Bearing Rocks in the West-Central Part of the Southern Anthracite Field, Pennsylvania, Western Area (Northern Half of Orwigsburg Quadrangle)*

Part 1. Chapter 3.

- Figure 3.1** **Underground Mine Development of the Tunnel Ridge/Elmwood Colliery on the Bottom Split Mammoth Vein**
- Figure 3.10** **Interconnection of Numerous Coal Beds through Rock Tunnels from the William Penn Colliery**
- Figure 3.11** **6 Nearly Horizontal Tunnels Interconnecting 4 Coal Beds in the Weston Colliery**
- Figure 3.12** **No. 6 Tunnel Connecting the West Shenandoah Colliery to the Kohinoor Colliery on the Little Buck Vein**
- Figure 3.13** **Diagram Showing the Chutes, Breasts, and Gangways**
- Figure 3.14a** **A Counter Chute Shown from the East Bear Ridge Colliery**
- Figure 3.14b** **A Counter Gangway Used to Transport Coal from the Upper Chutes and Breasts Westward within the Richards Colliery**
- Figure 3.15** **A Portion of the Raven Run Colliery, where Slants have been Developed**
- Figure 3.16a** **Another Example of Slants from the William Penn Colliery**
- Figure 3.16b** **Rock Holes or Small Tunnel Features from the William Penn Colliery**
- Figure 3.17a** **Inclined Rock Holes Driven to the Gangway above in the Lawrence Colliery**
- Figure 3.17b** **Inclined Rock Holes to the Veins above the South Dip Side of the Lawrence Colliery**
- Figure 3.18** **Numbered Rock Holes Inclined to a Rock Gangway above and Ventilation Features from the Hammond Colliery**
- Figure 3.19** **3 Levels of Anthracite Mining on the Top Split of the Mammoth Coal Vein from the Locust Gap Colliery**
- Figure 3.2** **A Typical 4-Compartment Shaft in the Gilberton Colliery**
- Figure 3.20a** **Barrier Pillars in the Kohinoor and Keehley Run Colliery**
- Figure 3.20b** **A More Complex Barrier Pillar Configuration in the Mahanoy City Colliery**
- Figure 3.20c** **A Longitudinal Barrier Basin Pillar Maintained along the Strike in the Base of the Syncline from the Hammond and Packer #5 Collieries**
- Figure 3.21** **A “Stopped” Date Mining Development of Gangways and Breasts at the Edge of a Barrier Pillar**
- Figure 3.22** **The William Penn Colliery Barrier Pillars Shown being Robbed by Bootleg Miners**

-
- Figure 3.23** A Reservation Pillar from the Henry Clay-Sterling Colliery Showing a 1000' Square "Reservation Pillar" to Protect the 3-Compartment Hoisting Shaft and Numerous Key Surface Features including the Breaker and Pump House
- Figure 3.24** A Large Circulation Reservation Pillar surrounding the 3-Compartment Indian Ridge Shaft from the Indian Ridge Colliery
- Figure 3.25a** A Plunging Synclinal Basin from the Richards Colliery
- Figure 3.25b** A Pattern of Curving Gangways in a Plunging Syncline from the Pennsylvania Colliery
- Figure 3.26a** A Gently Dipping Longitudinal Barrier Pillar of Coal Located North of the Barrier Pillar in the Scott Colliery
- Figure 3.26b** A Different Configuration of the Barrier Pillar from the Scott Colliery, adjacent to the Pennsylvania Colliery
- Figure 3.3a** Two Shafts from the Kohinoor Colliery on the Little Buck Vein
- Figure 3.3b** Two Shafts from the Maple Hill Colliery
- Figure 3.4** 6-Compartment Shaft in the Sayre Colliery
- Figure 3.5** Cross Section of the Valley View Tunnel Showing the Synclinal Structure of the Bedrock
- Figure 3.6** Photo of the R & S Drift Entry, near Pottsville, PA
- Figure 3.7** A Portion of the Kaiers Mine Workings near the Kaiers Borehole
- Figure 3.8** Gangways on Two Lifts, with Chutes, Breasts, and Cross-Hatched Pillars in the Glen Burn Colliery, near Shamokin, PA
- Figure 3.9a** Drawing of the Saint Nicholas and Suffolk Collieries
- Figure 3.9b** Eastern Portion of the Saint Nicholas Colliery in the Buck Mountain Coal Bed with the Bottom Split of the Mammoth Coal Bed Overlaying the Buck Mountain Workings.
- Figure 13** A Portion of the Germantown or Locust Run Colliery Showing the Centralia Drainage Tunnel Running Diagonally Across the South Dip Workings from the Centralia Colliery to the North

Part 1. Chapter 4.

Part 1. Chapter 5.

- Figure 5.1 **Structure of the Wyoming Basin**
- Figure 5.2 **Map of the Lackawanna Basin Showing the Colliery Boundaries, Locations of Major Discharges, Locations of Boreholes, and Water Table Contours**
- Figure 5.3 **Two Typical Borehole Plate Covers Commonly Found in the Middle of Municipal Streets and State Highways throughout the Coal Fields**
-
- Figure 2.42 **Schematic Diagram of Water Flow through the Mines (e.g. Barrier pillar breaches) in the Wyoming Basin**
- Table 5.1 **8 Major Mine Discharges of the Lackawanna Basin of the Northern Anthracite Coal Field with Flows**
- Table 5.2 **8 Major Mine Discharges of the Wyoming Basin of the Northern Anthracite Coal Field with Flows**

Part 1. Chapter 6.

- Figure 6.1 **Jeddo Tunnel System**
- Figure 6.2 **Plan Map Showing the Jeddo Tunnel Drainage System and General Internal Flow Directions**
- Figure 6.3 **Water discharge from the Jeddo Tunnel in Hazleton, and Wapwallopen Creek near Wapwallopen, PA, October 1, 1974 to September 30, 1975**
- Figure 6.4 **Jeddo Tunnel Flow Data**
- Figure 6.5 **Precipitation Data from the Hazleton Area (1996-1998)**
- Table 2. **Flows of Mine Tunnels in the Eastern Middle Anthracite Fields, April 1975**

Part 1. Chapter 7.

Table 1.	Characteristics of Six Plants in Northeastern Pennsylvania Currently Using Mine Pool Water
Table 2.	Summary of Processes Used to Treat Mine Water
Figure 1.	Geothermal Mine Pool Heating System General Schematic-AIRE
Figure 2.	Explaining Marywood’s Geothermal Energy Usage and outside Photo of School of Architecture Wellhead
Figure 3.	How an Open Geothermal System Works
Figure 4.	AMD emanating from lamp posts in front of the John Wesley AME Zion Church
Figure 5.	The John Wesley AME Zion Church, Hill District, Pittsburg, PA
Figure 6.	Schematic of the Geothermal Vault Utilized at the John Wesley AME Zion Church
Figure 13.	Map Showing Schuylkill River Drainage and Key Features

Part 2. Chapter 1.

Figure 2.2.1	Colliery Boundaries of the Western Middle Anthracite Coal Field
Figure 2.6(a)(b)	Box Plots Showing Differences in pH and Sulfates from the 4 Anthracite Fields in Eastern PA

Part 2. Chapter 2.

Graph 2.1	Borehole #1B—Mahanoy City (Elevation vs Time)
Graph 2.2	Borehole #2—Maple Hill (Elevation vs Time)
Graph 2.3	Borehole #3—Vulcan-Buck Mountain (Elevation vs Time)
Graph 2.4	Borehole #4A —Tunnel Ridge (Elevation vs Time)
Graph 2.5	Borehole #5—St. Nicholas (Elevation vs Time)
Graph 2.6	Borehole #7—Kohinoor (Elevation vs Time)
Graph 2.7	Borehole #8—Gilberton (Elevation vs Time)
Graph 2.7A	Borehole #9A—West Bear Ridge (Elevation vs Time)
Graph 2.8	Borehole #10-Packer #5—Girardville (Elevation vs Time)
Graph 2.9	Borehole #11A—Indian Ridge-Indian Ridge and Shenandoah City (Elevation vs Time)
Graph 2.10	Borehole #12A—Burnside (Elevation vs Time)
Graph 2.11	Borehole #13B—Green Back-Buck Ridge #1 (Elevation vs Time)
Graph 2.12	Borehole #15—Scott (Elevation vs Time)

-
- Graph 2.13 Borehole #16—Reliance (Elevation vs Time)
- Graph 2.14 Borehole #17—Sioux-Sayre (Elevation vs Time)
- Graph 2.15 Borehole #18B—Parks No. 1 & No. 2 (Elevation vs Time)
- Graph 2.16 Borehole #21—Knickerbocker (Elevation vs Time)
- Graph 2.17 Borehole #24—Germantown (Elevation vs Time)
- Graph 2.18 Borehole #25—Bast (Elevation vs Time)
- Graph 2.19 Borehole #26A—Tunnel (Elevation vs Time)
- Graph 2.20 Borehole #28—Potts (Elevation vs Time)
- Graph 2.21 Borehole #30A—Richards Shaft [See Old Richards Shaft] (Elevation vs Time)
- Graph 2.22 Borehole #31—Greenough (Elevation vs Time)
- Graph 2.23 Borehole #32—Scott Ridge (Elevation vs Time)
- Graph 2.24 Borehole #33—Alaska (Elevation vs Time)
- Graph 2.25 Borehole #35—Colbert (Elevation vs Time)

Part 2. Chapter 2.

- Graph 2.26 Borehole #36—Enterprise (Elevation vs Time)
- Graph 2.27 Borehole #37A—Maysville (Elevation vs Time)
- Graph 2.28 Borehole #38—LukeFidler (Elevation vs Time)
- Graph 2.29 Borehole #40—Henry Clay-Sterling (Elevation vs Time)
- Graph 2.30 Borehole #42—Bear Valley (Elevation vs Time)
- Graph 2.31 Borehole #43-North Franklin (Elevation vs Time)
- Graph 2.32 Borehole #46-Lawrence (Elevation vs Time)
- Graph 2.33 Borehole #47A—Hammond (Elevation vs Time)
- Graph 2.34 Borehole #48—Richards Water Level Tunnel (Elevation vs Time)
- Graph 2.35 Borehole #49—Natalie (Elevation vs Time)
- Graph 2.36 Borehole #50—Hickory Ridge (Elevation vs Time)
- Graph 2.37 Borehole #52—Royal Oak (Elevation vs Time)
- Graph 2.38 Borehole #53—Nielsen (Elevation vs Time)
- Graph 2.39 Borehole #55—Excelsior (Elevation vs Time)
- Graph 2.40 Borehole #57—William Penn (Elevation vs Time)

Graph 2.41	Borehole #58A—Lawrence (Elevation vs Time)
Graph 2.42	Shaft—Old Richards Shaft [See BH #30A] Mahanoy City (Elevation vs Time)
Graph 2.43	Borehole E-31—Luke Fidler [See BH #38] (Elevation vs Time)
Graph 2.44	Pennsylvania Shaft (Elevation vs Time)
Graph 2.45	N-62—Centralia (Elevation vs Time)
Table 2.46	Western Middle Anthracite Coal Field Borehole Dataset (1982-2003)

Part 2. Chapter 3.

Plate I	Historic Mine Pools: Eastern Portion, Western Middle Anthracite Coal Field, Schuylkill Co.
Plate II	Current Mine Pools: Eastern Portion, Western Middle Anthracite Coal Field, Schuylkill Co.
Plate III	Multi-Colliery Hydrologic Units: Eastern Portion, Western Middle Anthracite Coal Field, Schuylkill Co.
Table 1.	Mine Pools and Multi-Colliery Hydrologic Units-Western Middle Anthracite Coal Field
Map C-3	Coal Investigations (3 sheets and 1 sheet of cross-sections) by: (Rothrock, 1950) titled <i>Geology of Anthracite in the West-Central Part of the Mount Carmel Quadrangle, Pennsylvania</i>
Map C-7	Coal Investigations (2 sheets and 1 sheet of cross-sections) by: (Rothrock, 1951) titled <i>Geology of Anthracite in the Southwestern Part of the Mount Carmel Quadrangle, Pennsylvania</i>
Map C-10	Coal Investigations (2 sheets and 1 sheet of cross-sections) by: (Rothrock, 1951) titled <i>Geology of Anthracite in the East-Central Part of the Mount Carmel Quadrangle, Pennsylvania</i>
Map C-12	Coal Investigations (2 sheets and 1 sheet of cross-sections) by: (Rothrock, 1953) titled <i>Geology of Anthracite in the Southeastern Part of the Mount Carmel Quadrangle, Pennsylvania</i>
Map C-13	Coal Investigations (1 sheet and 1 sheet of cross-sections) by: (Rothrock, 1953) titled <i>Geology of Anthracite in the Western Part of the Ashland Quadrangle, Pennsylvania</i>
Map C-14	Coal Investigations (1 sheet and 1 sheet of cross-sections) by: (Haley, 1954) titled <i>Geology of Anthracite in the Eastern Part of the Ashland Quadrangle, Pennsylvania</i>
Map C-19	Coal Investigations (1 sheet and 1 sheet of cross-sections) by: (Kehn, 1955) titled <i>Geology of Anthracite in the Eastern Part of the Shenandoah Quadrangle, Pennsylvania</i>

-
- Map C-21** **Coal Investigations** (1 sheet and 1 sheet of cross-sections) by: (Danilchik, 1955) titled ***Geology of Anthracite in the Western Part of the Shenandoah Quadrangle, Pennsylvania***
- Map C-25** **Coal Investigations** (1 sheet and 1 sheet of cross-sections) by: (Maxwell, 1955) titled ***Geology of Anthracite in the Western Part of the Delano Quadrangle, Pennsylvania***
- Map C-43** **Coal Investigations** (1 sheet and 1 sheet of cross-sections) by: (Wood, 1958) titled ***Geology of the Northern Half of the Minersville Quadrangle and Part of the Northern Half of the Tremont Quadrangle, Schuylkill County, Pennsylvania***
- Map C-46** **Coal Investigations** (1 sheet and 1 sheet of cross-sections) by: (Danilchik, et al., 1962) titled ***Geology of Anthracite in the Eastern Part of the Shamokin Quadrangle, Northumberland County, Pennsylvania***
- Map C-47** **Coal Investigations** (1 sheet and 1 sheet of cross-sections) by: (Arndt, 1963) titled ***Geology of Anthracite in the Western Part of the Shamokin Quadrangle, Northumberland County, Pennsylvania***
- Map C-48** **Coal Investigations** (1 sheet and 1 sheet of cross-sections) by: (Arndt, et al., 1963b) titled ***Geology of Anthracite in the Southern Part of the Trevorton Quadrangle, Northumberland County, Pennsylvania***

Part 4. Chapter 1.

Figure 4.1 **Colliery Boundaries of the Southern Anthracite Coal Field**

Part 4. Chapter 2.

- Graph 3.1 Nesquehoning No. 3 Shaft (Elevations vs Time)**
- Graph 3.2 Lansford No. 4 Shaft (Elevation vs Time)**
- Graph 3.3 Rhan No. 11 Shaft (Elevation vs Time)**
- Graph 3.4 Greenwood No. 12 Shaft (Elevation vs Time)**
- Graph 3.5 Tamaqua No. 15 Shaft (Elevation vs Time)**
- Graph 3.6 Silver Creek Shaft (Elevation vs Time)**
- Graph 3.7 Eagle Hill Air Shaft (Elevation vs Time)**
- Graph 3.8 Repplier Shaft (Elevation vs Time)**
- Graph 3.9 Oak Hill Shaft (Elevation vs Time)**
- Graph 3.10 Lytle-Phoenix Park Shaft (Elevation vs Time)**
- Graph3.11 Otto Colliery-Primrose Shaft (Elevation vs Time)**
- Graph 3.12 Otto Colliery-Otto Shaft (Elevation vs Time)**
- Graph 3.13 Middle Creek Shaft (Elevation vs Time)**
- Graph3.14 John Veth Shaft (Elevation vs Time)**
- Graph 3.15 Sayre Shaft (Elevation vs Time)**
- Table 3.16 Southern Anthracite Coal Field Shaft Water Level Dataset (1975-1982)**

Part 4. Chapter 3.

Bibliography

- ARIPPA. 2011.** ARIPPA. *ARIPPA*. [Online] April 4, 2011. [Cited: April 4, 2011.] www.arippa.org.
- Arndt, Harold H. and Danilchik, Walter and Wood, Jr., Gordon H. 1963b.** *Geology of Anthracite in the Western Part of the Shamokin Quadrangle, Northumberland County, Pennsylvania*. Washington DC : US Geological Survey, 1963b. Coal Investigations Map.
- Arndt, Harold H. and Wood, Jr., Gordon H. and Danilchik, Walter. 1963a.** *Geology of Anthracite in the Southern Part of the Trevorton Quadrangle, Northumberland County, Pennsylvania*. Washington DC : US Geological Survey, 1963a. Coal Investigations Map.
- Arndt, Harold H. and Wood, Jr., Gordon H., and Schryver, Robert F. 1973.** *Geologic Map of the South Half of the Shamokin Quadrangle, Northumberland and Columbia Counties, Pennsylvania*. Department of the Interior, US Geological Survey. Washington DC : US Geological Survey, 1973. Miscellaneous Geologic Investigations Map I-734.
- Arndt, Harold H. 1971b.** *Geologic Map of the Ashland Quadrangle, Columbia and Schuylkill Counties, Pennsylvania*. Department of the Interior, US Geological Survey. Washington DC : US Geological Survey, 1971b. Geologic Quadrangle Map-918.
- . **1971a.** *Geologic Map of the Mount Carmel Quadrangle, Columbia, Northumberland, and Schuylkill Counties, Pennsylvania*. Department of the Interior, US Geological Survey. Washington DC : US Geological Survey, 1971a. Geologic Quadrangle Map-919.
- Ash, S. H., et al. 1953.** *Barrier Pillars in the Western Middle Field Anthracite Region of PA*. Department of the Interior-Bureau of Mines. Washington DC : US Government Printing Office, 1953. p. 92, Bulletin 521.
- Ash, S. H., et al. 1950a.** *Inundated Anthracite Reserves: Eastern Middle Field of PA*. Bureau of Mines. Washington DC : US Government Printing Office, 1950a. p. 28, Bulletin.
- Ash, S.H. and Dierks, H.A., Kennedy, D.O., and Miller, P.S. 1956.** *Flood Prevention in Anthracite Mines, Anthracite Region of Pennsylvania-Projects No. 4 & 5*. Department of the Interior, US Bureau of Mines. s.l. : US Bureau of Mines, 1956. p. 23, Bulletin.
- Ash, S.H. and Eaton, W.L. 1948.** *Barrier Pillars in the Anthracite Region of Pennsylvania. Barrier Pillars in the Anthracite Region of Pennsylvania*. s.l. : Trans. American Institute of Mining and Metallurgical Engineering, 1948, Vol. 177, pp. p. 62-81.
- Ash, S.H. and Kynor, H.D. 1953b.** *Barrier Pillars in the Southern Field*. Department of the Interior. s.l. : US Government Printing Office, 1953b. Bulletin.
- Ash, S.H. and Link, H.B. 1953a.** *Surface-Water Seepage into Anthracite Mines in the Western Middle Field*. Department of the Interior, US Bureau of Mines. s.l. : US Bureau of Mines, 1953a. p. 26, US Bureau of Mines Bulletin 532.

-
- Ash, S.H. and Link, H.B., Romischer, W.M. 1954d.** *Surface-Water Seepage into Anthracite Mines in the Southern Field, Anthracite Region of Pennsylvania.* Department of the Interior, US Bureau of Mines. s.l. : US Bureau of Mines, 1954d. p. 52, US Bureau of Mines Bulletin 539.
- Ash, S.H. and Others. 1951.** *Acid Mine Drainage Problems, Anthracite Region of Pennsylvania.* s.l. : US Bureau of Mines, 1951. p. 72, US Bureau of Mines Bulletin.
- **1952.** *Barrier Pillars in the Lackawanna Basin, Northern Field, Anthracite Region of Pennsylvania.* s.l. : US Bureau of Mines, 1952. p. 115, US Bureau of Mines Bulletin.
- **1952.** *Core Drilling at Shaft Sites of Proposed Mine Water Drainage Tunnel, Anthracite Region of Pennsylvania.* s.l. : US Bureau of Mines, 1952. p. 43, US Bureau of Mines Bulletin.
- **1950c.** *Data on Pumping at the Anthracite Mines of Pennsylvania.* US Bureau of Mines. 1950c. p. 264.
- **1948.** *Flood Prevention Projects at Pennsylvania Anthracite Mines, Progress Report for 1945.* s.l. : US Bureau of Mines Report of Investigations #4288, 1948. p. 51, US Bureau of Mines Report of Investigations #4288.
- **1952.** *Surface Water Seepage into Anthracite Mines, Lackawanna Basin, Northern Field, Anthracite Region of Pennsylvania.* US Bureau of Mines. s.l. : US Bureau of Mines, 1952. p. 37, US Bureau of Mines Bulletin.
- **1949.** *Water Pools in Pennsylvania Anthracite Mines.* s.l. : US Bureau of Mines Technical Paper #727, 1949. p. 78.
- Ash, S.H. and Whaite, R.H. 1954c.** *Surface-Water Seepage into Anthracite Mines in the Wyoming Basin, Northern Field, Anthracite Region of Pennsylvania.* Department of Interior, US Bureau of Mines. s.l. : US Bureau of Mines, 1954c. p. 30, US Bureau of Mines Bulletin 534.
- Ash, S.H. 1954b.** *Barrier Pillars in the Wyoming Basin, Northern Field, Anthracite Region of Pennsylvania.* Department of the Interior, US Bureau of Mines. Washington DC : s.n., 1954b. p. 251, Bulletin.
- **1950b.** *Buried Valley of the Susquehanna River, Anthracite Region of Pennsylvania.* s.l. : US Bureau of Mines Bulletin #494, 1950b. p. 27.
- **1954a.** *Mine Drainage Problems, Anthracite Region of Pennsylvania.* Department of the Interior, US Bureau of Mines. Washington DC : s.n., 1954a. p. 46, Bulletin. Presented at Annual Meeting, New York, NY, AIME, February 15-18, 1954.
- Ash, S.H., et al. 1947.** *Flood Prevention Projects at Anthracite Mines.* US Bureau of Mines. s.l. : US Bureau of Mines, 1947. p. 51, Report of Investigations 4288.
- Ash, S.H., et al. 1950.** *Inundated Anthracite Reserves: Eastern Middle Fields of Pennsylvania.* US Bureau of Mines. s.l. : US Bureau of Mines, 1950. p. 28, US Bureau of Mines Bulletin 491.

-
- Assembly, PA General. 1965.** Anthracite Coal Mining Laws of PA Act 346. *Anthracite%20Coal%20Mining%20Laws%20of%20PA%20Act%20346.pdf*. [Online] November 10, 1965. [Cited: 6 12, 2011.] *Anthracite%20Coal%20Mining%20Laws%20of%20PA%20Act%20346.pdf*.
- Averitt, P. 1975.** *Coal Resources of the United States*. s.l. : US Geological Survey Bulletin B 1412, 1975.
- Balleron, P.G., Paula B., Kocher, Christopher M. and Hollowell, P.G., Jerrald R. 1999.** *Assessment of Conditions Contributing Acid Mine Drainage to the Little Nescopeck Creek Watershed, Luzerne County, PA and an Abatement Plan to Mitigate Impaired Water Quality in the Watershed*. Harrisburg : Susquehanna River Basin Commission, 1999. p. 203, Publication.
- Balleron, Paula B. 1999.** *Water Balance for the Jeddo Tunnel Basin*. Harrisburg : Susquehanna River Basin Commission, 1999. p. 34, Publication.
- Barnes, Ivan, Stuart, W. T. and Fisher, Donald W. 1964.** *Field Investigations of Mine Water in the Northern Anthracite Field PA*. Washington DC : US Government Printing Office, 1964. p. 13, Professional Paper 473-B.
- Barnes, J.H. and Sevon, W.D. 2002.** *The Geological Story of PA*. 4th. Harrisburg : PA Geological Survey, 2002. p. 44.
- Bolles, W.H. and Geyer, A.R. 1976.** *Pennsylvania Interstate 81 Geologic Guide*. Harrisburg : PA Department of Education, 1976.
- Brady, K.B.C and Hornberger, R.J., and Fleeger G. 1998.** *Influence of Geology on Postmining Water Quality:Northern Appalachian Basin*. 1998.
- Brown, R.L. and Parizek, R.R. 1971.** *Shallow Ground Water Flow Systems beneath Strip and Deep Coal Mines at Two Sites, Clearfield County, Pennsylvania*. The Pennsylvania State University. University Park : s.n., 1971. p. 207, Special Report of Research SR-84.
- Census, US Bureau of. 1960.** 1960.
- Chow, M.M. 1951.** *The Pennsylvania Mill Creek Limestone in Pennsylvania*. 4th Series. s.l. : Pennsylvania Geological Survey, 1951. p. 36.
- Clark, G.M. and Ciolkosz, E.J. 1988.** Periglacial geomorphology of the Appalachian Highlands and Interior Highlands South of the Glacial Border-A Review. *Geomorphology*. 1988, Vol. 1, pp. pp. 191 - 220.
- Cline, G.D. 1968.** *Geologic Factors Influencing Well Yields In a Folded Sandstone-Siltstone-Shale Terrain within the E. Mahangtongo Creek Watershed*. Department of Geosciences, The Pennsylvania State University. University Park : The Pennsylvania State University, 1968. Masters Thesis.
- Council, PA Anthracite. 2011.** PA Anthracite Council. [Online] 2011. [Cited: April 4, 2011.] www.paanthracite.com.

Cravotta, Charles A., III and Kirby, Carl S. 2004. *Effects of Abandoned Coal-Mine Drainage on Streamflow and Water Quality in the Shamokin Creek Basin, Northumberland and Columbia Counties, Pennsylvania, 1999-2001.* US Geological Survey, US Department of the Interior. Denver, CO : US Geological Survey, 2004. p. 63, Water Resources Investigations Report 03-4311.

Cravotta, Charles A., III and Ward, S., Koury, D., and Koch, R. 2004. *Optimization of Limestone Drains for Long-Term Treatment of Acidic Mine Drainage, Swatara Creek Basin, Schuylkill County, PA.* Proceedings of the 2004 National Meeting of the American Society of Mining and Reclamation and the 25th W. Virginia Surface Mine Drainage Task Force. Lexington : American Society of Mining and Reclamation, 2004.

Cravotta, Charles A., III and Watzlaf, G.R. 2002. *Design and Performance of Limestone Drains to increase pH and Remove Metals from Acidic Mine Drainage.* s.l. : Elsevier Science (USA), 2002. pp. pp 19- 66, Handbook.

Cravotta, Charles A., III. 2008a. Dissolved Metals and Associated Constituents in Abandoned Coal Mine Discharges, Pennsylvania, USA. *Applied Geochemistry* 23. s.l. : US Geological Survey, 2008a, pp. pp. 166-202. 2008a; 41 Anthracite Samples; 92 Parameters including flow; 10 from Southern Field.

— **2008b.** Dissolved Metals and Associated Constituents in Abandoned Coal Mine Discharges, Pennsylvania, USA. *Applied Geochemistry* 23. s.l. : US Geological Survey, 2008b, pp. PP. 203-226.

— **2001.** *Effects of Abandoned Coal-Mine Drainage on Streamflow and Water Quality in the Mahanoy Creek Basin, Schuylkill, Columbia, and Northumberland Counties, Pennsylvania, 2001.* US Geological Survey, US Department of Interior. Reston, VA : US Geological Survey, 2005. p. 66, Scientific Investigations Report 2004-5291.

— **2000.** *Relations among Sulfate, Metals, Sediment, and Streamflow Data for a Stream Draining a Coal-Mined Watershed in East-Central Pennsylvania.* Littleton : Society for Mining, Metallurgy, and Exploration, 2000. pp. pp. 401- 410.

— **2003.** *Size and Performance of Anoxic Limestone Drains to Neutralize Acidic Mine Drainage.* s.l. : Journal of Environmental Quality, 2003. pp. pp. 1277-1289.

Danilchik, Walter and Arndt, Harold H. and Wood, Jr., Gordon H. 1962. *Geology of Anthracite in the Eastern Part of the Shamokin Quadrangle, Northumberland County, Pennsylvania.* Department of the Interior, US Geological Survey. Washington DC : US Geological Survey, 1962. Coal Investigations Map C-46.

DCNR, PA. 2011. <http://www.dcnr.state.pa.us/topogeo/map13/map13.aspx>.
<http://www.dcnr.state.pa.us/topogeo/map13/map13.aspx>. [Online] 2011. [Cited: 6 12, 2011.]
<http://www.dcnr.state.pa.us/topogeo/map13/map13.aspx>.

— **2011.** www.dcnr.state.pa.us/topogeo/maps/map11.pdf . www.dcnr.state.pa.us/topogeo/maps/map11.pdf . [Online] 2011. [Cited: 6 12, 2011.] www.dcnr.state.pa.us/topogeo/maps/map11.pdf .

DEP, PA. 1998. *Coal Mine Drainage Prediction and Pollution Prevention in Pennsylvania*. Harrisburg : Commonwealth of Pennsylvania, 1998.

Dodge, C.H. and Edmunds, W.E. 2003. *Coal Geology and Description of US Coal Fields-Pennsylvania*. s.l. : Keystone Coal Industrial Manual, 2003. pp. pp. 583-601.

Dublin, Thomas and Licht, Walter. 2005. *The Face of Decline: The PA Anthracite Region of in the 20th Century*. New York : Cornell University Press, 2005. p. 277. ISBN-10: 0-8014-8473.

Edmunds, W.E. and Berg, T.M., Sevon, W.D., Piotrowski, R.C., Heyman, L., and Rickard, L.V. 1979. *The Mississippian and Pennsylvanian (Carboniferous) Systems in the United States-Pennsylvania and New York*. Department of the Interior , US Geological Survey. s.l. : US Geological Survey, 1979. pp. pp. B-1 - B-33, US Geological Survey Professional Paper 1110-B.

Edmunds, W.E. and Skema, V.W., and Flint, N.F. 1999. *The Geology of PA-Pennsylvanian (Part II. Stratigraphy and Sedimentary Tectonics)*. [ed.] C.H. Schultz. Harrisburg : PA Geological Survey and the Pittsburgh Geological Society, 1999. pp. pp. 149-169.

Eggleston, J.R. and Kehn, T.M., and Wood, Jr. G.H. 1999. *Anthracite-Part VII. Mineral Resources*. [ed.] C.H. Schultz. Harrisburg : Pennsylvania Geological Survey and Pittsburgh Geological Society, 1999. pp. pp. 458-469.

Energy Information Administration. 2008. *Annual Coal Report 2008*. 2008.

Fail, R.T. 1997a. *A Geologic History of the North-Central Appalachians. Part 1. Orogenesis of the Mesoproterozoic through the Taconic Orogony*. s.l. : American Journal of Science, 1997a. pp. 551-619.

— **1997b.** *A Geologic History of the North-Central Appalachians. Part 2. The Appalachian Basin from the Silurian through the Carboniferous*. s.l. : American Journal of Science, 1997b. pp. 729-761.

— **1998a.** *A Geologic History of the North-Central Appalachians. Part 3. The Alleghany Orogeny*. s.l. : American Journal of Science, 1998a. pp. 131-179.

— **1998b.** *A Geologic History of the North-Central Appalachians. Part 4. The Atlantic Wilson Cycle*. s.l. : American Journal of Science, 1998b.

Fail, R.T., and Nickelsen R.P. 1999. *Appalachian Mountain Section of the Ridge and Valley Province (Part III. Structural Geological Tectonics)*. Harrisburg : PA Geological Survey and Pittsburg Geological Survey, 1999. pp. 268-285. In: *The Geology of Pennsylvania*, Edited by Schultz, C.H..

Fenneman, N.M. and Johnson, D.W. 1946. *Physical Divisions of the United States*. s.l. : US Geological Survey, 1946.

Fenneman, N.M. 1938. *Physiography of Eastern United States*. New York : McGraw-Hill Book Company, Inc., 1938. p. 714.

Foundry, Neenah. 2011. <http://www.nfco.com/>. <http://www.nfco.com/>. [Online] 2011. [Cited: 6 12, 2011.] <http://www.nfco.com/>.

Fox, J.F. and Hornberger, R.J., and Smith, M.W. 2001. *Coal Remining Statistical Support Document*. Washington DC : US EPA, 2001. EPA-821-B-01-011.

Gage, James R., PE. 1966. *Drawing G411, Plan Showing Natural Drainage from Lansford Mine to Nesquehoning Mine into Lausanne Tunnel, also from Coaldale Mines, #10 Mine, Rahn Mine, and #14 Mine to Deep Well Pumps*. 1966.

Goode, Daniel J., et al. 2011. *Water Budgets and Groundwater Volumes for Abandoned Underground Mines in the Western Middle Anthracite Coalfield, Schuylkil, Columbia, and Northumberland Counties, Pennsylvania-- Preliminary Estimates with Identification of Data Needs*. U.S. Department of the Interior. Reston, VA : US Geological Survey, 2011. p. 54. Scientific Investigations Report 2010–5261.

Growitz, D.J., Reed, L.A., and Beard, M.M. 1985. *Reconnaissance of Mine Drainage in the Coal Fields of Eastern PA*. s.l. : US Geological Survey, 1985. p. 54, Water Resources Investigations Report 83-4274.

Hack, J.T. 1960. *Interpretation of Erosional Topography in Humid Temperate Regions*. 1960, Vols. 258-A, pp. pp. 80 - 97.

—. **1979.** *Rock Control and Tectonism--Their Importance in Shaping the Appalachian Highlands*. Department of the Interior, US Geological Survey. s.l. : US Geological Survey, 1979. pp. pp. B1 - B17, Professional Paper 1126-B.

Hollowell, J.R. and Koester, H.E. 1975. *Groundwater Resources of Lackawanna County, PA*. s.l. : PA Geological Survey, 1975. p. 106, 4th Series, Water Resource Report 41.

Hollowell, J.R. 1974. *Hydrology of the Abandoned Coal Mines in the Wyoming Valley, PA*. s.l. : US Geological Survey, 1974. p. 47, Open File Report 74-237.

—. **1999.** *Surface Overflows of Abandoned Mines in the Eastern Middle Anthracite Field*. Harrisburg, PA : Susquehanna River Basin Commission, 1999. p. 39, Publication No. 207.

Hollowell, Jerald A. 1971. *Hydrology of the Pleistocene sediments in the Wyoming Valley, Luzerne County, Pennsylvania*. Harrisburg : Commonwealth of Pennsylvania, Bureau of Topographic and Geologic Survey, 1971. p. 77.

Hughes, R.E. and Hewitt, M.A. 2011. *The Anthracite Coal Fields*. [Map]. Ashley, PA, USA : EPCAMR, 2011.

Hunt, C.B. 1974. *Natural Regions of the United State and Canada*. San Francisco, CA : W.H. Freeman and Company, 1974. p. 725.

Inners, J.D. and Fabiny, J.M. 1997. *Stop 1. PA 29 Road near Ashley: Coalbeds and calcrete in the Upper Llewellyn Formation.* s.l. : In: Geology of the Wyoming-Lackawanna Valley and its Mountain Rim, Northeastern Pennsylvania, 62nd Annual Field Conference of PA Geologists, 1997. pp. pp. 80-85.

Inners, J.D. 1988. *The Eastern Middle Anthracite Field In: Inners, J.D., ed., Bedrock and glacial geology of the north branch Susquehanna Lowland and the eastern Middle Anthracite Field Guidebook for the Annual Field Conference of Pennsylvania Geologists.* Harrisburg : Field Conference of Pennsylvania Geologists, 1988. pp. pp. 32 - 39.

Kehn, Thomas M. and Wagner, Holly C. 1955. *Geology of Anthracite in the Eastern Part of the Shenandoah Quadrangle, Pennsylvania.* Department of the Interior, US Geological Survey. Washington DC : US Geological Survey, 1955. Coal Investigations Map C-19.

Kemmering. 2008. 2008.

King, P.B. 1977. *The Evolution of North America.* s.l. : Princeton University Press, 1977. p. 197.

King, P.B. 1977. *The Evolution of North America.* New Jersey : Princeton University Press, 1977. p. 197.

Kochanov, W. 1997. *Stop 5. The Elmhurst Boulevard Pit and "The Stumps": Fossil plants and the remains of a Mississippian Paleoforest in the Mauch Chunk Formation.* s.l. : In: Geology of the Wyoming-Lackawanna Valley and its Mountain Rim, Northeastern Pennsylvania, 62nd Annual Field Conference of PA Geologists, 1997. pp. pp. 111 - 119.

Ladwig, K. J., et al. 1988. *Stratification in Water Quality in Inundated Anthracite Mines, Eastern PA.* Department of the Interior, Bureau of Mines. Washington DC : s.n., 1988. Report of Investigations 8837. I 28.23:8837.

LaRegina, James A. 1988. *The Mine Drainage Tunnels of the Eastern Middle Anthracite Field.* Bloomsburg : Bloomsburg University, PA Geological Survey, and the Eckley Miners' Village, 1988. p. 12. October 6, 7, 8, 1988.

Lattman, L.H. and Parizek, R.R. 1964. Relationship between Fracture Traces and the Occurrence of Groundwater in Carbonate Rocks. 1964, Vol. 2, pp. pp. 73 - 91.

Levine, J.R. and Slingerland, R. 1987. *Upper Mississippian to Middle Pennsylvanian Stratigraphic Section Pottsville, Pennsylvania.* s.l. : Geological Society of America Centennial Field Guide-Northeast Section, 1987. pp. pp. 59 - 63.

Lohin, Paul. 2009. Schuylkill Headwaters Association volunteer and EPCAMR Board of Trustee. [interv.] EPCAMR Staff Michael A. Hewitt and Robert E. Hughes. *Heckscherville Valley AMD Tour.* Minersville, 2009.

Lovell, H.L. and Gunnet, J.W. 1974. *Hydrogeological Influences in Preventing Control of Mine Drainage from Deep Coal Mining.* The Pennsylvania State University. s.l. : US Bureau of Mines, 1974. Special Research Report #SR-100.

- Maxwell, John A. and Rothrock, Howard E. 1955.** *Geology of Anthracite in the Western Part of the Delano Quadrangle, Pennsylvania.* Department of the Interior, US Geological Survey. Washington DC : US Geological Survey, 1955. Coal Investigations Map C-25.
- McGurl, Bernard, et al. 2001.** *Lackawanna River Watershed Conservation Plan.* Scranton : Lackawanna River Corridor Association, 2001.
- Meckel, L.D. 1967.** Origin of Pottsville Conglomerates (Pennsylvanian) in the Central Appalachians. 1967, Vol. 78, pp. pp. 223-257.
- **1970.** *Paleozoic Alluvial Deposition in the Central Appalachians-A Summary.* New York : Wiley Interscience, 1970. pp. pp. 49 - 67.
- MHSA, US. 1959.** http://www.msha.gov/District/Dist_01/Reports/Knox/cover.htm.
http://www.msha.gov/District/Dist_01/Reports/Knox/cover.htm. [Online] 1959. [Cited: 6 12, 2011.]
http://www.msha.gov/District/Dist_01/Reports/Knox/cover.htm.
- Miller, Donald L. and Sharpless, Richard E. 1985.** *The Kingdom of Coal: Work, Enterprise, and Ethnic Communities in the Mine Fields.* Philadelphia : University of PA Press, 1985. p. 360.
- NMMR. 2011.** National Mine Map Repository. *National Mine Map Repository.* [Online] 2011. [Cited: April 25, 2011.] www.mmr.osmre.gov.
- Normandeau Associates Inc. and URS. January 2006.** "2006 Interim Report for the Wadesville Mine Water Withdrawal and Streamflow Demonstration Project". for Exelon Generating Company LLC. January 2006.
- **April 2004.** "Year One (2003) Interim Report for the Wadesville Mine Water Demonstration Project". for Exelon Generation Company LLC. April 2004.
- Parizek, R.R. and Tarr, E.G. 1972.** *Mine Drainage Pollution Prevention and Abatement Using Hydrogeological and GeoChemical Systems.* Monroeville : Bituminous Coal Research, Inc., 1972. pp. pp. 56-82, Research Paper. Found in the 4th Symposium on Coal Mine Drainage Research.
- Parizek, R.R. and White, W.B., and Langmuir, D. 1971.** *Hydrogeology and Geochemistry of Folded and Faulted Rocks of the Central Appalachia type and Related Land Use Problems.* The Pennsylvania State University. University Park : s.n., 1971. Mineral Conservation Series, Circular 92.
- Parizek, R.R. 1976.** *Lineaments and groundwater, in Interdisciplinary Applications and Interpretations of EREP Data Within the Susquehanna River Basin.* SKYLAB EREP Inv. 475. s.l. : ORSER-SSL Tech. Report 2-76, 1976. pp. pp. 4.59 - 4.86. May 1, 1973 - November 30, 1975.
- **1971.** *Prevention of Coal Mine Drainage Formation by Well Dewatering.* PA Department of Environmental Resources, The Pennsylvania State University. s.l. : PA Department of Environmental Resources, 1971. Special Research Report SR-82. Removal of Water is easier and cheaper than treating the water after exposure to toxic elements.

-
- . **1979.** *User's Manual for Pre-Mining Plannign of Eastern Coal Mining. Mine Hydrology.* Cincinatti : US Environmental Protection Agency, 1979. p. 381. Vol. 4.
- Rachunis, W. and Fortney, G.W. 1959.** *Report of Major Mine Inundation Disaster - River Slope Mine - May Shaft Section, Schooley Colliery - Knox Coal Company, Incorporated - Port Griffith.* 1959.
- Records, Lehigh Coal and Navigation Company. 1820-1965.** *Lehigh Coal and Navigation Company Records.* 1820-1965.
- Reed, L. A., Beard, M. M. and Growitz, D. W. 1987.** *Quality of Water in the Mines in the Western Middle Coal Field, Anthracite Region, East-Central PA.* s.l. : US Geological Survey, 1987. p. 51, Water Resources Investigations Report 85-4038.
- Rodgers, J. 1970.** *The Tectonics of the Appalachians.* New York : John Wiley and Sons, 1970. p. 271.
- Sevon, W.D. 2000b.** *Physiographic Provinces of Pennsylvania-PA DCNR Map 13.* Harrisburg : PA Geologic Survey, 2000b. Map.
- . **2000a.** *Regolith in the Piedmont Upland Section, Piedmont Province, York, Lancaster and Chester Counties, Southeastetrn Pennsylvania.* 2000a. pp. pp. 223-241. Vol. 39.
- Siddiqui, S.H. and Parizek, R.R. 1971a.** *Evaluation of measurement errors by repeated pumping tests.* s.l. : Journal of Hydrology, 1971a. pp. pp. 182 - 191. Vol. 13.
- Siddiqui, S.H. and Parizek, R.R. 1971b.** *Hydrogeologic factors influencing well yields in folded and faulted carbonate rocks in central Pennsylvania.* s.l. : Water Resources Res., 1971b. pp. pp. 1295 - 1312. Vol. 7.
- Stefanenko, R. 1983.** *Coal Mining Technology: Theory and Practice.* s.l. : Society for Mining Metallurgy, 1983. ISBN 0895204045..
- Stingelin, Ronald W., Ph.D. 1984.** *Defining the Anthracite Resources of Northeastern Pennsylvania.* US Bureau of Mines. s.l. : US Bureau of Mines, 1984. Mining Research Contract Report J0333932. Certified Professional Geologist, 120 Ronan Drive, State College, PA 16801-7809-Resource Technologies Corporation.
- Stuart, W.T. and Simpson, T.A. 1961.** *Variations of pH with Depth in Anthracite Mine-Water Pools.* Department of the Interior, US Geological Survey. s.l. : US Geological Survey, 1961. pp. p. B-82 to B-84, Professional Paper 424-B.
- Thelin, G.P., and Pike, R.J. 1991.** *Landforms of the Conterminous United States-A Digital Shaded Relief Portrayal.* US Geological Survey. s.l. : US Geological Survey, 1991. p. 16. Map I-2206.
- Thornbury, W.D. 1969.** *Principles of Geomorphology.* 2nd. New York : John Wiley and Sons, 1969. p. 594.
- . **1965.** *Regional Geomorphology of the United States.* New York : John Wiley and Sons, 1965. p. 609.

- Veil, John A., Kuper, John M. and Puder, Markus G. September 2003.** *Use of Mine Pool Water for Power Plant Cooling.* US Department of Energy, National Energy Technology Laboratory. s.l. : Argonne National Laboratory, September 2003. p. 52.
- Wallace, Anthony F.C. 1981.** *St. Clair: A 19th Century Coal Town's Experience with a Disaster-Prone Industry.* Ithaca : Cornell University Press, 1981. p. 501. ISBN-0-8014-9900-3.
- Way, J.H. 1999.** *Appalachian Mountain Section of the Ridge and Valley Province (Part V. Physiography).* Harrisburg : PA Geological Survey and Pittsburg Geological Survey, 1999. pp. 352-361. In: *The Geology of PA,* Edited by Schultz, C.H..
- White, C.D. 1900.** *The Stratigraphic Succession of the Fossil Floras of the Pottsville Group in the Southern Anthracite Field, Pennsylvania.* Department of the Interior, US Geological Survey. s.l. : US Geological Survey, 1900. pp. 749- 953, Annual Report Part 2 (1898-99).
- White, I.C. 1903.** *The Appalachian Coal Field: The Conemaugh Series.* s.l. : West Virginia Geological Survey, Vol. 2, 1903. pp. 225-332, Report.
- Wolensky, R.P., Kenneth C. Wolensky, and Nicole H. Wolensky. 1999.** *The Knox Mine Disaster, January 22, 1959-The Final Years of the Northern Anthracite Industry and the Effort to Rebuild a Regional Economy.* 2nd Edition. Harrisburg : Commonwealth of PA, 1999. p. 164. ISBN 0-89271-081-0.
- Wood, Charles R. 1996.** *Water Quality of Large Discharges from Mines in the Anthracite Region of Eastern PA.* Done in cooperation with the PA DCNR's Bureau of Topographic and Geologic Survey. s.l. : US Geological Survey, 1996. p. 68, Water Resources Investigations Report 95-4243.
- Wood, G. H., Jr. and Bergin, M. J. 1970.** *Structural Controls of the Anthracite Region, PA.* 1970.
- Wood, G. H., Jr., Arndt, H. H. and Hoskins, D. M. 1963.** *Geology of the Southern Part of the PA Anthracite Region.* Annual Meeting of the Geological Society of America. s.l. : US and PA Geological Survey, 1963. p. 84, Field Trip Guide Book 4.
- Wood, G. H., Jr., et al. 1956.** *Subdivision of the Pottsville Formation in the Southern Anthracite Field, PA.* s.l. : American Association of Petroleum Geologists Bulletin, 1956. p. 19, Bulletin, Volume 40.
- Wood, G. H., Jr., Kehn, T. M. and Eggleston, J. R. 1986.** *Deposition and Structural History of the PA Anthracite Region.* s.l. : Geological Society of America, 1986. p. 16, Special Paper 210. in Lyons, P.C. and Rice, C.L. eds.,
- Wood, G. H., Jr., Trexler, J. P. and Kehn, T. M. 1969.** *Geology of the WestCentral Part of the Southern Anthracite Field and adjoining areas, PA.* s.l. : US Geological Survey, 1969. p. 150, Professional Paper 602.
- Wood, G.H., Jr. and Trexler, J.P., and Kehn, T.M. 1968.** *Geologic Map of the Minersville Quadrangle, Schuylkill County, Pennsylvania.* Department of the Interior, US Geological Survey. s.l. : US Geological Survey, 1968. Map.

- Wood, G.H., Jr. 1974.** *Geologic Map of Anthracite-bearing Rocks in the Southern Half of the Delano Quadrangle, Schuylkill County, Pennsylvania.* Department of the Interior, US Geological Survey. Washington DC : US Geological Survey, 1974. Miscellaneous Geologic Investigations Map I-737.
- . **1972a.** *Geologic Maps of Anthracite-Bearing Rocks in the West-Central Part of the Southern Anthracite Field, Pennsylvania, Western Area (Northern Half of Orwigsburg Quadrangle).* Department of the Interior, US Geological Survey. s.l. : US Geological Survey, 1972a. Miscellaneous Geological Investigations Map.
- . **1972.** *Geologic Maps of Anthracite-Bearing Rocks in the West-Central Part of the Southern Anthracite Field, Pennsylvania, Western Area (Pottsville Quadrangle).* Department of the Interior, US Geological Survey. s.l. : US Geological Survey, 1972. Miscellaneous Geological Investigations Map.
- . **1974a.** *Geologic Maps of Anthracite-Bearing Rocks in the West-Central Part of the Southern Anthracite Field, Pennsylvania, Western Area (Tamaqua Quadrangle).* Department of the Interior, US Geological Survey. s.l. : US Geological Survey, 1974a. Miscellaneous Geological Investigations Map.
- Wood, G.H., Jr., et. al. 1968b.** *Geologic Maps of Anthracite-Bearing Rocks in the West-Central Part of the Southern Anthracite Field, Pennsylvania, Western Area (Tower City and Valley View Quadrangles).* Department of the Interior, US Geological Survey. s.l. : US Geological Survey, 1968b. Miscellaneous Geological Investigations Map.
- . **1968a.** *Geologic Maps of Anthracite-Bearing Rocks in the West-Central Part of the Southern Anthracite Field, Pennsylvania, Eastern Area (portions of the Minersville, Tremont, Pine Grove, and Swatara Hill Quadrangles).* Department of the Interior, US Geological Survey. s.l. : US Geological Survey, 1968a. Miscellaneous Geological Investigations Map.

Shamokin Creek Feasibility Study References- Investigation of AMD Treatment, Water/Solids Reuse and Industrial Development: Feasibility Study for the Scotts Tunnel, Colbert Breach, Excelsior Overflow, and Maysville Borehole Discharges; Jonathan Dietz, Ph. D. (2011)

- Alder, P.R. and P.L. Sibrell. 2003.** *Sequestration of Phosphorous by Acid Mine Drainage Flocculation.* J, Environ. Qual. 32(3) 1122-1129.
- American Water Works Association, Research Foundation (AWWARF). 2000.** *Commercial Application and Marketing of Water Plant Residuals.* American Water Works Association, ISBN-1-58321-030-x. 180p.
- Aube, B. and J. Zinck. 2003.** *Lime Treatment of Acid Mine Drainage in Canada.* Presented and published at “Brazil-Canada Seminar on Mine Rehabilitation”, Florianopolis, Brazil. December 1-3, 2003.

Cravotta C. A. III, and Kirby, C.S, 2004. *Effects of Abandoned Coal Mine Drainage on Streamflow and Water Quality in the Shamokin Creek Basin, Northumberland and Columbia Counties, Pennsylvania, 1999-2001, U.S. Geological Survey Water- Resources Investigations Report 03-4311*

Diz, H.R., and C.E. Via. 2006. *The Selective Oxide System™: Acid Mine Drainage Treatment that avoids the Formation of Sludge.* Mine Water and the Environment, International Mine Water Association 2006. pp. 1-7.

Elliot, H.A. , B.A. Dempsey, D.W. Hamilton, and J.R. Dewolfe. 1990. *Land Application of Water Treatment Sludges; Impacts and Management.* AWWA Research Foundation and American Water Works Association, Denver CO.

Fish, D. and J. Dietz 2007. *Use of Iron Oxides Produced From the Treatment of Coal Mine Drainage as Adsorbents to Remove Phosphorous from Secondary Wastewater Effluent.* Final Report for OSM PA (AMD-04), Pennsylvania Department of Environmental Protection.

Gannet Fleming Coddry and Carpenter, Inc., 1972, Operation Scarlift: Mine Drainage Abatement Measures for the Shamokin Creek Watershed, Project # SL 113, prepared for the PA Department of Environmental Resources. Identifies 54 discharges; recommends 5 active treatment systems and earth-moving for drainage control; not implemented. This study provided an assessment of the watershed. No water treatment resulted from this study, and these data, by themselves, are inadequate for planning passive treatment.

Kostenbader, P.D. and G.F., Haines. 1970. *High-Density Sludge Treats Acid Mine Drainage.* Coal Age 45:9, p.90

Geoexchange. 2011. Information obtained from the www.geoexchange website between January 1 and April 15, 2011.

Heal, K., P.L. Younger, K. Smith, S. Glendinning, P. Quinn, and K. Dobbie. 2003. *Novel use of Ochre from Mine Water Treatment Plants to Reduce Point and Diffuse Phosphorus Pollution.* Land Contamination & Reclamation, 11(2) 145-152.

Hedin, R.S., & R.W. Nairn. 1992. *Designing and Sizing Passive Mine Drainage Treatment Systems.* U.S. Bureau of Mines, Pittsburgh Research Center, Pittsburgh, USA

Hemenway, S. 2008. *Anthracite Collieries and Railroads of the Western Middle Field.* 216pp. Garrigues House, Publishers. Laurys Station, PA.

Hong, B.D. and E.R. Slatick. 1994. *Carbon Emission Factors for Coal.* U.S. Energy Information Administration, Quarterly Coal Report. DOE/EIA-01212(94/Q1), Washington, D.C. pp. 1-8.

Ippiloto, J., M. Stromberger, K. Barbarick, and R. Bayley. 2007. *Water Residuals and Biosolids: Effect of Co-Application on Soil Phosphorous.* AWWA Research Foundation Report 91143, ISBN 97818433999834, 72pp.

Iron Oxide Technologies (IOT). 2009. *Innovative Ex-situ Activated Iron Solids Treatment & Enhanced Iron Oxide Recovery from Various Types of High Flow Acidic Mine Drainage.* Pennsylvania Department of Environmental Protection, Innovative Technology Grant OSM PA (AMD-04). Final Report. 202pp.

Kirby, C.S. 2002. *An Introduction to the Geographic Information System (GIS) Coverage of the Shamokin Creek Watershed with Emphasis on Mine Drainage*

Kirby C.S., Cravotta, C.A., Hedin, R.S., Entz C., Shamokin Creek Watershed Scarlift Site 21 AMD Treatment Design, Ranshaw PA

Wei, X., R.C. Viadero, and S. Bhojappa. 2008. *Phosphorous Removal by Acid Mine Drainage Sludge from Secondary Effluent of Municipal Wastewater Treatment Plants.* Water Res. 42(13):3275-84

Martel, C.J. and C.J. Diener. 1991. *A Pilot-scale Study of Alum Sludge Dewatering in a Freezing Bed.* J. Amer. Water Works Assoc. 82(12):51-55

Mortula, M., M.K. Gibbons, C.B. Lake and G.A. Gagnon. 2006. *The Reuse of Alum Residuals for Wastewater Treatment: Effects on Aluminum Leachability.* National Research Council Centre for Sustainable Infrastructure, Regina, Canada. pp. 615-621.

Sanin, F.D., W.W. Clarksin, and P.A. Vesilind. 2011. *Sludge Engineering: The Treatment and Disposal of Wastewater Sludges.* DEStech Publications, Inc. Lancaster, PA, U.S.A. 388p.

Sibrell, P.L., G.A. Montgomery, K.L. Ritenour, and T.W. Ticker. 2009. *Removal of Phosphorous from Agricultural Wastewaters using Adsorption Media prepared from Acid Mine Drainage Sludge.* Water Research 43: 2240-2250.

Sibrell, P.L., B. Watten, and T. Boone. 2003. *Remediation of Acid Mine Drainage at the Friendship Hill National Site with a Pulsed Limestone Bed Process.* pp.1823-1838, In Volume 2: Electrometallurgy and Environmental Hydrometallurgy, from the Hydrometallurgy 2003 - Fifth International Conference.

Skousen, J.G. and P.F. Ziemkiewicz. 1995. *Acid Mine Drainage Control and Treatment.* West Virginia University, National Mined Land Reclamation Center. Morgantown, WV. 198pp.

Tchobanoglous, G. and F.L. Burton. 1991. *Wastewater Engineering: Treatment, Disposal, and Reuse.* McGraw-Hill Book Company, New York. 1334p.

United States Department of Energy (USDOE). 2008. *Ground Source Heat Pumps: Market Status, Barriers to Adoption, and Actions to Overcome Barriers.* U.S. Department of Energy, EERE Geothermal Technologies Program, ORNL/TM-2008/232. 46pp.

United States Environmental Protection Agency (EPA). 1983. *Design Manual: Neutralization of Acid Mine Drainage.* Office of Research and Development, Industrial Environmental Research Laboratory. Cincinnati, OH. EPA-600/2-83-001. 231p.

Watzlaf, G.R. and T.E. Ackman. 2007. *Flooded Underground Coal Mines: A Significant Source of Inexpensive Geothermal Energy, Reclamation Matters.* Issue 1 pp.1-7. Vol. 25, No. 1 pp. 1-14. U.S. Department of Energy, National Energy Technology Lab, Pittsburgh, PA.

Winner Global Energy & Environmental Services (WGE&ES). 2008. *In situ Treatment of Abandoned Mine Drainage utilizing Indigenous Bacteria in a Reducing Environment; Initial Bench Study Phase I.* Pennsylvania Department of Environmental Protection, Innovative Technology Grant OSM PA (AMD-04). Final Report Submitted by Western Pennsylvania Coalition for Abandoned Mine Reclamation. 23pp.

Winner Global Energy & Environmental Services (WGE&ES). 2009. *AMD Value Extraction Process.* Pennsylvania Department of Environmental Protection, Innovative Technology Grant GR# 410003675. Final Report. 169pp.

Jones, G. 2006. *Pumping Station Design.*