

18

MEDSUDMED - TECHNICAL DOCUMENTS

Identification sheets of early life stages of bony fish (Western Libya, Summer 2006)

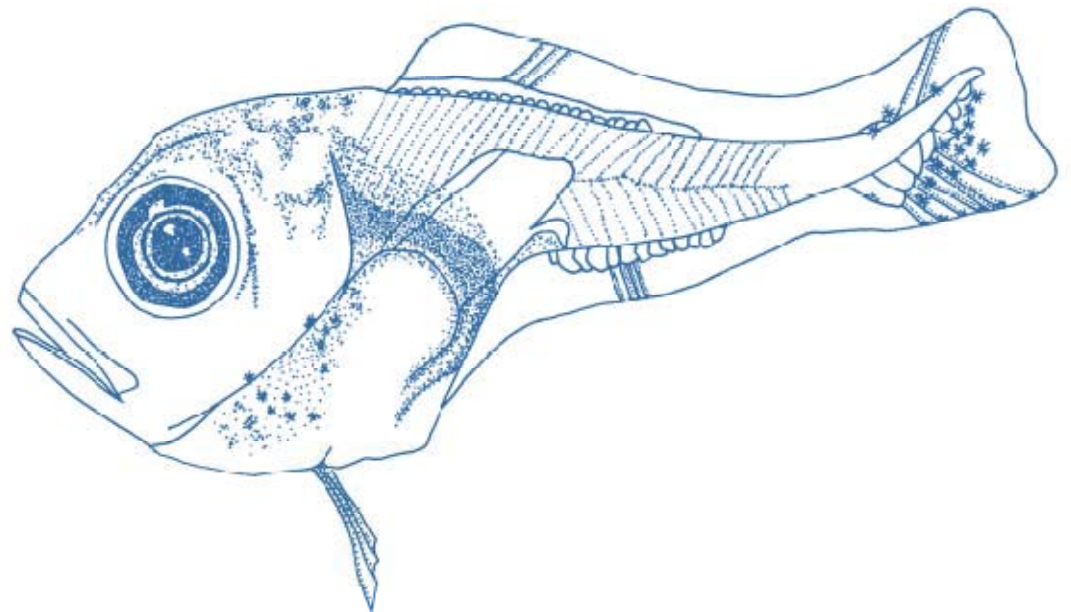

Cover photograph:

Larva of *Brama brama*. Courtesy of Mariangela Borghi.



MedSudMed

GCP/RER/010/ITA

Identification sheets of early life stages of bony fish
(Western Libya, Summer 2006)

The conclusions and recommendations given in this and in other documents in the *Assessment and Monitoring of the Fishery Resources and Ecosystems in the Straits of Sicily* Project series are those considered appropriate at the time of preparation. They may be modified in the light of further knowledge gained in subsequent stages of the Project. The designations employed and the presentation of material in this publication do not imply the expression of any opinion on the part of FAO or MiPAAF concerning the legal status of any country, territory, city or area, or concerning the determination of its frontiers or boundaries.

Preface

The Regional Project “Assessment and Monitoring of the Fishery Resources and the Ecosystems in the Straits of Sicily” (MedSudMed) is executed by the Food and Agriculture Organization of the United Nations (FAO) and funded by the Italian Ministry of Agriculture and Forestry Policies (MiPAAF). The Italian Regione Siciliana funded a project aimed at strengthening MedSudMed’s effectiveness on issues related to demersal resources, namely crustaceans for 18 months, starting from May 2011.

MedSudMed promotes scientific cooperation between research institutions of the four participating countries (Italy, Libya, Malta and Tunisia), for the continuous and dynamic assessment and monitoring of the state of the fisheries resources and the ecosystems in this area of the Mediterranean.

Research activities and training are supported to increase and use knowledge on fisheries ecology and ecosystems, and to create a regional network of expertise. Particular attention is given to the technical coordination of the research activities between the countries, which should contribute to the implementation of the Ecosystem Approach to Fisheries. Consideration is also given to the development of an appropriate tool for the management and processing of data related to fisheries and their ecosystems.

MedSudMed Project
FAO-FIRF
viale delle Terme di Caracalla
00153 Rome, Italy

Tel: +39 06 570 56092/54492/55386

Fax: +39 06 57055188

E-mail: medsudmed@fao.org

URL: <http://www.faomedsudmed.org>

GCP/RER/010/ITA Publications

The MedSudMed Project publications are issued as a series of Technical Documents (GCP/RER/010/ITA/MSM-TD-00) related to meetings, missions and research organized by or conducted within the framework of the Project.

Comments on this document would be welcomed and should be sent to the Project headquarters:

MedSudMed Project
FAO-FIRF, Room C351/352
Viale delle Terme di Caracalla
00153 Rome, Italy
medsudmed@fao.org

For bibliographic purposes this document
should be cited as follows:

MedSudMed. 2011. Identification sheets of early life stages of bony fish (Western Libya, Summer 2006). GCP/RER/ITA/MSM-TD-18. *MedSudMed Technical Documents* No 18: 251pp.

Preparation of this document

This document is the final version of the MedSudMed catalogue on the identification of fish larvae collected during the ichthyoplankton survey carried out on board the R/V Urania from 12 to 24 August 2006 in Libyan waters and organised in the framework of the FAO-MedSudMed Project (*Assessment and Monitoring of the Fisheries Resources and the Ecosystems in the Straits of Sicily*).

The survey and the preparatory work of this catalogue (i.e. fish larvae sorting and identification, and document preparation) were conducted within the MedSudMed Project component on “Small Pelagic Fish: Stock Identification and Oceanographic Processes Influencing their abundance and distribution”, in collaboration with the Istituto per l’Ambiente Marino Costiero (IAMC-CNR of Mazara del Vallo, Italy) and the Marine Biology Research Centre (MBRC of Tajura, Libya).

The catalogue aims at providing baseline indications for the identification of the species that were collected in 2006 in the area covered by the survey. The document is largely based on experience gained by IAMC-CNR and MBRC in the identification of fish larvae in the Straits of Sicily. It is of primary importance for the scientific institutions participating in the MedSudMed Project. The document is intended to assist in the identification of fish larvae in the waters of the countries bordering the Straits of Sicily (Italy, Libya, Malta and Tunisia). The catalogue may also be of interest for students and professionals of fisheries research, particularly in the field of ichthyoplankton identification. However, the document does not intend to be exhaustive nor representative of all bony fish species of the Strait of Sicily. Interested readers may find the literature given in Chapter 5 useful.

The catalogue is to be considered an output of the FAO-MedSudMed Project “Assessment and Monitoring of the Fishery Resources and the Ecosystems in the Strait of Sicily”. It is hoped that with this document a contribution is made towards the standardisation of fish larvae identification, in order to better understand the location (i.e. active and passive migration) of fish stocks in the southern-central Mediterranean.

The following authors contributed to the preparation of the document: Cuttitta, A., Zgozi, S., Bonanno, A., Basilone, G., Turki, A., Patti, B., Gmati, H., Buscaino, G., Hamza, M., Caruana, L., Patti, C., Mazzola, S., Tirelli, V., Borme, D., Amato, M., and Borghi, M.

Acknowledgements

All scientists and staff of the Marine Biology Research Centre of Tajura (Tripoli, Libya) and of the Consiglio Nazionale per le Ricerche (CNR, Italy) are gratefully thanked for the support in the planning and execution of the activities which have led to the preparation of this document.

MedSudMed. 2011.

Identification sheets of early life stages of bony fish (Western Libya, Summer 2006).

MedSudMed Technical Documents No 18. GCP/RER/ITA/MSM-TD-18, Rome, 2011. 251 pp.

ABSTRACT

This document describes the morphological and taxonomical characteristics of early life stages of bony fish collected during the MedSudMed ichthyoplankton survey which was carried out in Libyan waters on board the R/V Urania in August 2006.

The survey and data processing were conducted in the framework of the MedSudMed Project and in cooperation between the Institute for Coastal Marine Environment of the National Council for the Research (Italy) and the Marine Biology Research Centre (Libya).

The document is structured in order to provide the readers with the baseline knowledge for the identification of fish larvae found in the seas bordering the Libyan coasts. In particular, in Chapters 1 and 2 an introduction to the ecological relevance of ichthyoplankton and on the water mass circulation in Libyan waters are respectively reported, as well as a description of the materials and methods used to sample, store and identify fish larvae. Chapter 3 describes the criteria and technical background necessary for the species identification and the main morpho-biometric characteristics used to describe the fish larvae. In Chapter 4 a description of the larvae collected during the survey along the Libyan waters is provided according to a systematic classification. An overview of the references on this topic is also included in the document (Chapter 5).

Table of Contents

Preparation of this document	iv
Acknowledgements.....	v
Table of Contents	vi
1. Introduction.....	1
1.1. Studies on ichthyoplankton	1
1.2. Ecological importance of ichthyoplankton.....	1
1.3. Hydrological characteristics of the western Libyan sea.....	2
2. Material and methods: collection, preservation and identification of fish larvae	6
3. Life history stage definitions and relative diagnostic characters	7
3.1. Description, development and identification of pelagic eggs.....	7
3.2. Description, development and identification of pelagic larvae.....	9
3.3. Measurements, meristic characters and pigmentation	12
4. Larvae collected in western part of Libyan waters during the summer 2006.....	18
Order ANGUILLIFORMES.....	20
Muraena helena	23
Conger conger.....	27
GnathopHis mystax.....	29
Echelus myrus	33
Order CLUPEIFORMES.....	35
Engraulis encrasicolus.....	37
Sardinella aurita	41
Order OSMERIFORMES.....	43
Glossanodon leioglossus	45
Order STOMIIFORMES.....	47
Cyclothone braueri	49
Vinciguerria attenuata	53
Vinciguerria poweriae.....	55
Vinciguerria nimbaria	57
Order AULOPIIFORMES.....	59
Synodus saurus.....	61
Lestidiops jayakari jayakari	65
Order MYCTOPHIFORMES.....	68
Ceratoscopelus maderensis	71
Diaphus holti.....	73
Electrona risso.....	75
Lobianchia dofleini	79
Hygophum benoiti.....	81
Hygophum hygomii	83
Lampanyctus crocodilus	85
Lampanyctus pusillus.....	87
Symbolophorus veranyi	89
Myctophum punctatum	91
Myctophum punctatum	93
Order GADIFORMES.....	96

Order OPHIDIIFORMES	99
<i>Ophidion barbatum</i>	101
Order MUGILIFORMES	103
Family MUGILIDAE.....	104
<i>Mugil</i> spp	106
<i>Mugil cephalus</i>	107
Order SYNGNATHIFORMES	109
<i>Macroramphosus scolopax</i>	111
Order SCORPAENIFORMES	113
<i>Scorpaena scrofa</i>	115
<i>Lepidotrigla cavillone</i>	119
Order PERCIFORMES	122
Family SERRANIDAE	123
<i>Epinephelus costae</i>	125
Family APOGONIDAE	129
<i>Pomatomus saltatrix</i>	133
<i>Trachurus</i> spp.....	141
<i>Seriola</i> spp.....	143
<i>Spicara maena</i>	147
<i>Brama brama</i>	151
<i>Pagrus pagrus</i>	157
<i>Diplodus</i> spp	159
<i>Lithognathus mormyrus</i>	163
<i>Cepola macrophthalma</i>	169
<i>Chromis chromis</i>	173
<i>Coris julis</i>	177
<i>Trachinus</i> sp.	181
<i>Callionymus maculatus</i>	191
Family TRICHIURIDAE.....	196
<i>Lepidopus caudatus</i>	197
<i>Thunnus thynnus</i>	203
<i>Auxis rochei</i>	209
Order PLEURONECTIFORMES	211
<i>Arnoglossus thori</i>	213
<i>Arnoglossus laterna</i>	217
<i>Lepidorhombus boscii</i>	223
<i>Symphurus nigrescens</i>	227
Order TETRAODONTIFORMES	230
5.References	234

1. Introduction

The object of this monograph is to obtain guidance about the early developmental stages of teleost fish species inhabiting the Libyan Platform, through a description of the main meristic features of eggs and larvae and by means of a series of photographs and drawings that might prove to be useful in their identification.

1.1. Studies on ichthyoplankton

The studies on ichthyoplankton started in 1865 with the discovery, made by Sars, that eggs of Atlantic cod (*Gadus morhua*), haddock (*Melanogrammus aeglefinus*) and gurnard (*Eutrigla gurnardus*) are planktonic (Russell, 1976). During this period and early in the XXth century, in Europe, many scholars, such as Cunningham (1885-1889), McIntosh (1885-1897) and Masterman (1893; 1896a, b, 1897; 1901; 1910), started to carry out research on the species of commercial relevance. Ehrenbaum (1909) published the first comprehensive ichthyoplankton book for the Northeastern Atlantic. In Italy, Raffaele, Sanzo, Sparta with others produced 65 studies on the ichthyoplankton of the Mediterranean Sea which were the basis for the monograph “Eggs, larvae and juvenile phases of teleosts”, later completed with a series of papers on “Flora and Fauna in the Gulf of Neaples”. Important descriptive studies were also produced by Petersen who integrated the previous works with careful analyses and was also the creator of plankton sampling gears that could filter a large enough volume of water to catch larvae of most of the fish species (Petersen, 1909).

Over several years Froese developed and compared different computerized methods to identify fish larvae including digital taxonomy, expert systems and relational database. He drew the conclusion that the development of a data base to catalogue the species is the easiest to apply and use, since most larvae can be identified by means of a combination of few basic features (Froese, 1988, 1989; Froese *et al.*, 1989, 1990; Froese and Papisissi, 1990, Froese and Pauly, 2006).

In the Atlantic and Pacific Oceans many studies have been produced on the distribution, composition and quantity of larval fish (e.g. Lasker, 1981; Collette and Nauen, 1983; Fahay, 1983; Orozco Llerena, 1983; Moser *et al.*, 1984a; Whitehead, 1985; Gordina, 1986; Chirichigno *et al.*, 1998; Baumar *et al.*, 1989; Cohen *et al.*, 1990; Olivar and Fortuño, 1991; Nelson, 2006; Fisher *et al.*, 1995; Aguilera, 1998; Castro-Aguirre *et al.*, 1999; Matsuura and Olivar, 1999).

At present, most of the species of marine teleosts described (450 families) are included in Larval base (<http://www.larvalbase.org/>). This data base holds information on more than 1430 species, mainly from the northern Atlantic and from the Mediterranean in general, obtained from the initial analysis of more than 1500 bibliographic references (Froese, 1988, 1990 a,b).

1.2. Ecological importance of ichthyoplankton

The importance of the studies on ichthyoplankton is based on their contribution to furthering knowledge on the biological cycles of economically relevant species.

In particular the concentration of eggs and larvae is a useful parameter to define spawning areas and seasons, which are basic information for the sustainable exploitation of fishing resources.

More in detail Hempel (1979) and later Ré and Meneses (2009) classified the ichthyoplanktonic studies as follows:

1. Studies on systematics and ecology:

- Identification of undescribed species.
 - Clarification of the morphogenesis and systematic/phylogenetic position of some species or groups of species.
 - Studies on food consumption, growth, mortality, and physiology in general.
 - Importance as an element of the aquatic food webs.
 - Understanding of transportation and behaviour of fish at larval stage.
 - General knowledge of fish eggs and larvae themselves, their zoogeography, etc.
2. Studies on the identification and evaluation of resources of commercial interest:
- Knowledge of the egg-releasing season.
 - Determination of areas frequented by adult fish during the egg-releasing period.
 - Evaluation of the adults' spawning stock.
 - Evaluation of the variations in space-time composition and of the abundance of resources of economical interest.
 - Quantification of the relative amount of the population of economical interest.
 - Finding new resources.
 - Improvement of culturing fish eggs and larvae as an important requisite for aquaculture, including selective breeding, toxicity tests, physiological and genetic studies.

The morphological features of the eggs and larvae can be used to test the hypotheses on the developmental strategies (Froese, 1990 a).

Moreover, with the knowledge of the fecundity of a species, through a study of the numbers of eggs it became possible to estimate the population of the parent stock (Russell, 1976). Some authors have stressed the importance and usefulness of computerized systems and databases that can help to calculate the volume of the adult stock during the egg-releasing period (e.g. Froese and Schofer, 1987; Froese, 1988, 1989, 1990 a, b; Froese *et al.*, 1990) Understanding of the factors affecting egg and larval survival is fundamental, since the development of early stages will determine the success of recruitment and, in turn, the consistence of a year class.

1.3. Hydrological characteristics of the western Libyan sea

The region of the Strait of Sicily is the transitional area linking the Eastern and Western parts of the Mediterranean Sea. The western Strait of Sicily, between Sicily and Tunisia (the Sicily Channel), is 150 km wide and is mostly shallow (less than 200 m), except for two narrow channels having depths of about 430 and 365 m (Manzella, 1994). The eastern end of the Strait of Sicily is broader (more than 500 km), with the Malta Channel (between Sicily and Malta) forming the northern part and the large opening between Malta and Libya forming the southern part (Figure 1).

In the Strait of Sicily the classic Mediterranean circulation schemes (Wüst, 1961; Ovchinnikov, 1966; Lacombe *et al.*, 1981) indicate a prevalent anticyclonic circulation, both in the superficial and deep layers. No information can be deduced about the path of the Atlantic Water (AW) along the African coast, which generally moves eastward, as suggested by numerical simulations (Béranger *et al.*, 2005).

The general circulation of the Sicily Channel (i.e. the narrow area between the Tunisia and the West Sicily) is well known (e.g. Lermusiaux and Robinson, 2001) and consists of a two-layer system: the surface layer, with AW flowing eastward into the Eastern Mediterranean basin, and a lower layer of Levantine Intermediate Water (LIW), outflowing westward into the Western Mediterranean basin. Lermusiaux and Robinson (2001) have described qualitatively the general circulation of the area,

characterized by a main path of the AW as Atlantic Ionian Stream (AIS – Robinson *et al.*, 1999) which is strongest and most widely spread in summer (Figure 1). In winter this current is weaker and presents a different meander, while, on the other side of the Channel, the Atlantic Tunisian Current (ATC – Béranger *et al.*, 2004) becomes stronger. Dynamical circulation studies, with assimilated data from the surveys, indicate that the Adventure Bank Vortex (ABV), the Maltese Channel Crest (MCC), the Ionian Shelf Break Vortex (IBV) and the Messina Rise Vortex (MRV) are part of the Atlantic-Ionian Stream (AIS) circulation structure (Robinson *et al.*, 1999).

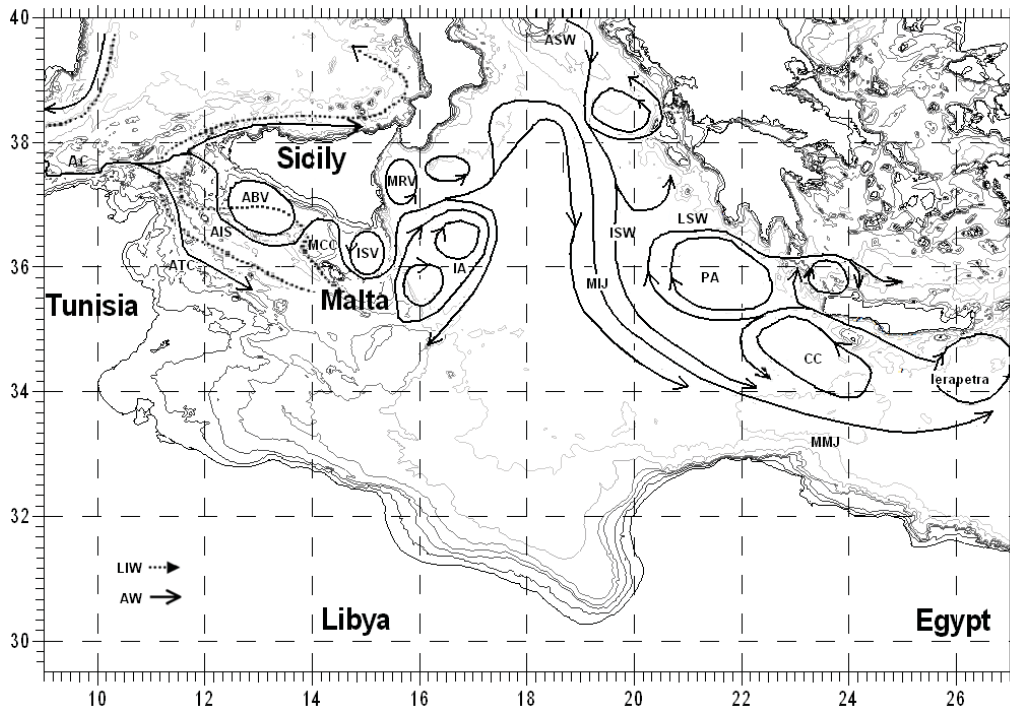

Figure 1. Water masses circulation proposed by Robinson *et al.* (1999) in the Strait of Sicily and by Malanotte-Rizzoli *et al.* (1997) in the Eastern Mediterranean basin.

AIS = Atlantic-Ionian Stream IA = Ionian Anticyclones
 PA = Pelops Anticyclone MIJ = Mid Ionian Jet
 MMJ = Mid-Mediterranean Jet CC = Cretan Cyclone
 AW = Atlantic Water AC = Atlantic Current
 ASW = Adriatic Surface Water ISW = Ionian Surface Water
 LSW = Levantine Surface Water ABV = Adventure Bank Vortex
 MRV = Messina Rise Vortex MCC = Maltese Channel Crest
 ISV = Ionian Shelf Break Vortex ATC = Atlantic-Tunisian Current
 LIW = Levantine Intermediate Water

It is worth noting that the knowledge of the Sicily Channel dynamics is mostly limited to the northern area, whereas what happens on the Tunisian shelf, along the Tunisian shelf break and in the deepest areas of the basin is relatively poorly known (Poulain and Zambianchi, 2007). In general, the ATC has not been very well studied because of the scarcity of data on the Tunisian and Libyan side. The latter consideration is also valid for the water mass circulation in all the Libyan sea area (Robinson *et al.*, 2001).

Poulain and Zambianchi (2007) studied the surface circulation in the central Mediterranean, including the Sicily Channel, the southern Tyrrhenian and western Ionian seas, using the data of more than 150 satellite-tracked drifters for the period 1990–1999.

The estimated mean surface circulation (Figure 2) shows the branching of the AW into several paths, proceeding into the Tyrrhenian sea (north of Sicily) and in the Strait of Sicily. The latter flow appears to split into one component flowing southward, near the Tunisian coast (ATC), and another

branch (between Pantelleria and Sicily), forming the main core of the AIS. Downstream of Pantelleria Island, the AIS separates into an eastward component, flowing north of Malta and intruding into the deep Ionian, and a southward flow, that eventually diverges into currents headed for the shallow Gulf of Gabés, and currents continuing to the south and then southeast reaching the Libyan coastal areas.

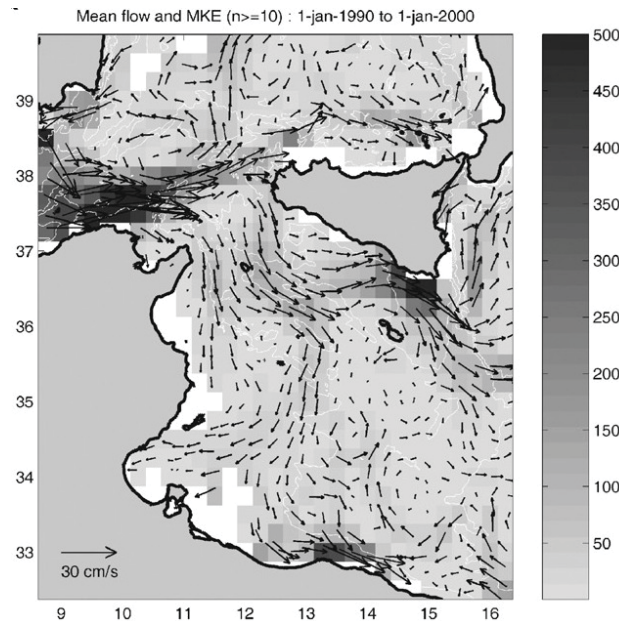

Figure 2. Pseudo-Eulerian statistics using the whole dataset of drifters: mean flow and MKE (Poulain and Zambianchi, 2007).

The authors found some seasonal variability of the surface circulation in the central Mediterranean. To this aim, two pseudo-Eulerian statistics were computed for two extended seasons of 6 months' duration (extended summer May–October, and extended winter November–April). In figure 3 the mean flow and the mean kinetic Energy (MKE) for the two extended periods are shown. The analysis of the figure shows that the AC appears stronger in winter. In summer, the Atlantic Current bifurcates on the Adventure Bank in a minor southward flow (ATC) and in a stream with larger extension (AIS). The latter stream meandering proceeds near the southern coast of Sicily north of Malta, veering then to the north in the Ionian (the maximal MKE south of south-eastern Sicily exceeds $500 \text{ cm}^2 \text{ s}^{-2}$). In winter, the circulation in the Sicily Channel is weaker, and instead of the classic AIS, the water appears to flow southward, south-eastward and eastward into two branches: one passing on the Adventure Bank and remaining confined to the Sicilian coast (with some limited meandering character) and the other one flowing near Cape Bon in the ATC, proceeding southward and veering to the east and then to the south (near latitude 36° N). The flow between Malta and the African continent is weak but in general westward in summer (particularly close to Libya), while it is slightly enhanced and reversed (towards the east) in winter. East of Sicily the northward current is stronger in summer.

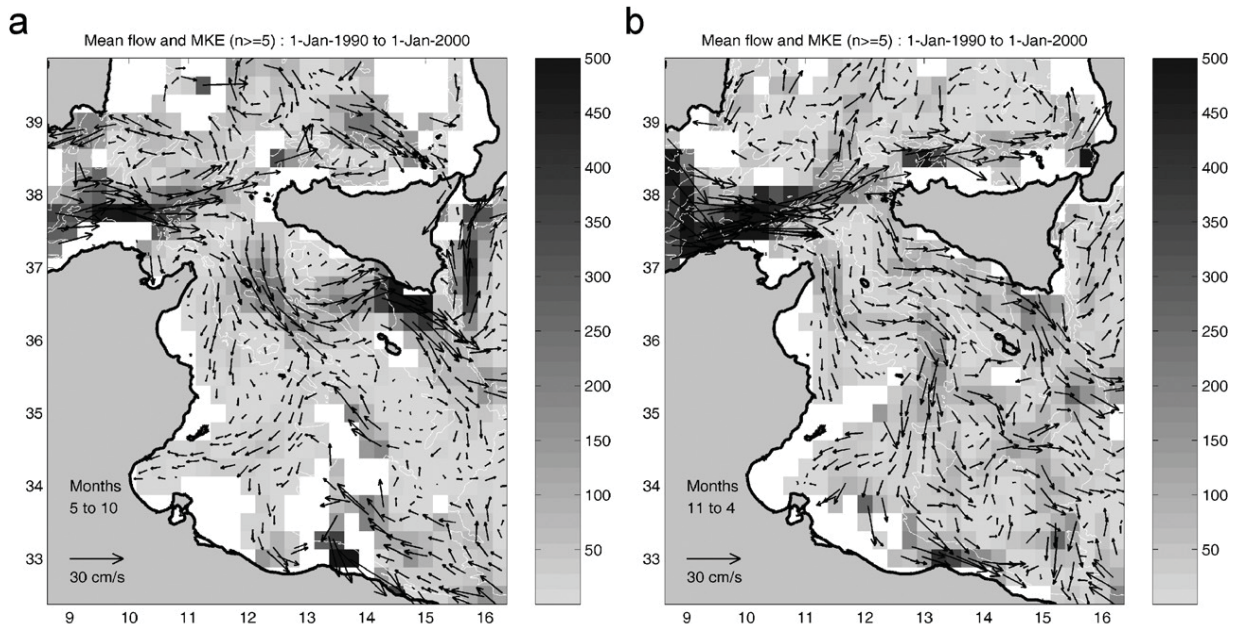

Figure 3. Pseudo-Eulerian statistics for the extended summer (a May–October) and the extended winter (b November–April): mean flow and MKE (Poulain and Zambianchi, 2007).

The MedSudMed-06 oceanographic survey (summer 2006) was the first hydrographic survey carried out along the western Libyan shelf. It allowed scientists to obtain evidence on the displacement of typical Mediterranean waters: the AW, moving eastward along the coast; the Ionian Surface Water (ISW), moving in opposite direction and far from the Libyan coast; the Levantine Intermediate Water (LIW), which moves westward.

The horizontal map of the salinity minimum (S_{min}) in figure 4a evidences a westward intrusion of fresher water along the coast, with the core at about 50-70 m depth. Its presence is well defined on the western side, while it becomes very thin moving eastward. The S_{min} distribution evidences several fragmented structures, suggesting the interaction between two different water masses: the AW, moving eastward, and the Ionian Surface Water (ISW), which moves in the opposite direction.

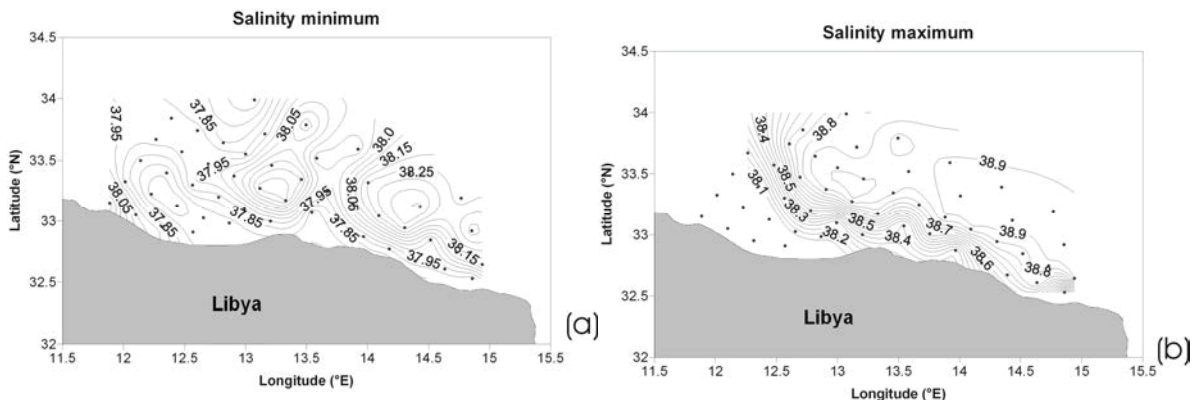

Figure 4. Horizontal distribution of (a) minimum of salinity (S_{min}) and (b) maximum of salinity (S_{max}).

The salinity maximum (S_{max}), the signature of the LIW core, shows values ranging from 38.92 to 38.71 (Figure 4b). The S_{max} is found below 200 m in the deep region, while along the continental shelf it is positioned at about 160-180 m. Its distribution appears more regular than that of S_{min} , even if some small structures may be observed, probably due to topographic effects. Salinity clearly decreases moving from east to west, confirming a prevalent westward spreading of the LIW.

Besides the presence of these well-known water masses, a cold and dense vein flowing along the Libyan margin was observed (Gasparini *et al.*, 2008). This vein, which has never been detected or predicted before, flows along the continental slope at a depth of about 250-300 m, and the region investigated corresponds to its final path before it cascades. Its dynamics are generally slow (the speed does not exceed 10 cm s^{-1}) with a weak entrainment, especially when the vein flows above the almost constant depth. The entrainment becomes significant when the vein is forced to sink at higher depths, due to topographic discontinuity, and its thickness increases from 50 to 200 m. The bottom stress has a prevailing effect, as suggested by the current profile, which shows reduced velocities near the bottom and the well-mixed vein interior.

Historical data (Guibout, 1987) clearly evidence the presence of cold and dense water in the deep basin (about 1000 m depth) in front of Tripoli. The signature in the historical data suggests that the vein observed during summer 2006 is not episodic and that its buoyancy equilibrium in the Ionian basin can be estimated at about 1500 m depth, which corresponds to the transitional Eastern Mediterranean Deep Water layer (EMDW). For these reasons this vein may have a role in determining the characteristics of the layer below the LIW.

2. Material and methods: collection, preservation and identification of fish larvae

The samples analysed were collected during the MedSudMed-06 survey, performing oblique tows with a Bongo plankton net, with a mouth diameter of 40 cm and a mesh of $200 \mu\text{m}$ fitted with a flowmeter.

The net was cast at a speed of 0.6 m s^{-1} . Once the expected depth was reached, it was stabilized for 30 seconds and then was towed at a speed of 0.3 m s^{-1} . During the operations, the boat kept an almost constant speed of 2 knots and an angle of 45° between net cable and the horizon.

The samples were preserved in 4% buffered formaldehyde (solution has been made permanently non-acid at about pH 9 with borax) and analyzed in the laboratory by means of a stereo-microscope. The identification of the larvae was carried out in the shortest possible time, in order to avoid the loss of colours associated with preservation (Mastail and Battaglia, 1978). The identified larvae underwent a morphometric analysis by means of the Optima Image Analysis software, which allowed calculation of larvae dimensions, thus defining growth stage.

To count fin rays and vertebrae microscope with transmitted light is generally used. In case of very transparent postlarvae they could be counted directly. Blaxter (1957) used polarized light to count myomeres in clupeids. But, in less transparent specimens, it is necessary to stain them with alizarin. In this case specimens should not have been preserved in acid fluids, in order to avoid decalcification (Russell, 1976).

3. Life history stage definitions and relative diagnostic characters

3.1. Description, development and identification of pelagic eggs

The majority of marine teleostean fishes living offshore have pelagic eggs which drift with the plankton. Main exceptions among Mediterranean species are sandeels (Ammodytidae) and sand smelts (Atherinidae).

Among shore fish, most have demersal eggs, attached singly or in layers or clumps to substrata such as stones, shells, weeds, rocks or in specially constructed nests; among these fishes there are blennies (Blennidae), gobies (Gobiidae) and wrasses (Labridae). In any case, after hatching, larvae float to the surface and pass into a planktonic stage. Regardless of depth of the adults' habitat, almost all demersal and pelagic fish spend the planktonic stage together in surface layer.

Pelagic eggs are quite small in size, ranging generally from 0.7 to 1.5 mm in diameter; larger eggs, up to 2.6 mm belongs to just a few species. All pelagic eggs are transparent and almost all present a spherical shape; except for the elliptic eggs of anchovy (*Engraulis encrasicolus*) and for the slightly ovoid eggs of some other species (e.g. *Lophius piscatorius*).

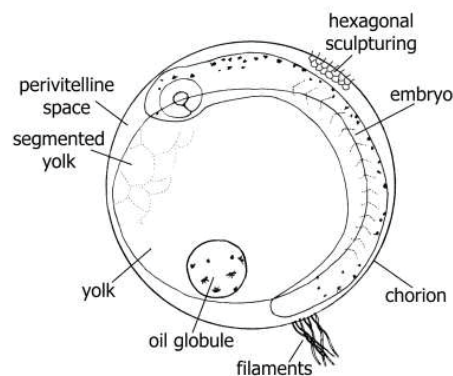

Figure 5. Anatomic features of early stages of fish egg (Ré and Meneses, 2009).

The egg is enclosed by a membrane consisting of a double layer, permeated by fine pores. The external surface of the egg membrane is usually smooth (except *Callionymus* egg, presenting an external raised hexagonal sculpturing, or *Belone* egg, presenting fine tendrils).

In the fertilized egg (Fig. 5), inside the membrane, there is a spherical yolk mass surrounded by a thin protoplasmic layer. The yolk is the necessary food reserve to feed the embryo all through its developmental phase, which concludes with hatching.

In most species the yolk almost completely fills the available space, leaving only a marginal area free (the perivitelline space); in a few species, as in *Sardina pilchardus*, the perivitelline space is large, surrounding a small sphere of yolk.

The yolk generally has a homogeneous appearance, but in some species the yolk may be divided into small segmental masses by ingrowths from the outer protoplasmic layer. For example in the *Sprattus sprattus* and *Sardina pilchardus* eggs the yolk is completely segmented, while in other genera (as *Solea*, *Trachurus* and *Callionymus*) only the peripheral portion shows segmentation.

One or more spherical globules of oil are present in the eggs of some species. When a single oil globule is present, this lies at first in the yolk opposite to the vegetative pole where the nucleus is situated. When there is more than one oil globule they may be of medium size and rather evenly distributed over the yolk surface, or they may be very small and collected together in clumps. In some species there may at first be several globules which coalesce during the development of the embryo to form a single oil globule.

Fertilization occurs when the sperm enter the egg by the micropyle, a pore in the membrane covering the egg. The egg that has just been fertilized usually floats with the oil globule on top, the vegetative pole with the micropyle and the germ being the heavier. During the development of embryo the oil globule, which at first is moveable, becomes fixed in its position.

Segmentation starts vertically to form a blastodisc. The proliferating cells from the periphery of the blastoderm gradually form a coating over the surface of the yolk; the area of the yolk not covered by this layer of cells forms the blastopore.

At first the embryo appears as a cylindrical rod pressing into the surface of the yolk. The outlines of the eyes and auditory sacs appear soon, at same time as myomeres form. After 2-3 days from closure of the blastopore, the embryo is about half way round the yolk and the first signs of pigmentation appear as fine dots in the dorsal region. The primordial fin membrane arises as a median fold enclosing a space filled with a jelly-like lymph. As development progresses, the caudal end of the embryo becomes raised from the yolk. When the embryo has a fish-like appearance and has completely surrounded the yolk, it is ready to hatch. In some species, with a long developmental period, the eyes are already pigmented and a recognizable pigmentation pattern is present on the body. But, in species with more rapid development, the eyes do not pigment and the arrangement of pigment on the body is less defined.

The incubation period, the time taken for development from the time of fertilization to hatching of the larva, varies according to the temperature and the size of the egg and amount of yolk. Incubation times may range from 22 hours, in case of *Sardinella aurita* in tropical waters (Matsuura, 1976), to 16 days, in case of *Theragra chalcogramma* in the Gulf of Alaska (Blood *et al.*, 1994).

To identify the pelagic eggs the main characters to be considered are:

- Number, size and position of oil globules.
- Homogeneous or segmented yolk.
- Width of perivitelline space.
- Egg membrana sculpturing and colour.
- Size of the egg.
- Size of the yolk.
- Shape of the egg.
- In the late stages of development (when embryo is visible) the main features for identification are:
 - timing of embryo development;
 - presence or absence of pigmentation on yolk sac or oil globule;
 - degree of pigmentation of the eyes;
 - pigmentation pattern of the embryo;
 - presence or absence of yellow or red pigment when examining living eggs;
 - number of myomeres;
 - presence or absence of elongate fin rays.

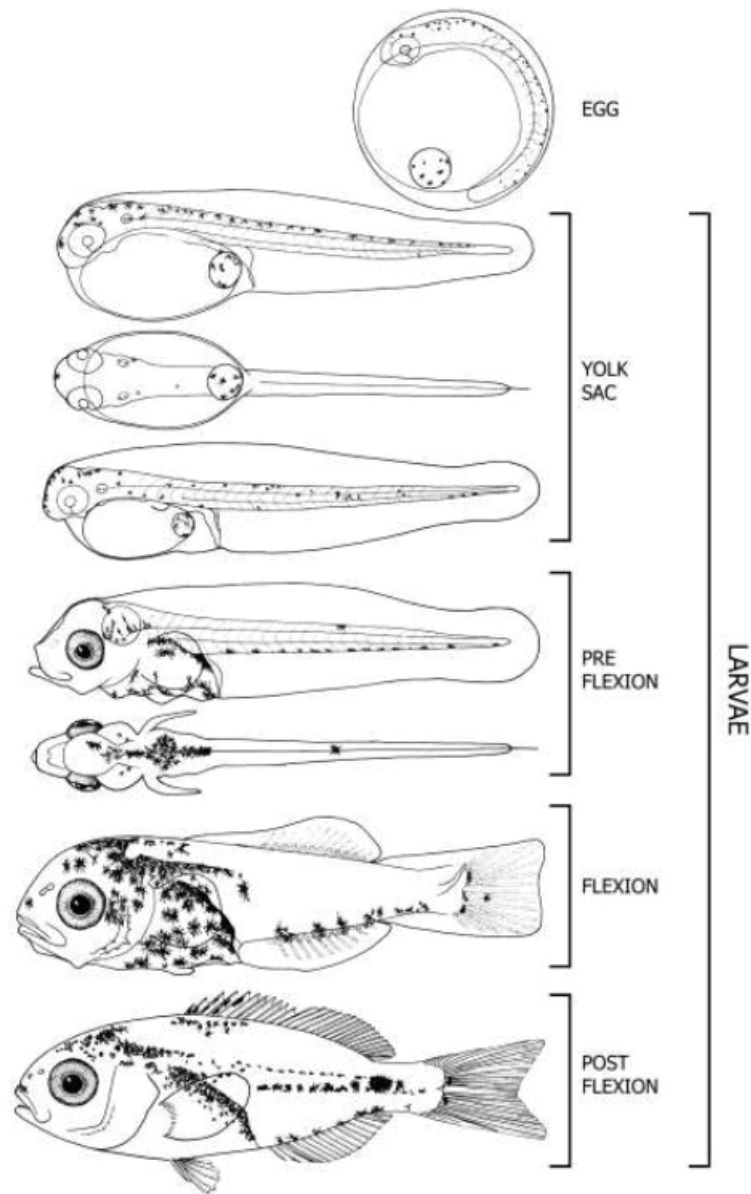

Figure 6. Example of ichthyoplanktonic developmental stages (Brownell, 1979).

3.2. Description, development and identification of pelagic larvae

To live in superficial waters, larvae developed body forms and a variety of morphological specializations adapted to the planktonic life. The number of stages of the larval development differs according to the species and each phase is characterized by different morpho-genetic elements (Fig. 6).

Yolk-sac stage (from hatching to complete absorption of yolk sac). In the majority of species with pelagic eggs the newly hatched larvae are less than 4.0 mm long, with exception of the elongated larvae of clupeids. At hatching some larvae may present an oral apparatus that allows them to feed autonomously; in other cases, they present a more or less developed yolk sac, which is prominent and situated on the anterior ventral part of the body, occupying about half of the total length. For larvae hatched from pelagic marine eggs, hatching generally occurs before the yolk sac has been

completely absorbed (Fig. 7). In species that present a yolk-sac stage (generally with a short incubation period), larvae usually hatch without a functional mouth, open anus, eye pigment and differentiated fins. In the newly born larva the whole length of the body, from near the crown of the head along the dorsal side, round the caudal end and along the ventral side to the posterior end of the yolk-sac, is fringed with the marginal primordial fin, with no signs of fin rays at this stage.

Diagnostic characters for yolk-sac larvae include:

- body size and shape;
- gut shape and length;
- position of the anus;
- pigment patterns (restricted to the body itself or extended on to the primordial fin, the yolk sac and the oil globule);
- number of myomeres;
- size and shape of yolk sac;
- oil globule size and position;
- presence or absence of specialized larval characters such as elongate fin rays, enlarged finfolds, and stalked eyes.

During development the contents of the yolk sac and the oil globule (if present) are gradually absorbed (endogenous feeding). When the yolk is completely used, the development of the sensorial, circulatory, muscular and digestive organs are complete and the larva starts feeding actively on plankton (exogenous feeding). The availability of the right food organisms at this stage is thus a critical factor.

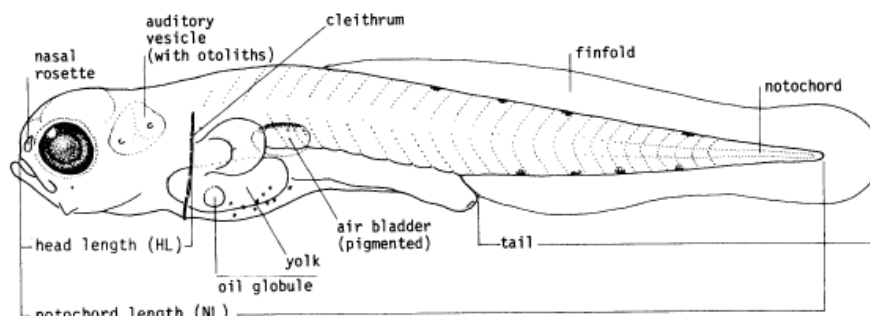

Figure 7. Yolk-sac stage teleost larva (Fahay, 1983).

In yolk-sac stage the end of the notochord (urostyle) is straight, but later, on its ventral side, a triangular thickening develops forming the rudiments of the hypural elements from which the first caudal fin rays will develop. As the larva grows, the urostyle bends upwards, the hypural elements become defined and the caudal rays develop (Fig. 8). This character is used to define the following developmental stages: pre-flexion, flexion and post-flexion (referred to the notochord in the urostyle region). These three phases lead to the last one that proceeds adulthood, which is defined juvenile phase.

Preflexion stage (from complete yolk-sac absorption to start of notochord flexion). Once both hatching and complete absorption of the yolk-sac have occurred, the preflexion stage begins. This stage ends when the notochord starts its flexion.

Diagnostic characters for preflexion larvae are similar to those for other larval stages:

- meristics (number of myomeres, number of fin rays);
- body size and shape;

- fin development sequence;
- gut shape and length;
- pigmentation pattern;
- presence or absence of spines on the head;
- presence or absence of specialized larval characters (such as fin-ray ornamentation, stalked eyes, and a trailing gut).

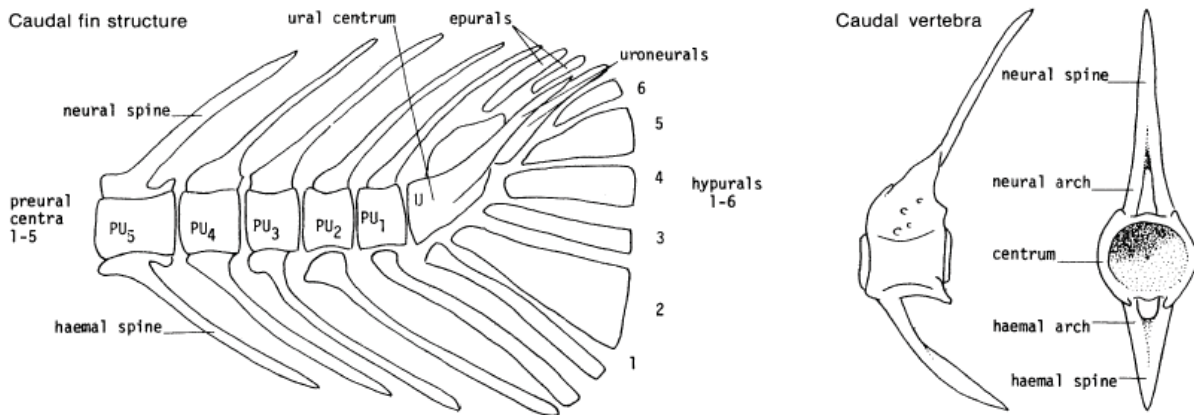

Figure 8. Bony structures used to identify larvae (Fahay, 1983).

Flexion stage (from the beginning of notochord flexion to completion of notochord flexion). This stage begins with the dorsal bending of the notochord tip, concurrently with the development of the caudal-fin rays and the supporting skeletal elements. The flexion stage ends when the notochord tip has reached its final position at approximately 45 degrees from the notochord axis and the principal caudal-fin rays and supporting skeletal elements are in the adult longitudinal position. At this stage the supporting skeletal elements may or may not be completely developed.

Diagnostic characters for preflexion larvae are similar to those for other larval stages, but, additionally, osteological characters such as the sequence and timing of ossification, become useful during this stage.

Postflexion stage (from completion of notochord flexion to start of metamorphosis). This stage starts when the notochord flexion is completed and ends at the onset of metamorphosis (transformation). Diagnostic characters for this stage are similar to those for other larval stages, with additional osteological characters (such as timing and sequence of bone and cartilage development) that should be considered.

Transformation stage (from the beginning of the metamorphosis to the complete development of fin-ray and beginning of scale formation). In this stage larval characters are lost and the juvenile/adult characters are attained. The end of transformation stage is defined as the completion of fin-ray development and the onset of scales. Its duration is different from taxa to taxa.

Changes generally occur in:

During this stage changes occur which may be dramatic in some species. They may regard:

- body shape;
- pigment pattern;
- fin migration;
- photophore formation;
- loss of specialized larval characters;

- eye migration;
- scale formation.

Juvenile stage (from complete fin-ray development and start of scale formation to sexual maturation). Juvenile individuals generally resemble small adults. Although in different families different characters are attained, the scale formation and the complete ossification of the skeleton occurs during this period. This stage ends when the sexual maturation is completed.

3.3. Measurements, meristic characters and pigmentation

The main characteristics to be considered in identification of larvae are described below.

Measurements. In many taxonomic works a large number of external features are given, either as percentages or as proportions of standard length or head length (in older literature). In some cases a body part can be expressed as x times larger than another (or contained x times within it). Among such proportional measurements, the following are the most useful (Whitehead, 1985):

- Standard length - from the tip of snout to the end of body (i.e. to base of caudal fin, where the fin rays reach the hypurals).
- Body depth - measured at deepest point, usually at the origin of the dorsal fin.
- Head length - the longest possible measurement, from the tip of snout to the hind border of gill cover (thus not always a horizontal measurement).
- Snout versus eye length - from the tip of snout to the frontal border of eye, compared with the horizontal diameter of the eye.
- Upper jaw length - from the tip of snout to the posterior tip of maxilla; most often expressed as the point reached by the maxilla (e.g. to beyond hind border of eye, to hind border of gill cover, etc.)
- Post-orbital length - from the posterior border of eye to the posterior border of gill cover, the longest measurement (thus not always horizontal).
- Fin positions - the origins of the dorsal and anal fins and the insertions of the pectoral and pelvic fins (their vertical position along the axis of the body); they are either compared, relative to each other (e.g. pelvic fin insertion in front of dorsal fin origin; anal fin origin behind dorsal fin base), or given as a pre-pectoral, pre-dorsal, pre-pelvic or pre-anal distance.
- Fin bases - the distance between the bases of first and last fin ray; rather than give fin ray numbers, it is often easier to state that the anal fin base is longer (or shorter) than the dorsal fin base.

Other measurements frequently used as diagnostic characteristics are shown in Figures 9 and 10.

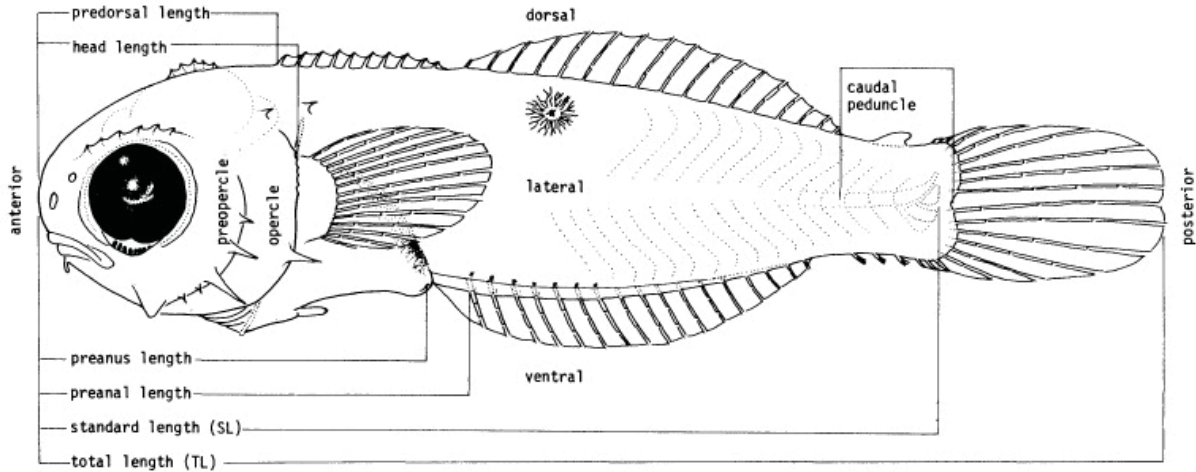

Fig. 9. Scheme of a teleost larva showing useful length measurements (Fahay, 1983).

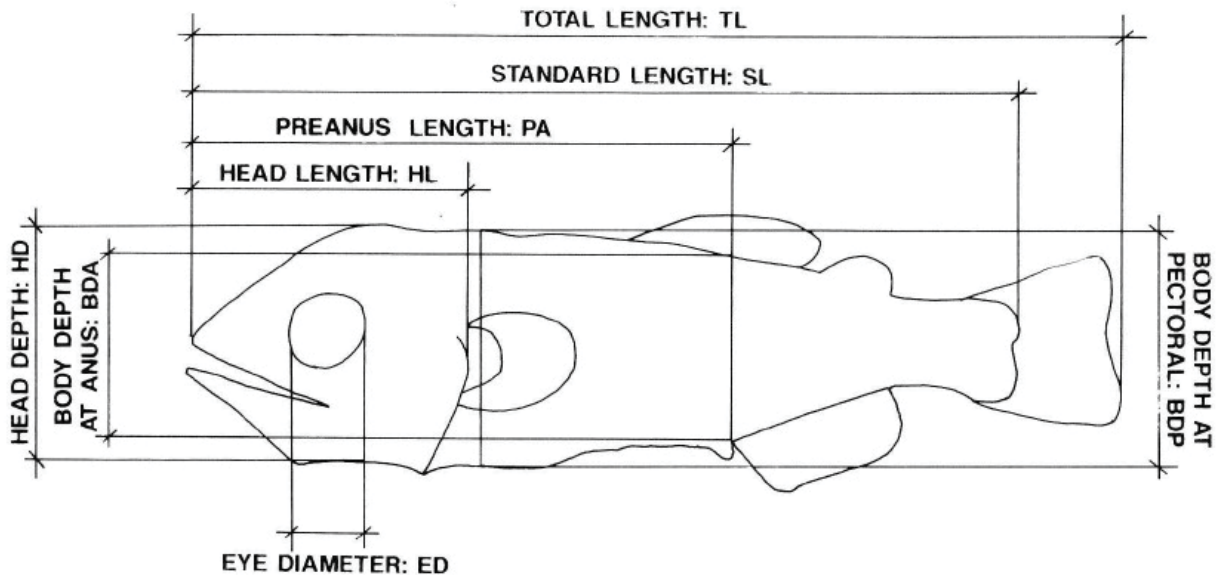

Fig. 10. Scheme of a teleost larva showing base points for measurements (Olivar and Fortuño, 1991).

Meristic characters. The meristic characters are particularly important as distinctive tools, they are countable structures occurring in series and are often species-specific.

The main meristic characters considered in identification of fish larvae are:

- vertebrae (total, precaudal, and caudal)
- branchiostegal rays
- gill rakers (upper and lower)
- pelvic fin elements (spines and rays)
- dorsal fin elements (spines and rays)
- pectoral fin rays
- anal fin rays (spines and rays)
- caudal fin rays (upper secondary, upper principal, lower principal, and lower secondary)

In counting the number of vertebrae it is usual to distinguish: the trunk vertebrae, situated in front of the anus whose rib bones enclose the abdominal cavity (including in the counts the first vertebra behind the skull bearing a dorsal spine); the caudal vertebrae, situated behind the anus, no carrying ribs (including in the counts the urostylar vertebra).

During the development of the fin rays the continuous margin of the primordial fin begins to break down to form the outlines of the fins (Fig. 11). Among paired fins the pectoral ones usually develop before the larva hatches, as unpaired flaps; their size is used as discriminating character for some genera. The pelvic fins generally develop much later and the length reached by the late larva, when rudiments of such fins appear they are used as diagnostic characters. Fin rays develop later, but they represent important diagnostic characters. In the dorsal and anal fins the first 2-4 fin rays are generally unbranched (the first is very small and easily missed); the remaining ones are branched (the last sometimes branched near its base, thus appearing as two, but counted as one). The first pectoral and pelvic fin rays are also unbranched.

Meristic characters are usually indicated by a formula. Indication of these characters is explained in the following examples:

- Vertebrae: (13) 14+18. Indicates that there are 14 precaudal vertebrae (rarely 13) and 18 caudal vertebrae.
- Dorsal fin rays: XV-XVI, 11-12. Indicates that there are 15 to 16 spines and 11 to 12 soft rays in the dorsal fin (formulae are similar in case of the other fins).
- Caudal fin: 13-14+9+8+10-11 Indicates that there are 13 to 14 dorsal procurrent rays, 9 upper and 8 lower principal rays, and 10 to 11 ventral procurrent rays in the caudal fin.

In many species the spiny armature in the head portion is also a useful characteristic to be considered. In some species other individual structures are temporarily present only during the late larval period, disappearing in the adults, but they could be useful as well to distinguish families or genera (Fig. 12).

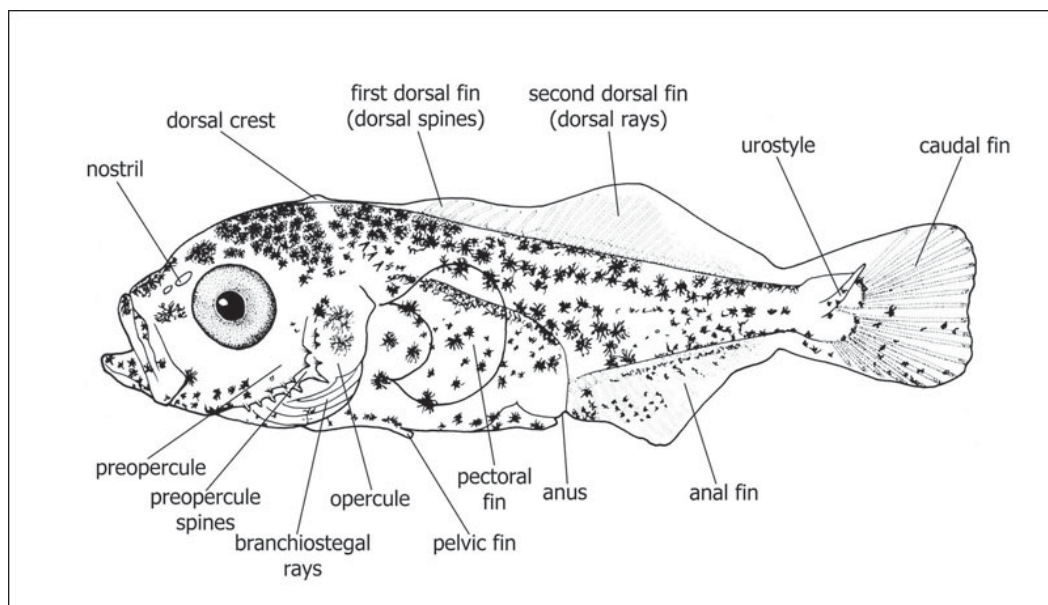

Figure 11. Fin position in the late larval stage and other characters (Ré and Meneses, 2009).

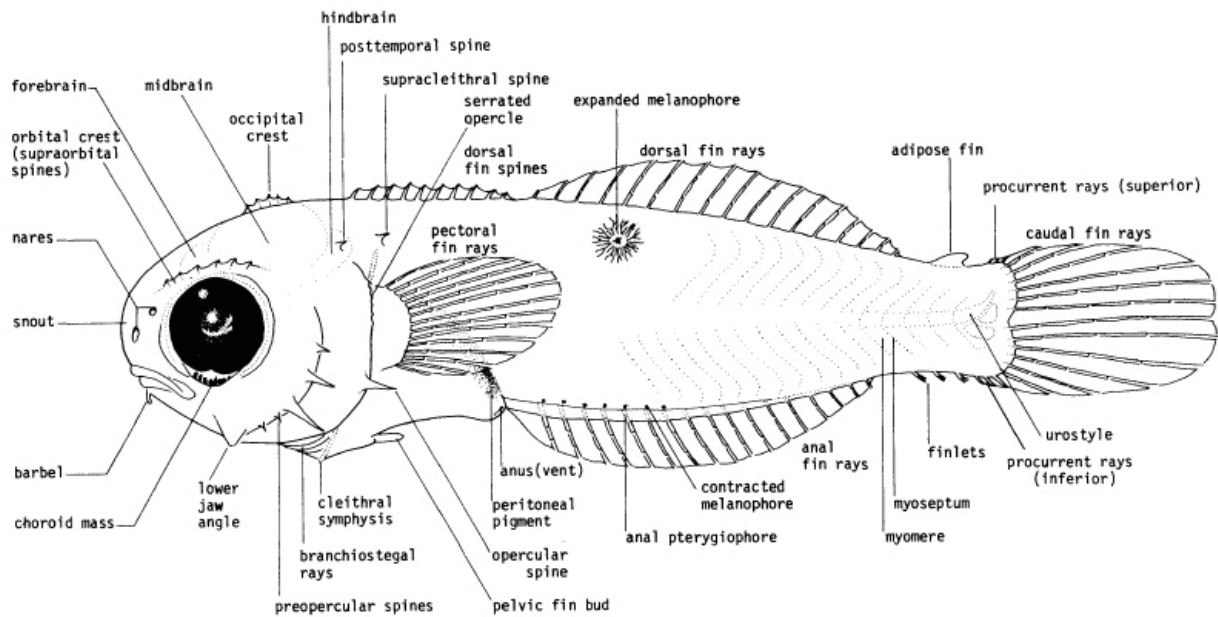

Figure 12. Morphological characters in the late larval stage (Fahay, 1983).

Pigmentation. In the earliest larval stages a pigmentation pattern usually appears and generally persists until pigmentation begins to become more diffuse or silvering occurs; then larval period is considered at an end and the larva's strictly planktonic life is over. Since this pattern is characteristic for the species, pigmentation is considered the best diagnostic character for the identification of the early stages of most species of fish (Russell, 1976).

There are several varieties of pigment cells (chromatophores): containing black or brown pigment (melanophores), containing yellow pigment (xanthophores) and those containing red pigment (erythrophores). In the late stages of development other types (iridophores) are responsible for silvering. The pigment in melanophores is in the form of solid granules, but the yellow and red pigments are mostly in solution. When preserved in formalin, only the black pigment remains, and in most of the descriptions in the following pages only melanophores are referred to. The general appearance of preserved specimens could be very different according to the degree of expansion or contraction of the melanophores. In samples which have been kept for a long time, the pigmentation will fade, especially if kept in the light. In freshly preserved specimens yellow or red pigmentation, if present, is often retained for a period and helps in identification (Russell, 1976).

Melanophores are situated externally in the epidermis and dermis, and internally on the peritoneum, but also above and below the vertebral column, and in the otocystic area. Pigmentation may be present in different areas of the body (Figures 13, 14a, 14b).

In the head region melanophores could be:

- Supraorbital - epidermal melanophores on upper surface of the head above eye.
- Ante-orbital - epidermal melanophores in front of the eye.
- Post-orbital - epidermal melanophores behind the eye.
- Snout - epidermal melanophores on upper or lower jaw.
- Mandibular - epidermal melanophores along the lower jaw or in its angle.
- Opercular - epidermal melanophores on operculum or preoperculum.
- Otolithic – internal melanophores inside the otocyst.
- Otocystic - internal melanophores in the vicinity of otocyst.

In the body region melanophores could be:

- Marginal - epidermal melanophores occurring singly or in rows along dorsal and postanal ventral contours of the body; rows could be single (along fin base) or double (on both side of marginal fin).
- Dorsolateral - epidermal melanophores between the centre line of the body and the dorsal contour row.
- Mediolateral - epidermal melanophores along the centre line.
- Ventrolateral - epidermal melanophores between the centre line of the body and the ventral contour row.
- Abdominal - epidermal melanophores over the preanal sides of the abdomen (anal melanophores could be internal).
- Throat - epidermal melanophores on the isthmus, on the ventral surface behind the operculum.
- Peritoneal - internal large starry melanophores on the dorsal area of the peritoneum.
- Notochordal - internal melanophores along dorsal side of the notochord.
- Haemal - internal melanophores as a row below the vertebral column.
- Swimbladder - internal melanophores on the dorsal side of the swimming bladder.

On the fins melanophores could be:

- On marginal fins, at the bases of the interspinal or on fin rays, or running outwards in rows between the rays.
- On pectoral fins, along the rays or in its distal region or its margin (even on fleshy base).
- On caudal fin, above the urochord (epural) or below the urochord (hypural).

Pigment associated with photophores is considered distinct from the melanistic pigment described above; it may be present in various regions of the body but it is not included in any of the previous pigment definitions.

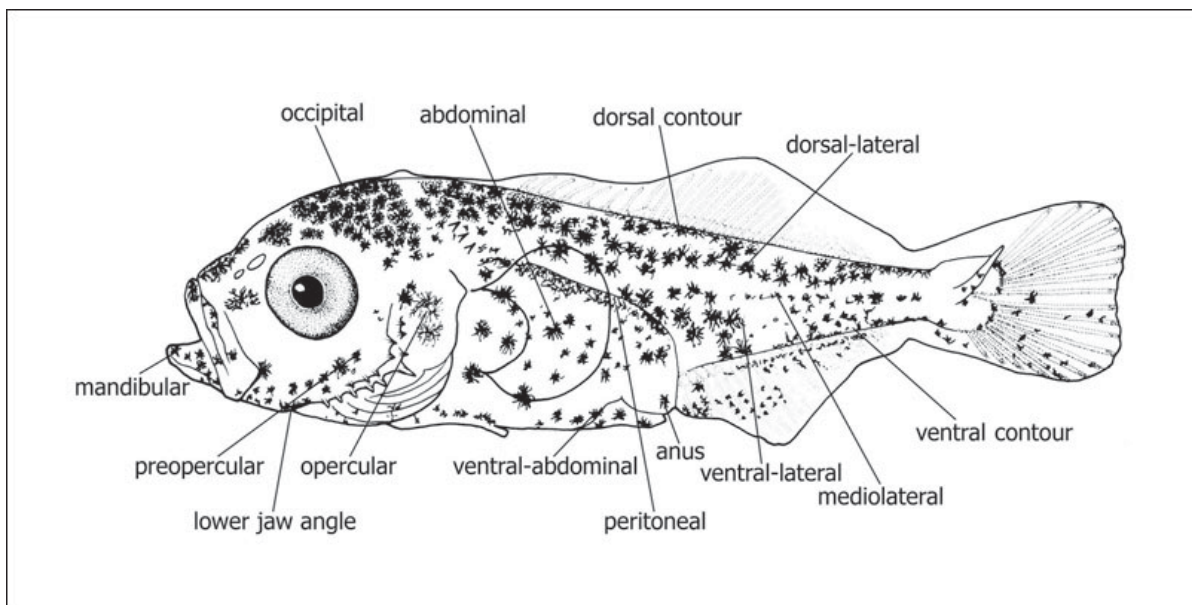

Figure 13. Melanophore pigmentation on different body areas of a fish larva (Ré and Meneses, 2009).

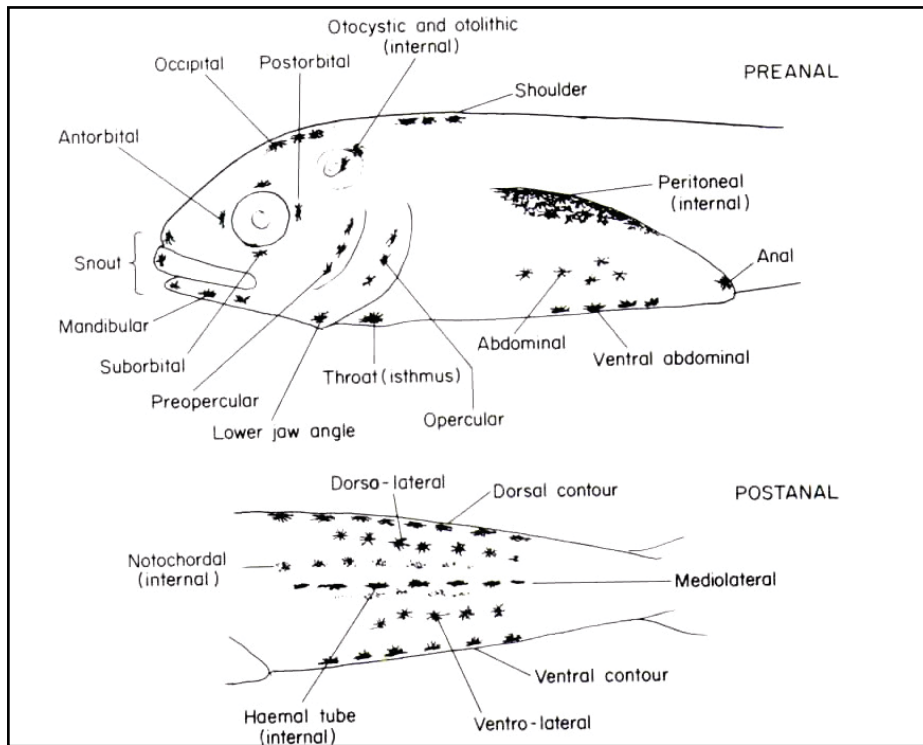

Figure 14a. Melanophores or chromatophores position (Russell, 1976).

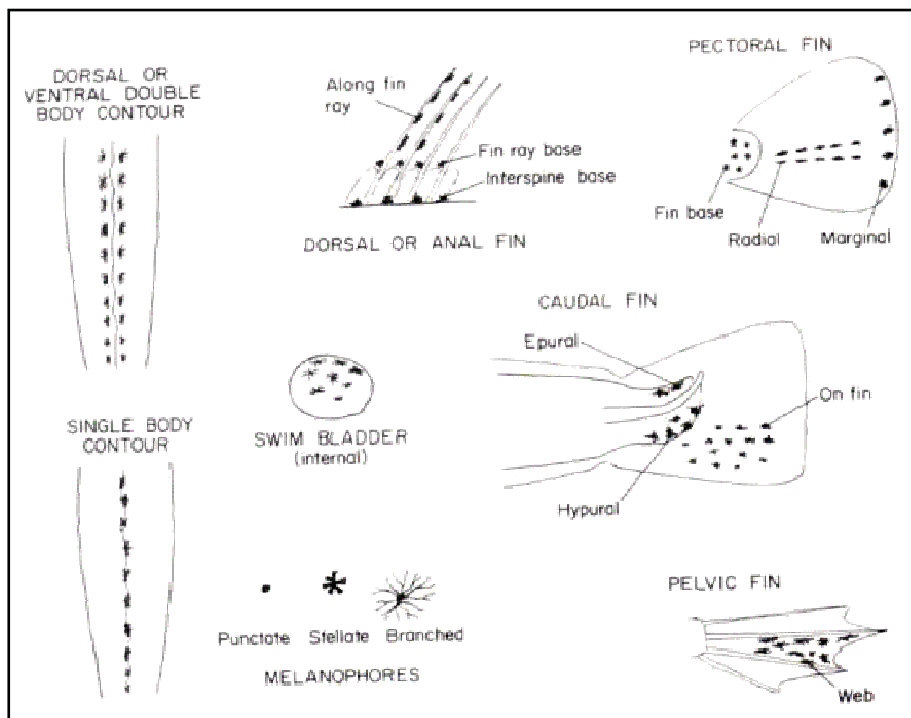

Figure 14b. Melanophores or chromatophores position (Russell, 1976).

4. Larvae collected in western part of Libyan waters during the summer 2006

The list of orders, families, genera and species of the larvae collected in the Western Libyan waters during summer is provided in this section.

In this work the latest revised classification of Nelson (2006) was mainly followed:

Phylum: Chordata;
Subphylum: Craniata;
Superclass: Gnathostomata;
Class: Actinopterygii;
Subclass: Neopterygii;
Division: Teleostei

Subdivision Elopomorpha

Order Anguilliformes
Family Muraenidae
Family Congridae
Family Ophichthidae

Subdivision Ostarioclupeomorpha

Superorder Clupeomorpha

Order Clupeiformes
Family Engraulidae
Family Clupeidae

Subdivision Euteleostei

Superorder Protacanthopterygii

Order Osmeriformes
Family Argentinidae

Superorder Stenopterygii

Order Stomiiformes
Family Gonostomatidae
Family Phosichthyidae

Superorder Cyclosquamata

Order Aulopiformes
Family Synodontidae
Family Paralepididae

Superorder Scopelomorpha

Order Myctophiformes
Family Myctophidae

Superorder Paracanthopterygii

Order Gadiformes
Family Gadidae
Order Ophidiiformes
Family Ophidiidae

Superorder Acanthopterygii

Order Mugiliformes
Family Mugilidae

Order Syngnathiformes
Family Centriscidae

Order Scorpaeniformes
Family Scorpaenidae
Family Triglidae

Order Perciformes
Family Serranidae
Family Apogonidae
Family Pomatomidae
Family Echeneidae

Family Carangidae
Family Centracanthidae
Family Bramidae
Family Sparidae
Family Chaetodontidae
Family Cepolidae
Family Pomacentridae
Family Labridae
Family Trachinidae
Family Ammodytidae
Family Blennidae
Family Callionymidae

Family Gobiidae
Family Trichiuridae
Family Scombridae

Order Pleuronectiformes
Family Bothidae
Family Scophthalmidae
Family Cynoglossidae

Order Tetraodontiformes
Family Monacanthidae

Order ANGUILLIFORMES

Main references: Alemany Llodrà, 1997; Blache, 1977; Castle, 1984; Charter and Moser, 1996; Fahay, 1983; Miller *et al.*, 2006; Nelson, 2006; Smith, 1979.

The larvae of this order are easily identified, being quite prolonged and with a unique morphology. They are known as *leptocephali*, because they resemble a transparent ribbon or a leaf. The eggs are also very characteristic: rather large in size and with a very wide perivitelline space, their chorion is highly transparent and the yolk is sac-like. The larvae are also very large, between 20 and 400 mm, and pigmentation is a key character for their identification.

General features of eggs:

- spherical shape
- large diameter
- smooth and transparent chorion
- segmented yolk
- wide perivitelline space

General features of the larvae from this order:

- body elongate, compressed and transparent, with small head

- preanal length 40-95% of standard length
- leptocephali visible over the lateral surface, with W-shaped myomeres, generally more than 100
- eyes round to moderately narrow
- head without spines
- gut runs along ventral margin of the body, appears as a simple tube or with swellings or convolutions
- elongated kidney lying along the top of the gut
- vertical blood vessels extend between gut and aorta, at the body midline
- pelvic fins not present
- dorsal and anal fins short to (usually) long, always confluent with the caudal one
- late formation of the pectoral fin rays, but fins may be reduced or absent
- caudal fin with 5-11 rays; fins may be absent in Ophichthidae
- larval teeth are fang-like, lost at metamorphosis
- marked transformation, implying shrinkage and regrowth

Family MURAENIDAE

Moray eels

Main references: Arbault and Boutin, 1968; Castle, 1984; Fahay, 1983; Ferreiro and Labarta, 1988; Marinaro, 1971; Miller *et al.*, 2006; Nelson, 2006.

The main family characters are:

- gut tubular, long 50-75% of the standard length
- body moderately deep, less than 50% of total length
- tail broadly rounded
- head short
- snout blunt
- maximum length of leptocephalus 60-70 mm
- myomeres from 114 to 174
- origin of the dorsal fin variable
- pectoral fin greatly reduced or absent
- pigmentation generally scarce
- gut pigment present
- lateral pigmentation absent

FAO name: Mediterranean moray

Libyan name: زمرينة (Zemrina)

Italian name: Murena (مورينة)

Synonyms: *Gymnothorax muraena* (Bloch and Schneider, 1801); *Limamuraena guttata* (Risso, 1827); *Muraena augusti* (Kaup, 1856)

Main references: Arbault and Boutin, 1968; D'Ancona, 1931; Ferreiro and Labarta, 1988; Marinaro, 1971; Nelson, 2006; Smith and Böhlke, 1990.

Distribution

Eastern Atlantic: from the south of British Isles to Senegal, including the Mediterranean Sea, Azores, Madeira, Canary Islands and Cape Verde.

Reproduction

In the Mediterranean Sea spawning occurs in summer.

EGGS

Diameter ranges from 5.0 to 5.5 mm. Smooth chorion. Not transparent. Yolk segmented. A characteristic wide perivitellin space is present. Oil globules are absent.

LARVAE

Morphology

At hatching 10.5-11.0 mm long and 1 mm tall. General body shape is typical, eel-like. Gut straight. 4 teeth clearly visible on each jaw.

After a couple of days the larva reaches the length of 14 mm with a height of about 1.5 mm. Snout pointed. Upper jaw prominent.

At 44 mm, body depth is 5 mm. Anus positioned at 2/3 of total length. Head short. Mouth stretches as far as half of the eye. Upper jaw slightly longer than the lower one. Teeth become oriented internally.

The biggest larva may be 80 mm long and 10 mm high, without change in other proportions: body is still thin, body depth is

uniform, tail is rounded. In bigger specimens mouth opening never stretches as far as the posterior margin of the eye. Upper jaw becomes less protruding on the lower one and, even at its apex, is relatively high and becomes blunter. The nostrils get nearer to their final position: the anterior one next to the apex of the jaw, the posterior one above the eye. The branchial cleft appears as a round hole.

Pigmentation

At hatching, many spots in subspinal region, starting on the anterior part of the body, firstly in sparse order and then very dense (may be up to 3 per each myomere), ending almost near the caudal tip. On the dorsal part of the gut there are some spots (3 or 5).

At 12 mm, spinal pigmentation along the hole body, constituted by tiny points. 4 spots of pigment above the gut.

At 14 mm sub-spinal pigment has grown in the back and in the anterior part, appearing more dense.

At 80 mm, all along the unpaired fin there is a thick scattering of spots, which is sometimes incomplete in the dorsal part of the tail, and sometimes reaches the head.

Vertebrae/myomeres

At hatching 76 preanal and 70 postanal myomeres.

At 14 mm, 145-150 total myomeres, of which 76-80 preanal.

At 80 mm, 139-144 myomeres, of which 68-71 preanal.

Fins

At 44 mm, the dorsal fin gets onward up to 2/3 of the total length. Pectoral fins absent. Caudal fin slightly higher than the dorsal one.

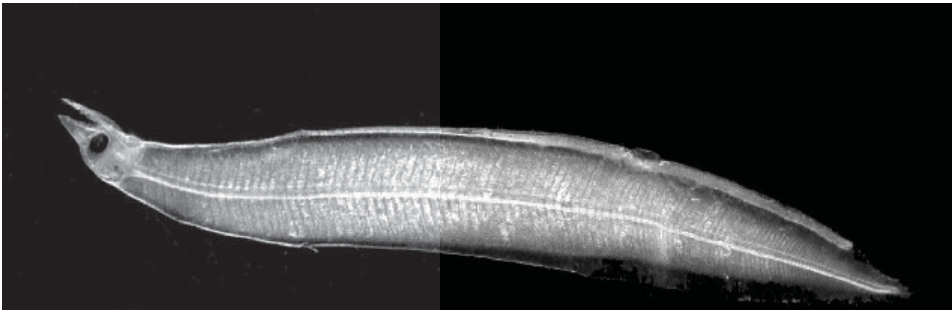

Muraena helena larva. (17.5 mm).

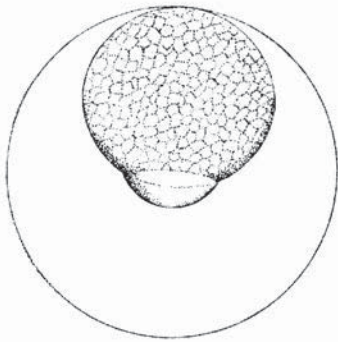

A



B: 14 mm



C: 22 mm

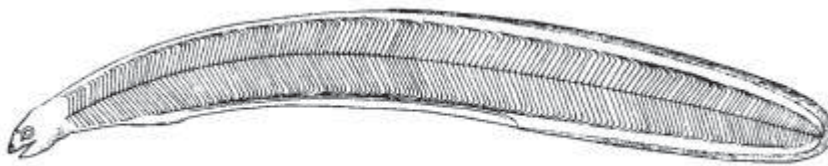

D: 44 mm

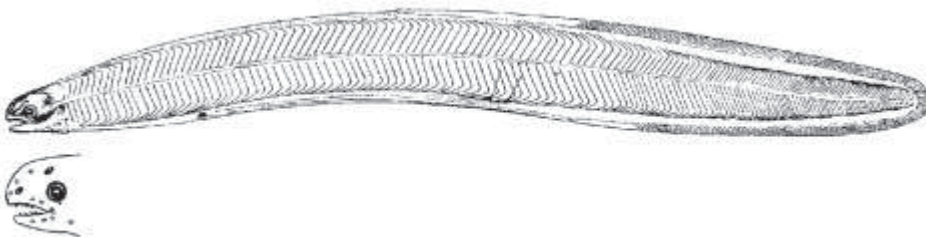

E: 80 mm

A-E: early stages of *Muraena helena*. A: egg Grassi (1913); B: Grassi (1913); C: Grassi (1917); D-E Grassi (1910).



Family CONGRIDAE

Conger and garden eels

Main references: Fahay, 1983; Miller *et al.*, 2006; Nelson, 2006; Smith, 1979, 1990.

The main family characters are:

- gut long as 75% or more of standard length
- body moderate to elongated
- tail moderate
- head moderately elongated
- leptocephalus maximal length about 100 mm (in some 200-300 mm)
- myomeres range wide
- body and head morphology variable
- number of myomeres variable
- dorsal fin origin variable
- gut pigment always present
- lateral pigment variable, sometimes absent
- larvae with short heads, generally present crescentic patch of pigment below the eye

Fao name: European conger

Libyan name: قرنقو (Grango)

Italian name: Grongo (قرنقو)

Synonyms: *Anguilla conger* (Linnaeus, 1758); *Anguilla obtusa* (Swainson, 1839); *Conger communis* (Costa, 1844)

Main references: Alemany Llodrà, 1997; Bauchot and Saldanha, 1986; D'Ancona, 1931; Fahay, 1983; Maigret and Ly, 1986; Muus and Nielsen, 1999; Nelson, 2006; O'Sullivan *et al.*, 2003; Ré and Meneses, 2009; Smith, 1990.

Distribution

Eastern Atlantic: from Norway and Iceland to Senegal. Also in the Mediterranean and Black Sea.

Reproduction

Like other species of the group, it reproduces only once in its life. Sexually mature at age of 5-15 years. In Atlantic (off Portugal) and Mediterranean spawns in summer. Adult females produce 3-8 million eggs.

EGGS

No available information.

LARVAE

Morphology

At hatching, body about 8 mm long and 1 mm deep. The ratio between post-caudal length and pre-anal length is 1:5. Characteristic body shape, eel-like. Gut straight. Upper jaw shorter

than the lower one. Each jaw bears 3 teeth on each side, clearly visible.

Above 50 mm appearance as leptocephali.

Development complete at lengths between 97 and 132 mm. Body thin, elongated and transparent. The ratio between maximum depth and total length is 1:13. Upper jaw protrudes on the lower one. Mouth extends to eyes level. Jaw with canine teeth, small and large teeth. Eyes slightly narrow.

The larval and semi larval life is supposed to last 12 months; transformation occurs at length of 150 mm.

Pigmentation

No melanophores are present on head or trunk, but 2-3 dots can be seen near the heart. A row of melanophores are present in the peritoneal region.

10 smaller evenly spaced spots are placed behind the basis of the anal fin, others can be seen on the caudal fin. On the tail there is a single melanophore. Sometimes some spots are placed at the basis of the dorsal fin, very close to the caudal tip.

Vertebrae/myomeres

Total number 148-155: about 93 preanal and 63 or more postanal myomeres.

Fins

At 8 mm, pectoral fins can be clearly seen.

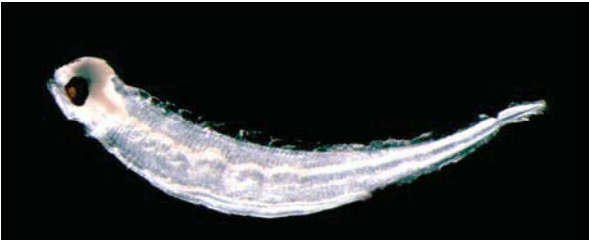

Conger conger larva (6 mm).

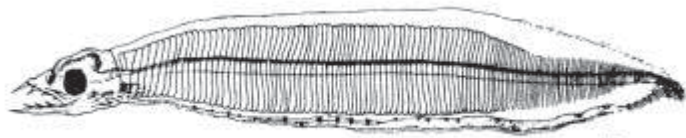

A: 16 mm

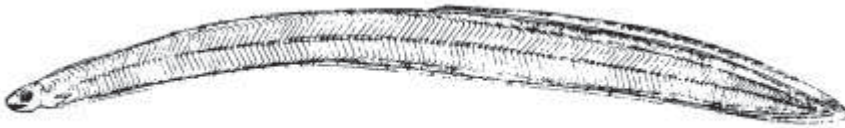

B: 150 mm

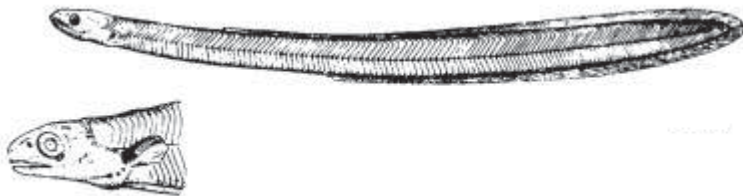

C: 80 mm

A-C *Conger conger* larvae. A: Grassi (1914); B-C: Grassi (1913).

FAO name: Thinlip conger

Libyan name : قرنقو صغير (Grango sagier)

Italian name: Grongo nasuto (قرنقو ناسوتو)

Synonyms: *Ariosoma mystax* (Delaroche, 1809); *Bathycongrus mystax* (Delaroche, 1809); *Conger mystax* (Delaroche, 1809)

Main references: Arbault and Boutin, 1968; Bauchot and Saldanha, 1986; Castle, 1969; D'Ancona, 1931; Ferreira and Labarta, 1988; Marinaro, 1971; Nelson, 2006; Olivar and Fortuño, 1991; Smith, 2002.

Distribution

Atlantic Ocean and Mediterranean Sea.

Reproduction

Spawning period ranges from August to October.

EGGS

Spherical and transparent, diameter ranges from 2.5 to 3 mm. Smooth corion. The yolk is segmented and measures 1.50-1.85 mm in diameter. Oil globules absent.

LARVAE

Morphology

Larva hatches after 4 days, at 6 mm length. Teeth absent.

At 8.5 mm, maximum depth is 0.5mm. Each jaw with 3 teeth.

At 12.5 mm snout more pointed and tail shorter than in *C. conger*.

At 20-30 mm snout very pointed. Body elongated, with small body depth (11.6% of standard length). Gut extending to 92% of total length. Head conical, 5.3% of total length. Eyes slightly oval, dorso-ventrally elongated. Origin of the swim bladder is located at the level of myomere 40. First vertical blood vessel located at level of myomere 12 and last one at myomere 47, other 12 secondary blood vessels are visible.

From 50 mm onwards, the snout becomes less sharp. Body laterally compressed.

Transformation variable, occurring at lengths from 70 to 85 mm. At transformation ratio between body depth and body length is 1:10. Jaws sub-equal. Teeth become more

numerous. Nostrils ovate. Last hypural characterized by a dorsal hump. Hypural before the last presents a hole near the basis.

Later, body becomes subcylindrical and compressed only on the tail. Snout becomes less pointed. Upper jaw extends over the lower one. Eyes becomes round. Teeth oriented internally.

Pigmentation

At hatching not pigmented.

At 8.5 mm, spots of pigment on jawbone and above the eyes. Some paired spots of pigment along gut. Some pigment on caudal tip.

At 12.5 mm anal pigmentation limited to caudal tip; pigmentation more developed dorsally than ventrally (in *C. conger* 10 evenly spaced anal spots, just behind the anus; few dorsal chromatophores on caudal region).

At 20-30 mm, 45 ocellated melanophores along the entire length of the gut; another is present on the throat. A single row of starry melanophores borders the base of the anal fin, splitting into a double row towards the end. A series of small starry melanophores also border the caudal fin. Lateral pigmentation absent.

At transformation, at the sides of the gut is present abdominal dotting, very thick, consisting of about 100 spots on each side, that stretches as far as the level of the pectoral fins. A crescentic patch of black pigment visible below the eyes.

Vertebrae/myomeres

At 8.5 mm in length the early larva presents 133-145 myomeres, 50-59 of which are preanal.

At transformation myomeres are 133-139; 105-118 of them are preanal.

Fins

Dorsal fin starting at the level of myomere 82. Pectoral fins well developed. Caudal fin rounded.

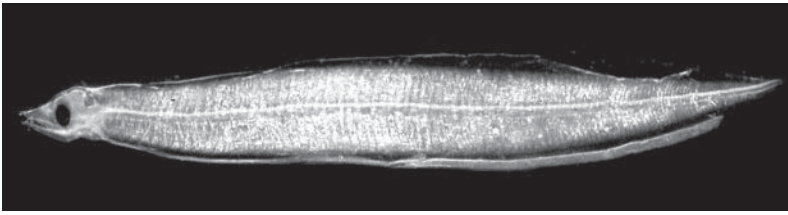

Gnathophis mystax larva.

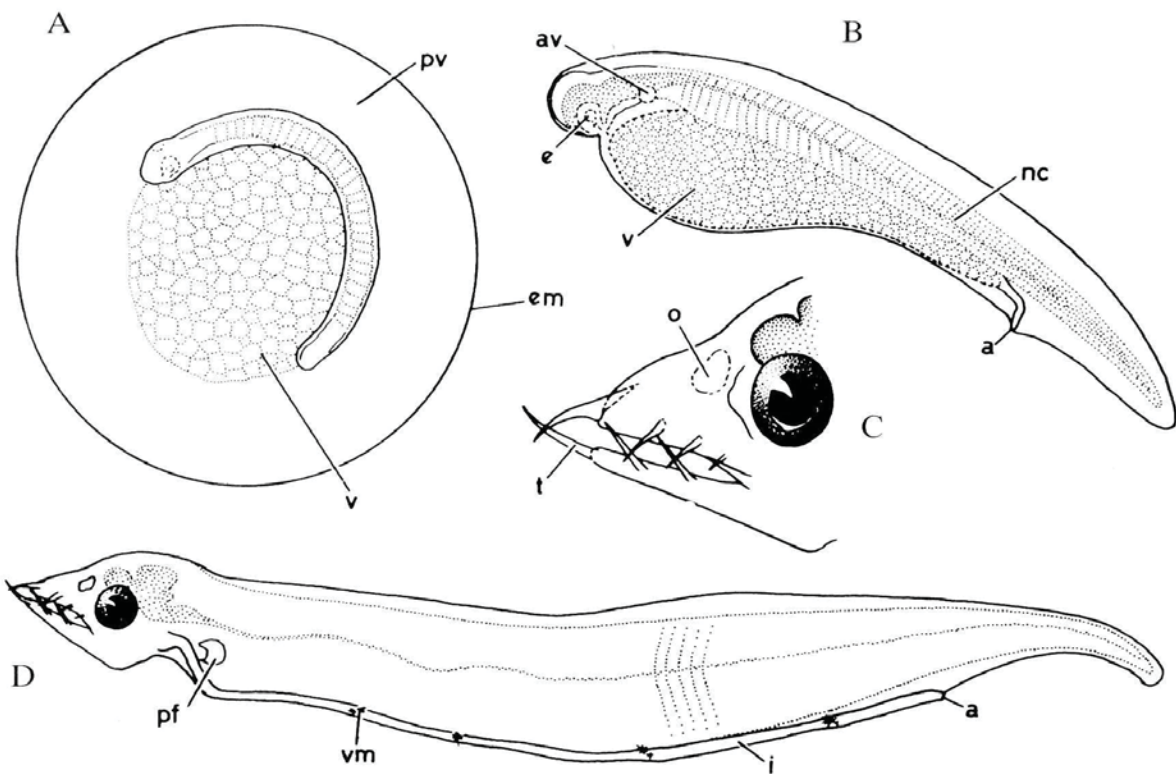

A-D: early stages of *Gnathophis mystax*. Abbreviations: a-anus, av-auditory vesicle, e-eye, em-egg membrane, i-intestine, nc-nerve cord, o-olfactory organ, pf-pectoral fin, pv-perivitelline space, t-larval tooth, v-vitellus, vm-ventral melanophore (Castle,1969).

Family OPHICHTHIDAE

Snake eels

Main references: Blache, 1977; Castle, 1984; Fahay, 1983; Leiby, 1982, 1990.

The main family characters are:

- body moderately elongated
- body depth less than 50% of total length
- head moderate to elongated
- gut length 50-67% of the standard length
- 3 or more gut swellings
- tail moderate to blunt (caudal fin often absent)
- maximum leptocephalus size 80-180 mm
- myomeres > 100
- dorsal fin origin variable
- ventral pigment concentrate on swellings
- lateral pigment variable

FAO name: Painted eel

Libyan name: حنش بحر (Hanesh baher)

Italian name: Miro (ميرو)

Synonyms: *Echelus punctatus* (Rafinesque, 1810); *Leptocephalus kefersteini* (Kaup, 1860); *Muraena longicollis* (Cuvier, 1816)

Main references: Arbault and Boutin, 1968; Castle, 1984; D'Ancona, 1931; Ferreiro and Labarta, 1988; Marinaro, 1971; Nelson, 2006.

Distribution

Eastern Atlantic Ocean, including the Mediterranean Sea.

Reproduction

In the Mediterranean Sea, spawning occurs in summer.

EGGS

Diameter 3.33 mm. Chorion reticulated, presenting an hexagonal pattern. Yolk diameter 1.60-1.85 mm. White oil globules are present.

LARVAE

Morphology

Larva hatches relatively late, after about 6 days, but it already presents teeth and pigment. After about 2 days, it is about 12 mm long and 1 mm high. Ratio between preanal length and postanal length is 2:1. Each jaw with 4 teeth. Some larvae may reach a length of 92 mm. Body elongated, often not very high (1/10 of the trunk length). Anus located behind half of the body. Snout pointed. Upper jaw slightly shorter than the lower one. In smaller specimens the nostrils are not parted and positioned in front of the eye (nearer to it than to the apex of the snout); in bigger specimens they are parted and nearer to the mouth. Eyes are perfectly round. Gut presenting 9-10 swellings.

Pigmentation

Embryo is pigmented on caudal fin and gut.

When longer than 12 mm has 7 ventro-lateral postanal spots and 9 abdominal.

At 12 mm, 5 spots of pigment on both sides of its gut, of which one near the anus. 1-2 other spots may be found behind the anus. Sometimes, there may be some pigment around the caudal apex. At the back of the gut there is a spot of pigment corresponding to each hollow, with the last one positioned on the same level as the anus. Some spots of pigment are placed centrally to the gut and some of them can be seen near the throat. The presence of dots along the anal fin is not continuous, sometimes being broken by a series of tiny spots. At the caudal apex there is some pigment on the fin, beyond a supraspinal dorsal pigmented line. On the head there is some pigment only on the apex of the upper mandible, towards its middle part and under the gills.

Vertebrae/myomeres

At 12 mm 135-141 myomeres, 57-60 of which are preanal.

At 20 mm, 58 preanal and 76 postanal myomeres.

At 92 mm, 147-155 total myomeres, of which 66-78 preanal.

Fins

At 12 mm, dorsal fin extending onwards, at level of the 3rd spot of pigment starting from the anus.

At 92 mm pectoral fins are well developed. Caudal fin rays are longer than dorsal and anal rays. Caudal fin rounded.



Echelus myrus larva.

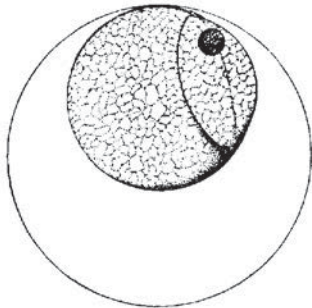

A

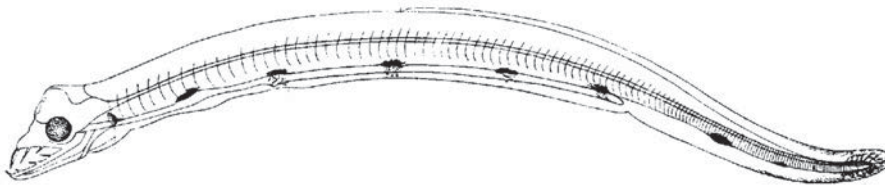

B: 12 mm

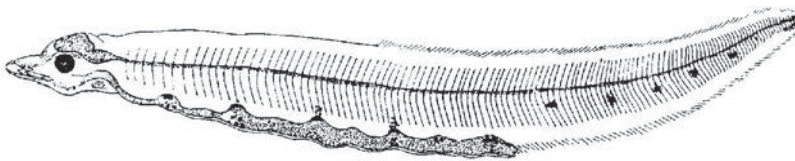

C: 20 mm

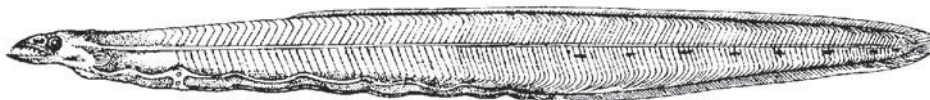

D: 50- 60 mm

A: egg of *Echelus myrus* Grassi (1913).

B-D: *Echelus myrus* larvae. B and D: Grassi (1913); C: Grassi (1917).

Order CLUPEIFORMES

Main references: Fahay, 1983; McGowan and Berry, 1984; Olivar and Fortuño, 1991.

This group of fishes frequently occurs in upwelling regions and typically inhabit areas close to the shore.

The eggs of the Mediterranean species are pelagic. The vertical distribution of eggs and larvae is generally concentrated in the superficial layers of the water column, with abundance peaks above depth of 25 m.

General features of eggs:

- spherical shape (mostly, but oval in Engraulidae)
- chorion smooth
- yolk segmented
- narrow to wide perivitelline space
- none or 1 oil globule

General features of the larvae from this order:

- body elongated, slender
- preanal length 65-95% of standard length
- gut straight, extending to more than 70% of standard length
- vertebrae 40-60
- eyes round
- head spines absent

- melanophores serially arranged along gut and on ventral mid-line between anus and caudal fin
- melanistic shield over the swim bladder
- no early formation of fin rays or spines
- marked transformation, implying fins migration

Main distinctive characters among species in early larval stages are ():

- size at hatching
- size of larvae when pigmentation of eyes starts
- pigmentation on the head
- pigmentation on the body

Main distinctive characters among species in larvae from 6 mm are:

- shape of the gut and the swim bladder
- length of the gut
- shape of head
- distinguishing pigmentation
- notochordal flexion
- number of pre-anal myomeres
- relative position of dorsal and anal fins

Family ENGRAULIDAE

Anchovies

Main references: Garcia Lafuente *et al.*, 2000, 2002; Ré, 1986 b; Matsuura and Olivar, 1999; Whitehead *et al.*, 1988.

General features of eggs:

- elliptical

- lacking oil globule

In Engraulidae the posterior margin of dorsal fin is located over anterior insertion of anal fin, whereas in Clupeidae some myomeres separate them.

FAO name: European anchovy

Libyan name: أنشوقة (Anchoga)

Italian name: Acciuga (انشوقة)

Synonyms: *Anchoa guineensis* (Rossignol and Blache, 1961); *Anchoviella guineensis* (Rossignol and Blache, 1961); *Clupea encrasicolus* (Linnaeus, 1758)

Main references: Arbault and Boutin, 1968; Borme *et al.* 2009; Coombs *et al.* 2003; Costa, 1999; Cuttitta, 2004; D'Ancona, 1931; Ferreiro and Labarta, 1988; King *et al.*, 1978; Koutrakis *et al.*, 2004; Marinaro, 1971; Nelson, 2006; Olivar and Fortuño, 1991; Olivar *et al.*, 2001; Ré, 1986b; Palomera and Leonart, 1989; Palomera, 1991; Ré, 1987, 1990; Sinovčić, 1988, 2004; Somarakis *et al.*, 2002; Tudela *et al.*, 2002; Whitehead, 1985.

Distribution

Eastern Atlantic Ocean: from Norway to South Africa. Reported from Estonia. Present all over the Mediterranean, Black and Azov seas, with stray individuals in Suez Canal and Gulf of Suez. Reported also from Western Indian Ocean: Mauritius, Seychelles, and upwelling area around Somalia.

Reproduction

Spawning in one clear seasonal peak per year, usually in the warmer months: from April to September with a peak in June and July. The limit of the spawning season is dependent on temperature and is therefore more restricted in the northern areas. Spawning occurs closer inshore than do the other species of Clupeiformes.

EGGS

Characterized by ellipsoidal shape whose maximum diameter is 1.15-1.25 mm and minimum diameter is 0.50-0.55 mm (in the Mediterranean). Smooth chorion. Segmented yolk. Narrow perivitelline space. No oil drops present. The blastoderm forms firstly in the lower pole of the ellipsoid; then the embryo develops following the major axis of the egg with the head facing the lower pole.

LARVAE

Morphology

In Mediterranean larvae are approximately 3.6 mm at hatching. Body transparent, with ovoidal yolk sack still visible. Notochord thick; its adipose cells are ordered in two rows. Gut slender, reaching the terminal region of the body and ending under dorsal fin. At hatching, the larva is not well developed. Mouth not yet opened. In the

first 2 days of life, larvae undergo a process of elongation that lasts 30 hours: number of myomeres increases; skull cartilages become visible; eyes become pigmented; otoliths enlarge; posterior part of gut grows thicker. From 6 mm, foregut narrower than the portion posterior to the swim bladder. Hindgut appears striated. Swim bladder is more conspicuous than in larvae of *S. pilchardus*, producing a bulge in the gut. End of gut situated between the midpoint and the end of the dorsal fin (characteristical for the genus). Eyes round to slightly elongated. At 7.5-8.6 mm, the flexion of the notochord takes place. At 15 mm, snout pointed and elongated. Pre-orbital cavity presents the same size as the eye diameter. Lower jaw becomes prominent on the upper one. In the following developmental stages, larva reaches its final shape: snout becomes obtuse; nostrils are parted; upper and lower jaw are more or less the same size.

Pigmentation

At 3.4-3.6 mm, pigmentation is present ventrally, from the pectoral fins to the caudal region; pigmentation on the ventral portion of the caudal tip is a highly characteristic feature. Eye pigmentation starts at 4 mm. No pigmentation is visible on the head. On the foregut 5-8 melanophores are present (fewer than in *S. pilchardus*). On the swim bladder 3-4 large melanophores are present, but they disappear with growth. In larvae up to 10 mm a single melanophore at the anus is visible. In larvae above 10 mm pigment is present in the throat and 4 melanophores are situated on the body, anteriorly to the anus. On the anal fin a row of melanophores becomes more conspicuous during larval development (present in number up to 8 at length of 18.5 mm); behind this there is another row of melanophores, spaced so closely each other that they cannot be distinguished.

Vertebrae/myomeres

Myomeres are present in number of 30+17.

Fins

After hatching, the dorsal fin is placed towards the back of the pelvic fins, a feature that is also common to the Clupeid larvae. At 11 mm the caudal fin gets its final symmetrical shape. At 15 mm the caudal fin becomes two-lobed and the rays of the uneven fins reach their final number.

Dorsal fin rays: II-III, 12-14.

Anal fin rays: II-III, 13-18.



Engraulis encrasicolus larva (9 mm).

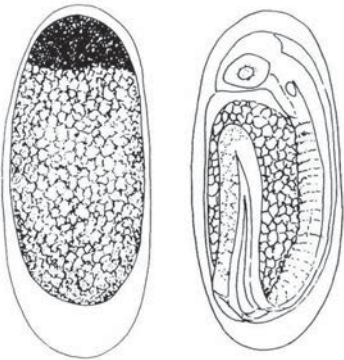

A

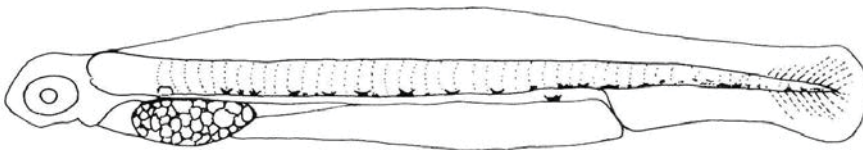

B: 3.5 mm

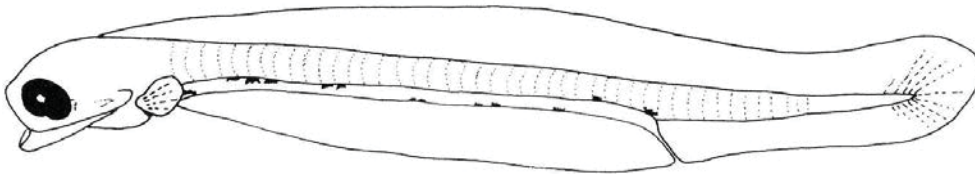

C: 3.8 mm

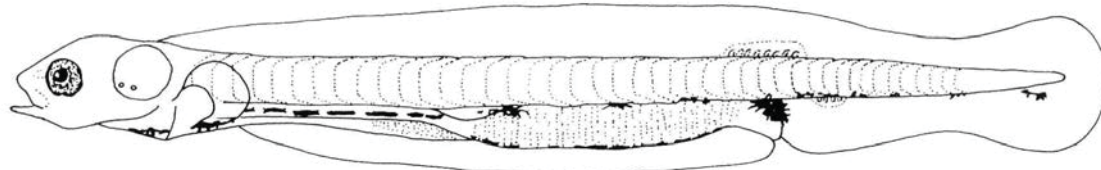

D: 5.9 mm

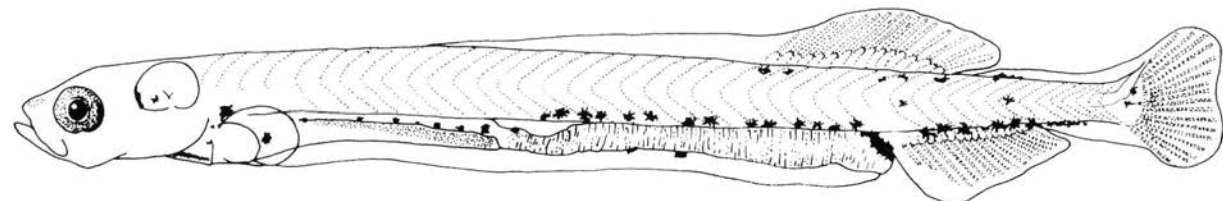

E: 8.9 mm

A: Egg of *Engraulis encrasicolus* redrawn by Olivar and Fortuño (1991) from King et al. (1978).
B-E: Redrawn by Olivar and Fortuño (1991) from Brownell (1979).



Family CLUPEIDAE

Herrings, shads, sardines, menhadens

Main references: Alemany Llodrà, 1997; Costa, 1999; D'Ancona, 1931; Fischer *et al.*, 1995; Matsuura and Olivar, 1999; Whitehead, 1985; Whitehead *et al.*, 1986.

General features of eggs:

- pelagic
- spherical shape
- yolk segmented
- chorion not ornamented

In Clupeidae larvae gut is closer to caudal region than in Engraulidae.

FAO name: Round sardinella

Libyan name: سردينية (Sardina)

Italian name: Alaccia Sardina (سردينية)

Synonyms: *Alosa senegalensis* (Bennett, 1831) (ambiguous synonym); *Clupanodon pseudohispanica* (Poey, 1860); *Clupea allecia* (Rafinesque, 1810) (ambiguous synonym)

Main references: Arbault and Boutin, 1968; Conand and Fagetti, 1971; Fahay, 1983; Ferreira and Labarta, 1988; Koutrakis *et al.*, 2004; Maigret and Ly, 1986; Marinaro, 1971; Morote *et al.*, 2008; Nelson, 2006; Olivar and Fortuño, 1991; Raffaele, 1888; Sinovčić *et al.*, 2004; Somarakis *et al.*, 2002.

Distribution

Eastern Atlantic Ocean: from Gibraltar to Saldanha Bay (South Africa). Also known from the Mediterranean and Black Sea. Western Atlantic Ocean.

Reproduction

Spawns probably throughout the year, but with distinct peaks; in some areas there are two main spawning seasons.

EGGS

Spherical, with a diameter of 1.18-1.44 mm. Chorion smooth, transparent and thin. Yolk segmented and amber-coloured. Large perivitelline space. A single oil globule with a diameter of 0.12-0.16 mm, usually yellow-coloured. The embryo is smaller than in *Sardina pilchardus*. When the larva hatches, the oil drop is placed medially on the ventral portion of the yolk sac (while in *S. pilchardus* is more posterior). This character is difficult to apply to larvae sampled at sea, in which the yolk is often broken.

LARVAE

Morphology

At hatching, 3.5 mm long. Body elongated and transparent. Gut long and straight. Anus positioned posteriorly to dorsal fin. Head similar in shape to that of *S. pilchardus* and *Engraulis encrasicolus*, but better developed than in other Clupeids, long 1/5 of total length. Eyes round and protuberant.

From 6 mm, foregut straight and narrower than the portion posterior to the swim bladder (it is shorter than in *S. pilchardus*). The hindgut appears striated. The end of the gut is situated 8-9 myomeres beyond the end of the dorsal fin.

At about 10 mm the flexion of the notochord takes place.

Transformation occurs at about 25 mm of total length.

Pigmentation

Eye pigmentation starts at 5 mm. No pigmentation is visible on the head in yolk-sac larvae. No melanophores are present on the body during the yolk-sac larva stage.

At 6.5 mm pigment is present in the ventral area of the notochord tip.

Up to the size of 7 mm, the smaller number of melanophores on the hindgut is useful to distinguish this species from *S. pilchardus*. 2 melanophores, more conspicuous than the anterior pigmentation, are present on the anus (while *S. pilchardus* presents only one melanophore).

Up to 10 mm, no pigmentation posteriorly to the anus (while *S. pilchardus* presents a band of melanophores); but after that size postanal pigmentation appears also in Round sardinella.

Vertebrae/myomeres

Myomeres are present in number of 41 (preanal) +7 (postanal).

Fins

At 11 mm, dorsal fin is already developed, caudal fin is symmetrical and the pelvic fins are visible. 5-8 myomeres present between dorsal and anal fins; predorsal myomeres decrease from 28 to 24. In larger larvae the last 2 anal rays become elongated.

Dorsal fin rays: III-IV, 14-16.

Anal fin rays: III, 13-15.

Pelvic fin rays: 8-10.

Caudal fin rays: 8+10+9+7.



Sardinella aurita larvae (10; 6.5; 6 mm).

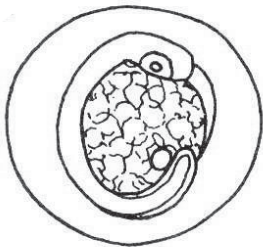

A

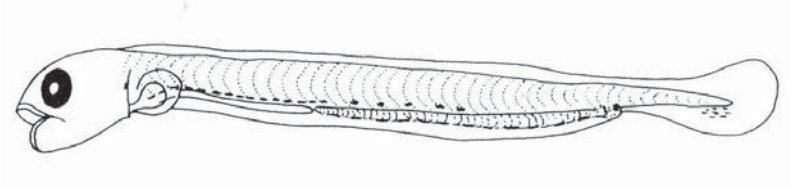

B: 5.3 mm

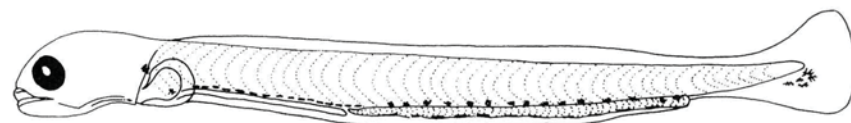

C: 7.0 mm

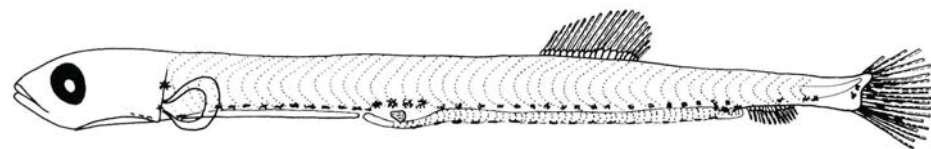

D: 10.3 mm

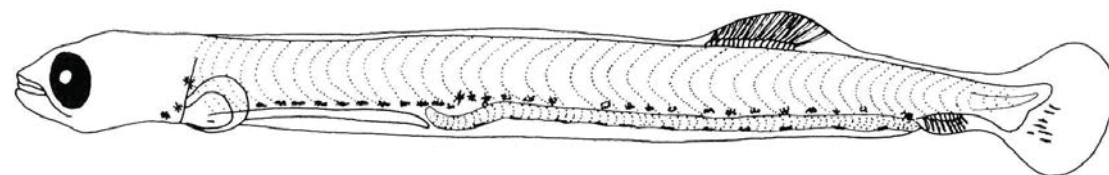

E: 16.5 mm

A: Egg of *Sardinella aurita* redrawn by Olivar and Fortuño (1991) from Kalinina (1980).

B-E: Redrawn by Olivar and Fortuño (1991) from Conand and Fagetti (1971).

Order OSMERIFORMES

Main references: Ahlstrom *et al.*, 1984b; Fahay, 1983; Matsuura and Olivar, 1999; Moser, 1981.

General features of eggs, referred to Argentinoidei:

- spherical shape
- chorion usually ornamented, with pustules on inner surface
- yolk segmented
- narrow to moderate perivitelline space
- 1 or many oil globules

General features of the larvae from this order:

- body elongated, slender
- preanal length 70-90% of standard length
- gut straight
- vertebrae 40-85
- round to narrow eyes, in some species stalked
- head spines absent
- voluminous fin fold, in many species with dorsal and anal fins developed within fin-fold tissue some distance from body
- no early formation of fin rays or spines
- marked transformation

Family ARGENTINIDAE

Argentines or herring smelts

Main references: Matsuura and Olivar, 1999.

General features of the larvae from this family:

- body slender
- head relatively small

- gut straight, extending beyond midpoint of body
- melanophores on ventral trunk representing main pigmentation feature useful in identification of this family

In *Argentina sphyraena* ventral blotches of pigment do not expand dorsally as in other argentinid species.

FAO name: Smalltoothed argentine

Libyan name: (ابوسنينة)

Italian name: Argentina lingua liscia

Synonyms: *Argentina leioglossa* Valenciennes, 1848; *Argentina silus* (non Ascanius, 1775)

Main references: Sanzo (1931)

Distribution

Eastern Atlantic: from southern Spain to Mauritania, including western Mediterranean. Generally present on outer continental shelf and upper slope.

Reproduction

In the Mediterranean spawning occurs from September to March.

EGGS

Spherical, transparent, with diameter from 1.44 to 1.52 mm. Chorion grained. Narrow perivitelline space. Yolk segmented. A single oil globule, coral-red coloured, with diameter 0.36 mm.

LARVAE

Morphology

At hatching scarcely developed. Mouth not opened. Eyes not pigmented. Yolk with red oil globule still present. Gut straight and thin, turning down at the margin of primordial fin fold. Preanal length about 75% of total body length.

At 6.68 mm, body slender.

At 15 mm flexion of the notochord starts.

Pigmentation

At hatching, 2 opposite large black spots over and behind caudal region, just before the caudal tip. 3 black spots along the gut: a small spot just behind the yolk sac; a slightly larger spot between the anus and the yolk sac end; a larger spot at the bending of the gut, near the anus.

At 6.68 mm, another black small spot between the anal and the caudal large spots. Other 7

spots, evenly spaced, are present along the gut, extending vertically from ventral side to dorsal side; the first of these spots at the base of pectoral fins. One more mark running obliquely from tip of snout to operculum, with an interruption of pigmentation around the eyes.

Finally, the spots are 10: 1 cephalic, 7 abdominal, 2 caudal. This pigment feature will remain up to 50 mm, when transformation to the juvenile stage will occur.

During development the 2 large spots on caudal region merge into one and the ventral bands reach the dorsal margin. Part of the caudal spot extends to the caudal fin. The cephalic spot concentrates on snout.

At 10 mm starts pigmentation of lower jaw.

Vertebrae/myomeres

At hatching 35 preanal and 17 postanal myomeres.

At 6.68 mm, 35 preanal and 16 postanal myomeres.

Fins

At 15 mm, pectoral fins still membranaceous; at 19.12 mm about 12 pectoral fin rays are present but not yet complete.

Sequence of fin rays formation: caudal fin at 20 mm; pectoral fins at 29.64 mm; dorsal, anal and ventral fins at 30 mm; caudal fin at 32 mm.

At 33-35 mm the primordial fin fold still remaining will form the adipose fin.

Dorsal fin rays: 13-14.

Anal fin rays: 11-12.

Pelvic fin rays: 12.

Pectoral fin rays: 21-22.

Caudal fin rays: 9-10 + 9-10.

Pelvic fins extending posteriorly, under posterior margin of dorsal fin base.



Glossanodon leioglossus larva.

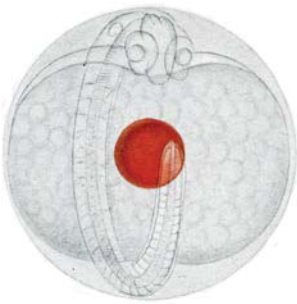

A

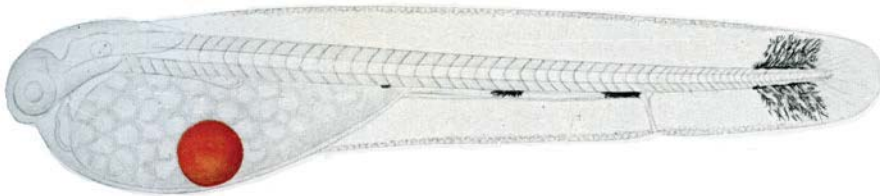

B: 5 mm



C: 12.48 mm

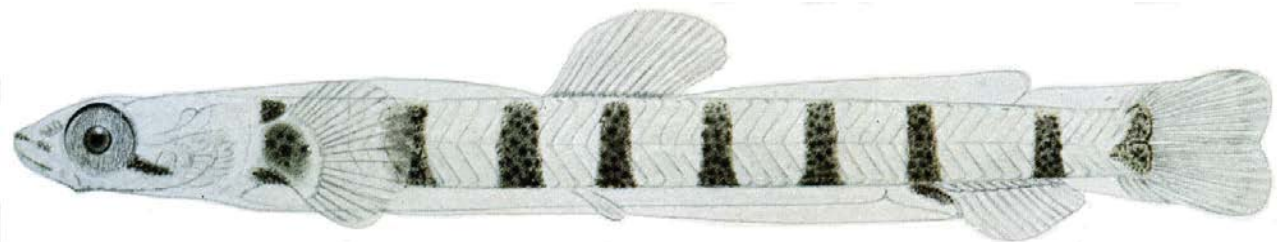

D: 29.64 mm

A-D: early stages of *Glossanodon leioglossus* from Sanzo (1931).

Order STOMIIFORMES

Main references: Ahlstrom *et al.*, 1984c; Matsuura and Olivar, 1999; Nelson, 2006.

Larvae of this order are characterized by high morphological diversity, even within families. Diversity regards also the eggs, at those of known species.

Common feature of larvae is the presence of photophores, whose pattern represents a useful diagnostic character in specific discrimination.

Family GONOSTOMATIDAE

Bristlemouths

Main references: Ahlstrom *et al.*, 1984c; Costa, 1999; Matsuura and Olivar, 1999; Nelson, 2006; Ozawa and Oda, 1986; Quéro *et al.*, 1990a; Richards, 1989.

Species of this family are distributed in Atlantic, Indian and Pacific Oceans. The genus *Cyclothone*, with its 12 species, occurs in virtually all the seas, including the Antarctic.

General features of larvae from this family:

- body slender
- teeth on maxilla and premaxilla
- gut straight, to 60% of body length

- swim bladder conspicuous
- fins usually form in adult position
- adipose fin may be present or absent
- anal fin base usually long, occupying most of postanal distance; from 16 to 68 rays
- pigmentation behind eyes present in *Gonostoma*, not in *Cyclothone*
- pigmentation pattern useful to discriminate species of *Cyclothone* and *Gonostoma*
- photophores usually present on isthmus (Fig. 15)
- branchiostegal photophores 8-16

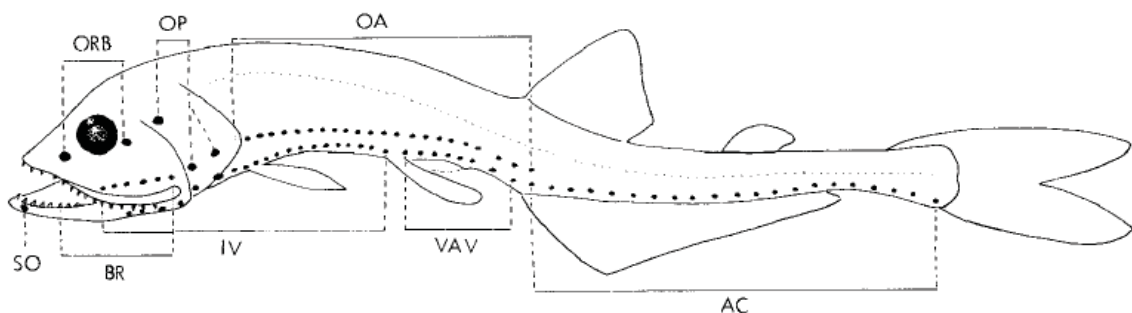

Fig. 15. Photophore group terminology Photophores pattern in Stomiiformes and their identification (Fahay, 1983).

FAO name: Garrick

Libyan name: بوقداح (Bogaddah)

Italian name: Bocca tonda (بوکا توندا)

Synonyms: *Cyclothone signata* (non Garman, 1899) (misapplied name)

Main references: Ahlstrom *et al.*, 1984c; Alemany Llodrà, 1997; Badcock, 1984; Fahay, 1983; Goodyear *et al.*, 1972; Jespersen and Tåning, 1926; Ozawa and Oda, 1986; Quéro *et al.*, 1990a; Sanzo, 1931.

Distribution

Present in all the tropical and sub-tropical seas: Indian, South Pacific and Atlantic Oceans, including the Mediterranean. Also found in the temperate North Atlantic, as far as 66° N, and in the sub-Antarctic waters south of Australia. Its depth range is 200-1000 m.

Reproduction

In Mediterranean, spawning occurs mainly in spring and summer.

EGGS

No available information.

LARVAE

Morphology

Body slender. Preanal length about 50% of standard length. Eyes round. Swim bladder present. Adipose fin absent.

Flexion of notochord occurs at about 4.5-5.5 mm of standard length.

At 6 mm, gut slightly curved. Head about 1/8 of body length. Jaws develop.

Transformation occurs suddenly, at about 14 mm of standard length. Body shrinks. Head changes in shape. Anus moves anteriorly from anal fin origin.

Pigmentation

At 4.8 mm, a ventral row of 11-12 evenly-spaced internal melanophores. 2-3 spots along gut (posteriormost at anus). Another spot forms at cleithral symphysis. Swim bladder pigmented.

At about 10 mm, after anal fin formation, 14-15 melanophores on the distal pterygiophores of the anal fin. 5 melanophores on ventrolateral portion of the anterior half of body. 1 spot under urostyle. 3 internal melanophores are present dorsally on the caudal region. Pigmentation on base of caudal fin is absent.

At about 11-12 mm, most of the photophores (unpigmented) form. Just a few (i.e. OA) form later. Photophores AC not forming in 2 groups.

At transformation most of the photophores become pigmented simultaneously.

Vertebrae/myomeres

Myomeres: 29-33.

Fins

At about 10 mm caudal and dorsal fins complete; anal fin soon after.

At about 12 mm, near the swim bladder, pelvic bud forms. At same length pectoral fin rays begin to form dorsally.

Dorsal fin rays: 12-15.

Anal fin rays: 16-21.

Pelvic fin rays: 6-7.

Pectoral fin rays: 9-13.

Notes

Before pigmentation larvae are very similar to those of *Vinciguerria*, but *Cyclothone* has rounded eyes, shorter preanal length and more spots along the anal fin base.

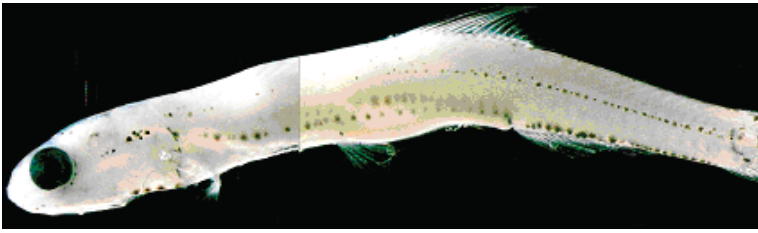

Cyclothone braueri larva.



A: 4.8 mm

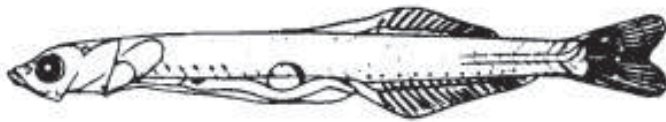

B: 10.04 mm

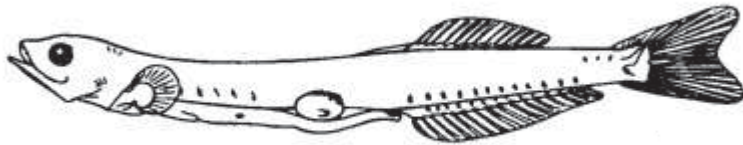

C: 13.7 mm

A-C Early life history stages of *Cyclothone braueri*. A and C: Tåning (1926); B: Sanzo (1931).

Family PHOSICHTHYIDAE

Lightfishes

Main references: Ahlstrom *et al.*, 1984c; Beebe, 1932; Bigelow *et al.*, 1964; Chirichigno *et al.*, 1998; Fahay, 1983; Golani, 1994; Gorbunova, 1981; Jespersen and Tåning, 1919; Matsuura and Olivar, 1999; Nelson, 2006; Quéro *et al.*, 1990b; Richards, 1989; Schaefer *et al.*, 1986; Whitehead *et al.*, 1984.

18 species, belonging to 7 genera, are distributed in Atlantic, Indian and Pacific Oceans. Their body has a similar shape to that of gonostomatids.

General features of larvae from this family:

- body elongate
- gut straight and long
- head flat
- supramaxillaries 2, usually
- adipose fin present in all (except in *Yarella*)
- dorsal fin rays 10-16
- anal fin rays 11-22
- barbel on lower jaw absent, in adults

General features of the genus *Vinciguerria*:

- body slender, elongated
- gut straight and long
- preanal length about 75% of standard length; decreases at transformation
- head length about 20% of standard length; increases at transformation
- occiput and snout concave
- eyes oval and semi-stalked
- pigment light
- caudal spot prominent

- transformation marked: body deepens; head and eyes increase in relative size; photophores develop almost simultaneously (some AC and OA slightly later)
- sequence of fin formation: caudal, dorsal and anal; pelvic buds and true pectoral rays forming at transformation; adipose fin present, but small and late forming.

Larvae of this family may be discriminated from those of clupeiforms because: mouth gape does not extend as far back as in engraulids; pigment spots are larger than in clupeids or engraulids; eye is oval.

Larvae of the genus *Vinciguerria* may be discriminated thanks to relative position of dorsal and anal fins, and on caudal pigmentation:

- *V. attenuata* origin of anal fin under rays 4-5 of the dorsal fin; caudal melanophore located medially on caudal peduncle; swim bladder pigmented
- *V. poweriae* origin of anal fin under rays 9-11 of the dorsal fin; caudal melanophore located medially on caudal peduncle; swim bladder not pigmented
- *V. nimbaria* origin of anal fin under rays 10-11 of the dorsal fin; caudal melanophore located ventrally on caudal peduncle; swim bladder not pigmented

FAO name: Slender lightfish

Libyan name: بوقداح (Bogaddah)

Italian name: Vinciguerria sottile (فنشيفوريا سوتيلي)

Synonyms: *Maurolicus attenuatus* Cocco, 1838; *Vinciguerria lucetia* (non Garman, 1899) (misapplied name); *Vinciguerria poweriae* (non Cocco, 1838) (misapplied name)

Main references: Alemany Llodrà, 1997; Arbault and Boutin, 1968; Badcock, 1984; Bigelow *et al.*, 1964; Fahay, 1983; Ferreiro and Labarta, 1988; Gorbunova, 1981; Jespersen and Tåning, 1926; Kalinina, 1980; Marinaro, 1971; Mercader *et al.*, 2003; Papisassi, 1989; Quéro *et al.*, 1990b; Richards, 1989; Sanzo, 1931; Schaefer *et al.*, 1986.

Distribution

Northwestern Atlantic: Canada. Eastern Atlantic: from Portugal to South Africa, including Mediterranean. Indian Ocean: off Inhaca Island, Mozambique. Southeastern Pacific: Chile. South China Sea.

Reproduction

In Mediterranean spawning occurs all over the year.

EGGS

Spherical, with diameter ranging from 0.84 to 0.92 mm. Chorion smooth. Yolk segmented. Perivitelline space narrow. A single oil globule, with diameter 0.18-0.20 mm.

LARVAE

Morphology

At 9.2 mm, body elongated. Snout elongated and depressed. Eyes elliptical. The urostile is flexed. Ratio of preanal to postanal length: 2.75.

At 12.4 mm, snout less compressed. Ratio of standard to postanal length: 2+.

At 15-17 mm of standard length, metamorphosis occurs. Substantial body shrinkage during transformation. Eyes become round. Ratio of standard to postanal length: 1.75.

At 24 mm, juveniles present more deep cephalic and abdominal region. Eyes tubular. Ratio of standard to postanal length: 1.5+.

Pigmentation

Caudal pigment spot in a medial position; increasing during development and becoming branched (sometimes may be lost at transformation). Eyes pigmented. Pigment absent above anal fin. Pigment over swim bladder.

At 12.4 mm, still weakly pigmented. SO photophore absent.

At 24 mm, trunk show melanophores: some branched on the dorsal part of gut; others arranged in 2 ventral rows from anus to opercles. 2 photophores in the vicinity of eyes; 3 behind orbits.

Vertebrae/myomeres

Vertebrae: 40-41.

Fins

At 9.2 mm, pectoral fins are small, elongated, membranaceous and slightly pedunculated.

At 12.4 mm, origin of anal fin is located under the 5th-6th ray of the dorsal fin.

At 18.3 mm, pectoral fins well developed, reaching the final number of rays. Bud of the adipose fin present.

Dorsal fin rays: 13-15.

Anal fin rays: 14-16.

Pelvic fin rays: 7.

Pectoral fin rays: 9-10.

Notes

At all stages, relative tail length is greatest in *V. attenuata* than in *V. nimbaria* and *V. poweriae*.



Vinciguerria attenuata larva (16 mm).

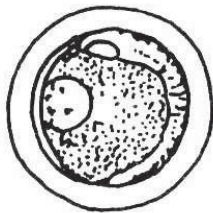

Egg of *Vinciguerria attenuata*, redrawn by Olivar and Fortuño (1991) from Kalinina (1980).

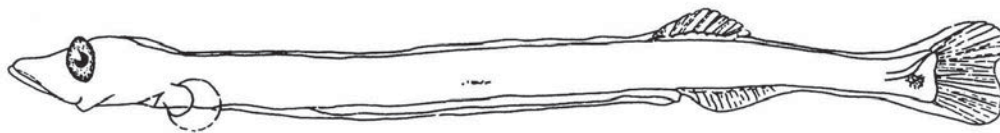

A: 9.7 mm

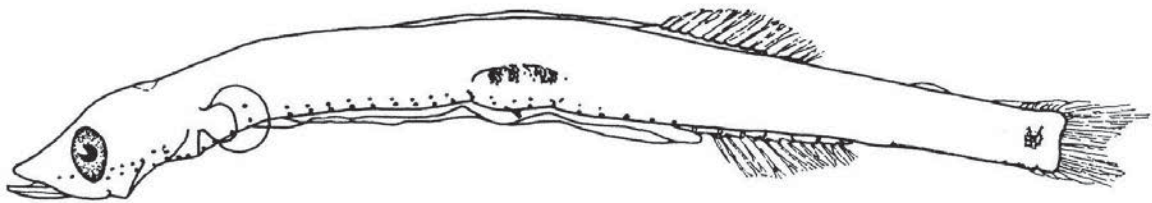

B: 18.3 mm

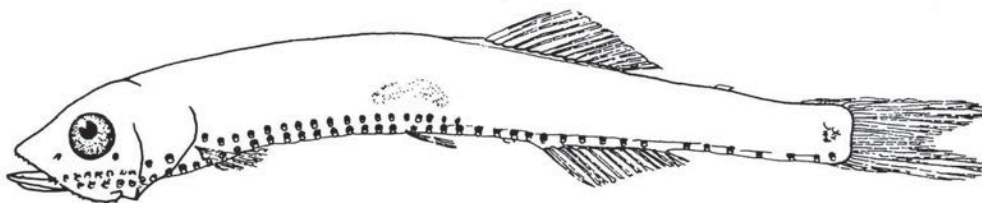

C: 18.5 mm

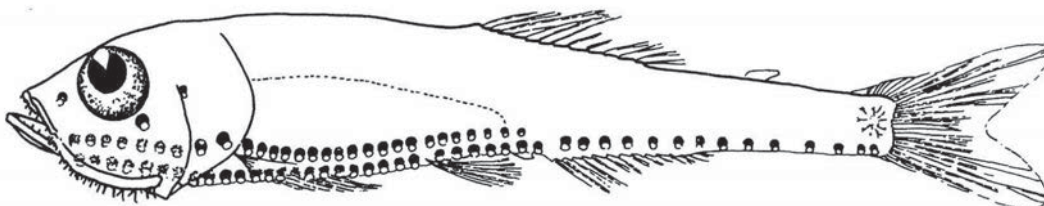

D: 20.8 mm

A-D early life stages of *Vinciguerria attenuata*, redrawn by Olivar and Fortuño(1991) from Jespersen and Tåning (1926).

FAO name: Power's deep-water bristle-mouth fish

Libyan name: بوقداح (Bogaddah)

Italian name: Vinciguerria (فنشيقوريا)

Synonyms: *Gonostomus poweriae* (Cocco, 1838); *Ichthyococcus poweriae* (Cocco, 1838); *Maurolicus poweriae* (Cocco, 1838)

Main references: Arbault and Boutin, 1968; Ahlstrom and Counts, 1958; Bekker *et al.*, 1982; Costa, 1999; Fahay, 1983; Ferreiro and Labarta, 1988; Gorbunova, 1981; Jespersen and Tåning, 1926; Kalinina, 1980; Marinaro, 1971; Papisissi, 1989; Richards, 1989; Sanzo, 1931; Schaefer *et al.*, 1986; Quéro *et al.*, 1990b; Watson, 1996a.

Distribution

Circumglobal in subtropical waters. Eastern Atlantic: from Portugal to Cape Verde, including the eastern Mediterranean. Western Atlantic: Gulf of Mexico. Northwest Atlantic: Canada. Western Pacific: Australia, Tasmania and New Zealand. Eastern Pacific: off California and Chile. South China Sea.

Reproduction

In Mediterranean spawning occurs all over the year, decreasing in winter. Sexual maturity at 30 mm.

EGGS

Spherical and transparent, with a diameter ranging from 0.75 to 0.85 mm. Yolk segmented. A single oil globule, with diameter ranging from 0.17 to 0.19 mm.

LARVAE

Morphology

At 9.2 mm, body elongate and slender. Snout prominent and strongly reduced. Eyes elliptical. Notochord appears flexed. Gut straight. Ratio of standard to postanal length: 3.

At 12 mm, body shape similar to that of *V. attenuata*. Presence of structure above the anal papilla which may appear as pigment.

At 20 mm, weakly pigmented. Eyes pigmented. A photopore at the end of the body, as in *V. attenuata*. Ratio of standard to postanal length: 3.

At 25.8 mm, close to transformation. Body shape still elongated, but depth increases. Snout becomes larger. Eyes become round. Ratio of standard to postanal length: 2.5+.

Substantial body shrinkage during transformation: body standard length decreases to 16-17 mm.

In juveniles ratio of standard to postanal length: 2.5.

Pigmentation

Unpigmented in preflexion-flexion stages. Eyes pigmented. A single melanophore may be present on midlateral portion of caudal peduncle, usually on one side only.

Weakly or not pigmented through postflexion stage. In specimens less than about 11 mm, no melanophores or just 1 midlateral, on each side of caudal peduncle. Swim bladder not pigmented. No pigmentation over anal fin. SO photophore absent.

At 23-24 mm, the pigment spot in medial position of caudal area persists. Body becomes highly pigmented, increasing. Photophores arrangement complete: 2 close to eyes; 3 on orbits; 7-9 on branchiostegal membrane; 8-10 on ventral region.

At transformation, pigment develops and increases dorsally and dorso-laterally, spreading on caudal and ventral regions.

Vertebrae/myomeres

Vertebrae: 38-39.

Fins

Sequence of fin development: caudal, dorsal, anal, pelvics, pectorals.

At 9.2 mm, caudal fin rays are nearly defined. The pectoral fins are small, membranous, and slightly peduncular.

At 12 mm, caudal fin rays complete.

At 20 mm, origin of anal fin is located under the 9th-11th ray of the dorsal fin.

At 23-24 mm, adipose fin is present.

Dorsal fin rays: 13-15.

Anal fin rays: 12-14.

Pelvic fin rays: 7.

Pectoral fin rays: 9-10.

Vinciguerria poweriae (Cocco, 1838)

Family PHOSICHTHYIDAE



Vinciguerria poweriae larva.



A: 11.3 mm

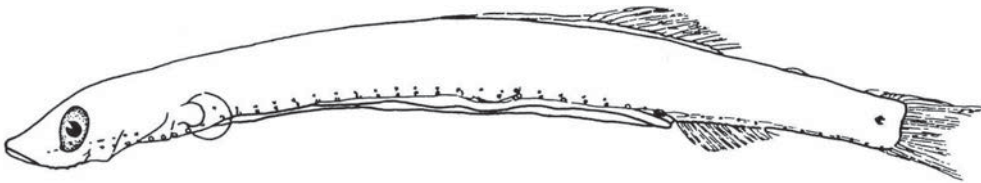

B: 20.0 mm

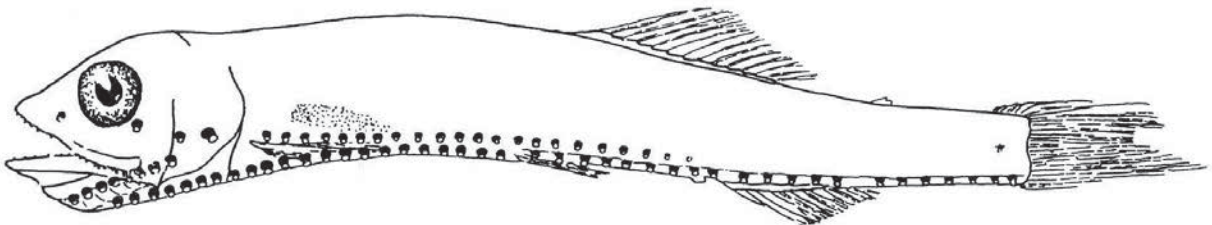

C: 17.7 mm

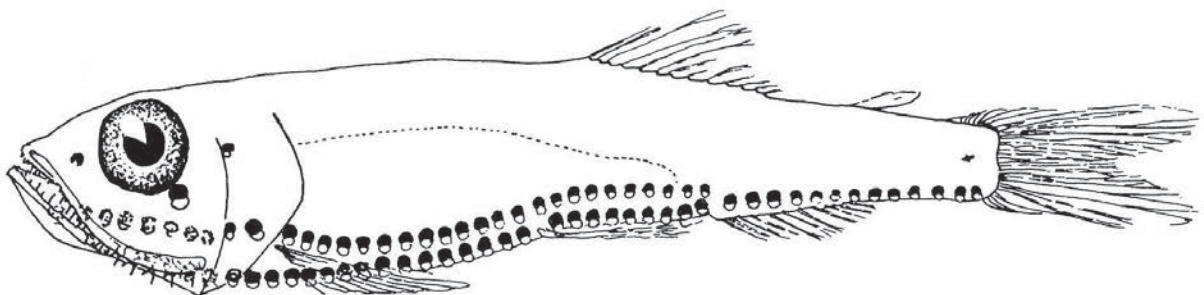

D: 21.3 mm

A-D early life stages of *Vinciguerria poweriae*, redrawn by Olivar and Fortuño (1991) from Jespersen and Tåning (1926).

FAO name: Oceanic lightfish

Libyan name: بوقداح (Bogaddah)

Italian name: Vinciguerria orbitaria
(فتشيقوريالوربييتارية)

Synonyms: *Vinciguerria lucetia* (non Garman, 1899) (misapplied name); *Vinciguerria nimbria* (Jordan and Williams, 1895); *Vinciguerria sanzoi* (Jespersen and Tåning, 1919)

Main references: Ahlstrom *et al.*, 1984c; Arbault and Boutin, 1968; Ahlstrom and Counts, 1958; Ahlstrom and Moser, 1981; Badcock 1984; Bigelow *et al.*, 1964; Fahay, 1983; Ferreiro and Labarta, 1988; Gorbunova, 1981; Jespersen and Tåning, 1926; Kalinina, 1980; Marinaro, 1971; Quéro *et al.* 1990b; Richards, 1989; Sanzo, 1931; Schaefer *et al.*, 1986.

Distribution

Distributed in: Western Central Atlantic (Florida, Cuba and the Antilles, Gulf of Mexico and the Caribbean); Eastern Atlantic (from 42°N to the tropical region); Northwest Atlantic (Canada); Mediterranean; Indo-Pacific; Southeastern Pacific (Chile); South China Sea.

Reproduction

In Mediterranean Sea spawning occurs all the year round.

EGGS

Spherical, with diameter ranging from 0.70 to 0.75 mm. Yolk irregularly segmented. No oil globules present.

LARVAE

Morphology

Yolk very big at hatching.

At 9.9 mm, body elongated and slender. Short caudal region. Eyes elliptical and pedunculated. Ratio of standard to postanal length in early larva: 3.

In late larvae the ratio of standard to postanal length becomes 2.75.

Metamorphosis occurs at a length of 13-16 mm. Substantial body shrinkage during transformation. Ratio of standard to postanal length at transformation: 2.5+.

In juveniles ratio of standard to postanal length: 2. Eyes become round.

Pigmentation

Not pigmented at hatching.

At 9.9 mm, caudal melanophore located on the ventral margin (lost at transformation). 2-3 melanophores on base of anal fin. Caudal fin base with 2-3 vertical lines of melanophores.

A narrow line of pigmented cells on junction between body and isthmus. Swim bladder not pigmented.

At metamorphosis, the melanophore located in the caudal region may be centrally present or absent. Pigment above the anal fin. Photopores appear on the gut as set of pigmented cells. Photopores may be present or absent in the sub-opercular region. 2 photopores linked to the eyes; 2 behind and 1 over orbital region; 7-9 upon the branchiostegal membrane; 1 upon the isthmus; 7 in the ventral zone. SO photophore forms.

Vertebrae/myomeres

Vertebrae: 40-42.

Fins

Origin of anal fin is located under the 10th-11th ray of the dorsal fin.

Dorsal fin rays: 14-15.

Anal fin rays: 13-15.

Pelvic fin rays: 7.

Pectoral fin rays: 9-10.



Vinciguerria nimbaria larva (13 mm).

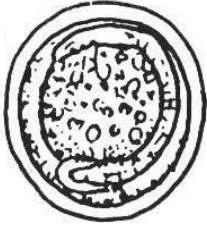

A Egg of *Vinciguerria nimbaria*, redrawn by Olivar and Fortuño(1991) from Kalinina (1980).



B: 7.3 mm

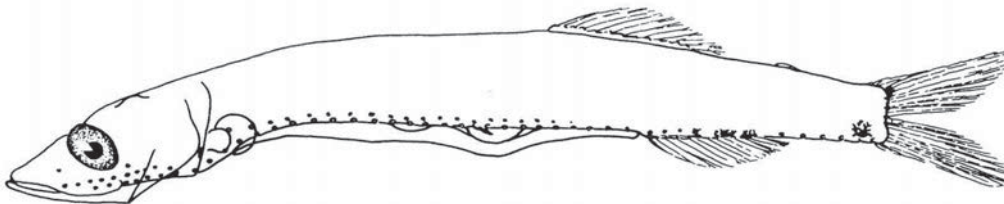

C: 14.3 mm

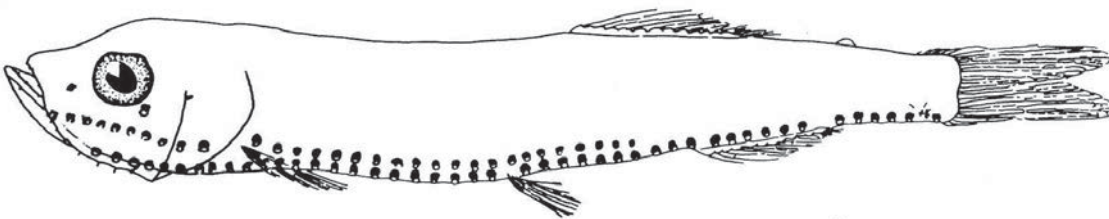

D: 15.0 mm

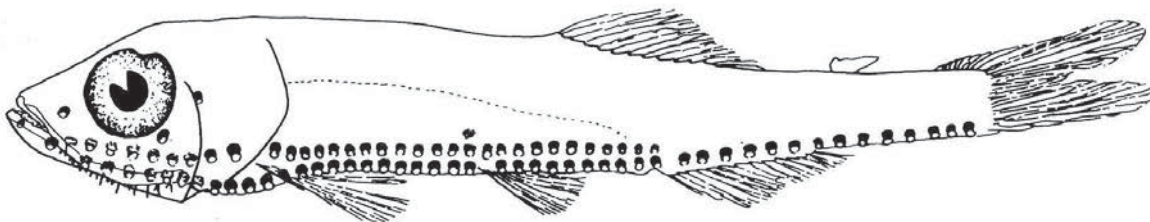

E: 20.3 mm

A Egg of *Vinciguerria nimbaria*, redrawn by Olivar and Fortuño(1991) from Kalinina (1980).

B-E early life stages of *Vinciguerria nimbaria*, redrawn by Olivar and Fortuño(1991) from Jespersen and Tåning (1926).

Order AULOPIFORMES

Main references: Johnson, 1974; Leis and Carson-Ewart, 2000; Matsuura and Olivar, 1999; Okiyama, 1988.

General features of the larvae from this order:

- may reach considerable size
- body shape mostly elongated and more or less tubular
- adipose fin generally present
- abdominal pelvic fins present
- greatly produced fins or bizarre gut or eye configuration are common
- several families are characterized by distinctive peritoneal melanophore patches or bands

Family SYNODONTIDAE

Lizardfishes

Main references: Alemany Llodrà, 1997; Anderson *et al.*, 1966; Arbault and Boutin, 1968; Bianchi *et al.*, 1993; Costa, 1999; Cressey, 1986; Fahay, 1983; Ferreiro and Labarta, 1988; Grothues and Cowen, 1999; Marinaro, 1971; Matsuura and Olivar, 1999; Nelson, 2006; Ozawa, 1986; Russell, 1999; Sulak, 1990; Whitehead *et al.*, 1984.

General features of the eggs of fish from this family:

- pelagic, spherical
- chorion sculptured with hexagonally-arranged points
- yolk unsegmented
- perivitelline space narrow

General features of the larvae from this family:

- body elongated
- mouth large
- gut long
- preanal finfold
- adipose fin present
- series of evenly spaced pairs of pigment patches along ventral body margin
- transformation occurring at large size
- dorsal fin rays : 10-13
- anal fin rays: 9-12 (except 2 species: 8-9 in *S. synodus* and 14-15 in *T. myops*)
- caudal fin rays : 9-16+10+9+9-14

The pigmentation pattern and meristic characters are useful in larval identification.

FAO name: Atlantic lizardfish

Libyan name: شكارمو (Shkarmo)

Italian name: Pesce lucertola (بيشة لوشيرتولا)

Synonyms: *Alpismaris risso* (Rafinesque, 1810); *Aulopus filamentosus* (non Bloch, 1792) (misapplied name); *Laurida mediterranea* (Swainson, 1838)

Main references: Arbault and Boutin, 1968; Bauchot, 1987; Ferreiro and Labarta, 1988; Golani, 1993; Grothues and Cowen, 1999; Hureau and Monod, 1979; Koutrakis *et al.*, 2004; Marinaro, 1971; Mercader *et al.*, 2003; Nelson, 2006; Papisissi, 1989; Sulak, 1990; Thresher, 1984.

Distribution

Atlantic Ocean and Mediterranean Sea. This is the only species of the genus *Synodus* present in the Mediterranean.

Reproduction

Spawns from June to September.

EGGS

Spherical, transparent, with diameter ranging from 1.10 to 1.35 mm. Chorion reticulated, presenting an hexagonal pattern (diameter of hexagonal elements 0.048 mm). Perivitelline space absent. Oil globules are not visible.

LARVAE

Morphology

At hatching the larva is 4.0-4.5 mm and it is transparent. Eyes oval. Snout convex. Mouth opens at hatching. Yolk sac extending from head to 3rd ventral spot.

At 5 mm, yolk sac is absorbed and a substantial shrinkage occurs. Body slender and laterally compressed.

At 12 mm, pectoral fins are formed.

At 30.39 mm, eyes are still narrow, becoming round at 62.65 mm.

During development the larva changes its habitat and some of its structures as well. Abandoning the open sea, body becomes more cylindrical, eyes move to the dorsal zone and head grows flatter.

At 45.5 mm, adult feature is reached. The ratio between body depth and standard body length is 1:7. The ratio between head depth and standard body length is 1:4.

Transformation complete at about 60 mm.

Pigmentation

At hatching, 5 ventral branched melanophores: first 4 of them are positioned between pectoral fins and anus. In the caudal region there are many tiny black spots.

At 7.5 mm the ventral chromatophores between pectoral fins and anus become larger, well defined and more numerous (from 4 to 6).

When anal fin is formed, the ventral spot behind anus splits into a row of spots at base of anal fin rays, one per each ray (excluding the first 2 rays). At 41.98 mm these spots are 7 and become 9 at the maximum larval development.

The patch of tiny spots on caudal tip persists during the whole larval development, becoming a black oblique stripe and reaching the caudal fin.

At 42 mm, a lateral spot of grey pigment appears under the adipose fin.

Later, other lateral large spots form, up to a series of 6 of them.

A new developmental stage starts when grey spots start to form on dorsal side of body. They extend vertically to reach the lateral spots. Ventral chromatophores disappear when lateral and dorsal pigmentation start, corresponding to habitat change. Pigmentation change from mainly ventral, during planktonic stage, to mainly dorsal, starting the benthonic stage.

Vertebrae/myomeres

58-60 myomeres, 39-40 preanal and 19-20 postcaudal.

Fins

Sequence of fin rays formation: caudal and anal fins (at 30.39 mm); pectoral fins (at 38 mm); dorsal and pelvic fins (at 42 mm). Adipose fin is distinct at 30.39 mm.

Dorsal fin rays: 10-13.

Anal fin rays: 8-9.

Pectoral fin rays: 11.

Pelvic fin rays: 8.

Caudal fin rays: 19 (principal) and other secondary smaller rays positioned dorsally and ventrally to caudal peduncle.

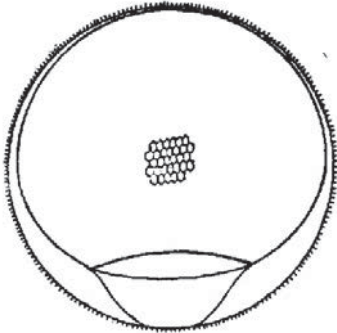

A



B: 4.58 mm

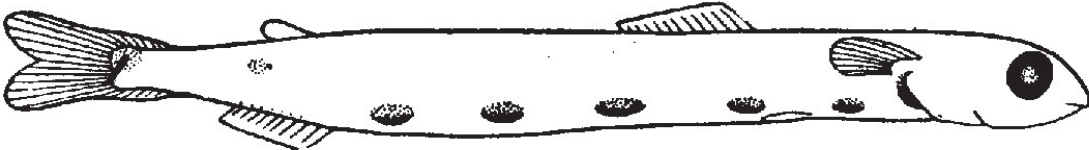

C: 41.98 mm

A: *Synodus saurus* egg (Sanzo,1915).
B-C: *Synodus saurus* larva (Sanzo,1915).



Family PARALEPIDIDAE

Barracudinas

Main references: Costa, 1999; Ege, 1930; Fahay, 1983; Matsuura and Olivar, 1999; Nelson, 2006; Rofen, 1966; Sulak, 1990; Thresher, 1984; Whitehead *et al.*, 1984

The larvae of this family are generally present at depths of 20-200 m. Genera *Paralepis* and *Notolepis* occur deeper than 100 m. It is not uncommon for larvae of several species to occur in two or three distinct depth strata (i.e. *Paralepis coregonoides*, with peaks at 100 m and again at 200 m). Larger larvae are commonly found deeper than smaller larvae. Eggs and rate of growth are undescribed.

Larval characters contrasting with other families are below considered:

- body elongated and compressed (vs round and segmented in Chlorophthalmidae and Scopelosauridae)
- extremely short intestine that lengthens gradually during larval development
- head pointed; top of head not angular (vs top of head angular in Omosudidae)
- snout and jaws not "duckbilled" (vs "duckbilled" in Chlorophthalmidae and Scopelosauridae)
- lower jaw slender, not deep (vs massive in Omosudidae and Alepisauridae).
- toothless margin of upper jaw at symphysis

- both jaws relatively straight (vs strongly curved in some Scopelarchidae)
- no teeth on tongue (vs hooked teeth on tongue in some Scopelarchidae)
- palatine teeth do not enter mouth profile when open (vs teeth do so in Evermannellidae)
- distinct slender teeth in 1-2 rows
- eyes large, lateral, round or slightly squared
- dorsal and pelvic fins posterior, about mid-trunk (vs anterior in Omosudidae, Scopelarchidae and Evermannellidae)
- dorsal fin small
- anal fin far posterior, usually most prominent fin
- anterior anal rays the longest
- pigmentation pattern as large melanistic blotches added serially along peritoneum (dorsal gut) as it elongates
- transformation occurs at large size

Important characters used to discriminate the species are represented by:

- relative shape and length of head and body
- position of pelvic fin relative to dorsal fin
- nature of pigment on caudal fin and peduncle
- number of gut pigment patches and size at which they develop

FAO name: Pacific barracudina

Libyan name: مغيزل (Mogizel)

Italian name: Barracudina (باراكودينة)

Synonyms: *Lestidium jayakari* (Boulenger, 1889);

Lestidium pseudosphyraenoides subsp. *danae* (Ege, 1930); *Macroparalepis egei* (Maul, 1945)

Main references: Alemany Llodrà, 1997; Costa, 1999; Fahay, 1983; Mercader *et al.*, 2003; Nelson, 2006; Somarakis *et al.*, 2002.

Distribution

This species is present in every tropical and tempered sea, especially in the Mediterranean Sea, the Atlantic Ocean and the Western Pacific.

Reproduction

Spawns all through the year, with a peak in summer. In the Sargasso Sea and the Bermuda area it spawns mainly from May to August.

EGGS

No available information.

LARVAE

Morphology

Body elongate, with a relatively short and deep head in the early stages.

At 12 mm, head large. Eyes round and very large.

At 8 mm, apex of notochord horizontal.

At 15 mm, flexion of the notochord takes place.

The gut becomes longer during the development: from 25% of the standard length at the early stages up to 60% of notochord length at 20 mm.

The anus reaches its final position, under dorsal fin origin, at length of about 20 mm.

Pigmentation

Patches of pigment are absent from the gut in small larvae.

At 8 mm, 2 peritoneal spots can be noticed. In the posterior half of the body two groups of 3 melanophores are placed in a vertical row and there is some pigment above the eyes, as well as 4 dots.

At lengths above 8 mm, 3 groups of pigment spots are present ventrally, one on caudal tip, one just behind the midpoint of body and another in between the two. Numerous melanophores are

present above and below the backbone, on the last 3 or 4 myomeres.

At 16.5 mm, the epurals are visible. 10 spots present on the peritoneum. Pigment on head becomes more visible.

At 20 mm, the spots on the peritoneum are 12: 2 of them are posterior to the pelvic fin. The initial accumulation of pigment is no longer distinguishable while a secondary series of 2 small chromatophores, running parallel to the posterior part of the caudal region, has developed: one of them lies between the upper trunk and the dorsal outline, the other between the central and the inferior part. Some small ventral chromatophores appear near the basis of the caudal fin.

At 37 mm, the stains on the peritoneum have been developing vertically and the chromatophores are larger.

To summarize, the gut pigment patches are: 2 at 8.0 mm, 5 at 13.0 mm, 10 at 16.5 mm, 12 at about 20 mm (being the maximum possible number of gut pigment patches).

Larvae of the two subspecies present in western North Atlantic (*L. jayakari jayakari* and *L. jayakari pseudosphyraenoides*) are similar, but differ in peduncle pigment. There are 3 diagnostic groups of pigment spots on the caudal peduncle: a ventral row between anus and anal fin origin; a ventral row over anterior anal fin; a midlateral on peduncle.

Vertebrae/myomeres

Total number of vertebrae 76-85, of which 30-35 are preanal.

Fins

At 12 mm, anal and dorsal fins start to develop.

At 20 mm, pelvic fins are visible; the anal fin is complete and presents 27-31 rays.

At 25, mm the pelvic fins are positioned anteriorly to dorsal fin and are complete; the dorsal fin is also complete and presents 10 rays.

At 37, mm the primitive irregular fin is reduced to a small edge in the posterior part of the trunk; it is higher and thicker in its posterior part (it will become the adipose fin of the adult).



Lestidiops jayakari jayakari larva.



A: 8 mm

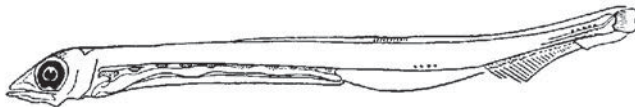

B: 16.5 mm

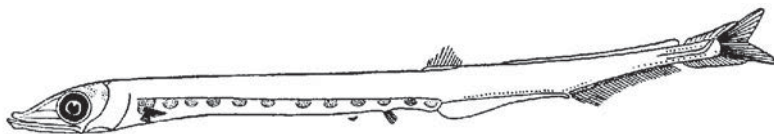

C: 37 mm

A-C Larvae of *Lestidiops jayakari jayakari* from Ege (1930).



Order MYCTOPHIFORMES

Main references: Fahay, 1983; Matsuura and Olivar, 1999; Nelson, 2006; Okiyama, 1984; Olivar, 1988.

The order includes Lanternfishes (Myctophidae) and Blackchins (Neoscopelidae) and presents a great variety of body shapes and photophore patterns.

General features of eggs:

- spherical shape
- chorion usually smooth
- segmented or homogeneous yolk
- narrow perivitelline space
- none or 1 oil globule

General features of the larvae from this order:

- body shape variable, but often elongated
- preanal length 40-70% of standard length
- straight gut, in most species extending to midbody
- vertebrae 28-45
- round to narrow eyes, in some species stalked
- head spines generally absent, but strong in some species
- occasional early formation of pectoral fin rays
- an adipose fin present in late larval stage
- variable transformation: marked, prolonged or delayed

Family MYCTOPHIDAE

Lanternfishes

Main references: Ahlstrom *et al.*, 1976; Arbault and Boutin, 1968; Costa, 1999; Fahay, 1983; Ferreiro and Labarta, 1988; Golani, 1994; Hulley, 1990; Lo Bianco, 1904, 1909; Marinaro, 1971; Moser and Ahlstrom 1970, 1972, 1974, 1996; Moser *et al.*, 1984b; Nelson, 2006; Okiyama, 1984; Olivar, 1988; Whitehead *et al.*, 1984.

20 genera are present in the North Atlantic Ocean.

With few exceptions myctophid eggs are virtually unknown. Characteristics of *Lampanyctodes hectoris* eggs, taken in a surface plankton tow near New Zealand, have been described:

- chorion slightly oval, fragile
- maximum diameter 0.74-0.83 mm
- minimum diameter: 0.65-0.72 mm
- narrow perivitelline space
- yolk strongly segmented
- single oil globule with diameter 0.21-0.23 mm

The larval stages of lanternfish are greatly variable. Larval characteristics:

- body shape ranges from slender and elongated to deep and big-headed: the majority of species with moderately slender body (e.g. some species of genera *Hygophum* and *Diaphus*); a second group of species much slenderer with flat heads; a third group with a robust body, large heads and

jaws (e.g. some species of genera *Myctophum* or *Lampanyctus*).

- variable gut length; in most species preanal length increases during larval development; in some species a gap is present between anus and anal fin origin
- distinctive transverse mucosal folds in the gut
- head varies from deep and narrow to short and slender
- eye round or narrow, some choroid tissue may be present under either type, but more developed under narrow eyes; several species with narrow and shortly stalked eyes (*Symbolophorus* and *Myctophum*)
- transformation occurs from about 10 mm (*Electrona*) to more than 20 mm (*Notolychnus*) .
- pigmentation may be very variable among species, even within a genus
- photophore below each eye
- series of spots on ventral midline of tail; if present, spots may increase or decrease in number during development
- pigment pattern usually changing during development
- adipose fin present
- pectoral fin rays develop early; in larvae may be present more rays than in adults
- caudal fin usually show first the rays ossification

- anal fin forms in same position of adult; its rays usually ossify after pectoral and caudal ones
- dorsal fin forms in same position of adult; its rays usually ossify after the anal ones
- pelvic fin usually the last to form; with 8 rays (rarely 6 or 7)
- in majority of genera, the number of anal fin rays exceed the dorsal ones (except in *Lobianchia*, *Lampadena* and *Notoscopelus* where the dorsal

rays outnumber the anal rays, and *Diaphus*, *Lepidophanes*, *Taaningichthys* and *Ceratoscopelus* where number of dorsal and anal fin rays are almost equal)-

The pigmentation pattern is considered of crucial importance for identification (see Fig. 16).

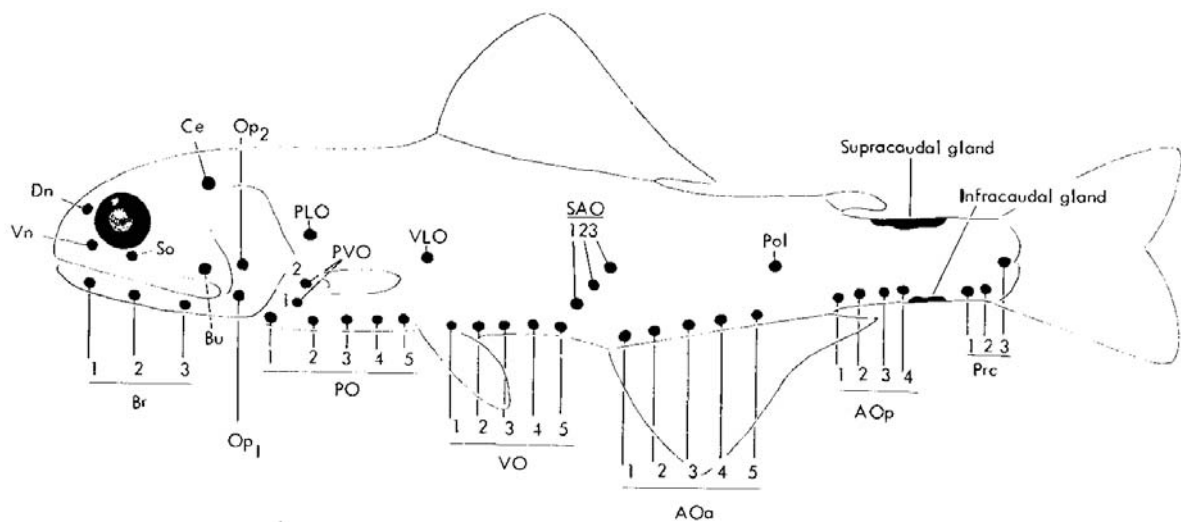

Fig. 16. Photophore group terminology from Moser and Ahlstrom (1972).

FAO name: Madeira lantern fish

Libyan name: بوقداح (Bogaddah)

Italian name: Pesce lanterna di Madera (*بيشة*
لانتيرنة دي ماديرة)

Synonyms: *Ceratoscopelus madeirensis* (Lowe, 1839); *Lampanyctus maderense* (Lowe, 1839); *Lampanyctus maderensis* (Lowe, 1839)

Main references: Alemany Llodrà, 1997; Backus, 1968; Costa, 1999; Fahay, 1983; Hulley, 1990; Koutrakis *et al.*, 2004; Lo Bianco, 1904, 1909; Moser and Ahlstrom 1972; Mytilineou *et al.*, 2005; Nelson, 2006; Papisissi, 1989; Richards, 1989; Somarakis *et al.*, 2002; Tåning 1918.

Distribution

Temperate-semisubtropical. Quite abundant in northern and eastern Atlantic; very common in the Mediterranean Sea. Defined both epipelagic and mesopelagic, since use to migrate during the night from the mesopelagic area to the epipelagic one.

Reproduction

Generally occurring in summer, from June to September. In the eastern Mediterranean spawning takes place earlier than in western Mediterranean. Sexual maturity completed at about 40 mm.

EGGS

No available information.

LARVAE

Morphology

Body elongated. Pre-natal development very short.

At hatching, eyes are oval.

At 5 mm, the snout is short and eyes rounded. Sliver of choroid tissue under eye. Gut is slightly sigmoid and stretches as far as half of the body; but this characteristic disappears when the development is completed.

At about 6 mm, flexion of notochord starts and at 8.6 mm is complete.

At 11.5 mm, the snout becomes elongated.

Transformation occurs at about 16 mm.

At 16.5 mm, the body has grown longer.

Pigmentation

At hatching, does not exhibit much pigment; the main character is a continuous row of melanophores between the anal papilla and the urostyle.

At 5 mm, a series of small spots present between the anus and a big-sized melanophore on the ventral peduncle; another large melanophore present at throat level.

At 7 mm, larger spots (3 dorsal, 4 ventral) present on midlines of caudal peduncle. A pre-orbital spot and a large melanophore below the point where pectoral fins start. A new melanophore appears in the pre-orbital area. Few faint spots on occipital, abdomen and sides of anus.

During maturation pigment can be found all over the body, particularly in the dorsal part. Photophores are very small; Br₂, Vn, PLO and PO₅ formed between 7 and 11 mm. Presence of photophores on the head can vary, especially in the area above the eyes where as many as 11-14 may be present.

At 16.5 mm there are photophores in the branchiostegal membrane, above and at the basis of the pectoral fins.

Vertebrae/myomeres

Number of vertebrae 35-38.

Gill rakers 5-6+1+12-15.

Fins

At 5 mm, only the pectoral fins are clearly distinguishable and the caudal fin is appearing.

At 8.6 mm the ventral fins are small.

At 16.5 mm all the fins have developed.

Dorsal fin rays: 13-14.

Anal fin rays: 13-15.

Pectoral fin rays: 13-14.



Larva *Ceratoscopelus maderensis* (5 mm).

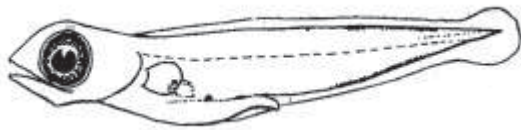

A: 4.2 mm

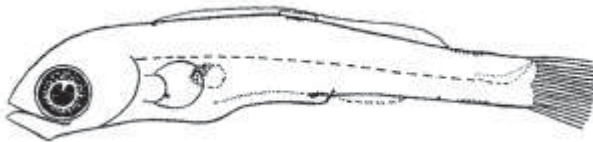

B: 5.7 mm

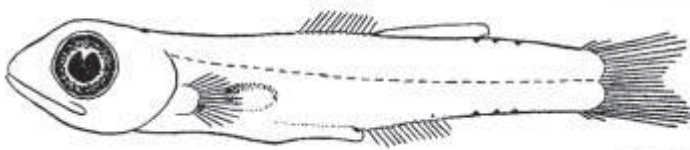

C: 7.4 mm

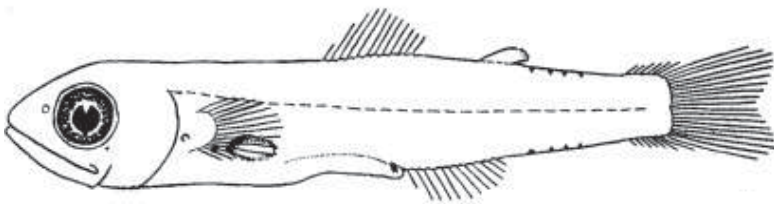

D: 9.4 mm

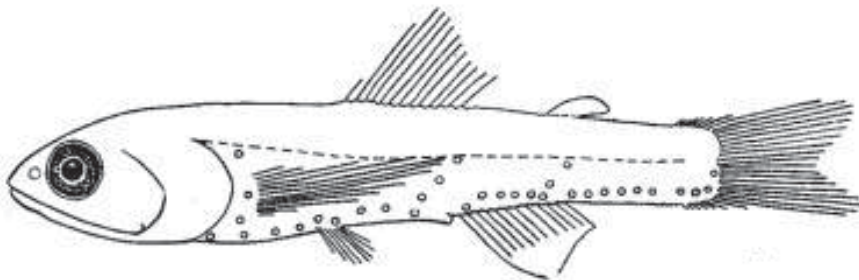

E: 61 mm

A-E: *Ceratoscopelus maderensis* larvae (Shiganova, 1977).

FAO name: Small lantern fish

Libyan name: بوقداح (Bogaddah)

Italian name: Occhio lucente minore (اكيو
لوشنتة مينورة)

Synonyms: *Diaphus rafinesquei* (Cocco, 1838) (misapplied name); *Diaphus theta* (Eigenmann and Eigenmann, 1890) (misapplied name); *Scopelus holti* (Tåning, 1918)

Main references: Alemany Llodrà, 1997; Barnabé and René, 1973; Costa, 1999; Fahay, 1983; Hulley, 1990; Koutrakis *et al.*, 2004; Nelson, 2006; Papisssi, 1989; Richards, 1989; Tåning, 1918; Whitehead *et al.*, 1986.

Distribution

Found in deep waters in the Mediterranean Sea and in the Atlantic and Indian Oceans. Can be found in depths of 650 m during the day while, at night, it migrates upwards to almost 40 m. In the Mediterranean Sea juveniles have been observed to migrate more widely than adults.

Reproduction

Spawns all year round.

EGGS

No available information.

LARVAE

Morphology

At 3 mm, the larva present a slender body with a small head and big, round, well pigmented eyes. The gut is elongate and ends in a downward bend with an anal papilla.

At 4 mm, the urostyle is completely flexed.

At final stages of development the mouth becomes bigger.

Transformation occurs at 10-11 mm.

Pigmentation

At 3 mm, 3-4 small black spots are located in the ventral part of the body, above the gut. In the post-anal area at least 12 inter-ventral melanophores are present.

Later, a spot is present at the anus and another on cteithral symphysis. A row of spots is visible along anal fin base and ventral midline of tail. A single, large spot present on lower half of the caudal fin base.

Photophores Br₂, PO₁ and PO₅ start formation at about 7 mm and complete at 10 mm.

During the completion of development, the posterior part of the trunk becomes yellow and dotted, the ventral region is partly dark, while the head is clearer and the eyes become very big with silvery irises.

Vertebrae/myomeres

Pre-anal myomeres: 6.

Post-anal myomeres: 18.

Vertebrae: 32-34.

Gill rakers: 5-6+1+11-13.

Fins

At 8 mm, the pelvic and adipose fins are well developed.

All fin rays are complete at 10 mm.

At final stages of development the caudal fin is bilobate.

Dorsal fin rays: 13-14.

Anal fin rays: 12-14.

Pectoral fin rays: 10-12.



Larva *Diaphus holti*.

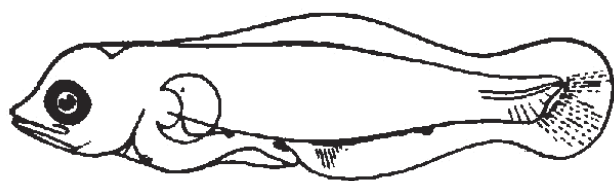

A: 10 mm

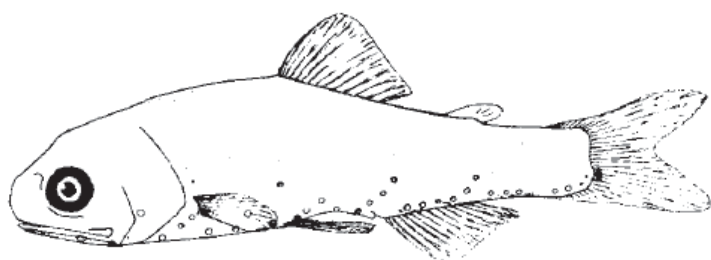

B: 11.5 mm

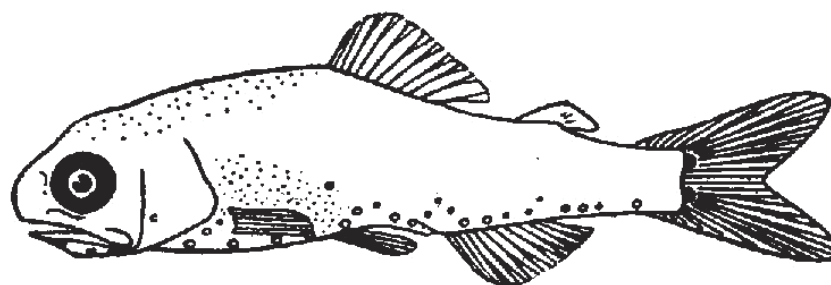

C: 14.5 mm

A-C: *Diaphus holti* larvae (Tåning, 1918).

FAO name: Chubby flashlightfish

Libyan name: بوقداح (Bogaddah)

Italian name: Elettrona (البيترونة)

Synonyms: *Electrona risso* subsp. *salubris* (Whitley, 1933); *Electrona rissoi* (Cocco, 1829); *Myctophum risso* (Cocco, 1829)

Main references: Alemany Llodrà, 1997; Barnabé and René, 1973; Costa, 1999; Fahay, 1983; Hulley, 1990; Linkowski, 1987; Moser and Ahlstrom, 1970, 1996; Nelson, 2006; Richards, 1989; Tåning, 1918.

Distribution

Found in the eastern part of the Atlantic and in the Indian Ocean. Even though not very common, can be found in some areas of the Mediterranean Sea; it is frequently observed in summer in the waters of the Sicily Channel.

Reproduction

Spawning occurs all year round with a peak between summer and autumn.

EGGS

No available information.

LARVAE

Morphology

At 6.3 mm, the body is robust. Characteristic gut shape: broad anteriorly and narrow posteriorly. Gut length about 50% of standard length at 3.4 mm, 53-58% of standard length during flexion, and 57-62% during later stages. Head large and broad, long 26-27% of standard length during preflexion and about 30% of standard length during postflexion. Dorsal part of snout concave during preflexion and rounded during postflexion. Eyes big and moderately oval, with small choroid mass. A slight space between anus and anal fin origin. Flexion occurs between 6.2 and 7.0 mm.

At 7.3 mm the head is slightly pointed and the flexion of the final part of the notochord begins.

At 8.5 mm small teeth start to appear.

Transformation occurs at about 10 mm.

At 10.8 mm the head is high.

At 12.8 mm the eyes are more round. Each nostril has two openings.

Pigmentation

Photophore Br₂ forms early in larvae (5.8 mm) at posteroventral margin of orbit.

Pigmentation is very scant. At about 6 mm one spot at symphysis of lower jaw. Possible pigmentation on snout tip.

At 6.3 mm, no pigment present on the pectoral fins, except for a patch above the operculum.

At 7.3 mm, some pectoral fin rays show a black pigment in the lower part.

At 12.8 mm, silver pigment is embedded on dorsal surface of swim bladder, but the body is still transparent. The branchiostegal photophore is bigger and another two have appeared posteriorly. In the lower, pre-orbital part of the operculum, appear the photophores that will definitively characterize the adult, except for the 2 orbital ones (naso-ventral and naso-dorsal).

At 16.12, mm pigmentation of the body is quite silvery and the peritoneal cavity shows black pigmentation.

Vertebrae/myomeres

At 6.3 mm myomeres are 29; at 7.3 mm they become 33 (this number corresponds to the final number of the vertebrae in the adult fish).

Vertebrae start to ossify at 8.2 mm and are completely formed at 9.0 mm.

Vertebrae: 32-34.

Gill rakers: 8-9+1+17-20.

Fins

At 6.3 mm, the caudal fin is already formed and both dorsal and anal fins can be barely noticed.

At 7.3, mm the unpaired fins are not yet differentiated and the posterior margin of the caudal fin is rounded.

At 8.5, mm the caudal fin becomes bilobate.

At 10.8 mm, all the fins are formed, except for the pelvic ones that are still very small.

Primary caudal fin rays start to ossify at 5.7 mm and are completely formed at 7.5 mm.

Pectoral rays start to ossify at 5.0 mm and are completely formed at 7.8 mm.

Anal rays start to ossify at 7.0 and are completely formed at 9.0 mm.

Dorsal rays start to ossify at 9.0 mm and are completely formed at 10.0 mm.

Pelvic rays start to ossify at 9.0 mm (bud visible at 6.2 mm) and are completely formed at 10.0 mm.

Dorsal fin rays: 13-14.

Anal fin rays: 18-19.

Pectoral fin rays: 13-16.

Caudal fin rays: 18-19.



Electrona risso larvae.



A

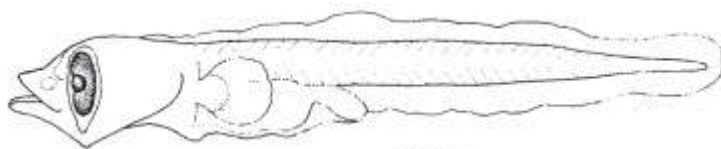

B: 3.9 mm

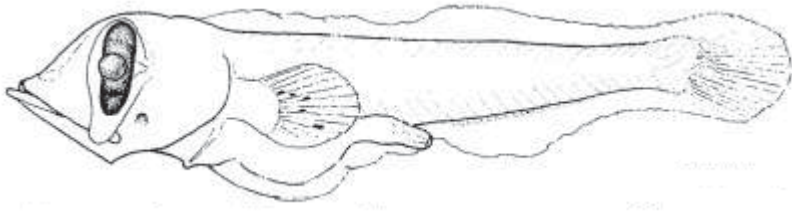

C: 6.3 mm

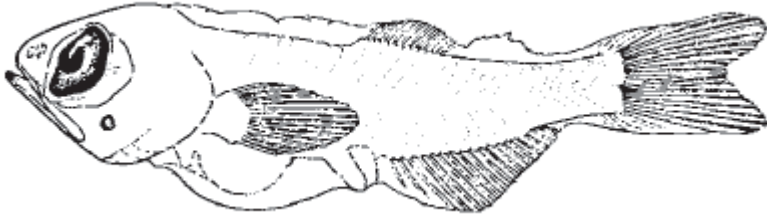

D: 7.9 mm

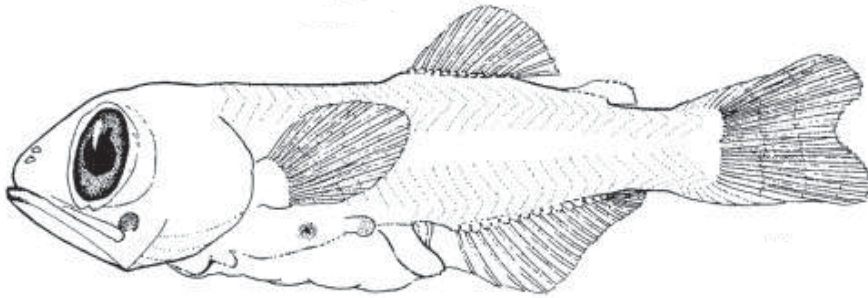

E: 9.2 mm

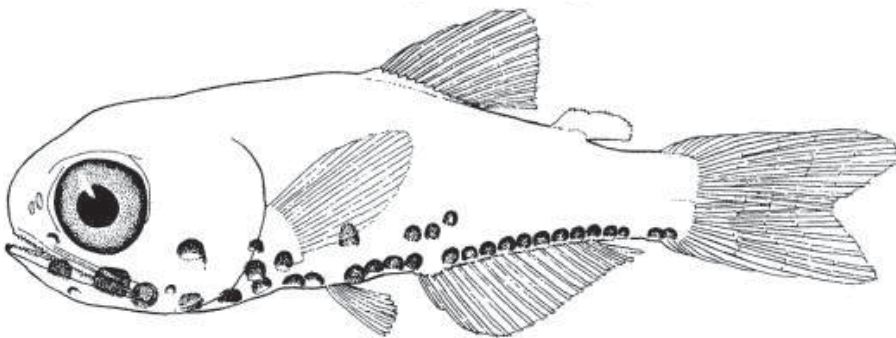

F: 9.9 mm

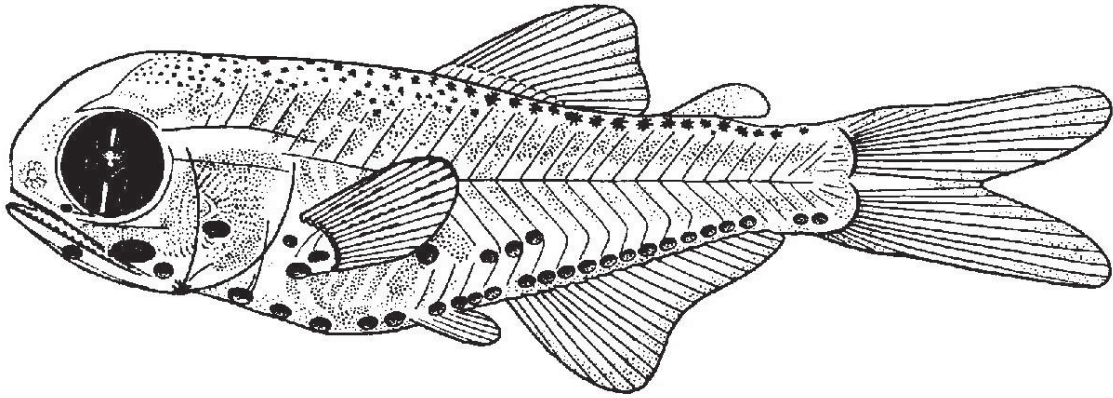

G: 13.6 mm

A: egg of *Electrona risso* (Sanzo, 1939).

B-F: *Electrona risso* larva (Moser and Ahlstrom, 1970).

G: *Electrona risso* larva (Sanzo, 1939).

FAO name: Dofleini's lantern fish

Libyan name: بوقداح (Bogaddah)

Italian name: Coda brillante (كودا بريلانتي)

Synonyms: *Diaphus agassizi* (non Gilbert, 1908) (misapplied name); *Diaphus dofleini* (Zugmayer, 1911); *Lampanyctus dofleini* (Zugmayer, 1911)

Main references: Alemany Llodrà, 1997; Barnabé and René, 1973; Costa, 1999; Fahay, 1983; Hulley, 1990; Moser and Ahlstrom, 1974, 1996; Nelson, 2006; Olivar *et al.*, 1999; Richards, 1989; Tåning, 1918.

Distribution

Temperate and semi-subtropical. Mainly found in the eastern Atlantic and in the Mediterranean Sea.

Reproduction

Spawns from winter until the end of summer. Females are sexually mature at 30 mm.

EGGS

No available information.

LARVAE

Morphology

At 6 mm the notochord completes its flexion. Eyes small and round.

Notochordal flexion occurs between 5 and 6 mm of standard length.

The transformation takes place at 10-11 mm of standard length.

At 11.5 mm, the body is short, stocky and deep. Head is large and broad. Gut extends up to the midpoint of the body. Eyes small, slightly oval in shape, with a squarish mass of choroid tissue at the base. Large pectoral fins, characteristic in shape, with lower rays shorter and the dorsal ones gradually longer.

Pigmentation

At 6-7 mm, only the PO₁ photophore may be present. Eyes are completely pigmented.

At 8 mm, some photophores appear on the operculum. Several scattered spots are present preanally and on the anus. Several small melanophores are present at the base of the pectoral and pelvic fins.

At about 11 mm, pigment spots are distributed on lateral walls of the gut. Scattered spots are present on the pectoral fin base and along its rays. Scattered spots are present below the dorsal fin and at the base of anal fin.

Further on, pectoral fin area becomes heavily pigmented. Pigment spots are distributed along the anal fin base and at the caudal fin base.

Photophores Br₂, PO₁ and PO₅ are the first to develop, when the individual is still in the larval period.

Vertebrae/myomeres

Vertebrae: 33-35.

Gill rakers: 5-6+1+12-15.

Fins

At 6 mm, the primitive unpaired fin is complete. The pelvic fins are still rudimental.

At 8.2 mm of standard length, all the rays of the caudal, pectoral, anal and dorsal fins may be seen and the adipose fin may be distinguished.

At 11.5 mm, ossification of all the fins is complete and the pectoral fins are quite developed.

Dorsal fin rays: 15-17.

Anal fin rays: 13-15.

Pectoral fin rays: 17-19 in larvae, 11-13 in adults.



Lobianchia dofleini larva (6.8 mm).

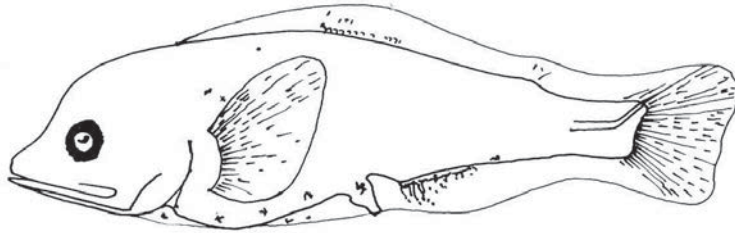

A: 5.5 mm

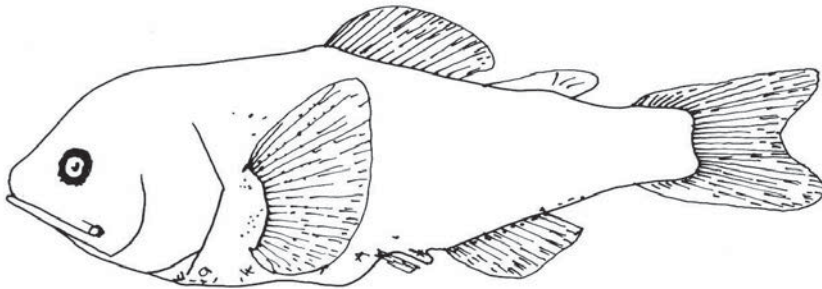

B: 8.0 mm

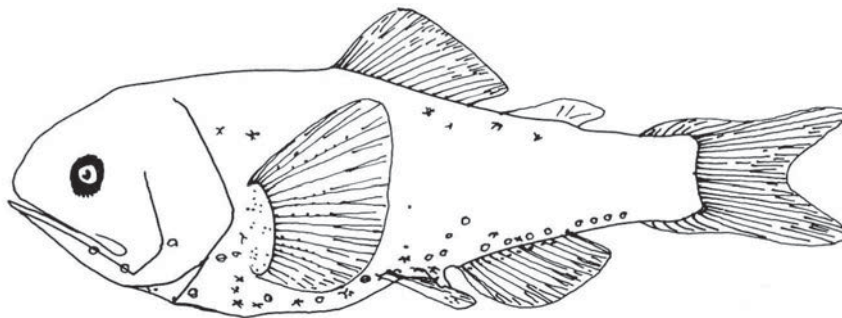

C: 11.5 mm

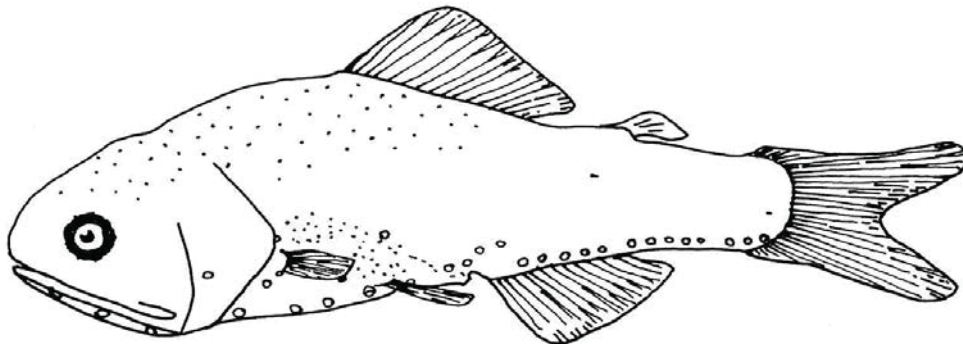

D: 11.0 mm

A-D: *Lobianchia dofleini* larvae redrawn by Olivar and Fortuño (1991) from Tåning (1918).

FAO name: Benoit's lanternfish

Libyan name: بوقداح (Bogaddah)

Italian name: Pesce lampadina (بيشة لامبادينة)

Synonyms: *Myctophum benoiti* (Cocco, 1838); *Scopelus benoiti* Cocco, 1838; *Scopelus humboldti* (non Risso, 1810) (misapplied name)

Main references: Alemany Llodrà, 1997; Barnabé and René, 1973; Costa, 1999; Fahay, 1983; Hulley, 1990; Moser and Ahlstrom, 1974, 1996; Nelson, 2006; Olivar and Palomera, 1994; Olivar *et al.*, 1999; Richards, 1989; Shiganova, 1977; Tåning, 1918.

Distribution

Pelagic, with wide distribution in the Atlantic Ocean and in the Mediterranean Sea.

Reproduction

Sexually mature at about 40 mm. Females may lay 330 eggs.

EGGS

No available information.

LARVAE

Morphology

Body rather elongate. Body depth (at level of pectoral fin base) is around 15-16% of SL at 7-8 mm, increasing to 22-24% of SL after 10 mm. Gut extends to about 60% of SL; preanal length increases from 50% of notochordal length to 62% of standard length during growth. Head length also increases, from 17% of notochordal length to 30% of standard length. Eyes have a conical mass of transparent choroid tissue at the base.

Notochordal flexion is complete even in the smallest larvae described, measuring 6.13 mm of standard length.

Transformation occurs at lengths from 10.0 to 13.6 mm.

Snout more rounded than in *H. hygomii* and eye slightly wider.

Pigmentation

At about 7 mm, spots are present at tip of snout. A black patch is situated at the rear of the hypurals. A melanophore is present on the anus and 3 melanophores are present in a row along the intestine (the first biggest). Some small melanophores on the isthmus.

At 14 mm, the inferior lobe of the caudal fin is extensively pigmented, with 2 big basal chromatophores. Spots of pigment are present at posterior margin of jaw and at lower jaw. 8-9 spots are present anterior to anus.

Photophore Br₂ appears at 11 mm of standard length and almost all the PO photophores at around 14 mm of standard length.

Vertebrae/myomeres

Vertebrae: 36-37.

Gill rakers: 4-5+1+13-14.

Fins

Fins develop at smaller size than in *H. hygomii*; pectoral, caudal and anal fin rays and the onset of adipose fin are discernible at 8-10 mm.

Dorsal fin rays: 13-15.

Anal fin rays: 20-22.

Pectoral fin rays: 15-16.

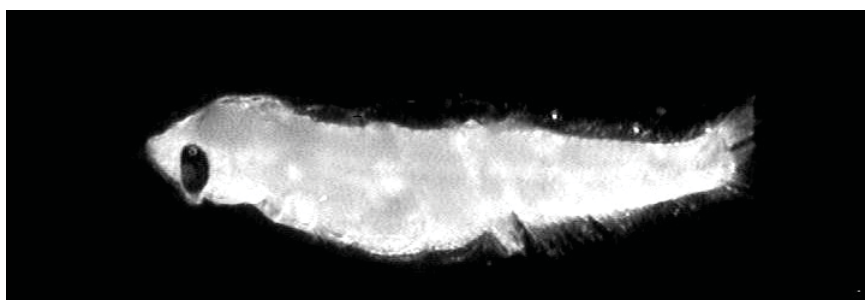

Hygophum benoiti larva.



A: 5 mm



B: 7 mm

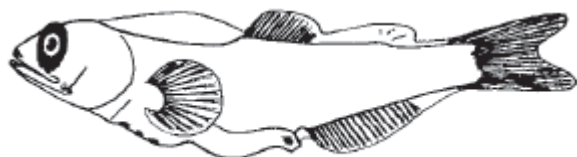

C: 8.5 mm

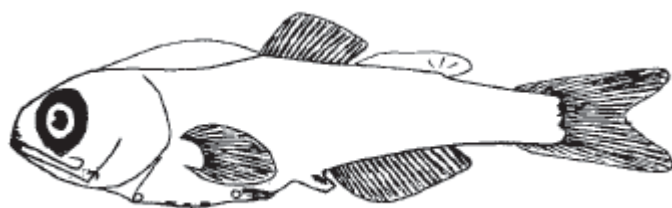

D: 10.5 mm

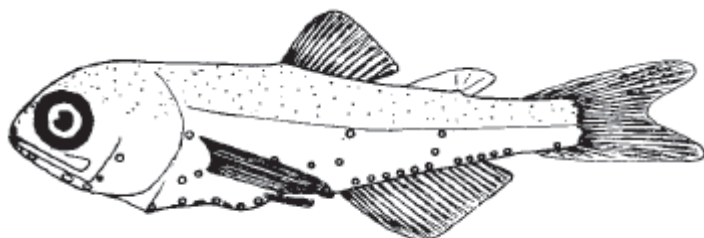

E: 11.5 mm

A-E: *Hygophum benoiti* larvae (Tåning, 1918).

FAO name: Bermuda lantern fish

Libyan name: بوقداح (Bogaddah)

Italian name: Pesce lampada (بيشة لامبادا)

Synonyms: *Hygophum higomii* (Lütken, 1892);

Hygophum hygomi (Lütken, 1892); *Hygophum*

hygonii (Lütken, 1892)

Main references: Alemany Llodrà, 1997;

Barnabé and René, 1973; Costa, 1999; Fahay,

1983; Hulley, 1990; Hureau and Monod,

1979; Moser and Ahlstrom, 1974, 1996;

Nelson, 2006; Olivar *et al.*, 1999; Papisissi,

1989; Pertseva-Ostroumova, 1974; Richards,

1989; Tåning, 1918.

Distribution

Bathypelagic, temperate-semisubtropical, with a wide distribution in the Atlantic, Pacific and Indian Oceans and in the Mediterranean Sea.

Reproduction

Spawns from the end of summer to autumn.

Sexual maturity reached at about 45 mm.

EGGS

No available information.

LARVAE

Morphology

At 5,4 mm, body moderately slender. Anus locates at anterior margin of anal fin (no gap).

Eyes without stalk, moderately elliptical with prominent choroid tissue.

At 9 mm, the notochord is straight.

At 12 mm, the snout becomes more steep.

Transformation occurs at 13.0-14.5 mm.

At 17 mm, the supracephalic cavity disappears.

The snout is more pointed and eyes narrower than in *H. benoiti*.

Pigmentation

In this genera pigment decreases during larval development; most pigment locates on head and gut; melanophores are present on isthmus. In this species spots are rarely found on snout tip, lower jaw and caudal rays.

At about 10 mm, there is a photophore above the operculus. At middle part of the intestine there are 3 chromatophores, one of them positioned exactly where the gut bends. A single melanophore present at the end of the intestine.

At 17 mm, pigmentation of pectoral fins reaches its maximum.

At 20 mm, body becomes transparent, with exception of some photophores.

Br₂ is usually the only photophore to form in the larval stage.

Vertebrae/myomeres

Vertebrae: 36-37.

Gill rakers: 5+1+13-15.

Fins

Dorsal fin forms late in larval period.

At 9 mm, the pectoral fins are round and covered with a thin membrane.

Fin rays ossify later than in *H. benoiti*; only anterior dorsal ray base formed at 8 mm.

Dorsal fin rays: 13-15.

Anal fin rays: 20-22.

Pectoral fin rays: 15-16.



Hygophum hygomii larva (20 mm).

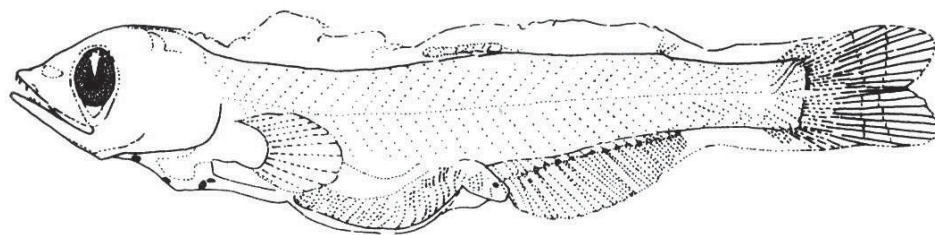

A: 8.1 mm

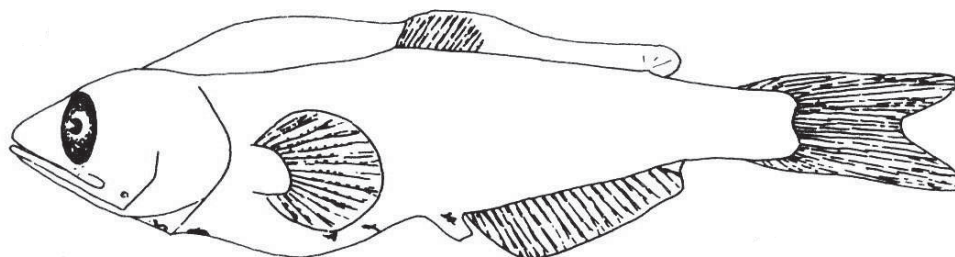

B: 11.5 mm

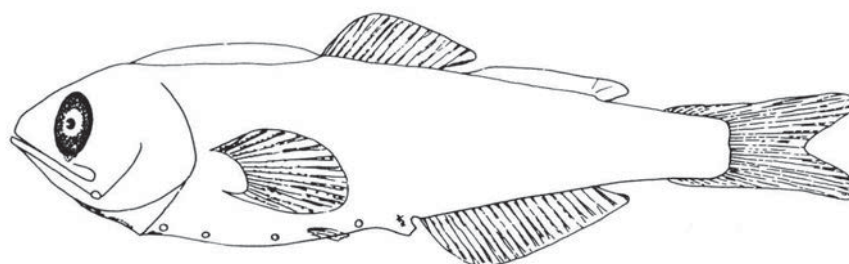

C: 14.5 mm

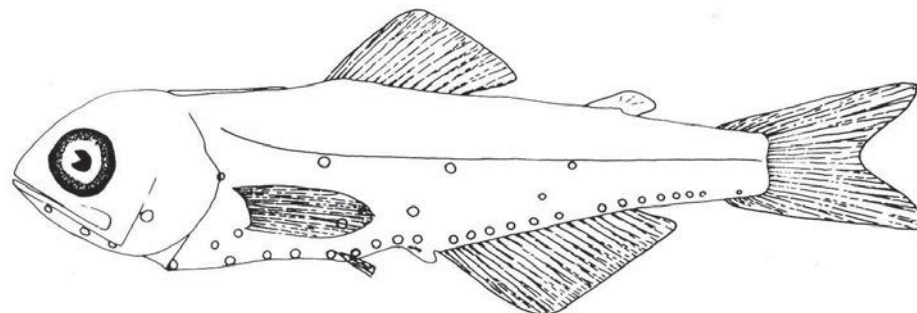

D: 13 mm

A-D: *Hygophum hygomii* larvae redrawn by Olivar and Fortuño (1991) from: A: Moser and Ahlstrom (1974); B-D: Tåning (1918).

FAO name: Jewel lanternfish

Libyan name: بوقداح (Bogaddah)

Italian name: Pesce lanterna cocodrillo (بيشة
لانتيرنة كوكودريلو)

Synonyms: *Gasteropelecus crocodilus* (Risso, 1810); *Lampanictus crocodilus* (Risso, 1810); *Lampanyctus gemmifer* Goode and Bean, 1896 (ambiguous synonym)

Main references: Alemany Llodrà, 1997; Barnabé and René, 1973; Costa, 1999; Fahay, 1983; Hulley, 1990; Koutrakis *et al.*, 2004; Labropoulou and Papaconstantinou, 2000; McAllister, 1993; Moser and Ahlstrom, 1996; Nelson, 2006; Olivar *et al.*, 1999; Richards, 1989; Tåning, 1918.

Distribution

Temperate-semisubtropical. Bathypelagic, found at variable depths (50-1000 m). Common in the Atlantic Ocean and wherever there are slope waters, also in Mediterranean Sea. During the night migrates from the mesopelagic area to the epipelagic one.

Reproduction

Spawns in summer.

EGGS

No available information.

LARVAE

Morphology

Body deep. Eyes round, with no choroid tissue. Large head. Jaws elongated.

At 4 mm, the urostyle is straight, but at 5 mm flexion starts.

During development body becomes more elongated.

Transformation is abrupt and occurs at 19-22 mm.

Body more elongated than *L. pusillus*.

Pigmentation

At about 4 mm it is well developed and presents some characteristic patches: one on the snout, one on the head, another one on the tip of the dorsal fin. There are other melanophores on the intestine.

At about 8 mm, pigmentation starts to form following myosepta above pectoral fin base.

Spot on anus and occiput persist during the larval development.

Br₂ is the only photophore forming in the larval period.

Vertebrae/myomeres

At 4 mm, myomeres are 31, of which 25 are post-anal; but at 5 mm their number increases. Vertebrae: 36-37.

Gill rakers: 4-5+1+10-12.

Fins

At about 5 mm, the rays in the dorsal fin and in the anal one are already visible.

At 12 mm, the dorsal fins have 12 rays, the anal one 16 and the pectorals 8.

At 19 mm, all fin rays are ossified.

Dorsal fin rays: 13-15.

Anal fin rays: 17-18.

Pectoral fin rays: 14-16.



Larva *Lampanyctus crocodilus*.

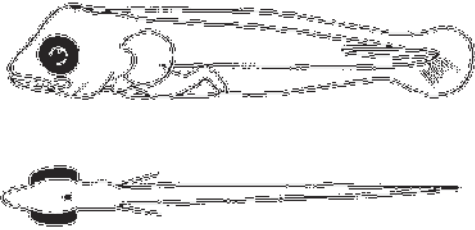

A: 5.5 mm, lateral and dorsal view

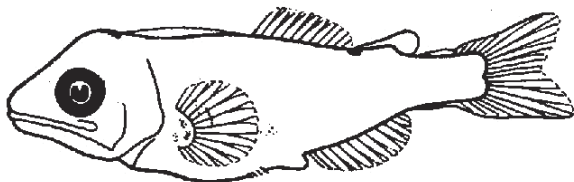

B: 8 mm.

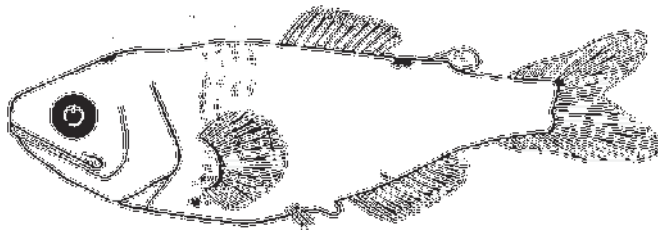

C: 14 mm.

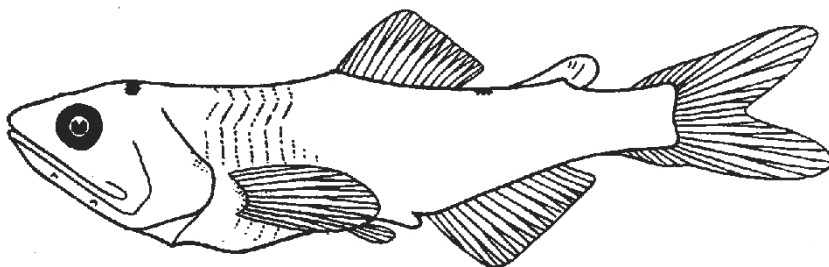

D: 19 mm.

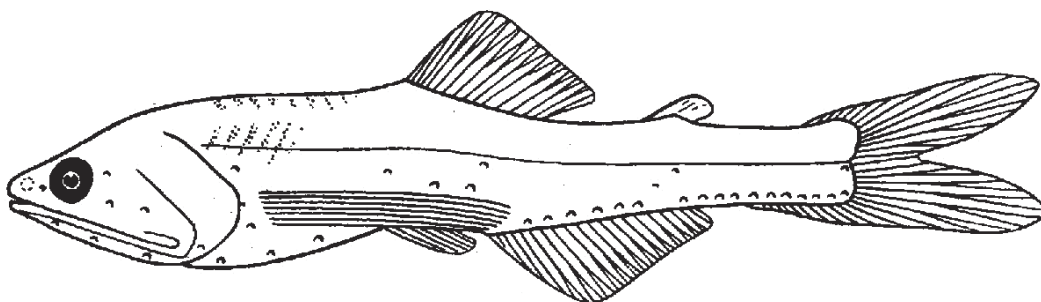

E: 23.55 mm.

A-E: *Lampanyctus crocodilus* larvae. (Tåning, 1918).

FAO name: Pygmy lanternfish

Libyan name: بوقداح (Bogaddah)

Italian name: Pesce lanterna minore (بيشة
لانتيرنة مينوري)

Synonyms: *Macrostoma pusillum* (Johnson, 1890); *Scopelus pusillus* Johnson, 1890

Main references:

Alemaný Llodrà, 1997; Barnabé and René, 1973; Costa, 1999; Fahay, 1983; Hulley, 1990; Koutrakis *et al.*, 2004; Labropoulou and Papaconstantinou, 2000; Moser and Ahlstrom, 1996; Nelson, 2006; Olivar *et al.*, 1999; Richards, 1989; Tåning, 1918.

Distribution

Temperate-semisubtropical, bathypelagic, found in the Atlantic Ocean, in the southern Pacific and in the Mediterranean Sea at a depth of 40-850 m.

Reproduction

Spawning occurs during the hole year, but peaks from the end of summer to autumn.

EGGS

No available information.

LARVAE

Morphology

Body short and stocky. Large head. Jaws elongate.

At 4 mm eyes are oval, later become round; no choroid tissue is present. Gut extends to about 60% of standard length.

At 5 mm flexion of the notochord is complete. Body depth at the base of pectoral fin is 35% of notochordal length, at 6.5-8.5 mm increases to more than 40% of standard length, then decreases gradually during development.

Transformation is abrupt and occurs at about 12 mm.

Pigmentation

Pigmentation weakly defined, individual pigment cells scattered over the entire body.

At 4 mm, 2 very characteristic black patches on the abdomen differentiate this species from the *L. crocodilus*: the first patch is at the same height as the pectoral fins, while the other is at the rear of the intestine (some small spots over abdomen are internal).

Occipital spots (1 or 2) are present. Spots are present also on posterior margin of gill cover, snout and lower jaw tip.

After 6 mm melanophores are present on dorsal margin, ventro-lateral walls of gut and median line of the body.

At 8.5 mm pigmentation is continuous and spread all over the body, particularly on the anterior portion.

Br₂ is the only photophore forming in the larval period.

Vertebrae/myomeres

Vertebrae: 32-34.

Gill rakers: 3-4+1+9-10.

Fins

At 4 mm the pectoral fins consist of a thin membrane.

At 6.5 mm all fin rays are distinguishable.

At 7.5 mm the dorsal fin has 11 rays, the anal 13, the pectoral ones 11.

All fin rays formed by 10 mm.

Dorsal fin rays: 12-13.

Anal fin rays: 14-16.

Pectoral fin rays: 13-15.



Lampanyctus pusillus larva.



A: 5 mm

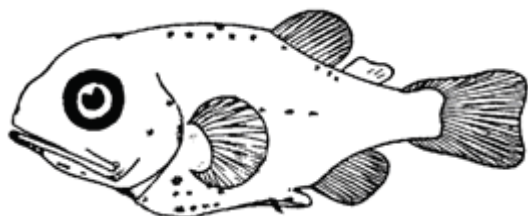

B: 6.5 mm

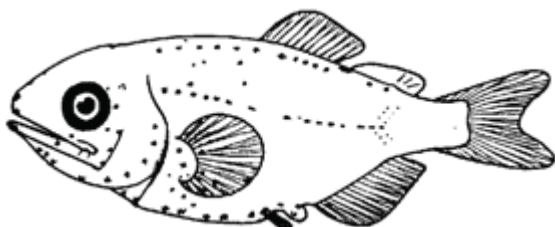

C: 8.5 mm

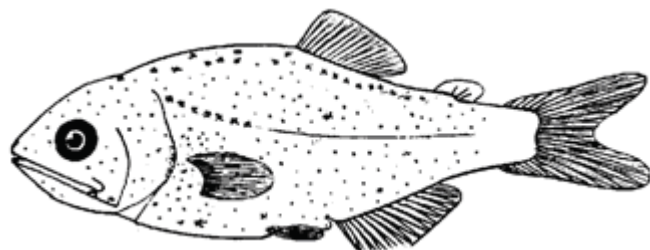

D: 10 mm

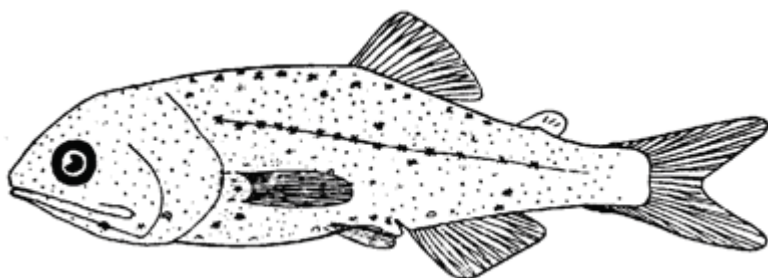

E: 12 mm

A-E: *Lampanyctus pusillus* larvae (Tåning, 1918).

FAO name: Large scale lantern fish

Libyan name: بوقداح (Bogaddah)

Italian name: Simboloforo (سينبولوفورو)

Synonyms: *Myctophum humboldti* (Risso, 1810) (misapplied name); *Myctophum humboldtii* (Risso, 1810) (misapplied name); *Scopelus humboldti* (Risso, 1810) (misapplied name)

Main references: Alemany Llodrà, 1997; Barnabé and René, 1973; Costa, 1999; Fahay, 1983; Hulley, 1990; Mazzarelli, 1912; Moser and Ahlstrom, 1996; Nelson, 2006; Papisissi, 1989; Richards, 1989; Tåning, 1918.

Distribution

Temperate, mesopelagic, found in the Atlantic Ocean and in the Mediterranean Sea (very common in the Tyrrhenian Sea and in the Sicily Channel).

Reproduction

Sexual maturation at 45 mm. Females of 82 mm can lay about 2800 eggs.

EGGS

No available information.

LARVAE

Morphology

At 6.2 mm, the body moderately elongated, transparent and compressed. Large head with pointed snout. Jaw well developed. Eyes are narrow, placed on short stalks, but the ocular peduncle doesn't protrude from the orbital cavity (this differentiates this species from *M. punctatum*). Snout flat. Anal papilla well developed and located in the anterior half of the body.

At 9 mm, body becomes deeper.

At 12 mm, eyes are still narrow but less protruding and present a small cone of choroid tissue.

At 20 mm, eyes become more circular and not protruding. Body is 3.1 mm high.

At 24 mm, body is 5.2 mm high. The supra-cefalic sinus is narrow.

Transformation occurs at about 20 mm.

Pigmentation

A single large spot on posterior edge of opercle. Spots on tip of lower jaw. Spots on tip of snout. Few preanal ventral spots.

At 17 mm, pigment on pectoral rays become heavier at their base.

At 24 mm, spots of pigment become more scattered.

Pigment decreases toward end of larval period. Photophore Br₂ is the only one forming during larval stage (at about 12 mm).

Vertebrae/myomeres

Vertebrae: 39-40.

Gill rakers: 5-6+1+12-14.

Fins

The pectoral fins are peculiarly shaped, very large with elongated bases; they extend beyond anus; their pigmentation consists of numerous, black spots.

At 9 mm, a rudimental caudal fin starts to appear.

At 12 mm, the caudal fin is well developed and its lobes start to appear.

At 17 mm, dorsal fin rays are not yet completely ossified, but at 24 mm are formed.

Dorsal fin rays: 12-14.

Anal fin rays: 21-23.

Pectoral fin rays: 12-13.



Symbolophorus veranyi larva, 7 mm long, dorsal view.



Symbolophorus veranyi larva, 7 mm long, lateral view.

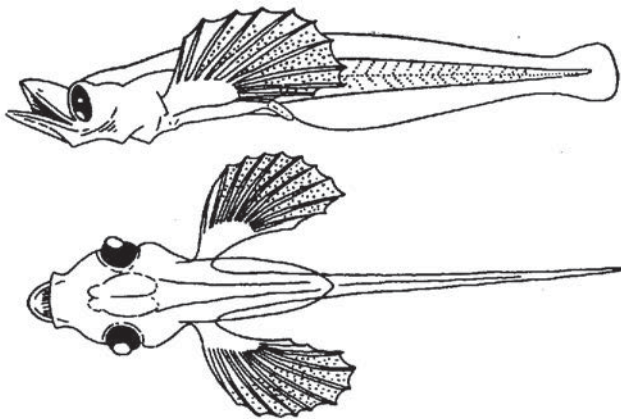

A: Dorsal and lateral view of *Symbolophorus veranyi* larva, 6.2 mm long (Mazzarelli, 1912).

GENERALITIES

FAO name: Spotted lanternfish

Libyan name: بوقداح (Bogaddah)

Italian name: Pesce lanterna puntato (بيشة
(لانتييرنة بونتاتو)

Synonyms: *Gasteropelecus humboldti* (Risso, 1810); *Myctophum humboldti* (Risso, 1810); *Myctophum phengodes* (non Lütken, 1892) (misapplied name)

Main references: Alemany Llodrà, 1997; Barnabé and René, 1973; Costa, 1999; Fahay, 1983; Hulley, 1990; Moser and Ahlstrom 1974, 1996; Nelson, 2006; Papisissi, 1989; Richards, 1989; Sanzo, 1915; Tåning 1918.

Distribution

Subpolar-temperate. Abundant in the Mediterranean Sea, in the northern Atlantic and western Pacific Oceans.

Reproduction

Spawns from winter to summer, with a peak in spring. Spawning does not occur in the western Atlantic.

EGGS

No available information.

LARVAE

Morphology

At 6.6 mm, larva shows elongated body, 0.5 mm deep. Snout pointed, flat and broad. Skull with a depression at the eyes level. Mouth opens upwards. Eyes narrow, stalked, with tapered choroid mass. Anal papilla visible.

At 7 mm, flexion is complete.

At 11 mm, body becomes more deep and snout less compressed.

During development skull grows bigger and orbital cavity becomes deeper. Eyes become more circular in shape and very large.

Transformation occurs at 21-22 mm.

Pigmentation

At 4.8 mm, 4 ventral post-anal chromatophores and one dorsal, opposite to the last of the ventral ones. Preanal series of spots from anus to head. A central branchiostegal photophore appears.

At 11 mm, large chromatophores at the base of the inter-radial cartilaginous plate of the pectoral fins and a few along the rays; chromatophores at the end of the adipose fin.

At 15.2 mm, black spots on posterior rays of dorsal, anal and adipose fins. Rows of spots on edges of upper and lower jaws, and spots on upper edge of opercle. Spots on branchiostegal membrane.

At 19.4 mm, body less transparent. Several melanophores on the head. Melanophores present on the fins, and some of them forming a vertical stain at the base of the caudal fin. Melanophores in caudal region are characteristic.

Photophore Br₂ is the only one forming during larval stage; others form at metamorphosis.

Vertebrae/myomeres

Vertebrae: 40.

Gill rakers: 6-8+1+16-18.

Fins

At 6.6 mm, the pectoral fins are the only ones already present, with rays; they are large, broad on a fanshaped base.

At 8 mm, dorsal and anal fin have defined shape and an outward bulge of the adipose fin.

At 11 mm, the caudal fin is bilobate, but pelvic fins are not yet shaped.

At 15.2 mm, all the fins are well developed.

Pelvic fin buds form at about 10 mm.

Dorsal fin rays: 13-14.

Anal fin rays: 20-22.

Pectoral fin rays: 13-14.



Myctophum punctatum larva, 5 mm long, dorsal view.



Myctophum punctatum larva, 5 mm long, ventral view.

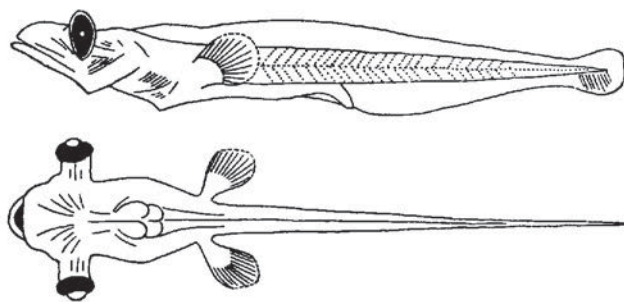

A: 7 mm (lateral and dorsal view)

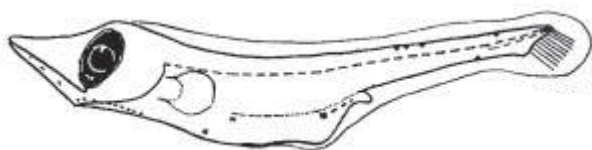

B: 6.2 mm

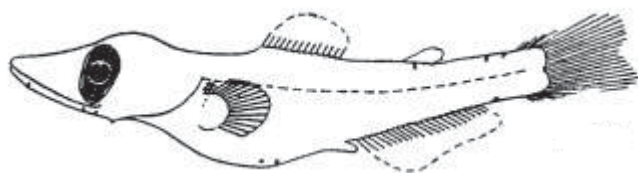

C: 9.4 mm

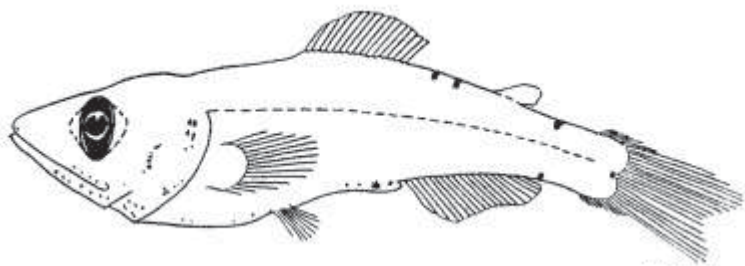

D: 14.2 mm

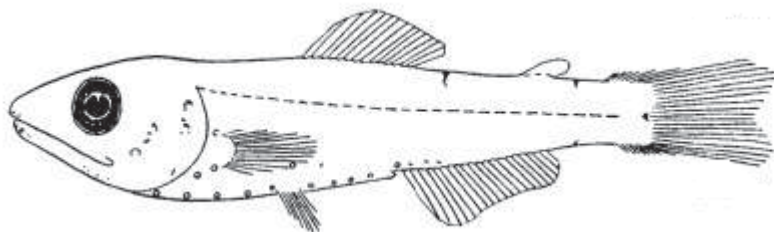

E: 17.2 mm

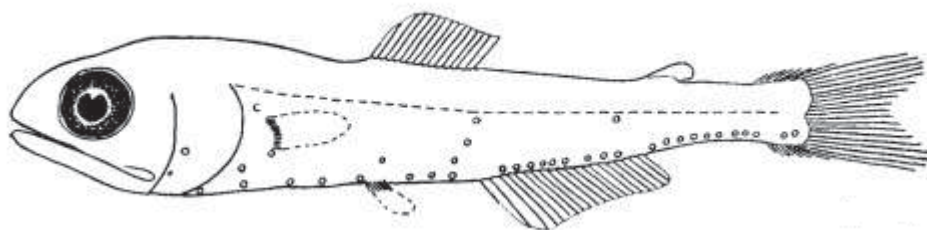

F: 17.6 mm

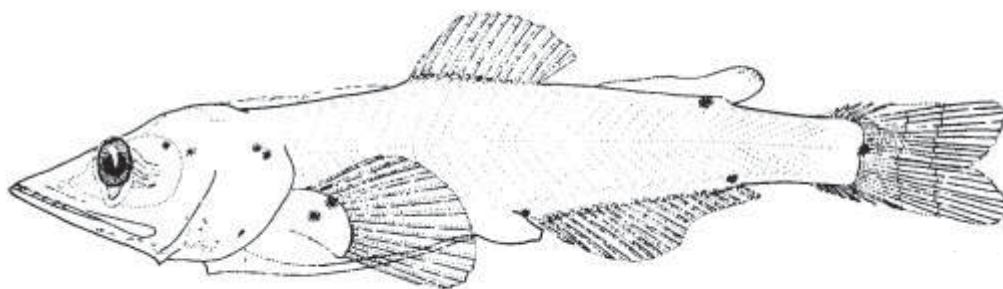

G: 13.6 mm

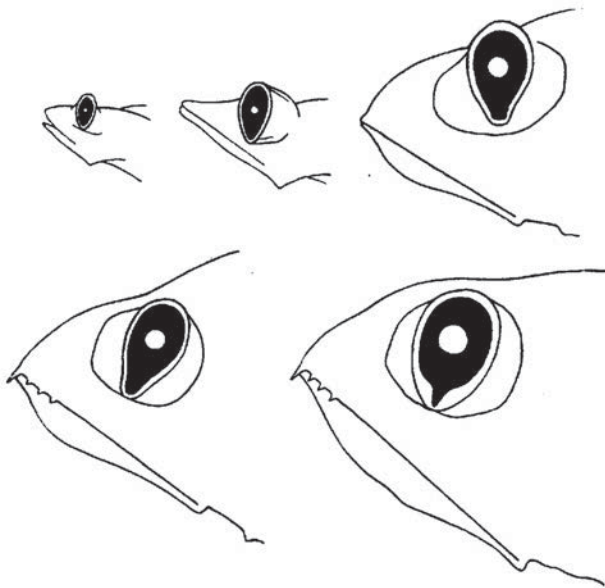

A-G : *Myctophum punctatum* larvae. A: Mazzarelli (1912); B-F: Shiganova (1977); G: Moser and Ahlstrom (1974).
H: Modifications of head and eye during the development of *Myctophum punctatum* from Mazzarelli (1912).



Order GADIFORMES

Main references: Cohen, 1984; Cohen *et al.*, 1990; Fahay, 1983; Fahay and Markle 1984; Matsuura and Olivar, 1999; Nelson, 2006.

The order includes two economically important taxa: Gadidae and Merluccidae.

General features of eggs:

- pelagic, buoyant and usually small (about 1 mm diameter)
- spherical shape
- usually smooth chorion (except hexagonal sculpturing in Macrouridae)
- homogeneous yolk
- narrow perivitelline space
- none, 1 (usually) or multiple coalescing oil globules

General features of the larvae from this order:

- pigment patterns usually well-developed at hatching (but not sufficient to identify some species)
- variable body shape, from elongate to stocky, overall tadpole-like appearance
- rounded head

- tapering post-anal region
- short and coiled gut
- preanal length 33-50% of standard length
- in early larvae anus opens at side of fanfold (not at margin)
- vertebrae 44-66, mostly
- round eyes
- head spines usually absent (except in *Gaidropsarus*)
- 1, 2 or 3 dorsal fins and 1 or 2 anal fins
- usually early formation of pelvic fins rays
- thoracic position of pelvic fins
- usually elongated pelvic fins
- pectoral fin bases slightly pedunculate
- high numbers of dorsal and anal fin rays
- barbels often form on symphysis of lower jaw (on snout in some species)
- gradual transformation

In larger larvae (>15 mm), when pigment patterns fuse, counts of precaudal vertebrae, anal fin rays and caudal rays on superior hypural are diagnostic.

Family GADIDAE

Cods and haddocks

Main references: Alonso-Allende *et al.*, 1978; Arbault and Boutin, 1968; Bauchot, 1987; Campillo, 1992; Cohen *et al.*, 1990; Fahay, 1983; Ferreiro and Labarta, 1988; Hureau and Monod, 1979; Labropoulou and Papaconstantinou, 2000; Marinaro, 1971; Mercader *et al.*, 2003; Nelson, 2006; Papaconstantinou *et al.*, 1993, 1994; Svetovidov, 1986; Whitehead *et al.*, 1986.

General features of the eggs from this family, compared to those of the family Merluccidae:

- egg diameter 0.63-1.80 mm (while 0.80-1.20 mm in Merluccidae)
- none, 1 or multiple oil globules: (none in *Gadus*, *Pollachius*, *Melanogrammus*) (1 in Merluccidae)

General features of the larvae from this family, compared to those of the family Merluccidae:

- elongated or stocky body shape

- 1-3 dorsal fins (in Merluccidae 2 dorsal fins, of which the 2nd divided by low midsection)
- 1-2 anal fins (in Merluccidae 1 anal fin, divided)
- pelvic fins form first (but in *Gadus*, *Pollachius*, *Melanogrammus* the caudal forms first; also in Merluccidae the caudal forms first and the pelvic in midsequence)
- pelvic fin elongated (not in *Gadus*, *Pollachius*, *Melanogrammus*; moderately elongated in Merluccidae)
- 3-4 pelvic fin rays (7 in Merluccidae)
- late formation of pectoral fin rays
- vertebrae 45-66 (while 53-56 in Merluccidae)
- barbels generally form on lower jaw
- pterotic spines present in *Gaidropsarus* and eastern Atlantic *Phycis*

Family GADIDAE



A

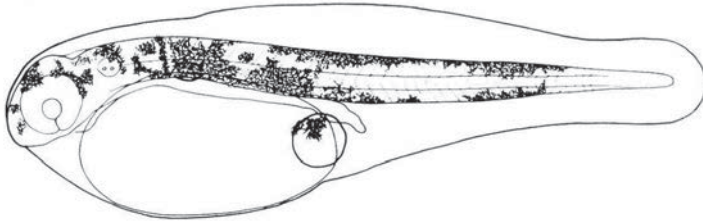

B: 1.8 mm

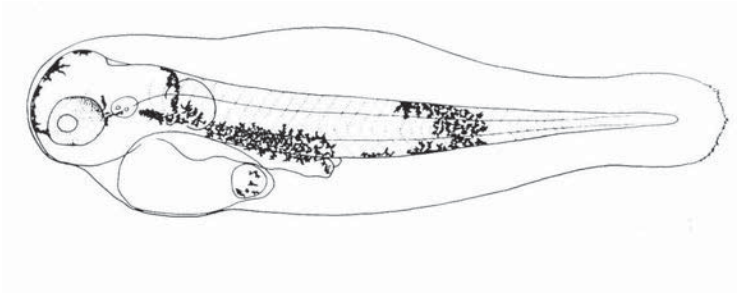

C: 2.1 mm

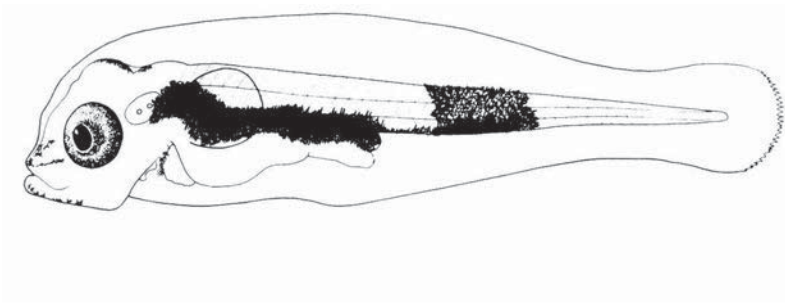

D: 2.2 mm

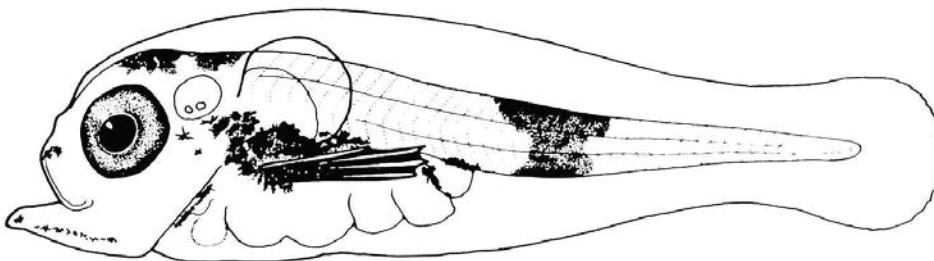

E: 2.8 mm

A-E: early stages of *Gaidropsarus capensis* (Kaup, 1858) after Brownell (1979).

Order OPHIDIIFORMES

Main references: Gordon *et al.*, 1984; Matsuura and Olivar, 1999; Nelson, 2006; Nielsen *et al.*, 1999.

This order is relatively small, containing about 380 species, belonging to 4 families. Their body is typically elongated; dorsal and anal fins are long-based and are often joined

to the caudal fin, while pelvic fins are inserted anteriorly and reduced. All known ophidiid larvae are similar, with moderately elongated, tapered body.

Most species inhabits the floor of the deep sea.

Family OPHIDIIDAE

Cusk-eels

Main references: Costa, 1999; Fahay, 1983; Gordon *et al.*, 1984; Leiby, 1990; Nelson, 2006 .

General features of the larvae from this family are:

- body elongated, with a preanal length <50% of the standard length
- number of myomeres: 50-80 (in specimens from western North Atlantic)
- angle of jaw typically protruding ventrally
- conspicuous swim bladder
- dorsal and anal fins very long, with high numbers of rays, confluent with the caudal fin
- pelvic fin with elongated rays, positioned far anteriorly
- pigmentation light and scattered (in most species)

FAO name: Snake blenny

Libyan name: بوزلفيط أعماق (*Bozelfit Amaq*)

Italian name: Galletto (قاليتو)

Synonyms: *Ophidion congrus* Gronow, 1854;

Ophidion maculatum Rafinesque, 1810;

Ophidium barbatum Linnaeus, 1758

Main references: Alemany Llodrà, 1997;

Arbault and Boutin, 1968; Costa, 1999;

Fahay, 1983; Ferreiro and Labarta, 1988;

Gordon *et al.*, 1984; Marinaro, 1971; Nelson,

2006.

Distribution

Widespread in Mediterranean and Atlantic Ocean.

Reproduction

Spawning period from June to October.

EGGS

Spherical, without oil globules, with diameter ranging from 0.76 to 0.96 mm.

LARVAE

Morphology

At hatching larva is 3.2 mm long. Anus at about middle of the body. The gas bladder is well developed.

Pigmentation

In larva ranging from 4 to 6 mm there are some melanophores located on the head and on caudal region. Eyes are not yet pigmented. Melanophores are present under the gut and along the ventral edge, from pectoral fins to the extreme point of urostyle. Series of melanophores also on dorsal region.

At 9 mm interrational pigmentation is present along the base of anal fin. Punctiform melanophores located in the final part of the trunk.

At 11 mm a series of small parallel points at the margin of operculum and on the lower jaw are visible.

Vertebrae/myomeres

Myomeres: 60 and 66.

Fins

At 9 mm formation of pelvic fins and of the base of anal fin.

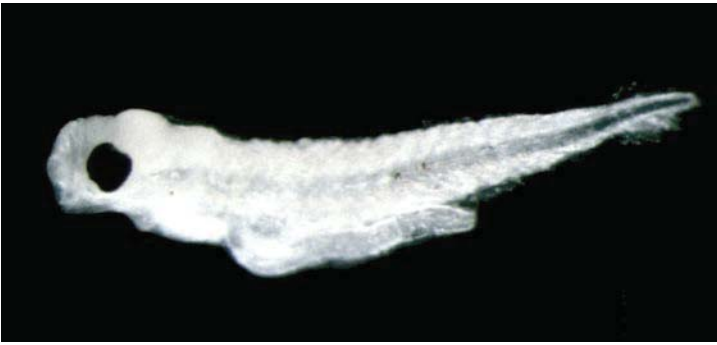

Ophidion barbatum larva (3.5 mm).

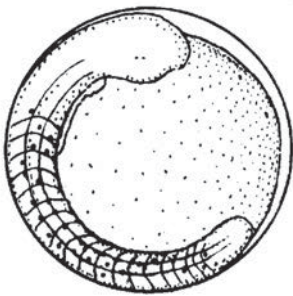

A



B: 3.4 mm

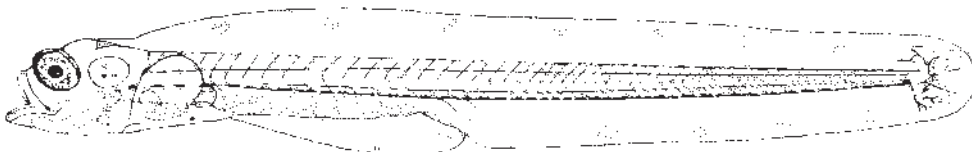

C: 4.04 mm

A: egg of *Ophidion barbatum* from Spartà (1929).

B-C: *Ophidion barbatum* larvae, at hatching (B) and after 4 days (C). From Spartà (1932).

Order MUGILIFORMES

Mulletts

Main references: Matsuura and Olivar, 1999.

Larvae are generally heavily pigmented, since the earliest life stages (yolk-sac stage). Identification to family level is easy. On the contrary, identification of larvae to species level is difficult because:

1. meristic characters and pigment patterns of larvae are similar within the family.
2. identification at specific level is usually based on characters appearing in the adult stage: number of scales on lateral line, relative positions of dorsal, anal, and pelvic fins.

Family MUGILIDAE

Main references: Breder and Rosen, 1966; Costa, 1999; Harrison, 1995; Matsuura and Olivar, 1999; Nelson, 2006; Sylva, 1984.

72 species, belonging to 17 genera, are distributed in all the tropical and temperate seas. The species are mainly marine and brackish, but a few live in freshwater.

Species of this family are distributed worldwide, except in polar regions.



FAO name: mullet

Libyan name: بوري (Buri)

Italian name: Muggine (موجينة)

Main references: Arbault and Boutin, 1968; Bruslé, 1980; Ferreiro and Labarta, 1988; Marinaro, 1971; Olivar and Fortuno, 1991; de Sylva, 1984.

Distribution

Cosmopolitan in coastal waters of the tropical and subtropical regions of all the seas.

Reproduction

Spawning takes place from spring to autumn.

EGGS

Spherical and transparent, with diameter ranging from 0.72 to 0.78 mm. Yolk segmented. A single oil globule ranging from 0.22 to 0.30 mm.

LARVAE

Morphology

At hatching 2-3 mm long.

Gut extends to about 60-70% of the standard length. Body depth about 20-25% of total length.

Pigmentation

At hatching, few melanophores are present on head and trunk. Tail is highly pigmented. Urostyle region may be pigmented, from time to time. Eyes not pigmented.

Vertebrae/myomeres

Vertebrae 24-26.

Fins

At about 7 mm, rays on the first and second dorsal fins are visible.

First dorsal fin rays: IV.

Second dorsal fin rays: I, 8-9.

Anal fin rays: III, 8-9.

Pelvic fin rays: I, 5.

Pectoral fin rays: 15-17.



Mugil spp. larva.

FAO name: Flathead mullet

Libyan name: بوري بومماغ (Buri bodmagh)

Italian name: Cefalo (تشفالو)

Synonyms: *Mugil albula* Linnaeus, 1766; *Mugil ashanteensis* Bleeker, 1863; *Mugil cephalotus* Valenciennes, 1836

Main references: Anderson, 1958; Arbault and Boutin, 1968; Bruslé, 1980; de Sylva, 1984; Fahay, 1983; Ferreiro and Labarta, 1988; Harrison, 1995; Marinaro, 1971; Martin and Drewry, 1978; Olivar and Fortuño, 1991.

Distribution

Cosmopolitan in coastal waters of the tropical and subtropical regions of all the seas.

Reproduction

Spawning occurs from June to October.

EGGS

Pelagic, spherical and transparent, with diameter ranging from 0.60 to 1.08 mm. Chorion smooth and transparent. Yolk homogeneous. Perivitelline space narrow. A single oil globule, ranging from 0.26 to 0.31 mm. When embryo is visible, melanophores appear on oil globule, yolk and embryo.

LARVAE

Morphology

At hatching, larva is 2.2-3.5 mm long. Body moderately stocky. Preanal length represents 60% of notochordal length in first feeding larvae.

Flexion of urostyle at 4-5 mm.

At 8-12 mm, preanal length represents 67% of standard length.

At 8 mm, body depth at pectoral fins level represents 20% of standard length.

At 12 mm, body depth at pectoral fins represents 25% of standard length.

Pigmentation

At hatching, eyes unpigmented. Dorsal region heavily pigmented, from head through second dorsal fin. Dorsal surface of gut heavily pigmented too. Pigment on ventral region, from anus to caudal fin base. Pigment along the lower jaw.

In larvae longer than 3 mm pigmentation is more widespread, covering the whole body.

Vertebrae/myomeres

Myomeres: 24.

Vertebrae: 11-12+12-13.

Fins

At 5.4 mm, pelvic fin buds appear.

Sequence of fin formation: caudal, second dorsal (at 5.4 mm), anal (at 6.2 mm), first dorsal (at 6.7 mm), pectoral and pelvic.

The 2 dorsal fins are well separated and posteriorly located on the body. Pectoral fins are highly positioned on trunk (visible even in early developmental stages).

First dorsal fin rays: IV

Second dorsal fin rays: I, 7-8.

Anal fin rays: III, 8.

Pelvic fin rays: I, 5.

Pectoral fin rays: 14-18.

Caudal fin rays: 7-8+7+7+7-8



Mugil cephalus larva.

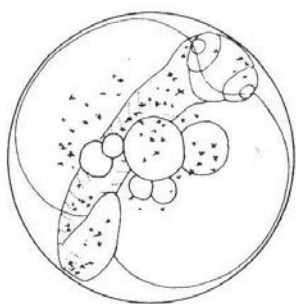

A

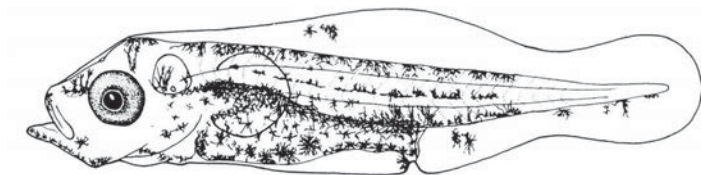

B: 3.8 mm

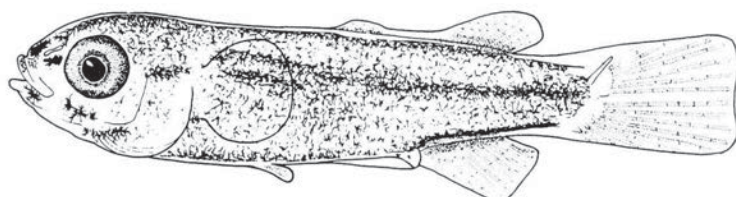

C: 7.6 mm

A-C: Early life history stages of *Mugil cephalus* from Brownell (1979).

Order SYNGNATHIFORMES

Main references: Nelson, 2006.

15 species, belonging to 5 genera, are mostly distributed in Indian and Pacific Oceans.

They generally present a body elongated and encased in a series of bony rings. The mouth

is small, positioned at the end of a tube-shaped snout. Upper jaw is not protractile. Circumorbital bones are usually absent. The first 3-6 vertebrae are elongated.

Family CENTRISCIDAE

Snipefishes and shrimpfishes

Main references: Bauchot, 1987; Bianchi *et al.*, 1993; Borges, 2001; Ehrich, 1990; Muus and Nielsen, 1999; Nelson, 2006; Papisissi, 1989.

Species of this family are mainly distributed in the Indian and Pacific Oceans.

In adults the body is extremely compressed, razorlike, with a sharp central edge. Mouth

placed at the end of a long tubular snout. Body almost entirely covered by thin bony plates, representing expansions of the vertebral column. First dorsal spine is very long and sharp, located at the extreme end of the body; 2 shorter spines follow it. Characteristical swimming in vertical position, with snout oriented downwards.

FAO name: Longspine snipefish

Libyan name: فحيل (Fahil)

Italian name: Pesce trombetta (بيشة ترومبيتة)

Synonyms: *Balistes scolopax* (Linnaeus, 1758); *Centriscus gracilis* (non Lowe, 1839) (misapplied name); *Centriscus scolopax* (Linnaeus, 1758)

Main references: Alemany Llodrà, 1997; Arbault and Boutin, 1968; Bigelow *et al.*, 1964; Bianchi *et al.*, 1993; Borges, 2001; Ehrich, 1990; Ferreira and Labarta, 1988; Heemstra, 1986; Marinaro, 1971; Muus and Nielsen, 1999; Papisssi, 1989; Richards, 1989.

Distribution

Indian Ocean; Western Pacific Ocean; Western Atlantic: from Gulf of Maine to Argentina; Eastern Atlantic and Mediterranean. Mainly distributed in temperate latitudes, between 20° and 40°N.

Reproduction

In Mediterranean, spawning occurs from October to March.

EGGS

Spherical, transparent, with diameter about 1 mm. Yolk homogeneous. A single oil globule, yellow or pink coloured, with diameter of 0.20 mm.

LARVAE

Morphology

During early stages the snout is concave and short, then gradually increase in length as development advances.

At 6 mm, body slim and elongate. Head 30% of total length. Eyes slightly narrow, in horizontal direction. Anus just before mid-body. Spines on posterior preopercular margin. Jaws well developed. Serrated crests appear around eyes. Whole body surface covered with spiny scales arranged in longitudinal lines.

At 7 mm, flexion of notochord.

At 10 mm, snout is already recognizable as the characteristic feature of the species, being elongate and compressed on the upper side.

Body more deep, 25% of total length. Eyes almost round. Occipital crest serrated. Supraorbital crest very conspicuous. Second dorsal fin turned backwards; hump forming on dorsal profile in that portion (remaining in adults). Gut extending beyond mid-body, with a characteristic handle-like aspect.

At 19-20 mm, body depth 20% of total length. Up to about 40 mm, juveniles are pelagic, with body more elongated than in the adults, snout shorter and shorter dorsal spine.

Pigmentation

At 6 mm melanophores on both jaws, on superior portion of head, along dorsal margin of trunk and covering the gut. 2 rows of chromatophores located in postanal portion: a row on medio-lateral, the other row ventral. Eyes silvery. Dorsal portion sky-blue coloured; ventral portion slightly silvery.

At 10 mm, snout pigmented. Upper parts of intestine have a characteristic pigmentation. Posterior parts of body also have 2 chromatophores in symmetrical positions.

As the larva develops, the body presents bands of colour associated with myomeres. Eyes highly pigmented.

Juveniles, at pelagic stage, are brilliant silvery-blue coloured.

Adults change colour: reddish pink dorsally and silvery ventrally.

Vertebrae/myomeres

Vertebrae: 24.

Fins

At 6 mm, caudal, second dorsal and anal fins start forming.

At 7 mm, first 2 spines of the dorsal fin are formed (the second one particularly long).

At 9 mm, caudal fin complete.

At 10 mm, second dorsal fin ray appear serrated.

Dorsal fin rays: VI-VIII, 11-13.

Anal fin rays: 18-20.

Pectoral fin rays: 16.

Caudal fin rays: 14.

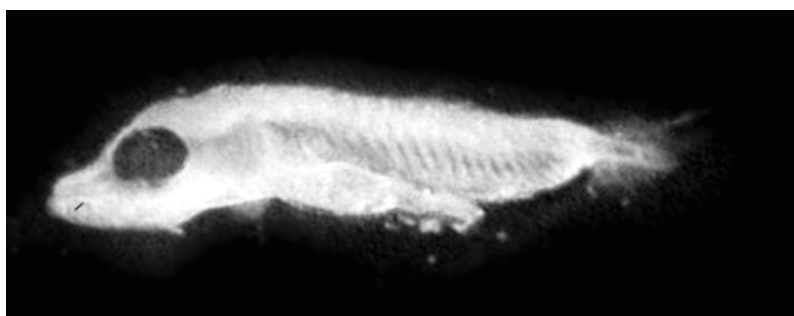

Macroramphosus scolopax larva.

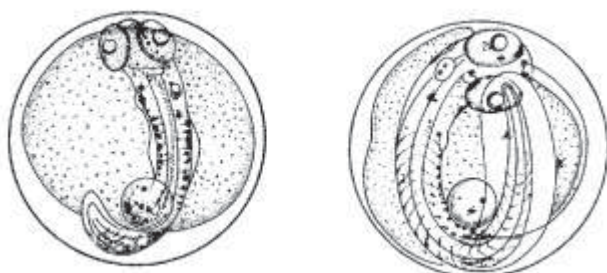

A

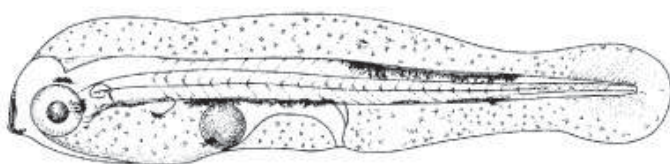

B: 3.0 mm

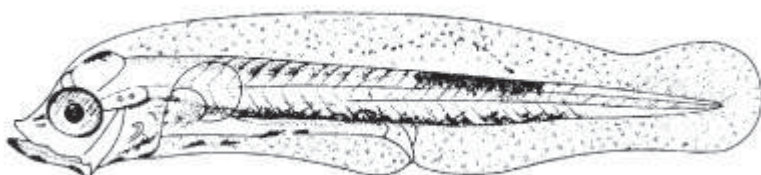

C: 3.4 mm



D: 4.8 mm

A-D: Early life history stages of *Macroramphosus scolopax* from Spartà (1936).

Order SCORPAENIFORMES

Main references: Alemany Llodrà, 1997; Fahay, 1983; Matsuura and Olivar, 1999; Moser *et al.*, 1977.

1,271 species, belonging to 25 families, make this the fourth largest group among Teleosts. Most species spawn demersal eggs or are ovoviviparous.

General features of eggs:

- spherical or slightly elliptical shape
- chorion smooth
- yolk homogeneous
- perivitelline space narrow
- 1 to many oil globules

General features of the larvae from this order:

- body shape stocky, mostly
- eyes round
- gut coiled
- preanal length 35-60% of standard length
- vertebrae 25-65
- head spines usually present and elaborate (characterized by crest-like parietal ridge, supra-occipital crest, and pre-opercular spines)
- fin rays or spines late forming
- pectoral fins often large and fan-like
- transformation gradual

Family SCORPAENIDAE

Scorpionfishes or rockfishes

Main references: Alemany Llodrà, 1997; Blanc and Hureau, 1979a; Costa, 1999; Hureau and Litvinenko, 1986; Matsuura and Olivar, 1999; Moser *et al.*, 1977; Nelson, 2006; Washington *et al.*, 1984.

This is the largest and most diverse family among Scorpaeniformes, with over 350 species. Distributed in all tropical and temperate seas. Mostly marine, rare in fresh water. Most species live on or near the bottom at adult stage. Fertilization mostly internal. Eggs laid in a gelatinous balloon in some species. Larvae are planktonic.

Typical larvae of this family are difficult to characterize. General features:

- body moderately deep, laterally compressed
- head relatively large
- body poorly pigmented, translucent, allowing easy count of myomeres
- vertebrae 24-27
- gut compact, extending to midpoint of body

- head normally well armoured, with a jagged crest (many spines from flexion stage on)
- 3 strong spines on margin of pre-opercle
- tail tapering
- primordial fin extending beyond the profile of head
- particular dermic elements located principally below the profile of dorsal primordial fin and preanal section
- usually 1 dorsal fin, often notched
- pectoral fins large, fan-shaped (from pre-flexion stage), with rounded external margin, forming before other fins
- medial surface of pectoral fin base solidly pigmented

Early stages difficult to discriminate, being larvae very similar and not resembling the adult stages. Pigmentation and pectoral fin rays are useful characters to discriminate the different species.

FAO name: Large-scaled scorpionfish

Libyan name: شكورفو أحمر (Shcorfo ahmer)

Italian name: Scorfano rosso (سكورفانو رسو)

Synonyms: *Scorpaena barbata* (non Bonnaterre, 1788) (misapplied name); *Scorpaena barbata* (non Gronow, 1854) (misapplied name); *Scorpaena lutea* (Risso, 1810)

Main references: Arbault and Boutin, 1968; Ferreiro and Labarta, 1988; Marinaro, 1971; Eschmeyer, 1986; Whitehead *et al.*, 1986.

Distribution

Eastern Atlantic, from British Islands (rare) to Senegal, including Mediterranean, but excluding Black Sea.

Reproduction

In Mediterranean spawning season occurs from May to September.

Pelagic eggs, layed in agglutinated masses measuring 14-20 mm.

EGGS

Transparent, elliptical, with major axis 0.88-0.90 mm and minor 0.68-0.74 mm. Chorion smooth. Yolk homogeneous. Perivitelline space narrow. No oil globules are present.

LARVAE

Morphology

Hatching occurs after 4-5 days. Length at hatching 2.80 mm. Eyes narrow and pigmented. Primordial fin prolonging on anterior region of head. Pectoral fins reaching anus. Anus opening at level of myomere 8.

At 2.96 mm, head becomes deeper. Mouth large and oblique. Very strong cephalic spinal armature, with several different spines: supraorbital crest, 1 occipital spine, 1 spine on superior corner of opercle, 1 long spine on mid of preopercle. Pectoral fins exceeding anus.

At 3.64 mm, head as long as deep. Gut triangular. Supraorbital crest with a serrated spine. Occipital notched crest. Preopercle edge with 5 spines, differently long and in 2 rows.

At 6.95 mm, supraorbital and occipital crests decrease or disappear.

Pigmentation

Pigmentation early. Melanophores on head and trunk. No melanophores on tail. Urostyle region unpigmented at early stages. Melanophores on dorsal side of peritoneum. Primordial fin with refracting elements on its dorsal profile. Pectoral fins with marginal row of melanophores.

From 3.64 to 9.72 mm, red pigment on pectoral fins and their bases, on supraorbital space, on dorso-caudal trunk, and even more present on ventro-caudal trunk. Red pigment slightly present even on lower jaw, on dorsal trunk, at pelvic fins bases, at caudal fin base, but disappears at 7.88 mm.

Up to 12.40 mm, a black spot is present on ventral profile of head, just before the bases of pelvic fins.

At 14.80 mm, melanophores present under occipital crest, around eyes, along jaw, on dorsal trunk and on bases of spinous rays.

Vertebrae/myomeres

Myomeres 24, of which 8 preanal.

Fins

Sequence of fins completion: pectoral (at 3.64 mm), anal (at 6.08 mm), caudal (at 6.96 mm), dorsal and pelvic (at 9.72 mm).

Dorsal fin rays: XI-XII, 9-10.

Anal fin rays: III, 5.

Pelvic fin rays: I, 5.

Pectoral fin rays: 18.

Caudal fin rays: 17-18.

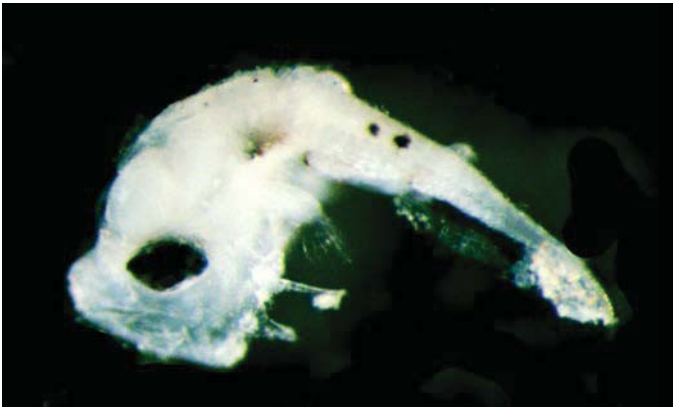

Scorpaena scrofa larva (2.5 mm).

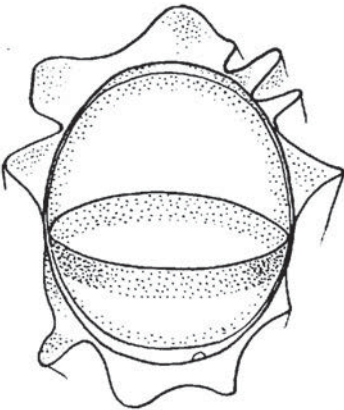

A

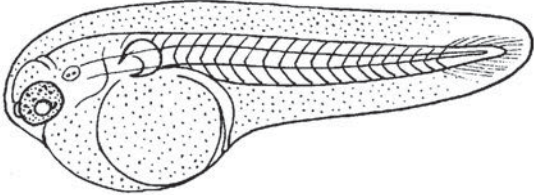

B: 2.8 mm

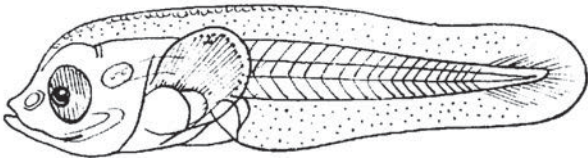

C: 2.72 mm

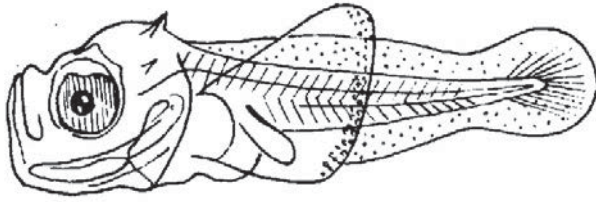

C: 2.96 mm

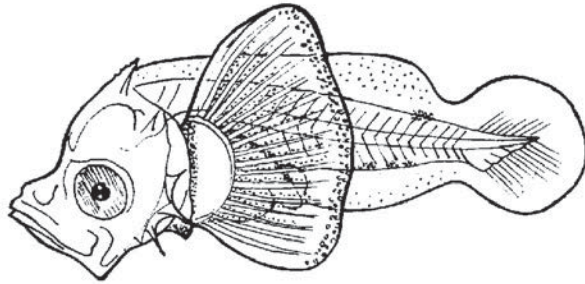

D: 3.64 mm

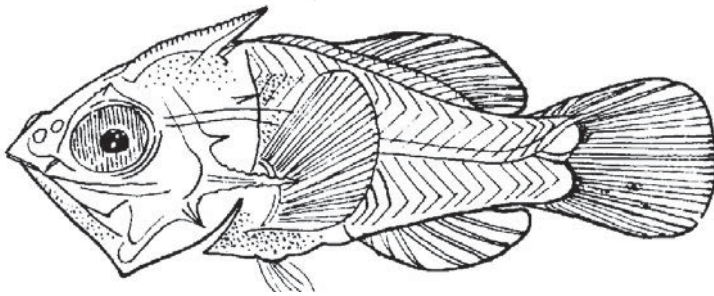

E: 7.88 mm

A: egg of *Scorpaena scrofa* (0,88x0,68 mm)(Spartà, 1942).
B-E: *Scorpaena scrofa* larvae(Spartà, 1942).

Family TRIGLIDAE

Searobins

Main references: Blanc and Hureau 1979b; Costa, 1999; Hureau, 1986; Fahay, 1983; Matsuura and Olivar, 1999; Nelson, 2006; Somarakis *et al.*, 2002; Whitehead *et al.*, 1986.

100 species, belonging to 14 genera, are distributed in all temperate and tropical seas. Adults are benthic.

General features of the larvae from this family:

- body elongated, with a triangular cross-section (deep ventrally)
- head large, with depressed profile
- head spines strong

- bony ridge over eye strong
- pectoral fins large, fan-shaped, early forming, with characteristic pigment patterns
- melanophores outlining dorsal surface of head
- melanophores at edge of upper jaw
- melanophores on corner of lower jaw
- row of melanophores along post-anal ventral mid-line (visible during pre-flexion stage)
- dorsal fins separated
- 3 lowermost pectoral rays separate from rest of fin (in adults used for food detection)

FAO name: Large-scaled gurnard

Libyan name: دجاج (Dajaj)

Italian name: Capocchione

Synonyms: *Lepidotrigla aspera* Günther, 1860; *Trigla aspera* (Cuvier, 1829); *Trigla cavillone* (Lacepède, 1801)

Main references: Arbault and Boutin, 1968; Breder and Rosen, 1966; Costa, 1999; Ferreiro and Labarta, 1988; Marinaro, 1971.

Distribution

Eastern Atlantic: from southern coast of Portugal to Mauritania, including the Mediterranean. Not found in the Black Sea.

Reproduction

Spawning occurs in spring.

EGGS

Spherical, with diameter ranging from 1 to 1.7 mm. Yolk homogeneous and transparent. A single oil globule, rose coloured, with diameter 0.21-0.22 mm.

LARVAE

Morphology

At 3rd day after fecundation, tail of embryo separates from yolk.

At hatching, yolk sac is elliptical, with oil globule posteriorly positioned. Gut running straightly along the body and suddenly coiling with 90° at its terminal portion.

4 days after hatching, yolk-sac is resorbed. Head triangular. Mouth large. Lower jaw well developed, exceeding upper jaw.

At 4.5 mm, head becomes larger. Mouth becomes very large. Preanal length about 30% of standard length.

At 5.5 mm, head appears with the characteristic depressed profile.

At 10-11 mm, well developed head spines: occipital, pre-opercular and super-orbital.

Pigmentation

At 3rd day after fecundation, abundant branched melanophores and yellow chromatophores (xantophores) on yolk surface.

At hatching, pigment not really abundant, but homogeneously distributed all over the body, on the yolk and on the primordial fin. Row of melanophores forming an arch on the antero-dorsal portion of primordial fin.

4 days after hatching, fins highly pigmented by melanophores and xantophores. Eyes with emerald reflections. Few melanophores on the terminal part of trunk.

At later stages, melanophores on head. Peritoneum covered with melanophores. Urostyle region unpigmented.

At 19 mm, heavily pigmented pectoral fins, with dark chromatophores. Head becomes deeper and shorter.

Vertebrae/myomeres

Fins

At 5.5 mm, pectoral fins large and asymmetrical.

At 7 mm, pectoral fins very large and asymmetrical (3rd ray longer than others), asymmetrical caudal fin and still rudimentary pelvic fins.

At 11 mm, last 3 rays of the pectoral fins become separated and thicker than others.

At 10 mm, dorsal fins formed.

First dorsal fin rays: VIII-IX

Second dorsal fin rays: 15-16.

Anal fin rays: 15-16.

Pelvic fin rays: I, 5

Pectoral fin rays: 10-11+3.

Caudal fin rays: 8+11+6

Notes

Other species of Triglidae present 16 rays both in anal and second dorsal fin.



Lepidotrigla cavillone larva.

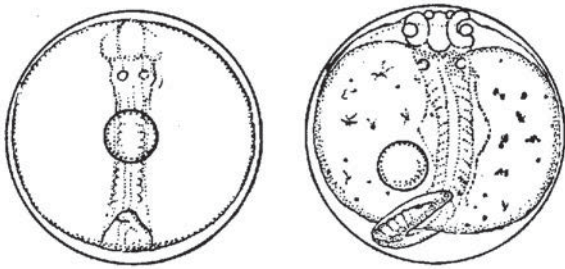

A

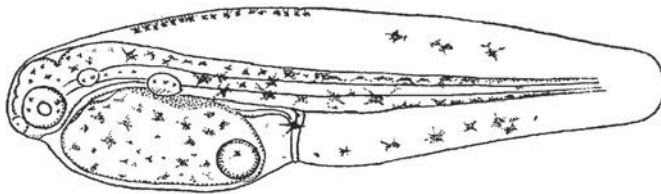

B: just after hatching

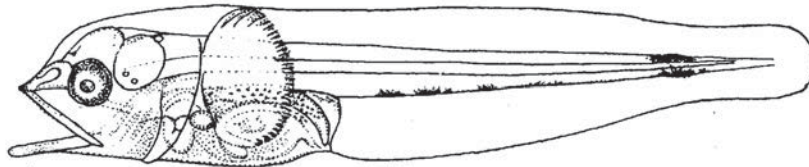

C: 4 days after hatching

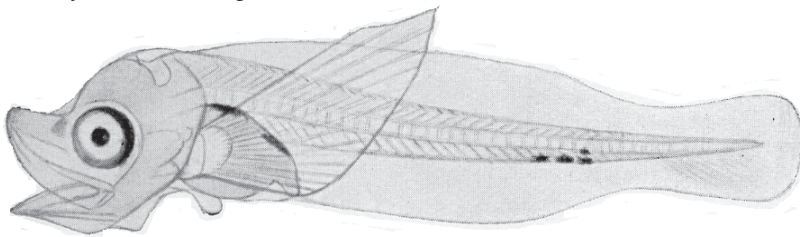

D: 6mm

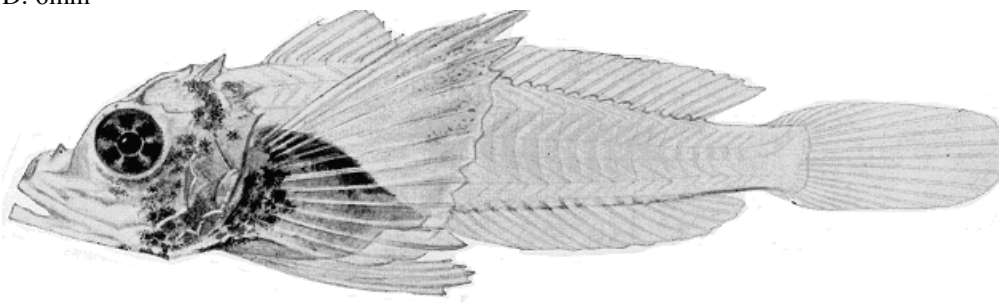

E: 13 mm

A: egg of *Lepidotrigla cavillone* from Raffaele (1888).

B-E: Larvae of *Lepidotrigla cavillone*. B-C: Raffaele (1888); D-E: Lo Bianco (1956).

Order PERCIFORMES

Main references: Alemany Llodrà, 1997; Helfman *et al.*, 1997; Fahay, 1983; Johnson and Gill, 1998; Nelson, 2006.

The largest and most diverse order, with 9500 species belonging to 160 families. Their length is widely variable, from the smallest (gobies) to the largest bony fishes (marlins). This group is difficult to characterize and numerous are the exceptions to the following descriptions.

General features of eggs:

- pelagic or demersal
- shape spherical
- chorion smooth
- yolk homogeneous
- perivitelline space narrow
- none, 1 or more oil globules

General features of the larvae from this order:

- body shape from moderately elongated to stocky
- preanal length 20-60% of standard length
- gut coiled, mostly
- vertebrae 24-28, mostly
- eyes generally round
- head spines vary from none to very strong
- sometimes early formation of fin rays or spines on the pelvic or anterior dorsal fins
- adipose fin absent
- pelvic fins in thoracic or jugular position, below or anterior to pectorals, with 1 spine and 5 or fewer soft rays
- 17 or fewer caudal fin rays
- usually gradual transformation

Family SERRANIDAE

Sea basses: groupers and fairy basslets

Main references: Costa, 1999; Fahay, 1983; Heemstra and Randall, 1993; Kendall, 1984; Matsuura and Olivar 1999; Tortonese, 1986e.

The 449 species, belonging to 62 genera, are distributed in tropical and temperate oceans. Some enter freshwater.

General features of eggs of this family (referred to Serraninae from Atlantic and Eastern Pacific):

- pelagic
- spherical
- relatively small, with diameter about 1.0 mm
- larval length at hatching about 1.5-2.5 mm
- yolk sac large
- eyes unpigmented
- mouth unformed
- pigment changing considerably during yolk absorption

Morphological characters common to serranid larvae are:

- body with very variable forms, from deep and laterally compressed, to slim and elongated
- head bulky
- eyes generally large and circular
- jaws usually extending to more than half of the diameter of eye
- preoperculum with serrated margin and often sharp spines

- anus situated at about mid-length of body
- body weakly pigmented and generally transparent
- vertebrae 24-26, in most species
- caudal fin usually with rounded external margin
- ventral fins early forming; may become very large
- dorsal fins with hard spines; in many species, first and second dorsal fin rays are serrated and quite long (when folded back, reaching the origin of the caudal fin)

The family Serranidae is divided in 4 subfamilies: Anthiinae, Epinephelinae Serraninae and Grammistinae.

Morphological characters of larvae from subfamily Anthiinae:

- relatively deep body
- many spines on opercular region
- head armoured, in some species
- inter-opercle with characteristic long spine, posteriorly-directed, overlain by even larger spine on pre-opercle
- pelvic and some dorsal spines strong, not very elongated
- pigment usually light; some large blotches are present
- 10 preanal and 16 postanal vertebrae
- dorsal fin rays: X, 13-20
- anal fin rays: III, 7-8

Morphological characters of larvae from subfamily Epinephelinae:

- body moderately long
- spines on dorsal and anal fins are elongated and serrated
- preopercle with spines
- pigment present especially on caudal peduncle
- 10 preanal and 14 postanal vertebrae
- dorsal fin rays: IX-XI, 13-20
- anal fin rays: III, 7-12

Morphological characters of larvae from subfamily Serraninae:

- body moderately stubby
- spines on fins short and weak; if elongated, not serrated
- weak head armature
- pigment usually light, variable
- 10 preanal and 14 postanal vertebrae

- dorsal fin rays: X, 11-15
- anal fin rays: III, 6-8

Morphological characters of larvae from subfamily Grammistrinae:

- body moderately long
- dorsal fin with 1 or 2 spines, which are elongate, filamentous, with pigmented sheath
- head armature reduced (weak spines, if present)
- slightly pigmented
- 10 preanal and 14-15 postanal vertebrae
- dorsal fin rays: II-III or VII-VIII, 24-26 or 12-15
- anal fin rays: 0 or III, 15-17 or 7-8

FAO name: Goldblotch grouper

Libyan name: دوٺ (Dooth)

Italian name: Dotto (دوٺ)

Synonyms: *Cerna chrysotaenia* Doderlein, 1882; *Epinephelus alexandrinus* (Valenciennes, 1828); *Cerna alexandrina* (Valenciennes, 1828); *Epinephelus marginalis* (Bloch, 1793); *Serranus fasciatus* (Forsskål, 1775)

Main references: Arbault and Boutin, 1968; Bini, 1969; Costa, 1999; Fahay, 1983; Ferreiro and Labarta, 1988; Glamuzina *et al.*, 2000; Marinaro, 1971; Heemstra and Randall, 1993; Nelson, 2006.

Distribution

Distributed in central eastern Atlantic (from Mauritania to Togo). Common in eastern Mediterranean, but not in Black Sea.

Reproduction

Groupers are protogynous hermaphrodites. They change sex from females to a few dominant males.

EGGS

Spherical and transparent. Chorion smooth. Yolk homogeneous, with a single oil globule.

LARVAE

Morphology

At 3.6 mm, gut triangular. Numerous spines on the head.

Pigmentation

At 3.6 mm, gut pigmented. A large dark dot is present on the ventral side of the caudal region.

Vertebrae/myomeres

10 preanal and 14 postanal vertebrae.

Fins

At 3.6 mm, larvae have a very characteristic dorsal fin with the first ray very elongate and spiny. Also pelvic fins present a very long and spiny first ray. Each ray with small transverse teeth.

At 4.9 mm, first dorsal ray is still very long and pigmented on its tip.

Dorsal fin rays: XI, 16

Anal fin rays: III, 8.

Pectoral fin rays: 16.

Pelvic fin rays: I, 5.

Caudal fin rays: 17

Notes

The early-forming, elongated, slender dorsal fin spines clearly distinguish Epinephelinae larvae from most other fish larvae.



Epinephelus costae larva.

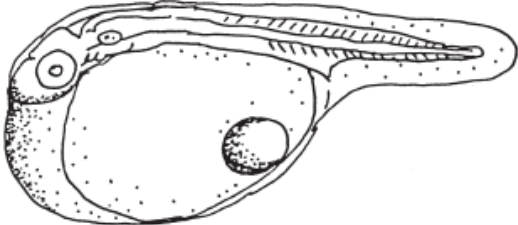

A: newly-hatched larva

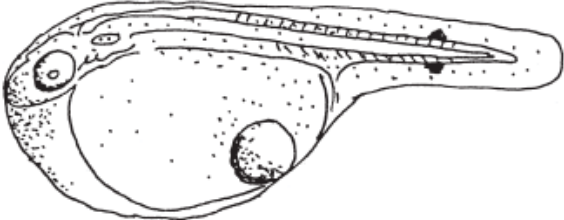

B: 5-hour old larva

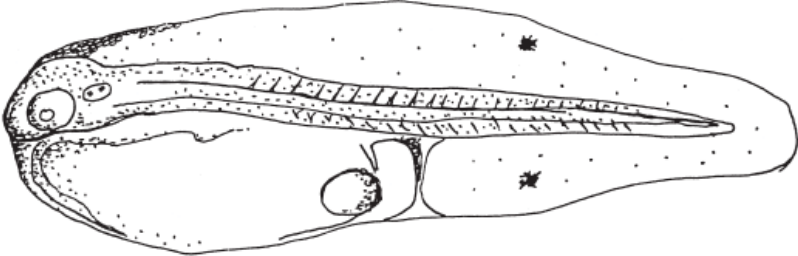

C: 24-hour old larva

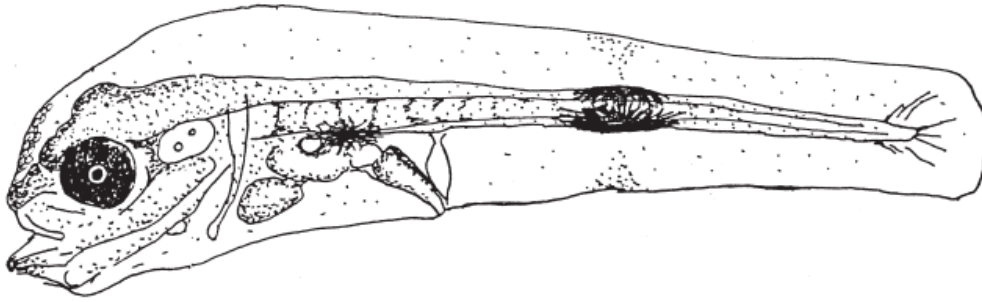

D: 80-hour old larva

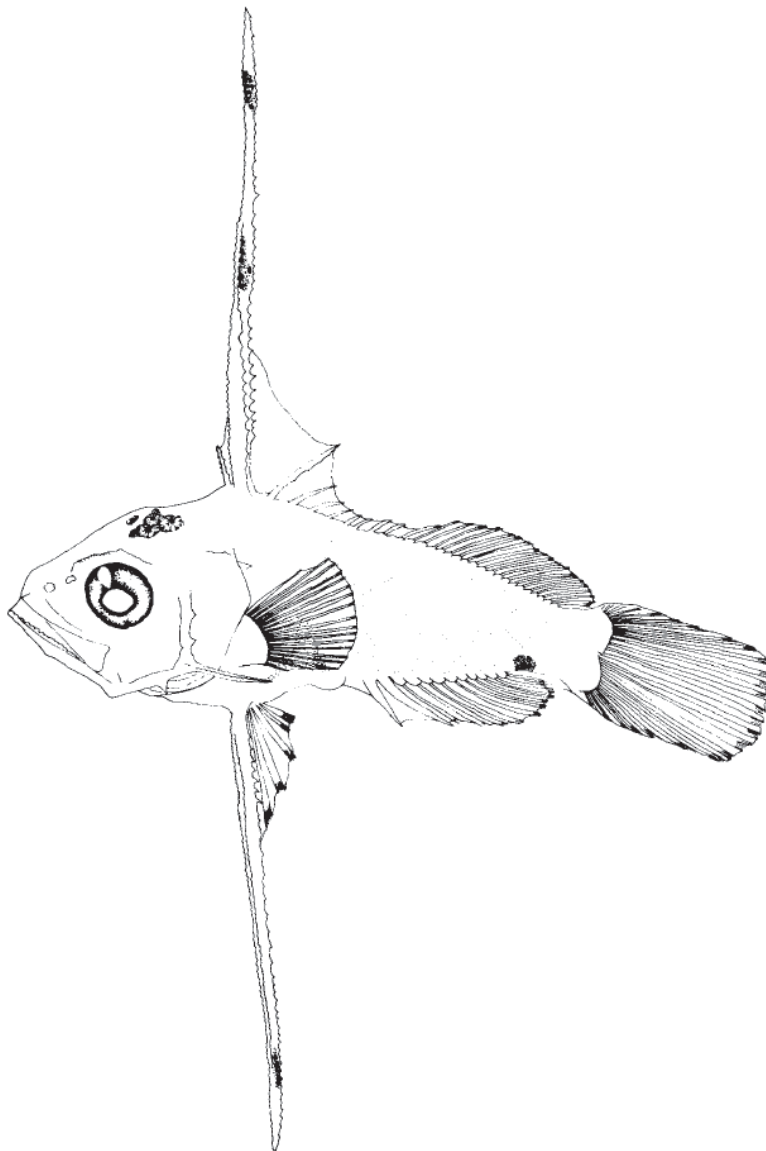

E: 8.4 mm standard length

A-D: *Epinephelus costae* larvae from Glamuzina *et al.* (2000); E Larva *Epinephelus* sp. From Kendall (1979).

Family APOGONIDAE

Cardinalfishes

Main references: Costa, 1999; Garnaud, 1962; Hureau and Monod, 1979; Leis and Carson-Ewart, 2000; Lo Bianco, 1909; Nelson, 2006; Somarakis *et al.*, 2002; Tortonese, 1986a.

Distributed in the Mediterranean and Atlantic Ocean. Spawning occurs in winter. Eggs often brooded orally.

General features of eggs of this family:

- spherical shape (although spindle-shaped eggs are known)
- widely variable size, with diameters from 0.4 to 2.5 mm
- majority of species brood their eggs orally

Larvae of this family are extremely variable in morphology and developmental pattern.

General features of larvae from this family:

- hatching length 2.5-6.0 mm
- yolk-sac small
- body deep and laterally compressed
- head large
- head spination very variable, from completely absent to present in different regions
- spination in the preopercle and opercle in most species
- eyes large, pigmented and roundish

- mouth well formed, reaching about mid eye, varying from nearly horizontal to very oblique
- gut deeply coiled and extending to about midbody
- conspicuous swim bladder
- fin development extremely variable
- dorsal and anal fins form early (at about 5 mm)
- 2 dorsal fins separated; the second dorsal fin is short (less than 10 rays)
- pectoral fin rays vary in length and are usually the last to form
- dorsal fin ossify at length of 3.2-4.7 mm
- marked pigmentation on head
- pigmentation consistently present on the dorsal surface of the swim bladder
- myomeres 23-24: 8-12 preanal and 12-16 postanal
- size at notochord flexion: 3.2-4.1 mm

Meristic characters of the genus *Apogon*:

- dorsal fin rays: VI-VIII+I, 8-9
- anal fin rays: II, 8-9
- pelvic fin rays: I, 5
- pectoral fin rays: 12-17
- caudal fin rays: 9+8
- vertebrae: 10+14

Family APOGONIDAE

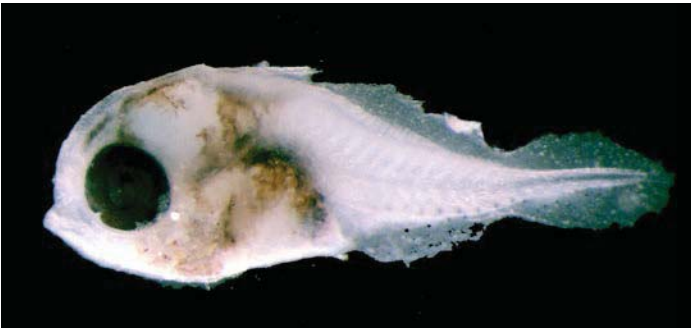

Apogonidae larva (3.5 mm).

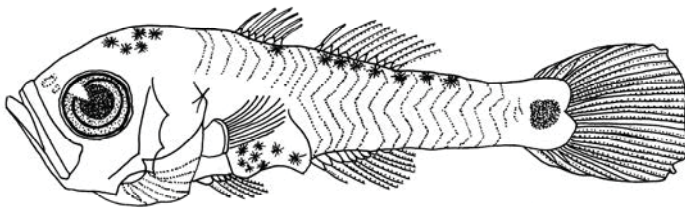

A

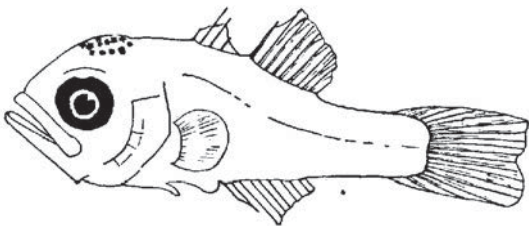

B: 6.5 mm

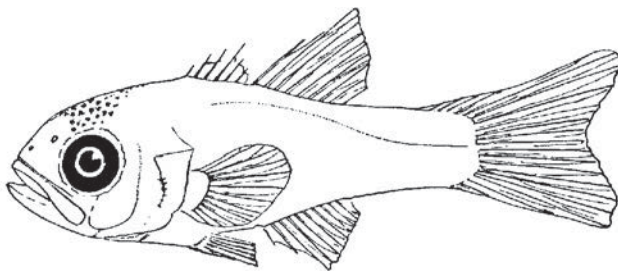

C: 14 mm

A: Apogonidae larva, original drawing by Cuttitta.

B-C: *Apogon imberbis* larva as example, from Fage (1918).



Family POMATOMIDAE

Bluefishes

Main references: Fahay, 1983; Hureau and Monod, 1979; Monod 1979a, Nelson, 2006; Tortonese, 1986b.

Species of this family are distributed in Indian, Pacific and Atlantic Oceans, including the Mediterranean Sea.

General features of larvae from this family:

- body slender
- first dorsal fin rays: VII-VIII
- second dorsal fin rays: I+13-28
- anal fin rays: II-III+12-27
- vertebrae 26

FAO name: Bluefish

Libyan name: مغرس (Magres)

Italian name: Pesce serra

Synonyms: *Gasterosteus saltatrix* (Linnaeus, 1766); *Cheilodipterus saltatrix* (Linnaeus, 1766); *Cheilodipterus heptacanthus* (Lacepède, 1801)

Main references: Agassiz and Whitman, 1885; Arbault and Boutin, 1968; Fahay, 1983; Ferreiro and Labarta, 1988; Kendall and Walford, 1979; Marinaro, 1971; Matsuura and Olivar, 1999; Nelson, 2006; Wilk, 1977.

Distribution

Circumglobal: from tropical to subtropical waters.

Reproduction

Serial spawning. Spawning period variable; for example it occurs in summer in Mid-Atlantic Bight, earlier in South Atlantic Bight. Fecundity varies from 400,000 to 2,000,000 eggs, depending on the size of the female.

EGGS

Pelagic, spherical and transparent, with diameter ranging from 0.95 to 1.00 mm. Chorion smooth and transparent. Yolk homogeneous. Narrow perivitelline space: 1 oil globule with diameter 0.26-0.29 mm.

LARVAE

Morphology

Hatching occurs at 2.0-2.4 mm. Oil globule positioned posteriorly. Yolk absorbed at 3.3-3.6 mm.

At 4.3 mm, teeth well developed and diagnostic.

Flexion of notochord occurs at 4.3-5.0 mm.

Body moderately elongated. Preanal length changes during development: from 50% of standard length, decreases to 33% of standard length, and increases again to 50% of standard length in juvenile stage.

At about 6 mm, body becomes more deep.

Preopercular spines increase from 2 at 4.8 mm, to 6 at 9.5 mm and to 7 at 12.8 mm.

They are tiny and about equal in length, the preopercle appearing serrated (while in carangids the spine at preopercle angle is pronounced).

Pigmentation

At hatching eyes with no pigmentation.

At 4.3 mm, several melanophores scattered on top of head. 3 series of melanophores: 2 rows of melanophores along dorsal and ventral margins of body, 1 row of melanophores on post-anal mid-lateral line. Dorso-lateral surfaces of gut heavily pigmented.

At 26 mm, fine dots all over the body.

Vertebrae/myomeres

At hatching, pre-anal myomeres are 9; become 12 at 8.5 mm.

Ossification of vertebrae is complete at 6.0-6.5 mm.

11 pre-anal and 15 post-anal vertebrae.

Fins

At 4.3 mm, the caudal, dorsal and anal fins are slightly differentiated.

At 7.3 mm, fin rays are differentiated.

At 26 mm, the spinous dorsal fin is further developed. The caudal fin becomes forked.

Beginning of fin rays ossification, in sequence: caudal, second dorsal, anal, first dorsal, pectoral, pelvic. Completion of fin rays ossification: dorsal at 7.0 mm, anal at 7.5 mm, pelvic at 8.5 mm, caudal at 13.0 mm, and pectoral at 14.0 mm.

Dorsal fin rays: VII-IX, 23-28.

Anal fin rays: II-III, 24-29.

Pectoral fin rays: 18.

Pelvic fin rays: I, 5.

Caudal fin rays: 9-10+9+8+9-10.



Pomatomus saltatrix larva.

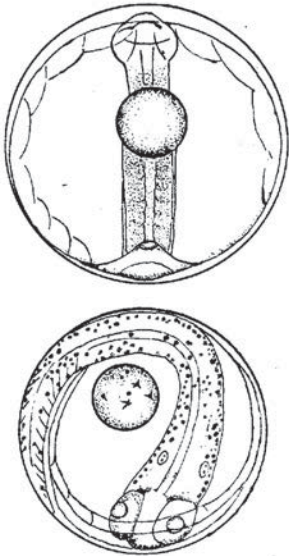

A

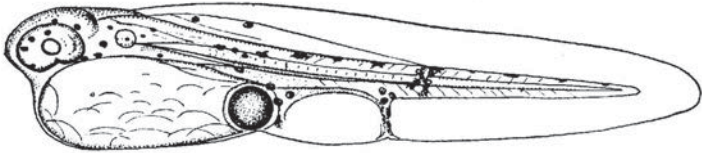

B: 2.15 mm

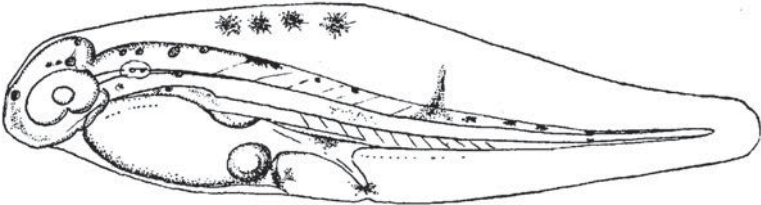

C: 36 hours after hatching

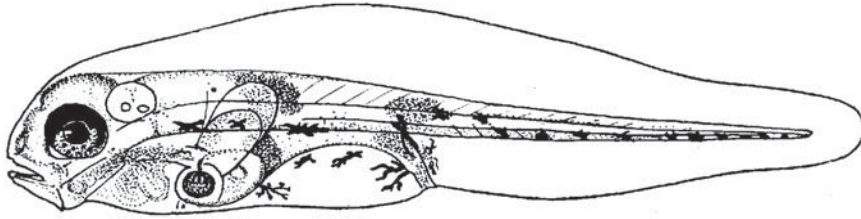

D: 9 days after hatching

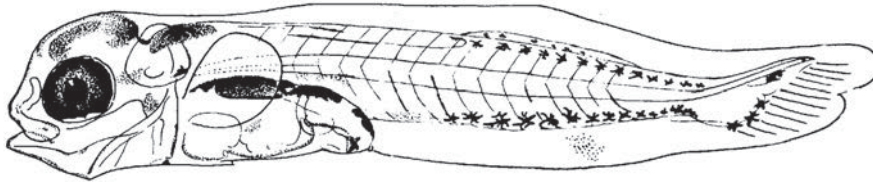

E

A: egg of *Pomatomus saltatrix* at two different stages of development (Agassiz and Whitmann, 1885).
B-E: *Pomatomus saltatrix* larvae, from Agassiz and Whitmann (1885).

Family ECHENEIDAE

Remoras

Main references: Alemany Llodrà, 1997; Lagler *et al.*, 1962; Leis and Carson-Ewart, 2000; Johnson, 1984; Nelson, 2006.

Species of this family are distributed in Indian, Pacific and Atlantic Oceans, including the Mediterranean. Spawning occurs generally in spring and summer, but also in autumn in the Mediterranean.

General features of eggs of *Echeneis naucrates* and *Remora remora*, species belonging to this family, are:

- pelagic
- shape spherical
- diameter ranging between 1.4 and 2.6 mm

General features of early larval stages of *Echeneis naucrates* and *Remora remora*, species belonging to this family, are reported as example:

- length at hatching 4.7-7.5 mm
- yolk sac large
- eyes unpigmented
- mouth not completely formed
- pigment during yolk absorption variable from species to species

Morphological features of larvae from this family:

- body elongated to very elongated, roundly-rectangular in cross section
- myomeres 26-38 (13-18 + 11-20)
- head elongated, moderate in size

- head becoming depressed when sucking disk begins to form
- snout elongated, pointed; initially slightly concave, but later becomes straight in profile and wedge-like
- mouth initially reaching the eye; later becomes shorter
- upper jaw with small teeth; lower jaw with very large, recurved to hooked teeth (persisting throughout larval stage)
- eye small to moderate, slightly elongate
- short gill covers: gill arches and filaments exposed posteriorly until notochord flexion
- head spines absent
- gut straight, elongated, with relatively large diameter
- preanal length up to 73% of body length in pre-flexion larvae; only 50-62% of body length in post-flexion larvae
- anus moving anteriorly during development
- swim bladder not visible
- sucking disk derived from the dorsal fin spines, appearing at the end of the pre-flexion stage in some species, to as late as about 35 mm in *E. naucrates*
- dorsal fin elements ossify at 6.1-7.5 mm
- pectoral fin rays ossify after notochord flexion, being completely ossified at 8.5-22 mm, depending on species

- pelvic fin complete at 17 mm in *Remora*
- flexion of notochord occurring at relatively large body length (at 6.1-7.5 mm)

- middle caudal fin rays very elongated in the subfamily Echeneinae



A: diameter 1.4-1.52 mm

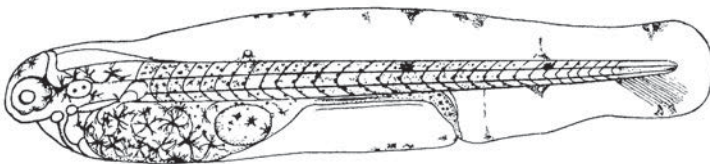

B: 4.7 mm

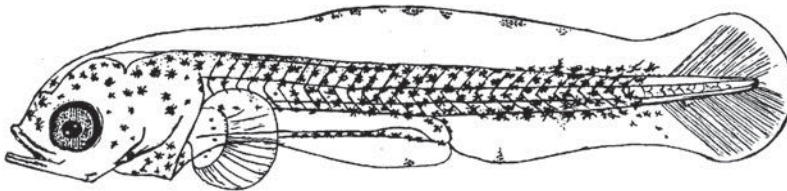

C: 5 mm

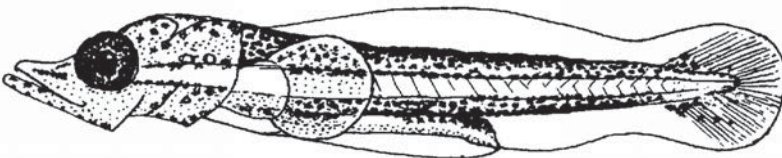

D: 3.68 mm

A: egg of *Remora remora* from Sanzo (1928).
 B-D: *Remora remora* larva from Sanzo (1928).

Family CARANGIDAE

Jacks and pompanos

Main references: Aboussouan, 1975; Alemany Llodrà, 1997; Costa, 1999; Fahay, 1983; Hureau and Monod, 1979; Hureau and Tortonese 1979, Matsuura and Olivar, 1999; Riera *et al.* 1999, Smith-Vaniz, 1986, Somarakis *et al.*, 2002.

This family comprises about 140 species belonging to 30 genera. Distributed in Atlantic, Pacific and Mediterranean. Spawning occurs in spring and summer.

General features of eggs from this family:

- pelagic
- chorion smooth
- yolk homogeneous or segmented
- 1 oil globule, anterior in late eggs and hatchling

Morphology is highly diverse. General features of larvae from this family:

- body shape from slender to deep
- median occipital crest present in some species
- orbital crest and post-temporal spines present in some species
- 2 series of pre-opercular spines: one along posterior margin, the other on anterior margin (number of pre-opercular spines changes during development)
- usually 24 myomeres (maximum 26)

- melanophores in different rows on dorsal, ventral and mid-lateral regions of the body
- principal caudal fin rays: 9+8
- pelvic fin rays: I, 5
- first 2 anal spines widely separated from 3rd spine
- first dorsal fin has a maximum of 8 spines (less in some species)
- fin ray and gillraker counts are useful in discriminating *Caranx* longer than 14 mm SL

The form of supra-occipital crest is used to distinguish some genera:

- if dorsal fin rays are just few more than anal rays:
 - *Caranx* - relatively deep-body, with median occipital crest.
 - *Trachurus* - relatively elongated body, with median occipital crest.
 - *Trachinotus* - relatively elongated body, with no occipital crest.
- if dorsal fin rays are many more than anal rays:
 - *Naucrates* - relatively deep-body, with median occipital crest.
 - *Seriola* - relatively elongate body, with no occipital crest.

Another discriminating character is the separation, in the anal fin, of the 2 anterior-most spines from the 3rd one.

FAO name: Horse mackerel

Libyan name: صاورو (Sauro)

Italian name: Suro (صورو)

Main references: Alemany Llodrà, 1997; Arbault and Boutin, 1968; Ben-Salem, 1988; Costa, 1999; Fahay, 1983; Ferreiro and Labarta, 1988; Karlou-Riga, 1995; Karlou-Riga and Economidis, 1997; Korichi, 1988; Kyrtatos, 1998; Marinaro, 1971; Matsuura and Olivar, 1999; Olivar and Fortuño, 1991; Santic *et al.*, 2003; Smith-Vaniz, 1986.

Distribution

Pelagic, oceanodromous. In North Eastern Atlantic and Mediterranean.

Reproduction

Adults aggregate in large schools in coastal areas with sandy substrate. Batch spawning. Females lay up to 140,000 eggs. Spawning in spring-summer.

EGGS

Spherical, transparent, with diameter ranging from 0.72 to 0.97 mm. Yolk segmented only in its peripheral area. Diameter range of oil globules from 0.19 to 0.29 mm.

LARVAE

Morphology

At hatching, 2.7 mm long; development limited and mouth closed. Eyes without colour. Anus is at considerable distance from the yolk sac and the preanal distance is 2/3 of the total length.

At 3.4 mm, yolk almost completely re-absorbed. Mouth opened. Thereafter body depth increases considerably, the maximum being at head. Head relatively large, with supra-occipital crest. Several spines on posterior and anterior margins of pre-opercle.

At 5 mm, the maximum depth between head and trunk, representing 25% of total length. Swim bladder very large.

At 6 mm, head becomes larger, about 34% of body length.

Flexion of notochord at 6-8 mm (referred to *Trachurus trachurus capensis*).

Pigmentation

After hatching, black pigment forms, limited to body and surface of the oil globule; yolk sac develops a dark yellow pigment. Relatively few melanophores distributed on cephalic region and lower half of caudal region.

At about 4 mm, small melanophores on head region. 2 rows of melanophores along dorsal and ventral margins of body. Anterior row along mid-lateral line on the tail. Dorso-lateral surface of gut heavily pigmented.

At 6 mm, pigmentation is widespread.

Vertebrae/myomeres

10 preanal and 14 postanal vertebrae; complete at about 10-12 mm length (referred to *Trachurus trachurus*).

Fins

Caudal fin is the first to form.

At 3.4 mm, pectoral fins are differentiated.

Unpaired fins develop relatively late.

Meristic counts referred to *Trachurus trachurus*:

First dorsal fin rays: VIII.

Second dorsal fin rays: I, 29.

Anal fin rays: II, I, 27.

Pelvic fin rays: I, 5.

Caudal fin rays: 9+8.



Trachurus spp. larva (5 mm).

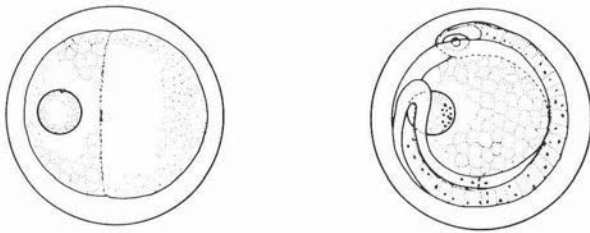

A

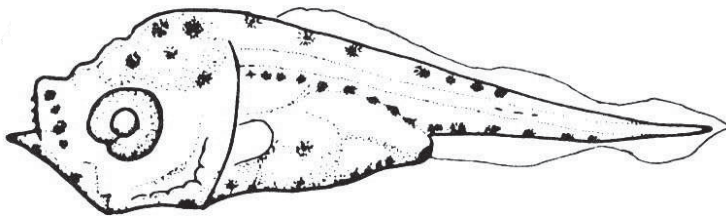

B: 3.3 mm

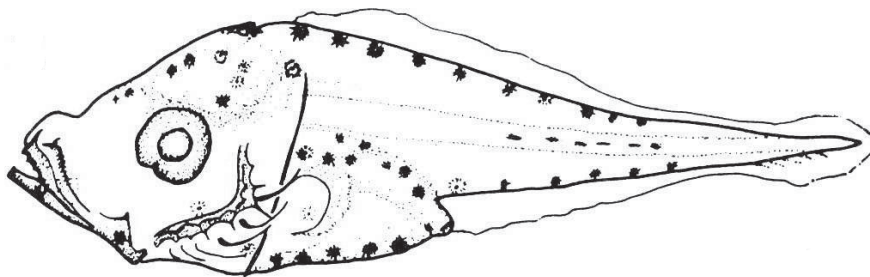

C: 4.5 mm

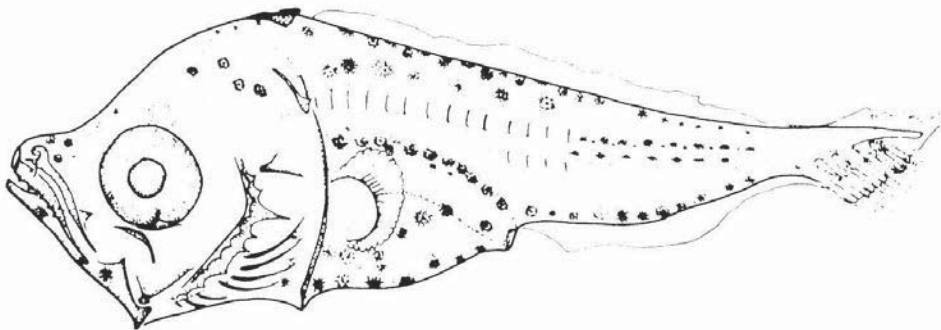

E: 5.8 mm

A: egg of *Trachurus trachurus capensis* from King *et al.* (1977).
B-E: *Trachurus trachurus capensis* larva from Haigh (1972).

FAO name: Amberjack

Libyan name: شولة (Shola)

Italian name: Seriola (سريولة)

Main references: Arbault and Boutin, 1968; Castriota *et al.*, 2002; Fahay, 1983; Ferreiro and Labarta, 1988; Hildebrand and Cable, 1930; Marinaro, 1971; Marino *et al.*, 1995; Massuti and Stefanescu, 1993; Sanzo 1933; Smith-Vaniz, 1986.

Distribution

Worldwide. Also in the Mediterranean Sea.

Reproduction

Spawning occurs during summer, in coastal areas.

EGGS

Spherical and transparent, diameter ranging from 1 to 2.09 mm. Chorion smooth. Narrow perivitelline space. Yolk segmented. One oil globule with diameter 0.28 mm.

LARVAE

Morphology

Body much more slender and heavily pigmented than larvae of *Trachurus* sp. Gut

triangular in shape, but more elongated than in *Trachurus*. In pre-flexion stages, body depth at pectoral fins represents 19-23% of length (while in *Trachurus* is 30%). Supraoccipital crest is absent (while present in *Trachurus*). Spinal armature appears early and presents several different spines.

At 5 mm, larva presents 4 pre-opercular spines, 3 of which are much longer.

Pigmentation

Pigmentation consists of serial melanophores outlining dorsal and ventral margins of body. Other melanophores are present on tail, head, and peritoneum, as well as in the urostyle region.

Vertebrae/myomeres

Vertebrae 24 (referred to *Seriola dumerili*).

Fins

Meristic counts referred to *Seriola dumerili*:

First dorsal fin rays: VII.

Second dorsal fin rays: I, 29-35.

Anal fin rays: II, I, 19-22.

Seriola spp.

Family CARANGIDAE

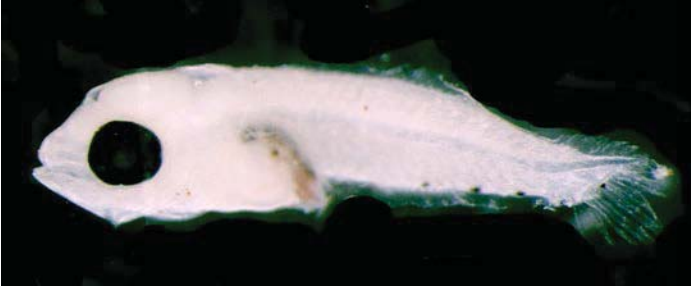

Seriola spp. larva (4 mm).

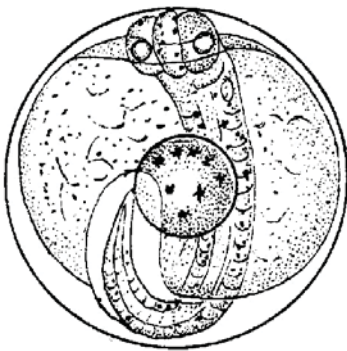

A: diameter 1.04-1.12 mm

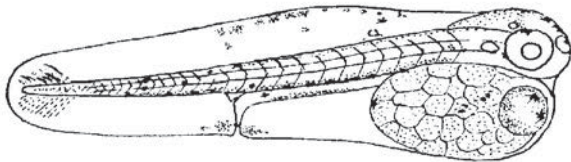

B: 3.6 mm

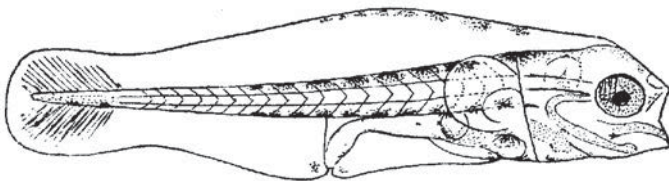

C: 4.6 mm

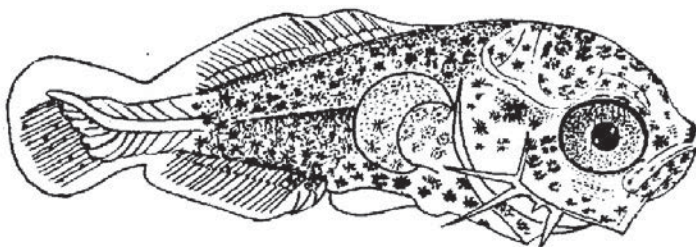

D: 4.8 mm

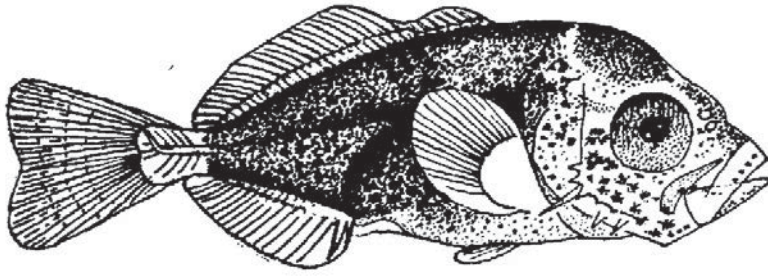

E: 9.72 mm

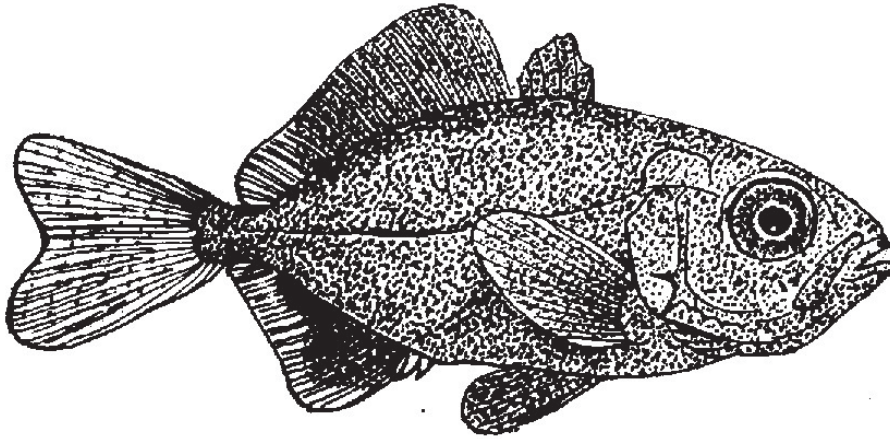

F: 17 mm

A-F Early stages of *Seriola dumerii* from Sanzo (1933).

Family CENTRACANTHIDAE

Picarels

Main references: Hureau and Monod, 1979; Labropoulou and Papaconstantinou, 2000; Montalenti, 1933; Turan, 2011.

Species of this family are present in the Eastern Atlantic, from the Mediterranean to South Africa.

Spawning occurs on detritic sandy bottoms, where nests are excavated. Males are brightly coloured and actively guard the nests. At the end of incubation period, males lose their coloration. After spawning individuals aggregate in large schools moving to feeding grounds.

Larvae elongated, with preanal length about 30% of body length.

Juveniles with slender body, pigmented by black and yellow or yellow-reddish chromatophores. Juveniles very similar to those of sparids, but body of centracanthids is more slender.

Upper jaw is highly protractile and their diet is mainly planktivorous.

General meristic counts in adult stages belonging to this family:

Dorsal fin rays: XI-XIII, 9-12.

Anal fin rays: III, 9-10.

Pelvic fin rays: I, 5.

Pectoral fin rays: 15-18.

Vertebrae: 67-92.

FAO name: Blotched picarel

Libyan name: زريقة (Zriga)

Italian name: Menola (مينولا)

Synonyms: *Maena chryselis* (Valenciennes, 1830); *Maena jusculum* (Cuvier, 1829); *Maena maena* (Linnaeus, 1758)

Main references: Arbault and Boutin, 1968; Ferreiro and Labarta, 1988; Labropoulou and Papaconstantinou, 2005; Marinaro, 1971; Montalenti, 1933; Tortonese, 1986c, Turan, 2011.

Distribution

Eastern Atlantic: Portugal, Morocco and Canary Islands, including Mediterranean and Black Sea.

Reproduction

Protogynous hermaphrodite. Spawning occurs in spring.

EGGS

Demersal, adherent to external objects. Spherical, with diameter ranging from 0.84 to 0.92 mm. Yolk homogeneous, yellow coloured. A single oil globule with diameter of 0.20 mm.

LARVAE

Morphology

At hatching, body slender. Preanal length about 30% of body length. Wide primordial fin, extending anteriorly to the head.

At 6 mm, body slender. Gut with a triangular shape. Preopercular spinal armature is present, but will disappear with development.

Pigmentation

At hatching, body highly transparent.

Later develops 1-4 ventral preanal pigments; one of them is always situated close to the anus.

Peritoneum covered with melanophores. Ventral row of 11-18 postanal melanophores. A single melanophore on tail, head and trunk. In juveniles, black, yellow and yellow-reddish chromatophores are present.

Vertebrae/myomeres

Vertebrae 68-83.

Fins

Meristic counts at completion of development:

Dorsal fin rays: XI, 11-12.

Anal fin rays: III, 9-10.

Pelvic rays: I, 5.

Caudal fin rays: 17.

Pectoral fin rays: 15-16.



Spicara maena larva.



A



B: newly hatched larva

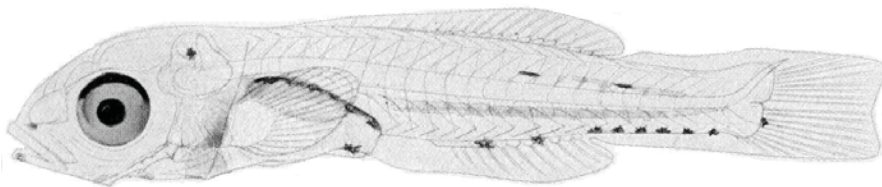

C: 10 mm

A-C Early stages of *Spicara smaris* from Lo Bianco (1937).



Family BRAMIDAE

Pomfrets

Main references: Costa, 1999; Fahay, 1983; Gomes, 1990; Haedrich, 1986; Olivar and Fortuño, 1991; Somarakis *et al.*, 2002.

The species of this family are typically oceanic. Most of the them spawn in winter, a few in summer.

General features of larvae from this family, referred to North Western Atlantic species:

- preanal body portion prominent
- spination on preopercle, variable among species
- high number of myomeres
- fins large
- fins with weak spines or without them
- pelvic fin rays: I, 5.
- caudal rays: 9+8.

FAO name: Atlantic pomfret

Libyan name: قصىطة (Gasitla)

Italian name: Pesce castagna (بيشة كستانية)

Synonyms: *Brama chilensis* Guichenot, 1848 (ambiguous synonym); *Brama marina* Fleming, 1828;

Brama pinnasquamata Couch, 1849

Main references: Alemany Llodrà, 1997; Arbault and Boutin, 1968; Costa, 1999; Fahay, 1983; Ferreiro and Labarta, 1988; Gomes, 1990; Haedrich, 1986; Marinaro, 1971; Olivar and Fortuño, 1991; Somarakis *et al.*, 2002.

Distribution

Present in Western Atlantic (from New Scotland, Canada, Bermudas up to Belice and the Antillas) and in Eastern Atlantic (from Central Norway to Sud Africa). Also present in the Indian Ocean, South Pacific and Mediterranean. Found in the Strait of Sicily during the summer months.

Reproduction

Spawning occurs from May to September.

EGGS

Spherical and transparent. Chorion smooth. Yolk unsegmented. Narrow perivitelline space. Diameter ranges from 1.56 to 1.60 mm. Oil globules with diameter of 0.40 mm, not coloured.

LARVAE

Morphology

At hatching, larvae are usually small. Body compressed. Head large and round.

At 4 mm, head depth is 21% of notochordal length. Gut extends to 27% of notochordal length.

At about 5 mm, head depth becomes 35% of standard length. Coiling of gut is complete. Preanal region is prominent throughout development. Small spines are visible on margin of preopercle.

Notochordal flexion occurs from 5 to 6.5 mm of standard length.

At 6.4 mm, gut extends to 44% of standard length.

At 9 mm, 8 preopercular spines are still present.

Transformation occurs at 11 mm of standard length.

Pigmentation

Yolk-sac larvae with numerous melanophores on finfold of the caudal region.

Large number of melanophores spread over entire preanal region, at all stages of development.

At 3 mm, head is strongly pigmented. Pigment on dorsal side of peritoneum. Before coiling of gut, melanophores are spread out above the branchiostegal membrane.

Vertebrae/myomeres

Vertebrae: preanal 16-17, postanal 24-25.

Fins

Sequence of fin formation: caudal; pectoral; pelvic; dorsal; anal. At 14 mm of standard length rays of all the fins are completely developed.

Dorsal fin rays: 35-38.

Anal fin rays: 29-32.

Pectoral fin rays: 20-23.



Brama brama larva (2 mm).



A

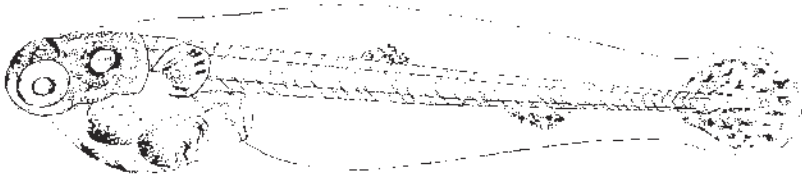

B: 4.8 mm



C: 4.2 mm

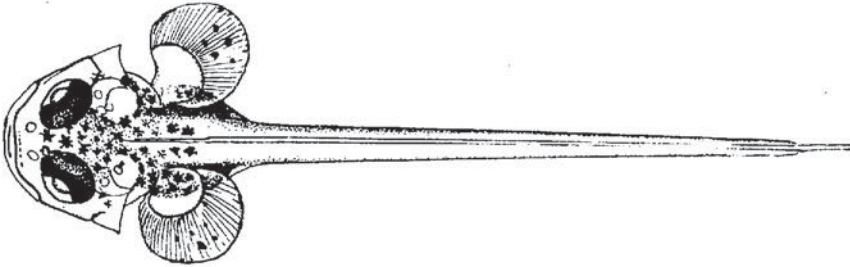
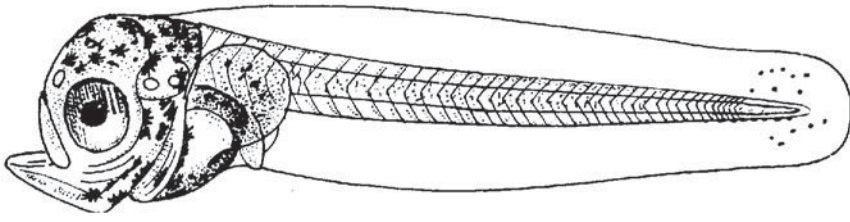

D: 4.36 mm, lateral and dorsal view.

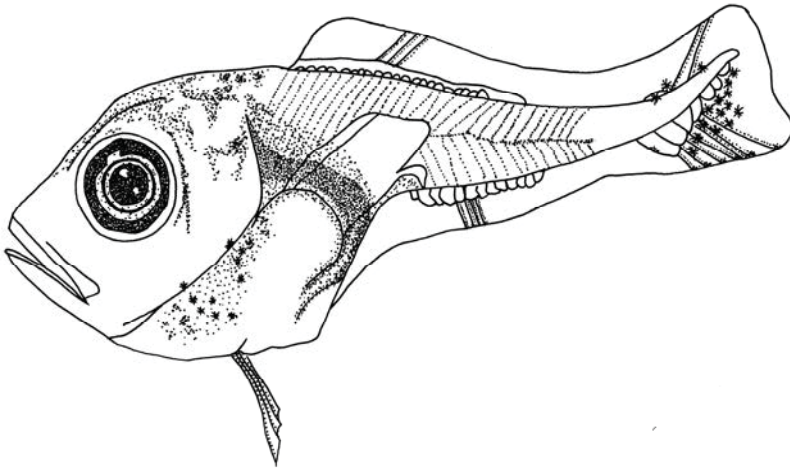

E: 7 mm

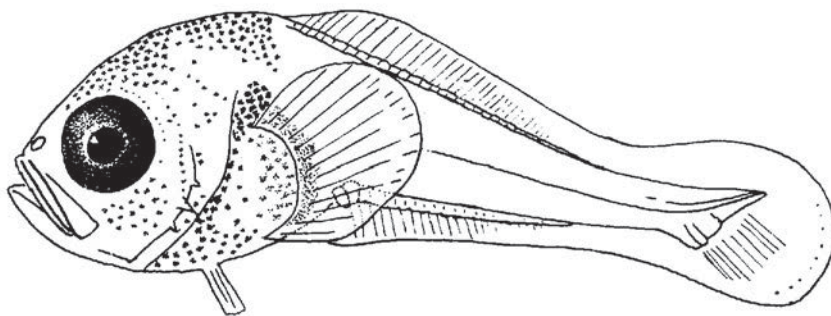

F: 7 mm

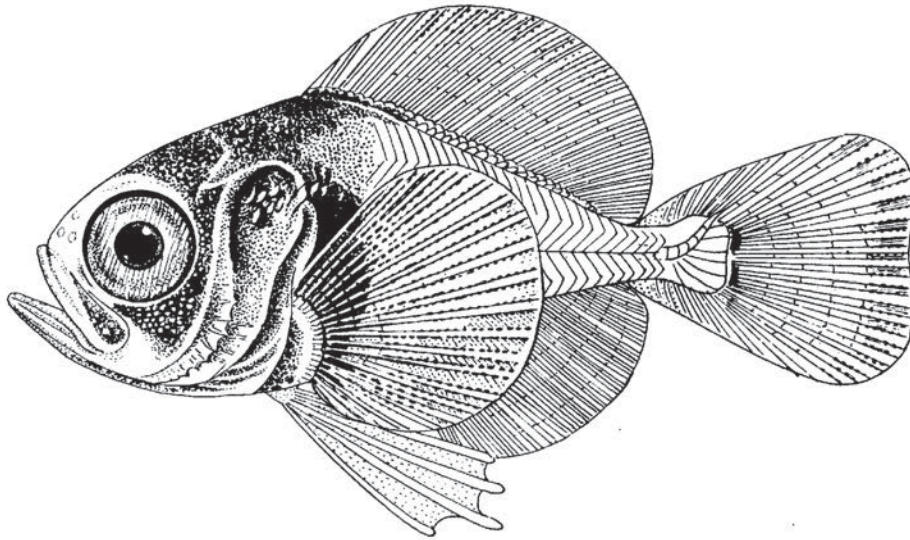

G: 14.32 mm

A: egg of *Brama brama* from Sanzo (1928b).

B-F: *Brama brama* larvae. B -D: Sanzo (1928b); E: original drawing by Mariangela Borghi. F-G: Schmidt and Strubberg (1918).



Family SPARIDAE

Porgies

Main references: Bauchot and Hureau, 1990; Costa, 1999; Fahay, 1983; Matsuura and Olivar, 1999.

Species of this family are distributed in tropical and subtropical waters of Pacific, Indian and Atlantic Oceans, including the Mediterranean Sea.

Many species are hermaphroditic; some may have male and female gonads simultaneously, others change sex during growth, being proterandric or protogynous hermaphrodites.

General features of larvae from this family:

- at hatching, oil globule posteriorly located in yolk
- pigment present on yolk and oil globule
- body slender and transparent
- gut <50% of total length
- head spines weak or totally absent

- pre-opercle with slightly serrate margin
- at about 7 mm, second dorsal and anal fins are present on tail region and have about the same number of rays
- spines of first dorsal fin appear later
- myomeres usually 24
- ventral row of postanal spots
- numerous chromatophores of highly variable colours ranging from yellow to blue, in various parts of body
- pigmentation pattern drastically variable from species to species

Specimens are difficult to distinguish at a specific level in the early embryonic stage. Chromatophores are not always valid for identification since colour fades quickly after capture. Individuals larger than 25-30 mm, are easily identified since their meristic features are the same as in adults.

FAO name: Red porgy

Libyan name: باقرو (Bagro)

Italian name: Pagro (باقرو)

Synonyms: *Aurata orphus* (non Linnaeus, 1758) (misapplied name); *Pagrus orphus* (non Linnaeus, 1758) (misapplied name); *Pagrus pagrus* subsp. *pagrus* (Linnaeus, 1758)

Main references:; Arbault and Boutin, 1968; Bauchot and Hureau, 1990; Costa, 1999; Ferreiro and Labarta, 1988; Marinaro, 1971; Ré and Meneses, 2009 Richards, 1989.

Distribution

Benthopelagic species with a depth range 0-250 m. Distributed in the Eastern Atlantic: Strait of Gibraltar to 15°N (rare southward of 20°N), including Madeira and the Canary Islands; Mediterranean and northward to the British Isles. Also distributed in the Western Atlantic: New York, USA and northern Gulf of Mexico to Argentina, including the continental coast of the Caribbean Sea.

Reproduction

Spawning period ranges from May to October.

EGGS

Spherical and transparent, with diameter 1.0 mm. Chorion smooth. Yolk unsegmented, transparent, without pigments. 1 oil globule with diameter 0.22 mm.

LARVAE

Morphology

Body elongated. Head small. Eye round and pigmented. Gut short, ending in a fold. Strong occipital spine. Operculum serrated, with 2 opercular crests bordered by very well developed spines.

Pigmentation

Few pigments. Ventral row of postanal melanophores. Peritoneal pigmentation.

Vertebrae/myomeres

At 2.7 mm, 23 vertebrae.

Fins

Pelvic fins rounded, lacking pigmentation.

Dorsal fin rays: XII+10-11.

Anal fin rays: III+8-9.

Pelvic fin rays: I+5.

Pectoral fin rays: 15.

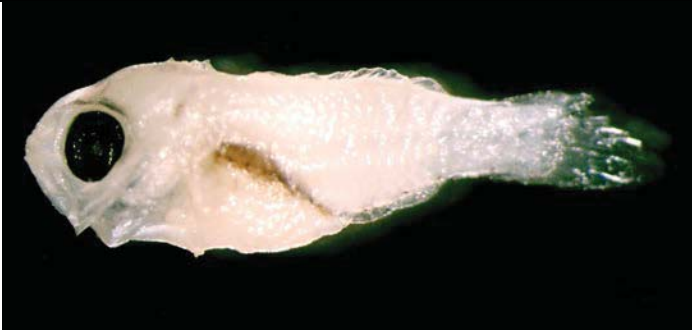

Pagrus pagrus larva (5.5 mm).

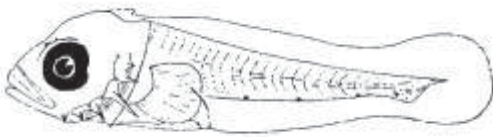

A: 5.0 mm

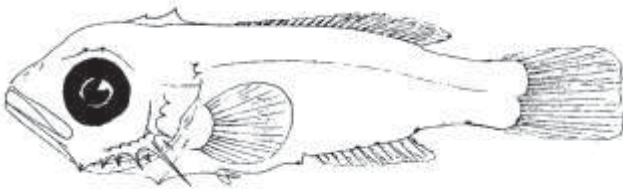

B: 9.0 mm

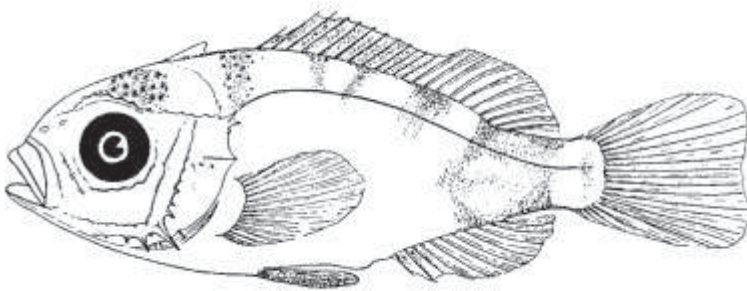

C: 15.0 mm

A-C: early life stages of *Pagrus pagrus* from Fage (1918).

FAO name: Seabream

Libyan name: قراقوز (*Gharagous*)

Italian name: Sarago (سارغو)

Main references: Bauchot and Hureau, 1990; Costa, 1999; Matsuura and Olivar, 1999; Ranzi, 1933; Ré and Meneses, 2009; Richards, 1989.

Distribution

Demersal species, inhabiting both marine and brackish waters in a depth range of 0–50 m. Range distribution of genus *Diplodus*: Eastern Atlantic, Madeira and Canary islands, along coast of Portugal, northward to the Bay of Biscay; Mediterranean; Black Sea and Sea of Azov. Some species also from Angola to South Africa.

Reproduction

Sexes separate or protandrous, behaving as male after its first sexual maturity to become female later on. Sexual maturity of *Diplodus sargus* reached at 2 years, with an approximate size of 17 cm. Spawning generally presents one clear seasonal peak per year (*Diplodus sargus* from January to March). Planktonic eggs and larvae.

EGGS

(referred to *Diplodus sargus*)

Spherical, with diameter range from 0.7 to 1.0 mm. Chorion smooth. Yolk homogeneous and transparent. 1-2 oil globules ranging from 0.16 to 0.20 mm.

LARVAE

Morphology

Length at hatching 1.7-2.6 mm.

At 4 mm, yolk-sac is absorbed.

At 7 mm, operculum with 2 protruding crests, the inner one with 3 fine teeth, the outer one with 5 teeth. Gut with triangular shape.

At 10 mm, operculum with 2 crests, the inner one without teeth, the outer with 6 (the 4th of which is the most developed). Preopercular spines are present during flexion, but disappear in early juveniles.

Body rather elongated. Body depth at base of pectoral fin represents 10-20% of notochordal length during preflexion, 29% of standard length during flexion and 35% of standard length at 14.4 mm.

Gut initially short; at 2.9 mm extends to 35% of notochordal length; at flexion extends to 50% of standard length; at 14.4 mm reaches 57% of standard length.

In Mediterranean flexion occurs at 7.5-8 mm.

Pigmentation

Embryo with 4 large spots of pigment located above and under the eyes, along the whole trunk, tail and scattered on the yolk.

Diplodus sargus larvae present several melanophores scattered on the head and on gut region and row of melanophores on the post-anal ventral mid-line of the tail. The melanophore located dorsally on the tail at the level of myomere 16 is extremely characteristic. Early pigmentation of swim bladder.

At 12 mm, dorso-lateral row could have starry melanophores. Peritoneum covered with melanophores.

Vertebrae/myomeres

Myomeres 24: 10 pre-anal and 14 post-anal.

Fins

Meristic counts referred to *Diplodus sargus*:

Dorsal fin rays: XI-XII+12-15.

Anal fin rays: III+12-14.

Pelvic fin rays: I+5.

Pectoral fin rays: 15-16.



Diplodus spp. larva.

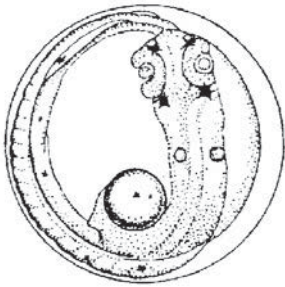

A

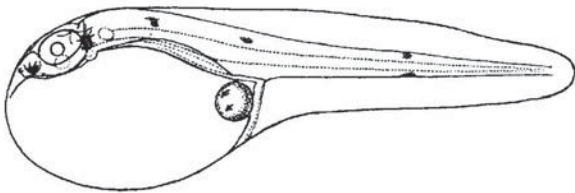

B: newly-hatched larva

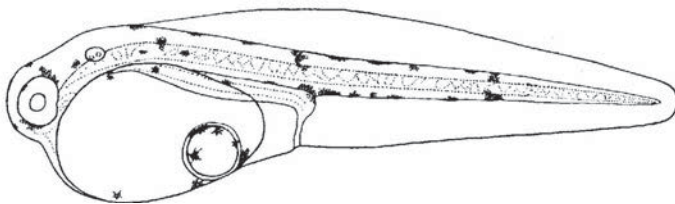

C: 2.9 mm

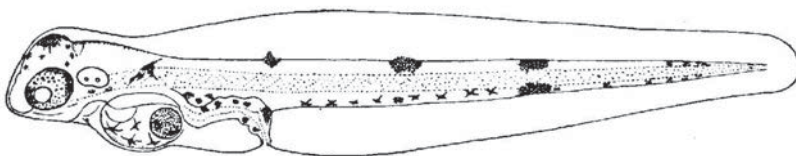

D: 3.7 mm

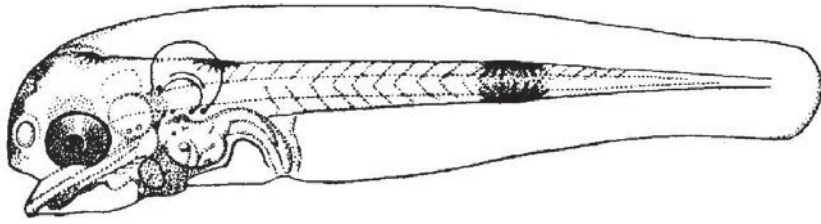

E: 4th day after hatching

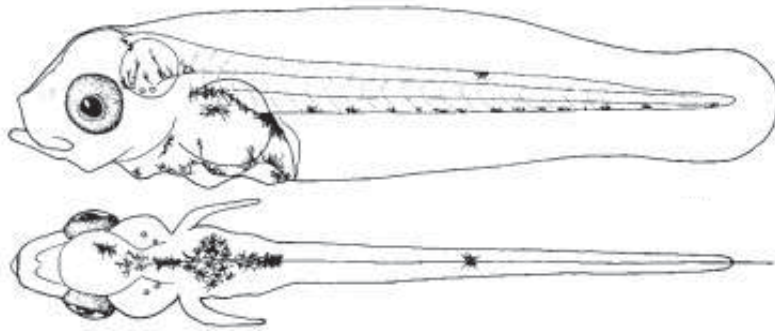

F: 4.5 mm, lateral and dorsal view

A-F: early life stages of *Diplodus sargus* as example of *Diplodus* sp. A-E: Raffaele (1888); F: Brownell (1979).



FAO name: Sand steenbras

Libyan name: منكوس (Mankous)

Italian name: Mormora (مورمورا)

Synonyms: *Pagellus goreensis* (Valenciennes, 1830); *Pagellus mormyrus* (Linnaeus, 1758);

Sparus mormyrus (Linnaeus, 1758)

Main references: Arbault and Boutin, 1968; Bauchot and Hureau, 1990; Brownell, 1979; Ferreira and Labarta, 1988; Marinaro, 1971; Costa, 1999; Hare and Walsh, 2001; Richards, 1989.

Distribution

Distributed in subtropical regions. Eastern Atlantic and Mediterranean. Also found in the Western Indian Ocean. Demersal, depth ranges from 0 to 150 m.

Reproduction

Protandric hermaphrodite. Sex inversion occurring mainly between 24 and 35 cm of total length, corresponding to 3.5 years of age. Spawning occurs in one clear seasonal peak per year, in Mediterranean from June to November.

EGGS

Spherical and transparent, with diameter ranging from 0.83 to 0.92 mm. Chorion smooth. Yolk homogeneous and transparent. Perivitelline space narrow. 1 oil globule with diameter 0.19-0.21.

LARVAE

Morphology

Body rather elongated. Body depth at base of pectoral fin represents 15% of notochordal length during preflexion, 21% of standard length during flexion and 25% of standard

length in early juveniles 11.7 mm long. Gut initially short, extending to 35% of notochordal length; at flexion extends to 46% of standard length; reaches 55% of standard length in early juveniles.

Preopercular spines are present during flexion, but disappear in early juveniles.

Flexion of notochord at 7 mm of standard length.

Pigmentation

Early stages present similar pigmentation to *Diplodus sargus*. At early stages the dorsal melanophore midway along the tail is absent (while it is present in *Diplodus sargus*). Urostyle region is pigmented early. Peritoneum covered by melanophores. Swim bladder pigmented. Row of melanophores running along mid-ventral line from pectoral fin to caudal tip.

At 4 mm, hindbrain region becomes pigmented.

During flexion 3 rows of postanal melanophores are present: on the dorsal margin of tail, on the ventral margin of tail, above the lateral line (while they are absent in *Diplodus sargus*).

Vertebrae/myomeres

Myomeres 24: 10 preanal and 14 postanal.

Fins

Dorsal fin rays: XI+12-13.

Anal fin rays: III+10-11.

Pelvic fin rays: I+5.

Pectoral fin rays: 15-16.



Lithognathus mormyrus larva (3mm).

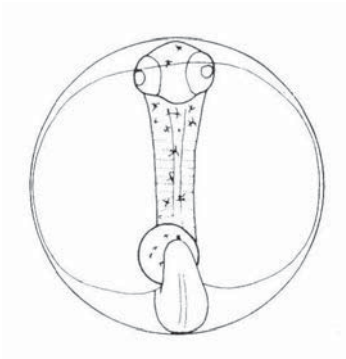

A

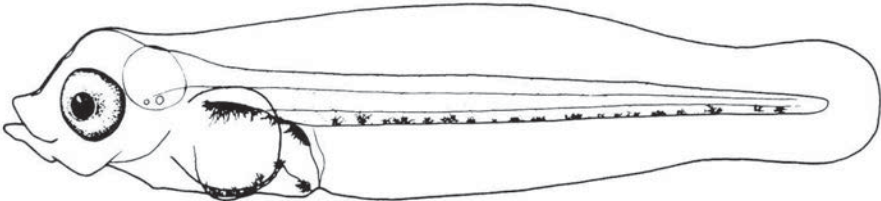

B: 3.4 mm, lateral view

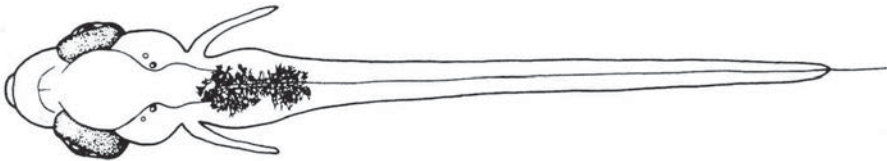

C: 3.4 mm, dorsal view

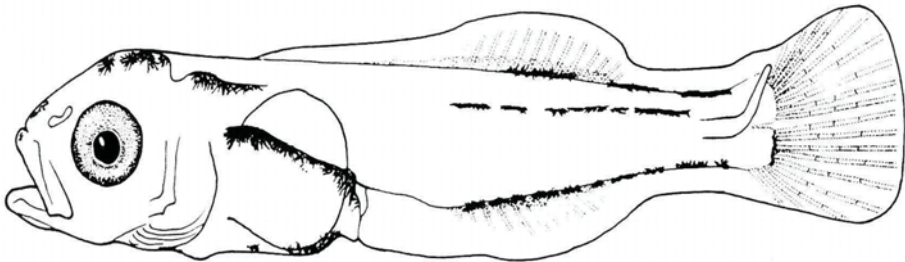

D: 7.0 mm

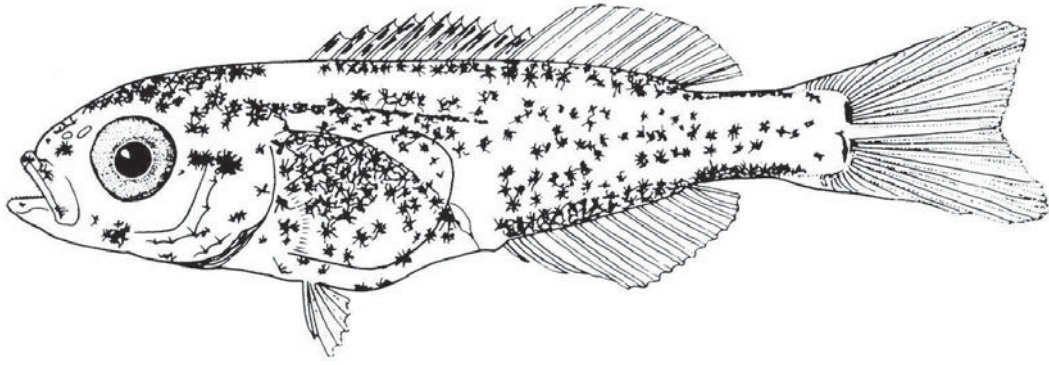

E: 11.7 mm

A: egg of *Lithognathus mormyrus* from Brownell (1979).

B-E: early life stages of *Lithognathus mormyrus* from Brownell (1979).

Family CHAETODONTIDAE

Butterflyfishes

Main references: Alemany Llodrà, 1997; Leis and Rennis, 1983; Matsuura and Olivar, 1999; Monod, 1979; Nalbant, 1986; Nelson, 2006.

Representatives of this family are distributed in tropical to temperate areas of the Pacific, Indian and Atlantic Oceans, including the Mediterranean. They are pelagic spawners.

Larvae exhibit morphological variation in some species; for example butterfly fish larvae show conspicuous head spination at post-flexion stage, which is variable from genus to genus.

General features of larvae of the genus *Chaetodon* are reported as an example:

- drastic morphological change while developing from pre-flexion to flexion stages
- head completely encased in a bony armour
- post-flexion larvae with a spine directed posteriorly at the angle of pre-opercle
- 2 rows of melanophores present along the mid-lateral line
- vertebrae: 24
- continuous dorsal fin, with rays: VI-XVI, 15-30; with second dorsal spine elongate
- anal fin rays: III-V, 14-23
- caudal fin rays: 15

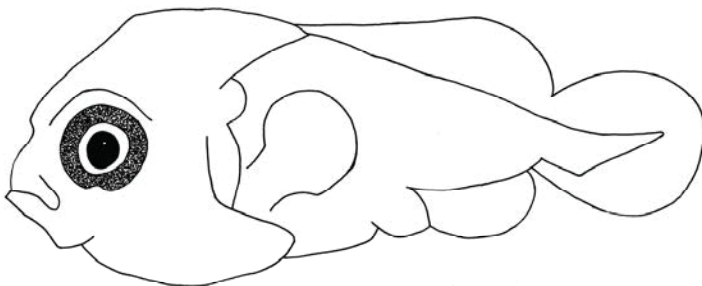

A: Chaetodontidae larva, original drawing by Mariangela Borghi.



Family CEPOLIDAE

Bandfishes

Main references: Nelson, 2006; Quero 1990, Tortonese, 1986d.

19 species belonging to 4 genera. This family includes species of small size, reaching a maximum length of 70 cm, in the species *Cepola rubescens*. They live in temperate and tropical seas of the Eastern Atlantic

(including Mediterranean), Indian and Western Pacific Oceans (including New Zealand).

Spawning occurs in spring, summer or autumn, depending on the species.

Most species live in self-made burrows in muddy or fine-sand areas, feeding on zooplankton. Pelagic eggs.

FAO name: Red bandfish

Libyan name: سبتة ملونة (Sebta)

Italian name: Bandiera rossa (بنديرة روسا)

Synonyms: *Cepola attenuata* (Swainson, 1839); *Cepola gigas* (Swainson, 1839) (ambiguous synonym); *Cepola jugularis* (Swainson, 1839)

Main references: Alemany Llodrà, 1997; Arbault and Boutin, 1968; Ferreiro and Labarta, 1988; Marinaro, 1971; Nelson, 2006; Quéro, 1990; Ré and Meneses, 2009; Russel, 1976; Tortonese, 1986d.

Distribution

Eastern Atlantic, from British Isles to north of Senegal, including the Mediterranean Sea.

Reproduction

Spawning from May to September.

EGGS

Planktonic, spherical and transparent, with a diameter of 0.72 mm. Chorion smooth. A single oil globule with diameter 0.14 mm.

LARVAE

Morphology

At 3 mm, body elongated. Head well-developed, with a serrate crest.

At 7 mm flexion is completed.

The most characteristic features are on head region. Supraorbital ridge with 4 to 5 teeth. 7-9 preopercular spines. Occipital presents 2 spines at early stages, but later becomes a toothed ridge with a longer posterior spine. Row of 6-7 denticles along lower margin of the jaw.

Swim bladder not visible.

Pigmentation

1-3 caudal melanophores. Melanophores on head, jaw, snout and abdomen. Peritoneum covered with melanophores.

Urostyle distinctly pigmented at all larval stages.

Vertebrae/myomeres

Myomeres: 15 preanal, 54 postanal.

Fins

At 7 mm, anal and dorsal fin rays are visible.

Dorsal fin rays: 67-74.

Anal fin rays: 60-70.

Pelvic fin rays: I, 5.

Pectoral fin rays: 12-18.

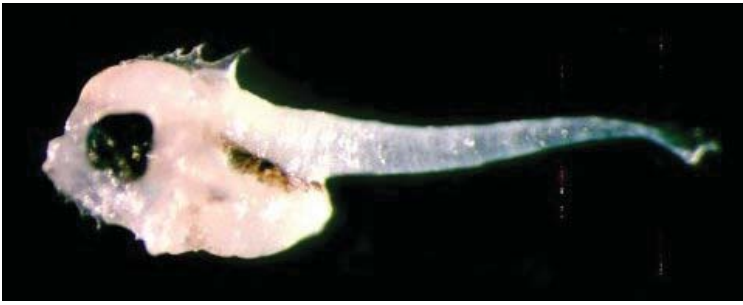

Cepola macrophthalmal larva (3 mm).

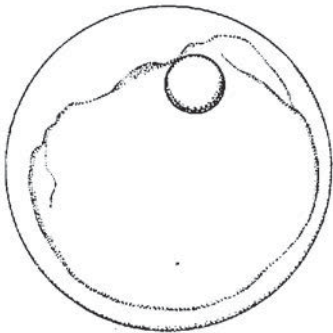

A: diameter 0.72 mm

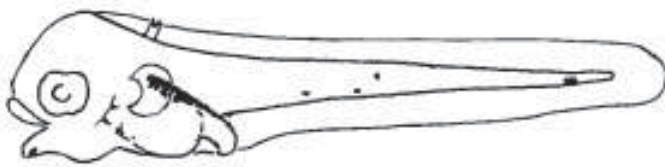

B: 3 mm

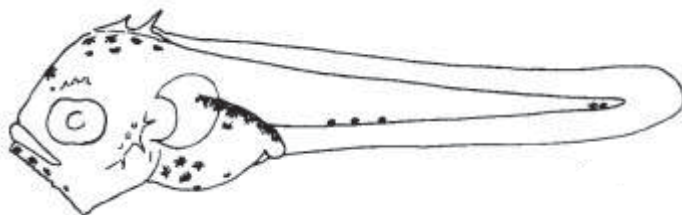

C: 3.7 mm

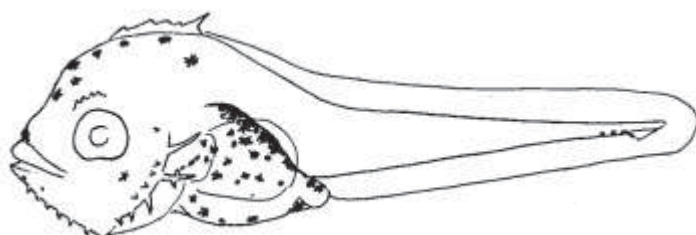

D: 4.5 mm

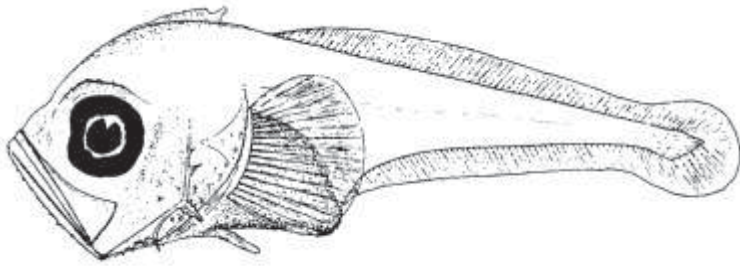

E: 6.0 mm

A: egg of *Cepola macrophthalma* from Holt (1891).

B-E: *Cepola macrophthalma* larvae. B-D: Fage (1918); E: Russell (1976).

Family POMACENTRIDAE

Damselfishes

Main references: Costa, 1999; Hureau and Monod, 1979; Nelson, 2006; Quignard and Pras, 1986b.

Species of this family are common in tropical seas and the Mediterranean. Spawning period is different from species to species.

General features of eggs of this family:

- demersal
- elliptical shape
- long axis 0.7-4.0 mm
- short axis 0.4-1.2 mm

General features of larvae from this family:

- length at hatching 2.1-4.0 mm
- length at flexion of the notochord 2.5-4.4 mm
- body short, deep and laterally compressed
- hunch-backed appearance of some species
- snout short
- head spination usually weak
- gut short, coiled and triangular in shape
- inconspicuous swim bladder
- pectoral fins start forming after flexion

- pelvic or pectoral fins may become large, up to middle of anal fin (in a few species)
- ossification of dorsal fin elements starts at 2.5-4.5 mm
- dorsal fin complete at 3.4-6.3 mm
- anal fin complete at 2.7-8.8 mm
- pectoral fins complete at 3.4-7.7 mm
- in subfamily Chrominae spine-like procurent caudal rays form at 3.4-4.2 mm
- fin spines unornamented, generally short (except in some *Chromis* species)
- single dorsal fin rays: VIII-XVII+8-10
- anal fin rays: II
- vertebrae: 26
- preflexion pigment pattern: melanophores generally occurring on the brain, over the gut, and on ventral and often lateral midlines of the tale
- abrupt heavy pigmentation during flexion

Pigment patterns represent useful characteristics to discriminate different pomacentrid species.

Quite similar families are mullids and gerreids, especially during the preflexion stage.

FAO name: Damsel fish

Libyan name: شلفاح (Shelfah)

Italian name: Castagnola (كاستانيولا)

Synonyms: *Chromis castanea* (Cuvier, 1814);

Chromis mediteranea (Cloquet, 1817);

Heliases limbatus (Valenciennes, 1833)
(misapplied name)

Main references: Alemany Llodrà, 1997; De Gaetani, 1932; Loris and Rucabado, 1990; Papisassi, 1989.

Distribution

Atlantic Ocean and Mediterranean Sea: along the Portuguese coast up to the Gulf of Guinea, sometimes up to Angola. More frequent around the islands (Azores, Canary Islands, Cape Verde) rather than on continental coasts.

Reproduction

Spawning in July and August.

EGGS

Demersal with adhesive filaments. Transparent, uncoloured. Elliptical shape, with major axis 0.70-0.90 mm and minor axis 0.50-0.70 mm. Perivitelline space very thin at minor axis and relatively wide at poles along major axis. Yolk segmented. A single oil globule, with diameter about 0.20 mm.

LARVAE

Morphology

At hatching, 2 mm long. Body slender. Preanal length about 30% of body length. Mouth wide.

Flexion of urostyle complete at 4.4 mm.

Pigmentation

After hatching, melanophores are present in the ventral zone of gut, in the postanal ventral thoracic area and near the urostyle.

At 3.5 mm, a pigmented band is present on the thorax between the anus and the caudal fin. Additional pigmentation on the head.

At 6 mm, base of caudal fin presents a single melanophore. Scattered melanophores on body and head: 2-3 melanophores anterior to anus; sometimes 1-2 melanophores medio-lateral to operculum. A melanophore located at the end of the eye. Other melanophores located on the head. A group or a series of melanophores arranged in 2 bands, positioned on dorso-ventral surface of the body. Urostyle not pigmented. Peritoneum covered with melanophores.

Vertebrae/myomeres

Vertebrae 26.

Fins

At 3.5 mm, primordial fin appears.

Dorsal fin rays: 10-11.

Anal fin rays: 10-12.



Chromis chromis larva.

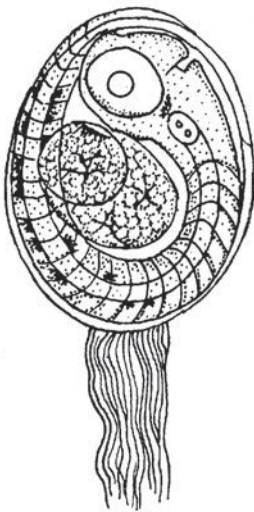

A

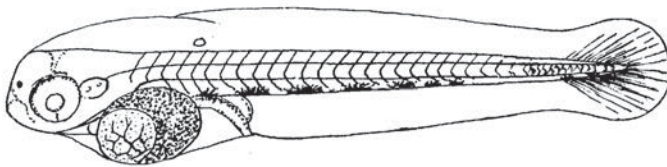

B 2.6 mm

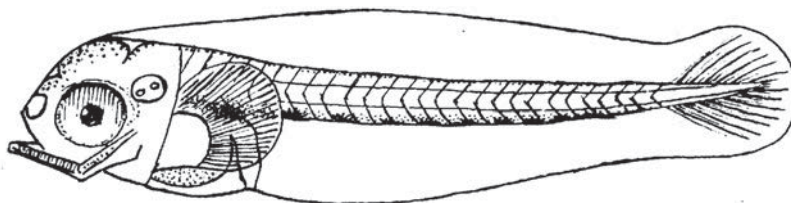

C 2.64 mm

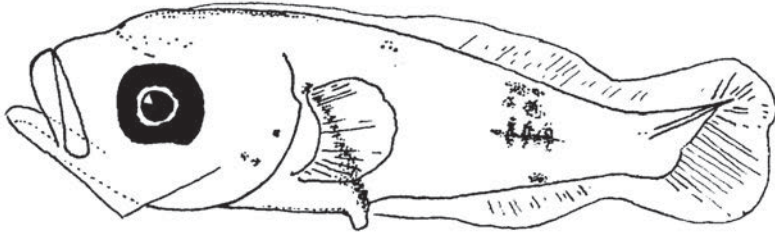

D: 3.5 mm

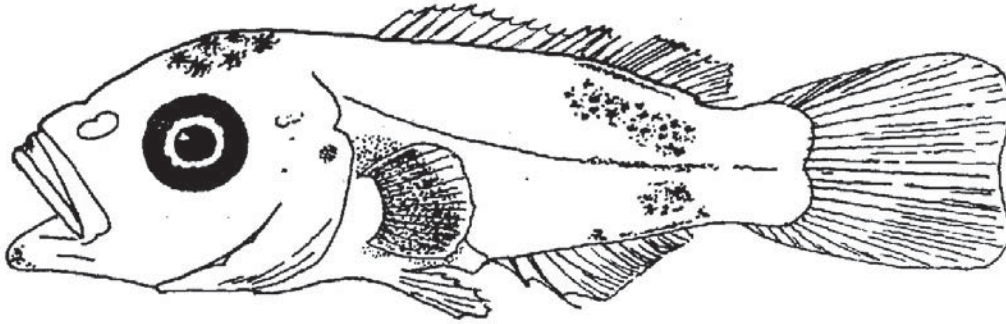

E: 8 mm

A: egg of *Chromis chromis* from De Gaetani (1932).

B-E: *Chromis chromis* larvae. B-C: De Gaetani (1932); D-F: Fage (1918).

Family LABRIDAE

Wrasses

Main references: Costa, 1999; Leis and Carson-Ewart 2000; Matsuura and Olivar, 1999; Nelson, 2006; Russell, 1976; Quignard and Pras, 1986a.

Species of this family are common in tropical and subtropical seas; also abundant in the Mediterranean Sea.

In European species protogyny is most frequent. Spawning occurs after complex mating rituals.

General features of larvae from this family:

- body elongated
- head small
- mouth small
- head spines absent
- notochord flexion at 3.2-5.6 mm

- dorsal fin continuous, extending from behind of head to caudal peduncle
- caudal fin round
- usually no gap between anus and anal fin
- dorsal and anal fins appear at 3.0-5.6 mm and are completely developed at 5.5-7.3 mm (except in *Xyrichthys*)
- fin spines forming before the rays; generally no longer than the rays (except, for example, in *Xyrichthys* and *Thalassoma*)
- dorsal-most rays of the pectoral fins present at 4.0-5.3 mm and complete at 5.7-6.0 mm
- pelvic fins appear at 4.0-7.5 mm; rays may be present at 7.0 mm; their size is variable from species to species
- anterior part of the body highly pigmented



Labridae larva.

FAO name: Mediterranean rainbow wrasse

Libyan name: عريسة (Arisa)

Italian name: Donzella (دونزيلة)

Synonyms: *Coris festiva* (Valenciennes, 1839); *Coris speciosa* (Risso, 1827); *Coris taeniatus* (Steindachner, 1863)

Main references: Alemany Llodrà, 1997; Arbault and Boutin, 1968; Ferreiro and Labarta, 1988; Marinaro, 1971; Quignard and Pras, 1986a; Ré and Meneses, 2009.

Distribution

Widespread in the Eastern Atlantic (from Sweden to south of Cape Lopez, Gabon) and Mediterranean. Found between 1-60 m, usually in the littoral zone, near rocks and eelgrass beds.

Reproduction

Protandric; sexual maturity reached at the end of the first year. Spawning period ranges from June to November. Planktonic eggs and larvae.

EGGS

Spherical, transparent, yellow coloured, with diameter 0.67-0.92 mm. Chorion smooth. Yolk unsegmented. 1 oil globule, located

anteriorly, with diameter from 0.12 to 0.16 mm.

LARVAE

Morphology

At hatching, 2.5 mm long. Yolk-sac projects beyond the snout.

Body typically slender. Anus opening at center of the body. Eyes round. Swim bladder developed but not visible. Caudal fin convex.

At 9.8 mm, flexion of urosyle is complete.

Pigmentation

At 3 mm, a cluster of melanophores on dorsal and ventral surfaces in the posterior half of the tail. Another cluster of melanophores located dorso-ventrally near the anus.

Eyes highly pigmented. A coloured spot on the lower lip. Urostyle highly pigmented, as the peritoneum.

Vertebrae/myomeres

Myomeres: 25-26.

Fins

Dorsal fin rays: IX, 12-13.

Anal fin rays: III, 11-13.

Pelvic fin rays: I, 5.

Pectoral fin rays: 12-14.



Coris julis larva.

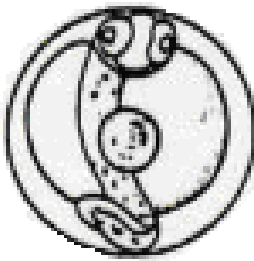

A



B: 2.5 mm



C: 4.0 mm

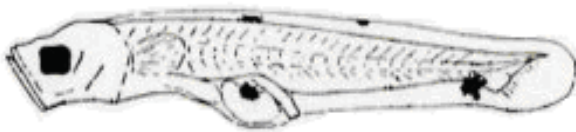

D: 6.0 mm



E: 8.0 mm

A-E: early life stages of *Coris julis*. A-B: Raffaele (1888); C-E: Fage (1918).



Family TRACHINIDAE

Weeverfishes

Main references: Nelson, 2006; Roux, 1990.

8 species, belonging to a single genus, are known. Members of this family are common in Eastern Atlantic, Mediterranean, and Black Sea.

Spawning takes place from spring to summer.

General features of larvae from this family:

- long body

- prominent mouth
- thick premaxillary
- preoperculum with 5 spines
- gut triangular and short
- patches of pigment on head and body
- peritoneum heavily pigmented
- pelvic fins with jagged and pigmented edges
- 1 melanophore on the tail
- vertebrae 34-43

FAO name: Weever fish

Libyan name: طراجنا (Trajna)

Italian name: Tracina (تراتشينا)

Synonyms:

Main references: Arbault and Boutin, 1968; Ferreiro and Labarta, 1988; Jardas, 1996; Marinaro, 1971; Muus and Nielsen, 1999; Roux, 1990.

Distribution

Common in Eastern Atlantic Ocean, Mediterranean and Black Sea.

Reproduction

Spawning period ranges from June to September.

EGGS

Spherical with diameter ranging from 0.9 to 1.10 mm. Yolk homogeneous. Oil globules numerous.

LARVAE

Morphology

At 4.6 mm, body elongated. Preoperculum with 5 spines.

At 5.6 mm, body becomes deeper. Gut triangular and very short. Mouth prominent, with thick premaxillary.

Pigmentation

At 4.60 mm, pigment patches on head and body.

At 5.60 mm, pigment spots on body and head. Peritoneum well pigmented. A single melanophore on the tail.

Vertebrae/myomeres

Myomers 40.

Fins

First dorsal fin rays: V-VII.

Second dorsal fin rays: 24-32.

Anal fin rays: I-II, 26-34.

Pectoral fin rays: 15-17.

Pelvic fin rays: I, 5.



Trachinus spp. larva (5 mm).

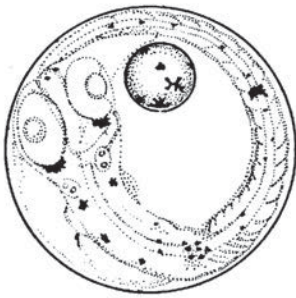

A: diameter 0.96-1.11 mm

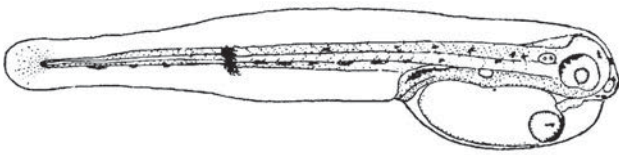

B: 3 mm

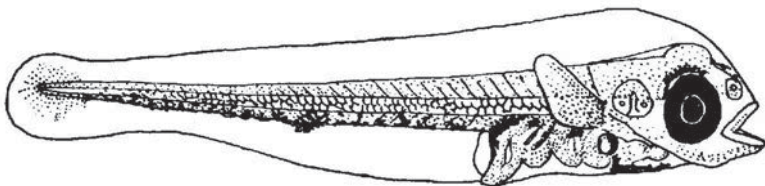

C: 5 days after hatching.

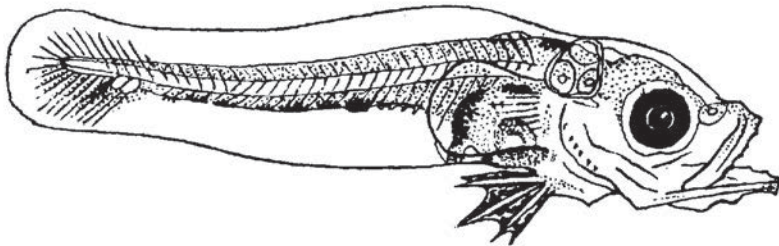

D: 4.3 mm

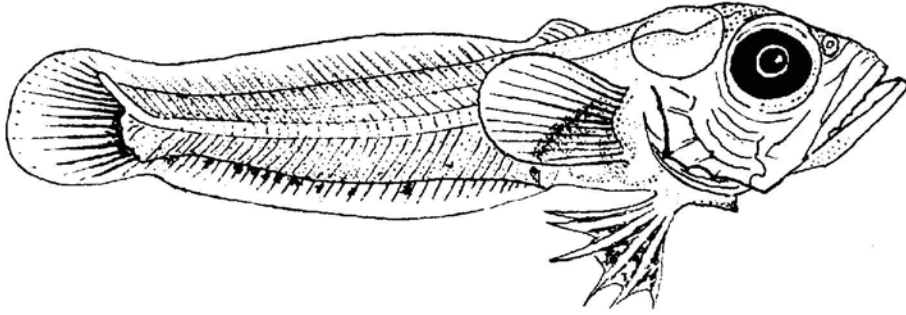

E: 7.5 mm

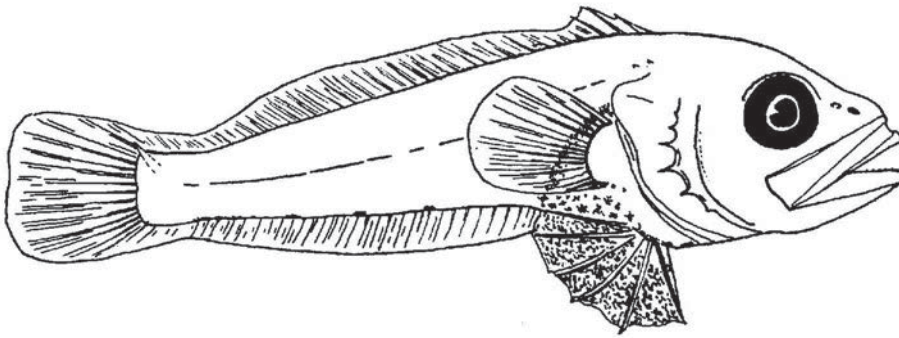

F: 9.5 mm

A: egg of *Trachinus draco* from Boeke (1903).

B-F: *Trachinus draco* larvae as example of family Trachinidae. B-C: Boeke (1903); D-E: Boeke (1907); E: Fage (1918).



Family AMMODYTIDAE

Sand lances

Main references: Costa, 1999; Fahay, 1983; Nelson, 2006; Reay, 1986; Wheeler, 1979a; Whitehead *et al.*, 1986.

A small family of fish living in temperate and cold seas, on sandy bottoms. They are small in size, benthonic, gregarious and carnivorous. Most species spawn from autumn to winter; few spawn from spring to summer.

General features of eggs of the genus *Ammodytes*:

- demersal
- irregular shape
- diameter: 0.67-0.91 mm
- chorion sculptured, with rough surface and brownish colour
- perivitelline space fairly wide
- yolk homogeneous, amber coloured
- 1 oil globule, located posteriorly in yolk sac
- oil globule diameter: 0.27 mm

General features of larvae of the genus *Ammodytes* sp:

- hatching length about 4 mm
- embryo with no pigment
- body elongated
- anus opening at side of finfold (not at margin)
- gut long
- lower jaw protruding anteriorly
- flexion of notochord occurring at about 10-12 mm
- caudal fin rays form at 8 mm, complete at 15 mm and becoming forked at 22 mm
- dorsal and anal fin rays form at 13 mm; development proceeds anteriorly
- late formation of pectoral fin rays
- pelvic fin absent
- spots of pigment along dorsal edge of gut
- ventral row of spots on tail
- spots at base of caudal fin
- myomeres: 59-78
- vertebrae: 61-75
- dorsal fin rays: 51-67
- anal fin rays: 23-35
- pectoral fin rays: about 13

Family AMMODYTIDAE

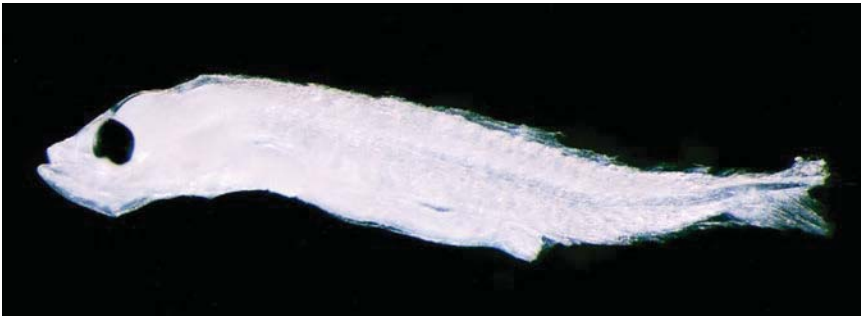

Ammodytidae larva (4 mm).

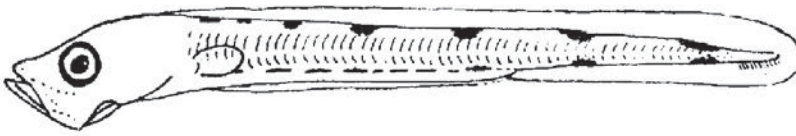

A: 7.5 mm

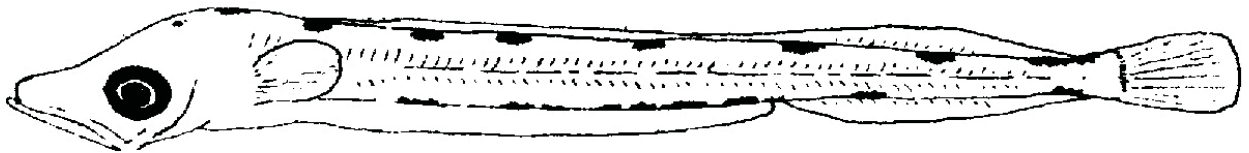

B: 11 mm

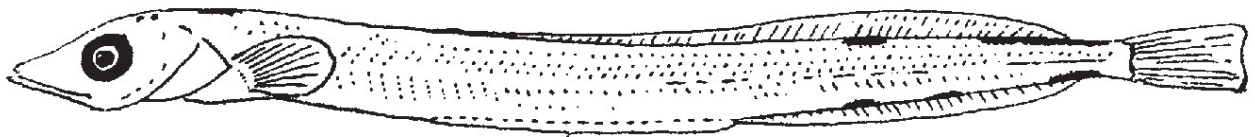

C: 25 mm

A-C: *Gymnammodytes cicereus* larvae (Fage, 1918).

Family BLENNIDAE

Combtooth blennies

Main references: Bath, 1979; Breder and Rosen, 1966; Costa, 1999; Fahay, 1983; Hureau and Monod, 1979; Labropoulou and Papaconstantinou, 2000; Lo Bianco, 1909; Matsuura and Olivar, 1999; Nelson, 2006; Nieder *et al.*, 2000; Olivar and Fortuño, 1991; Ré and Meneses, 2009.

Members of this family usually live along the shores of temperate and tropical seas; some of them may be found in fresh water.

Eggs are benthic, laid on bottom substrate, and male or both parents tend the eggs. As example general features of eggs of *Blennius ocellaris* are reported:

- nearly spherical shape
- diameter 1.12-1.20 mm
- chorion smooth
- yolk unsegmented
- many oil globules

General features of larvae from this family:

- hatching length about 2.5-3.5 mm
- planktonic larvae
- body fairly elongated
- head small and bulbous
- mouth subterminal
- snout short
- eyes large, round and pigmented
- pre-opercle with spines
- gut short
- flexion occurs at about 4-5 mm
- pectoral fins well developed
- dorsal and anal fins continuous, extending over long tail margin

- pelvic fins in jugular position, with 2-4 soft rays each (appearing in post-flexion stage)
- pectoral fins usually heavily pigmented
- row of melanophores on post-anal ventral mid-line (in many species)
- location of pigment on head and nape may be specifically diagnostic

As example merystic counts of the species *Blennius ocellaris* are reported:

- dorsal fin rays: XI-XII+14-16
- anal fin rays: II, 14-16
- pelvic fin rays: I, 3
- pectoral fin rays: 12

The following table summarizes the main characters differentiating the larvae of some species of the Mediterranean blennies:

Species	i	ii	iii	iv
<i>Blennius ocellaris</i>			+	
<i>Parablennius gattorugine</i>	+	+	+	
<i>Parablennius tentacularis</i>	+	+		
<i>Parablennius sanguinolentus</i>		+	+	+
<i>Parablennius zvonimiri</i>		+	+	+
<i>Salaria pavo</i>	+	+		
<i>Salaria fluviatilis</i> *				

- i: pectoral fins rounded and with moderate size
- ii: base of pectoral fins pigmented in small larvae
- iii: rays of pectoral fins pigmented
- iv: pigmentation on dorsal surface of the trunk
- *: only small larvae

Family BLENNIDAE



Blennidae larva (2.8 mm).

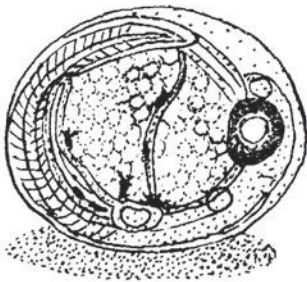

A

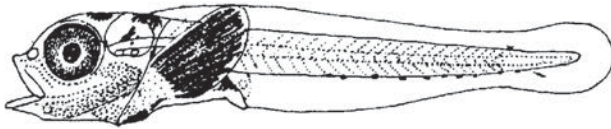

B: 4.6 mm

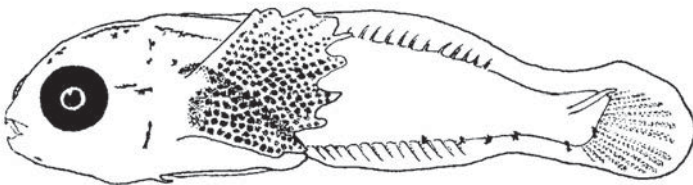

C: 8.5 mm

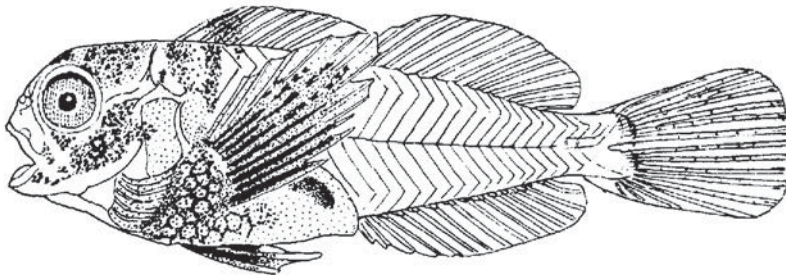

D: 14.08 mm

A: egg of *Blennius ocellaris* after Cipria (1938).

B-D: *Blennius ocellaris* larvae as example of Blennidae. B and D: after Cipria (1938); C: after Ford (1922).

Family CALLIONYMIDAE

Dragonets

Main references: Davis and Fricke 1990, Demir 1972; Fahay, 1983; Fricke, 1986; Houde, 1984; Hureau and Monod, 1979; Labropoulou and Papaconstantinou, 2000; Matsuura and Olivar, 1999; Mytilineou *et al.* 2005, Nelson, 2006; Wheeler 1979b.

Species of this family are present in all the warm and temperate seas.

They usually show sexual dimorphism and pelagic spawning.

General features of larvae from this family:

- body similar in shape to a tadpole, at early stages
- body laterally compressed and moderately deep in pre-flexion larvae
- mouth terminal and small
- flexion of notochord at about 2.5 mm
- preopercular spines well-developed and branched (in *Callionymus* from

SW Atlantic evident from flexion stage)

- after flexion the notochord tip remains in the caudal finfold
- second dorsal and anal fins short-based (few rays) and opposite each other
- pigmentation moderate to heavy (gives relatively dark colour to larvae)
- usually heavy pigmentation in postanal region
- broken line of melanophores along mid-lateral line (particularly on tail)
- notochord tip elongated and not pigmented in pre-flexion and flexion larvae

Early larvae may be similar to some Sciaenidae larvae, but callionymids are very small in the early stages (total length ~1 mm) and sciaenids have a much larger mouth.

FAO name: Dragonet

Libyan name: تنين (Tennin)

Italian name: Dragoncello minore (دراقوانشيلو)
(مينوري)

Synonyms: *Callionymus cithara* Valenciennes, 1837; *Callionymus dracunculus* (non Linnaeus, 1758) (misapplied name); *Callionymus maculatus* subsp. *atlantica* Ninni, 1934

Main references: Arbault and Boutin, 1968; Bauchot, 1987; Ferreiro and Labarta, 1988; Fricke, 1986; Marinaro, 1971; Papisissi, 1989; Ré and Meneses, 2009.

Distribution

Along the coasts of temperate and tropical seas. Present in the Eastern Atlantic (from SW Iceland and Norway to Senegal) and Mediterranean (not in the Black Sea). Living at a depth range of 45-650 m, on sand or mud, upon which easily move and hide thanks to ventral fins.

Reproduction

Remarkable sexual dimorphism, with males showing larger size, shiny colours and fins with peculiar shape. Spawning occurs in spring and summer.

EGGS

Planktonic, spherical, with diameter ranging from 0.66 to 0.9 mm. Chorion with honeycomb-like sculpturing. Yolk with peripheral segmentation. Oil globules absent.

LARVAE

Morphology

At hatching, 2.29 mm long.

At 4 mm, flexion of notochord.

Peculiar body shape. Head very big and dorso-ventrally compressed. Body depth at head and base of pectoral fins decrease as develop advances. Eyes very large, up to 10-

13% of standard length; gradually shifting to nearly dorsal position. Gut extending to 55-60% of standard body length.

Pre-opercular spines are a peculiar specific character (very distinct from that of *C. lyra*). Transformation at 10 mm length.

Pigmentation

Intense pigmentation from early stage of development; some pigments persist during development.

At 5.5 mm, body covered by yellow chromatophores. Urostyle very wide, lacking melanophores. Strongly pigmented pectoral fins.

Both *C. lyra* and *C. maculatus* present pigmentation on the ventral surface of the gut, but only *C. maculatus* presents pigmentation on the ventral fins. Pigmentation is stronger than *C. lyra* in branchiostegal and mandibular regions.

Vertebrae/myomeres

In *Paracallionymus costatus* vertebral number: 9 preanal, 12 postanal, plus the urostyle.

Fins

At 3.0-3.5 mm, pelvic fins develop; at 6.5 mm they reach midpoint of the base of pectoral fins. At comparable sizes, the pelvic fins of *C. lyra* are longer.

First dorsal fin rays: IV.

Second dorsal fin rays: 9-10.

Anal fin rays: 8-9.

Pelvic fin rays: I, 5.

Pectoral fin rays: 16-20.

Notes

Preopercular spines useful in specific identification.



Callionymus maculatus larva.

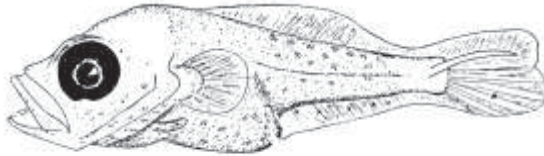

A: 5.0 mm

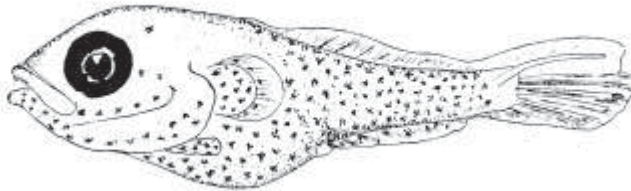

B: 7.0 mm

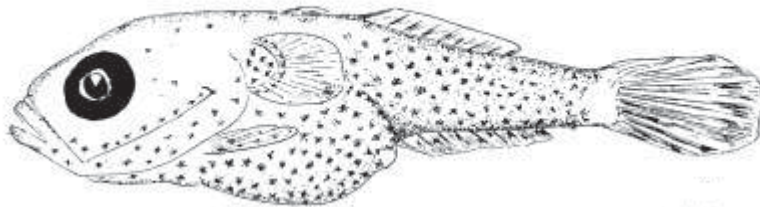

C: 8.0 mm

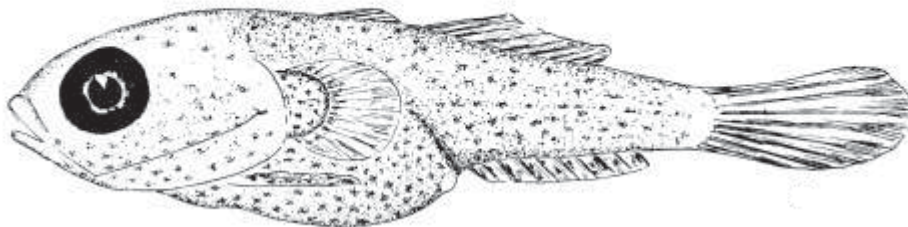

D: 10 mm

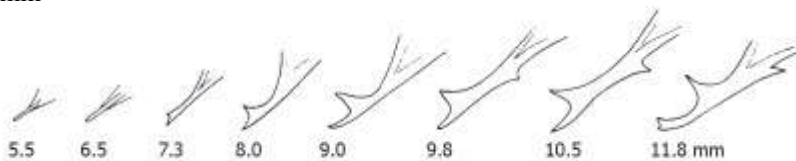

E

A-D: Larva *Callionymus maculatus* larvae (Fage, 1918).

E: Preopercular spines of *Callionymus maculatus* larva (Demir, 1972).

Gobies

Main references: Alemany Llodrà, 1997; Costa, 1999; Fahay, 1983; Ferreiro, 1986; Lagler *et al.*, 1962; Matsuura and Olivar, 1999; Nelson, 2006; Russell, 1976.

Species distributed in the Mediterranean and Black Sea.

Since a large number of species belongs to this family, it is very difficult to identify a spawning period, depending on the different species. However, in Mediterranean many genera spawn in spring-summer (e.g. *Gobius*, *Paganellus*, *Padogobius*, etc.)

The identification of larvae and juveniles of this family is very difficult because even genera cannot be separated on the basis of vertebrae and fin ray counts. Pigmentation is the only characteristic that can be used to identify the larvae.

Their eggs are generally laid on bottom substrate and present a cigar-shape, but larvae are planktonic.

General features of larvae from this family:

- body slightly elongated to slender in all stages of development
- body maximum depth 16-18% of standard length
- preanal length about 50% of standard length
- gut straight
- swim bladder prominent, with heavily pigmented dorsal surface
- 2 dorsal fins well separated; first dorsal fin is spiny and is the last to form
- pelvic fins united as sucking disc, cup-like (in late post-flexion larvae)
- row of melanophores along ventral margin of tail
- shorter row of dorsal melanophores near caudal peduncle (in some)

Family GOBIIDAE



Gobiidae larva.

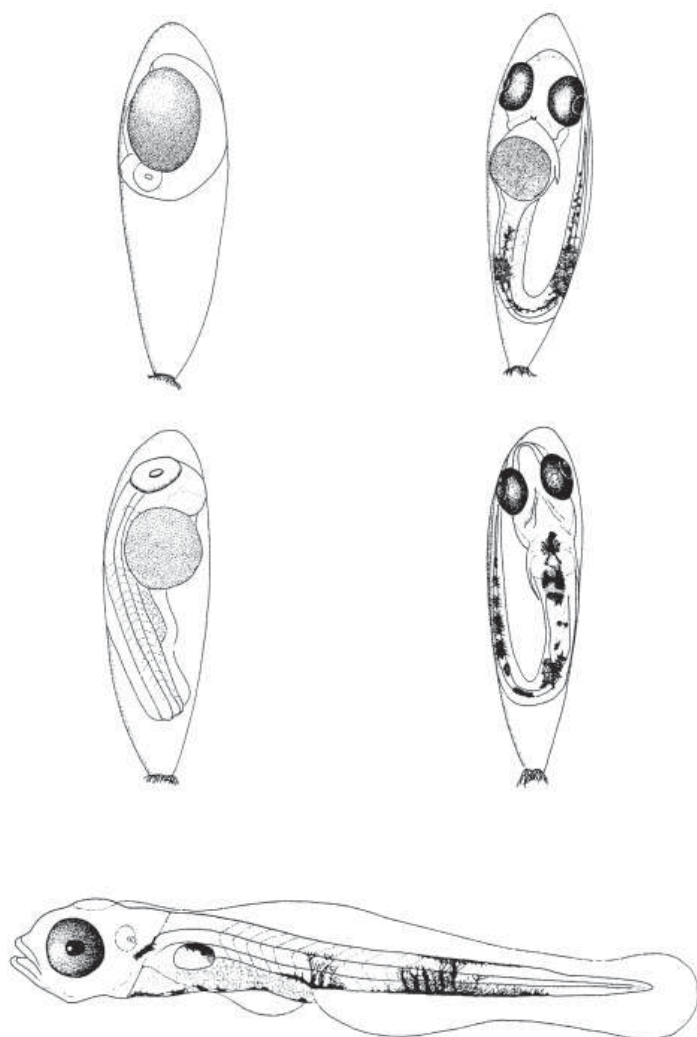

Gobius cruentatus eggs and larva (3.3 mm), as example of Gobiidae from Gil *et al.* (2002).



Family TRICHIURIDAE

Cutlassfishes

Main references: Costa, 1999; Matsuura and Olivar, 1999; Nakamura and Parin, 1993, Nelson, 2006.

At present 32 species, belonging to 9 genera, are known. They are distributed in Atlantic, Indian, and Pacific Oceans.

- body elongated
- caudal and pelvic fins reduced or absent
- gut short during pre-flexion, but becomes elongated during flexion and post-flexion
- vertebrae 58-192 (34-53+24-151)

General features of larvae from this family:

FAO name: Silver scabbardfish

Libyan name: سـبـتة (Sebta)

Italian name: Pesce sciabola (شـابـولا بـشـي)

Synonyms: *Lepidopus argenteus* (Bonnaterre, 1788); *Lepidopus gouanianus* (Lacepède, 1800); *Lepidopus lex* (Phillipps, 1932)

Main references: Arbault and Boutin, 1968; Ferreiro and Labarta, 1988; Marinaro, 1971; Nakamura and Parin, 1993; Schmidt and Strubberg, 1918.

Distribution

Almost cosmopolitan species, distributed in Pacific and Atlantic Oceans, including Mediterranean Sea. Also found in southern areas of the Indian Ocean. In the Mediterranean it is particularly frequent in the southern Tyrrhenian, at a depth between 100 and 400 m.

Reproduction

Spawning occurs from May to October.

EGGS

Spherical and transparent, with diameter ranging from 1.6 to 1.7 mm. Chorion rather thick with a bright pink colour. Yolk homogeneous. Narrow perivitelline space. Oil globules red or yellow, with diameter 0.4 mm. At advanced developmental stage, eggs become easy to identify, thanks to the numerous melanophores on the oil globule and to the pigmentation of the embryo.

LARVAE

Morphology

At hatching, notochordal length of the yolk-sac larva is about 6 mm. Body slender and elongated. Body depth at base of the pectoral fin is 10% of notochordal length. Head small and round. Eyes round. Mouth prominent. Gut straight and very short, about 26% of notochordal length.

Flexion of the notochord occurs at about 12 mm. In flexion larvae body depth at the base

of the pectoral fin is 14% of standard length. Snout becomes pointed with development. Gut reaches about 50% of notochordal length. 2-3 preopercular spines.

In juveniles longer than 30 mm, body depth at the base of the pectoral fin is 8% of standard length. Preopercular spines disappear.

Pigmentation

In yolk-sac larvae some extremely conspicuous melanophores are present dorsally and ventrally on the caudal tip. 3 melanophores on the trunk: 2 dorsal and 1 ventral, in the middle.

Later, the trunk melanophores migrate to the periphery of the body, until they locate on the fins. Caudal pigmentation spreads out on the ventral region, vanishing on the dorsal region. Numerous melanophores on the walls of the gut, on the snout and on the top of head. Melanophores on the dorsal portion of trunk, when dorsal fin rays are developing, firstly located in the anterior portion, then back towards the caudal region.

Vertebrae/myomeres

At 10 mm of standard length, 113 myomeres, of which 13 preanal.

Fins

Dorsal fin with spiny rays, of which the first one is very long (useful diagnostic character). It appears in yolk-sac larvae as a protuberance preceding the dorsal fin. At 8.4 mm of standard length, it becomes a sort of flagellum with a pigmented tip. Later, at 11.4 mm of standard length, it decreases in size.

Sequence of fins development: dorsal, caudal, anal, pectoral and pelvic.

Dorsal fin rays: C-CV.

Anal fin rays: XXXI-XXXVI, 21-25.

Pectoral fin rays: 12.

Ventral fin rays: I.



Lepidopus caudatus larva (9 mm).

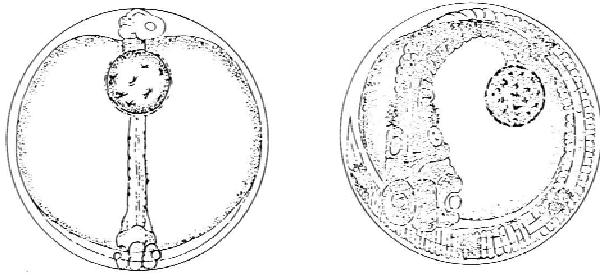

A

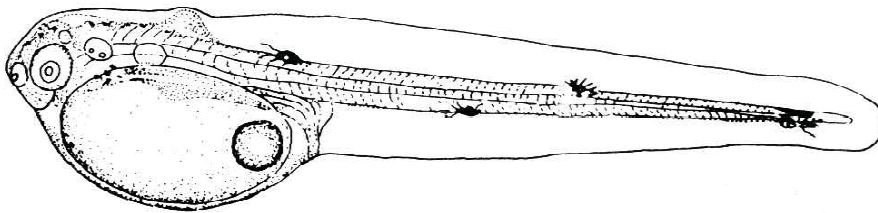

B: 6.0 mm

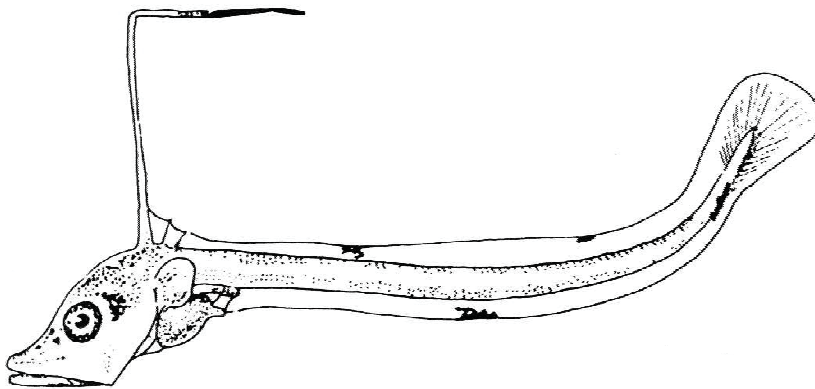

C: 9.0 mm

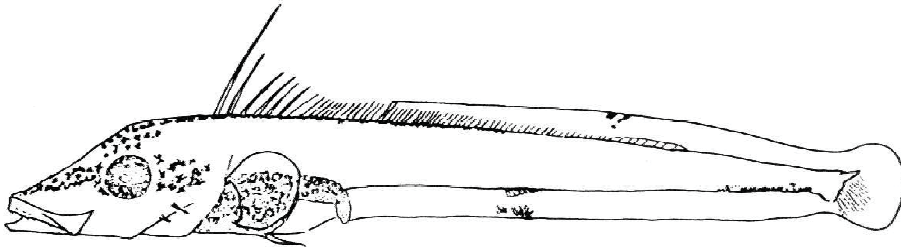

D: 12.0 mm

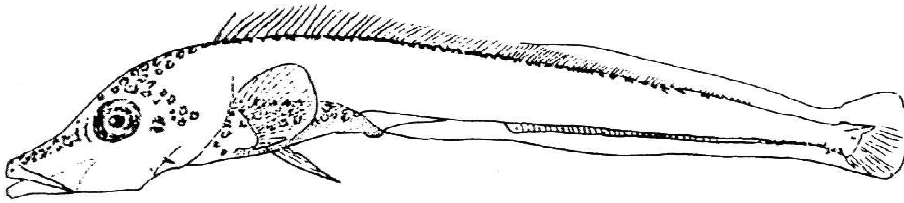

E: 12.0 mm

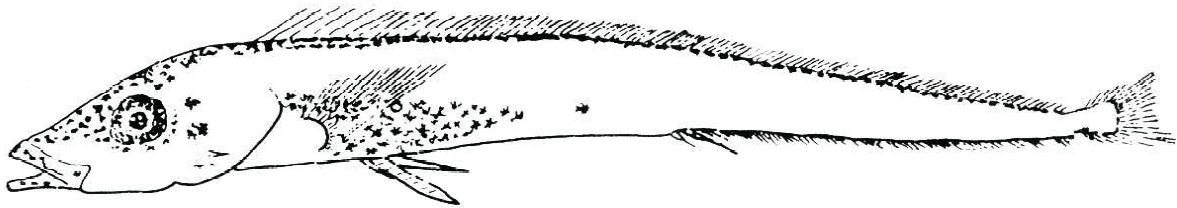

F: 26.0 mm

A-F: early stages of *Lepidopus caudatus* redrawn by Olivar and Fortuño (1991) from: A-C: Raffaele (1888); D: Emery (1885); G: Schmidt and Strubberg (1918).

Mackerels, tunas, bonitos

Main references: Fahay, 1983; Hureau and Monod, 1979; Matsuura and Olivar 1999; Megalofonou, 1990; Nelson, 2006; Richards, 1989; Somarakis *et al.*, 2002.

Members of this family are distributed in tropical and subtropical seas.

Females of the majority of the species present larger size than males. Batch spawning of most species takes place in spring and summer, frequently inshore. Eggs and larvae are both pelagic.

Morphological characters common to scombrid larvae are:

- deep body
- large head
- eyes large
- snout pronounced, may be elongated (i.e. *Acanthocybium*)
- large mouth opening, jaws well-developed
- preopercular spines (also opercular, supra-ocular, and post-temporal or pterotic spines) well-developed (except in *Scomber*)
- posterior migration of anus with growth
- myomeres 31-66

- vertebral number usually stable and with narrow range within a species
- sequence of fin formation (development starts at top and proceeds ventrally): caudal, first dorsal fin and pelvic fin (except delayed in *Acanthocybium*), second dorsal fin (except in *Scomber*)
- fin rays usually complete by ~15 mm of standard length
- finlets present posteriorly to dorsal and anal fins
- caudal fin rays: 9+8
- pelvic fin always: I, 5
- number of pectoral fin rays represents an important diagnostic character
- gap between anus and anal fin origin (except in *Acanthocybium*)
- pigmentation variable but important in some areas
- head pigment always present (except in some preflexion larvae)
- pigment from top of head to in front of the eyes in *Euthynnus*
- pigment on top of head but not in front of eyes in *Auxis*
- ventral pigment on tail becomes coalescent in later larvae; subsequently spots increase and dorsal pigment increases too

Family SCOMBRIDAE

The following table summarizes the main meristic characters differentiating the larvae of some Scombridae genera of the Mediterranean (from Fahay, 1983):

Genera	<i>Scomber</i>	<i>Auxis</i>	<i>Euthynnus</i>	<i>Thunnus</i>	<i>Sarda</i>
First dorsal spines	10-17	10-12	15-16	13-16	20-23
Second dorsal rays	9-15	10-12	11-12	12-17	13-18
Dorsal finlets	4-6	8-9	7	7-10	6-9
Anal spines and rays	11-14	12-14	12	12-16	14-17
Anal finlets	4-6	7-8	7	7-10	6-8
Pectoral rays	17-22	24-25	26-27	30-36	23-26-
Vertebrae	31	39	39	39	50-55

The following table summarizes the main developmental characters differentiating the larvae of some Scombridae genera of the Mediterranean (from Fahay, 1983):

Genera	<i>Scomber</i>	<i>Auxis</i> <i>Euthynnus</i> <i>Thunnus</i>	<i>Sarda</i>
Morphological features			
Dorsal fin development	D ₂ first	D ₁ first	D ₁ first
Myomeres	31	39-41	50-55
Head/Standard length ratio	<1/3	>1/3	>1/3
Snout	rounded	pointed	elongate
Jaws	equal-sized	equal-sized	equal/unequal
Premaxillary teeth	minute	large	large
Gut	space between anus and anal fin origin	space between anus and anal fin origin	space between anus and anal fin origin
Spines			
Supraoccipital	absent	absent	absent
Preopercular	absent	present	present
Supraorbital	absent	absent	crest present
Pterotic	absent	present	present
Pigment			
Dorsal body	heavy	light	light
Postanus	extensive	present in all but few spots (or absent) in <i>Thunnus</i>	extensive
Cleithral symphysis	yes (in <i>S. scombrus</i>) no (in <i>S. japonicus</i>)	yes (in <i>Auxis</i> and <i>Euthynnus</i>) no (in <i>Thunnus</i>)	yes

FAO name: Northern bluefin tuna

Libyan name: التونة (Tuna)

Italian name: Tonno rosso (روسو تونو)

Synonyms: *Albacora thynnus* (Linnaeus, 1758); *Orcynus seconidorsalis* (Storer, 1855); *Orcynus thynnus* (Linnaeus, 1758)

Main references: Alemany Llodrà, 1997; Baglin, 1982; Collette and Nauen, 1983; Fahay, 1983; Farrugio, 1981; Ferreiro and Labarta, 1988; Labelle *et al.*, 1997; Marinaro, 1971; Morovic, 1961; Orsi Relini *et al.*, 1999; Potthoff, 1974; Richards and Potthoff, 1974; Sanz Brau, 1990.

Distribution

Subtropical, between 72°N and 58°S. Western Atlantic: from Canada to Brazil. Eastern Atlantic, from Lofoten Islands to Canary Islands. Mediterranean and southern part of Black Sea. Reported from Mauritania. Highly migratory species. Oceanic, but seasonally coming close to shore and can tolerate a wide range of temperatures.

Reproduction

Batch spawning, occurring in spring-summer. Length at first maturity 97-110 cm. Large females (270-300 Kg) are able to produce up to 10,000,000 eggs in each spawning. Eggs and larvae are pelagic.

EGGS

Pelagic, spherical and transparent, with diameter ranging from 0.94 to 1.12 mm. Chorion sculptured. Yolk homogeneous. A single oil globule with diameter ranging from 0.18 to 0.32 mm.

LARVAE

Morphology

At 24°C, embryo development lasts about 32 hours. Larval length at hatching is about 2-3 mm. Pre-anal length 47% of total length. Yolk sac large, with a posteriorly located oil globule. Mouth not yet opened. Gut curved almost forming a right angle. Anus opens at a short distance from posterior margin of the yolk sac.

At about 3.8 mm, mouth is opened. Yolk sac is much reduced.

At 5 mm, the yolk is almost totally absorbed. Eyes are still narrow. Tip of snout pointed. Head considerably deep at pectoral fin base and representing more than 1/3 of standard length (cephalic shape is characteristic in thunnids larvae). Upper and lower jaws equal in size and without teeth. Abdominal cavity considerably deep. Space between anus and anal fin origin.

Flexion of notochord occurs at about 5-6 mm of standard length.

At 6.8 mm, several preopercular spines in 2 rows; their number increase with growth from 5 at 3.8 mm up to 15; late stage of spinal armature comprises several elongate posterior spines.

Larval stages last about 30 days.

Pigmentation

At hatching, eyes colourless. Patches of yellow pigment on margin of the anterior portion of the primordial dorsal fin. Little yellow pigment at bending of gut and on the yolk sac around the oily globule. Few melanophores on sides of the trunk. Melanophores around the oily globule, on the anterior portion of the yolk sac, on bending of the gut, and on the cephalic region.

At about 3.8 mm, eyes start pigmentation. Black pigment on the head becomes less abundant. Pigment increases at gut finfold. Some yellow patches persist on the anterior and dorsal margin of the primordial fin. Lower jaw tip with 2 spots on inner edge. 1-3 spots on dorsal edge of trunk (rarely 0 or 4). 1-3 spots on ventral edge of trunk (rarely 4, 5 or 6). 0-2 spots present laterally, near mid-trunk. 1st dorsal fin membrane prominently dark.

At 5 mm, yellow pigment has completely disappeared. Continuous series of melanophores along ventral margin of the caudal region. Series of melanophores on the dorsal profile limited to 2-3 marks at the end of tail. Peritoneal pigmentation present.

At 6-7 mm, upper jaw tip appears pigmented. Internal pigment may be present near vertebral column. No black spots on cleithral symphysis. No black spots on caudal fin.

Vertebrae/myomeres

Myomeres: 39.

Pre-caudal vertebrae 18, post-caudal vertebrae 21 (with the 1st closed haemal arch on vertebra n° 10).

Fins

At 5 mm, fins become larger.

At 6.8 mm, pelvic fins have appeared; at 8 mm they are complete.

First dorsal fin rays: XIII-XIV.

Second dorsal fin rays: 13-15.

N° dorsal finlets: 8-10.

Anal fin rays: 13-16.

N° anal finlets: 7-9.

Pelvic fin rays: I, 5.

Pectoral fin rays: 30-36.

Notes

Scomber larvae may be distinguished from those of tuna species thanks to: smaller number of myomeres; heavier body pigmentation; absence of preopercular spines; stockier head; development of the second dorsal fin, which is earlier than that of the first dorsal fin (while in tunnids first dorsal fin develops earlier than the second dorsal fin).

7 species of tuna belong to the genus *Thunnus*. All their larvae present 39 myomeres and are slightly pigmented. Most species are discriminated on basis of melanophores. Pigment pattern is similar to *Thunnus atlanticus* larvae from South Atlantic, but can be separated basing on number of pre-caudal and caudal vertebrae.



Thunnus thynnus larva (5 mm).

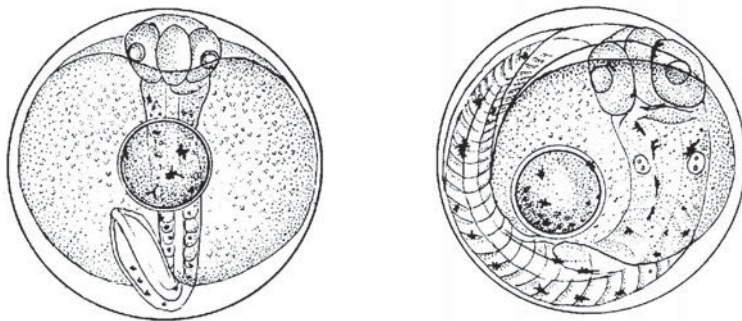

A

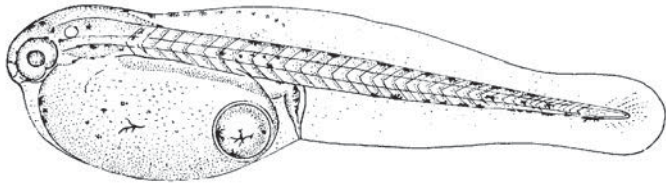

B: 3 mm

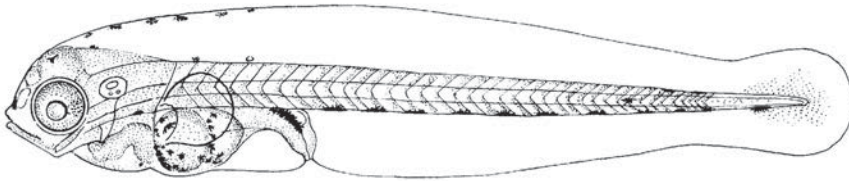

C: 3.84 mm

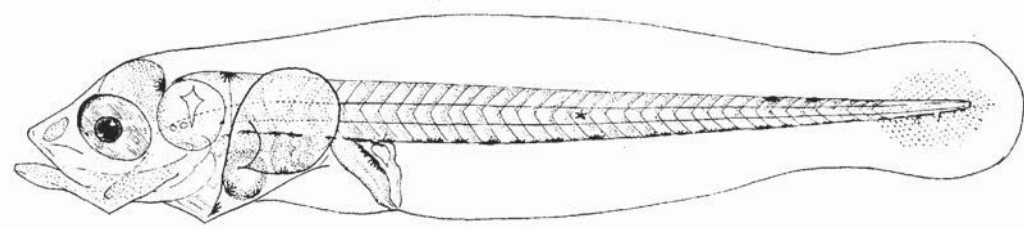

D: 3.4 mm

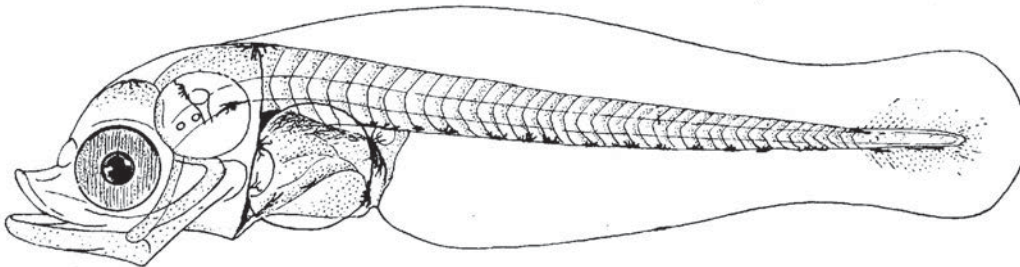

E: 3.8 mm

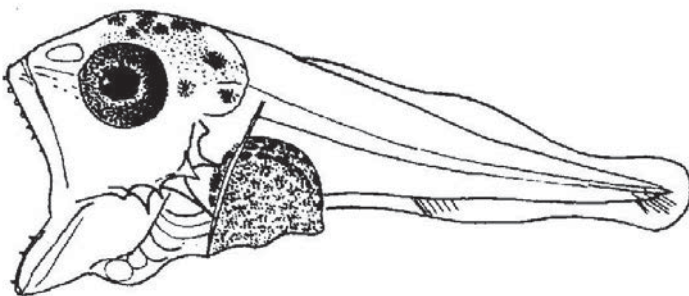

F: 4.7 mm

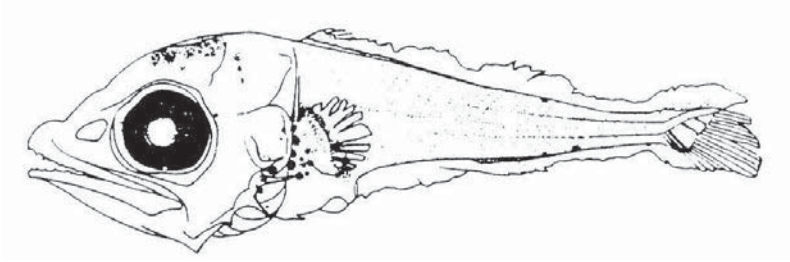

G: 5.3 mm

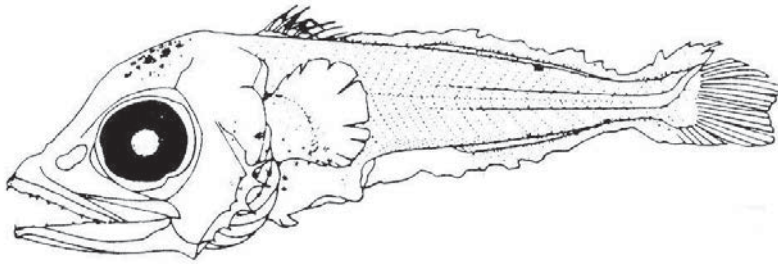

H: 6.1 mm

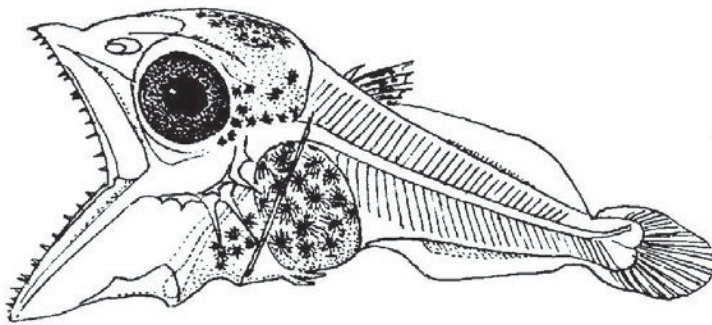

I: 6.8 mm

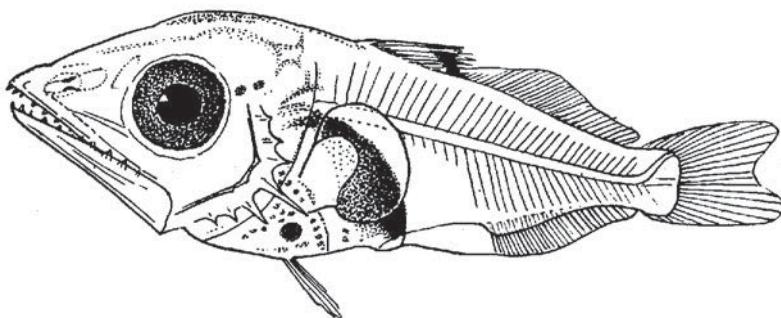

L: 7.3 mm

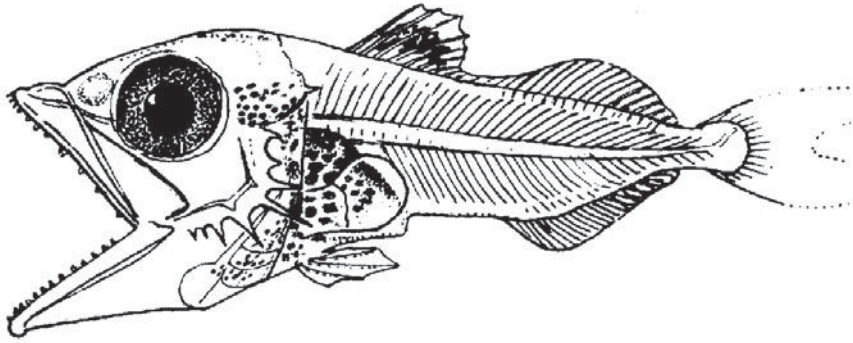

M: 9.4 mm

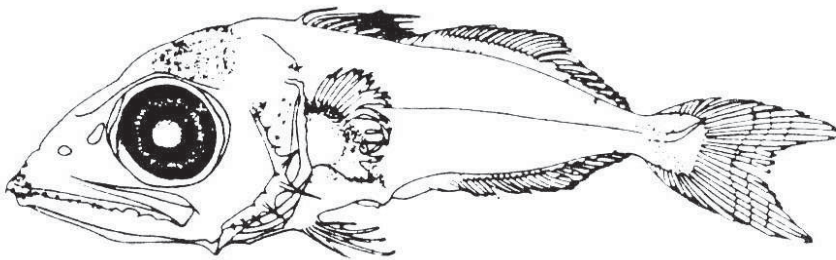

N: 9.6 mm

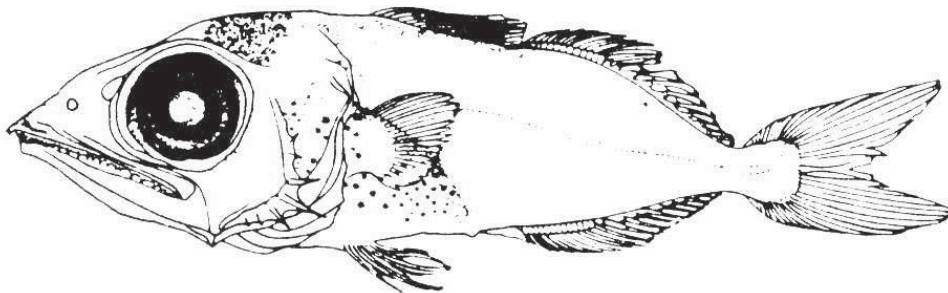

O: 12.2 mm

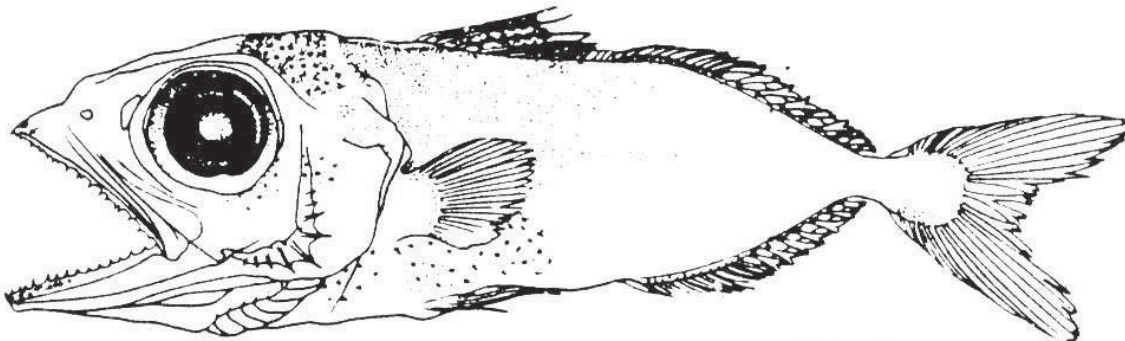

P: 16.8 mm

A Eggs of *Thunnus thynnus* from Sanzo (1932).

B-P: *Thunnus thynnus* larvae. B-E: Sanzo (1932); F, I-M: Ehrenbaum (1924); G, H, N-P: Yabe *et al.* (1966).

FAO name: Bullet tuna

Libyan name: ماتسـيـتي (Matseti)

Italian name: Tombarello (تومبـاريلو)

Synonyms: *Auxis bisu* (Rafinesque, 1810); *Auxis vulgaris* (Cuvier, 1832); *Scomber rochei* (Risso, 1810)

Main references: Alemany Llodrà, 1997; Arbault and Boutin, 1968; Collette and Nauen, 1983; Fahay, 1983; Ferreiro and Labarta, 1988; Marinero, 1971.

Distribution

Indian, Pacific and Atlantic Oceans, including the Mediterranean Sea. Highly migratory species.

Reproduction

Protogynous hermaphrodite. Batch spawning, with a variable frequency. Females may produce between 31,000 and 103,000 eggs per spawning, according to their size.

EGGS

Pelagic, spherical, transparent, with diameter ranging from 0.82 to 1.10 mm. Yolk homogeneous. Perivitelline space very narrow. A single oil globule (or up to 5 smaller), coloured, with diameter 0.24-0.29 mm.

LARVAE

Morphology

Length at hatching 2.0-2.5 mm. Preanal length representing 37-50% of standard length. Head large (larger than in *Scombrus*). Snout pointed. Supraoccipital and supraorbital spines absent. Preopercle and pterotic spines present (while they are absent in *Scombrus*): 2 series of opercular spines, of which the second one is much developed, with straight spines. Upper and lower jaws about equal in size.

Flexion of notochord occurs at 4.5-6.0 mm.

Pigmentation

At hatching, 1 large dorsal melanophore in the middle of the trunk.

2 large melanophores in the optic region. Large concentration of melanophores in the middle of the gut. Postanal pigmentation shows 4 dots. Series of melanophores in the ventral part of trunk.

Between 4 and 8 mm, spots on the ventral trunk row decrease in number; their number increase again during growth.

At about 6 mm, spots appear on dorsal trunk; their number increases with growth.

At about 7-8 mm, spots of pigment on cleithral symphysis. Pigment on occipital region, not extending in front of eyes.

At about 8-10 mm, there are very characteristic spots present on the first dorsal fin. Pelvic fins without pigment (while pigment is present in the similar species *Sarda sarda*).

The same species may present variants about presence/absence of spots at side of caudal peduncle.

Vertebrae/myomeres

Myomeres 39.

Precaudal vertebrae 20 (or 19), post-caudal vertebrae 19 or (20).

Fins

At 6.0 mm, dorsal, anal and pelvic fin rays start forming.

At 7-8 mm, low number of dorsal spines (10-12) are discernible.

At 8.7 mm, pelvic fins well formed.

After juvenile stage, space between 1st and 2nd dorsal fins is present.

First dorsal fin rays: X-XII.

Second dorsal fin rays: 10-12.

N° dorsal finlets: 8-9.

Anal fin rays: 12-14.

N° anal finlets: 7-8.

Pectoral fin rays: 24-25.

Pelvic fin rays: I, 5.



Auxis rochei larva.

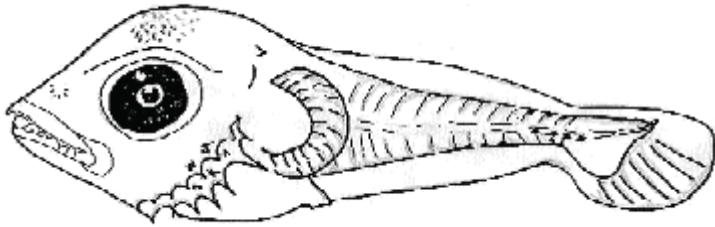

Auxis rochei larva (8.1 mm). Original drawing by Cuttitta.

Order PLEURONECTIFORMES

Main references: Ahlstrom *et al.*, 1984a; Desoutter, 1990; Fahay, 1983; Nelson, 2006.

The main characteristic of this order is that both eyes are located on the same side of the head, but this condition appears in juveniles and adults. During larval stages eyes are symmetrical and one of them migrates to right or left side of head at the end of pelagic stage. This metamorphosis occurs rapidly, just before becoming juveniles and settling on the bottom. Flatfish families whose eyes are situated on the left side of the head are: Psettoideidae, Citharidae, Bothidae, Achiropsettidae, Scophthalmidae, Paralichthyidae and Cynoglossidae. Flatfishes families whose eyes are situated on the right side of the head are: Pleuronectidae, Samaridae, Achiridae and Soleidae.

General features of eggs:

- spherical shape
- chorion smooth
- yolk homogeneous
- perivitelline space narrow
- none, 1 or more oil globules

General features of the larvae from this order:

- body compressed, symmetrical, variable in shape
- midbrain protrudes dorsally to varying degrees
- eyes round
- head spines frequently present
- gut coiled, bulging out from body outline
- preanal length <40-50% of standard length
- vertebrae 25-65
- frequent early formation of pelvic or anterior dorsal fin rays or spines
- dorsal and anal fins usually with long base, long rays and high ray numbers
- dorsal fin extending from head to base of caudal fin
- transformation marked, implying eye migration, pectoral fins shrinkage, ossification of pectoral fin rays, increment of pigment on eyed side
- larval stage may be long; some species may reach large size before transformation

Family BOTHIDAE

Lefteye flounders

Main references: Ahlstrom *et al.*, 1984a; Brownell 1979, Costa, 1999; Fahay, 1983; Kyle, 1913; Matsuura and Olivar, 1999; Nelson, 2006.

116 species, belonging to 13 genera, are distributed in tropical and temperate waters of Atlantic, Indian, and Pacific Oceans.

Pelagic spawners. In Atlantic Ocean spawning season between March and June.

General features of larvae from this family:

- eggs with 1 oil globule
- body thin to diaphanous, slightly pigmented
- slightly protruding midbrain, in most
- mouth terminal
- preanal length about 50% of total length, decreasing during development

- developing elongated first or second dorsal fin ray
- no spiny rays
- eye migrating from right to left side
- transformation size <15 mm, (few larger southern of 35° N)

At flexion, in the genus *Bothus*, left pelvic fin base is longer than the right one; left fin origin is positioned on urohyal; left fin base is positioned on midline; right fin base is positioned above midline (see figure below).



FAO name: Thor's scaldfish

Libyan name: مداس (Mdass)

Italian name: Suacia mora (سواتشا مورا)

Synonyms: *Arnoglossus moltoni* (Torchio, 1961); *Arnoglossus moltonii* (Torchio, 1961); *Arnoglossus thory* (Kyle, 1913)

Main references: Aldebert *et al.*, 1990; Alemany Llodrà, 1997; Arbault and Boutin, 1968; Ferreira and Labarta, 1988; Holt, 1899; Kyle, 1913; Marinaro, 1971; Padoa, 1956.

Distribution

Common in Western Atlantic Ocean, Canary Islands, Mediterranean and Black Sea. Found in the Strait Sicily Channel in summer and autumn.

Reproduction

Spawning period from July to October.

EGGS

Spherical, uncoloured, with diameter ranging from 0.6 to 0.7 mm. Yolk homogeneous. A single oil globule ranging from 0.12 to 0.15 mm.

LARVAE

Morphology

Length at hatching 1.59-2.3 mm.

At 3 mm, yolk sac is absorbed. Body elongate, laterally compressed. Eyes small, round, and pigmented. Preanal length 50% of standard length. Gut highly coiled.

At 7 mm, 5 to 8 spined plates along the ventral margin of the abdomen, under the large liver. Single spines or spined plates on head, at the base of the tentacle.

At 8-9 mm, flexion of notochord.

At 12-20 mm, very large swim bladder.

At 20-25 mm, metamorphosis, with disappearance of teeth and spines, bending up

of the tip of the large liver, disappearance of the swim bladder.

Pigmentation

At 3.6 mm, swim bladder is pigmented.

At 6 mm, abdominal, postanal and caudal bars are present; in formalin-preserved specimens colour darker rusty-brown than the pale-yellow of *A. laterna*.

At 7 mm, caudal pigment disappears, but 2 postanal transverse bands (a single band in *A. laterna*) of melanophores: one immediately above the anal papilla, the other near the end of the tail. Pigment starts fading on the blind side.

At 8-9 mm, dorsal margin with a row of melanophores along the base of interspinous area.

At 12 mm, melanophores of postanal bar spread onto interspinous region, with few melanophores on the fin; bar located on 18th - 21st caudal vertebra. Dorsal marginal row of melanophores well developed, while ventral margin with just a few melanophores.

At 12-20 mm, well marked postanal bar of melanophores.

Vertebrae/myomeres

Vertebrae 27-30.

Fins

Dorsal tentacle is present; it forms very early, arising from a longitudinal splitting along the margin of dorsal primordial fin; when intact (rarely after sampling at sea), at its extremity it has a swollen oval-shaped bulb covered with melanophores. This tentacle disappears suddenly when the eye is migrating.

At 18 mm, pelvic fins complete.

Dorsal fin rays: 84-92.

Anal fin rays: 63-69.



Arnoglossus thori larva.

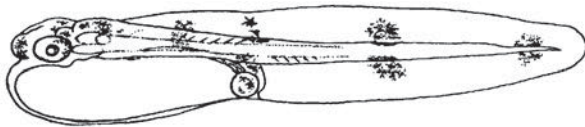

A: 2.3 mm

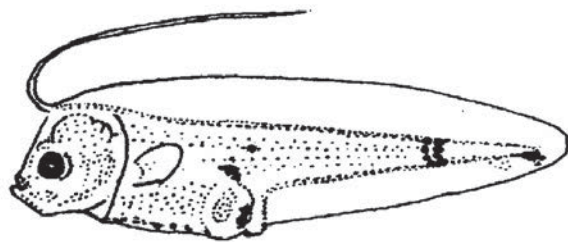

B: 6 mm

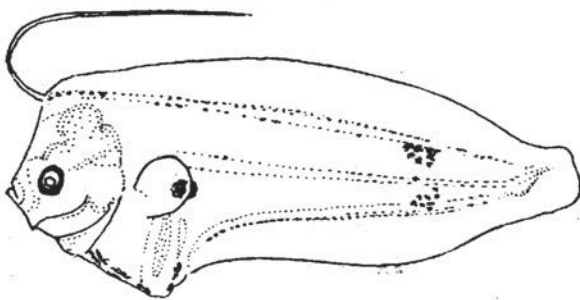

C: 8.5 mm

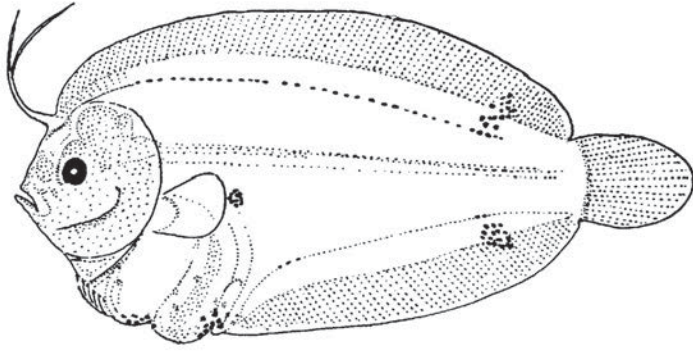

D: 12.5 mm

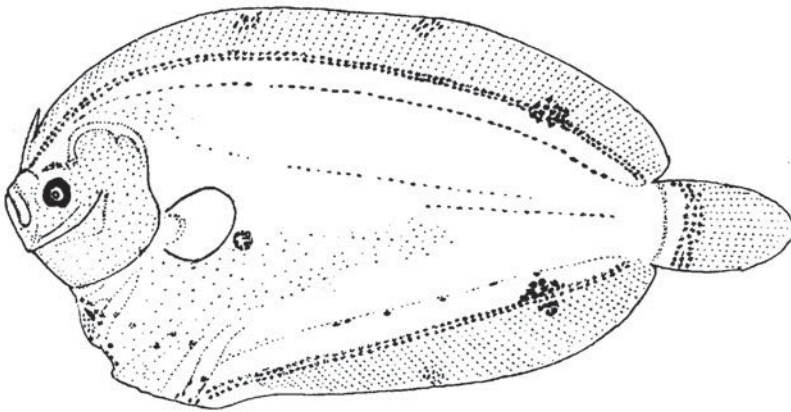

E: 21 mm

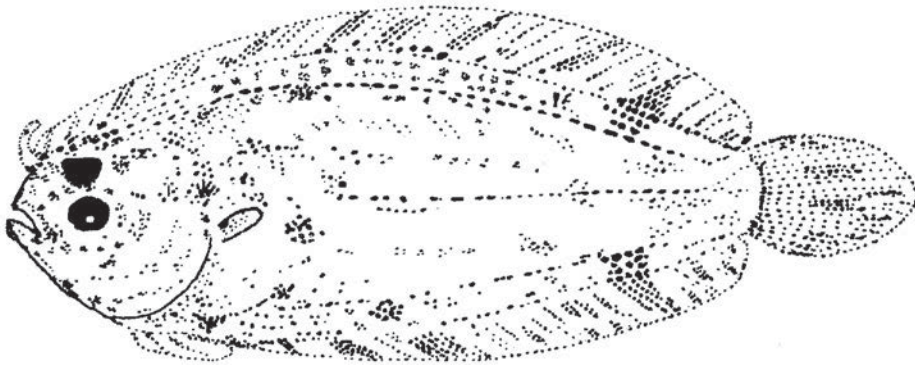

F: 22.5 mm

A-F: *Arnoglossus thori* larvae. A: Raffaele (1888); B-F: Kyle (1913).

FAO name: Scaldfish

Libyan name: مداس (Mdass)

Italian name: Suacia (سواتشا)

Synonyms: *Arnoglossus aspilos* (non Bleeker, 1850); *Arnoglossus laterna* subsp. *microstoma* (Kyle, 1913); *Arnoglossus macrostoma* (Kyle, 1913)

Main references: Aldebert *et al.*, 1990; Alemany Llodrà, 1997; Arbault and Boutin, 1968; Ehrenbaum, 1897; Ferreiro and Labarta, 1988; Holt, 1899; Kyle, 1913; Marinaro, 1971; Padoa, 1956; Russell, 1976.

Distribution

Eastern Atlantic: from Norway to Angola, including Mediterranean and Black Sea.

Reproduction

Spawning period from June to October.

EGGS

Spherical, uncoloured, with diameter ranging from 0.6 to 0.7 mm. Yolk homogeneous. A single oil globule ranging from 0.12 to 0.15 mm.

LARVAE

Morphology

Length at hatching 2.8 mm, with a preanal length of 1.1 mm. Yolk sac elongated, with posteriorly positioned oil globule surrounded by brown-red pigment.

Body elongated, laterally compressed. Eyes small. Gut coiled. Presence of a tentacle, derived from the fragmentation of the primordial fin.

At 4.7 mm, tentacle on head developed. Swim bladder appears.

At 6-7 mm, spines appear on the head near the base of the tentacle.

Length at metamorphosis is variable (16-30 mm), being related to water depth (delayed in deeper water). In Bay of Biscay transformation occurs at 26-30 mm.

Pigmentation

Living embryo presents rose-red or rusty-brown pigment on the body and black pigment only as small points.

In newly-hatched living larva brown-red chromatophores distributed on head and

neighbouring primordial fin: on 4 positions along dorsal margin and on mid-way along postanal portion of body (as a bar). Other pigment present on rectal area.

Swim bladder pigmented. Head pigmented. Melanophores are present on postanal bar, on peritoneum and on anal papilla. On the head a tentacle is present with pigmented bands, corresponding to the spots on the primordial fin.

Two main pigmented forms of this species may develop: a pale form and a well pigmented form. The well developed black pigmented pattern consists of: caudal cluster or band or postanal bar located between 18th-21st postanal segments; 1-2 melanophores along dorsal margin (while a row of well developed melanophores is present in *A. thori*); a row of evenly spaced and well developed melanophores along ventral body margin; melanophores around anus; melanophores on swim bladder; 1-2 melanophores on caudal region and anteriorly in the otocystic region. Melanophores are generally present also all along the abdominal ventral margin (in contrast to *A. thori* there are no spots on the end of tail) and along lower jaw.

Pigmentation decreases during development, so that at 10 mm it may be reduced to 1-2 melanophores only (as remains of postanal bar), and 1-2 melanophores around the anus.

Vertebrae/myomeres

At 7 mm, all vertebrae are developed.

Vertebrae: 27-32.

Consistently with variability in length at metamorphosis, also the vertebral number is slightly higher in deeper water forms. In Bay of Biscay average vertebral number is 30.42.

Fins

At 7 mm, all fin rays developed.

Dorsal fin rays: 84-98.

Anal fin rays: 63-75.

At late developmental stages none of the dorsal fin rays are prolonged.



Arnoglossus laterna larva.

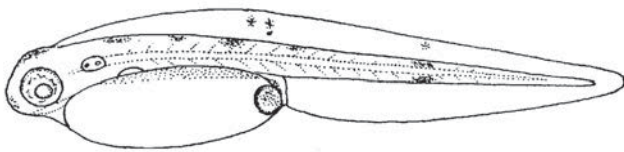

A: 2.57 mm

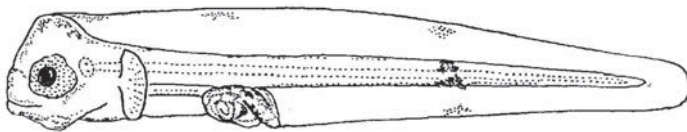

B: 2.83 mm

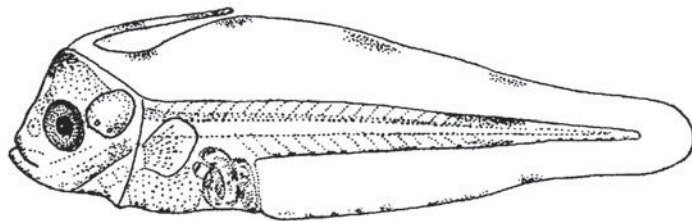

C: 4.7 mm

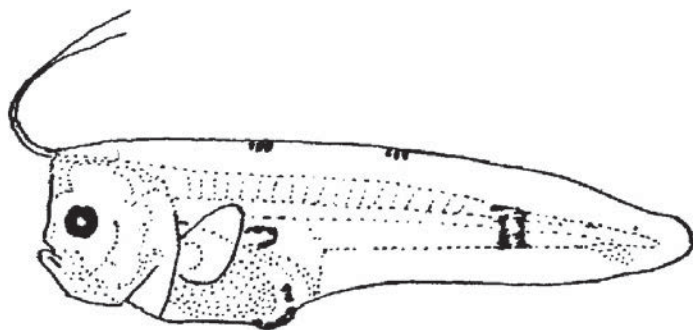

D: 6 mm

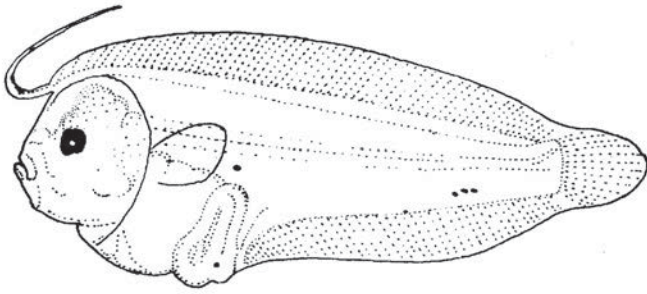

E: 10.3 mm

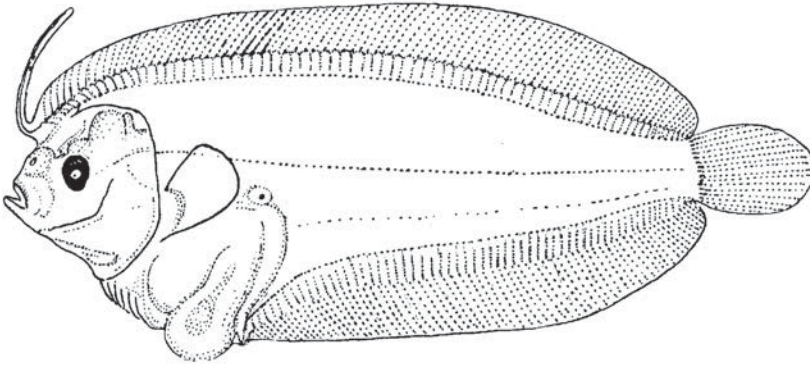

F: 21 mm

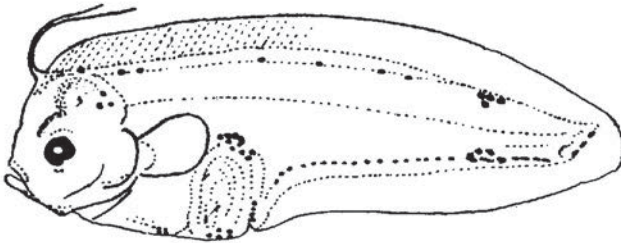

G: 8.5 mm, pigmented form

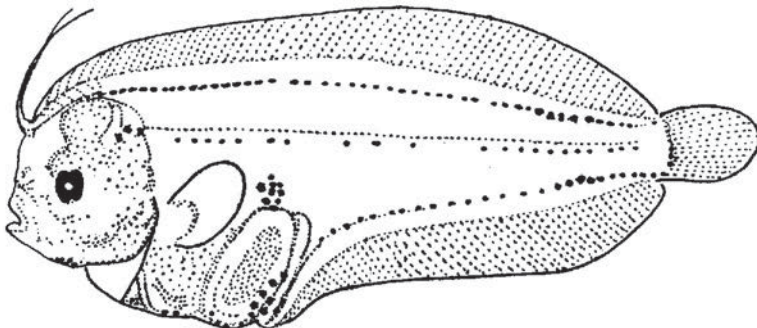

H: 12.5 mm, pigmented form

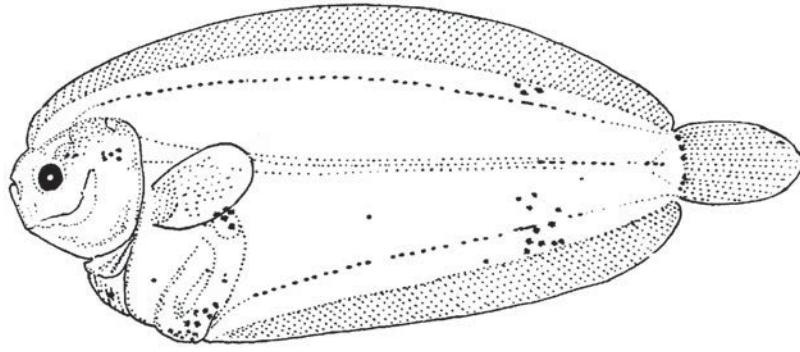

I: 24 mm, pigmented form

A-I: Larvae of *Arnoglossus laterna* larvae. A-C: Ehrenbaum (1897); D-I: Kyle (1913).

Family SCOPHTHALMIDAE

Turbots

Main references: Fahay, 1983; Kyle, 1913; Nelson, 2006.

The family presents 18 species, belonging to 5 genera. They are distributed in North Atlantic Ocean and Baltic, Mediterranean and Black Seas.

General features of larvae from this family:

- eggs with 1 oil globule
- slightly protruding midbrain, in most
- mouth terminal and large
- lower jaw prominent
- preanal length about 50% of total length, decreasing during development
- fin rays often elongate

- eye migrating from right to left side
- transformation size <15 mm, (few at larger size, southern of 35° N)

At flexion, in the genus *Scophthalmus*, both pelvic fins bases are long; both their origins are positioned on urohyal; left fin base is positioned on midline; right fin base is positioned above midline (see figure below).



FAO name: Fourspotted megrim

Libyan name: سمك موسى (Samak mousa)

Italian name: Rombo quattrocchi (رومبو كواتروكي)

Synonyms: *Arnoglossus boscii* (Risso, 1810);

Pleuronectes boscii (Risso, 1810);

Hippoglossus boscii (Risso, 1810)

Main references: Alemany Llodrà, 1997; Arbault and Boutin, 1968; Ferreiro and Labarta, 1988; Marinaro, 1971; Nielsen, 1990; Ré and Meneses, 2009.

Distribution

Distributed in the Atlantic Ocean, from Morocco to Scotland, including the Western Mediterranean and Adriatic Sea. Common in Italian seas at a depth of 100-200 m, but found also at 900 m.

Reproduction

Spawning occurs in winter and spring.

EGGS

Spherical, uncoloured, with diameter ranging from 1.07 to 1.22 mm. A single oil globule with diameter ranging from 0.12 to 0.15 mm.

LARVAE

Morphology

At 6 mm, maximum body depth posterior to pectoral fin end. Head represents about 30% of total length, with the cephalic region fairly compressed. Preoperculum with many small spines aligned in two distinct rows behind the otocystic region. Snout elongated, with a depression on its top. Upper jaw turned upwards and slightly more prominent than the lower one. Eyes large and almost round. Gut coiled, but straight in its final part, at mid-body.

Flexion of notochord occurs at 9 mm.

Pigmentation

7 groups (as bands) of melanophores along the margin of the dorsal fin and 3 along the margin of the anal fin.

Vertebrae/myomeres

Myomeres highly evident on the trunk: 10 preanal and 32 postanal.

Fins

At 6 mm, a primitive unpaired fin is present.

Dorsal fin rays: 79-86.

Anal fin rays: 65-69.

Pelvic fin rays: 6.

Pectoral fin rays: 11-12.

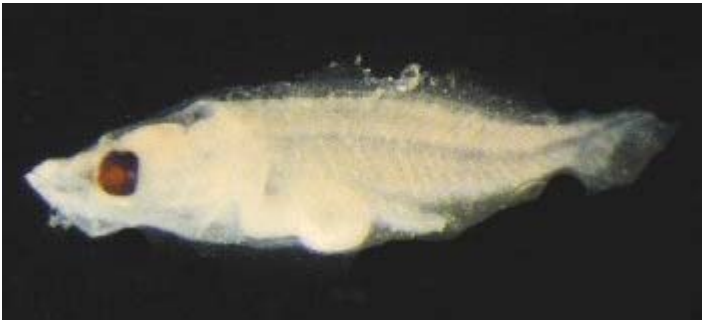

Lepidorhombus boscii larva.

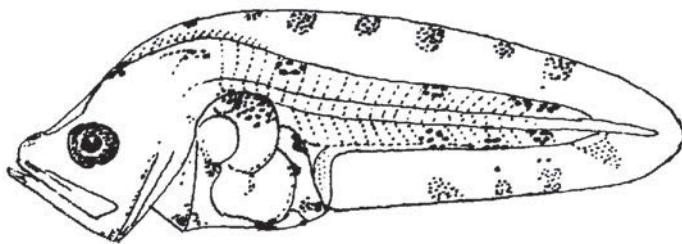

A: 7.0 mm

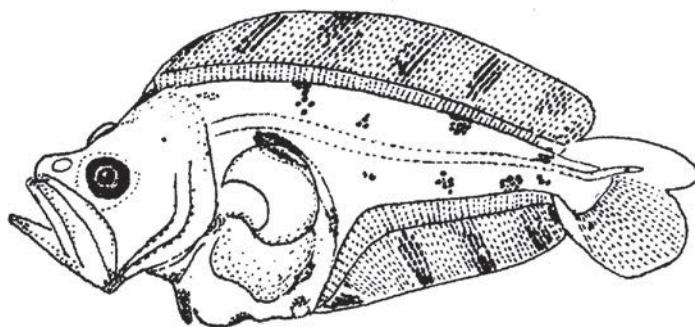

B: 10.4 mm

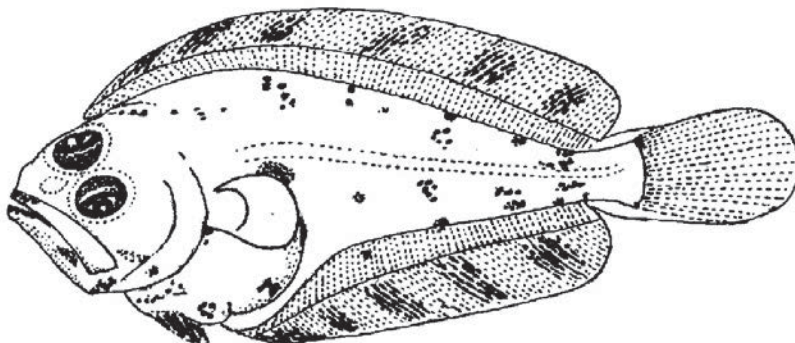

C: 17 mm

A-C: early life stages of *Lepidorhombus boscii* from Petersen (1909).



Family CYNOGLOSSIDAE

Tonguefishes

Main references: Ahlstrom *et al.*, 1984; Desoutter, 1990; Fahay, 1983; Kyle 1913; Matsuura and Olivar, 1999; Menon, 1977; Nelson, 2006; Padoa, 1956.

110 species, belonging to 3 genera, distributed in tropical and subtropical waters of all the oceans (between 40° latitudes). Most species occur in shallow water or estuaries.

General features of eggs and larvae from this family:

- eggs with multiple oil globules
- body tapering
- preanal length about 40% of total length
- relatively large head
- prominent protruding midbrain
- eye migrating from right to left side of head
- mouth oblique, twisted
- gut mass protruding beyond ventral profile of body

- transformation size about 10 mm
- dorsal, anal and caudal fins confluent
- dorsal fin origin at level of fixed (lower) eye
- anterior dorsal fin rays elongate
- pectoral fins are lost during development
- vertebrae usually 9-10 preanal and 33-66 postanal

The combination of short and long dorsal rays can be used for specific identification; fin ray counts also represent an important diagnostic character for species identification.

At flexion, in the genus *Symphurus*, the right pelvic fin is lost at transformation; left fin base is positioned posteriorly to cleithral symphysis, on midline (see figure below).



FAO name: Tonguesole

Libyan name: مداس (Mdass)

Italian name: Lingua di cane (لنقوا دي كاني)

Synonyms: *Ammopleurops lacteus* (Bonaparte, 1833); *Plagusia lactea* (Bonaparte, 1833)

Main references: Alemany Llodrà, 1997; Costa, 1999; Desoutter, 1990; Matsuura and Olivar, 1999.

Distribution

Mediterranean Sea and Eastern Atlantic Ocean, from the Bay of Biscay to Angola, including Saint Helena and the Azores. Their bathymetric distribution is wide, ranging from 20 m to 1,000 m.

Reproduction

Spawning season from May to October.

EGGS

No available information.

LARVAE

Morphology

At 3 mm, body elongated and robust. Head rounded. The embryonic fin is present. Eyes almost round and moderate in size. Mouth terminal. Jaws equal in length.

Swim bladder conspicuous. Gut long and thin; its mass protruding beyond ventral profile of body, with conical appendix attached to trailing gut coil.

At 8-9 mm, urochord not yet flexed. Intestine partially hangs free out of the visceral sac.

Pigmentation

At 3 mm, the long gut appendix is pigmented with small melanophores.

At 5.5 mm there are also pigments on the ventral surface of the gut, on the anal papilla, on the trunk and on primordial fin.

Vertebrae/myomeres

9 preanal and 39 postanal vertebrae.

Fins

At 3 mm, long dorsal fin with first 4 rays arched; pelvic fins with 4 rays, characteristic even in adults.

At 6 mm : dorsal fin rays 85; anal fin rays 70.

At 8-9 mm, fin rays are definitely formed.

Dorsal fin rays: 5+85.

Anal fin rays 76.

The first dorsal fin ray is very short, while the second one is very long.

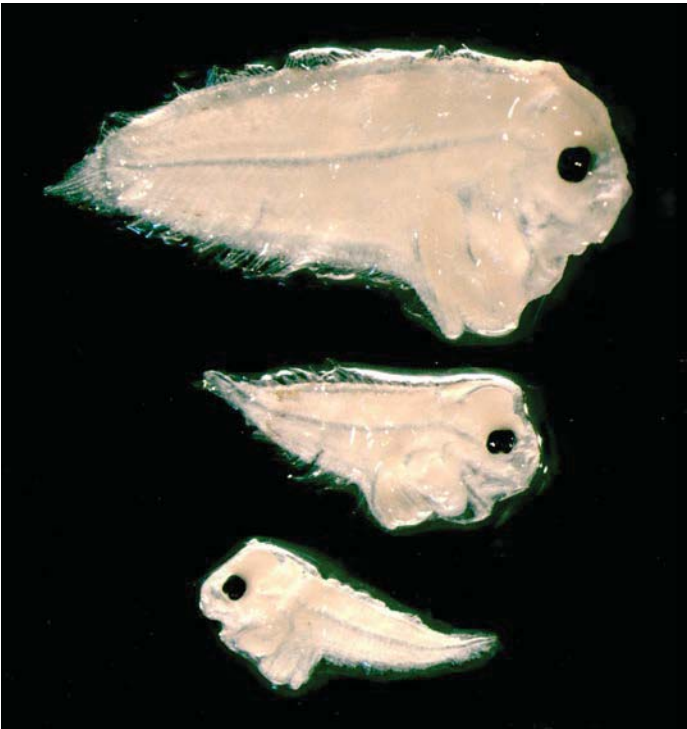

Symphurus nigrescens larvae (11.5; 6.5; 5 mm).

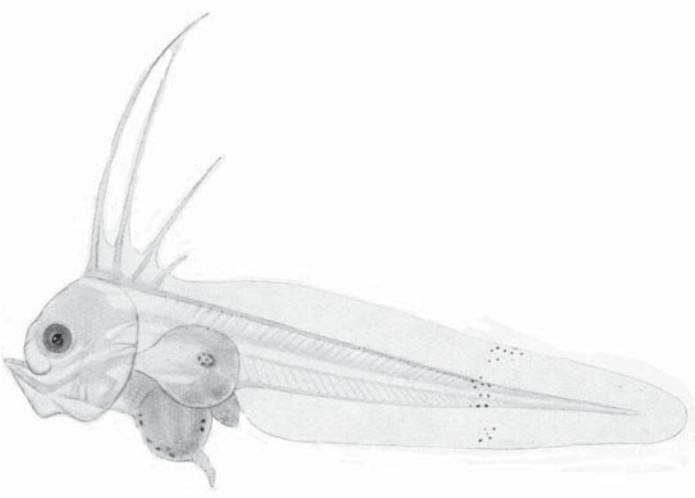

A: 5.5 mm

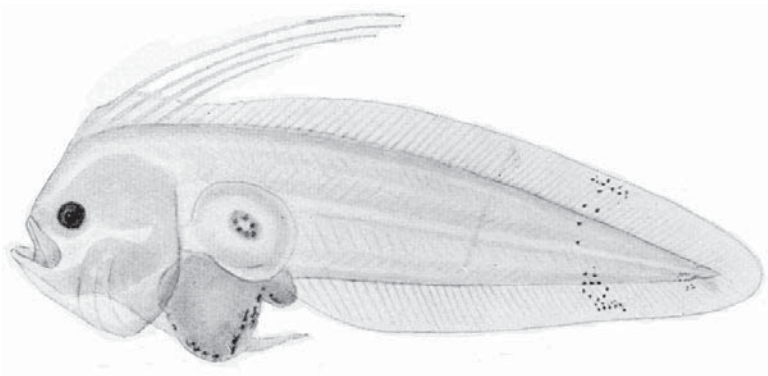

B: 6.5 mm

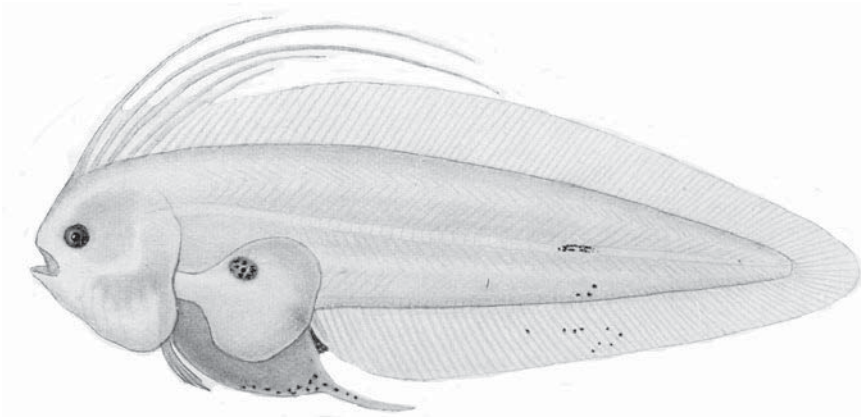

C: 18 mm

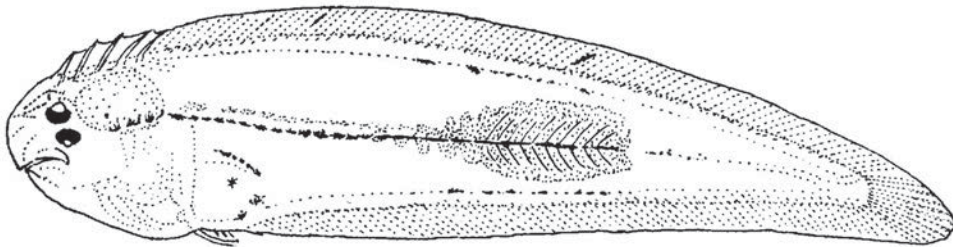

D: 20 mm

A-D: *Symphurus nigrescens* larvae. A-D: Padoa (1956); E: Kyle (1913).

Order TETRAODONTIFORMES

Main references: Helfman *et al.*, 1997; Fahay, 1983; Fischer *et al.*, 1995; Leis, 1984; Nelson, 2006.

Relatively few early life history characters may apply to Tetraodontiformes as a whole group, fewer still could be considered derived.

General features of eggs:

- demersal and adhesive
- shape spherical
- chorion sculptured
- yolk homogeneous
- perivitelline space narrow to moderate
- oil globules multiple

General features of the larvae from this order:

- body shape deep and stocky
- preanal length about 50% of standard length
- gut coiled and voluminous
- vertebrae 17-23
- eyes round
- head spines rarely present
- no early formation of fin rays or spines (may be early dorsal spine)
- late formation of caudal fin
- various early-forming scale specializations
- transformation gradual

Filefishes

Main references: Bruslé, 1983; Fahay, 1983; Leis, 1984; Matsuura and Olivar, 1999; Nelson, 2006.

95 species, belonging to 31 genera, distributed in Atlantic, Indian and Pacific Oceans.

Spawning season is prolonged, potentially all year-round. Demersal eggs are laid in a prepared site and are guarded by the male or both parents. Some of the subtropical species release eggs in open water. Larvae are pelagic, frequently found in plankton samples in tropical oceans. Monacanthid larvae develop a large single dorsal spine since early larval stages, becoming strongly armoured with hooks in later stages.

Eggs undescribed.

General features of the larvae from this family:

- body elongated to deep, with narrow peduncle
- mouth terminal, very small
- spinules present in a small cluster on posterior margin of pre-opercle; may be totally absent
- small spines scattered over forebrain and ventral side of head

- spines also in pelvic region
- some melanophores on dorsal side of gut, opercle and pelvis
- at 5 mm, body shape similar to adult stage
- early development of pelvic and dorsal spines (the latter with secondary barbs)
- first hooked dorsal spine located over mid-brain
- at 8 mm, fin rays developed
- vertebrae: 7 preanal+12 postanal
- dorsal fin rays: II, 29-35
- anal fin rays: 28-35
- pelvic fin rays: I
- pectoral fin rays: 12-15
- caudal fin rays: 0+6+6+0

In Filefishes 1 large dorsal spine and many dorsal and anal rays are present; if 2 dorsal spines are present, the 2nd is usually much smaller. In Triggerfishes 3 dorsal spines (1 large) and fewer dorsal and anal rays are present.

Stephanolepis diaspros Fraser-Brunner, 1940, the Reticulated leatherjacket, is described by Tortonese (1956) as the only species of this family living in Mediterranean Sea (usually found in its eastern part).

Family MONACANTHIDAE

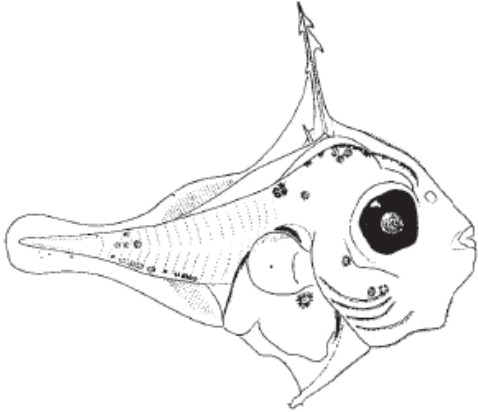

A: 3.1 mm

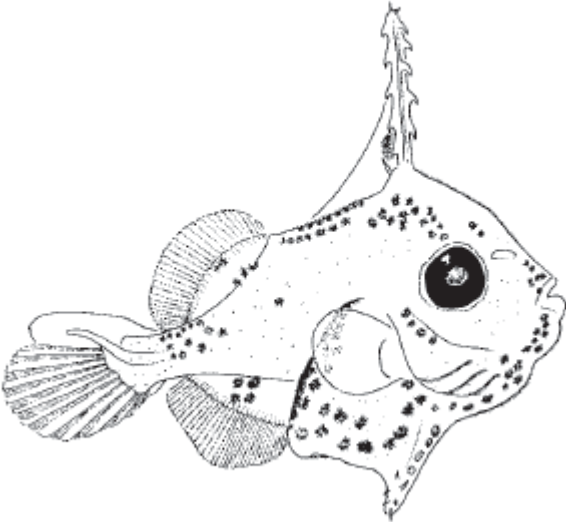

B: 5.5 mm

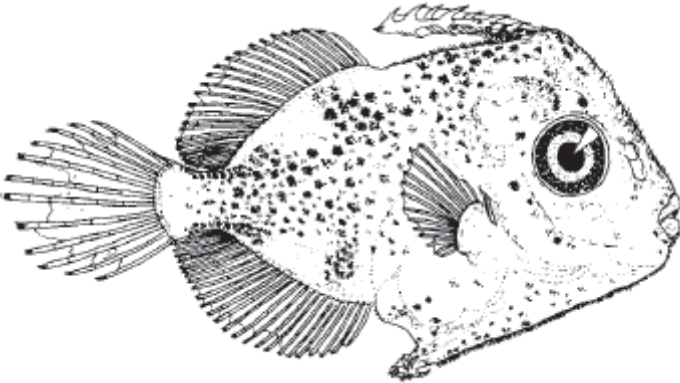

C: 6.5 mm

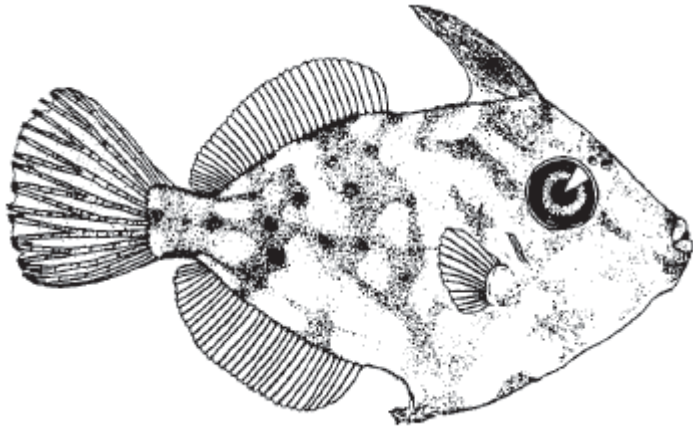

D: 15.2 mm

A-D: Larvae of *Stephanolepis hispidus* larvae as example of Monacanthidae. A-B: redrawn by Fahay (1983) from Aboussouan (1966); C-D: Berry and Voegelé (1961).

5. References

- Aboussouan A. 1966. Oeufs et larves teleostéens de l'Ouest Africain. III. Larves de *Monacanthus hispidus* (L.) et *Balistes forcipatus* Gm. Bull. Inst. Fondam. Afr. Noire (A. Sci. Nat.), 28 (1): 276-282.
- Aboussouan A. 1975. Oeufs et larves de téléostéens de l'Ouest Africain. XIII. Contribution à l'identification des larves de Carangidae. Bull. Inst. Fondam. Afr. Noire, Sér. A, Sci. Natur., 37: 899-938.
- Agassiz A., Whitman C.O. 1885. The development of osseous fishes. The pelagic stages of young fishes. Mem. Mus. Compar. Zool. Harvard Coll., 14 (1): 56 pp.
- Aguilera O. 1998. Los peces marinos del occidente de Venezuela. Acta Biol. Venez., 18: 43-57.
- Ahlstrom E.H., Counts R.G. 1958. Development and distribution of *Vinciguerria lucetia* and related species in the Eastern Pacific. Fish. Bull. Fish Wildl. Serv., 58 (139): 363-416.
- Ahlstrom E.H., Moser H.G. 1981. Systematics and development of early life history stages of marine fishes: achievements during the past century, present status and suggestions for the future. Rapp. p.-v. Réun. Cons. int. Explor. Mer, 178: 541-547.
- Ahlstrom E.H., Moser H.G., O'Toole M.J. 1976. Development and distribution of larvae and early juveniles of the commercial lanternfish, *Lampanyctoides hectoris* (Günther), off the west coast of Southern Africa with a discussion of phylogenetic relationships of the genus. Bull. Southern California Acad. Sci., 75: 138-152.
- Ahlstrom E.H., Amaoka K., Hensley D.A., Moser H.G., Sumida B.Y. 1984a. Pleuronectiformes: Development. In: Moser H.G., Richards W.J., Cohen D.M., Fahay M.P., Kendall A.W., Richardson Jr.S.L. (eds.) Ontogeny and systematics of fishes. Amer. Soc. Ichthyol. Herpetol., Gainesville, Spec. Publ. 1: 640-670.
- Ahlstrom E.H., Moser H.G., Cohen D.M. 1984b. Argentinoidei: Development and relationships. In: Moser H.G., Richards W.J., Cohen D.M., Fahay M.P., Kendall A.W., Richardson Jr.S.L. (eds.) Ontogeny and systematics of fishes. Amer. Soc. Ichthyol. Herpetol., Gainesville, Spec. Publ. 1: 155-169.
- Ahlstrom E.H., Richards W.J., Weitzman S.H. 1984c. Families Gonostomatidae, Sternoptychidae, and associated stomiiform groups: Development and relationships. In: Moser H.G., Richards W.J., Cohen D.M., Fahay M.P., Kendall A.W., Richardson Jr.S.L. (eds.) Ontogeny and systematics of fishes. Am. Soc. Ichthyol. Herpetol., Gainesville. Spec. Publ. 1: 184-198.
- Aldebert Y., Desoutter M., Quéro J.C. 1990. Bothidae. In: Quéro J.C., Hureau J.C., Karrer C., Post A., Saldanha L. (eds.) Check-list of the fishes of the eastern tropical Atlantic (CLOFETA). JNICT, Lisbon; SEI, Paris; and UNESCO, Paris, 2: 1027-1036.
- Alemany Llodrà F. 1997. Ictioplancton del Mar Balears. Resultados de las campañas "Balearia", "Miver", "Canal de Ibiza", proyecto "Bahia" y proyecto "Radiales". Tesis Doctorales.
- Alonso-Allende J.M., Vazquez A., Labarta E., Fuertes J.R., Perez-Gandaras G., Touron J. 1978. Análisis de la pesquería demersal de Galicia. Resultados de la campaña Galicia III (Junio 1976). Res. Exp. Clent. B/O Cornide, 7: 93-130.
- Anderson W.W., Gehringer J.W., Berry F.H. 1966. Family Synodontidae: Lizardfishes. In: Anderson W.W. et al. (eds.) Fishes of the western North Atlantic. Part five. New Haven, Sears Found. Mar. Res., Yale Univ., p: 30-102.
- Anderson W.W. 1958. Larval development, growth and spawning of striped mullet (*Mugil cephalus*) along the South Atlantic

- coast of the U.S. Fish. Bull. U.S., 58: 501-519.
- Arbault S., Boutin N. 1968. Ichthyoplanton. Oeufs et larves de poissons téléostéens dans le golfe de Gascogne en 1964. Rev. Trav. Off. Sci. Tech. Pêch. Marit., 32 (4): 413-476.
- Backus R.H. 1968. *Ceratoscopelus maderensis*: peculiar sound-scattering layer identified with this myctophid fish. Science, 160: 911-993.
- Badcock J. 1984. Gonostomatidae. In: Whitehead P.J.P., Bauchot M.L., Hureau J.C., Nielsen J., Tortonese E. (eds.) Fishes of the north-eastern Atlantic and the Mediterranean. UNESCO, Paris, 1: 284-301.
- Baglin, R.E. Jr. 1982. Reproductive biology of western Atlantic bluefin tuna. Fish. Bull., 80: 121-134.
- Barnabè G., Renè F. 1973. Aquaculture marine. Reproduction contrôlée et production d'alevins chez la dorade *Sparus auratus*. C.R. Acad. Sci. Paris Ser. D., 276: 1621-1624.
- Bath H. 1979. Blenniidae. In: Hureau J.C., Monod Th. (eds.) Check-list of the fishes of the north-eastern Atlantic and of the Mediterranean (CLOFNAM). UNESCO, Paris, 1: 519-527.
- Bauchot M.L. 1987. Poissons osseux. In: Fischer W., Bauchot M.L., Schneider M. (eds.) Fiches d'identification pour les besoins de la pêche. (rev. 1). Méditerranée et mer Noire. Zone de pêche 37. Vol. 2. Commission des Communautés Européennes and FAO, Rome, p: 891-1421.
- Bauchot M.L., Saldanha L. 1986. Congridae (including Heterocongridae). In: Whitehead P.J.P., Bauchot M.L., Hureau J.C., Nielsen J., Tortonese E. (eds.) Fishes of the north-eastern Atlantic and the Mediterranean. UNESCO, Paris, 2: 567-574.
- Bauchot M.L., Hureau J.C. 1990. Sparidae. In: Quérou J.C., Hureau J.C., Karrer C., Post A., Saldanha L. (eds.) Check-list of the fishes of the eastern tropical Atlantic (CLOFETA). JNICT, Lisbon; SEI, Paris; and UNESCO, Paris, 2: 790-812.
- Baumar J., Marin E., Gomez A.G., Urosa L.J. 1989. Taxonomia y distribucion del ictioplanton en la fosa de Cariaco, Venezuela. Bol. Inst. Oceanogr. Venez. Univ. Oriente, 28: 15-27.
- Beebe W. 1932. Nineteen new species and four post-larval deep-sea fish. Zoologica, 13: 47-107.
- Ben Salem M. 1988. Régime alimentaire de *Trachurus trachurus* (Linnaeus, 1758) et de *T. mediterraneus* (Steindachner, 1868), (poissons, téléostéens, Carangidae) de la province atlantico-méditerranéenne. Cybium, 12 (3): 247-253.
- Béranger K., Mortier L., Gasparini G.P., Gervasio L., Astraldi M., Crépon M. 2004. The dynamics of the Sicily Strait: a comprehensive study from observations and models, Deep Sea Res. II, 51 (4-5): 411-440.
- Béranger K., Mortier L., Crepon M. 2005. Seasonal variability of water transport through the Straits of Gibraltar, Sicily and Corsica, derived from a high-resolution model of the Mediterranean circulation. Prog. Oceanogr., 66 (2-4): 341-364.
- Berry F.H., Vogele L.E. 1961. Filefishes (Monacanthidae) of the western North Atlantic. Fish. Bull. U.S., 61: 60-109.
- Bianchi G., Carpenter K.E., Roux J.P., Molloy F.J., Boyer D., Boyer H.J. 1993. FAO Species Identification Field Guide for Fisheries Purposes. The Living Marine Resources of Namibia. FAO, Rome, 1: 1-250.
- Bigelow H.B., Breder C.M., Olsen Y.H., Cohen D.M., Schroeder W.C., Mead G.M., Schultz L.P., Merriman D., Tee-Vann J. (eds.) 1964. Fishes of the Western North Atlantic. Part Four. Order Isospondyli (part). Suborder Argentinioidea. Suborder Stromiatioidea. Suborder Esocioidea. Suborder Bathylaconoidea. Order Giganturoidei. New Haven, Connecticut: Sears Foundation for Marine Research, Yale University, 599 pp.

- Bini G. 1969. Atlante dei pesci delle coste italiane. Mondo Sommerso Editrice.
- Blache J. 1977. Leptocephales des poissons anguilliformes dans la zone Sud du Golfe de Guinée. ORSTOM, Faune Tropicale, 20: 1-381.
- Blanc M., Hureau J.C. 1979a. Scorpaenidae. In: Hureau J.C., Monod Th. (eds.) Check-list of the fishes of the north-eastern Atlantic and of the Mediterranean (CLOFNAM). UNESCO, Paris, 1: 579-585.
- Blanc M., Hureau J.C. 1979b. Triglidae. In: Hureau J.C., Monod Th. (eds.) Check-list of the fishes of the north-eastern Atlantic and of the Mediterranean (CLOFNAM). UNESCO, Paris, 1: 586-590.
- Blaxter J.H.S. 1957. Herring rearing – III. The effect of temperature and other factors on myotome counts. Mar. Res., 1: 1-16.
- Blood D.M., Matarese A.C., Yoklavich M.M. 1994. Embryonic development of wallaye pollock, *Theragra chalcogramma*, from Sheilikof Strait, Gulf of Alaska. Fish. Bull., 92: 207-222.
- Boeke J. 1903. On the early development of the Weever fish (*Trachinus vipera* and *Trachinus draco*). Tijdschr. Nederl. Dierk. Vereen., s. 2, vol. 8, p. 148.
- Boeke J. 1907. The later development of Trachinidae (*Trachinus vipera* and *Trachinus draco*). Tijdschr. Nederl. Dierk. Vereen., vol. 10, p. 245.
- Borges L. 2001. A new maximum length for the snipefish *Macrocramphosus scolopax*. Cybium, 25 (2): 191-192.
- Borme D., Tirelli V., Brandt S.B., Fonda Umani S., Arneri E. 2009. Diet of *Engraulis encrasicolus* in the northern Adriatic Sea (Mediterranean): ontogenetic changes and feeding selectivity. Mar Ecol. Prog. Ser., 392: 193-209.
- Breder C.M., Rosen D.E. 1966. Modes of reproduction in fishes. T.F.H. Publications, Neptune City, New Jersey, 941 pp.
- Brownell C.L. 1979. Stages in the early development of 40 marine fish species with pelagic eggs from the Cape of Good Hope. Ichthyological Bulletin of the J.L.B. Smith Institute of Ichthyology, Rhodes University, Grahamstown, (40): 84 pp.
- Bruslé S. 1980. Etude ultrastructurale des cellules germinales primordiales et de leur différenciation chez *Mugil cephalus* L. 1758 (Téléostéen, Mugilidé). Bull. Ass. Anat., 64 (185): 207-216.
- Campillo A. 1992. Les pêcheries françaises de Méditerranée: synthèse des connaissances. IFREMER, 206 pp.
- Castle P.H.J. 1969. Eggs and early larvae of the congrid eel *Gnathopis capensis* off Southern Africa. Ichthyol. Bull. J.L.B. Smith Inst. Ichthyol. Spec. Publ., 5: 1-5.
- Castle P.H.J. 1984. Notacanthiformes and Anguilliformes: Development. In: Moser H.G., Richards W.J., Cohen D.M., Fahay M.P., Kendall A.W., Richardson Jr.S.L. (eds.) Ontogeny and Systematics of Fishes. Amer. Soc. Ichthyol. Herpetol., Gainesville, Spec. Publ., 1: 62-93.
- Castriota L., Greco S., Marino G., Andaloro F. 2002. First record of *Seriola rivoliana* Cuvier, 1833 in the Mediterranean. J. Fish Biol., 60 (2): 486-488.
- Castro-Aguirre J.L., Espinosa Pérez H.S., Schmitter-Soto J.J. 1999. Ictiofauna estuarino-lagunar y vicaria de México. Colección Textos Politécnicos. Serie Biotecnologías: 1-711.
- Charter S.R., Moser H.G. 1996. Anguilliformes. In: Moser H.G. (ed.) The early stages of fishes in the California current region. CalCOFI Atlas, 33: 86-87.
- Chirichigno F., Norma D., Vélez J. 1998. Clave para identificar los peces marinos del Peru (Segunda edición, revidada y actualizada). Inst. Mar Peru, Publ. espec., 496 pp.
- Cipria G. 1938. Uova, stadi embrionali e post-embrionali di *Blennius ocellaris* L. ottenuti per fecondazione artificiale. Not. Ist. Biol. Rovigno, vol. 2, No. 4.
- Cohen D.M. 1984. Gadiformes overview. In: (Moser H.G., Richards W.J., Cohen D.M.,

- Fahay M.P., Kendall A.W., Richardson Jr.S.L. (eds.) Ontogeny and systematics of fishes. Amer. Soc. Ichthyol. Herpetol., Gainesville, Spec. Publ. No. 1: 259-264.
- Cohen D.M., Inada T., Iwamoto N., Scialabba N. 1990. FAO species catalogue. Gadiform fishes of the world (Order Gadiformes). An annotated and illustrated catalogue of cods, hakes, grenadiers and other gadiform fishes known to date. FAO Fish. Synop., 10: 442 pp.
- Collette B.B., Nauen C.E. 1983. FAO Species Catalogue. Vol. 2. Scombrids of the world. An annotated and illustrated catalogue of tunas, mackerels, bonitos and related species known to date. FAO Fish. Synop., 125 (2): 137 pp.
- Conand F., Fagetti E. 1971. Description et distribution saisonnière des larves de sardinelles des côtes du Sénégal et de la Gambie en 1968 et 1969. Cah. ORSTOM Sér. Océanogr., 9 (3): 293-318.
- Coombs S.H., Giovanardi O., Halliday N.C., Franceschini G., Conway D.V.P., Manzueto L., Barrett C.D., McFadzen I.R.B. 2003. Wind mixing, food availability and mortality of anchovy larvae *Engraulis encrasicolus* in the Northern Adriatic Sea. Mar. Ecol. Progr. Ser., 248: 221-235.
- Costa F. 1999. I pesci del Mediterraneo. Stadi larvali e giovanili. Edizioni Grafo Editor.
- Cressey R.F. 1986. Synodontidae. In: Smith M.M., Heemstra P.C. (eds.) Smiths' Sea Fishes. Springer-Verlag, Berlin, p: 270-273.
- Cunningham J.T. 1885. Relations of yolk to gastrula in teleosteans. Q. J. Microsc. Sci., 26 (2): 1-35.
- Cunningham J.T. 1887. The eggs and larvae of teleosteans. Trans. R. Soc. Edinb., 33 (1): 97-136.
- Cunningham J.T. 1888. Remarks on some teleostean ova, and their development. Rep. Br. Assoc. Advmt. Sci., 58 meet.: 703-704.
- Cunningham J.T. 1888. The reproductive organs of *Bdellostoma* and a teleostean ovum from the west coast of Africa. Trans. R. Soc. Edinb., 33 (1): 247-250.
- Cunningham J.T. 1889. Studies of the reproduction development of teleostean fishes occurring in the neighborhood of Plymouth. J. Mar. Biol. Ass. U.K., 1 (1): 10-54.
- Cunningham J.T. 1889. Notes on recent experiments relating to the growth and rearing of food fish at the laboratory. J. Mar. Biol. Ass. U.K., 1 (4): 367-370.
- Cuttitta A. 2004. Ecologia de huevos y larvas de anchoa *Engraulis encrasicolus* en el Canal de Sicilia. Tesis doctoral. Universidad de Vigo.
- D'Ancona U. 1931. Engraulidae. In: Bardi G.; Friedländer R. & Sohn (eds) Uova, larve e stadi giovanili di Teleostei. Fauna e Flora del Golfo di Napoli, Monogr., 38: 16-20.
- D'Ancona U. (1931). Apodes. In: Bardi G.; Friedländer R. & Sohn (eds) Uova, larve e stadi giovanili di Teleostei. Fauna e Flora del Golfo di Napoli, Monogr., 38: 94-156.
- Davis W.P, Fricke R. 1990. Callionymidae. In: Quéro J.C., Hureau J.C., Karrer C., Post A., Saldanha L. (eds.) Check-list of the fishes of the eastern tropical Atlantic (CLOFETA). JNICT, Lisbon, SEI, Paris; and UNESCO, Paris, 2: 921-924.
- De Gaetani 1932 Uova, larve e stadii giovanili di *Heliastes chromis*. Mem. R. Com. Talass. It. CXCI.
- de Sylva D.P. 1984. Mugiloidei: development and relationships. Moser H.G., Richards W.J., Cohen D.M., Fahay M.P., Kendall A.W.Jr., Richardson S.L. (eds.) Ontogeny and systematics of fishes. Am. Soc. Ichthyol. Herpetol. Spec. Publ., 1: 530-533.
- Demir N. 1972. The abundance and distribution of the eggs and larvae of some teleost fishes off Plymouth in 1969 and 1970. II. The postlarvae of *Callionymus*. J. Mar. Biol. Ass. U.K., 52: 997-1010.
- Desoutter M. 1990. Cynoglossidae. In: Quéro J.C., Hureau J.C., Karrer C., Post A., Saldanha L. (eds.) Check-list of the fishes of the eastern tropical Atlantic (CLOFETA). JNICT, Lisbon; SEI, Paris; and UNESCO, Paris, 2: 1050-1054.

- Ege V. 1930. Suididae (*Paralepis*). Rep. Danish Oceanogr. Exp. Med. 1908-1910, 2 (A 13): 1-201.
- Ehrenbaum E. 1897. Eier und Larven von Fischen der deutschen Bucht. Wiss. Meeresuntersuch. Helgoland, N.F., 2: 255-324. Pls III-VI.
- Ehrenbaum E. 1909. Eier und larven von Fischen. In: Lipsius und Tischer (eds.) Nordisches Plankton. Kiel, 1: 1-414.
- Ehrenbaum E. 1924 Scombriformes. Rep. Danish Oceanogr. Exp. 1908-1910, 2 (A 11), 42 pp.
- Ehrich S. 1990. Macroramphosidae. In: Quérou J.C., Hureau J.C., Karrer C., Post A., Saldanha L. (eds.) Check-list of the fishes of the eastern tropical Atlantic (CLOFETA). JNICT, Lisbon; SEI, Paris; and UNESCO, Paris, 2: 656-657.
- Emery C. 1885. Contribuzioni all'Ittiologia. XIII: *Bellottia apoda*. XIV. *Pteridium atrum*. Mitt. Zool. Stat. Neapel, 6: 157 pp.
- Eschmeyer W.N. 1986. Scorpaenidae. In: Smith M.M., Heemstra P.C. (eds.) Smiths sea fishes. Johannesburg: Macmillan South Africa, p: 463-478.
- Fage L. 1918. Shore-fishes: Macrorhamphosidae, Ammodytidae, Atherinidae, Serranidae, Chilodipteridae, Cepolidae, Sparidae, Mullidae, Pomacentridae, Labridae, Caproidae, Scorpaenidae, Triglidae, Cyclopteridae, Trachindae, Uranoscopidae, Callionymidae, Blennidae, Ophididae. Rep. Dan. Oceanogr. Exped. 1908-1910, Medit. adjac. Seas, 2 (A 3): 1-154.
- Fahay M.P. 1983. Guide to the early stages of marine fishes occurring in the western North Atlantic Ocean, Cape Hatteras to the southern Scotian Shelf. J. Northwest Atl. Fish. Sci., 4: 423 pp.
- Fahay M.P., Markle D.F. 1984. Gadiformes: Development and relationships. In: Moser H.G., Richards W.J., Cohen D.M., Fahay M.P., Kendall A.W.Jr., Richardson S.L. (eds.) Ontogeny and systematics of fishes. Allen Press, Lawrence, KS. Am. Soc. Ichthyol. Herpetol. Spec. Publ. 1: 265-283.
- Farrugio H. 1981. Exploitation et dynamique des populations de thon rouge *Thunnus thynnus* (Linné, 1758) atlanto-méditerranéennes. Université des Sciences et Techniques du Languedoc.
- Ferreiro M.J. 1986. Ictioplancton de la ria de Vigo. Tesis Doctoral. Universidad de Santiago de Compostela.
- Ferreiro M.J., Labarta U. 1988. Distribution and abundance of teleostean eggs and larvae on the NW coast of Spain. Mar. Ecol. Progr. Ser., 43: 189-199.
- Fischer W., Krupp F., Schneider W., Sommer C., Carpenter K.E., Niem V.H. 1995. Guía FAO para la identificación para los fines de la pesca. Pacífico centro-oriental. Volumen 2. Vertebrados-Parte 1. Guía Pesca Cent.-Orient. Pacífico, p: 647-1200.
- Ford E. 1922 On the young stages of *Blennius ocellaris*, *B. pholis*, *B. gattorugine*. J. Mar. Biol. Plymouth, vol. XII, 688 pp.
- Fricke R. 1986. Callionymidae. In: Whitehead P.J.P, Bauchot M.L., Hureau J.C., Nielsen J., Tortonese E. (eds.) Fishes of the North-eastern Atlantic and the Mediterranean. UNESCO, Paris, 3: 1086-1093.
- Froese R. 1988. The use of quadratic discriminant functions in connection with video-based measurements for identification of fish larvae. ICES C.M. 1988/L., 11: 8 pp.
- Froese R. 1989. Computer-aided approaches to identification. II. Numerical taxonomy. Fishbyte, 7: 25-28.
- Froese R. 1990a. Growth strategies of fish larvae. ICES C.M. 1990/L., 91: 20 pp.
- Froese R. 1990b. Moderne Methoden zur Bestimmung von Fischlarven. Universität Hamburg. Doctoral thesis. 260 pp.
- Froese R., Schöfer W. 1987. Computer-aided identification of fish larvae. ICES C.M. 1987/L., 23: 10 pp.
- Froese R., Schöfer W., Röpke A., Schnack D. 1989. Computer-aided approaches to

- identification of aquatic organisms: the use of Expert Systems. *Fishbyte*, 7 (2): 18-19.
- Froese R., Papisissi C. 1990. The use of modern relational databases for identification of fish larvae. *J. Appl. Ichthyol.*, 6: 37-45.
- Froese R., Achenbach I., Papisissi C. 1990. Computer-aided approaches to identification. III. (Conclusion). Modern databases. *Fishbyte*, 8: 25-27.
- Froese R., Pauly D. (eds.) 2006. Fishbase. World Wide Web electronic publication. <http://www.fishbase.org>.
- García Lafuente J., García A., Mazzola S., Quintanilla L., Delgado J., Cuttita A., Patti B. 2000. Influence of the surface circulation on the spawning strategy of the Sicilian Channel anchovy. Contributions Agendas and Ordes of the Day Abstracts. ICES Annual Science Conference 27-30 September 2000 – 88th Statutory Meeting 24 September to 4 October 2000. Congress Centre Oud Sint-Jan, Brugge, Belgium.
- García Lafuente J., García A., Mazzola S., Quintanilla L., Delgado J., Cuttita A., Patti B. 2002. Hydrographic phenomena influencing early life stages of the Sicilian Channel anchovy. *Fish. Oceanogr.*, 11: 31-44.
- Garnaud J. 1962. Monographie de l'Apogon méditerranéen: *Apogon imberbis* (L.) 1758. *Bull. Inst. Océanogr. Monaco*, 1248: 83 pp.
- Gasparini G.P., Bonanno A., Zgozi S., Basilone G., Borghini M., Buscaino G., Cuttita A., Essarbout N., Mazzola S., Patti B., Ramadan A. B., Schroeder K., Bahri T., Massa F. 2008. Evidence of a dense water vein along the Libyan continental margin. *Ann. Geophys.*, 26: 1-6.
- Gil F., Borges R., Faria C., Gonçalves E.J. 2002. Early development of the red mouthed goby, *Gobius cruentatus* (Pisces: Gobiidae). *J. Mar. Biol. Ass. U.K.*, 82: 161-163.
- Glamuzina B., Glavić N., Tutman P., Kožul V., Skaramuca B. 2000. Egg and early larval development of laboratory reared goldblotch grouper, *Epinephelus costae* (Steindachner, 1878) (Pisces, Serranidae). *Sci. Mar.*, 64 (3): 341–345.
- Golani D. 1993. The biology of the Red Sea migrant, *Saurida undosquamis* in the Mediterranean and comparison with the indigenous confamilial *Synodus saurus* (Teleostei: Synodontidae). *Hydrobiologia*, 271 (2): 109-117.
- Golani D. 1994. Gonostomatidae, Photichthyidae and Myctophidae from the Mediterranean coast of Israel. *Senckenb. Marit.*, 25 (1-3): 33-40.
- Gomes J. 1990. Bramidae. In: Quéro J.C., Hureau J.C., Karrer C., Post A., Saldanha L. (eds.) Check-list of the fishes of the eastern tropical Atlantic (CLOFETA). JNCT, Lisbon; SEI, Paris; and UNESCO, Paris, 2: 758-764.
- Goodyear R.H., Zauranec B.J., Laurence W., Gibbs R.H. 1972. Ecology and vertical distribution of Mediterranean and mid-water fishes. *Mediterr. Biol. Stud. Limnol. Rep.*, 1: 91-229.
- Gorbunova N.N. 1981. Larvae of the genus *Vinciguerrria* (Gonostomidae) with keys. *J. Ichthyol.*, 21: 138-141.
- Gordina A.D. 1986. Species composition of ichthyoplankton in seven regions of the East-Central Atlantic during January-April 1981. *J. Ichthyol.*, 26: 117-123.
- Gordon D.J., Markle D.F., Olney J.E. 1984. Ophidiiformes: Development and relationships. In: Moser H.G., Richards W.J., Cohen D.M., Fahay M.P., Kendall A.W. Jr., Richardson S.L. (eds.) Ontogeny and systematics of fishes. Allen Press, Lawrence, KS. *Am. Soc. Ichthyol. Herpetol. Spec. Publ.*, 1: 308-319.
- Grassi B. 1910 Contribuzione allo studio dello sviluppo dei Murenoidi. *Mem. R. Com. Talass. It. I.*
- Grassi B. 1913 Metamorfosi dei Murenoidi. *Ricerche sistematiche ed ecologiche*. Jena.
- Grassi B. 1914 Contributo alla conoscenza delle uova e delle larve dei Murenoidi. (Aggiunta I alla Monografia sulla

- metamorfosi dei Murenoidi). Mem. R. Accad. Lincei, ser. 5, vol. X, p. 37 e Mem. R. Com. Talass. It. XLII.
- Grassi B. 1917 Contributo alla conoscenza delle uova e delle larve dei Murenoidi. (Aggiunta II alla Monografia sulla metamorfosi dei Murenoidi). Mem. R. Com. Talass. It. XLV e Mem. R. Accad. Lincei, ser. 5, vol. X, fasc. XVI, 1915.
- Grothues T.M., Cowen R.K. 1999. Larval fish assemblages and water mass history in a major faunal transition zone. Cont. Shelf. Res., 19 (9): 1171-1198.
- Guibout P. 1987. Atlas hydrologique de la Méditerranée, Ifremer et S.H.O.M., Brest.
- Haedrich R.L. 1986. Bramidae. In: Whitehead P.J.P., Bauchot M.L., Hureau J.C., Nielsen J., Tortonese E. (eds.) Fishes of the north-eastern Atlantic and the Mediterranean. UNESCO, Paris, 2: 847-853.
- Haigh E.H. 1972. Development of *Trachurus trachurus* (Carangidae), the south African maasbanker. Ann. S. Afr. Mus., 59 (8): 139-149.
- Harrison I.J. 1995. Mugilidae. Lisas. In: Fischer W., Krupp F., Schneider W., Sommer C., Carpenter K.E., Niem V. (eds.) Guía FAO para identificación de Especies para lo Fines de la Pesca. Pacífico Centro-Oriental. FAO, Rome, 3: 1297-1298.
- Heemstra P.C. 1986. Macrorhamphosidae. In: Smith M.M., Heemstra P.C. (eds.) Smith's sea fishes. Springer-Verlag, Berlin, p: 459-461.
- Heemstra P.C., Randall J.E. 1993. FAO Species Catalogue. Groupers of the World (Family Serranidae, Subfamily Epinephelinae). FAO, Rome, 16: 382 pp.
- Helfman G., Collette B., Facey D. 1997. The diversity of fishes. Blackwell Science, Malden, MA., 528 pp.
- Hempel G. 1979. Early life history of marine fish. The egg stage. Univ. Washington Press, Seattle, p: 1-70.
- Hildebrand S.F., Cable L.E. 1930. Development and life history of fourteen teleostean fishes at Beaufort, N.C. Bull. U.S. Bur. Fish., 46: 383-488.
- Holt E.W.L. 1891 Survey of fishing grounds, west coast of Ireland, 1890-1. On the eggs and larvae of Teleosteans. Trans. R. Dublin Soc. , vol. 4, 435 pp.
- Holt E.W.L. 1899. Recherches sur la reproduction des Poissons osseux principalement dans le Golfe de Marseille. Anns Mus. Hist. nat. Marseille, 5, Mém. 2, 128 pp., Pls 1-9.
- Houde E.D. 1984. Callionymidae: development and relationships. In: (Moser H.G., Richards W.J., Cohen D.M., Fahay M.P., Kendall A.W., Richardson Jr.S.L. (eds.) Ontogeny and systematics of fishes. Amer. Soc. Ichthyol. Herpetol., Gainesville, Spec. Publ. 1: 637-640.
- Hulley P.A. 1990. Myctophidae. In: Quéro J.C., Hureau J.C., Karrer C., Post A., Saldanha L. (eds.) Check-list of the fishes of the eastern tropical Atlantic (CLOFETA). JNICT, Lisbon; SEI, Paris, 1: 398-467.
- Hureau J.C. 1986. Triglidae. In: Whitehead P.J.P., Bauchot M.L., Hureau J.C., Nielsen J., Tortonese E. (eds.) Fishes of the North-eastern Atlantic and the Mediterranean. UNESCO, Paris, 3: 1230-1238.
- Hureau J.C., Litvinenko N.I. 1986. Scorpaenidae. In: Whitehead P.J.P., Bauchot M.L., Hureau J.C., Nielsen J., Tortonese E. (eds.) Fishes of the North-eastern Atlantic and the Mediterranean. UNESCO, Paris, 3: 1211-1229.
- Hureau J.C., Monod Th. 1979. Check-list of the fishes of the north-eastern Atlantic and Mediterranean with supplement 1978. (CLOFNAM). Unesco, Paris, 1-2. (Supplement: Tortonese E.).
- Hureau J.C., Tortonese E. 1979. Carangidae. In: Hureau J.C., Monod Th. (eds.) Check-list of the fishes of the north-eastern Atlantic and of the Mediterranean (CLOFNAM). UNESCO, Paris, 1: 373-384.
- Jardas I. 1996. Jadranska ihtiofauna. Školska knjiga, Zagreb, 533 pp.

- Jespersen P., Tåning A.V. 1919. Some Mediterranean and Atlantic Sternoptychidae. Preliminary note. Vidensk. Medd. dansk. naturh. Foren. Kbh, p: 215-226.
- Jespersen P., Tåning A.V. 1926. Ecologie alimentaire de *Cyclothone braueri* (Gonostomatidae) en mer Ligure, Méditerranée occidentale. J. Plankton Res., 12 (3): 519-534.
- Johnson G.D. 1974. A revision of the alepisauroid family Scopelarchidae (Pisces: Myctophiformes). Field Zool., 66: 1-249.
- Johnson G.D. 1984. Percoidei: Development and relationships. In: H.G. Moser, W.J. Richards, D.M. Cohen, M.P. Fahay, A.W. Kendall, Jr.S.L. Richardson, (eds.) Ontogeny and systematics of fishes. Spec. Publ. No. 1, Amer. Soc. Ichthyol. Herpetol., Gainesville, pp: 464-498.
- Johnson G.D., Gill A.C. 1998. Perches and their allies. In: Paxton J.R., Eschmeyer W.N. (eds) Encyclopedia of Fishes (2nd edition). Academic Press, San Diego: 181-194.
- Kalinina E.M. 1980. Key to the pelagic eggs of central-eastern Atlantic fishes. Ekologiya Morya, 4: 50-62.
- Karlou-Riga C. 1995. Biology and dynamics of the *Trachurus* species (Pisces, Carangidae) in the Saronikos Gulf. Ph.D. Thesis, Aristotle University of Thessaloniki, 296 pp.
- Karlou-Riga C., Economidis P.S. 1997. Spawning frequency and batch fecundity of horse mackerel, *Trachurus trachurus* (L.), in the Saronikos Gulf (Greece). J. Appl. Ichthyol., 13 (3): 97-104.
- Kendall A.W.Jr. 1979. Morphological comparisons of North American sea bass larvae (Pisces: Serranidae). NOAA Tech. Rep. NMFS Circ., 428, 50 pp.
- Kendall A.W.Jr. 1984. Serranidae: development and relationships. In: (Moser H.G., Richards W.J., Cohen D.M., Fahay M.P., Kendall A.W., Richardson Jr.S.L. (eds.) Ontogeny and systematics of fishes. Amer. Soc. Ichthyol. Herpetol., Gainesville, Spec. Pub 1: 499-510.
- Kendall A.W.Jr., Walford LA. 1979. Sources and distribution of bluefish, *Pomatomus saltatrix*, larvae and juveniles off the east coast of the United States. Fish. Bull. U. S., 77: 213-227.
- King D.P.F., O'Toole M.J., Robertson A.A. 1977. Early development of South African maasbanker *Trachurus trachurus* L. at controlled temperatures. Fish. Bull. (S. Afr.), 9: 16-22.
- King D.P.F., Robertson A.A., Shelton P.A. 1978. Laboratory observation on the development of the anchovy *Engraulis capensis* from the Cape peninsula. Fish. Bull. (S. Afr.), 10: 37-45.
- Korichi H.S. 1988. Contribution à l'étude biologique des deux espèces de saurels: *Trachurus trachurus* (Linné, 1758) et *Trachurus mediterraneus* (Steindachner, 1868) et de la dynamique de *Trachurus trachurus* (Linné, 1758) en baie de Bou-Ismaïl (Alger). ISMAL. Alger. Thèse de Magister., 203 pp.
- Koutrakis E.T., Kallianiotis A.A., Tsikliras A.C. 2004. Temporal patterns of larval fish distribution and abundance in a coastal area of northern Greece. Sci. Mar., 68 (4): 585-595.
- Kyle H.M. 1913. Flat-fishes (Heterosomata). Rep. Dan. Oceanogr. Exped. 1908-1910. Medit. adjac. seas, Vol. II, Biology. A 1, 150, 30 pp. Text-figs, Pls I-VI.
- Kyrtatos N.A. 1998. Contribution à la connaissance de la nourriture de *Trachurus mediterraneus* (Steind.) et de son influence sur les chaînes alimentaires de la mer Égée Centrale. Rapp. Comm. Int. Explor. Sci. Mer Méditerr., 35: 452-453.
- Labelle M., Hoch T., Liorzou B., Bigot J.L. 1997. Indices of bluefin tuna (*Thunnus thynnus thynnus*) abundance derived from sale records of French purse seine catches in the Mediterranean sea. Aquat. Living Resour., 10: 329-342.

- Labropoulou M., Papaconstantinou C. 2000. Community structure of deep-sea demersal fish in the North Aegean Sea (northeastern Mediterranean). *Hydrobiologia*, 440: 281-296.
- Lacombe H., Gascard J.C., Gonella J., Bethoux J.P. 1981. Response of the Mediterranean to the water and energy fluxes across its surface, on seasonal and interannual scales. *Oceanol. Acta*, 4 (2): 247-255.
- Lagler K.F., Bardaci J.E., Miller R.R. 1962. *Ichthyology*. Wiley, New York.
- Lasker R. 1981. The role of a stable ocean in larval fish: survival and subsequent recruitment. In: Lasker R. (ed.) *Marine Fish Larvae, Ecology, and Relation to Fisheries*. University of Washington Press, Seattle and London, 131 pp.
- Leiby M.M. 1982. Leptocephalus larvae of the tribe Sphagebranchini (Pisces, Ophichthidae) in the western North Atlantic. *Bull. Mar. Sci.*, 32: 220-236.
- Leiby M.M. 1990. Ophichthidae. In: Quéro J.C., Hureau J.C., Karrer C., Post A., Saldanha L. (eds.) *Check-list of the fishes of the eastern tropical Atlantic (CLOFETA)*. JNICT, Lisbon; SEI, Paris; and UNESCO, 1: 176-192.
- Leis J.M. 1984. Tetraodontoidei: development. In: Moser H.G., Richards W.J., Cohen D.M., Fahay M.P., Kendall A.W., Richardson Jr.S.L. (eds.) *Ontogeny and systematics of fishes*. Amer. Soc. Ichthyol. Herpetol., Gainesville, Spec. Publ. 1: 447-450.
- Leis J.M., Rennis D.S. 1983. The larvae of Indo-Pacific coral reef fishes. New South Wales Univ. Press, Kensington, p: 1-269.
- Leis J.M., Carson-Ewart B.M. 2000. *Fauna Malesiana Handbooks 2. The larvae of Indo-Pacific coastal fishes. An identification guide to marine fish larvae*. E.J. Brill, Leiden, 857 pp.
- Lermusiaux P.F.J., Robinson A.R. 2001. Features of dominant mesoscale variability, circulation patterns and dynamics in the Strait of Sicily. *Deep-Sea Res. Part I*, 48: 1953-1997.
- Linkowski T.B. 1987. Age and growth of four species of *Electrona* (Teleostei, Myctophidae).
- Lo Bianco S. 1904. Pelagiche Tiefseefischerei der "Maja" in der Umgebung von Capri. Jena, p: 41-45.
- Lo Bianco S. 1909. Notizie biologiche riguardanti specialmente il periodo di maturità sessuale degli animali del golfo di Napoli. *Mitt. Zool. Stn. Neapel*, 19: 513-761.
- Lo Bianco 1937 Tavola XXXI. In: Bardi G.; Friedländer R. & Sohn (eds) *Uova, larve e stadi giovanili di Teleostei*. Fauna e Flora del Golfo di Napoli, Monografia 38.
- Lo Bianco 1956. Tavola XXXIX. In: Bardi G.; Friedländer R. & Sohn (eds) *Uova, larve e stadi giovanili di Teleostei*. Fauna e Flora del Golfo di Napoli, Monografia 38.
- Loris D., Rucabado J. 1990. Pomacentridae. In: Quéro J.C., Hureau J.C., Karrer C., Post A., Saldanha L. (eds.) *Check-list of the fishes of the eastern tropical Atlantic (CLOFETA)*. JNICT, Lisbon; SEI, Paris; and UNESCO, Paris, 2: 842-850.
- Maigret J., Ly B. 1986. Les poissons de mer de Mauritanie. *Science Nat., Compiègne*, 213 pp.
- Malanotte-Rizzoli P., Manca B., Ribera d'Alcalà M., Theocharis A., Bergamasco A., Bregant D., Budillon G., Civitarese G., Georgopoulos D., Michelato A., Sansone E., Scarazzato P., Souvermezoglou E. 1997. A synthesis of the Ionian Sea hydrography, circulation and water mass pathways during POEM Phase I, *Progr. Oceanogr.*, 39: 153-204.
- Manzella G.M.R. 1994. The seasonal variability of the water masses and transport through the Strait of Sicily. In: La Violette P.E. (ed.) *Coastal and estuarine studies 46: Seasonal and Interannual Variability of the Western Mediterranean Sea*, AGU. Washington DC, p: 33-45.

- Marinero J.Y. 1971. Contribution à l'étude des oeufs et larves pélagiques de poissons méditerranéens. V. Oeufs pélagiques de la Baie d'Alger. Pelagos, Bull. Inst. Océanogr. Alger., 3 (1): 1-118.
- Marino G., Mandich A., Massari A., Andaloro F., Porrello S. 1995. Aspects of reproductive biology of the Mediterranean amberjack (*Seriola dumerilii* Risso) during the spawning period. J. Appl. Ichthyol., 11 (1-2): 9-24.
- Martin F.D., Drewry G.E. 1978. Development of fishes of the mid-Atlantic Bight: an atlas of eggs, larvae and juvenile stages. Vol. 6. Stromateidae through Ogcocephalidae. Biol. Ser. Prog., Fish Wildl. Serv., U.S. Dept. Interior, 416 pp.
- Massutì E., Stefanescu C. 1993. First record of *Seriola fasciata* (Bloch, 1793) (Osteichthyes: Carangidae) in the Mediterranean. J. Fish Biol., 42 (1): 143-144.
- Mastail M., Battaglia A. 1978. Amélioration de la conservation des pigments du zooplacton. CIEM Conseil International pour l'Exploration de la Mer, Comité de l'Océanographie biologique, C.M.1978/L, 20 pp.
- Masterman A.T. 1893. General report on the pelagic eggs, larval and young fishes procured by the "Garland" in 1892 and 1893. 11th Annu. Rep. Fish. Board Scotl., p: 250-264.
- Masterman A.T. 1896a. Note on the rate of growth, larval and post-larval forms of the herring. 14th Annu. Rep. Fish. Board Scotl., p: 294-502.
- Masterman A.T. 1896b. The effects of pelagic spawning habit on the life histories of fishes. Rep. Br. Assoc. Advmt. Sci., 66th Mtg., 837 pp.
- Masterman A.T. 1897. A review of the work of the "Garland" in connection with the pelagic eggs of the food-fishes, 1890-1896. 15th Annu. Rep. Fish. Board Scotl., pt. 3: 219-261.
- Masterman A.T. 1901. A contribution to the life histories of the cod and whiting. Trans. R. Soc. Edinb., 40: 1-14.
- Masterman A.T. 1910. Report on the later stages of the Pleuronectidae. Rapp. P.-v. Reun. Cons. prm. it. Explor. Mer, 12 C (4): 1-82.
- Matsuura Y. 1976. A study of the early life history of the Brazilian sardine *Sardinella braziliensis* (Steindalhnner, 1879) and oceanographic conditions. Ph. D. Diss., Ocean Res. Inst., Univ. Tokyo, p: 1-133.
- Matsuura Y., Olivar M.P. 1999. Fish larvae. In: Demetrio Boltovskoy (ed) South Atlantic zooplankton, Backhuys Publishers, Leiden, Vol. 2, p: 1445-1496.
- Mazzarelli G. 1912. Studi sui pesci batipelagici nello stretto di Messina. I. Larve stiloftalmoidi ("periscopiche" di Holt e Byrne) di Scopelidi e loro metamorfosi iniziale. Riv. Mens. Pesca, Pavia, vol. VII, n. 1-3, p. 1.
- McAllister D.E. 1993. Marine biodiversity: jewel lanternfish, *Lampanyctus crocodilus*. Sea Wind, 6: 25-26.
- McGowan M.F., Berry F.H. 1984. Clupeiformes: Development and relationships. In: Moser H.G., Richards W.J., Cohen D.M., Fahay M.P., Kendall A.W., Richardson Jr.S.L. (eds.) Ontogeny and systematics of fishes. Amer. Soc. Ichthyol. Herpetol., Gainesville, Spec. Publ. 1: 108-126.
- McIntosh W.C. 1885. Notes from the St. Andrews Marine Laboratory. III. On the ova of *Callionymus lyra* L. Ann. Mag. Nat. Hist. 5, Ser. 15: 480-492.
- McIntosh W.C. 1885. The spawning of certain marine fishes. Ann. Mag. Nat. Hist. 7.
- McIntosh W.C. 1885. The eggs of fish. Nature, Lond., 31 (1885): 534-536, 555-557.
- McIntosh W.C. 1886. Remarks on the eggs of British marine fishes. Nature, Lond. 34: 147-148.

- McIntosh W.C. 1887. On the pelagic fauna of our shores in its relation to the nourishment of the young foodfishes. *Ann. Mag. Nat. Hist.* 5, Ser. 19: 137-145.
- McIntosh W.C. 1887. Notes from the St. Andrews Marine Laboratory; on a post-larval *Labrus* with remarks on the colour of pelagic fins. *Ann. Mag. Nat. Hist.* 5, Ser. 20: 300-304.
- McIntosh W.C. 1889. The eggs of fishes. *Bull. U.S. Fish Commn.*, 7: 58-62.
- McIntosh W.C. 1889. On the larval and postlarval stages of the sole and other foodfishes. *Rep. Br. Ass. Advmt. Sci.*, 59: 618.
- McIntosh W.C. 1890. Notes from the St. Andrews Marine Laboratory. XII (3). On the young stages of the gunnel (*Centronotus gunnellus*). *Ann. Mag. Nat. Hist.* 6, Ser. 6: 182-185.
- McIntosh W.C. 1890. Report on the pelagic ova, larval and young food-fishes procured by the "Garland." *Annu. Rep. Fish. Board Scotl.*, 8: 283-289.
- McIntosh W.C. 1890. Development and life histories of the teleostean fishes. *Edinburgh*, No. 4.
- McIntosh W.C., Prince E.E. 1890. On the development and life-histories of the teleostean food and other fishes. *Trans. R. Soc. Edimb.*, 35 pp.
- McIntosh W.C. 1891. Further observations on the life-histories and development of the food and other fishes. *Annu. Rep. Fish. Board Scotl.*, 9 (3): 317-342.
- McIntosh W.C. 1892. Contributions to the life-histories and development of the food and other fishes. IV. *Annu. Rep. Fish. Bd. Scotl.*, (1891) 10 (3): 273-322.
- McIntosh W.C. 1893. Contributions to the life-histories and development of the food and other fishes. IV. *Annu. Rep. Fish. Board Scotl.*, 11 (3): 239-249.
- McIntosh W.C. 1894. Contributions to the life-histories and development of the food and other fishes. IV. *Annu. Rep. Fish. Board Scotl.*, 12 (3): 218-230.
- McIntosh W.C. 1895. Contributions to the life-histories and development of the food and other fishes. *Annu. Rep. Fish. Board Scotl.*, (1894) 13 (3): 220-235.
- McIntosh W.C. 1896. Contributions to the life-histories and development of the food and other fishes. *Annu. Rep. Fish. Board Scotl.*, (1895) 14 (3): 171-185.
- McIntosh W.C. 1897. Contributions to the life-histories and development of the food and other fishes. *Annu. Rep. Fish. Board Scotl.*, (1896) 15 (3): 194-211.
- Megalofonou P. 1990. First age estimates of albacore, *Thunnus alalunga* Bonn, in the Aegean Sea using scales. *Rapports et Procès-Verbaux des Réunions Commission Internationale pour l'Exploration Scientifique de la Mer Méditerranée*, 32: 268 pp.
- Menon A.G.K. 1977. A systematic monograph of the tongue soles of the genus *Cynoglossus* Hamilton-Buchanan (Pisces: Cynoglossidae). *Smithson. Contrib. Zool.*, 238: 1-129.
- Mercader L., Lloris D., Rucabado J. 2003. Tots els peixos del mar Catala. *Diagnosis i claus d'identificació*. Institut D'estudis Catalans. Barcelona, 350 pp.
- Miller M.J., Aoyama J., Mochioka N., Otake T., Castle P.H.J., Minagawa G., Inagaki T., Tsukamoto K. 2006. Geographic variation in the assemblages of leptocephali in the western South Pacific. *Deep-Sea Res. Part A*, 53 (5): 776-794.
- Monod T. 1979a. Pomatomidae. In: Hureau J.C., Monod Th. (eds.) Check-list of the fishes of the north-eastern Atlantic and of the Mediterranean (CLOFNAM), UNESCO, Paris, 1: 369-370.
- Monod T. 1979. Chaetodontidae. In: Hureau J.C., Monod Th. (eds.) Check-list of the fishes of the north-eastern Atlantic and of the Mediterranean (CLOFNAM), UNESCO, Paris, 1: 422-423.

- Montalenti G. 1933. Maenidae. In: Bardi G.; Friedländer R. & Sohn (eds.) Uova, larve e stadi giovanili di Teleostei. Fauna e Flora del Golfo di Napoli, Monografia 38, p: 383-384.
- Morote E., Olivar M.P., Villate F., Uriarte I. 2008. Diet of round sardinella, *Sardinella aurita*, larvae in relation to plankton availability in the NW Mediterranean. J. Plankton Res., 30: 807-816.
- Morovic D. 1961. Contribution to the knowledge of the nutrition of blue-fin tuna (*Thunnus thynnus* L.) in the Adriatic from fishes caught with ring nets. Proceedings and Technical Papers of the General Fisheries Council for the Mediterranean 6: 155-157.
- Moser H.G. 1981. Morphological and functional aspects of marine fish larvae. In: R. Lasker (ed.) Marine fish larvae. Morphology, ecology and relation to fisheries. Univ. Washington Press, Seattle, p: 89-131.
- Moser H.G., Ahlstrom E.H. 1970. Development of lanternfishes (Family Myctophidae) in the California Current. Part I. Species with narrow-eyed larvae. Nat. Hist. Mus. Los Ang. Cty. Sci. Bull., 7: 145 pp.
- Moser H.G., Ahlstrom E.H. 1972. Development of lanternfish, *Scopelopsis multipunctatus* Brauer 1906, with a discussion of its phylogenetic position in the family Myctophidae and its role in a proposed mechanism for the evolution of photophore patterns in lanternfishes. Fish. Bull., 70: 541-564.
- Moser H.G., Ahlstrom E.H. 1974. Role of larval stages in the systematic investigations of marine teleosts: the Myctophidae, a case study. Fish. Bull. U.S., 72: 391-413.
- Moser H.G., Ahlstrom E.H. 1996. Myctophidae: lanternfishes. In: Moser H.G. (ed.) The early stages of fishes in the California Current region. California Cooperative Oceanic Fisheries Investigations (CalCOFI) Atlas, 33: 387-475.
- Moser H.G., Ahlstrom E.H., Sandknop E.M. 1977. Guide to the identification of Scorpionfish larvae (Family Scorpaenidae) in the Eastern North Pacific with comparative notes on the species of *Sebastes* and *Helicolenus* from other oceans. NOAA Techn. Rep., NMFS Circ., 402: 1-71.
- Moser H.G., Richards W.J., Cohen D.M., Fahay A., Kendall W.Jr, Richardson S.L. 1984a. Ontogeny and systematics of fishes. Am. Soc. Ichthyol. Herpetol. Spec. Pub. 1: 760 pp.
- Moser H.G., Ahlstrom E.H., Paxton J.R. 1984b. Myctophidae: Development. In: Moser H.G., Richards W.J., Cohen D.M., Fahay M.P., Kendall A.W., Richardson Jr.S.L. (eds.) Ontogeny and systematics of fishes, Amer. Soc. Ichthyol. Herpetol., Gainesville, Spec. Publ. 1: 218-239.
- Muus B.J., Nielsen J.G. 1999. Sea fish. Scandinavian Fishing Year Book, Hedehusene, Denmark, 340 pp.
- Mytilineou C., Politou C.Y., Papaconstantinou C., Kavadas S., D'Onghia G., Sion L. 2005. Deep-water fish fauna in the Eastern Ionian Sea. Belg. J. Zool., 135 (2): 229-233.
- Nakamura I., Parin N.V. 1993. FAO species catalogue. Snake mackerels and cutlassfishes of the world (Families Gempylidae and Trichiuridae). FAO Fish. Synop., 15: 136 pp.
- Nalbant T. 1986 Chaetodontidae. In: Whitehead P.J.P., Bauchot M.L., Hureau J.C., Nielsen J., Tortonese E. (eds.) Fishes of the north-eastern Atlantic and the Mediterranean. UNESCO, Paris, 2: 914-915.
- Nelson J.S. 2006. Fishes of the World. 4th Edition. New York, John Wiley and Sons, Inc., 624 pp.
- Nieder J., La Mesa G., Vacchi M. 2000. Blennidae along the Italian coasts of the Ligurian and the Tyrrhenian Sea: community structure and new records of *Scartella cristata* for northern Italy. Cybium 24 (4): 359-369.

- Nielsen J.G. 1990. Scophthalmidae. In: Quéro J.C., Hureau J.C., Karrer C., Post A., Saldanha L. (eds.) Check-list of the fishes of the eastern tropical Atlantic (CLOFETA). JNICT, Lisbon; SEI, Paris; and UNESCO, Paris, 2: 1026 pp.
- Nielsen J.G., Cohen D.M., Markle Robins C.R. 1999. Ophidiiform fishes of the world (Order Ophidiiformes). An annotated and illustrated catalogue of pearlfishes, cusk-eels, brotulas and other ophidiiform fishes known to date. FAO Fish. Synop. 125, 18: 178.
- Okiyama M. 1984. Myctophiformes: Development. In: H.G. Moser, W.J. Richards, D.M. Cohen, M.P. Fahay, A.W. Kendall, Jr.S.L. Richardson (eds.) Ontogeny and systematics of fishes. Amer. Soc. Ichthyol. Herpetol., Gainesville, Spec. Publ. 1: 206-218.
- Okiyama M. (ed.) 1988. An atlas of the early stage fishes in Japan. Tokai Univ. Press, Tokyo, p: 1-1154.
- Olivar M. P. 1988. Planktonic stages of lanternfishes (Osteichthyes, Myctophidae) in the Benguela upwelling region. Invest. Pesq., 52 (3): 387-420.
- Olivar M.P., Fortuño J.M. 1991. Guide to ichthyoplankton of the Southeast Atlantic (Benguela Current Region). Sci. Mar., 55: 1-383.
- Olivar M.P., Palomera I. 1994. Ontogeny and distribution of *Hygophum benoiti* (Pisces, Myctophidae) of the Northwestern Mediterranean. J. Plankton Res., 16 (8): 977-991.
- Olivar M.P., Moser H.G., Beckley L.E. 1999. Lanternfish larvae from the Agulhas current (SW Indian Ocean). Sci. Mar., 63: 101-120.
- Olivar M.P., Salat J., Palomera I. 2001. Comparative study of spatial distribution patterns of the early stages of anchovy and pilchard in the NW Mediterranean Sea. Mar. Ecol. Progr. Ser., 217: 111-120.
- Orozco Llerena M.V. 1983. Distribution and abundance of fish eggs and larvae from the northwestern region of the Cuban platform (Zone C.). Cienc. Biol., 9: 107-119.
- O'Sullivan S., Moriarty C., FitzGerald R.D., Davenport J, Mulcahy M.F. 2003. Age, growth and reproductive status of the European conger eel, *Conger conger* (L.) in Irish coastal waters. Fish. Res., 64: 55-69.
- Orsi Relini L., Cima C., Palandri G., Relini M., Garibaldi F. 1999. Feeding of the juvenile bluefin tuna in the offshore pelagic ecosystem of the Ligurian sea. Biol. Mar. Mediterr., 6 (2): 295-302.
- Ovchinnikov I.M. 1966. Circulation in the surface and intermediate layers of the Mediterranean. Oceanology, 24: 168-173.
- Ozawa T. 1986. Early life history of the family Myctophidae in the ocean off southern Japan. In: Ozawa T. (ed.) Studies on the oceanic ichthyoplankton in the western North Pacific. Kyushu Univ. Press, Fukuoka, p: 114-188.
- Ozawa T., Oda K. 1986. The larvae of gonostomatid genus *Cyclothone* in the western North Pacific. In: studies on the oceanic ichthyoplankton in the western North Pacific (T. Ozawa, ed.), Kyushu Univ. Press, Kukuoka, p: 52-67.
- Padoa E. 1956. Heterostomata. In Bardi G.; Friedländer R. & Sohn (eds.) Uova, larve e stadi giovanili di Teleostei, Fauna e Flora del Golfo di Napoli, Monografia 38.
- Palomera I. 1991. Vertical distribution of eggs and larvae of *Engraulis encrasicolus* in stratified waters of the western Mediterranean. Mar. Biol., 11: 37-44.
- Palomera I., Lleonaart J. 1989. Field mortality estimates of anchovy larvae (*Engraulis encrasicolus*) in the Western Mediterranean. Journal of Fish Biology, 35 (Suppl. A): 133-138.
- Papaconstantinou C., Caragitsou E., Vassilopoulou V., Petrakis G., Mytilineou C., Fourtouni A., Tursi A., Politou C.Y., Giagnisi M., D'Onghia G., Siapatis A., Matarese A., Economou A., Papageorgiou E. 1993. Investigation of the abundance and distribution of demersal stocks of primary

- importance to the Greek fishery in the Northern Aegean Sea (Greece). National Centre for Marine Research, Athens, Hellas, Technical Report March 1993, 316 pp.
- Papaconstantinou C., Politou C.Y., Caragitsou E., Stergiou K.I., Mytilineou C., Vassilopoulou V., Fourni A., Karkani M., Kavadas S., Petrakis G., Siapatis A., Chatzinikolaou P., Giagnisi M. 1994. Investigations on the abundance and distribution of demersal stocks of primary importance in the Thermatikos Gulf and the Thracian Sea (Hellas). National Centre for Marine Research, Athens, Hellas, Technical Report, North Aegean Sea Series 4/1994, 356 pp.
- Papasissi C. 1989. A contribution to the study of the biology of the ichthyoplankton in the Gulf of Kissamos (N.W. Crete, Greece). Thesis, 300 pp.
- Pertseva-Ostroumova T.A. 1974. New data on lanternfish larvae (Myctophidae, Pisces) with oval eyes from the Indian and Pacific Oceans. Trudy Inst. Okeanol. Akad. Nauk SSSR, 96: 77-142.
- Petersen C.G.J. 1909. On the larval and post-larval stages of some Pleuronectidae (*Zeugopterus*, *Arnoglossus*, *Solea*). Medd. Kom. Havunders. Kobenhavn, Ser. Fiskeri, 3 (1): 1-18.
- Potthoff T. 1974. Osteological development and variation in young tunas, genus *Thunnus* (Pisces, Scombridae) from the Atlantic Ocean. Fish. Bull., 72: 563-588.
- Poulain P.M., Zambianchi E. 2007. Surface circulation in the central Mediterranean Sea as deduced from Lagrangian drifters in the 1990s. Cont. Shelf Res., 27: 981-1001.
- Quéro J.C. 1990. Cepolidae. In: Quéro J.C., Hureau J.C., Karrer C., Post A., Saldanha L. (eds.) Check-list of the fishes of the eastern tropical Atlantic (CLOFETA). JNICT, Lisbon; SEI, Paris; and UNESCO, Paris, 2: 853-854.
- Quéro J.C., Njock J.C., de la Hoz M.M. 1990a. Gonostomatidae. In: Quéro J.C., Hureau J.C., Karrer C., Post A., Saldanha L. (eds.) Check-list of the fishes of the eastern tropical Atlantic (CLOFETA). JNICT, Lisbon; SEI, Paris; and UNESCO, Paris, 1: 283-292.
- Quéro J.C., Njock J.C., de la Hoz M.M. 1990b. Photichthyidae. In: Quéro J.C., Hureau J.C., Karrer C., Post A., Saldanha L. (eds.) Check-list of the fishes of the eastern tropical Atlantic (CLOFETA). JNICT, Lisbon; SEI, Paris; and UNESCO, Paris, 1: 343-348.
- Quignard J.P., Pras A. 1986a. Labridae. In: Whitehead P.J.P., Bauchot M.L., Hureau J.C., Nielsen J., Tortonese E. (eds.) Fishes of the north-eastern Atlantic and the Mediterranean. UNESCO, Paris, 2: 919-942.
- Quignard J.P., Pras A. 1986b. Pomacentridae. In: Whitehead P.J.P., Bauchot M.L., Hureau J.C., Nielsen J., Tortonese E. (eds.) Fishes of the north-eastern Atlantic and the Mediterranean. UNESCO, Paris, 2: 916-918.
- Raffaele F. 1888. Le uova galleggianti e le larve dei Teleostei nel Golfo di Napoli. Mitth. Zool. Stat. Neapel., vol. VIII, p. 1.
- Ranzi S. 1933. Famiglia 3: Sparidae. In: Uova, larve e stadi giovanili di Teleostei, Fauna Flora Golfo Napoli, Monogr., 38: 330-382.
- Ré P. 1986a. Ecologia da postura e da fase planctónica de *Sardina pilchardus* (Walbaum, 1792) na região central da costa portuguesa. Bol. Soc. Port. Cienc. Nat., 23: 5-81.
- Ré P. 1986b. Ecologia da postura e fase planctónica de *Engraulis encrasicolus* (Linnaeus, 1758) do estuário do Tejo. Publicações do Instituto de Zoologia "Dr. Augusto Nobre", 196: 45 pp.
- Ré P. 1987. Ecology of the planktonic phase of the anchovy, *Engraulis encrasicolus* (L.), within Mira estuary (Portugal). Invest. Pesq., 51: 581-598.
- Ré P. 1990. Ecologia da postura e da fase planctónica de *Engraulis encrasicolus* (L.) em três estuários portugueses. I Congresso do Tejo, 2: 231-236.

- Ré P., Meneses I. 2009. Early stages of marine fishes occurring in the Iberian Peninsula. *Ipimar/Imar*: 282 pp. ISBN-978-972-9372-34-6.
- Reay P.J. 1986. Ammodytidae. In: Whitehead P.J.P., Bauchot M.L., Hureau J.C., Nielsen J., Tortonese E. (eds.) *Fishes of the north-eastern Atlantic and the Mediterranean*. UNESCO, Paris, 2: 945-950.
- Richards W.J. 1989. Preliminary guide to the identification of the early life history stages of scombroid fishes of the western central Atlantic. NOAA Technical Memorandum NMFS-SEFC-240, 101 pp.
- Richards W.J., Potthoff T. 1974. Analysis of the taxonomic characters of young scombrid fishes, genus *Thunnus*. In: *The early life history of fish* (J.H.S. Blaxter, ed.), Springer-Verlag, Berlin, p: 623-648.
- Riera F., Grau A., Grau A.M., Pastor E., Quetglas A., Pou S. 1999. Ichthyofauna associated with drifting floating objects in the Balearic Islands (western Mediterranean). *Sci. Mar.*, 63 (3-4): 229-235.
- Robinson A.R., Sellschopp J., Warn-Varnas A., Leslie W.G., Lozano C.J., Haley P.J., Anderson L.A., Lermusiaux P.F.J. 1999. The Atlantic Ionian Stream. *J. Mar. Syst.*, 20: 129-156.
- Robinson A.R., Leslie W.G., Theocharis A., Lascaratos A. 2001. Mediterranean Sea Circulation. In: *OCEAN CURRENTS* doi: 10.1006/rwos.2001.0376.
- Rofen R.R. 1966. Family Paralepididae. In: *Fishes of the western North Atlantic* (G.W. Mead, ed.), *Mem. Sears. Found. Mar. Res.*, 1. Pt. 5, pp: 205-461.
- Roux C. 1990. Trachinidae. In: Quéro J.C., Hureau J.C., Karrer C., Post A., Saldanha L. (eds.) *Check-list of the fishes of the eastern tropical Atlantic (CLOFETA)*. JNICT, Lisbon; SEI, Paris; and UNESCO, Paris, 2: 893-895.
- Russell F.S. 1976. *The eggs and planktonic stages of British marine fishes*. Academic Press, London, UK., 524 pp.
- Russell B.C. 1999. Families Synodontidae, Bathysauridae. In: Carpenter K.E. and Niem V.H. (eds.) *The Living Marine Resources of the Western Central Pacific*. FAO Species Identification Guide for Fisheries Purposes. Rome, FAO, 3: 1928-1947.
- Santic M., Jardas I., Pallaoro A. 2003. Feeding habits of Mediterranean horse mackerel, *Trachurus mediterraneus* (Carangidae), in the central Adriatic Sea. *Cybius*, 27 (4): 247-253.
- Sanz Brau A. 1990. Sur la nourriture des jeunes thons rouges *Thunnus thynnus* (L. 1758) des côtes du Golfe de Valence.
- Sanzo L. 1915. Contributo alla conoscenza dello sviluppo degli Scopelini. *Mem. R. Com. Talass. It.* XLIX
- Sanzo L. 1928a. Uova e larve di *Remora remora*. *Mem. R. Com. Talass. It.* CXXXVIII.
- Sanzo L. 1928b. Contributo alla conoscenza di uova e larve di *Brama raji*. *Mem. R. Com. Talass. It.* CXLVII.
- Sanzo L. 1931. Sottordine: Salmonoidei e Stomiatoidei. In: Bardi G. and Friedländer R. & Sohn (eds) *Uova, larve e stadi giovanili di Teleostei*, Fauna e Flora del Golfo di Napoli, Monogr., 38: 21-92.
- Sanzo L. 1932. Uova e primi stadi larvali di Tonno (*Orcynus thynnus* Ltkn). *Mem. R. Com. Talass. It.* CXXXIX.
- Sanzo L. 1933. Uova e larve di *Seriola dumerili* Risso. *Mem. R. Com. Talass. It.* CCV.
- Sanzo L. 1939. Nuovo contributo alla conoscenza dello sviluppo di *Myctophum rissoi* (Cocco). *Atti Accad. Gioenia Sci. Natur. Catania*, ser. 6, vol. 3, 25: 1-8.
- Schaefer S., Johnson R.K., Badcock J. 1986. Photichthyidae. In: Smith M.M., Heemstra P.C. (eds.) *Smiths' sea fishes*. Springer-Verlag, Berlin, p: 243-247.
- Schmidt J., Strubberg A. 1918. Mediterranean Bramidae and Trichiuridae. *Rep. Dan. Ocean. Exp. 1908-1910. Medit. Ad. Seas.*, A 6, 15 pp.

- Shiganova T.A. 1977. Larvae and juvenile of lanternfishes (Myctophidae, Pisces) of the Atlantic Ocean. Proceedings of the P.P. Shirshov Institute of Oceanology, 109: 42-112.
- Sinovčić G. 1988. Age and growth of Anchovy, *Engraulis encrasicolus* (L.) in the Middle Adriatic. Rapp.Comm.int.Mer Médit., 31 (2): 266 pp.
- Sinovčić G. 2004. Growth and length-weight relationship of the juvenile anchovy, *Engraulis encrasicolus*, in the nursery ground (Zrmanja River estuary - eastern Adriatic Sea). J. Appl. Ichthyol., 20 (1): 79-80.
- Smith D.G. 1979. Guide to the leptocephali (Elopiformes, Anguilliformes and Notacantiformes). NOAA Techn. Rep., NMFA Circ., 424: 1-39.
- Smith D.G. 1990. Congridae. In: Quéro J.C., Hureau J.C., Karrer C., Post A., Saldanha L. (eds.) Check-list of the fishes of the eastern tropical Atlantic (CLOFETA). JNICT, Lisbon; SEI, Paris; and UNESCO, Paris, 1: 159-160.
- Smith D.G. 2002. Congridae. Conger eels. In: Carpenter K.E. (ed.) FAO species identification guide for fishery purposes. The living marine resources of the Western Central Atlantic, 2: 2743-2750.
- Smith D.G., Böhlke E.B. 1990. Muraenidae. In: Quéro J.C., Hureau J.C., Karrer C., Post A., Saldanha L. (eds.) Check-list of the fishes of the eastern tropical Atlantic (CLOFETA). JNICT, Lisbon; SEI, Paris; and UNESCO, Paris, 1: 145-146.
- Smith-Vaniz W.F. 1986. Carangidae. In: Whitehead P.J.P., Bauchot M.L., Hureau J.C., Nielsen J., Tortonese E. (eds.) Fishes of the north-eastern Atlantic and the Mediterranean. UNESCO, Paris, 2: 815-844.
- Somarakis S., Drakopoulos P., Filippou V. 2002. Distribution and abundance of larval fish in the Northern Aegean Sea - eastern Mediterranean - in relation to early summer oceanographic conditions. J. Plankton Res., 24 (4): 339-357.
- Spartà A. 1929 Contributo alla conoscenza di uova e larve negli Ofidi *Ophidium vassalli* Risso ed *O. barbatum* L. Mem. R. Com. Talass. It. CXLIX.
- Spartà A. 1932 Nuovo contributo alla conoscenza dello sviluppo post-embrionale in *Ophidium barbatum* L. e in *O. vassalli* Risso. Mem. R. Com. Talass. It. CLXXXII.
- Spartà A. 1936. Contributo alla conoscenza di uova, stadi embrionali e post-embrionali in *Macrorhamphosus scolopax* L. Mem. R. Com. Talass. Ital. 225: 1-14.
- Spartà A. 1942 Contributo alla conoscenza di uova, stadi embrionali e post-embrionali negli Scorpenidi. II. *Scorpaena scrofa* L. III. *Scorpaena ustulata* Lowe. IV *Scorpaena dactyloptera* De La Roche. Arch. Ocean. Limnol., vol. 1.
- Sulak K.L. 1990. Synodontidae. In: Quéro J.C., Hureau J.C., Karrer C., Post A., Saldanha L. (eds.) Check-list of the fishes of the eastern tropical Atlantic (CLOFETA). JNICT, Lisbon; SEI, Paris, 1: 365-370.
- Svetovidov A.N. 1986. Gadidae. In: Whitehead P.J.P., Bauchot M.L., Hureau J.C., Nielsen J., Tortonese E. (eds.) Fishes of the north-eastern Atlantic and the Mediterranean. UNESCO, Paris, 2: 680-710.
- Tåning A.V. 1918. Mediterranean Scopelidae (*Saurus aulopus*, *Cholorphthalmus*, and *Myctophum*). Rep. Dan. Oceanogr. Exped. 1908-1910. Mediterr. ad. Seas, 2 (A.7).
- Tåning A.V. 1926 Position du disque céphalique chez le Echéneïdes ou curs de l'ontogénèse. C. R. Acad. Sc. Paris, vol. 182, p: 1293.
- Thresher R.E. 1984. Reproduction in reef fishes. T.F.H. Publications, Inc. Ltd., Neptune City, New Jersey, 399 pp.
- Tortonese E. 1956. Plectognathi. In: Bardi G.; Friedländer R. & Sohn (eds.) Uova, larve e stadi giovanili di Teleostei, Fauna e Flora del Golfo di Napoli, Monografia 38.
- Tortonese E. 1986a. Apogonidae. In: Whitehead P.J.P., Bauchot M.L., Hureau J.C., Nielsen J., Tortonese E. (eds.) Fishes

- of the north-eastern Atlantic and the Mediterranean. UNESCO, Paris, 2: 803-809.
- Tortonese E. 1986b Pomatomidae. In: Whitehead P.J.P, Bauchot M.L., Hureau J.C., Nielsen J., Tortonese E. (eds.) Fishes of the north-eastern Atlantic and the Mediterranean. UNESCO, Paris, 2: 812-813.
- Tortonese E. 1986c. Centranchidae. In: Whitehead P.J.P, Bauchot M.L., Hureau J.C., Nielsen J., Tortonese E. (eds.) Fishes of the north-eastern Atlantic and the Mediterranean. UNESCO, Paris, 2: 908-911.
- Tortonese E. 1986d. Cepolidae. In: Whitehead P.J.P, Bauchot M.L., Hureau J.C., Nielsen J., Tortonese E. (eds.) Fishes of the north-eastern Atlantic and the Mediterranean. UNESCO, Paris, 2: 810-811.
- Tortonese E. 1986e. Serranidae. In: Whitehead P.J.P, Bauchot M.L., Hureau J.C., Nielsen J., Tortonese E. (eds.) Fishes of the north-eastern Atlantic and the Mediterranean. UNESCO, Paris, 2: 780-792.
- Tudela S., Palomera I., Quilez G. 2002. Feeding of anchovy *Engraulis encrasicolus* larvae in the Northwest Mediterranean. Journal of Marine Biological Association UK, 82: 349-350.
- Turan C. 2011. The systematic status of the Mediterranean *Spicara* species (Centranchidae) inferred from mitochondrial 16S rDNA sequence and morphological data. J. Black Sea/Mediterranean Environment, 17 (1): 14-31.
- Washington B.B., Moser H.G., Laroche W.A., Richards W.J. 1984. Scorpaeniformes: development. In: Moser H.G., Richards W.J., Cohen D.M., Fahay M.P., Kendall A.W., Richardson S.L. Jr. (eds.) Ontogeny and Systematics of Fishes. Amer. Soc. Ichthyol. Herpetol., Gainesville, Spec. Publ. 1: 405-428.
- Watson W. 1996a. Phosichthyidae: Lightfishes. In: Moser H.G. (ed.) The early stages of fishes in the California Current Region. California Cooperative Oceanic Fisheries Investigations (CalCOFI) Atlas, 33: 284-293.
- Wheeler A. 1979a Ammodytidae. In: Hureau J.C., Monod Th. (eds.) Check-list of the fishes of the north-eastern Atlantic and of the Mediterranean (CLOFNAM). UNESCO, Paris, 1: 446-448.
- Wheeler A. 1979b Callionymidae. In: Hureau J.C., Monod Th. (eds.) Check-list of the fishes of the north-eastern Atlantic and of the Mediterranean (CLOFNAM). UNESCO, Paris, 1: 516-518.
- Whitehead P.J.P. 1984. Engraulidae. In: Whitehead P.J.P., Bauchot M.L., Hureau J.C., Nielsen J., Tortonese E. (eds.) Fishes of the north-eastern Atlantic and the Mediterranean. UNESCO, Paris, 1: 282-283.
- Whitehead P.J.P. 1985. FAO species catalogue. Clupeoid fishes of the world (Suborder Clupeoidei). An annotated and illustrated catalogue of the herrings, sardines, pilchards, sprats, shads, anchovies and wolf-herrings. Part 1 Chirocentridae, Clupeidae and Pristigasteridae. FAO Fish. Synop., 125 (7/1): 1-303.
- Whitehead P.J.P., Bauchot M.L., Hureau J.C., Nielsen J., Tortonese E. 1984. Fishes of the North-eastern Atlantic and the Mediterranean., vol. 1: 1-510.
- Whitehead P.J.P., Bauchot M.L., Hureau J.C., Nielsen J., Tortonese E. 1986. Fishes of the North-eastern Atlantic and the Mediterranean - Poissons de l'Atlantique du Nord-Est et de la Méditerranée.- UNESCO, Paris, vol. 3: 1009-1473.
- Whitehead P.J.P., Nelson G.J., Wongratana T. 1988. FAO species catalogue. Clupeoid fishes of the world. (Suborder Clupeoidei). An annotated and illustrated catalogue of the herrings, sardines, pilchards, sprats, shads, anchovies and wolf-herrings. Part 2 Engraulididae. FAO Fish. Synop., 125 (7/2): 1-579.

Wilk S.J. 1977. Biological and fisheries data on bluefish, *Pomatomus saltatrix* (Linnaeus). Tech. Ser. Rep. 11, Sandy Hook Lab., NMFS Northeast Fish. Sci. Cent., Highlands NJ 07732. 56 pp.

Wüst G. 1961. On the vertical circulation of the Mediterranean Sea, J. Geophys. Res., 66: 3261-3271.

Yabe H.S., Ueyanagi S., Watanabe H. 1966. Studies on the early life history of bluefin tuna, *Thunnus thynnus*, and on the larva of the southern bluefin tuna *T. macoyii*. Rep. Nankai. Fish. Res. Lab., 23: 95-129.



FAO MEDSUDMED PROJECT

**Food and Agriculture Organization of the United Nations (FAO)
Fisheries and Aquaculture Department
Viale delle Terme di Caracalla
00153 Rome, Italy
Tel.: +39 06 570 54492 - Fax: +39 06 570 55188
email: medsudmed@fao.org
URL: <http://www.faomedsudmed.org>**



**ITALIAN MINISTRY OF AGRICULTURE, FOOD
AND FORESTRY POLICIES**



**Ministero delle Politiche Agricole Alimentari e Forestali
Viale dell'Arte 16
00144 Roma, Italia
URL: <http://www.politicheagricole.it>**