



RZ  
Medizintechnik  
GmbH

*Progress in Surgery*

GENERAL  
SURGERY



**1**

**Diagnostik**  
**Diagnostics**  
2-9



Siehe Spezialkatalog / See special catalogue

**2**

**Skalpelle**  
**Scalpels**  
10-17



**3**

**Scheren**  
**Scissors**  
18-49



**4**

**Pinzetten**  
**Forceps**  
50-65



**5**

**Arterienklemmen,**  
**Tuchklemmen**  
**Hemostatic and**  
**Towel Forceps**  
66-99



**6**

**Tupfer- und**  
**Kornzangen**  
**Cotton Swab**  
**Forceps etc.**  
100-103



**7**

**Sonden,**  
**Watteträger**  
**Probes,**  
**Applicators**  
104-106



**8**

**Impfen,**  
**Punktion, Saugen**  
**Vaccination,**  
**Puncture, Suction**  
107-117



**9**

**Wundhaken, und**  
**Wundsperrer**  
**Retractors**  
118-161

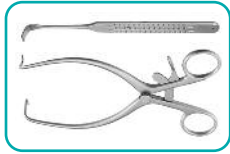

**10**

**Naht**  
**Suture**  
162-193



**11**

**Knochenchirurgie**  
**Bone Surgery**  
194-199



Siehe Spezialkatalog / See special catalogue

**12**

**Darm, Magen,**  
**Mastdarm**  
**Intestines,**  
**Stomach, Rectum**  
200-210



**13**

**Leber, Galle, Niere**  
**Liver, Gall, Kidney**  
211-214



**14**

**Blase, Urologie**  
**Bladder, Urology**  
215-217



Siehe Spezialkatalog / See special catalogue

**15**

**Gynäkologie**  
**Gynecology**  
218-244



**16**

**Geburtshilfe**  
**Obstetrics**  
245-247

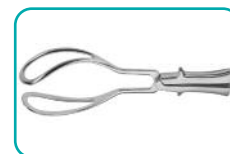

**17**

**Dermatologie**  
**Dermatology**  
248-249



Siehe Spezialkatalog / See special catalogue

**18**

**Instrumentenpflege**  
**Maintenance of**  
**Instruments**  
250-253

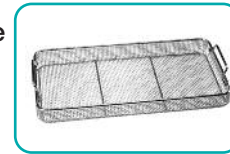

Siehe Spezialkatalog / See special catalogue



1



**Taylor**  
17.0 cm, 6 3/4"  
100-111-170  
20.0 cm, 8"  
100-111-200



**Traube**  
16.0 cm, 6 1/4"  
100-112-160

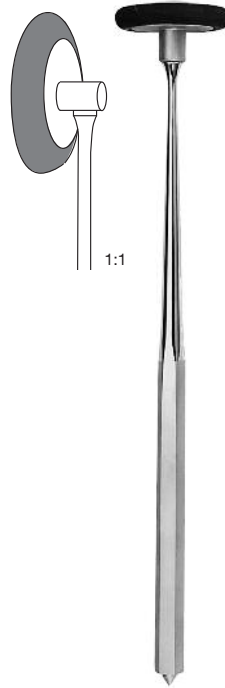

**Babinsky**  
22.0 cm, 8 5/8"  
100-110-220



**Troemner**  
24.0 cm, 9 1/2"  
100-113-240



**Dejerine**  
20.0 cm, 8"  
100-114-200



**Dejerine**  
20.0 cm, 8"  
100-115-200



**Berliner**  
17.0 cm 6 3/4"  
100-116-170

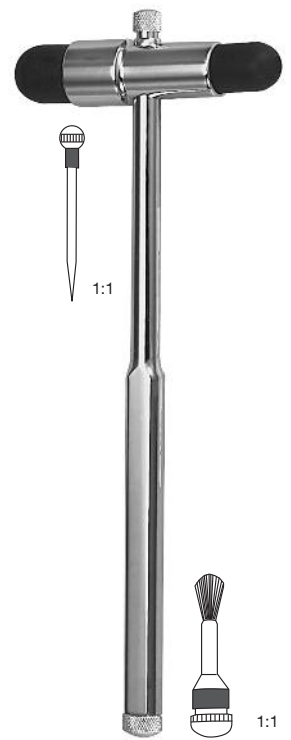

**Buck**  
18.0 cm, 7"  
100-117-180



1



**Moeltgen**  
Winkelmesser  
Goniometer  
100-412-000



**Wartenberg**  
Nadelrad / Pinwheel  
19.0 cm, 7 1/2  
100-416-190



**Aly**  
17.0 cm, 6 3/4"  
100-417-170



**Weber**  
9.0 cm, 3 1/2"  
100-411-000



**Collin**  
Dynamometer

Erwachsene, Adults  
100-012-001

Kinder, Children  
100-012-002

Metall-Meßstäbe, rostfrei, cm/inch  
Rulers, metal, stainless, cm/inch



10.0 cm, 4"	100-418-100
20.0 cm, 8"	100-418-200
30.0 cm, 12"	100-418-300
50.0 cm, 20"	100-418-500



15.0 cm, 6" 100-422-150



1



**Pinard**  
aus Aluminium  
of aluminium  
100-109-150

**Pinard**  
aus Plastik  
of plastic  
100-109-180



**Baby Duplex**  
Bruststück: ø 40 mm  
chest piece: ø 40 mm  
100-109-000



**Duplex**  
Bruststück: ø 45 mm  
chest piece: ø 45 mm  
100-108-000



<b>Duplex Color</b>	Rot, red	100-108-001
Bruststück: ø 45 mm	Blau, blue	100-108-002
chest piece: ø 45 mm	Grün, green	100-108-003
	Gold, gold	100-108-004



1



**Bowles**  
Bruststück: ø 40 mm  
chest piece: ø 40 mm  
**100-105-000**



**Cardiophon**  
Bruststück: ø 45 mm  
chest piece: ø 45 mm  
**100-110-000**



**Ford**  
Bruststück: ø 26 mm  
chest piece: ø 26 mm  
**100-106-000**



<b>Anestophon</b>	Silber, silver	<b>100-106-001</b>
Bruststück: ø 48 mm	Gold, gold	<b>100-106-002</b>
chest piece: ø 48 mm	Grün, green	<b>100-106-003</b>
	Blau, blue	<b>100-106-004</b>
	Rot, red	<b>100-106-005</b>



1



**Minimus II**

Einhand-Modell mit Einschlauch Anschluß  
One-hand model with one tube connection  
**100-007-000**



**Precisa N**

Einhand-Modell mit Zweischlauch Anschluß  
One-hand model with two tube connection  
**100-008-000**



**Babyphon**

Komplettes Set für Neugeborene, Säuglinge  
und Kinder. Inklusiv drei Manschetten und  
Manometer in Kunstledertasche

Complete set for newborn, infants and  
children. Including three velcro cuff and  
manometer in leatherette case

**100-109-100**



**Diplomat**

Quecksilbergerät in Metalltui  
Mercury apparatus in metal case  
**100-002-000**



**1**



**Big Ben**  
 Wandmodell mit Velcromanschette  
 Wall model with velcro cuff  
**100-107-100**

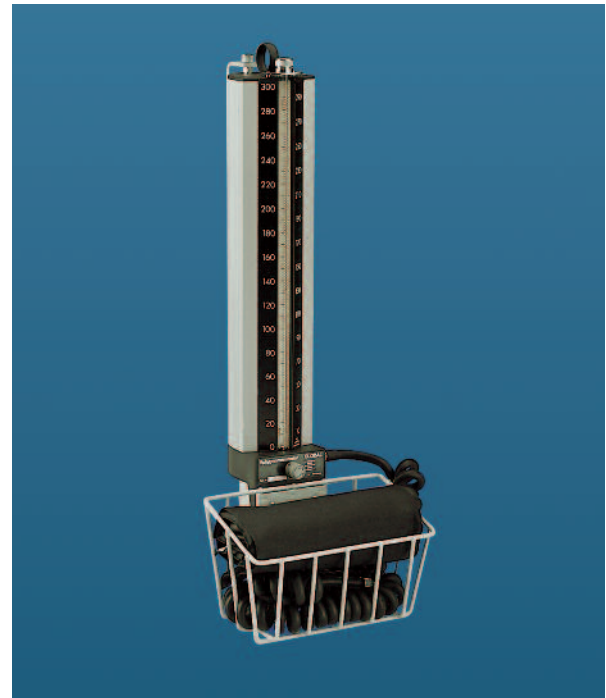

**Global**  
 Wandmodell mit Velcromanschette  
 Wall model with velcro cuff  
**100-010-000**



**Oto-Ophthalmoscope Set**  
**100-046-000**  
 Otoskop mit drei Ohrtrichtern, Ophthalmoskop,  
 Nasenspekulum, Lampenträger und zwei  
 Kehlkopfspiegeln, ein Griff 2.5V Standardbeleuchtung,  
 in Etui

Otoscope with three ear specula, ophthalmoscope, nasal  
 specula, lamp holder and two laryngeal mirrors,  
 one handle 2.5V standard illumination, in case



**Ophthalmoskop Set**  
 110V **100-045-000**      220V **100-045-001**  
 Ophthalmoskop mit Fiber-Optik und  
 Halogenbeleuchtung, stufenlose Fokussiereinrichtung,  
 eine Beleuchtungslinse, aufladbarer Metallgriff,  
 in Etui

Ophthalmoscope with fiber-optic and halogen  
 illumination, stepless focusing, one illumination lens,  
 rechargeable metal handle, in case





1



**Otoscope Set**

110V **100-039-000** 220V **100-039-001**

Otoskop mit Fiber-Optik und Halogenbeleuchtung, vier wiederverwendbaren und zehn Einmal-Ohrtrichtern, Operationslupe (3.5fach), aufladbarer Metallgriff 3.5V, in Etui

Otoscope with fiber optic and halogen illumination, four reusable and ten disposable ear specula, magnifying lense (3.5fold), rechargeable metal handle 3.5V, in case



**Oto-Rhinoscope Set**

110V **100-040-000** 220V **100-040-001**

Otoskop mit Fiber-Optik und Halogenbeleuchtung, vier wiederverwendbare und zehn Einmal-Ohrtrichter, Nasenspekulum, Spatelhalter, Operationslupe (3.5fach), aufladbarer Metallgriff 3.5V in Etui

Otoscope with fiber optic and halogen illumination, four reusable and ten disposable ear specula, nasal specula, tongue blade holder, magnifying lense (3.5fold), rechargeable metal handle 3.5V, in case



**De Luxe Set**

110V **100-041-000** 220V **100-041-001**

Otoskop mit Fiber-Optik und Halogenbeleuchtung, vier wiederverwendbare und zehn Einmal-Ohrtrichter, Ophthalmoskop, Nasenspekulum, Spatelhalter, zwei Kehlkopfspiegel, Lampenträger, aufladbarer Metallgriff 3.5V, in Etui

Otoscope with fiber optic and halogen illumination, four reusable and ten disposable ear specula, ophthalmoscope, nasal speculum, tongue blade holder, two laryngeal mirrors, lamp holder, rechargeable metal handle 3.5V, in case



**Laryngoscopy Set**

**100-213-100**

Griff, groß, ohne Batterien, drei McIntosh Spatel Fig. 1,2 und 3 mit konventioneller Beleuchtung, mit zwei Halogen Ersatzlampen, in Kunstleder Etui

Handle, large without batteries, three McIntosh blades fig. 1,2 and 3 with standard illumination, with two spare halogen bulbs, in pouch bag



**100-102-006**  
Ersatzbirne  
spare bulb

**Clar**  
Stirnlampe, Head light  
**100-102-000**

Stirnlampe, 6 Volt, mit verstellbarem Gelenk, weißes Kunststoff-Kopfband und Schaumstoffpolster, mit Kabel für den Anschluß an Transformator (100-103-001)

Head Light, 6 Volt, with adjustable joint, white celluloid head band with foam rubber pad, cord with plugs for transformer (100-103-001)

**100-102-001**

weißes Kunststoff-Kopfband, allein (für 100-102-000)  
white celluloid head band, only (for 100-102-000)

**100-102-002**

Ersatzspiegel, allein (für 100-102-000)  
Spare mirror, only (for 100-102-000)



**100-104-006**  
Ersatzbirne  
spare bulb

**Clar 55**  
Stirnlampe, Head light  
**100-104-000**

Stirnlampe, 6 Volt, mit verstellbarem Gelenk, weißes Kunststoff-Kopfband und Schaumstoffpolster, mit Kabel für den Anschluß an Transformator (100-103-001)

Head Light, 6 Volt, with adjustable joint, white celluloid head band with foam rubber pad, cord with plugs for transformer (100-103-001)

**100-104-001**

weißes Kunststoff-Kopfband, allein (für 100-104-000)  
white celluloid head band, only (for 100-104-000)

**100-104-002**

Ersatzspiegel, allein (für 100-104-000)  
Spare mirror, only (for 100-104-000)



**100-110-010**  
**Ziegler**

Ziegler Stirnspiegel ø 90 mm mit weißem Stirnband  
Ziegler head mirror ø 90 mm with white head band

**100-100-020**

Ziegler Stirnspiegel ø 90 mm mit schwarzem Stirnband  
Ziegler head mirror ø 90 mm with black head band

**100-100-000**

Ziegler Stirnspiegel, allein ø 100 mm  
Ziegler head mirror, only ø 100 mm

**100-100-002**

Stirnband, schwarz, allein  
Head band, black, only

**100-100-003**

Stirnband, weiß, allein  
Head band, white, only



**100-103-001**

Klein-Transformator, für 220 Volt Wechselstrom,  
Steckbuchse für Schwachstrom

Mini-Transformer Unit for 220 volts alternating current,  
outlet for low voltage current



RZ-Medizintechnik Skalpellklingen sind zu 100 Stück in einem Karton verpackt. Nummer und Abbildung der Klingen sind auf den Karton gedruckt. Alle Klingen sind gammabestrahlt (2.5 M-RAD).

RZ-Medizintechnik scalpel blades come in packages of 100 pieces. Article number and illustration of the blade is shown on the package. All blades are sterilized by gamma radiation (2.5 M-RAD).

**2**



1:1

Fig. 10  
 110-201-010



1:1

Fig. 11  
 110-201-011

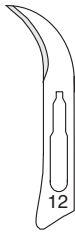

1:1

Fig. 12  
 110-201-012

doppelschneidig  
 double cutting edge



1:1

Fig. 12d  
 110-201-112



1:1

Fig. 13  
 110-201-013



1:1

Fig. 15  
 110-201-015



1:1

Fig. 15c  
 110-201-115



Nr. 3  
 No. 3  
 13.0 cm, 5"  
 110-110-003



Nr. 3, graduiert  
 No. 3, graduated  
 13.0 cm, 5"  
 110-114-003



Nr. 3L  
 No. 3L  
 21.0 cm, 8 1/4"  
 110-116-033



Nr. 7  
 No. 7  
 16.5 cm, 6 1/2"  
 110-130-077

gleich wie  
 Nr. 5  
 Same as  
 No. 5



Nr. 7K  
 No. 7K  
 13.0 cm, 5 "  
 110-130-007



RZ-Medizintechnik Skalpellklingen sind zu 100 Stück in einem Karton verpackt. Nummer und Abbildung der Klingen sind auf den Karton gedruckt. Alle Klingen sind gammabestrahlt (2.5 M-RAD).

RZ-Medizintechnik scalpel blades come in packages of 100 pieces. Article number and illustration of the blade is shown on the package. All blades are sterilized by gamma radiation (2.5 M-RAD).

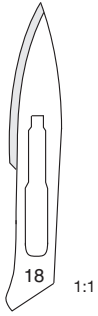

Fig. 18  
**110-201-018**

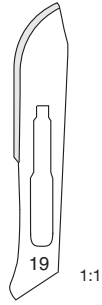

Fig. 19  
**110-201-019**

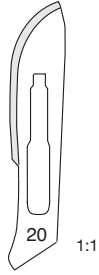

Fig. 20  
**110-201-020**

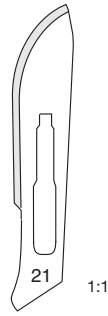

Fig. 21  
**110-201-021**

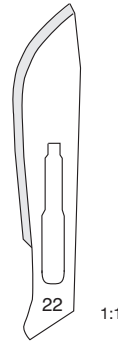

Fig. 22  
**110-201-022**

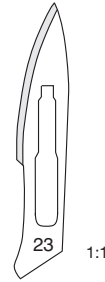

Fig. 23  
**110-201-023**

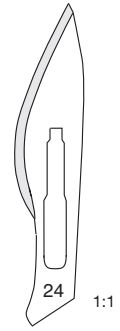

Fig. 24  
**110-201-024**



Nr. 4  
 No. 4  
 13.5 cm, 5 3/8"  
**110-140-004**



Nr. 4L  
 No. 4L  
 21.0 cm, 8 1/4"  
**110-144-004**



Nr. 8  
 No. 8  
 13.5 cm, 5 3/8"  
**110-146-008**



Nr. 9  
 No. 9  
 14.5 cm, 5 3/4"  
**110-146-009**

2



**Operation**  
17.0 cm, 6 3/4"

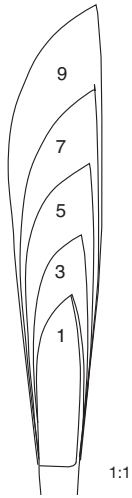

Fig. 1 **110-005-001**  
Fig. 3 **110-005-003**  
Fig. 5 **110-005-005**  
Fig. 7 **110-005-007**  
Fig. 9 **110-005-009**

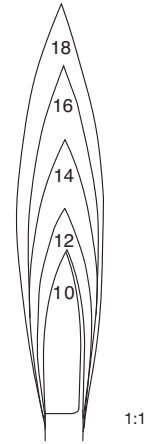

Fig. 10 **110-005-010**  
Fig. 12 **110-005-012**  
Fig. 14 **110-005-014**  
Fig. 16 **110-005-016**  
Fig. 18 **110-005-018**



**Collin**  
16.0 cm, 6 1/4"



Fig. 1 **110-006-001**  
Fig. 2 **110-006-002**  
Fig. 3 **110-006-003**

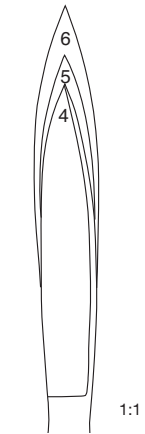

Fig. 4 **110-006-004**  
Fig. 5 **110-006-005**  
Fig. 6 **110-006-006**



**Dissecting**  
17.0 cm 6 3/4"

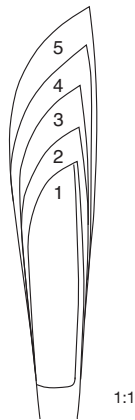

Fig. 1 **110-010-001**  
Fig. 2 **110-010-002**  
Fig. 3 **110-010-003**  
Fig. 4 **110-010-004**  
Fig. 5 **110-010-005**

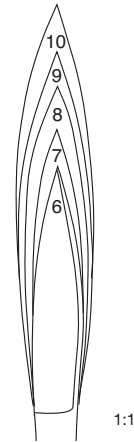

Fig. 6 **110-010-006**  
Fig. 7 **110-010-007**  
Fig. 8 **110-010-008**  
Fig. 9 **110-010-009**  
Fig. 10 **110-010-010**



**Dieffenbach**  
16.0 cm, 6 1/4"

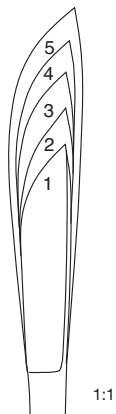

Fig. 1 **110-015-001**  
Fig. 2 **110-015-002**  
Fig. 3 **110-015-003**  
Fig. 4 **110-015-004**  
Fig. 5 **110-015-005**

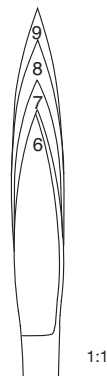

Fig. 6 **110-015-006**  
Fig. 7 **110-015-007**  
Fig. 8 **110-015-008**  
Fig. 9 **110-015-009**

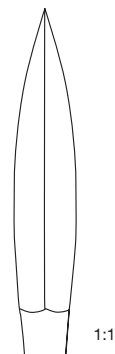

Fig. 15 **110-015-015**

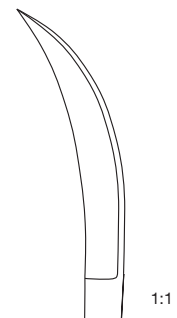
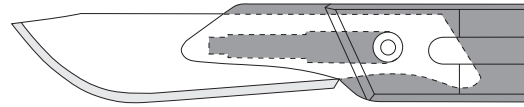

Fig. 16 **110-015-016**



**Steril, sterile**

Einmal-Skalpelle mit Kunststoffgriff, in Packungen zu 10 Skalpellen  
Disposable scalpels with plastic handle, in boxes of 10 scalpels



2

doppelschneidig  
double cutting edge



Fig. 10 110-220-010    Fig. 11 110-220-011    Fig. 11s 110-220-111    Fig. 12 110-220-012    Fig. 12d 110-220-112    Fig. 13 110-220-013    Fig. 15 110-220-015    Fig. 15c 110-220-115



Fig. 18 110-220-018    Fig. 19 110-220-019    Fig. 20 110-220-020    Fig. 21 110-220-021    Fig. 22 110-220-022    Fig. 23 110-220-023    Fig. 24 110-220-024    Fig. 25 110-220-025

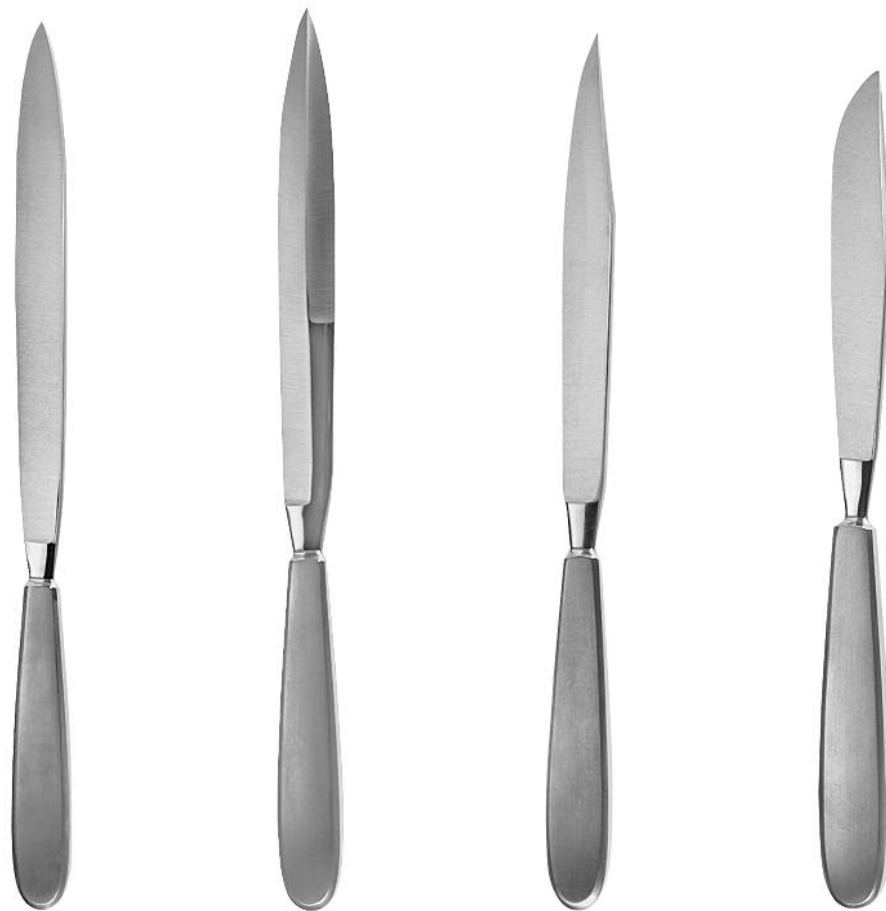

Schnittlängen Lengths of blades	Collin	Catlin	Liston	Langenbeck
12.0 cm, 4 3/4"				110-020-012
13.0 cm, 5"	110-014-013			110-020-013
16.0 cm, 6 1/4"	110-014-016	110-018-016		
17.0 cm, 6 3/4"			110-019-017	
19.0 cm, 7 1/2"	110-014-019	110-018-019		
20.0 cm, 8"			110-019-020	
22.0 cm, 8 5/8"	110-014-022	110-018-022	110-019-022	
28.0 cm, 11"	110-014-028			





**Walb** Organmesser kommen hauptsächlich in der Pathologie zum Einsatz. Mit ihnen werden Körperteile sowie Organe durchtrennt. Zur guten Handhabung haben **Walb** Organmesser einen schweren Griff, welcher mit Holzschalen ausgestattet ist.

**Walb** organ knives are used in pathology. With those knives, body parts and organs will be cut. For better handling the **Walb** organ knives have a heavy wooden handle.

Mit Hirnmessern nach **Virchow** werden in der Pathologie Hirnteile durchtrennt.

**Virchow** Hirnmesser besitzen stets einen Hohlgriff, und sind extrem leicht. Die Schneide ist besonders lang und dünn.

**Virchow** brain knives are used in pathology to cut parts of the brain. **Virchow** brain knives have an extremely light hollow handle. The blades are especially long and thin.

**Resektions- und Knorpelmesser** werden zum Resezieren, sowie zum Durchtrennen von Extremitäten verwendet. Da diese Körperteile nicht sehr voluminös sind, besitzen beide Messer relativ kurze Schneiden.

**Resection and Cartilage knives** are used for resection and cutting of small parts of the body. These parts are normally not very big, therefore the cutting blades are relatively short.

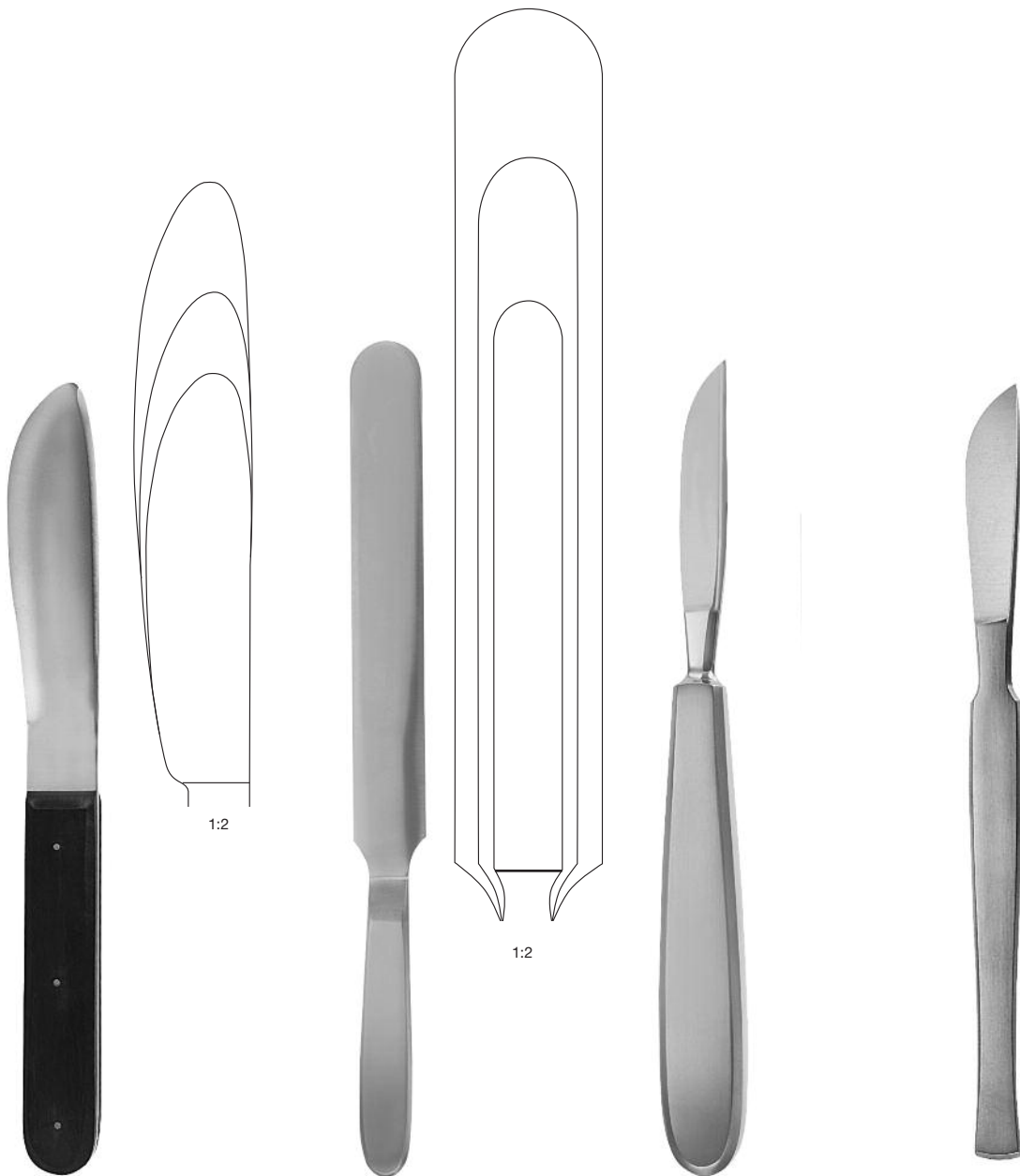

**Walb**

Schneide blade	
11.0 cm, 4 1/2"	<b>110-050-110</b>
14.0 cm, 5 1/2"	<b>110-050-140</b>
17.0 cm, 6 3/4"	<b>110-050-170</b>

**Virchow**

Schneide blade	
16.0 cm, 6 1/4"	<b>110-060-160</b>
20.0 cm, 8"	<b>110-060-200</b>
24.0 cm, 9 1/2"	<b>110-060-240</b>

**Langenbeck**

Metallheft metal handle	
18.0 cm, 7"	<b>110-026-055</b>

**Cartilage**

mit Schaberende with dissector end	
17.5 cm, 6 5/8"	<b>110-030-175</b>



**Braithwaite**  
30.0 cm, 12"  
110-098-305

Ersatzklinge, Spare blade  
110-098-399



**Silver**  
19.0 cm, 7 1/2"  
110-096-019

Ersatzklinge, Spare blade  
110-096-119



**Schink**  
30.0 cm, 12"  
110-090-000

Ersatzklinge, Spare blade  
110-090-001

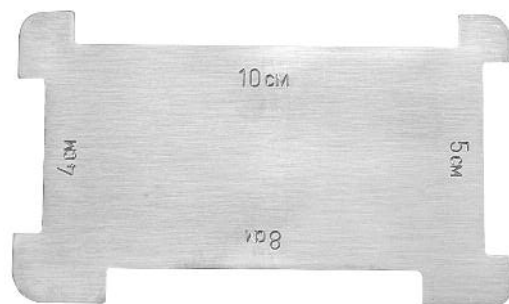

Spannplatte  
Skin straightening plate  
110-090-002

Auf speziellen Wunsch können wir auch sterile Ersatzklingen für die Dermatome liefern.  
On special request we can also supply sterile spare blades for the dermatomes.

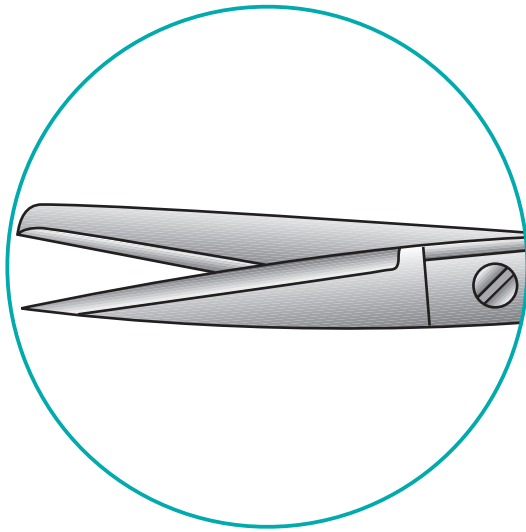

Alle Scheren mit RZ-Dur Cut Hartmetalleinlagen zeichnen sich durch eine über lange Zeit gleichmäßige, weiche und dauerhafte Schnittgenauigkeit aus. Alle Scheren mit Hartmetalleinlagen haben zur Kennzeichnung vergoldete Ringe und sind in unserem Katalog mit gelber Farbe unterlegt.

All scissors with RZ-Dur Cut tungsten carbide inserts are distinguished by a uniform, smooth and accuracy cutting. Scissors with tungsten carbide inserts are identified by gold-plated rings and adjusted in yellow color in our catalog.

3

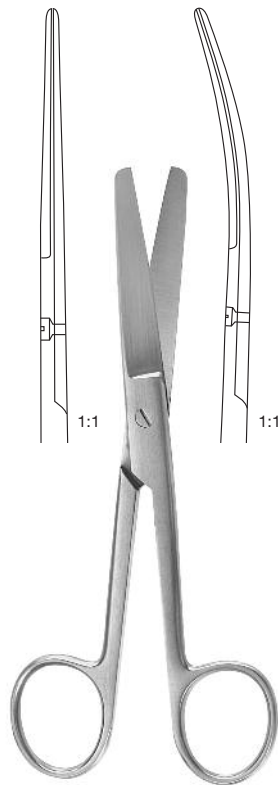

Fig.1

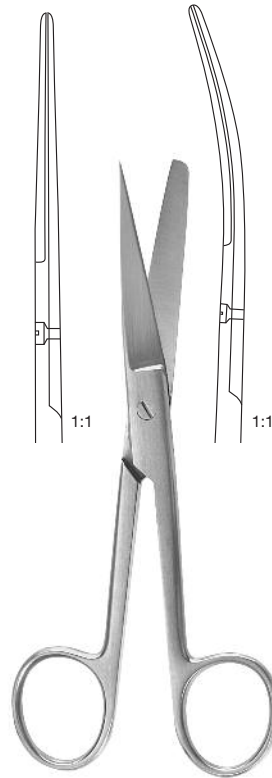

Fig.2

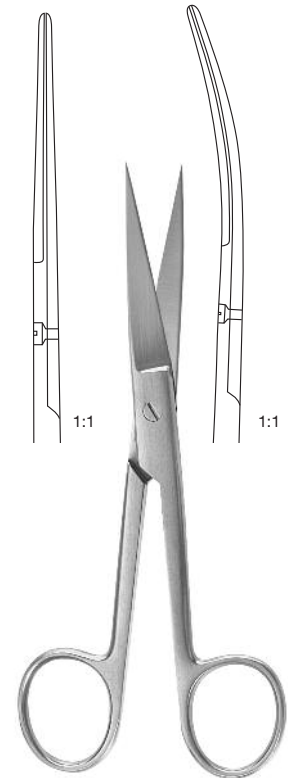
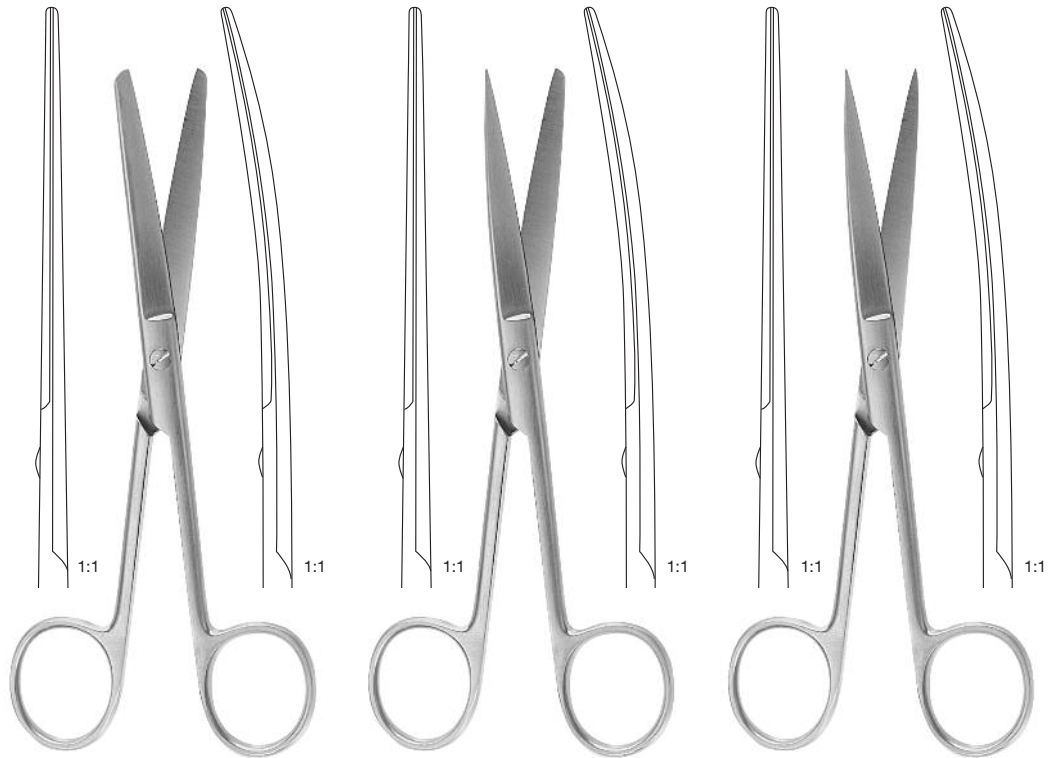
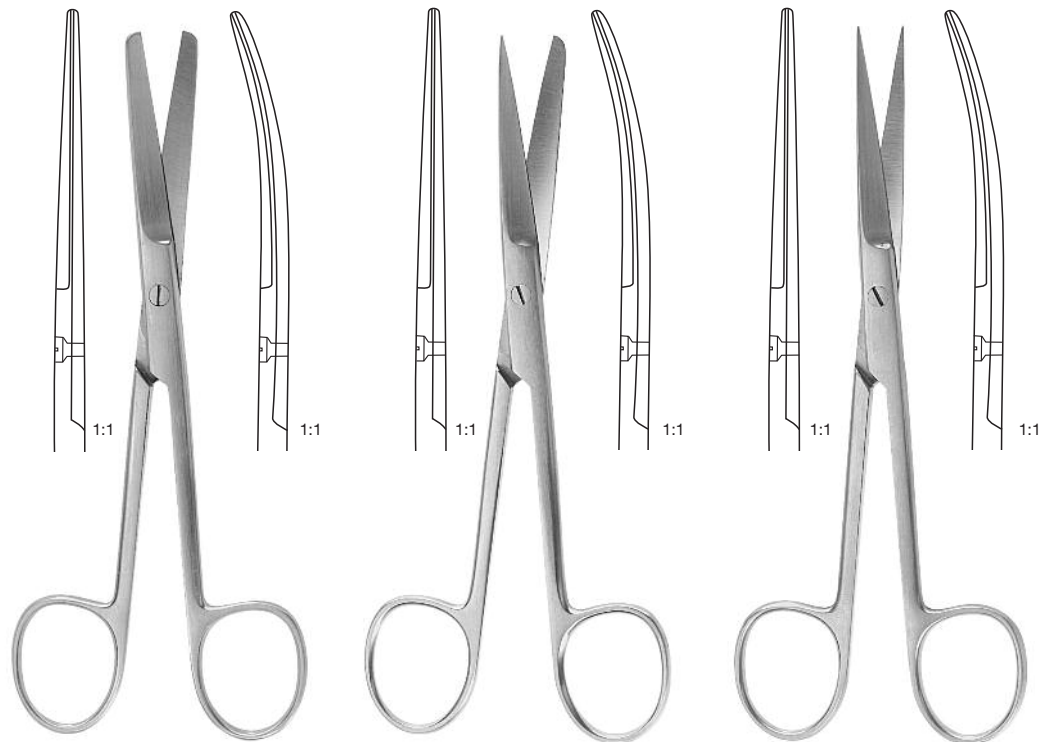

Fig.3

Standard	gerade straight	gebogen curved	gerade straight	gebogen curved	gerade straight	gebogen curved
10.5 cm, 4 1/4"	120-010-105	120-011-105	120-012-105	120-013-105	120-014-105	120-015-105
11.5 cm, 4 1/2"	120-010-115	120-011-115	120-012-115	120-013-115	120-014-115	120-015-115
13.0 cm, 5"	120-010-130	120-011-130	120-012-130	120-013-130	120-014-130	120-015-130
14.5 cm, 5 3/4"	120-010-145	120-011-145	120-012-145	120-013-145	120-014-145	120-015-145
14.5 cm, 5 3/4"	120-500-145	120-501-145	120-502-145	120-503-145	120-504-145	120-505-145
15.5 cm, 6"	120-010-155	120-011-155	120-012-155	120-013-155	120-014-155	120-015-155
16.5 cm, 6 1/2"	120-010-165	120-011-165	120-012-165	120-013-165	120-014-165	120-015-165
16.5 cm, 6 1/2"	120-500-165	120-501-165	120-502-165	120-503-165	120-504-165	120-505-165
17.5 cm, 6 5/8"	120-010-175	120-011-175	120-012-175	120-013-175	120-014-175	120-015-175
18.5 cm, 7 1/4"	120-010-185	120-011-185	120-012-185	120-013-185	120-014-185	120-015-185
18.5 cm, 7 1/4"	120-500-185	120-501-185	120-502-185	120-503-185	120-504-185	120-505-185
20.0 cm, 8"	120-010-200	120-011-200	120-012-200	120-013-200	120-014-200	120-015-200



Grazil	gerade	gebogen	gerade	gebogen	gerade	gebogen
	straight	curved	straight	curved	straight	curved
13.0 cm, 5"	<b>120-016-130</b>	<b>120-017-130</b>	<b>120-018-130</b>	<b>120-019-130</b>	<b>120-020-130</b>	<b>120-021-130</b>
14.5 cm, 5 3/4"	<b>120-016-145</b>	<b>120-017-145</b>	<b>120-018-145</b>	<b>120-019-145</b>	<b>120-020-145</b>	<b>120-021-145</b>



Deaver	gerade	gebogen	gerade	gebogen	gerade	gebogen
	straight	curved	straight	curved	straight	curved
12.0 cm, 4 3/4"	<b>120-026-120</b>	<b>120-027-120</b>	<b>120-024-120</b>	<b>120-025-120</b>	<b>120-028-120</b>	<b>120-029-120</b>
13.0 cm, 5"	<b>120-026-130</b>	<b>120-027-130</b>	<b>120-024-130</b>	<b>120-025-130</b>	<b>120-028-130</b>	<b>120-029-130</b>
14.5 cm, 5 3/4"	<b>120-026-145</b>	<b>120-027-145</b>	<b>120-024-145</b>	<b>120-025-145</b>	<b>120-028-145</b>	<b>120-029-145</b>

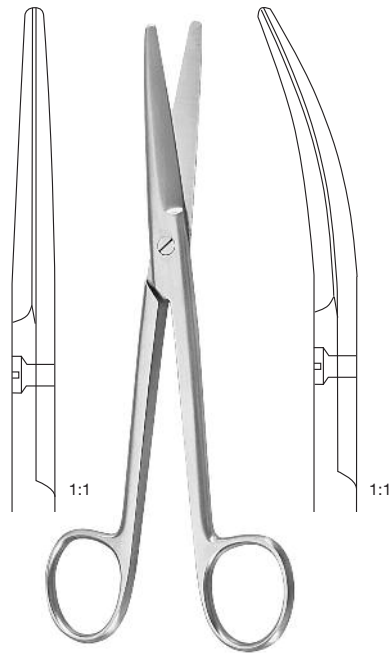

**Mayo**

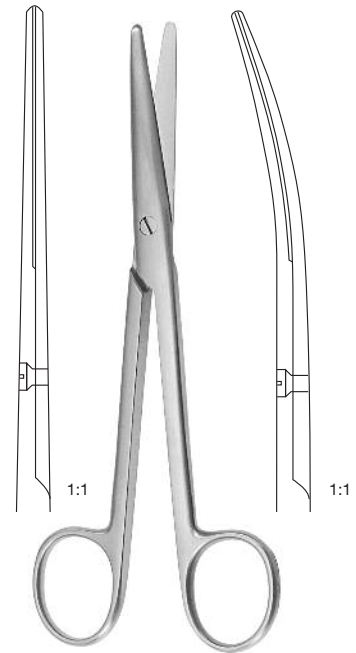

**Mayo-Stille**

	gerade straight	gebogen curved	gerade straight	gebogen curved
14.5 cm, 5 3/4"	120-030-145	120-031-145		
14.5 cm, 5 3/4"	120-506-145	120-507-145		
15.0 cm, 6"	120-030-150	120-031-150	120-036-150	120-037-150
15.0 cm, 6"			120-508-150	120-509-150
17.0 cm, 6 3/4"	120-030-170	120-031-170	120-036-170	120-037-170
17.0 cm, 6 3/4"	120-506-170	120-507-170	120-508-170	120-509-170
19.5 cm, 7 3/4"			120-036-195	120-037-195
21.0 cm, 8 1/4"			120-036-210	120-037-210
23.0 cm, 9"	120-030-230	120-031-230		
23.0 cm, 9"	120-506-230	120-507-230		
28.0 cm, 11"	120-030-280	120-031-280		

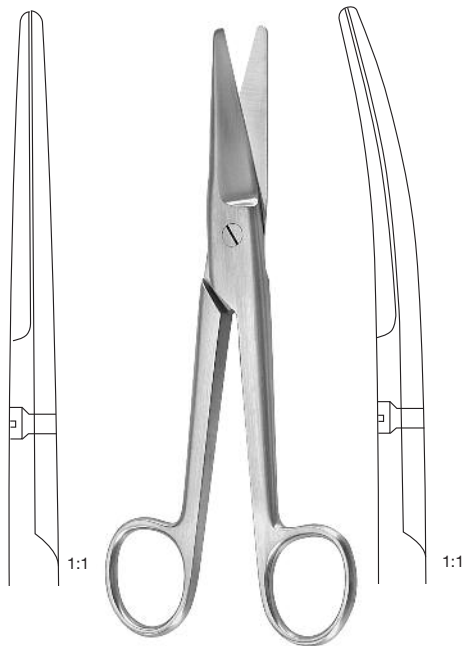

**Mayo-Noble**

gerade, straight	gebogen, curved
17.0 cm, 6 3/4"	17.0 cm, 6 3/4"
120-048-170	120-049-170

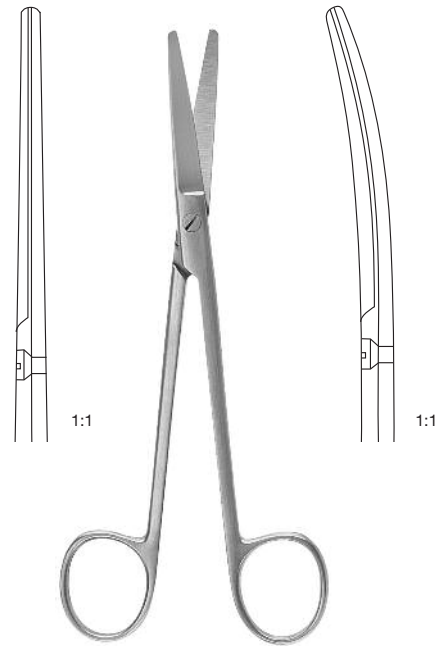

**Mixer**

gerade, straight	gebogen, curved
15.5 cm, 6"	15.5 cm, 6"
120-050-155	120-051-155



Inzisionsschere  
Incision scissors  
13.0 cm, 5"  
**120-022-130**  
14.5 cm, 5 3/4"  
**120-022-145**



Inzisionsschere  
Incision scissors  
16.5 cm, 6 1/2"  
**120-023-165**



**Richter**  
14.5 cm, 5 3/4"  
**120-034-145**



**Fergusson**  
16.5 cm, 6 1/2"  
**120-035-165**  
18.0 cm, 7"  
**120-035-180**

3



**Lawson Tait**  
12.5 cm, 5"  
**120-236-125**



	Kelly	
	gerade, straight	gebogen, curved
16.0 cm, 6 1/4"	<b>120-046-160</b>	<b>120-047-160</b>
18.0 cm, 7"	<b>120-046-180</b>	<b>120-047-180</b>



3



**Wertheim**  
19.5 cm, 7 3/4"  
**120-053-195**  
22.5 cm, 8 3/4"  
**120-053-225**



**Dubois**  
gerade, straight 27.0 cm, 10 5/8"  
**120-116-270**  
gebogen, curved 27.0 cm, 10 5/8"  
**120-117-270**



Sims	gerade straight	gerade straight	gerade straight	gebogen curved	gebogen curved	gebogen curved
20.0 cm, 8"	<b>120-062-200</b>	<b>120-072-200</b>	<b>120-074-200</b>	<b>120-063-200</b>	<b>120-073-200</b>	<b>120-075-200</b>
<b>20.0 cm, 8"</b>	<b>120-532-200</b>	<b>120-534-200</b>	<b>120-536-200</b>	<b>120-533-200</b>	<b>120-535-200</b>	<b>120-537-200</b>
23.0 cm, 9"	<b>120-062-230</b>	<b>120-072-230</b>	<b>120-074-230</b>	<b>120-063-230</b>	<b>120-073-230</b>	<b>120-075-230</b>
<b>23.0 cm, 9"</b>	<b>120-532-230</b>	<b>120-534-230</b>	<b>120-536-230</b>	<b>120-533-230</b>	<b>120-535-230</b>	<b>120-537-230</b>



Doyen	gerade, straight	gerade, straight	gebogen, curved	gerade, straight	gebogen, curved
16.0 cm, 6 1/4"	<b>120-042-160</b>	<b>120-040-160</b>	<b>120-041-160</b>		
17.5 cm, 6 5/8"				<b>120-040-175</b>	<b>120-041-175</b>

3

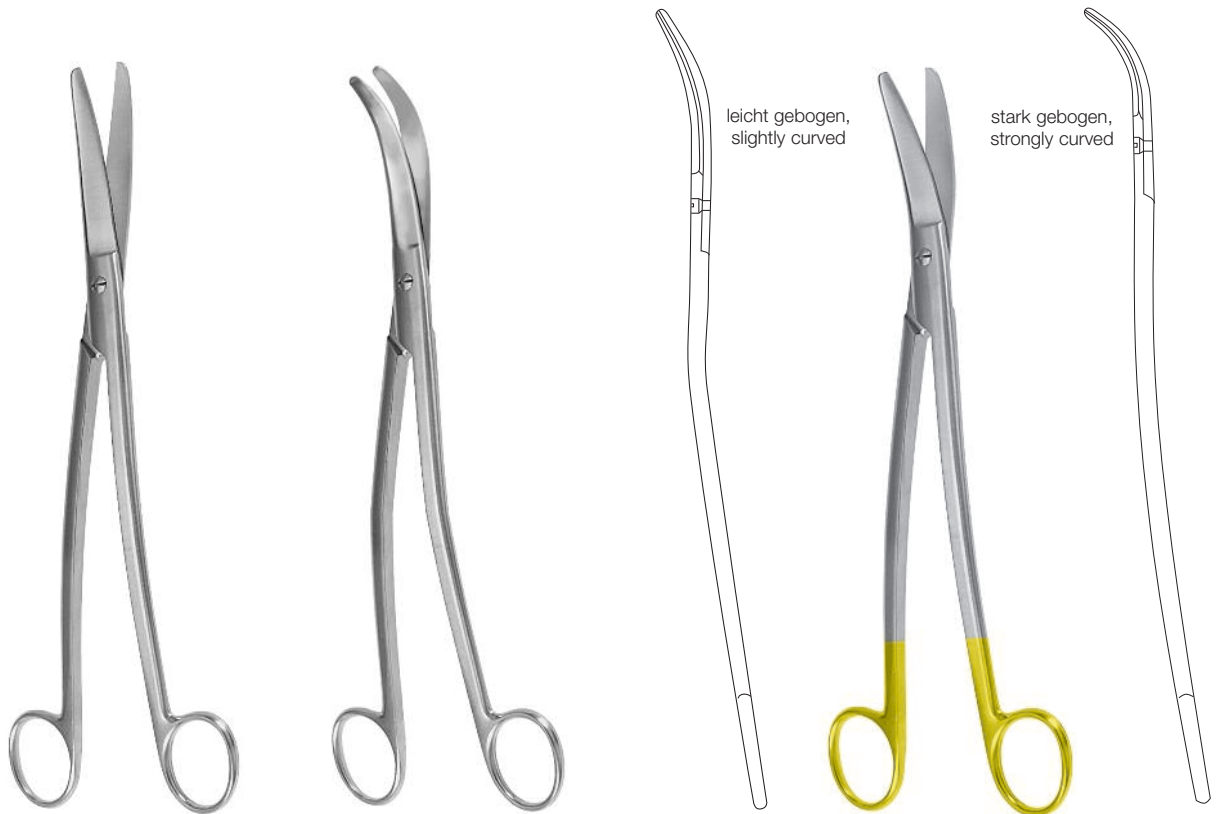

**Siebold**  
 S-gebogen, S-curved  
 24.0 cm, 9 1/2"  
**120-061-240**

**Bozemann**  
 S-gebogen, S-curved  
 22.0 cm, 8 3/4"  
**120-061-220**

**Hysterektomie**  
 25.5 cm, 10"  
**120-571-255**

**Hysterektomie**  
 25.0 cm, 9 3/4"  
**120-572-250**





3

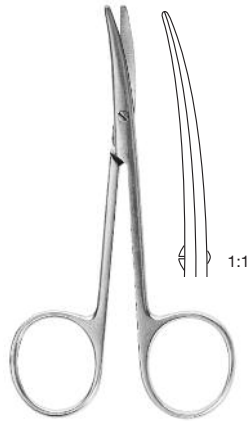
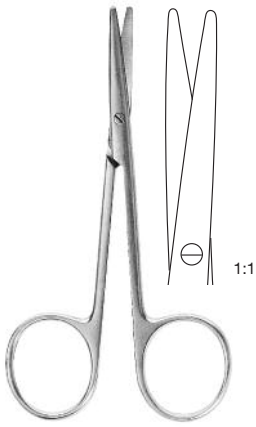

**Metzenbaum-Baby**  
 Fig. 1  
 11.5 cm, 4 1/2"  
 gerade, straight  
**120-110-115**  
**120-510-115**

**Metzenbaum-Baby**  
 Fig. 1  
 11.5 cm, 4 1/2"  
 gebogen, curved  
**120-111-115**  
**120-511-115**

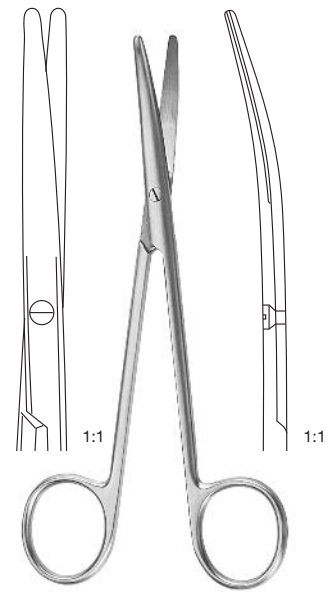
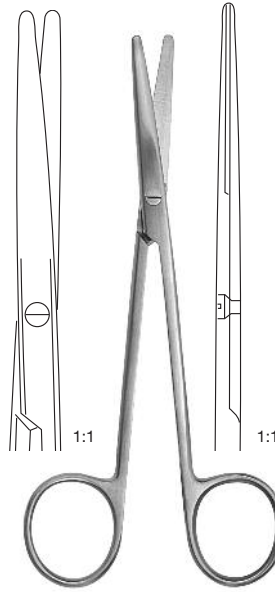

**Metzenbaum**  
 Fig. 1  
 14.5 cm, 5 3/4"  
 gerade, straight  
**120-110-145**  
**120-510-145**

**Metzenbaum**  
 Fig. 1  
 14.5 cm, 5 3/4"  
 gebogen, curved  
**120-111-145**  
**120-511-145**

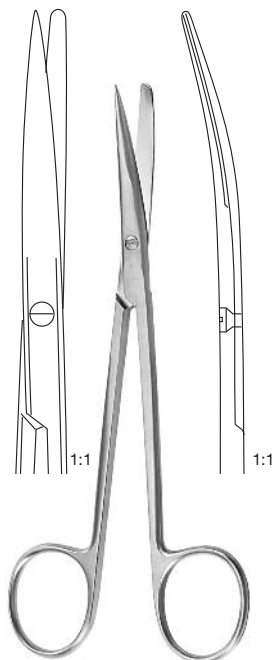
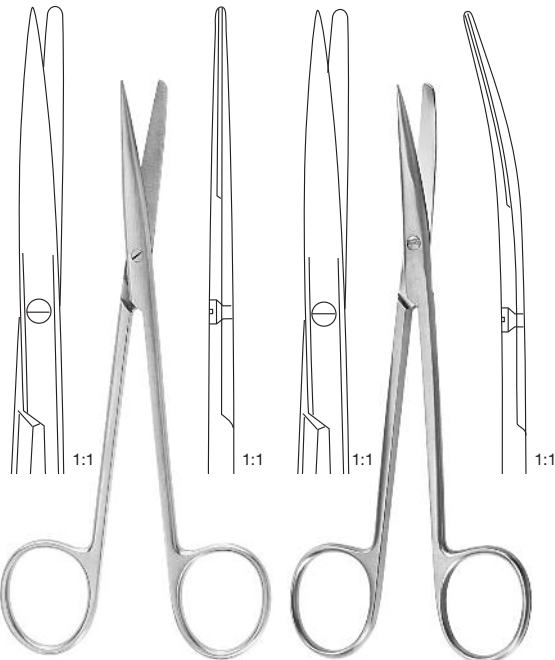

**Metzenbaum**  
 Fig. 2  
 14.5 cm, 5 3/4"  
 gerade, straight  
**120-112-145**  
**120-512-145**

**Metzenbaum**  
 Fig. 2  
 14.5 cm, 5 3/4"  
 gebogen, curved  
**120-113-145**  
**120-513-145**

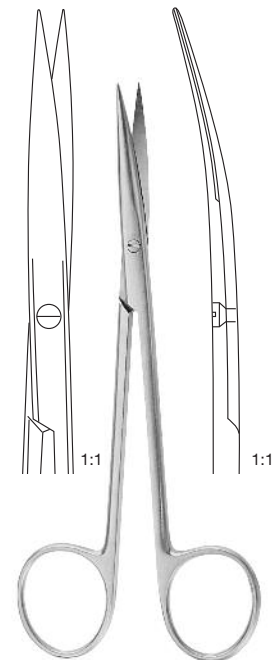
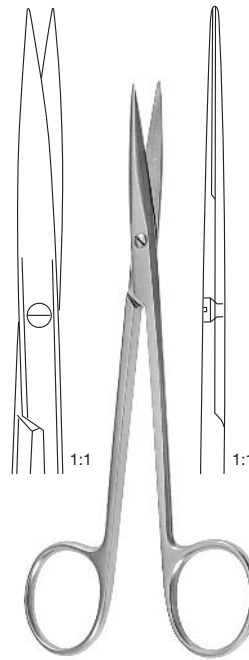

**Metzenbaum**  
 Fig. 3  
 14.5 cm, 5 3/4"  
 gerade, straight  
**120-114-145**  
**120-514-145**

**Metzenbaum**  
 Fig. 3  
 14.5 cm, 5 3/4"  
 gebogen, curved  
**120-115-145**  
**120-515-145**



Metzenbaum-Nelson

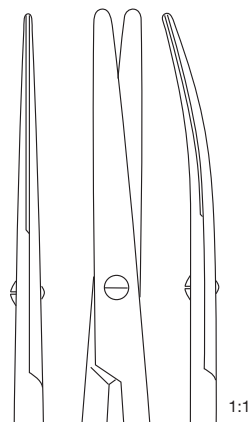

Fig. 1

gerade  
straight

gebogen  
curved

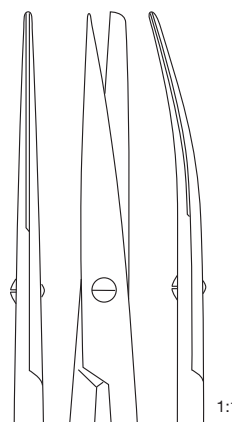

Fig. 2

gerade  
straight

gebogen  
curved

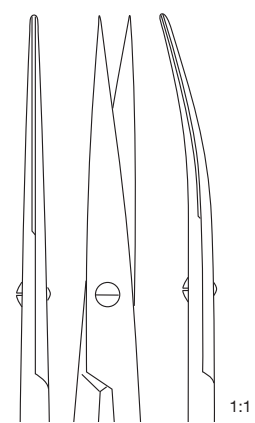

Fig. 3

gerade  
straight

gebogen  
curved

18.0 cm / 7"	120-110-180	120-111-180	120-112-180	120-113-180	120-114-180	120-115-180
18.0 cm / 7"	120-510-180	120-511-180	120-512-180	120-513-180	120-514-180	120-515-180
20.0 cm / 8"	120-110-200	120-111-200	120-112-200	120-113-200	120-114-200	120-115-200
20.0 cm / 8"	120-510-200	120-511-200	120-512-200	120-513-200	120-514-200	120-515-200
23.0 cm / 9"	120-110-230	120-111-230	120-112-230	120-113-230	120-114-230	120-115-230
23.0 cm / 9"	120-510-230	120-511-230	120-512-230	120-513-230	120-514-230	120-515-230
25.0 cm / 10"	120-110-250	120-111-250	120-112-250	120-113-250	120-114-250	120-115-250
25.0 cm / 10"	120-510-250	120-511-250	120-512-250	120-513-250	120-514-250	120-515-250
28.0 cm / 11"	120-110-280	120-111-280	120-112-280	120-113-280	120-114-280	120-115-280
28.0 cm / 11"	120-510-280	120-511-280	120-512-280	120-513-280	120-514-280	120-515-280
30.0 cm / 12"	120-110-300	120-111-300	120-112-300	120-113-300	120-114-300	120-115-300
30.0 cm / 12"	120-510-300	120-511-300	120-512-300	120-513-300	120-514-300	120-515-300

Alle **Metzenbaum / Metzenbaum-Nelson** Präparierscheren mit RZ-Dur Cut können auch mit dem speziellen RZ-Wellenschliff geliefert werden. Der Wellenschliff verhindert das Ausgleiten des zu schneidenden Materials, ohne die Schneidfähigkeit zu reduzieren oder die Schnitthaltigkeit zu beeinträchtigen. Bei der Bestellung ist diese Angabe besonders zu vermerken. Diese Scheren haben einen schwarzen und einen goldenen Ring.

All **Metzenbaum / Metzenbaum-Nelson** Dissecting Scissors with RZ-Dur Cut can be also delivered with the special RZ-corrugated grinding. This corrugated grinding prevents the material to be cut from slipping out without reducing the actual cutting or the durability of the scissors. Please indicate on your order the type / pattern you require. Those scissors have one black and one gold ring.



3

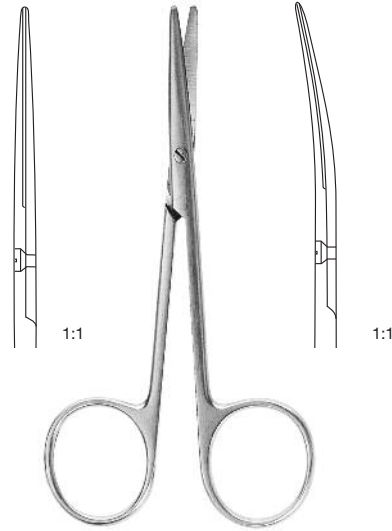

**Lexer-Baby**  
 gerade, straight      gebogen, curved

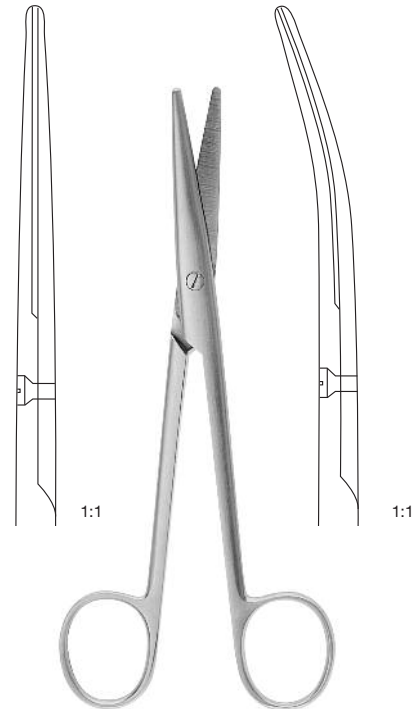

**Lexer**  
 gerade, straight      gebogen, curved

10.0 cm, 4 "	<b>120-136-100</b>	<b>120-137-100</b>		
16.0 cm, 6 1/4"			<b>120-126-160</b>	<b>120-127-160</b>
<b>16.0 cm, 6 1/4"</b>			<b>120-516-160</b>	<b>120-517-160</b>
21.0 cm, 8 1/4"			<b>120-126-210</b>	<b>120-127-210</b>
<b>21.0 cm, 8 1/4"</b>			<b>120-516-210</b>	<b>120-517-210</b>

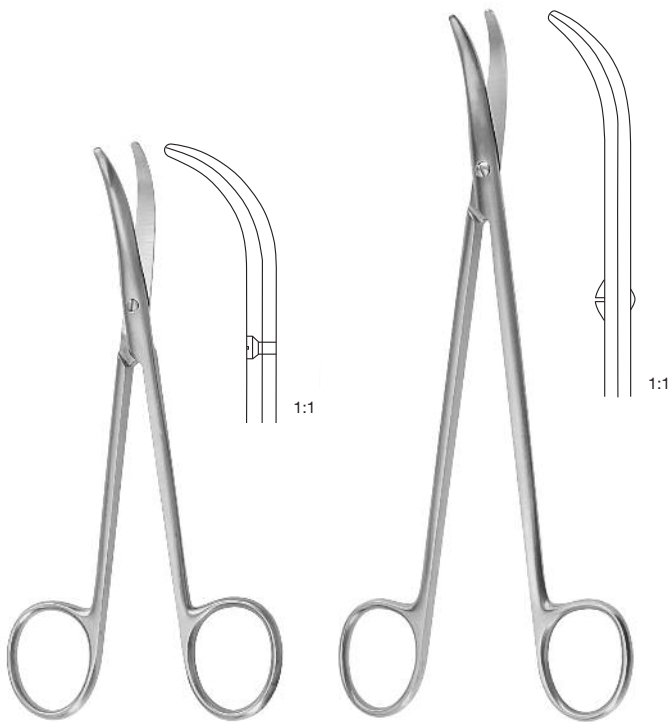

**Fomon**  
 13.5 cm, 5 3/8"  
**120-131-135**

**Thorek**  
 19.0 cm, 7 1/2"  
**120-133-190**

**Nerv-Präparierschere**  
 Nerve dissecting scissors

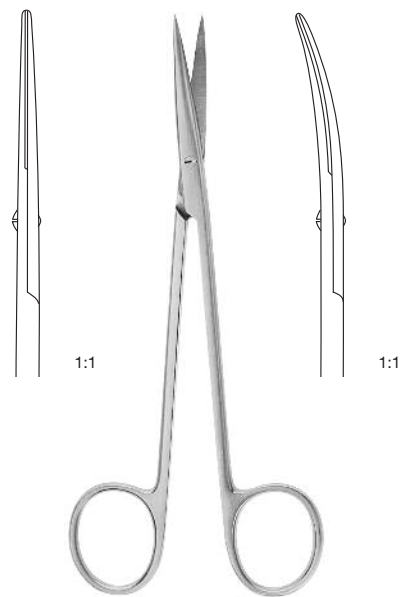

15.0 cm, 6"  
 gerade, straight      gebogen, curved  
**120-120-150**      **120-121-150**

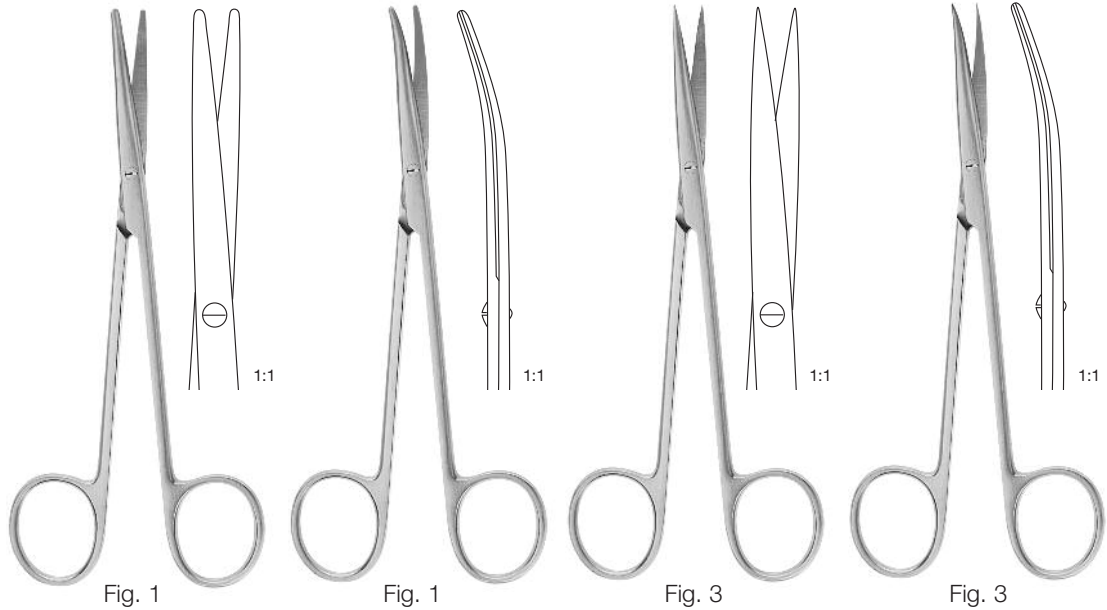

Metzenbaum-Fino

14.5 cm, 5 3/4"	<b>120-152-145</b>	<b>120-153-145</b>	<b>120-154-145</b>	<b>120-155-145</b>
14.5 cm, 5 3/4"	<b>120-520-145</b>	<b>120-521-145</b>	<b>120-522-145</b>	<b>120-523-145</b>

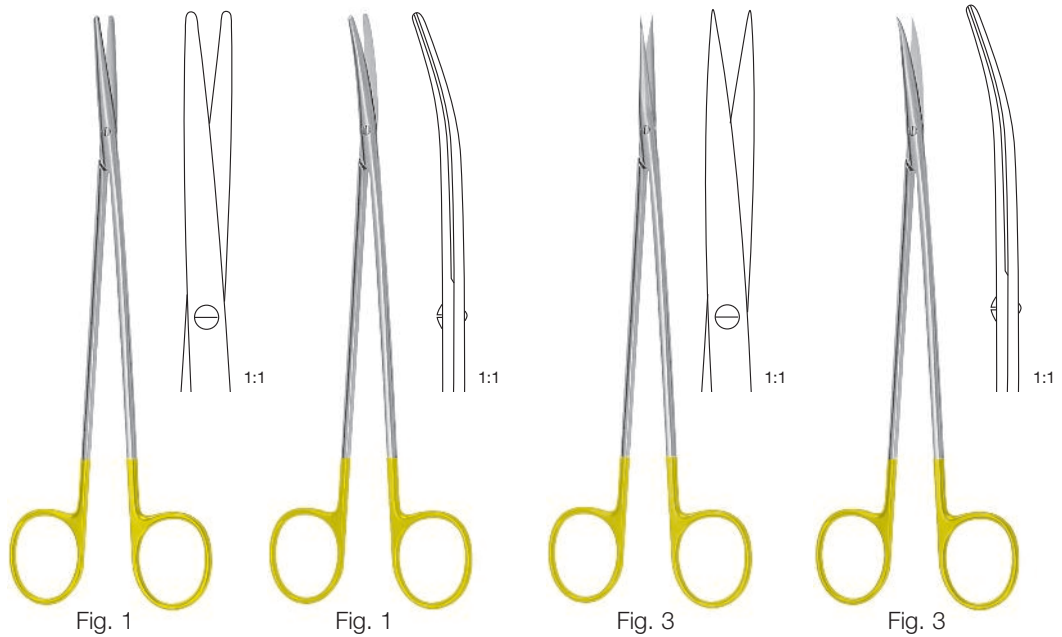

Metzenbaum-Fino

18.0 cm, 7"	<b>120-152-180</b>	<b>120-153-180</b>	<b>120-154-180</b>	<b>120-155-180</b>
18.0 cm, 7"	<b>120-520-180</b>	<b>120-521-180</b>	<b>120-522-180</b>	<b>120-523-180</b>
20.0 cm, 8"	<b>120-152-200</b>	<b>120-153-200</b>	<b>120-154-200</b>	<b>120-155-200</b>
20.0 cm, 8"	<b>120-520-200</b>	<b>120-521-200</b>	<b>120-522-200</b>	<b>120-523-200</b>
23.0 cm, 9"	<b>120-152-230</b>	<b>120-153-230</b>	<b>120-154-230</b>	<b>120-155-230</b>
23.0 cm, 9"	<b>120-520-230</b>	<b>120-521-230</b>	<b>120-522-230</b>	<b>120-523-230</b>
25.0 cm, 10"	<b>120-152-250</b>	<b>120-153-250</b>	<b>120-154-250</b>	<b>120-155-250</b>
25.0 cm, 10"	<b>120-520-250</b>	<b>120-521-250</b>	<b>120-522-250</b>	<b>120-523-250</b>
28.0 cm, 11"	<b>120-152-280</b>	<b>120-153-280</b>	<b>120-154-280</b>	<b>120-155-280</b>
28.0 cm, 11"	<b>120-520-280</b>	<b>120-521-280</b>	<b>120-522-280</b>	<b>120-523-280</b>
30.0 cm, 12"	<b>120-152-300</b>	<b>120-153-300</b>	<b>120-154-300</b>	<b>120-155-300</b>
30.0 cm, 12"	<b>120-520-300</b>	<b>120-521-300</b>	<b>120-522-300</b>	<b>120-523-300</b>



3

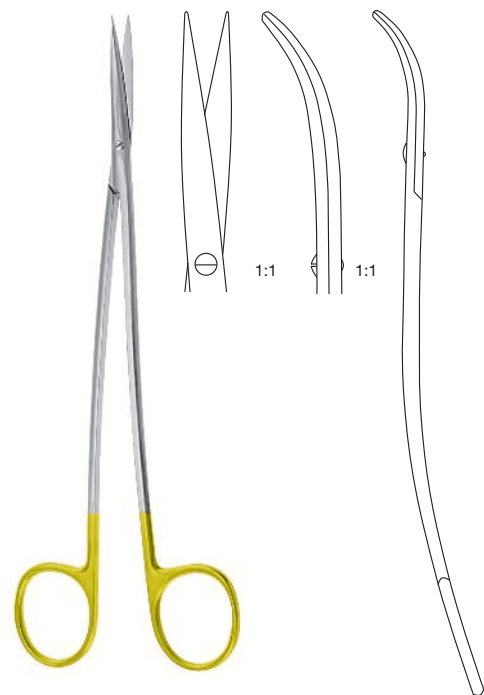
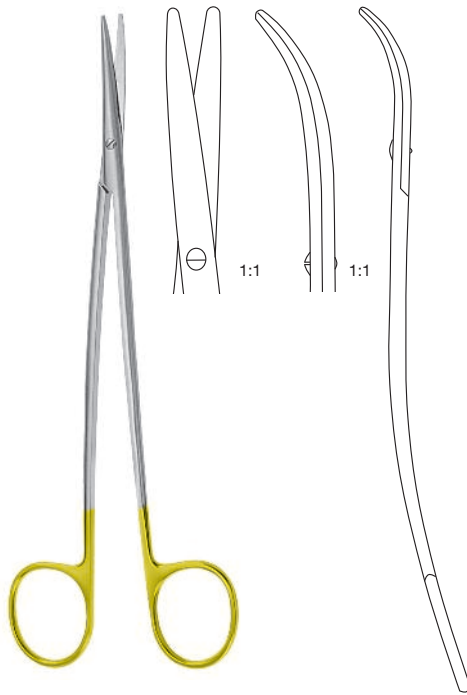

**Metzenbaum-Fino**  
 S-gebogen, S-curved

**Metzenbaum-Fino**  
 S-gebogen, S-curved

18.0 cm, 7"	<b>120-157-180</b>	<b>120-159-180</b>
<b>18.0 cm, 7"</b>	<b>120-525-180</b>	<b>120-527-180</b>
20.0 cm, 8"	<b>120-157-200</b>	<b>120-159-200</b>
<b>20.0 cm, 8"</b>	<b>120-525-200</b>	<b>120-527-200</b>
23.0 cm, 9"	<b>120-157-230</b>	<b>120-159-230</b>
<b>23.0 cm, 9"</b>	<b>120-525-230</b>	<b>120-527-230</b>



**Metzenbaum-Lahey**  
 14.0 cm, 5 1/2"  
 gebogen, curved  
**120-530-140**

**Toennis-Adson**  
 17.0 cm, 6 3/4"  
 gebogen, curved  
**120-257-170**  
**120-531-170**

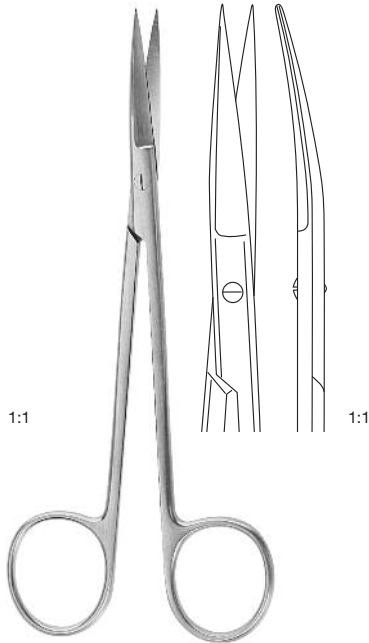
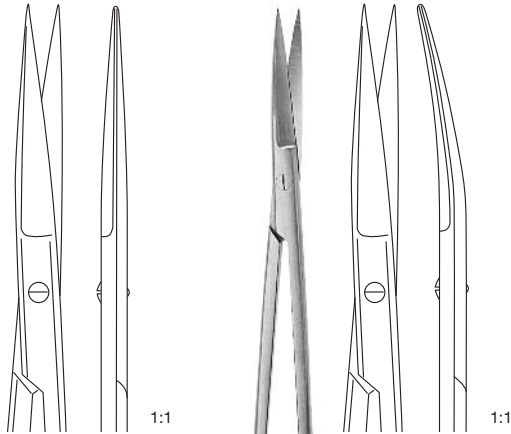

**Sanvenero**  
 14.0 cm, 5 1/2"

gerade, straight  
**120-056-140**



gebogen, curved  
**120-057-140**

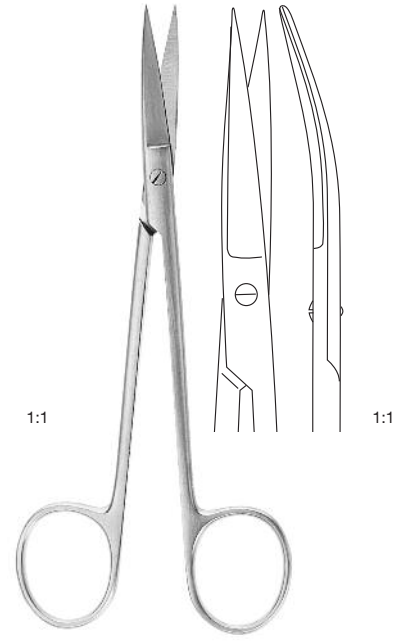
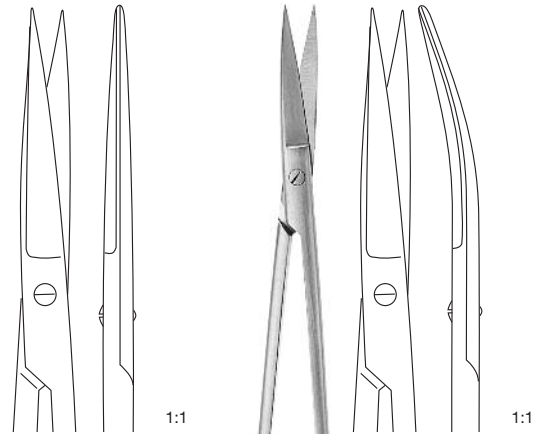

**Joseph**  
 14.0 cm, 5 1/2"

gerade, straight  
**120-058-140**

gebogen, curved  
**120-059-140**

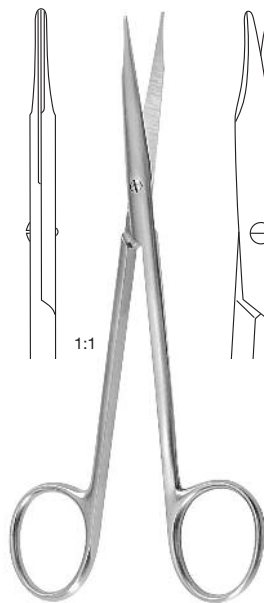
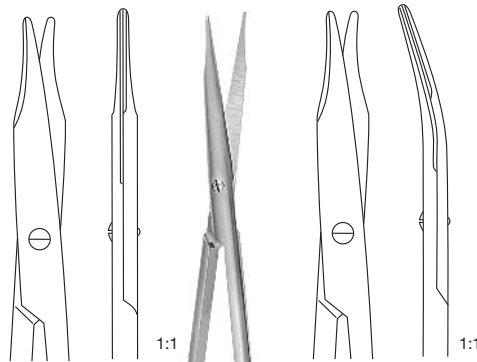

**Reynolds**

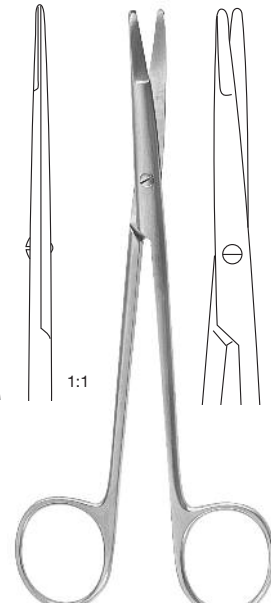
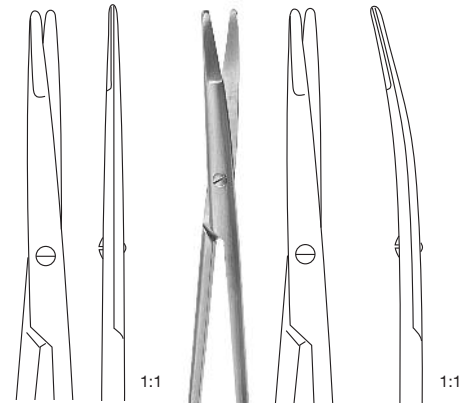

**Kilner (Ragnell)**

12.0 cm, 4 3/4"			<b>120-064-120</b>	<b>120-065-120</b>
15.0 cm, 6"	<b>120-042-150</b>	<b>120-043-150</b>	<b>120-064-150</b>	<b>120-065-150</b>
<b>15.0 cm, 6"</b>	<b>120-542-150</b>	<b>120-543-150</b>		
18.0 cm, 7"	<b>120-042-180</b>	<b>120-043-180</b>	<b>120-064-180</b>	<b>120-065-180</b>
20.0 cm, 8"			<b>120-064-200</b>	<b>120-065-200</b>



**3**

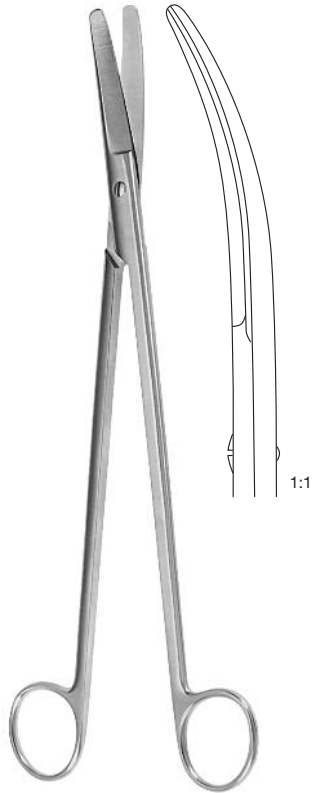

**Crafoord**  
 30.0 cm, 12"  
 120-201-300

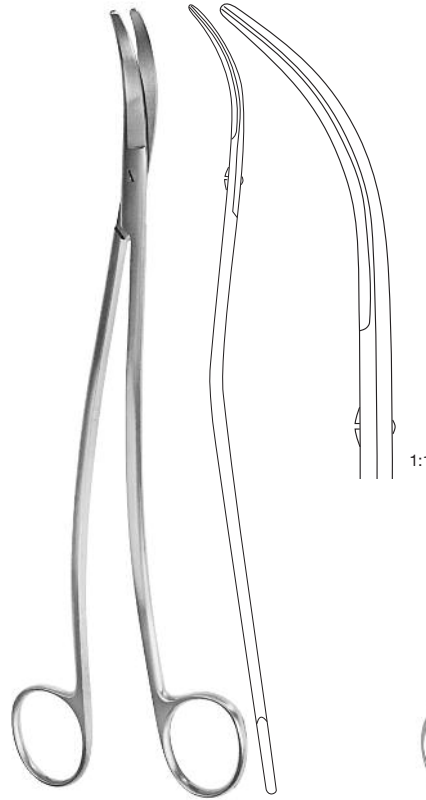

**Satinsky**  
 24.5 cm, 9 5/8"  
 120-203-245

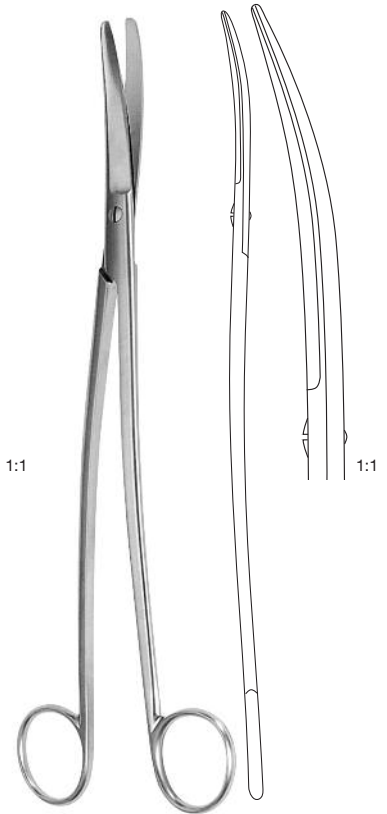

**Klinkenberg-Loth**  
 23.0 cm, 9"  
 120-205-230



**Dietrich-Hegemann**  
 18.0 cm, 7"

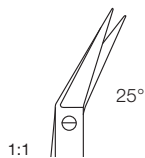

**120-175-025**  
**120-570-025**

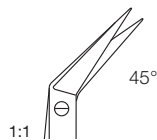

**120-175-045**  
**120-570-045**

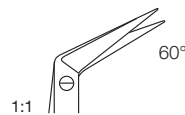

**120-175-060**  
**120-570-060**



**120-175-090**  
**120-570-090**

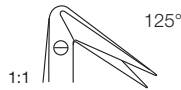

**120-175-125**  
**120-570-125**

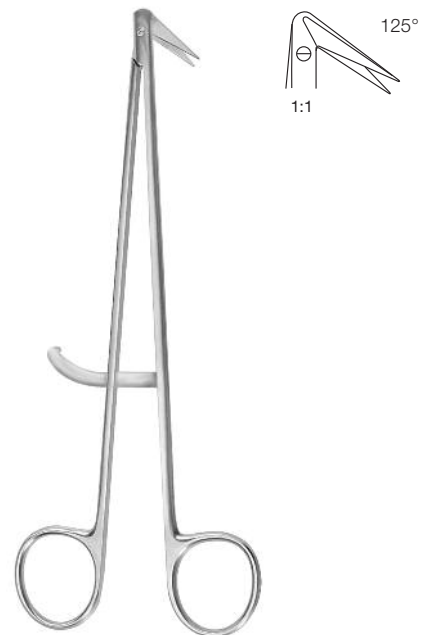

**Diethrich**  
 Circumflex  
 17.5 cm, 6 5/8"  
**120-176-125**  
**120-576-125**

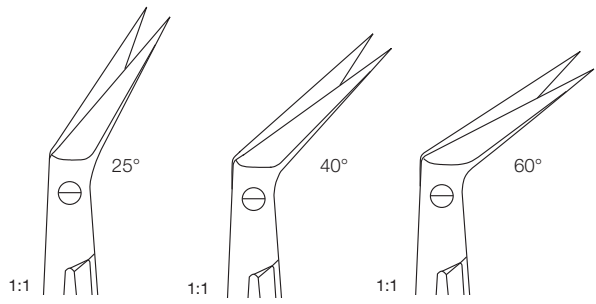
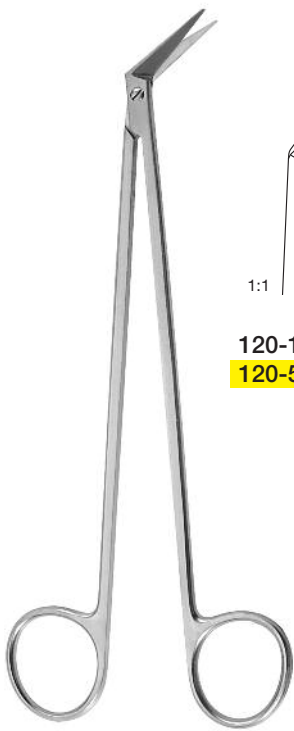

**120-181-190**  
**120-581-190**

**120-182-190**  
**120-582-190**

**120-183-190**  
**120-583-190**

**Potts-Smith**  
 19.0 cm, 7 1/2"

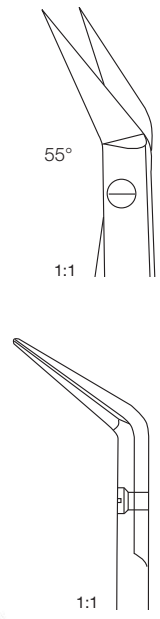

**Potts-Smith**  
 18.0 cm, 7"  
**120-185-180**

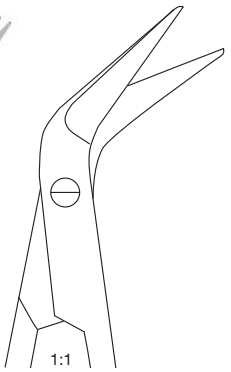
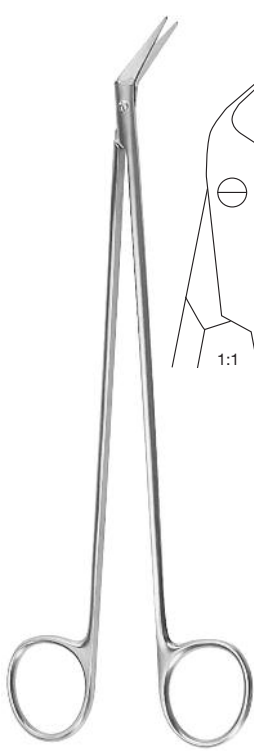

**Potts de Martel**  
 21.0 cm, 8 1/4"  
**120-179-210**

24.0 cm, 9 1/2"  
**120-179-240**  
**120-579-240**

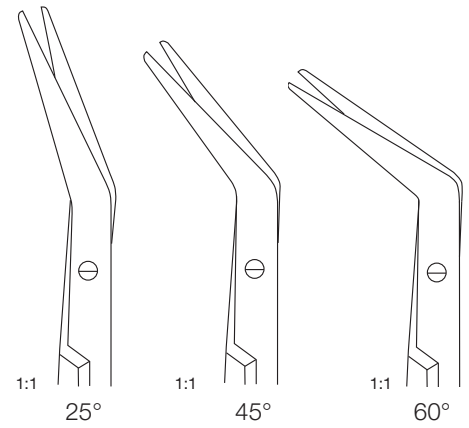

16.0 cm, 6 1/4"	<b>120-192-025</b>	<b>120-192-045</b>	<b>120-192-060</b>
23.0 cm, 9"	<b>120-193-025</b>	<b>120-193-045</b>	<b>120-193-060</b>
<b>23.0 cm, 9"</b>	<b>120-593-025</b>	<b>120-593-045</b>	<b>120-593-060</b>
28.0 cm, 11"	<b>120-194-025</b>	<b>120-194-045</b>	<b>120-194-060</b>

**De Bakey**





3

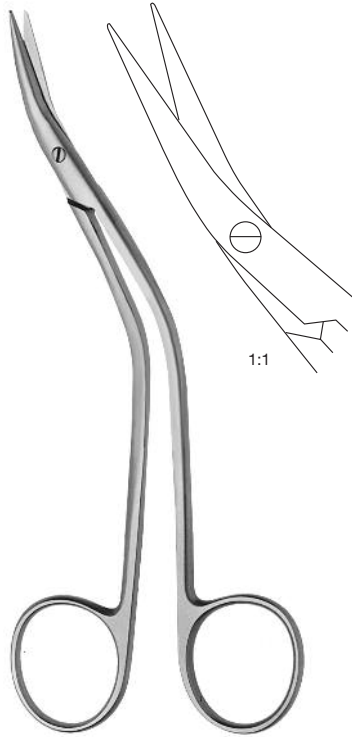

**De Bakey**  
15.5 cm, 6"  
120-195-155

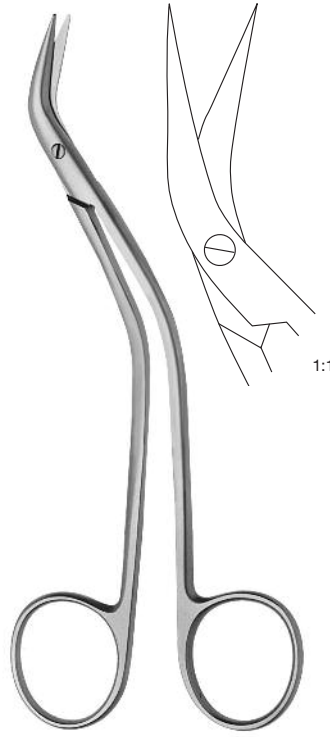

**De Bakey**  
15.5 cm, 6"  
120-197-155

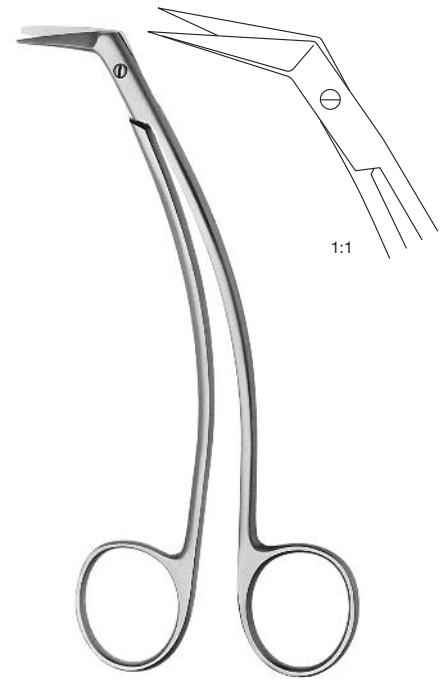

**Favaloro**  
15.5 cm, 6"  
120-199-155

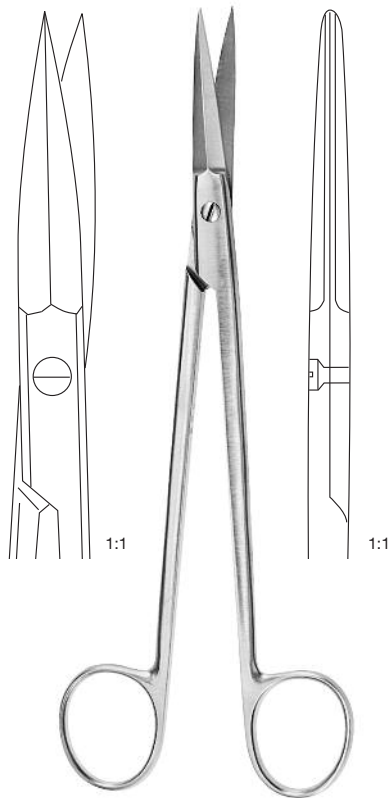

**Mc Indoe**  
19.0 cm, 7 1/2"  
120-190-190



**Coronar-Schere**  
**Coronary-Scissors**  
11.5 cm, 4 1/2"  
120-420-115

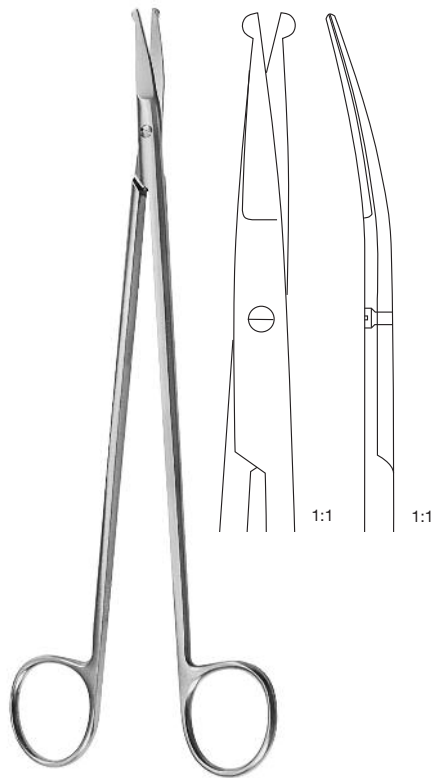

**Strully**  
22.0 cm, 8 5/8"  
120-250-220

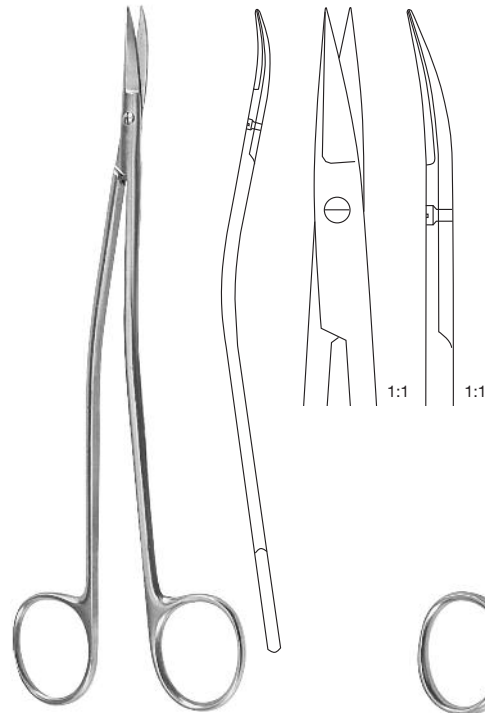

**Dandy**  
17.0 cm, 6 3/4"  
120-253-170

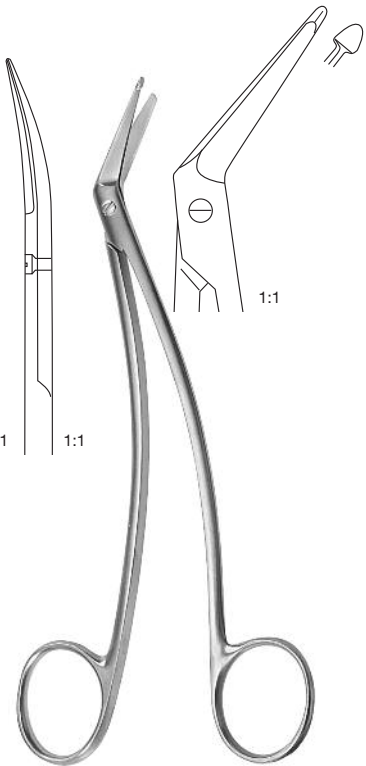

**Schmieden-Taylor**  
17.0 cm, 6 3/4"  
120-430-170



**Lincoln**  
17.0 cm, 6 3/4"

gerade, straight 120-260-170  
gebogen, curved 120-261-170

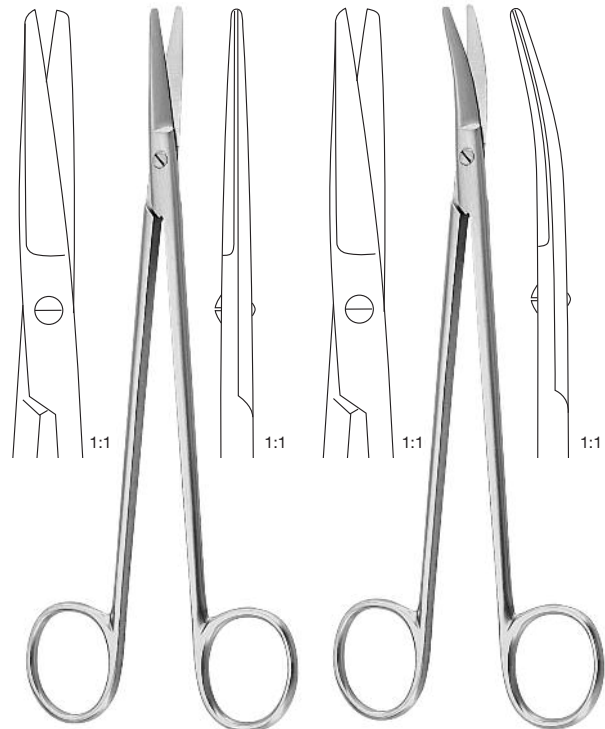

**Toennis**  
18.0 cm, 7"  
gerade, straight  
120-254-180

gebogen, curved  
120-255-180



3



**Halle**  
19.0 cm, 7 1/2"  
120-275-190

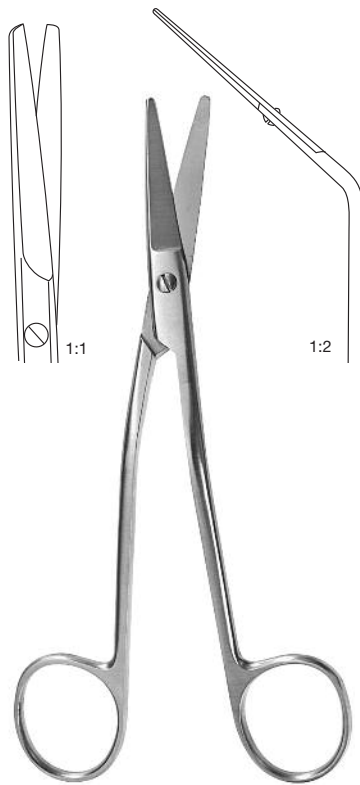

**Fomon**  
15.0 cm, 6"  
120-280-150

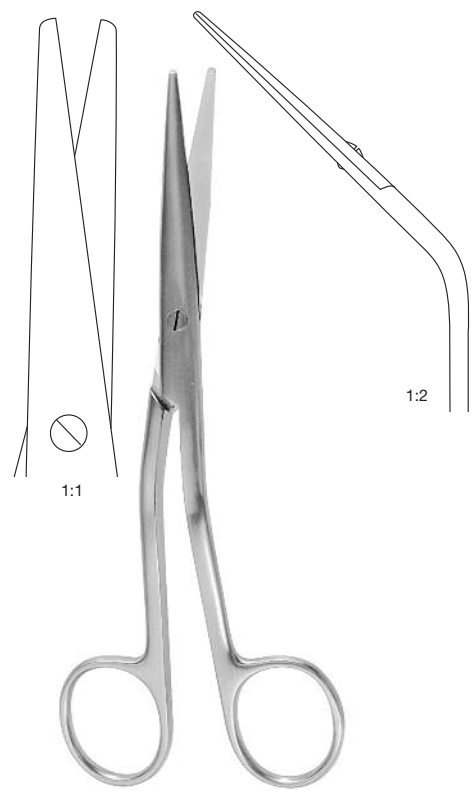

**Cottle**  
16.0 cm, 6 1/4"  
120-281-160

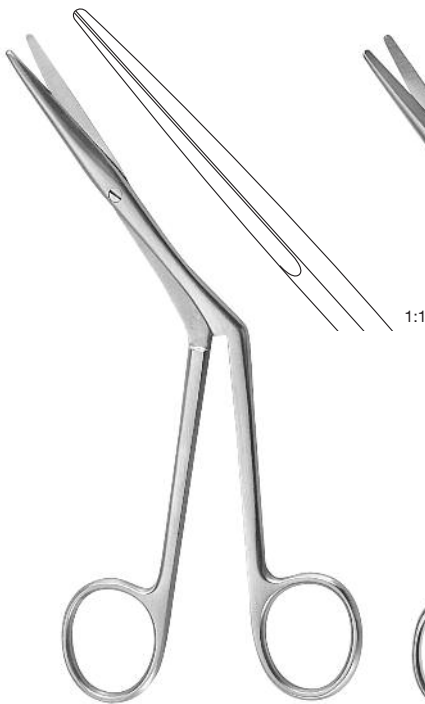

**Heymann**  
18.0 cm, 7"  
120-283-180

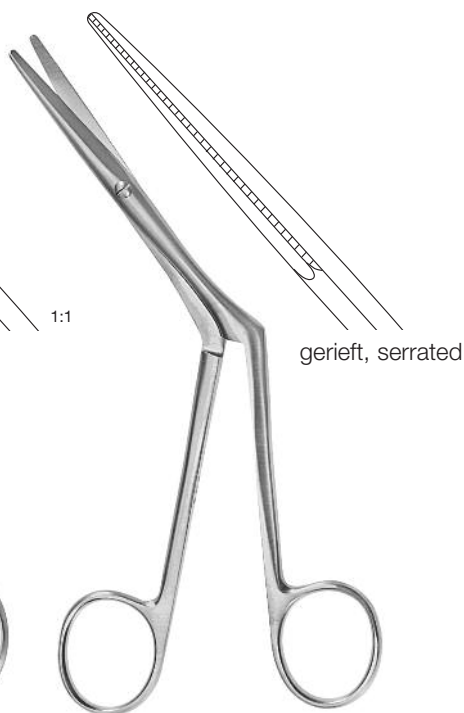

**Kirstein**  
18.0 cm, 7"  
120-285-175



**Caplan**  
22.0 cm, 8 5/8"  
gerade, straight      gebogen, curved  
120-286-220      120-287-220

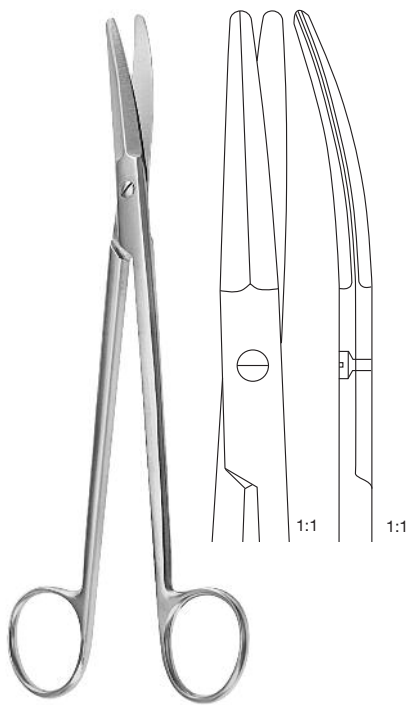

**Boettcher**  
 18.0 cm, 7"  
 120-209-180

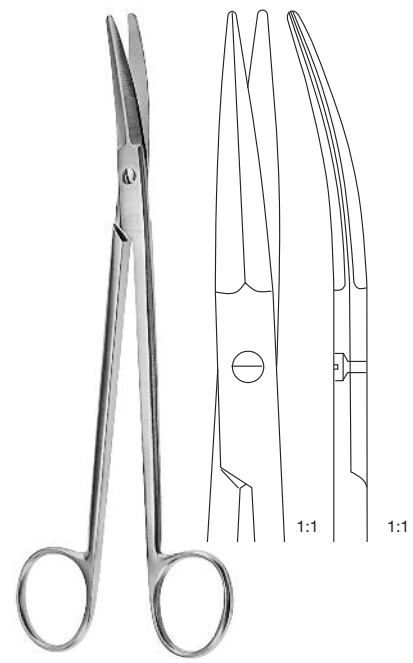

**Prince**  
 17.5 cm, 6 5/8"  
 120-213-175

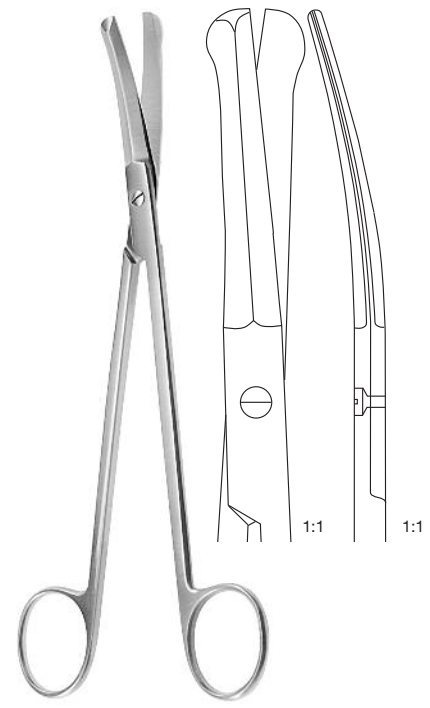

**Good**  
 19.0 cm, 7 1/2"  
 120-217-190



**Martin-Cartilage**  
 20.0 cm, 8"  
 120-206-200



21.0 cm, 8 1/4"  
 120-233-210



21.0 cm, 8 1/4"  
 120-234-210



21.0 cm, 8 1/4"  
 120-235-210



3

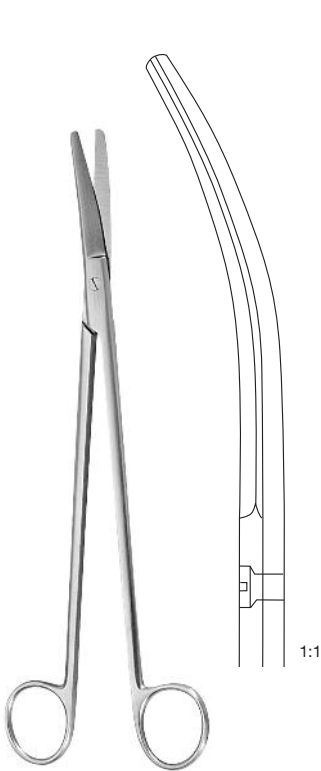

**Lloyd-Davies  
(Goligher's)**  
27.0 cm, 10 <sup>5</sup>/<sub>8</sub>"  
120-240-270

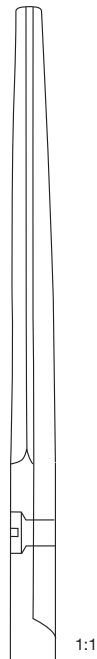

**Stelzner**  
31.0 cm, 12 <sup>1</sup>/<sub>4</sub>"

gerade, straight  
120-242-310



gebogen, curved  
120-243-310

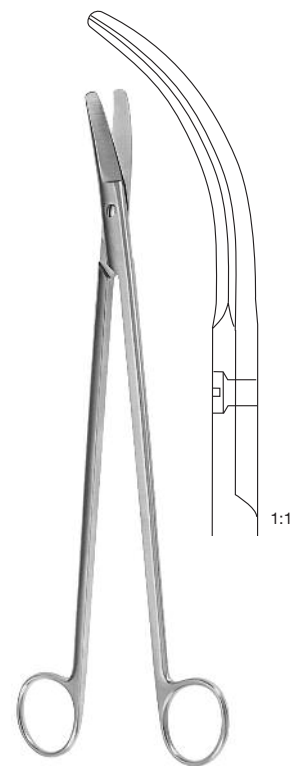

**Rectal**  
gebogen, curved  
32.5 cm, 12 <sup>3</sup>/<sub>4</sub>"  
120-245-325



**Willauer**

gerade, straight

gebogen, curved

25.0 cm, 9 <sup>3</sup>/<sub>4</sub>"

120-214-250

120-215-250

28.0 cm, 11"

120-214-280

120-215-280

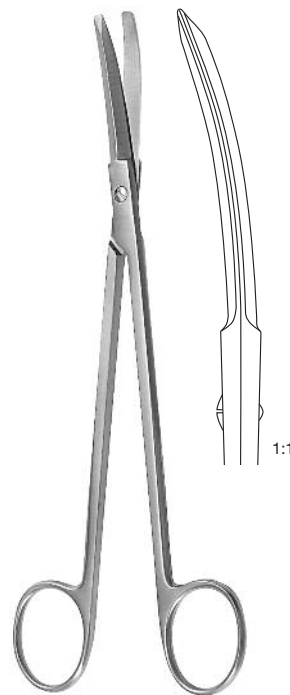

**Potts-Smith**

19.0 cm, 7 <sup>1</sup>/<sub>2</sub>"

120-216-190

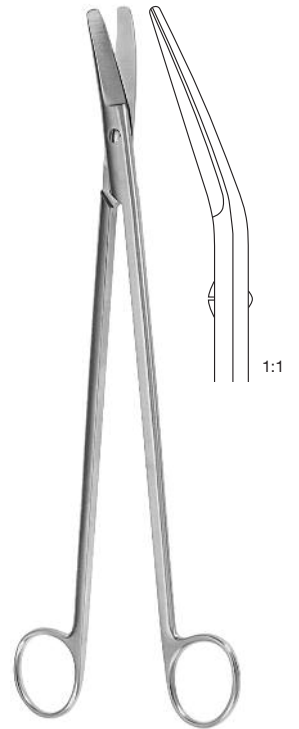

**Finochietto**

27.0 cm, 10 <sup>5</sup>/<sub>8</sub>"

120-210-270



**Waldmann**  
18.0 cm, 7"  
120-231-180



**Braun-Stadler**  
14.5 cm, 5 3/4"  
120-225-145  
  
20.0 cm, 8"  
120-225-200



**RZ-Episiotomy**  
20.0 cm, 8"  
120-232-200



**Mod. USA**  
10.5 cm, 4 1/8"  
120-233-105



**Busch**  
13.5 cm, 5 3/8"  
120-229-135  
  
16.0 cm, 6 1/4"  
120-229-160



**Schumacher**  
16.0 cm, 6 1/4"  
120-227-160



**3**



**Wagner**  
 12.0 cm, 4 3/4"



Fig.1  
 gerade, straight  
 120-046-120



Fig.1  
 gebogen, curved  
 120-047-120

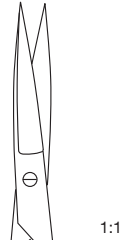

Fig.3  
 gerade, straight  
 120-054-120

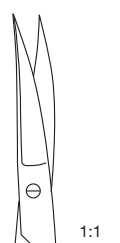
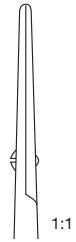

Fig.3  
 gebogen, curved  
 120-055-120



**Strabismus**  
 11.5 cm, 4 1/2"



gerade, straight  
 120-094-115

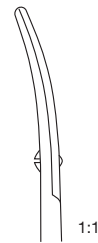

gebogen, curved  
 120-095-115



**Iris**

9.0 cm, 3 1/2"	120-070-090	120-071-090		
10.5 cm, 4 1/8"	120-070-105	120-071-105	120-080-105	120-081-105
11.5 cm, 4 1/2"	120-070-115	120-071-115	120-080-115	120-081-115
11.5 cm, 4 1/2"	120-554-115	120-555-115		



3



11.5 cm, 4 1/2"  
120-083-115



11.5 cm, 4 1/2"  
120-085-115



12.0 cm, 4 3/4"  
120-086-120



12.0 cm, 4 3/4"  
120-087-120

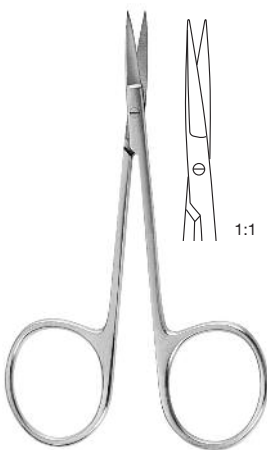

1:1

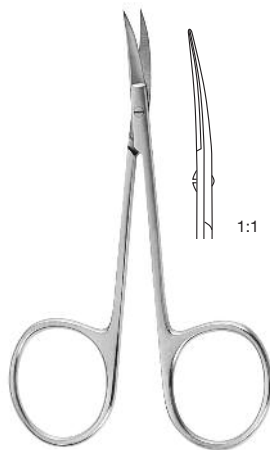

1:1

**Mod. Bonn**

sehr fein, extra delicate  
8.0 cm, 3 1/4"

gerade, straight  
120-072-080

gebogen, curved  
120-073-080

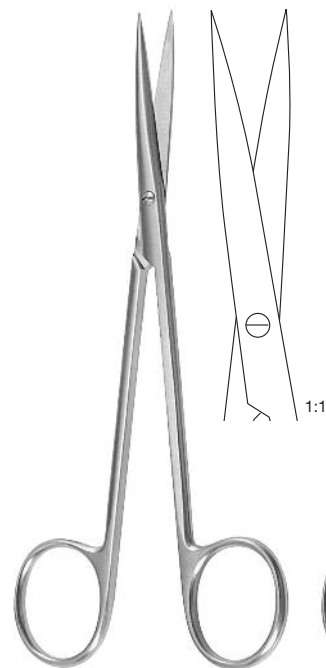

1:1

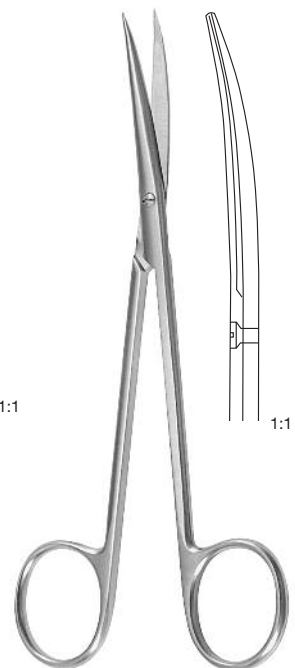

1:1

**Brophy  
(Sullivan)**

14.0 cm, 5 1/2"

gerade, straight  
120-054-140

gebogen, curved  
120-055-140





3

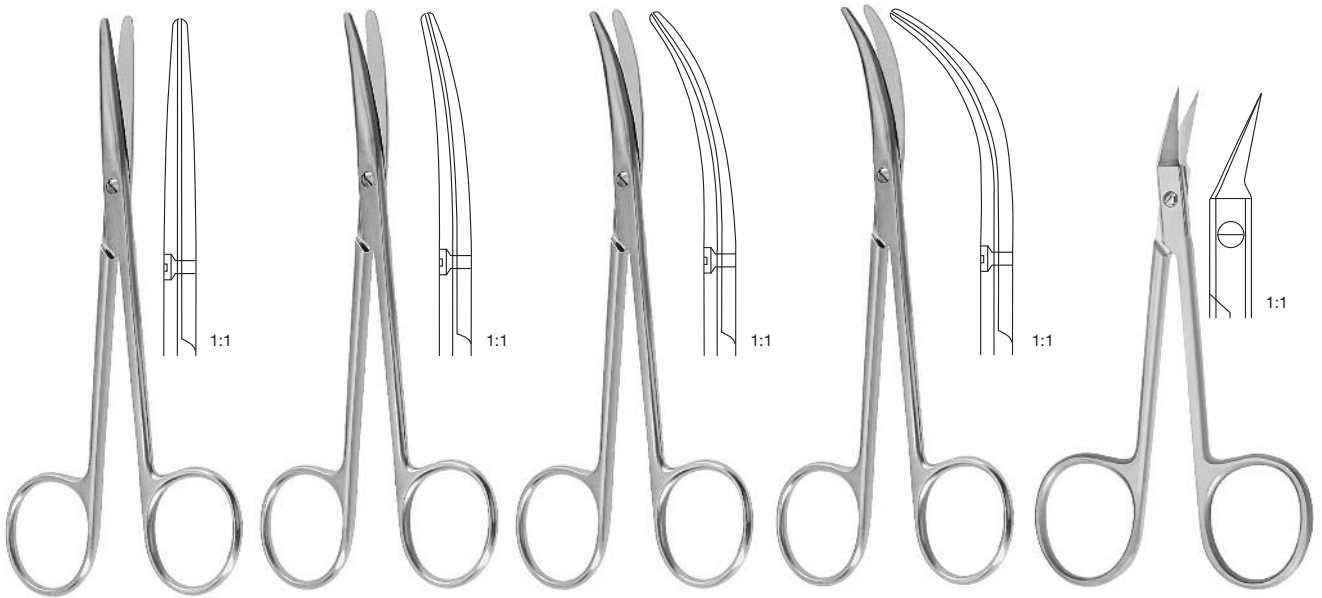

**Landolt**  
 12.5cm, 5"

gerade  
 straight  
 120-122-125

leicht gebogen  
 slightly curved  
 120-123-125

gebogen  
 curved  
 120-124-125

stark gebogen  
 acutely curved  
 120-125-125

**O'Brien**  
 9.5 cm, 3 3/4"  
 120-084-095

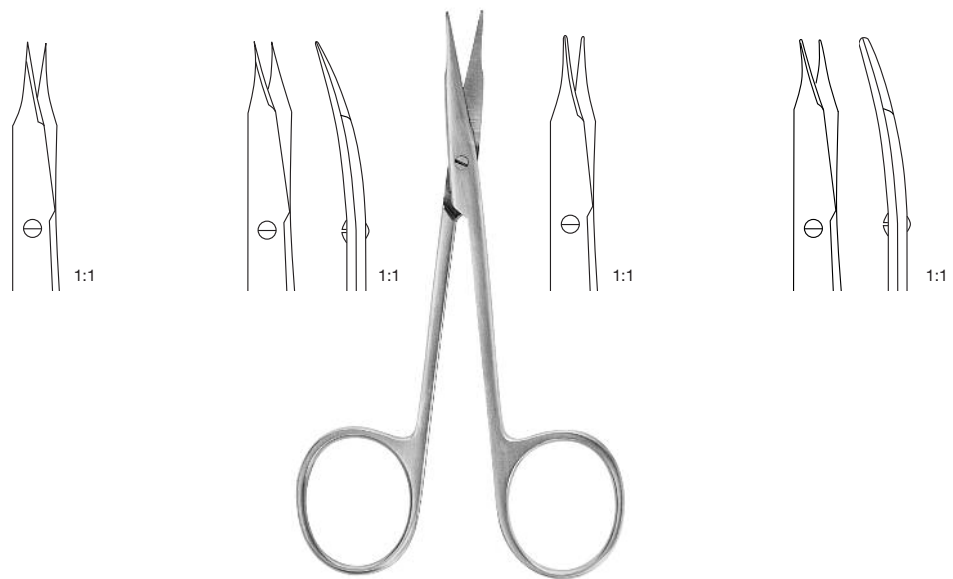

**Stevens**

	spitz, pointed		stumpf, blunt	
	gerade, straight	gebogen, curved	gerade, straight	gebogen, curved
10.5 cm, 4 1/8"	<b>120-090-105</b>	<b>120-091-105</b>	<b>120-092-105</b>	<b>120-093-105</b>
11.5 cm, 4 1/2"	<b>120-090-115</b>	<b>120-091-115</b>	<b>120-092-115</b>	<b>120-093-115</b>



**Spencer**

9.0 cm, 3 1/2"	<b>120-220-090</b>
10.5 cm, 4 1/8"	<b>120-220-105</b>
13.0 cm, 5"	<b>120-220-130</b>



**Littauer**

11.5 cm, 4 1/4"	<b>120-224-115</b>
14.0 cm, 5 1/2"	<b>120-224-140</b>

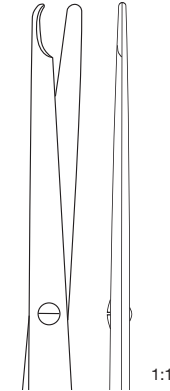

**120-228-145**

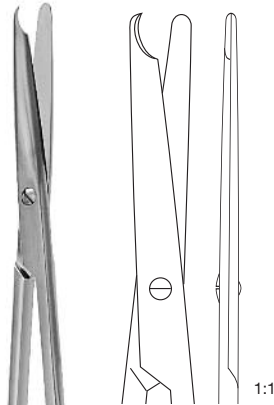

**120-228-180**

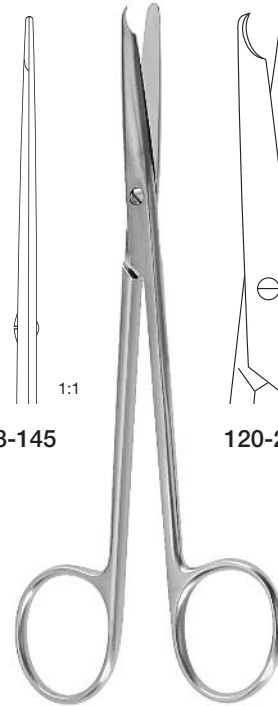

**Buck**

14.5 cm, 5 3/4"	<b>120-228-145</b>
18.0 cm, 7"	<b>120-228-180</b>



**Shortbent**

9.0 cm, 3 1/2"	<b>120-223-090</b>
----------------	--------------------



**Northbent**

13.0 cm, 5"	<b>120-222-130</b>
-------------	--------------------



**Eiselsberg**

12.0 cm, 4 3/4"	<b>120-230-120</b>
-----------------	--------------------

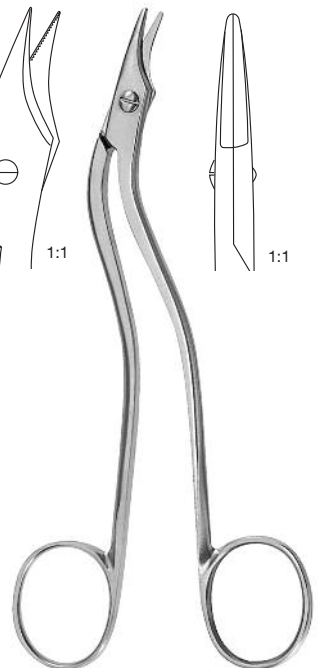

**Heath**

16.0 cm, 6 1/4"	<b>120-226-160</b>
-----------------	--------------------



**Verband und Gips**

**Draht-, Kleider- und Verbandscheren**  
**RZ-Dur Cut Scheren**

**Dressing**

**Wire, Utility and Bandage Scissors**  
**RZ-Dur Cut Scissors**

**3**

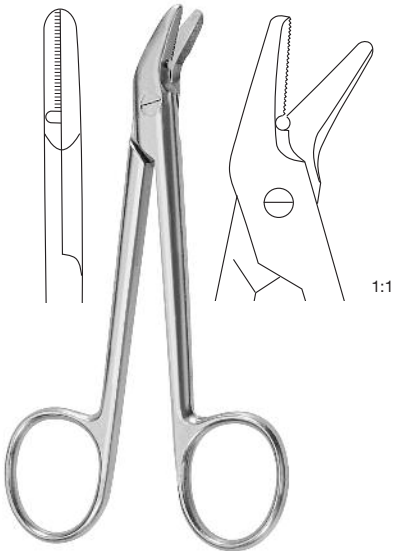

**Universal**  
 gezahnt, saw edge  
 12.0 cm, 4 3/4"  
**120-265-120**  
**120-565-120**



143°C autoklavierbar,  
 293°F autoclavable  
  
 andere Farben  
 auf Anfrage  
 other colours on  
 request  
  
**Universal**  
 blau, blue  
 18.0 cm, 7"  
**190-209-180**



<b>Smith (Mod. USA)</b>	
16.0 cm, 6 1/4"	<b>120-270-160</b>
18.0 cm, 7"	<b>120-270-180</b>
20.0 cm, 8"	<b>120-270-200</b>
23.0 cm, 9"	<b>120-270-230</b>



<b>Lister</b>	
9.0 cm, 3 1/2"	<b>190-165-090</b>
11.0 cm, 4 3/8"	<b>190-165-110</b>
14.0 cm, 5 1/2"	<b>190-165-140</b>
18.0 cm, 7"	<b>190-165-180</b>
<b>18.0 cm, 7"</b>	<b>190-291-180</b>
20.0 cm, 8"	<b>190-165-200</b>



<b>Lister</b>	
18.5 cm, 7 1/4"	<b>190-170-185</b>
21.0 cm, 8 1/4"	<b>190-170-210</b>

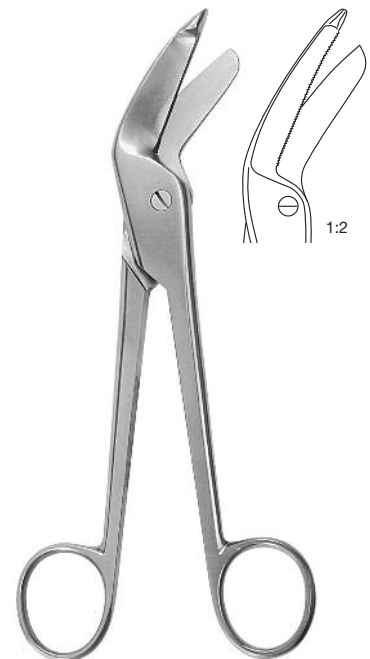

<b>Lister-Excentric</b>	
gezahnt, saw edge	
16.0 cm, 6 1/4"	<b>190-177-160</b>
19.0 cm, 7 1/2"	<b>190-177-190</b>

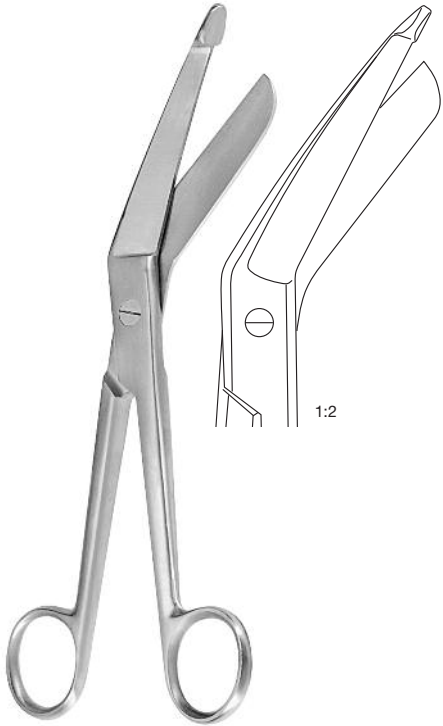

**Bergmann**  
 23.0 cm, 9"  
 190-195-230

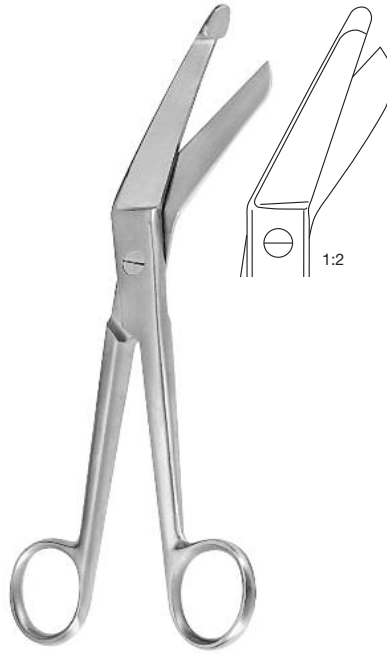

**Esmarch**  
 20.0 cm, 8"  
 190-205-200  
 22.0 cm, 8 5/8"  
 190-205-220



**Knowles**  
 14.0 cm, 5 1/2"  
 190-160-140

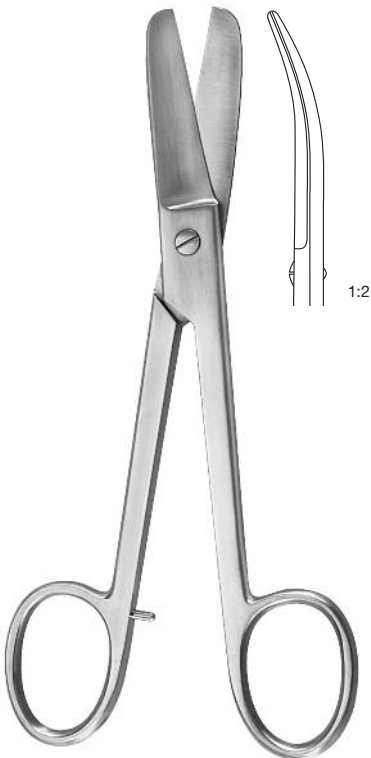

**Lorenz**  
 23.0 cm, 9"  
 190-155-230

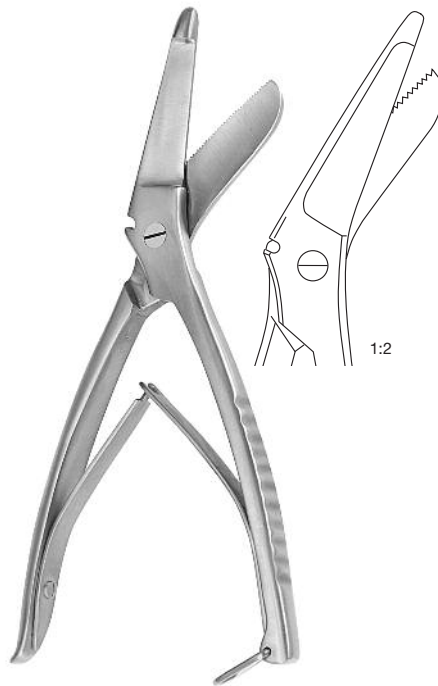

**RZ-Multi**  
 gezahnt, saw edge  
 20.0 cm, 8"  
 190-211-200

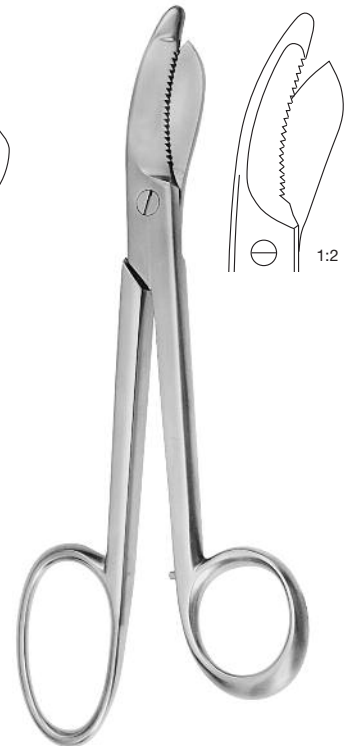

**Bruns**  
 24.0 cm, 9 1/2"  
 gezahnt, saw edge  
 190-223-240

**Bruns**  
 24.0 cm, 9 1/2"  
 glatt, smooth  
 190-224-240  
**190-297-240**



3

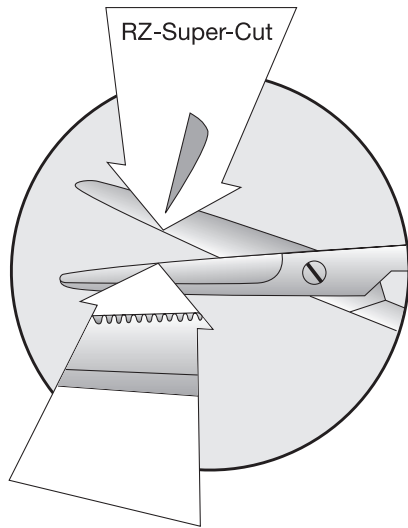

Das RZ-Super-Cut Blatt besitzt eine einzigartige rasierklingscharfe Schneidekante, zum mühelosen Schneiden des Gewebes.

Das untere Blatt besitzt eine ganz feine Riefung, die das Abgleiten des Gewebes verhindert.

Zur leichten Identifizierung hat die RZ-Super Cut Schere schwarze Ringe.

The RZ-Super-Cut blade has a uniquely designed razor sharp edge to cut effortlessly through tissue.

The lower blade has very fine serrations to prevent tissue slippage. For easy identification RZ-Super-Cut scissors have two black rings.

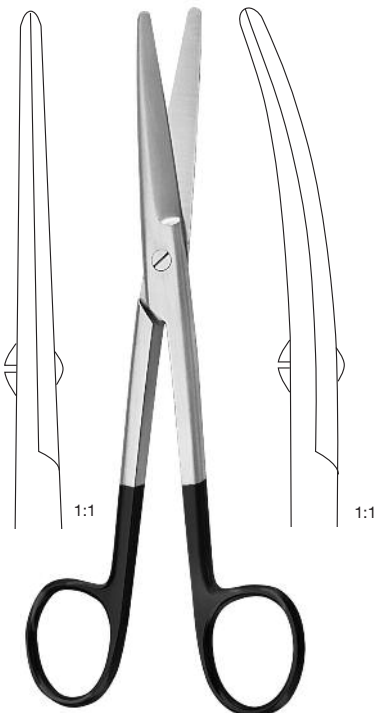

**Mayo**  
17.0 cm, 6 3/4"  
gerade, straight  
**121-030-170**  
gebogen, curved  
**121-031-170**

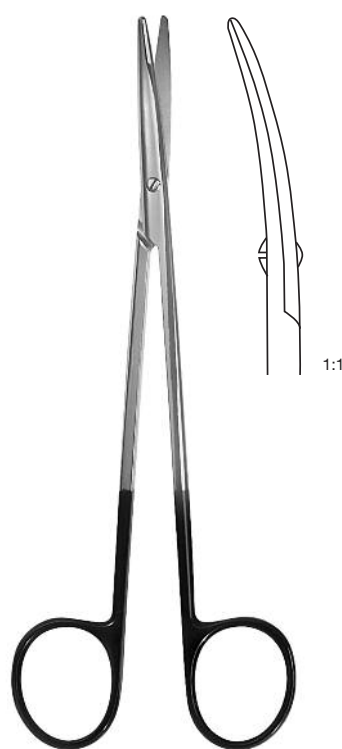

**Metzenbaum**  
gebogen, curved

14.5 cm, 5 3/4"	<b>121-111-145</b>
18.0 cm, 7"	<b>121-111-180</b>
20.0cm, 8"	<b>121-111-200</b>
23.0 cm, 9"	<b>121-111-230</b>

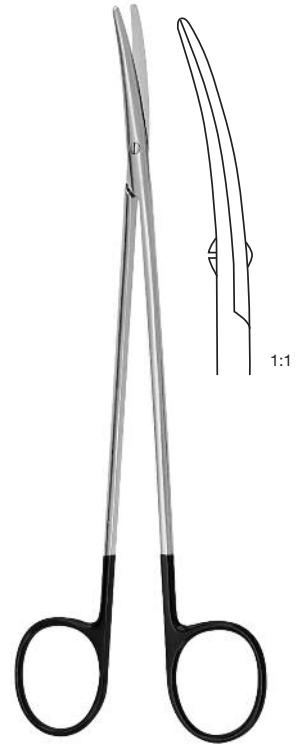

**Metzenbaum-Fino**  
gebogen, curved

14.5 cm, 5 3/4"	<b>121-153-145</b>
18.0 cm, 7"	<b>121-153-180</b>
20.0cm, 8"	<b>121-153-200</b>
23.0 cm, 9"	<b>121-153-230</b>



3

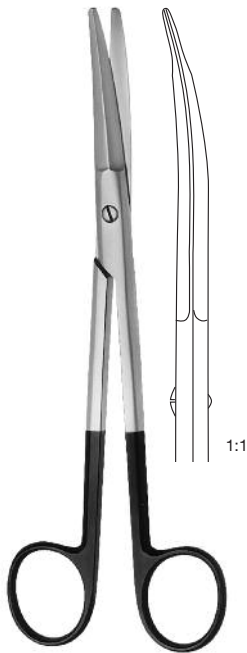

**Kaye Face Lift**  
gebogen, curved  
15.0 cm, 6"  
121-311-150  
19.0 cm, 7 1/2"  
121-311-190



**Jabaley**  
gebogen, curved  
große Ringe, large rings  
13.0 cm, 5"  
121-089-130



**Endarterectomy**  
gebogen, curved  
18.0 cm, 7"  
121-320-180



**Toennis-Adson**  
gebogen, curved  
17.0 cm, 6 3/4"  
121-319-170

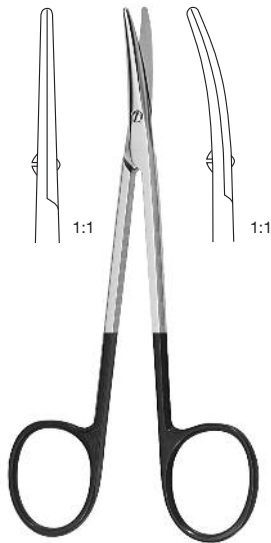

**Strabismus**  
11.5 cm, 4 1/2"  
gerade, straight  
121-094-115  
gebogen, curved  
121-095-115



**Strabismus**  
12.0 cm, 4 3/4"  
gerade, straight  
121-100-120  
gebogen, curved  
121-101-120



**Jamison**  
gebogen, curved  
15.0 cm, 6"  
121-315-150  
18.0 cm, 7"  
121-315-180



**Reynolds**  
gebogen, curved  
12.5 cm, 5"  
121-318-125



3



**Iris**  
11.0 cm, 4 <sup>3</sup>/<sub>8</sub>"  
gerade, straight  
121-070-110  
gebogen, curved  
121-071-110

**Metzenbaum-Baby**  
gebogen, curved  
11.0 cm, 4 <sup>3</sup>/<sub>8</sub>"  
121-317-110  
14.5 cm, 5 <sup>3</sup>/<sub>4</sub>"  
121-317-145

**Stevens Tenotomy**  
11.0 cm, 4 <sup>3</sup>/<sub>8</sub>"  
gerade, straight  
121-196-110  
gebogen, curved  
121-197-110

**Par Type**  
11.0 cm, 4 <sup>3</sup>/<sub>8</sub>"  
gerade, straight  
121-330-110  
gebogen, curved  
121-331-110



**Potts**  
19.0 cm, 7 <sup>1</sup>/<sub>2</sub>"

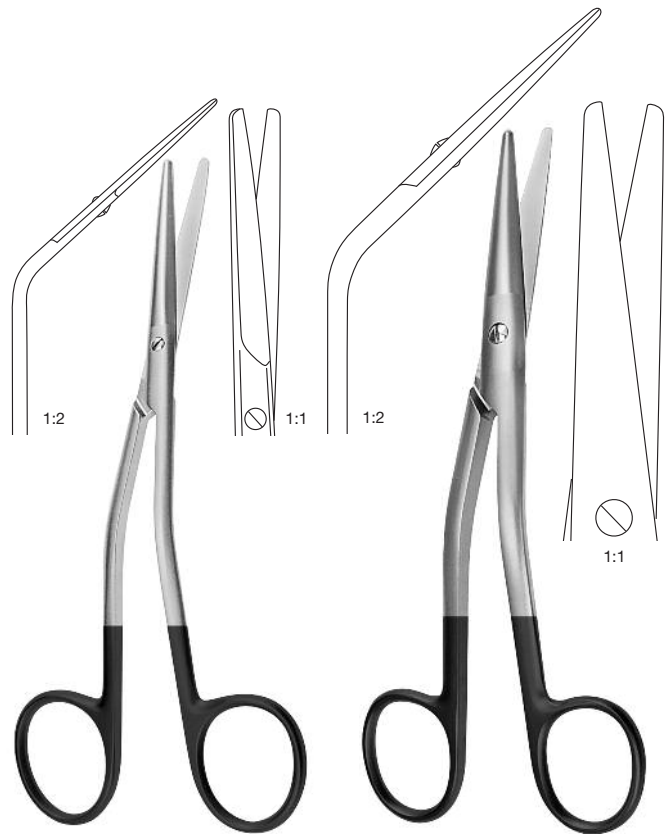
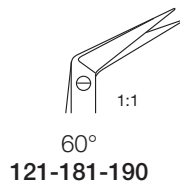
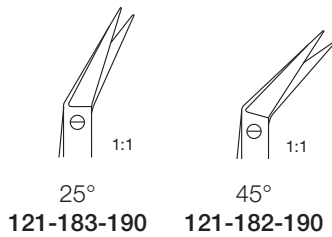

**Fomon**  
14.5 cm, 5 <sup>3</sup>/<sub>4</sub>"  
121-280-145

**Cottle**  
16.5 cm, 6 <sup>1</sup>/<sub>2</sub>"  
121-290-165



Westcott

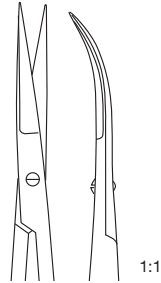

11.0 cm, 4 3/8"  
spitz, sharp  
400-102-110

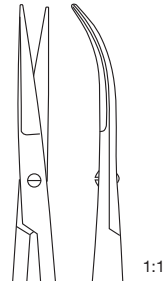

11.0 cm, 4 3/8"  
stumpf, blunt  
400-103-110



Gomel

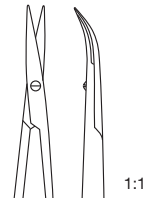

gerieft, serrated  
gebogen, curved  
14.0 cm, 5 1/2"  
120-177-140  
16.0 cm, 6 1/4"  
120-177-160

Mikro-Präparierscheren, Micro Dissecting Scissors



Hepp/Scheidel

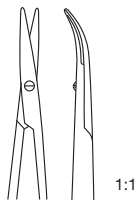

gebogen, curved  
14.0 cm, 5 1/2"  
120-179-140  
16.0 cm, 6 1/4"  
120-179-160



18.5 cm, 7 1/4"

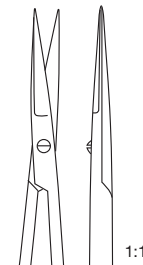

gerade, straight  
120-150-185

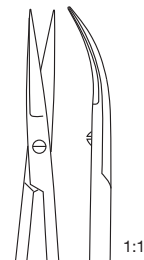

gebogen, curved  
120-151-185

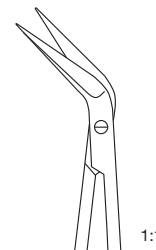

abgewinkelt, angled  
120-153-185





3

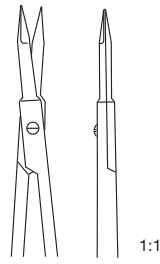

gerade  
straight

1:1

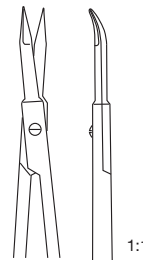

gebogen  
curved

1:1

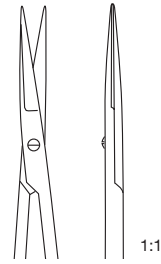

gerade  
straight

1:1

18.5 cm, 7 1/4"	<b>120-168-185</b>	<b>120-169-185</b>	<b>120-170-185</b>
22.5 cm, 8 3/4"	<b>120-168-225</b>	<b>120-169-225</b>	<b>120-170-225</b>

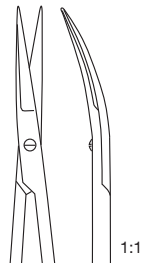

aufgebogen,  
curved upwards

1:1

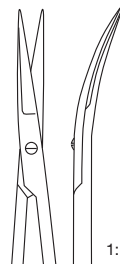

abgebogen,  
curved downwards

1:1

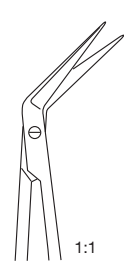

abgewinkelt  
angled

1:1

18.5 cm, 7 1/4"	<b>120-171-185</b>	<b>120-172-185</b>	<b>120-173-185</b>
22.5 cm, 8 3/4"	<b>120-171-225</b>	<b>120-172-225</b>	<b>120-173-225</b>



18.0 cm, 7"



25°

**120-182-025**

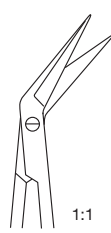

45°

**120-182-045**

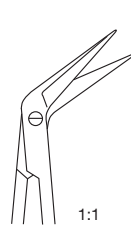

60°

**120-182-060**

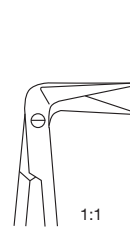

90°

**120-182-090**

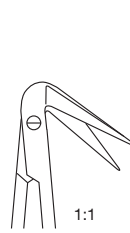

125°

**120-182-125**



25°

**120-183-025**

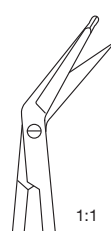

45°

**120-183-045**

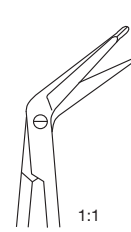

60°

**120-183-060**

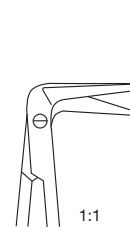

90°

**120-183-090**

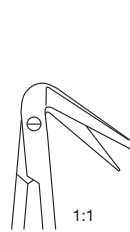

125°

**120-183-125**

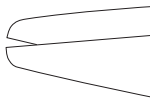

**Dissektionsscheren** - gebogene, abgerundete Spitzen zur leichten Dissektion  
**Dissecting Scissors** - curved blades, rounded tips for fine dissection



15.0 cm 6"



15 mm Schneide, gebogen  
15 mm blades, curved  
**251-551-150**

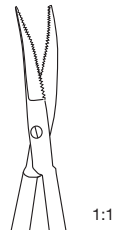

15 mm Schneide, gebogen,  
mit feinen Zähnen  
15 mm blades, curved,  
with micro serrations  
**251-553-150**

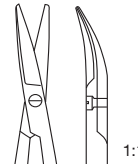

9 mm Schneide  
9 mm blades



15.0 cm, 6"  
8 mm ø Rundgriff,  
8 mm ø round handle  
**120-180-150**

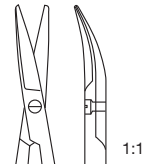

10 mm Schneide  
10 mm blades



18.0 cm, 7"  
8 mm ø Rundgriff,  
8 mm ø round handle  
**120-180-180**



**Adventitiascheren** - gerade, zugespitzte Klingen für feinste Präparationen  
**Adventitia Scissors** - straight blades, pointed at the tip for fine trimming



15.0 cm, 6"



15 mm Schneide, gerade  
15 mm blades, straight  
**251-550-150**

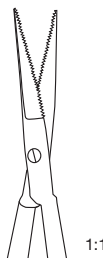

15 mm Schneide, gerade  
mit feinen Zähnen  
15 mm blades, straight  
with micro serrations  
**251-552-150**

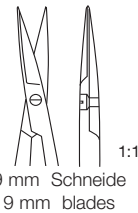

9 mm Schneide  
9 mm blades



15.0 cm, 6"  
8 mm ø Rundgriff,  
8 mm ø round handle  
**120-178-150**

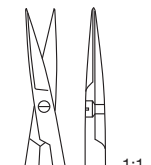

9 mm Schneide  
9 mm blades



18.0 cm, 7"  
8 mm ø Rundgriff,  
8 mm ø round handle  
**120-178-180**

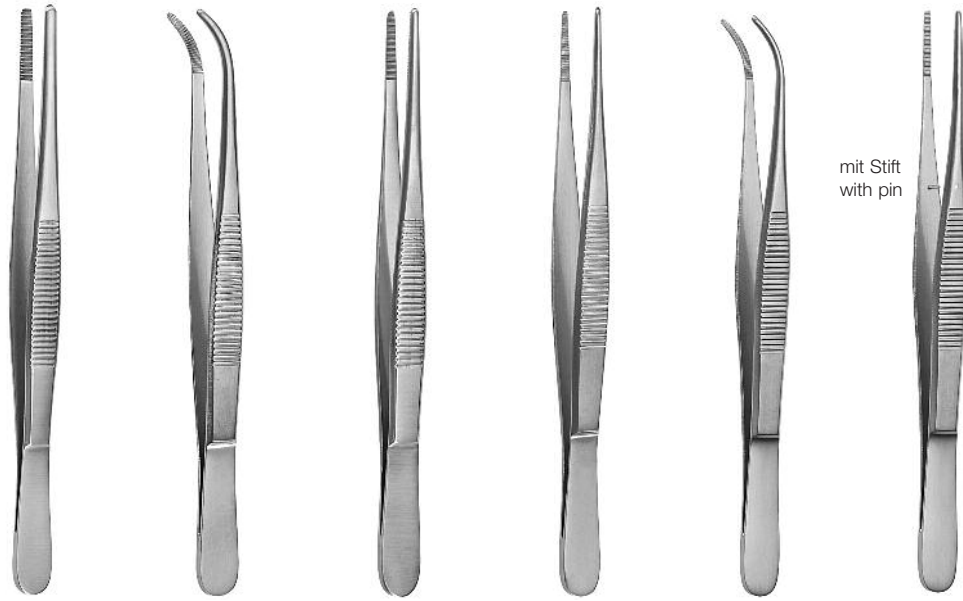

**Standard** schmal slender schmal slender fein delicate fein delicate fein delicate

10.5 cm, 4 1/8"	130-010-105	130-013-105	130-012-105	130-014-105	130-015-105	130-018-105
11.5 cm, 4 1/2"	130-010-115	130-013-115	130-012-115	130-014-115	130-015-115	130-018-115
13.0 cm, 5"	130-010-130	130-013-130	130-012-130	130-014-130	130-015-130	130-018-130
14.5 cm, 5 3/4"	130-010-145	130-013-145	130-012-145	130-014-145	130-015-145	130-018-145
15.0 cm, 6"	130-010-150					
16.0 cm, 6 1/4"	130-010-160	130-013-160	130-012-160	130-014-160	130-015-160	130-018-160
18.0 cm, 7"	130-010-180	130-013-180	130-012-180	130-014-180	130-015-180	130-018-180
20.0 cm, 8"	130-010-200	130-013-200	130-012-200	130-014-200	130-015-200	130-018-200
25.0 cm, 10"	130-010-250	130-013-250	130-012-250	130-014-250	130-015-250	130-018-250
30.0 cm, 12"	130-010-300	130-013-300	130-012-300	130-014-300	130-015-300	130-018-300

4

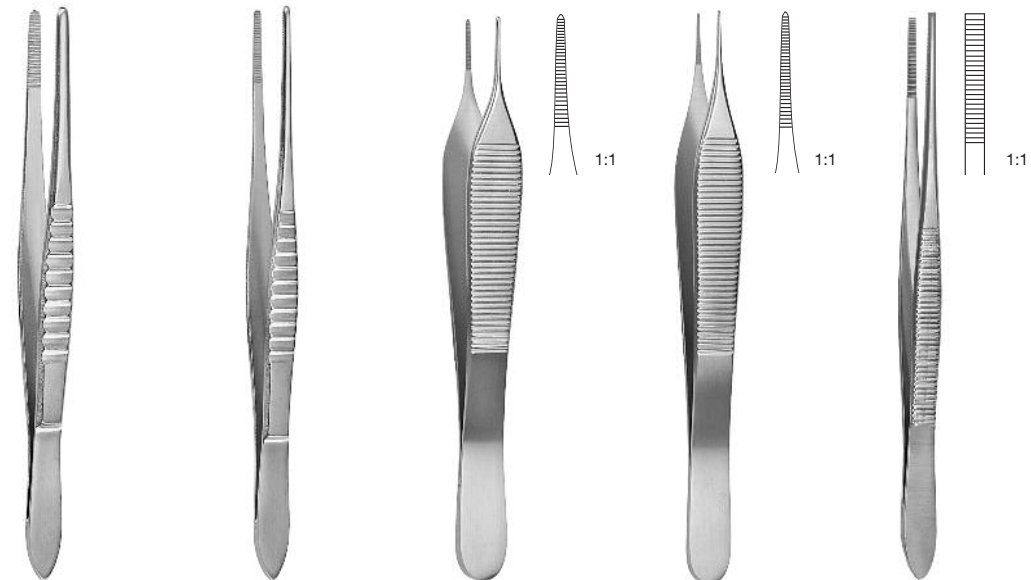

**Modell USA** **Modell USA** **Adson** **Micro-Adson** **Stille**  
schmal, slender

12.0 cm, 4 3/4"	130-046-120	130-048-120	130-026-120	130-548-120	
13.0 cm, 5"	130-046-130	130-048-130			
14.5 cm, 5 3/4"	130-046-145	130-048-145			
15.0 cm, 6"	130-046-150	130-048-150	130-026-150	130-548-150	130-022-150
18.0 cm, 7"	130-046-180	130-048-180			
20.0 cm, 8"	130-046-200	130-048-200			
25.5 cm, 10"	130-046-250	130-048-250			
30.0 cm, 12"	130-046-300				

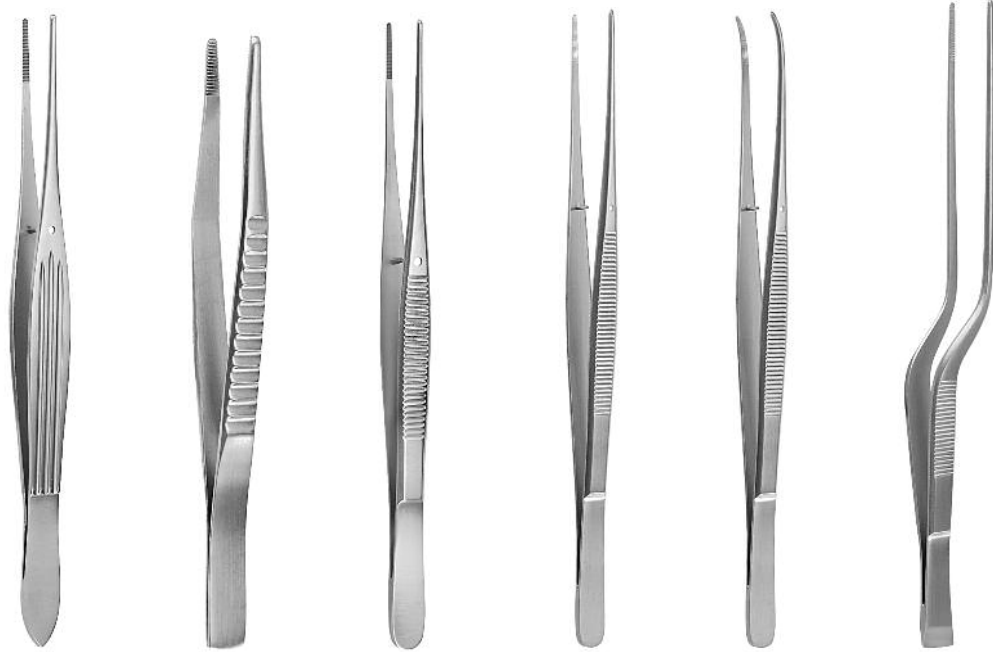

McIndoe

engl. Modell  
English pattern

Semken

Taylor

Taylor

Taylor  
mit Dissektorende  
with dissector end

12.5 cm, 5"			130-144-125		
13.0 cm, 5"		130-040-130			
14.5 cm, 5 3/4"		130-040-145			
15.0 cm, 6"	130-028-150	130-040-150	130-144-150		
17.5 cm, 6 5/8"				130-030-175	130-133-175
18.5 cm, 7 1/4"					130-035-185

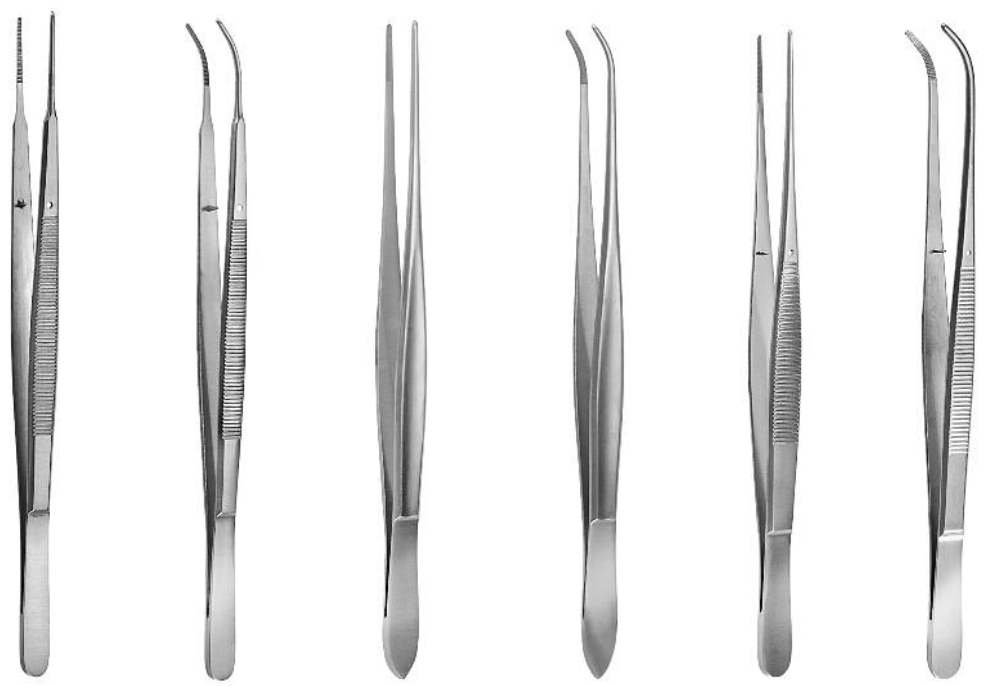

Gerald

Gerald

Cushing

Cushing

Potts-Smith

Potts-Smith

17.5 cm, 6 5/8"			130-036-175	130-037-175		
18.0 cm, 7"	130-034-180	130-035-180			130-038-180	130-037-180
21.0 cm, 8 1/4"					130-038-210	130-037-210
25.0 cm, 10"					130-038-250	130-037-250

4



4

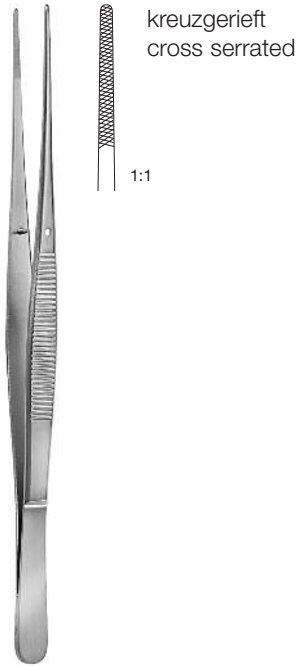

**Waugh**  
15.0 cm, 6"  
130-162-150  
20.0 cm, 8"  
130-162-200



**Brophy**  
20.0 cm, 8"  
130-042-200



**Brophy**  
20.0 cm, 8"  
130-043-200



**Ramsey**  
18.0 cm, 7"  
130-039-180



**Bonney**  
18.0 cm, 7"  
130-043-180



**Singley-Tuttle**  
23.0 cm, 9"  
130-560-230



**Dennis Brown**  
20.0 cm, 8"  
130-053-190



**Standard**

10.5 cm, 4 1/4"	<b>130-110-105</b>			
11.5 cm, 4 1/2"	<b>130-110-115</b>	<b>130-112-115</b>		
13.0 cm, 5"	<b>130-110-130</b>	<b>130-112-130</b>	<b>130-114-130</b>	<b>130-116-130</b>
14.5 cm, 5 3/4"	<b>130-110-145</b>	<b>130-112-145</b>	<b>130-114-145</b>	<b>130-116-145</b>
15.0 cm, 6"	<b>130-110-150</b>			
16.0 cm, 6 1/4"	<b>130-110-160</b>	<b>130-112-160</b>	<b>130-114-160</b>	<b>130-116-160</b>
18.0 cm, 7"	<b>130-110-180</b>	<b>130-112-180</b>	<b>130-114-180</b>	<b>130-116-180</b>
20.0 cm, 8"	<b>130-110-200</b>	<b>130-112-200</b>	<b>130-114-200</b>	<b>130-116-200</b>
25.0 cm, 10"	<b>130-110-250</b>	<b>130-112-250</b>		
30.0 cm, 12"	<b>130-110-300</b>	<b>130-112-300</b>		

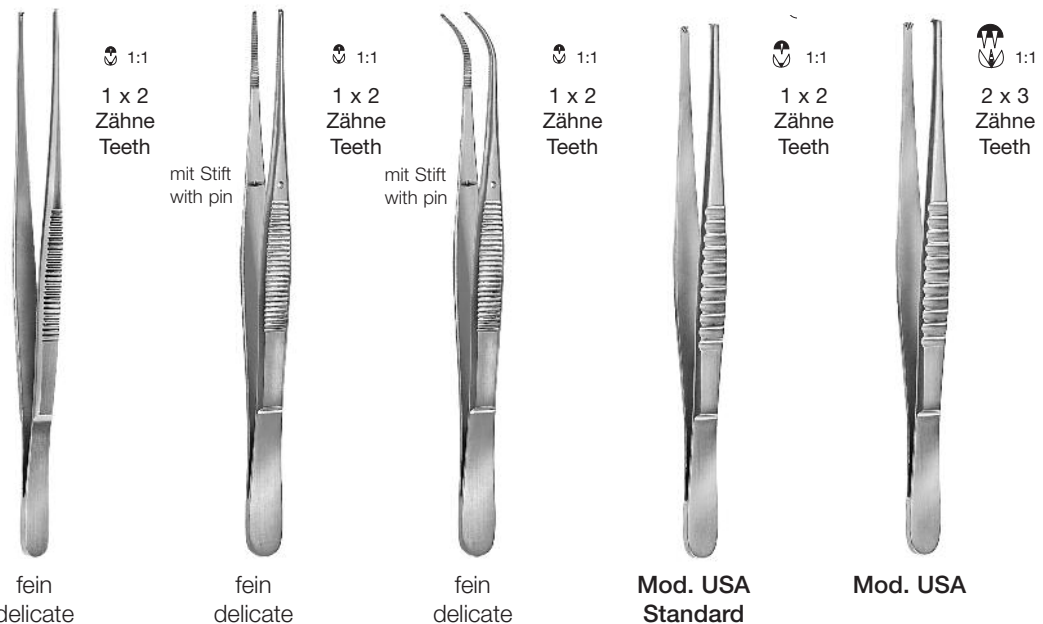

12.0 cm, 4 3/4"			<b>130-121-120</b>	<b>130-126-120</b>	<b>130-127-120</b>
13.0 cm, 5"	<b>130-120-130</b>	<b>130-118-130</b>	<b>130-121-130</b>	<b>130-126-130</b>	<b>130-127-130</b>
14.5 cm, 5 3/4"	<b>130-120-145</b>	<b>130-118-145</b>	<b>130-121-145</b>	<b>130-126-145</b>	<b>130-127-145</b>
15.5 cm, 6"	<b>130-120-155</b>	<b>130-118-155</b>	<b>130-121-155</b>	<b>130-126-155</b>	<b>130-127-155</b>
16.0 cm, 6 1/4"	<b>130-120-160</b>	<b>130-118-160</b>	<b>130-121-160</b>		
18.0 cm, 7"	<b>130-120-180</b>	<b>130-118-180</b>	<b>130-121-180</b>	<b>130-126-180</b>	<b>130-127-180</b>
20.0 cm, 8"	<b>130-120-200</b>	<b>130-118-200</b>	<b>130-121-200</b>	<b>130-126-200</b>	<b>130-127-200</b>
25.0 cm, 10"	<b>130-120-250</b>	<b>130-118-250</b>	<b>130-121-250</b>	<b>130-126-250</b>	<b>130-127-250</b>
30.0 cm, 12"	<b>130-120-300</b>	<b>130-118-300</b>	<b>130-121-300</b>	<b>130-126-300</b>	<b>130-127-300</b>

4

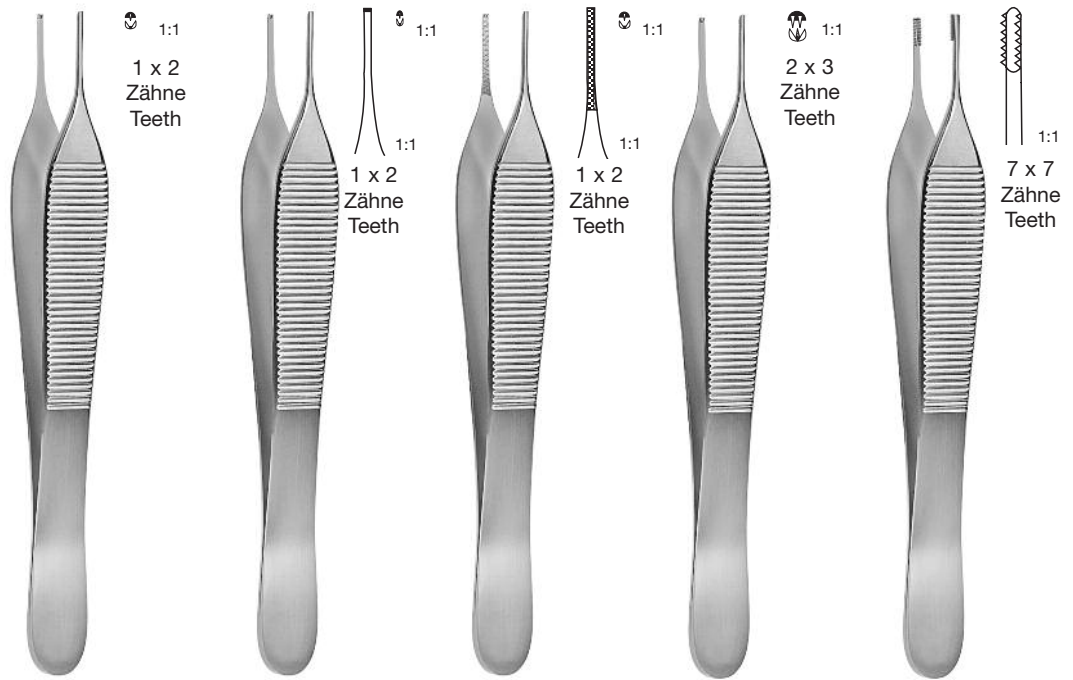

	Adson	Micro-Adson	Adson	Adson	Adson-Brown
12.0 cm, 4 3/4"	130-140-120	130-550-120	130-557-120	130-555-120	130-552-120
15.0 cm, 6"	130-140-150	130-550-150		130-555-150	130-552-150

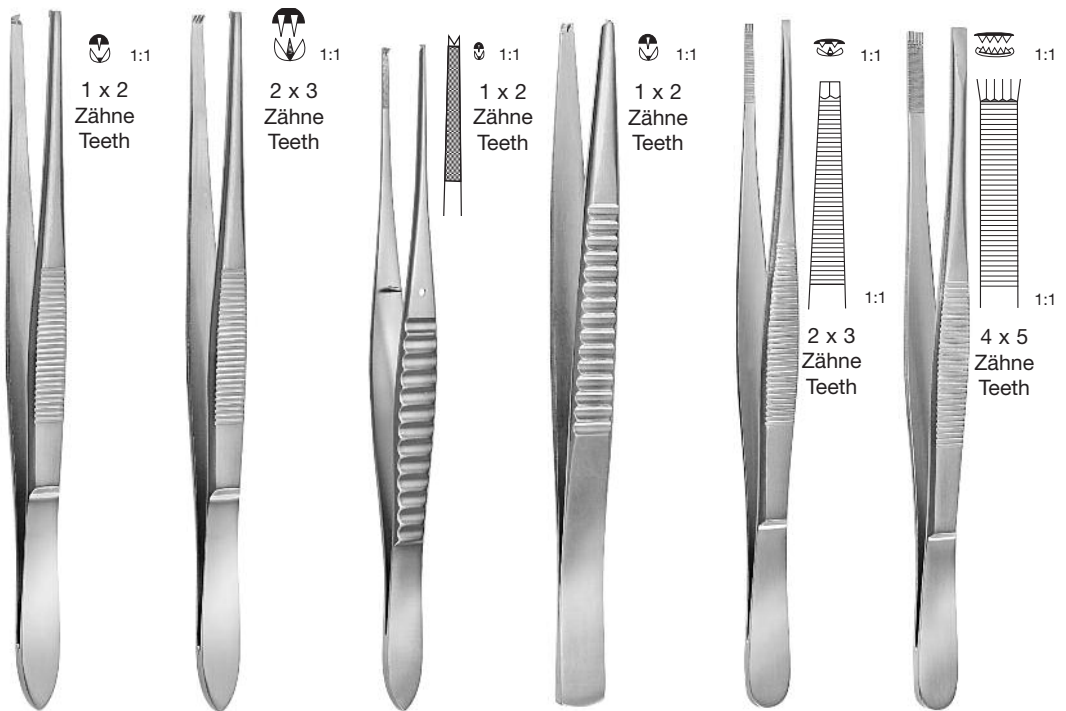

	Stille	Stille	Gillies	engl. Modell English pattern	Adlerkreuz	Adlerkreuz
13.0 cm, 5"				130-274-130		
14.5 cm, 5 3/4"				130-274-145		
15.0 cm, 6"	130-122-150	130-124-150	130-120-150	130-274-150	130-137-150	130-138-150
20.0 cm, 8"					130-137-200	130-138-200



1:1  
1 x 2  
Zähne  
Teeth

Semken



1:1  
2 x 3  
Zähne  
Teeth

Semken



1:1  
1 x 2  
Zähne  
Teeth

Taylor



1:1  
1 x 2  
Zähne  
Teeth

Taylor



1:1  
1 x 2  
Zähne  
Teeth

Taylor  
mit Dissektorende  
with dissector end

12.5 cm, 5"	130-145-125	130-147-125		
15.5 cm, 6"	130-145-150			
17.5 cm, 6 5/8"		130-147-175	130-149-175	130-157-175



1:1  
1 x 2  
Zähne  
Teeth

McIndoe



1:1



1:1  
1 x 2  
Zähne  
Teeth

Gerald



1:1  
1 x 2  
Zähne  
Teeth

Gerald



1:1  
1 x 2  
Zähne  
Teeth

Cushing



1:1  
1 x 2  
Zähne  
Teeth

Cushing

15.0 cm, 6"	130-041-150			
17.5 cm, 6 5/8"			130-152-175	130-153-175
18.0 cm, 7"		130-150-180	130-151-180	



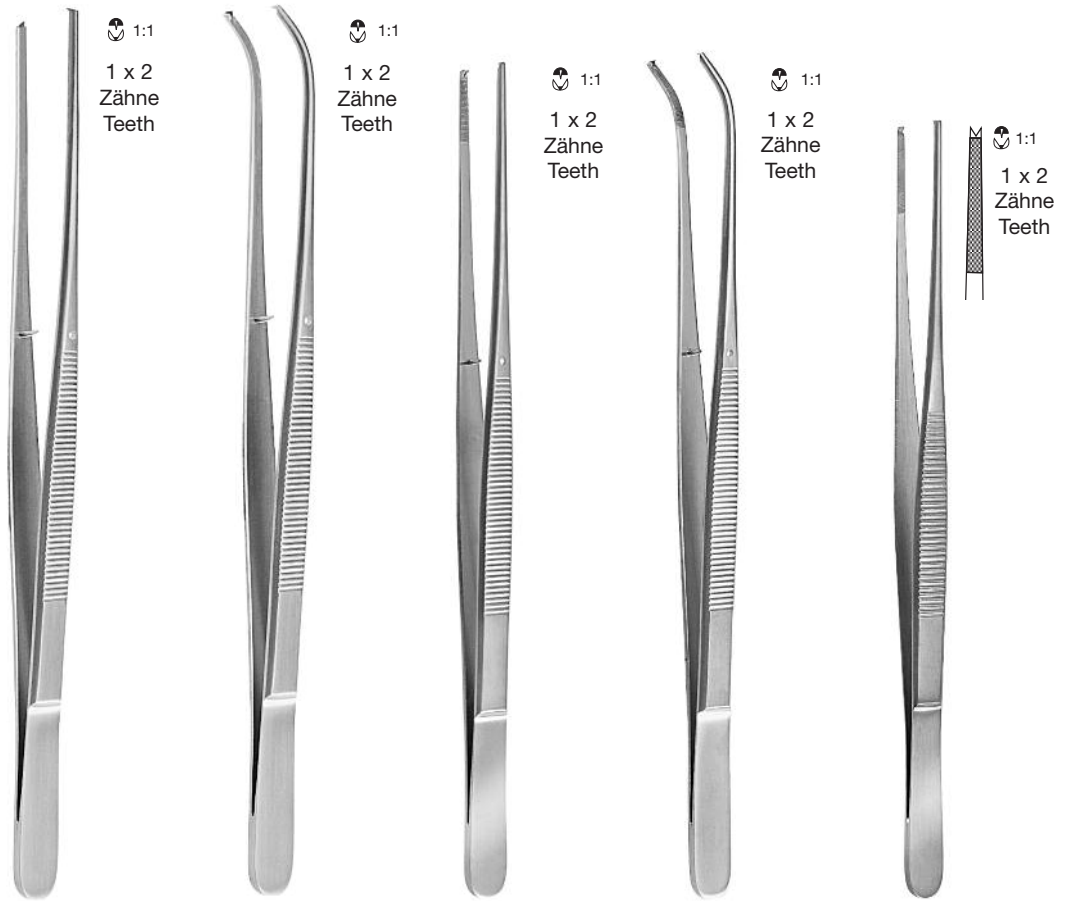

	Potts-Smith	Potts-Smith	Brophy	Brophy	Waugh
15.0 cm, 6"					130-160-150
18.0 cm, 7"	130-154-180	130-155-180			
20.0 cm, 8"			130-034-200	130-035-200	130-160-200
21.0 cm, 8 1/4"	130-154-210	130-155-210			
25.0 cm, 10"	130-154-250	130-155-250			



**Duehrssen**  
20.0 cm, 8"

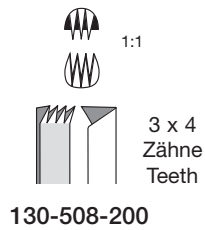
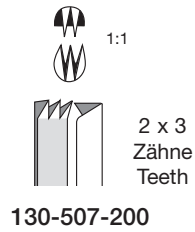
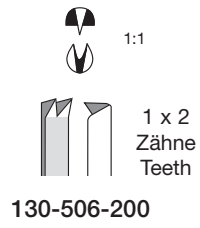

	Russ. Modell	Durante
14.5 cm, 5 3/4"		130-511-145
15.0 cm, 6"	130-510-150	
16.0 cm, 6 1/4"		130-511-160
20.0 cm, 8"	130-510-200	130-511-200
25.0 cm, 10"	130-510-250	



**Duval**  
14.0 cm, 5 1/2"

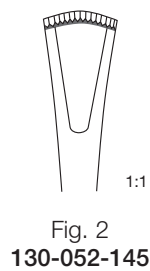
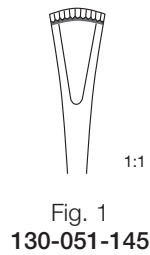

**Collin-Duval**  
20.0 cm, 8"

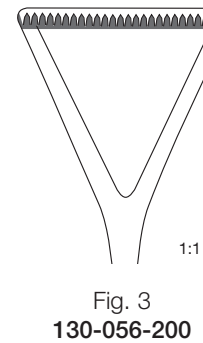
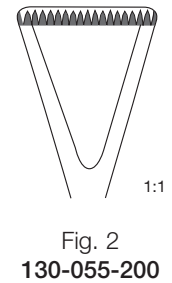



1:1  
1 x 2  
Zähne  
Teeth



1:1  
2 x 3  
Zähne  
Teeth



1:1  
7 x 7  
Zähne  
Teeth



1:1  
1 x 2  
Zähne  
Teeth

Lane

Lane

Brown

Treves

13.0 cm, 5"				130-119-130
14.5 cm, 5 3/4"	130-130-145	130-131-145		
15.0 cm, 6"			130-554-160	130-119-150
20.0 cm, 8"	130-130-200	130-131-200	130-554-200	



1:1  
1 x 2  
Zähne  
Teeth

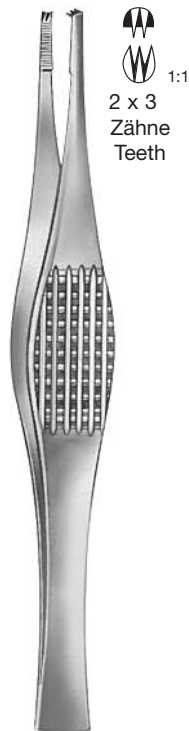

1:1  
2 x 3  
Zähne  
Teeth

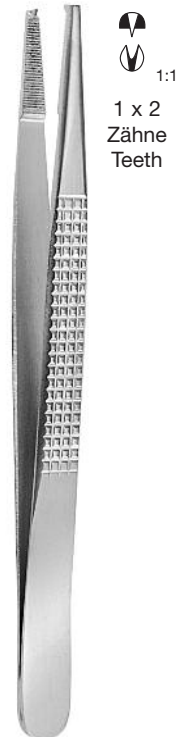

1:1  
1 x 2  
Zähne  
Teeth



1:1  
2 x 3  
Zähne  
Teeth



1:1

Ramsey

Ramsey

Bonney

Bonney

Nelson

15.0 cm, 6"				130-562-150
18.0 cm, 7"	130-138-180	130-139-180	130-143-180	130-145-180
20.0 cm, 8"				130-562-200
23.0 cm, 9"				130-562-230

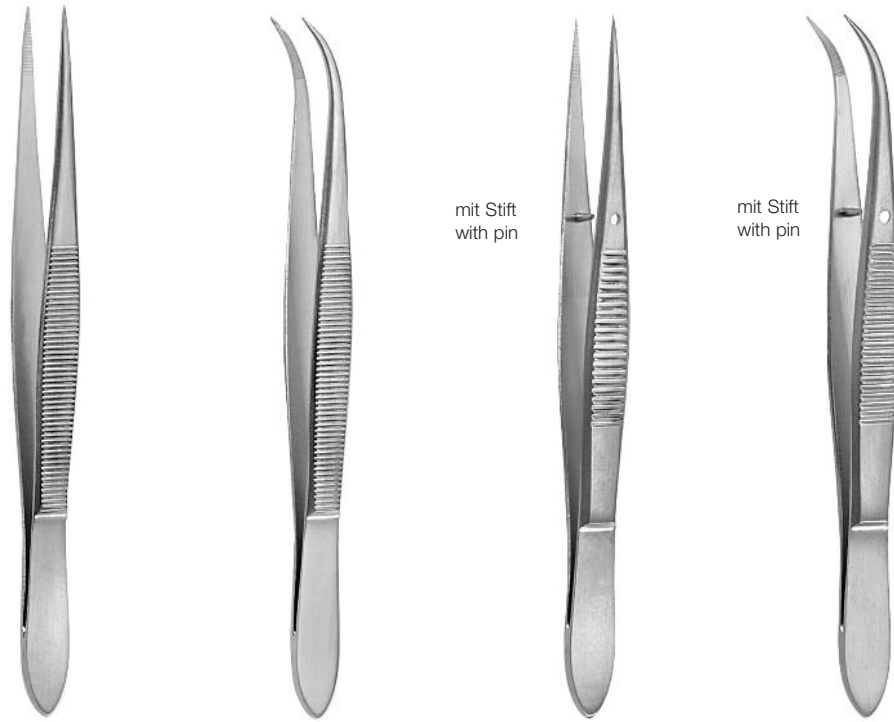

8.0 cm, 3 1/4"	130-622-080	130-623-080	130-625-080	130-627-080
9.0 cm, 3 1/2"	130-622-090	130-623-090	130-625-090	130-627-090
10.5 cm, 4 1/4"	130-622-105	130-623-105	130-625-105	130-627-105
11.5 cm, 4 1/2"	130-622-115	130-623-115	130-625-115	130-627-115
13.0 cm, 5"	130-622-130	130-623-130	130-625-130	130-627-130
14.5 cm, 5 1/2"	130-622-145	130-623-145	130-625-145	130-627-145

4

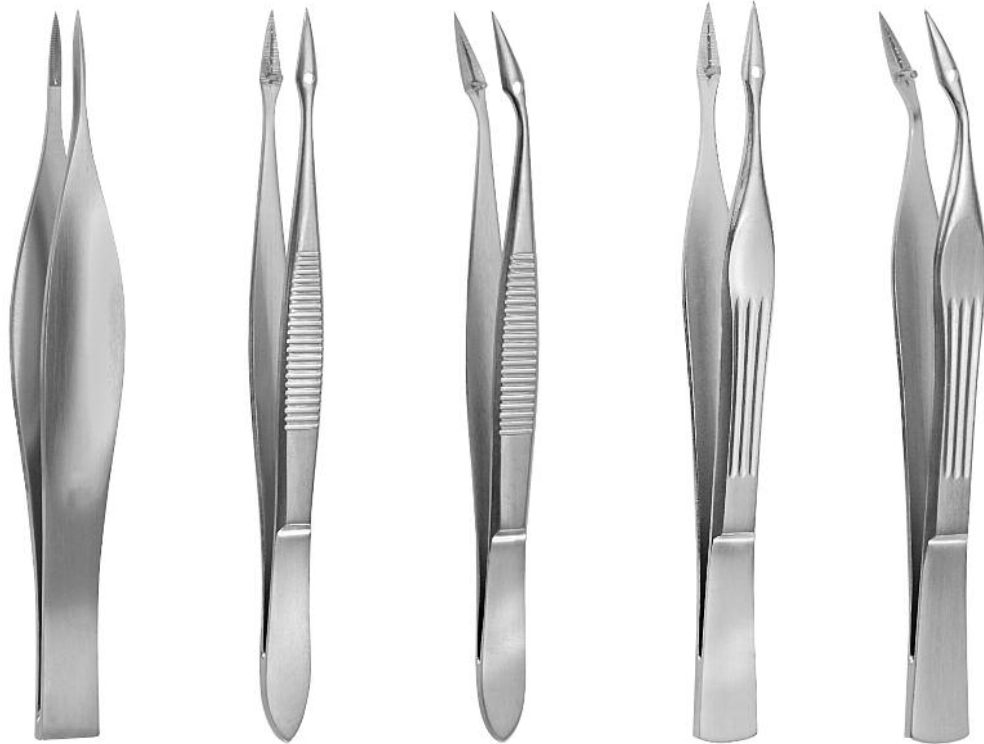

	<b>Feilchenfeld</b>	<b>Hunter</b>	<b>Hunter</b>	<b>Walter-Carmalt</b>	<b>Walter-Carmalt</b>
8.0 cm, 3 1/4"	130-630-075				
9.0 cm, 3 1/2"	130-630-090				
10.5 cm, 4 1/4"		130-624-105	130-626-105	130-632-105	130-633-105
11.5 cm, 4 1/2"	130-630-115				



4



10.0 cm, 4"  
130-500-100



10.0 cm, 4"  
130-501-100



10.0 cm, 4"  
130-502-100



10.0 cm, 4"  
130-503-100



10.0 cm, 4"  
130-504-100



10.0 cm, 4"  
130-505-100

1:1  
1 x 2  
Zähne  
Teeth

1:1  
1 x 2  
Zähne  
Teeth

1:1  
1 x 2  
Zähne  
Teeth

Uhrmacher-Pinzetten  
Jeweller's Forceps



10.0 cm, 4"  
130-437-100



10.0 cm, 4"  
130-438-100



10.0 cm, 4"  
130-439-100



No. 3  
11.5 cm, 4 1/2"  
400-060-003



No. 4  
11.0 cm, 4 3/8"  
400-060-004



No. 5  
11.0 cm, 4 3/8"  
400-060-005



No. 7  
11.5 cm, 4 1/2"  
400-060-007

1:1

1:1

1:1



Abgewinkelte Gefäßdilatoren können sowohl als Nadelhalter als auch als Nahtpinzetten verwendet werden. Um bessere Eigenschaften beim Halten eines Objektes zu erreichen, kann man die Spitzen dieser Pinzetten mit Diamantstaub beschichten.

Angled vessel dilators can be used as needle holders or tying forceps. All forceps can be modified to include diamond dust on tip for superior holding characteristic.



gerade, straight  
 Spitze 0.3 mm ø  
 Tip 0.3 mm ø

9 mm breit  
 9 mm wide  
 13.5 cm, 5 3/8"  
**251-611-130**



gerade, straight  
 Spitze 0.3 mm ø  
 Tip 0.3 mm ø

7 mm breit  
 7 mm wide  
 13.5 cm, 5 3/8"  
**251-612-130**



gerade, straight  
 Spitze 0.3 mm ø  
 Tip 0.3 mm ø

9 mm breit  
 9 mm wide  
 12.0 cm, 4 3/4"  
**251-611-120**



45° abgewinkelt,  
 45°angled  
 Spitze 0.3 mm ø  
 Tip 0.3 mm ø

9 mm breit  
 9 mm wide  
 13.5 cm, 5 3/8"  
**251-614-130**



45° abgewinkelt,  
 45°angled  
 Spitze 0.3 mm ø  
 Tip 0.3 mm ø

7 mm breit  
 7 mm wide  
 13.5 cm, 5 3/8"  
**251-615-130**



45° abgewinkelt,  
 45°angled  
 Spitze 0.3 mm ø  
 Tip 0.3 mm ø

9 mm breit  
 9 mm wide  
 11.0 cm, 4 3/8"  
**251-616-110**



90° abgewinkelt,  
 90°angled  
 Spitze 0.3 mm ø  
 Tip 0.3 mm ø

9 mm breit  
 9 mm wide  
 11.0 cm, 4 3/8"  
**251-617-110**



gerade, straight  
 Spitze 0.3 mm ø  
 Tip 0.3 mm ø

9 mm breit  
 9 mm wide  
 11.0 cm, 4 3/8"  
**251-613-110**



45° abgewinkelt  
 diamantiert,  
 45°angled  
 diamond dusted  
 Spitze 0.3 mm ø  
 Tip 0.3 mm ø

9 mm breit  
 9 mm wide  
 11.0 cm, 4 3/8"  
**251-619-110**



gebogen, curved  
 Spitze 0.4 mm ø  
 Tip 0.4 mm ø

9 mm breit  
 9 mm wide  
 12.0 cm, 4 3/4"  
**251-618-120**

**4**



4



DeBakey



1.5 mm

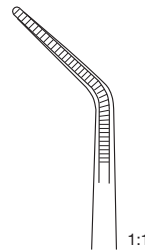

1.5 mm

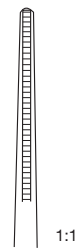

2.0 mm

16.0 cm, 6 1/4"	<b>290-550-160</b>	<b>290-551-160</b>	<b>290-552-160</b>
20.0 cm, 8"	<b>290-550-200</b>	<b>290-551-200</b>	<b>290-552-200</b>
24.0 cm, 9 1/2"	<b>290-550-240</b>	<b>290-551-240</b>	<b>290-552-240</b>
30.0 cm, 12"	<b>290-550-300</b>	<b>290-551-300</b>	<b>290-552-300</b>

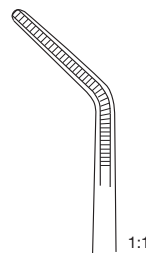

2.0 mm

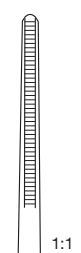

2.4 mm

16.0 cm, 6 1/4"	<b>290-553-160</b>	<b>290-557-160</b>
20.0 cm, 8"	<b>290-553-200</b>	<b>290-557-200</b>
24.0 cm, 9 1/2"	<b>290-553-240</b>	<b>290-557-240</b>
30.0 cm, 12"	<b>290-553-300</b>	<b>290-557-300</b>



DeBakey

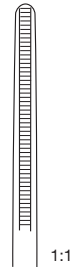

1:1

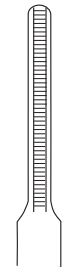

1:1

2.8 mm

2.8 mm

16.0 cm, 6 1/4"	<b>290-548-160</b>	<b>290-558-160</b>
20.0 cm, 8"	<b>290-548-200</b>	<b>290-558-200</b>
24.0 cm, 9 1/2"	<b>290-548-240</b>	<b>290-558-240</b>
30.0 cm, 12"	<b>290-548-300</b>	<b>290-558-300</b>

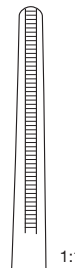

1:1

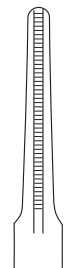

1:1

3.5 mm

3.5 mm

16.0 cm, 6 1/4"	<b>290-554-160</b>	<b>290-555-160</b>
20.0 cm, 8"	<b>290-554-200</b>	<b>290-555-200</b>
24.0 cm, 9 1/2"	<b>290-554-240</b>	<b>290-555-240</b>
30.0 cm, 12"	<b>290-554-300</b>	<b>290-555-300</b>





Die RZ-Grip Hartmetalleinlagen zeichnen sich durch ein Grundprofil aus, welches ein gutes Festhalten des Gewebes gewährleistet.

The RZ-Grip tungsten carbide inserts feature a fine structure ensuring improved tissue grip.

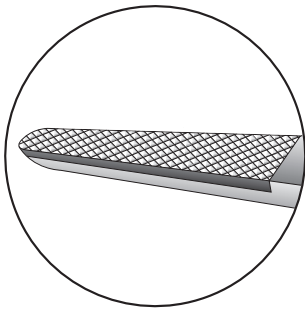

Standard



Semken



Oehler

14.0 cm, 5 1/2"		130-522-140
14.5 cm, 5 3/4"	130-518-145	
16.0 cm, 6 1/4"	130-518-160	130-522-160
18.0 cm, 7"	130-518-180	130-522-180
20.0 cm, 8"	130-518-200	130-522-200
25.0 cm, 9 3/4"	130-518-250	130-522-250
30.0 cm, 12"	130-518-300	130-522-300



Gillies  
15.0 cm, 6"  
130-520-150



Mc Indoe  
15.0 cm, 6"  
130-522-150

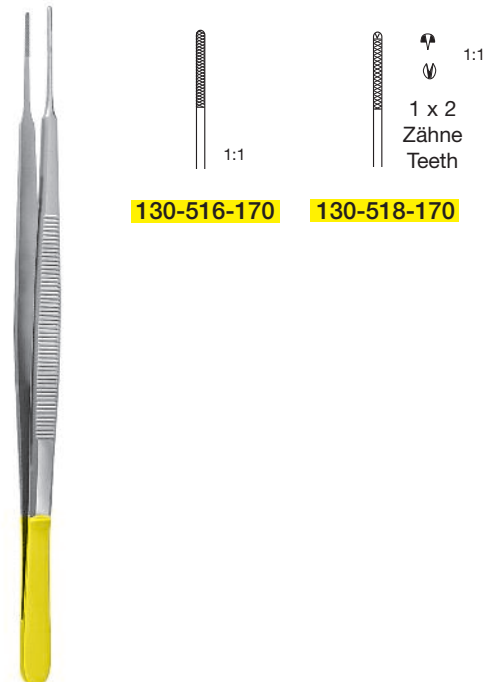

Gerald  
17.0 cm, 6 3/4"

130-516-170

130-518-170

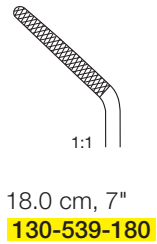
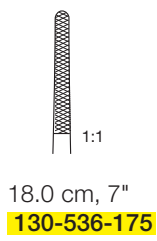

Cushing

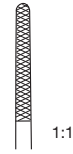

Cushing-Taylor  
18.0 cm, 7"  
**130-541-180**

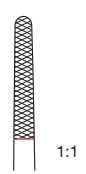

15.0 cm, 6"  
**130-542-150**  
18.0 cm, 7"  
**130-542-180**  
21.0 cm, 8"  
**130-542-210**

Potts-Smith

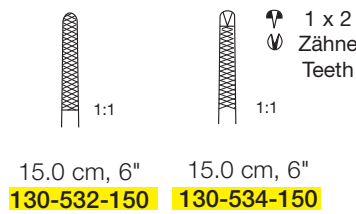
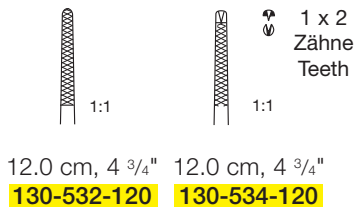

Adson

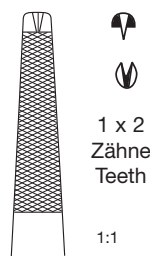

Bonney  
18.0 cm, 7"  
**130-514-170**



Wangensteen  
15.0 cm, 6" **130-566-150**  
23.0 cm, 9" **130-566-230**  
25.0 cm, 10" **130-566-250**



Dieffenbach

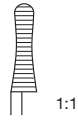

3.5 cm, 1 1/2"  
gerade, straight  
**140-114-035**

5.0 cm, 2"  
gerade, straight  
**140-114-050**

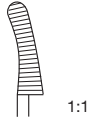

3.5 cm, 1 1/2"  
gebogen, curved  
**140-115-035**

5.0 cm, 2"  
gebogen, curved  
**140-115-050**



**Hess**  
Maullänge  
length of jaw:  
2.0 cm, 3/4"  
**140-056-020**



**Hess**  
Maullänge  
length of jaw:  
3.0 cm, 1 1/8"  
**140-056-030**

5



**Johns-Hopkins**

3.8 cm, 1 1/2"	<b>140-050-038</b>	<b>140-051-038</b>
5.0 cm, 2"	<b>140-050-050</b>	<b>140-051-050</b>
6.3 cm, 2 1/2"	<b>140-050-063</b>	<b>140-051-063</b>
7.6 cm, 3"	<b>140-050-076</b>	<b>140-051-076</b>
9.0 cm, 3 1/2"	<b>140-050-090</b>	<b>140-051-090</b>

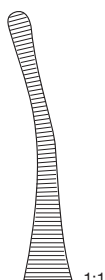
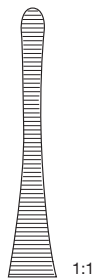

Die Johns-Hopkins An- und Ablegezange kann mit allen Bulldogklemmen, welche auf den folgenden Seiten abgebildet sind verwendet werden.

The Johns Hopkins applying and removing forceps can be used with every bulldog clamp shown on the both pages.

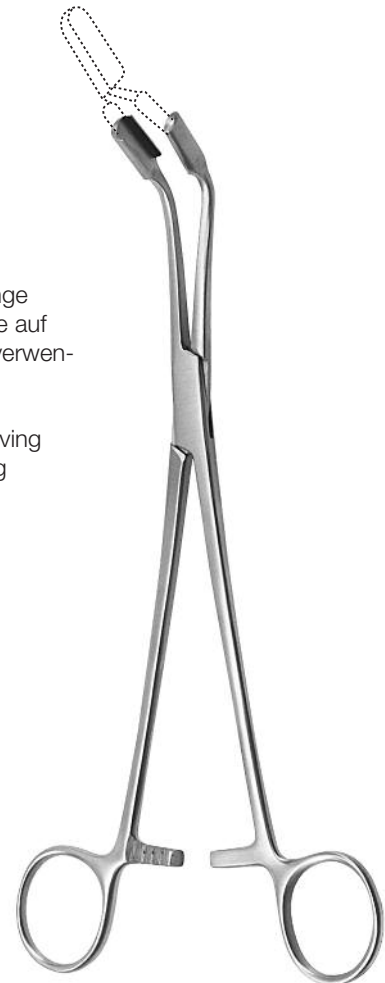

**Johns-Hopkins**  
23.0 cm, 9"  
**140-152-230**

**Allgemeines Instrumentarium**  
**Bulldogklemmen**  
**mit Atrauma-Zahnung**

**General Instruments**  
**Bulldog Clamps**  
**with Atrauma Serration**



Die atraumatische Zahnung schützt Gewebe sowie Gefäße vor Verletzungen und garantiert einen sicheren und standhaften Halt

Atrauma serrations prevents damage to tissue and vessels. It also ensures a safe and firm grip of tissue.



DeBakey	Gesamtlänge total length	Maullänge length of jaw
140-120-075	8.0 cm, 3 1/8"	2.5 cm, 1"
140-120-085	9.0 cm, 3 1/2"	3.5 cm, 1 3/8"
140-120-105	10.5 cm, 4 1/8"	5.0 cm, 2"
140-120-120	12.4 cm, 5"	6.8 cm, 2 3/4"

DeBakey	Gesamtlänge total length	Maullänge length of jaw
140-119-075	7.8 cm, 3 1/8"	2.5 cm, 1"
140-119-085	8.6 cm, 3 3/8"	3.5 cm, 1 3/8"
140-119-105	9.7 cm, 3 3/4"	5.0 cm, 2"
140-119-120	11.4 cm, 4 1/2"	6.8 cm, 2 3/4"



3.5 cm, 1 3/8"  
 vena **140-216-035**  
 arteria **140-216-135**



3.5 cm, 1 3/8"  
 vena **140-217-035**  
 arteria **140-217-135**



4.0 cm, 1 5/8"  
 vena **140-216-040**  
 arteria **140-216-140**



4.0 cm, 1 5/8"  
 vena **140-217-040**  
 arteria **140-217-140**



Glover	Gesamtlänge total length	Maullänge length of jaw
140-130-070	6.8 cm, 2 3/4"	3.3 cm, 1 3/8"
140-130-090	9.6 cm, 3 3/4"	5.0 cm, 2"
140-130-110	11.7 cm, 4 3/4"	6.9 cm, 2 3/4"



Glover	Gesamtlänge total length	Maullänge length of jaw
140-131-070	6.5 cm, 2 1/2"	3.3 cm, 1 3/8"
140-131-090	9.1 cm, 3 1/2"	5.0 cm, 2"
140-131-110	11.0 cm, 4 3/8"	6.9 cm, 2 3/4"



**Chaput**  
13.0 cm, 5"  
140-134-130



**Tuffier**  
13.0 cm, 5"  
140-135-130

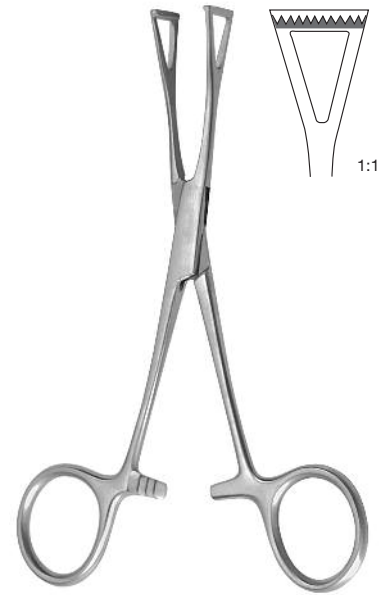

**Collin**  
14.0 cm, 5 1/2"  
140-235-140

5

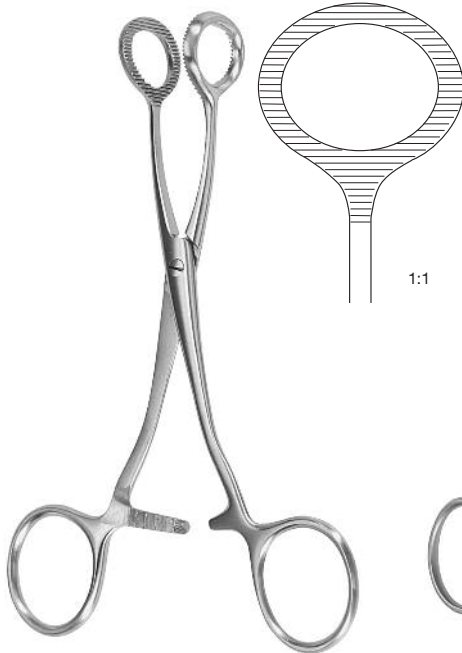

**Collin**  
16.0 cm, 6 1/4"  
140-236-160

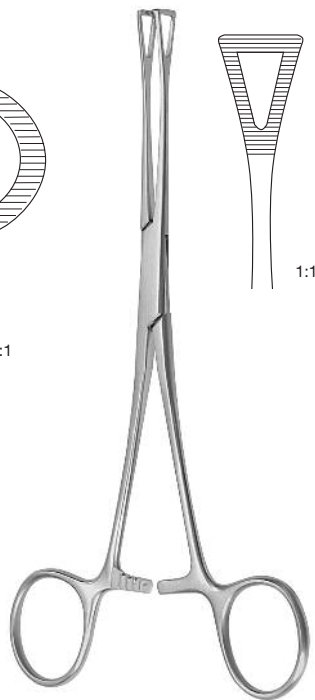

**Pennington**  
15.5 cm, 6"  
140-240-155  
20.0 cm, 8"  
140-240-200

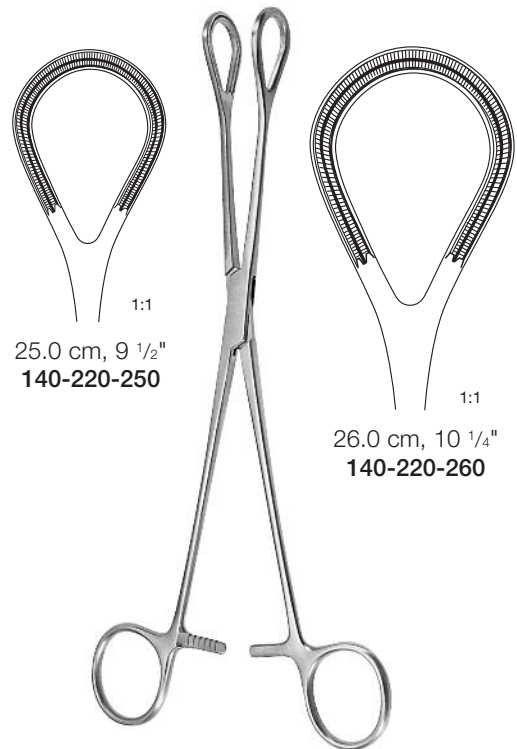

**Atrauma**

25.0 cm, 9 1/2"  
140-220-250

26.0 cm, 10 1/4"  
140-220-260

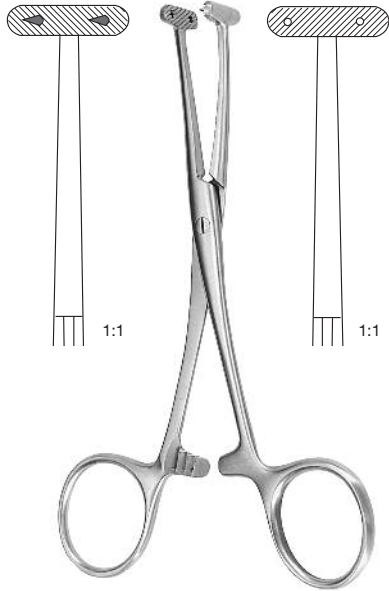

**Martel**  
14.0 cm, 5 1/2"  
140-267-140

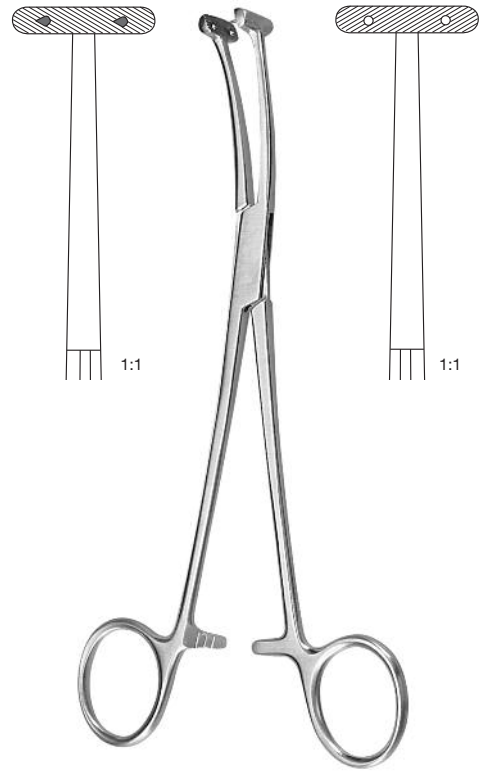

**Willet-Martel**  
19.0 cm, 7 1/2"  
140-267-190



**Pratt**  
15.0 cm, 6"  
140-282-150

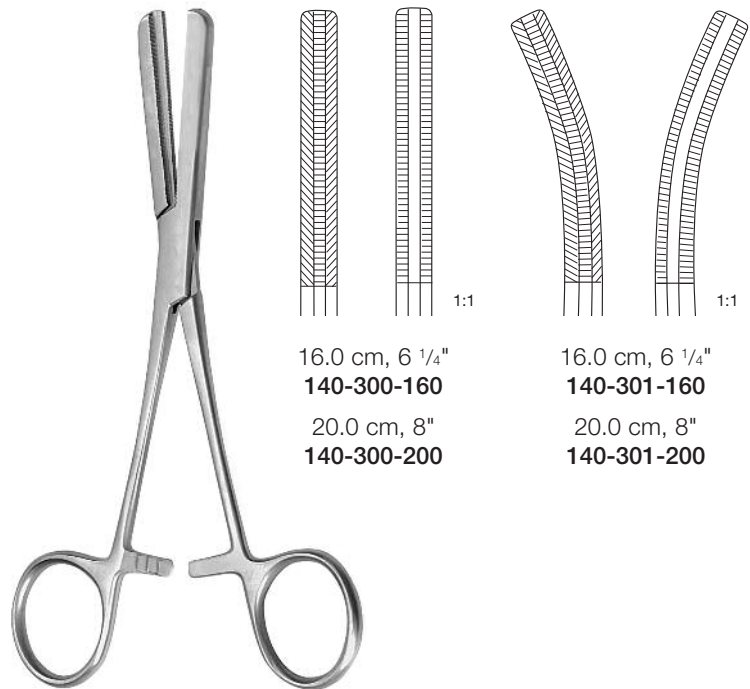

16.0 cm, 6 1/4"  
140-300-160  
20.0 cm, 8"  
140-300-200

16.0 cm, 6 1/4"  
140-301-160  
20.0 cm, 8"  
140-301-200

**Ferguson**

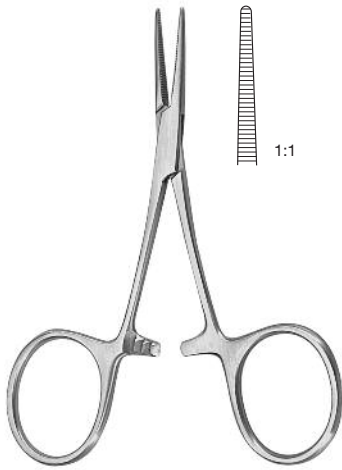

**Carrel**  
10.0 cm, 4"  
140-232-100

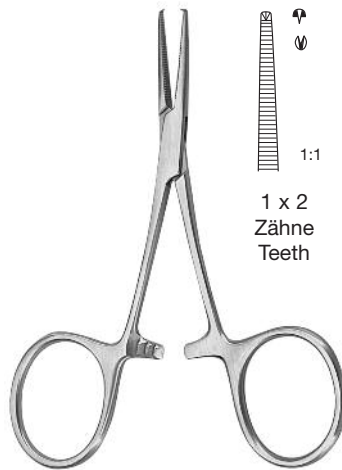

**Terrier**  
10.0 cm, 4"  
140-233-100

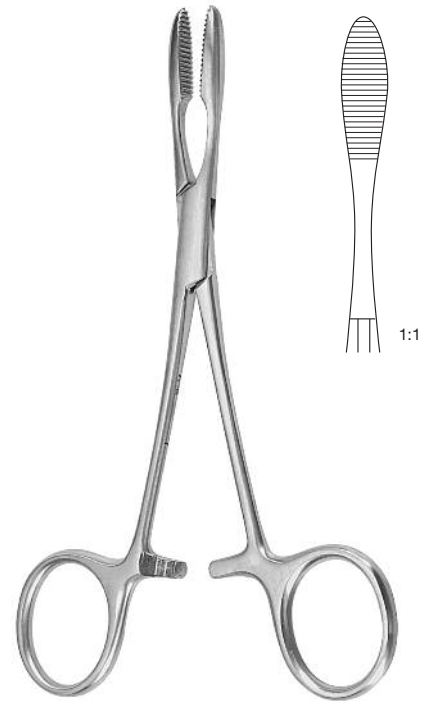

**Pean**  
14.0 mm, 5 1/2"  
140-228-140  
16.0 mm, 6 1/4"  
140-228-160

5

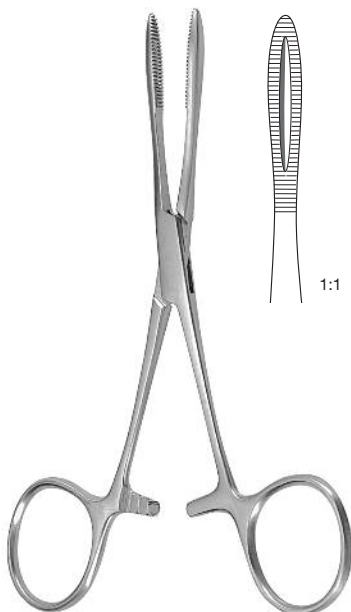

**Kroenlein**  
13.0 cm, 5"  
140-229-130

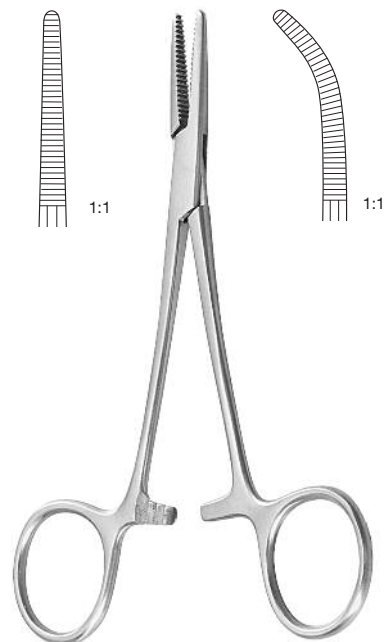

	gerade, straight	gebogen, curved
13.0 cm, 5"	140-150-130	140-151-130
15.0 cm, 6"	140-150-150	140-151-150
18.0 cm, 7"	140-150-180	140-151-180
20.0 cm, 8"	140-150-200	140-151-200

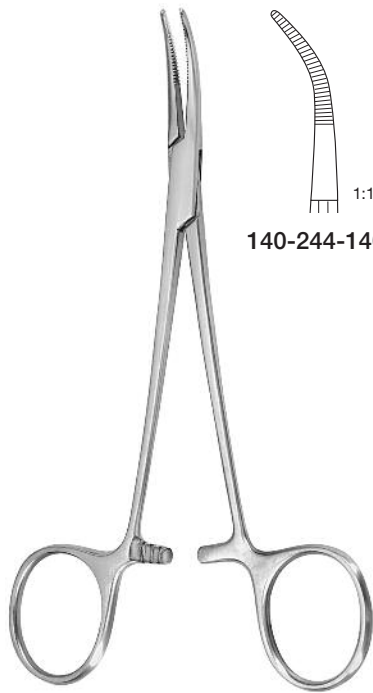

**Baby-Mixer**  
14.0 cm, 5 1/2"

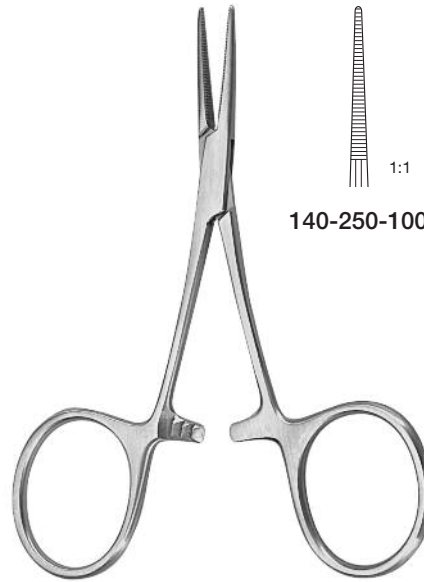
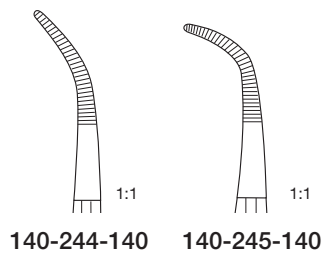

**Hartmann**  
10.0 cm, 4"

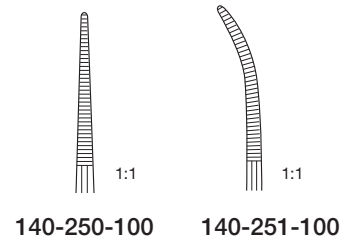

5



**Halsted-Mosquito**

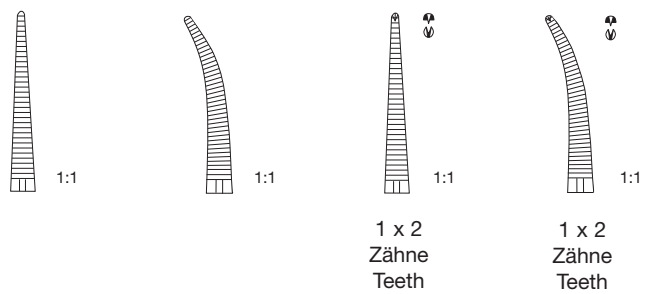

12.5 cm, 5"	140-254-125	140-255-125	140-256-125	140-257-125
14.0 cm, 5 1/2"	140-254-140	140-255-140	140-256-140	140-257-140





Halsted-Mosquito



18.0 cm, 7"  
140-254-180

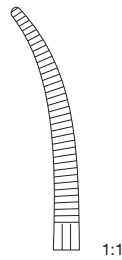

18.0 cm, 7"  
140-255-180

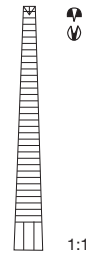

18.0 cm, 7"  
1 x 2 Zähne / Teeth  
140-256-180

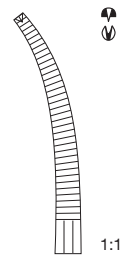

18.0 cm, 7"  
1 x 2 Zähne / Teeth  
140-257-180

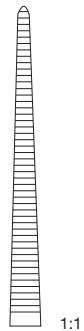

21.0 cm, 8 1/4"  
140-254-210

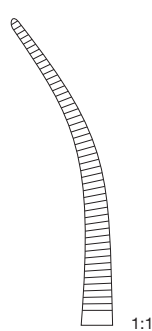

21.0 cm, 8 1/4"  
140-255-210

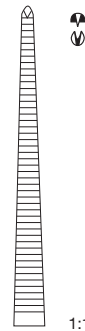

21.0 cm, 8 1/4"  
1 x 2 Zähne / Teeth  
140-256-210

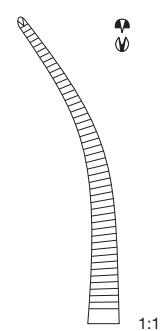

21.0 cm, 8 1/4"  
1 x 2 Zähne / Teeth  
140-257-210

5



Micro-Mosquito



10.0 cm, 4"  
140-270-100

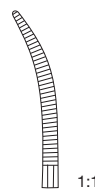

140-271-100

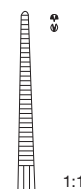

1 x 2  
Zähne  
Teeth

140-272-100

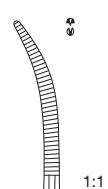

1 x 2  
Zähne  
Teeth

140-273-100

12.0 cm, 4 3/4"  
140-270-120

140-271-120

140-272-120

140-273-120



140-274-140

**Providence-Hospital**  
14.0 cm, 5 1/2"

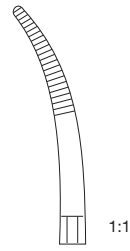

1:1

140-275-140

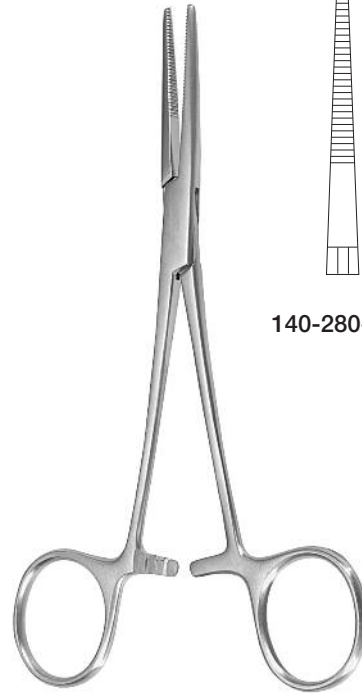

140-280-140

**Kelly**  
14.0 cm, 5 1/2"

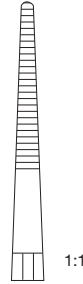

1:1

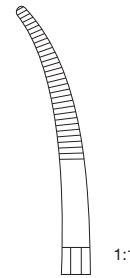

1:1

140-281-140



**Leriche**  
15.0 cm, 6"



1:1

140-276-150

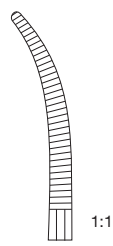

1:1

140-277-150

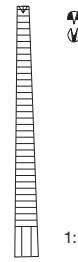

1:1

140-278-150

1 x 2  
Zähne  
Teeth

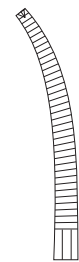

1:1

140-279-150

1 x 2  
Zähne  
Teeth

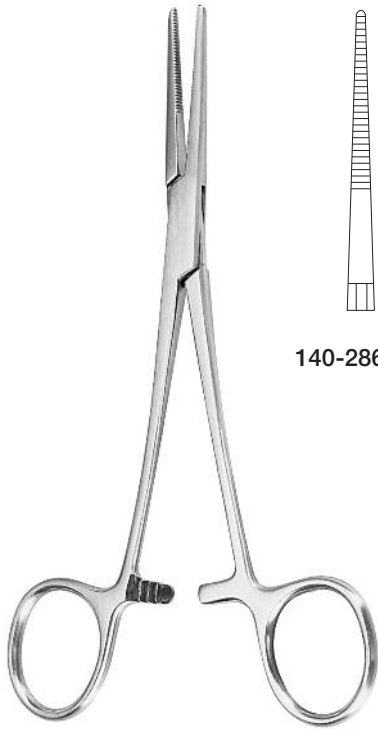

**Kelly-Rankin**  
16.0 cm, 6 1/4"

140-286-160



1:1

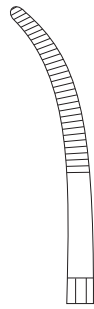

1:1

140-287-160



**Baby-Overholt**  
13.5 cm, 5 1/4"

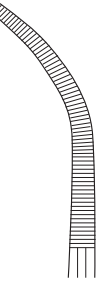

1:1

140-285-135

5

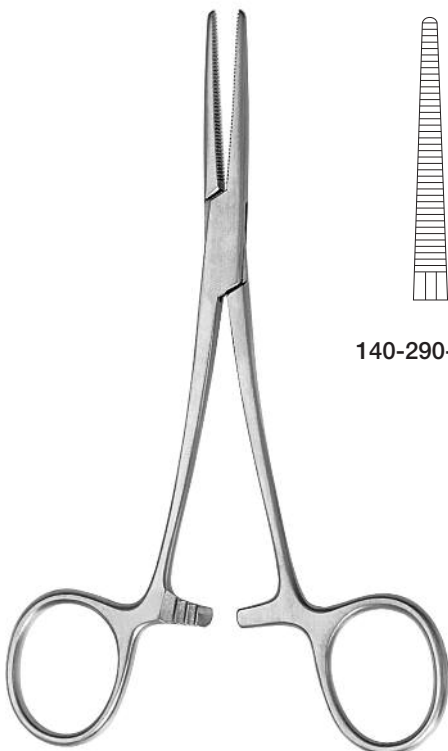

**Crile**  
14.0 cm, 5 1/2"

140-290-140

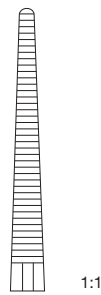

1:1

140-291-140

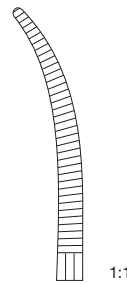

1:1

140-292-140

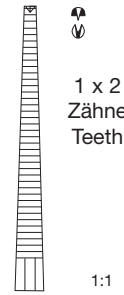

1 x 2  
Zähne  
Teeth

1:1

140-293-140

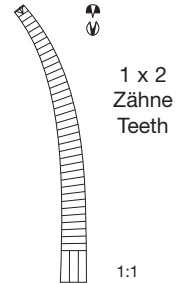

1 x 2  
Zähne  
Teeth

1:1



**Crile-Rankin**  
16.0 cm, 6 1/4"

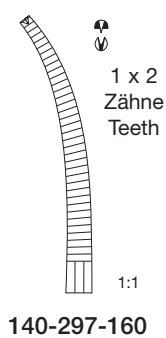
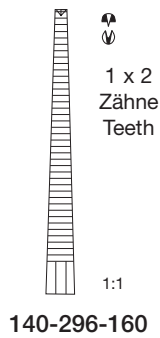
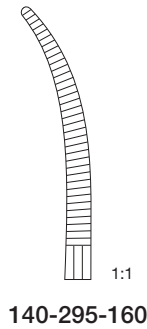
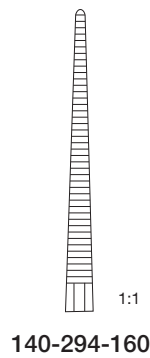

**Dixon-Lovelace**  
16.0 cm, 6 1/4"

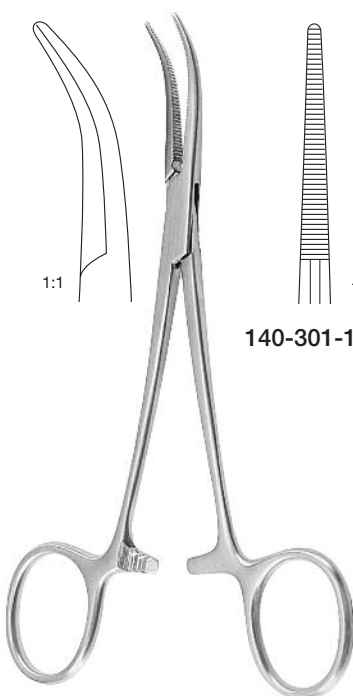
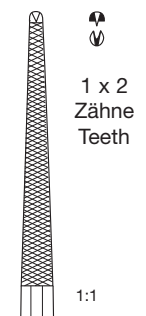
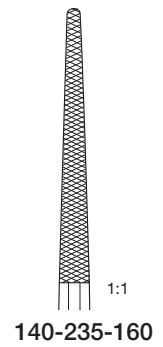

**Dandy**  
14.0 cm, 5 1/2"

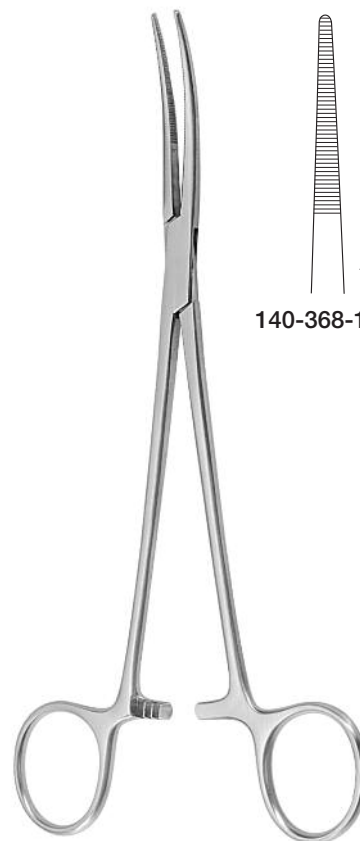
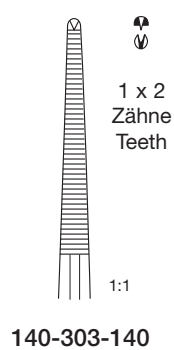
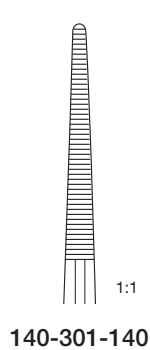
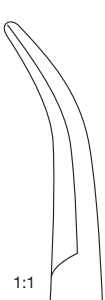

**Birkett**  
18.5 cm, 7 1/4"

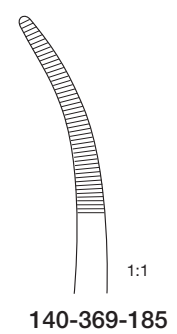
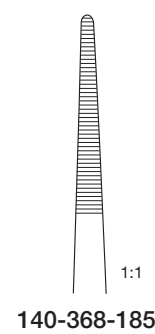

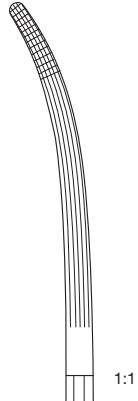
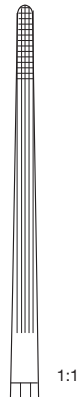
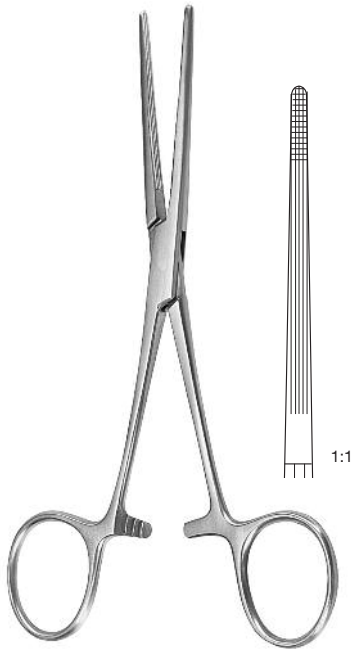

<b>Bainbridge</b>		
15.0 cm, 6"	140-442-150	140-443-150
18.5 cm, 7 1/4"	140-442-185	140-443-185

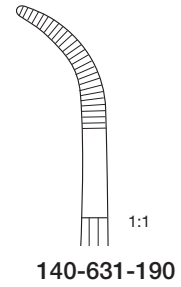
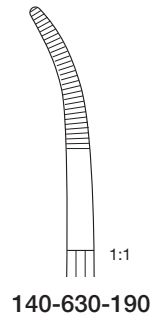

**Schnidt**  
19.0 cm, 7 1/2"

5

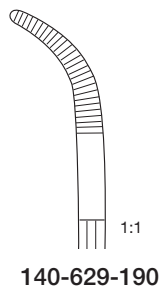
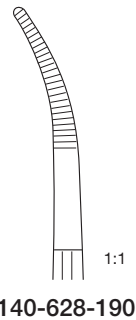
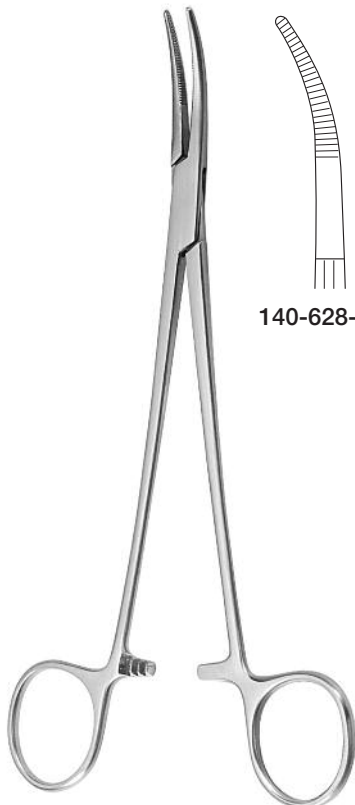

**Schnidt-Sawtell**  
19.0 cm, 7 1/2"

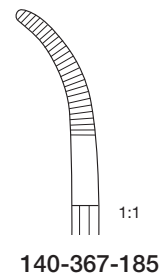
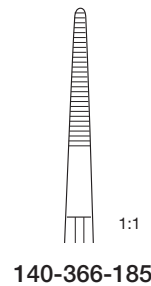
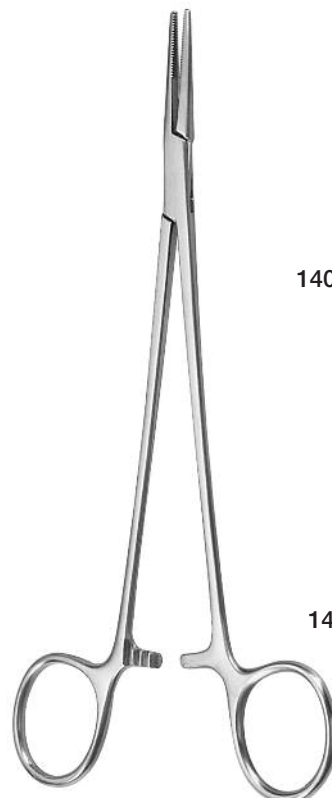

140-366-185

140-367-185

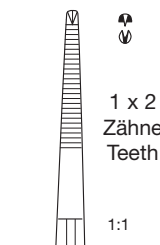

1 x 2  
Zähne  
Teeth

140-372-185

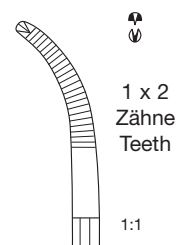

1 x 2  
Zähne  
Teeth

140-373-185

**Adson**  
18.5 cm, 7 1/4"



Rochester-Carmalt

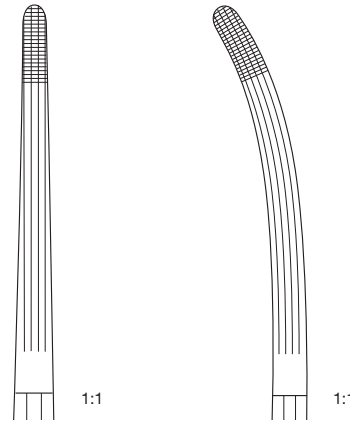

16.0 cm, 6 1/4"	140-314-160	140-315-160
20.0 cm, 8"	140-314-200	140-315-200

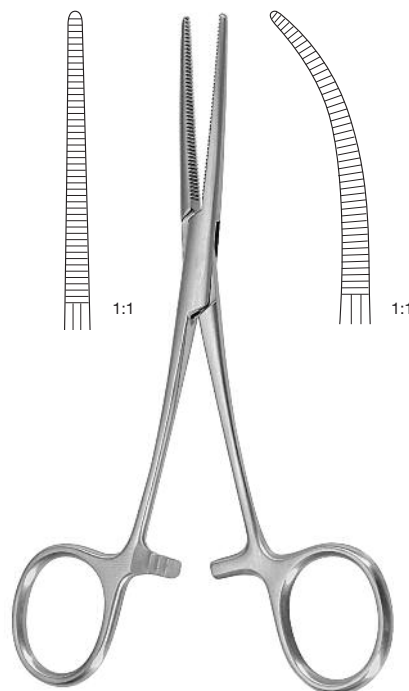

Pean delicate

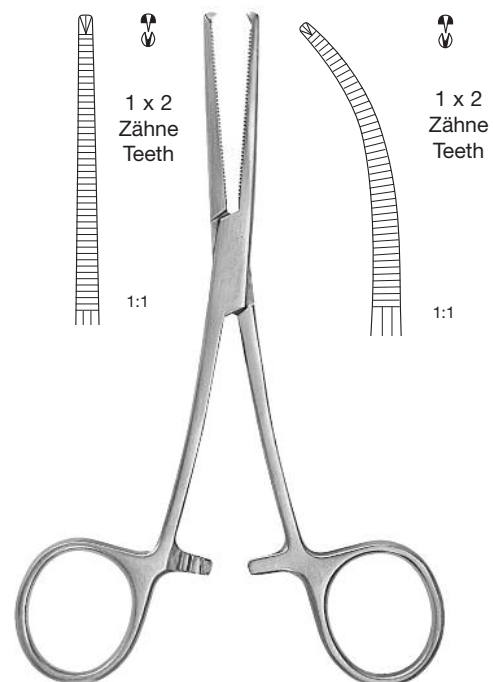

Kocher delicate

13.0 cm, 5"	140-316-130	140-317-130	140-318-130	140-319-130
14.0 cm, 5 1/2"	140-316-140	140-317-140	140-318-140	140-319-140
16.0 cm, 6 1/4"	140-316-160	140-317-160	140-318-160	140-319-160



Rochester-Pean

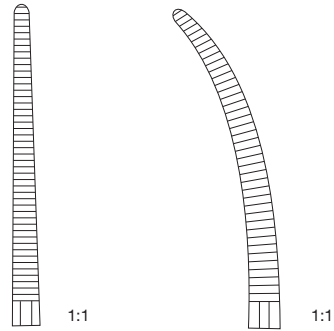

14.0 cm, 5 1/2"	140-330-140	140-331-140
16.0 cm, 6 1/4"	140-330-160	140-331-160
18.0 cm, 7"	140-330-180	140-331-180
20.0 cm, 8"	140-330-200	140-331-200
22.0 cm, 8 5/8"	140-330-220	140-331-220
24.0 cm, 9 1/2"	140-330-240	140-331-240
26.0 cm, 10 1/4"	140-330-260	140-331-260
30.0 cm, 12"	140-330-300	140-331-300

5



Kocher-Ochsner

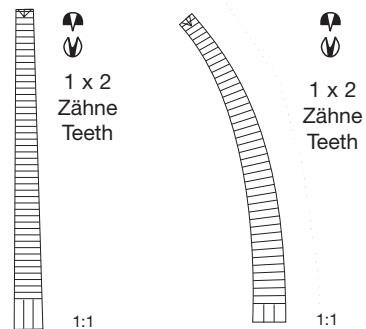

14.0 cm, 5 1/2"	140-332-140	140-333-140
16.0 cm, 6 1/4"	140-332-160	140-333-160
18.0 cm, 7"	140-332-180	140-333-180
20.0 cm, 8"	140-332-200	140-333-200
22.0 cm, 8 5/8"	140-332-220	140-333-220
24.0 cm, 9 1/2"	140-332-240	140-333-240
26.0 cm, 10 1/4"	140-332-260	140-333-260
30.0 cm, 12"	140-332-300	140-333-300

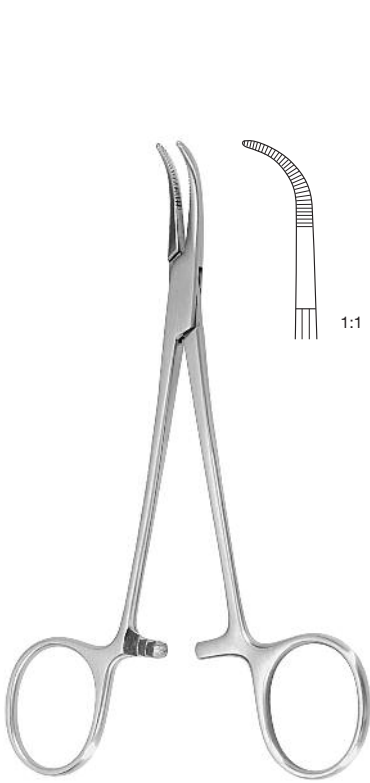

**Baby-Adson**  
14.0 cm, 5 1/2"  
140-339-140  
18.0 cm, 7"  
140-339-180



**Baby-Mixer**  
18.0 cm, 7"  
140-337-180

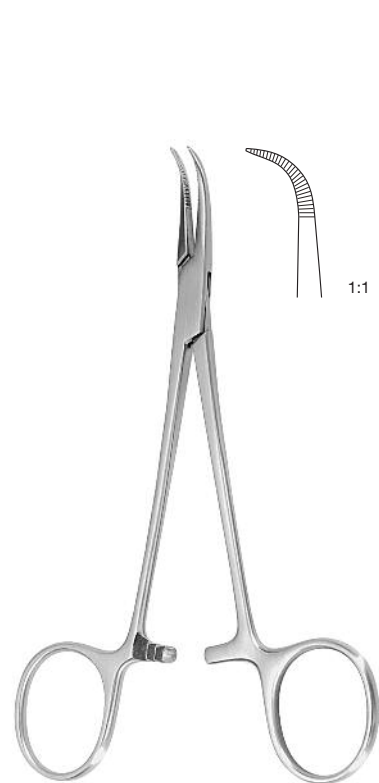

**Micro-Adson**  
14.0 cm, 5 1/2"  
140-338-140

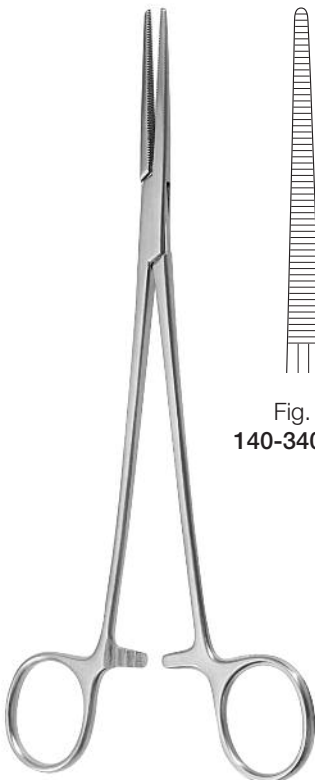

**Heiss**  
20.0 cm, 8"

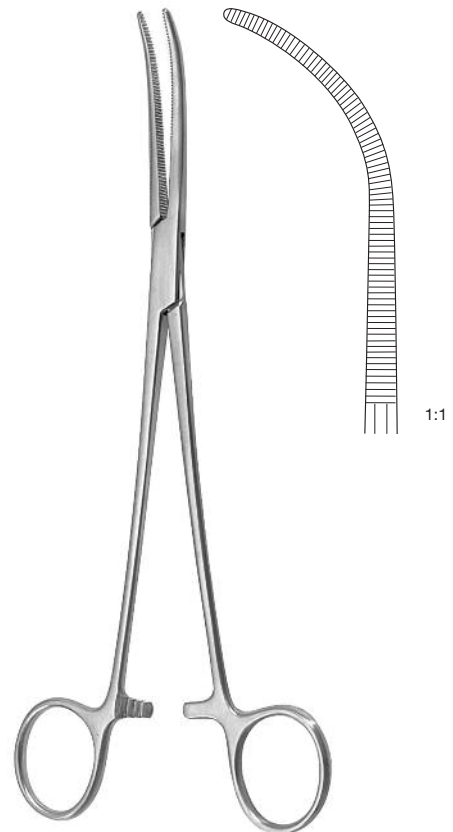
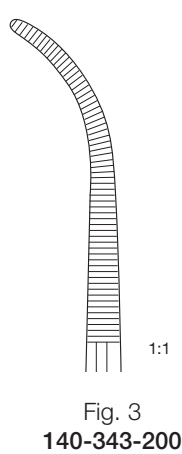
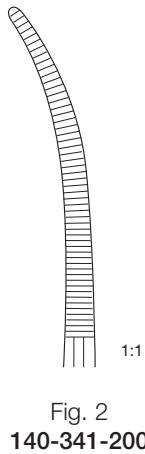
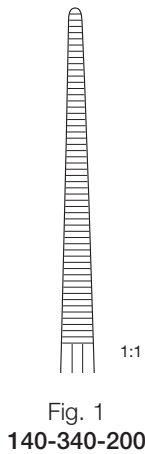

**Overholt-Mixer**  
21.0 cm, 8 1/4"  
140-345-210





Bengolea

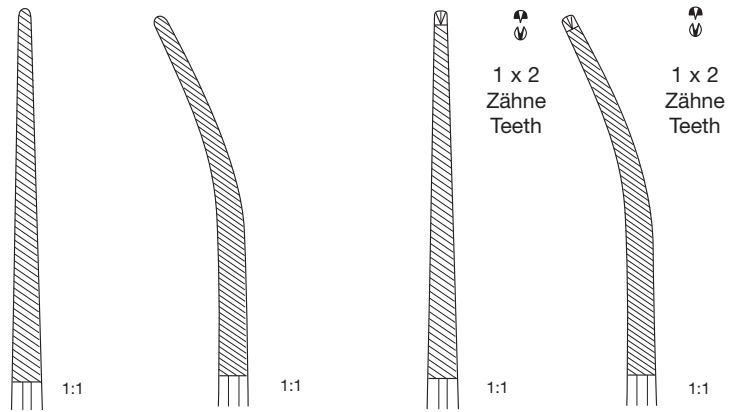

20.0 cm, 8"	140-140-200	140-141-200	140-142-200	140-143-200
26.0 cm, 10 1/4"	140-140-260	140-141-260	140-142-260	140-143-260

5



Overholt  
S-gebogen, S-curved

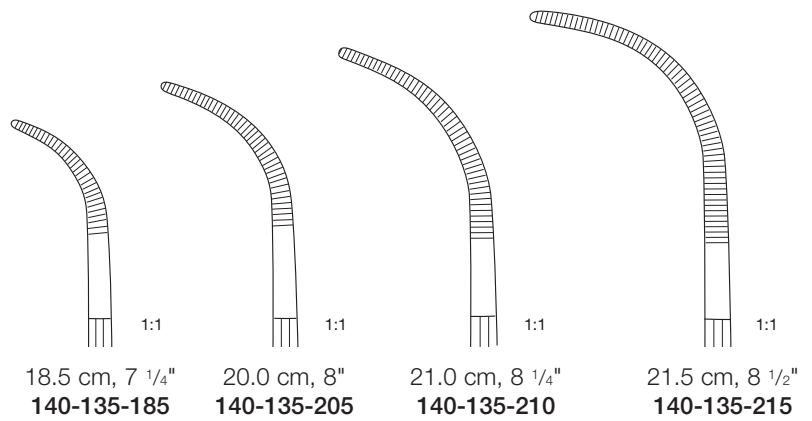

18.5 cm, 7 1/4"	20.0 cm, 8"	21.0 cm, 8 1/4"	21.5 cm, 8 1/2"
140-135-185	140-135-205	140-135-210	140-135-215

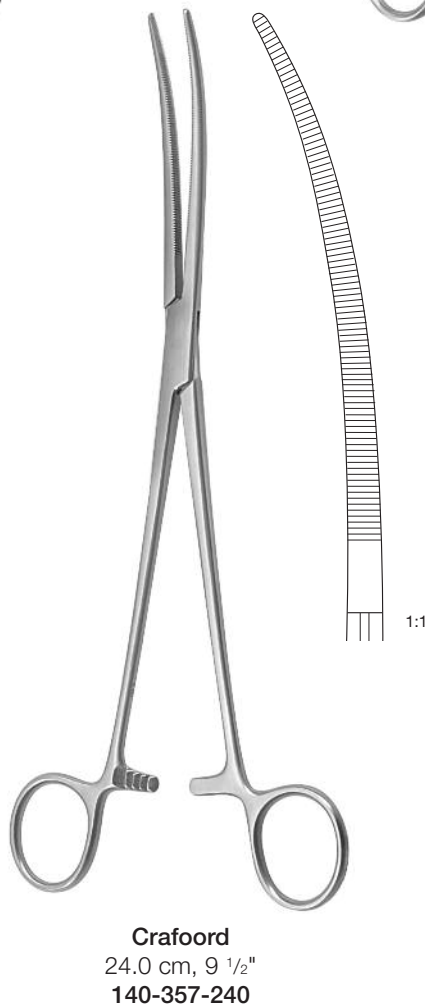
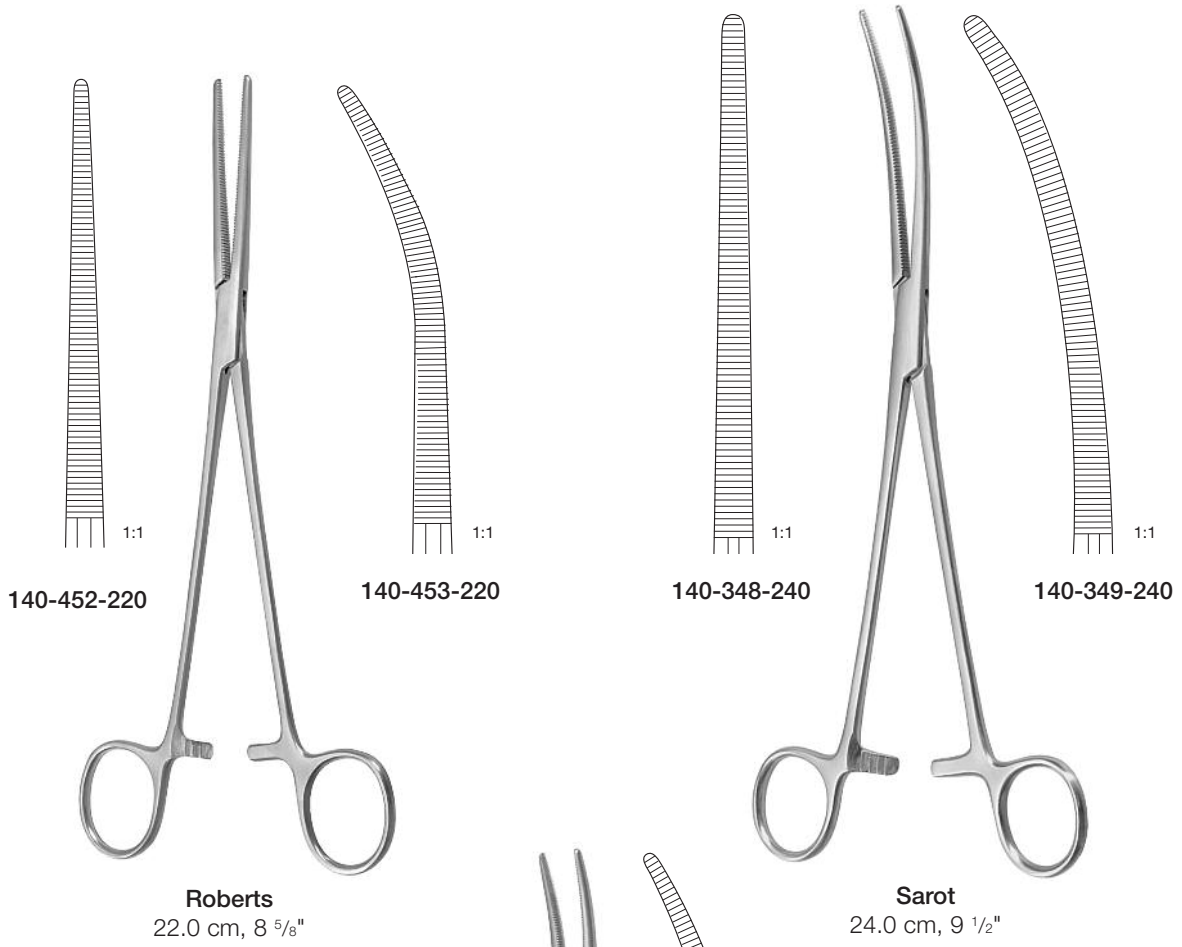

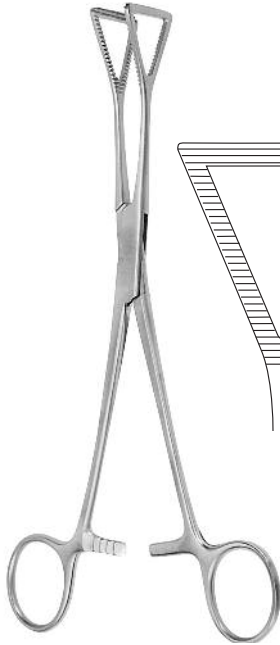

**Lovelace**  
20.0 cm, 8"  
290-286-200

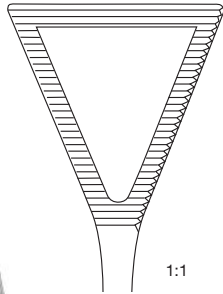

1:1



**Lovelace**  
20.0 cm, 8"  
290-287-200



**Harrington**  
30.5 cm, 12"  
290-269-305



**Harrington**  
29.5 cm, 11 5/8"  
290-271-295

5



**Price-Thomas**  
22.0 cm, 8 5/8"  
290-241-220

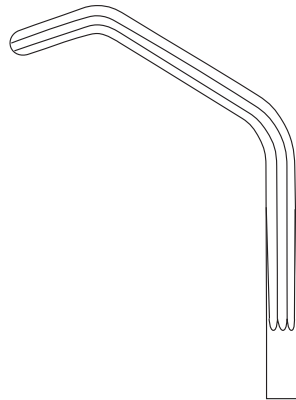

1:1

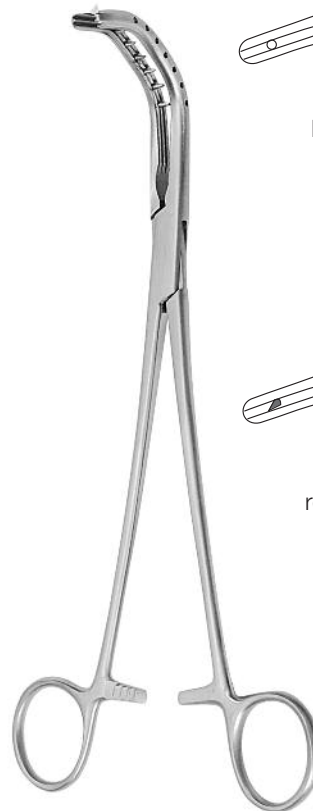

**Price-Thomas**  
links, left  
22.0 cm, 8 5/8"  
290-245-220

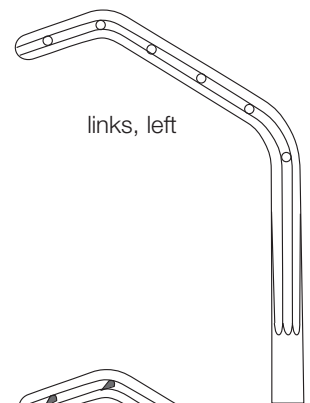

links, left

1:1

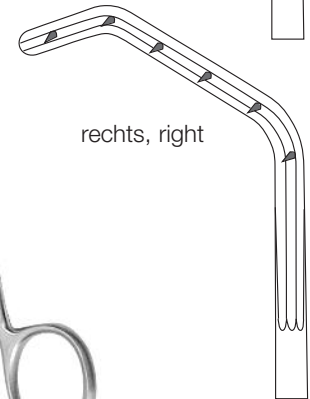

rechts, right

1:1

**Price-Thomas**  
rechts, right  
22.0 cm, 8 5/8"  
290-247-220

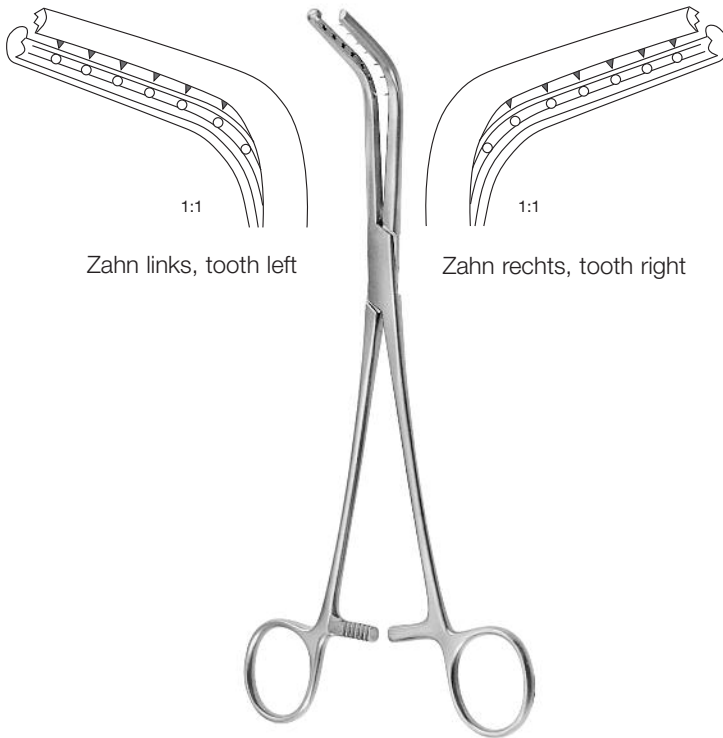

Zahn links, tooth left

Zahn rechts, tooth right

**Sarot**

Zahn links, tooth left  
23.0 cm, 9"  
290-237-230

**Sarot**

Zahn rechts, tooth right  
23.0 cm, 9"  
290-238-230

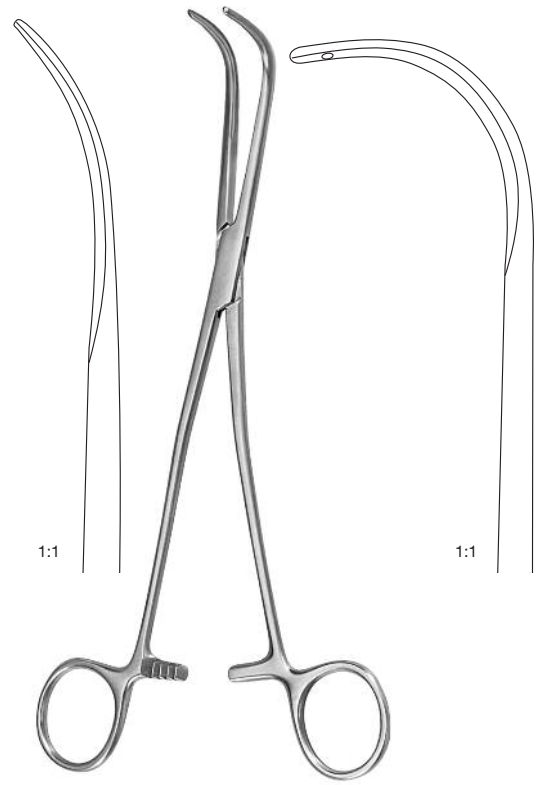

1:1

1:1

**Semb**

24.0 cm, 9 1/2"  
290-265-240

**Semb**

24.0 cm, 9 1/2"  
290-267-240

**Anastomosen-Klemmen**  
Anastomosis Clamps

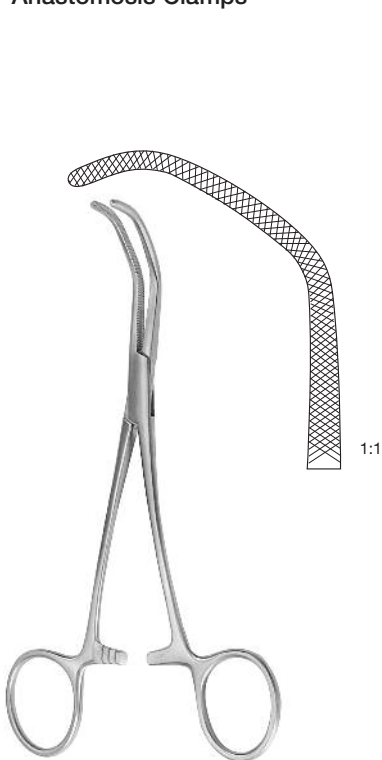

**Satinsky**  
15.0 cm, 6"  
290-331-150



**Satinsky**  
26.0 cm, 10 1/4"

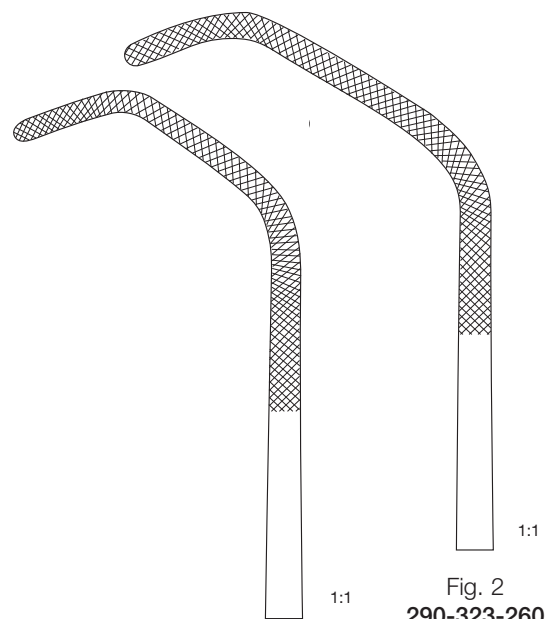
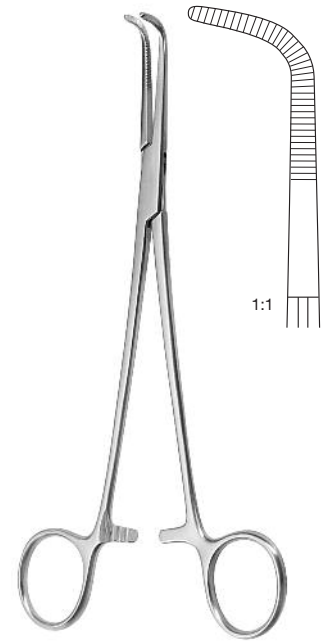
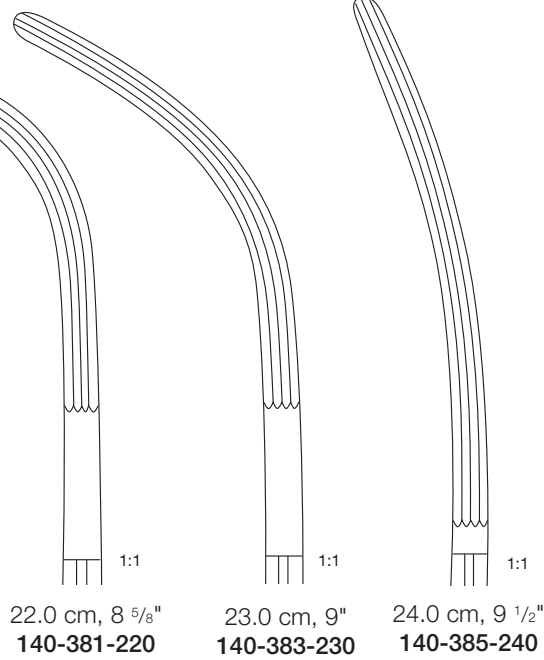

Fig. 1  
290-321-260

Fig. 2  
290-323-260



Crafoord-Sellors



Kantowitz

19.0 cm, 7 1/2"	<b>140-417-190</b>
24.0 cm, 9 1/2"	<b>140-417-240</b>
28.0 cm, 11"	<b>140-417-280</b>

5



Overholt-Geissendoerfer

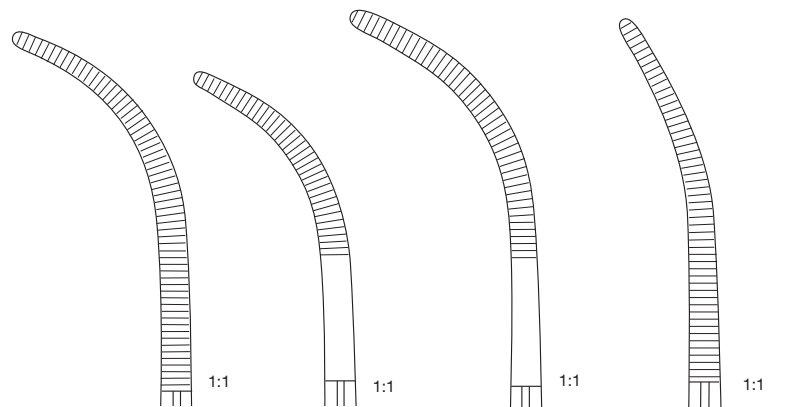
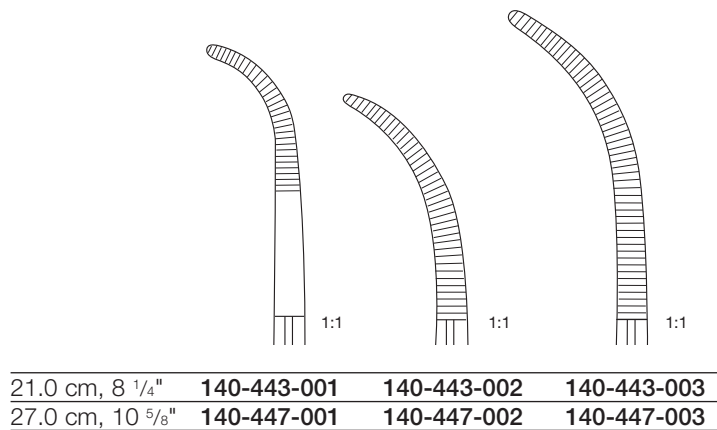



Toennis

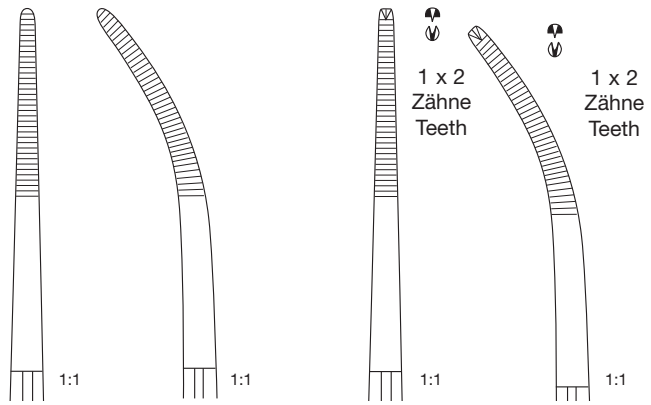

21.0 cm, 8 1/4"	140-412-210	140-413-210	140-414-210	140-415-210
26.0 cm, 10 1/4"	140-412-260	140-413-260	140-414-260	140-415-260

5

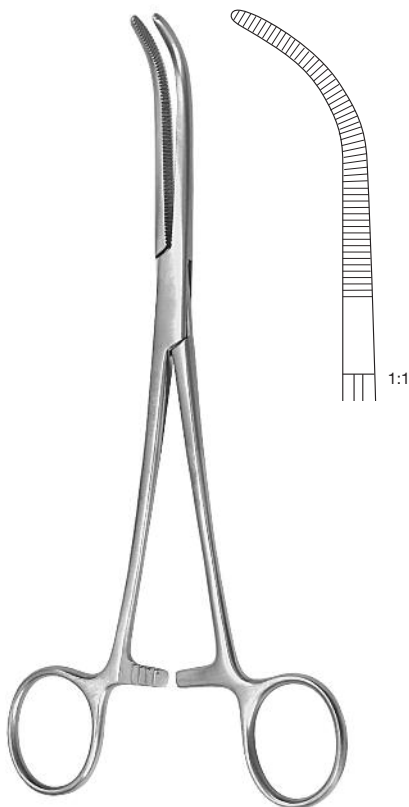

Johns Hopkins  
20.0 cm, 8"  
140-410-200

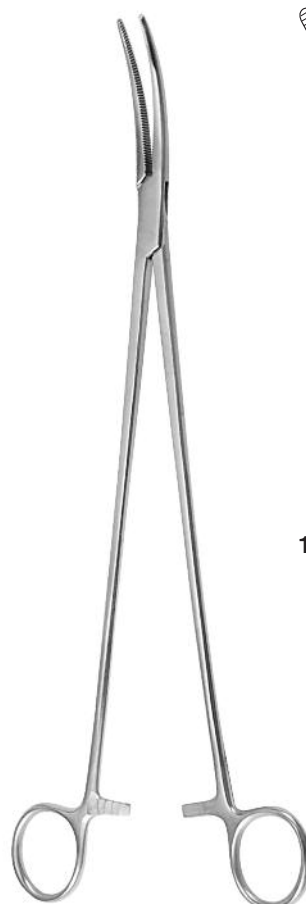

Zenker  
29.5 cm, 11 5/8"

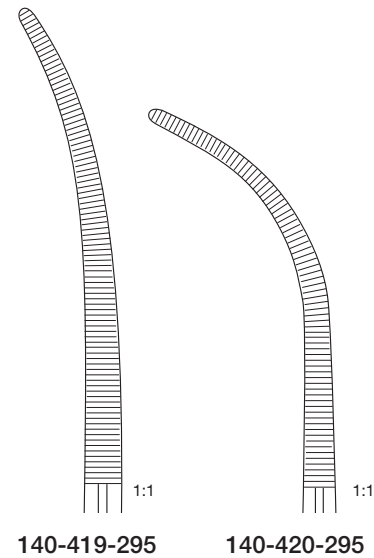



Mini-Gemini

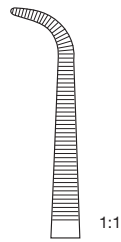

13.0 cm, 5"	<b>140-359-130</b>
16.0 cm, 6 1/4"	<b>140-359-160</b>
18.0 cm, 7"	<b>140-359-180</b>
20.0 cm, 8"	<b>140-359-200</b>
22.0 cm, 8 5/8"	<b>140-359-220</b>
23.0 cm, 9"	<b>140-359-230</b>
25.0 cm, 9 3/4"	<b>140-359-250</b>
28.0 cm, 11"	<b>140-359-280</b>

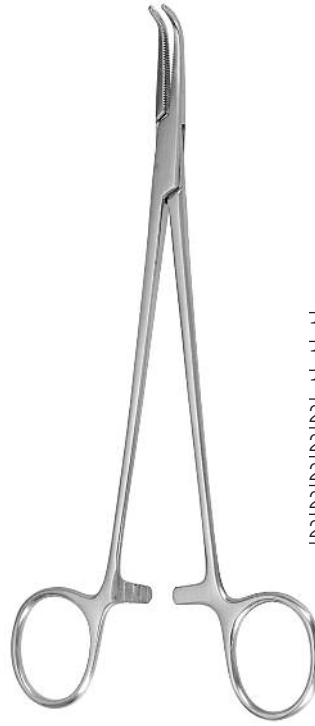

Gemini

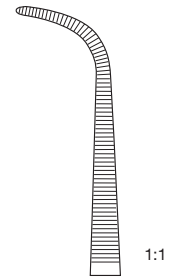

13.0 cm, 5"	<b>140-361-130</b>
16.0 cm, 6 1/4"	<b>140-361-160</b>
18.0 cm, 7"	<b>140-361-180</b>
20.0 cm, 8"	<b>140-361-200</b>
22.0 cm, 8 5/8"	<b>140-361-220</b>
23.0 cm, 9"	<b>140-361-230</b>
25.0 cm, 9 3/4"	<b>140-361-250</b>
28.0 cm, 11"	<b>140-361-280</b>

5



Rumel  
23.0 cm, 9"

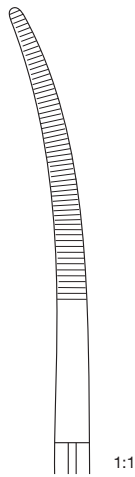

140-346-001

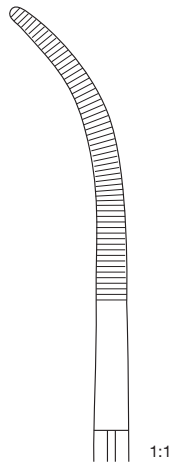

140-346-002

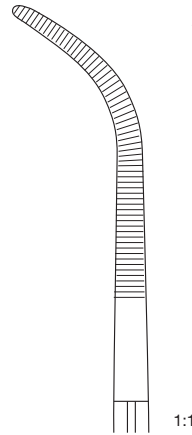

140-346-003

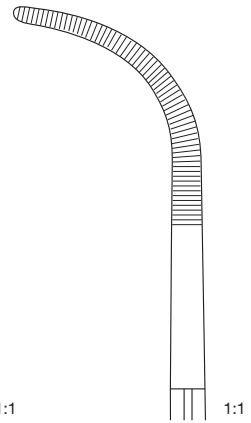

140-346-004

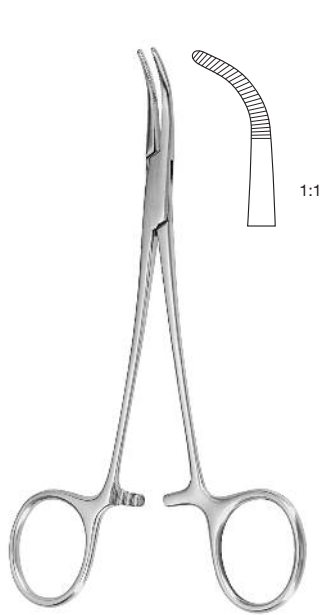

**Mixer Baby**  
14.0 cm, 5 1/2"  
140-421-140

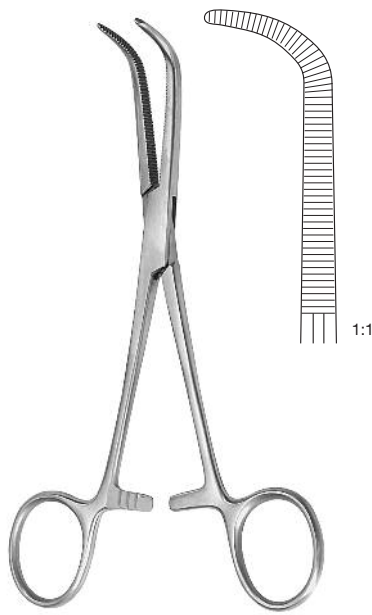

**Mixer**  
15.5 cm, 6"  
140-423-155  
19.0 cm, 7 1/2"  
140-423-190

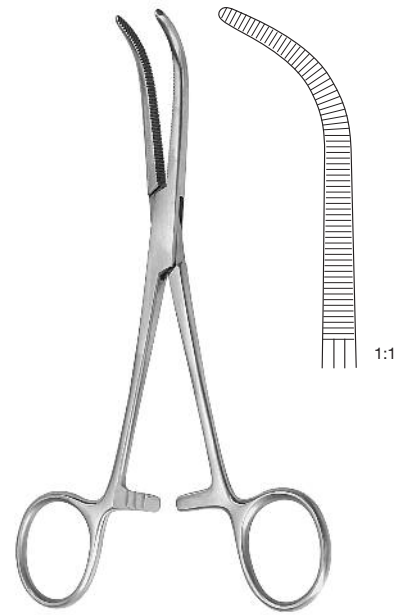

**Mixer-O'Shaugnessy**  
15.5 cm, 6"  
140-425-155  
19.0 cm, 7 1/2"  
140-425-190

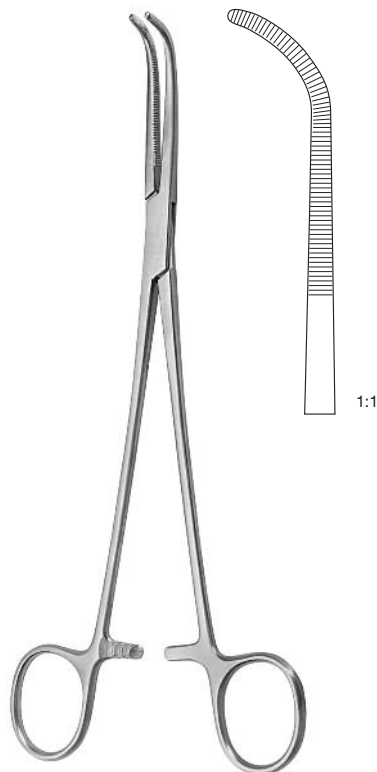

**Mixer**  
22.0 cm, 8 3/4"  
140-427-220



**Mixer**  
23.0 cm, 9"  
140-429-230



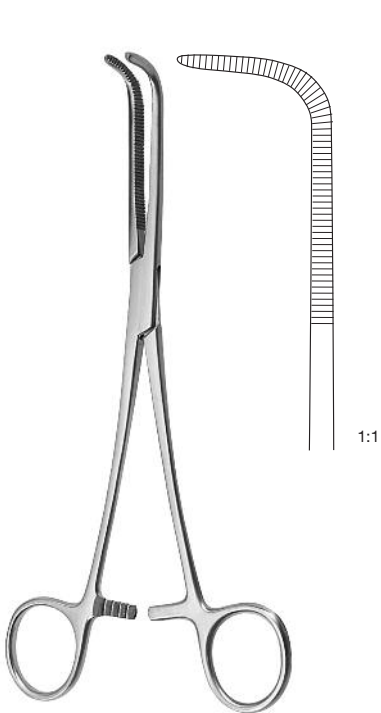

**Wikstroem**  
21.0 cm, 8 1/4"  
140-431-210  
24.0 cm, 9 1/2"  
140-431-240

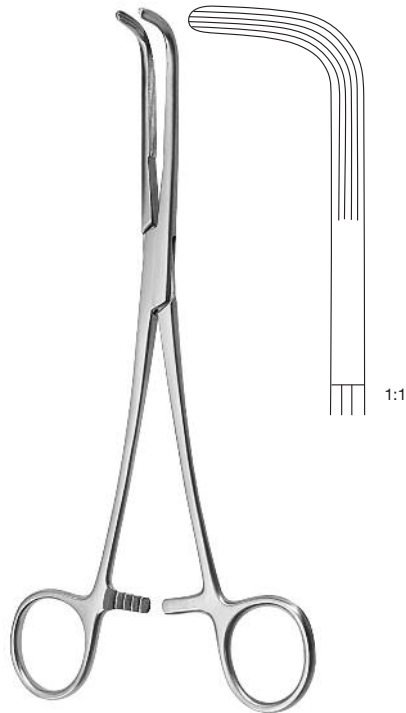

**Mixer**  
22.0 cm, 8 5/8"  
140-433-220  
25.0 cm, 9 3/4"  
140-433-250  
28.0 cm, 11"  
140-433-280

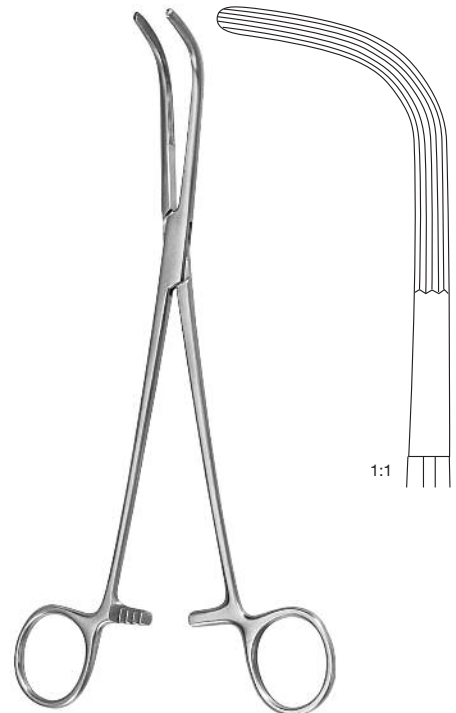

**McQuigg-Mixer**  
22.0 cm, 8 5/8"  
140-435-220

5



**Lower**  
18.0 cm, 7"  
140-437-180

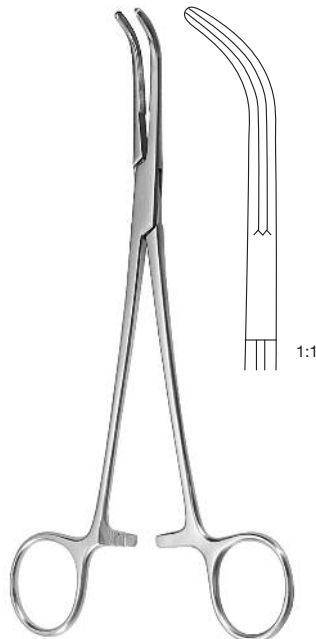

**Lahey**  
19.0 cm, 7 1/2"  
140-439-190  
23.0 cm, 9"  
140-439-230

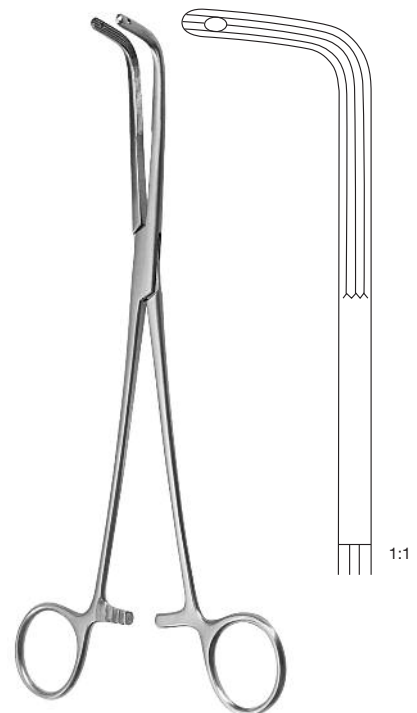

**Finocchietto**  
24.0 cm, 9 1/2"  
140-440-240



**Kelly**

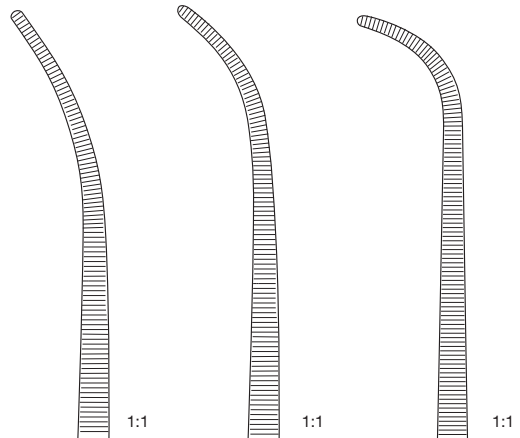

19.0 cm, 7 1/2"	<b>140-633-190</b>	<b>140-635-190</b>	<b>140-637-190</b>
22.0 cm, 8 5/8"	<b>140-633-220</b>	<b>140-635-220</b>	<b>140-637-220</b>
24.0 cm, 9 1/2"	<b>140-633-240</b>	<b>140-635-240</b>	<b>140-637-240</b>

**5**



**Hosemann**  
 21.0cm, 8 1/4"

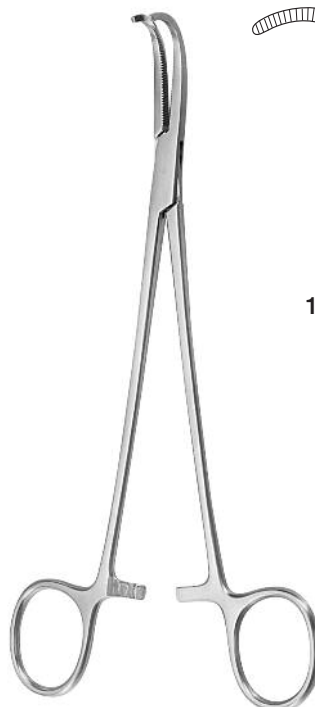
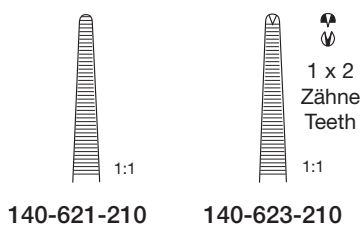

**Negus**  
 19.0cm, 7 1/2"

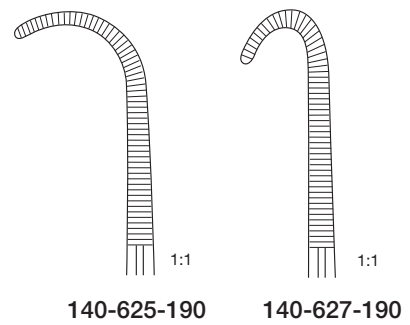

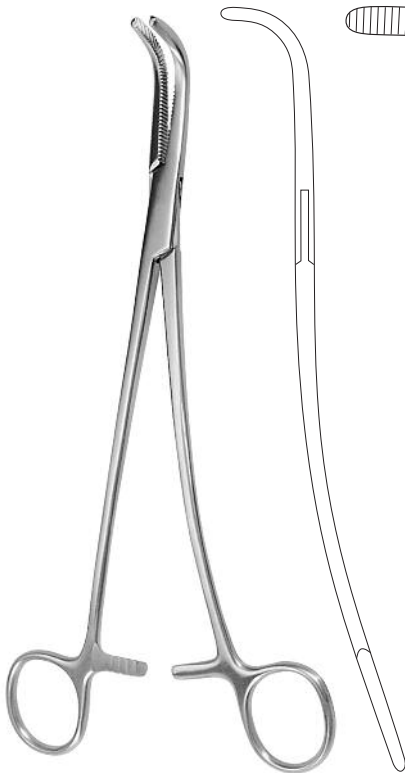

Gray

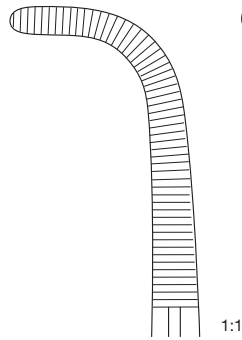

22.0 cm, 8 5/8"  
140-607-220

23.0 cm, 9"  
140-607-230

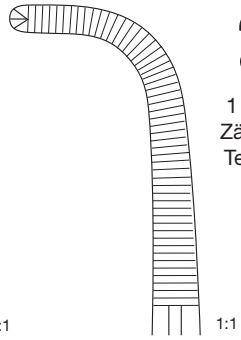

22.0 cm, 8 5/8"  
140-608-220

23.0 cm, 9"  
140-608-230

1 x 2  
Zähne  
Teeth

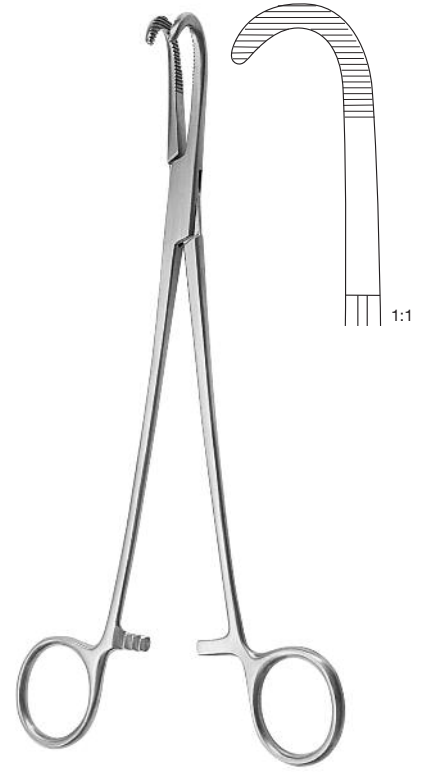

Desjardins  
21.0 cm, 8 1/4"  
140-609-210

5



Lawrence  
27.5 cm, 10 3/4"  
140-617-275

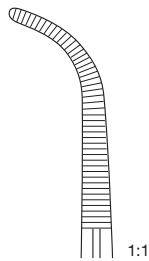

Meeker

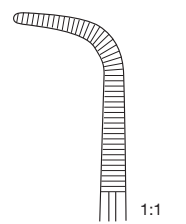

18.0 cm, 7"  
140-619-180

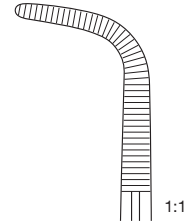

27.5 cm, 10 3/4"  
140-619-275



**Uro-Tangential**  
26.0 cm, 10 1/4"

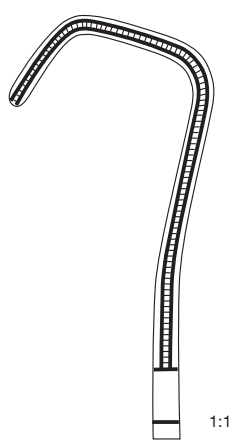

Fig. 1  
140-500-001

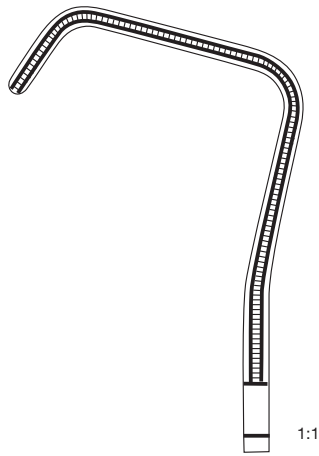
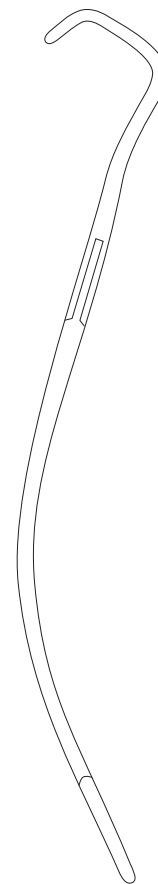
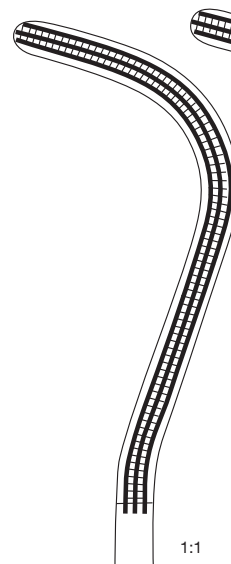

Fig. 2  
140-500-002



**Guyon**



23.0 cm, 9"  
140-498-230

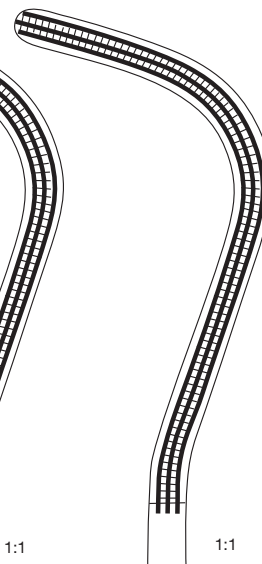

24.0 cm, 9 1/2"  
140-498-240

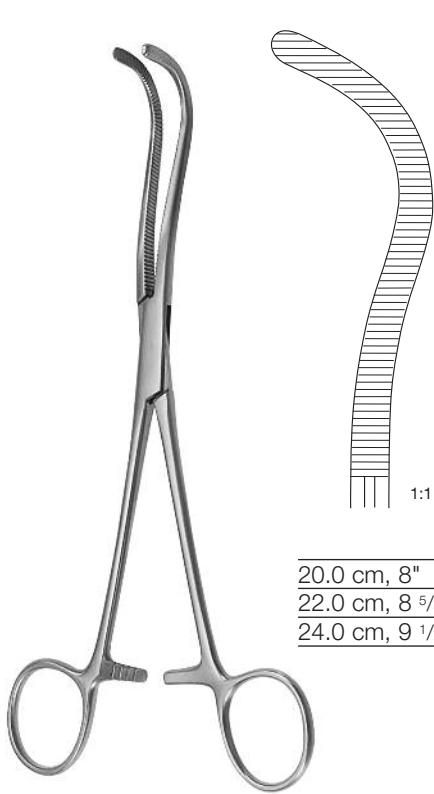

20.0 cm, 8"	140-600-200
22.0 cm, 8 5/8"	140-600-220
24.0 cm, 9 1/2"	140-600-240

Guyon

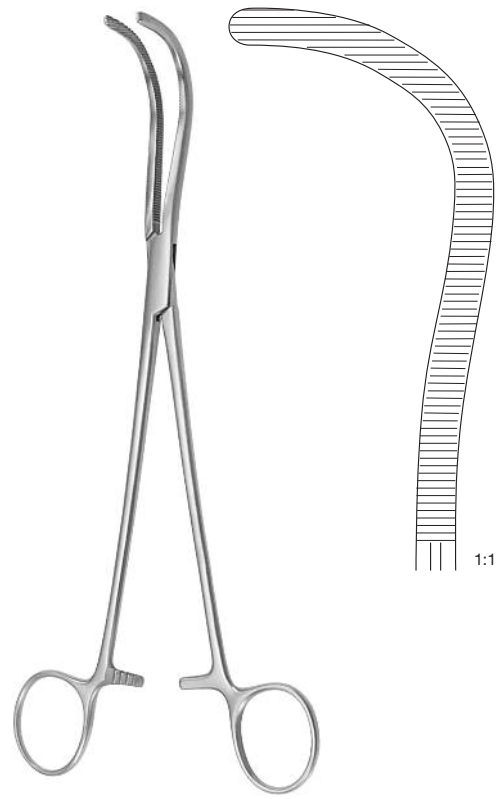

Guyon  
23.0 cm, 9"  
140-603-230

5

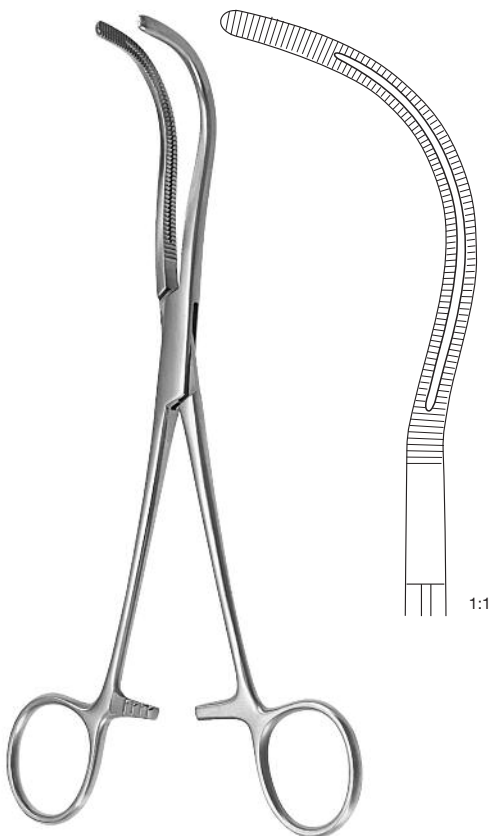

Stille  
23.0 cm, 9"  
140-602-230

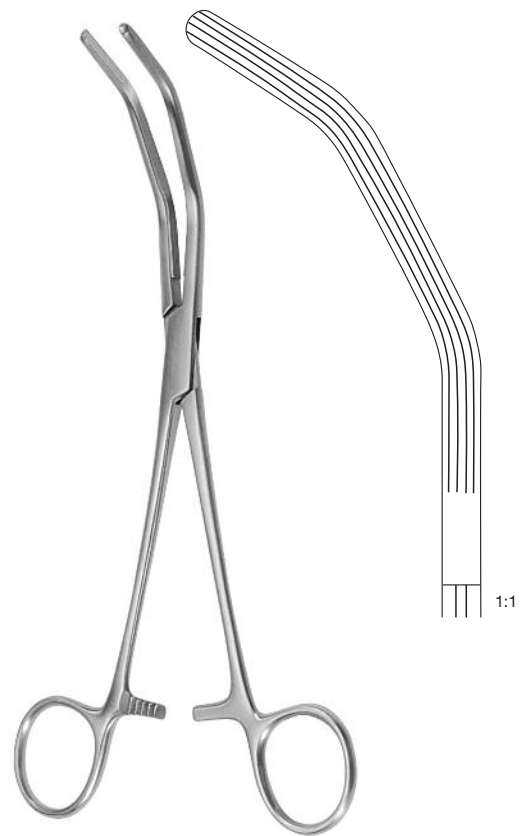

Herrick  
23.0 cm, 9"  
140-604-230

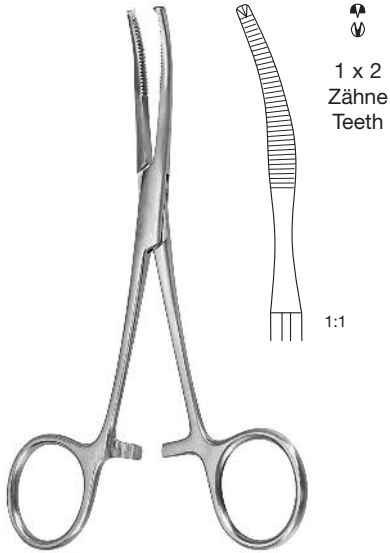

**Baby-Mikulicz**  
 14.0 cm, 5 1/2"  
 140-547-140

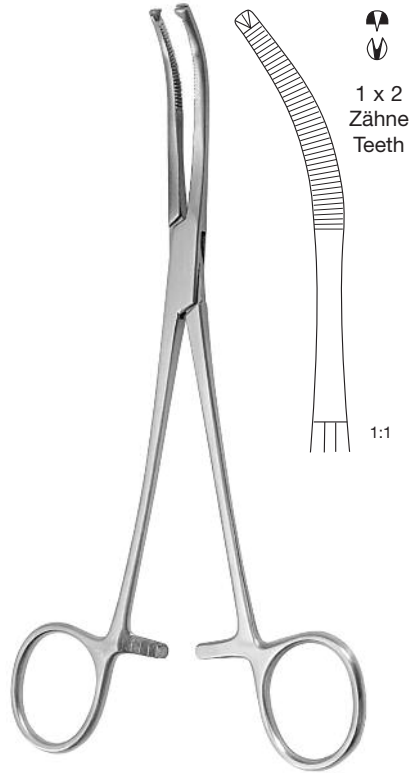

**Mikulicz**  
 20.0 cm, 8"  
 140-549-200

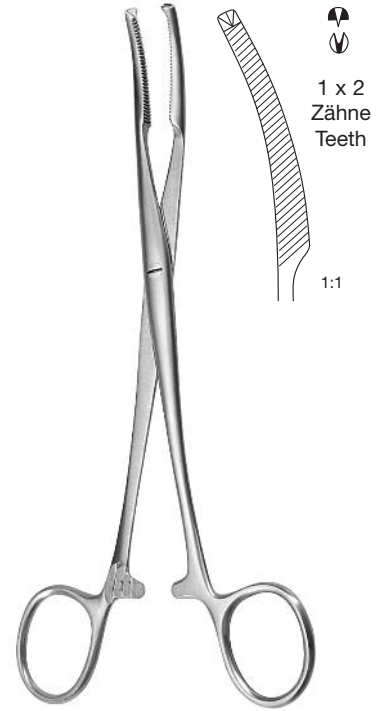

**Mikulicz**  
 18.0 cm, 7"  
 140-548-180

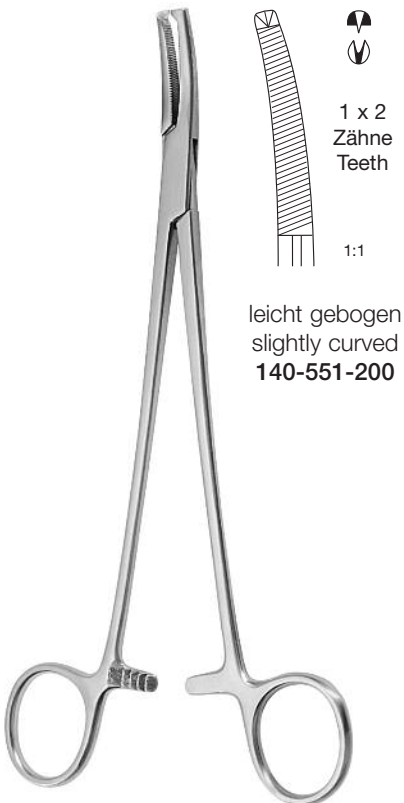

**Faure**  
 20.0 cm, 8"

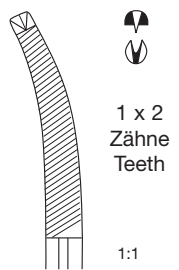

leicht gebogen  
 slightly curved  
 140-551-200



stärker gebogen  
 stronger curved  
 140-553-200

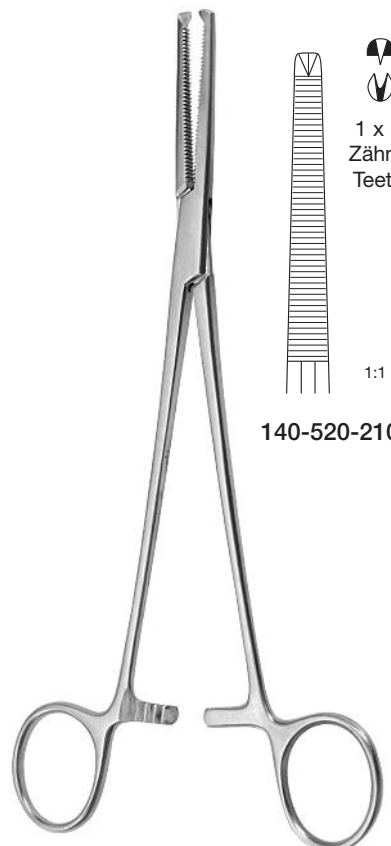

**Phaneuf**  
 21.5 cm, 8 1/2"

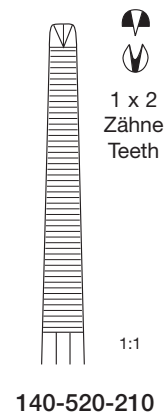

140-520-210

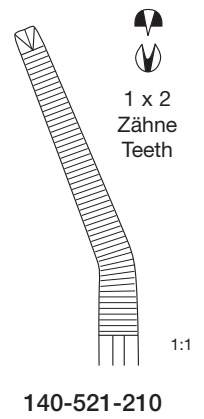

140-521-210



5

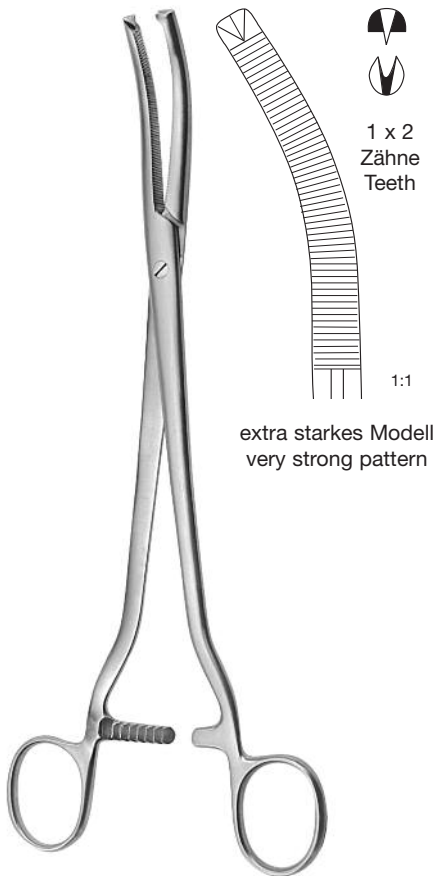

**Wertheim**  
24.0 cm, 9 1/2"  
140-643-240

extra starkes Modell  
very strong pattern

1 x 2  
Zähne  
Teeth

1:1

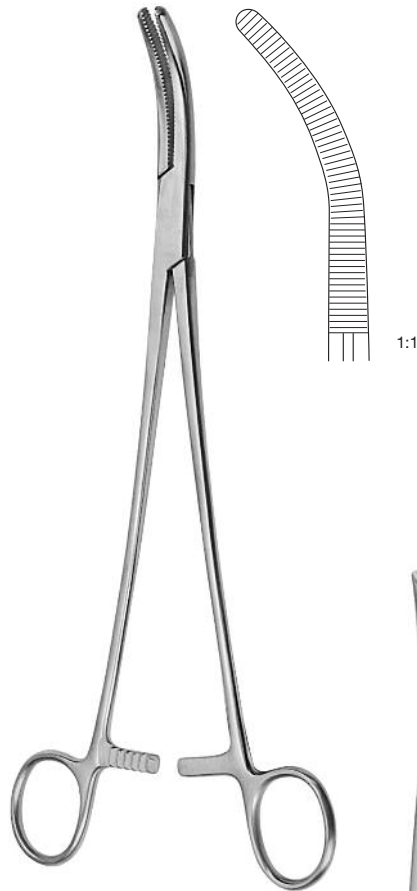

**Wertheim**  
25.0 cm, 10"  
140-697-250

1:1

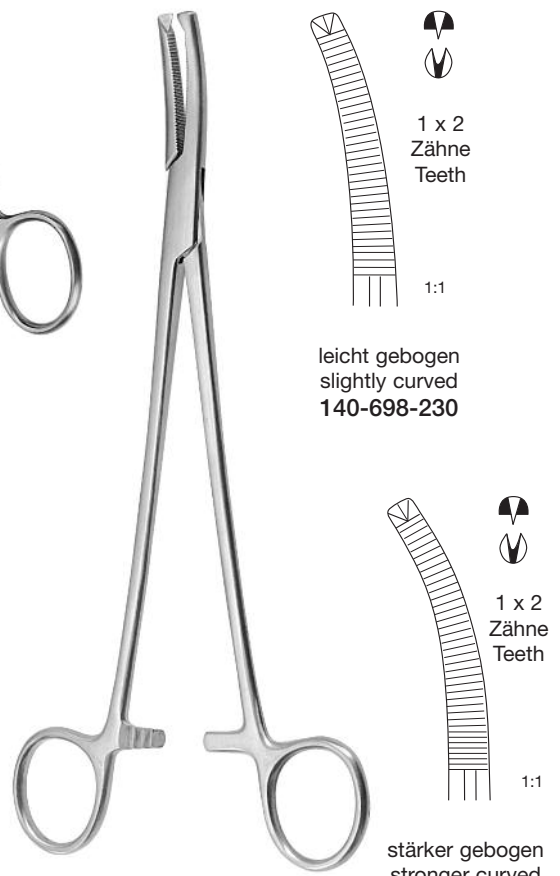

leicht gebogen  
slightly curved  
140-698-230

1 x 2  
Zähne  
Teeth

1:1



stärker gebogen  
stronger curved  
140-699-230

1 x 2  
Zähne  
Teeth

1:1

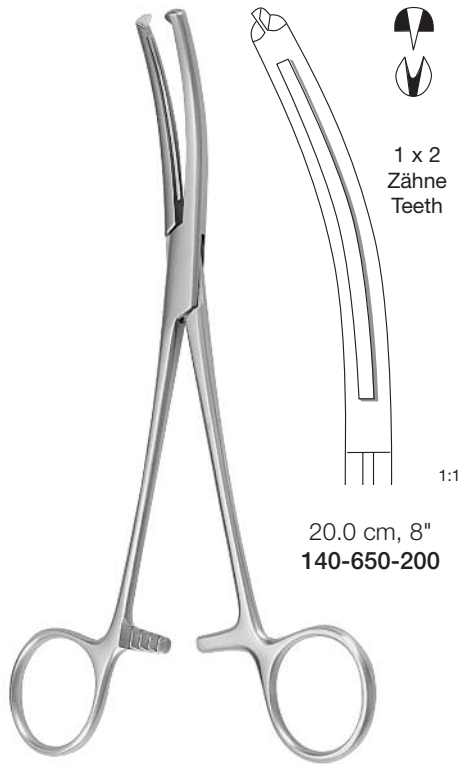

20.0 cm, 8"  
140-650-200

Maingot

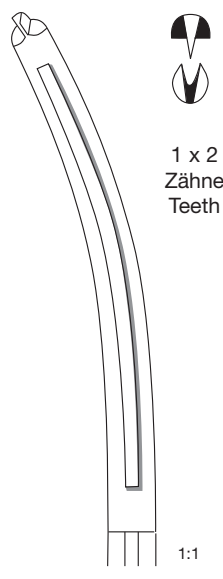

25.0 cm, 10"  
140-650-240

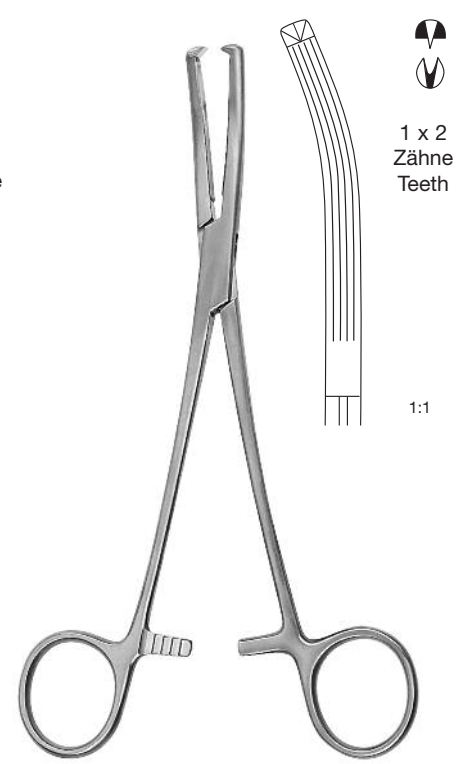

Long  
19.0 cm, 7 1/4"  
140-652-190

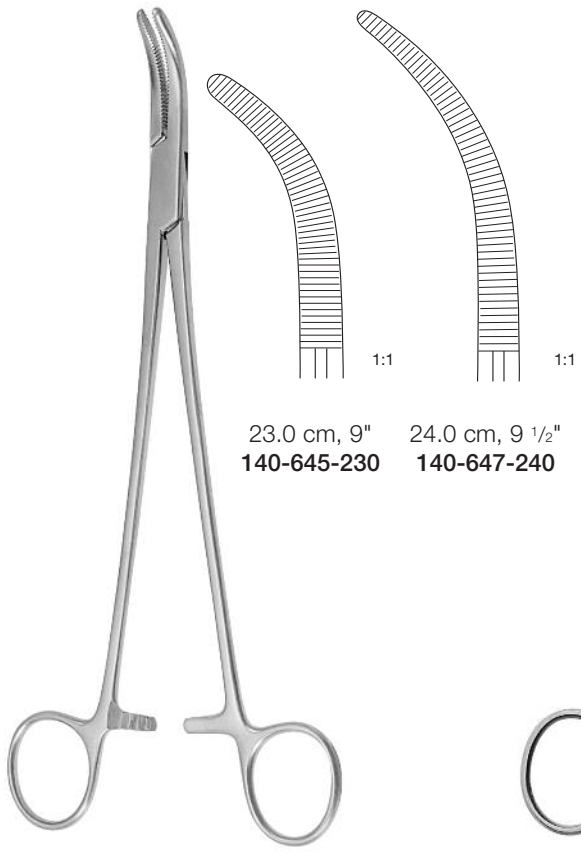

23.0 cm, 9" 140-645-230  
24.0 cm, 9 1/2" 140-647-240

Moynihan

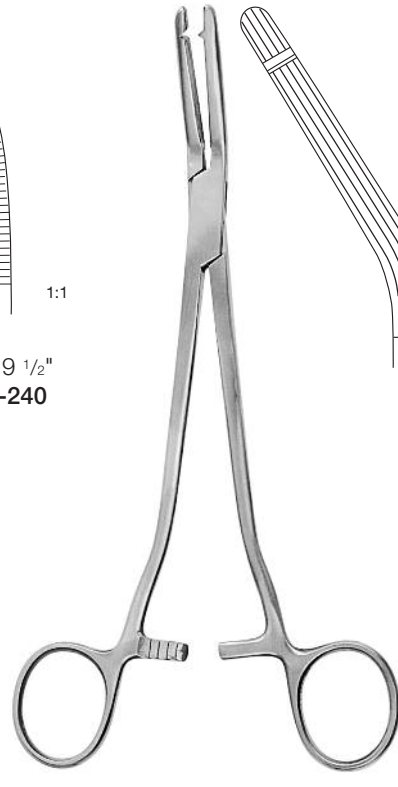

Garland  
21.0 cm, 8 1/4"  
140-639-210

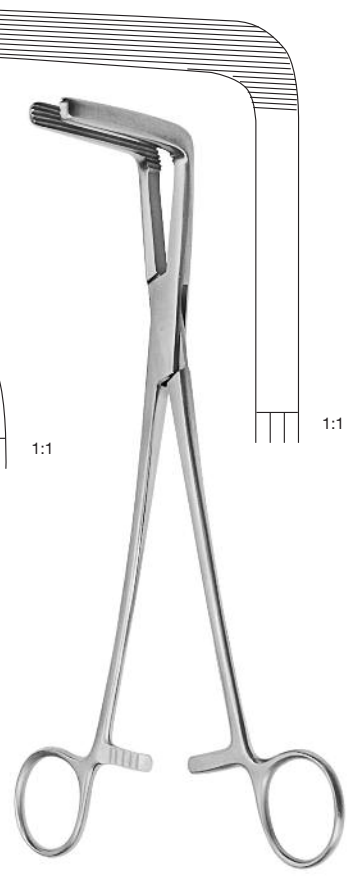

Wertheim-Cullen  
21.5 cm, 8 1/2"  
140-641-215



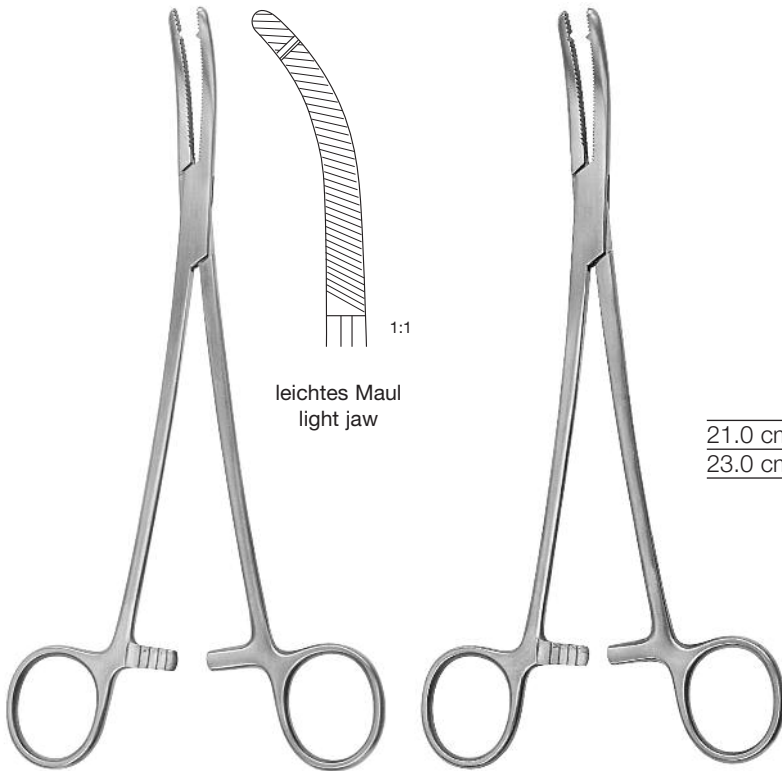

leichtes Maul  
light jaw

21.0 cm, 8 1/4"	140-613-210	140-615-210
23.0 cm, 9"	140-613-230	140-615-230

**Heaney**  
21.0 cm, 8 1/4"  
140-612-210

**Heaney**

5

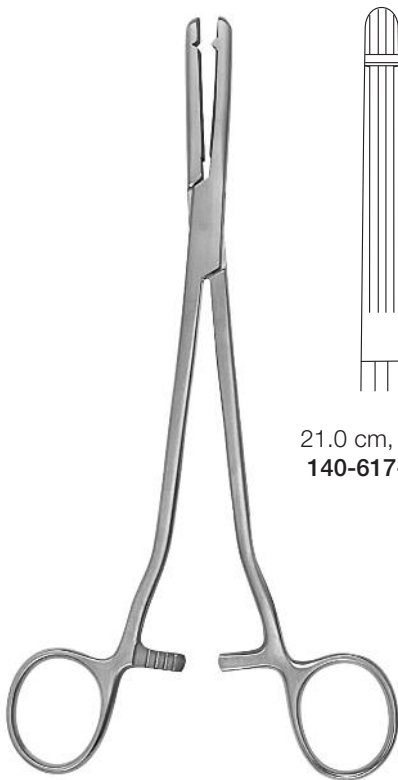

21.0 cm, 8 1/4"  
140-617-210

**Heaney-Ballantine**

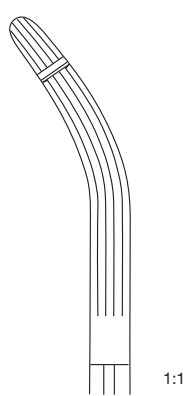

21.0 cm, 8 1/4"  
140-618-210

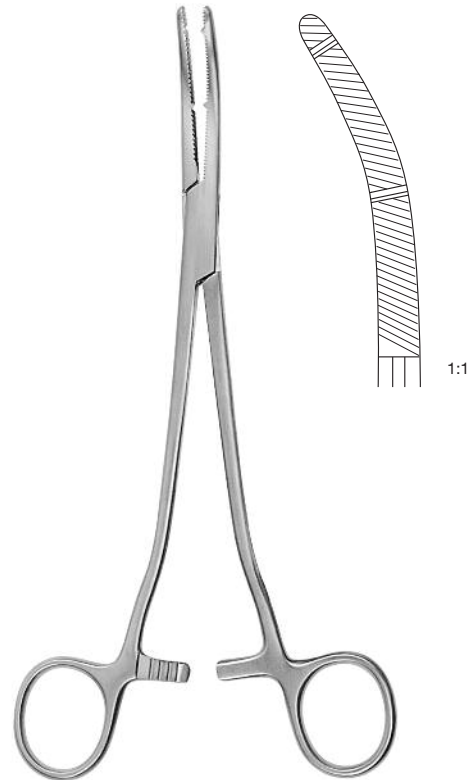

**Heaney-Kanter**  
21.0 cm, 8 1/4"  
140-619-210

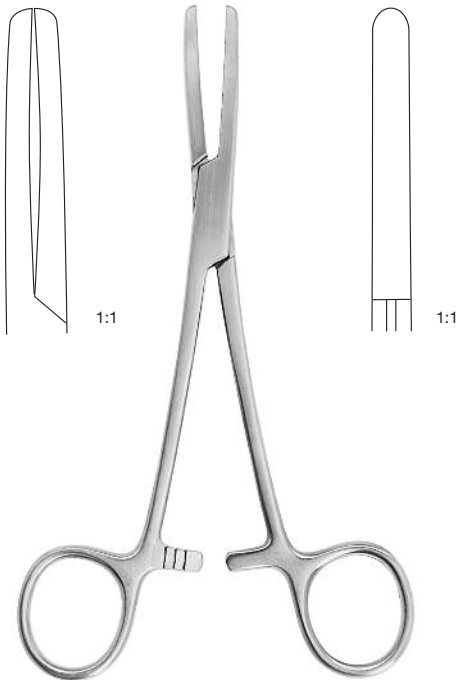

**Presbyterian**  
16.5 cm, 6 1/2"  
140-601-165  
18.0 cm, 7"  
140-601-180  
20.0 cm, 8"  
140-601-200

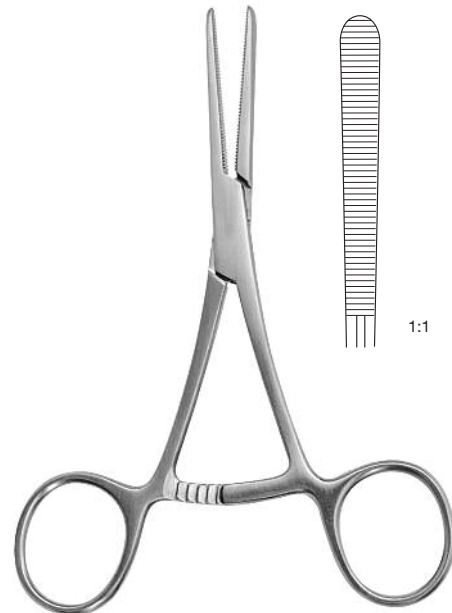

mit langer Sperre  
with long ratchet  
14.5 cm, 5 3/4"  
140-600-145

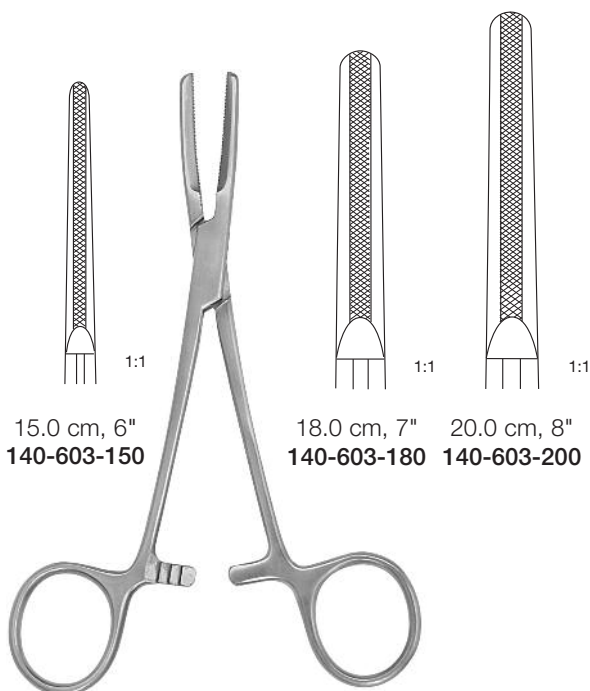

15.0 cm, 6"  
140-603-150  
18.0 cm, 7"  
140-603-180  
20.0 cm, 8"  
140-603-200

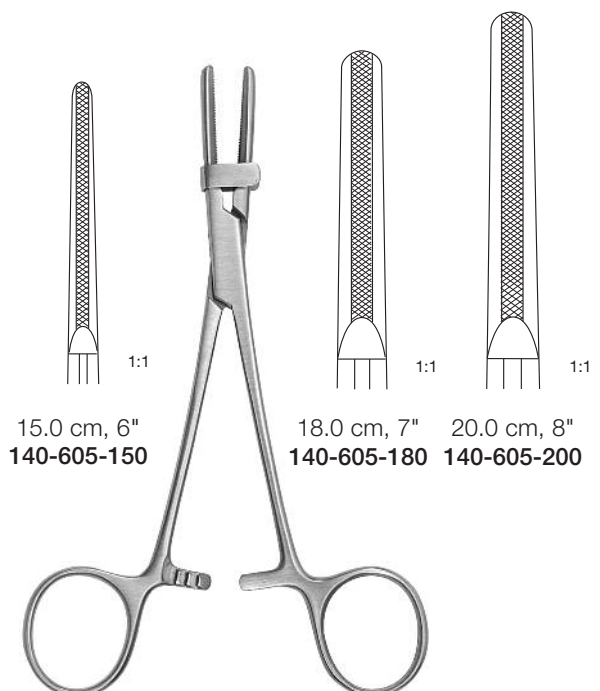

15.0 cm, 6"  
140-605-150  
18.0 cm, 7"  
140-605-180  
20.0 cm, 8"  
140-605-200



**Schaedel**  
9.0 cm, 3 1/2"  
140-559-090



**Engl. Modell**  
9.0 cm, 3 1/2"  
140-560-090



**Jones**  
5.0 cm, 2"  
140-561-050  
9.0 cm, 3 1/2"  
140-561-090



**Jones-Clip**  
9.0 cm, 3 1/2"  
140-562-090

Mit Schlauch- bzw.  
Kabelhalter  
With clip for tubing  
or cable fixation

5



1:1

<b>Backhaus</b>	
8.0 cm, 3 1/8"	140-573-080
9.0 cm, 3 1/2"	140-573-090
11.0 cm, 4 3/8"	140-573-110
13.0 cm, 5"	140-573-130
15.0 cm, 6"	140-573-150



Mit Schlauch- bzw.  
Kabelhalter  
With clip for tubing  
or cable fixation

11.0 cm, 4 3/8"  
140-575-110



**Roeder**  
13.0 cm, 5"  
140-579-130  
15.0 cm, 6"  
140-579-150

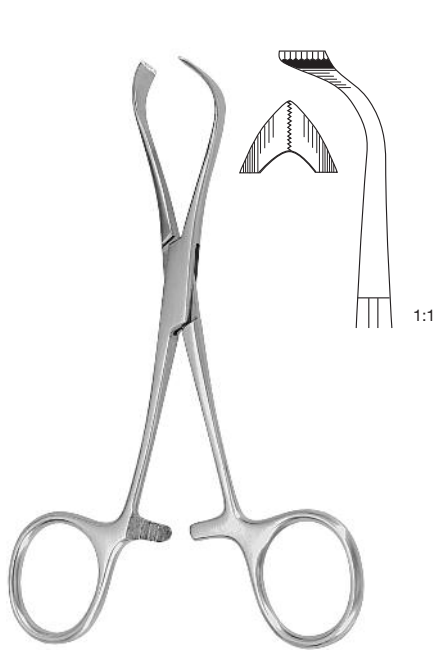

**Lorna**  
10.0 cm, 4"  
140-578-100  
13.0 cm, 5"  
140-578-130



**Lane**

15.0 cm, 6"	140-585-150
18.0 cm, 7"	140-585-180
20.0 cm, 8"	140-585-200

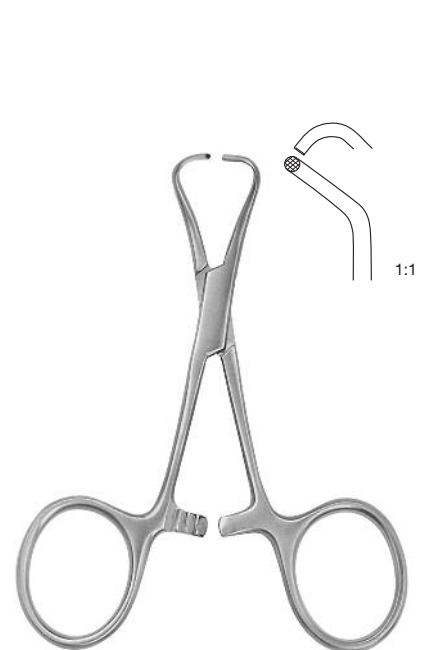

**Tohoku-Japan**  
10.0 cm, 4"  
140-590-100  
13.0 cm, 5"  
140-590-130



**Ball and Socket**  
13.0 cm, 5"  
140-580-130



**Peers**  
14.5 cm, 5 3/4"  
140-595-145



**Bernhard**  
16.5 cm, 6 1/2"  
140-579-165



Ulrich

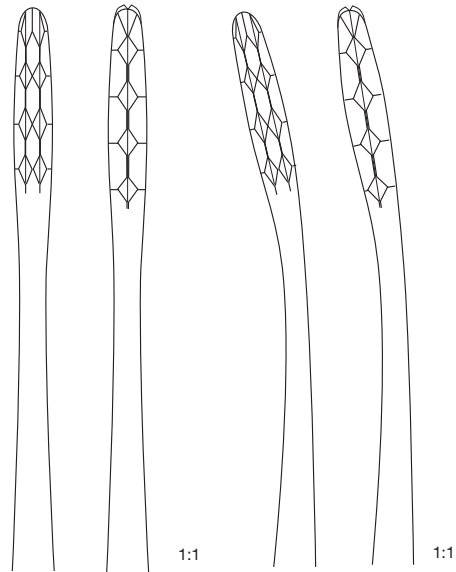

22.0 cm, 8 5/8"	150-010-220	150-011-220
25.0 cm, 9 3/4"	150-010-250	150-011-250
27.0 cm, 10 5/8"	150-010-270	150-011-270

6



Gross-Maier

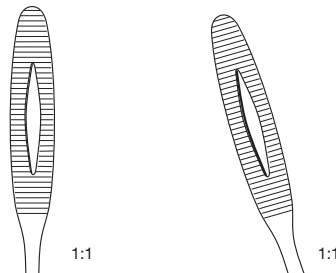

20.0 cm, 8"	150-030-200	150-031-200
22.0 cm, 8 5/8"	150-030-220	150-031-220
25.0 cm, 9 3/4"	150-030-250	150-031-250
27.0 cm, 10 5/8"	150-030-270	150-031-270

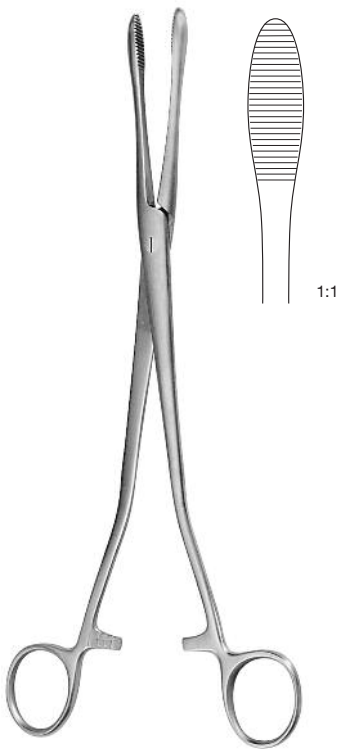

**Collin**  
 25.0 cm, 9 3/4"  
 150-038-250

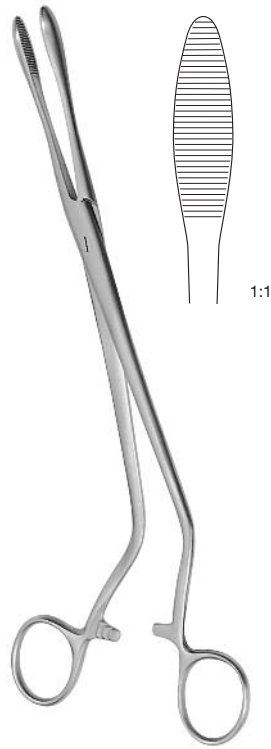

**Cheron**  
 25.0 cm, 9 3/4"  
 150-290-250

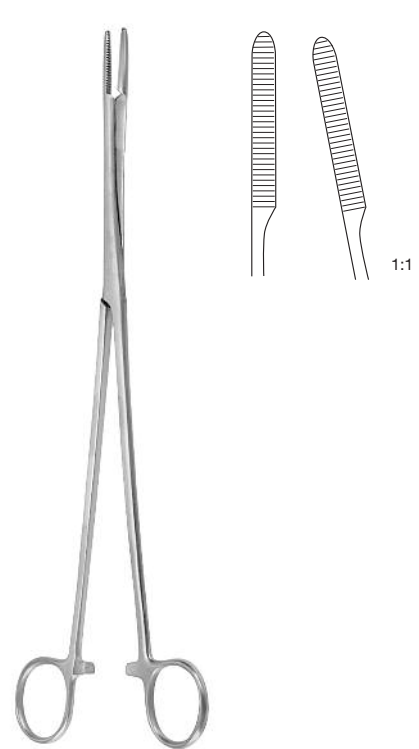

**Pelkmann**  
 25.0 cm, 9 3/4"  
 150-045-250

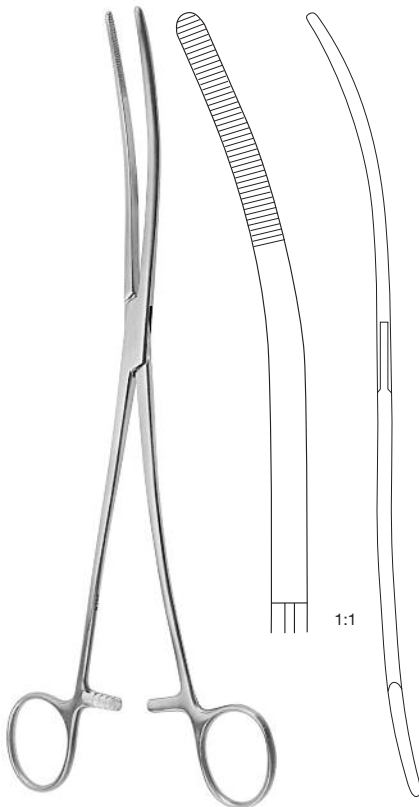

**Bozemann**  
 26.0 cm, 10 1/4"  
 150-041-260

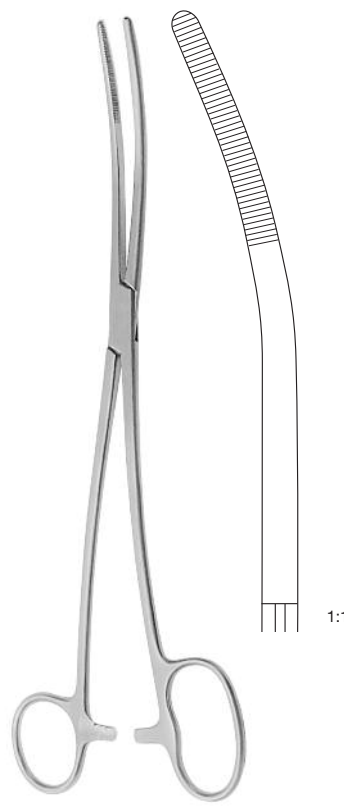

**Bozemann-Douglas**  
 26.0 cm, 10 1/4"  
 150-043-260

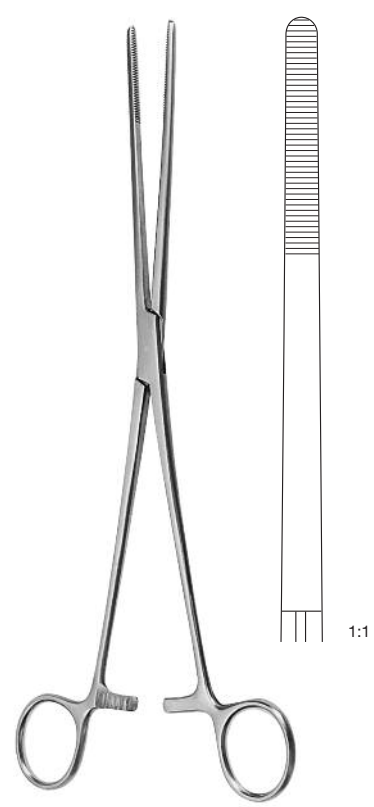

**Bozemann**  
 26.0 cm, 10 1/4"  
 150-040-260

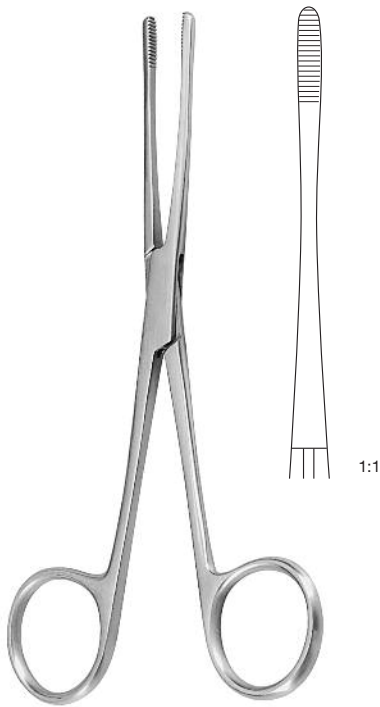

**Lister**

13.0 cm, 5"	<b>150-080-130</b>
16.0 cm, 6 1/4"	<b>150-080-160</b>
18.0 cm, 7"	<b>150-080-180</b>

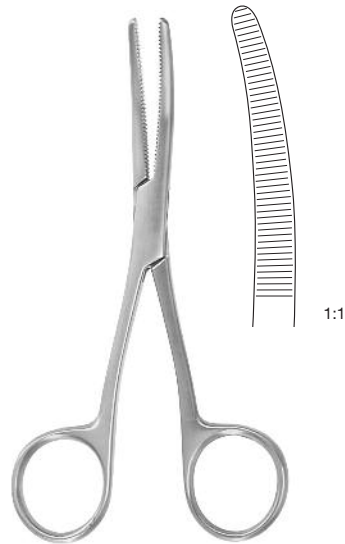

**Bryant**

13.0 cm, 5"  
**150-035-130**

**6**



**Foerster**

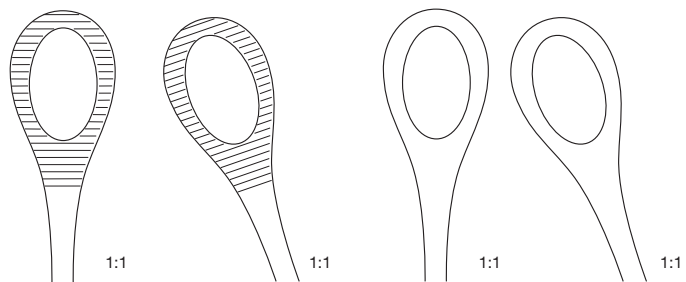

18.0 cm, 7"	<b>150-052-180</b>	<b>150-055-180</b>	<b>150-050-180</b>	<b>150-053-180</b>
20.0 cm, 8"	<b>150-052-200</b>	<b>150-055-200</b>	<b>150-050-200</b>	<b>150-053-200</b>
25.0 cm, 9 3/4"	<b>150-052-250</b>	<b>150-055-250</b>	<b>150-050-250</b>	<b>150-053-250</b>



**Foerster**

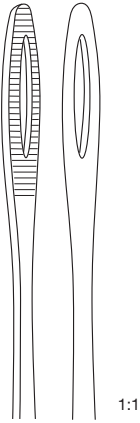

25.0 cm, 9 3/4"  
**150-060-250**

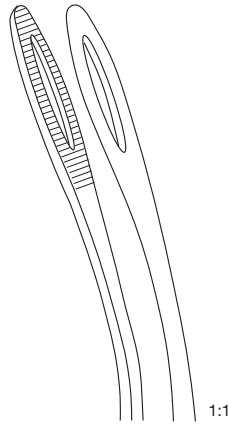

25.0 cm, 9 3/4"  
**150-061-250**

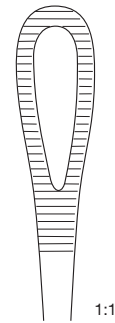

**Rampley**  
 18.0 cm, 7"  
**150-070-180**

25.0 cm, 9 3/4"  
**150-070-250**



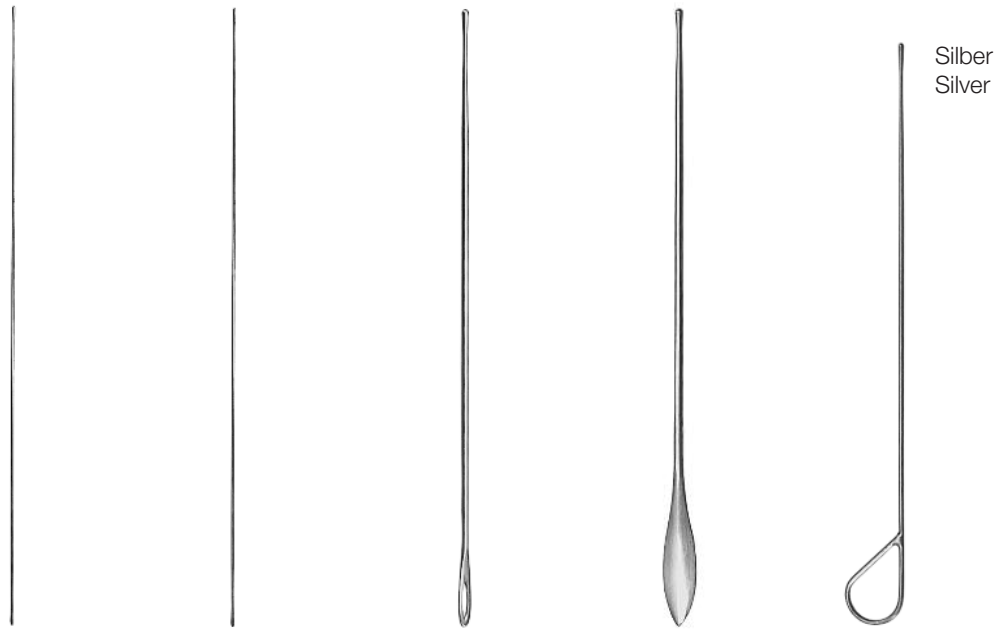

ø 1.0 mm

ø 2.0 mm

mit Ohr, with eye  
ø 2.0 mm

Myrtenblatt  
Myrtle Leaf

Stacke  
ø 1.0 mm

Silber  
Silver

10.5 cm, 4 1/8"				
11.5 cm, 4 1/2"	<b>160-102-115</b>	<b>160-100-115</b>	<b>160-108-115</b>	<b>160-130-105</b>
13.0 cm, 5"	<b>160-102-130</b>	<b>160-100-130</b>	<b>160-108-130</b>	
14.5 cm, 5 3/4"	<b>160-102-145</b>	<b>160-100-145</b>	<b>160-108-145</b>	<b>160-150-145</b>
16.0 cm, 6 1/4"	<b>160-102-160</b>	<b>160-100-160</b>	<b>160-108-160</b>	<b>160-150-160</b>
18.0 cm, 7"	<b>160-102-180</b>	<b>160-100-180</b>	<b>160-108-180</b>	<b>160-150-180</b>
20.0 cm, 8"	<b>160-102-200</b>	<b>160-100-200</b>	<b>160-108-200</b>	<b>160-150-200</b>



Doyen

Nélaton

11.5 cm, 4 1/2"	<b>160-107-115</b>		
13.0 cm, 5"	<b>160-107-130</b>		<b>160-170-130</b>
14.5 cm, 5 3/4"	<b>160-107-145</b>	<b>160-175-145</b>	<b>160-170-145</b>
16.0 cm, 6 1/4"	<b>160-107-160</b>		<b>160-170-160</b>
18.0 cm, 7"	<b>160-107-180</b>		<b>160-170-180</b>
20.0 cm, 8"	<b>160-107-200</b>		<b>160-185-160</b>



**Brodie**  
20.0 cm, 8"  
160-090-200

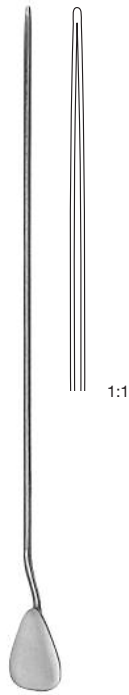

**Lockhart-Mummery**  
Fig. 1  
160-110-001

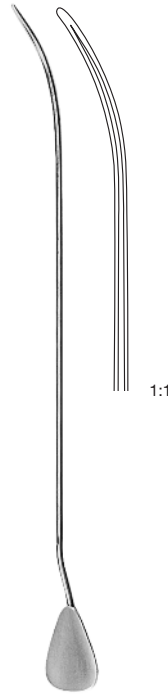

**Lockhart-Mummery**  
Fig. 2  
160-110-002

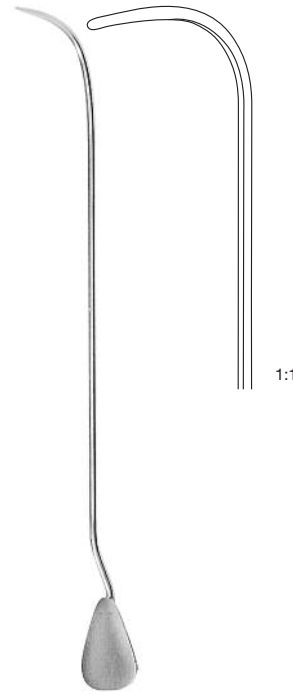

**Lockhart-Mummery**  
Fig. 3  
160-110-003

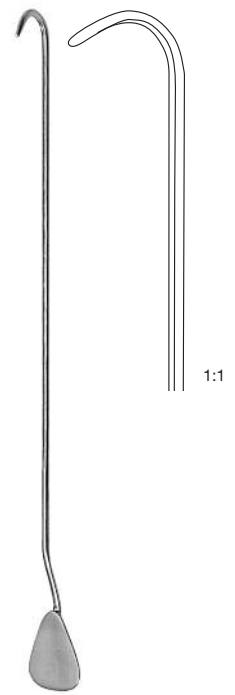

**Lockhart-Mummery**  
Fig. 4  
160-110-004



Zinn, biegsam  
tin, malleable  
ø 3.5 mm  
25.0 cm, 9 3/4"  
**160-415-250**

30.0 cm, 11 3/4"  
**160-415-300**



**Farrell (Lathbury-Uebe)**  
ø 0.9 mm  
12.0 cm, 4 3/4"  
**160-420-120**

ø 0.9 mm  
14.0 cm, 5 1/2"  
**160-420-140**

ø 1.1 mm  
16.5 cm, 6 1/2"  
**160-420-165**

ø 1.2 mm  
18.0 cm, 7"  
**160-420-180**



**Farrell**  
ø 0.9 mm  
12.0 cm, 4 3/4"  
**160-426-120**

ø 0.9 mm  
14.0 cm, 5 1/2"  
**160-426-140**

ø 1.1 mm  
16.5 cm, 6 1/2"  
**160-426-165**

ø 1.2 mm  
18.0 cm, 7"  
**160-426-180**

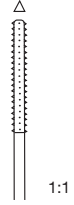

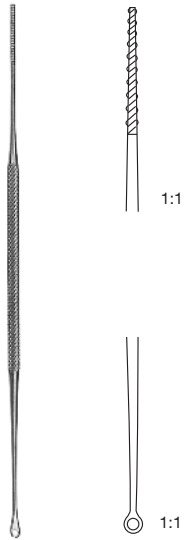

**Uckermann**  
16.0 cm, 6 1/4"  
160-254-160

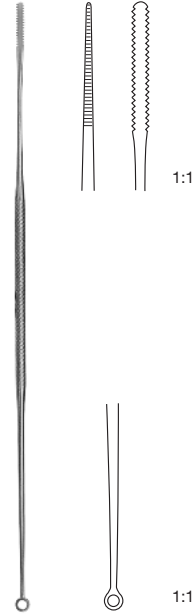

**Jobson-Horne**  
18.0 cm, 7"  
160-255-180

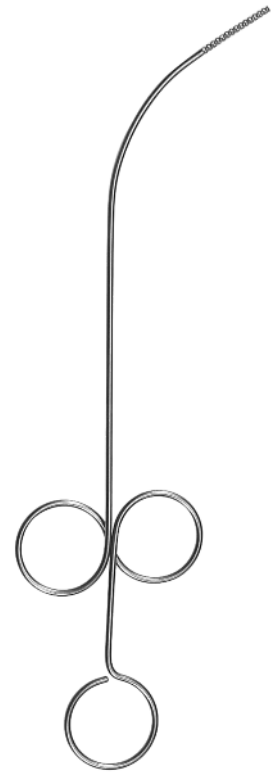

**Fein**  
28.0 cm, 11"  
160-495-280



3.0 mm  
160-250-003



6.0 mm  
160-250-006

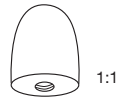

9.0 mm  
160-250-009

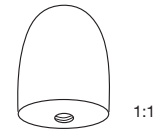

12.0 mm  
160-250-012

**7**

Handgriff alleine  
Handle, only  
160-250-080

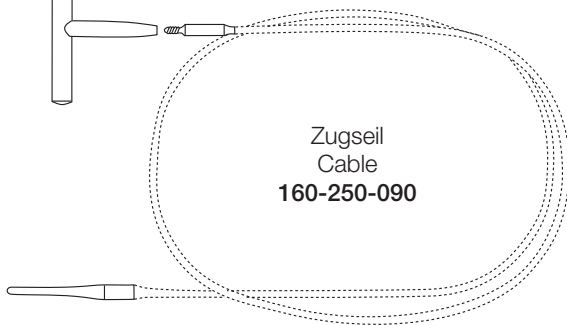

Zugseil  
Cable  
160-250-090

Metalletui  
Metal case  
135 x 100 x 25 mm  
160-250-095



**Nabatoff**  
komplett, complete  
160-250-000

Kunststoff-Sondenspitze  
probe tip, plastic  
160-250-002



**Standard**  
11.0 cm, 4 3/8"

ø 3.0 mm	<b>165-020-003</b>
ø 3.5 mm	<b>165-020-035</b>
ø 4.0 mm	<b>165-020-004</b>
ø 4.5 mm	<b>165-020-045</b>
ø 5.0 mm	<b>165-020-005</b>
ø 5.5 mm	<b>165-020-055</b>
ø 6.0 mm	<b>165-020-006</b>



**Standard**  
12.0 cm, 4 3/4"

ø 3.0 mm	<b>165-022-003</b>
ø 3.5 mm	<b>165-022-035</b>
ø 4.0 mm	<b>165-022-004</b>
ø 4.5 mm	<b>165-022-045</b>
ø 5.0 mm	<b>165-022-005</b>
ø 5.5 mm	<b>165-022-055</b>
ø 6.0 mm	<b>165-022-006</b>



**Standard**  
12.0 cm, 4 3/4"

ø 3.0 mm	<b>165-024-003</b>
ø 3.5 mm	<b>165-024-035</b>
ø 4.0 mm	<b>165-024-004</b>
ø 4.5 mm	<b>165-024-045</b>
ø 5.0 mm	<b>165-024-005</b>
ø 5.5 mm	<b>165-024-055</b>
ø 6.0 mm	<b>165-024-006</b>



**Universal**  
Satz zu 3 Stück  
Set of 3 pieces  
**165-001-003**

Satz zu 4 Stück  
Set of 4 pieces  
**165-001-004**

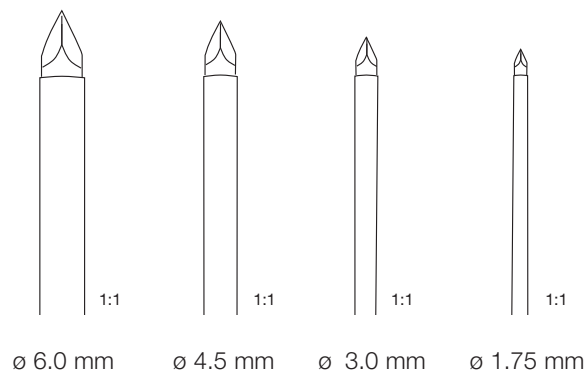

**Universal**  
Satz zu 3 Stück  
Set of 3 pieces  
**165-002-003**

Satz zu 4 Stück  
Set of 4 pieces  
**165-002-004**



**Landau**  
ø 2.0 mm  
165-025-001



**Landau**  
ø 2.0 mm  
165-025-002



**Davidson**  
ø 6.0 mm  
165-035-006



**Buelau**  
24.0 cm, 9 1/2"  
ø 8.0 mm  
165-030-240



**Hurwitz**  
ø 7.3 mm **165-031-007**  
ø 8.7 mm **165-031-009**  
ø 12.0 mm **165-031-012**



**Campbell**  
ø 6.0 mm  
**165-033-006**  
ø 8.0 mm  
**165-033-008**



**Nelson**  
21.0 cm, 8 1/2"

ø 7.5 mm	<b>165-010-007</b>
ø 9.0 mm	<b>165-010-009</b>
ø 10.5 mm	<b>165-010-011</b>
ø 12.0 mm	<b>165-010-012</b>



**Ochsner**  
14.0 cm, 5 1/2"

ø 4.0 mm	<b>165-034-004</b>
ø 4.6 mm	<b>165-034-045</b>
ø 5.5 mm	<b>165-034-055</b>
ø 6.5 mm	<b>165-034-065</b>



**Krause**  
ø 5.5 mm  
**165-056-055**



**Coakley**  
ø 2.25 mm  
**165-058-225**



**Lichtwitz**  
ø 1.8 mm  
**165-052-018**



**Douglas**  
Trokarkanüle  
Trocar Cannula  
ø 3.0 mm  
**165-061-110**



Kieferhöhlentrokar  
Antrum Puncture Trocar  
11.0 cm, 4 1/2"  
**165-062-110**



**Pierce**  
ø 3.0 mm **165-054-003**  
ø 4.0 mm **165-054-004**  
ø 5.0 mm **165-054-005**

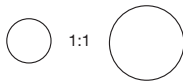

<b>Poole</b>	
22.0 cm, 8 5/8"	
∅ 6.0 mm	<b>165-549-220</b>
∅ 10.0 mm	<b>165-550-220</b>

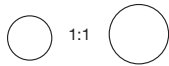

<b>Poole</b>	
22.0 cm, 8 5/8"	
∅ 6.0 mm	<b>165-552-220</b>
∅ 8.0 mm	<b>165-551-220</b>



**Coupland**  
17.0 cm, 6 3/4"  
**165-558-000**



**Yankauer**  
27.0 cm, 10 5/8"  
**165-543-270**



**DeBakey**  
27.0 cm, 10 5/8"  
**165-065-270**



**Andrews-Pynchon**  
24.0 cm, 9 1/2"  
**165-066-000**



**Anthony**  
26.0cm, 10 1/4"  
**165-064-000**



**Cooley**  
35.0 cm, 13 3/4"  
ø 8.0 mm  
165-552-350



**Cooley**  
30.0 cm, 11 3/4"  
ø 7.0 mm  
165-552-300



**Cooley**  
31.0 cm, 11 3/4"  
ø 10.0 mm  
165-552-310



**Cooley**  
33.0 cm, 13"  
ø 8.0 mm  
165-552-330



Olive allein  
Olive only  
165-543-000





- $\varnothing$  1.5 mm  
165-560-001
- $\varnothing$  2.5 mm  
165-560-002
- $\varnothing$  3.5 mm  
165-560-003

**Byrd**  
20.0 cm, 8"



**Cogswell**  
23.0 cm, 9"  
 $\varnothing$  2.0 mm  
165-562-230



**Hepp/Scheidel**  
22.5 cm, 8 3/4"  
165-546-225



**Adson**  
21.0 cm, 8 1/4"  
 $\varnothing$  4 mm  
165-521-004



**Magill**  
17.5cm, 6 5/8"

$\varnothing$ 1.0 mm	410-404-010
$\varnothing$ 2.0 mm	410-404-020
$\varnothing$ 3.0 mm	410-404-030
$\varnothing$ 4.0 mm	410-404-040



$\varnothing$ mm	Charr./ Fr.	19.0 cm, 7 1/2"
2.0	6.0	165-523-006
2.5	8.0	165-523-008
3.0	10.0	165-523-010
4.0	12.0	165-523-012



18.0cm, 7"
165-525-006
165-525-008
165-525-010
165-525-012



13.0 cm, 5"
165-526-006
165-526-008
165-526-010
165-526-012



**Luer-Lock**

**Injektionskanülen, Hypodermic Needles**

Fig. 1	ø 0,90 x 38 mm, 20 G x 1 1/2"	<b>165-690-001</b>
Fig. 2	ø 0,80 x 32 mm, 21 G x 1 1/4"	<b>165-690-002</b>
Fig. 12	ø 0,70 x 32 mm, 22 G x 1 1/4"	<b>165-690-012</b>
Fig. 14	ø 0,65 x 28 mm, 23 G x 1 1/8"	<b>165-690-014</b>
Fig. 16	ø 0,60 x 25 mm, 22 G x 1"	<b>165-690-016</b>
Fig. 18	ø 0,50 x 23 mm, 25 G x 7/8"	<b>165-690-018</b>
Fig. 20	ø 0,45 x 20 mm, 26 G x 3/4"	<b>165-690-020</b>

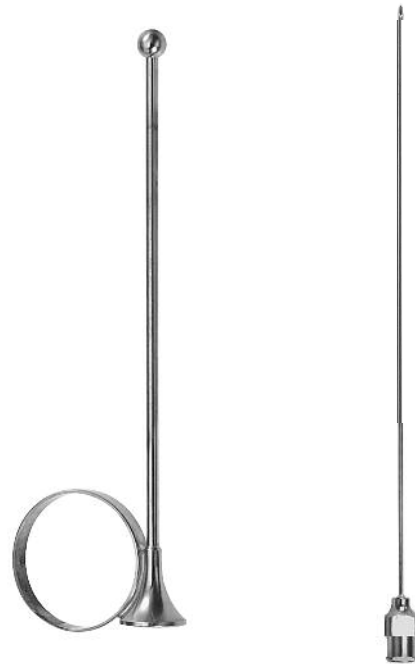

**Iowa**  
**165-695-000**

**Nadel, needle 1.0 x 185 mm**  
**165-695-001**

Spezialbesteck für die Transvaginale Injektion bei Paracervical- und Pudendusanaästhesie inklusive Führungshülse und Nadel

Special Set for transvaginal injection for paracervical anaesthesia as well as anaesthesia of the pudendus incl. guide sheath and needle

Nach Applikation der Führungshülse am Injektionsort wird die Kanüle (mit aufgesetzter Spritze) durch den Trichter bzw. durch die Hülse hindurchgeführt und ins Gewebe eingestochen. Verletzungen der Vagina werden hierbei vermieden, da die Einstichtiefe nur ca 10 mm erreicht.

After introducing the guide sheath at the spot to be injected, the needle (mounted on the syringe) is then passed through the guide sheath and the tissue is injected.

Injuries of the vagina are thus avoided, because the depth of puncture is limited to approximately 10 mm.

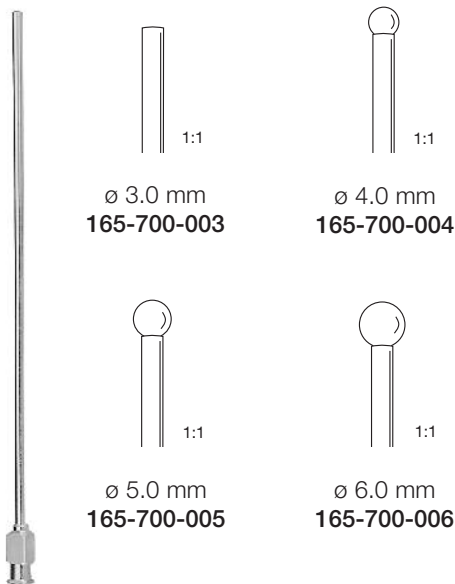

ø 3.0 mm  
**165-700-003**

ø 4.0 mm  
**165-700-004**

ø 5.0 mm  
**165-700-005**

ø 6.0 mm  
**165-700-006**

**Schmid**

15.0 cm, 6"

Gefäßspülkanülen, biegsam  
Vessel irrigating cannulas,  
malleable



Kanülen zum Einbinden  
in die Vene  
Cannulas, venous

ø 1.20 x 80 mm, 18 G x 3 1/8"  
**165-705-120**

ø 1.50 x 80 mm, 17 G x 3 1/8"  
**165-705-150**

**Mock**

Gefäßspülkanüle  
Vessel irrigating  
cannula

6.0 cm, 2 3/8"  
**165-710-060**



**Veress Nadel**  
**Veress Needle**

ø 2.00 x 100 mm, 14 G x 4"

**300-195-100**

ø 2.00 x 120 mm, 14 G x 4 3/4"

**165-195-120**

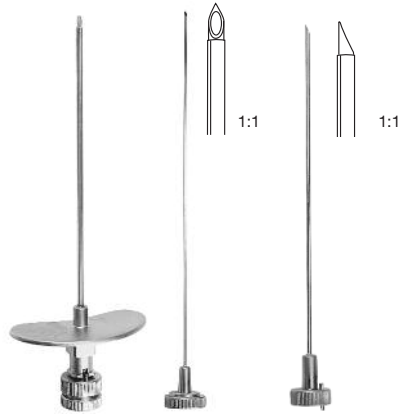

**Seldinger-Stille**  
Arteriographiekanülen  
Arteriography needles

ø 1.60 x 70 mm, 16 G x 2 3/4"

**165-716-160**

ø 2.00 x 70 mm, 14 G x 2 3/4"

**165-716-205**



**Klima-Rossegger**  
Kanüle zur Sternal-Punktion  
Sternum puncture needle

ø 1.60 x 40 mm, 16 G x 1 5/8"

**165-049-037**

Kanülen zur Lumbalpunktion  
Lumbar puncture needles



**Bier**



**Quinke**



**Tuhoy**

mit Spezial-Spitze  
with special tip

ø 3.00 x 90 mm, 11 G x 3 1/2"	<b>165-049-092</b>
ø 2.80 x 90 mm, 12 G x 3 1/2"	<b>165-049-093</b>
ø 2.40 x 90 mm, 13 G x 3 1/2"	<b>165-049-094</b>
ø 2.10 x 90 mm, 14 G x 3 1/2"	<b>165-049-095</b>
ø 1.80 x 90 mm, 15 G x 3 1/2"	<b>165-049-096</b>
ø 1.60 x 90 mm, 16 G x 3 1/2"	<b>165-049-097</b>

ø 1.20 x 76 mm, 18 G x 3"	<b>165-049-076</b>
ø 1.20 x 89 mm, 18 G x 3 1/2"	<b>165-049-077</b>
ø 1.00 x 76 mm, 19 G x 3"	<b>165-049-078</b>
ø 1.00 x 89 mm, 19 G x 3 1/2"	<b>165-049-079</b>
ø 0.70 x 76 mm, 22 G x 3"	<b>165-049-080</b>
ø 0.70 x 50 mm, 22 G x 2"	<b>165-049-081</b>
ø 0.70 x 89 mm, 22 G x 3 1/2"	<b>165-049-082</b>

ø 1.20 x 76 mm, 18 G x 3"	<b>165-047-120</b>
ø 1.40 x 76 mm, 17 G x 3"	<b>165-047-140</b>
ø 1.60 x 76 mm, 16 G x 3"	<b>165-047-160</b>



**Menghini**

Kanülen für die Leberblindpunktion  
 einschließlich Stopsonde  
 Liver blind puncture needles with  
 stopping probe

- ø 1.00 x 35 mm, 19 G x 1 <sup>3</sup>/<sub>8</sub>" **165-050-001**
- ø 1.00 x 70 mm, 19 G x 2 <sup>3</sup>/<sub>4</sub>" **165-050-002**
- ø 1.20 x 70 mm, 18 G x 2 <sup>3</sup>/<sub>4</sub>" **165-050-003**
- ø 1.20 x 100 mm, 18 G x 4" **165-050-004**
- ø 1.40 x 70 mm, 17 G x 2 <sup>3</sup>/<sub>4</sub>" **165-050-005**
- ø 1.40 x 100 mm, 17 G x 4" **165-050-006**
- ø 1.60 x 70 mm, 16 G x 2 <sup>3</sup>/<sub>4</sub>" **165-050-007**
- ø 1.80 x 100 mm, 15 G x 4" **165-050-008**



**Menghini**

Kanülen zur gezielten Leberpunktion  
 Needles for controlled liver puncture

- ø 1.40 x 168 mm, 17 G x 3" **165-055-140**
- ø 1.80 x 168 mm, 15 G x 6 <sup>3</sup>/<sub>4</sub>" **165-055-180**



Trocar zum Einführen der  
 Leberpunktionkanülen  
 Trocar for introduction of liver puncture  
 needles

- ø 1.40 x 168 mm, 17 G x 3" **165-056-140**
- ø 1.80 x 168 mm, 15 G x 6 <sup>3</sup>/<sub>4</sub>" **165-056-180**



Zwischenstück  
 LLA weibl.-RC männl.  
 Adapter LLA female -  
 RC male  
**300-011-504**



Zwischenstück  
 LA männl.  
 Adapter LA male  
**300-011-505**



Schlauch-Olive  
 LLA männl.  
 Hose end with LLA male  
 ø 6 mm  
**300-011-506**  
 ø 8 mm  
**300-011-508**



Schlauch-Olive  
 LLA weibl.  
 Hose end with LLA  
 female  
**300-011-509**



Schlauch-Olive  
 RC weibl.-RC männl.  
 Hose end RC female -  
 RC male  
**300-011-510**



Durchflußhahn  
 LLA weibl.-LLA männl.  
 One-way stopcock  
 LLA female-LLA male  
**300-011-511**



Durchflußhahn  
 LLA weibl.  
 One way stopcock  
 LLA female  
**300-011-512**



Dreiweghahn  
 1 LLA männl.-2 LLA weibl.  
 Three-way stopcock  
 1 LLA male-2 LLA female  
**300-011-513**



Dreiweghahn  
 3 LLA weiblich  
 Three-way stopcock  
 3 LLA female  
**300-011-514**



RZ-Spritzen werden den Forderungen der ärztlichen Praxis in Einfachheit und Zuverlässigkeit im Gebrauch in jeder Weise gerecht.

Vorzüge:

- Kolben und Glaszylinder der RZ-Spritzen sind untereinander beliebig austauschbar; Ersatzteile können in stets passender Ausführung nachgeliefert werden.
- Der Zylinder ist glasklar und zeigt, ebenso wie der Kolben aus nichtrostendem Stahl, selbst nach langem Gebrauch keine Zeichen der Abnutzung.
- Keine Bruchgefahr, wenn die RZ-Spritze zum Sterilisieren nicht auseinander genommen wird.
- Eine neuartige Kolbenbremse in der Sechskantkappe erübrigt den Kolbenring. Der Kolben ist glatt und gewährleistet daher eine erhöhte Dichtigkeit.

RZ Syringes fulfill the demands of medical practice in simplicity and reliability in every way.

Features:

- Plunger and glass cylinder of the RZ Syringes can be interchanged as desired. Replacement parts can be supplied subsequently to fit.
- The cylinder is transparent and even after long use shows no signs of wear, as does the stainless steel plunger.
- There is no danger of breakage if the RZ Syringe is not taken to pieces for sterilising.
- A new type of plunger brake in the hexagonal cap allows a piston ring to be dispensed with. The plunger is smooth and so ensures enhanced tightness.



	Luer	Zylinder, barrels
1 ml	165-850-010	165-851-010
2 ml	165-850-020	165-851-020
5 ml	165-850-050	165-851-050
10 ml	165-850-100	165-851-100
20 ml	165-850-200	165-851-200
50 ml	165-850-500	165-851-500



	Luer Lock	Zylinder, barrels
1 ml	165-800-010	165-801-010
2 ml	165-800-020	165-801-020
5 ml	165-800-050	165-801-050
10 ml	165-800-100	165-801-100
20 ml	165-800-200	165-801-200
50 ml	165-800-500	165-801-500



	Luer Lock	Zylinder, barrels
2 ml	165-855-020	165-856-020
5 ml	165-855-050	165-856-050
10 ml	165-855-100	165-856-100



	Insulin Luer	Zylinder, barrels
1 ml	165-859-010	165-860-010
2 ml	165-859-020	165-860-020

**Impfen, Punktion, Saugen**  
**Spritzen, Wund- und Blasenspritzen,**  
**Ganzglas Spritze**

**Vaccination, Puncture, Suction**  
**Syringes, Wound- and Bladder**  
**Syringes, Glass Syringes**

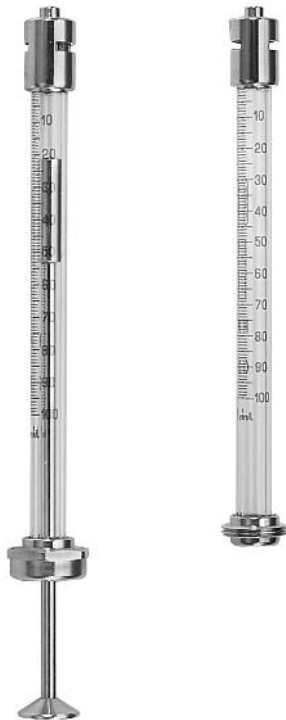

**Tuberkulin Luer-Lock** Zylinder, barrels  
 1 ml **165-857-010** **165-858-010**



**Janet** Zylinder, barrels  
 50 ml **165-860-050** **165-861-050**  
 100 ml **165-860-100** **165-861-100**  
 150 ml **165-860-150** **165-861-150**  
 200 ml **165-860-200** **165-861-200**



**Luer Lock**  
 Druckspritze für Arteriographie  
 und Angiographie  
 Pressure syringe for arteriography  
 and angiography Zylinder, barrels  
 10 ml **165-865-010** **165-866-010**  
 20 ml **165-865-020** **165-866-020**  
 30 ml **165-865-030** **165-866-030**  
 50 ml **165-865-050** **165-866-050**



**Toomey**  
 50 ml **253-450-050**



**Gillies**  
 18.0 cm, 7"



Fig. 1  
 230-205-180



Fig. 2  
 230-207-180

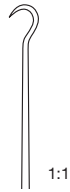

Fig. 3  
 230-209-180



**Kilner**  
 15.0 cm, 6"  
 230-203-150



1:1



**Frazier**  
 13.0 cm, 5"  
 170-013-130



1:1



**Kleinert-Kutz**  
 16.0 cm, 6 1/4"

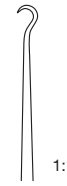

1:1

Fig. 1  
 170-020-001



1:1

Fig. 2  
 170-020-002



1:1

Fig. 3  
 170-020-003



16.0 cm, 6 1/4"



Fig. 1  
 170-015-160



Fig. 2  
 170-016-160



Fig. 3  
 170-017-160

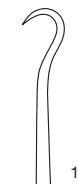

Fig. 4  
 170-018-160



**O'Connor**  
 16.0 cm, 6 1/4"  
 170-040-160



1:1



**Graefe**  
 16.0 cm, 6 1/4"



1:1

spitz, sharp  
 170-010-160



1:1

stumpf, blunt  
 170-012-160



flexibel, flexible  
 16.0 cm, 6 1/4"

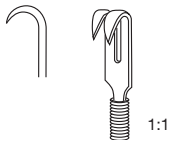

170-079-162

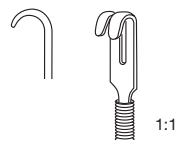

170-076-162

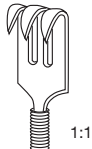

170-079-163

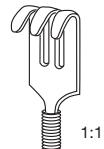

170-076-163

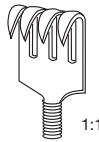

170-079-164

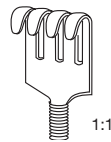

170-076-164



**Joseph**  
 16.0 cm, 6 1/4"  
**170-014-001**



**Joseph**  
 16.0 cm, 6 1/4"

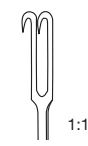

2 mm  
**170-014-002**

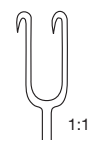

5 mm  
**170-014-005**

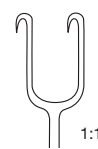

7 mm  
**170-014-007**



10 mm  
**170-014-010**



**Guthrie**  
 16.0 cm, 6 1/4"

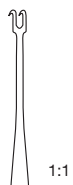

Fig. 1  
**170-042-160**

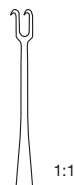

Fig. 2  
**170-044-160**



**Knapp**  
 13.0 cm, 5"



spitz, sharp  
**170-080-001**



stumpf, blunt  
**170-080-002**



**Langenbeck-Green**  
 16.0 cm, 6 1/4"

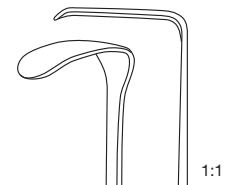

16 x 6 mm  
**170-314-160**

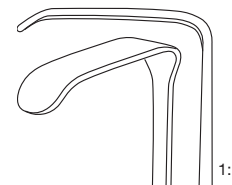

24 x 6 mm  
**170-314-240**





16.0 cm, 6 1/4"

scharf, sharp

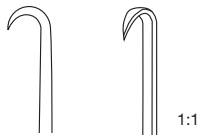

170-074-161

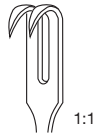

170-074-162



170-074-163



170-074-164

halbscharf, semi-sharp

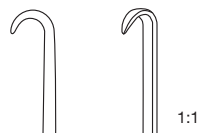

170-077-161

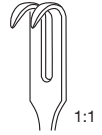

170-077-162

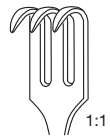

170-077-163

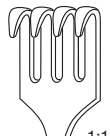

170-077-164

stumpf, blunt

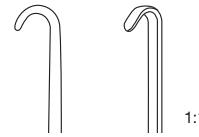

170-075-161

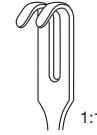

170-075-162

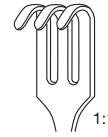

170-075-163



170-075-164



16.0 cm, 6 1/4"

scharf, sharp

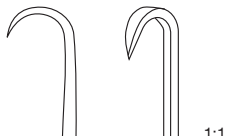

170-074-261

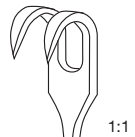

170-074-262

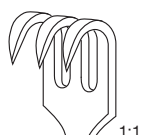

170-074-263

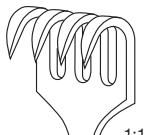

170-074-264

stumpf, blunt

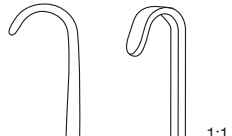

170-075-261



170-077-262

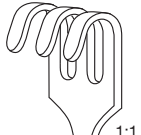

170-077-263

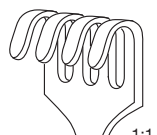

170-077-264



Cushing  
19.0 cm, 7 1/2"

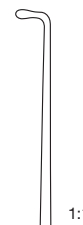

Fig. 1  
170-060-001

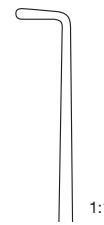
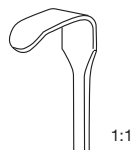

Fig. 2  
170-060-002



**Meyerding**  
18.0 cm, 7"



18 x 7 mm  
**170-079-181**

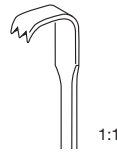

7 x 4 mm  
**170-079-183**

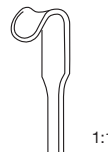

7 x 4 mm  
**170-079-185**



16 x 5 mm  
**170-079-182**

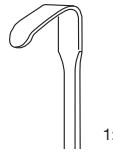

10 x 3 mm  
**170-079-184**

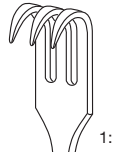

4 x 10 mm  
**170-079-186**



**Senn-Green**  
15.0 cm, 6"



10 x 6 mm  
**170-209-150**

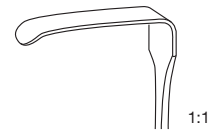

20 x 6 mm  
**170-208-150**



**Mini-Langenbeck**  
16.0 cm, 6 1/4"

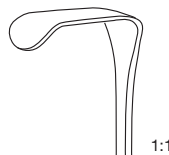

10 x 6 mm  
**170-130-160**

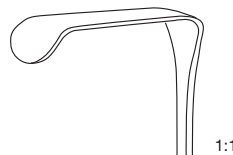

17 x 5 mm  
**170-131-160**

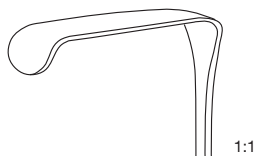

20 x 6 mm  
**170-132-160**

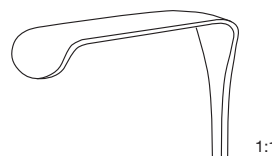

22 x 8 mm  
**170-133-160**



16.0 cm, 6 1/4"

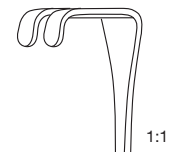

14 x 8 mm  
**170-134-160**

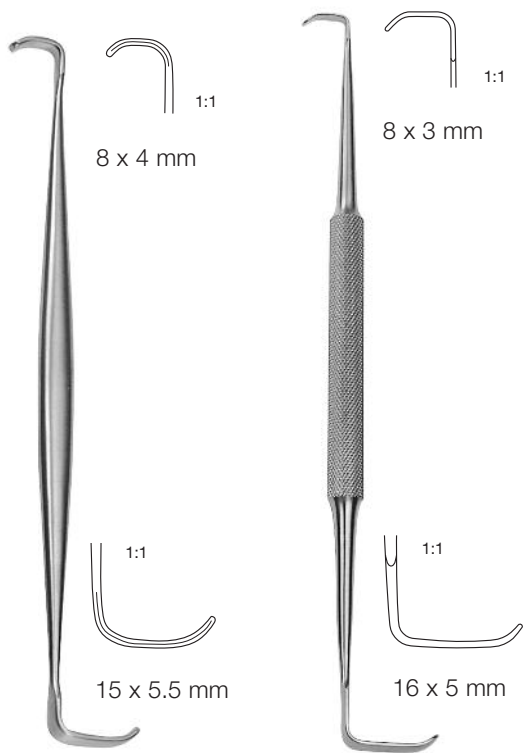

**Ragnell-Davis**  
14.0 cm, 5 1/2"  
170-207-140

**Ragnell**  
15.0 cm, 6"  
170-206-150

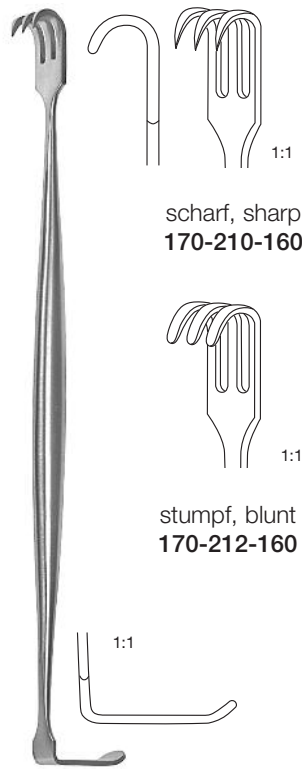

**Senn-Miller**  
16.0 cm, 6 1/4"

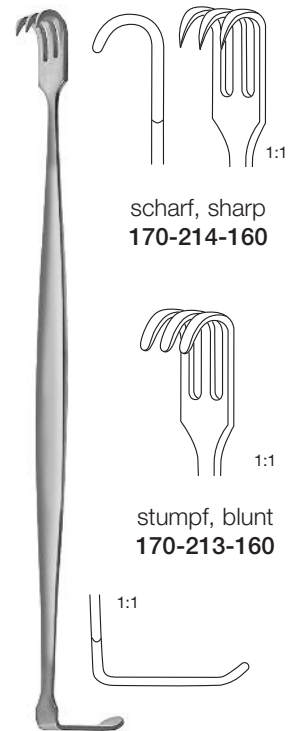

**Baby-Senn-Miller**  
15.0 cm, 6"

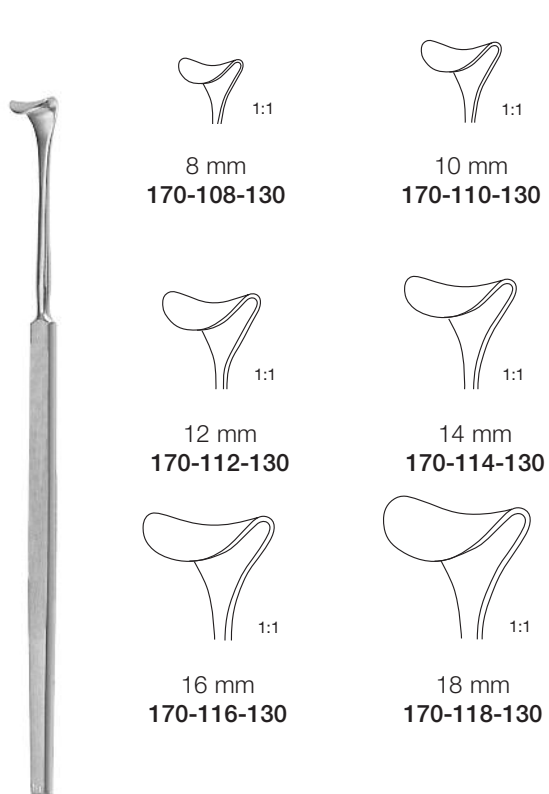

**Desmarres**  
13.0 cm, 5"

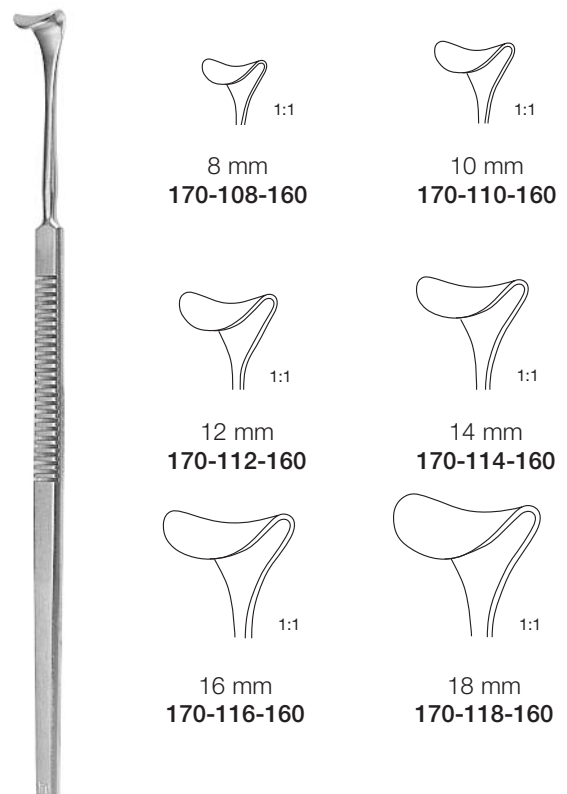

**Desmarres**  
16.0 cm, 6 1/4"



	8 mm 170-231-080	10 mm 170-231-100		8 mm 170-233-080	10 mm 170-233-100
	12 mm 170-231-120	14 mm 170-231-140		12 mm 170-233-120	14 mm 170-233-140
	16 mm 170-231-160	18 mm 170-231-180		16 mm 170-233-160	18 mm 170-233-180
<b>Cushing</b> 20.0 cm, 8"			<b>Cushing</b> 24.0 cm, 9 1/2"		

	8 mm 170-235-080	11 mm 170-235-110		8 mm 170-237-080	11 mm 170-237-110
	13 mm 170-235-130	15 mm 170-235-150		13 mm 170-237-130	15 mm 170-237-150
	17 mm 170-235-170	20 mm 170-235-200		17 mm 170-237-170	20 mm 170-237-200
<b>Gil-Vernet</b> 24.5 cm, 9 5/8"			<b>Gil-Vernet</b> 28.0 cm, 11"		



**Volkman**  
21.5 cm, 8 1/2"

	scharf, sharp					
	9 x 8 mm	9 x 13 mm	9 x 19 mm	9 x 29 mm	9 x 40 mm	
	170-220-215	170-222-215	170-224-215	170-226-215	170-228-215	170-230-215
	halbscharf, semi-sharp					
	170-231-215	170-233-215	170-235-215	170-237-215	170-239-215	170-241-215
	stumpf, blunt					
	170-221-215	170-223-215	170-225-215	170-227-215	170-229-215	170-231-215

**Kocher**  
22.0 cm, 8 5/8"

	scharf, sharp					
	9 x 8 mm	15 x 15 mm	15 x 20 mm	15 x 30 mm	15 x 40 mm	
	170-310-221	170-310-222	170-310-223	170-310-224	170-310-226	170-310-228
	halbscharf, semi-sharp					
	170-312-221	170-312-222	170-312-223	170-312-224	170-312-226	170-312-228
	stumpf, blunt					
	170-311-221	170-311-222	170-311-223	170-311-224	170-311-226	170-311-228



**Koerte**  
8 Zähne, 8 prongs  
24.0 cm, 9 1/2"

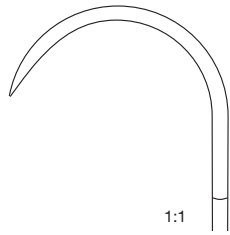

26 x 40 mm  
scharf, sharp  
170-218-008

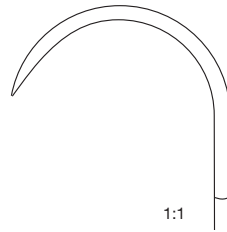

26 x 40 mm  
stumpf, blunt  
170-219-008



**Israel**  
25.0 cm, 9 3/4"

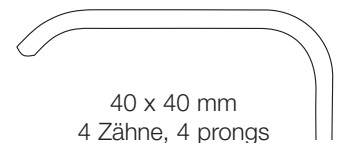

40 x 40 mm  
4 Zähne, 4 prongs  
170-220-004

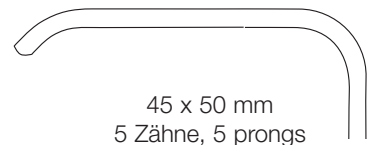

45 x 50 mm  
5 Zähne, 5 prongs  
170-220-005

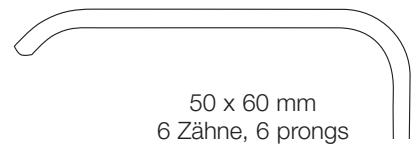

50 x 60 mm  
6 Zähne, 6 prongs  
170-220-006

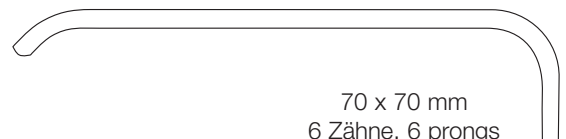

70 x 70 mm  
6 Zähne, 6 prongs  
170-220-007



**Langenbeck**  
21.0 cm, 8 1/4"

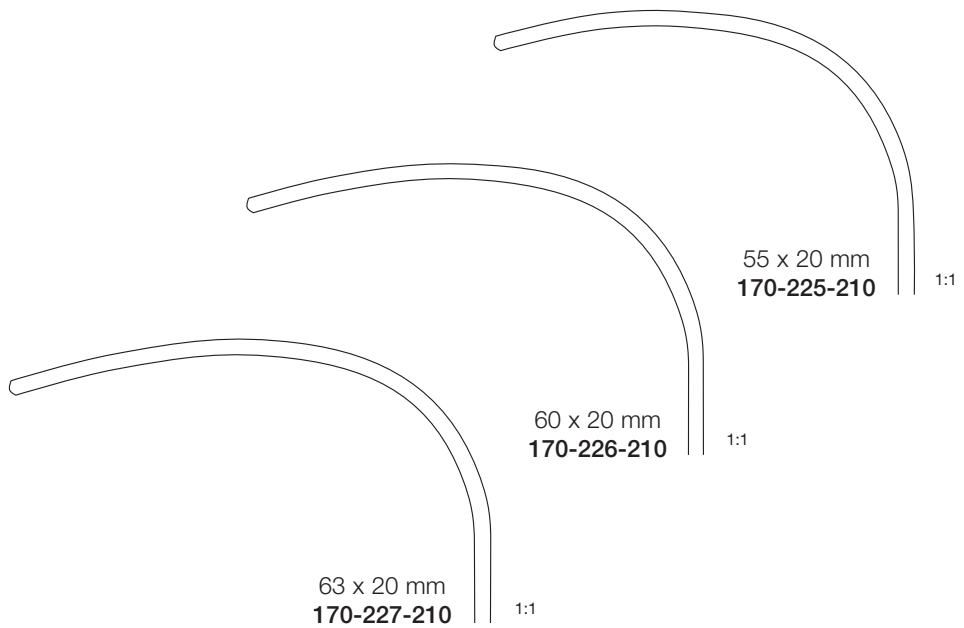

**Langenbeck**  
22.0 cm, 8 5/8"  
170-222-...

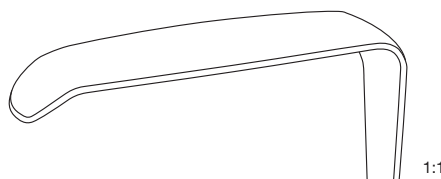
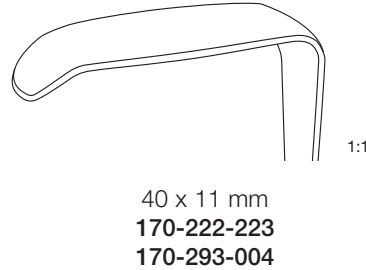
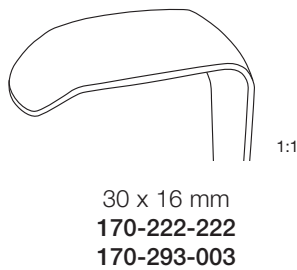
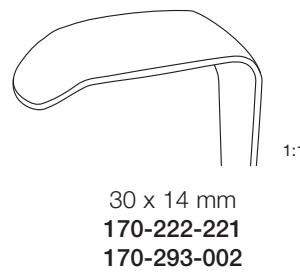
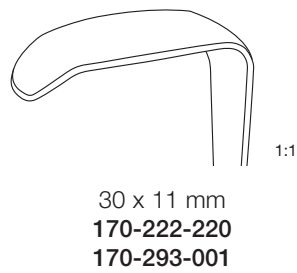

**Langenbeck**  
22.0 cm, 8 5/8"  
170-293-...



**Kocher-Langenbeck**  
21.5 cm, 8 1/2"



22 x 6 mm  
**170-317-022**



25 x 8 mm  
**170-317-025**

25 x 6 mm  
**170-317-026**



35 x 8 mm  
**170-317-035**

35 x 11 mm  
**170-317-036**

35 x 15 mm  
**170-317-037**

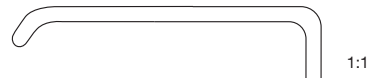

40 x 11 mm  
**170-317-040**

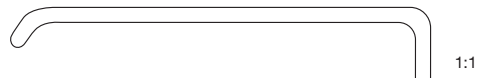

55 x 11 mm  
**170-317-055**



70 x 15 mm  
**170-317-070**

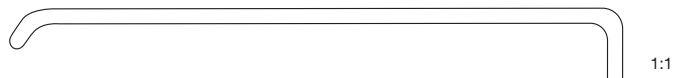

80 x 12 mm  
**170-317-080**

80 x 15 mm  
**170-317-081**





**Kocher**  
23.0 cm, 9"



40 x 18 mm  
**170-315-018**



60 x 20 mm  
**170-315-020**

60 x 25 mm  
**170-315-025**

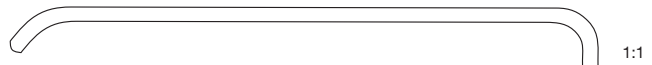

75 x 30 mm  
**170-315-030**

75 x 40 mm  
**170-315-040**



**Sauerbruch**  
22.5 cm, 8 3/4"



44 x 16 mm  
**170-561-001**



55 x 22 mm  
**170-561-002**



72 x 19 mm  
**170-561-003**



**Brunner**

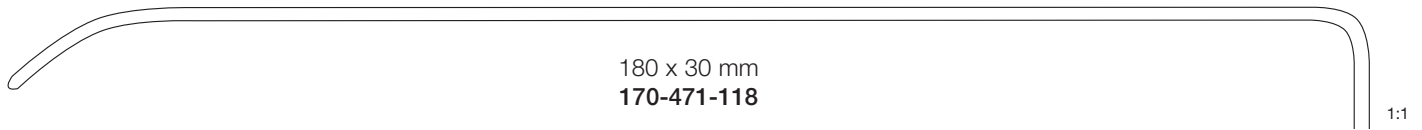

180 x 30 mm  
170-471-118

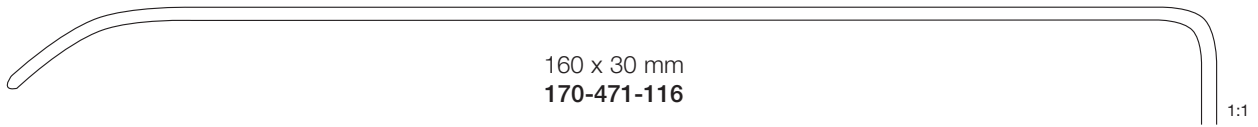

160 x 30 mm  
170-471-116

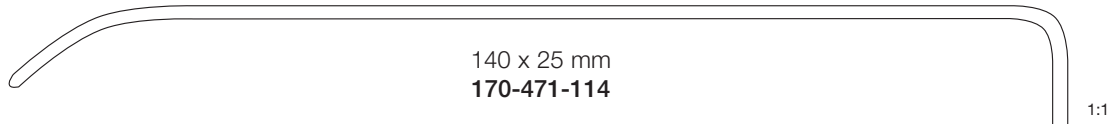

140 x 25 mm  
170-471-114

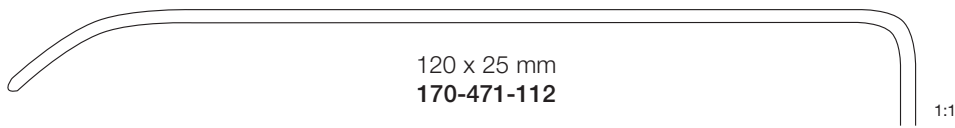

120 x 25 mm  
170-471-112

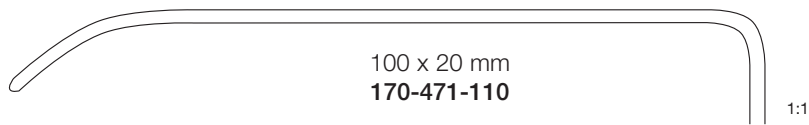

100 x 20 mm  
170-471-110

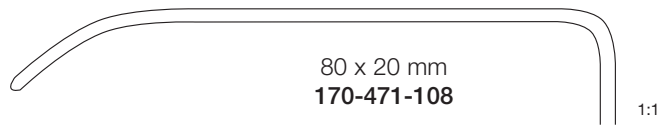

80 x 20 mm  
170-471-108



**Brunner**  
21.0 cm, 8 1/4"



28 x 6 mm

**Lahey**  
19.0 cm, 7 1/2"  
170-312-190



12 x 14 mm

**Little**  
20.0 cm, 8"  
170-313-200



Middeldorpf  
170-363-...

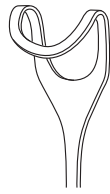

21.5 mm, 8 1/2"  
14 x 17 mm  
170-363-001  
170-325-001

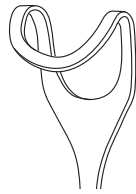

22.0 mm, 8 5/8"  
20 x 22 mm  
170-363-002  
170-325-002

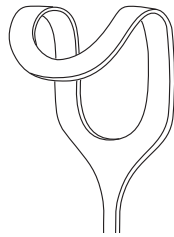

23.5 mm, 9 1/4"  
26 x 30 mm  
170-363-003  
170-325-003



Middeldorpf  
170-325-...



Richardson (Kelly)  
24.0 cm, 9 1/2"

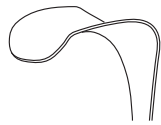

28 x 20 mm  
170-383-001

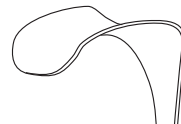

36 x 28 mm  
170-383-002

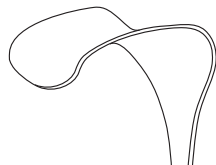

44 x 38 mm  
170-383-003

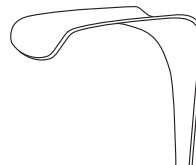

52 x 22 mm  
170-383-004

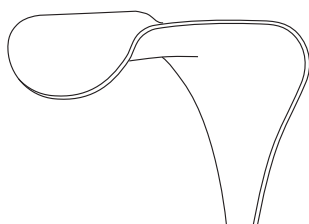

65 x 50 mm  
170-383-005

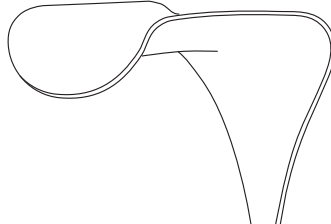

70 x 65 mm  
170-383-006

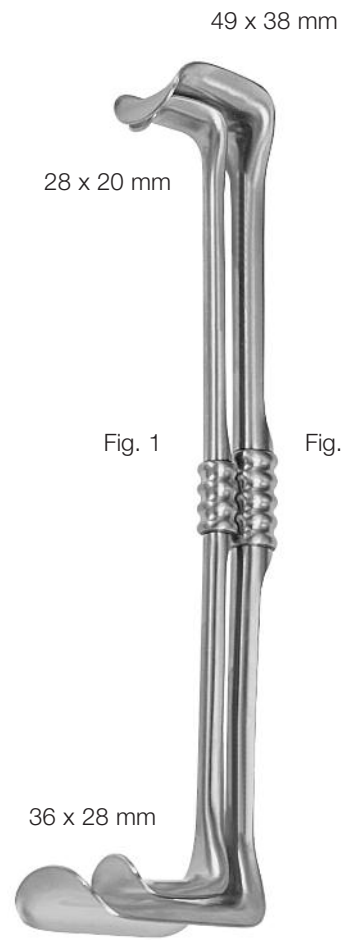

Fig. 1

Fig. 2

Richardson-Eastman  
Fig. 1+2  
170-381-000

Fig. 1  
26.0 cm, 10 1/4"  
170-381-001

Fig. 2  
28.0 cm, 11"  
170-381-002



**Doyen-Stille**  
22.0 cm, 8 5/8"

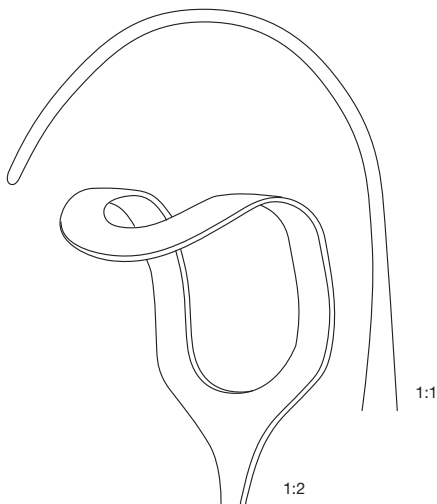
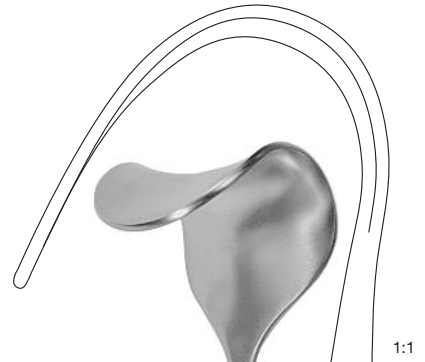
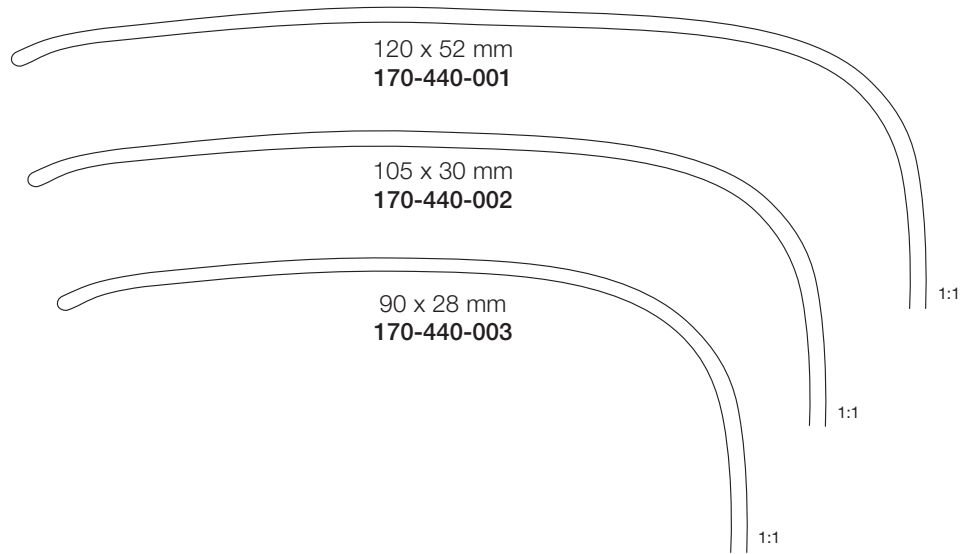

40 x 45 mm  
170-443-001

45 x 50 mm  
170-443-002

55 x 70 mm  
170-443-003



**Middeldorpf**  
25.5 cm, 10"

**Fritsch**  
24.0 cm, 9 1/2"

45 x 40 mm	170-447-040
45 x 50 mm	170-447-050
45 x 60 mm	170-447-060
55 x 75 mm	170-447-075
65 x 85 mm	170-447-085



50 x 85 mm

**Doyen**  
25.0 cm, 10"  
170-461-250

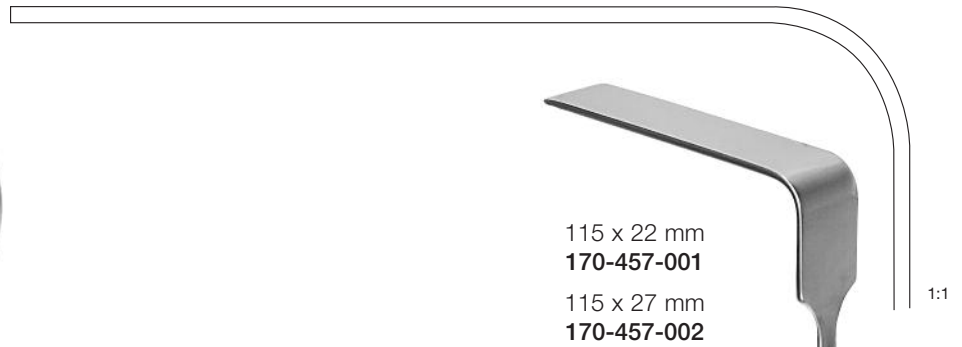

115 x 22 mm  
**170-457-001**  
115 x 27 mm  
**170-457-002**

1:1

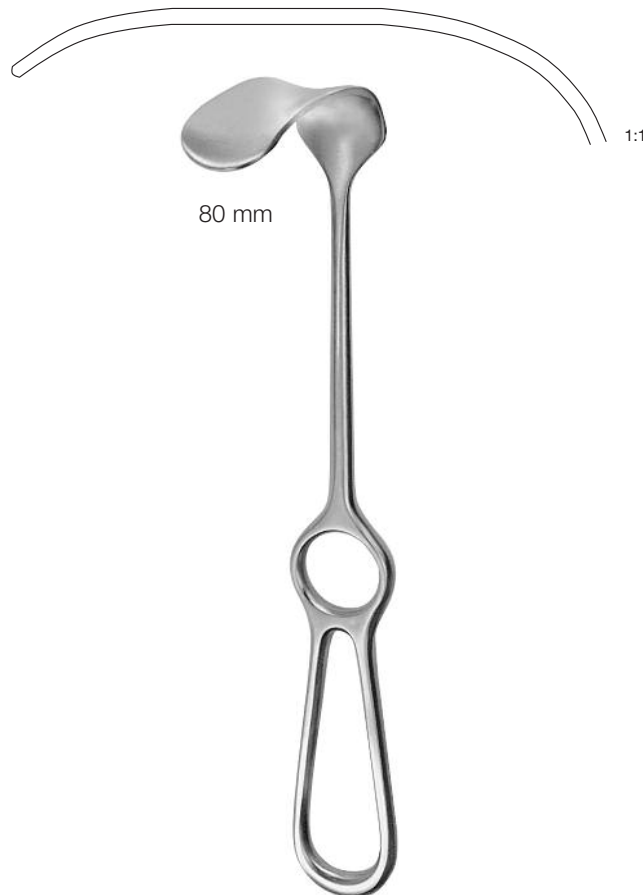

80 mm

1:1

**Simon**  
28.0 cm, 11"

**Kocher**

70 x 25 mm	22.0 cm, 9"	<b>170-449-225</b>
80 x 42 mm	25.0 cm, 10"	<b>170-451-002</b>
80 x 50 mm	25.0 cm, 10"	<b>170-451-003</b>
80 x 60 mm	25.0 cm, 10"	<b>170-451-004</b>

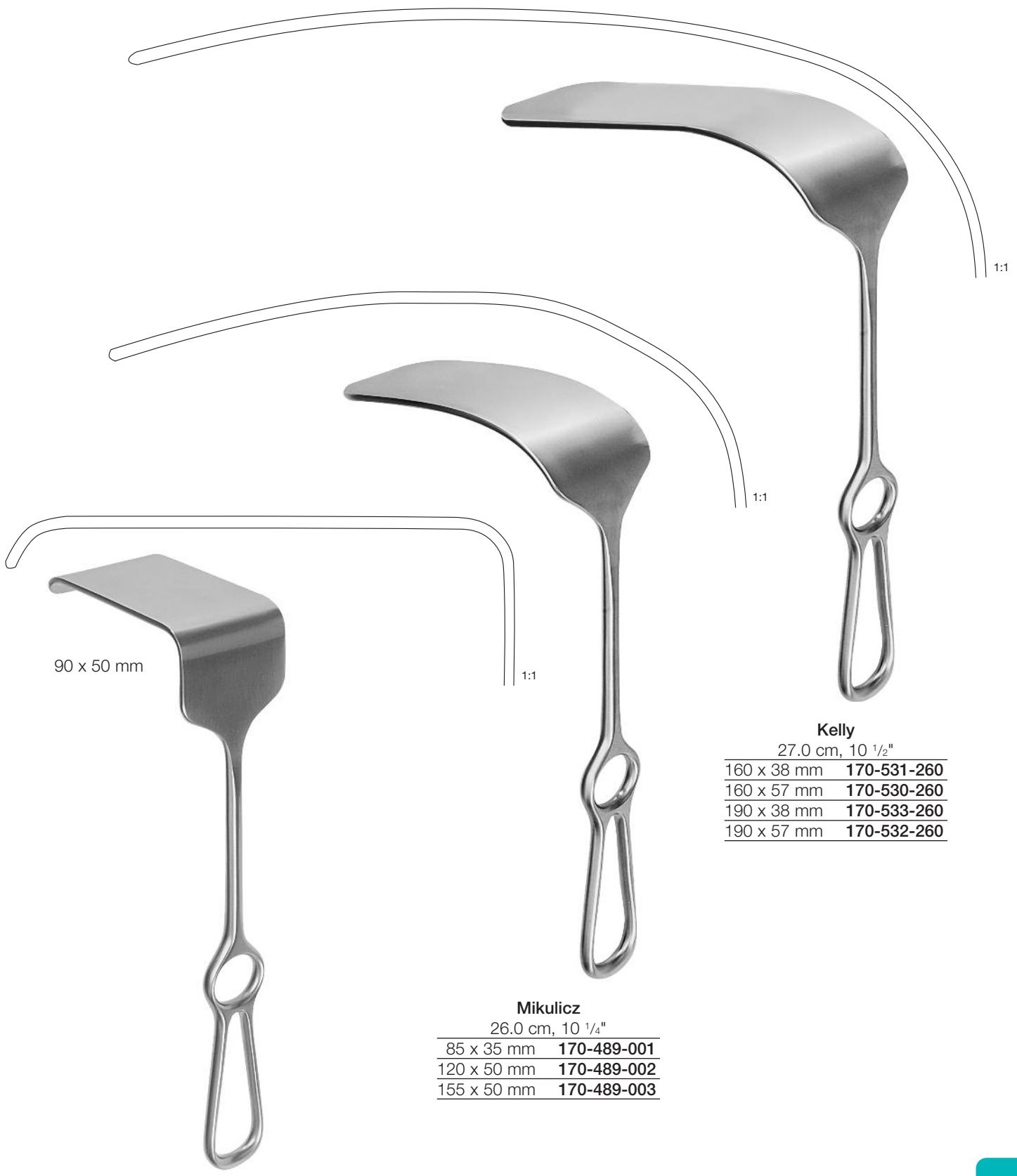

90 x 50 mm

1:1

1:1

1:1

**Mikulicz**  
26.0 cm, 10 1/4"  
170-607-260

**Mikulicz**  
26.0 cm, 10 1/4"  
85 x 35 mm **170-489-001**  
120 x 50 mm **170-489-002**  
155 x 50 mm **170-489-003**

**Kelly**  
27.0 cm, 10 1/2"  
160 x 38 mm **170-531-260**  
160 x 57 mm **170-530-260**  
190 x 38 mm **170-533-260**  
190 x 57 mm **170-532-260**



**Morris**  
24.5 cm, 9 5/8"  
70 x 38 mm  
**170-465-380**  
70 x 50 mm  
**170-465-510**

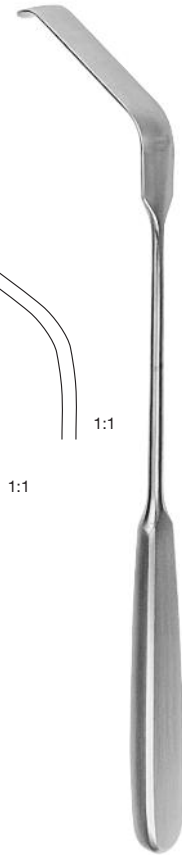
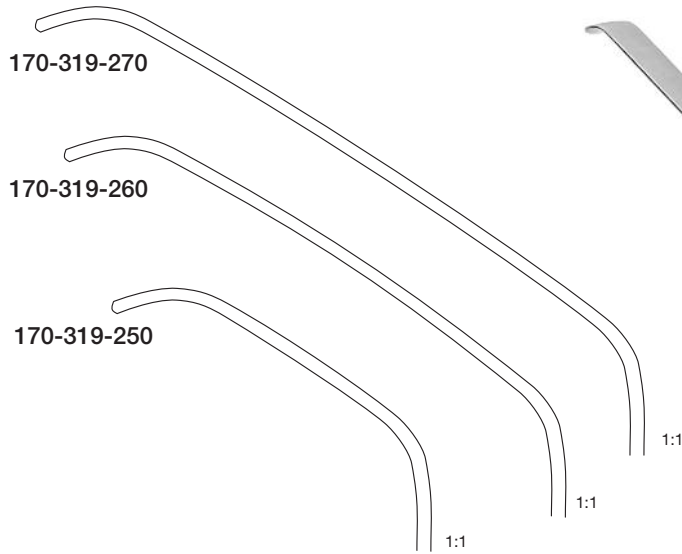

<b>Zenker</b>			
25.0 cm, 9 3/4"	35 x 8 mm	<b>170-319-250</b>	
26.0 cm, 10 1/4"	60 x 12 mm	<b>170-319-260</b>	
27.5 cm, 10 3/4"	75 x 12 mm	<b>170-319-270</b>	



**Meyerding**  
22.5 cm, 8 3/4"

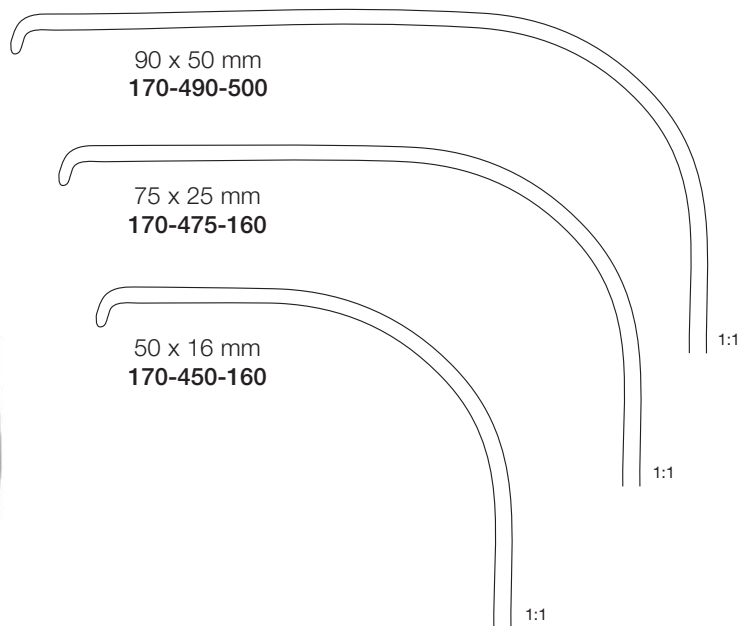

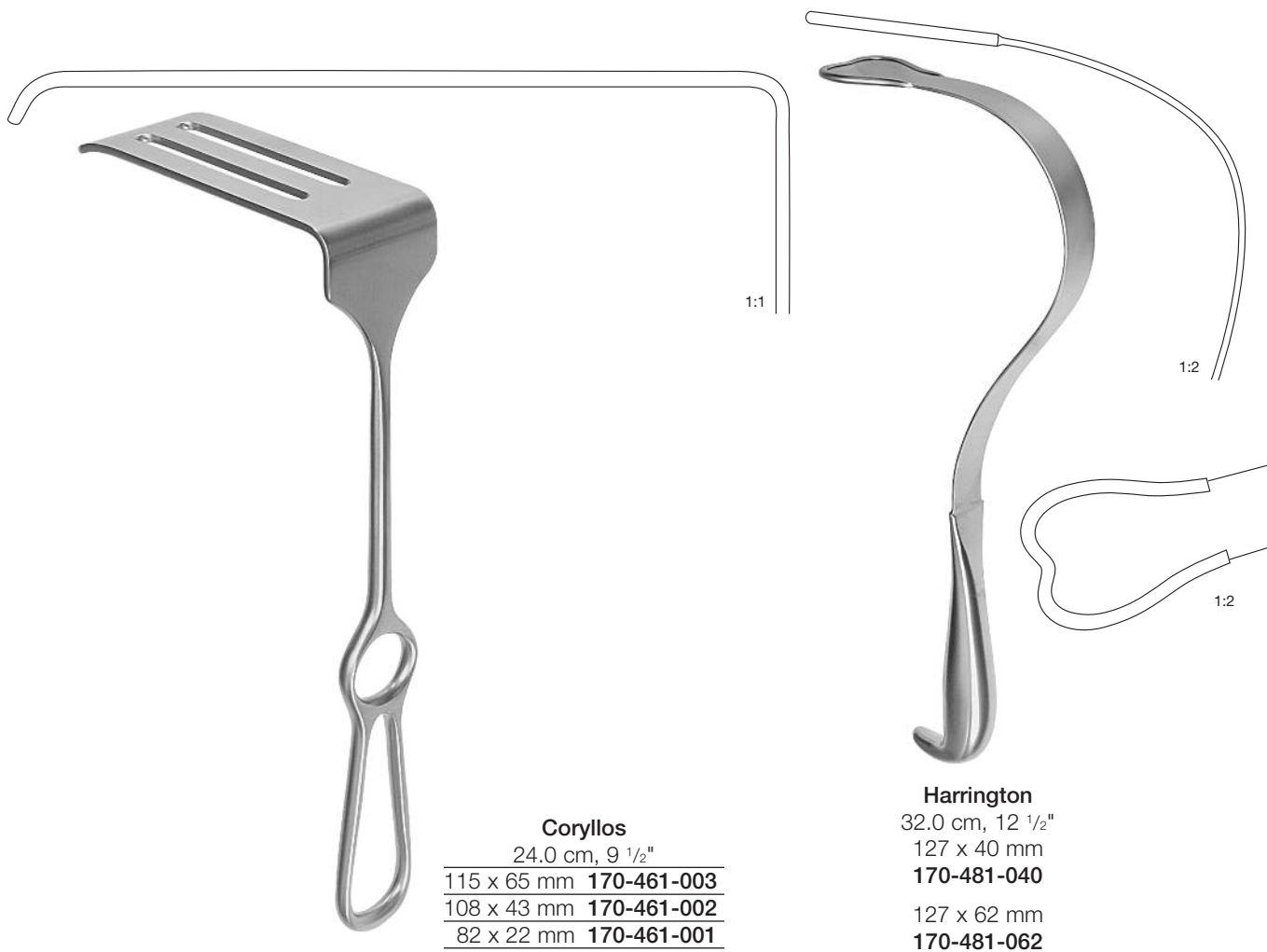
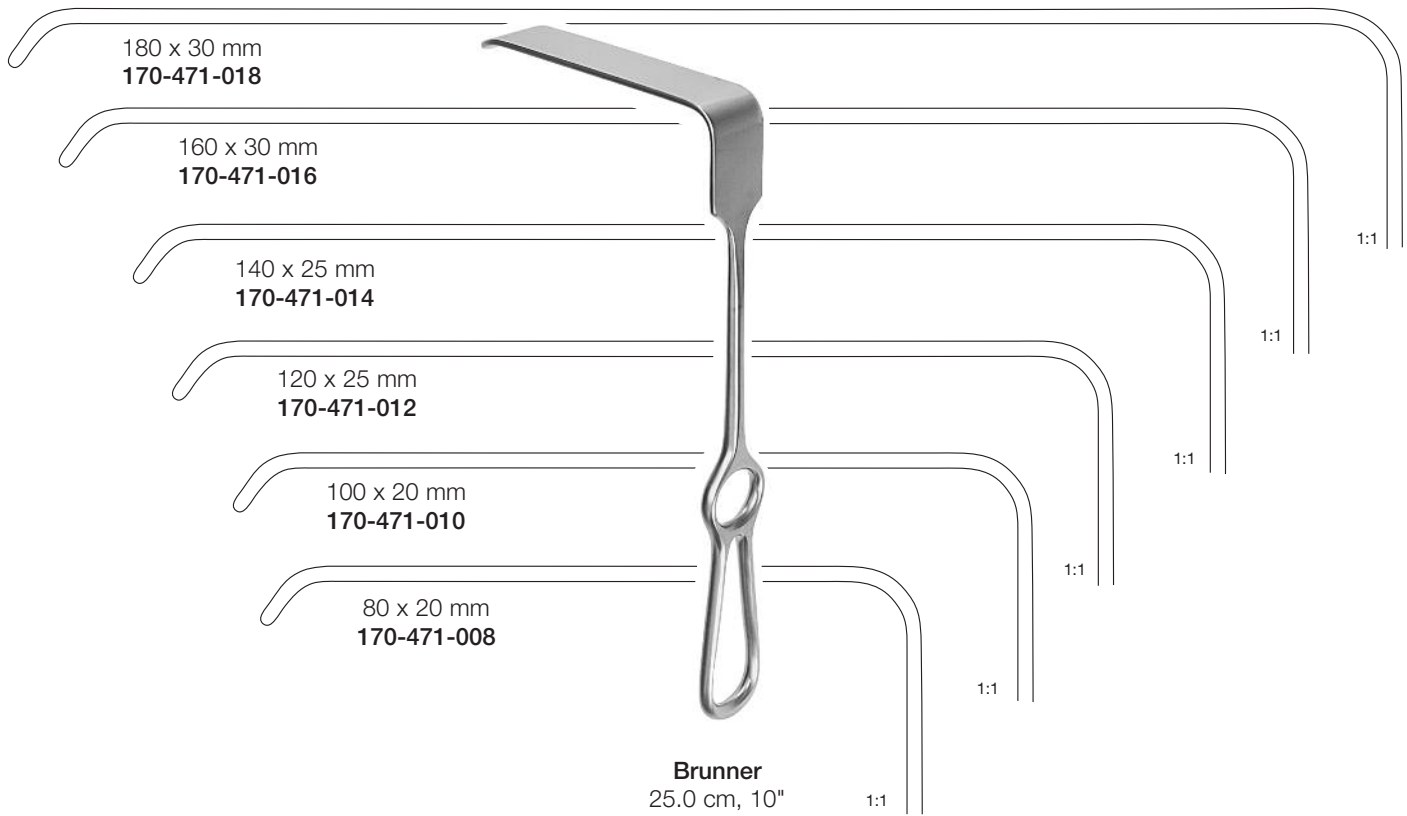





**Deaver Grip**  
30.0 cm, 12"  
170-483-...



**Deaver**  
18.0 cm, 7"  
170-591-180



**Deaver**  
21.5 cm, 8 1/2"  
170-591-215



**Deaver**  
23.0 cm, 9"  
170-591-230

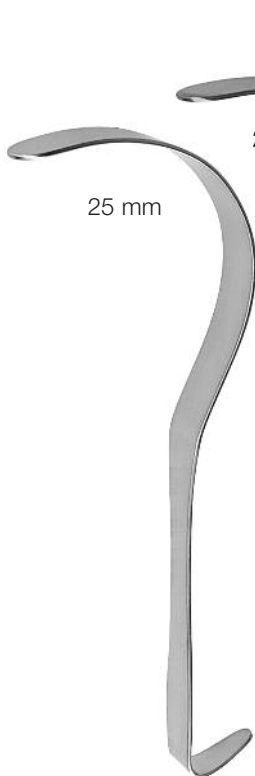

**Deaver**  
30.0 cm, 12 3/4"  
170-591-300  
170-483-025



**Deaver**  
33.0 cm, 13"  
170-591-330



**Deaver**  
36.0 cm, 14 1/8"  
170-591-360



**Deaver**  
30.0 cm, 11 3/4"  
170-593-300  
170-483-038



**Deaver**  
30.0 cm, 11 3/4"  
170-595-300  
170-483-050



**Deaver**  
30.0 cm, 11 3/4"  
170-597-300  
170-483-075



**Allison**  
30.0 cm, 11 3/4"  
40 mm Breite/width  
**290-505-300**  
32.0 cm, 11 3/4"  
54 mm Breite/width  
**290-505-320**



**Davidson**  
16.0 cm, 6 1/4"  
75 x 50 mm  
**170-463-001**  
75 x 90 mm  
**170-463-002**



**St. Marks**

mit Lippe  
with lip

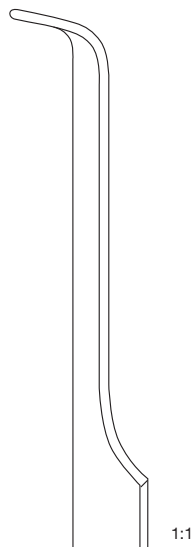

29.0 cm, 11 1/2"  
130 x 60 mm  
**170-493-001**

33.0 cm, 13"  
180 x 60 mm  
**170-493-002**

ohne Lippe  
without lip

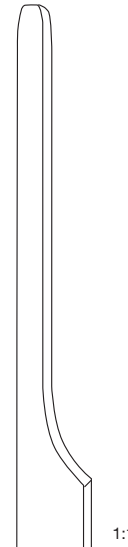

29.0 cm, 11 1/2"  
130 x 60 mm  
**170-493-004**

33.0 cm, 13"  
180 x 60 mm  
**170-493-003**



Fig. 1 24 x 20 mm  
Fig. 2 29 x 26 mm  
Fig. 3 33 x 29 mm  
Fig. 4 29 x 24 mm

Fig. 1 30 x 28 mm  
Fig. 2 36 x 36 mm  
Fig. 3 38 x 43 mm  
Fig. 4 45 x 28 mm

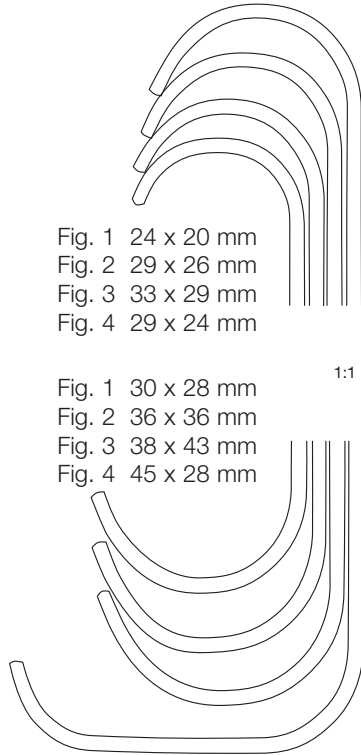

1:1



12.0 cm, 4 3/4"  
Fig. 1 30 x 10 mm  
Fig. 2 26 x 10 mm  
15.0 cm, 5 3/4"  
Fig. 1 23 x 16 mm  
Fig. 2 27 x 16 mm

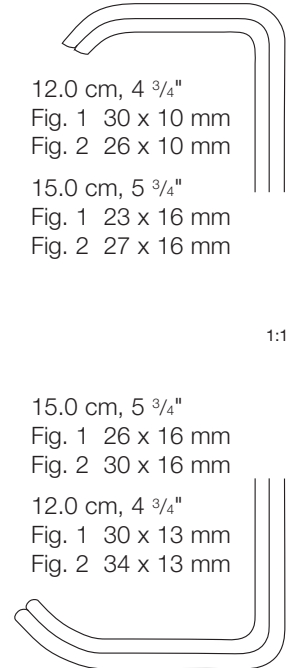

1:1

15.0 cm, 5 3/4"  
Fig. 1 26 x 16 mm  
Fig. 2 30 x 16 mm  
12.0 cm, 4 3/4"  
Fig. 1 30 x 13 mm  
Fig. 2 34 x 13 mm

**Roux**

Satz, Set: Fig. 1-3	<b>170-655-000</b>
Fig. 1 14.0 cm, 5 1/2"	<b>170-655-140</b>
Fig. 2 15.0 cm, 6"	<b>170-655-150</b>
Fig. 3 17.0 cm, 6 3/4"	<b>170-655-170</b>
Fig. 4 18.0 cm, 7"	<b>170-655-180</b>

**Farabeuf**

Satz, Set	
12.0 cm, 4 3/4"	<b>170-663-120</b>
15.0 cm, 6"	<b>170-665-150</b>



1:1

1:1

**Mini-Roux**  
14.0 cm, 5 1/2"  
**170-667-006**

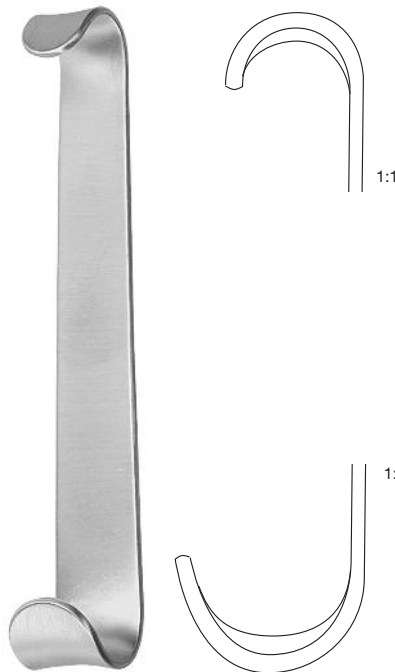

1:1

1:1

**Baby-Roux**  
13.0 cm, 5"  
**170-669-130**

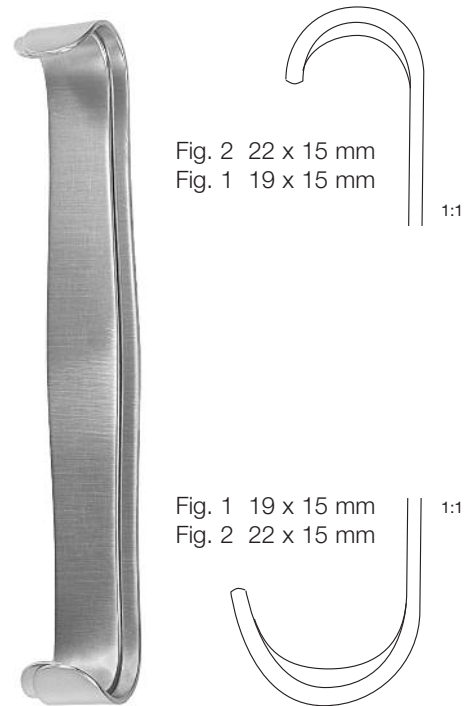

Fig. 2 22 x 15 mm  
Fig. 1 19 x 15 mm

1:1

Fig. 1 19 x 15 mm  
Fig. 2 22 x 15 mm

1:1

**Parker**  
Satz, Set  
13.5 cm, 5 3/8"  
**170-673-001**

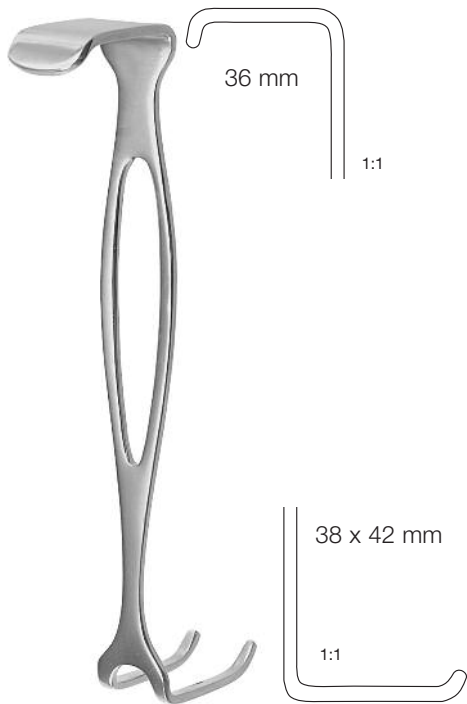

**Czerny**  
17.5 cm, 7"  
170-653-000



**Canny Ryal**  
19.0 cm, 7 1/2"  
16 mm  
170-654-016  
20 mm  
170-654-020  
20.0 cm, 8"  
25 mm  
170-654-025

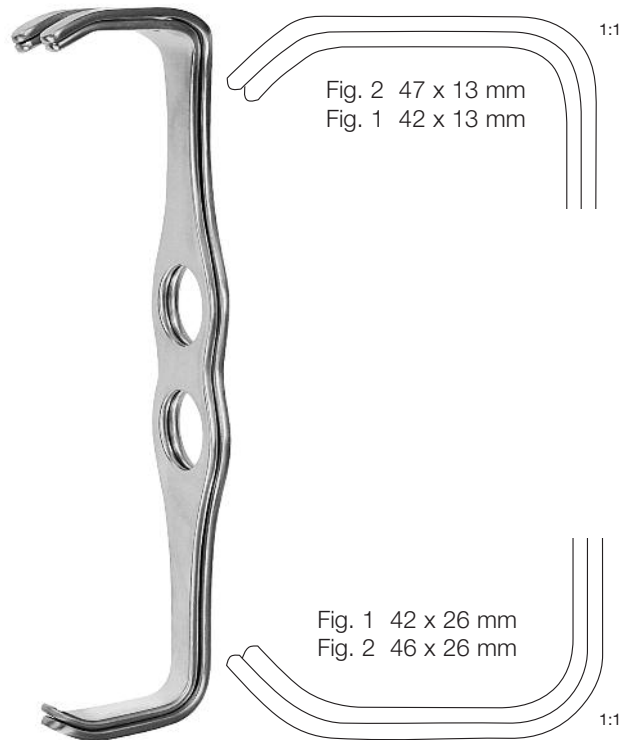

**Mathieu**  
Satz, Set  
20.0 cm, 8"  
170-683-000

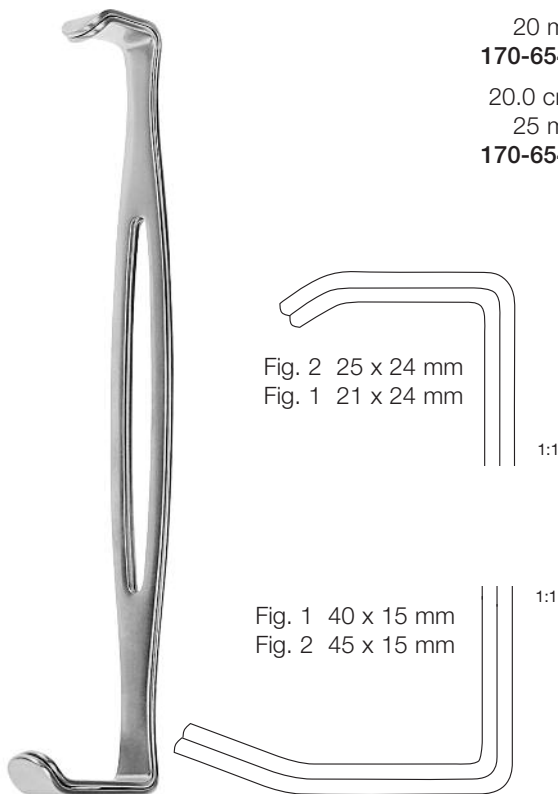

**Parker-Langenbeck**  
US-Modell, US-pattern  
Satz, Set  
21.0 cm, 8 1/4"  
170-687-210

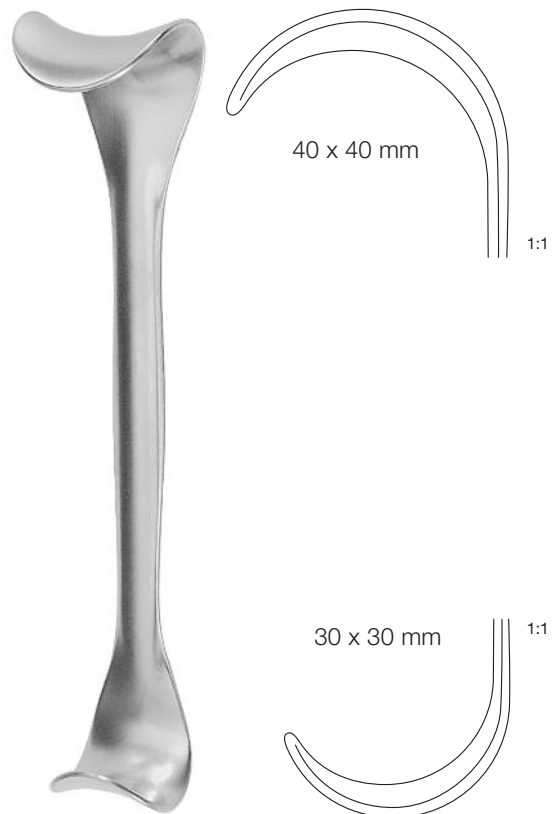

**Goelet**  
19.0 cm, 7 1/2"  
170-695-000

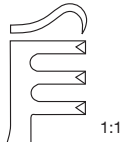

scharf, sharp  
170-700-050

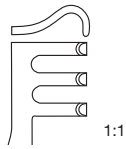

stumpf, blunt  
170-701-050



**Finsen**  
3 x 3 Zähne, teeth  
5.0 cm, 2"



**Jansen**  
3 x 3 Zähne, teeth  
10.0 cm, 4"

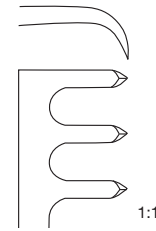

scharf, sharp  
170-720-100

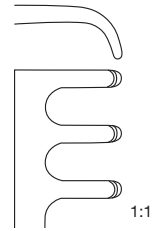

stumpf, blunt  
170-723-100



**Alm**

4 x 4 Zähne	scharf	halbscharf	stumpf
4 x 4 teeth	sharp	semisharp	blunt
7.0 cm, 2 3/4"	170-714-070	170-716-070	170-715-070
10.0 cm, 4"	170-714-100	170-716-100	170-715-100

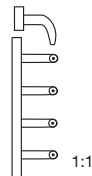
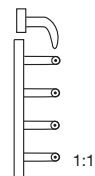
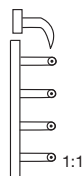

**Allport**  
4 x 4 Zähne, teeth  
9.5 cm, 3 3/4"  
170-719-095

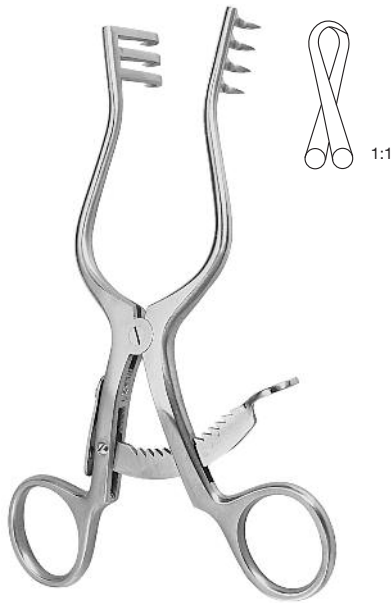

**Scalp-Contour**  
3 x 4 Zähne, teeth  
14.0 cm, 5 1/2"  
scharf, sharp  
**170-725-140**  
stumpf, blunt  
**170-727-140**



**Adson-Baby**  
3 x 4 Zähne, teeth  
16.0 cm, 6 1/4"  
scharf, sharp  
**170-728-160**  
stumpf, blunt  
**170-729-160**



<b>Adson</b>	Zähne teeth	scharf sharp	stumpf blunt
26.5 cm, 10 1/2"	3 x 4	<b>170-730-265</b>	<b>170-731-265</b>
27.0 cm, 10 5/8"	5 x 6	<b>170-732-265</b>	<b>170-733-265</b>



**Anderson-Adson**  
4 x 4 Zähne, teeth  
20.0 cm, 8"  
scharf, sharp  
**170-732-200**  
stumpf, blunt  
**170-733-200**



**Mollison**  
4 x 4 Zähne, teeth  
15.5 cm, 6"  
scharf, sharp  
170-754-155

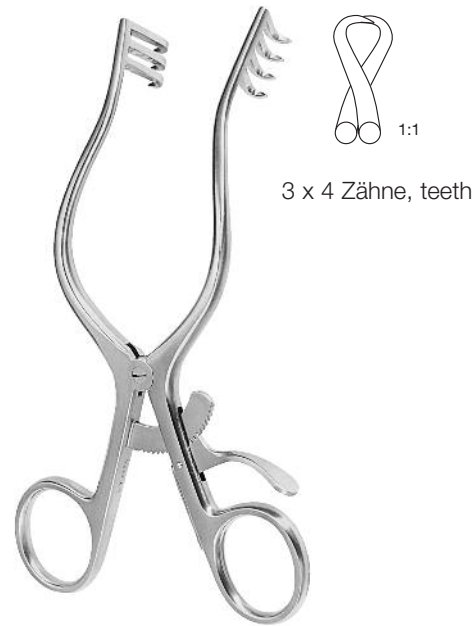

**Wullstein**

	scharf sharp	stumpf blunt
10.5 cm, 4 1/8"	170-742-105	170-743-105
13.0 cm, 5"	170-742-130	170-743-130
15.0 cm, 6"	170-742-150	170-743-150
18.0 cm, 7"	170-742-180	170-743-180



**Schuhknecht**  
3 x 4 Zähne, teeth  
12.5 cm, 5"  
scharf, sharp  
170-758-125  
stumpf, blunt  
170-759-125



**Mayo-Adams**  
16.5 cm, 6 1/2"  
170-812-165



scharf, sharp  
**170-748-105**  
stumpf, blunt  
**170-749-105**

**Weitlaner-Loktite**  
2 x 3 Zähne, teeth  
10.5 cm, 4 1/8"

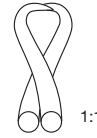

13.0 cm, 5"  
scharf, sharp  
**170-750-130**  
stumpf, blunt  
**170-751-130**

**Weitlaner**  
3 x 4 Zähne, teeth

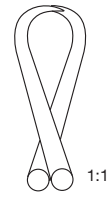

16.5 cm, 6 1/2"  
scharf, sharp  
**170-750-165**  
stumpf, blunt  
**170-751-165**



scharf, sharp  
**170-752-130**  
stumpf, blunt  
**170-753-130**

**Weitlaner-Wullstein**  
3 x 3 Zähne, teeth  
13.0 cm, 5"

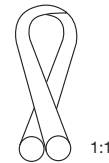

20.0 cm, 8"  
scharf, sharp  
**170-734-200**  
stumpf, blunt  
**170-735-200**

**Weitlaner**  
3 x 4 Zähne, teeth

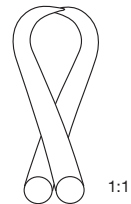

24.0 cm, 9 1/2"  
scharf, sharp  
**170-734-240**  
stumpf, blunt  
**170-735-240**





**Plester**  
2 x 2 Zähne, teeth  
13.0 cm, 5"



scharf, sharp  
**170-763-130**  
stumpf, blunt  
**170-762-130**



**Plester**  
2 Zähne, teeth  
stumpf, blunt  
11.0 cm, 4 3/8"  
**170-761-110**

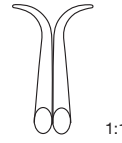

**Plester**  
2 Zähne, teeth  
stumpf, blunt  
11.0 cm, 4 3/8"  
**170-760-110**

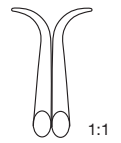

**Milligan**  
3 x 3 Zähne, teeth  
13.0 cm, 5"  
**170-768-130**

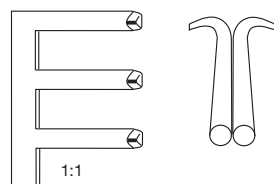

**Weitlaner-Baby**  
13.0 cm, 5"  
**170-767-130**

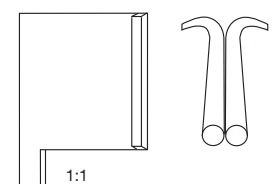



scharf, sharp  
20.0 cm, 8"  
**170-795-200**

26.0 cm, 10 1/4"  
**170-795-260**



stumpf, blunt  
20.0 cm, 8"  
**170-794-200**

26.0 cm, 10 1/4"  
**170-794-260**

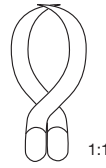

scharf, sharp  
**170-786-001**

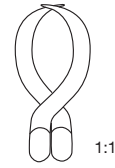

stumpf, blunt  
**170-786-000**



**Adson**  
3 x 4 Zähne, teeth



**Beckmann-Adson**  
4 x 4 Zähne, teeth  
31.0 cm, 12 1/4"

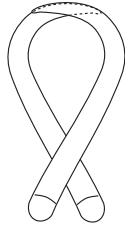

1:1

**Beckmann**  
4 x 4 Zähne, teeth  
scharf, sharp  
31.0 cm, 12 1/4"  
170-786-310

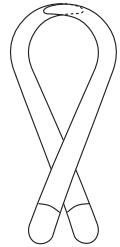
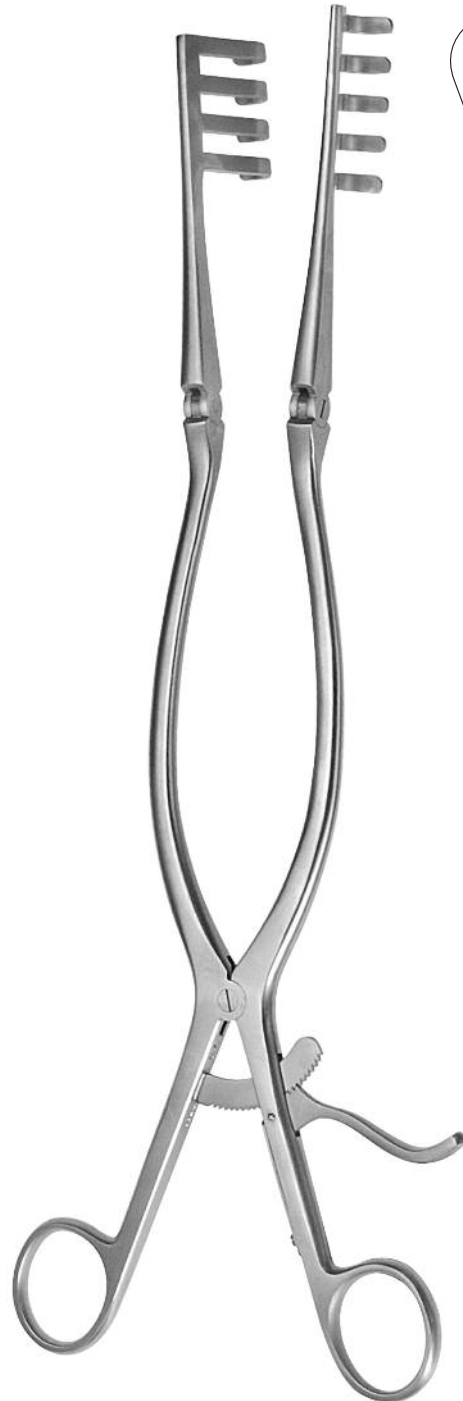

1:1

**Adson**  
4 x 5 Zähne, teeth  
stumpf, blunt  
32.0 cm, 12 1/2"  
170-784-320

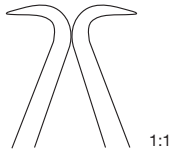

**Gelpi**  
13.5 cm, 5 3/8"  
170-802-135

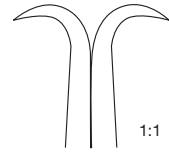

**Gelpi**  
18.0 cm, 7"  
170-802-180

Femur Wundsperrer  
Femur retractor

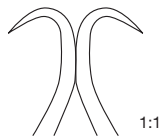

**De Bakey**  
10.0 cm, 4"  
170-745-100  
17.0 cm, 6 3/4"  
170-745-170

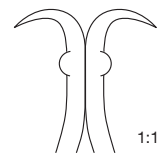

**Gelpi-Loktite**  
18.0 cm, 7"  
170-803-180

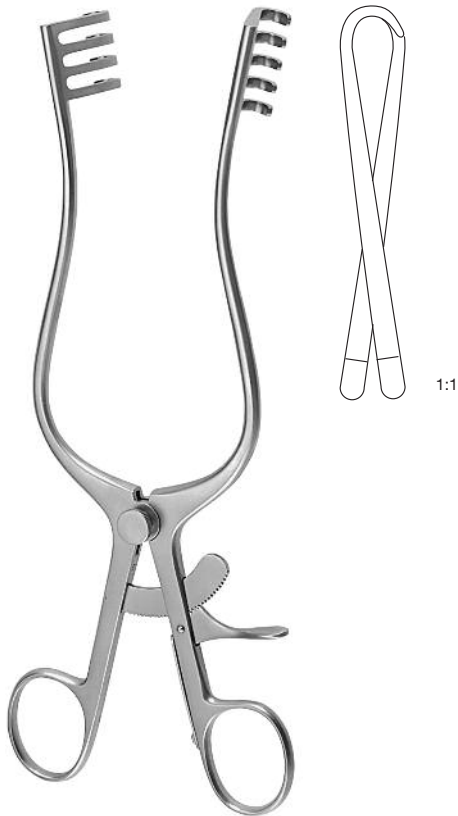

**Norfolk and Norwich**  
4 x 5 Zähne, teeth  
stumpf, blunt  
22.0 cm, 8 5/8"  
170-776-220

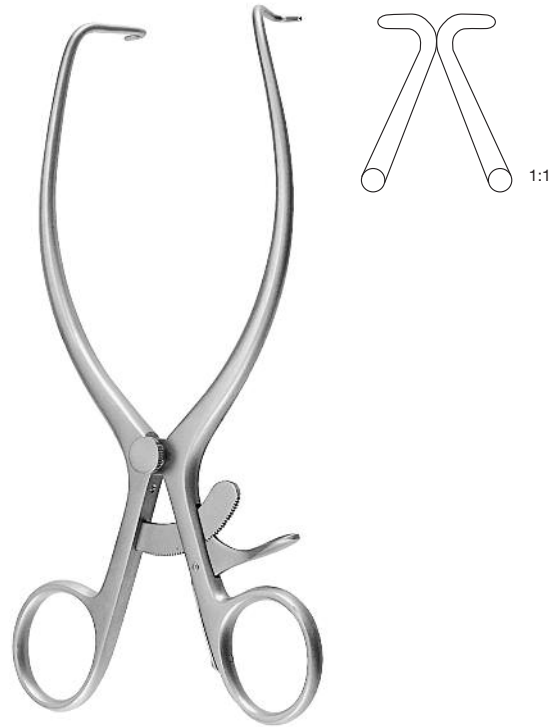

**Jackson Burrows**  
stumpf, blunt  
17.5 cm, 7"  
170-776-175



**Richter**  
17.0 cm, 6 3/4"  
170-778-170



**Joll (Friedman)**  
15.5 cm, 6"  
440-500-000



**Henley**  
16.0 cm, 6 1/4"  
scharf, sharp  
170-769-160  
stumpf, blunt  
170-770-160

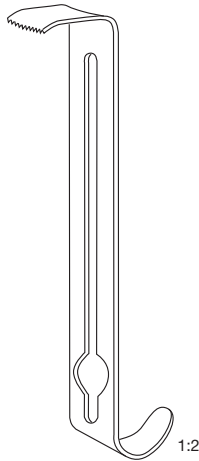

19 x 16 mm  
170-771-001

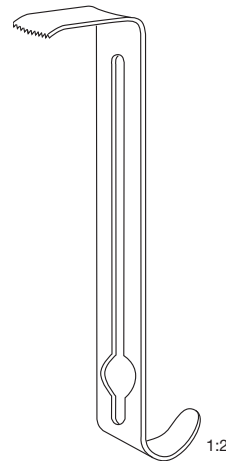

25 x 16 mm  
170-771-002

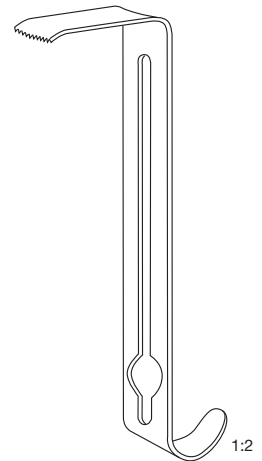

32 x 16 mm  
170-771-003



**Mayo-Adams**  
17.0 cm, 6 3/4"  
170-815-170

30 x 44 mm



**Collin-Baby**  
18.0 cm, 7"  
170-819-000

23 x 44 mm

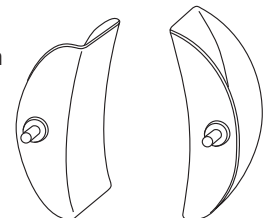

Kugelschnellverschluß  
Ball Snap Closure

mit 2 Paar Valven  
with 2 pairs of blades



Kugelschnellverschluß  
Ball Snap Closure

Seitenvalven  
Lateral blades

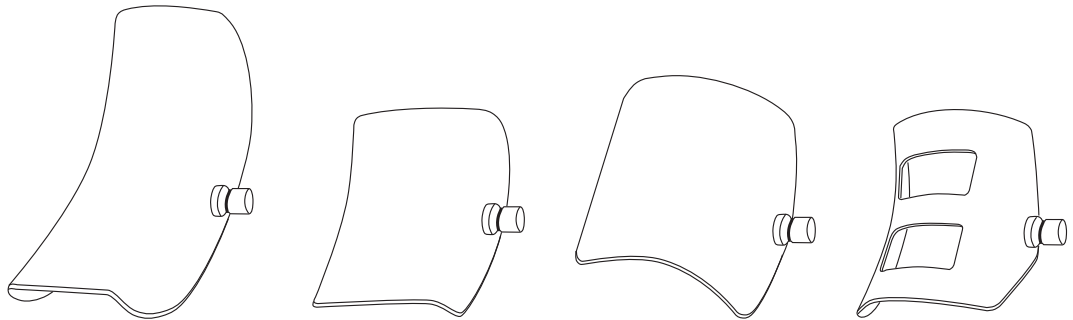

38 x 62 mm	<b>170-839-038</b>			
40 x 80 mm	<b>170-839-040</b>			
50 x 58 mm			<b>170-829-050</b>	
60 x 80 mm	<b>170-839-060</b>	<b>170-832-060</b>	<b>170-829-060</b>	<b>170-834-060</b>
72 x 85 mm			<b>170-829-070</b>	

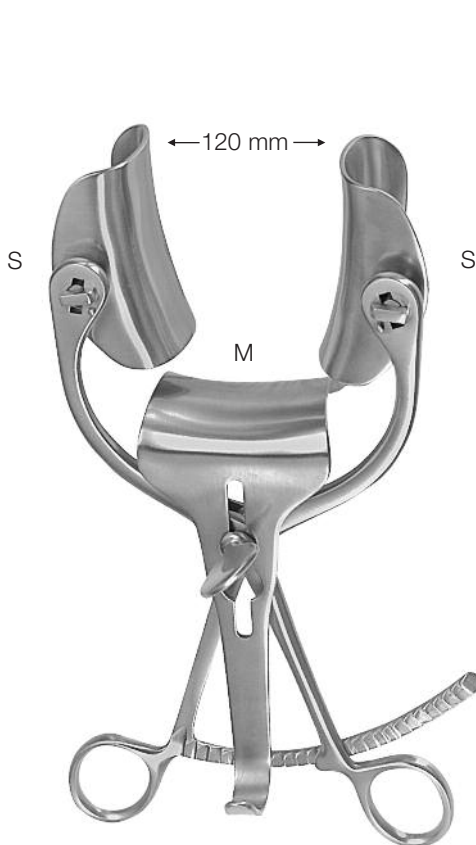

**Collin**  
komplett, complete

S	M	
38 x 62 mm	55 x 55 mm	<b>170-823-000</b>
40 x 80 mm	55 x 65 mm	<b>170-824-000</b>
60 x 80 mm	60 x 75 mm	<b>170-825-000</b>

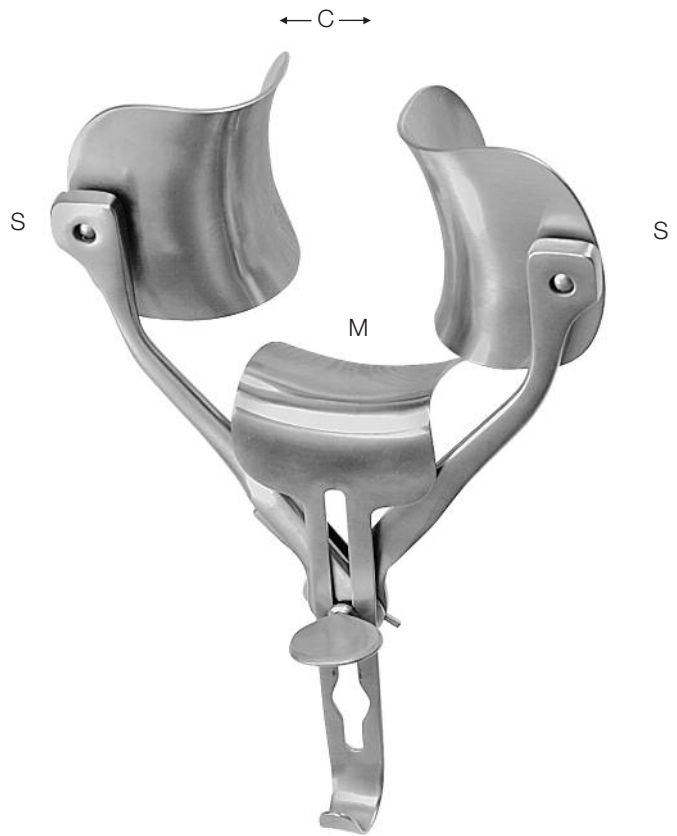

**Ricard**  
komplett, complete

S	M	C	
72 x 85 mm	80 x 90 mm	28.0 cm	<b>170-827-000</b>
60 x 80 mm	55 x 70 mm	30.0 cm	<b>170-829-000</b>

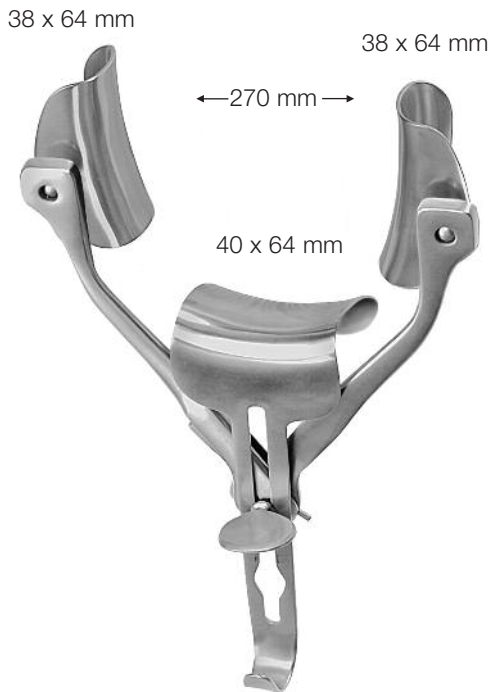

**Robin-Masse**  
komplett, complete  
170-835-000



**Gosset**  
170-818-100

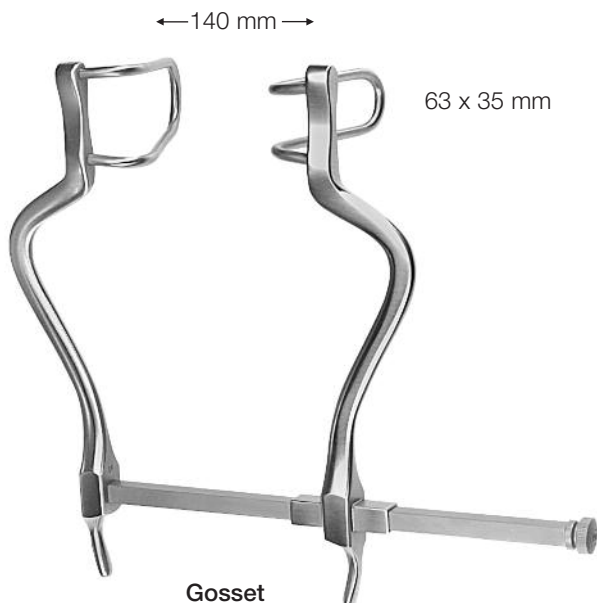

**Gosset**  
170-818-140

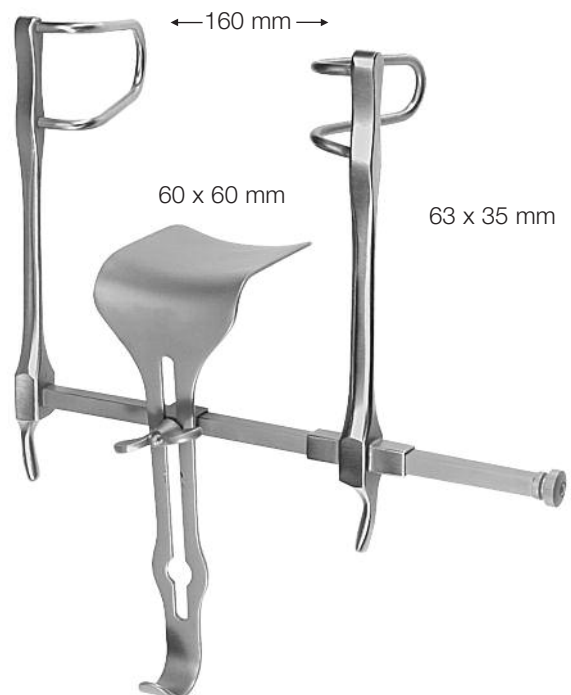

**Gosset**  
170-818-160



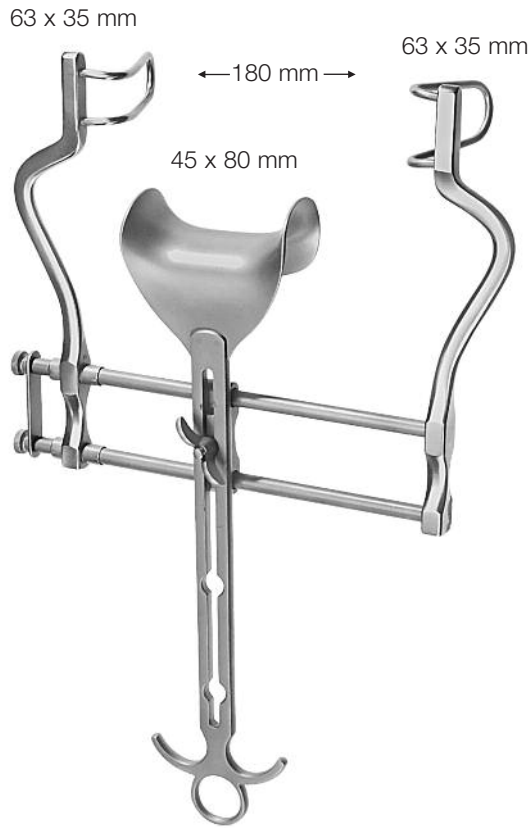

**Balfour**  
170-852-000

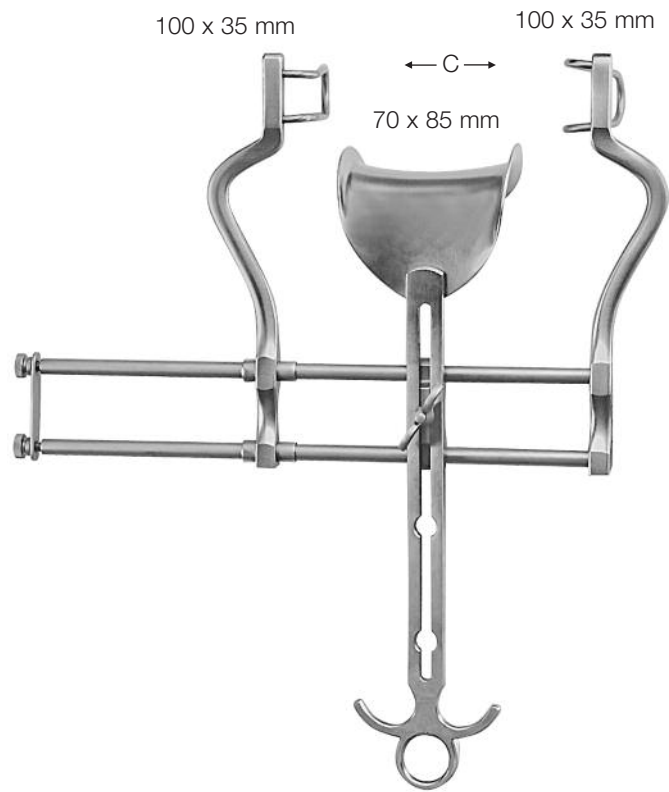

**Balfour**  
C  
20.0 cm, 8" 170-856-000  
25.0 cm, 9 3/4" 170-840-000

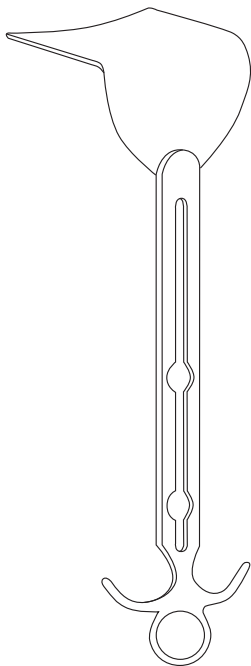

100 x 70 mm  
170-841-010

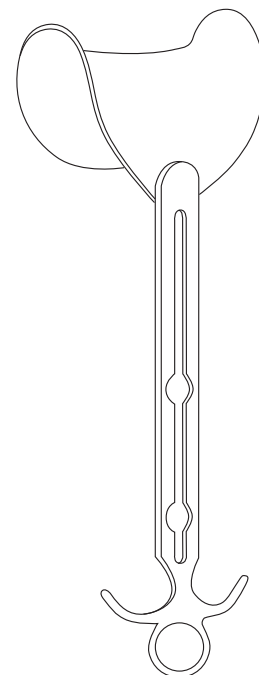

**Balfour**  
45 x 80 mm 170-841-001  
70 x 85 mm 170-841-002  
80 x 90 mm 170-841-003

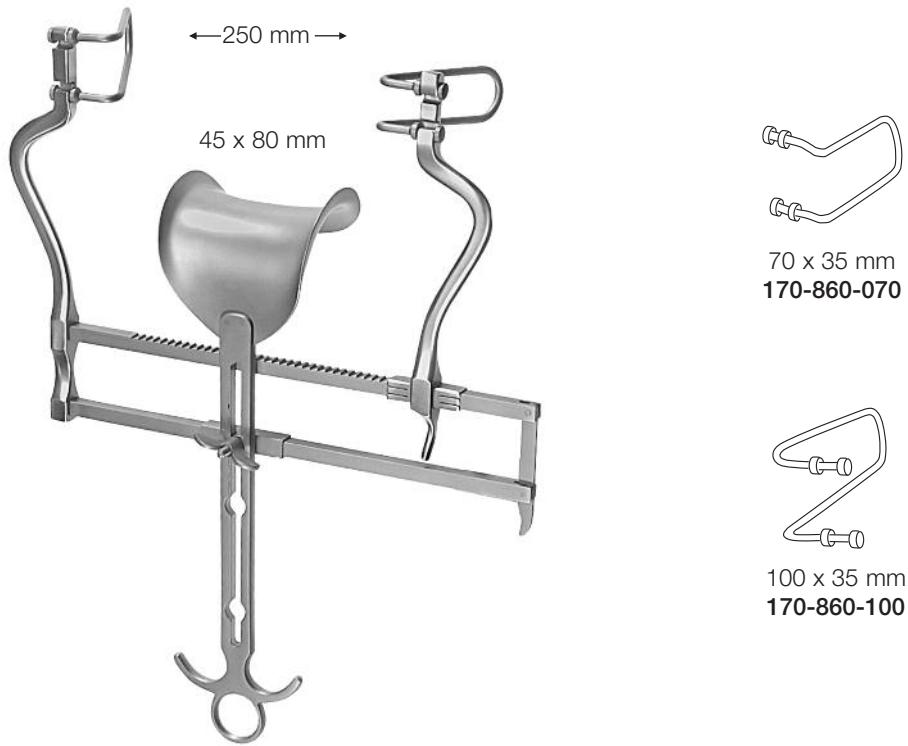

**Balfour US-Type**  
komplett mit 2 Paar Valven  
Complete with 2 pairs of blades  
**170-860-000**

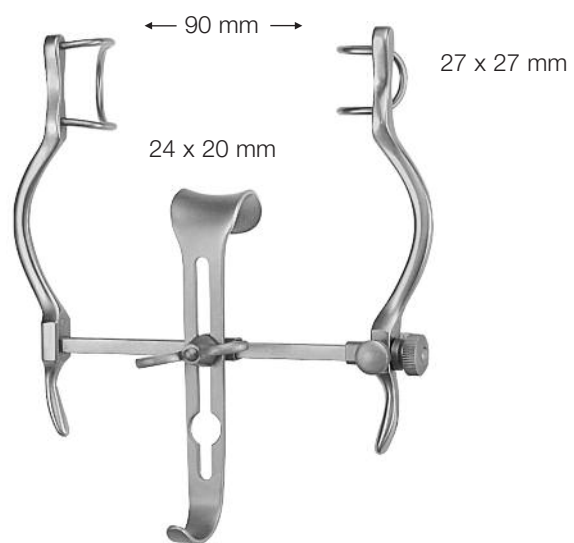

**Balfour-Baby**  
**170-766-090**



**Abadie**  
3 x 4 Zähne, teeth  
Spreizweite, opening 11.5 cm, 4 1/2"  
170-862-000

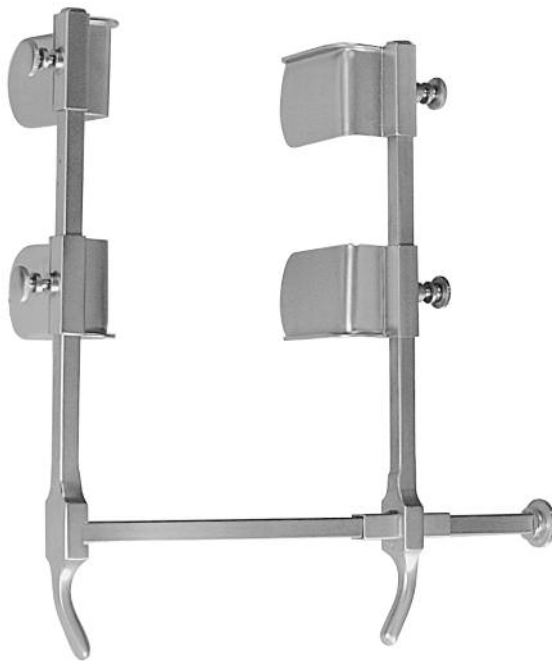

**Berkeley**  
Seitliche Valven 35 x 60mm  
Lateral blades 35 x 60mm  
170-864-000

Mittelvalven  
Central blades

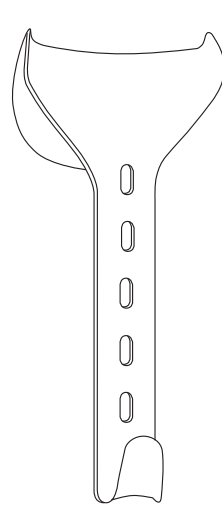

60 x 38 mm  
170-864-038

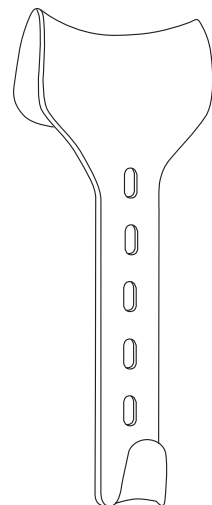

64 x 51 mm  
170-864-051



Turner Warwick Bauchdeckenhalter  
Turner Warwick Abdominal Retractor Set

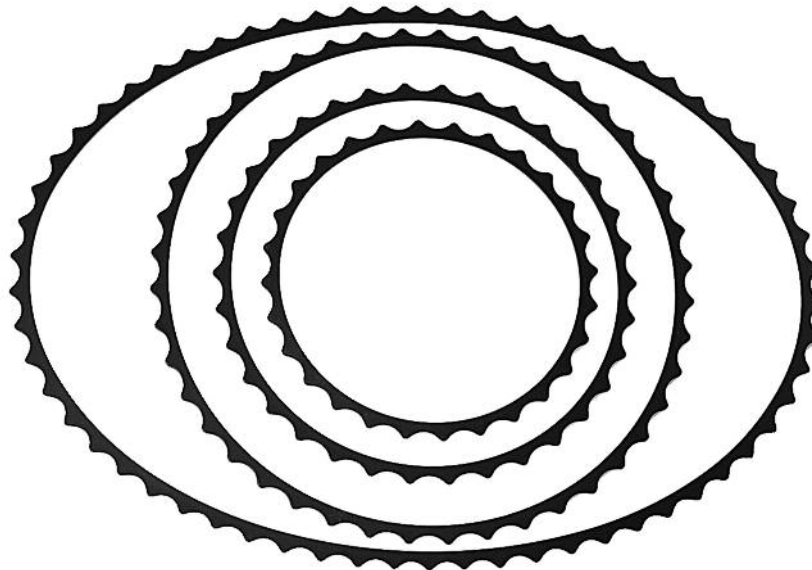

Rahmen, geschwärzt  
frames, black finish

ø 18.0 cm, 7"	170-900-001
ø 23.0 cm, 9"	170-900-002
ø 30.5 cm, 12"	170-900-003
oval 45.5 x 33.0 cm, 17 3/4" x 13"	170-900-004

Valven  
Blades



Valve gebogen, geschwärzt  
blade curved, black finish

1 Zahn, 13 mm tief  
single hook, 13 mm deep

**170-900-009**

51 x 38 mm  
**170-900-010**

76 x 60 mm  
**170-900-011**



Valve gebogen, geschwärzt  
blade curved, black finish

114 x 60 mm  
**170-900-015**

89 x 60 mm  
**170-900-016**



Valve aus Kupfer, geschwärzter Schaft  
copper on black

19 x 76 mm  
**170-900-020**

38 x 102 mm  
**170-900-021**

57 x 89 mm  
**170-900-022**

57 x 114 mm  
**170-900-023**

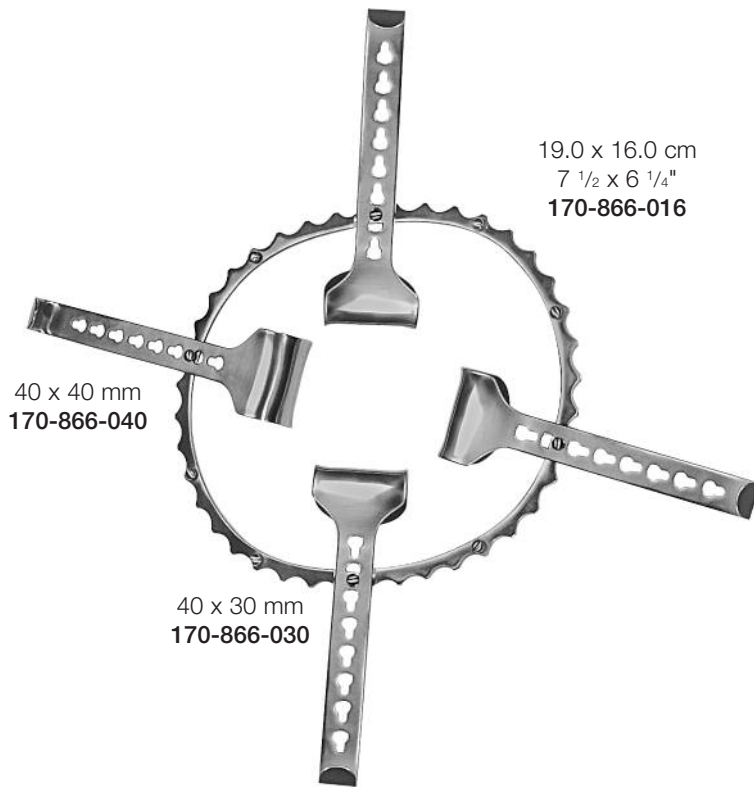

19.0 x 16.0 cm  
7 1/2 x 6 1/4"  
170-866-016

40 x 40 mm  
170-866-040

40 x 30 mm  
170-866-030

**Denis-Browne**  
komplett, incl. 4 Valven  
complete, incl. 4 blades  
170-866-000



80 x 45 mm

110 x 70 mm

**O-Sullivan-O'Connor**  
komplett, complete  
170-868-000

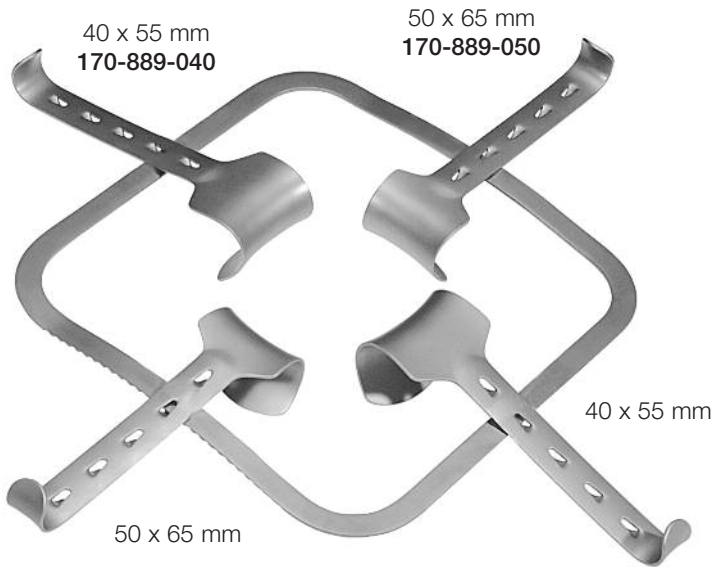

**Kirschner**  
komplettes Set, complete set  
**170-884-000**

Rahmen allein, frame only  
24.0 x 24.0 cm, 9 1/2" x 9 1/2"  
**170-884-024**

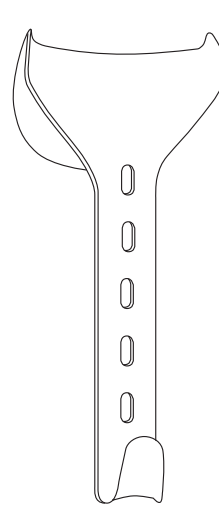

78 x 65 mm  
**170-889-075**

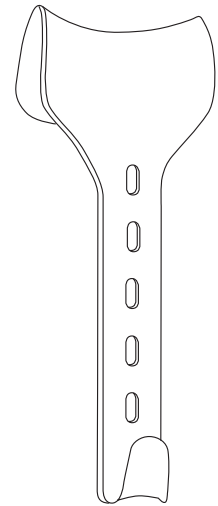

80 x 90 mm  
**170-889-086**

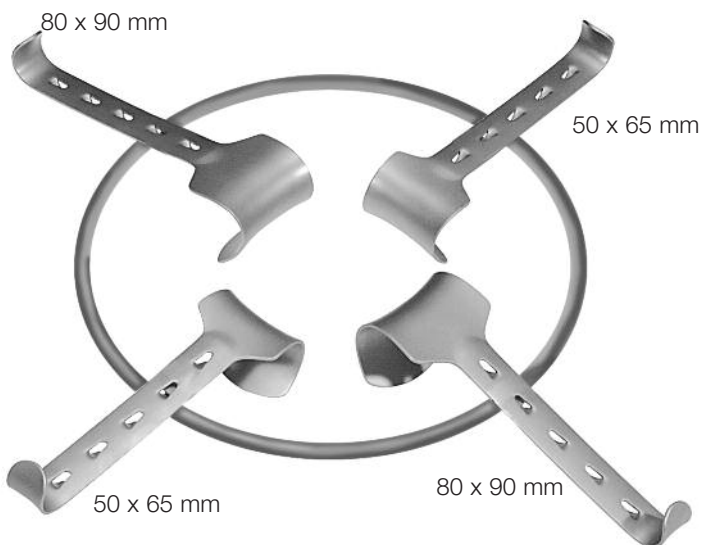

**Semm**  
komplettes Set, complete Set  
**170-882-000**

Rahmen allein, frame only  
27.5 x 25.0 cm, 10 3/4" x 9 3/4"  
**170-882-030**

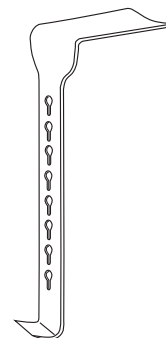

98 x 52 mm  
**170-889-098**

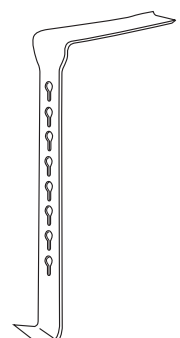

105 x 35 mm  
**170-889-099**



Kugelschnellverschluß  
Ball Snap Closure

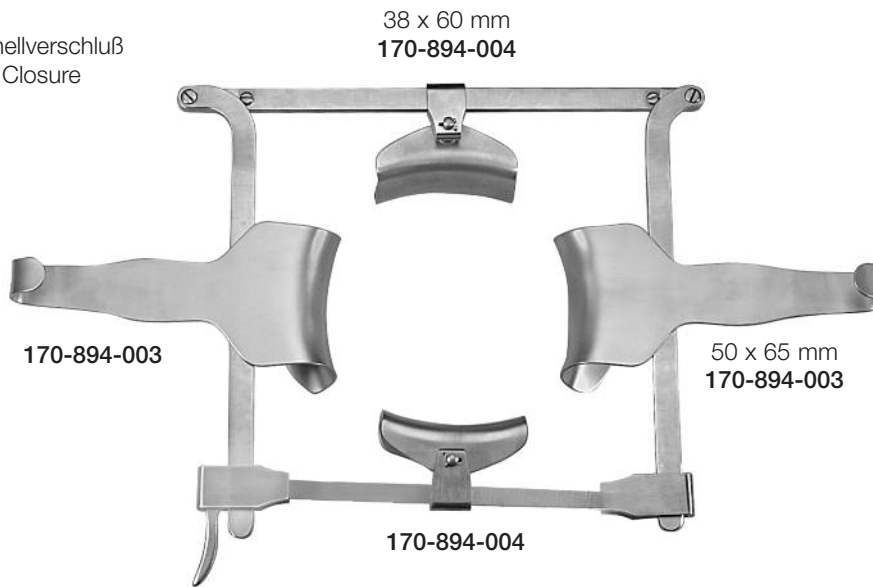

**Franz**  
komplettes Set, complete set  
170-894-000

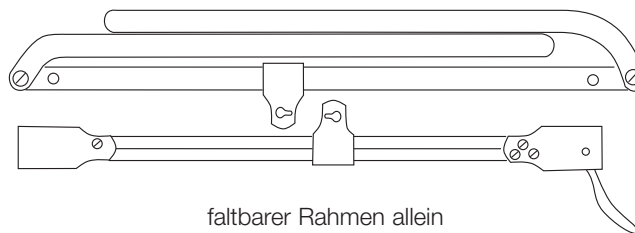

faltbarer Rahmen allein  
foldable frame only  
30.0 x 30.0 cm, 11 3/4" x 11 3/4"  
170-894-300

Valven  
Blades

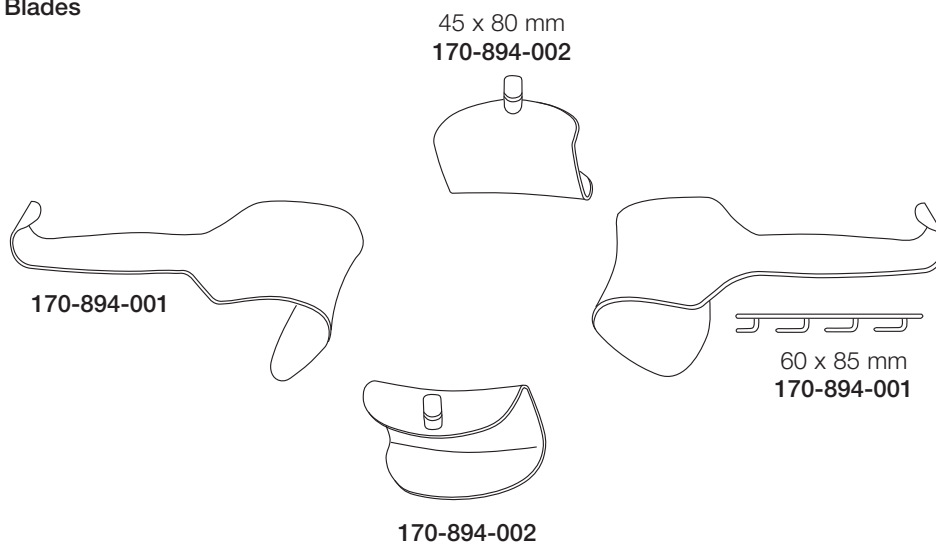



**Doyen**  
28.0 cm, 11"

95 x 60 mm	<b>170-879-001</b>
105 x 65 mm	<b>170-879-002</b>
115 x 65 mm	<b>170-879-003</b>
125 x 65 mm	<b>170-879-004</b>



Kette mit Gewicht  
chain with weight  
78.5cm, 31"  
645 g  
**170-880-100**

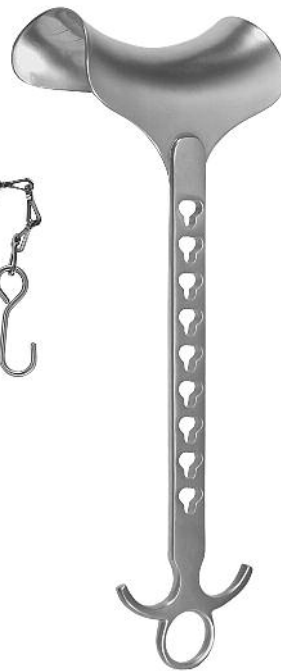

**Rochard**  
28.0 cm, 11"

95 x 48 mm	<b>170-950-090</b>
105 x 48 mm	<b>170-950-105</b>
115 x 48 mm	<b>170-950-115</b>
125 x 48 mm	<b>170-950-125</b>
155 x 48 mm	<b>170-950-155</b>



**Rochard**  
Haltevorrichtung,  
fixation device  
19.0 cm, 7 1/2"  
**170-950-050**



**Rochard**  
Montagerahmen für eine Seite  
mounting frame for one side  
**170-950-000**



**Rochard**  
Montagerahmen für zwei Seiten  
mounting frame for two sides  
**170-950-100**



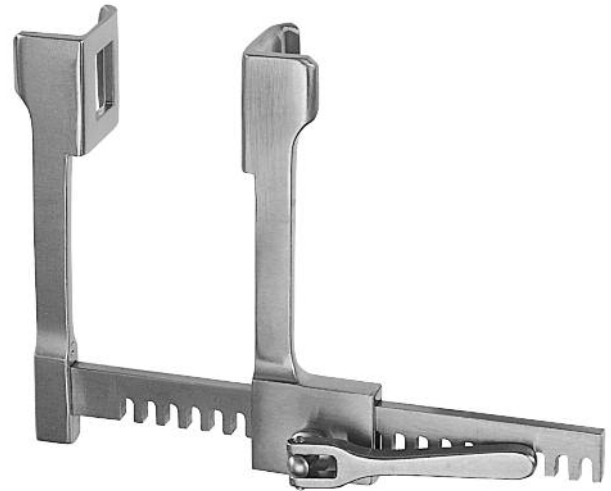
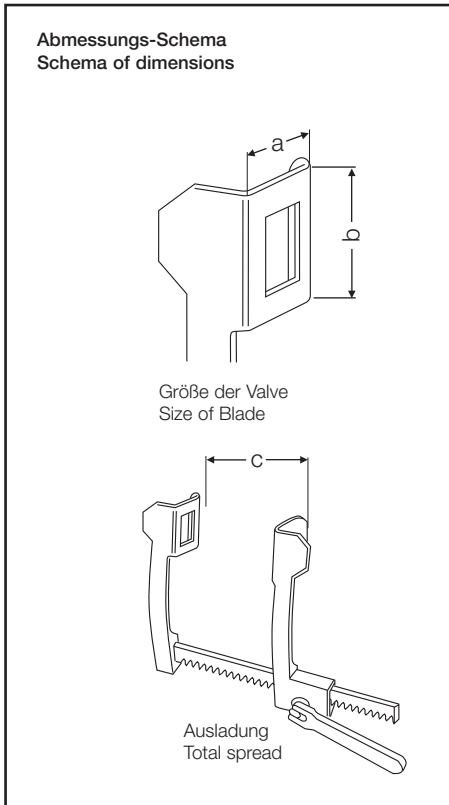

**Finocchetto-Baby**

a	b	c	
18 mm	20 mm	75 mm	<b>290-177-075</b>

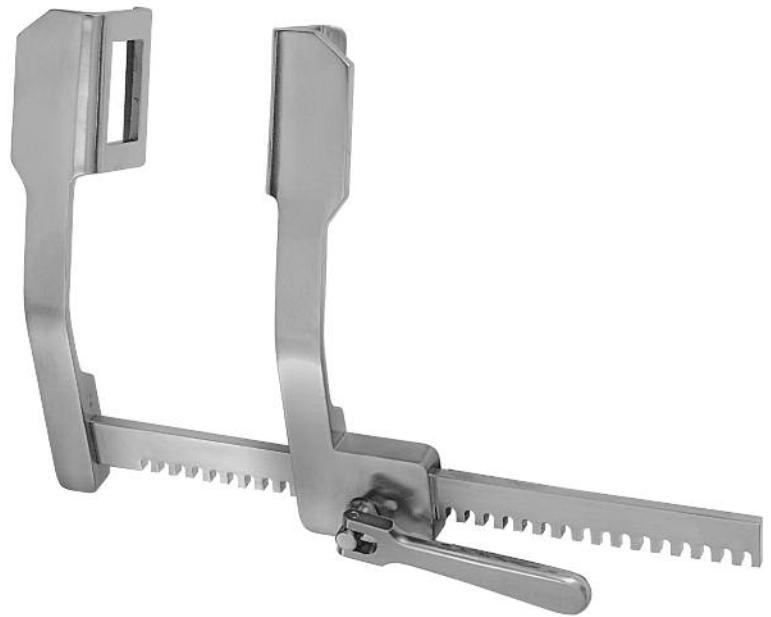

**Finocchetto**

a	b	c	
40 mm	40 mm	165 mm	<b>290-178-165</b>
45 mm	65 mm	200 mm	<b>290-178-200</b>
70 mm	65 mm	250 mm	<b>290-178-250</b>



**Tuffier**

a	b	c	
50 mm	45 mm	165 mm	<b>290-174-000</b>



**Ribbon**

biegsam, malleable

200 x 6 mm 170-973-006

200 x 12 mm 170-973-012

200 x 17 mm 170-973-017

200 x 20 mm 170-973-020

250 x 25 mm 170-973-025



**Ribbon**

biegsam, malleable

330 x 13 mm 170-963-013

330 x 25 mm 170-963-025

330 x 32 mm 170-963-032

330 x 40 mm 170-963-040

330 x 50 mm 170-963-050



**Tuffier**

biegsam, malleable

200 x 25/17 mm

**170-975-250**

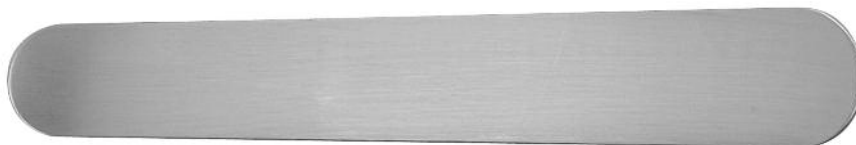

**Haberer**

biegsam, malleable

280 x 25/30 mm 170-971-250

300 x 37/45 mm 170-971-300

300 x 40/50 mm 170-971-370



**Reverdin**

280 x 45/60 mm

**170-953-280**



Vorteile der RZ-Medizintechnik Nadel:

- Für die Herstellung von RZ Nadeln werden nur hochwertige Materialien verwendet.
- Eine hochglanzpolierte Fläche verleiht der Nadel eine bessere Gleitfähigkeit und verringert dadurch die Traumatisierung.
- Der Durchmesser der Nadel ist so ausgelegt, daß nur eine minimale Perforation des Gewebes stattfindet. Hierdurch wird eine bessere Heilung erfolgen.

Advantages of RZ-Medizintechnik needles:

- For the production of RZ needles only high quality materials will be used.
- A mirror finish surface gives the needle a better slide and reduces any trauma.
- The diameter of the needle is kept to a minimum, allowing a minimum of perforation. Thus assisting the healing process.

**in Packungen zu 12 Nadeln**  
**in packages of 12 needles**

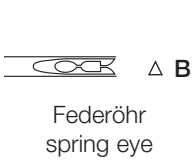

- 1: 180-010-001
- 2: 180-010-002
- 3: 180-010-003
- 4: 180-010-004
- 5: 180-010-005
- 6: 180-010-006
- 7: 180-010-007
- 8: 180-010-008
- 9: 180-010-009
- 10: 180-010-010
- 11: 180-010-011
- 12: 180-010-012
- 13: 180-010-013
- 14: 180-010-014
- 15: 180-010-015
- 16: 180-010-016

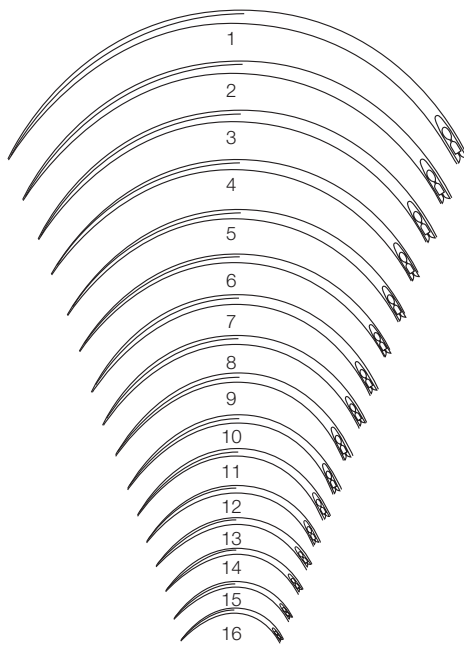

- 1: 180-012-001
- 2: 180-012-002
- 3: 180-012-003
- 4: 180-012-004
- 5: 180-012-005
- 6: 180-012-006
- 7: 180-012-007
- 8: 180-012-008
- 9: 180-012-009
- 10: 180-012-010
- 11: 180-012-011
- 12: 180-012-012
- 13: 180-012-013
- 14: 180-012-014
- 15: 180-012-015
- 16: 180-012-016

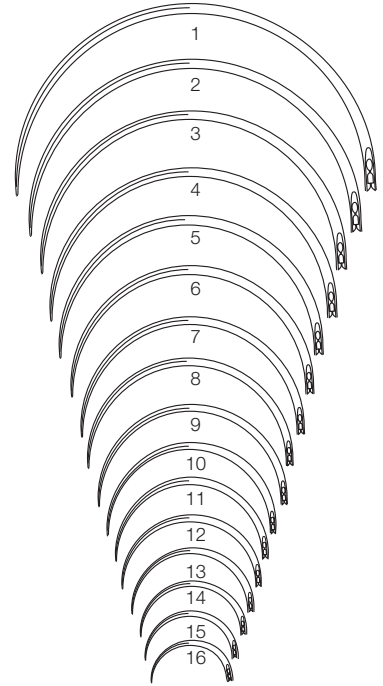

Die folgenden Nadeln sind alle für die Haut- und Muskelnaht bestimmt. Es handelt sich um schneidende oder Rundkörpernadeln.

The following suture needles are basically used for muscular and skin suture. They are either cutting or roundbody needles.

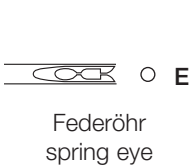

- 000: 180-018-030
- 00: 180-018-020
- 0: 180-018-010
- 1: 180-018-001
- 2: 180-018-002
- 3: 180-018-003
- 4: 180-018-004
- 5: 180-018-005
- 6: 180-018-006

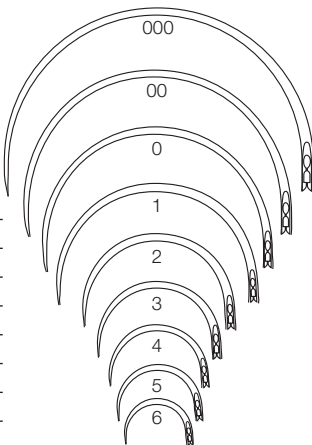

- 1: 180-020-001
- 2: 180-020-002
- 3: 180-020-003
- 4: 180-020-004
- 5: 180-020-005
- 6: 180-020-006

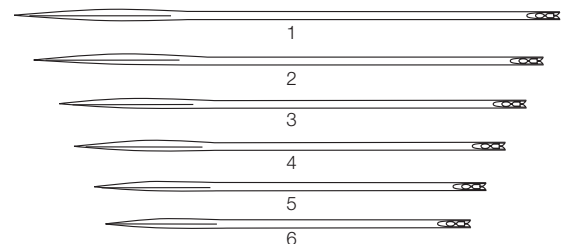



Die folgenden Nadeln sind für die Gefäß- und Augennaht bestimmt. Es handelt sich um Rundkörperradeln oder Rundkörperradeln mit Trokarspitze.

The following suture needles are basically used for vein and eye suture. They are either roundbody or roundbody needles with trocar tip.

 **△ Ob**

Federöhr  
spring eye

- 0: **180-030-010**
- 1: **180-030-001**
- 2: **180-030-002**
- 3: **180-030-003**
- 4: **180-030-004**
- 5: **180-030-005**

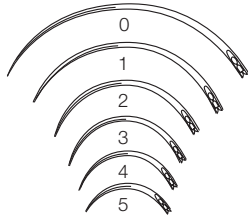

 **△ Og**

Federöhr  
spring eye

- 0: **180-032-010**
- 1: **180-032-001**
- 2: **180-032-002**
- 3: **180-032-003**
- 4: **180-032-004**
- 5: **180-032-005**

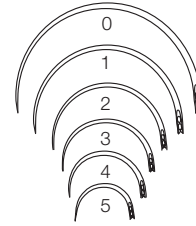

 **○ Kalt**

geschlossenes Öhr  
plain eye

- 00: **180-036-020**
- 0: **180-036-010**
- 1: **180-036-001**
- 2: **180-036-002**
- 3: **180-036-003**

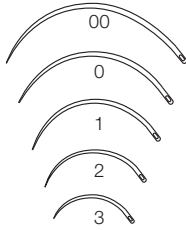

 **○ Payr**

geschlossenes Öhr  
plain eye

- 00: **180-040-020**
- 0: **180-040-010**
- 1: **180-040-001**
- 2: **180-040-002**
- 3: **180-040-003**

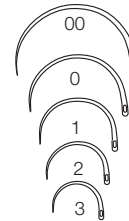

Die Nadeln Fig. Pb, Pc sind speziell für die Darmnaht bestimmt. Es handelt sich hierbei um Rundkörperradeln.

The needles Fig. Pb, Pc are specially designed for intestinal suture. They are always roundbody needles.

 **○ Pb**

Federöhr  
spring eye

- 00: **180-024-020**
- 0: **180-024-010**
- 1: **180-024-001**
- 2: **180-024-002**
- 3: **180-024-003**
- 4: **180-024-004**
- 5: **180-024-005**

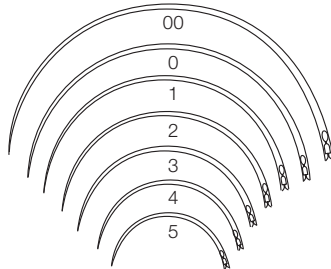

 **○ Pc**

Federöhr  
spring eye

- 00: **180-022-020**
- 0: **180-022-010**
- 1: **180-022-001**
- 2: **180-022-002**
- 3: **180-022-003**
- 4: **180-022-004**
- 5: **180-022-005**
- 6: **180-022-006**
- 7: **180-022-007**
- 8: **180-022-008**

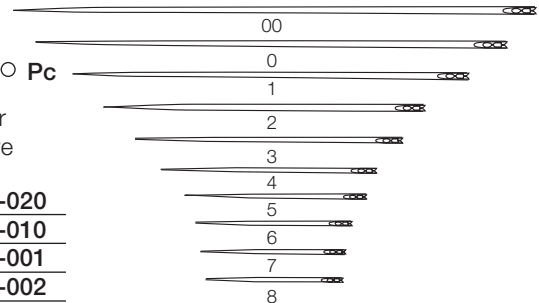

Weitere Nadelmodelle, sowie Mikro Nahtmaterial sind auf Anfrage erhältlich. Alle Nadeln können auch steril geliefert werden.

Further needle patterns and mikro suture material are available on request. All suture needles can be delivered also steril.



10



400-352-100



400-353-100

**Barraquer-Troutman**  
10.0 cm, 4"



11.0 cm, 4<sup>3</sup>/<sub>8</sub>"  
400-345-110



13.0 cm, 5"  
400-348-135

**Barraquer**

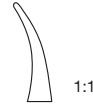

**Barraquer**  
13.5 cm, 5 <sup>3</sup>/<sub>8</sub>"  
400-350-135

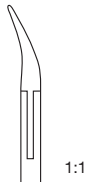

**Gomel**  
14.0cm, 5 1/2"  
250-064-140



250-064-244



250-064-245

ohne Sperre, without catch  
18.5 cm, 7 1/4"



250-064-246



250-064-247

mit Sperre, with catch  
18.5 cm, 7 1/4"

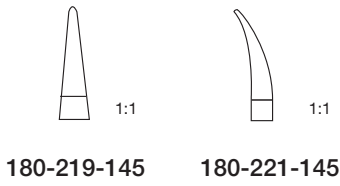

180-219-145

180-221-145

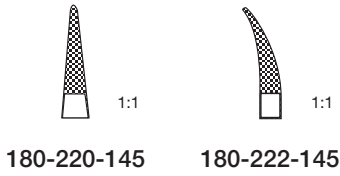

180-220-145

180-222-145

**Castroviejo**  
mit Sperre, with catch  
14.5 cm, 5 3/4"

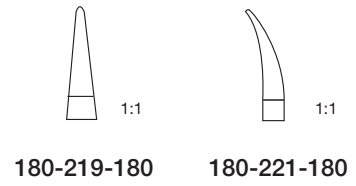

180-219-180

180-221-180

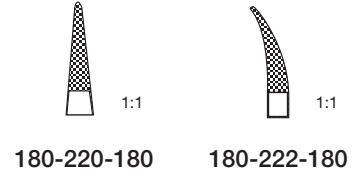

180-220-180

180-222-180

**Castroviejo**  
mit Sperre, with catch  
18.0 cm, 7"

Spezielle Nadelhalter für Mikro- und Gefäßchirurgie  
Special needle holders for micro- and vessel surgery



Flachgriff, flat handle 8 mm  
14.0 cm, 5 1/2"  
Spitze, tip 0.4 mm



Rundgriff, round handle 10 mm  
13.0 cm, 5"  
Spitze, tip 0.5 mm



Rundgriff, round handle 8 mm  
13.0 cm, 5"  
Spitze, tip 0.4 mm

gerade, ohne Sperre  
straight, without catch  
**250-064-149**

gebogen, ohne Sperre  
curved, without catch  
**250-064-150**

gebogen, mit Sperre  
curved, with catch  
**250-064-151**

**250-064-146**

**250-064-145**

**250-064-148**

**250-064-147**

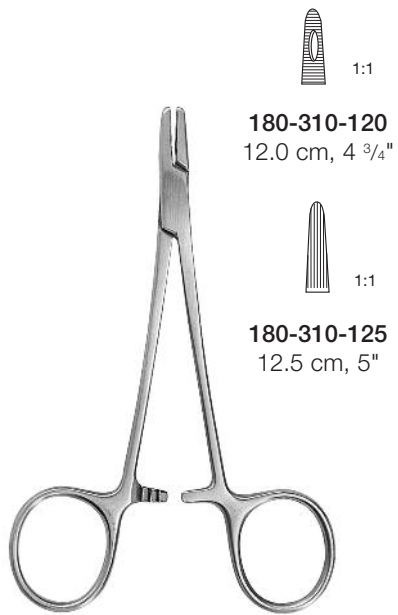

Derf



Collier  
12.5 cm, 5"  
180-314-125

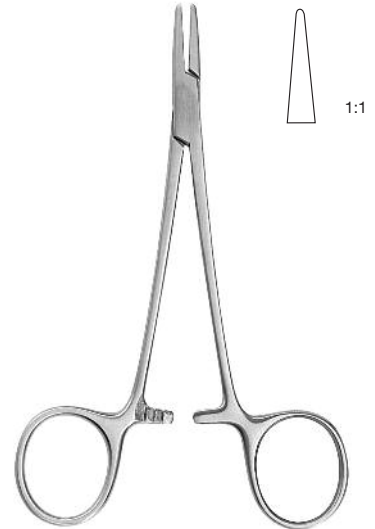

Webster  
13.0 cm, 5"  
180-318-130

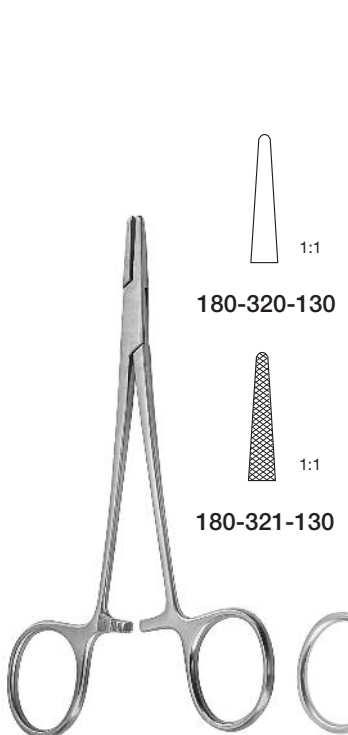

Halsey  
13.0 cm, 5"

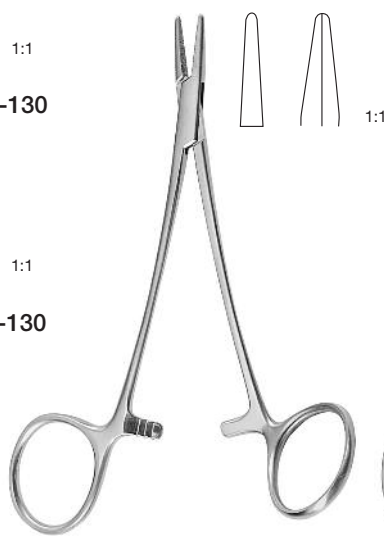

Neivert  
13.0 cm, 5"  
180-322-130



Hegar-Baumgartner  
14.0 cm, 5 1/2"  
180-324-140

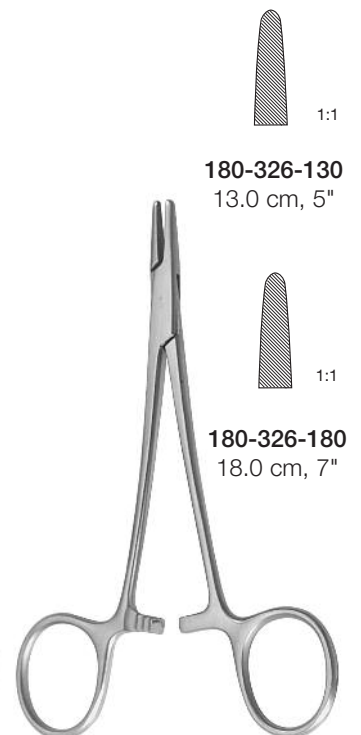

Brown

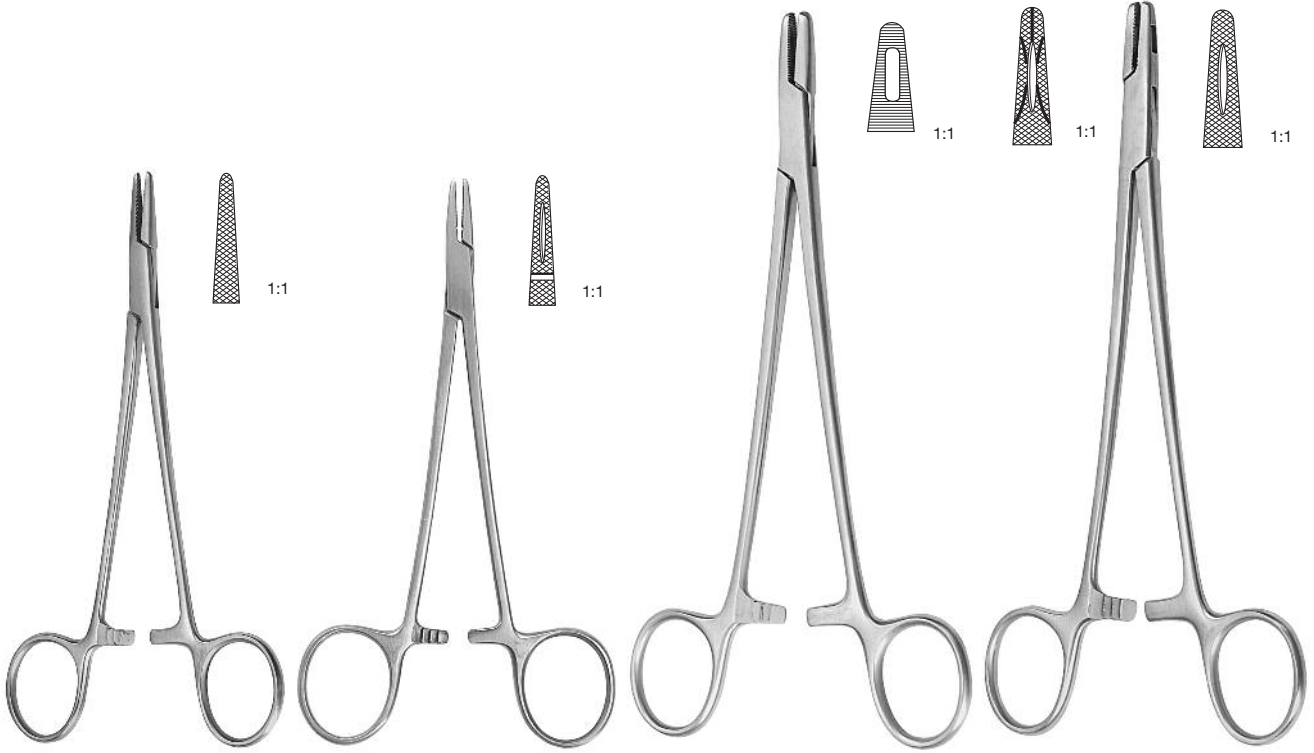

**Crile-Murray**  
15.0 cm, 6"  
180-330-150

**Crile-Wood**  
15.0 cm, 6"  
180-332-150  
18.0 cm, 7"  
180-332-180

**Adson**  
18.0 cm, 7"  
180-334-180

**Metzenbaum**  
18.0 cm, 7"  
180-336-180

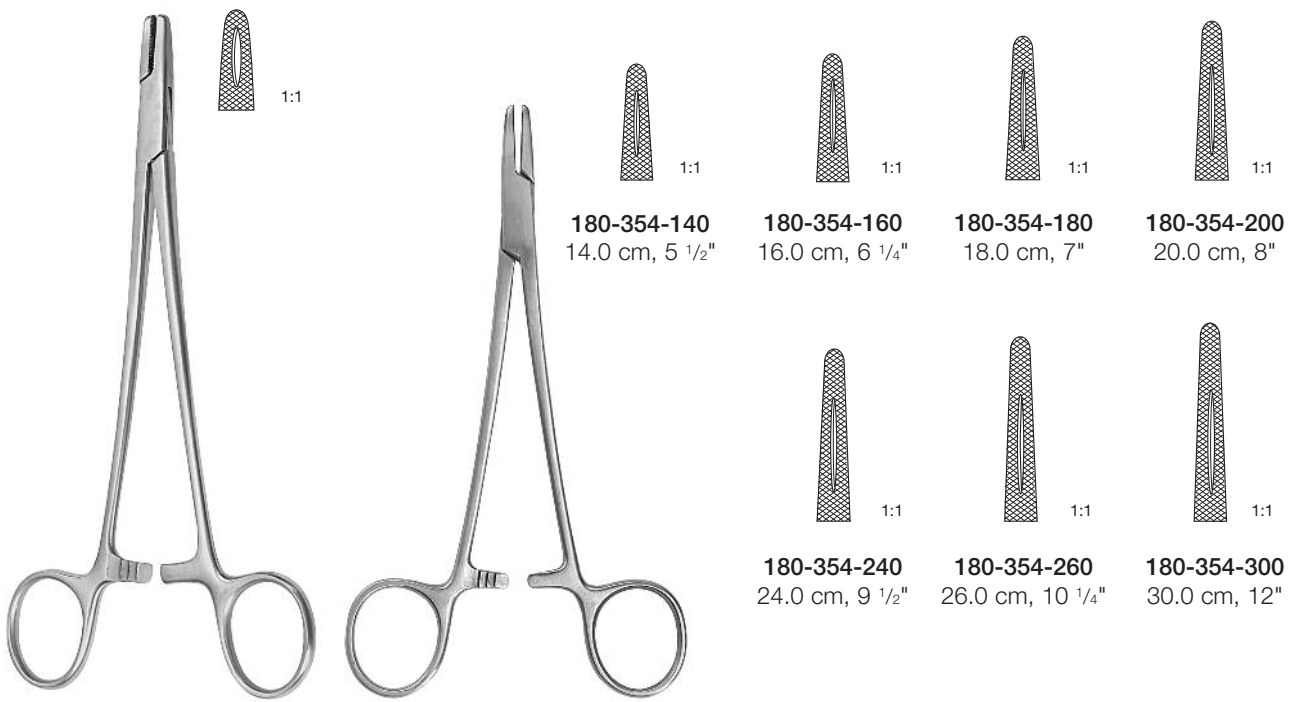

**M.G.H.**  
**Mass.-General-Hospital**  
17.0 cm, 6 3/4"  
180-330-170

**Mayo-Hegar**

**180-354-140**  
14.0 cm, 5 1/2"

**180-354-160**  
16.0 cm, 6 1/4"

**180-354-180**  
18.0 cm, 7"

**180-354-200**  
20.0 cm, 8"

**180-354-240**  
24.0 cm, 9 1/2"

**180-354-260**  
26.0 cm, 10 1/4"

**180-354-300**  
30.0 cm, 12"





10



**Mayo-Hegar**  
Schlankes Modell  
delicate pattern

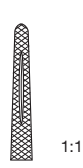

**180-356-160**  
16.0 cm, 6 1/4"

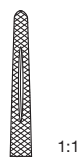

**180-356-180**  
18.0 cm, 7"

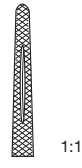

**180-356-200**  
20.0 cm, 8"



**Lawrence**  
15.0 cm, 6"  
**180-381-150**



**Heaney**  
21.0 cm, 8 1/4"  
**180-361-210**

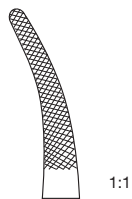

**Jamison**  
23.5 cm, 9 1/4"  
**180-362-235**

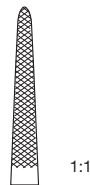

**Masson**  
27.0 cm, 10 1/2"  
**180-364-270**

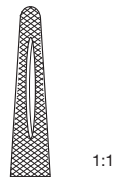



**Finocchietto**  
27.0 cm, 10 5/8"  
180-367-270



**Wangensteen**  
27.0 cm, 10 5/8"  
180-370-270

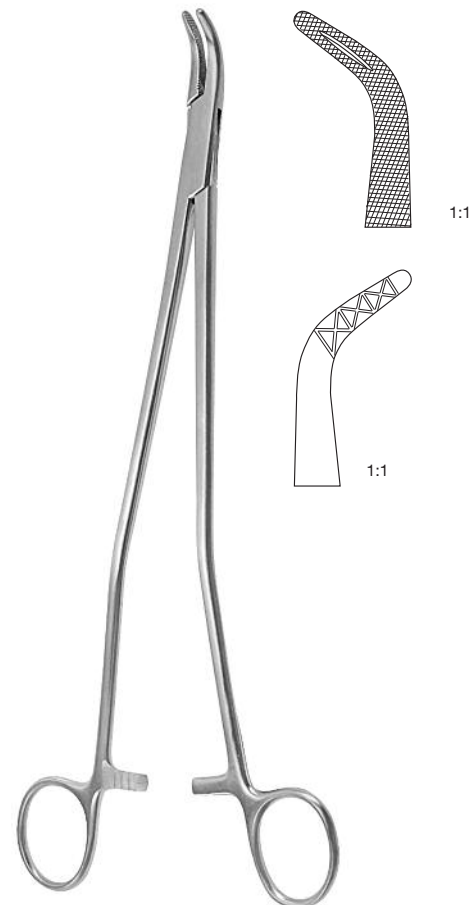

**Johnson**  
27.0 cm, 10 5/8"  
180-374-270



10

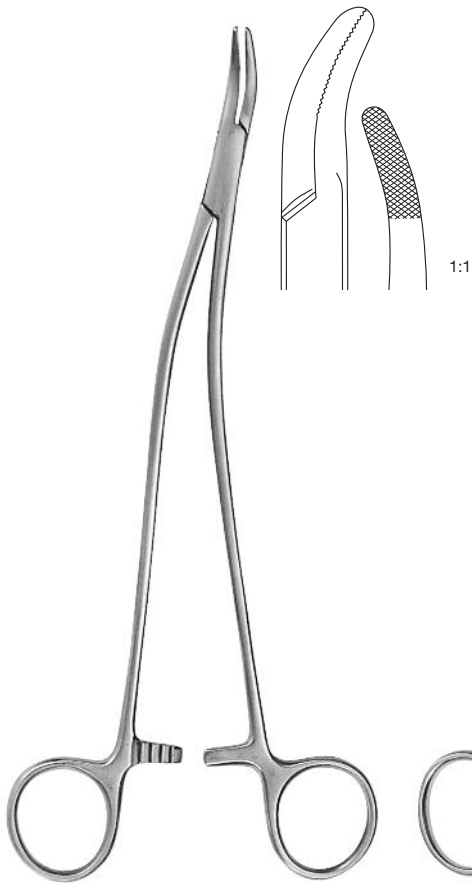

**Stratte**  
23.0 cm, 9"  
180-377-230

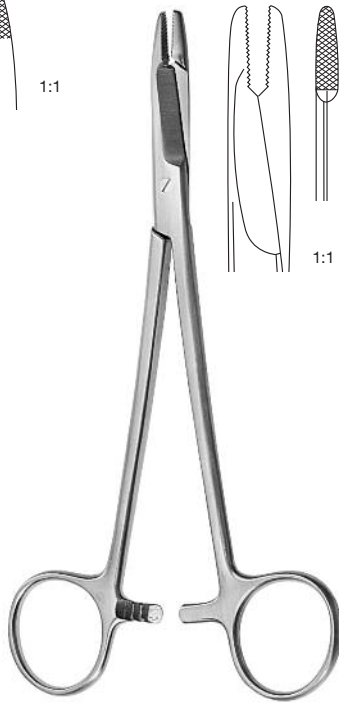

**Olsen-Hegar**  
17.0 cm, 6 3/4"  
180-382-170

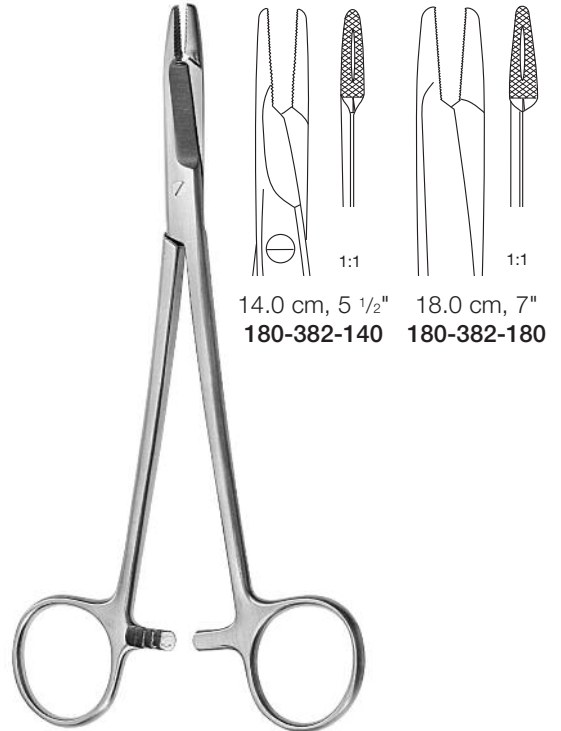

**Olsen-Hegar**

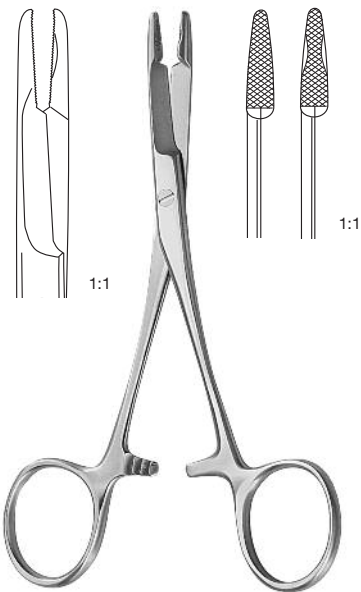

**Olsen-Hegar**  
14.0 cm, 5 1/2"  
180-384-140



**Gillies**  
16.0 cm, 6 1/4"  
180-389-160



**Toennis**  
18.0 cm, 7"  
180-440-180



Mathieu

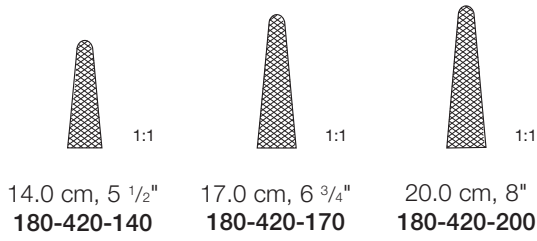

Mathieu  
schlanke Maul  
delicate jaw



Mathieu



Mathieu-Kocher

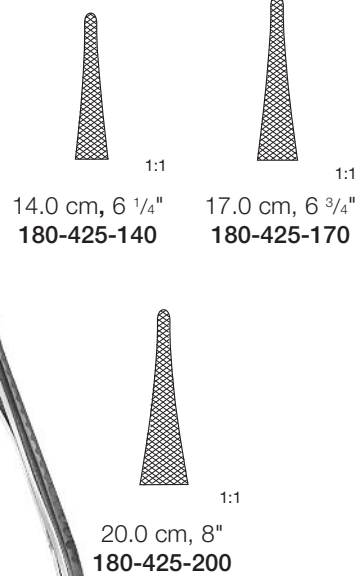

Lichtenberg  
20.0 cm, 8"  
180-450-200



**Naht**  
**Nadelhalter mit Hartmetalleinlagen**

**Suture**  
**Needle Holder**  
**with Tungsten Carbide Inserts**

10

Je nach Anwendungsgebiet werden unsere TC-Nadelhalter mit den jeweils passenden TC-Einsätzen versehen.

Depending on their usage, our TC-needle holders are equipped with the most suitable TC-inserts.

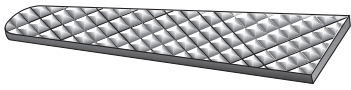

**Normal** 0.5 mm  
für Nadeln und Nahtmaterial bis Stärke 4-0

**Regular** 0.5 mm  
for use with sutures up to size 4-0

**R**

massive Hartmetalleinlagen aus diamantharter Chrom-Wolfram-Legierung garantieren langwährenden sicheren Halt der Nadel.

micro-bonded inserts of solid Tungsten Carbide for longlasting secure hold of suture needle

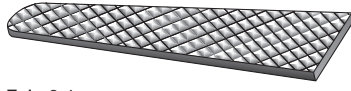

**Fein** 0.4 mm  
für feine Nadeln und Nahtmaterial Stärke 5-0 und 6-0

**Fine** 0.4 mm  
for delicate needles and sutures sizes 5-0 and 6-0

**F**

durchgehend vacuum-gehärtet für gleichbleibende Elastizität und Stabilität

vacuum-hardened throughout for consistent flexibility and alignment



**Extra-Fein** 0.3 mm  
für Mikro-Nadeln und Nahtmaterial bis Stärke 10-0

**Extra-Fine** 0.3 mm  
for use with micro-needles and sutures up to size 10-0

**EF**



**Glatt**  
für feine Nadeln und Nahtmaterial Stärke 7-0 bis 10-0

**Smooth**  
for delicate needles and suture sizes 7-0 thru 10-0

**S**

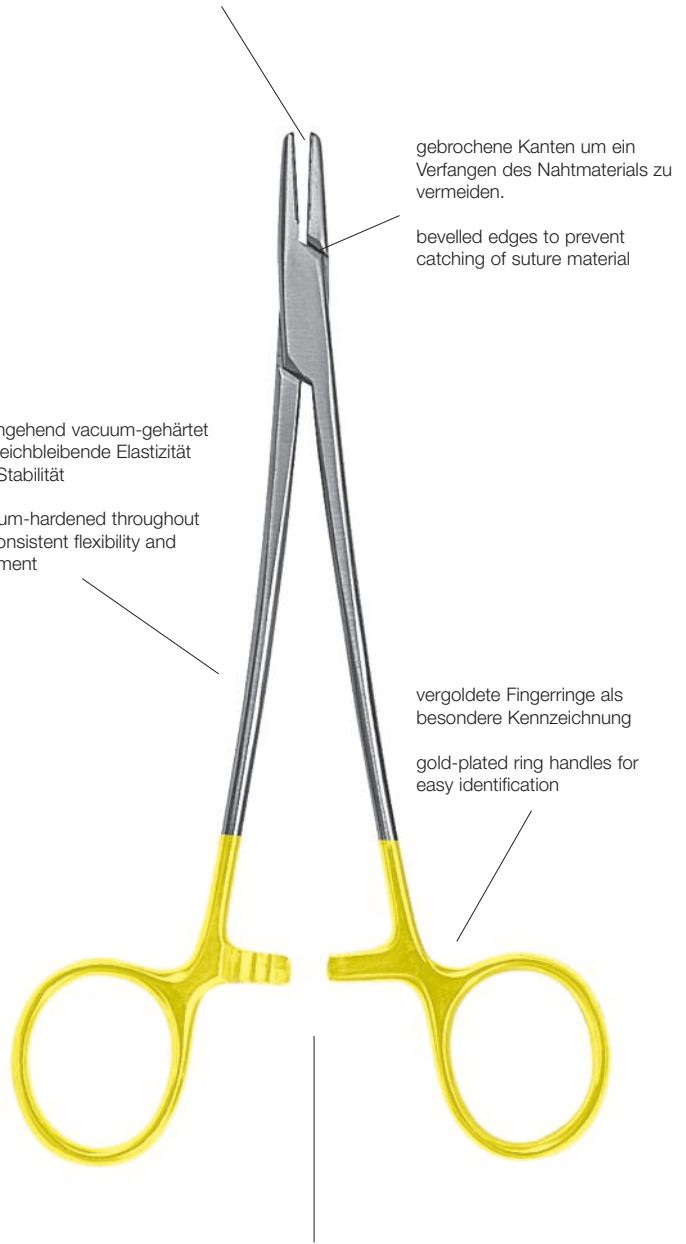

gebrochene Kanten um ein Verfangen des Nahtmaterials zu vermeiden.

bevelled edges to prevent catching of suture material

vergoldete Fingerringe als besondere Kennzeichnung

gold-plated ring handles for easy identification

Präzisionsperre für sicheres Öffnen und Schließen

precision-cut ratchet for safe opening and closing

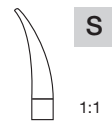
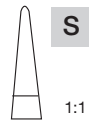

**180-519-145**

**180-521-145**

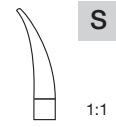
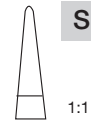

**180-519-180**

**180-521-180**

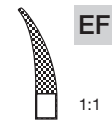
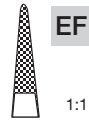

**180-520-145**

**180-522-145**

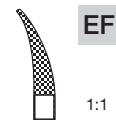

**180-520-180**

**180-522-180**

**Castroviejo**  
mit Sperre, with catch  
14.5 cm, 5 3/4"

**Castroviejo**  
mit Sperre, with catch  
18.0 cm, 7"

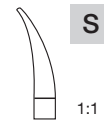
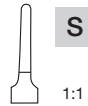
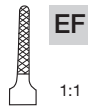

**180-510-145**

**180-511-145**



**180-512-145**

**180-513-145**



- Diethrich**
- 16.0 cm, 6 1/2" **180-530-160**
  - 18.0 cm, 7" **180-530-180**
  - 20.0 cm, 8" **180-530-200**
  - 23.0 cm, 9" **180-530-230**
  - 26.0 cm, 10 1/4" **180-530-260**

- Kalt**
- 13.5 cm, 5 3/8" **180-524-135**

- Hepp Scheidel**
- 18.0 cm, 7" **180-512-180**

- Barraquer**
- 14.5 cm, 5 3/4"



**10**

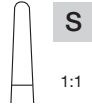

**Webster**  
13.0 cm, 5"  
**180-570-130**

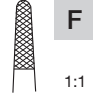

**Derf**  
12.0 cm, 4 3/4"  
**180-532-120**

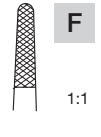

12.5 cm, 5"  
**180-534-125**

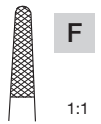

14.0 cm, 5 1/2"  
**180-534-140**



**180-536-130**

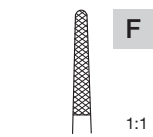

**180-537-130**

**Halsey**  
13.0 cm, 5"

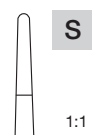

**Webster**  
13.0 cm, 5"  
**180-538-130**

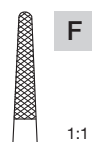



**Crile-Wood**  
15.0 cm, 6"  
**180-540-150**  
18.0 cm, 7"  
**180-540-180**



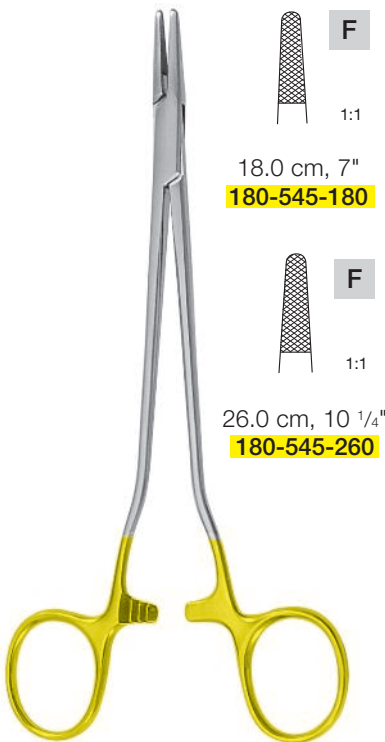





**10**

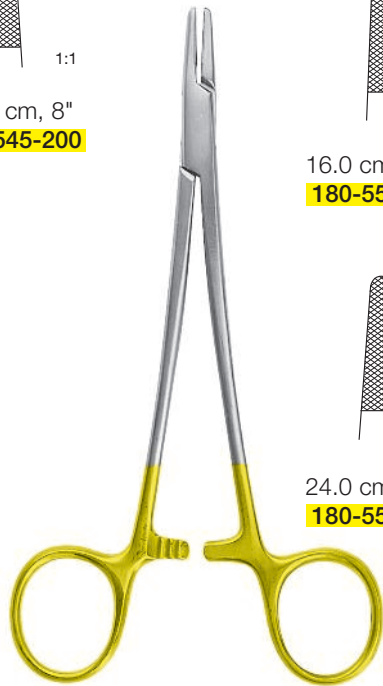

- |   |   |
|---|---|
|  <b>F</b><br>1:1 |  <b>F</b><br>1:1 |
| 18.0 cm, 7"<br><b>180-545-180</b>   | 20.0 cm, 8"<br><b>180-545-200</b>   |
|  <b>F</b><br>1:1 |   |
| 26.0 cm, 10 1/4"<br><b>180-545-260</b>  |   |

Sarot



- |  |   |   |
|--|---|---|
|  <b>R</b><br>1:1 |  <b>R</b><br>1:1 |  <b>R</b><br>1:1 |
| 16.0 cm, 6 1/4"<br><b>180-550-160</b>  | 18.0 cm, 7"<br><b>180-550-180</b>   | 20.0 cm, 8"<br><b>180-550-200</b>   |
|  <b>R</b><br>1:1 |  <b>R</b><br>1:1 |  <b>R</b><br>1:1 |
| 24.0 cm, 9 1/2"<br><b>180-550-240</b>  | 26.0 cm, 10 1/4"<br><b>180-550-260</b>  | 30.0 cm, 12"<br><b>180-550-300</b>  |



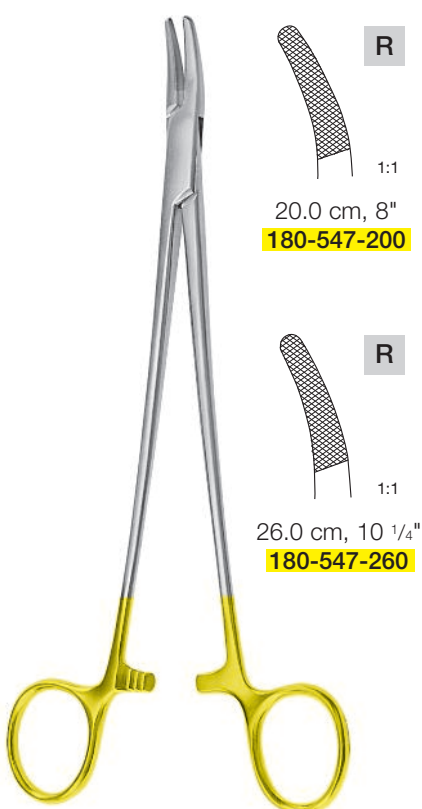

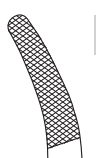
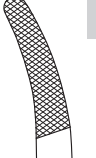
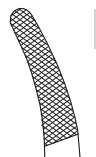
Mayo-Hegar

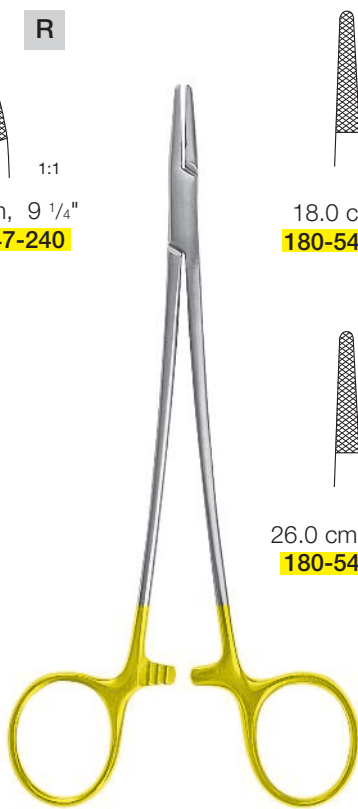

- |   |   |
|---|---|
|  <b>R</b><br>1:1 |  <b>R</b><br>1:1 |
| 20.0 cm, 8"<br><b>180-547-200</b>   | 24.0 cm, 9 1/4"<br><b>180-547-240</b>   |
|  <b>R</b><br>1:1 |   |
| 26.0 cm, 10 1/4"<br><b>180-547-260</b>  |   |

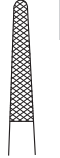
Mayo-Hegar (Heaney)

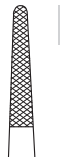

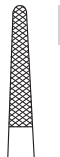
- |  |   |   |
|--|---|---|
|  <b>F</b><br>1:1 |  <b>F</b><br>1:1 |  <b>F</b><br>1:1 |
| 18.0 cm, 7"<br><b>180-548-180</b>  | 20.0 cm, 8"<br><b>180-548-200</b>   | 23.0 cm, 9"<br><b>180-548-230</b>   |
|  <b>F</b><br>1:1 |  <b>F</b><br>1:1 |  <b>F</b><br>1:1 |
| 26.0 cm, 10 1/4"<br><b>180-548-260</b>   | 31.0 cm, 12 1/4"<br><b>180-548-310</b>  | 37.0 cm, 14 1/2"<br><b>180-548-370</b>  |

DeBakey





10



Ryder-Vascular



EF

1:1

13.0 cm, 5"

180-561-130



EF

1:1

15.0 cm, 6"

180-561-150

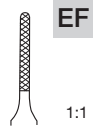

EF

1:1

18.0 cm, 7"

180-561-180

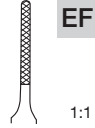

EF

1:1

20.0 cm, 8"

180-561-200

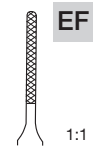

EF

1:1

23.0 cm, 9"

180-561-230

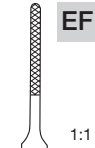

EF

1:1

26.0 cm, 10 1/4"

180-561-260

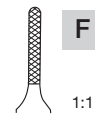

F

1:1

13.0 cm, 5"

180-560-130

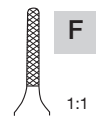

F

1:1

16.0 cm, 6"

180-560-160

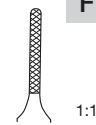

F

1:1

18.0 cm, 7"

180-560-180

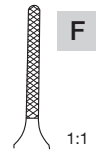

F

1:1

20.0 cm, 8"

180-560-200

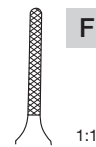

F

1:1

23.0 cm, 9"

180-560-230

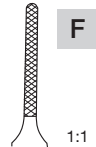

F

1:1

26.0 cm, 10 1/4"

180-560-260



Ryder

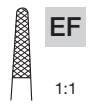

EF

1:1

15.0 cm, 6"

180-555-150

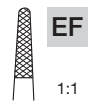

EF

1:1

17.0 cm, 6 3/4"

180-555-170

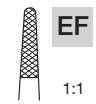

EF

1:1

20.0 cm, 8"

180-555-200

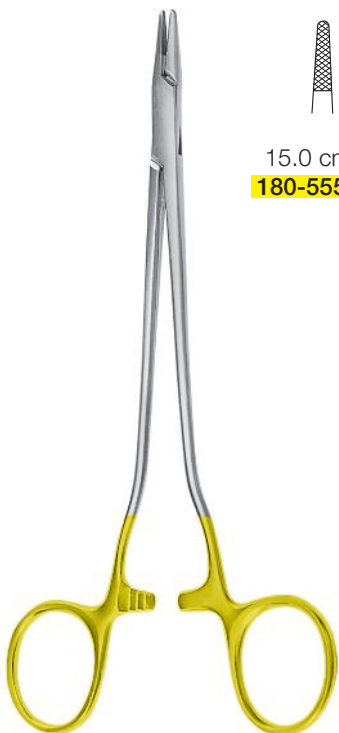

Schwedisches Modell



**Finocchio**  
27.0 cm, 10 5/8"  
**180-558-270**



**Wangenstein**  
27.0 cm, 10 5/8"  
**180-562-270**



**Masson**  
27.0 cm, 10 5/8"  
**180-556-270**



**Naht**  
Nadelhalter mit Hartmetalleinlagen

**Suture**  
Needle Holder  
with Tungsten Carbide Inserts



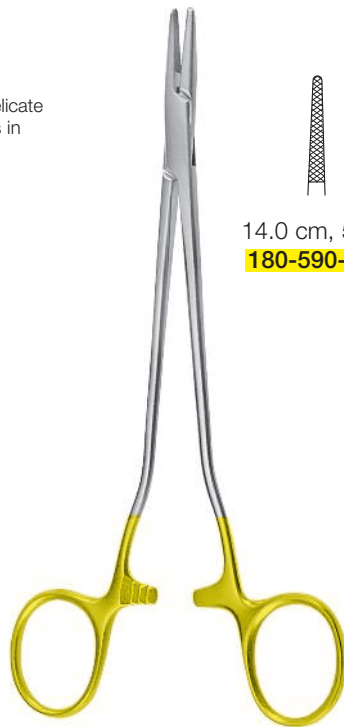

10

Diese Nadelhalter mit extra schlankem Maul sind auf die Anforderungen der Gefäßchirurgie abgestimmt.

These needle holders with extremely delicate jaws meet with the particular conditions in vascular surgery.

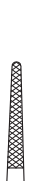

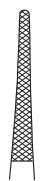

Hegar-Vascular

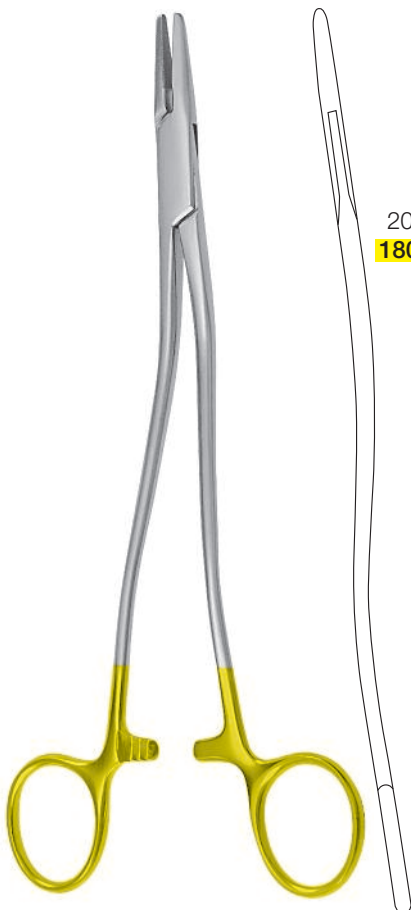
			
EF	EF	EF	EF
1:1	1:1	1:1	1:1
14.0 cm, 5 1/2"	18.0 cm, 7"	20.0 cm, 8"	23.0 cm, 9"
<b>180-590-140</b>	<b>180-590-180</b>	<b>180-590-200</b>	<b>180-590-230</b>



Bozemann



	
R	R
1:1	1:1
20.0 cm, 8"	24.0 cm, 9 5/8"
<b>180-571-200</b>	<b>180-571-240</b>

R
1:1
26.0 cm, 10 1/4"
<b>180-571-260</b>



Hegar

	
R	R
1:1	1:1
20.0 cm, 8"	24.0 cm, 9 1/2"
<b>180-572-200</b>	<b>180-572-240</b>



Berry Sternal

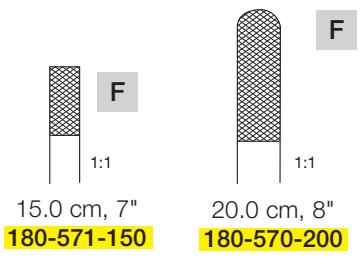

Stratte

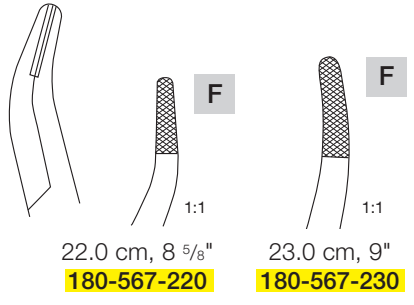

Olsen-Hegar

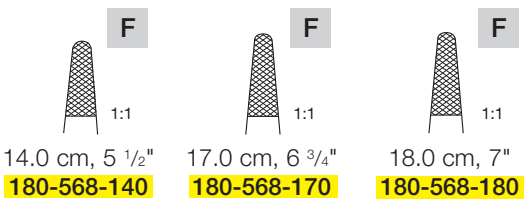

Gillies  
16.0 cm, 6 1/4"  
180-570-160

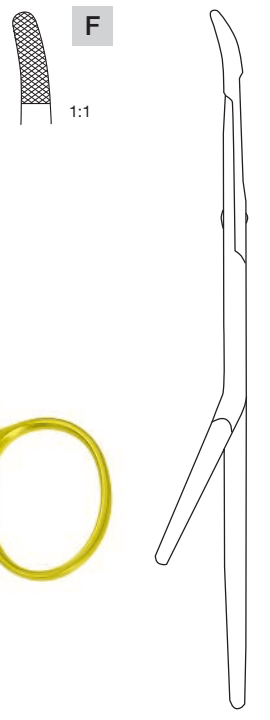



10



Mathieu-Kocher

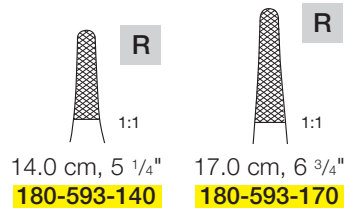

Mathieu

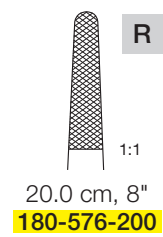
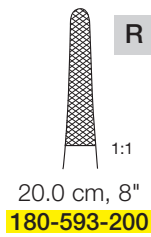
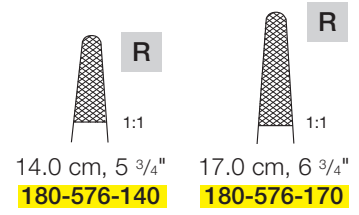

Mathieu

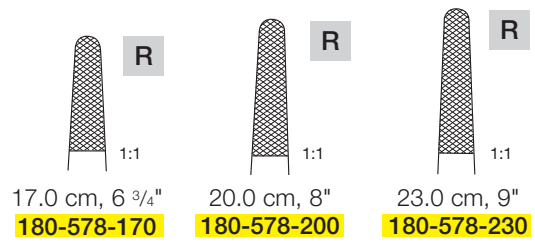

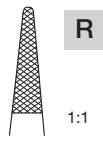

**Toennis**  
18.0 cm, 7"  
**180-580-180**

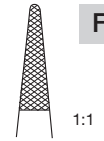

**Lichtenberg**  
17.0 cm, 6 3/4"  
**180-582-170**

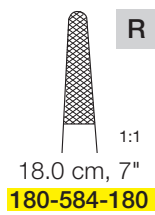

**Langenbeck**

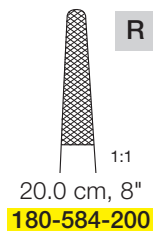

**180-584-200**

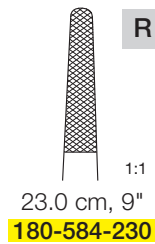

**180-584-230**

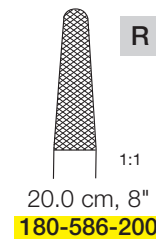

**180-586-200**

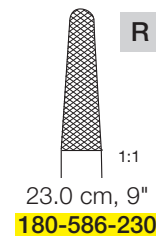

**180-586-230**

**Zweifel**



10



Reverdin  
14.0 cm, 5 1/2"

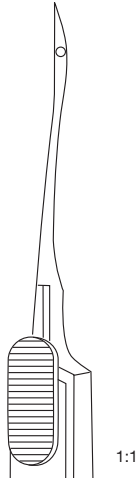

Fig. 1  
180-701-140

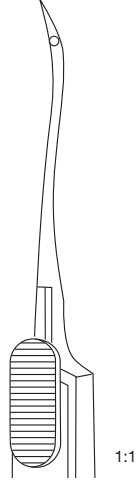

Fig. 2  
180-702-140

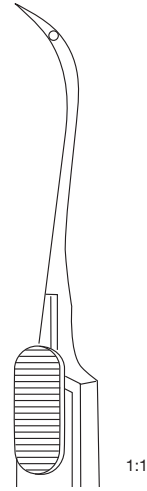

Fig. 3  
180-703-140

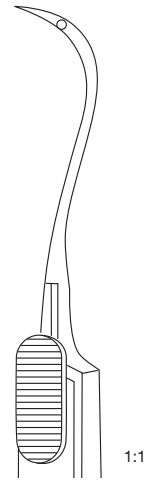

Fig. 4  
180-704-140



Reverdin  
19.5 cm, 7 3/4"  
22.5 cm, 8 3/4"

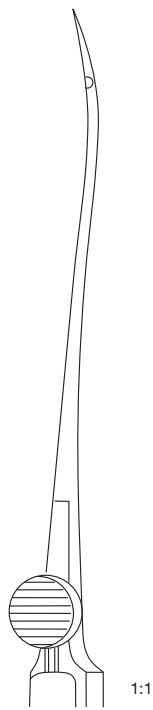

Fig. 1  
180-701-195  
180-701-225

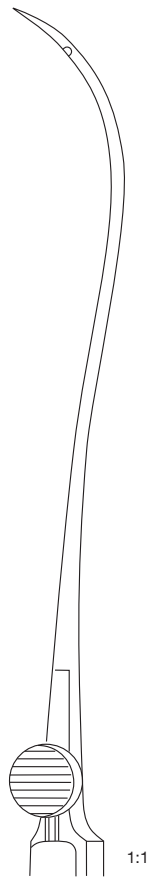

Fig. 2  
180-702-195  
180-702-225

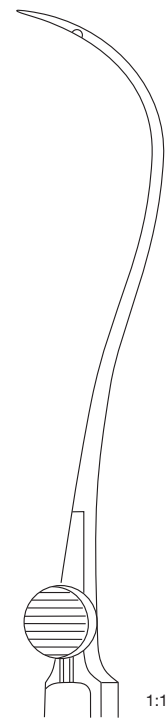

Fig. 3  
180-703-195  
180-703-225

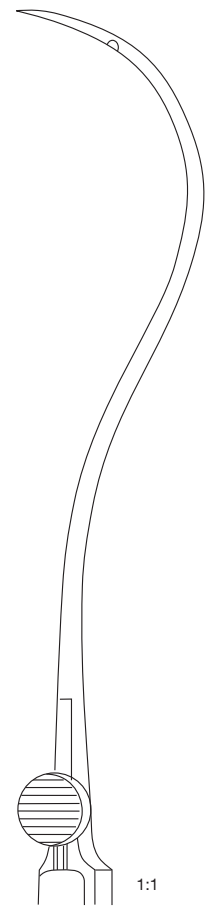
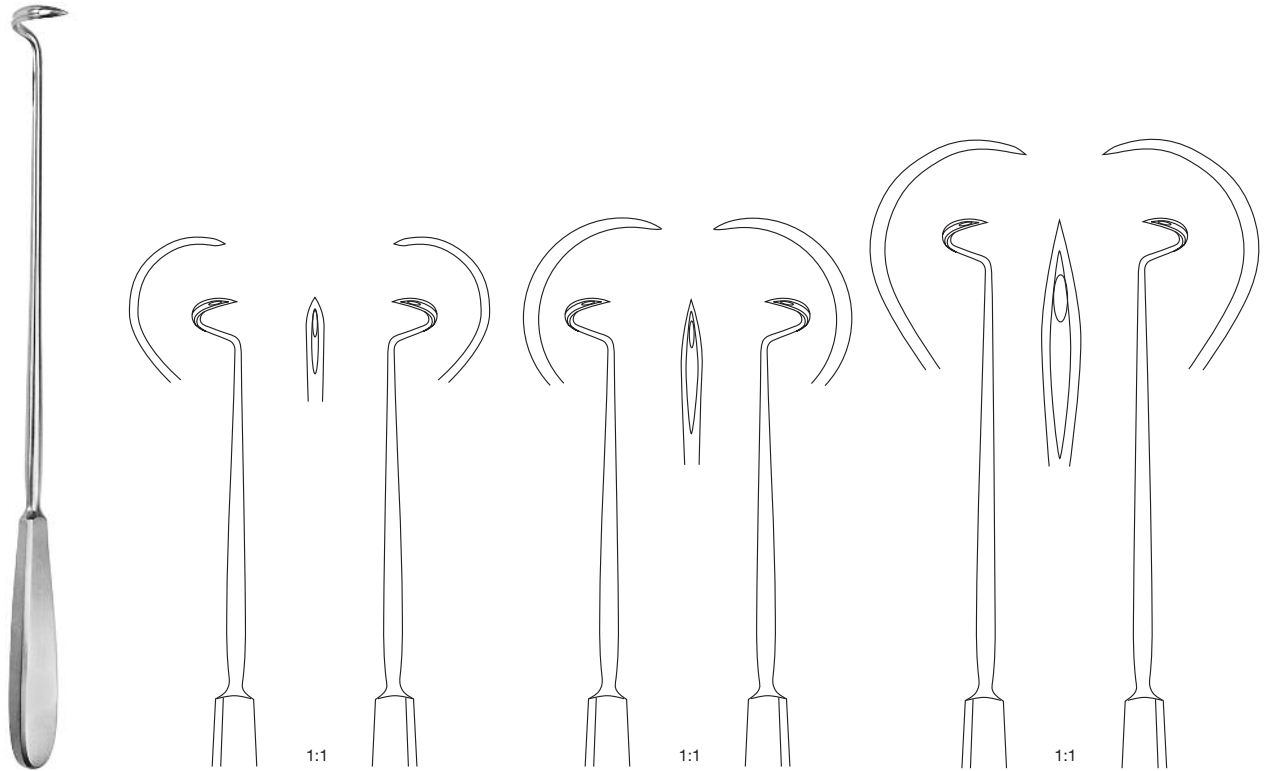
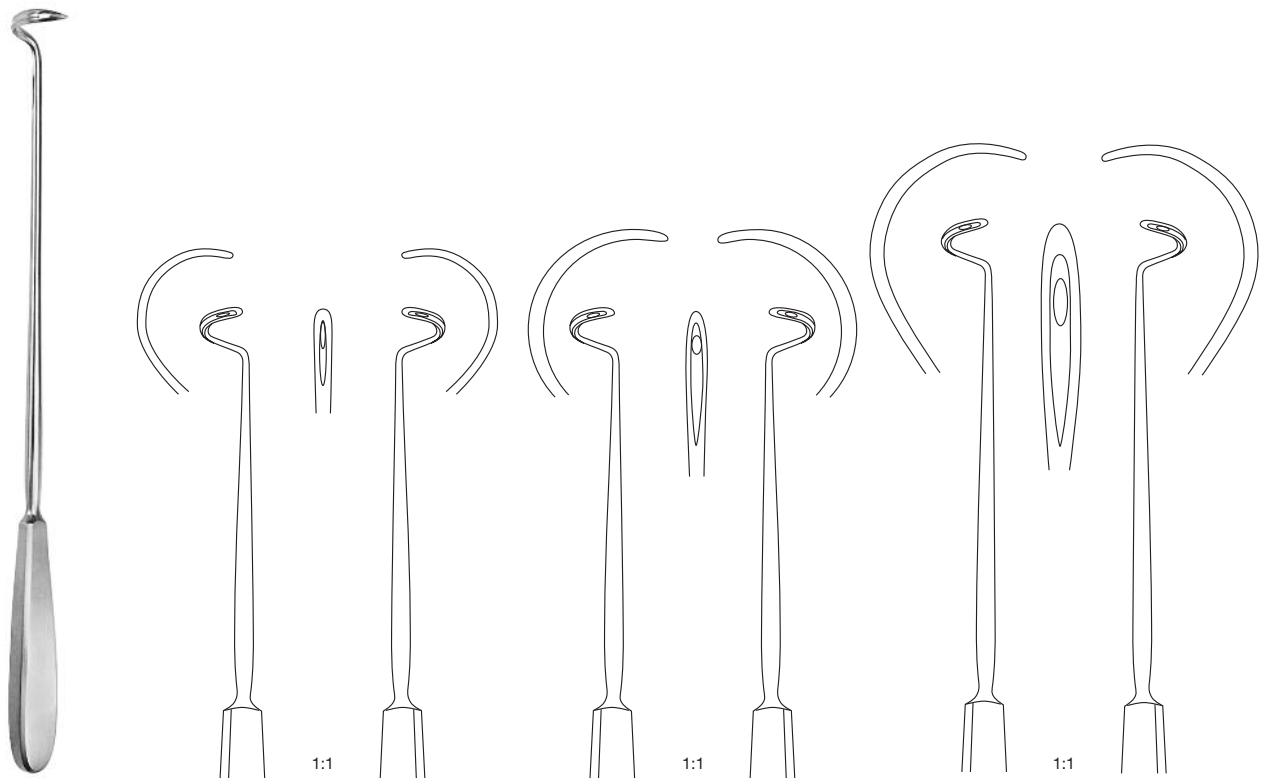

Fig. 4  
180-704-195  
180-704-225



Deschamps		scharf, sharp					
20.0 cm, 8"	180-736-200	180-737-200	180-724-200	180-728-200			
21.0 cm, 8 1/4"					180-728-210	180-729-210	
27.0 cm, 10 5/8"					180-732-270	180-733-270	



Deschamps		stumpf, blunt					
20.0 cm, 8"	180-738-200	180-739-200	180-722-200	180-723-200			
21.0 cm, 8 1/4"					180-726-210	180-727-210	
27.0 cm, 10 5/8"					180-730-270	180-731-270	





**10**

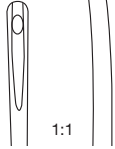
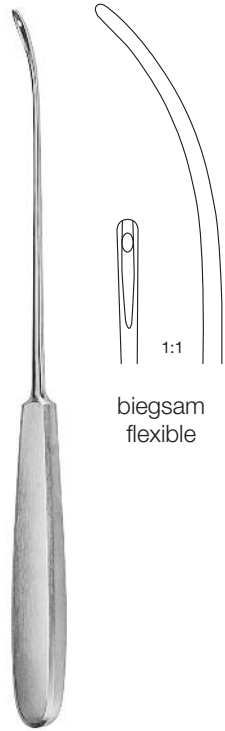

biegsam  
flexible

20.0 cm, 8"  
180-716-200

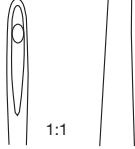
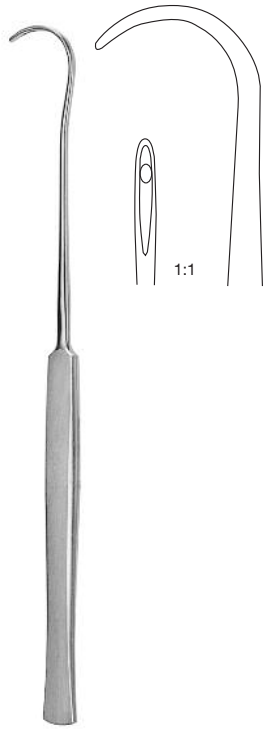

**Cooper**  
19.0 cm, 7 1/2"  
180-732-190

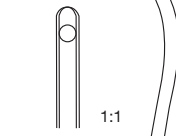

17.0cm, 6 3/4"  
180-725-170

**Syme**  
15.0 cm, 6"  
180-725-150

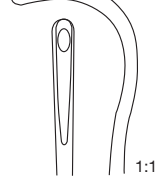

**Cooper**  
20.0 cm, 8"  
180-732-200

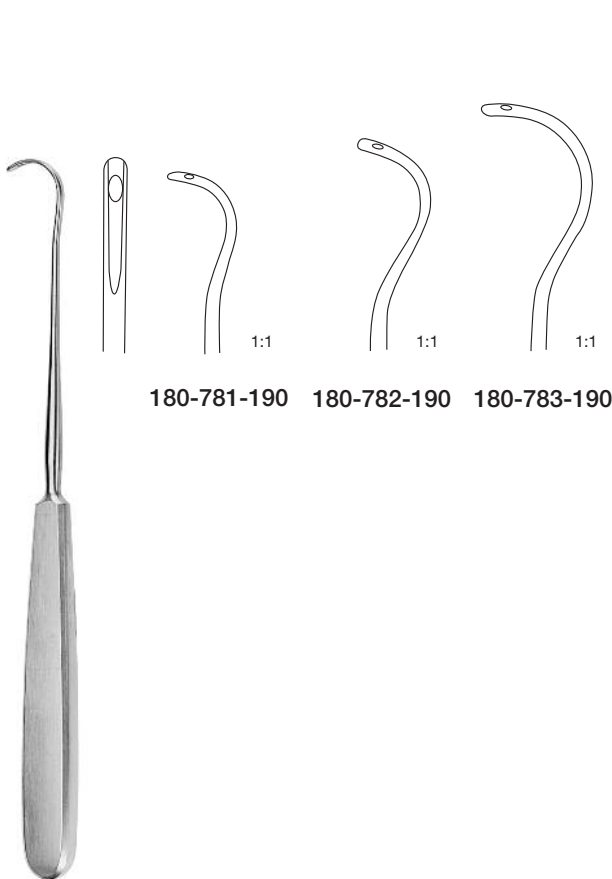

180-781-190 180-782-190 180-783-190

**Kocher**  
19.0 cm, 7 1/2"

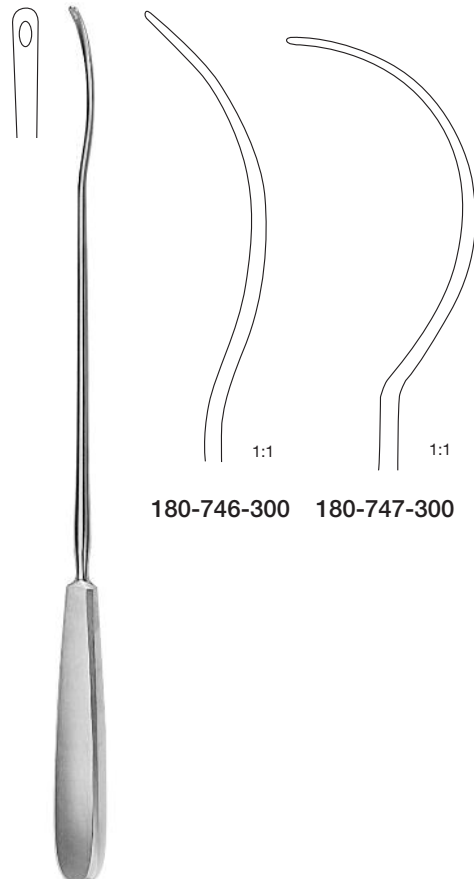

180-746-300 180-747-300

**Brunner**  
30.0 cm, 11 3/4"

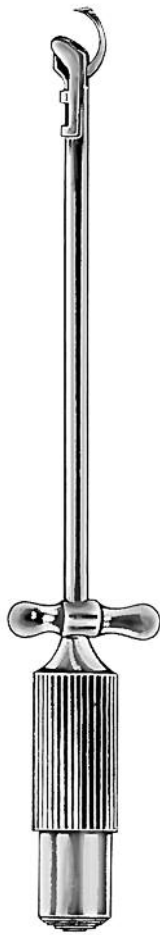

**Young-Hryntschak**  
mit 1 Nadel 180-706-001  
with 1 needle 180-706-001  
24.0 cm, 9 1/2"  
180-706-240

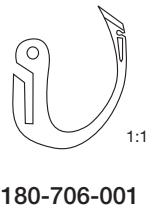

180-706-001

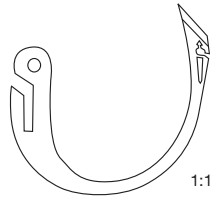

180-706-002

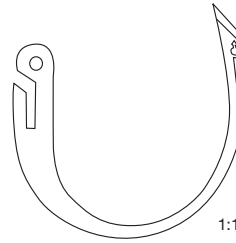

180-706-003



**Brunner**  
25.0 cm, 9 3/4"  
180-713-250



**Schmieden**  
21.0 cm, 8 1/4"  
180-712-210



**De La Roza**  
12.0 cm, 4 3/4"  
180-714-120



**De La Roza**  
12.0 cm, 4 3/4"  
180-715-120

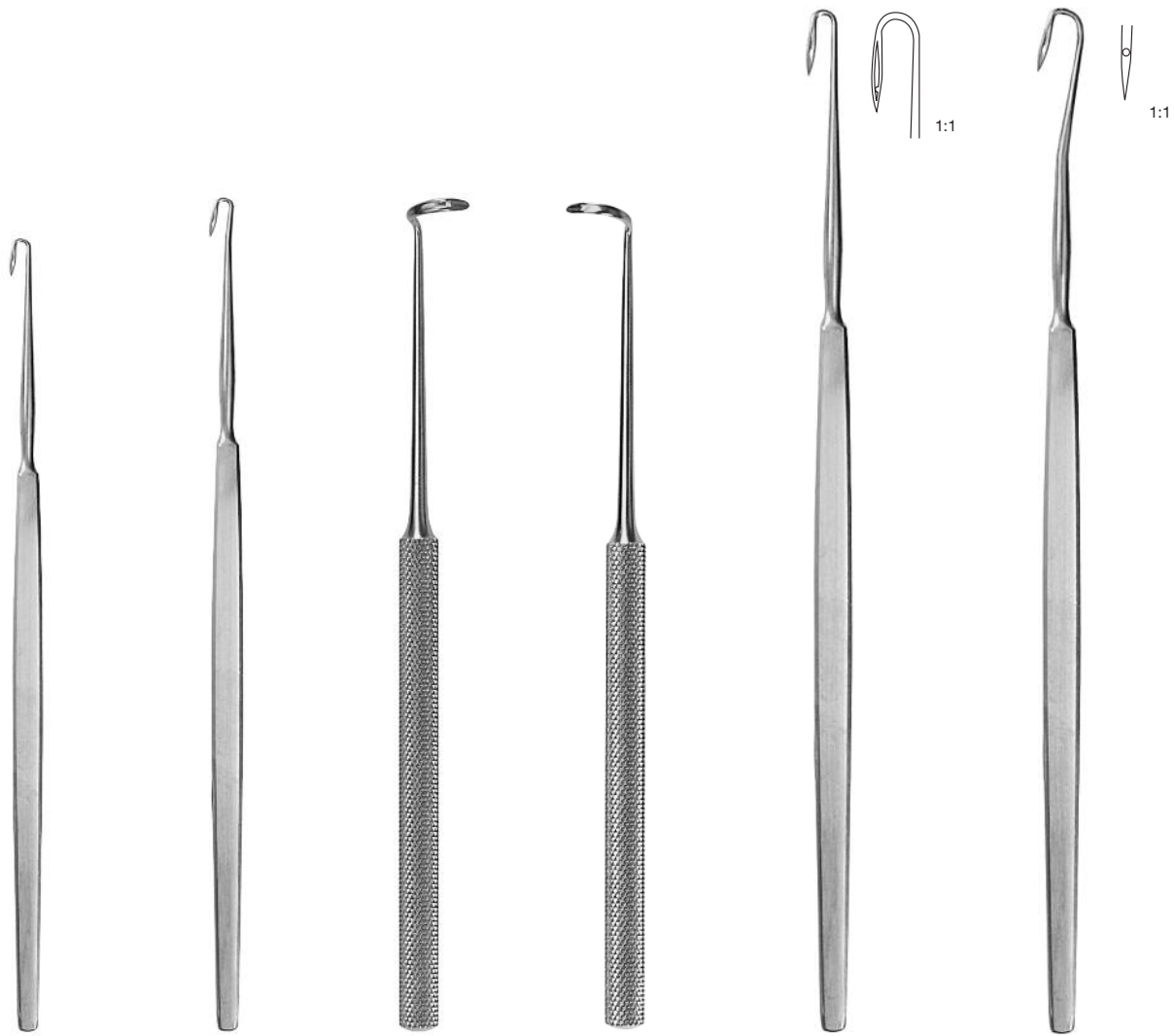

**Jakobi**  
14.0 cm, 5 1/2"  
180-708-140

**Hesseberg**  
15.0 cm, 6"  
180-707-150

**Kronecker**  
15.0 cm, 6"  
180-752-150

**Kronecker**  
15.0 cm, 6"  
180-751-150

**Trélat**  
23.0 cm, 9"  
180-717-230

**Claus**  
23.0 cm, 9"  
180-718-230

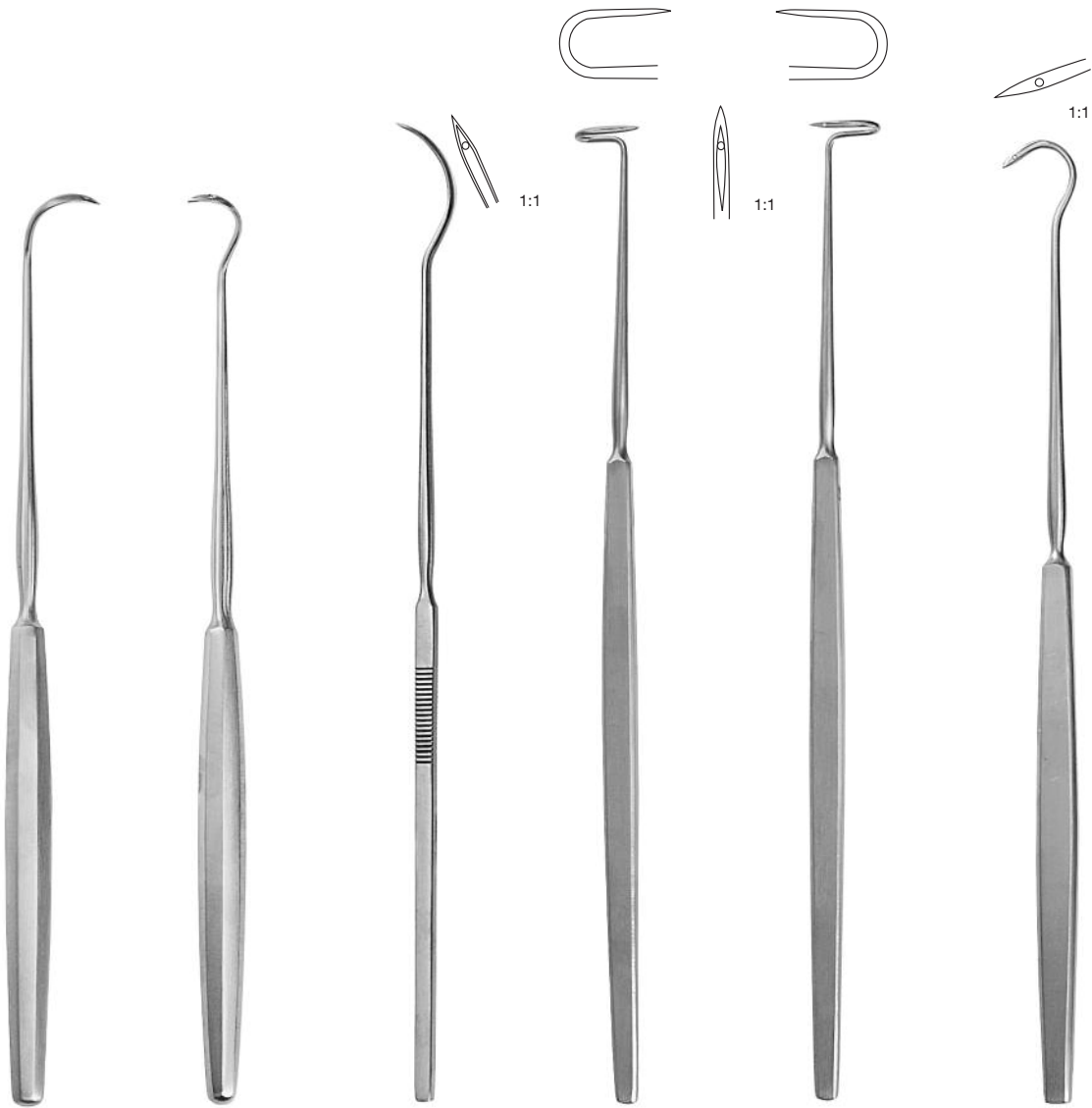

**Hurd**  
21.0 cm, 8 1/4"  
180-719-210

**Hurd**  
21.0 cm, 8 1/4"  
180-718-210

**Nager**  
24.0 cm, 9 1/2"  
180-711-240

**Falk**  
24.0 cm, 9 1/2"  
180-722-240

**Falk**  
24.0 cm, 9 1/2"  
180-723-240

**Claus-Eicken**  
23.0 cm, 9"  
180-720-230



10

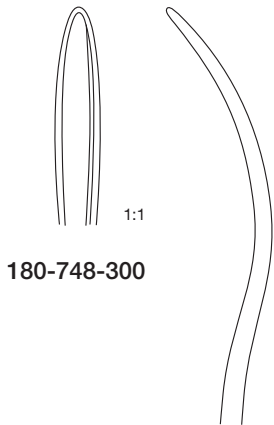

180-748-300

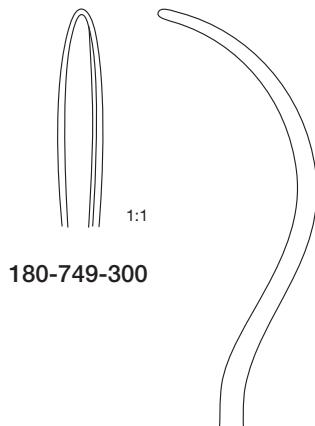

180-749-300

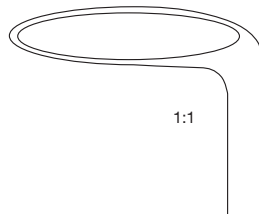

180-745-300



180-744-300

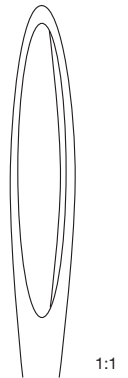

Brunner  
25.0 cm, 9 3/4"  
180-743-250



**Payr**  
22.0 cm, 8 5/8"  
180-776-220



**Payr**  
22.0 cm, 8 5/8"  
180-777-220

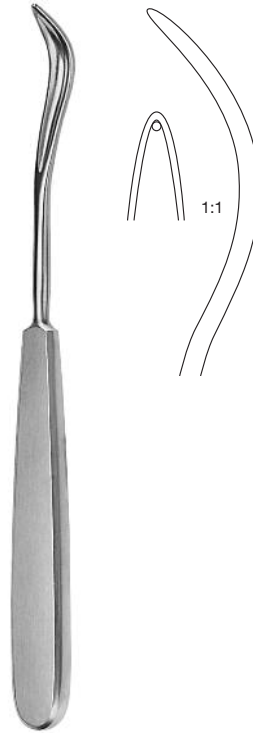

**Schmieden-Payr**  
19.0 cm, 7 1/2"  
180-720-190

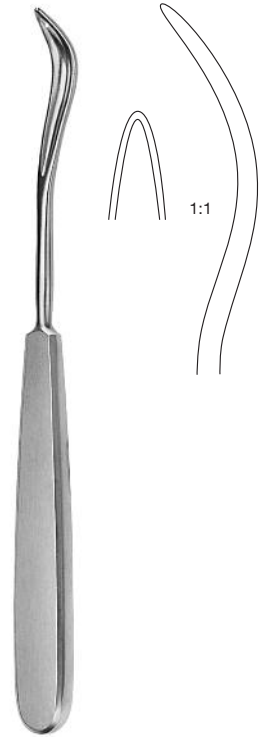

**Schmieden**  
19.0 cm, 7 1/2"  
180-770-190

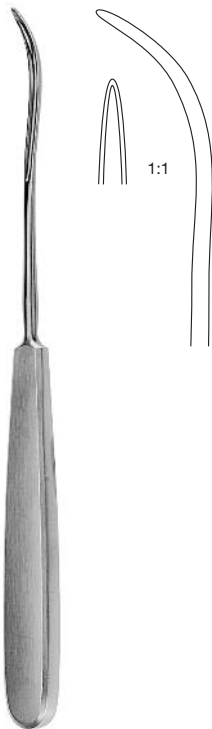

**König**  
19.5 cm, 7 3/4"  
180-774-195

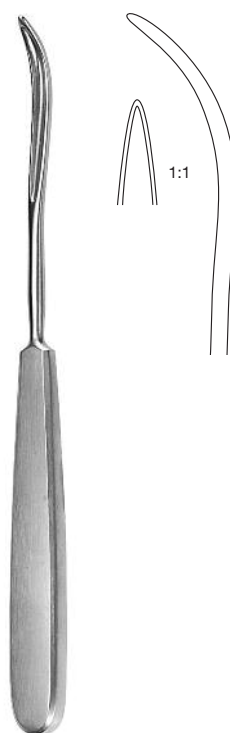

**König**  
19.5 cm, 7 3/4"  
180-775-195

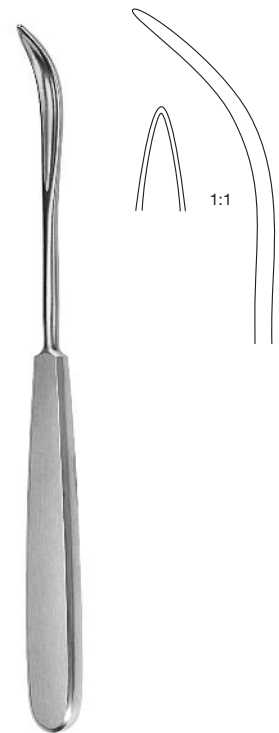

**König**  
19.5 cm, 7 3/4"  
180-776-195



10

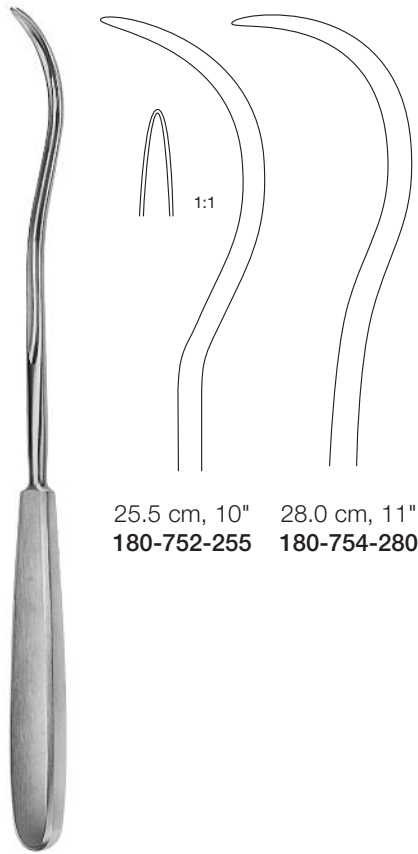

25.5 cm, 10"  
180-752-255

28.0 cm, 11"  
180-754-280

Kirschner

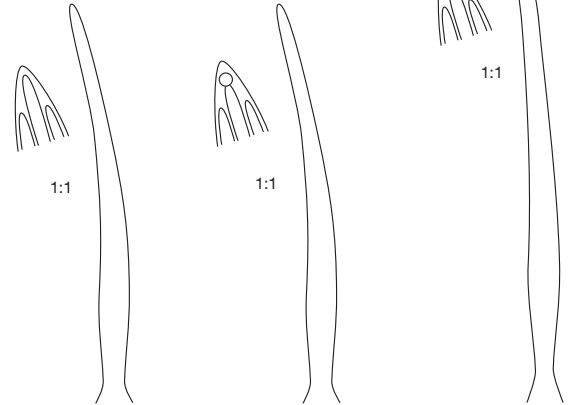

15.0 cm, 6"  
440-220-150

15.0 cm, 6"  
440-221-150

18.0 cm, 7"  
440-222-180

16.0 cm, 6 1/4"  
440-220-160

16.0 cm, 6 1/4"  
440-221-160

Kocher



**Brunner-Ferrozell**  
18.0 cm, 7"  
180-760-180

27.0 cm, 10 5/8"  
180-760-270



**Mod. Wien**  
23.5 cm, 9 1/4"  
180-778-235



**Bozemann**  
21.0 cm, 8 1/4"  
180-780-210



23.0 cm, 9"  
180-781-230



**Michel**  
Anlegen und Entfernen von  
Wundklammern  
applying and removing of clips  
12.0 cm, 4 3/4"  
**180-920-120**



**Collin**  
Entfernen von Wundklammern  
removing of clips  
13.0 cm, 5"  
**180-934-130**

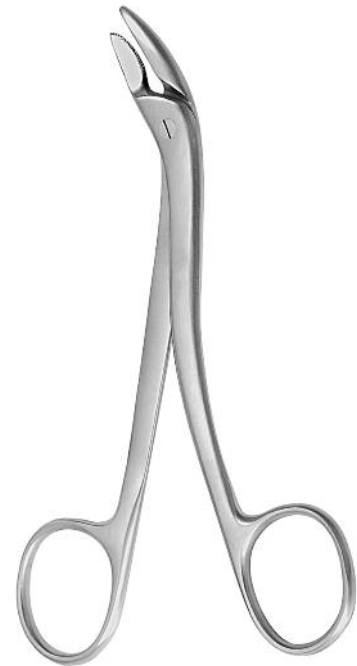

**Richter-Heath**  
Entfernen von Wundklammern  
removing of clips  
14.0 cm, 5 1/2"  
**180-936-140**



**Wachenfeldt**  
Anlegepinzette von  
Wundklammern  
applying forceps of clips  
12.5 cm, 5"  
**180-922-125**



**Hegenbarth**  
Anlegepinzette von  
Wundklammern  
applying forceps of clips  
12.5 cm, 5"  
**180-920-125**



**Michel**  
Anlegepinzette von  
Wundklammern  
applying forceps of clips  
12.0 cm, 4 3/4"  
**180-916-120**





**Lange**  
10.0 cm, 4"  
180-906-100



**Childe**  
18.0 cm, 7"  
180-909-180



**Childe**  
18.0 cm, 7"  
180-910-180



**RZ-Clip Set**  
130 x 45 x 18 mm  
180-950-000

Wundnahtbesteck im Metall-Etui,  
bestehend aus:  
Wundklammerzängchen Michel zum Anlegen und Entfernen  
von Wundklammern  
Wundrand-Faßpinzette Wachenfeld mit Klammerhalter  
50 Stück Wundklammern Michel

Suture clip set in metal case,  
consisting of:  
Suture clip removing forceps Michel  
Applying forceps Wachenfeldt with clip rack  
50 pieces suture clips Michel

Verkaufseinheit: 1 Packung = 100 Stück  
Unit for Sale: 1 package = 100 ea.

7.5 x 1.75 mm **180-940-075**



11.0 x 2.0 mm **180-940-110**



12.0 x 3.0 mm **180-940-120**



14.0 x 3.0 mm **180-940-140**



16.0 x 3.0 mm **180-940-160**



18.0 x 3.0 mm **180-940-180**



20.0 x 3.0 mm **180-940-200**



22.0 x 3.0 mm **180-940-220**





### Mini-Assistent

165 x 90 x 20 mm

**180-959-000**

komplettes Besteck, in Metalletui, mit Stegen für Instrumente im Etui

**Inhalt:**

- 1 Nadelhalter Mathieu, 14.0 cm
- 1 Nähseide in Alkohol
- 3 Nähnadeln, sortiert
- 1 Nadeldose 50 x 25 mm, gelocht
- 1 Wundklammerzange Michel
- 20 Wundklammern auf Halter
- 1 Skalpellgriff mit Klinge
- 2 Klingen, auswechselbar
- 1 gerade Schere st./sp., 13.0 cm
- 1 feine anatomische Pinzette, 12.5 cm

complete set in metal case  
with interior instrument rack

**Contents:**

- 1 Mathieu Needle Holder, 5 1/2"
- 1 Flacon with sterilized silk in alcohol
- 3 Suture Needles, assorted
- 1 Needle Case, 50 x 25 mm, perforated
- 1 Michel Suture Clip Forceps
- 20 Michel Suture Clips with Clip Holder
- 1 Scalpel Handle with Blade
- 2 Scalpel Blades, interchangeable
- 1 Scissors, straight, blunt/sharp, 5"
- 1 Dressing Forceps, fine, 5"

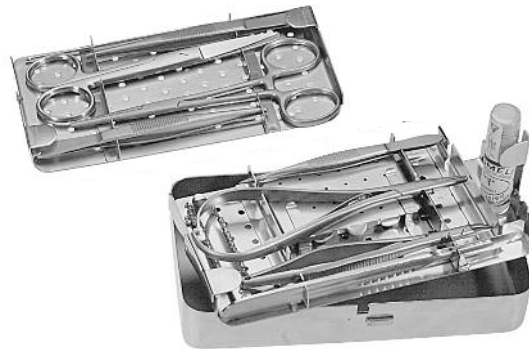

### Assistent Standard

165 x 90 x 28 mm

**180-960-000**

komplett, in Metalletui, mit 2 herausnehmbaren gelochten Einlagen mit Stegen für Instrumente

**Inhalt:**

- 1 Nadelhalter Mathieu, 14.0 cm
- 1 Nähseide in Alkohol
- 6 Nähnadeln, sortiert
- 1 Nadeldose 65 x 42 mm, gelocht
- 1 Wundklammerzange Michel
- 20 Wundklammern auf Halter
- 1 Skalpellgriff mit Klinge
- 3 Klingen, auswechselbar
- 1 gerade Schere Fig.2., 13.0 cm
- 1 anatomische Pinzette, 11.5 cm
- 1 Hakenpinzette, 12.0 cm, 1 x 2 Zähne
- 1 Splitterpinzette Hunter, 10.5 cm
- 1 Arterienklemme Kocher, 13.0 cm
- 1 Myrtenblattsonde, 13.0 cm

complete set in metal case with 2 removable perforated  
trays for instruments

**Contents:**

- 1 Mathieu needle holder, 5 1/2"
- 1 Flacon with sterilized silk in alcohol
- 6 Suture needles, assorted
- 1 Needle case, 64 x 42 mm, perforated
- 1 Michel suture clip forceps
- 20 Michel suture clips with clip holder
- 1 Scalpel handle with blade
- 3 Scalpel blades, interchangeable
- 1 Scissors, straight, Fig.2, 5"
- 1 Dressing forceps, fine, 4 1/2"
- 1 Tissue forceps, 4 1/2", 1 x 2 teeth
- 1 Hunter splinter forceps, 4 1/8"
- 1 Kocher artery forceps, straight, 5"
- 1 Probe with myrtle leaf, 5"

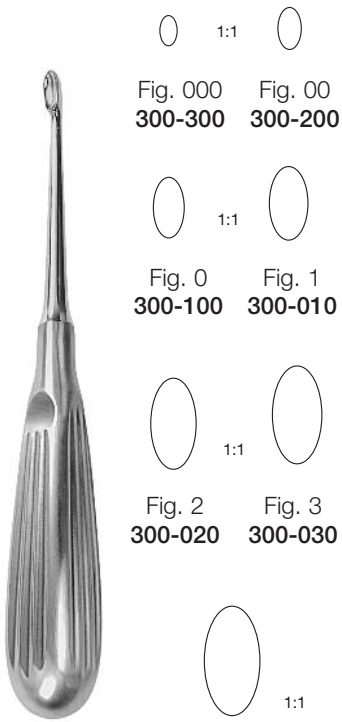

**Schede**  
17.0 cm, 6 3/4"  
210-...

Fig. 000 1:1 Fig. 00  
300-300 300-200

Fig. 0 1:1 Fig. 1  
300-100 300-010

Fig. 2 1:1 Fig. 3  
300-020 300-030

Fig. 4 1:1  
300-040

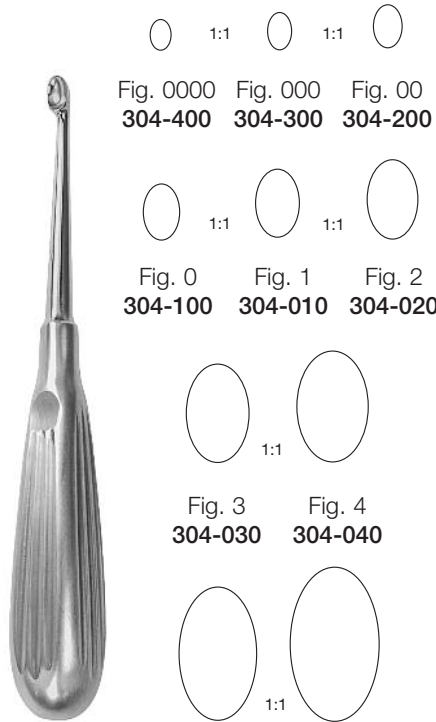

**Volkmann**  
17.0 cm, 6 3/4"  
210-...

Fig. 0000 1:1 Fig. 000 1:1 Fig. 00  
304-400 304-300 304-200

Fig. 0 1:1 Fig. 1 1:1 Fig. 2  
304-100 304-010 304-020

Fig. 3 1:1 Fig. 4  
304-030 304-040

Fig. 5 1:1 Fig. 6  
304-050 304-060

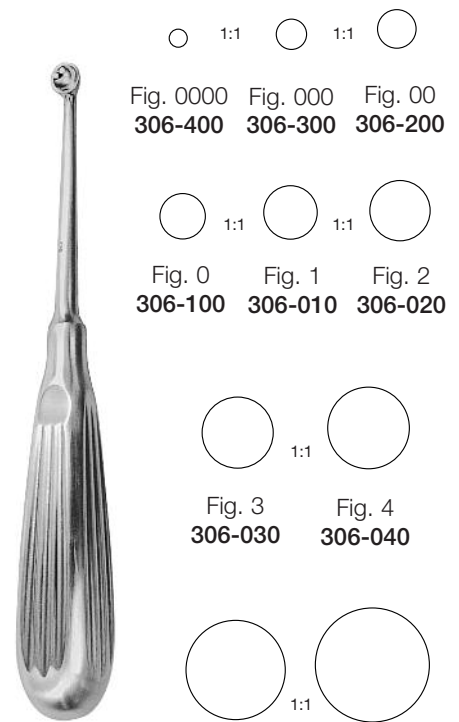

**Bruns**  
16.0 cm, 6 1/4"  
210-...

Fig. 0000 1:1 Fig. 000 1:1 Fig. 00  
306-400 306-300 306-200

Fig. 0 1:1 Fig. 1 1:1 Fig. 2  
306-100 306-010 306-020

Fig. 3 1:1 Fig. 4  
306-030 306-040

Fig. 5 1:1 Fig. 6  
306-050 306-060

biegsam  
malleable

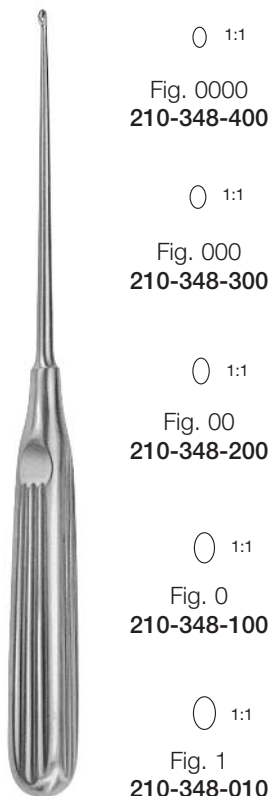

**Lempert**  
21.5 cm, 8 1/2"

Fig. 0000 1:1  
210-348-400

Fig. 000 1:1  
210-348-300

Fig. 00 1:1  
210-348-200

Fig. 0 1:1  
210-348-100

Fig. 1 1:1  
210-348-010

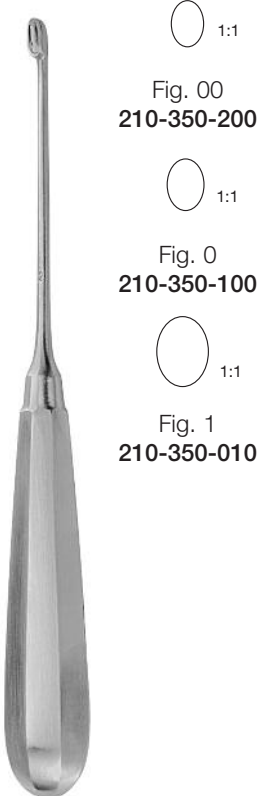

**Halle**  
21.0 cm, 8 1/4"

Fig. 00 1:1  
210-350-200

Fig. 0 1:1  
210-350-100

Fig. 1 1:1  
210-350-010

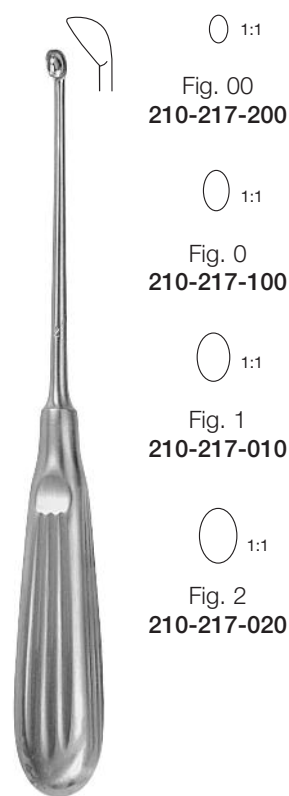

**Daubenspeck**  
20.0 cm, 8"

Fig. 00 1:1  
210-217-200

Fig. 0 1:1  
210-217-100

Fig. 1 1:1  
210-217-010

Fig. 2 1:1  
210-217-020



**Williger**  
17.0 cm, 6 3/4"

Fig. 1 1:1  
210-294-010

Fig. 2 1:1  
210-294-020



**Volkman**



13.0 cm, 5"  
210-210-130



14.0 cm, 5 1/2"  
210-210-140



17.0 cm, 6 3/4"  
210-210-170



**Williger**  
14.0 cm, 5 1/2"  
210-215-140



**Jansen**  
15.0 cm, 6"  
210-216-150



**Martini**  
14.0 cm, 5 1/2"  
210-218-140



**Martini**  
14.0 cm, 5 1/2"  
210-219-140



**Jansen**  
16.0 cm, 6 1/4"  
210-218-160



**Watson-Cheyne**  
17.5 cm, 6 5/8"  
210-525-175



**McDonald**  
19.0 cm, 7 1/2"  
210-527-190

11



6 mm breit  
6 mm wide

**Williger**

17.0 cm, 6 3/4"  
210-396-170



5 mm breit  
5 mm wide

**Williger**

16.0 cm, 6 1/4"  
210-395-160



8 mm breit  
8 mm wide

**Langenbeck**

20.0 cm, 8"  
210-395-200

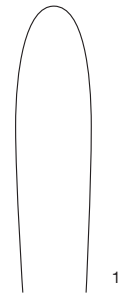

10 mm breit  
10 mm wide

**Langenbeck**

20.0 cm, 8"  
210-397-200

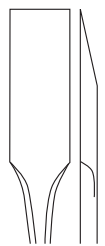

210-484-170



210-485-170



210-486-170

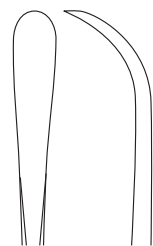

210-487-170

**Adson**

17.0 cm, 6 3/4"

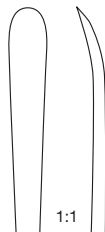

**König**

15.5 cm, 6"  
210-553-150



10 mm  
210-461-210

15 mm  
210-462-210

20 mm  
210-463-210

25 mm  
210-464-210

**Lambotte**

21.0 cm, 8 1/4"

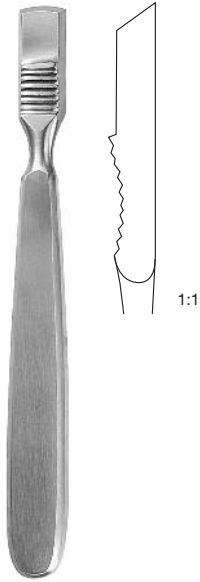

**Farabeuf**  
15.0 cm, 6"  
210-310-150

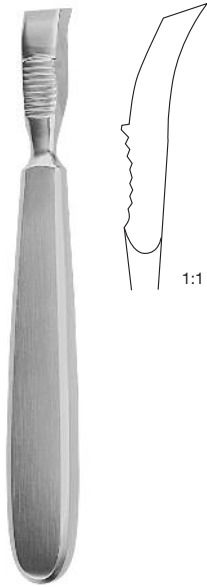

**Farabeuf**  
15.0 cm, 6"  
210-311-150

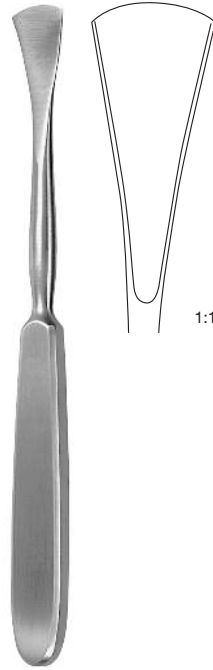

**Langenbeck**  
19.0 cm, 7 1/2"  
210-303-190



**Sedillot**  
21.0 cm, 8 1/4"  
210-315-210



**Williger**  
16.0 cm, 6 1/4"  
210-436-160



**Doyen**  
17.0 cm, 6 3/4"



**Doyen**  
17.0 cm, 6 3/4"

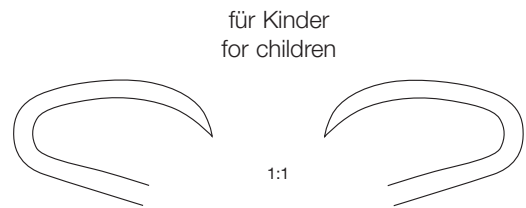

210-335-170

210-337-170

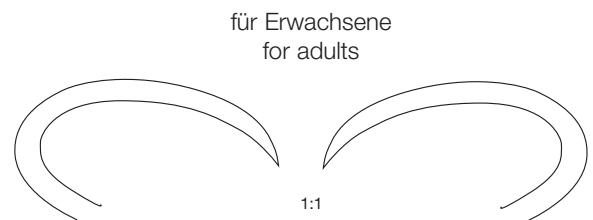

210-331-170

210-333-170



11

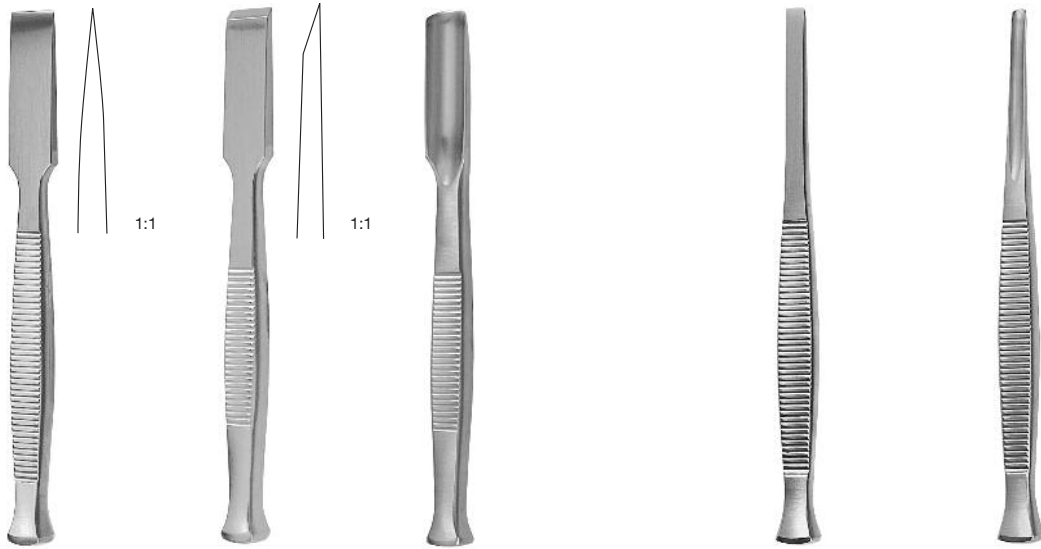

Breite width mm	13.5 cm, 5 3/8"	13.5 cm, 5 3/8"	13.5 cm, 5 3/8"
8	210-008-135	210-108-135	210-208-135
10	210-010-135	210-110-135	210-210-135
12	210-012-135	210-112-135	210-212-135
14	210-014-135	210-114-135	210-214-135
16	210-016-135	210-116-135	210-216-135

Breite width mm	Partsch 13.5 cm, 5 3/8"	Partsch 13.5 cm, 5 3/8"
3	210-303-135	210-403-135
4	210-304-135	210-404-135
5	210-305-135	210-405-135
6	210-306-135	210-406-135



Breite width mm	Alexander 18.0 cm, 7"	Alexander 18.0 cm, 7"
4	210-504-180	210-604-180
6	210-506-180	210-606-180
8	210-508-180	210-608-180
10	210-510-180	210-610-180
12	210-512-180	210-612-180
14	210-514-180	210-614-180

Breite width mm	Stille 20.0 cm, 8"	Stille 20.0 cm, 8"	Stille 20.0 cm, 8"
10	210-710-200	210-810-200	210-510-200
15	210-715-200	210-815-200	210-515-200
20	210-720-200	210-820-200	210-520-200
25	210-725-200	210-825-200	210-525-200



Breite width mm	Smith-Petersen 20.0 cm, 8"	Smith-Petersen 20.0 cm, 8"	Smith-Petersen 20.0 cm, 8"	Smith-Petersen 20.0 cm, 8"	Lambotte 24.0 cm, 9 1/2"	Lambotte 24.0 cm, 9 1/2"
6	210-106-200	210-206-200			210-132-006	210-133-006
9	210-109-200	210-209-200	210-309-200	210-409-200		
13	210-113-200	210-213-200	210-313-200	210-413-200		
15					210-132-015	210-133-015
16	210-116-200	210-216-200	210-316-200	210-416-200		
19	210-119-200	210-219-200	210-319-200	210-419-200		
20					210-132-020	210-133-020
25	210-125-200	210-225-200	210-325-200	210-425-200	210-132-025	210-133-025
32	210-132-200	210-232-200			210-132-032	210-133-032
38					210-132-038	210-133-038
44					210-132-044	210-133-044
50					210-132-050	210-133-050



**Collin**  
20.0 cm, 8"  
210-220-200



**Partsch**  
18.0 cm, 7"  
210-224-180

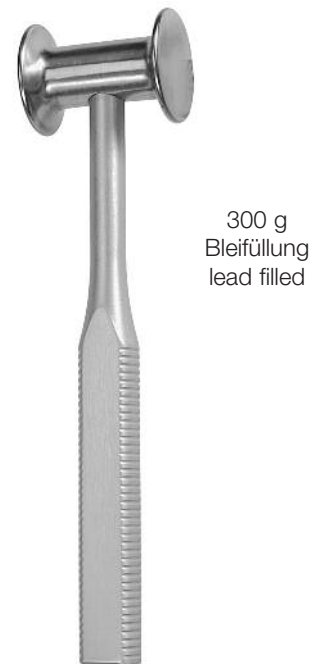

**Bergmann**  
24.0 cm, 9 1/2"  
210-300-240



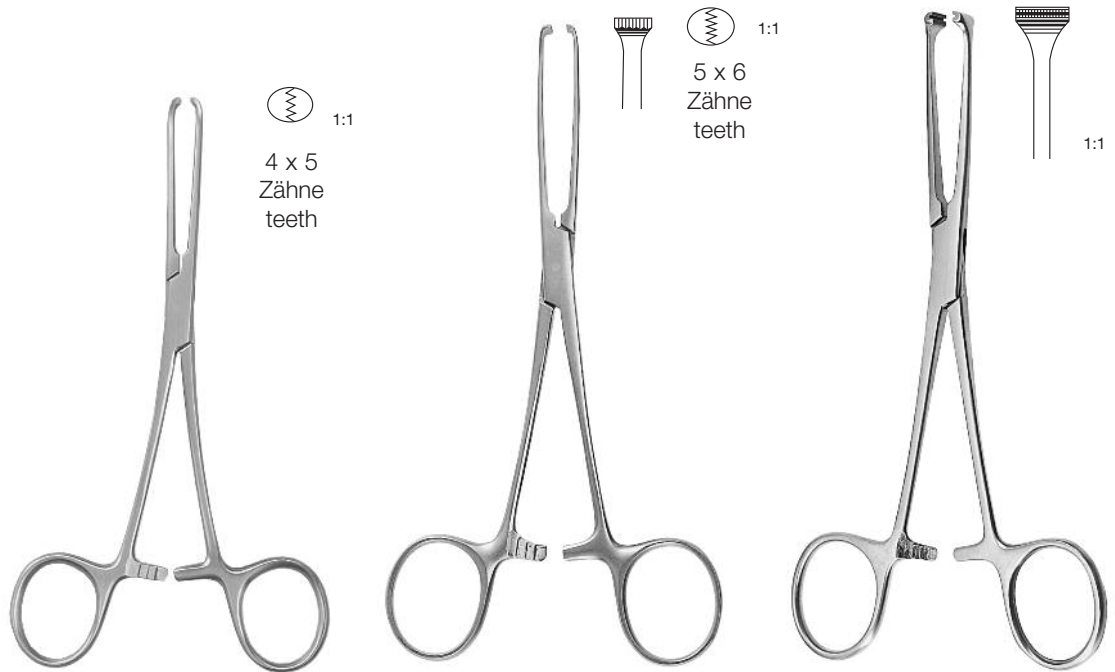

	Allis-Baby	Allis	Allis-Atrauma
12.0 cm, 4 3/4"	310-010-120		
15.0 cm, 6"	310-010-150	310-014-150	
16.0 cm, 6 1/4"			310-020-160
19.0 cm, 7 1/2"		310-014-190	
20.0 cm, 8"			310-020-200
25.0 cm, 9 3/4"		310-014-250	310-020-250

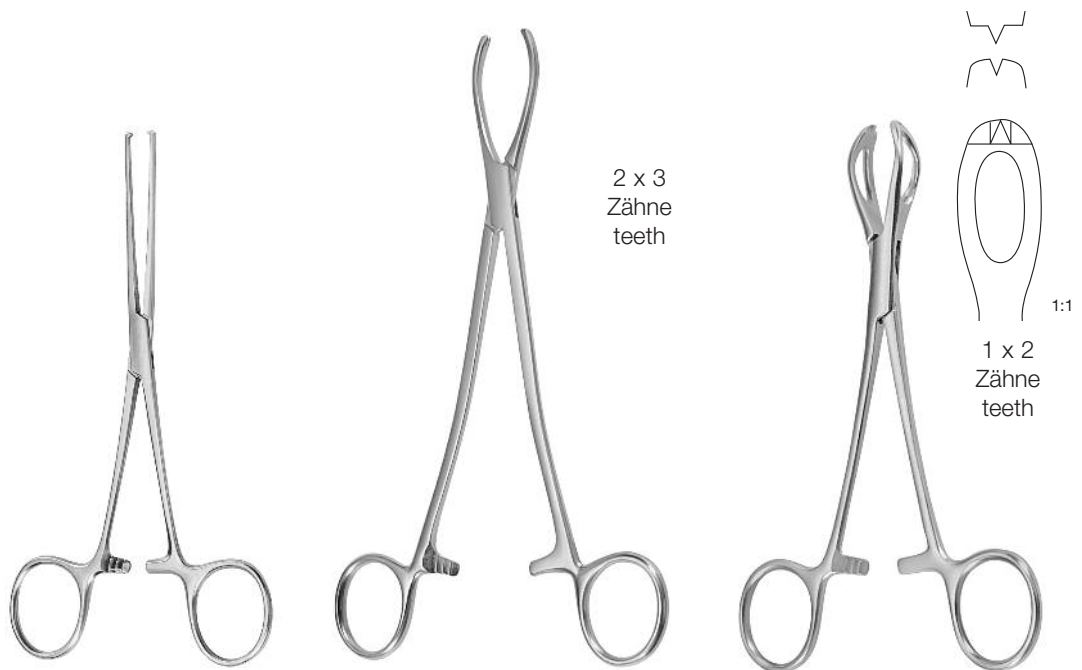

	Allen	Littlewood	Lane
12.5 cm, 5"			310-030-125
15.0 cm, 6"			310-030-150
15.5 cm, 6"	310-116-155		
18.5 cm, 7 1/4"		310-025-185	
19.5 cm, 7 3/4"			310-030-195
20.0 cm, 8"	310-116-200		
23.0 cm, 9"	310-116-230		

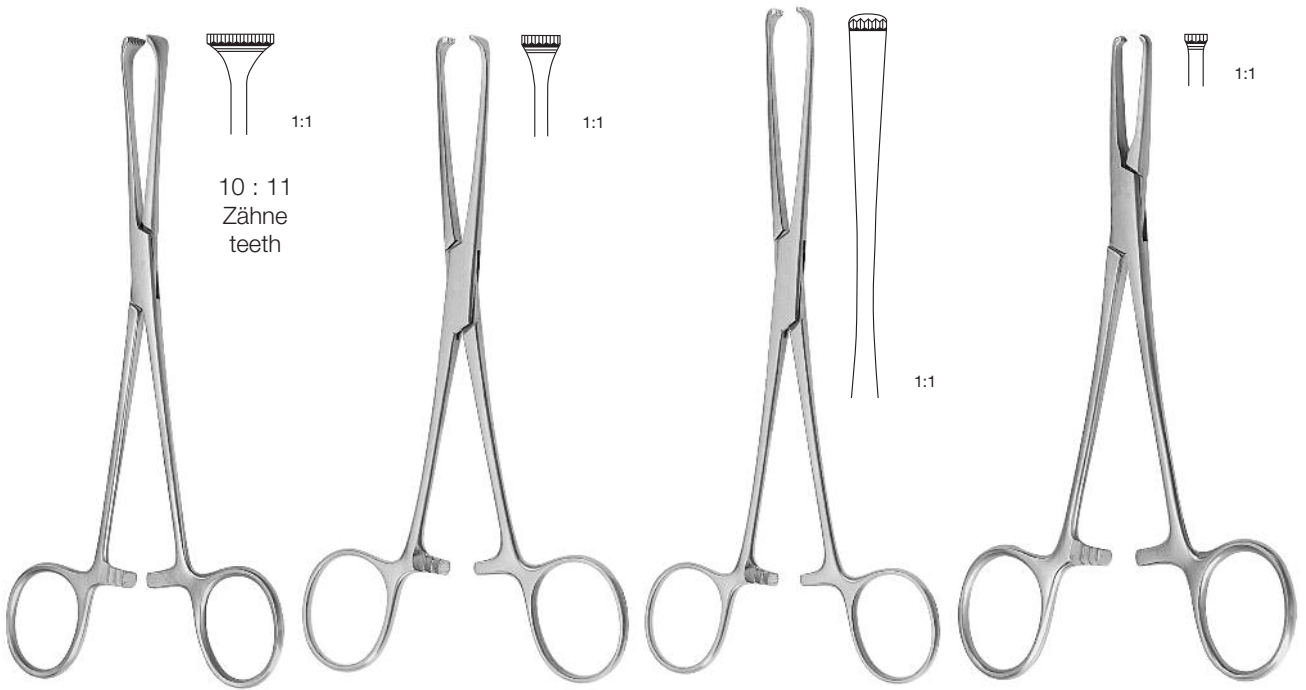

**Allis-Adair**  
15.5 cm, 6"  
310-027-155

**Boys-Allis**  
15.5 cm, 6"  
310-029-155

**Lockwood-Allis**  
16.0 cm, 6 1/4"  
310-026-160  
20.0 cm, 8"  
310-026-200

**Judd-Allis**  
15.0 cm, 6"  
310-028-150  
19.0 cm, 7 1/2"  
310-026-190

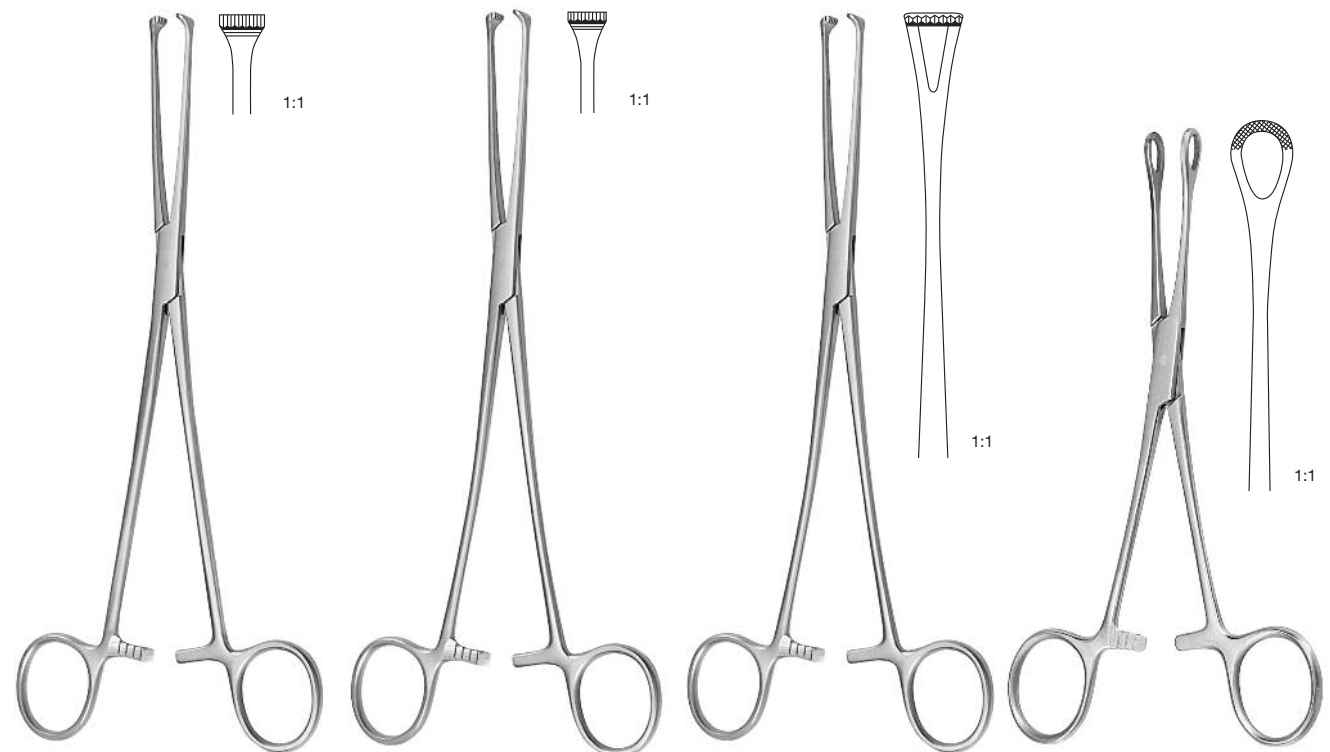

**Thoms-Allis**  
20.0 cm, 8"  
310-030-200

**Allis**  
20.0 cm, 8"  
310-031-200

**Lockwood**  
20.0 cm, 8"  
310-100-200

**Williams**  
16.0 cm, 6 1/4"  
310-115-160



12

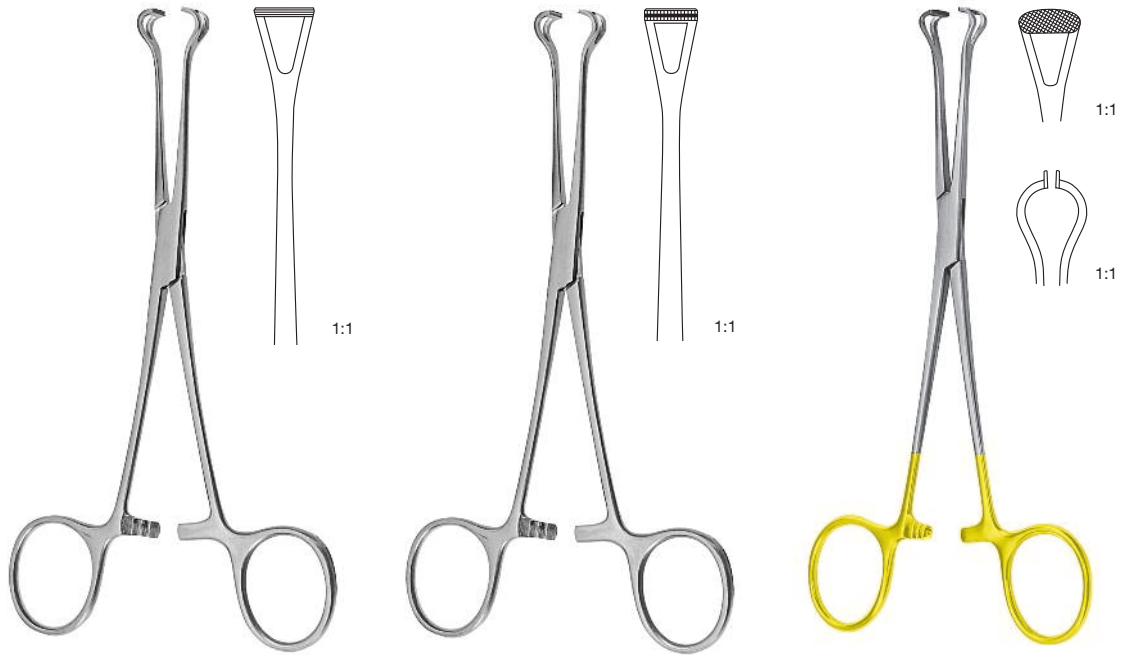

	Babcock	Babcock-Atrauma	Babcock
16.0 cm, 6 1/4"	310-110-160	310-111-160	310-118-160
18.0 cm, 7"	310-110-180		
20.0 cm, 8"	310-110-200	310-111-200	310-118-200
24.0 cm, 9 1/2"	310-110-240		



Duval

18.0 cm, 7"  
310-112-180  
20.0 cm, 8"  
310-112-200

20.0 cm, 8"  
310-114-200  
23.0 cm, 9"  
310-114-230

Duval  
20.0 cm, 8"  
310-113-200

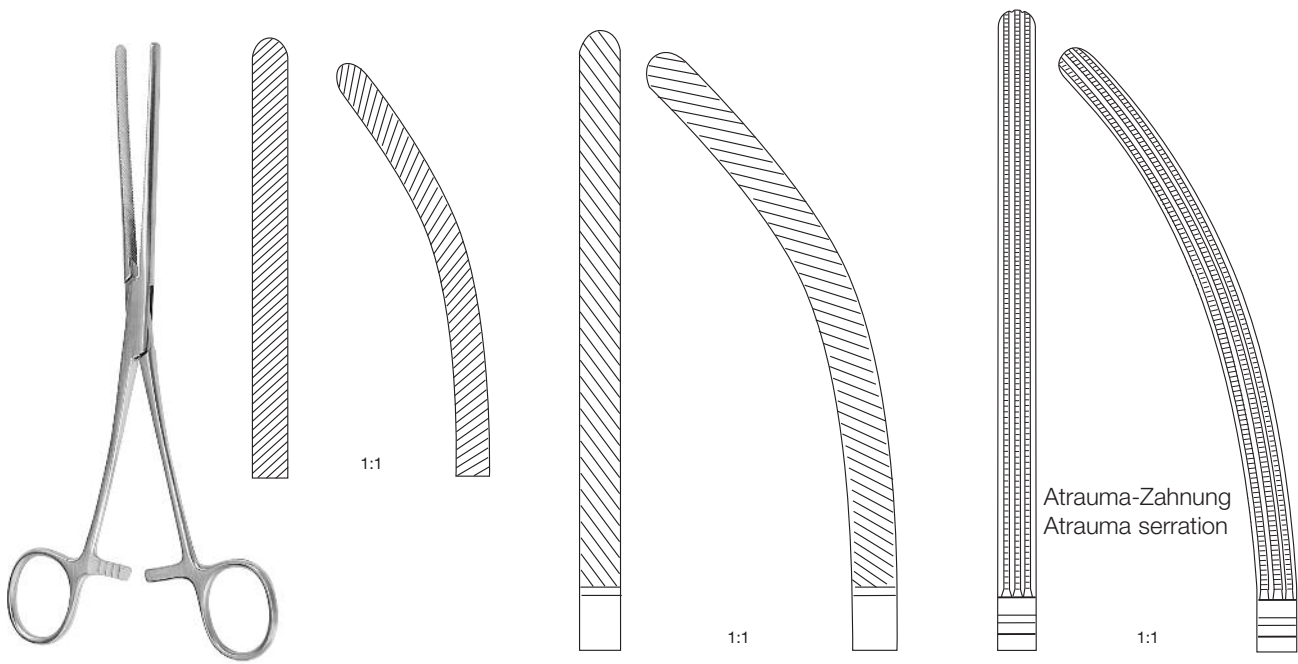

	Doyen-Baby		Doyen		Doyen	
16.0 cm, 6 1/4"					310-550-160	310-551-160
18.0 cm, 7"	310-290-180	310-291-180			310-550-180	310-551-180
21.0 cm, 8 1/4"			310-290-210	310-291-210	310-550-210	310-551-210
23.0 cm, 9"			310-290-230	310-291-230	310-550-230	310-551-230

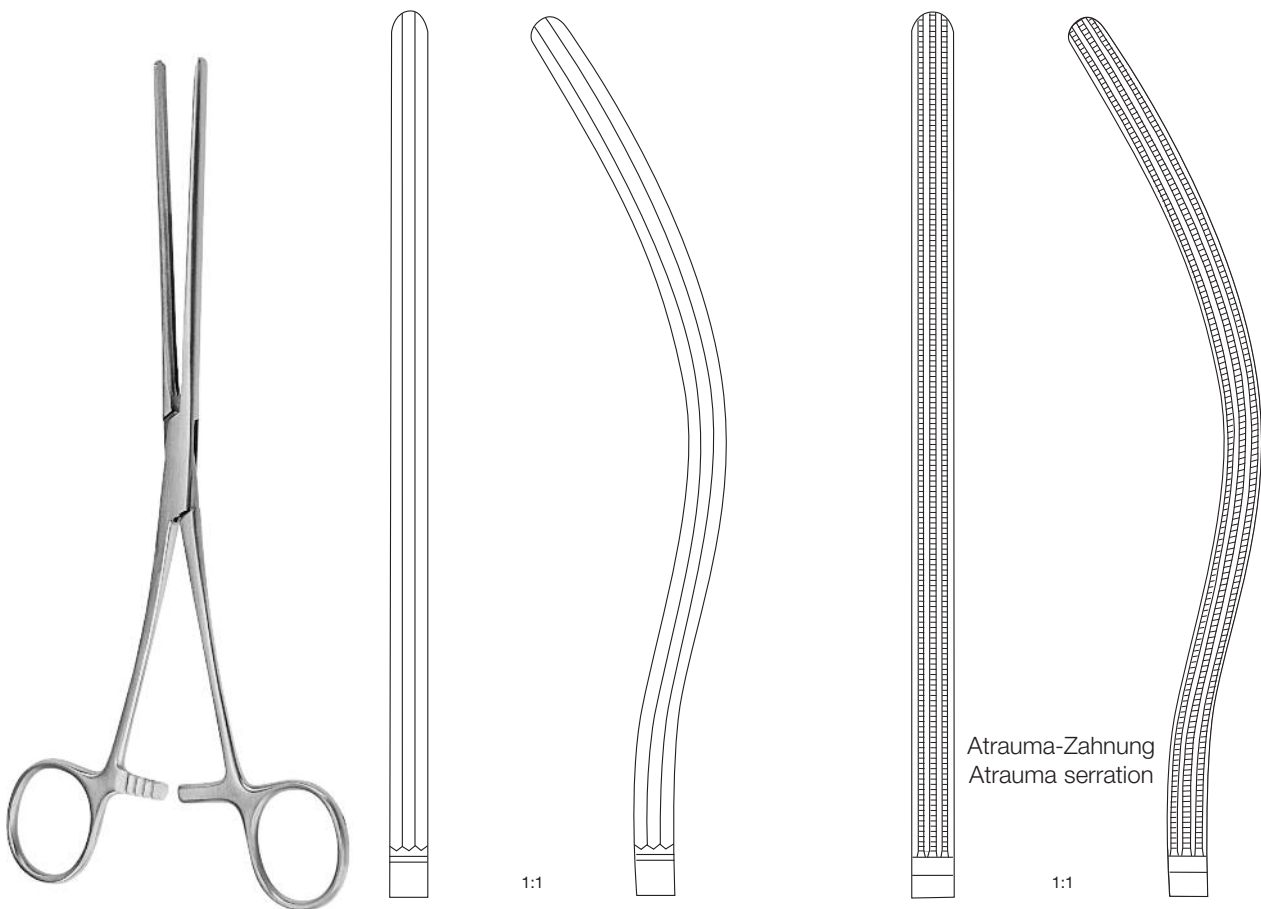

Kocher						
22.0 cm, 8 5/8"	310-124-220	310-125-220	310-126-220	310-127-220		
25.0 cm, 9 3/4"	310-124-250	310-125-250	310-126-250	310-127-250		
28.0 cm, 11"	310-124-280	310-125-280	310-126-280	310-127-280		



12

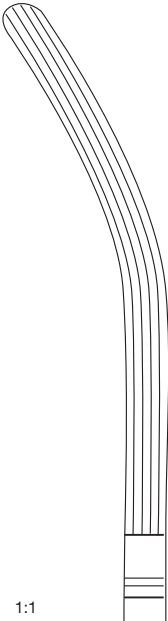

1:1

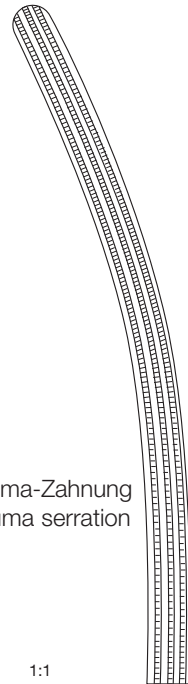
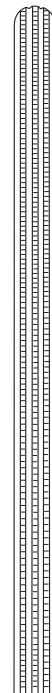

1:1

Atrauma-Zahnung  
Atrauma serration

**Mayo Robson**

21.0 cm, 8 1/4"	310-130-210	310-131-210	310-140-210	310-141-210
23.0 cm, 9"	310-130-230	310-131-230	310-140-230	310-141-230
25.0 cm, 9 3/4"	310-130-250	310-131-250	310-140-250	310-141-250

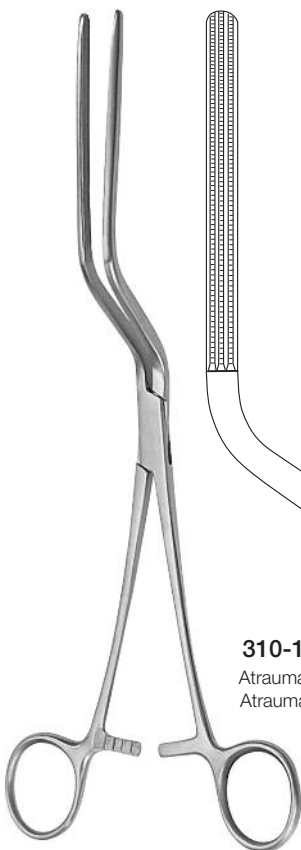

**Brunner**  
24.0 cm, 9 1/2"  
310-150-240

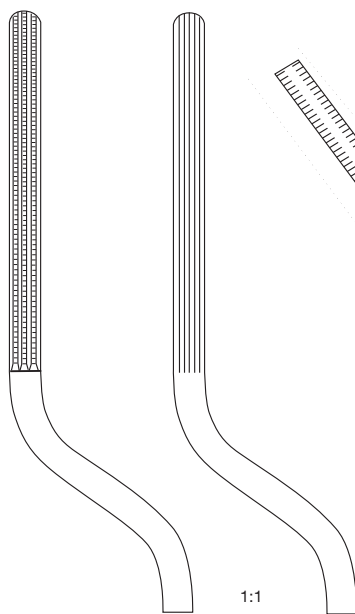

**310-150-240**  
Atrauma-Zahnung  
Atrauma serration

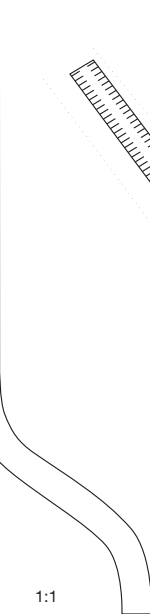

**310-151-240**

1:1

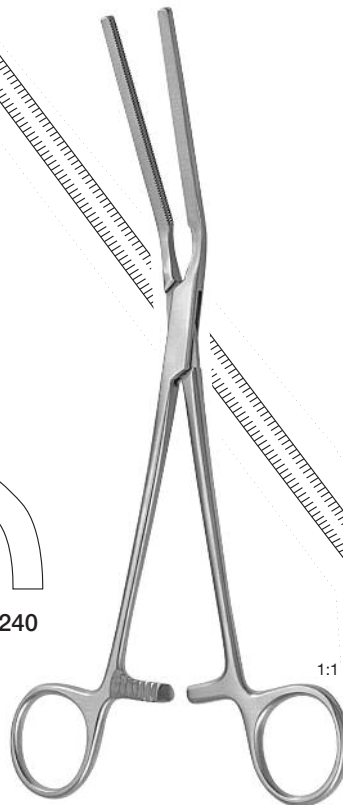

**Glassman**  
22.9 cm, 9"  
310-200-229

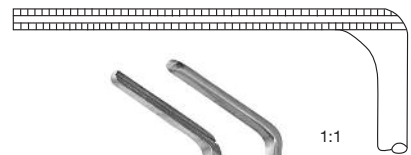

1:1

1:1



**Glassman**  
23.5 cm, 9 1/4"  
310-201-235

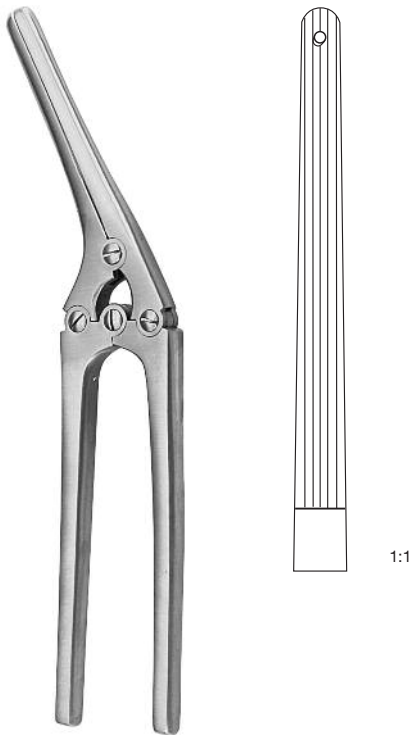

	ohne Stift without pin	mit Stift with pin
<b>Payr</b>		
21.0 cm, 8 1/4"	<b>310-032-210</b>	<b>310-033-210</b>
29.0 cm, 11 1/2"	<b>310-032-290</b>	<b>310-033-290</b>

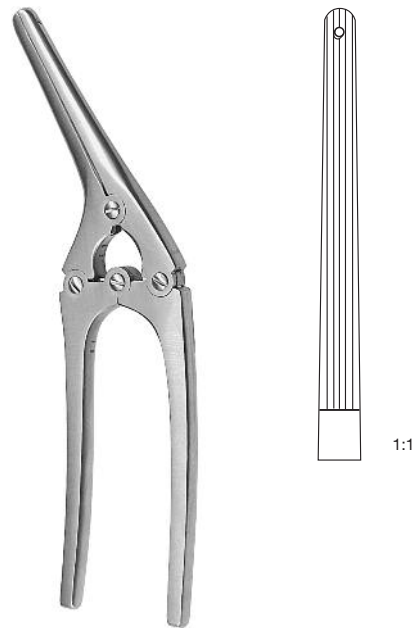

	ohne Stift without pin	mit Stift with pin
<b>Payr-Baby</b>		
15.0 cm, 6"	<b>310-031-150</b>	<b>310-032-150</b>

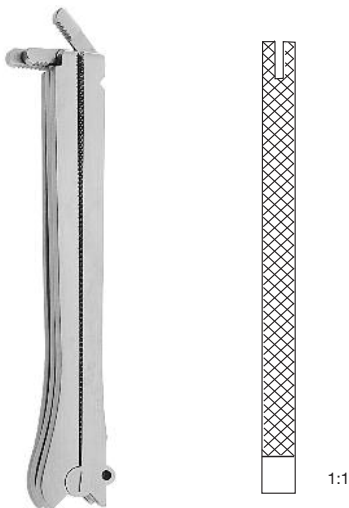

**De Martel-Wolfson**  
Satz zu 3 Klemmen, Set of 3 clamps  
Mauillänge  
jaw length

5.0 cm, 2"	<b>310-400-005</b>
7.0 cm, 2 1/4"	<b>310-400-007</b>
10.0 cm, 4"	<b>310-400-010</b>



8.5 cm, 3 1/2"  
**310-410-085**



**De-Martel-Wolfson**  
26.0 cm, 10 1/4"  
**310-412-260**



12



**Lane**  
30.0 cm, 11 3/4"



310-500-300

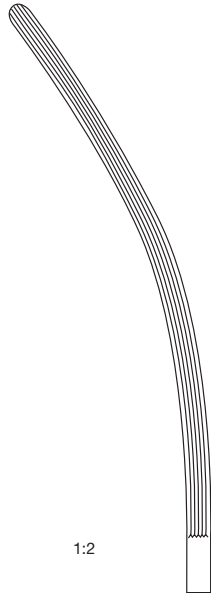

1:2

310-501-300



**Scudder-Atrauma**  
33.0 cm, 13"



310-152-330

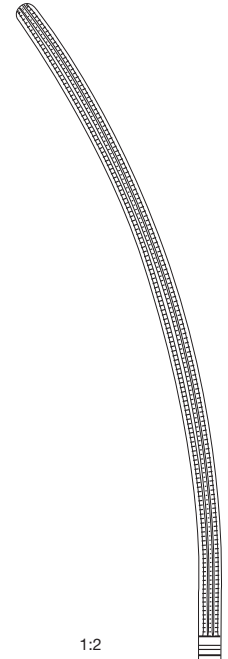

1:2

310-153-330

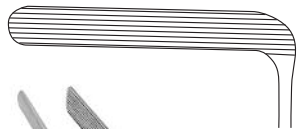

1:2



**Mikulicz**  
19.0 cm, 7 1/2"  
310-155-190



**Hayes**

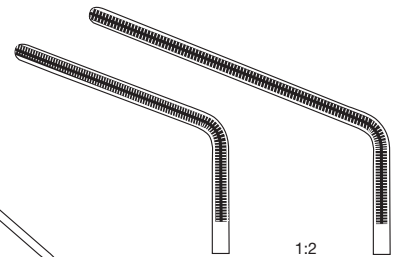

1:2

26.0 cm, 10"  
310-310-260

28.0 cm, 11"  
310-310-280



17 x 89 mm

**Sims**  
 15.0 cm, 6"  
 310-603-150



17 x 89 mm

**Bodenhammer**  
 15.0 cm, 6"  
 310-601-150



25 x 89 mm

**Mathieu**  
 21.0 cm, 8 1/4"  
 310-606-210

Mittelvalve allein  
 Central blade only  
 25 x 95 mm  
 310-025-095



Valve, blade  
 22 x 95 mm  
 310-022-095

Valve, blade  
 22 x 75 mm  
 310-022-075



75 x 23 mm

**Smith-Buie**  
 15.0 cm, 6"  
 310-610-150



Sperrer, allein  
 Spreader, only  
 310-022-135

**Alan Parks komplett**  
 13.5 cm, 5 3/8"  
 310-020-135

Die Alan Park Anal- und Sphinkterotomie Retraktor Kombination hat den Vorteil, daß alle Valven austauschbar sind und somit sowohl für Erwachsene als auch für Kinder geeignet ist. Alle Valven sind speziell geformt, um den anatomischen Bedingungen des Körpers gerecht zu werden. Sie sind aus dünnwandigem Material hergestellt, um das Einführen zu erleichtern.

The Alan Park anal and sphincterotomy retractor combination provides interchangeable blades for use in children and adults. All blades are specially rounded and shaped to meet anatomical requirements. They are slightly tapered and lipped to facilitate insertion.





**Kelly**  
22 mm ø x 50 mm      **310-675-050**  
22 mm ø x 100 mm    **310-675-100**  
22 mm ø x 145 mm    **310-675-145**  
22 mm ø x 200 mm    **310-675-200**  
21 mm ø x 50 mm      **310-679-210**  
27 mm ø x 50 mm      **310-679-270**



**Hirschmann**  
Fig 1: 16 mm ø x 65 mm      **310-655-001**  
Fig 2: 19 mm ø x 65 mm      **310-655-002**  
Fig 3: 22 mm ø x 65 mm      **310-655-003**  
Fig 4: 22 mm ø x 130 mm      **310-655-004**



**Chelsea Eaton**  
22 mm ø x 65 mm  
**310-022-065**  
30 mm ø x 65 mm  
**310-030-065**



**Ives Fansler**  
22 mm ø  
mit Kaltlichtanschluß  
with cold light connection  
**310-695-022**  
ohne Kaltlichtanschluß  
without cold light connection  
**310-695-122**



Beleuchtungsstab für Morgan  
 Proktoskope  
 Illumination adapter for Morgan  
 proctoscope  
**310-710-000**



**Fansler**  
 25 mm ø x 65 mm **310-705-025**  
 29 mm ø x 65 mm **310-705-029**  
 38 mm ø x 70 mm **310-705-038**

**Morgan**  
 17 mm ø x 65 mm **310-700-065**  
 17 mm ø x 80 mm **310-700-080**  
 20 mm ø x 65 mm **310-701-065**  
 20 mm ø x 80 mm **310-701-080**  
 24 mm ø x 65 mm **310-702-065**  
 24 mm ø x 80 mm **310-702-080**



Kaltlichtklammer  
 für Proktoskope  
 Cold light mounting clip  
 for proctoscopes  
**310-710-100**

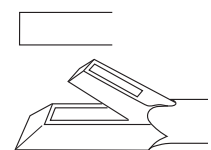
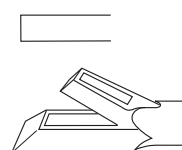
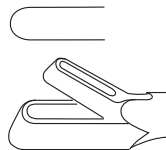
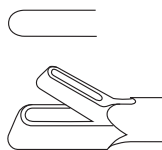

Yeoman	Fig. 1	Fig. 2	Fig. 3	Fig. 4
28.0 cm, 11"	<b>310-720-280</b>	<b>310-721-280</b>	<b>310-722-280</b>	<b>310-723-280</b>
35.0 cm, 13 3/4"	<b>310-720-350</b>	<b>310-721-350</b>	<b>310-722-350</b>	<b>310-723-350</b>
42.0 cm, 16 1/2"	<b>310-720-420</b>	<b>310-721-420</b>	<b>310-722-420</b>	<b>310-723-420</b>



**Darm, Magen, Mastdarm**

**Hämorrhoiden-Ligatoren, Fistelhaken  
Hämorrhoiden-Faßzangen**

**Intestines, Stomach, Rectum**

**Haemorrhoidal Ligator, Fistula Hook  
Haemorrhoidal Forceps**

Ladekegel, cone 12 mm  
340-012-000



**Rudd Hämorrhoiden-Ligator**  
mit Ladekegel 12 mm und 100 Gummiringen  
with 12 mm cone and 100 rubber rings  
340-010-000

Ligatur Gummiringe, Pack à 100 Stück  
Ligature rubber ring, package of 100 pieces  
340-011-000

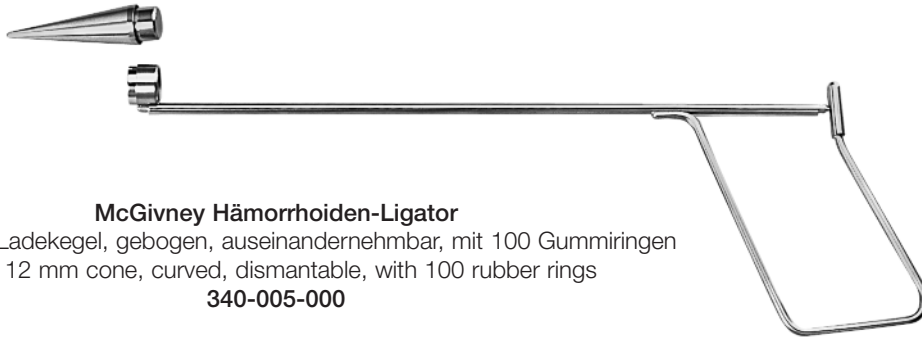

**McGivney Hämorrhoiden-Ligator**  
mit 12 mm Ladekegel, gebogen, auseinandernehmbar, mit 100 Gummiringen  
with 12 mm cone, curved, dismantable, with 100 rubber rings  
340-005-000



**McGivney**  
19.0 cm, 7 1/2"  
340-008-190

**McGivney**  
19.0 cm, 7 1/2"  
340-009-190



**Pratt**  
21.0 cm, 8 1/4"



340-401-210



340-402-210



340-403-210

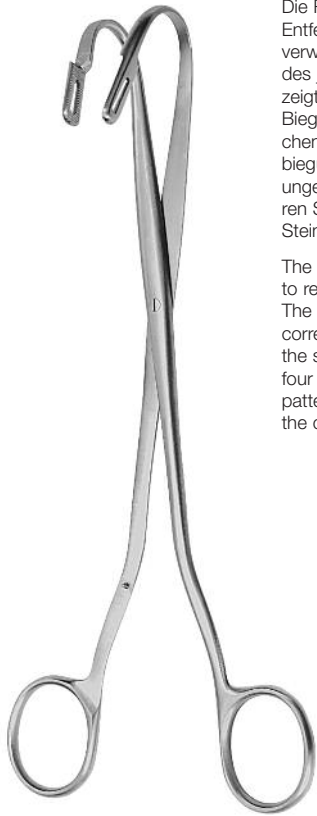

Die Randall-Nierensteinzange wird zum Entfernen von Nierensteinen im Nierenkelch verwendet. Die schematische Darstellung des jeweiligen Instrumentes in der Niere zeigt, wie wichtig die zweckentsprechende Biegung ist, um den richtigen Kelch zu erreichen. Zusätzlich zu den vier Standardbiegungen haben wir noch zwei Neuerungen aufgenommen, welche einen längeren Schaft haben, um auch tiefer sitzende Steine zu erreichen.

The Randall kidney stone forceps are used to remove kidney stones in the kidney cup. The illustration shows, how important the correct angle of the instrument is to remove the stones out of the cup. In addition to the four standard angulations we have two new patterns, with a longer shaft to access to the deeper cups.

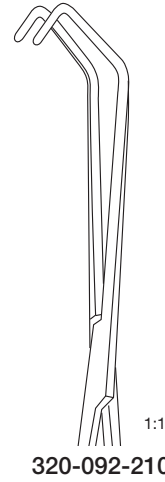

Randall	Fig.	
320-101-230	1	23.0 cm, 9"
320-103-220	2	22.0 cm, 8 5/8"
320-105-220	3	22.0 cm, 8 5/8"
320-107-220	4	22.0 cm, 8 5/8"
320-109-190	5	19.0 cm, 7 1/2"
320-111-190	6	19.0 cm, 7 1/2"

Lurz  
21.0 cm, 8 1/4"  
320-090-210

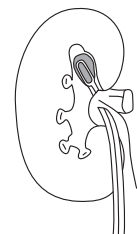
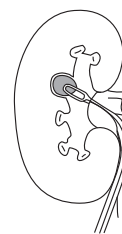
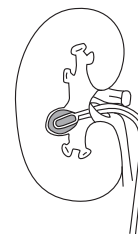
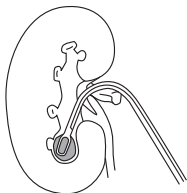
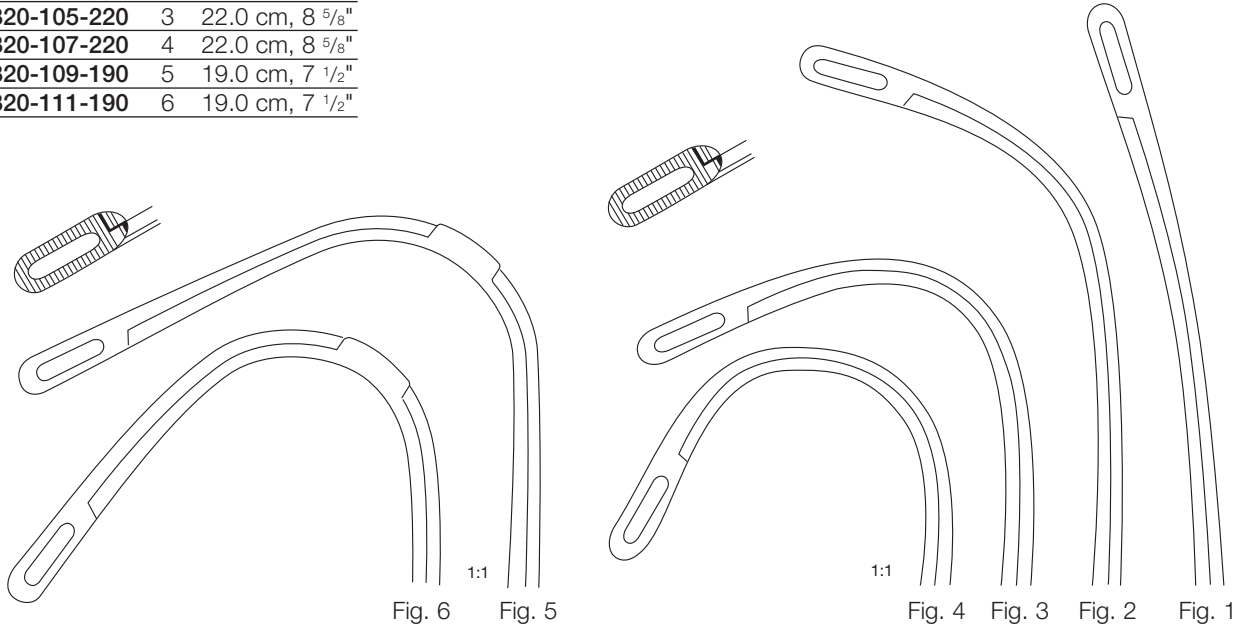



13

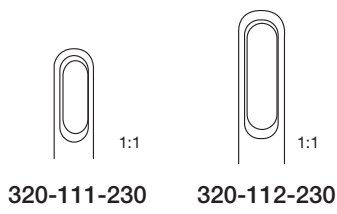

**Desjardins**  
23.0 cm, 9"  
gebogen, curved



**Mayo Blake**  
20.0 cm, 8"  
gebogen, curved  
320-115-200

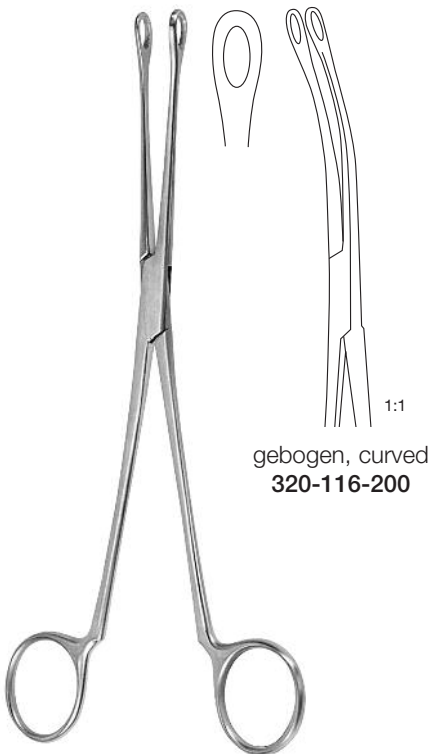

**Blake**  
20.0 cm, 8"  
gerade, straight  
320-117-200

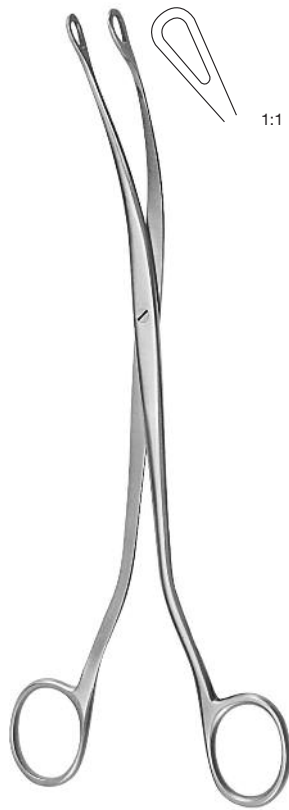

**Mixer**  
22.0 cm, 8 5/8"  
gebogen, curved  
320-119-220

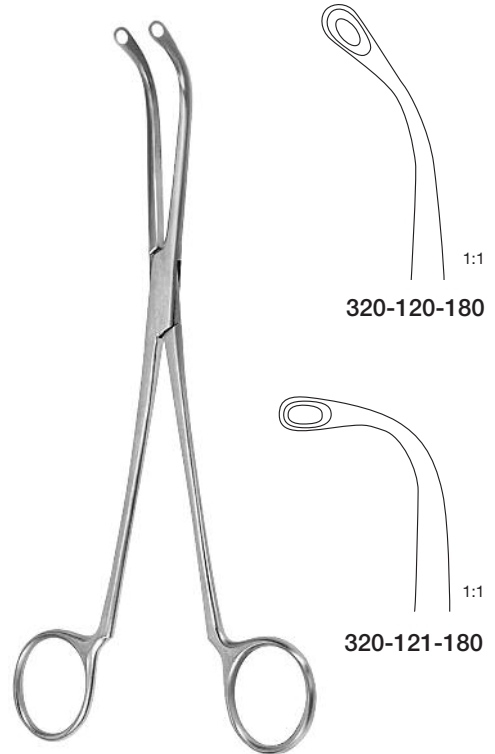

**Turner-Warwick**  
18.0 cm, 7"  
gebogen, curved



**Luer-Körte**  
24.0 cm, 9 1/2"  
biegsam, malleable



1:1

Fig. 000  
2.8 mm  
320-140-300



1:1

Fig. 00  
3.4 mm  
320-140-200



1:1

Fig. 0  
4.3 mm  
320-140-100



1:1

Fig. 1  
5.5 mm  
320-140-010



1:1

Fig. 2  
6.7 mm  
320-140-020



1:1

Fig. 3  
8.0 mm  
320-140-030



Fig. 4  
11.0 mm  
320-140-040



Fig. 5  
15.0 mm  
320-140-050

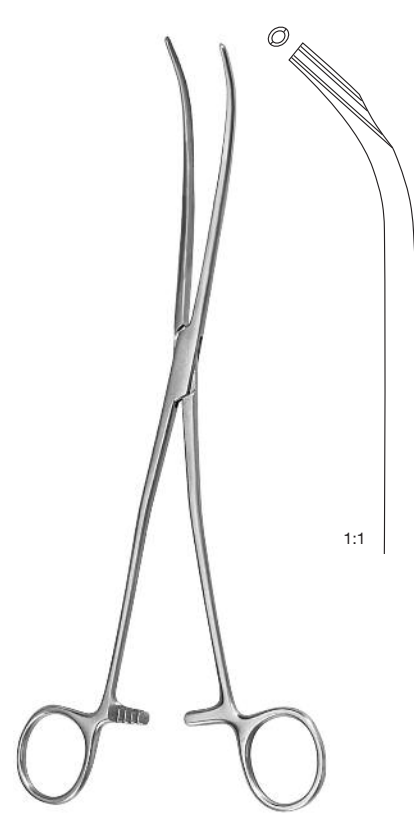

**Sökeland**  
24.0 cm, 9 1/2"  
320-080-240



**Moore**  
30.0 cm, 12"  
320-145-280



**Czerny**  
24.5 cm, 9 5/8"  
320-135-245



1:1



**Mayo**  
32.0 cm, 12 1/2"  
320-129-320



**Ochsner**  
35.0cm, 13 3/4"  
320-128-350



**Leber, Galle, Niere**  
**Gallensteinlöffel, Gallensteinsonden**  
**Gallengang-Dilatatoren**

**Liver, Gall Bladder, Kidney**  
**Gall Stone Scoops, Gall Stone Probes**  
**Gall Duct Dilators**

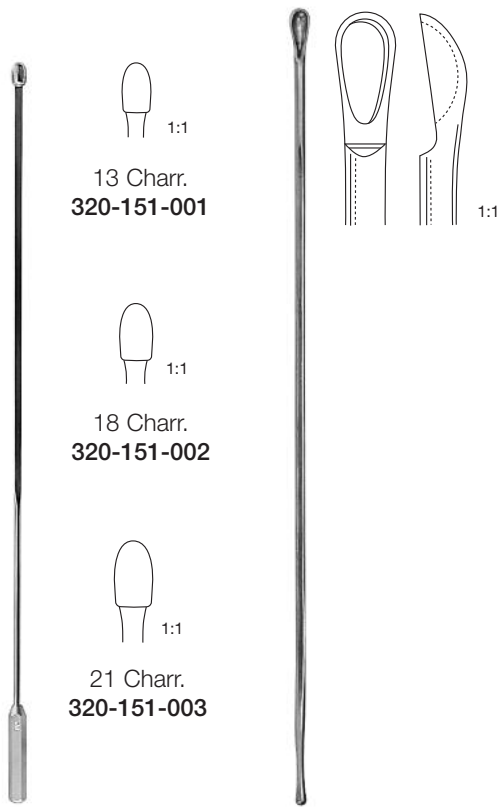

**Desjardins**  
28.0 cm, 11"

**Moynihan**  
34.0 cm, 13 3/8"  
320-142-340

**Bakes**  
30.0 cm, 11 3/4"  
320-150-...

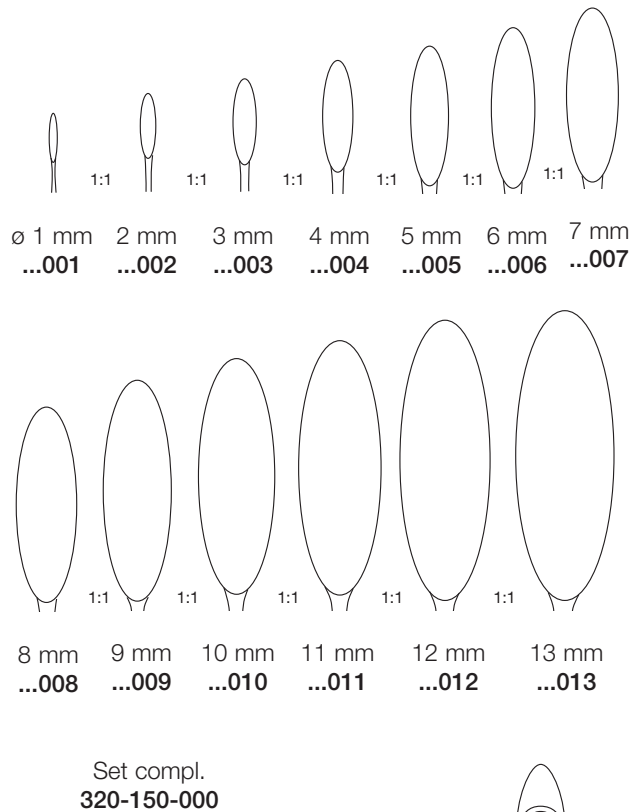

Set compl.  
320-150-000

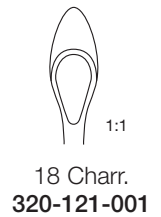

18 Charr.  
320-121-001

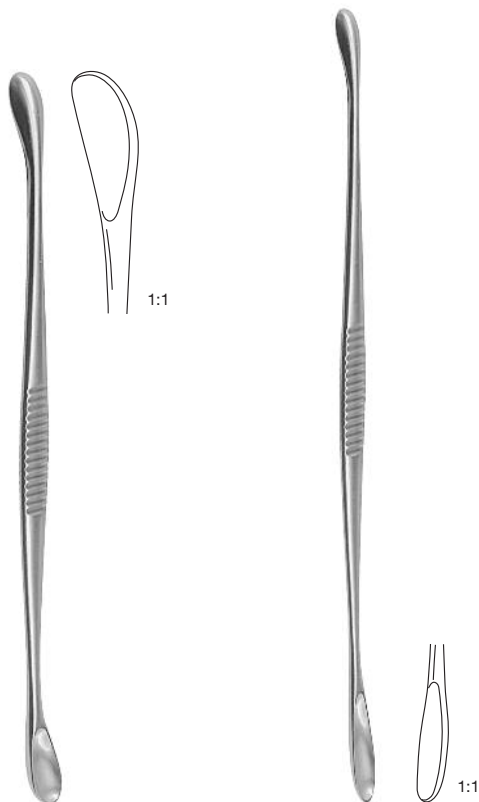

**Ferguson**  
21.5 cm, 8 1/2"  
320-150-215

**Mayo**  
27.0 cm, 10 5/8"  
320-152-270

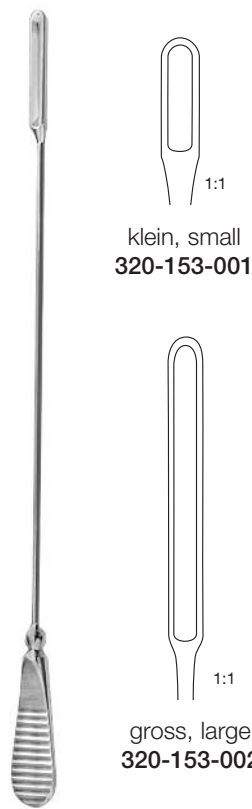

klein, small  
320-153-001

gross, large  
320-153-002

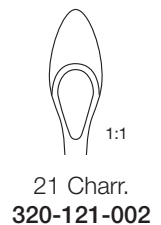

21 Charr.  
320-121-002



24 Charr.  
320-121-003

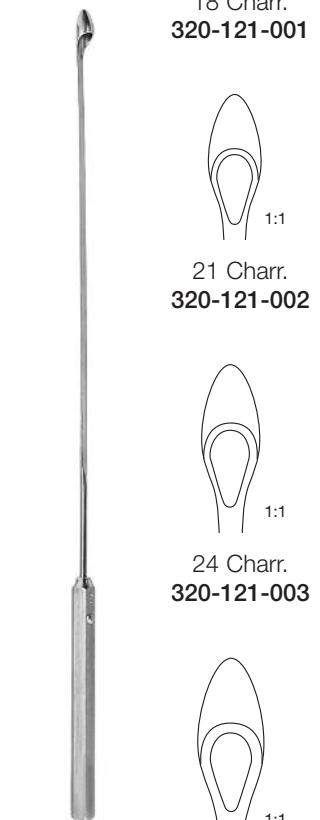

**Desjardins**  
27 Charr.  
320-121-004

**Mayo**  
27.0 cm, 10 5/8"  
biegsam, malleable

13



**Thomson-Walker**  
320-190-000

Mittelvalve, allein  
Central blade, only  
105 x 45 mm  
320-185-004



**Millin**  
komplett, complete  
320-185-000

Valve, blade  
57 x 25 mm  
320-185-002

Valve, blade  
82 x 25 mm  
320-185-003

Sperrer allein  
Spreader only  
320-185-001

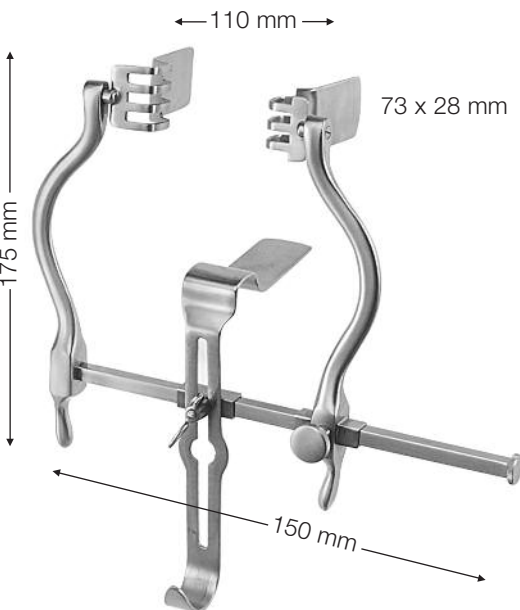

**Judd-Masson**  
320-195-000

105 x 44 mm

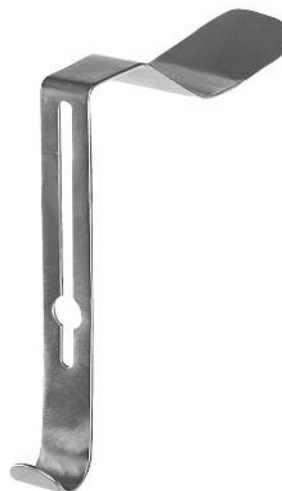

**Millin**  
Mittelvalve  
Central blade  
320-195-001

← 95 mm →



**Legueu**  
320-200-000

Valve, blade  
27 x 60  
mm

Mittelvalve  
Central blade  
80 x 31 mm



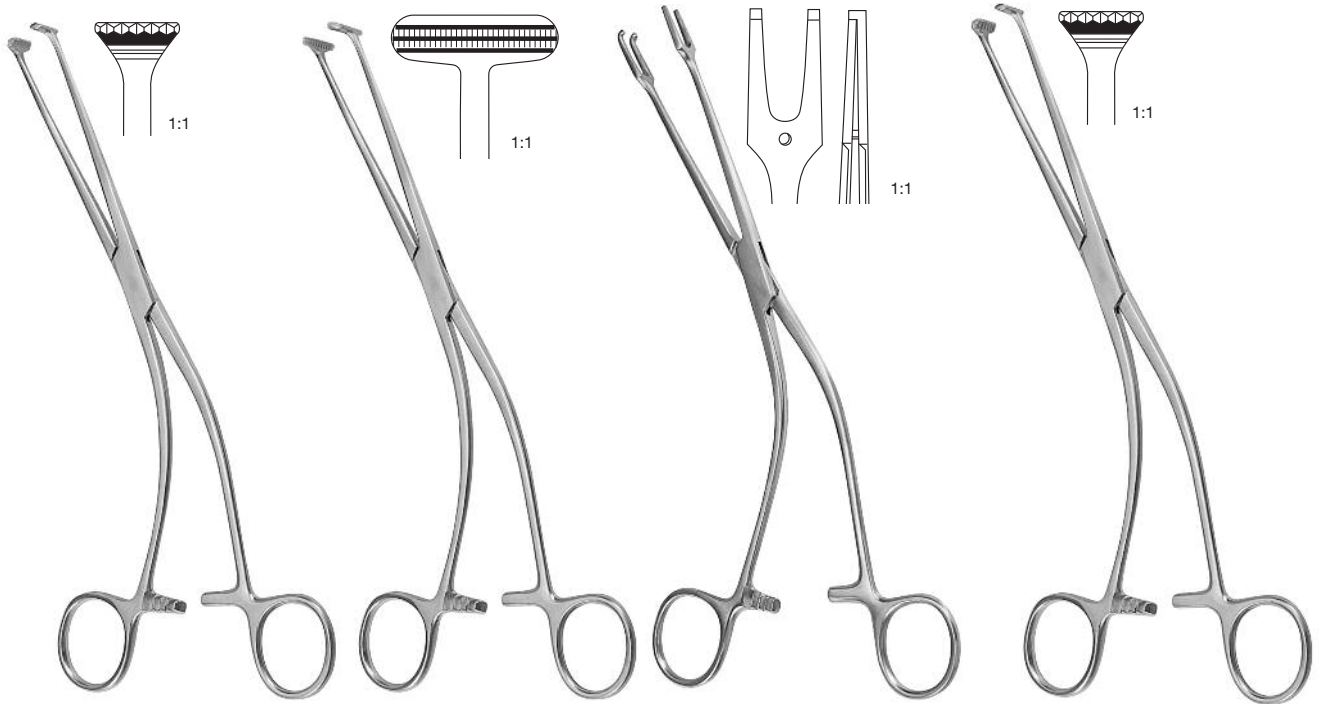

**Millin**  
KapselFaßzange  
Capsule forceps  
23.0 cm, 9"  
320-150-230

**Millin**  
KapselFaßzange  
Capsule forceps  
23.0 cm, 9"  
320-151-230

**Millin**  
Fadenführungs-  
zange  
Ligature carrying forceps  
24.5 cm, 9"  
320-151-245

**Millin**  
Faßzange-vordere Lappen  
Lobe Holding Forceps,  
9 x 9 Zähne, teeth  
320-152-230

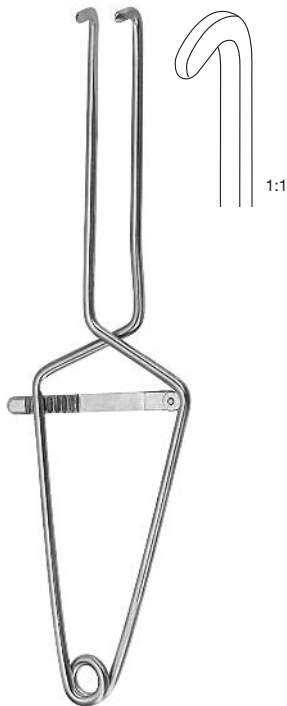

**Millin**  
Blasenhalsperrer  
Bladder Neck Spreader  
28.5 cm, 11 1/4"  
320-165-285



**Mathieu**  
Fremdkörperzange  
Foreign body forceps  
19.0 cm, 7 1/2"  
320-350-190  
28.0 cm, 11"  
320-350-280

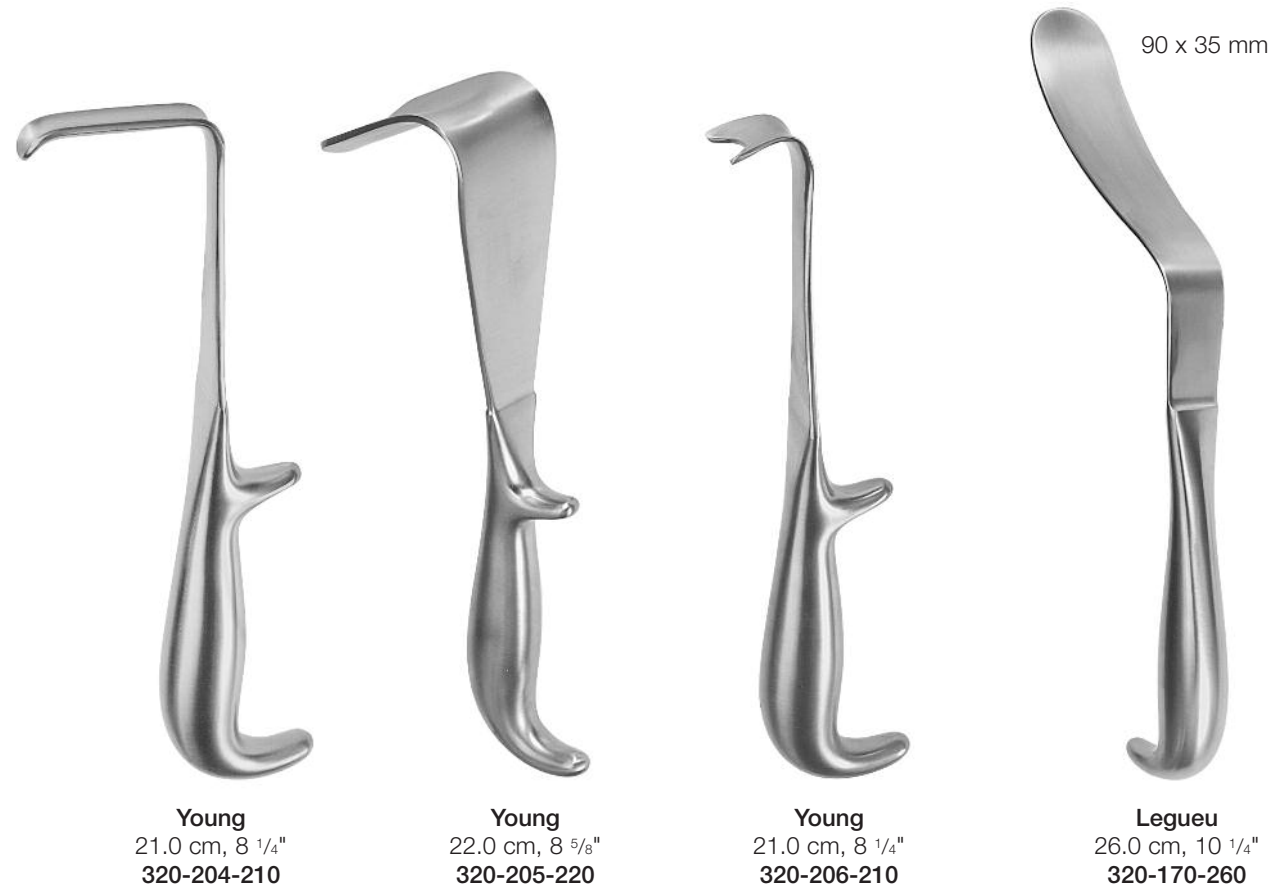

**Young**  
 21.0 cm, 8 1/4"  
 320-204-210

**Young**  
 22.0 cm, 8 5/8"  
 320-205-220

**Young**  
 21.0 cm, 8 1/4"  
 320-206-210

**Legueu**  
 26.0 cm, 10 1/4"  
 320-170-260



90 x 61 mm

**Kocher**  
 23.5 cm, 9 1/4"  
 320-175-235



**Katheter, Männer**  
 Catheter, male  
 29.0 cm, 11 1/2"

	Charr.
320-720-080	8
320-720-100	10
320-720-120	12
320-720-140	14
320-720-160	16
320-720-180	18
320-720-200	20
320-720-220	22
320-720-240	24



**Strauss**  
 13.0 cm, 5 1/8"  
 320-999-000



**Stockmann**  
 8.0 cm, 3 1/4"  
 320-998-000

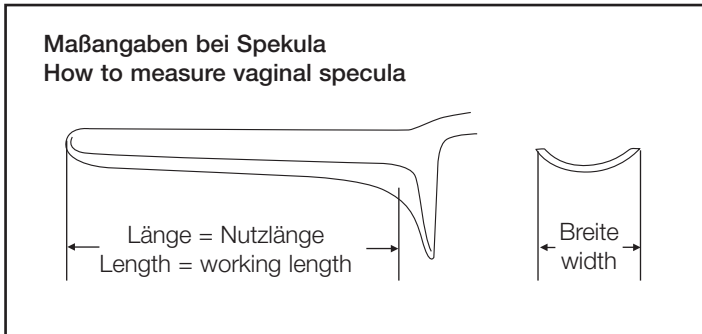

**Collin**  
für Kinder, for children  
65 x 10 mm  
350-009-001



**Collin**  
für Jungfrauen, for virgins  
65 x 20 mm  
350-110-001



Collin	Fig.	mm
350-110-002	1	85 x 30
350-110-003	2	100 x 35
350-110-004	3	110 x 40

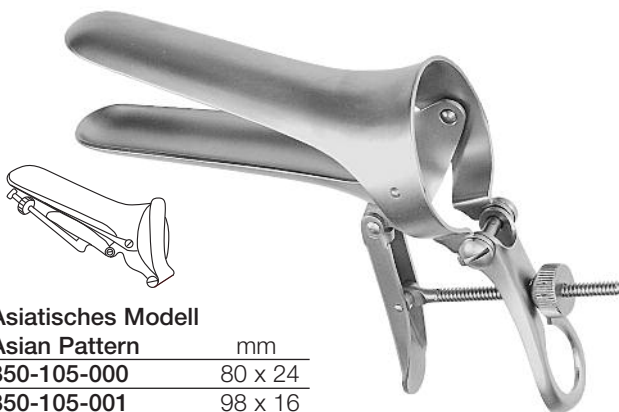

**Asiatisches Modell**  
**Asian Pattern**

	mm
350-105-000	80 x 24
350-105-001	98 x 16
350-105-002	105 x 25
350-105-003	107 x 29
350-105-004	115 x 35
350-105-006	80 x 32

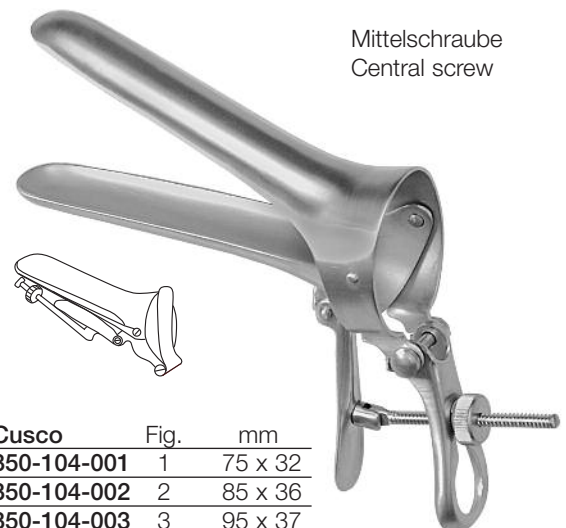

Mittelschraube  
Central screw

Cusco	Fig.	mm
350-104-001	1	75 x 32
350-104-002	2	85 x 36
350-104-003	3	95 x 37

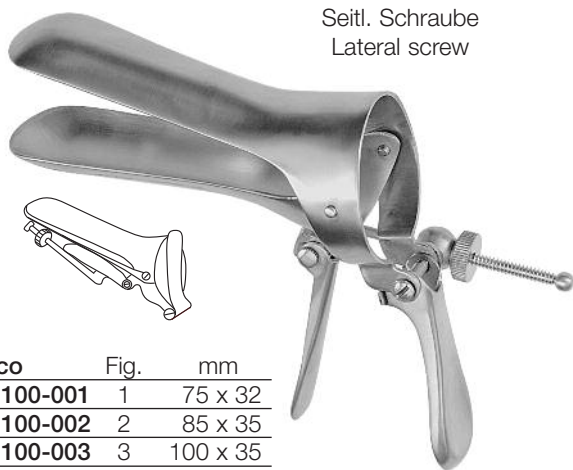

Seitl. Schraube  
Lateral screw

Cusco	Fig.	mm
350-100-001	1	75 x 32
350-100-002	2	85 x 35
350-100-003	3	100 x 35

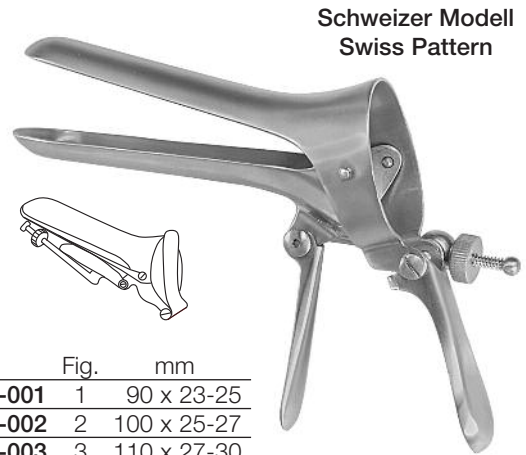

Schweizer Modell  
Swiss Pattern

Cusco	Fig.	mm
350-102-001	1	90 x 23-25
350-102-002	2	100 x 25-27
350-102-003	3	110 x 27-30



Cusco  
75 x 17 mm  
350-103-000

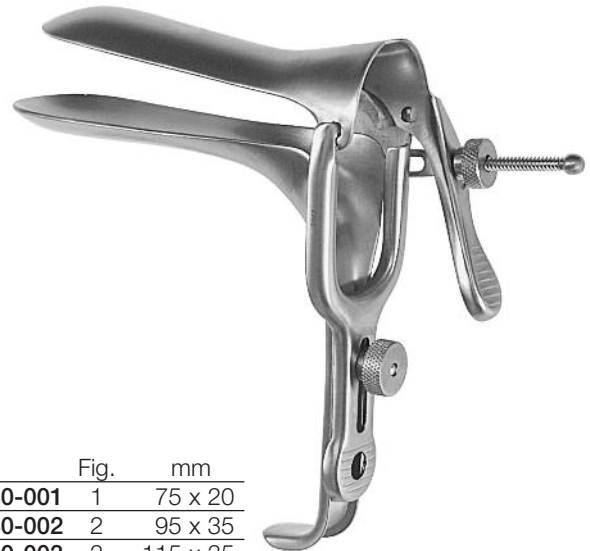

Grave  
350-130-001 1 75 x 20  
350-130-002 2 95 x 35  
350-130-003 3 115 x 35



Pederson	Fig.	mm
350-140-001	1	75 x 13
350-140-002	2	100 x 22
350-140-003	3	120 x 25



Semm	mm
350-120-001	100 x 17-20
350-120-002	100 x 25-30



**Weissbarth**  
21.0 cm, 8 1/4"  
80 x 42 mm  
330-312-000

mit abnehmbarem  
Auffangsieb,  
with removable strainer



mit abnehmbarem  
Gewicht 1.14 Kg.  
with removable weight 1.14 Kg  
75 x 38 mm  
350-310-000

mit festem Gewicht 1.4 Kg  
with fixed weight 1.4 Kg  
105 x 38 mm  
350-311-000

**Auvard**  
24.0cm, 9 1/2"

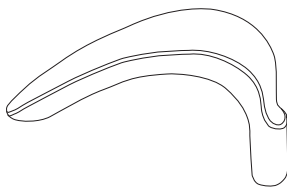

80 x 30 mm  
330-301-001

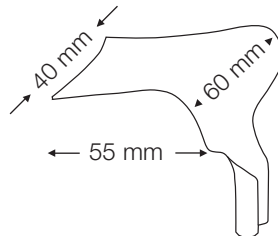

55 x 40-60 mm  
330-301-004

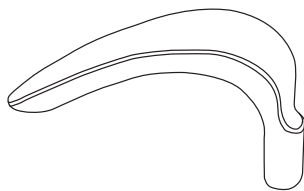

85 x 35 mm  
330-301-002

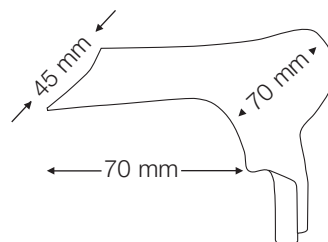

70 x 45-70 mm  
330-301-005

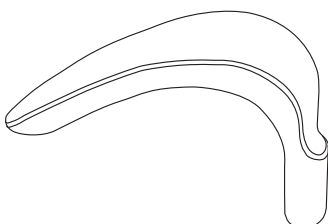

85 x 40 mm  
330-301-003



**Scherback**  
komplettes Set bestehend aus:  
complete Set containing:  
350-301-001, 350-301-002,  
350-301-003, 350-301-004,  
350-301-005, 350-303-001  
350-300-000

Gewicht, weight (400 g)  
350-302-001

Gewicht, weight (800 g)  
350-302-002

Scherback Griff, allein  
Scherback handle, only  
350-303-000

15



Spekula, Specula

Kristeller	Fig.	mm
350-230-001	1	105 x 26
350-230-002	2	105 x 28
350-230-003	3	105 x 33



Halter, Retractor

Kristeller	Fig.	mm
350-231-001	1	115 x 22
350-231-002	2	115 x 24
350-231-003	3	115 x 29



Satz, Set

Kristeller	Fig.
350-232-001	1
350-232-002	2
350-232-003	3



Spekula, Specula

Kristeller	Fig.	mm
350-240-001	1	105 x 27
350-240-002	2	105 x 30
350-240-003	3	105 x 36



Halter, Retractor

Kristeller	Fig.	mm
350-241-001	1	105 x 23
350-241-002	2	105 x 26
350-241-003	3	105 x 32



Satz, Set

Kristeller	Fig.
350-250-001	1
350-250-002	2
350-250-003	3

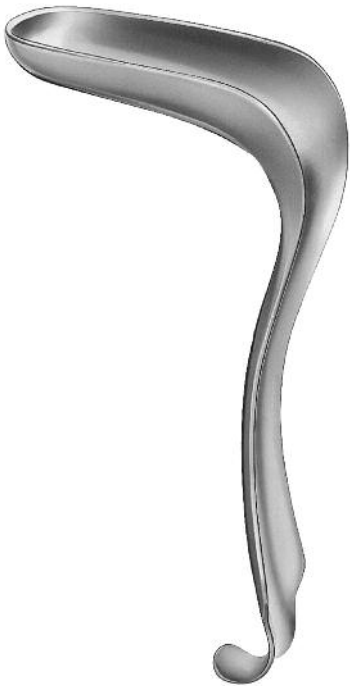

Spekula, Specula

Kristeller	Fig.	mm
350-210-000	0	70 x 15
350-210-001	1	70 x 27
350-210-002	2	80 x 30
350-210-003	3	90 x 36



Halter, Retractor

Kristeller	Fig.	mm
350-211-000	0	70 x 10
350-211-001	1	75 x 23
350-211-002	2	85 x 26
350-211-003	3	100 x 32



Satz, Set

Kristeller	Fig.
350-212-000	0
350-212-001	1
350-212-002	2
350-212-003	3



Spekula, Specula

Kristeller	mm
350-220-001	105 x 18
350-220-002	105 x 21



Halter, Retractor

Kristeller	mm
350-221-001	110 x 14
350-221-002	115 x 17



Satz, Set

Kristeller	Fig.
350-222-001	1
350-222-002	2

15



70 x 15 mm

**Kristeller**  
17.0 cm, 6 3/4"  
350-215-000



75 x 39 mm

**Kallmorgen**  
17.0 cm, 6 3/4"  
350-270-000



Spekulum, Specula	
<b>Kallmorgen</b>	mm
350-270-001	70 x 40
350-270-002	90 x 40

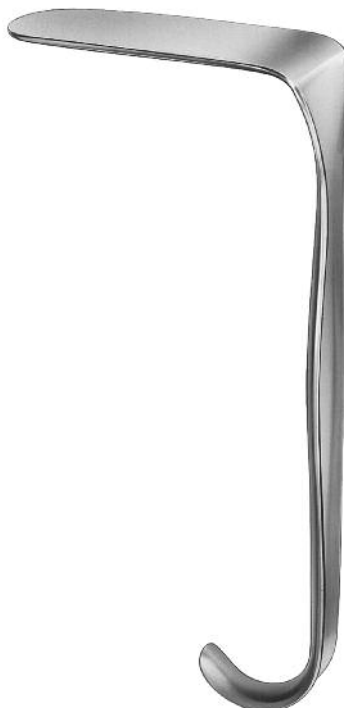

Halter, Retractor	
<b>Kallmorgen</b>	mm
350-271-001	70 x 33
350-271-002	90 x 33



Satz, Set	
<b>Kallmorgen</b>	Fig.
350-272-001	1
350-272-002	2





Jackson	Fig.	mm
350-206-001	1	75 x 38
350-206-002	2	90 x 38
350-206-003	3	100 x 38



Breisky	Fig.
350-190-001	1
350-190-002	2
350-190-003	3



Sims	Fig.
350-200-001	1
350-200-002	2
350-200-003	3

350-200-004 Satz, set

15

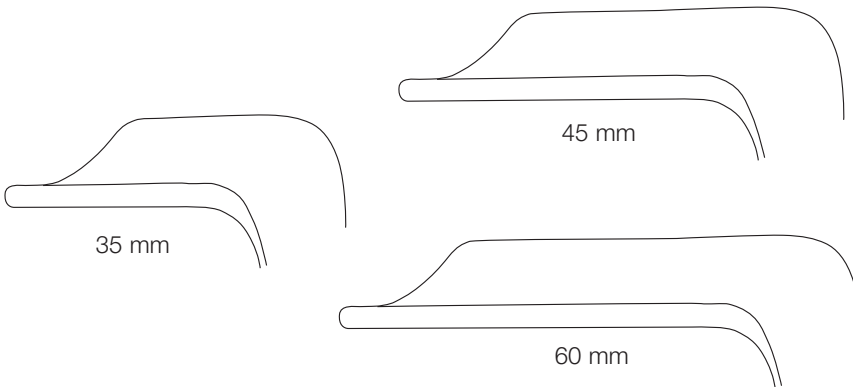

**Doyen**  
leichthohl, slightly-concave

	Fig.	mm
350-290-001	1	55 x 35
350-290-002	2	85 x 35
350-290-003	3	115 x 35
350-290-004	1	55 x 45
350-290-005	2	85 x 45
350-290-006	3	115 x 45
350-290-007	4	160 x 45
350-290-008	1	55 x 60
350-290-009	2	85 x 60
350-290-010	3	115 x 60
350-290-011	4	160 x 60

**Doyen**  
halbhohl, medium-concave

	mm
350-291-001	90 x 35
350-291-002	120 x 35
350-291-003	60 x 45
350-291-004	90 x 45
350-291-005	120 x 45
350-291-006	60 x 60
350-291-007	90 x 60
350-291-008	120 x 60





Breisky	mm
350-320-020	100 x 20
350-320-025	100 x 25
350-320-030	100 x 30
350-320-035	100 x 35
350-320-040	100 x 40
350-322-020	130 x 20
350-322-025	130 x 25
350-322-030	130 x 30
350-322-035	130 x 35
350-322-040	130 x 40
350-324-040	155 x 40



Landau	mm
350-330-001	100 x 28
350-330-002	100 x 38



Spekula, Specula	Fig.
Mathieu	1
350-281-001	1
350-281-002	2



Halter, Retractor	Fig.
Mathieu	1
350-282-001	1
350-282-002	2



**Matzenauer**  
leicthohl, slightly-concave  
27.0-31.0 cm, 10 5/8"-12 1/4"  
mm

350-293-020	90 x 20
350-294-010	100 x 10
350-294-015	100 x 15
350-294-020	100 x 20
350-294-025	100 x 25
350-295-015	125 x 15
350-295-020	125 x 20
350-295-025	125 x 25
350-295-030	125 x 30
350-295-035	125 x 35
350-295-040	125 x 40



85 x 17 mm

**Braun, modif.**  
19.0 cm, 7 1/2"  
350-267-001



**Doyen**  
seitliches Spekulum  
lateral speculum  
23.0 cm, 9"  
350-295-001



**Doyen**  
seitliches Spekulum  
lateral speculum  
25.0 cm, 9 3/4"  
350-295-002



**Wertheim**  
30.0 cm, 12"  
350-332-000



**Kogan**  
mit Schraubengriff (SH),  
with screw handle (SH)  
24.0 cm, 9 1/2"



**Kogan**  
mit Daumensperre (RH),  
with thumb ratchet (RH)  
24.0 cm, 9 1/2"

Skalensperre mit  
Fixierschrauben.  
Scale ratchet  
with fixing screws.

SH 350-361-001  
RH 350-362-001



SH 350-361-002  
RH 350-362-002



SH 350-361-003  
RH 350-362-003



15



**RZ Lateral Retraktor**  
350-340-000

Jeder Gynäkologe hat bereits die Erfahrung gemacht, den Gebärmutterhals zu beobachten trotz eines Kollapses der seitlichen Vagina-Wände. Einige Ärzte haben sogar versucht Zungendrucker und Kondome, die Sie über das Spekulum stülpen, zu benutzen um die Wand zurückgezogen zu halten. Jetzt endlich gibt es eine Lösung des Problems.

RZ-Medizintechnik bietet einen seitlichen Vagina-Reetraktor an, der in Ihr Spekulum paßt. Der seitliche Retraktor verringert oder eliminiert sogar den Kollaps der Vagina-Wände im Blickfeld um einen totalen Einblick in den Muttermund zu gewährleisten. Dies ist ein unschätzbare Vorteil bei einer Gebärmutterhals-Untersuchung, einer Kolpophotographie und verschiedenen Laser- sowie HF-Chirurgie-Eingriffen. Der Retraktor hat auch einen Sperrenmechanismus, der ein einfaches Öffnen und Schließen erlaubt.

Every gynecologist has experienced the problem of trying to view a patient's cervix despite the collapse of the lateral vaginal walls. Some have even resorted to using tongue depressors or condoms over their speculum to try to keep the walls retracted. Finally there's a convenient way to solve this problem.

RZ-Medizintechnik introduces the lateral vaginal retractor, a vaginal spreader that fits inside your speculum. The lateral vaginal retractor reduces or eliminates the collapse of the vaginal walls into the field of view, providing complete visualization when examining the cervix. It is invaluable for gaining a wider field of view, when performing cervicography, colpophotography, laser or electrosurgery procedures.

It also features a convenient locking mechanism with a thumb-ratchet release that keeps it open and in place.

Die Cohen Uterus Sonde wird zur Manipulation des Uterus verwendet. Eine federnde Zangenhalterung garantiert, daß die Sonde zusammen mit einer Hakenzange verwendet werden kann.

The Cohen Uterine Cannula is used for manipulating the uterus. A spring-loaded fixation guarantees, that the cannula can be used together with a tenaculum forceps.



**Cohen Sonde**  
Self Retaining Cannula  
350-750-000

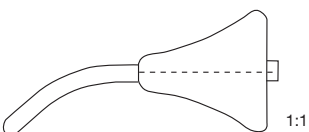

**Portio Adapter**  
groß, large  
350-750-002

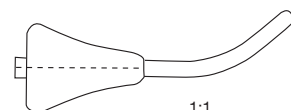

**Portio Adapter**  
klein, small  
350-750-001



Diese lange Tenaculum Faßzange gewährt größte Muttermund-Stabilität, bedingt durch die beiden langen Haken.

This tenaculum forceps provides maximum cervical stabilization through its two opposing hooks.

autoklavierbar, autoclavable



**RZ-Hakenzange**  
**RZ-tenaculum forceps**  
1 x 1 beschichteter Zahn, coated tooth  
gerade, straight  
24.0 cm, 9 1/2"  
**350-401-250**

Zum Entfernen von abgetrennten Gewebeprobe im Vaginalkanal

To remove the looped tissue sample in the vaginal canal



**RZ-Ringfaßzange**  
**RZ-ring forceps**  
beschichtetes, ringförmiges Maul  
coated, ringshaped jaw  
gerade, straight  
24.0 cm, 9 1/2"  
**150-150-250**

15

Graves Vaginal Spekulum, beschichtet, mit Absaugkanal  
Graves vagina speculum, coated, with smoke evacuation tube

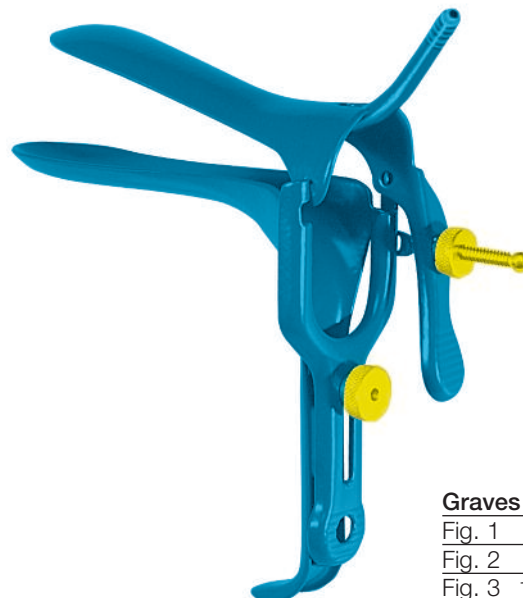

**Graves**  
Fig. 1 75 x 20 mm **350-131-001**  
Fig. 2 95 x 35 mm **350-131-002**  
Fig. 3 115 x 35 mm **350-131-003**



Zum Ziehen des Gewebes und damit zum leichteren Schneiden und Manipulieren.  
For stretching of tissue and for easier cutting and manipulation.

autoklavierbar, autoclavable



25.0 cm, 9 3/4"



**RZ-Iris**  
Haken, hook  
beschichtet, coated  
350-770-250



**RZ-Emmett**  
Tenaculum Haken,  
tenaculum hook  
beschichtet, coated  
350-767-240



**RZ-Zweier**  
Zweierhaken, two-prong-hook  
beschichtet, coated  
350-768-240



**RZ-Dreier**  
Dreierhaken, three-prong-hook  
beschichtet, coated  
350-769-240



**Hegar**

mit Muldengriff

sloped handle

	∅
<b>350-380-010</b>	1.0 mm
<b>350-380-015</b>	1.5 mm
<b>350-380-020</b>	2.0 mm
<b>350-380-025</b>	2.5 mm
<b>350-380-030</b>	3.0 mm
<b>350-380-035</b>	3.5 mm
<b>350-380-040</b>	4.0 mm
<b>350-380-045</b>	4.5 mm
<b>350-380-050</b>	5.0 mm
<b>350-380-055</b>	5.5 mm
<b>350-380-060</b>	6.0 mm
<b>350-380-065</b>	6.5 mm
<b>350-380-070</b>	7.0 mm
<b>350-380-075</b>	7.5 mm
<b>350-380-080</b>	8.0 mm
<b>350-380-085</b>	8.5 mm
<b>350-380-090</b>	9.0 mm
<b>350-380-095</b>	9.5 mm

	∅
<b>350-380-100</b>	10.0 mm
<b>350-380-105</b>	10.5 mm
<b>350-380-110</b>	11.0 mm
<b>350-380-115</b>	11.5 mm
<b>350-380-120</b>	12.0 mm
<b>350-380-125</b>	12.5 mm
<b>350-380-130</b>	13.0 mm
<b>350-380-135</b>	13.5 mm
<b>350-380-140</b>	14.0 mm
<b>350-380-145</b>	14.5 mm
<b>350-380-150</b>	15.0 mm
<b>350-380-155</b>	15.5 mm
<b>350-380-160</b>	16.0 mm
<b>350-380-165</b>	16.5 mm
<b>350-380-170</b>	17.0 mm

15



**Hegar**

Satz mit 14 Dilatoren

Set of 14 dilators

∅ 4, 5, 6, 7, 8, 9, 10, 11, 12,  
13, 14, 15, 16, 17 mm  
im Metalletui mit Scharnierdeckel  
in metal case with hinged lid

**350-381-001**



**Hegar**

mit konischer Spitze,  
doppelendig  
With conical point,  
double-ended

	∅
<b>350-382-020</b>	1.0 / 2.0 mm
<b>350-382-040</b>	3.0 / 4.0 mm
<b>350-382-060</b>	5.0 / 6.0 mm
<b>350-382-080</b>	7.0 / 8.0 mm
<b>350-382-100</b>	9.0 / 10.0 mm
<b>350-382-120</b>	11.0 / 12.0 mm
<b>350-382-140</b>	13.0 / 14.0 mm
<b>350-382-160</b>	15.0 / 16.0 mm
<b>350-382-180</b>	17.0 / 18.0 mm
<b>350-382-200</b>	19.0 / 20.0 mm
<b>350-382-220</b>	21.0 / 22.0 mm
<b>350-382-240</b>	23.0 / 24.0 mm
<b>350-382-260</b>	25.0 / 26.0 mm



**Hegar**

Satz mit 8 Dilatoren  
Set of 8 dilator  
∅ <sup>3</sup>/<sub>4</sub>-<sup>17</sup>/<sub>18</sub> mm  
in auskochbarer Stoff-Rolltasche  
in boilable canvas roll  
**350-383-001**





**Hank**

mit konischer Spitze,  
doppelendig, amerikanische Größen  
With conical point, double-ended,  
american scale Fig.  $\varnothing$

<b>350-390-010</b>	9/10	4.5 / 5.0 mm
<b>350-390-012</b>	11/12	5.5 / 6.0 mm
<b>350-390-014</b>	13/14	6.5 / 7.0 mm
<b>350-390-016</b>	15/16	7.5 / 8.0 mm
<b>350-390-018</b>	17/18	8.5 / 9.0 mm
<b>350-390-020</b>	19/20	9.5 / 10.0 mm

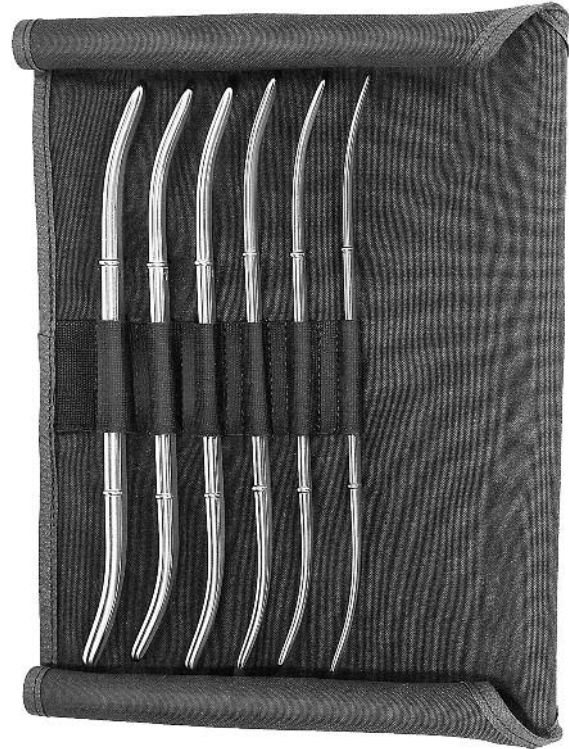

**Hank**

Satz mit 6 Stück in Stoff-Rolltasche  
Set of 6 pieces on canvas roll

**350-391-002**

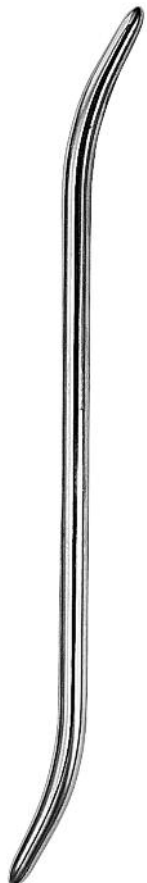

**Pratt**

französische Größen  
French scale  $10 \frac{3}{8}$ "

<b>350-392-015</b>	13-15
<b>350-392-019</b>	17-19
<b>350-392-023</b>	21-23
<b>350-392-027</b>	25-27
<b>350-392-031</b>	29-31
<b>350-392-035</b>	33-35
<b>350-392-039</b>	37-39
<b>350-392-043</b>	41-43

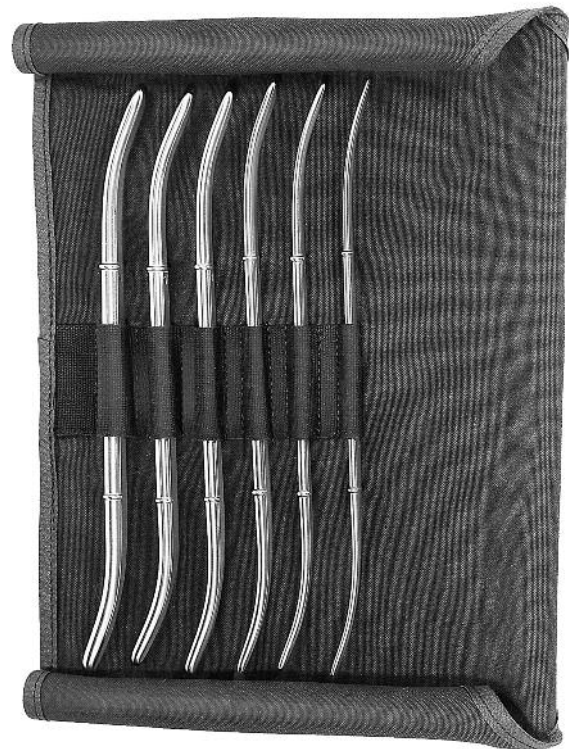

**Pratt**

Satz mit 8 Stück in Stoff-Rolltasche  
Set of 8 pieces on canvas roll

**350-392-000**

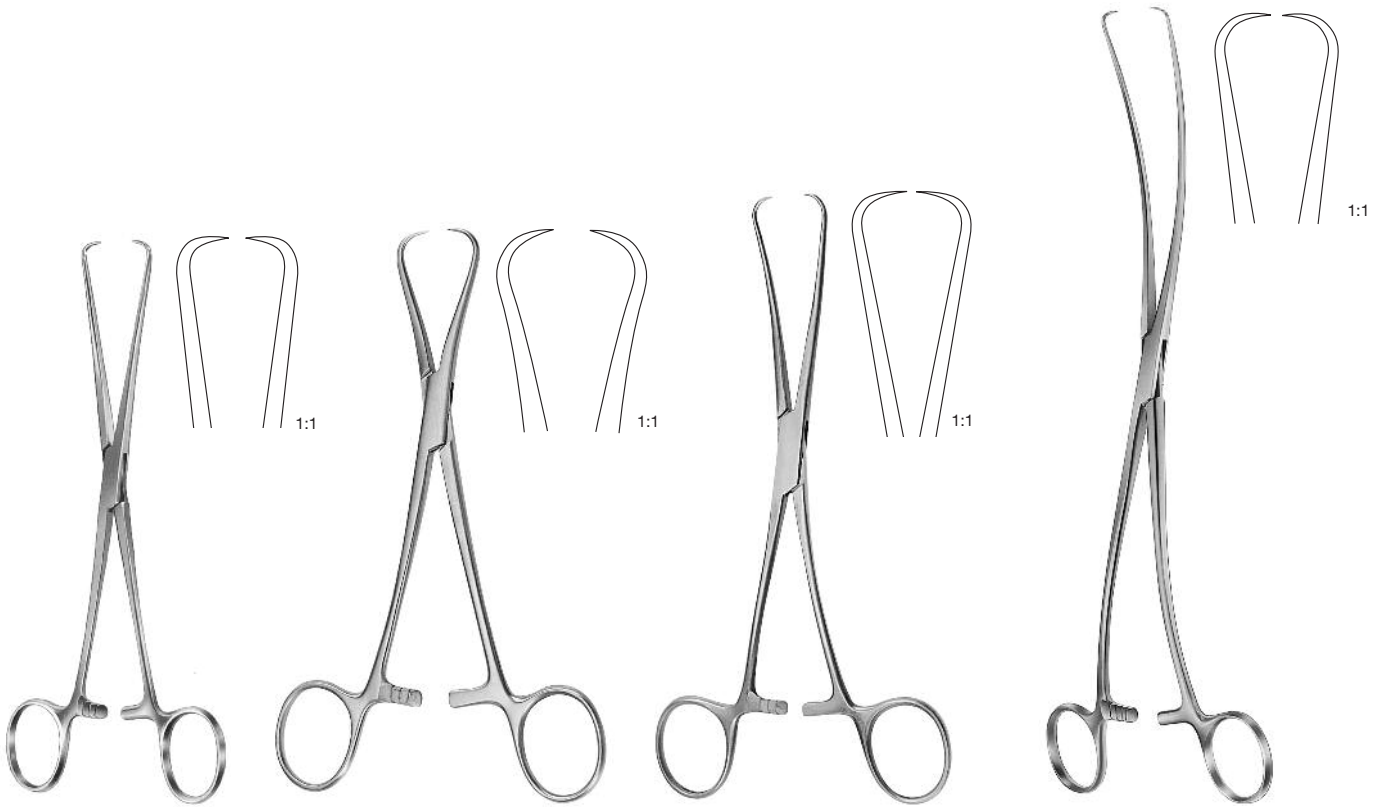

**Barrett**  
18.0 cm, 7"  
350-426-180

**Adair**  
19.0 cm, 7 1/2"  
350-426-190

**Jarcho**  
20.0 cm, 8"  
350-427-200

**Duplay**  
28.0 cm, 11"  
350-428-280

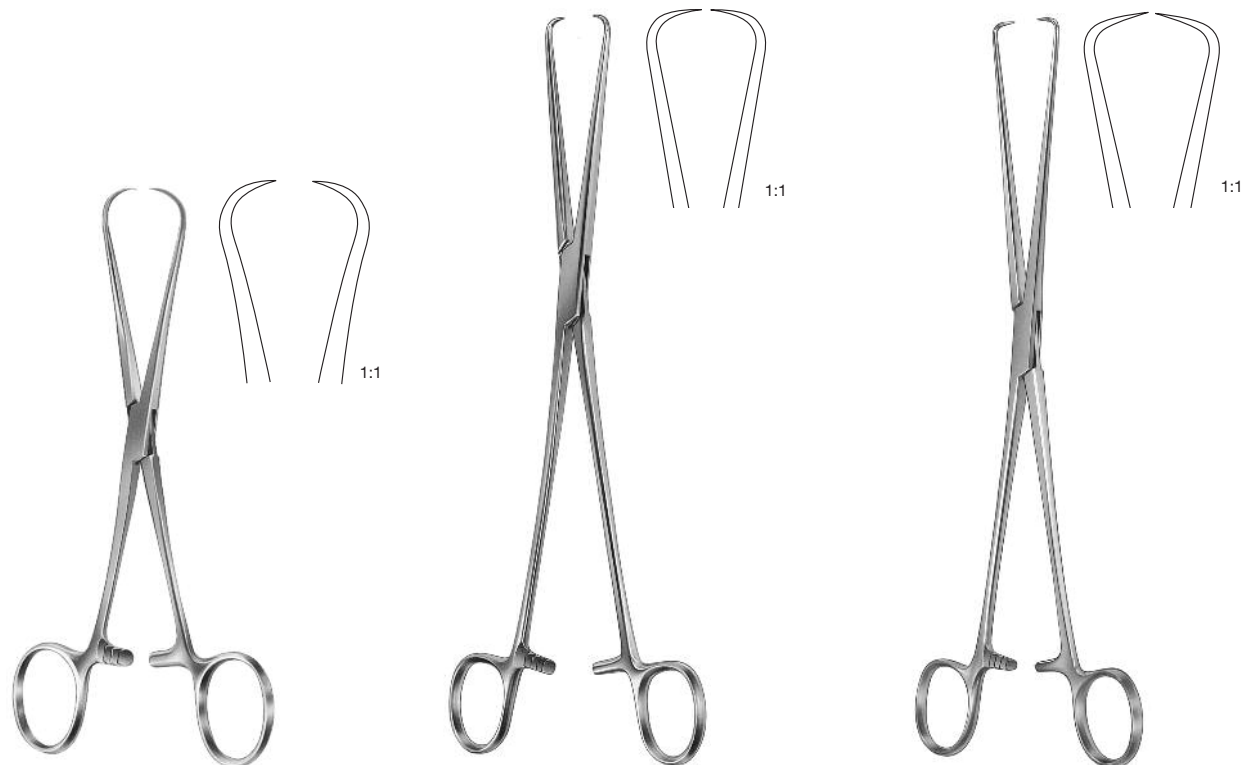

**Staude-Moore**  
17.0 cm, 6 3/4"  
350-422-170

**Schroeder**  
25.0 cm, 9 3/4"  
350-400-250

**Braun**  
25.0 cm, 9 3/4"  
350-410-250

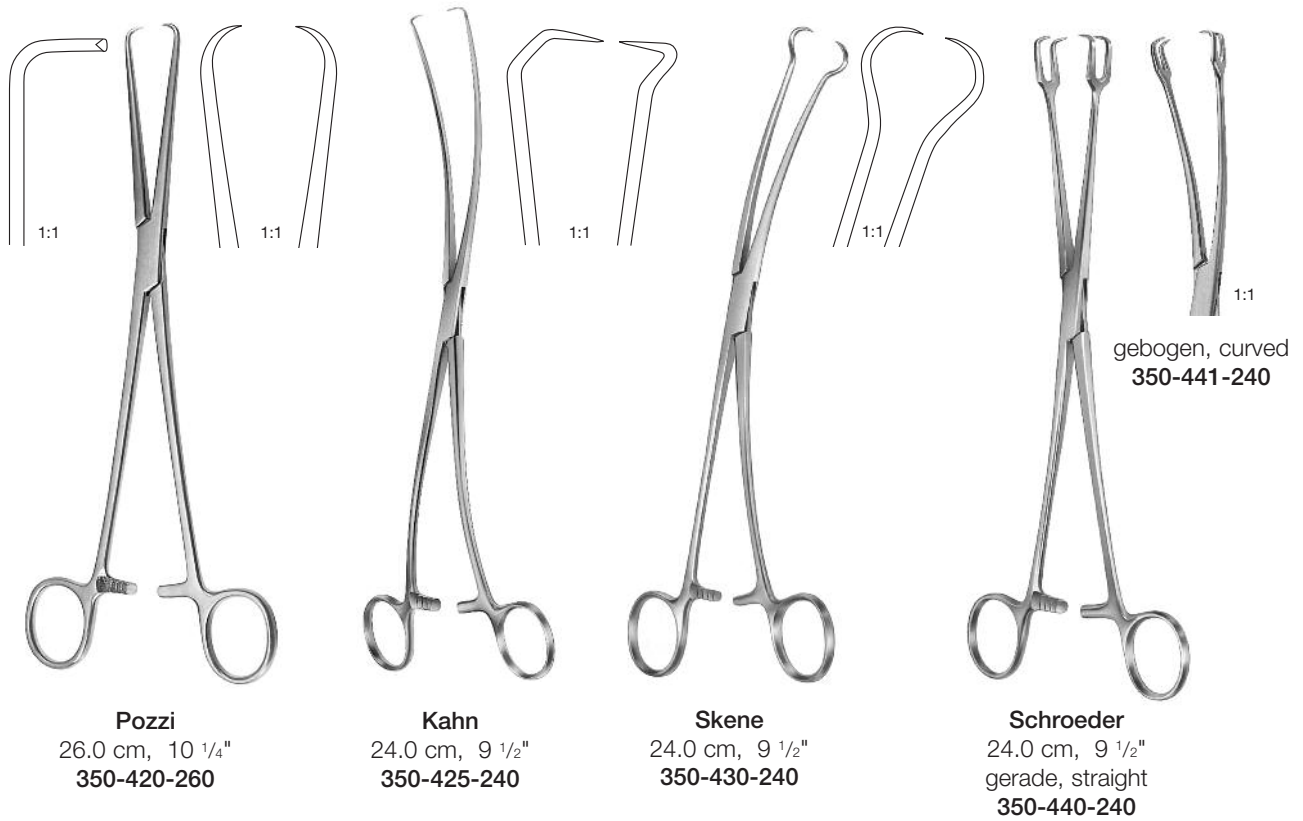

Hakenzangen  
Vulsellum forceps

15

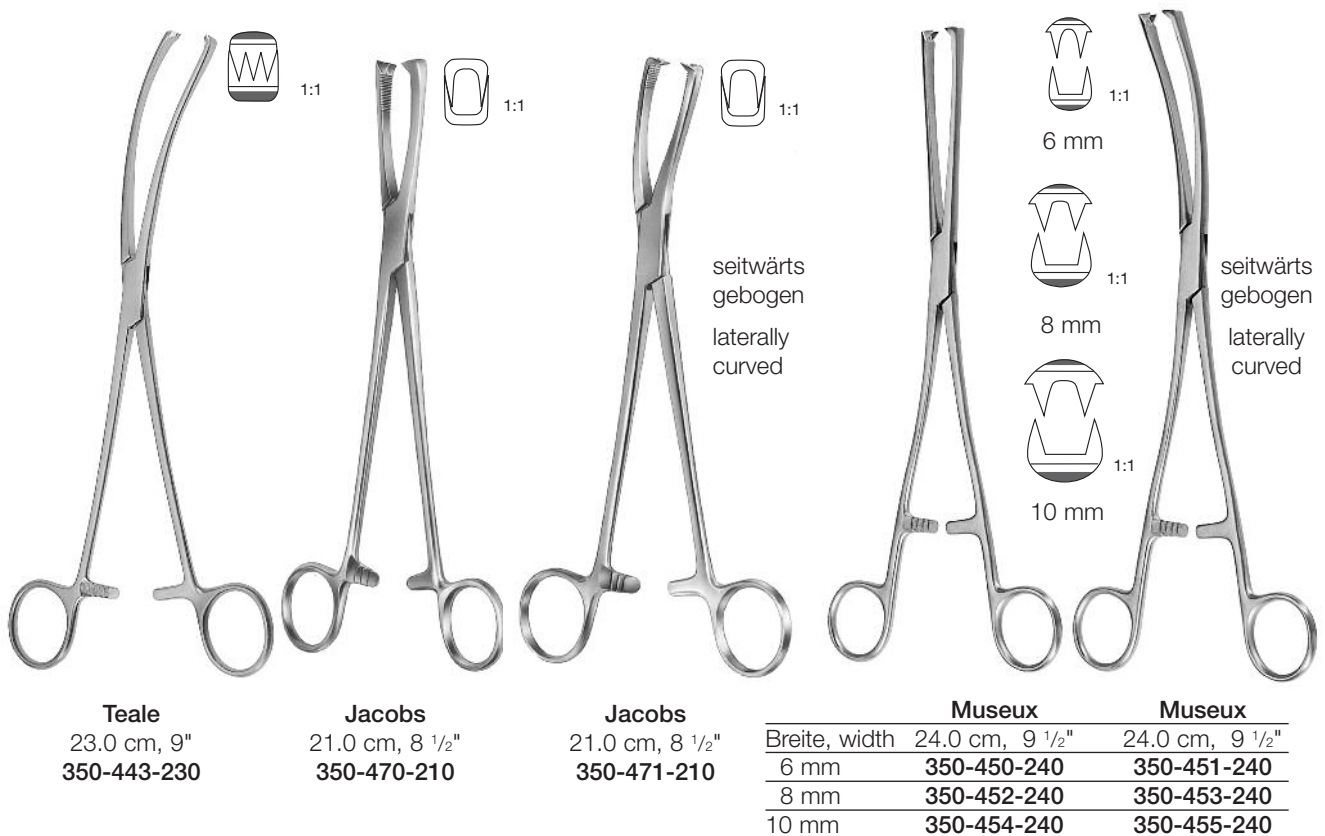

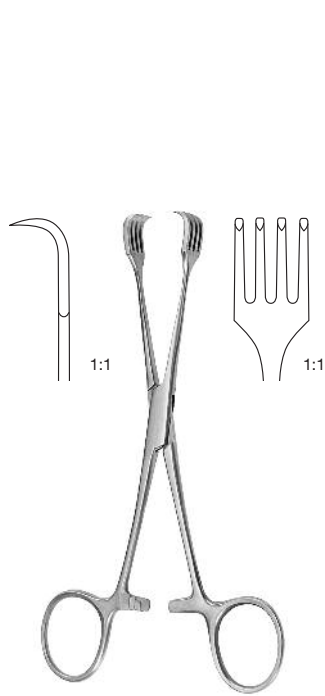

**Braun**  
15.5 cm, 6"  
350-476-155

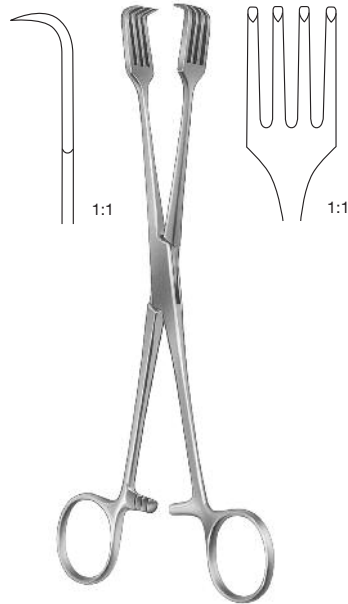

**Czerny**  
20.5 cm, 8"  
350-480-205

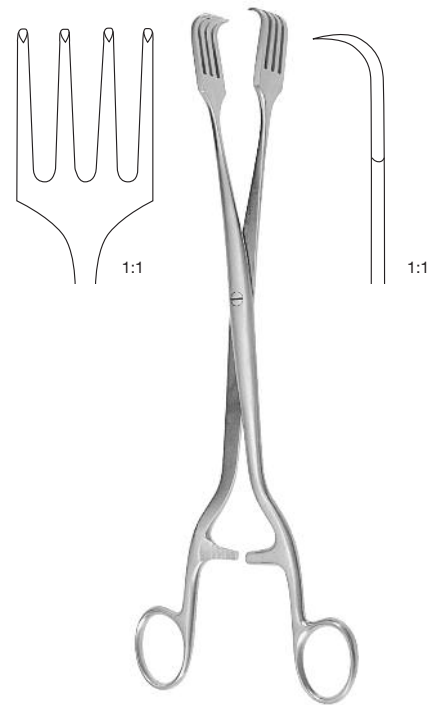

**Pratt**  
26.0 cm, 10 1/4"  
350-474-260

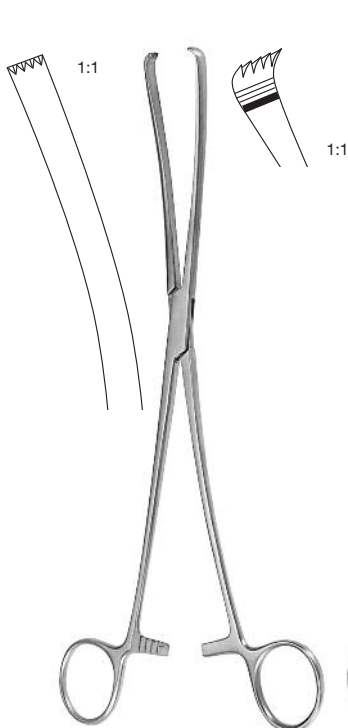

**Iova**  
26.0 cm, 10 1/4"  
350-445-260

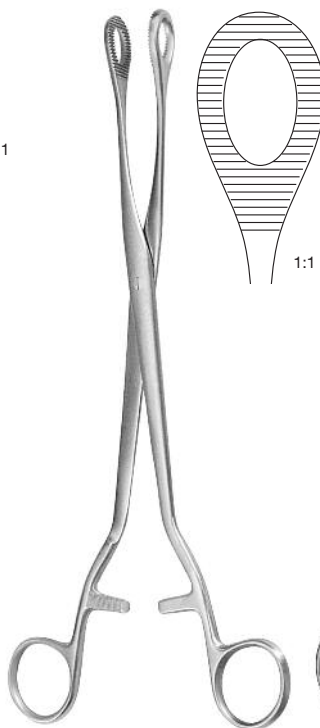

**Noto**  
27.0 cm, 10 5/8"  
350-492-270

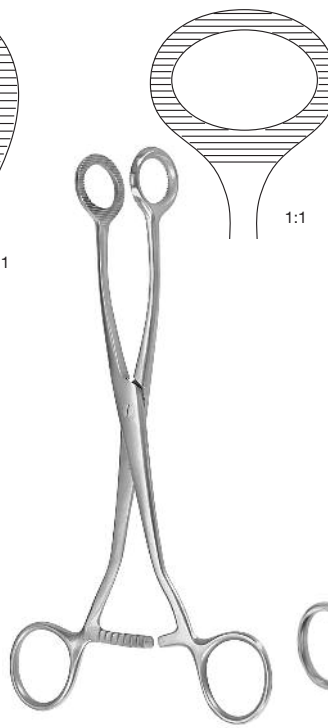

**Doyen**  
20.0 cm, 8"  
350-494-200

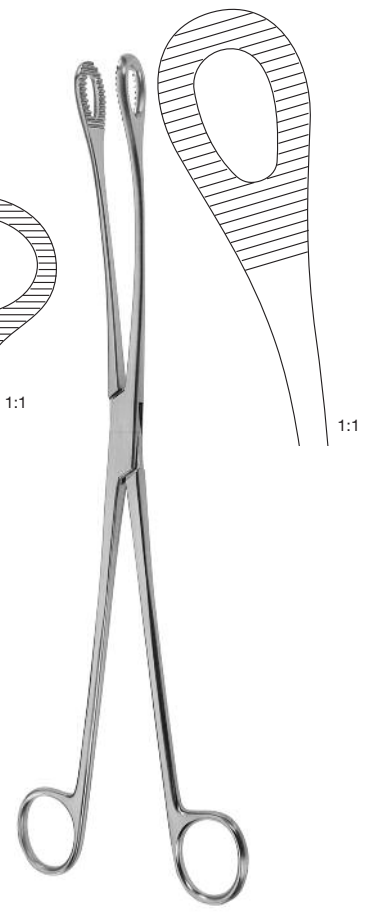

**Kelly**  
32.0 cm, 12 1/2"  
350-490-320

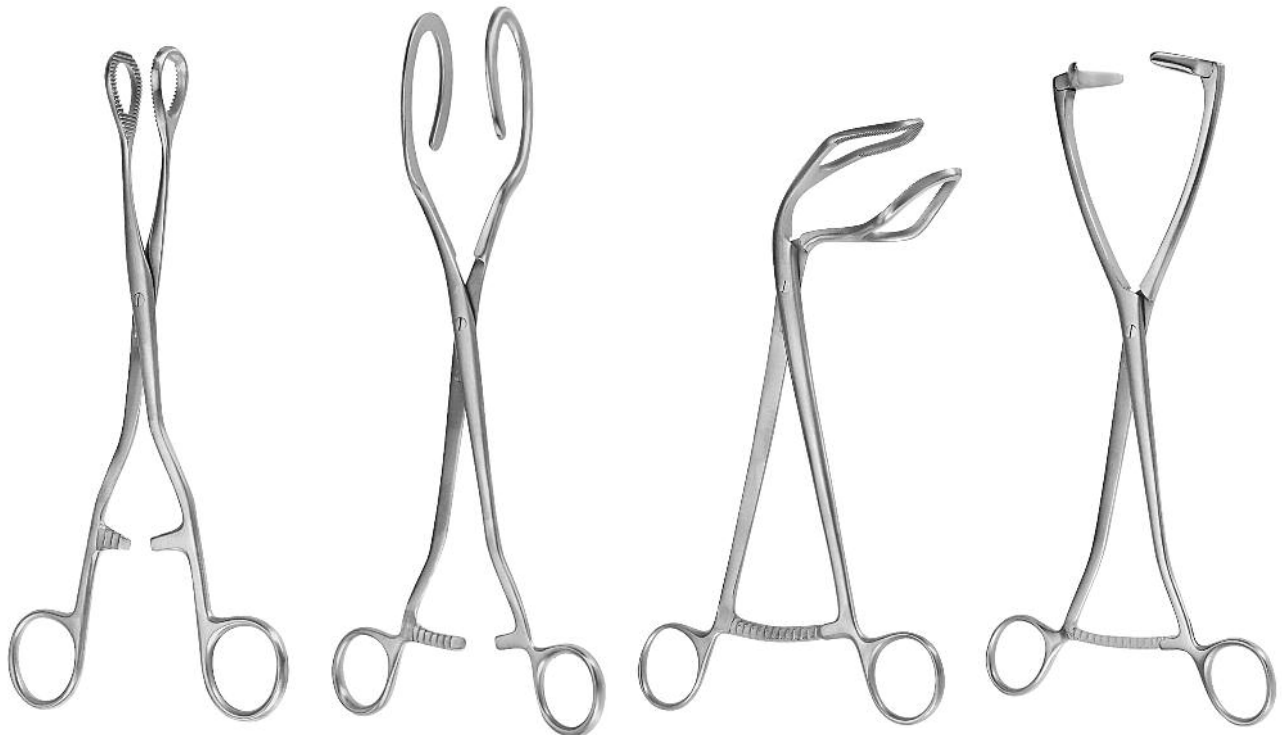

**Heywood-Smith**  
 25.0 cm, 9 3/4"  
 350-491-250

**Dartigues**  
 27.0 cm, 10 3/4"  
 350-493-270

**Somer**  
 23.0 cm, 9"  
 350-493-230

**Collin**  
 25.0 cm, 9 3/4"  
 350-493-250

Amniotom  
 Amniotome

Uterus-Depressor  
 Uterine depressor

Katheter  
 Catheter



**Beacham**  
 26.0 cm, 10 1/4"  
 350-429-260



**Braun**  
 28.0 cm, 11"  
 350-399-280



Metallkatheter für Frauen  
 Female catheters, metal

16.0 cm, 6 1/4"	Charr.
320-721-060	6
320-721-070	7
320-721-080	8
320-721-090	9
320-721-100	10
320-721-110	11
320-721-120	12
320-721-130	13
320-721-140	14
320-721-150	15
320-721-160	16
320-721-180	18
320-721-200	20

15



**Sims**  
32.0 cm, 12 1/2"  
starr, rigid  
350-395-320

biegsam, malleable  
350-396-320



**Martin**  
32.0 cm, 12 1/2"  
starr, rigid  
350-393-320

biegsam, malleable  
350-394-320



**Valleix**  
350-398-250



**Simpson**  
29.0 cm, 11 1/2"  
biegsam, malleable  
350-396-290



**Collin**  
28.0 cm, 11"  
350-392-280



**Kevorkian**  
30.0 cm, 12"



1:1

biegsam, malleable  
mit Korb, with basket  
350-601-300



1:1

starr, rigid  
mit Korb, with basket  
350-600-300



1:1

starr, rigid  
ohne Korb, without basket  
350-599-300

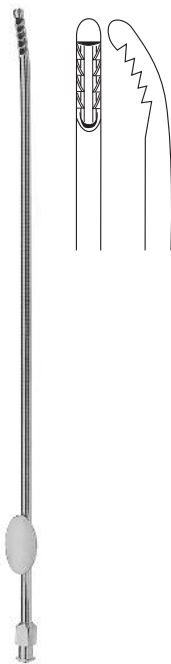

**Novak**  
23.0 cm, 9"  
ø 4 mm  
350-604-230

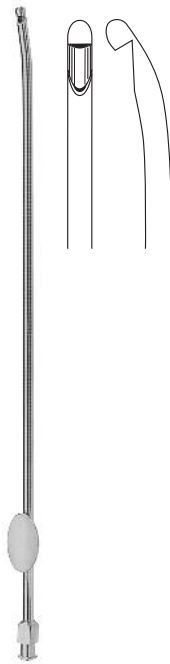

**Randall**  
24.0 cm, 9 1/2"  
ø 4 mm  
350-602-240



**Milan**  
29.0 cm, 11 1/2"  
starr, rigid  
350-605-007  
biegsam, malleable  
350-607-007



Ringgriff, ring handle  
biegsam, malleable  
25.0 cm, 9 3/4"  
350-766-001



Rundgriff, round handle  
biegsam, malleable  
25.0 cm, 9 3/4"  
350-766-100



Emmett  
22.0 cm, 8 5/8"



Fig. 1  
350-765-001



Fig. 2  
350-765-002



Fig. 3  
350-765-003



Simon  
22.0 cm, 8 5/8"  
350-766-220



Segond  
27.0 cm, 10 5/8"  
350-800-000

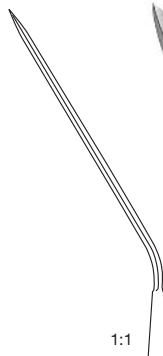
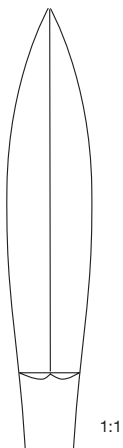

1:1



1:1

Ayre  
23.0 cm, 9"  
350-810-000

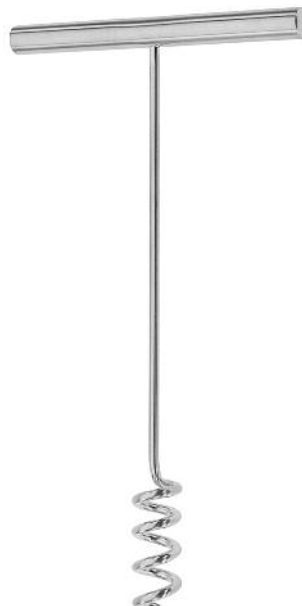

Doyen  
19.0 cm, 7 1/2"  
350-757-190

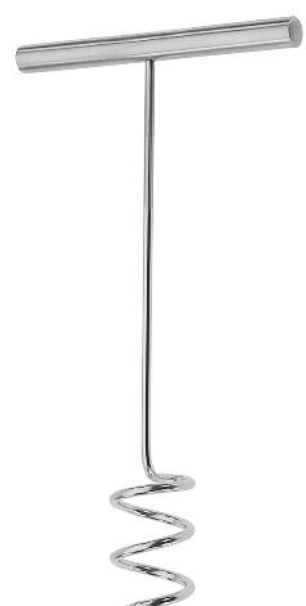

Doyen  
17.0 cm, 6 3/4"  
350-759-170

15



**Sims**  
28.5 cm, 11 1/4"

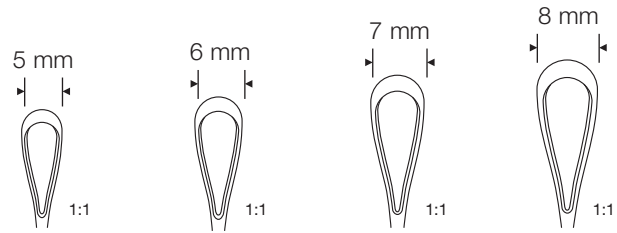

	Fig. 00	Fig. 0	Fig. 1	Fig. 2
fest - scharf, rigid - sharp	350-630-005	350-630-006	350-630-007	350-630-008
fest - stumpf, rigid - blunt	350-926-050	350-926-060	350-926-070	350-926-080
biegsam - scharf, malleable - sharp	350-631-005	350-631-006	350-631-007	350-631-008
biegsam - stumpf, malleable - blunt	350-927-050	350-927-060	350-927-070	350-927-080

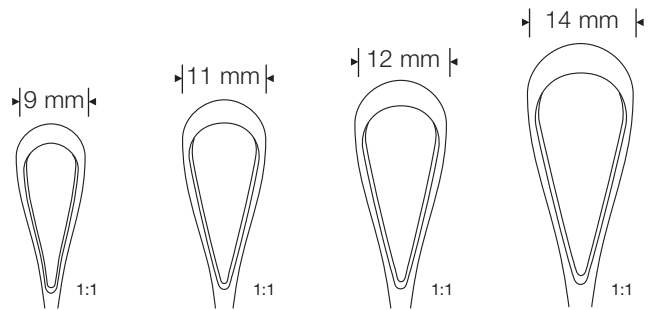

	Fig. 3	Fig. 4	Fig. 5	Fig. 6
fest - scharf, rigid - sharp	350-630-009	350-630-011	350-630-012	350-630-014
fest - stumpf, rigid - blunt	350-926-090	350-926-110	350-926-120	350-926-140
biegsam - scharf, malleable - sharp	350-631-009	350-631-011	350-631-012	350-631-014
biegsam - stumpf, malleable - blunt	350-927-090	350-927-110	350-927-120	350-927-140

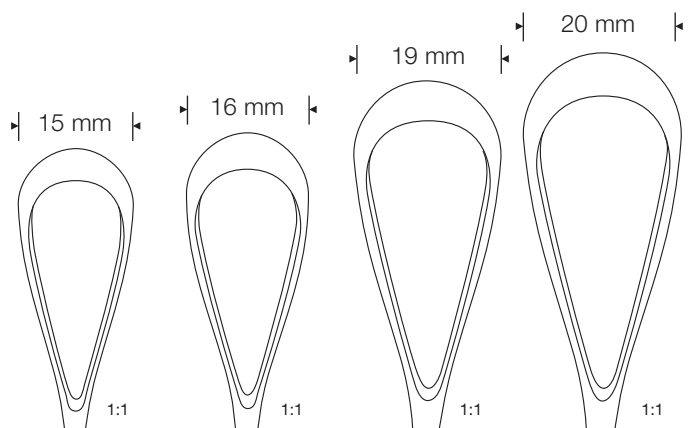

	Fig. 7	Fig. 8	Fig. 9	Fig. 10
fest - scharf, rigid - sharp	350-630-015	350-630-016	350-630-019	350-630-020
fest - stumpf, rigid - blunt	350-926-150	350-926-160	350-926-190	350-926-200
biegsam - scharf, malleable - sharp	350-631-015	350-631-016	350-631-019	350-631-020
biegsam - stumpf, malleable - blunt	350-927-150	350-927-160	350-927-190	350-927-200





**Recamier**  
31.0 cm, 12 1/4"

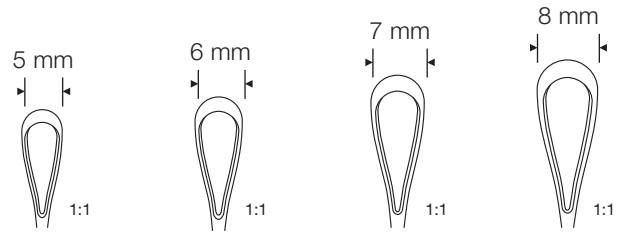

	Fig. 00	Fig. 0	Fig. 1	Fig. 2
fest - scharf, rigid - sharp	350-620-005	350-620-006	350-620-007	350-620-008
fest - stumpf, rigid - blunt	350-619-005	350-619-006	350-619-007	350-619-008
biegsam - scharf, malleable - sharp	350-621-005	350-621-006	350-621-007	350-621-008
biegsam - stumpf, malleable - blunt	350-622-005	350-622-006	350-622-007	350-622-008

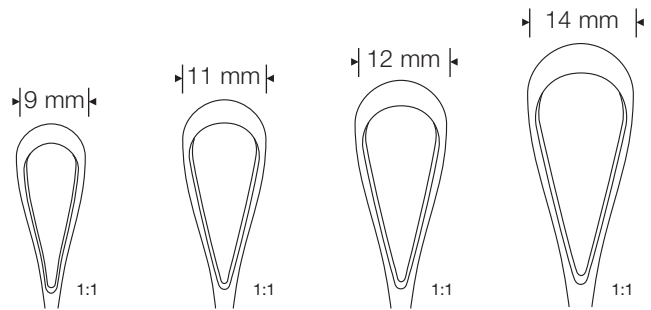

	Fig. 3	Fig. 4	Fig. 5	Fig. 6
fest - scharf, rigid - sharp	350-620-009	350-620-011	350-620-012	350-620-014
fest - stumpf, rigid - blunt	350-619-009	350-619-011	350-619-012	350-619-014
biegsam - scharf, malleable - sharp	350-621-009	350-621-011	350-621-012	350-621-014
biegsam - stumpf, malleable - blunt	350-622-009	350-622-011	350-622-012	350-622-014

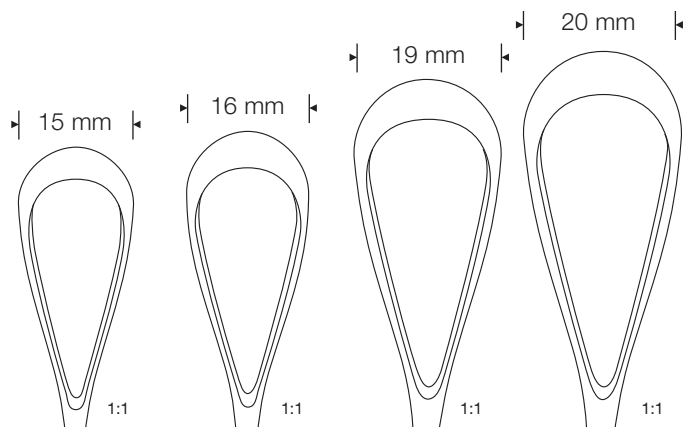
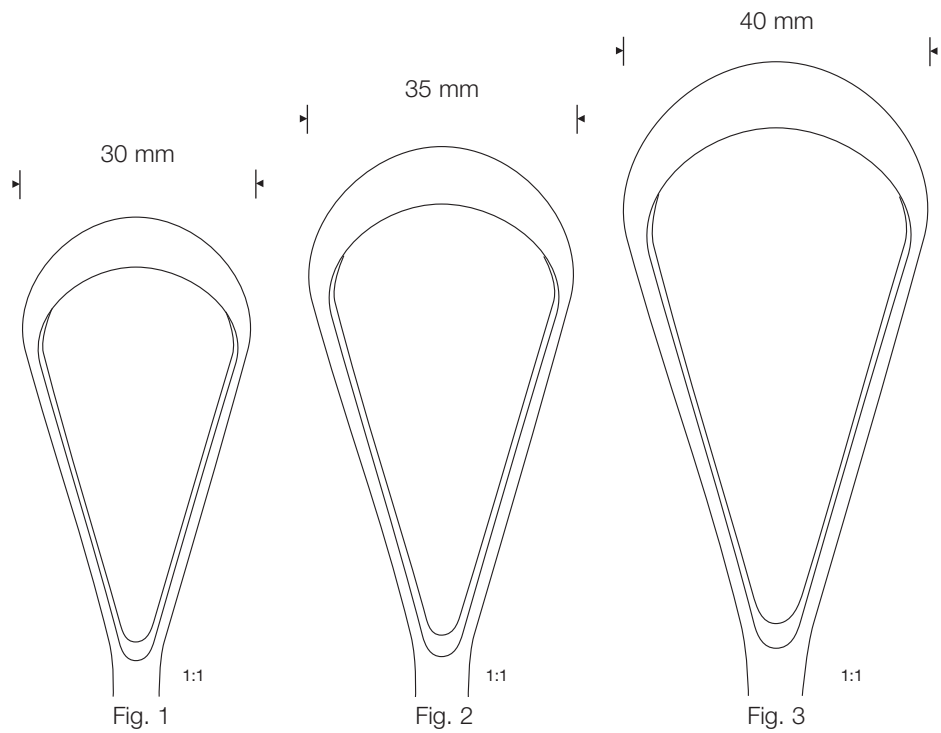

	Fig. 7	Fig. 8	Fig. 9	Fig. 10
fest - scharf, rigid - sharp	350-620-015	350-620-016	350-620-019	350-620-020
fest - stumpf, rigid - blunt	350-619-015	350-619-016	350-619-019	350-619-020
biegsam - scharf, malleable - sharp	350-621-015	350-621-016	350-621-019	350-621-020
biegsam - stumpf, malleable - blunt	350-622-015	350-622-016	350-622-019	350-622-020



Bumm



fest - scharf, rigid - sharp	350-920-300	350-920-350	350-920-400
fest - stumpf, rigid - blunt	350-926-300	350-926-350	350-926-400
biegsam - scharf, malleable - sharp	350-928-300	350-928-350	350-928-400
biegsam - stumpf, malleable - blunt	350-929-300	350-929-350	350-929-400



Simon  
 scharf, sharp  
 25.0 cm, 9 3/4"

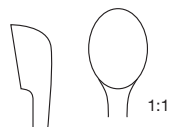

Fig. 1  
 350-610-001

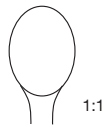

Fig. 2  
 350-610-002

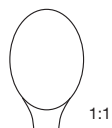

Fig. 3  
 350-610-003

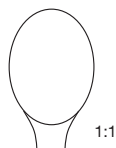

Fig. 4  
 350-610-004

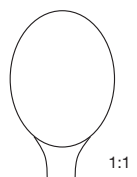

Fig. 5  
 350-610-005

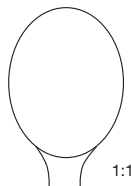
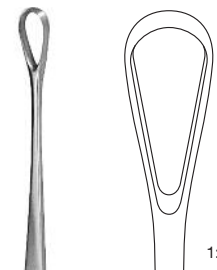
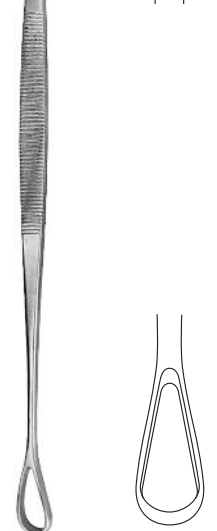

Fig. 6  
 350-610-006



1:1



1:1

Blake  
 scharf / stumpf  
 sharp / blunt  
 27.0 cm, 10 5/8"  
 350-614-270

Die charakteristische S-Form der Van Doren und Thoms-Gaylor Biopsiezangen gewährleistet eine freie Sicht auf das Operationsfeld, wodurch der Operateur eine scharf begrenzte Probeentnahme durchführen kann.

The typical S-shaped design of the Van Doren and Thoms-Gaylor biopsy forceps allows a clear view on the operation field to take a fine, precise probe



**Van Doren**  
26.7 cm, 10 1/2"  
350-855-267



**Thoms-Gaylor**  
gebogen, curved  
22.0 cm, 8 5/8"  
350-857-220  
24.0 cm, 9 1/2"  
350-857-240

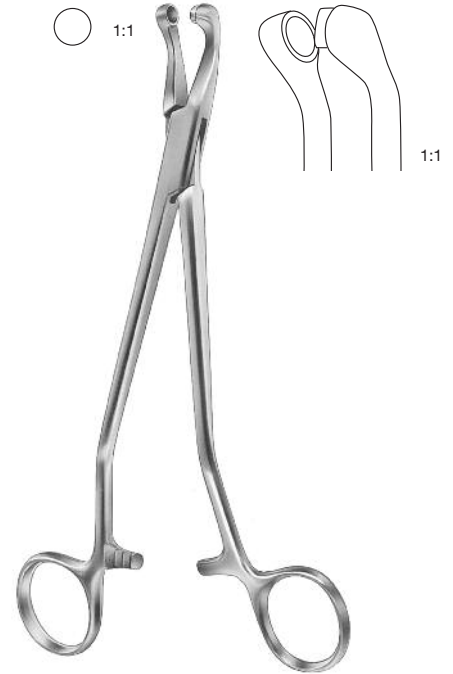

**Thoms-Gaylor**  
24.0 cm, 9 1/2"  
350-849-240



**Faure**  
21.0 cm, 8 1/4"  
350-843-210



**Schubert**  
21.0 cm, 8 1/4"  
350-844-210  
29.0 cm, 11 1/2"  
350-844-290



**Schubert**  
26.0 cm, 10 1/4"  
350-847-260



Die folgenden Biopsiezangen sind besonders gut für eine Kolposkopie geeignet, da man mit ihnen auch in tiefere Zonen eindringen kann.

The following Biopsy Forceps are specially suitable for Colposcopy, because with the long shaft you also come to deeper fields.

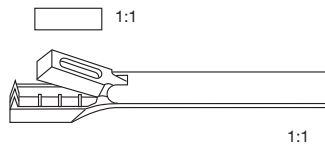

**Kevorkian**  
24.0 cm, 9 1/2"  
9 x 3 mm  
310-730-240

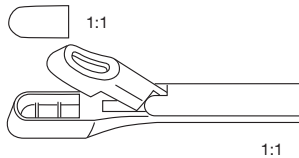

**Eppendorfer**  
20.0 cm, 8"  
4.5 x 8 mm  
310-760-200

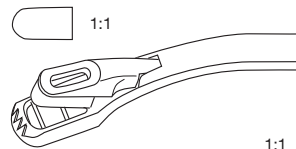

**Wittner**  
20.0 cm, 8"  
4.5 x 8 mm  
gebogen, angled  
310-761-200  
gerade, straight  
310-762-200

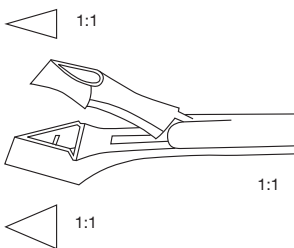

**Schumacher**  
24.0 cm, 9 1/2"  
Fig. 1, 4 mm  
310-729-001  
Fig. 2, 6 mm  
310-729-002

Der Vorteil der **Schumacher** Biopsiezangen ist, daß diese durch ihre Nase an der Spitze einen Anhak-Effekt auslösen, und hierdurch das Gewebe sehr gut erfassen können. Des weiteren haben die **Schumacher** Biopsiezangen einen sehr großen Öffnungswinkel, und können so auch an narbigem, flachem Scheidengewölbe angesetzt werden. Ebenfalls haben sie einen glatten ziehenden Schnitt, wodurch sich die Wunde wieder selber schließt und so gut heilen kann.

The advantage of the **Schumacher** Biopsy Forceps is, that the small crook on the upper jaw gives a kind of hoking effect, which grasps the tissue safely. Another advantage is, that angle of opening is also very large, so it can also be used for scarred, flat vaginal vault. Further they also have a smooth steady cut, to get a self-sealing wound which heals well.

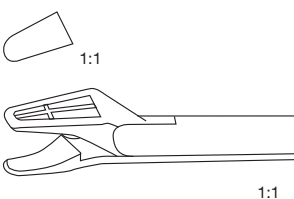

**Alexander**  
28.0 cm, 11"  
310-735-280

Der Vorteil der **Alexander** Biopsiezange ist, daß man bedingt durch die Linksbiegung des Maulteiles eine gute Sicht auf das Operations-feld hat. Des weiteren liegt die Schnittkante direkt im Gewebe, welches zur Folge hat, daß man einen exakten und sauberen Schnitt durchführen kann. Sie hat ebenfalls einen ziehenden Schnitt, wodurch eine gute Heilung der Wunde gewährleistet wird.

The advantage of the **Alexander** Biopsy Forceps is, that the left curvage of the jaw allows a good view on the operating field. Further the cutting edge is planted into the tissue, which helps to make an exact and precise bite. It also has a smooth steady cut, so the wound will heal well.

Vorteile der RZ-Biopsie Stanzen  
Advantages of the RZ-biopsy punches

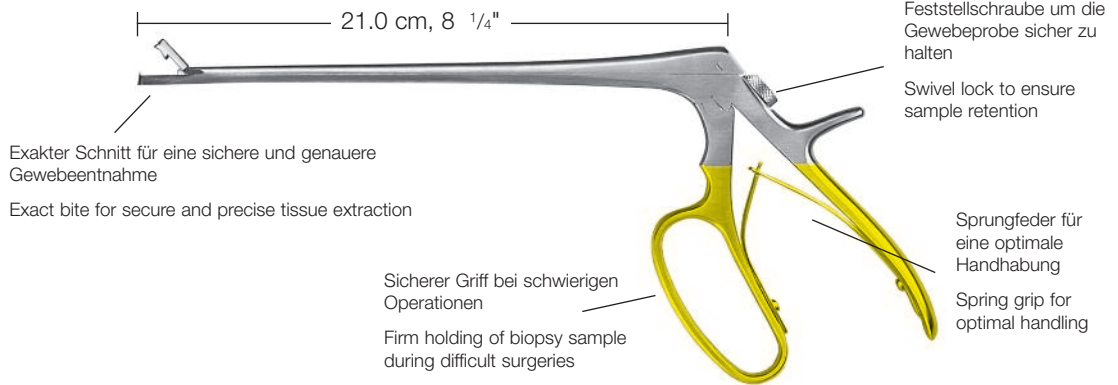

Exakter Schnitt für eine sichere und genauere Gewebeentnahme  
Exact bite for secure and precise tissue extraction

Sicherer Griff bei schwierigen Operationen  
Firm holding of biopsy sample during difficult surgeries

Feststellschraube um die Gewebeprobe sicher zu halten  
Swivel lock to ensure sample retention

Swivel lock to ensure sample retention

Sprungfeder für eine optimale Handhabung

Spring grip for optimal handling

1:1



**Tischler-Morgan**  
7 x 3 mm  
310-733-001

Die klassische Biopsie-Stanze, die von vielen Gynäkologen gegenüber anderen Stanzen bevorzugt wird. Dieses einzigartige Maul hat einen hervorragenden Schneidemechanismus, der das Gewebe in das Maul hineinzieht und das Herausgleiten verhindert.

The classic biopsy punch, a favorite of many gynecologists. The unique jaw has a superior bite mechanism which draws tissue into the jaw and prevents it from slipping out.

1:1



**Mini-Townsend**  
2.3 x 4 mm  
310-733-002

Diese Biopsie-Stanzen sind besonders geeignet bei Patientinnen mit einem engen, externen Muttermund, wenn eine kleine Schädigung im Scheidenkanal sichtbar ist. Die Stanzen bieten die Möglichkeit extrem kleine Gewebeproben zu entnehmen.

1:1



**Baby-Tischler**  
2.3 x 4 mm  
310-733-003

This biopsy punches are particular valuable in patients with a tight, external os, where a small lesion is just seen inside the vaginal canal. The punches offer the opportunity to obtain very small biopsy samples.

1:1



**Tischler-Kevorkian**  
9 x 3 mm  
310-731-200

Diese Biopsie-Stanze vereinigt die Möglichkeit einer Gewebeprobe mit einer rechteckigen Schnittkonfiguration und dem Vorteil eines Tischler Handgriffs, der eine optimale Handhabung gewährleistet.

The biopsy punch combines the opportunity of taking a square configuration tissue sample and the advantage of a Tischler handle which secures an optimal handling.

1:1



**Kevorkian-Pacific**  
9 x 3 mm  
310-732-200

Der Schnitt dieser Stanze ist jedem Gynäkologen bekannt, da er geringe Gewebeverletzungen verursacht. Dies ist die alternative im asiatischen Raum zur gewöhnlichen Kevorkian Biopsie Stanze mit Ringgriff.

The bite of this punch is familiar to all gynecologists because of the little tissue lesion in particular in asian countries. This design is an alternative to the common Kevorkian biopsy punch with the ring handle design.

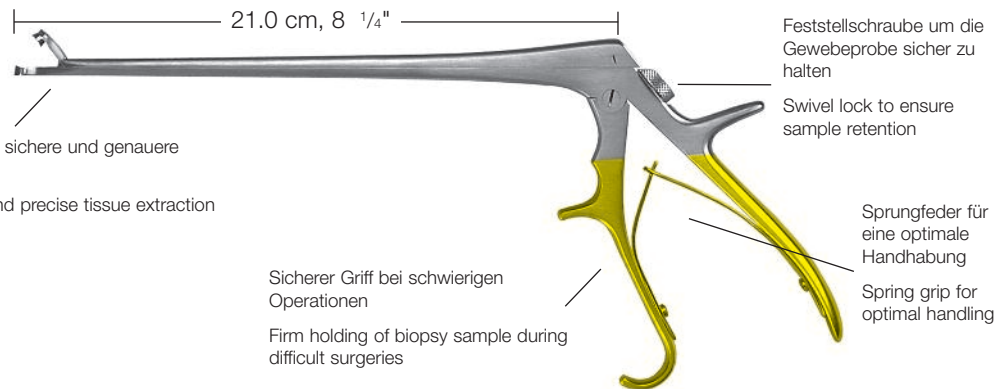

Exakter Schnitt für eine sichere und genauere Gewebeentnahme  
Exact bite for secure and precise tissue extraction

Sicherer Griff bei schwierigen Operationen  
Firm holding of biopsy sample during difficult surgeries

Feststellschraube um die Gewebeprobe sicher zu halten  
Swivel lock to ensure sample retention

Swivel lock to ensure sample retention

Sprungfeder für eine optimale Handhabung

Spring grip for optimal handling

1:1



**Burke**  
5 x 3 mm  
310-732-000

Dieses Modell gewährleistet einen schmalen, präzisen Schnitt mit scharfen Zähnen  
This punch provides a small, precise bite with sharp teeth



**Wrigley**  
28.0 cm, 11"  
340-011-280



**Simpson**  
30.0 cm, 11 3/4"  
340-013-300



**Simpson-Braun**  
33.0 cm, 13"  
340-012-330  
36.0 cm, 14 1/8"  
340-012-360



**Simpson-Luikart**  
36.0 cm, 14 1/8"  
340-029-360



**DeLee**  
30.0 cm, 11 3/4"  
340-018-300



**DeLee**  
36.0 cm, 14 1/8"  
340-018-360

39.0 cm, 15 3/8"  
340-018-390



**Mc Lean**  
36.0 cm, 14 1/8"  
340-020-360



**Kielland**  
41.0 cm, 16"  
340-014-410



**Kielland-Luikart**  
40.0 cm, 15 3/4"  
340-016-400



**Piper**  
44.0 cm, 17 1/4"  
340-017-440



**Elliot**  
32.0 cm, 12 1/2"  
340-025-320  
38.0 cm, 15"  
340-025-380



**Naegele**  
36.0 cm, 14 1/8"  
340-015-360  
40.0 cm, 15 3/4"  
340-015-400

Die Green Armytage Klemmzange wird zur Blutstillung an den Schnitträndern im unteren Segment bei Kaiserschnitt-Entbindungen verwendet.

The Green-Armytage caesarean section hemostatic forceps is used for staunch bleeding edges of the transverse incision in the lower segment.

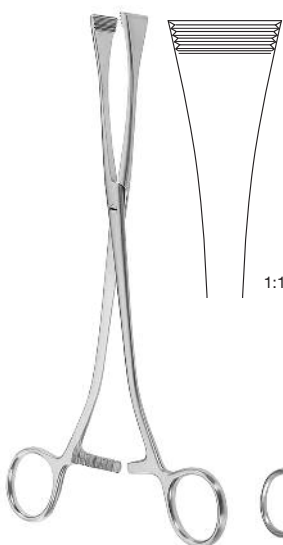

**Green-Armytage**  
21.0 cm, 8 1/4"  
340-150-210

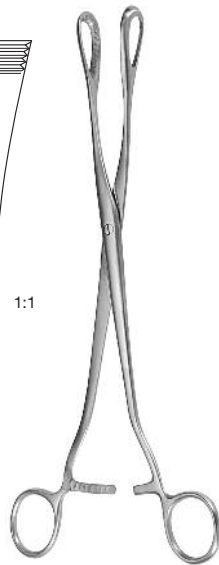

**Saenger**  
27.0 cm, 10 5/8"  
gerade, straight  
340-798-270

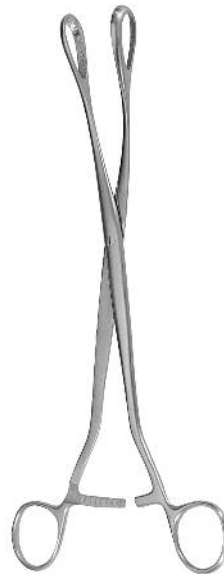

**Saenger**  
27.0 cm, 10 5/8"  
gebogen, curved  
340-799-270

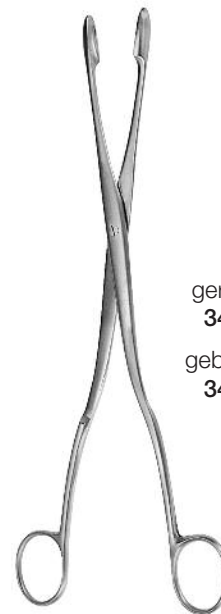

**Winter**  
28.0 cm, 11"

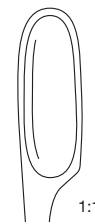

Fig. 1  
gerade, straight  
340-800-280  
gebogen, curved  
340-801-280

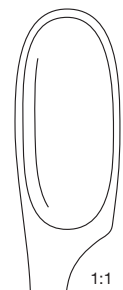
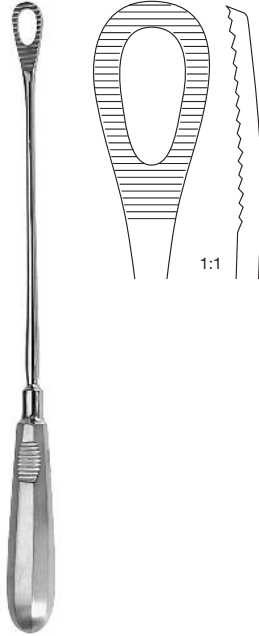
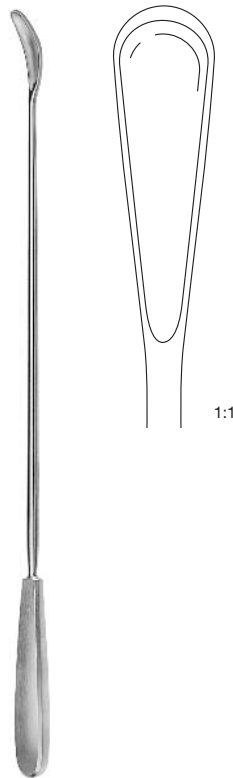

Fig. 2  
gerade, straight  
340-799-280  
gebogen, curved  
340-802-280



**Pestalozza**  
30.0 cm, 11 3/4"  
340-500-300



**Wallich**  
stumpf, blunt  
42.0 cm, 16 1/2"  
340-510-420



**Bierer**  
Ovarienfaßzange, Ovum forceps  
33.0 cm, 13"

Maul jaws	ohne Sperre without ratchet	mit Sperre with ratchet
16 mm	<b>350-496-330</b>	<b>350-497-330</b>
19 mm	<b>350-498-330</b>	<b>350-499-330</b>

Beckenzirkel  
Pelvimeter



cm / Zoll-Skala  
cm / inch-scale  
34.0 cm, 13 3/8"  
340-103-340

Circumcisionsgerät  
Circumcision instrument



**Gomco**

Ø	
8 mm	<b>340-600-008</b>
11 mm	<b>340-600-011</b>
13 mm	<b>340-600-013</b>
16 mm	<b>340-600-016</b>
21 mm	<b>340-600-021</b>
26 mm	<b>340-600-026</b>
32 mm	<b>340-600-032</b>

Zusammen mit zwei Arterien- oder Präparierklemmen wird die Vorhaut über die glockenförmige Schutzkappe gezogen, so daß die Eichel geschützt ist. Nun wird die Flügelschraube so stark angezogen, daß die Vorhaut gequetscht wird. Mit einem Skalpell wird die Vorhaut über der Schutzglocke abgeschnitten. Das Circumcisionsgerät bleibt noch einige Zeit angezogen um eine Blutung zu verhindern. Im Falle, daß doch Blutungen auftreten und eine große Ader, speziell die Eichenbändchen-Arterie, verletzt worden sein sollte, muß eine Naht durchgeführt werden. Hierfür eignet sich hervorragend unser Mini-Assistent, Artikel-Nummer 180-959-000 auf Seite 193. Ein Vorteil bei dieser Methode ist der Kosmetische Aspekt, da nur eine minimale Narbe nach dem Entfernen des kleinen Hautstückes übrig bleibt.

Together with two Hemostats or Ligature Forceps the foreskin is pushed over the bellshaped protection-rod and the glans is placed safely into it. By now, the nut is tightened as close as possible, so the foreskin is annularly compressed. The foreskin is cut off with a scalpel, right next to the compression ring. The compression ring should remain a few minutes to avoid bleeding. In case that any large vein, specially the frenular artery, is cut through, a ligature must be set. The advantage of the method described is the cosmetically favourable scar which is left after rejection of the small necrotized portion.



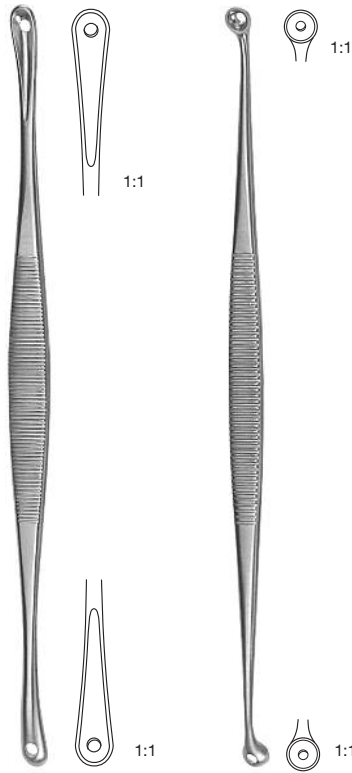

**Unna**  
 14.0 cm, 5 3/4"  
 230-230-140

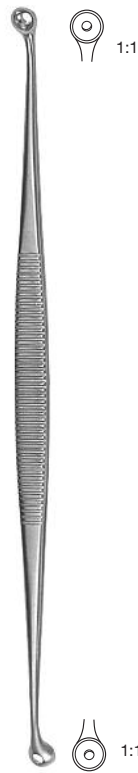

**Unna**  
 14.0 cm, 5 3/4"  
 230-232-140

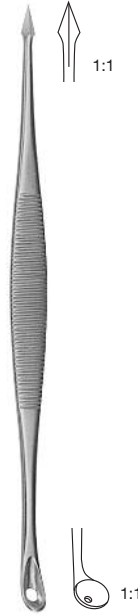

**Saalfeld**  
 10.0 cm, 4"  
 230-239-100



**Saalfeld**  
 14.0 cm, 5 3/4"  
 230-236-140

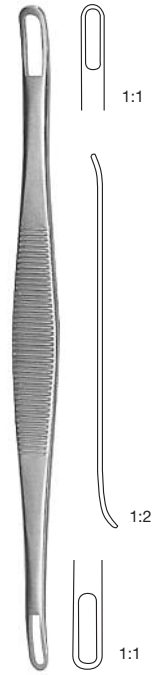

**Schamberg**  
 10.0 cm, 4"  
 230-238-100



**Walton**  
 14.0 cm, 5 3/4"  
 230-240-140



**Fox**  
 14.0 cm, 5 3/4"



3 mm  
 230-151-140



4 mm  
 230-152-140



5 mm  
 230-153-140



6 mm  
 230-154-140



**Piffard**  
 14.0 cm, 5 3/4"



Fig. 1  
 230-155-001



Fig. 2  
 230-155-002



Fig. 3  
 230-155-003

2 mm  
 230-160-002



12.0 cm, 4 3/4"

3 mm  
 230-160-003

4 mm  
 230-160-004

5 mm  
 230-160-005

6 mm  
 230-160-006

7 mm  
 230-160-007

8 mm  
 230-160-008



**Keys**  
 komplett, complete  
 230-160-000

**Keys**



Sägeblatt  
Saw Blade  
210-972-000

**Walton**  
Fingerringsäge  
Finger ring saw  
210-972-160



Sägeblatt  
Saw Blade  
210-976-000

Fingerringsäge  
Finger ring saw  
210-975-170

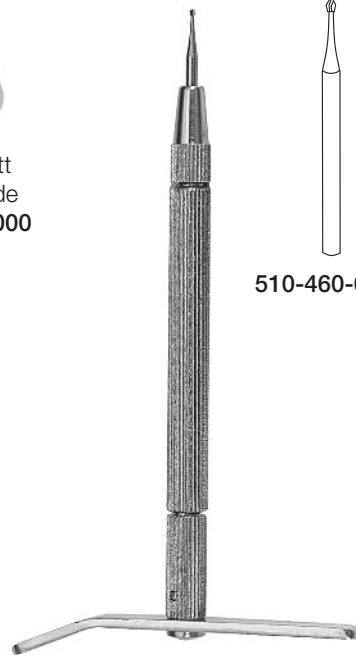

Nagelbohrer mit 3 Bohrern  
Finger nail drill with 3 drill points  
510-460-000

Bohrer allein  
drill points only

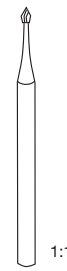

510-460-001



510-460-002

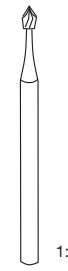

510-460-003



**Radolf**  
Nagelausreißzange  
Nail extracting forceps  
13.5 cm, 5 3/8"  
510-462-130



Nagelspaltzange  
Nail splitting forceps  
13.5 cm, 5 3/8"  
510-334-140



Nagelzange  
Nail nipper  
13.0 cm, 5"  
510-347-130



Nagelzange  
Nail nipper  
14.0 cm, 5 1/2"

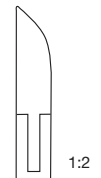

510-323-140

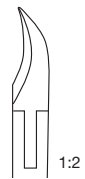

510-324-140



## Instrumentenpflege

Sterilisierzangen, Sterilisierklammern  
Standgefäße

## Maintenance of Instruments

Sterilizing Forceps, Safety Pins  
Jars



20.0 cm, 8"  
600-080-200



**Cheatle**  
27.0 cm, 10 <sup>5</sup>/<sub>8</sub>"  
600-095-270



**Rogge**  
23.0 cm, 9"  
600-087-230



**Pye-Smith (Harrison)**  
35.0 cm, 13 <sup>3</sup>/<sub>4</sub>"  
600-088-350



**Mayo**  
14.0 cm, 5 <sup>1</sup>/<sub>2</sub>"  
660-100-140



**Bunt**  
12.0 cm, 4 <sup>3</sup>/<sub>4</sub>"  
660-102-120



Standgefäß ohne Deckel  
jar without lid

75 mm ø x 130 mm	<b>660-142-006</b>
75 mm ø x 175 mm	<b>660-142-007</b>
100 mm ø x 175 mm	<b>660-142-008</b>
100 mm ø x 200 mm	<b>660-142-009</b>



runde Schale, round bowl

40 mm ø	<b>600-231-040</b>
60 mm ø	<b>600-231-060</b>
80 mm ø	<b>600-231-080</b>
100 mm ø	<b>600-231-100</b>
120 mm ø	<b>600-231-120</b>
150 mm ø	<b>600-231-150</b>



Nierenschale, kidney tray

170 mm	<b>600-673-170</b>
250 mm	<b>600-673-250</b> (Standard)
275 mm	<b>600-673-275</b>



runde Schale, round bowl

165 x 55 mm	0.75 l	<b>600-170-165</b>
175 x 70 mm	1.00 l	<b>600-170-175</b>
225 x 100 mm	2.00 l	<b>600-170-225</b>
240 x 95 mm	2.75 l	<b>600-170-240</b>
260 x 120 mm	4.00 l	<b>600-170-260</b>
315 x 150 mm	5.50 l	<b>600-170-315</b>
325 x 135 mm	8.00 l	<b>600-170-325</b>
360 x 165 mm	12.00 l	<b>600-170-360</b>
415 x 150 mm	14.00 l	<b>600-170-415</b>
290 x 100 mm	5.00 l	<b>600-170-290</b>



Instrumentenkasten, instrument box

200 x 150 x 25 mm	<b>600-310-200</b>
260 x 180 x 30 mm	<b>600-310-260</b>
300 x 220 x 30 mm	<b>600-310-300</b>
350 x 220 x 40 mm	<b>600-310-350</b>
220 x 170 x 50 mm	<b>600-312-220</b>
280 x 200 x 50 mm	<b>600-312-280</b>
320 x 240 x 50 mm	<b>600-312-320</b>
370 x 270 x 50 mm	<b>600-312-370</b>
420 x 320 x 50 mm	<b>600-312-420</b>

Aus Drahtgeflecht  
wire mesh

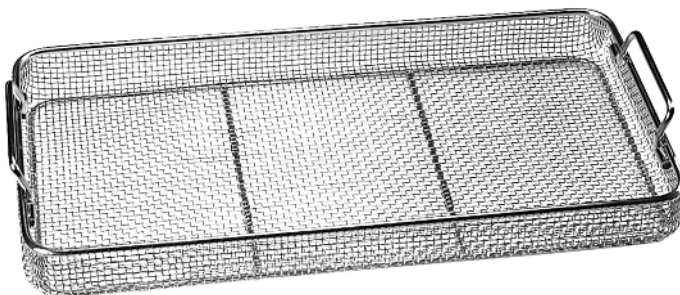

Sterilisierkorb, Sterilizing tray

240 x 250 x 50 mm	<b>600-281-240</b>
480 x 250 x 50 mm	<b>600-281-480</b>
550 x 250 x 50 mm	<b>600-281-550</b>



Nadelsterilisierdose  
Needle sterilizing case  
ø 65 x 17 mm  
**600-100-065**

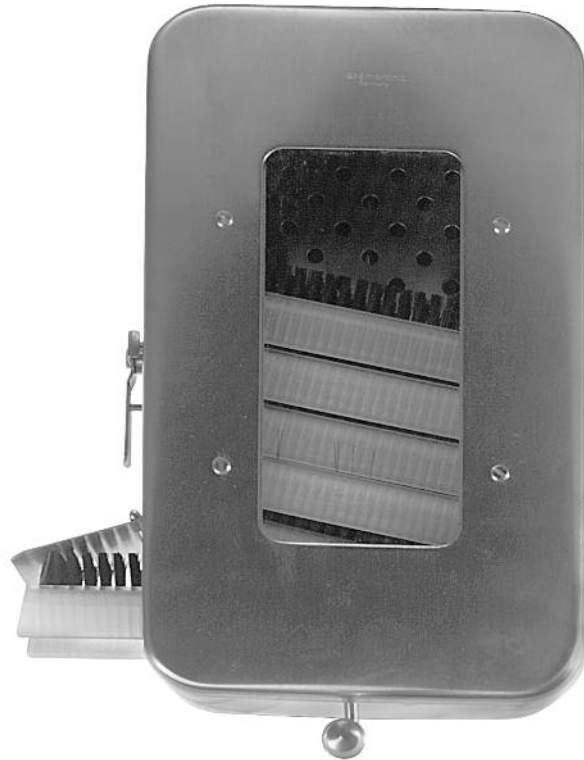

**RZ-Bürstenspender**  
**RZ-Brush dispenser**  
für 10 Bürsten (ohne Bürsten),  
mit Aufhängevorrichtung  
for 10 brushes (without brushes),  
with suspension hook  
**600-950-100**

**RZ-Bürstenspender**  
**RZ-Brush dispenser**  
für 20 Bürsten (ohne Bürsten),  
mit Aufhängevorrichtung  
for 20 brushes (without brushes),  
with suspension hook  
**600-951-100**

Aufhängevorrichtung für kleinen  
RZ-Bürstenspender  
Suspension hook for small  
RZ-Brush dispenser  
**600-950-101**  
für große RZ-Bürstenspender  
for large RZ-Brush dispenser  
**600-951-101**

mehr als 400 x autoklavierbar  
more than 400 x autoclavable

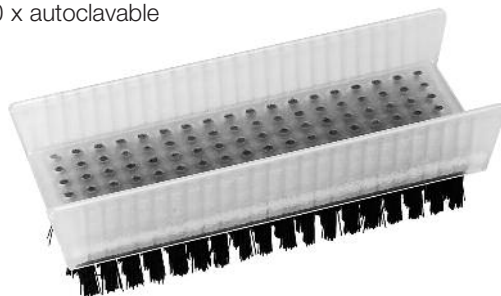

Handwaschbürste, (1 Packung beinhaltet 10 Bürsten)  
handbrush, (1 box containing 10 brushes)  
**600-050-000**



Die RZ-Medizintechnik Farbbänder stellen eine schnelle und kostengünstige Möglichkeit dar, um chirurgische Instrumente zu markieren. RZ-Farbbänder machen es Ihnen einfach, Ihr eigenes Markierungssystem zu entwickeln, um Instrumente nach ihrer Art, Anwendung oder nach Eigentümer zu kennzeichnen.

Die haltbaren Rollen sind in zehn auffälligen Farben lieferbar. Sie sind sehr leicht anzubringen. Sie wurden klinisch getestet und wurden als sicher bei normaler Flash und Gas-Sterilisation anerkannt.

RZ-Farbbänder sind 6.5 mm, 1/4" breit und werden in 7.6 m, 300" Länge auf Spulen geliefert. Dies reicht aus, um ungefähr 250 Instrumente zu markieren. Jede Spule wird in einer harten Plastikbox geliefert und kann dadurch leicht gelagert werden.

**Anwendung:**

Das Instrument sowie die Hände müssen trocken und frei von jeglichen Mitteln sein. RZ-Medizintechnik Farbbänder müssen abgeschnitten und nicht abgerissen werden. Es muß genug abgeschnitten werden, so daß sich das Band mindestens einmal selber überklebt.

RZ-Farbbänder dürfen nicht gedehnt werden.

Nachdem das Farbband aufgetragen wurde, muß das Instrument sterilisiert werden. Dadurch haftet das Band nun am Instrument und hat sich mit diesem fest verbunden.

Nach dem Gebrauch die Rolle wieder in die Plastikbox legen.

Die Bänder sollten alle 6-8 Monate gewechselt werden.

Bei Scheren muß das Band an den Ringen angebracht werden, so daß die Funktion nicht beeinträchtigt wird.

Um das Band vom Instrument zu entfernen, nimmt man ein Skalpell zur Hilfe und reinigt es anschließend mit einer gewöhnlichen Reinigungsmilch.

RZ-Medizintechnik presents an inexpensive way of color coding surgical instruments. RZ-Coding Tapes make it easy to create your own labeling system for identifying and sorting instruments by type, specialty and ownership.

The durable tapes come in ten highvisible colors. They are easy to apply. They have been clinically tested and found safe for use in conventional flash or gas sterilization units.

RZ-Color Coding Tapes are 6.5 mm, 1/4" wide and packaged of spools in 7.6 m, 300" length. That's enough to code approximately 250 instruments. Each spool comes in it's own hard-plastic box for easy storage.

**Instructions:**

The instrument and the hands must be dry and free from any residue.

RZ-Color Coding Tapes must be cut not torn.

Enough tape must be cut to overlap itself at least once.

The tape must not be stretched.

Upon completing the application of RZ-Color Coding Tapes, autoclave the instruments. The tape will bond itself to the instruments. Replace the roll in its plastic box after use.

Do not put the tape on the shanks of scissors, as this interferes with the function of the instrument. Place the tape on the finger rings of the scissors.

Change RZ-Color Coding Tapes at least every 6-8 months.

To remove the tape, cut with a razor blade and clean with any instrument cleaner.

Grün, green	900-950-001
Gelb, yellow	900-950-002
Blau, blue	900-950-003
Rot, red	900-950-004
Braun, brown	900-950-005
Weiß, white	900-950-006
Orange, orange	900-950-007
Schwarz, black	900-950-008
Lila, purple	900-950-009
Hellorange, bright orange	900-950-010



### Metric Conversion

To Convert	to	Multiply by
millimeter (mm)	centimeter (cm)	0.1
millimeter (mm)	meter (m)	0.001
centimeter (cm)	meter (m)	0.01
cubic centimeter (cc)	milliliter (ml)	1
cubic centimeter (cc)	liter (l)	0.001
gramm (g)	miligramm (mg)	1 000
gramm (g)	kilogramm (kg)	0.001
centimeter (cm)	millimeter (mm)	10
meter (m)	millimeter (mm)	1 000
meter (m)	centimeter (cm)	100
milliliter (ml)	cubic centimeter (cc)	1
liter (l)	cubic centimeter (cc)	1 000
miligramm (mg)	gramm (g)	0.001
kilogramm (kg)	gramm (g)	1.000

### English Conversion

To Convert	to	Multiply by
inch	millimeter (mm)	25.4
inch	centimeter (cm)	2.54
quart	liter (l)	0.946
ounce (fluid)	liter (l)	0.0296
ounce (fluid)	cubic centimeter (cc)	29.6
ounce (fluid)	milliliter (ml)	29.6
pound (dry)	kilogramm (kg)	0.454
ounce (dry)	gramm (g)	28.3
millimeter (mm)	inch	0.0394
centimeter (cm)	inch	0.394
liter (l)	quart	1.06
liter (l)	ounce (fluid)	33.8
cubic centimeter (cc)	ounce (fluid)	0.0338
milliliter (ml)	ounce (fluid)	0.0338
kilogramm (kg)	pound (dry)	2.20
gramm (g)	ounce (dry)	0.035

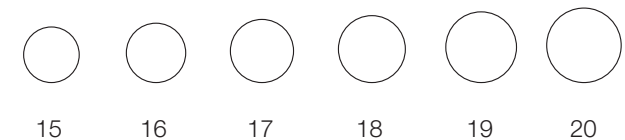
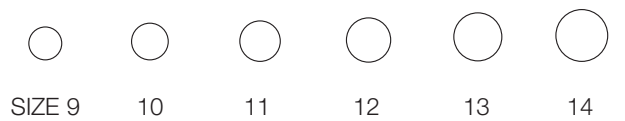
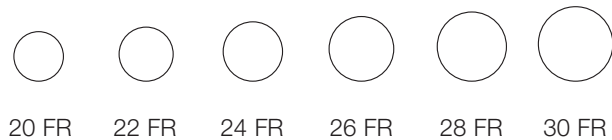
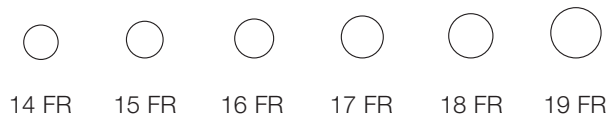

### French Scale

6 French	2.0 mm	16 French	5.3 mm
7 French	2.3 mm	17 French	5.7 mm
8 French	2.7 mm	18 French	6.0 mm
9 French	3.0 mm	19 French	6.3 mm
10 French	3.3 mm	20 French	6.7 mm
11 French	3.7 mm	22 French	7.3 mm
12 French	4.0 mm	24 French	8.0 mm
13 French	4.3 mm	26 French	8.7 mm
14 French	4.7 mm	28 French	9.3 mm
15 French	5.0 mm	30 French	10.0 mm

### American Scale

Size 9	4.5 mm	Size 15	7.5 mm
Size 10	5.0 mm	Size 16	8.0 mm
Size 11	5.5 mm	Size 17	8.5 mm
Size 12	6.0 mm	Size 18	9.0 mm
Size 13	6.5 mm	Size 19	9.5 mm
Size 14	7.0 mm	Size 20	10.0 mm

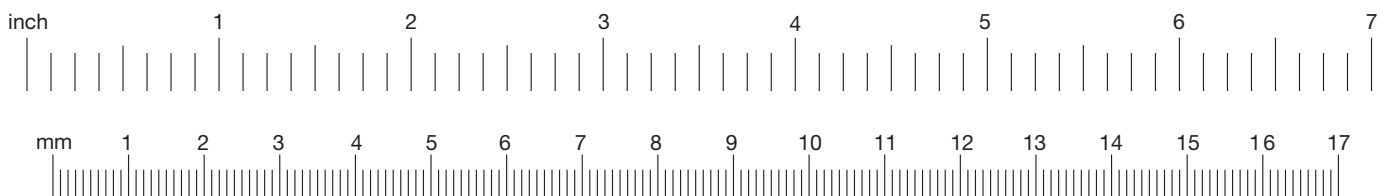



Seite page	Seite page	Seite page
<b>A</b>		
<b>Abadie</b> , Bauchdeckenhalter	154	<b>Babinsky</b> , Perkussionshammer
Abortuskürette	247	<b>Baby-Adson</b> , Präparierklemme
Abortuslöffel	247	<b>Baby-Mikulicz</b> , Hysterektomieklammer
Abortuszangen	246	<b>Baby-Mixer</b> , Arterienklemme
<b>Adair</b> , Hakenzange	233	<b>Baby-Mixer</b> , Präparierklemme
<b>Adlerkreutz</b> , Pinzette	54	<b>Baby-Overholt</b> , Arterienklemme
<b>Adson</b> , Arterienklemme	76	<b>Baby-Roux</b> , Wundhaken
<b>Adson</b> , Elevatoren	196	<b>Baby-Senn-Miller</b> , Wundhaken
<b>Adson</b> , Nadelhalter	167	<b>Baby-Tischler</b> , Uterus-Biopsiezange
<b>Adson</b> , Pinzetten	50,54,65	<b>Baby Duplex</b> , Stethoskop
<b>Adson</b> , Raspatorium	196	<b>Babyphon</b> , Blutdruckmeßgerät
<b>Adson</b> , Saugrohr	112	<b>Backhaus</b> , Tuchklemme
<b>Adson</b> , Wundsperrerr	141,145,146	<b>Bainbridge</b> , Arterienklemme
<b>Adson-Baby</b> , Wundsperrerr	141	<b>Bakes</b> , Gallenkanal-Dilatatore
<b>Adson-Brown</b> , Pinzette	54	<b>Balfour</b> , Bauchdeckenhalter
<b>Alan Parks</b> , Mastdarm Spreizer	207	<b>Balfour-Baby</b> , Bauchdeckenhalter
<b>Alexander</b> , Hohlmeißel	198	<b>Ball and Socket</b> , Tuchklemme
<b>Alexander</b> , Meißel	198	<b>Barraquer</b> , Mikro-Nadelhalter
<b>Alexander</b> , Uterus-Biopsiezange	243	<b>Barraquer-Troutman</b> , Mikro-Nadelhalter
<b>Allen</b> , Darmfaßzange	200	<b>Barrett</b> , Hakenzange
Allgemeines Instrumentarium	10-161	<b>Bauchdeckenhalter</b>
<b>Allis</b> , Darmfaßzange	200	<b>Bauchspatel</b>
<b>Allis-Adair</b> , Darmfaßzange	201	<b>Beacham</b> , Uterus-Amniotom
<b>Allis-Atrauma</b> , Darmfaßzange	200	<b>Beckenzirkel</b>
<b>Allis-Baby</b> , Darmfaßzange	200	<b>Beckmann</b> , Wundsperrerr
<b>Allison</b> , Lungenspatel	137	<b>Beckmann-Adson</b> , Wundsperrerr
<b>Allport</b> , Wundsperrerr	140	<b>Bengolea</b> , Arterienklemme
<b>Alm</b> , Wundsperrerr	140	<b>Bergmann</b> , Hammer
<b>Aly</b> , Sensibilitäts-Instrument	3	<b>Bergmann</b> , Kleiderschere
Amniotom	236	<b>Berkeley</b> , Bauchdeckenhalter
Amputationsmesser	15,16	<b>Berliner</b> , Perkussionshammer
Anal Spreizer	207	<b>Bernhard</b> , Tuchklemme
Anatomische Skalpelle	13	<b>Berry Sternal</b> , Nadelhalter
<b>Anderson-Adson</b> , Wundsperrerr	141	<b>Bier</b> , Kanüle
<b>Andrews-Pynchon</b> , Saugrohr	110	<b>Big Ben</b> , Blutdruckmeßgerät
<b>Anestophon</b> , Stethoskop	5	<b>Biopsieküretten</b>
Anlegezange, Bulldogklemmen	66	<b>Biopsiezangen, Mastdarm</b>
<b>Anthony</b> , Saugrohr	110	<b>Biopsiezangen, Gynäkologie</b>
Anuskope	208	<b>Birkett</b> , Arterienklemme
Arterienklemmen	69-81,89	<b>Blake</b> , Nierensteinzange
<b>Asiatisches Modell</b> , Scheidenspekula	218	<b>Blake</b> , Uteruskürette
<b>Assistent Standard</b> , Taschen-Nahtbesteck	193	<b>Blasen-Wundspreizer</b>
<b>Atrauma</b> , Organfaßzange	68	<b>Blasenspritzen</b>
<b>Auvard</b> , Scheidenspekula	220	<b>Blutdruckmeßgeräte</b>
<b>Ayre</b> , Myommesser	238	<b>Bodenhammer</b> , Mastdarm Spekulum
<hr/>		
<b>B</b>		
<b>Babcock</b> , Darmfaßzange	202	<b>Boettcher</b> , Tonsillenschere
<b>Babcock-Atrauma</b> , Darmfaßzange	202	<b>Bonn</b> , Schere
<hr/>		
<b>C</b>		
		<b>Bonney</b> , Pinzetten
		<b>Bowles</b> , Stethoskop
		<b>Boys-Allis</b> , Darmfaßzange
		<b>Bozemann</b> , gynäkologische Schere
		<b>Bozemann</b> , Fadenschlingendreher
		<b>Bozemann</b> , Nadelhalter
		<b>Bozemann</b> , Polypenzange
		<b>Bozemann-Douglas</b> , Polypenzange
		<b>Braithwaite</b> , Dermatome
		<b>Braun</b> , Hakenzange
		<b>Braun, modif.</b> , Scheidenhalter
		<b>Braun</b> , Uterusdepressor
		<b>Braun-Stadler</b> , Dammschere
		<b>Breisky</b> , Scheidenspekula
		<b>Brodie</b> , Sonde
		<b>Brophy (Sullivan)</b> , Schere
		<b>Brophy</b> , Pinzette
		<b>Brown</b> , Nadelhalter
		<b>Brown</b> , Pinzette
		<b>Brunner</b> , Darmklemme
		<b>Brunner</b> , Führungshohlsonden
		<b>Brunner</b> , Unterbindungsnadeln
		<b>Brunner</b> , Wundhaken
		<b>Brunner-Ferrozell</b> , Führungshohlsonde
		<b>Bruns</b> , Gipsschere
		<b>Bruns</b> , Küretten
		<b>Bryant</b> , Tupferzange
		<b>Buck</b> , Ligaturschere
		<b>Buck</b> , Perkussionshammer
		<b>Buelau</b> , Trokar
		<b>Bulldogklemmen</b>
		<b>Bumerang</b> , Nadelhalter
		<b>Bumm</b> , Uterusküretten
		<b>Bunt</b> , Sterilisierklammer
		<b>Burke</b> , Uterus-Biopsiezange
		<b>Bürstenspender</b>
		<b>Busch</b> , Nabelschnurschere
		<b>Byrd</b> , Saugrohr
		<hr/>
		<b>Campbell</b> , Trokar
		<b>Canny Ryal</b> , Wundhaken
		<b>Caplan</b> , Nasenschere
		<b>Cardiophon</b> , Stethoskope
		<b>Carrel</b> , Arterienklemme
		<b>Cartilage</b> , Knorpelmesser
		<b>Castroviejo</b> , Mikro-Nadelhalter
		<b>Catlin</b> , Amputationsmesser





## Alphabetischer Index

	Seite page		Seite page		Seite page
<b>Chaput</b> , Gewebefaßzange	68	<b>D</b>		<b>Doyen</b> , Myomheber	238
<b>Cheatle</b> , Sterilisierzange	250	<b>Dandy</b> , Arterienklemme	75	<b>Doyen</b> , Raspatorium	197
<b>Chelsea Eaton</b> , Anuskope	208	<b>Dandy</b> , neurochirurgische Schere	33	<b>Doyen</b> , Scheidenspekula	224,226
<b>Cheron</b> , Tupferzange	101	Darmklemmen	203-206	<b>Doyen</b> , Sonde	104
<b>Childe</b> ,		Darmquetschklemmen	205,206	<b>Doyen</b> ,	
Wundnahtpinzetten	192	<b>Dartigues</b> ,		Uterus-Polypenzange	235
Chirurgische Nadeln	162,163	Uterusfaßzange	236	<b>Doyen</b> , Wundhaken	132
Choledochus Klemme	89	<b>Daubenspeck</b> , Knochenküretten	194	<b>Doyen-Baby</b> , Darmklemme	203
Circumcisionsgerät	247	<b>Davidson</b> , Lungenspatel	137	<b>Doyen-Stille</b> , Wundhaken	131
<b>Clar 55</b> , Stirnlampe	9	<b>Davidson</b> , Trokar	108	Druckklemmen	69
<b>Clar</b> , Stirnlampe	9	<b>De La Roza</b> ,		<b>Dubois</b> ,	
<b>Claus</b> ,		Unterbindungsnaht	185	gynäkologische Schere	22
Unterbindungsnaht	186	<b>De Luxe Set</b> , Diagnostik Set	8	<b>Duehrssen</b> , Pinzette	57
<b>Claus-Eicken</b> ,		<b>De Martel-Wolfson</b> ,		<b>Duplay</b> , Hakenzange	233
Unterbindungsnaht	187	Darmklemmen-Satz	205	<b>Duplex Color</b> , Stethoskop	4
<b>Coakley</b> , Kieferhöhlentrommel	109	<b>Deaver</b> ,		<b>Duplex</b> , Stethoskop	4
<b>Cogswell</b> , Saugrohr	112	chirurgische Schere	19	Durahäkchen	118,119
<b>Cohen</b> , Uterus Sonde	227	<b>Deaver</b> , Wundhaken	136	<b>Durante</b> , Pinzette	57
<b>Collier</b> , Nadelhalter	166	<b>DeBakey</b> ,		<b>Duval</b> , Darmfaßzange	202
<b>Collin</b> , Amputationsmesser	15	atraumatische Pinzette	62,63	<b>Duval</b> , Pinzette	57
<b>Collin</b> , Bauchdeckenhalter	150	<b>DeBakey</b> , Bulldogklemme	67	Dynamometer	3
<b>Collin</b> , Dynamometer	3	<b>DeBakey</b> , Gefäßschere	31,32		
<b>Collin</b> , Gewebefaßzange	68	<b>DeBakey</b> , Nadelhalter	175	<b>E</b>	
<b>Collin</b> , Hammer	199	<b>DeBakey</b> , Saugrohr	110	<b>Eiselsberg</b> , Ligaturschere	41
<b>Collin</b> , Operations-Skalpell	12	<b>DeBakey</b> , Wundsperrer	147	Elektrochirurgie Instrumente	228,229
<b>Collin</b> , Scheidenspekula	218	<b>Dejerine</b> , Perkussionshammer	2	Elevatoren	195,196
<b>Collin</b> , Tupferzange	101	<b>DeLee</b> , Geburtszangen	245	<b>Elliot</b> , Geburtszange	246
<b>Collin</b> , Uterus-Sonde	237	<b>Denis-Browne</b> ,		<b>Emmett</b> , Fistelhaken	229,238
<b>Collin</b> , Uterusfaßzange	236	Bauchdeckenhalter	156	<b>Enderarterectomy</b> , Schere	45
<b>Collin</b> ,		<b>Dennis Brown</b> , Pinzette	52	Endospekula	226
Wundklammerzängchen	191	<b>Derf</b> , Nadelhalter	166,174	<b>Engl. Modell</b> , Pinzetten	51,54
<b>Collin-Baby</b> , Wundsperrer	149	Dermatome	17	<b>Engl. Modell</b> , Tuchklemme	98
<b>Collin-Duval</b> , Pinzette	57	<b>Deschamps</b> ,		<b>Eppendorfer</b> ,	
<b>Cooley</b> , Saugrohre	111	Unterbindungsnaht	183	Uterus-Biopsiezange	243
<b>Cooper</b> ,		<b>Desjardins</b> ,		<b>Esmarch</b> , Gipsschere	43
Unterbindungsnaht	184	Gallensteinlöffel	214		
<b>Coryllos</b> , Wundhaken	135	<b>Desjardins</b> ,		<b>F</b>	
<b>Cottle</b> , Tonsillenschere	34,46	Gallensteinsonde	214	Fadenschlingendreher	190
<b>Coupland</b> , Saugrohr	110	<b>Desjardins</b> ,		<b>Falk</b> , Unterbindungsnaht	187
<b>Crafoord</b> , Arterienklemme	81	Nierensteinzange	212	<b>Fansler</b> , Proktoskope	209
<b>Crafoord</b> , Thorax-Schere	30	<b>Desjardins</b> ,		<b>Farabeuf</b> , Raspatorium	197
<b>Crafoord-Sellors</b> ,		Nierenstiellklemme	90	<b>Farabeuf</b> , Wundhaken	138
Präparierklemme	84	<b>Desmarres</b> , Venenhaken	122	<b>Farrell</b> , Watteträger	105
<b>Crile-Murray</b> , Nadelhalter	167	Diagnostik Bestecke	7,8	Faßzange, Ovarien	247
<b>Crile-Rankin</b> ,		<b>Dieffenbach</b> ,		Faßzangen, Gewebe	68
Arterienklemme	75	Bulldogklemme	66	Faßzangen, Lunge	82
<b>Crile-Wood</b> , Nadelhalter	167,174	<b>Dieffenbach</b> , Skalpelle	13	Faßzangen, Organ	68
<b>Crile</b> Arterienklemme	74	<b>Diethrich</b> , Gefäßschere	30	<b>Faure</b> ,	
<b>Cusco</b> , Scheidenspekula	218,219	<b>Diethrich</b> ,		Hysterektomieklemme	93
<b>Cushing</b> , Nervhaken	120	Mikro-Nadelhalter	173	<b>Faure</b> , Uterus-Biopsiezange	242
<b>Cushing</b> , Pinzetten	51,55,65	<b>Diethrich-Hegemann</b> ,		<b>Favaloro</b> , Gefäßschere	32
<b>Cushing</b> , Venenhaken	123	Gefäßschere	30	<b>Feilchenfeld</b> ,	
<b>Cushing-Taylor</b> , Pinzette	65	<b>Dilatatoren</b> , Gefäß	61	Splitterpinzette	59
<b>Czerny</b> , Gallensteinzange	213	<b>Diplomat</b> , Blutdruckmeßgerät	6	<b>Fein</b> , Watteträger	106
<b>Czerny</b> , Hakenzange	235	<b>Dissecting</b> , Skalpelle	13		
<b>Czerny</b> , Wundhaken	139	<b>Dixon-Lovelace</b> ,			
		Arterienklemme	75		
		<b>Douglas</b> , Trokarkanüle	109		
		<b>Doyen</b> , Bauchdeckenhalter	159		
		<b>Doyen</b> , Darmklemme	203		
		<b>Doyen</b> ,			
		gynäkologische Schere	23		



	Seite page		Seite page		Seite page
<b>Fergusson,</b> chirurgische Schere	21	<b>Gray,</b> Gallenkanalklemme	90	<b>Heywood-Smith,</b> Uterusfaßzange	236
<b>Fergusson,</b> Druckklemme	69	<b>Grazil,</b> chirurgische Schere	19	Hirnmesser	16
<b>Fergusson,</b> Gallensteinlöffel	214	<b>Green-Armytage,</b> Uterusklemmzange	246	<b>Hirschmann,</b> Anuskope	208
<b>Fergusson,</b> Saugrohr	112	<b>Gross-Maier,</b> Polypenzange	100	Hohlmeißel	198,199
Fingernagel Instrumente	249	<b>Guthrie,</b> Hauthäkchen	119	<b>Hosemann,</b> Choledochusklemme	89
Fingernagelbohrer	249	<b>Guyon,</b> Nierenklemme	91,92	<b>Hunter,</b> Splitterpinzette	59
Fingerringssäge	249			<b>Hurd,</b> Unterbindungsnadel	187
<b>Finocchietto,</b> Lungenschere	36			<b>Hurwitz,</b> Trokar	108
<b>Finocchietto,</b> Nadelhalter	169,177			<b>Hysterektomie,</b> gynäkologische Schere	23
<b>Finocchietto,</b> Nierenstiellklemme	88	<b>H</b>		Hysterektomieklemmen	93-96
<b>Finocchietto,</b> Rippensperrer	160				
<b>Finocchietto-Baby,</b> Rippensperrer	160	<b>Haberer,</b> Bauchspatel	161		
<b>Finsen,</b> Wundsperrer	140	Hähne	115		
Fistelhaken	210,238	Hakenzangen	233-235	<b>I</b>	
Fistelsonde	105	<b>Halle,</b> Knochenküretten	194		
<b>Foerster,</b> Tupferzange	102,103	<b>Halle,</b> Tonsillenschere	34		
<b>Fomon,</b> Nasenscheren	26,34,46	<b>Halsey,</b> Nadelhalter	166,174		
<b>Ford,</b> Stethoskop	5	<b>Halsted-Mosquito,</b> Arterienklemmen	71,72		
<b>Fox,</b> Lupus-Küretten	248	Hämmer	199	Injektionsnadeln	113,114
<b>Franz,</b> Bauchdeckenhalter	158	Hämorrhoiden Faßzangen	210	Injektionsbesteck	113
<b>Frazier,</b> Durahäkchen	118	Hämorrhoiden Ligatoren	210	Instrumentenkästen	251
<b>Frazier,</b> Saugrohr	112	Handwaschbürste	252	<b>Insulin Luer,</b> Spritze	116
<b>Fritsch,</b> Wundhaken	131	<b>Hank,</b> Uterusdilator	232	Inzisionschere	21
Führungshohlsonden	188-190	<b>Harrington,</b> Lungenfaßzange	82	<b>Iowa,</b> Spezialbesteck für transvaginale Injektion	113
		<b>Harrington,</b> Wundhaken	135	<b>Iowa,</b> Uterus-Polypenzange	235
		<b>Hartmann,</b> Arterienklemme	71	<b>Iris,</b> Scheren	38,46
		Hauthäkchen	118,119	<b>Israel,</b> Wundhaken	125
		Hautstanzen	248	IUD Haken	238
		<b>Hayes,</b> Anastomosenzange	206	<b>Ives Fansler,</b> Anuskope	208
		<b>Heaney,</b> Hysterektomieklemme	96		
<b>G</b>		<b>Heaney,</b> Nadelhalter	168	<b>J</b>	
Gallenblasenlöffel	213	<b>Heaney-Ballantine,</b> Hysterektomieklemme	96		
Gallenkanalklemmen	87,88,90	<b>Heaney-Kanter,</b> Hysterektomieklemme	96	<b>Jabaley,</b> Schere	45
Gallenkanalsonde	213	<b>Heath,</b> Ligaturschere	41	<b>Jackson Burrows,</b> Wundsperrer	148
Gallensteinlöffel	213,214	<b>Hegar,</b> Nadelhalter	178	<b>Jackson,</b> Scheidenspekula	224
Gallensteinzangen	213	<b>Hegar,</b> Uterusdilator	230,231	<b>Jacobs,</b> Hakenzange	234
<b>Garland,</b> Hysterektomieklemme	95	<b>Hegar-Baumgartner,</b> Nadelhalter	166,174	<b>Jakobi,</b> Unterbindungsnadel	186
Geburtszangen	245,246	<b>Hegar-Vascular,</b> Nadelhalter	178	<b>Jamison,</b> Nadelhalter	168
<b>Gelpi,</b> Wundsperrer	147	<b>Hegenbarth,</b> Wundklammerpinzetten	191	<b>Jamison,</b> Schere	45
<b>Gelpi-Loktite,</b> Wundsperrer	147	<b>Heiss,</b> Ligaturklemme	79	<b>Janet,</b> Spritze	117
<b>Gemini,</b> Präparierklemme	86	<b>Henley,</b> Wundsperrer	149	<b>Jansen,</b> Kürette	195
<b>Gerald,</b> Pinzetten	51,55,64	<b>Hepp/Scheidel,</b> Mikro-Nadelhalter	173	<b>Jansen,</b> Wundsperrer	140
Gewebefaßzangen	200-202	<b>Hepp/Scheidel,</b> Saugrohr	112	<b>Jarcho,</b> Hakenzange	233
<b>Gil-Vernet,</b> Venenhaken	123	<b>Herrick,</b> Nierenstiellklemme	92	<b>Jobson-Horne,</b> Watteträger	106
<b>Gillies,</b> Hauthäkchen	118	<b>Hess,</b> Bulldogklemme	66	<b>Johns-Hopkins,</b> Anlegezange	66
<b>Gillies,</b> Nadelhalter	170,179	<b>Hesseberg,</b> Unterbindungsnadel	186	<b>Johns-Hopkins,</b> Bulldogklemme	66
<b>Gillies,</b> Pinzette	54,64	<b>Heymann,</b> Nasenschere	34	<b>Johns-Hopkins,</b> Ligaturklemme	85
<b>Glassman,</b> Darmklemme	204			<b>Johnson,</b> Nadelhalter	169
<b>Global,</b> Blutdruckmeßgerät	7				
<b>Glover,</b> Bulldogklemme	67				
<b>Goelet,</b> Wundhaken	139				
<b>Gomco,</b> Circumcisionsgerät	247				
<b>Gomel,</b> Mikro-Nadelhalter	164				
<b>Gomel,</b> Mikro-Schere	47				
<b>Good,</b> Knorpelschere	35				
<b>Gosset,</b> Bauchdeckenhalter	151				
<b>Graefe,</b> Hauthäkchen	118				
<b>Grave,</b> Scheidenspekula	219,228				



## Alphabetischer Index

	Seite page		Seite page		Seite page
<b>Joll (Friedman),</b> Wundsperrer	148	Klemmen, Druck	69	<b>Landau,</b> Scheidenspekula	225
<b>Jones,</b> Tuchklemme	98	Klemmen, Ligatur	79,84-89	<b>Landau,</b> Trokar	108
<b>Jones-Clip,</b> Tuchklemme	98	Klemmen, Penis	217	<b>Landolt,</b> chirurgische Schere	40
<b>Joseph,</b> chirurgische Schere	29	Klemmen, Präparation	79,84-89	<b>Lane,</b> Darmklemme	206
<b>Joseph,</b> Wundhaken	119	Klemmen, Schlauch	97	<b>Lane,</b> Gewebe-Faßzange	200
<b>Judd-Allis,</b> GewebeFaßzange	201	Klemmen, Tonsillen	76	<b>Lane,</b> Pinzette	58
<b>Judd-Masson,</b> Blasen-Wundspreizer	215	<b>Klima-Rossegger,</b> Kanüle	114	<b>Lane,</b> Tuchklemme	99
		<b>Klinkenberg-Loth,</b> Thoraxschere	30	<b>Lange,</b> Wundrandfaßpinzette	192
		<b>Knapp,</b> Wundhaken	119	<b>Langenbeck,</b> Elevator	196
		Knochenhaken	124	<b>Langenbeck,</b> Lappenmesser	15
		Knochenküretten	194,195	<b>Langenbeck,</b> Nadelhalter	181
		Knorpelmesser	16	<b>Langenbeck,</b> Raspatorium	197
		<b>Knowles,</b> Kleiderschere	43	<b>Langenbeck,</b> Resektionsmesser	16
		<b>Kocher,</b> Darmklemme	203	<b>Langenbeck,</b> Wundhaken	126
		<b>Kocher,</b> Führungshohlsonde	190	<b>Langenbeck-Green,</b> Wundhaken	119
		<b>Kocher,</b> Prostatahaken	217	Lappenmesser	15
		<b>Kocher,</b> Unterbindungsnadel	184	Laryngoskopie Set	8
		<b>Kocher-Langenbeck,</b> Wundhaken	127	<b>Lathbury-Uebe,</b> Watteträger	105
		<b>Kocher-Ochsner,</b> Arterienklemme	78	<b>Lawrence,</b> Gallenkanalklemme	90
		<b>Kocher delicate,</b> Arterienklemme	77	<b>Lawrence,</b> Nadelhalter	168
		<b>Kocher,</b> Knochenhaken	124	<b>Lawson Tait,</b> chirurgische Schere	21
		<b>Kocher,</b> Wundhaken	124,128	<b>Legueu,</b> Blasen-Wundspreizer	215
		<b>Koerte,</b> Wundhaken	125	<b>Legueu,</b> Prostatahaken	217
		<b>Kogan,</b> Scheidenspekula	226	<b>Lempert,</b> Knochenküretten	194
		Komedoneninstrumente	248	<b>Leriche,</b> Arterienklemme	73
		Komedonenquetscher	248	<b>Lermoyez,</b> Trokar	108
		<b>König,</b> Elevator	196	<b>Lexer,</b> Präparierschere	26
		<b>König,</b> Führungshohlsonden	189	<b>Lexer-Baby,</b> Präparierschere	26
		Kornzangen	100-103	<b>Lichtenberg,</b> Nadelhalter	171,181
		Krampfaderbesteck	106	<b>Lichtwitz,</b> Kieferhöhlentrokhar	109
		<b>Krause,</b> Kieferhöhlentrokhar	109	<b>Lincoln,</b> neurochirurgische Schere	33
		<b>Kristeller,</b> Scheidenspekula	221-223	<b>Lister,</b> Kleider- und Verbandschere	42
		<b>Kroenlein,</b> Arterienklemme	70	<b>Lister,</b> Tupferzange	102
		<b>Kronecker,</b> Unterbindungsnadel	186	<b>Lister-Excentric,</b> Verbandschere	42
		Küretten, Abortus	247	<b>Liston,</b> Amputationsmesser	15
		Küretten, Biopsie	237	<b>Littauer,</b> Ligaturschere	41
		Küretten, Knochen	194,195	<b>Little,</b> Wundhaken	129
		Küretten, Lupus	248	<b>Littlewood,</b> GewebeFaßzange	200
		Küretten, Uterus	237,239- 241	<b>Lloyd-Davies (Goligher's),</b> Rektumschere	36
				<b>Lockhart-Mummery,</b> Fistel-sonde	105
		<b>L</b>		<b>Lockwood,</b> Darmfaßzange	201
		<b>Lahey,</b> Gallenkanalklemme	88	<b>Lockwood-Allis,</b> Darmfaßzange	201
		<b>Lahey,</b> Wundhaken	129	Löffel, Abortus	247
		<b>Lambotte,</b> Osteotome	199	<b>Long,</b> Hysterektomie-klemme	95
		<b>Lambotte,</b> Raspatorium	196		



	Seite page		Seite page		Seite page
<b>Lorenz</b> , Gipsschere	43	<b>McIndoe</b> , Thoraxschere	32	<b>Mod. USA</b> ,	
<b>Lorna</b> , Tuchklemme	99	<b>McLean</b> , Geburtszangen	245	Nabelschnurschere	37
<b>Lovelace</b> , Lungenfaßzange	82	<b>McQuigg-Mixter</b> ,		<b>Mod. USA</b> , Pinzetten	50,53
<b>Lower</b> , Gallenkanalklemme	88	Gallenkanalklemme	88	<b>Mod. Wien</b> , Nahthäkchen	190
<b>Luer-Körte</b> , Gallensteinlöffel	213	<b>Meeker</b> , Gallenkanalklemme	90	<b>Moeltgen</b> , Winkelmesser	3
<b>Luer-Lock</b> ,		Meißel	198,199	<b>Mollison</b> , Wundsperrerr	142
Injektionskanülen	113	<b>Menghini</b> , Kanüle	115	<b>Moore</b> , Gallenblasenlöffel	213
<b>Luer Lock</b> , Druck-Spritzen	117	Meßstäbe	3	<b>Morgan</b> , Proktoskope	209
<b>Luer Lock</b> , Spritzen	116	<b>Metzenbaum</b> , Nadelhalter	167	<b>Morris</b> , Wundhaken	134
<b>Luer</b> , Spritzen	116	<b>Metzenbaum</b> ,		<b>Moynihan</b> , Gallensteinlöffel	214
Lumbal Punktion-Kanülen	114	Präparierscheren	24,44	<b>Moynihan</b> ,	
Lungenspatel	137	<b>Metzenbaum-Baby</b> ,		Hysterektomieklammer	95
<b>Lurz</b> , Nierensteinzange	211	Präparierscheren	24,46	<b>Museux</b> , Hakenzange	234
		<b>Metzenbaum-Fino</b> ,		Myom Instrumente	238
		Präparierscheren	27,28,44	Myomheber	238
		<b>Metzenbaum-Lahey</b> ,		Myommesser	238
		Präparierscheren	28	<b>Myrtenblatt</b> , Sonde	104
		<b>Metzenbaum-Nelson</b> ,			
		Präparierscheren	25		
<b>M</b>		<b>Meyerdling</b> , Wundhaken	121,134		
<b>M.G.H. Mass.-General-Hospital</b> ,		<b>Michel</b> , Wundklammern	192	<b>N</b>	
Nadelhalter	167	<b>Michel</b> ,			
Magenklemmen	205	Wundklammerpinzette	191	<b>Nabatoff</b> ,	
<b>Maingot</b> ,		<b>Michel</b> ,		Krampfaderbesteck	106
Hysterektomieklammer	95	Wundklammerzängchen	191	Nadelhalter	164-181
<b>Martel</b> , Kopfhautklemme	69	<b>Micro-Adson</b> , Pinzetten	50,54	Nadelrad	3
<b>Martin</b> , Uterus-Sonde	237	<b>Micro-Adson</b> ,		Nadelsterilisierdose	251
<b>Martin-Cartilage</b> ,		Präparierklemme	79	<b>Naegele</b> , Geburtszange	246
Knorpelschere	35	<b>Micro-Mosquito</b> ,		Nagelausreißzange	249
<b>Martini</b> , Knochenkürette	195	Arterienklemme	72	Nagelspaltzangen	249
<b>Masson</b> , Nadelhalter	168,177	<b>Middeldorpf</b> , Wundhaken	130,131	Nagelzange	249
Mastdarm Biopsiezangen	209	Mikro-Nadelhalter	164,165,	<b>Nager</b> , Unterbindungsnadel	187
Mastdarm Spekula	207		173	Nahtbodyesteeke	193
Mastdarm Spreizer	207	<b>Mikulicz</b> , Darmklemme	203	Nahthäkchen	190
<b>Mathieu</b> ,		<b>Mikulicz</b> ,		<b>Negus</b> , Ligaturklemme	89
Fremdkörperzange	216	Hysterektomieklammer	93	<b>Neivert</b> , Nadelhalter	166
<b>Mathieu</b> ,		<b>Mikulicz</b> , Wundhaken	133	<b>Nelaton</b> , Sonde	104
Mastdarm Spreizer	171	<b>Milan</b> , Uteruskürette	237	<b>Nelson</b> , Pinzette	58
<b>Mathieu</b> , Nadelhalter	171,180	<b>Milligan</b> , Wundsperrerr	144	<b>Nelson</b> , Trokar	109
<b>Mathieu</b> , Scheidenspekula	225	<b>Millin</b> , Blasen-Wundspreizer	215	Nerv-Präparierschere	26
<b>Mathieu</b> , Wundhaken	139	<b>Millin</b> , Blasenhalssperrerr	216	Nervhaken	120
<b>Mathieu-Kocher</b> ,		<b>Millin</b> , Fadenführungszange	216	Nierenklemmen	92
Nadelhalter	171,180	<b>Millin</b> , Faßzange	216	Nierenschalen	251
<b>Matzenauer</b> ,		<b>Millin</b> , KapselFaßzange	216	Nierensteinzangen	211,212
Scheidenspekula	225	<b>Mini-Assistent</b> ,		Nierenstiellklemmen	90-92
<b>Mayo</b> , Gallenkanalsonde	213	Taschen-Nahtbodyesteeke	193	<b>Norfolk and Norwich</b> ,	
<b>Mayo</b> , Gallensteinlöffel	214	<b>Mini-Gemini</b> ,		Wundsperrerr	148
<b>Mayo</b> ,		Präparierklemme	86	<b>Northbent</b> , Ligaturschere	41
gynäkologische Scheren	20,44	<b>Mini-Langenbeck</b> ,		<b>Noto</b> , Uterus-Polypenzange	235
<b>Mayo</b> , Sterilisierklammer	250	Wundhaken	121	<b>Novak</b> , Uteruskürette	237
<b>Mayo-Adams</b> , Wundsperrerr	142,149	<b>Mini-Roux</b> , Wundhaken	138		
<b>Mayo-Blake</b> ,		Mini-Townsend,			
Nierensteinzange	212	Uterus-Biopsiezange	244		
<b>Mayo-Hegar</b> , Nadelhalter	167,168,	<b>Minimus II</b> ,			
	175	Blutdruckmeßgerät	6		
<b>Mayo-Noble</b> ,		<b>Mixter Baby</b> ,		<b>O</b>	
gynäkologische Schere	20	Präparierklemme	87	<b>O'Connor</b> , Hauthäkchen	118
<b>Mayo-Robson</b> ,		<b>Mixter</b> , chirurgische Schere	20	<b>O'Sullivan-O'Connor</b> ,	
Darmklemme	204	<b>Mixter</b> , Gallenkanalklemme	87	Bauchdeckenhalter	156
<b>Mayo-Stille</b> ,		<b>Mixter</b> , Nierensteinzange	212	<b>Ochsner</b> ,	
gynäkologische Schere	20	<b>Mixter</b> , Präparierklemme	88	Gallenkanal-Sonde	213
<b>McDonald</b> , Elevator	195	<b>Mixter-O'Shaughnessy</b> ,		<b>Ochsner</b> , Trokar	109
<b>McGivney</b> ,		Gallenkanalklemme	87		
Hämorrhoiden-Ligator	210	<b>Mock</b> , Gefäßspülkanüle	113		
<b>McIndoe</b> , Pinzetten	51,55,64				



## Alphabetischer Index

	Seite page		Seite page		Seite page
<b>Oehler</b> , Pinzette	64	<b>Poole</b> , Saugrohre	110	<b>Richardson (Kelly)</b> , Wundhaken	130
<b>Olsen-Hegar</b> , Nadelhalter	170,179	<b>Poppen</b> , Saugrohre	112	<b>Richter</b> , chirurgische Schere	21
<b>Operation</b> , Skalpell	12	<b>Potts</b> , Schere	46	<b>Richter</b> , Wundsperrer	148
Operations-Skalpelle	12	<b>Potts-Smith</b> , Gefäßschere	31	<b>Richter-Heath</b> , Wundklammerzängchen	191
<b>Ophtalmoskop Set</b>	7	<b>Potts-Smith</b> , Lungenschere	36	Rippensperrer	160
Organmesser	16	<b>Potts-Smith</b> , Pinzetten	51,56,65	<b>Roberts</b> , Arterienklemme	81
Osteotome	198,199	<b>Potts de Martel</b> , Gefäßschere	31	<b>Robin-Masse</b> , Bauchdeckenhalter	151
<b>Oto-Ophtalmoskop Set</b>	7	<b>Pozzi</b> , Hakenzange	234	<b>Rochard</b> , Bauchdeckenhalter	159
<b>Oto-Rhinoscope Set</b>	8	Präparierklemmen	84	<b>Rochester-Carmalt</b> , Arterienklemme	77
<b>Otoscope Set</b>	8	Präparierscheren	24-28	<b>Rochester-Pean</b> , Arterienklemme	78
Ovarienfaßzange	247	<b>Pratt</b> , Arterienklemme	69	<b>Roeder</b> , Tuchklemme	98
<b>Overholt</b> , Arterienklemme	80	<b>Pratt</b> , Fistelhaken	210	<b>Rogge</b> , Sterilisierzange	250
<b>Overholt-Geissendoerfer</b> , Präparierklemme	84	<b>Pratt</b> , Hakenzange	235	<b>Roux</b> , Wundhaken	138
<b>Overholt-Mixer</b> , Ligaturklemme	79	<b>Pratt</b> , Uterusdilator	232	<b>Rudd</b> , Hämorrhoiden-Ligator	210
		<b>Precisa N</b> , Blutdruckmeßgerät	6	<b>Rumel</b> , Präparierklemme	86
		<b>Presbyterian</b> , Schlauchklemme	97	<b>Russ. Modell</b> , Pinzette	57
		<b>Price-Thomas</b> , Bronchusklemme	82	<b>Ryder</b> , Nadelhalter	176
<b>P</b>		<b>Prince</b> , Nasenschere	35	<b>Ryder-Vascular</b> , Nadelhalter	176
<b>Par Type</b> , Schere	46	Proktoskope	208,209	<b>RZ-Dreier Haken</b>	229
<b>Parker</b> , Wundhaken	138	Prostata Instrumente	216	<b>RZ-Emmett Haken</b>	229
<b>Parker-Langenbeck</b> , Wundhaken	139	Prostatahaken	217	<b>RZ-Episiotomy</b> , Dammschere	37
<b>Partsch</b> , Hammer	199	<b>Providence-Hospital</b> , Arterienklemme	73	<b>RZ-Farbbänder</b>	253
<b>Partsch</b> , Hohlmeißel	198	<b>Pye-Smith (Harrison)</b> , Sterilisierzange	250	<b>RZ-Hakenzange</b>	228
<b>Partsch</b> , Meißel	198			<b>RZ-Iris Haken</b>	229
<b>Payr</b> , chirurgische Nadeln	163	<b>Q</b>		<b>RZ-Multi</b> , Kleiderschere	43
<b>Payr</b> , Darmquetschklemme	205	<b>Quinke</b> , Kanüle	114	<b>RZ-Ringfaßzange</b>	228
<b>Payr</b> , Führungshohlsonde	189			<b>RZ-Zweier Haken</b>	229
<b>Payr-Baby</b> , Darmquetschklemme	205			<b>RZ Clips Set</b> , Wundnahtbesteck	192
<b>Pean delicate</b> , Arterienklemme	77			<b>RZ Lateral Retraktor</b>	227
<b>Pean</b> , Arterienklemme	70				
<b>Pederson</b> , Scheidenspekula	219			<b>S</b>	
<b>Peers</b> , Tuchklemme	99			<b>Saalfeld</b> , Komedonenquetscher	248
<b>Pelkmann</b> , Polypenzange	101			<b>Saenger</b> , Placentarzange	246
Pelvishaken	137			<b>Sanvenero</b> , chirurgische Schere	29
Penisklemmen	217			<b>Sarot</b> , Arterienklemme	81
<b>Pennington</b> , Gewebefaßzange	68	<b>R</b>		<b>Sarot</b> , Bronchusklemme	83
Perkussionshämmer	2	<b>Radolf</b> , Nagelausreibzange	249	<b>Sarot</b> , Nadelhalter	175
<b>Pestalozza</b> , Abortuskürette	247	<b>Ragnell</b> , Wundhaken	122	<b>Satinsky</b> , Bronchusklemme	83
<b>Phaneuf</b> , Hysterektomieklammer	93	<b>Ragnell-Davis</b> , Wundhaken	122	<b>Satinsky</b> , Thoraxschere	30
<b>Pierce</b> , Trokar	109	<b>Ramley</b> , Tupferzange	103	<b>Sauerbruch</b> , Wundhaken	128
<b>Piffard</b> , Küretten	248	<b>Ramsey</b> , Pinzetten	52,58	Saugrohre	110-112
<b>Pinard</b> , Stethoskop	4	<b>Randall</b> , Biopsiekürette	237	<b>Scalp-Contour</b> , Wundsperrer	141
Pinzetten, anatomisch	50-52, 64,65	<b>Randall</b> , Nierensteinzange	211	<b>Schaedel</b> , Tuchklemme	98
Pinzetten, atraumatisch	62,63	Raspatorien	196,197	Schalen	251
Pinzetten, chirurgisch	53-58, 64,65	<b>Recamier</b> , Uterusküretten	240	<b>Schamberg</b> , Komedonenquetscher	248
Pinzetten, fein	60	<b>Rectal</b> , Rektumschere	36	<b>Schede</b> , Küretten	194
Pinzetten, Splitter	59	Resektionsmesser	16	Scheidenspekula	218-226
Pinzetten, Uhrmacher	60	<b>Reverdin</b> , Bauchspatel	161		
Pinzetten, Wundnaht	192	<b>Reverdin</b> , Unterbindungs-Nadeln	182		
<b>Piper</b> , Geburtszange	246	<b>Reynolds</b> , chirurgische Schere	29,45		
Placentarzangen	246	<b>Ribbon</b> , Bauchspatel	161		
<b>Plester</b> , Wundsperrer	144	<b>Ricard</b> , Bauchdeckenhalter	150		
Polypenzangen	100-103	<b>Richardson-Eastman</b> , Wundhaken	130		



	Seite page		Seite page		Seite page
<b>Scherback,</b>		<b>Shortbent,</b> Ligaturschere	41	<b>Strully,</b>	
Scheidenspekula, Set	220	<b>Siebold,</b>		neurochirurgische Schere	33
Scheren, Coronar	32	gynäkologische Schere	23	<b>Syme,</b> Unterbindungsnadel	184
Scheren, Adventitia	49	<b>Silver,</b> Dermatom	17		
Scheren, Chirurgie	18-21	<b>Simon,</b> Fistelhaken	238		
Scheren, Damm	37	<b>Simon,</b> Uteruslöffel	241		
Scheren, Darm	35	<b>Simon,</b> Wundhaken	132		
Scheren, Dissektion	49	<b>Simpson,</b> Geburtszange	245	<b>T</b>	
Scheren, Draht	42	<b>Simpson,</b> Uterus-Sonde	237		
Scheren, fein	29,38-40	<b>Simpson-Braun,</b>			
Scheren, Gefäß	30-32	Geburtszangen	245	<b>Taylor,</b> Perkussionshammer	2
Scheren, Gips	43	<b>Simpson-Luikart,</b>		<b>Taylor,</b> Pinzetten	51,55
Scheren, Gynäkologie	22,23	Geburtszange	245	<b>Teale,</b> Hakenzange	234
Scheren, Kleider	42,43	<b>Sims,</b>		<b>Terrier,</b> Arterienklemme	70
Scheren, Knorpel	35	gynäkologische Schere	22	<b>Thoms-Allis,</b> Darmfaßzange	201
Scheren, Ligatur	41	<b>Sims,</b> Mastdarm Spekulum	207	<b>Thoms-Gaylor,</b>	
Scheren, Lunge	36	<b>Sims,</b> Scheidenspekula	224	Uterus-Biopsiezangen	242
Scheren, Mikro	47-49	<b>Sims,</b> Uterus-Sonde	237	<b>Thomson-Walker,</b>	
Scheren, Nabelschnur	37	<b>Sims,</b> Uterusküretten	239	Blasen-Wundspreizer	215
Scheren, Nase	34,35	<b>Singley-Tuttle,</b> Pinzette	52	<b>Thorek,</b> Präparierschere	26
Scheren, Neurochirurgie	33	Skalpelli-Griffe	10,11	<b>Tischler-Kevorkian,</b>	
Scheren, Präparation	24-28,49	Skalpelli-Klingen	10,11	Uterus-Biopsiezange	244
Scheren, Rektum	36	Skalpelle	10-14	<b>Tischler-Morgan,</b>	
Scheren, Sehnen	40	<b>Skene,</b> Hakenzange	234	Uterus-Biopsiezange	244
Scheren, Super Cut	44	<b>Smith,</b> Kleiderschere	42	<b>Toennis,</b> Ligaturklemme	85
Scheren, Thorax	30-32	<b>Smith-Buie,</b>		<b>Toennis,</b> Nadelhalter	170,181
Scheren, Tonsillen	34,35	Mastdarm-Spreizer	207	<b>Toennis,</b>	
Scheren, Verband	42	<b>Smith-Petersen,</b> Hohlmeißel	199	neurochirurgische Schere	33
<b>Schink,</b> Dermatom	17	<b>Smith-Petersen,</b> Meißel	199	<b>Toennis-Adson,</b>	
<b>Schmid,</b> Gefäßspülkanüle	113	<b>Smith-Petersen,</b> Osteotome	199	Präparierschere	28,45
<b>Schmieden,</b>		<b>Sökeland,</b> Katheterführer	213	<b>Tohoku-Japan,</b>	
Führungshohlsonde	189	<b>Somer,</b> Uterusfaßzange	236	Tuchklemme	99
<b>Schmieden,</b>		<b>Sonde,</b> Gallenkanal	213	Tonsillenklemmen	76
Unterbindungsnadel	185	<b>Sonden</b>	104,105	Transformator	9
<b>Schmieden-Payr,</b>		<b>Spencer,</b> Ligaturschere	41	<b>Traube,</b>	
Führungshohlsonde	189	<b>Spencer-Wells,</b>		Perkussionshammer	2
<b>Schmieden-Taylor,</b>		Arterienklemme	70	<b>Trélat,</b> Unterbindungsnadel	186
neurochirurgische Schere	33	Spritze, Angiographie	117	<b>Treves,</b> Pinzette	58
<b>Schnidt,</b> Arterienklemme	76	Spritze, Arteriographie	117	<b>Troemner,</b>	
<b>Schnidt-Sawtell,</b>		Spritze, Ganzglas	117	Perkussionshammer	2
Arterienklemme	76	Spritzen	116,117	Trokare	107-109
<b>Schroeder,</b> Hakenzange	233,234	<b>St. Marks,</b> Pelvishaken	137	<b>Tuberkulin Luer-Lock,</b>	
<b>Schubert,</b>		<b>Stacke,</b> Sonde	104	Spritze	117
Uterus-Biopsiezangen	242	<b>Standard,</b> Trokare	106	Tuchklemmen	98,99
<b>Schuhknecht,</b> Wundsperrerr	142	Standgefäße	250	<b>Tuffier,</b> Bauchspatel	161
<b>Schumacher,</b>		<b>Staude-Moore,</b>		<b>Tuffier,</b> Gewebefaßzange	68
Nabelschnurschere	37	Hakenzange	233	<b>Tuffier,</b> Rippensperrerr	160
<b>Schumacher,</b>		<b>Stelzner,</b> Rektumschere	36	<b>Tuohy,</b> Kanüle	114
Uterus-Biopsiezange	243	Sterilisierklammern	250	Tupferzangen	100-103
<b>Schwedisches Modell,</b>		Sterilisierkorb	251	<b>Turner-Warwick,</b>	
Nadelhalter	176	Sterilisierzangen	250	Bauchdeckenhalter-Set	155
<b>Schweizer Modell,</b>		Stethoskope	4,5	<b>Turner-Warwick,</b>	
Scheidenspekula	219	<b>Stevens,</b> Sehnenschere	40,46	Nierensteinzange	212
<b>Scudder-Atrauma,</b>		<b>Stille,</b> Hohlmeißel	198		
Magenklemme	206	<b>Stille,</b> Meißel	198		
<b>Sedillot,</b> Raspatorium	197	<b>Stille,</b> Nierenklemme	92		
<b>Segond,</b> Myommesser	238	<b>Stille,</b> Pinzetten	50,54	<b>U</b>	
<b>Seldinger-Stille,</b> Kanüle	114	<b>Stille,</b> Osteotome	198		
<b>Semb,</b> Bronchusklemme	83	Stirnlampen	9		
<b>Semken,</b> Pinzetten	51,55,64	Stirnspiegel	9	<b>Uckermann,</b> Watteträger	106
<b>Semm,</b> Bauchdeckenhalter	157	<b>Stockmann,</b> Penisklemme	217	<b>Ulrich,</b> Tupferzange	100
<b>Semm,</b> Scheidenspekula	219	<b>Strabismus,</b> feine Schere	38,45	<b>Universal,</b> Drahtschere	42
<b>Senn-Green,</b> Wundhaken	121	<b>Stratte,</b> Nadelhalter	170,179	<b>Universal,</b> Kleiderschere	42
<b>Senn-Miller,</b> Wundhaken	122	<b>Strauss,</b> Penisklemme	217	<b>Universal,</b> Trokare	107
Sensibilitäts-Instrumente	3				



## Alphabetischer Index

	Seite page		Seite page
<b>Unna</b> , Komedonenquetscher	248	<b>Weitlaner-Wullstein</b> ,	
Unterbindungsadeln	182-187	Wundsperrerr	143
<b>Uro-Tangential</b> ,		<b>Wertheim</b> ,	
Nierenstielklemme	91	gynäkologische Schere	22
Uterus-Biopsiezangen	242-244	<b>Wertheim</b> ,	
Uterus-Depressor	236	Hysterektomieklemme	94
Uterus-Dilatatoren	230-232	<b>Wertheim</b> , Scheidenspekula	226
Uterus-Faßzangen	236	<b>Wertheim-Cullen</b> ,	
Uterus-Klemmzange	246	Hysterektomieklemme	95
Uterus-Küretten	237, 239-241	<b>Westcott</b> , Mikro-Schere	47
Uterus-Löffel	241	<b>Wikstroem</b> ,	
Uterus-Polypenzangen	235	Präparierklemme	88
Uterus-Sonden	227,237	<b>Willauer</b> , Lungenschere	36
<hr/>		<b>Willet-Martel</b> ,	
<b>V</b>		Arterienklemme	69
		<b>Williams</b> , Darmfaßzange	201
<b>Valleix</b> , Uterus-Sonde	237	<b>Williger</b> , Elevator	196
<b>Van Doren</b> ,		<b>Williger</b> , Knochenküretten	194,195
Uterus-Biopsiezangen	242	<b>Williger</b> , Raspatorium	197
Venenhaken	122-123	Winkelmesser	3
<b>Veress</b> , Injektionskanüle	114	<b>Winter</b> , Abortuszange	246
<b>Virchow</b> , Hirnmesser	16	<b>Wittner</b> ,	
<b>Volkmann</b> , Knochenhaken	124	Uterus-Biopsiezange	243
<b>Volkmann</b> , Knochenküretten	194,195	<b>Wrigley</b> , Geburtszange	245
<b>Volkmann</b> , Wundhaken	124	<b>Wullstein</b> , Wundsperrerr	142
<hr/>		Wundhaken	118-139
<b>W</b>		Wundklammern	192
		Wundklammerpinzetten	191,192
<b>Wachenfeldt</b> ,		Wundklammerzangen	191
Wundklammerpinzetten	191	Wundsperrerr	141-149
<b>Wagner</b> , Schere	38	Wundspritzen	117
<b>Walb</b> , Organmesser	16	<hr/>	
<b>Waldmann</b> , Dammschere	37	<b>Y</b>	
<b>Wallich</b> , Abortuslöffel	247	<b>Yankauer</b> , Saugrohr	110
<b>Walter-Carmalt</b> ,		<b>Yeoman</b> ,	
Splitterpinzette	59	Mastdarm Biopsiezange	209
<b>Walton</b> , Fingerringsäge	249	<b>Young</b> , Prostatahaken	217
<b>Walton</b> ,		<b>Young-Hryntschak</b> ,	
Komedonenquetscher	248	Bumerang Nadelhalter	185
<b>Wangensteen</b> , Nadelhalter	169,177	<hr/>	
<b>Wangensteen</b> , Pinzette	65	<b>Z</b>	
<b>Wartenberg</b> , Nadelrad	3	<b>Zenker</b> , Präparierklemme	85
<b>Watson-Cheyne</b> , Elevator	195	<b>Zenker</b> , Wundhaken	134
Watteträger	105-106	<b>Ziegler</b> , Stirnspiegel	9
<b>Waugh</b> , Pinzetten	52,56	<b>Zweifel</b> , Nadelhalter	181
<b>Weber</b> ,			
Sensibilitäts-Instrument	3		
<b>Webster</b> , Nadelhalter	166,174		
<b>Weissbarth</b> ,			
Scheidenspekula	220		
<b>Weitlaner</b> , Wundsperrerr	143		
<b>Weitlaner-Baby</b> ,			
Wundsperrerr	144		
<b>Weitlaner-Loktite</b> ,			
Wundsperrerr	143		

# Alphabetical Index



	Seite page		Seite page		Seite page
<b>A</b>		<b>B</b>		Bladder retractors	215
<b>Abadie</b> , abdominal retractor	154	<b>Babcock</b> ,		Bladder syringes	117
Abdominal retractors	150-159	intestinal grasping forceps	202	<b>Blake</b> , kidney stone forceps	212
Abdominal spatulas	161	<b>Babcock-Atrauma</b> ,		<b>Blake</b> , uterine curette	241
<b>Adair</b> , tenaculum forceps	233	intestinal grasping forceps	202	Blood pressure apparatus	6,7
<b>Adlerkreutz</b> , tissue forceps	54	<b>Babinsky</b> ,		<b>Bodenhammer</b> ,	
<b>Adson</b> , dressing forceps	50,65	percussion hammer	2	rectal speculum	207
<b>Adson</b> , elevator	196	<b>Baby-Adson</b> ,		<b>Boettcher</b> , tonsil scissors	35
<b>Adson</b> , hemostatic forceps	76	dissecting forceps	79	Bone curettes	194,195
<b>Adson</b> , needle holder	167	<b>Baby-Mikulicz</b> ,		Bone retractor	124
<b>Adson</b> , raspatories	196	hysterectomy forceps	93	<b>Bonn</b> , scissors	39
<b>Adson</b> ,		<b>Baby-Mixer</b> ,		<b>Bonney</b> , dressing forceps	52
self-retaining retractor	141,145,146	dissecting forceps	79	<b>Bonney</b> , tissue forceps	58,65
<b>Adson</b> , suction tube	112	<b>Baby-Mixer</b> ,		Boomerang needle holder	185
<b>Adson</b> , tissue forceps	54,65	hemostatic forceps	71	<b>Bowles</b> , stethoscope	5
<b>Adson-Baby</b> ,		<b>Baby-Overholt</b> ,		Bowls	251
self-retaining retractor	141	hemostatic forceps	74	<b>Boys-Allis</b> ,	
<b>Adson-Brown</b> , tissue forceps	54	<b>Baby-Roux</b> ,		intestinal grasping forceps	201
<b>Alan Parks</b> , anal retractor	207	hand held retractor	138	<b>Bozemann</b> ,	
<b>Alexander</b> , chisel	198	<b>Baby-Senn-Miller</b> ,		cotton swab forceps	101
<b>Alexander</b> , gouge	198	hand held retractor	122	<b>Bozemann</b> ,	
<b>Alexander</b> ,		<b>Baby-Tischler</b> ,		gynecological scissors	23
uterine biopsy forceps	198	uterine biopsy forceps	244	<b>Bozemann</b> , loop twister	190
<b>Allen</b> ,		<b>Baby Duplex</b> , stethoscope	4	<b>Bozemann</b> , needle holder	178
intestinal grasping forceps	200	<b>Babyphon</b> ,		<b>Bozemann-Douglas</b> ,	
<b>Allis</b> ,		blood pressure apparatus	6	cotton swab forceps	101
intestinal grasping forceps	200	<b>Backhaus</b> , towel forceps	98	Brain knives	16
<b>Allis-Adair</b> ,		<b>Bainbridge</b> ,		<b>Braithwaite</b> , dermatome	17
intestinal grasping forceps	201	hemostatic forceps	76	<b>Braun</b> ,	
<b>Allis-Atrauma</b> ,		<b>Bakes</b> , gall duct dilators	214	modif. vaginal retractor	225
intestinal grasping forceps	200	<b>Balfour</b> ,		<b>Braun</b> , tenaculum forceps	233,235
<b>Allis-Baby</b> ,		abdominal retractor	152,153	<b>Braun</b> , uterine depressor	236
intestinal grasping forceps	200	<b>Balfour-Baby</b> ,		<b>Braun-Stadler</b> ,	
<b>Allison</b> , lung spatula	137	abdominal retractor	153	episiotomy scissors	37
<b>Allport</b> , self-retaining retractor	140	<b>Ball and Socket</b> ,		<b>Breisky</b> , vaginal specula	224
<b>Alm</b> , self-retaining retractor	140	towel forceps	99	<b>Brodie</b> , probe	105
<b>Aly</b> sensibility instrument	3	<b>Barraquer</b> ,		<b>Brophy (Sullivan)</b> , scissors	39
Amniotome	236	micro needle holder	164,173	<b>Brophy</b> , dressing forceps	52
Amputating knives	15	<b>Barraquer-Troutman</b> ,		<b>Brophy</b> , tissue forceps	56
Anal retractors	207	micro needle holder	164	<b>Brown</b> , needle holder	166
<b>Anderson-Adson</b> ,		<b>Barrett</b> , tenaculum forceps	233	<b>Brown</b> , tissue forceps	58
self-retaining retractor	141	<b>Beacham</b> ,		<b>Brunner</b> , hand held retractor	129,135
<b>Andrews-Pynchon</b> ,		uterine elevating amniotome	236	<b>Brunner</b> , intestinal clamps	204
suction tube	110	<b>Beckmann</b> ,		<b>Brunner</b> , ligature conductors	188
<b>Anestophon</b> , stethoscope	5	self-retaining retractor	146	<b>Brunner</b> , ligature needle	184,185
Angiotribes	69	<b>Beckmann-Adson</b> ,		<b>Brunner-Ferrozell</b> ,	
<b>Anthony</b> , suction tube	110	self-retaining retractor	145	ligature conductor	190
Anuscopes	208	<b>Bengolea</b> ,		<b>Bruns</b> , bone curette	194
Applying forceps,		hemostatic forceps	80	<b>Bruns</b> , plaster-of-paris shears	43
bulldog clamps	66	<b>Bergmann</b> , mallet	199	Brush dispenser	252
<b>Asian Pattern</b> , vaginal specula	218	<b>Bergmann</b> , utility scissors	43	<b>Bryant</b> , cotton swab forceps	102
<b>Assistent Standard</b> ,		<b>Berkeley</b> ,		<b>Buck</b> , ligature scissors	41
suture pocket case	193	abdominal retractor	154	<b>Buck</b> , percussion hammer	2
<b>Atrauma</b> , organ holding forceps	68	<b>Berliner</b> , percussion hammer	2	<b>Buelau</b> , trocar	108
<b>Auvard</b> , vaginal specula	220	<b>Bernhard</b> , towel forceps	99	Bulldog clamps	66,67
<b>Ayre</b> , myomatome	238	<b>Berry Sternal</b> , needle holder	179	<b>Bumm</b> , uterine curette	241
		<b>Bier</b> , lumbar puncture needle	114	<b>Bunt</b> , safety pin	250
		<b>Big Ben</b> ,		<b>Burke</b> , uterine biopsy forceps	244
		blood pressure apparatus	7	<b>Busch</b> , umbilical cord scissors	37
		Biopsy curettes	237	<b>Byrd</b> , suction tubes	112
		Biopsy forceps, rectum	209		
		Biopsy forceps, gynecology	242-244		
		<b>Birkett</b> , hemostatic forceps	75		





## Alphabetical Index

Seite page	Seite page	Seite page	
<b>C</b>			
<b>Campbell</b> , trocar	108	<b>Crafoord-Sellors</b> , dissecting forceps	84
<b>Canny Ryal</b> , hand held retractor	139	<b>Crile</b> , hemostatic forceps	74
<b>Caplan</b> , nasal scissors	34	<b>Crile-Murray</b> , needle holder	167
<b>Cardiophon</b> , stethoscope	5	<b>Crile-Rankin</b> , hemostatic forceps	75
<b>Carrel</b> , hemostatic forceps	70	<b>Crile-Wood</b> , needle holder	167,174
Cartilage knives	16	Curette, biopsy	237
<b>Cartilage</b> , cartilage knife	16	Curette, bone	194,195
<b>Castroviejo</b> , micro needle holder	165,173	Curette, lupus	248
Catheter introducer	213	Curette, ovum	247
Catheter, male	217	Curette, uterine	237,239-241
Catheter, female	236	<b>Cusco</b> , vaginal speculum	218,219
<b>Catlin</b> , amputating knife	15	<b>Cushing</b> , dressing forceps	51,65
<b>Chaput</b> , tissue holding forceps	68	<b>Cushing</b> , nerve hook	120
<b>Cheatle</b> , sterilizing forceps	250	<b>Cushing</b> , tissue forceps	55
<b>Chelsea Eaton</b> , anoscopes	208	<b>Cushing</b> , vein retractors	123
<b>Cheron</b> , cotton swab forceps	101	<b>Cushing-Taylor</b> , dressing forceps	65
<b>Childe</b> , suture forceps	192	<b>Czerny</b> , gall stone forceps	213
Chisel	198,199	<b>Czerny</b> , hand held retractor	139
Choledochus clamp	89	<b>Czerny</b> , tenaculum forceps	235
Circumcision instrument	247		
<b>Clar 55</b> , head light	9	<b>D</b>	
<b>Clar</b> , head light	9	<b>Dandy</b> , hemostatic forceps	75
<b>Claus</b> , ligature needle	186	<b>Dandy</b> , neurosurgical scissors	33
<b>Claus-Eicken</b> , ligature needle	187	<b>Dartigues</b> , uterine elevating forceps	236
Clip applying and removing forceps	191,192	<b>Daubenspeck</b> , bone curette	194
<b>Coakley</b> , antrum trocar	109	<b>Davidson</b> , lung spatula	137
<b>Cogswell</b> , suction tube	112	<b>Davidson</b> , trocar	108
<b>Cohen</b> , self retaining uterine cannula	227	<b>De La Roza</b> , ligature needle	185
<b>Collier</b> , needle holder	166	<b>De Luxe Set</b> , diagnostic set	8
<b>Collin</b> , abdominal retractor	150	<b>De Martel-Wolfson</b> , intestinal clamp set	205
<b>Collin</b> , amputating knife	15	<b>Deaver</b> , hand held retractors	136
<b>Collin</b> , cotton swab forceps	101	<b>Deaver</b> , operating scissors	19
<b>Collin</b> , dynamometer	3	<b>DeBakey</b> , atraumatic tissue forceps	62,63
<b>Collin</b> , knife	15	<b>DeBakey</b> , bulldog clamp	67
<b>Collin</b> , mallet	199	<b>DeBakey</b> , needle holder	175
<b>Collin</b> , operating knife	12	<b>DeBakey</b> , self retaining retractor	147
<b>Collin</b> , suture forceps	191	<b>DeBakey</b> , suction tube	110
<b>Collin</b> , tissue holding forceps	68	<b>DeBakey</b> , vascular scissors	31,32
<b>Collin</b> , uterine elevating forceps	236	<b>Dejerine</b> , percussion hammer	2
<b>Collin</b> , uterine sound	237	<b>DeLee</b> , obstetrical forceps	245
<b>Collin</b> , vaginal specula	218	<b>Denis-Browne</b> , abdominal retractor	156
<b>Collin-Baby</b> , self-retaining retractor	149	<b>Dennis Brown</b> , dressing forceps	52
<b>Collin-Duval</b> , tissue forceps	57	<b>Derf</b> , needle holder	166,174
Comedo extractors	248	Dermatomes	17
Comedo instruments	248	<b>Deschamps</b> , ligature needles	183
<b>Cooley</b> , suction tubes	111	<b>Desjardins</b> , gall stone probes	214
<b>Cooper</b> , ligature needles	184	<b>Desjardins</b> , gall stone scoops	214
<b>Coryllos</b> , hand held retractor	135	<b>Desjardins</b> , kidney pedicle clamp	90
<b>Cottle</b> , tonsil scissors	34,36	<b>Desjardins</b> , kidney stone forceps	212
Cotton applicators	105,106	<b>Desmarres</b> , vein retractor	122
Cotton swab forceps	100-103	Diagnostic Sets	7,8
<b>Coupland</b> , suction tube	110	<b>Dieffenbach</b> , bulldog clamp	66
<b>Crafoord</b> , hemostatic forceps	81	<b>Dieffenbach</b> , dissecting knife	13
<b>Crafoord</b> , thoracic scissors	30	<b>Diethrich</b> , micro needle holder	173
		<b>Dietrich</b> , vascular scissors	30
		<b>Dietrich-Hegemann</b> , vascular scissors	30
		Dilators, vessel	61
		<b>Diplomat</b> , blood pressure apparatus	6
		Dissecting forceps	64,65
		Dissecting knives	13
		Dissecting scissors	24-28
		<b>Dissecting</b> , dissecting knife	13
		<b>Dixon-Lovelace</b> , hemostatic forceps	75
		<b>Douglas</b> , trocar cannula	109
		<b>Doyen</b> , abdominal retractor	159
		<b>Doyen</b> , gynecological scissors	23
		<b>Doyen</b> , hand held retractor	132
		<b>Doyen</b> , intestinal clamps	203
		<b>Doyen</b> , myoma screw	238
		<b>Doyen</b> , probe	104
		<b>Doyen</b> , raspatories	197
		<b>Doyen</b> , uterine polypus forceps	235
		<b>Doyen</b> , vaginal speculas	224,226
		<b>Doyen-Baby</b> , intestinal clamps	203
		<b>Doyen-Stille</b> , hand held retractor	131
		Dressing forceps	100-103
		<b>Dubois</b> , gynecological scissors	22
		<b>Duehrssen</b> , tissue forceps	57
		<b>Duplay</b> , tenaculum forceps	233
		<b>Duplex Color</b> , stethoscope	4
		<b>Duplex</b> , stethoscope	4
		Dura retractors	118-119
		<b>Durante</b> , tissue forceps	57
		<b>Duval</b> , intestinal grasping forceps	202
		<b>Duval</b> , tissue forceps	57
		Dynamometer	3
		<b>E</b>	
		<b>Eiselsberg</b> , ligature scissors	41
		Electrosurgery instruments	228-229
		Elevators	195,196
		<b>Elliot</b> , obstetrical forceps	246
		<b>Emmett</b> , fistula hook	238
		<b>Emmett</b> , tenaculum hook	229
		<b>Enderterectomy</b> , scissors	45
		<b>Endospecula</b>	226
		<b>Engl. Modell</b> , towel forceps	98

# Alphabetical Index



	Seite page		Seite page		Seite page
<b>English pattern,</b> dressing forceps	51	Forceps, splinter	59	<b>H</b>	
<b>English pattern,</b> tissue forceps	54	Forceps, sterilizing	250	<b>Haberer,</b> abdominal spatula	161
<b>English pattern,</b> towel forceps	98	Forceps, suture	192	Haemorrhoidal forceps	210
<b>Eppendorfer,</b> biopsy forceps	243	Forceps, tissue	53-58, 64,65	Haemorrhoidal ligator	210
<b>Esmarch,</b> plaster-of-paris shears	43	Forceps, tissue holding	68	<b>Halle,</b> bone curettes	194
		Forceps, tonsil	76	<b>Halle,</b> tonsil scissors	34
		<b>Ford,</b> stethoscop	5	<b>Halsey,</b> needle holder	166,174
		<b>Fox,</b> lupus curettes	248	<b>Halsted-Mosquito,</b> hemostatic forceps	71,72
		<b>Franz,</b> abdominal retractor	158	Hand held retractors	120-139
		<b>Frazier,</b> dura retractor	118	Handbrush	252
		<b>Frazier,</b> suction tubes	112	<b>Hank,</b> uterine dilator set	232
		<b>Fritsch,</b> hand held retractor	131	<b>Harrington,</b> hand held retractor	135
				<b>Harrington,</b> lung grasping forceps	82
<b>F</b>				<b>Hartmann,</b> hemostatic forceps	71
		<b>G</b>		<b>Hayes,</b> sigmoid anastomosis forceps	206
<b>Falk,</b> ligature needle	187	Gall bladder scoops	213	Head light	9
<b>Fansler,</b> proctoscopes	209	Gall duct clamps	87,88, 90	Head mirror	9
<b>Farabeuf,</b> hand held retractor	138	Gall duct probes	213	<b>Heaney,</b> hysterectomy forceps	96
<b>Farabeuf,</b> raspatories	197	Gall stone forceps	213	<b>Heaney,</b> needle holder	168
<b>Farrell,</b> cotton applicator	105	Gall stone scoops	213,214	<b>Heaney-Ballantine,</b> hysterectomy forceps	96
<b>Faure,</b> hysterectomy forceps	93	<b>Garland,</b> hysterectomy forceps	95	<b>Heaney-Kanter,</b> hysterectomy forceps	96
<b>Faure,</b> uterine biopsy forceps	242	<b>Gelpi,</b> self-retaining retractor	147	<b>Heath,</b> ligature scissors	41
<b>Favaloro,</b> vascular scissors	32	<b>Gelpi-Loktite,</b> self-retaining retractor	147	<b>Hegar,</b> needle holder	178
<b>Feilchenfeld,</b> splinter forceps	59	<b>Gemini,</b> dissecting forceps	86	<b>Hegar,</b> uterine dilator	225
<b>Fein,</b> cotton applicator	106	<b>Gerald,</b> dressing forceps	51,64	<b>Hegar-Baumgartner,</b> needle holder	166,174
<b>Fergusson,</b> angiotribs	69	<b>Gerald,</b> tissue forceps	55,64	<b>Hegar-Vascular,</b> needle holder	178
<b>Fergusson,</b> gall stone scoop	214	<b>Gil-Vernet,</b> vein retractors	123	<b>Hegenbarth,</b> clip applying forceps	191
<b>Fergusson,</b> operating scissors	21	<b>Gillies,</b> needle holder	170,179	<b>Heiss,</b> ligature forceps	79
<b>Fergusson,</b> suction tubes	112	<b>Gillies,</b> skin retractor	118	Hemostatic Forceps	69-81, 89
Finger nail drill	249	<b>Gillies,</b> tissue forceps	54,64	<b>Henley,</b> self-retaining retractor	149
Finger nail instruments	249	<b>Glassman,</b> intestinal clamps	204	<b>Hepp/Scheidel,</b> micro needle holder	173
Finger ring saw	249	<b>Global,</b> blood pressure apparatus	7	<b>Hepp/Scheidel,</b> micro scissors	47
<b>Finocchietto,</b> kidney pedicle clamp	88	<b>Glover,</b> bulldog clamp	67	<b>Hepp/Scheidel,</b> suction tube	112
<b>Finocchietto,</b> lung scissor	36	<b>Goelet,</b> hand held retractor	139	<b>Herrick,</b> kidney pedicle clamp	92
<b>Finocchietto,</b> needle holder	169,177	<b>Gomco,</b> circumcision instrument	247	<b>Hess,</b> bulldog clamp	66
<b>Finocchietto,</b> rib spreader	160	<b>Gomel,</b> micro needle holder	164	<b>Hesseberg,</b> ligature needle	186
<b>Finocchietto-Baby,</b> rib spreader	160	<b>Gomel,</b> micro scissors	47	<b>Heymann,</b> nasal scissors	34
<b>Finsen,</b> self-retaining retractor	140	Goniometer	3	<b>Heywood-Smith,</b> uterine elevating forceps	236
Fistula hook	210,238	<b>Good,</b> cartilage scissors	35	<b>Hirschmann,</b> anoscopes	208
Fistula probe	105	<b>Gosset,</b> abdominal retractor	151	<b>Hosemann,</b> choledochus forceps	89
Flap knives	15	Gouges	198,199	<b>Hunter,</b> splinter forceps	59
<b>Foerster,</b> cotton swab forceps	102,103	<b>Graefe,</b> skin retractor	118	<b>Hurd,</b> ligature needle	187
<b>Fomon,</b> scissors	26,34,46	<b>Grave,</b> vaginal specula	219,228	<b>Hurwitz,</b> trocar	108
Forceps, atraumatic	62,63	<b>Gray,</b> gall duct clamp	90	Hypodermic needles	113,114
Forceps, biopsy	209, 242-244	<b>Gray,</b> operating scissor	19	Hysterectomy forceps	93-96
Forceps, delicate	60	<b>Grazil,</b> operating scissor	19	<b>Hysterektomie,</b> gynecological scissors	23
Forceps, dissecting	79,84-89	<b>Green-Armytage,</b> uterine hemostatic forceps	246		
Forceps, dressing	50-52, 64,65	<b>Gross-Maier,</b> polypus forceps	100		
Forceps, hemostatic	69-81,89	<b>Guthrie,</b> skin retractor	119		
Forceps, jeweller's	60	<b>Guyon,</b> kidney clamp forceps	91,92		
Forceps, kidney pedicle clamp	91				
Forceps, ligature	79, 84-89				
Forceps, lung grasping	82				
Forceps, obstetrical	245,246				
Forceps, organ holding	68				
Forceps, ovum	247				



## Alphabetical Index

Seite page		Seite page	Seite page
<b>I</b>		<b>Kalt</b> , suture needles	163
Incision scissors	21	<b>Kantrowitz</b> , dissecting forceps	84
Injection set	113	<b>Kaye Face Lift</b> , scissors	45
Instrument boxes	251	<b>Keith</b> , suture needles	162
<b>Insulin Luer</b> , syringe	116	<b>Kelly</b> , dissecting forceps	89
Intestinal clamps	203-206	<b>Kelly</b> , hand held retractor	133
<b>Iowa</b> , transvaginal injection	113	<b>Kelly</b> , hemostatic forceps	73
<b>Iowa</b> , uterine polypus forceps	235	<b>Kelly</b> , operating scissors	21
<b>Iris</b> scissors	38,46	<b>Kelly</b> , proctoscopes	208
<b>Israel</b> , hand held retractor	125	<b>Kelly</b> , uterine polypus forceps	235
IUD hooks	238	<b>Kelly-Rankin</b> , hemostatic forceps	74
<b>Ives Fansler</b> , anoscopes	208	<b>Kevorkian</b> , biopsy curettes	237
		<b>Kevorkian</b> , uterine biopsy forceps	243
		<b>Kevorkian-Pacific</b> , uterine biopsy forceps	244
<b>J</b>		<b>Keyes</b> , skin trephines	248
		Kidney clamps	92
<b>Jabaley</b> , scissors	45	Kidney stone forceps	211,212
<b>Jackson Burrows</b> , self-retaining retractor	148	Kidney trays	251
<b>Jackson</b> , vaginal specula	224	<b>Kielland</b> , obstetrical forceps	245
<b>Jacobs</b> , vusellum forceps	234	<b>Kielland-Luikart</b> , obstetrical forceps	246
<b>Jakobi</b> , ligature needle	186	<b>Kilner(Ragnell)</b> , operating scissors	29
<b>Jamison</b> , needle holder	168	<b>Kilner</b> , skin retractor	118
<b>Jamison</b> , scissors	45	<b>Kirschner</b> , abdominal retractor	157
<b>Janet</b> , syringes	117	<b>Kirschner</b> , ligature conductor	190
<b>Jansen</b> , bone curette	195	<b>Kirstein</b> , nasal scissors	34
<b>Jansen</b> , self-retaining retractor	140	<b>Kleinert-Kutz</b> , skin retractor	118
<b>Jarcho</b> , tenaculum forceps	233	<b>Klima-Rossegger</b> , sternal puncture needle	114
Jars	250	<b>Klinkenberg-Loth</b> , thoracic scissors	30
<b>Jobson-Horne</b> , cotton applicator	106	<b>Knapp</b> , hand held retractor	119
<b>Johns-Hopkins</b> , applying forceps	66	<b>Knowles</b> , utility scissors	43
<b>Johns-Hopkins</b> , bulldog clamp	66	<b>Kocher</b> , bone retractor	124
<b>Johns-Hopkins</b> , ligature forceps	85	<b>Kocher</b> , hand held retractor	124,128
<b>Johnson</b> , needle holder	169	<b>Kocher</b> , intestinal clamps	203
<b>Joll (Friedman)</b> , self-retaining retractor	148	<b>Kocher</b> , ligature conductors	190
<b>Jones</b> , towel forceps	98	<b>Kocher</b> , ligature needle	184
<b>Jones-Clip</b> , towel forceps	98	<b>Kocher</b> , prostatic retractor	217
<b>Joseph</b> , scissors	29	<b>Kocher-Langenbeck</b> , hand held retractor	127
<b>Joseph</b> , skin retractor	119	<b>Kocher-Ochsner</b> , hemostatic forceps	78
<b>Judd-Allis</b> , intestinal grasping forceps	201	<b>Kocher delicate</b> , hemostatic forceps	77
<b>Judd-Masson</b> , bladder retractor	215	<b>Koerte</b> , hand held retractor	125
		<b>Kogan</b> , vaginal specula	226
		<b>König</b> , elevator	196
		<b>König</b> , ligature conductors	189
		<b>Krause</b> , antrum trocar	109
		<b>Kristeller</b> , vaginal specula	221-223
<b>K</b>		<b>Kroenlein</b> , hemostatic forceps	70
		<b>Kronecker</b> , ligature needle	186
<b>Kahn</b> , tenaculum forceps	234		
<b>Kallmorgen</b> , vaginal specula	223		
<b>Kalt</b> , micro needle holder	173		
		<b>L</b>	
		<b>Lahey</b> , gall duct clamp	88
		<b>Lahey</b> , hand held retractor	129
		<b>Lambotte</b> , osteotomes	199
		<b>Lambotte</b> , raspatories	196
		<b>Landau</b> , trocar	108
		<b>Landau</b> , vaginal specula	220
		<b>Landolt</b> , operating scissors	40
		<b>Lane</b> , intestinal clamp	206
		<b>Lane</b> , intestinal grasping forceps	200
		<b>Lane</b> , tissue forceps	58
		<b>Lane</b> , towel forceps	99
		<b>Lange</b> , suture forceps	192
		<b>Langenbeck</b> , elevator	196
		<b>Langenbeck</b> , flap knife	15
		<b>Langenbeck</b> , hand held retractor	126
		<b>Langenbeck</b> , needle holder	181
		<b>Langenbeck</b> , raspatories	197
		<b>Langenbeck</b> , resection knife	16
		<b>Langenbeck-Green</b> , hand held retractor	119
		Laryngoscopy set	8
		<b>Lathbury-Uebe</b> , cotton applicator	105
		<b>Lawrence</b> , gall duct clamp	90
		<b>Lawrence</b> , needle holder	168
		<b>Lawson Tait</b> , operating scissors	21
		<b>Legueu</b> , bladder retractor	215
		<b>Legueu</b> , prostatic retractor	217
		<b>Lempert</b> , bone curettes	194
		<b>Leriche</b> , hemostatic forceps	73
		<b>Lermoyez</b> , trocar	108
		<b>Lexer</b> , dissecting scissors	26
		<b>Lexer-Baby</b> , dissecting scissors	26
		<b>Lichtenberg</b> , needle holder	171,181
		<b>Lichtwitz</b> , antrum trocar	109
		Ligature conductors	188-190
		Ligature needles	182-187
		<b>Lincoln</b> , neurocurgical scissors	33
		<b>Lister</b> , bandage scissors	42
		<b>Lister</b> , cotton swab forceps	102
		<b>Lister-Excentric</b> , bandage scissors	42
		<b>Liston</b> , amputating knife	15
		<b>Littauer</b> , ligature scissors	41
		<b>Little</b> , hand held retractor	129
		<b>Littlewood</b> , tissue grasping forceps	200
		Liver puncture needle	115
		<b>Lloyd-Davies (Goligher's)</b> rectal scissors	36
		<b>Lockhart-Mummery</b> , fistula probes	105
		<b>Lockwood</b> , intestinal grasping forceps	201
		<b>Lockwood-Allis</b> , intestinal grasping forceps	201
		<b>Long</b> , hysterectomy forceps	95

# Alphabetical Index



Seite page	Seite page	Seite page
Loop twister 190	<b>McIndoe</b> , tissue forceps 55	<b>Mod. USA</b> , dressing forceps 50
<b>Lorenz</b> , plaster-of-paris shears 43	<b>McLean</b> , obstetrical forceps 245	<b>Mod. USA</b> , standard tissue forceps 50
<b>Lorna</b> , towel forceps 99	<b>McQuigg-Mixter</b> , gall duct clamp 88	<b>Mod. USA</b> , umbilical cord scissors 37
<b>Lovelace</b> , lung grasping forceps 82	<b>Meeker</b> , gall duct clamps 90	<b>Mod. Wien</b> , suture hook 190
<b>Lower</b> , gall duct clamp 88	<b>Menghini</b> , puncture needle 115	<b>Moeltgen</b> , goniometer 3
<b>Luer-Koerte</b> , gall stone scoop 213	<b>Metzenbaum</b> , dissecting scissors 24,44	<b>Mollison</b> , self-retaining retractor 142
<b>Luer-Lock</b> , needles 113	<b>Metzenbaum</b> , needle holder 167	<b>Moore</b> , gall bladder scoop 213
<b>Luer Lock</b> , syringes 116,117	<b>Metzenbaum-Baby</b> , dissecting scissors 24,46	<b>Morgan</b> , proctoscopes 209
<b>Luer</b> , syringes 116	<b>Metzenbaum-Fino</b> , dissecting scissor 27,28,44	<b>Morris</b> , hand held retractor 134
Lumbar puncture needles 114	<b>Metzenbaum-Lahey</b> , dissecting scissors 28	<b>Moynihan</b> , gall stone scoop 214
Lung spatula 137	<b>Metzenbaum-Nelson</b> , dissecting scissors 25	<b>Moynihan</b> , hysterectomy forceps 95
Lupus curettes 248	<b>Meyerding</b> , hand held retractor 121,134	<b>Museum</b> , vusellum forceps 231
<b>Lurz</b> , kidney stone forceps 211	<b>Michel</b> , clip applying and removing forceps 191	Myoma instruments 238
	<b>Michel</b> , clip applying forceps 191	Myoma screws 238
	<b>Michel</b> , clips 192	Myomatome 238
<b>M</b>	<b>Micro-Adson</b> , dissecting forceps 79	<b>Myrtle Leaf</b> , probe 104
	<b>Micro-Adson</b> , dressing forceps 50	
<b>M.G.H. Mass.-General-Hospital</b> , need- le holder 167	<b>Micro-Adson</b> , tissue forceps 54	<b>N</b>
<b>Maingot</b> , hysterectomy forceps 95	<b>Micro-Mosquito</b> , hemostatic forceps 72	<b>Nabatoff</b> , varicose vein probe set 106
Mallets 199	Micro needle holder 164,165, 173	<b>Naegele</b> , obstetrical forceps 246
<b>Martel</b> , scalp flap forceps 69	<b>Middeldorpf</b> , hand held retractor 130,131	<b>Nager</b> , ligature needle 187
<b>Martin</b> , uterine sound 237	<b>Mikulicz</b> , hand held retractor 133	Nail extracting forceps 249
<b>Martin-Cartilage</b> , cartilage scissors 35	<b>Mikulicz</b> , hysterectomy forceps 93	Nail nipper 249
<b>Martini</b> , bone curette 194	<b>Mikulicz</b> , intestinal forceps 206	Nail splitting forceps 249
<b>Masson</b> , needle holder 168,177	<b>Milan</b> , uterine curettes 237	Needle holders 164-181
<b>Mathieu</b> , anal retractor 207	<b>Milligan</b> , self-retaining retractor 144	Needle sterilizing case 251
<b>Mathieu</b> , foreign body forceps 216	<b>Millin</b> , bladder neck spreader 216	Needles 113,114
<b>Mathieu</b> , hand held retractor 139	<b>Millin</b> , bladder retractor 215	Needles, ligature 182-187
<b>Mathieu</b> , needle holder 171,180	<b>Millin</b> , capsule forceps 216	Needles, sternum puncture 114
<b>Mathieu</b> , vaginal specula 225	<b>Millin</b> , ligature carrying forceps 216	<b>Negus</b> , ligature forceps 89
<b>Mathieu-Kocher</b> , needle holder 171,180	<b>Millin</b> , prostatic forceps 216	<b>Neivert</b> , needle holder 166
<b>Matzenauer</b> , vaginal specula 225	<b>Mini-Assistent</b> , suture pocket case 193	<b>Nelaton</b> , probe 104
<b>Mayo</b> , gall duct probe 213	<b>Mini-Gemini</b> , dissecting forceps 86	<b>Nelson</b> , tissue forceps 58
<b>Mayo</b> , gall stone scoop 214	<b>Mini-Langenbeck</b> , hand held retractor 121	<b>Nelson</b> , trocar 109
<b>Mayo</b> , gynecological scissors 20,44	<b>Mini-Roux</b> , hand held retractor 138	Nerve dissecting scissor 26
<b>Mayo</b> , safety pin 250	<b>Mini-Townsend</b> , uterine biopsy forceps 244	Nerve hook 120
<b>Mayo-Adams</b> , self-retaining retractor 142,149	<b>Minimus II</b> , blood pressure apparatus 6	<b>Norfolk and Norwich</b> , self-retaining retractor 148
<b>Mayo-Blake</b> , kidney stone forceps 212	<b>Mixter Baby</b> , dissecting forceps 87	<b>Northbent</b> , ligature scissors 41
<b>Mayo-Hegar (Heaney)</b> , needle holder 175	<b>Mixter</b> , dissecting forceps 88	<b>Noto</b> , uterine polypus forceps 235
<b>Mayo-Hegar</b> , needle holder 167,168, 175	<b>Mixter</b> , gall duct clamp 87	<b>Novak</b> , biopsy curette 237
<b>Mayo-Noble</b> , gynecological scissors 20	<b>Mixter</b> , kidney stone forceps 212	
<b>Mayo-Robson</b> , intestinal clamps 204	<b>Mixter</b> , operating scissors 20	<b>O</b>
<b>Mayo-Stille</b> , gynecological scissors 20	<b>Mixter-O'Shaughnessy</b> , gall duct clamp 87	<b>O'Connor</b> , skin retractor 118
<b>McDonald</b> , elevator 195	<b>Mock</b> , vessel cannula 113	<b>O'Sullivan-O'Connor</b> , abdominal retractor 156
<b>McGivney</b> , haemorrhoidal ligator 210		Obstetrical forceps 245,246
<b>McIndoe</b> , dressing forceps 51,64		<b>Ochsner</b> , gall stone probe 213
<b>McIndoe</b> , thorax scissors 32		<b>Ochsner</b> , trocar 109
		<b>Oehler</b> , tissue forceps 64



## Alphabetical Index

	Seite page		Seite page		Seite page
<b>Olsen-Hegar</b> , needle holder	170,179	<b>Potts-Smith</b> , tissue forceps	56	<b>Richardson-Eastman</b> ,	
Operating knives	12	<b>Potts-Smith</b> , vascular scissors	31	hand held retractor	130
Operating scissors	18-21	<b>Potts de Martel</b> ,		<b>Richardson (Kelly)</b> ,	
<b>Operation</b> , operating knife	12	vascular scissors	31	hand held retractor	130
<b>Ophthalmoscopy Set</b>	7	<b>Pozzi</b> , tenaculum forceps	234	<b>Richter</b> , operating scissors	21
Osteotomes	198,199	<b>Pratt</b> , fistula hook	210	<b>Richter</b> ,	
<b>Oto-Ophthalmoscopy Set</b>	7	<b>Pratt</b> , hemostatic forceps	69	self-retaining retractor	148
<b>Oto-Rhinoscope Set</b>	8	<b>Pratt</b> , tenaculum forceps	235	<b>Richter-Heath</b> ,	
<b>Otoscope Set</b>	8	<b>Pratt</b> , uterine dilator	232	clip removing forceps	191
<b>Overholt</b> , hemostatic forceps	80	<b>Precisa N</b> ,		<b>Roberts</b> , hemostatic forceps	81
<b>Overholt-Geissendoerfer</b> ,		blood pressure apparatus	6	<b>Robin-Masse</b> ,	
dissecting forceps	84	<b>Presbyterian</b> , tubing clamp	97	abdominal retractor	151
<b>Overholt-Mixter</b> ,		<b>Price-Thomas</b> ,		<b>Rochard</b> , abdominal retractor	159
ligature forceps	79	bronchus forceps	82	<b>Rochester-Carmalt</b> ,	
Ovum curettes	247	<b>Prince</b> , nasal scissors	35	hemostatic forceps	77
Ovum forceps	246,247	Probe, gall duct	213	<b>Rochester-Pean</b> ,	
Ovum scoops	247	Probes	103	hemostatic forceps	78
		Proctoscopes	208,209	<b>Roeder</b> , towel forceps	98
		Prostatectomy instruments	216	<b>Rogge</b> , sterilizing forceps	250
		Prostatic retractors	217	<b>Roux</b> , hand held retractor	138
		<b>Providence-Hospital</b> ,		<b>Rudd</b> , haemorrhoidal ligator	210
		hemostatic forceps	73	Rulers	3
		<b>Pye-Smith (Harrison)</b> ,		<b>Rumel</b> , dissecting forceps	86
		sterilizing forceps	250	<b>Russ. Modell</b> , tissue forceps	57
		Pylorus clamp	205	<b>Ryder</b> , needle holder	176
				<b>Ryder-Vascular</b> ,	
				needle holder	176
<b>P</b>				<b>RZ-Multi</b> , utility scissors	43
<b>Par Type</b> , scissors	46			<b>RZ-Clip set</b> , suture clip set	192
<b>Parker</b> , hand held retractor	138	<b>Q</b>		<b>RZ-Color coding tapes</b>	253
<b>Parker-Langenbeck</b> ,				<b>RZ-Emmett hook</b>	299
hand held retractor	139			<b>RZ-Episiotomy</b> ,	
<b>Partsch</b> , chisel	198			episiotomy scissors	37
<b>Partsch</b> , gouge	198	<b>Quinke</b> , needle	114	<b>RZ-Iris hook</b> , Needles	182
<b>Partsch</b> , mallet	199			<b>RZ-Lateral retractor</b>	227
<b>Payr</b> , intestinal clamp	205			<b>RZ-Ring forceps</b>	228
<b>Payr</b> , ligature conductor	189			<b>RZ-Three-prong-hook</b>	229
<b>Payr</b> , suture needles	163			<b>RZ-Two-prong-hook</b>	229
<b>Payr-Baby</b> , intestinal forceps	205			<b>RZ-Tenaculum forceps</b>	228
<b>Pean delicate</b> ,		<b>R</b>			
hemostatic forceps	77				
<b>Pean</b> , hemostatic forceps	70	<b>Radolf</b> ,		<b>S</b>	
<b>Pederson</b> , vaginal specula	219	nail extracting forceps	69	<b>Saalfeld</b> , Comedo extractors	248
<b>Peers</b> , towel forceps	99	<b>Ragnell</b> ,		<b>Saenger</b> , placenta forceps	246
<b>Pelkmann</b> , polypus forceps	101	hand held retractor	120	Safety pins	250
Pelvimeter	247	<b>Ragnell-Davis</b> ,		<b>Sanvenero</b> ,	
Pelvis retractors	137	hand held retractor	122	operating scissors	29
<b>Pennington</b> ,		<b>Rampley</b> ,		<b>Sarot</b> , bronchus forceps	83
tissue holding forceps	68	cotton swab forceps	103	<b>Sarot</b> , hemostatic forceps	81
Percussion hammers	2	<b>Ramsey</b> , dressing forceps	52	<b>Sarot</b> , needle holder	175
<b>Pestalozza</b> , ovum curette	247	<b>Ramsey</b> , tissue forceps	58	<b>Satinsky</b> , bronchus forceps	83
<b>Phaneuf</b> ,		<b>Randall</b> , biopsy curette	237	<b>Satinsky</b> , thoracic scissors	30
hysterectomy forceps	93	<b>Randall</b> ,		<b>Sauerbruch</b> ,	
<b>Pierce</b> , trocar	109	kidney stone forceps	211	hand held retractor	128
<b>Piffard</b> , lupus curettes	248	Raspatories	196,197	<b>Scalp-Contour</b> ,	
<b>Pinard</b> , stethoscope	4	<b>Recamier</b> , uterine curettes	240	self-retaining retractor	141
Pinwheel	3	Rectal biopsy forceps	209	Scalpel blades	10,11
<b>Piper</b> , obstetrical forceps	246	Rectal specula	207	Scalpel handles	10,11
Placenta forceps	246	<b>Rectal</b> , rectal scissors	36	Scalpels	10-14
<b>Plester</b> ,		Resection knives	16	<b>Schaedel</b> , towel forceps	98
self-retaining retractor	144	<b>Reverdin</b> , abdominal spatula	161	<b>Schamberg</b> , comedo extractor	248
Polypus forceps	100-103	<b>Reverdin</b> , ligature needles	182		
<b>Poole</b> , suction tubes	110	<b>Reynolds</b> , scissors	29,45		
<b>Poppen</b> , suction tubes	112	Rib spreader	160		
Post mortem knives	15,16	<b>Ribbon</b> , abdominal spatula	161		
<b>Potts</b> , scissors	46	<b>Ricard</b> , abdominal retractor	150		
<b>Potts-Smith</b> ,					
dressing forceps	51,65				
<b>Potts-Smith</b> , lung scissors	36				

# Alphabetical Index



	Seite page		Seite page		Seite page
<b>Schede</b> , bone curette	194	<b>Semm</b> , vaginal specula	219	Suction tubes	110-112
<b>Scherback</b> , vaginal specula	220	<b>Senn-Green</b> , hand held retractor	121	Suture clips	192
<b>Schink</b> , dermatome	17	<b>Senn-Miller</b> , hand held retractor	122	Suture hooks	190
<b>Schmid</b> , vessel cannula	113	Sensibility instruments	3	Suture needles	162,163
<b>Schmieden</b> , ligature conductor	189	Shears, plaster-of-paris	43	Suture sets	193
<b>Schmieden</b> , ligature needle	185	<b>Shortbent</b> , ligature scissors	41	<b>Swiss Pattern</b> , vaginal specula	220
<b>Schmieden-Payr</b> , ligature conductor	189	<b>Siebold</b> , gynecological scissors	23	<b>Syme</b> , ligature needle	184
<b>Schmieden-Taylor</b> , neurosurgical scissors	33	<b>Silver</b> , dermatome	17	Syringes	116-117
<b>Schnidt</b> , hemostatic forceps	76	<b>Simon</b> , fistula hook	238		
<b>Schnidt-Sawtell</b> , hemostatic forceps	76	<b>Simon</b> , hand held retractor	132		
<b>Schroeder</b> , tenaculum forceps	233,234	<b>Simon</b> , uterine scoop	241	<b>T</b>	
<b>Schubert</b> , uterine biopsy forceps	242	<b>Simpson</b> , obstetrical forceps	245		
<b>Schuhknecht</b> , self-retaining retractor	142	<b>Simpson</b> , uterine sound	237	<b>Taylor</b> , dressing forceps	51
<b>Schumacher</b> , umbilical cord scissor	37	<b>Simpson-Braun</b> , obstetrical forceps	245	<b>Taylor</b> , percussion hammer	2
<b>Schumacher</b> , uterine biopsy forceps	243	<b>Simpson-Luikart</b> , obstetrical forceps	242	<b>Taylor</b> , tissue forceps	55
<b>Schwedisches Modell</b> , needle holder	176	<b>Sims</b> , gynecological scissors	22	<b>Teale</b> , vulsellum forceps	234
Scissors, adventitia	49	<b>Sims</b> , rectal speculum	207	Tenaculum forceps	233-235
Scissors, bandage	42	<b>Sims</b> , uterine curettes	239	Tenaculum hooks	229
Scissors, cartilage	35	<b>Sims</b> , uterine sound	237	<b>Terrier</b> , hemostatic forceps	70
Scissors, coronary	32	<b>Sims</b> , vaginal specula	224	<b>Thoms-Allis</b> , intestinal grasping forceps	201
Scissors, delicate	29,38-40	<b>Singley-Tuttle</b> , dressing forceps	52	<b>Thoms-Gaylor</b> , biopsy forceps	242
Scissors, dissecting	24-28,49	<b>Skene</b> , tenaculum forceps	234	<b>Thomson-Walker</b> , bladder retractor	215
Scissors, enterotomy	35	Skin retractors	118,119	<b>Thorek</b> , dissecting scissors	26
Scissors, episiotomy	37	Skin trephines	248	<b>Tischler-Kevorkian</b> , uterine biopsy forceps	244
Scissors, gynecology	22,23	<b>Smith</b> , utility scissor	42	<b>Tischler-Morgan</b> , uterine biopsy forceps	244
Scissors, ligature	41	<b>Smith-Buie</b> , anal retractor	207	Tissue grasping forceps	200-202
Scissors, lung	36	<b>Smith-Petersen</b> , chisel	199	<b>Toennis</b> , ligature forceps	85
Scissors, micro	47-49	<b>Smith-Petersen</b> , gouges	199	<b>Toennis</b> , needle holder	170,181
Scissors, nasal	34,35	<b>Smith-Petersen</b> , osteotomes	199	<b>Toennis</b> , neurosurgical scissors	33
Scissors, nerve dissecting	26	<b>Sökeland</b> , catheter introducer	213	<b>Toennis-Adson</b> , dissecting scissors	28,45
Scissors, neurosurgical	33	<b>Somer</b> , uterine elevating forceps	236	<b>Tohoku-Japan</b> , towel forceps	99
Scissors, operating	18-21	<b>Spencer</b> , ligature scissors	41	Tonsil forceps	76
Scissors, rectal	36	<b>Spencer-Wells</b> , hemostatic forceps	70	Towel forceps	98-99
Scissors, super cut	44	<b>St. Marks</b> , pelvis retractor	137	Transformer	9
Scissors, suture	41	<b>Stacke</b> , probe	104	<b>Traube</b> , percussion hammer	2
Scissors, tenotomy	40	<b>Standard</b> , trocars	106	<b>Trélat</b> , ligature needle	186
Scissors, thorax	30-32	<b>Staude-Moore</b> , tenaculum forceps	233	<b>Treves</b> , tissue forceps	58
Scissors, tonsil	34,35	<b>Stelzner</b> , rectal scissors	36	Trocars	107-109
Scissors, umbilical cord	37	Sterilizing forceps	250	<b>Troemner</b> , percussion hammer	2
Scissors, utility	42,43	Sterilizing trays	251	<b>Tuberkulin Luer-Lock</b> , syringe	117
Scissors, vascular	30-32	Sternum puncture needle	114	Tubing clamps	97
Scissors, wire	42	Stethoscopes	4,5	<b>Tuffier</b> , abdominal spatula	161
Scoop, ovum	247	<b>Stevens</b> , tenotomy scissors	40,46	<b>Tuffier</b> , rib spreader	160
<b>Scudder-Atrauma</b> , intestinal forceps	206	<b>Stille</b> , chisels	198	<b>Tuffier</b> , tissue holding forceps	68
<b>Sedillot</b> , raspatory	197	<b>Stille</b> , dressing forceps	50	<b>Tuohy</b> , needle	114
<b>Segond</b> , myoma knife	238	<b>Stille</b> , gouges	198	<b>Turner-Warwick</b> , abdominal retractor	155
<b>Seldinger-Stille</b> , needle	114	<b>Stille</b> , kidney clamp	92	<b>Turner-Warwick</b> , kidney stone forceps	212
Self-Retaining Retractors	141-149	<b>Stille</b> , osteotomes	198		
<b>Semb</b> , bronchus forceps	83	<b>Stille</b> , tissue forceps	54		
<b>Semken</b> , dressing forceps	51	<b>Stockmann</b> , penis seizing forceps	217		
<b>Semken</b> , tissue forceps	55,64	Stop-cocks	115		
<b>Semm</b> , abdominal retractor	157	<b>Strabismus</b> , scissors	38,45		
		<b>Stratte</b> , needle holder	170,179		
		<b>Strauss</b> , penis seizing forceps	217		
		<b>Strully</b> , neurosurgical scissors	33		



## Alphabetical Index

	Seite page		Seite page
<b>U</b>			
<b>Uckermann</b> , cotton applicator	106	<b>Wangensteen</b> , needle holder	169,177
<b>Ulrich</b> , cotton swab forceps	100	<b>Wartenberg</b> , pinwheel	3
<b>Universal</b> , trocars	107	<b>Watson-Cheyne</b> , elevator	195
<b>Universal</b> , utility scissors	42	<b>Waugh</b> , dressing forceps	52
<b>Universal</b> , wire scissors	42	<b>Waugh</b> , tissue forceps	56
<b>Unna</b> , comedo extractors	248	<b>Weber</b> , sensibility instrument	3
<b>Uro-Tangential</b> ,		<b>Webster</b> , needle holder	166,174
kidney pedicle clamp	91	<b>Weissbarth</b> , vaginal specula	220
Uterine biopsy forceps	242-244	<b>Weitlaner</b> ,	
Uterine cannulas	227	self-retaining retractor	143
Uterine curettes	237, 239-241	<b>Weitlaner-Baby</b> ,	
Uterine depressor	236	self-retaining retractor	144
Uterine dilators	230-232	<b>Weitlaner-Loktite</b> ,	
Uterine elevating forceps	236	self-retaining retractor	143
Uterine hemostatic forceps	246	<b>Weitlaner-Wullstein</b> ,	
Uterine polypus forceps	235	self-retaining retractor	143
Uterine scoops	241	<b>Wertheim</b> ,	
Uterine sounds	237	gynecological scissors	22
<hr/>			
<b>V</b>			
Vaginal speculas	218-226	<b>Wertheim</b> ,	
<b>Valleix</b> , uterine sound	237	hysterectomy forceps	94
<b>Van Doren</b> ,		<b>Wertheim</b> , vaginal specula	226
uterine biopsy forceps	242	<b>Wertheim-Cullen</b> ,	
Varicose vein probe set	106	hysterectomy forceps	95
Vein retractors	122,123	<b>Westcott</b> , micro scissors	47
<b>Veress Needle</b> ,		<b>Wikstroem</b> ,	
injection needle	114	dissecting forceps	88
Vessel cannulas	113	<b>Willauer</b> , lung scissors	36
Vessel dilators	61	<b>Willet-Martel</b> ,	
<b>Virchow</b> , brain knife	16	hemostatic forceps	69
<b>Volkmann</b> , bone curette	194,195	<b>Williams</b> ,	
<b>Volkmann</b> , bone retractor	124	intestinal grasping forceps	201
<b>Volkmann</b> , hand held retractor	124	<b>Williger</b> , bone curette	194,195
Vulsellum forceps	234	<b>Williger</b> , elevators	196
<hr/>			
<b>W</b>			
<b>Wachenfeldt</b> ,		<b>Williger</b> , raspatory	197
clip applying forceps	190	<b>Winter</b> , ovum forceps	246
<b>Wagner</b> , scissors	38	<b>Wittner</b> ,	
<b>Walb</b> , post mortem knife	16	uterine biopsy forceps	243
<b>Waldmann</b> ,		Wound syringes	117
episiotomy scissors	37	<b>Wrigley</b> , obstetrical forceps	245
<b>Wallich</b> , ovum scoop	247	<b>Wullstein</b> ,	
<b>Walter-Carmalt</b> ,		self-retaining retractor	142
splinter forceps	59	<hr/>	
<b>Walton</b> , comedo extractor	248	<b>Y</b>	
<b>Walton</b> , finger ring saw	249	<b>Yankauer</b> , suction tube	110
<b>Wangensteen</b> ,		<b>Yeoman</b> , rectal biopsy forceps	209
dressing forceps	65	<b>Young</b> , prostatic retractors	217
<hr/>			
<b>Z</b>			
		<b>Young-Hryntschak</b> ,	
		boomerang needle holder	185
		<hr/>	
		<b>Zenker</b> , dissecting forceps	85
		<b>Zenker</b> , hand held retractor	134
		<b>Ziegler</b> , head mirror	9
		<b>Zweifel</b> , needle holder	181

## Nummern Index

## Numerical Index



Katalog Nr. Catalogue No.	Seite page	Katalog Nr. Catalogue No.	Seite page	Katalog Nr. Catalogue No.	Seite page
100-002-000	6	110-005-001	12	110-110-003	10
100-010-000	7	110-005-003	12	110-114-003	10
100-012-001	3	110-005-005	12	110-116-033	10
100-012-002	3	110-005-007	12	110-130-007	10
100-039-000	8	110-005-009	12	110-130-077	10
100-039-001	8	110-005-010	12	110-140-004	11
100-040-000	8	110-005-012	12	110-144-004	11
100-040-001	8	110-005-014	12	110-146-008	11
100-041-000	8	110-005-016	12	110-146-009	11
100-041-001	8	110-005-018	12	110-201-010	10
100-045-000	7	110-006-001	12	110-201-011	10
100-045-001	7	110-006-002	12	110-201-012	10
100-046-000	7	110-006-003	12	110-201-013	10
100-100-000	9	110-006-004	12	110-201-015	10
100-100-002	9	110-006-005	12	110-201-018	11
100-100-003	9	110-006-006	12	110-201-019	11
100-100-020	9	110-010-001	13	110-201-020	11
100-102-000	9	110-010-002	13	110-201-021	11
100-102-001	9	110-010-003	13	110-201-022	11
100-102-002	9	110-010-004	13	110-201-023	11
100-102-006	9	110-010-005	13	110-201-024	11
100-103-001	9	110-010-006	13	110-201-112	10
100-104-000	9	110-010-007	13	110-201-115	10
100-104-001	9	110-010-008	13	110-220-010	14
100-104-002	9	110-010-009	13	110-220-011	14
100-105-000	5	110-010-010	13	110-220-012	14
100-106-000	5	110-014-013	15	110-220-013	14
100-106-001	5	110-014-016	15	110-220-015	14
100-106-002	5	110-014-019	15	110-220-018	14
100-106-003	5	110-014-022	15	110-220-019	14
100-106-004	5	110-014-028	15	110-220-020	14
100-106-005	5	110-015-001	13	110-220-021	14
100-107-000	6	110-015-002	13	110-220-022	14
100-107-100	7	110-015-003	13	110-220-023	14
100-108-000	4	110-015-004	13	110-220-024	14
100-108-000	6	110-015-005	13	110-220-025	14
100-108-001	4	110-015-006	13	110-220-111	14
100-108-002	4	110-015-007	13	110-220-112	14
100-108-003	4	110-015-008	13	110-220-115	14
100-108-004	4	110-015-009	13	120-010-105	18
100-109-000	4	110-015-015	13	120-010-115	18
100-109-100	6	110-015-016	13	120-010-130	18
100-109-150	4	110-018-016	15	120-010-145	18
100-109-180	4	110-018-019	15	120-010-155	18
100-110-000	5	110-018-022	15	120-010-165	18
100-110-010	9	110-019-017	15	120-010-175	18
100-110-220	2	110-019-020	15	120-010-185	18
100-111-170	2	110-019-022	15	120-010-200	18
100-111-200	2	110-020-012	15	120-011-105	18
100-112-160	2	110-020-013	15	120-011-115	18
100-113-240	2	110-026-055	16	120-011-130	18
100-114-200	2	110-030-175	16	120-011-145	18
100-115-200	2	110-050-110	16	120-011-155	18
100-116-170	2	110-050-140	16	120-011-165	18
100-117-180	2	110-050-170	16	120-011-175	18
100-213-100	8	110-060-160	16	120-011-185	18
100-411-000	3	110-060-200	16	120-011-200	18
100-412-000	3	110-060-240	16	120-012-105	18
100-416-190	3	110-090-000	17	120-012-115	18
100-417-170	3	110-090-001	17	120-012-130	18
100-418-100	3	110-090-002	17	120-012-145	18
100-418-200	3	110-096-019	17	120-012-155	18
100-418-300	3	110-096-119	17	120-012-165	18
100-418-500	3	110-098-305	17	120-012-175	18
100-422-150	3	110-098-399	17	120-012-185	18





## Nummern Index

## Numerical Index

Katalog Nr. Catalogue No.	Seite page	Katalog Nr. Catalogue No.	Seite page	Katalog Nr. Catalogue No.	Seite page
120-012-200	18	120-030-280	20	120-071-115	38
120-013-105	18	120-031-145	20	120-072-080	39
120-013-115	18	120-031-150	20	120-072-200	22
120-013-130	18	120-031-170	20	120-072-230	22
120-013-145	18	120-031-230	20	120-073-080	39
120-013-155	18	120-031-280	20	120-073-200	22
120-013-165	18	120-034-145	21	120-073-230	22
120-013-175	18	120-035-165	21	120-074-200	22
120-013-185	18	120-035-180	21	120-074-230	22
120-013-200	18	120-036-150	20	120-075-200	22
120-014-105	18	120-036-170	20	120-075-230	22
120-014-115	18	120-036-195	20	120-080-105	38
120-014-130	18	120-036-210	20	120-080-115	38
120-014-145	18	120-037-150	20	120-081-105	38
120-014-155	18	120-037-170	20	120-081-115	38
120-014-165	18	120-037-195	20	120-083-115	39
120-014-175	18	120-037-210	20	120-084-095	40
120-014-185	18	120-040-160	23	120-085-115	39
120-014-200	18	120-040-175	23	120-086-120	39
120-015-105	18	120-041-160	23	120-087-120	39
120-015-115	18	120-041-175	23	120-090-105	40
120-015-130	18	120-042-150	29	120-090-115	40
120-015-145	18	120-042-160	23	120-091-105	40
120-015-155	18	120-042-180	29	120-091-115	40
120-015-165	18	120-043-150	29	120-092-105	40
120-015-175	18	120-043-180	29	120-092-115	40
120-015-185	18	120-046-120	38	120-093-105	40
120-015-200	18	120-046-160	21	120-093-115	40
120-016-130	19	120-046-180	21	120-094-115	38
120-016-145	19	120-047-120	38	120-095-115	38
120-017-130	19	120-047-160	21	120-110-115	24
120-017-145	19	120-047-180	21	120-110-145	24
120-018-130	19	120-048-170	20	120-110-180	25
120-018-145	19	120-049-170	20	120-110-200	25
120-019-130	19	120-050-155	20	120-110-230	25
120-019-145	19	120-051-155	20	120-110-250	25
120-020-130	19	120-053-195	22	120-110-280	25
120-020-145	19	120-053-225	22	120-110-300	25
120-021-130	19	120-054-120	38	120-111-115	24
120-021-145	19	120-054-140	39	120-111-145	24
120-022-130	21	120-055-120	38	120-111-180	25
120-022-145	21	120-055-140	39	120-111-200	25
120-023-165	21	120-056-140	29	120-111-230	25
120-024-120	19	120-057-140	29	120-111-250	25
120-024-130	19	120-058-140	29	120-111-280	25
120-024-145	19	120-059-140	29	120-111-300	25
120-025-120	19	120-061-220	23	120-112-145	24
120-025-130	19	120-061-240	23	120-112-180	25
120-025-145	19	120-062-200	22	120-112-200	25
120-026-120	19	120-062-230	22	120-112-230	25
120-026-130	19	120-063-200	22	120-112-250	25
120-026-145	19	120-063-230	22	120-112-280	25
120-027-120	19	120-064-120	29	120-112-300	25
120-027-130	19	120-064-150	29	120-113-145	24
120-027-145	19	120-064-180	29	120-113-180	25
120-028-120	19	120-064-200	29	120-113-200	25
120-028-130	19	120-065-120	29	120-113-230	25
120-028-145	19	120-065-150	29	120-113-250	25
120-029-120	19	120-065-180	29	120-113-280	25
120-029-130	19	120-065-200	29	120-113-300	25
120-029-145	19	120-070-090	38	120-114-145	24
120-030-145	20	120-070-105	38	120-114-180	25
120-030-150	20	120-070-115	38	120-114-200	25
120-030-170	20	120-071-090	38	120-114-230	25
120-030-230	20	120-071-105	38	120-114-250	25

## Nummern Index

## Numerical Index



Katalog Nr. Catalogue No.	Seite page	Katalog Nr. Catalogue No.	Seite page	Katalog Nr. Catalogue No.	Seite page
120-114-280	25	120-169-225	48	120-220-105	41
120-114-300	25	120-170-185	48	120-220-130	41
120-115-145	24	120-170-225	48	120-222-130	41
120-115-180	25	120-171-185	48	120-223-090	41
120-115-200	25	120-171-225	48	120-224-115	41
120-115-230	25	120-172-185	48	120-224-140	41
120-115-250	25	120-172-225	48	120-225-145	37
120-115-280	25	120-173-185	48	120-225-200	37
120-115-300	25	120-173-225	48	120-226-160	41
120-116-270	22	120-175-025	30	120-227-160	37
120-117-270	22	120-175-045	30	120-228-145	41
120-120-150	26	120-175-060	30	120-228-180	41
120-121-150	26	120-175-090	30	120-229-135	37
120-122-125	40	120-175-125	30	120-229-160	37
120-123-125	40	120-176-125	30	120-230-120	41
120-124-125	40	120-177-140	47	120-231-180	37
120-125-125	40	120-177-160	47	120-232-200	37
120-126-160	26	120-178-150	49	120-233-105	37
120-126-210	26	120-178-180	49	120-233-210	35
120-127-160	26	120-179-140	47	120-234-210	35
120-127-210	26	120-179-160	47	120-235-210	35
120-131-135	26	120-179-240	31	120-236-125	21
120-133-190	26	120-180-150	49	120-240-270	36
120-136-100	26	120-180-180	49	120-242-310	36
120-137-100	26	120-181-190	31	120-243-310	36
120-150-185	47	120-182-025	48	120-245-325	36
120-151-185	47	120-182-045	48	120-250-220	33
120-152-145	27	120-182-060	48	120-253-170	33
120-152-180	27	120-182-090	48	120-254-180	33
120-152-200	27	120-182-125	48	120-255-180	33
120-152-230	27	120-182-190	31	120-257-170	28
120-152-250	27	120-183-025	48	120-260-170	33
120-152-280	27	120-183-045	48	120-261-170	33
120-152-300	27	120-183-060	48	120-265-120	42
120-153-145	27	120-183-090	48	120-270-160	42
120-153-180	27	120-183-125	48	120-270-180	42
120-153-185	47	120-183-190	31	120-270-200	42
120-153-200	27	120-185-180	31	120-270-230	42
120-153-230	27	120-190-190	32	120-275-190	34
120-153-250	27	120-192-025	31	120-280-150	34
120-153-280	27	120-192-045	31	120-281-160	34
120-153-300	27	120-192-060	31	120-283-180	34
120-154-145	27	120-193-025	31	120-285-175	34
120-154-180	27	120-193-045	31	120-286-220	34
120-154-200	27	120-193-060	31	120-287-220	34
120-154-230	27	120-194-025	31	120-420-115	32
120-154-250	27	120-194-045	31	120-430-170	33
120-154-280	27	120-194-060	31	120-500-145	18
120-154-300	27	120-195-155	32	120-500-165	18
120-155-145	27	120-197-155	32	120-500-185	18
120-155-180	27	120-199-155	32	120-501-145	18
120-155-200	27	120-201-300	30	120-501-165	18
120-155-230	27	120-203-245	30	120-501-185	18
120-155-250	27	120-205-230	30	120-502-145	18
120-155-280	27	120-206-200	35	120-502-165	18
120-155-300	27	120-209-180	35	120-502-185	18
120-157-180	28	120-210-270	36	120-503-145	18
120-157-200	28	120-213-175	35	120-503-165	18
120-157-230	28	120-214-250	36	120-503-185	18
120-159-180	28	120-214-280	36	120-504-145	18
120-159-200	28	120-215-250	36	120-504-165	18
120-159-230	28	120-215-280	36	120-504-185	18
120-168-185	48	120-216-190	36	120-505-145	18
120-168-225	48	120-217-190	35	120-505-165	18
120-169-185	48	120-220-090	41	120-505-185	18



## Nummer Index

## Numerical Index

Katalog Nr. Catalogue No.	Seite page	Katalog Nr. Catalogue No.	Seite page	Katalog Nr. Catalogue No.	Seite page
120-506-145	20	120-521-145	27	121-071-110	46
120-506-170	20	120-521-180	27	121-089-130	45
120-506-230	20	120-521-200	27	121-094-115	45
120-507-145	20	120-521-230	27	121-095-115	45
120-507-170	20	120-521-250	27	121-100-120	45
120-507-230	20	120-521-280	27	121-101-120	45
120-508-150	20	120-521-300	27	121-111-145	44
120-508-170	20	120-522-145	27	121-111-180	44
120-509-150	20	120-522-180	27	121-111-200	44
120-509-170	20	120-522-200	27	121-111-230	44
120-510-115	24	120-522-230	27	121-153-145	44
120-510-145	24	120-522-250	27	121-153-180	44
120-510-180	25	120-522-280	27	121-153-200	44
120-510-200	25	120-522-300	27	121-153-230	44
120-510-230	25	120-523-145	27	121-181-190	46
120-510-250	25	120-523-180	27	121-182-190	46
120-510-280	25	120-523-200	27	121-183-190	46
120-510-300	25	120-523-230	27	121-196-110	46
120-511-115	24	120-523-250	27	121-197-110	46
120-511-145	24	120-523-280	27	121-280-145	46
120-511-180	25	120-523-300	27	121-290-165	46
120-511-200	25	120-525-180	28	121-311-150	45
120-511-230	25	120-525-200	28	121-311-190	45
120-511-250	25	120-525-230	28	121-315-150	45
120-511-280	25	120-527-180	28	121-315-180	45
120-511-300	25	120-527-200	28	121-317-110	46
120-512-145	24	120-527-230	28	121-317-145	46
120-512-180	25	120-530-140	28	121-318-125	45
120-512-200	25	120-531-170	28	121-319-170	45
120-512-230	25	120-532-200	22	121-320-180	45
120-512-250	25	120-532-230	22	121-330-110	46
120-512-280	25	120-533-200	22	121-331-110	46
120-512-300	25	120-533-230	22	130-010-105	50
120-513-145	24	120-534-200	22	130-010-115	50
120-513-180	25	120-534-230	22	130-010-130	50
120-513-200	25	120-535-200	22	130-010-145	50
120-513-230	25	120-535-230	22	130-010-150	50
120-513-250	25	120-536-200	22	130-010-160	50
120-513-280	25	120-536-230	22	130-010-180	50
120-513-300	25	120-537-200	22	130-010-200	50
120-514-145	24	120-537-230	22	130-010-250	50
120-514-180	25	120-542-150	29	130-010-300	50
120-514-200	25	120-543-150	29	130-012-105	50
120-514-230	25	120-554-115	38	130-012-115	50
120-514-250	25	120-555-115	38	130-012-130	50
120-514-280	25	120-565-120	42	130-012-145	50
120-514-300	25	120-570-025	30	130-012-160	50
120-515-145	24	120-570-045	30	130-012-180	50
120-515-180	25	120-570-060	30	130-012-200	50
120-515-200	25	120-570-090	30	130-012-250	50
120-515-230	25	120-570-125	30	130-012-300	50
120-515-250	25	120-571-255	23	130-013-105	50
120-515-280	25	120-572-250	23	130-013-115	50
120-515-300	25	120-576-125	30	130-013-130	50
120-516-160	26	120-579-210	31	130-013-145	50
120-516-210	26	120-579-240	31	130-013-160	50
120-517-160	26	120-581-190	31	130-013-180	50
120-517-210	26	120-582-190	31	130-013-200	50
120-520-145	27	120-583-190	31	130-013-250	50
120-520-180	27	120-593-025	31	130-013-300	50
120-520-200	27	120-593-045	31	130-014-105	50
120-520-230	27	120-593-060	31	130-014-115	50
120-520-250	27	121-030-170	44	130-014-130	50
120-520-280	27	121-031-170	44	130-014-145	50
120-520-300	27	121-070-110	46	130-014-160	50

## Nummer Index

## Numerical Index



Katalog Nr. Catalogue No.	Seite page	Katalog Nr. Catalogue No.	Seite page	Katalog Nr. Catalogue No.	Seite page
130-014-180	50	130-053-190	52	130-126-155	53
130-014-200	50	130-054-200	57	130-126-180	53
130-014-250	50	130-055-200	57	130-126-200	53
130-014-300	50	130-056-200	57	130-126-250	53
130-015-105	50	130-110-105	53	130-126-300	53
130-015-115	50	130-110-115	53	130-127-120	53
130-015-130	50	130-110-130	53	130-127-130	53
130-015-145	50	130-110-145	53	130-127-145	53
130-015-160	50	130-110-150	53	130-127-155	53
130-015-180	50	130-110-160	53	130-127-180	53
130-015-200	50	130-110-180	53	130-127-200	53
130-015-250	50	130-110-200	53	130-127-250	53
130-015-300	50	130-110-250	53	130-127-300	53
130-018-105	50	130-110-300	53	130-130-145	58
130-018-115	50	130-112-115	53	130-130-200	58
130-018-130	50	130-112-130	53	130-131-145	58
130-018-145	50	130-112-145	53	130-131-200	58
130-018-160	50	130-112-160	53	130-133-175	51
130-018-180	50	130-112-180	53	130-137-150	54
130-018-200	50	130-112-200	53	130-137-200	54
130-018-250	50	130-112-250	53	130-138-150	54
130-018-300	50	130-112-300	53	130-138-180	58
130-022-150	50	130-114-130	53	130-138-200	54
130-026-120	50	130-114-145	53	130-139-180	58
130-026-150	50	130-114-160	53	130-140-120	54
130-028-150	51	130-114-180	53	130-140-150	54
130-030-175	51	130-114-200	53	130-143-180	58
130-034-180	51	130-116-130	53	130-144-125	51
130-034-200	56	130-116-145	53	130-144-150	51
130-035-180	51	130-116-160	53	130-145-125	55
130-035-185	51	130-116-180	53	130-145-150	55
130-035-200	56	130-116-200	53	130-145-180	58
130-036-175	51	130-118-130	53	130-147-125	55
130-037-175	51	130-118-145	53	130-147-175	55
130-037-180	51	130-118-155	53	130-149-175	55
130-037-210	51	130-118-160	53	130-150-180	55
130-037-250	51	130-118-180	53	130-151-180	55
130-038-180	51	130-118-200	53	130-152-175	55
130-038-210	51	130-118-250	53	130-153-175	55
130-038-250	51	130-118-300	53	130-154-180	56
130-039-180	52	130-119-130	58	130-154-210	56
130-040-130	51	130-119-150	58	130-154-250	56
130-040-145	51	130-120-130	53	130-155-180	56
130-040-150	51	130-120-145	53	130-155-210	56
130-041-150	55	130-120-150	54	130-155-250	56
130-042-200	52	130-120-155	53	130-157-175	55
130-043-180	52	130-120-160	53	130-160-150	56
130-043-200	52	130-120-180	53	130-160-200	56
130-046-120	50	130-120-200	53	130-162-150	52
130-046-130	50	130-120-250	53	130-162-200	52
130-046-145	50	130-120-300	53	130-274-130	54
130-046-150	50	130-121-120	53	130-274-145	54
130-046-180	50	130-121-130	53	130-274-150	54
130-046-200	50	130-121-145	53	130-324-160	64
130-046-250	50	130-121-155	53	130-324-180	64
130-046-300	50	130-121-160	53	130-437-100	60
130-048-120	50	130-121-180	53	130-438-100	60
130-048-130	50	130-121-200	53	130-439-100	60
130-048-145	50	130-121-250	53	130-500-100	60
130-048-150	50	130-121-300	53	130-501-100	60
130-048-180	50	130-122-150	54	130-502-100	60
130-048-200	50	130-124-150	54	130-503-100	60
130-048-250	50	130-126-120	53	130-504-100	60
130-051-145	57	130-126-130	53	130-505-100	60
130-052-145	57	130-126-145	53	130-506-200	57



## Nummer Index

## Numerical Index

Katalog Nr. Catalogue No.	Seite page	Katalog Nr. Catalogue No.	Seite page	Katalog Nr. Catalogue No.	Seite page
130-507-200	57	130-624-105	59	140-150-130	70
130-508-200	57	130-625-080	59	140-150-150	70
130-510-150	57	130-625-090	59	140-150-180	70
130-510-200	57	130-625-105	59	140-150-200	70
130-510-250	57	130-625-115	59	140-151-130	70
130-511-145	57	130-625-130	59	140-151-150	70
130-511-160	57	130-625-145	59	140-151-180	70
130-511-200	57	130-626-105	59	140-151-200	70
130-514-170	65	130-627-080	59	140-152-230	66
130-516-170	64	130-627-090	59	140-216-035	67
130-518-145	64	130-627-105	59	140-216-135	67
130-518-160	64	130-627-115	59	140-217-035	67
130-518-170	64	130-627-130	59	140-217-135	67
130-518-180	64	130-627-145	59	140-220-250	68
130-518-200	64	130-630-075	59	140-220-260	68
130-518-250	64	130-630-090	59	140-228-140	70
130-518-300	64	130-630-115	59	140-228-160	70
130-520-150	64	130-632-105	59	140-229-130	70
130-522-140	64	130-633-105	59	140-232-100	70
130-522-150	64	140-050-038	66	140-233-100	70
130-522-160	64	140-050-050	66	140-235-140	68
130-522-180	64	140-050-063	66	140-235-160	75
130-522-200	64	140-050-076	66	140-236-160	68
130-522-250	64	140-050-090	66	140-237-160	75
130-522-300	64	140-051-038	66	140-240-155	68
130-532-120	65	140-051-050	66	140-240-200	68
130-532-150	65	140-051-063	66	140-244-140	71
130-534-120	65	140-051-076	66	140-245-140	71
130-534-150	65	140-051-090	66	140-250-100	71
130-536-175	65	140-056-020	66	140-251-100	71
130-539-180	65	140-056-030	66	140-254-125	71
130-541-180	65	140-114-035	66	140-254-140	71
130-542-150	65	140-114-050	66	140-254-180	72
130-542-180	65	140-115-035	66	140-254-210	72
130-542-200	65	140-115-050	66	140-255-125	71
130-548-120	50	140-119-075	67	140-255-140	71
130-548-150	50	140-119-085	67	140-255-180	72
130-550-120	54	140-119-105	67	140-255-210	72
130-550-150	54	140-119-120	67	140-256-125	71
130-552-120	54	140-120-075	67	140-256-140	71
130-552-150	54	140-120-085	67	140-256-180	72
130-554-160	58	140-120-105	67	140-256-210	72
130-554-200	58	140-120-120	67	140-257-125	71
130-555-120	54	140-130-045	67	140-257-140	71
130-555-150	54	140-130-070	67	140-257-180	72
130-557-120	54	140-130-090	67	140-257-210	72
130-560-230	52	140-130-110	67	140-267-140	69
130-562-150	58	140-131-045	67	140-267-190	69
130-562-200	58	140-131-070	67	140-270-100	72
130-562-230	58	140-131-090	67	140-270-120	72
130-566-150	65	140-131-110	67	140-271-100	72
130-566-230	65	140-134-130	68	140-271-120	72
130-566-250	65	140-135-130	68	140-272-100	72
130-622-080	59	140-135-185	80	140-272-120	72
130-622-090	59	140-135-205	80	140-273-100	72
130-622-105	59	140-135-210	80	140-273-120	72
130-622-115	59	140-135-215	80	140-274-140	73
130-622-130	59	140-140-200	80	140-275-140	73
130-622-145	59	140-140-260	80	140-276-150	73
130-623-080	59	140-141-200	80	140-277-150	73
130-623-090	59	140-141-260	80	140-278-150	73
130-623-105	59	140-142-200	80	140-279-150	73
130-623-115	59	140-142-260	80	140-280-140	73
130-623-130	59	140-143-200	80	140-281-140	73
130-623-145	59	140-143-260	80	140-282-150	69

## Nummer Index

## Numerical Index



Katalog Nr. Catalogue No.	Seite page	Katalog Nr. Catalogue No.	Seite page	Katalog Nr. Catalogue No.	Seite page
140-285-135	74	140-337-180	79	140-433-280	88
140-286-160	74	140-338-140	79	140-435-220	88
140-287-160	74	140-339-140	79	140-437-180	88
140-290-140	74	140-339-180	79	140-439-190	88
140-291-140	74	140-340-200	79	140-439-230	88
140-292-140	74	140-341-200	79	140-440-240	88
140-293-140	74	140-343-200	79	140-442-150	76
140-294-160	75	140-345-210	79	140-442-185	76
140-295-160	75	140-346-001	86	140-443-001	84
140-296-160	75	140-346-002	86	140-443-002	84
140-297-160	75	140-346-003	86	140-443-003	84
140-300-160	69	140-346-004	86	140-443-004	84
140-300-200	69	140-348-240	81	140-443-005	84
140-301-140	75	140-349-240	81	140-443-006	84
140-301-160	69	140-357-240	81	140-443-007	84
140-301-200	69	140-359-130	86	140-443-150	76
140-303-140	75	140-359-160	86	140-443-185	76
140-314-160	77	140-359-180	86	140-447-001	84
140-314-200	77	140-359-200	86	140-447-002	84
140-315-160	77	140-359-220	86	140-447-003	84
140-315-200	77	140-359-230	86	140-447-004	84
140-316-130	77	140-359-250	86	140-447-005	84
140-316-140	77	140-359-280	86	140-447-006	84
140-316-160	77	140-361-130	86	140-447-007	84
140-317-130	77	140-361-160	86	140-452-220	81
140-317-140	77	140-361-180	86	140-453-220	81
140-317-160	77	140-361-200	86	140-498-230	91
140-318-130	77	140-361-220	86	140-498-240	91
140-318-140	77	140-361-230	86	140-500-001	91
140-318-160	77	140-361-250	86	140-500-002	91
140-319-130	77	140-361-280	86	140-520-210	93
140-319-140	77	140-366-185	76	140-521-210	93
140-319-160	77	140-367-185	76	140-547-140	93
140-330-140	78	140-368-185	75	140-548-180	93
140-330-160	78	140-369-185	75	140-549-200	93
140-330-180	78	140-372-185	76	140-551-200	93
140-330-200	78	140-373-185	76	140-553-200	93
140-330-220	78	140-381-220	84	140-559-090	98
140-330-240	78	140-383-230	84	140-560-090	98
140-330-260	78	140-385-240	84	140-561-050	98
140-330-300	78	140-410-200	85	140-561-090	98
140-331-140	78	140-412-210	85	140-562-090	98
140-331-160	78	140-412-260	85	140-573-080	98
140-331-180	78	140-413-210	85	140-573-090	98
140-331-200	78	140-413-260	85	140-573-110	98
140-331-220	78	140-414-210	85	140-573-130	98
140-331-240	78	140-414-260	85	140-573-150	98
140-331-260	78	140-415-210	85	140-575-110	98
140-331-300	78	140-415-260	85	140-578-100	99
140-332-140	78	140-417-190	84	140-578-130	99
140-332-160	78	140-417-240	84	140-579-130	98
140-332-180	78	140-417-280	84	140-579-150	98
140-332-200	78	140-419-295	85	140-579-165	99
140-332-220	78	140-420-295	85	140-580-130	99
140-332-240	78	140-421-140	87	140-585-150	99
140-332-260	78	140-423-155	87	140-585-180	99
140-332-300	78	140-423-190	87	140-585-200	99
140-333-140	78	140-425-155	87	140-590-100	99
140-333-160	78	140-425-190	87	140-590-130	99
140-333-180	78	140-427-220	87	140-595-145	99
140-333-200	78	140-429-230	87	140-600-145	97
140-333-220	78	140-431-210	88	140-600-200	92
140-333-240	78	140-431-240	88	140-600-220	92
140-333-260	78	140-433-220	88	140-600-240	92
140-333-300	78	140-433-250	88	140-601-165	97



## Nummer Index

## Numerical Index

Katalog Nr. Catalogue No.	Seite page	Katalog Nr. Catalogue No.	Seite page	Katalog Nr. Catalogue No.	Seite page
140-601-180	97	150-031-200	100	160-170-130	104
140-601-200	97	150-031-220	100	160-170-145	104
140-602-230	92	150-031-250	100	160-170-160	104
140-603-150	97	150-031-270	100	160-170-180	104
140-603-180	97	150-035-130	102	160-175-145	104
140-603-200	97	150-038-250	101	160-185-160	104
140-603-230	92	150-040-260	101	160-250-000	106
140-604-230	92	150-041-260	101	160-250-002	106
140-605-150	97	150-043-260	101	160-250-003	106
140-605-180	97	150-045-250	101	160-250-006	106
140-605-200	97	150-050-180	102	160-250-009	106
140-607-220	90	150-050-200	102	160-250-012	106
140-607-230	90	150-050-250	102	160-250-080	106
140-608-220	90	150-052-180	102	160-250-090	106
140-608-230	90	150-052-200	102	160-250-095	106
140-609-210	90	150-052-250	102	160-254-160	106
140-612-210	96	150-053-180	102	160-255-120	106
140-613-210	96	150-053-200	102	160-415-250	105
140-613-230	96	150-053-250	102	160-415-300	105
140-615-210	96	150-055-180	102	160-420-120	105
140-615-230	96	150-055-200	102	160-420-140	105
140-617-210	96	150-055-250	102	160-420-165	105
140-617-275	90	150-060-250	103	160-420-180	105
140-618-210	96	150-061-250	103	160-426-120	105
140-619-180	90	150-070-180	103	160-426-140	105
140-619-210	96	150-070-250	103	160-426-165	105
140-619-275	90	150-080-130	102	160-426-180	105
140-621-210	89	150-080-160	102	160-495-280	106
140-623-210	89	150-080-180	102	165-001-003	107
140-625-190	89	150-150-250	228	165-001-004	107
140-627-190	89	150-290-250	101	165-002-003	107
140-628-190	76	160-090-200	105	165-002-004	107
140-629-190	76	160-100-115	104	165-010-007	109
140-630-190	76	160-100-130	104	165-010-009	109
140-631-190	76	160-100-145	104	165-010-011	109
140-633-190	89	160-100-160	104	165-010-012	109
140-633-220	89	160-100-180	104	165-020-003	107
140-633-240	89	160-100-200	104	165-020-004	107
140-635-190	89	160-102-115	104	165-020-005	107
140-635-220	89	160-102-130	104	165-020-006	107
140-635-240	89	160-102-145	104	165-020-035	107
140-637-190	89	160-102-160	104	165-020-045	107
140-637-220	89	160-102-180	104	165-020-055	107
140-637-240	89	160-102-200	104	165-022-003	107
140-639-210	95	160-107-115	104	165-022-004	107
140-641-215	95	160-107-130	104	165-022-005	107
140-643-240	94	160-107-145	104	165-022-006	107
140-645-230	95	160-107-160	104	165-022-035	107
140-647-240	95	160-107-180	104	165-022-045	107
140-650-200	95	160-107-200	104	165-022-055	107
140-650-240	95	160-108-115	104	165-024-003	107
140-652-190	95	160-108-130	104	165-024-004	107
140-697-250	94	160-108-145	104	165-024-005	107
140-698-230	94	160-108-160	104	165-024-006	107
140-699-230	94	160-108-180	104	165-024-035	107
150-010-220	100	160-108-200	104	165-024-045	107
150-010-250	100	160-110-001	105	165-024-055	107
150-010-270	100	160-110-002	105	165-025-001	108
150-011-220	100	160-110-003	105	165-025-002	108
150-011-250	100	160-110-004	105	165-030-240	108
150-011-270	100	160-130-105	104	165-031-007	108
150-030-200	100	160-150-145	104	165-031-009	108
150-030-220	100	160-150-160	104	165-031-012	108
150-030-250	100	160-150-180	104	165-033-006	108
150-030-270	100	160-150-200	104	165-033-008	108



Katalog Nr. Catalogue No.	Seite page	Katalog Nr. Catalogue No.	Seite page	Katalog Nr. Catalogue No.	Seite page
165-034-004	109	165-550-220	110	165-859-010	116
165-034-045	109	165-551-220	110	165-859-020	116
165-034-055	109	165-552-220	110	165-860-010	116
165-034-065	109	165-552-300	111	165-860-020	116
165-035-002	108	165-552-310	111	165-860-050	117
165-035-003	108	165-552-330	111	165-860-100	117
165-035-006	108	165-552-350	111	165-860-150	117
165-047-120	114	165-558-000	110	165-860-200	117
165-047-140	114	165-558-004	110	165-861-050	117
165-047-160	114	165-560-001	111	165-861-100	117
165-049-037	114	165-560-001	112	165-861-150	117
165-049-076	114	165-560-002	111	165-861-200	117
165-049-077	114	165-560-002	112	165-865-010	117
165-049-078	114	165-560-003	112	165-865-020	117
165-049-079	114	165-562-230	112	165-865-030	117
165-049-080	114	165-690-001	113	165-865-050	117
165-049-081	114	165-690-002	113	165-866-010	117
165-049-082	114	165-690-012	113	165-866-020	117
165-049-092	114	165-690-014	113	165-866-030	117
165-049-093	114	165-690-016	113	165-866-050	117
165-049-094	114	165-690-018	113	170-010-160	118
165-049-095	114	165-690-020	113	170-012-160	118
165-049-096	114	165-695-000	113	170-013-130	118
165-049-097	114	165-695-001	113	170-014-001	119
165-050-001	115	165-700-003	113	170-014-002	119
165-050-002	115	165-700-004	113	170-014-005	119
165-050-003	115	165-700-005	113	170-014-007	119
165-050-004	115	165-700-006	113	170-014-010	119
165-050-005	115	165-705-120	113	170-015-160	118
165-050-006	115	165-705-150	113	170-016-160	118
165-050-007	115	165-710-060	113	170-017-160	118
165-050-008	115	165-716-160	114	170-018-160	118
165-052-018	109	165-716-205	114	170-020-001	118
165-054-003	109	165-800-010	116	170-020-002	118
165-054-004	109	165-800-020	116	170-020-003	118
165-054-005	109	165-800-050	116	170-040-160	118
165-055-140	115	165-800-100	116	170-042-160	119
165-055-180	115	165-800-200	116	170-044-160	119
165-056-055	109	165-800-500	116	170-060-001	120
165-056-140	115	165-801-010	116	170-060-002	120
165-056-180	115	165-801-020	116	170-074-161	120
165-058-225	109	165-801-050	116	170-074-162	120
165-061-110	109	165-801-100	116	170-074-163	120
165-062-110	109	165-801-200	116	170-074-164	120
165-064-000	110	165-801-500	116	170-074-261	120
165-065-270	110	165-850-010	116	170-074-262	120
165-066-000	110	165-850-020	116	170-074-263	120
165-521-004	112	165-850-050	116	170-074-264	120
165-523-006	112	165-850-100	116	170-075-161	120
165-523-008	112	165-850-200	116	170-075-162	120
165-523-010	112	165-850-500	116	170-075-163	120
165-523-012	112	165-851-010	116	170-075-164	120
165-525-006	112	165-851-020	116	170-075-261	120
165-525-008	112	165-851-050	116	170-075-262	120
165-525-010	112	165-851-100	116	170-075-263	120
165-525-012	112	165-851-200	116	170-075-264	120
165-526-006	112	165-851-500	116	170-076-162	119
165-526-008	112	165-855-020	116	170-076-163	119
165-526-010	112	165-855-050	116	170-076-164	119
165-526-012	112	165-855-100	116	170-077-161	120
165-543-000	111	165-856-020	116	170-077-162	120
165-543-270	110	165-856-050	116	170-077-163	120
165-546-225	112	165-856-100	116	170-077-164	120
165-549-220	110	165-857-010	117	170-079-162	119
		165-858-010	117	170-079-163	119





## Nummer Index

## Numerical Index

Katalog Nr. Catalogue No.	Seite page	Katalog Nr. Catalogue No.	Seite page	Katalog Nr. Catalogue No.	Seite page
170-079-164	119	170-231-215	124	170-317-070	127
170-079-181	121	170-231-215	124	170-317-080	127
170-079-182	121	170-233-080	123	170-317-081	127
170-079-183	121	170-233-100	123	170-319-250	134
170-079-184	121	170-233-120	123	170-319-260	134
170-079-185	121	170-233-140	123	170-319-270	134
170-079-186	121	170-233-160	123	170-325-001	130
170-080-001	119	170-233-180	123	170-325-002	130
170-080-002	119	170-233-215	124	170-325-003	130
170-108-130	122	170-235-080	123	170-363-001	130
170-108-160	122	170-235-110	123	170-363-002	130
170-110-130	122	170-235-130	123	170-363-003	130
170-110-160	122	170-235-150	123	170-381-000	130
170-112-130	122	170-235-170	123	170-381-001	130
170-112-160	122	170-235-200	123	170-381-002	130
170-114-130	122	170-235-215	124	170-383-001	130
170-114-160	122	170-237-080	123	170-383-002	130
170-116-130	122	170-237-110	123	170-383-003	130
170-116-160	122	170-237-130	123	170-383-004	130
170-118-130	122	170-237-150	123	170-383-005	130
170-118-160	122	170-237-170	123	170-383-006	130
170-130-160	121	170-237-200	123	170-440-001	131
170-131-160	121	170-237-215	124	170-440-002	131
170-132-160	121	170-239-215	124	170-440-003	131
170-133-160	121	170-241-215	124	170-443-001	131
170-134-160	121	170-293-001	126	170-443-002	131
170-206-150	122	170-293-002	126	170-443-003	131
170-207-140	122	170-293-003	126	170-447-040	131
170-208-150	121	170-293-004	126	170-447-050	131
170-209-150	121	170-293-005	126	170-447-060	131
170-210-160	122	170-310-221	124	170-447-075	131
170-212-160	122	170-310-222	124	170-447-085	131
170-213-160	122	170-310-223	124	170-449-225	132
170-214-160	122	170-310-224	124	170-450-160	134
170-218-008	125	170-310-226	124	170-451-002	132
170-219-008	125	170-310-228	124	170-451-003	132
170-220-004	125	170-311-221	124	170-451-004	132
170-220-005	125	170-311-222	124	170-457-001	132
170-220-006	125	170-311-223	124	170-457-002	132
170-220-007	125	170-311-224	124	170-461-001	135
170-220-215	124	170-311-226	124	170-461-002	135
170-221-215	124	170-311-228	124	170-461-003	135
170-222-215	124	170-312-190	129	170-461-250	132
170-222-220	126	170-312-221	124	170-463-001	137
170-222-221	126	170-312-222	124	170-463-002	137
170-222-222	126	170-312-223	124	170-465-380	134
170-222-223	126	170-312-224	124	170-465-510	134
170-222-224	126	170-312-226	124	170-471-008	135
170-223-215	124	170-312-228	124	170-471-010	135
170-224-215	124	170-313-200	129	170-471-012	135
170-225-210	126	170-314-160	119	170-471-014	135
170-225-215	124	170-314-240	119	170-471-016	135
170-226-210	126	170-315-018	128	170-471-018	135
170-226-215	124	170-315-020	128	170-471-108	129
170-227-210	126	170-315-025	128	170-471-110	129
170-227-215	124	170-315-030	128	170-471-112	129
170-228-215	124	170-315-040	128	170-471-114	129
170-229-215	124	170-317-022	127	170-471-116	129
170-230-215	124	170-317-025	127	170-471-118	129
170-231-080	123	170-317-026	127	170-475-160	134
170-231-100	123	170-317-035	127	170-481-040	135
170-231-120	123	170-317-036	127	170-481-062	135
170-231-140	123	170-317-037	127	170-483-025	136
170-231-160	123	170-317-040	127	170-483-038	136
170-231-180	123	170-317-055	127	170-483-050	136



Katalog Nr. Catalogue No.	Seite page	Katalog Nr. Catalogue No.	Seite page	Katalog Nr. Catalogue No.	Seite page
170-483-075	136	170-735-200	143	170-835-000	151
170-489-001	133	170-735-240	143	170-839-038	150
170-489-002	133	170-742-105	142	170-839-040	150
170-489-003	133	170-742-130	142	170-839-060	150
170-490-500	134	170-742-150	142	170-840-000	152
170-493-001	137	170-742-180	142	170-841-001	152
170-493-002	137	170-743-105	142	170-841-002	152
170-493-003	137	170-743-130	142	170-841-003	152
170-493-004	137	170-743-150	142	170-841-010	152
170-530-260	133	170-743-180	142	170-852-000	152
170-531-260	133	170-745-100	147	170-856-000	152
170-532-260	133	170-745-170	147	170-860-000	153
170-533-260	133	170-748-105	143	170-860-070	153
170-561-001	128	170-749-105	143	170-860-100	153
170-561-002	128	170-750-130	143	170-862-000	154
170-561-003	128	170-750-165	143	170-864-000	154
170-591-180	136	170-751-130	143	170-864-038	154
170-591-215	136	170-751-165	143	170-864-051	154
170-591-230	136	170-752-130	143	170-866-000	156
170-591-300	136	170-753-130	143	170-866-016	156
170-591-330	136	170-754-155	142	170-866-030	156
170-591-360	136	170-758-125	142	170-866-040	156
170-593-300	136	170-759-125	142	170-868-000	156
170-597-300	136	170-760-110	144	170-879-001	159
170-607-260	133	170-761-110	144	170-879-002	159
170-653-000	139	170-762-130	144	170-879-003	159
170-654-016	139	170-763-130	144	170-879-004	159
170-654-020	139	170-766-090	153	170-880-100	159
170-654-025	139	170-767-130	144	170-882-000	157
170-655-000	138	170-768-130	144	170-882-030	157
170-655-140	138	170-769-160	149	170-884-000	157
170-655-150	138	170-770-160	149	170-884-024	157
170-655-170	138	170-771-001	149	170-889-040	157
170-655-180	138	170-771-002	149	170-889-050	157
170-663-120	138	170-771-003	149	170-889-075	157
170-665-150	138	170-776-175	148	170-889-086	157
170-667-006	138	170-776-220	148	170-889-098	157
170-669-130	138	170-778-170	148	170-889-099	157
170-673-001	138	170-784-320	146	170-894-000	158
170-683-000	139	170-786-000	145	170-894-001	158
170-687-210	139	170-786-001	145	170-894-002	158
170-695-000	139	170-786-310	146	170-894-003	158
170-700-050	140	170-794-200	145	170-894-004	158
170-701-050	140	170-794-260	145	170-894-300	158
170-714-070	140	170-795-200	145	170-900-001	155
170-714-100	140	170-795-260	145	170-900-002	155
170-715-070	140	170-802-135	147	170-900-003	155
170-715-100	140	170-802-180	147	170-900-004	155
170-716-070	140	170-803-180	147	170-900-009	155
170-716-100	140	170-812-165	142	170-900-010	155
170-719-095	140	170-815-170	149	170-900-011	155
170-720-100	140	170-818-100	151	170-900-015	155
170-723-100	140	170-818-140	151	170-900-016	155
170-725-140	141	170-818-160	151	170-900-020	155
170-727-140	141	170-819-000	149	170-900-021	155
170-728-160	141	170-823-000	150	170-900-022	155
170-729-160	141	170-824-000	150	170-900-023	155
170-730-265	141	170-825-000	150	170-950-000	159
170-731-265	141	170-827-000	150	170-950-050	159
170-732-200	141	170-829-000	150	170-950-090	159
170-732-265	141	170-829-050	150	170-950-100	159
170-733-200	141	170-829-060	150	170-950-105	159
170-733-265	141	170-829-070	150	170-950-115	159
170-734-200	143	170-832-060	150	170-950-125	159
170-734-240	143	170-834-060	150	170-950-155	159



## Nummer Index

## Numerical Index

Katalog Nr. Catalogue No.	Seite page	Katalog Nr. Catalogue No.	Seite page	Katalog Nr. Catalogue No.	Seite page
170-953-280	161	180-022-004	163	180-354-260	167
170-963-013	161	180-022-005	163	180-354-300	167
170-963-025	161	180-022-006	163	180-356-160	168
170-963-032	161	180-022-007	163	180-356-180	168
170-963-040	161	180-022-008	163	180-356-200	168
170-963-050	161	180-022-010	163	180-361-210	168
170-971-250	161	180-022-020	163	180-362-235	168
170-971-300	161	180-024-001	163	180-364-270	168
170-971-370	161	180-024-002	163	180-367-270	169
170-973-006	161	180-024-003	163	180-370-270	169
170-973-012	161	180-024-004	163	180-374-270	169
170-973-017	161	180-024-005	163	180-377-230	170
170-973-020	161	180-024-010	163	180-381-150	168
170-973-025	161	180-024-020	163	180-382-140	170
170-975-250	161	180-030-001	163	180-382-170	170
180-010-001	162	180-030-002	163	180-382-180	170
180-010-002	162	180-030-003	163	180-384-140	170
180-010-003	162	180-030-004	163	180-389-160	170
180-010-004	162	180-030-005	163	180-420-140	171
180-010-005	162	180-030-010	163	180-420-170	171
180-010-006	162	180-032-001	163	180-420-200	171
180-010-007	162	180-032-002	163	180-422-140	171
180-010-008	162	180-032-003	163	180-422-170	171
180-010-009	162	180-032-004	163	180-425-140	171
180-010-010	162	180-032-005	163	180-425-170	171
180-010-011	162	180-032-010	163	180-425-200	171
180-010-012	162	180-036-001	163	180-430-170	171
180-010-013	162	180-036-002	163	180-430-200	171
180-010-014	162	180-036-003	163	180-440-180	170
180-010-015	162	180-036-010	163	180-450-200	171
180-010-016	162	180-036-020	163	180-510-145	173
180-012-001	162	180-040-001	163	180-511-145	173
180-012-002	162	180-040-002	163	180-512-145	173
180-012-003	162	180-040-003	163	180-512-180	173
180-012-004	162	180-040-010	163	180-513-145	173
180-012-005	162	180-040-020	163	180-519-145	173
180-012-006	162	180-219-145	165	180-519-180	173
180-012-007	162	180-219-180	165	180-520-145	173
180-012-008	162	180-220-145	165	180-520-180	173
180-012-009	162	180-220-180	165	180-521-145	173
180-012-010	162	180-221-145	165	180-521-180	173
180-012-011	162	180-221-180	165	180-522-145	173
180-012-012	162	180-222-145	165	180-522-180	173
180-012-013	162	180-222-180	165	180-524-135	173
180-012-014	162	180-310-120	166	180-530-160	173
180-012-015	162	180-310-125	166	180-530-180	173
180-012-016	162	180-314-125	166	180-530-200	173
180-018-001	162	180-318-130	166	180-530-230	173
180-018-002	162	180-320-130	166	180-530-260	173
180-018-003	162	180-321-130	166	180-532-120	174
180-018-004	162	180-322-130	166	180-534-125	174
180-018-005	162	180-324-140	166	180-534-140	174
180-018-006	162	180-326-130	166	180-536-130	174
180-018-010	162	180-326-180	166	180-537-130	174
180-018-020	162	180-330-150	167	180-538-130	174
180-018-030	162	180-330-170	167	180-540-150	174
180-020-001	162	180-332-150	167	180-540-180	174
180-020-002	162	180-332-180	167	180-545-180	175
180-020-003	162	180-334-180	167	180-545-200	175
180-020-004	162	180-336-180	167	180-545-260	175
180-020-005	162	180-354-140	167	180-547-200	175
180-020-006	162	180-354-160	167	180-547-240	175
180-022-001	163	180-354-180	167	180-547-260	175
180-022-002	163	180-354-200	167	180-548-180	175
180-022-003	163	180-354-240	167	180-548-200	175



Katalog Nr. Catalogue No.	Seite page	Katalog Nr. Catalogue No.	Seite page	Katalog Nr. Catalogue No.	Seite page
180-548-230	175	180-702-140	182	180-776-195	189
180-548-260	175	180-702-195	182	180-776-220	189
180-548-310	175	180-702-225	182	180-777-220	189
180-548-370	175	180-703-140	182	180-778-235	190
180-550-160	175	180-703-195	182	180-780-210	190
180-550-180	175	180-703-225	182	180-781-190	184
180-550-200	175	180-704-140	182	180-781-230	190
180-550-240	175	180-704-195	182	180-782-190	184
180-550-260	175	180-704-225	182	180-783-190	184
180-550-300	175	180-706-001	185	180-906-100	192
180-555-150	176	180-706-002	185	180-909-180	192
180-555-170	176	180-706-003	185	180-910-180	192
180-555-200	176	180-706-240	185	180-916-120	191
180-556-270	177	180-707-150	186	180-920-120	191
180-558-270	177	180-708-140	186	180-920-125	191
180-560-130	176	180-711-240	187	180-922-125	191
180-560-160	176	180-712-210	185	180-934-130	191
180-560-180	176	180-713-250	185	180-936-140	191
180-560-200	176	180-714-120	185	180-940-075	192
180-560-230	176	180-715-120	185	180-940-110	192
180-560-260	176	180-716-200	184	180-940-120	192
180-561-130	176	180-717-230	186	180-940-140	192
180-561-150	176	180-718-210	187	180-940-160	192
180-561-180	176	180-718-230	186	180-940-180	192
180-561-200	176	180-719-210	187	180-940-200	192
180-561-230	176	180-720-190	189	180-940-220	192
180-561-260	176	180-720-230	187	180-950-000	192
180-562-270	177	180-722-200	183	180-959-000	193
180-567-220	179	180-722-240	187	180-960-000	193
180-567-230	179	180-723-200	183	190-155-230	43
180-568-140	179	180-723-240	187	190-160-140	43
180-568-170	179	180-724-200	183	190-165-090	42
180-568-180	179	180-725-150	184	190-165-110	42
180-570-130	174	180-725-170	184	190-165-140	42
180-570-150	179	180-726-210	183	190-165-180	42
180-570-160	179	180-727-210	183	190-165-200	42
180-571-185	179	180-728-200	183	190-170-185	42
180-571-200	178	180-728-210	183	190-170-210	42
180-571-240	178	180-729-210	183	190-177-160	42
180-571-260	178	180-730-270	183	190-177-190	42
180-572-200	178	180-731-270	183	190-195-230	43
180-572-240	178	180-732-190	184	190-205-200	43
180-576-140	180	180-732-200	184	190-205-220	43
180-576-170	180	180-732-270	183	190-209-180	42
180-576-200	180	180-733-270	183	190-211-200	43
180-578-170	180	180-736-200	183	190-223-240	43
180-578-200	180	180-737-200	183	190-224-240	43
180-578-230	180	180-738-200	183	190-291-180	42
180-580-180	181	180-739-200	183	190-297-240	43
180-582-170	181	180-743-250	188	210-008-135	198
180-584-180	181	180-744-300	188	210-010-135	198
180-584-200	181	180-745-300	188	210-012-135	198
180-584-230	181	180-746-300	184	210-014-135	198
180-586-200	181	180-747-300	184	210-016-135	198
180-586-230	181	180-748-300	188	210-106-200	199
180-590-140	178	180-749-300	188	210-108-135	198
180-590-180	178	180-751-150	186	210-109-200	199
180-590-200	178	180-752-150	186	210-110-135	198
180-590-230	178	180-752-255	190	210-112-135	198
180-593-140	180	180-754-280	190	210-113-200	199
180-593-170	180	180-760-180	190	210-114-135	198
180-593-180	180	180-760-270	190	210-116-135	198
180-701-140	182	180-770-190	189	210-116-200	199
180-701-195	182	180-774-195	189	210-119-200	199
180-701-225	182	180-775-195	189	210-125-200	199



## Nummer Index

## Numerical Index

Katalog Nr. Catalogue No.	Seite page	Katalog Nr. Catalogue No.	Seite page	Katalog Nr. Catalogue No.	Seite page
210-132-006	199	210-304-400	194	210-525-200	198
210-132-015	199	210-305-135	198	210-527-190	195
210-132-020	199	210-306-010	194	210-553-150	196
210-132-025	199	210-306-020	194	210-604-180	198
210-132-032	199	210-306-030	194	210-606-180	198
210-132-038	199	210-306-040	194	210-608-180	198
210-132-044	199	210-306-050	194	210-610-180	198
210-132-050	199	210-306-060	194	210-612-180	198
210-132-200	199	210-306-100	194	210-614-180	198
210-133-006	199	210-306-135	198	210-710-200	198
210-133-015	199	210-306-200	194	210-715-200	198
210-133-020	199	210-306-300	194	210-720-200	198
210-133-025	199	210-306-400	194	210-725-200	198
210-133-032	199	210-309-200	199	210-810-200	198
210-133-038	199	210-310-150	197	210-815-200	198
210-133-044	199	210-311-150	197	210-820-200	198
210-133-050	199	210-313-200	199	210-825-200	198
210-206-200	199	210-315-210	197	210-972-000	249
210-208-135	198	210-316-200	199	210-972-160	249
210-209-200	199	210-319-200	199	210-975-170	249
210-210-130	195	210-325-200	199	210-976-000	249
210-210-135	198	210-331-170	197	230-151-140	248
210-210-140	195	210-333-170	197	230-152-140	248
210-210-170	195	210-335-170	197	230-153-140	248
210-212-135	198	210-337-170	197	230-154-140	248
210-213-200	199	210-348-010	194	230-155-001	248
210-214-135	198	210-348-100	194	230-155-002	248
210-215-140	195	210-348-200	194	230-155-003	248
210-216-135	198	210-348-300	194	230-160-000	248
210-216-150	195	210-348-400	194	230-160-002	248
210-216-200	199	210-350-010	194	230-160-003	248
210-217-010	194	210-350-100	194	230-160-004	248
210-217-020	194	210-350-200	194	230-160-005	248
210-217-100	194	210-395-160	196	230-160-006	248
210-217-200	194	210-395-200	196	230-160-007	248
210-218-140	195	210-396-170	196	230-160-008	248
210-218-160	195	210-397-200	196	230-203-150	118
210-219-140	195	210-403-135	198	230-205-180	118
210-219-200	199	210-404-135	198	230-207-180	118
210-220-200	199	210-405-135	198	230-209-180	118
210-224-180	199	210-406-135	198	230-230-140	248
210-225-200	199	210-409-200	199	230-232-140	248
210-232-200	199	210-413-200	199	230-236-140	248
210-294-010	194	210-416-200	199	230-238-100	248
210-294-020	194	210-419-200	199	230-239-100	248
210-300-010	194	210-425-200	199	230-240-140	248
210-300-020	194	210-436-160	197	250-064-140	164
210-300-030	194	210-461-210	196	250-064-145	165
210-300-040	194	210-462-210	196	250-064-146	165
210-300-100	194	210-463-210	196	250-064-147	165
210-300-200	194	210-464-210	196	250-064-148	165
210-300-240	199	210-484-170	196	250-064-149	165
210-300-300	194	210-485-170	196	250-064-150	165
210-303-135	198	210-486-170	196	250-064-151	165
210-303-190	197	210-487-170	196	250-064-244	164
210-304-010	194	210-504-180	198	250-064-245	164
210-304-020	194	210-506-180	198	250-064-246	164
210-304-030	194	210-508-180	198	250-064-247	164
210-304-040	194	210-510-180	198	251-550-150	49
210-304-050	194	210-510-200	198	251-551-150	49
210-304-060	194	210-512-180	198	251-552-150	49
210-304-100	194	210-514-180	198	251-553-150	49
210-304-135	198	210-515-200	198	251-611-120	61
210-304-200	194	210-520-200	198	251-611-130	61
210-304-300	194	210-525-175	195	251-612-130	61



Katalog Nr. Catalogue No.	Seite page	Katalog Nr. Catalogue No.	Seite page	Katalog Nr. Catalogue No.	Seite page
251-613-110	61	300-011-504	115	310-124-280	203
251-614-130	61	300-011-505	115	310-125-220	203
251-615-130	61	300-011-506	115	310-125-250	203
251-616-110	61	300-011-508	115	310-125-280	203
251-617-110	61	300-011-509	115	310-126-220	203
251-618-120	61	300-011-510	115	310-126-250	203
251-619-110	61	300-011-511	115	310-126-280	203
253-450-050	117	300-011-512	115	310-127-220	203
290-174-000	160	300-011-513	115	310-127-250	203
290-177-075	160	300-011-514	115	310-127-280	203
290-178-165	160	300-195-100	114	310-130-210	204
290-178-200	160	300-195-120	114	310-130-230	204
290-178-250	160	310-010-120	200	310-130-250	204
290-237-230	83	310-010-150	200	310-131-210	204
290-238-230	83	310-014-150	200	310-131-230	204
290-241-220	82	310-014-190	200	310-131-250	204
290-245-220	82	310-014-250	200	310-140-210	204
290-247-220	82	310-020-135	207	310-140-230	204
290-265-240	83	310-020-160	200	310-140-250	204
290-267-240	83	310-020-200	200	310-141-210	204
290-269-305	82	310-020-250	200	310-141-230	204
290-271-295	82	310-022-065	208	310-141-250	204
290-286-200	82	310-022-075	207	310-150-240	204
290-287-200	82	310-022-095	207	310-151-240	204
290-321-260	83	310-022-135	207	310-152-330	206
290-323-260	83	310-025-095	207	310-153-330	206
290-331-150	83	310-025-185	200	310-155-190	206
290-505-300	137	310-026-160	201	310-200-229	204
290-505-320	137	310-026-190	201	310-201-235	204
290-548-160	63	310-026-200	201	310-290-180	203
290-548-200	63	310-027-155	201	310-290-210	203
290-548-240	63	310-028-150	201	310-290-230	203
290-548-300	63	310-029-155	201	310-291-180	203
290-550-160	62	310-030-065	208	310-291-210	203
290-550-200	62	310-030-125	200	310-291-230	203
290-550-240	62	310-030-150	200	310-310-260	206
290-550-300	62	310-030-195	200	310-310-280	206
290-551-160	62	310-030-200	201	310-400-005	205
290-551-200	62	310-031-150	205	310-400-007	205
290-551-240	62	310-031-200	201	310-400-010	205
290-551-300	62	310-032-150	205	310-410-085	205
290-552-160	62	310-032-210	205	310-412-260	205
290-552-200	62	310-032-290	205	310-500-300	206
290-552-240	62	310-033-210	205	310-501-300	206
290-552-300	62	310-033-290	205	310-550-160	203
290-553-160	62	310-100-200	201	310-550-180	203
290-553-200	62	310-110-160	202	310-550-210	203
290-553-240	62	310-110-180	202	310-550-230	203
290-553-300	62	310-110-200	202	310-551-160	203
290-554-160	63	310-110-240	202	310-551-180	203
290-554-200	63	310-111-160	202	310-551-210	203
290-554-240	63	310-111-200	202	310-551-230	203
290-554-300	63	310-112-180	202	310-601-150	207
290-555-160	63	310-112-200	202	310-603-150	207
290-555-200	63	310-113-200	202	310-606-210	207
290-555-240	63	310-114-200	202	310-610-150	207
290-555-300	63	310-114-230	202	310-655-001	208
290-557-160	62	310-115-160	201	310-655-002	208
290-557-200	62	310-116-155	200	310-655-003	208
290-557-240	62	310-116-200	200	310-655-004	208
290-557-300	62	310-116-230	200	310-675-050	208
290-558-160	63	310-118-160	202	310-675-100	208
290-558-200	63	310-118-200	202	310-675-145	208
290-558-240	63	310-124-220	203	310-675-200	208
290-558-300	63	310-124-250	203	310-679-210	208



## Nummer Index

## Numerical Index

Katalog Nr. Catalogue No.	Seite page	Katalog Nr. Catalogue No.	Seite page	Katalog Nr. Catalogue No.	Seite page
310-679-270	208	320-140-030	213	320-721-120	236
310-695-022	208	320-140-040	213	320-721-130	236
310-695-122	208	320-140-050	213	320-721-140	236
310-700-065	209	320-140-100	213	320-721-150	236
310-700-080	209	320-140-200	213	320-721-160	236
310-701-065	209	320-140-300	213	320-721-180	236
310-701-080	209	320-142-340	214	320-721-200	236
310-702-065	209	320-145-280	213	320-998-000	217
310-702-080	209	320-150-000	214	320-999-000	217
310-705-025	209	320-150-001	214	330-301-001	220
310-705-029	209	320-150-002	214	330-301-002	220
310-705-038	209	320-150-003	214	330-301-003	220
310-710-100	209	320-150-004	214	330-301-004	220
310-720-280	209	320-150-005	214	330-301-005	220
310-720-350	209	320-150-006	214	330-312-000	220
310-720-420	209	320-150-007	214	340-005-000	210
310-721-280	209	320-150-008	214	340-008-190	210
310-721-350	209	320-150-009	214	340-009-190	210
310-721-420	209	320-150-010	214	340-010-000	210
310-722-280	209	320-150-011	214	340-011-000	210
310-722-350	209	320-150-012	214	340-011-280	245
310-722-420	209	320-150-013	214	340-012-000	210
310-723-280	209	320-150-215	214	340-012-330	245
310-723-350	209	320-150-230	216	340-012-360	245
310-723-420	209	320-151-001	214	340-013-300	245
310-729-001	243	320-151-002	214	340-014-410	245
310-729-002	243	320-151-003	214	340-015-360	246
310-730-240	243	320-151-230	216	340-015-400	246
310-731-200	244	320-151-245	216	340-016-400	246
310-732-000	244	320-152-230	216	340-017-440	246
310-732-200	244	320-152-270	214	340-018-300	245
310-733-001	244	320-153-001	214	340-018-360	245
310-733-002	244	320-153-002	214	340-018-390	245
310-733-003	244	320-165-285	216	340-020-360	245
310-735-280	243	320-170-260	217	340-025-320	246
310-760-200	243	320-175-235	217	340-025-380	246
310-761-200	243	320-185-000	215	340-029-360	245
310-762-200	243	320-185-001	215	340-103-340	247
320-080-240	213	320-185-002	215	340-150-210	246
320-090-210	211	320-185-003	215	340-401-210	210
320-092-210	211	320-185-004	215	340-402-210	210
320-101-230	211	320-190-000	215	340-403-210	210
320-103-220	211	320-195-000	215	340-500-300	247
320-105-220	211	320-195-001	215	340-510-420	247
320-107-220	211	320-200-000	215	340-600-008	247
320-109-190	211	320-204-210	217	340-600-011	247
320-111-190	211	320-205-220	217	340-600-013	247
320-111-230	212	320-206-210	217	340-600-016	247
320-112-230	212	320-350-190	216	340-600-021	247
320-114-200	212	320-350-280	216	340-600-026	247
320-115-200	212	320-720-080	217	340-600-032	247
320-116-200	212	320-720-100	217	340-798-270	246
320-117-200	212	320-720-120	217	340-799-270	246
320-119-220	212	320-720-140	217	340-799-280	246
320-120-180	212	320-720-160	217	340-800-280	246
320-121-001	214	320-720-180	217	340-801-280	246
320-121-002	214	320-720-200	217	340-802-280	246
320-121-003	214	320-720-220	217	350-009-001	218
320-121-004	214	320-720-240	217	350-100-001	219
320-121-180	212	320-721-060	236	350-100-002	219
320-128-350	213	320-721-070	236	350-100-003	219
320-129-320	213	320-721-080	236	350-102-001	219
320-135-245	213	320-721-090	236	350-102-002	219
320-140-010	213	320-721-100	236	350-102-003	219
320-140-020	213	320-721-110	236	350-103-000	219

## Nummer Index

## Numerical Index



Katalog Nr. Catalogue No.	Seite page	Katalog Nr. Catalogue No.	Seite page	Katalog Nr. Catalogue No.	Seite page
350-104-001	218	350-241-001	221	350-322-040	225
350-104-002	218	350-241-002	221	350-324-040	225
350-104-003	218	350-241-003	221	350-330-001	225
350-105-000	218	350-250-001	221	350-330-002	225
350-105-001	218	350-250-002	221	350-332-000	226
350-105-002	218	350-250-003	221	350-340-000	227
350-105-003	218	350-267-001	225	350-361-001	226
350-105-004	218	350-270-000	223	350-361-002	226
350-105-006	218	350-270-001	223	350-361-003	226
350-110-001	218	350-270-002	223	350-362-001	226
350-110-002	218	350-271-001	223	350-362-002	226
350-110-003	218	350-271-002	223	350-362-003	226
350-110-004	218	350-272-001	223	350-380-010	230
350-120-001	219	350-272-002	223	350-380-015	230
350-120-002	219	350-281-001	225	350-380-020	230
350-130-001	219	350-281-002	225	350-380-025	230
350-130-002	219	350-282-001	225	350-380-030	230
350-130-003	219	350-282-002	225	350-380-035	230
350-131-001	228	350-290-001	224	350-380-040	230
350-131-002	228	350-290-002	224	350-380-045	230
350-131-003	228	350-290-003	224	350-380-050	230
350-140-001	219	350-290-004	224	350-380-055	230
350-140-002	219	350-290-005	224	350-380-060	230
350-140-003	219	350-290-006	224	350-380-065	230
350-190-001	224	350-290-007	224	350-380-070	230
350-190-002	224	350-290-008	224	350-380-075	230
350-190-003	224	350-290-009	224	350-380-080	230
350-200-001	224	350-290-010	224	350-380-085	230
350-200-002	224	350-290-011	224	350-380-090	230
350-200-003	224	350-291-001	224	350-380-095	230
350-200-004	224	350-291-002	224	350-380-100	230
350-206-001	224	350-291-003	224	350-380-105	230
350-206-002	224	350-291-004	224	350-380-110	230
350-206-003	224	350-291-005	224	350-380-115	230
350-210-000	222	350-291-006	224	350-380-120	230
350-210-001	222	350-291-007	224	350-380-125	230
350-210-002	222	350-291-008	224	350-380-130	230
350-210-003	222	350-293-020	225	350-380-135	230
350-211-000	222	350-294-010	225	350-380-140	230
350-211-001	222	350-294-015	225	350-380-145	230
350-211-002	222	350-294-020	225	350-380-150	230
350-211-003	222	350-294-025	225	350-380-155	230
350-212-000	222	350-295-001	226	350-380-160	230
350-212-001	222	350-295-002	226	350-380-165	230
350-212-002	222	350-295-015	225	350-380-170	230
350-212-003	222	350-295-020	225	350-381-003	230
350-215-000	223	350-295-025	225	350-382-020	231
350-220-001	222	350-295-030	225	350-382-040	231
350-220-002	222	350-295-035	225	350-382-060	231
350-221-001	222	350-295-040	225	350-382-080	231
350-221-002	222	350-300-000	220	350-382-100	231
350-222-001	222	350-302-001	220	350-382-120	231
350-222-002	222	350-302-002	220	350-382-140	231
350-230-001	221	350-303-000	220	350-382-160	231
350-230-002	221	350-310-000	220	350-382-180	231
350-230-003	221	350-311-000	220	350-382-200	231
350-231-001	221	350-320-020	225	350-382-220	231
350-231-002	221	350-320-025	225	350-382-240	231
350-231-003	221	350-320-030	225	350-382-260	231
350-232-001	221	350-320-035	225	350-383-001	231
350-232-002	221	350-320-040	225	350-390-010	232
350-232-003	221	350-322-020	225	350-390-012	232
350-240-001	221	350-322-025	225	350-390-014	232
350-240-002	221	350-322-030	225	350-390-016	232
350-240-003	221	350-322-035	225	350-390-018	232





## Nummer Index

## Numerical Index

Katalog Nr. Catalogue No.	Seite page	Katalog Nr. Catalogue No.	Seite page	Katalog Nr. Catalogue No.	Seite page
350-390-020	232	350-610-002	241	350-631-006	239
350-391-002	232	350-610-003	241	350-631-007	239
350-392-000	232	350-610-004	241	350-631-008	239
350-392-015	232	350-610-005	241	350-631-009	239
350-392-019	232	350-610-006	241	350-631-011	239
350-392-023	232	350-614-270	241	350-631-012	239
350-392-027	232	350-619-005	240	350-631-014	239
350-392-031	232	350-619-006	240	350-631-015	239
350-392-035	232	350-619-007	240	350-631-016	239
350-392-039	232	350-619-008	240	350-631-019	239
350-392-043	232	350-619-009	240	350-631-020	239
350-392-280	237	350-619-011	240	350-750-000	227
350-393-320	237	350-619-012	240	350-750-001	227
350-394-320	237	350-619-014	240	350-750-002	227
350-395-320	237	350-619-015	240	350-757-190	238
350-396-290	237	350-619-016	240	350-759-170	238
350-396-320	237	350-619-019	240	350-765-001	238
350-398-250	237	350-619-020	240	350-765-002	238
350-399-280	236	350-620-005	240	350-765-003	238
350-400-250	233	350-620-006	240	350-766-001	238
350-401-250	228	350-620-007	240	350-766-100	238
350-410-250	233	350-620-008	240	350-766-220	238
350-420-260	234	350-620-009	240	350-767-240	229
350-422-170	233	350-620-011	240	350-768-240	229
350-425-240	234	350-620-012	240	350-769-240	229
350-426-180	233	350-620-014	240	350-770-250	229
350-426-190	233	350-620-015	240	350-800-000	238
350-427-200	233	350-620-016	240	350-810-000	238
350-428-280	233	350-620-019	240	350-843-210	242
350-429-260	236	350-620-020	240	350-844-210	242
350-430-240	234	350-621-005	240	350-844-290	242
350-440-240	234	350-621-006	240	350-847-260	242
350-441-240	234	350-621-007	240	350-849-240	242
350-443-230	234	350-621-008	240	350-855-267	242
350-445-260	235	350-621-009	240	350-857-220	242
350-450-240	234	350-621-011	240	350-857-240	242
350-451-240	234	350-621-012	240	350-920-300	241
350-452-240	234	350-621-014	240	350-920-350	241
350-453-240	234	350-621-015	240	350-920-400	241
350-454-240	234	350-621-016	240	350-926-050	239
350-455-240	234	350-621-019	240	350-926-060	239
350-470-210	234	350-621-020	240	350-926-070	239
350-471-210	234	350-622-005	240	350-926-080	239
350-474-260	235	350-622-006	240	350-926-090	239
350-476-155	235	350-622-007	240	350-926-110	239
350-480-205	235	350-622-008	240	350-926-120	239
350-490-320	235	350-622-009	240	350-926-140	239
350-491-250	236	350-622-011	240	350-926-150	239
350-492-270	235	350-622-012	240	350-926-160	239
350-493-230	236	350-622-014	240	350-926-190	239
350-493-250	236	350-622-015	240	350-926-200	239
350-493-270	236	350-622-016	240	350-926-300	241
350-494-200	235	350-622-019	240	350-926-350	241
350-496-330	247	350-622-020	240	350-926-400	241
350-497-330	247	350-630-007	239	350-927-050	239
350-498-330	247	350-630-008	239	350-927-060	239
350-499-330	247	350-630-009	239	350-927-070	239
350-599-300	237	350-630-011	239	350-927-080	239
350-600-300	237	350-630-012	239	350-927-090	239
350-601-300	237	350-630-014	239	350-927-110	239
350-602-240	237	350-630-015	239	350-927-120	239
350-604-230	237	350-630-016	239	350-927-140	239
350-605-007	237	350-630-019	239	350-927-150	239
350-607-007	237	350-630-020	239	350-927-160	239
350-610-001	241	350-631-005	239	350-927-190	239

## Nummer Index

## Numerical Index



Katalog Nr. Catalogue No.	Seite page	Katalog Nr. Catalogue No.	Seite page
350-927-200	239	600-310-260	251
350-928-300	241	600-310-300	251
350-928-350	241	600-310-350	251
350-928-400	241	600-312-220	251
350-929-300	241	600-312-280	251
350-929-350	241	600-312-320	251
350-929-400	241	600-312-370	251
350-930-005	239	600-312-420	251
350-930-006	239	600-673-170	251
400-060-003	60	600-673-250	251
400-060-004	60	600-673-275	251
400-060-005	60	600-950-100	252
400-060-007	60	600-950-101	252
400-102-110	47	600-951-100	252
400-103-110	47	600-951-101	252
400-345-110	164	660-100-140	250
400-348-130	164	660-102-120	250
400-350-135	164	660-142-006	250
400-352-100	164	660-142-007	250
400-353-100	164	660-142-008	250
410-404-010	112	660-142-009	250
410-404-020	112	900-950-001	253
410-404-030	112	900-950-002	253
410-404-040	112	900-950-003	253
440-220-150	190	900-950-004	253
440-220-160	190	900-950-005	253
440-221-150	190	900-950-006	253
440-221-160	190	900-950-007	253
440-222-180	190		
440-500-000	148		
510-323-140	249		
510-324-140	249		
510-334-140	249		
510-347-130	249		
510-460-000	249		
510-460-001	249		
510-460-002	249		
510-460-003	249		
510-462-130	249		
600-050-000	252		
600-080-200	250		
600-087-230	250		
600-088-350	250		
600-095-270	250		
600-100-065	251		
600-170-165	251		
600-170-175	251		
600-170-225	251		
600-170-240	251		
600-170-260	251		
600-170-290	251		
600-170-315	251		
600-170-325	251		
600-170-360	251		
600-170-415	251		
600-231-040	251		
600-231-060	251		
600-231-080	251		
600-231-100	251		
600-231-120	251		
600-231-150	251		
600-281-240	251		
600-281-480	251		
600-281-550	251		
600-310-200	251		