

1	INTRODUCTION.....	3	5	CHECK AND REPAIR.....	58
1.1	Purpose of the document.....	3	5.1	Activation and deactivation of the technical services program for TouchControl	58
1.2	Pictograms	3	5.2	Technical Services Program for TouchControl.....	66
2	SAFETY	4	5.3	NTC sensor checks	71
2.1	Safety warnings	4	5.4	Fan checks	72
2.2	Repair warnings	4	5.5	Coil checks.....	72
2.3	EGB	5	5.6	Induction unit checks (ELIN)	73
3	COMPONENTS AND FUNCTION	8	5.7	Checks for when the circuit breaker trips	74
3.1	Electronic Induction (ELIN)	8	5.8	Radio interference	82
3.2	Bosch TouchControl.....	12	5.9	Checking the level of supplied power.....	84
3.3	Siemens TouchControls.....	15	5.10	Checking hob flatness.....	93
3.4	Neff TouchControl	18	5.11	Checking standard operation noises.....	94
3.5	Balay TouchControl.....	21	5.12	Checking pot detection	95
3.6	ELIN support	23	5.13	Checking of broken glass	97
3.7	Glass frame	25	5.14	Cookware for induction and recommendations.....	99
3.8	Fan	28	5.15	Disassembly of the TouchControl.....	102
3.9	NTC	29	5.16	Check: low sensitivity on the TouchControl Slider	103
3.10	Inductors.....	33	5.17	Checking the replacement part is correct	104
3.11	Connections	38	5.18	Checking SQ YL-196 TouchControl operation.....	109
3.12	Perfect Built in union accessory	43	5.19	Checking the “foam”	110
4	FAULT DIAGNOSTICS.....	47	5.20	Checking perfect built-in accessory joint.....	111
4.1	Error codes or warnings sent by the ELIN.....	47	5.21	Checking necessary ventilation: 60/70 cm.....	114
4.2	Error codes or warnings sent by the TouchControl	53	5.22	Installation of flat recess in timber using accessory....	116
			5.23	Assembly and disassembly: 2i.....	118

5.24 Check of residual heat indication..... 120

1 INTRODUCTION

1.1 Purpose of the document

The repair manual provides support for the official technician to help diagnose faults and repair the electrical appliances.

Apart from the repair manual, the technician may also use the following documents:

- Blow-up diagram of parts of the appliance.
- Diagrams
- List of parts
- Associated technical reports on specific occasions



The diagnosis of faults plus their repair should only be carried out by an officially authorised technician.

1.2 Pictograms



Warning!



Components sensitive to electrostatic shock:
Respect EGB reference



Sharp edges:
Use protective gloves!



Information or advice



Electrical hazard!

2 SAFETY

2.1 Safety warnings



Electrical hazard!

Repairs should only be carried out by the manufacturer's technical staff.

Inadequate repairs can harm the users.

The sheath and framework may be subjected to voltage in case of failure.

The appliance should be disconnected from the mains before dismantling. It contains parts inside that are subjected to high voltage.

Always use a current-breaker switch if it is necessary to conduct low-voltage tests.

The earth connection should not exceed standardised values. This is of the utmost importance for people's safety and normal working conditions of the appliance.

Once the appliance has been repaired, it should be subjected to tests VDE 0701 or the specific regulations that are in force in the country concerned.

The replacement of the power cable can only be carried out by authorised technical staff, using the replacement cable.

Special warnings for induction hobs!



Pacemaker

Induction hobs comply with the safety and electromagnetic compatibility regulations currently in force (EN50366). People with fitted pacemakers should abstain from using or repairing such an appliance. The operation of the appliance may interfere with the operation of the pacemaker.

People with hearing aids may experience discomfort.

2.2 Repair warnings



Warning!

Never attempt to carry out repairs involving the indiscriminate exchange of component parts.

Proceed in a systematic way, with reference to the technical specifications supplied with the appliance.

The electronic plates should not be repaired, but replaced with original spare parts. Exceptions are indicated in separate documents.



Components sensitive to electrostatic shock:

Respect EGB reference



Sharp edges:

Use protective gloves!

2.3 EGB

2.3.1 Concept

EGB = “Elektrostatisch Gefährdete Bauelemente“ (Electrostatic-Sensitive Devices)
(Component sensitive to electrostatic shock)

2.3.2 Pictogram



Electronic devices with components that are sensitive to electrostatic shock (EGB in German) are marked with the pictogram shown here.

2.3.3 General specifications

The use of cutting-edge electronic technology in current electrical appliances guarantees high levels of profitability, protection of the environment, easy handling, operability and safety. Such high-performance technology can only be handled by qualified technicians with specialised knowledge.

All electronic modules and constructive units incorporate elements with a potentially dangerous electrostatic voltage.

2.3.4 Dangerous components

Amongst others, these constructive elements are threatened by electrostatic voltage:

- ▶ μ Processors

- ▶ ICs
- ▶ Transistors
- ▶ Tiristors
- ▶ Triacs
- ▶ Diodes
- ▶ etc.

2.3.5 Causes and effect

The human body can generate electrostatic charges in certain environmental situations. This charge is favoured by dry air and the coating on insulated floors.

People can transfer an electrostatic voltage:

- ▶ of up to 35,000 volts when standing on a non-conductive carpet.
- ▶ of up to 12,000 volts when standing on a non-conductive PVC floor.
- ▶ of up to 1.800 volts when sitting in a padded chair.

The electrostatic voltage in the human body is transferred to electronic devices and components that are sensitive to electrostatic shock by touching them, sometimes resulting in damage depending on the circumstances.

2.3.6 Indications for components sensitive to electrostatic shock

In all electronic modules and constructive units there are components that are sensitive to electrostatic shock.

In order to protect such components, the following steps should be taken:

1. Read the corresponding label for the modules and constructive units with care.
2. Before touching and measuring any components that are sensitive to electrostatic shock, apply an electrostatic protection system (wristband with earth block).
3. Avoid touching these components with electrostatically-sensitive plastics (plastic sheeting, etc.).
4. Constructive units, modules and plate should be picked up as far as possible without touching the printed circuit boards and connections.
5. Components that are sensitive to electrostatic shock should not be located close to monitors or televisions.
6. For transport purposes, only conductive materials or the original packing should be used.

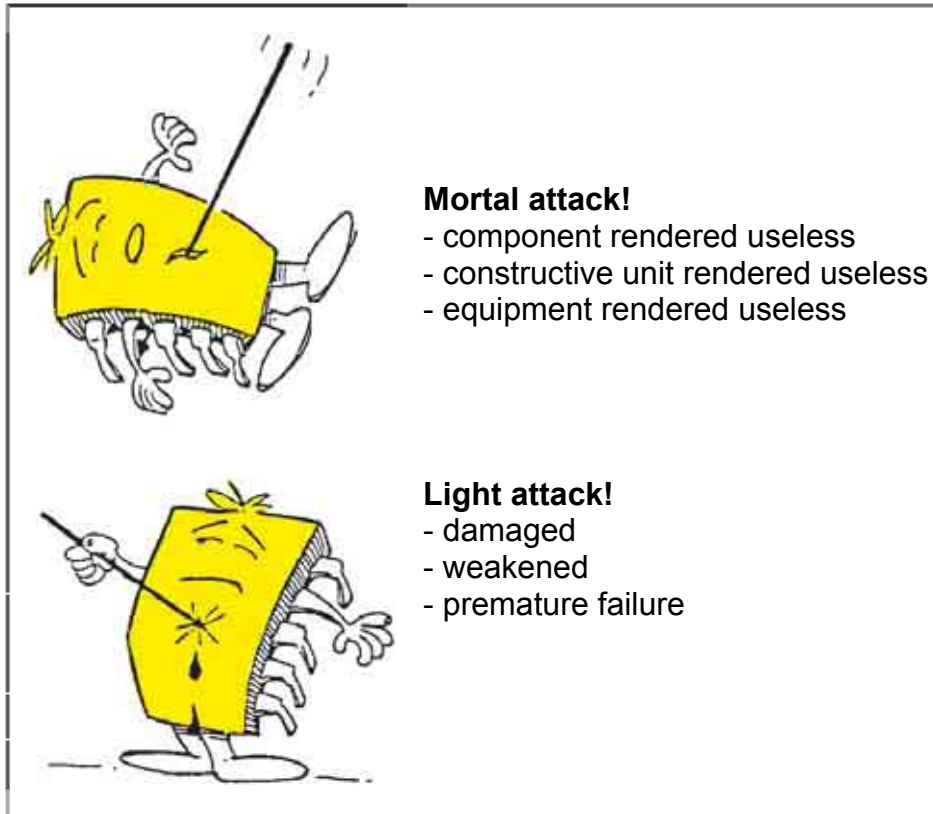

2.3.7 Electrostatic protection system

There are several different electrostatic protection systems.

These electrostatic protection systems act to prevent the electrostatic shock from affecting the human body or by shunting the existing electrostatic voltage to earth.

In the electrostatic protection system used at the after-sales customer service, the electrostatic voltage in the body is transferred by means of a wristband and earth block.



For safety reasons, this is not carried out directly but using a combination of elements

The connection with the earthwire conductor or protective conductor should be in perfect condition

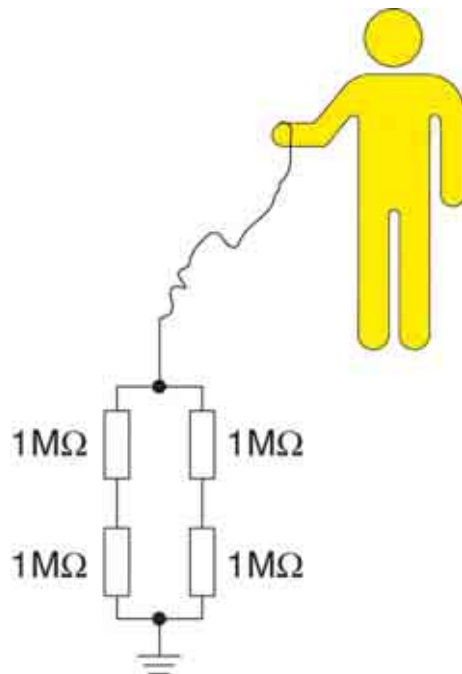

Combination of elements with wristband

3 COMPONENTS AND FUNCTION

3.1 Electronic Induction (ELIN)

There are two types of elin (electronic induction).

- One with its own power supply (“left or main elin”)
- Another one without its own power supply (“right or secondary elin”), which is powered by the main elin.

They are attached to the elin bracket with clips, plus a couple of screws.

They communicate with the TouchControl through the LIN connector.

The TouchControl sends power level orders for each burner and the elin returns the state of the burner (pan recognition, error detection, etc.)

Depending on the type of model there are:

Domino	1 main elin
2l 60 cm	1 main elin
4l 60cm	1 main elin / 1 secondary elin
4l 70 cm	1 main elin / 1 secondary elin
4l 80cm	1 main elin / 1 secondary elin
3l	1 main elin / 1 secondary elin
5l 90cm	2 main elin / 1 secondary elin

3.1.1 ELIN with own power supply (“left Elin”)

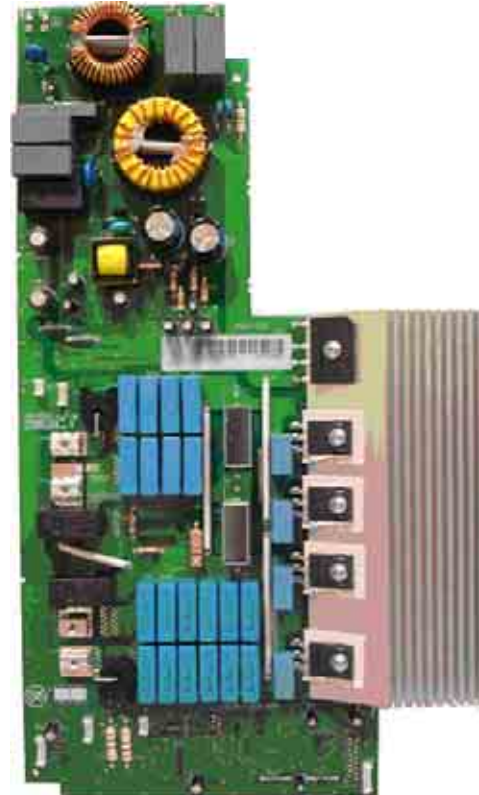

3.1.1.1 Components of Elin with own power supply

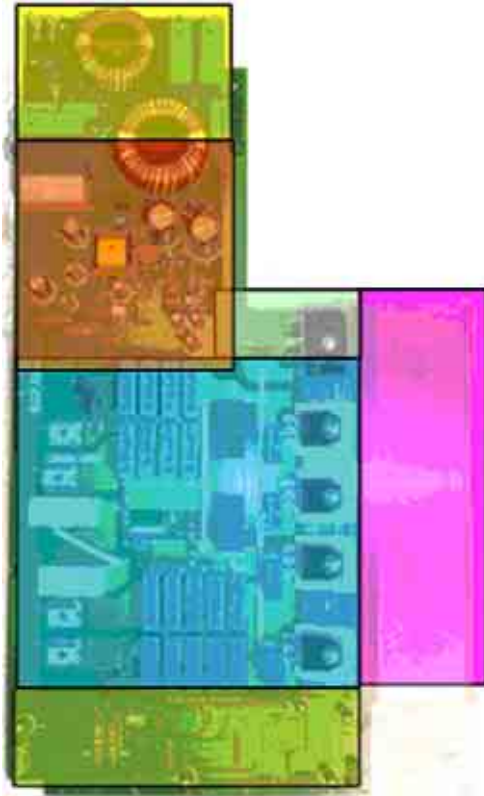

- 1- Interference filter (yellow)
- 2- Power supply (red)
- 3- Rectifier (light green)
- 4- Power inverter (blue)
- 5- Control (green)
- 6- Cooling element (pink)

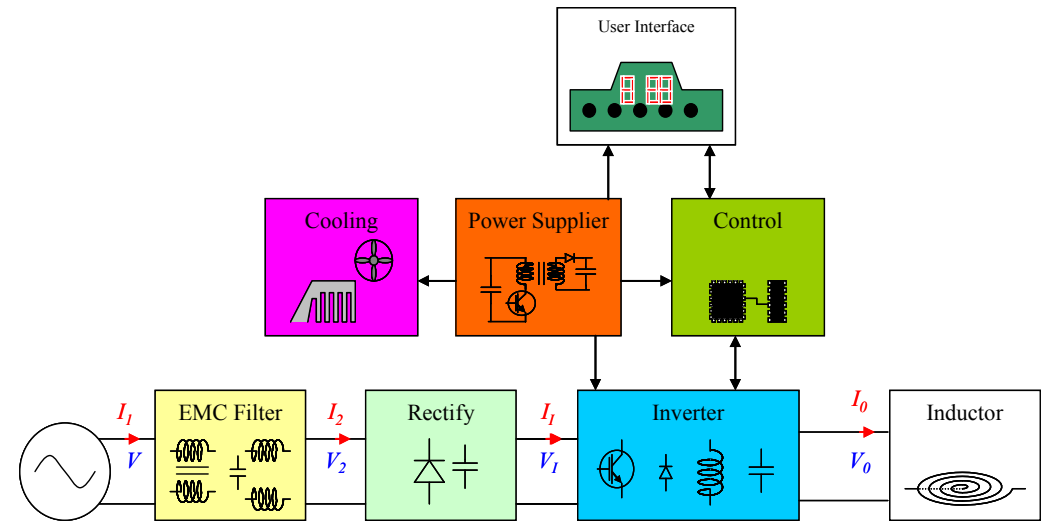

3.1.2 ELIN without own power supply (“right ELIN”)



3.1.2.1 Components of elin without own power supply

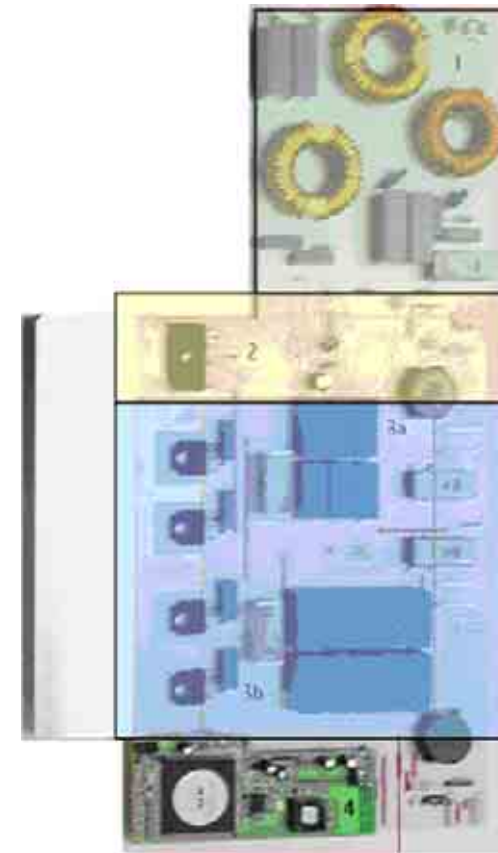

- 1- Interference filter (light green)
- 2- Rectifier (light yellow)
- 3- Power inverter (blue)
- 4- Control (green, bottom part)
- 5- Cooling element (left grey)

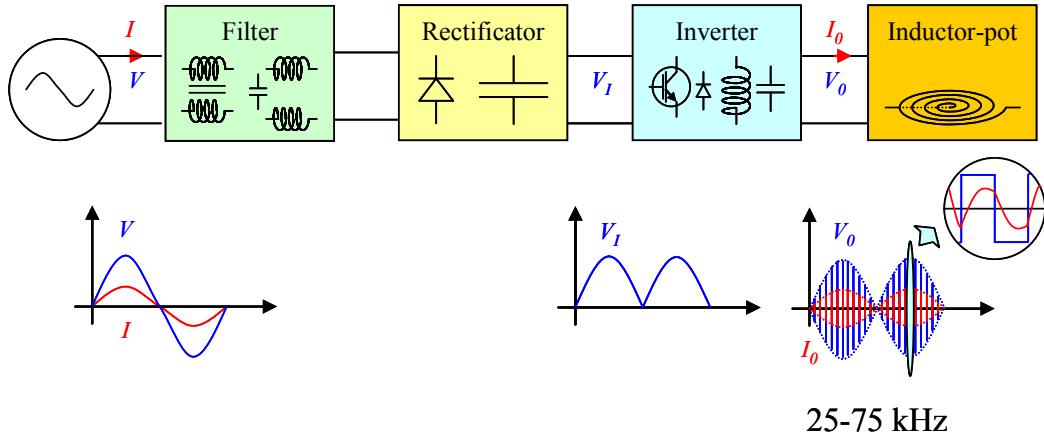

3.1.3 ELIN functions

3.1.3.1 Power supply

Elins with their own power supply power the various components of the induction hob (fan, touchControl, elin without its own power supply, etc...)

3.1.3.2 Regulation

The elin regulates the power of the inductors by means of the IGBTs (insulated-gate bipolar transistors) and coordinates the signals given by the user through the control panel with the various induction zones.

3.1.3.3 Communication

- The elin returns the state of the burner.
For example, if the pan is not detected, the power selected starts flashing (See pan recognition)
- It indicates the warnings and errors sent by the elin (See errors and warnings)
- It communicates with the touchControl by means of the 4-cable LIn connector.

3.2 Bosch TouchControl

3.2.1 Bosch dominos

3.2.1.1 Control knobs YL-167



- **Control knobs**
- 9 power levels
- Powerboost function
- “On/Off” sensor

3.2.1.2 Precise TouchControl YL-199



- **Precise TouchControl**
- One sensor for each level – intuitive direct access to each level
- 9 power levels
- Direct switch off for each cooking zone
- Powerboost function with separate sensor
- “On/Off” sensor
- Timer function
- Residual heat indicator H/h
- Power Management

3.2.2 Bosch 60 / 70 / 80 / 90 cm

3.2.2.1 TouchControl Superquattro (SQ) YL-196

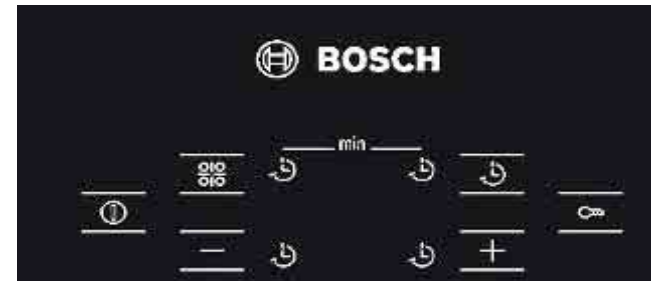

- One +/- Sensor for each cooking zone
- 17 power levels
- Powerboost function after level 9
- “On/Off” sensor
- Timer function depending on model
- Residual heat indicator H/h
- Power management
- Child lock

- 17 power levels
- Powerboost function after level 9
- Sensor “On”
- Timer function depending on model
- Residual heat indicator H/h
- Power management
- Child lock

3.2.2.2 +/- TouchControl Sensor YL-202

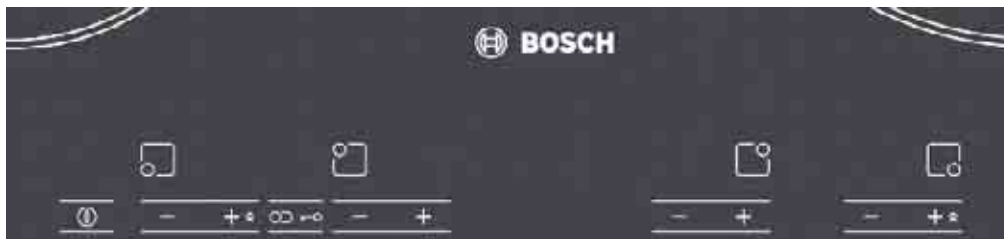
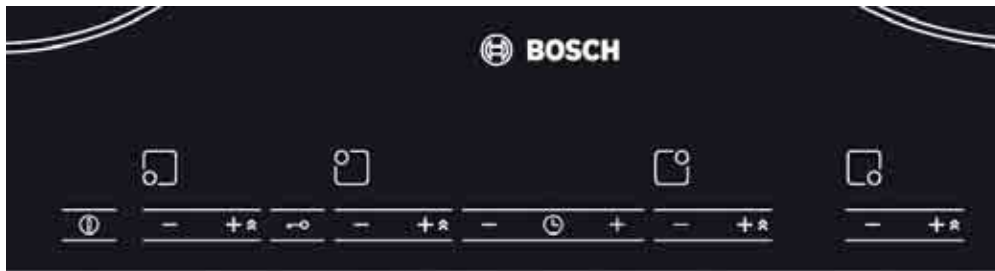

- +/- Sensors for each cooking zone

3.2.2.3 PreciseTouchControl 60 / 70 / 80 / 90 cm YL-180



- One sensor for each level – intuitive direct access to each level
- 17 power levels
- Direct switch off for each cooking zone
- Powerboost function with separate sensor
- “On/Off” sensor
- Timer function
- **Frying sensor depending on model with 4 levels (low-min-med-max)**
- **9 Frying sensor programs**
- **Cooking sensor depending on model with 5 levels.**
- **9 Cooking sensor programs**
- Residual heat indicator H/h
- Power management

- Child lock
- Key lock

3.2.2.4 Semi-preciseTouchControl 60 / 70 / 80 / 90 cm YL-180



- One sensor for each level and one +/- for each intermediate level
- 17 power levels
- Direct switch off for each cooking zone
- Powerboost function with separate sensor
- “On/Off” sensor
- Timer function
- **Frying sensor depending on model with 4 levels (low- min-med-max)**
- **9 Frying sensor programs**
- Residual heat indicator H/h
- Power management
- Child lock
- Key lock

3.2.2.5 Metal Touch Control (Precise) YL-205



- One sensor for each level – intuitive direct access to each level
- 17 power levels
- Direct switch off for each cooking zone
- Powerboost function with separate sensor
- “On/Off” sensor
- Timer function
- **Frying sensor depending on model with 4 levels (low- min-med-max)**
- **9 Frying sensor programs**
- **Cooking sensor depending on model with 5 levels.**
- **9 Cooking sensor programs**
- Residual heat indicator H/h
- Power management
- Child lock
- Key lock

3.3 Siemens TouchControls

3.3.1 Siemens dominos

3.3.1.1 Control knobs YL-167

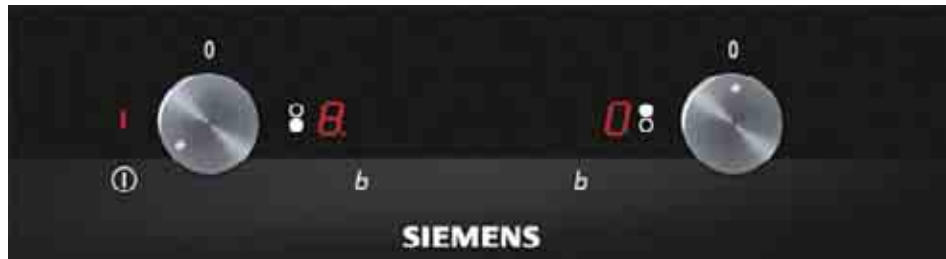

- **Control knobs**
- 9 power levels
- Powerboost function
- "On/Off" sensor

3.3.1.2 TouchControl Slider YL-207



- TouchControl Slider – intuitive direct access to each level
- 17 power levels
- Direct switch off for each cooking zone
- Powerboost function
- "On/Off" sensor
- Timer function
- Residual heat indicator H/h
- Power Management

3.3.2 60 / 70 / 80 / 90 cm Siemens

3.3.2.1 TouchControl Superquattro (SQ) YL-196



- One +/- sensor for all cooking zones
- 17 power levels

- Powerboost function after level 9
- “On/Off” sensor
- Timer function depending on model
- Residual heat indicator H/h
- Power management
- Child lock

3.3.2.2 +/- TouchControl Sensor YL-202

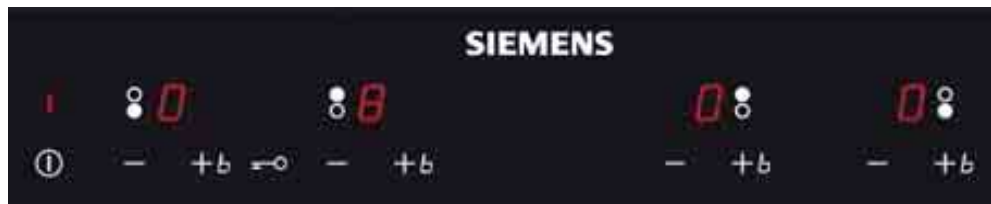

- +/- Sensors for each cooking zone
- 17 power levels
- Powerboost function after level 9
- “On” Sensor
- Timer function depending on model
- Residual heat indicator H/h
- Power management
- Child lock

3.3.2.3 TouchControl Slider 60 / 70 / 80 / 90 cm YL-190



- TouchControl Slider – intuitive direct access to each level
- 17 levels of power
- Direct switch off for each cooking zone
- Powerboost function
- “On/Off” sensor
- Timer function
- Residual heat indicator H/h
- Power Management
- **Frying sensor depending on model with 4 levels (low-min-med-max)**
- **9 Frying sensor programs**
- **Cooking sensor depending on model with 5 levels.**
- **9 Cooking sensor programs**
- Residual heat indicator H/h
- Power management
- Child lock
- Key lock

3.3.2.4 TouchControl multislider 60 / 70 / 80 / 90 cm YL-169/-170



- One Slider touch control for each cooking zone – intuitive direct access to each level
- 17 power levels
- Direct switch off for each cooking zone
- Powerboost function
- “On/Off” sensor
- Timer and Egg timer function, one sensor for each cooking zone
- Residual heat indicator H/h
- Keep Warm function
- Power management
- Child lock
- Key lock

3.3.2.5 Metal TouchControl (slider) YL-204



- One sensor for each level – intuitive direct access to each level
- 17 power levels
- Direct switch off for each cooking zone
- Powerboost function with separate sensor
- “On/Off” sensor
- Timer and Egg timer function
- **Frying sensor function depending on model with 4 levels (low-min-med-max)**
- **9 Frying sensor programs**
- **Cooking sensor function depending on model with 5 levels.**
- **9 Cooking sensor programs**
- Residual heat indicator H/h
- Power management
- Child lock
- Key lock

3.4 Neff TouchControl

3.4.1 Neff dominos

3.4.1.1 TouchControl YL-199



- One +/- Sensor for each cooking zone
- 9 power levels
- Powerboost function after level 9
- Powerboost function with separate sensor "P"
- "On/Off" sensor
- Residual heat indicator H/h
- Child lock
- Cleaning protection
- Power management

3.4.1.2 With controls

The control is oval and just as those of the oven.



3.4.2 60 / 70 / 80 / 90 cm Neff

3.4.2.1 TouchControl Digiselect YL-188



- One +/- Sensor for all cooking zones
- 9 power levels
- Powerboost function after level 9
- Powerboost function with separate sensor “P”
- “On/Off” sensor
- Power management
- Timer function depending of the variant
- Residual heat indicator H/h
- Child Lock or Keep Warm function “L”
- Cleaning protection
- Keep Warm function for each cooking zone



With Frying Sensor function

3.4.2.2 TouchControl metalTouch YL-206



- One +/- Sensor for all cooking zones
- 9 power levels
- Powerboost function after level 9
- Powerboost function with separate sensor “P”
- Timer function depending of the variant
- Residual heat indicator H/h
- Child Lock or Keep Warm function “L”
- Cleaning protection
- Keep Warm function for each cooking zone
- Power management

The sensors are integrated in a metallic profile.

3.4.2.3 Touch Control Tippad YL-189



- A only central control device
- Powerboost function after level 9
- Powerboost function with separate sensor “P”
- “On/Off” sensor
- Timer function
- Residual heat indicator H/h
- Power management
- Child Lock “L”
- Key Lock “L”
- Cleaning protection

3.5 Balay TouchControl

3.5.1 Balay dominos

3.5.1.1 TouchControl YL-213

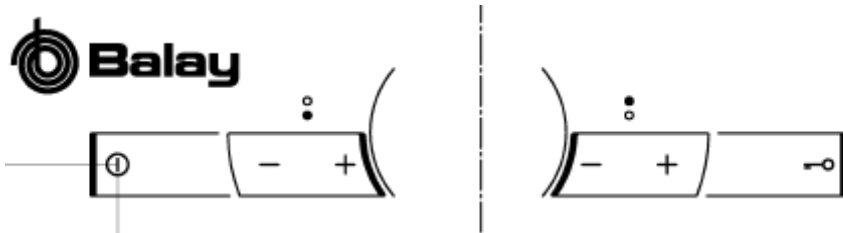

- One +/- sensor for each cooking zone
- 9 power levels
- Powerboost function after level 9
- Powerboost function with separate sensor
- “On/Off” sensor
- Residual heat indicators H/h
- Child lock

3.5.2 Balay 60 / 70 / 80 / 90 cm

3.5.2.1 TouchControl Superquattro (SQ) YL-196

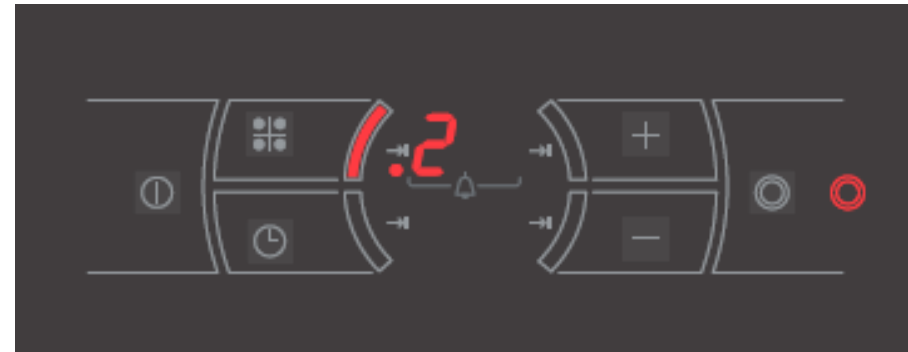

- One +/- sensor for each cooking zone
- 9 power levels
- Powerboost function after level 9
- “On/Off” sensor
- Timer function depending on model
- Residual heat indicator H/h
- Child lock

3.5.2.2 TouchControl Básico+ línea de texto YL-197

It has been cancelled.

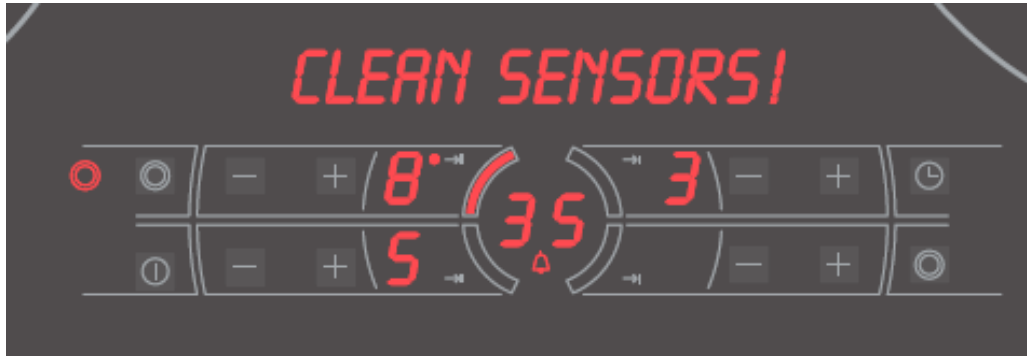

- +/- sensors for each cooking zone
- 9 power levels
- Powerboost function after level 9
- “On” sensor
- Timer function depending on model
- Residual heat indicator H/h
- Power management
- Child lock
-

3.5.2.3 Touch Control Metal Balay

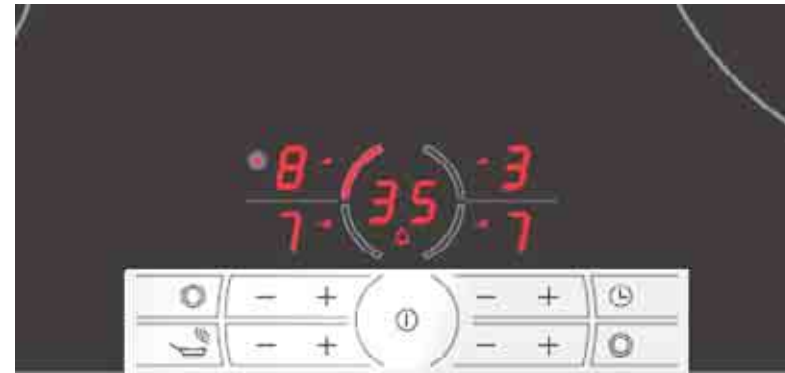

- +/- sensors for each cooking zone
- 9 power levels
- Powerboost function after level 9
- “On/Off” sensor
- Timer function
- **Frying sensor depending on model with 4 levels (low- min- med-max)**
- **9 Frying sensor programs**
- Residual heat indicator H/h
- Power management
- Child lock
- Key lock

3.6 ELIN support

In IH4 (previous project) there was a plastic support without a metal frame.

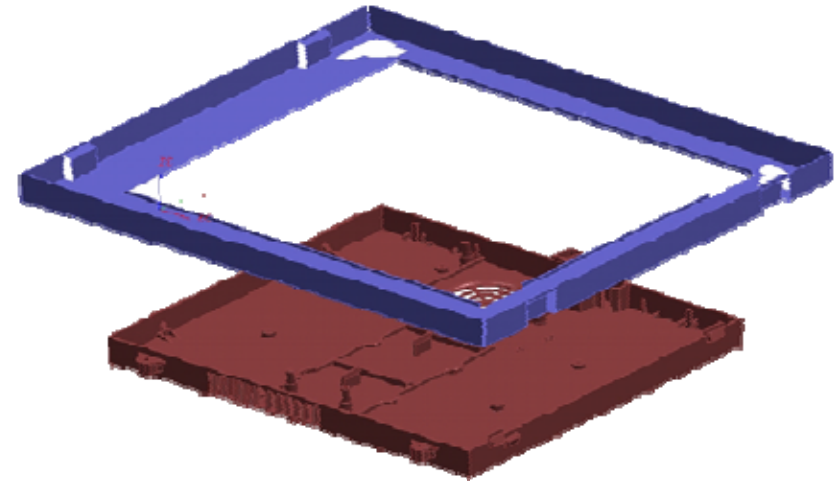
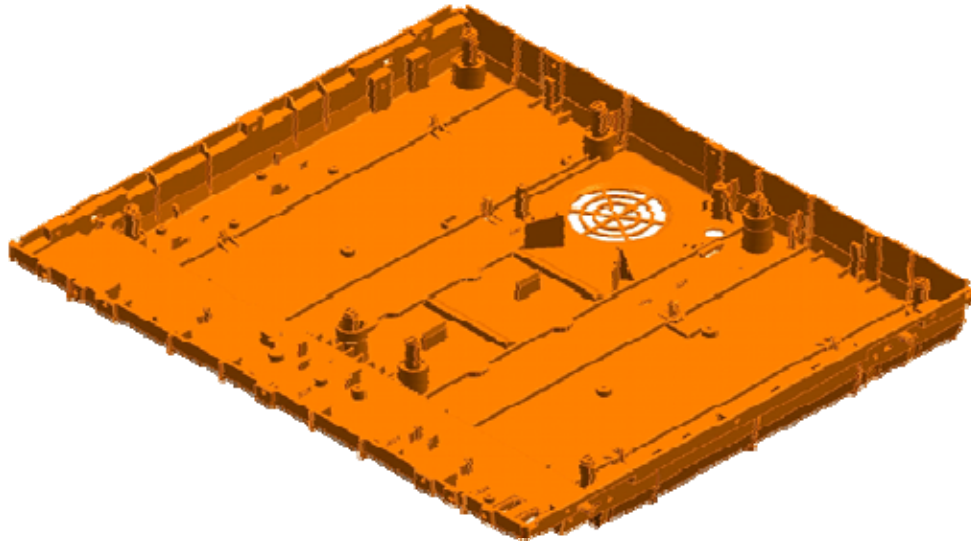

3.6.2 ELIN support 1 for dominos and combinations

In the new IH5 project there are two types of support:

- ELIN support 1
- ELIN support 2
- Along with a metal frame, which makes it possible to insert the turrets for the cooking sensor and two more relay modules.

3.6.1 ELIN support 2 for 60-70 cm hobs

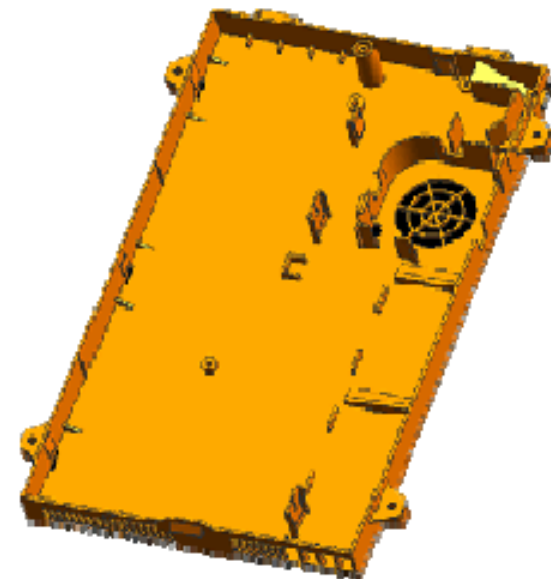

3.6.3 90cm hob

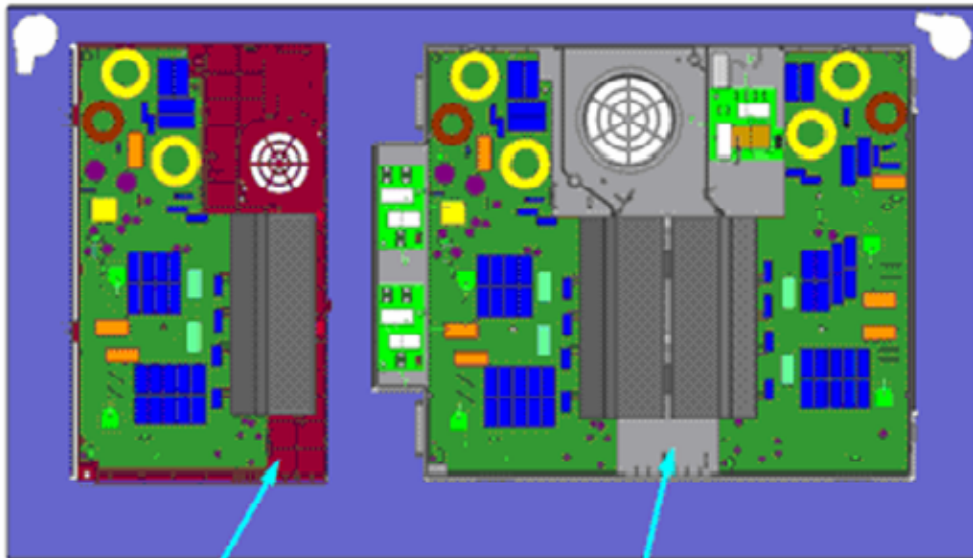

A

B

A- ELIN support 1

B- ELIN support 2

3.6.4 90*35 cm panoramic hob

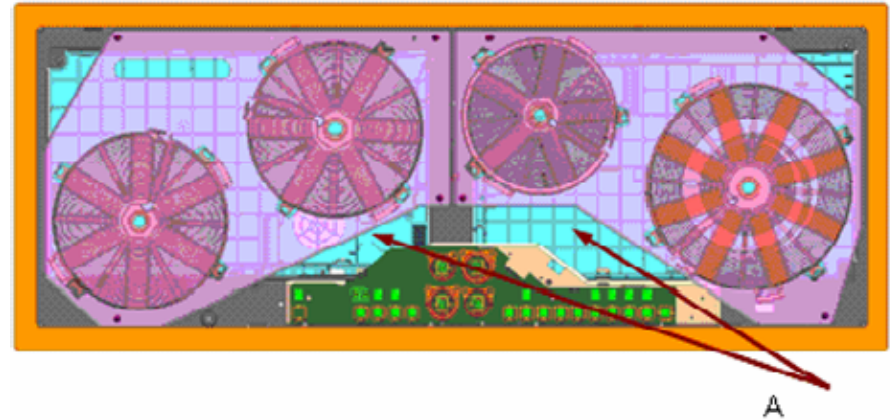

A

A- ELIN support 1

3.7 Glass frame

3.7.1 Characteristics

The inner framework of the glass frame units consists of 4 frames stuck together.

This design improves the tension that might be created.



The hermetic seal has been replaced by foam, which is fitted by robot.

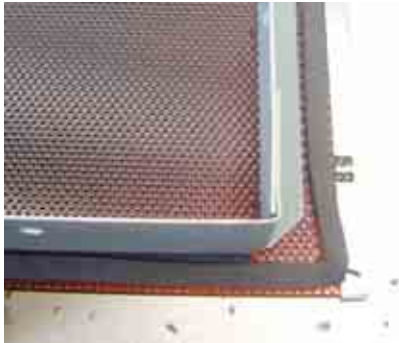

Old seal



New seal = foam

There are greater advantages to be obtained with foam as opposed to using the hermetic seal:

- Automatically constant thickness
- Site of application is controlled
- Average flatness is reduced by 0.2 mm.

3.7.2 Types

We have different sizes and styles for glass frame units.

Sizes:

30 cm; 40 cm; 60 cm; 70 cm; 80 cm and 90 cm.

Styles

The various styles differ with respect to outer trim, colour of the glass and / or type of mounting, apart from the way the model can be recognised.

Black vitroceramic glass

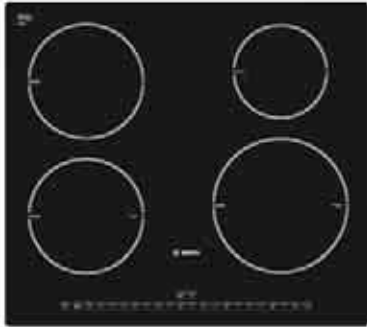

Metal look vitroceramic glass

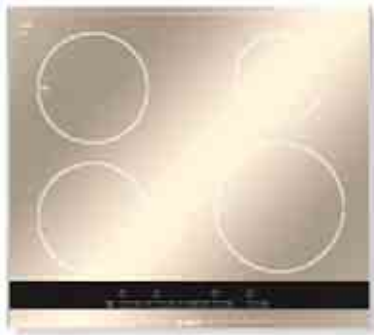

White vitroceramic glass

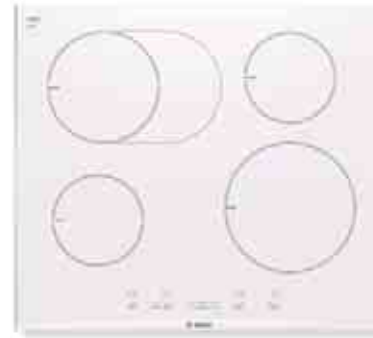

3.7.3 Markings on glass

In the models for Balay and Lynx there is a label at the top on the right with the complete model without KI printed on it.

The other models only have the supplier's number, at the top on the left, enabling us to find out what model it is.

This number is not easy to see. See photo below.

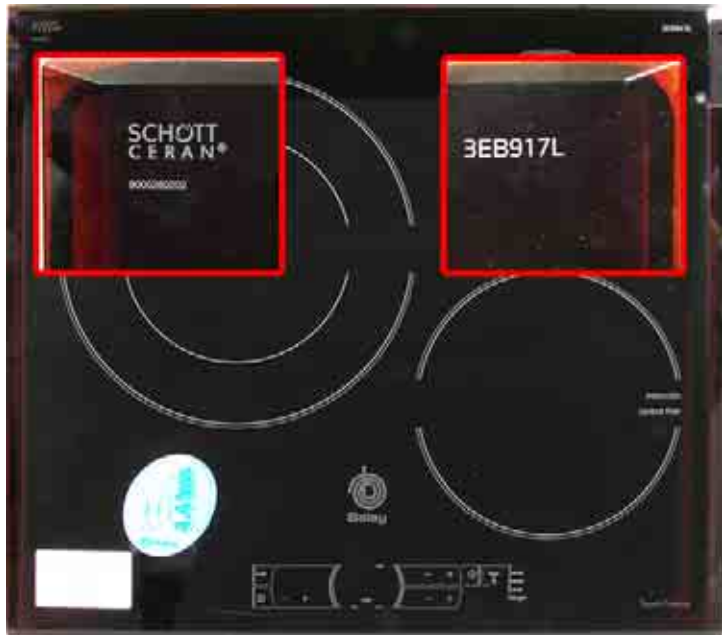

All replacement glass frames will be supplied like this. However, they will have a sticker to remind the people handling them, printed with the following warning:



3.7.4 Replacing glass frame for basic units



Warning!

The basic units have trim all around the edge of the glass.

Until recently, the outer metallic trim was completely stuck to the glass with silicon.

Now, although they will be supplied together, they will not be stuck with silicon but with foam, which only keeps the trim in place.

Thus, special care should be taken when handling the replacement glass frame, since it might fall and cause injury should the glass fall on top of us.

3.8 Fan

3.8.1 Characteristics and assembly

The fan used operates on direct current (without dynamo brushes) and contains electronic components.

It is connected to the ELIN plate by means of a 3-wire connection with some of the ends soldered to the fan's circuit board

+24V

GND = earth

TACHO = tachograph

It is attached by means of clips (dominos and 2I). In other models it is attached to a bracket, which is screwed into place.

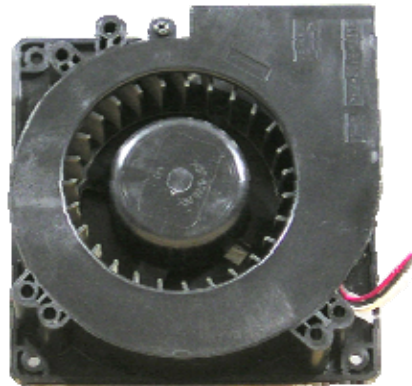

1.1.2 Function

To cool the electronic components.



Warning!

Between the content of the housing and the entrance of the fan there should be a gap of at least 2 cm.

Do not keep small objects and papers in the box, since these could be absorbed by the fan and reduce the cooling effect, or damage the fan.

3.9 NTC

3.9.1 Types

There are two types of NTCs.

- NTCs for the inductors.
- NTCs for the electronic module (ELIN)

3.9.2 Characteristics and assembly

3.9.2.1 NTCs for the inductors

In both IH4-I (previous project) and IH5-I (current project) the NTCs measure the temperature directly on top of the glass.

The difference lies in the way the NTC is mounted in the inductor and the fact that they have polarity (i.e. 3 channels for the frying function NTC).

For mounting purposes, a silicon support bracket is used instead of a metal spring. This reduces the time taken to assemble the component.

The external NTC has a 3-wire connector and controls the frying sensor function.

They are both interchangeable and have a different code number (internal 2-wire NTC connector and external 3-wire NTC connector) and can be supplied as spare parts.

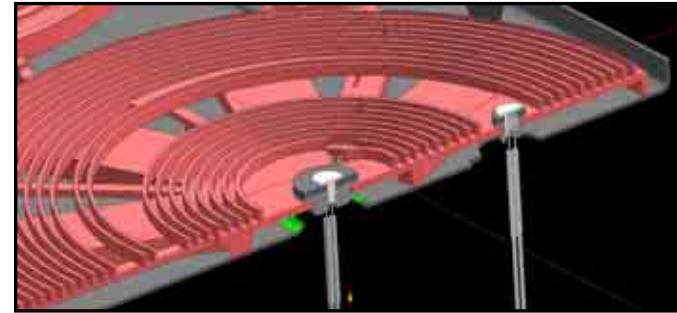
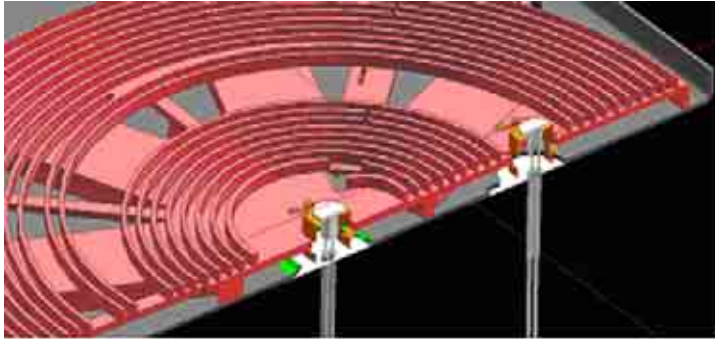

Photo of NTC and cross section of new IH5-I project

IH4-I



1.1.2.2 NTCs for induction module

These are two NTCs located behind the induction module, next to the bolts. They are not interchangeable.

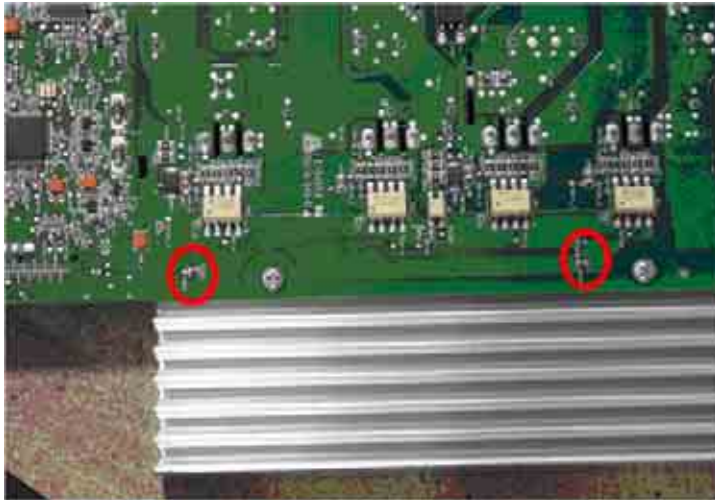

1.1.2 Function of inductor NTCs

These measure the operating temperature for the inductors. If the temperature limits are exceeded, the power supply is cut off, with a warning being sent to the TouchControl panel. Once the NTCs have cooled down again, the power supply is renewed.

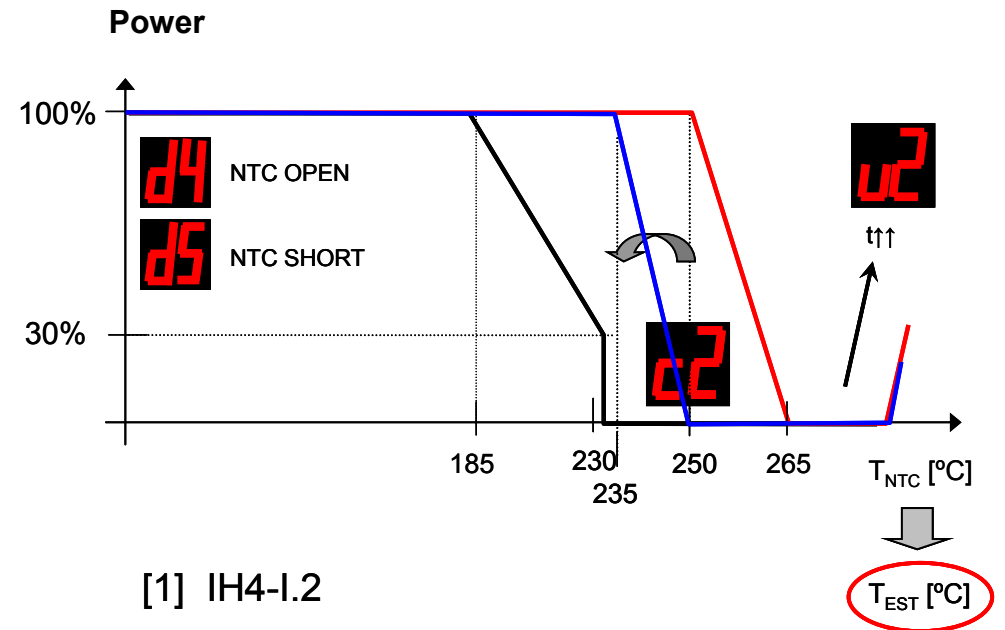

[1] IH4-I.2

[2] IH5-I

[3] IH5-I critical modules

3.9.3 Function of NTCs for electronic module

These measure the temperature of the IGBTs (insulated-gate bipolar transistor, the element that supplies power to the electronic module) and cut off the power supply if they reach the maximum temperature.

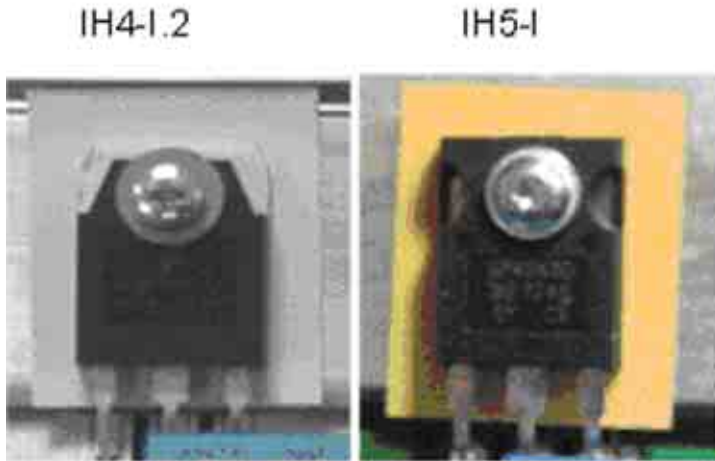

IGBTs.

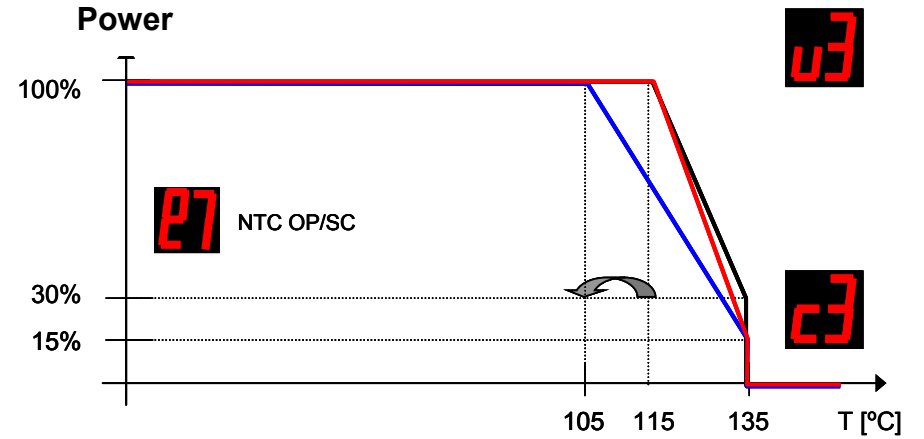







[1] IH4-I.2

[2] IH5-I

[3] IH5-I critical modules

3.10 Inductors

3.10.1 Characteristics, types and assembly

Type	name
 145 mm	
 180 mm	
 180 mm 180x280 mm	Bräter
 210 mm	
 180 mm 280 mm	28cm double
 280 mm	
 210 mm 260 mm 320 mm	Triple 32 cm (NEW for IH5-I)

The 145,180 and 210 mm inductors have been changed, to include the function of frying and to improve the efficiency, heat distribution and recipient detection. (Before, there was only frying in the 210mm inductor).

In the **frying models**, the 180 and 210 inductors have a second NTC (3-way connector). In the case of the 145mm inductor it is necessary to insert into the ELIN a short-circuited 3-way connector (a type of jumper with its own code).



Warning!

When changing the part of the ELIN of the 145mm inductor with frying function, the jumper of the original part should be taken and installed in the new ELIN.

If we do not install the jumper, the frying will not operate.

Does not come with spare.



Mount upon the inductor assembly.

In case of damage, the complete assembly must be replaced.

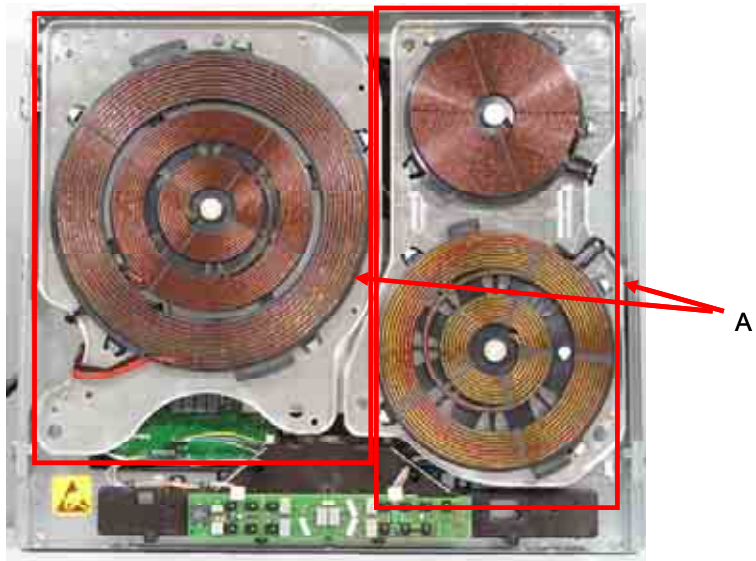

A- Inductor assembly

1.1.2 32 cm triple inductor (New feature IH5-I)

Made up of 3 rings: internal, middle and external.

Internal ring = 210mm

Middle ring = 260mm

External ring= 320mm

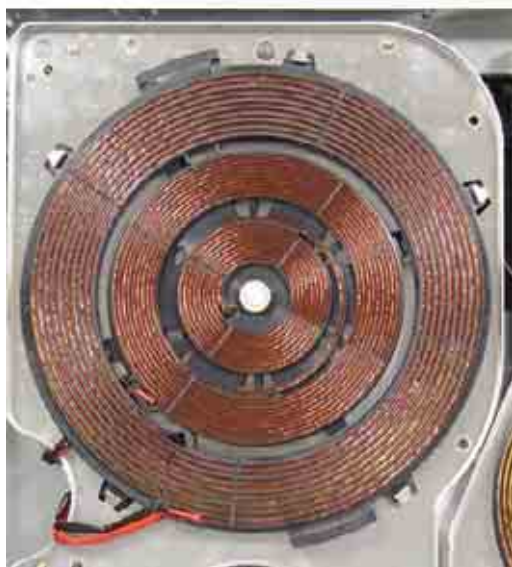

3.10.1.1 Power table in Watts.

Power/diameter	210 mm	260 mm	320 mm
P Standard	2200	2600	3300
P booster	3300	3400	3600
P Superbooster	-	-	4600

In order to activate the superbooster of the triple inductor, an auxiliary plate is needed. See relay plate.

The superbooster can only be activated on the external ring.

3.10.2 28 cm Double Inductor

The auxiliary plate of the double inductor in order to activate the superbooster has been integrated into the ELIN, simplifying the connection diagram.

3.10.2.1 Power table in Watts

Power/diameter	180 mm	280 mm
P Standard	1800	2800
P booster	2500	3000
P Superbooster	-	4400

3.10.3 Bräter Inductor

The auxiliary plate of the Bräter inductor in order to activate the booster has been integrated into the ELIN, simplifying the connection diagram.

3.10.3.1 Power table in Watts

Power/diameter	180 mm	280 mm
P Standard	1800	2000
P booster	2500	2600
P Superbooster	-	-

3.10.3 Double, triple or Bräter cooking zones

These zones can recognize recipients of different sizes. Depending on the material and the properties of the recipient, the zone will adapt automatically; either only the simple zone or its entirety and supplying the adequate power to obtain good cooking results. There is no light indicator indicating how many rings are active. Even if the external ring is not active, the internal ring can supply more power than if the external one were active.



Warning!

The double, triple and Bräter (multiples) inductors have **polarity**, that is, the connection of its elements cannot be inverted. If this is not taken into account, the detection of the recipient could fail and if the ring were activated or the auxiliary element the correct power will not be supplied. For this reason, the cables of the inductor are of a different colour.

3.10.4 Booster in multiple inductors

The booster is always possible. A b appears on the display, but the power depends on the elements which are active.

The detection of the number of active rings is not indicated with any light signal.

The superbooster can only be activated in the external ring.

For example:

4.6 kW inductors on the right disconnected and external ring active

3.6 kW a right inductor connected and external ring active

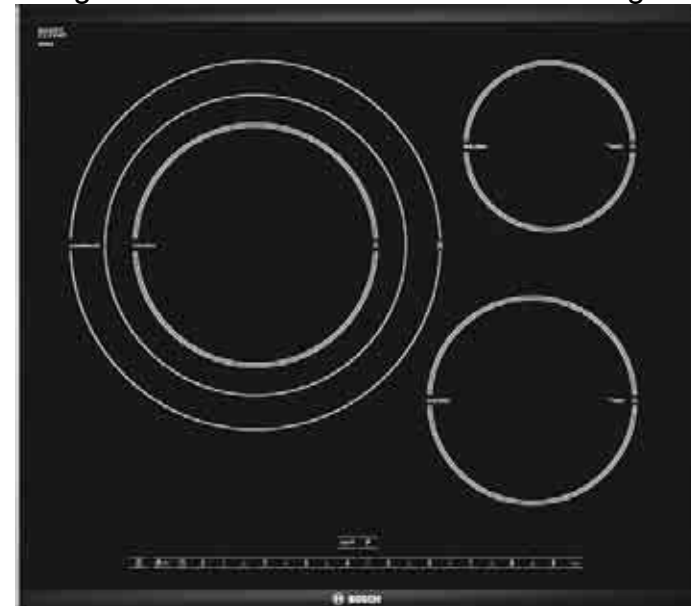

3.10.5 Booster in Bräter

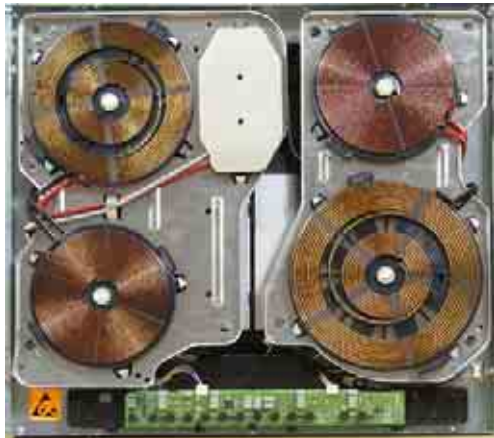











For IH5-I the Bräter has a booster power of 2.6 kW (2 kW of nameplate power) when the left front inductor is turned off.

For IH4-I (Ind IV) there was no booster and the nameplate power was of 2.6 kw.

The detection of the Bräter is not indicated on the touchControl.

3.10.6 Powers table level 9, booster and superbooster

		Level 9	PowerBoost	SuperBoost	
	145 mm	1.400 W	1.800 W (+28%)		New
	180 mm	1.800 W	2.500 W (+38%)		New
	180 mm	1.800 W	2.500 W (+38%)		
	180x280 mm	2.000 W	2.600 W (+30%)		
	210 mm	2.200 W	3.300 W (+50%)		New
	180 mm	1.800 W	2.500 W (+38%)		
	280 mm	2.800 W	From 3.600 W (+21%)	to 4.400 W (+57%)	
	280 mm	2.400 W	3.600 W (+50%)		
	210 mm	2.200 W	3.300 W (+50%)		
	260 mm	2.600 W	3.400 W (+11%)		New
	320 mm	3.300 W	From 3.600 W (+9%)	to 4.600 W (+28%)	

3.11 Connections

3.11.1 Input feed connection

There is a valid input connection for all the electrical configurations and installations throughout Europe.



3.11.1.1 Domino Connection (1 Module)

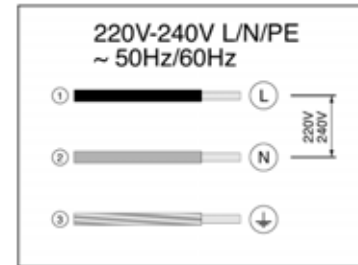

3.11.1.2 60 cm, 70 cm and 80 cm Connection (2 modules)

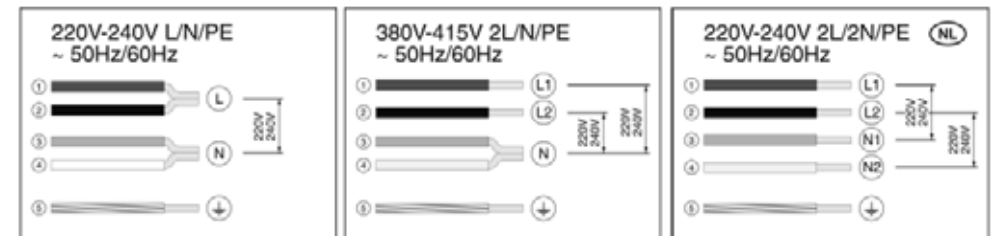

3.11.1.3 90 cm Connection (3 modules)

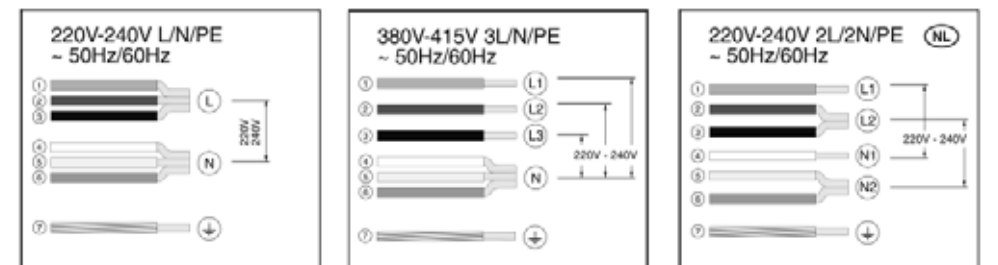

3.11.2 Touch Control feed connection



The 4-wire connector between the ELIN and Touch Control is the one which feeds Touch Control.

3.11.3 Jumper connector for 15 cm frying sensor



In order for the frying sensor function of this 15 cm inductor to work it is necessary to connect this jumper; if not, the frying sensor function is not activated.

For the rest of the inductors with frying it is not necessary, because we connect the 3-way NTC, which controls the frying and activates the function.

3.11.4 Connection of the Cooking Sensor

The outer part must be positioned to prevent excessive overheating.

Example of bad positioning

Example of good positioning

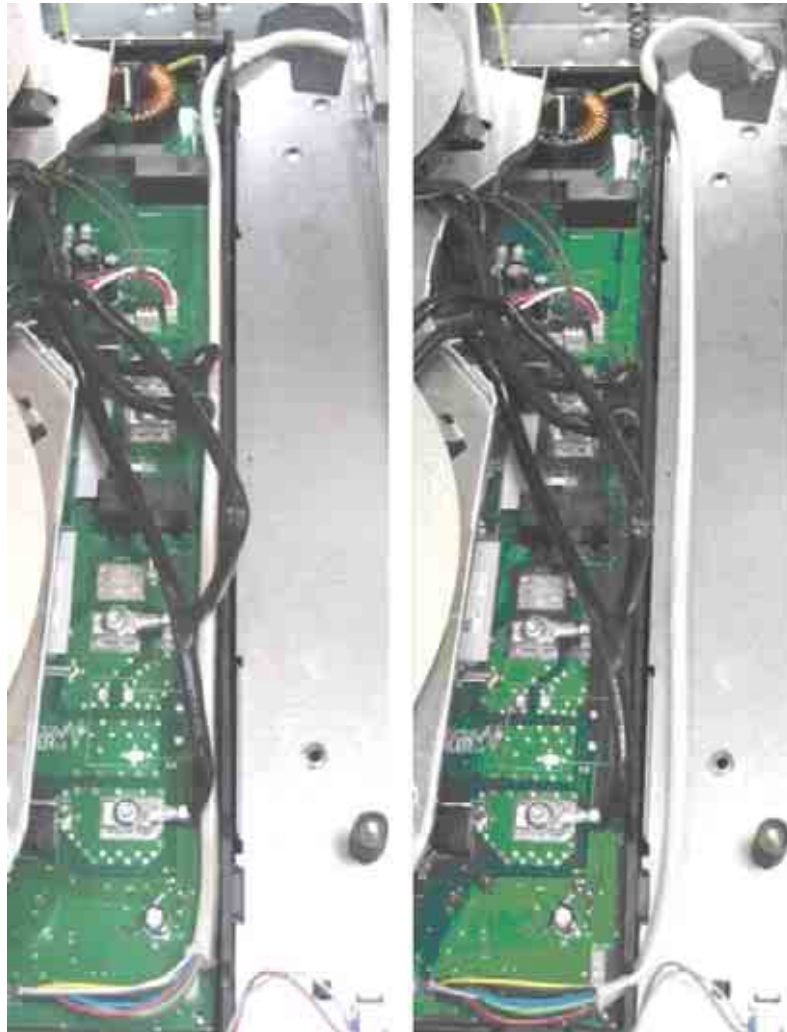

3.11.4.1 Domino (1 fan)



3.11.4.2 2l (fan)

The fan connection is guided through the white support and the connector of the relay plate goes behind the condensers.



3.11.4.3 60 cm, 70 cm and 80 cm (1 fan)



3.11.4.4 90 cm (2 fans)



3.11.5 Connection between ELINS

3.11.5.1 3l, 5l: 16-way connector

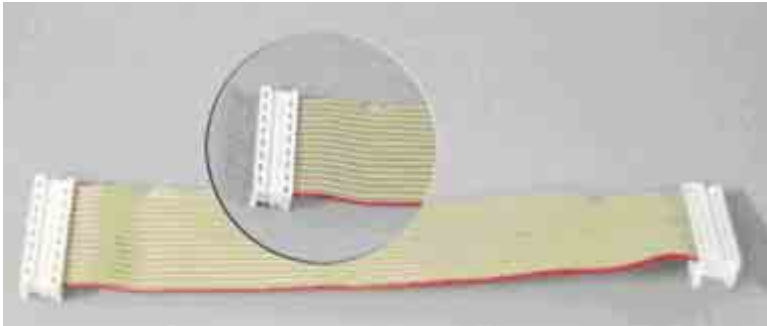

This is a 16-way connector.
Care should be taken upon dismantling it, as it could be damaged.



In case of bad connection, check the connector pins; they may be slightly bent.

3.11.5.2 Other models: 8-way connector



3.11.6 Superbooster Connection

This is the lower white connector.

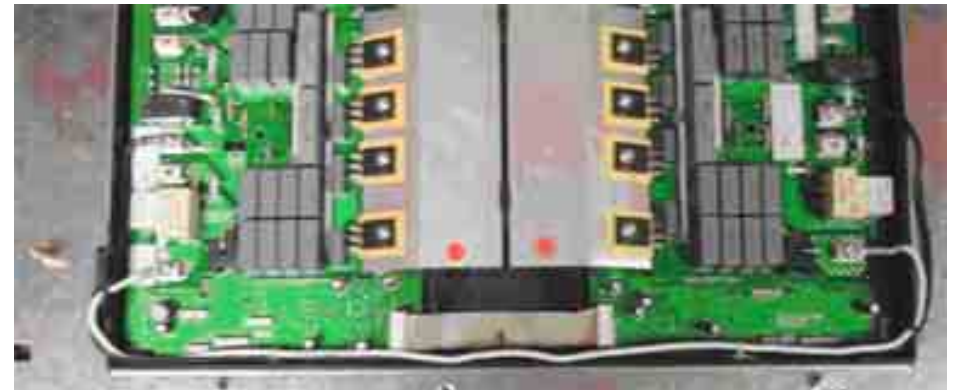

3.12 Perfect Built in union accessory

3.12.1 Union accessory components

This accessory is for combining dominos with other types of counters so that they are totally level. .

Bosch HEZ394301

Siemens HZ394301

Neff Z9914X0

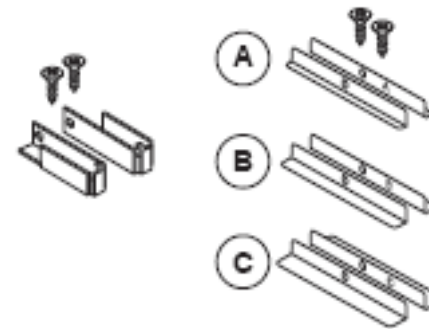
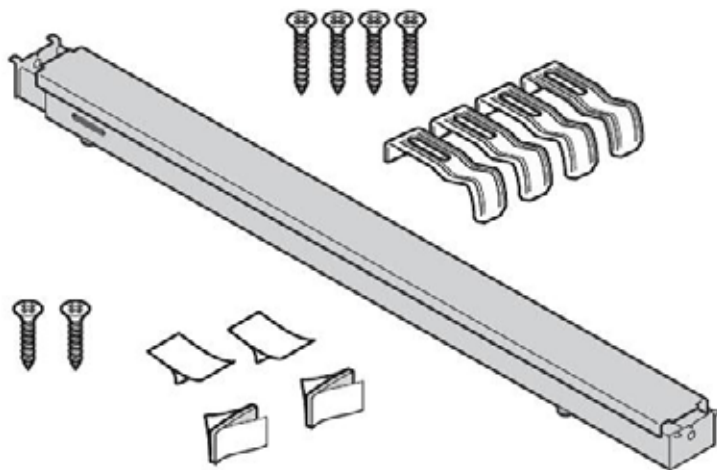

- Combination profile
- Some screws for fastening the profile in case of having a wood counter.
- Stickers in case of being granite or marble
- Some screws and metal pieces to fit the counter.
- Safety profiles (3 types: A, B , C and D)

Safety	SE	BO / NE	BA
Angles			
60 cm	B	B	
80 cm	C	A	
80 cm FTH	A	A	

1.1.1.1 Characteristics

The dimensions of the combination kits changes for each trademark.



For Bosch and Neff

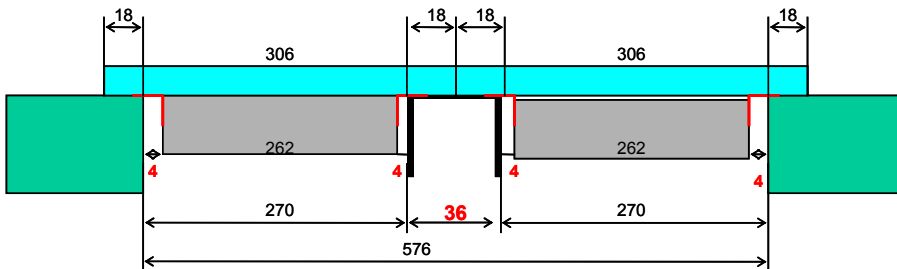

Domino width **306 mm**
Accessory width **36 mm**

For Siemens:

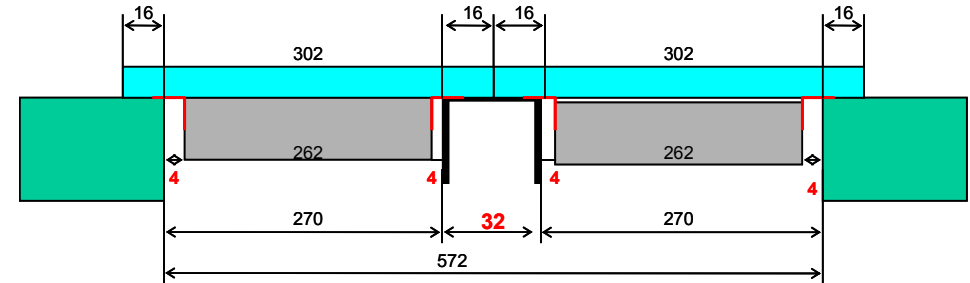

Domino width **302 mm**
Accessory width **32 mm**

For Balay

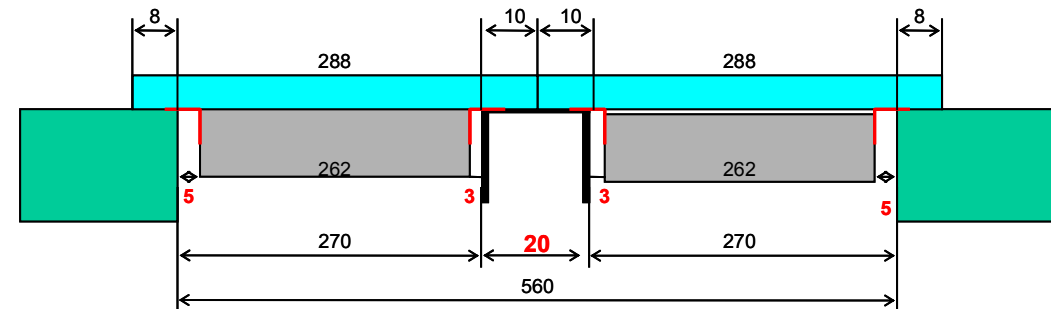

Domino width **288 mm**
Accessory width **20 mm**

3.12.1.1 Possible fitting combinations and measurements

3.12.1.1.1 32 mm Kit

- 2 dominos

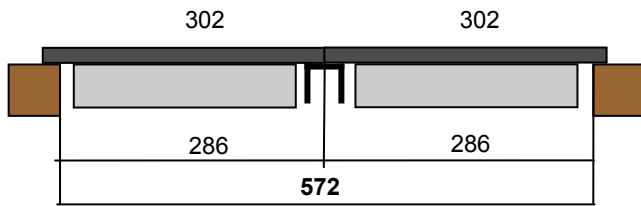

- Domino + domino 38 cm

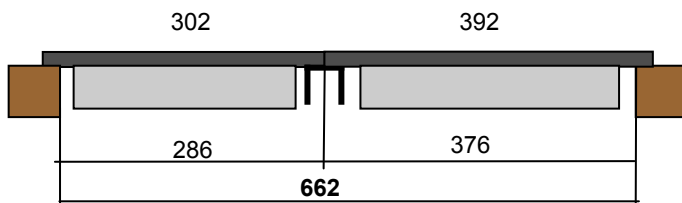

- Domino + 60 cm

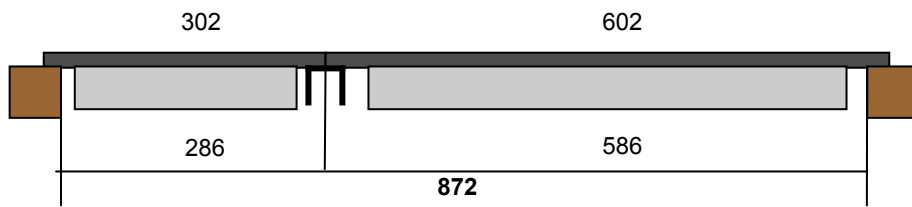

- Domino + 80 cm

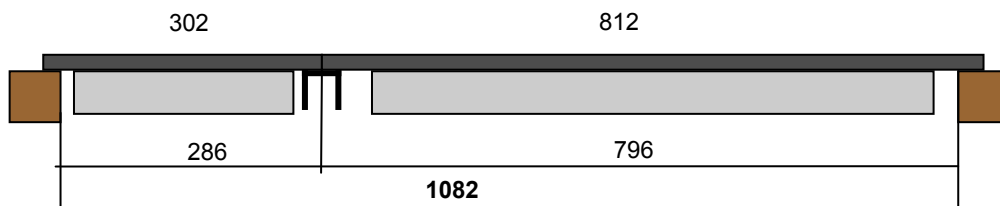

- Domino + domino + 60 cm



- Domino + 60 cm + domino

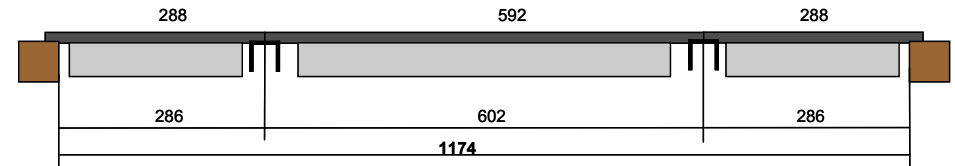

- 3 Dominos

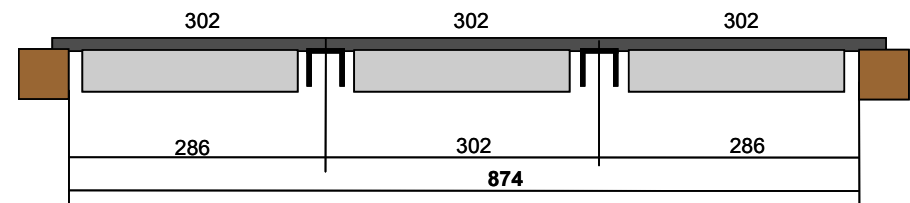

3.12.1.1.2 36 cm Kit

- 2 dominos

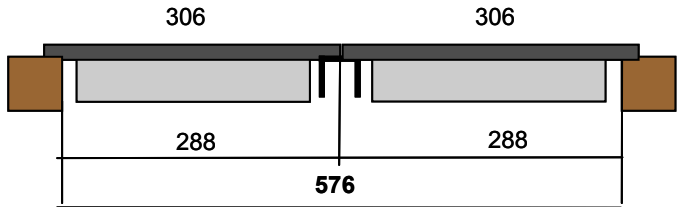

- Domino + domino 38 cm

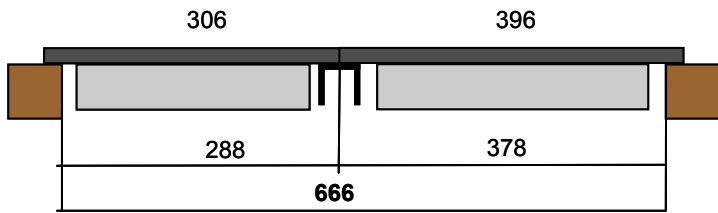

- Domino + 60 cm

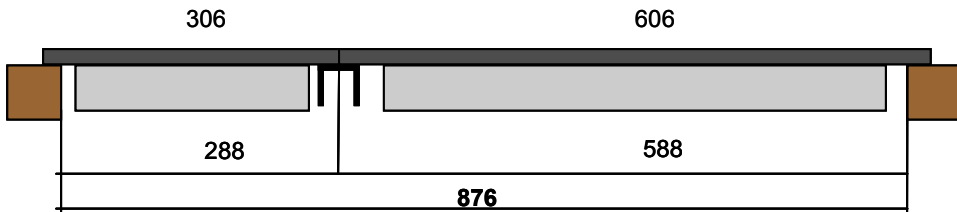

- Domino + 80 cm

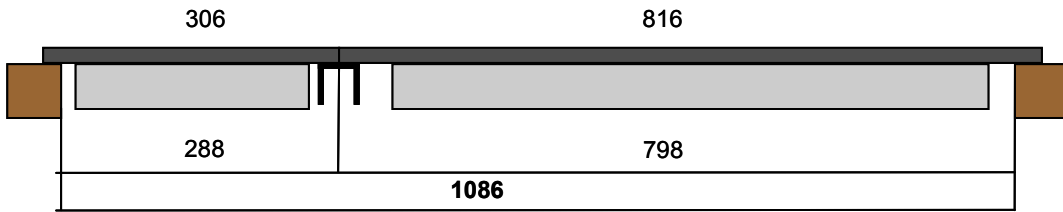

- Domino + domino + 60 cm

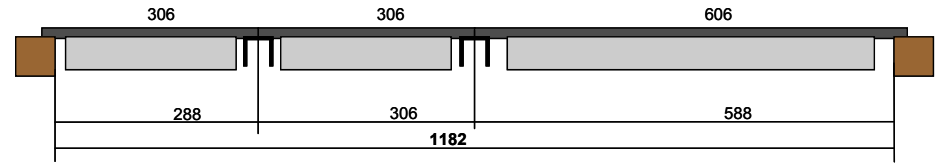

- Domino + 60 cm + domino

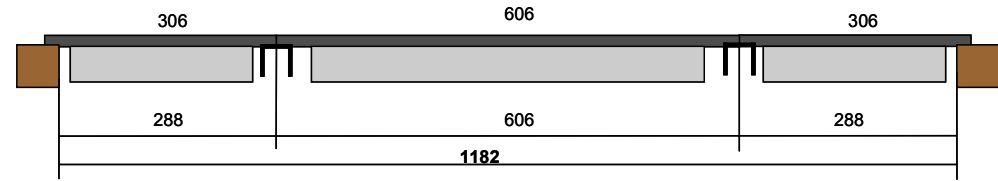

- 3 Dominos

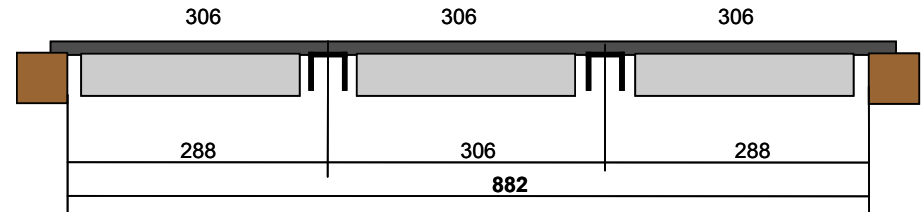

4 FAULT DIAGNOSTICS

4.1 Error codes or warnings sent by the ELIN

There are 3 types of error messages or warnings that can be sent by the ELIN (induction electronics):

- 1- Warnings and safety cut-outs.
- 2- Fault detection concerning connections or elements external to the induction electronics (NTC not connected, fan...).
- 3- Faults with the induction electronics (ELIN) that require a replacement to be made.



Warning!

Before carrying out any type of repair to the equipment, first switch it off and then on again.

Should the fault not be resolved by switching the equipment off and on again, disconnect it from the mains supply, wait 20 seconds and reconnect it.

WARNINGS AND SAFETY CUT-OUTS: "Encoded with the letter U"

The codes are listed below in decreasing order of priority. In the event of more than one, only the highest priority warning is displayed.

Fault / Warning Code	Fault / Warning	Cause	Solution	User Message
U1	The input voltage is less than 150 V or greater than 275 V.	The input connection may be faulty.	1- Check the power input connection. 2- This error appears and disappears without action by the user, it is displayed without connecting power to coils and would disappear when the input voltage is within the established limits.	When this message is displayed, all coils are switched off. The message is displayed on all for coils if it is full induction and only on the induction coils if it is a 2i unit.
U2	The NTC on the induction unit is blocking operation.	The NTC is not heating up within the established limits according to the power supplied.	1- Check connections on the indicated induction module NTC. 2- If the connection is correct and the fault continues, replace the NTC.	
U3	The NTCs on the ELIN are blocking operation.	Excess temperature on the specific module.	Leave to cool and reset the hob.	
U4	The NTC on the cooking sensor is blocking operation.	Excess temperature on the cooking sensor module.	Leave to cool and replace cooking sensor if fault continues.	Perhaps a hot pot has been left near the cooking sensor.

Fault detection concerning connections or elements external to the induction electronics (NTC not connected, fan...)

: “Encoded with the letter d”

The codes are listed below in decreasing order of priority. In the event of having more than one, only the highest priority warning is displayed.

Fault / Warning Code	Fault / Warning	Cause	Solution	User Message
d0	Communication failure between the TouchControl and ELIN or between ELINs. ⁰⁰	The connections between the TouchControl and the ELIN or between ELINs may be faulty.	1- Check connection between the TouchControl and ELIN or between ELINs. 2- Replace connections.	
d1	ASIC communication failure between ELINs (Superbooster). Fault on the right module in superbooster models.	1- The 16 conductor cable between ELINs may be faulty. 2- The connector for the 16 conductor cable may have bent flaps.	1- Check the 16 conductor connection between ELINs. 2- If any of the flaps are bent, it is not necessary to replace the cable. It is enough to straighten the flaps and reconnect the 16 conductor cable.	
d2	Superbooster relay error.	The superbooster relay located in the ELIN has become damaged.	This error is common on the paella dish module, although it is possible that the relay not operating correctly is the one on the right or secondary ELIN.	
d3	Fan error.	The fan cables are badly connected or the fan has become damaged.	Check fan connection or replace the fan if it does not work.	
d4	The NTC on the induction unit is on an open circuit.	The NTC on an induction unit is not connected.	Check NTC connections.	

d5	The NTC on the induction unit is short circuiting.	The NTC on an induction unit has become damaged.	Replace NTC on the indicated induction unit.	
d6	The cooking sensor signal is on an open circuit.	The cooking sensor is not connected to the ELIN	Check cooking sensor connection.	
d7	The cooking sensor signal is short circuiting.	The cooking sensor has become damaged.	Replace cooking sensor.	



Warning!

The Superbooster fault on the triple-ring paella coil is not encoded. One symptom of this error is that low-level power is supplied.

The relay board is not included within the ELIN itself on the triple-ring paella coil. It will be necessary to check the relay module.

Faults with the induction electronics (ELIN) that require replacements to be made : “Encoded with the letter e”

The codes are listed below in decreasing order of priority. In the event of having more than one, only the highest priority warning is displayed.

Fault / Warning Code	Fault / Warning	Cause	Solution	User Message
e0	The input relay on the ELIN is faulty.	This error is displayed when it is attempted to close the relay by switching on a coil.	<ol style="list-style-type: none"> 1- Switch off and on again to see if the fault is resolved. 2- Replace the ELIN that corresponds to the fault location. 	<p>This can be shown on the display if we supply power only to a specific burner.</p> <p>Instruct the user to switch off and on again and to reset the mains supply.</p>
e1	Damaged ELIN measurement circuit.	The Vbus measurement circuit has become damaged.	<ol style="list-style-type: none"> 1- Replace the ELIN that corresponds to the fault location. 	<p>Instruct the user to switch off and on again and to reset the mains supply.</p>
e2	Main synchronisation signal error.	The synchronisation signal is faulty.	<ol style="list-style-type: none"> 1- Replace the ELIN that corresponds to the fault location. 	<p>Instruct the user to switch off and on again and to reset the mains supply.</p>
e3	Software security error.	It may be a sporadic fault and caused by an internal microcontroller fault.	<ol style="list-style-type: none"> 1- Switch off and on again to see if the fault is resolved. Reset and if not; 2- Replace the ELIN that corresponds to the fault location. 	<p>Instruct the user to switch off and on again and to reset the mains supply.</p>
e4	ASIC communication error within the ELIN itself.	ASIC communication has become damaged.	<ol style="list-style-type: none"> 1- Replace the ELIN that corresponds to the fault location. 	<p>Instruct the user to switch off and on again and to reset the mains supply.</p>

e5	Configuration relay error on every induction unit.	They may have become stuck together or been damaged when activating the induction coil.	<ul style="list-style-type: none"> 1- Switch off and on again to see if the fault is resolved. Reset and if not; 2- Replace the ELIN that corresponds to the fault location. 	<p>Instruct the user to switch off and on again and to reset the mains supply.</p> <p>This is only displayed if the burner is activated.</p>
e6	IGBT inverter error.	The IGBTs have become damaged or the connection on the induction units may be faulty.	<ul style="list-style-type: none"> 1- Check the connection on the induction units. 2- Replace the ELIN that corresponds to the fault location. 	Instruct the user to switch off and on again and to reset the mains supply.
e7	NTC on the ELIN short circuiting or on an open circuit.	NTC short or open circuit.	<ul style="list-style-type: none"> 1- Replace the ELIN that corresponds to the fault location. 	Instruct the user to switch off and on again and to reset the mains supply.
e8	The power measurement circuit has become damaged.	The power measurement is incorrect.	<ul style="list-style-type: none"> 1- Replace the ELIN that corresponds to the fault location. 	Instruct the user to switch off and on again and to reset the mains supply.

4.2 Error codes or warnings sent by the TouchControl



Warning!

Before carrying out any type of repair to the equipment, first switch it off and then on again.

Should the warning display remain after having switching the equipment off and on again, disconnect it from the mains supply, wait 20 seconds and reconnect it.

Internal TouchControl faults: "Encoded with the letters ErXY"

The XY correspond to specific error numbers. Below is a list of the most common errors. It is not a comprehensive list.

Fault / Warning Code	Fault / Warning	Cause	Solution	User Message
Er32	Internal TouchControl error.	Spare parts confusion or a 4i module has been installed instead of a 2i module.	Check replacement parts (they are labelled with the supplier number) and check the correct code.	Control module fault.
Er12	Relay error.	They may have become stuck together.	Replace the TouchControl.	Control module fault.
Er13	EEprom fault	The EEprom recording is not good.	Replace the TouchControl.	Control module fault.
Er21 and beep	Overheating of the control module.	Extended operation of the coils near to the TouchControl.	Leave to cool and press a sensor to stop the beep alarm.	Leave to cool and press a sensor to stop the beep alarm.
Er22	Sensor fault.	The sensors have become damaged.	Replace the TouchControl.	Control module fault.
Er25	Incorrect TouchControl connection.	Bad connection of the TouchControl.	Check the TouchControl connections.	Control module fault.
Er26	Voltage too high in standby mode.	The voltage is too high in standby mode. The relay activation circuit is defective.	Replace the TouchControl.	Control module fault.
E and beep	Sensor pressed for more than 10 seconds or water has fallen on it.	Sensor pressed for more than 10 seconds or water has fallen on it.	Remove finger from the sensor or dry any water on the TouchControl.	Sensor pressed for more than 10 seconds or water has fallen on it. Remove finger from the sensor or dry any water

				on the TouchControl.
--	--	--	--	----------------------

Warnings / Non-faults indicated on the TouchControl

: “Encoded with the letter F”

These are listed in the final section of the instruction booklet

Fault / Warning Code	Fault / Warning	Cause	Solution	User Message
F0	Interface fault with the cooking sensor or the frying sensor. Communication failure with the induction coil.	The connections on the cooking / frying sensor may be loose. The connection is loose or faulty on induction modules.	3- Check / replace connections between the cooking / frying sensor board and the TouchControl in the case of smaller modules (vitros). Replace TouchControl (including frying sensor board). 4- Check connections on induction modules. Replace the module that controls the zone with F0.	
F2	TouchControl overheating.	Extended operation of the coils near the TouchControl. Above > 105 °C.	3- Leave to cool.	The areas affected by this error may not operate during a short period of time. Once the TouchControl reaches an accepted temperature, simply touch any button for the warning message to disappear.
Key symbol displayed	The equipment is blocked	The user has blocked it without realising.	Perform the technical service program for TouchControl. (step P2).	

F4	The temperature of the TouchControl is excessively high.	Above > 140 °C and higher than F2.	1- Leave to cool.	The areas affected by this error may not operate during a short period of time. Once the TouchControl reaches an accepted temperature, simply touch any button for the warning message to disappear.
F8	The maximum operation time for one or more coils has been exceeded.	These times depend on the selected power level and may range between 1 and 10 hours.	1- Leave to cool.	Simply touch any button for this message to be removed. Should you wish to continue cooking, switch the hob on again and select the desired power level.
F9	Metal touch failure.	It may have come loose due to a knock.	1- Check the connection cable. 2- Replace the entire glass assembly.	
The residual heat H/h appears immediately after switching on	Fictitious residual heat H/h indication on the displays.	Various tests that are performed at the factory.	Perform the technical service program for TouchControl. (step P2).	

5 CHECK AND REPAIR

1.1 Activation and deactivation of the technical services program for TouchControl



Warning!

The procedure for accessing the technical services program may only be completed during the first 60 minutes after connecting the TouchControl to the mains supply.

TouchControl units come with a label containing information on the type of TouchControl it is or whether this information can be gained via Quickfinder by clicking on the TouchControl unit.

5.1.1 Superquattro SQ YL196 TouchControl

Step	Operation and indication
0	The unit is off
1	Press and hold the selection button
2	Press and hold the On button
3	A short flash of all segments
4	Release the selection button in under 1 second whilst still pressing the On sensor
5	A short flash of all segments
6	Press the selection button in under 1 second
7	“P” and “0” flash on the displays. The services program has been initiated
8	The services program ends automatically if no buttons are pressed for 120 seconds or after completing programs P0, P2, P8 and P9.

5.1.2 Basic Balay YL197 TouchControl

Step	Operation and indication
0	The unit is off
1	Press and hold the “-“ button in zone 3
2	Press and hold the On button
3	A short flash of all segments
4	Release the “-“ button in zone 3 in under 1 second whilst still pressing the On sensor
5	A short flash of all segments
6	Press and hold the “-“ button in zone 3 in under 1 second
7	“P” and “0” flash on the displays. The services program has been initiated
8	The services program ends automatically if no buttons are pressed for 120 seconds or after completing programs P0, P2, P8 and P9.

5.1.3 Bosch YL180 precision selection TouchControl

In order to find the sensor for accessing the services program, the worktop must be on. Once the location is known, it should be turned off again, remembering the location of the sensor.

Step	Operation and indication
0	The unit is off
1	Press and hold the button in zone 3
2	Press and hold the On button
3	A short flash of all segments
4	Release the button in zone 3 in under 1 second whilst still pressing the On sensor
5	A short flash of all segments
6	Press and hold the button in zone 3 in under 1 second
7	“P” and “0” flash on the displays. The services program has been initiated
8	The services program ends automatically if no buttons are pressed for 120 seconds or after completing programs P0, P2, P8 and P9.

5.1.4 Siemens YL190 monoSlider TouchControl

Step	Operation and indication
0	The unit is off
1	Press and hold the sensor in zone 3
2	Press and hold the On button
3	A short flash of all segments
4	Release the sensor in zone 3 in under 1 second whilst still pressing the On sensor
5	A short flash of all segments
6	Press and hold the sensor in zone 3 in under 1 second
7	“P” and “0” flash on the displays. The services program has been initiated
8	The services program ends automatically if no buttons are pressed for 120 seconds or after completing programs P0, P2, P8 and P9.

5.1.5 Neff Digiselect YL188 / Tippad YL189 / metaltouch YL206 TouchControl

Step	Operation and indication
0	The unit is off
1	Press and hold the sensor in zone 3
2	Press and hold the On button
3	A short flash of all segments
4	Release the sensor in zone 3 in under 1 second whilst still pressing the On sensor
5	A short flash of all segments
6	Press and hold the sensor in zone 3 in under 1 second
7	“P” and “0” flash on the displays. The services program has been initiated
8	The services program ends automatically if no buttons are pressed for 120 seconds or after completing programs P0, P2, P8 and P9.

5.1.6 Gaggenau Comfort YL201 / twistpad YL203 TouchControl

In order to find the sensor for accessing the services program, the worktop must be on. Once the location is known, it should be turned off again, remembering the location of the sensor.

Step	Operation and indication
0	The unit is off
1	Press and hold the sensor in zone 3
2	Press and hold the On button
3	A short flash of all segments
4	Release the sensor in zone 3 in under 1 second whilst still pressing the On sensor
5	A short flash of all segments
6	Press and hold the sensor in zone 3 in under 1 second
7	“P” and “0” flash on the displays. The services program has been initiated
8	The services program ends automatically if no buttons are pressed for 120 seconds or after completing programs P0, P2, P8 and P9.

5.1.7 Metal Touch BO YL205 / SE YL204 TouchControl

Step	Operation and indication
0	The unit is off
1	Press and hold the “-“ button in zone 3
2	Press and hold the On button
3	A short flash of all segments
4	Release the “-“ button in zone 3 in under 1 second whilst still pressing the On sensor
5	A short flash of all segments
6	Press and hold the “-“ button in zone 3 in under 1 second
7	“P” and “0” flash on the displays. The services program has been initiated
8	The services program ends automatically if no buttons are pressed for 120 seconds or after completing programs P0, P2, P8 and P9.

5.1.8 Thermador Digiselect YL192 TouchControl

Step	Operation and indication
0	The unit is off
1	Press and hold the sensor in zone 3
2	Press and hold the On button
3	A short flash of all segments
4	Release the sensor in zone 3 in under 1 second whilst still pressing the On sensor
5	A short flash of all segments
6	Press and hold the sensor in zone 3 in under 1 second
7	“P” and “0” flash on the displays. The services program has been initiated
8	The services program ends automatically if no buttons are pressed for 120 seconds or after completing programs P0, P2, P8 and P9.

5.1.9 Multislider YL169 / YL170 TouchControl

Step	Operation and indication
0	The unit is off
1	Press and hold the ST2 timer sensor in zone 2 or the timer sensor on the left of on/off sensor for 5i
2	Press and hold the On button
3	A short flash of all segments
4	Release the ST2 timer sensor in zone 2 in under 1 second or the timer sensor on the left of on/off sensor for 5i whilst still pressing the On sensor
5	A short flash of all segments
6	Press and hold the ST2 timer sensor in zone 2 or the timer sensor on the left of on/off sensor for 5i in under 1 second
7	“P” and “0” flash on the displays. The services program has been initiated
8	The services program ends automatically if no buttons are pressed for 120 seconds or after completing programs P0, P2, P8 and P9.

5.1.10 Basic BO/SE YL202 TouchControl

Step	Operation and indication
0	The unit is off
1	Press and hold the sensor in zone 3
2	Press and hold the On button
3	A short flash of all segments
4	Release the sensor in zone 3 in under 1 second whilst still pressing the On sensor
5	A short flash of all segments
6	Press and hold the sensor in zone 3 in under 1 second
7	“P” and “0” flash on the displays. The services program has been initiated
8	The services program ends automatically if no buttons are pressed for 120 seconds or after completing programs P0, P2, P8 and P9.

5.1.11 Domino balay YL213 TouchControl

Step	Operation and indication
0	The unit is off
1	Press and hold the “+” sensor in zone 2
2	Press and hold the On button
3	A short flash of all segments
4	Release the “+” sensor in zone 2 in under 1 second whilst still pressing the On sensor
5	A short flash of all segments
6	Press and hold the “+” sensor in zone 2 in under 1 second
7	“P” and “0” flash on the displays. The services program has been initiated
8	The services program ends automatically if no buttons are pressed for 120 seconds or after completing programs P0, P2, P8 and P9.

5.1.12 Domino BO/Ne/TH YL199 TouchControl

Step	Operation and indication
0	The unit is off
1	Press and hold the sensor furthest to the right
2	Press and hold the On button
3	A short flash of all segments
4	Release the sensor furthest to the right in under 1 second whilst still pressing the On sensor
5	A short flash of all segments
6	Press and hold the sensor furthest to the right in under 1 second
7	“P” and “0” flash on the displays. The services program has been initiated
8	The services program ends automatically if no buttons are pressed for 120 seconds or after completing programs P0, P2, P8 and P9.

5.1.13 Domino SE Slider YL207 TouchControl

Step	Operation and indication
0	The unit is off
1	Press and hold the right-hand side of the slider (position 9)
2	Press and hold the On button
3	A short flash of all segments
4	Release the right-hand side of the slider in under 1 second whilst still pressing the On sensor
5	A short flash of all segments
6	Press and hold the right-hand side of the slider in under 1 second
7	“P” and “0” flash on the displays. The services program has been initiated
8	The services program ends automatically if no buttons are pressed for 120 seconds or after completing programs P0, P2, P8 and P9.

5.1.14 Oven models. YL 190

Step	Operation and indication
0	The unit is off
1	Press and hold the sensor in the additional zone of zone 4
2	Press and hold the child safety button
3	A short flash of all segments
4	Release the sensor in the additional zone of zone 4 in under 1 second whilst still pressing the child safety sensor
5	A short flash of all segments
6	Press and hold the sensor in the additional zone of zone 4 in under 1 second
7	“P” and “0” flash on the displays. The services program has been initiated
8	The services program ends automatically if no buttons are pressed for 120 seconds or after completing programs P0, P2, P8 and P9.

5.1.15 Oven models. YL202

Step	Operation and indication
0	The unit is off
1	Press and hold the “+” sensor in zone 4
2	Press and hold the “-“ sensor in zone 1
3	A short flash of all segments
4	Release the “+” sensor in zone 4 in under 1 second whilst still pressing the “-“ sensor in zone 1
5	A short flash of all segments
6	Press the “+” sensor in zone 4 in under 1 second
7	“P” and “0” flash on the displays. The services program has been initiated
8	The services program ends automatically if no buttons are pressed for 120 seconds or after completing programs P0, P2, P8 and P9.

5.2 Technical Services Program for TouchControl

	Operation	Indication	Status
1	The unit is in technical services mode. See access to the technical services program in Chapter 5.	The coil indicator displays are flashing “P” and “0”	The services program can be closed down from this menu.
2	On/Off button to select next program	The coil indicator displays are flashing “P” and “1”	Sensor, buzzer and displays test
2.1	Wait while the TouchControl detects the reference values. The upper horizontal segments of the display will remain lit during this process. You must wait until the central horizontal segments of the displays are lit. Individually press all the sensors (except the on/off switch, which is used for selecting the next program) and check the indication shown on the display.	“0”: → sensor correct “1”: → sensor lacking sensitivity “2”: → sensor overly sensitive “3”: → operating beyond tolerance limits “4”: → problem with the on/off sensor “9”: → simultaneous activation of sensors	After checking all the sensors and whether they are working correctly, the program automatically switches to the buzzer and displays test. The buzzer sounds for 2 seconds and all segments and LEDs are lit for 10 seconds.
3	On/Off switch for selecting next program	The coil indicator displays are flashing “P” and “2”	This menu enables reset to factory default settings and the cancellation of changes made by the user: <ul style="list-style-type: none"> • Removal of a fictitious residual heat “H/h” indication • Deletion of data stored in the memory • Deactivation of the “buzzer off” selection • Deactivation of the reduced block time function • Deactivation of the child safety feature (key)
3.1	After selecting P2, press any sensor except the on/off sensor	A buzzer will sound and the display will show “o o o o” for 2 seconds	When the “o o o o” appears, factory default settings have been restored.

	Operation	Indication	Status
4	On/Off switch for selecting next program	The coil indicator displays are flashing “P” and “5”	This menu only exists if a Cooking sensor is present The cooking sensor can be calibrated for each zone
4.1	Selection of the cooking sensor in the zone	The active calibration value is shown on the display	
4.2	Use the element that makes changes (+/- or 1-9 or slider or controls)	The new calibration is shown on the display	If there are other cooking sensors in other zones, this process can be repeated.
4.3	To store the new calibration values, you must press the on/off button	The warning buzzer sounds. “P” and “6” are shown on the corresponding displays.	This menu only exists if a frying sensor is present. The frying sensor can be calibrated for each zone.
5	Selection of the frying sensor in the zone	The new calibration is shown on the display	
5.1	Use the element that makes changes (+/- or 1-9 or slider or controls)	The new calibration is shown on the display	If there are other frying sensors in other zones, this process can be repeated.
5.2	To store the new calibration values, you must press the on/off button	The warning buzzer sounds. “P” and “7” are shown on the corresponding displays.	Indication of parameters.
5.3	From left to right, press all the TouchControl sensors, except the on/off switch. The sensor following the on/off switch is sensor 1, the next to the right is sensor 2, etc.	Sensor 1: → for example “51.04” Sensor 2: → for example “0000” Sensor 3: → for example “0000” Sensor 4: → for example “0000” Sensor 5: → for example “P 112” Sensor 6: → for example “0000” Sensor 7: → for example “- - - -”	<ul style="list-style-type: none"> • Software version, e.g. V1.04 • Current fault counter (400V) • Max. Temp. of the TouchControl (conversion necessary) • Operation hours counter • Piece number • Counter for the number of times turned on • Reserved

	Operation	Indication	Status
6	On/Off switch for selecting next program	The coil indicator displays are flashing "P" and "8"	This menu enables life or durability tests to be performed automatically. This is not used for tasks related to technical services.
7	On/Off switch for selecting next program	The coil indicator displays are flashing "P" and "9"	Deactivation of the maximum operation time limit
7.1	Press any sensor, except the on/off switch, for 3 seconds.	" I I I I " will be shown on all displays	After the 3 seconds, the key LED will be lit and the unit will go into stand-by mode.
8	On/Off switch for selecting next program	The coil indicator displays are flashing "P" and "A"	This is a detailed test of the sensors. The procedure is the same as for P1. This is not available for worktops with metaltouch.



Warning!

Summary of the steps for the technical services program.

P0	Access and close of the technical services program
P1	Sensor, buzzer and displays test
P2	Reset factory default values
P5	Cooking sensor calibration
P6	Frying sensor calibration
P7	Indication of parameters
P8	Life test
P9	Deactivation of the maximum operation time limit
PA	Detailed sensor test

5.2.1 Step “P1” for testing the twist or tippad

5.2.1.1 With twist or tippad on the worktop

Wait while the TouchControl detects the reference values. The upper horizontal segments of the display will remain lit during this process. You must wait until the central horizontal segments of the displays are lit.

5.2.1.2 Without twist or tippad on the worktop

In this case, a **0** is shown if the **signal is correct**.
A **1** is shown if the **signal is weak**.
A **2** is shown if the **signal is strong**.
A **3** is shown if the **signal is different to the calibration**.
A **4** is shown if the **TouchControl has yet to be calibrated**.

Procedure with twist

Decentralise the twist or tippad in all permitted directions. If the signal is 0, it is OK.
A 1 is shown if the signal is weak.
A 2 is shown if the signal is strong.

“- -“ must be shown if the test is OK and we are turning the twist or tippad clockwise.
When we turn between 360° and 420°, a counter from 11 to 66 in steps of 11 should appear.
After a further 60° turn, “- -“ should appear, meaning that the controller is OK.
If it does not count up to 66, there is a problem with the rotation detection.

5.2.2 Step "P1" for testing the slider

The Slider test must be performed in order, from left to right in the slider area.

A 1 will be shown in the display during the process. After 2 seconds, the result will be shown.

The speed at which the test is performed must be taken into consideration. If the test is performed too quickly, it is impossible to obtain correct signals.

Code	Meaning
0	Correct operation
1	Sensor lacking sensitivity
2	Sensor overly sensitive
3	Beyond tolerance limits
5	Adjacent sensors very different
6	Simultaneous activation of sensors

5.3 NTC sensor checks

5.3.1 Inductor NTC

Each one of the inductors uses an NTC sensor to control operational temperature. The inductor NTC is a replaceable part.



5.3.2 Induction module NTC

The temperature of the semiconductor devices is measured by two NTC sensors that protect the electronics from excessively high temperatures. These sensors are not replaceable parts.

5.3.3 NTC sensor conversion table

Temp (°C)	R (KOhm)	Temp (°C)	R (KOhm)
10	98.264	26	47.788
11	93.229	27	45.794
12	88.632	28	43.873
13	84.404	29	42.019
14	80.489	30	40.228
15	76.845	31	38.496
16	73.435	32	36.819
17	70.233	33	35.193
18	67.213	34	33.616
19	64.357	35	32.085
20	61.647	36	30.597
21	59.070	37	29.150
22	56.613	38	27.741
23	54.264	39	26.369
24	52.016	40	26.065
25	49.860		

5.4 Fan checks

- ▶ Check that the rotor is not blocked.
- ▶ The operational voltage is 24 V DC.
- ▶ It is possible to check the fan using a suitable direct current.

The fan can not be checked by measuring its resistance because it contains a diode in series within its own electronics.

5.5 Coil checks

The inductor contains no functional parts except for the NTC temperature sensor. Therefore, it is not usually the source of faults. However, the following procedure can be followed:

- ▶ Inductor checks must be performed without voltage.
- ▶ Remove the mica film carefully so as not to damage it and perform a visual inspection. Check that there are no burnt areas.
- ▶ Check continuity of the inductor with a tester ($<10\Omega$).
- ▶ Replace the mica film carefully so as not to damage it.

Do not replace the inductor unless burnt areas are found or there is no electrical continuity.

5.6 Induction unit checks (ELIN)

- ▶ Checks must be performed with no voltage.
- ▶ Perform a visual inspection paying particular attention to any burnt components.
- ▶ IGBT checks. The resistance values between

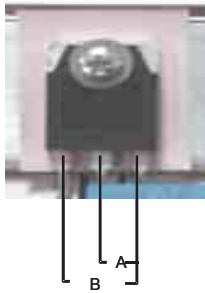

- ▶ the feet of the IGBT's must be:

$$A > 10 \text{ Kohm}$$

$$B > 5 \text{ Kohm}$$

- ▶ Check that the thread on the inductor connection screw is not worn. If it is, replace the screw. If the thread problem is with the attachment piece, replace the entire unit.
- ▶ If the induction associated to this coil continues to fail when the above checks provided negative results, replace the coil.
- ▶ Check that the 2 fusible connections (for the power (B) and the mains supply (A)) are intact. If not, the entire coil should be replaced.

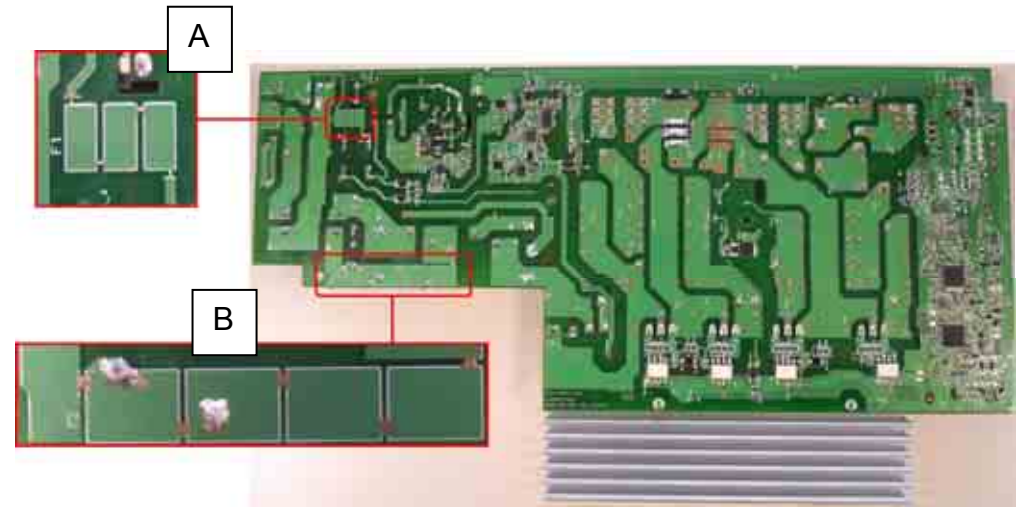

5.7 Checks for when the circuit breaker trips

5.7.1 Unexpected circuit breaker (CB) trip in homes

5.7.1.1 Problem

Problems involving unexpected CB trips are becoming increasingly more frequent.

During initial assessment, it is possible to say that they are caused by the fact that the standard circuit breakers that are installed in homes are AC and do not operate correctly with the electronic devices we connect to our installations.

5.7.1.2 Cause

Electronic equipment, used on a massive scale nowadays, is fitted with filtration and protection devices (condensators and varistors) that give rise to transitory leak currents when voltage transitions take place (very difficult to detect).

A particularly important example of such transition is that caused by short circuits to earth points on work sites.

These cases may affect a large number of users connected to the same low voltage network.

5.7.1.3 Solution

The most suitable solution is to adapt the distribution fuse boxes to correctly supply the electrical charges. This means always using type A circuit breakers that are immune to transition.

These systems are not standardised, meaning that each brand provides different names according to their own criteria, such as for example, super-immune (MERLIN GERIN) and high immunity (ABB), etc.

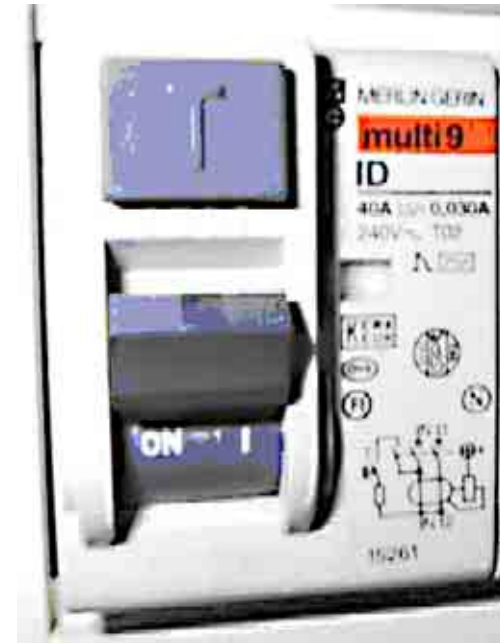

5.7.1.4 What is a circuit breaker?

An electrical device that must be installed in the general fuse box of all homes; its purpose is to rapidly disconnect the electrical installations in the event of a leak or earth connection, thus meaning that the installation will have been disconnected before anyone touches the faulty equipment. In the event of someone touching a live connection, the circuit breaker will disconnect the installation in a sufficiently short period of time so as not to cause serious injury to the affected person.

Circuit breakers are differentiated by having a range of sensitivities.

The **sensitivity** is the value that appears in the catalogue and that identifies the model. It is used to indicate the current strength at which it is desired for the circuit breaker to "trip", in other word, the current strength, if reached, that will result in disconnection of the installation.

The various sensitivities are:

- Very high sensitivity: 10 mA
- High sensitivity: 30 mA
- Standard sensitivity: 100 and 300 mA
- Low sensitivity: 0.5 and 1 A

The type of circuit breaker normally used in homes is in the high sensitivity category (30 mA).

The degree of damage caused to people is determined by several factors. The following table shows how the body is affected by the flow of current depending on the duration of the flow:

- Zone 1: Perception of the current
- Zone 2: Significant discomfort and/or pain
- Zone 3: Muscular contractions
- Zone 4: Risk of heart attack

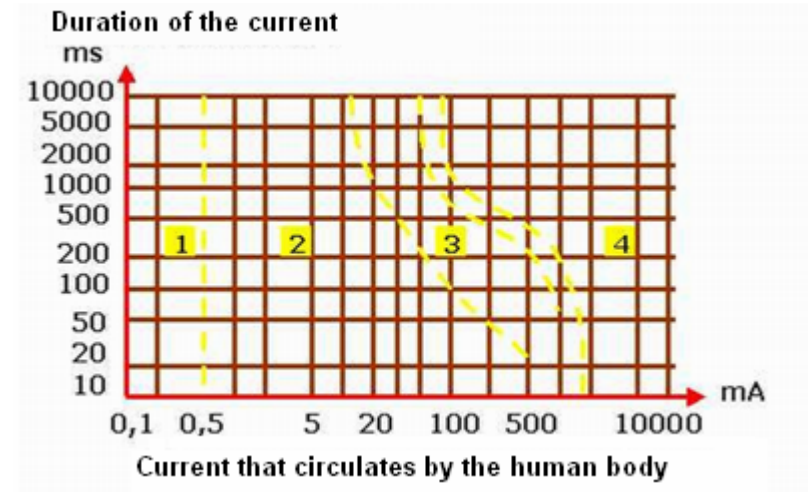

Circuit breakers normally have a **test button** (indicated with a **T**) that simulates a problem with the installation and, therefore, will disconnect the installation when pressed. It is recommended that this button be pressed regularly (for example, once a month).

Types of CB

According to manufacturing standards, there are three types:

1. **Type AC** for alternating sine wave currents.
2. **Type A** for alternating sine wave currents or direct pulse currents
3. Timed **type S**, not used in homes as they are not permitted by the REBT unless one of the above breakers is present further along the circuit.

99% of homes have the most simple and economical Type AC fitted, which creates two problems:

1. They are not tripped by pulse currents and may even become blocked

2. They may be tripped unexpectedly (even at night) by high frequency components

The type A circuit breakers provide increased safety due to two basic improvements: they are tripped by pulse currents; and, in the event of permanent failure of the direct circuit, they avoid the relay blocking and not operating correctly with alternating shunts. For this reason:

1. The REBT itself (Article 3.5 of the ITC-BT 24) states: "when it is foreseen that the differential currents may not be sine wave..., the CB devices used shall be of class A"
2. Certain electrical appliance manufacturers (Bosch Siemens) recommend the use of type A circuit breakers for their equipment. Furthermore, countries such as Germany, Switzerland and Belgium only accept the installation of this type of CB and do not accept type AC under any circumstances.

5.7.1.5 Procedure for the technician

- Measurement with the Gossen to ensure correct operation of the appliance according to regulation VDE0701. The method of measurement using the Gossen to check that the repair is correct as a safety test for the equipment is explained below (Rpe < 0.3 Ohms; Riso >= 0.5 Mohms).
The value that must be measured in the event of a circuit breaker trip is the Ipe or Iea current. The measured value should be checked against the table of permitted leak current according to the type of equipment in order to know whether it is operating correctly.

Ipe (old Gossen) = **Iea** (new Gossen)

Note:

The probe is not necessary to measure the Ipe or Iea current

- Fill in the insulation report to provide copy to the user, which contains a recommendation to have their CB type replaced by a professional electrician.
 - Attached is an example report form and another for delivery to the user.

Table of equivalent measurements between new/old Gossen

Gossen measurements	
Old	New
Rpe	Rsl
Riso	Riso
Ipe	Iea
If	Idiff

5.7.1.6 How to measure using the old GOSSSEN

Necessary material

- Gossen
- A chip with cable and socket, because worktops in newly-constructed buildings will be connected to a 25 A socket (according to low voltage regulations), in order to be able to trip the socket on the same and take measurements with our adapted cable. There will be no problem with those fitted with 16 A connections.
- Equipment for checking.

Connections diagram. Type I Hobs.

Measurement process:

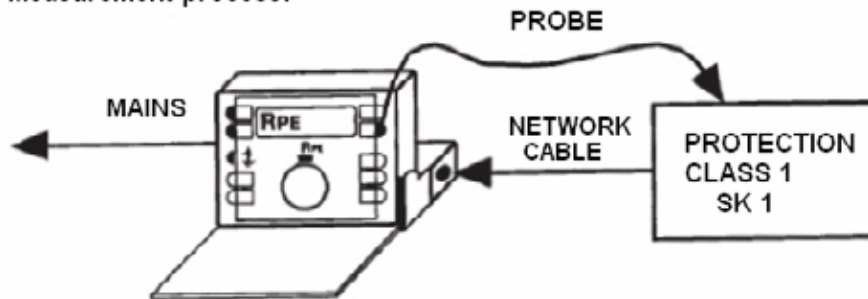

The SK1 box is the worktop to be checked. The unplugged mains cable from the worktop must be connected to the chip and to the Gossen.

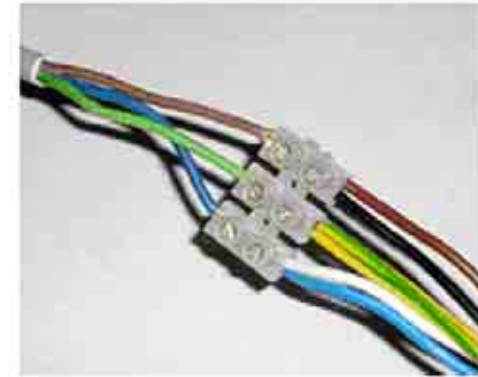

The probe (blue wire in the photo) must be connected to the external or internal metal frame, depending on the model.



Finally, the Gossen must be connected to the mains supply.

Measurement examples:

1- Continuity of the earth cable or resistance of the earth cable.

Connect the Gossen to the Rpe and press the Start button on the Gossen.

The resistance should be below 0.30 Ohms. If a bad result is produced, ensure it is not a problem with the pin, as they are liable to fail. Also check the probe clip as they sometimes come loose on bevelled glass worktops for example.

The average value is 0.08 Ohms.



2- Measurement of the insulation resistance

Connect the Gossen selector to the Rlso and press the Start button on the Gossen.

The resistance level should be above 0.5 Mohms.

The average value is 29.99 Mohms.



Should the measured value be incorrect, the device alarm will sound and an alarm signal will be shown on the display.

3- Measurement of the Ipe for checking against the table of permitted leak intensities

The probe must be removed for this measurement. Switch the selector to Ipe and press the Start button. Even if the alarm sounds, the measurement is incorrect. It must be checked against the table of permitted leak intensities depending on the type of equipment.

5.7.1.7 New Gossen

Code new GOSSEN - **340756** (830 eur)
Must be calibrated every two years (the old model is no longer available)



GMC-I Gossen-Metrawatt GmbH
Service-Center
Thomas-Mann-Straße 20
90471 Nürnberg · Germany
Telefon +49-(0)-911-8602-0
Telefax +49-(0)-911-8602-253
E-Mail service@gossenmetrawatt.com

Measurement procedure using the new GOSSEN

The equipment must be connected to the socket shown with the arrow in the image above.

The Gossen is connected to the electricity supply.

The probe must also be connected for Rsl and Riso measurements.

This is not necessary for lea measurements.

Position the switch to the corresponding measurement and press the green On button. Press the Test button to switch it off.

5.7.1.8 Photograph to explain the procedure

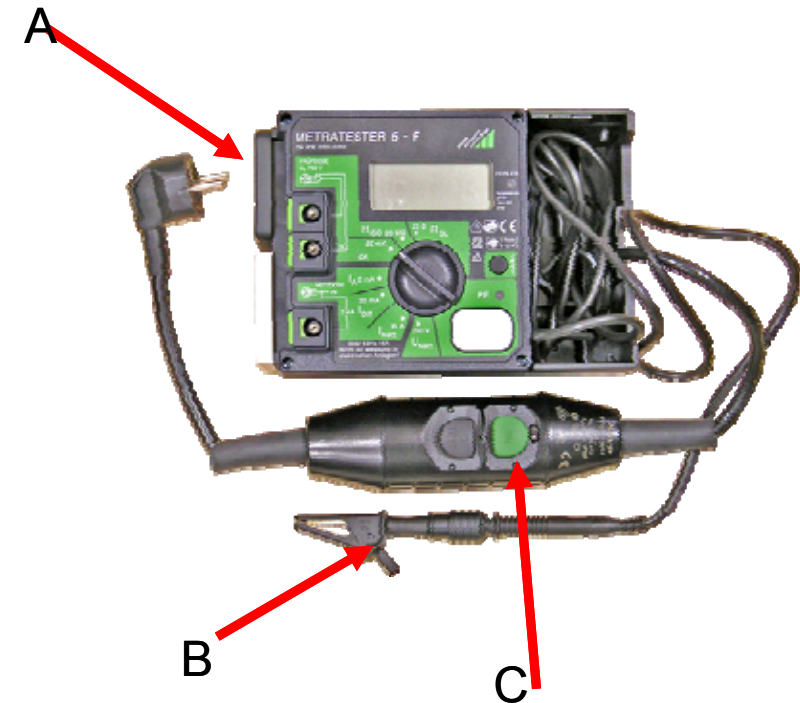

- A- connection for the power cable from the worktop
- B- probe for safety test measurement
- C- Green button for taking measurement

5.7.1.9 Model report to be provided

Date of issue: 18.03.2008		Insulation Report		B/S/H	
Page: 1/1					
Report on insulation measurements carried out on the following appliance		Centre: 5300	Bulletin N°: XXXXXX		
Specifications of appliance:					
Make: Halay	FD: 8801				
Model: 3ET815LP	Serial N°: 1114				
Specifications of measuring device:					
Model: PG0701N	Gossen	Calibrated in compliance with standard: VDE0701		Date of calibration: 20/06/2007	
Details of Measurements taken:					
Rpe	0.11 M Ohms	Earth wire resistance			
Riso	29.99 M Ohms	Insulation resistance			
Ipe	5.45 mA	Earth wire strength			
If	0.005 mA	Leakage current			
Test result	X OK				
Recommendation: contact your electrician The differential for your home is not compatible with this electrical appliance since it works with high frequencies. You should have a type-A differential installed fitted with a super immunity filter.					
Stamped by the Service Center:		Date of inspection: 18/3/2008			
Specimen copy					

5.7.1.10 Report to be filled in

This can be extracted from the ATI or ARM attached.

Date of issue: 18.03.2008		Insulation Report		B/S/H	
Page: 1/1					
Report on insulation measurements carried out on the following appliance		Centre: 5300	Bulletin N°: XXXXXX		
Specifications of appliance:					
Make: Balay	FD: 8801				
Model: 3ET815LP	Serial N°: 1114				
Specifications of measuring device:					
Model: PG0701N	Gossen	Calibrated in compliance with standard: VDE0701		Date of calibration: 20/06/2007	
Details of Measurements taken:					
Rpe	0.11 M Ohms	Earth wire resistance			
Riso	29.99 M Ohms	Insulation resistance			
Ipe	5.45 mA	Earth wire strength			
If	0.005 mA	Leakage current			
Test result	X OK				
Recommendation: contact your electrician The differential for your home is not compatible with this electrical appliance since it works with high frequencies. You should have a type-A differential installed fitted with a super immunity filter.					
Stamped by the Service Center:		Date of inspection: 18/3/2008			
Specimen copy					

5.7.1.11 Table of permitted leak current

Total leak 230V @ 50Hz		
Type of equipment	I min	I max
Domino	1.7	3
Domino 38 cm	1.7	3
2I	1.7	3
3I 28Simple	3.5	6
3I 28Double	3.5	6
3I 32Triple	3.5	6
4I	3.5	6
4I BRATER	3.5	6
80 plate warmer	3.5	6
80 28Simple	3.5	6
80 Bräter+plate warmer	3.5	6

Total leak 230V @ 50Hz		
Type of equipment	I min	I max
90 5I 28Double	5.5	8.6
90 5I 32Triple	5.5	8.6
90 3I 28Simple	3.5	6
90 4I	3.5	6
60cm 2I 28Simple	1.7	3

If the measured I_{pe} = I_{lea} value is between I_{min} and I_{max}, the equipment is correct, although the alarm may sound.

5.8 Radio interference

5.8.1 Problem

The radio cannot be heard properly when operating the inductor.

5.8.2 Cause

Inductor worktops and radios interfere with each other.

Regulations establish certain emission and immunity levels for electronic devices in order to avoid such interference problems. If they occur, they may be caused by one of several reasons:

- The worktop does not comply with the emission limits defined by the regulations governing the product. In our case, the worktops are certified according to European and international regulations EN55011 and CISPR 11. Therefore, they comply with the established emission limits.

See the list of regulations and emission / immunity tests with which all our inductor equipment comply.

- The radio does not comply with the immunity regulations for the product.
- It is possible for interference to occur when the two devices comply with their respective regulations. These regulations are unable to cover the infinite possible number of individual cases (only general situations) and interference may occur.

5.8.3 Solution

Check that the radio receiver complies with the corresponding immunity regulations for the product.

In those cases where the two devices comply with their respective regulations and interference still occurs, it is recommended to separate them sufficiently.

5.8.3.1 List of regulations and emission / immunity tests

EMC - Emission	
Code	Title
EN 55011	Industrial, scientific and medical (ISM) radio-frequency Equipment. Electromagnetic disturbance characteristics. Limits and methods of measurement
EN 61000-3-2	Electromagnetic compatibility (EMC) - Part 3-2: Limits – Section 2: Limits for harmonic current emissions (equipment input current greater than or equal to 16 A per phase)
EN 61000-3-3	Electromagnetic compatibility (EMC) – Part 3-3: Limits – Section 3: Limitation of voltage changes, voltage fluctuations and flicker in public low-voltage supply systems, for equipment with rated current =16 A per phase

EMC – Immunity	
Code	Title
EN 55014-2	Electromagnetic compatibility. Requirements for household appliances, electric tools and similar apparatus. Part 2: Immunity.
EN 61000-4-2	Electromagnetic compatibility (EMC). Part 4: Testing and measurement techniques. Section 2: Electrostatic discharge immunity test.
EN 61000-4-3	Electromagnetic compatibility (EMC). Part 4: Testing and measurement techniques. Section 3: Radiated, radio-frequency, electromagnetic field immunity test
EN 61000-4-4	Electromagnetic compatibility (EMC). Part 4: Testing and measurement techniques. Section 4: Rapid electrical transition immunity test
EN 61000-4-5	Electromagnetic compatibility (EMC). Part 4: Testing and measurement techniques. Section 5: Surge immunity test
EN 61000-4-6	Electromagnetic compatibility (EMC). Part 4: Testing and measurement techniques. Section 6: Immunity to conducted disturbances, induced by radio-frequency fields
EN 61000-4-11	Electromagnetic compatibility (EMC). Part 4: Testing and measurement techniques. Section 11: Immunity tests for voltage gaps, short interruptions and voltage variations.
EN 61000-4-13	Electromagnetic compatibility (EMC). Part 4: Testing and measurement techniques. Section 13: Harmonics, interharmonic including mains signalling at A. C. Power port, Immunity tests.

5.9 Checking the level of supplied power

5.9.1 Problem

- Low level of supplied power
- Less power is supplied with the new inductor

5.9.2 Cause

- The pot is not suitable. See list of suitable pots and check the pot detection system.
- The new IH5-I technology supplies less power than the old IH4-I technology (ind IV). See regulations.
- Certain regulations governing power have come into force. See regulations.
- The positioning spring that brings the inductors closer to the glass is not in place.
See position of the spring.

5.9.3 Solution

5.9.3.1 Power regulation

5.9.3.1.1 Booster power regulation

For the first ten minutes, the Booster operates at maximum power, in other words, it supplies 150% of inductor power. Subsequently, the booster is regulated and lowered to power level 9.

If the user wishes to reactivate the booster, this can be done. The booster will supply maximum power for a further 2 minutes and then return to power level 9. After the 12 minutes with the booster at maximum power, if the user tries to reactivate it once more, only 83% of the 150% of inductor power will be supplied and then it will return to power level 9 (100% inductor power).

At this time, if the user wishes to activate the booster again, they must wait for the same period of time as the time they wish it to be activated for, provided that this is less than 10 minutes.

Superbooster (Paella dish)

On these models, it is not possible to reactivate the booster after the initial 10 minutes at maximum power.

If it has been used for 10 minutes, we must wait for 10 minutes in order to try and activate it again.

If we have used it for 5 minutes, we must wait for 5 minutes in order to try and activate it again.

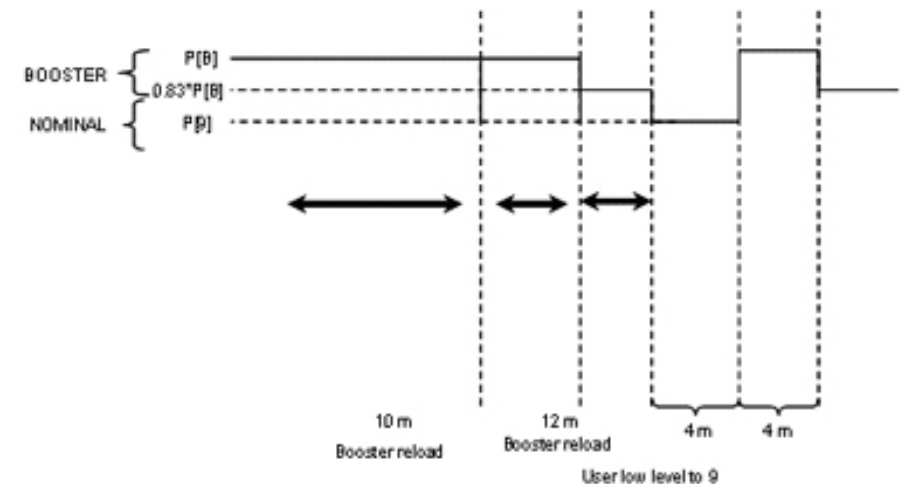

5.9.3.1.2 Power regulation according to the type and size of the pot



Warning!

The power supplied according to the size of the pot with IH5-I is less than with IH4 (ind IV advanced).

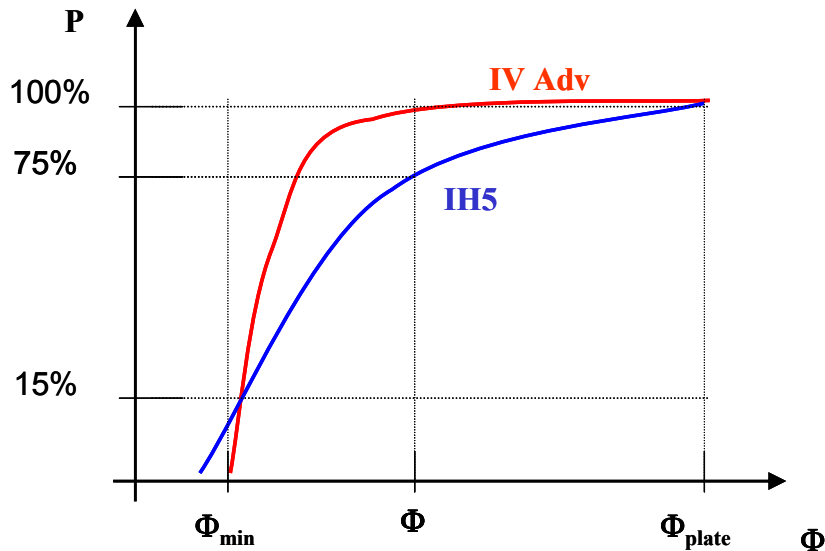

Pot Diameter

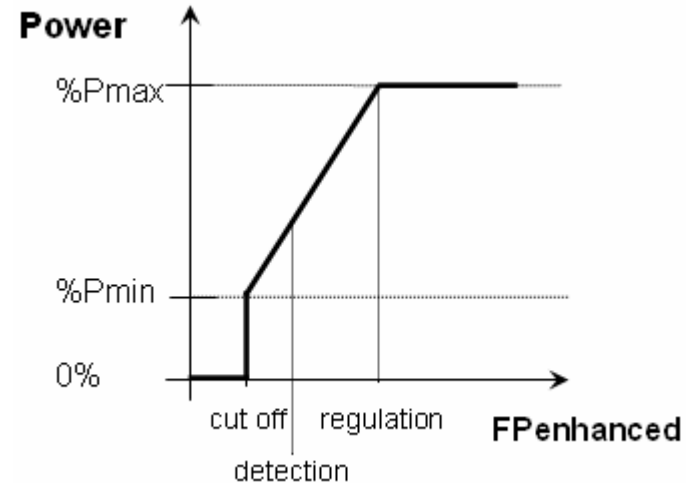
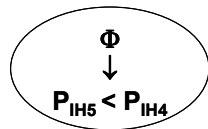

By taking into account the material and size of the pot, the level of power supplied can be reduced and even shut off so as to avoid excessive currents.

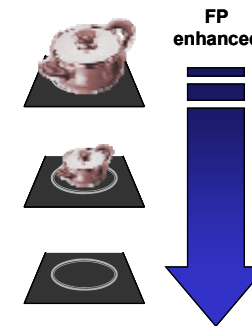

For example, for a pot with a base diameter identical to the size of the inductor coil and of a material with good electro-magnetic properties, the FP enhanced obtained gives us maximum power. If we have no pot, the FP enhanced is nil and the power supplied is nil. The display flashes.

If the pot is not of a suitable diameter and its composition is not suitable for our induction cooker, the FP enhanced calculated by our technology will be so low that the power supplied will be nil.

5.9.3.1.3 Power regulation according to the temperature of the IGBT's

The temperature of the IGBT's is measured using the NTC's located on the rear of the inductor modules. They are marked in red.

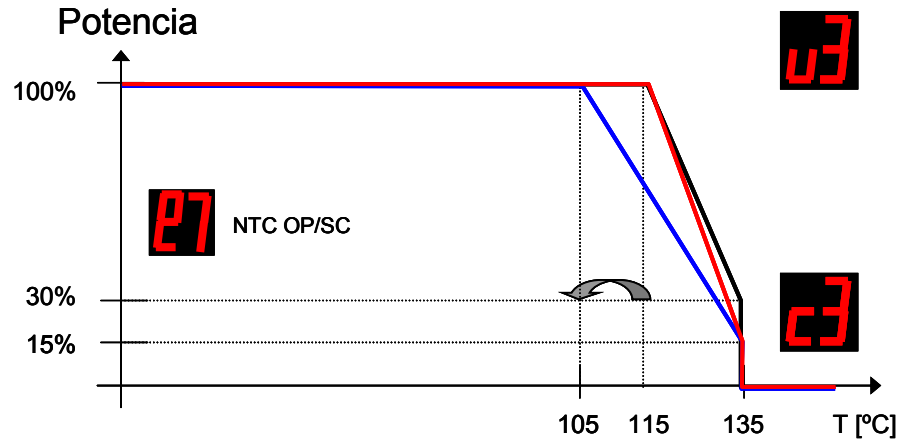

[1] IH4-I.2

[2] IH5-I

[3] IH5-I critical modules

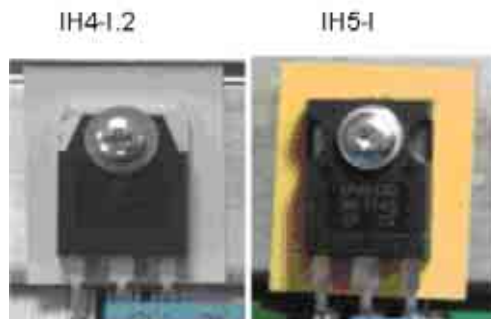

See the chapter on error codes and warnings sent via the TouchControl.

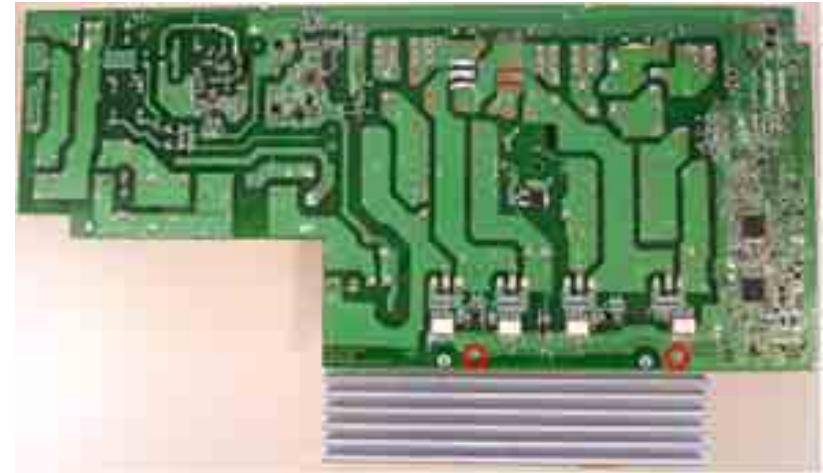

When certain temperature limits are exceeded, a warning is provided via an indication on the TouchControl so as to avoid damage to the IGBT's.

5.9.3.1.5 Power regulation according to the supply voltage

When the supply voltage is less than 215V, an indication is shown on the TouchControl display. See the error codes and warnings sent via the ELIN.

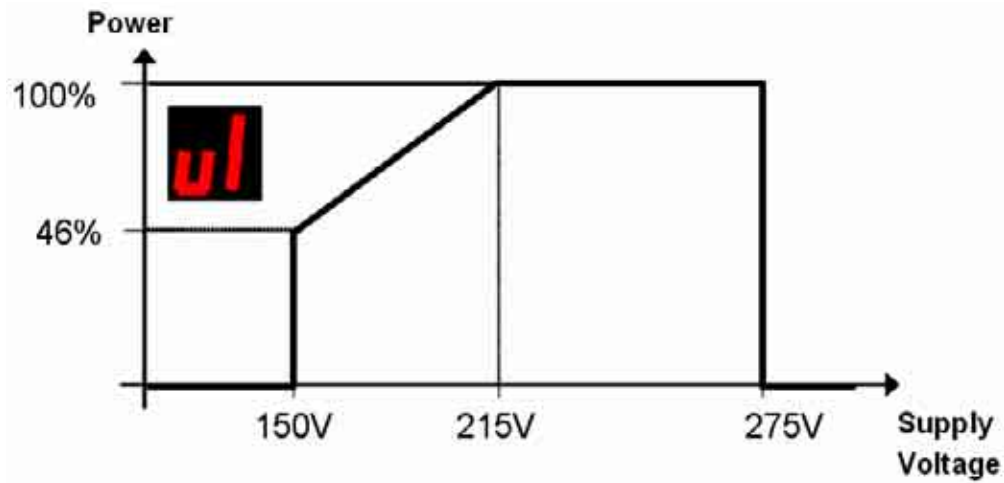

5.9.3.2 Position of the spring

If the spring is not in place, it is possible that the distance between the glass and the inductor is too great and the pot is not being detected correctly and/or the power being supplied may be too low.



1.1.3.3 Tables of power according to type of inductor being checked

Measurement's conditions

To measure the power supply with the hotplates of an IH5 induction hob, a pot with a bottom diameter matching the tested hotplate is placed centered.

A matching diameter means: bottom-Ø pot = bottom-Ø hotplate +20/-5mm. At table 1 a pot or pan for each IH5 hotplate is recommended for measuring.

The energy consumption is measured with nominal power and afterwards with the boost function like explained in the following:

- The pot is filled with a small amount of water and placed at the hotplate. The pot should never be used empty.
 - The Boost power level is started.
 - Wait 10-15 seconds until the power is supplied constantly.
 - Then measure the energy consumption for a time period of 2 minutes.
-
- The supplied power is calculated: $P(W) = \text{energy consumption (Wh)} \times 30$
 - The calculated supplied power is compared with the nominal power (see table 2) of the tested hotplate1.
 - The same is repeated with the nominal power level.

Important note:

1) Be aware that regarding the supplied power the tolerance rate of produced BSH induction hobs is -10%/+5% of the nominal power (n.p.)

This means with an induction 4-hotplates-hob the nominal power supply should be between 6480W (=90% of n.p.) and 7560W (=105% of n.p.).

The same applies for each hotplate.

2) The "super boost" power is supplied with the 26T, 28D or 32T hotplate until any other hotplate is activated. At this the power is supplied with more than one module.

In case of activating another hotplate, the "boost" power is supplied, because only the module of the hotplate is available. It changes automatically from "super boost" to "boost" when activating a second hotplate.

"Super boost" and "boost" are not indicated different at the Touch control.

Table 1: Pots/Pans for measuring the power supply

hotplate (cm)	15	18	21	26	28	32	Roaster zone
Pot	Hackmann	Hackmann	Hackmann	Demeyere	Kuhn Rikon	Lacor	Demeyere
serie / article nr.	littala	littala	littala	multiline - REF 42632	cater star REF 31134	inox durit REF 60224	HEZ390010
Ø bottom (mm)	156	184	222	260	283	315	285*170
Ø upside (mm)	188	207	242	320	320	400	320*208
Height (mm)	102	130	134	55	62	50	70
	Accessory						Accessory

Table 2: Overview objective power per IH5 hotplate with nominal and boost function

Objective nominal and boost power (W) with IH5 hotplates									
Power levels	15	18	21	28S	28D	26T	32T	18B	
9	17	1400 W	1800 W	2200 W	2400 W	2800	2600	3300	2000
Boost	18	1800 W	2500 W	3300 W	3500	3400	3400	3600	2600
Super Boost ²	18	-	-	-	-	4400	3400	4600	-

B = function booster

SB = Superbooster







((in case of 26T, 28D and 32T: if another hotplate is active, only the Boost function is available.))

S = single hotplate

D = double hotplate

T = triple hotplate

Pictures of the recommended pots and pans

hotplate (cm)	15	18	21
<p style="writing-mode: vertical-rl; transform: rotate(180deg);">picutres</p>			
	<p style="writing-mode: vertical-rl; transform: rotate(180deg);">picutres</p>	 	 

5.10 Checking hob flatness

5.10.1 Problem

The equipment does not sit flush to the surface of the hob.

5.10.2 Cause

- Installation has been performed incorrectly. It is possible that the recess guide rails are missing.
- If the FD< 8708, the design of the glass frame assembly may cause flatness problems. There are now 4 profiles within the glass frame assembly to facilitate the solution of this problem.

5.10.3 Solution

Procedure to be followed:

- Check installation.
 - Are the recess guide rails in place?
 - Is the size of the recess space correct?
- Assemble and disassemble the glass frame to free tension.
- If the FD< 8708 and the above has been checked, a replacement for FD >8709 must be processed.
- In order to check whether this is within tolerance limits (0.5-0.7mm), measurements must be taken using gauges at the points indicated in the diagram and photographs taken in order to be able to send the correctly documented IUA to our factory. This will enable the correct resolution of real flatness problems and speed up the process.

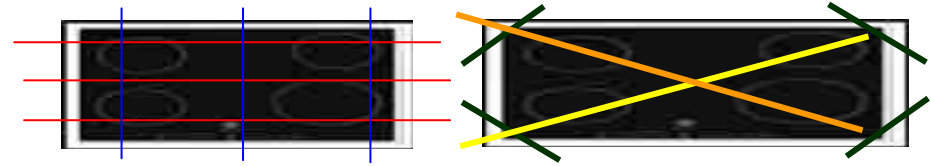

5.11 Checking standard operation noises

5.11.1 Problem

The inductor makes a noise when cooking.

5.11.2 Cause

Induction heating technology is based on the creation of electromagnetic fields that cause heat to be generated directly on the base of the pot. These fields, depending on the construction of the pot, may cause certain noises or vibrations.

5.11.3 Solution

The user should be informed that information about normal operation noises can be found at the back of the instruction booklet and is included below.

These noises form part of the induction technology and do not indicate a fault.

5.11.3.1 Low-pitched buzzing sound coming from the transformer

This noise occurs when cooking with a high level of power. It is caused by the amount of energy being transferred from the hotplate to the pot. This noise will disappear or weaken as the level of power is decreased.

5.11.3.2 A low-pitched whistling sound

This noise occurs when the pot is empty. This noise will disappear as soon as water or food is added to the food.

5.11.3.3 Creaking

This noise occurs with pots that are made of various superimposed materials.

The noise is caused by the vibrations that are created on the joint surfaces between the various superimposed materials.

This noise comes from the pot. The amount and manner of cooking the food may vary.

5.11.3.4 High-pitched whistling sounds

These noises are more common with pots made of different superimposed materials, as soon as they are put on the cooker at high power and in both cooking areas at the same time. These whistling noises disappear or reduce as soon as the power is reduced.

5.11.3.5 Noise from the fan

For optimum use of the electronic system, the hotplate must operate at a controlled temperature. Therefore, the hotplate is fitted with a fan that operates when certain temperature levels are detected via different power levels. The fan may also operate under inertia after the hotplate has been turned off if the detected temperature is still too high.

5.12 Checking pot detection

All inductor areas are fitted with an automatic pot detection system included in the inductor control system. The minimum diameter is approximately 50% of the nominal diameter, although this may vary depending on the material.

When the pot is considered to be of a small size, the inductor control system automatically reduces the supplied power to adapt to the size of the pot.

After activating the cook area, if no pot is placed on it or the pot is made of an unsuitable material, the display showing the level of power will flash. After 90 seconds the TouchControl will emit an acoustic warning and turn off the cook area.

When a pot is recognised as suitable, the power level display will remain constant and the level of power indicated by the display will be supplied.

5.12.1 Problem

- One inductor plate does not detect a pot but another of a smaller diameter does.
- The pot is not detected on any inductor plates.

5.12.2 Cause

- The diameter of the pot is not suitable for that hotplate. See table of recommended minimum diameters.
- The pot is not suitable for our induction technology (the magnet sticks sometimes). Depending on the composition of the pot, our technology may not be programmed to detect it as suitable so as to avoid possible module faults arising from operation in unsuitable conditions. See power supply reduction or cut-off diagram depending on the pot being used.

5.12.3 Solution

See chapter on recommended pots

5.12.3.1 Minimum recommended diameters

This table is provided as a guide only in order to help the understanding of the problems that may arise in the market. These values may vary depending on the composition of each type of pot.

Inductor type	Nominal diameter (cm)	Minimum diameter (cm)
15	14.5	6.5
18	18	11.5
21	21	15
28 Simple	28	15.5
18 Bräter	23	18
28 Double	28	23.5
26 (Triple)	27	25
32 (Triple)	32	29

5.12.3.2 Power supply reduction diagram depending on the pot being used

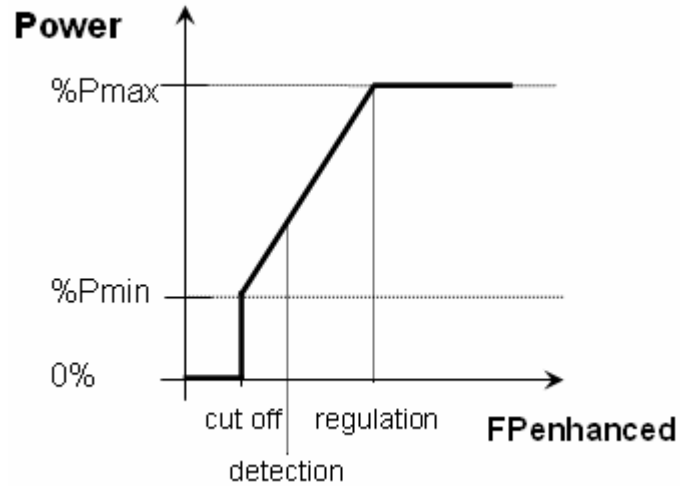

For example, for a pot with a base diameter that is identical to the size of the inductor plate and made from a material with good electromagnetic properties, the enhanced FP obtained gives us maximum power. If there is no pot, the enhanced FP is nil and the level of power supplied is also nil. The display will flash. If the pot is not of a suitable diameter and the composition of the pot is not suitable for our inductor, the enhanced FP calculated by our technology will be so low that the level of power supplied will be nil.

According to the material and size of the pot, the level of power supplied may be reduced or cut off in order to avoid excessive currents.

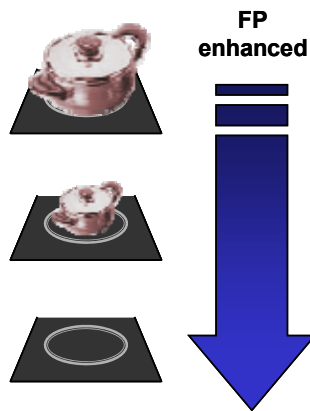

5.13 Checking of broken glass

5.13.1 Problem

The glass has broken. The enamel from the pot has become welded to the vitroceramic glass.



5.13.2 Cause

- Generally-speaking, cases involving the breakage of glass are caused by a strong increase in temperature to the base of the pot (over 400°C). The heat from the pot is transferred to the glass (in fact, it can even weld enamel and glass) and the high temperature causes the glass to break.
- This has been seen to occur when using **pots in bad conditions**, with cracks or scratches: the inducted currents “avoid” these areas and concentrate in specific areas, which generate extremely high temperatures.
- Another possibility is with **thinly enamelled pots** or pots in bad states of disrepair: the flatness of the base is lost in the centre and the defective contact with the plate gives rise to areas with extremely high temperatures.

5.13.3 Solution

- This is more commonly seen with inductors when the user is not used to the shorter heating times compared to radiator plates and insufficient attention is paid when using them. In order to mitigate this problem, it has been thought to include in the user manuals comments such as “If you use thinly enamelled pots, you may cause damage to your hotplate. We recommend that you pay particular attention during the cooking process and do not overheat them”.
- Such thinly enamelled pots, due to the type of material and especially due to the thickness of the base, are very weak and can overheat rapidly. This is even more so when using high levels of power, empty pots or with little oil. If they are left for too long, in other words, when the pot is “abandoned”, firstly the pot covering deteriorates and secondly the base begins to deform, above 250°C. Deformation of the base then results in the average temperature measured by the sensor under the glass (NTC) being less than the actual temperature, the hob is not regulated and the overheating process is accentuated. When reaching some 500°C, the enamelled base begins to melt and degrade (forming bubbles) and may even crack or break the glass.

5.14 Cookware for induction and recommendations

5.14.1 General

All saucepans and frying pans with a ferromagnetic base are suitable for induction.

Only pots whose base is uniformly in contact with the magnet should be used (check the entire base).

When using other types of pots, the inductor does not heat up and the power level display will flash.

The minimum diameter of the pot should also be taken into consideration.

5.14.2 Suitable saucepans and frying pans

Enamelled steel saucepans and frying pans

Cast iron saucepans and frying pans

Iron saucepans

Stainless steel saucepans and frying pans, provided that they have a special ferromagnetic base for induction purposes

5.14.3 Unsuitable saucepans and frying pans

Non-ferromagnetic or non-metallic materials

Aluminium saucepans and frying pans

Copper saucepans and frying pans

Tin saucepans and frying pans

Standard stainless saucepans and frying pans

Glass containers ("Pyrex")

Clay pots

5.14.4 Recommendations

5.14.4.1 ITTALA / DEMEYERE



Pots and pans

444218 pot 16 cm.

444217 pot 18 cm

444210 pot 20 cm

444216 pot 24 cm

444219 pot 22 cm.

464355 frying sensor pan

5.14.4.3 ZENITH MASTER PAELLA PAN



Paella Pans

464338, D 28 cm., D base 23,5 cm.

464339, D 30 cm., D base 25,5 cm.

464340, D 32 cm., D base 28 cm.

464341, D 34 cm., D base 29 cm.

5.14.4.4 28 cm Kuhn-Rikón Paella Pan

The available accessories are:

HZ390260 (Siemens)

HEZ390260 (Bosch)

Z9460X0 (Neff)



5.14.4.5 Bräter

The available accessory is:

HEZ390010

HZ390010



5.14.4.6 Pans for the frying sensor

The available accessories are:

HZ390210 (Siemens); HEZ390210 (Bosch): 15 cm
HZ390220 (Siemens); HEZ390220 (Bosch): 18 cm
HZ390230 (Siemens); HEZ390230 (Bosch): 21 cm



They are available in three sizes: 15 cm, 18 cm and 21 cm
They have a sandwich base.

5.14.4.7 WMF Wok

The available accessories are:

HZ390090(Siemens) ; HEZ390090(Bosch)

Maximum diameter 36 cm and minimum diameter 16 cm.



5.15 Disassembly of the TouchControl

The TouchControl is attached to the TouchControl support with two plastic clips.

This attachment is new compared to IH4.

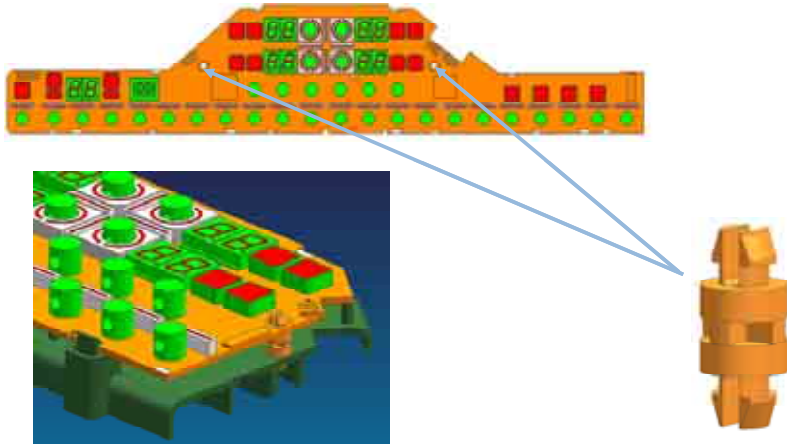

Warning!

A bic tape is required for disassembly without causing damage.

In the event of damage, they can be ordered as spare parts (see Quickfinder).

5.16 Check: low sensitivity on the TouchControl Slider

5.16.1 Problem

Poor sensitivity when touching the slider. It must be pressed for longer and the reaction is very slow.

5.16.2 Cause

The design of the slider with metal pins is not optimum. They may be pressed down when used without breaking the slider.

Once the slider is in a lower position to the glass, sensitivity is decreased.

Top-down view

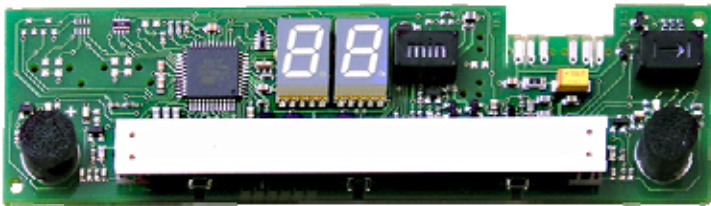

Front view



5.16.3 Solution



Warning!

Carefully try to pull the metal pins upwards.

In the event that this does not improve sensitivity, order a new part and take care when handling it.

5.17 Checking the replacement part is correct

5.17.1 Problem

The replacement part does not coincide with the original

5.17.2 Cause

- The supplier has sent the wrong one.
- The warehouse stock has got mixed up.
- The module software is badly saved.

5.17.3 Solution

Inform central office for them to manage the incident.

If the replacement part is an electronic item or module, the supplier code will be located on it. Check to see if this code corresponds to the code on the original part and if not, include this information in the report.

- The label is located on the reverse side of TouchControl units.



- The label is located on the front side of ELIN units.



See table of supplier codes for replacement parts according to model.

The left 1 ELIN is the one located on support ELIN-2.

The left 2 ELIN is the one located on support ELIN-1.

5.17.3.1 Table of replacement parts with supplier code

MODEL	DESCRIPTION	Left 1 ELIN	Right ELIN	Left 2 ELIN	TC
3EB800L	BA.2I.60.SQ.X.X	9000274561	--	--	9000183912
3EB800X	BA.2I.60.SQ.X.X	9000274561	--	--	9000183912
3EB815L	BA.3I.60.SQ.28S.X	9000275522	9000274537	--	9000229599
3EB815X	BA.3I.60.SQ.28S.X	9000275522	9000274537	--	9000229599
3EB820L	BA.4I.60.SQ.X.X	9000274564	9000274537	--	9000183912
3EB820X	BA.4I.60.SQ.X.X	9000274564	9000274537	--	9000183912
3EB900L	BA.2I.60.BAS.X.X	9000274561	--	--	9000237964
3EB900X	BA.2I.60.BAS.X.X	9000274561	--	--	9000237964
3EB9030L	BA.2I.30.BAS.X.X	9000275514	--	--	9000248165
3EB910F	BA.2I.60.BAS.X.FS	9000274561	--	--	9000261599
3EB914L	BA.2I.60P.BAS.28S.X	9000275516	--	--	9000248165
3EB915L	BA.3I.60.BAS.28S.X	9000275522	9000274537	--	9000237965
3EB915X	BA.3I.60.BAS.28S.X	9000275522	9000274537	--	9000237965
3EB917F	BA.3I.60.BAS.28D.FS	9000275523	9000275496	--	9000237967
3EB917L	BA.3I.60.BAS.28D.FS	9000275523	9000275496	--	9000237967
3EB917M	BA.3I.60.BAS.28D.FS	9000275523	9000275496	--	9000283860
3EB917P	BA.3I.60.PZ.28D.FS	9000275523	9000275496	--	9000261070
3EB918L	BA.3I.60.BAS.32T.FS	9000275524	9000275509	--	9000237967
3EB919F	BA.3I.60.LCD.32T.FS	9000275524	9000275509	--	LCD
3EB920L	BA.4I.60.BAS.X.X	9000274564	9000274537	--	9000237964
3EB920X	BA.4I.60.BAS.X.X	9000274564	9000274537	--	9000237964
3EB925F	BA.4I.60.BAS.X.FS	9000274564	9000274537	--	9000237966
3EB925L	BA.4I.60.BAS.X.FS	9000274564	9000274537	--	9000237966
3EB925M	BA.4I.60.BAS.X.FS	9000274564	9000274537	--	9000286371
3EB928L	BA.3I.90P.BAS.28S.X	9000275518	--	9000275521	9000237965
3EB929F	BA.4I.60.LCD.X.FS	9000274564	9000274537	--	LCD
3EB950L	BA.4I.80.BAS.28S.X	9000275526	9000275510	--	9000237964
3EB950M	BA.4I.80.BAS.28S.X	9000275526	9000275510	--	9000283861
3EB957F	BA.4I.80.BAS.28S.FS	9000275526	9000275510	--	9000237966
3EB990F	BA.5I.90.TOP.32T.FS	9000275524	9000275496	9000275520	9000261069
4ET800LT	LY.2I.60.SQ.X.X	9000274561	--	--	9000183912
4ET800XT	LY.2I.60.SQ.X.X	9000274561	--	--	9000183912
4ET813LT	LY.3I.60.SQ.28D.X	9000275523	9000275496	--	9000229599
4ET820LT	LY.4I.60.SQ.X.X	9000274564	9000274537	--	9000183912
CA420350	CN.2I.60.BAS.X.X	9000274561	--	--	9000250933
CA421350	CN.4I.60.BAS.X.X	9000274564	9000274537	--	9000250938
CA422350	CN.4I.60.BAS.BR.X	9000275525	9000274537	--	9000250938
CA428350	CN.4I.80.BAS.BW.X	9000275525	9000275513	--	9000250941
CI261102	GA.4I.60.TOP.BR.FS	9000275525	9000274537	--	9000227509

MODEL	DESCRIPTION	Left 1 ELIN	Right ELIN	Left 2 ELIN	TC
CI261112	GA.4I.60.TOP.BR.FS	9000275525	9000274537	--	9000227509
CI262102	GA.3I.60.TOP.28D.FS	9000275523	9000275496	--	9000216182
CI262112	GA.3I.60.TOP.28D.FS	9000275523	9000275496	--	9000216182
CI263112	GA.4I.60.TOP.BR.FS	9000275525	9000274537	--	9000195219
CI264112	GA.3I.60.TOP.28D.FS	9000275523	9000275496	--	9000196261
CI271112	GA.4I.70.TOP.BR.FS	9000275525	9000274537	--	9000227509
CI273112	GA.4I.70.TOP.BR.FS	9000275525	9000274537	--	9000195219
CI481102	GA.4I.80.TOP.28S.FS	9000275526	9000275510	--	9000216183
CI481112	GA.4I.80.TOP.28S.FS	9000275526	9000275510	--	9000216183
CI481612	GA.4I.80.TOP.28S.FS	9000275526	9000275510	--	9000216183
CI490112	GA.4I.90P.TOP.X.FS	9000275517	--	9000275521	9000227509
CI491102	GA.5I.90.TOP.28D.FS	9000275523	9000275496	9000275520	9000227510
CI491112	GA.5I.90.TOP.28D.FS	9000275523	9000275496	9000275520	9000227510
CI491602	GA.5I.90.TOP.28D.FS	9000275523	9000275496	9000275520	9000227510
CI491612	GA.5I.90.TOP.28D.FS	9000275523	9000275496	9000275520	9000227510
CIS365GB	TH.5I.90.BAS.32T.CS	9000275524	9000275496	9000275520	9000297517
CIT304GB	TH.4I.80.BAS.28S.X	9000275526	9000275510	--	9000242586
CIT304GM	TH.4I.80.BAS.28S.X	9000275526	9000275510	--	9000242586
CIT365GB	TH.5I.90.BAS.32T.X	9000275524	9000275496	9000275520	9000242588
CIT365GM	TH.5I.90.BAS.32T.X	9000275524	9000275496	9000275520	9000242588
EH375CE11E	SE.2I.30.KB.X.X	9000275514	--	--	9000303876
EH375ME11E	SE.2I.30.TOP.X.X	9000275514	--	--	9000248136
EH475ME11E	SE.1I.40.TOP.28D.X	9000275515	--	--	9000248159
EH575ML11E	SE.2I.60P.TOP.28S.X	9000275516	--	--	9000248136
EH601EB11	SE.4I.60.BAS.BR.X	9000275525	9000274537	--	9000250940
EH601MB11	SE.4I.60.TOP.BR.X	9000275525	9000274537	--	9000231127
EH601MD21E	SE.3I.60.TOP.32T.FS	9000275524	9000275509	--	9000231126
EH601ME21E	SE.4I.60.TOP.X.FS	9000274564	9000274537	--	9000231129
EH601TE11E	SE.4I.60.BAS.X.X	9000274564	9000274537	--	9000250938
EH601TK11E	SE.3I.60.BAS.28D.X	9000275523	9000275496	--	9000250937
EH645EB11	SE.4I.60.BAS.BR.X	9000275525	9000274537	--	9000250940
EH645EB11E	SE.4I.60.BAS.BR.X	9000275525	9000274537	--	9000250940
EH645EC11	SE.2I.60.BAS.X.X	9000274561	--	--	9000250933
EH645MB11M	SE.4I.60.TOP.BR.X	9000275525	9000274537	--	9000231127
EH645QE11E	SE.4I.60.SQ.X.X	9000274564	9000274537	--	9000183912
EH645RE11E	SE.4I.60.SQ.X.X	9000274564	9000274537	--	9000229602
EH645RL11E	SE.3I.60.SQ.28S.X	9000275522	9000274537	--	9000229601
EH645TE11E	SE.4I.60.BAS.X.X	9000274564	9000274537	--	9000250938
EH645TE11X	SE.4I.60.BAS.X.X	9000274564	9000274537	--	9000250938

MODEL	DESCRIPTION	Left 1 ELIN	Right ELIN	Left 2 ELIN	TC
EH651RE11E	SE.4I.60.SQ.X.X	9000274564	9000274537	--	9000229602
EH651RF11E	SE.2I.60.SQ.X.X	9000274561	--	--	9000229600
EH651RL11E	SE.3I.60.SQ.28S.X	9000275522	9000274537	--	9000229601
EH651TE11E	SE.4I.60.BAS.X.X	9000274564	9000274537	--	9000250938
EH651TF11E	SE.2I.60.BAS.X.X	9000274561	--	--	9000250934
EH651TK11E	SE.3I.60.BAS.28D.X	9000275523	9000275496	--	9000250937
EH675LD21E	SE.3I.60.LCD.32T.FS	9000275524	9000275509	--	LCD
EH675LE21E	SE.4I.60.LCD.X.FS	9000274564	9000274537	--	LCD
EH675LE31E	SE.4I.60.LCD.X.CS	9000274564	9000274537	--	LCD
EH675MB11E	SE.4I.60.TOP.BR.X	9000275525	9000274537	--	9000231127
EH675MD11E	SE.3I.60.TOP.32T.X	9000275524	9000275509	--	9000231125
EH675MD21E	SE.3I.60.TOP.32T.FS	9000275524	9000275509	--	9000231126
EH675ME11E	SE.4I.60.TOP.X.X	9000274564	9000274537	--	9000231127
EH675ME21E	SE.4I.60.TOP.X.FS	9000274564	9000274537	--	9000231129
EH675ME31E	SE.4I.60.TOP.X.CS	9000274564	9000274537	--	9000264650
EH675MF11E	SE.2I.60.TOP.X.X	9000274561	--	--	9000231124
EH675MK21E	SE.3I.60.TOP.28D.FS	9000275523	9000275496	--	9000231126
EH675TE11E	SE.4I.60.BAS.X.X	9000274564	9000274537	--	9000250938
EH675TK11E	SE.3I.60.BAS.28D.X	9000275523	9000275496	--	9000250937
EH679MD21	SE.3I.60.TOP.32T.FS	9000275524	9000275509	--	9000231126
EH685MB21E	SE.4I.60.PZ.BR.FS	9000275525	9000274537	--	9000242579
EH685MD21E	SE.3I.60.PZ.32T.FS	9000275524	9000275509	--	9000242580
EH685ME11E	SE.4I.60.PZ.X.X	9000274564	9000274537	--	9000260114
EH685ME21E	SE.4I.60.PZ.X.FS	9000274564	9000274537	--	9000242579
EH685MK11E	SE.3I.60.PZ.28D.X	9000275523	9000275496	--	9000259838
EH775LD21E	SE.3I.60.LCD.32T.FS	9000275524	9000275509	--	LCD
EH775ME21E	SE.4I.60.TOP.X.FS	9000274564	9000274537	--	9000231129
EH785ME21E	SE.4I.60.PZ.X.X	9000274564	9000274537	--	9000260114
EH801ME21E	SE.4I.80.TOP.WP.FS	9000274564	9000275513	--	9000231130
EH801SB11	SE.4I.80.TOP.BW.X	9000275525	9000275513	--	9000303899
EH801TB11	SE.4I.80.BAS.BW.X	9000275525	9000275513	--	9000250941
EH811TL11	SE.4I.80.BAS.28S.X	9000275526	9000275510	--	9000250938
EH811TL11E	SE.4I.80.BAS.28S.X	9000275526	9000275510	--	9000250938
EH845EB11	SE.4I.80.BAS.BW.X	9000275525	9000275513	--	9000250942
EH845EB11E	SE.4I.80.BAS.BW.X	9000275525	9000275513	--	9000250942
EH845TE11E	SE.4I.80.BAS.WP.X	9000274564	9000275513	--	9000250941
EH845TL11E	SE.4I.80.BAS.28S.X	9000275526	9000275510	--	9000250938
EH875LB21E	SE.4I.80.LCD.BW.FS	9000275525	9000275513	--	LCD
EH875LB31E	SE.4I.80.LCD.WP.CS	9000274564	9000275513	--	LCD
EH875LE21E	SE.4I.80.LCD.WP.FS	9000274564	9000275513	--	LCD
EH875LL21E	SE.4I.80.LCD.28S.FS	9000275526	9000275510	--	LCD
EH875ME21E	SE.4I.80.TOP.WP.FS	9000274564	9000275513	--	9000231130
EH875ML11E	SE.4I.80.TOP.28S.X	9000275526	9000275510	--	9000231127

MODEL	DESCRIPTION	Left 1 ELIN	Right ELIN	Left 2 ELIN	TC
EH875ML21E	SE.4I.80.TOP.28S.FS	9000275526	9000275510	--	9000231129
EH875SB11E	SE.4I.80.TOP.BW.X	9000275525	9000275513	--	9000303899
EH875TE11E	SE.4I.80.BAS.WP.X	9000274564	9000275513	--	9000250941
EH876ML11U	SE.4I.80.TOP.28S.X	9000275526	9000275510	--	9000231127
EH879ML11U	SE.4I.80.TOP.28S.X	9000275526	9000275510	--	9000231127
EH885MB11E	SE.4I.80.PZ.BW.X	9000275525	9000275513	--	9000260115
EH885MB21E	SE.4I.80.PZ.BW.FS	9000275525	9000275513	--	9000242558
EH901SK11	SE.5I.90.TOP.28D.X	9000275523	9000275496	9000275520	9000303878
EH975LD21E	SE.5I.90.LCD.32T.FS	9000275524	9000275496	9000275520	LCD
EH975LK31E	SE.5I.90.LCD.28D.CS	9000275523	9000275496	9000275520	LCD
EH975MD21E	SE.5I.90.TOP.32T.FS	9000275524	9000275496	9000275520	9000231131
EH975ME11E	SE.4I.90P.TOP.X.X	9000275517	--	9000275521	9000231127
EH975MK11E	SE.5I.90.TOP.28D.X	9000275523	9000275496	9000275520	9000231132
EH975MK21E	SE.5I.90.TOP.28D.FS	9000275523	9000275496	9000275520	9000231131
EH975ML11E	SE.3I.90P.TOP.28S.X	9000275518	--	9000275521	9000231125
EH975ML21E	SE.3I.90P.TOP.28S.FS	9000275518	--	9000275521	9000231126
EH975SK11E	SE.5I.90.TOP.28D.X	9000275523	9000275496	9000275520	9000303878
EH975YK11E	SE.5I.90.TOP.28D.X	9000275523	9000275496	9000275520	#N/A
EH976LD21U	SE.5I.90.LCD.32T.FS	9000275524	9000275496	9000275520	LCD
EH979MD11U	SE.5I.90.TOP.32T.X	9000275524	9000275496	9000275520	9000231132
EH985ME21E	SE.4I.90P.PZ.X.FS	9000275517	--	9000275521	9000242579
EH985MK21E	SE.5I.90.PZ.28D.FS	9000275523	9000275496	9000275520	#N/A
EI601TB11	SE.4I.60.POL.BR.X	9000275525	9000274537	--	9000270673
EI645EB11	SE.4I.60.POL.BR.X	9000275525	9000274537	--	9000270672
EI645EB11E	SE.4I.60.POL.BR.X	9000275525	9000274537	--	9000270672
EI645EB11M	SE.4I.60.POL.BR.X	9000275525	9000274537	--	9000270672
EI675TB11E	SE.4I.60.POL.BR.X	9000275525	9000274537	--	9000270673
EI875TB11E	SE.4I.80.POL.BW.X	9000275525	9000275513	--	9000270674
N44D30N0	NE.2I.30.BAS.X.X	9000275514	--	--	9000257251
N44K30N0	NE.2I.30.KB.X.X	9000275514	--	--	9000109346
N44K45N0	NE.1I.40.KB.28D.X	9000275515	--	--	9000303875
NIB601T14E	BO.4I.60.POL.BR.X	9000275525	9000274537	--	9000270673
NIB645E14E	BO.4I.60.POL.BR.X	9000275525	9000274537	--	9000270672
NIB672T14E	BO.4I.60.POL.BR.X	9000275525	9000274537	--	#N/A
NIB675T14E	BO.4I.60.POL.BR.X	9000275525	9000274537	--	9000270673
NIB679T14E	BO.4I.60.POL.BR.X	9000275525	9000274537	--	9000270673
NIB801T14E	BO.4I.80.POL.BW.X	9000275525	9000275513	--	9000270674
NIB872T14E	BO.4I.80.POL.BW.X	9000275525	9000275513	--	#N/A
NIB875T14E	BO.4I.80.POL.BW.X	9000275525	9000275513	--	9000270674
NIC645E14E	BO.2I.60.POL.X.X	9000274561	--	--	9000270670
NIT5065UC	BO.4I.80.TOP.28S.X	9000275526	9000275510	--	9000236088
NIT5665UC	BO.5I.90.TOP.28D.X	9000275523	9000275496	9000275520	9000236094
NIT8065UC	BO.4I.80.PZ.28S.FS	9000275526	9000275510	--	9000242582

MODEL	DESCRIPTION	Left 1 ELIN	Right ELIN	Left 2 ELIN	TC
NIT8665UC	BO.5I.90.PZ.28D.FS	9000275523	9000275496	9000275520	9000296949
PIB601N24E	BO.4I.60.TOP.BR.FS	9000275525	9000274537	--	9000236089
PIB675L24E	BO.4I.60.LCD.BR.FS	9000275525	9000274537	--	LCD
PIB675L34E	BO.4I.60.LCD.BR.CS	9000275525	9000274537	--	LCD
PIB675M24E	BO.4I.60.TOP.BR.FS	9000275525	9000274537	--	9000249294
PIB675N24E	BO.4I.60.TOP.BR.FS	9000275525	9000274537	--	9000236089
PIB675T14E	BO.4I.60.BAS.BR.X	9000275525	9000274537	--	9000250938
PIB685N24E	BO.4I.60.PZ.BR.FS	9000275525	9000274537	--	9000242582
PIB801N24E	BO.4I.80.TOP.BW.FS	9000275525	9000275513	--	9000236090
PIB875L24E	BO.4I.80.LCD.BW.FS	9000275525	9000275513	--	LCD
PIB875L34E	BO.4I.80.LCD.BW.CS	9000275525	9000275513	--	LCD
PIB875N24E	BO.4I.80.TOP.BW.FS	9000275525	9000275513	--	9000236090
PIB875T14E	BO.4I.80.BAS.BW.X	9000275525	9000275513	--	9000250941
PIB885N24E	BO.4I.80.PZ.BW.FS	9000275525	9000275513	--	9000242581
PIC645E14E	BO.2I.60.BAS.X.X	9000274561	--	--	9000250933
PID675N14E	BO.3I.60.TOP.32T.X	9000275524	9000275509	--	9000236086
PID675N24E	BO.3I.60.TOP.32T.FS	9000275524	9000275509	--	9000236087
PID685N24E	BO.3I.60.PZ.32T.FS	9000275524	9000275509	--	9000242583
PID775L24E	BO.3I.60.LCD.32T.FS	9000275524	9000275509	--	LCD
PID975L24E	BO.5I.90.LCD.32T.FS	9000275524	9000275496	9000275520	LCD
PID975N24E	BO.5I.90.TOP.32T.FS	9000275524	9000275496	9000275520	9000236091
PIE375C14E	BO.2I.30.KB.X.X	9000275514	--	--	9000303876
PIE375N14E	BO.2I.30.TOP.X.X	9000275514	--	--	9000248170
PIE601N24E	BO.4I.60.TOP.X.FS	9000274564	9000274537	--	9000236089
PIE611T14E	BO.4I.60.BAS.X.X	9000274564	9000274537	--	9000250940
PIE645Q14E	BO.4I.60.SQ.X.X	9000274564	9000274537	--	9000183912
PIE645R14E	BO.4I.60.SQ.X.X	9000274564	9000274537	--	9000229602
PIE645T14E	BO.4I.60.BAS.X.X	9000274564	9000274537	--	9000250938
PIE651R14E	BO.4I.60.SQ.X.X	9000274564	9000274537	--	9000229602
PIE651T14E	BO.4I.60.BAS.X.X	9000274564	9000274537	--	9000250938
PIE675L24E	BO.4I.60.LCD.X.FS	9000274564	9000274537	--	LCD
PIE675N14E	BO.4I.60.TOP.X.X	9000274564	9000274537	--	9000236088
PIE675N24E	BO.4I.60.TOP.X.FS	9000274564	9000274537	--	9000236089
PIE685N24E	BO.4I.60.PZ.X.FS	9000274564	9000274537	--	9000242582
PIE775N14E	BO.4I.60.TOP.X.X	9000274564	9000274537	--	9000236088
PIE801N24E	BO.4I.80.TOP.WP.FS	9000274564	9000275513	--	9000236090
PIE845T14E	BO.4I.80.BAS.WP.X	9000274564	9000275513	--	9000250941
PIE875N24E	BO.4I.80.TOP.WP.FS	9000274564	9000275513	--	9000236090
PIE875T14E	BO.4I.80.BAS.WP.X	9000274564	9000275513	--	9000250941
PIE975N14E	BO.4I.90P.TOP.X.X	9000275517	--	9000275521	9000236088
PIF645R14E	BO.2I.60.SQ.X.X	9000274561	--	--	9000229600
PIF645T14E	BO.2I.60.BAS.X.X	9000274561	--	--	9000250934
PIF651R14E	BO.2I.60.SQ.X.X	9000274561	--	--	9000229600

MODEL	DESCRIPTION	Left 1 ELIN	Right ELIN	Left 2 ELIN	TC
PIF651T14E	BO.2I.60.BAS.X.X	9000274561	--	--	9000250934
PIK601N24E	BO.3I.60.TOP.28D.FS	9000275523	9000275496	--	9000236087
PIK651T14E	BO.3I.60.BAS.28D.X	9000275523	9000275496	--	9000250937
PIK675N24E	BO.3I.60.TOP.28D.FS	9000275523	9000275496	--	9000236087
PIK675T14E	BO.3I.60.BAS.28D.X	9000275523	9000275496	--	9000250937
PIK975N24E	BO.5I.90.TOP.28D.FS	9000275523	9000275496	9000275520	9000236091
PIL575N14E	BO.2I.60P.TOP.28S.X	9000275516	--	--	9000248170
PIL645R14E	BO.3I.60.SQ.28S.X	9000275522	9000274537	--	9000229601
PIL651R14E	BO.3I.60.SQ.28S.X	9000275522	9000274537	--	9000229601
PIL811T14E	BO.4I.80.BAS.28S.X	9000275526	9000275510	--	9000250940
PIL845T14E	BO.4I.80.BAS.28S.X	9000275526	9000275510	--	9000250938
PIL875L24E	BO.4I.80.LCD.28S.FS	9000275526	9000275510	--	LCD
PIL875N14E	BO.4I.80.TOP.28S.X	9000275526	9000275510	--	9000236088
PIL875N24E	BO.4I.80.TOP.28S.FS	9000275526	9000275510	--	9000236089
PIL975L34E	BO.5I.90.LCD.28D.CS	9000275523	9000275496	9000275520	LCD
PIL975N14E	BO.3I.90P.TOP.28S.X	9000275518	--	9000275521	9000236086
T42D20X0	NE.4I.60.BAS.X.X	9000274564	9000274537	--	9000231118
T42D30X0	NE.3I.60.BAS.28D.X	9000275523	9000275496	--	9000231116
T42D85X0	NE.4I.80.BAS.28S.X	9000275526	9000275510	--	9000231118
T42P90X0	NE.3I.90P.BAS.28S.X	9000275518	--	9000275521	9000231116
T43D10N0	NE.3I.60.BAS.28S.X	9000275522	9000274537	--	9000231116
T43D20N0	NE.4I.60.BAS.X.X	9000274564	9000274537	--	9000231119
T43D20S0	NE.4I.60.BAS.X.X	9000274564	9000274537	--	9000231119
T43D40N0	NE.4I.60.BAS.BR.X	9000275525	9000274537	--	9000231119
T43D80N0	NE.4I.80.BAS.BW.X	9000275525	9000275513	--	9000231121
T43P90N0	NE.4I.90P.BAS.X.X	9000275517	--	9000275521	9000231119
T43R10N0	NE.2I.60.BAS.X.X	9000274561	--	--	9000231115
T43R20N0	NE.2I.60.BAS.X.X	9000274561	--	--	9000231115
T43T20N0	NE.4I.60.TOP.X.X	9000274564	9000274537	--	9000231057
T43T40N0	NE.4I.60.TOP.BR.X	9000275525	9000274537	--	9000231057
T43T80N0	NE.4I.80.TOP.BW.X	9000275525	9000275513	--	9000231110
T43T85N0	NE.4I.80.TOP.28S.X	9000275526	9000275510	--	9000231057
T44C80N0	NE.4I.80.LCD.BW.FS	9000275525	9000275513	--	LCD
T44C90N0	NE.5I.90.LCD.28D.FS	9000275523	9000275496	9000275520	LCD
T44D20N0	NE.4I.60.BAS.X.X	9000274564	9000274537	--	9000231119
T44D30N0	NE.3I.60.BAS.28D.X	9000275523	9000275496	--	9000231116
T44D35N0	NE.3I.60.BAS.32T.FS	9000275524	9000275509	--	9000231117
T44D85N0	NE.4I.80.BAS.28S.X	9000275526	9000275510	--	9000231119
T44M40N0	NE.4I.60.PZ.BR.X	9000275525	9000274537	--	9000242584
T44M80N0	NE.4I.80.PZ.BW.X	9000275525	9000275513	--	9000242585
T44T30N0	NE.3I.60.TOP.28D.X	9000275523	9000275496	--	9000264435
EI675ZK11E	SE.3I.60.POL.28D.X	9000275523	9000275496	--	#N/A
T44T40N0	NE.4I.60.TOP.BR.X	9000275525	9000274537	--	9000231057

MODEL	DESCRIPTION	Left 1 ELIN	Right ELIN	Left 2 ELIN	TC
T44T70N0	NE.4I.60.TOP.BR.X	9000275525	9000274537	--	9000231057
T44T80N0	NE.4I.80.TOP.BW.X	9000275525	9000275513	--	9000231110
T44T90N0	NE.5I.90.TOP.28D.X	9000275523	9000275496	9000275520	9000231113
T45C80X0	NE.4I.80.LCD.BW.FS	9000275525	9000275513	--	LCD
T45D40X0	NE.4I.60.BAS.BR.X	9000275525	9000274537	--	9000231119
T45D80X0	NE.4I.80.BAS.BW.X	9000275525	9000275513	--	9000231121
T45P90X0	NE.4I.90P.BAS.X.X	9000275517	--	9000275521	9000231119
T45T40X0	NE.4I.60.TOP.BR.X	9000275525	9000274537	--	9000231057
T45T80X0	NE.4I.80.TOP.BW.X	9000275525	9000275513	--	9000231110
T45T90X0	NE.5I.90.TOP.28D.X	9000275523	9000275496	9000275520	9000231113
T83I40N0MC	NE.4I.60.TOP.BR.FS	9000275525	9000274537	--	9000231058
T83I80N0MC	NE.4I.80.TOP.BW.FS	9000275525	9000275513	--	9000231111
NIK675Z14E	BO.3I.60.POL.28D.X	9000275523	9000275496	--	#N/A
NIB645E14M	BO.4I.60.POL.BR.X	9000275525	9000274537	--	9000270672
CA423350	CN.3I.60.BAS.28S.X	9000275522	9000274537	--	9000250937
PIB645M24M	BO.4I.60.TOP.BR.FS	9000275525	9000274537	--	#N/A
EH679ME21	SE.4I.60.TOP.X.FS	9000274564	9000274537	--	#N/A

MODEL	DESCRIPTION	Left 1 ELIN	Right ELIN	Left 2 ELIN	TC
EH679ME11	SE.4I.60.TOP.X.X	9000274564	9000274537	--	#N/A
EH679MB11	SE.4I.60.TOP.BR.X	9000275525	9000274537	--	9000231127
PIE679T14E	BO.4I.60.BAS.X.X	9000274564	9000274537	--	9000250938
PIB679T14E	BO.4I.60.BAS.BR.X	9000275525	9000274537	--	9000250938
EH651RF11E	SE.2I.60.SQ.X.X	9000274561	--	--	9000229600
EH879SB11	SE.4I.80.TOP.BW.X	9000275525	9000275513	--	9000303899
EH679MK11	SE.3I.60.TOP.28D.X	9000275523	9000275496	--	9000231125
EI645EC11	SE.2I.60.POL.X.X	9000274561	--	--	9000270670
PIL879T14E	BO.4I.80.BAS.28S.FS	9000275526	9000275510	--	9000250938
EH679MK21	SE.3I.60.TOP.28D.FS	9000275523	9000275496	--	9000231126
EH879ME21	SE.4I.80.TOP.WP.FS	9000274564	9000275513	--	9000231130
PIK679T14E	BO.3I.60.BAS.28D.FS	9000275523	9000275496	--	9000250937
EH879ML11	SE.4I.80.TOP.28S.X	9000275526	9000275510	--	9000231127
T44T40M0	NE.4I.60.TOP.BR.X	9000275525	9000274537	--	9000242584
T44T80M0	NE.4I.80.TOP.BW.X	9000275525	9000275513	--	9000242585
CI273612	GA.4I.70.TOP.BR.FS	9000275525	9000274537	--	9000227509
CI490612	GA.4I.90P.TOP.X.FS	9000275517	--	9000275521	9000227509

5.18 Checking SQ YL-196 TouchControl operation

5.18.1 Problem

The new SQ (YL196) has two rows of sensors and, depending on the physiognomy of the finger and the inclination/manner in which the sensors are pressed, certain mistakes can be made. For example, when a user tries to press the hotplate SELECT button, the MINUS button is also accidentally “pressed” (or detected).

If this happens, the TouchControl does nothing because 2 buttons have been pressed at the same time. The user may think that it is not working.



5.18.2 Cause

- The manner in which the buttons are pressed and/or the physiognomy of the user's finger.

5.18.3 Solution

In these cases, the TouchControl should not be replaced but rather the user should be informed/shown how to press the SELECT and TIMER so that only the desired button is pressed, arching the finger if necessary (the TouchControl SQ operates with infrared sensors and contact may be detected even though no contact was made).

5.19 Checking the “foam”

These seals should always be carried in the technician’s tool bag.

5.19.1 What is the Foam?

It is a watertight silicon seal. It is applied robotically and improves flatness of the hobs.

before

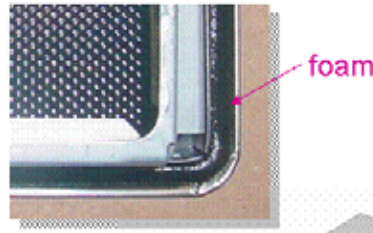
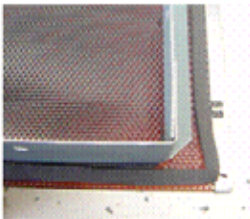

5.19.1.1 Problem

It is very sensitive to movement and adjustments.

5.19.1.2 Procedure to be followed after repairs

The quality of the foam should always be checked after performing repairs.

If it appears damaged or degraded, the foam should be removed using a knife and a conventional watertight seal be installed on the edge of the recess of the hob in order for it not to be seen extruding beyond the glass. In order to choose the spare part, we must look for it in qfinder in the position 0199.



Warning!

5.20 Checking perfect built-in accessory joint

5.20.1 Installation method

5.20.1.1 Select a combination from the installation manual

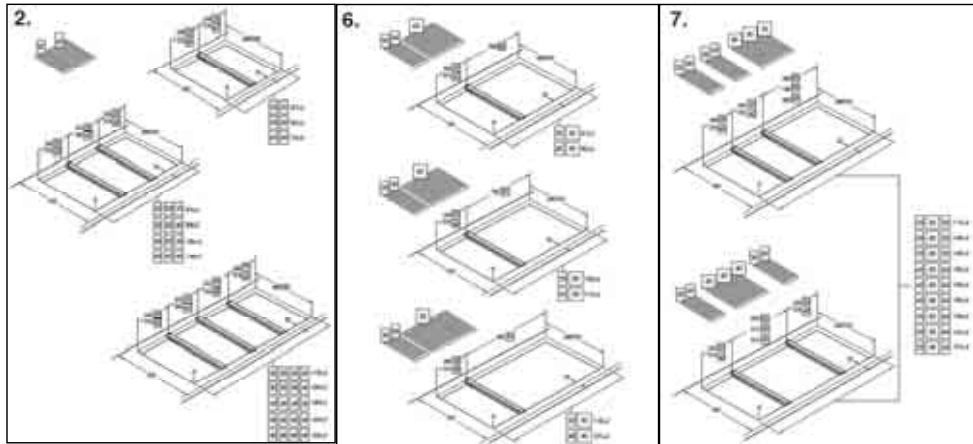

For example:

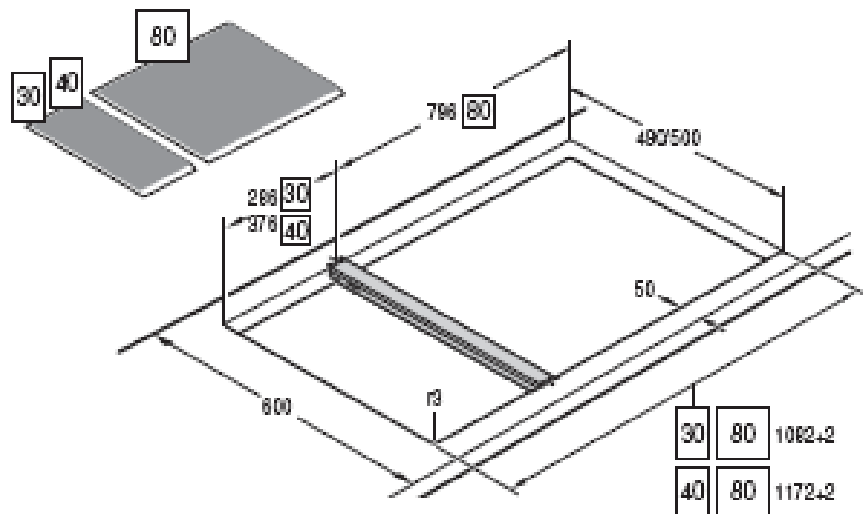

5.20.1.2 Prepare the kitchen furniture item

The possibility of having to make adjustments to the interior walls of the kitchen furniture item must be taken into consideration.

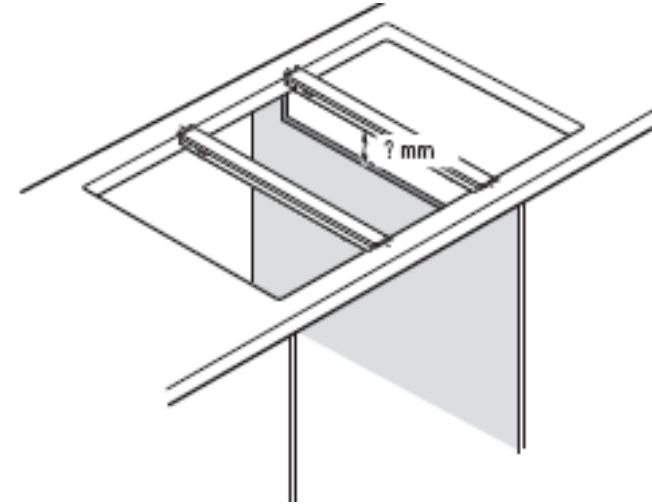

5.20.1.3 Select the necessary adapter

If it is required to combine a domino with a 60 or 80 cm cooker, the suitable adapter must be selected.

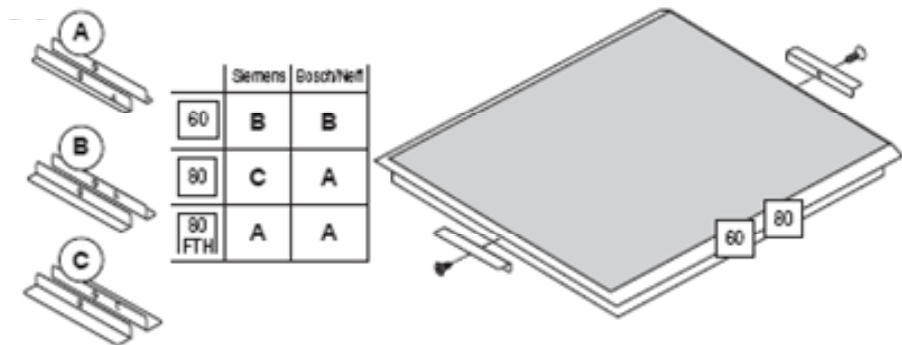

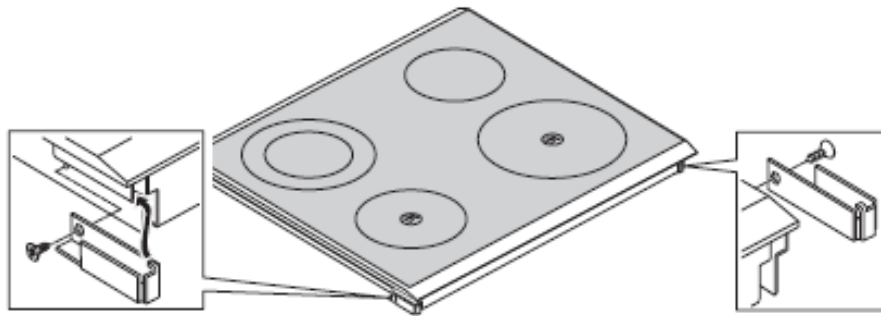

5.20.1.4 Prepare the recess

Take measurements for attaching the support. In the case of wooden hobs, the support is attached using screws and, in the case of marble or granite worktop, it is attached using adhesives.

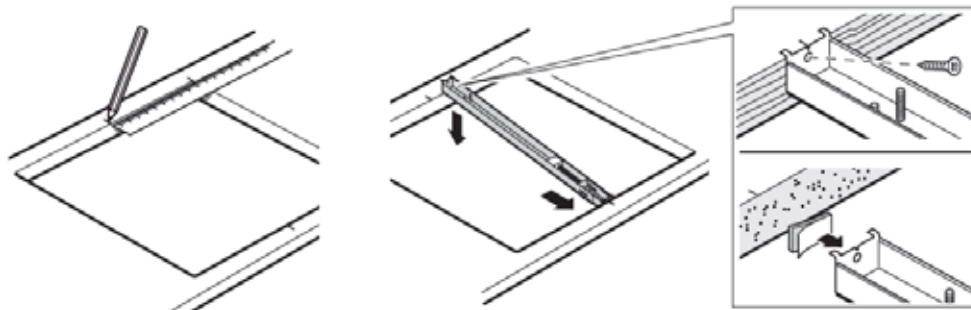

5.20.1.5 Install the upper cover on the support

Adjust the upper cover of the support and protect metal parts with adhesives.
Clean the work area.

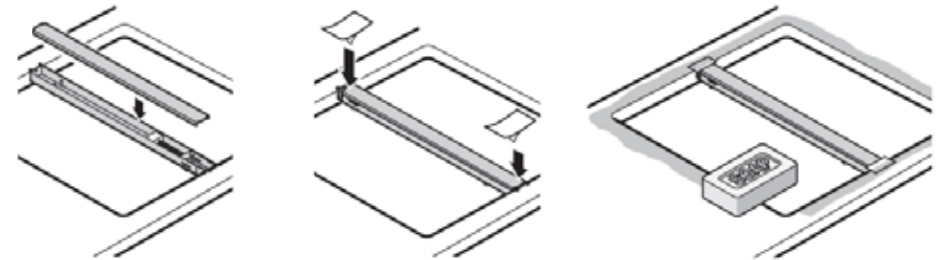

5.20.1.6 Assembly the cooker and fix it in place

Cookers are fixed in place using metal supports.

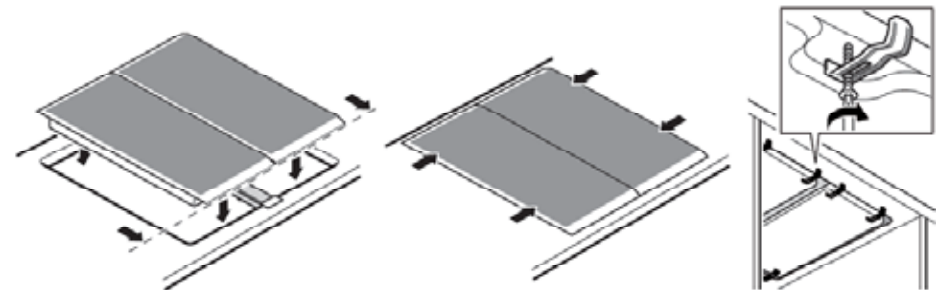

5.20.1.7 Adjust the height of the cookers

In order to provide perfect height adjustments, screws can be found on the lower part of the joint accessory for raising and lowering each part individually.

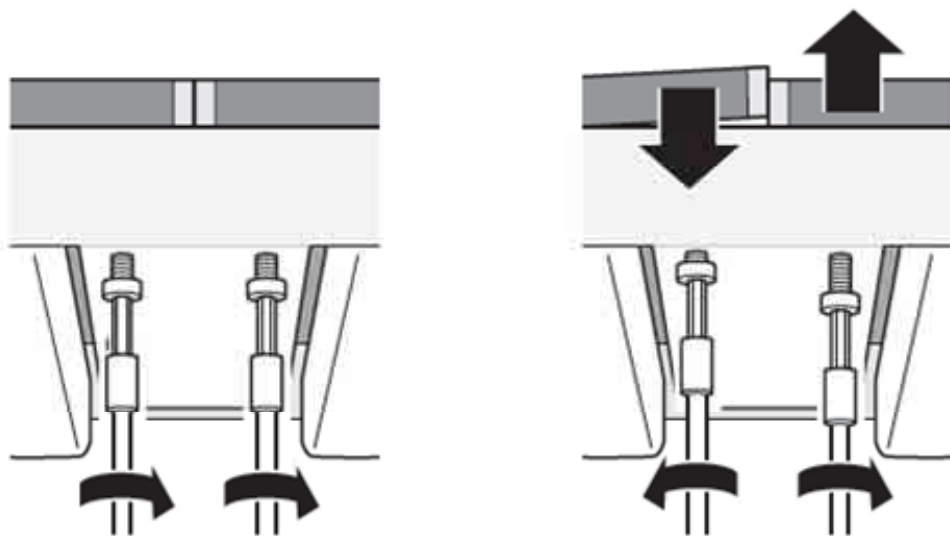

5.21 Checking necessary ventilation: 60/70 cm

5.21.1 Installation method

5.21.1.1 60/70 cm installation with basic frame

- The recess measurements are: 560 x 490 mm. The necessary ventilation space must be taken into consideration. See diagrams.
- Installation in a 20 mm thick worktop is possible.
- If the cooker is installed above an oven, maintain the recommended measurements for the rear. In these cases, the worktop must have a minimum thickness of 30 mm.

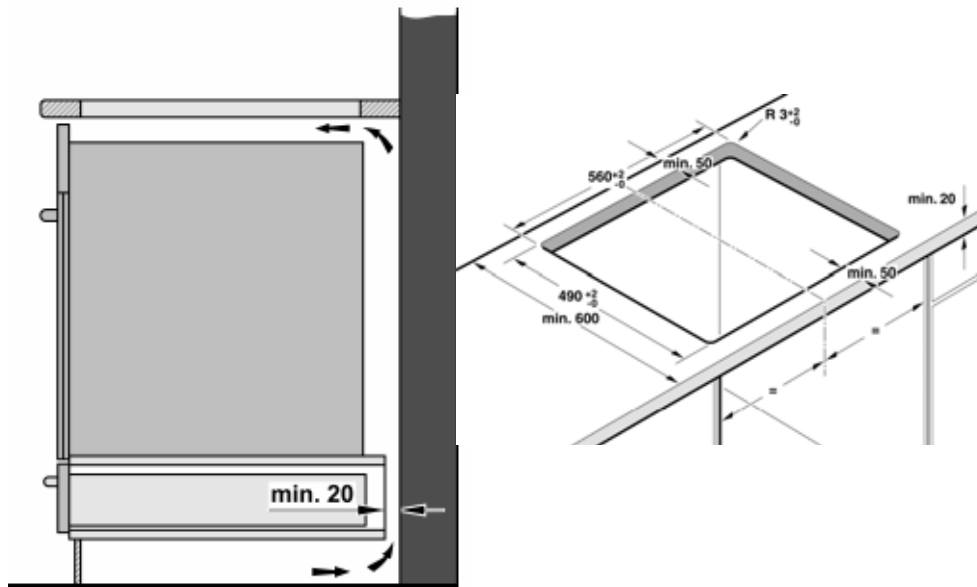

- If the cooker is installed above a drawer, the minimum ventilation measurements for the rear must be considered and a distance of 65mm between the upper part of the cooker and the upper part of the drawer must be maintained.

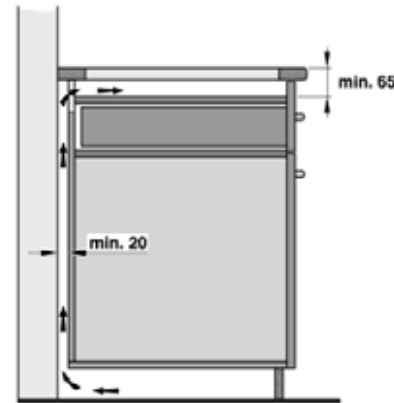

If the objects contained in the drawer heat up, the following option may be offered to the client provided that the 65mm gap has been maintained: a wooden panel can be installed (A: 4I and 3I; B: 2I) or order an accessory from the technical service with code **680502**.

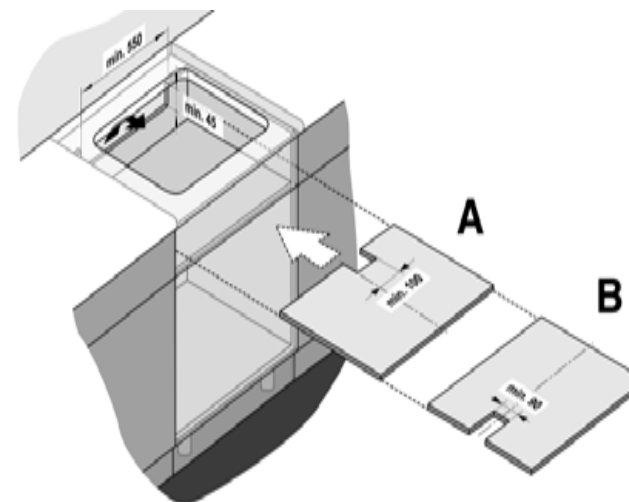

5.21.1.2 60/70 cm installation with top frame

The only difference from the previous method is the size of the recess hole.

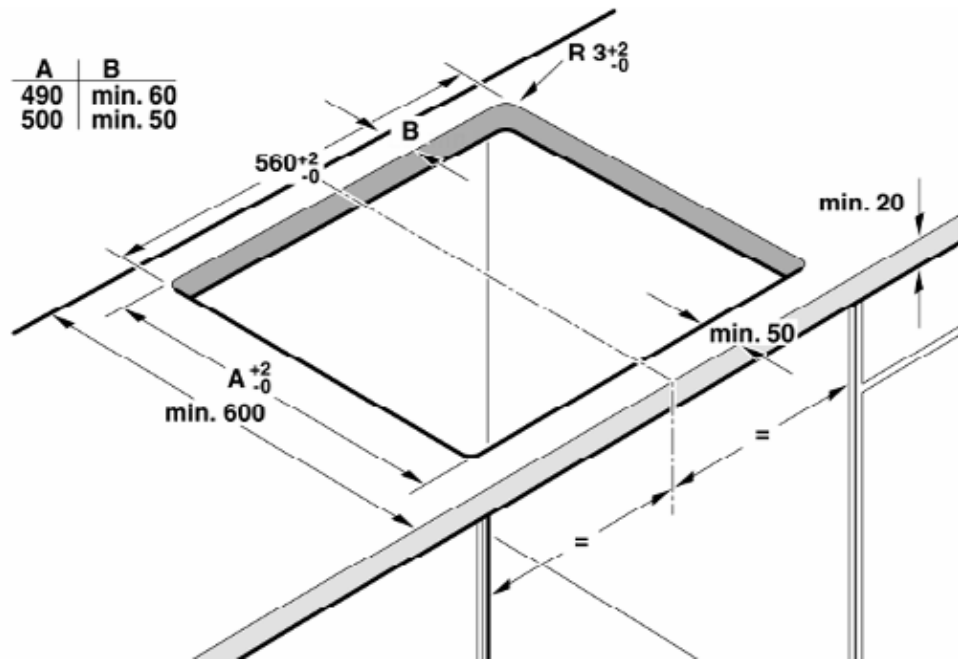

5.22 Installation of flat recess in timber using accessory

5.22.1 Components

The accessory consists of two parts, the recess model and the flat frame. It is only available for 60cm and 80cm cookers and 2 accessories must be ordered so as to have a complete accessory.

60 cm flat frame	60 cm recess model	80cm flat frame	80cm recess model
HZ395600	HZ395601	HZ395800	HZ395801
HEZ395600	HEZ395601	HEZ395800	HEZ395801

5.22.2 Installation method

5.22.2.1 Attachment of recess template to the worktop

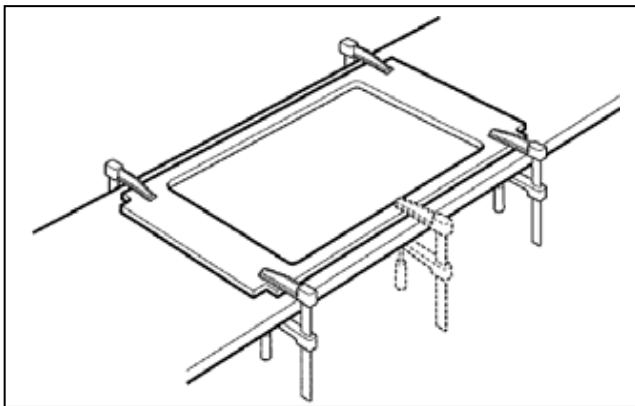

5.22.2.2 Prepare the recess hole, bearing in mind the measurements in the installation manual

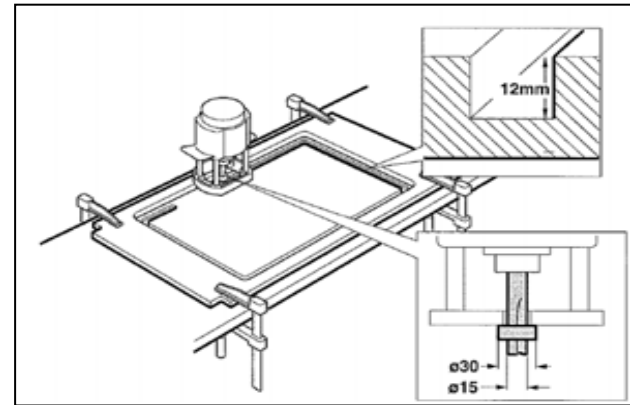

5.22.2.3 Saw the hole in the worktop around the line prepared using the recess template

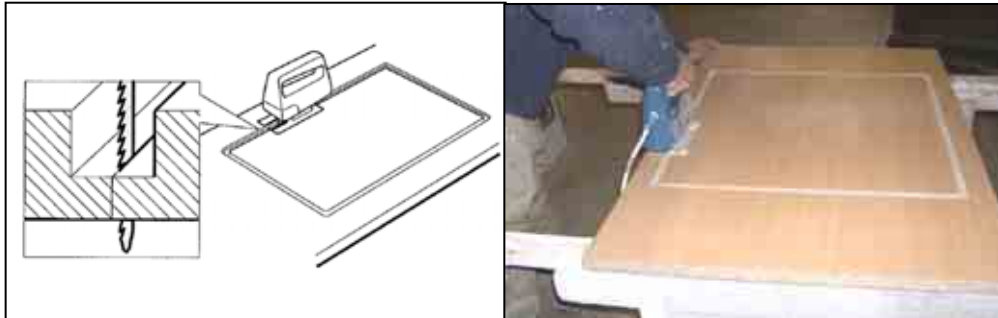

5.22.2.5 Attach the frame first and the cooker second

5.22.2.4 Stick the frame using silicone

Silicone must be used on the worktop and on the frame.

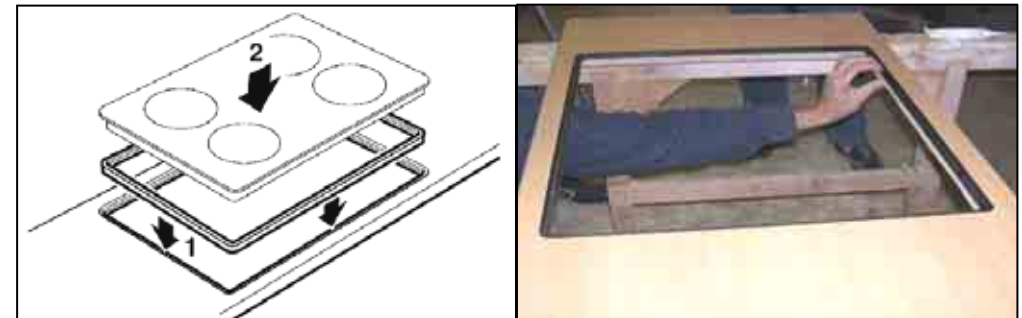
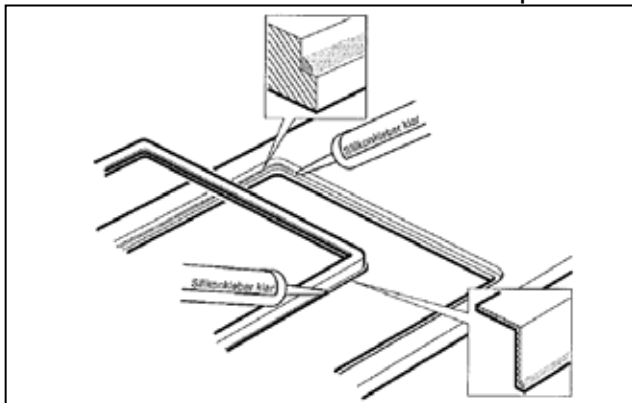

5.22.2.6 Wait one hour

After one hour, the gap between the worktop and the frame must be filled with silicone.

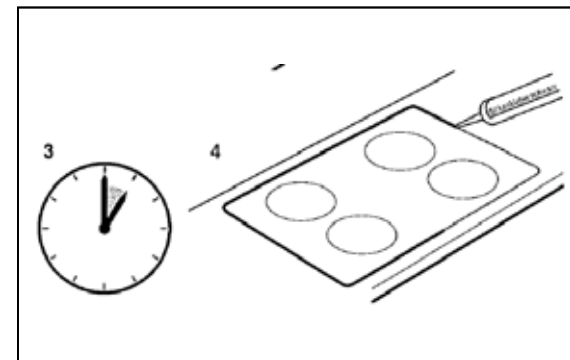

5.23 Assembly and disassembly: 2i

5.23.1 Disassembly of the apparatus:

- ▶ Remove the cooker plate carefully so as not to damage the installation pivots.
- ▶ Place the plate on top of the cooker with the glass face up, taking care not to damage it.

To access the radiating heater elements:

- ▶ Disassemble the vitro cover (sheet metal) by removing the screws



In this way, the TC can be replaced, for example.

To access the electronic components:

- Remove the screws from the 2i electronic support and the TouchControl support.
- Turn the 2i electronic assembly over.



To access the ELIN plate, relays plate or the fan:

- Disconnect the TouchControl and remove the support.
- Disconnect the inductor (4 power connection screws, two NTC connectors and an earth terminal)

5.23.2 Assembly of the apparatus:

- ▶ Follow the above steps in reverse.
- ▶ Install the plate in the cooker carefully so as not to damage the installation pivots.



Warning!

Power connection to the inductors is made using an eye terminal and a metric thread screw. Turn the screw until the terminal can no longer be turned by hand. Should the screw be tightened too far, the electronic inductor plate may be rendered inoperational.

5.23.3 Assembly of the relay plate control cable



Warning!

It must be installed in the area near to the IGBT's.

1.1.4 Replacement of the glass



Warning!

All 2-inductor models have rivets on the front.

This means that the glass-frame assembly on the interior frame can not be disassembled. Therefore, if it is necessary to replace the glass or any of the frames, the rivet must be removed with a rivet remover tool.

This is the case due to certain technical problems.

5.24 Check of residual heat indication

Spare part number 341176

Spare part number 340961

We have two levels which indicate residual heat:

“h” for lower temperatures or operating times

“H” for higher temperatures or longer operating times.



Warning!

Avoid touching the cooking zone showing this indication.

5.24.1 Induction zones

The h/H remain lit while they are above certain temperature values.

The temperature is measured by the NTC of the inductor and it is the ELIN which transfers the value to the touch Control.

The residual heat indication doesn't appear while the zone is giving power. It only appears when the zone is not working or when there is no pan above.

The indication is programmed to appear in the cooling curve after a heating upper 100 °C.

It can be measured above the glass ceran with a temperature sensor for surfaces with the following spare part number.



For the previous project IH4-I:
Two levels of residual heat indication

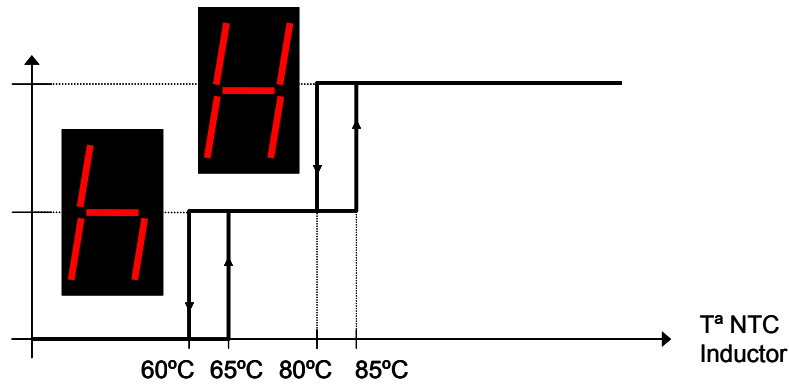

„h „ is shown when the temp. Of the NTC of the inductor is higher than 65 °C and lower than 80 °C. and disappears when the temp is lower than 60 °C.
“H” is shown when the temp. of the NTC of the inductor is higher than 85 °C and disappears when the temp is lower than 80°C.

For the new project IH5-I:
Two levels of residual heat indication

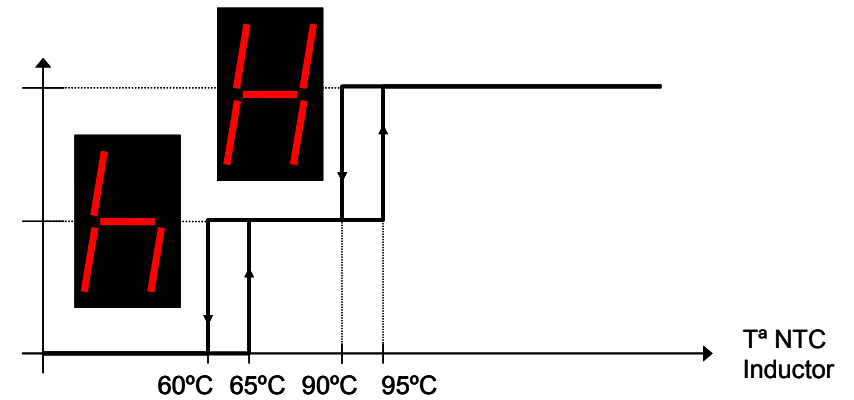

„h „ is shown when the temp. of the NTC of the inductor is higher than 65 °C and lower than 90 °C. and it disappears when the temp is lower than 60 °C.
“H” is shown when the temp. of the NTC of the inductor is higher than 95 °C and disappears when the temp. is lower than 90°C.

5.24.2 Radiant heaters of mixed devices

The h/H stay lit while they are above certain values of times, depending on the power selected.

The time counter is found in the ELIN, which transfers the corresponding residual heat indication value to the touch Control .

To provide an example, a graph is shown here, valid only for maximum powers.

If, for example, we switch on any burner at maximum level, in approximately 8 seconds, the small letter appears.

When it rises above 128°C = 2 MINUTES (straight pink line) the capital H appears

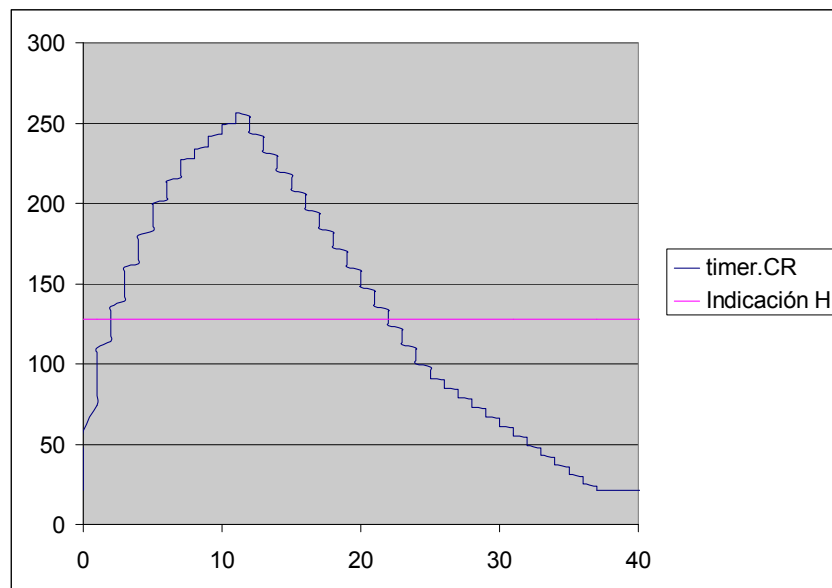

T^a °C - axis of the Y

Time in minutes – axis of the X

On average, it takes about 11 minutes to reach 250 °C.

5.24.3 False indication of residual heat

In the factory, some device operation tests are carried out and at times they forget to return to the factory values.

Then, when the device is connected, the small “h” appears in the touch Control without having switched on any zone. .

The small “h” remains static for 37 minutes until disappearing and then the operation returns to normal.

It can also be deleted entering the technical service programme and accessing step 2. See technical service programme and how to access according to the corresponding model.