



THE BIG ORANGE BOOK

your complete
Leisure Accessory
Wholesaler

www.groveproducts.co.uk



Grove Products Ltd
Broadway, Hyde
Cheshire, SK14 4QF

Tel: 0161 367 7070
Fax: 0161 367 7303

Email: sales@groveproducts.co.uk
Web: www.groveproducts.co.uk

Welcome to the latest Grove catalogue. Inside you will again find many new products and product ranges.

We trust that the information in this catalogue is as current as possible, including more sizes and specifications for your convenience. All steps have been taken to ensure that the information is as complete as possible, but your comments are always very welcome.

Our on-line facility is becoming more popular for obtaining new product information and special offers. Setting up an account only takes minutes and allows you to check stock availability and prices at any time. If you are not already using this facility please speak to your sales contact for more information.

Thank you for your
continued support!

The Grove team

CONTENTS

Chassis & Towing	Section A
Security	Section B
Electrical	Section C
Satellite & TV	Section D
Waste & Water	Section E
Sanitation	Section F
Gas & Safety	Section G
Cooking & Heating	Section J
Refrigeration	Section K
Tableware & Outdoor Dining	Section L
Housewares	Section M
Caravan cleaning	Section N
Rooflights & Ventilators	Section P
Workshop	Section Q
Steps & legs	Section R
Automotive & Motorhome	Section S
Camping, Tent & Awning	Section T
Books & Toys	Section U
Furniture	Section V

Large enough to cope
Small enough to care

13 pin electrics	A8
7 pin electrics	A8, A9
7-shot cleaners	N3

A

Adapters 12v	C1, C2
Adhesives	Q2, Q3
Adapt-its	C2
Aerials FM & TV	D8
Aerial masts	D5
A-frame covers	A4
Air beds & pumps	T9
Air conditioning units	P4, P5
Airers	M6
Alan rogers	U1
Alarms, security	B6
Alarms, safety	G6
Alcosense	G5
Al-Ko Secure	B2, B3
Al-Ko Stabilisers	A6
Alloy wheels	A1
Aprons	M7
Aqua Kem / rinse	F1
Aquarolls and accessories	E1, E2
Assorment boxes	Q5
Automatic satellite systems	D1 - D3
Awning accessories	T5 - T7, T10, T11
Awning bags	T5
Awning cleaners and reproofers	T1
Awning companion	T3
Awning curtains	T5
Awnings Dometic	S12
Awnings Fiamma	S4, S6, S9, S10
Awning lamps	C19, C21, C22
Awning rail	Q15, T4
Awning rail care	T4
Awning spares Eurovent / Trio	T4 - T10, T11
Awning tie down kits	S5, S8, T3, T4
Axle stands	A2

B

Barbecues	L6 - L8
Barrel locks	B5
Basins	E16 - E17
Batteries, 12v	C14
Batteries, dry cell	C12
Battery chargers	C9 - C12
Battery lights & torches	C23 - C26
Beam converters	A11
Berker sockets	C2

Bike covers	S2
Bike racks	S1, S2
Bins	M5, M7
Black streak remover	N1-N3
B-line	M5
Bolts, High tensile	A3, A9
Books	U1, U2
Bottle holders	M7
Bowls, Sinks	M5
Bowls, melamine	L1 - L3
Bowls, sinks	E16, E17, J3
Brake cleaner	Q1
Breakaway cables	A3
Bulbs	C5, C20, Q6
Bumper protection	A9

C

Cabinet heaters	J8
Cable keepers	C8
Cable ties	Q7, Q9
Cables	C8
Cables, coiled	A8, A9
Cadac barbecues	L6, L7
Camos satellite	D3
Camping toasters	T7
Candles	L3, N5
Caravan cleaners	N1 - N3, Q3
Caravan covers	A16
Caravan movers	A15
Caravan weight control	A11
Carbon monoxide alarms	G6
Carpet protector	N6
Cartridge gun	Q1
Cassette toilets	F5
Catches	Q11 - Q13
Cavagna regulators	G2
CBE	C4, C9, C10, C11
Chairs	V1 - V2
Chargers	C9, C10, C11
Chemical toilets	F4, F5
Chocks	A4
Citronella candles	L3
Clipsal plugs & sockets	C3
Cloths	N4
Cluster lamps	A12
Coat hangers	M6
Coffee makers	M9
Coil spring assisters	A11

Combicool RC range	K4
Combination lamps	A11
Combination units	J2
Comficarpet matting	T7
Compressors	A2
Cookers	J1, J2, L6, L7
Cool boxes	K4, K5
Copper tube	G3
Cord wheel	C8
Corner bowls	E16
Corner steady braces	A3
Corner steady nuts	A3
Coupling heads	A3
Crank up satellite systems	D3
Crystal Mk 2	E4, E5
C-Tek	C12
Cup and plate racks	M5, M7
Cupboard catches	Q11 - Q13
Cupboard stays	Q11, Q12
Curtain track & fittings	Q15
Curtains, awning	T5
Cutlery	M1
Cutlery trays	M5, M7
Cycle carriers	S1, S2

D

Digits	A14
DIN plugs and sockets	C1, C2, C4, C7
Dish & treat	M5
Distribution panels	C9 - C11
Dog leashes	T12
Dometic air conditioning	P4, P5
Dometic awnings	S12
Dometic refrigerators	K2, K3
Door locks	B5
Door mats	N5
Door retainers	Q11, Q12
Doors, service	F6
Downlighters, 12v	C19 - C21
Drain down system, Floe	E9
Drainers	M5
Drill bits	Q7
Drinkware	L4
Drop plates	A3
Dry-bag	M10
Drying racks	M5, M6
Dukdalf furniture	V1
Dust pan	M7

E

EFOY	C17
Electrical terminals	C6, Q6
Elixir rooflight	P1
Elsan toilet chemicals	F2
Eurovent spares	T11
Event shelter	T8
Extension leads, 12v	C1, C2
Extension leads, 230v	C8
Extract and light	P6
Extractor fans	J3, J6, P6
Eyelets	Q10, T2, T6

F

Fabsil	T1
Farecla	Q4
Fenwicks	
- Awning range	T1
- Cleaning range	N1, Q3
- Toilet chemicals	F3
Fiamma	
- Awning lights	C22
- Bi-pot	F4
- Bike cover	S2
- Caravanstore	S3, S4
- CS accessories	S5
- Caravanstore Zip	S3, S9
- Carry-Bike	S1, S2
- Drip stop	S2
- F45	S3, S6
- F45 accessories	S7, S8
- Pack organisers	S11
- Privacy Room	S7
- Privacy CS light	S4
- Rooflights	P3
- Ultra-box	S11
- Utility pockets	S11
- Zip	S3, S10
Fill up tubes	E1, E2
Filler caps	E3
Filters, water	E5, E9, E10
Fires, gas	J6 - J8
Fire blankets	G6
Fire extinguishers	G6
First aid kits	G6
Floe	E9
Fluorescent lighting, 12v	C18, C20
Fluid, toilet	F1 - F3, N1
FM Aerials	D8
Food covers	M4
Foot pumps	T9
Foot switches	E11
Freshlight	P2
Fresh-up sets	F5
Friction pads	A5, A6
Fridge fans	K6
Fridges	K1 - K3

Fridge vents	K6
Front marker lamps	A13
Fuel	C17, G5, L5
Fuel cells	C17
Furniture	V1, V2
Furniglyde	Q15
Fuses	C5, Q6

G

Gas alarms	G6
Gas cartridges	G5, L5
Gas cookers	J1, J2, L6, L7
Gas fires	J6 - J8
Gas fittings	G3
Gas hose	G1 - G3
Gas lanterns	L5
Gas level indicators	G4
Gas lighter refill	M8
Gas lighters	M8
Gas manifolds	G3
Gas outlet boxes	G4
Gas Pigtails	G1
Gas regulators	G1, G2
Gas stoves	L5, L8
Gloves	N5, Q10
Glues and adhesives	Q2, Q3
Grease	Q1
Griddle	M2
Grill pans	M2
Grip track	A4, A5
Groundsheets	T7
Guides, site	U1

H

Hairdryer	M9
Halogen heaters	J8
Hammers	Q8, Q10
Handy cleaning products	N4
Handy mirrors, towing	A10
Hang tabs	N6
Happy bowl	F3
Haynes manuals	U1
Headlamp converters	A11
Heaters, space	J6 - J8
Heaters, water	J4, J5
Heki rooflights	P2
Hercules	T3
High viz vests	G5
Hinges	Q11, Q12
Hitch heads	A3
Hitch covers	A4, A6
Hitchlocks	A6, B1, B4
Hobs	J1, J2

Holding tanks	F5
Hooks	N7
Hook-up adaptors	C7
Hose clips	E7, G3, Q7, Q11
Hoses, gas	G1 - G3
Hoses, water and waste	E6
Hot plates	J1, J2

I

Ice packs	K5
In-line water filters	E9
In-line water pumps	E10, E11
Inner tents	T5
Insect protection	T8
Interior lights	C18 - C21
Inverters	C13
Ironing	M6
I-spy books	U2

J

J-strip	T5
Jacks	A2
Jack pads	A4
Jerrycans	E3
Jockey wheels	A7
Jumbo mover	A15

K

Kettles	M8, M9
Keys	B5
Kilrock	M10
Kitchen gadgets	M4
Kitchen stand	T7
Kitchen utensils	M1 - M4
Knives, trimming	Q7, Q9, Q10

L

Labcraft	C20, C21
Ladders	R2
Lamps, Awning	C19, C21, C22
Lamps, Battery	C22, C23, C25, C26
Lamps, Interior	C18 - C21
Lamps, Marker lights	A13
Lamps, Number plate	A12
Lamps, Rear combination	A12
Lamps, Spot	C18, C19
Lanterns, Battery	C23, C25
Lanterns, Gas	L5
Lanterns, rechargeable	C24
Laundry	M6
LED lights	C19 - C26
Leisure batteries	C14

Levelling Aids	A4, A5
Lighter type plugs & sockets	C1 - C4, C7
Lighting, 12v	C18 - C25
Lighting, 230v	C22, C23, C25
Lighting, gas	L5
Locks, door	B4, B5
Luggage elastic	T4
Lumo	C18 - C20

M

Mains extension leads	C8
Mains hook-up adaptors	C7, C8
Mains installation kits	C9
Mains inlets & outlets	C7
Mains plugs and sockets	C7
Mains power supply	C9
Mains testing equipment	C8
Malaga	J4
Mallets	T2
Mantles	L5
Maps	U1
Marker lamps	A13
Mats	N6
Matting, awning	T7
Matting, non slip	N5
Mattress toppers	V2
Maxview satellite dishes	D1 - D4
Measuring tapes	Q9
Megascrew	T3
Melamine cleaners	L3
Melamine tableware	L1 - L3
Methanol	C17
Microwave ware	M1
Mirrors	A10
Mosquito netting	T8
Moisture absorbers	M10
Morco water heaters	J5
Motorhome cleaner	N1 - N3
Move control movers	A15
MPK rooflights	P1 - P3
Mugs	L1, L2
Multimeters	C6
Multisockets	C1, C2
Mushroom vents	P6

N

Nilaqua	N8
Non slip matting	N6
Nose weight guages	A11
Number plates	A14
Number plate lamps	A12
Nylonglyde	Q15

O

Onboard pumps	E10
One shot nuts	A3
Onedrywash	N2, Q3
Outdoorchef	L7
Oven gloves	M7
Oven shelves	J3
Ovens	J1

P

Pampervan	N2
Panel trim	Q15
Pans	M1
Pegs	T2, T3
Pen knives	Q10
Pet cleaning	N8
Pet range	T12
Phone chargers	C6
Pigtails	G1, G2
Pipes, gas	G1 - G3
Pipes, plastic	E4, E6
Pipes, semi-rigid	E6
Pingi	M10
Plugs, Towing	A8, A9
Plugs & sockets 12v	C1 - C4, C7
Plugs & sockets 230v	C2 - C4
Plugs, sink	E7
Pole tensioners	T3
Polishing	Q4
Polyplastic stays	Q14
Porta Potti	F4
Portable satellite dishes	D4
Portable shower	E18, T7
Pots & pans	M1, M2
Power distribution	C8, C9, C10
Prewired sockets	A8, A9
Propex heatsource	J6
Propex water heaters	J4
Pumps, Tyre inflation	A2, T9
Pumps, water	E5, E10, E11
Pumps, air bed	T9
Purifiers, water	E8

Puriclean	E8
Push fit	E6
Push locks	Q14

R

Radiators	J8
Ratchet straps	T4
Rear view lens	A11
Rectifiers	K5
Reflectors	A13
Refrigerators	K1 - K3
Regulator spanners	G2
Regulators	G1, G2
Relaxers	V1
Relays	A8
Remis spares	Q13
Repair adhesive	T1
Ring smartcharge	C12
Ring towing accessories	A8, A9
Rivets	Q6
Roadpro domes	D1
Rok straps	T4
Roof boxes	S11
Rooflights	P1 - P3
Rotary dryer	M6

S

Safes	B6
Satellite cables	D9, D10
Satellite dishes	D2 - D4
Satellite domes	D1
Satellite finders	D6, D7
Satellite receivers	D7
Satellite sockets	D9
Saucepans	M1, M2
Screw drivers	Q8 - Q10
Screws	Q5, Q11
Sealants	Q2, Q3
Sealing strip	Q1
Security devices	B1 - B4, B6
Security handles	B4
Secure wheel locks	B2, B3
Seitz blind spares	Q13
Service doors	F6
Shock absorbers	A4
Shower, portable	T7
Shower taps	E14, E15
Shower trays	E17
Shurflo pumps	E10
Side lift jack	A2
Signal boosters	D6
Silent gliss	Q15
Silicone kitchen equipment	M3
Silky	N3

Sink waste outlets	E7
Sinks	E16, E17, J2, J3

Sink wastes	E7
Site guides	U1
Site plugs 230v	C7
Sleeping bags	V2
Smart chargers	C12
Smart Tent	T8
Smev	E16, J1 - J3
Smoke alarms	G6
Socket assemblies	A8, A9
Socket covers	A9
Socket plates	A8, A9
Sockets, towing	A8, A9
Sockets 230v	C2 - C4
Soft dock	A3
Solar panels	C15 - C16
spacers	A3
Spanners	Q8, Q9
Spare wheel carriers	A2
Spatter screens	M2
Spot lamps	C23 - C24
Sponges	N4
Spray bottles	Q1
Spring assisters	A11
Stabilisers, Hitch type	A6
Stabilisers, leaf type	A5
Steamers	M2
Stellings	C9, C10
Steps	R1
Stick 'n' guard	N6
Stickers	A14
Sticky stuff remover	N3
Storage boxes	M9
Submersible pumps	E5, E11
Sweepers	N5

T

Tables	V1 - V2
Table legs	R2
Table strip	Q15
Tableware	L1 - L3
Tank cleaner	E8, F1 - F3, L3, N3
Tapes	Q3
Taps, gas	G3
Taps, water	E11 - E15
Tea towels	M7
Teapots	M5
Telescopic brushes	N4

Tents	T8
Tent and awning spares	T1 - T7, T10, T11
Terminals	C6, Q6

Thetford Chemicals	F1
Thetford common spares	F6
Thetford refrigerators	K1
Thetford Toilets	F4, F5
Tie down kits	S5, S8, T3
Tip-up sinks	E17
Toilet accessories	E18
Toilet chemicals	F1 - F3
Tool boxes	Q8
Tool kits	Q7 - Q9
Tools	Q7 - Q10
Top boxes	S11
Torches	C23 - C26
Torque wrenches	Q7
Towball bolts	A3
Towball boots	A3
Towballs	A3, A6
Towing electrics	A8, A9
Towing mirrors	A10
Towing protectors	A16
Toys	U2
Trailer boards	A9
Trailer wheels	A1
Transformer/chargers	C9 - C12
Travel safety	G5, G6
Trays	L1 - L3
Triangles, reflective	A11, A13
Trigano Activ	F3
Trio spares	T11
Tripods, satellite	D5
Trolleys	E2, M9
Truma fans	J6, J7
Truma regulators	G1, G2
Truma water heaters	J4 - J6
Truma water systems	E4, E5
Trumatic heaters	J7
Turbo-vent	P3
TV aerials	D8
TV cables	D9, D10
TV sockets	D9
Tyre guages	A2

U

Ultraflow	E4, E5
Ultraheat	J7
Ultrastore	J4
Umefa	T10

V

Vacuum cleaners	N5
Vanity bowls	E16, E17
Vanity cabinets	E17
Velcro	N7
Ventilators	P6
Visa tape & track	Q15
Vistron receivers	D7
Voltage testers	C6

W

W4 stand packages	C5, C6, D10, E6, Q12, Q13, T6
Waecorefrigerators	K2, K3
Warning triangles	A11
Washing machine	M6
Waste bins	M5, M7
Waste containers	E1, E3
Waste pipe	E6
Wastemasters and accessories	E1
Water containers	E1, E3
Water filters	E5, E9
Water fittings	E6, E7, Q11
Water heaters	J4 - J6
Water hose	E2, E4
Water level sensors	C11, E1
Water inlets	E3, E4, E11
Water pipe	E6
Water proofing	N1, T1
Water pumps	E5, E10, E11
Water purification	E8
Water taps	E11 - E14
Weight control	A11
Wheel carriers	A2
Wheel chocks	A4
Wheel clamps	B1 - B3
Wheel covers	A1
Wheel rims	A1
Wheel trims	A1
Wheel wrench	A3
Widney fires	J8
Windbreaks	T5
Window stays	Q14
Window trim	Q15
Windowize	N1
Winterban	E8
Wipes	N5
Witter cycle carriers	S2

Z

Zig	C10, C11
-----	----------

Wheel Rims



Prins LD1361 rim
4.5J x 13" 4 Stud **005016**
Prins LD1360 rim
5J x 13" 4 Stud **005004**



Prins LD1362 rim
4.5J x 13" - B + B **005038**



Lemmerz rim
5.5J x 14" 4 stud **005020**



Lemmerz rim
5.5J x 14" 5 stud (silver) **005025**
6J x 15" 5 stud **005030**

Trailer wheels & tyres

Wheel rim with 4 ply tyre
400-8" No cut out **005048**
500-10" **005050**



Wheel Trims - Caravan wheel trims available singly or 12 per outer



Alaska
Supplied in pairs
13" White/chrome **006020**
14" White **006021**



Tourer
Supplied in pairs
13" Silver **006000**
13" Ivory **006001**



Alaska
Supplied boxed in a set of 4
13" Silver **006016**
14" Silver **006017**



Motorhome wheel trims
Supplied boxed - in a set of 4
15" Silver **006022**
16" Silver **006024**

Alloy Wheel Rims



Alloy rim

Dion 5.5J x 14" 5 stud 112mm p.c.d.
775kg load per wheel
Tyre range: 165R 14, 175R 14, 185R 14, 195R 14,
175/65R 14, 175/70R 14, 185/70R 14, 195/65R 14,
195/70R 14 **005145**



Alloy wheel lock nuts
M12 Set of 4
005148



Alloy wheel bolt
STW M12R
005147

Wheel cover protectors

Protect your investment by protecting your wheel and tyre from UV, wind and rain. Available in assorted colours. Usually available in blue, green and burgundy please specify if colour is important. Sold individually

Single axle **007347**
Twin axle **007348**



Spare wheel accessories

AL-KO side lift jack

Can be fitted to all caravans manufactured after 1980. The jack is easy to position and operate and is supplied with mounting brackets which are bolted to the main chassis members immediately behind the wheel. The jack can also be used as an aid to levelling. Can be lowered to 85mm and raised to 375mm. The mounting bracket design ensures correct positioning and operation. **WARNING:** When in use the caravan must be attached to the towing vehicle.

AL-KO 800kg side lift jack

Maximum load 1600kg, static load 800kg

AL-KO side lift jack in a bag **007364**

AL-KO side lift jack boxed **007351**

AL-KO 1000kg side lift jack

Maximum load 2000kg, static load 1000kg **007357**

AL-KO 2 tonne scissor jack

For caravans manufactured after 1980 on AL-KO chassis with a maximum total weight of 2000kg. Static load 1000kg. Maximum load 2000kg Specifically developed for use on tandem axle caravans **007359**

Side lift jack bracket kit

Suitable for use only with Al-Ko Side Lift Jack or 2 Tonne Jack.

Comprises of 2 x galvanised mounting brackets and fixing kit

007403

Spare bracket

007402

Spare wheel carriers

AL-KO spare wheel carriers

For AL-KO chassis with fixing holes. Check AL-KO technical brochure for wheel size compatibility. Telescopic action for easy wheel removal and replacement. AL-KO part no. 241859 for chassis with a distance between the main members of 1260mm - 1515mm **004004**

AL-KO part no. 241860 for chassis with a distance between the main members of 1510mm - 1815mm **004015**

AL-KO part no. 1287180 for chassis with a distance between the main members of 1410mm - 1715mm. Pre-assembled **004006**



Stack Jack axle stands

Set of 4 aluminium axle stands. Max capacity 2722kg per jack. Extends 28-43cm.

For stabilizing only - Not for lifting **007358**

Tyre gauges



RING

Digital tyre keyring gauge

- LED light

Available singly or 8 per outer **007377**



RING

Digital tyre & tread gauge

- 360° connection
- Tread depth gauge

Available singly or 6 per outer **007373**



RING

Programmable digital tyre & tread gauge

- 360° connection
- Automatically stores recommended tyre pressure
- Tread depth gauge

Available singly or 6 per outer **007374**



Rolson digital tyre gauge

- Simple push button operation
- LCD display in PSI and bar

007366

Compressors



Air compressor inflater/deflator

12v digital air compressor for tyre inflation and inflater for air beds & other leisure accessories. Preset pressure mode with automatic cut off. High intensity LED white light. Handy storage case and a tyre deflation valve. Inflates a tyre to 35psi in under 3 minutes

017304



Cordless air compressor

Rechargeable version of 017304 with the addition of a removable tyre pressure gauge

017306



Digital air compressor

12v. Preset pressure mode with automatic cut off. Red light for SOS and high intensity LED light. Handy storage case and a tyre deflation valve. Inflates a tyre to 35psi in under 3 minutes

017303



Digital air compressor

12v 120psi. Self select pressure mode with automatic switch off. Complete with 2 piece adapter kit. Fitted with fused cigarette lighter plug and approximately 3.3m of cable. Built in white light for direction and red light for alert/SOS. Flexible air hose with screw set.

Available singly or 6 per outer **017305**

Towball accessories



Towball
50mm ball. 'E' approved.
Available singly or 10 per outer
007062



AL-KO towball kit
Extended necked towball
includes 2 x 50mm nuts,
bolts and spring washers
008003



AL-KO towball boot
Black plastic
008006



Towball boot
Black plastic
Loose (50) **012191**
Packaged **014460**



Towball boot with reflector
Black plastic
014465



High tensile bolt sets
Available singly or 10 per outer
45mm **007073**
55mm (in Ring Packaging) **014475**
65mm **007084**
75mm **007095**
75mm (in Ring Packaging) **014478**
100mm **007085**



Ring towball cover
Chrome **014452**
Black **014455**



AL-KO soft ball
Supplied in a display box of 24
Red **012200**
Black **012201**
Blue **012202**



W4 Cover-up
Tow ball cover with grease
reservoir. Supplied in a counter
display box of 20 pieces
012205



Spacers
13mm **007040**
25mm **007051**



Drop plates
51mm **007007**
76mm **007018**
100mm adjustable **007029**



AK300 coupling head
The AL-KO AK300 is designed for a
draw shaft of 50mm. Spacers are
available for smaller draw shafts
- See AL-KO spares in section 1 of
the spares section
007361



AL-KO soft dock
Can be used on AL-KO coupling
heads AK7, AK10/2 and AK252.
Supplied in a display box of 12
007159

Chassis spares

Note: More chassis spares can be found in the spares section of the catalogue

WOW Bulk offers of 50 or more are available



Corner steady nuts
16mm thread \varnothing **007428**
20mm thread \varnothing **007429**



One shot nuts
Supplied 10 per outer
20mm thread \varnothing **007662**
25mm thread \varnothing **007689**

Breakaway cables

Note: Cables should be connected as per instructions to ensure effective operation.

AL-KO

A - Standard **007130**
B - Detachable **007135**

W4

Available singly or 10 per outer. Poly-bagged and header carded.

C - Breakaway cable **007118**
D - Plastic coated cable **007120**
E - Cable with split ring **007125**
F - Easy fit cable **007127**



Corner steady braces & wheel wrenches

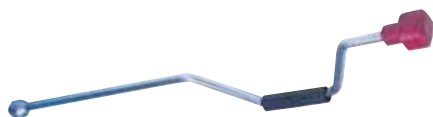

AL-KO corner steady brace
Available singly or 10 per outer
007168



Groove extension sockets
For use with cordless drills for lowering
and raising corner steadies.
Available singly or 10 per outer
30cm **007164**
45cm **007163**



Budget corner steady brace
007167



Budget wheel brace
007166

Master wheel wrench



Chrome plated carbon steel body with
17/19mm vanadium socket. Telescopic handle
gives adjustable length of 375-495mm. TUV/GS
approved. Available singly or 10 per outer
007169

Hitch covers



W4 hitch tidy

White P.V.C. weather - proofing cover with drawstring for secure fixing. Available singly or 10 per outer **007335**



W4 'A' Frame cover

Hard-wearing cover which protects the hitch, handbrake mechanism and cable storage ports. Available singly or 5 per outer **007336**



PVC hitch cover

Supplied 10 per outer
Black **007337**
White **007338**



AL-KO deluxe hitch cover

To cover the towing hitch/stabiliser Suitable for the AKS2004/3004 stabiliser **007350**



Nylon hitch cover

PVC coated green nylon cover with drawstring. Available singly or 10 per outer **007340**

Printed with your company name and logo. Minimum order of 100 pieces. Alternative colours also available **007341**



National hitch covers

PVC coated nylon cover with drawstring. Available singly or 10 per outer
England **007342**



Scotland **007343**



Wales **007344**

Heritage "Keep Calm and Caravan" hitch cover

100% cotton canvas hitch cover with drawstring. Wet and rotproof. High quality desirable product **007345**

Also available in cost effective nylon **007339**



The Heritage range also available in a mains cable bag (see section C) **016177** and a peg bag (see section T) **109563**

WOW Heritage range. Choose your colour, change the crown for your logo or even display your phone number? - all for the same unit cost. Minimum order quantity - 50. Please speak to your sales contact for more details. For personalised product please allow 6 weeks for first time orders and 4 weeks for repeat orders to receive your delivery.

Hitch cover **007346**

Shock absorbers

Octagon shock absorbers

Designed to complement AL-KO Euro Axles. Colour coded for easy weight identification - provides the ultimate in road holding and ride comfort. Set of 2.



Axle weights (gvw)	Single	Tandem	Part No.
Green	Up to 900kg	Up to 1600kg	007425
Blue	901 - 1300kg	1601 - 2600kg	007426
Red	1301 - 1800kg	2501 - 3500kg	007427
Black	1801 - 4000kg	3501 - 7500kg	007424

Levelling accessories



Wheel chock

A vital safety device when parking up or changing a wheel. Available singly or 24 per outer **007312**

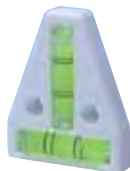

Levelling device

Available singly or 10 per outer **007295**

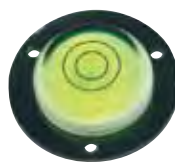

W4 Target level

Circular spirit level for 360° levelling indication. Self adhesive **007297**
10 per outer
Magnetic **007298**
Available singly or 10 per outer



3 piece level set

Available singly or 12 per outer **007293**



W4 grip trak

Ridged on both sides of track for maximum wheel to ground traction **007388**



Jumbo foot jack pads

Budget priced set of four pads and pins
Green. Available singly or 10 per outer **007385**
Spare jumbo foot and pin green **007384**
Black. Available singly or 10 per outer **007379**
Spare jumbo foot and pin black **007378**



Stabilizer jack pads

Set of four plastic jackpads **007380**

Levelling accessories



007320

Level PRO (2)
 Dimensions (mm) 430 x 170.
 Maximum height 90.
 Maximum axle weight 5 tons.
 Grey
 Available singly or 6 per outer
007320



007328

Anti slip plate (2)
 To help prevent slipping on paved surfaces. Suitable for all blocks except Level System Jumbo. Grey
007328



Level Up (2)
 Dimensions (mm) 570 x 200.
 Maximum height 130. Maximum axle weight 5 tons. Grey
007326



Kit Level Up (2)
 As above with washable Polyester carry bag. Easy to carry with comfortable shoulder strap with velcro
007316

Level Plate (2)

Anti skid system for installation on Fiamma level up. It increase traction, avoiding skids and slips on smooth surfaces and helps to prevent sinking on soft ground. Grey
007329



Level System® Magnum (2)

Dimensions (mm) 500 x 200. Maximum height 90.
 Maximum axle weight 8 tons
 Available singly or 6 per outer
007322



Jumbo (2)

Dimensions (mm) 600 x 260. Maximum height 120.
 Maximum axle weight 12 tons
007323



Kit Level Up Jumbo (2)

Dimensions (mm) 580 x 240. Maximum height 140. Maximum axle weight 8 tons. Grey. Comes with washable Polyester carry bag. Easy to carry with comfortable shoulder strap
007318



Level bag S

For level pro (007320), magnum (007322) and wheel saver (007331)
007332

Level bag

For level up (007326)
007333



Wheel savers

Ideal for long stays or storage. Suitable for wheels up to 70cm diameter. Dimensions (mm) 460 x 210. Maximum height 60. Grey
007331



Chock level (2)

Lightweight chock for use with Level up, Pro and Magnum on longer stays. Comes with 2 steel hooks to firmly fasten two chocks when used on levels
007327

Leaf type stabilisers



Driver stabiliser

Comes with quick release kit, 4.5" friction discs and standard L bracket to suit AL-KO and similar taperline chassis
007800



4.5" Friction discs
007825



4" Friction discs
007824



4 Hole car plate
007804



2 Hole car plate
007805



TC car plate
007808

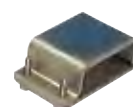

Clamp on adaptor
007816



Toggle screw
007819



L bracket
007812



Extended L bracket
007814



Slipper block
007822



Quick release kit
007834



Tommy bar 10mm
007828



Stronghold stabiliser

2 year mechanical warranty, with quick release mechanism and fast fit 'L' bracket that clamps onto the chassis which eliminates drilling. Fitted with 2 x 4" friction discs. Supplied with canvas carry bag.
007775

Stabilisers & Spares

AL-KO



AL-KO AKS 1300 stabiliser

The AKS 1300 stabiliser has been developed for caravans and trailers up to a maximum gross weight of 1360kg

- AKS 1300 Stabiliser **007950**
- AKS 1300 security device **007960**
- Integral barrel lock **002118**



AKS 1300 Triple pack consisting of stabiliser, security device, towball and safety ball **007970**



AL-KO MkII AKS 3004 stabiliser

The MkII AKS 3004 stabiliser has been developed for caravans and trailers from 200kg up to a maximum gross weight of 3000kg

- AKS 3004 Stabiliser **007938**
- AKS 3004 Security device **007940**

MkII AKS 3004 Triple pack consisting of stabiliser, security device, towball and safety ball **007939**



Winterhoff WS3000 stabiliser

The arrangement of the front and rear friction elements reduces the unpleasant pitching movement of the car/trailer combination. The slender design guarantees excellent angular flexibility for manoeuvring.

- WS 3000 stabiliser **007850**
- Robstop security device **007860**



Friction pads

1300 stabilisers - side **007957**



AKS security barrel and two keys **007723**



Friction pads

For Winterhoff WS3000 Stabiliser from Aug 2002 onwards **007852**



Side friction pads

To 1993 for 2000/2500 stabilisers **008004**

From 1994 2004/3004 stabilisers **008005**



Towball kit **008003**



Towball cover **008006**



Front/rear friction pads

2004 stabilisers **007935**

3004 stabilisers **007936**



AKS 1300 security device

Comes with necessary fittings **007960**



AKS 3004 security device

Fits all models of 2004/3004 stabilisers **007940**



AKS 2700 security device

008007



Winterhoff Robstop security device

Supplied complete with safety ball **007860**



Stronghold Winterhoff hitchlock

Designed for Winterhoff WS3000. Sold secure and insurance approved. Comes with carry case. Weight 2.6kg **001705**



Stronghold AL-KO hitchlock

Designed for Alko Hitches, AK130, AK160, AKS1300, AKS2004 and AKS3004. Sold Secure and Insurance Approved. Comes with carry case. Weight 2.6kg **001703**



AL-KO deluxe hitch cover

To cover the towing hitch. Suitable for all AKS2004/3004 stabilisers **007350**



AKS 3004 4x4 handle

Replacement handle for 4x4's to avoid fouling of the rear door **007934**



AL-KO Safety ball

Locks into hitch head for extra security. Supplied in a display box of 24 **002120**



AL-KO soft ball

Supplied in a display box of 24
 Red **012200**
 Black **012201**
 Blue **012202**

Jockey wheels

AL-KO



AL-KO 48mm jockey assembly
Budget priced jockey assembly.
Available singly or 5 per outer **007194**



AL-KO heavy duty assemblies
48mm ø stem
With soft wheel **007192**
With pneumatic wheel **007197**



AL-KO jockey assembly
48mm ø stem
plastic wheel rubber tyre **007195**



AL-KO pin stop lock jockey assembly
48mm ø stem **007191**



Pneumatic jockey wheel and clamp
48mm ø stem **007174**



Jockey wheel and clamp
48mm ø stem **007172**



Jockey wheel and clamp
34mm ø stem **007170**



AL-KO Premium jockey wheel 48mm
Incorporates weight gauge. Maximum dynamic load bearing capacity 300kg with static capacity 180kg. Tube diameter 48mm with a grooved rubber wheel (230 x 80mm).
Boxed **007193B**



AL-KO manoeuvring handle
For use with caravan and trailer jockey wheel assemblies with 48mm diameter stems **007250**



WOW
Demonstration DVD available



Reich Easy Wheel set
Transform your existing jockey wheel into a double jockey wheel. Increase your manoeuvrability on any surface. Quick and easy assembly / disassembly. **007210**

Spare wheels



For 34mm jockey assembly
Overall ø 160mm
Spindle hole length 60mm **007171**



For std 48mm jockey assembly
Overall ø 195mm
Spindle hole length 60mm **007173**



AL-Ko Soft wheel
Overall ø 240mm
Spindle hole length 90mm **007196**



AL-Ko pneumatic wheel & tyre
Overall ø 250mm
Spindle hole length 90mm **007199**



Pneumatic wheel & tyre
Overall ø 250mm
Spindle hole length 90mm **007189**

Jockey wheel clamps



Jockey wheel clamp
Suitable for 48mm tube **007276**



007639



007640



007620

AL-KO jockey wheel clamps

AL-KO

Pressed steel for 90S/3 assembly **007639**
Pressed steel for 161S & 251S assemblies **007619**
Cast clamp for 161S & 251S assemblies **007640**
Cast clamp for 161S & 251S assemblies (inc bolts) **007620**



007642



007178

13 pin electrics

- Please note that all UK caravans produced from Sept 2008 have a 13 pin plug fitted as standard



13 pin plug
Available singly or 10 per outer
012037



13 pin socket
Available singly or 10 per outer
012038



13 pin alignment tool
A simple tool to re-align the pins when the plug and socket have not separated correctly. Available singly or 10 per outer
012050



7 pin 12N plug to 13 pin socket
Available singly or 10 per outer
012044



13 pin plug to 7 pin 12N socket
Available singly or 10 per outer
012043



13 pin socket to 7 pin 12N/12S plugs
Enables a car with 12N and 12S sockets to connect to a caravan with a 13 pin plug
Available singly or 10 per outer
012041



012042
13 pin plug to 7 pin 12N/12S trailing sockets
Enables a car with a 13 pin socket to connect to a caravan with 12N / 12S plugs



012045

Prewired sockets

Please see additional prewired sockets on page A9



Wiring kit 12N
014006



Wiring kit 12S
014017



Wiring kit Twin
014028



Coiled cable kits

Consists of a length of cable which extends to 1.2m and has a 7 pin plug on each end. Kit contains a 7 pin socket to mount on caravan A frame.

12N **014310**
12S **014311**

Relays



W4 Combi Master
Combined fridge power supply and charging relay enabling the fridge to operate and an auxiliary battery to be charged whilst towing
014076



W4 Self Switching Combi Master
The same specification as the Combi Master but with the addition that it senses the vehicles battery level - switching off when there is insufficient power available. So the vehicles power can continue to be used when the engine is switched off without worrying that the auxiliary battery or fridge will be draining your vehicles battery
014077



Ring relays Combination
Split charge relay for charging auxiliary battery & operating a refrigerator whilst towing. With automatic cut off
014405

Audible
Rear mounting sensor relay
014407



ERL11
ERL7
Automotive relays
12V 40A
Centre pin not used
ERL11
12V 20/30A
ERL7

Socket mounting and bumper protection



Socket mounting plates

Manufactured from mild steel plate.
 Single **012087**
 Double straight **012096**
 Double 'T' **012105**
 Available singly or 25 per outer



Bumper protection

Protects your vehicle whilst hitching up
 With two socket mounting points **012109**

Mini bumper protection plates **012110**
 Available singly or 10 per outer



Towing accessories

WOW All relays are easy to select from the 'Which relay do I need?' chart on the pack. They are easy to fit using the full instructions provided. Suitable for 12V negative earthed vehicles



Combination relay

Split charge relay for charging auxiliary battery or operating a refrigerator whilst towing **014405**



Audible relay

Rear mounting sensor relay **014407**

WOW Comprehensive 18 page 'Towing Electrics' guide with each kit giving handy tips on legal requirements and wiring diagrams



Single socket

N type with fog cut out **014390**
 S type **014392**



Twin socket

With fog cut out **014395**



Plastic plugs

12N **014313**
 12S **014329**
 Available singly or 10 per outer



Metal plugs

12N **014314**
 12S **014332**



Plastic sockets

12N **014312**
 12S **014328**
 Available singly or 10 per outer



Metal sockets

12N **014315**
 12S **014330**
Socket seal kit
 Available singly or 10 per outer **014470**



Socket cover

Black **014457**



Towball covers

Chrome **014452**
 Black **014455**



High tensile bolts

2 per pack
 55mm **014475**
 75mm **014478**
 Available singly or 10 per outer



Socket plates

Single **014445**
 Twin **014450**
 Available singly or 10 per outer



Trailer lamps

Small square **014424**



Towball boots

Black **014460**
 Black with reflector **014465**

Complete towing stand

Ask your sales contact for details **014479**

Towing mirrors



HANDY mirror range

This range of "E" marked mirrors feature the unique "Handy" ratchet system which gives minimal vibration and maximum stability. Simple to install and remove: the unique "Handy" ratchet allows a tight fit to the existing mirror every time. Attaching to the vehicle's existing mirror these universal fitting mirrors are suitable for most vehicles and include models suitable for vans and motorhomes as well as cars, and will fit left or right hand mirrors.

Glass size 190mm x 120mm. All available singly or 6 per outer.



Handy XL standard mirror

Arm length 310mm
120140



Handy XL extended mirror

As per the XL version this mirror has extended arms for a wider field of vision.
Arm length 370mm
120142



Handy Super Flex mirror

This model has wide angle arms to make it suitable for most vans and motor homes.
Arm length 230mm
120144

Standard towing mirror

Excellent value clip-on 'E' marked extension mirror.

Glass size 150mm x 110mm.

Arm length 220mm

Available singly or 20 per outer

120154

Spare straps 120153



Excellent view towing mirror

After initial set up the bracket can be left on, head and extension mirror can be removed. Virtually vibration free with excellent

visibility. 'E' marked.

Glass size 185mm x 120mm.

Arm length 270mm

Available singly or 20 per outer

120168

Available singly or 10 per outer

With blind spot 120167

Spare straps 120169



WOW The XXL fits vehicles with tall wing mirrors such as the Ford Transit

XXL towing mirror

Large head for improved vision and safety, extra long securing straps make this mirror suitable for vehicles with large wing mirrors. 'E' marked.

Glass size 185mm x 120mm.

Arm length 200mm

Available singly or 20 per outer

120158



Reich Mirror Control

The Reich **MIRROR CONTROL** enables you to adjust the caravan's clip-on mirrors from inside the vehicle without any other assistance. With infrared remote control, the mirror can be adjusted regardless of horizontal or vertical installation. The adjustment is done by the use of electro-motors fed by the internal batteries supplied.

Available to order



Towing mirrors

All mirrors are "E" approved, quick and easy to fit to most vehicles and are available singly or 10 per outer.



RV98T towing mirror

Adjustable arms, mirror head adjustable through 360° and shatterproof glass.
120148



RV3100 towing mirror

Adjustable arms, mirror head adjustable through 360°, shatterproof glass and complete with built-in blind spot.
120150



RV3200 towing mirror

Removeable arm, mirror head adjustable through 360°, shatterproof glass and complete with built-in blind spot.
120151

Towing safety

Caravan Weight Control

The Caravan Weight Control (CWC) gives you 100% control over the total weight and the partial weights of the individual wheels. Using the handy balance may easily prevent excess and uneven loads which may have a negative impact on vehicle handling.

- Can measure the load per wheel up to 1000Kg yellow or 1500kg orange
- Totals the weight once measured on either a single or twin axle vehicle
- Can be used as a nose weight gauge
- Requires 3 x AAA batteries (not included)
- Simple to use
- Weighs 1 Kg

1500Kg orange **007304**

1000Kg yellow **007305**



TLC Towbar load control



A new, accurate digital gauge for measuring the weight of the hitch on the towball. The unit is both lightweight and compact. The TLC's accuracy and reliability is due to the use of load cell technology. The TLC is small and light enough to take with you. The twin version will automatically take into account the different load distribution involved.

- Digital read out in 1Kg steps
 - Clear to read
 - Safe function without spring
 - Maximum nose weight 100Kg
- Requires 2 x AA batteries (not included)

Single axle **007306**

Twin axle **007308**

NOTE: The TLC MUST be removed before towing

WOW Simple to use - Accurate, lightweight and compact



W4 weigh-it extra

Calibrated in both pounds and kilograms. Measures nose weight up to 250lbs/115kg

007310



Warning triangle

E approved.
Available singly or 10 per outer

007387



Beam converters

Headlamp beam adaptor for continental driving. By law, at any time - day or night, when driving in Europe you must convert your headlamps to avoid dazzling other road users.

015606

Rear view lens

Manufactured from optical grade PVC with viewing angles of upward 13° sideways 25° and downward 28°, these lenses help eliminate the blind spot and therefore make reversing safer.

9" x 7" **120137**

10" x 8" **120138**

14" x 11" **120139**



Grayston coil spring assisters

To stiffen and raise suspension by approximately 38mm. *To measure the size - jack the vehicle up to take weight from springs then measure the gap between two parts of the spring*

GE13 18mm-25mm **008019**

GE14 26mm-38mm **008008**

GE15 39mm-51mm **008027**

GE15A 52mm-65mm **008036**



Combination lights



Jokon wrap round
Combines stop/tail, flasher, reverse and fog lamp. 385mm x 112mm
015007



Jokon wrap round small
Combines stop/tail, flasher and fog lamp. 305mm x 112mm
015004



Jokon wrap round
Combines stop, tail, flasher and fog lamp. 385mm x 112mm
015006



Hella wrap round/reverse
Combines stop/tail flasher and reverse
015011



Hella mini wrap round/reverse
Combines stop/tail, flasher and reverse
015009



Hella wrap round
Combines stop/tail flasher and fog lamp
015010



Jokon combination lamps
Combines stop/tail, flasher and fog lamp
Left hand lamp **015012**
Spare lens **015023**
Right hand lamp **015034**
Spare lens **015045**



Britax 9002 lamp
015056



Britax 9300 wrap round
Combines stop/tail, flasher, fog and reverse. 382mm x 130mm
015050

Caraluna caravan



MK1 left hand
015001



MK1 Right hand, fog light
No longer available



MK2 left hand
015000



MK2 right hand, fog light
015003



MK2 left hand, fog light
015017



MK2 left hand fog clear lens
015021



MK2 right hand clear lens
015020

Caraluna motorhome



MK1 left hand
No longer available



MK1 Right hand, fog light
No longer available



MK2 left hand, reversing light
015013



MK2 Right hand, fog light
015014

Caraluna modular



Dimensions (HxWxD):
612 x 163 x 92mm

Left hand
014490

Right hand
(as illustrated)
014491

Caraluna vertical



Dimensions (HxWxD):
406 x 168 x 80mm

Left hand
- Includes fog
014493

Right hand
- Includes reverse
014494

Number plate lamps



Britax number plate lamp
Small **015476**



Hella number plate lamp
Small **015479**



Hella number plate lamp
Large **015483**

Marker lamps
Front



Hella oblong front marker
Lamp 015461



Jokon EL61 front marker
Lamp 015457
Lens 015458



Britax 881 front marker
Lamp 015438



Jokon front marker
Lamp 015465
Lens 015466



Hella oval front marker
Lamp 015444



Jokon PL96 front marker
Lamp 015454
Lens 015455



Britax 814 front marker
Lamp 015384



Britax 764 front marker
Lamp 015337



Hella front marker
Lamp 015375



Britax 536 front marker
Lamp 015450

Side



Hella oblong side marker
Lamp 015463

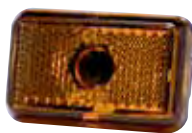

Jokon EL61 side marker
Lamp 015459
Lens 015460



Britax 883 side marker
Lamp 015440



Jokon side marker
Lamp 015467
Lens 015468



Hella oval side marker
Lamp 015446



Jokon PL96 side marker
Lamp 015456



Britax 813 side marker
Lamp 015404



Jokon side marker
Lamp 015472



Jokon side marker with screw on lens
015473



Jokon side marker
Lamp 015470
Lens 015471



Jokon oblong side marker red/white
015474

Rear



Hella oblong rear marker
Lamp 015464



Jokon EL61 rear marker
Lamp 015452
Lens 015453



Britax 882 rear marker
Lamp 015442

Reflectors



Self adhesive reflectors

105 x 50mm. 79mm hole centres.
10 per outer

- Red 015268
- Amber 015277
- White 015286



Reflective red triangle (2)

Screw on, pack of 2. Height max: 155mm,
Width max: 135mm, Hole centres: 70mm.
Available singly or 10 per outer
015492

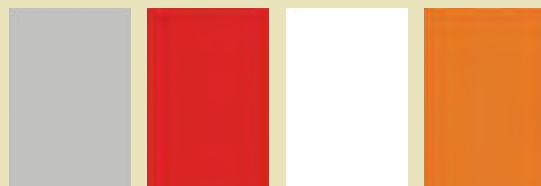

Repair stickers

- 250 x 70mm
- Headlight reflective repair tape (silver vinyl) 013620
- Red lens repair tape (red vinyl) 013621
- clear lens repair tape (clear vinyl) 013623
- Orange lens repair tape (amber vinyl) 013622
- 10 per outer

Number plates



Reflective yellow **013305**
 Reflective white **013313**
 100 per outer



Bordered yellow **013303**
 Bordered white **013322**
 100 per outer



Euro GB yellow **013304**
 Euro GB white **013323**
 100 per outer



Bordered Euro GB yellow **013314**
 Bordered Euro GB white **013318**
 100 per outer

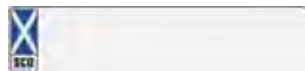

Scottish yellow **013311**
 Scottish white **013310**
 100 per outer



Border Scottish yellow **013309**
 100 per outer



Cymru yellow **013312**
 100 per outer



Square yellow **013317**
 100 per outer



Acrylic plates
 50 per outer
 Oblong **013306**
 25 per outer
 Square **013315**



Digit starter pack
 100 of each digit
013407
 Individual digits (100)
013408
 Followed by number or letter
 3D digits (50)
013409
 Followed by number or letter

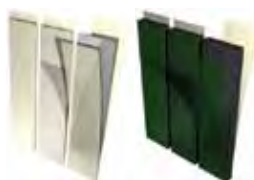

Adhesive pads
 20 per outer
 1mm **013523**
 6mm **013524**
 Bulk 150 per outer
 1mm **013525**
 6mm **013526**



Staticlean fluid
 Apply to the acrylic sheet (and to the reflective if required) before use in order to reduce static
013512
Sponge pad bottle
013421

Self adhesive stickers All stickers are sold 10 per outer



Euro GB
 Large oval
 180 x 135mm
013604



Euro GB
 122 x 88mm (W4)
013605



Euro Scotland
 122 x 88mm (W4)
013575



Euro Cymru
 122 x 88mm (W4)
013580



Euro plate stickers
 40 x 110mm
 Adapt your number plate for European driving
 GB **013608**
 Cymru **013583**
 Ireland **013589**



Euro GB
 Rectangle
 60 x 48mm
013607



Scotland flag
 Medium rectangle
 110 x 65mm (W4)
013577



Wales flag
 Medium rectangle
 110 x 65mm (W4)
013582



Ireland flag
 Medium rectangle
 110 x 65mm (W4)
013588



Kernow flag
 Medium rectangle
 110 x 65mm (W4)
013596



Kernow
 Large oval
 140 x 100mm (W4)
013595



AA GB Magnetic badge
 Large oval
 180 x 135mm
013598



GB sticker
 Large oval
 180 x 135mm
013603



GB sticker
 Large oval
 140 x 100mm (W4)
013602



GB sticker inside
 Large oval
 140 x 100mm (W4)
013606



GB sticker
 Small oval
 100 x 62mm (W4)
013601



GB plaque
 Small oval
 80 x 58mm
013600



NI
 Large oval (W4)
 140 x 100mm
013586



SCO
 Large oval (W4)
 140 x 100mm
013576



Cymru
 Large oval (W4)
 140 x 100mm
013581



IRL
 Large oval (W4)
 140 x 100mm
013587



No smoking
 Round (W4)
 small 75mm Ø **013616**
 Large 100mm Ø **013617**



Fresh water
 60 x 55mm (W4)
013618



60mph
 100mm Ø (W4)
013609



Tracking fitted
 110 x 65mm (W4)
 Motorhome **013613**
 Caravan **013614**



Vital statistics
 60 x 48mm (W4)
013619



Tyre pressure
 60 x 48mm (W4)
013615



LPG sticker
 100 x 100mm (W4)
013610

REICH Caravan movers

Move Control Jumbo by Reich

Moving your caravan could cause backache and even injury. Let Move Control Jumbo take care of the heavy work

- Designed to ISO 9001:2000 CE / TÜV approved
- One model to fit the majority of single axle caravans (with or without shock absorbers), Transfers to new caravan easily
- Fitting brackets available for non standard chassis and to accommodate spare wheel carrier and jacking points
- TWIN axle version is 4-wheel drive
- Motor and gearbox inside the chassis and not in spray area of the wheels
- Longer rollers - the grooved area covers the complete tread on any tyre for better traction in wet conditions
- Softstart and softstop electronics for smooth operation - no stress on chassis - exact positioning for easy connection to towing vehicle
- Remote control as standard but can be hard wired with cable provided if problems with radio interference or battery failure
- Cross actuation as standard, rollers can be put on/off from one side of the caravan with a hand brace or cordless power tool - no effort required

● 5 year warranty

Single axle **006900**

Twin axle **006925**

Reich Move Control Eco-Line

- Softstart and Softstop operation
- Aluminium rollers
- Individual operation of each driving unit with optimum force
- Motor drive (automatic engagement)
- Perfect ground clearance by design
- Max vehicle weight: Single axle 1800kg
Twin axle 2800kg
- Weight: Single axle 36kg
Twin axle 75kg

● 5 year warranty

Single axle **006926**

Twin axle **006927**



Other Reich movers

We keep in stock for your convenience the following Reich Move Control movers:

Comfort single axle **S00126**

Comfort twin axle **S00130**

Comfort single axle with motor drive **S00125**

Comfort twin axle with motor drive **S00129**

Compact single axle **S00124**

Compact twin axle **S00128**

Cross single axle **S00127**

Cross twin axle **S00131**

The Truma mover

Truma manoeuvring assistant

- Very light - Weighs just 34kg
- Low-wear aluminium rollers
- Softstart and Softstop for jerk-free manoeuvring
- Cross actuation as standard (manual engagement and disengagement of aluminium rollers from one side)
- No drilling or welding of chassis required (no need for TUV approval)
- Power consumption: Max 120A, Average 20A
- Max vehicle weight 1800kg (on a 15% gradient)
- 5 year warranty

Single axle **006800**



Caravan mover spares

Note: More mover spares can be found in the spares section of the catalogue



Reich manual engagement Handset

Single axles **006930**

Twin axle **006932**



Battery isolator switch

Max rating 100A - can withstand 500A for 5 seconds **010325**

Battery isolator switch key

10 per outer **010015**



Housing for isolator switch

006960



Wheel carrier bracket GB

To allow the Al-Ko spare wheel carrier to be moved to fit Reich movers **006978**

Towing protectors

towprolite specialised covers

**Waterproof – Strong – Impact absorbing – Durable
– Soft non-scratch fleece – UV protected material**

The next generation of universal fit protective towing covers. One piece construction with “T-FIT system” for quick and easy fitting. Double vented design for enhanced fit. Protects lower van front windows from impact damage, over 85% of van covered. Duo-tone, black and grey. Hi-viz reflective strips for added visibility on the road. Exclusive fitted, push operated and removeable “LED eye lights” for day and night use whilst towing. 8 x strap and click system for easy adjustability. Strap loops hold your straps in place whilst towing. A-frame strap and click system. A-frame seal stretches to adjust to different A-frames. Steadies strap and click system stops dirt going behind the cover from the undercarriage. Velcro fastening for extra fit. Uses awning channels to secure the cover to the van. Accessories pack included to enable you to expose the front marker lights neatly.

Tow pro lite - New universal fit towing protector

Fits caravans up to 2.5m with 2 awning rails
Front marker lights shine through side pieces

Accessories pack included

2 LED eye lights included

Designed to fit a wide variety of new and used caravans

106701



Caravan Covers

Maypole caravan top covers

- Superior top cover offering protection for your caravan top
- Water resistant heavy duty silver polyester material
- Ideal for winter storage
- UV stable material ensuring long product life
- Elasticated straps with nylon coated steel hooks
- Elasticated hem for tailored fit
- Storage bag included
- Additional straps supplied to allow different fitment options
- 12 months warranty

Caravan top cover up to 14' **106830**

Caravan top cover 14-17' **106831**

Caravan top cover 17-19' **106832**

Caravan top cover 19-21' **106833**

Caravan top cover 21-23' **106834**

Caravan top cover 23-25' **106835**



Maypole caravan covers

- Breathable material allows condensation to evaporate
- Superior cover offering excellent water resistance
- Easy to fit (fitting instructions included)
- Ideal for winter storage
- UV stable
- Nylon straps for a secure fit
- Elasticated hem for tailored fit
- Storage bag included
- 2 Zips for easy access
- 12 months warranty

Technical specification

Layers: 4

Composition: SB*SB*FILM*SB***

Bond Pattern: rectangle oval

Weight: 163gm/m2

Water resistance: 1000mm

Rain test: <0.1

***SB = Spunbound polypropylene

***Film = Better water resistance than a membrane

Caravan Cover 12-14' **106801**

Caravan Cover 14-17' **106802**

Caravan Cover 17-19' **106803**

Caravan Cover 19-21' **106804**

Caravan Cover 21-23' **106805**

Caravan Cover 23-25' **106806**



Wheel clamps

Stronghold wheel clamps come with a 2 year mechanical warranty. All clamps have high security pick free locks supplied with 3 keys giving thousands of key combinations. High visibility yellow units. Wheel clamps are supplied in robust plastic carry storage cases with colour pictorial fitting instructions.



The alloy wheel clamp

- Sold Secure
- Fits 13" to 15" rim sizes
- Fits 165mm to 205mm tyre sizes
- Easy fit onto security wheel bolt within 20 seconds
- Robust case hardened anti-saw steel construction
- Supplied with 10mm allen key

001722



The Scimitar alloy wheel clamp

- 50mm alloy wheel spoke gap required
- Fits wheel size 13"-15"
- Fits tyre sizes 165mm-205mm
- Easy fitment in under 30 seconds
- Case hardened with patented lock
- Weight 6kgs
- Colour fitting instructions

001730



The strongarm wheel clamp

- Sold Secure
- Fits 12" to 14" rim sizes
- Fits 155mm to 190mm tyre sizes
- Easy fit onto security wheel bolt/nut within 5 seconds
- Locks onto the wheel instead of over the tyre
- Robust steel construction
- Case hardened anti-saw bar feature
- Fits over bolt on wheel trims

001714



The wheel clamp

- Fully adjustable for wheel diameter and width
- Covers wheel nuts, wheel trims and alloy wheels
- Electro-plated arms for rust protection
- Robust heavy duty steel construction
- 8"-10" fits 100-175 tyre **001716**
- 10"-14" fits 155-205 tyre **001718**
- 14"-16" fits 185-250 tyre **001720**

Hitchlocks and security devices

Stronghold hitchlocks come with a 2 year mechanical warranty. The hitchlocks can be fitted hitched or unhitched. All locks have high security pick free locks, supplied with 3 keys giving millions of key combinations. Supplied with robust plastic carry storage cases and colour pictorial fitting instructions. DO NOT USE WHILST TOWING



Stronghold AL-KO hitchlock

- Sold Secure
- Fits Alko Hitches, AK130, AK160, AKS1300, AKS2004 and AKS3004 (all versions)
- Easy fit in under 10 seconds
- High visibility yellow
- Case hardened steel body and locking bolt

001703



Strongbox hitchlock

- Fits Alko, Albe, Winterhoff, Harrison, B&B and most other original open handle hitch types
- High visibility yellow
- Robust steel construction
- Anti-prising lip

001701



Stronghold Winterhoff hitchlock

- Sold Secure
- Fits Winterhoff WS3000 hitches
- Easy fit in under 10 seconds
- Supplied with steel security ball for the un-hitched position
- Case hardened anti-saw location pins

001705

The leg lock



- 2 year mechanical warranty
- Electro-plated for rust protection
- Robust heavy duty steel construction
- Dual locking system
- Supplied with 3mm allen key and hexagon adjustor key

001707



AKS 1300 security device

Comes with necessary fittings **007960**



AKS 3004 security device

Fits all models of 2004/3004 stabilisers **007940**



AKS 2700 security device

008007



Winterhoff Robstop

Sold Secure GOLD security device to fit the Winterhoff WS3000 stabiliser. Supplied complete with safety ball **007860**



AL-KO safety ball

Locks into hitch head for extra security. Supplied in a display box of 24 **002120**

WOW More trailer hitch locks on page B4

AL-KO Secure wheel clamps



The AL-KO Secure Wheel lock has proven itself year after year to be a superb caravan security device. Available as a standard fitment to many 2006 caravans onwards it has been tested to Diamond standard from SOLD Secure and is **the only product on the market with this level of security.**

Years of research and development into the methods and practices employed by caravan thieves ensures that AL-KO Secure protects your caravan. The AL-KO Secure Lock provides over 30,000 security combinations together with a drill resistant lock and anti-pick tumbler mechanism ensuring that your caravan is safer than it has ever been from theft. At home, on site or in storage, there is no better product to protect your investment.

There are 3 models - Compact kit, Plus kit & Premium kit - plus the option of buying the lozenge insert on it's own. Some locks are not available in all models. Where the item is not held in stock the AL-KO number is shown to assist identification.



Lozenge insert only

For use where owners change their caravan and own a Secure wheel lock. Simply use the existing barrel with the new lozenge insert and re-register.

Compact kit

For use on AL-KO chassis vehicles with the receiver plate pre-fitted. Lozenge with full instructions and key registration documents supplied.

Plus kit - *must be professionally installed*

For use on AL-KO chassis vehicles where no receiver plate is pre-fitted, but the brake drum is pre-drilled. Lozenge and receiver plate with full instructions and key registration documents supplied.

Premium kit - *must be professionally installed*

For use on AL-KO chassis vehicles with no receiver plate pre-fitted and brake drum is not pre-drilled. Brake drum (2051) plate, lozenge and receiver with full instructions and key registration documents supplied.

Where the Grove Number is "special" please speak to your sales contact for current price and availability

	Lozenge No. 1 - Bailey 14" <i>Used only by Bailey</i>
	Grove No. AL-KO No.
Lozenge insert	Special 1389041
Compact Kit	001907 1287642
Plus Kit	001916 1287716
Premium kit	001941 1287727

	Lozenge No. 27 - Pegasus 14" <i>Used only by Bailey on Pegasus & Olympus models</i>
	Grove No. AL-KO No.
Lozenge insert	Special 1552665
Compact Kit	001889 1289779
Plus Kit	
Premium kit	

	Lozenge No. 20 - Pageant 6 14" <i>Used only by Bailey on Pageant series 6 models</i>
	Grove No. AL-KO No.
Lozenge insert	Special 1550532
Compact Kit	001882 1289576
Plus Kit	Special 1289578
Premium Kit	

	Lozenge No. 22 - Senator 6 14" <i>Used only by Bailey on Senator series 6 models</i>
	Grove No. AL-KO No.
Lozenge insert	Special 1551031
Compact Kit	001883 1289577
Plus Kit	Special 1289579
Premium kit	

	Lozenge No. 28 - Unicorn 15" <i>Used only by Bailey on Unicorn models</i>
	Grove No. AL-KO No.
Lozenge insert	Special 1555231
Compact Kit	001884 1289824
Plus Kit	
Premium kit	

	Lozenge No. 8 - Salida 14" <i>Used only by Lunar</i>
	Grove No. AL-KO No.
Lozenge insert	Special 1389050
Compact Kit	001903 1287650
Plus Kit	001913 1287723
Premium kit	001944 1287736

	Lozenge No. 11 - Quicksilver 14" <i>Used only by Lunar</i>
	Grove No. AL-KO No.
Lozenge insert	Special 1389051
Compact Kit	001904 1287651
Plus Kit	001915 1287724
Premium kit	001945 1287737

	Lozenge No. 24 - Lunar 5514 14" <i>Used only by Lunar</i>
	Grove No. AL-KO No.
Lozenge insert	Special 1551986
Compact Kit	001895 1289166
Plus Kit	Special 1289205
Premium kit	

	Lozenge No. 31 - Lunar 14" <i>Used only by Lunar</i>
	Grove No. AL-KO No.
Lozenge insert	Special 1555305
Compact Kit	001887 1555497
Plus Kit	
Premium kit	



Lozenge No. 21
- Lunar Venus 14"
Used by Lunar and Avondale

Grove No. AL-KO No.
Lozenge insert **Special** 1550918
Compact Kit **001888** 1288559
Plus Kit
Premium kit



Lozenge No. 10
- Dion 14"
Used by Avondale

Grove No. AL-KO No.
Lozenge insert **Special** 1389049
Compact Kit **001902** 1287649
Plus Kit **001911** 1287722
Premium kit **001940** 1287735



Lozenge No. 2
- Hawk 14"
Used by various manufacturers

Grove No. AL-KO No.
Lozenge insert **Special** 1389042
Compact Kit **001900** 1287647
Plus Kit **001910** 1287667
Premium kit **001942** 1287728



Lozenge No. 19
- Hawk 15"
Used by various manufacturers

Grove No. AL-KO No.
Lozenge insert **Special** 1389048
Compact Kit **001908** 1287990
Plus Kit **Special** 1287725
Premium kit **001943** 1287736



Lozenge No. 29
- Vortex 14"
Used by Coachman

Grove No. AL-KO No.
Lozenge insert **Special** 1553574
Compact Kit **001885** 1289825
Plus Kit
Premium kit



Lozenge No. 30
- Vortex 15"
Used by Coachman

Grove No. AL-KO No.
Lozenge insert **Special** 1553575
Compact Kit **001886** 1289826
Plus Kit
Premium kit



Lozenge No. 14
- Debut 14"
Used only by Swift

Grove No. AL-KO No.
Lozenge insert **Special** 1389052
Compact Kit **001897** 1287991
Plus Kit **001918** 1287668
Premium kit **001950** 1287738



Lozenge No. 15
- Challenger 14"
Used by Swift on Challenger & Conqueror models

Grove No. AL-KO No.
Lozenge insert **Special** 1389816
Compact Kit **001892** 1287992
Plus Kit **Special** 1287996
Premium kit



Lozenge No. 6
- Challenger 15"
Used by Swift on Challenger & Conqueror models

Grove No. AL-KO No.
Lozenge insert **Special** 1389053
Compact Kit **001893** 1287652
Plus Kit **Special** 1287726
Premium kit **Special** 1287739



Lozenge No. 16
- Rimfire 14"
Used by Swift on GTS, Vogue Cameo & Spectrum models

Grove No. AL-KO No.
Lozenge insert **Special** 1389817
Compact Kit **001909** 1287993
Plus Kit **001917** 1287997
Premium kit



Lozenge No. 17
- Rimfire 15"
Used by Swift on GTS, Vogue Cameo & Spectrum models

Grove No. AL-KO No.
Lozenge insert **Special** 1389818
Compact Kit **001896** 1287994
Plus Kit **Special** 1287998
Premium kit **Special** 1288328



Lozenge No. 5
- Mirage 14"
Used by Swift

Grove No. AL-KO No.
Lozenge insert **Special** 1389043
Compact Kit **001906** 1287644
Plus Kit **001914** 1287717
Premium kit **001946** 1287729



Lozenge No. 4
- Mirage 15"
Used by Swift

Grove No. AL-KO No.
Lozenge insert **Special** 1389044
Compact Kit **001905** 1287645
Plus Kit **Special** 1287718
Premium kit **Special** 1287730



Lozenge No. 3
- Star 14"
Used by Swift on a range of models

Grove No. AL-KO No.
Lozenge insert **Special** 1389046
Compact Kit **001898** 1287643
Plus Kit **001912** 1287720
Premium kit **001949** 1287732



Lozenge No. 18
- Star 15"
Used by Swift on a range of models

Grove No. AL-KO No.
Lozenge insert **Special** 1389819
Compact Kit **001899** 1287995
Plus Kit **Special** 1287999
Premium kit **Special** 1288329



Lozenge No. 23
- Roven 14"
Used by Swift on a range of models

Grove No. AL-KO No.
Lozenge insert **Special** 1551985
Compact Kit **001894** 1289106
Plus Kit **Special** 1289107
Premium kit **Special** 1289108



Lozenge No. 25
- Storm 14"
Used by Swift on a range of models

Grove No. AL-KO No.
Lozenge insert **Special** 1552663
Compact Kit **001890** 1289487
Plus Kit **001921** 1289488
Premium kit



Lozenge No. 26
- Storm 15"
Used by Swift on a range of models

Grove No. AL-KO No.
Lozenge insert **Special** 1552664
Compact Kit **001891** 1289489
Plus Kit **001920** 1289490
Premium kit

FIAMMA SECURITY

Security handles

Security device made from solid painted aluminium with 30mm diameter and 2mm thickness. It also serves as a conventional handle to make entering and exiting the vehicle easier. Adapts to all doors opening both to the right and to the left

Security 31

31cm white **001201**
31cm grey **001200**

Security 46

46cm white **001203**
46cm grey **001202**



Security 46 PRO

Special version of Security for motor home doors or for applications where a strong structure is required. Made in light but solid aluminium. Delivered with Kit Security Lock that offers major safety and strength thanks to a third fastening point on the door

46cm white **001204**

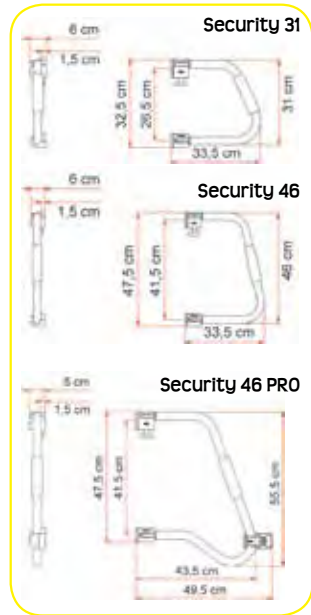

SAFE DOOR®

Safe Door®

Safety block for motor home or caravan door. It works as an anti-theft device as it is made from sturdy anodized aluminium without plastic parts. It is easily installed to the vehicle wall with bolts and internal support brackets

white **001205**



Safe Door® Frame

A Safe Door® that is installed on the side frame of the door or garage compartment with self-tapping screws.

white **001207**

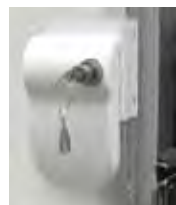

Safe Door® Magnum

A Safe Door® with extended length to 20cm in order to cover the locks of camper doors

White **001211**



Trailer hitchlocks



AL-KO coupling lock

A compact and sturdy universal 50mm ball coupling lock. Available singly or 5 per outer

002092



Grayston hitchlock

To fit 50mm ball couplings. Supplied with 2 keys

002087



Trailerlock Mk2

Fits into hitch head. Comes with allen key and 2 keys. Suitable for 50mm ball couplings

002090



AL-KO AKS 1300 lock

Integral lock for the AKS1300 stabiliser. Comes with 2 keys

002118



AL-KO AK 10 lock

Integral lock for Al-Ko AK 7, 9 + 10 hitches. Comes with 2 keys.

Available singly or 10 per outer **002105**



AL-KO AK 13 lock

Integral lock for Al-Ko AK13, AK21 and AKS 2700 stabiliser. Comes with 2 keys

002116

Locks and keys

Exterior door locks

wow A left hand lock fits on a door with the hinges on the left as you look from the outside



Caraloc 680
001001



Caraloc 700
Left hand 001078
Right hand 001089
Exterior only 001091

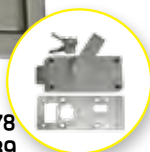

W4 external locker door lock
Replacement door lock assembly complete with WD lock and 2 keys. Used by manufacturers on external lockers
001169



Caraloc 640
Left hand complete 001103
Right hand complete 001105
Left hand interior only 001104
Right hand interior only 001106



Caraloc 2000
Left hand complete 001012
Right hand complete 001014
Left hand interior only 001013
Right hand interior only 001015

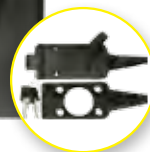

Zadi round door lock
Right hand black 001131
Left hand black 001132
R/H cream 001133
L/H cream (black interior) 001134



Compartment lock assembly
Complete assembly and 2 keys
001168



Locker locks

- 1 Black oblong 50mm 001161
- 2 Black square 45mm 001180
- 3 Black square 45mm inc cover 001162



- 4 Chrome 001182

Keys

All keys are supplied individually packed in outers of 3

MC keys

To fit Caraloc door locks 1-80
001147 followed by key number

WD keys

72 keys numbered between 1 and 199.

001155 followed by key number

Zadi key

70 keys numbered between 9600 and 9800.

001152 followed by key number

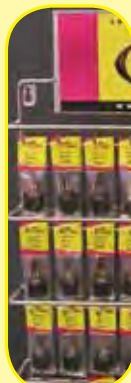

W4 Identitags (4)
10 per outer
001135

Key merchandisers

Includes 3 keys of each available number

MC 1-40 001149
MC 41-80 001150

WD 72 keys between 1 and 199 001160

Zadi 70 keys between 9600 and 9800 001153

Caraloc

Spare barrel

Supplied with 2 MC keys

001130



Security barrel

To replace caraloc and WD standard barrels with a high security lock with over 1000 combinations. Comes with removal tool and 4 keys

002127



WD Series

Spare barrels

Supplied with 2 WD keys

WD standard barrel with removal tool 001164



WD short barrel 001166



A short WD barrel lock with a female thread to enable attachment to gas locker door mechanisms.

001167



Zadi

As used on Hartel doors and Vecam lock assemblies

Spare barrel

Supplied with 2 Zadi keys

001154



Snake-Cut Lock

Replacement barrel lock cylinder, complete with one fold-away key fob and one over-moulded key. As used by Coachman Caravans

001170



Alarm systems

IDM4 Alarm kit

A keypad operated alarm system utilising the latest power saving technology. The system is able to operate for many months from its integral battery, thus removing reliance on the leisure battery. The main features are:

- Stylish keypad with 10,000 possible codes, sensor and battery test functions and programmable settings
- 3 possible power sources - plug-top charger, leisure battery, solar panel (optional extra)

002174

**IDM alarm spares**

IDM PIR sensor
Fits IDM 2, 3 & 4
002173



IDM charger
Fits IDM 2, 3 & 4
002171



IDM battery
Fits IDM 2, 3 & 4
002172

**Caravan alarm system**

Two multifunction, 4 button easy to use remote key fobs. Micro processing tilt/motion sensor. Advanced interior movement sensor. Auto charging battery back up siren. Visual or non visual status LED illumination. Easy connection design 002150

RF100 advanced alarm system

A keyfob operated alarm system utilising the latest power saving technology. The system is able to operate for many months from its integral battery, thus removing reliance on the leisure battery. The main features are:



002176

- Pocket keyfob complete with arm/disarm button, 2 x 12v switching channels (also 230v via adaptor), secure rolling code algorithm, low battery detection
- PIR, tilt/movement and contact sensors
- Low battery consumption
- Charging via leisure battery, mains or optional solar panel
- Outputs for triggering paging and tracking systems

Other security

Remote control P.I.R.

Detects human movement - 110° arc. 105dB alarm. Activated by remote control (2 with batteries supplied). The P.I.R. is also battery powered (4 x AA not supplied). Can be used free standing or wall mounted 002160

Solar powered dummy camera

Solar panel with rechargeable batteries. Flashing red light. Robust and weather proof body. Indoor and outdoor use. Operational during day and night.

Wall mountable with 360° rotating base
002216

Personal alarm with LED

Super bright 1 LED 13000-15000 MCD. Supplied with 4 AG13 batteries. 102dB alarm. When pin is pulled out alarm will sound. 002167



Corner steady lock
For use with AL-KO premium corner steady
007436

Engraver 3V
Robson pen style engraver. Security mark your valuables for easy identification.
002260

Safes & padlocks

**AL-KO Personal effects safe**

Complete with removable internal shelf, mounting plate, with all fixing and 2 keys. External Dimensions: 300 x 240 x 200mm, Internal Volume: 14 Litres, Outer wall thickness: 3mm, Weight: 8.5kgs

002165



Security cable and lock
10 per outer 001176



Waterproof laminated padlock
Available singly or 20 per outer
001177



Waterproof 65mm padlock
10 per display outer
001174



Robson heavy duty chain and padlock
3 per outer 001178



Key rock



Soup 002252



Beans 002253

Safe Can

Store your valuables where the thief won't find them. All labels and cans are 100% genuine and supplied by the manufacturer under licence. Recognised by Police Forces, Neighbourhood Watch groups and Insurance Companies worldwide as an excellent deterrent to theft, the Safe Can is an ideal place to hide money, jewellery and valuables. Just unscrew one end to reveal a great hiding place. Supplied 10 per outer

Key rock 002256

Supplied 50 per outer

Assorted soup, beans, spaghetti 002250

Plugs, sockets, multisockets and testers

Ring 12v MultiSockets & testers

Enables multiple use of 12v appliances with cigar lighter plugs. All come with battery status indicator with the exception of 011701 & 011710. All are blister packed with euro slot

**Twin MultiSocket & tester**

Available singly or 10 per outer
011702

**USB MultiSocket charging adaptor**

12v USB charging socket suitable for MP3 and mobile phone recharging. Available singly or 10 per outer **011710**

**Triple MultiSocket & tester**

Available singly or 10 per outer
011703

**4-way MultiSocket & tester**

Available singly or 10 per outer
011704

Can Multi-Socket & tester

10 amp 12v DC can shaped multi socket with battery analyser, width adjusting fitment collar, guide light rings and coiled cable. Available singly or 10 per outer

Twin with twin USB
Triple

011714
011716

**Twin MultiSocket**

Available singly or 10 per outer **011701**

**Twin MultiSocket 12v/USB & tester**

Allows the recharging of MP3 players and mobile phones. Available singly or 10 per outer **011712**

12/24v plugs and sockets

**Lighter type socket**

12/24v, surface mounted, heavy-duty socket. 20amp
011695

**Lighter type socket & cap**

12/24v. Panel mounted, with a dust and splash proof cap. Push fit mounting. 20amp
011698

**DIN to Lighter type converter**

12/24v. Converts any single pole socket to a lighter-type socket. No fuse. 8amp
011691

**DIN socket & cap**

Single pole socket surface mounted with a dust & splash-proof cap. 16amp
011690

**DIN multisocket**

12/24v. Three single pole sockets mounted on a 90 x 36mm panel. 16amp
011693

**Universal plug**

12/24v. Heavy duty suitable for use in both lighter type sockets and single pole sockets. 8 amp fused
011665

**Universal plug**

12/24v. Heavy duty suitable for use in both lighter type sockets and single pole sockets. 16 amp fused, built in power indication LED
011694

**Bendable universal plug**

A heavy duty plug similar to 011665 but can be angled at up to 90°. 8 amp fused
011696

**Standard DIN plug**

12/24v basic single pole plug without a fuse. Rated 8amp
011689

**Standard DIN plug**

A high-quality single pole plug without a fuse. Rated 15amp
011697

**Coiled extension lead**

12/24v. 8amp fused universal plug with coiled cable (0.6 to 3m) **011699**

**Lighter socket extension 3.6m**

12/24v. Heavy-duty extension lead rated to 20amps. Lighter-type plug on one end, lighter-type socket on the other. Length 12 feet, 3.6 metre **011682**

**4-way multi-plug power adaptor**

Provides 12v power from a lighter type socket to appliances. Contains the following plugs: 1 x 2.5mm mini jack & 1 x 3.5mm mini jack and 1 x 2.1mm power & 2.5mm power connections **011688**

Plugs, sockets, multisockets and testers



W4 illuminated cigar socket
Flush fitting in 28mm round hole. 12v
011671



W4 surface mounted lighter socket
Flush mounted socket for permanent fixing.
10 per outer **011669**



W4 lighter socket
Inline socket. 10amp. 10 per outer
011649



W4 fused lighter Plug
With 5amp fuse. 10 per outer **010647**



W4 2-way adaptor
Converts a lighter type socket to a double socket - internally fused at 15amps. Available singly or 10 per outer **011685**



W4 cigar plug/socket lead
Adaptor lead to extend lighter type sockets to a distance of 2 or 5 metres. Fuse (5 amp) built into plug. Available singly or 10 per outer
2m **011675** 5m **011680**



W4 Dual USB charging point
Available singly or 10 per outer
011720



W4 DIN socket
Single pole flush fitting socket **011631**



W4 DIN plug & socket
Single pole 8A plug & socket. 10 per outer
011630



Hella plug and socket
Single pole plug. Available singly or 10 per outer
011635
Single pole socket & cap
011646



W4 adapt-it 1
2 pin 12v plug to lighter type socket adaptor. 10amp. Available singly or 5 per outer **011650**



W4 adapt-it 2
3 pin 12v plug to lighter type socket adaptor. 2amp. Available singly or 5 per outer **011652**



W4 adapt-it 3
Parallel pin 12v plug to lighter type socket adaptor. 10amp. Available singly or 5 per outer
011654



W4 adapt-it 4
2 fully insulated crocodile clips to lighter type socket adaptor with 1 metre cable. 10amp. Available singly or 5 per outer **011655**



W4 adapt-it 5
Single pole plug to lighter type socket adaptor. 8 amp. Hella type. Available singly or 5 per outer
011657

Berker sockets



230V 13A socket

White **038800**
Anthracite **038801**
Brown **038802**

Rocker switch

White **038828**
Anthracite **038829**
Brown **038830**

Rocker switch twin

White **038832**
Anthracite **038833**
Brown **038834**

12V single pole socket

White **038808**
Anthracite **038809**
Brown **038810**

TV aerial point

White **038812**
Anthracite **038813**
Brown **038814**

TV/satellite point

White **038816**
Anthracite **038817**
Brown **038818**

Satellite point

White **038820**
Anthracite **038821**
Brown **038822**



USB charging point

White **038824**
Anthracite **038825**
Brown **038826**

12V cigar socket

Anthracite **038805**



Single frames

Granite **038851**
White **038852**
Anthracite **038853**
Brown **038854**
Chrome **038855**
White & lid (IP44) **038870**
Anthracite & lid (IP44) **038871**



Back box
038850



Double frames

Granite **038860**
White **038861**
Anthracite **038862**
Brown **038863**
Chrome **038864**



Triple frame

Anthracite **038866**

Clipsal plugs, sockets and switches

Beige

Please note: Clipsal beige plugs and sockets have been discontinued by the manufacturer. Products shown are currently still available. Unfortunately other Clipsal beige items are not available even by special request

**2 pin plug**

10 amp
polarised plug
038610
W4 2 pin 12 volt
plug. 10 per
outer **038609**

**2 pin socket**

15 amp
polarised
socket
75mm x 32mm
038615

**Single switch**

75mm x 32mm
038625

**Coax socket**

75mm x 32mm
038620

**Mounting box**

For units
measuring
86mm x 32mm
038650

**Coax and 2 pin socket**

86mm x 32mm
038635

**Double switch**

230v 10 amp
two gang 1
way/2 way.
86mm x 32mm
038640

**Illuminated single switch**

86mm x 32mm
038645

**2 pin socket**

15 amp
polarised
socket
87mm x 87mm
038617

**2 pin socket and coax**

87mm x 87mm
038678

**Fused switch with neon**

230v 13 amp
fused switch
with neon
indicator
038675

**Coax socket**

87mm x 87mm
038622

**Plug**

13 amp
038672

**Blanking plate**

038686

**3 pin plug**

2 amp
038600

**3 pin socket**

2 amp
038605

Black / Brown/ silversand

**2 pin plug**

12v polarised
plug
038613

**2 pin socket**

12v polarised
socket.
75mm x 32mm
038614

**Single switch**

10 amp switch.
75mm x 32mm
038633

**Coax and 2 pin socket**

86mm x 32mm
038638

**Double switch**

10 amp. Two
gang switch.
86mm x 32mm
038643

**Single gang socket**

Brown and
silversand
038682

**2 pin socket and coax**

12v 2 pin polarised
socket and coax
socket 87mm x
87mm
038681

**Silver sand surround only**

038684

**Single surface mounting box**

89mm x
89mm x 30mm
038663

**Divided box**

For two single sockets. Dimensions
Overall: 175mm x 85mm
Recess: 165mm x 75mm
038669

**Single flush mounting box**

89mm x 89mm
x 30mm
038662

**Single flush mounting box**

With push on
black trim.
89mm x
89mm x 30mm
038664

**Twin flush mounting box**

With push on black trim.
149mm x 89mm x 30mm
038674

**W4 mains backing boxes**

Suitable for flush fitting of most 13 amp sockets. Box simply pushes into cavity. Integral lugs click into position to retain box and clamp on partition when pulled forward. Self adjusting for material thickness 1-10mm. Available singly or 10 per outer

Single **038723**
Double **038724**
Twin **038725**

Electrical CBE sockets and switches



WOW CBE switches and sockets are supplied in three parts. Please order the support frame and "ni" frame as well as the switch or socket required.



Single support frame grey
86x78mm **038500**



Double support frame grey
139x78mm **038503**



Triple support frame grey
192x78mm **038506**



Light grey **038509**
Light grey **038512**
Light grey **038515**

Single module "ni" frame
Double module "ni" frame
Triple module "ni" frame

Dark grey **038518**
Dark grey **038521**
Dark grey **038524**



12V Switch
2 way. Grey **038527**



12V Switch & LED
Grey **038530**



12V Double switch
2 way. Grey **038533**



12/24V Switch & 3 position step switch
2 way. Grey **038563**



Pump & light switch
Grey **038560**



230V uk socket
Comes with back box
Grey **038536**



12V lighter type socket
Grey **038545**



12V watertight lighter type socket
Grey **038548**



12V Single pole socket
Grey **038551**



USB charging socket
Grey **038539**



TV & satellite socket
Grey **038542**



12V lighter type, TV & satellite socket
Grey **038554**



12V single pole, TV & satellite socket
Grey **038557**



CO detector
Grey **038572**



LPG detector
Grey **038575**



12V battery tester
4 level indication.
Includes frame and spacer. Grey **038569**



Waste & fresh water level indicator
4 level fresh and full indication waste. Includes 2 x 4m cables, frame, spacer and probes. Grey **038566**



Fresh water level indicator
4 level indication.
Includes 4m cable, frame, spacer and probe. Grey **038578**



Waste water level indicator
4 level indication.
Includes 4m cable, frame, spacer and probe. Grey **038581**



Fuse holder 4 fuse
Grey **038590**



Digital clock
LCD 65x32x11mm
038584



Fuse holder 50A
038587



Back box
50mm 34mm depth **038593**
45mm 22mm depth **038596**

W4 Electrical 1 - Bulb and Fuse

Complete stand

Complete with 10 packs of 48 of the best selling items in this range. Items

marked * are not included on the stand **010700**

All sold in outers of 10 unless otherwise stated

Bulb terminology

Ba = bayonette fitting

G/GX = Bi-pin connector

S = Single contact

E = Edison screw fitting

GU = Twist lock Bi-pin connector

d = Double contact

WOW All W4 pack-it items can be ordered loose at a preferential rate. Please speak to your sales contact for details.



12v 4W Ba9s
Side/No. plate
010511



12v 10W Ba9s
Halogen
Side/No. plate
010650 *



12v 5W capless
Tail/side
010556



12v 5W Ba15s
Tail/side
010512



12v 21W Ba15s
Indicator
010510



12v 21W Ba15s
Amber. Indicator
010564
Offset pins
010595



12v 21/5W
Ba15d
Stop/tail
010509



12v Ba15d
Tail/interior
5W **010550**
21W **010553**



12v G4 Halogen (2)
Interior
5W **010543**
10W **010563**
20W **010591**



240v 25W G9
halogen
Interior
010544



12v G4
30° MR11
dichroic
Interior
10W **010533**
20W **010534**



12v GX5.3
36° MR16
dichroic
Interior
10W **010651**
20W **010652**



12v LED GX5.3 36°
MR16 dichroic
Interior. Available
singly
15 LED **010655 ***
20 LED **010656 ***



230v GU10
40° dichroic
Interior. Available
singly
20W **010588 ***
50W **010589 ***



230v LED GU10
40° dichroic
Interior. Available
singly
15 LED **010657 ***
20 LED **010658 ***



12v Ba15s
Interior
10W **010551**
15W **010552**



12v Ba15s
Halogen
Interior
5W **010558 ***
10W **010559 ***



12v 24W
B22d
Interior
010560 *



12v E14
Interior
15W **010554 ***
25W **010555 ***



230v B22d
Globe bulb
Interior
25W **010590 ***
40W **010596 ***



230V 25W E14
Pigmy bulb
Interior
010561 *



230v 25W E14
Golf ball bulb
Interior
010562 *



12v Festoon
Interior/Awning
5W **010508**
10W **010513**
18W **010557**



10A in-line fuse holder
010516



Blade fuse holder
010642



4 Way blade fuse box
010594



LED Blade fuses (3)
LED glows when fuse blown
5A **010670 ***
10A **010671 ***
15A **010672 ***
20A **010673 ***



Mini blade fuses
mixed (8)
2 x 5A, 10A, 15A
& 20A
010631 *



Blade fuses
mixed (10)
2 x 3A, 5A, 10A,
15A & 20A
010633 *



30 x 6.35mm fuses (3)
3A **010519**
5A **010520**
10A **010521**
15A **010518**

Mains fuses 30mm
mixed (6)
2 x 3A, 5A & 13A
010644



Continental fuse
mixed (6)
2 x 8A, 16A & 25A
010643



20 x 5mm fuses (3)
1A **010632**
2A **010522**
3.15A **010523**
5A **010524**
10A **010525**

Mini blade
fuses (3)
5A **010605**
10A **010610**
15A **010615**
20A **010620**

Blade fuses (3)
3A **010634**
5A **010635**
7.5A **010636**
10A **010637**
15A **010638**
20A **010639**
25A **010640**
30A **010641**

Bulb and fuse kits



W4 Inside/outside bulb and fuse kit

Contents:

20mm fuses (1A, 2A, 3A, 5A & 10A)

30mm fuses (5A, 10A & 15A)

Mains fuses (5A & 13A)

Blade fuses (3A, 5A, 10A & 15A)

12v bulbs x 9 (Stop and tail, flasher/fog, no. plate, tail, 10W spot, 15W spot, 10W G4, 5W festoon & 10W festoon).

Available singly or 25 per outer
010800



W4 Budget bulb and fuse kit

Contents:

12V bulbs x 7 (5W festoon, 4W Ba9s, 5W capless bulb, 5W Ba15s, 10W Ba15s, 21W Ba15s & 5/21W Ba15s)

Blade fuses (10A, 15A)

010801



W4 Motor home headlight kits

Contents:

12V bulbs x 7 (5W festoon, 4W Ba9s, 5W capless bulb, 5W Ba15s, 10W Ba15s, 21W Ba15s & 5/21W Ba15s)

Blade fuses (10A, 15A & 20A)

Mini blade fuses (10A & 15A)

Plus the following

H1 headlight bulb **010803**

H4 headlight bulb **010804**

H7 headlight bulb **010805**



Universal bulb kit

Contents: H1, H4 & H7 headlight bulbs.























11 assorted bulbs, 3 assorted blade fuses and 2 assorted mini blade fuse

010802

W4 Electrical 2

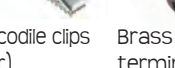
Complete stand

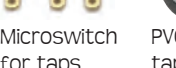
Complete with 10 each of the 48 best selling items in this range. Including the W4 fused lighter plug on page C2 and the TV pack-it range on page D10 **010598**
All sold in outers of 10

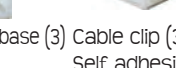
						
Push-On terminal (3) Male 6.35mm Red 010569 Blue 010570	Push-On terminal (3) Female 2.8mm Red 010575	Push-On terminal (3) Insulated female 6.35mm Red 010566 Blue 010567	Piggy back terminal (3) 6.35mm Blue 010573	Push-on terminal & cover (4) Female 6.35mm 010503	Ring terminal (3) Blue 6mm \varnothing 010578 Yellow 8mm \varnothing 010579	Self stripping cable connectors (4) Blue 010506
						
30A Terminal strip 6 way 010500	15A Terminal strip 12 way 010504	2A Terminal strip 12 way 010531	Cable clip (10) Flat 10mm 010501	Cable clip round (10) 6mm 010502 10mm 010565	Cables ties 100 x 2.5 mm (6) 010526 190 x 4.8 mm (3) 010527	Releasable cable ties (3) 300 x 4.8 mm 010593
						
Crocodile clips (pair) 5A 010517	Crocodile clips (pair) 50A 010529 25A 010530	Brass battery terminals (Pair) 010645	Press switch 010514	Bolt set (3) For towing sockets M5 x 35mm 010515	Microswitch for taps 010583	PVC insulation tape 19m x 4.5mm 010507
						
Cable tie base (3) 010528	Cable clip (3) Self adhesive 010592					

WOW Cable terminals are colour coded for easy identification
Red for fitting to 0.5-1.5mm² cables
Blue for fitting to 1.5-2mm² cables
Yellow for fitting to 4-6mm² cables
Workshop bulk packs can be found in section Q

WOW All W4 pack-it items can be ordered loose at a preferential rate. Please speak to your sales contact for details.

Voltage testers



W4 Battery tester

Useful gadget for checking power in all sizes of dry cell batteries. Available singly or 10 per outer **016093**

DC voltage tester

6-24V DC tester with neon indicator complete with 1 metre lead and crocodile clip. Available singly or 10 per outer **016041**

The intelligent screwdriver

Tests voltage, continuity, bulbs, fuses and much more. Available singly or 10 per outer **016092**

Digital voltage tester

This product is easy, safe, quick and accurate to use. It will detect AC voltage, is a neutral checker and performs earthline connection checks. 20 per outer **016091**



W4 Compact digital multimeter

Tests AC/DC voltage, DC current, resistance. Audible continuity check. Automatic low battery indicator. Available singly or 10 per outer **016094**



W4 Digital multimeter

Tests AC/DC voltage, DC current and resistance, diode & transformer check. Audible continuity check. Auto polarity indication. With impact resistant holder and plug in leads. Battery supplied. Available singly or 10 per outer **016096**



Rolson Digital multimeter

Tests AC/DC voltage, DC current, decibel ratios, continuity, diode & transistors. With plug in leads. Battery supplied. Available singly or 24 per outer **016097**



Battery, bulb & fuse tester

Checks power level of most 1.5V & 9V batteries. Also checks power level of most fuses and bulbs. Easy to read meter. Requires 9V battery. Available singly or 12 per outer **019210**

Emergency power

4 in 1 Universal power adapter

230V, 12V and USB charging system. Adaptors for iPhone (4 generations), Blackberry, PSP and others.

4 per outer **017101**

3 in 1 Universal power adapter

12V and USB charging system. Adaptors for iPhone (4 generations), Blackberry, PSP and others.

5 per outer **017102**

Emergency phone charger

Suitable for charging Nokia, Samsung, Iphone, Ipod and Motorola. Includes mini USB adaptor. Supplied with AA battery. 12 per outer **011750**

5 in 1 charger

Comes with five different adaptors to charge various phone brands such as Siemens, Nokia and Sony Ericsson through car cigarette socket. 6 per outer **017100**

230v plugs, sockets and accessories

**Mains site plug**

230v male 3 pole 16A plug complying with BS4343 and IEC 309 CEE17

Available singly or 10 per outer

W4 packed **016007**

Bulk loose **016008**

**Mains coupler**

230v female 3 pole 16A plug complying with BS4343 and IEC 309 CEE17

Available singly or 10 per outer

W4 packed **016018**

Bulk loose **016019**

**Mains hook-up adaptor U.K.**

Enables a mains lead to be connected to a 13A 3 pin socket

Available singly or 10 per outer

W4 packed **016118**

**Mains hook-up adaptor continental**

Enables a mains lead to be connected to a continental 13A 2 pin socket

Available singly or 10 per outer

W4 packed **016125**

**13A trailing socket**

230v male site plug with 13A trailing socket. Available singly or 10 per outer **016090**

**W4 Mains angled inlet**

Surface mounted 230v male 3 pole 16A inlet complying with BS4343 and IEC 309 CEE17

016029

**W4 flush mains inlet**

230v male 3 pole 16A mains inlet with lever release in an IP44 housing. Installation hole: 100x100x80mm (HxWxD). Available singly or 10 per outer. White **016045**

**Cover and pins**

Fits 016036, 016038, 016039 and 016043 (by cutting fins).

160 x 100mm

016040

**Oblong flush mains inlet**

230v male 3 pole 16A mains inlet in an IP44 housing. Installation hole: 150x92x65mm (HxWxD)

016036

**W4 flush mains outlet**

230v female 13A socket in an IP44 housing. Installation hole: 150x92x65mm (HxWxD)

016039

**W4 waterproof flush socket**

IP55 230v 13A socket in an IP44 housing. Installation hole: 150x92x65mm (HxWxD)

016043

**W4 flush dual 230v/12v outlet**

230v female 13A socket & 12v lighter type socket in an IP44 housing. Installation hole: 150x92x65mm (HxWxD) **016038**

**Garage socket**

230V female 3 pole 16A mains outlet. IP44

016049

**W4 waterproof socket**

230v 13A socket IP55

016044

**Travel adaptor**

UK 3 pin socket to Euro 2 pin plug 7.5A capacity. Available singly or 10 per outer **016130**

230v mains testing equipment

**W4 mains tester**

For electrical safety. Considered essential on the continent. Tests Earth, Live and Neutral. Available singly or 5 per outer **016099**

**W4 mains testing kit**

For checking the polarity directly from site electrical post. Components can be used separately **016095**

**W4 Universal mains testing kit**

All you need to test the site supply at source, both in the UK and Europe. Especially useful for testing for polarity reversal **016100**

230v mains leads and accessories

Heritage "Keep Calm and Caravan" mains cable bag

100% cotton canvas hitch cover with drawstring. Wet and rotproof. High quality desirable product **016177**
Also available in more economical Nylon **016176**

WOW Heritage range. Choose your colour, change the crown for your logo or even display your phone number? - all for the same unit cost. Minimum order quantity - 50. Please speak to your sales contact for more details. For personalised product please allow 6 weeks for first time orders and 4 weeks for repeat orders to receive your delivery. Mains cable bag **016178**



The Heritage range also available in a hitch cover (see section A) **007345** and a peg bag (see section T) **109563**

Mains extension lead

Specification 16A 230V cable to BS6500 1975

10m lead **016171**

25m lead **016172**

Mains cable

100m roll **016175**

**Mains lead bag**

Reinforced nylon bag **016174**

Printed bags

Minimum 100 **016173**

WOW Printed bags have the same unit cost as standard bags (for single colour printing) minimum quantity 100. Please speak to your sales contact for more details. For personalised product please allow 6 weeks for first time orders and 4 weeks for repeat orders to receive your delivery.

**W4 cable keeper & storage bag** **016267****W4 cable keeper**

Will hold up to 25 metres of cable **016266**

**Cord wheel**

Stores up to 45 meters of cable, cord, rope or flat hose keeping it tangle free and ready for use.

6 per outer **016268**

**Cable connecting case**

Waterproof safety box for housing the connection when using 2 mains cables **016170**

Cables



Priced per metre. Sold in rolls.

7 core Black PVC sheath with PVC insulated cores - 21 x 0.2mm 100m roll

7 core Black PVC sheath with PVC insulated cores - BS 16452004/5 100m roll

7 core Grey PVC sheath with PVC insulated cores - 6 of 21 x 0.3mm and 1 of 35 x 0.3mm 30m roll

Twin flat Twin core flat cable 2 x 32/0.2, 8 amp, (1.0mm²) black sheath, 30m roll

Mains cable 3 x 2.5mm² with orange outer sheath 100m roll

011542

011544

011553

011586

016175

Mains power supply



CEC mains unit 225SPN

Fully insulated enclosure containing a 40A RCD and two single pole, neutral switched MCB's (10A and 6A). Used in conjunction with a charging system and distribution panel the 225SPN can supply and protect all aspects of power supply to a caravan or motor home.

Dimensions: 183x118x104mm (HxWxD)

017050



CBE DS120 mains distribution unit

The DS120 is a RCD main switch with a double pole 13A MCB to control and protect various mains circuits.

138x180x85mm

017004



W4 mains electrical pack

Contains all the necessary components for a safe and efficient mains installation in a caravan. Full fitting instructions supplied

016277

Mains and 12v power supply



STE48 Mains consumer unit

Charger Specification

- 230v AC Input 1.5A 50/60HZ
- 18A Maximum output current
- 14.5v Maximum output voltage
- Protected from output faults
- Operating temp. -25°C to +50°C

Main Unit Specification

- 0-16A 230v AC Input (Site Limited)
- 3 x 10A MCB - 40A RCD Protected
- Water & Space Heater Outputs
- BS EN 60335-2-29 Approved

Available singly or 5 per outer

017125

Wiring harness adapters

STE48 to Nord NE143RM 017128

017127 STE48 to Nord NE143DU



CEC PMS 3

Power management system combining mains/12V distribution and protection with a 18A battery charger. Terminal block connections for easy installation. 40A RCD, 3 resettable MCBs (10A, 6A & 6A), polarity indicator, pump switch, battery selector switch and battery condition indicator

Vertical 017040

Horizontal 017041



CEC PMS 4

A combined mains 230v AC and 12v DC distribution unit. Earth leakage protection via 40A RCD device. Over current protection via 3 x MCB devices (10A, 6A & 6A). Reverse polarity 240v neon indicator. 12A or 18A charger with overcurrent, short circuit and thermal protection. Six fused outputs via automotive blade fuses. Connecting kit with all necessary plugs and sockets provided. Dimensions: 225x335x115mm

017051



CEC ESM 2000/2 supply module

Designed to operate on a mains supply of 185-265 volts AC. The 40A RCD gives protection against earth faults and also acts as the main switch. Includes 3 resettable MCBs, to protect against overcurrent.

Allocation of the MCBs is as follows:

- MCB1 (10A) - Sockets / heater
- MCB2 (6A) - Water heater / Lights
- MCB3 (6A) - Fridge / Charger

Includes a transformer/charger. Provides 12V circuits with power and charges the 12V battery when connected to the mains supply. 18A maximum output.

Dimensions: 225x123x255mm (HxWxD)

017045



CBE DS300 12V distribution unit

With 9 fused circuits

017006

Mains and 12v power supply continued...

CF8 charger

Fully automatic electronic charging plus 230/12v conversion. 12A max charge depending on battery state. Up to 4.5A continuous current on transformer. Features include 3 x 10A switched and fused outlets for the vehicle accessories, battery condition monitor, automatic self re-setting, current overload and thermal trip. Dimensions: 162x206x110 (HxWxD)
Black **017024** Brown **017026**

**CF9 charger**

Fully automatic electronic charging plus 230/12v conversion. 12A max charge depending on battery state. Up to 4.5A continuous current on transformer. Switched selection of source, car or auxiliary battery. Double pole illuminated mains switch. Safety - the C9 incorporates no less than 8 protection devices to eliminate overheating and over current problems. Dimensions: 105x300x140mm (HxWxD)
Brown **017028**



Chargers

**CBE chargers**

Designed specifically for the caravan, motorhome and marine markets. These chargers have thermal protection from overheating and short circuit and reverse polarity protection on 12v. For lead acid and gel batteries. TUV approved. Available in 10A or 16A maximum charge versions. Automatic operation, once voltage is reached it will continue to charge for 90mins (lead acid) or 8hrs (gel). Continuous maintenance 13.5V (lead acid) and 13.8V (gel). After 10 hours of maintenance the charger will switch to standby and charge again only when the battery drops below 13V. Dimensions: 180x140x85mm (LxWxD)
10A CB510 **017000**
16A CB516 **017001**

**STE47 3 stage charger 18A**

- 230v AC Input 1.5A 50/60HZ
 - 18A maximum output current
 - 14.5V maximum output voltage
 - Protected from output faults
 - Operating temp. -25°C to +50°C
 - BS EN 60335-2-29 Approved
- Available singly or 5 per outer
017138

3 stage 18A open charger

Specification as 017138 without cover
017124

**CEC 3 stage charger 18A**

A light weight and efficient leisure battery charger. Thermal, short circuit and overload protection. Fan protection. 3-stage charging - bulk mode, absorption mode and float mode - charges your battery to 100% capacity. Operates from 184v to 264v AC. Temperature operation -25°C to +50°C. Dimensions: 176x162x74mm (LxWxD)
017053

Open charger for CEC 18A

This open charger can be used on all CEC units. May need slight adjustment on the fixing points on older models. If you are using this on an ESM2000 make sure the small switch on the side is pointing at "FLOAT" not "3 stage". Dimensions: 167x113x59mm (LxWxD)
017052

**X70 ce charger 12.5A**

A lightweight compact battery charger and power supply with a stabilised output for maximum efficiency and control. L195 x W115mm x H70mm
017020

**X80 ce charger 16.5A**

A lightweight 230V AC low noise forced cool battery charger and power supply with increased power for additional accessories. L195mm x W115mm x H90mm
017022

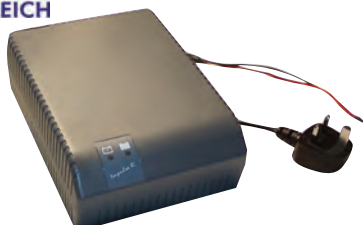
Impulse battery charger

The Impulse is a fully automatic computer controlled and safeguarded power supply and charger. TUV/GS approved, designed with double insulation. Operates in low voltage situations (e.g. 200v) to help prevent damage the leisure battery

- High frequency technique
 - Weight 1.5Kg
 - Can be used as a power supply without battery
 - Suitable for lead acid and gel batteries
 - Automatic overheating reset
 - LED fault finding
- 10 amp **017070**

Control panels and indicators

**Zig VM4 voltmeter**

Only two connections required for accurate up to date battery condition. The meter's scale reads from 8 to 15 Volts with warning areas either side of the optimum voltage. Black **017030**

**Zig CPX7 control panel**

The Zig CPX7 battery condition meter allows both car and caravan battery voltages to be monitored from the caravan depending on which is being used to supply power. Dimensions 60x95x50mm. Black **017034**

**Zig MK1 control panel**

Three way switched and fused 12v distribution panel, analogue battery condition monitor and power source selector switch. Black **017032**

**CEC Custom volt meter**

Provides a useful indication of the voltage available at your battery terminals **017055**

**CBE 12V battery tester**

4 level LED indication. Includes frame and spacer. Grey **038569**

**CEC KT9SCU distribution panel**

Switch the power from car/cab batteries and van/auxiliary batteries or isolate both. Includes pump isolation switch which will inhibit the inboard or outboard water pump. Pump running indicator displays water pump activity **017057**

**Zig WG4 water gauge**

12v water gauge suitable for all water tanks. It can also be fitted to portable water carriers. At the push of a button the gauge provides an accurate reading. Dimensions: 65x85x60mm (HxWxD) Probe: 8 inches (cut to size)

Black **017036** Brown **017038**

**CBE PC200 control panel**

LCD control panel only. Microprocessor controlled digital system. Includes: Clock, battery (car and aux) level indication, fresh water level indication (%), internal and external temperature display, and controls for lights, water pump, fridge, car battery charging and exterior lights. Fuse protection and save battery function. Dimensions: 192x78mm **017003**

WOW To make up a PC200 kit add the following items to the control panel.

017006 DS300 12V distribution and fuse protection

017000 10A charger or **017001** 16A charger

Fresh water tank probe **017007** 400mm or **017009** 300mm

017010 Waste water tank probes

017012 Cables for probes - please order 1 for fresh and 1 for waste if necessary - not illustrated

017013 Cables for control panel - not illustrated

017015 Cables with internal and external temperature sensors

038587 50A fuse and fuse holder

**CBE Waste & fresh water level indicator**

4 level fresh and full indication waste. Includes 2 x 4m cables, frame, spacer and probes. Grey **038566**

**CBE Fresh water level indicator**

4 level indication. Includes 4m cable, frame, spacer and probe. Grey **038578**

**CBE Waste water level indicator**

4 level indication. Includes 4m cable, frame, spacer and probes. Grey **038581**



017000 or **017001**



017006



017015



038587



017010



017007 or **017009**

**Truma text control**

Control your Truma heaters with the Text Control that allows you to turn on and off your Truma product by simple text message. **017130**

More chargers



CTEK chargers

Charges all types of batteries to the maximum capacity. Lightweight and portable. Enables the leisure battery to provide as much as 25% more power than the 'on board' system. Can significantly prolong a battery's life. Can help prevent a 'dead' battery. Can be permanently connected to ensure perfect battery condition. Guaranteed for 2 years

- MXS 3.6 charger 3.6A (Battery size 1.2ah to 120ah) **010025**
- MXS 5.0 charger 5.0A (Battery size 1.2ah to 160ah) **010026**
- MXS 7.0 transformer/charger 7.0A (Battery size 14ah to 225ah) **010027**



- Smart battery charging
- Diagnostics
- Repair and maintenance

Smartcharge+ fully automatic chargers, ideal for charging 12v batteries. Supplied with 230v 13A plug. Connect and forget, can be left permanently connected. De-sulphation and recondition battery maintenance tools and LED display. Includes USB charging socket (except +8) LED light and hook. Fast, safe battery charging with multiple charge rates



Smartcharge+8
2 to 8A Dimensions:
259x133x70mm (HxWxD)
010047



Smartcharge+12
2 to 12A Dimensions:
259x133x70mm (HxWxD)
010049



Smartcharge+16
2 to 16A Dimensions:
335x160x92mm (HxWxD)
010051

Ring Standard Charge 8

12v, 8A fully automatic battery charger. Fast (8A) and slow (3.7A) charge rate settings. Easy to read LED indicators clearly show charger status. Reverse polarity indicating LED. Ideal for DIY, enthusiasts and standard battery charging. Dimensions: 215x260x100mm (HxWxD). For leisure batteries up to 120Ah **010054**



Ring Standard Charge 12

12v, 12A fully automatic battery charger. LED display screen shows battery voltage and charge rate applied. Fast (12A) and slow (3.7A) charge rate settings. Reverse polarity indicating LED. Ideal for DIY, enthusiasts and standard battery charging. Dimensions: 215x260x100mm (HxWxD). For leisure batteries up to 180Ah **010056**



Ring Workshop Charge 20

12v, 20A fully automatic battery charger. Tough metal and rubber construction for professional use. Fast (20A) and slow (3A) charge rate settings. 80A jump start function. High quality professional battery chargers. Dimensions: 215x265x230mm (HxWxD). **010058**



Dry cell batteries

Counter display stand 019150



Duracell alkaline batteries

Size AA MN 1500 (4)	20 per outer	019126
Size AA MN 1500 (2)	20 per outer	019135
Size AAA MN 2400 (4)	10 per outer	019140
Size C MN 1400 (2)	10 per outer	019117
Size D MN 1300 (2)	10 per outer	019108
Size 9v MN 1604	10 per outer	019144



019145



019147

Zinc Chloride batteries

High quality dry cell batteries at a budget price.

Size AA (4)	24 per outer	019204
Size C (2)	24 per outer	019202
Size D (2)	12 per outer	019200
Size 9v	24 per outer	019206
Clock battery MN9100 (2)	12 per outer	019145
Hob/igniter battery E23A	10 per outer	019147

Please note that the image is for illustration purposes only the manufacturer will change periodically.

RING POWERING Inverters



PowerSource inverters

The PowerSource modified sine inverters are internally protected by a fuse. For extra peace of mind the cigar lighter plug is also fused. An audible alarm sounds when the input voltage drops to 10.6v. The PowerSource will automatically shut down when the input voltage exceeds 15v DC. If the battery voltage drops below 10.0v the PowerSource will automatically cut off, leaving enough voltage to crank/restart the vehicle. The inverter will automatically shut down if draw exceeds the maximum rating of the PowerSource. If the internal temperature reaches 65°C the PowerSource will shut down automatically. Made from light weight durable ABS

- 150W 1 x AC socket & 1 x 2.1A USB **017215**
- 300W 1 x AC socket & 1 x 2.1A USB **017230**
- 500W 1 x AC socket & 1 x 2.1A USB **017234**



MP:75 Mininverter 75w

Transform your vehicle into a mobile office or home from home and never be caught short of electrical power again! Simply insert the MP:75 into your car's cigarette lighter socket and plug in any appliance upto 75w e.g. laptop **017212**



E:Can Inverter 150w

12v DC to 230v AC can sized modified sine inverter suitable for cup holders, 150w power suitable for laptop computers, video game consoles, MP3 players and many other applications, USB charging point to allow the recharging of electronic devices, coiled DC lead. Max Power Rating: 150W. Peak Power Rating: 240W. Operates from 10-15 volts. Low battery shutdown protection, over voltage protection, overload protection and temperature protection **017213**



PowerSourcePro Inverters

High quality modified sine inverters, ideal for the professional user requiring mains power for heavy duty applications. Power shown is the continuous power rating (for 12 hours). Includes USB charging port. Digital display shows application wattage and battery voltage. Both 2100W and 3100W versions include a wired remote control.



1100W **017238**

Applications

Domestic TV, games consoles, refrigerator, pro drill, jigsaw, strimmer, office laptop, PC & monitor, fan



2100W **017241**

Applications

Domestic TV, games consoles, refrigerator, toaster, hairdryer, pro drill, jigsaw, strimmer, circular saw, angle grinder, office laptop, PC & monitor, fan, fan heater



3100W **017243**

Applications

Domestic TV, games consoles, refrigerator, toaster, hairdryer, kettle, oil filled radiator, pro drill, jigsaw, strimmer, circular saw, angle grinder, hot air gun, pressure washer, office laptop, PC & monitor, fan, fan heater



Ring remote switch

Provides convenient remote on/off control of the 1100W PowerSource Inverter. **017245**

Wires5

A pair of multi-wire battery connectors. For round battery terminal posts. Connect up to 5 cables. Simply tighten the screws onto wires. **017tbc**



Battery accessories

Battery box deluxe

Features a 100A battery isolation switch, a battery power meter (at a touch of a button test the battery's condition), a 12v lighter type socket, external connections, and an adjustable carry handle. Made from impact resistant polypropylene. Accommodates all batteries up to (LxWxH) 356x208x228mm. **010322**



Battery boxes

Acid resistant plastic boxes. Comes with battery strap, 2 retainers and a buckle. Internal Dim (mm): 270x195x190 **010320** 410x200x200 **010321**



Lift-Off battery clamps

Suitable for all standard round battery terminals. Colour coded. Pair (packed). Available singly or 10 per outer **010009** Bulk pack. 150 pairs per outer **200100**



Battery isolator switch

12v 100A. Max rating 500A for 5 seconds **010325**

Isolator switch housing only 006960

Isolator switch key only 10 per outer 010015



W4 battery strap retainers

2 per pack. 10 packs per outer **010324**



Leisure batteries

Note: All batteries are despatched from a local distribution depot. Please check when ordering for current lead times.

Powerstart batteries *Minimum order quantity of 5 assorted.***XV24MF - 86ah**

Sealed leisure battery with dual post terminals, magic eye indicator, reinforced case, advance plate technology and a 3 year guarantee

Dimensions: (mm)
L257 x W172 x H220
Weight 18.8kg **010300**

**XV27MF - 96ah**

Sealed leisure battery with dual post terminals, magic eye indicator, reinforced case, advance plate technology and a 3 year guarantee

Dimensions: (mm)
L302 x W172 x H220
Weight 21.2kg **010304**

**XV31MF - 110ah**

Sealed leisure battery with dual post terminals, magic eye indicator, reinforced case, advance plate technology and a 3 year guarantee

Dimensions: (mm)
L330 x W172 x H242
Weight 23.3kg **010306**

**LV22MF - 75ah**

Leisure battery with magic eye indicator and a 2 year guarantee

Dimensions: (mm)
L266 x W175 x H225
Weight 16.9kg **010302**

**LV25MF - 90ah low box**

Sealed leisure battery with magic eye indicator and a 2 year guarantee

Dimensions: (mm)
L354 x W175 x H190
Weight 21.1kg **010309**

**LV26MF - 100ah**

Leisure battery with magic eye indicator and a 2 year guarantee

Dimensions: (mm)
L302 x W172 x H225
Weight 21.1kg **010308**

UK Giant batteries *Minimum order quantity of 5 assorted (UK Giant and Platinum - subject to geographic limitations)*

Built with extra deep cycle plates and glass fibre separators to prolong life. Durability is increased with the use of anti-vibration glue and plate locks to help combat damage by vibration.

**UK Giant 75ah**

Leisure battery with magic eye indicator and a 2 year guarantee

Dimensions: (mm)
L267 x W172 x H222
Weight 16.3kg **010315**

**UK Giant 100ah - low box**

Sealed leisure battery with magic eye indicator and a 2 year guarantee

Dimensions: (mm)
L351 x W174 x H188
Weight 22.6kg **010317**

**UK Giant 110ah**

Leisure battery with magic eye indicator and a 2 year guarantee

Dimensions: (mm)
L350 x W175 x H225
Weight 24.9kg **010316**

Platinum batteries *Minimum order quantity of 5 assorted (UK Giant and Platinum - subject to geographic limitations)*

Envelope and fibre glass separation for longer life. Thick Grid Technology for greater capacity and deep cycle durability. Fast charge capability.

**Platinum 75ah**

Leisure battery with magic eye indicator and a 2 year guarantee

Dimensions: (mm)
L267 x W172 x H222
Weight 16.3kg **010310**

**Platinum 100ah - low box**

Sealed leisure battery with magic eye indicator and a 2 year guarantee

Dimensions: (mm)
L351 x W174 x H188
Weight 22.6kg **010313**

**Platinum 110ah**

Leisure battery with magic eye indicator and a 2 year guarantee

Dimensions: (mm)
L350 x W175 x H225
Weight 24.9kg **010311**

Solar panels

Watt-peak (Wp) is a measure of the nominal power of a photovoltaic solar panel under laboratory illumination conditions. It is important to buy a quality product that is guaranteed to give you many years of service. Solar Technology panels are based on the finest crystalline technology, which is more efficient than amorphous or other film technologies. Solar Technology panels are all accredited with the internationally recognised IEC 61215 certification that guarantees robust construction and high performance in all weather conditions. 10 year module warranty - 20 year cell output warranty.



18Wp 010356



28Wp 010357



43Wp 010359

	Power (Watt peak)	Size (mm)	Weight (kg)	Amps per hour	Amps per day
010356	18	638 x 278 x 25	2.2	1.21	Up to 8.47
010357	28	559 x 407 x 25	2.8	1.71	Up to 11.90
010359	43	634 x 534 x 35	4.3	2.5	Up to 17.50

Caravan panel kits

Complete with all necessary cables, connectors, charge control and fitting instructions

- 18Wp 010356
- 28Wp 010357
- 43Wp 010359



80Wp 010364



120Wp 010366



Solar panel stand

Universal stand to suit every panel size up to 43Wp
010362



WOW Display stand

Free of charge with the purchase of 2x18Wp, 3x 28Wp and 2x 43Wp panels 010363

	Power (Watt peak)	Size (mm)	Weight (kg)	Amps per hour	Amps per day
010364	80	1198x534x35	7.9	5	Up to 35.00
010366	120	1483x671x35	11.5	7.93	Up to 55.51

Motorhome panel kits

Complete with all necessary cables, connectors, charge control, digital multi meter, sikaflex adhesive, angled fixing brackets and fitting instructions

- 80Wp 010364
- 120Wp 010366

Solar panels

**Folding solar panel kits**

The new PV Logic range of folding solar panels are perfect for anyone looking for a highly portable system which is quick and easy to use. Each panel has it's own integrated stand, charge controller and battery connectors, so all you need to do is open it up, stand it up and connect it to your battery for instant power.

These rugged weather proof panels are supplied with a premium padded carry bag.

Available singly or 5 per outer

40W **010351**

60W **010352**

90W **010353**

	Power	Size closed(mm)	Weight (kg)	Typical Watts per day
010351	40	500 x 353 x 76	7	260
010352	28	500 x 500 x 76	8.5	390
010353	43	700 x 520 x 76	11.5	585

**Solar briefcase panel 13w**

Made with a high impact plastic case and built-in stand, flashing LED and internal cable storage. Magnetic catches on handles keep panel closed when not in use. Dimensions: 510mm x 37mm closed. Weight 4.5kg. Output 13W, 1.08A/hour in best conditions. Overcast approximately 50% loss.

Available singly or 5 per outer **010350**

Solar autotrickle charger 12v

Designed for motorhomes when in storage to send a maintenance level charge to the battery, helping prevent flat batteries. Simply sits on the dashboard or windscreen and connects to the 12v cigar lighter socket.

Complete with suction cups (for windscreen mounting), LED charge indicator, 12V DC power plug, battery clips and 2.7 metre lead. Can be left connected overnight.

- Solar panel trickle charger to manage battery drain in parked vehicles.
- Can be connected to the cigarette lighter or directly to the battery.
- Will not overcharge or damage batteries.
- Charging voltage 13-14V, open circuit 22V.
- Applicable for all types of 12v batteries

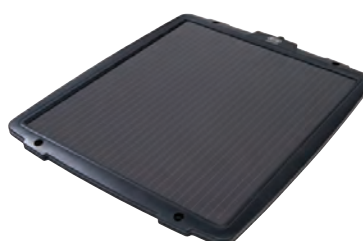

Power 1.5W
Power 2.4W
Power 6W

Dimension: 520x170x30mm (HxWxD) **010370**
Dimension: 525x265x35mm (HxWxD) **010373**
Dimension: 580x385x60mm (HxWxD) **010377**



If you want to use electrical power in your leisure vehicle exactly the way you do at home, you'll find mobile power sources quickly show their limitations. The EFOY COMFORT fuel cells are the solution for people who don't want to do without all the conveniences of home. These fuel cells will keep your batteries charged even in winter and allow you to park wherever you want - regardless of the weather and the season.

How does the EFOY work?

The EFOYs built in regulator constantly monitors the battery voltage. If the voltage drops below 12.3V, it will automatically switch on to recharge the battery. Once it's recharged, the EFOY will revert automatically to standby mode. You don't have to worry about a thing. EFOY makes sure that your battery will always be charged.

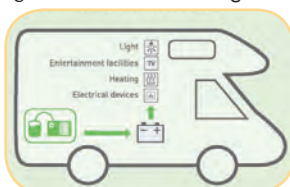

EFOY[®] COMFORT

The best energy supply for your travel enjoyment



Technical data

Grove No.	010336	010340	010342
EFOY COMFORT	80	140	210
Maximum power	40 W	72 W	105 W
Charge capacity / day	80 Ah	140 Ah	210 Ah
Nominal voltage	12 V	12 V	12 V
Charge current @ 12 V	3.3 A	6.0 A	8.8 A
Nominal consumption / kWh	0.9 l	0.9 l	0.9 l
Connectable batteries	12 V rechargeable lead batteries (lead acid, lead gel or AGM)		
Weight	7.0 kg	7.5 kg	8.2 kg
Dimensions (L x W x H)	44.3 x 20.2 x 28.8 cm		
Operating temperature	-20 to +40 °C		
Warranty ¹	2 years ²	2 years ²	5 years

¹ The valid warranty conditions apply

² Warranty can be extended to 5 years as an option

Fuel cartridge M5 010347 M10 010348

Nominal capacity	5.5 kWh / 460 Ah	11.1 kWh / 925 Ah
Volume	5 l	10 l
Weight	4.3 kg	8.4 kg
Dimensions (L x W x H)	19 x 14.5 x 28.3 cm	23 x 19.3 x 31.8 cm
Capacity in days	15 ³	30 ³

³ Based on experience; actual days of utilisation depending on the usage pattern

WOW New longer fuel lead for more installation options

Accessories

EFOY COMFORTs are supplied with all necessary accessories required for installation.

Ref	Description	Grove No.	Efoy No.
A	Control panel for EFOY 600-2200	010332	157 077 003
B	Control panel for EFOY COMFORT		157 077 053
C	Data Line		157 077 033
D	Insulated exhaust hose	010326	151 904 003
E	Surface mounting panel for EFOY 600-2200	010333	157 077 020
F	Surface mounting panel for EFOY COMFORT		157 077 054
G	External face plate		151 903 013
H	Off heat elbow		151 903 014
I	Off heat flange		151 903 023
J	Off heat tube	010327	151 904 001
K	Fuel cartridge holder		151 905 021
L	Belt for fuel cartridge holder		151 908 003
M	Mounting plate for EFOY COMFORT		151 908 020
N	Belt for mounting plate		151 908 022
O	Connecting line to EFOY		151 906 004
P	Battery fuse 2A-sense line		151 906 007
Q	Battery fuse 15A-power line		151 906 024
R	Complete charge line		151 906 034
S	Power line extension 8m	010328	151 906 006
T	Sense line extension 8m	010329	151 906 005
U	Service fluid	010334	150 903 001

WOW items without Grove numbers can be ordered as specials

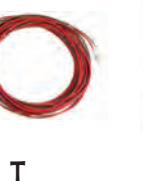

Lumolighting Interior lighting *lighting on the move*

www.lumo.eu.com

Fluorescent wall / ceiling lights

12v dc lighting specifically designed for use in caravans and motorhomes

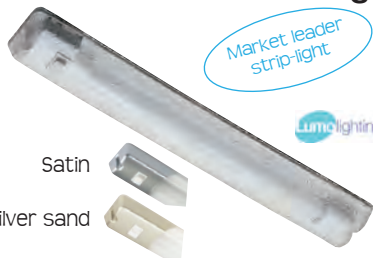

Market leader strip-light

Satin
Silver sand

Lumo 1
12v 8W switched fluorescent
Available singly or 10 per outer
Clear/white **018046**
Satin ends **018049**
Silver sand ends **018048**



Lumo XL
12v 8W switched fluorescent
Available singly or 10 per outer
Satin **018060**

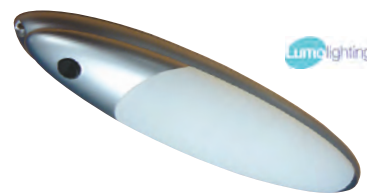

Ellipse
Stylish elliptical 12v 2 x 8W switched fluorescent, wall or ceiling light
Silver Sand **018276**

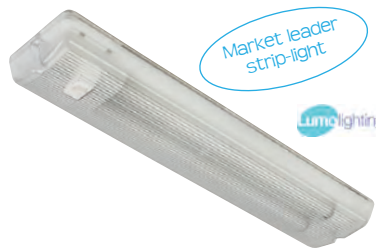

Market leader strip-light

Lumo 3
12v 2 x 8W switched fluorescent
Clear/white **018057**



Lumo 13
12v 13W switched fluorescent
Clear/white **018062**



LED tubes
T5 LED30 tube **018044**
Includes instructions on how to replace an 8W fluorescent tubes with an LED tube. Under no circumstances should the tube be simply swapped. It must be wired directly to the 12v d.c. supply. Available singly

Halogen wall / ceiling lights

PL tube wall / ceiling lights



Coronet
Discreet 12v switched wall or ceiling light. 10W G4
Silver sand **018273**



Crown
12v switched ceiling light. 20W G4
Silver sand **018260**
Satin (illustrated) **018258**



Coronet
Discreet 12v switched wall or ceiling light.
Chrome 9W **018274**



Crown
12v switched ceiling light.
Chrome Ice 9W **018261**

Halogen spot lights and down lights



MiniSpot
12v switched. 10W halogen
MR11 dichroic
White **018350**
Satin/Chrome **018359**
Black **018360**
Silver Sand **018362**



Dora SpotLite
12v switched. 10W halogen
MR11 dichroic
Brushed Nickel **018370**



EyeLite
12v. 5W G4. Ideal bunk light, surface mount or recess.
Push diffuser to switch on/off
Satin **018016**



Saturn DownLite
switched surface mount or recess 10W G4 halogen
Satin **018375**



PL-S tubes
Replacement 4-pin tubes in cool white
7W **019528**
9W **019533**
11W **019537**

How to Choose Your Lighting			
	LED Light Emitting Diode	HALOGEN Tungsten Halogen	FLUORESCENT/CFL Fluorescent/ Compact Fluorescent
Good	Green	Yellow	Green
OK	Green	Yellow	Yellow
Poor	Green	Red	Red
	Energy Efficiency	Energy Efficiency	Energy Efficiency
	Light Output	Light Output	Light Output
	Shores Colour	Shores Colour	Shores Colour
	Heat	Heat	Heat
	Cost	Cost	Cost
	Life	Life	Life

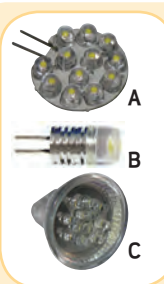

Replace your traditional bulbs with low energy LED bulbs...

Replace halogen in down lights with:

A LED12 TransAx **018024**

Replace halogen in spot lights with:

B LED1 Capsule **018014**

C LED12 MR11 **018013**

Available singly or 10 per outer





LED lights



LED24 StripLite
2W LED Switched. Available singly or 10 per outer satin **018000**

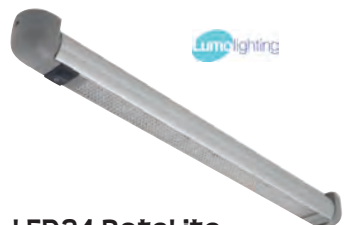

LED24 RotaLite
2W LED rotating head, switched Grey **018001**



LED20 RotaLite Mini
2.4W LED rotating head, switched Satin **017999**

LED Rigid StripLite
Can be cut to size every 3 LEDs.
18 LED 300mm **017978**
30 LED 500mm **017979**



LED01 ecospot
1W LED, switched
Brushed Nickel **017984**



LED01 Lily spot light
1W LED, switched
Brushed Nickel **017983**



LED01 Teoni
1W LED, switched
Brushed Nickel **018023**



LED01 SpotLite
1W LED, switched
Chrome **018010**



LED01 FlexSpot
1W LED, switched
Brushed Nickel **018022**

WOW Teoni has a slightly longer head than Lily and is conical shaped



LED9 CeilingLite
0.75W LED, switched.
Surface mount or recess
Satin **018009**



Ciara Eyeball DownLite
1W LED, switched
Chrome **017980**



LED01AD DownLite
1W LED Brushed Nickel **018008**



LED021L DownLite
2W 21LEDs. Warm White
Brushed Nickel **018004**

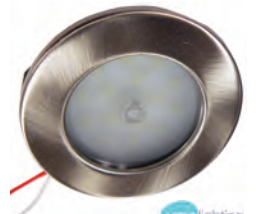

LED09 Touch DownLite
2W 9LEDs. Warm White
Brushed Nickel **017991**



LED21 Sensor CupboardLite
Satin **017997**



LED Coronet
Discreet 12v switched wall or ceiling light 3.5W LED.
Chrome **018019**



LED Crown
12v switched wall or ceiling light 3.5W LED.
Satin **018017**

WOW Ask your sales contact about the superb lumo LED Lighting sales unit **018380**



LED MouseLite
1W LED, switched
Satin **018005**



LED AwningLite
Easy to install, smooth, stylish water-resistant external light
10W halogen + LED
With 'Find-Me' day/night photocell controlled LED giving security with low battery drain
White **018390**
Satin **018392**
LED12
Consuming only 3W
White **018391**
Satin **018393**



LED Theo awning light
30 LED 2.4W **018395**



LED21 CeilingLite
1.75W unswitched with 'dimming facility', water-resistant
White **018002**
Satin **018003**





Interior lighting



Labcraft linear

Budget range. 12v switched fluorescent. Low profile, low energy - only 4.5A @ 12v with tough polycarbonate lens. 351 x 78 x 24mm

8W **018215**
16W **018220**



Labcraft trilite KL8

12v switched fluorescent, 8W. Supplied with one 8w tube but up to two more tubes can be added. Long bulb life - 10,000 hours. 381 x 78 x 24mm

018240



Labcraft XL 16

12v 2 x 8W recessed switched fluorescent. Strong durable unit. 800 lumens (2 x 8W tubes emit 800 lumens of light **018162**



Labcraft pearl

12v switched fluorescent
8W White 427 x 45 x 35mm **018210**
13W White 655 x 45 x 35mm **018212**



Labcraft DL

12v switched fluorescent
DL9 8w light 353 x 58mm **018172**
DL9 diffuser **018194**
DL14 13w light 582 x 58mm **018183**
DL14 diffuser **018205**

Square light

12v light with input of only 16w but output equivalent to a 100w light bulb using only 1/4 of the energy normally required. The tube will also last up to 4 times longer than a 100w light bulb.
Square light **018322** Spare tube **018331**



LED lights - with 2 year guarantee



Nebula LED strip light

12v switched. The Nebula incorporates the Orion LED strip in a tough aluminium housing to provide a bright low profile surface mounted solution. Length 625mm
018025



LED pole light

12v. Length 600mm. The LED pole light is the perfect solution for illuminating areas such as inside cupboards and wardrobes (strong enough for hanging purposes). Low energy 2.2W
018026



Orion LED striplight

12v. Budget light with 24 high intensity LEDs in a weather proof casing. 522mm x 17mm x 10mm **018028**



Callisto downlighter

12v. Super bright Power LED. Ideal for use in bathrooms, chilled/refrigerated areas and as an external light source
018039



2D bulb

4 pin 12v 16W
W4 **010587**
Available singly or 10 per outer
Labcraft **018331**
Available singly

Common replacement interior bulbs

Note: For more bulbs see C4.



Fluorescent tubes

10 per outer
Replacement 8W tube **018249**
Replacement 13W tube **018257**

LED tubes

Available singly
T5 LED30 tube **018044**



12v G4 Halogen
(2) 10 per outer
5W **010543**
10W **010563**
20W **010591**



240v 25W G9 halogen. 10 per outer
010544



12v G4 30° MR11 dichroic. 10 per outer
10W **010533**
20W **010534**



12v GX5.3 36° MR16 dichroic. 10 per outer
10W **010651**
20W **010652**



12v LED GX5.3 36° MR16 dichroic. Available singly or 5 per outer
15 LED **010655**
20 LED **010656**



230v GU10 40° dichroic. 10 per outer
20W **010588**
50W **010589**



230v LED GU10 40° dichroic. Available singly or 5 per outer
15 LED **010657**
20 LED **010658**



LED1 Capsule
Available singly or 10 per outer
018014



LED12 TransAX
018024



12v G4 MR11 dichroic. Available singly or 10 per outer
LED 12 **018013**



12v Ba15d
10 per outer
5W **010550**



12v Ba15s
10 per outer
10W **010551**
15W **010552**



12v Ba15s Halogen. 10 per outer
5W **010558**
10W **010559**



12v Festoon
10 per outer
5W **010508**
10W **010513**
18W **010557**

Assorted interior lighting

**LED sticky light set**

Bright white LED that can last up to 100 hours on a single set of batteries. Simply stick to any surface. Push to activate the 3 LEDs. Each light requires 3 x AAA batteries (not supplied) 8 per display box **019740**

**W4 LED handy lamp**

Powered by USB lead (supplied) or 3 x AA batteries (not supplied). Available singly or 10 per outer **019498**

**W4 LED instant light**

Ideal for cupboards or drawers. Powered by 3 x AG13 batteries supplied. 10 per outer **019497**

**W4 Clip-on LED light**

Powered by 3 x LR44 batteries supplied. 10 per outer **019495**

Fixed awning lights

AwningLite 

Easy to install, smooth, stylish water-resistant external light

10W halogen + LED

With 'Find-Me' day/night photocell controlled LED giving security with low battery drain

White **018390**

Satin **018392**

LED12

Consuming only 3w

White **018391**

Satin **018393**

Zoe light 

High power halogen reading light. Fully enclosed dichroic bulb, gives 30% more light than conventional downlighters. CE approved. 12v with quick release 10W bulb 30° MR11 G4 dichroic

Silver sand (illustrated) **018335**

Matt chrome **018336**

Spare bulb 10W MR11 **018339**

Available singly or 10 per outer

Ultra awning light **Ultra awning light**

Self-sealing weatherproof diffuser and multi-point fixing for easy replacement of existing awning lamp.

018431

**Ultra security light**

A unique security awning light with built in PIR movement detector. Offers automatic dusk to dawn activation for security and as a welcome light for occupants. Wide angle detector of 110°, detecting movement in a 7m range. 30 second "on" timer provides security without excessive battery drain

018435

Replacement lens **018433**

**Britax 891 awning lamp**

12V switched light. Can be used as interior or awning lamp. Complete with 10W festoon bulb. Dimensions: 133 x 133mm

891 awning light **018404**

Spare lens **018415**

Spare switch **018388**

Britax 896 awning lamp mk2

12V switched light. With rubber seal. Complete with 10W festoon bulb. Dimensions: 200 x 70mm

896 awning light **018386**

Spare lens **018387**

Spare switch **018388**

**LED Theo awning light** 

30 LED 2.4W

018395

**Astro LED awning light**

12v. 24 high intensity LEDs encapsulated in a weatherproof casing. Low energy - only 2.2 W. 2 year guarantee. Total length 592mm **018043**

**LED awning light**

31 LED 12v light made of solid painted aluminium.

Dim: 574x36x32mm (LxDxH)

018500

**LED garage light**

Similar to 018500 but complete with switch **018511**

**LED sensor light**

Similar to 018500 but complete with light and movement sensors. It only lights up in the dark and will stay lit for 60 seconds when activated

018508

Tent and awning lights

Link light

30cm solid 27 LED tent/awning light. Velcro or clip attachment for universal fitting. More add on units can be added for bespoke lighting solutions. Light output: 155 lumens per length.



Starter kit comes with 12V and 230V adaptors and 2m cables. **019646**



Add on unit (requires starter kit) has 2m additional cable **019647**



Flexi light

90cm flexi 90 LED tent/awning light. Comes with 12V and 230V adaptors and 2m cables. Velcro or clip attachment for universal fitting. Light output: 294 lumens. Available singly or 6 per outer **019653**



Tent and awning lights

Shower proof battery powered LED tent light. Comes with pegs to attach to poles, and packaging is complete with test button.

- Light output: 45 lumens 2pk
60 lumens 3pk
- Run time: 8hrs 2pk
7hrs 3pk
- Operates from: 4 x AA supplied

Available singly or 6 per outer
2 Lights **019640**
3 Lights **019642**



Rafter LED

12v switched telescopic rafter with 17 LED lights for use on all F45 awnings. Comes with switching bracket that allows power to the light as soon as the rafter is fitted. The bracket requires installation. Variable length (142-265cm).

018505



Kit awning LED

12v switched LED light with 2 x 10 LED lengths. Can be installed on F45 or F65 (including older versions). Comes with 5m of cable. Simply clicks into the front bar

018501



Awning arms LED

2 x 2 LED light kits containing 9 LED lights on each 30cm length (17x7mm). Each length comes with 5m of cable. For permanent mounting on the arms of any F45, F65 or ZIP awning.

018503



Kit cables rail

Ideal for hiding supply cables. 2 x Self adhesive lengths of 1225x13x3mm. Made from PVC

018514



LED warning solar lights (2)

Kit of 2 lights (LxWxH) 8x5.5x2.5cm which automatically turn on at twilight. 6 red intermittent signals continue for hours and recharge around 500 times. Can be used on tie down straps, steps, bike carriers, and much more...

018520

Assorted lighting



Mercury clip-on light

Useful addition at a very low cost. 230v light with spring clip. Available singly or 10 per outer **018381**



Mains awning lamp

230v external impact resistant light with double insulation. Complete with pole fixing clips, 5 metres of cable and fitted with a 13A fused domestic plug. 60w ES bulb. Available singly or 6 per outer **018450**

Rechargeable lanterns



Bright, effective lighting with the added benefit of operating from batteries (sold separately) or the CPX 6V Rechargeable Power Cartridge (sold separately). The large format combined with LED bulbs are perfect for group camps or working at home.

**CPX 6V Rechargeable power cartridge (RPC)**

Run any CPX 6 product with this rechargeable battery cartridge. LED changes from red to green when fully charged, mains and 12v adapters included.

Dimensions: 28 x 34 x 33mm (HxWxD)
109823

**CPX 6 Display stand**

Ask your sales contact for details

109825A

**CPX Duo LED lantern**

Light panels have individual on/off switches

- Light output: Lantern - 216 lumens
Panel - 91 lumens
- Beam distance: Lantern - 10 metres
Panel - 8 metres
- Run time: Lantern - 56hrs
Panel - 2.5hrs
- Operates from: 4D batteries or 6v RPC
- Size: 26.7cm H x 16.5cm W
- Weight: 1915g (with batteries)

109812

**CPX Portable electronics charger**

Charge your phone or other small electrical devices with this energy pack. Flexible power, storage compartment for cables, 5V and USB connections, up to 500mA.

- Operates from: 4D batteries or 6v RPC
- Size: 9.7cm H x 11.1cm W x 15.5cm D
- Weight: 913g (with batteries)

109824

**CPX Pivoting LED work light**

- Light output: 158 lumens
- Beam distance: 241m
- Run time: 82hrs
- Operates from: 4D batteries or 6v RPC
- Size: 28cm H x 12.1cm W x 14.2cm D
- Weight: 1199g (with batteries)

109816

**CPX Easy hanging LED lantern**

Can be hung in multiple orientations - even sideways - incredibly bright portable, overhead lighting.

- Light output: High - 141 lumens
Low - 58 lumens
- Beam distance: High - 8 metres
Low - 5 metres
- Run time: High - 65hrs
Low - 155hrs
- Operates from: 4D batteries or 6v RPC
- Size: 24.9cm H x 12.9cm W
- Weight: 1310g (with batteries)

109809

**CPX Heavy duty LED flashlight**

- Light output: 172 lumens
- Beam distance: 347 metres
- Run time: 94hrs
- Operates from: 4D batteries or 6v RPC
- Size: 18.3cm H x 19.3cm W x 11.7cm D
- Weight: 1125g (with batteries)

109822

**CPX led classic lantern**

- Light output: High - 115 lumens
Low - 72 lumens
- Beam distance: High - 7 metres
Low - 5 metres
- Run time: High - 85hrs
Low - 122hrs
- Operates from: 4D batteries or 6v RPC
- Size: 25.7cm H x 16cm W
- Weight: 1128g (with batteries)

109814

**CPX Ultra high power LED spotlight**

- Light output: 273 lumens
- Beam distance: 403 metres
- Run time: 50hrs
- Operates from: 4D batteries or 6v RPC
- Size: W
- Weight: 1199g (with batteries)

109821

Assorted rechargeable and wind-up products

**Ventus eco lantern**

- 5 x LED natural white light
- 2 x LED amber night light
- 12V, wind up (1mins winding = 20 mins light) or USB rechargeable
- Hanging, table top or wall mounted.

019779

**Ring Mini eco lantern**

- Eco friendly. Self wind lantern with 9 super bright LEDs
- Convex reflector for increased light output. Rechargeable with a 12v charger (included) 85mm x 175mm.

6 per outer

019590

**Ventus eco safety station**

Mains power station with automatic floodlight and audio alert when power fails

- 3 x powerful LED torches
- Also wind up (1 mins winding = 30 mins light) rechargeable

019774

**Ventus My Magic torch and phone charger**

Wind up (1 mins winding = 30 mins light), and USB rechargeable. Emergency phone charger. NO power? Just wind the handle whilst connected to your phone. Includes adaptors for Nokia, Motorola, Samsung, & iPhone and carry pouch

Silver 019771
Black 019772

**Rechargeable lantern with remote**

High quality plastic body lantern, with bright fluorescent light and long life rechargeable 6V battery. One full charge of approximately 18 hours will provide up to 5 hours of operating time. Supplied with replaceable 9W PL tube, remote control key fob, 12V and mains chargers. 6 per outer

019594

**Coleman Classic LED rechargeable lantern**

- Charges from 230v AC or 12v DC (both chargers included)
 - 12v charger can be stored in lantern base
 - Weather resistant
 - Light output: 64 lumens
 - Beam distance: 6 metres
 - Run time: 12 hrs
 - Dimensions: 33.5 x 18 cm ø
 - Weight: 2.8 kg
- 2 per outer
109820

**Rolson 4 LED windup dyno lantern**

Soft rubberised finish and simple on/off push button. One minute of winding can generate up to 7-8 minutes of light Ideal for camping, boating, hiking, and emergencies

12 per display box

019592

**Rolson 1 million candle power torch**

- Battery type 6V-4Ah rechargeable lead acid.
- Lens size 82mm.
- Locking trigger switch for safety.
- Rubberised lens protector and grip.
- Built in hanging lanyard.
- 12V DC charger & 230V 50Hz AC adaptor.
- Halogen bulb.
- One full charge of 10-15 hours with AC charger provides 30mins of continuous operation

4 per outer 019758

**Rolson 30 LED rechargeable spotlight**

- 30 LEDs with 12000mcd Lum
 - Rechargeable Ni-MH battery 12v 500mAh
 - Durable ABS housing and PC transparent lens
 - Charge time 6 hours approx
 - Operates for approx 1.5 hours on one full charge
 - Red and green charge indicator light
 - Auto shutoff prevents full battery run down
 - Lighting mode on/flash/off
- Supplied with 12v DC charger and 12v in car adaptor
6 per display box 019753

Ventus eco mini torch

Wind up (1 mins winding = 60 mins light) or USB rechargeable. High/low beam LED, tough, impact resistant.

019770

**Rolson Dyno torch 3 LED**

Super bright 3LED 13000MCD. Wind up 1 minute can generate 7-8 minutes of bright light. No batteries required With wrist strap. 12 per display outer 019726

**Ring Cyba-lite wind-up LED torch**

Eco torch wind for 60 seconds for 5 minutes of super bright light. With 3 super bright LEDs! 019605

Battery lights

**Rolson 24 LED bright light**

Super bright 24 LED, with simple on/off push button operation, complete with hanging ring. Ideal for camping or as a patio table light. Supplied with 4 x D batteries. 6 per display box

019733

**Rolson 30 LED multifunction lantern**

Super bright 2 x 15 LED. Panels individually switched and rotated. 3D batteries supplied. 2 per display box

019749

**Rolson 15 LED lantern with dimmer switch**

Built in compas. 195mm high. 12000mcd. 3 x AA batteries supplied.

4 per display box

019593

**Rolson 6 LED camping light**

Ultra bright 6 LED lantern, with simple push button operation. Super bright 6 LED, 11000-13000Lcd. Supplied with 3 x AA batteries.

3 per display box

019751

**Rolson 72 LED camping light**

Super bright 72 LED light with three strong magnets on reverse for mounting on most metal objects, along with swivel hook for hanging. Supplied with 4 x AA batteries.

5 per display box

019730

**Rolson 12 LED pocket light**

Super bright 4 LED front light. 8 LED side light. 3 x AAA batteries supplied.

7 per display box

019722

**Rolson 9 LED Aluminium lantern/torch**

Handy sturdy torch which doubles as a lantern

10 per display box 019596

**Rolson 1 LED aluminium keyring torch**

Pink and green assorted

24 per display box

019724

**Rolson 4 LED Aluminium torch**

Super bright 4 LED torch 12000-15000MCD. Rubber ON/OFF push button. Overall size 43 X 25mm.

16 per display box 019727

**Rolson LED keyring torch**

Bright white LED 22000 MCD. Zinc alloy keyring. Supplied with 2 x CR 2016 button cell batteries. 10 per display box

019725

**Ring LED rubber torches**

Shock proof rubber body, 3 super bright white LEDs, burn time up to 100,000 hours. Batteries included. 8 per outer

Small (2 x AA)

019540

Large (2 x D)

019542

**Ring LED aluminium torch**

9 super bright white LEDs. LED burn time up to 100,000 hours. Handy carry strap. 3x AAA batteries included. Ideal impulse buy to sit on counter top.

12 per display box

S00117

**Coleman Focusing LED flashlight**

- Light output: 83 lumens narrow
93 lumens wide
- Beam distance: 110 metres narrow
21 metres wide
- Run time: up to 7hrs
- Operates from: 3 x AAA supplied
- Size: 14.1cm L x 3.4cm ø
- Weight: 157g (with batteries)

109829

Work lights and assorted lights

**Rolson 24 LED multipurpose light**

Super bright LED. 3 x AA batteries supplied.
5 per display box
019734

**Rolson 28 + 4 LED work light**

Swivel head 28 + 4 LED worklight. Super bright white LEDs 13000-15000 MCD with magnet and swivel hook on reverse. 3 x AAA batteries supplied. 4 per display box
019599

**Rolson 24 LED lamp with hook & magnet**

Super bright 70mm 24 LED light requires 3 x AAA batteries. Ideal for garage, camping, emergency, household and numerous other applications. Complete with magnet on reverse and swivel hook to assist with hands free operation. 10 per display box
019735

**Rolson 3 piece 10 LED headlight**

- 3 mode switch - 4 LED on, 10 LED on, 10 LED flash and off
- Super bright LED light 12000 MCD
- Adjustable head band
- Supplied with 9 x AAA batteries

3 per outer **019765**

**Rolson Flexi LED torch 7.5"**

Reflector tube system for extrabrightness. Shock proof and water resistant, anodized metal casing with 108mm flexible shaft. Pocket clip and three button cell batteries. 6 per outer **019729**

**Rolson 20 LED work light**

Ultra bright 20 LED lantern, with soft grip handle. 8LED's at front of torch. 12LED's on base stand gives hand free illumination. Supplied with 4 x AA batteries. 6 per display box
019755

Workshop lights

Ring LED inspection lamp



Rechargeable and cordless for convenient use

- Charging indicator
- Compact design
- Suitable for professional, trade and DIY use
- Integral belt clip
- 15 High intensity LEDs
- Precision reflector providing wide angle light output
- Virtually unbreakable polycarbonate lens
- AC Charging point

Specifications: Light Output: 650 lux at 0.5m
Battery: 1800mAh NiMH Mains adapter: Input 230v - 50Hz. Output 6v - 500mA LED: Class 1 Approved
019597

Rolson 36 LED inspection lamp on stand



- Manufactured from ABS.
- Light mode push button once for 0.5W torch / off / 36 LED light / off.
- Magnetic function: Two magnets on base of stand, one magnet on back.
- Plastic hanging hook with easy 360° rotation.
- Operates from 3 x AA batteries supplied.
- 36 LED 15000 - 18000 mcd.

4 per display box **019598**

Satellite TV on the move

One of the most common questions we get asked is: "What satellite TV channels can I get for free?" The answer is thousands.

Choosing the receiver. It won't matter which receiver you buy, the footprint (the area in which the satellite signal can be received) remains the same. What's the difference between Free-to-air, Freesat, and subscription boxes such as a SKY Digibox? Free-to-air receivers will receive all channels that are not subscription (subject to reception), the program guide will be "Now & Next". On Freesat you will get most of the same channels (although not all), with a 7 day TV guide allowing you to plan your viewing. A subscription box is designed for home use and will often be pre programmed for UK satellite reception and can become complicated to set up, especially abroad, but would receive all the channels that you would get at home (subject to geographical limitations). All our receivers have 12v inputs, are Free-to-air and are designed for mobile use. If you get a picture on the screen, then the receiver is working. Issues with the type of channels found are problems with dish alignment and / or geographical limitations.

Choosing the dish. There are many types of satellite systems: portable kits, crank-up manual and automatic systems, as well as roof mounted automatic domes. Put simply the larger the dish the further toward the edges of the footprint you will receive a signal, although planar dishes such as the Camos flat-sat are more efficient and so can be slightly smaller than a conventional dish equivalent. In the UK, all our systems should be able to pick up your favourite channels.

Satellite footprints. The footprint will vary for each dish and each satellite, and so should be used as a rough guide only. When travelling abroad the channels that you receive will vary, but most satellites will have some English language channels such as BBC World News, CNN, Bloomberg etc. To connect to the Astra 2 range of satellites (which broadcasts most of the UK's main channels) in much of continental Europe would require a much larger dish than would be practical on the move. Below is a map of the predicted reception area of a RoadPro 40cm Sat Dome.

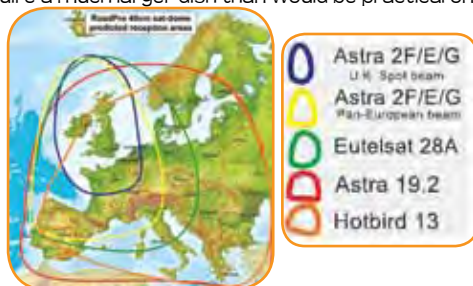

Astra 2F/E/G

By the end of 2013, all BBC, ITV, Channel 4 and Five TV channels as well as BBC radio stations will have moved to Astra 2E and Astra 2F.

Astra 2F/E/G Pan European

It is possible, and some say probable, that some of SKY's subscription channels will be broadcast on this beam when they are moved from their previous positions.

Thanks to RoadPro for the information on satellite reception!

WOW Many changes were made to the satellite broadcast network in 2012 and many more are to come in 2013 and 2014. The situation is constantly changing, and so the area in which you will receive certain channels may change at any time, therefore it is difficult to give definitive information at this time.

For listings of which TV channels are broadcast on which satellites try visiting www.kingofsat.net.

Roof mounted satellite systems

Automatic dome satellite systems



Sat dome foot

Now sold individually
20cm x 13 cm **039999**

RoadPro domes powered by Wiworld

Complete protection against wind and weather. Roadpro domes offer the widest range of models of any sat-dome manufacturer. Average satellite search times of 30 seconds. One button operation, just switch it on!

- Operating voltage 12V
- Fixes to the roof with sikaflex and / or screws (mounting kit for neater installation available 039999)
- Space required for operation: 76cm diameter including mounting feet
- Search controller dimensions H x W x D mm: 42 x 245 x 146
- Search options: Astra 2 (N & S), Eurobird 1, Astra 1, Hotbird, Sirius, Atlantic bird 3, Hispasat
- Off-set dish inside a protective plastic cover
- All weather resistant white dome casing, can be painted
- Can be used with any satellite receiver including Freesat, Free to air & SKY receivers (not included)
- 3 year guarantee

WOW Choose 30cm model where height is an issue - 40cm model for maximum coverage abroad. Use twin LNB version to use pause, record, or other functions of a recording receiver or to use 2 receivers at once. In motion versions allow passengers to watch TV or the driver to listen to the radio when travelling.

Part Number	Dish size (W x H cm)	LNB type	Weight approx. kg (Dish & motor)	Dome height cm	Current consumption Amps approx.	
					During search	In use (search complete)
Static models						
039990	46 x 25	Single universal	9.5	30	1.5	< 0.1
039992A	46 x 25	Twin universal	9.7	30	1.5	< 0.1
039992	46 x 35	Single universal	9.5	40	1.5	< 0.1
039990A	46 x 35	Twin universal	9.7	40	1.5	< 0.1
In motion models						
039993	46 x 35	Single universal	9.7	40	2.5	1.8

Automatic satellite systems



Maxview domes

The Maxview dome is a fully automatic dome satellite system which will remove the need for any manual tuning.

- Ideal for use in both the UK and Europe.
- Fast satellite acquisition with a typical search time for acquiring the satellite of between 30 to 60 seconds.
- Twin LNB version is ideal for use with PVR's, SKY+ or 2 receivers at the same time
- Receives transmissions from Astra, Astra 2, Hotbird and more
- Lightweight, designed to be permanently mounted to a vehicle roof
- Kit includes: Clear and easy to use control box (receiver not included)
- Very easy to install - only connect the coaxial cable(s) to the control box, no need to connect a separate power supply to the dome
- All weather resistant and fully tested dome casing
- Compatible with all DVB-S std and high definition satellite receivers including SKY
- 3 year guarantee

- LNB Output: Single 1 - Twin 2
 - LNB Type: Universal
 - Polarisation: H & V
 - Frequency Range: 10.7GHz 12.75GHz
 - Antenna Gain: 33dBi
 - Elevation Range: 18° - 64°
 - Azimuth Range: Single unlimited - Twin 540
 - Tracking Speed: 50°/s
 - Search Time: Typically 30-60 sec
 - Temperature Range: -20°C to +60°C
 - Dome Weight: 9kg
 - Dish size: Equivalent performance to a 40cm dish
 - Dome Height: 40cm
 - Dome Base: 70cm Ø
- Single LNB **040055**
Twin LNB **040056**

Control box specification

- Power supply: 12-24V
- RS 232 upgrade port: Yes
- On/Off power switch: Yes
- 1 button search operation: Yes
- Satellites Programmed: Astra 2N, Astra 2S, Astra 1, Hotbird, Sirius, AB3, Hispasat

Maxview Omnisat Seeker Wireless

Maxview's Omnisat Seeker Wireless system has been designed with the user in mind. Simple to use, easy and flexible installation options with elegant and modern styling. The ultimate in convenience along with its latest features surpass any other automatic satellite system available on the market. The unique wireless backlit LCD control panel features animated display icons feeding back antenna status to the user at all times. The wireless feature allows unlimited mounting options and easy installation, making unsightly cable runs and fixing problems a thing of the past. The control box comes with unique versatile mounting brackets offering flexible installation options and can be coupled with any satellite receiver (not supplied) to give the ultimate package.

- 12V operation
- Maximum 2A consumption during search
- Average search time: 30-60 seconds typical
- Automatic lowering ignition safety system
- High quality 0.2db universal twin LNB
- Stores up to 15 satellites
- Pre-programmed with satellites including Astra 19.2E, Hotbird and Astra 28.2E
- Control box allows any satellite receiver to be connected
- Full customer service back up and support
- Low streamline profile 17cm
- Complete with all installation cables and accessories - plug and play

WIRELESS CONTROL PANEL:

- Wireless or hard wired (included) as standard
- Backlit LCD display
- Stand alone or magnetic wall mount bracket (included)
- Simple to operate
- Clock/Temperature display

CONTROL BOX:

- Compact size
- Future proof design - USB updates available for future satellites
- Universal mount
- Integral easy access fuse



Available with either a 65cm satellite dish for use with receiving Freesat channels in the UK and Central Europe, or the larger 85cm version for an extended coverage area.

040050 Omnisat Seeker 65

- Antenna unit weight - 10kg
- 65cm offset aluminium antenna
- 36dB gain

040052 Omnisat Seeker 85

- Antenna unit weight - 11kg
- 85cm offset aluminium antenna
- 38.1dB gain

Manual crank up satellite systems

Camos flat-sat

Instead of a conventional dish, the Flat-Sat uses a planar antenna to catch a satellite's beam. This is a very efficient method and enables the "dish" to be much smaller, taking up less room on a vehicle's roof and making it easier both to install and use. The "flat-sats" have a performance of a larger diameter conventional dish and when it's in the parked position the unit's height is just 12cm.

The antenna's design makes it much more resistant to wind than a normal dish, allowing it to be used in conditions where other systems would have to be lowered for safety.

The dish is controlled from inside the vehicle using a ceiling-mounted cranking handle. It is essential to use a satellite signal finder for ease of use, see page D6.

Also available twin LNB enabling the functionality of Sky+ or other similar satellite receivers so that two channels can be watched at the same time.

If you are visiting Spain, Germany, Italy or Eastern Europe we recommend one of the larger crank-up "plus" satellite dishes

Flat sat	039995
Flat sat "plus"	039996
Flat sat twin LNB	039997
Flat sat "plus" twin LNB	039998



Maxview Omnisat 65 crank-up

Simply adjust the system from the comfort of your vehicle with the easy to operate direction unit, effortlessly raising and rotating the dish to locate and lock onto your favourite UK TV channels, anywhere in the UK and across into Europe.

- Improved handle design with clear and precise elevation display
- Low streamline profile, only 17cm in height in park position
- Elegant modern styling design
- No through the roof mast required, thus giving maximum flexibility on roof installations
- Designed for easier and improved installation
- Cable entry junction box allows for the system to be fitted in the most convenient position on roof
- Easy to align using the ceiling mounted "Crank Up" handle and elevation zone map
- Twin LNB as standard - Designed for use with SKY +/HD or free to air receiver with hard drive recording. Alternatively can be used to feed two separate receivers for independent working
- All weather resistant construction
- Designed for permanent mounting, but can be transferred to another vehicle
- Complete with Operation and Set Up Guide
- 3 year guarantee
- When in park position, the system is compact and hidden out of view and only a little higher than most sky lights
- Antenna unit weight - 9kg
- 65cm Offset aluminium antenna
- 36dB gain

040014



Remote control portable satellite kits



Maxview VuQube

Maxview's Omnisat VuQube remote controlled satellite system has been designed with the user in mind. Simple to use, easy and flexible. Portable, ultra lightweight with ergonomically designed carry handle. Dynamic dish levelling allows the system to be placed on uneven surfaces. Easily elevate & rotate the dish to locate the required signal with heavy duty LCD display wireless remote control (works to 15m). Complete with operation manual, Compass & set up guide

- Weighs only 4.5kg
- Twin LNB
- 37cm dish equivalent to 54cm offset dish
- All weather resistant casing
- Includes 2 x 10M of cable allowing easy positioning
- Dimensions H:46cm - W:42cm
- Powered by your receiver
- 2 year guarantee

040054

Portable satellite kits

**Maxview 54cm kit**

Complete kit to receive all available Digital satellite TV and radio channels when used with a compatible satellite receiver. Ideal for use in the UK and central Europe. Designed specifically for touring vehicles. Suitable for a tent or awning (although signal quality may deteriorate under wet canvas). Can be used with any Free to air, Freesat or Sky receiver.

Includes: Portable satellite dish with folding LNB arm, 10m coaxial cable, tripod stand, satellite finder, satellite compass, easy to use zone map, holdall and all required fixings.

- Weight: Under 9kg
- Universal LNB: 10,70-12,75GHz
- LNB noise figure: 0,3dB typical
- 2 year guarantee

54cm **040001** 66cm **040002**

**Maxview 66cm kit**

WOW Upgrade your existing satellite kit to enable functions like Pause, Rewind and record on modern receivers

Twin LNB upgrade kit

Upgrade your single LNB version for use with SKY+ and other hard drive recording receivers with the Twin LNB upgrade kit. Can also be used with 2 receivers for independent viewing. Includes low noise 0,2dB LNB, adapter and 10m twin coaxial cable. Designed specifically for use with Maxview satellite dishes **040004**

**Multimo mobile satellite dish**

This compact portable satellite dish is suitable for use with analogue or digital transmissions. The Multimo can be used with any satellite receiver including SKY digiboxes. Although only 40cm wide, it performs like a 55cm dish and can be used Europe wide. Mounted on a base for use on a flat surface, it also has a clamp to attach it to a shelf, step, pole or tripod. Used with the Zehnder sat finder it only takes minutes to set up

Single LNB **039980**
Twin LNB **039981**

Multimo carry bag

Made of hard-wearing, water-resistant nylon material and has a strong fabric handle and two zipped compartments: one for the dish itself and one for accessories and cable **039980A**

Multimo magnetic mounting foot

A powerful magnet which can be used with MULTIMO satellite dishes. It can be glued to the inside of the base and because it is slightly above the level of the base, it will not scratch the mounting surface. Glue is not supplied but we recommend an epoxy type such as Araldite. Please bear in mind that the efficacy of any magnet will be affected by paint or other materials which come between it and the steel surface on which it is being used **039980B**

Satellite tripods



Maxview tripod

Suitable for satellites up to 90cm with a universal mast fitting. Upper mast section rotates freely for ease of use to aid satellite alignment. Folds together for compact storage **040003**



Maxview deluxe tripod

Suitable for satellites up to 90cm with a universal mast fitting. Upper mast section rotates freely for ease of use to aid satellite alignment. Retractable upper mast section to lengthen the mast by up to 500mm. Helps to mount the dish clear of possible obstructions. Long legs and additional locking device ensure stability. Folds together for compact storage. Includes carry holdall **040005**

TV aerial masts



Maxview Unimax mounting mast

For mounting a TV aerial to the side of a vehicle. Can be permanently fixed using screw holes or temporarily fixed using the self adhesive backing. Designed for quick and easy installation. Lightweight design. Length 58cm **040089**



Maxview jockey wheel mast

For mounting a TV aerial to the jockey wheel. Light weight aluminium mast with universal fixing bracket. Designed for quick and easy installation. Complete in 5 sections. For temporary fixing only. Combined height of all 5 sections 360cm **040114**



Mercury mast and clamp

Provides three 3' masts and a jockey wheel clamp. Suitable for use with both the Overlander and Tourer aerials and other aerials with a conventional 'V' bolt fixing **040112**



W4 Jockey wheel satellite pole

A sturdy 30" pole complete with two specially designed brackets for safe attachment to the caravan jockey wheel. Also supplied with a 'U' bolt for the fixing of the satellite dish. Keeps the dish in a safe and unobtrusive area, no tripod to trip over! **040119**



Maxview Unimax brackets

For mounting a TV aerial to the side of a vehicle. Can be permanently fixed using screw holes or temporarily fixed using the self adhesive backing. Blister packed (2) **040017**
Loose **040086**



W4 aerial pole clamps

One pair of specially designed clamps. For safe attachment of an aerial pole to the jockey wheel. **040117**



W4 aerial pole kit

Fully telescopic lightweight pole kit extendable to 3.2m. Helps to receive a full range of TV signals with its infinite variety of height adjustments. Can be fitted to the jockey wheel with the special clamps provided **040115**

Signal boosters and finders

WOW British made **Easy boost**

Variable gain signal booster. Available as 2 or 4 outlet version. 12/24v operation. 2 Outlets **040063** 4 Outlets **040064**

**Easy tune**

Uniquely combines a TV booster with signal finder, so TV signal level is "visible" when setting gain. Available as 2 or 4 outlet version. 12/24v operation. 2 Outlets **040060** 4 Outlets **040061**

**Maxview 12v/24v signal booster**

Boosts digital and analogue signals in weaker signal areas. Variable gain to optimise strength. Professional gold plated "F" connectors for improved corrosion resistance and signal performance. 2 year guarantee **040062**

**UHF TV signal finder**

Designed and developed by a caravanner for the leisure market. 9v battery supplied **040057**

Simple to use!

1. Connect the aerial lead into the appropriate socket
2. Turn on the power switch
3. Rotate the aerial/dish until the greatest number of LEDs are lit. This indicates the strongest signal and the best position for your aerial or dish
4. Disconnect the finder and reconnect the aerial lead to your TV

**Worldwide UHF/VHF signal finder**

For use anywhere in the world. 9v battery supplied **040058**

**Pro TV and satellite signal finder**

Used by professional aerial installers and now available to the leisure market. 9v battery supplied **040059**

**Maxview digital TV signal finder**

Optimise signal reception before auto tuning TV/receiver. Assists aerial alignment for the best digital reception. Essential for use with a directional touring TV aerial. Ideal for Freeview / DVB-T. Includes battery and velcro mounts. 2 year guarantee **040048**

**Maxview satellite compass**

Alignment window to help locate the satellite signal zone for Astra and Hotbird satellites quickly and easily. Can be used as a normal navigation compass. Includes neck strap and user instructions **040013**

**Maxview digital compass**

Satellite alignment zone to help locate the direction of the satellite signal for all the main European satellites. Distortion feature to identify magnetic fields causing possible error to compass accuracy. Can be calibrated to maintain accuracy when placed near iron objects. All major European satellite positions pre-programmed, available at the press of a button. Modes ASTRA 1, 2 Hotbird, Digital Compass, time & Thermometer with back lid LCD display **040018**

**W4 satellite finder**

Easy to read analogue dial as well as an audible signal. Enables effective, quick and reliable satellite alignment for optimum reception. Adjustable gain and sensitivity to suit all situations **040009**

**Maxview satellite finder**

Varying audible tone and ascending visual LED display to help align satellite dish to the satellite. Signal sensitivity control for ease of satellite adjustment and alignment. Complete with flylead and full instructions. **040011**

**Zehnder HP480 satellite finder**

Varying audible tone and ascending visual LED display to help align satellite dish to the satellite. Signal sensitivity control for ease of satellite adjustment and alignment. Complete with flylead **040010**

Satellite and TV receivers

Vistron satellite receivers are designed and made in Germany and we think they are of excellent quality. There are three models in the range and they cover several options. We've made sure that they work perfectly with any 12V satellite system and that they are easy & straightforward for your customers to use.

WOW Vistron satellite receivers are preset with the channels in a sensible order. BBC1, BBC2, ITV, C4 etc. ideal for touring caravans and motorhomes. Other receivers will as standard put the list in the order in which the channels are found.



Vistron VT101 a 12V Free-to-air satellite receiver which receives thousands of TV and radio programs. 2 x Scart outputs. **039988**



Vistron V201 a 12V Free-to-air satellite receiver which receives thousands of TV and radio programs. Scart & HDMI outputs. **039982**



Vistron V230 a 12V HD Free-to-air satellite receiver with HD output and the ability to record onto a USB or external hard drive, HDMI & phono outputs. **039986**



Maxview free-to-air satellite receiver
Receives thousands of TV and radio programs. Mains and 12V leads supplied as standard **040020**



Maxview free-to-air satellite receiver with "Easy find" LNB
Built in satellite signal finder which receives thousands of TV and radio programs. Mains and 12V leads supplied as standard **040020A**



Maxview receiver bracket
040087



USB Freeview receiver
039987

Specification	VT101	VT201	VT230	Maxview	Maxview with Easy find LNB
Type of receiver	Free-to-air	HD Free-to-air	HD Free-to-air	Free-to-air	Free-to-air
Power supply	12V	12V	12V	12v or 230v	12v or 230v
Scart socket	Yes x 2	Yes	No	Yes x 2	Yes x 2
HDMI socket	No	Yes	Yes	No	No
Phono socket	No	No	Yes	No	No
Electronic Programme guide	Now and Next	Now and Next	Now and Next	Now and Next	Now and Next
Available channel positions	4000	6000	6000	Thousands	Thousands
Timer function	Sleep timer	Yes	Yes 10 positions	Yes 10 positions	Yes 10 positions
Preprogrammed for satellites	Astra 1, Astra 2, Hotbird, Turksat 1C	Astra 1, Astra 2, Hotbird, Turksat 1C	Astra 1, Astra 2, Hotbird, Turksat 1C	Astra 1, Astra 2, Eutelstat, Hotbird & more	Astra 1, Astra 2, Eutelstat, Hotbird & more
Remote control	Yes	Yes	Yes	Yes	Yes
Remote control sensor	Yes	Yes	Yes	Yes	Yes
Power consumption	12W, 1A at 12V	16.8W, 1.4A at 12V	30W, 2.5A at 12V	5W 0.5W on standy	5W 0.5W on standby
Dimensions H x W x D	35 x 190 x 140mm	35 x 230 x 140mm	35 x 230 x 140mm	40 x 230 x 140mm	40 x 210 x 135mm
Weight (approx.)	450g	450g	580g	660g	660g
Comes with	12V lead, remote control, remote sensor, receiver	12V lead, remote control, remote sensor, receiver	12V lead, remote control, remote sensor, receiver	12V lead, mains lead, remote control, remote sensor, receiver	12V lead, mains lead, remote control, remote sensor, receiver, Easy find LNB
Part no.	039988	039982	039986	040020	040020A

TV aerials

**Maxview Gazelle aerial**

Streamlined Omni-directional aerial designed to receive all available analogue and digital terrestrial UHF TV, FM and DAB signals through 360°. Designed specifically for use on any touring or HGV vehicle. Includes: variable gain signal booster, 5m co-axial cable and fitting instructions. Frequency range 40-860MHz. 2 year guarantee **040008**

**Maxview Omnimax aerial**

Omni-directional aerial designed to receive all available analogue and digital terrestrial UHF TV, FM and DAB signals through 360°. Designed specifically for use on any touring or HGV vehicle. Includes: variable gain signal booster, 5m co-axial cable and fitting instructions. Can be used on a pole, suction base, magnetic base or permanently mounted. Frequency range 40-860MHz. 2 year guarantee **040006**

**Maxview suction base**

Use to temporarily mount the Maxview Omnimax Touring aerial to the top of a flat roof of a touring or HGV vehicle. Designed with 4 heavy duty suction pads **040080**

**Maxview magnetic base**

Use to temporarily mount the Maxview Omnimax Touring aerial to the top of a flat steel roof of a touring or HGV vehicle. Designed with a very strong magnet **040081**

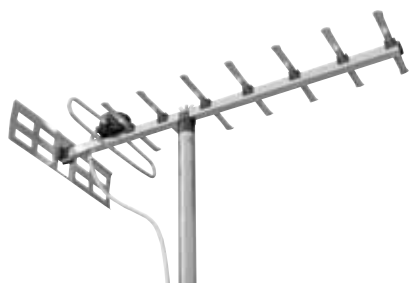
**Maxview Mobile Digital touring aerial kit**

Designed to receive all available digital and analogue terrestrial UHF TV channels. Designed specifically for use on any touring or HGV vehicle. Digital Freeview compatible. Includes: 5m co-axial cable, 5m coaxial cable, fixing accessories, Unimax mast and full instructions. Frequency range 470-860MHz. 1 year guarantee **040043**

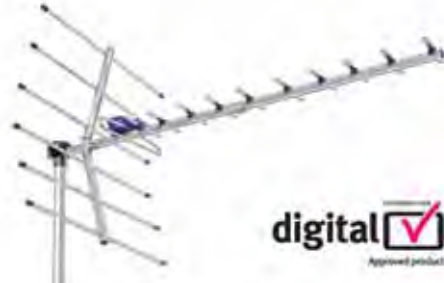
**Maxview Digital Tourer high gain aerial**

Ideal for receiving all available digital and analogue terrestrial UHF TV channels. *Most shown not included.* Designed for weak signal areas. Directional Aerial. Compact size for easy, tidy storage - breaks down into 4 sections. Digital Freeview compatible. Includes: 5m co-axial cable, boom clamp and fitting instructions. Frequency range 470-860MHz. 1 year guarantee **040110**

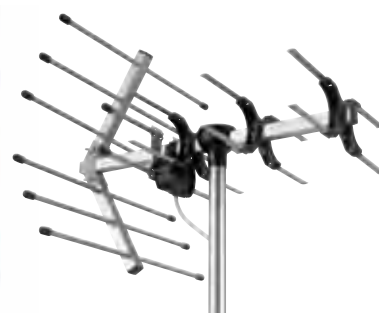
**Maxview Compact high gain aerial**

Designed to receive all available digital and analogue terrestrial UHF TV channels. *Most shown not included.* Digital Freeview compatible. Includes: 5m co-axial cable, fixing accessories and full instructions. 1 year guarantee **040045**

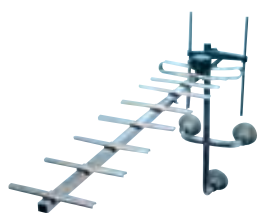
**Mercury Overlander aerial**

Wide band aerial for high gain. A unique clamp enables

aerial to tilt, swivel and rotate through 360° without adjusting the mast. Fixes with three suction pads for stability and easy removal **040105**

**Mercury Digital Outdoor aerial**

For reception of digital TV and radio programmes. Suitable for mobile applications such as caravanning, camping and marine use. Waterproof and UV resistant. Plug and play. High gain - low noise

on all programme channels. Supplied with mounting kit **040107**

**Mobile digital TV aerial**

Designed for caravanning, camping and marine use. The aerial has a built in amplifier. Can be mounted on a pole up to 38mm diameter using the clamp supplied. **040106**

**Magic wand aerial**

Covers all UHF TV signals, both analogue and digital. Amplified, high gain,

omni-directional & multi-positional. Battery powered with 500 hours continuous use from 2xAA Alkaline batteries. Optional DC input (7 - 24VDC) on/off switch with LED **040102**

**Magic Circle aerial**

Battery powered amplifier/aerial which gives

400hrs continuous use from 4 x AA alkaline batteries. For use inside metal or concrete buildings **040100**

**Maxview Truivison set top aerial**

Compatible with terrestrial digital receivers. Freeview HD compatible. Ready to use. Folds flat for easy storage. 2m Co-ax cable. 1 year guarantee **040046**

**Ring FM aerial**

Compact design 12v electronic leisure aerial.

Telescopic with six sections - overall length 39cm **040129**

TV sockets and cables



Maxview weatherproof sockets

Provides a neat external, weatherproof cable entry point into a vehicle or boat. Complete with self adhesive foam seal and screws for easy installation. Unobtrusive design. 3m cable length. White.

- Single socket with "F" connector **A 040023**
- Single socket with co-axial connector **B 040095**
- Twin socket with an "F" and a co-ax connector **C 040015**
- Twin socket with 2 x "F" connectors **D 040022**

Maxview waterproof cable entry point

Provides a neat external, waterproof cable entry point into a vehicle or boat. Complete with self adhesive foam seal with the option of fixing with the 4 screw fixing holes. Waterproof IP66 double membrane seals. For 5-9mm ø cables. Can take up to 2 cables. Easy installation - cable simply pushes through seals **E 040034**



Scart lead

scart to scart
0.8m **040016**
1.5m **040025**

HDMI lead

Multimedia cable
0.8m **040085**
1.5m **040037**

Standard coaxial fly lead

2m **040027**
4m **040028**
10m **040084**

Digital coaxial fly lead

2m **040026**
4m **040083**
10m **040029**

"F" to "F" plug fly lead

2m **040038**
4m **040039**
10m **040040**



Fast fit coaxial plugs (2)

Plastic **040030**

Alloy coaxial plugs (2)

040019

Back to back connectors (2)

040031

Coaxial connecting kit

040033

Splitter

040035



Push on "F" connector

040090

"F" connector

040041

Back to back "F" connector

040032

Satellite cable connecting kit

040036

"F" to coax adaptor

040042



WOW Ask your sales contact about the superb Maxview display stand deal. **040098**

W4 Pack-it TV range

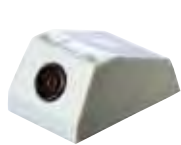
**Surface TV point**Co-ax socket
040546**Surface co-ax / satellite point**Co-ax and F socket
040588**Surface satellite point**F socket
040576**Satellite lead**2m F to F plug
040585**Aerial lead**2m male to male
040547**Co-ax cable**5m
040542**Co-ax plug**

040543

**2-way coax splitter**

040586

**Satellite 'F' plug**

040577

**2 pin plug**12v 10A
040535**2 pin flush fitting socket & plug**12v 10A
040537**TV Universal Power Lead**

040595

**Co-ax coupler**

040544

**2 pin socket**12v 10A
040536

WOW All W4 pack-it items can be ordered loose at a preferential rate. Please speak to your sales contact for details.

Other TV accessories

**W4 digital TV hook up lead**

Connect directly to the site TV point with this purpose made 25 metre lead.

Just hook up, tune in, watch and relax!

- High quality WF100 cable
- Solid copper centre conductor
- Water tight physical foam dielectric injected with nitrogen gas
- Twin screened with copper foil and braid
- Robust outer sheath for added protection
- Factory tested
- Reel enables easy rewind and storage

040541

**Through window cable adaptor**

Because satellite co-ax cable can be damaged if squashed it's usually not advisable to pass cable through a closed window. This adaptor kit includes a special flat cable which can be used in just this situation and connects at either end to regular cable. All necessary connectors and instructions included. **039985A**

**Flat screen TV carrier**

Nylon bag with carrying handles.

Suitable for up to 15" TV **040177**Suitable for up to 19" TV **040176****Mercury co-ax plug (2)**

040300

**Mercury aerial lead**2m male to male
040325

Aquaroll® and Wastemaster™ products

Wastemaster™

A strong dual-purpose waste carrier for caravanners. Takes the waste water and toilet cassette to the disposal point in one trip. The wastemaster™ will slide under most caravans. Anchoring holes take the securing straps supplied to hold the cassette in place. Rigid high density Polyethylene container has a unique shape that gives good balance when transporting, 38 litre full load filler and 30 litre low level filler for lighter loads. Bottom emptying outlet with cap retaining socket. Available in original beige and metallic silver.

Dimensions: (HxWxD) 1000 x 355 x 160/225mm (min/max)

Beige original **050046**
Metallic silver **050045**



Axle and hub caps		050217
Wheel and hub cap		050218
Spare cap with strap	80mm	050206
Spare Straps for cap (2)		050223
Luggage elastics	Pair	050226

Wastemaster™ Superclean

Especially formulated product for cleaning Wastemaster and other waste tanks or other waste water pipe work. The product is highly concentrated and one 200ml bottle is sufficient to clean a wastemaster twice.

20 per outer **050048**



Wastemaster™ storage bag

Made from water resistant heavy duty PVC coated nylon. With all round zip **050047**

Aquaroll®

The aquaroll high quality water carriers have the added advantage of an extra side opening to connect directly to a mains water supply via the mains adaptor kit (supplied separately. See page E2). Even without the mains facility the high capacity of the 40 litre Aquaroll® is a must for in modern caravanning. High quality tyres on deep rims give excellent ground clearance. Easily removeable handle with rust proof ball joints. Filler tube with tap connector and handle included. Available in original beige or metallic silver.

Dimensions: (L x Ø) 40L: 500 x 400mm 29L: 440 x 375mm

Beige original 40L **050185**

Metallic silver 40L **050184**

Beige original 29L **050181**

Metallic silver 29L **050180**



Cap with tap	050251
Level indicator	050200
Filler tube	050236
Pump connector 40 litre	050231
Pump connector 29 litre	050230
Spare cap with strap 80mm	050206
Spare Straps for cap (2)	050223
40 litre tyre	050215
Handle	050192
End sockets (2)	050219
40 litre stand	050259
29 litre stand	050258

Aquaroll® storage bag

Made from water resistant heavy duty PVC coated nylon. With draw string **050190**

Aquaroll® and Wastemaster™ products



Aquaroll® mains adaptor

Designed to give caravans the benefit of running water where mains supply is available. Can be used with any caravan, with no expensive alterations needed. A quantity of water is held in the Aquaroll®. As there is no mains pressure inside the caravan, the danger of flooding is eliminated. Easy to fit ball valve. 7.5 metres of food quality hose. Snap-on, 1/2" and 3/4" threaded tap connectors included. Snap-on connector to ball valve. Fits both 29L and 40L Aquarolls that have a side cap **050187**



7.5m Extension hose

050188

Mains adaptor hose connectors kit

050221

Mains extension connectors kit

050222

Tap connector seals kit

050220

Ball valve only

050193

Ball valve service kit

050225



Aquaroll® mains adaptor storage bag

Made from water resistant heavy duty PVC coated nylon. With all round zip **050189**



050221



050222

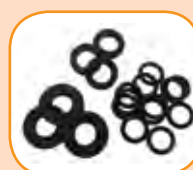

050220



050225



W4 fill-ups

Suitable for a variety of tap sizes.

Available singly or 25 per outer

Fill-up 1 (1.25m hose) **050240**

Available singly or 15 per outer

Fill-up 2 (2m hose) **050241**

Available singly or 10 per outer

Fill-up 5 (5m hose) **050242**



W4 Tap swirler

Suitable for a variety of tap sizes. 10 per outer **104845**



W4 Aquaduct

To connect water supply to hose socket on caravan, with integral non return valve

051444



W4 Aqua cap

Dust cap for use with plastic water containers. Available singly or 10 per outer **050049**



Aqua Bag 40ltr

PVC coated nylon storage bag with drawstring **050186**

Printed bags

PVC coated nylon storage bags. 100 per outer **050191**



Insulated Aquaroll bag

Designed to reduce the risk of freezing in winter. Reversible with reflective lining to keep water cooler in summer. Clever wrap-round design to remove the need to lift the full container **050194**



Trolleys

Rolson Folding trolley trucks

Sponge grip handle. Light weight aluminium frame. Easily folds compactly for ease of storage. Toe plate and wheels open simultaneously.

Tubing: 50mm diameter. Wheel: 177mm diameter

Load max 80kg

Height: 1m (open) 736mm (closed) Width: 482mm **050267**

Load max 60kg

Height: 1m (open) 736mm (closed) Width: 390mm **050269**

Load max 45kg

Height: 965cm (open) 690mm (closed) Width: 390mm **050266**

Fresh water containers

**Jerrycan**25 litre **050055**Available singly or 12 per outer
10 litre **050077**

Available singly or 12 per outer

Spare cap **050079**Cap with integrated tap **050109****Jerrycans with taps**

The tap is held inside the jerrycan for transport, protecting it from damage.

25 litre **050096**

Available singly or 6 per outer

10 litre **050078**

Available singly or 12 per outer

Cap with integrated tap **050109****Fiamma 70L fresh water tank**Constructed from non-toxic materials. It can be installed either vertically or horizontally. Complete with all fittings for installation. Water inlet pipe 38mm ϕ , with air outlet of 13mm ϕ . Dimensions: (LxDxH) 70x47x24cm **050050****Fiamma fresh water roll tank**

Convenient portable 23 litre water tank with discharge cap at base. Supplied with an extra blanking cap.

Weight 3kg **050054**Spare cap **050056**Discharge cap **050057****Compact carrier**Folding jerrycan with tap. Capacity 20 litres. Available singly or 24 per outer **050170****Collapsible jerrycan**Space saving concertina shape with tap. Capacity 10 litres. Available singly or 12 per outer **050172****Fiamma waste water roll tank**Practical and portable 23 litre tank for waste water with discharge cap at base. Weight 3kg **050051**Spare cap **050056**Discharge cap **050057**

Waste water containers

**Waste container**23ltr capacity container which has a large cap on the side to take two waste pipes. 6 per outer **050033**
Cap **050032****Grove take-a-waste**

Designed to fit under most caravans and trailer tents. Capacity 23 litres. Breather hole on shoulder to allow air to escape for problem free filling.

4 per outer **050007**Cap **050020**Bung **050029****Jerrycan with filler spout**10 litre **050115**20 litre **050116**

Available singly or 12 per outer

**Fiamma roll tank flex kit 23w**Drain kit for waste tank 23 (**050051**) below, complete with threaded cap and level indicator, 30mm diameter flexible hose which can be extended up to 90cm **050060**

Filler caps

**Water filler cap**78mm ϕ , 25 (+22)mm depthBlack **050064**White **050062****Water filler assembly**Dimensions: 38mm ϕ outlet, with 10mm ϕ overflow. 118mm overall ϕ , 85mm ϕ cut outBlack **050066**White **050068****Reich water tank connector**Designed to fit a hosepipe directly to an external fitting. 75mm ϕ Twist fit **050059****Fiamma water filler cap assembly**Locking water cap which complies with European closure system standards. Dim: Overall 112mm ϕ , Internal 80mm ϕ , Pipes: large 60mm small 10mm.Black **050052**White **050053**

Truma Water systems

Housings

Waste & water



WOW Now
available in
dark grey



Crystal 2 filter housing assembly

Complete with crystal 2 filter and blanking plug.
White **801467** Lid and pins only white **605359**
Ivory **N/A** Lid and pins only Ivory **605358**
Hinge pins only(2) **605376**

Ultraflow filter housing assembly

Complete with Ultraflow active carbon filter and blanking plug. The ultraflow housing comes with an exterior accessory point which can be connected (via optional connector) to allow the use of the exterior shower set (optional). Template size: 108mm x 163mm
White **846011** Lid only white **846961**
Ivory **846012** Lid only Ivory **846962**
Grey **846061**



WOW The
compact
shower outlet
looks the same
as this but has
no electrical
terminals. See
below

Crystal 2 winter kit

No longer available please use Compact conversion kit below.
Lid only white **605375**
Lid only Ivory **605374**
Hinge pins only(2) **605376**

Compact housing

The Ultraflow compact housing / winter kit is the standard housing for a pump assembly that does not include a filtration system, accessory point or blanking plug. Dimensions: 143 x 105mm, bore hole 50mm diameter
White **846031** Lid only white **846974**
Ivory **846032** Lid only Ivory **846973**



Compact conversion kit

The Ultraflow compact housing with an Ultraflow pistol grip pump connector to allow the user to utilise their existing pump assembly. Dimensions: 143 x 105mm, bore hole 50mm diameter
White **846034**
Ivory **846035**



Conversion kits

To convert Crystal Mk2 to Ultraflow system whilst enabling the use of the original pump assembly. Kits consist of Ultraflow housing, pistol grip pump connector and filter. Template size: 108mm x 163mm
White **846014** Ivory **846015**



Crystal / ultraflow adaptor plate

Adaptor plate that allows you to convert a Mk1 Crystal housing to the Ultraflow system using the conversion kit
846979



Outdoor shower set

The pistol grip of the Outdoor Shower is simply plugged in to the Ultraflow filter housing. After fitting the connector it is ready for use. For pressurised water systems only **846080**
Replacement Ultraflow bridge connector **846967**
Shower head only **896800**



Compact shower

Exterior shower housing. For pressurised water systems only
White **846071** Lid only white **846975**
Ivory **846072** Lid only Ivory **846976**
Shower head only **896800**



Surge damper

The surge damper with integrated pressure switch. The electronically controlled pressure switch has an intelligent control sequence turning the pump on and off when the tap is opened and closed whilst maintaining an even water flow **846050**

Mains water adaptors



Crystal Waterline

A 15 metre 'food quality' hose pipe which comes complete with fittings and a special pressure reducing adaptor which allows caravanners to connect their water system directly to a mains water supply without modification. Compatible with the Crystal filter and Crystal compact water systems, simply by being locked on to the external Crystal housing **802679**



Mk2 - Mk3 Waterline converter

Convert a Crystal Waterline to a MK3 system with this adaptor **854500**



Ultraflow Waterline

A 15 metre 'food quality' hose pipe which comes complete with fittings and a special pressure reducing adaptor which allows caravanners to connect their water system directly to a mains water supply without modification. Compatible with the Ultraflow filter and Ultraflow compact water systems, simply by being plugged into the Ultraflow housing **846090**

Water inlets and pump assemblies



Ultraflow Inlet hose

Compatible with any Ultraflow housing **846340**



Ultraflow pump assembly

This 12v water pump with ergonomically shaped pistol grip is plugged into the Ultraflow filter or compact housing. 9 litres per minute at 3m head at 1.5bar. Tube length 800mm **846041**



Crystal mk2 pump assembly

Maxi pump comes complete with hose, container cover, storage clip and hose connector. Self priming and extremely quiet in operation. 9 litres per minute at 3m head at 1.5bar. This pump fits any MK2 crystal housing **801927**



Maxi pump only

9 litres per minute at 3m head at 1.5bar. **801928**

Accessories



Pistol grip pump connector
846977



Blanking plug and O ring
846966



Ultraflow pump connector O rings (4)
846729

846880



Non return valves
John Guest 12mm **846880**
Flexible hose **846900**



Ultraflow push fit to flex adaptor
846999



Mk2 hose adaptor plug
801038



Mk2 blanking plug
801254



Pump connector O rings (2)
MK2 o ring **801023**
MK3 o ring **802421**



Mk2 crystal retaining pegs (2)
10 per outer **802530**



Crystal cut blue hose
801017

Filters

WOW A complete range of Truma spares are available in the spares section



Crystal 2 filter cartridge
12 per outer **801256**



Removal tool for MK2 filter
For easy removal
801257



Ultraflow filter
Filter only
12 per outer **846020**



Ultraflow filter + mk2 cap
Filter and MK2 Crystal cap to allow the filter to be used in Crystal 2 housings
846021



Blue filter cap and O ring
846964

Hoses

Sold by the metre priced by the roll



Non toxic hose
1/2" 30m roll
051339



Non toxic hose
3/8" 30m roll 051317
1/2" 30m roll 051325
3/4" 30m roll 051348



Reinforced non toxic hose
1/2" 30m roll
051356



Flexible waste hose
20mm 30m roll
051360



Convoluted waste hose
23.5mm 50m roll
051365
28.5mm 25m roll
051368



Tube 12 x 8.5mm
Blue 25m 055200



Tube 12 x 8.5mm
Red 25m 055201



Flat hose 15m
051310

W4 push fit fittings

Individually packed push fittings for semi rigid tube - All packed 5 per outer



Equal tee
12mm 055202
15mm 055302



Equal straight
12mm 055204
15mm 055304



Equal elbow
12mm 055203
15mm 055303



Two way adaptor
12mm 055275



Straight reducer
12-8mm 055205
12-10mm 055220
15-12mm 055312



Elbow reducer
12-10mm 055221



Stem adaptor male
3/8" bsp-12mm 055263
1/2" bsp-12mm 055264



Stem reducer
Female to male
12-10mm 055210
15-12mm 055215



Stem enlarger
Female to male
12-15mm 055216



Stem elbow
12mm 055222
15mm 055322



Straight adaptor female
3/8" f-12mm 055238
1/2" f-12mm 055232



Straight adaptor male
3/8" bsp-12mm 055213
1/2" bsp-12mm 055214



Straight adaptor
12mm-1/2" 055206



Bulkhead connector
12mm 055212



Tank fitting assembly
12mm 055266



In-line filter/strainer
055294



Shut off valve
12mm 055270



Stem shut off valve
12mm 055272



Non return check valve
12mm 055273

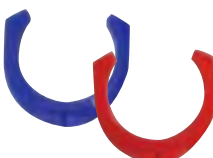

Collet clip 12mm
Blue (5) 055292
Red (5) 055293



Tube cutters
Light duty 055295



Mounting clips
12mm (5) 055265



End plug
12mm 055208
15mm 055308

WOW All W4 water fittings are suitable for contact with foodstuffs and drinking water. ISO 9001 and ISO 14001 certified. FDA and WRAS approved. Complying with the requirements of UK water regulation.

Push fit system stand

Not illustrated. Complete with 5 packs of 24 of the best selling items in this range 055299

Water fittings

- Grove packaged items
- for W4 water fittings see page Q12



Y connectors

1/2" **051128** 28.5mm **051139**
3/4" **051137**
10 per outer



W4 easi 2 drain

For caravans with two 28.5mm waste outlets. Pre-assembled **051138**
Available singly or 10 per outer



7 piece 'Y' kit

Versatile kit to allow different combinations of outlets be reduced into 1. For 28.5mm hose **051380**
Available singly or 10 per outer



Sink top clip

051239
10 per outer



Straight connectors

3/8" **051140**
1/2" **051155**
3/4" **051163**
28.5mm **051167**
10 per outer



Elbow

1/2" **051198**
10 per outer



T pieces

1/2" **051174**
3/4" **051182**
10 per outer



Reducer

1/2" - 3/4" **051146**
10 per outer



P clips (5)

3/4" **051284**
1" **051293**
10 per outer



Herbie hose clips (2)

Re-usable hose clips in heat resistant nylon. Will not rust or corrode and can be fitted with pipe in place. Depending on size withstands up to 160°C and 120psi
1/2" **051205**
3/4" **051216**
10 per outer



28.5 - 20mm reducer

Takes 28.5mm down to 20mm plus enables smell trap to be connected to 20mm hose. 10 per outer **051371**



28.5mm - 1 1/4 inch reducer

Enables 28.5mm hose to fit 1 1/4" sink wastes. 10 per outer **051369**



Hose sealing sleeves

Enables a better fit between the hose and the connector. 23.5mm hose sealing sleeves also allow 23.5mm hose to be connected to 20.5mm fittings
10 per outer
23.5mm **051366**
28.5mm **051367**



Tap connector

Suitable for use on 1/2" (12mm) round taps. Adjustable hose clip, ABS plastic, frost resistant and shatterproof gaiter grip clamp to fit 1/2" hose. 25 per display box **051305**



Hose socket with flap

1/2" **051394**
3/4" **051405**
28mm **051408**
5 per outer



Dust caps

3/8" / 1/2" **051416**
3/4" **051427**
10 per outer



Drain taps

Fresh water food grade. 28mm **051373**
Waste water. 28mm **051374**



Hose clip (2)

Grove packaged. 10 per outer
000/M00 (8-16mm) **070249**
00 (12-22mm) **051246**
OX (16-27mm) **051268**
W4 packaged. 10 per outer
000/M00 (8-16mm) **104832**
00 (12-22mm) **104833**
OX (16-27mm) **104834**
1X (25-45mm) **104836**

Sink and shower waste outlets



1 1/4 inch straight waste outlet

3/4" outlet **051042**
28mm outlet **051045**
5 per outer



1 1/4 inch angled waste outlet

3/4" outlet **051064**
28mm outlet **051067**
5 per outer



Sink waste plug

1/4" **051075**
10 per outer



3/4 inch straight waste outlet

Plastic top **051086**
Stainless steel top **051097**
5 per outer



Sink waste plug (2)

3/8" **051227**
10 per outer



Smell trap

Designed to fit onto 28mm waste water fittings. Fits rigid or flexible convoluted hose. Detachable cap gives access to remove debris **051385**

Water purification



WOW AquaStar 1+2 and 3 are designed to work in harmony with one another and unfold their full potential when used as a set

**AquaStar 1+2**

The professional installation cleaning system, specifically designed for recreational vehicles.

AquaStar 1 - tough on lime scale.

For maintaining installations preventing the build up of limescale.

AquaStar 2 - shows no mercy to germs.

For a germ free water installation. AquaStar 2 unleashes its two phase action using active oxygen and silver, the oxygen dissolves the biofilm, whilst the silver ions kill any bacteria lurking in it

AquaStar 1+2 **052040**

AquaStar 3

Transforms water into drinking water. For water sterilisation and preservation.

- Uses active oxygen to inactivate bacteria and germs within 1 hour

- Uses silver ions to protect water against contamination, algae and bad smells for up to 6 months

AquaStar 3 **052041**

Floor display stand **052044**

Counter display **052044**

**Elsan fresh water tank clean**

Leaves the tank free from micro-organisms and black spot. It also removes calcium and other deposits that can eventually clog the system. Tank Clean contains no chlorine.

1 litre **050035 12 per outer**

Winterban

Prevents freezing pipes and other damage by winterising your motor home or caravan. Winterban replaces the water in the water system and is safe for fresh water plumbing.

It is a propylene glycol solution (1 part winterban to 1 part water protects down to -46°C) which has a dramatically lower burst point than water. This is the point at which the liquid expands when frozen, thus protecting the system from frost damage. It is recommended that you drain as much water from your system as possible (use the Floe drain

down system on E9). Any excess water will be absorbed by the solution and prevents damage to pipes, taps and water heaters through expansion of frozen water. 6 per outer. 1 gallon per bottle **052050**

**Clear pure water kit**

Each Kit Contains Puriclean 100g to clean the water tank and system and 6 Aqua Clean Tabs to purify the water **052026**

**Puriclean**

Cleanses water systems and tanks

100g tub **052002**

400g tub **052024**

**Aqua Sol**

Aqua Sol is a powerful biocide which destroys all water borne bacteria and viruses. In addition it removes tastes and odours caused by plastics, chlorine, GRP and metals, keeping water fresh for a very long time. Aqua Sol is approved by the D.O.E. The 250ml size will treat 625 litres of water. Aqua Sol 250ml. 6 per outer **052030**

**Waste Guard**

Waste Guard provides rapid control of odour producing waste products. It selectively reacts to oxidise odours from many sources and does not emit harmful by products. 300ml. 6 per outer **052039**

**Aqua clean tabs**

Water purification tablets. One tablet per 5 gallons of Water. 32 tablets per pack. 12 packs per outer **052013**

**Aqua tabs mini**

Water purification tablets. One tablet per 1 litre of Water. 40 tablets per pack. 18 packs per outer **052012**

**Aqua mega tabs**

Aqua Mega Tabs are rapid dissolving effervescent water purifying tablets. For use with water storage tanks with a capacity of 50 gallons or more. 12 per outer **052015**

**Puri Sol**

Cleans, sterilises and deodorises in one action, leaving no taint or odour. Clean, disinfect and deodorise water storage tanks, pipe work and fittings. 300ml. 6 per outer **052032**

Drain down system floe

Drain down

The floe system is a simple and cost saving way to drain your water system, protecting it from winter frosts and reducing risk of infection from stagnant water throughout the year. With the simple step by step instructions, you will be guided through the quick and easy process, enabling you to use your leisure vehicle all year round. A matter of minutes draining down your water system will give you peace of mind whatever the season. The Drainage kits all come with 1 x Drain down, relevant adaptors and an instruction DVD showing a drain down demonstration.



Drainage kits

- Truma Ultraflow **051980**
- Truma Crystal 2 **051982**
- Whale **051984**
- U.K. Motorhomes **051990**
- European Motorhomes **051988**

Drain down only

- Homes, static caravans, and holiday homes **051996**



WOW Practical Caravan Tourer of the year awards 2012. Recommended Best accessory



Water filters



Grove purawater filter

The filter should be replaced every season or after filtering 4500 litres of water. Original is suitable for connection to 3/8" flexible hose or standard 12mm semi rigid connectors. Now available with 15mm ends for connection to 15mm semi rigid or 1/2" flexible hose. Available singly or 10 per outer 12mm filter **055066**
12mm adaptor kit (2 x 12mm straight push fit connectors) **055068**
15mm filter **055067**

WOW Truma filters can be found on E5



Reich aqua filter

To ensure a constant filter performance it should be replaced every season or after 4500 litres (approximately) have been filtered. The aqua filter has threaded ends and is supplied complete with screw on copper nozzles for ease of fitting into flexible hose **054350**



3M replacement filter

The filter reduces unpleasant taste and odour and removes sediment, dirt, rust, sand and silt to 5 micron size. It also incorporates a bacteria inhibitor. With a capacity of over 7,500 litres. Replacement filter **055105**
Filter and housing **055100**

Universal portable water filter

Versatile, compact and lightweight filter for any tap. As easy to fit as push on, then pull off. Filters up to 10,000 litres (or 12 months) with normal potable water quality and usage. Max pressure 22psi (1.5 bar). Max flow rate 3 litres per minute. Fits taps up to 19mm / 3/4" diameter. Produces healthy remineralised water, whilst substantially reducing chemical levels for safer drinking water. Ceramic spheres can be recycled in the garden to help soil drainage and improve plant growth **054350**

WOW Ideal for camping. Filter your water when filling your Aquaroll or Jerrycan.



Onboard pumps and accessories



	Trail King 7	Trail King 7	Trail King 10	Trail King 10	Trail King 10
Voltage	12V	12V	12V	12V	24V
Flow rate (l/min)	7	7	10.6	7	10.6
Pressure	20 p.s.i. 1.1 Bar	30 p.s.i. 2.1 Bar	30 p.s.i. 2.1 Bar	45 p.s.i. 3 Bar	30 p.s.i. 2.1 Bar
Max current	4.5A	4.5A	4A	4A	3.5A
Weight	1.9kg	1.9kg	1.9kg	1.9kg	1.9kg
Part No.	053017	053018	053020	053021	053023

Shurflo pumps

- Range of fully automatic triple diaphragm positive displacement freshwater pumps with integral pressure switch
- Heavy duty die cast alloy lower housing with twin ball bearing drive
- Motors have internal circuit breaker for electrical overload protection
- Run dry without damage
- Low amp draw and extremely quiet in operation
- Barbed hose adaptor and inlet side strainer supplied with pump



Shurflo filter
Screw-on filter for attachment to Shurflo pumps
053035



Shurflo filter
Screw-on filter for attachment to Shurflo pumps
With wing nut
053036



Shurflo in-line filter
For use with all types of water pump
053042



Pump fittings
½" elbow and straight connectors
053053

WOW A complete range of Shurflo spare parts can be found in the Spares section



Fiamma aqua 8 pump

Includes anti-vibration silent plate. Will pump water vertically over 3m with no priming. The stainless steel filter prevents impurities from entering. An automatic pressure switch starts and stops the pump. The pump is resistant to limestone deposits and oxidation. Can run dry without damage. Angle and straight connectors for 13mmØ pipes standard delivered
Pressure switch kit **053028**

	Fiamma Aqua 8	Fiamma Aqua 8
Voltage	12V	12V
Flow rate (l/min)	7	10
Pressure	21.75 p.s.i. 1.5 Bar	21.75 p.s.i. 1.5 Bar
Operating current	1.4A	3.4A
Weight	1.5kg	1.5kg
Noise	55/60 db	65/70 db
Part No.	053025	053026



Fiamma A20 expansion tank

Ideal addition to Aqua 8, previous models and all other types of pressure switch pumps. Eliminates the pulsating operation of pressure switch pumps and supplies a constant flow of water in the required quantity. Extends the life of the pump and boiler as well as cutting water consumption. The internal pressurised diaphragm provides a smooth, surge-free flow. Can be adapted to all pressure switch pumps on the market **053030**

Dometic PowerPump



Dometic PowerPump series pressurised water pumps are specially designed for leisure vehicles. Created by comfort specialist Dometic, the pumps excel with their well thought-out practical features, their durability and extremely quiet running. Powerful in performance they make economical use of energy. Dometic PowerPumps can run dry without

damage and feature vibration-absorbing mounts. Self priming pumps with an integrated pressure switch, which means they can be placed above the water tank. Their unique four-chamber diaphragm design ensures maintenance-free operation over the whole service lifetime. Thanks to a patented click system the pump strainer and the three different ½-inch hose connectors included in each set are quick and easy to install. These pumps are available in two performance categories each: 7 or 10 litres per minute.

WOW PowerPumps have a 4 chamber diaphragm with independent operation. This allows the pump to continue to function when one or more of the chambers are faulty

	Power Pump PP127	Power Pump PP1210
Voltage	12V	12V
Flow rate (l/min)	7	10
Pressure	20 p.s.i. 1.4 Bar	30 p.s.i. 2.1 Bar
Operating current	2.2A	3.0A
Weight	2.2kg	2.2kg
Part No.	053010	053011

Submersible pumps and accessories



Reich and Bohler pumps are especially durable and powerful. Their durability is enhanced by special high-tech sealing. A patented vent in many pumps speeds delivery once submerged. All pumps are extremely quiet in use and the housing material is resistant to dirt and this makes them easier to clean when necessary. For Truma submersible pumps please see E5.

Reich 15 litre slimline



12v submersible pump. 1 bar. 40mm ø. Available singly or 10 per outer **055010**

Reich pump and hose assembly

A 76cm length of twin tube blue hose attached to 055010 Available singly or 10 per outer **055030**



Reich twin 19 litre

12v twin submersible pump. 1.4 bar with automatic vent, strainer and non return valve. If one pump fails the TWIN pump will continue to work with reduced power **055017**

WOW 055010 15l slimline pump can be used as a direct replacement for the old Carver/Truma Thames pump. It has the same dimensions and specifications.

Reich 14 litre Easy pump



12v submersible pump. 0.5 bar. 43mm ø **055003**
Bulk 25 per outer **055003B**

Reich 18 litre



12v submersible pump. 0.9 bar with automatic vent and strainer. 45mm ø. Available singly or 10 per outer **055014**

Reich 15 litre In-line



12v booster pump. 0.5 bar. 48mm ø. Available singly or 10 per outer **055020**

Bohler 8 litre



12v submersible pump. 0.6 bar. 46mm ø **055001**

Reich 12 litre



12v submersible pump. 0.5 bar with automatic vent. 45mm ø **055009**

Reich Powerjet 22 litre



12v submersible pump. 1.8 bar with automatic vent. 55mm ø **055018**

Comet exterior water inlet 12v



Complete with plug set for pump cable and sealing cap for water spout. 58mm x 58mm x 55mm **053005**
Spare plug set **053006**

Pump protector



Attach to the lower awning rail to keep your pump off the ground whilst refilling your water container. 10 per outer **055059**

Reich non return valves



With 2 x 1/2" connectors **054368**

With 2 x 12mm push fit connectors **054367**

Comet foot switch



Beige plastic 12v switch suitable for pump control. 61mm ø **053001**

Reich 12v foot switch



Brown plastic 12v switch suitable for pump control. 57mm x 45mm **054366**

Single taps



Comet Novo single tap

Complete with microswitch. Cable length 300mm. Overall tap height 40mm. Maximum pressure 3 bar
Two tone beige **053970**
Brown/beige **053971**
Spare spout beige **053974**
Microswitch **053979**



Mini deluxe single tap

With a slightly smaller control knob and same spout as standard deluxe. Installation hole 16mm (standard deluxe is 20mm)
Matt nickel **054215**
Microswitch **054274**



Deluxe single tap

Complete with microswitch. Cable length 300mm. Overall tap height 40mm. Maximum pressure 3 bar. Installation hole 20mm
Matt nickel **054222**
White **054223**
Beige **054224**
Microswitch **054274**
Spare spout matt nickel **054067**

Fold down mixer taps

**Comet Novo mixer tap**

Mixer tap complete with microswitches. Cable lengths 300mm. Overall tap height 40mm. Maximum pressure 3 bar
 Two tone beige **053972**
 Brown/beige **053973**
 Spare spout beige **053974**
 Microswitch **053979**

**Deluxe mixer tap**

Mixer tap complete with microswitch. Cable length 300mm. Overall tap height 40mm. Maximum pressure 3 bar
 Matt nickel **054233**
 White **054234**
 Beige **054235**
 Microswitch **054274**
 Spare spout matt nickel **054067**

**Smev / Comet Florenz**

Single lever mixer complete with microswitch. Cable length 600mm. Overall tap height 40mm. Maximum pressure 3 bar. Installation hole 33mm
 Chrome **091240**

**Style 2005**

Single lever mixer complete with micro-switch. Cable length 300mm. Overall tap height 40mm. Maximum pressure 3 bar. Installation hole 20mm
 Chrome **054270**
 Matt nickel **054271**
 Microswitch **054274**
 Spare spout matt nickel **054320**
 Spare spout chrome **054321**

**Keramik style**

Single lever mixer tap complete with microswitch. Cable length 600mm. The spout raises and lowers vertically. Ceramic cartridge. Overall tap height 40mm. Maximum pressure 6 bar. Installation hole 33mm
 Chrome **054306**
 Matt nickel **054305**
 Microswitch **054274**
 Spare spout matt nickel **054320**
 Spare spout chrome **054321**

**Keramik deluxe**

Note: will fit Smev sinks. Single lever mixer. Same features as Twist but has ceramic sealing and regulating discs instead of a ceramic cartridge.
 Chrome **054307**
 Microswitch **054274**

**Twist**

Single lever mixer tap complete with microswitch. Cable length 600mm. The spout raises and lowers vertically. Ceramic cartridge. Overall tap height 43mm. Maximum pressure 6 bar. Installation hole 50mm. Right hand illustrated
 Matt nickel left hand **054301**
 Matt nickel right hand **054296**
 Chrome left hand **054302**
 Chrome right hand **054304**
 Microswitch **054303**
 Spare spout matt nickel **054320**
 Spare spout chrome **054321**

**Twist 90° elbow**

Single lever mixer tap complete with microswitch. Cable length 600mm. The spout raises and lowers vertically. Ceramic cartridge. Overall tap height 40mm. Maximum pressure 6 bar. Installation hole 39mm. Left hand illustrated
 Chrome left hand - 90° elbow **054297**
 Microswitch **054303**
 Spare spout chrome **054321**

**Trend A**

Single lever mixer complete with microswitch. Cable length 600mm. Overall tap height 40mm. Maximum pressure 3 bar. Installation hole 27mm
 Chrome **054260**
 Microswitch **054274**

WOW More Reich tap spare parts can be found in the spares section of the catalogue

**Spare spout**

Chrome **054321**
 Matt nickel **054320**

**'O' ring**

Spare 'o' ring for spout **054247**

Mixer taps

caraflo

WOW All Caraflo taps are supplied without tails to enable the customer to select which tails they require - see page E14. They are designed for a pressure-switched system. *Spout length is measured from the front of the tap to the centre of the flow of water along the horizontal.

**Milana**

Single lever basin mixer tap. Installation hole 30mm

Spout length*	Colour	Part No.
120mm	Chrome	054400
160mm	Chrome	054403
180mm	Chrome	054406
180mm	Nickel	054409
240mm	Chrome	054412

**Modesta**

Single lever basin mixer tap. Installation hole 30mm

Spout length*	Colour	Part No.
160mm	Chrome	054415

**Anzia**

Single lever basin mixer tap. Installation hole 30mm.

Spout length*	Colour	Part No.
90mm	Chrome	054418

**Kami**

Single lever basin mixer tap and 120mm solid metal extension for tails. Installation hole 30mm ø

Spout length*	Colour	Part No.
90mm	Chrome	054421

**Charisma**

Single lever mixer tap with a 160mm outlet spout that rotates 360°. Complete with microswitch. Cable length 600mm. Ceramic cartridge. Maximum pressure 6 bar. Installation hole 30-35mm

Colour	Part No.
Chrome	054293
Microswitch	054295

**Pelikan**

Single lever mixer tap complete with microswitch. Cable length 600mm. Spout rotates 360° for versatility. Ceramic cartridge. Maximum pressure 6 bar. Installation hole 33mm

Colour	Part No.
Chrome	054290
Microswitch	054311

**Keramik concept S**

Single lever mixer tap with a flat spout that avoids dripping of residual water. Spout swivels 360°. Comes with microswitch. Cable length 600mm. Maximum pressure 6 bar. Installation hole 33mm

Colour	Part No.
Chrome	054313
Microswitch	054287

**Kama**

Single lever mixer tap complete with microswitch. Cable length 600mm. Ceramic cartridge.

Installation hole	Part No.
33mm	054275
27mm	054279
Microswitch	054287

**Trend E**

Single lever mixer tap with a brass lever and a lightweight plastic body. Ceramic cartridge can be replaced without removing the tap. Complete with microswitch. Cable length 600mm. Maximum pressure 6 bar. Spout length 134mm. Installation hole 33mm

Colour	Part No.
Chrome	054268
Spout chrome	054269
Microswitch	054311

**Keramik cascada**

Single lever mixer tap with a height of 162.5mm. Generates a very soft water jet ideal for hand wash basins. Maximum pressure 6 bar. Comes with microswitch. Cable Length 600mm. Spout length 110mm. Installation hole 33mm

Colour	Part No.
Chrome	054308
Microswitch	054311

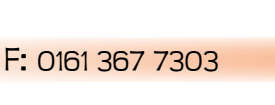
**Trend S**

Single lever mixer tap featuring premium plastic parts for lightness and brass lever and spout for the highest quality finish. Spout rotates 360°. Comes with microswitch. Cable length 600mm. Maximum pressure 6 bar. Spout length 315mm. Installation hole 33mm

Colour	Part No.
Chrome	054266
Microswitch	054311

**Trend B**

Single lever mixer tap supplied with a 360° swivelling metal spout. Spout length 200mm. Folds down into bowl to a height of 40mm. Comes with microswitch. Cable length 600mm. Maximum pressure 3 bar. Installation hole 27mm

Colour	Part No.
Chrome	054263
Microswitch	054274



Shower taps



Elisa
Single lever pull out mixer tap. Installation hole 40mm
Chrome **054430**



Mila
Single lever shower mixer tap. Installation hole 30mm
Chrome **054427**



Moda
Single lever shower mixer tap. Installation hole 30mm
Chrome **054424**

Comet Novo



Shower mixer tap complete with microswitches. Cable lengths 300mm. Overall tap height 40mm. Maximum pressure 3 bar
Shower tap only. Brown and beige **053975**
Shower tap, 1.5 metre hose, adjustable shower head for jet or spray and a wall bracket. As illustrated. White **053977**



Kama with Julia shower
Single lever mixer shower tap complete with microswitch with 600mm cable. Can be used as a normal tap or shower tap. Maximum pressure 6 bar
Chrome **054285**
Microswitch **054287**



Twist - table top



Twist - under table top

Single lever mixer tap that can be used with a variety of shower sets. Any standard 1/2" hose will connect to the outlet. Complete with microswitch. Cable length 600mm. Maximum pressure 6 bar. Installation hole 39mm
Table top version **054299**
Under table top version **054298**
Microswitch **054303**

Tap accessories

SP200 SP210 SP220 SP230



Caraflo tails

Model	Connection	Length	Part No.
SP200	12mm male nylon	350mm	054440
SP210	12mm cone (1/2") SS	220mm	054443
SP220	12mm female nylon	350mm	054446
SP230	15mm female nylon	390mm	054449

Adaptor plates



Useful plate when replacing other taps with Reich, or to neaten any installation

Single (as illustrated) 113mm x 55mm
Chrome **054315**
Matt nickel **054316**
Double 163mm x 55mm
Chrome **054318**
Matt nickel **054319**

Turbo spray plus



Designed to reduce water used by improving the power of the spray. Ideal for caravans. Improves the flow of the water jet without costly new pumps. Screws into the rosette of most caravan taps. **054390**



Ceramic cartridge
Caraflo 35mm ø **054452**



Ceramic cartridge
Reich 35mm ø **054312**
Reich 25mm ø **054312A**

Shower heads and accessories



Carisma
Plastic lever shower head
054325
O ring for Carisma shower head
054327



Sun
Plastic shower head
054468



Kama Julia
Plastic shower head
054323



Trigger
Metal lever shower head
054465



Duett swivelling shower set
Includes the duett shower spout, a 1.5m high quality shower hose and a swivelling konus bracket. Maximum pressure 3 bar. Installation hole for bracket 33mm
Chrome **054283**

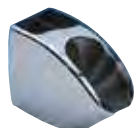

Konus
Wall bracket
054331



Shower head & hose
Chrome single setting plastic shower head with 1.5m hose
054510



Shower head & hose
Chrome three settings plastic shower head with 1.5m hose
054512



Metal shower hose
1.5m
054328



Sun shower rail set
Riser rail, 1.5m hose, and Sun shower head plastic
054459



Sun shower wall set
Wall bracket, 1.5m hose, and Sun shower head plastic
054462



Sun shower hose
Double lock 1.5m metal shower hose
054475

ECOCAMEL
POWERFUL PRODUCTS POWERFUL SAVINGS



Better energy saving performance from your shower and your hot water system

Powerful products that pay for themselves within months - or your money back

Ecocamel shower heads

Water and energy saving shower heads. Patented technology increases the water flow from the showerhead. You get the same powerful shower as a full flow shower, but you use up to 45% less water. Using less water means you automatically use less energy to heat it - so you can help save the environment, whilst cutting your bills in the process. Fantastic for caravans and motorhomes!

- Reduce the need to refill water tanks, or to empty waste tanks.
- With typical 10-14L water heater tank capacity in leisure vehicles, the Ecocamel range makes this equal to a 14-20L tank.
- Less power consumption means fewer gas bottles purchased.

WOW Using Ecocamel you get the same powerful shower as a full flow shower, without using more water.



Jetstorm E



Cobra

Cobra. Fitted by Lunar
054530
Jetstorm E with twin venturi. Fitted by Bailey
054525
Ecocamel shower rail riser set 60cm
054540



1.5 metre hose
Riser rail and adjustable bracket

Sinks



Corner bowl

11" corner bowls are pre-drilled to take any 3/4" sink wastes, 14" bowls are pre-drilled to take 1 1/4" sink wastes (not supplied)

White 11" **050816** 14" **050860**
Ivory 11" **050818** 14" **050861**



Vanity bowls

Pre-drilled to take any 3/4" sink wastes

Dimensions: 508mm x 286mm
Ivory **050777** Beige **050773**



Vanity bowl

Sink waste not pre-drilled
Dimensions: 520mm x 356mm x 138mm
White **050770**



Vehicle bowl

12" x 10 1/2" Stainless steel with lip. Bowl 9 1/2" tapering to 7" ø base. Depth 5" **050523**



Stainless steel sink and drainer

21 1/4" x 14" **050534**



Thetford Kitchen centre

Brushed stainless steel. W470mm x D360mm x H153mm. Sink bowl 11 litres. Weight 3.2 Kg with lid. Chinchilla glass - toughened, heat resistant cutting surface. Optional extras - plastic bowl insert, plastic drainer, chopping board, cutlery rack (as illustrated). Prices on application **091160**



Thetford Rectangular bowl

Stainless steel. W400mm x D445mm x H145mm. Weight 2.9 Kg. Takes 1/4" sink wastes. Pre-drilled tap hole 33mm. **091158**



Thetford Triangular bowl

Stainless steel. WxDxH: 400 x 445 x 145mm. Weight 2.9 Kg. Takes 1/4" sink wastes. Pre-drilled tap hole 33mm. Left hand **091155** Right hand **091156** as illustrated

Smev 8306 sink and drainer



Integrated heat-resistant safety glass, stainless steel drainer, tap fitting inside, AC 540 siphon, rubber seal. W680mm x D440mm x H150mm **091233**
Optional tap **091240**

Thetford Argent sink



Stainless steel. W630mm x D470mm. Sink bowl 146mm deep. Weight 5.5kg. Chinchilla glass - toughened, heat resistant cutting surface
Left hand **091153** as illustrated
Right hand **091152**

Smev sinks with lid

WOW All smev sinks come with an integrated heat-resistant safety glass lid, AC 540 siphon, rubber seal and a pre-drilled tap hole (39mm)

8006

WxDxH: 420x440x145mm
Built in dimensions W405 x D425mm
091232



8005

WxDxH: 420x370x145mm
Built in dimensions W405mm x D355mm
091234



VA7306

ø 420mm
Depth 148mm
Built in dimensions ø 400mm
091231



Optional tap **091240**

Vanity units

Perfecto wall unit



A contemporary design suitable for use in caravans, motorhomes & pleasure boats amongst others. Space saving design, with split level storage and door hinge option. Incorporates an inset mirror and stylish brush metal handle.

Size HxWxD: 540 x 520 x 150 mm
(excludes handle)
Silver **050893**
White **050891**

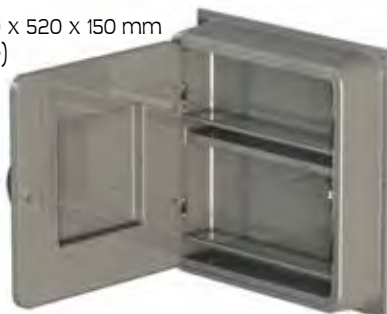

Perfecto pedestal

Ideal for tap mounting, hides pipework and looks fantastic in any toilet or shower.

Dimensions: 750 x 300 x 90mm
Silver **050647**
White **050645**



Perfecto tip up sink



Space saving design with removable bowl and tip to empty mechanism. Incorporates moulded shelf for tap installation.

Size HxWxD: 660h x 520 x 135 mm
(excludes handle)
Silver **050637**
White **050635**



Shower mats



Square shower mat

45cm square. Available singly or 24 per outer
050940



Vanity unit

Manufactured from high impact polystyrene. Features a twin mirror sliding door with travel lock and useful shelf with retainer

Size HxWxD: 550 x 515 x 100mm
050899

Tip up basin

Size HxWxD:
Open: 345 x 500 x 170 mm
Closed: 200 x 500 x 320 mm
050630



Rectangular bath mat

70 x 40cm. Available singly or 12 per outer
050941

Shower trays



Apollo shower tray

Dimensions: 584mm x 584mm x 127mm
Ivory **050930**



C200 shower trays

Moulded to fit the C200 range of cassette toilets
Left hand as shown. Dimensions: 1030 x 670mm **050932**
Right hand. Dimensions: 1020 x 700mm **050933**

W4 Concept accessories

**Towel ring**

Designed with the confined space of caravan and boat washrooms in mind yet still large enough to hold a bath towel. Complete with screw covers and stainless steel screws. Available singly or 10 per outer **095596**

**Toilet roll holder**

Plastic holder with special mechanism to prevent roll unravelling whilst towing. Large self adhesive fixing pad. Available singly or 10 per outer **060351**

**Towel rail**

Compact rail with non slip covering and hanging hooks. Available singly or 10 per outer **095594**

**3 way towel grip**

Complete with screw covers and stainless steel screws. Available singly or 10 per outer **099041**

**2 way robe hook**

Complete with screw covers and stainless steel screws. Available singly or 10 per outer **099040**

**4-way toothbrush holder**

Compact 4 way toothbrush holder complete with screw covers and stainless steel screws. Available singly or 10 per outer **050916**

**Soap holder**

Keeps the soap bar in place when on the move, comes with clip on drip tray. Complete with screw covers and stainless steel screws. Available singly or 10 per outer **050915**

**Washroom beaker and holder**

Invert beaker for storage or transit. Complete with screw covers and stainless steel screws. Available singly or 10 per outer **050914**

**Mini loo brush 2**

A compact brush and holder designed for use with caravan/boat toilets. The brush easily clips into the wall mounted holder to keep it secure in transit. Available singly or 10 per outer **060346**

**Toilet brush & holder**

White coated metal. Available singly or 6 per outer **060340**

**Gripstrip hang it all**

Brush type towel holder. 12 per outer **095603**

**Hold steady**

Stops tins, jars, bottles, aerosols from rolling around. Can be used vertically or horizontally **095883**

**Fiamma toilet brush**

Toilet brush with container for all types of toilet. Complete with self-adhesive strips **060347**

**Ring portable shower 12v or drycell**

Ideal for camping and leisure activities features an electric pump. Operates with 4 x D cell batteries (not included) or via 12V power source. Adjustable water flow. Includes handy storage bag, suction cup and hanging hook. Available singly or 12 per outer **050920**

**Shower curtain**

White. Superior quality. Waterproof. Size 71" square. 6 per outer **050945**

THETFORD

Aqua products

WOW Thetford Aqua products suppress unpleasant smells, reduce gas build up, stimulate the breakdown of solids and toilet paper making it easier to empty, keep the waste tank pure and clean, and protect moving parts to extend the lifespan of the toilet.

Aqua Kem blue

Thick non-drip toilet fluid, use 120ml per 20 litre holding tank capacity

- Lasts 4-5 days with average use



1 litre Non-dosage **060295** 12 per outer
 1 litre Dosage **060292** 12 per outer
 2 litre **060301** 6 per outer

Aqua Kem green

Biological toilet fluid, use 150ml per 20 litre holding tank capacity

- Safe to empty in septic tank (Test ISO 11734)
- 4 days with average use
- It remains liquid up to -20°C and remains active after defrosting



375ml **060304**
24 per outer

1.5 litre **060305**
6 per outer



Aqua Rinse plus

New improved formula. Use 100ml per 15 litre of flush tank capacity. Provides a more effective flush, and keeps the flush water fresh and clean. Septic tank safe.

- Leaves a protective film in the bowl that prevents deposit from forming
- The lubrication action makes the blade of the waste-holding tank easier to open and close



400ml **060275**
24 per outer

1.5 litre **060282**
6 per outer



Aqua Kem sachets



One sachet per 20 litre holding tank capacity

- Easy to use: sachets completely dissolve in water
- Highly concentrated
- Suitable for winter camping
- One dose lasts 4 to 5 days with average use

060307 15 per pack, 6 packs per outer



060306 10 per pack, 6 packs per outer

Aqua Kem green sachets

Biological action. Environmentally friendly. Safe for use in septic tanks. One sachet per 20 litre holding tank capacity

- Easy to use: sachets completely dissolve in water
- Highly concentrated
- Suitable for winter camping
- One dose lasts 4 days with average use

Aqua Soft tissue



- Dissolves quickly
- Prevents clogging
- Easier to empty waste-holding tank
- Prevents malfunctions or damage to the waste-holding tank
- Super-soft

060312 4 per pack, 12 packs per outer
060312B 72 packs per pallet

THETFORD

Maintenance products



Seal Lubricant

- Protects, lubricates, ensures pliability
 - For periodical care and maintenance
 - Developed for safe lubricating of Thetford toilet parts
 - Absolutely safe for plastics, no colouring on plastic parts
 - Ensures smooth operation of valve blades and other items
- 200ml **060355** 12 per outer

Toilet Bowl cleaner

750ml

- Removes hard water and soil deposits while safe for plastic and toilet seals
- Descaling qualities ensure a smooth surface of the toilet bowl, preventing build up of soil
- Provides optimal hygiene and creates shine and brilliance
- Thick concentrated formula coats the bowl for better cleaning and targets hard to reach areas
- Thoroughly cleans leaving a lovely fresh scent behind

050037 9 per outer



Bathroom cleaner

500ml

- Powerful cleaning agent for daily maintenance
 - Safe for all plastics surfaces, including the outside of the toilet
 - Guarantees perfect hygiene
 - Active foam removes calcium deposits
 - Gives a lovely shine
- 098320** 9 per outer



Cassette Tank cleaner

- Thoroughly cleans the inside of the waste-holding tank
 - Easily removes stubborn calcium deposits
 - No scrubbing required
 - Prolongs life span waste-holding tank
 - Pleasant fresh scent
- 1 litre **060325** 12 per outer



Tank Freshener

- Reduces deposits and grease contamination in your waste water tank and tubing.
 - Prevents unpleasant smells
 - Improves hygiene
 - Promotes trouble-free discharge of your tank
 - Safe for all plastics
- 1.5 litres **050038** 6 per outer



WOW Please speak to your sales contact for current special offers on Thetford Aqua products. e.g. Duo pack **060298**

Elsan chemical toilet products

**Elsan Blue**

Elsan Blue's powerful anti-bacterial formula kills germs and eliminates odours. British Standard 2893:2005
2 litre **060362** 8 per outer
4 litre **060373** 4 per outer

**Elsan Pink**

Elsan Pink keeps the toilet fresh and removes bad odours when the toilet is flushed. It is anti-bacterial so it prevents algae build-up in your flush tank. It also lubricates and cleans the bowl.
2 litre **060365** 8 per outer

**Elsan Organic toilet fluid**

Elsan Organic has been developed with brand new biological technology which works in a completely different way to conventional toilet fluids. By dissolving waste and removing odours naturally, the chemical smell has at last been eliminated and replaced with a delightful mild fragrance. It can be used in both flush and waste tanks. And because it is biodegradable and free from harsh chemicals, it can be safely emptied into a septic tank.
400ml **060356** 24 per outer
2L organic and FREE 750ml Toilet bowl cleaner
060359 4 per outer

Elsan Double

Double concentrated to give you the same Elsan performance and reliability on which you've always relied. Now however you only need to use half the quantity giving you a big saving on each dose. British Standard 2893:2005

**Double Blue**

400ml **060376** 24 per outer
1 litre **060378** 12 per outer

**Double Rinse**

400ml **060377** 24 per outer
1 litre **060379** 12 per outer

**Double BOGOF**

2L blue double concentrate and 2L rinse double concentrate fluid
060375 4 per outer

**Elsan Tank clean**

Leaves the fresh water tank free from micro-organisms and black spot. It also removes calcium and other deposits that can eventually clog the system. Tank Clean contains no chlorine.
1 litre **050035** 12 per outer

**Elsan Toilet Bowl cleaner**

Leaves toilet bowls fresh and clean. Concentrated power to remove scale deposits. Especially made for caravan and motorhome toilets.
750ml **060381** 12 per outer

**Elsan Blue bags**

As the sachet comes in contact with water it quickly dissolves, killing the bacteria and eliminating odours whilst imparting a pleasant fragrance. And because each sachet contains an exact dose of concentrated powder, no measuring is required. Clean, safe and easy to use, Blue Bags provide the ultimate in performance and reliability.
060332 18 per pack, 12 packs per outer

Assorted chemical toilet products

TRIGANO

Activ by **THETFORD**

WOW Manufactured by Thetford, the economical Activ range has the same advantages as the Thetford Aqua products, use a similar dose, but are effective for a slightly shorter period.

**Activ rinse**

Use 70ml per 10 litre of flush tank capacity. Provides a more effective flush, and keeps the flush water fresh.

- Leaves a protective film in the bowl that prevents deposit from forming
- The lubrication action makes the blade of the waste-holding tank easier to open and close

2 litre **060245** 6 per outer

**Activ blue**

Thick non-drip toilet fluid, use 60ml per 10 litre holding tank capacity

- One dose lasts 3-4 days with average use

2 litre **060246** 6 per outer

**Activ green**

Biological toilet fluid, use 60ml per 10 litre holding tank capacity

- Safe to empty in septic tank
- One dose lasts 3 days with average use
- It remains liquid up to -20°C and remains active after defrosting

2 litre **060247** 6 per outer



FIVE reasons why you will love

1. They're hygienic
2. They're biodegradable
3. They reduce water usage
4. They reduce odour with a fast flush
5. They work

Happy bowl liners

Biodegradable toilet bowl liners. Use them to line your caravan, motor home, or portable toilet. Simply flush the toilet after use, and the bowl liner and contents are flushed away, leaving your bowl clean and fresh.

060311 50 per pack, 10 packs per outer

FENWICK'S

ADVANCED CARAVAN CARE

**Fenwick's top & tail**

A unique toilet fluid designed for use in both top and bottom tanks which makes it easier to use and more economical.

2.5 litres **060266** 8 per outer

**Citrus fresh toilet cleaner**

"Fresh coat" helps prevent marks and stains. Helps maintain seals, improves flush action and sanitises.

1 litre **060265** 15 per outer

**Waste pipe & tank cleaner**

Cleans shower and sink drains, toilet cassettes, and eliminates unpleasant odours.

1 litre **097063** 15 per outer

FIAMMA**Fiamma soft toilet tissue**

It won't clog up tanks or waste valves. Special 2-ply soft toilet tissue, formulated for chemical toilets. Stronger and softer tissue dissolves quickly in water. 300 sheets per roll.

060388 6 per pack, 10 packs per outer

**Mini loo brush 2**

A compact brush and holder designed for use with caravan/boat toilets. The brush easily clips into the wall mounted holder to keep it secure in transit. Available singly or 10 per outer **060346**

**Fiamma toilet brush**

Toilet brush with container for all types of toilet. Complete with self-adhesive strips **060347**

**Toilet brush & holder**

White coated metal. Available singly or 6 per outer **060340**

**Toilet roll holder**

Plastic holder with special mechanism to prevent roll unravelling whilst towing. Large self adhesive fixing pad. Available singly or 10 per outer **060351**

Portable toilets

THETFORD Porta Potti range - 3 year warranty. Integrated cover lock for easy transportation, with recess for opening. The smooth lines and subtle curves are not just important to the appearance of the toilets, but also provide optimum comfort and ease of use. An improved blade opener. A new more comfortable handle on the waste holding tank.

Porta Potti®
QUBE



Part no.	Porta Potti Model	Body Colour	Dimensions H x W x D	Pump Type	Level Indicator	Waste tank	Flush Tank	Pack size
056966	Qube 145	White	330 x 383 x 427	Bellows	No	12L	15L	All Porta Potti toilets are available singly or 5 per outer
056968	Qube 165	White	414 x 383 x 427	Bellows	No	21L	15L	
056970	Qube 335	White	315 x 342 x 382	Piston	Waste	10L	10L	
056971	Qube 345	White	330 x 383 x 427	Piston	Waste	12L	15L	
056973	Qube 365	White	414 x 383 x 427	Piston	Waste	21L	15L	
056980	Excellence	White	458 x 388 x 450	Piston	Waste/flush	21L	15L	
056981	Excellence	White	458 x 388 x 450	Electric	Waste/flush	21L	15L	

Porta Potti®
EXCELLENCE



Porta Potti Excellence floor plate

Floor plate to enable you to mount the Porta Potti Excellence to the floor. Helps to prevent accidental movement of the toilet. The toilet simply detaches from the floor plate for emptying. Ideal for boats or home use

056983



Bi-Pot

Bi-Pots are simple, self-contained fresh water flush portable toilets. A very simple system that is both strong and easy to clean. Compact, it can be completely dismantled, including the valve for thorough and total cleaning. Sturdy and solid handle for easy transportation. Large waste cap: no drainpipe, emptying is easy and hygienic, no clogging. Each tank is electronically tested for a perfect seal. Handy side clips to connect the upper and lower tanks.

- Sturdy piston pump guarantees 3 powerful rinsing jets
- Comfortable and wide seat for adults
- Scratch-resistant tank built in only one piece without seams to support more weight
- Sliding watertight valve with anti-odour seal
- Large and handy charge and discharge openings with semi-transparent lid for better level control
- No leakage and watertight



Bi-Pot 30

HxWxD 300x345x435mm
Flush tank 10 litres
Waste tank 11 litres
056948



Bi-Pot 34

HxWxD 340x360x435mm
Flush tank 15 litres
Waste tank 13 litres
056949



Bi-Pot 39

HxWxD 392x360x435mm
Flush tank 15 litres
Waste tank 20 litres
056950



Elsan bristol toilet

Near in height to a household toilet, the Bristol is made from high grade easy-to-clean plastic.

It features a removable inner container with close-fitting anti-spill lid, a strong, full size seat and lid together with quick release floor fixings, and strong nylon coated carrying handle.

HxWxD 432x362x437mm
Capacity 21 litres
060205



Dometic 966 portable toilet

Full size seat and lid provide comfort and support. Sturdy construction with an easy to clean matt finish. Double sealed valve prevents leaks and odours. Large discharge opening.

Flush tank 9.8 litres
Waste tank 19 litres
HxWxD 394x419x368mm
Available singly or 10 per outer
056965



Cassette toilets **THETFORD**

WOW For professional vehicle convertors and manufacturers please ask about the range of OEM toilets stocked by Grove. These are packaged for manufacturers and sold as individual parts to tailor the product to your individual needs.

C402C



Bench model toilet for caravans and motor homes.

- Electric touch button flush
- Waste holding tank on wheels with retractable handle
- LED display indicates when waste tank is full
- Flush tank capacity: 15L
- Waste tank capacity: 19.3L
- Dimensions (HxWxD mm): 512(847 with lid open)x670x400

A right hand toilet has the waste tank removed from the right hand side when sitting on the toilet

Right hand **060093**
Left hand **060094**

C200 CS



This version is designed to fit in vehicles with an on-board tank

- Electric flush
- Waste level indicator.
- No flush tank
- Waste tank capacity 17L
- Dimensions (HxWxD mm): 538 (822 with lid open) x 353 x 570

060095

C200 CW



Features a swivel bowl to free additional space when not in use. It is the most compact cassette type toilet on the market.

- Manual flush
- Waste level indicator.
- Flush tank capacity 7L
- Waste tank capacity 17L
- Dimensions (HxWxD mm): 728 (822 with lid open) x 353 x 570

060100

WOW The C260 Cassette Toilet is the ultimate sanitary solution for your caravan or camper. With its contemporary design, the C260 has several exciting new and improved features.

C260 CS



This version is designed to fit in vehicles with an on-board tank.

- Electric flush
- Waste-holding tank level indicator
- Waste-holding tank with integrated wheels and with easy pull-out handle
- No flush tank
- Waste tank capacity 17.5L
- Optimal use of space: 2 x 90 degrees rotating toilet bowl
- Dimensions (HxWxD mm): 750 (847 with lid open) x 417 x 603

Plastic bowl **060061**

C260 CWE



This toilet is also available with a full ceramic bowl for a true domestic sanitary experience.

- User-friendly control panel
- Electric flush
- Waste-holding tank level indicator
- Waste-holding tank with integrated wheels and with easy pull-out handle
- Flush tank capacity 8L
- Waste tank capacity 17.5L

Plastic bowl **060060**
Ceramic bowl **060064**

- Optimal use of space: 2 x 90 degrees rotating toilet bowl
- Dimensions (HxWxD mm): 750 (847 with lid open) x 417 x 603

Fresh-up sets



Each fresh-up set contains a cassette holding tank, toilet seat and lid in white, cassette tank cleaner 1 litre, 2 x sample additives, flip chart manual for converting holding tank to left or right hand. Available singly or 5 per outer

C200 swivel type **060088**
C250/260 swivel type **057196**
C2/3/4 bench type **060089**
C400 range bench type **060241**

Holding tanks only



C400
LH **060090**
RH **060091**

C250/260/263
057181



Service doors **THETFORD**

A comprehensive range of high grade UV resistant quality plastic doors suitable for cassette toilets or as service doors for gas bottles and water tanks. They can all be mounted vertically or horizontally

- Incorporate double seal to help waterproof locks and assist insulation
- Integrated hinges
- Suit wall thickness 24mm to 40mm

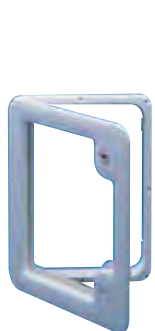

Door 3
Standard cassette toilet door.
Aperture: 330 x 280mm.
Overall dimensions: 385 x 335mm
Cream **060102**
White **060105**

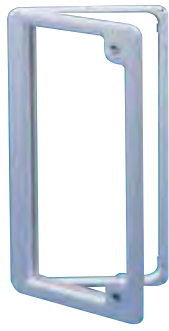

Door 4
Gas and water tank door.
Aperture: 630 x 330mm.
Overall dimensions: 700 x 395mm
Cream **060098**



Door 5
Water tank and general luggage door.
Aperture: 730 x 280mm.
Overall dimensions: 785 x 340mm
Cream **060099**



Door 6
General luggage door for large objects.
Aperture 980 x 400mm.
Overall dimensions: 1038 x 465mm
Cream **060097**



Door 7
General luggage door for large objects.
Aperture 1051 x 282mm.
Overall dimensions: 1108 x 346mm
Cream **060106**



Lock mkll door 2
060159



Lock door 3, 4, 5
060164



Lock cover
060162



Door 3/4/5 hinge pins
060111

Popular replacement parts

WOW A complete range of Thetford spare parts are available in the spares section of the catalogue



Dump Cap
Yellow **060113**



Measuring Cap
Yellow **057200**
White **057201**



Autovent
060110



Porta potti dump cap
White **060167**



Cassette lip seal
To June 2000 **060128**
From June 2000 **060101**



Porta potti lip seal
060134



Cassette vent seal
060127



Cassette seat & lid
060130



Blade opener
060084



Slide cover
060141



Glass fuse
3amp **060132**



Cassette switch
060119



LED indicator light
C200 **060082**



Cassette mechanism
C2, C3 **060114**



Manual pump C200
060085



Bezel / switch assembly
C200CWE **060086**



Cassette Pump
Except c250 **060118**



C250 Pump
057169



Porta potti bellows
White **060123**



C200 drain plug
060174



Waterfill funnel Cap
060158

Fixed regulators

**Truma fixed regulators**

M20 x 1.5kg/h, 30mbar with pressure protection, integrated 90° elbow and test point

8mm outlet **070520**

10mm outlet **070525**

WOW Cavagna fixed regulators are on G2



Elbow for Truma regulator
070526

**Truma gas filter**

Helps to prevent blocked regulators by filtering any oily residue in the gas.

Filter and housing **070555**

Replacement filter **070556**

Fixed regulator equipment

**Propane pigtails**

BS3212:1991/2/6.3

Cavagna 500mm **070515**

Cavagna 750mm **070518**

Truma 450mm **070534**

Truma S/steel 450mm **070538**

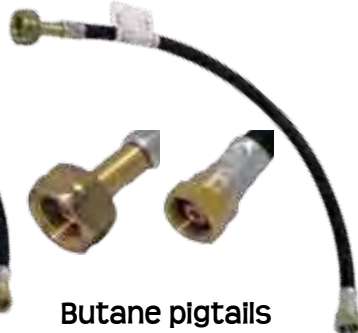
**Butane pigtails**

BS3212:1991/2/6.3

Cavagna 500mm **070514**

Cavagna 750mm **070517**

Truma 450mm **070533**

Truma S/steel 450mm **070539**

**Pigtail washer W20**

070535

**21mm butane clip-on adaptor**

Truma **070542**

EN1949 **070545**

**27mm butane clip-on adaptor**

With 90° elbow

Truma **070531**

**Campingaz adaptor**

Truma **070541**

EN1949 **070548**

DuoControl CS

The DuoControl can be retrofitted, and has a built in crash sensor (CS) and integrated test point. **Not** for use in commercial vehicles.



- Automatic changeover from empty to full gas cylinder.
- Visual display indicating the status of the operating cylinder (empty/full)
- Manual selection of operating cylinder using control knob
- Inlet M20
- Regulator capacity 1.5kg/h
- Crash sensor is easy to reset
- For vertical installation
- Crash sensor activation value: 3.5g +/- 0.5g
- Models available on request for horizontal installation

30 mbar 10/8mm **070377**

50 mbar 8mm **070378**

MonoControl CS

This safety gas pressure regulation system is ideally suited to ensuring safe heating whilst on the move. The MonoControl can be retrofitted, and has a built in crash sensor (CS) and integrated test point. Also for use in commercial vehicles in accordance with BGV D 34



- Inlet M20
- Regulator capacity 1.5kg/h
- Crash sensor is easy to reset
- For vertical installation
- Crash sensor activation value: 3.5g +/- 0.5g
- Models also available on request for horizontal installation

WOW Can be upgraded to a 2 cylinder system by using the Truma DuoComfort changeover valve

30 mbar 10/8mm **070373**

50 mbar 8mm **070374**

For special gas tank mounting applications (not illustrated)

30 mbar 10/8mm **070371**

DuoComfort

The addition of a DuoComfort turns any Truma single cylinder system into an automatic changeover system. Use with other brand regulators is not permitted. Also for use in commercial vehicles in accordance with BG-V D 34



- Compliant with all directives governing heating whilst towing (when used with a MonoControl CS)
- Visual display indicating the status of the operating cylinder (empty/full)
- Manual selection of operating cylinder using control knob

070370



5 Year warranty



Caravan / Motorhome regulators

30mbar double stage regulator with 1.5kg/h flow capacity. "UDS" is the standard built in safety device. With integrated test point. W20 inlet

- Straight 8mm outlet **070399**
- Straight 10mm outlet **070400**
- 90° 8mm outlet **070395**
- 90° 10mm outlet **070396**



Caravan / Motorhome auto changeover regulator

The Reca automatic changeover gas regulator (30mbar) with 1.5kg/h flow capacity. It combines an automatic changeover with a double stage regulator and an integrated "PRV" safety device. Therefore it is the most compact gas regulation system in Europe. W20 inlet

- 8mm outlet **070415**
- 10mm outlet **070416**

Standard regulators



Butane regulator

Outlet pressure 28mbar 1.3Kg/h. EN 12864 approved. Available singly or 10 per outer **070323**



Clip-on regulator

21mm - Outlet pressure 29mbar 1Kg/h. EN 12864 approved. Available singly or 10 per outer **070350**



Propane regulator

Outlet pressure 37mbar 1.5Kg/h. EN 12864 approved. Available singly or 10 per outer **070336**



Propane handwheel regulator

Outlet pressure 37mbar. 1.5Kg/h. EN 12864 approved. Available singly or 10 per outer **070337**



Gaz regulator

For use with Campinggaz cylinders. Integral control valve. Outlet pressure 29mbar 0.8Kg/h. EN 12864 approved. Available singly or 10 per outer **070342**



Campinggaz regulator

To operate campinggaz® refillable cylinders. Simply screws onto 901, 904, & 907 cylinders **109919**



Patio gas regulator

27mm clip on regulator for Calor patio gas. Outlet pressure 37mbar. EN 12864 approved. Available singly or 10 per outer **070345**



BP Gas light regulator

Outlet pressure 37mbar. 1.5Kg/h. **070543**



Butane regulator & hose pre-pack

4.5Kg butane regulator comes pre-packed with 1m of HP hose and 2 hose clips. Available singly or 10 per outer **070324**



Propane regulator & hose pre-pack

Propane regulator comes pre-packed with 1m of HP hose and 2 hose clips. Available singly or 10 per outer **070335**



Regulator washers(5)

10 per outer **070227**



Regulator spanners

- Light weight loose **070221**
- Light weight packed 10 per outer **070220**
- Heavy duty **070222**
- Truma **070224**

Gas manifolds



Straight quick acting valve
8mm 823110



2 way manifold valve
8mm 824111

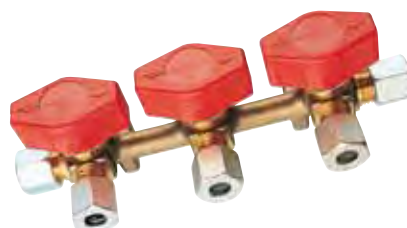

3 way manifold valve
8mm 824131
10mm 824132

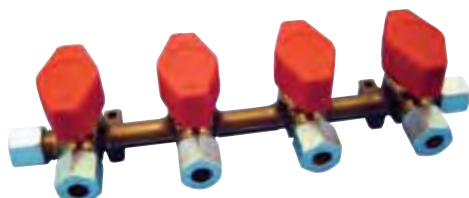

4 way manifold valve
8mm 824151
10mm 824152

Gas fittings

ALL GAS FITTINGS AND ACCESSORIES SHOULD BE FITTED/CHECKED BY A QUALIFIED TECHNICIAN
5 packs per outer unless stated otherwise



Copper tube
Supplied in 30m rolls
1/4" O.D. 070290
5/8" O.D. 070295
3/8" O.D. 070300



Straight couplings
1/4" 070004
5/8" 070006
3/8" 070008
8mm 070010
10mm 070012
15mm 070014

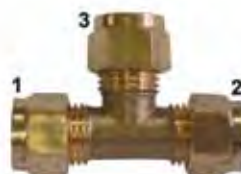

Tee pieces
1 x 2 x 3
1/4" x 1/4" x 1/4" 070068
5/8" x 5/8" x 5/8" 070074
3/8" x 3/8" x 3/8" 070079
5/8" x 5/8" x 1/4" 070081
8 x 8 x 8mm 070080
8 x 10 x 8mm 070083
10 x 10 x 8mm 070085
15 x 15 x 10mm 070087
15 x 15 x 8mm 070089



Copper nozzles
1/4" 070099
5/8" 070102
3/8" 070105
15mm 070146



Gas hose BS3212
Composite low pressure black gas hose
5/8" bore x 1/8" 50m 070234
High pressure orange gas hose
5/8" bore 50m 070236
HOSES NOT SUPPLIED ON A REEL

Reducers
5/8" - 1/4" 070045
3/8" - 1/4" 070051
3/8" - 5/8" 070055
10-8mm 070057
15mm-3/8" 070059



Male nozzle
1/4" 070120



Hose clips
000 (2) W4 104832
000 (2) carded 070249
000 Bulk 070255
00 (2) carded 051246
00 Bulk 051257



bulkhead coupling
8-10mm 070144



Elbows
1/4" 070180
5/8" 070181
8mm 070175
10mm 070177
Elbow reducers
10-8mm 070179



Female nozzle
1/4" 070137
3/8" 070140



Three way nozzle
10 per outer 070174



Copper olives (5)
1/4" 070267
5/8" 070269
3/8" 070273



Copper to taper
1/4"C - 1/4"M 070063



Line taps
Available singly
1/4" 070196
5/8" 070194
3/8" 070198



Floor mounted control tap
Available singly
1/4" 070185



Stop end
1/4" 070170



Blank nuts
1/4" 070183

Gas level indicator



Truma LevelCheck

Gas cylinder level indicator for all (LPG) steel or aluminium gas cylinders with a diameter of 200 to 350mm. The device measures whether there is liquefied gas in the cylinder at the measuring point (by horizontal connection) and indicates this.

- Reliable ultrasonic measurement
- Easy to use with 9v battery supplied
- Integrated LED torch with On/Off switch
- Status LED (green/red/orange) green = Gas, red = no gas, orange = indicates measuring process (also with audible tone)
- Under voltage display

*Not suitable for tank gas cylinders or fillable gas tanks

070560

Gas servicing equipment



Truma leak test device

For workshop use.

Complete kit **070550**

Volumiser canister **070552**

Leak test hose **070551**



Universal thermocouple

Thermostatic sensor device which will fit almost all gas appliances. 900mm length **070215**



Dometic GasChecker GC100

Indicator for identifying the fill level of all standard propane and butane gas bottles

- Reliable ultrasonic measurement
- Easy to use
- Suitable for all steel bottles 200-350mm Ø

070562

Gas box equipment



Truma BBQ gas point

Enables external gas appliances to be connected. The only additional equipment you need is a gas pipe with an 8mm diameter

White **070536**

Ivory **070537**



Reich gas supply box with lock and valve

Supply connection for gas, with safety valve and lock. 10mm inlet. Installation dimensions: 157x67mm **070465**



Gas outlet box and lid

Fits into outside wall of caravan for easy connection of BBQ. Cut out -60mm Ø 60mm depth. Finished - 90mm x 85mm

070463

Lid only

070461

Nozzle only

070462



W4 compression lock for gas locker

WD barrelled compression lock with lever attachments. As used by manufacturers including Explorer, Bailey and Coachman. Supplied with 2 keys **070318**



Gas bottle holder

Keeps gas bottle fixed while in transit. Available singly or 10 per outer **070320**



W4 gas bottle retaining kit

Gas bottle retaining kit secures up to 7kg gas bottle when travelling. **070321**



W4 gas locker key

Replacement steel key for gas lockers (070319). Available singly or 10 per outer **070322**



W4 gas bottle locker lock

Lock supplied together with necessary fittings to enable easy installation into a variety of locker types. Supplied without keys **070319**

Fuel

**C206**

Pierceable. Contains 190g of butane/propane mix. 36 per outer **109964**

**CV 300 Plus**

High security self-sealing valve. Can be easily disconnected and reconnected even when not empty. Contains 240g of butane/propane mix. 24 per outer **109966**

**CV 470 Plus**

High security self-sealing valve. Can be easily disconnected and reconnected even when not empty. Contains 450g of butane/propane mix. 12 per outer **109967**

**Coleman 250**

Contains 220g of 70/30 butane/propane mix in threaded self-sealing cartridges with safety valve. Size: Ø 105 x 90 mm. 24 per outer **109970**

**Coleman 500**

Contains 445g of 70/30 butane/propane mix in threaded self-sealing cartridges with safety valve. Size: Ø 105 x 160 mm. 12 per outer **109971**

**Propane non-refillable cylinder**

Thanks to physical properties of Propane, every last gram of gas in the cylinder is used to operate the appliance. It is also a cleaner combusting fuel, producing less carbon dioxide and as a result, less pollution. Coleman® Contains 465 g of propane. Size: Ø 195 x 100 mm. Weight: 935 g. 12 per outer **109973**

**Coleman camp fuel**

Coleman fuel is a liquid petroleum fuel (100% light hydrotreated distillate). It has an octane rating of 50 to 55 and a flammability similar to petrol. 1 litre 12 per outer. **109974**

**Stove cartridge**

Cellophane wrapped economical 4 pack of gas for camping stoves. Resealable, can be removed when part full for convenient and safe storage. 6 per outer **109945**

**CP250**

Contains 250g of isobutane. For use with Bistro® type stoves. 12 per outer **109965**

**Cadac gas canister**

190g Pierceable **070450**
36 per outer
500g Resealable **070456**
12 per outer

**CG 1750**

Taymar cartridge, for use with blowlamps and blowtorches. 175g. 12 per outer **109969**

**Refil for gas lighters**

250ml. 12 per outer **070480**

Travel safety

**Alcosense breathalyser kit**

It is a legal requirement when driving in France to carry a breathalyser kit in your vehicle. It has to have NF approval, therefore a UK breathalyser kit is not suitable for use in France. Alcosense meets NF approval, but also meets the level of 0.5%BAC which is adopted by most European countries. Available singly or 100 (singles) or 36 (twin) per outer

Single pack

070598

Twin pack

070599

**AA high viz vest**

Reflective vest conforms to EN471 high visibility clothing. Wipe clean only **070602**

**AA euro travel kit**

Euro travel kit includes: AA Glovebox Atlas Europe, AA Driving in Europe Guide - Essential Travel Information, hazard warning triangle, headlamp beam converters, magnetic GB plate, reflective emergency jacket, first aid kit **070621**

**Emergency hooded poncho (3)**

Light weight reusable emergency rain ponchos. 2 Adult and 1 child. 24 per outer **070603**

Gas safety

**Dual sensor gas alarm**

Specially designed for Home, Boat, Caravan & Motor home installation. HxWxD: 11.5cm x 7.5cm x 4cm

Detects:

- Carbon Monoxide (CO)
- Diethyl-ether ("knock-out" Gas)
- Butane and Propane LPG
- Coal gas
- Ultra compact design
- 12v DC or 230v AC
- Low current consumption (50mA @ 12v DC)
- Built in loud siren (90db @ 1M)
- Status LED's for power, triggering and sensor malfunction
- Test button with auto reset

Available singly or 6 per outer **070660**

**FireAngel smoke alarm**

Built-in nuisance alarm silencer, comes complete with battery. 5 year guarantee. NCC approved. Available singly or 10 per outer **070650**

**Kidde carbon monoxide alarm**

Comes complete with 3 x AA batteries. 5 year guarantee. Available singly or 12 per outer **070668**

**FireAngel carbon monoxide alarm**

Comes complete with 2 x AA batteries. 7 year guarantee. NCC approved. Available singly or 5 per outer **070665**

**Sleepsafe CO detector**

Twin pack

- Colour change Carbon Monoxide detector
- Ideal for use in homes, offices, hotels, bedsits, caravans, boats and aircraft
- Reacts to low level Carbon Monoxide (<50ppm)
- Easy to use

070656

Fire safety



It is important to choose the right fire extinguisher as specific extinguishers are designed for different types of fire. The UK recognizes six fire classes:

Class A fires involve organic solids such as paper and wood.

Class B fires involve flammable or combustible liquids, including petrol, grease, and oil.

Class C fires involve flammable gases.

Class D fires involve combustible metals.

Class E fires involving electrical appliances (no longer used as when the power supply is turned off an electrical fire can fall into any category).

Class F fires involve cooking fat and oil (use blankets)

**Anaf foam AB extinguisher**

- Rating A & B
- Fire Rating 34AB
- Ideal for kitchen, car, garage, motorhome

0.85 litre. Available singly or 6 per outer **070630**

**Anaf powder ABC extinguisher plus gauge**

- Rating A, B, C & electrical
- Fire Rating 34AB 5A 34 BC CEN EN3 approved
- Marine approval
- Ideal for caravan, car, boat, home, motorhome

1kg 6 per outer **070635**

**Fire blanket with holder**

Manufactured to BS6575. Supplied in rigid plastic container which can be hung on the wall. 1 m² blanket. Available singly or 10 per outer **070627**

**Fire blanket**

Manufactured to BS6575. Supplied in wallet which can be hung on the wall. 1 m² blanket. Available singly or 10 per outer **070625**

**Fire bucket and lid**

28cm tall. 22cm ø base. 26cm ø lid. Available singly or 20 per outer **070672**

First aid kits

Grove camping first aid pouch

Contents:

- 1 x Guidance on first aid leaflet
- 5 x Skin closure strips 75 x 3mm
- 2 x 20ml Eye/wound wash solution
- 1 x Roll-on insect repellent
- 1 x Medium powder free vinyl gloves
- 1 x Microporous tape 1.25cmx10m
- 5 x Sterile gauze swabs 8ply 5cm²
- 3 x Burnshield hydrogel 3.5ml sachet

- 1 x Foil survival blanket 56 x 84"
- 1 x Sterile eye pad dressing
- 1 x Triangular bandage 90x90x127cm with 2 pins
- 1 x Sterile medium dressing 120x120mm
- 1 x Sterile No. 16 Eye pad dressing
- 1 x Resuscitation face shield foil pack
- 4 x Alcohol-free moist wipes
- 1 x Small scissors green handle 4"
- 20 x Assorted transparent plasters

070607

Grove caravan & motor home first aid kits

Contents:

- 1 x Guidance on first aid leaflet
- 10 x Assorted transparent plasters
- 10 x Children's plasters
- 1 x 20ml Eye/wound wash solution
- 1 x Triangular bandage 90x90x127cm
- 2 x Safety pins
- 2 x Sterile medium dressing 120x120mm
- 1 x Sterile large dressing 180x180mm

- 10 x Alcohol-free moist wipes
- 1 x Medium powder free vinyl gloves
- 1 x Scissors
- 1 x Plastic tweezers

Box **070605**
Pouch **070606**

**Grove first aid pouch**

Contents include: Alcohol-free wipes, plasters, dressings, bandages, gloves, tape, scissors, emergency blanket, safety pins **070612**

Oven only

**Thetford Cara oven**

- 34 litre capacity with 3 shelf positions
- Thermostatically controlled oven
- Grillbox compatible with Spinflo hobs
- Flame failure device
- Total heat input 1.5 Kw
- W480 x D450 x H550mm. Excludes open door
- Internal: W375 x D360 x H252mm
- Operating pressure: Propane 37mbar, Butane 28mbar

091170**Thetford Duplex oven & grill**

- 36 litre capacity
- Total heat input: grill 1.6 Kw
- Total heat input oven 1.6 Kw
- Flame failure device
- External: W456 x D440 x H408mm
- Built in: W445 x D505 x H424mm
- Weight: 13.5 Kg

091172

Ovens with grills

**Smev 30 litre oven & grill FO311GT**

- Voltage 12v DC (electric ignition)
- Oven output 1.2kw
- Gas consumption oven 87g/h
- Grill output 1.6kw
- Gas consumption grill 116g/h
- Gas supply pressure. 30 mbar
- Total output 2.3kw
- Total consumption 203 g/h
- Oven capacity 30L
- Stainless steel
- Thermostatically controlled
- Interior lamp
- Overall: W530 x D415 x H430mm
- Built in: W500 x D460 x H410mm
- Weight 19.5 Kg
- Test Mark CE

091203**Thetford Duplex oven & grill with sliding door**

As 091172 except that the door slides back into oven when open.

- Oven Capacity 32.4 litres
- External: W527 x D530 x H408mm
- Built in: W525 x D460 x H424mm
- Weight: 14.5 Kg

091174**Smev 20 litre mini oven & grill FO211GT**

- Same specification as 30 litre
- Oven capacity 20L
- Overall: W530 x D410 x H310mm
- Built in: W504 x D460 x H283mm
- Weight 13.2 Kg

091200**Thetford Midi Prima oven & separate grill**

- Stainless steel
- Independent oven & grill
- Oven Capacity 36 litres
- Total heat input grill 1.6 Kw
- Total heat input oven 1.5 Kw
- Flame failure device
- W445 x D490 x H826mm
- Weight: 19.5 Kg

091185

Oven, hob & grill

**Thetford Triplex oven, grill and 3 burner hob**

- 36 litre capacity
- Total heat input grill 1.6 Kw
- Total heat input oven 1.6 Kw
- Total heat input hotplate 2 x 1.8 Kw + 1 x 2.4 Kw burners
- Flame failure device
- External: W463 x D500 x H468mm
- Weight 21.5 Kg

091177**Thetford Aspire oven, separate grill & 4 burner hob**

- Capacity 42 litres 9.74W
- Total heat input grill 1.6 Kw
- Total heat input oven 1.6 Kw
- Hob: 2 x 2Kw, 1 x 1.5Kw & 1 x 1Kw burners
- Flame failure with automatic gas shut-off on all burners
- W517 x D535 x H920
- Weight: 31.5 Kg

091187**Thetford Caprice Mk3 oven, separate grill & 4 burner hob**

- 36 litre capacity
- Stainless steel
- Total heat input grill 1.6Kw
- Total heat input oven 1.5Kw
- Total heat input hotplate 3 x 1.5 Kw + 1 x 1 Kw burners
- Flame failure with automatic gas shut-off on all hotplate burners
- W513 x D500 x H844mm
- Weight 27.5 Kg

091181

Combination units

Smev 9222 combi sink & lid



Supplied with hole for optional tap (39mm)

- Voltage 12v DC (electric ignition)
- Power rating Output 1x1kw, 1x1.8kw
- Gas consumption 204g/h
- Gas supply pressure 30 mbar
- 2 burners
- W900 x D370 x H152mm
- Built in dimensions W793 x D307mm
- Weight 5.8 Kg
- Test Mark CE

Left hand

091224

Right hand (as shown)

091223

Optional tap **091240**

Smev 2 and 3 burner combi unit



Supplied with hole for tap (39mm)

- Voltage 12v DC (electric ignition)
- Power rating 2.8kw (2 burner) 3.8kw (3 burner)
- Gas consumption 204 g/h (2 burner) 227 g/h (3 burner)
- Gas supply pressure 30 mbar
- W680 x D440 x H142mm
- Built in dimensions W666 x D426mm
- Weight 5.6 Kg
- Test Mark CE

Smev 8322 2 burner **091225**

Smev 8323 3 burner **091226**

Optional tap **091240**

Smev combi sink & lid



Lid made from safety glass, piezo ignition. Supplied with hole for optional tap (39mm)

- Output 1.0 kw
- Gas consumption 73 g/h
- Gas supply pressure 30 mbar
- 1 burner
- W525 x 421 x H152mm
- Test Mark CE

Left hand

091222

Right hand (as shown)

091221

Optional tap **091240**



Tap for Smev sinks

091240

Hobs

Thetford rectangular hob



- 12V electric spark ignition
- Stainless steel
- 2 x 1.5Kw burners
- 1 x rapid burner 2.5Kw
- 40mm black knobs
- W540 x D445 x H98.2mm
- Weight 5.6 Kg

091149

Smev 8063 hob & lid



- Voltage 12v DC
- Output 4.6kw
- Gas consumption 335 g/h
- Gas supply pressure 30 mbar
- 3 burners
- W560mm x D440mm
- Test Mark CE

091219

Smev 8062 hob & lid



- Voltage 12v DC
- Output 2.8kw
- Gas consumption 204g/h
- Gas supply pressure 30 mbar
- 2 burners
- W480mm x D370mm
- Test Mark CE

091215

Thetford Toplevel 160 hob



No rattle design can also be surface mounted.

- 12V electric spark ignition
- Flame failure device
- Sealed, metal cast burners
- 2 x 1.5 kW, 1 x 2.5 kW burners
- Chinchilla glass lid
- 2 year limited warranty
- W546 x D482 x H105mm
- Weight 10.7 Kg

091164

Thetford triangular hob



- 12V electric spark ignition
- Stainless steel
- 3 x 1.5Kw burners
- 40mm black knobs
- W480 x D480 x H100.5mm
- Weight 4.1Kg

Left hand (as shown)

091146

Right hand

091147

Thetford Argent 4 burner hob



- 12V electric spark ignition
- Gas hotplate 4 x 1.5Kw
- Stainless steel
- W470 x D570 x H110mm
- Weight 6.5 Kg
- Chinchilla glass-toughened, heat resistant cutting surface

Left hand

091162

Right hand (as shown)

091161

Sinks

Smev 8306 sink & drainer



Integrated heat-resistant safety glass, stainless steel drainer, pre-drilled tap hole 39mm, AC 540 siphon, rubber seal. W680 x D440 x H150mm

091233

Optional tap **091240**

Smev 8005 sink & lid



Integrated heat-resistant safety glass, pre-drilled tap hole 39mm, AC 540 siphon, rubber seal. W420 x D370 x H145mm

091234

Optional tap **091240**

Smev 8006 sink & lid



Integrated heat-resistant safety glass lid, tap fitting inside, AC 540 siphon, rubber seal, pre-drilled tap hole 39mm. W420 x D440 x H145mm.

Built in dimensions W405 x D425mm. Weight 3.4 Kg

091232

Optional tap **091240**

Smev VA7306 round sink & lid



Integrated heat-resistant safety glass lid, tap fitting inside, AC 540 siphon, rubber seal, pre-drilled tap hole 39mm. W420 x D148mm. Built in dimensions 400mm. Weight 3.4Kg

091231

Optional tap **091240**



Tap for Smev sinks
091240

Thetford Kitchen centre



- Brushed stainless steel
- W470 x D360 x H153mm
- Sink bowl 11 litres
- Weight 3.2 Kg with lid
- Chinchilla glass - toughened, heat resistant cutting surface

- Optional extras - plastic bowl insert, plastic drainer, chopping board, cutlery rack (as illustrated)

● Prices on application
091160

Thetford triangular bowl



- Stainless steel
 - W400 x D445 x H145mm
 - Weight 2.9 Kg
 - Pre-drilled tap hole 33mm
 - Waste takes 1¼" outlet
- Left hand **091155**
Right hand (as shown) **091156**

Thetford rectangular bowl



- Stainless steel
 - W400 x D445 x H145mm
 - Weight 2.9 Kg
 - Pre-drilled tap hole 33mm
 - Waste takes 1¼" outlet
- 091158**

Thetford Argent sink



- Stainless steel
 - W630 x D470mm
 - Sink bowl 157mm deep
 - Weight 5.5 Kg
 - Chinchilla glass - toughened, heat resistant cutting surface
- Left hand **091153** as illustrated
Right hand **091152**

Oven shelves



Universal oven shelf

- Adjustable shelf
 - Suitable for most ovens and fridges
 - Min 350mm, max 560mm
- 091190**



Stoves oven shelf

355mm x 308mm
091193



Oven shelf guard

Withstands temperatures up to 300°C. Supplied in pairs
091195

Cooker hood

CK 2000 cooker hood display stand

Attractive shop merchandiser supplied free when you order 4 x CK2000 cooker hoods **091301**

Dometic CK2000 cooker hood



- Lateral air suction ensures efficient performance - 50 m3/h
- Easy installation as no roof mounted ventilator is necessary
- 2 fan-speed regulation and integrated halogen lights
- Washable grease filter and exchangeable carbon filter
- Easy access to filters and lamps
- 2x10w 12v halogen lamps **091300**



Storage water heaters

WOW A full range of spares for Truma and Propex water heaters are available in the spares section

Truma Electroboiler 14 Litre



Electric 14 litre capacity boiler using innovative insulation which maintains the temperature of the hot water for longer periods of time making it extremely energy efficient.

- With control panel, 2.5m connecting cable and safety drain valve
 - Minimal heat loss (approx 1.1°C per hour) due to EPP foam insulation
 - Short heating time - from 15°C to 70°C in just 70 minutes
 - 230v power supply
 - 850w heating element (230v / 3.7A)
 - Water pressure of up to 2.8bar
 - Weight 3.0kg
 - 40.5cm wide, 29.5cm in height
 - Max water temp 70°C
- 871200**



Truma Ultrastore



- Stainless steel water tank
- Space saving - 10 litre tank only measuring 26cm in height
- Powerful 1.5kw gas burner
- Heating up time 35 minutes for 10 litres - 50 minutes for 14 litres
- Reduces to 20 minutes with the gas and electric version (10 litres)
- Closed combustion system with wall flue
- Easy to operate - temperature selection approximately 30°C - 70°C
- Low battery load - 12v - ignition 0.17A - heating up 0.08A - stand-by 0.04A
- Suitable for all submersible and pressure pumps up to 2.8 bar

Four different models available:

871552	Rapid GE Gas and electric (450w)	10 litre capacity	Complete with control panel
871512	Gas only	10 litre capacity	Complete with control panel
871632	Rapid GE Gas and electric (450w)	14 litre capacity	Complete with control panel
871612	Gas only	14 litre capacity	Complete with control panel
871300	Ultrastore accessory pack stand		



Malaga E water heater



- Capacity 13.5 litre
 - Efficient gas burner for faster warm up
 - 750W element - use on its own or with the gas burner for speed
 - Small flue terminal - neat appearance outside the van
 - Safe - combustion products are completely sealed from the caravan interior
 - Easy to fit and service
 - Electronic control
 - Resettable cut out
 - Dimensions H250 x W325 x D445mm
- 070741**



Malaga flue terminal
070736



Cascade/Malaga adaptor plate

For use when replacing a Carver Cascade water heater with a Malaga
070742

Propex water heater 10 Litre



The mounting bracket has range of securing options and can be screwed to the wall or floor. Supplied water hose connectors gives options of 12mm push fit female fitting or adapter to 12mm barbed hose connector

- Voltage: 220v
 - Power: 900w
 - Rated frequency: 50Hz/60Hz
 - Current: 4.1A
 - Pressure: 0.8MPa (116psi)
 - Minimum start-up pressure: 0.05MPa (7psi)
 - Water temperature: 75°C
 - Fitted socket: 250V, 16A
 - Heating efficiency: >90%
 - 5 Year tank guarantee
 - Dimensions 378 x 276 x 280mm
 - Weight 6.5kg
- 070754**

Storage water heaters

Truma Therme TT-2



The proven Truma Therme warms water up using heat from the heating system – a warm air duct runs directly through the device. The Therme also features an electric heating element (300w) so water can be warmed up even if you do not have the heating on.

- Heating time (electrical operation) from approximately 15°C to approximately 60°C - 50minutes
- Power supply 230v 50Hz
- Power consumption 1.3Amp (300w)
- Temperature limit 65°C
- W220 x D370 x H230mm
- Water capacity 5 litres
- Operating pressure (maximum) 1.2bar
- Weight 2Kg

842012

Drain valve
800400

Water container
801500

Heating element
814200

Control panel
819900



Instantaneous water heaters



Morco D61

See table below.



Morco G11E

See table below.



Flue cowl **Flue Pipe**

D61 **070728**

070730

G11 **070710**

WOW A full range of spares for Morco water heaters are available in the spares section

Model Number	D61B	D61E	G11E
Hot water delivery @ 25°C temperature rise	6 litres/min	6 litres/min	11 litres/min
Ignition type	Piezo	Electronic	Electronic
Gas type and pressure	All models - Propane 37 mbar / Butane 28 mbar		
Minimum inlet water pressure required for operation with hot tap open	1 bar	1 bar	1 bar
Maximum inlet water pressure	10 bar	10 bar	10 bar
Maximum heat input	11.1kw	11.1kw	22.8kw
Maximum heat output	9.4kw	9.4kw	19.2kw
Dimensions (mm) Height	573	573	680
Width	266	266	350
Depth including controls knobs	225	225	265
Excluding knobs	190	190	230
Grove Part Number	070703	070705	070707

Combination water and space heaters



Technical details	
* Minimum installation dimensions in mm (please ensure that there is enough room for installation and servicing work to be carried out)	
Time to heat water up from approx. 15°C to approx. 60°C	Approx. 20 min. (boiler), approx. 80 min. (heater + boiler), approx. 45 min. (electrical operation)
Air flow rate	Max. 287 m³/h
Power consumption (12 V) (heater + boiler) (heating up boiler)	Combi 4 Ø 1.1 A (0.2 – 5.6 A), Combi 6 Ø 1.3 A (0.2 – 5.6 A) 0.4 A
Power consumption (230 V)	900 W 3.9 A 1800 W 7.8 A
Rest current	0.001 A
Water capacity	10 litres
Water pressure	Max. 2.8 bar
Weight without water	Combi Combi E
Without peripherals	14.0 kg 15.1 kg
With peripherals	14.5 kg 15.6 kg
Product ID number	CE-0085BS0085
	Combi 4 Combi 6
Burner stage	1 2 1 2 3
Rated thermal output	2000 W 4000 W 2000 W 4000 W 6000 W
Gas consumption	160 g/h 320 g/h 160 g/h 320 g/h 480 g/h

Truma Combi 4 (E), Combi 6 (E)

LP gas and electric heater with water boiler. Heater (excluding exhaust duct) complete with room thermostat, control panel with 3 m cable, mounting parts, current-free frost control safety/drain valve and elbow fittings for 10 mm Ø water hoses. Models with water connections for semi-rigid piping (John Guest system) available on request.

Combi 4 **833700**

Combi 4E **833710**

Combi 6 **833800**

Combi 6E **833810**

WOW A full range of spares for Truma and Propex water heaters are available in the spares section

Blown air space heaters



Propex heatsource

- The smallest of this type of heater on the market.
- One of the quietest combustion heaters in production
- Designed for reliable, maintenance-free operation
- Fast warm-up time
- Airflow sensing detects blocked or restricted flue pipes
- Self-diagnostic fault finding

2000W **090016**

2800W **090028**

Ducting 60mm per metre **090018**
Outlet (no reducer) **090019**
Reducer **090017**

Blown air heaters

*Gas and current consumption is calculated on a 'continuous running' basis

Model	Heatsource 2000	Heatsource 2800
Average gas consumption	128g/hr	225g/hr
Heat Input	2kw	3kw
Heat Output	1.8kw	2.8kw
Voltage	12v or 24v	12v or 24v
Current consumption	1.2A	1.9A
Air throughput	50 C.F.M.	85 C.F.M.
Dimensions (mm)	312x168x95	415x210x120

Trumavent fans

For use with Trumatic S heaters circulates hot air throughout the vehicle.

- In all Trumavent fans a flap enables you to individually regulate the air output between the two warm air outlets to suit the room division
- On the TEB-2 / 3 with automatic speed control the air output adjusts to the respective thermal output
- High air flow rate of over 200,000 litres/h

Common spare parts

Motor for TEB 2 **842000**

Cable for TEB 2 control panel (case control) 800mm **845000**

Control panel (case control) TEB 2 **846000**

PCB for TEB 2 **857100**

	TEB 2	TEB 2	TN-2	TEB 3	TEB 3	TN-3	Multi-vent
Power Supply	12v	12v	230v	12v	12v	230v	12v
Current	0.3 - 1A	0.3 - 1A	0.5A	0.3 - 1A	0.3 - 1A	0.5A	0.23 - 0.5A
Power	4 - 13W	4 - 13W	65W	4 - 13W	4 - 13W	65W	3 - 6W
For use with	S3002	S3002	S5002	S3004	S3004	S5004	S2200 / Extractor
Control	Case control	Wall control	Wall control	Case control	Wall control	Wall control	
Part no.	841121	841122	841222	841241	841242	841251	841140

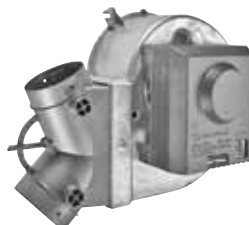

TEB 2



TN 3



Multi-vent

Radiant heaters

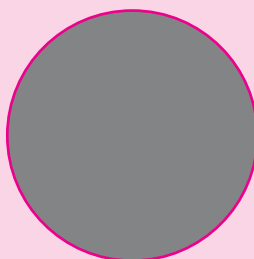

Titanium Grey
(aka Titan Grey)

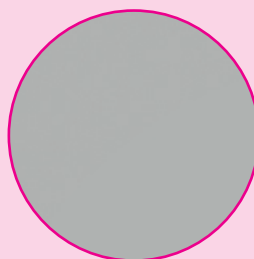

Pearl Grey

WOW A contemporary new design for the Trumatic range of gas heaters from Truma. Please order the heater and front casing separately.

Trumatic S3004 gas heater

Designed for use in average sized caravans

- Automatic ignition or piezo ignition
- Thermostat and installation box as standard
- Choice of colour on casing
- Uniform heat distribution with the addition of a Trumavent fan
- Exhaust duct via the roof
- Thermal output 3.5kW
- Gas consumption 30 - 280 g/h
- Please note cases to be ordered separately

S3004 gas heater with auto ignition **831380**

S3004 gas heater with piezo ignition **831390**

Front case Titanium grey **830060TG**

Front case Pearl grey **830060PG**

Trumatic S5004 gas heater

For large caravans and motor homes

- With automatic ignitor
- Exhaust duct via the roof
- Thermostat and installation box as standard
- Even heat distribution and full utilisation of the high heating capacity with Trumavent fan
- Thermal output 6kW, gas consumption 60 - 480 g/h
- Please note cases to be ordered separately

S5004 heater **831570**

Front case Titanium grey **830070TG**

Front case Pearl grey **830050PG**



Ultraheat electric heater

Additional electric heater with thermostat, control panel and 3 metre connecting cable. Installation is between the heat exchanger and installation box

IMPORTANT!! Installation must be carried out by an expert

- Power supply: 230v/50Hz
- Power consumption at power rating; 500w: 2.2A, 1000w: 4.5A, 2000w: 8.5A

Suitable for use with Trumatic S3002, S5002, S3002(P) after July 1981, Trumatic S5002 after April 1998 (with semicircular front design) and with the new Trumatic S3004 and S5004. Installation is between the heat exchanger and installation box

830401

Blown air accessories

WOW A full range of blown air ducting and outlets is shown in the spares section.



Awning warmer

For guiding the warm air from the existing caravan heater directly into the awning. Contents:

- Warm air outlet with cover
- 1 metre of ducting
- 65mm diameter straight connector
- T-pipe TS and duct shut-off SP2

White **840365**

Heater	Flue - Inner pipe	Flue - Outer pipe	Blown air distribution pipe	Insulating ducting
S2200	801536	801288		
S3002/S3004	801536	801288		
S5002/S5004	AE 5 : 30160-00	UR 5 : 40250-00		
Combi / Combi E	AA 3 : 39320-00	ZR 80 : 39580-00	801288	801291
E2400	839420	ZR24 : 39440-00	839580	
E4000	AA 3 : 39320-00	ZR 80 : 39580-00	839550	80 : 39570-00
TEB 2/3			801288 or 839550	
TN 2/3			801288 or 839550	
Multivent			801288 or 839550	

Mobile heating

**Radiant heater with clip-on regulator**

- 4.2 Kw of heat output
- 3 heat settings
- Full anti-tilt safety device & oxygen analyser
- Piezo/pulse ignition system
- Sturdy lockable castors
- Revolutionary case design, door folds in when cylinder not fitted to save space
- Suits up to 15kg gas cylinders
- Colour: Black
- W460 x D390 x H775mm
- Weight 9.3 Kg
- Gas type LPG
- Fully CE approved BS EN449

WARNING

USE ONLY IN A WELL VENTILATED AREA

090089**Radiant mini heater with clip-on regulator**

- Simple, safe and silent operation
- Piezo/pulse ignition system
- Provides even distribution of heat quickly and efficiently
- Oxygen analyser
- Easy rolling swivel castors
- Powerful and efficient 4.2 Kw
- Suits up to 7kg gas cylinders
- W403x D367 x H625mm
- Weight 6.8 Kg
- Gas type LPG
- Fully CE approved BS EN449

WARNING

USE ONLY IN A WELL VENTILATED AREA

090088**Mini radiator 450W**

- 5 fin
- 450W
- Overheat safety thermostat
- Built in carry handle

090092**Frost watcher 500w**

- 230v heater
 - Ideal for caravans to protect against frost over winter
 - Thermostatic control
 - H 270 x W 245 x D 105mm
- Available singly or 6 per outer

090069

Halogen heating

Halogen heater

- Instant heat
- Safety cut off feature
- 2 heat settings - 400w / 800w
- Voltage 230v - 50Hz
- Easily cleaned
- Simple controls
- Carry handle

090065**Oscillating halogen heater**

- Instant heat
- Voltage 230v - 50Hz
- On/off oscillating facility
- 3 heat levels - 400w / 800w / 1200w
- Safety cut off feature
- Thermofuse cut off

Available singly or 6 per outer
090066**Oscillating halogen heater with remote control**Specification as 090066 with the addition of:
● Remote control - on/off, timer, swing & power
Available singly or 6 per outer
090067

Holiday home heating

**WIDNEY Modena gas fire**

- 3.8 kw heat output
- Suitable for use on butane 28 mbar or propane 37 mbar
- Contemporary design compliments latest mantel/marble settings
- Simple fixing
- Radiant heat output

090105**Ring car heater 12v**

Compact design with hidden foldable handle to provide directional heating and defrosting. Fitted with fused 12V cigarette lighter plug 150W. Cooler fan and heater selector switch. LED light. 360° angle swivel base.

Available singly or 6 per outer **090071**

THETFORD refrigerators – other models available for manufacturers only

N3080E - Absorption refrigerator with electric ignition and wheel arch cut out. Manual power source selection. White door bins and vegetable bin. Light grey framed door and control panel. Power cables and gas inlet tube are at the rear base of the refrigerator **089068**



Gross capacity		81 litre with freezer compartment 10 litre freezer compartment
Energy supply		230v AC / 50Hz 12v DC LPG 28 mbar butane, 37 mbar propane
Consumption	230v/12v Gas	2.4 kWh / 24h 240 g / 24h
Dimensions W x H x D		486 x 821 x 543mm
Wheel arch model		Yes
Display		LED
Weight		22.5 Kg

N3100E - Absorption refrigerator with electric ignition. Manual power source selection. White door bins and vegetable bin. Light grey framed door and control panel. Power cables and gas inlet tube are at the rear base of the refrigerator **089071**



Gross capacity		97 litre with freezer compartment 11 litre freezer compartment
Energy supply		230v AC / 50Hz 12v DC LPG 28 mbar butane, 37 mbar propane
Consumption	230v/12v Gas	2.8 kWh / 24h 330 g / 24h
Dimensions W x H x D		525 x 821 x 543mm
Wheel arch model		No
Display		LED
Weight		27 Kg

N3112A - Absorption refrigerator with electric ignition. Automatic power source selection. White door bins and vegetable bin. Light grey framed curved door and control panel. Wheel arch cut out. Power cables and gas inlet tube are at the rear base of the refrigerator **089069**



Gross capacity		113 litre with freezer compartment 14 litre freezer compartment
Energy supply		230v AC / 50Hz 12v DC LPG 28 mbar butane, 37 mbar propane
Consumption	230v/12v Gas	2.6 kWh / 24h 270 g / 24h
Dimensions W x H x D		525 x 821 x 628mm
Wheel arch model		Yes
Display		LCD / Touch control
Weight		24 Kg

N3145A - Absorption refrigerator with electric ignition. Automatic power source selection. Redesigned interface with touch control. Fade-in interior light. White door bins and vegetable bin. Black framed door and control panel. Power cables and gas inlet tube are at the rear base of the refrigerator **089073**



Gross capacity		118 litre refrigerator compartment 23 litre freezer compartment
Energy supply		230v AC / 50Hz 12v DC LPG 28 mbar butane, 37 mbar propane
Consumption	230v/12v Gas	4 kWh / 24h 420 g / 24h
Dimensions W x H x D		525 x 1245 x 543mm
Wheel arch model		No
Display		LCD / Touch control
Weight		37 Kg

Absorption refrigerators Dometic

Dometic provide the most comprehensive range of absorption refrigerators available in the caravan and motorhome market. These virtually silent appliances are more efficient and lighter than ever!

WOW Many more models available on request please speak to your sales contact for details.

How absorption cooling works

A concentrated ammonia solution is heated in a boiler and expelled as vapour. The pressurised ammonia gas is then liquified in a condenser. Supplied with hydrogen, it evaporates and extracts heat from the storage container. The ammonia gas then enters the absorber where it is re-absorbed in a weak solution of ammonia. Finally, the saturated solution flows back to the boiler where the whole cycle starts again.

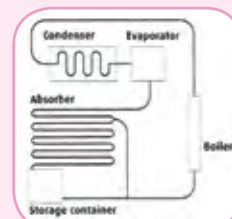

ABSORPTION MODELS	RM122	RM123E	RF60	RM5310	RM5330	RM8401	RMS8401
Grove part number	088040	088042	088046	087995	087996	088006	088007
Ignition system	Piezo	Reignitor	12v battery	Battery	Battery	MES	MES
Gross capacity (L)	31	31	Approx. 60	60	70	90	80
Includes freezer compartment of (L)	-	-	-	5	5	8*	8*
Input rating							
230V (Watts)	-	75	110	125	125	135	125
12V (Watts)	75	75	110	120	120	130	120
Gas (g/h)	8.6	8.6	14.8	18.3	18.3	18.3	18.3
Consumption /24h							
230V (kW/h)	-	1.3	1.9	2.5	2.5	2 to 2.2	2 to 2.2
12V (kW/h)	1.3	1.3	1.9	2.5	2.5	2 to 2.2	2 to 2.2
Gas (g)	140	140	325 / 375	270	270	250 to 270	250 to 270
Cooling capacity							
Refrigerator/freezer temperature at ambient temperatures up to 32°C	Refrigerator +7°C	Refrigerator +7°C	Up to 30°C below ambient temperature	Refrigerator +7°C Freezer up to -12°C	Refrigerator +7°C Freezer up to -12°C	Refrigerator +7°C Freezer up to -12°C	Refrigerator +7°C Freezer up to -12°C
Insulation (PU foam all around)	No	No	Yes	Yes	Yes	Yes	Yes
Dimensions (W x H x D mm)	380x585x440	380x585x440	486x615x490	486x618x474	486x821x474	486x821x569	486x821x569
Stepped model to allow installation over a wheel arch	No	No	Not designed for installation	No	Yes	No	Yes
Weight	15	15	26	20	22	27.5	25

* These models have removable freezer compartments to allow increased refrigerator volume. In doing so the gross volume is increased by 5 litres

Compressor refrigerators

Premium built-in refrigerator in stainless steel finish for motor homes, caravans, yachts and boats. Interior light. Double lock door with magnetic seal. CRP40 has a detachable cooling unit (saving 182mm depth when installed separately)

How compressor cooling works

Compressor units operate using a refrigerant that changes from a liquid to a gaseous state in the evaporator. The evaporation extracts heat from the interior of the cooling unit - the temperature drops. The compressor draws in the refrigerant, compresses it and passes it on to the condenser. Here, the absorbed heat is released to the atmosphere. The refrigerant liquifies again and flows to the evaporator, where the cycle begins again.

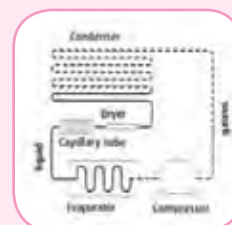

COMPRESSOR MODELS	CRP40	CR50	CR80	CR110
Grove part number	087090	087091	087095	087097
Gross capacity (L)	39	48	80	108
Includes freezer compartment of (L)	5.3	5	7.9	10.2
Energy supply	12/24V	12/24V	12/24V	12/24V
Average power consumption (Watts)	40	40	48	50
Consumption (Ah/h) at				
+25°C	0.77	1.4	1.8	2.2
+32°C	1.77	1.7	2.1	2.5
with interior temperature at +5°C				
Weight	18	19	23	28
Dimensions (W x H x D mm)	380 x 536 x 310 (+182)	380 x 534 x 500	475 x 640 x 528	520 x 745 x 558

Coolpower EPS100

Mains rectifier for hassle free connection of 12/24V cooling appliances to 230V mains. Suitable for Waeco CR range.

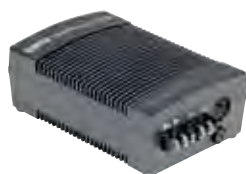

- Input voltage: 230 volts AC
 - Output voltage: 25 volts DC
 - Output power: 100 Watts
 - Battery voltage: 12/24 volts DC
 - Output current: 4 Amps
 - Switch mode, automatic priority for mains operation
- 087110**

**RM122**

Compact 31 litre refrigerator. Excellent size for small campervans. 12V and gas operation. Thermostatically controlled on gas **088040**

**RM123E**

Same specification as RM122 with addition of 230V operation with thermostatic control, and an electronic re-ignitor to re-light the flame if it blows out **088042**

**RF60**

High performance cooling. Not designed for permanent installation this 12V, 230V and gas model is ideal for use in well ventilated areas such as trailer tents, awnings or anywhere where permanent installation is impractical. **MUST BE WELL VENTILATED!** **088046**

**RM5310**

New look 5-series 3 way refrigerator. Under the counter model with user-friendly control panel and separate freezer compartment. Replaces RM4210 and RM4211 LM **087995**

**RM5330**

New look 5-series 3 way refrigerator. Wheel arch cut out model with user-friendly control panel and separate freezer compartment. Replaces RM4230 L **087996**

**RM8401**

8-series 3 way refrigerator with easy to remove 8 litre freezer compartment giving excellent versatility and comfort **088006**

WOW Please be aware that the 8 series fridges are not designed to have the hinge side swapped (other series are). The 8 series are supplied with a hinge on the left. Right hand can be supplied by special order.

**RMS8401**

8-series with same space requirements and similar specification to the RM8401 but with wheel arch cut out **088007**

**CRP40**

Ideal where depth of installation is an issue, this compressor refrigerator has a cooling unit that can be installed separately **087090**

**CR50**

Compact model compressor refrigerator, ideal for small campervans and conversions **087091**

**CR80**

Under the counter model compressor refrigerator **087095**

**CR110**

Compressor refrigerator used for installations up to the full height of the counter **087997**

Absorption chest coolers

Combicool RC range

Absorption chest coolers, 12v, 230v and gas operation. Piezo ignition, thermostat regulation in 230v mode, 3 stage flame regulation in gas mode. Vertical space for 1.5 and 2 litre bottles. Recessed integrated handles, includes ice cube tray. PU foam all around insulation

WOW Competitively priced 3 way absorption chest coolers

- 12v supply in the vehicle
- 230v mains supply at home or at the campsite
- Gas operation for remote locations

	RC1200	RC1600	RC2200
Pat number	089190	089191	089192
Gross Capacity (litres)	41	31	41
Input rating 230v (watts)	85	75	85
Input rating 12v (watts)	85	75	85
Input rating gas (g/h)	10.6	10.5	10.5
Temperature range (max cooling below ambient temperature °C)	25	30	33
Material	Coated sheet steel	Coated sheet steel	Aluminium
Colour	Silver/grey	Silver/grey	Aluminium/black
Dimensions (H x W x D mm)	441 x 500 x 508	444 x 500 x 443	444 x 500 x 487



MOBICOOL
Our Name is our Mission

12v / 230v Coolers

B40 12v / 230v hybrid cooler/freezer

Maintenance-free, fully hermetic cooling system, reinforced insulation, blue coated steel case, pale grey lid and cover, with all-round rubber seal and magnetic lock, quick-chill functionality thanks to powerful AC compressor.

- Cooling maximum 20°C below ambient temperature
- 230v compressor for AC operation, cooling from +12°C to -15°C
- 40 litre
- Coronet blue
- H x W x D mm: 450 x 520 x 510mm
- Weight 21 Kg

Available singly or 5 per outer **089200**

WOW The powerful compressor means the B40 can also be used as a freezer at a competitive price



W40 12v / 230v cool box

Car and indoor use with dual voltage system, two sturdy wheels and multi-functional pull-out handle, fold-away side handles, split lid to minimise cold loss, cable compartment in lid, fits 2 litre bottles standing, 2 removable divider grids, double fan system.

- Cooling up to 18°C below ambient temperature
- 40 litre
- H x W x D mm: 420 x 560 x 380
- Weight 8.4 Kg

089157



Q40 12v / 230v cool box

Car and indoor use with dual voltage system, sturdy, unbreakable aluminium housing, fold-away side handles, split lid to minimise cold loss, cable compartment in lid, fits 2 litre bottles standing, 2 removable divider grids, double fan system.

- Cooling below ambient temperature - 12v DC: up to 22°C below 230v AC: up to 20°C below
- 40 litre
- H x W x D mm: 440 x 580 x 390
- Weight 9.6 Kg

089159



V25 12v / 230v cool box

Car and indoor use with dual voltage system, carrier handle serves to either fix or support the lid, cable compartment in lid, fits 2 litre bottles standing, double fan system

- A peltier cell with 12v direct feed or 230v built in adaptor
- Cooling up to 18°C below ambient temperature
- H x W x D mm: 395 x 396 x 296
- Weight 4.0 Kg
- Capacity 24L

089169

12v / 230v Coolers

Powerbox® 28L Deluxe



Cools to 16°C below the ambient temperature but it also heats to 65°C. An additional lightweight lid is also provided for extra convenience.

- Operates from 12v dc (or mains adaptor sold separately)
- Holds 2 x 1.5 litre bottles
- Handy drinks container in lid
- Comes with spare passive lid
- Brushless motor and battery control
- Cable storage compartment
- Integrated battery control system prevents car battery from draining
- Detachable and reversible plug for cooling or heating
- Capacity 28 litre
- Weight 4.3kg

089147

Powerbox® 24L Classic



Cooling to 16°C below the ambient temperature.

- Cable storage compartment
- Operates from 12v dc (or mains, adaptor sold separately)
- Capacity 24 litre
- Weight 3.5kg

089145

Passive coolers



Xtreme® coolers

Designed for the long haul, these Xtreme passive coolers have excellent insulation to allow you to keep food and drinks cool for the longest possible time

- Thermozone insulation
- Hinged lid with deep beverage holders
- Lid takes elastic cords for additional dry storage on top

50 Quart Xtreme® wheeled cooler

- Large wheels for easy manoeuvrability
- Telescopic handle
- Moulded handles for easier lifting and storing
- Capacity: 48L
- Dimensions H x W x D cm: 47.5 x 66 x 42

089174

70 Quart Xtreme® cooler

- Two way handles for flexibility
- Capacity: 66.2L
- Dimensions H x W x D cm: 46 x 74 x 37

089176



WOW Keeps ice frozen for 5 days even in temperatures of 32°C

Cool box accessories



M10 185x95x30mm
M20 200x168x28mm
M30 254x200x30mm

Freez'Pack®

Can be used in any cool box or soft cooler to keep food and drinks cooler for longer. Simply freeze them, then put them inside the cooler with the food or drink. They're available in a range of sizes and the bigger they are the longer they stay cool.

M10 duo pack 12 per outer 089187

M20 18 per outer 089181

M30 12 per outer 089183



Dometic rectifier 230/12v

Running most 12v coolers from the 230V mains is no problem at all with this 230V AC to 12V DC adapter. 5amp - 60w. Available singly or 12 per outer

089152



Coleman Campingaz rectifier 230/12v

Running most 12v coolers from the 230V mains is no problem at all with this 230V AC to 12V DC adapter.

5amp - 60w 089140

Ventilators and flue kits

Dometic ventilation system



Dometic turnbuttons for vent cover
White **089014**
Cream **089015**

Dometic Flue Kit
089063

The Dometic ventilation and extraction system ensures optimal performance from your absorption refrigerator. Includes: Upper and lower mounting frames, 2 x grilles (upper with flue insert), upper and lower winter covers and 4 x turn buttons. The mounting frames fit 451mm x 156mm apertures in the outer wall. The flue (not supplied) is integrated into the upper grille for a tidy appearance. Rainproof grilles are secured to the mounting frames by turnbuttons.

- A1620 Vent System White **089010** Cream **089011**
- A1620 Winter Cover (2) White **089012** Cream **089013**
- A1620 Insert White **089017** Cream **089018**



Fridge fan with auto heat sensor

Improves fridge performance. Fully automatic. Easy installation. Maintenance free. Uses only 0.25 amps. No television/radio interference. 10,000 hour continuous rated motor **089005**



Thetford fridge vent
Supplied singly with frame, vent and flyscreen. 448 x 158mm
White **089074**
Cream **089075**



Thetford winter cover
436 x 130mm
White **089097**
Cream **089098**



Thetford winter cover large
Used on some Lunar, swift and Explorer caravans and motorhomes. 480 x 233mm
White **089101**



Direct leisure vent kit
Bianco White 384mm x 203mm
Vent **089000** Cover **089004**



MPK vents
Designed for aperture 342mm x 117mm. Vent colour white.
Surface mounted vent **089031**
Recessed vent **089032**
Vent cover (blushtone) **089033**



Double refrigerator bar
Helps prevent movement of contents whilst travelling. 40cm closed. Extending to 75cm. 8.5cm high **089065**



Double cupboard bar
Useful addition to stop items falling if door opens in transit. 25cm closed. Extending to 45cm. 8.5 cm high **095689**



Thetford ventilation kit
Fits all models. Extra cooling performance for your Thetford fridge **089300**

WOW We carry a large selection of refrigerator spare parts. This is just a small selection of our most common items sold. For more comprehensive information please see our spares section at the back of the catalogue.

Common refrigerator spares

Gas valves



Dometic **089073** Thetford **089226**

Thetford travel catches



089091 **089240**

Freezer hinge



Dometic **088107** Thetford Pair **089238**

Switches



230V **088069**

Dometic travel catches



088058 **088079** **088104** **088120**

Dometic elements



12V, 100W **088089** 230V, 105W **088090** 230V, 125W **089020**
12V, 120W **088077** 230V, 220W **088123** 230V, 125W **088109**
230V, 125W **088122**

Dometic Knobs



088068 **088086** **088067** **088087** **088108** **088118**

Melamine tableware

Contemporary designs and colours to complement the latest vehicle interiors



Black Onyx

Dinner set 16 piece	Singly or 6 per outer	081089
Dinner plate	6 per outer	081086
Side plate	6 per outer	081081
Soup/cereal bowl	6 per outer	081082
Mug	4 per outer	081080
Salad bowl	Singly or 6 per outer	081088
Rectangular platter	Singly or 6 per outer	081087



Heritage

Dinner set 16 piece	Singly or 6 per outer	081097
Dinner plate	6 per outer	081094
Side plate	6 per outer	081092
Soup/cereal bowl	6 per outer	081093
Mug	4 per outer	081091
Salad bowl	Singly or 6 per outer	081096
Rectangular platter	Singly or 6 per outer	081095



Zen

Dinner set 16 piece	Singly or 6 per outer	081167
Dinner plate	6 per outer	081163
Side plate	6 per outer	081161
Soup/cereal bowl	6 per outer	081162
Mug	4 per outer	081160
Salad bowl	Singly or 6 per outer	081166
Rectangular platter	Singly or 6 per outer	081165



Cappuccino

Dinner set 16 piece	Singly or 6 per outer	081177
Dinner plate	6 per outer	081173
Side plate	6 per outer	081171
Soup/cereal bowl	6 per outer	081172
Mug	4 per outer	081170
Salad bowl	Singly or 6 per outer	081176
Rectangular platter	Singly or 6 per outer	081175
3 piece container set	Singly or 12 per outer	081178



Pebbles



Pansy



Navy Pinstripe



Ribbons

		Pebbles	Pansy	Navy Pinstripe	Ribbons
Dinner set 16 piece	Singly or 6 per outer	081188	081214	081148	081195
Dinner plate	6 per outer			081145	
Side plate	6 per outer			081143	
Soup/cereal bowl	6 per outer			081144	
Mug	4 per outer	081185	081211	081142	
Salad bowl	Singly or 6 per outer	081187	081213	081147	081194
Rectangular platter	Singly or 6 per outer	081186	081212	081146	081193
3 piece container set	Singly or 12 per outer	081189	081215		



Swirl

White melamine tableware.
All available 12 per outer.
Dinner plate **081352**
Side plate **081353**
Cereal bowl **081354**



Summer acrylic tableware

All available singly or 36 per outer
Dinner plate 21cm **080352**
Dinner plate 25cm **080351**
Hi ball glass **080357**
Wine glass **080355**
Salad bowl 14cm **080354**

Olive

High quality heavy weight melamine with embossed olive pattern.

Dinner plate 300x210mm 12 per outer **081342**
Bowl 160x142x65mm 12 per outer **081343**
Mug Printed not embossed 12 per outer **081340**
Salad plate 255x165mm 12 per outer **081341**
Appetiser Tray 387x75mm 6 per outer **081349**
Salad Bowl 300x195x125mm Singly **081345**
Round Platter 470x325mm 6 per outer **081347**

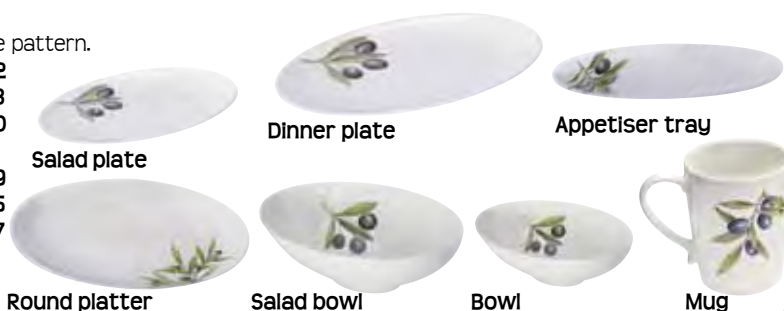

Round platter

Salad bowl

Bowl

Mug

Dinner plate

Appetiser tray

Salad plate

Children's melamine



Child's dinner sets

Consists of a plate, a bowl, a tumbler, a fork and a spoon. Available singly or 12 per outer
Oscars' Kitchen **080300**
Charlie & friends **080307**

Child's tumbler sets

Consists of 4 different named acrylic tumblers. Available singly or 12 per outer
Charlie & friends **080314**



Linea 16 piece dinner set

Consisting of 4 x dinner plates, 4 x side plates, 4 x soup/cereal bowls and 4 x mugs. Available singly or 6 per outer
081300

Melamine cleaner



Thermo Clean

The ultimate way to remove stains and odours. 30 per outer **081410**



Melamine soak

Supplied in a tub of 20 tablets. 12 per outer **081409**



40 Shot Dish & treat

Low foaming washing up liquid that also acts as a tank cleaner. Just wash the dishes and let the washing up liquid clean and protect your pipes and tank. 10 per outer **095575**



Tray with drainer

3 Assorted designs
Small 13.5" x 10"
Available singly or 24 per outer **081380**
Large 17" x 13"
Available singly or 12 per outer **081381**



Hands free glass holder

Holds wine glasses on the grass or beach, made in the UK from 100% recycled polycarbonate. 4 per pack. 24 per outer **080162**

Hands free glass holder stand

080163

citronella candles



Citronella rustic pillar

75 hours burn time
086134 6 per outer



Tealights (30)

4.5 hours burn time
086143 10 per outer



XXL novelty citronella torches

8 hours burn time
24 per outer
086157



Garden torches citronella

2 hours burn time. 2 per pack
24 packs per outer
086155



Citronella garden light

45 hours burn time
086133 6 per outer



Maxi tealights (12)

10 hours burn time
086145 6 per outer

Drinkware

**Polycarbonate wine goblet boxed**

2 per display carton. Available singly or 12 per outer
Small **080119**
Large **080116**

**Bella goblets**

14oz goblet suitable for wine, beer or juice. 4 per display carton. Available singly or 12 per outer
080089

**Soda glass**

Assorted Colours
12 per outer
080148

**Wine goblet grey**

10oz wine goblet with grey base. 4 per display carton. Available singly or 12 per outer
080141

**Bella goblet grey**

14oz goblet with grey base. Supplied in display carton of 4 pieces. Available singly or 12 per outer
080146

**Slim jim tumblers grey**

With grey base. 4 per display carton. 10oz
12 per outer.
080143

**Alfresco wine goblet**

4 per display carton. 8 per outer
080139

**Alfresco juice/wine goblet**

4 per display carton. 8 per outer **080137**

**Alfresco tumblers**

4 per display carton. 8 per outer
Short **080138** as illustrated
Hi-ball **080136**

**Acrylic wine goblets**

Small 12 per outer **080100**
Large 6 per outer **080102**

**Stackable goblet**

2 per display carton. 24 per outer
080122

**Stackable tumbler**

2 per display carton. 24 per outer
Low **080126**
High **080128**

**Acrylic tumblers clear**

Available singly or 24 per outer
Tumbler **080090**
Available singly or 12 per outer
Tall tumbler **080092**

**Beer mug**

12 per outer
Clear **080098**
Dimpled **080099**

**Nonic beer tumbler**

Inexpensive 1pt tumbler. 24 per outer
080095

**Pilsner glass**

Ideal for large gatherings where glass is dangerous. 500ml. Available singly or 12 per outer
080096

**Beer stein**

6 per outer
080097

Outdoor lanterns

Lumostar plus lantern



New Easy Clic® Plus connection. Ingenious detachable globe system. Easy access to mantle. Durable. Operates from Campingaz CV Plus cartridges.
Power 80 Watt
Weight: 247g
Available singly or 10 per outer **109946**
Mantles(3) **070425**
Globe **109961**



Powerhouse 2 mantle lantern



Operates from unleaded petrol or Coleman® liquid fuel.
Run time: Up to 14h
Weight: 1.72 kg
109884
Mantles (3) **109960**

Northstar fuel lantern



Operates from unleaded petrol or Coleman® liquid fuel. Electronic ignition. Run time: Up to 14h. Weight: 1.8 kg
109886
Mantles (3) **109959**

WOW Other torches and lanterns can be found in section C
Gas canisters can be found in section G

Campingaz mantles

Small mantle (3)

Fits Bleuet CV 270L, Bivouac, Camping 206L, Lumostar C, M and plus, and Stellia R
070425



Medium mantle (3)

Fits L470, Rhapsody 470, Soleio R, Sun Force, Symphony, Super Symphony and Frontier CPS
109956



Large mantle (3)

Fits Belvedere, GP 470, Lumogaz 270, N206, T206, R, RPZ, 470, RS180 and 900RL
109957

Instaclip (3)

Fits Single, Double and Powerhouse unleaded lanterns **109960**

Instaclip tube (3)

Fits Northstar unleaded lanterns **109959**

Fuel burning stoves

Sportster Stove



The stove is efficient and robust, and as it runs from either Coleman® fuel or unleaded petrol, you will never be hungry wherever you are.

- Operates off unleaded petrol or Coleman® liquid fuel

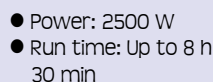

- Power: 2500 W
- Run time: Up to 8 h 30 min
- Size: 15 x 12cm
- Weight: 1185g

109880

Generator for Sportster Stove

109881

Coleman camp fuel

Coleman fuel is a liquid petroleum fuel (100% light hydrotreated distillate). It has an octane rating of 50 to 55 and a flammability similar to petrol. 1 litre 10 per outer **109974**

Unleaded 2 burner Stove



- Operates off unleaded petrol or Coleman liquid fuel
- Power 4225 watt
- Run time up to 2h
- Boil time 4 min
- Size 46 x 29 x 12cm
- Weight 5.3kg

109882

WOW More gas stoves and BBQs can be found later in section L



Camp Bistro

- Power: 2200 watt
- Size: 35cm x 28cm
- Automatic piezo ignition
- Cartridge safety locking system
- Enamelled pan support
- Aluminium burner
- Convenient plastic carry case
- Operates off CP250 cartridge

109941

Portable Gas Stove

- Lightweight design and easy to carry
- Comes with storage and carrying case
- Suitable for picnics, camping, garden etc
- Requires butane gas cartridge

109943

Campingaz CP250

Contains 250g Isobutane. For use with Bistro® type stoves 12 per outer **109965**



Stove cartridges (4)

For use with portable gas stoves 6 per outer **109945**

WOW Rechargeable, battery and mains powered torches and lanterns can be found in section C
More gas stoves and BBQs can be found later in section L
Other gas canisters can be found in section G

Outdoor dining



All tops are modular and interchangeable the burner pan has improved wind protection. There is a common deflector plate for the grill and barbecue, the skottel and grill have increased in size and are simpler to use. All Carri chef barbecues are complete with a carry bag. All backed with a 2 year no quibble guarantee.



086077

Grill "O" gas Braai

Robust design with a cast iron reversible 38cm top. Ribbed on one side smooth on the other. The cast iron ensures consistent, even heat distribution and retention. It comes with a stainless steel burner and a rust-proof, porcelain enamelled pan support. The unit operates from a hose and regulator (not included) connected to high pressure Camping Gaz or low pressure gas cylinders. Comes with carry bag. Supplied singly or 6 per outer **086077**



086081

Carri chef BBQ/grill combo

Comprising detachable legs, burner unit, double sided grill plate/barbecue top and carry bag. For connection to larger type refillable gas cylinders (hose and regulator not included). Dome top, skotel-wok, pot stand and other accessories can be added as optional extras (see below) **086081**



086086

Carri chef 'Grove' special

All-in-one outdoor cooking convenience, the carri chef Grove special includes 3 interchangeable cooking surfaces and a dome top, allowing for a variety of cooking options at an economical price. Using the convenient carry bags the unit is light enough to be taken anywhere and the legs are detachable. It has a condiment tray and a useful pot stand for boiling water. The unit operates from a hose and regulator (not included) connected to high pressure Camping Gaz or low pressure gas cylinders. Doesn't include skottel-wok **086086**



086084

Carri chef deluxe

All-in-one outdoor cooking convenience, the carri chef deluxe includes 4 interchangeable cooking surfaces, the BBQ, skottel-wok, non stick reversible grill and a dome top, allowing for a variety of cooking options. Using the convenient carry bag the unit is light enough to be taken anywhere as the legs are detachable. It has a condiment tray, useful pot stand for boiling water and includes a FREE full colour recipe book to "Take your Taste buds on an Adventure". The unit operates from a hose and regulator (not included) connected to high pressure Camping Gaz or low pressure gas cylinders **086084**



BBQ dome
086092

Reversible grill plate
086102

086052



Safari chef

With 5 interchangeable cooking surfaces, a foldaway camping stove, mini BBQ, non-stick ribbed grill, non-stick flat grill and wok. BBQ lid doubles-up as a saucepan. Supplied in a carry bag, weighs less than 4kgs. Low pressure operated from LPG cylinder via regulator for better economy (hose and regulator not included) **086052**

Safari chef roast pan
086056



Pot stand
086099

Chef skottel - wok
086093

Paella pan
086090

Chef roast pan

The non-stick interior makes it ideal for preparing roast chicken, vegetables etc **086087**

Non stick skottel folie

The liner works without the use of cooking fats and oils. Easy to clean by simply rinsing with hot water or placing in a dishwasher **086088**

Skottel food warmer

Vitreous enamelled food separators. **086095**

Barbecue cover
086098



Cadac valve tail piece
086075



Cadac regulator assembly
086120



Enables low pressure appliances to operate off gas cartridges. Includes a hose and tailpiece, tailpiece fits 1/4" BSP left hand. Available singly or 10 per outer **086120**

Outdoor dining



The Outdoorchef City gas kettle barbecue has a flip funnel inside the kettle that eliminates flare-ups and unpleasant smoke emission. It unites incredible barbecuing versatility and precision with healthy and delicious results. Positioning the funnel allows you to grill, roast, bake, or stir-fry.

Grilling - Cooking - Baking

For indirect barbecuing and baking, the upper funnel is placed inside the kettle with the large opening pointing upwards. The heat from the gas burner rises up along the sides of the kettle, distributing an even, indirect heat on all sides. With the lid on, there is no need to turn the food at all throughout the cooking process.



Cooking - Roasting

For grilling at very high temperatures or with the cast-iron griddle, the upper funnel is placed in the kettle the other way round. This creates high, concentrated heat in the middle of the cooking grid or the cast-iron griddle. The kettle lid is not absolutely necessary for this method of cooking.



Cast iron griddle
086009



Gourmet set
Consists of a deep enamelled 18cm diameter pan and a pizza type grid
086011



City Gas bag
086010

WOW All Outdoorchef BBQs have an overall diameter of 42cm with a cooking diameter of 39.5cm.



City charcoal 420 BBQ
A charcoal version of the City Gas Grill. Approximate cooking height 70cm
086007

City gas BBQ

The world's most compact Gas Kettle BBQ. Piezo ignition. Lid thermometer for perfect cooking temperatures. 4.3kW output. 315g/h consumption
With tripod legs H70cm **086001**
With cradle H41cm **086002**
Optional tripod legs **086003**



City electro BBQ

A mains electric version of the City Gas. Approximate cooking height 70cm. Complete control over power (heat) settings. 7 settings up to 2kW
086005



Aluminium protection foils (3)

Protects the heat reflector. For use with City Electro only. 6 per outer
086012

BBQ Cleaning



Cadac BBQ cleaner

Removes grease and food particles after baking, frying and grilling. Caution only use on black enameled parts and BBQ. Not suitable for aluminium, laquered or non stick coated items. 400ml aerosol. 12 per outer **086072**

Elsan BBQ Cleaner

This anti-bacterial cleaner not only removes burnt on deposits and cooking grease but is also anti-bacterial to sanitise food preparation areas before and after cooking. 750ml 18 per outer **086125**



Outdoorchef BBQ cleaner

Dissolves burnt on food. Quick reaction time. Swiss quality product. 500ml. 12 per outer **086014**

BBQ Fuel

Cocochef briquettes



2kg box made from coconut husks. Renewable, gives even heat distribution and lights quickly.
086008

Portable Stoves **CAMPINGAZ**



Campingaz fold 'n' go

Folding 2 burner stove.

- Independently adjustable 2 burners
- Compact with handles
- Large cooking area
- Aluminized steel cook top
- Power: 1375 W per burner
- Weight: 3.65 kg
- Operates from CV470 plus cylinders

109901



Base camp with lid

2 burner with lid.

- Operates from Campingaz® and other butane cylinders
- Convenient lid for easy and clean storage
- Dimensions: 430 x 240 x 80 mm
- Weight: 1.9 kg

109911

Twister plus stove



New twister with new design and Easy Clic® plus connection.

- Power: 2.9kW
- Weight: manual 263g - Piezo 274g

Manual available singly or 10 per outer **109938**
Piezo (PZ) **109939**

Super carena



Designed to take large heavy pans, it has an integrated windshield and carrying handle.

- Power: 3kW
- Weight: 600g

109937



Cylinder 3 in 1 grill

- Large cooking surface 645cm²
- Removable cooktop/grease pan
- Compact and nesting unit
- Piezo ignition
- 1.5kW oval burner
- Porcelain coated lid
- Secure, locking catch
- Cooking surfaces lock down for storage
- Operates from CV plus, Campingaz® and other butane cylinders
- Weight: 5.6kg

109918



Camping chef

2 burner stove and grill, packs into a briefcase for easy storage.

- Push and turn child safety knobs
- Power: Stove = 2 x 2.3kW; Grill = 1.1kW
- Operates from Campingaz® and other butane cylinders
- Dimensions: L52.5 x W31 x H22cm
- Weight: 5.8kg

109909

Party grill stove and pouch



Piezo grill, griddle or stove, with detachable legs and a lockable lid.

- Non stick cooking area
- Includes carry bag
- Bowl to collect fat
- Power: 1.35kW

● Operates from CV plus cylinders

- Weight: 2.3kg

109915



Bistro 300

One burner stove and case with piezo ignition

- Operates from Campingaz® CV300 plus cylinders

- Power: 2.6kW
- Dimensions: 33 x 22 x 12 cm
- Weight: 1.5 kg

109942



Camp Stove Oven

- Interstart piezo ignition
- Large oven (can fit a 30cm pizza)
370 x 340 x 140mm
- Oven: 900W/250°C
- Stove: 2 x 1800W (fully adjustable)
- Operates from Campingaz® and other Butane cylinders
- Run Time: Oven 42 h (R907)
Stove 10 ½ h (R907)
Oven & stove 8h 20min (R907)
- Boil time: 7min
- Overall dimensions: 690 x 470 x 380mm
- Weight: 18.5kg

109920



Camping chef vario grill

2 burner stove and grill, packs into a briefcase for easy storage. With piezo ignition.

- Dimensions: L56.5 x W32.5 x H11 cm
- Operates from Campingaz® and other Butane cylinders
- Weight: 4.5 kg

109903

Optional vario leg set

Raise your Camping Chef Vario to the perfect cooking height with the telescopic leg set. Clips into the base unit of the stove.

109904



2 Burner carry bag

Carry bag to store and carry Campingaz® and other 2 burner stoves.

- Dimensions: L57 x W35 x H14cm

109912

Microwave ware

WOW Polycarbonate is a superb material for microwave cookware. Tough, non stick, odour resistant and non staining. Completely transparent to cook faster and more evenly. Dishwasher safe.



Microwave saucepan and lid

Capacity 0.6L. Available singly or 10 per outer **093039**



Microwave set

Set includes 1 litre saucepan with a whisk and a mini pot with sealable lid for storage. Available singly or 12 per outer **093041**



Microwave omelette pan

The hinged design makes food folding omelettes easy. Available singly or 10 per outer **093043**



Microwave egg poacher

The first microwave egg poacher designed to cook eggs in water to give traditional taste and texture. Available singly or 10 per outer **093045**



Microwave rice and veg steamer

The perfect design for cooking rice and steaming vegetables that retain flavour, vitamins and texture. Available singly or 6 per outer **093048**



Microwave mini pots (2)

Each mini pot has side handles which stay cool in the microwave for easy handling. The lid is vented for safety and gives better results than simply resting a storage lid on top. Cook two foods at the same time using Minipots. Available singly or 10 per outer **093054**



Microwave multi-purpose tray

Designed to raise food so that it cooks more evenly and allows any fat or liquid to drain away. Has an extremely low thermal conductivity. It also stays much cooler than glass and ceramics. Available singly or 10 per outer **093050**



Microwave plate cover

Designed to keep your microwave oven clean when re-heating or cooking. Available singly or 10 per outer **093052**

Cutlery



Cutlery set Newport

16 piece set. Available singly or 10 per outer **095132**



Cutlery set Coconut

16 piece set. Available singly or 6 per outer **095133**



Cutlery set Huckleberry

16 piece set. Available singly or 6 per outer **095134**



Palermo

16 piece cutlery set
6 per outer **095130**



Venice

16 piece cutlery set
24 per outer **095131**



Translucent Green 16 piece cutlery set

Available singly or 8 per outer **095128**



Cutlery set Lino

24 piece set and stand
Available singly or 12 per outer
Black **095137**
Cream **095140**



Cutlery set Loop

24 piece set and stand
Available singly or 12 per outer
095141

Linear cutlery packs



12 per outer
Teaspoon (6)
095152



Fork (4)
095154



Knife (4)
095153



Dessert spoon (4)
095155



4 Piece cutlery set

Assorted colours 24 per outer **095148**



Folding cutlery set

3 piece camping set. Packed in display outers of 7 **095150**



Multipurpose bottle opener

Packed in display outers of 16 **105543**

Grill pans



094020



094019

Grill pans

Complete with trivet and detachable handle.

27 x 27 x 5cm

094020

Spare trivet 24 x 21cm

094021

27 x 22 x 3cm

094019

Spare trivet 21 x 18cm

094022

Handle only

094026



Stainless steel grill pan

Supplied with trivet.

Dimensions: 28cm x 23cm.

Available singly or 12 per

outer 094016



Folding handle grill pan

Vitreous enamel grill pan,

durable non stick wire rack.

Handle folds easy for storage.

Dimensions 32cm x 20cm.

Available singly or 10 per outer

094017



Spatter screens

Diameter: 29cm

Non stick coated mesh

Available singly or 12 per outer

095009

Mesh

Available singly or 10 per outer

095005



Non stick grill pan

29cm². Available singly or 8 per outer 094051

Cast aluminium griddle

Non stick interior and exterior, folding handle,

deep ridged base. 20cm square 5mm gauge.

Available singly or 12 per outer 094050



Egg pan 14cm

Non stick egg pan.

Available singly or 6 per outer

Cream 093020

Purple 093021

Pots, pans and cooking accessories



Stainless steel pan set

Good quality 3 piece set with one each 16, 18 and 20cm pans with lids in a full colour display box 093017



3 tier steamer

20cm. Stainless steel with glass lid. Available singly or 6 per outer 093037



Salad spinner 24.5cm

Available singly or 6 per outer 095448



Milk pan and frying pan

Non stick aluminium 2mm gauge PTFE Silver exterior. Available singly or 12 per outer

Milk pan 14cm 093032

Frying pan 20cm 093033

Quickachips mesh
33 x 33cm

- Quickachips basket allows hot air to circulate to give your oven chips, garlic bread and pastries that perfect all-round crispness!
- Allows more even contact with the heat of the oven and therefore avoids soggy foods.
- Great for BBQ's and gives you control over your cooking

095013

Roaster bags



- Self basting oven bag
- 2 bags extra large size – 45cm x 55cm approx with tie closures
- Suitable for microwaving, re-heating, boiling, freezing and storing meat and vegetables
- Helps meat to brown without having to baste
- Prevents fats from splashing helping to keep oven clean

095012

Toaster bags



- No fuss – No mess!!
- Use each bag up to 50 times simply wash and re-use
- A tasty hassle free snack in just a few minutes
- 2 bags per pack

095010

Kitchen gadgets

**Colander collapsible 20cm**

Silicone. Available singly or 12 per outer

Black **095200**
Purple **095201****Colander collapsible 22.5cm**

Silicone. Available singly or 12 per outer

Black **095208**
Purple **095209****Colander collapsible 20cm with handle**

Silicone. Available singly or 12 per outer

Black **095204**
Purple **095205****Silicone spatula**

12 per outer

Black **095212**
Purple **095213****Silicone turner**

12 per outer

Black **095214**
Purple **095215****Silicone spoon**

12 per outer

Black **095218**
Purple **095219****Silicone spoon rest**

Available singly or 24 per outer

Black **095228**
Purple **095229****Silicone trivet 17cm²**

12 per outer

Black **095230**
Purple **095231****Silicone tongs**

12 per outer

Black **095220**
Purple **095221****Kitchen tool set & stand 5pc**Available singly or 6 per outer
095305**Kitchen tool set 5pc**Available singly or 12 per outer
095307**Cushion Grip Scissors**3 piece
12 per outer **095424****All purpose scissors**8". Available singly or 12 per outer
095459**Kitchen tongs**12 per outer **095452****Butterfly can opener**Available singly or 12 per outer **095425****Corkscrew**Chrome plated
Available singly or 12 per outer **095396****Cutty vegetable knife**24 per display **095423****Quick peeler**48 per display **095403****Sidewinder can opener**18 per display **095421**

Kitchen gadgets



2 in 1 salt 'n' pepper mill

Twist one way for salt the other for pepper. 12 per outer

White **095428**
Black **095429**



Sauce bottles

Set of 2. 12 per outer **095453**



Rotary grater

12 per outer **095451**



Tea towel holders

Set of 2 - colours may vary
12 per outer **095458**



Tea towel holder 4 hole

12 per outer **095455**



Sink strainer

Stainless steel. 12 per outer
095454



Sink mats

Can be trimmed to size for a perfect fit

White 26 x 31cm **095535**
White 32cm round **095536**
Available singly or 6 per outer



Tablecloth clip (4)

Available singly or 12 per outer
095640



Gripstrip hang it all

12 per outer **095603**



Mug holder

Free standing. 6 per outer
Cream **095500**
Purple **095501**



Bottle stoppers

12 per outer **095300**



Curtain/tablecloth clip

4 per pack. Available singly or
10 per outer **095632**



Adjustable kitchen roll holder

Fits the majority of sizes
available. 6 per outer **095461**



Pop Up food cover

Weight 120g Dimensions 30 x
20cm
10 per outer **095462**



Daisy food cover

12 per outer
30cm square Weight 100g
095463
48cm square Weight 200g
095464



Chef Aid food cover

095457



Kitchen towel holder

12 per outer **095460**



Fiamma omni stop

An innovative yet simple
accessory, ideal to keep plates
and items in place as you
travel. Securing bar made
from anodized aluminium
095697



Double refrigerator bar

Helps prevent movement
of contents while travelling.
40cm closed. Extending up to
75cm. 8.5cm high **089065**



Double cupboard bar

Stop items falling if doors
open in transit. 25cm closed.
Extending up to 45cm. 8.5cm
high **095689**



Kitchen towel holder

Free standing. 6 per outer
Cream **095505**
Purple **095506**

Drying rack, bowls, drainers and canisters



Studio caddy
Cutlery drainer
and holder



Washing up bowls
Round 26cm
Square 29cm



Canister set
Tea, coffee and sugar
canister set



Tip Top bin
10 litre capacity



Studio drainer
Slim and compact, holds cups,
plates and cutlery



Cutlery tray
Dimensions: 357 x 242 x 45mm



Sink mat
Can be cut to size 33cm x 26cm

B-Line kitchen accessories		Beige	Blue	Silver	Black	Plum
All available singly or in outer quantities for a more competitive price.						
Studio caddy	10 per outer	095745	095747	095750	095746	095749
Studio drainer	12 per outer	095490	095492	095495	095491	095496
Cutlery tray	12 per outer	095775	095776	095779	095778	095780
Washing up bowl square	12 per outer	095540	095542	095544	095541	095545
Washing up bowl round	12 per outer	095556	095558	095561	095557	095562
Sink mat	12 per outer	095530	095532	095534	095533	N/A
Canister set	9 per outer	095645	095647	095646	095649	095650
Tip Top bin	5 per outer	095980	095982	095984	095983	095985

Drying racks and drainers



Mini dish drainer
Nylon coated wire measuring
30cm x 20cm
White **095520**
Chrome **095510**
Available singly or 10 per outer

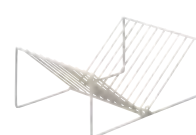
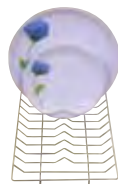

Wire plate wrack
Can be secured for safe
transportation of plates.
Measures 27cm wide x 20cm
deep x 12cm high.
White **095521**
Chrome **095511**
Available singly or 10 per outer

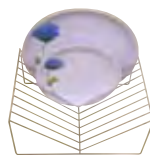

Wire mug holder
Can be secured for safe
transportation of mugs or
cups. Measuring 9cm square x
19cm high
White **095527**
Chrome **095517**
Available singly or 10 per outer



40 Shot Dish & treat

Low foaming washing up
liquid that also acts as a
tank cleaner. Just wash
the dishes and let the
washing up liquid clean
and protect your pipes
and tank for up to 7 days.
10 per outer **095575**



Folding plate rack
Open dimensions (LxWxH):
37x27x27cm
Chrome **095512**
Available singly or 20 per outer



Dish drainer rack

- Very practical and functional
- Folds out. Can be used in two sizes according to need
- Complete with cutlery slots
- Space saving when folded
- Folded (LxWxH): 36x28x7cm
- Open (LxWxH): 36x49x7cm

6 per outer **095488**



**Over sink drainer &
chopping board**
Versatile food preparation
space saver.
Basket 34x24cm.
Extends from 38-56cm when
fully open.
Available singly or 4 per outer
095529



Cutlery caddy cream
Available singly or 12 per outer
095740

Laundry and ironing

**Drying rack**

Hooks over the edge of the caravan window providing 6 metres of drying space. Folds flat when not in use. Manufactured from medium gauge steel wire, nylon coated 4.5mm thick. Folded dimensions (WxD): 58 x 48cm Available singly or 10 per outer **095477**

**Mini drying frame**

Ideal for small washes, suitable for all radiators, baths, balconies. Dimensions 23" x 5.5". 10 per outer **095479**

**Adjustable drying frame**

Multipurpose frame for drying clothes. Designed for small wash loads. Closed dimensions (WxDxH): 50 x 24 x 5 cm. 4 per outer **095478**

**Fiamma Easy Dry**

Additional drying rack suitable for use on the folding rail of the Fiamma Carry-Bikes and other brands with a tube diameter of 35mm. You can also travel with the Easy Dry in situ. Complete with plasticized ropes and adjustable handles. Manufactured from anodized aluminium. Weight 1.2kg **095480**

**Rotary 3 arm dryer and tripod**

Convenient clothes dryer, taking up little space when folded. **095465**

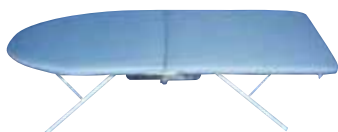
**Folding ironing board**

Folding legs, quality fabric cover, pressed wood top, chrome-wire iron rest. Folds in half for compact storage in re-usable storage bag. Surface area 81 x 30cm **095095**

**230V Travel steam iron**

230V. 750W. Available singly or 6 per outer **095097**

**Laundry bag**

Available singly or 10 per outer **095486**

**Magic hanger**

- Increases your wardrobe capacity by 100%
 - Provides optimal use of all space
 - Holds up to 5 hangers
- 095610** 10 per outer

**Multihanger non-slip**

- Multiple hanger with revolving hook
 - Non-slip revolving bars with clips
- 095612** 12 per outer

**Jumbo clothes pegs**

36 per pack Assorted colours. 24 per outer **095487**

**Twist washing line**

Removes the need for clothes pegs. Available singly or 10 per outer **095483**

**Adult coat hangers**

8 per pack. Budget priced. 24 per outer **095620**

**Sock dryer**

With 13 pegs, useful for drying any small item. Available singly or 24 per outer **095485**

**Children's coat hangers**

10 per pack. Budget priced. 24 per outer **095621**

Twister

Twister washing machine



Self powered washing machine. 4L capacity. Perfect for camping, caravanning, power cuts or simply to use at home when you just need to soak, pre-wash, rinse or spin a small load.

- Use anywhere
- Waste less water
- No energy costs
- Pedal powered
- Portable

Available singly or 12 per outer **095099**

Crockery and bottle holders

**Stepped cup and plate rack**535mm x 90mm. Beige **095695** Ivory **095701****Free standing cup and plate rack**525mm x 180mm x 90mm. Beige **095682** Ivory **095684****Cutlery trays**Three slot tray 370mm x 190mm x 50mm
Beige **095752** Ivory **095759****Glass and bottle holders**

Manufactured from coated sprung steel

Available singly or 10 per outer

Three glass **095850** Six glass **095858**Single bottle **095862** Two bottle **095872**Three bottle **095880**

Waste bins

**Garbina waste unit**Easily fixed to any vertical surface with bags held in place by a rubber strap **095920**
Spare bags (25) **095935****Snapsac bin**Lightweight holder for disposable waste bags. Snaps closed to seal in odours **095899**
Spare bags (25) **095913****Bag bin**Wall fixing unit from which you suspend carrier bags **095995**
12 per outer **095995****B-Line tip top bin**

10 litre capacity

Beige **095980**Blue **095982**Silver **095984**Black **095983**Plum **095985**

Available singly or 5 per outer of one colour

**Cupboard door bin**4 per outer **095939****Pedal bin**Metal coated white.
3L round. 4 per outer **095970**

Assorted kitchen items

Best of British

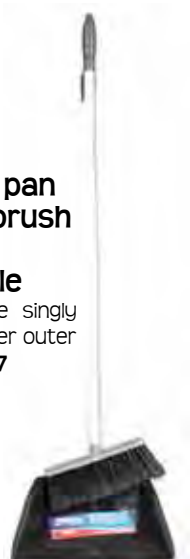
**Tea towels**Set of 3
24 per outer **095250****Single oven glove**Available singly or 24 per outer **095251****Apron**Available singly or 24 per outer **095252****Recycle bags set 3**Each bag: 315 x 315 x 435mm.
Available singly or 20 per outer **095999****Dust pan and brush**Grey. Available singly or 12 per outer **096080****Dust pan and brush long handle**Available singly or 48 per outer **096087**

Kettles and teapots



Whistling kettle
Stainless steel. Suitable for use on gas, electric, halogen or ceramic hobs. 2.2 litre. Available singly or 12 per outer **095025**



Whistling kettle
Stainless steel. Available singly or 12 per outer
1L **095028**
1.35L **095029**



Polished kettle
2 litre with hinged whistle, individually boxed. Available singly or 12 per outer **095019**



Whistling kettle
2 litre capacity
Green **095038**
Blue **095041**
Red **095042**
6 per outer of one colour



Whistling kettle
2.5L capacity. Available singly or 6 per outer
Cream **095046**
Purple **095047**



De-luxe lacquer kettle
2 litre kettle with fixed whistle
Blue **095033** Green **095036**
Wine **095034** Flame **095037**
Brown **095035**
Available singly or 6 per outer of one colour



De-luxe lacquer kettle
1.5 litre with separate whistle
Blue **095020** Green **095022**
Wine **095021** Black **095023**
Available singly or 6 per outer of one colour



Camping kettle
1 litre capacity with fixed whistle
Blue **095016**
Polished **095015**
Red **095017**
Green **095018**
Available singly or 12 per outer of one colour



De-luxe lacquer kettle
1.5 litre with separate whistle. Handle folds for easy storage
Wine **095030**
Blue **095031**
Available singly or 6 per outer of one colour



Teapot steel 32oz
Available singly or 10 per outer **094067**



Teapot 900ml
Stainless steel. Available singly or 12 per outer **094069**

Gas Lighters



Piezo lighter
24 per display **070486**



Cooker lighter pencil
Assorted colours. Packed in display outers of 12 **070490**



Cooker lighter silver
Packed in display outers of 12 **070494**



Cooker lighter bendable
Assorted colours. Packed in display outers of 24 **070496**



Refillable gas lighters
Also used for lighting pilot lights, gas stoves, fires. Each pack contains one short and one long reach lighter with adjustable flame. 12 per outer **070497**



Gas safety lighter
Long reach flame lighter
12 per outer **070498**



Refill for gas lighters 250ml
12 per outer **070480**

230v kettles

**Kingavon travel kettle**

- 0.5Ltr capacity
 - ON/OFF indicator light
 - 230v
 - Automatic switch off
- 095063**

**Kingavon cordless travel kettle**

- Boil-dry protection
 - ON/OFF Indicator Light
 - 1Ltr capacity
 - 900 watt, 230volt
 - Automatic Switch Off
- 095064**

**Cafe-tea-er maker**

- 230v
 - 350w
 - Complete with washable filter
 - Includes 2 ceramic mugs
- 095080**

**Waeco one cup**

- 12V coffee maker. 150ml capacity WxHxD 135 x190 x 110mm
- 095087**

12/24v kettles

**Car/truck jug kettle**

- Compact design with water level gauge. Fitted with cigar lighter plug. 6 per outer
- 12v **095086** 24v **095091**

**Waeco car kettle**

- 12V Kettle. 750ml capacity. WxHxD 190 x 205 x 125mm
- 095083**

**Coffee maker**

- 12v
 - Complete with washable filter
 - Includes 2 ceramic mugs
- 095090**

**Beverage heater**

- Ideal for camping, picnics & emergency use
 - 12v plugs directly into cigar lighter socket
 - For use with glass or ceramic containers
- 095089**

Other 12v appliances

12v Hairdryer

- Plugs directly into cigar lighter socket
 - Useful for defrosting windscreens
 - Folding handle and hang loop for easy storage
 - 8' power cord
 - 14 amps
 - Rotating air vent outlet for better air flow
- 095100**

Storage

**Folding storage box**

- 32 litre capacity. Measures 475 x 345 x 240mm (43mm when closed). Assorted colours. Available singly or 10 per outer
- 095892**

**Stack 'n' store box**

- Capacity 30 litres. 450 x 355 x 250mm. 6 per outer **095895**

**Folding boot cart**

- Folds flat when not in use
 - Lightweight, durable, rustproof with smooth rolling rubber wheels
 - Extendable aluminium handle
 - Dimensions: 380 x 330 x 360mm
 - Capacity 25Kg
- 6 per outer **095888**

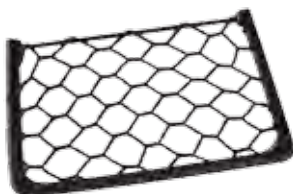
**W4 elasticated storage pocket**

- Can be attached to the inside of cupboard doors. Ideal to store magazines, maps, toiletries etc. Dimensions 30cm x 17cm
- 095882**

Moisture absorbers



WOW Recharge in the oven

Dry-Bag

An effective and economical product that is both simple and safe to use, eliminating condensation and damp problems. Protects interior fittings, fabrics, clothes, leather, electrical equipment from corrosion, rot, mould, mildew and odours. The Dry-Bag is manufactured using a cloth bag with lanyard and vertical window for hanging and monitoring, the colour will change from light brown to dark brown as it absorbs moisture. Each 1kg bag can dehumidify an area of approximately 6-10 cubic metres

- Re-usable, simply dry out contents as per instructions
- Can be stored for up to 2 years
- 100% environmentally friendly
- Absorbs up to 75% of its dry weight
- Will not drip even when saturated
- Activated by removing from plastic bag

Dry-Bag 2 x 250g **110025** 24 per outer

Dry-Bag 2 x 500g **110050** 12 per outer

Dry-Bag 1 x 1000g **110100** 15 per outer



WOW Recharge in the microwave

Pingi drying bags

The Pingi moisture bags are easy to recharge in the microwave oven. When the patented indicator changes from blue to pink, full saturation has been reached and Pingi is ready to be recharged. Good for the environment and for your wallet. Within a few minutes, Pingi is ready for use again.

250g 100cc **110115** Available singly or 12 per outer

450g 180cc **110117** Available singly or 12 per outer

**Pingi iDry**

These incredibly durable and easy-to-use moisture absorbers remove damp without electricity or batteries. Time to recharge? It only takes a brief stay in the 230V power point.

iDry L 120cc **110121** Available singly or 6 per outer

iDry XL 200cc **110124** Available singly or 6 per outer

**Slimline moisture trap**

Allows significantly more Air Flow than other traps in which the crystals sit very low and restricts air exposure

- Works immediately
- Suitable for all rooms
- No electricity or batteries required
- Easy fill top lid
- No spill sides
- Refill indicator

110170 12 per outer

**Mini moisture trap**

- Absorbs moisture
- Helps protect against damp
- Combats musty odour
- Improves air quality
- Last 6-8 weeks

110180 12 per outer

**Moisture crystal refill**

- Ideal for kitchen, caravans, boats and many more places where you need to keep the atmosphere dry
- Should be sufficient to dehumidify a closed room measuring up to 40 cubic metres (8ft x 12ft x 12ft)
- Excess moisture can cause mildew, wet rot, musty odours and other problems

500g **110172** 12 per outer

1kg **110175** 8 per outer

2.5kg **110177** 4 per outer

Gel safe moisture trap

110185 16 per outer

WOW Turns moisture into a gel, stored in a paper bag. By placing the bag in the bin, it makes disposal safe and easy.

Damp is the main cause of damage to materials in the home, this regulates excess humidity, keeping it at the optimum level. This helps prevent damp, mould, mildew, bacteria and musty odours, improving overall air quality and comfort. The gel residue cannot be spilled, this makes it ideal for multi-purpose use i.e.: wardrobes, cupboards, caravans and boats.

- Absorbs 400ml moisture and turns it to gel
- Controls excess humidity for 6-8 weeks
- Protects against damp
- Improves air quality
- Quick and easy to use
- Non spill and non leak

**Gel safe refill**

Extremely easy to replace
110187 12 per outer

FENWICK'S
ADVANCED CARAVAN CARE

Cleaning and proofing products



WOW The whole Fenwick's range has been designed with the needs of the caravan, motor home and car owner in mind. Many products have been created from specific requests by satisfied customers.

Fenwicks display stands

Please ask your sales contact for details

098062S

098062L



Caravan cleaner

Safe and economical to use one bottle will clean up to 40 average size caravans. It will safely remove black streaks, algae, moss, fungus, road and traffic film. Safe to use on acrylic windows, aluminium, rubber, decals, mastics, sealants etc.

1 litre **098056** 10 per outer

25 litre **098061**



Motor home cleaner

Improved formula for use on motor homes. Contains corrosion inhibitors to protect steelwork. Power washers are often used so cleaning activity has been increased

1 litre **098057** 10 per outer



Bobby dazzler

A unique finishing product for caravans, motor homes, cars, vans and lorries. Provides a protective coating and enhances shine. Simply applied in the rinse water it protects against road traffic film, salt spray, acid rain, rust and air borne pollutants and it contains an algae and mould inhibitor to slow their return.

1 litre **098058** 10 per outer



Waste pipe & tank cleaner

Cleans shower and sink drains, toilet cassettes, and eliminates unpleasant odours. Formerly known as Fendox concentrate. Dilute to a 10:1 solution to clean work surfaces, cookers, fridges, sinks, wash basins, showers and toilets. Fully biodegradable and food safe, kills e-coli, salmonella and other germs. Also removes nicotine, egg, limescale, formaldehyde, and other hard to remove stains

1 litre **097063** 15 per outer



Overwintering

Superb product to make spring cleaning easy. Simply coat the caravan or motor home with a dilution of overwintering to protect the surface from tree sap, bird droppings and general grime which accumulates over the winter months. Simply rinse with Fenwicks caravan or motorhome cleaner in the spring. Supplied in 1 litre bottles - enough to cover the average caravan twice

1 litre **098054** 10 per outer



Windowize

An effective product to remove scratches from acrylic and plastic windows. When applied by hand it will remove scuff marks caused by trees as well as light scratches caused by dirt and grit.

100ml **098052** 10 per outer



Awning & Gazebo reproofer

Quickly restores waterproofing qualities to synthetic and canvas awnings, tents and gazebos. Protects against stains from dirt, grease, oil, food spills, and drinks. Deep penetrating, water based, non flammable formula. Can be applied in damp conditions. 1L covers up to 30m². Far safer than solvent based products, due to the biodegradable and environmentally friendly properties.

1 litre **108405** 10per outer



Awning & gazebo cleaner

Quickly and effectively cleans awnings, tents and gazebos. Removes black streaks, green algae and general grime. Spray on, wash off formula.

1 litre **108401** 10 per outer



Black streak remover

A 10 to 1 solution of caravan cleaner in a handy trigger spray for removing black streaks between washes.

1 litre **098055** 10per outer



Multi-surface cleaner

Ideal for cleaning and sanitising plastic and hard surfaces.

1 litre **098051** 10 per outer



Citrus fresh toilet cleaner

"Fresh coat" helps prevent marks and stains. Helps maintain seals, improves flush action and sanitises

1 litre **060265** 15 per outer



Fenwicks top & tail

A unique toilet fluid designed for use in both top and bottom tanks which makes it easier to use and more economical.

2.5 litre **060266** 8 per outer

Cleaning



The revolutionary **waterless** way to clean your car, caravan, motor home, boat, motorbike, or any other metal, glass, or painted surface, even around the house on windows, mirrors, stainless steel and so much more.

Onedrywash is so easy to use. Simply spray on, spread with a soft cloth, working on one area at a time for a few seconds or longer depending on the ambient temperature. Then effortlessly polish to a shine with a second clean cloth. In very little time at all your surface is clean, polished and protected.

**Cleaning kit**

Kit contains:
1 x 500ml 1drywash with trigger
2 x microfibre cloths
Available singly or 10 per outer
098075

**1 litre refill pack**

Kit contains
2 x 500ml 1drywash with trigger
Available singly or 10 per outer
098077

**100ml Trial pack**

Not tried 1drywash yet? Why not give it a go with our brilliant trial pack which gives you everything you need, including a comprehensive illustrated usage and top tips card to help you get the most from your first experience of our product. The trial pack bottle holds 100ml of 1drywash, which is enough to clean, shine & protect an average sized family car or caravan.

Kit contains:
100ml 1drywash with trigger and a microfibre cloth
098073



Replacement trigger
098085

Tyre shine

Simply spray around the tyres and black rubber and leave to dry. Comes with trigger.
250ml.
10 per outer **098081**



Display Stand
Free of charge
098087

Upholstery cleaner

Upholstery cleaner is an effective 21st century surface cleaner for carpets, fabric, leather and vinyl, made completely from an enzyme of plant origins. Enzymes are proteins which act as a catalysts for chemical reactions and emulsifiers which suspend grease in an emulsion which is a safe water soluble solution. This makes it harmless to the environment unlike other cleaners as it contains no acids, bleaches, solvents, corrosives or abrasives and it's odour

free and totally biodegradable. All of this without losing effective cleaning power and does not harm your skin or damage your upholstery through mis use.

1. Adjust nozzle to produce a fine spray.
2. Spray lightly, working on small areas.
3. Spread with a soft cloth.500ml.

10 per outer
098082

Pampervan 1 litre

Pampervan is a 'dense gel' concentrate, 1 litre is sufficient to clean as many as 20 motorhomes and caravans. Cleans all types of caravan and motorhome bodywork and panels, winter build up, tar spots, tree sap, dead flies, and many more. The ideal solution for cleaning stained carpets and upholstery including leather. You will be amazed at the results.

098065 12 per outer

**Valeting pack**

Kit contains:
2 x 1 litre 1drywash
12 x micro fibre cloths
1 x pressurised dispenser
12 x latex gloves
098069

**Valeting pack refill**

10 x 1 litre 1drywash. Very economical for own use!
098068



WOW Manufactured and designed in the UK

7-shot

Save money and the environment - Buy concentrate. This simple idea provides 4.5L of cleaning solution. Supplied with 650ml of ready made solution and 120ml of concentrate that allows you to recharge the bottle a further 6 times. With the easy to use measuring device, you avoid over-dosing.



7-Shot Interior multiclean

Anti-bacterial multi-surface formula, with added anti-static agent. Leaves interior surfaces, showers, sinks, fridges and acrylic windows sparkling, and prevents mould and mildew build-up in your bathroom too!
10 per outer **098042**

7-Shot Upholstery cleaner

Cleans curtains, carpets and sofas, with built-in water softening agent to maximise performance in hard water areas. A great spot remover for cleaning up those accidental spillages.
10 per outer **098043**

7-Shot Black streak remover

Anti-static, multi-purpose spot remover for stubborn stains, black streaks and winter algae. Leaves a waxed showroom finish.
10 per outer **098048**



Sticky stuff remover

The modern answer for removing paint, oil, grease, adhesive, tar, sticker residue etc.
250ml **098095** 6 per outer
50ml **098096** 12 per outer



Silky cream

A cleaner for all painted and synthetic surfaces. Non abrasive. 480ml
098063 12 per outer



Dometic Seitz window cleaner set

All you need for appropriate cleaning of acrylic glass surfaces.
Includes: Acrylic glass cleaner - Antistatic cleaning and care product. Ideal for pre-treatment of acrylic glass surfaces prior to polishing. Acrylic glass polish - Effectively removes blind spots and scratches. Contains no wax. Special polishing cloth - Extremely soft and hard-wearing. Elastic, fluff-free and washable up to 40°C **098107**



Elsan anti-bacterial screen wash plus

This has been specifically designed to attack Legionnaires disease in the windscreen washer system and help eradicate this risk. It is also effective against other water borne bacteria to sanitise the system and avoid all unnecessary risks.
5 litre **097050** 4 per outer



40 Shot Dish & treat

Low foaming washing up liquid that also acts as a tank cleaner. Just wash the dishes and let the washing up liquid clean and protect your pipes and tank.
10 per outer **095575**



Melamine soak

Supplied in a tub of 20 tablets.
12 per outer
081409

Cleaning apparatus



Kent telescopic brush
Flow through brush with long reach handle. Measures 105cm when closed extending to 170cm
12 per outer
097058



Telescopic brush
Flow through handle with heavy duty brush head. Measures 100cm when closed extending to 170cm
18 per outer
097057



Telescopic brush
Budget flow through brush with long reach handle. Measures 100cm when closed extending to 170cm
12 per outer
500136



Extra long 3 section brush
Flow through handle with heavy duty brush head. Measures 130cm when closed extending to 330cm
097060

Display stand
097056



Heavy duty bucket
14.5 litre. Available singly or 12 per outer **097070**



Super jumbo car sponge
Available singly or 6 per outer **097005**



Rolson 4 piece cloth set
4 microfibre cloths. 12 per outer **097025**



Car wash glove
Microfibre mitt. Ideal for dusting, polishing and washing **097010**



Microfibre duster
● Microfibre attracts and lifts dirt whilst protecting surfaces
● Soft and scratch free
● Works best on dry surfaces
● Machine washable
097045 6 per outer



Chamois leather
Wholeskin approximately 5sq ft. Available singly or 6 per outer **097040**



Laundered polish cloths
Weight 10kg
097053



Microfibre cloths
● Made from microfibre
● Cleans without chemicals
● Lint and streak free results
● Machine washable and dry
● Environmentally friendly
● Magnetic to dust
12 per pack
097046 20 per outer



Bug & tar remover sponge
Available singly or 12 per outer
097022



Demister pad
24 per outer
097030



3 in 1 ice scraper
20 per outer
097023



Ice scraper / snow brush
6 per outer
097024



Kent cleaning cloths

- Made from microfibre
- Cleans without chemicals
- Lint and streak free results
- Machine washable and dry
- Environmentally friendly



Kitchen cloth
097041 10 per outer



Glass cleaning cloth
097042 10 per outer



Multi purpose cleaning cloth
097043 10 per outer



Bathroom cleaning cloth
097044 10 per outer

Cleaning wipes



Glass wipes

Contains 50 large wipes which cut through grease and dirt on plastics, glass and other modern surfaces

098109 16 per outer



Bathroom wipes

Contains 50 large wipes which help combat the build up of limescale

098115 16 per outer



Toilet wipes

Contains 50 large wipes, helps combat salmonella, listeria and E coli; ideal for cleaning toilet lids and seats

098121 16 per outer



Auto interior wipes

Contains 50 large wipes which are ideal for cleaning all surface including glass, seats and dashboards

098135 16 per outer

Air fresheners



Plug-in-air fresher assorted

Orange blossom, Freesia & Jasmine and Fresh linen

098153 12 per outer



Scented candles assorted

Candles in 11 assorted fragrances.

Each candle has a burn time of up to 30 hours

098159 24 per outer

Hand care



W4 handies

One size disposable latex gloves, powdered for easy fitting. 6 pairs per pack

098150 10 per outer



Latex gloves

10 pairs per pack

098149 50 per outer



sanitizer

Comes in three assorted fragrances, wild berry, lemon & lime and non-perfumed

098140 12 per outer

Vacuums and sweepers



Ring handyvac

12V wet&dry vacuum cleaner

- Complete with detachable nozzle, crevice tool and squeegee
- Ideal to pick up small wet and dry spills in the home, car, garage and caravan
- Cable length approximately 3.5 metres
- 12 volts / 90 watt
- 'e' marked
- CE approved

Available singly or 10 per outer

096090

Ring handyvac rechargeable

Mains rechargeable wet&dry vacuum cleaner

- Ideal to pick up small wet and dry spills in the home, car, garage and caravan
- Wall mounting charger base
- 4.8 volts/45 watt 230v
- CE approved

Available singly or 4 per outer

096091



Everyday cordless sweeper

Removable handle/visor for effective stair cleaning

- Easy empty dust tray
- Dynamic steering joint
- Low profile and long reach
- Run Time: up to 20 minutes (depending on floor surface)
- Power: 4.8V rechargeable batteries
- Weight: 1.3kg

096094



Deluxe cordless sweeper

From cleaning hard floors to removing stubborn pet hairs from carpets and upholstery, its multi-patented design features an edge cleaning wheel, responsive steering and long reach telescopic handle. Weight: 1.6kg

096095



Waeco Powervac PV-100

Wet/dry vacuum cleaner with rechargeable battery. Includes hose, attachments for upholstery, rugs and narrow gaps, carrying strap, mains adapter, 12-volt charging cable and operating instructions. Holds charge for 18 minutes of uninterrupted operation. 2.15kg. HxWxD 270 x 320 x 198mm

096093

Mats and runners

**Rimini runner**

- Machine washable to 40°C
 - Latex backing and anti slip
- 57cm x 180cm, assorted colours
096029 12 per outer

**Rimini mat**

- Machine washable to 40°C
 - Anti slip latex backing
- 40cm x 57cm, assorted colours
096028 24 per outer

**Door mat**

- Ribbed pile
 - Suitable for many locations
 - Easy to keep clean with brush or vacuum
- 40cm x 60cm, assorted colours
096046 10 per outer

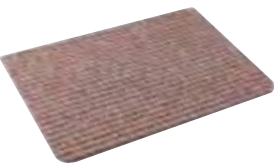
**W4 mini mat extra**

- Ridged door mat with non-slip backing. 49 x 33cm
096044 10 per outer

**Carpet mat stand**

Please ask your representative for details **096049**

**Marled barrier mat**

- Mixed fibre barrier mat
 - Washable at 40°C
 - Flexible non-slip backing
 - Extremely durable, absorbs dirt and moisture
 - Suitable for outdoor use
- 60 x 90cm
096027 10 per outer

**Furness mat**

- Machine washable at 40°C
 - 70% cotton and 30% synthetic fibre
 - Flexible PVC backing
- 40cm x 60cm
096032 16 per outer

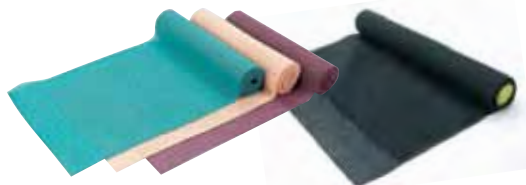

Camco 12' x 12"

Rolson 125cm x 45cm

Camco non slip matting

Suitable for many applications. Supplied in 12" wide rolls. Available singly or 10 per outer

- 12' beige **096015**
12' green **096016**
12' burgundy **096017**

Rolson non slip matting

Supplied in 45cm wide rolls. 30 per outer
125cm Black heavy duty **096020**

**Carpet protector 30m roll**

Plastic carpet protector 68cm wide 30 metres per roll
120124

Carpet protector pre-cut retail

- Suitable for use on carpets
 - Supplied in carry home polybag
- 68cm x 175cm. Available singly or 17 per outer **120121**

**Magi-Mat**

- Machine washable at 40°C
 - Surface 100% woven polypropylene
 - Stain resistant
 - Easily cleaned with damp sponge or cloth
 - Juice, coffee and wine wipe easily away
 - Soft and comfortable to the touch
- 60cm x 140cm **096023** 8 per outer

**Harmony barrier mat**

- Pure, soft cotton pile
 - Easy care, machine washable at 40°C
 - Supplied in a pack of 4 mottled colours
 - Ideal around the home, caravan or in pet beds
 - 100% cotton pile
 - Soft latex backing
 - Retail packed with header and hanger
- 40cm x 60cm **096024** 12 per outer
50cm x 80cm **096035** 12 per outer

**Ideal barrier mat**

- Hardwearing polypropylene pile.
 - Machine washable at 40°C
 - Vinyl backing
- 40cm x 60cm, assorted colours
096025 16 per outer

**Stick'n'Guard**

Self adhesive protective carpet film - ideal for use in high traffic areas where carpets need temporarily protecting. Supplied in 10m x 60cm retail packs.

- 6 rolls per outer **120125**
100 metres x 60cm **120126**

WOW Stick 'n' Guard is often used to protect sales vehicles when on display not just by workshops when working inside customers vehicles

Hooks, hangers and tape

WOW Hang, organise, decorate, fix until you want to take it down.
Command™ Adhesive removes cleanly without damaging walls

**Mini hooks**

Holds 0.225kg
6 per pack
099049
6 packs per outer

**Small hooks**

Holds 0.45kg
2 per pack
099050
6 packs per outer

**Medium hooks**

Holds 1.36kg
2 per pack
099051
6 packs per outer

**Large hook**

Holds 2.25kg
Packed individually
099052
6 packs per outer

**Jumbo hook**

Holds 3.40kg
Packed individually
099053
6 packs per outer

**Small oval hooks**

3 per pack
White **099011**
Beige **099012**
10 per outer

**Large oval hooks**

2 per pack
White **099015**
Beige **099016**
10 per outer

**Tea cloth holder**

099034
10 per outer

**Double sided tape**

Length 6ft
099000
10 per outer

**Small square hooks**

4 per pack
White **099019**
Beige **099020**
10 per outer

**Large square hooks**

2 per pack
White **099023**
Beige **099024**
10 per outer

**Cup hook white**

4 per pack
099027
10 per outer

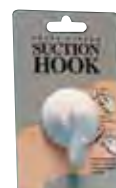
**Suction hook**

099030
10 per outer

Velcro® Velcro counter display unit **099439****Velcro® in handy dispensers**

10 metre length, 20mm wide
Stick 'N' Stick Ecru **099412**
Stick 'N' Stick White **099413**

**Velcro® stick on coins**

Self adhesive discs with many uses. 16 per pack
099423 12 per outer

**Velcro® sticky foam pads**

Double sided sticky foam pads for permanent fixing, quick & easy to use
099429 12 per outer

**Hang tabs**

Repairs euro hook slots when damaged. 500 tabs per box (10 x 50)
099080

**Velcro® heavy duty tape 50mm x 5mtr**

Extra Strong. Weather resistant adhesive. For indoor and outdoor use
099415

**Velcro® heavy duty strips retail pack**

Extra Strong. Weather resistant adhesive. For indoor and outdoor use
099420 12 per outer

**Velcro® self-grip ties 30mm x 5mtr**

Perfect for organising bulky heavyweight cables
099427 6 per outer

Personal grooming



Nilaqua's no rinse bathing products allow you to wash safely and effectively without using any water whatsoever! This range of no rinse liquid soap shampoo's leave your body clean and fresh from head to toe.

Simple, fast and effective.

These amazing products are liquid based and leave no sticky residues. Simply apply the liquid directly and generously to your body, massage to release dirt and grease, and then to remove simply thoroughly towel dry.

The perfect alternative to traditional bathing.

Nilaqua has many uses: e.g. for busy lifestyles to freshen up between washes or when there is a lack of water, for example travelling, festivals, camping, hiking, sports (cycling, marathons etc), yachting, truckers, military, etc. Many festival goers prefer to wash from the comfort and privacy of their tent, rather than queuing up for showers.

WOW

- Paraben and alcohol free
 - Kind to the skin
- Simple and easy to use
- Safe perineal cleanser
- Moisturises as it cleans
- Microwaveable wipes and shampoo caps

No Water Or Rinsing Required



Nilaqua body wash

- Ready to use
- No rinsing required
- Leaves skin clean, refreshed, and odour free
- No alcohol means no dryness
- Gentle on sensitive skin
- Safe and effective perineal cleanser
- Moisturises as it cleans

65ml **098414** 12 per outer

200ml **098415** 24 per outer



Nilaqua shampoo

- Ready to use
- No rinsing required
- Hospital tested and approved
- Completely cleans hair without water
- Just apply, massage to a lather, towel dry, and style
- No alcohol means no dryness
- Leaves hair fresh, clean, and odour free

65ml **098400** 12 per outer

200ml **098401** 24 per outer

500ml **098402** 12 per outer



Nilaqua body wash wipes

- Ready to use
- Contains 8 x premoistened 20cm² wipes
- No rinsing required
- Leaves skin clean, refreshed, and odour free
- No alcohol means no dryness
- Gentle on sensitive skin
- Safe and effective perineal cleanser
- Moisturises as it cleans
- Microwaveable for a warm luxurious wash

098409 24 per outer



Nilaqua shampoo shower caps

- Ready to use
- No rinsing required
- Hospital tested and approved
- Completely cleans hair without water
- Just place cap over hair, massage to a lather, towel dry, and style
- No alcohol means no dryness
- Leaves hair fresh, clean, and odour free

098418 24 per outer



Nilaqua pet shampoo

- Ready to use
- No rinsing required
- Bathe your dog without stress or mess
- Apply massage to a lather and towel dry. No rinsing required
- PH balanced, contains no alcohol
- Recommended by vets and professional groomers
- Removes odours without masking. Lifts the dirt up and away from the skin

200ml **098420** 12 per outer

500ml **098421** 12 per outer



Nilaqua smilesaver toothbrush

The waterless disposable toothbrush with a single dose of toothpaste stored inside the handle. To use simply push the handle into the head to dispense the toothbrush and brush your teeth

- No rinsing required
- No foam - no mess
- Fresh minty flavour

098419 30 per outer



Nilaqua conditioner

- A wonderful finish for any shampoo
- Ready to use
- No rinsing required, no residue, no greasiness
- Eliminates snarls and tangles while leaving hair soft and easy to manage
- No alcohol means no dryness
- Provides silkiness, softness, and lustre
- Just apply, massage into hair, comb, and style
- Can be rinsed like a traditional conditioner

65ml **098405** 12 per outer

20ml **098406** 12 per outer

WOW Free counter display box **098425**

Rooflights and accessories

MPK complete rooflights

Size mm (aperture)	Dome colour	Interior colour	Grove number
280 x 280 with flynet	Opaque	Beige	102002
	Opaque	White	101972
360 x 320 with flynet	Opaque	Beige	102008
	Opaque	White	101978
400 x 400 with flynet	Opaque	Beige	102013
	Opaque	White	101983
MPK 420 400 x 400 with flynet and blind	Opaque	Beige	102016
	Opaque	White	101986
	Clear	Beige	102028

MPK rooflights opaque

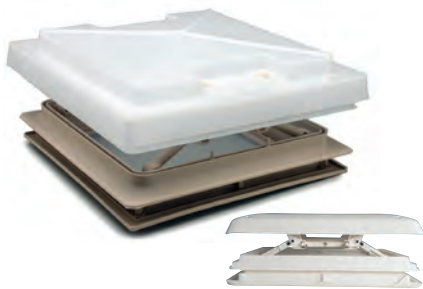

Multi-directional rooflight with opaque, flexible double skinned dome and frame available in two colours, beige or white. Telescopic arms allow the rooflight to be opened to any side. The dome skins have spacers between to guarantee free airflow that cannot be reduced by snow weight. Comes complete with removable flynet, and the 420 version comes with flynet and integrated roller blind.

MPK rooflight clear



- Large clear dome with snow protection frame
 - With free airflow
 - With flynet roller and roller blind
 - Automatic pressure release locking device
 - Covered fixing screws
- Measures: Aperture: 400mm x 400mm, Size of dome: 560mm x 560mm, Free airflow: 150cm

MPK replacement domes - opaque Complete with handles

Size mm (aperture)	Dome colour	Handle colour	Grove number
280 x 280	Opaque	Beige	102005
	Opaque	White	101975
360 x 320	Opaque	Beige	102010
	Opaque	White	101980
400 x 400	Opaque	Beige	102012
	Opaque	White	101982



Other rooflights

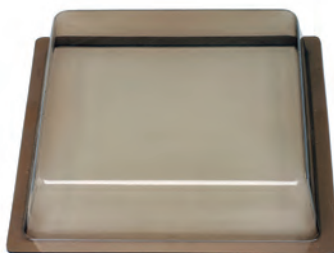

Rooflight domes

Manufactured from vacuum formed acrylic. The domes are not pre-drilled
 14,5" x 14,5" **102055**
 18" x 18" **102065**



Elixir rooflight

Single glazed unit with one way wind up mechanism. Metal surround. To fit aperture size: 360mm x 360mm
 White **102033**
Spare dome
 White **102037**

MPK flynets and blinds

Size mm (aperture)	Interior colour	Part	Grove number
280 x 280	Beige	Flynet	102019
	White	Flynet	101989
290 x 290	Beige	Flynet	102020
	White	Flynet	101990
360 x 320	Beige	Flynet	102021
	White	Flynet	101991
400 x 400	Beige	Flynet	102023
	White	Flynet	101993
MPK 420 400 x 400	Beige	Blind and flynet	102026
	White	Blind and flynet	102024
	Beige	Roller blind only	102017



280 x 280mm



290 x 290mm



360 x 320mm



400 x 400mm



For MPK 420
400 x 400mm



Replacement roller blind

Stays



MPK rooflight catches

Catch to lock rooflight in open or closed position 420/430.
 4 per pack (2 black and 2 grey)
102018



Brevette stays

2 per pack **102162**

Dometic Heki rooflights

Heki rooflights

All heki rooflights come complete with inner frame, blind and flyscreen.

With weather proof ASA frames and PMMA glazing, they are designed to provide excellent protection from the elements

Model	Roof thickness mm		Dimensions mm (cut out)	Installation area required mm	For caravans or motorhomes	With or without forced ventilation	Glazing	Features	Grove number
	Standard	Fits							
Mini Heki plus	42	25-42	400 x 400	550 x 510	Caravan	Vent	Double glazed	Lever opening 3 position to 50°	102080
					Motorhome	No vent			102077
	60	43-60			Caravan	Vent			102081
					Motorhome	No vent			102078
Mini Heki S	42	23-42	400 x 400	500 x 500	Caravan	Vent	Single glazed	Handle opening 5 position up to 80mm	102074
	60	43-60							102075
Midi Heki	30-34	25-34 up to 60 (with additional assembly kit)	700 x 500	880 x 650	Caravan	Vent	Double glazed	Lever opening 3 position to 45°	102084
					Motorhome	No vent			102085
Heki 2	27	up to 60 (with additional assembly kit)	960 x 655	1080 x 790	Caravan	Vent	Double glazed	Lever opening 3 position to 55°	102092
Heki 2 Deluxe	25-32							4 x 5W 12v integrated lights Lever opening 3 position to 55°	102093
Heki 3 plus	25-32				2 x 8W 12v integrated lights Crank opening variable position to 70°	102096			
Heki 4 plus	25-32				2 x 8W 12v integrated lights Electric opening (with remote) variable position to 70° With rain sensor	102097			



Mini Heki S - 2.9kg



Mini Heki plus - 3.3kg

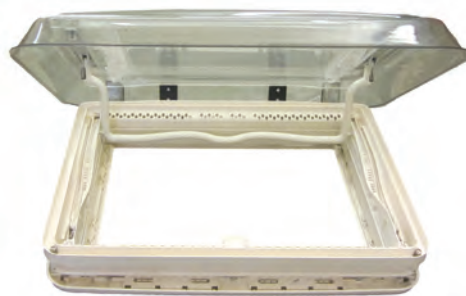

Midi Heki - 8kg



Heki 2 - 11kg

Heki 2 deluxe - 11kg

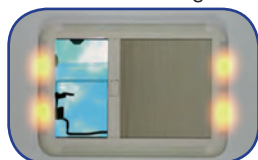
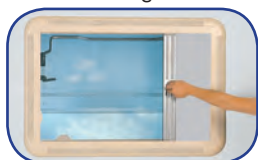

Heki 3 plus - 15kg

Heki 4 plus - 15.5kg

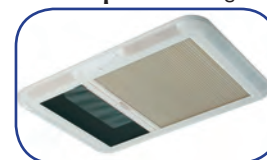

Seitz S4 windows - Dometic Seitz S4 windows are available to order from Grove Products. Usually delivered within 7 - 10 days, please speak to your sales contact for current prices and delivery time scales.

FIAMMA Rooflights

400 x 400 rooflights

The Fiamma range of 40 cm rooflights offers high quality and durability. Aerodynamic, thanks to its elegant external profile top, it does not require the use of the Spoiler. During high-speed testing, noise and vibrations were greatly reduced. Thanks to the new outside cover and exclusive patented rubber seal, a watertight system guarantees rain streams down without the possibility of it coming in. ABE approved. Made with high quality UV-resistant materials. Interchangeable with the old Fiamma Roof-lights 40x40 and with rooflights from 36x36cm to 42x42cm thanks to the reinforced frame. Supplied with permanent airflow ventilation.

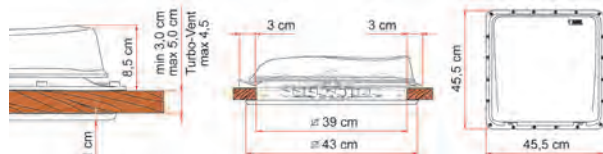

Fiamma Vent

Manually operated opening with permanent air flow ventilation and mosquito screen.

Vent 40

White 102030W
Crystal 102030C

Spare dome

For all Fiamma 40 x 40cm rooflights

White 102031W
Crystal 102031C



Turbo-Vent

Manually operated opening with permanent air flow ventilation and a big fan with a 12V DC variable speed motor with 10 blades. It changes and refreshes the air inside your vehicle within seconds. The electronic circuit allows a rapid, problem-free, change of rotation. The transparent grating permits maximum air circulation and filtering of light.

White 101092
Crystal 101091

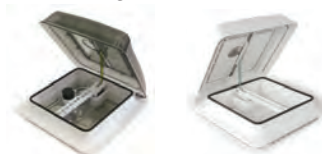

Crystal

White



Universal extension kit

To suit all Fiamma roof lights 102036



Fiamma handle extension

102034

Vent 28

28 x 28cm version of the Vent 40 rooflight, ideal for airing small spaces. Installation with sandwich technology with screws tightened inside the vehicle

White 101096
Crystal 101097

Spare dome

For vent 28

White 102033W
Crystal 102033C

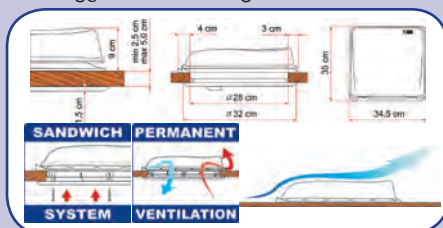

Fiamma turbo kit

Kit to convert your rooflight into a fan. Turbo kit 12V DC with telescopic hanging system allows installation on any rooflight from 40x40cm to 50x70cm when the vehicle is stationary and the roof is open. 24cm diameter fan with 2 telescopic hangers adjustable from 36 to 48cm. Comes with 1 cable for lighter type socket and 1 cable for vehicles electric circuit. Can also work on 8 x D batteries not supplied.

- Low consumption: 12 Vdc
- Absorbed power: 4 W
- Electric input: 0.2 to 0.33 A

● Max air flow: 7.2m³/min
101095

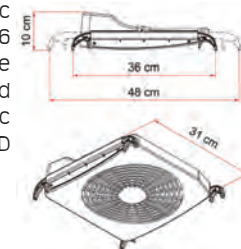

Rooflight accessories



Fiamma thermo vent 40

Insulated vent shield. Keeps your vehicle warmer in the winter and cooler in the summer. Suitable for all 40x40 rooflights. 40cm square 102032



Fiamma rollo kit 40 x 40 LED

Roller blind system suitable for 40 x 40cm rooflights, includes 4 LED lights, each with 9 warm white LED lamps

- Low consumption: 12 Vdc
 - Absorbed power: 8.64 W
 - Electric input: 0.72 A
 - Complete with switch
 - Easy installation without drilling
- 102029LED

Fiamma rollo kit 40 x 40

As above without the 12v LED lights 102029



WOW Turns any rooflight (40x40cm to 50x70cm) into an extracting rooflight!



Fiamma rooflight spoiler

A universal aerodynamic roof spoiler, ideal for reducing vibrations and rooflight noise while travelling. Made of UV-ray resistant sturdy PVC material. It can be shortened to adapt itself to the different rooflights with dimension from 110cm to 28cm. Easy to install can be attached with suitable adhesives (Sika), no drilling needed. Dimensions 110 x 20 x 12cm 102039

Dometic Air conditioning units - roof air conditioners for 230V stationary operation

Exterior



Freshjet 1100
102181

Freshjet 1700
102183

Freshjet 2200
102185

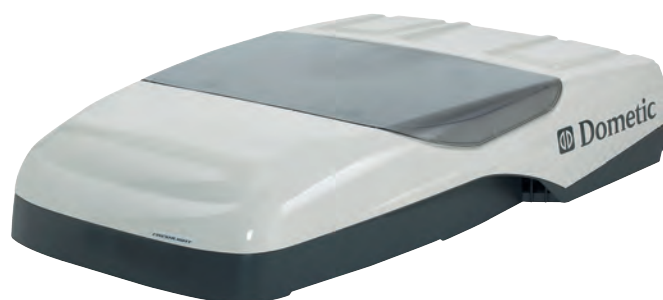

FreshLight 1600
102193

FreshLight 2200
102195

Interior



You can control all functions of your Dometic air conditioner easily by remote control. The digital display shows the selected settings, such as temperature, blower speed, battery status, timer etc.



DC2 Kit

Allows you to run an air conditioners through the 12V DC circuit whilst the vehicle is running. Travelling occupants of the living area can be air-conditioned and you can enjoy perfect climate inside when you get to your holiday destination. Includes charging current distributor **102170**

WOW FreshLight - The world's first roof air conditioner with integrated roof window with active ventilation system and single-pleated blackout screen

	Freshjet 1100 102181	Freshjet 1700 120183	Freshjet 2200 120185	Freshlight 1600 120193	Freshlight 2200 120195
Cooling capacity	1000 watts 3400 Btu/h	1700 watts 5800 Btu/h	2200 watts 7500 Btu/h	1550 watts 5300 Btu/h	2200 watts 7500 Btu/h
Heating capacity (230v mode only)		800 watts	2700 watts	2050 watts	2700 watts
Power consumption (cooling / heating)	430 / - watts	620 / 800 watts	950 / 1200 watts	620 / 800 watts	950 / 1200 watts
Input voltage	230 volts AC 50 Hz	230 volts AC 50 Hz	230 volts AC 50 Hz	230 volts AC 50 Hz	230 volts AC 50 Hz
Current consumption (cooling / heating)	2.0 / 0 Amps	2.7 / 3.5 Amps	4.1 / 5.2 Amps	2.7 / 3.5 Amps	4.1 / 5.2 Amps
Necessary circuit protection (cooling / heating)	3 / - Amps	4 / 4 Amps	5 / 6 Amps	3 / 4 Amps	5 / 6 Amps
No. of blower speeds	4	4	4	4	4
Remote control	Yes	Yes	Yes	Yes	Yes
External dimensions (W x H x D) mm	562 x 225 x 787	562 x 225 x 787	562 x 225 x 787	758 x 210 x 1105	758 x 210 x 1105
Internal dimensions (W x H x D) mm	480 x 47 x 535	480 x 47 x 535	480 x 47 x 535	550 x 53 x 880	550 x 53 x 880
Roof opening (W x D) mm	400 x 400	400 x 400	400 x 700	400 x 400	400 x 700
Roof thickness mm	25 to 60	25 to 60	25 to 60	25 to 60	25 to 60
Integrated lighting	LED	LED	LED	LED with dimmer	LED with dimmer
Can use DC2 Kit for 12V mobile operation	Yes optionally	Yes optionally	Yes optionally	Yes optionally	Yes optionally
Recommended max length of vehicle	5 metres	6 metres	7 metres	6 metres	7 metres
Weight approx. kg	22	29	32	40	42
Part no.	102181	102183	102185	120193	102195



Air conditioning units - roof air conditioners for 230V stationary operation

Aventa Comfort

Behind the Aventa Comfort air conditioning system are two powerful and efficient units. It cools and dehumidifies the interior on hot days and can be used as a heatsource through an energy saving heat pump on cooler evenings.

- Powerful cooling and exceptionally high air output
- Maximum efficiency in both cooling and heating operation
- Extremely light
- Sleep function for quiet cooling
- Practical timer function
- Retrofitting is very quick and easy

Choice of two interior colours, cream or grey



WOW Easy retrofit through 400 x 400 rooflight, especially with the optional sealing frame **102169**



Optional sealing frame
102169

Aventa Eco

The Aventa Eco air conditioning system will provide you with the required temperature quickly with its high cooling power. It uses such low power that it can be used on camp sites with the lowest fuse protection. Perfect for performance and economy

- Powerful cooling
- Extremely low power consumption
- Extremely light
- Sleep function for quiet cooling
- Practical timer function
- Retrofitting is very quick and easy

Choice of two interior colours, cream or grey

WOW Aventa Eco - Powerful cooling only (no heating function). Why pay for heating when it is already installed in the vehicle. Save weight, money and power!



1. On/off
2. Mode
3. Fan speed
4. temperature selection
5. Clock
6. Sleep
7. Interior lighting
8. Timer
9. Resend
11. Reset



Interior cream



Interior grey

	Aventa Comfort 102166	Aventa Eco 102163
Cooling capacity	2400 watts	1700 watts
Heating capacity	800 watts	
Input voltage	230 volts AC 50 Hz	230 volts AC 50 Hz
Current consumption (cooling / heating)	4.2 / 3.7 Amps	2.8 Amps
External dimensions (W x H x D) mm	650 x 235 x 980	650 x 235 x 980
Internal dimensions (W x H x D) mm	500 x 50 x 560	500 x 50 x 560
Roof opening (W x D) mm	400 x 400	400 x 400
Integrated lighting	Dimmable LED ambient lighting	Dimmable LED ambient lighting
Recommended max length of vehicle	7.5 metres	6 metres
Weight approx. kg	33	28
Part no.	102166	102163
Air distribution unit cream	102167	102164
Air distribution unit grey	102168	102165



Air conditioning units - under bench air conditioner



Is the under-bench storage space still free? Then there are a number of reasons to house the air conditioner there:

- No roof load, vehicle centre of gravity and height remain unaffected
- 3 separate outlets can be positioned individually

	FreshWell 2000 102197
Cooling capacity	1800 watts / 6100 Btu/h
Input voltage	230 volts AC 50 Hz
Current consumption	2.8 Amps
Dimensions (W x H x D) mm	400 x 286 x 560
Recommended max length of vehicle	6 metres
Weight approx. kg	20
Part no.	102197

Ventilators

Extract and light kit

12v extractor fan complete with an integral downlighter in white surround. Ideal for fitting in cupboard above hot plate or in a toilet compartment. Complete with exhaust ducting and external vent. Supplied blister packed with Euro slot. Can also stand on shelves. Comes complete with a G4 10w halogen bulb **103250**

Extract and light loose

12v extractor fan complete with an integral downlighter. Supplied in bubble wrap with no external vent or exhaust ducting. 10 per outer

White **103252**
 Chrome **103253**
 Gold **103254**

**Dometic GY20 vent**

A passive ventilator with easy push/pull closing action. Creates permanent ventilation to cut down condensation and musty smells **103202**

**Mushroom vent**

White Dimensions: 110mm Ø,
 Height 50mm, Roof 22-54mm
103204

**Roof cowl Truma AK3**

801020
 More truma cowls and vents in the spares section of the catalogue

**MPK vent 5038**

117mm diameter (overall)
 109mm (vent)
103200

**Hit and miss vent**

White 9.5" x 3.5" **103101**
 Brown 9.5" x 3.5" **103112**

**Hit and miss vent and flyscreen**

White 9.5" x 3.5" **103123**
 White 9.5" x 6.5" **103134**

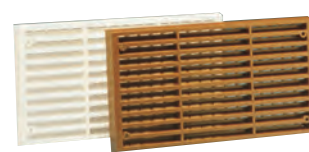
**Interior louvre vent**

White 6.75" x 3.5" **103038**
 Brown 6.75" x 3.5" **103047**

**Exterior louvre vent**

White 9.5" x 6.5" **103029**

**Exterior louvre vent and flyscreen**

White 9.5" x 3.5" **103083**
 White 9.5" x 6.5" **103092**

**Exterior louvre vent**

White 9.5" x 3.5" **103011**
 Brown 9.5" x 3.5" **103020**

**MPK side wall vent**

170mm x 50mm - aperture size
103201

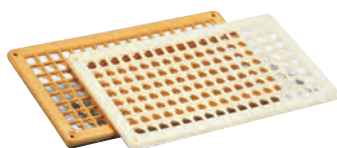
**Grille vent**

White 6.75" x 3.5" **103145**
 Beige 6.75" x 3.5" **103156**

**3" hexagonal vent -pair**

White **103167** Brown **103178**
 10 packs per outer

Consumables

THE WORKSHOP

WOW For workshop consumables please order in units of 1 to receive quantity in brackets.



Brake cleaner
500ml aerosols (6) SAS2
2.5 litre (4) SAS82



Zinc spray
500ml aerosols (6)
SAS24



Clear fine oil
500ml aerosols (6)
SAS56



Silicone spray
500ml aerosols (6)
SAS8



Tyre foam
500ml aerosols (6)
SAS43



White grease PTFE
500ml aerosol (6)
SAS7



Copper grease
500ml aerosols (6)
SAS17



Clear grease
500ml aerosols (6)
SAS18



Silicone grease
500ml aerosols (6)
SAS19



Multi purpose EP grease
400g cartridges (12) VC181
5Kg tub VC182



Sealant strips

W4 sealing strip

WOW New high performance formula in white available now!

Formulated for the sealing and re-bedding of caravan and trailer tent fittings. Suitable for use on aluminium mouldings, overlap joints, awning rails, exterior lights, window surrounds, grab handles and most external trims.

Retail packs

19mm x 2.5mm x 5m
Grey 107089
White 107092
32mm x 2.5mm x 5m
Grey 107090
White 107093
45mm x 2.5mm x 5m
White 107094



Workshop packs

19mm x 2.5mm x 19m
Grey 107116
White 107119
32mm x 2.5mm x 19m
Grey 107117
White 107120
45mm x 2.5mm x 19m
Grey 107118
White 107121



Containers



Chemical sprayer
Not suitable for solvents including brake cleaner.
600ml CAN8



Pressol chemical sprayer
Heavy duty polyethylene. 750ml capacity. Fully adjustable nozzle. Suitable for use with cleaning fluids, lubricants and penetrating agents
CAN3A



Solvent sprayer
Polyamid pump with viton seals. Polyethylene, 1 litre container. Can be used with brake cleaner
CAN12



Solvent sprayer
With viton seals. 1 litre container. Can be used with brake cleaner
CAN7



Grease gun metal

Metal bodied with extension pipe and 4 jaw coupler. $\frac{1}{8}$ " bsp 2.0cc/stroke. Withstands pressure to 10,000psi. Takes 400g cartridges
TL922



Rolson caulking gun

Steel skeleton frame, handle with plunger and release lever. Suitable for most 380-425ml cartridges. Available singly or 12 per outer
107087

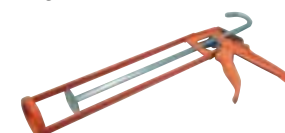

Cartridge gun

Heavy duty for 400ml sealant or grease cartridges
TL885

Sealants & adhesives



Dekaphon 9735

An under body and wheel arch protection coating. It does not spray mist when applied, very good resistance to water and abrasion. Can be used on plywood, wood and metal. 500ml aerosol

Black **107038**

Available singly or 12 per outer

Dekaphon 9750

An under body and wheel arch protection coating, that can also be used as a wood primer. It is a water based product that has very good resistance to water and abrasion, an excellent primer for MS-Polymer. Can be used on plywood, wood and metal. 1 litre Black **107040**

Available singly or 12 per outer

Dekapur 2K-90

Flexible polyurethane plastic repair adhesive. Can be used on ABS, PMMA, wood, metals, PVC, Polyester and painted metal. Very fast cure, 5 minutes! Easy and cost effective repair.

50ml Black **107042**

Available singly or 24 per outer

Dekapur 2K-6000

A 2 part polyurethane construction adhesive, used for bonding sandwich panels. Can be used on wood, plywood, aluminium, polyester and stony materials. Solventfree, short pressing time of 5 hours, with high gap filling properties. 5kg tub + 0.85kg tin.

Beige **107044**

Available singly

Dekalin

Dekalin products are designed especially for use in the caravan, motorhome and boat industries. Made in Holland and Germany, the range includes adhesives, sealants, protective coatings and more. All products use the highest quality materials and can be used with complete confidence.

- Use Dekaphon for enhancement and protection. Seals under-carriages and wheel arches, protecting against water ingress from below. Dekaphon 9750 can also be used as a primer for wood.
- Use Dekapur for bonding sandwich panels and plastic repairs.
- Use Dekaseal for sealing any fixture that may have to be removed in the future for repair or replacement such as windows, access doors, rooflights and panel overlaps.
- Use Dekasyll for fitting equipment such as solar panels, satellite domes and TV aerials to vehicle roofs. Extremely high bond strength and elasticity.

WOW Ask your sales contact about the useful Dekalin application chart

DEKALIN ADHESIVE, SEALANT AND COATING GUIDE



Dekasyll MS2

A multi-purpose adhesive / sealant. Based on MS polymer, it's ideal for fitting equipment such as solar panels, satellite systems, etc to vehicle roofs. It has very high U.V. stability and excellent performance with no need for a primer before application. 310ml cartridge

Black **107020**

Grey **107021**

White **107022**

Available singly or 12 per outer



Dekaseal 8936

A permanently slightly sticky, non-hardening, sealant. Surplus amounts can be easily dabbed away, saving time and avoiding the risk of damaging side panels. Common uses are for sealing of windows, sun-roofs and overlaps and joints in vehicle construction. Excellent UV-resistance and ageing properties without any pre-treatment. 310ml cartridge

Black **107025** Anthracite **107026**

Light Grey **107027**

Available singly or 12 per outer



Sikaflex 512 caravan

Multi purpose non-sag elastic one-part sealant. Resistant to UV radiation, ageing and weathering. Bonds well to many substrates. 310ml cartridge

White **107082**

12 per outer



IDL mastic sealant

Non-drying bedding sealant. 380ml cartridge

Cream **107077** White **107078**

15 per outer



Sikaflex 221

Fast setting one part polysulphide adhesive and sealant. Hardens to a flexible rubber-like consistency.

310ml cartridge

White **107080**

Black **107081**

12 per outer



Hodgsons seamseal CV sealant

Non-drying bedding sealant. 380ml cartridge

White **107015**

Available singly or 24 per outer



MK40

Polyurethane sealant and adhesive in one.

310ml cartridge

White **107079**

12 per outer



Hodgsons silfix

Silicone sealant for many uses in and around the leisure vehicle e.g. sealing around toilets, shower trays etc.

310ml cartridge

White **107066** Clear **107067**

Available singly or 25 per outer

1	ENHANCEMENT & PROTECTION																								
	<table border="1"> <thead> <tr> <th>Product</th> <th>Description</th> <th>Colour</th> <th>Applications</th> <th>Substrates</th> <th>Features</th> </tr> </thead> <tbody> <tr> <td>Dekaphon 9735</td> <td>underbody coating</td> <td>black</td> <td>enhancement underbody wheel housing underbody protection</td> <td>plywood wood</td> <td>does not spray mist when applied avoids dusting properties very good resistance to water and abrasion</td> </tr> <tr> <td>Dekaphon 9750</td> <td>protective wood primer</td> <td>black</td> <td>underbody protection adhesive enhancement</td> <td>plywood wood</td> <td>waterbased product excellent wood preparation excellent primer for MS Polymer adhesives very good resistance to water and abrasion</td> </tr> </tbody> </table>	Product	Description	Colour	Applications	Substrates	Features	Dekaphon 9735	underbody coating	black	enhancement underbody wheel housing underbody protection	plywood wood	does not spray mist when applied avoids dusting properties very good resistance to water and abrasion	Dekaphon 9750	protective wood primer	black	underbody protection adhesive enhancement	plywood wood	waterbased product excellent wood preparation excellent primer for MS Polymer adhesives very good resistance to water and abrasion						
Product	Description	Colour	Applications	Substrates	Features																				
Dekaphon 9735	underbody coating	black	enhancement underbody wheel housing underbody protection	plywood wood	does not spray mist when applied avoids dusting properties very good resistance to water and abrasion																				
Dekaphon 9750	protective wood primer	black	underbody protection adhesive enhancement	plywood wood	waterbased product excellent wood preparation excellent primer for MS Polymer adhesives very good resistance to water and abrasion																				
	<table border="1"> <thead> <tr> <th>Product</th> <th>Description</th> <th>Colour</th> <th>Applications</th> <th>Substrates</th> <th>Features</th> </tr> </thead> <tbody> <tr> <td>Dekapur 2K-90</td> <td>2K PU plastic repair</td> <td>black</td> <td>plastic (lightly repair) hole repair</td> <td>ABS, PMMA, polyurethane, wood</td> <td>very fast cure, 5 minutes long and cost effective repair</td> </tr> <tr> <td>Dekapur 2K-6000</td> <td>2K polyurethane construction adhesive</td> <td>beige</td> <td>bonding sandwich panels</td> <td>wood, plywood, aluminium, plastic</td> <td>solventfree short pressing time of 5 hours high gap filling properties</td> </tr> <tr> <td>Dekaplastid</td> <td>polyurethane filler</td> <td>yellow</td> <td>extended body work body repair</td> <td>steel, aluminium 2K acrylic, polyurethane 2K water based</td> <td>two part system fast curing easy to apply</td> </tr> </tbody> </table>	Product	Description	Colour	Applications	Substrates	Features	Dekapur 2K-90	2K PU plastic repair	black	plastic (lightly repair) hole repair	ABS, PMMA, polyurethane, wood	very fast cure, 5 minutes long and cost effective repair	Dekapur 2K-6000	2K polyurethane construction adhesive	beige	bonding sandwich panels	wood, plywood, aluminium, plastic	solventfree short pressing time of 5 hours high gap filling properties	Dekaplastid	polyurethane filler	yellow	extended body work body repair	steel, aluminium 2K acrylic, polyurethane 2K water based	two part system fast curing easy to apply
Product	Description	Colour	Applications	Substrates	Features																				
Dekapur 2K-90	2K PU plastic repair	black	plastic (lightly repair) hole repair	ABS, PMMA, polyurethane, wood	very fast cure, 5 minutes long and cost effective repair																				
Dekapur 2K-6000	2K polyurethane construction adhesive	beige	bonding sandwich panels	wood, plywood, aluminium, plastic	solventfree short pressing time of 5 hours high gap filling properties																				
Dekaplastid	polyurethane filler	yellow	extended body work body repair	steel, aluminium 2K acrylic, polyurethane 2K water based	two part system fast curing easy to apply																				
	<table border="1"> <thead> <tr> <th>Product</th> <th>Description</th> <th>Colour</th> <th>Applications</th> <th>Substrates</th> <th>Features</th> </tr> </thead> <tbody> <tr> <td>Dekaseal 8936</td> <td>PU sealant</td> <td>offwhite, light grey</td> <td>windows, frames external protection, opening, plastic, pipes</td> <td>aluminium, ABS, PMMA, wood</td> <td>very low modulus repair permeability allows caulking after use unless sealed under track to be fit before been mechanical can be painted over</td> </tr> <tr> <td>Dekaseal 8939</td> <td>butyl sealant</td> <td>grey</td> <td>hubs, openings, doors external periphery</td> <td>brass, aluminium, ABS, PMMA, wood</td> <td>can be used as under seal and on top of joints can be painted over</td> </tr> <tr> <td>Dekaseal 912 & 917</td> <td>butyl sealant</td> <td>off white, black</td> <td>hubs, openings, doors external periphery</td> <td>brass, aluminium, ABS, PMMA, wood</td> <td>can be used as under seal and on top of joints free of aromatic solvents can be painted over</td> </tr> </tbody> </table>	Product	Description	Colour	Applications	Substrates	Features	Dekaseal 8936	PU sealant	offwhite, light grey	windows, frames external protection, opening, plastic, pipes	aluminium, ABS, PMMA, wood	very low modulus repair permeability allows caulking after use unless sealed under track to be fit before been mechanical can be painted over	Dekaseal 8939	butyl sealant	grey	hubs, openings, doors external periphery	brass, aluminium, ABS, PMMA, wood	can be used as under seal and on top of joints can be painted over	Dekaseal 912 & 917	butyl sealant	off white, black	hubs, openings, doors external periphery	brass, aluminium, ABS, PMMA, wood	can be used as under seal and on top of joints free of aromatic solvents can be painted over
Product	Description	Colour	Applications	Substrates	Features																				
Dekaseal 8936	PU sealant	offwhite, light grey	windows, frames external protection, opening, plastic, pipes	aluminium, ABS, PMMA, wood	very low modulus repair permeability allows caulking after use unless sealed under track to be fit before been mechanical can be painted over																				
Dekaseal 8939	butyl sealant	grey	hubs, openings, doors external periphery	brass, aluminium, ABS, PMMA, wood	can be used as under seal and on top of joints can be painted over																				
Dekaseal 912 & 917	butyl sealant	off white, black	hubs, openings, doors external periphery	brass, aluminium, ABS, PMMA, wood	can be used as under seal and on top of joints free of aromatic solvents can be painted over																				
	<table border="1"> <thead> <tr> <th>Product</th> <th>Description</th> <th>Colour</th> <th>Applications</th> <th>Substrates</th> <th>Features</th> </tr> </thead> <tbody> <tr> <td>Dekasyll MS-2</td> <td>MS Polymer elastic adhesive and sealant</td> <td>black, grey, white</td> <td>glass and PMMA windows, stainless frames, galvanized steel, perforator</td> <td>PMMA, PVC, glass, aluminium, stainless galvanized steel, perforator</td> <td>very good UV resistance and ageing properties no special surface treatment possible after skin forming</td> </tr> <tr> <td>Dekasyll MS-5</td> <td>MS Polymer elastic adhesive and sealant</td> <td>black, white</td> <td>glass and PMMA windows, stainless frames, substrates</td> <td>PMMA, PVC, glass, aluminium, stainless galvanized steel, perforator</td> <td>high green strength very good UV resistance and ageing properties no special surface treatment possible after skin forming</td> </tr> </tbody> </table>	Product	Description	Colour	Applications	Substrates	Features	Dekasyll MS-2	MS Polymer elastic adhesive and sealant	black, grey, white	glass and PMMA windows, stainless frames, galvanized steel, perforator	PMMA, PVC, glass, aluminium, stainless galvanized steel, perforator	very good UV resistance and ageing properties no special surface treatment possible after skin forming	Dekasyll MS-5	MS Polymer elastic adhesive and sealant	black, white	glass and PMMA windows, stainless frames, substrates	PMMA, PVC, glass, aluminium, stainless galvanized steel, perforator	high green strength very good UV resistance and ageing properties no special surface treatment possible after skin forming						
Product	Description	Colour	Applications	Substrates	Features																				
Dekasyll MS-2	MS Polymer elastic adhesive and sealant	black, grey, white	glass and PMMA windows, stainless frames, galvanized steel, perforator	PMMA, PVC, glass, aluminium, stainless galvanized steel, perforator	very good UV resistance and ageing properties no special surface treatment possible after skin forming																				
Dekasyll MS-5	MS Polymer elastic adhesive and sealant	black, white	glass and PMMA windows, stainless frames, substrates	PMMA, PVC, glass, aluminium, stainless galvanized steel, perforator	high green strength very good UV resistance and ageing properties no special surface treatment possible after skin forming																				

Adhesives and glues



Evo-stik strong bond
Clear adhesive. Multi purpose 32g **107140**
6 per outer



Evo-stik impact
Instant contact adhesive. Multi purpose 30g **107145**
6 per outer



Evo-stik instant
Hard plastic adhesive. Instant bond 3g **107155**
6 per outer



Super glue
20g bottle **SAS4950**
5g bottles (5) **SAS495/5**
3g tubes (5) **SAS401/5**

SAS activator aerosol
Accelerates bonding of super glues. For use on PVCU, metal, glass and plastic. 200ml **SAS325**



Loctite 401 instant adhesive
20g bottle **VC906**



Bostik Super glue
Original strong bond 3g **107150**
12 per outer



Super glue
3g. 2 per pack **107152**
48 per outer



Araldite rapid adhesive
2x15ml tubes (2) **VC393**



Araldite rapid adhesive
24ml syringe **VC394**



Captain Tolley's Creeping Crack Cure

Multi-purpose liquid sealant that finds and fixes leaks and seals hairline cracks. Compatible with all caravan building materials. Does not dissolve polystyrene **107290**
12 per outer



Geocel clear marine sealant
Permanently flexible and waterproof clear silicone rubber sealant 78g tube **107005**
6 per outer



Rolson glue gun
230v 75W. Takes 11mm ø glue sticks 100mm long. 6 per outer **107160**

Rolson glue sticks (10)
11mm ø glue sticks 100mm long. Glues most plastics, wood, fabric, paper etc **107161**



Delamination kit
Floor fix 1.5Kg 2 part low odour epoxy adhesive is supplied with a 2.6ltr bucket for mixing, a pack of 20 (approx.) bungs and a syringe for application **107010**



SAS rapid epoxy
Repair compound for fast bonding of metals, glass, most plastics and other materials 24ml **SAS450**

Tapes and packaging

Stretchfilm pallet wrap
Clear 400mm x 300 metres **203034**
Black 400mm x 300 metres **203035**



Duct tape
Multi-purpose heavy duty tape for indoor or outdoor use. 10 metres silver. 24 per outer **107316**



AL-KO red sealant
Used for marking the nut position **107008**



Double sided tape
Non-foam type. 12mm x 50 metres **VC406**
25mm x 50 metres **VC408**



PVC insulation tape (10)
Electrical insulation tape. Black. Flame retardant to BS 3924 1980 Category 2. 19mm x 20 metres **EPT1**



Carton sealing tape
50mm x 66 metres 6 per outer **203031**



Fragile sealing tape
50mm x 66 metres 6 per outer **203030**



Airsafe bubble wrap
1.5 metres x 100 metres **203036**

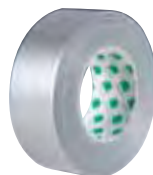

Gaffa tape
Multi-purpose heavy duty tape for indoor or outdoor use. Silver Available singly 10 metres **107300**
Available singly or 24 per outer 50 metres **107315**



Double sided adhesive foam tape
Green backing. General purpose tape. Suitable for interior and exterior use. 25mm x 10 metres **VC404**



Advance AT7 (10)
Electrical insulation tape. Black. Flame retardant to BS EN6054, self extinguishing. 19mm x 20 metres **EPT7**



Sealing tape gun
Tape dispenser **203033**



PTFE tape (10)
12mm x 12 metres **GLU5**

Professional surface finishing



WOW Ask your sales contact about the useful Farecla application chart

G mop back plate



6" Advanced back plate with interface pad for use with 6" industrial applicators. 14mm thread size.
AGMPIP

G mop lambswool pad 6"



Hook & loop allows rapid fitting and removal from backing plate. Gives a greater cut than foam. Leaves few swirl marks and polishes to a high gloss **AGMLWP**

Profile 300

Profile 300 can be used to rejuvenate or remove scratches from your caravan windows either by machine or by hand



Directions - By hand. Lightly dampen a lint-free cloth and apply 4 pea-sized amounts of Profile 300 to the cloth. Rub the cloth across the window using a straight back and forth motion starting left to right and then switching to up and down. Apply even pressure and repeat until a desired finish is achieved. Remove residue and buff with a soft dry cloth or microfiber finishing cloth.

Where there is deep ground in dirt such as roofs of the caravan a polishing machine might be required. Profile 300 in conjunction with a lambswool mop will offer a greater cut and high gloss.



Directions - By machine. Using backplate attach a lambswool pad to the polishing machine. Apply a small amount of Profile 300 to the pad and use the pad and polishing machine to spread the product before starting the machine. Then start the machine at low speed and polish the surface using even pressure. Gradually increase the machine speed to 1500rpm. Once the product is used up wipe the surface clean using a microfibre cloth. Reapply product if more work is required.

1 litre bottle **PR03001400** 6 per outer
200ml bottle **PR0300200** 12 per outer

Profile Caravan wash

Profile wash can be diluted or used as a neat product on the surface without any detriment to the surface. The wash leaves no streaks after use.



Directions - Rinse caravan thoroughly to remove excess dirt. Shake bottle well and pour 10-30ml Profile Power Wash into a bucket of warm water. Apply Power Wash with a clean sponge working from the top of the caravan downwards. Rinse thoroughly with clean water and wipe dry with a clean microfiber cloth for a streak-free, high shine finish. Can also be used neat on heavy stains without any detriment to the surface.
1 litre bottle **PPW101** 6 per outer



Profile Gelcoat restorer & wax

Profile Gelcoat Restorer & Wax is the perfect product for rejuvenating faded caravan surfaces by hand.



Directions - Lightly dampen a lint-free cloth and apply a small amount of Profile Gelcoat Restorer & Wax to the cloth. Rub the cloth across the faded caravan surface using a straight back and forth motion starting left to right and then switching to up and down. Apply even pressure and repeat until a desired finish is achieved. Remove residue and buff with a soft dry cloth or microfibre finishing cloth.

1 litre bottle **PGC501** 12 per outer

Profile Polymer wax

Profile Polymer Wax is a high gloss water resistant product with an even application. Can be applied either by hand or machine under most conditions.



Directions - Shake bottle well before use. Pour a small amount of Profile Polymer Wax onto a soft lint-free cloth (not directly onto the vehicle) and apply in a circular overlapping motion being careful to avoid contact with plastic trim. Allow to dry to a haze, then using a clean and soft lint-free or microfibre cloth, simply buff off for a beautiful high gloss water-resistant finish. Apply extra layers for maximum shine and protection.

1 litre bottle **PPW106** 6 per outer

Workshop cleaning



Hand gel red beaded
5 litres
VC505



Paper wipes
2 ply blue.
VC537
Paper wipes stand
VC526

Fenwicks commercial caravan cleaner



One litre will clean up to 40 average size caravans. It will safely remove black streaks, algae, moss, fungus, road and traffic film. Safe to use on acrylic windows, aluminium, rubber, decals, mastics, sealants etc. 25 litres

098061

1Drywash commercial valeting pack



Kit contains: 2 x 1 litre 1drywash, 12 x micro fibre cloths, 1 x pressurised dispenser, 12 x latex gloves **098069**

Valeting pack refill

10 x 1 litre 1drywash
098068

Assortment boxes

Bulk packs



'O' rings metric
404 pieces
AB100



'O' rings imperial
382 pieces
AB101



'O' rings metric
325 pieces
AB81



Heat shrink tubing
50mm lengths 172 pieces
AB103



Fastener assortment
Includes Zinc high tensile setscrews,
steel nuts & flat washers
M5 440 pieces AB163
M6 415 pieces AB128
M8 220 pieces AB129
M10 145 pieces AB130



Machine screws
Body screws. Pan head
Pozi metric (zinc) 250 pieces
AB134



Nylon lock nuts metric
300 pieces
AB15



Heat shrink tubing
200mm lengths 30 per
pack
AP33



Repair washers
240 pieces
AB22



Flat washers imperial
"Table 4" Heavy 530 pieces
AB109
"Table 3" Heavy 1000 pieces
AB20



Rivets aluminium
Black 200 pieces
AB112



Display rack
For 10 assortment boxes
ABR



Split pins
1000 pieces
AB32



'R' clips
75 pieces
AB88



Insulated terminals
Blue 280 pieces
AB161

Screws and miscellaneous



Self tapping screws
Counter sunk . Pozi- Zinc
200 per pack
No.6 5/8" 16mm **HTC6/5**
No.6 3/4" 19mm **HTC6/6**
No.6 1" 25mm **HTC6/8**
No.6 1 1/2" 38mm **HTC6/12**
No.8 5/8" 16mm **HTC8/5**
No.8 3/4" 19mm **HTC8/6**
No.8 1" 25mm **HTC8/8**
No.8 1 1/2" 38mm **HTC8/12**



Pan head screws
Pozi - stainless steel
200 per pack
No.6 x 1/2" 13mm **HTA6/4**
No.6 x 3/4" 19mm **HTA6/6**
No.6 x 1" 25mm **HTA6/8**
No.8 x 1/2" 13mm **HTA8/4**
No.8 x 3/4" 19mm **HTA8/6**
No.8 x 1" 25mm **HTA8/8**

Repair washers

Zinc
M6 x 19mm
i.d 1/4" x o.d. 3/4"
200 per pack
HRW14



Flat washers

Zinc gold "Form
C" metric M8.
i.d 8.4mm o.d.
21mm.Thickness
1.6mm
500 per pack
HFW61



Split pins



500 per pack
3/32" x 1 1/2"
HSP4
250 per pack
5/32" x 1 5/8"
HSP12

Clevis pins



50 per pack
3/16" x 5/8" **HCP1**

Flange nuts



Serrated zinc
metric M8
200 per pack
HSN58

Rivets

Steel rivets



Standard flange 100 per pack
4.8 x 12mm **PRS4**
4.8 x 16.5mm **PRS5**

Peel back rivets

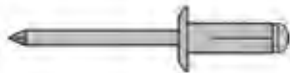

100 per pack
4.8 x 12mm **PR47**
4.8 x 19mm **PR48**

Avex (multigrip) rivets



500 per pack
4 x 12mm **PR3**

Aluminium rivets



Black large flange
100 per pack
3.2 x 10mm **PRB21**

Relays

Electrically operated switch that can be used to isolate the auxiliary battery from the vehicle battery.

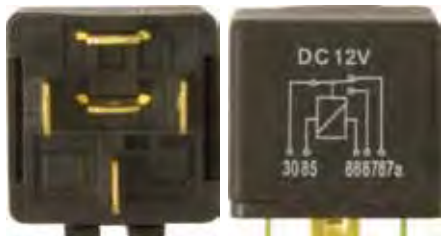

12v 20/30A
Normally open contact
ERL7



12v 40A
Normally open contact
ERL11

Fuses and bulbs

Standard blade fuses



50 per pack
3amp **EFX3**
4amp **EFX4**
5amp **EFX5**
7.5amp **EFX7.5**
10amp **EFX10**
15amp **EFX15**
20amp **EFX20**
25amp **EFX25**
30amp **EFX30**

Blade fuses



50 per pack
1amp **EFB1**
2amp **EFB2**
30amp **EFB30**

Side & tail bulb

BA15s single contact
10 per pack
Carlex bulbs
5w **EB207**
10w **EB245**
Ring bulbs
10w **ER245**



Side & tail bulb

BA15d double contact
10 per pack
Carlex bulbs
10w **EB209**



Capless bulb

W2 x 4.6D
10 per pack
Carlex bulbs
1.2w **EB286**



Stop or flasher bulb

BA15s single contact
10 per pack
Carlex bulbs
21w **EB382**



Stop or flasher bulb

BA15s single contact
Amber
10 per pack
Carlex bulbs
21w **EB581**



Stop/tail & daylight running bulb

BAY15d double contact
10 per pack
Ring bulbs
21/5w **ER380**



Cable connectors

Yellow fits 4 to 6mm² \emptyset cable - **Blue** fits 1.5 to 2mm² \emptyset cable - **Red** fits 0.5 to 1.5mm² \emptyset cable



Push-on female

100 per pack
Red 6.3mm **ET6**
Blue 6.3mm **ET7**
Yellow 6.3mm **ET8**
Yellow 9.5mm **ET12**



Bullets

100 per pack
Blue 5mm **ET16**



Heat shrink butt connectors

Adhesive lined
Red 3.7mm 25 per pack
Blue 5mm 25 per pack
Yellow 6.5mm 10 per pack

ET91
ET92
ET92



Scotchlok connectors

3M no. 560
100 per pack
ESL2



Insulated female

100 per pack
Red 6.3mm **ET9**
Blue 6.3mm **ET10**
Yellow 6.3mm **ET11**



Receptacle socket

100 per pack
Blue 5mm **ET19**



Butt connector

100 per pack
Red 3.3mm **ET33**
Blue 4.0mm **ET34**
Yellow 5.5mm **ET35**



Copper tube terminals

10 per pack
35mm x 8mm **ET73**
35mm x 10mm **ET74**



Push-on male

100 per pack
Red 6.3mm **ET36**
Blue 6.3mm **ET37**
Yellow 6.3mm **ET38**



Ring terminals

100 per pack
Blue 6.4mm **ET26**
Yellow 8.4mm **ET30**
Yellow 10.5mm **ET32**



Terminal block

12 way 10 per pack
5amp **ETB5**
15amp **ETB15**
30amp **ETB30**

Tools



Hose clip driver
175mm shaft, 7mm nut spanner **TL923**



Trimming knife
Metal bodied, heavy duty with snap-off 18mm blade **TL675**



Trimming knife blades only
Snap-off 18mm for TL675. 10 blades per pack, 10 packs per outer **TL666**



Blade dispenser
With 100 heavy duty blades **TL658**



Crimping pliers
Heavy duty **TL934**



Teng Torque wrenches ½" drive

- For both tightening and final checking of torque
- Reversible with lever (right hand action for torque checking only)
- Angular gauge for after tightening
- Graduated in Nm and lbs/ft
- Lockable setting
- Accuracy +/- 4%
- Degree scale for after tightening of cylinder heads
- Satin finish with rubber handle

Range 40-200 Nm, 30-150ft.lb. Length 465mm **TG1281**
Range 70-350 Nm, 50-250ft.lb. Length 632mm **TG1282**



Tubeless valve
Type TR418. Fits 11.5mm hole. Length 61.5mm. Complete with caps. 25 per pack **TY127**



File set
Each with detachable ABS handle. Second cut BS498. 4 pieces in wallet - 2 x Hand 8", 1 x Half-round 8", 1 x Round 8" **TL766**



Emery roll
Blue twill. 50mm width 80 grit. 50 metre roll **WER30**



Torque wrench ½" drive

- Heat treated steel ratchet head.
- Fully hardened and tempered.
- Chrome plated for corrosion resistance.
- Micrometer type torque range adjustment with flip reverse ratchet mechanism.

Range 27-200 Nm, 20-150ft.lb. Length 465mm
Available singly or 10 per outer **105535**

Clips and ties



Hellermann cable ties
Black 100 per pack T30R
150mm x 3.5mm **ECT35**
100mm x 2.5mm **ECT81**



Cable tie base
Self adhesive with 2 screw holes 50 per pack
4.8mm **EAC4**



Eurolok cable ties
Silver-grey 100 per pack
295 x 4.8mm **ECTG53**
370 x 4.8mm **ECTG57**



P clips
4.8mm 100 per pack **EAC405**
6.0mm 100 per pack **EAC406**
9.0mm 100 per pack **EAC409**
12.0mm 100 per pack **EAC412**
19.1mm 50 per pack **EAC419**



O-clips
Double ear 25 per pack
11-13mm **OC3**
13-15mm **OC4**
15-18mm **OC5**



Cable clips
Self adhesive 50 per pack
8mm **EAC2**
14mm **EAC3**

Jobber twist drill bits

Sizes up to 10mm 10 per pack	
1mm	DRM1
1.5mm	DRM1.5
2mm	DRM2
2.5mm	DRM2.5
3mm	DRM3
3.2mm	DRM3.2
3.3mm	DRM3.3
3.5mm	DRM3.5
4mm	DRM4
4.5mm	DRM4.5
4.8mm	DRM4.8

Sizes 10.5mm+ 5 per pack	
10.5mm	DRM10.5
11mm	DRM11
11.5mm	DRM11.5
12mm	DRM12
12.5mm	DRM12.5
13mm	DRM13

5mm	DRM5
5.5mm	DRM5.5
6mm	DRM6
6.5mm	DRM6.5
7mm	DRM7
7.5mm	DRM7.5
8mm	DRM8
8.5mm	DRM8.5
9mm	DRM9
9.5mm	DRM9.5
10mm	DRM10



HSS "sprint" DIN 338



Tool Sets



WOW Display stand available please ask your sales contact for details
60cm Cardboard **105651**

Screwdriver, pliers, & bits tool set (45 pieces)



Consists of a screwdriver handle with magnetic bit holder, 6 x screwdrivers supplied on wall rack, 6 x precision screwdriver, 30 x 25mm screwdriver bits. 150mm combination pliers, and 150mm side cutting pliers. 8 per display unit **105519**

Screwdriver tool kit (15 pieces)



Consists of a 2 in 1 screwdriver handle with box, 1 x spirit level, 5 x 25mm bits: PH1, PH2, SL4, SL5 and SL6, 1 x 1m tape measure, 1 x adaptor and 4 x drive socket 7, 8, 9 and 10mm.
8 per display unit **105571**

Mechanics tool kit (52 pieces)



Ideal roadside emergency tool kit. Contents: 150mm long nose pliers, 150mm diagonal pliers, 150mm adjustable wrench, 125mm lock wrench pliers, 8 piece star key set, $\frac{3}{8}$ " Dr ratchet, ratchet spin disc, 75mm extension bar, 1 x $\frac{3}{8}$ "- $\frac{1}{4}$ " Dr adaptor, 3 x $\frac{1}{4}$ " Dr 8 point sockets, 4 x $\frac{3}{8}$ " Dr sockets, 28 x $\frac{1}{4}$ " Dr sockets, and hard case. Available singly or 8 per outer **105575**

Mini trifold tool kit (26 pieces)



Contents: 10 x 25mm bit assortment, magnetic tip screwdriver bit handle, mini long nose pliers, mini side cutting pliers, tweezers, 4 x $\frac{1}{4}$ " Dr sockets, 75mm extension bar, 6 x precision screwdrivers, and hard case. Available singly or 40 per outer **105573**

Household tool kit



Contents: Stubby claw hammer, 150mm combination pliers, 22pc precision screwdriver set, 2pc spirit level, 2pc snap off blade knife, 3m tape measure, 2pc screwdriver, 2pc precision screwdriver + 600 piece house hold assortment. Available singly or 8 per outer **105576**

Tool kit (161 pieces)



Consists of a 8oz stubby claw hammer with magnetized tip, 4 in 1 pistol grip ratchet screwdriver with bit storage in handle (includes 4 x 25mm screwdriver bits - slot 4, 5, crosspoint PH2, PZ2), magnetic wrist band, 6.5mm masonry drill bit, 3mtr x 16mm tape measure (with pause button on side and base, thumb operated lock, wrist strap and belt clip on reverse) and mini spirit level. Supplied with 65pc picture hanging, and 90pc hardware assortment. 6 per display outer
Yellow/black **105578**
Pink **105579**

Bicycle tool kit



The ultimate bicycle repair and maintenance kit. 32 in 1. Consists of box wrenches, spoke wrenches, hex keys, socket wrench, crosspoint and slot screwdrivers. Complete with puncture repair kit, and two tyre levers. Supplied with canvas type pouch. Available singly or 4 per outer **105586**

50cm tool box



Complete with lift out tote tray. Outer dimensions 485 x 261 x 225mm. Available singly or 12 per display unit **105577**

Hand tools
**Mini folding star driver**

With LED & D-Ring. T8, T9, T10, T15, 1 LED torch (11000-13000MCD), supplied with 4 x AG1 batteries. Overall size folded 50 x 28 x 17mm **105509**

**Folding hex key set**

With LED & D-Ring. HEX: 1.5, 2, 2.5, 3, 4.5mm. 1 LED torch (11000-13000MCD), supplied with 4 x AG1 batteries. Overall size folded 50 x 28 x 17mm **105549**

**Hex key set (10 pieces)**

Chemically blackened. Sizes 1.5, 2, 2.5, 3, 4, 5, 5.5, 6, 8, and 10.0mm. Available singly or 10 per outer **105550**

**Box joint pliers**

Manufactured from drop forged carbon steel. Hardened and tempered. Insulated grips, with seven position positive locking head. Length 250mm. 6 per display outer **105529**

**8" combination plier**

Drop forged. Fully polished heads. Double dipped cushion handles. Length 200mm. 10 per display outer **105527**

**Side cutting pliers**

Drop forged. Fully polished heads. Double dipped cushion handles. Length: 180mm. 20 per outer **105531**

**10" adjustable wrench**

Drop forged. Heat treated steel. Fully polished jaw faces. Rubber dipped comfort grip handle. 6 per display outer **105533**

**Combination spanner set (5 pieces)**

Drop forged, heat treated, and chrome plated (8, 10, 12, 13, 17mm) Supplied on plastic storage rack. 12 per display outer **105560**

**Stubby screwdriver set (38 pieces)**

Consists of stubby ratchet screwdriver. Sizes include Star T10, T15, T20, T25, T27, T30, T40. Square 1, 2, 3. PZ0, PZ1, PZ2 x 2pcs, PZ3. PH0, PH2 x 2pcs, PH3 Hex H2, 3, 4, 5, 6, 1/8", 5/32", 3/16", 7/32", 1/4" Slot 3, 4, 5, 6, 7mm. 6 per display outer **105516**

**Ratchet screwdriver (16 pieces)**

Consists of a ratchet screwdriver, 50mm 1/4" Dr socket extension, 10 x 25mm screwdriver bits (slot 4, 5, 6mm, PH1, PH2, PH3, PZ1, PZ2, PZ3, 1/4" Dr adaptor), and 4 x 1/4" Dr sockets (5, 6, 10, 11mm). 10 per display outer **105515**

**Cushion handle screwdriver set (2 pieces)**

Consists of: 1 x 100mm crosspoint PH2 and 1 x 100mm slotted 6. Manufactured with Chrome Vanadium shaft and soft cushion grip. 10 per display outer **105517**

**Screwdriver set (4 pieces)**

Manufactured from carbon steel, with plastic handles. 1 x 75mm slot 5, 1 x 38mm slot 6, 1 x 75mm crosspoint PH1, and 1 x 38mm crosspoint PH2. 20 per display outer **105510**

**Screwdriver set (7 pieces)**

Manufactured from chrome vanadium, with cushion grip handles and magnetic tips. 1 x 100mm slot 5.5, 1 x 38mm slot 6.5, 1 x 75mm slot 3, 1 x 100mm PZ2, 1 x 38mm PZ2, 1 x 75mm PH1 and 1 x 38mm PH2. 6 per display outer **105511**

**6 in 1 precision screwdriver**

Simply select the desired bit and engage the blade by pushing the black button to the tip of the driver. Contains 6 x 25mm screwdriver bits (slot 1.5, 2, 2.5, crosspoint PH1, PH00, PH0). Available singly or 12 per outer **105518**

**LED precision screwdriver**

Aluminium screwdriver handle with LED straw light, 1500 MCD with pocket clip. Contains 6 x 25mm screwdriver bits (slot 1.5, 2, 3, crosspoint PH1, PH00, PH0). 4 x LR41 cell batteries supplied. 8 per outer **105514**

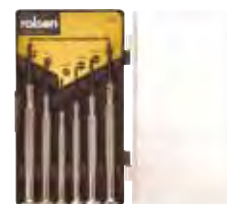
**Precision screwdriver set**

Contains 6 x precision screwdrivers (slot 1.4, 1.8, 2.3, 3, crosspoint PH0, PH1). 20 per display outer **105513**



Tools and Accessories



3 LED magnetic pick up tool

Easily retrieves small objects from confined areas. With 3 bright LED's to help retrieve metallic objects. Adjustable length extends from 170 to 545mm. Maximum weight capacity 2.27kg. Supplied with 3 x LR44 button cell batteries. 12 per outer **105588**



Telescopic inspection mirror

Stainless steel tube with ABS protected mirror head. Mirror 42 x 65mm. Adjustable from 29 to 87cm. 2 LEDs on mirror head. Batteries supplied. 12 per outer **105589**



Safety utility knife

Spring activated blade that automatically returns to case after use. 12 per outer **105545**



Tape measure with key ring spirit level

3m x 16mm width blade. Impact resistant. With carry strap and belt clip, and thumb lock. 12 per outer **105537**



Tape measure with rubber cover

Automatic blade lock, push button retrieval, and belt clip. 12 per outer
5m x 19mm **105539**
7.5m x 25mm **105540**



Knife blade set

Standard two notch blades supplied in plastic containers. 20 pieces per pack. 24 packs per outer **105546**



Multi tool 12 in 1

Folds down to 100mm. Tools include: pliers, wire cutters, file, saw, small and large slotted screwdriver, knife, crosspoint screwdriver, fish scaler, hook, ruler, and canvas belt pouch. 6 per display unit **105522**



Multi function pocket knife

Contains: can opener, saw, scaler, hook, scissors, slotted and crosspoint screwdriver, bottle opener, corkscrew, needle, nail file, bradawl, knife, and canvas type pouch. 6 per display unit **105548**



9 function multi tool

Manufactured from stainless steel, with rubber inserts on grip. Nine functions include: knife, saw, nail file, bottle opener, hammer head, combination pliers, wire stripper, slotted screwdriver, crosspoint screwdriver. Complete with canvas type carry pouch. 6 per display unit **105523**



Mini multi tool set

Contains: Mini multi tool - 6 functions include: knife, bottle opener, saw, cross point screwdriver, pliers, and belt clip carabiner. Mini multi knife - 10 functions include: can opener, knife, scissors, bottle opener, slotted screwdriver, crosspoint screwdriver, corkscrew, nail file/cleaner, and supplied with key ring facility. 7 per display unit **105521**



9 in 1 Multi tool with axe

Manufactured from stainless steel, with wooden inserts. Nine functions include hammer, nut holder sizes 16 & 12mm, axe, cross point screwdriver, mini saw, file, ruler, and knife. Folded size 165mm, complete with canvas type pouch. 5 per display unit **105524**



Stubby claw hammer

Extra strong high grade carbon steel. Soft rubber grip. Magnetized nail holder. Weight 8oz. 12 per display unit **105501**



Stoning hammer 1Kg

Fibreglass shaft and rubber handle. 6 per outer **105505**



Stubby camping axe

450g. Manufactured from carbon steel. Ground cutting edge and TPR handle. 8 per outer **105504**



Tools and Accessories

**3 function pocket tool**

Handy pocket tool that contains two double ended 45mm screwdriver bits (slot 3, 5, PZ1, PZ2). Item is flat on one side and has a built in spirit level. Complete with magnetic bit holder, LED light and pocket clip. 24 per display outer **105520**

**Aluminium hacksaw**

Easy release mechanism for removing and inserting blades. Aluminium alloy frame. Comfortable rubber handle. Blade adjusts to 6 cutting positions. Available singly or 40 per outer **105557**

**Cable tie pack (150 pieces)**

Nylon. Includes: 2.5 x 100mm (100), 2.5 x 160mm (25), 4.8 x 190mm (25). Available singly or 48 per outer **105559**

**Spectacle repair kit**

Contains: 4 x nose pads, 4 x side screws, and 4 x nose screws, double ended screwdriver (crosspoint and slot) and resealable container. 12 per display unit **105587**

**Grommet assortment**

For use in replacing worn or broken grommets in leaky taps, hoses and more. Black PVC construction. 140 assorted pieces. Includes: 30 x 6.4mm, 30 x 8.0mm, 30 x 9.5mm, 20 x 11.0mm, 20 x 12.5mm, 4 x 15.9mm, 3 x 22.2mm, 3 x 25.4mm. 6 per outer **105564**

**Washer assortment**

250 assorted pieces. Copper washer: 10 x 04, 10 x 05, 10 x 06, 10 x 08, 5 x 010, 5 x 012. Lock washer: 30 x 04, 25 x 05, 15 x 06, 15 x 08, 10 x 010, 5 x 012. Flat washer: 30 x 04, 25 x 05, 15 x 06, 15 x 08, 10 x 010, 5 x 012. 6 per outer **105563**

**Rolson 4 piece caulking tool kit**

Complete with nylon brush with scraper & 3 piece sealant finishing tool. 8 per display outer **107086**

**Rolson silicone scraper & tool**

6 per display outer **107085**

**Rigger glove**

Heavy duty cuff and manufactured with protective leather on palm and fingers along with reflective strip across knuckle. 12 pairs per display outer **105555**

**Gel knee pads**

Industrial strength cap for easy movement. Thick memory foam for extreme comfort. Neoprene strap fastens below knee, one size fits all. Loop straps for extra secure fit. Available singly or 12 per outer **105556**



WOW Amazing value

Bike kit (5pc)

Contains: One 5 LED front light (3 x AA batteries not supplied), one 5 LED back light (2 x AAA batteries not supplied), one 10mm x 650mm PVC coated lock with 2 keys and two reflective bands with buckles (30 x 180mm) Available singly or 4 per outer **106368**

**7" eyelet plier set**

Designed to punch and secure eyelets into many materials including sheeting, tarpaulins, and cloth. Complete with 100pc x 7mm eyelets. Length 190mm. 10 per display outer **105502**

**Drain cleaner**

For clearing blocked waste pipes, fully plated steel probe with integrated handle. 6mm² length 1800mm. 12 per outer **105553**

**Fill no spill funnel**

Simply clip on necks of most commonly used bottles for simple pouring of liquid without spillage. 12 per display unit **105590**

**Wire brush**

Heavy duty wire brush with brassed steel wire. Comfortable grip handle. 12 per outer **105595**

W4 fixings range

'Pack-it' stand complete with 10 of all 24 items below Part no. **103470**

All supplied 10 packs per outer

Self-Tapping Countersunk (5)			Stainless Steel
Size			
½"	No.4	13 x 2.9mm	103432
½"	No.6	13 x 3.5mm	103433
¾"	No.6	19 x 3.5mm	103434
¾"	No.8	19 x 4.2mm	103435
¾"	No.10	19 x 4.8mm	103444
1"	No.6	25 x 3.5mm	103436
1"	No.8	25 x 4.2mm	103437
1"	No.10	25 x 4.8mm	103438

Self-Tapping Pan Head (5)			Stainless Steel
Size			
½"	No.4	13 x 2.9mm	103418
½"	No.6	13 x 3.5mm	103419
½"	No.8	13 x 4.2mm	103439
¾"	No.6	19 x 3.5mm	103420
¾"	No.8	19 x 4.2mm	103421
¾"	No.10	19 x 4.8mm	103441
1"	No.6	25 x 3.5mm	103422
1"	No.8	25 x 4.2mm	103423
1"	No.10	25 x 4.8mm	103424

Polytop Pins (10)		
¾"	(20mm) plated	103427
¾"	(20mm) plated bulk (500)	013427B
1"	(25mm) plated	103428
1"	(25mm) plated bulk (500)	103428B
1"	(25mm) s/steel	103416

Screw Covers (5)		Peel Rivet (5)
Plastic. To fit screw size 6 to 8, 4.2mm, Beige 103447		¾" x ¾". 4.8 x 30mm 103446

Cavity fixer rubber (2)
103429

Cavity fixer metal (2)
103430

WOW All W4 pack-it items can be ordered loose at a preferential rate. Please speak to your sales contact for details.

W4 Door retainers



Lever release
Black **104797**
Grey **104796**
White **104795**



Quick release barrel
Black **104798**
Grey **104798G**



W4 metal barrel
To fit door thickness 27-31.8mm **104799**



W4 plastic barrel
To fit door thickness 27-31.8mm **104800**

Catches and water

'Pack-it' stand complete with all 48 items below (except *) Part no. **104849**
All supplied 10 packs per outer



Nylon door retainer
104801



Plastic door retainer
104802

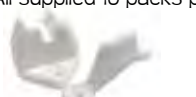

Veneta door retainer
104803



Viva door retainer
104848



Extended Viva door retainer
104847



Magnetic catch
104823



Double roller catch (2)
Brown **104817**



Rocker catch
White **104818**



Panco catch
White **104819**



Roller catch
Brown **104821**



Mini latch
104822



Magnetic catch heavy duty
104824



Plastic turnbuckle
104810



Metal turnbuckle
104811



Plastic hinge (2)
Brown 1½" (45mm) **104825**



Flush hinge (2)
2" Bronze 50mm **104826**
1½" Brass 38mm **104844**



Cranked hinge (2)
2" Bronze 50mm **104827**



Sliding door gliders
(tombstone) **104835**



Push-in vent (2)
Beige **104815**



Hexagonal vent (2)
Beige **104816**



Pipe clip (5)
½" (6mm) **104828**
⅝" (16mm) **104829**
¾" (9mm) **104830**
1" (25mm) **104831**
1¼" (31mm) **104809**



Hose connector straight
½" (12mm) **104838**
¾" (19mm) **104841**



Hose connector Y
½" (12mm) **104839**
¾" (19mm) **104842**
28.5mm **051139 ***



Hose clip (2)
000/M00 (8-16mm) **104832**
00 (12-22mm) **104833**
0X (16-27mm) **104834**
1X (25-45mm) **104836**



Gas bottle locker catch
plus padlock **104808**



Sink top retainer
104812



Cupboard stay
150mm **104846**



Hose sealing sleeve
23.5mm **104806**
28.5mm **104807**



Hose connector elbow
½" (12mm) **104805**

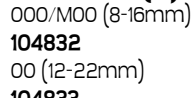

Hose connector reducer
¾" x ½" (10 x 12mm) **104837**



Combination padlock
104813



Target leveller
Adhesive **007297**
Magnetic **007298 ***



Air bed plugs
109480



Universal tap connector
104845



Hose connector T
½" (12mm) **104840**
¾" (19mm) **104843**

Catches and fittings 2

Pack-it stand complete with 10 of all 24 items below Part no. **104898**
All supplied 10 packs per outer



Table support catch
104855



Double roller catch
Metal 104857



Pegaline catch
104856



Decmo catch
104860



Cord locks (2)
109479



Wardrobe rail support end (2)
5/8" (16mm)
104850



Flush hinge with finials (2)
Brass 2" (50mm)
104864



Flush hinge with finials (2)
Bronze 2" (50mm)
104865



Flush hinge
Brass 2" (50mm)
104862



Cranked flush hinge (2)
Brass 2" (50mm)
104863



Nylon hinge (2)
2" (50mm)
104868



Barrel hinge (2)
104867

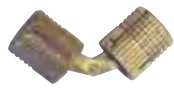

Concealed hinge (2)
12mm 104881



Brass bolt
2" (50mm)
104872



Brass necked bolt
2" (50mm)
104873



Turnbuckle set
104870



Turnbuckle spacer
104869



Single turnbutton (2)
104852



Identitags (4)
001135



Metal cupboard stay
140mm 104853



Locker stay (1)
130mm 104861



Lock cover (2)
104854



Cupboard door stops (12)
104871



Suction cup and hook
2 per pack 104859

Catches, hinges and fasteners

WOW All packaged with Grove logo • 10 packs per outer



Nylon door retainer
104002



Viva door retainer
104004



Plastic door retainer
104011



External catch
104790



Roller catch
Brown 104106
White 104107



Turn button, spacer & striker
Beige 104030
Ivory 104033



Plastic turnbuckle
104037



Metal turnbuckle
104048



Stable door catch beige
104015



Double roller catch (2)
104108



Metal cupboard hinge
104200



Metal overhead stay
104202



Cupboard stay
150mm 104301



Kitchen flap support bracket
104323



Table storage bracket (2)
104187



Stable door bolt
104176



Greenfield latch
104132



Sink top clip
051239



Panco catch
104077



Anti rattle fastener (2)
104019



Flush hinge (2)
Bronze 2" (50mm)
104220



Butt hinge (2)
With stainless steel pin 2" (50mm)
104229



Plastic flap hinge (2)
104209



Cranked flush hinge (2)
50mm
104222

Push Locks



Push lock Single

With one side opening. Cupboard catch opens from outside only

White **103500**
Brown **103502**
Matt Nickel **103504**



Mini push lock single

With one side opening. Cupboard catch opens from outside only

White **103522**
Brown **103524**
Matt Nickel **103526**



Push lock double

With dual side opening. Toilet door catch opens from both sides

White **103512**
Brown **103514**



Push lock with rod

3 point locking. For long cupboards, use single side opening. For toilet doors, use dual side opening. Includes fittings. Rod length 2m

White	Single Sided	103506
White	Double sided	103518
Brown	Single Sided	103508
Brown	Double sided	103520
Matt Nickel	Single sided	103510

Button and rose

Button 23mmØ x H 19mm
Rose 38mmØ x H 7.5mm

Chrome **103528**
Brown **103530**
Brass **103532**
Matt Nickel **103534**



Mini button and rose

Button 16mmØ x H 16mm
Rose 24.5mmØ x H 7mm

Matt Nickel **103536**
Brown **103538**



Blind and rooflight spares



Remis clip grey

Closing clip for Remismart
105200



Remis clip grey

Closing clip for Remistar rooflight
105222



Remis end cap

Left **105202**
Right **105204**



Remis end cap covers

105206



Remis spring mechanism

105216

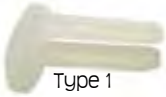

Type 1

Remis insert type 1

105210

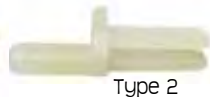

Type 2

Remis insert type 2

105212



Remis additional spare parts

105220



Remis repair kit

105214



Remis mechanism end supports

105218



Remis mechanism (2)

105208



Window blind spares



Retaining knob

105224



Long handle

105226



Blind lock long

105232

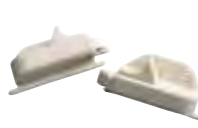

Blind lock

105254

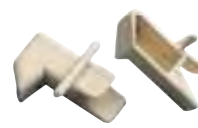

Retaining hook

105252



Guides

Left and Right
105234



End cap cover

Left **105228**
Right **105230**



Rail end

Left **105248**
Right **105250**



End piece

105240



Clip beige

105244



Mechanism (end)

105236



Spring 285mm
105242



Spring 295mm
105246



Spring 360mm
105238



Window fittings and accessories

All polyplastic window fittings are available in either a 'standard' screw-on fitting or the more recent variant of the side-on 'Polyfix' design.

The slide-on 'Polyfix' design are easily recognisable by the deep groove moulded into the back of the window fitting. It is this that slides over the adaptor fitted to the window.



How to measure

Stay lengths are found by measuring between points A and B as shown here.



Blister packed

All Polyplastic window stays are sold blister packed in pairs unless otherwise stated.



Screw on fitting

Supplied in pairs with all fittings unless otherwise stated

Tube stays with lever lock



Size	Polyplastic no.	Grove no.
200mm	9.00.152.00.00.	105300
300mm	9.00.154.00.00.	105303

Tube stays with perma-fix end



Size	Polyplastic no.	Grove no.
140mm	9.00.751.00.00.	105310

*Right hand stay only no fittings

Auto stays with lever lock



Size	Polyplastic no.	Grove no.
230mm	9.00.162.00.00.	105305
280mm	9.00.164.00.00.	105308

Auto stays with perma-fix end

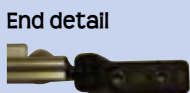

Size	Polyplastic no.	Grove no.
210mm	9.00.766.00.00.	105312
300mm	9.00.768.00.00.	105315

Lever lock catch



Item	Polyplastic no.	Grove no.
Catch complete	9.00.451.90.	105322

Polyfix slide on fitting

Supplied in pairs of stays only - no fittings

Tube stays with lever lock



Size	Polyplastic no.	Grove no.
200mm	9.05.152.00.00.	105350
300mm	9.05.154.00.00.	105353

Tube stays with perma-fix end

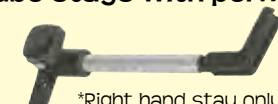

Size	Polyplastic no.	Grove no.
140mm	9.05.751.00.00.	105360

*Right hand stay only

Auto stays with lever lock



Size	Polyplastic no.	Grove no.
230mm	9.05.162.00.00.	105355

Auto stays with perma-fix end



Size	Polyplastic no.	Grove no.
200mm	9.05.766.00.00.	105362

Lever lock catch



Item	Polyplastic no.	Grove no.
Catch only	9.05.451.00.	105372

Other window accessories



Item	Polyplastic no.	Grove no.
200 series toggle catch	9.00.440.90.	105320

Supplied as packed singles with all fittings



Item	Polyplastic no.	Grove no.
Lock plate (2)	9.00.715.00.00.	105326
Large		105324
Small		



Item	Polyplastic no.	Grove no.
Pop-out window stay	9.00.715.00.00.	105318

Supplied as packed singles with all fittings



Item	Polyplastic no.
End caps Polyplastic (2)	105398

Loose, black



Item	Polyplastic no.
End cap cover	105396

Loose, brown

Curtain track and fittings



Furniglyde Track (2.5m)
 5 lengths per outer **105011**
Glidors (20) 10 packs per outer **105033**
Button hooks (20) 10 packs per outer **105022**
End stops (2) 10 packs per outer **105044**
Curtain hooks (25) 20 packs per outer **105055**

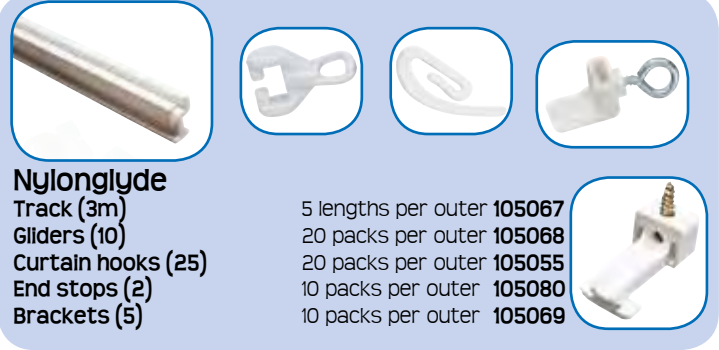

Nylonglyde Track (3m)
 5 lengths per outer **105067**
Glidors (10) 20 packs per outer **105068**
Curtain hooks (25) 20 packs per outer **105055**
End stops (2) 10 packs per outer **105080**
Brackets (5) 10 packs per outer **105069**



Top track 105005
Bottom track 105006

Visa curtain system
Top track (2m) 5 lengths per outer **105005**
Bottom track (2m) 5 lengths per outer **105006**
Pop-it tape 25m roll **105009**
Pop-it tape 200m **105010**
End stops (2) 20 packs per outer **105007**

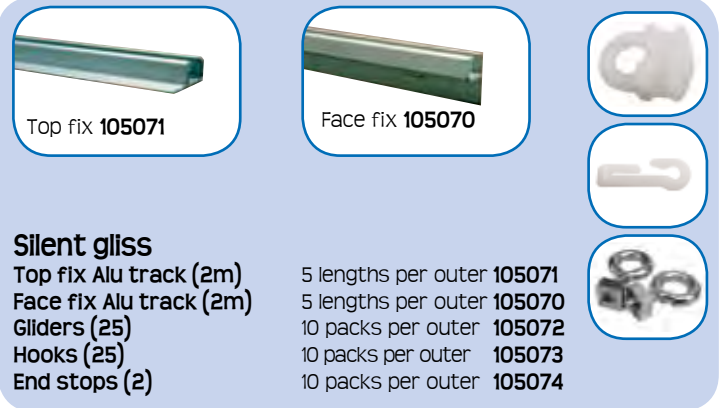

Top fix 105071
Face fix 105070

Silent gliss
Top fix Alu track (2m) 5 lengths per outer **105071**
Face fix Alu track (2m) 5 lengths per outer **105070**
Glidors (25) 10 packs per outer **105072**
Hooks (25) 10 packs per outer **105073**
End stops (2) 10 packs per outer **105074**

Awning rail



Aluminium awning rail
 2.12 metre lengths. 4mm opening. 9mm internal diameter, 12mm external.
 10 lengths per outer **105099**



Plastic awning rail
 Pre-drilled 2.5 metre lengths
 10 lengths per outer **105088**



Sprite curtain clips (20)
 For use with curtain wire
 10 packs per outer **105077**

Panel Trims



Panel trim 15mm
 With single lip. Supplied in 10m lengths
 Brown **105184**
 Grey **105186**



Sealing panel trim 15mm
 With sealing rubber. Supplied in 10m lengths
 Brown **105188**
 Grey **105190**



Door sealing panel trim 15mm
 With sealing bubble for doors. Supplied in 10m lengths
 Brown **105192**
 Grey **105194**

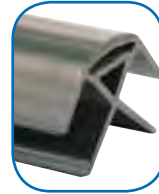

Corner Trim 16mm
 2.2m lengths
 Brown **105196**
 Grey **105198**

Table strip



Two part table hinge length 600mm
105167

Window trim



White plastic supplied in 10m rolls. Please note that the trim is measured by the size of the wood that the trim fits over and not the size of the trim.

30mm - 1 1/5"	105130
35mm - 1 3/5"	105135
39mm - 1 1/2"	105139
45mm - 1 3/4"	105145

Battery box seal



Supplied in 2m lengths. Pre-masticated
105170

Steps

**Single step**

Rigid metal based step light in weight but sturdy construction.

H260mm x W395mm x Overall depth 415mm.

Capacity 150kg maximum total load.

Available singly or 10 per outer **106198**

**Double step**

Rigid metal based step light in weight but sturdy construction.

H350mm x W440mm x Overall depth 760mm.

Capacity 150kg maximum total load.

Available singly or 5 per outer **106211**

**Folding step stool**

Stool is designed to fold flat for easy carrying and storage, with a capacity up to 200lbs, also very sturdy and robust. 20 per outer

106220

**Flat packed double step**

Space saving double step, folds flat for easy storage when not in use. 12 connection points (no tools required) for extremely sturdy performance.

H350mm x W440mm Overall depth 760mm.

Capacity 150kg maximum total load.

Available singly or 5 per outer **106219**



Steps and accessories

**Fiamma magnum step**

Oversized and reinforced step. HxWxD 24 x 58 x 40cm. Top surface - 48x28cm. Approved to hold 200kg. Colour platinum. Available singly or 10 per outer **106201P**

**Fiamma step mat**

Made of soft and flexible anti-skid UV resistant rubber. Dimensions 45 x 27cm **106205**

**Fiamma LED step light 12v**

Low consumption lighting system for the entrance of the motor home, to increase safety of the steps and step wells. Made from anodized aluminium, it can be shortened from 50 to 23 cm **106204**

FIAMMA Table leg system



Fiamma table leg system

The 70cm table leg is made from sturdy anodised aluminium – the leg can be cut to reduce height. It is supplied with two plastic caps. The above floor and recessed bases are also aluminium and supplied with self-threading fixing screws. There is also a reinforced and more stable tripod base for outside use.

- Table leg 70cm aluminium **106001**
- Above floor base aluminium **106024**
- Recessed base aluminium **106036**
- Cap for recessed base **106038**
- Tripod base brown **106039**

Table legs



Island table leg system

- 26" stainless steel **106004**
- 28" chrome plated **106014**



Island leg clip
106093



Above floor base
Silver **106025**



Recess base
Silver **106037**



Free standing table legs

Folding table leg, powder coated steel 660mm high. Square section. Available singly or 5 per outer
Silver sand **106091**
Brown **106092**



Folding table leg

Tubular steel leg 26". Available singly or 5 per outer **106099**



Single table leg

27" but can be cut to size required. Available singly or 5 per outer **106115**

FIAMMA Ladder

Deluxe 5D ladder
High quality exterior ladder in anodized aluminium with 10 steps. Inside width: 24cm. Total step width: 31cm. Non-skid steps. It can be folded up while travelling. **106225**

FIAMMA CARRY-BIKE®

Carry bike Pro

Specially reinforced for strength and with its telescope rail support, can be extended up to 74cm from the vehicle wall. Sturdy rail support in stainless steel. Standard version for 2 bikes (supplied with bike blocks 1 & 3), addition of a further 2 rails means up to 4 bikes can be carried. Certified to carry up to 60kg **106353**

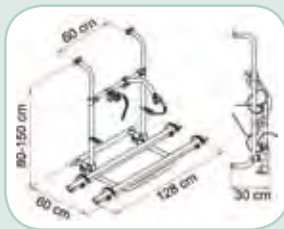

Carry bike Pro C

More compact design than the pro C for a built to last premium quality carrier. Suitable for installation under the rear window with the removal of the upper part. Standard version for 2 bikes (supplied with bike blocks 1 & 3), addition of a further 2 rails means up to 4 bikes can be carried. Certified to carry up to 60kg **106354**

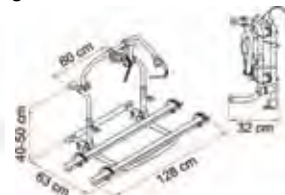

Carry bike 200 DJ

For vans with double rear doors, not necessary to drill holes in the vehicle except for the security screws. Rear door can be opened without removing the bikes. Can be combined with the Deluxe 6 DJ ladder. Supplied with 2 premium rails, 2 bike blocks (106362 bike blocks 1 & 2, 106364 bike blocks D1 x 2), a rack holder, installation bracket and fixing-bar. Certified to carry up to 35kg



Fiat Ducato after June 2006 **106362**
Fiat Ducato, Peugeot Boxer, Citroen Jumper/Relay and Ford Transit after 2000. Also Mercedes Sprinter before 06/2006 **106364**

Carry bike UL

Universal bike carrier with compact dimensions, suitable for both caravans and motor homes. Supplied with bike block 3 and rack holder to carry 2 bikes. Can be cut and shortened or adjusted to fit various installation heights. Certified to carry up to 55kg **106352**

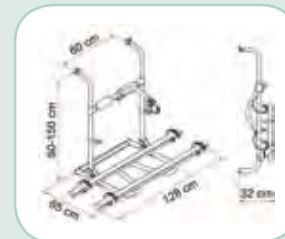

Carry bike Trigano - CI - Roller Team

Provided with a fixed structure and height of 39.5cm it comes without the upper and lower fixing kit (with wheelbase of 60cm) that is already installed only on CI & Roller Team. Supplied with 2 rail quick red, bike block 3, rack holder & security strip. Certified to carry up to 50kg **106355**

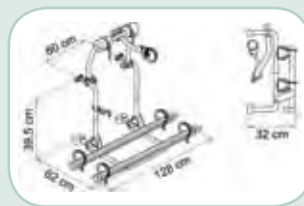

Carry bike L80 Laika

Special version of bike carrier Pro C with 80cm wheelbase, suitable for Laika motor homes. Supplied with 2 rail quick 128 red, 2 bike blocks (1 & 3), 2 rack holder & security strip. Certified to carry up to 60kg **106357**

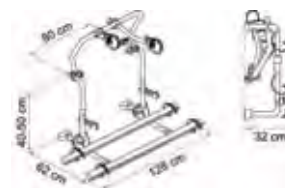

Carry bike caravan XL A

Fits all caravans with a standard A frame, Hobby type (with extended frame) and new AL-KO frame. Carries 2 bikes. Pivots forward allowing access to the storage compartment. The installation does not require drilling. Supplied with 2 fastening strips to fix the bikes. Certified to carry up to 35kg **106366**



Carry bike caravan XL A Pro 200

Carries 2 bikes. Pivots forward allowing access to the storage compartments, even with the bikes mounted. Supplied with 1 quick and 2 mini rail, 1 Strip for the first bike, 1 Bike block 2 for the second bike. Certified to carry up to 50kg **106367**

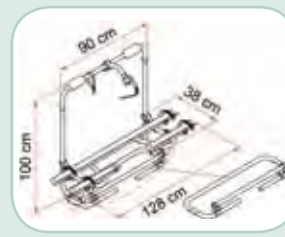

FIAMMA CARRY-BIKE® accessories

Bike block Pro

New and improved rapid and safe bicycle fixing system. The quick front clasp with its large base adapts to all round and oval bike tubes having diameters of 25 to 100mm. Suitable for all Carry bike models.

- Bike block 1 **106372**
- Bike block 2 **106373**
- Bike block 3 **106374**
- Bike block 4 **106375**



Rail quick 128 red

Sturdy rail 128cm in length with reinforced double thick base. Easy to install on the Carry bike thanks to its ready drilled holes. Complete with 2 sliding quick-safe strips **106386**



Rail quick C red

Telescopic rail can be adjusted to the desired extension, adjustable from 101 to 167cm. Supplied with 2 quick safe straps. Ideal to limit rail overhang. It can be easily installed on almost all bike carriers **106387**



Fiamma quick-safe

Sliding safety lock system. Can be installed only on original Carry bike reinforced rails. Will not rust **106390**



Carry bike support Bar

Kit of 2 perforated smart bars to fix the carry bike on the walls of the motor homes. Made of sturdy and light anodized aluminium. Complete with through screws, internal fixing brackets and end caps. Dimensions 74 x 4cm **106393**



Fiamma bike cover S

Reinforced polyester material. It is lightweight and waterproof. It adapts to load size thanks to its adjustable straps. Comes with a transparent pocket to insert the rear signal plate. Not suitable for roof mounted bike racks. Covers 2-3 bikes. Colour platinum **106370**



Rear signal

For motorhomes, caravans and 4-wheel drive vehicles. Made from lightweight plastic material with 4 reflectors. 50 X 50cm **106395**



Bike rail end cap

Red **106377**



Fiamma strip kit

Kit of 2 original strips with stainless steel 18/10 buckle. Fits the majority of cycle carrier brands. Length 39cm. Width 13mm. 2 per pack **106388**



Carry bike Top fixing kit

106394

Bicycle accessories



Bike kit (5pc)

WOW Amazing value

Contains: One 5 LED front light (3 x AA batteries not supplied), one 5 LED back light (2 x AAA batteries not supplied), one 10mm x 650mm PVC coated lock with 2 keys and two reflective bands with buckles (30 x 180mm)

Available singly or 4 per outer **106368**



Deluxe bicycle cover

Water resistant nylon cover to protect up to two bikes. It has two Velcro flaps to allow it to be mounted on most bike carriers. Two webbing straps tighten the cover to reduce flapping when being transported. Dimensions 190cm x 140cm **106399**



W4 Hi-vis cargo straps

A pair of highly visible, quick to use velcro straps. Simply thread the strap through the nylon buckle, adjust to size and fasten it back on itself. Length 400mm **109514**



W4 Cargo straps

A pair of retaining straps (3m approx) with durable nylon grip-lock buckles - won't mark or scratch **109513**

Witter cycle carriers



ZX89

Fitted and removed in seconds, holds up to 3 or 4 cycles depending upon the type and size. Maximum load 65kg. Flanged bracket fits behind the towball, designed to be used whilst towing. Supplied complete with individual cycle retaining clamps **106301**



ZX99

Specification as ZX89 but designed for vehicles with a rear mounted spare wheel and a small overhang (up to 110mm) e.g. Landrover Discovery **106303**

WOW Display stand available. Please speak to your sales contact for more details.

Assorted accessories



Fiamma Drip stop

Prevents black streaks from forming on the side of the vehicle. Made from a wide based polyvinyl. Superior quality adhesive and aluminium reinforced strips guarantee long life and hold over time

- 75cm **108277**
- 300cm **108278**



Motorhome dirt skirt

Keeps the rear of the motor home including windows and cycles clean, protecting against dirt, splashes and slush. Kit contains 2 lengths of dirt skirt 122cm wide x 57cm deep **106400**



		F45 S (see page S6)	F45 L (see page S6)	Caravan- store (see page S4)	Fiamma Zip (see page S10)	Caravan- store Zip (see page S9)
Vehicle	Motorhomes and Motorcaravans	●	●		●	
	Caravan	●	●	●	●	●
	Vans, 4x4s and cars	●				
Characteristics	Maximum length cm	450	550	440	450	440
	Maximum extension cm	250	250	225	250	225
	Minimum weight kg	13	38.8	6.1	27.5	9.1
	Maximum weight kg	30	46.2	13	39	13.1
	Installation kit	●	●		●	
	Winch opening	●	●		●	
	Manual opening			●		●
	Support arms (to the wall)	●	●	●	●	●
	Support legs (to the ground)	●	●	●	●	●
	Auto lock	●	●		●	
	Dual security	●	●		●	
	One way roll	●	●		●	
	Dual shock-absorber	●	●		●	
	Presto-fix	●	●		●	
	Double guide	●	●	●	●	●
Case box	Aluminium box (Polar White or Titanium)	●	●		●	
	Soft box, grey PVC			●		●
Canopy colour	Deuxe Grey or Blue Ocean	●	●	●	●	●
	Sahara, Evergreen, Bordeaux or Pearl Grey	● (special order)	● (special order)			
Enclosures	Enclosure (Privacy Room)	● (S7)	● (S7)	● (S4)	●	●
	Blocker Pro	● (S7)	● (S7)	● (S5)		
	Side blocker (Side W pro)	● (S7)	● (S7)	● (S5)		
	Side blocker (Side W)	● (S7)	● (S7)	● (S5)		

● Standard ● Optional (page no.)

Case colours



Polar White Titanium Deep Black

Case: in extra strong extruded aluminium. Very light yet highly resistant with external Polar White, Titanium or Deep Black coating.



REINFORCED BAG SOFT BOX

Reinforced bag with anti-scratch tape and wall fixing kit in rubber!

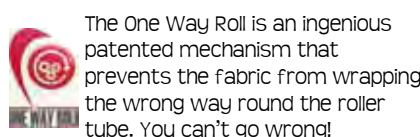

ONE WAY ROLL

The One Way Roll is an ingenious patented mechanism that prevents the fabric from wrapping the wrong way round the roller tube. You can't go wrong!

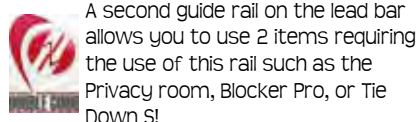

SECOND GUIDE RAIL

A second guide rail on the lead bar allows you to use 2 items requiring the use of this rail such as the Privacy room, Blocker Pro, or Tie Down!

Canopy colours



Italian Design anti-scratch canopies printed on both sides and along the whole length in vibrant colours, without seams and high resistance to UV rays.

*Deluxe Grey and Blue Ocean held in stock, other colours available by special order. Lead times will vary.



LEGS IN

The legs are inside the rollertube, easy to take out and install as they are hinged and telescopic, so they cannot fall down or be lost.

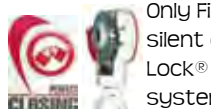

WINCH CLOSING

Only Fiamma awnings have a silent opening TÜV certified Auto-Lock® self-locking winch safety system: with its long life Aluminium mechanical parts it offers a quality product vastly superior to other comparable mechanisms on the market. The security of Fiamma awnings is also guaranteed by the Dual Security® system. The device indicates the correct closure of the facia by two small plastic flags inside the side end caps.



DUAL SECURITY



- Anti-scratch coat
- Printed vinyl
- Adhesive
- Strong Polyester fabric
- Adhesive
- Printed vinyl
- Anti-scratch coat



PRESTO FIX

Only Fiamma has the new patented adjusting system that enables you to adjust the closing of the facia. If over a period of time, one side should stop closing perfectly due to fabric and arm movements, you can use Presto Fix to realign it.

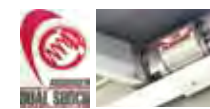

DUAL SHOCK

Only Fiamma has the Dual Shock-Absorber® which protects both your vehicle and your awning. The arms are fixed with the certified double bolts system "Double Block" which grants more stability and ease of tensioning.

CARAVANSTORE FIAMMA



Blue Ocean

Deluxe Grey

The easy to use, sturdy and lightweight bag awning with manual operation. The only awning for caravans and minivans with tubular rewind for wrinkle-free fabric. The Fiamma Caravanstore is easy to use and install: it takes only seconds to roll it out completely. The legs are inside the rollertube, easy to take out and install as they are hinged and telescopic, so they cannot fall down or be lost. The roller can be rolled-up either way. Thanks to its patented wide roller the Caravanstore is easy to unroll and roll up, and above all the fabric is wrinkle-free!

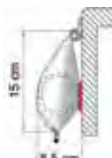

- 1 Open the bag to slide easily into the existing awning rail!
- 2 Position the canopy!
- 3 Roll out and raise!
- 4 Pull out leg and roof bar from each side!
- 5 Position telescopic leg and roof bar on each side!

	Awning length A	Canopy length B	Canopy Extension C	Weight kg	Deluxe Grey	Blue Ocean
Caravanstore 190	196 cm	162 cm	180 cm	5.4	108201/DG	108202/BO
Caravanstore 225	236 cm	202cm	225 cm	7.1	108203/DG	108204/BO
Caravanstore 255	266 cm	232 cm	225 cm	7.6	108205/DG	108206/BO
Caravanstore 280	288 cm	254 cm	225 cm	7.8	108207/DG	108208/BO
Caravanstore 310	318 cm	284 cm	225 cm	8.3	108209/DG	108210/BO
Caravanstore 360	369 cm	334 cm	225 cm	9.5	108211/DG	108212/BO
Caravanstore 410*	419 cm	384 cm	225 cm	10.1	108213/DG	108214/BO
Caravanstore 440**	449 cm	414 cm	225 cm	10.7	108215/DG	108216/BO

*Caravanstore 410 comes with one caravanstore centre rafter included.

**Caravanstore 440 comes with one caravanstore centre rafter and one caravanstore support leg included.

WOW For Caravanstore Zip see page S9

PRIVACY ROOM CS Light



Easy installation. The side panels have large roller blind windows with mosquito nets. The front panel, with a large openable window and mosquito screen, slides in the front rail of the roller tube and thanks to the auto-lubricant zippers it's easy to fasten the side panels. Standard delivered with the Fast Clip CS installation kit, pegs and elastic kit, Ocean curtains for the front windows and a mega bag light.

Privacy room CS Light	Length A	Height B	Part no.	Weight kg
Privacy 280	288 cm	240 to 260 cm	108208P	11.6
Privacy 310	318 cm		108210P	11.8
Privacy 360	369 cm		108212P	12.3
Privacy 410	419 cm		108214P	12.8
Privacy 440	449 cm		108200P	13.3



Quick Lock



The Fast Clip CS is especially designed for Fiamma Privacy Room CS Light. It works using a sandwich system of hinged profiles locked in place by a Quick Lock spring system. The side panels of the Privacy are quickly and easily joined with the fabric of the awning. Made from anodized aluminium.

Caravanstore blockers & sides **CARAVANSTORE**

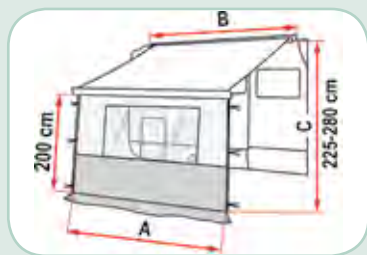

Blocker Pro

The Blocker Pro is a front panel equipped with one large full light crystal window and vinyl extension to the floor. Simply slides along the guide rail of the canopy and ties onto the awning's legs for stability. It gives you more privacy and more protection from the wind. Made of anti-rot vinyl, washable fabric with UV protection. Comes with elastic hooks and pegs.



Side W Pro

The Side W Pro is a side panel made of anti-rot vinyl, washable fabric with UV protection. Equipped with one large full light crystal window and vinyl extension to the floor. Simply attaches to the roof pole and ties onto the leg pole. Comes with telescopic tension rafter, elastic hooks and pegs.



Side W

The Side W Pro is a side panel made of anti-rot vinyl, washable fabric with UV protection. Equipped with one large full light crystal window. Simply attaches to the roof pole and ties onto the leg pole. Comes with elastic hooks and pegs.



Description	Canopy length A	Case length B	Height C	Part no.	Weight kg
Blocker Pro 255	235 cm	255 cm	225-280 cm	108302	2.7
Blocker Pro 280	255 cm	280 cm	225-280 cm	108301	3.0
Blocker Pro 310	285 cm	310 cm	225-280 cm	108303	3.2
Blocker Pro 360	335 cm	360cm	225-280 cm	108304	3.8
Blocker Pro 410	385 cm	400 cm	225-280 cm	108305	4.5
Blocker Pro 440	415 cm	440 cm	225-280 cm	108306	4.9
Side W Pro	Depth 210 cm		225-280 cm	108215	4.5
Side W	Depth 210 cm		225-280 cm	108216	3.9



Accessories **CARAVANSTORE**



Caravanstore rafter

Anodised aluminium with 30mm diameter Adjustable length: 142-265 cm. Suitable for extensions up to 250cm and for length up to 550 cm **108221**



Tie down kit S

Strap kit allowing a solid anchoring of the awning to the ground. Fits into the awning guide or the side clip of the Privacy Room. Includes: 2 adjustable black straps (3m), 2 stakes with 2 tension springs and 2 front hooks **109502**



Fiammastore plate

Ideal for fixing the front legs to the ground, in order to increase the resistance in case of strong wind and to protect the legs. Made with extra strong plastic. Dimensions: 20cm x 20cm **108226**



Awning pegs kit

Range of screw pegs ideal for awnings, enclosures and mats. Made from UV resistant plastic. Kit includes drill chuck key, 8 x 20cm and 8 x 14cm screw pegs. 8 x hooks, 2 awning plates and carry bag **108309**



Wall brackets

Aluminium wall mounting brackets for support legs **108265**



Fiamma rope kit **108223**



Caravanstore end stops

Prevents the Caravanstore moving in transit **108222**



Repair kit plus

This kit makes DIY repairs so easy with its 3 transparent PVC strips **108271**



Mega bag light

Strong bag in lightweight material, suitable for transporting Privacy Light. Dimensions 140 x 25 x 25cm **108308**



Caravanstore Hobby kit

Kit to fix Caravanstore to Hobby and other caravans **108139**



Caravanstore plastic leg pins **108224**



Caravanstore rubber foot

For the end of the Caravanstore rafter **108227**



Awning hangers kit

6 hooks to insert in the lead bar profile to hang light objects **109503**



Blue Ocean

Deluxe Grey

The easy-to-use awning which joins today's best technologies, service and quality! Constantly renewed, the F45 S awning is compact, functional, and of superior quality, assuring it to be the best choice for your holidays! The F45 L has the same specification with a larger roller tube and larger case.



Manual winch operation



Roller support means the canopy always stays tight
 Extra strong arms
 Secure lock
 Reinforced leg knuckle
 Arms preset to take wiring for lighting
 Drip moulding

WOW Standard delivered with installation brackets (Kit AS), other kits available see page S8. For front blockers, side blockers, Privacy rooms and other accessories to fit the F45 S please see pages S8 and S9.

Deluxe Grey and Blue Ocean readily available. Other colours available by special order. Please ask your sales contact for lead times.

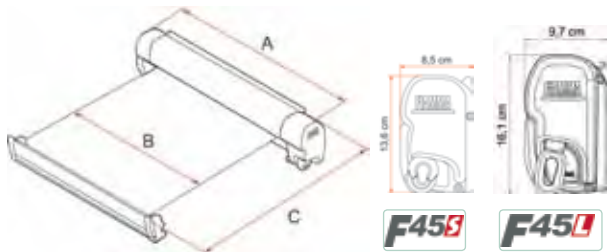

F45S	Awning length A	Canopy length B	Canopy Extension C	Weight kg	Polar White Casing Deluxe Grey Canopy	Polar White Casing Blue Ocean Canopy	Titanium Casing Deluxe Grey Canopy	Titanium Casing Blue Ocean Canopy	Deep Black Casing Deluxe Grey Canopy
F45 S 260	263 cm	247 cm	200 cm	19.5	108233/PW/DG	108233/PW/BO	108233/T/DG	108233/T/BO	108233/B/DG
F45 S 300	308 cm	292 cm	250 cm	23	108240/PW/DG	108240/PW/BO	108240/T/DG	108240/T/BO	
F45 S 350	348 cm	331 cm	250 cm	25	108248/PW/DG	108248/PW/BO	108248/T/DG	108248/T/BO	
F45 S 400*	398 cm	381 cm	250 cm	27	108256/PW/DG	108256/PW/BO	108256/T/DG	108256/T/BO	
F45 S 450*	448 cm	431 cm	250 cm	30	108257/PW/DG	108257/PW/BO	108257/T/DG	108257/T/BO	

*1 tension rafter made from anodised aluminium included

F45L	Awning length A	Canopy length B	Canopy Extension C	Weight kg	Polar White Casing Deluxe Grey Canopy	Polar White Casing Blue Ocean Canopy	Titanium Casing Deluxe Grey Canopy	Titanium Casing Blue Ocean Canopy
F45 L 450*	452 cm	435 cm	250 cm	38.8	108272/PW/DG	108272/PW/BO	108272/T/DG	108272/T/BO
F45 L 500*	502 cm	485 cm	250 cm	42.5	108273/PW/DG	108273/PW/BO	108273/T/DG	108273/T/BO

*1 tension rafter made from anodised aluminium included

The Fiamma Privacy Room is the only enclosure that allows full aeration on all windows. With the Privacy Room you can transform your awning into a comfortable living area. The side panels are quickly put together with the exclusive patented Fast Clip that combines the canopy with the side walls. No other fixing system is as stable. A protective sponge is fitted, vertically, on the back part of the side panels along the support pole to guarantee a close fit. The front panel slides into the guide rail of the awning and thanks to the auto-lubricant zippers it's easy to fasten the side panels. Standard delivered with the Fast Clip installation kit, pegs and elastic kit, Ocean curtains for the front windows and a mega bag light.



The Fast Clip for a quick and easy installation. It works using a sandwich system of hinged profiles locked in place by a Quick Lock spring system. The side panels of the Privacy are quickly and easily joined with the fabric of the awning. Made from anodized aluminium.



Side door panel right



Quick Lock

Privacy room	Length A	Height B	Extension C	Part no.	Weight kg
Privacy 300 Medium	300 cm	225 to 250 cm	250 cm	108283	24.4
Privacy 350 Medium	350 cm		250 cm	108285	24.9
Privacy 400 Medium	400 cm		250 cm	108287	25.4
Privacy 450 Medium*	450 cm		250 cm	108289	25.9
Privacy 300 Large	300 cm	251 to 280 cm	250 cm	108284	24.7
Privacy 350 Large	350 cm		250 cm	108286	25.2
Privacy 400 Large	400 cm		250 cm	108288	25.7
Privacy 450 Large*	450 cm		250 cm	108291	26.2
Privacy 500 Large*	500 cm		250 cm	108293P	26.7
Side door panel right - Medium		225-250 cm	250 cm	108310	3.9
Side door panel right - Large		251-280 cm	250 cm	108311	4.5

*Privacy Rooms 450 and larger come delivered with a vertical telescopic door pole

F45 blockers & sides **F45B**

Blocker Pro

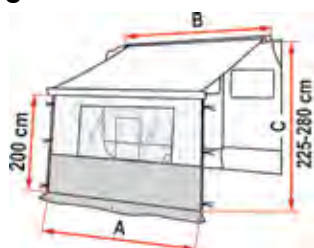

The Blocker Pro is a front panel equipped with one large full light crystal window and vinyl extension to the floor. Simply slides along the guide rail of the canopy and ties onto the awning's legs for stability. It gives you more privacy and more protection from the wind. Made of anti-rot vinyl, washable fabric with UV protection. Comes with elastic hooks and pegs.

Side W Pro

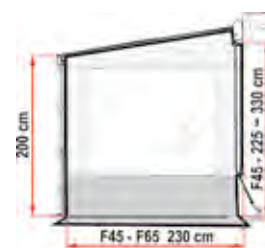

The Side W Pro is a side panel made of anti-rot vinyl, washable fabric with UV protection. Equipped with one large full light crystal window and vinyl extension to the floor. Simply attaches to the roof pole and ties onto the leg pole. Comes with telescopic tension rafter, elastic hooks and pegs.



Description	Canopy length A	Case length B	Height C	Part no.	Weight kg
Blocker Pro 250	235 cm	260 cm	225-280 cm	108302	2.7
Blocker Pro 260	247 cm	260 cm	225-280 cm	108300A	2.8
Blocker Pro 300	285 cm	300 cm	225-280 cm	108303	3.2
Blocker Pro 350	335 cm	350 cm	225-280 cm	108304	3.8
Blocker Pro 400	385 cm	400 cm	225-280 cm	108305	4.5
Side W Pro F45	Depth 230cm		225-280 cm	108263	4.2



Adapters **F45S** & **F45L**

WOW All other adapters available on request by special order. Please speak to your sales contact for details.

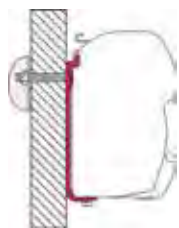

AS120

For F45 and Fiamma Zip awnings. Standard delivered with 2.5m - 4m awnings. Includes 2 x 12cm brackets and 1 x 8cm bracket **108229**

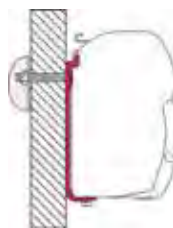

AS400

For F45 and Fiamma Zip awnings. Standard delivered with 4.5m & 5m awnings. Includes 2 x 40cm brackets and 1 x 12cm bracket **108230**



Fiat ducato

Also Citroen Jumper, Peugeot Boxer. High roof. After 06/2006. 2 x 8cm brackets **108228C**

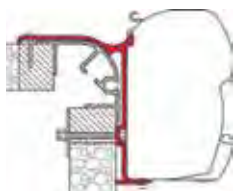

Bailey Pegasus

3 x 15cm brackets **108235**

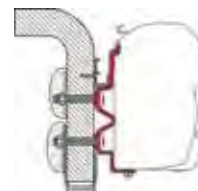

Hymercamp

Hymercamp Swing, Starline, Hobby Van, Caravan Hobby '09. 1 x 400cm bracket. Can be cut to size **108228D**

Accessories **F45S** & **F45L**



F45 tension rafter

Anodised aluminium. Adjustable length: 142-265 cm. Suitable for extensions up to 250cm and for length up to 550 cm **108262**



Tie down kit S

Strap kit allowing a solid anchoring of the awning to the ground. Fits into the awning guide or the side clip of the Privacy Room. Includes: 2 adjustable black straps (3m), 2 stakes with 2 tension springs and 2 front hooks **109502**



Fiammastore plate

Ideal for fixing the front legs to the ground, in order to increase the resistance in case of strong wind and to protect the legs. Made with extra strong plastic. Dimensions: 20cm x 20cm **108226**



Awning pegs kit

Range of screw pegs ideal for awnings, enclosures and mats. Made from UV resistant plastic. Kit includes drill chuck key, 8 x 20cm and 8 x 14cm screw pegs, 8 x hooks, 2 awning plates and carry bag **108309**



Repair kit plus

This kit makes DIY repairs so easy with its 3 transparent PVC strips **108271**



F45 Rafter Pro curved

The Rafter Pro is made of two sturdy anodized aluminium telescopic bars. Ideal for awnings with extension up to 250cm, it is adjustable in length from 144 to 265cm. Limit usage at high temperatures as it may affect the fabric tension. **108261**



Mega bag light

Strong bag in lightweight material, suitable for transporting Privacy Light. Dimensions 140 x 25 x 25cm **108308**



Wall brackets

Aluminium wall mounting brackets for support legs **108265**



Awning hangers kit

6 hooks to insert in the lead bar profile to hang light objects **109503**

Rain guard

Convenient rubber guard to seal the space between the awning and the vehicle wall to prevent water from infiltrating. Can be installed without removing the awning. Priced by the metre sold in 5m lengths

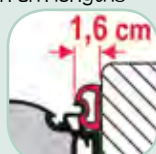

Rain guard S For awnings installed with standard AS120 brackets on flat walls. Fits gaps up to 16mm **108282**



Rain guard L For awnings mounted with adaptor spaced out from the wall up to 9cm or on curved walls **108280**

The Caravanstore ZIP comes complete with the canopy and the enclosure. The innovative Caravanstore ZIP system joins the side panels to the awning's fabric with two special sturdy zips. In a few instants the awning can be transformed into a complete enclosure, doubling your living space.

Blue Ocean

Deluxe Grey

CARAVANSTORE ZIP



-  1 Erect the awning!
-  2 Position the side walls!
-  3 Waterproof zips attach the walls to the roof in conjunction with the Fast Clip system!
-  4 Slide the front panel through the guide rail and zip to sides!
-  5 Use the Rapid Set to secure frame and peg out!

	Awning length A	Height B	Canopy Extension C	Canopy length D	Weight kg	Deluxe Grey	Blue Ocean
CS ZIP 280	288 cm	240 to 260 cm	225 cm	254 cm	24.2	108195/DG	108189/BO
CS ZIP 310	318 cm		225 cm	284 cm	26.1	108196/DG	108190/BO
CS ZIP 360*	369 cm		225 cm	334 cm	28.8	108197/DG	108191/BO
CS ZIP 410*	419 cm		225 cm	384 cm	31.8	108198/DG	108192/BO
CS ZIP 440**	449 cm		225 cm	414 cm	34.5	108199/DG	108193/BO

*Caravanstore ZIP 360 and 410 come with one caravanstore support leg included.

**Caravanstore ZIP 440 comes with one caravanstore centre rafter and one caravanstore support leg included.

Caravanstore ZIPs come delivered with:

The **canopy** (Caravanstore type) in either Deluxe Grey or Blue Ocean.



Mega Bag storage bag. Dimension: L:140xW:27xH:40cm. Colour: black/red.



The **Rapid Set** Caravanstore installation kit aluminium poles.



This fixing structure is composed of a horizontal rafter to be inserted in to the side panels and a telescopic vertical rafter next to the wall of the vehicle to increase the stability.

2 side panels with windows and mosquito nets



A **curtain Kit** for all 3 windows in Blue Ocean



A **front panel** with interchangeable door and window with mosquito net

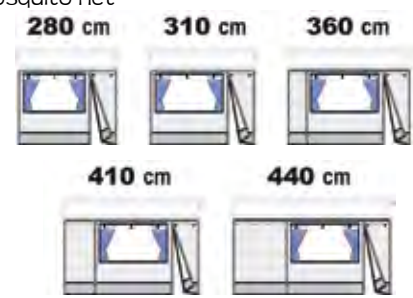



Blue Ocean

Deluxe Grey

Fiamma ZIP is based on F45 awnings. The canopy has a ZIP system allowing a fast installation and perfect fit. The innovative Fiamma ZIP system joins the side panels to the fabric of the awning with two special sturdy zippers. The awning is transformed into a completely enclosed room in a few minutes.



Manual winch operation



Available in Deluxe Grey and Blue Ocean canopies only!



Available in Polar White casing only!

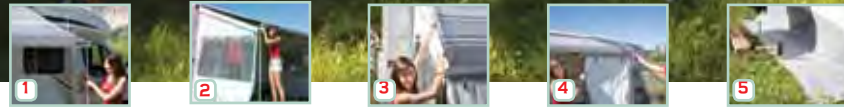

- 1 Erect the awning!
- 2 Position the side walls!
- 3 Waterproof zips attach the walls to the roof!
- 4 Slide the front panel through the guide rail and zip to sides!
- 5 Use the Rapid Set to secure frame and peg out!

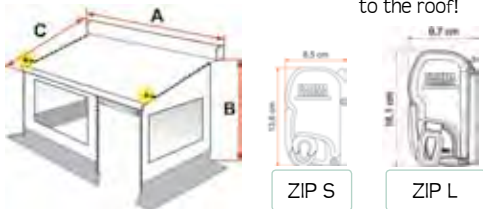

WOW Standard delivered with installation brackets (kit AS), other kits available see page S8

ZIP	Awning length A	Height B	Canopy Extension C	Weight kg	Deluxe Grey Canopy	Blue Ocean Canopy
ZIP S 300 Medium	306 cm	225-250 cm	250 cm	42.4	108294/DG	108294/BO
ZIP S 350 Medium	356 cm	225-250 cm	250 cm	46.3	108296/DG	108296/BO
ZIP L 400 Medium	406 cm	225-250 cm	250 cm	58.4	108298/DG	108298/BO
ZIP L 450 Medium	456 cm	225-250 cm	250 cm	62.4	108314/DG	108314/BO
ZIP S 300 Large	306 cm	251-280 cm	250 cm	42.6	108295/DG	108295/BO
ZIP S 350 Large	356 cm	251-280 cm	250 cm	46.5	108297/DG	108297/BO
ZIP L 400 Large	406 cm	251-280 cm	250 cm	58.6	108299/DG	108299/BO
ZIP L 450 Large	456 cm	251-280 cm	250 cm	62.6	108315/DG	108315/BO
Side door panel right (for Zip Medium)		251-280 cm	250 cm	4.1	108312	
Side door panel right (for Zip Large)		251-280 cm	250 cm	4.7	108313	

ZIP Medium delivered with 1 rafter included
ZIP Large delivered with 1 rafter and 1 door pole included

ZIPs come delivered with:

The **awning** (F45 type) in either Deluxe Grey or Blue Ocean.



Mega Bag storage bag. Dimension: L:140 x W:27 x H:40cm. Colour: black/red.



The **Rapid Set** awning installation kit aluminium poles. This fixing structure is composed of a horizontal



rafter to be inserted into the side panels and a telescopic vertical rafter next to the wall of the vehicle to increase stability.

Side panels with windows and mosquito nets.



A **curtain Kit** for all 3 windows in Blue Ocean



A **front panel** with interchangeable door and window with mosquito net.



Draft skirting (60cm tall). Includes wheel arch cover with press studs.



Roof and cycle carrier boxes



These boxes are made from superior quality ABS-PLUS, highly resistant to impacts and exposure to poor weather conditions. A completely reinforced aluminium structure with a watertight foam seal. High UV resistance to protect against deterioration. Supplied with installation brackets and rust proof stainless steel hinges. Colour: White.

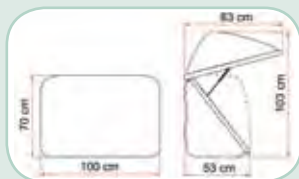

Ultra-box 320
12kg. 320 litre capacity **102256**

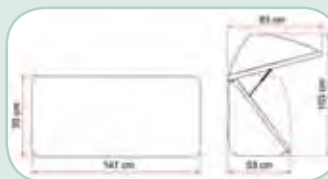

Ultra-box 500
17kg. 500 litre capacity **102258**



Note: Ultra-box 320 and 500 are supplied with brackets to allow them to be neatly installed on the Carry-Bike range



Ultra-box 2
13kg. 400 litre capacity **102252**



Ultra-box 3
17kg. 520 litre capacity **102254**



Note: The Ultra-box 2 is supplied with 4 brackets and Ultra-box 3 with 6



Carry Kayak

Kit of 2 support brackets to easily transport canoes, kayaks and surfboards. Compact by easy to load thanks to its inclined design. Made of folding anodized aluminium tubes, standard delivered with soft coverings and fixing straps. Suitable for some cars with roof bars. **106401**

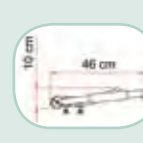

Organisers and utility pockets



Pocket M



Pocket L



Pocket XL



Multipurpose pocket made of scratch resistant plastic easy to install with the screws provided.

- Pocket M** White **106412**
- Pocket L** White **106414**
- Pocket XL** Grey **106416**



Pack organiser toiletry

Numerous pockets and large storage compartment for transporting your bathroom essentials. Made from waterproof polyester complete with hanging hook. Dimensions:

Open 30 x 118 x 11cm
Closed 30 x 37 x 11cm
106410

Pack organiser seat

Attaches to seat back giving extra storage **106409**



Pack organiser S

Folding container with multiple pockets, it can be easily hung on doors and walls. They are made of strong waterproof material. Adjustable straps or eyelet installation. Practical handles for easy carrying. Can be folded when not in use

S 50 x 84cm **106405**

L 88 x 39cm **106406**



Pack organiser L

WOW Pack Organizer L and Pack Organizer S can be fixed in 3 different ways:

- A) using the rail - B) using the eyelets (screws not supplied) - C) with Fix Organizer (optional 106408).

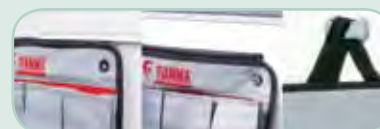

Fix organiser

The easy way to hang your organiser **106408**

Dometic Premium Awnings

This new motor home awning eclipses its competitors by eliminating inconvenient support struts, just like your canopy at home. This means you can use the entire space in front of your recreational vehicle. It completely eliminates the awkward, time-consuming setup of conventional camping awnings. You're bound to use your Dometic Premium Awning even during short stops by the roadside thanks to it extending in only a few seconds. Particularly convenient and safe is the electric version with remote control and wind sensor.

Characteristics that make the Dometic Premium Awning stand out

- Comprehensive UV protection
- Scratch-resistant
- Non-bleaching colours
- Stain-proof
- Available in three housing colours white, silver and anthracite
- Fabric made of highly resistant vinyl with a transparent acrylic coating
- Fabric colours blue or silver

Arm Joint - made of forged steel, extremely strong, essential for convenient use without vertical struts

Tilt angle - the factory-set tilt angle of approximately 10° can be adjusted to approximately 17° at the arm joint

Comfort features

- Premium Awning
- Simply extend and enjoy - no awkward setup
- No inconvenient struts, the entire space in front of the vehicle is yours to use
- Electric version comes with remote control and wind sensor
- Sturdy awning fabric with pattern on both sides
- Two tilt angles possible
- Top cover features integrated brush
- Additional accessories for both awning variants

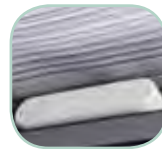

Wind Sensor



Remote Control

Standard with Electric Version only

Wind Sensor

As standard for the electric version. Awning automatically retracts in strong winds

Remote Control

As standard for the electric version. Convenient retraction and extension as well as stopping in any position at the touch of a button.

Sun Sensor

Optional for electric version: for optimal shade depending on sunlight; wall-mounted radio remote control for convenient operation at the location of your choice.

Electric version

Casing: Anthracite Colour: Silver

Size	Part Number
3.1m	108130/A/S
3.5m	108131/A/S
4m	108132/A/S
4.7m	108133/A/S

Casing: Anthracite Colour: Blue

Size	Part Number
3.1m	108130/A/B
3.5m	108131/A/B
4m	108132/A/B
4.7m	108133/A/B

Casing: Silver Colour: Silver

Size	Part Number
3.1m	108130/S/S
3.5m	108131/S/S
4m	108132/S/S
4.7m	108133/S/S

Casing: Silver Colour: Blue

Size	Part Number
3.1m	108130/S/B
3.5m	108131/S/B
4m	108132/S/B
4.7m	108133/S/B

Casing: Polar White Colour: Silver

Size	Part Number
3.1m	108130/P/S
3.5m	108131/P/S
4m	108132/P/S
4.7m	108133/P/S

Casing: Polar White Colour: Blue

Size	Part Number
3.1m	108130/P/B
3.5m	108131/P/B
4m	108132/P/B
4.7m	108133/P/B



Manual version

Casing: Anthracite Colour: Silver

Size	Part Number
3.1m	108134/A/S
3.5m	108135/A/S
4m	108136/A/S
4.7m	108137/A/S

Casing: Anthracite Colour: Blue

Size	Part Number
3.1m	108134/A/B
3.5m	108135/A/B
4m	108136/A/B
4.7m	108137/A/B

Casing: Silver Colour: Silver

Size	Part Number
3.1m	108134/S/S
3.5m	108135/S/S
4m	108136/S/S
4.7m	108137/S/S

Casing: Silver Colour: Blue

Size	Part Number
3.1m	108134/S/B
3.5m	108135/S/B
4m	108136/S/B
4.7m	108137/S/B

Casing: Polar White Colour: Silver

Size	Part Number
3.1m	108134/P/S
3.5m	108135/P/S
4m	108136/P/S
4.7m	108137/P/S

Casing: Polar White Colour: Blue

Size	Part Number
3.1m	108134/P/B
3.5m	108135/P/B
4m	108136/P/B
4.7m	108137/P/B

Fabric Maintenance



The whole Fenwick's range has been designed with the needs of the caravan, motor home and car owner in mind. Many products have been created from specific requests by satisfied customers.

Awning & Gazebo reproofer

Quickly restores waterproofing qualities to synthetic and canvas awnings, tents and gazebos. Protects against stains from dirt, grease, oil, food spills, and drinks. Deep penetrating, water based, non flammable formula. Can be applied in damp conditions. 1L covers up to 30m². Far safer than solvent based products, due to the biodegradable and environmentally friendly properties.

1 litre **108405** 10 per outer



Awning & gazebo cleaner

Quickly and effectively cleans awnings, tents and gazebos. Removes black streaks, green algae and general grime. Spray on, wash off formula.

1 litre **108401** 10 per outer



ORIGINAL PERFORMANCE RESTORED.

Waterproofs and mould proofs weathered canvas of all weights: cotton, nylon, terylene fabrics and unpainted leather. It preserves them and keeps them cleaner. As no film is formed the breathing of canvas fabrics and leather is retained. The tinned Fabsil contains a UV protector



1 litre Reproofer
With UV protector
10 per outer
108319



2.5 litre Reproofer
With UV protector
6 per outer
108327



5 litre Reproofer
With UV protector
3 per outer
108336



400ml Reproofer
12 per outer
108345



600ml Reproofer
12 per outer
108353



Fabsil display stands

Single display stand **108379**
Double display stand (back to back) **108380**



Universal fabric cleaner
1 litre. 6 per outer
108372



Clothing Superpruf
Clothing reproofer
250ml spray. 12 per outer **108357**



Wax Cotton proofer
Reproofer 250ml spray. 12 per outer
108360



Footwear cleaner
Footwear foaming cleaner 250ml spray. 12 per outer **108363**



Footwear deodorant
Footwear deodorant 250ml spray. 12 per outer **108365**



Footwear proofer
Footwear reproofer with conditioner 250ml spray. 12 per outer **108367**



Beeswax proofer
Clothing reproofer
80g 24 per outer **108369**



Stormseal repair adhesive
Permanent, flexible & waterproof, repairs natural and man-made fabrics. 12 per outer **109448**



Seal repair adhesive 28g
Suitable for most types of fabric. Gives an extremely durable mend. Dries to a flexible finish. Easy to apply. 12 per outer **109449**



Nylon repair tape kit
Self adhesive 7.5cm strips of ripstop nylon in assorted colours. For emergency repairs to tents, jackets and parkas. 4 strips per pack. 12 packs per outer **109450**



Fiamma repair kit plus
This kit makes DIY repairs so easy with its 3 transparent PVC strips **108271**

Mallets etc



Mallet & peg puller
16oz. Available singly or 10 per outer **109431**



Rubber mallet
16oz. Metal shaft. Available singly or 10 per outer **109432**



Rubber mallet
31oz. Available singly or 24 per outer **109434**



Peg extractor
For easier removal of tent pegs. 10 per outer **109425**



Arro eyelets
Self sealing eyelet for plastic or canvas sheeting. 24 per outer **109130**



Tent accessory pack
6 x 6" metal pegs, 20m high visibility guy line, 1 x rubber mallet & 1 x peg extractor. Available singly or 20 per outer **109435**

Pegs



Plastic Grey groundsheet



Plastic Red



Plastic Grey



Wire



Metal skewer



Steel rippled



Heavy duty



W4 Awning



Rolson Superstake



Hard ground



Half round



Tarzan rock



Type of peg (quantity per pack)	Size	Loose (quantity per outer)	Grove packaged (quantity per pack/packs per outer)	W4 Packaged (quantity per pack/packs per outer)	Hard case Available singly (outer quantity)
Plastic Grey groundsheet	3.5"	109422 (200)		108577 (5/10)	
Plastic Red	5.5"			108594 (5/10)	
Plastic Red	8"	109404 (200)		108570 (5/10)	
Plastic Grey	8"	901095 (singly)			
Plastic Red	12"	109413 (200)			
Wire	7"		109367 (10/10)	108593 (5/10)	
Wire	9"	109395 (250)	109389 (10/10)	108571 (5/10)	
Wire (25)	10"	901104 (singly)			
Metal Skewer (4)	8"	901098 (singly)			
Metal Skewer (4)	9"	901107 (singly)			
Steel Rippled	8"			108596 (3/10)	
Heavy Duty	8"			108597 (1/10)	
W4 Awning peg	8" + head	109483 (50)		109482 (5/8) (Display box)	
Rolson Superstake	28 cm	109415 (12)			
Hard ground pegs (20)	8"				109400
Half round pegs (20)	18 cm				109396 (24)
Tarzan rock pegs (20)	23 cm				109397 (24)

Screw pegs

Megascrew mKill



Screw tent pegs are a great way of securing your tent or awning to a variety of surfaces including hard standing and grassed areas. You can hammer them into grass or use a drill with the drill bit for hard ground when required. Each megascrew utilises a soft seal to protect pepping rubbers and guy lines from chafing.

Blue (25 pack) **109419** Blue (10 pack) **109417**
 Grey (25 pack) **109418** Grey (10 pack) **109416**



13mm Drill bit
 Multi angle for ease of use
109420

WOW The Camping and Caravan club likes Megascrew - "sturdy pegs", "resilient plastic end" and "even a modest head torch is well reflected"



Fiamma awning pegs kit

Range of screw pegs ideal for awnings, enclosures and mats. Made from UV resistant plastic. Kit includes drill chuck key, 8 x 20cm and 8 x 14cm screw pegs. 8 x hooks, 2 awning plates and carry bag **108309**

Tie down kits



Fiamma tie down kit S

For use with Fiamma awnings. Composed of 2 black adjustable bands 300cm long, 2 stakes and 2 tension springs **109502**



Fiamma tie down kit

To secure awnings in windy conditions. Available in Black strap or Yellow strap for extra visibility. Will fit awning up to 6 metres in length. Available singly or 10 per outer

Yellow strap **109501**
 Black strap **109500**



W4 quick release awning tie down kit

- Durable nylon buckle, easy to fit, quick to release
- Dual tensioners with 2 heavy duty elasticated cord and snap hooks for easy adjustment
- Two land anchors for secure fixing
- Supplied with 10 metres of high tensile strapping

Available singly or 10 per outer **109510**



W4 porch tie down kit

Used to secure porch awnings during windy conditions. Featuring a shorter strap than standard tie down kits. 2 lightweight plastic yellow pegs. Available singly or 10 per outer **109509**



W4 Reflect-a-line

Reflective strips to fit on guy lines for safety at night. 10 per outer **109423**



Multi-purpose anchor

Suitable for use as a dog tether, tent or awning storm anchor, temporary land anchor for boats and many more uses.

W4 Screw-it. Available singly or 10 per outer **109021**
 Bulk 12 per outer **109021B**



W4 awning anti friction pads (2)

A pair of cushioned nylon pads that slide on to the strapping of most awning tie down kits to help prevent vibration and chafing. A simple answer to a constant problem **109511**

Tent and awning tensioners

Awning companion

Designed especially for tensioning awning poles in seconds with one hand and without the hassle you will wonder how you ever managed without it. Available singly or 6 per outer **109585**



Hercules

Hook the Hercules to the pole at a distance of approximately 15cm from the screw. Let the steel loop rest on the nut. Now see how easy it is to tension your awning correctly **109580**



Awning rail care

W4 awning rail lubricant

Makes awnings much easier to thread. Clean the awning channel before application. Can also be applied to ease the fitting and removal of toilet seals. 10 per outer **105100**



Awning rail spreader

Simply insert into the awning rail and tap through any troublesome areas. The compact head is especially effective on awkward corners. 10 per outer **105104**



Awning rail brush

Useful brush for cleaning or lubricating awning rail. Available singly or 5 per outer **105085**



Awning rail care kit

Contains one each awning rail lubricant, awning rail spreader and awning rail brush, supplied in a handy vinyl pouch **105105**



Awning rail protection strip

Diverts rainwater away from the channel which also helps prevent black streaks. Supplied in 12m lengths **105107**

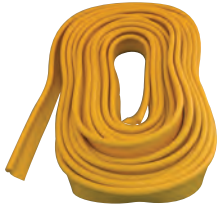

Aluminium awning rail

2.12 metre lengths 10 lengths per outer **105099**

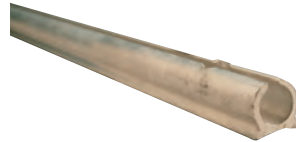

Plastic awning rail

Pre-drilled 2.5 metre lengths 10 lengths per outer **105088**



Luggage Elastic

W4 adjustable luggage elastic

1 metre length with 1 fixed and 1 self locking hook. 10 per outer **109519**



W4 Multi hook luggage elastics

10 per outer
4 way **109520** 6 way **109521**
8 way **109522**

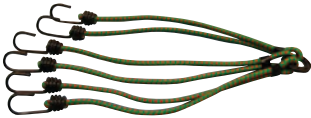

W4 Luggage elastic (2)

Meets BS AU 258. 10 per outer
46cm **109515** 60cm **109516**
76cm **109517** 91cm **109518**



Rolson D-ring bungee cord

1200 x 8mm bungee cord with easy to attach d-ring facility. Suitable for tying down on roof racks and trailers **109525**



Rolson retractable ratchet tie down

25mm x 5 metre ratchet tie-down. With plastic handle retraction. Breaking strength 4901kg. Working load 245kg **109526**



Rolson 4.2m ratchet tie down (2)

2 piece 25mm x 4.2 metre ratchet tie-down. Breaking strength 681kg. Working load 227kg. Aluminium alloy handle with PVC grip. High visibility webbing. **109524**



Rolson 15ft ratchet tie down

1" strap . 136kg approx. tie down capacity. Trouble free, push button quick release mechanism. 12 packs per outer **109523**



Multipurpose rope 30m

Working load limit of 175lbs. Working load limit is a guideline for the maximum allowable weight capacity of a new rope. 6 packs per outer **109436**



WOW Double shank hoop for double strength. Plastic coated non-scratch hooks. Sewn-in hooks for increased strength. Rot resistant & UV protected materials for safer, longer working life. Flat cord resists rolling, increases strength and protects cargo. 100% natural rubber for superior stretch and tear resistance.



Part No.	ROK Strap	Size
109600	Standard	300mm x 20mm
109601	Standard	450mm x 20mm
109602	Standard	600mm x 20mm
109603	Standard	750mm x 20mm
109607	Standard	900mm x 25mm
109608	Standard	1200mm x 25mm
109609	Standard	1500mm x 25mm
109615	Adjustable	1500mm x 25mm
109616	Adjustable	3000mm x 25mm
109617	Adjustable	4500mm x 25mm



Awning accessories



W4 awning sucker

Replacement rubber suckers. Packed suckers are sold 2 per pack, available singly or 10 packs per outer. Bulk suckers are sold 20 per outer. For pole size $\frac{3}{4}$ " (19mm)

Packed **109489**

Bulk **109488**

For pole sizes $\frac{7}{8}$ " (22mm) & 1" (25mm)

Packed **109487**



Awning pads (3)

Simply glue to inner roof beading to hold awning poles and remove the need to screw awning brackets to the caravan.

Available singly or 10 per outer **109040**



W4 ease-it

A simple tool to make the erection of awnings easier. Attach the reinforced eyelet to your awning then pull through channel with the hooked pole. Available singly or 10 per outer **109490**

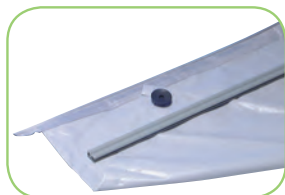

W4 awning skirt wheel arch cover

Figure 8 and suckers ensure a neat result without drilling or screwing into the caravan wall. Both available singly, single axle version also available 10 per outer

Single axle **109498**

Twin axle **109497**

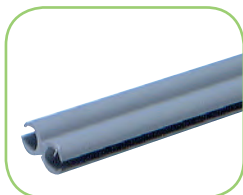

W4 figure 8 channel

Plastic double channel strip to join the wheel cover to the awning skirt. Available singly or 10 per outer

Length 750mm **109495**

Length 1200mm **109496**



Inner tent

Superior quality polyester for heavy use. Reinforced heavy duty PVC base with welded corner fasteners. The ultimate inner tent that is also rot proof

2 Berth 205x135x180cm **109975**

3 Berth 205x205x190cm **109976**



Inner tent tall annexe

Fits all tall annexes and includes a heavy duty reinforced base. 198x130x160cm **109980**

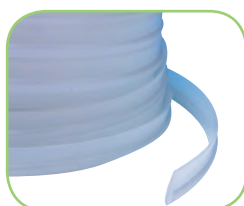

J strip

Plastic strip for attachment of awning curtains. Supplied in 100m roll. Priced by the metre **109570**



Awning curtains

Good quality polyester/cotton. Each one measures 33" x 60" approx. Fitted with clips and sewn in seam for curtain rods. Assorted designs **123455**



Attachable awning windbreak

18' long and 5' tall, manufactured from patented good quality rip-stop material. Rot proof and complete with awning beading to attach to the caravan. 7 pole **107790**

Awning bags

A variety of storage bags which can be personalised with your own company details - minimum 100. All products are manufactured from heavy duty PVC coated nylon



Awning bag

Holds canvas from even the largest awning. Piped circular base for maximum strength. Available singly or 10 per outer **109550**

Personalised **109551**



Pole bag

For the storage of awning poles, but can also be used for small tents and poles. Available singly or 10 per outer **109553**

Personalised **109554**



Peg bag

Versatile bag for carrying awning, tent and groundsheet pegs or other small items. Available singly or 10 per outer **109561** Personalised **109562**

Heritage "Keep Calm and Caravan" peg bag

100% cotton canvas peg bag with zip. Wet and rotproof. High quality desirable product **109563**

Also available in cost effective nylon **109560**



The Heritage range also available in a mains cable bag (see section C) **016177** and a hitch cover (see section A) **007345**

WOW Heritage range. Choose your colour, change the crown for your logo or even display your phone number - all for the same unit cost. Minimum order quantity - 50. Please speak to your sales contact for more details. Please allow 6 weeks for first time orders and 4 weeks for repeat orders to receive your delivery. Peg bag printed **109564**

Tent and awning spares - All packed 10 per outer



WOW All W4 pack-it items can be ordered loose at a preferential rate. Please speak to your sales contact for more details



Brass eyelets
 $\frac{3}{8}$ " (9.5mm) (20) 108559
 $\frac{1}{2}$ " (13mm) (10) 108552



Eyelet closing tool
 $\frac{3}{8}$ " (9.5mm) 108560
 $\frac{1}{2}$ " (13mm) 108553



Awning skirt studs (5)
108561



Awning skirt studs, poppers & screws (5)
108562



Awning popper closing tool
108578



Cord lock (2)
109479



Awning rail screws (10)
108563



Plastic guy line runners (5)
108595



Metal guy line runners bent (5)
108554



Metal guy line runners slotted (5)
108555



Guy line 6 metres
108569



Elasticated cord 5 metres
108590



Awning brackets (2)
108572



Pole ends (2)
 $\frac{3}{4}$ " (19mm) 108583
 $\frac{7}{8}$ " (22mm) 108584
 1 " (25mm) 108585



Gutter clamp (2)
 21-23mm 108645
 25-28mm 108646



Pole C clips (2)
 $\frac{3}{4}$ " (19mm) 108566
 $\frac{7}{8}$ " (22mm) 108567



Pole clamps (2)
 $\frac{3}{4}$ " (19mm) 108556
 $\frac{7}{8}$ " (22mm) 108557
 1 " (25mm) 108586
 $1\frac{1}{4}$ " (29mm) 108580



Inner tent clips (3)
 $\frac{3}{4}$ " (19mm) 108551
 $1\frac{1}{4}$ " (25mm) 108641*



Pole spike
 $\frac{3}{4}$ " (19mm) 108568



Rain cowls (2)
108589



Pole flanged foot
 19mm 108588
 22mm 108647
 25mm 108648



Pole spring joiners (3)
108558



Spring buttons (3)
108550



Pole marking kit
108576



Toggled tent band (5)
108579



Tent band - large (3)
90mm 108574



Tent band - extra large (3)
150mm 108587



Inner tent suspension bands (5)
108575



Ladder bands (5)
108573



Ball loops 75mm (3)
108549



Bunk bracket with stainless steel screws*
 $\frac{1}{4}$ " (32mm) 108591



Canopy hooks (3)*
108581



Rope hooks (3)*
108582



Pole hanging hooks (3)
108565



Small padlock*
108564



Pole ring with 2 pins (2)
108548



Ground sheet pegs (5)
 $\frac{3}{2}$ " (90mm) 108577



Tent peg - plastic (5)*
 $\frac{5}{2}$ " (140mm) 108594



Tent pegs - plastic (5)
 8" (200mm) 108570



Airbed plugs (3)*
 Replacement airbed plugs. 10 per outer 109480

Wall mounted 'Pack-it' stand

With optional feet for free standing conversion. Tent & awning 48 hook range 108650.

Items marked with * are not currently included in the stand package



Heavy duty peg
108597



Tent pegs-steel (5)
 9" (225mm) 108571
 7" (150mm) 108593



Rippled peg - steel (3)*
 8" (200mm) 108596



Self adhesive awning stud (2)

Available singly or 5 per outer 109128

Grove packaged awning accessories



Awning hooks (3)
10 packs per outer
19mm **109047**
23mm **109056**



Pole adjusting clamps (2)
10 packs per outer
23mm **109102**



Inner tent clips (6)
For suspending inner tent in 10 packs per outer awning. 10 packs per outer
109082



Nylon 'C' clips (4)
19mm **109113**
23mm **109124**



Awning brackets (3)
Supplied with screws.
10 packs per outer
109038

Camping accessories



Multi hook hanger
Useful five hook plastic hanger for tent or awning poles. Available singly or 10 per outer **109010**

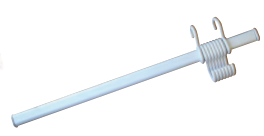

Plastic hanger with 7 hooks
Available singly or 10 per outer **109011**



Clip-on mirror
Available singly or 10 per outer **109761**



Flock air bed repair kit
Available singly or 12 per outer **109481**



Emergency hooded ponchos
Both lightweight and convenient, made from a reusable polyethylene. Each pack contains 2 adult sizes and 1 child's size.
24 per outer **070603**



3 Tier concertina workstation
Folds for easy storage, carry bag included. Detachable wind shield, 2 storage shelves
106cm x 61cm x 35cm
109755



Camp toaster
Stainless steel wire grill, mesh, heat diffuser, frame lock and folding wire handle **109646**



Folding toaster
22cm diameter with four folding wire strut supports. Available singly or 12 per outer **109643**



Egg holder
Protective plastic case for carrying eggs
109649



Salt/pepper shaker
No spill flip caps. Bottoms remove for easy filling
Available singly or 12 per outer **109648**

Groundsheets

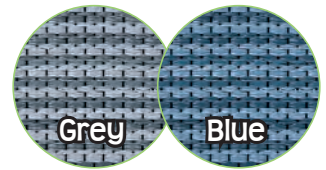

Breathable woven matting for use in the awning or tent. Supplied in a choice of pre-cut sizes. Lightweight yet durable in use.

Length (2.5m width)	Grey	Blue
4m	107860	107862
5m	107865	107867
6m	107871	107873



Solar shower
20lt capacity gives you a 7 minute shower. Leave in the sun to heat water - will heat up to 40°C in 3 hours.
Available singly or 24 per outer **109700**

P.V.C. groundsheets



10' x 8'	108060
12' x 8'	108065
14' x 8'	108075
16' x 8'	108085
18' x 8'	108095
20' x 8'	108100

Supplied in P.V.C. with brass eyelets and welded seams



Breathable groundsheet
Breathable polyester coated groundsheet, hardwearing and rot proof. Easily folded and stored in its own water and mud proof nylon zipped bag.
3m x 2m black **107945**

Event Tents



Event shelter

Polyester flysheet 450mm PU aluminium coated steel poles. Living area: 20.25m². Headroom: 228cm (centre) 190cm (sides). Dimensions: 450cm x 450cm. Pack size: 102 x 26 x 20cm. Rectangular carry bag included. Weight 18kg **109781**



Eurovent Mosquito Dome

Versatile and light weight 190T Polyester roof with mosquito net sides. 11mm diameter fibreglass roof poles, with 19mm diameter steel leg poles. Weight 10kg. 2.2m tall in centre. Approx. 20m² floor area **109777**



Smart tent

A quick erecting tent that allows you to sleep off the ground. No more packing away a dirty groundsheet or water coming up through the floor. As simple as putting up a camp bed. Erects in 30 seconds.

- Off ground technology
- Outstanding durability
- Consistent quality throughout conditions
- UV resistant
- Naturally insulating
- Breathable
- Craftsmanship
- Locking device from inside

Weight - 12.2kg

Weight Limit tent - 120kg (18 Stone)

Dimensions:

217w x 70D x 31/105H cm

31cm - floor to bed, 105cm - top of tent to floor

Hydrostatic head rating - 2000mm

Green **108503**

Orange **108501**



Event shelter sunwall
109783



Event shelter sunwall and door
109782



Sundome with UV guard

The perfect accessory for the beach. Polyester flysheet 500mm PU silver coated, Groundsheet: PE 110 g/m², zips ON and OFF to the flysheet. Fibreglass poles, headroom 118cm. Tubular carry bag including draw cord opening and sand pockets. Pack size: 55 x 10cm. Weight 1.8kg **109789**



Windshield classic

Backed by the reassurance of Coleman quality, this smart accessory provides the desired level of privacy and essential protection from the elements. Polyester flysheet 500mm PU coated, fibreglass poles. Tubular with draw cord opening carry bag included. 10 pre-attached guy ropes and pegs provide stability. Dimensions 550 x 150cm. Weight 2.6kg **109788**

Mosquito protection



W4 mosquito netting

A useful range of pre-cut lengths of netting for use on windows or rooflights. Complete with fixing kit

1m square	101070
1m x 1.5m	101080
1m x 2m	101075
Mosquito fixing kit	101085



Fiamma mosquito net

Mosquito screen for motor home and caravan door consisting of 2 overlapping panels. Each panel is reinforced and stays taut and is 230cm high, 35cm wide. Easily installed by sliding onto wall track, adjustable height **101088**



Rolson magnetic door curtain/net

Mosquito screen for domestic use, consisting of 2 overlapping panels. Maximum size 215cm x 97cm. Easily installed by sticking on velcro strips along the frame. **101090**

Air Beds

**Coleman comfort airbeds**

Airtight® system: patented Double Lock™ valve locks in air two ways. Repair kit included. Phthalate free
 Single: 188cm x 85cm x 22cm. Weight 2.3kg.
 Available singly or 6 per outer **109856**
 Double 188cm x 137cm x 22cm. Weight 3.7kg.
 Available singly or 4 per outer **109858**

**Coleman raised quickbed queen**

Exclusive Wrap'n'Roll™ system. Double height for extra comfort 47 cm. Airtight® system: patented. Double-Lock™ valve locks in air. Repair kit included. Phthalate free.
 213cm x 168cm x 47cm. Weight: 73 kg
 2 per outer **109862**

**Airbed plugs (3)**

Replacement airbed plugs
 10 packs per outer
109480

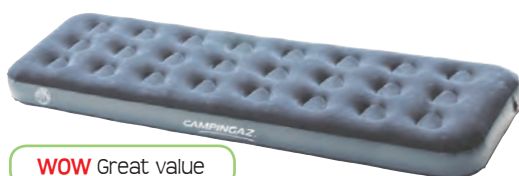

WOW Great value

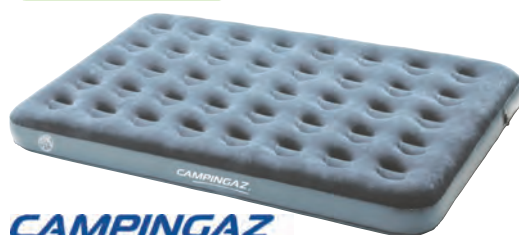

CAMPINGAZ

Campingaz quickbed airbeds

A reliable and comfortable inflatable bed for camping or to use as a spare bed. It is fitted with Airtight system making it leak free and more resilient. Repair kit included
 Single 188cm x 74cm x 19cm. Weight 1.6kg
 6 per outer **109848**
 Double 188cm x 137cm x 19cm. Weight 2.9kg
 4 per outer **109849**



the original
aerobed

**Aerobed Active airbeds**

Powerful, rechargeable, cordless pump for inflation. Air coil system ensures a stable, even sleeping surface. Proven by experts to eliminate pressure points. Woosh™ Valve super-fast deflation in seconds. Smooth flocked sleep surface. Bed rolls up and stores compactly in a durable carry bag included. Non-allergenic - Hygienic and dust mite free sleeping surface.
 Single: L198cm x W99cm x H23cm
109846
 Double L198cm x W137cm x H23cm
109847

Air pumps

**Campingaz 4D quickpump**

2 separate functions: inflates and deflates. Operates on 4D/R20 batteries (not included) Running time: 30 minutes. Airflow: 340 litres per minute. Carry bag included. Weight 360g.
 Available singly or 6 per outer **109868**

**Coleman 12v quickpump**

2 separate functions: inflates and deflates. Operates from 12v DC. Air flow: 500 litres per minute. Carry bag included
 Weight 1.7 kg.
 Available singly or 4 per outer **109870**

**Double foot pump with gauge**

Fitted with 480mm flexible hose and thumb lock lever tyre connector. Gauge graduated in psi (range 0-100psi) and bar (0-7bar)
 Includes pre set indicator **109726**

Tent and awning poles



A new range of camping poles. Excellent value!
Steel poles are zinc coated and Aluminium poles are anodised for excellent resistance to corrosion. All products are bagged and header carded with easy to read labelling to enable the consumer to buy without the need to ask busy sales staff.



WOW Umeфа point of sale helps the consumer easily identify the pole or poles required. 109250 Display "stand". Ask your sales contact for details.

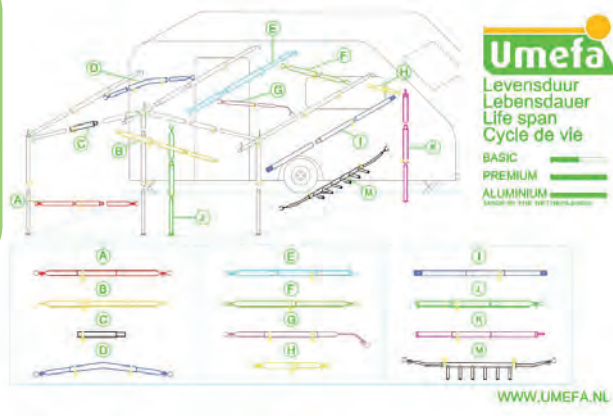

- 109160
- 109162
- 109164
- 109166

Verandah bars

Pole clamp on both ends.
Available singly or 10 per outer

Steel 22/19mm 170-250cm	109160
Steel 25/22mm 170-250cm	109162
Aluminium 25/22mm 120-200cm	109164
Aluminium 25/22mm 170-260cm	109166

- 109170
- 109172
- 109174

Roof beams

Pole clamp on one end with pole hook on the other.
Available singly or 10 per outer

Steel 22/19mm 170-250cm	109170
Steel 25/22mm 170-250cm	109172
Aluminium 25/22mm 170-260cm	109174

- 109180
- 109182
- 109184

Pole spike with basic foot

Pole spike on one end with blanking plug foot on the other.
Available singly or 10 per outer

Steel 22/19mm 180-250cm	109180
Steel 22/19mm 110-200cm	109182
Aluminium 25/22mm 170-260cm	109184

- 109190
- 109192

Storm pole with flanged foot

Pole clamp on one end with flanged foot on the other.
Available singly or 10 per outer

Steel 22/19mm 170-250cm	109190
Aluminium 25/22mm 170-260cm	109192

- 109196
- 109198

Storm pole with foot

Available singly or 10 per outer
Pole spike on one end with foot on the other.

Steel 22/19mm 170-250cm	109196
Pole spike on one end with angled foot on the other.	109198
Aluminium 25/22mm 170-250cm	109198



Twistable storm pole

Pole spike on one end with spiked foot on the other. Twist to lock. Available singly or 5 per outer

Aluminium 28/25mm 90-230cm	109202
----------------------------	---------------

- 109210
- 109212

Stretching pole

Bent with clamps on both ends.
Available singly or 5 per outer

Steel 22/19mm 165-255cm	109210
Aluminium 25/22mm 210-275cm	109212

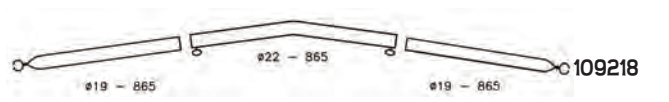

Bent crossbeam pole

Bent with clamps on both ends.
Available singly or 5 per outer

Steel 22/19mm 170-250cm	109218
-------------------------	---------------



Power grip
 Reversible
 For fibre frames
 901185



Power grip
 For steel frames
 901067



Plastic collar
 For aluminium frame 25mm
 901060



Pole hook
 20/22mm
 901090



Pole end
 Eyelet
 20/22mm
 901187



Pole end
 Eyelet
 25/28mm
 901188



Centre plastic corner
 For steel frame
 901066



Corner plastic bracket
 For new fibre frame used for either corner
 901175



Centre corner plastic bracket
 For new fibre frame
 901178



Pole clip
 For new fibre frame 25/28mm
 901190



Spiked foot
 For new fibre frame 20/22mm
 901195



Canopy pole end
 For new fibre frame 20/22mm
 901025



Metal washer
 901035



Trifix fixing bracket
 901064



Awning bracket
 901039



Plastic pole end
 23-25mm
 901049



Plastic pole end
 25mm
 901054



Grey feet
 23-25mm
 901084



Spiked foot
 22mm
 901078



Ball joint
 6mm thread
 901068



Pole hook
 22mm
 901087



Pole hook
 25mm
 901089



Plastic hooked clip
 25mm
 901092



Pole eye hook
 22mm
 901086



Pole end
 20-22mm
 901075



Roof lining / inner tent clip
 901121



Pole clamp
 25-32mm
 901017



Pole clamp
 25 - 32mm
 901086



Spring button
 901000



Spring button
 22-25mm
 901005



P shaped adjuster bolt
 901023



Metalic collars (4)
 20mm
 901072

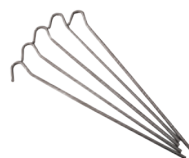

Angled pegs (25)
 901104



Skewer pegs (4)
 560114 901098
 570258 901107



Grey plastic pegs
 901095



Rubber rings
 40 x 48 x 9mm
 901131



Peg puller
 901128



Connecting spring
 901027



Metal clip
 20-22mm
 901012



Guy line 5m
 2.5mm
 901135



Tensioner
 901044



Adjustable peg strap
 901138



Curtain hook - annexe
 901115



Curtain hooks
 901117



Curtain rod end
 901119



Rain cowli
 901057

Pet Range



Cable dog leash
6ft 182cm 12 per outer
124132



Reflective dog collar
24 per outer 124127



Adjustable LED dog collar
12 per outer
124126



Dog play balls (4)
24 per outer
124122



Doggy waste pick up tool
12 per outer 124120
Doggy waste refill kit
3 x 18 bags. 12 per outer 124121



Garden tie out stake
12 per outer
124020



2qt adjustable double diner
124111



Dog leashes



Just enough stretch to avoid jolts, but maintains great control. Padded hold-loops for comfort. Modern, stylish design & colour range. High quality manufacture. Unlike recoil-leads, ROK's progressive tension keeps you in control and signals your pet to stop - without the jolt. Solid natural rubber core with nylon outer braid extremely chew resistant. Built-in Traffic Leader and Car Restraint. Less jolts on you, and your pet's collar and neck. Unlike "bungees", has minimal recoil if released.



ROK Dog leash Small dog 54"
For small pets upto 18kg
Blue/Black 124140
Pink Camo 124141



ROK Dog leash Medium dog 54"
For medium pets from 18-36kg
Black/Orange 124148
Jungle 124149



ROK Dog leash Large dog 54"
For large pets from 36kg+
Blue/Black 124156
Black/Reflective 124157



ROK Dog leash Large dog 36"
For large pets from 36kg+
Black/Green 124164
Black/Red 124165



Alan Rogers guides

All Alan Rogers books are available singly or 10 per outer.



GB & Ireland

Covering over 550 selected camping and caravanning parks. **12018713**

Europe

Covering over 900 selected campsites in 24 European countries. **12018813**

France

Covering over 900 selected camping and caravanning parks. **12018913**

Spain & Portugal

Covering over 260 selected camping and caravanning sites. **12019513**

Italy

Covering over 320 selected camping and caravanning sites. Including Sicily and Sardinia. **12019613**

Netherlands

Over 250 inspected and selected camping and caravanning sites in the Netherlands, Belgium and Luxembourg. **12019713**

101 best camp sites

Great campsites across Europe perfect for your chosen hobby. Choose from these three titles.



101 Fishing
Angling and sea fishing. **12018413**



101 Golf
Ideal for golfers. **12018513**



101 You & Your Dog
Where dogs are welcome. **12018113**

WOW Country guides now include a FREE Alan Rogers Travel card with extra benefits and savings! These books offer a unique update facility - you can return unsold books to Grove Products and we will replace them free of charge with the new years book. Time barring applies please speak with your sales contact to make sure you don't miss out!

Manuals and Books



The caravan manual

Content includes guidance on maintaining older caravans as well as detailed information on recent developments **120175**



The motorcaravan manual

This comprehensive illustrated manual is full of practical information and advice for both the novice and the experienced owner **120177**



Build your own motorcaravan book

The complete guide to van conversions, coachbuilds and major renovation projects **120178**

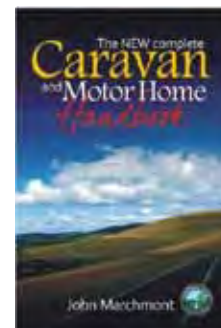

The caravan & motor home handbook

This book contains information on all aspects of caravan and motorhome ownership **120173**

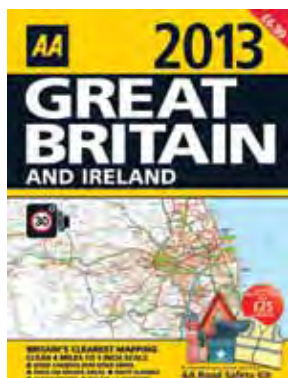

AA road atlas GB

A3. Clear 4 miles to 1 inch scale. Fully updated, route planner and 8,000 places to visit. New speed camera locations. 10 per outer **120200**

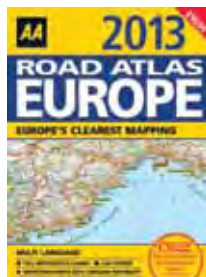

AA road atlas Europe

A4 Multi scale coverage of Europe, 45 countries, 34 city route maps. Available singly or 10 per outer **120202**

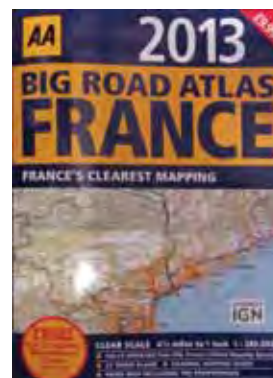

AA road atlas France

A3. Clear scale, 20 town plans. Available singly or 10 per outer **120204**

I-Spy books

All packed 6 per outer
I-Spy Merchandiser 120265 Please ask your representative for details

WOW The perfect travelling companion for children



Every Vehicle on the Road
120254



Car Badges
120248

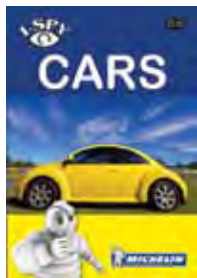

Cars
120242

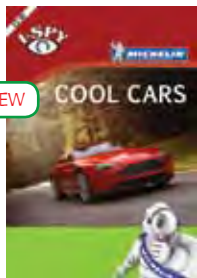

Cool cars
120236

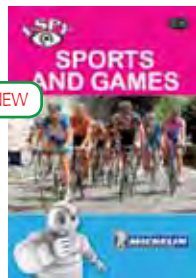

Sports & games
120230

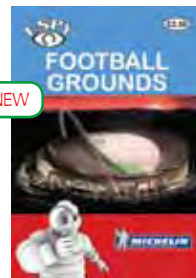

Football grounds
120232

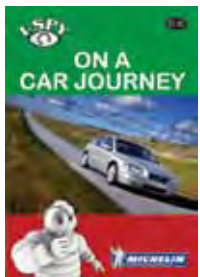

On a Car Journey
120245



On a car Journey in France
120256

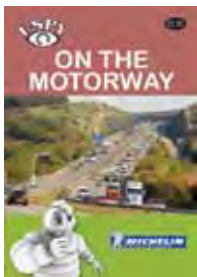

On the Motorway
120251

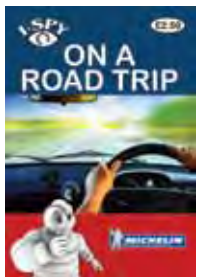

On a Road Trip
120255

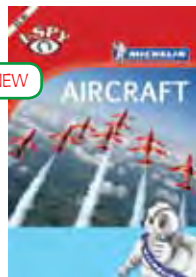

Aircraft
120235



Camping
120247

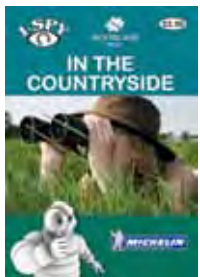

In the Countryside
120252



At the Seaside
120246



Minerals, rocks & fossils
120233

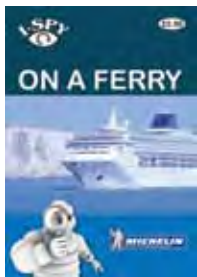

On a Ferry
120253



On the water
120239

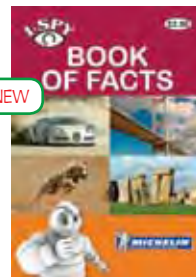

Book of facts
120231



Nature
120244



Birds
120241



Creepy Crawlies
120243

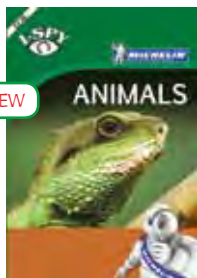

Animals
120238



Dogs
120237

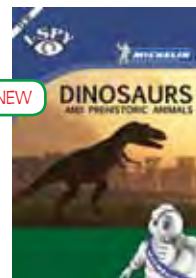

Dinosaurs
120234

Toys



Sea cruiser transporter
6 per display outer
124074



Jeep with leisure vehicle
6 per display outer
124072

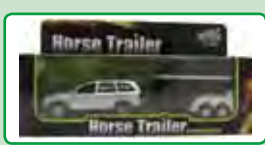

Horse trailer
6 per display outer
124071



Motorhome & trailer
6 per display outer
124070



Holiday fun car & caravan
6 per display outer
124069

Dukdalf



The new Dukdalf camping furniture range is produced in the Netherlands.

All of our Dukdalf chairs have a unique folding system using a sliding hinge and Italian designed upholstery.

WOW 4 year warranty
on all items!

DYNAMIC

Seat: 47 x 44 cm.
Seat-height: 45 cm.
Backrest: 77 cm.
Folded: 100 x 61 x 9 cm.
Weight: 4 kg.
Maximum capacity 140 kg.
Material: 70% PVC, 30% Polyester

A stable and compact chair with an ergonomically shaped back and seat. It can be folded to less than 9cm thickness and thanks to it's special design. The frame of double reinforced anodised oval aluminium tube makes the chair not only very strong but also very light. Thanks to the 10 position adjustable extra wide armrests, the chair can be used from comfortable chair to an almost horizontal relaxed recliner (using the optional leg rest).

Available singly or 4 per outer

Blue **107601**

Grey (as illustrated) **107602**

DYNAMIC L

Seat: 47 x 44 cm.
Seat-height: 50 cm.
Backrest: 80 cm.
Folded: 110 x 61 x 9 cm.
Weight: 4.2 kg.
Maximum capacity 140 kg.
Material: 70% PVC, 30% Polyester

Also a stable and compact chair with an ergonomically shaped back and seat. It has an extra tall back and higher seating position than the Dynamic. It can also be folded to less than 9cm thickness thanks to it's special design. The frame of double reinforced anodised oval aluminium tube makes the chair not only very strong but also very light. Thanks to the 10 position adjustable extra wide armrests, the chair can be used from comfortable chair to an almost horizontal relaxed recliner (using the optional leg rest).

Available singly or 4 per outer

Blue (as illustrated) **107605**

Grey **107606**

ASPEN

Seat: 49 x 43 cm.
Seat-height: 44 cm.
Backrest: 78 cm.
Folded: 108 x 60 x 10 cm.
Weight: 2.8kg.
Maximum capacity 100 kg.
Material: 70% PVC, 30% Polyester

Very light weight, the Aspen chair has a round aluminium tubular frame. It can be folded to 10cm thickness and reclines in 8 positions. It features a high back with built-in head rest.

Available singly or 2 per outer

Blue **107617**

Grey (as illustrated) **107618**

**Legrest DYNAMIC F**

The ergonomic legrest fits all Dukdalf chairs and offers extra comfort. Simply lays across the sampler bar attached to each chair, turning a comfortable chair into a relaxer. Oval legs.

Dimensions folded: 86 x 49 x 8 cm

Maximum capacity: 25 kg.

Available singly or 4 per outer

Blue **107613**

Grey **107614**

**Legrest SAMPLER**

The ergonomic legrest fits all Dukdalf chairs and offers extra comfort. Simply lays across the sampler bar attached to each chair, turning a comfortable chair into a relaxer. Tubular legs.

Dimensions folded: 86 x 49 x 8 cm

Maximum capacity: 25 kg.

Available singly or 4 per outer

Blue **107621**

Grey **107622**

**Camping table STABILIC**

With a fast and stepless variable height, the table can almost easily be set at the correct height (56 - 72cm). The tables from the Stabilic series are equipped with a quality Sevelit table top, with up to 50 kg max load. Heat resistant up to 180°C, waterproof and easy to clean. Individually boxed.

Available in 2 sizes.

Stabilic I 107650

80 x 60 x 56-72cm. 6 kg.

Stabilic II 107651

100 x 68 x 56-72cm. 9 kg.

Both tables are 4.5cm deep when folded

Chairs



Deck chair khaki
W62cm x D55cm x H78cm
4 per pack **109801**



Sling chair khaki
W58cm x D72cm x H93cm
4 per pack **109805**



Deck chair khaki with table
4 per pack **109803**

Relaxers



Relaxer chair small
Dimensions H115cm x W65cm x D73cm
Weight 7.4kg
107460 Cream
107461 Black



Cup holder for relaxer chairs
107470



Relaxer chair large
Dimensions H115cm x W75cm x D73cm
Weight 9kg
107466 Black/brown

WOW
Extra wide!

Children's sleeping bags

Sleeping bags with 50% Polyester 50% Cotton outer, 100% hollofibre filled, washable, non allergenic, zipped detachable pillow & pillow case. Size 42x66cm/26x56" approximately



America
8 per outer **123016**



Teddies
8 per outer **123017**



Dalmation blue
8 per outer **123018**



Dalmation red
8 per outer **123019**



Dalmation pink
8 per outer **123020**

Adult sleeping bags

All adult bags are 52oz filling. Dimensions: 200cm x 91cm approx.



Red check microfibre
6 per outer **123144**



Green check microfibre
6 per outer **123145**



Inca maroon hollofibre
6 per outer **123116**

WOW Reversible, zip any two of the same bag together to make a double bag



Sahara hollofibre 6 per outer
Maroon **123121**

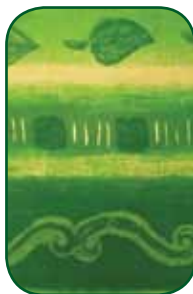

Green **123122**



Terracotta **123123**

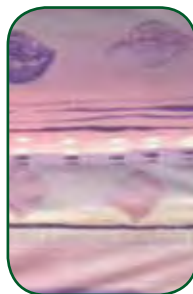

Lilac **123124**

Mattress Toppers



Memory foam mattress topper

Orthopaedic, non allergenic, visco elastic memory foam. Temperature sensitive foam moulds to your body's heat & weight to provide the right amount of support your body needs to aid a restful nights sleep.

Single size 90cm x 190cm x 2.5cm

123295

Double size 135cm x 190cm x 2.5cm

123296