

# ViewSonic®

VT3210LED/VT4210LED

LED TV

- User Guide

- Guide de l'utilisateur

- Guida dell'utente

IMPORTANT: Please read this User Guide to obtain important information on installing and using your product in a safe manner, as well as registering your product for future service. Warranty information contained in this User Guide will describe your limited coverage from ViewSonic Corporation, which is also found on our web site at <http://www.viewsonic.com> in English, or in specific languages using the Regional selection box in the upper right corner of our website.

"Antes de operar su equipo lea cuidadosamente las instrucciones en este manual"

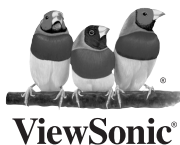

Model No. : VS13772-1M  
VS13776-1M

# Contents

<b>Compliance Information</b> .....	<b>i</b>
<b>Declaration of RoHS Compliance</b> .....	<b>ii</b>
<b>Copyright Information</b> .....	<b>iii</b>
<b>Product Registration</b> .....	<b>iii</b>
<b>TV Wall Mount</b> .....	<b>iv</b>
<b>Safety Instructions</b> .....	<b>iv</b>
<b>Wet Location</b> .....	<b>iv</b>
<b>Outdoor Use</b> .....	<b>iv</b>
<b>Disconnect Device - The Mains Plug or An Appliance Coupler</b> .....	<b>iv</b>
<b>WARNING</b> .....	<b>v</b>
<b>USE</b> .....	<b>vi</b>
<b>Important Safety Instructions</b> .....	<b>vi</b>
<b>List of Features</b> .....	<b>10</b>
<b>Package Contents</b> .....	<b>10</b>
<b>Installing the LED TV</b> .....	<b>11</b>
Disconnecting the stand.....	11
Installing the stand.....	11
Mounting ViewSonic LED TV to the wall.....	12
Wall Mount Kit Specifications (VESA).....	13
Front and side View .....	14
Rear View.....	15
<b>Connecting the LED TV</b> .....	<b>17</b>
Cable System or VHF/UHF Antenna System.....	17
Cable System and VHF/UHF Antenna System.....	17
HD Cable Box/HD Satellite Box .....	18
Personal Computer .....	19
Digital audio system.....	19
Other Equipments .....	20
Acceptable signal formats for VGA IN and HDMI terminals.....	21
<b>Remote Control and TV Controls</b> .....	<b>22</b>
Inserting Remote Control Batteries .....	22
Remote Control and TV Controls.....	23
<b>Operation</b> .....	<b>24</b>
Turning the TV On and Off.....	24
Changing Channels.....	24
Adjusting the Volume .....	24
Viewing the Source Information .....	24
Automatic Power Down.....	24

No Signal Power Down .....	24
Using the OSD Menu .....	25
Customizing the Picture Settings .....	25
Customizing the Audio Settings .....	27
Customizing the Preferences Settings .....	29
Customizing the Locks Settings .....	30
Customizing the Setup Settings .....	32
<b>Cleaning the LED TV .....</b>	<b>34</b>
Disclaimer .....	34
<b>Troubleshooting .....</b>	<b>35</b>
<b>Specifications .....</b>	<b>38</b>
<b>Limited Warranty .....</b>	<b>41</b>
<b>Mexico Limited Warranty .....</b>	<b>42</b>

# Compliance Information

## FCC Statement

This device complies with part 15 of FCC Rules. Operation is subject to the following two conditions: (1) this device may not cause harmful interference, and (2) this device must accept any interference received, including interference that may cause undesired operation.

This equipment has been tested and found to comply with the limits for a Class B digital device, pursuant to part 15 of the FCC Rules. These limits are designed to provide reasonable protection against harmful interference in a residential installation. This equipment generates, uses, and can radiate radio frequency energy, and if not installed and used in accordance with the instructions, may cause harmful interference to radio communications. However, there is no guarantee that interference will not occur in a particular installation. If this equipment does cause harmful interference to radio or television reception, which can be determined by turning the equipment off and on, the user is encouraged to try to correct the interference by one or more of the following measures:

- Reorient or relocate the receiving antenna.
- Increase the separation between the equipment and receiver.
- Connect the equipment into an outlet on a circuit different from that to which the receiver is connected.
- Consult the dealer or an experienced radio/TV technician for help.

**Warning:** You are cautioned that changes or modifications not expressly approved by the party responsible for compliance could void your authority to operate the equipment.

## Following information is only for EU-member states:

The mark shown to the right is in compliance with the Waste Electrical and Electronic Equipment Directive 2002/96/EC (WEEE).

The mark indicates the requirement NOT to dispose the equipment as unsorted municipal waste, but use the return and collection systems according to local law.

If the batteries, accumulators and button cells included with this equipment, display the chemical symbol Hg, Cd, or Pb, then it means that the battery has a heavy metal content of more than 0.0005% Mercury or more than, 0.002% Cadmium, or more than 0.004% Lead.



## ENERGY STAR Information:

To ensure your television is operating at optimal energy efficiency, select [Home] mode during initial activation.

To return to [Home] mode settings, select [Standard] picture mode. [Standard] mode is recommended for normal home use.

Keeping the TV at its factory default settings that meet ENERGY STAR criteria.

Enabling certain features and functionality of LED TV will increase its energy consumption, possibly beyond the limits required for ENERGY STAR qualification.

# Declaration of RoHS Compliance

This product has been designed and manufactured in compliance with Directive 2002/95/EC of the European Parliament and the Council on restriction of the use of certain hazardous substances in electrical and electronic equipment (RoHS Directive) and is deemed to comply with the maximum concentration values issued by the European Technical Adaptation Committee (TAC) as shown below:

Substance	Proposed Maximum Concentration	Actual Concentration
Lead (Pb)	0.1%	< 0.1%
Mercury (Hg)	0.1%	< 0.1%
Cadmium (Cd)	0.01%	< 0.01%
Hexavalent Chromium (Cr <sup>6+</sup> )	0.1%	< 0.1%
Polybrominated biphenyls (PBB)	0.1%	< 0.1%
Polybrominated diphenyl ethers (PBDE)	0.1%	< 0.1%

Certain components of products as stated above are exempted under the Annex of the RoHS Directives as noted below:

Examples of exempted components are:

1. Mercury in compact fluorescent lamps not exceeding 5 mg per lamp and in other lamps not specifically mentioned in the Annex of RoHS Directive.
2. Lead in glass of cathode ray tubes, electronic components, fluorescent tubes, and electronic ceramic parts (e.g. piezoelectronic devices).
3. Lead in high temperature type solders (i.e. lead-based alloys containing 85% by weight or more lead).
4. Lead as an alloying element in steel containing up to 0.35% lead by weight, aluminium containing up to 0.4% lead by weight and as a copper alloy containing up to 4% lead by weight.

# Copyright Information

Copyright © ViewSonic® Corporation, 2011. All rights reserved.

ViewSonic, the three birds logo, OnView, ViewMatch, and ViewMeter are registered trademarks of ViewSonic Corporation.

ENERGY STAR® is a registered trademark of the U.S. Environmental Protection Agency (EPA).

As an ENERGY STAR® partner, ViewSonic Corporation has determined that this product meets the ENERGY STAR® guidelines for energy efficiency.

Disclaimer: ViewSonic Corporation shall not be liable for technical or editorial errors or omissions contained herein; nor for incidental or consequential damages resulting from furnishing this material, or the performance or use of this product.

In the interest of continuing product improvement, ViewSonic Corporation reserves the right to change product specifications without notice. Information in this document may change without notice.

No part of this document may be copied, reproduced, or transmitted by any means, for any purpose without prior written permission from ViewSonic Corporation.

## Product Registration

To meet your future needs, and to receive any additional product information as it becomes available, please register your product on the Internet at: [www.viewsonic.com](http://www.viewsonic.com).

### For Your Records

<b>Product Name:</b>	VT3210LED/VT4210LED ViewSonic LED TV
<b>Model Number:</b>	VS13772 (VT3210LED-1M) /VS13776 (VT4210LED-1M)
<b>Document Number:</b>	VT3210LED-1M_UG_ENG Rev. 1B 09-20-11 VT4210LED-1M_UG_ENG Rev. 1B 09-20-11
<b>Serial Number:</b>	_____
<b>Purchase Date:</b>	_____

### Product disposal at end of product life

ViewSonic respects the environment and is committed to working and living green. Thank you for being part of Smarter, Greener Computing. Please visit ViewSonic website to learn more.

USA & Canada: <http://www.viewsonic.com/company/green/recycleprogram/>

Europe: <http://www.viewsoniceurope.com/uk/support/recyclinginformation/>



Taiwan: <http://recycle.epa.gov.tw/recycle/index2.aspx>

# TV Wall Mount

To find the perfect mount for VT3210LED / VT4210LED, please browse [www.viewsonic.com](http://www.viewsonic.com) or call our service team: United States 1-800-688-6688, Canada 1-866-463-4775.

## Safety Instructions



	<p>The symbol is intended to alert the user to presence of un-insulated “Hazardous Voltage” within the product’s enclosure that may be of sufficient magnitude to constitute a risk of electric shock to persons.</p>
	<p>This symbol is intended to alert the user that improper use of the product may result in product malfunction. The user should pay attention to avoid accidents or unnecessary problems.</p>

## Wet Location

Apparatus shall not be exposed to dripping or splashing and that no objects filled with liquids, such as vases, shall be placed on the apparatus.

## Outdoor Use

WARNING: To reduce the risk of fire or electric shock, do not expose this apparatus to rain or moisture.

## Disconnect Device - The Mains Plug or An Appliance Coupler

The mains plug or an appliance coupler is used as the disconnect device for disconnection from the mains, the disconnect device shall remain readily operable.

## WARNING

Do not expose this TV to rain or moisture. It may increase the risk to fire or electronic shock.



### Dangerous Voltage:

The lightning flash with arrowhead symbol, within an equilateral triangle, is intended to alert the user to the presence of dangerous voltage within the inside of the product that may be sufficient level to constitute a risk of electric shock to persons.



**Instruction:** The exclamation point within an equilateral triangle is intended to alert the user to the presence of important operating and servicing instructions in the literature accompanying the appliance.

The TV shall not be exposed to dripping or splashing. Do not put objects filled with liquids, such as vases, on the TV.

## CAUTION

To prevent electric shock, do not use this polarized AC plug with an extension cord, receptacle or other outlet unless the blades can be fully inserted to prevent blade exposure.

### Declaration of Conformity

Trade Name: ViewSonic Model: VT3210LED / VT4210LED Responsible Party: ViewSonic Corporation Address: 381 Brea Canyon Road, Walnut, CA. 91789 USA Telephone Number: 1-800-688- 6688 This device complies with part 15 of the FCC rules. Operation is subject to the following two conditions: 1) This device may not cause harmful interference, and 2) this device must accept any interference received, including interference that may cause undesired operation.

## NOTIFICATION

This device has been tested and found to comply with the limits for a Class B digital device, pursuant to Part 15 of the ViewSonic

FCC Rules. These limits are designed to provide reasonable protection against harmful interference in a residential installation. This device generates, uses and can radiate radio frequency energy and, if not installed and used in accordance with the instructions, may cause harmful interference to radio communications.

However, there is no guarantee that interference will not occur in a particular installation. If this equipment does cause harmful interference to radio or television reception, which can be determined by turning the equipment off and on, the user is encouraged to try to correct the interference by one or more of the following measures:

- Reorient or relocate the receiving antenna.
- Increase the separation between the device and receiver.
- Connect the device into an outlet on a circuit different from that to which the receiver is connected.
- Consult the dealer or an experienced radio/TV technician for help.

Pursuant to FCC regulations, be cautioned that any changes or modifications not expressly approved in this manual could void your authority to operate this equipment.

## SAFETY

- Operate the TV on 120V AC only.
- Use the AC power cord specified by ViewSonic and suitable for the voltage where you use it.
- The plug is designed, for safety purposes, to fit into the wall outlet only one way.
- If you are unable to insert the plug fully into the outlet, contact your dealer.
- If any liquid or solid object should fall inside the cabinet, stop operating, unplug the TV immediately and have it checked by qualified service technician.
- If you will not be using the TV for a long time, disconnect the power by pulling the plug itself. Do not pull on the cord.
- For details concerning safety precautions, refer to Important Safety instructions on page 3.

## Installation

- The TV should be installed near an easily accessible power outlet.
- To prevent internal heat buildup, do not block the ventilation openings.
- Do not install the TV in a hot or humid place, or in a place subject to excessive dust or mechanical vibration.
- Avoid operating the TV at temperatures below 41°F (5°C).
- When the TV is transported directly from a cold to a warm location, or if the room temperature changes suddenly, the picture may be blurred or show poor color due to moisture condensation. In this case, please wait a few hours before turning on the TV, in order to let the moisture evaporate first.
- To ensure best picture quality, do not expose the screen to direct illumination or sunlight. We recommend you use spot lighting directed down from the ceiling or to cover the windows that face the screen with opaque curtains. It is better that TV is installed where the floor and walls are not of a reflective material.

## TO CUSTOMERS

To install the specified TV, sufficient expertise is required. Make sure you subcontract the installation to ViewSonic dealer or licensed contractors and pay adequate attention to safety during the installation.

### Note

This television includes a QAM demodulator, which should allow you to receive unscrambled digital cable television programming via subscription service to a cable service provider. The type of programming and signal provided by your cable service provider will affect the availability of digital cable television programming in your area.

## TRADEMARK INFORMATION

- Macintosh is a trademark of Apple Manufactured under license from Dolby Laboratories. Dolby and the double-D symbol are trademarks of Dolby Laboratories.
- HDMI, the HDMI logo and High-Definition Multimedia Interface are trademarks or registered trademarks of HDMI Licensing LLC in the United States and other countries.



• This production contains Bitstream Vera Sans fonts under the following copyright.  
 Copyright © 2003 by Bitstream, Inc. All Rights Reserved.  
 Bitstream Vera is a trademark of Bitstream, Inc.

## IMPORTANT SAFETY INSTRUCTIONS

1. Read these instructions completely before using the equipment.
2. Keep these instructions in a safe place.
3. Heed all warnings.
4. Follow all instructions.
5. Do not use this apparatus near water.
6. Clean with a soft, dry cloth.
7. Do not block any ventilation openings.

Install the equipment in accordance with the manufacturer's instructions.

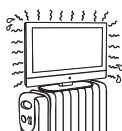

8. Do not install near any heat sources such as radiators, heat registers, stoves, or other devices (including amplifiers) that produce heat.
9. Do not attempt to circumvent the safety provisions of the polarized or grounding-type plug. A polarized plug has two blades with one wider than the other. A grounding type plug has two blades and a third grounding prong. The wide blade and the third prong are provided for your safety. If the provided plug does not fit into your outlet, consult an electrician for replacement of the outlet.
10. Prevent the power cord from being tread upon or pinched, particularly at the plug, convenience receptacles, and the point where they exit from the device. Be sure that the power outlet is located near the equipment so that it is easily accessible.
11. Only use attachments/ accessories specified by the manufacturer.
12. Use only with the cart, stand, tripod, bracket, or table specified by the manufacturer, or sold with the apparatus. When a cart is used, use caution when moving the cart/ apparatus combination to avoid injury from tip-over.
13. Unplug this apparatus when it will be unused for a long period of time.
14. Refer all servicing to qualified service personnel. Servicing is required when the apparatus has been damaged in any way, such as power-supply cord or plug is damaged, liquid has been spilled or objects have fallen into the apparatus, the apparatus has been exposed to rain or moisture, or the unit does not operate normally, or has been dropped.



## USE

### AC power Cord

Keep the following guidelines to protect the AC power cord from being damaged. If the AC power cord is damaged, it may result in a fire or an electric shock. Stop using it and ask your dealer or ViewSonic service center to exchange it.

- Do not place the TV where the power cord is subject to wear or abuse.
- Do not pinch, bend, or twist the cord excessively.
- The core lines may be bared and cut, causing a short-circuit,

- and resulting in a fire or an electric shock.
- Do not convert or damage the power cord.
- Avoid power cord being rolled over or rested upon.
- When the power cord is plugged in, do not move the TV.
- Keep the power cord away from heat sources.
- When you disconnect the AC power cord, disconnect it from the wall outlet first.
- When disconnecting the power cord, grasp the plug instead of pulling the power cord.
- Use only an original ViewSonic AC power cord, not other brands.
- Do not use the supplied AC power cord on any other equipment.



### Wall outlet

Insert the plug fully into the outlet. If it is loose, do not use it. Doing so may cause arcing and result in a fire. Contact your electrician to change the outlet.

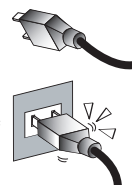

### Wiring

For your safety, be sure to unplug the AC power cord when connecting cables.

Take care not to trip on the cables. It may cause damage to the TV set.

### Electric shock

Do not touch the AC power cord or the TV with a wet hand. If you plug/unplug the AC power cord from the TV with a wet hand, it may cause electric shock.



### Lightning storms

During a lightning storm, unplug the TV from the wall outlet and disconnect the antenna to prevent damage to the TV.

### When not in use

If you will not be using the TV set for long periods of time, the TV set should be disconnected from the AC power outlet to prevent power line surges. The TV set is not disconnected from the AC power source when the TV set is switched off. To disconnect the TV set completely, unplug from the AC power outlet.

### Overloading

This TV set is designed to operate on a 120V AC supply only. If there are too many appliances connected to the same AC power outlet, it could result in a fire or an electric shock.

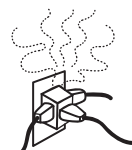

### Optional equipment

If optional equipment is to be installed, leave some space between optional equipment and the TV set. Picture distortion and/or noisy sound may occur if the TV set is positioned in close proximity to any equipment emitting electromagnetic radiation.

### Small accessories

Keep small accessories in a safe place where children are unable to reach.

## ANTENNAS

### Outdoor antenna grounding

If an outdoor antenna is installed, follow the precautions below. Do not install the outdoor antenna system near of overhead power lines or other electric light or power circuits, or where it can come in contact with such power lines or circuits.

**WHEN INSTALLING AN OUTDOOR ANTENNA SYSTEM, EXTREME CARE SHOULD BE TAKEN TO KEEP FROM CONTACTING SUCH POWER LINES OR CIRCUITS AS CONTACT WITH THEM IS ALMOST INVARIABLY FATAL.**

Be sure the antenna system is grounded so that it can provide some protection against voltage surges and built-up static charges.

Section 810 of the National Electrical Code (NEC) in the U.S.A. and Section 54 of the Canadian Electrical Code in Canada provides information with in regard to proper grounding of the mast and supporting structure, grounding of the lead-in wire to an antenna discharge unit, size of grounding conductors, location of antenna discharge unit, connection to grounding electrodes, and requirements for the grounding electrode.

### Antenna grounding according to the National Electrical Code, ANS/NFPA 70

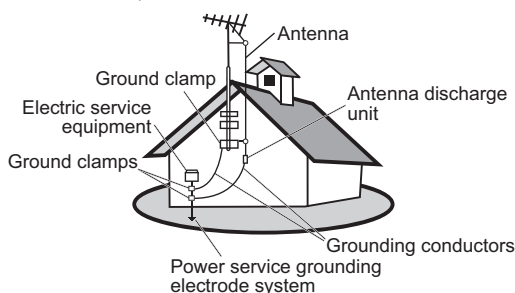

### Batteries

- Do not cast away batteries in a fire.
- Do not disassembled, overheat, or short-circuit the batteries.
- If the battery is replaced in the wrong way, it may cause danger of explosion. Replace only with the same or equivalent type.
- Batteries must not be exposed to excessive heat such as sunshine, fire or the like.

### Dispose used batteries

To preserve our environment, dispose of used batteries according to your local laws or regulations.

## CLEANING

### Cleaning the AC power plug

Unplug the AC power plug and clean it regularly. If the plug is covered with dust and gathers moisture, its insulation may deteriorate and result in a fire.



### Cleaning the screen surface/ cabinet of the TV set

When cleaning this TV, unplug the AC power cord. If not, it may result in electric shock. Use a dry soft cloth to clean the cabinet of the TV. To remove dust near the screen, wipe it gently with a soft cloth. Stubborn stains



may be removed with a cloth slightly dampened with a solution of mild soap and warm water. Never use strong solvents such as thinner or benzine for cleaning. If using a chemically pretreated cloth, please follow the instruction provided on the package. The ventilation holes can accumulate dust over time.

To ensure proper ventilation, we recommend you to remove the dust periodically (once a month) using a vacuum cleaner, while the LED TV is powered off.

### MAGNETIC INFLUENCE

This TV contains a strong magnet in the speaker unit that generates a magnetic field. Keep any items susceptible to magnetic fields away from the speaker.

### SOUND

If you hear snapping or popping sound comes from the TV continuously or frequently while the TV is operating, unplug the TV and consult your dealer or service technician. It is normal for some TVs to make occasional snapping or popping sounds, particularly when being turned on or off.

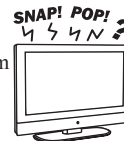

### CARRYING THE TV

#### Carry the TV as instructed

To prevent dropping the TV and causing serious injury, you must follow these guidelines:

- Disconnect all cables before carrying the TV.
- Carrying the large size TV requires at least two or three people.
- When you carry the TV, place your hands as illustrated and hold it securely. Do not put stress on the LCD panel and the frame around the screen.
- When carrying the TV, do not subject it to shocks, vibration, or excessive force.
- When lifting or moving the TV, hold it securely from the bottom. Place your palm directly under the panel.

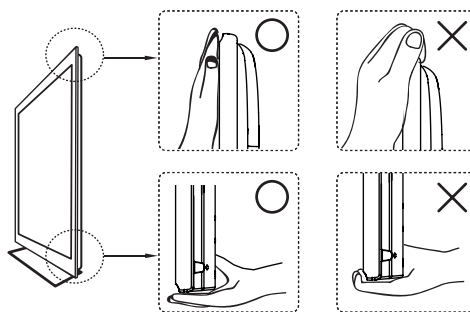

### VENTILATION

Slots and openings in TV are provided for ventilation. To ensure reliable operation of the TV and to protect it from overheating, be sure these openings are not blocked or covered.

The TV may accumulate dust and get dirty if proper ventilation is not provided. For proper ventilation, follow the following guidelines:

- Never install the TV face up, down or sideways.
- Never install the TV turned over or upside down.
- Never cover the slots and openings with a

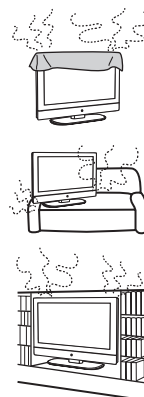

cloth or other materials.

- Never block the slots and openings by placing the TV on a bed, sofa, rug or other similar surface.
- Never place the TV in a confined space, such as a bookcase or built-in cabinet, unless proper ventilation is provided.

Leave some space around the TV set as shown below. Otherwise, air-circulation may be inadequate and cause overheating, which may cause a fire or damage to the TV set.

**Installed on the wall**

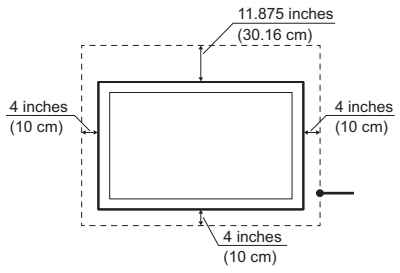

**Installed with stand**

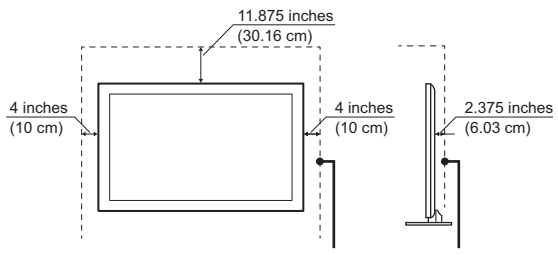

Leave at least this space around the set.

Do not install the TV set as follows:

Air circulation is blocked.

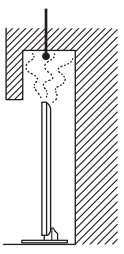

Air circulation is blocked.

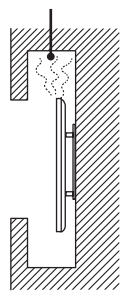

**Objects and ventilation holes**

Never push any objects into the slots on the TV cabinet as they may touch dangerous voltage points or short out parts that could result in a fire or an electric shock. Do not place any objects on the TV.

**MOISTURE**

**Moisture and flammable objects**

- Keep the product away from moisture. Do not expose this appliance to rain or moisture. Do not place objects filled with liquids, such as vases, on the TV.
- Do not use power-line operated V sets near water, such as in places like a bathtub, washbowl, kitchen sink, laundry tub, a wet basement, or near a swimming pool, etc. It may cause fire or electric shock.

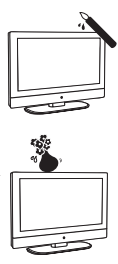

- Do not let this TV get wet. Never spill liquid of any kind on the TV. If water penetrates into the product, unplug the power cord and contact ViewSonic.
- Do not operate the TV when wet. It may result in electric shock or damage to the TV.
- To prevent fire, keep flammable objects or open flame (e.g. candles) away from the TV.

**INSTALLATION**

To do Wall mount installation, you need a Wall-Mount Bracket. When installing or removing the TV using the Wall-Mount Bracket, be sure to use qualified contractors. If not properly secured during installation or removal from the Wall-Mount Bracket, the TV may fall and cause serious injury.

**Optional wall mount**

- When installing the TV using a Wall-Mount Bracket, make sure you follow the operating instructions supplied with the Wall-Mount Bracket.
- Attach the brackets supplied with the Wall-Mount Bracket.
- The TV is not designed for hanging from the ceiling. It may fall and cause serious injury.

**Placement**

The TV should be installed near an easily accessible AC power outlet.

Observe the following to prevent the TV from falling from the stand or wall mount.

- Place the TV on a stable, level surface.
- Do not hang anything on the TV. Do not allow children to climb on the TV.
- Do not install the TV in places subject to extreme temperature, such as in direct sunlight, near a radiator, or heating vent. If the TV is exposed to extreme temperature, the TV may overheat and cause deformation of the enclosure or cause malfunction.
- Do not install the TV in a place exposed to direct air conditioning.
- If the TV is installed in such a location, moisture may condense inside and may cause a malfunction.
- Do not place the TV in hot, oily, humid or excessively dusty places.
- Do not install the TV where insects may enter.
- Do not install the TV where it may be exposed to mechanical vibration.
- Do not install the TV in a location where it may spear up, such as on or behind a pillar, or where you might bump your head on it. It may cause injury.



**Preventing the TV from toppling over**

To prevent the TV from toppling over, secure the TV to a wall or stand.

**Placement for watching**

We suggest you to watch the TV at a distance of 3-7 times that of the screen height, and not in excessive brightness. It is easy to cause eye fatigue if you watch TV for too long or in a dark room. To obtain clear picture, do not expose the screen to direct illumination or sunlight. Use spot lighting directed down from the ceiling if you can.

### Use in outdoor

This TV is not designed for outdoors installation. Do not expose the TV to rain, as it may result in a fire or an electric shock. Also, do not expose the TV to direct sunlight, as it may heat up and become damaged.

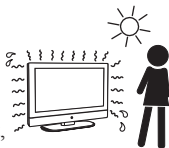

### Vehicle, ships and other vessels

Do not install this TV in a vehicle. Car accidents may cause the TV to fall down and cause injury.



Do not install this TV in a ship or vessel.

If the TV is exposed to seawater, it may cause a fire or damage the TV.



### Medical institutions

Do not place this TV in a place where medical equipment is in use. It may cause the medical equipment to malfunction.

### VOLUME ADJUSTMENT

- Adjust the volume to avoid disturbing your neighbors. Sound carries easily at night. Therefore, we suggest you close the windows or use headphones.
- When using headphones, adjust the volume to appropriate levels, or hearing damage may result.

### LCD SCREEN

- Although the LCD screen is made with high precision technology and has effective pixels of 99.99% or more, black dots or bright points or light (red, blue, or green) may appear constantly on the LCD screen. This is a structural property of the LCD panel and is not a malfunction.
- The LCD screen is made with high-precision technology. To achieve a high level of performance and picture quality, this TV's backlight setting is set to maximize the brightness of the TV. However, uneven brightness may be observed when the LED TV is viewed in a dark environment without an input source or a blank screen. This is a normal condition, not a malfunction of the TV. To improve this condition, change the Picture mode, Backlight setting, enable the Light Sensor, or turn on the Power management.
- Avoid exposing the LCD screen surface to direct sunlight. It is likely to damage the LCD panel.
- Do not push or scratch the LCD screen, or place objects on top of the TV. The image may be uneven or the LCD panel may be damaged.
- If the TV is used in a cold place, a smear may occur in the picture or the picture may become dark. It is not caused by a failure. This condition will improve as the temperature rises.
- When still pictures are displayed continuously, ghosting may occur. It should disappear after a short period of time.
- The screen and cabinet get warm when the TV is in use. This is a normal condition.
- Spraying insect repellent with volatile material on the screen will cause damage.
- Do not make prolonged contact with rubber or plastic material.

### Broken pieces

Do not throw anything at the TV. Doing so may break the screen glass and cause serious injury.

If the surface of the TV cracks, unplug the AC



power cord before touching the TV. Otherwise electric shock may result.

### Handling of broken glass and liquid crystal leakage

If the LCD panel gets damaged, crystalline liquid leakage may occur, or scattered broken glass may result. Do not touch broken glass or crystalline liquid which is toxic, with bare hands as cuts, poisoning or skin irritation may occur. Also do not glass fragments or leaked crystalline liquid get into your eyes or mouth. Should either contacted your eyes or mouth, rinse the contacted area thoroughly with water and consult your doctor.

### SERVICING

Do not attempt to repair the TV yourself, since opening the cabinet may expose you to dangerous voltage or other hazards. Ask qualified service personnel to do the servicing for your TV.



### Replacement parts

When replacement parts are required, be sure the service technician certifies in writing that he/she has used replacement parts specified by the manufacturer that have the same characteristics as the original parts. Unauthorized substitutions may cause a fire, an electric shock or other hazards.

### Safety check

Upon completion of repairs to the TV, ask the service technician to perform routine safety checks (as specified by the manufacturer) to determine that the TV is safe for operating, and to so certify.

Ask a qualified service technician to dispose of the TV.

### For Customers in the United States

There is mercury in the lamp of this product. Disposal of these materials may be regulated due to environmental considerations. For disposal or recycling information, please contact your local authorities or the Electronic Industries Alliance (<http://www.eiae.org>).

# Getting Started

## List of Features

1. Enjoy HDTV with 1366 x 768 (32"), 1920 x 1080 (42") native image resolution.
2. Built-in digital tuners (HDTV, NTSC, Clear QAM-digital cable).
3. **Multiple video/computer inputs:** HDMI (x2), VGA, one set of YPbPr (Component)/Video (Composite) input (Includes standard A/V connections. These are switched by AV input mode (see page 29).)
4. **Digital Audio Out** optical audio connection with Dolby® Digital optical output format.
5. **HDMI-CEC** allows control of external devices from the TV remote via HDMI connection. (see page 33).
6. **Media Player** allows you to view photo files. (see page 33).
7. Powerful 10W + 10W speakers.

## Package Contents

Check the contents of your package. It should contain:



LED TV

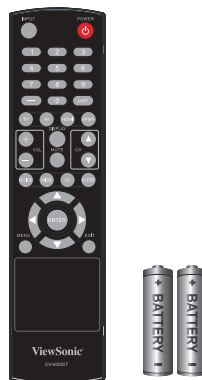

Remote Control with batteries

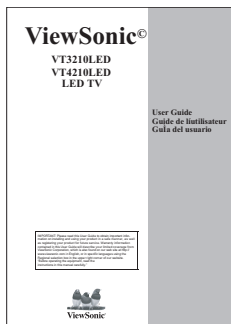

ViewSonic User Guide

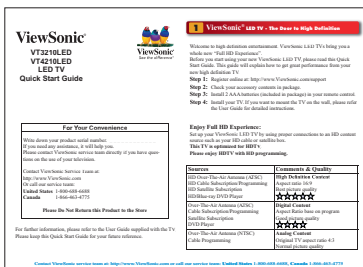

ViewSonic Quick Start Guide

# Getting Started

## Installing the LED TV

### *Disconnecting the stand*

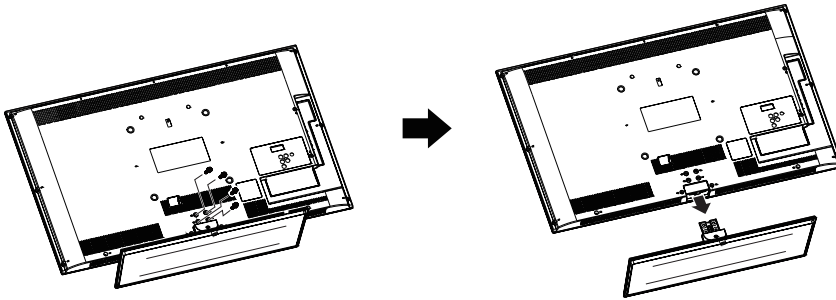

1. Place the TV face down on a soft cloth or cushion on a table.
2. Remove the screw securing the base to the stand.
3. Remove the base.

### *Installing the stand*

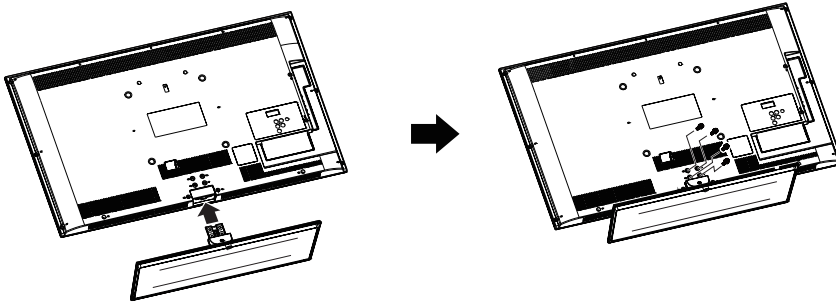

1. Place the TV face down on a soft cloth or cushion on a table.
2. Attach the base to the stand with 4 screw.

# Getting Started

## *Mounting ViewSonic LED TV to the wall*

The LED TV can be used in a free standing or wall-mounted position. Before installing the product to the wall, please consider the following guidelines:

- Read the Important Safety Instructions, at the start of this manual.
- Do not install in a moist or wet environment. This equipment is intended for indoor use.
- Do not install near heat source, or strong magnetic fields.
- Use only UL approved wall-mounting brackets to support the LED TV weight.
- Before attaching the wall mount plate to the back cover, ensure the product is working.
- If your LED TV is already set up for free-standing operation, you need to first remove the stand before mounting the device to the wall.

To attach the wall-mount bracket to LED TV safely, please use the following guidelines:

- Disconnect the power and any other cables that might hinder moving the LED TV.
- Set the LED TV on a table or work surface, placing the screen face down on a towel or woolen blanket to protect the screen surface from damage while installing plate.
- Before installing the LED TV on the wall, ensure you have recorded the product serial number on page (i) of the User Guide, as you will need the serial number to request service should there be a service need.
- Install the wall mount plate to the LED TV using screws NO LONGER than 10mm, as longer screws found in universal (non-ViewSonic) wall mount kits may damage the power supply causing the unit to fail. The wall-mount screw type is M6 x L13 or M6 x L10.
- Mount the wall mount bracket to the wall ensuring use of proper screws to support the installation. Ensure there is at least 3 cm of space surrounding any air-vents of your LED TV to allow adequate cooling during operation.
- Hang the LED TV wall mount plate to the wall mount bracket, completing installation.  
Enjoy your ViewSonic LED TV!

# Getting Started

## Wall Mount Kit Specifications (VESA)

When attaching to other building materials, please contact your nearest dealer.

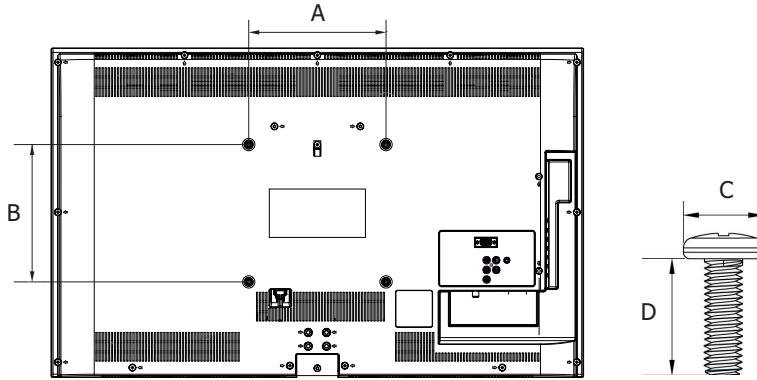

Product Family	Model	VESA Spec. (A x B)	Standard Screw (C x D)	Quantity
LED TV	VT3210LED	200 x 200 mm	M6 x L13	4
LED TV	VT4210LED	200 x 200 mm	M6 x L10	4

- ViewSonic provides the standard dimensions for wall mount kits as shown in the table above.
- When purchasing our wall mount kit, a detailed install manual and all parts necessary for assembly are provided.
- Do not use the screws that are longer than the standard dimension, as they may cause damage to the inside of the TV set.

To find the perfect mount for VT3210LED or VT4210LED, please browse [www.viewsonic.com](http://www.viewsonic.com) or call our service team:

United States 1-800-688-6688, Canada 1-866-463-4775.



# Getting Started

## Front and side View

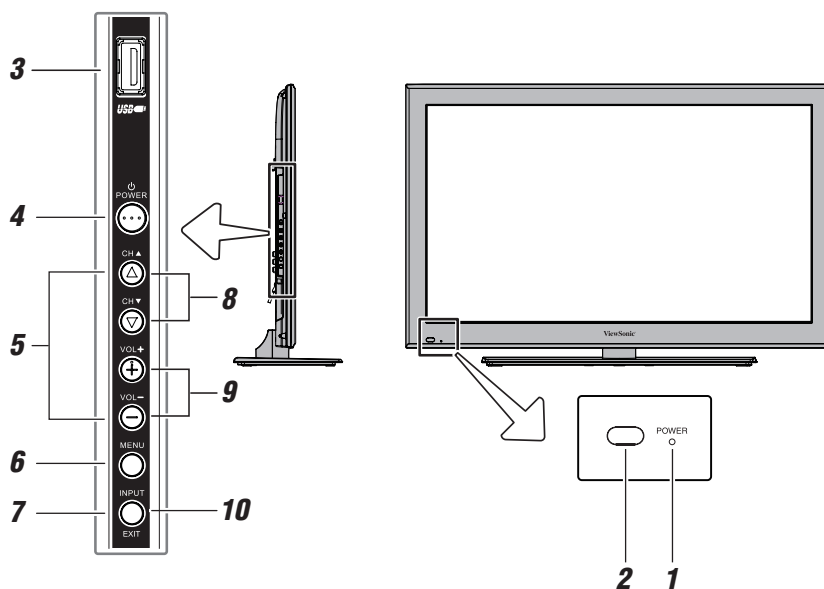

Item	Description
1 <b>Green LED</b>	Power LED (Green) = Power indicator
2 <b>Remote sensor</b>	Point the remote control toward this remote sensor.
3 <b>USB port</b>	To access photo files.
4 <b>POWER</b>	Press to turn the TV on and off. If the TV stops responding to the controls on the remote control or TV control panel and you cannot turn off the TV, please unplug the power cord few seconds then re-plug to try again.
5 <b>ARROWS ▲▼ +-</b>	When a menu is on-screen, these buttons function as up/down/left/right menu navigation buttons.
6 <b>MENU (ENTER)</b>	Press to access the menu system. When a menu is onscreen, the MENU button on the TV's control panel functions as the ENTER button.
7 <b>EXIT</b>	Press to instantly close an on-screen menu.
8 <b>CHANNEL ▲▼</b>	When no menu is on-screen, these buttons change the channel (programmed channels only).
9 <b>VOLUME +-</b>	These buttons adjust the volume level.
10 <b>INPUT</b>	Repeatedly press to change the source you are viewing (TV, YPbPr, HDMI 1, HDMI 2, VGA).

# Getting Started

ENGLISH

## Rear View

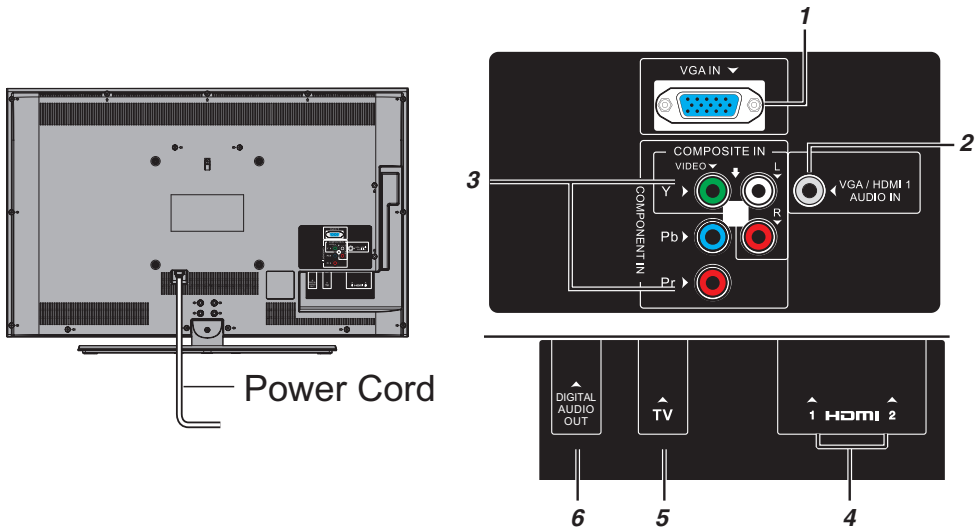

Item	Description
1 <b>VGA IN</b>	For use when connecting a personal computer.
2 <b>VGA/HDMI-1 (AUDIO) IN</b>	VGA audio input terminal is shared with HDMI-1 analog audio input terminal, and its use can be configured in the Audio Setup menu.
3 <b>VIDEO IN</b>	These include standard A/V connections. These are switched by AV input mode (see page 29). <b>Note:</b> Component / Standard (composite) video cables carry only video information; separate audio cables are required for a complete connection.
4 <b>HDMI® IN</b>	High-Definition Multimedia Interface input receives digital audio and uncompressed digital video from an HDMI device or uncompressed digital video from a DVI device. HDMI connection is necessary to receive 1080p signals.
5 <b>TV</b>	Input that supports analog (NTSC) and digital (ATSC) off-air antenna signals and analog and digital Cable TV (QAM) signals.
6 <b>Digital Audio OUT</b>	Optical audio output in Dolby Digital or PCM (pulse-code modulation) format for connecting an external Dolby Digital decoder, amplifier, or home theater system with optical audio input.

# Getting Started

## AV connection

Connect the composite video and audio input jacks to the corresponding output jacks of your A/V device.

- VIDEO: Composite Video input [3]
- YPbPr: Component Video input [3]
- AUDIO: AV Audio input [3]

## HDMI connection

HDMI (High-Definition Multimedia Interface) is a licensable audio/video connector interface for transmitting uncompressed, encrypted digital streams between an HDMI equipped TV and an HDMI equipped audio/video equipment.

- Be sure to use only an HDMI cable that bears the HDMI logo.
- If the equipment has a DVI jack rather than an HDMI jack, connect the DVI jack to the HDMI Input Terminal (with DVI-to-HDMI cable or adapter), and connect the Audio cable to the Audio In jacks.

With HDMI-HDMI cable: HDMI Input Terminal [4]

With HDMI-DVI cable:

- VIDEO: HDMI Input Terminal [4]
- AUDIO: DVI Audio Input [2]

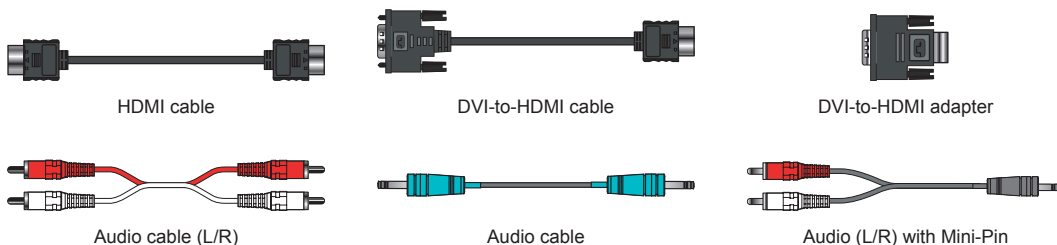

## Computer connection

Connect the VGA cable and audio cable from the VGA Signal Input and VGA Audio Input to the corresponding ports on your A/V device.

- VIDEO: VGA Signal Input [1]
- AUDIO: VGA Audio Input [2]

# Getting Started

ENGLISH

## Connecting the LED TV

### Cable System or VHF/UHF Antenna System

Enjoy the high-definition and standard-definition digital programming along with standard definition analog programming.

- This TV is capable of receiving unscrambled digital programming for both cable and external VHF/UHF antenna.
- We strongly recommend that you connect the antenna/cable input using a 75-ohm coaxial cable (not supplied) to ensure the best picture quality.

#### Cable or VHF/UHF



### Cable System and VHF/UHF Antenna System

Use an optional A-B RF switch (not supplied) to switch between the cable and antenna programming as shown below.

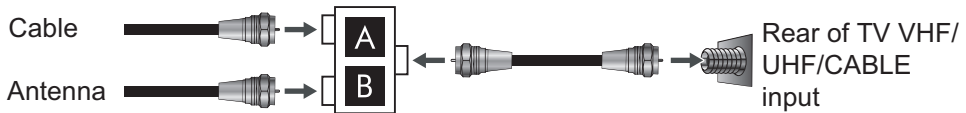

# Getting Started

## HD Cable Box/HD Satellite Box

You can also enjoy high-definition programming by subscribing to a high-definition cable service or a high-definition satellite service. For the optimum picture quality, be sure to connect this device to your TV via the HDMI on the back of your LED TV.

### HDMI Connection

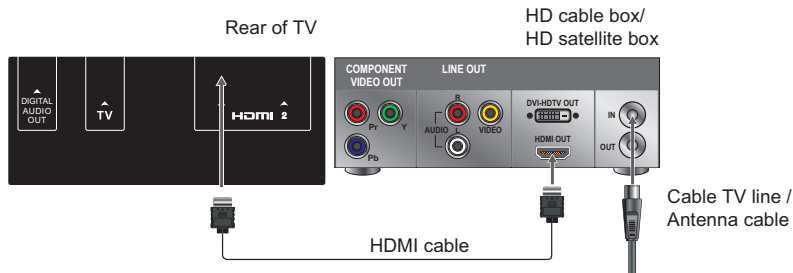

### DVI Connection

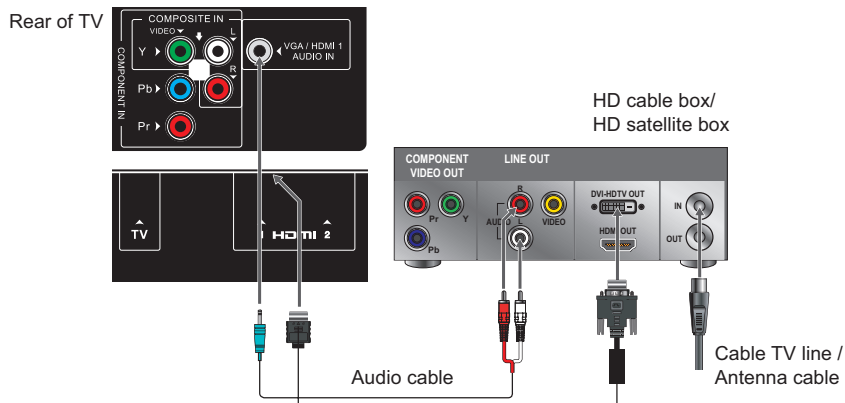

### Composite Connection

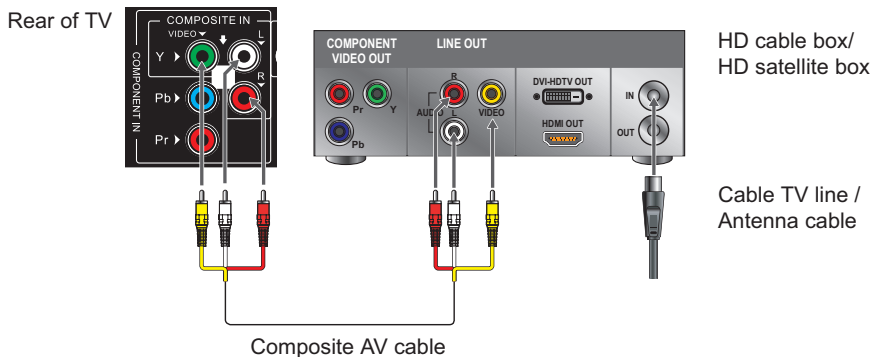

- If the equipment has a DVI jack rather than an HDMI jack, connect the DVI jack to the HDMI jack [4] and connect the audio jack to the AUDIO In jacks of HDMI [2].

# Getting Started

ENGLISH

## Personal Computer

Use the LED TV as the monitor of your computer.

The picture below shows the connection for PC. The LED TV can also be connected to PC with DVI or HDMI output.

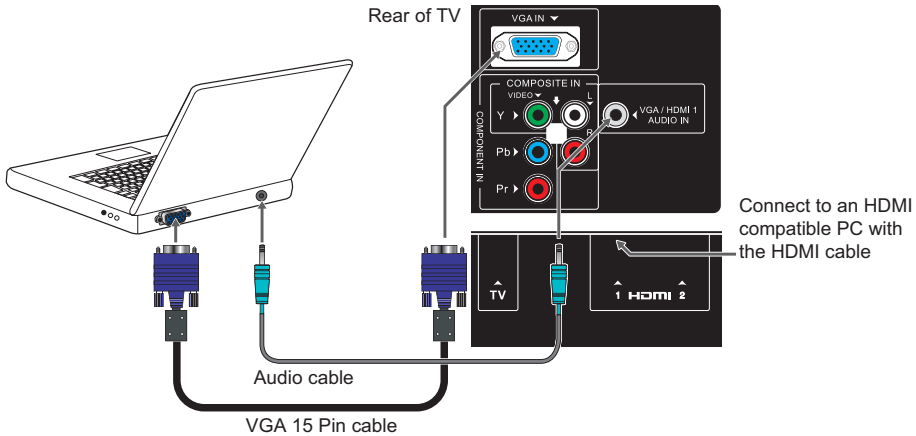

- Connect the VGA Signal In jack to the PC using a 15-pin cable.
- Connect the VGA Audio In jack to the PC using an audio cable.

## Digital audio system

The TV's **DIGITAL AUDIO OUT** terminal outputs a \*Dolby® Digital or 2-channel down-mixed PCM (pulse-code modulation) signal for use with an external Dolby® Digital decoder or other external audio system with optical audio input.

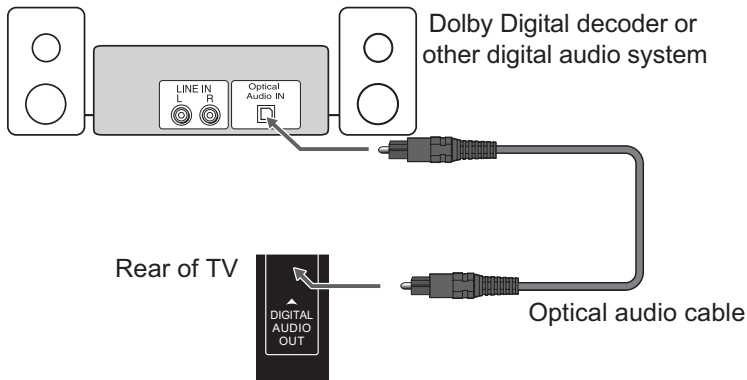

- You will need an optical audio cable (Use an optical audio cable that has the larger “TosLink” connector and not the smaller “mini-optical” connector.)
- To control the audio (**Optical Output Format** on page 28)

### Note:

- Some audio systems may not be compatible with Dolby Digital bitstream signals. Older audio systems that are not compatible with standard optical out signals may not work properly, creating a high noise level that may damage speakers or headphones. **THIS DAMAGE IS NOT COVERED BY YOUR WARRANTY.**
- The DIGITAL AUDIO OUT terminal may not output some digital audio sources because of copy restrictions.

# Getting Started

## Other Equipments

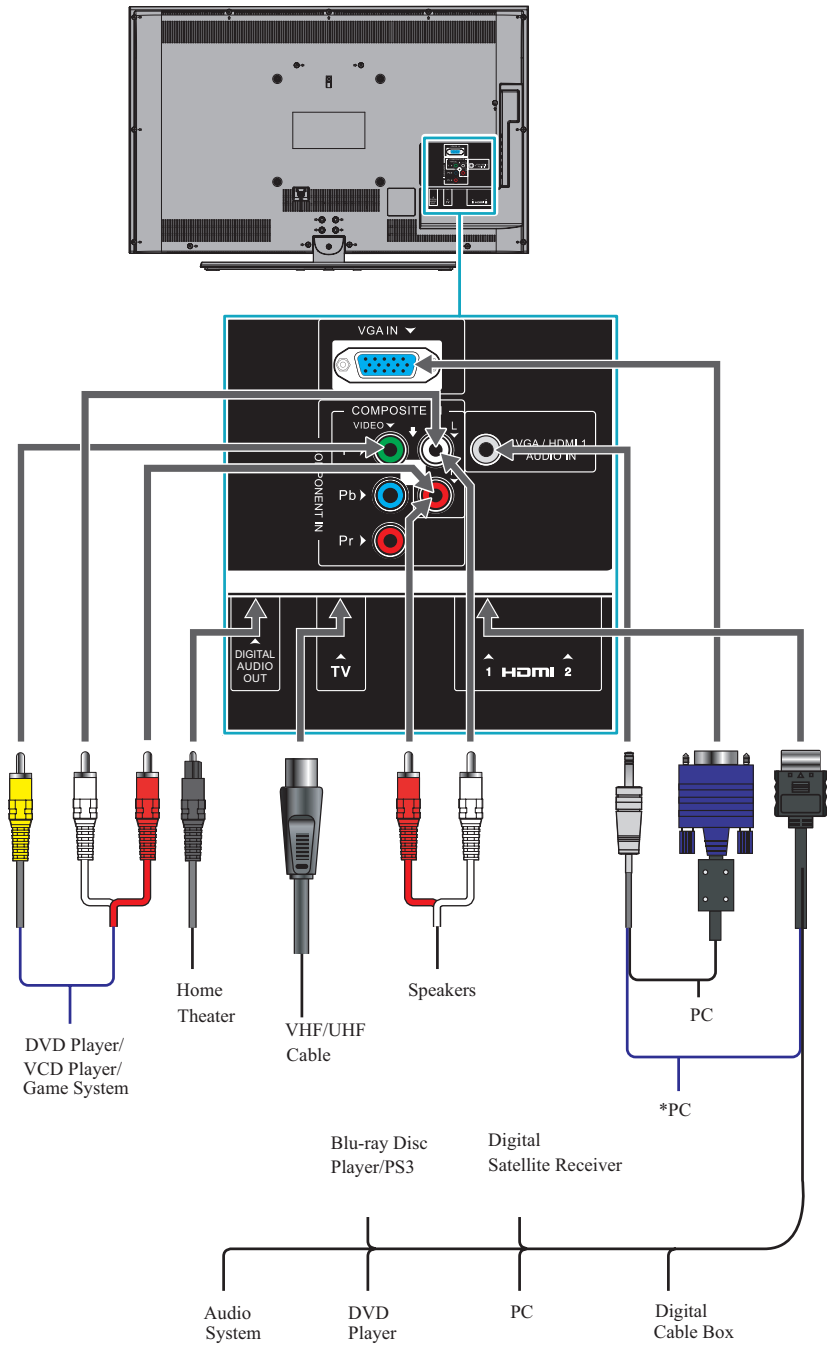

**\*Note:** For DVI connection please use DVI-to-HDMI cable/adapter.

# Getting Started

## Acceptable signal formats for VGA IN and HDMI terminals

### VGA IN signal formats

**Note:** Depending on the connected PC, the following status may occur; incorrect display, false format detection, picture position failure, blur, or judder. But this is not a malfunction of your TV.

Format	Resolution	V. Frequency	H. Frequency	Pixel Clock Frequency
VGA	640 × 480	59.940Hz	31.469kHz	25.175MHz
SVGA	800 × 600	60.317Hz	37.879kHz	40.000MHz
XGA	1024 × 768	60.004Hz	48.363kHz	65.000MHz
WXGA	1280 × 768	59.870Hz	47.776kHz	79.500MHz
	1360 × 768	60.015Hz	47.712kHz	85.500MHz

### HDMI signal formats

Format	Resolution	V. Frequency	H. Frequency	Pixel Clock Frequency
VGA	640 × 480	59.940Hz	31.469kHz	25.175MHz
SVGA	800 × 600	60.317Hz	37.879kHz	40.000MHz
XGA	1024 × 768	60.004Hz	48.363kHz	65.000MHz
WXGA	1280 × 768	59.870Hz	47.776kHz	79.500MHz
	1360 × 768	60.015Hz	47.712kHz	85.500MHz
SXGA	1280 × 1024	60.020Hz	63.981kHz	108.000MHz
480i	720 × 480i	59.940Hz	15.734kHz	27.000MHz
480p	720 × 480p	59.940Hz	31.469kHz	27.000MHz
720p	1280 × 720p	60.000Hz	45.000kHz	74.250MHz
1080i	1920 × 1080i	60.000Hz	33.750kHz	74.250MHz
1080p	1920 × 1080p	24.000Hz	27.000kHz	74.250MHz
1080p	1920 × 1080p	60.000Hz	67.500kHz	148.500MHz



# Using TV Features

## Remote Control and TV Controls

### *Inserting Remote Control Batteries*

1. Remove the battery cover by pulling then lifting the knob on the cover.
2. Insert the batteries, corresponding to the (+) and (-) markings on the battery compartment.
3. Reattach the battery cover.

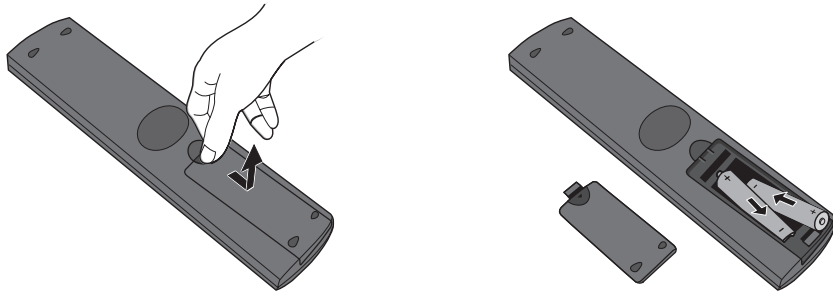

#### CAUTION

- Only use the specified AAA batteries.
- Do not mix new and old batteries. This may result in creaking or leakage, which may pose a risk of fire or lead to personal injury.
- Insert batteries according to (+) and (-) markings. Inserting the batteries incorrectly may result in leakage, which may pose a risk of fire or lead to personal injury.
- Dispose of the battery in accordance with local laws and regulations.
- Keep the batteries away from children or pets.
- When the remote control will not be used for an extended period, remove the batteries.

# Using TV Features

## Remote Control and TV Controls

ENGLISH

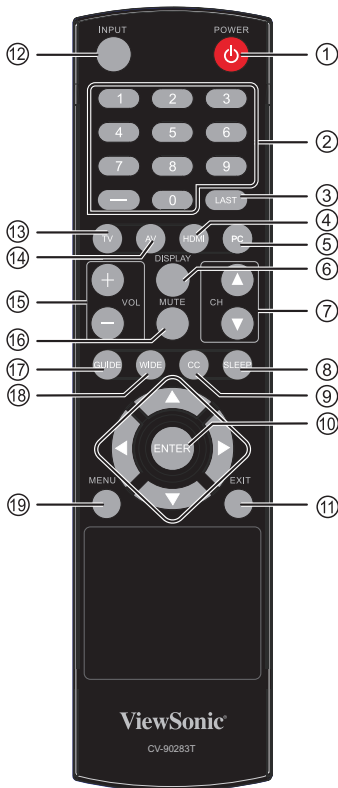

Button	Description
1	<b>POWER</b> Press to turn the power on from standby mode. Press again to return to the standby mode.
2	<b>Channel keys</b> Use to key in the channel number. See “Changing Channels” on page 24 for more details.
3	<b>LAST</b> Press to return to the last viewed channel or source.
4	<b>HDMI</b> Press to toggle among HDMI1 and HDMI2 modes.
5	<b>PC</b> Press to switch to PC(VGA) mode.
6	<b>DISPLAY</b> Press to display the input source or channel information.
7	<b>▲ CH ▼</b> Press to change the channels in sequence.
8	<b>SLEEP</b> Press to access the sleep timer.
9	<b>CC</b> Press to access the closed caption.
10	<b>ENTER</b> Activate highlighted items in the main menu system.
11	<b>EXIT</b> Close on-screen menus.
12	<b>INPUT</b> Press to display the input source list, repeat press to change the input.
13	<b>TV</b> Press to switch to TV source when in any other source.
14	<b>AV</b> Press to switch to AV mode.
15	<b>+ VOL -</b> Press to adjust the volume.
16	<b>MUTE</b> Press to turn off the sound. To restore the sound, press this button again, or press the + VOL - button.
17	<b>GUIDE</b> Display TV status information as well as program details, when available.
18	<b>WIDE</b> Cycle through the picture sizes: Natural, Wide 1/2/3, Full, 4:3 HD, Native and Dot by Dot (available in PC Mode Only).
19	<b>MENU</b> Access the main TV menu system.

# Using TV Features

## Operation

### Turning the TV On and Off

Press the **POWER** button on the remote control. You can also use the Power button on the side of the panel.

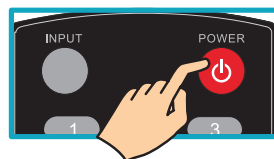

### Changing Channels

#### *Using the Channel Button*

Change channels using the **+ CH -** button, and the TV changes channels in sequence. You will see all channels that have been memorized. Channels erased or not memorized will not be shown.

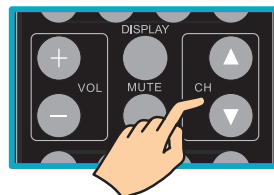

#### *Using the Channel Keys*

Switch to the desired channel using the channel keys (0-9 and “-”).

- **Tuning analog channels:**

Press the Channel Number (0–9) on the remote control.

For example, to select channel 102, press 1, 0, 2, then **ENTER**.

- **Tuning digital channels:**

Press the Channel Number (0–9) on the remote control, followed by the dash (-) button and then the sub-channel number. For example, to select digital channel 102-1, press 1, 0, 2, -, 1, then **ENTER**.

### Adjusting the Volume

- Press **+ VOL -** to adjust the volume.
- Press **MUTE** to turn off the volume.
- To restore the volume, press **MUTE** again, or press **+VOL-** directly.

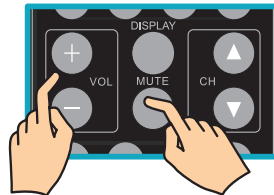

### Viewing the Source Information

To display the information of the current input source:

Press **DISPLAY**, the input source or channel information is displayed on the screen.

To display TV status information as well as program details, when available:

Press **GUIDE**, the channel information, as well as the title, detailed description, system date and time are displayed on the screen (if applicable).

### Automatic Power Down

The TV will automatically turn itself off (standby) after 4 hours, if you do not operate the TV either from the remote control or the TV control panel.

**Note:** 1 minute before switching to standby, a warning message will appear.

### No Signal Power Down

The TV will automatically turn itself off after 15 minutes when no signal is detected.

**Note:** 1 minute before switching to standby, a warning message will appear.

# Using TV Features

## Using the OSD Menu

Read this section to learn how to make adjustments to your TV settings.

1. Press **POWER** to turn the LED TV on.
2. Press **MENU** on the remote control to display the Main menu.

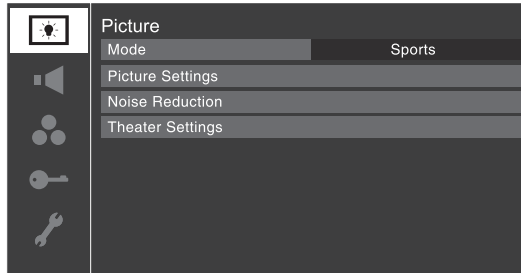

3. When a menu is open, use the up/down/left/right arrow buttons (**▲▼◀▶**) on the remote control to move in the corresponding direction in the menu.
4. Press **ENTER** to save your menu settings or select a highlighted item. (A highlighted menu item appears in a different color in the menu.)
5. All menus close automatically if you do not make a selection within 60 seconds.
6. To close a menu instantly, press **EXIT**.

## Customizing the Picture Settings

Allows you to make adjustments to your picture settings.

1. Press **MENU** and highlight the Picture menu icon.
2. Press **ENTER** or **▶** to open the Picture menu.
3. Use **▲▼** to highlight an individual Picture option.
4. Use **ENTER** and **◀▶** to change the settings, then press **EXIT** to exit.

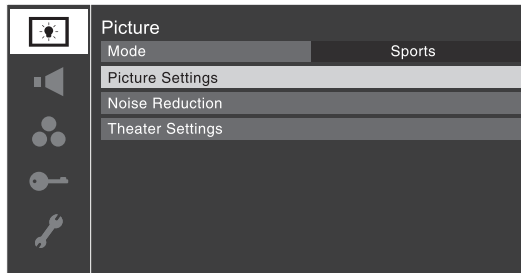

The Picture menu includes the following options:

<b>Mode</b>	Selects the picture mode. Five modes are available: Sports, Standard, Movie, PC, and Preference.
<b>Picture Settings</b>	<b>Contrast</b> Controls the difference between the brightest and darkest regions of the picture. <b>Backlight</b> Changes the backlight of the TV set.

# Using TV Features

---

	<p><b>Dyna-Backlight</b> This function automatically strengthens the black coloring of dark areas in the video according to the level of darkness.</p> <p><b>Brightness</b> Controls the overall brightness of the picture.</p> <p><b>Color</b> Controls the overall color of the picture.</p> <p><b>Tint</b> Controls the difference between the green and red regions of the picture.</p> <p><b>Sharpness</b> Increase this setting to see crisp edges in the picture; decrease it for soft edges.</p> <p><b>Advanced Picture Setting</b></p> <ul style="list-style-type: none"> <li>• <b>Dynamic Contrast -</b> Dynamic Contrast detects changes in picture quality that affect the appearance of your contrast settings and then automatically adjusts the video.</li> <li>• <b>Color Temperature -</b> Adjusts the color temperature to achieve a warm or cool effect: Warm: Increases warm effect. Normal: Neutral. Cool: Increases cool effect.</li> </ul>
<p><b>Picture Settings</b></p>	<hr/> <p><b>DNR</b> Enables you to "soften" the screen representation of a weak signal to reduce the noise effect.</p> <p><b>MPEG Noise Reduction</b> Allows you to reduce visible interference caused by MPEG compression.</p>
<p><b>Noise Reduction</b></p>	<hr/> <p><b>Picture Size</b> Natural, Wide 1, Wide 2, Wide 3, Full, 4:3 HD, Native, and Dot by Dot (available in PC Mode Only).</p> <p><b>Picture Scroll</b> You can set separate scroll settings for the Wide 2 and Wide 3 modes for each input.</p> <p><b>Auto Aspect Ratio</b> When the auto aspect ratio feature is set to On, the TV will automatically select the picture size when one of the following input sources is received:</p> <ul style="list-style-type: none"> <li>• A 480i, 480p, 720p, 1080i digital signal from the TV input</li> <li>• A 480i signal from the Video or YPbPr input</li> <li>• A 480i, 480p, 720p, 1080i, 1080p, or VGA (60Hz) signal from the HDMI 1/2 input</li> </ul> <p><b>Cinema Mode</b> When you view a DVD (3:2 pulldown processed) from a DVD player connected to the Video, YPbPr (component video), or HDMI inputs on the TV, smoother motion can be obtained by setting the Cinema Mode to Film.</p> <p><b>MEMC 120Hz</b> Doubles the frame rate from 60 frames per second to 120 frames per second to eliminate motion blur and judder.</p>
<p><b>Theater Settings</b></p>	

# Using TV Features

## Customizing the Audio Settings

Allows you to make adjustments to your audio settings.

1. Press **MENU** and highlight the Sound menu icon.
2. Press **ENTER** or **▶** to open the Sound menu.
3. Use **▲▼** to highlight an individual Sound option.
4. Use **ENTER** and **◀▶** to change the settings, then press **EXIT** to exit.

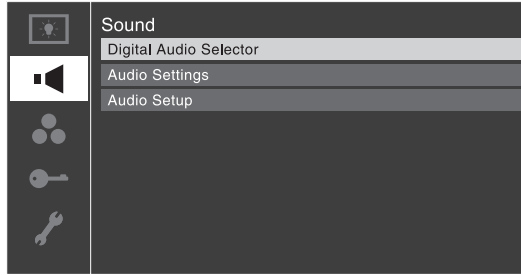

The Sound menu includes the following options:

---

	<b>Closed Caption</b> Refer to the <b>CC Selector</b> .(see Page 29)
<b>Digital Audio Selector</b>	<b>Audio</b> You can use the Digital Audio Selector to conveniently switch between audio tracks on a digital channel (for those channels that have multiple audio tracks). This temporarily overrides the audio track chosen by the language option under <b>Audio Setup</b> .
	<b>Bass</b> Controls the relative intensity of low-pitched sounds.
<b>Audio Settings</b>	<b>Treble</b> Controls the relative intensity of high-pitched sounds.
	<b>Balance</b> Adjusts the relative volume of the speakers in a multiple speaker system.

---

# Using TV Features

---

## Audio Setup

### PC Audio

Allows you to output or mute the sound from your PC when connecting using the VGA IN terminal and an analog RGB cable.

### HDMI 1 Audio

Selects the HDMI 1 audio mode.(Auto is the recommended mode.)

- Auto: When viewing the HDMI 1 input, if digital audio from the HDMI input is available, it will be output. If not, the TV will automatically detect and output analog audio from the PC Audio input.
- Digital: When viewing the HDMI 1 input, digital audio from the HDMI input will be output.
- Analog: When viewing the HDMI 1 input, analog audio from the PC Audio input will be output.

### MTS

The multi-channel TV sound (MTS) feature allows you to output high-fidelity stereo sound. MTS also can transmit a second audio program (SAP) containing a second language, music, or other audio information (when provided by individual stations). When the TV receives a stereo or SAP broadcast, the word "STEREO" or "SAP" appears on-screen when DISPLAY is pressed.

The MTS feature is only available for analog signals on the TV input.

### Language

To listen to an alternate language on an ATSC digital station (if available).

### Optical Output Format

Selects the optical audio output format when you connect a Dolby Digital decoder or other digital audio system to the Optical Audio Out terminal on the TV.

### Dolby Digital Dynamic Range Control

This dynamic range control feature causes Dolby Digital dynamic range to be further compressed, allowing you to switch from digital to analog broadcasts at the same dynamic range.

---

# Using TV Features

## Customizing the Preferences Settings

Allows you to customize the Preferences settings.

1. Press **MENU** and highlight the Preferences menu icon.
2. Press **ENTER** or **▶** to open the Preferences menu.
3. Use **▲▼** to highlight an individual Preferences option.
4. Use **ENTER** and **◀▶** to change the settings, then press **EXIT** to exit.

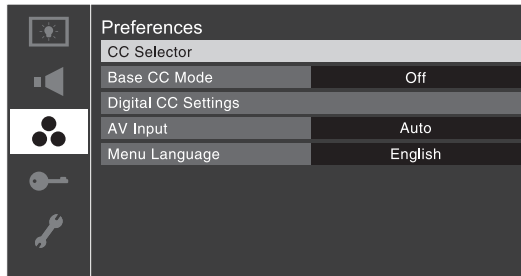

### CC Selector

#### Closed Caption

You can use the **CC Selector** to temporarily override the default analog caption mode (set in **Base CC Mode**) for a particular channel.

However, once you change to another analog channel, the closed caption setting will automatically change back to the current **Base CC Mode** setting.

You can also use the **CC Selector** to select digital closed caption services (if available). When such services are not available, the CC Selector presents a default list of services. If the selected service is not available, the next best service will be used instead.

#### Audio

Refer to the **Digital Audio Selector**. (see Page 27)

The closed caption mode has two options:

- **Captions**—An on-screen display of the dialogue, narration, and sound effects of TV programs and videos that are closed captioned (usually marked "CC" in program guides).

To view captions: Highlight CC1, CC2, CC3, or CC4. (CC1 displays translation of the primary language in your area.)

**Note:** If the program or video you selected is not closed captioned, no captions will display on-screen.

- **Text**—An on-screen display of information not related to the current program, such as weather or stock data (when provided by individual stations).

To view text: Highlight T1, T2, T3, or T4.

**Note:** If text is not available in your area, a black rectangle may appear on screen. If this happens, set the Base CC Mode to Off.

**Note:** A closed caption signal may not display in the following situations:

- When a videotape has been dubbed
- When the signal reception is weak
- When the signal reception is non-standard

### Base CC Mode

### Digital CC Settings

You can customize the closed caption display characteristics by changing the background color, opacity, text size, type, edge, and color.

### AV Input

This setting determines the configuration of the shared AV input on your TV. You can set this input for either **YPbPr** or **Video**.

### Menu Language

Chooses from three different languages (English, Français and Español) for the on-screen display of menus and messages.



# Using TV Features

## Customizing the Locks Settings

Allows you to customize the Locks settings.

1. Press **MENU** and highlight the Locks menu icon.
2. Press **ENTER** or **▶** to open the Locks menu.
3. Enter your four-digit PIN code.
4. Use **▲▼** to highlight an individual Locks option.
5. Use **ENTER** and **◀▶** to change the settings, then press **EXIT** to exit.

**Note:**

1. The Lock System screen will appear if a PIN code has not been stored. Press the Channel Number buttons to enter a new four-digit code, enter the code a second time to confirm, and press **ENTER**.
2. PIN code cannot be set to "0000".
3. **If you cannot remember your PIN code**, while the PIN code entering screen is displayed, enter the common PIN code "3660" to unlock.

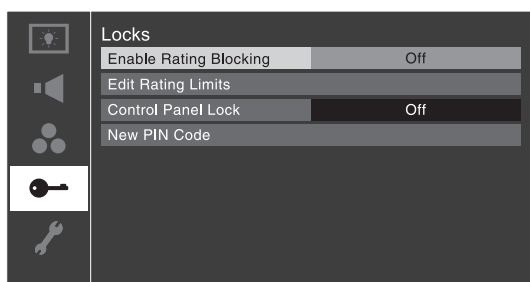

<b>Enable Rating Blocking</b>	Select ON/OFF to activate/deactivate the access control of programs according to their rating.
<b>Edit Rating Limit</b>	Blocks and unblocks TV programs and movies. Selects the level of blocking you prefer. A box with an "X" is a rating that will be blocked.

	<b>Ratings</b>	<b>Description and Content themes</b>
<b>Edit Rating Limit (TV)</b>	TV-MA	Mature Audience Only (This program is specifically designed to be viewed by adults and therefore may be unsuitable for children under 17.) L) Crude or indecent language S) Explicit sexual activity V) Graphic violence
	TV-14	Parents Strongly Cautioned (This program contains some material that many parents would find unsuitable for children under 14 years of age.) D) Intensely suggestive dialog L) Strong, coarse language S) Intense sexual situations V) Intense violence
	TV-PG	Parental Guidance Suggested (This program contains material parents may find unsuitable for younger children.) D) Some suggestive dialog L) Infrequent coarse language S) Some sexual situations V) Moderate violence
	TV-G	General Audience (Most parents would find this program suitable for all ages.)
	TV-Y7, TV-Y7FV	Directed to Older Children (This program is designed for children age 7 and above. Note: Programs in which fantasy violence may be more intense or more combative than other programs in this category are designated TV-Y7FV.)
	TV-Y	All Children (This program is designed to be appropriate for all children.)

# Using TV Features

ENGLISH

<b>Edit Rating Limit (Movies)</b>	<b>Ratings</b>	<b>Description and Content themes</b>
	X	X-rated (For adults only)
	NC-17	Not intended for anyone 17 and under
	R	Restricted (Under 17 requires accompanying parent or adult)
	PG-13	Parents Strongly Cautioned (Some material may be inappropriate for children under 13)
	PG	Parental Guidance Suggested (Some material may not be suitable for children)
	G	General Audience (Appropriate for all ages)
<b>Canada Rating (English)</b>	<b>Rating</b>	<b>Description and Content themes</b>
	E	Exempt shows
	C	Children ages of 2 to 7 years
	C8+	Children 8 years and older
	G	General programming
	PG	Parental Guidance
	14+	Viewers 14 and older
18+	Adult programming	
<b>Canada Rating (French)</b>	<b>Rating</b>	<b>Description and Content themes</b>
	E	Exempt shows
	G	General programming
	8 ans+	Not recommended for ages under 8
	13 ans+	Not recommended for ages under 13
16 ans+	Not recommended for ages under 16	
18 ans+	Programming restricted to adults	
<b>Control Panel Lock</b>	You can lock the control panel to prevent your settings from being changed accidentally (by children, for example). When the control panel lock is On, none of the controls on the TV control panel will operate except POWER.	
<b>New PIN Code</b>	Changes your PIN code	

# Using TV Features

## Customizing the Setup Settings

Allows you to customize the Setup settings.

1. Press **MENU** and highlight the Setup menu icon.
2. Press **ENTER** or **▶** to open the Setup menu.
3. Use **▲▼** to highlight an individual Setup option.
4. Use **ENTER** and **◀▶** to change the settings, then press **EXIT** to exit.

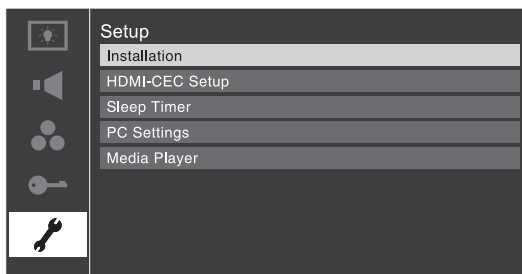

[Contains the Terrestrial and System Status menus]

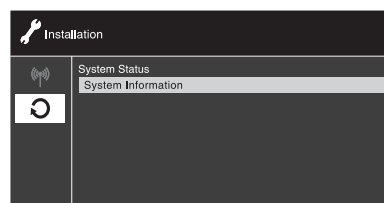
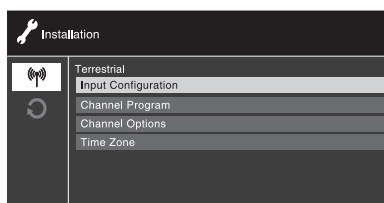

### Installation

#### Terrestrial

- **Input Configuration**  
Configures the antenna input source for the TV terminal.
- **Channel Program**  
Automatically creates a list of receivable channels for the source you select in the Input Configuration.
- **Channel Options**  
Locks or skips specific channels. The locked channels can only be accessed by entering the PIN.
- **Time Zone**  
Allows you to specify the correct time zone for your region.

#### System Status

- **System Information**
  - Support Information*- View the system status.
  - Factory Defaults*- Reset all settings and channels to their factory default values.

# Using TV Features

---

<b>HDMI-CEC Setup</b>	<p><b>Enable HDMI-CEC</b> Select ON/OFF to activate/deactivate HDMI-CEC control.</p> <p><b>TV Auto Input Switch</b> If a connected HDMI device starts playing video or audio, the TV will automatically switch to the appropriate HDMI input.</p> <p><b>TV Auto Power</b> If a HDMI-CEC device is turned on, the TV turns on automatically.</p> <p><b>Device Auto Power</b> If the TV is turned off the TV will send a message to turn off all of the HDMI-CEC devices connected to the TV.</p> <p><b>Speaker Preference</b> From this item, you can set your audio output preference to the TV speakers or the audio receiver speakers. When this item is set to Audio Receiver, the TV remote can be used to adjust or mute the volume of the audio. This item will be grayed out unless a HDMI-CEC compatible audio receiver is connected.</p> <p><b>Note:</b> When you turn on the Audio Receiver, change its input source, or adjust the sound volume, the sound will be output from the audio receiver's speakers even if TV Speakers has been selected. Turn the TV off and on again to output the sound from the TV speakers.</p>
<b>Sleep Timer</b>	<p>Sets the sleep timer to turn off the TV after a set length of time (maximum of 180 minutes).</p>
<b>PC Settings</b>	<p>When a PC is connected to the TV's VGA IN terminal, you can use the PC Settings feature to make adjustments to the image.</p> <p><b>Horizontal Position</b> Adjusts the horizontal position of the display.*</p> <p><b>Vertical Position</b> Adjusts the vertical position of the display.*</p> <p><b>Clock phase</b> Helps to reduce noise and sharpen the picture.*</p> <p><b>Sampling Clock</b> Helps to reduce noise and minimize periodic vertical stripes on the screen.*</p> <p><b>Auto Adjust</b> Highlight this item then press <b>ENTER</b> to get an optimum adjustment automatically.</p> <p>* The default settings may vary depending on the input signal format.</p>
<b>Media Player</b>	<p>You can enjoy photos contents stored on a USB storage device.</p> <ul style="list-style-type: none"><li>• <b>Photo Viewer specifications:</b> Data type: JPEG Exif ver2.1 File format: JPEG Maximum photo size: 6 MB Maximum number of files: 500 / folder Maximum photo resolution: 4096 x 4096 pixels Best photo resolution: 1366 x 768 pixels</li><li>• <b>Supported file system:</b> FAT16 and FAT32</li></ul>

# Other Information

---

## Cleaning the LED TV

- Make sure the LED TV is turned off.
- Never spray or pour any liquid directly onto the screen or case.

### To clean the screen:

1. Wipe the screen with a clean, soft, lint-free cloth. This removes dust and other particles.
2. If still not clean, apply a small amount of non-ammonia, non-alcohol based glass cleaner onto a clean, soft, lint-free cloth, and wipe the screen.

### To clean the case:

1. Use a soft, dry cloth.
2. If still not clean, apply a small amount of a non-ammonia, non-alcohol based, mild non-abrasive detergent onto a clean, soft, lint-free cloth, then wipe the surface.

## Disclaimer

ViewSonic® does not recommend the use of any ammonia or alcohol-based cleaners on the LED TV screen or case. Some chemical cleaners have been reported to damage the screen and/or case of the LED TV. ViewSonic will not be liable for damage resulting from use of any ammonia or alcohol-based cleaners.

# Other Information

## Troubleshooting

Please contact ViewSonic service team directly if you have questions, service needs, or require technical assistance related on the use of your television. Contact ViewSonic Service Team at:

<http://www.ViewSonic.com>

Or call our service team:

United States 1-800-688-6688

Canada 1-866-463-4775

Before calling a service technician, please check this chapter for a possible cause of the problem and some solutions you can try.

<i>Problem</i>	<i>Possible Solution</i>
<b>Black box on-screen</b>	<ul style="list-style-type: none"><li>• The closed caption feature is set to one of the Text modes (T1, T2, T3, or T4). Set the closed caption feature to Off (page 29).</li></ul>
<b>TV stops responding to controls</b>	<ul style="list-style-type: none"><li>• If the TV stops responding to the controls on the remote control or TV control panel and you cannot turn off the TV, please unplug the power cord few seconds then re-plug to try again.</li></ul>
<b>Other problems</b>	<ul style="list-style-type: none"><li>• If your TV's problem is not addressed in this Troubleshooting section or the recommended solution has not worked, use the Restore Factory Defaults procedure (page 32).</li></ul>
<b>TV will not turn on</b>	<ul style="list-style-type: none"><li>• Make sure the power cord is plugged in, and then press <b>POWER</b>.</li><li>• The remote control batteries may be dead. Replace the batteries or try the control panel buttons.</li></ul>
	<i>General picture problems</i> <ul style="list-style-type: none"><li>• Check the antenna/cable connections.</li><li>• Press INPUT on the remote control or TV and select a valid video input source (page 23). If no device is connected to a particular input on the TV, no picture will display when you select that particular input source. For device connection details, see <b>Connecting the LED TV</b> (page 17).</li><li>• Antenna reception may be poor. Use a highly directional outdoor antenna (if applicable).</li><li>• The station may have broadcast difficulties. Try another channel.</li><li>• Adjust the picture qualities (page 25).</li></ul>
<b>Picture problems</b>	<i>Noisy picture</i> <ul style="list-style-type: none"><li>• If you are watching an analog channel (offair broadcast or Cable TV), you can set the DNR feature to reduce visible interference in the TV picture (page 26).</li></ul> <i>Video Input Selection problems</i> <ul style="list-style-type: none"><li>• If the <b>Input Selection</b> window does not appear when you press INPUT on the remote control or TV, press INPUT a second time, which will change to the next video input source and display the Input Selection window.</li></ul>

## Other Information

---

### Picture problems

#### *Poor color or no color*

- The station may have broadcast difficulties. Try another channel.
- Check the AV Input mode when you use **Video** or **YPbPr** (page 29).
- Adjust the Tint and/or Color (page 26).

#### *Poor composite picture*

- If the TV is connected to an external A/V device (e.g., DVD player, video game system, set-top box, etc.) try using YPbPr or HDMI video connection instead.

#### *Picture and sound are out of sync*

- As with all products that contain a digital display, in rare instances, when viewing certain content (e.g., television broadcasts, video games, DVDs), you may notice that the sound and picture are slightly out of sync. This phenomenon can be caused by various factors including, without limitation, video processing within the TV, video processing in an attached gaming system, and video processing or different compression rates used by broadcasters in their programming. You may want to try one or more of the following suggestions, which may help to reduce the effect of this phenomenon:
  - If the TV is connected to an A/V receiver that has a programmable audio delay feature, use this feature to help synchronize the sound to the picture.
  - If you notice this phenomenon only on certain TV channels, please contact your local broadcast, cable, or satellite provider to inform them of this issue.

### Sound problems

- Check the antenna/cable connections.
- The station may have broadcast difficulties. Try another channel.
- The sound may be muted. Press **VOLUME**.
- If you hear no sound, try setting the **MTS** feature to **Stereo** mode (page 28).
- If you are not receiving a second audio program from a known SAP source, make sure the **MTS** feature is set to **SAP** mode (page 28).
- If you hear audio that seems “incorrect” for the program you are watching (such as music or a foreign language), the **SAP** mode may be on. Set the **MTS** feature to Stereo mode (page 28).

### Remote control problems

- Remove all obstructions between the remote control and the TV.
  - The remote control batteries may be dead. Replace the batteries (page 22).
  - If the TV still does not act as expected, use the Reset Factory Defaults procedure (page 32).
-

# Other Information

---

<b>Channel tuning problems</b>	<ul style="list-style-type: none"><li>• The channel may have been erased from the channel memory by the Programming channels automatically feature. Add the channel to the channel memory (page 32).</li><li>• The channel may be blocked by the LOCK feature. Unblock the channel (Channel Option on page 32).</li><li>• If you are unable to tune digital channels, check the antenna configuration (Input Configuration on page 32). If you are still unable to tune digital channels, clear all channels from the channel list and reprogram channels into the channel memory (page 32). If you are still unable to tune digital channels, use the Reset Factory Defaults procedure (page 32). Also see “TV stops responding to controls” and “Other Information” (page 35).</li></ul>
<b>Closed caption problems</b>	<ul style="list-style-type: none"><li>• If the program or video you selected is not closedcaptioned, no captions will display (page 29).</li><li>• If text is not available, a black rectangle may appear. If this happens, turn off the closed caption feature (page 29).</li><li>• A closed-caption signal may not display correctly in the following situations: a) when a videotape has been dubbed; b) when the signal reception is weak; or c) when the signal reception is nonstandard (page 29).</li></ul>
<b>Rating blocking (V-Chip) problems</b>	<ul style="list-style-type: none"><li>• If you forget your PIN code: While the PIN code entering screen is displayed, enter the common PIN code "3660" to unlock (page 30).</li></ul>
<b>No HDMI-CEC operation</b>	<ul style="list-style-type: none"><li>• The HDMI-CEC feature is available for the HDMI-CEC compatible devices.</li><li>• Make sure the HDMI cables with the HDMI Logo (<b>HDMI</b>) are used.</li><li>• When the connected HDMI-CEC device does not work correctly after you have changed settings of the device, turn off your TV and unplug the power cord, then plug and turn on again.</li><li>• If several devices are connected, HDMI-CEC feature may not operate properly.</li><li>• Read the instruction manual furnished with the connected HDMI-CEC device.</li></ul>
<b>HDMI problems</b>	<p><i>For HDMI cables</i></p> <ul style="list-style-type: none"><li>• Make sure to use cables with the HDMI Logo (<b>HDMI</b>)</li></ul>
<b>Media Player problems</b>	<ul style="list-style-type: none"><li>• Make sure that devices are connected correctly.</li><li>• Incorrect behavior may occur with a USB HUB connection.</li><li>• Photo files that was processed and edited by using the PC's application software may not be able to be viewed.</li><li>• The TV may select one format automatically and play it when contents that support two or more formats are played.</li><li>• Confirm contents of the USB storage device are formats that correspond with this TV (page 33).</li></ul>



# Other Information

## Specifications

### VT3210LED / VT4210LED

For 32"

<b>LCD</b>	Type	32" HD Active Matrix RGB Pixel Pitch: 0.17025 (H) x 0.51075 (V) mm
	Color Filter Glass surface	RGB vertical stripe Anti-Glare
	Native Resolution	1366 x 768
<b>Display area</b>	Full Scan	697.6845 mm (H) x 392.256 mm (V) 27.47" (H) x 15.44" (V)
<b>Dimensions</b>	Physical(W) x (H) x (D)	775.5 mm x 512 mm x 198.2 mm 30.53" x 20.16" x 7.8"
<b>Weight</b>	Net	8.1 kg (17.9 lbs)
<b>Regulations</b>		UL/cUL, FCC-B (Doc-B), BETS-7, ENERGY STAR®, HDMI
<b>Power consumption</b>	On Standby	Max. 120 W (green LED) < 1 W (dark LED)

For 42"

<b>LCD</b>	Type	42" FHD Active Matrix RGB Pixel Pitch: 0.1615 (H) x 0.4845 (V) mm
	Color Filter Glass surface	RGB vertical stripe Anti-Glare
	Native Resolution	1920 x 1080
<b>Display area</b>	Full Scan	937.24 mm (H) x 523.26 mm (V) 36.9" (H) x 20.6" (V)
<b>Dimensions</b>	Physical(W) x (H) x (D)	1006.24 mm x 655.43 mm x 228.23 mm 39.62" x 13.84" x 8.99"
<b>Weight</b>	Net	13.5 kg (29.8 lbs)
<b>Regulations</b>		UL/cUL, FCC-B (Doc-B), BETS-7, ENERGY STAR®, HDMI
<b>Power consumption</b>	On Standby	Max. 120 W (green LED) < 1 W (dark LED)

# Other Information

ENGLISH

<b>Input signal</b>	RGB	15-Pin D-sub Analog RGB, Separate Sync.
	RF	NTSC standard ATSC standard (8VSB) Digital Cable (64 QAM, 256 QAM; in-the-clear, unencrypted)
	Video	1 Video (Composite) } Shared AV input 1 YPbPr (Component) } 2 HDMI, 1 VGA
	USB	Photo viewer, supported file format: JPEG, File system: FAT16 and FAT32
	Audio	1 mini-stereo 1 pair of RCA (L/R) stereo
<b>Compatibility</b>	PC	640 x 480 @ 60Hz 800 x 600 @ 60Hz 1024 x 768 @ 60Hz 1280 x 768 @ 60Hz 1360 x 768 @ 60Hz
<b>Resolution Table</b>	Video (composite)	NTSC
	YPbPr (component )	480i/p @ 60Hz 720p @ 60 Hz 1080i @ 60Hz
	HDMI	480i/p @ 60Hz 720p @ 60 Hz 1080i @ 60Hz 1080p @ 60Hz/24Hz
<b>Speaker output</b>		10W + 10W
<b>Audio output</b>		1 SPDIF
<b>Power</b>	Voltage	120VAC, 60 Hz
<b>Operating conditions</b>	Temperature	32°F to - 95°F (0°C to - 35°C)
	Humidity	20% to 80% (no moisture condensation)
	Altitude	0 to 6562 feet
<b>Storage condition</b>	Temperature	32°F to + 140°F (0°C to + 60°C)
	Humidity	5% to 90% (non condensation)
	Altitude	Shipping (Non operating): 0 to 40,000 feet.
<b>Warning:</b> Do not set the graphics card in your computer to exceed these refresh rates; doing so may result in permanent damage to the LED TV.		

**Note:** Product Specifications are subject to change without notice.

## Other Information

### Customer Support

For technical support or product service, see the table below or contact your reseller.

**Note:** You will need the product serial number.

Country/Region	Website	T = Telephone F = FAX	Email
United States	www.viewsonic.com	T (Toll-Free)= 1-800-688-6688 T (Toll)= 1-424-233-2530 F= 1-909-468-3757	service.us@viewsonic.com
Canada	www.viewsonic.com	T (Toll-Free)= 1-866-463-4775 T (Toll)= 1-424-233-2533 F= 1-909-468-3757	service.ca@viewsonic.com
Latin America (Argentina)	www.viewsonic.com/la/	T= 0800-4441185	soporte@viewsonic.com
Latin America (Chile)	www.viewsonic.com/la/	T= 1230-020-7975	soporte@viewsonic.com
Latin America (Columbia)	www.viewsonic.com/la/	T= 01800-9-157235	soporte@viewsonic.com
Latin America (Mexico)	www.viewsonic.com/la/	T= 001-8882328722	soporte@viewsonic.com
Renta y Datos, 29 SUR 721, COL. LA PAZ, 72160 PUEBLA, PUE. Tel: 01.222.891.55.77 CON 10 LINEAS Electroser, Av Reforma No. 403Gx39 y 41, 97000 Mérida, Yucatán. Tel: 01.999.925.19.16 Other places please refer to <a href="http://www.viewsonic.com/la/soporte/index.htm#Mexico">http://www.viewsonic.com/la/soporte/index.htm#Mexico</a>			
Latin America (Peru)	www.viewsonic.com/la/	T= 0800-54565	soporte@viewsonic.com

# Other Information

## Limited Warranty VIEWSONIC LED TV

### What the warranty covers:

ViewSonic warrants its products to be free from defects in material and workmanship, under normal use, during the warranty period. If a product proves to be defective in material or workmanship during the warranty period, ViewSonic will, at its sole option, repair or replace the product with a like product. Replacement product or parts may include remanufactured or refurbished parts or components.

### How long the warranty is effective:

ViewSonic LED TVs are warranted for 1 year for all parts excluding the light source and 1 year for labor from the date of the first customer purchase.

### Who the warranty protects:

This warranty is valid only for the first consumer purchaser.

### What the warranty does not cover:

1. Any product on which the serial number has been defaced, modified or removed.
2. Damage, deterioration or malfunction resulting from:
  - a. Accident, misuse, neglect, fire, water, lightning, or other acts of nature, unauthorized product modification, or failure to follow instructions supplied with the product.
  - b. Repair or attempted repair by anyone not authorized by ViewSonic.
  - c. Any damage of the product due to shipment.
  - d. Removal or installation of the product.
  - e. Causes external to the product, such as electric power fluctuations or failure.
  - f. Use of supplies or parts not meeting ViewSonic's specifications.
  - g. Normal wear and tear.
  - h. Any other cause which does not relate to a product defect.
3. Any product exhibiting a condition commonly known as "image burn-in" which results when a static image is displayed on the product for an extended period of time.
4. Removal, installation, and set-up service charges.
5. When you mount it on the wall, the following must be noticed:
  - a. The accessories attached with this product are applicable for this product only.
  - b. When the product is mounted on the wall, holes and fixed screws will remain in the wall body.
  - c. Wall face may discolor when this product has been mounted on the wall for a long time.

### How to get service:

1. For information about receiving service under warranty, contact ViewSonic Customer Support (please refer to Customer Support page). You will need to provide your product's serial number.
2. To obtain warranted service, you will be required to provide (a) the original dated sales slip, (b) your name, (c) your address, (d) a description of the problem, and (e) the serial number of the product.
3. Take or ship the product freight prepaid in the original container to an authorized ViewSonic service center or ViewSonic.
4. For additional information or the name of the nearest ViewSonic service center, contact ViewSonic.

### Limitation of implied warranties:

There are no warranties, express or implied, which extend beyond the description contained herein including the implied warranty of merchantability and fitness for a particular purpose.

### Exclusion of damages:

ViewSonic's liability is limited to the cost of repair or replacement of the product. ViewSonic shall not be liable for:

1. Damage to other property caused by any defects in the product, damages based upon inconvenience, loss of use of the product, loss of time, loss of profits, loss of business opportunity, loss of goodwill, interference with business relationships, or other commercial loss, even if advised of the possibility of such damages.
2. Any other damages, whether incidental, consequential or otherwise.
3. Any claim against the customer by any other party.

### Effect of state law:

This warranty gives you specific legal rights, and you may also have other rights which vary from state to state. Some states do not allow limitations on implied warranties and/or do not allow the exclusion of incidental or consequential damages, so the above limitations and exclusions may not apply to you.

### Sales outside the U.S.A. and Canada:

For warranty information and service on ViewSonic products sold outside of the U.S.A. and Canada, contact ViewSonic or your local ViewSonic dealer.

The warranty period for this product in mainland China (Hong Kong, Macao and Taiwan Excluded) is subject to the terms and conditions of the Maintenance Guarantee Card.

For users in Europe and Russia, full details of warranty provided can be found in [www.viewsoniceurope.com](http://www.viewsoniceurope.com) under Support/Warranty Information.

4.3: ViewSonic LED TV Warranty

LTV\_LW01 Rev. 1C 06-25-07

# Other Information

## Mexico Limited Warranty VIEWSONIC LED TV

### What the warranty covers:

ViewSonic warrants its products to be free from defects in material and workmanship, under normal use, during the warranty period. If a product proves to be defective in material or workmanship during the warranty period, ViewSonic will, at its sole option, repair or replace the product with a like product. Replacement product or parts may include remanufactured or refurbished parts or components & accessories.

### How long the warranty is effective:

ViewSonic LED TVs are warranted for 1 year for all parts excluding the light source and 1 year for labor from the date of the first customer purchase.

### Who the warranty protects:

This warranty is valid only for the first consumer purchaser.

### What the warranty does not cover:

1. Any product on which the serial number has been defaced, modified or removed.
2. Damage, deterioration or malfunction resulting from:
  - a. Accident, misuse, neglect, fire, water, lightning, or other acts of nature, unauthorized product modification, unauthorized attempted repair, or failure to follow instructions supplied with the product.
  - b. Any damage of the product due to shipment.
  - c. Causes external to the product, such as electrical power fluctuations or failure.
  - d. Use of supplies or parts not meeting ViewSonic's specifications.
  - e. Normal wear and tear.
  - f. Any other cause which does not relate to a product defect.
3. Any product exhibiting a condition commonly known as "image burn-in" which results when a static image is displayed on the product for an extended period of time.
4. Removal, installation, insurance, and set-up service charges.

### How to get service:

For information about receiving service under warranty, contact ViewSonic Customer Support (Please refer to the attached Customer Support page). You will need to provide your product's serial number, so please record the product information in the space provided below on your purchase for your future use. Please retain your receipt of proof of purchase to support your warranty claim.

For Your Records

Product Name: \_\_\_\_\_

Model Number: \_\_\_\_\_

Document Number: \_\_\_\_\_

Serial Number: \_\_\_\_\_

Purchase Date: \_\_\_\_\_

Extended Warranty Purchase? \_\_\_\_\_ (Y/N)

If so, what date does warranty expire? \_\_\_\_\_

1. To obtain warranty service, you will be required to provide (a) the original dated sales slip, (b) your name, (c) your address, (d) a description of the problem, and (e) the serial number of the product.
2. Take or ship the product in the original container packaging to an authorized ViewSonic service center.
3. Round trip transportation costs for in-warranty products will be paid by ViewSonic.

### Limitation of implied warranties:

There are no warranties, express or implied, which extend beyond the description contained herein including the implied warranty of merchantability and fitness for a particular purpose.

### Exclusion of damages:

ViewSonic's liability is limited to the cost of repair or replacement of the product. ViewSonic shall not be liable for:

1. Damage to other property caused by any defects in the product, damages based upon inconvenience, loss of use of the product, loss of time, loss of profits, loss of business opportunity, loss of goodwill, interference with business relationships, or other commercial loss, even if advised of the possibility of such damages.
2. Any other damages, whether incidental, consequential or otherwise.
3. Any claim against the customer by any other party.
4. Repair or attempted repair by anyone not authorized by ViewSonic.

# Other Information

ENGLISH

## Contact Information for Sales & Authorized Service (Centro Autorizado de Servicio) within Mexico:

**Name, address, of manufacturer and importers:**

México, Av. de la Palma #8 Piso 2 Despacho 203, Corporativo Interpalmas,  
Col. San Fernando Huixquilucan, Estado de México  
Tel: (55) 3605-1099  
<http://www.viewsonic.com/la/soporte/index.htm>

### NÚMERO GRATIS DE ASISTENCIA TÉCNICA PARA TODO MÉXICO: 001.866.823.2004

**Hermosillo:**

Distribuciones y Servicios Computacionales SA de CV.  
Calle Juárez 284 local 2  
Col. Bugambilias C.P: 83140  
Tel: 01-66-22-14-9005  
E-Mail: [disc2@hmo.megared.net.mx](mailto:disc2@hmo.megared.net.mx)

**Villahermosa:**

Compumantenimientos Garantizados, S.A. de C.V.  
AV. GREGORIO MENDEZ #1504  
COL, FLORIDA C.P. 86040  
Tel: 01 (993) 3 52 00 47 / 3522074 / 3 52 20 09  
E-Mail: [compumantenimientos@prodigy.net.mx](mailto:compumantenimientos@prodigy.net.mx)

**Puebla, Pue. (Matriz):**

RENTA Y DATOS, S.A. DE C.V. Domicilio:  
29 SUR 721 COL. LA PAZ  
72160 PUEBLA, PUE.  
Tel: 01(52).222.891.55.77 CON 10 LINEAS  
E-Mail: [datos@puebla.megared.net.mx](mailto:datos@puebla.megared.net.mx)

**Veracruz, Ver.:**

CONEXION Y DESARROLLO, S.A DE C.V. Av.  
Americas # 419  
ENTRE PINZÓN Y ALVARADO  
Fracc. Reforma C.P. 91919  
Tel: 01-22-91-00-31-67  
E-Mail: [gacosta@qplus.com.mx](mailto:gacosta@qplus.com.mx)

**Chihuahua**

Soluciones Globales en Computación  
C. Magisterio # 3321 Col. Magisterial  
Chihuahua, Chih.  
Tel: 4136954  
E-Mail: [Cefeo@soluglobales.com](mailto:Cefeo@soluglobales.com)

**Cuernavaca**

Compusupport de Cuernavaca SA de CV  
Francisco Leyva # 178 Col. Miguel Hidalgo  
C.P. 62040, Cuernavaca Morelos  
Tel: 01 777 3180579 / 01 777 3124014  
E-Mail: [aquevedo@compusupportcva.com](mailto:aquevedo@compusupportcva.com)

**Distrito Federal:**

QPLUS, S.A. de C.V.  
Av. Coyoacán 931  
Col. Del Valle 03100, México, D.F.  
Tel: 01(52)55-50-00-27-35  
E-Mail : [gacosta@qplus.com.mx](mailto:gacosta@qplus.com.mx)

**Guadalajara, Jal.:**

SERVICRECE, S.A. de C.V.  
Av. Niños Héroes # 2281  
Col. Arcos Sur, Sector Juárez  
44170, Guadalajara, Jalisco  
Tel: 01(52)33-36-15-15-43  
E-Mail: [mmiranda@servicrece.com](mailto:mmiranda@servicrece.com)

**Guerrero Acapulco**

GS Computación (Grupo Sesicomp)  
Progreso #6-A, Colo Centro  
39300 Acapulco, Guerrero  
Tel: 744-48-32627

**Monterrey:**

Global Product Services  
Mar Caribe # 1987, Esquina con Golfo Pérsico  
Fracc. Bernardo Reyes, CP 64280  
Monterrey N.L. México  
Tel: 8129-5103  
E-Mail: [aydeem@gps1.com.mx](mailto:aydeem@gps1.com.mx)

**MÉRIDA:**

ELECTROSER  
Av Reforma No. 403Gx39 y 41  
Mérida, Yucatán, México CP97000  
Tel: (52) 999-925-1916  
E-Mail: [rrrb@sureste.com](mailto:rrrb@sureste.com)

**Oaxaca, Oax.:**

CENTRO DE DISTRIBUCION Y  
SERVICIO, S.A. de C.V.  
Murguía # 708 P.A., Col. Centro, 68000, Oaxaca  
Tel: 01(52)95-15-15-22-22  
Fax: 01(52)95-15-13-67-00  
E-Mail: [gpotai2001@hotmail.com](mailto:gpotai2001@hotmail.com)

**Tijuana:**

STD  
Av Ferrocarril Sonora #3780 L-C  
Col 20 de Noviembre  
Tijuana, Mexico

**FOR USA SUPPORT:**

ViewSonic Corporation  
381 Brea Canyon Road, Walnut, CA. 91789 USA  
Tel: 800-688-6688 (English); 866-323-8056 (Spanish);  
Fax: 1-800-685-7276  
E-Mail: <http://www.viewsonic.com>



**ViewSonic®**